



Booklet available in English on
Heft in deutscher Sprache erhältlich auf
Livret disponible en français sur
Libretto disponibile in Italiano su
Folletto disponibile en español en
如需中文版手册，请访问



21323





Meet Your Masterpiece

Ladies and gentlemen and everyone in between,

We're proud to present to you this LEGO® masterpiece in craft and innovation.

Carefully designed from nearly 4000 (3662) individual pieces, the LEGO Grand Piano is a feat of ingenuity.

With this intricate instrument, you can build a crescendo of creativity. One brick and one note at a time. Because today, you are the maestro. You are center stage, and this is your time to play.

So, without further ado, please, put your bricks together for your masterpiece.

Bravo, from our fan designer Donny Chen and all of us at the LEGO Group.



“ Music gives a soul to the universe. ”
Plato

“ Music is a higher revelation than all wisdom and philosophy. ”

Ludwig van Beethoven



“ Music is the universal language of mankind. ”
Henry Wadsworth Longfellow



Meet the Maestro

Hello, my name is Donny Chen and I'm the designer behind the LEGO® Ideas Grand Piano. Originally from Guangzhou, China, I now work as a piano teacher and tuner in Australia.

I've always seen toys as something to be imagined, not just played with.

When I was a child, I liked to build toys from scratch. I was fascinated with toy cars, construction toys and anything with a mechanical element to it. For me, the joy was in the endless possibilities of creating.

“ I think that my piano set is a unique LEGO® creation, which will be loved by people of all ages, especially music lovers around the world. I really hope you like it as much as I do. ”

Donny Chen



Growing up in China, LEGO bricks weren't easy to get hold of.

I was 25 years old when I bought my first set 8 years ago, and it hasn't stopped surprising me since. Although I was a latecomer to LEGO toys, I've since fallen in love with the bricks and it's now my biggest hobby by far, aside from music. In fact, I've even created a model of my own home, including five pianos.

This build brought together my two greatest passions in life.

When I'm not building with LEGO bricks, I'm teaching, tuning or writing music on my piano. So, when I first discovered LEGO Ideas, I knew I wanted to build something that could make the musical and LEGO worlds come together.

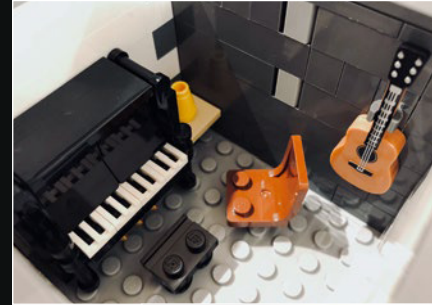

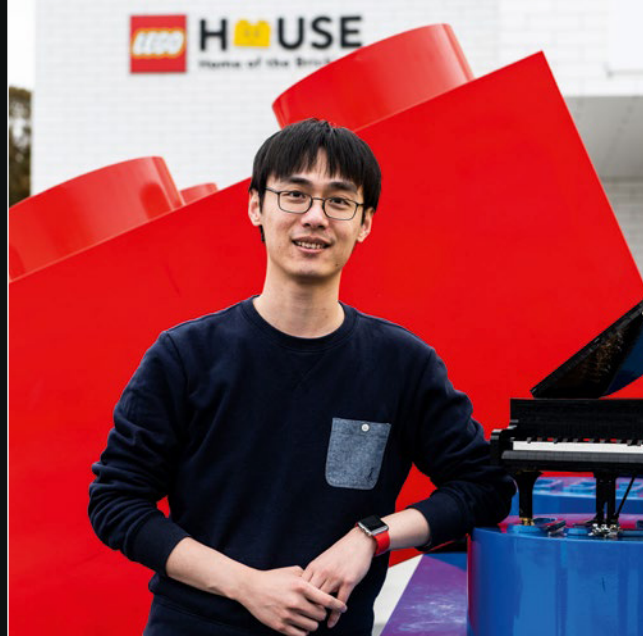

I'm as interested in how a piano works as the music it makes.

I've always been fascinated with the mechanics of how things work and the engineering behind great pianos. As a teacher, I also have to explain what goes on beneath the lid to my students. This model seemed like a great way to show them on a smaller scale.

I worked every day for six weeks to make the model as accurate as possible.

It was really important to me that it felt real, that it worked and looked as close to a life-sized piano as possible. It took at least 15 hours to achieve that authenticity and make sure the keyboard, bench, damper, pedals and piano player function all worked like the real thing.



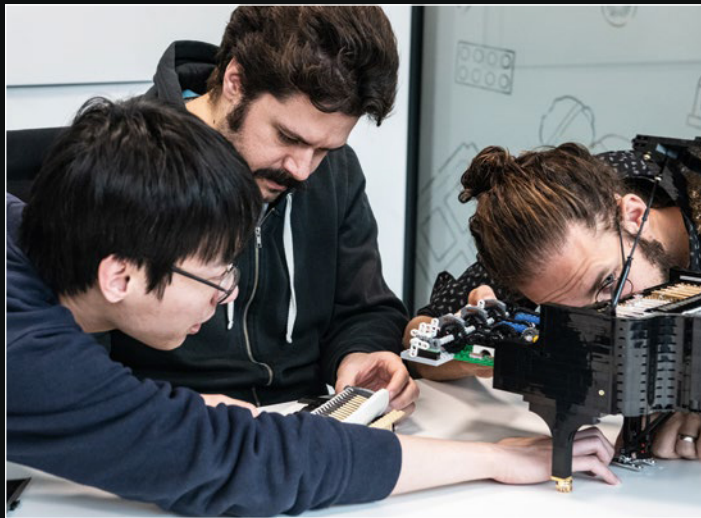

Not everything went 100% according to plan.

There were a few hiccups during the design process, particularly with the fall board (the lid that covers the keys). I must have changed the design four times until I got it right. In the end, I was happy that it closed, felt and worked exactly like a working piano. But of course, making the LEGO® Grand Piano playable was my main focus when I designed it, and at the same time, the most challenging part of the build.

When Donny came to Billund and visited the Ideas team...

...we arranged a surprise for him so he could meet a couple of his LEGO designer role models. To Donny's delight, some of his favorite designers surprised him by bursting in on a meeting, and then proceeded to discuss the fine details of his model. He later met with the LEGO Ideas team and Woon Tze, who was the main LEGO designer for the project.





Woon Tze Chee

My wife plays and teaches the piano and was my inspiration to work on this project. Over the years, she has been very understanding and supportive of my LEGO® hobby and our move to Denmark, so I felt very happy and lucky that I got to work on a project that supports her main hobby. This was truly a great way to bring our individual passions for music and LEGO toys together. This is my way of saying thank you to her.

I was impressed when I first saw the model on LEGO Ideas. Donny did an amazing job with all the details and functionality. We tried to keep the model as authentic as possible. Although small, the model is as much an engineering challenge as a real piano and all the components are so interconnected that any slight modification in one section will cause a chain reaction in another. By striving for the strictest of LEGO quality, we hope fans will have a great building experience.



Steen Sig Andersen

I was asked to help out with the concept model and once I saw it, I gladly took the task. It was such a cool model with some interesting challenges. From the very beginning, there was a huge excitement from all sides; tech, design and marketing, because here we had the opportunity to make something really special. For me personally, it was the challenge of turning a very cool fan model into a proof-of-concept model, especially the play mechanism which I was delighted to work on.

What I love most about the model is the fact that you can 'play' on the piano, and the functions are similar to the ones on a real piano.

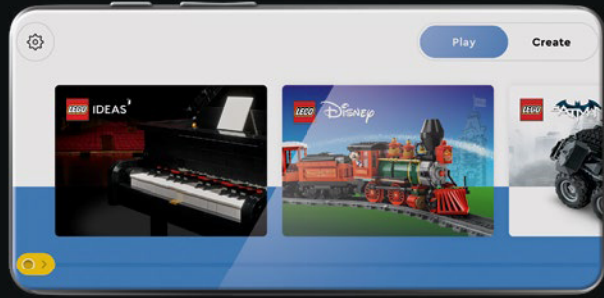



[LEGO.com/brickseparator](https://www.lego.com/brickseparator)

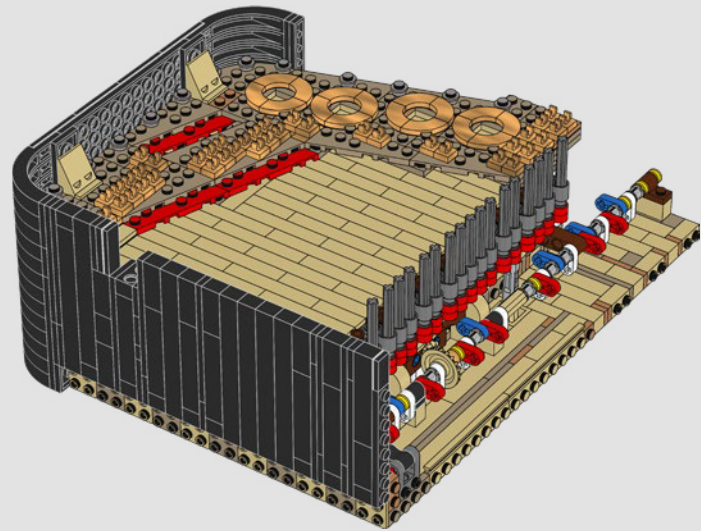
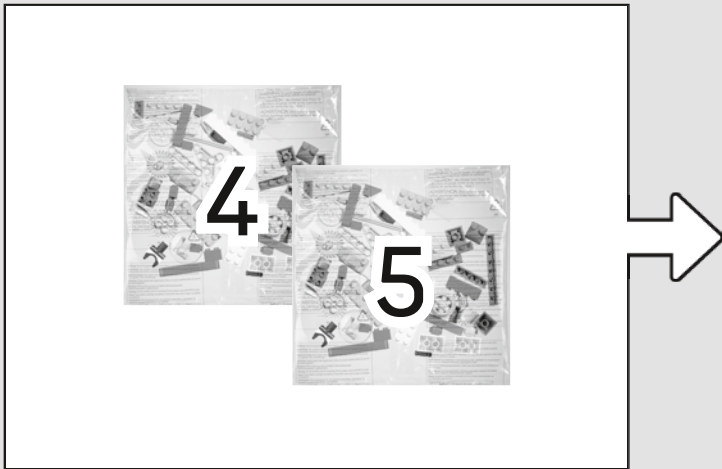
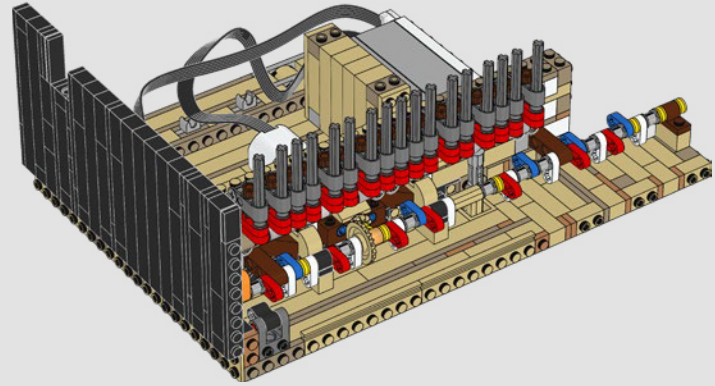
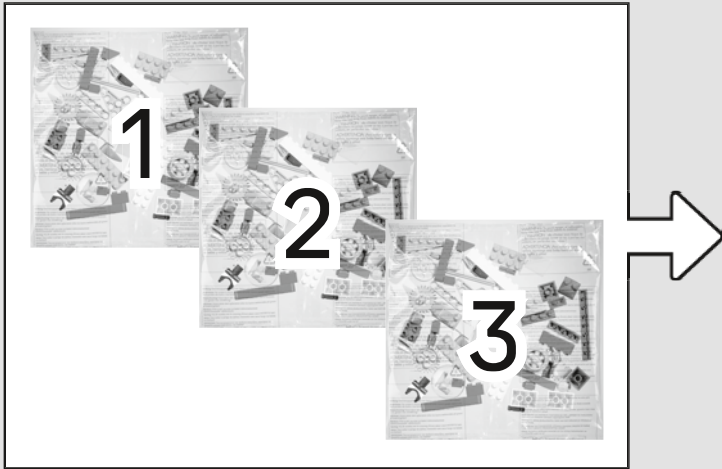

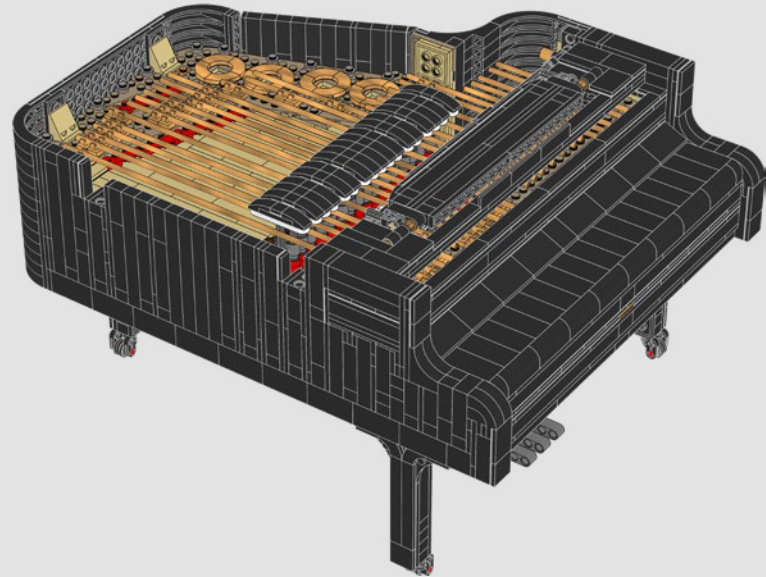
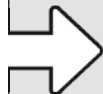
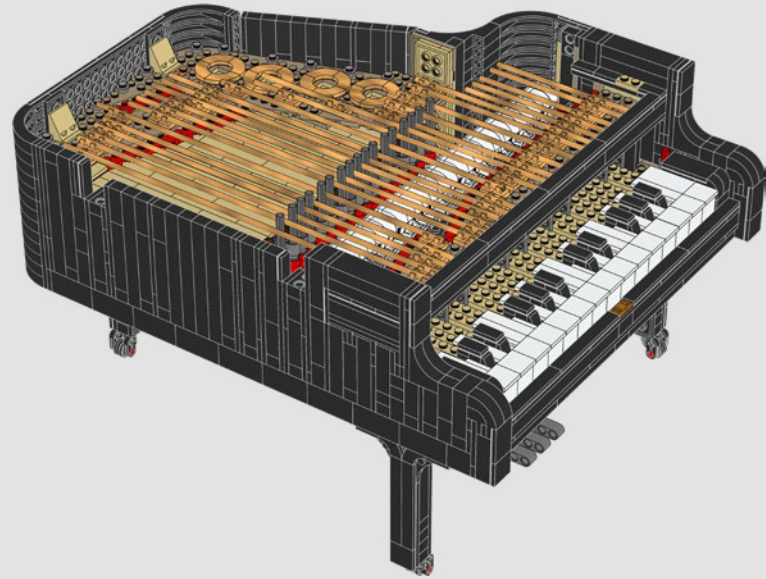
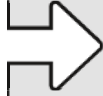

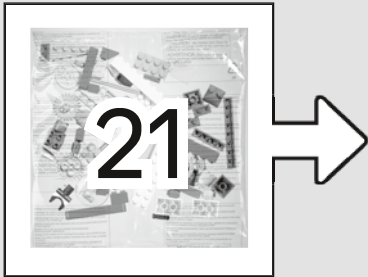
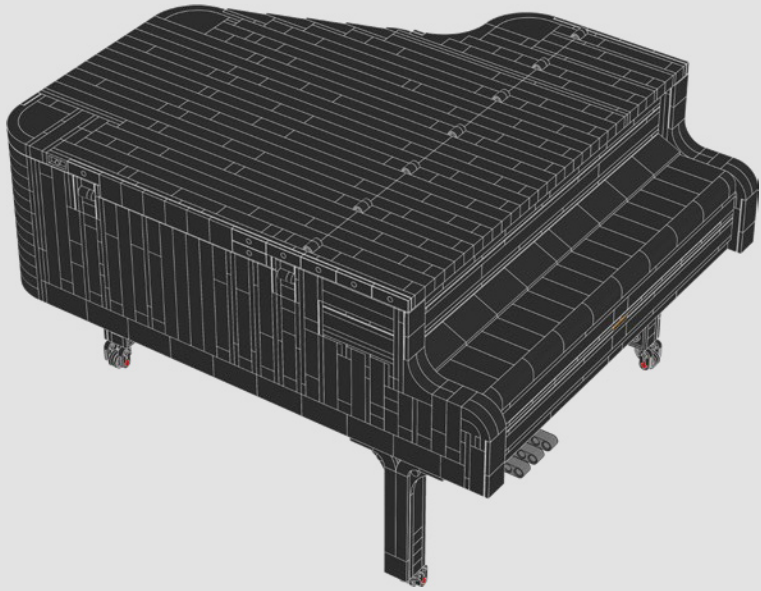
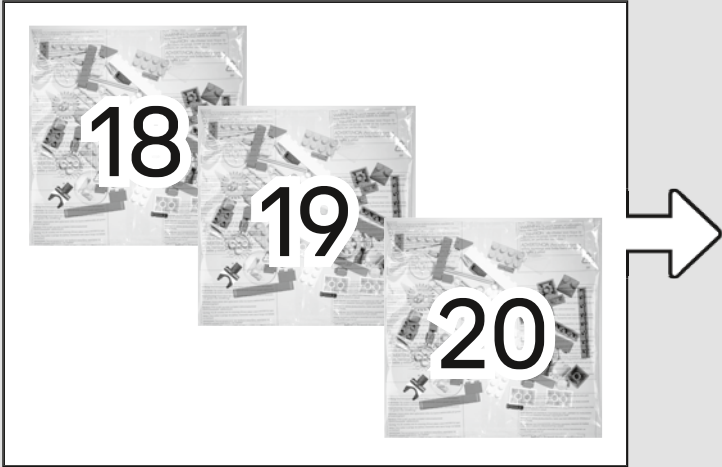

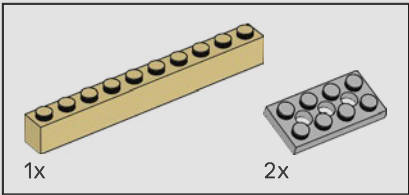
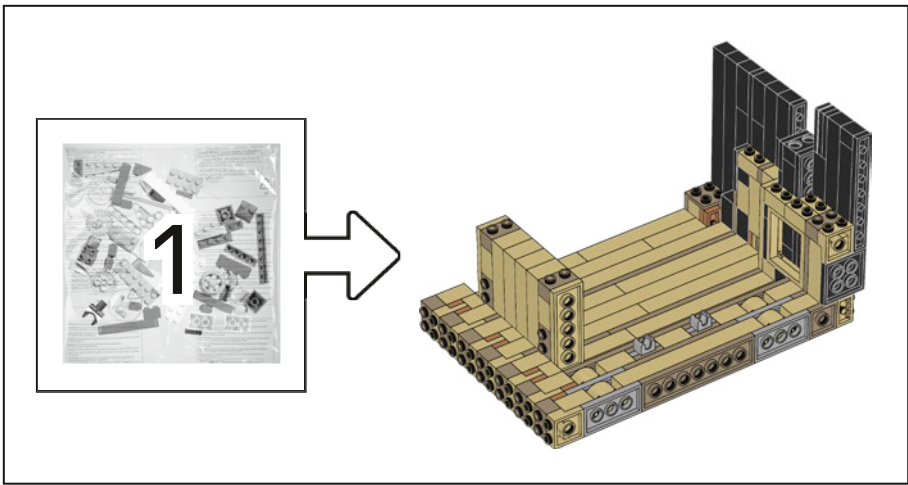

2

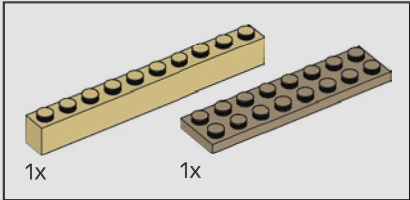

1

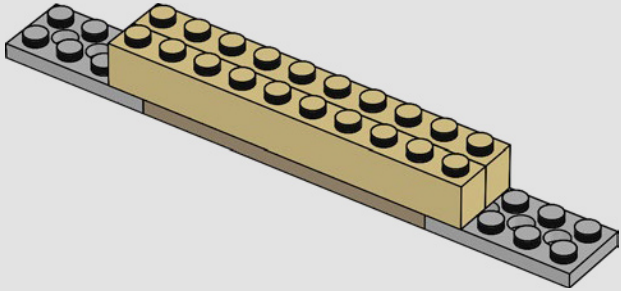
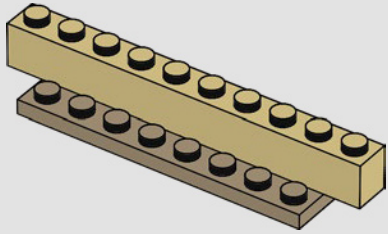

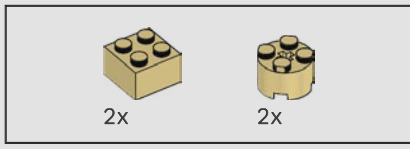

3

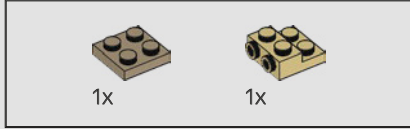
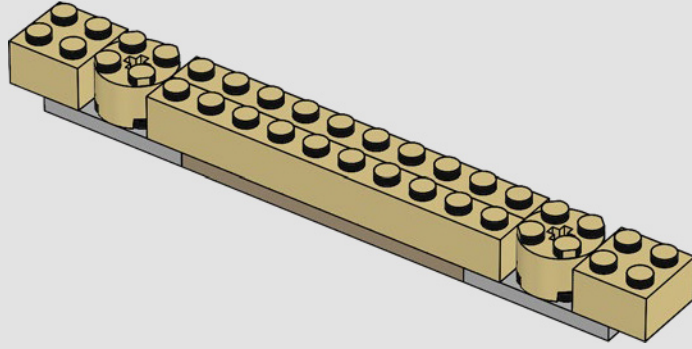

4

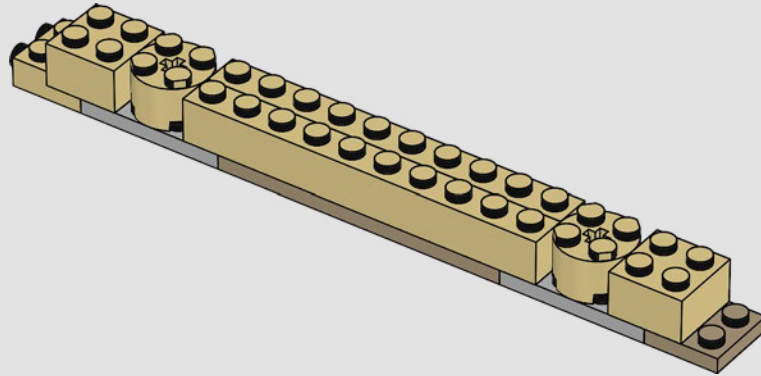

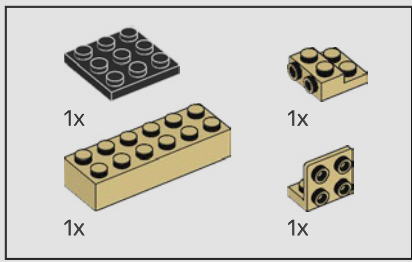

5

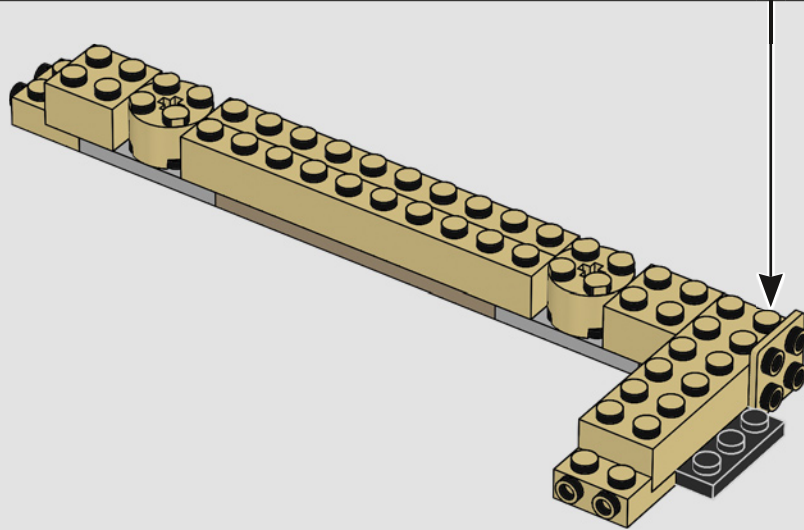
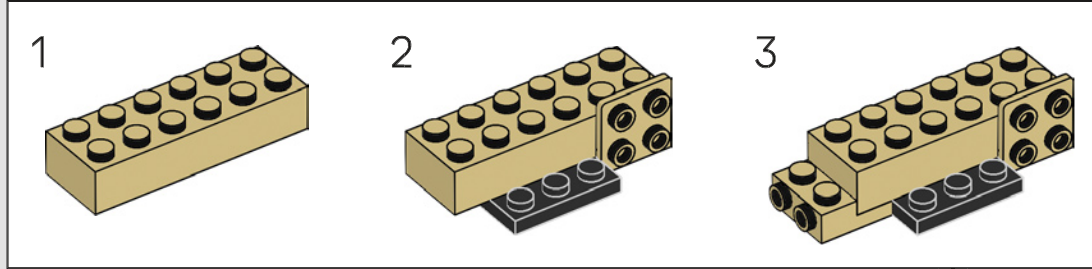

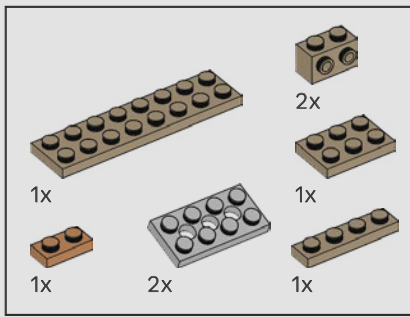

6

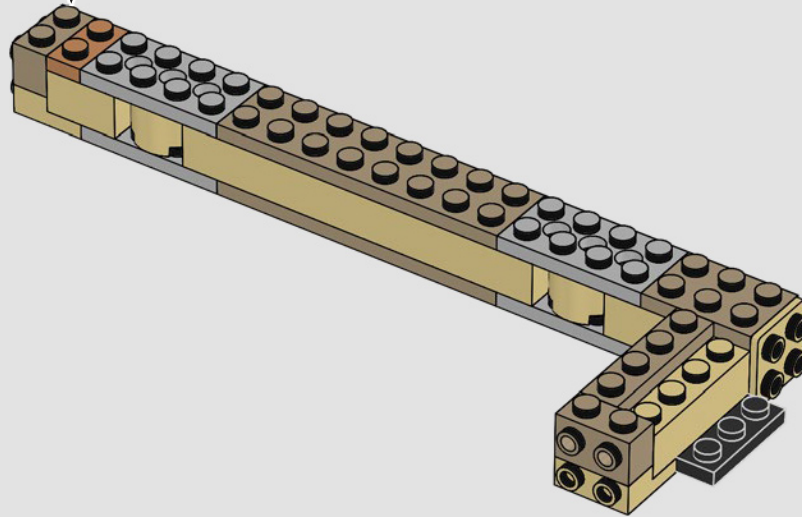
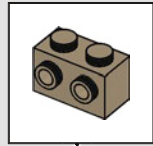

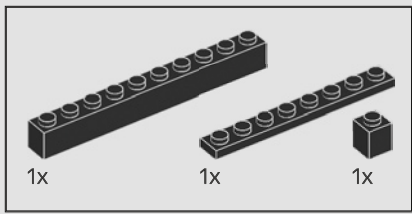

7

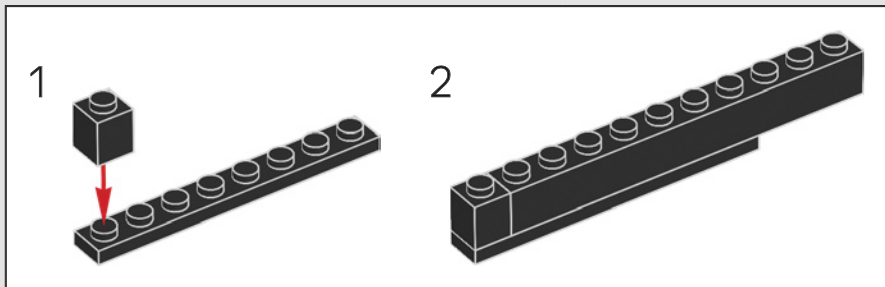
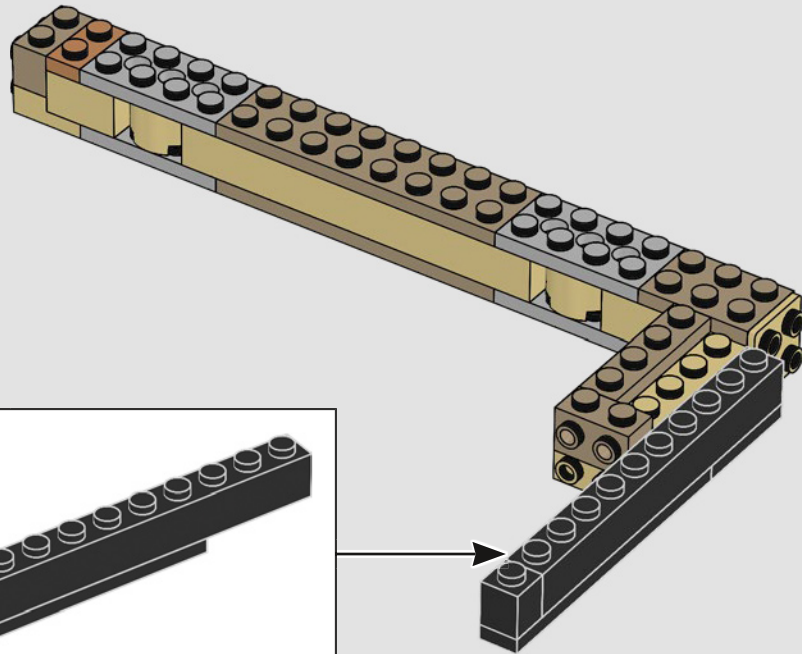

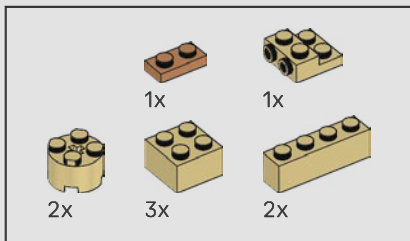

8

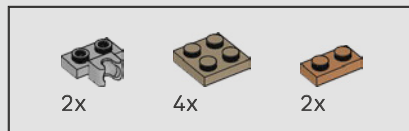
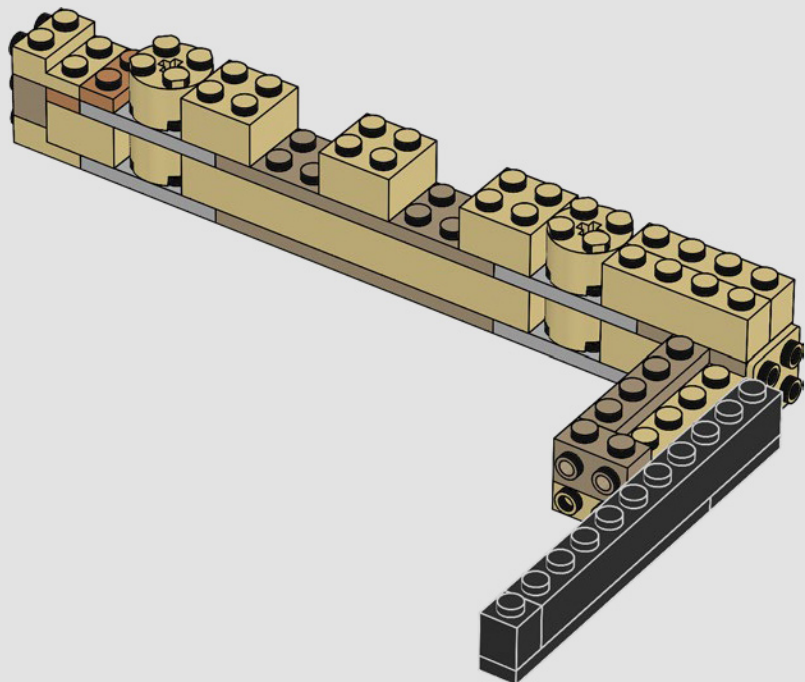

9

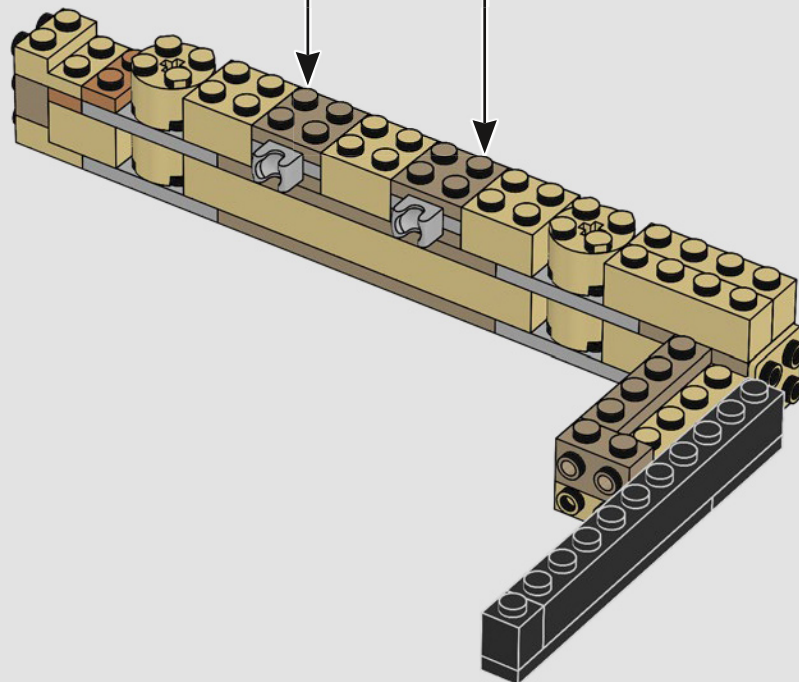
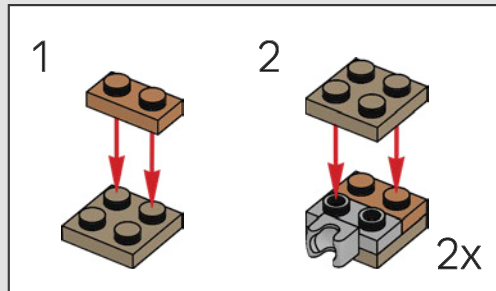

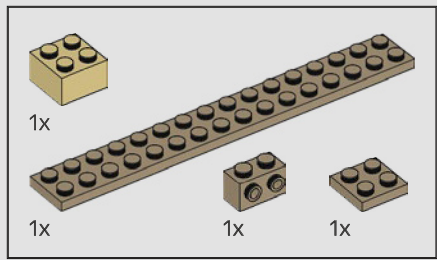

10

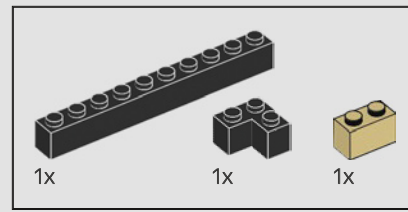
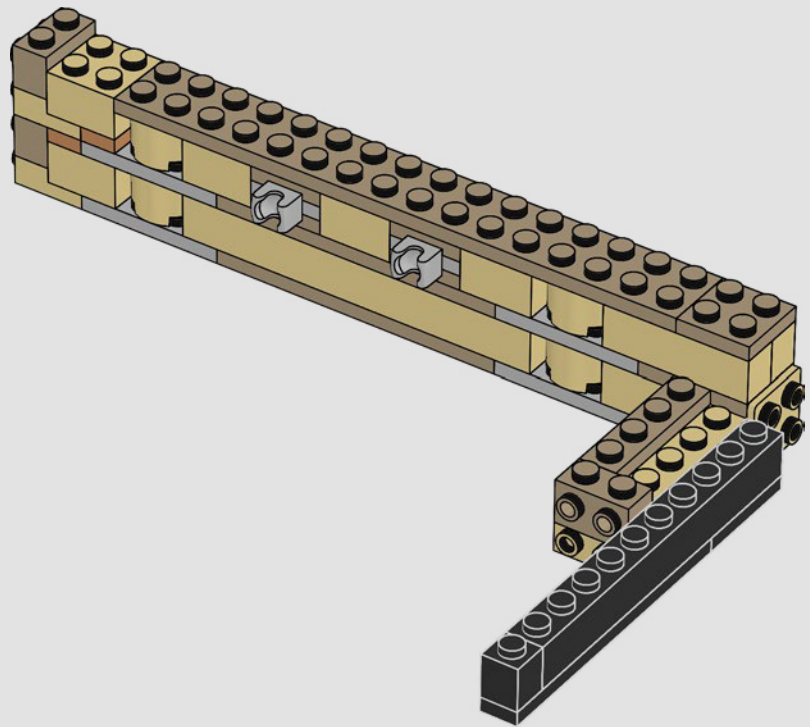

11

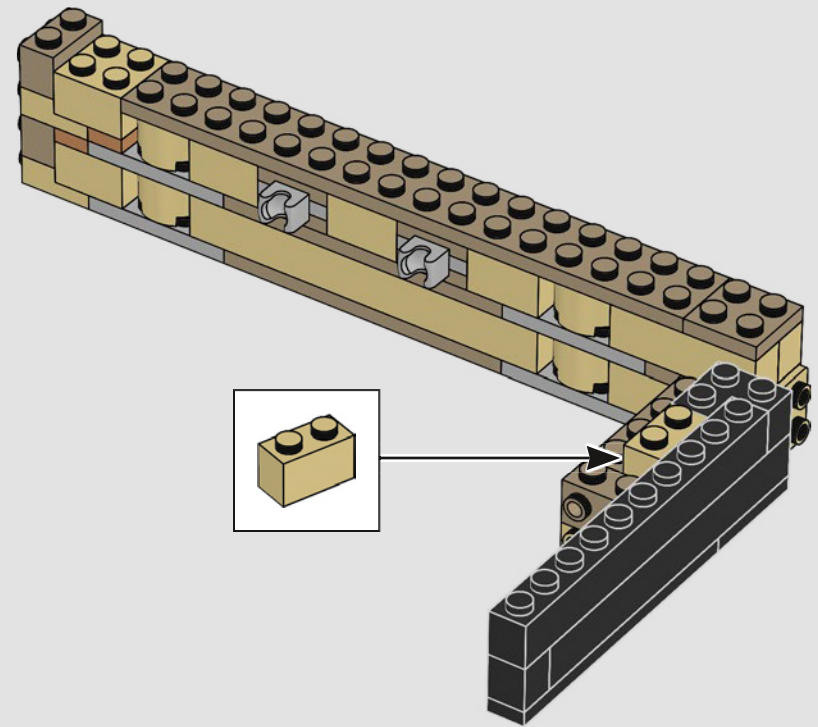

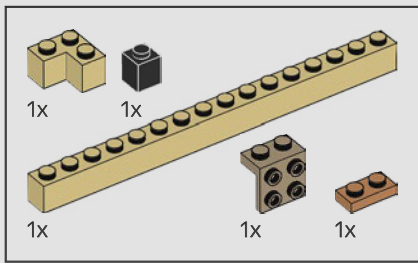

12

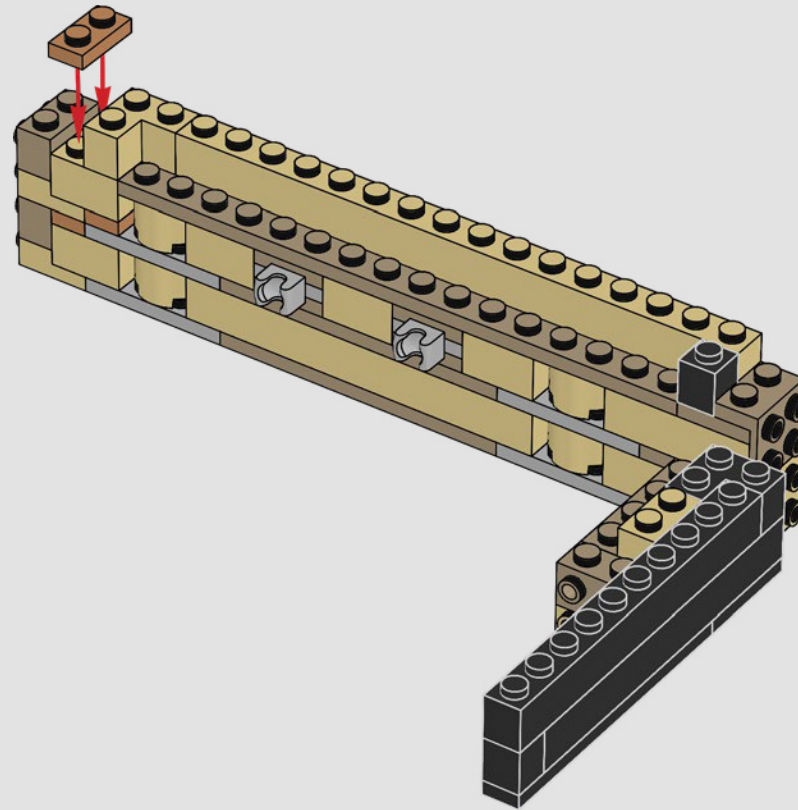



13

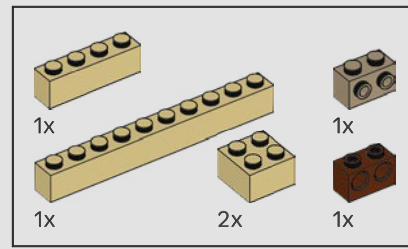
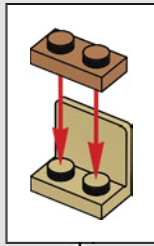
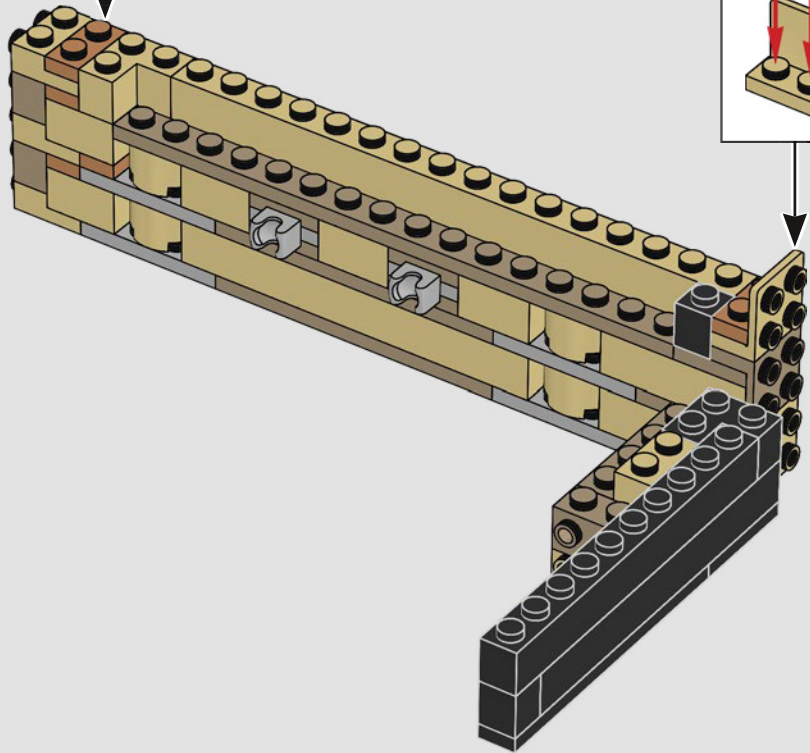
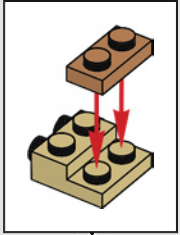

14

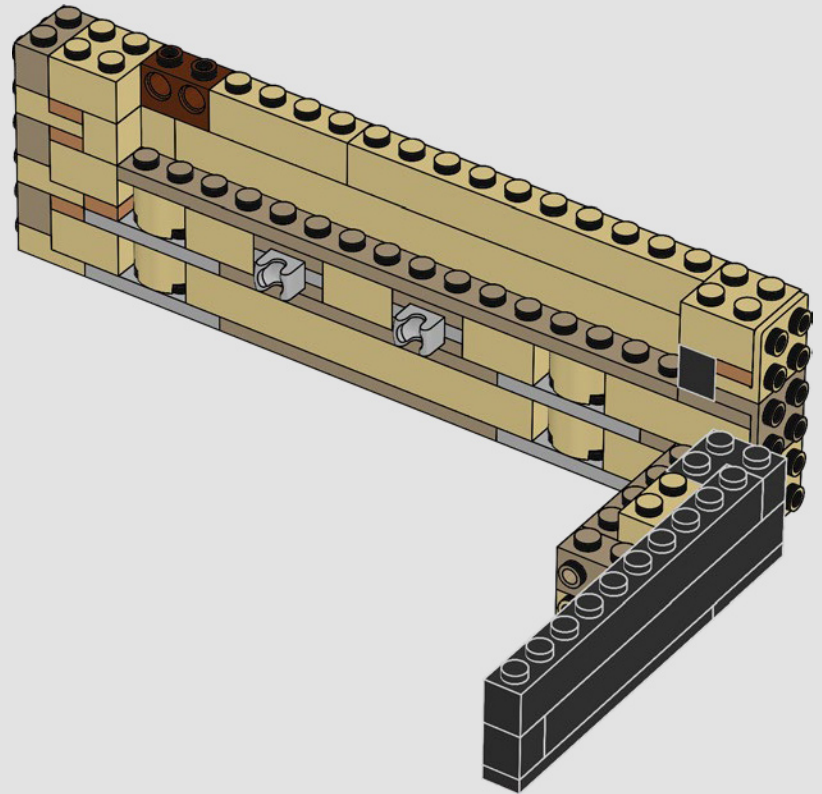

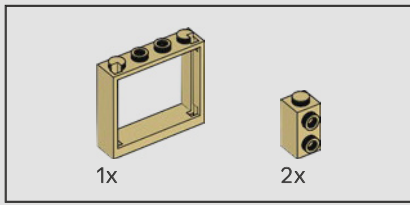

15

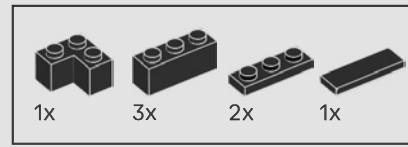
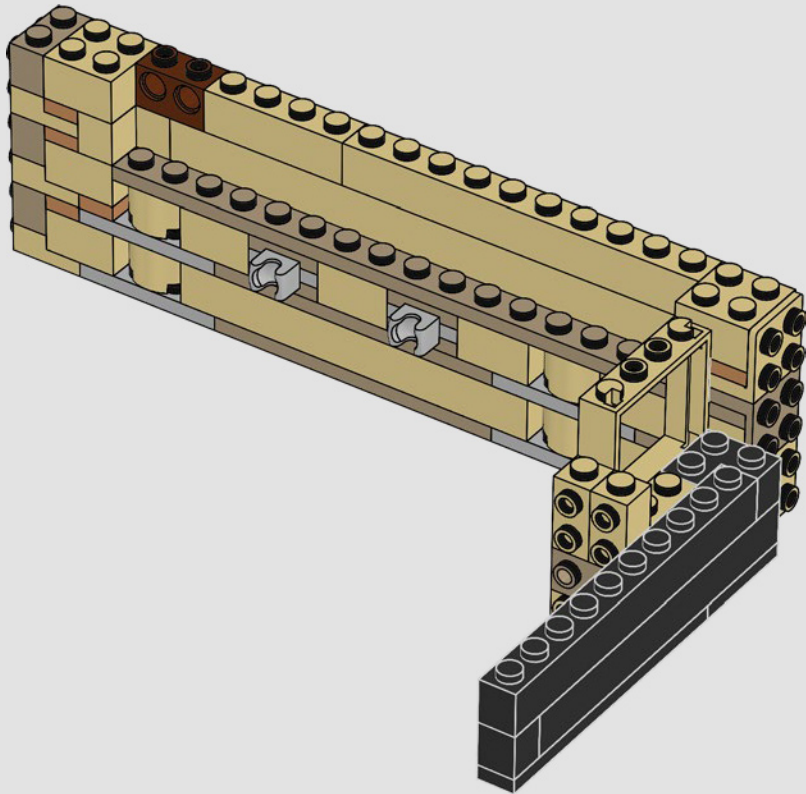

16

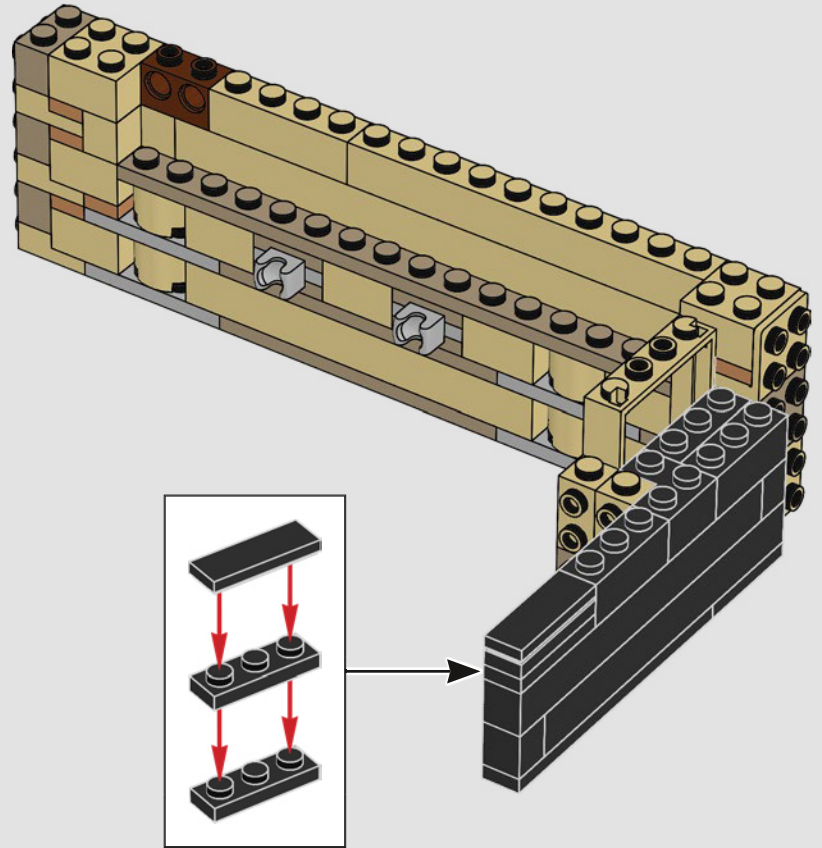

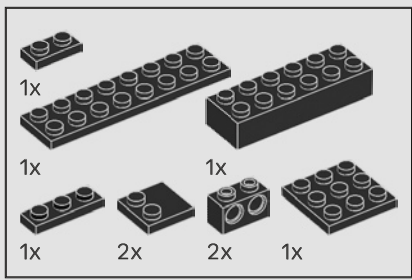

17

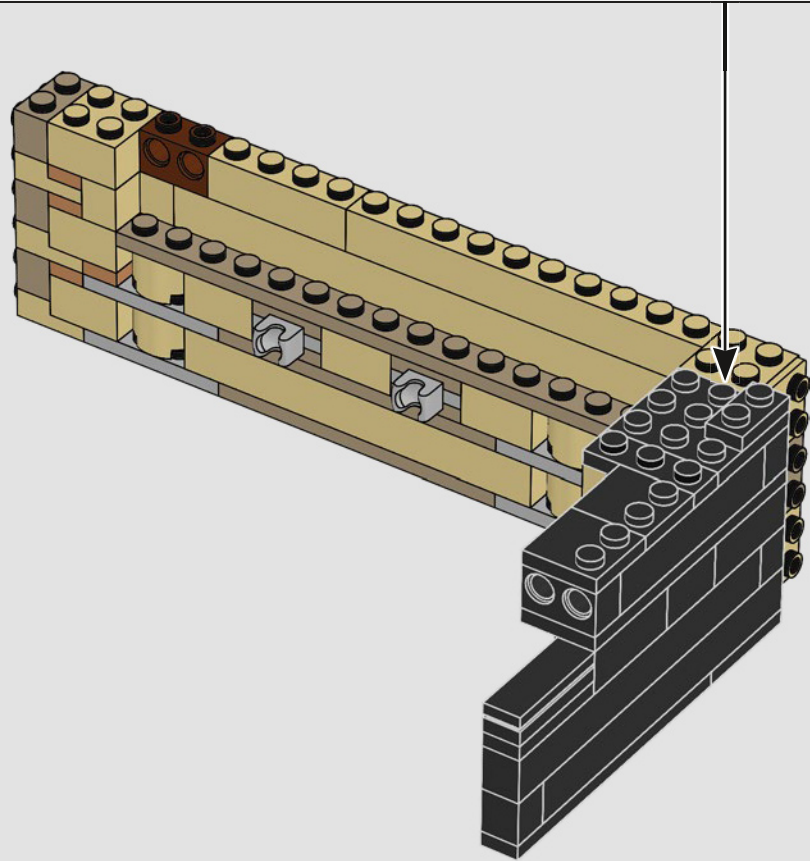
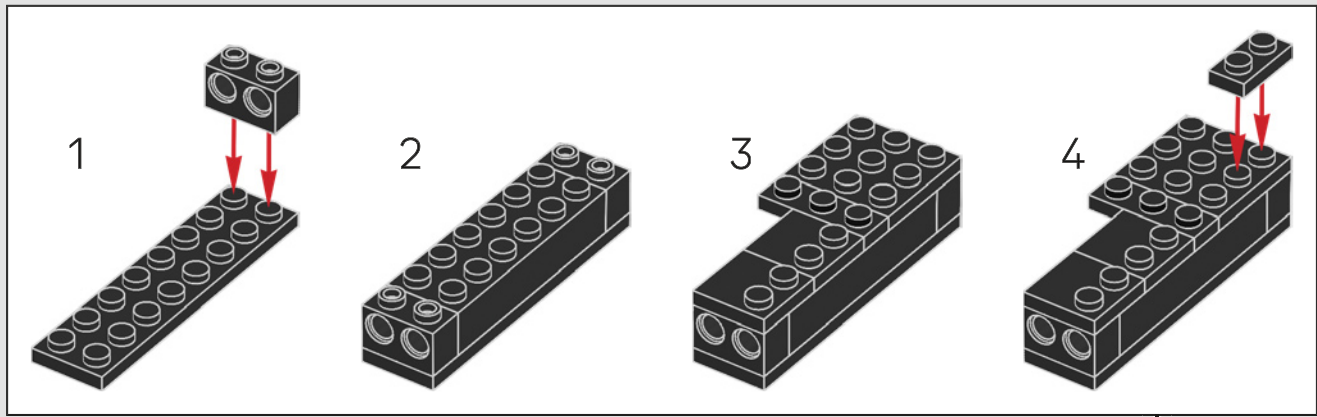

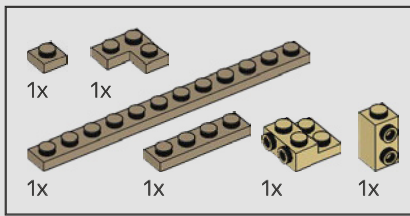

18

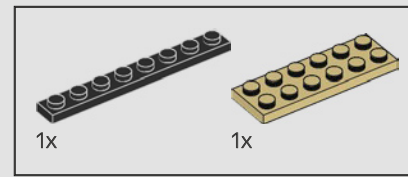
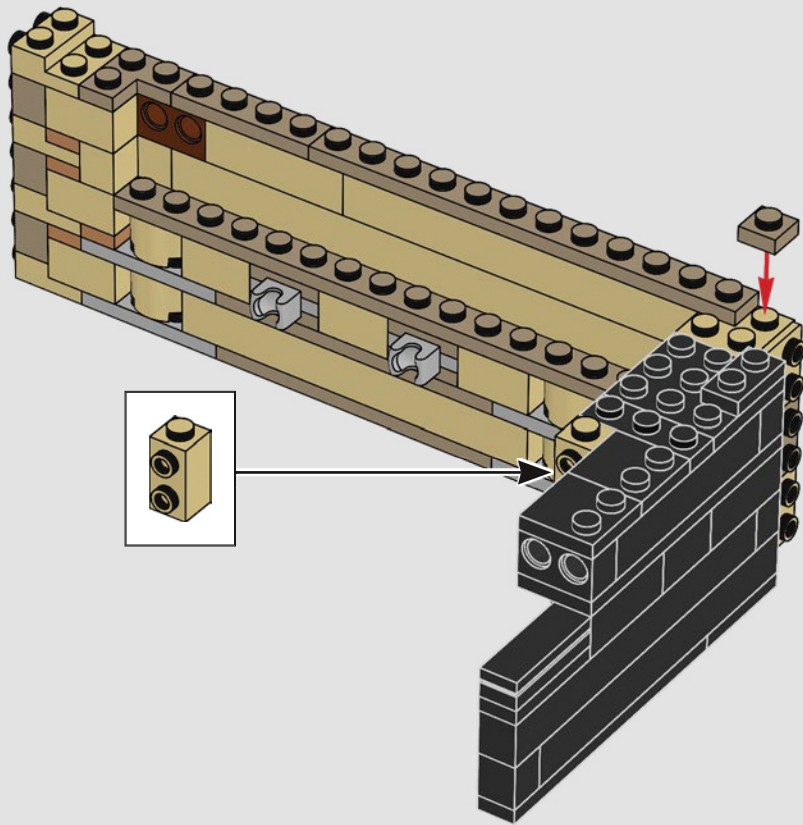

19

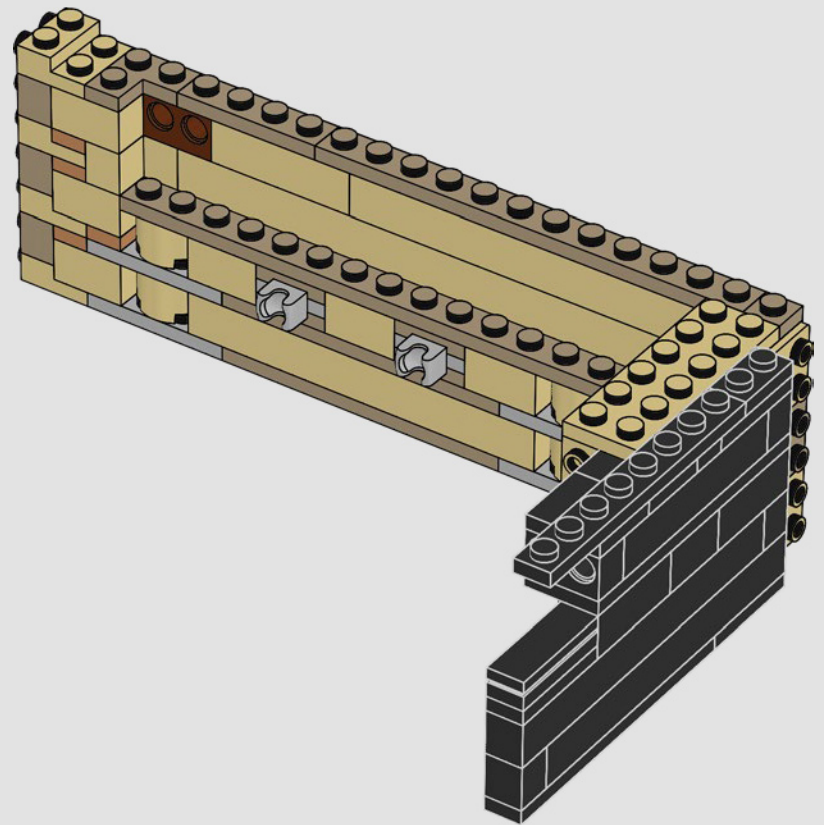

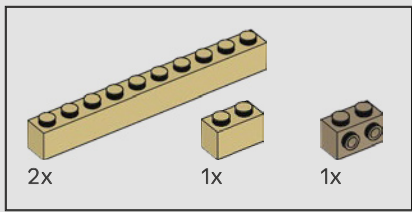

20

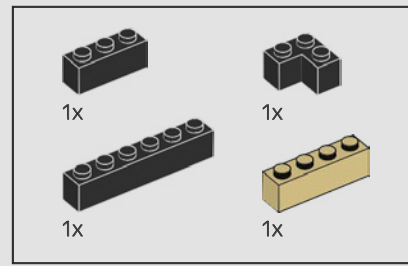
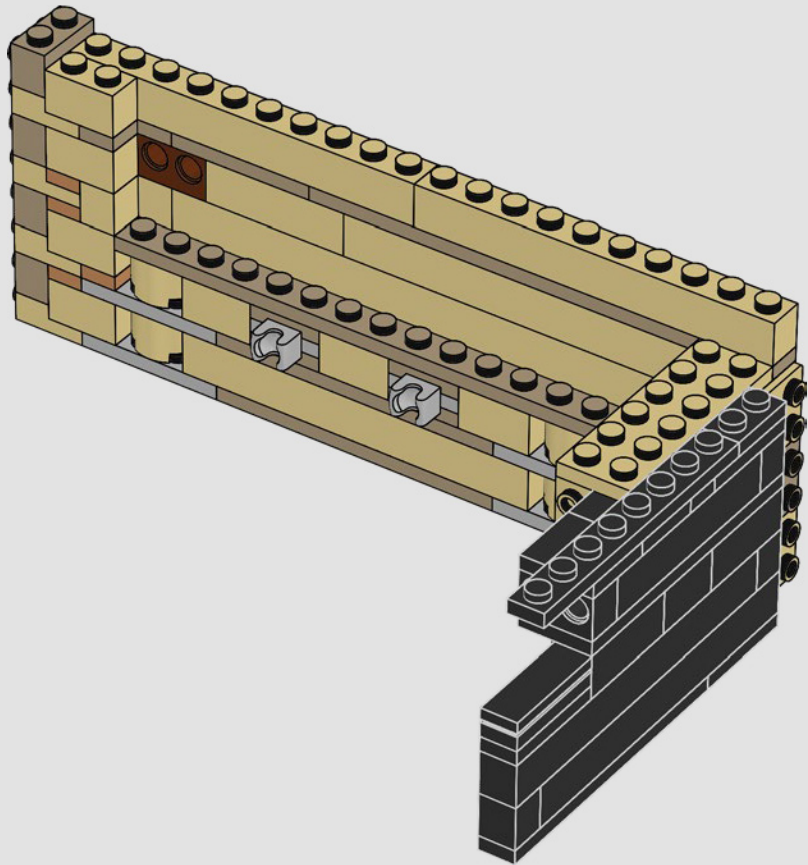

21

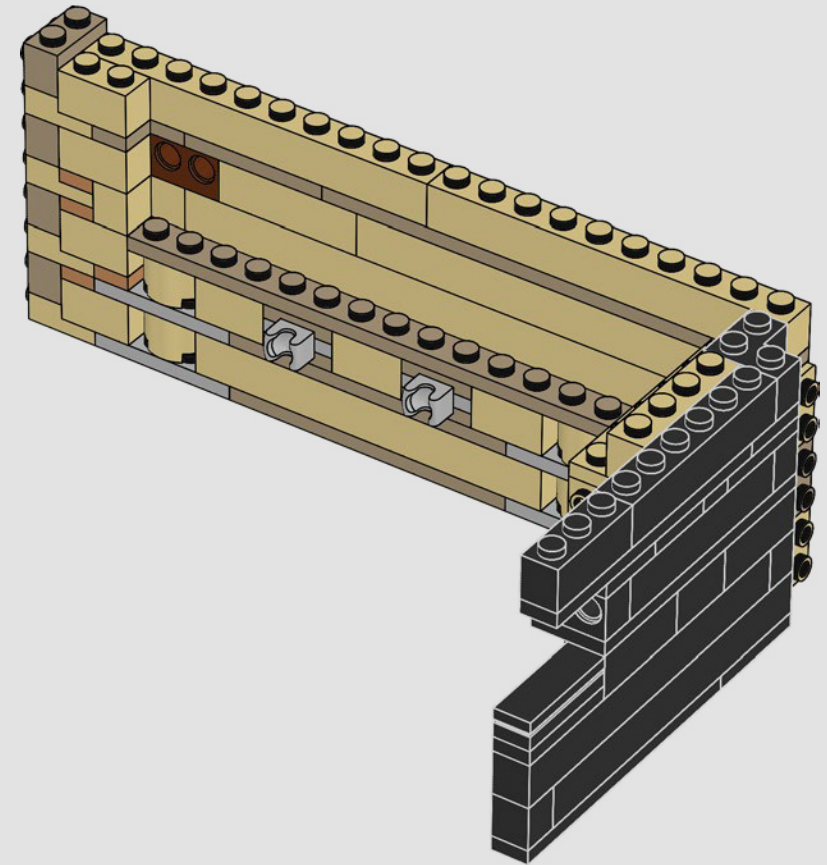

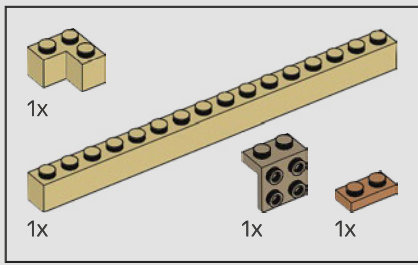

22

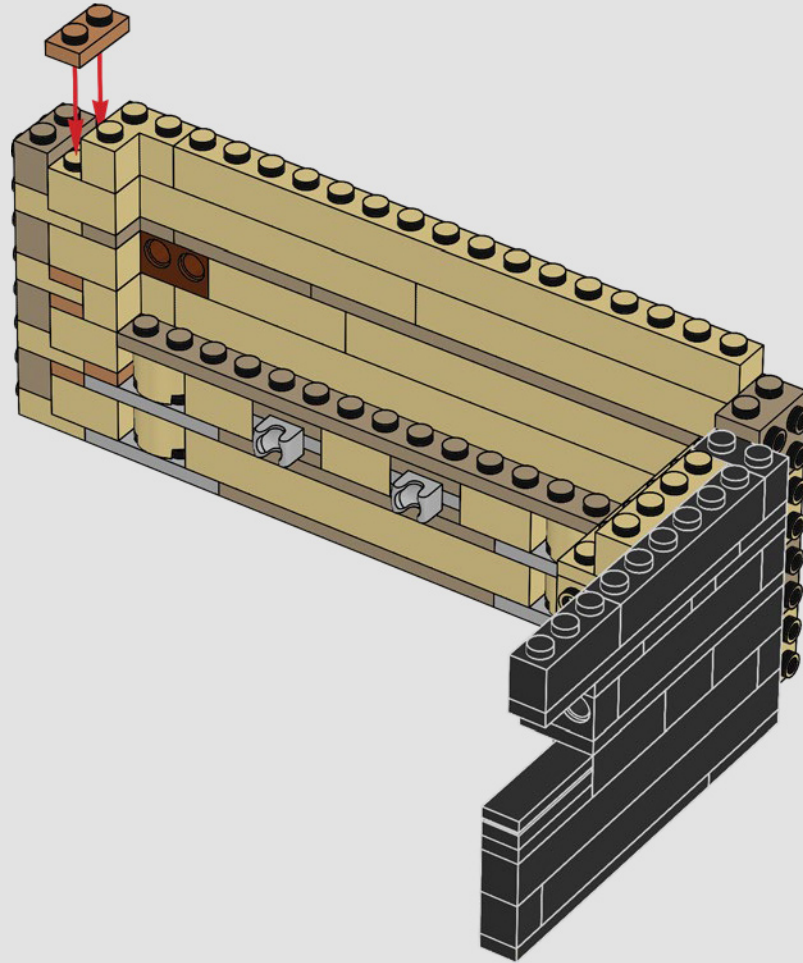



23

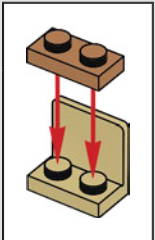
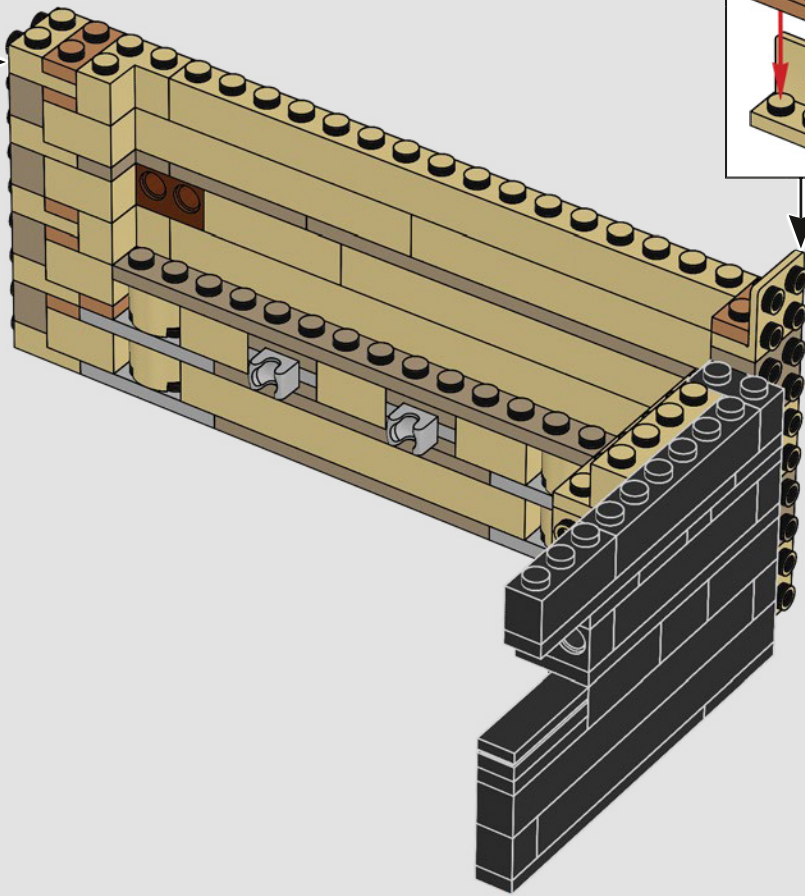
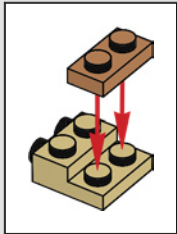

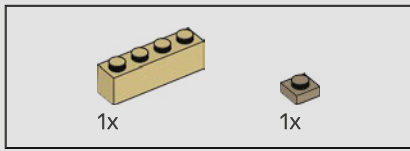

24

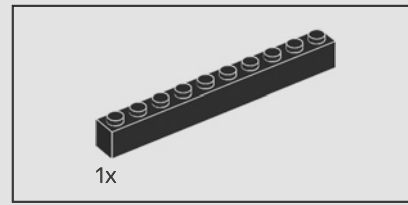
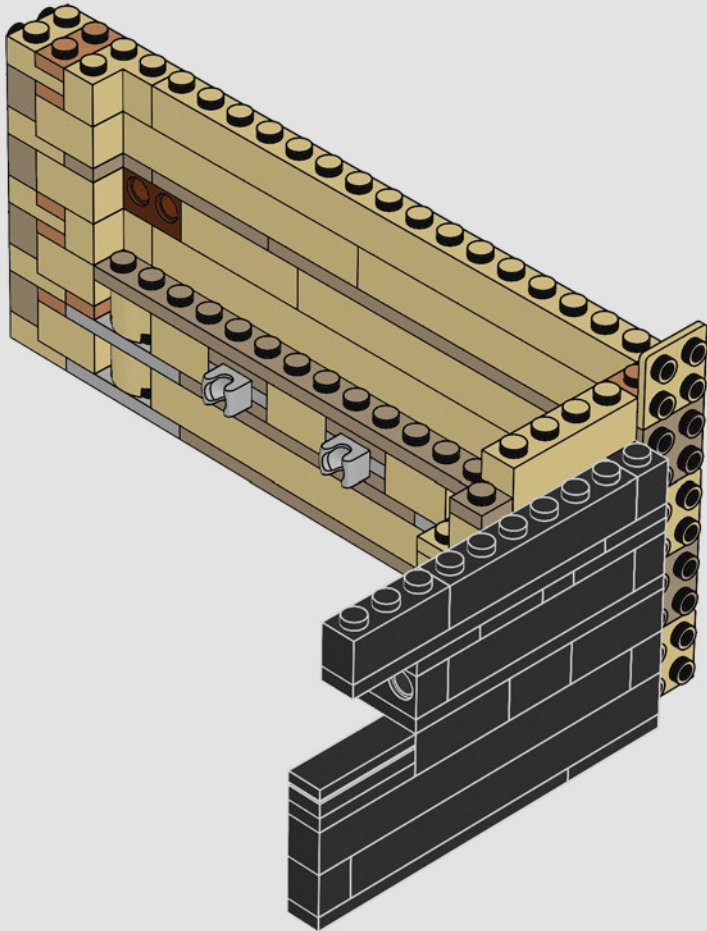

25

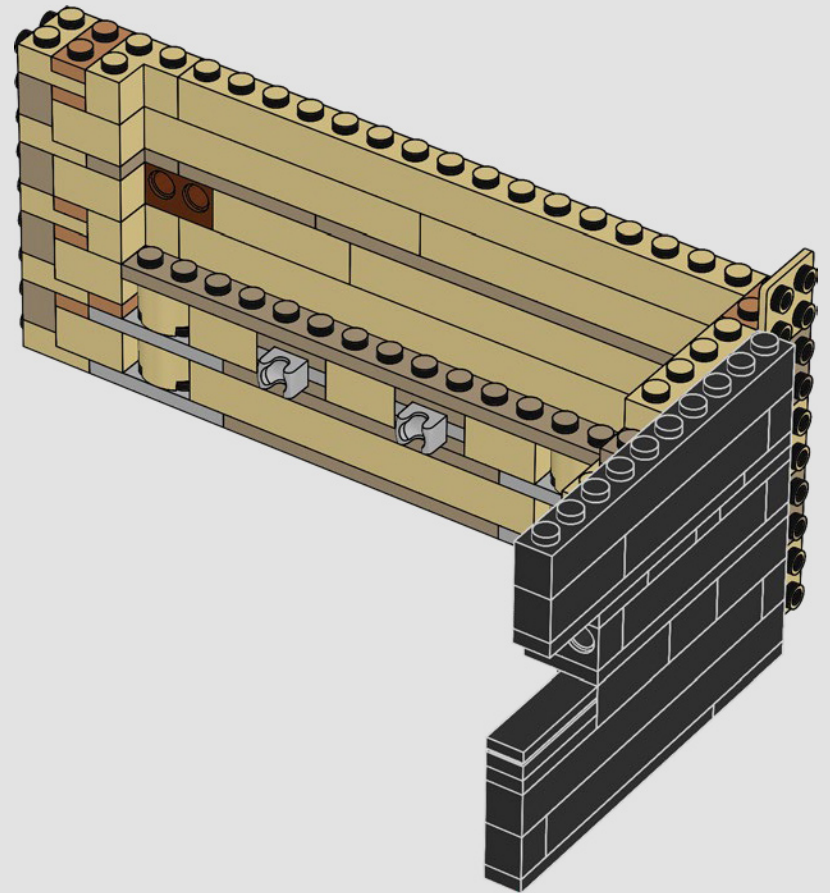

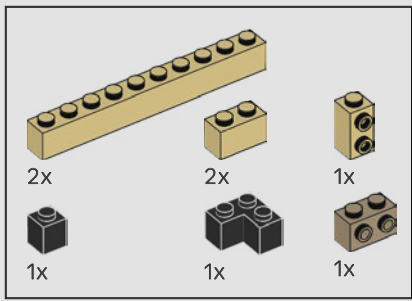

26

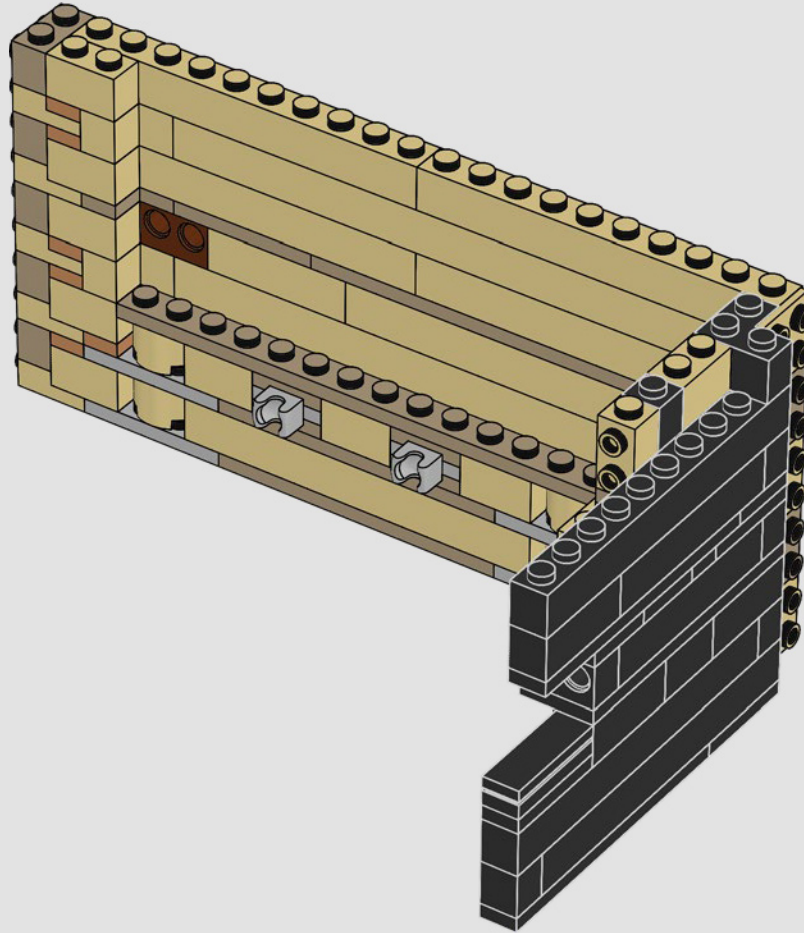

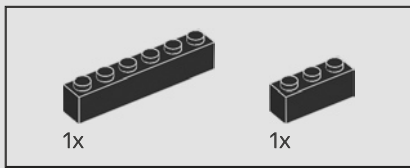

27

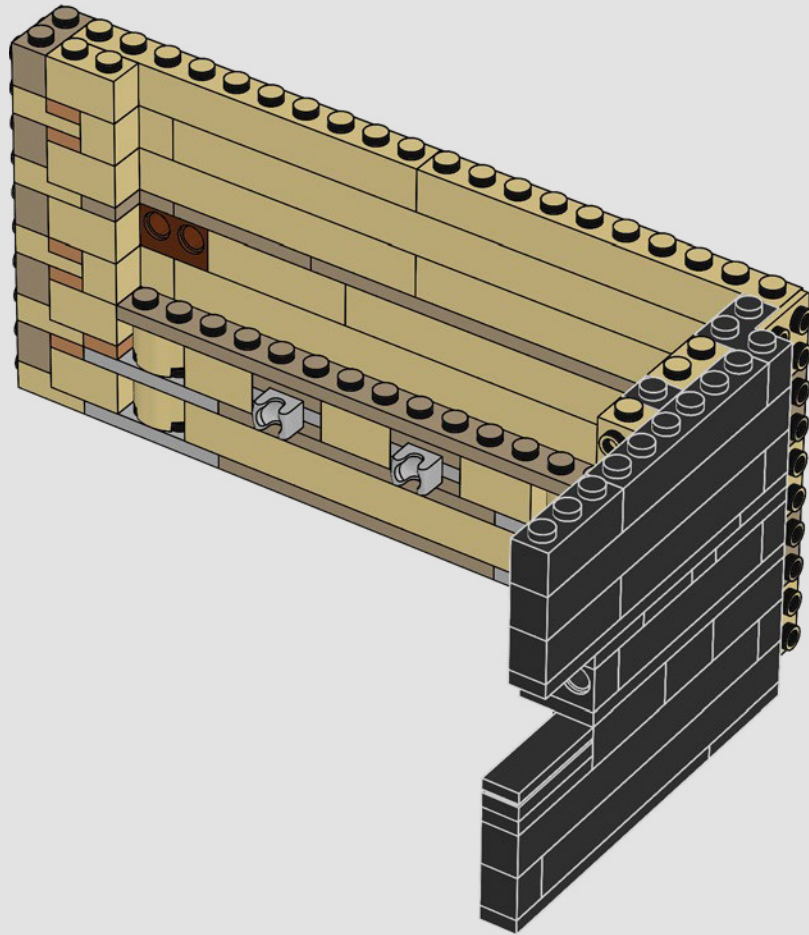

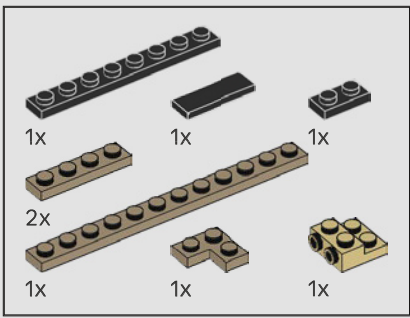

28



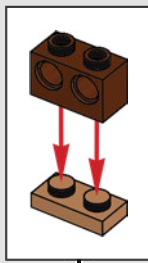
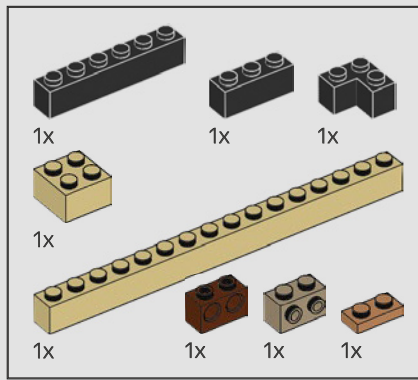

29

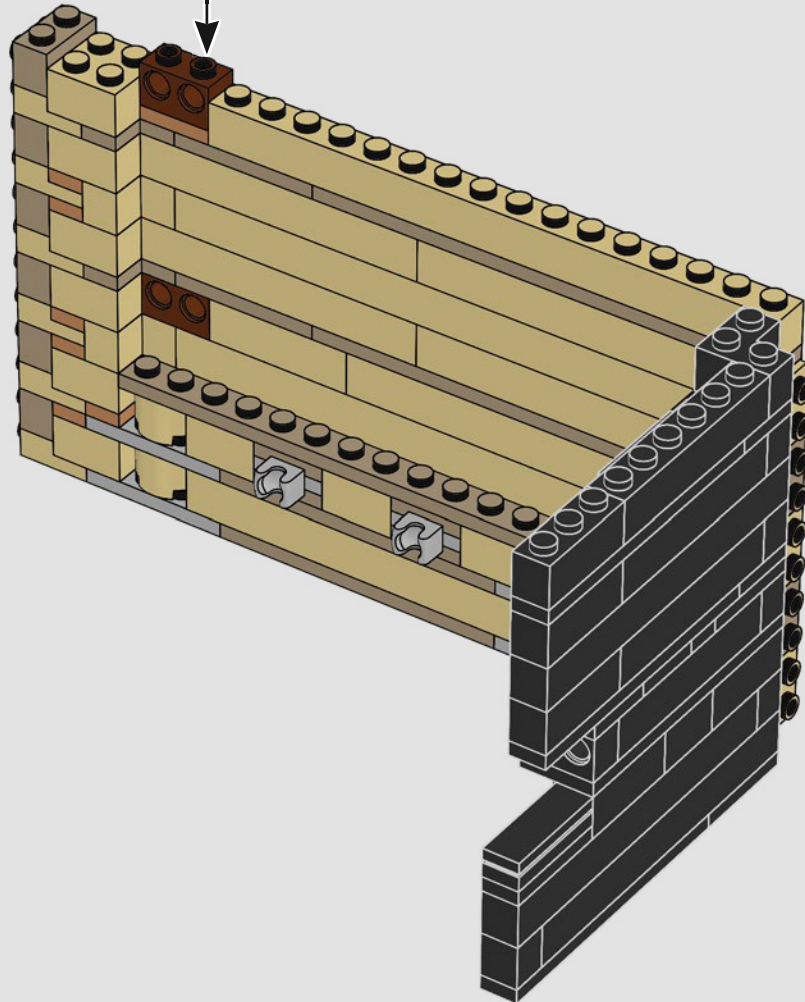

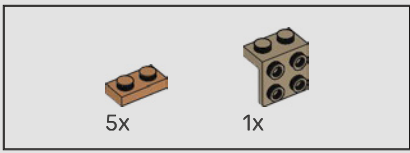

30

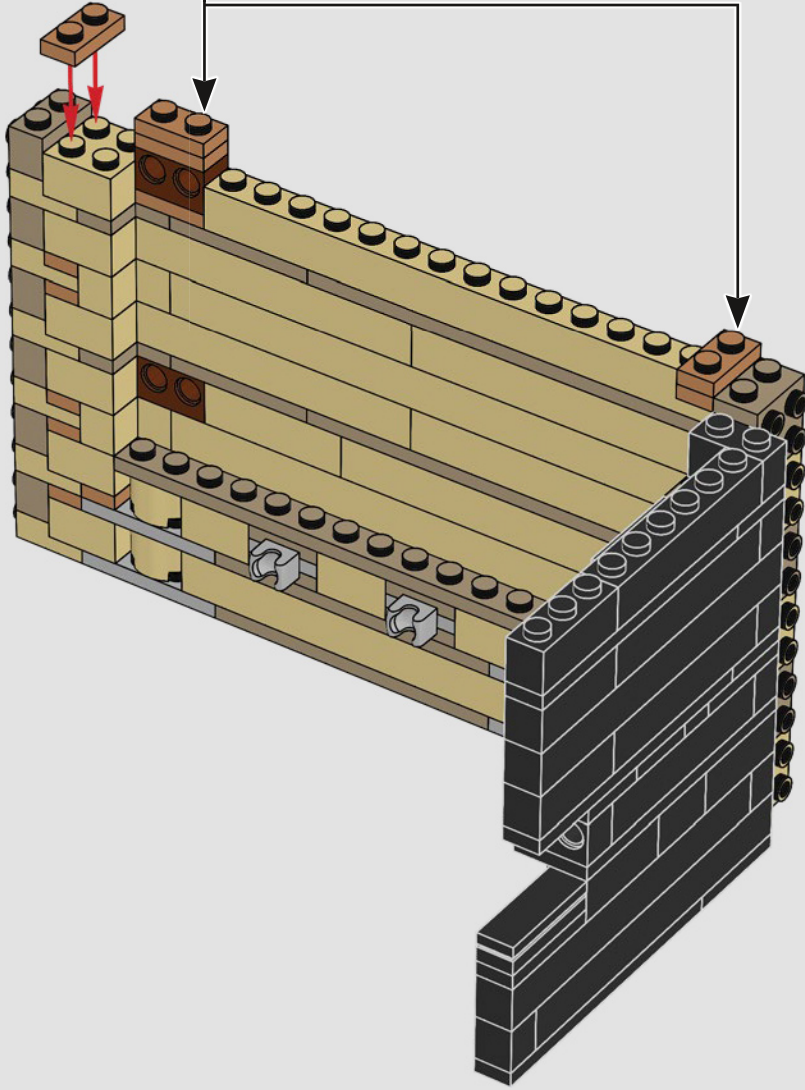
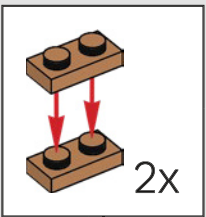

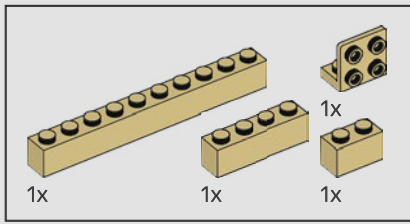

31

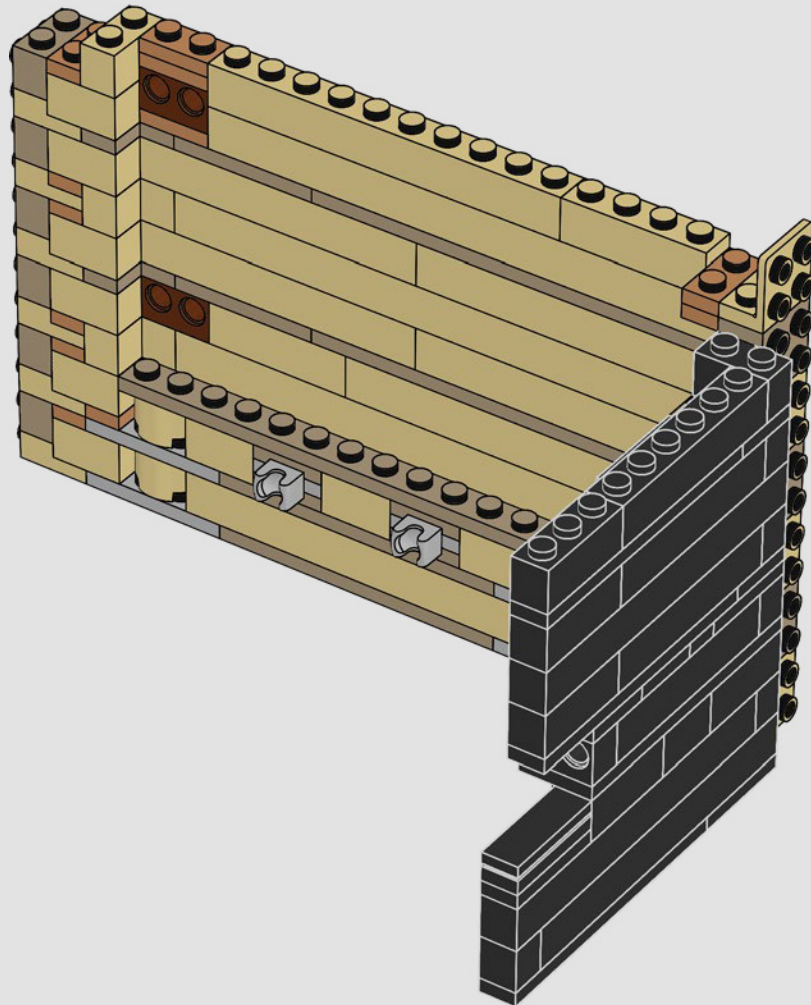

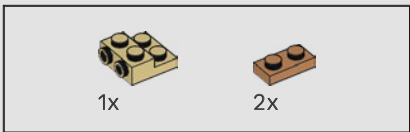

32

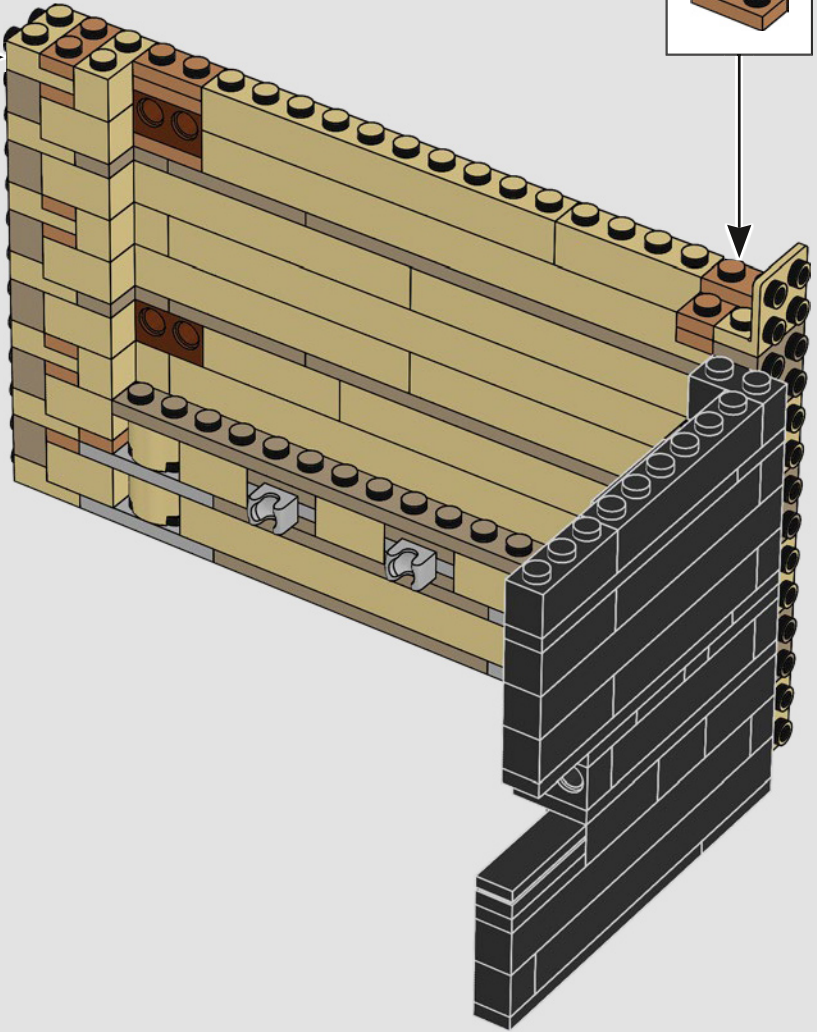
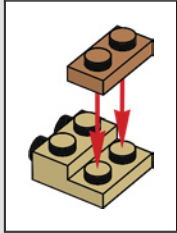

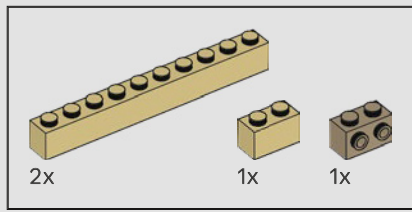

33

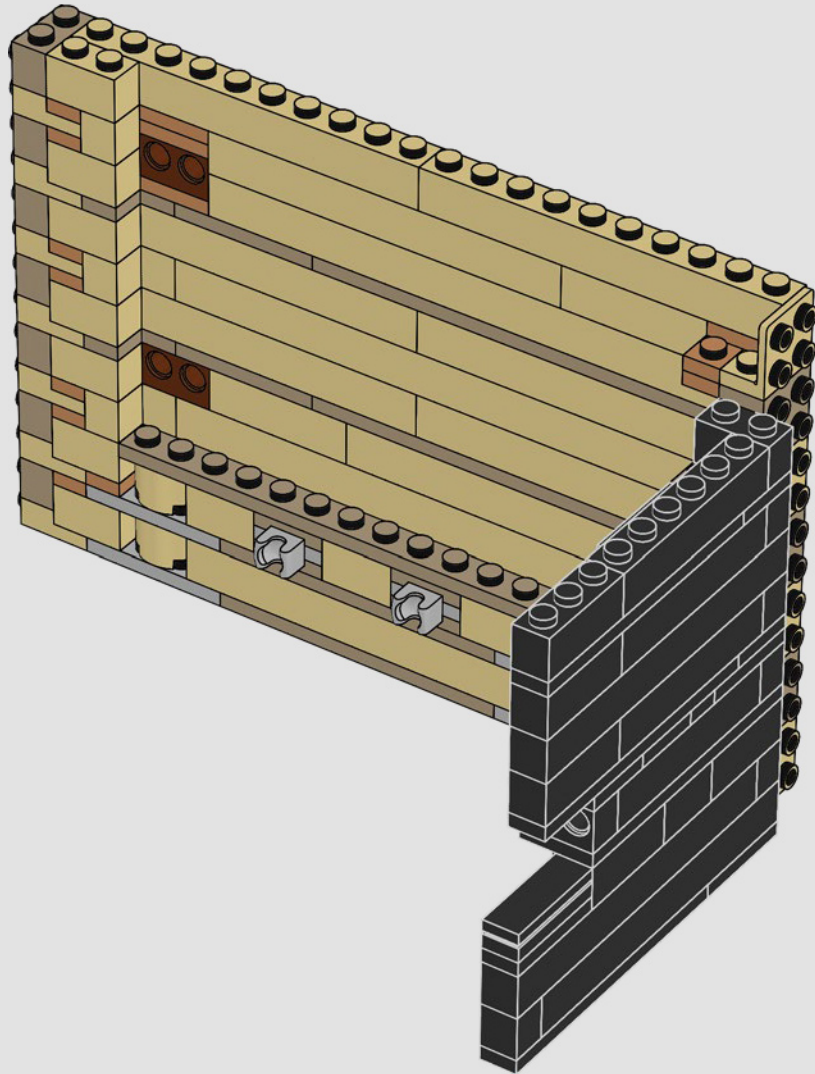

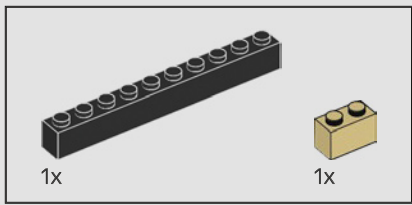

34

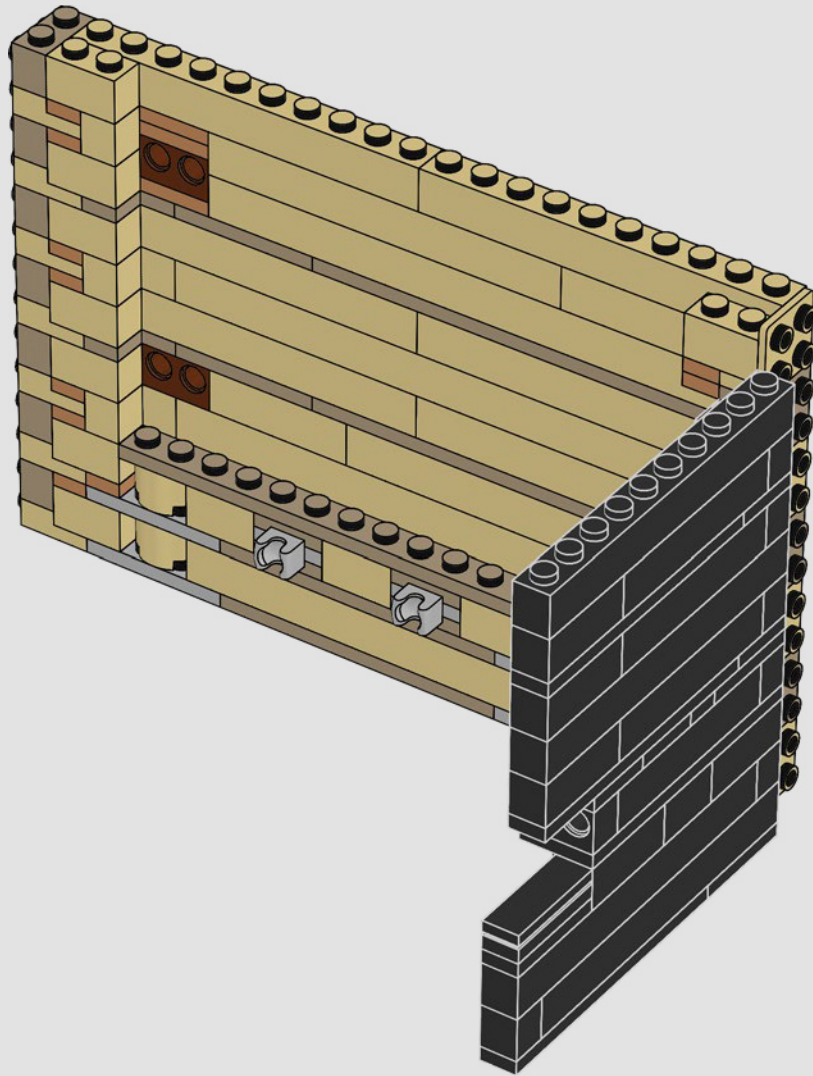

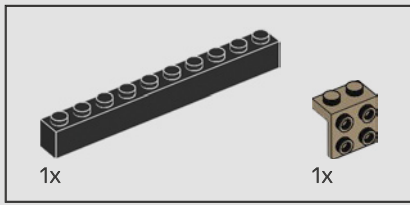

35

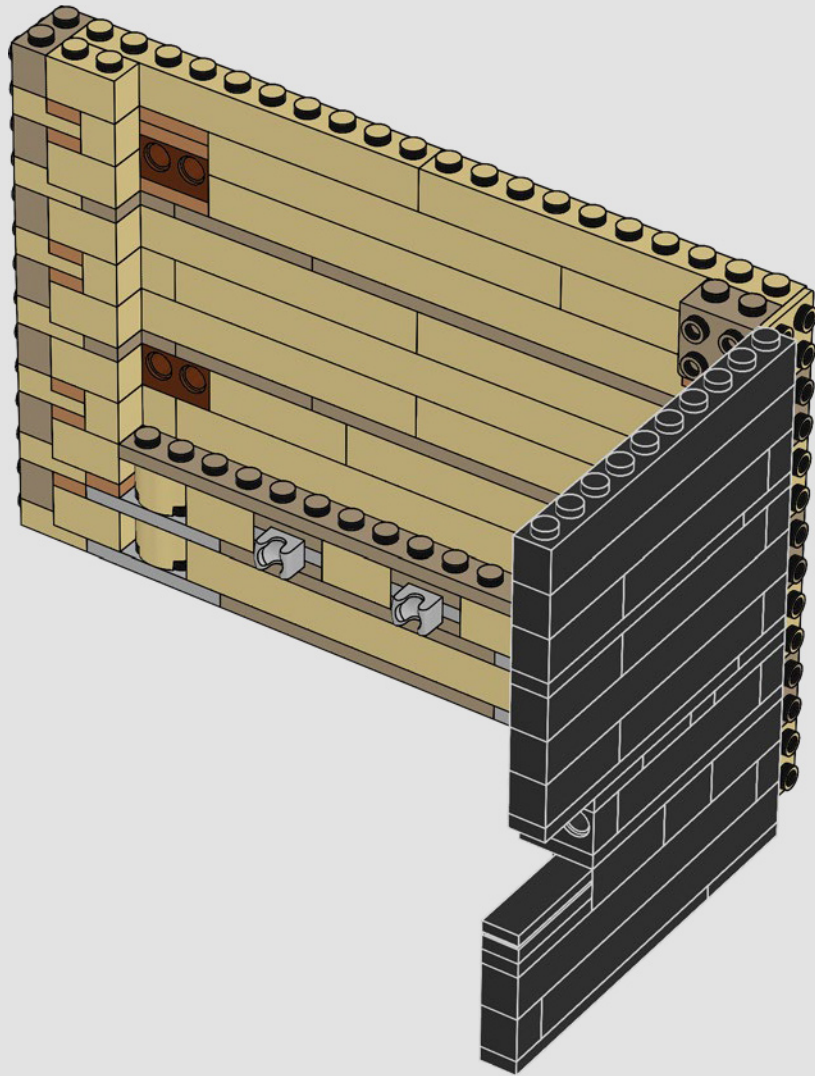

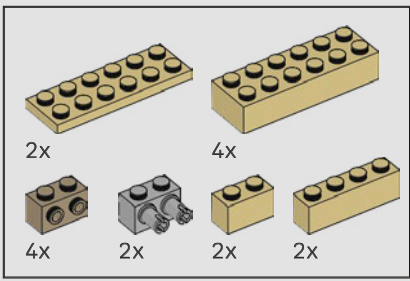

36

1

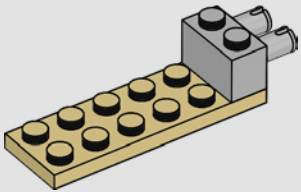

2

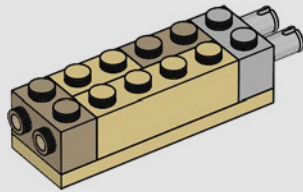

3

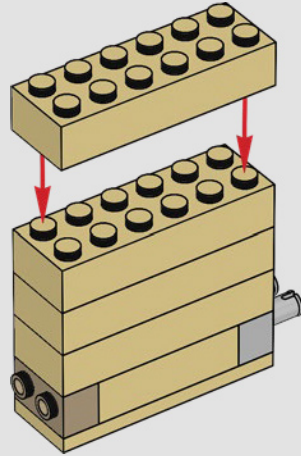

4

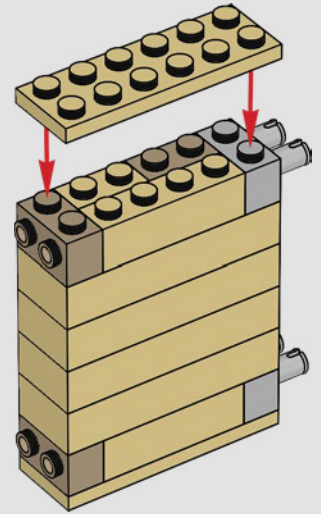

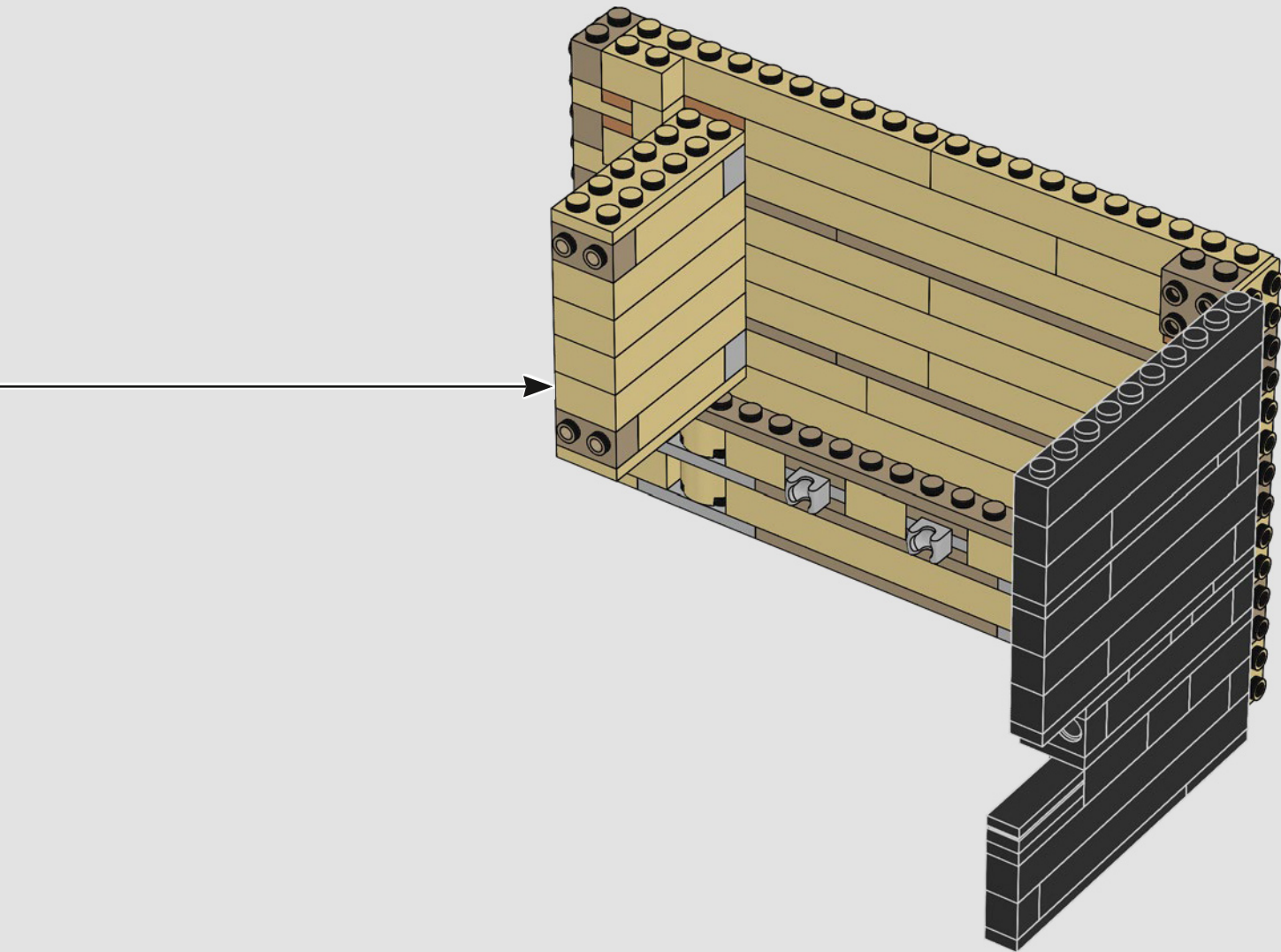

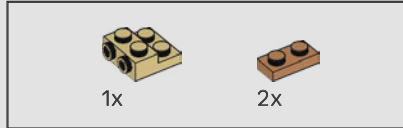
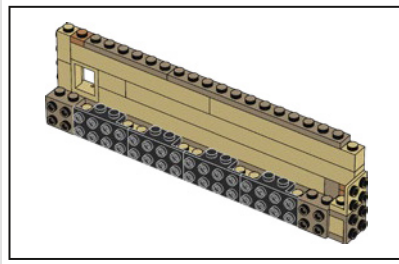
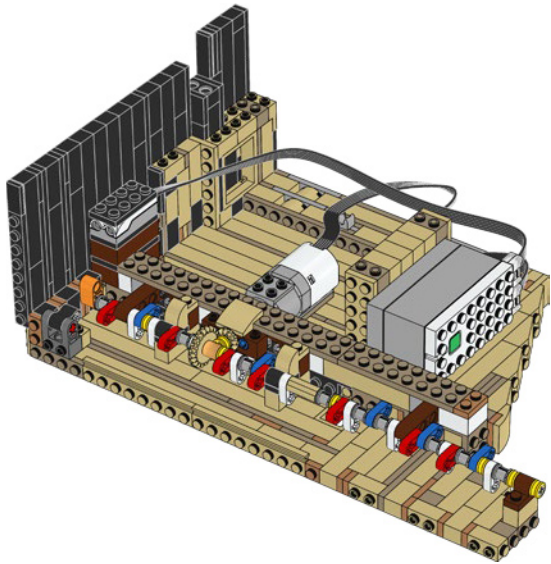
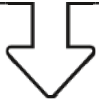
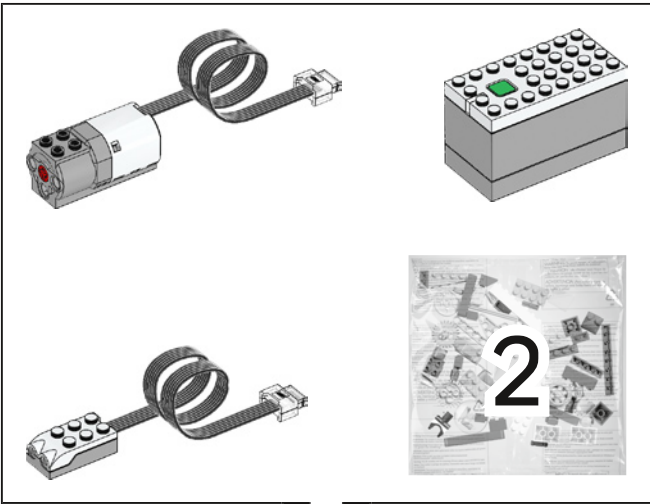

37

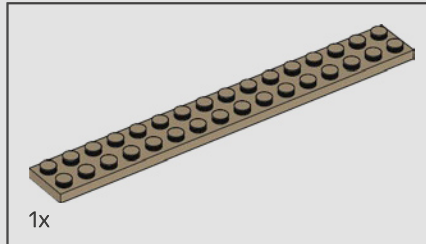
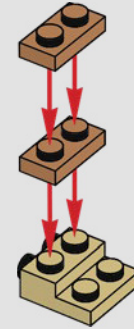

38

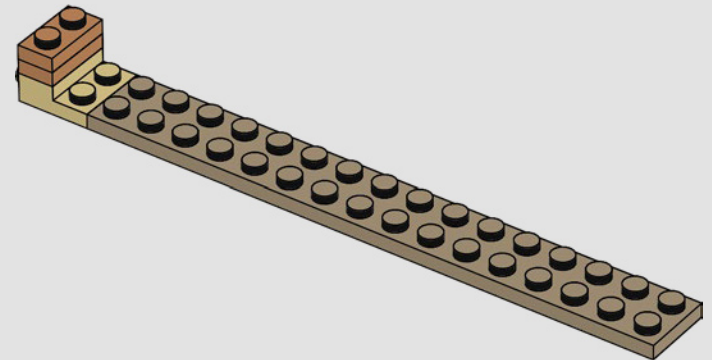

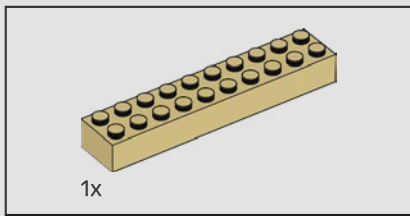

39

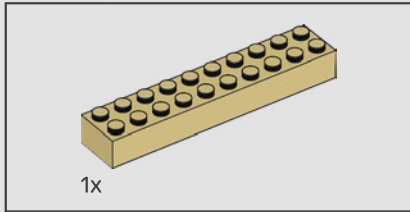
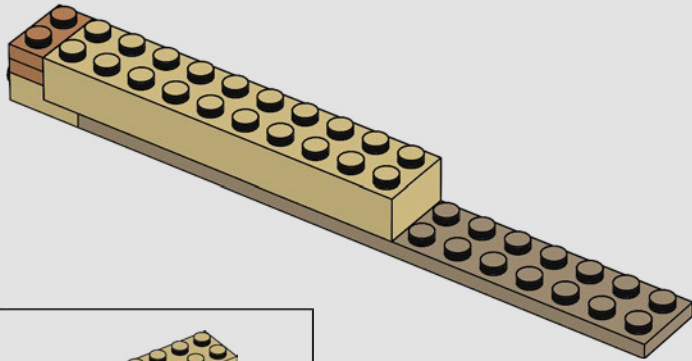

40

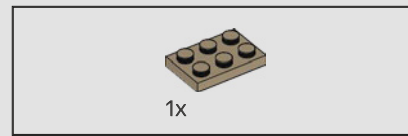
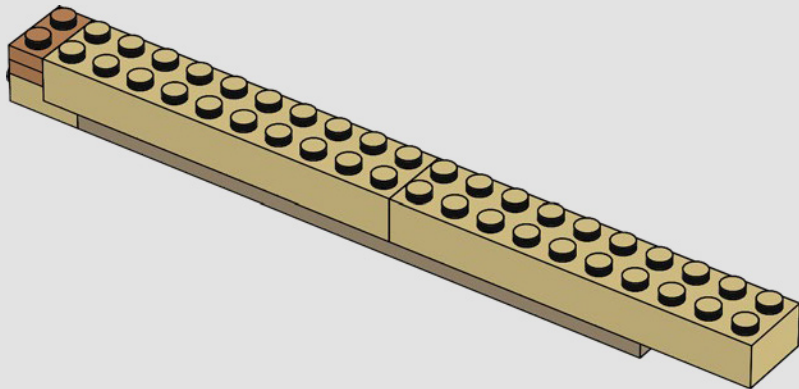

41

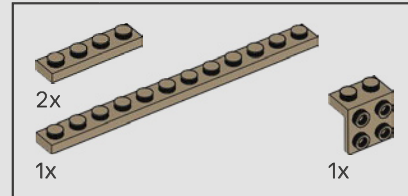
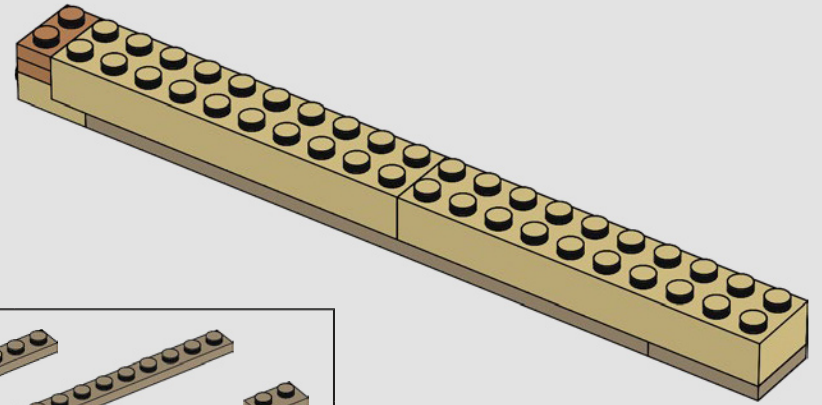

42

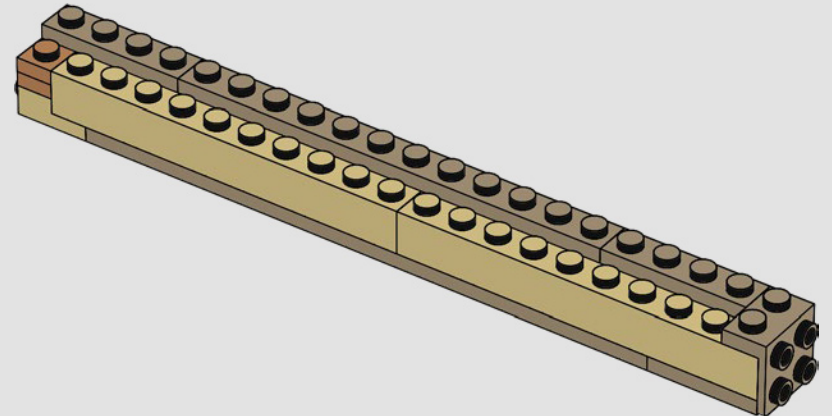



43

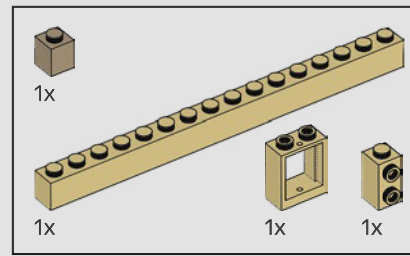
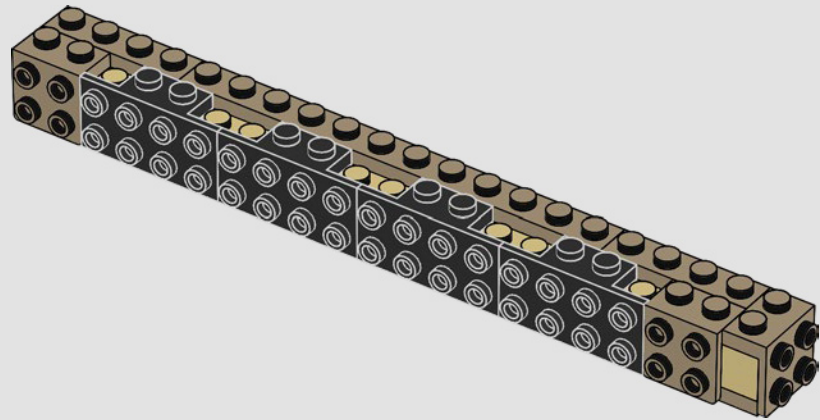

44

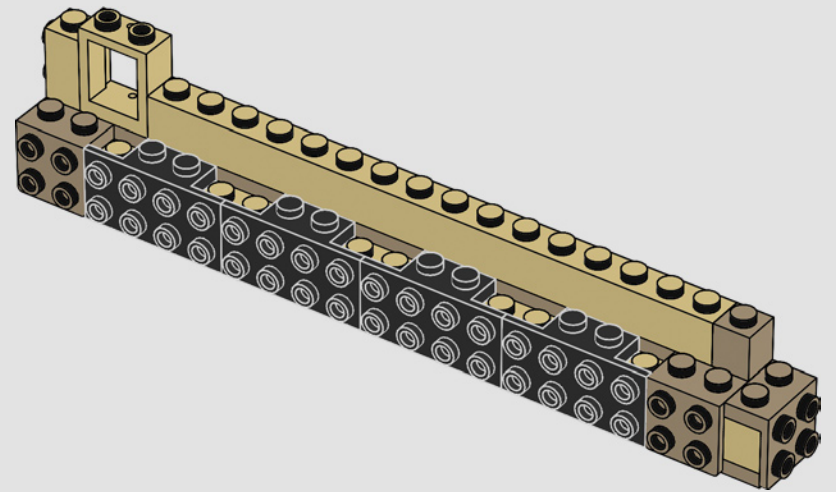

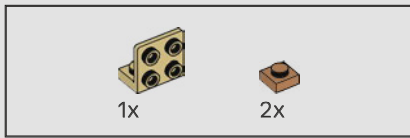

45

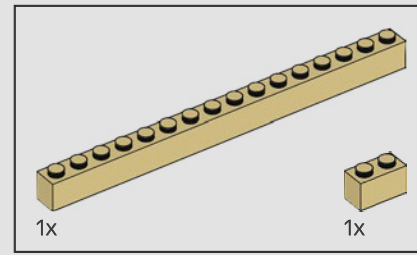
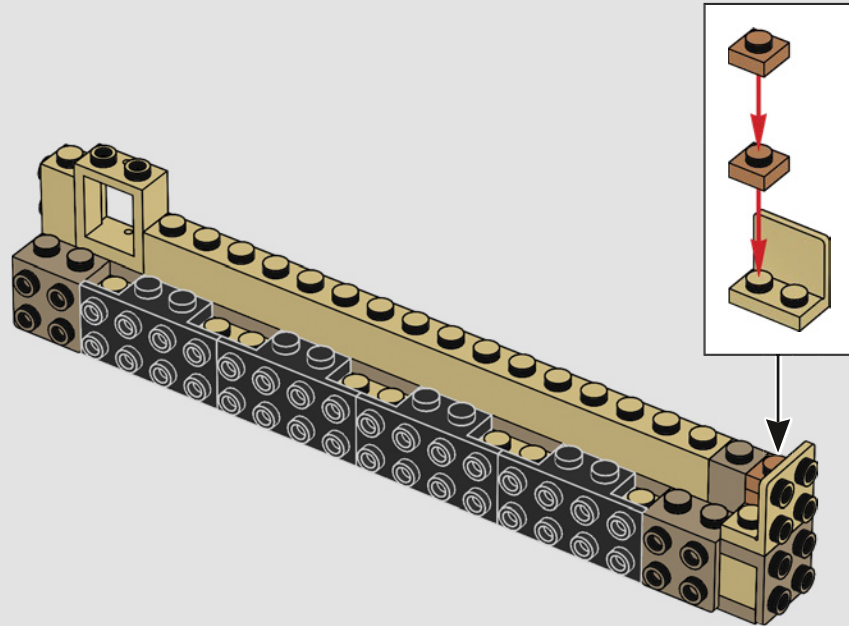

46

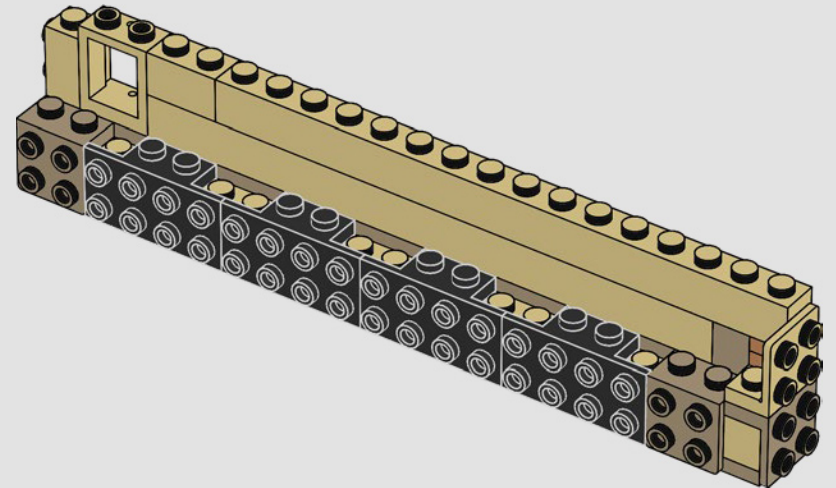

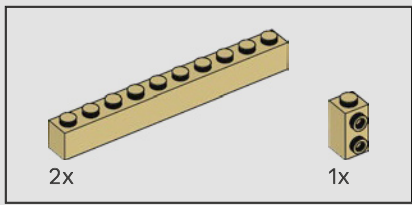

47

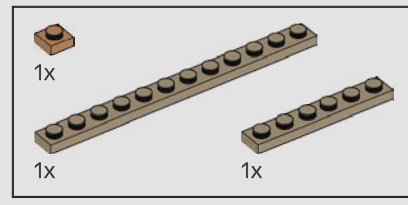
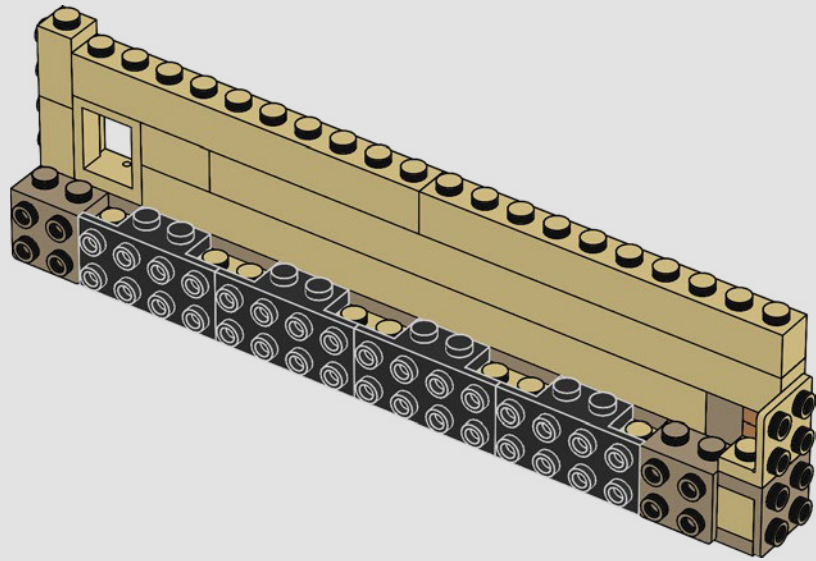

48

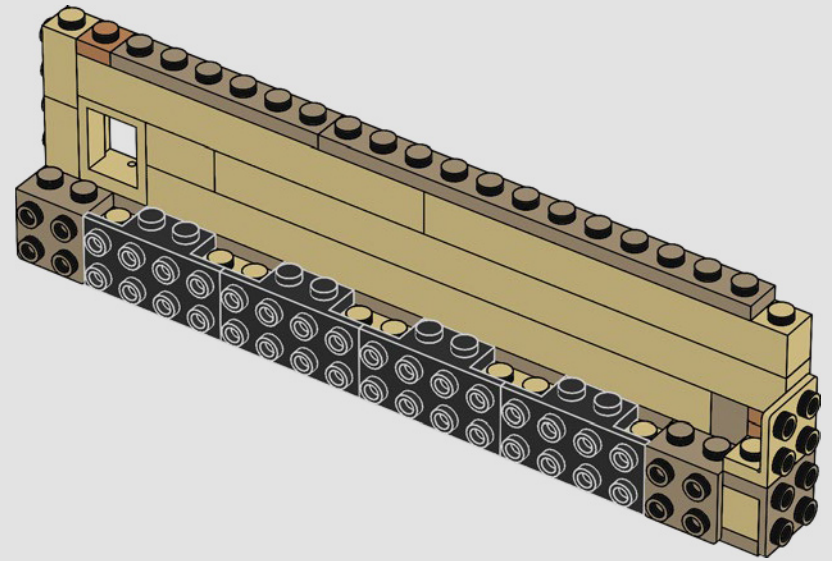

49

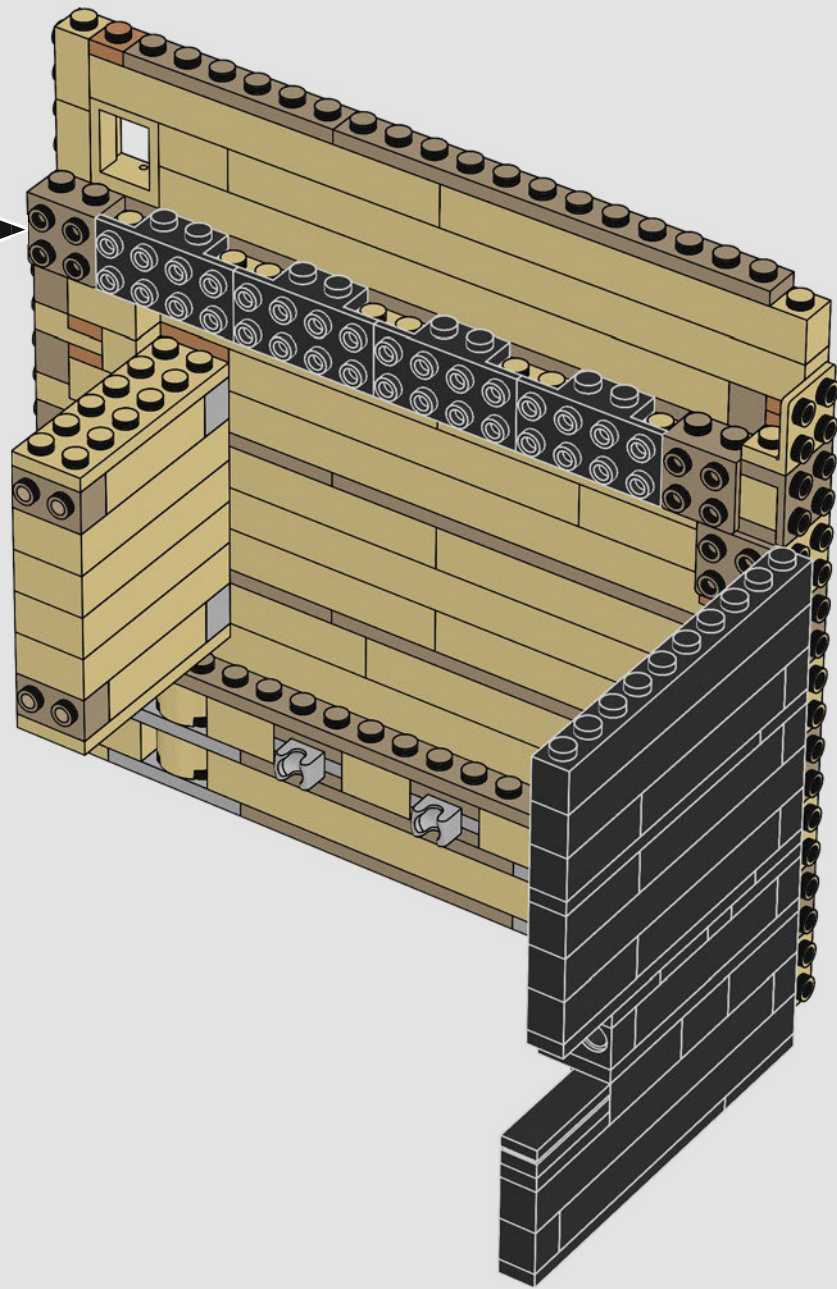

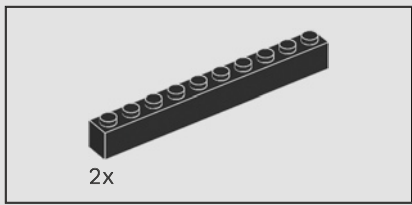

50

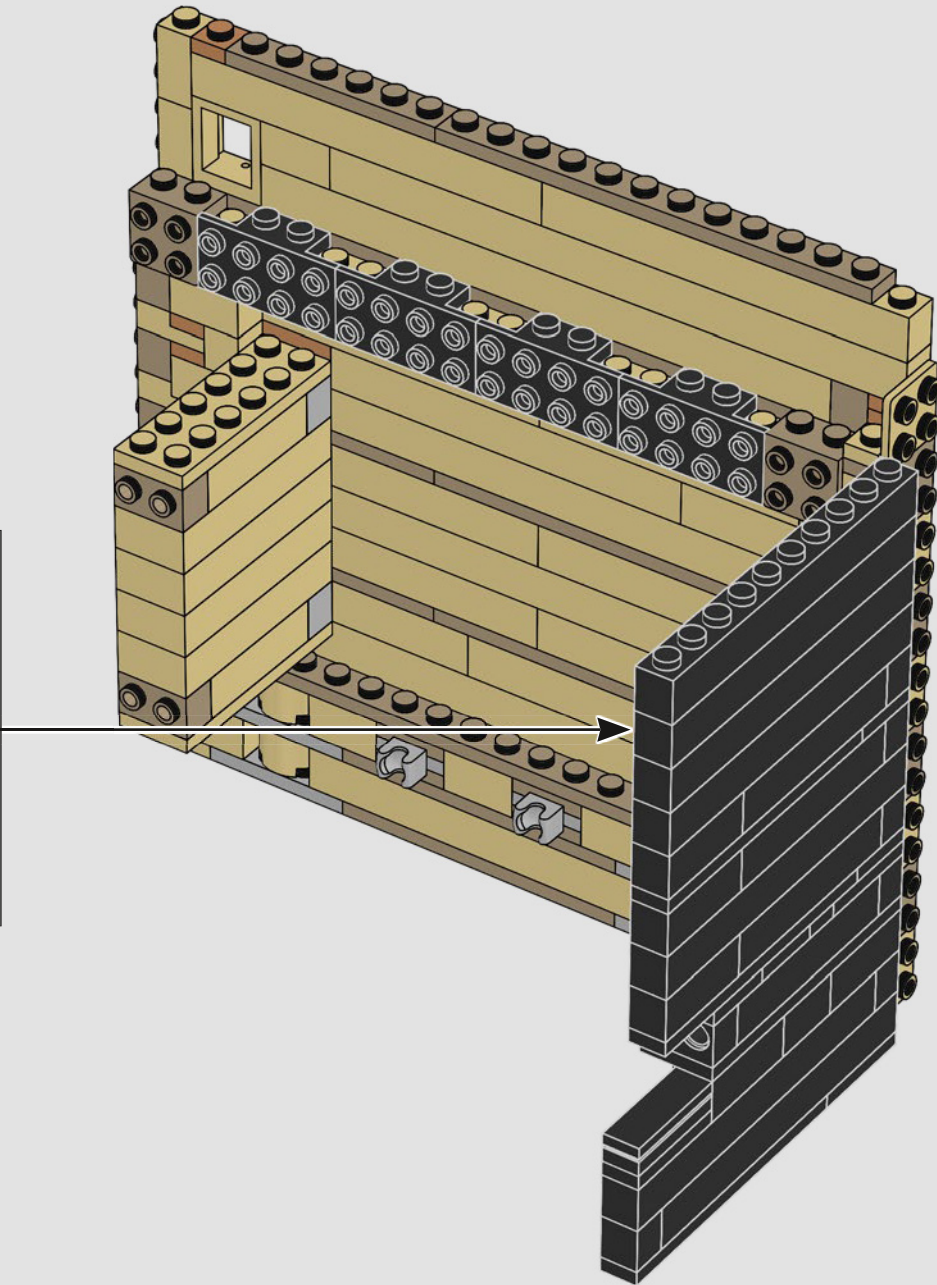
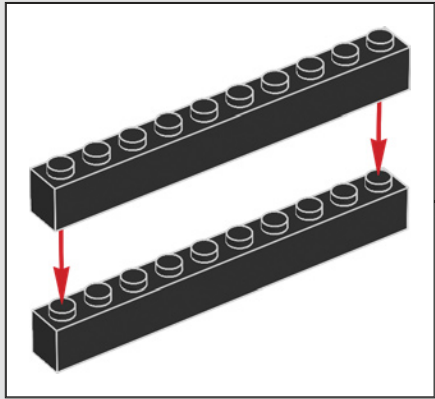

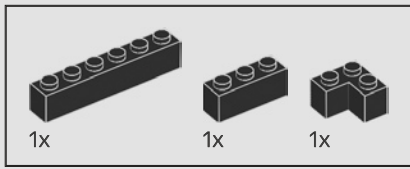

51

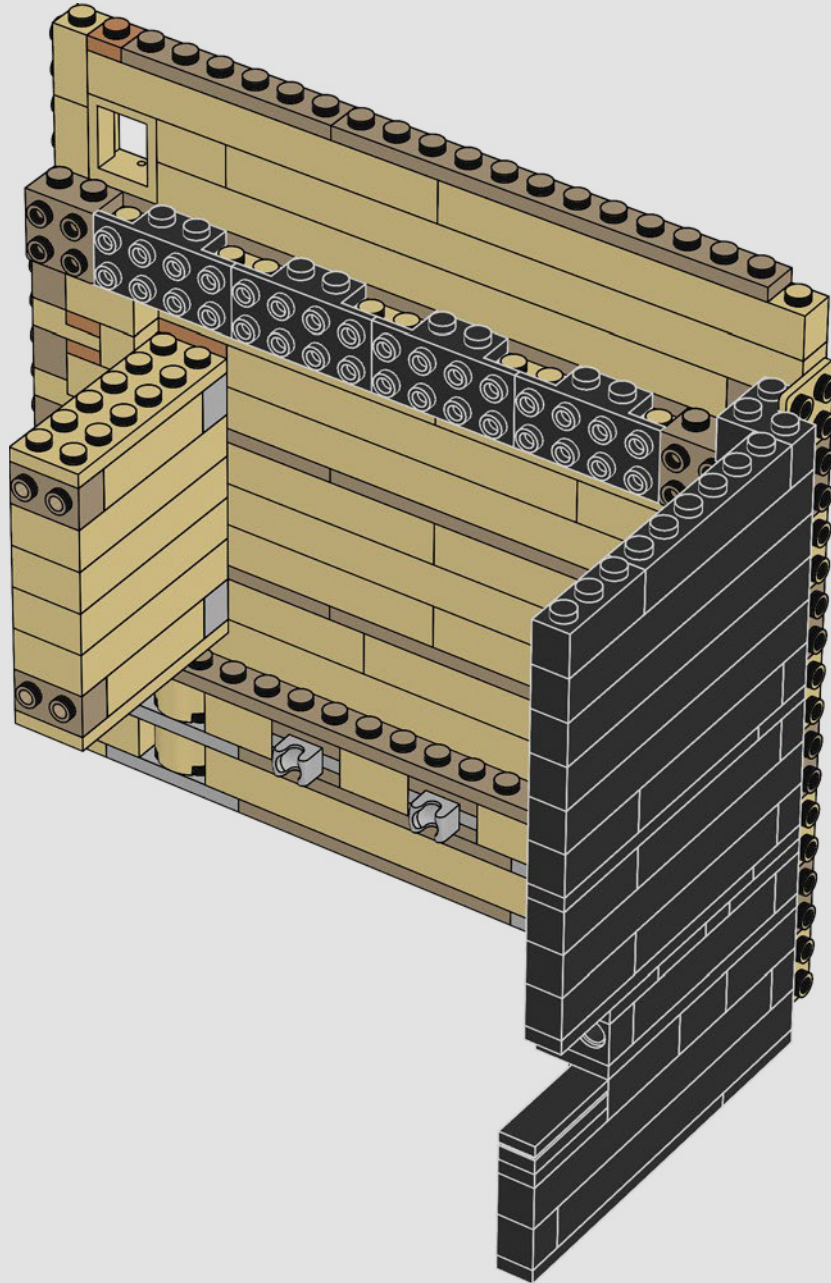

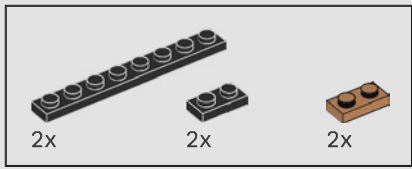

52

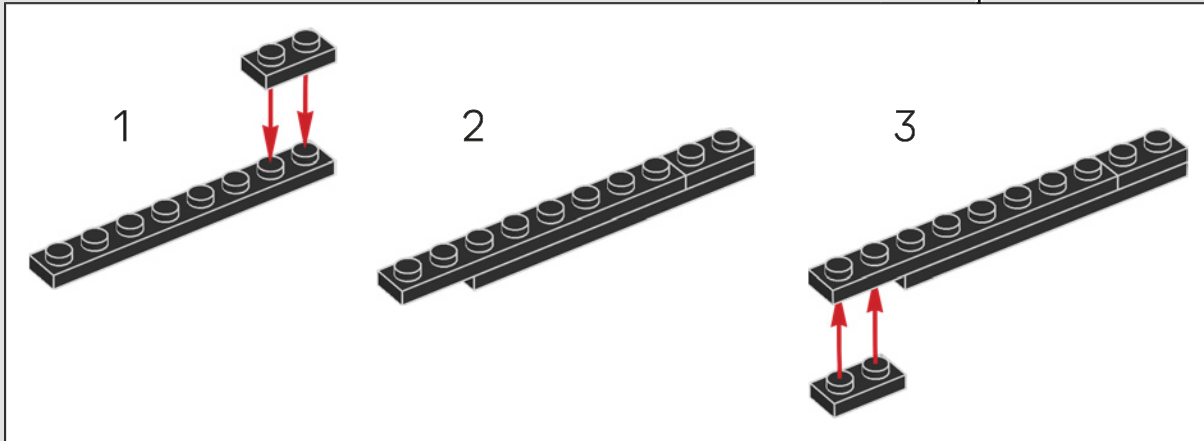
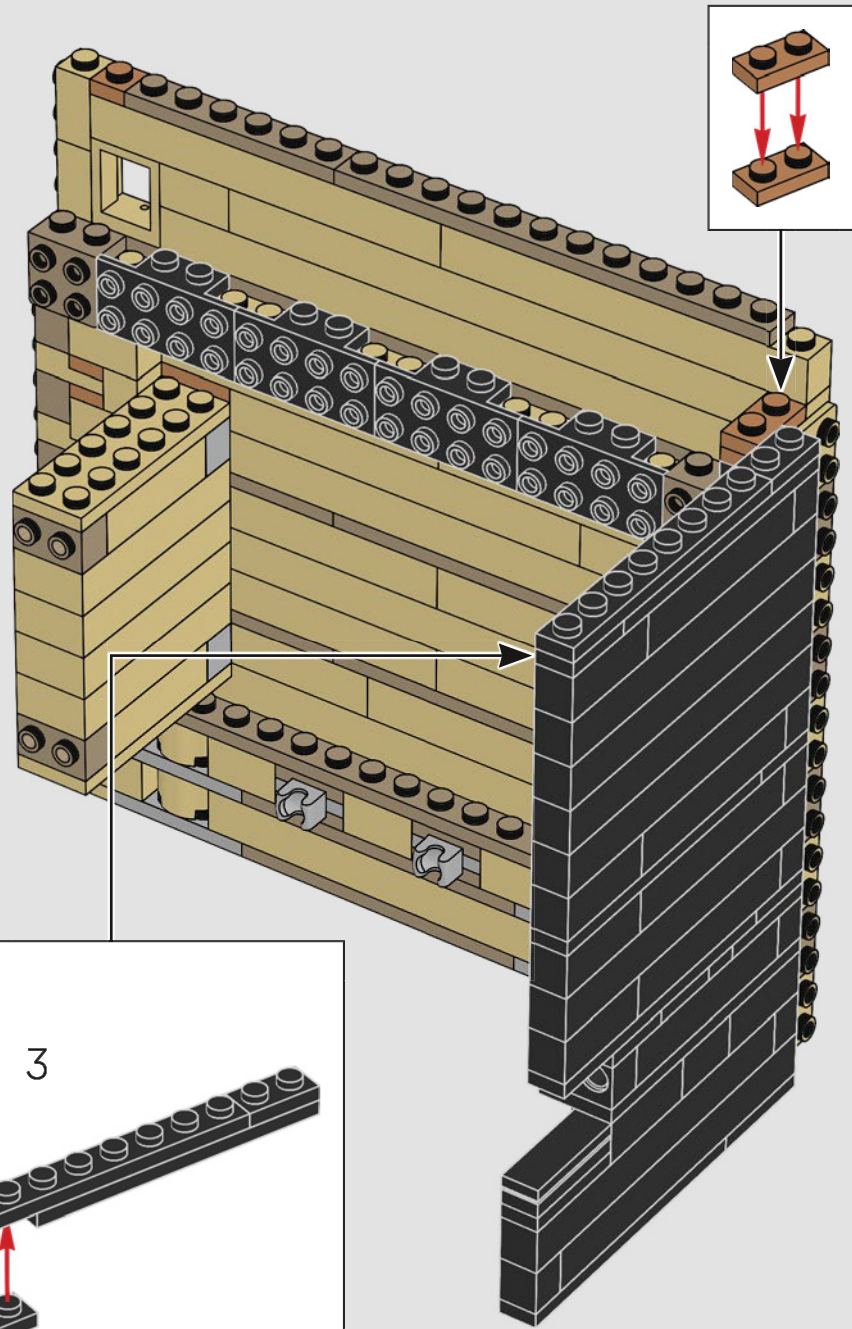

54

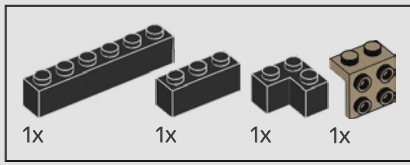

53

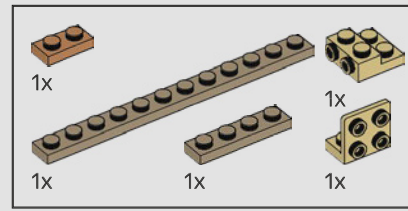
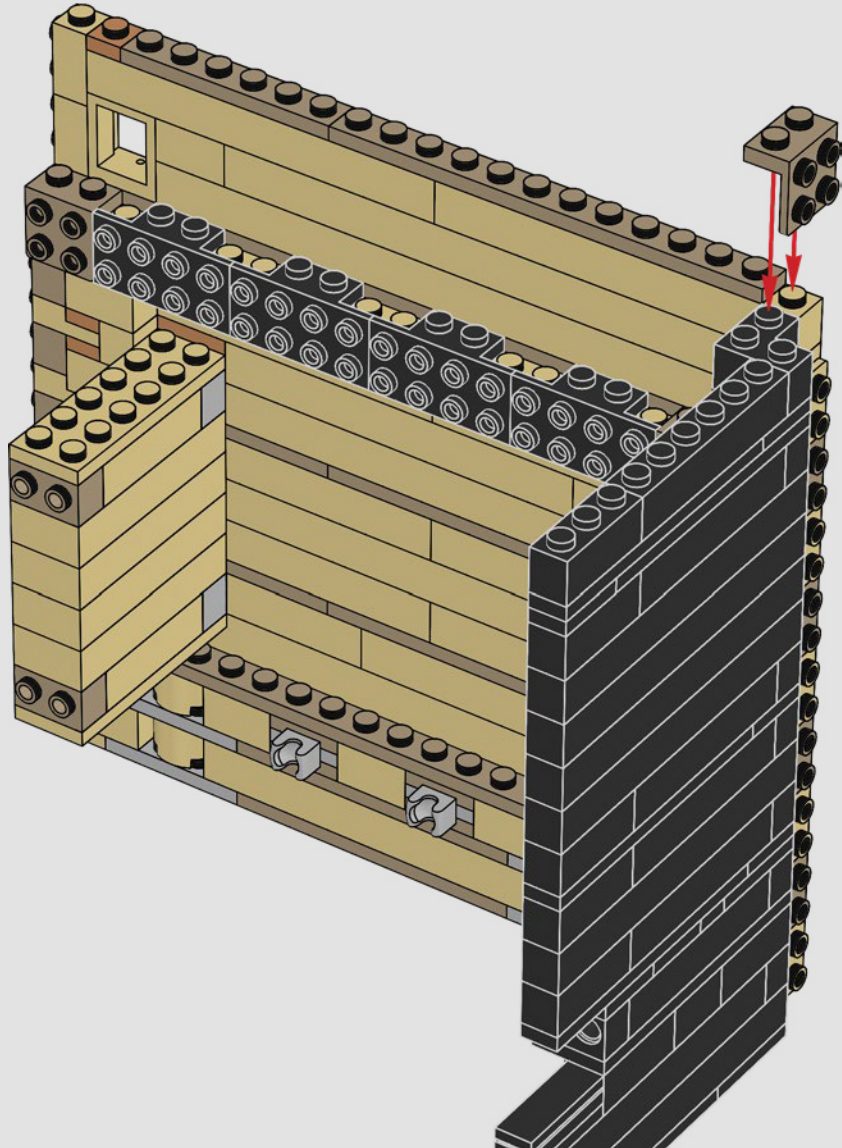

54

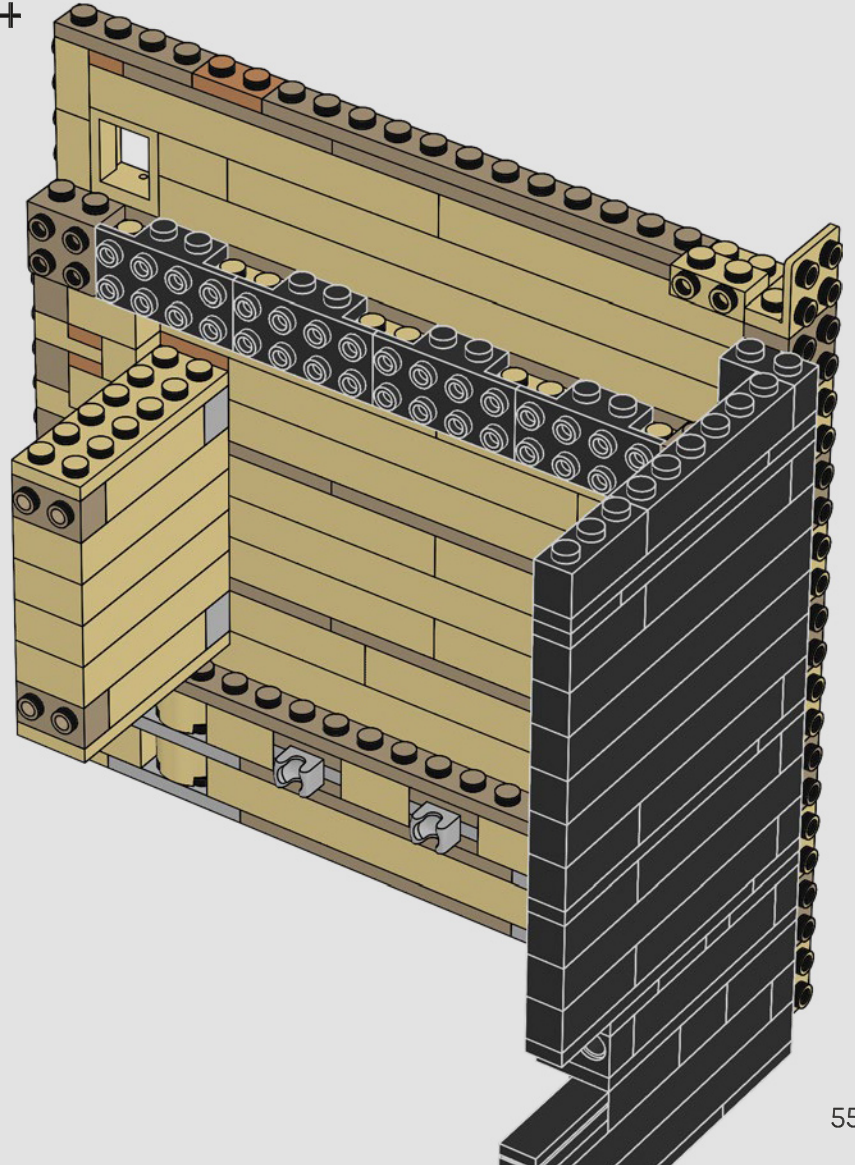

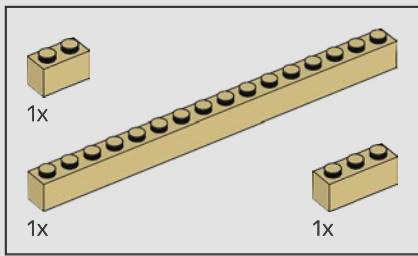

55

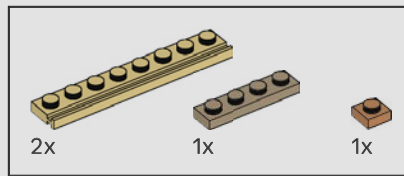
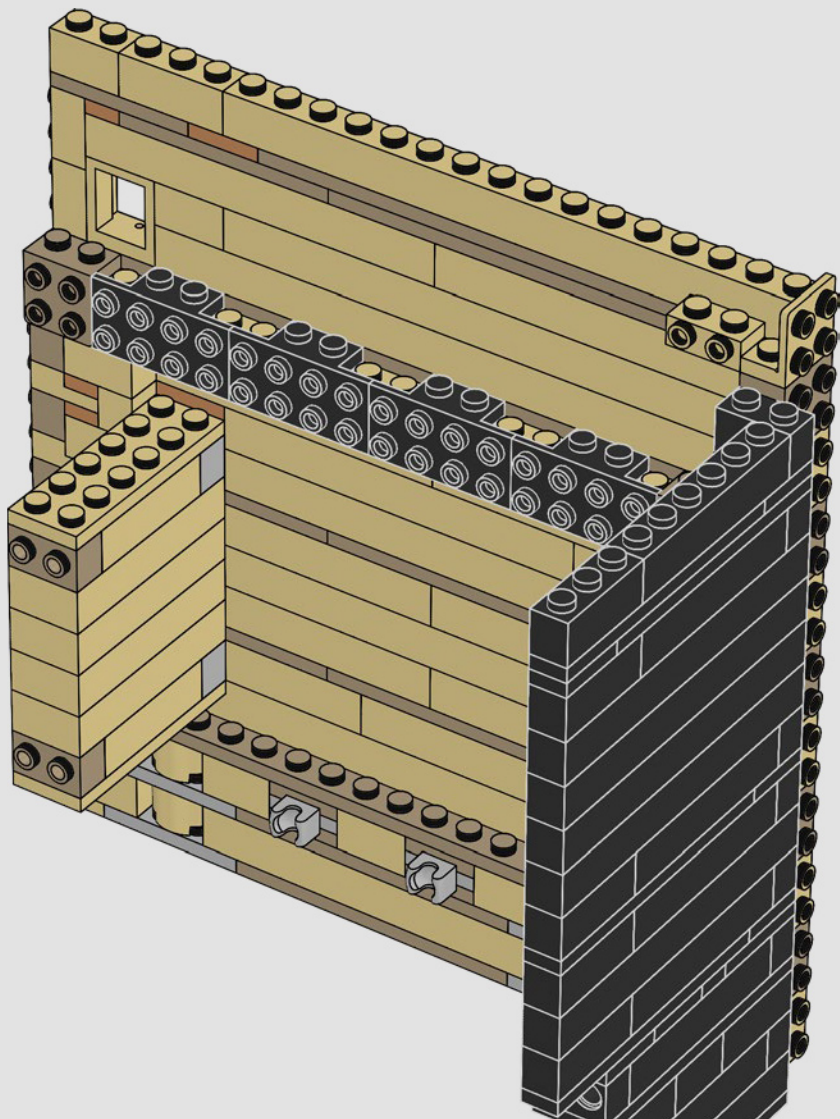

56

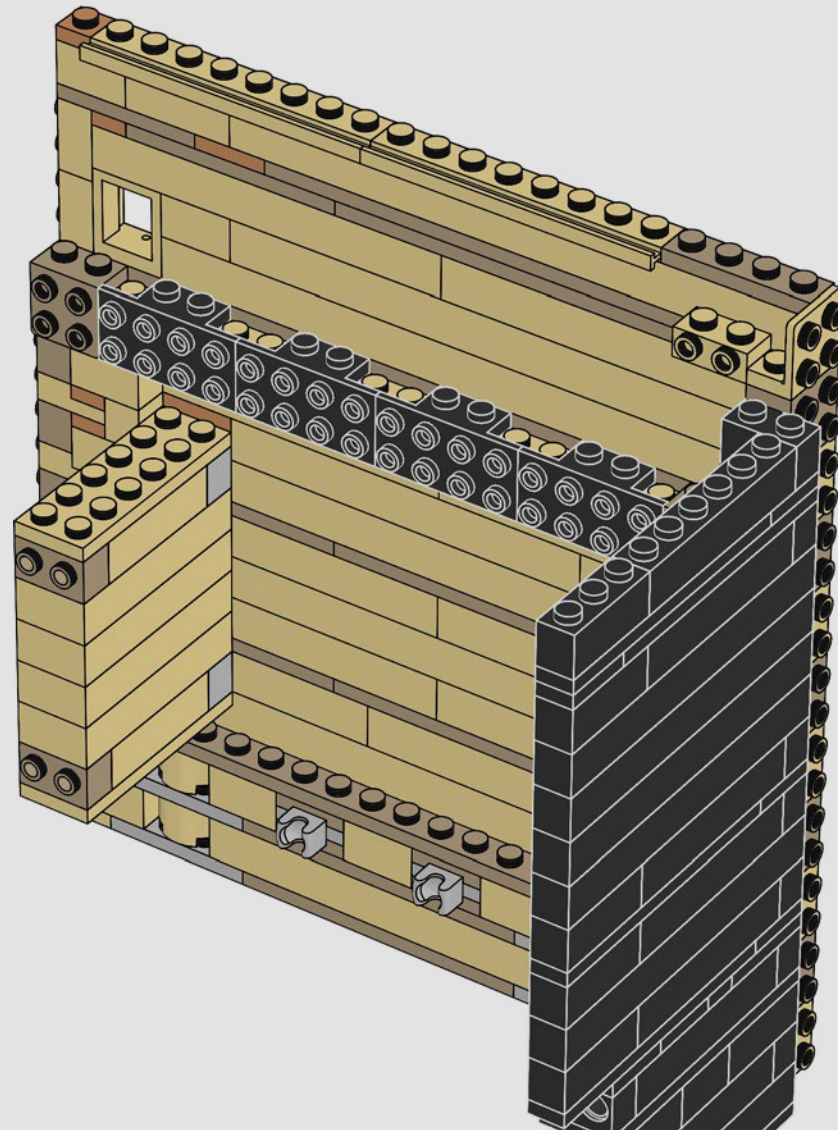

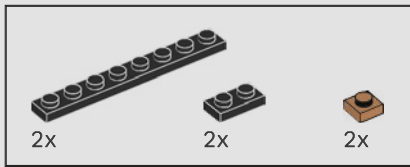

57

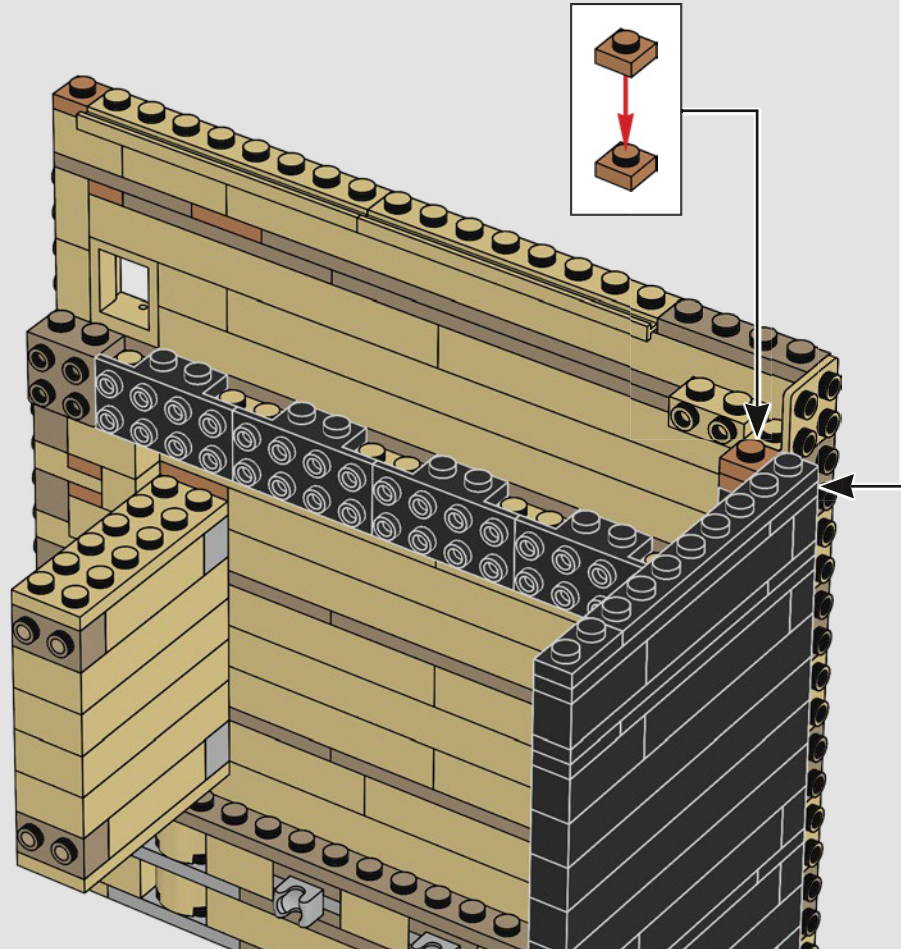
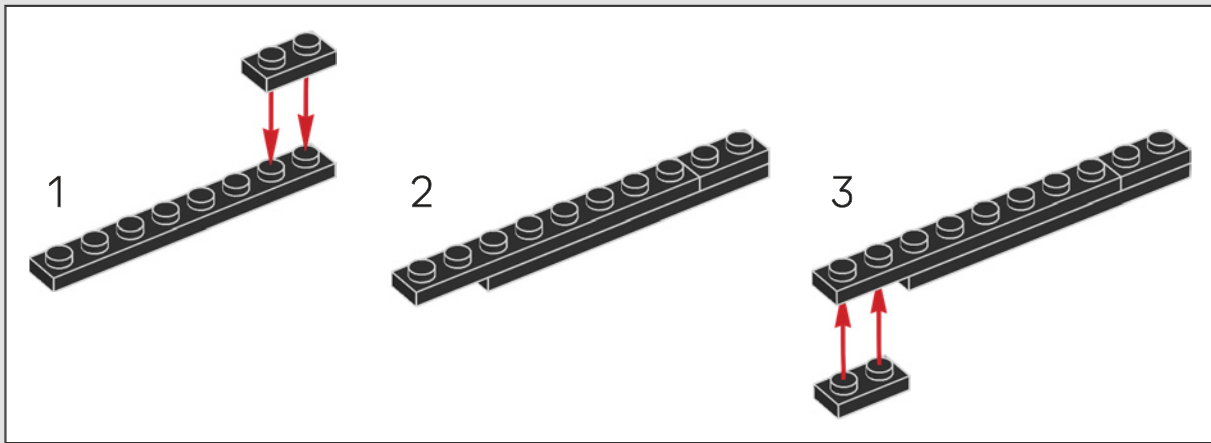



58

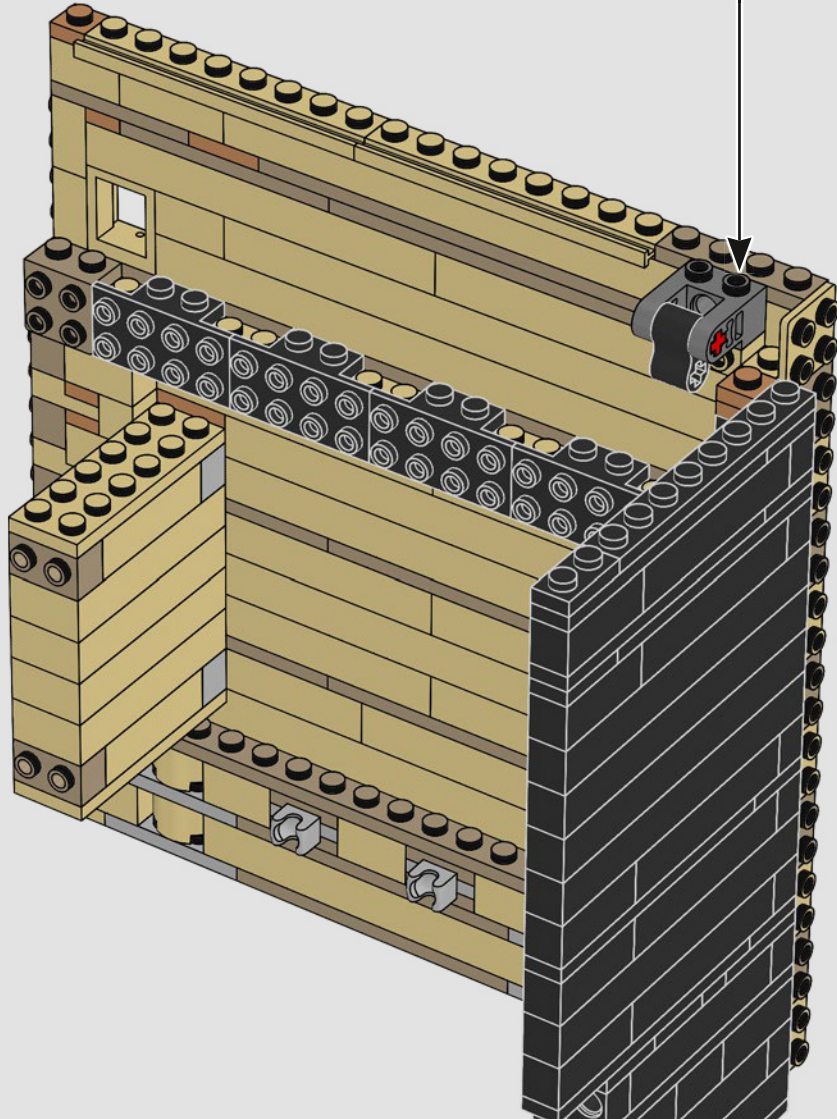
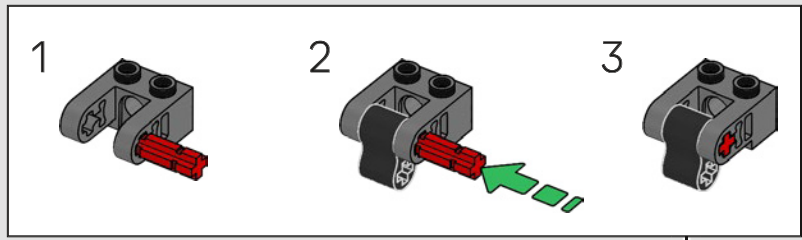

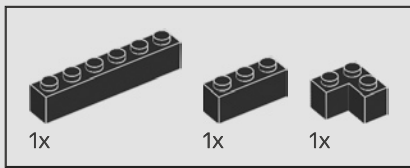

59

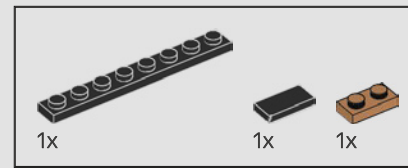
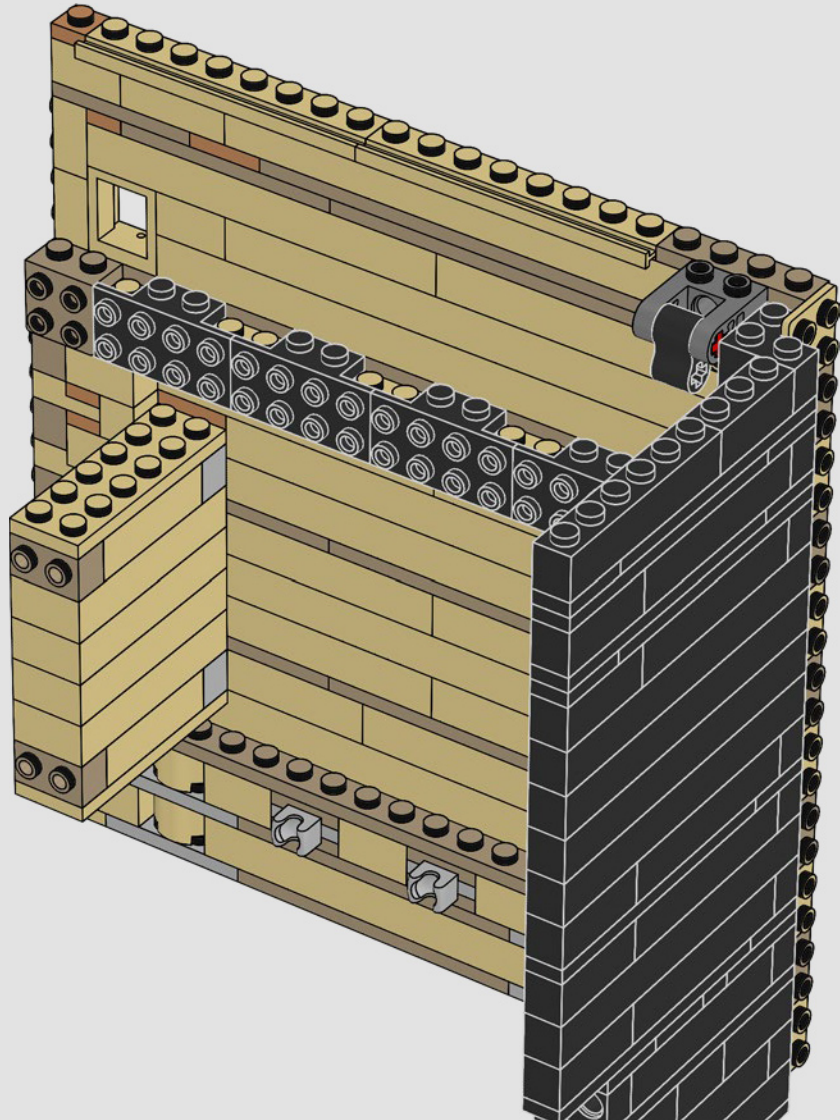

60

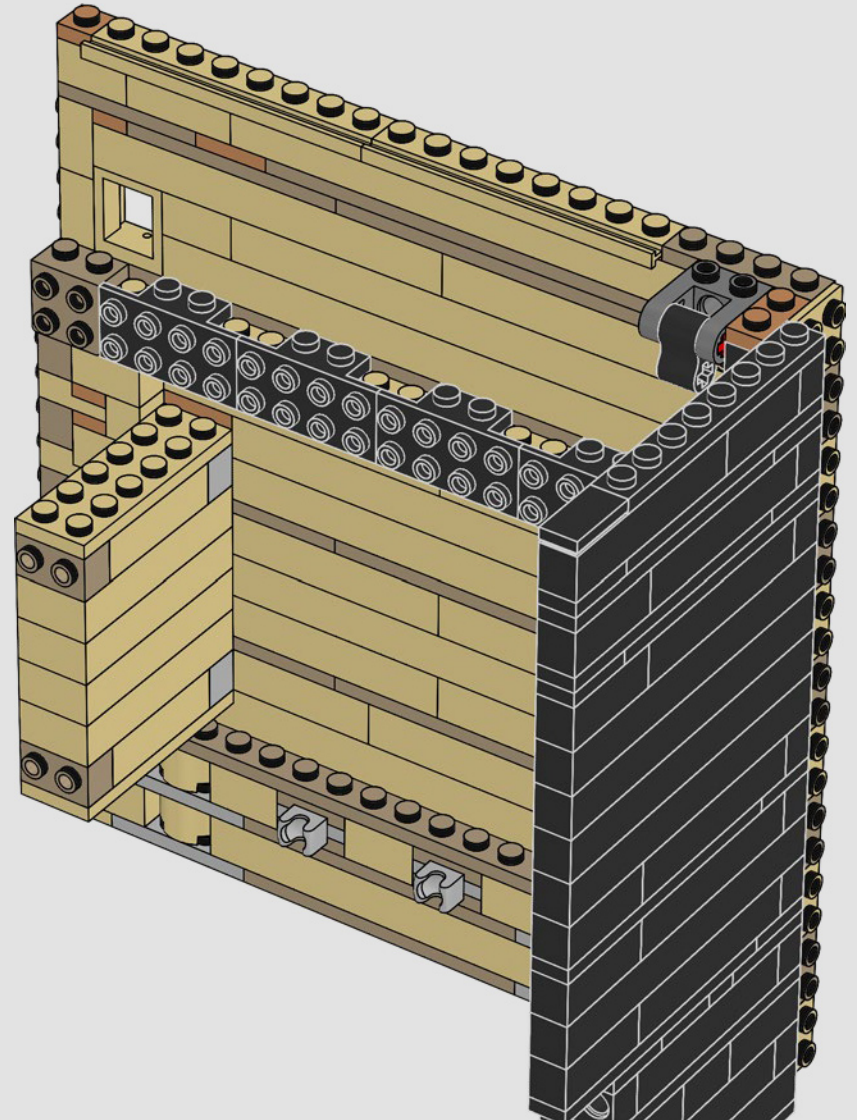

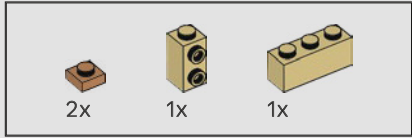
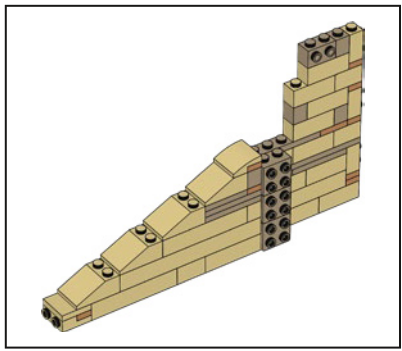

61

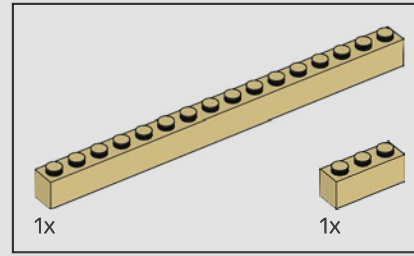
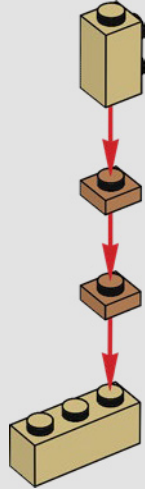

62

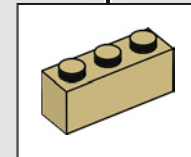
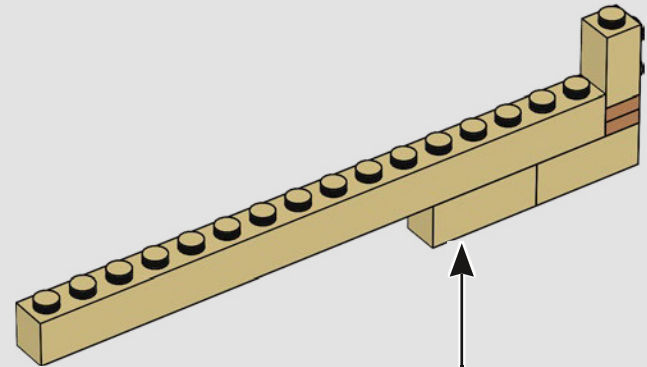

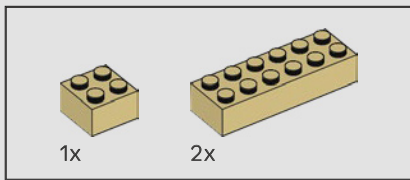

63

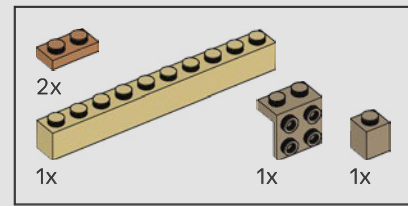
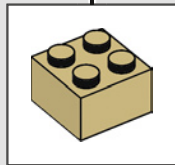
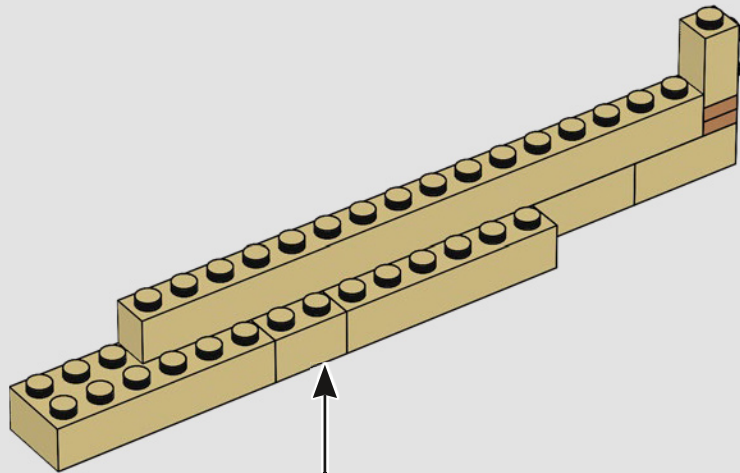

64

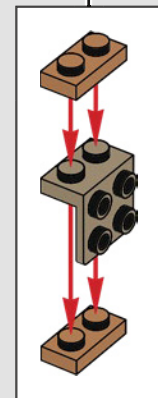
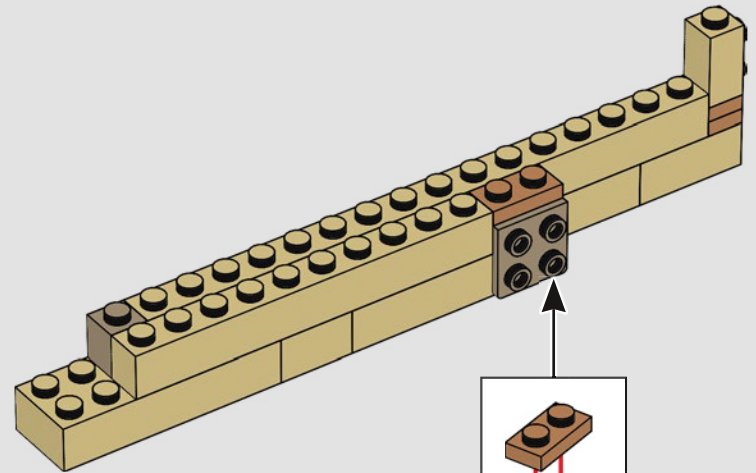

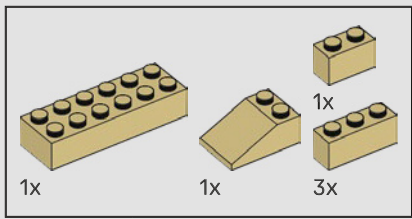

65

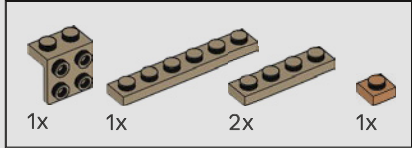
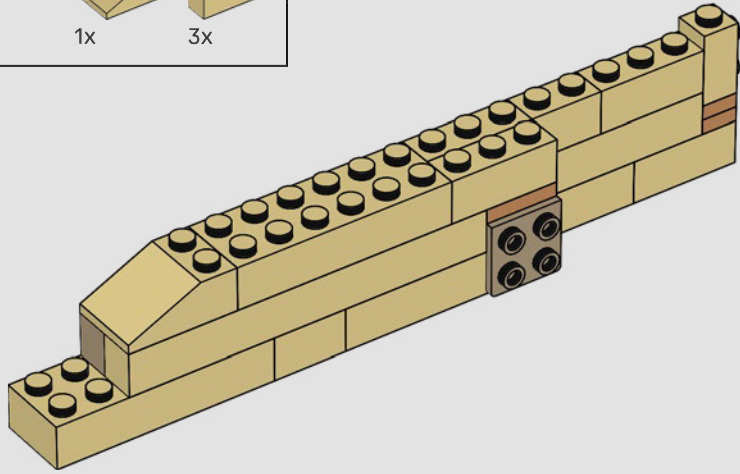

66

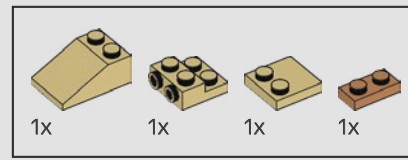
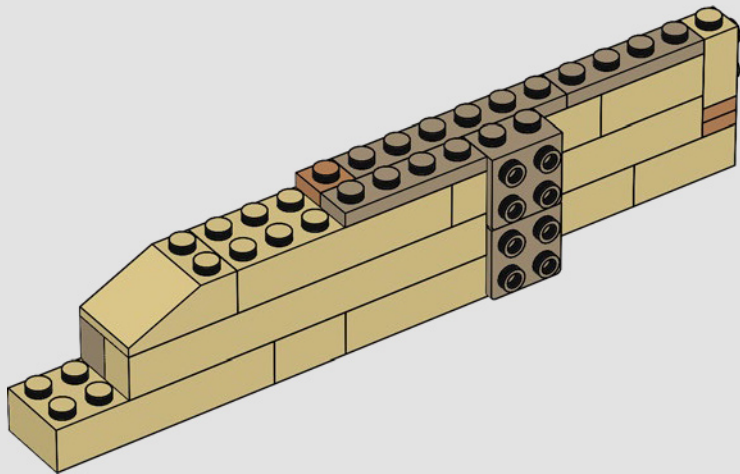

67

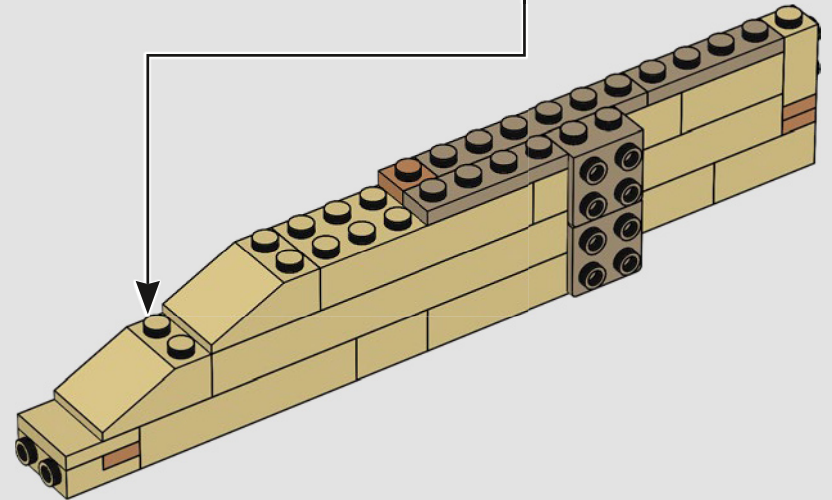
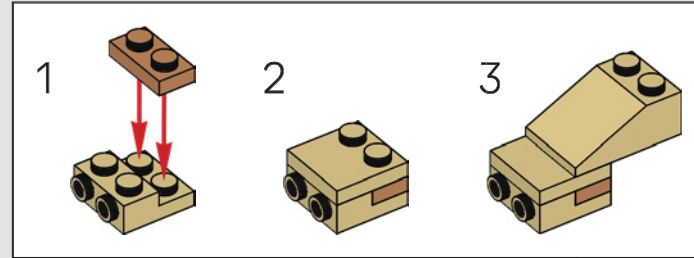

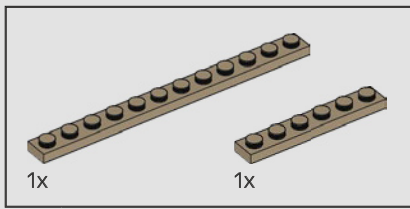

68

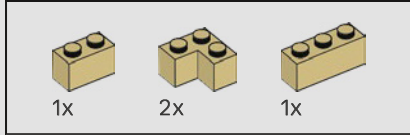
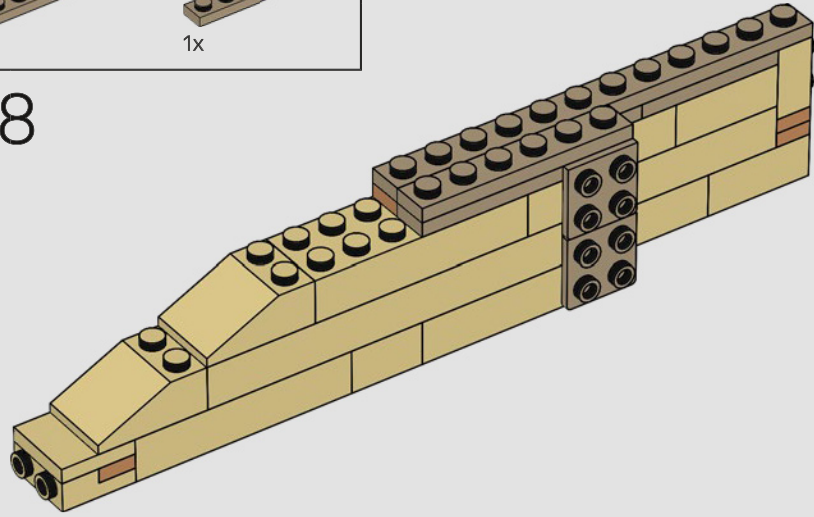

69

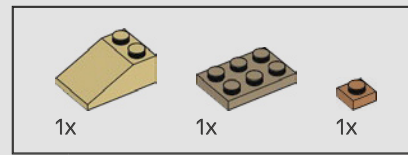
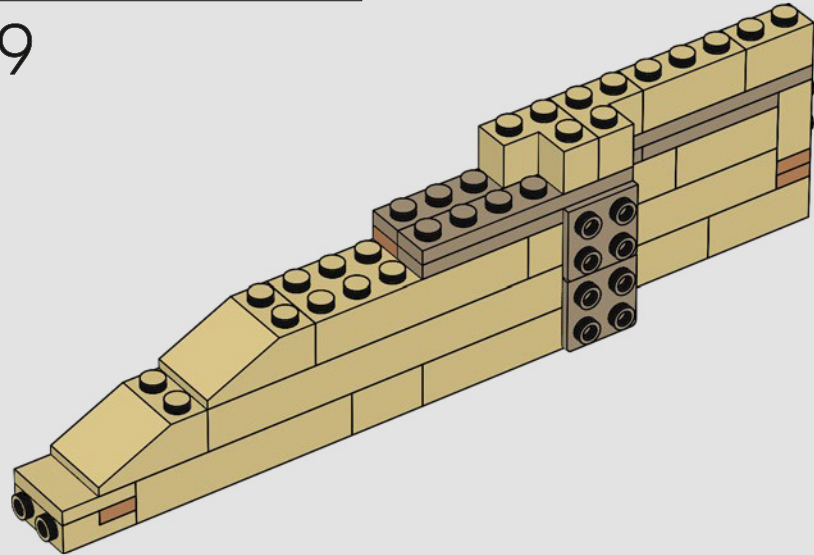

70

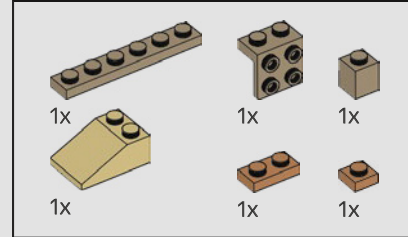
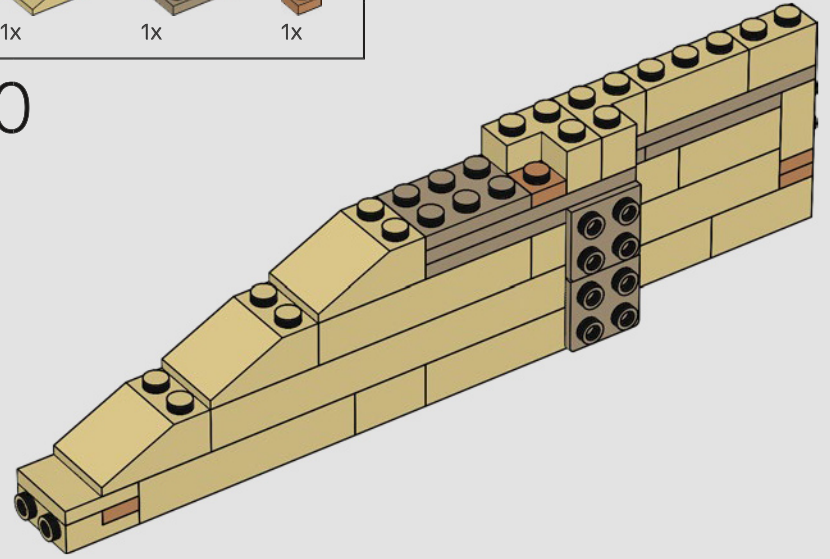

71

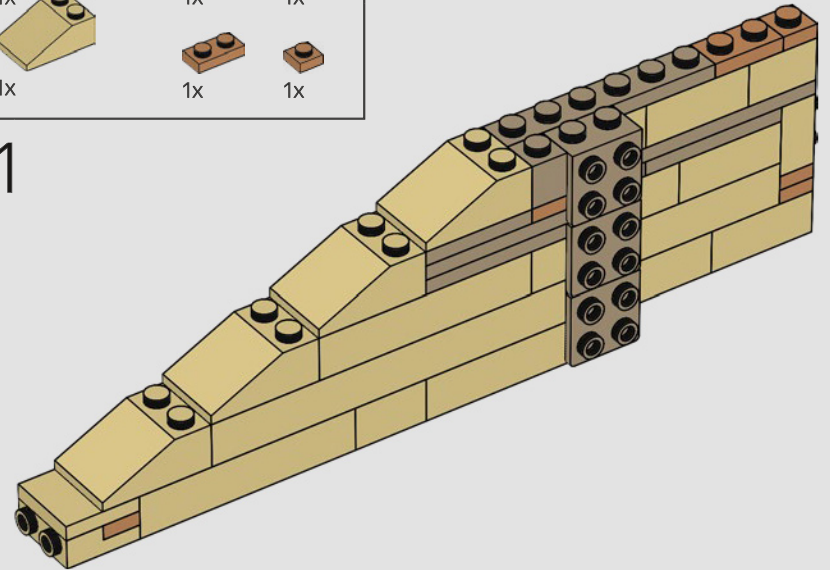

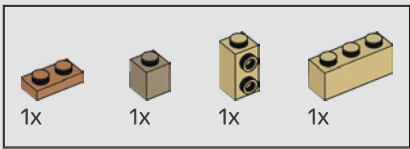

72

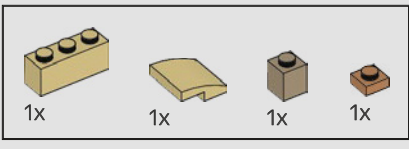
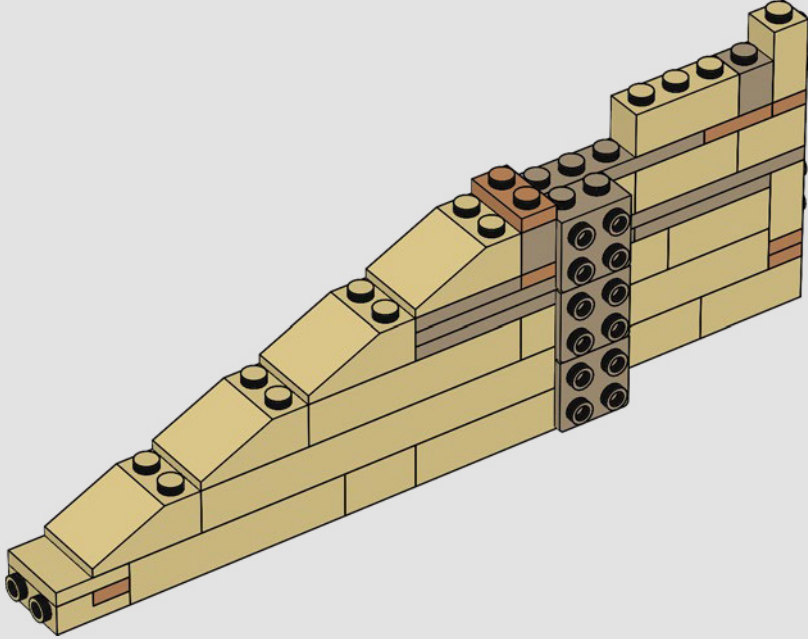

73

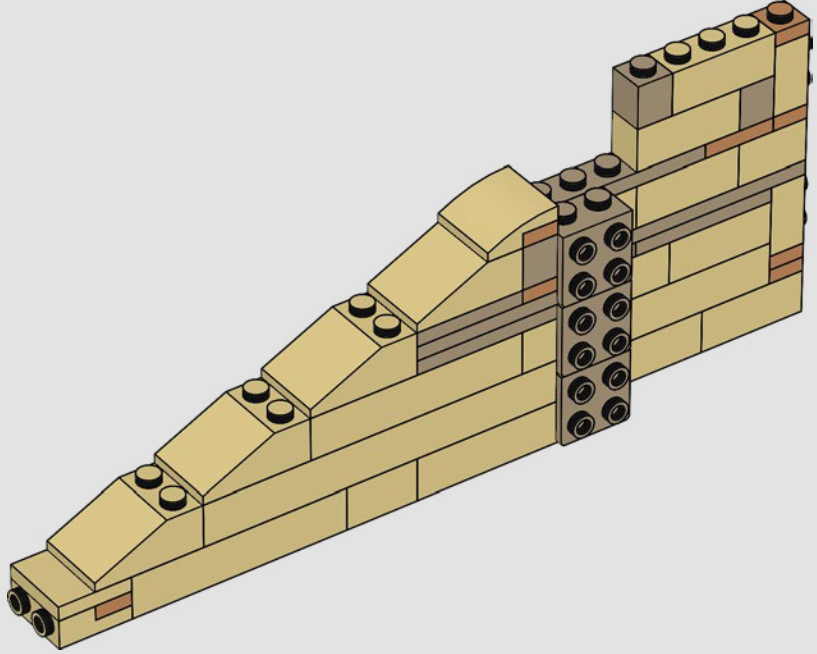

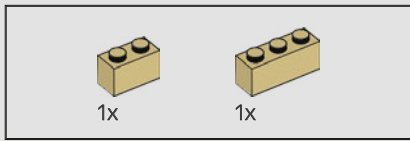

74

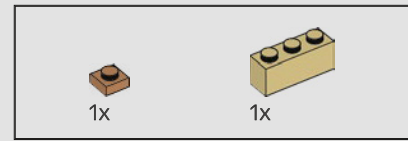
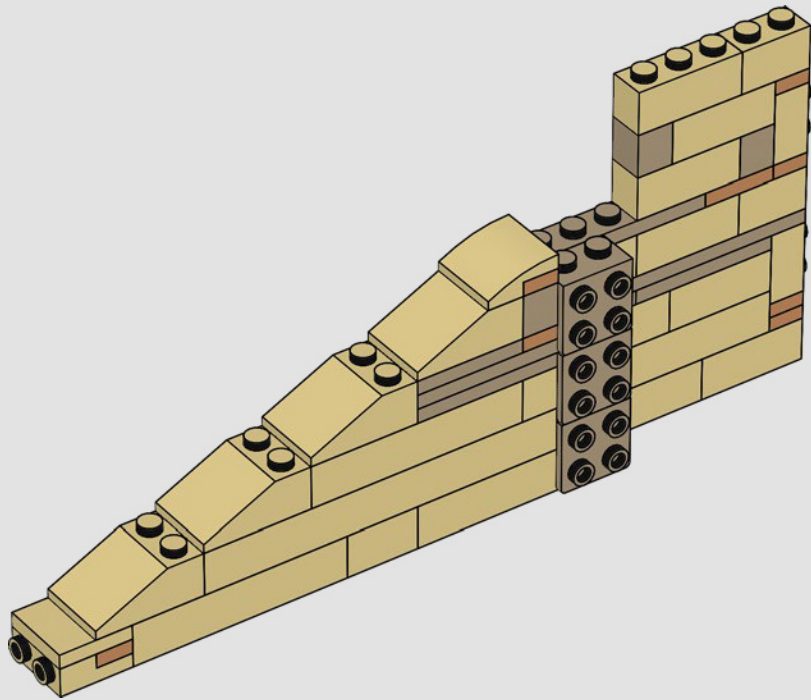

75

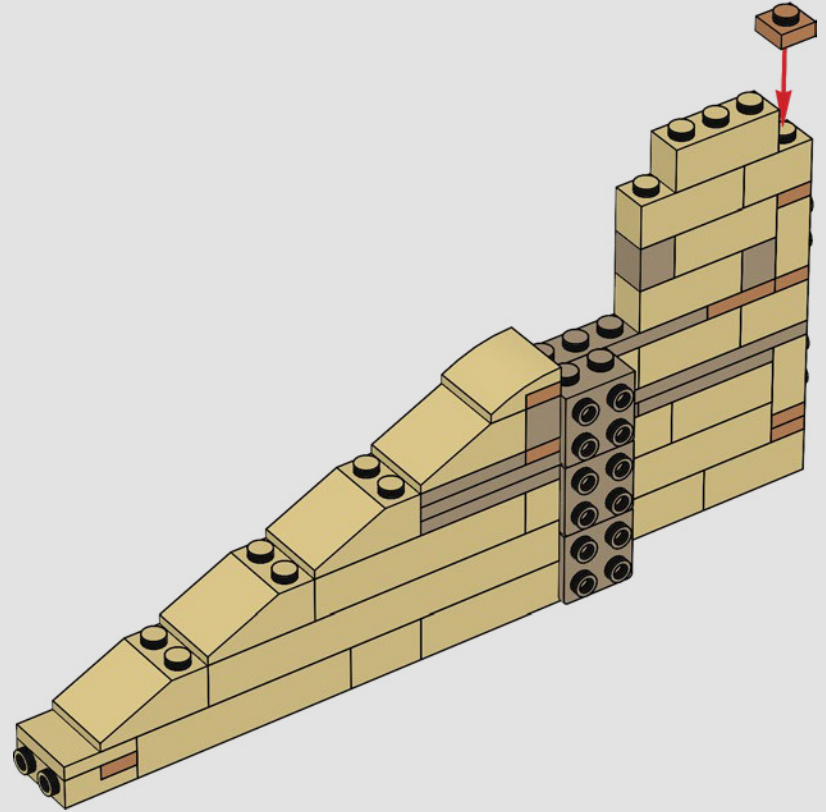

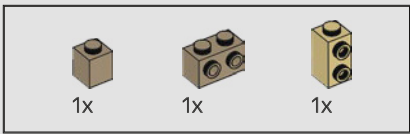

76

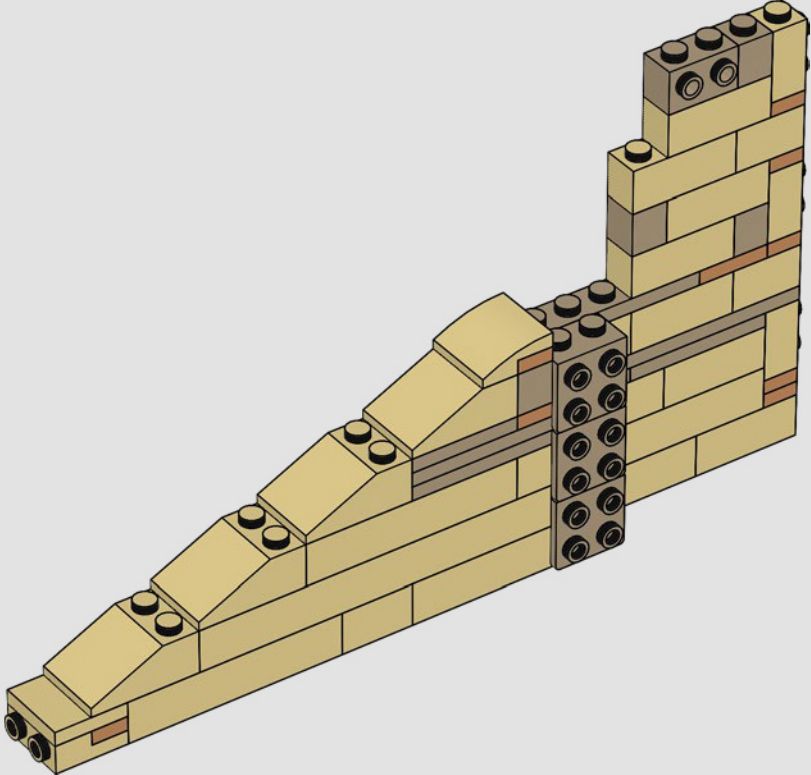

77

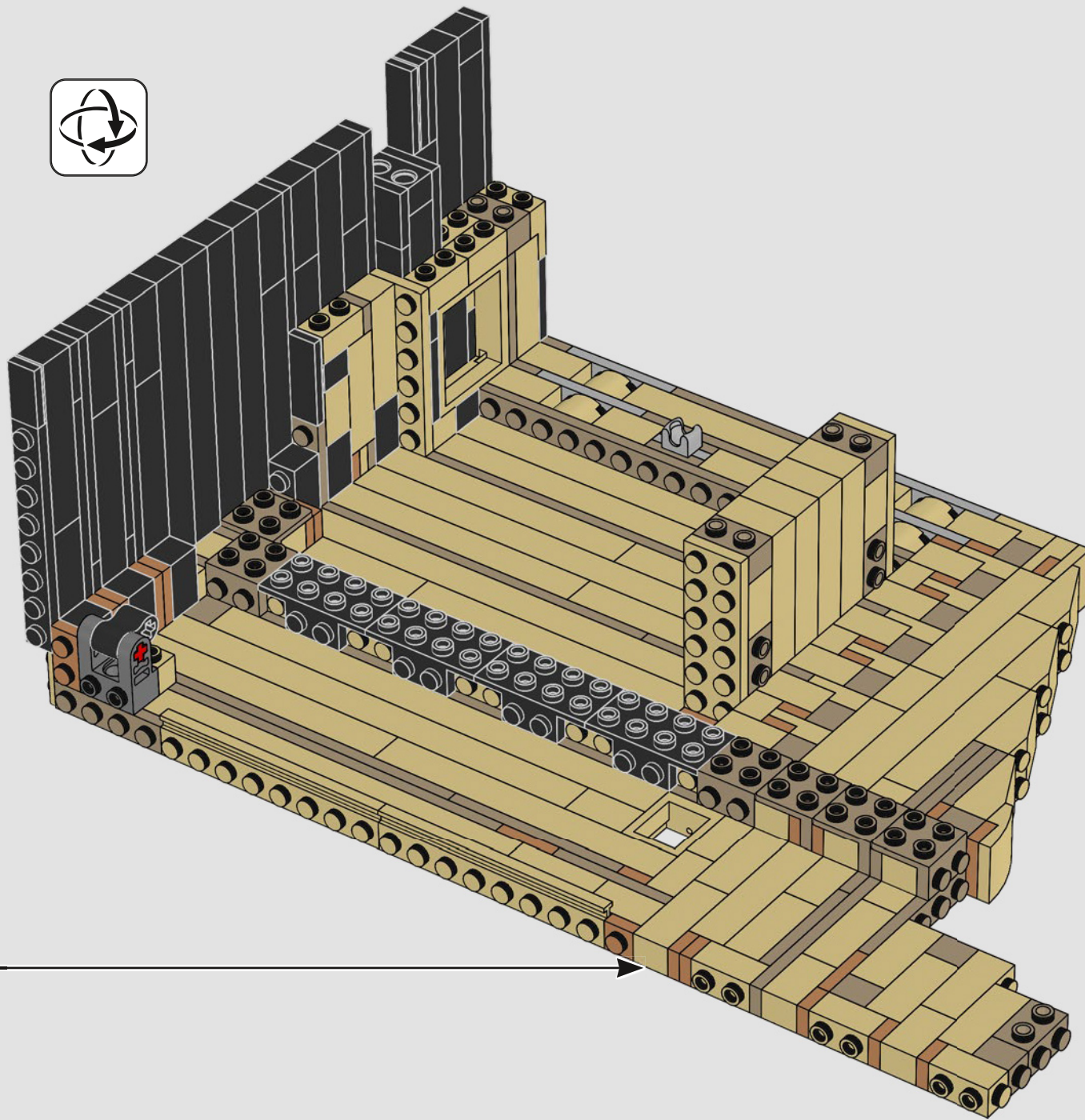

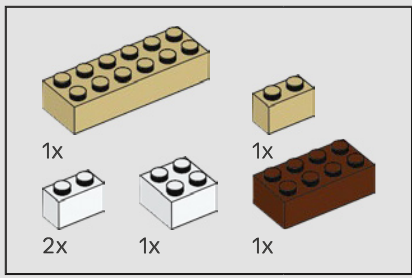

78

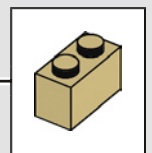
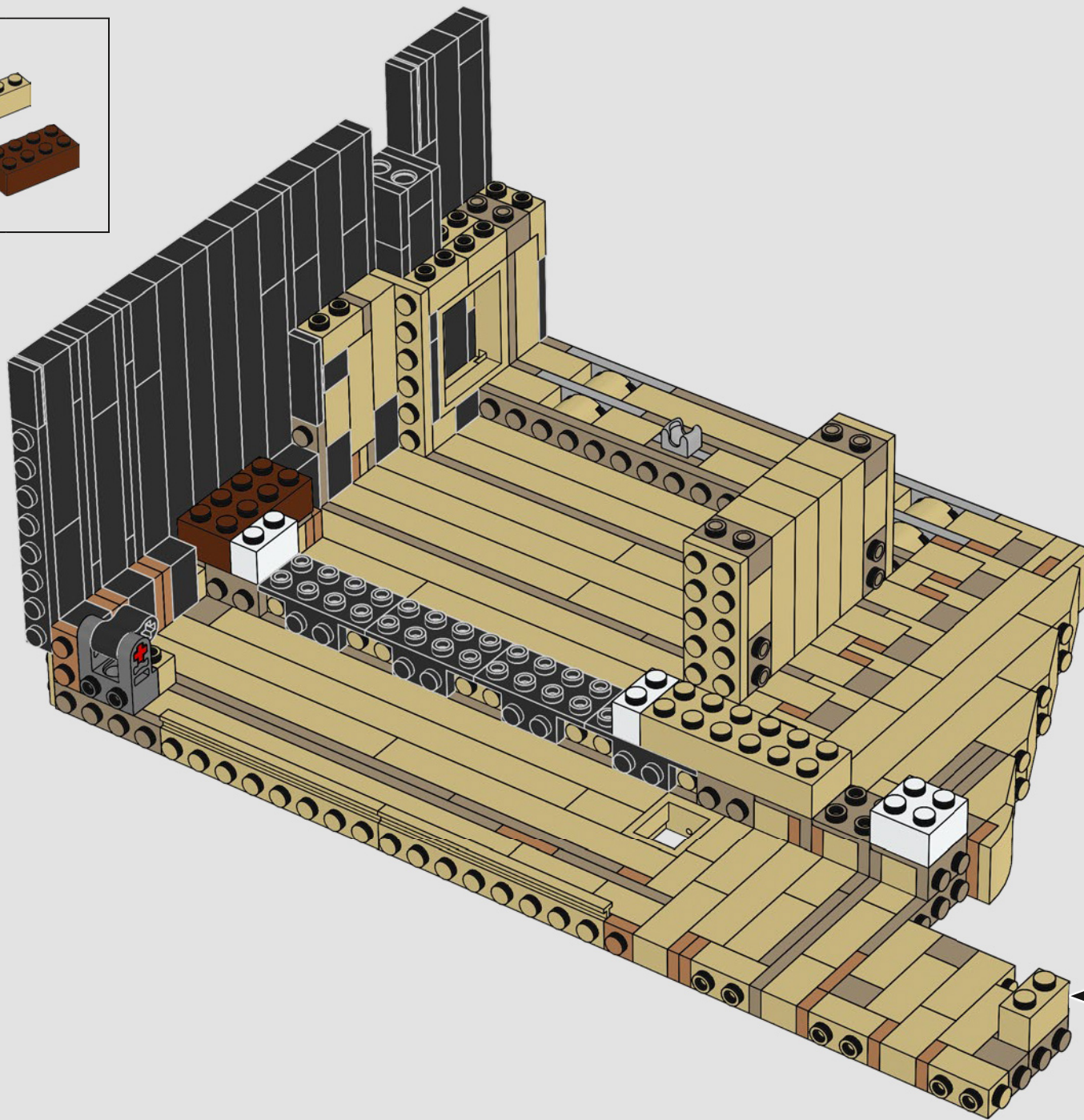

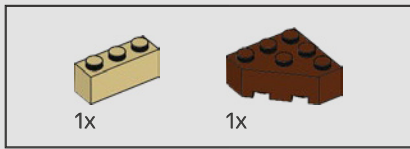

79

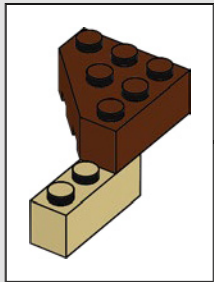
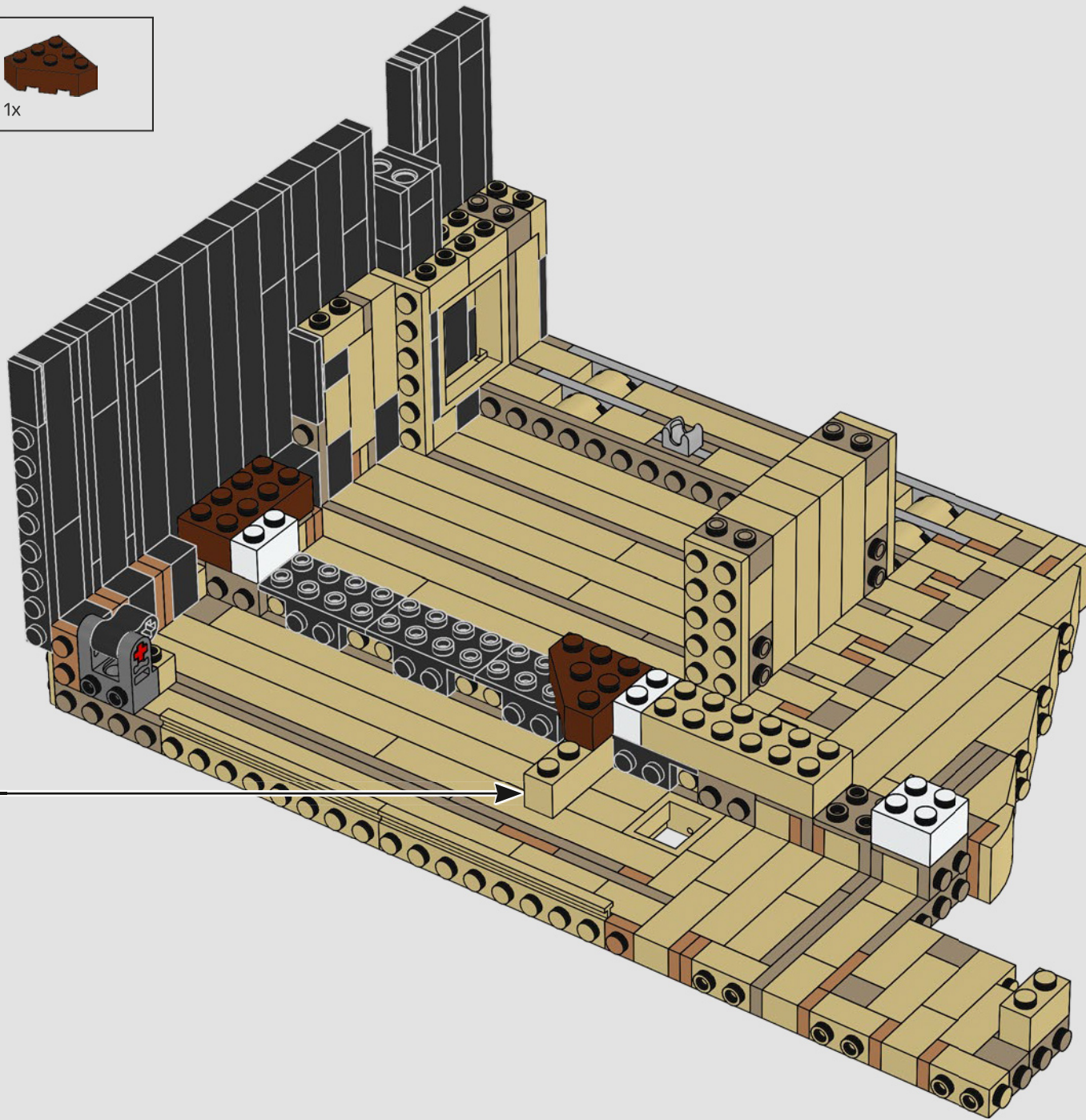

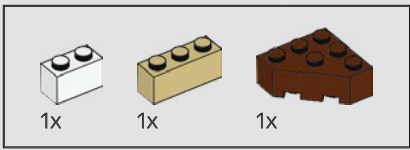

80

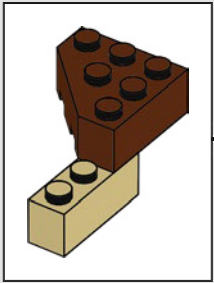
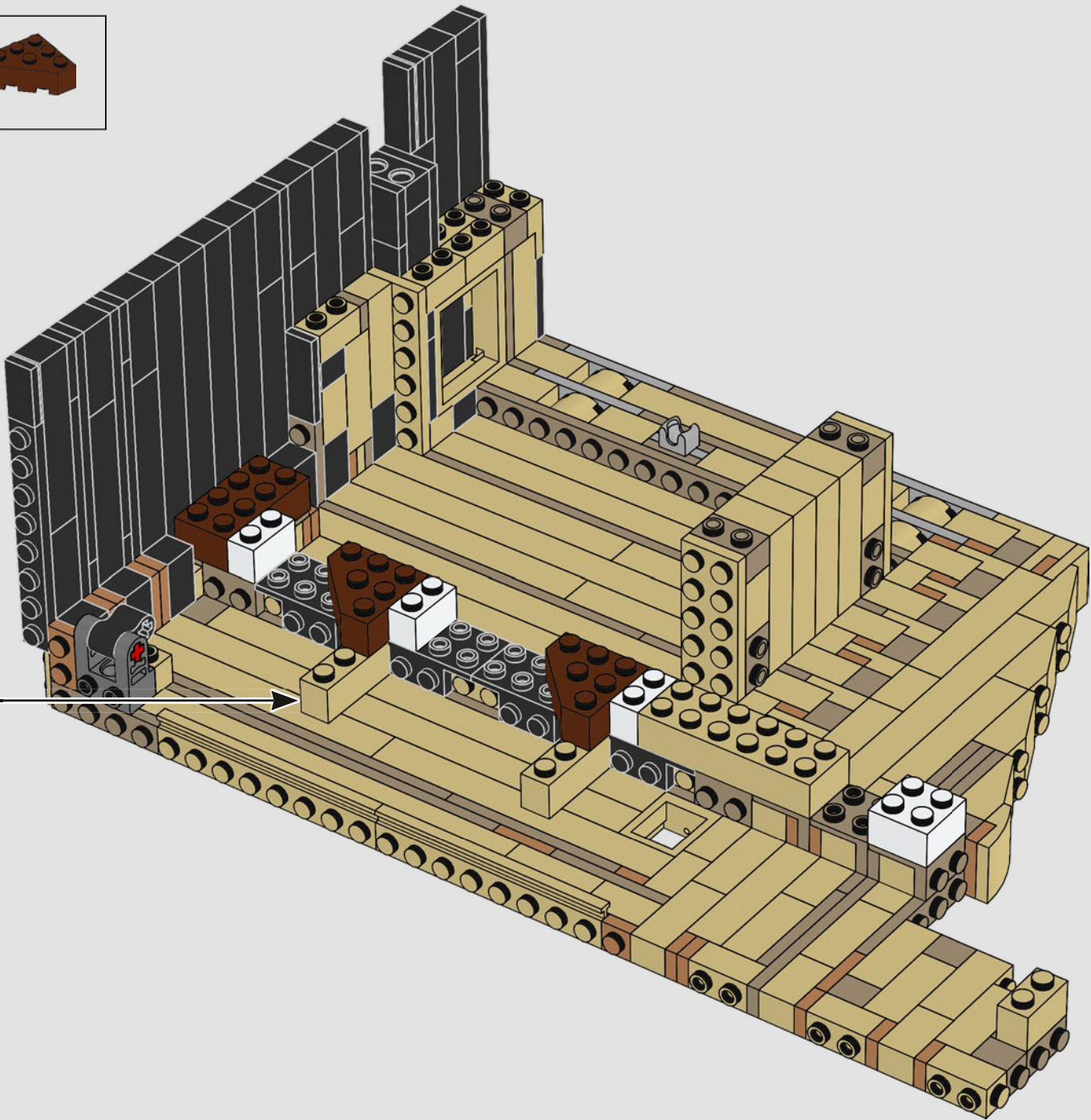

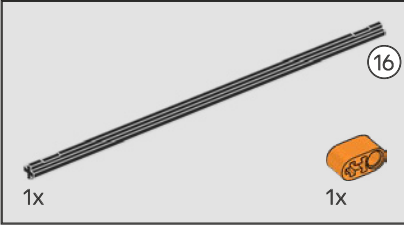
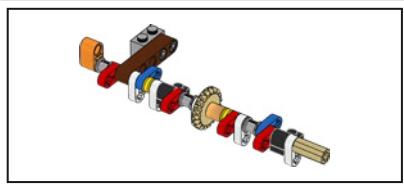

81

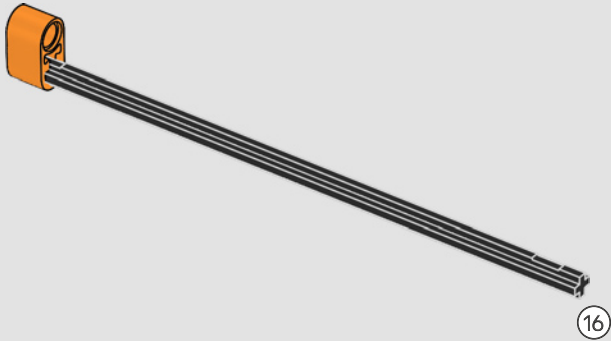

82

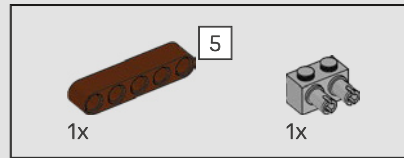
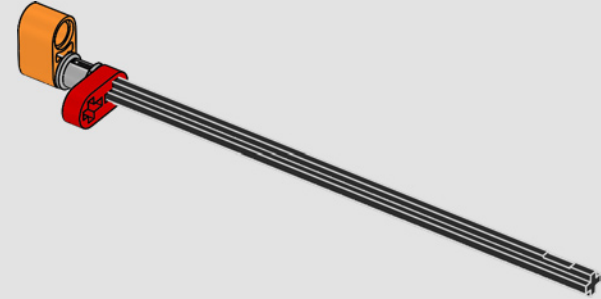

83

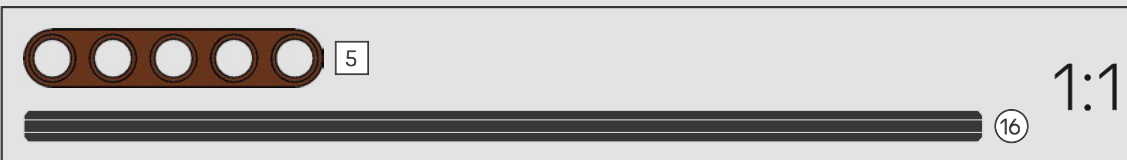
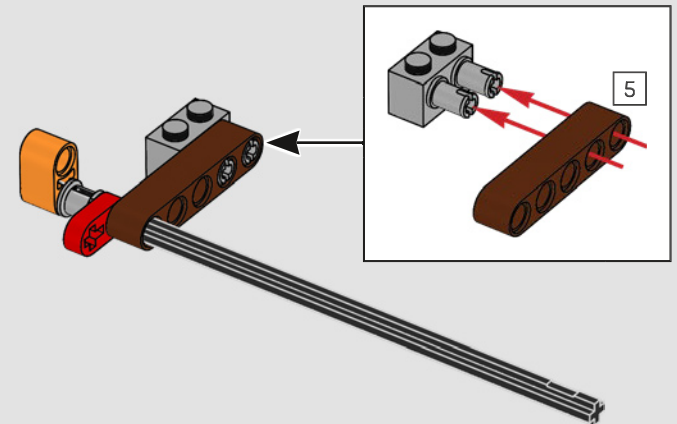

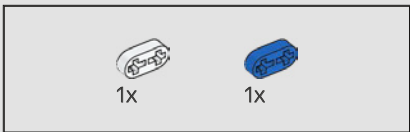

84

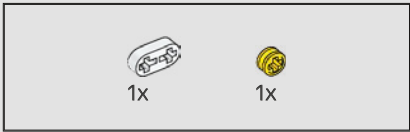
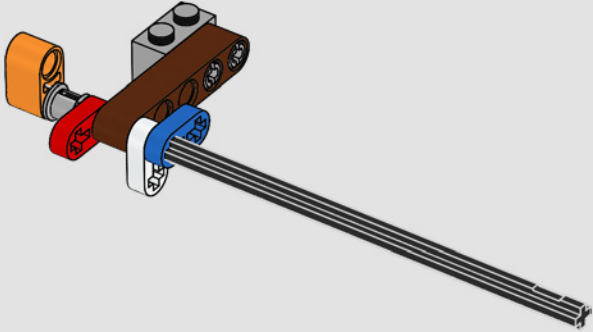

85

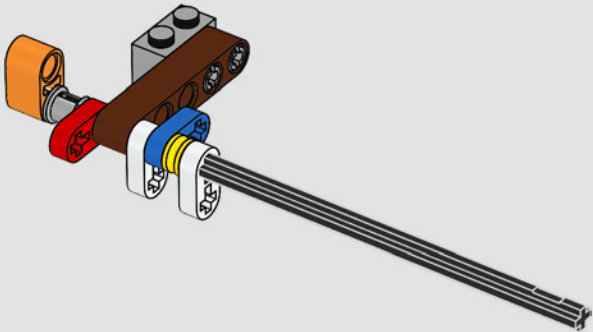

86

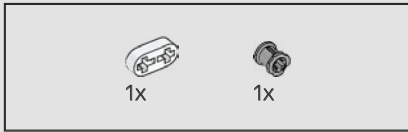
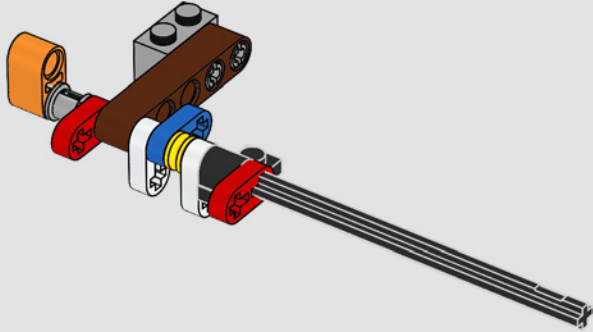

87

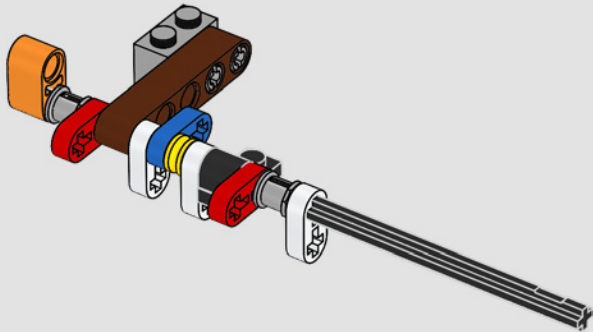



88

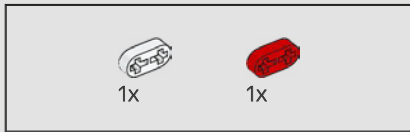
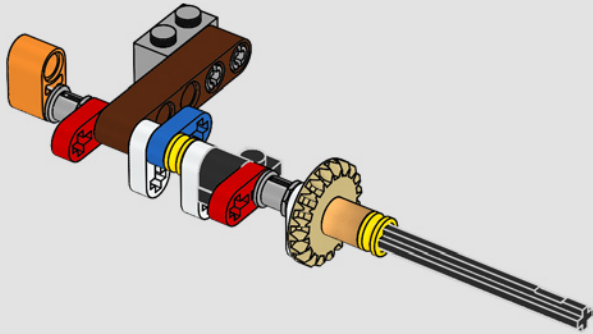

89

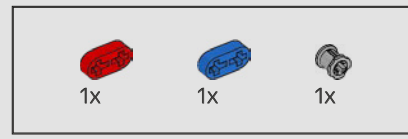
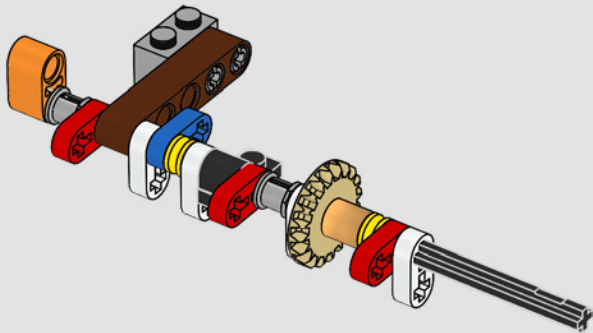

90

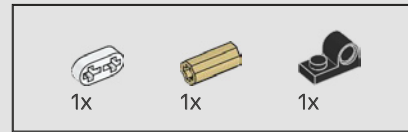
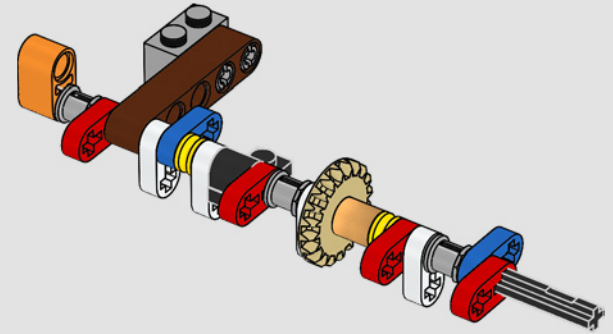

91

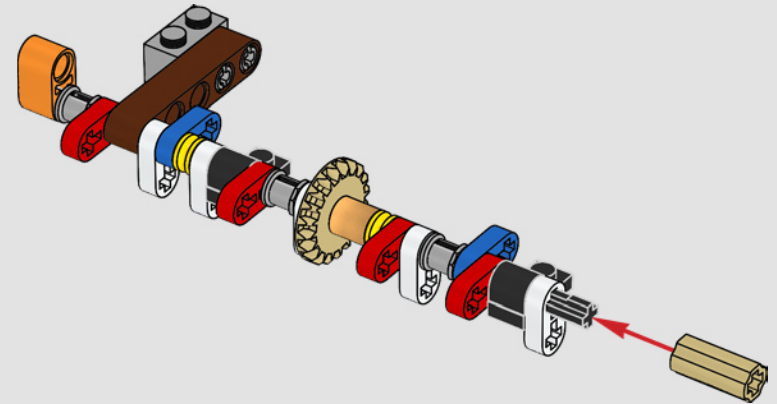

92

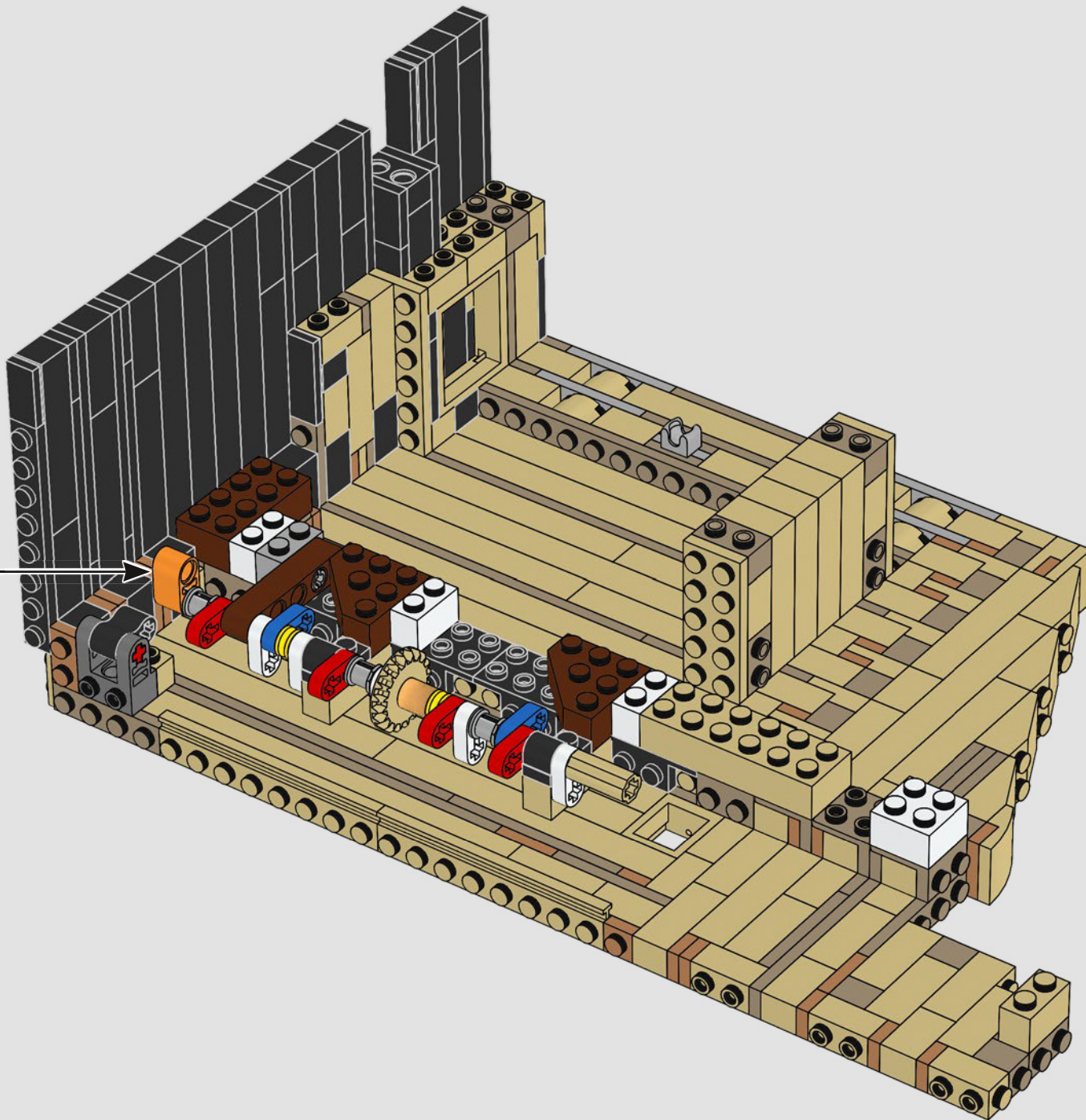

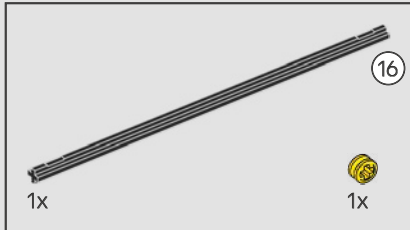
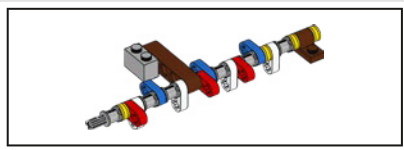

93

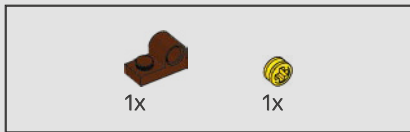
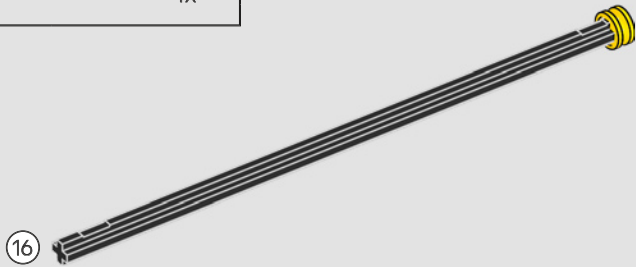

94

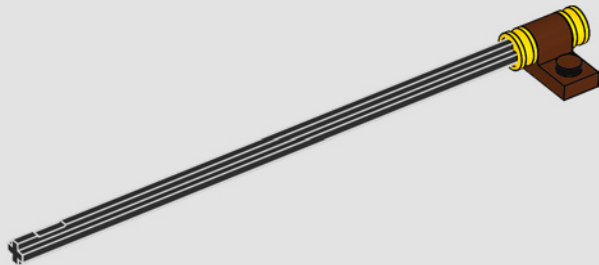

95

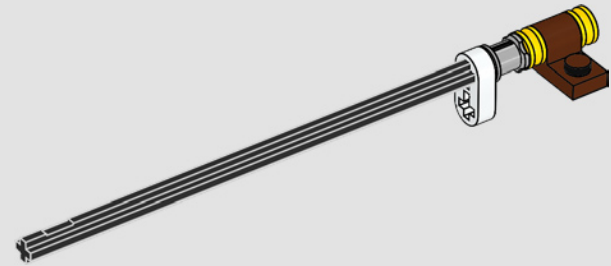

96

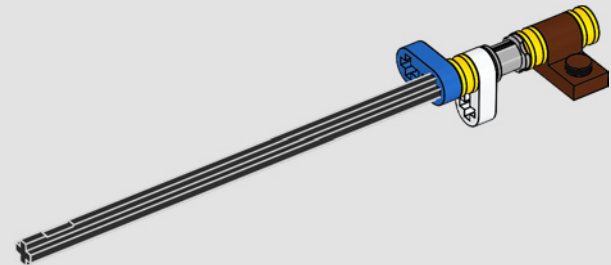

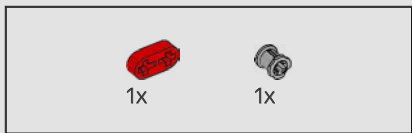

97

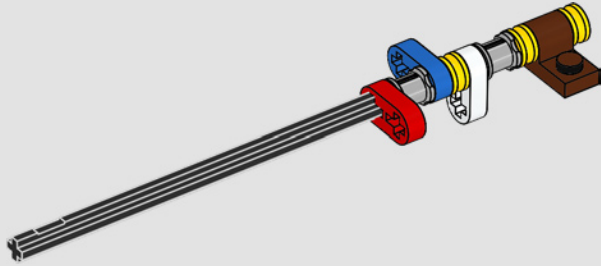

98

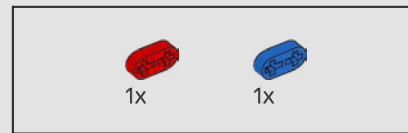
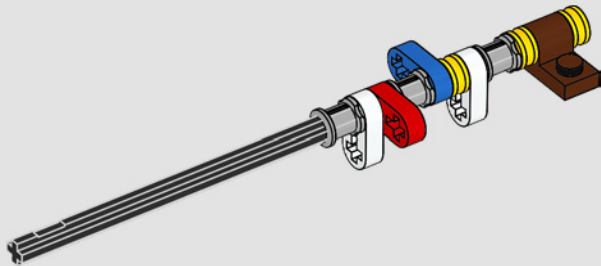

99

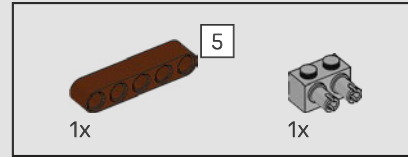
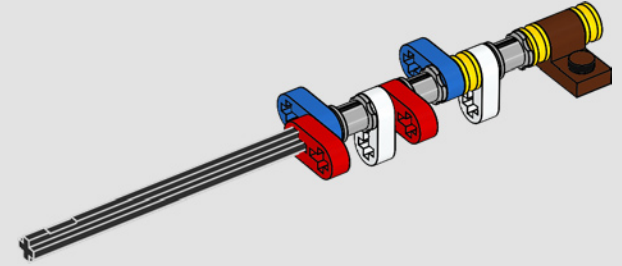

100

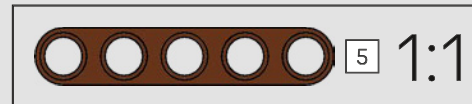
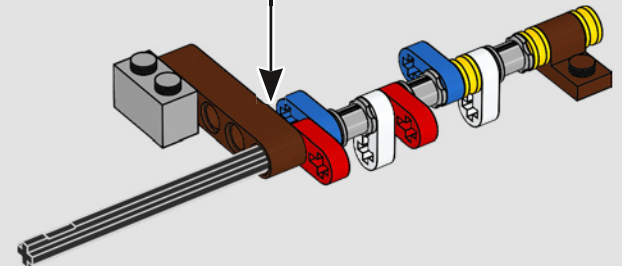
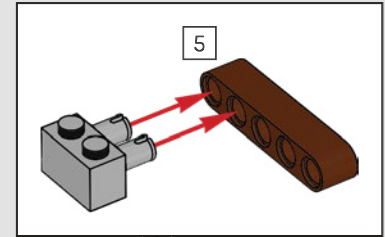

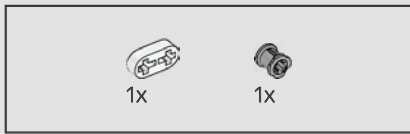

101

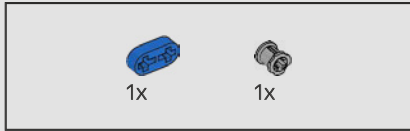
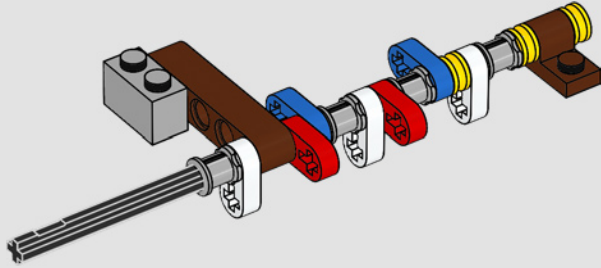

102

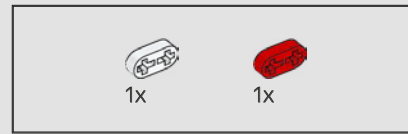
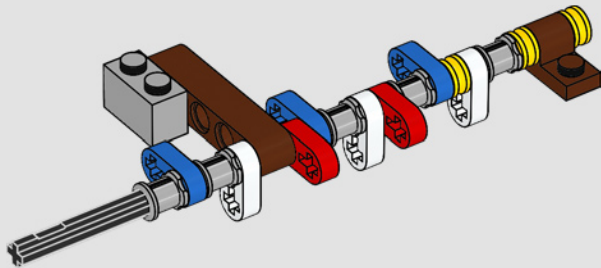

103

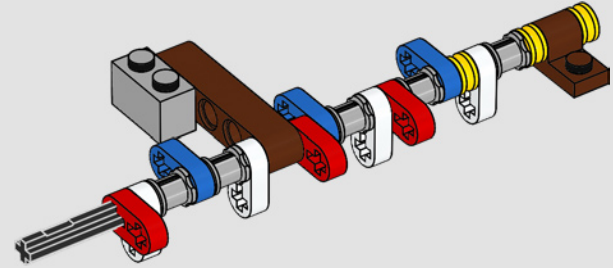

104

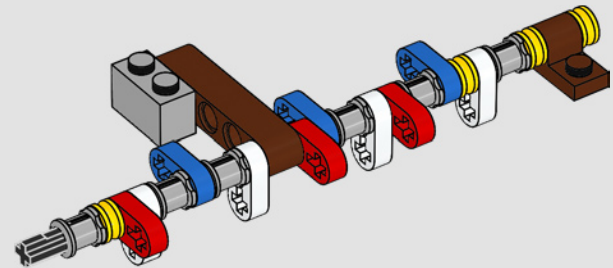

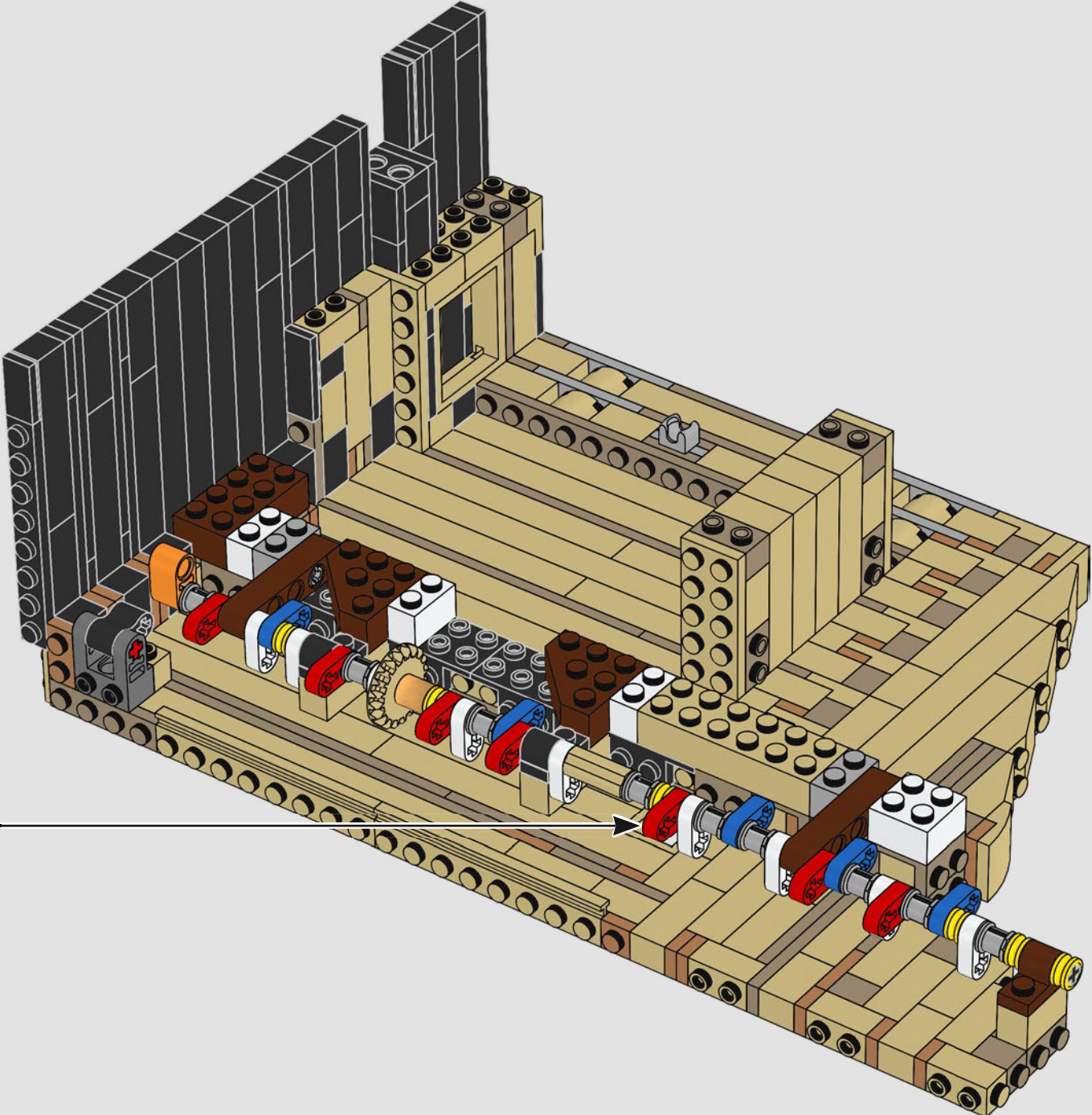

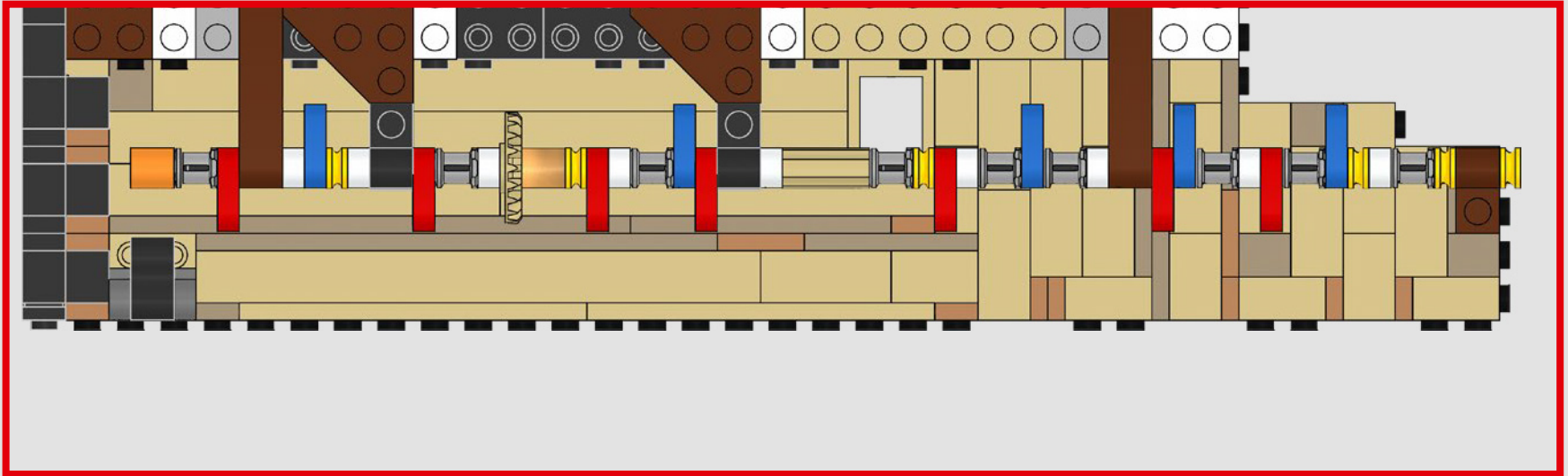

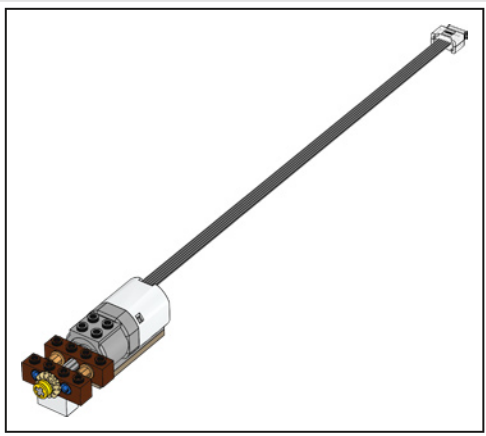

106

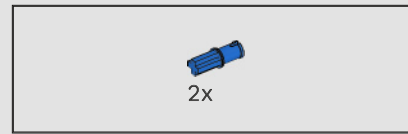
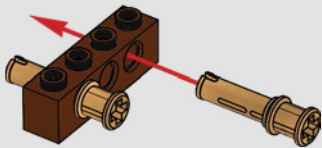

107

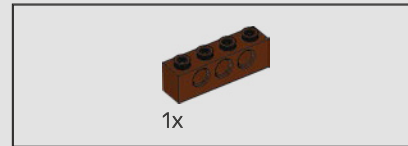
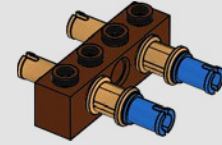

108

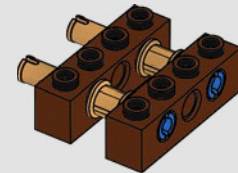

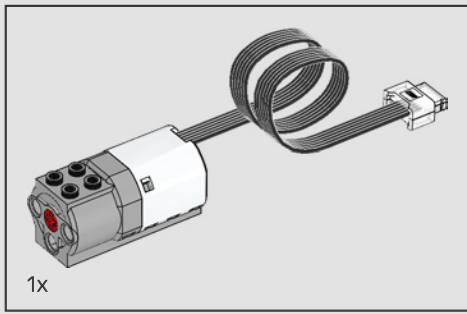

109

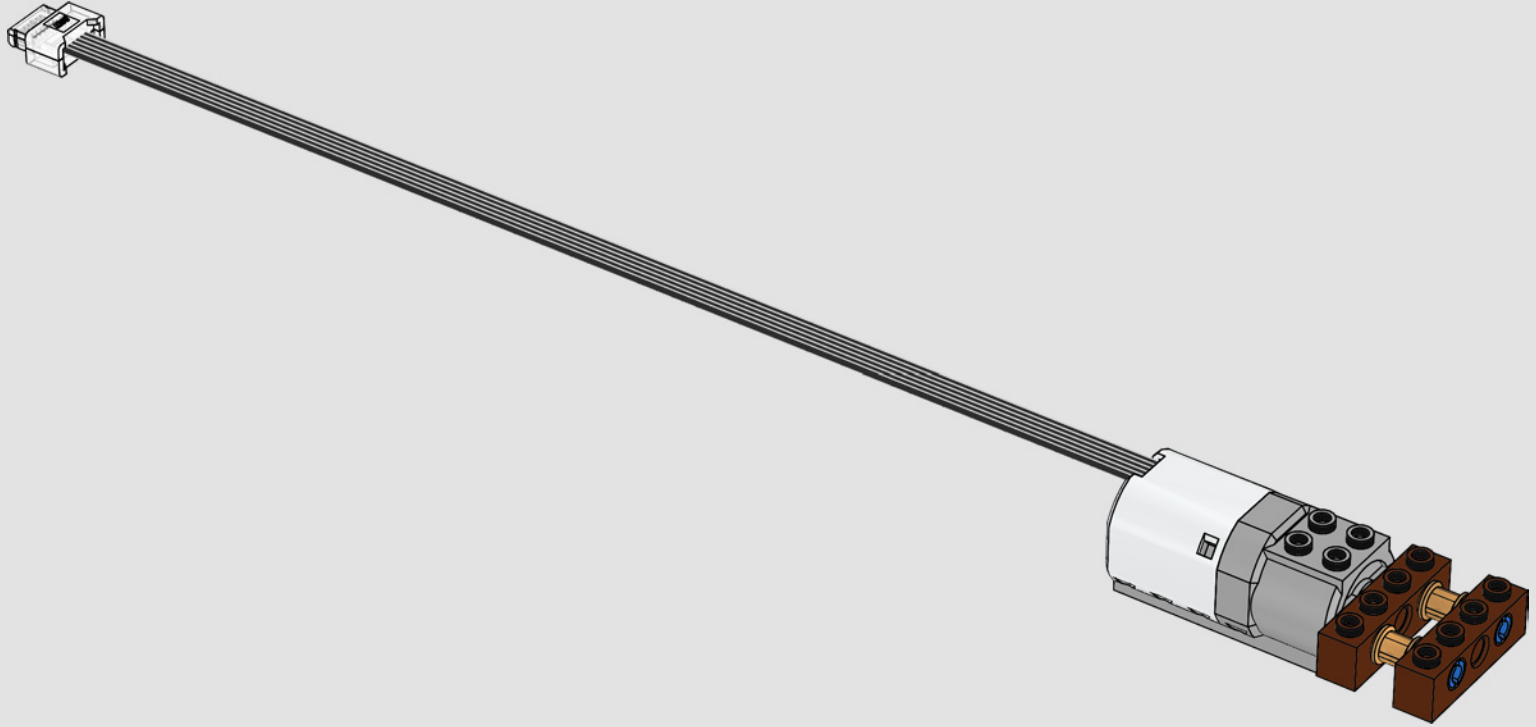

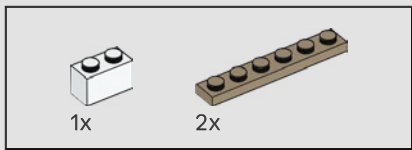

110

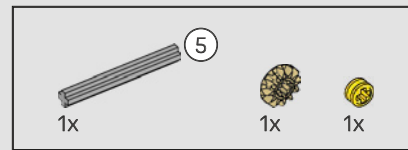
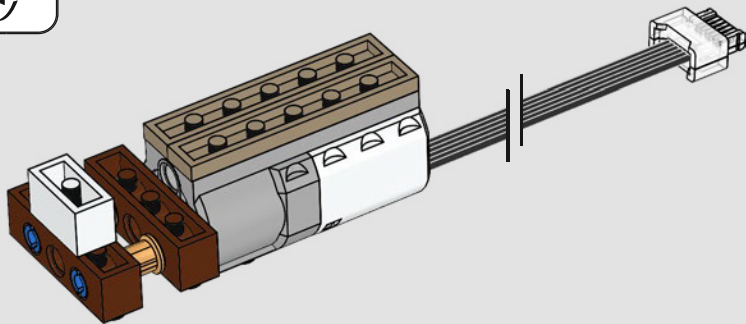

111

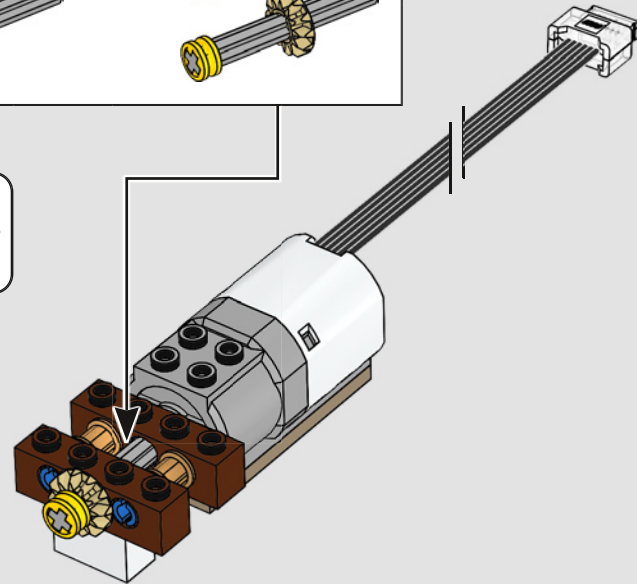
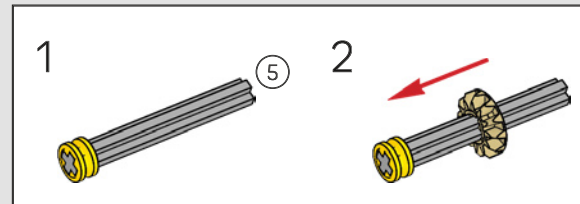
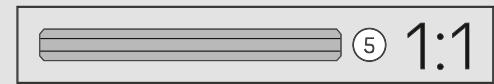

112

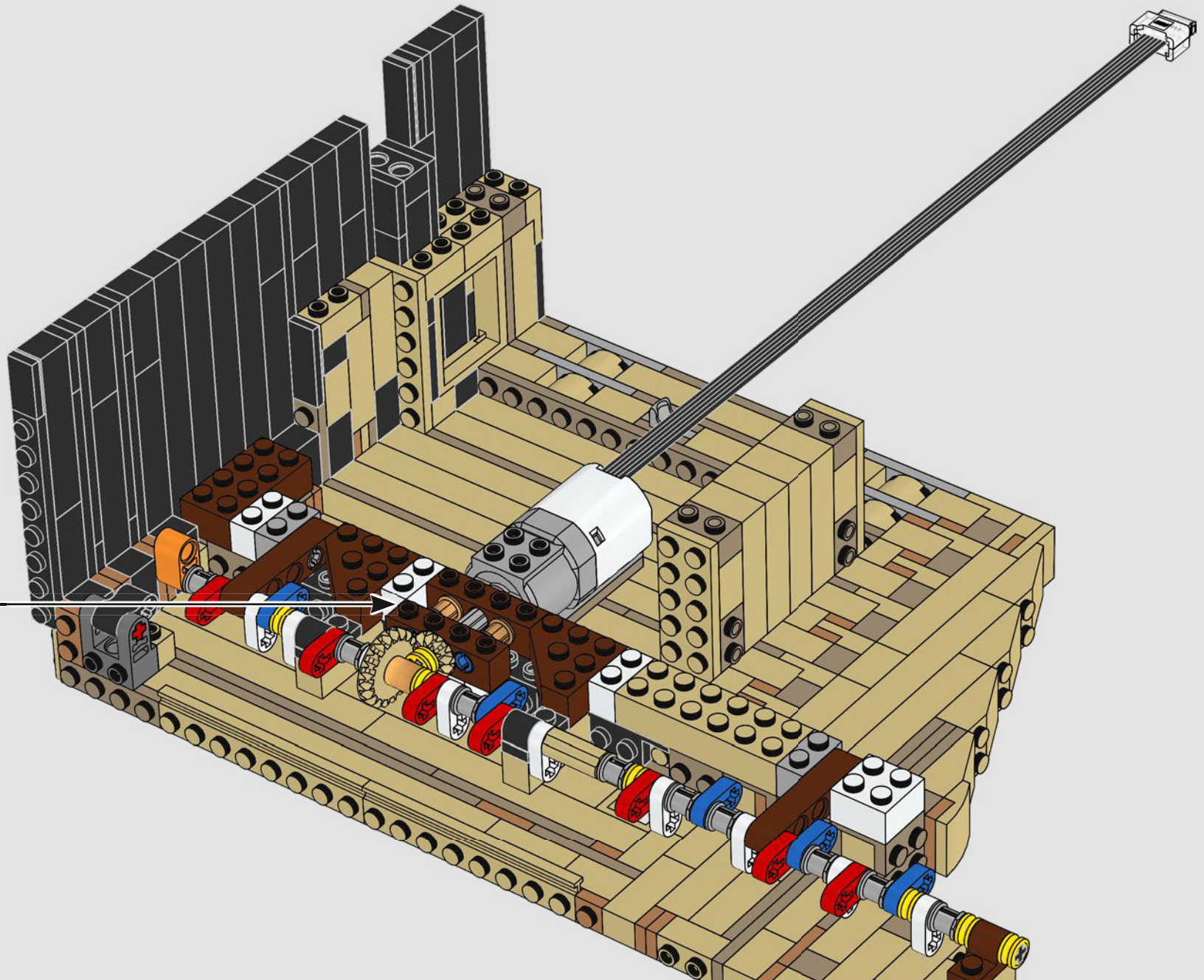

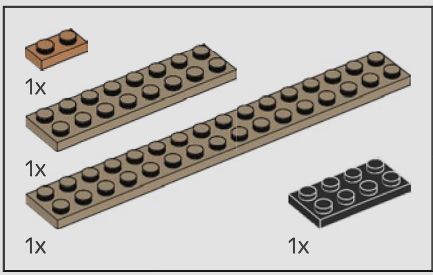

113

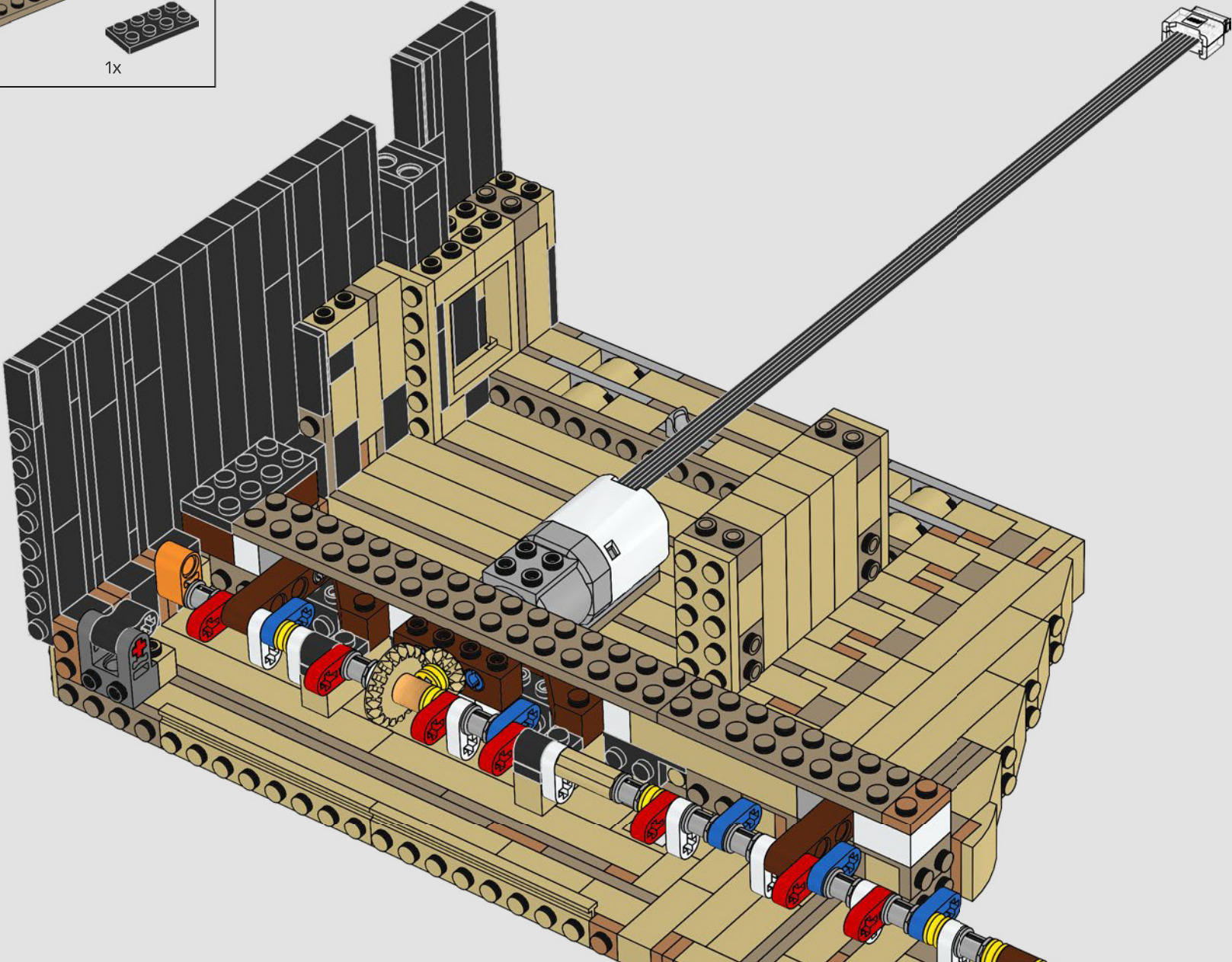

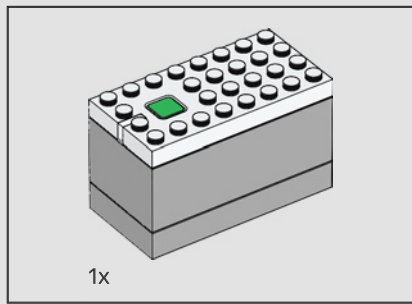

114

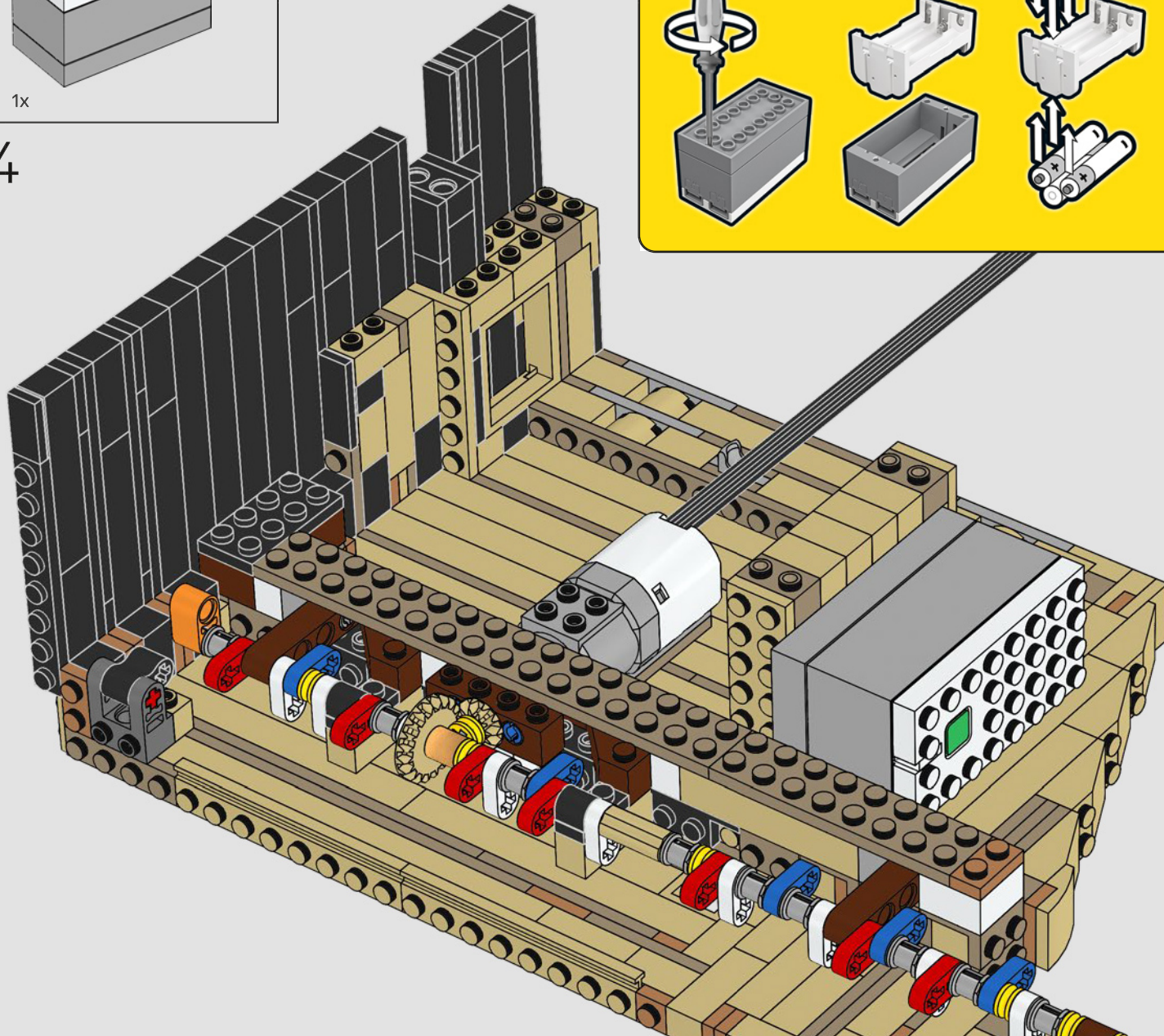
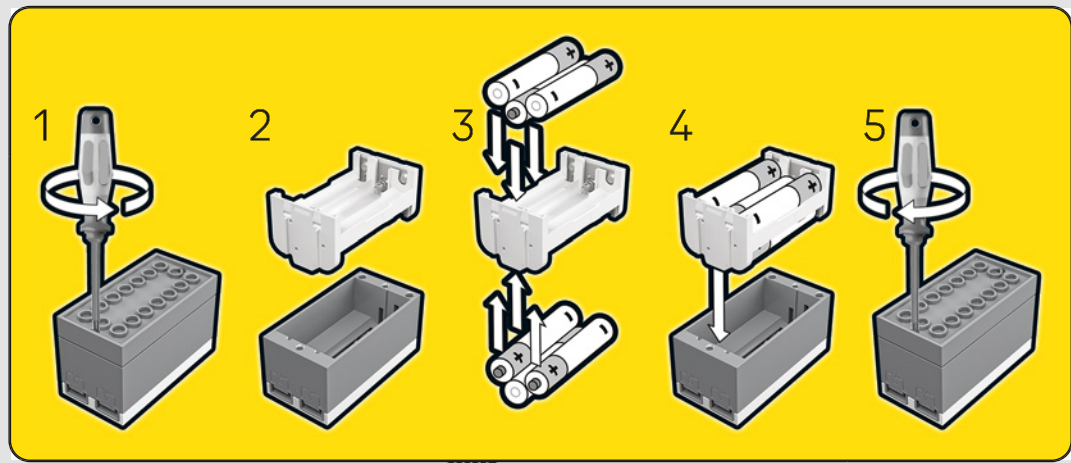

115



A

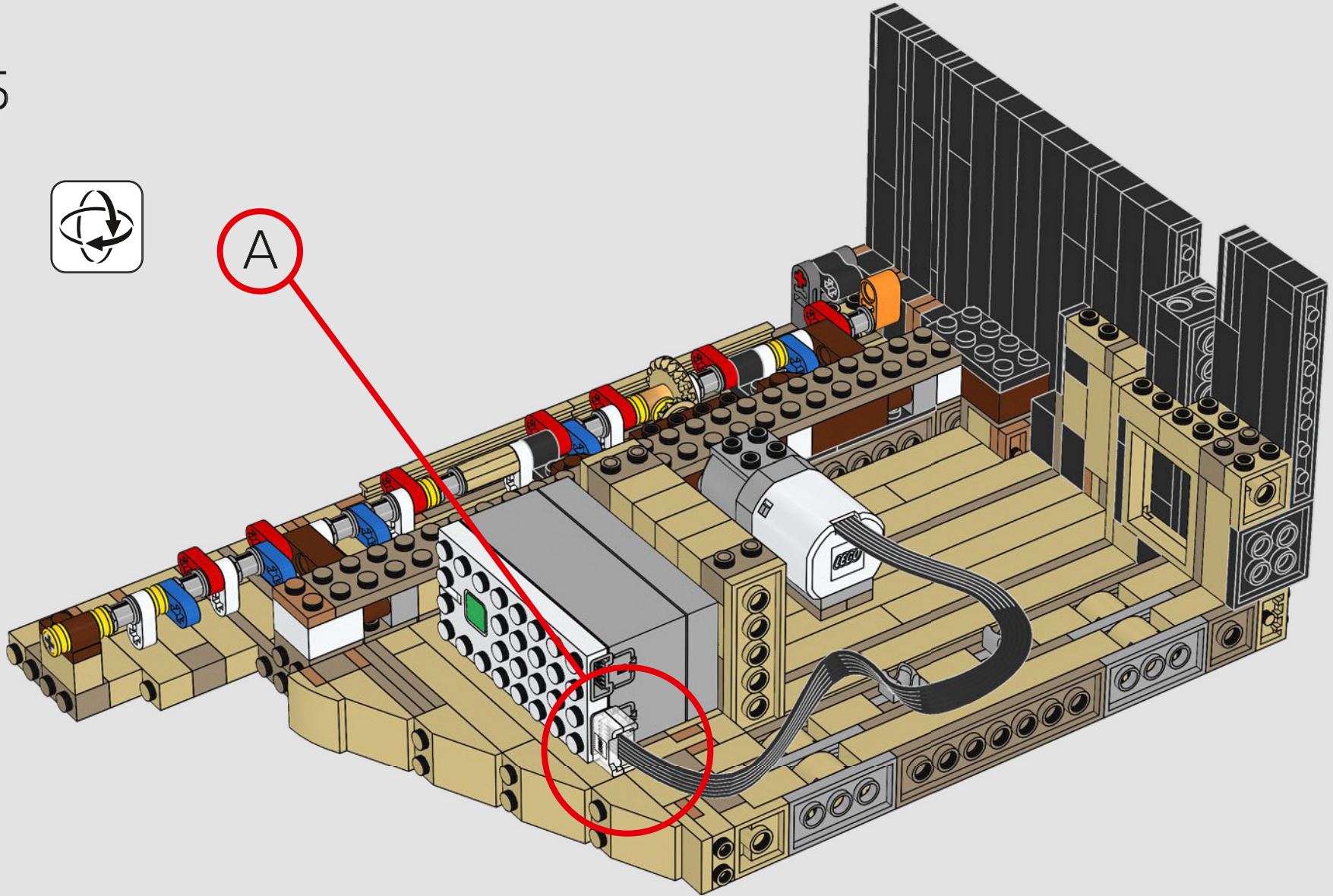

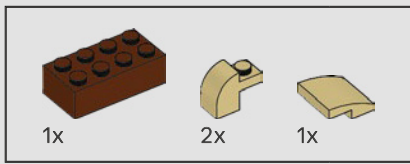

116

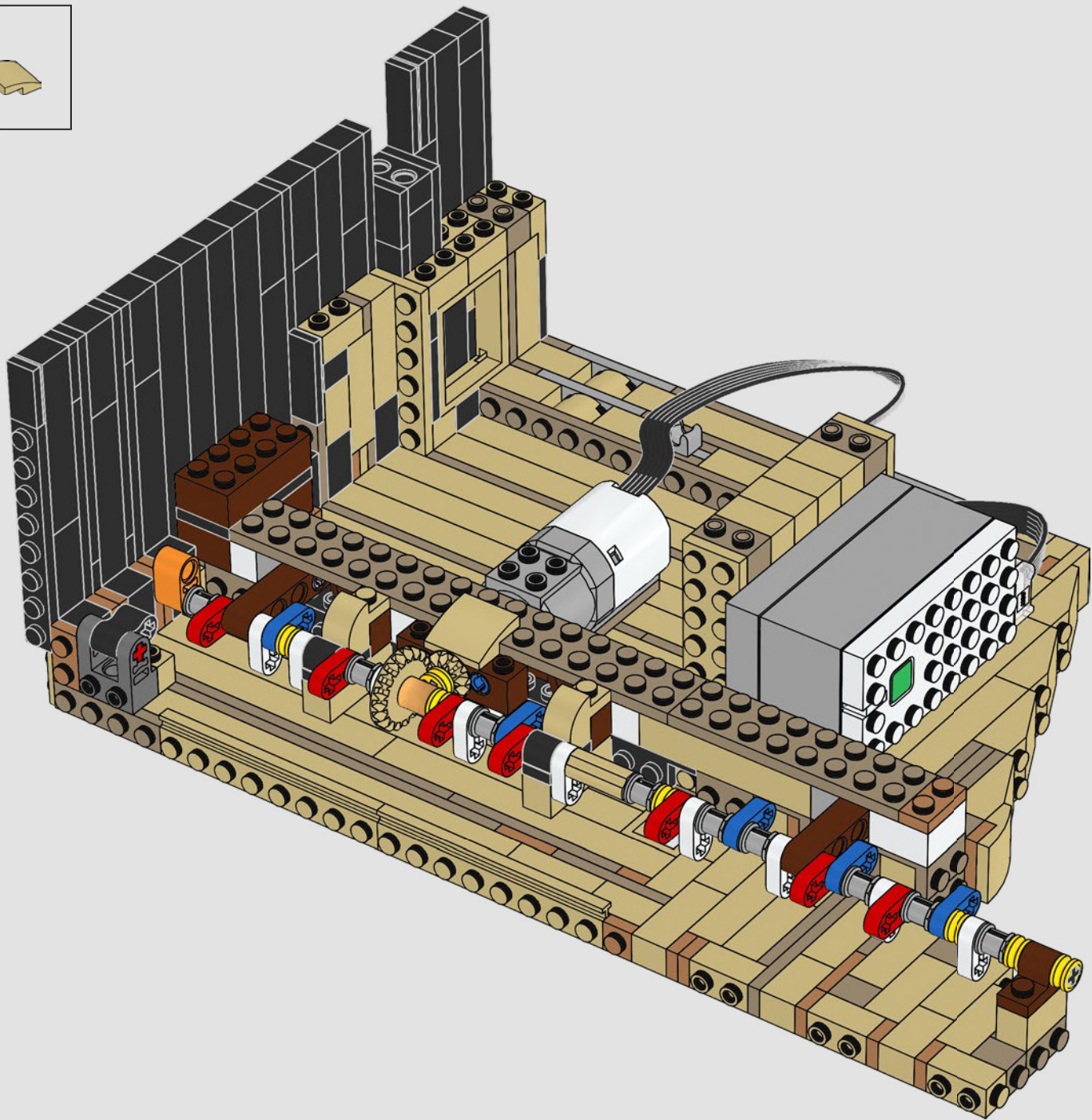

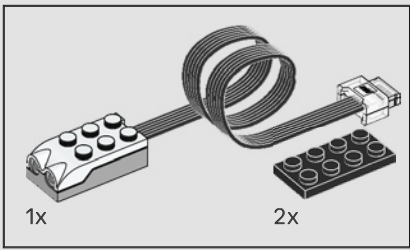

117

1

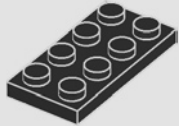

2



3

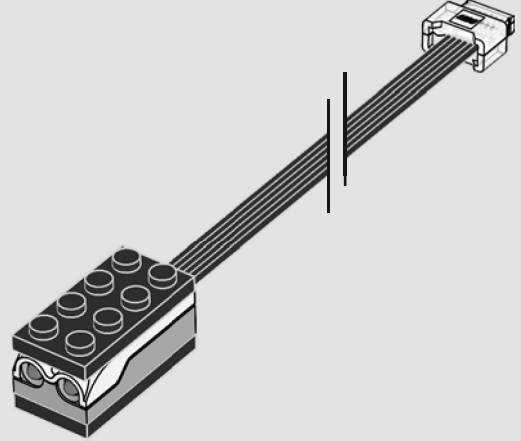

118

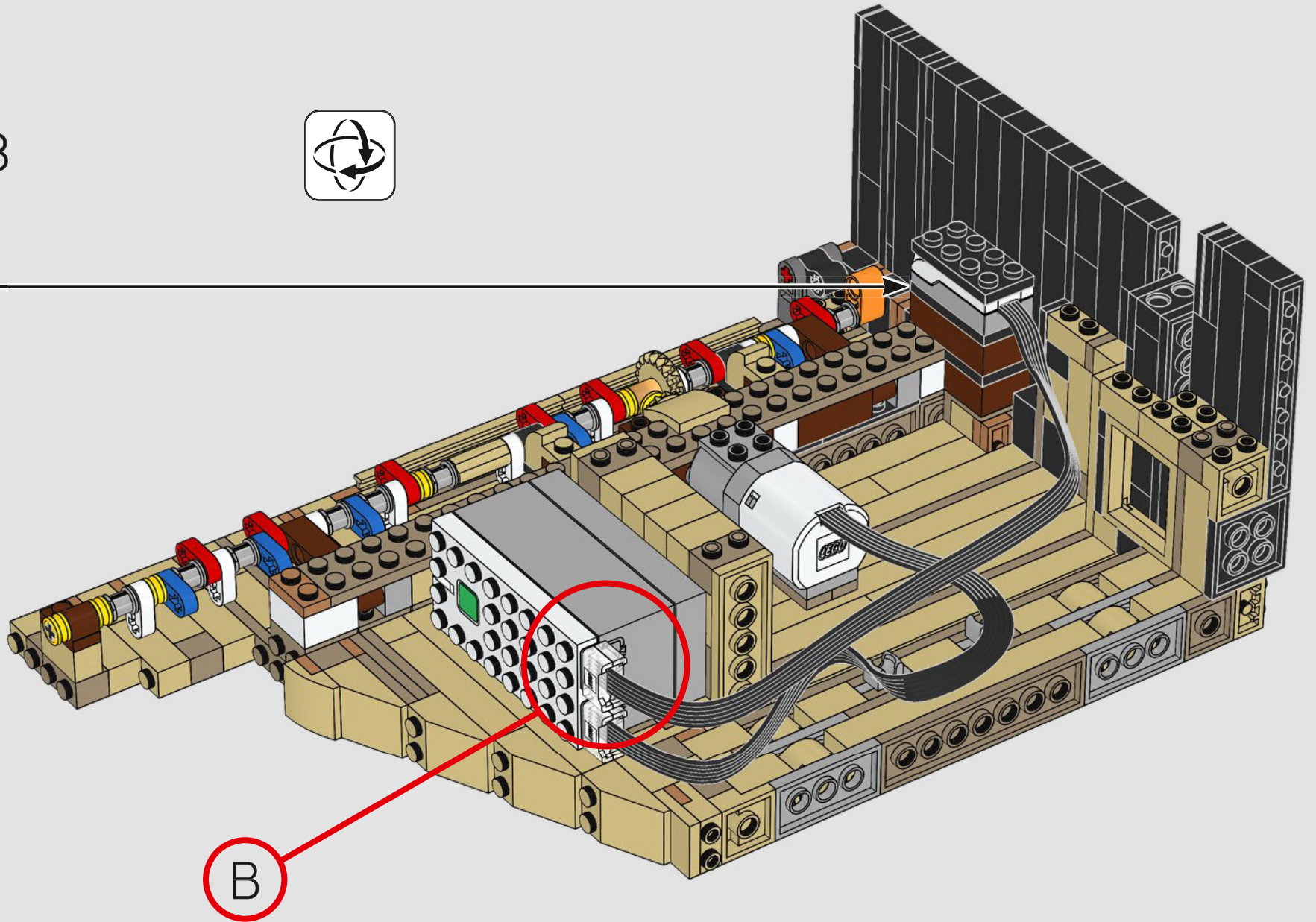

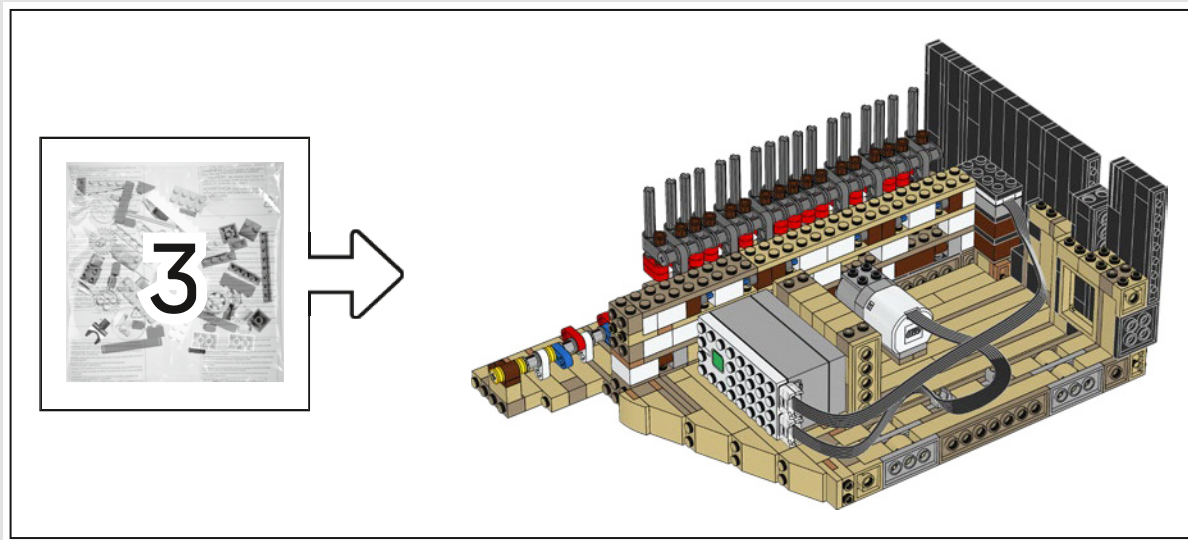

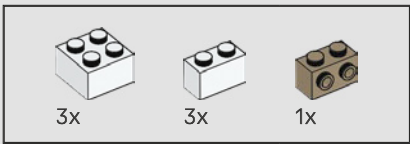

119

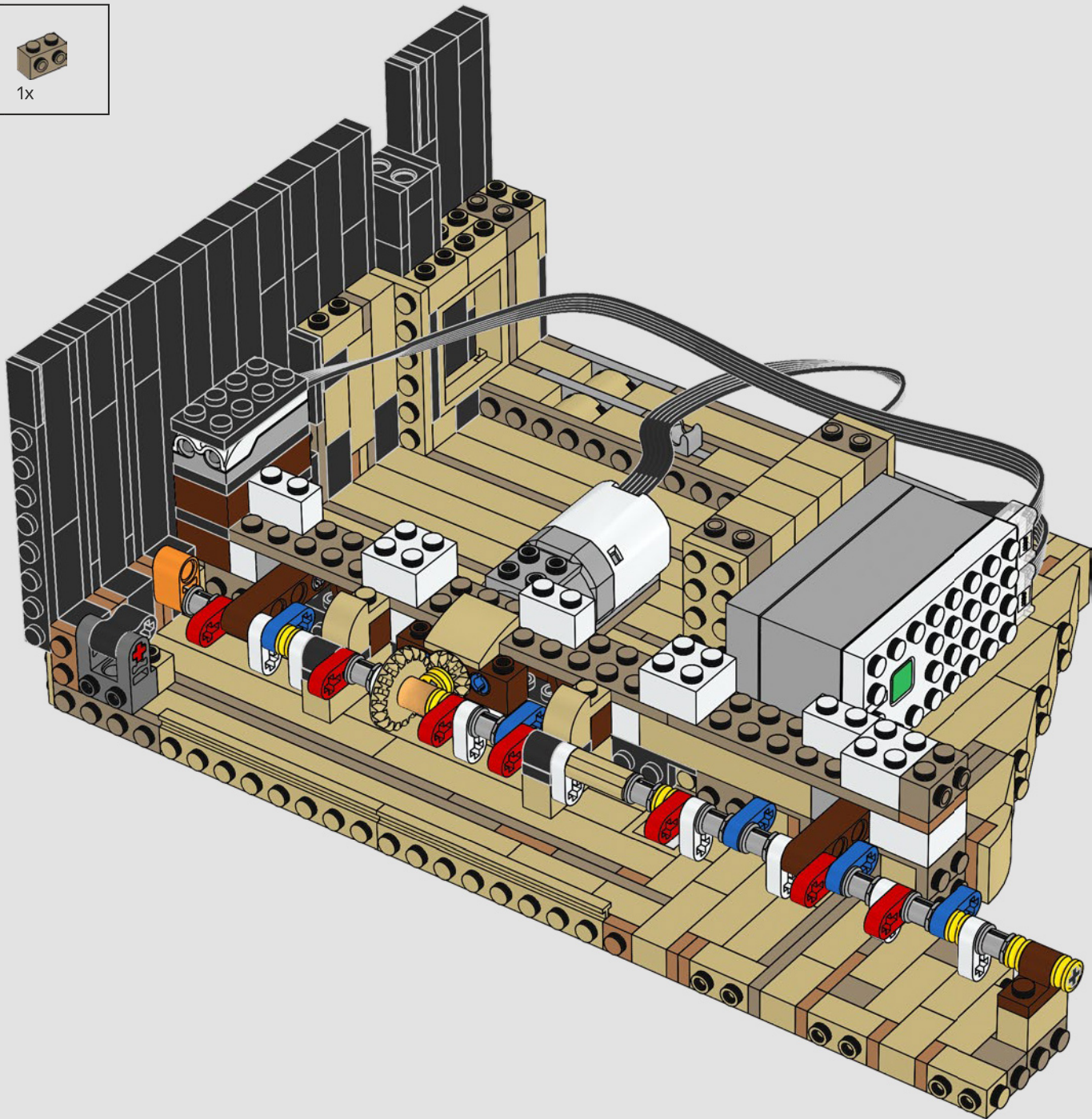

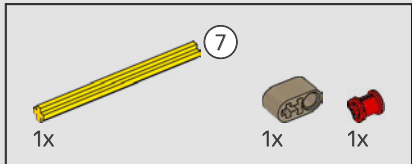
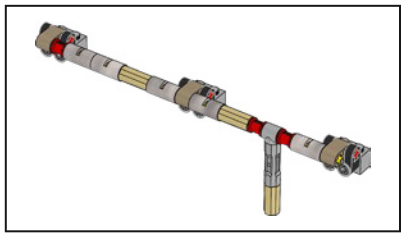

120

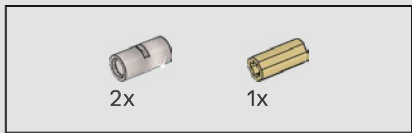
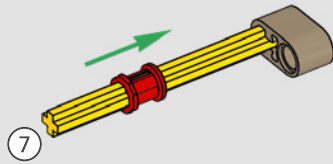

121

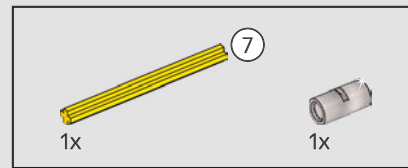
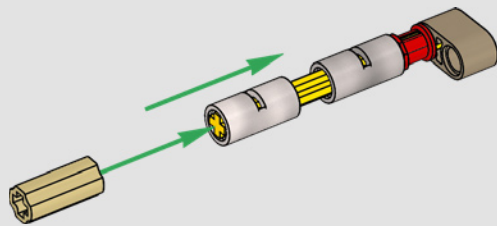

122

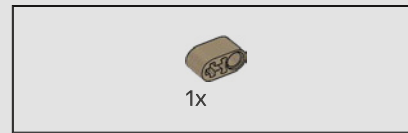
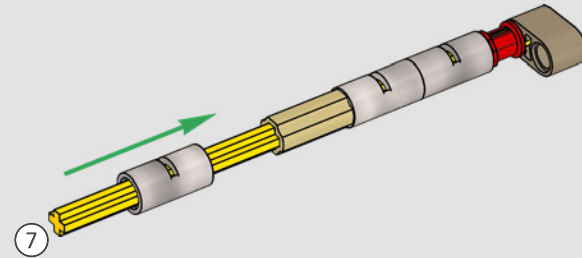

123

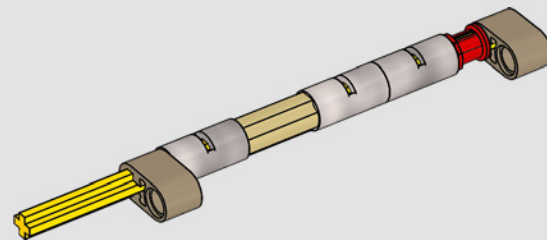

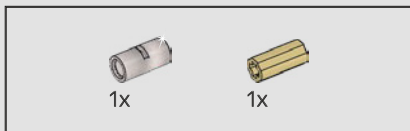

124

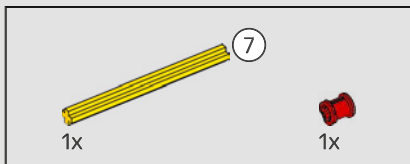
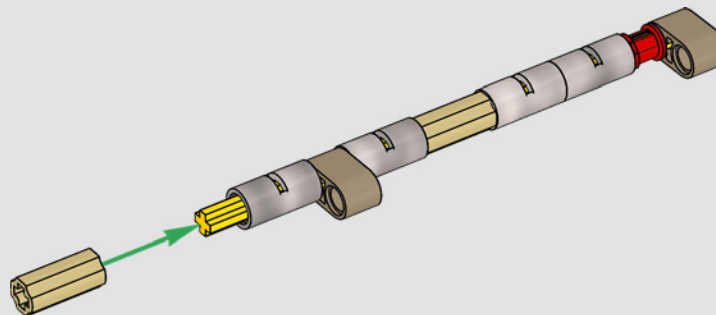

125

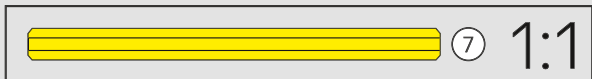
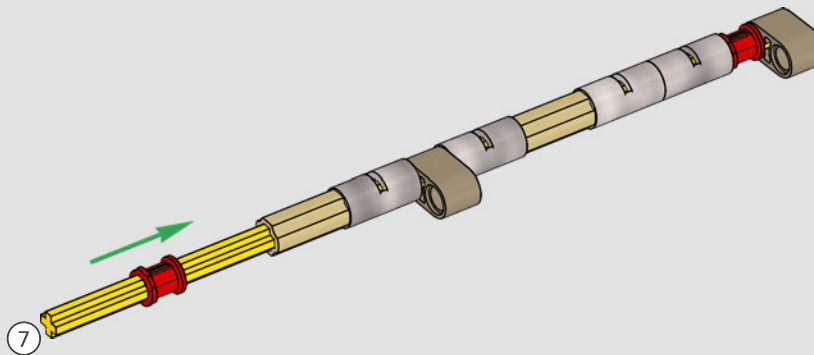



126

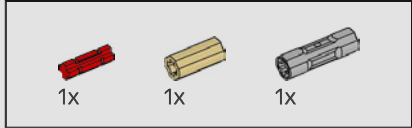
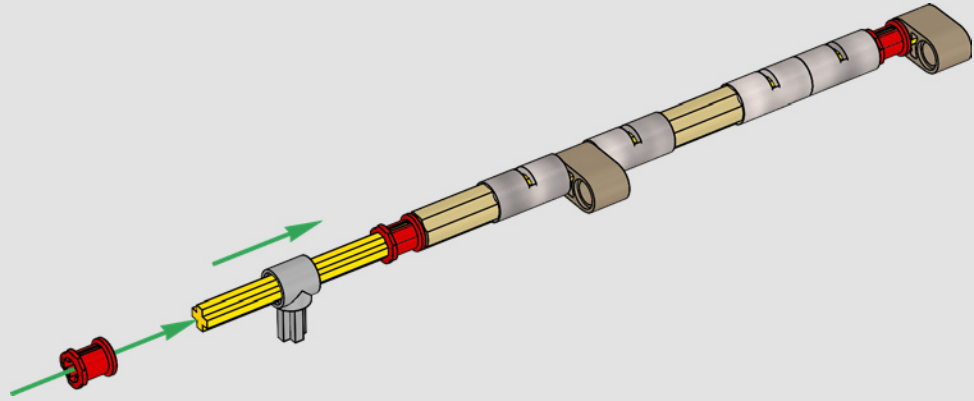

127

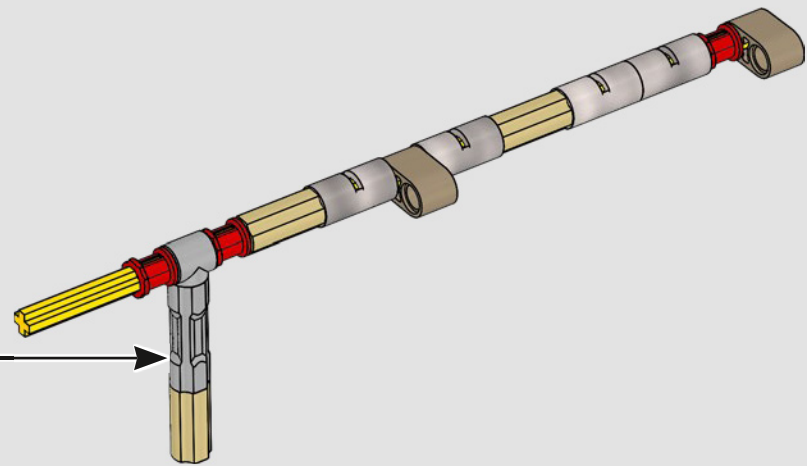
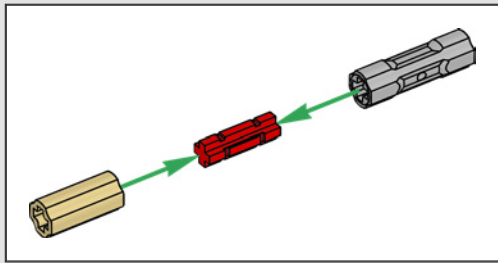

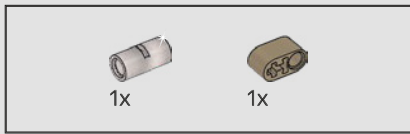

128

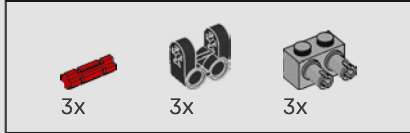
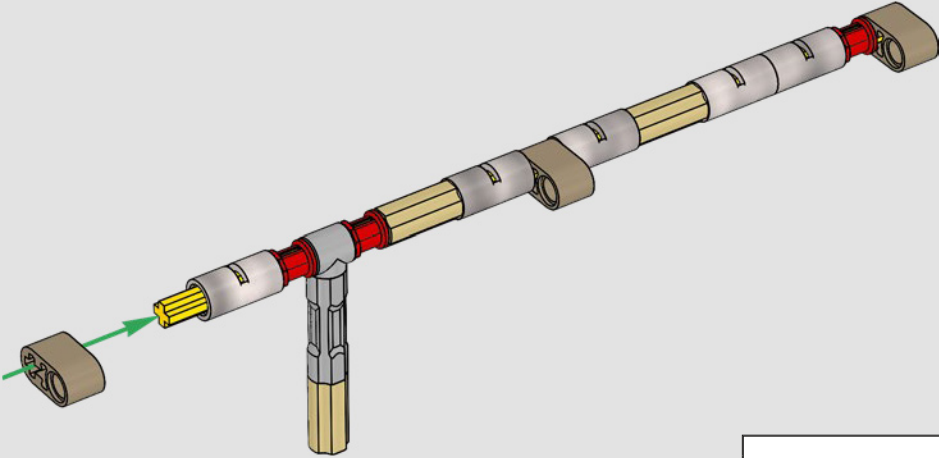

129

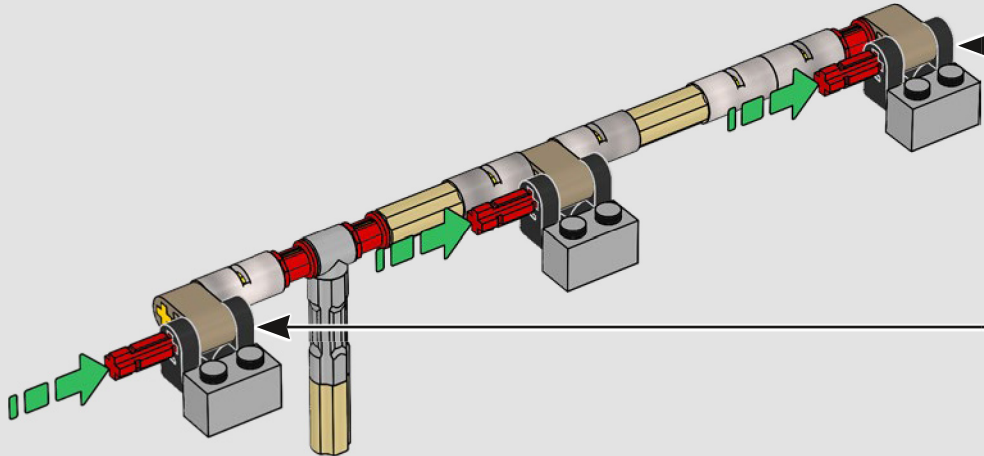
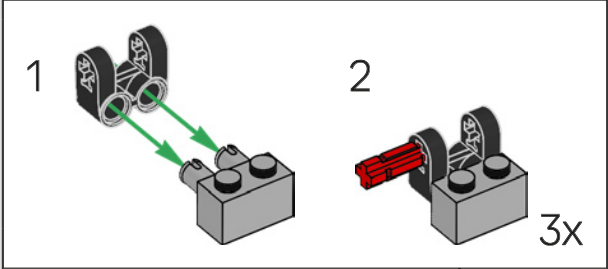

130

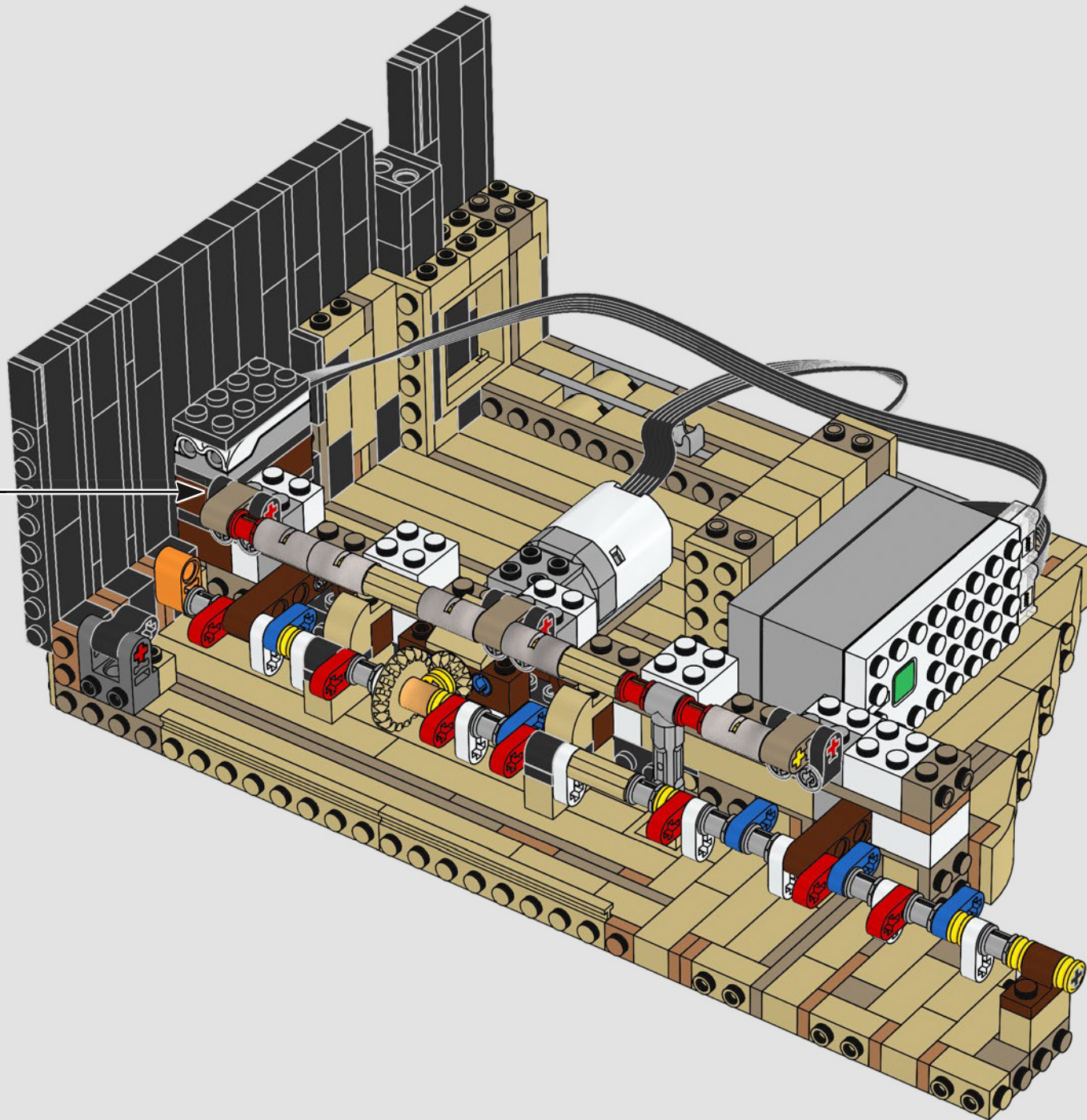



131

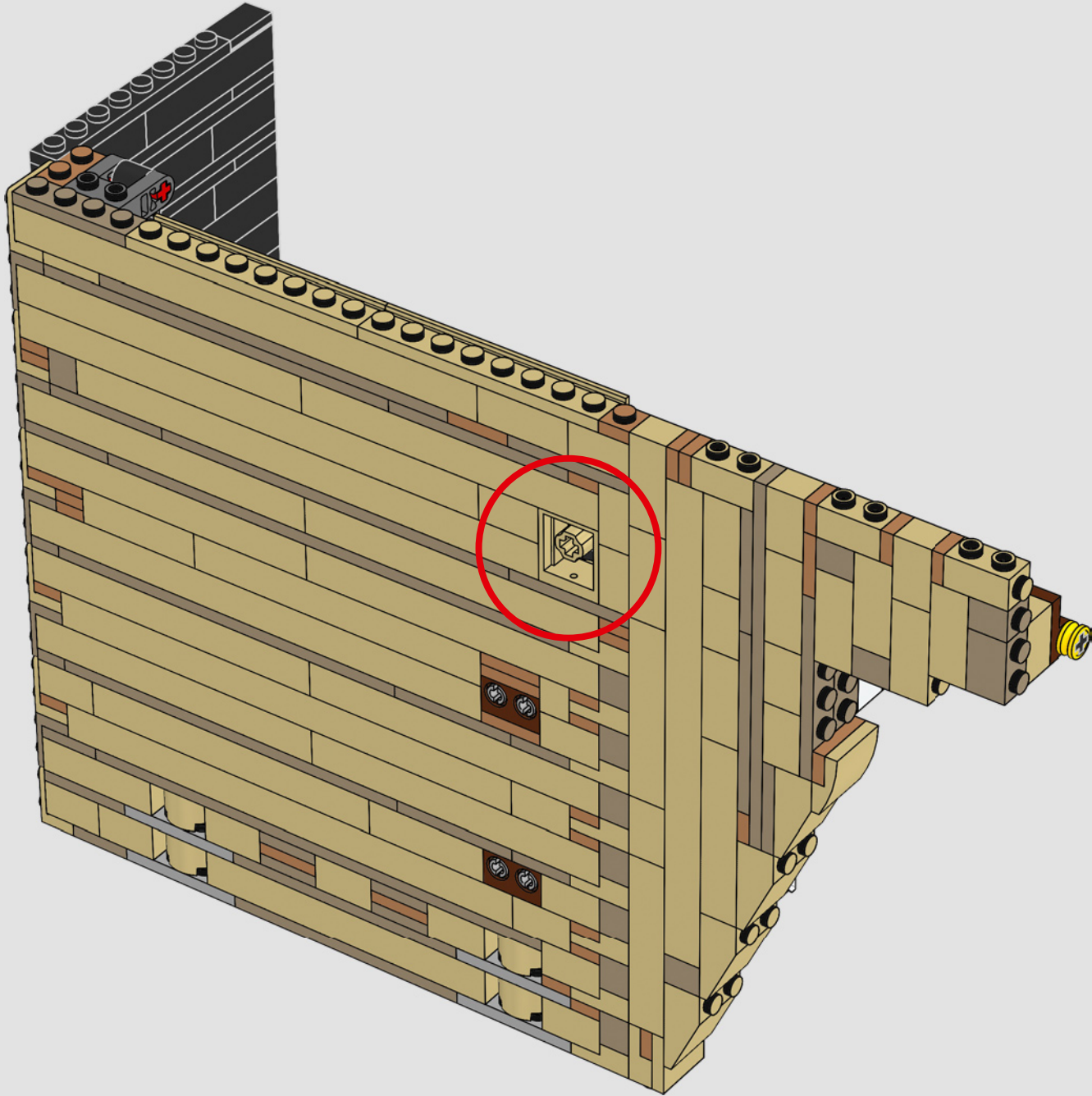

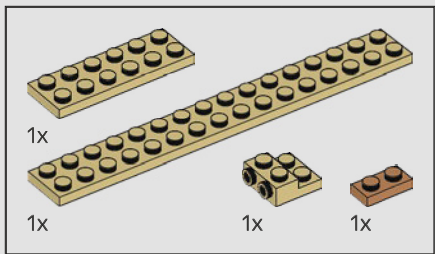

132

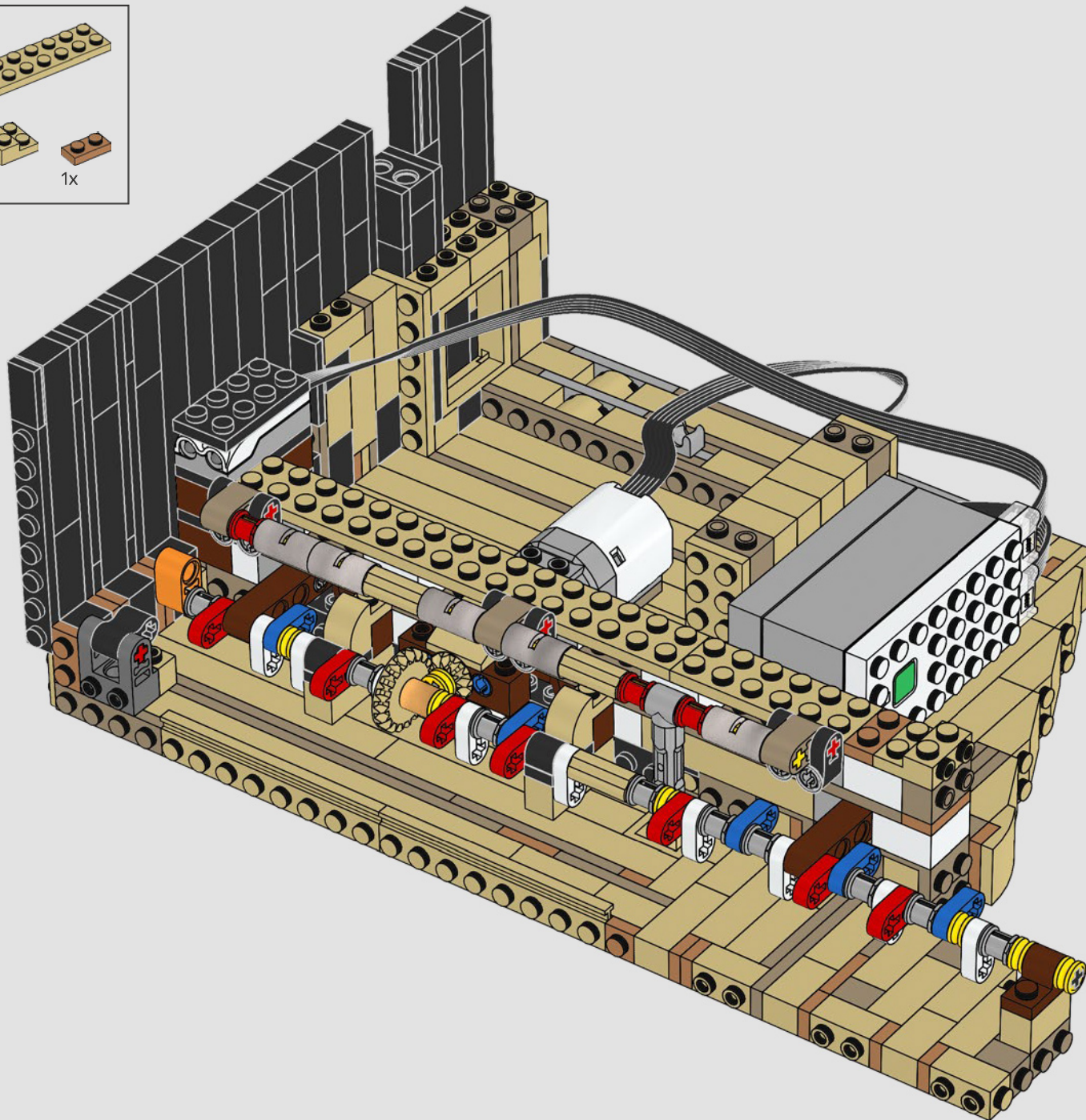

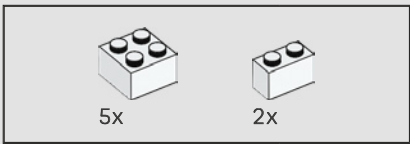

133

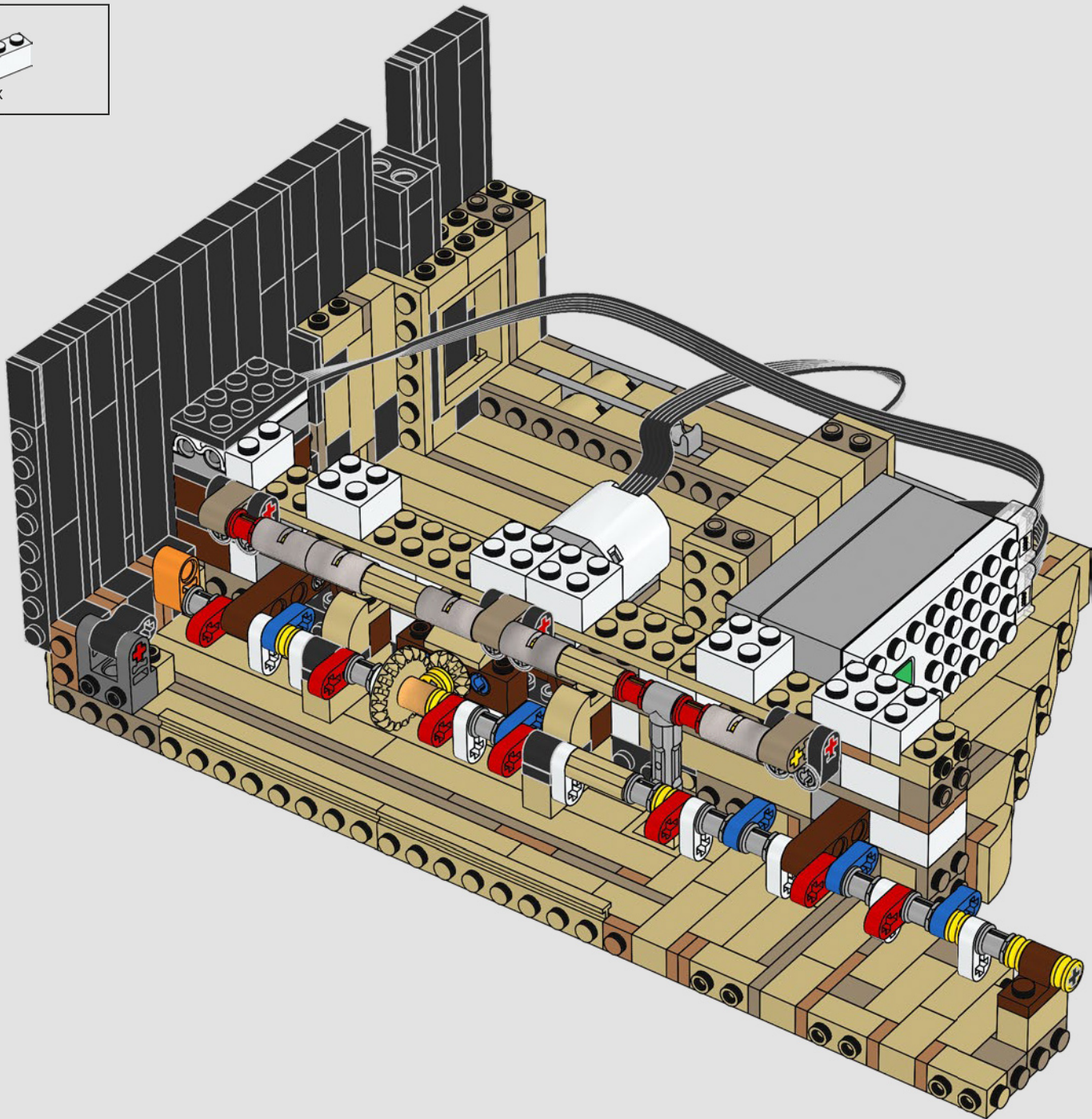

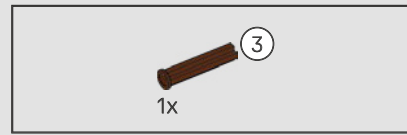
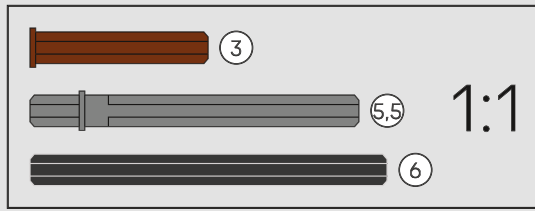
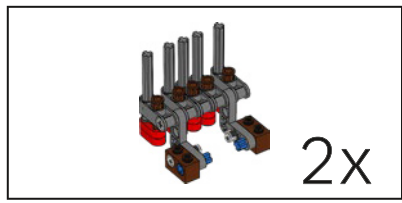

136

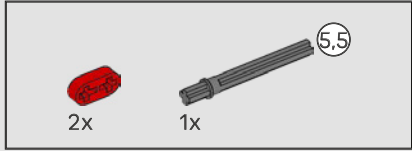

134

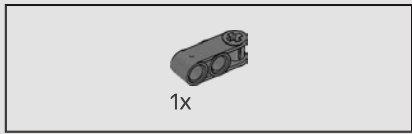
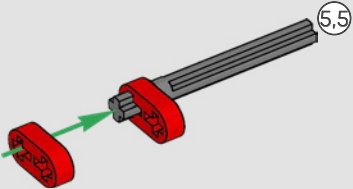

135

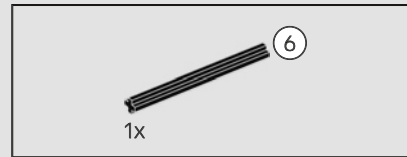
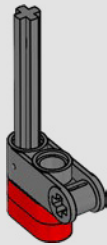

137

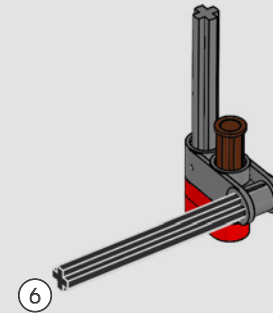
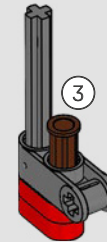

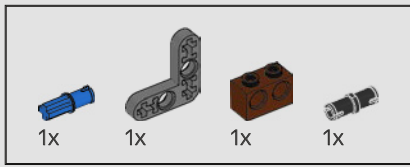

138

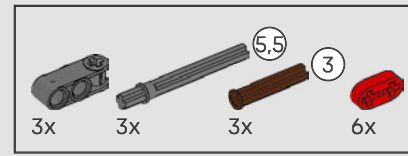
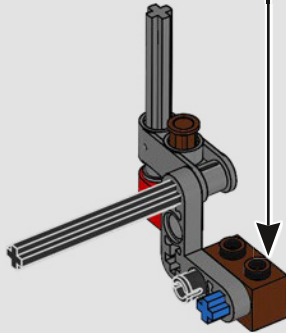
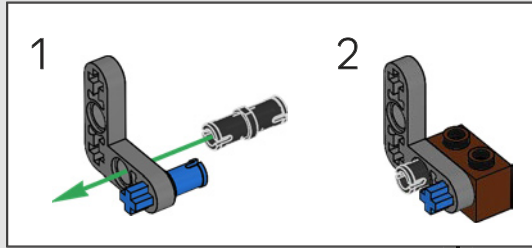

139

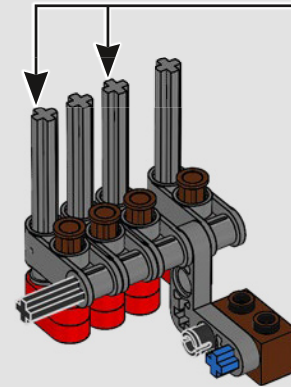
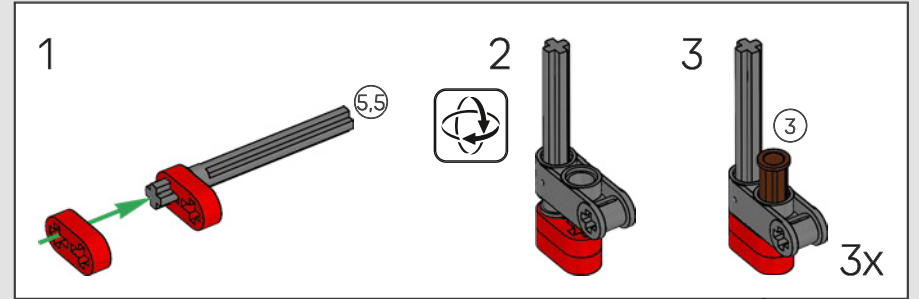

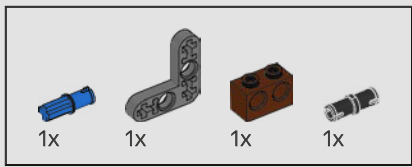

140

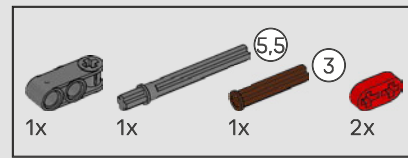
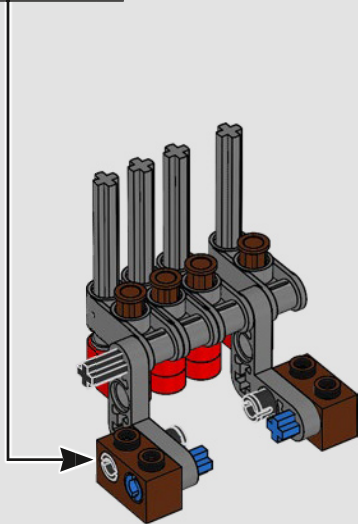
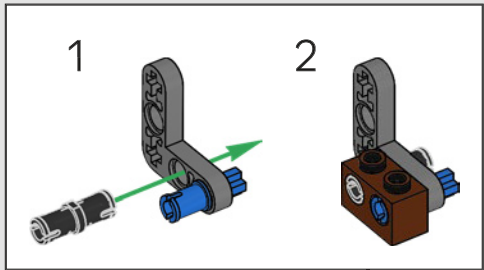

141

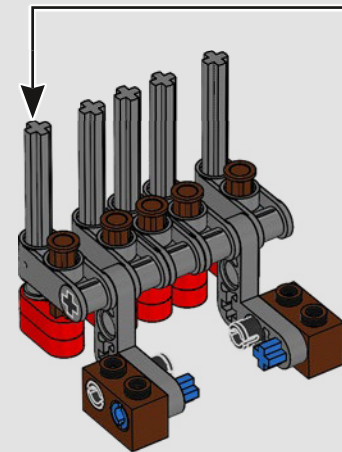
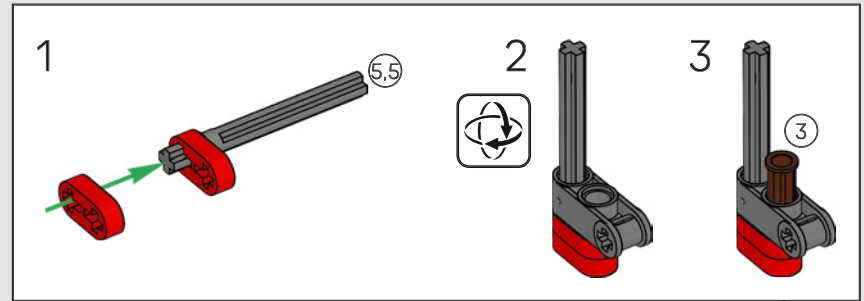

2x

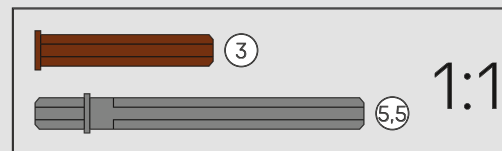



142

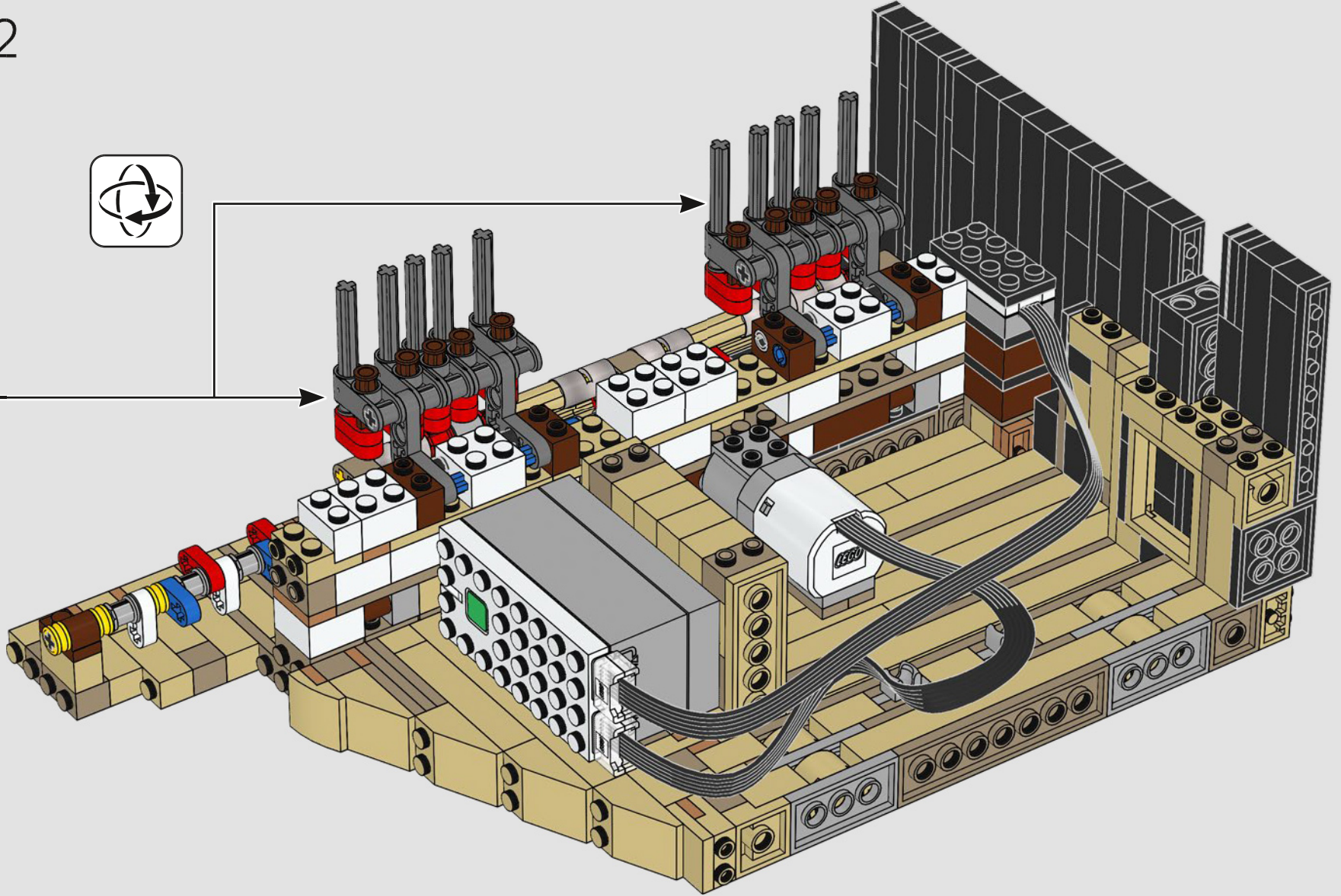

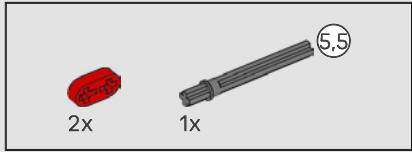
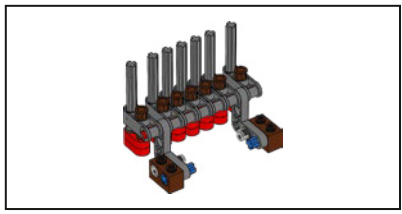

143

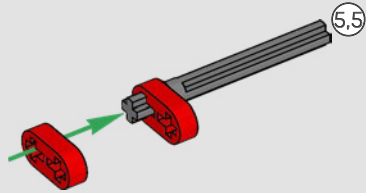

144

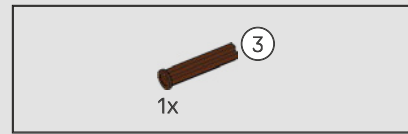
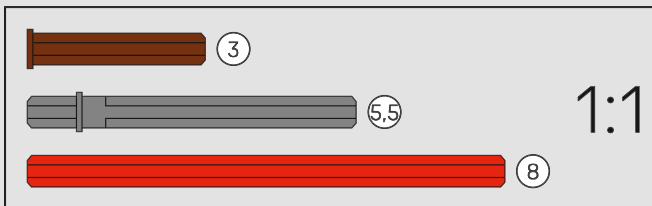
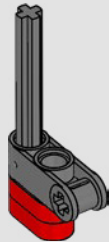

145

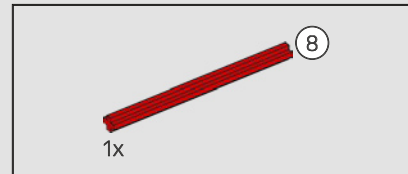
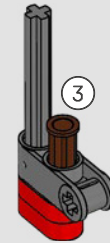

146

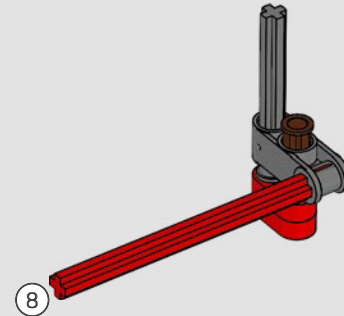

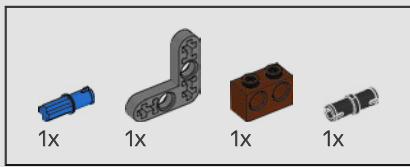

147

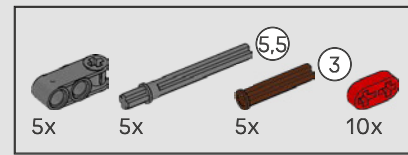
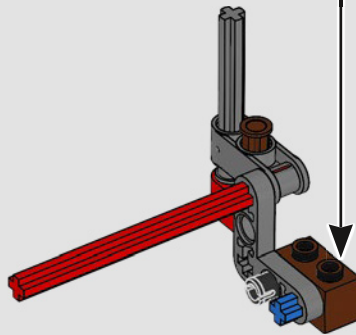
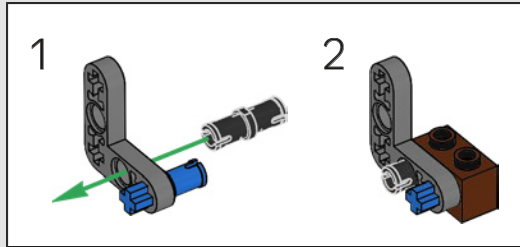

148

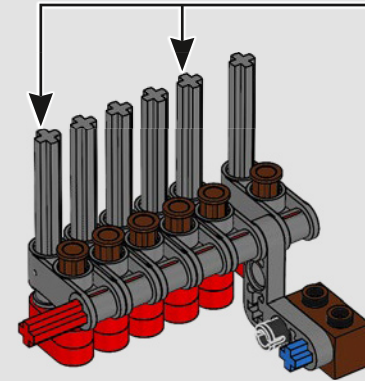
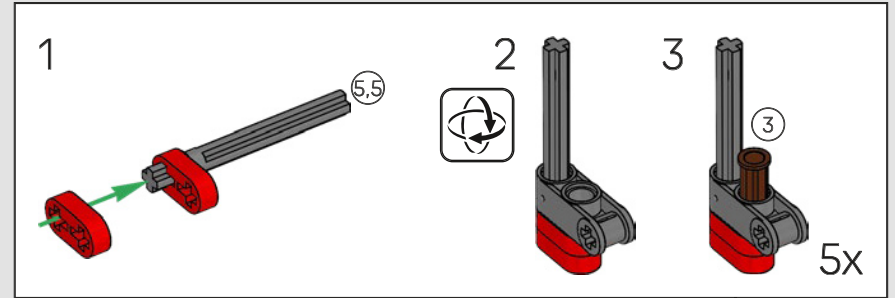

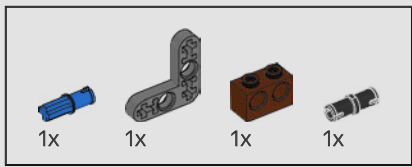

149

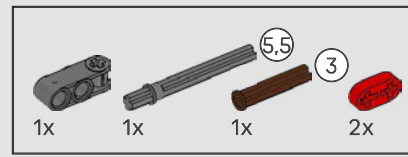
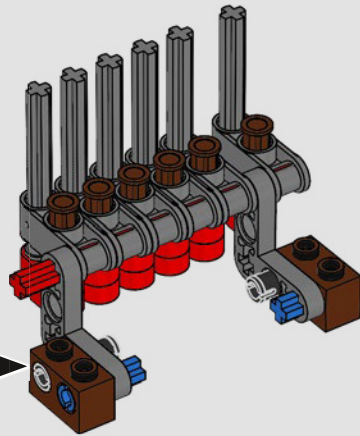
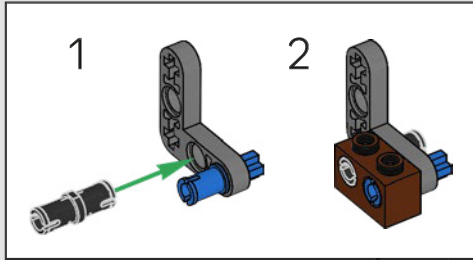

150

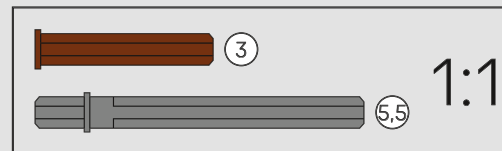
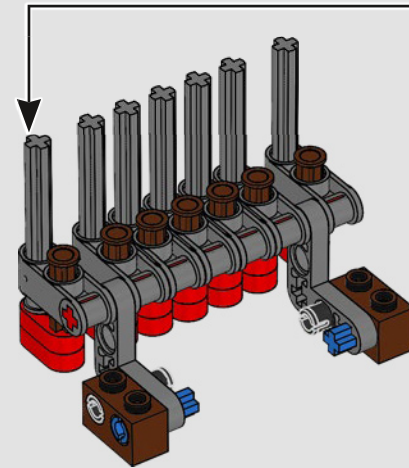
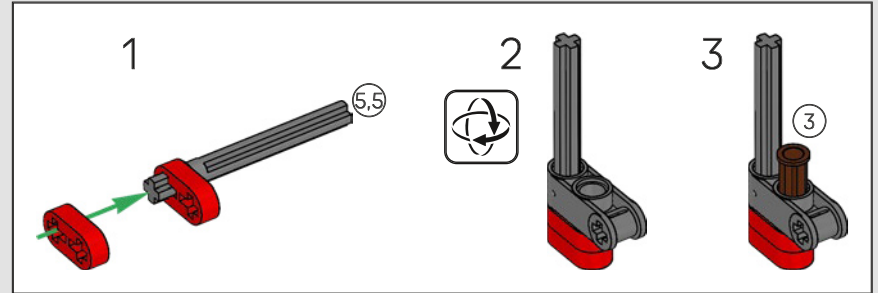

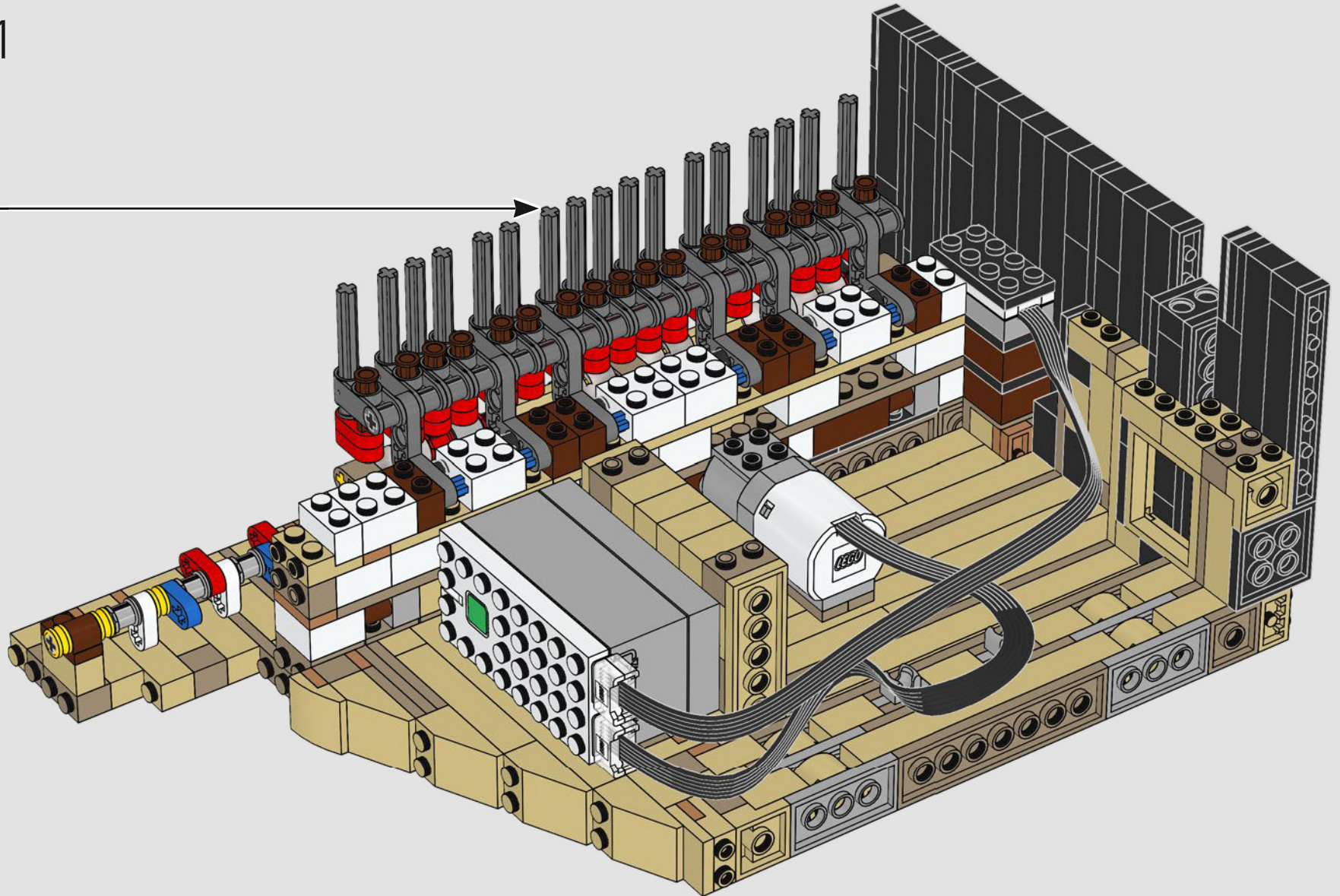

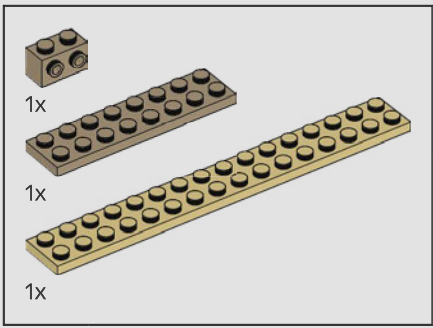

152

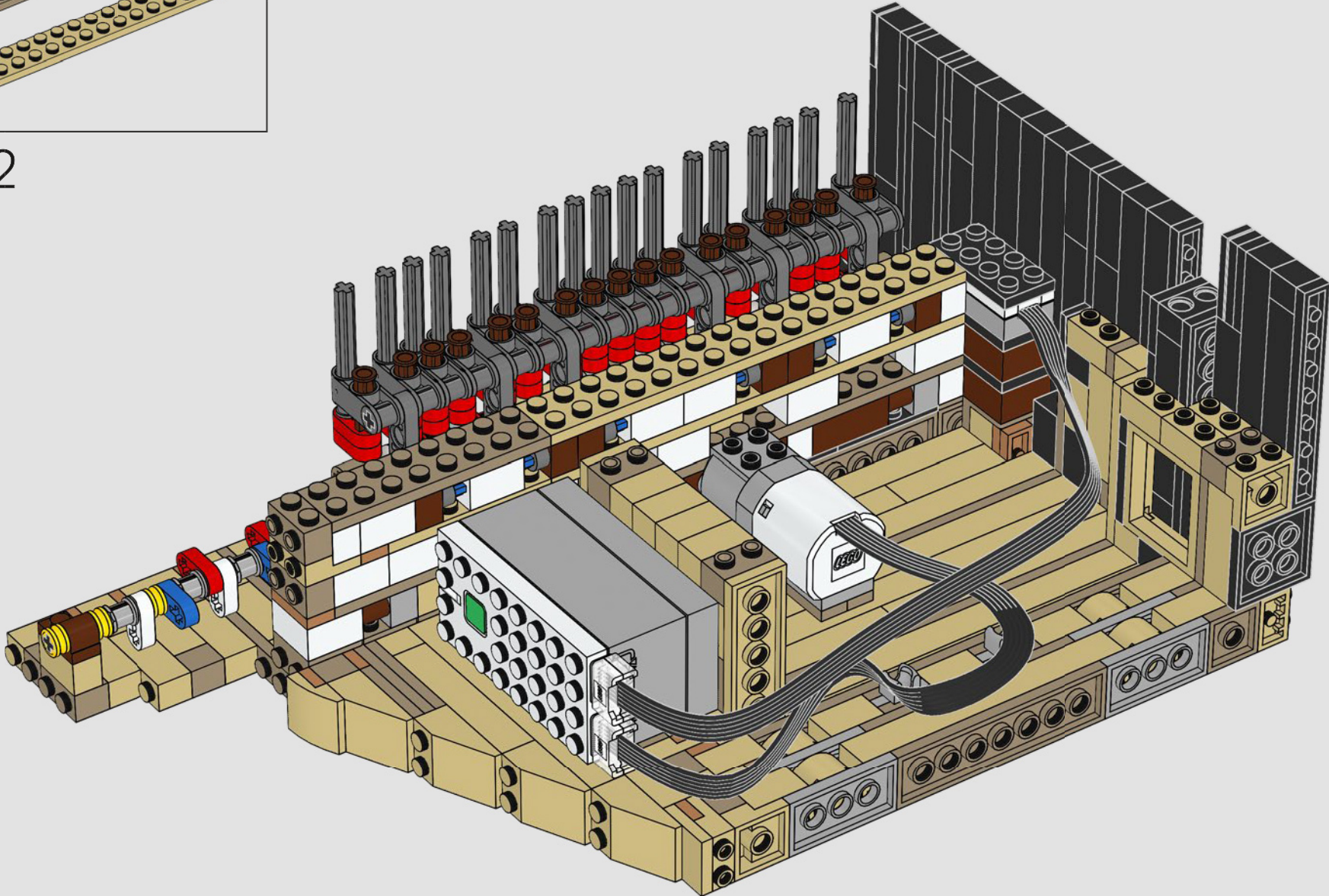

1

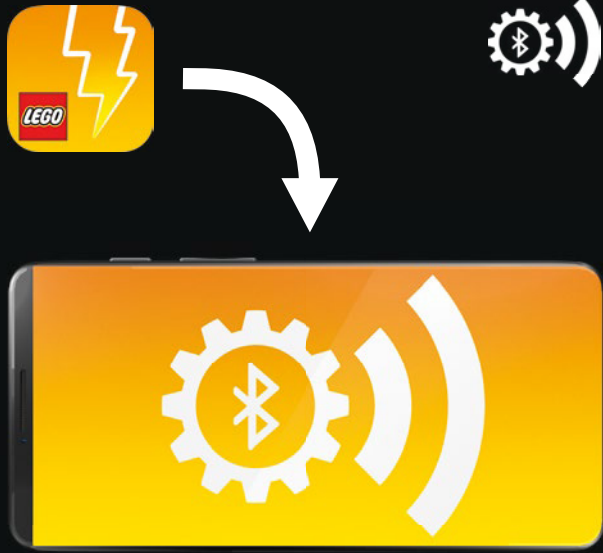

2

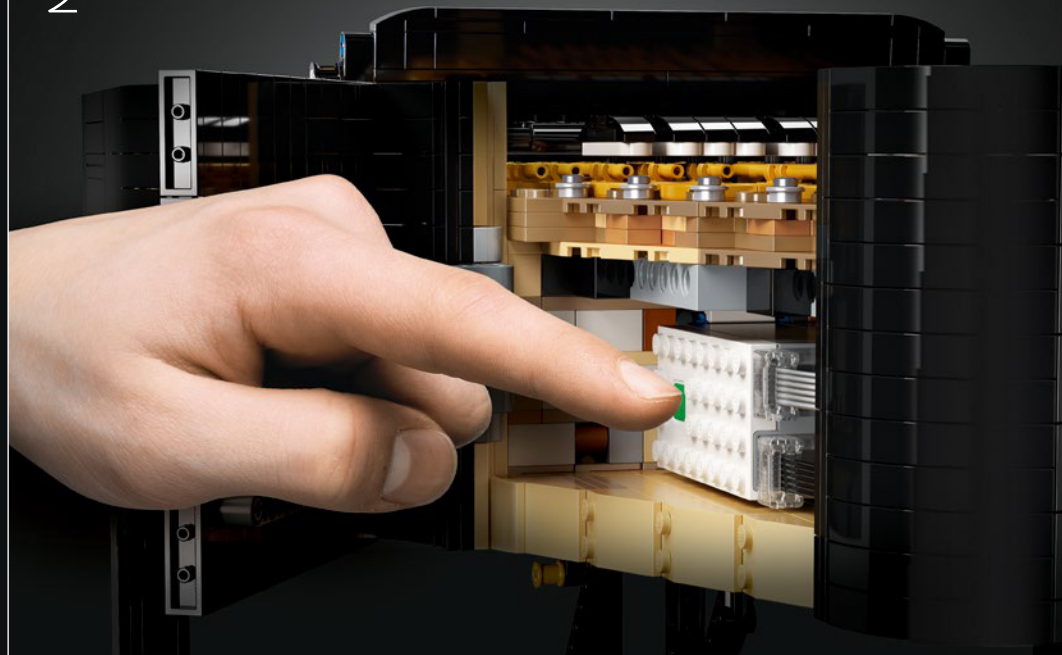

3

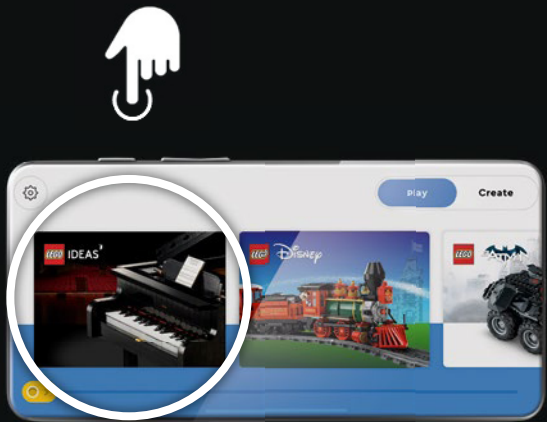

4

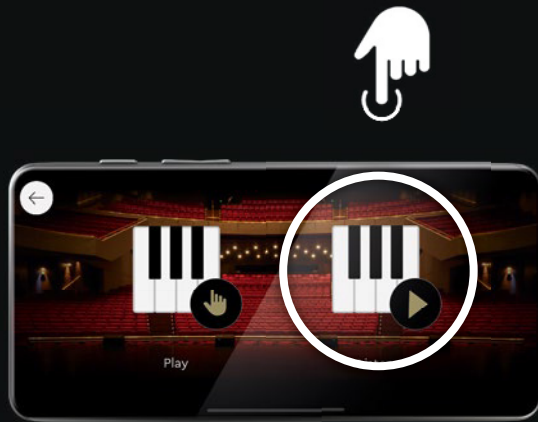

5



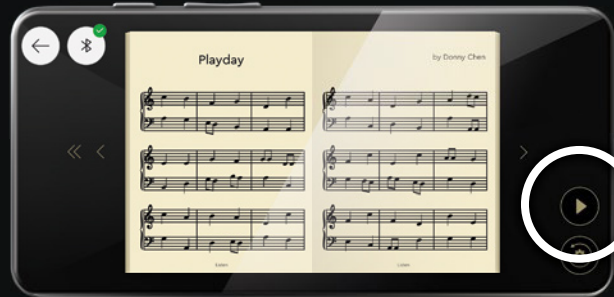
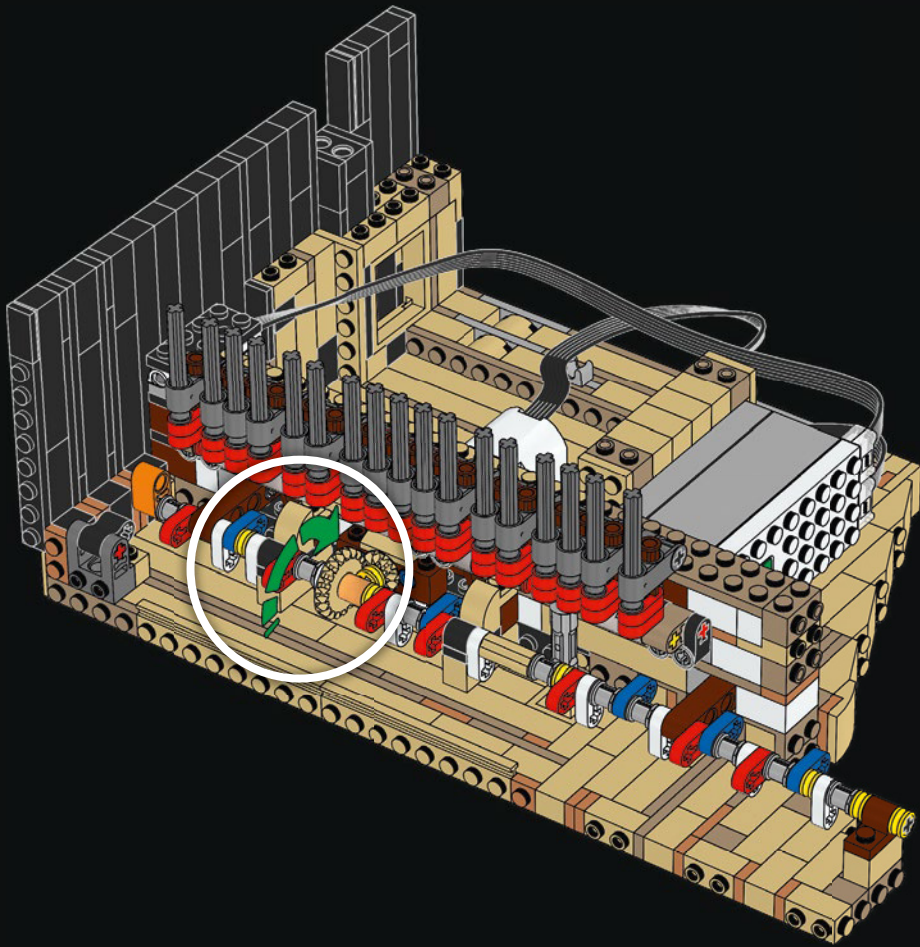

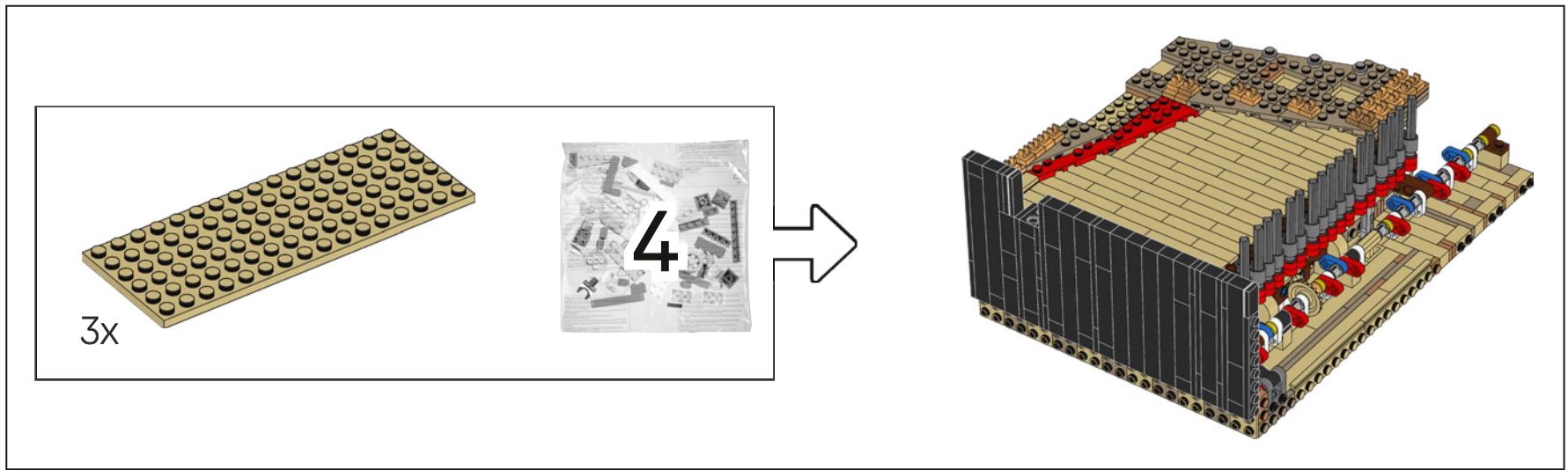

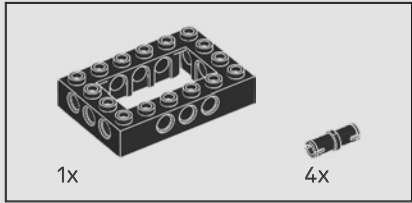
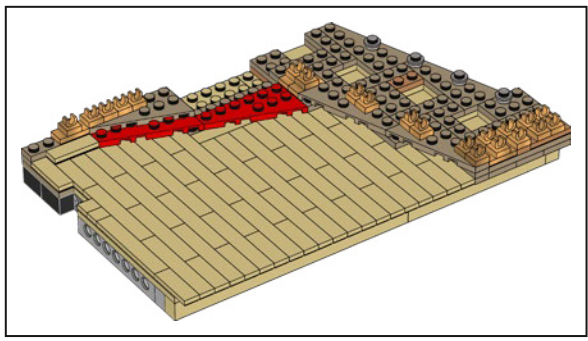

153

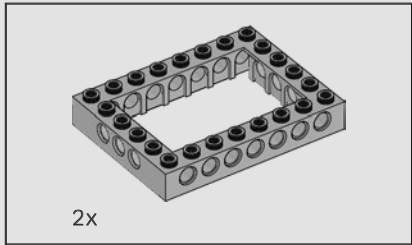
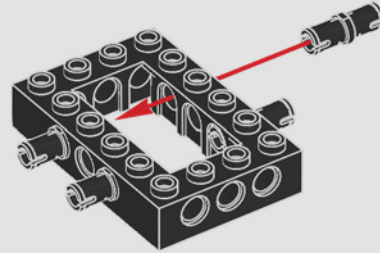

154

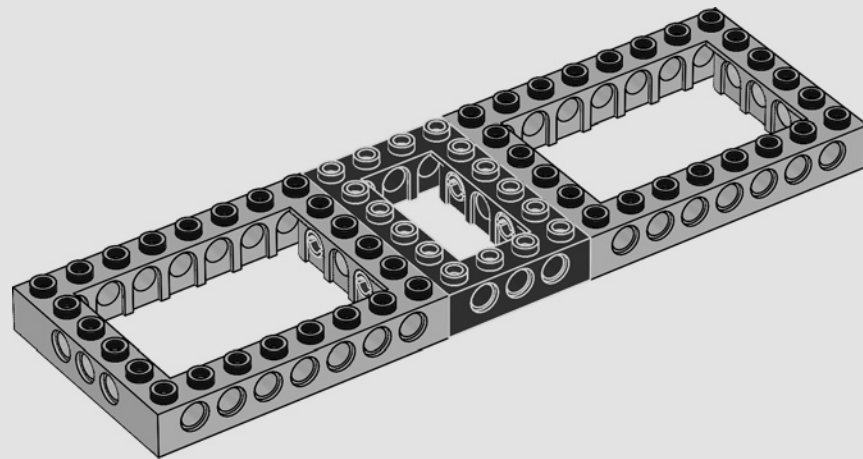

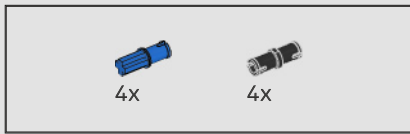

155

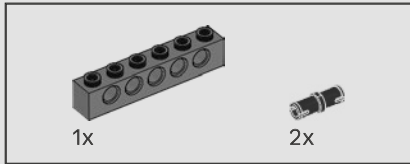
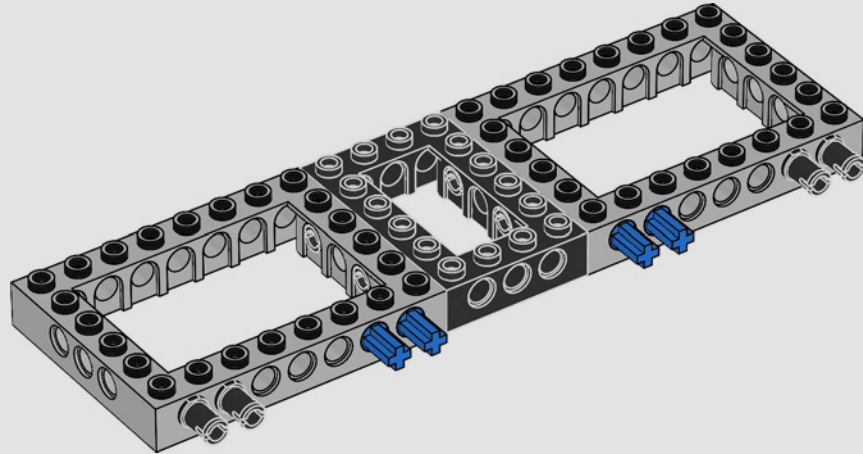

156

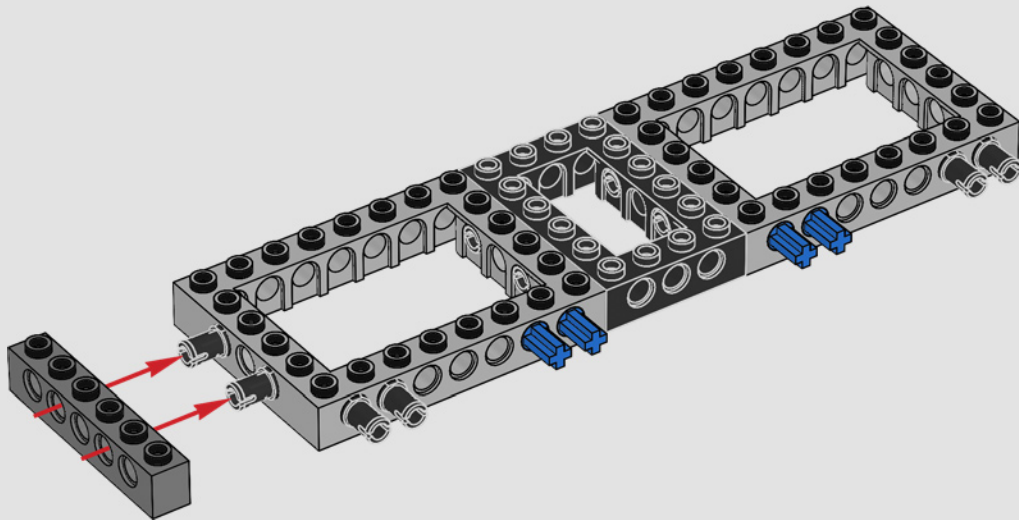



3x

157

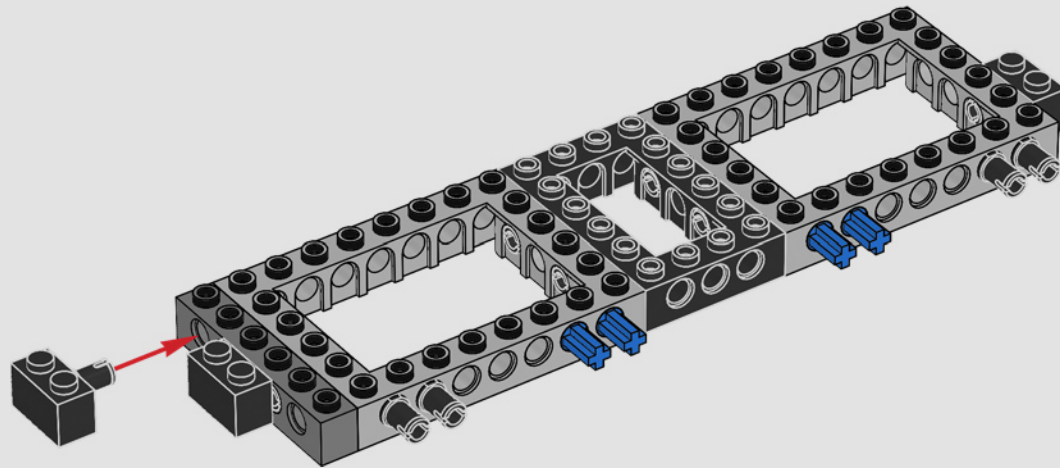

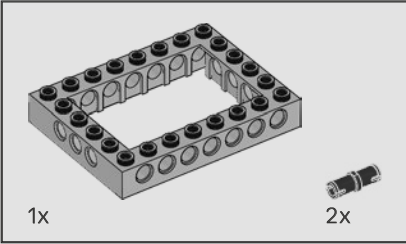
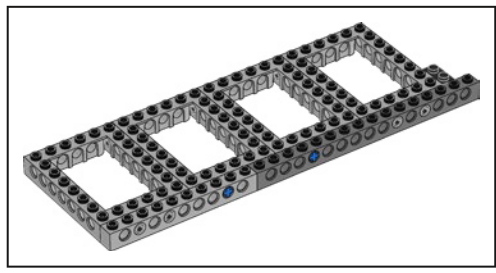

158

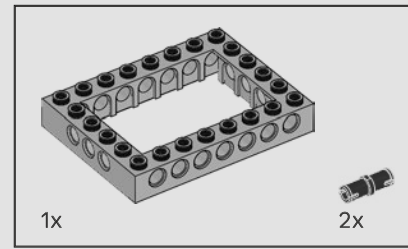
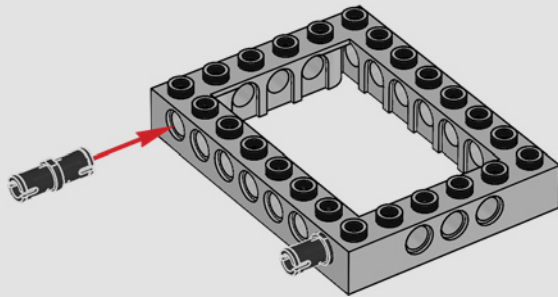

159

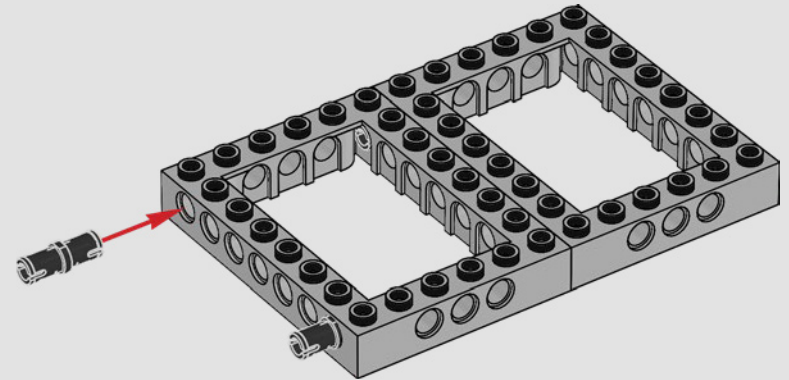

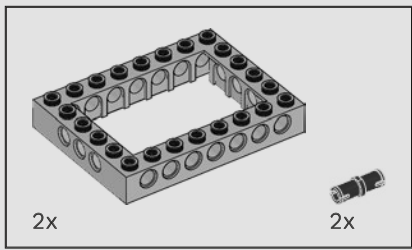

160

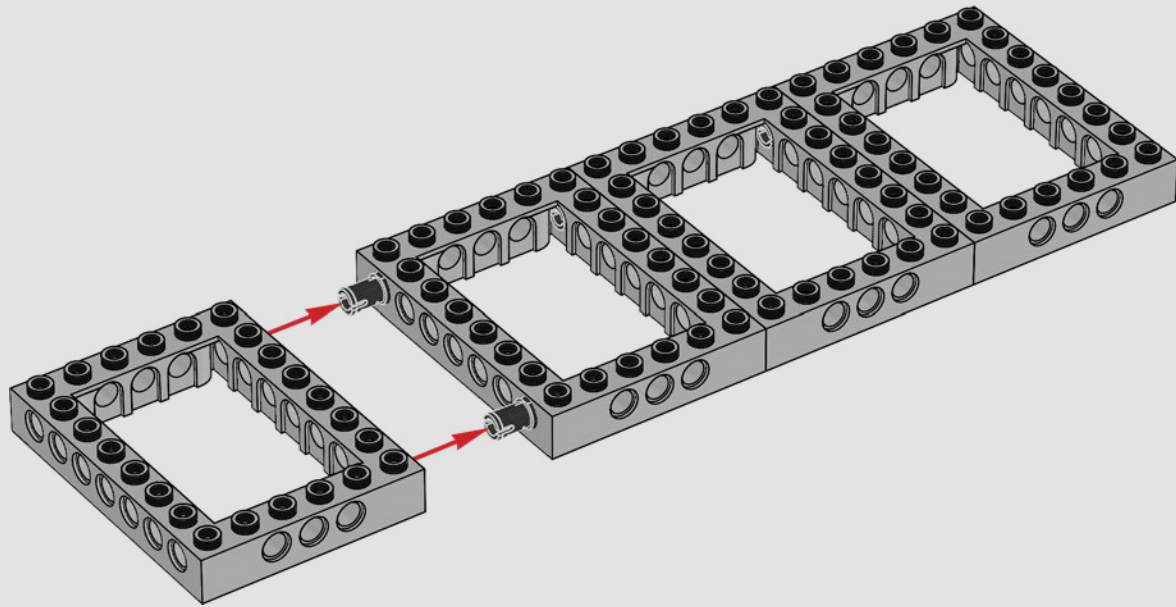

161

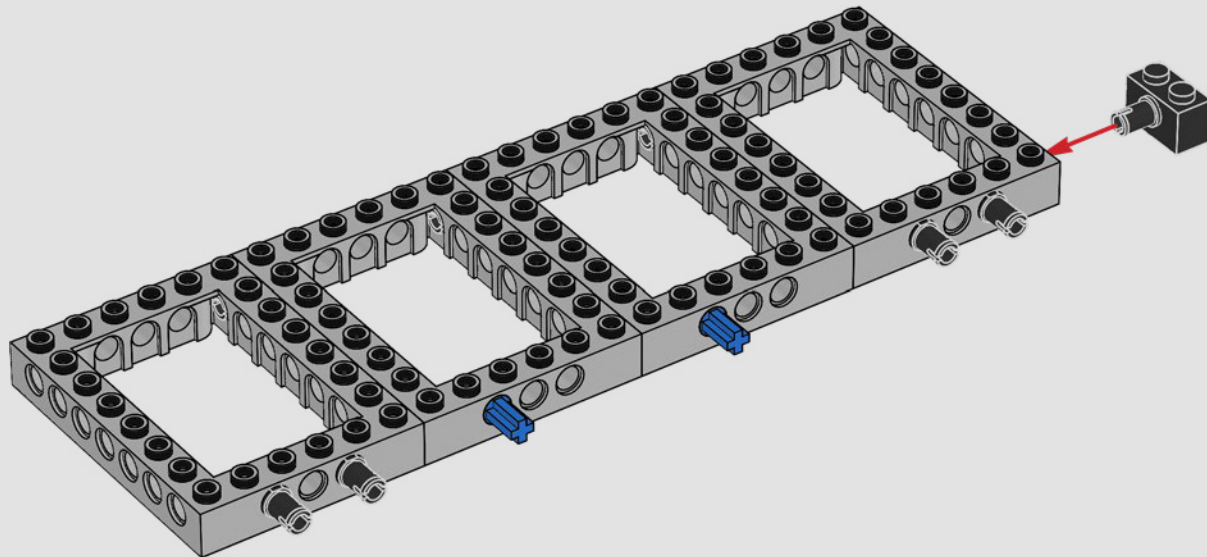

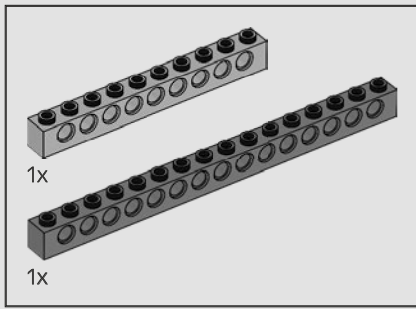

162

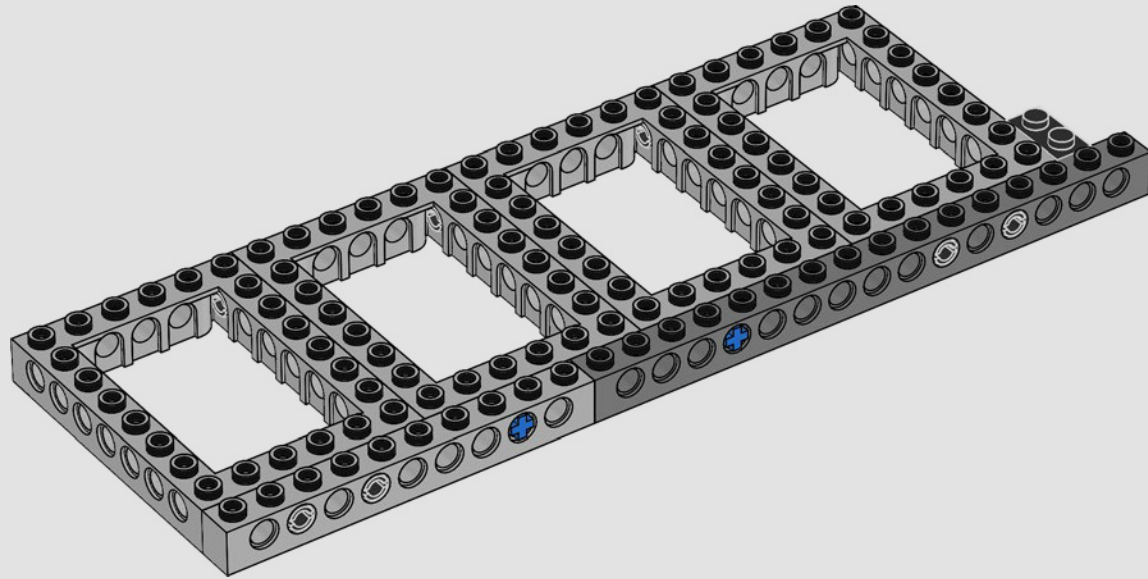

163

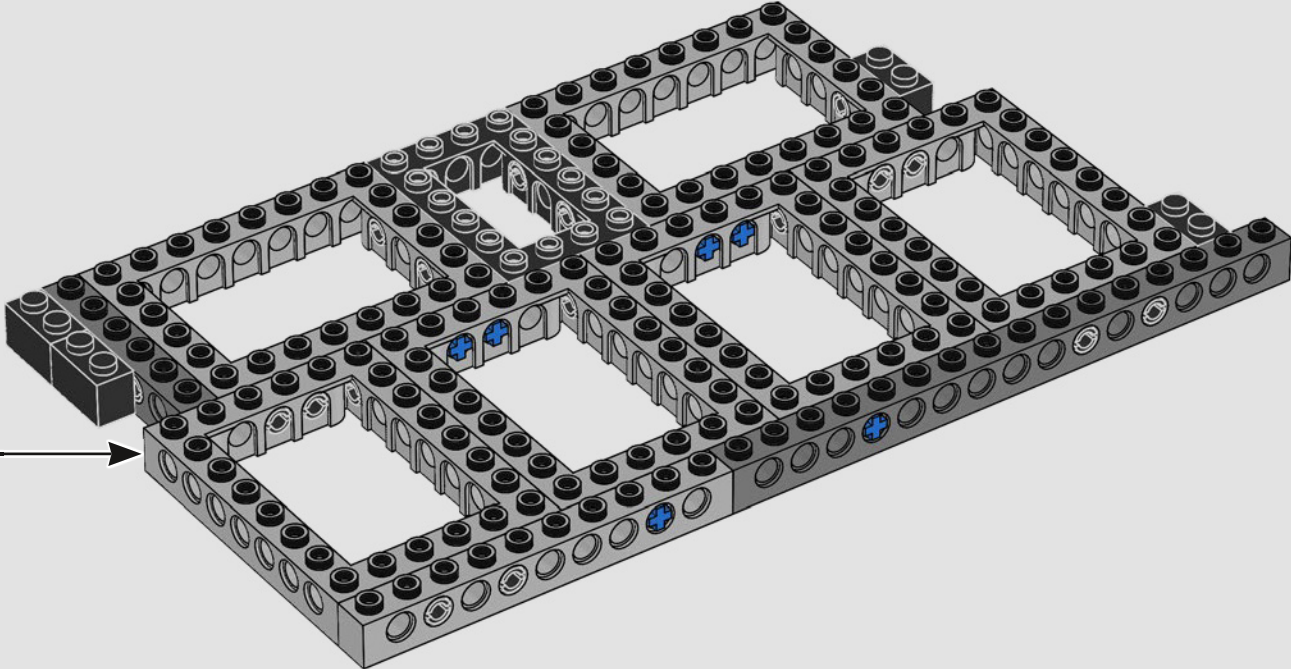

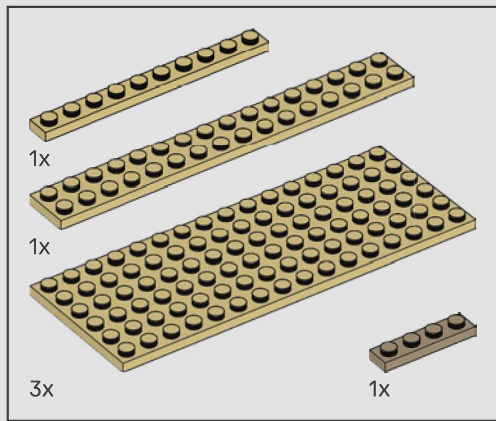

164

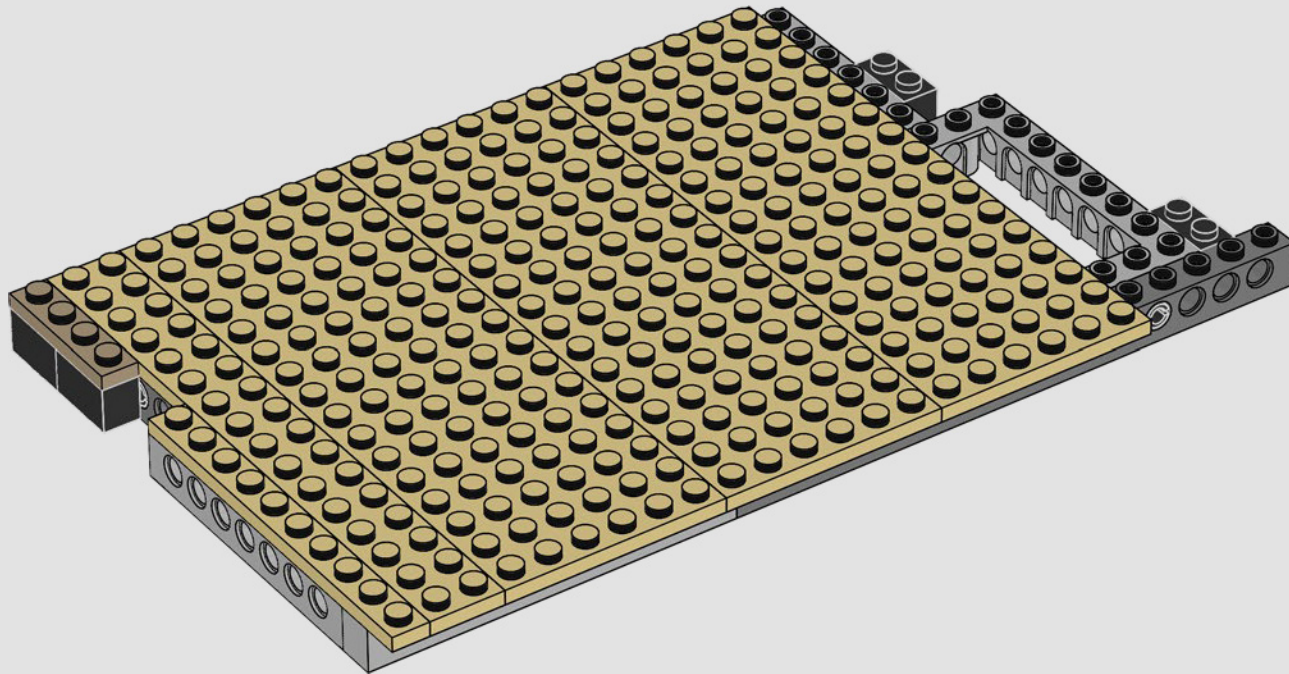

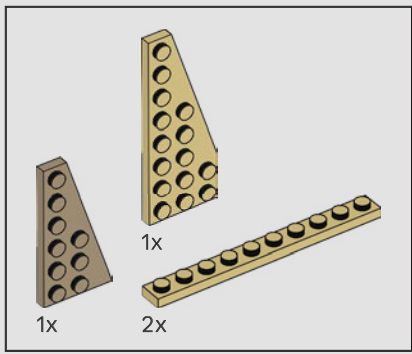

165

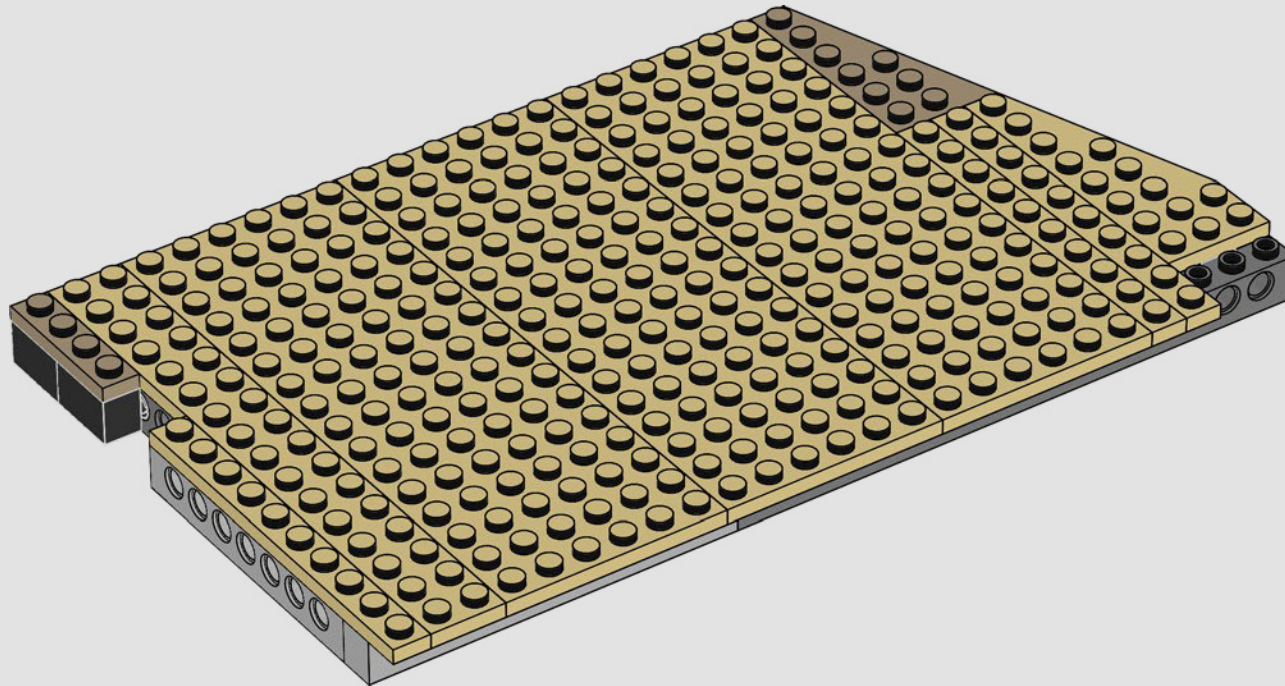

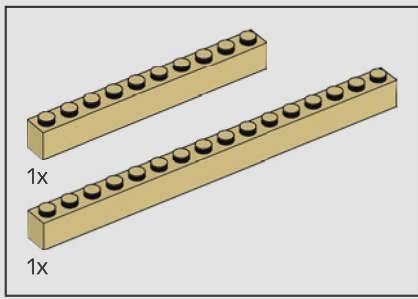

166

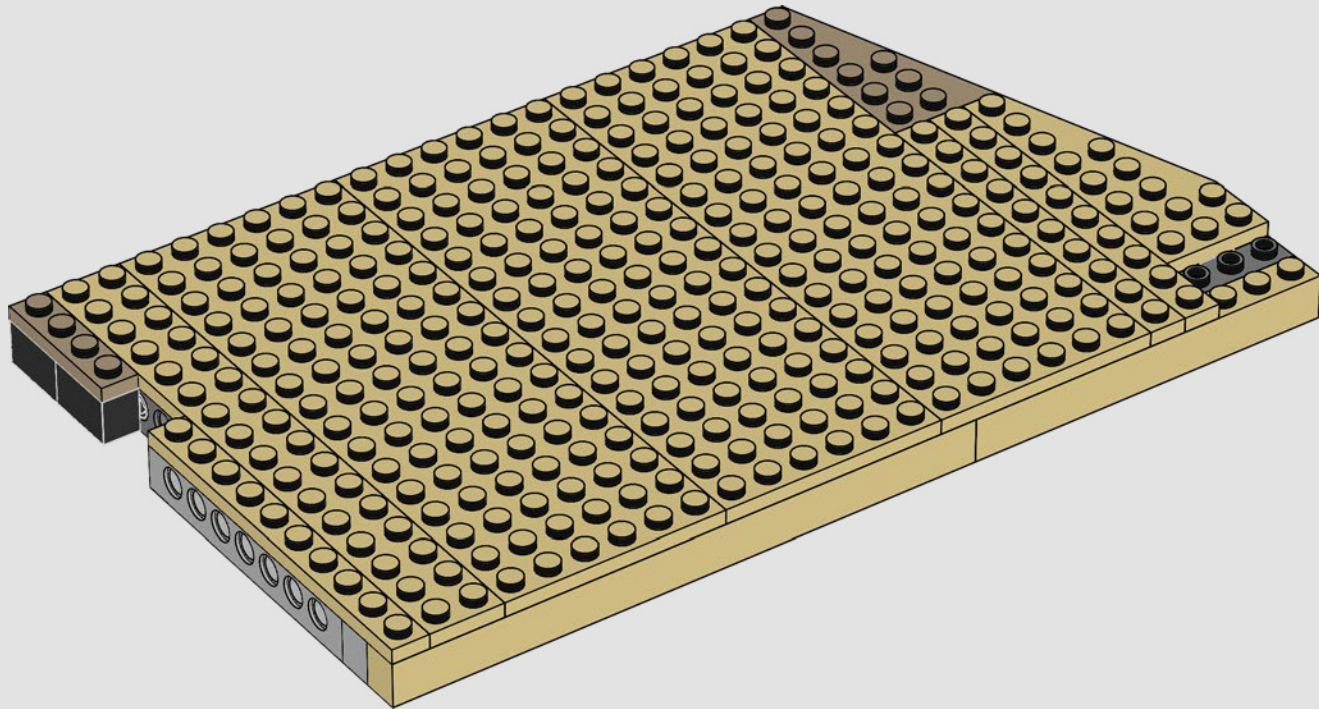

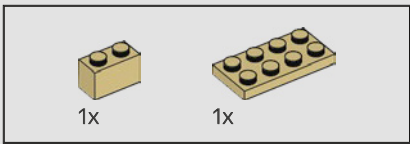

167

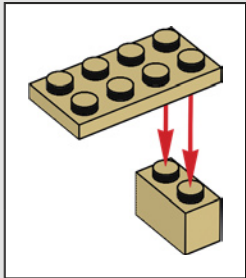
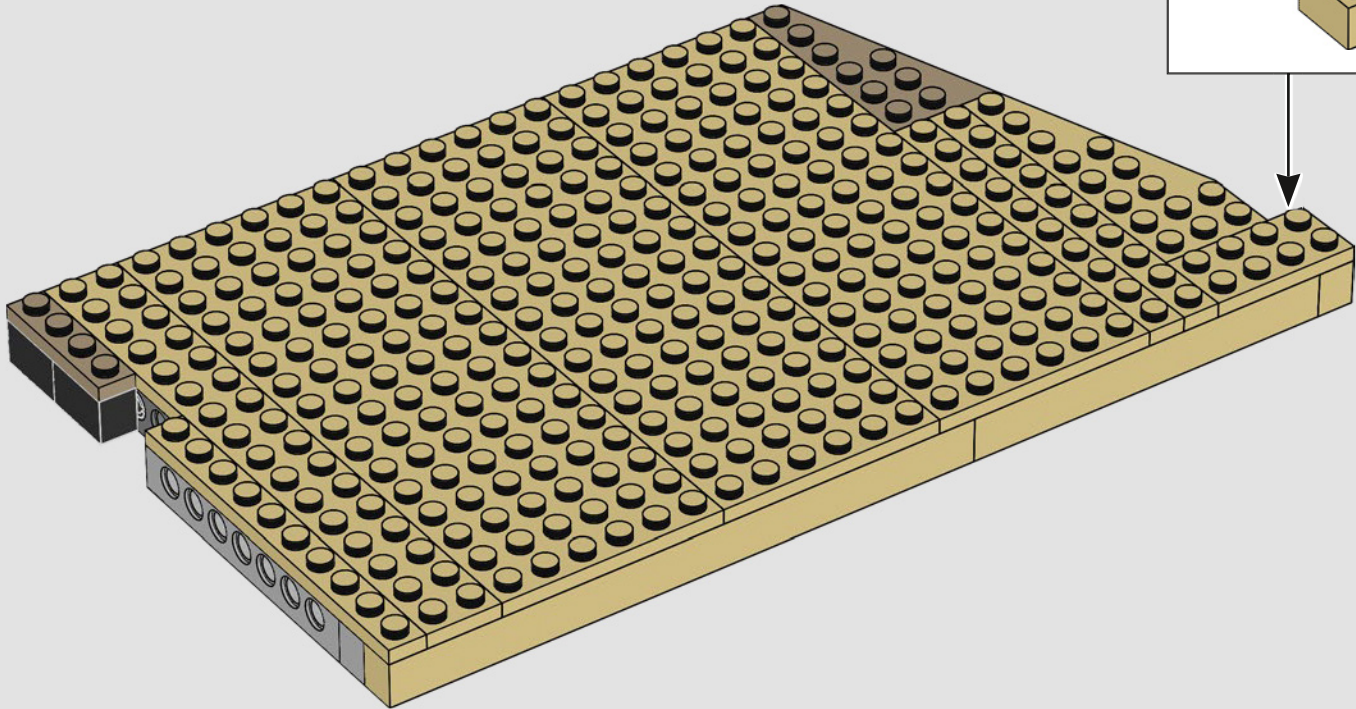

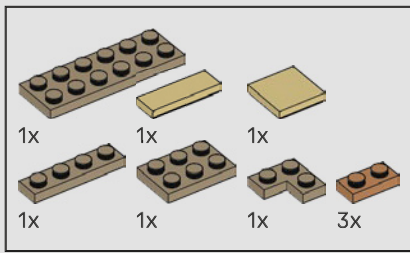

168

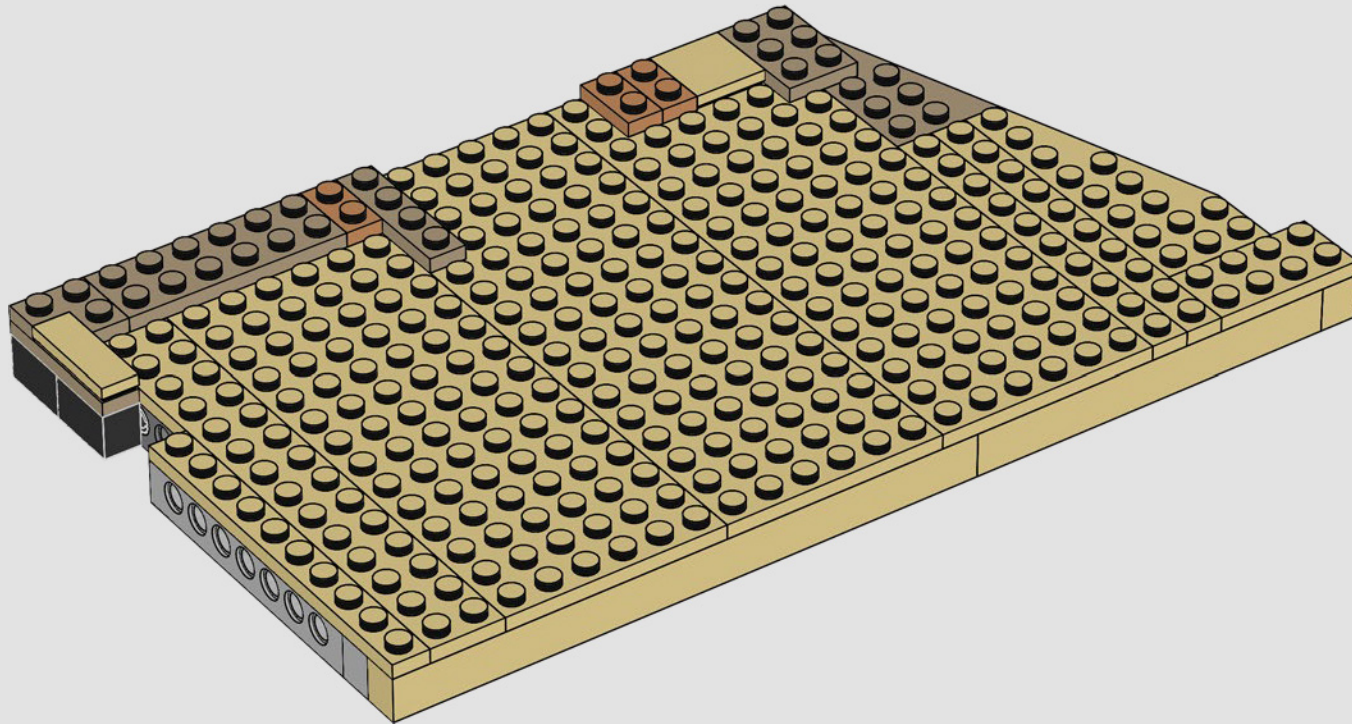

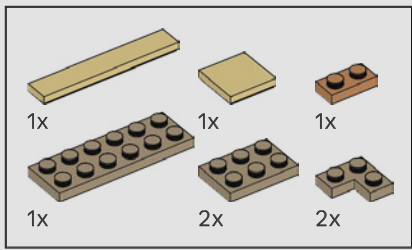

169

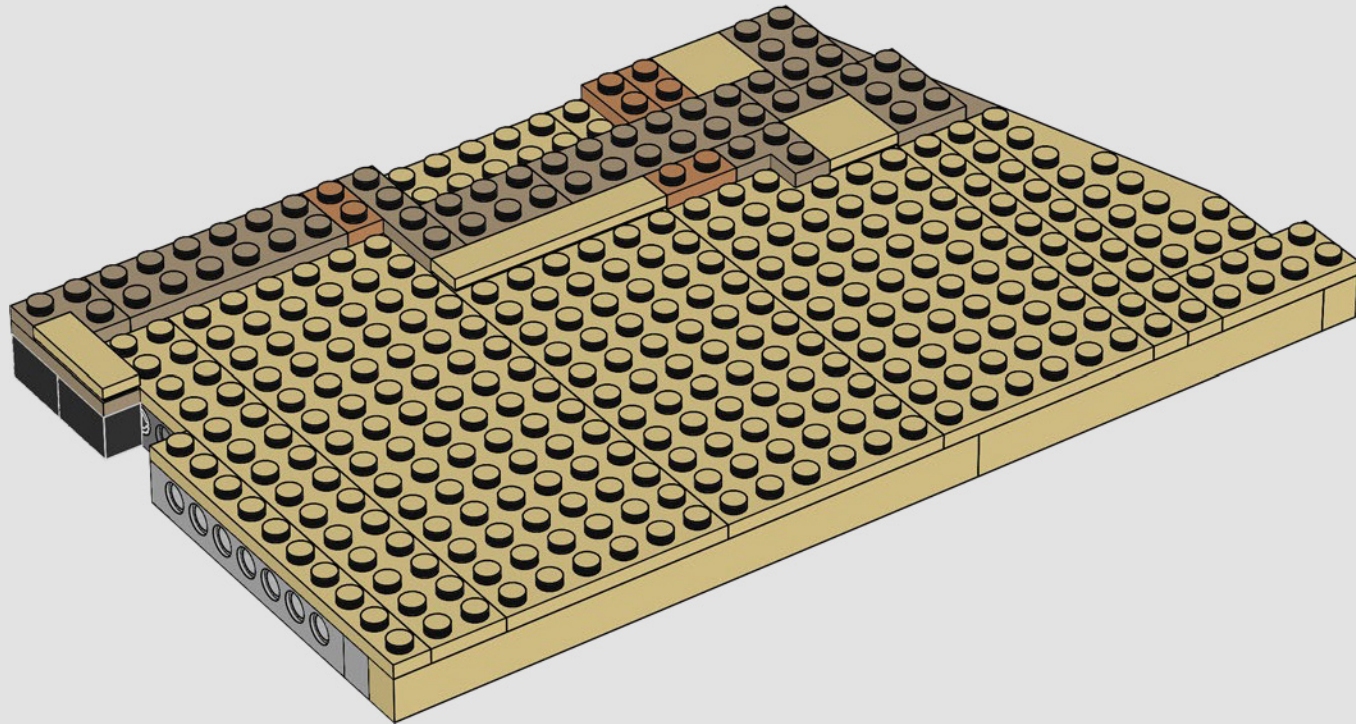

“ Music produces a kind of pleasure which human nature cannot do without. ”

Confucius

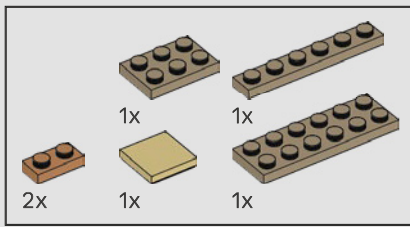

170

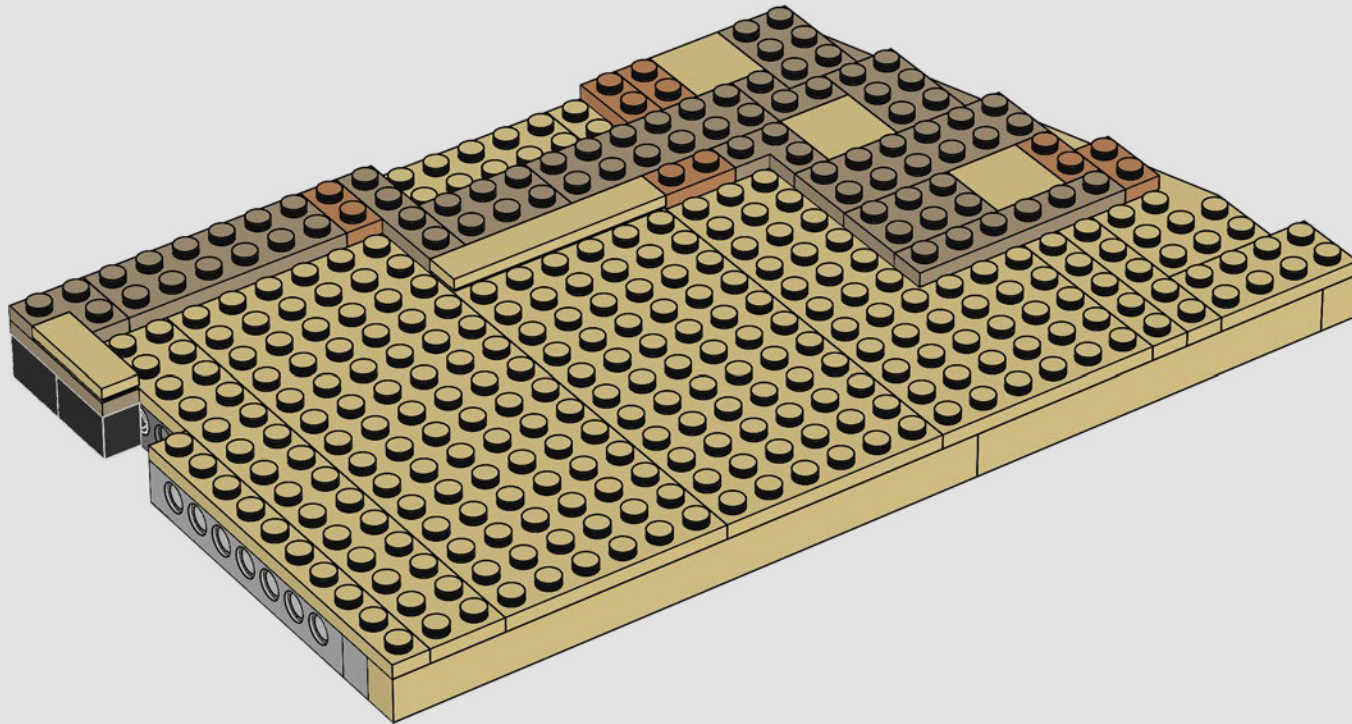

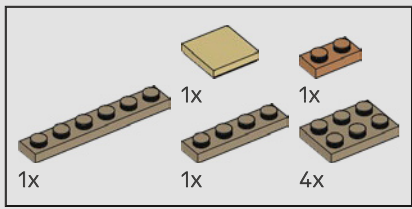

171

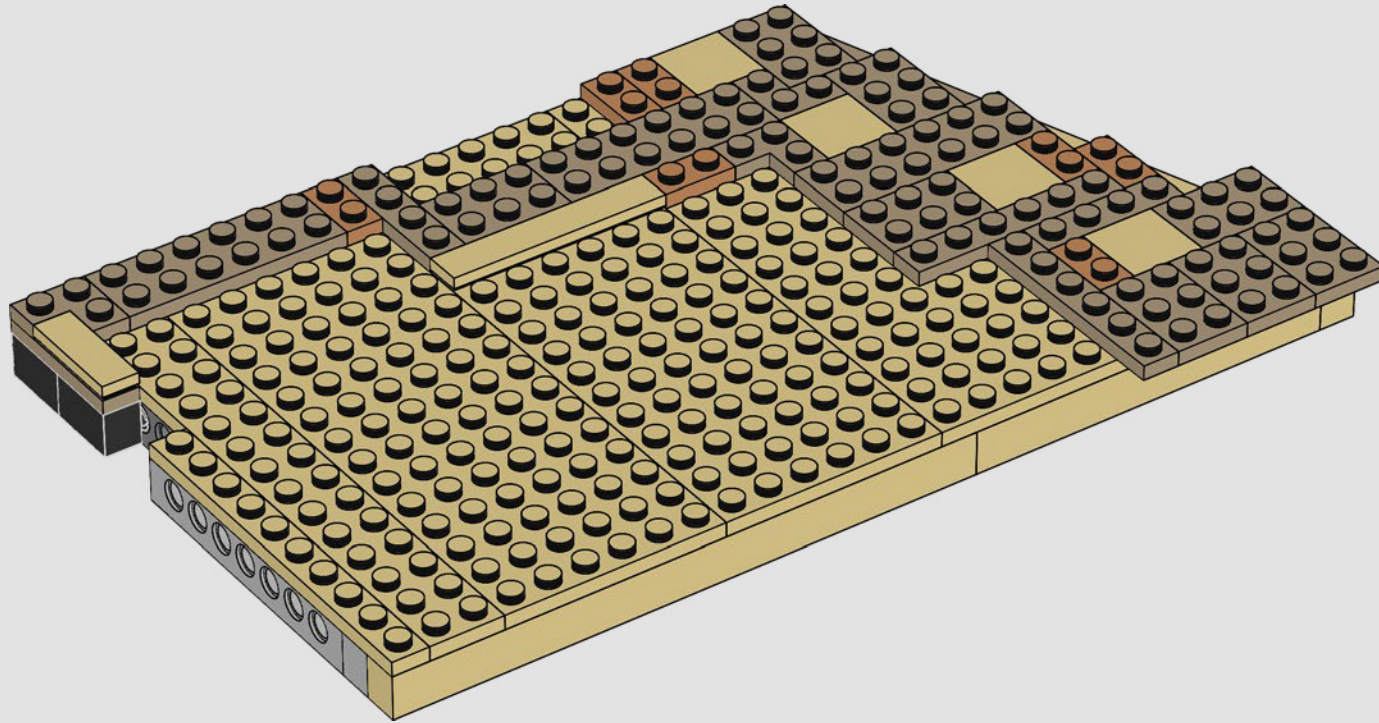

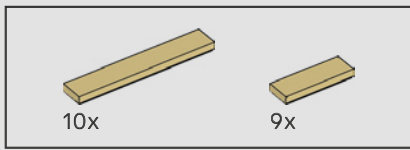

172

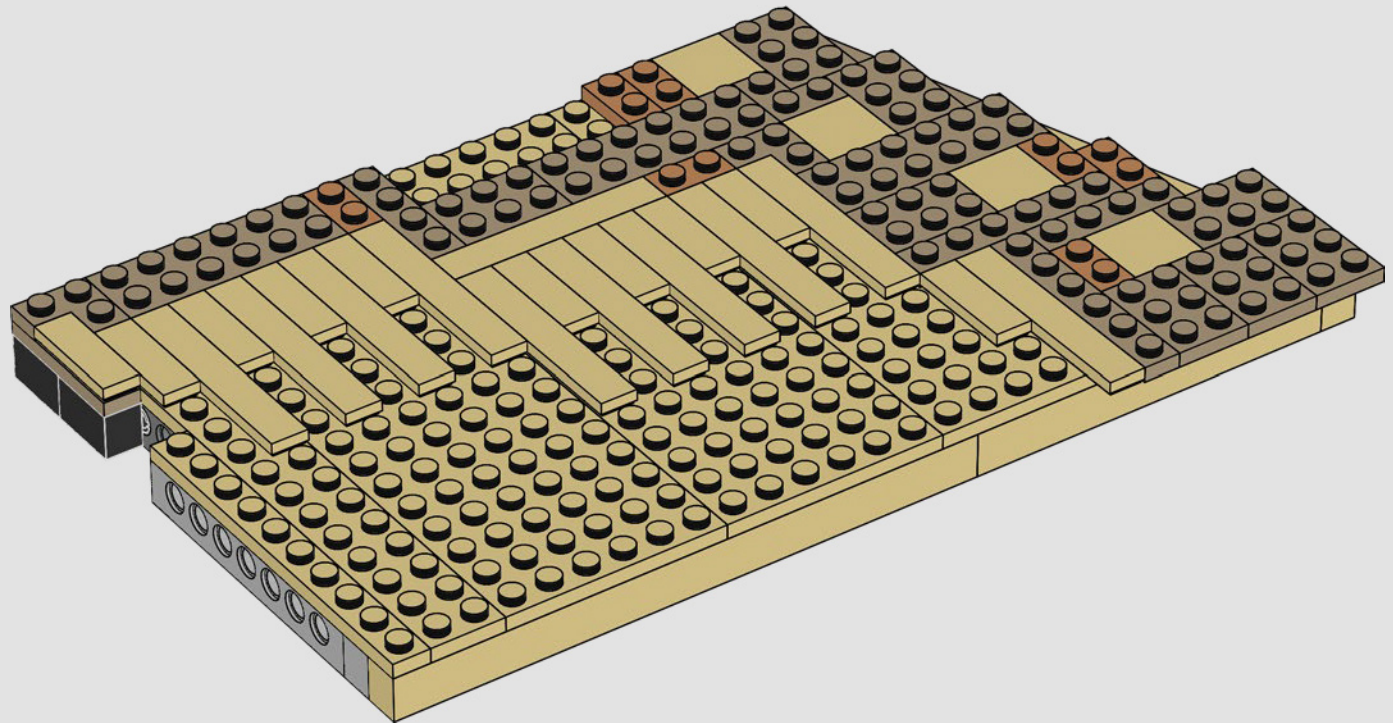

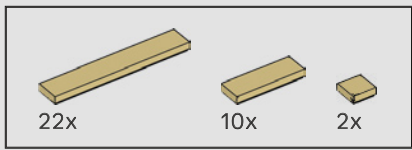

173

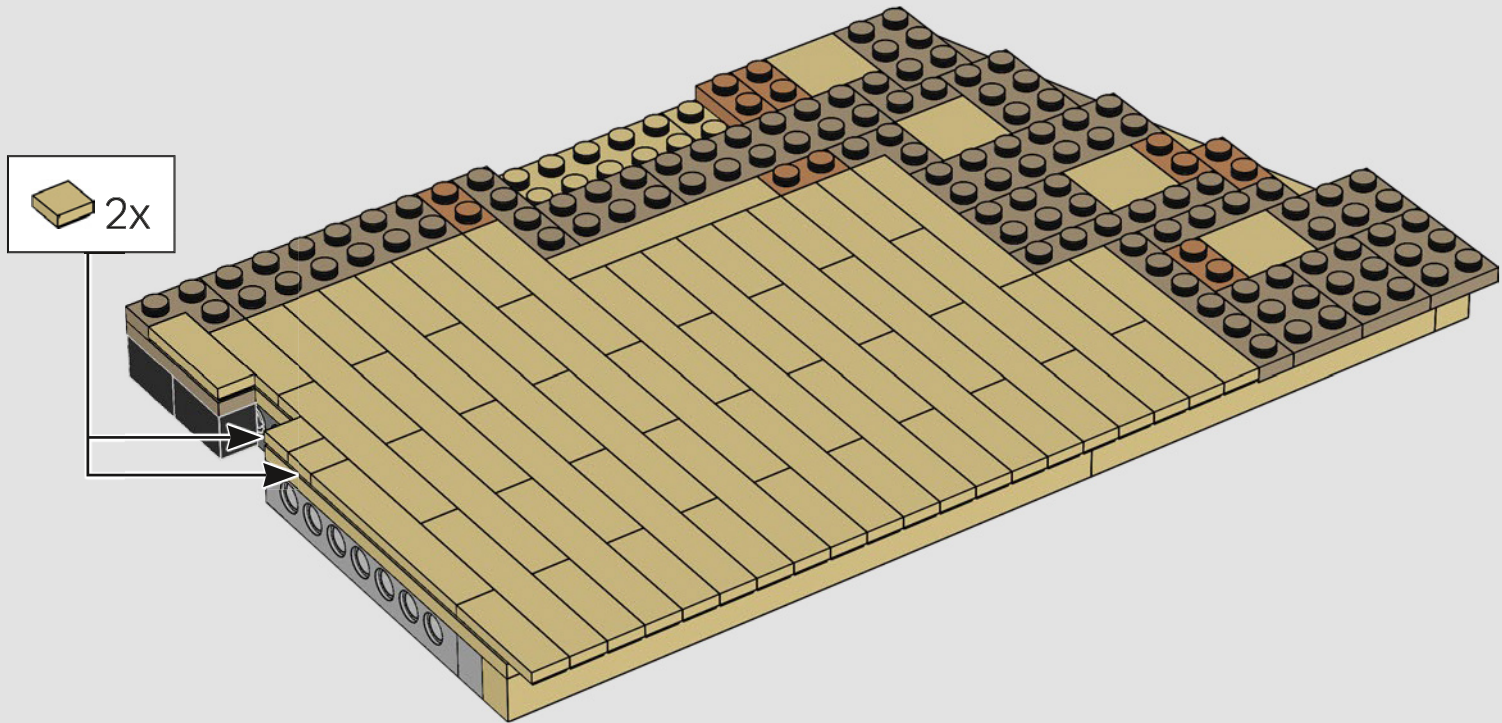

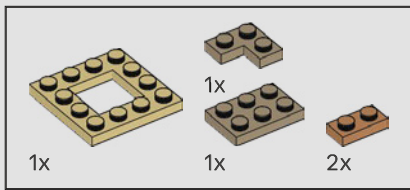

174

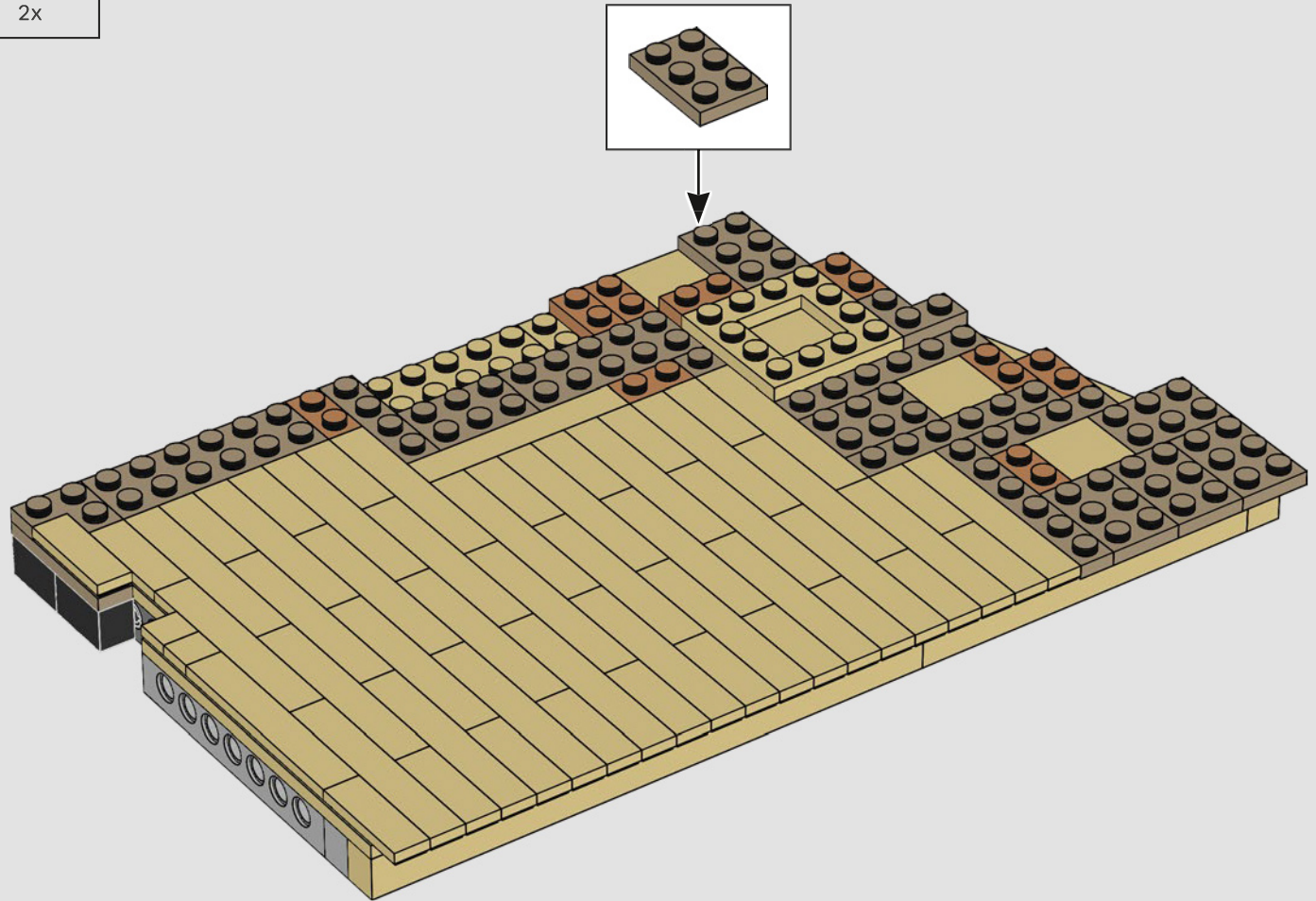

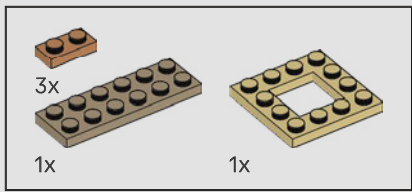

175

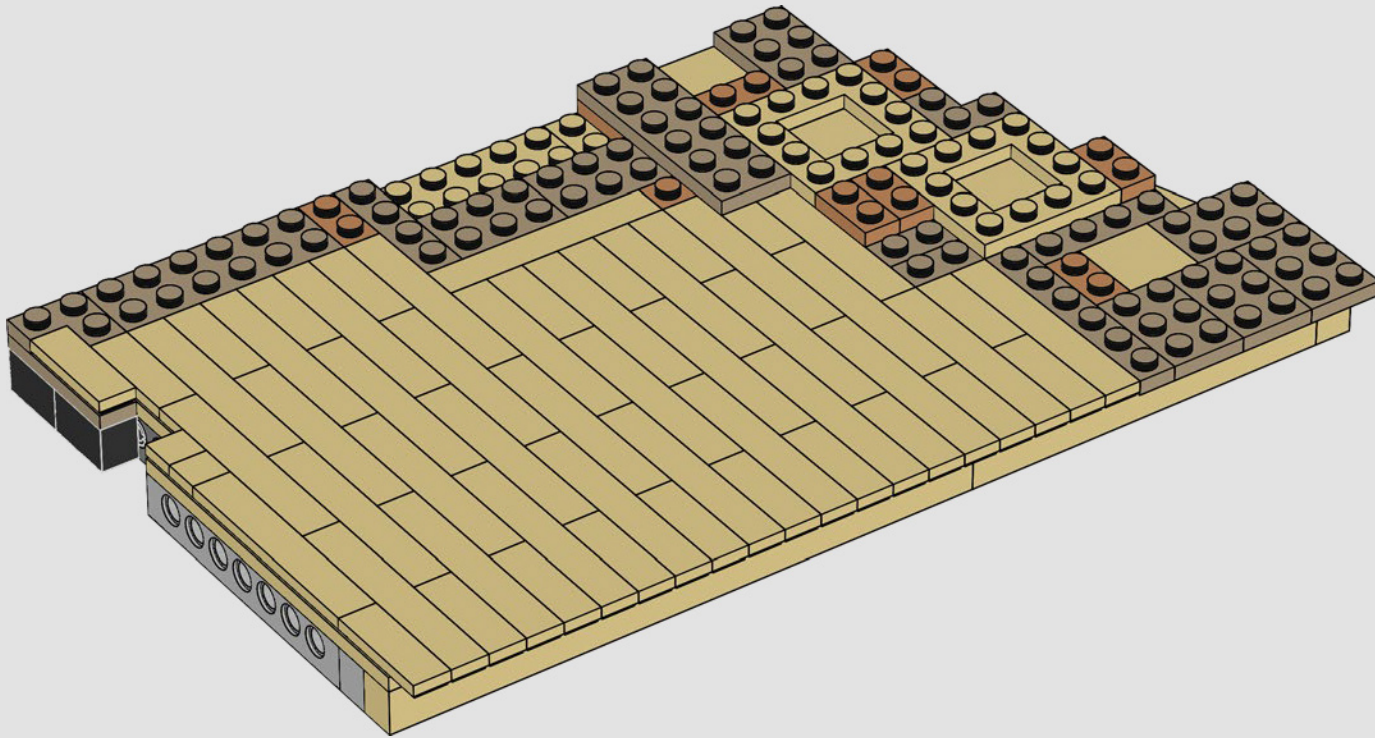

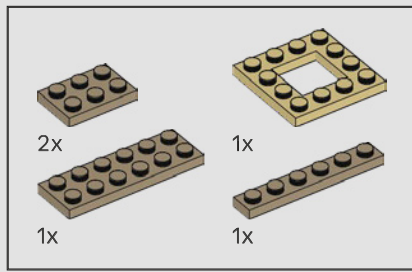

176

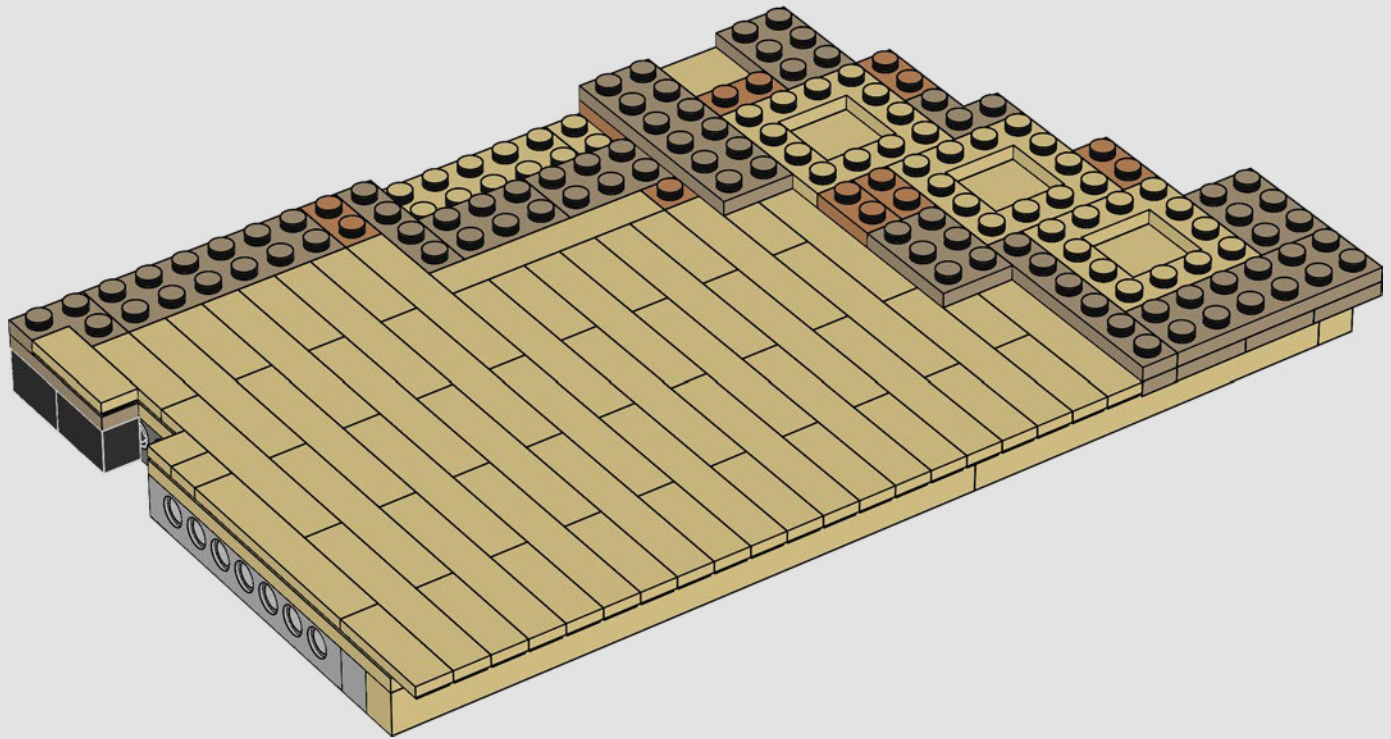

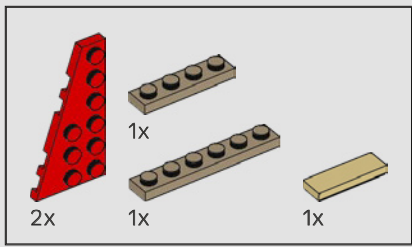

177

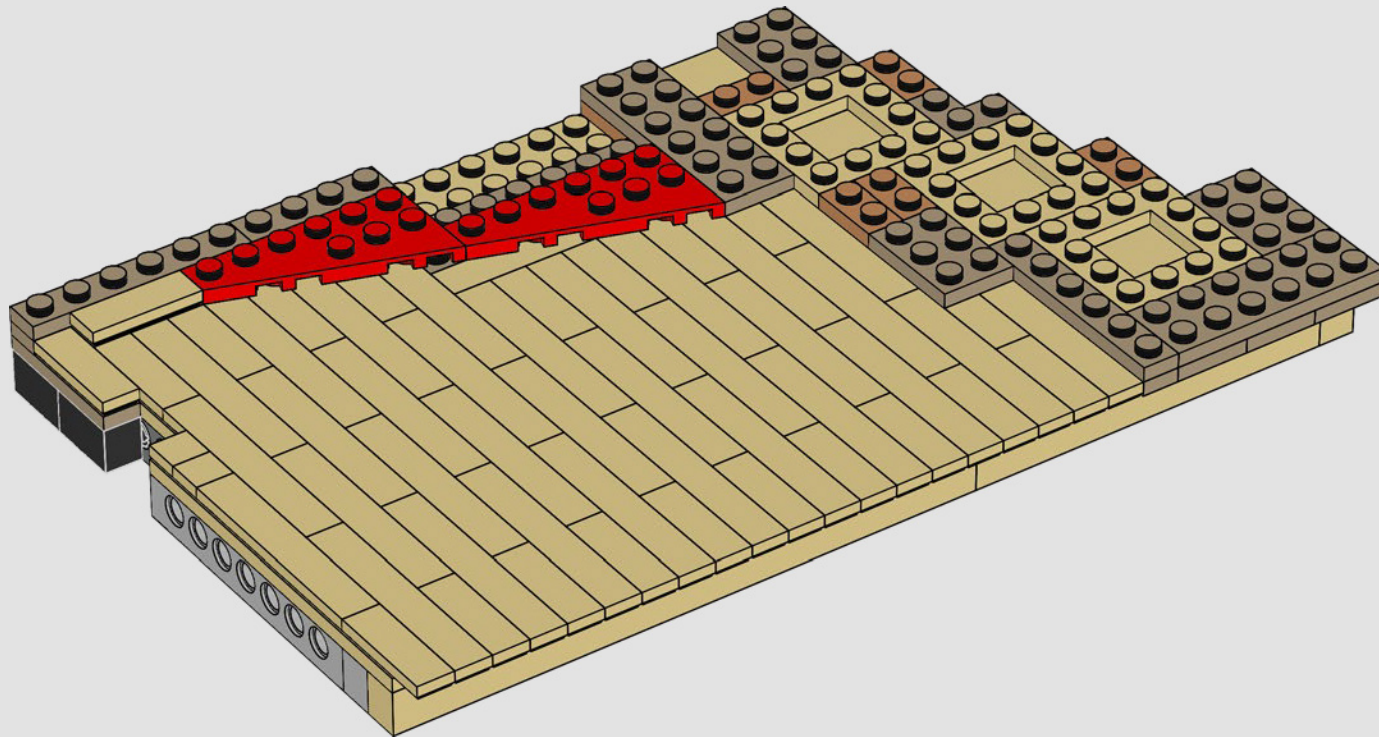

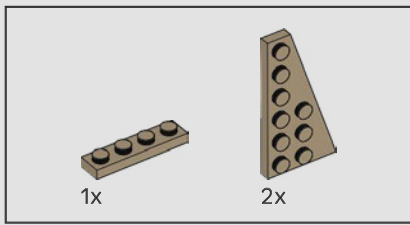

178

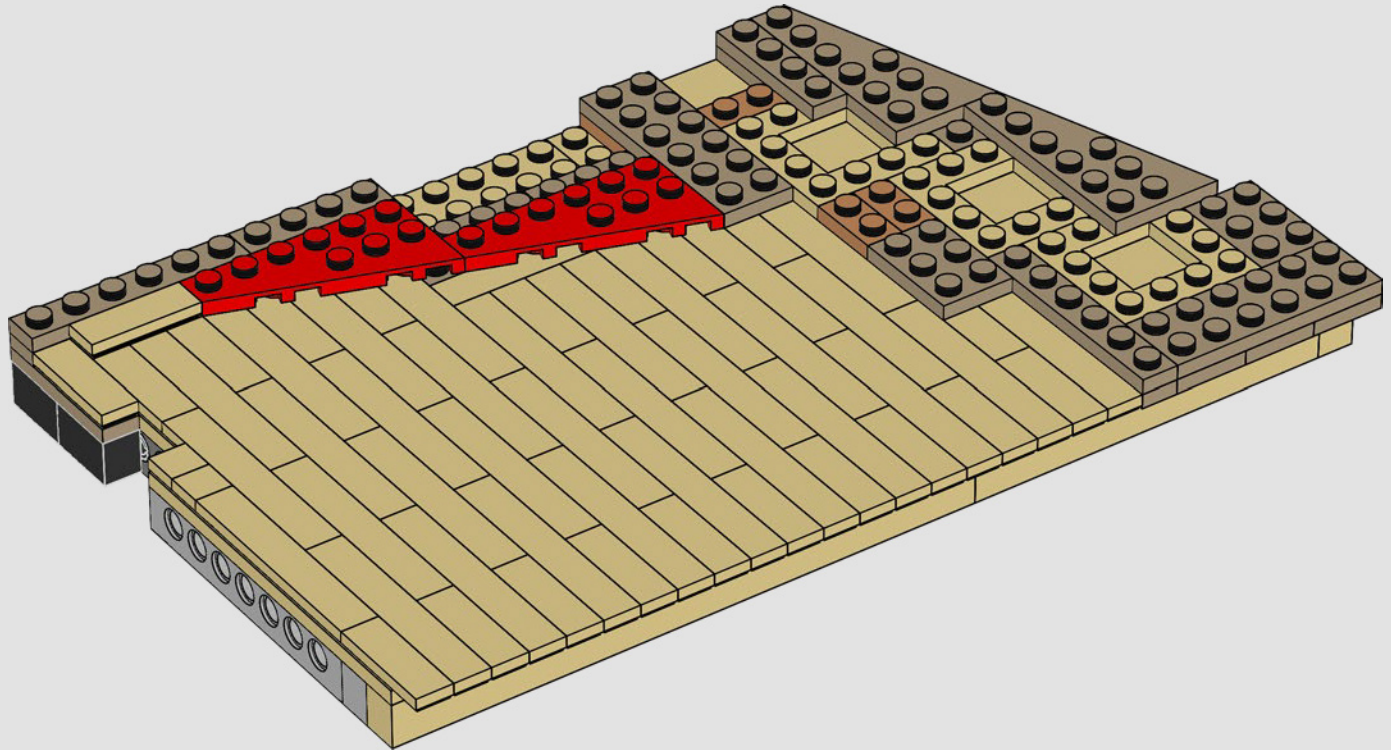

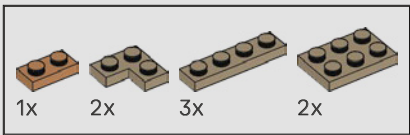

179

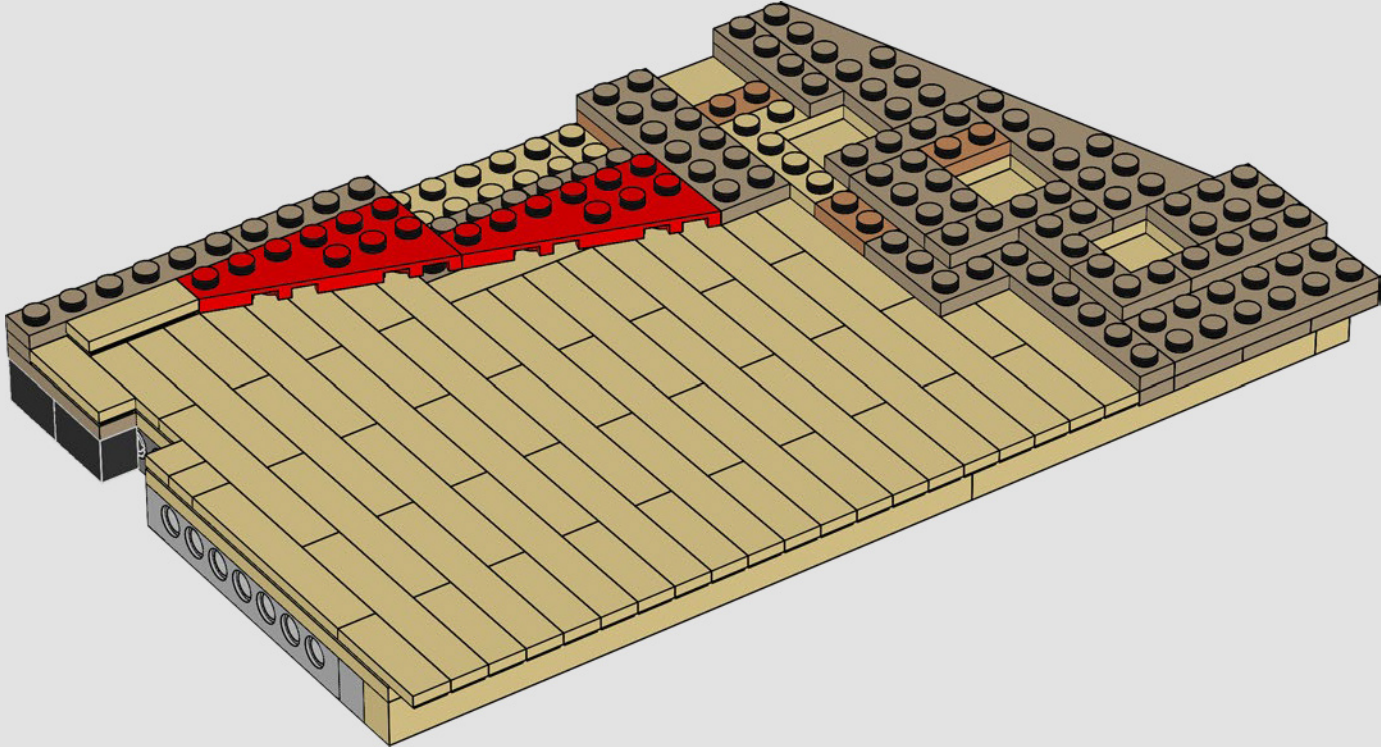

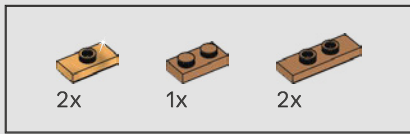

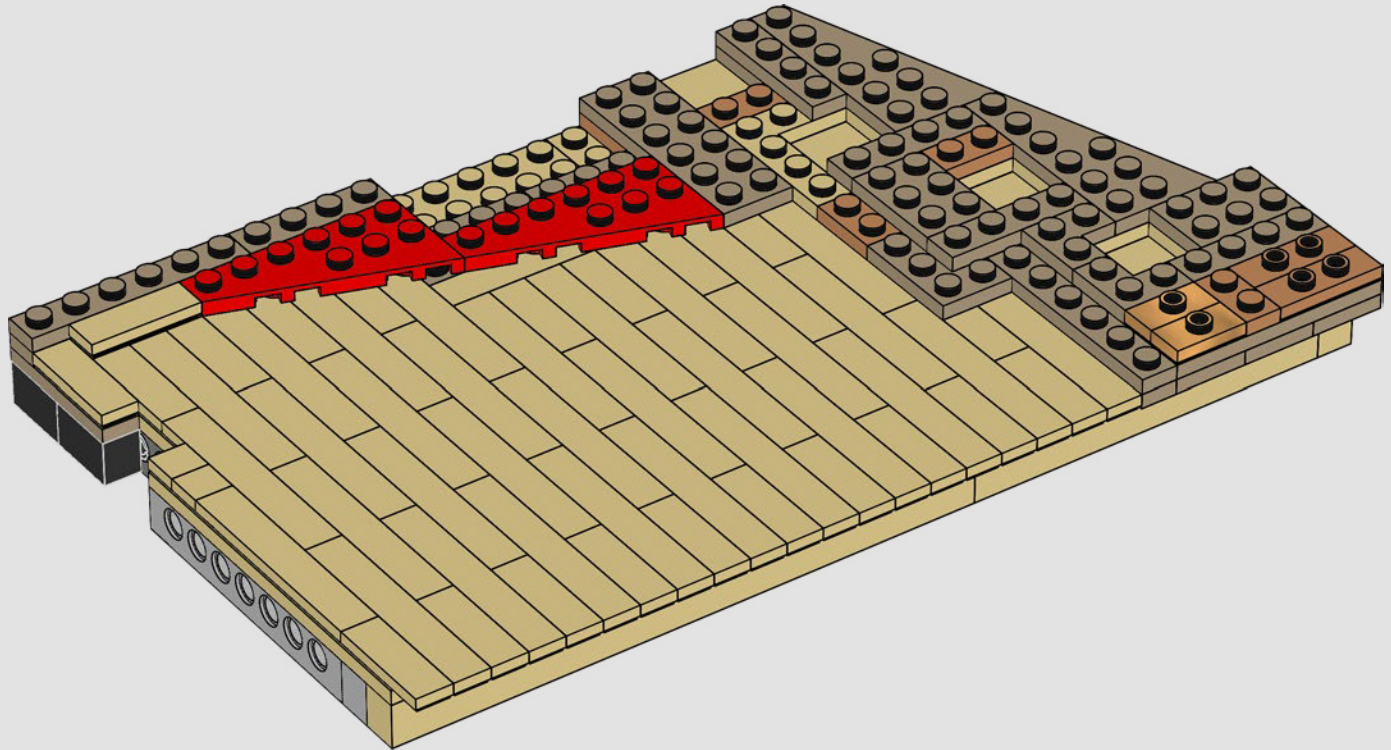

180

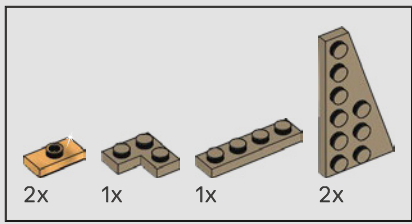

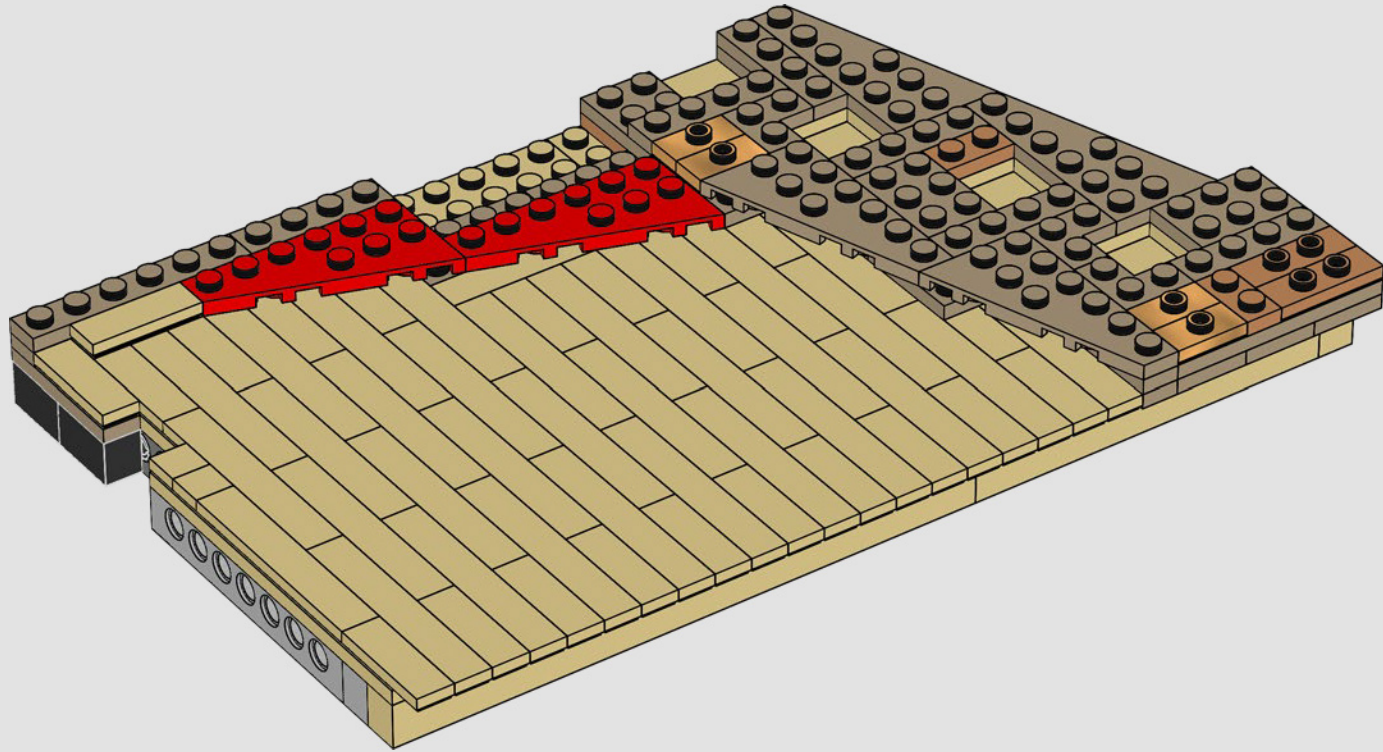

181



 4x	 21x
--	---

183

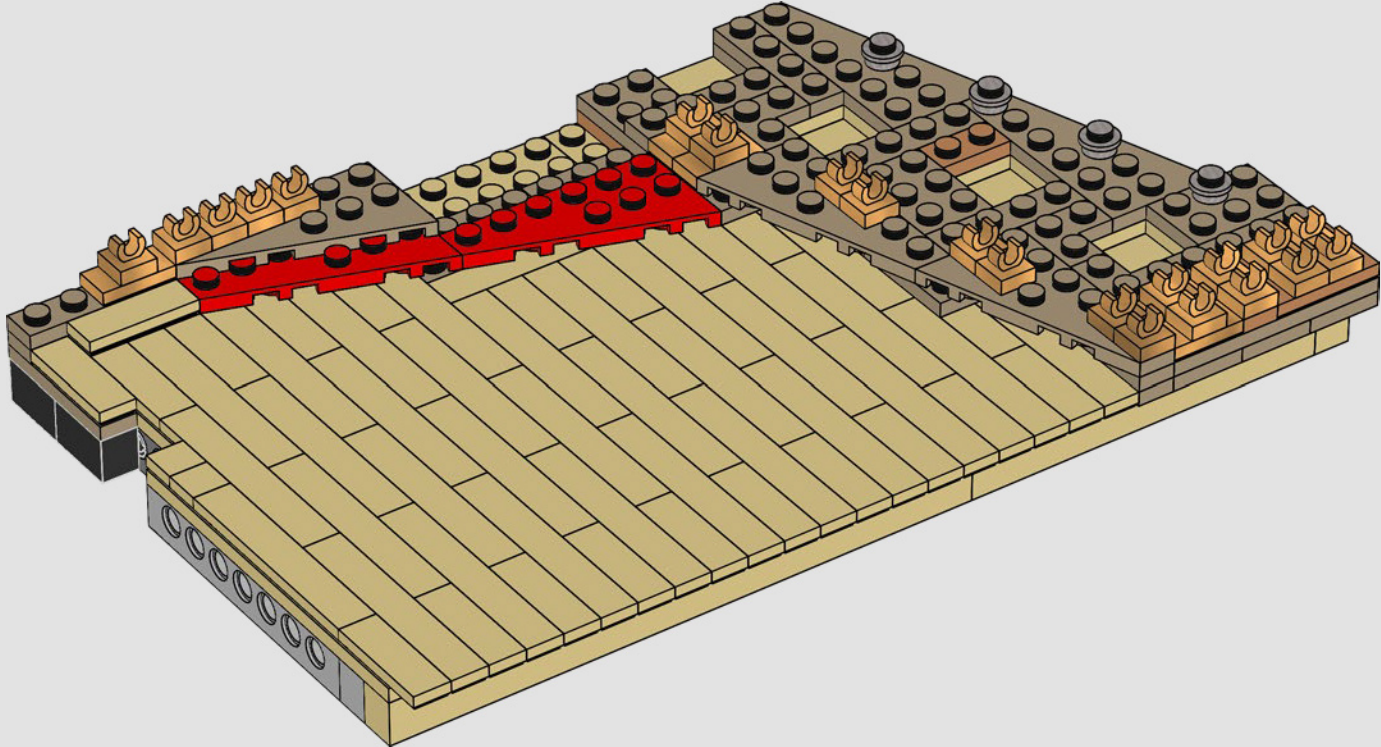

184

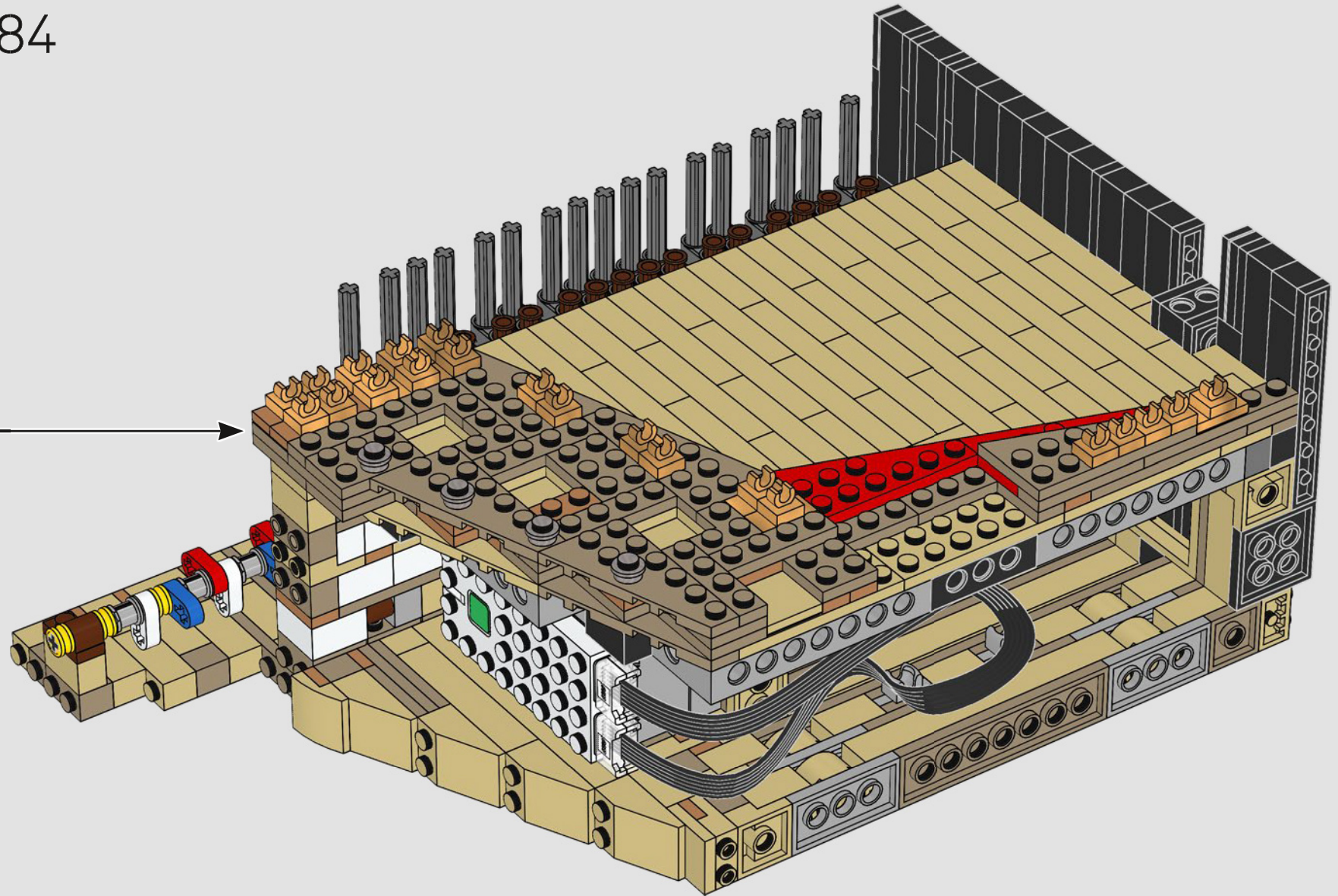

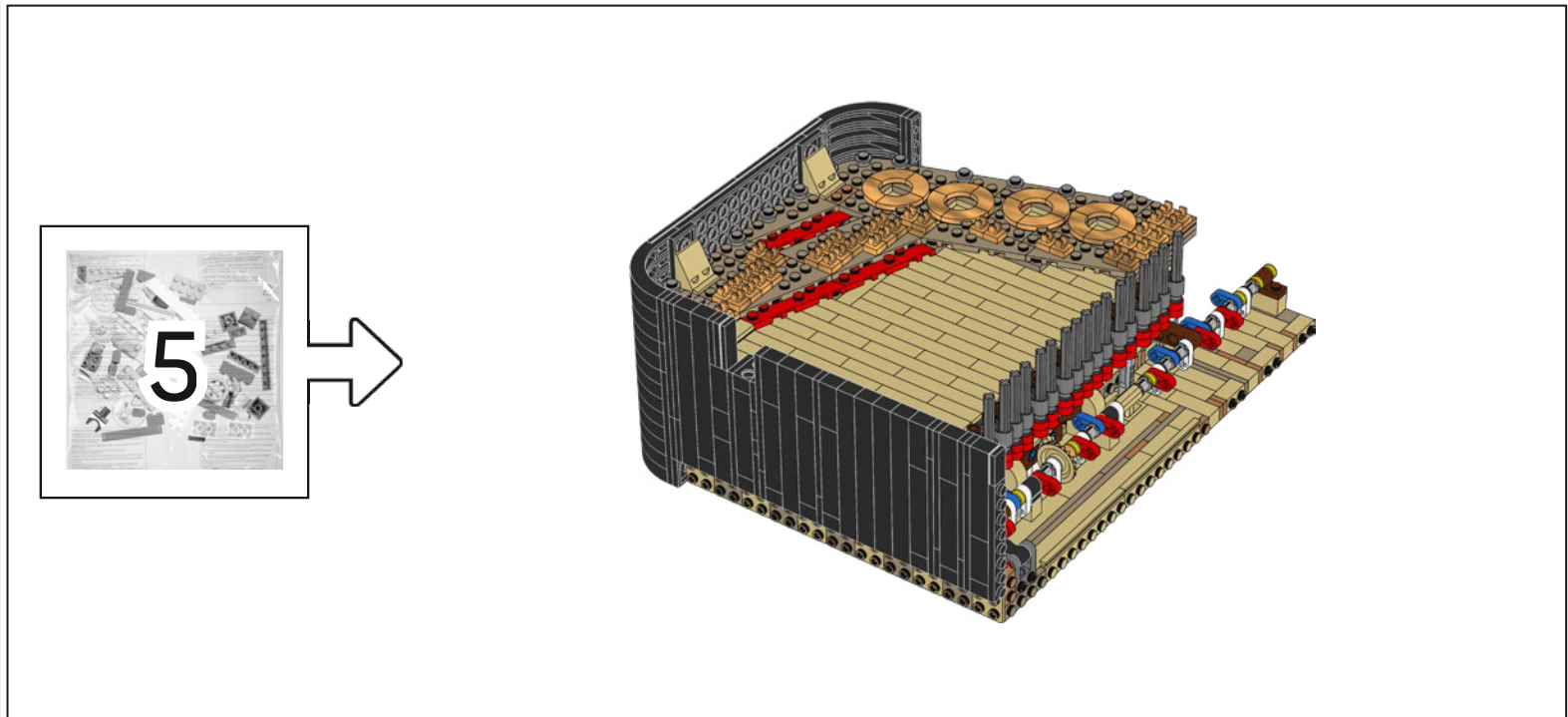

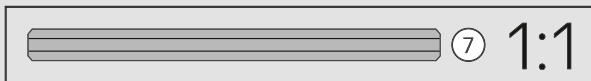
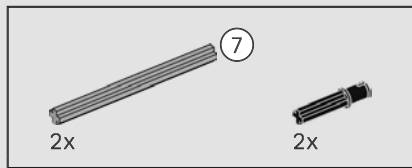

185

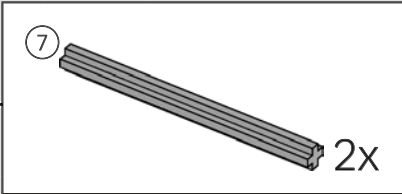
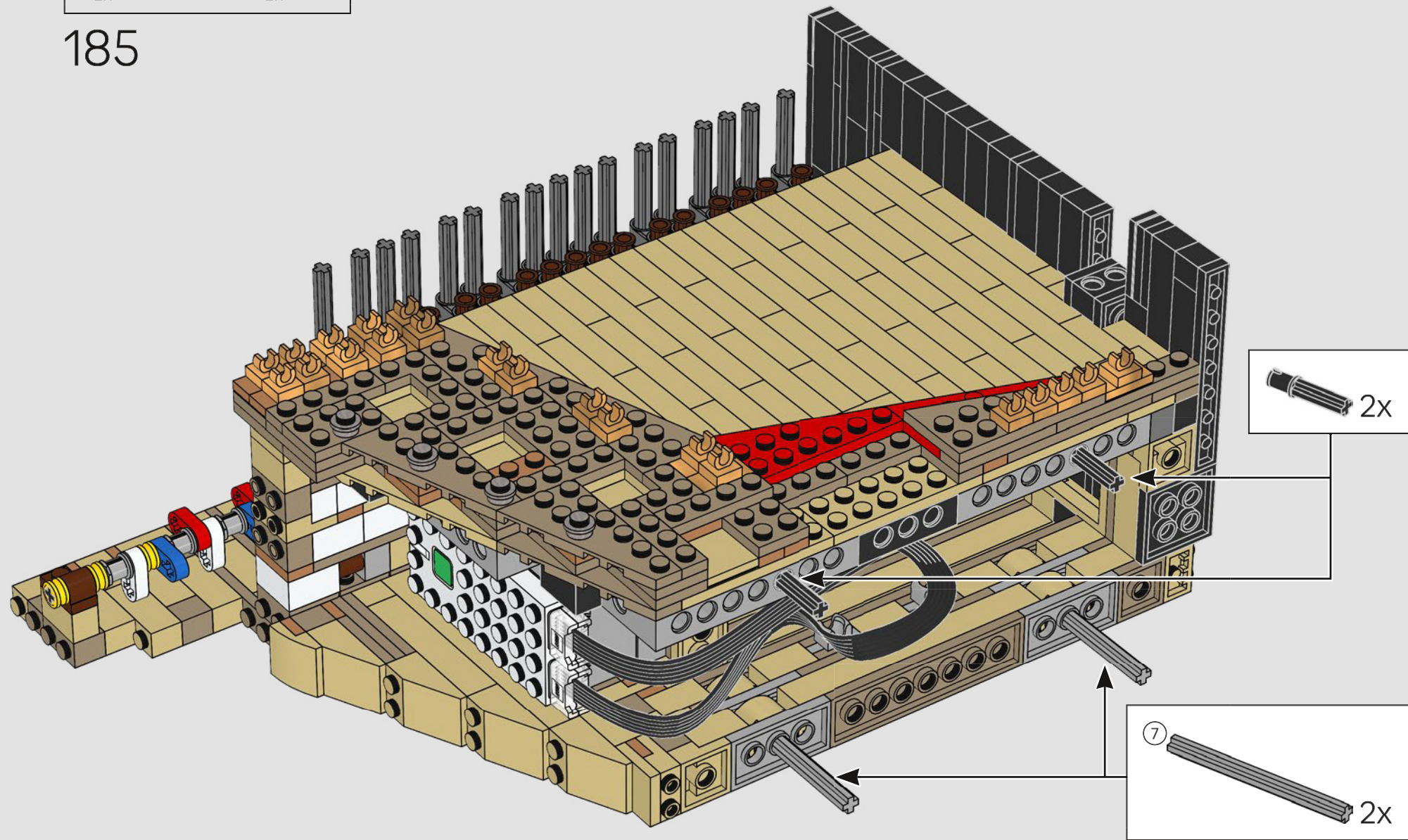

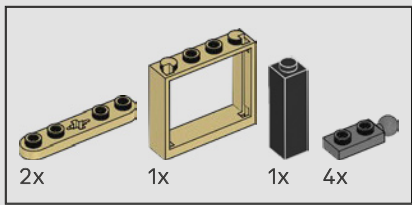

186

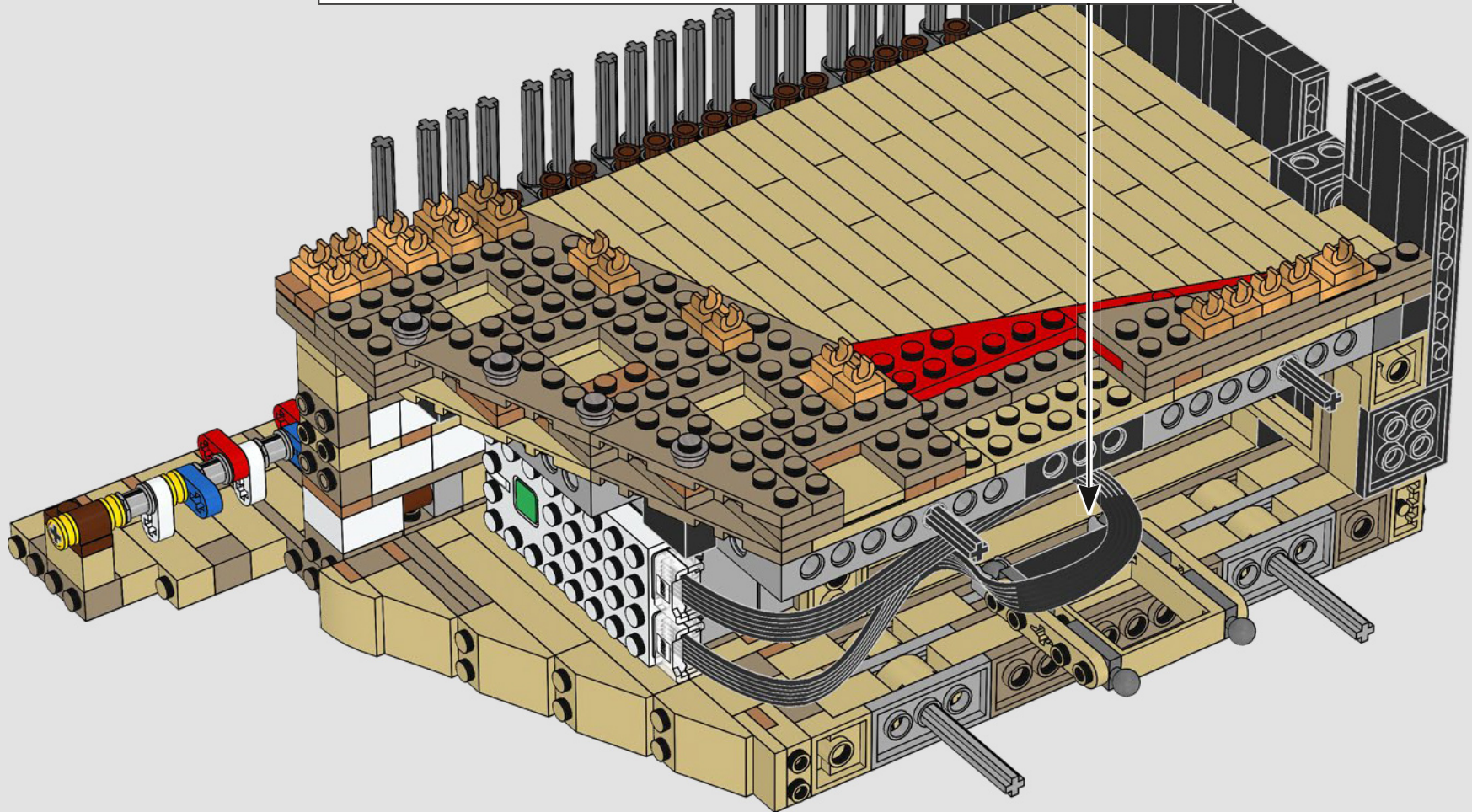
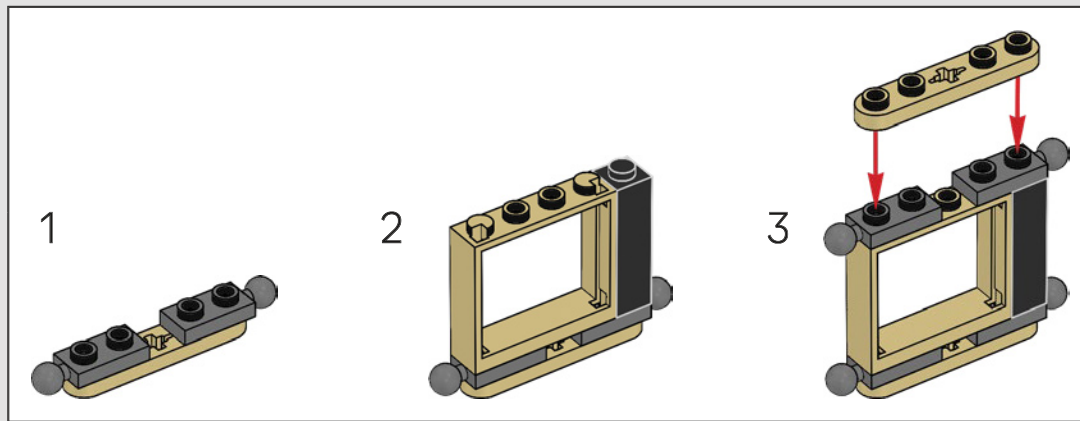

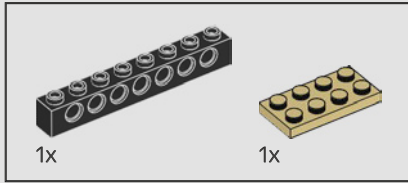
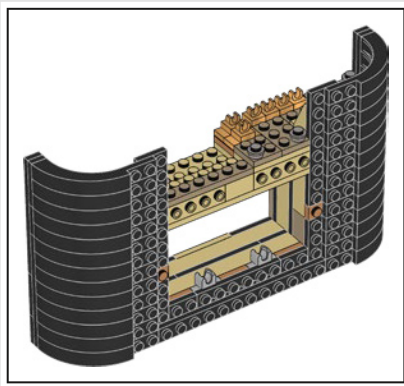

187

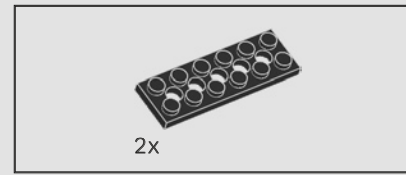
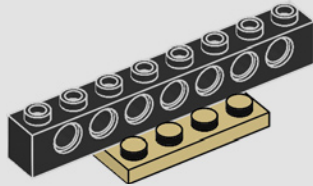

188

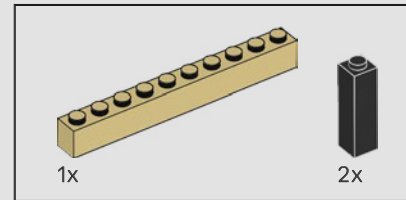
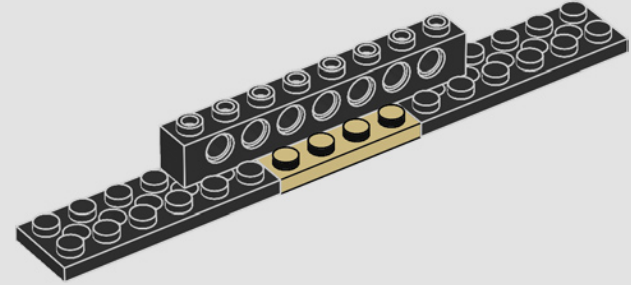

189

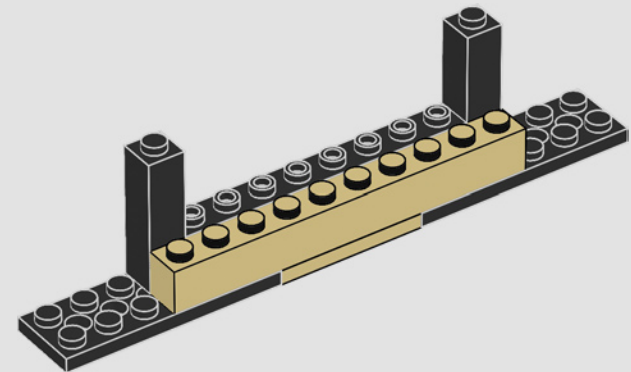

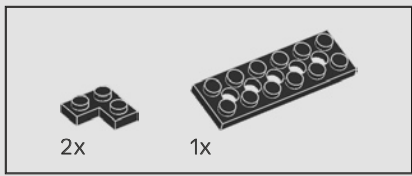

190

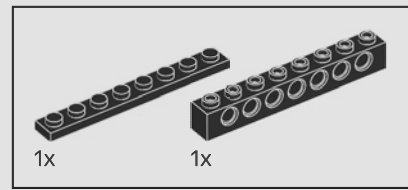
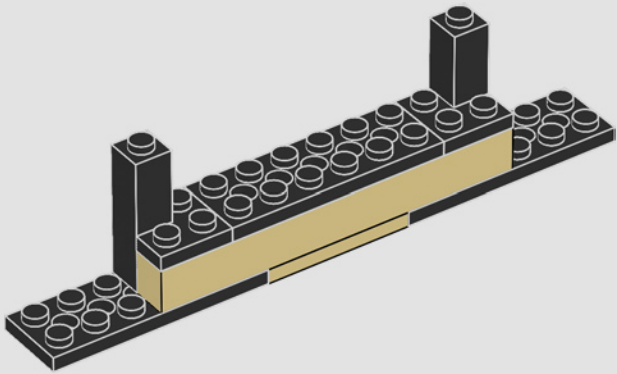

191

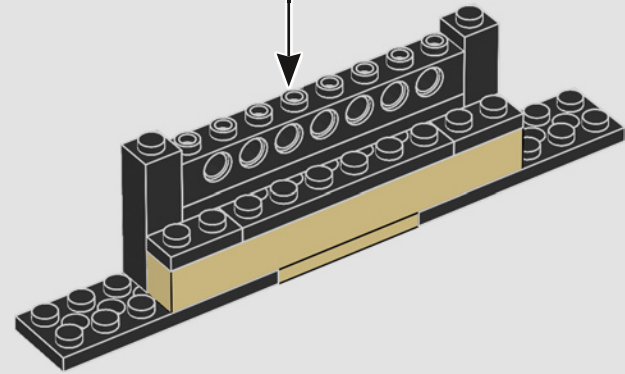
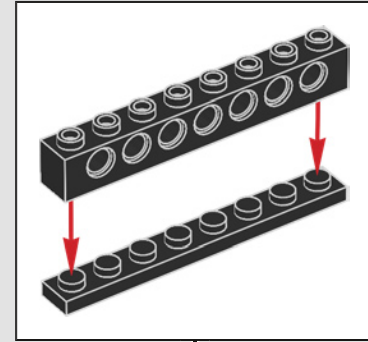

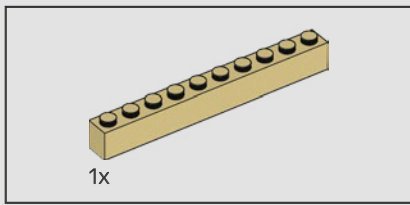

192

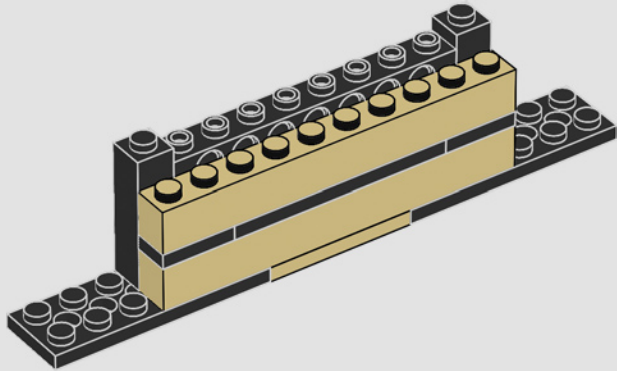

193

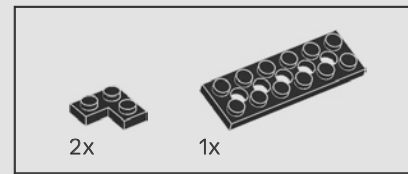
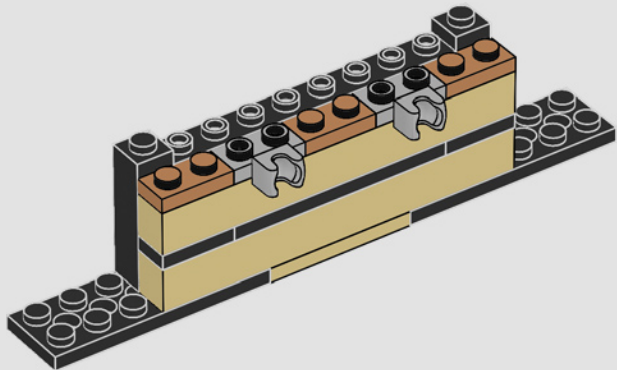

194

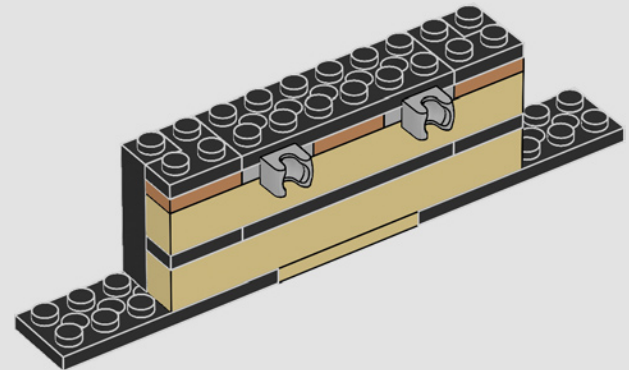

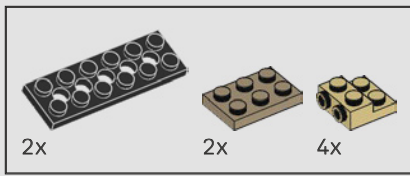

195

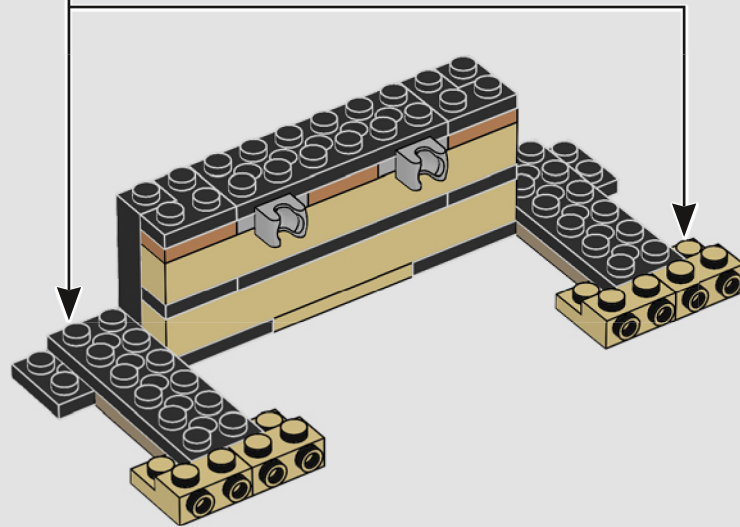
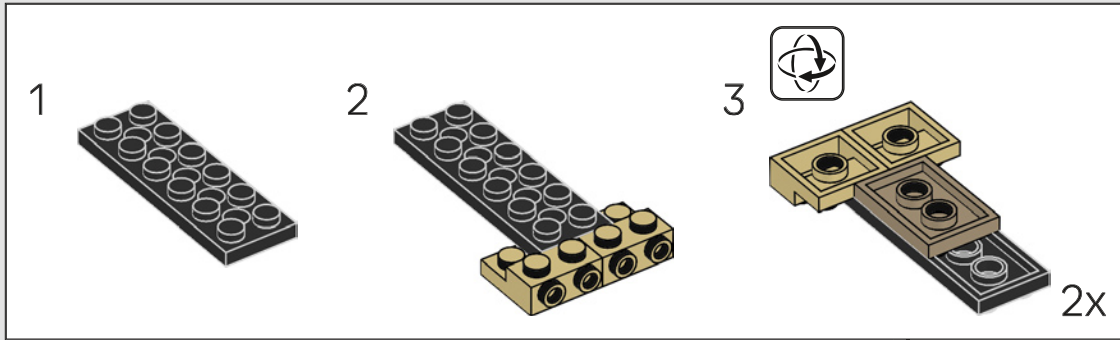

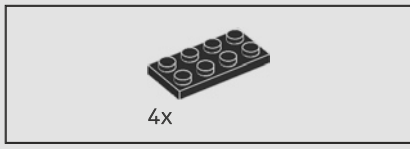

196

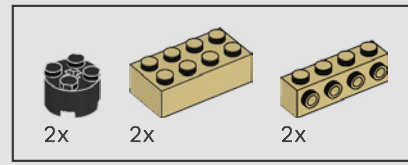
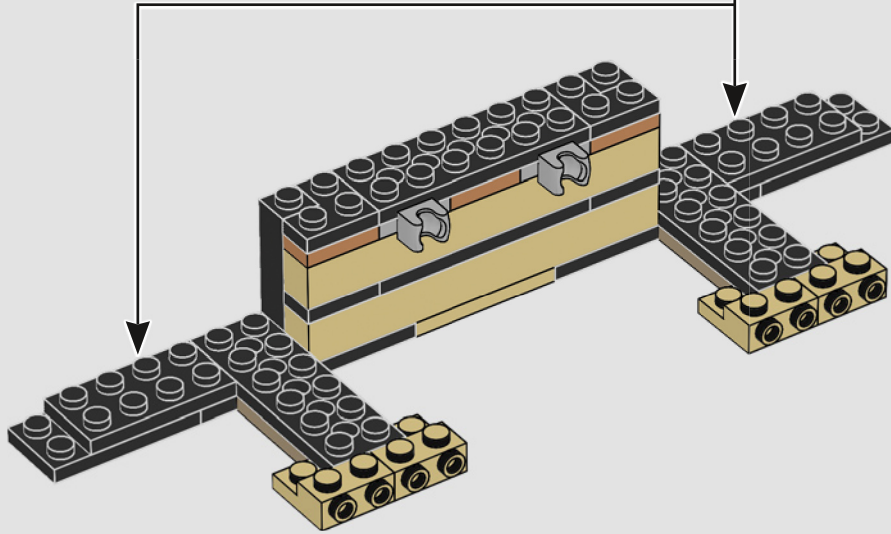
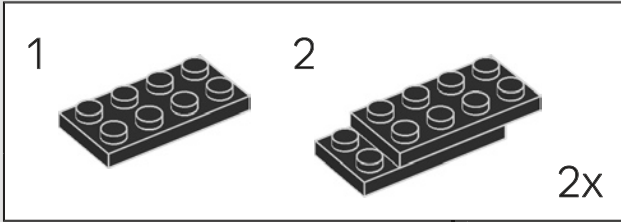

197

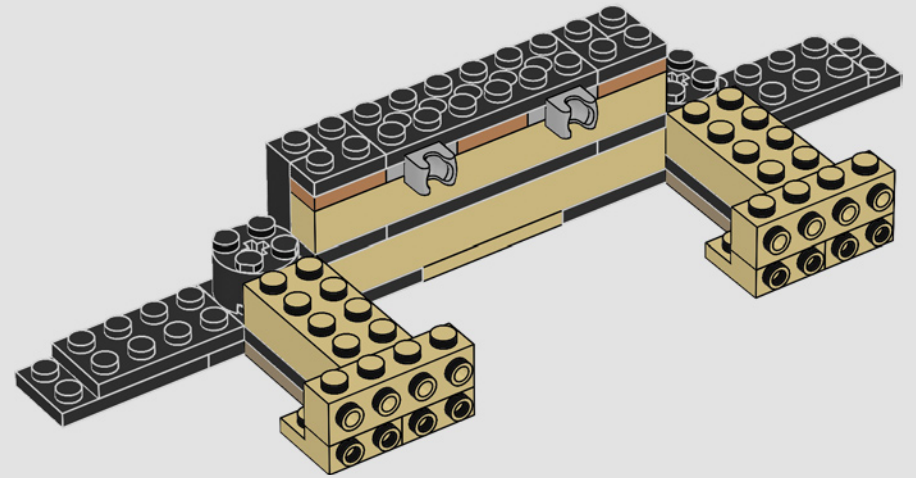

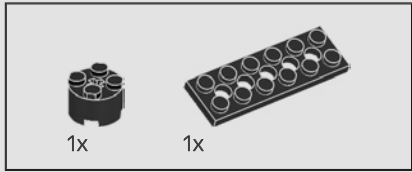
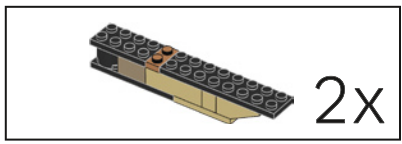

198

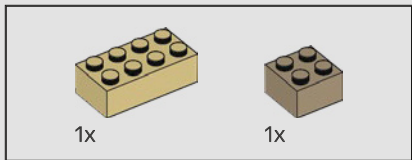
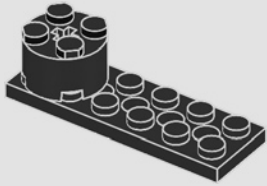

199

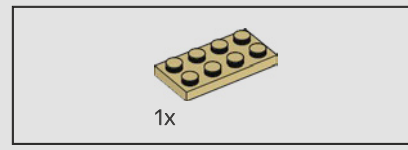
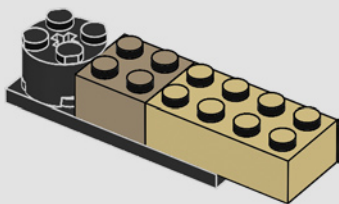

200

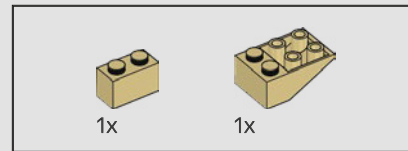
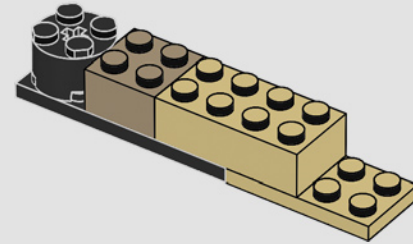

201

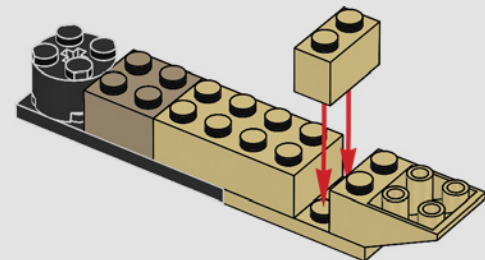

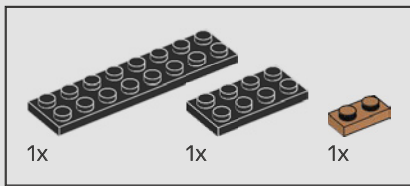

202

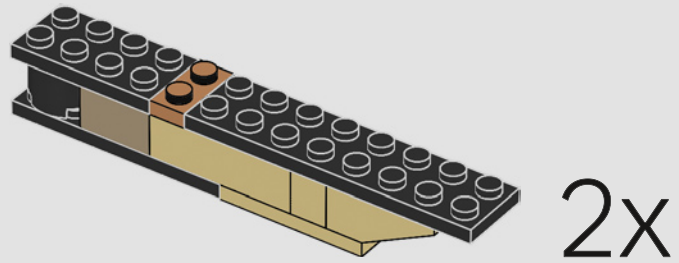

203

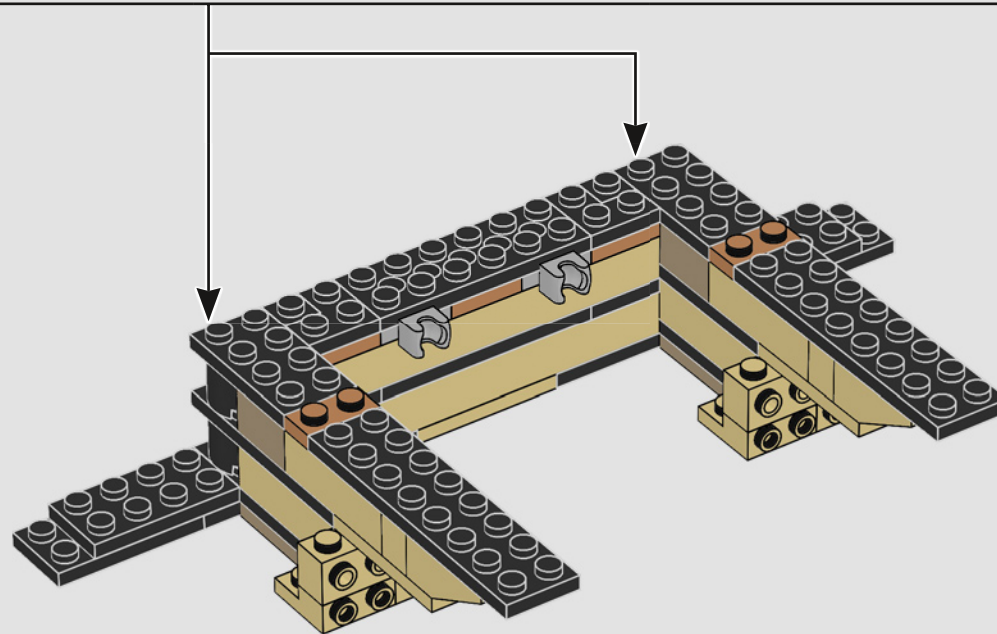

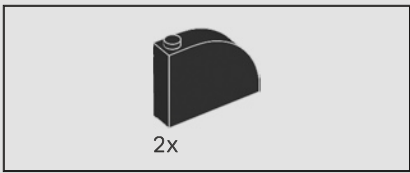

204

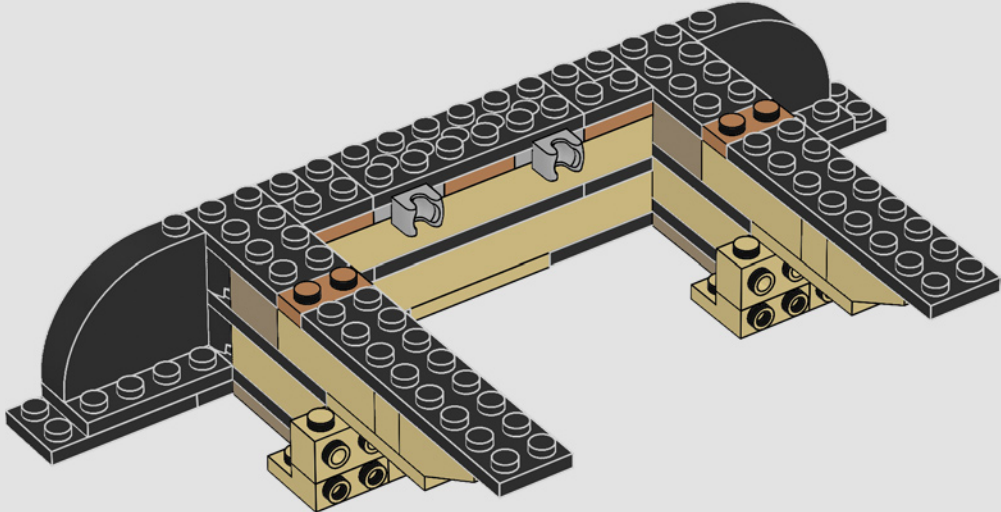

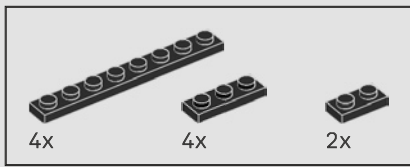

205

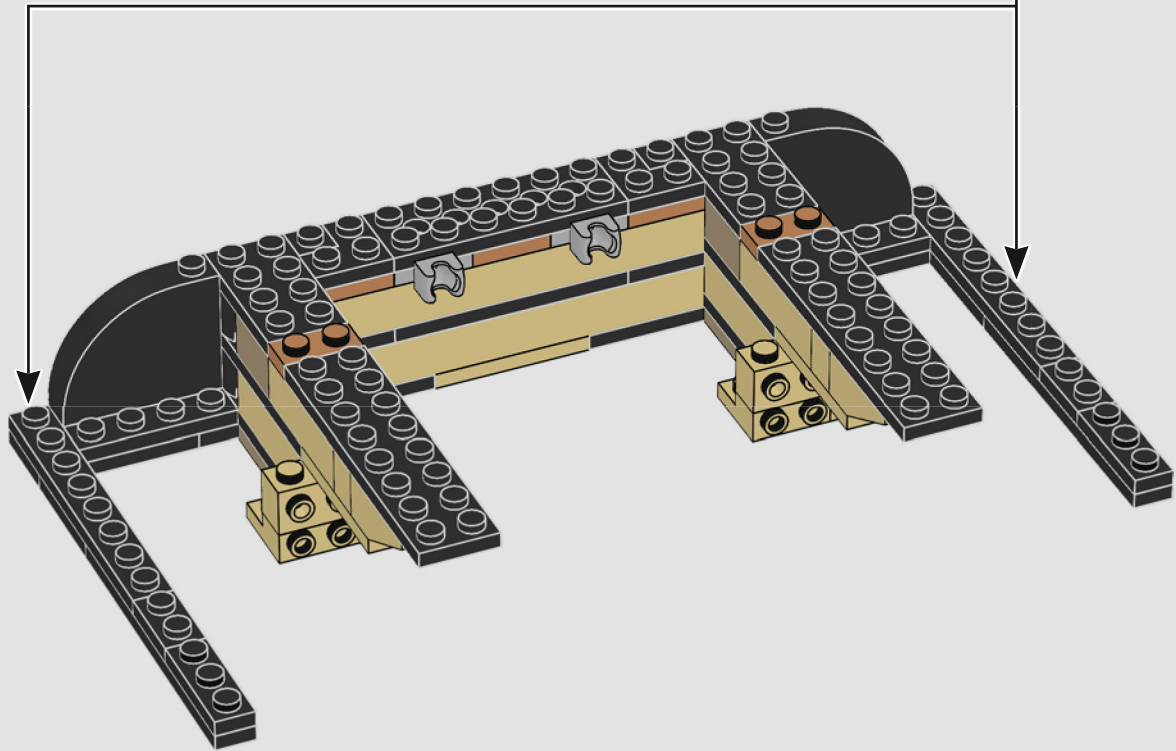
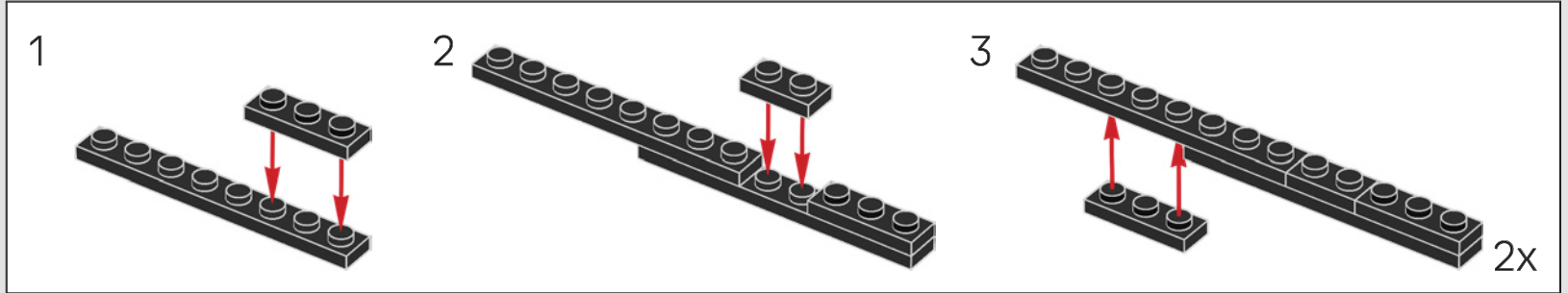

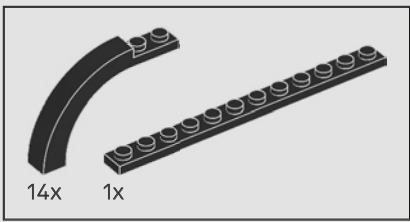

206

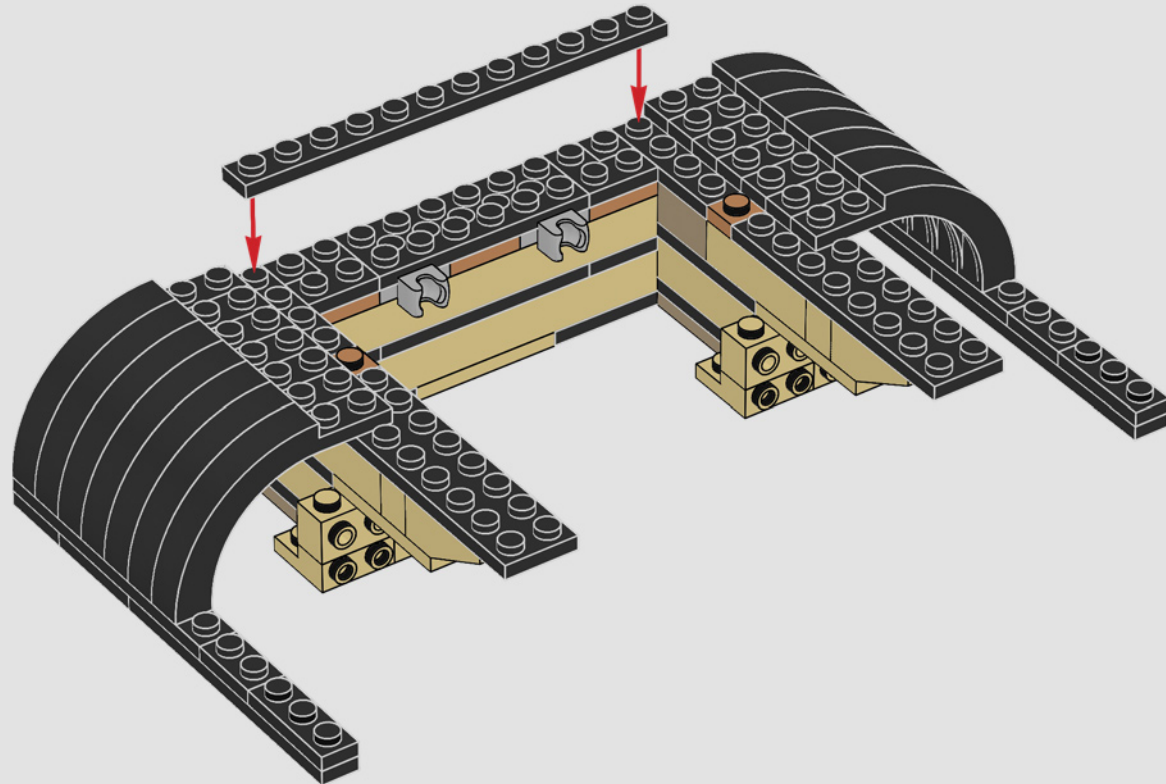

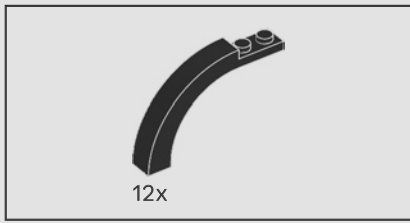

207

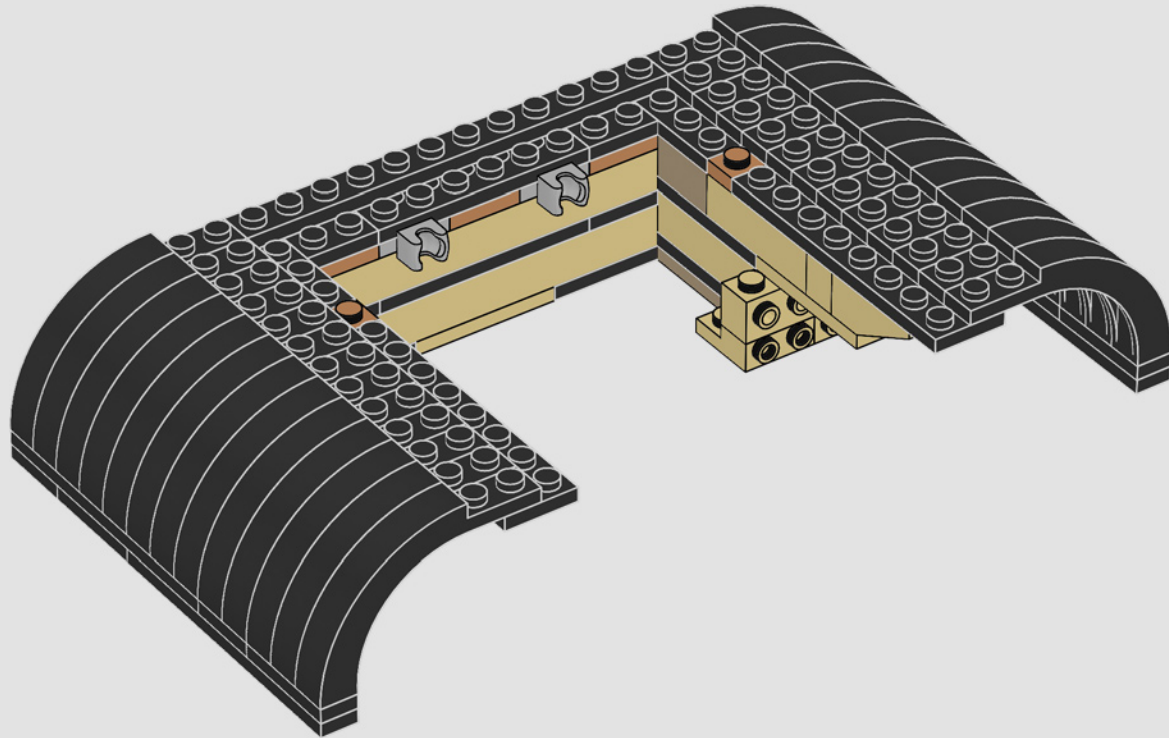

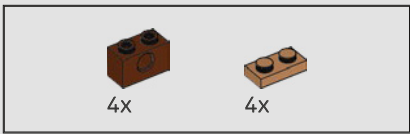

208

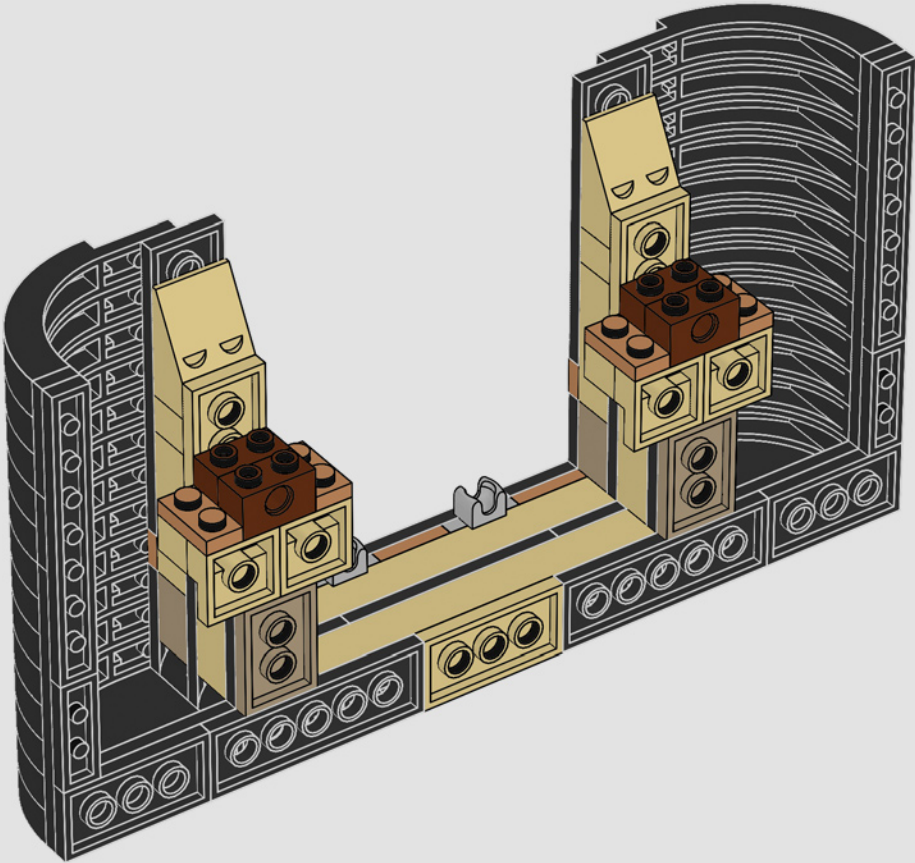

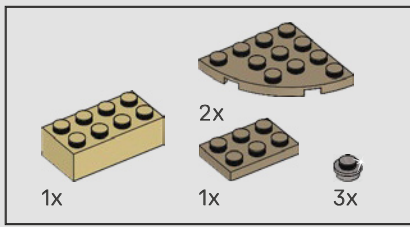

209

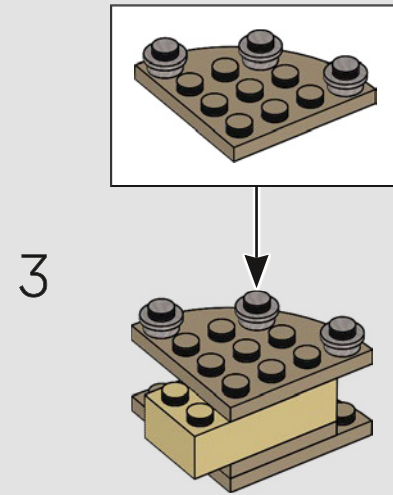
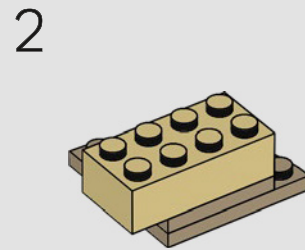
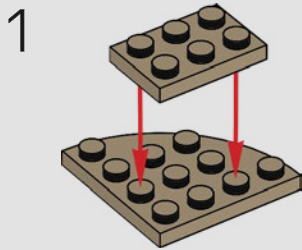

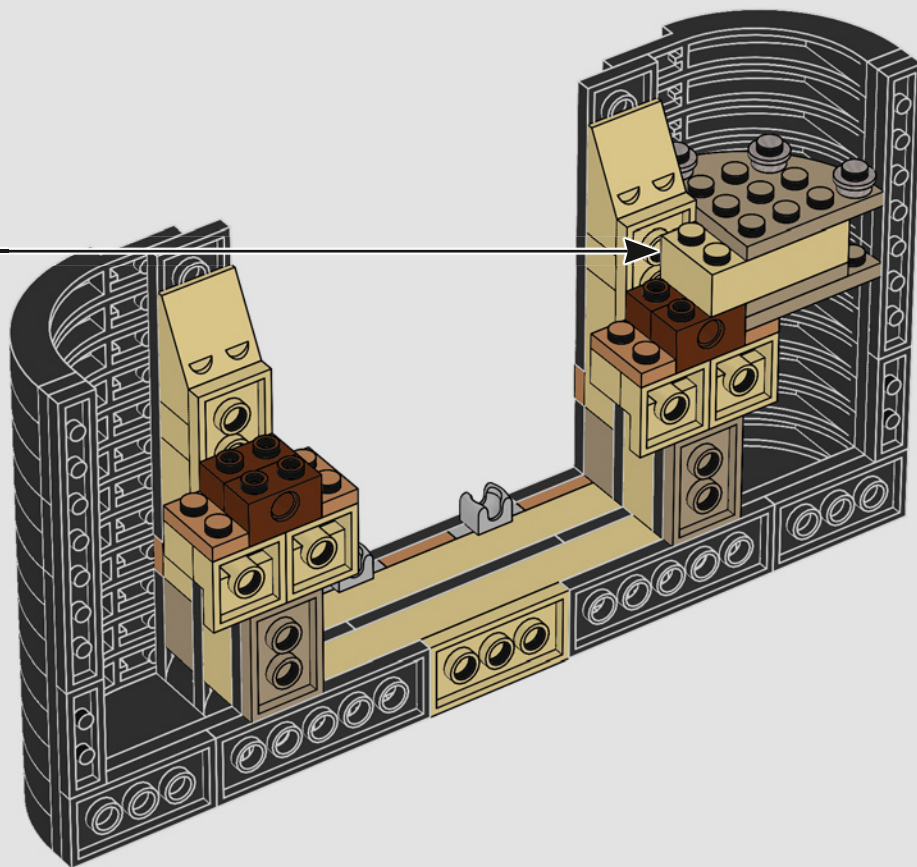

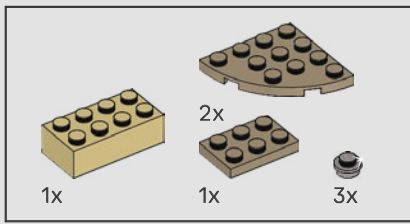

210

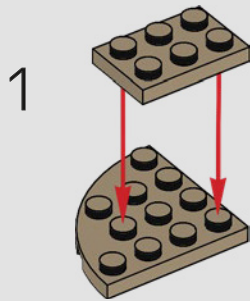

2

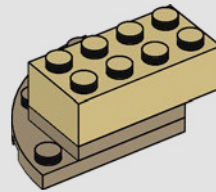

3

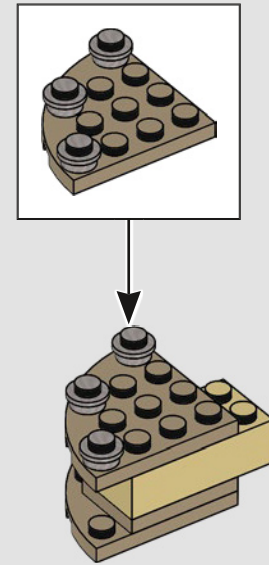

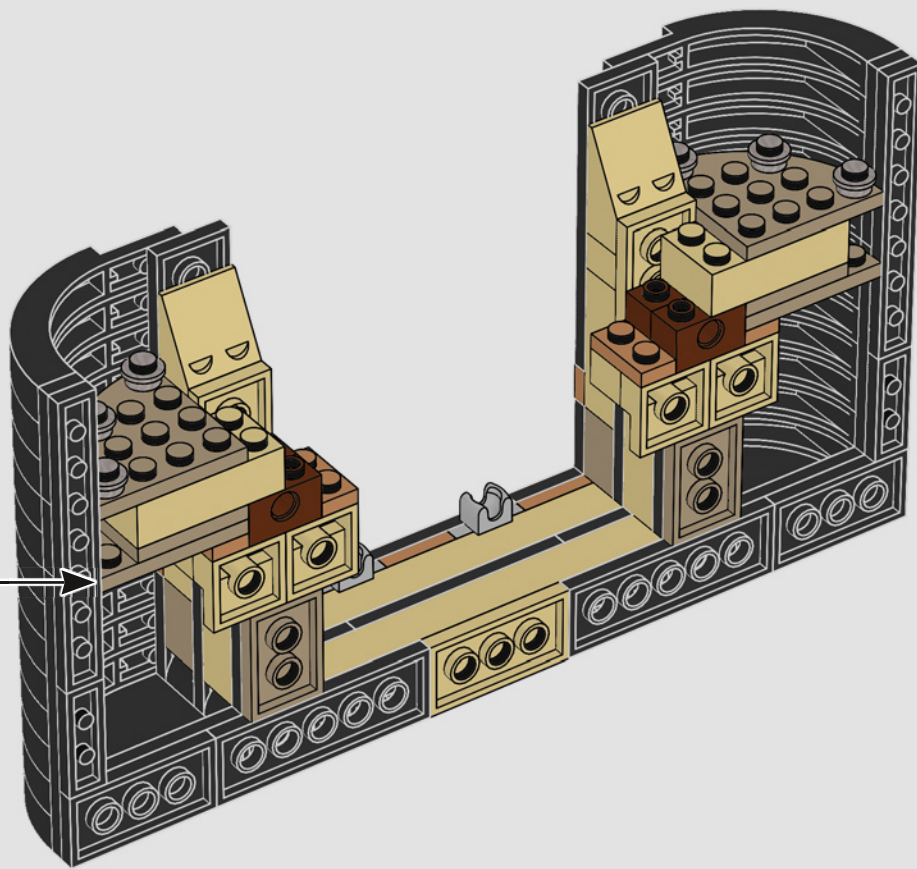

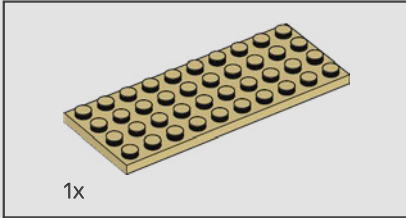
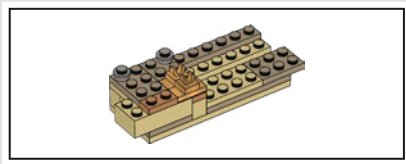

1x

211

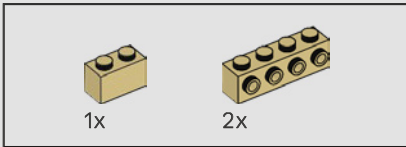
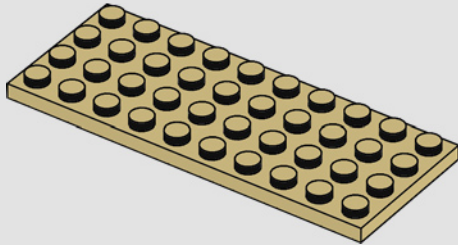

1x

2x

212

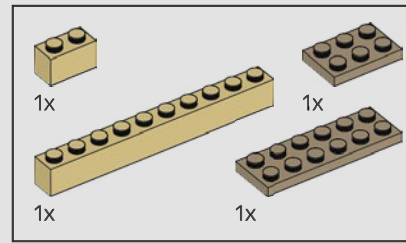
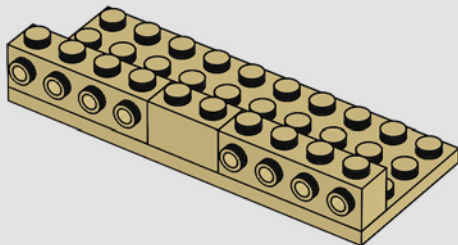

1x

1x

213

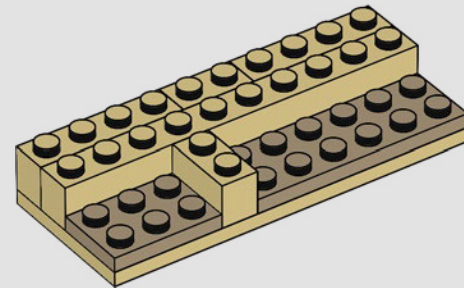

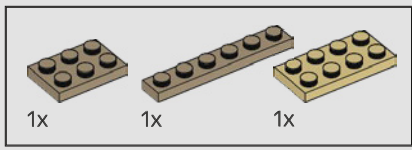

214

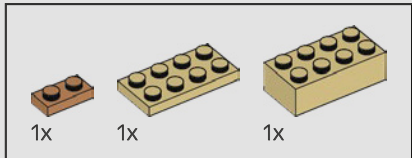
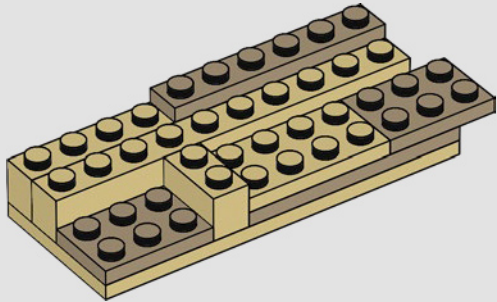

215

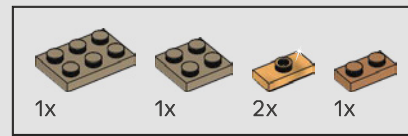
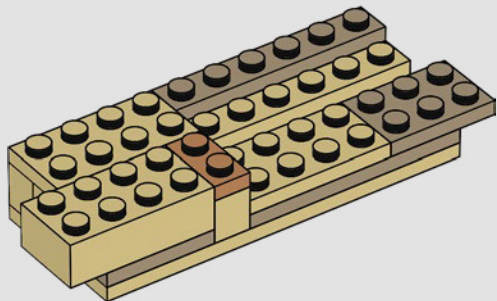

216

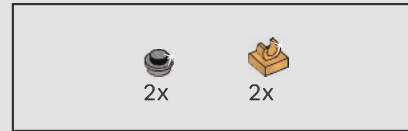
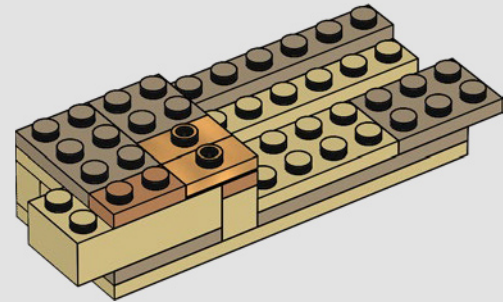

217

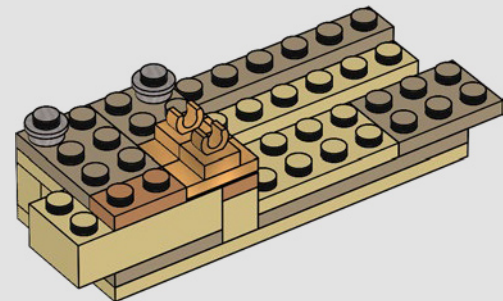

218

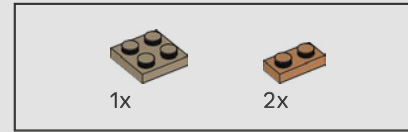
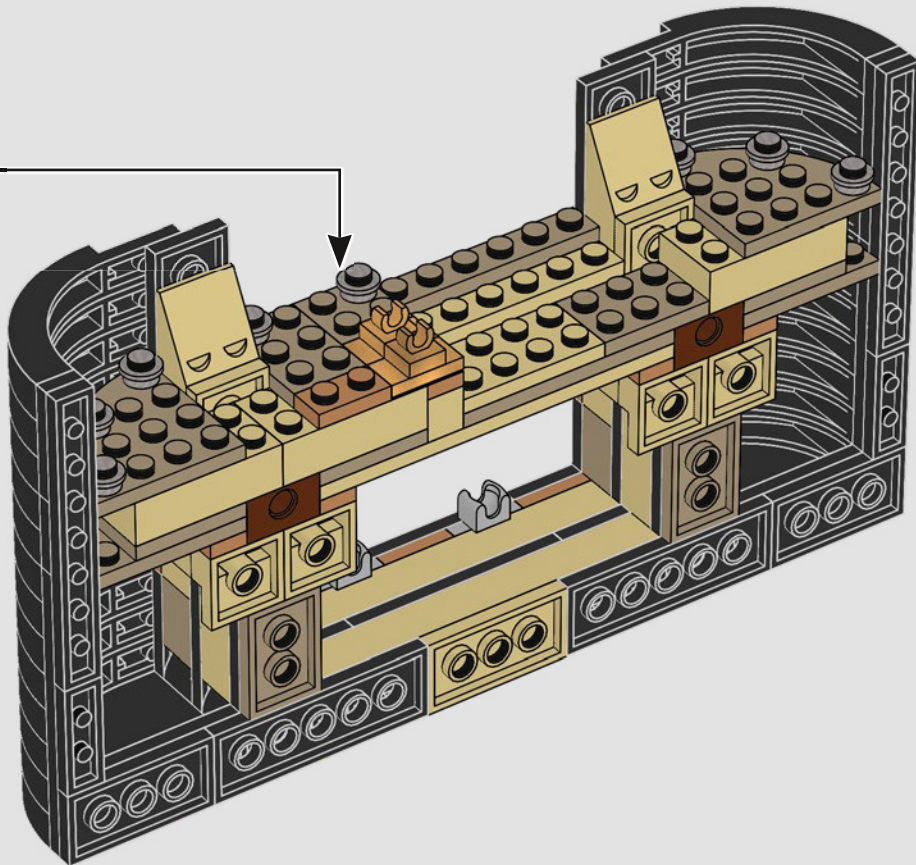

219

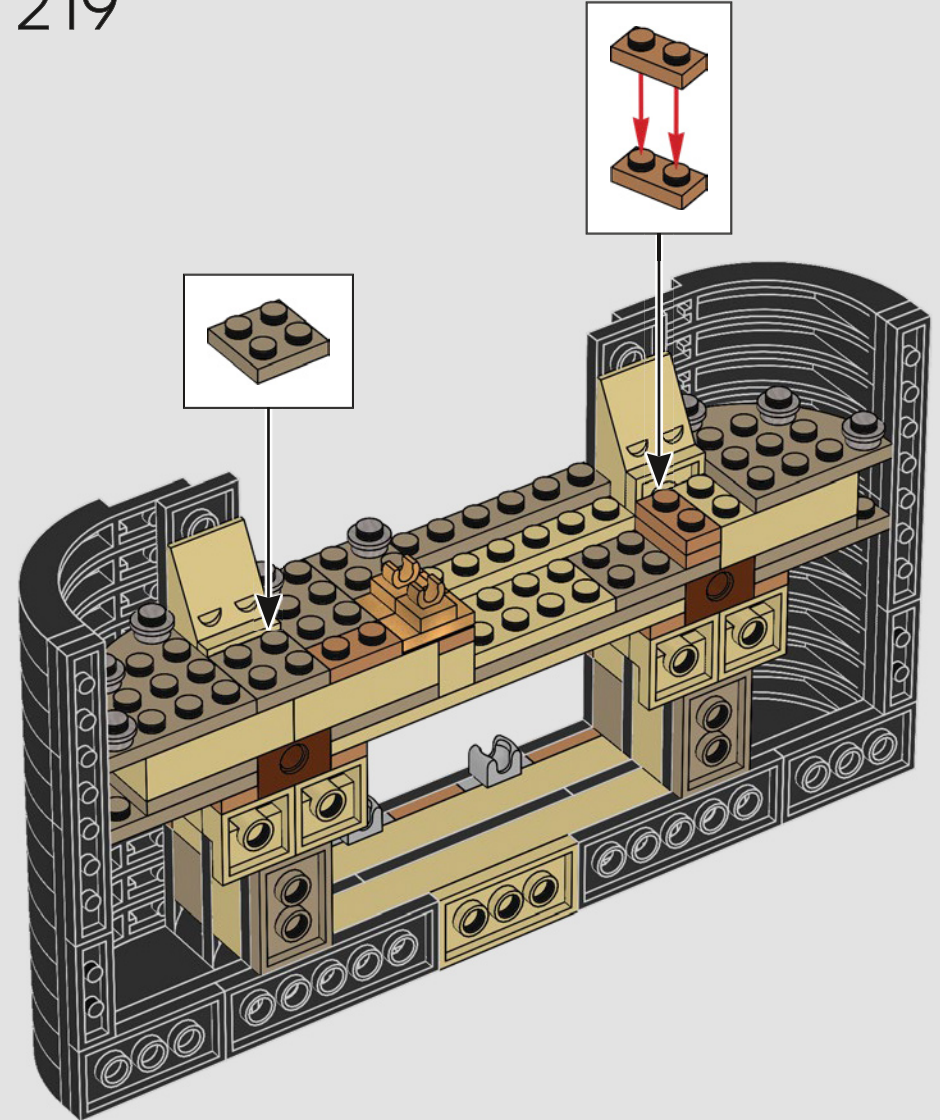



4x

220

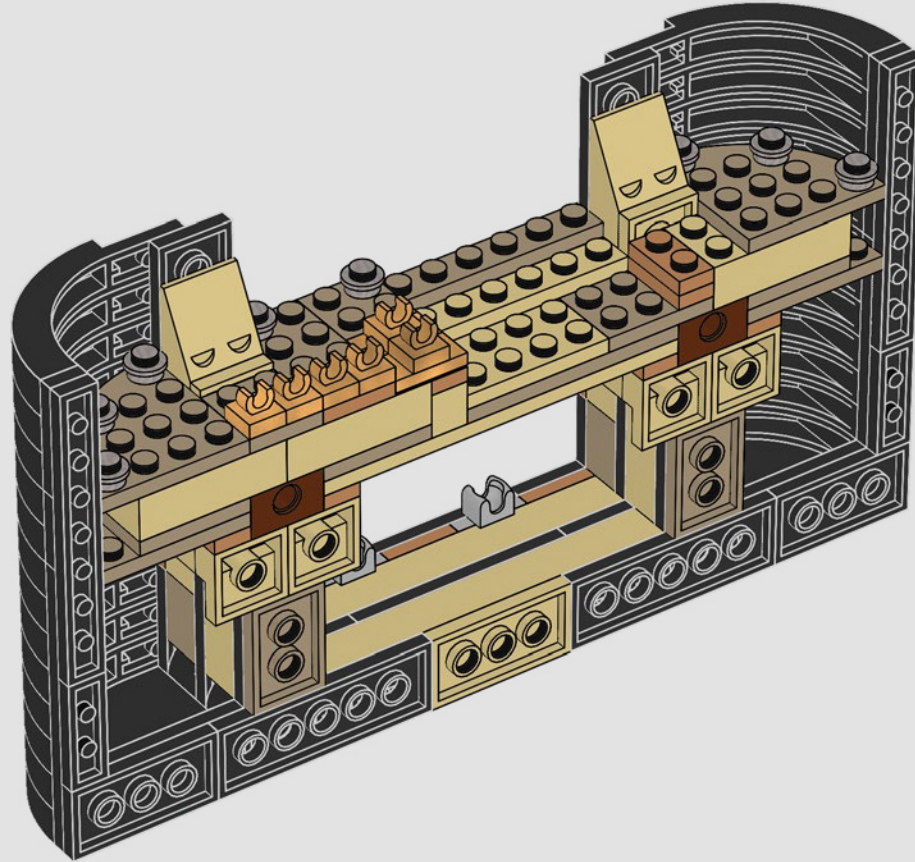

221

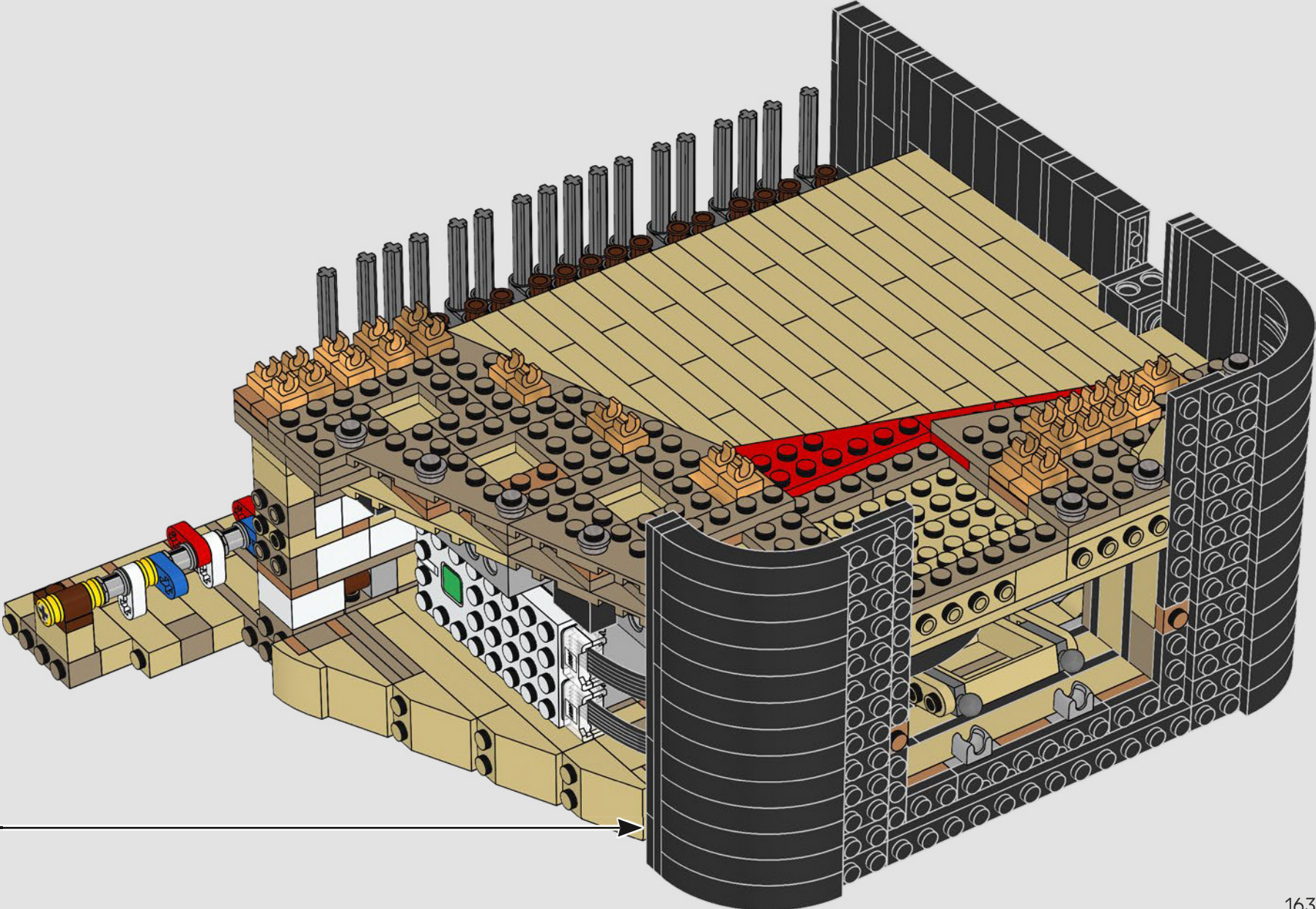

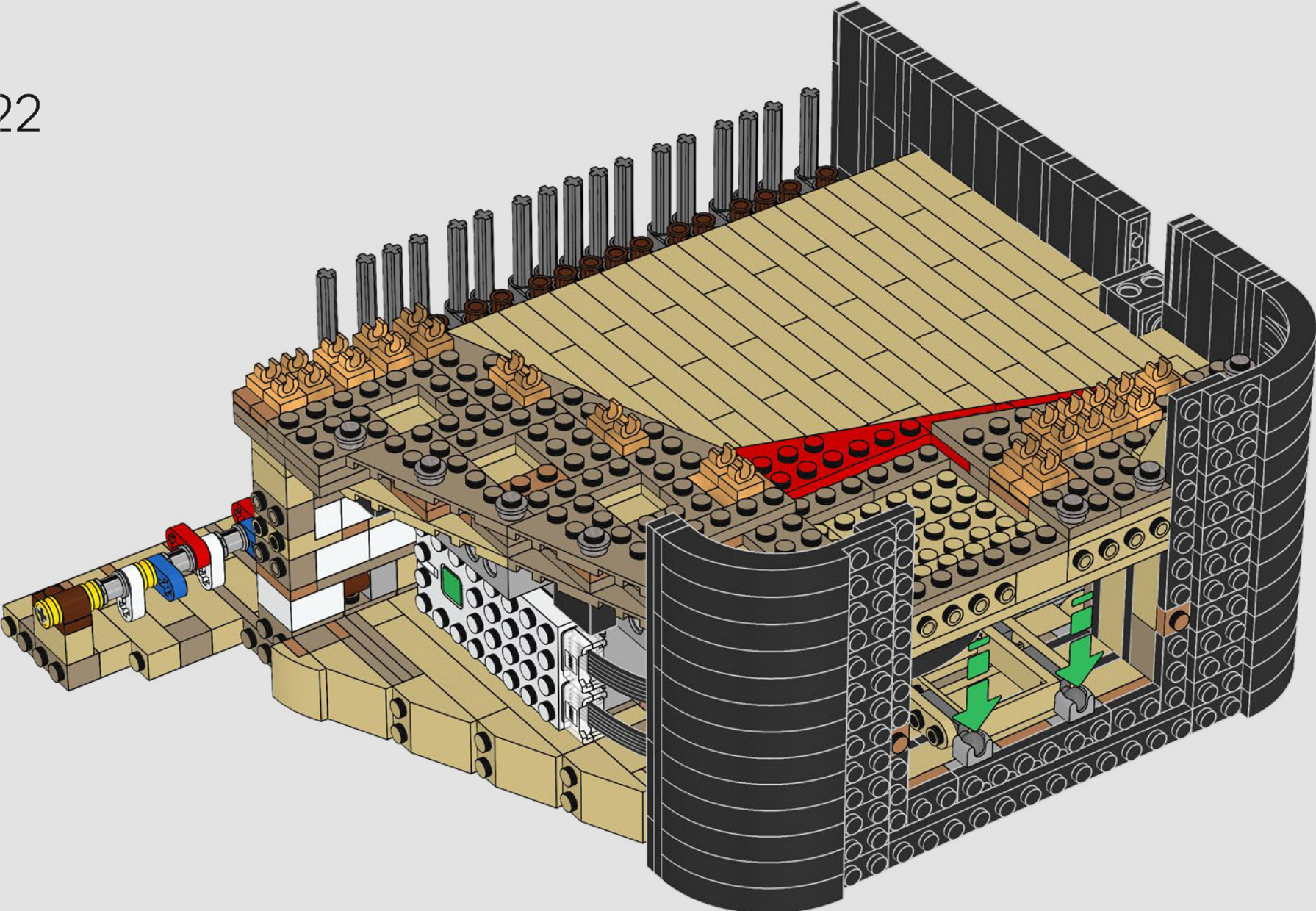

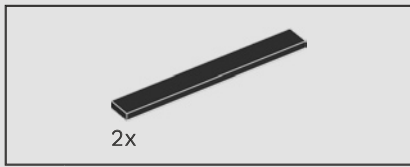

223

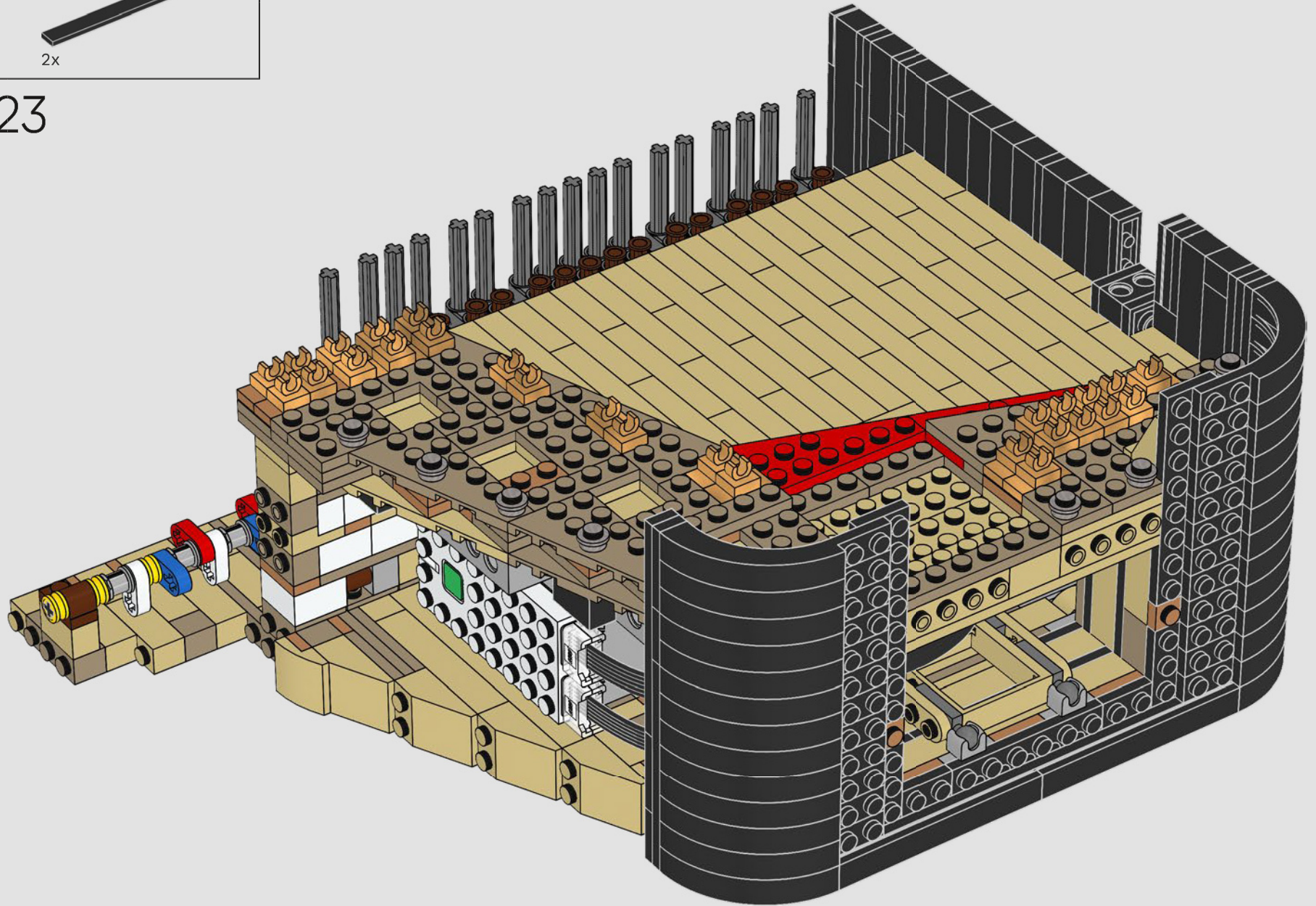

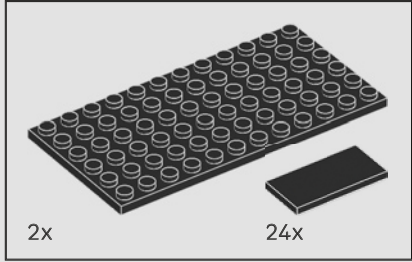
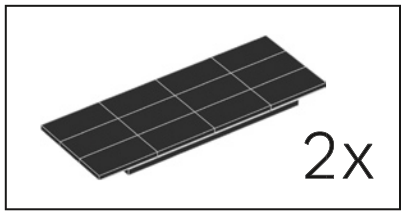

224

1

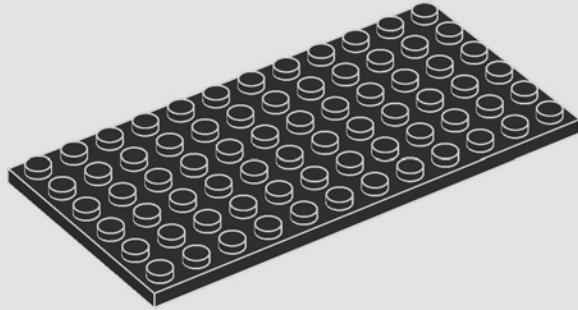

2

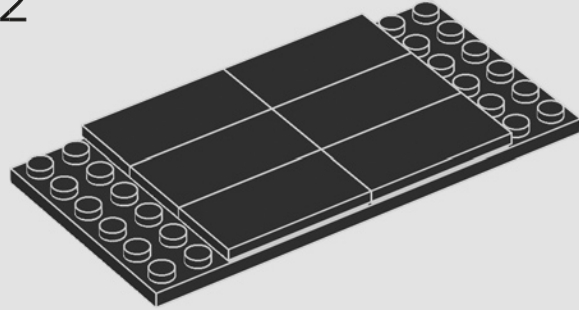

3

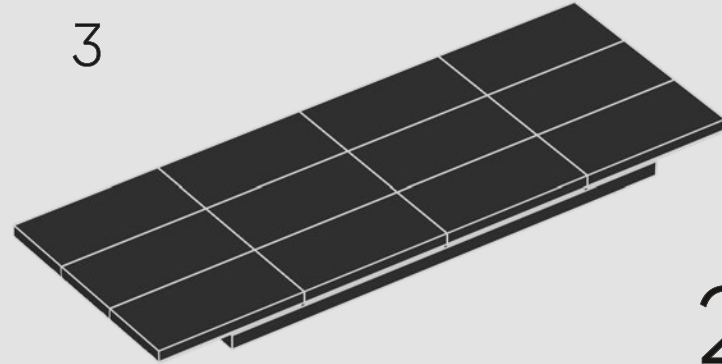

2x



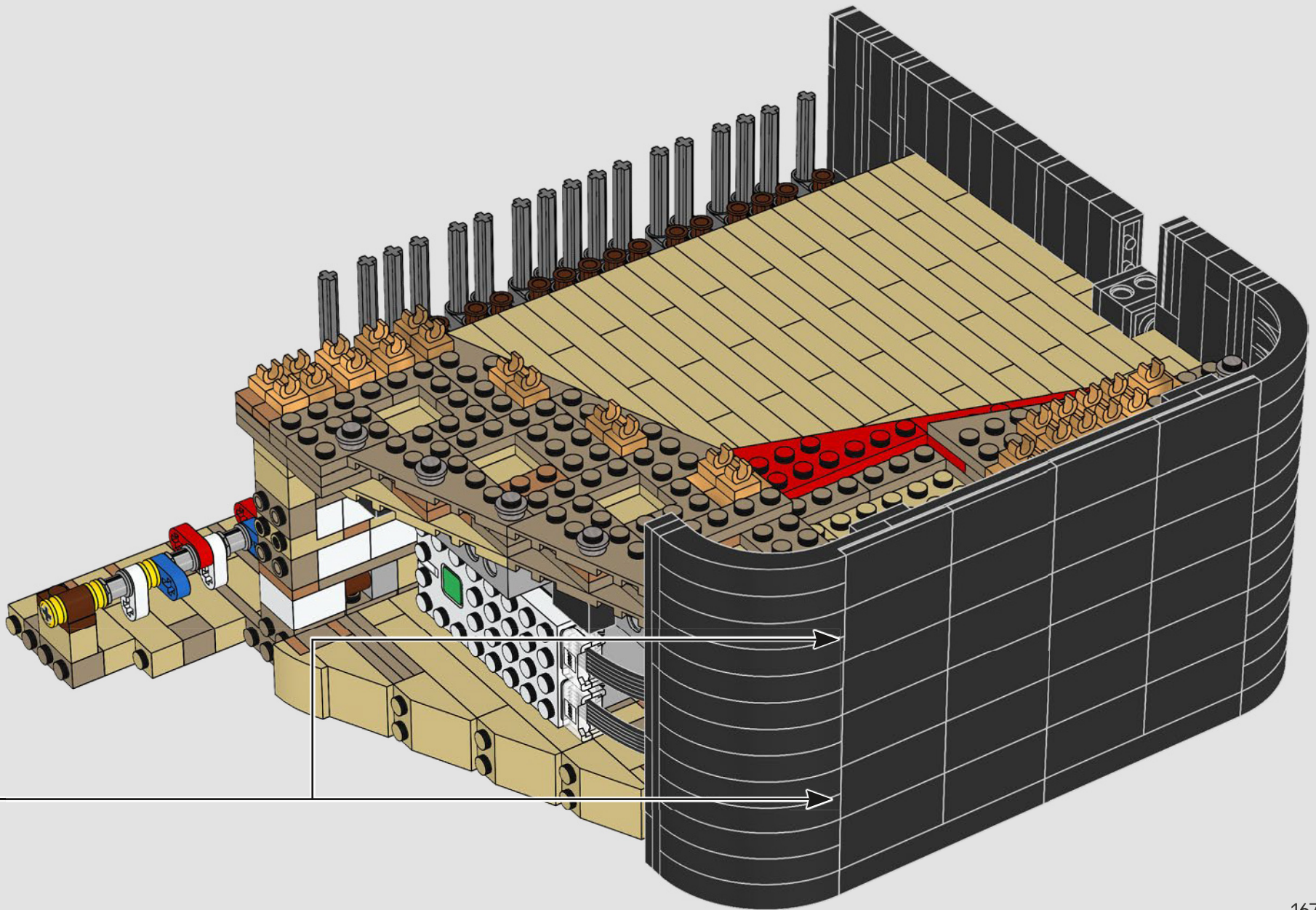

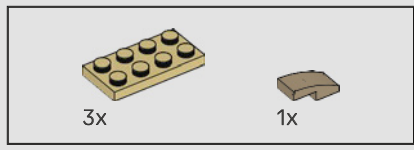

225

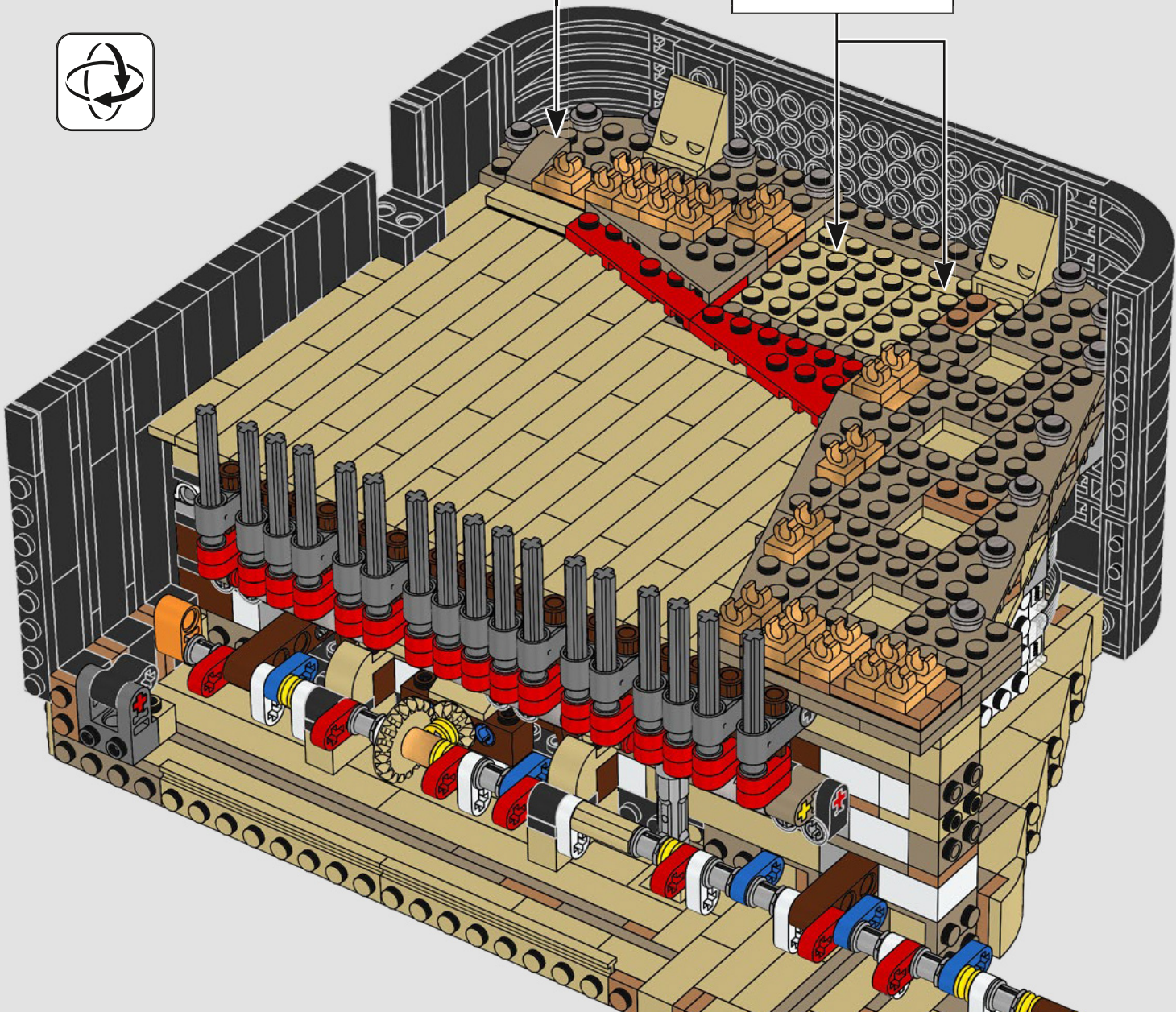
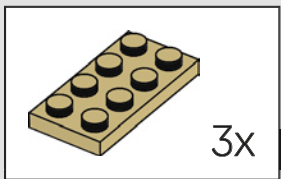
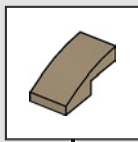

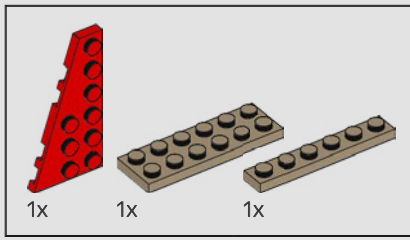

226

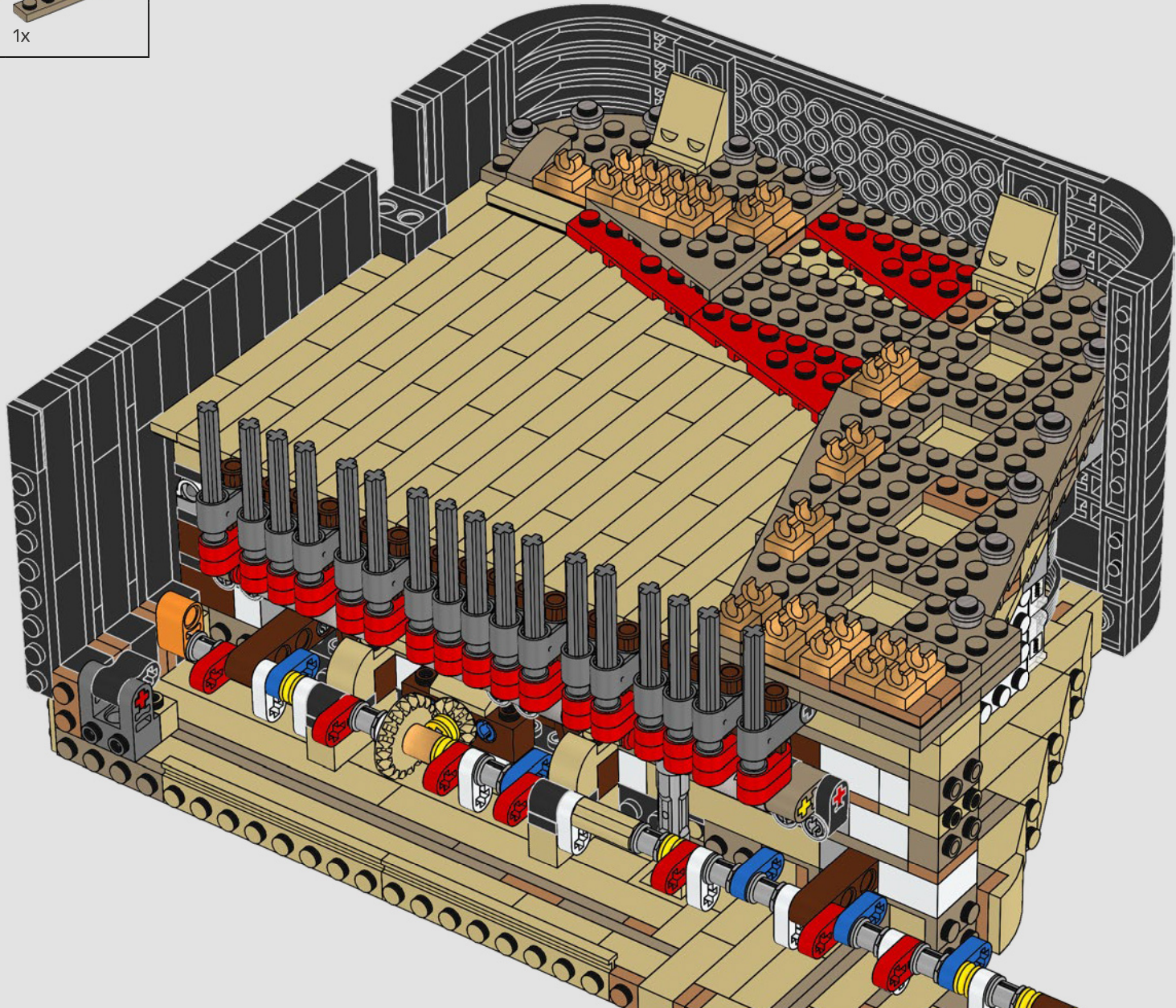

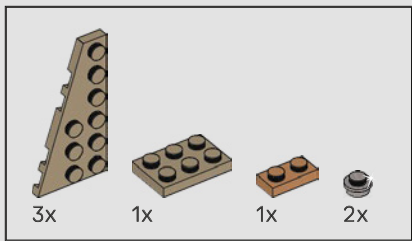

227

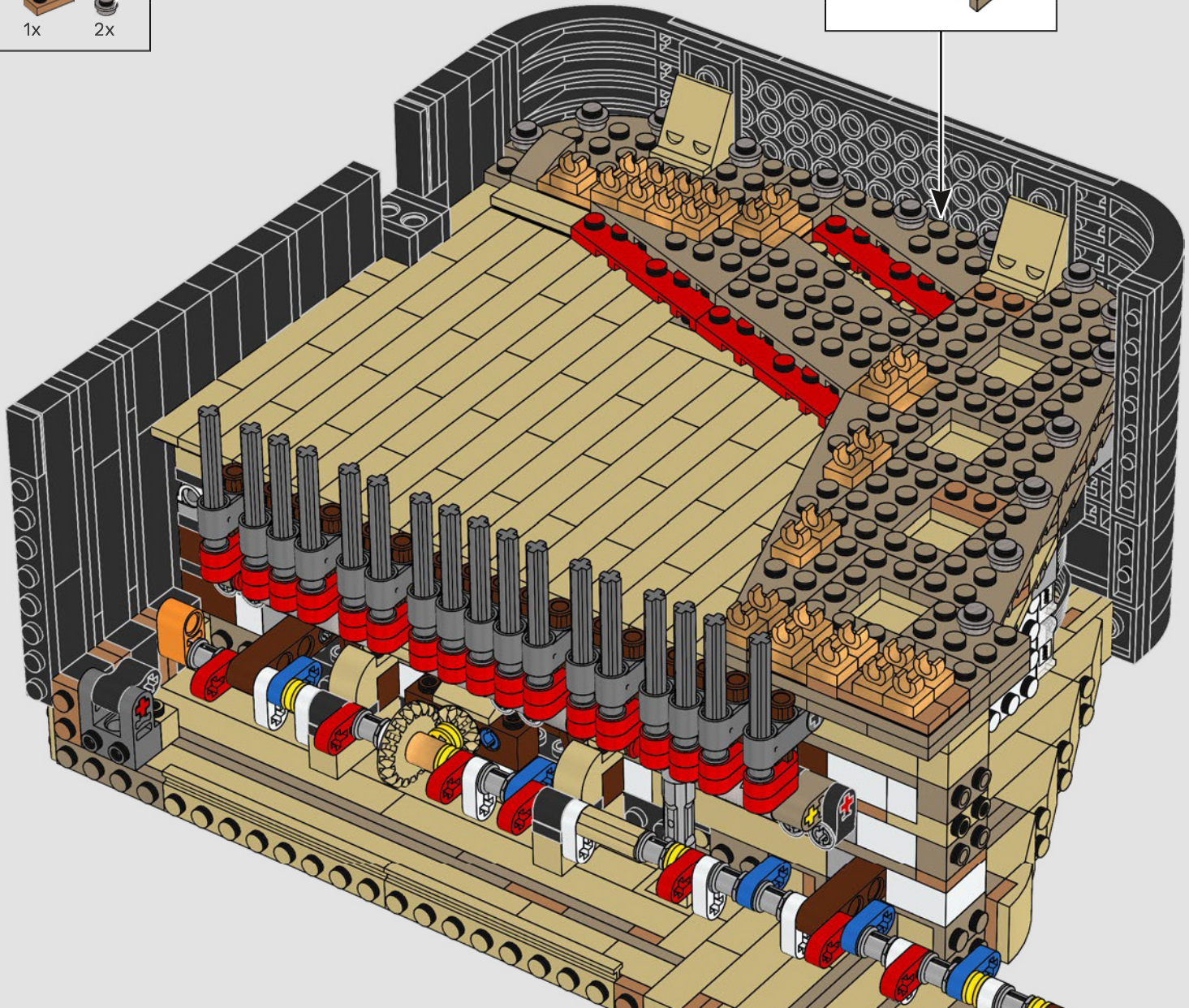
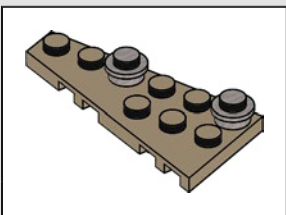



12x

228

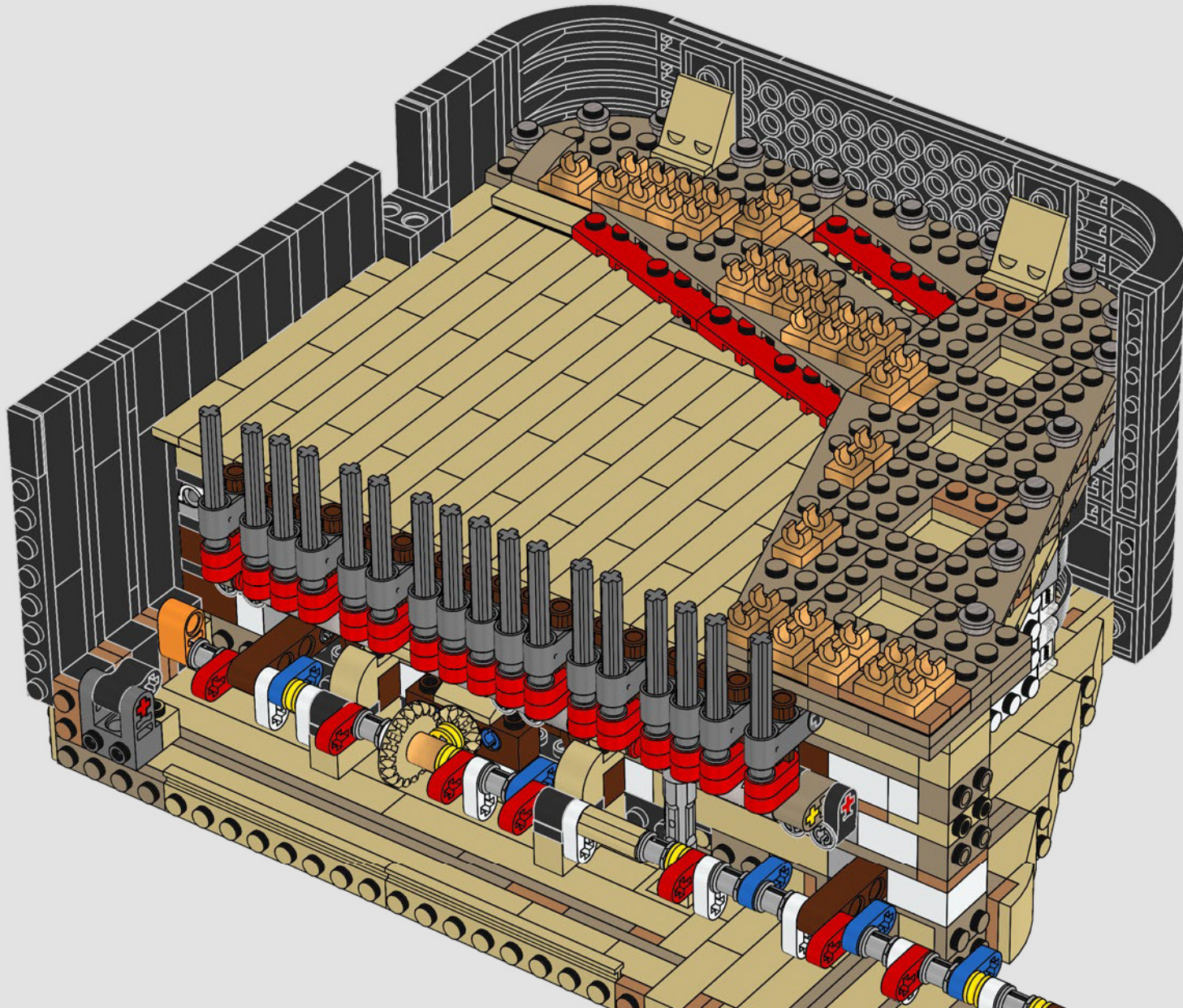



229

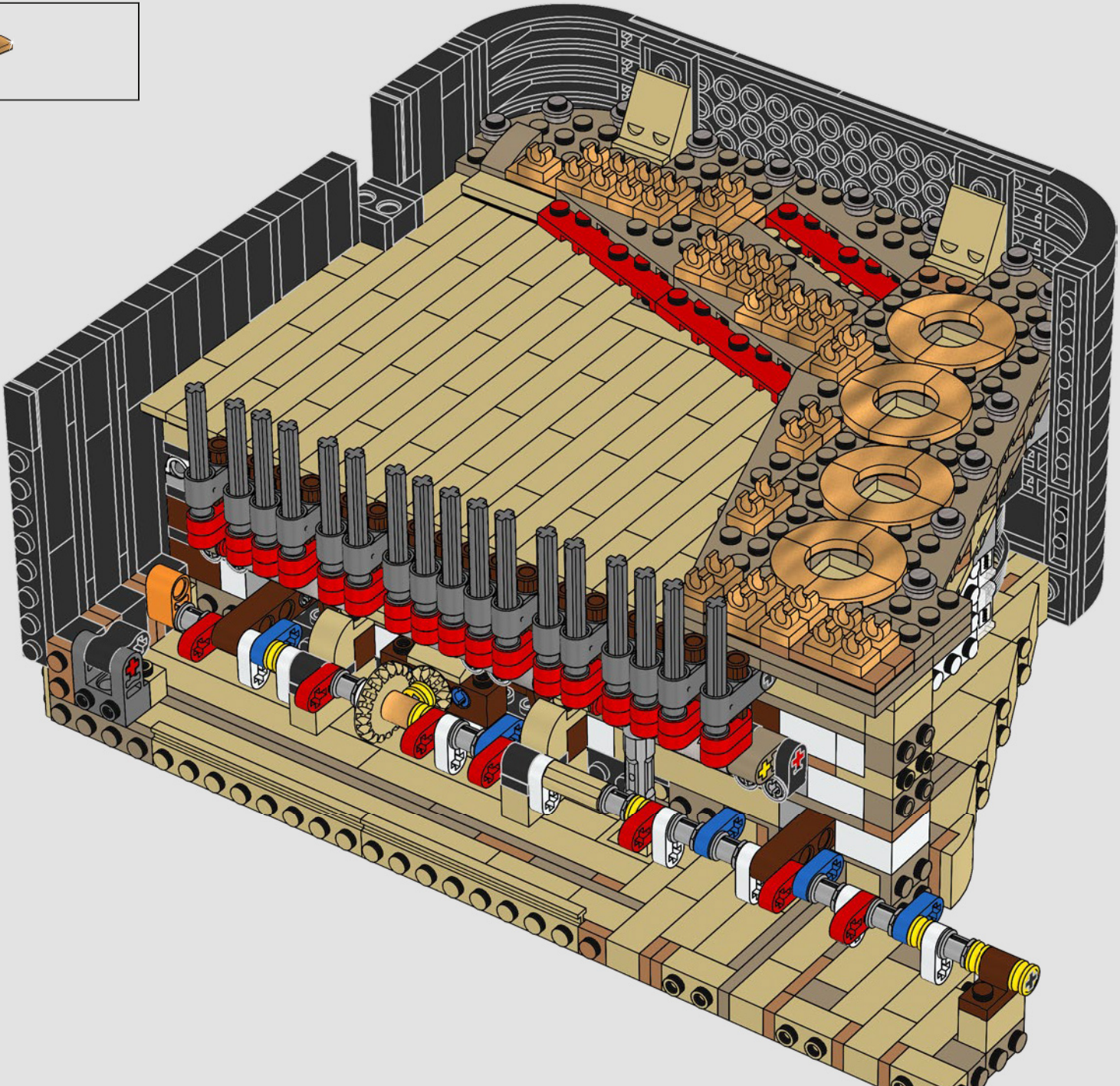

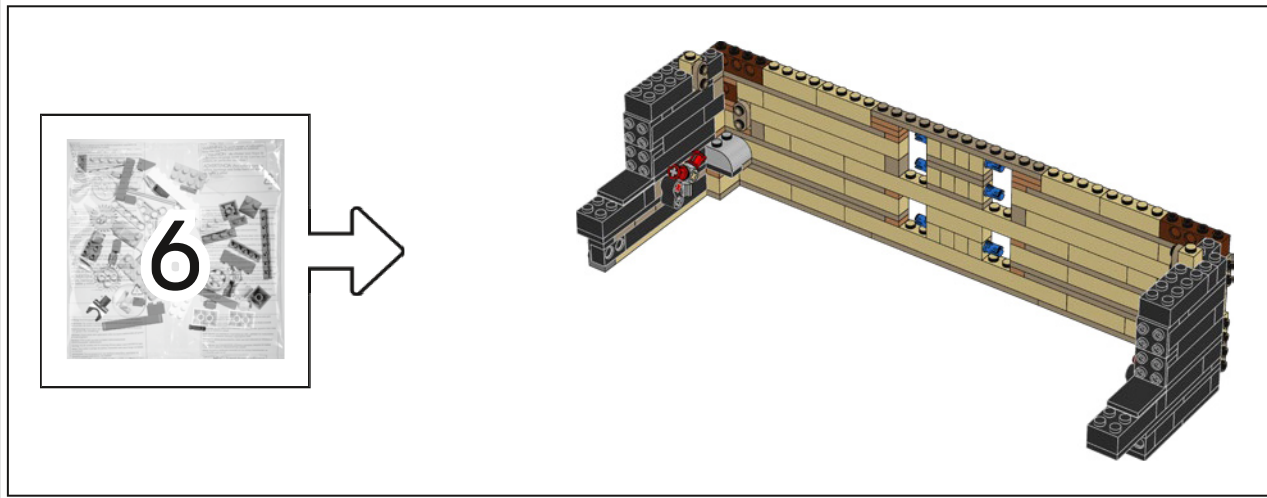

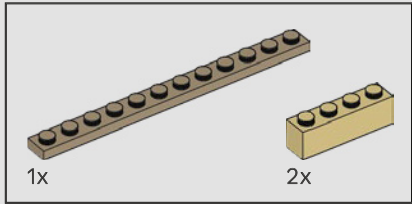
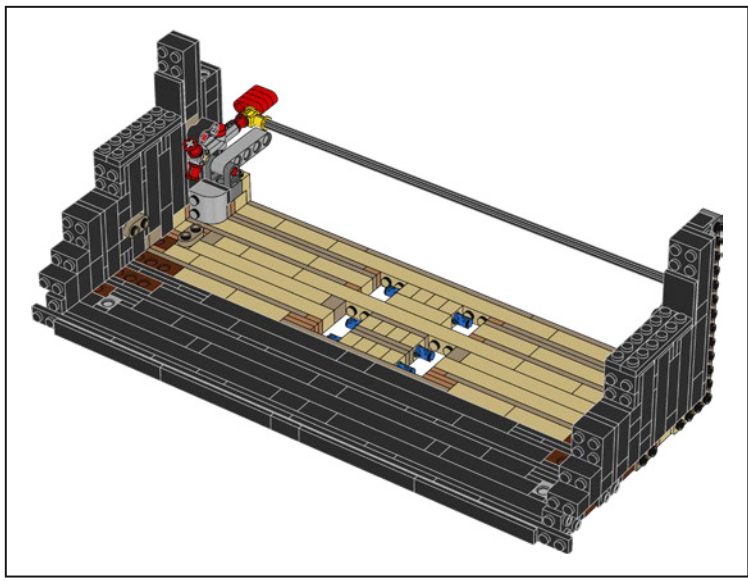

230

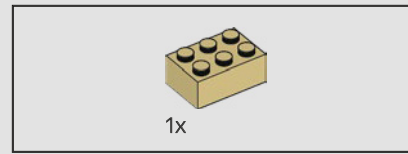
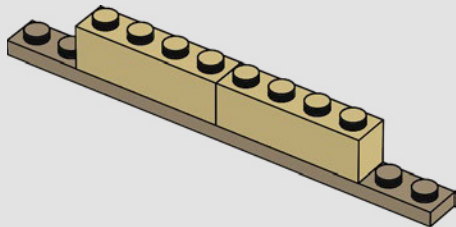

231

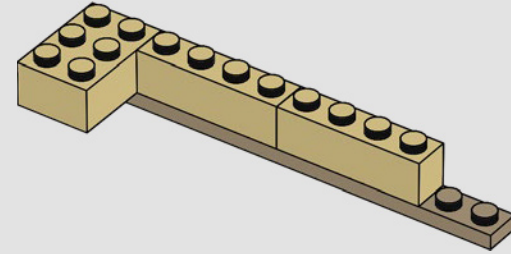

232

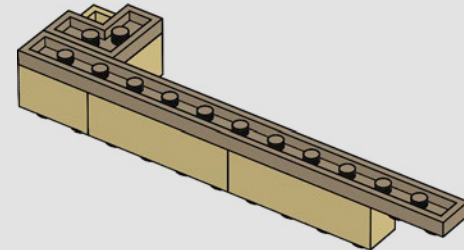
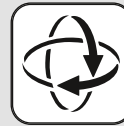

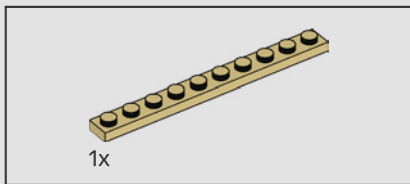

233

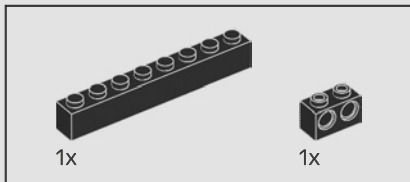
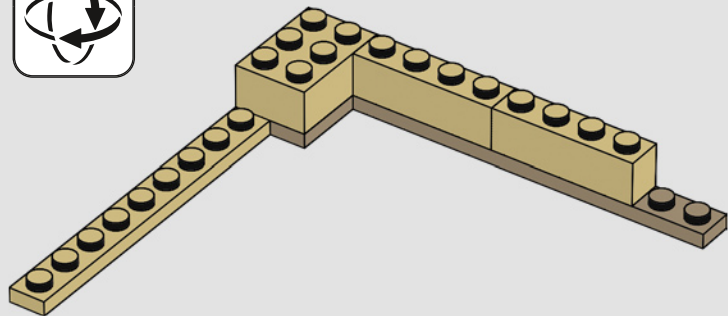

234

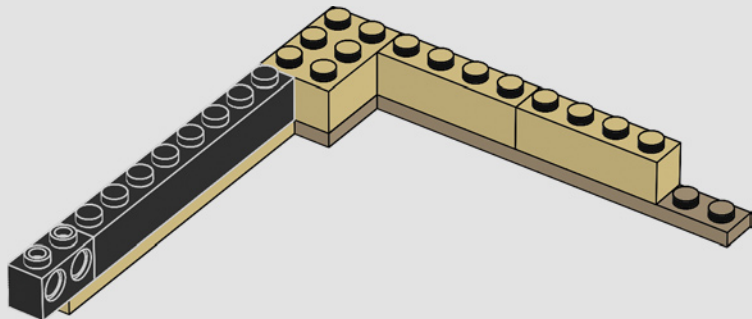

235

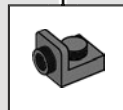
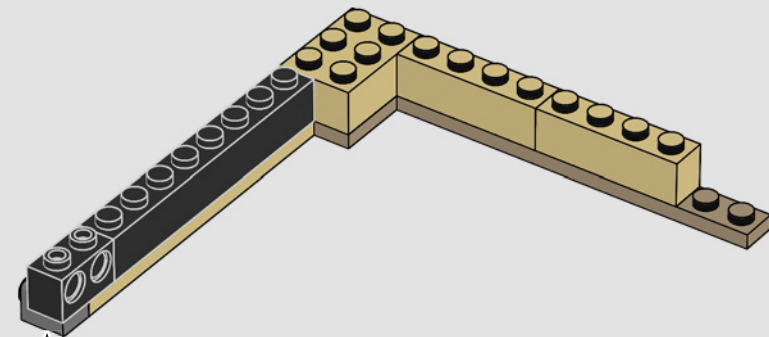

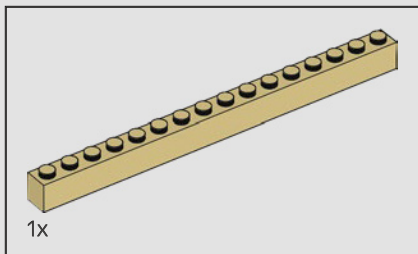

236

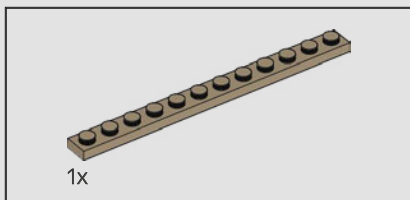
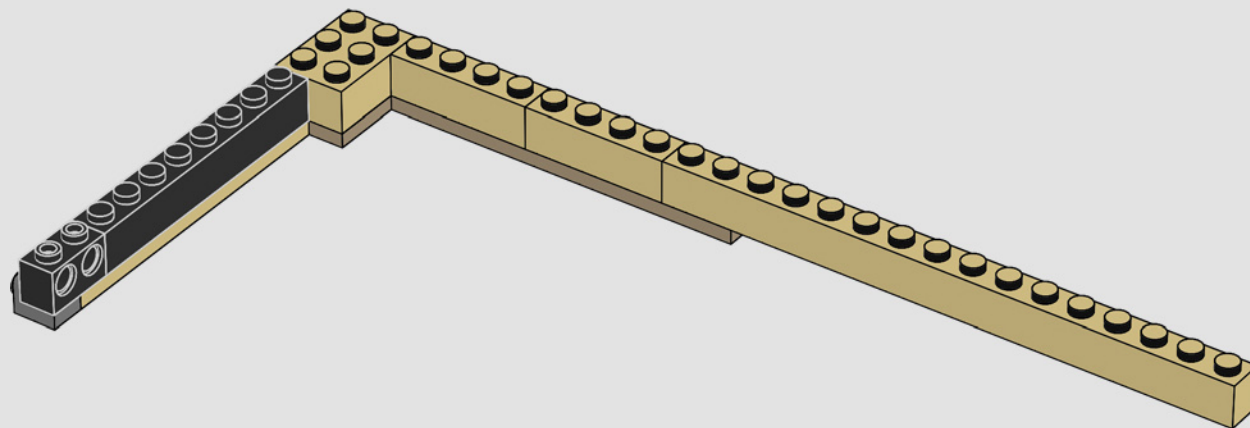

237

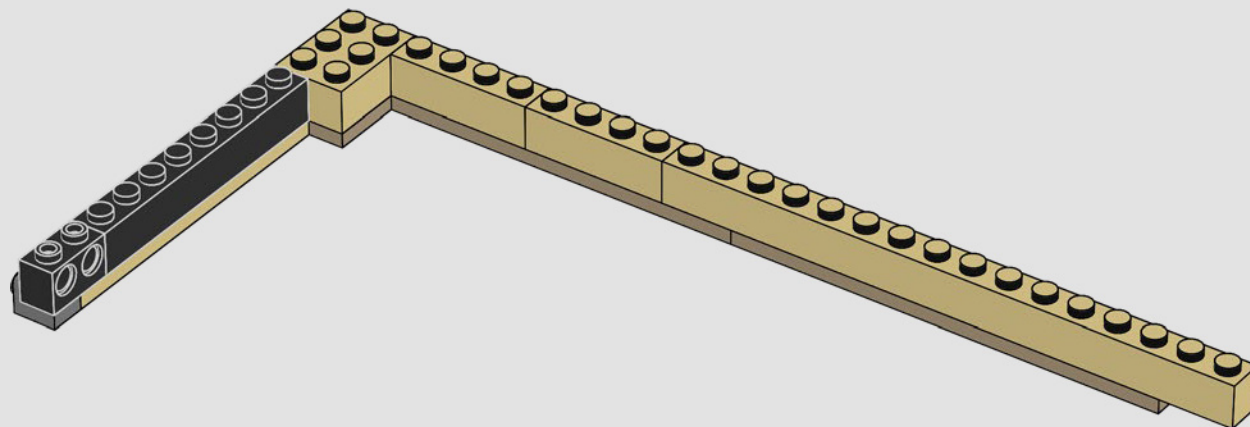

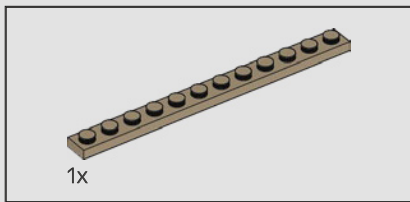

238

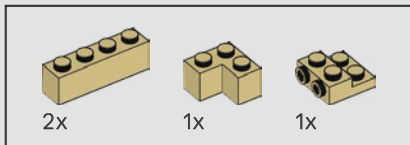
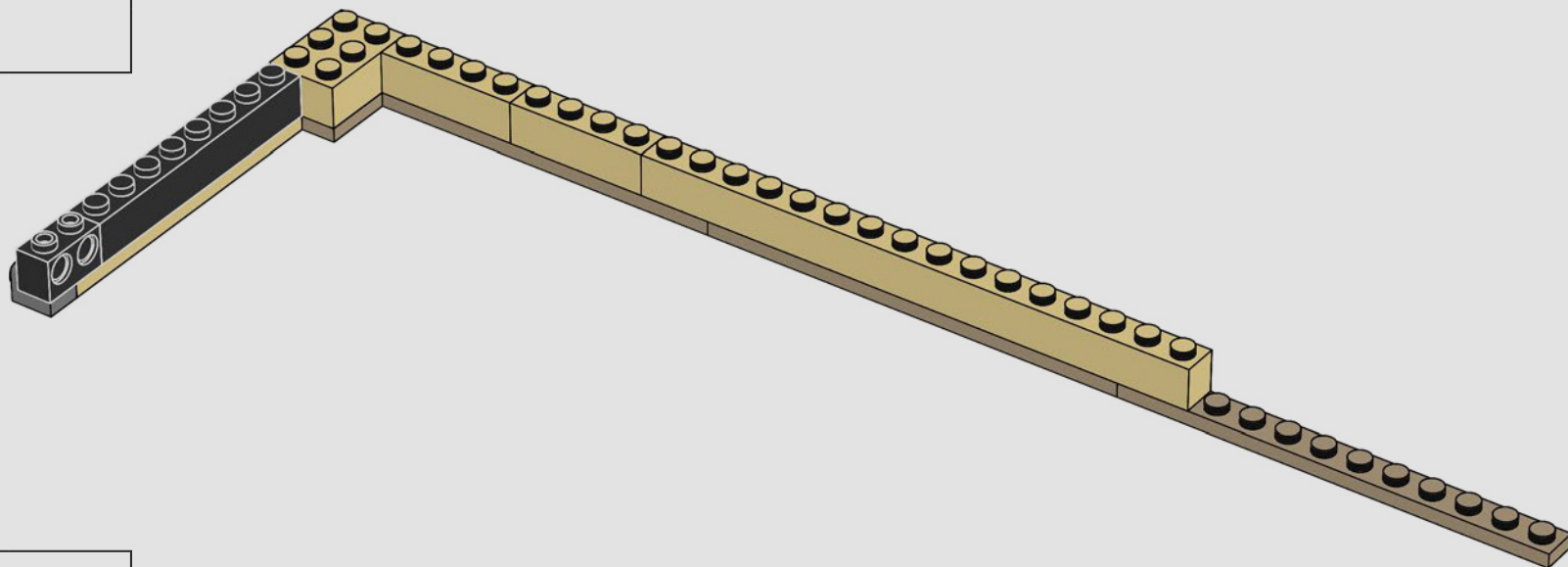

239

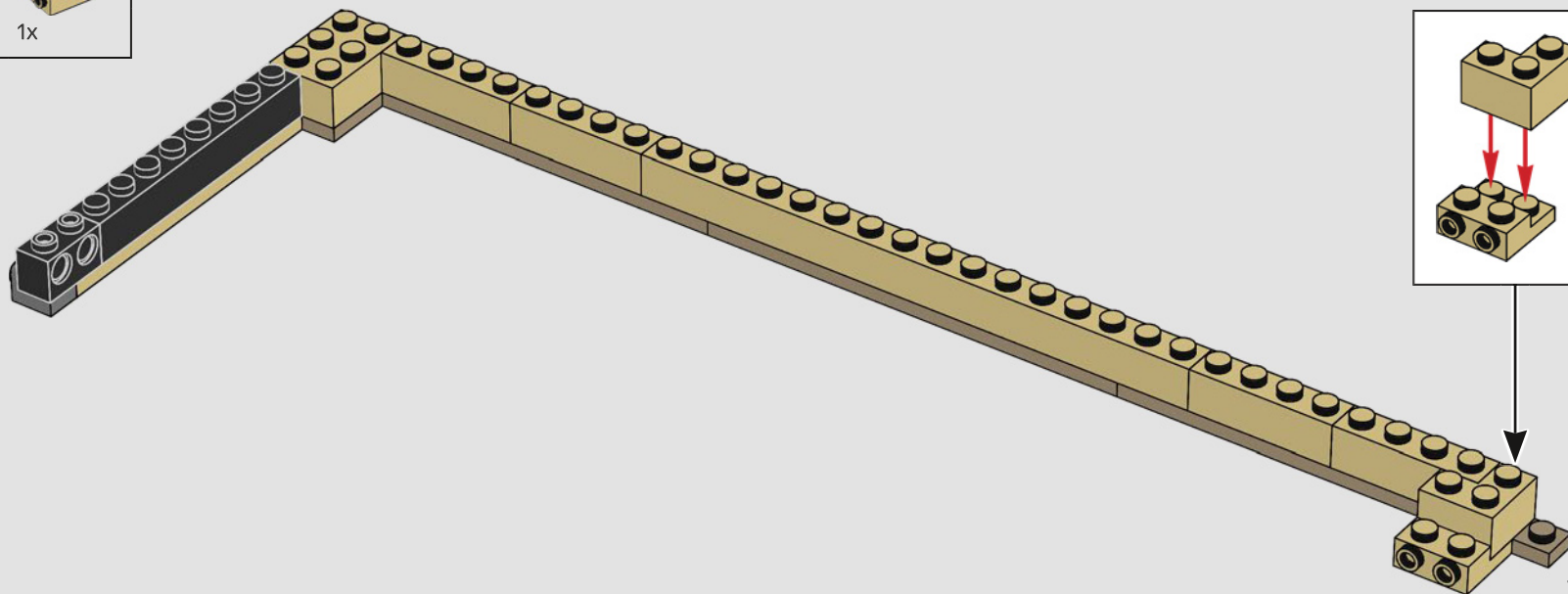

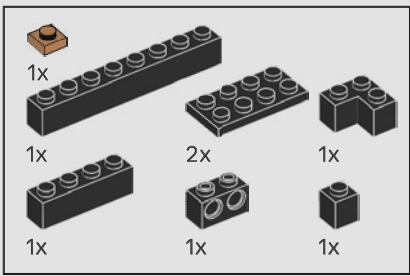

240

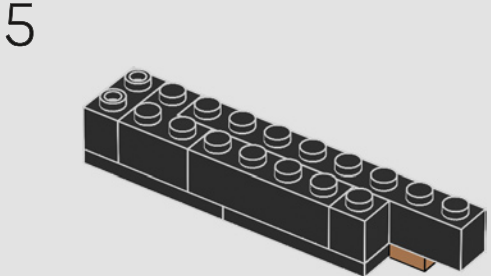
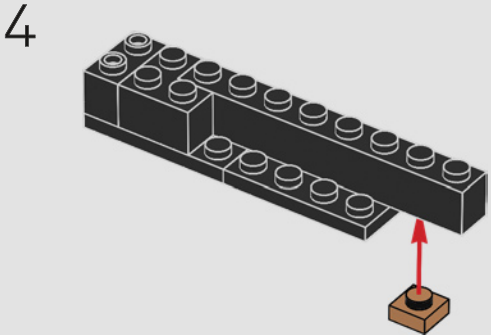
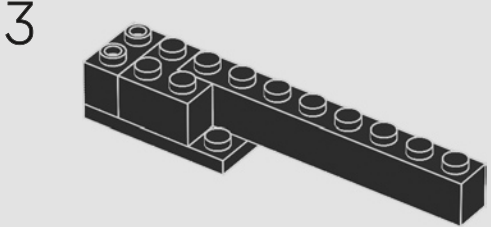
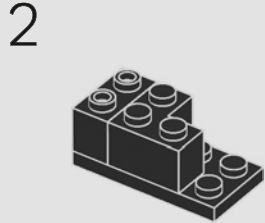
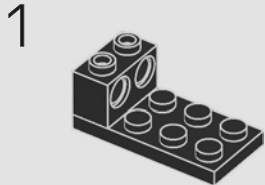

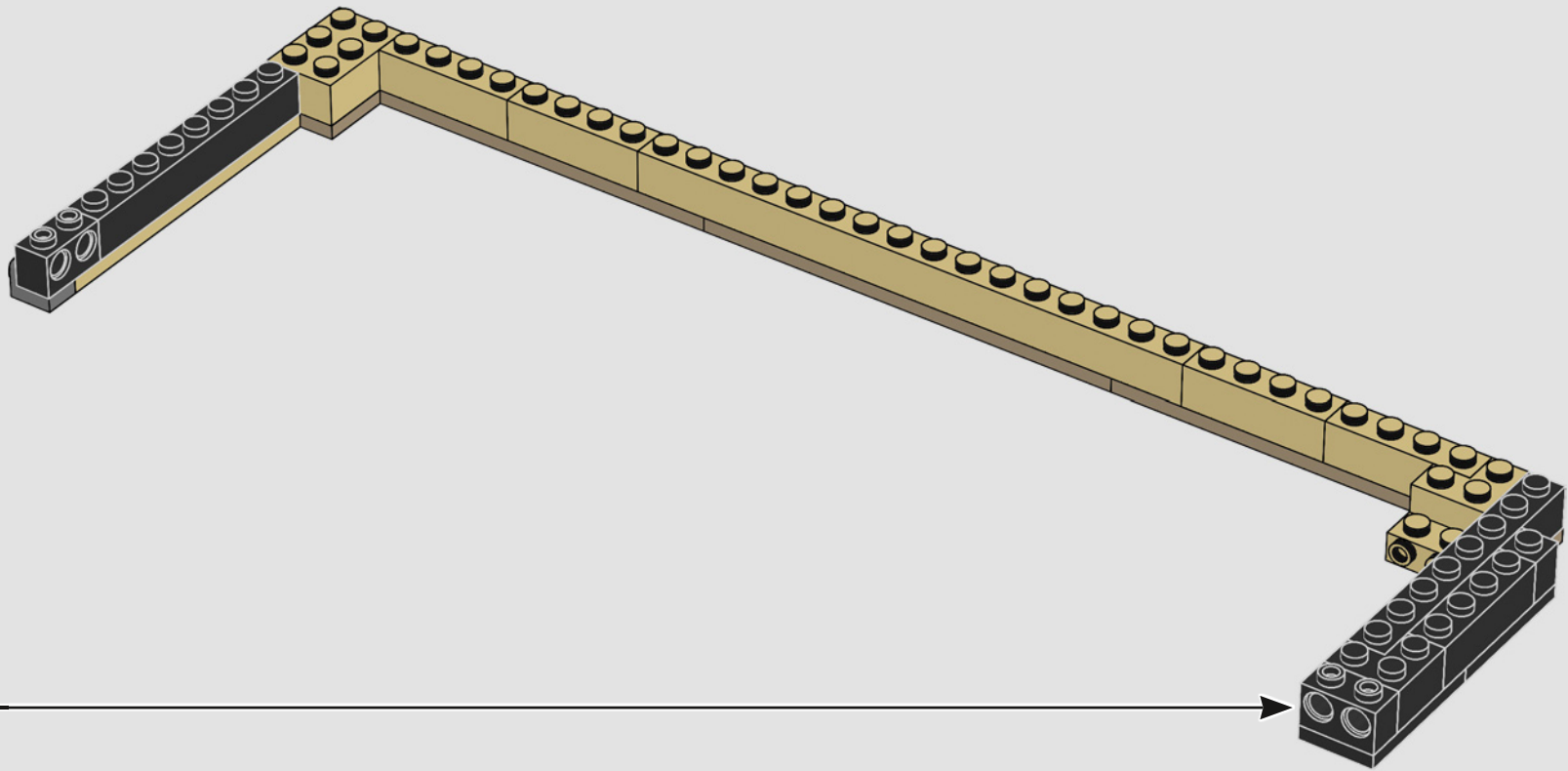

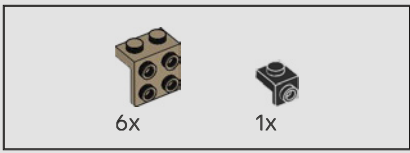

241

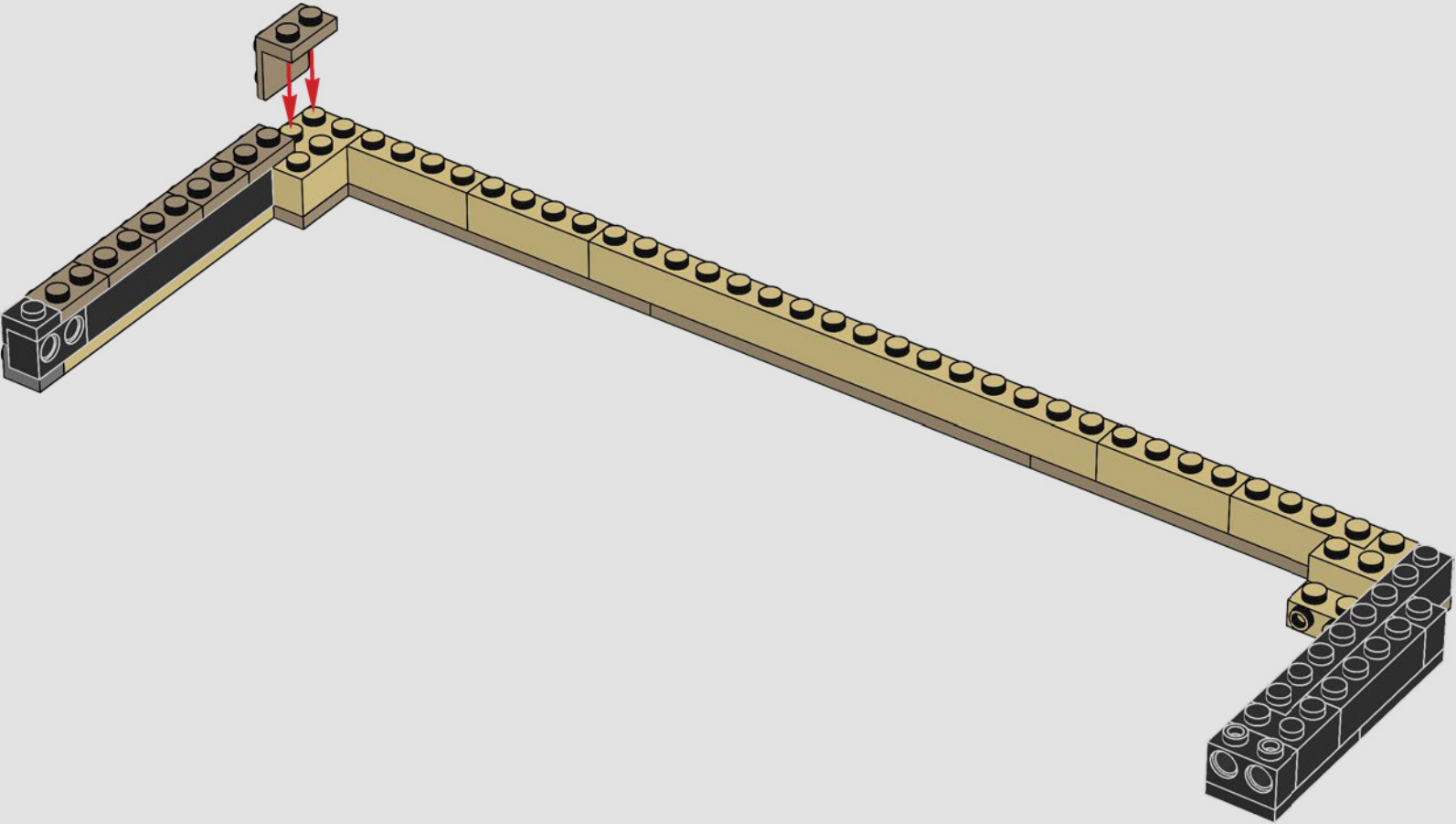

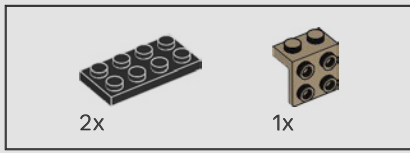

242

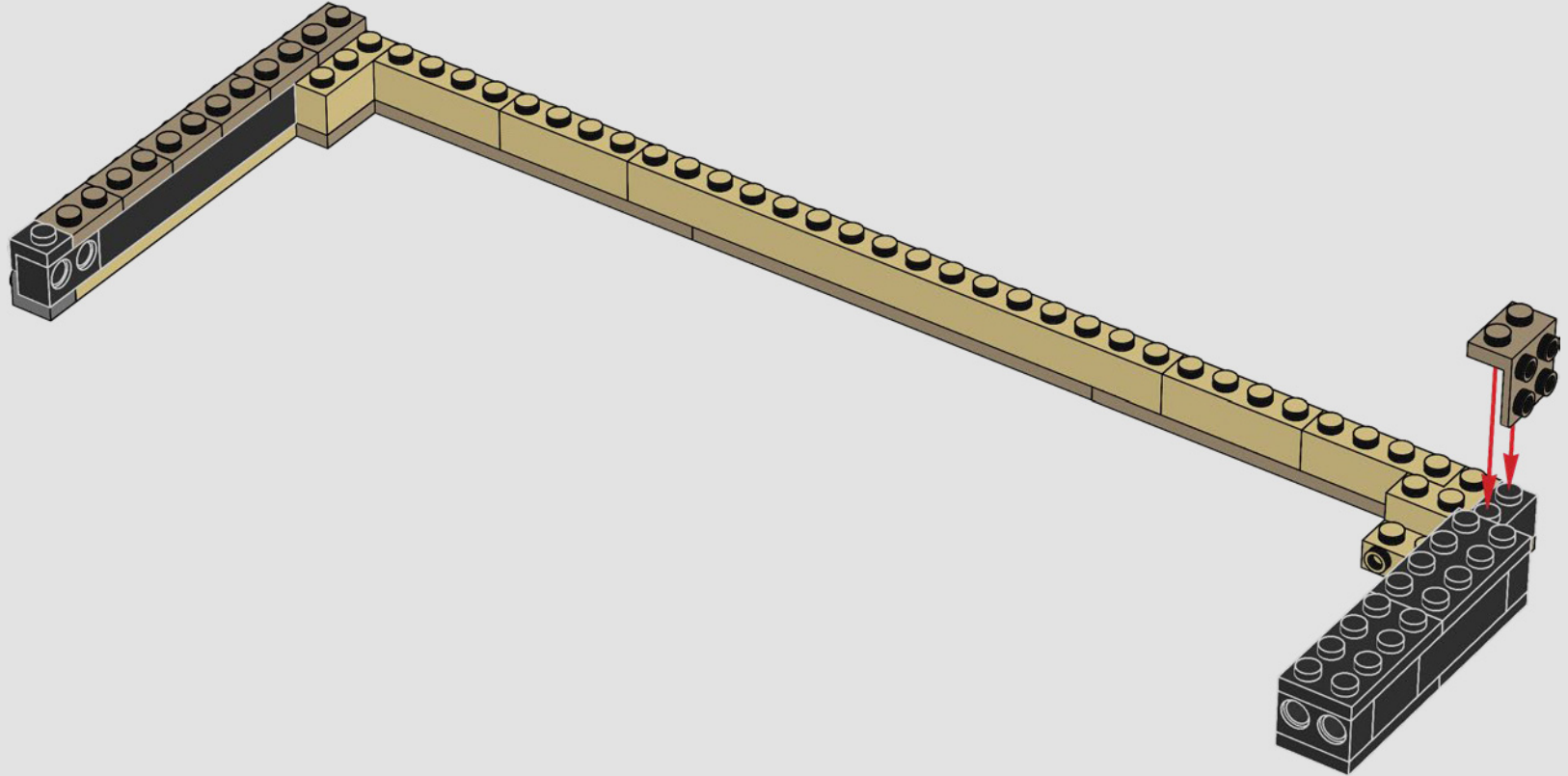

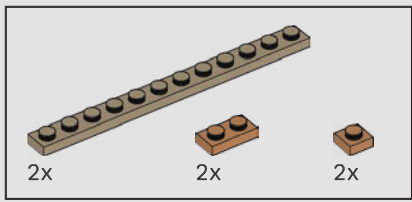

243

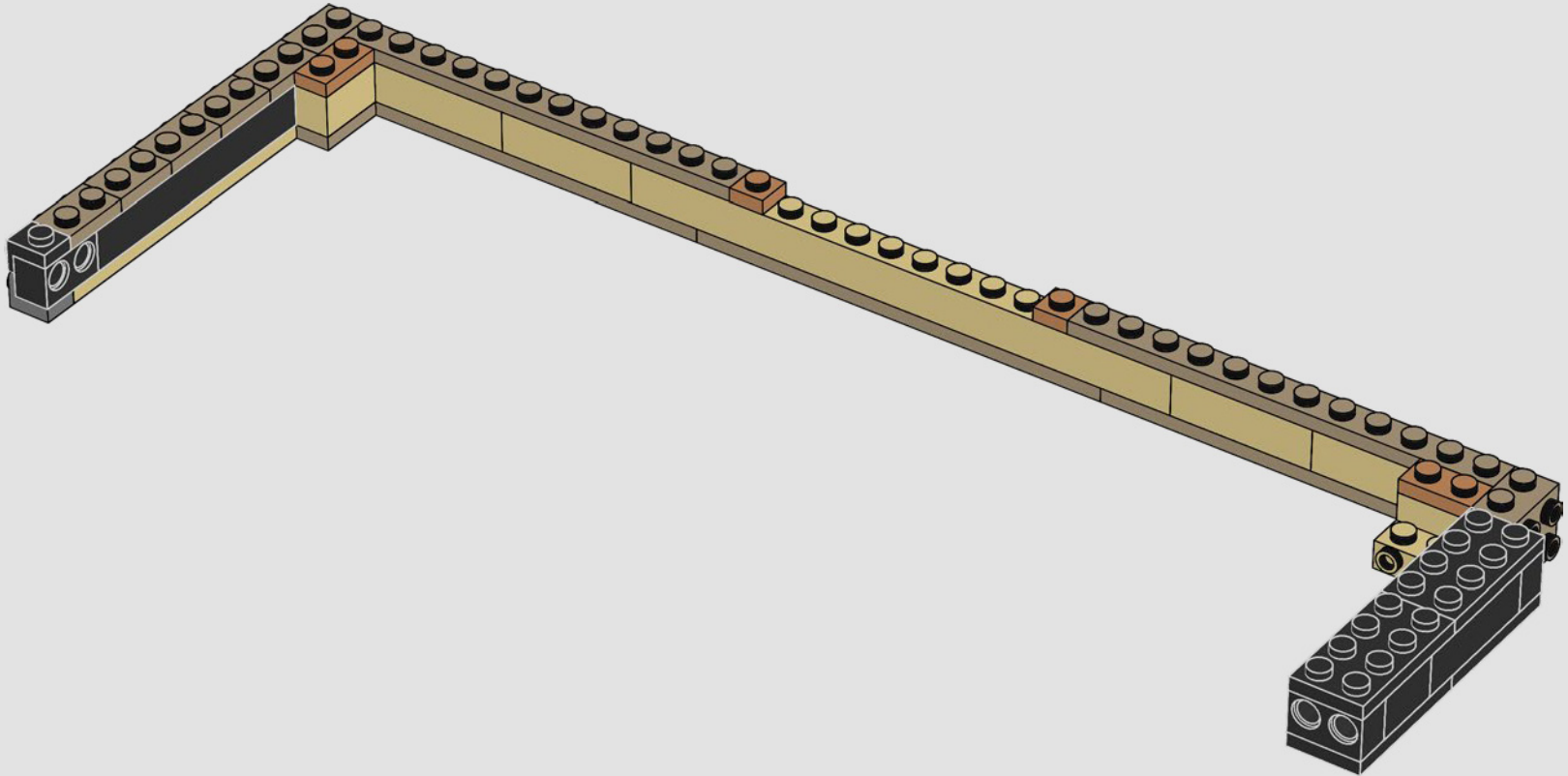

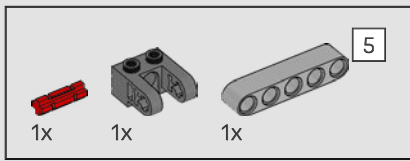

244

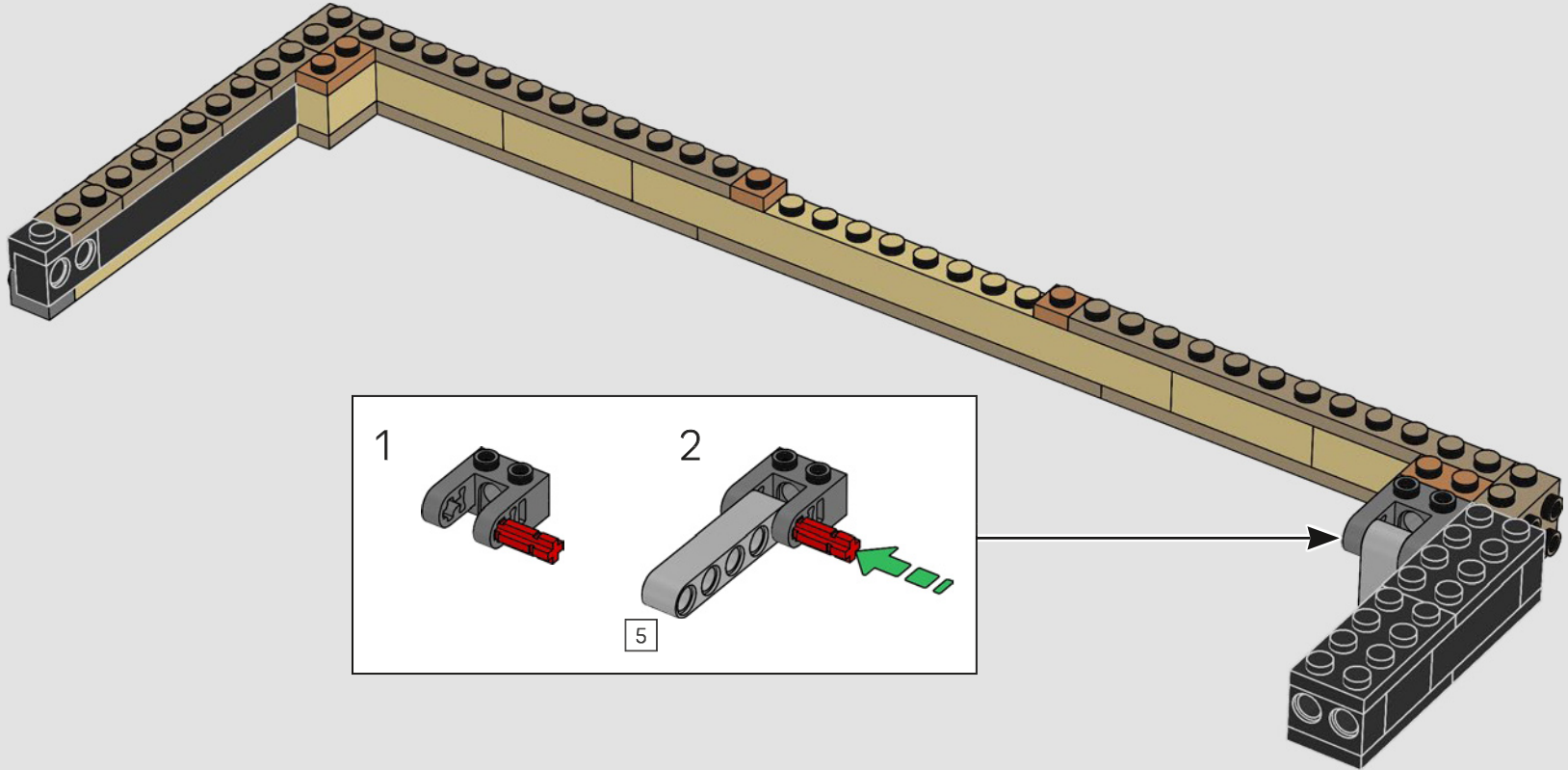

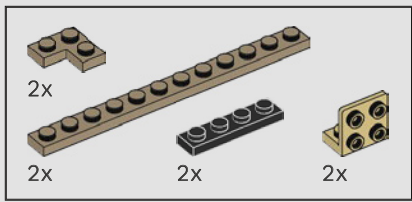

245

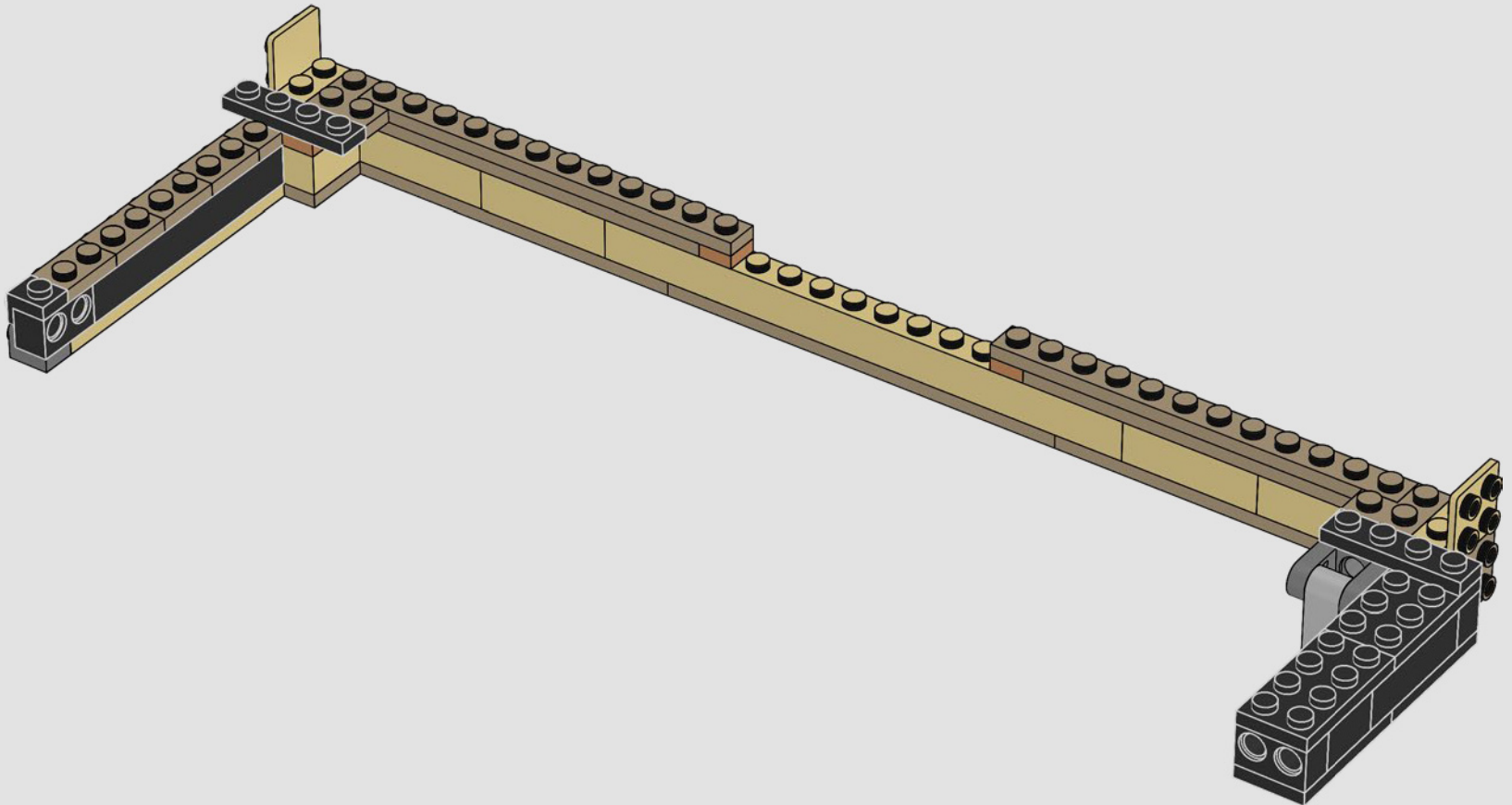

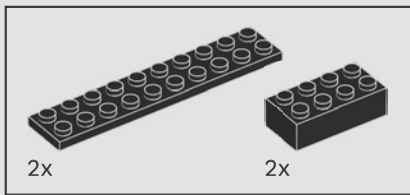

246

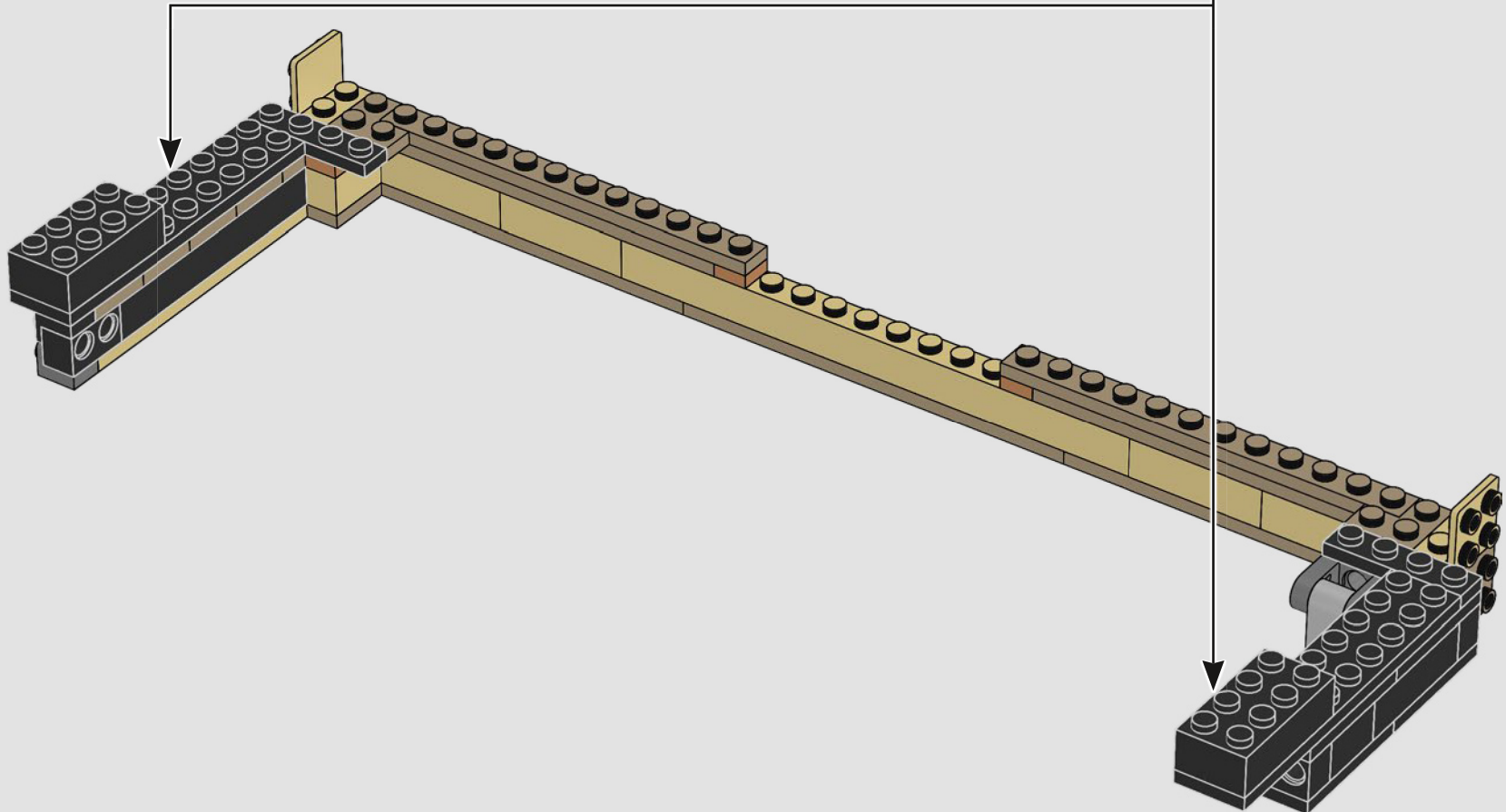
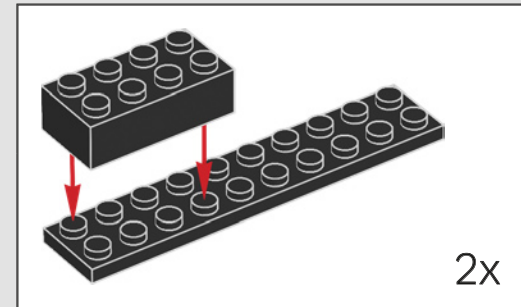

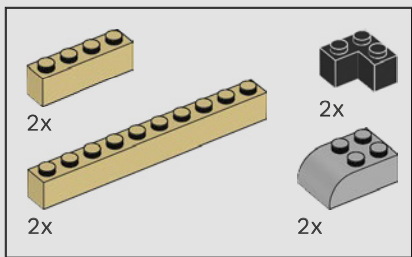

247

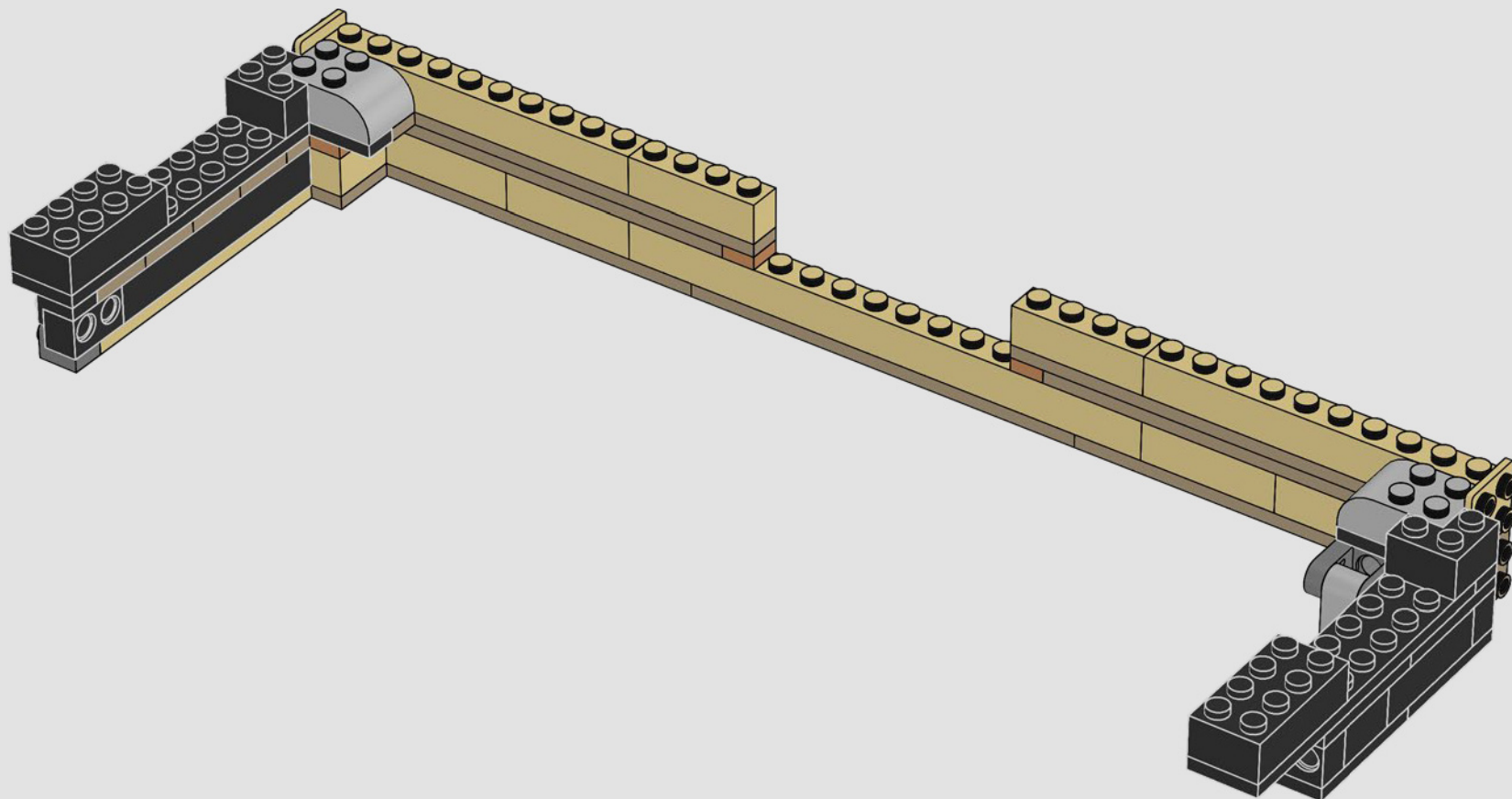



248

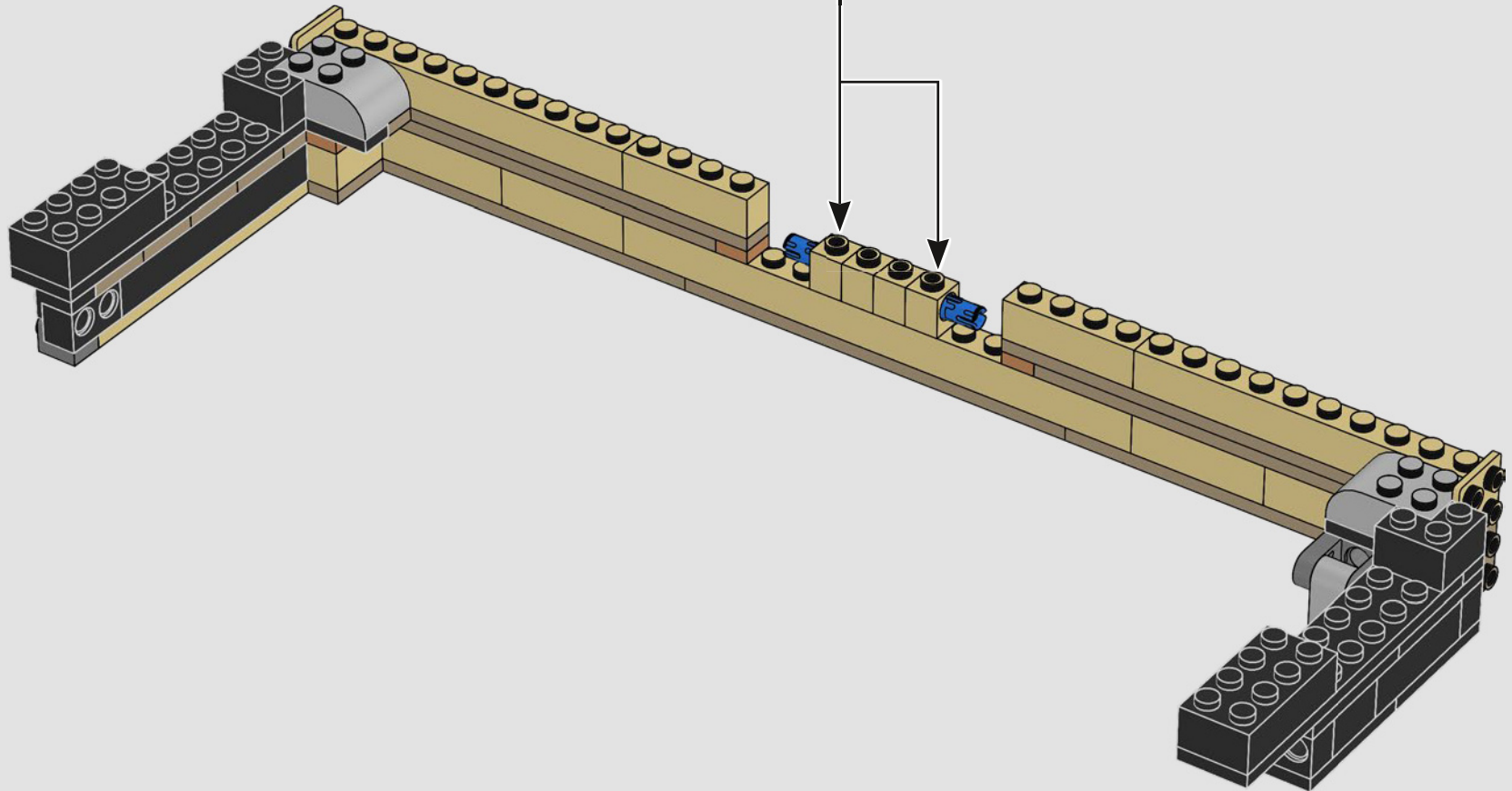
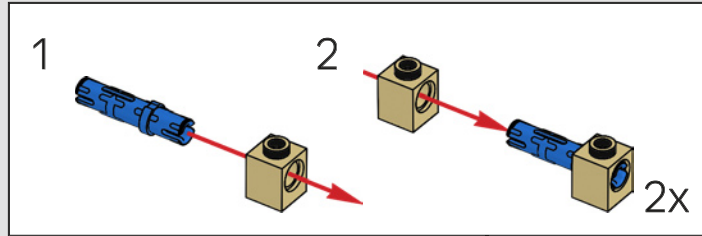

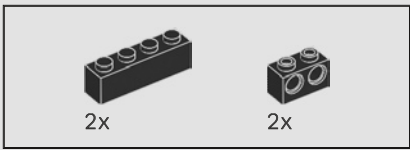

249

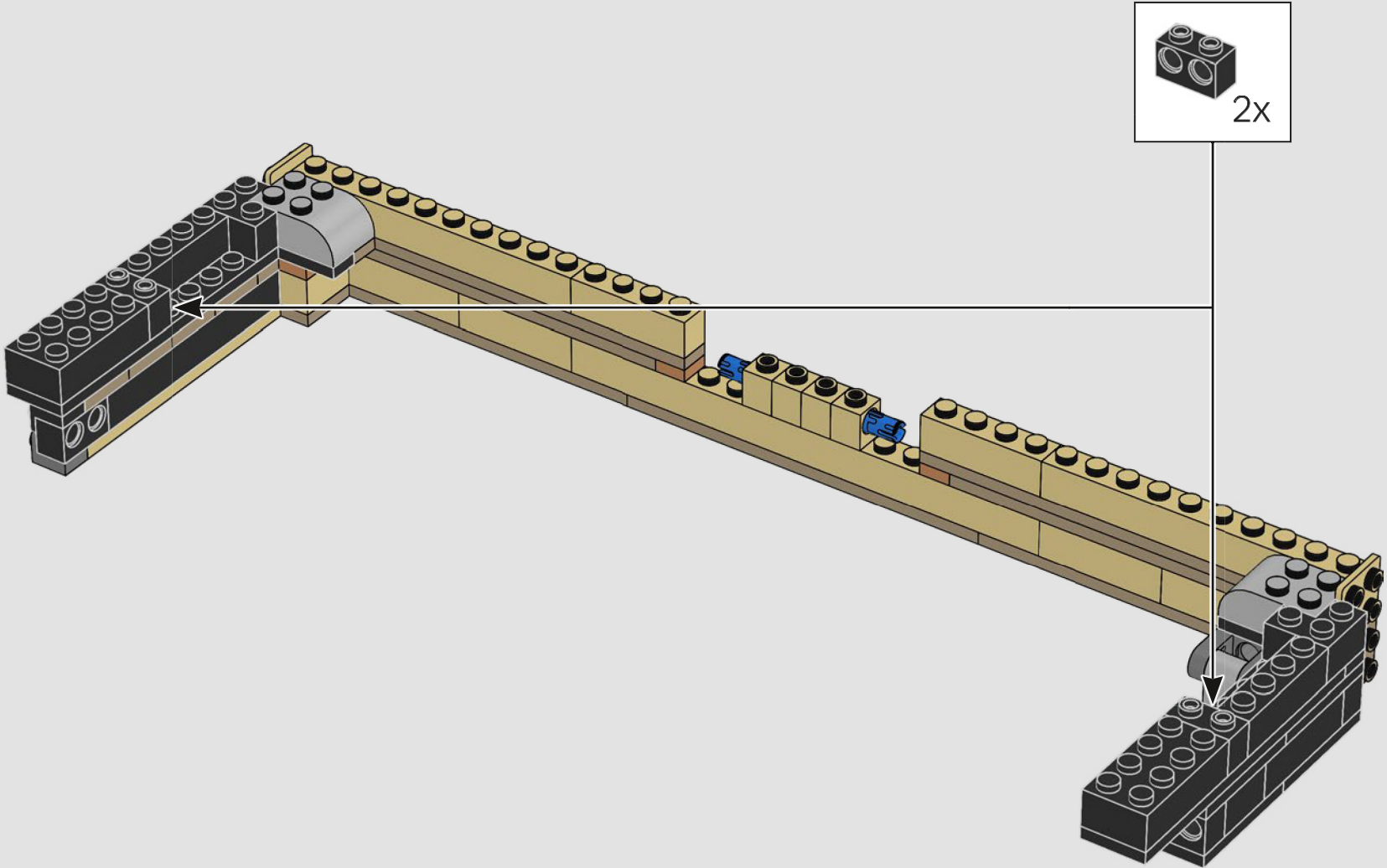



250

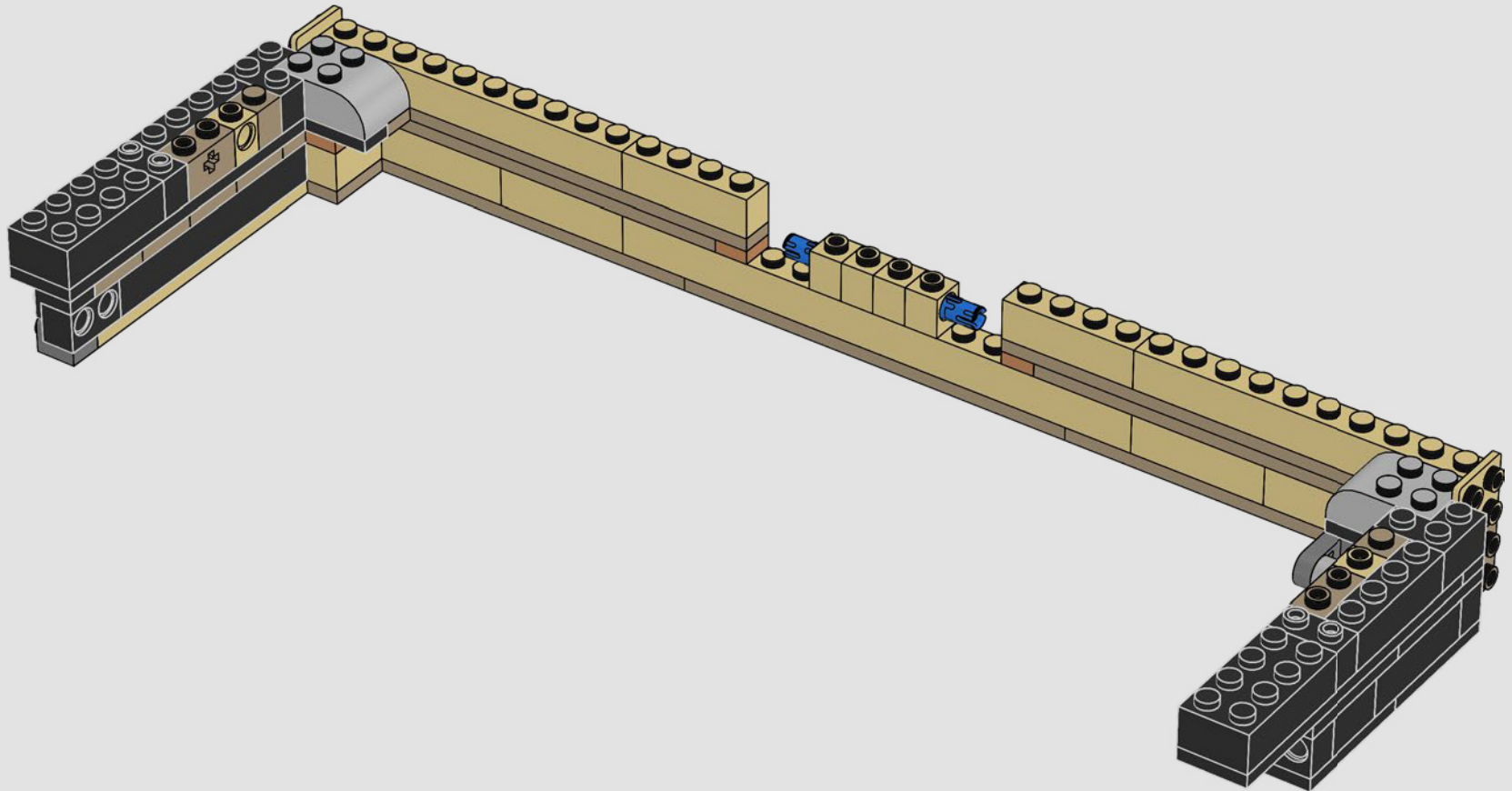

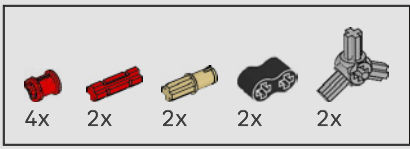

251

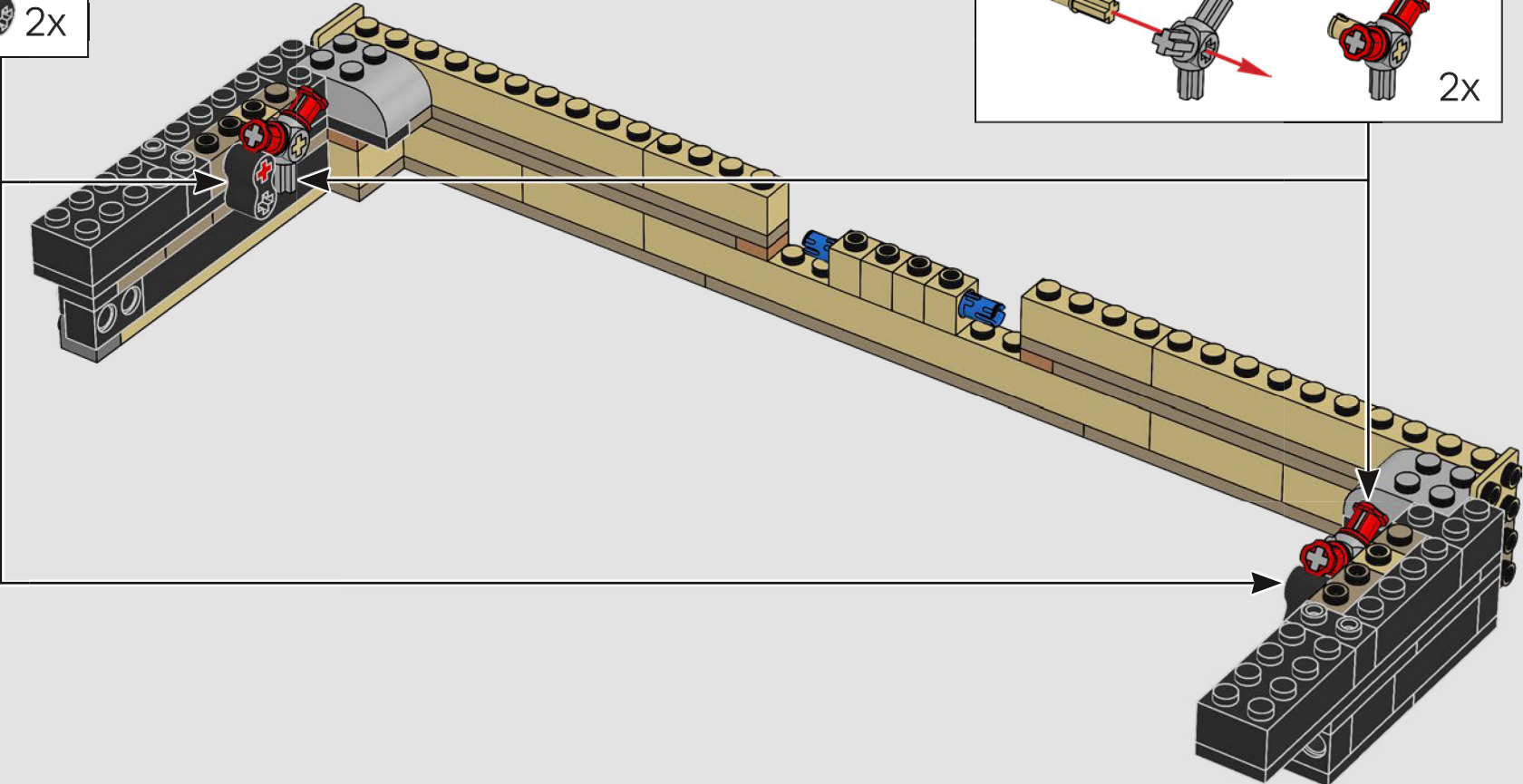
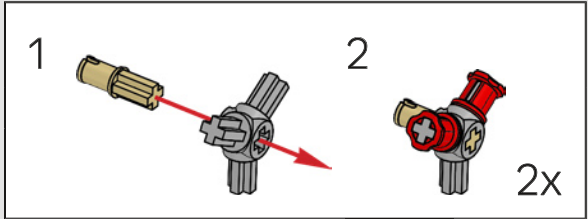
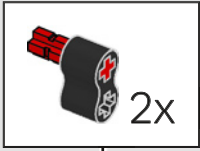

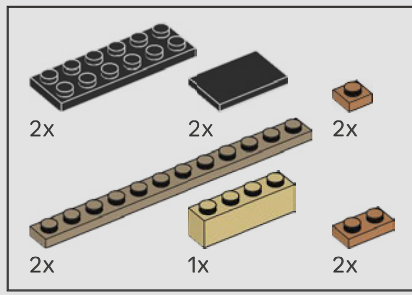

252

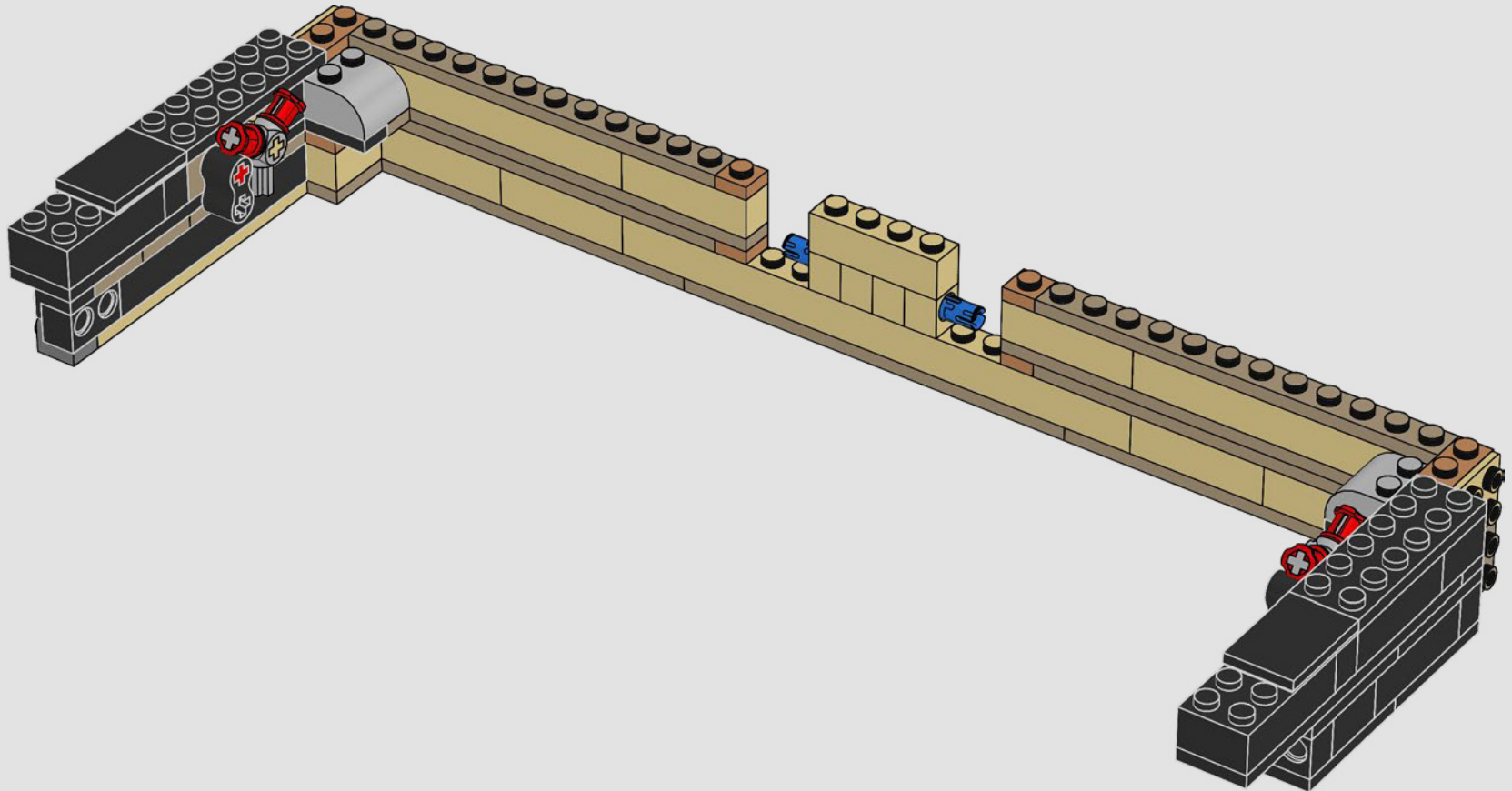

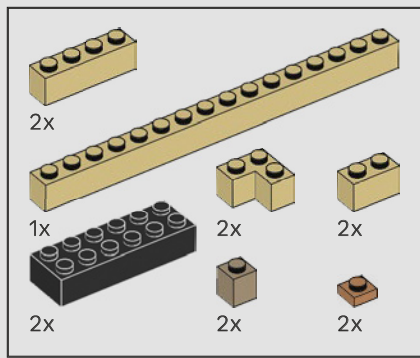

253

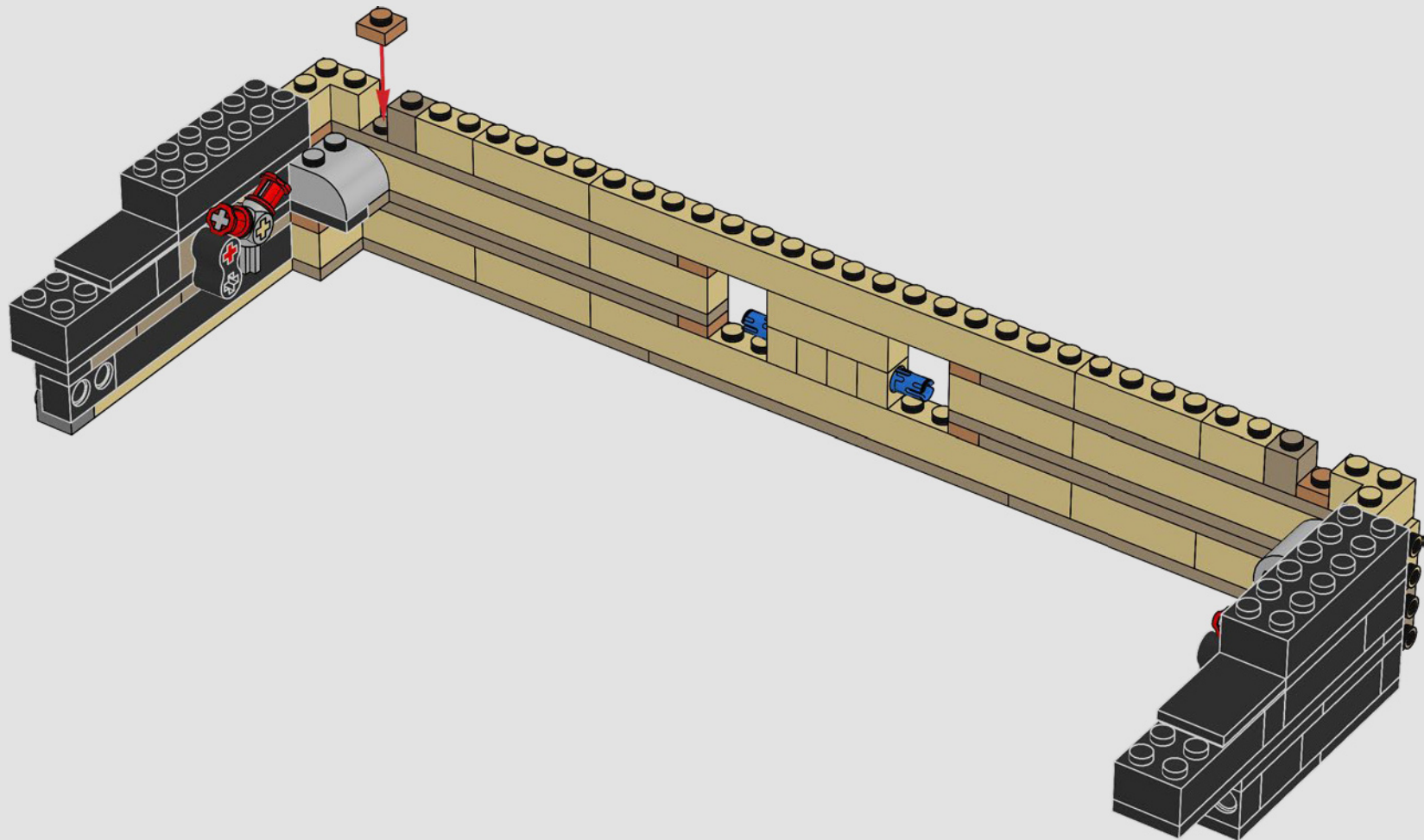

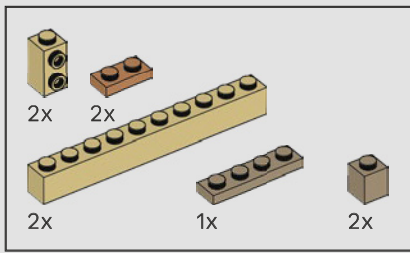

254

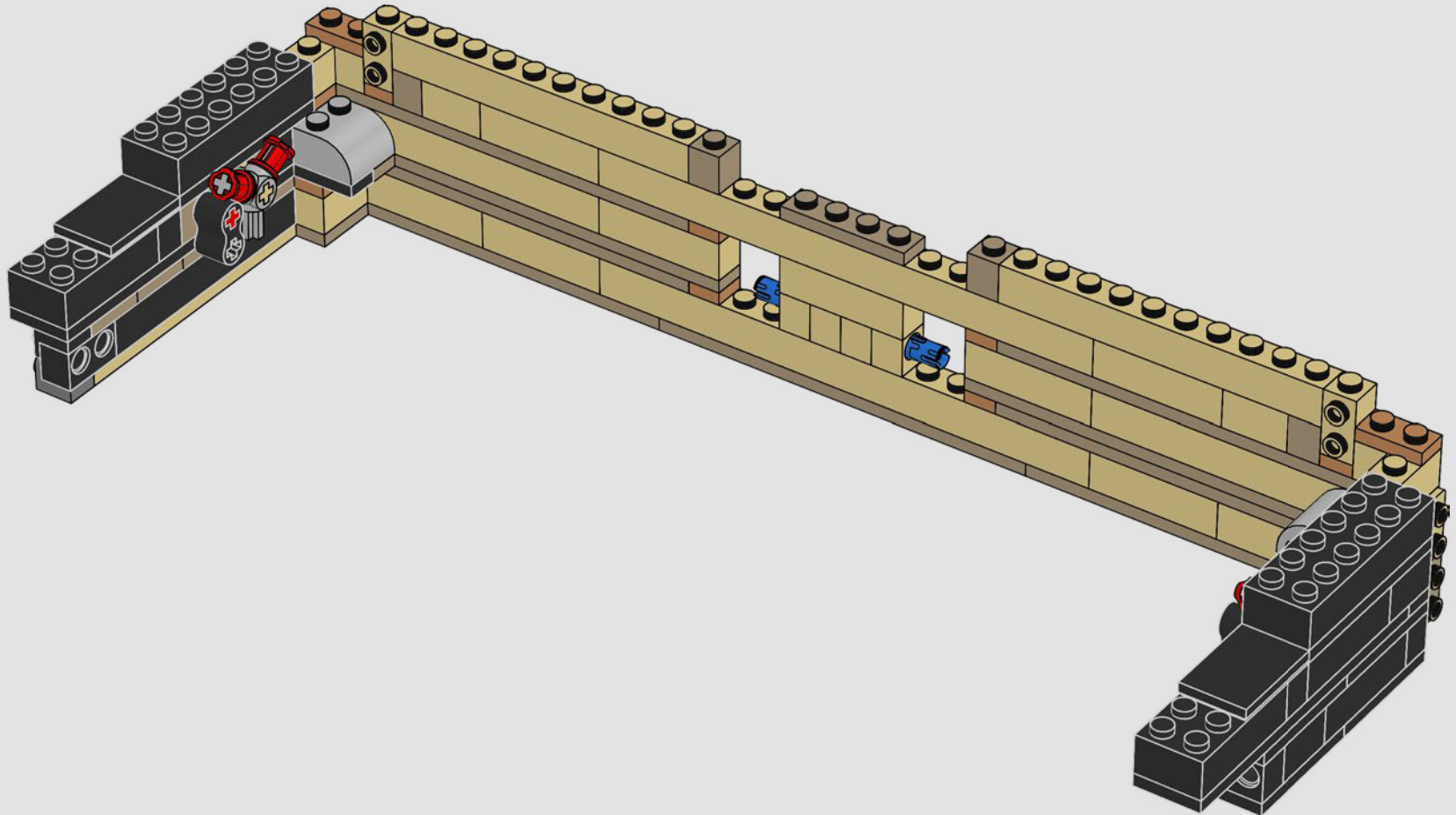



255

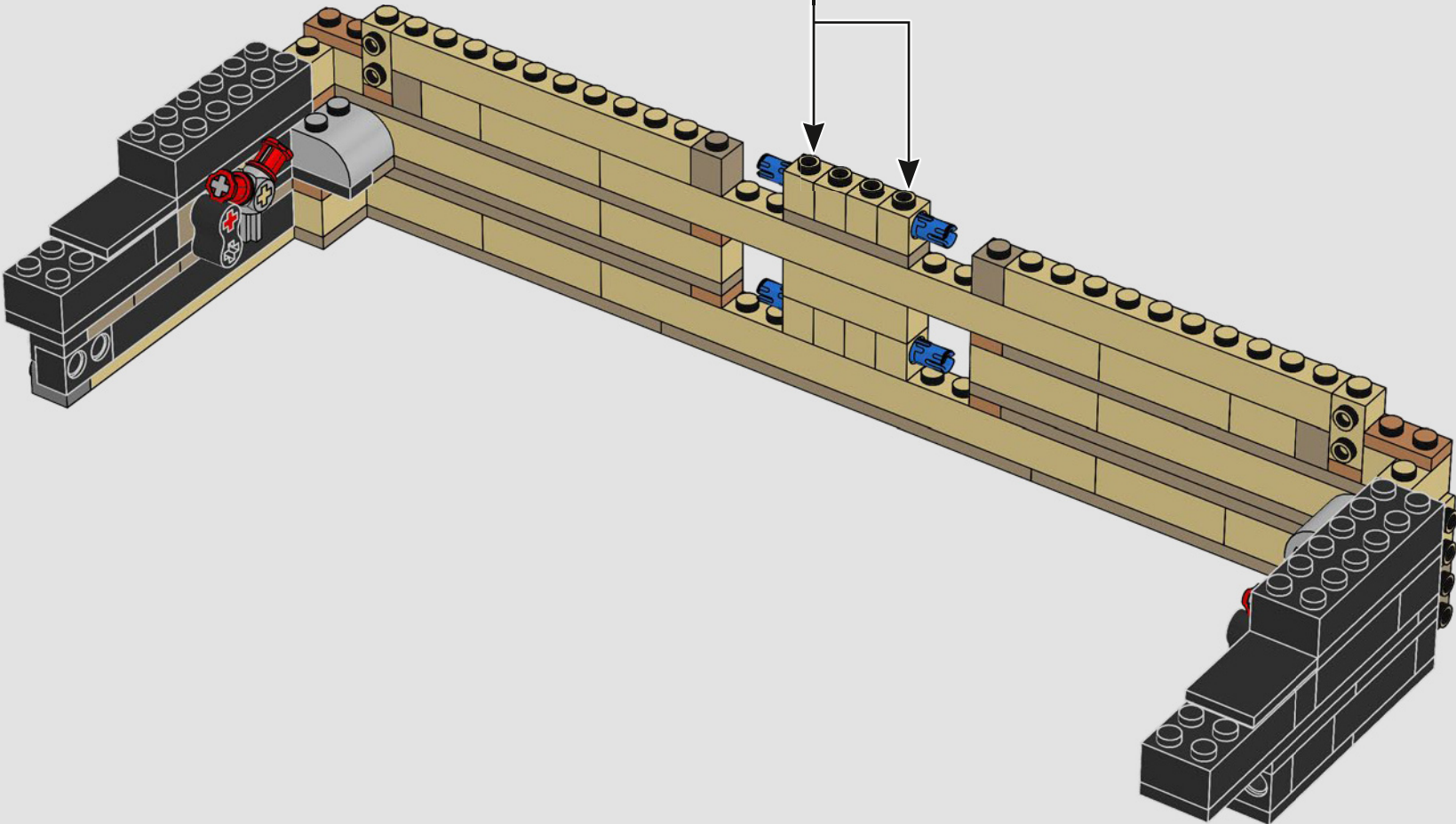
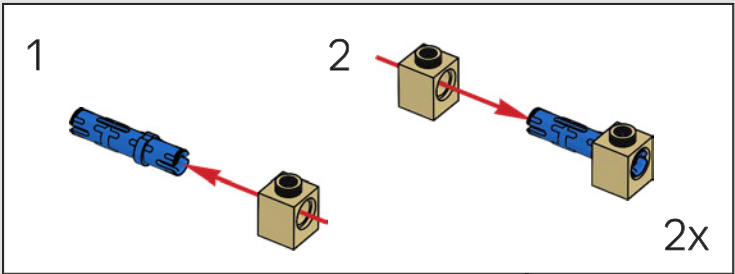

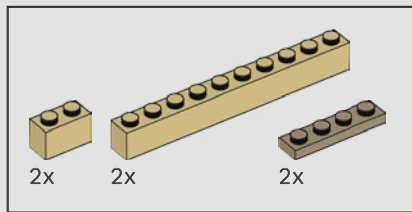

256

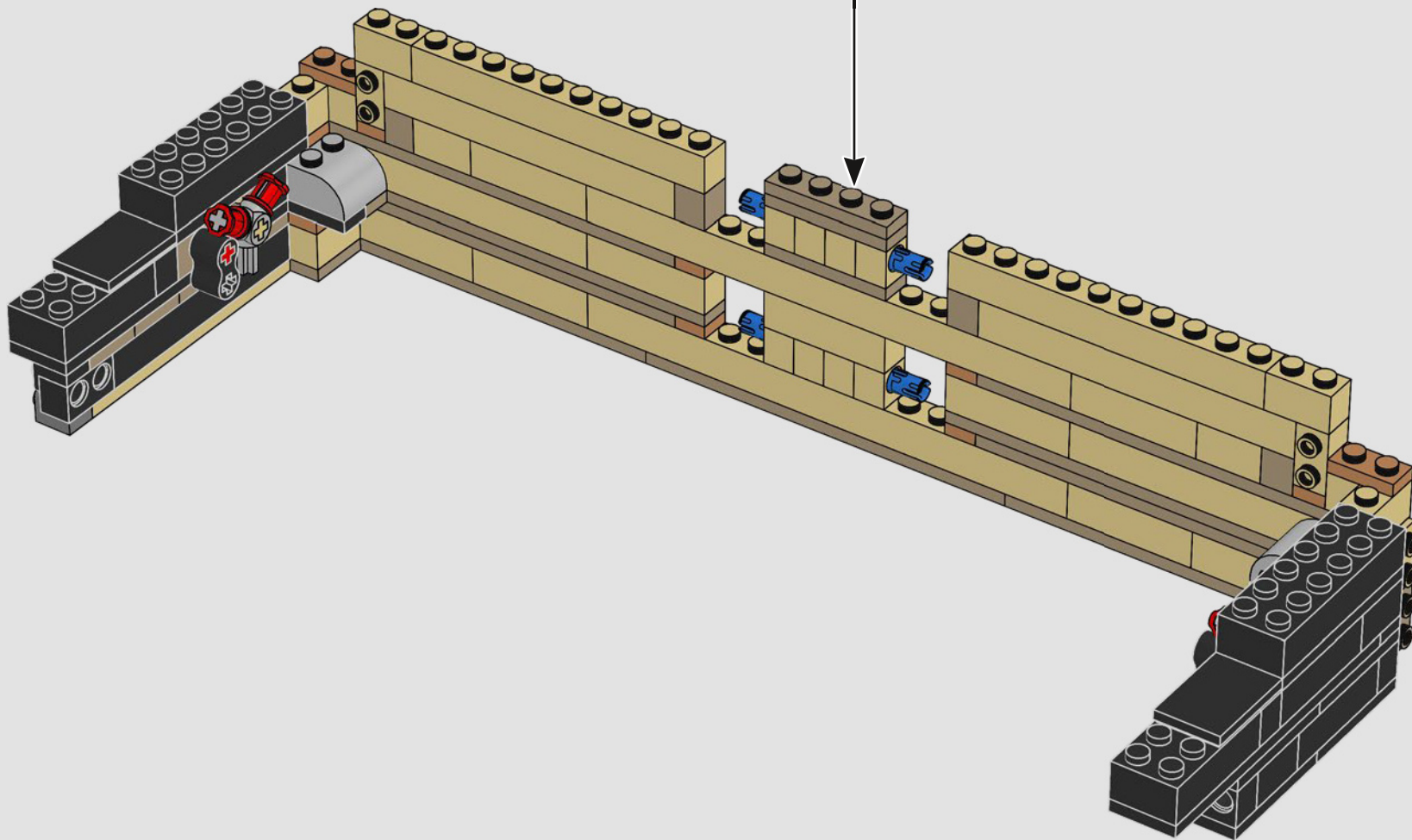
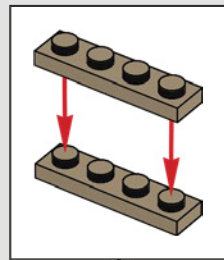

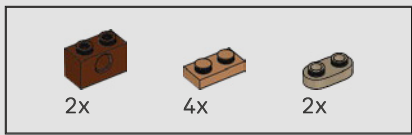

257

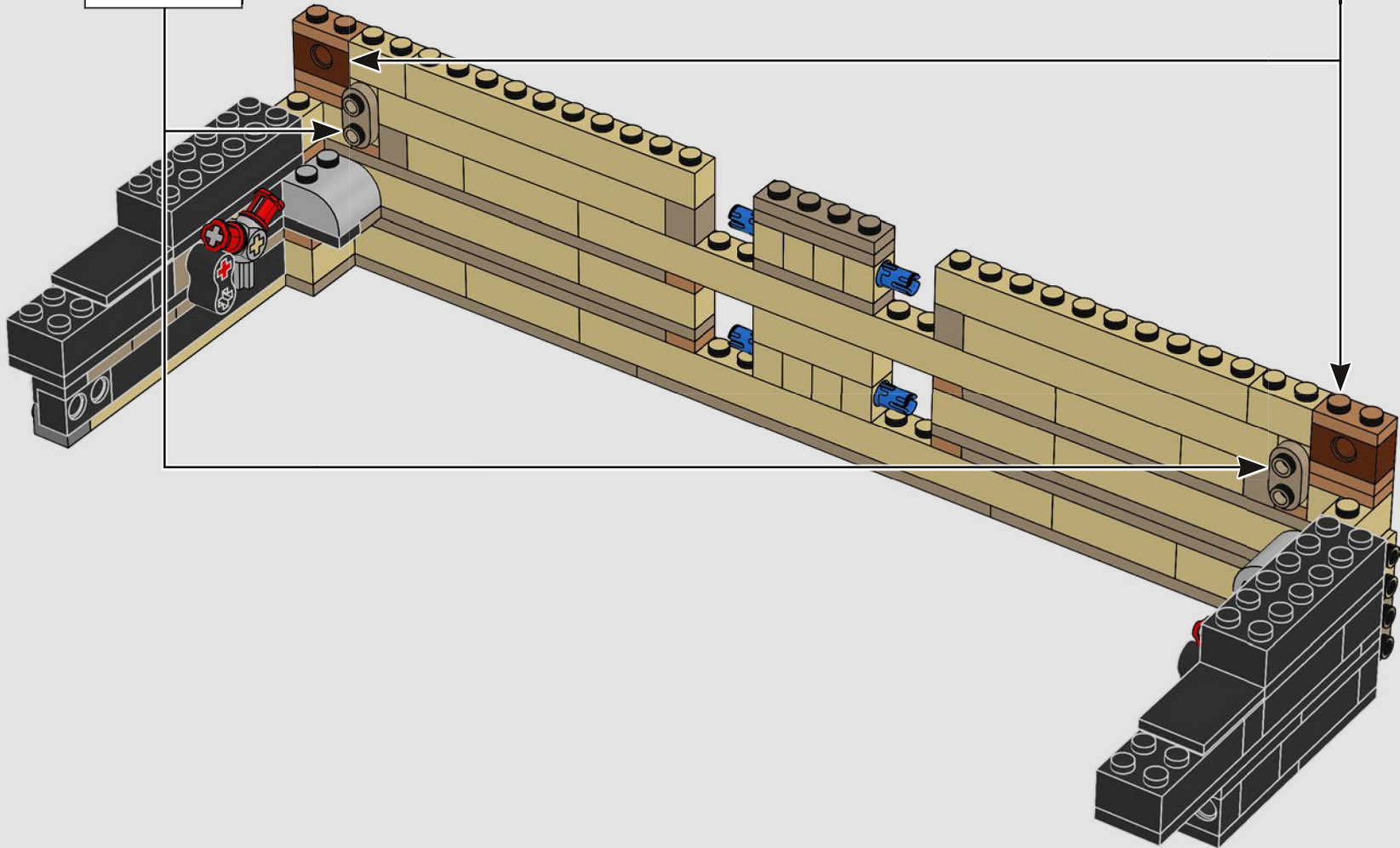
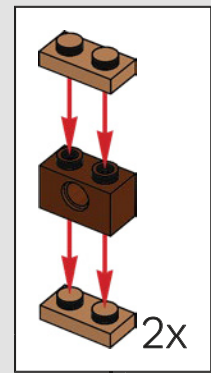

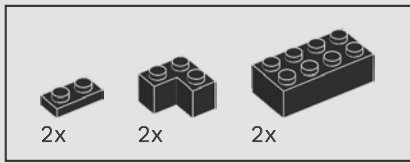

258

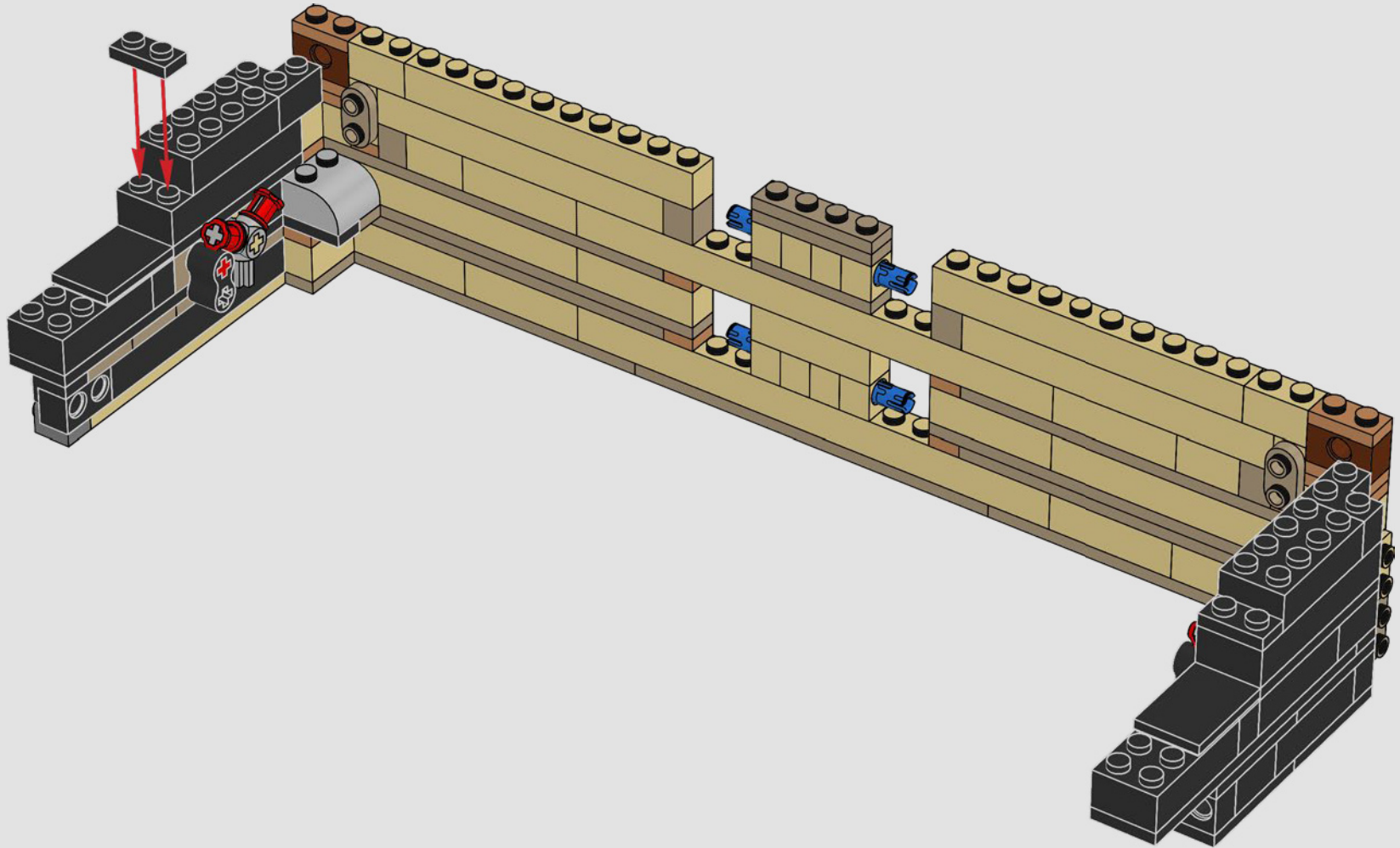

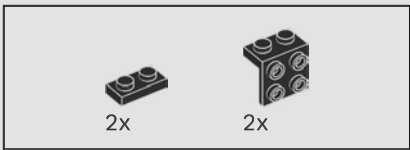

259

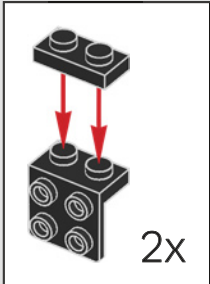
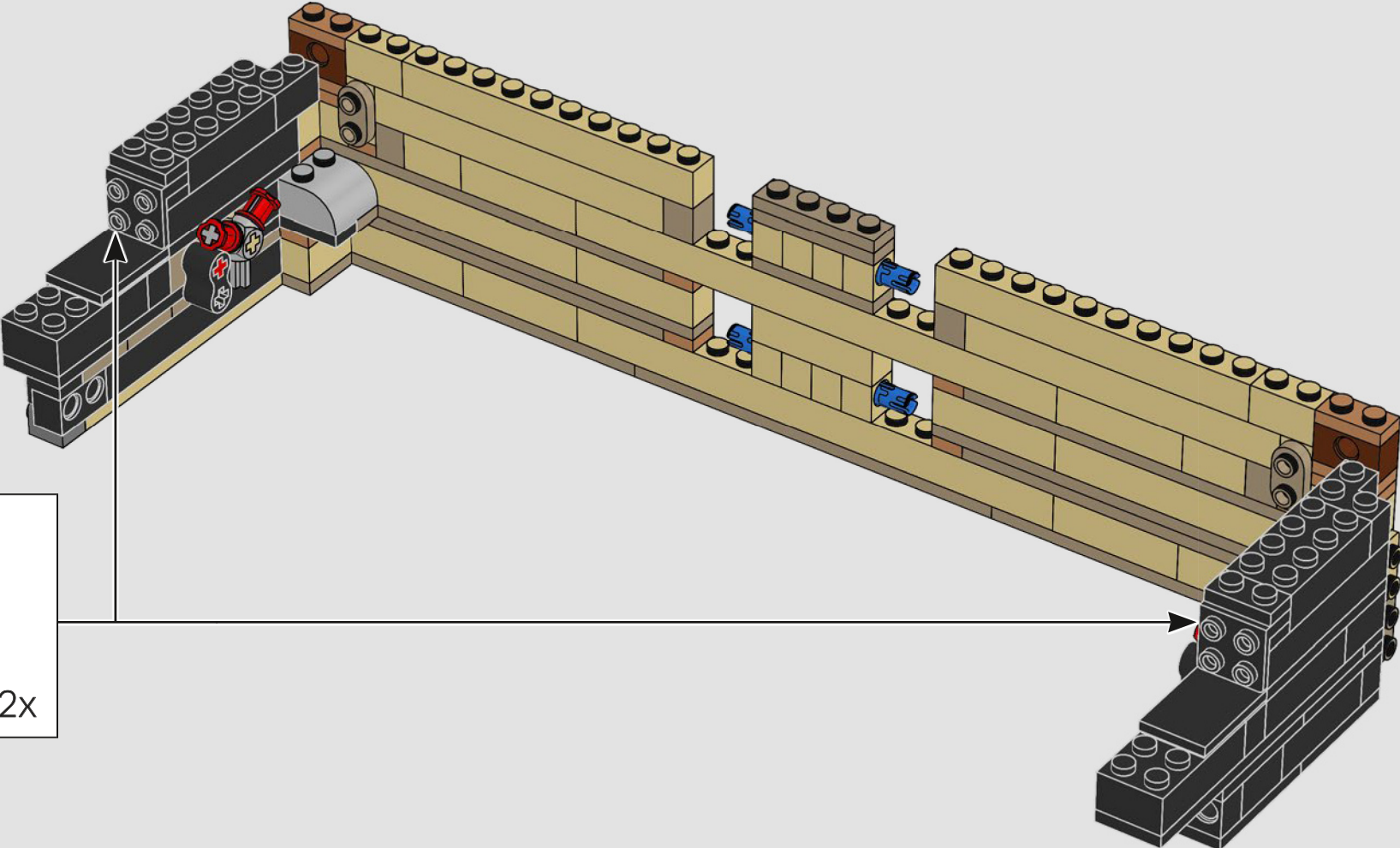

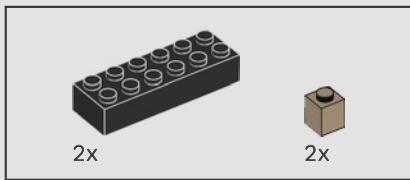

260

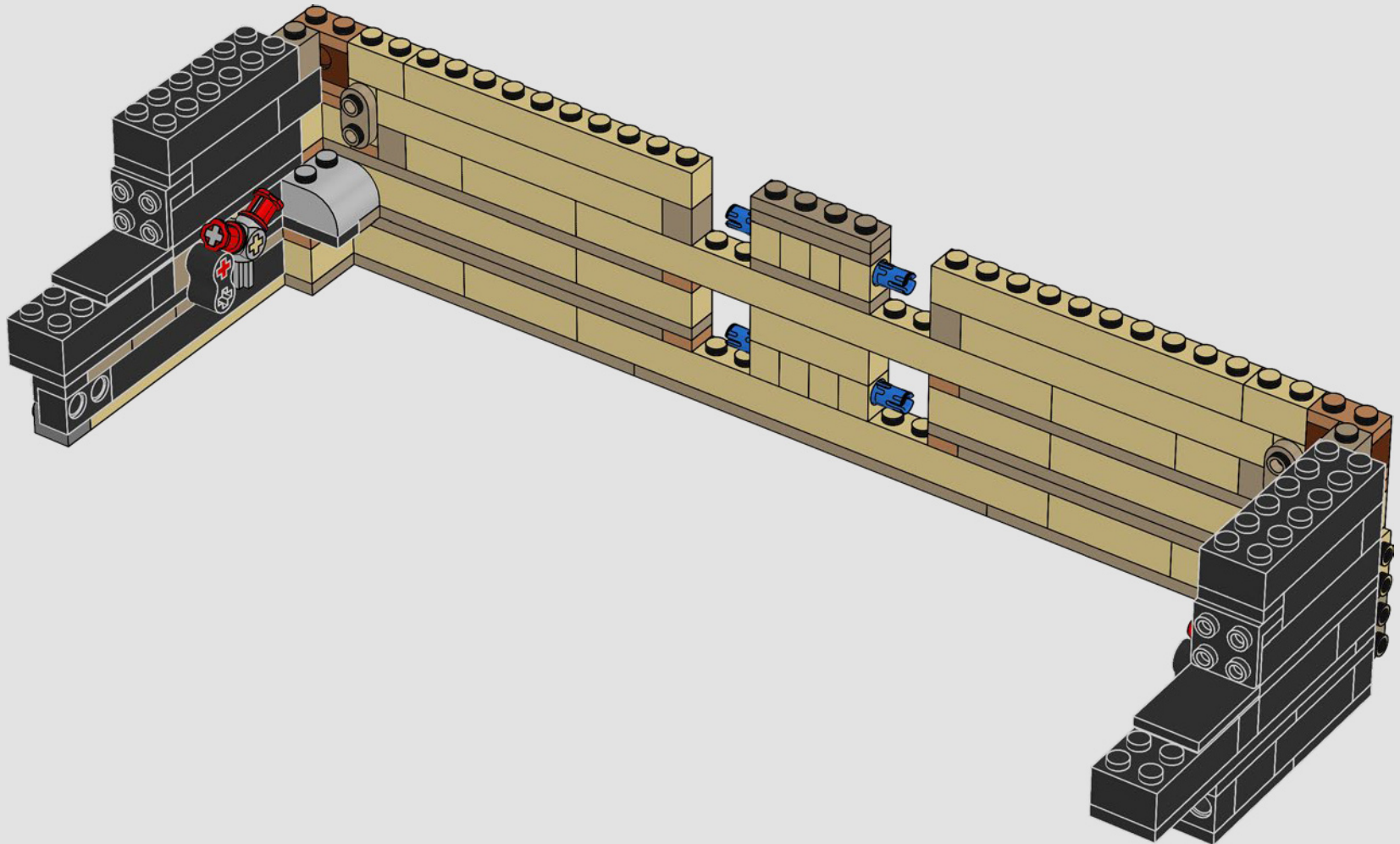

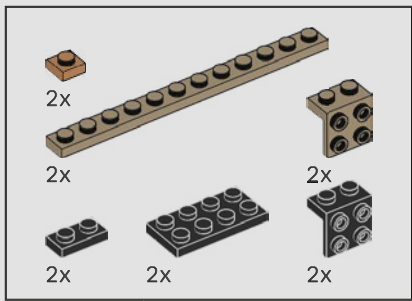

261

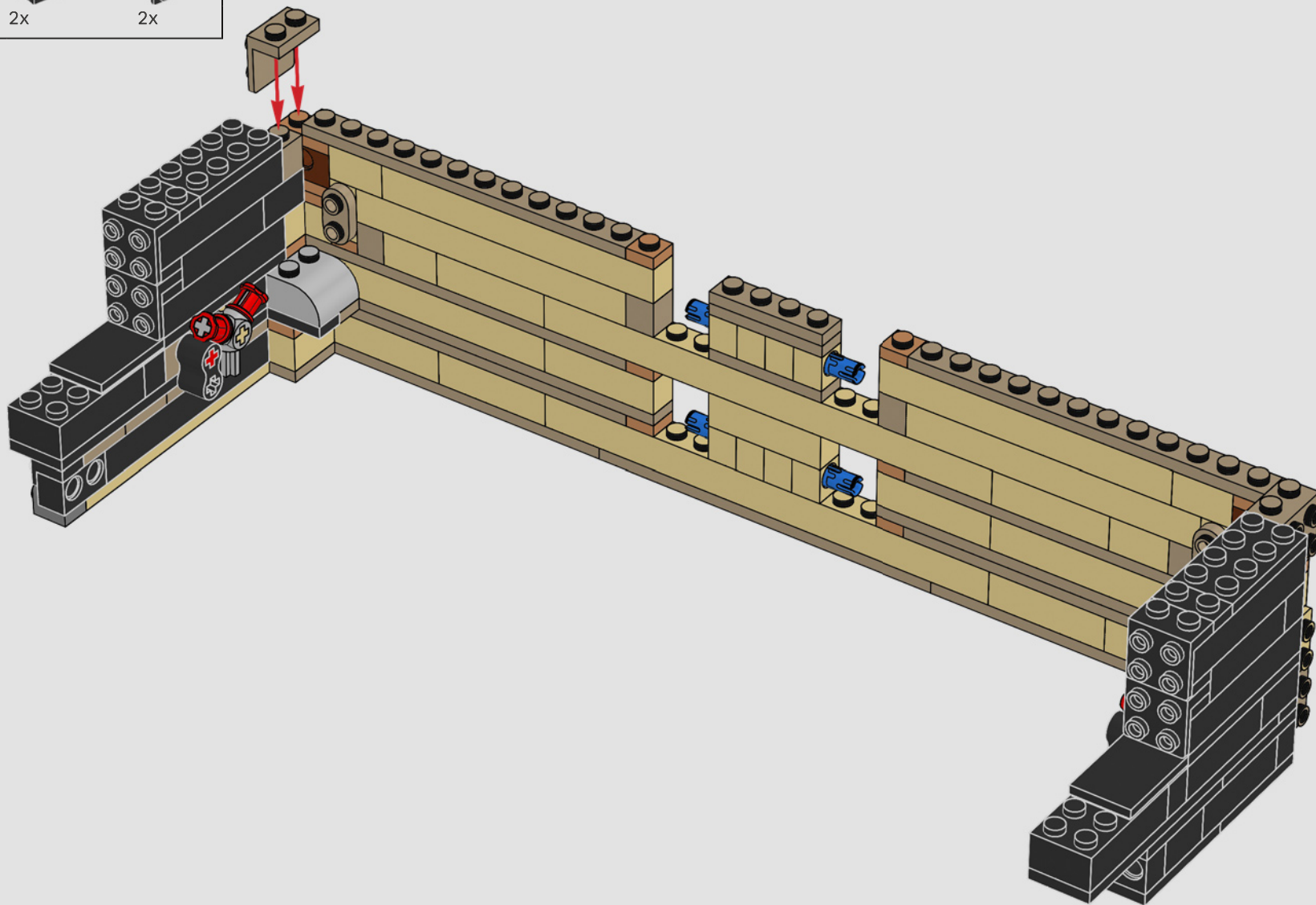



262

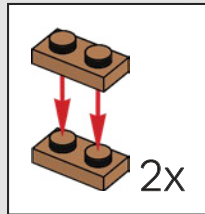
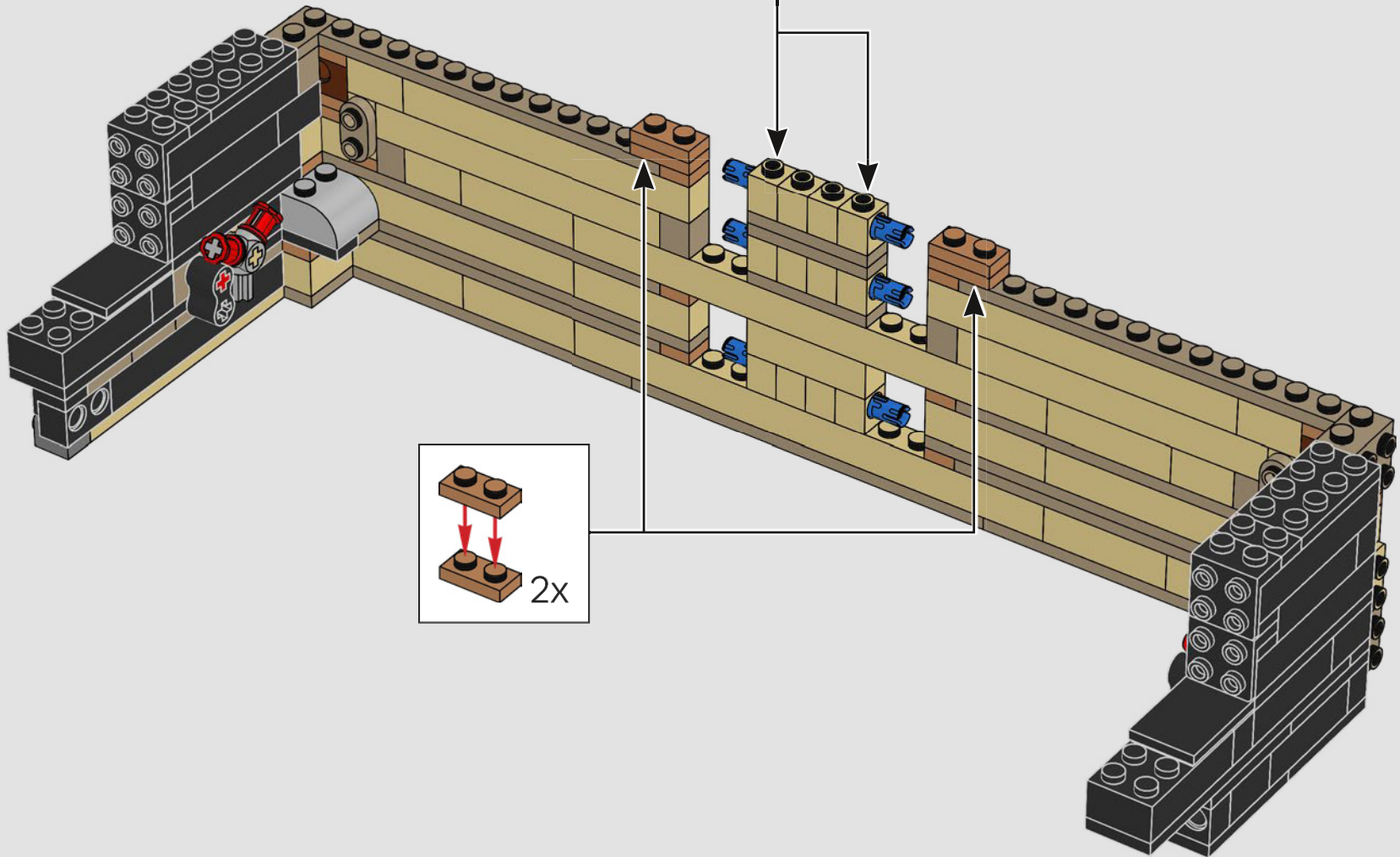
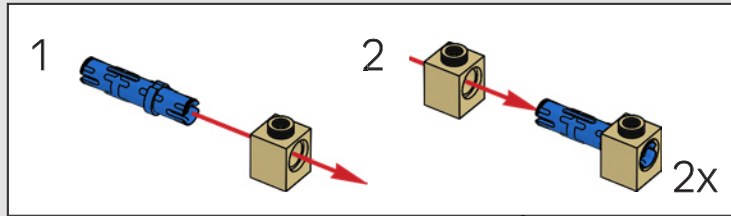

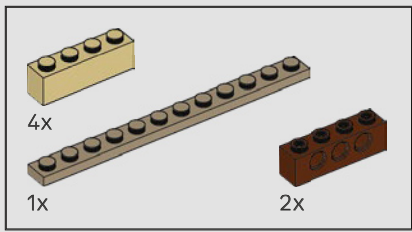

263

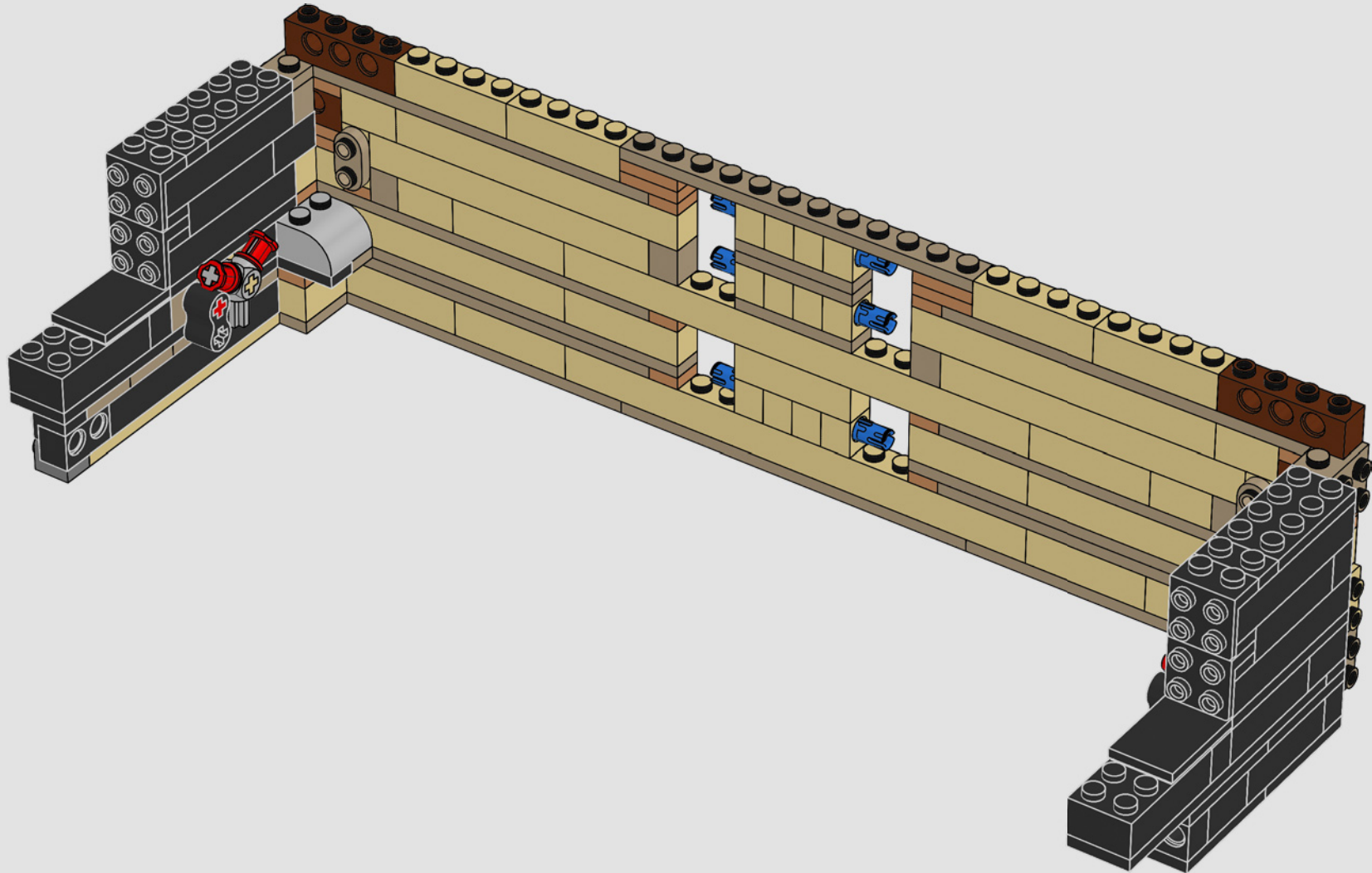

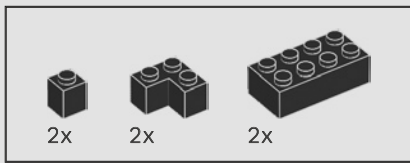

264

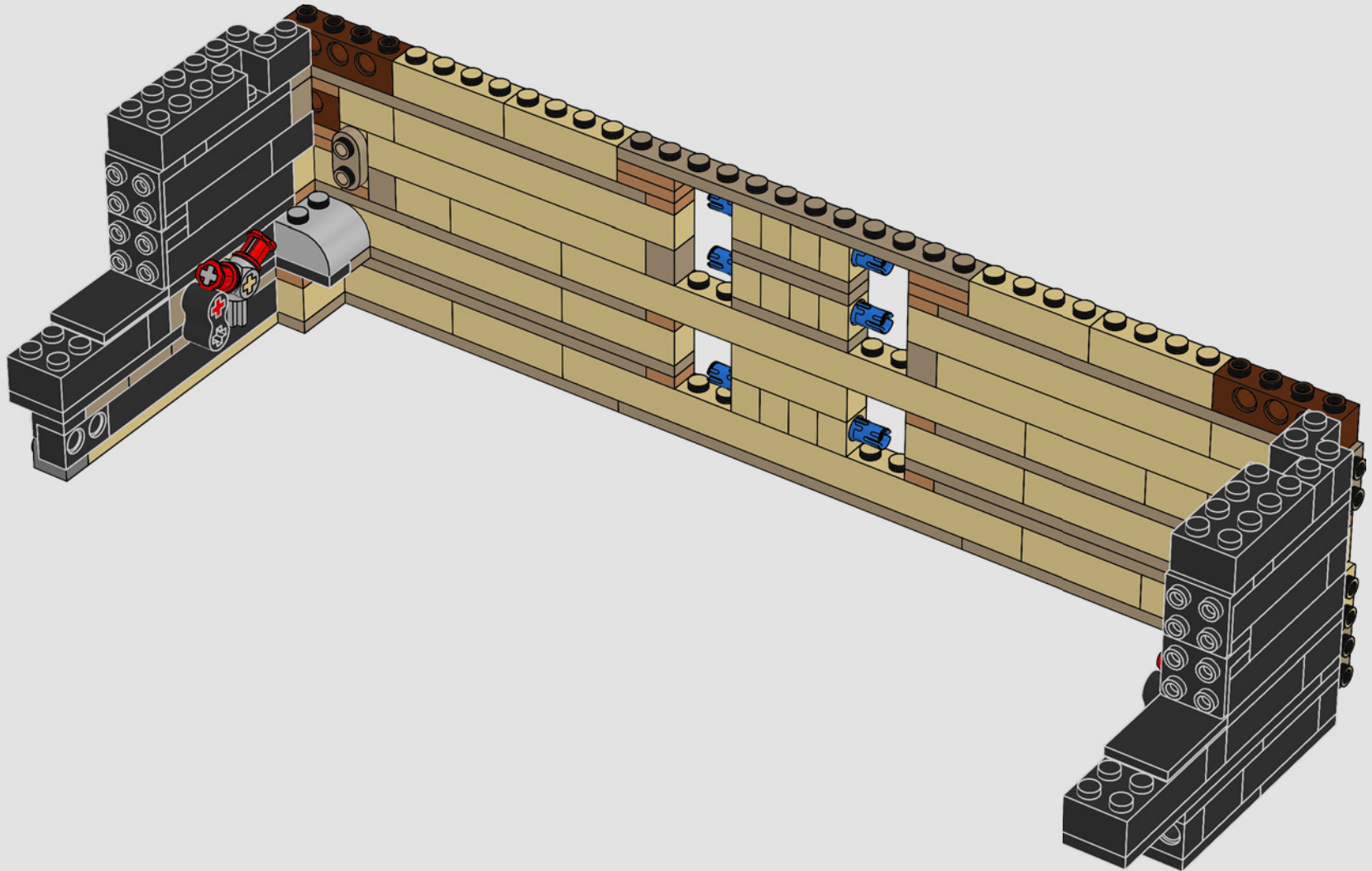

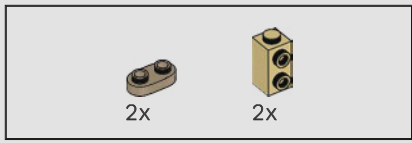

265

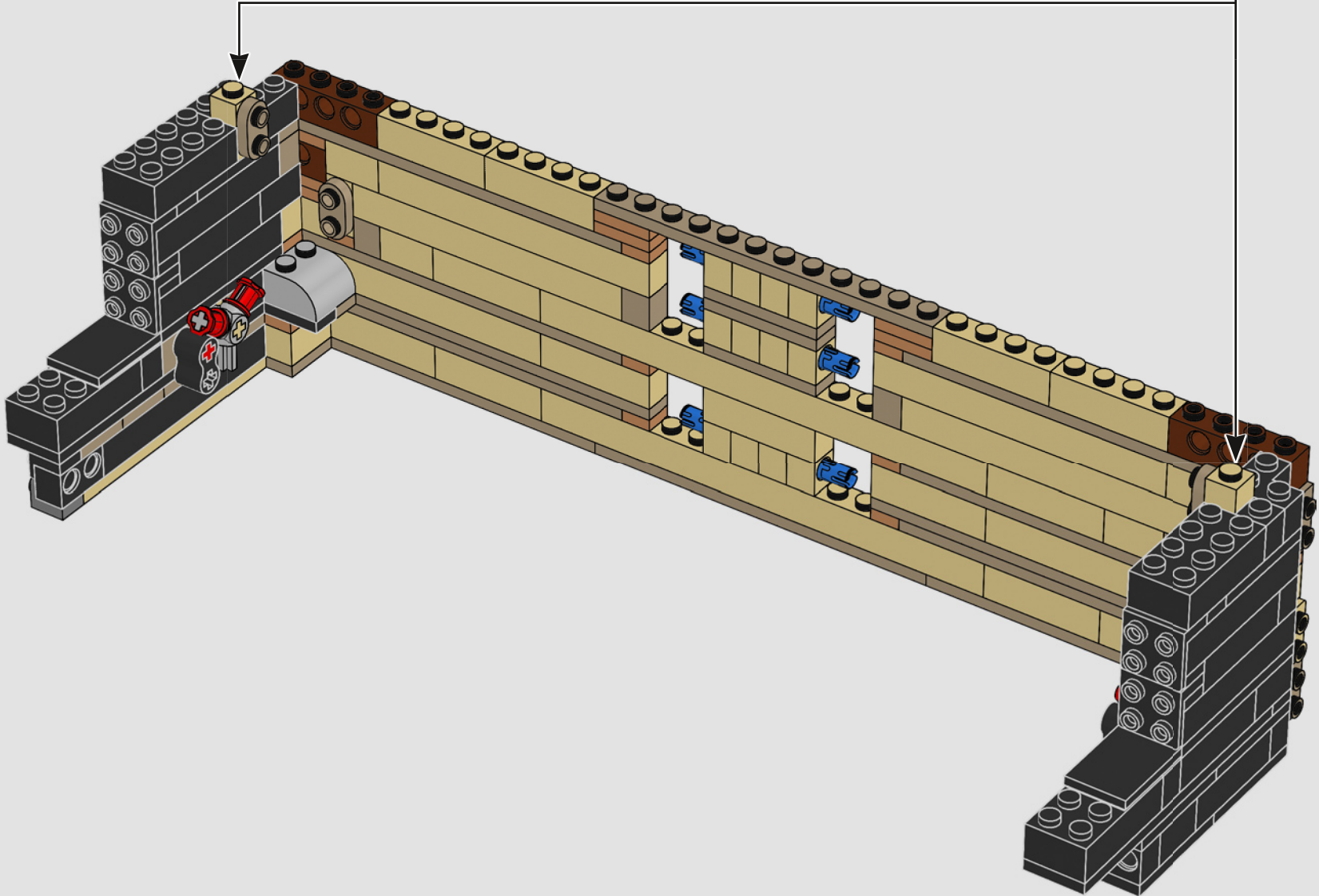
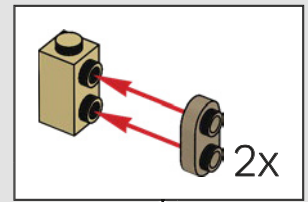

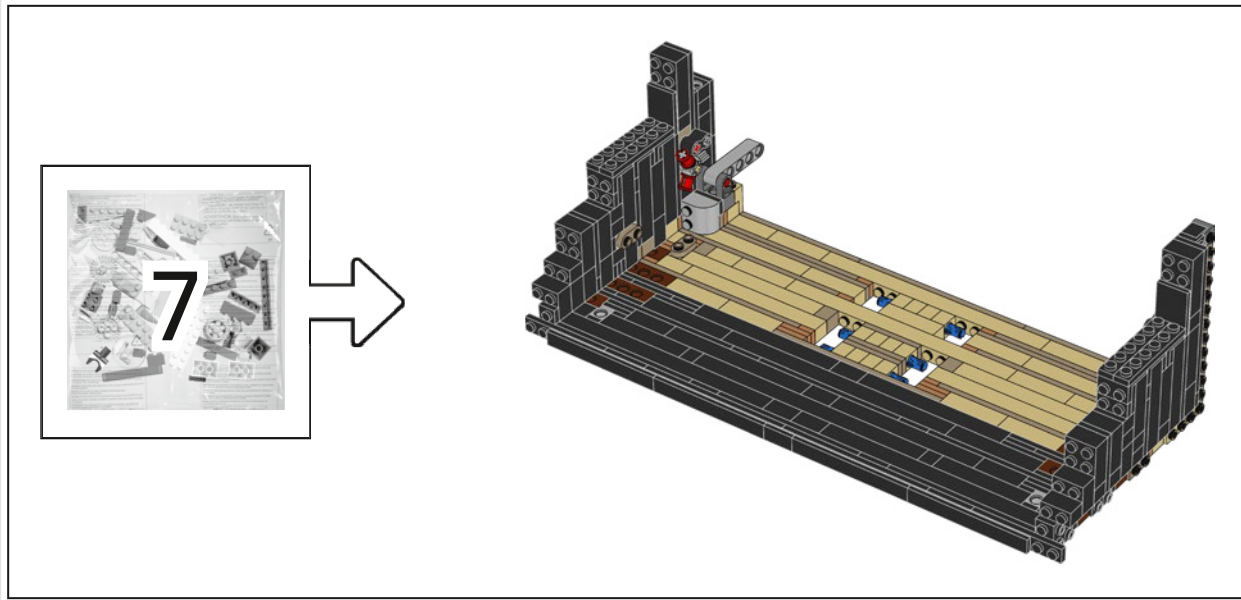

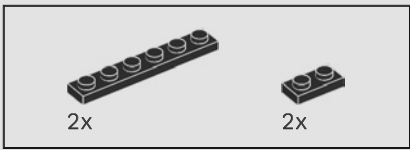

266

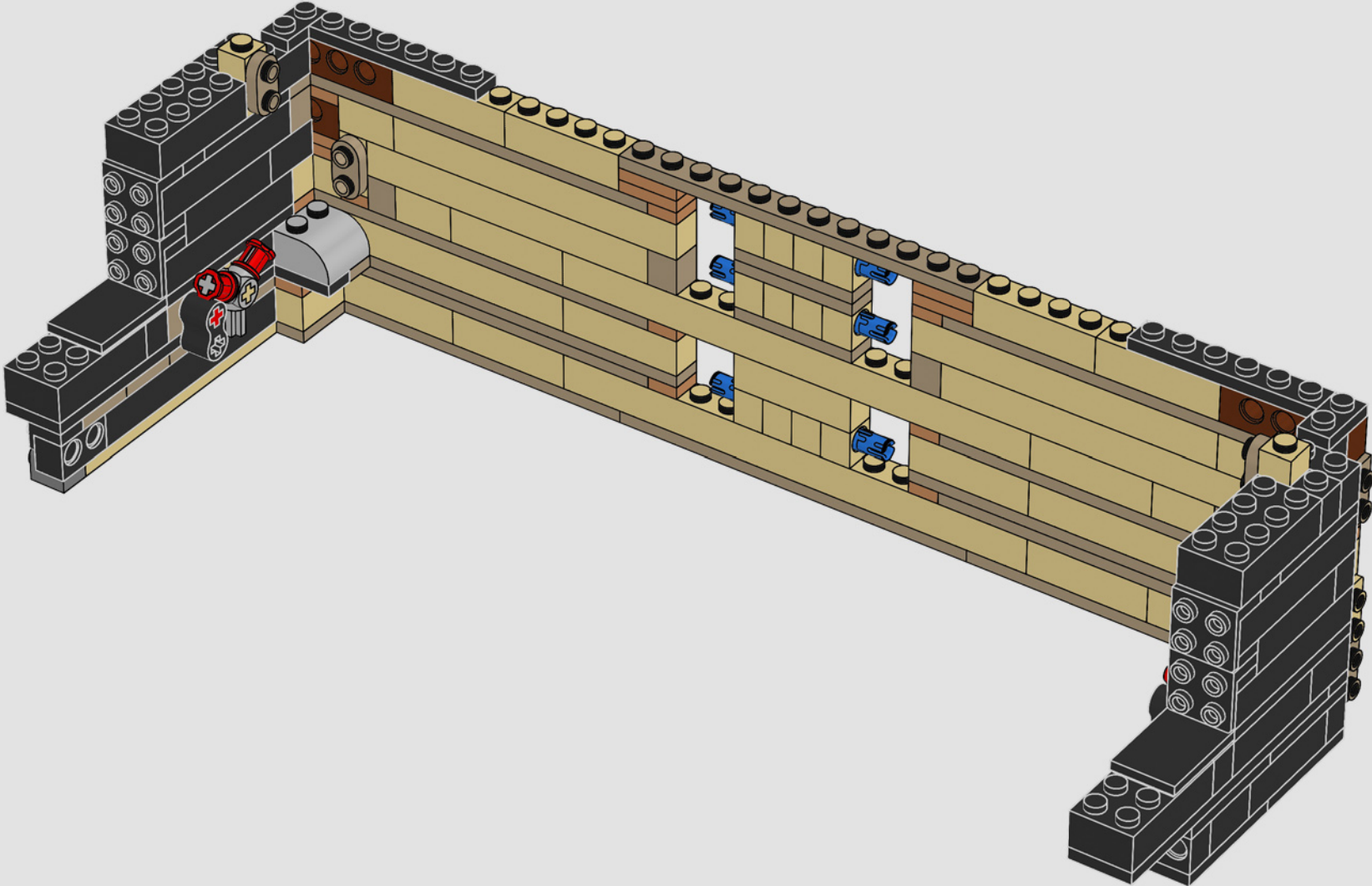

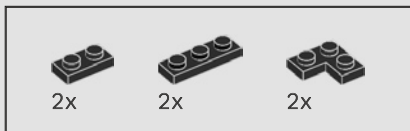

267

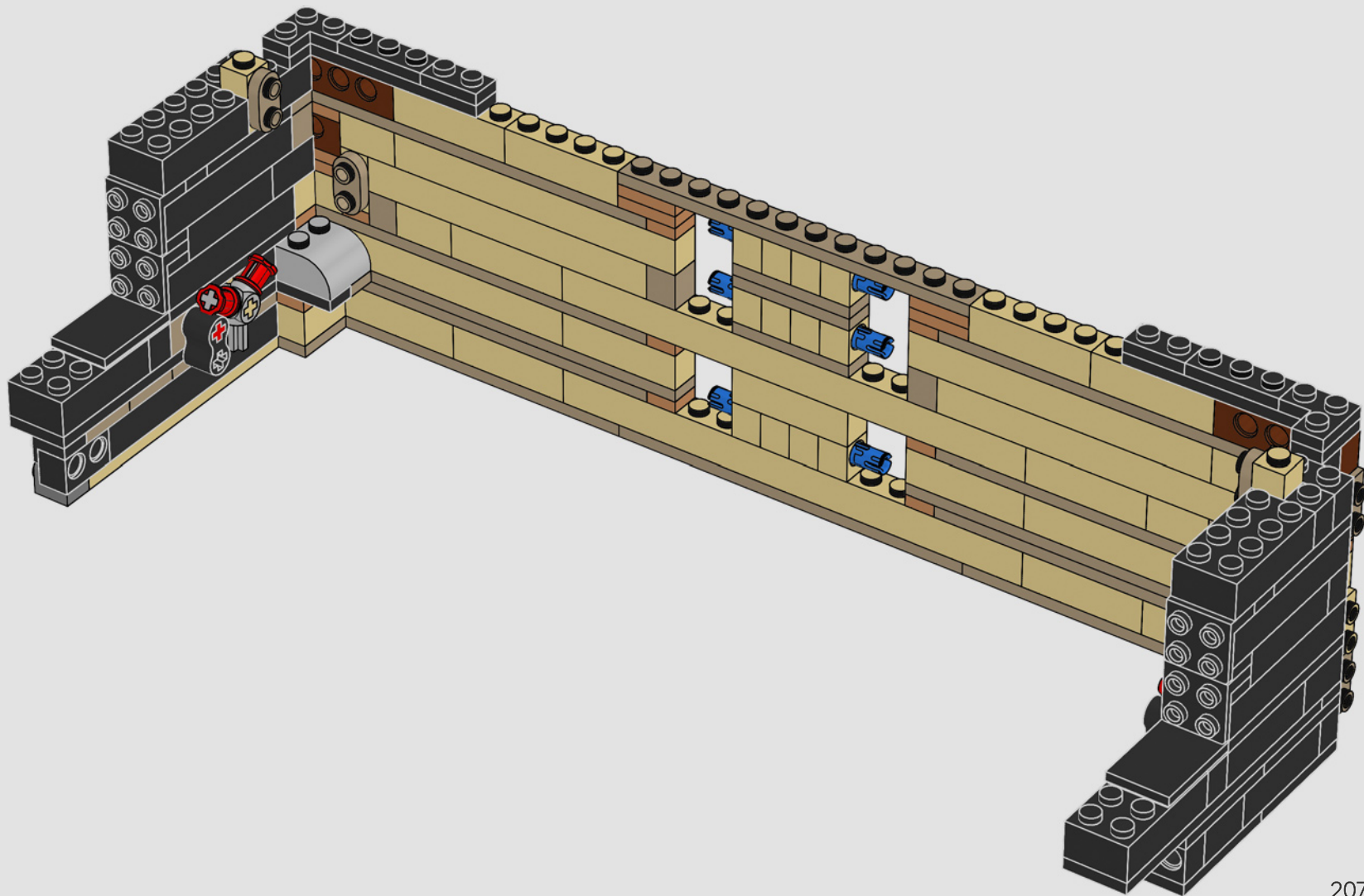

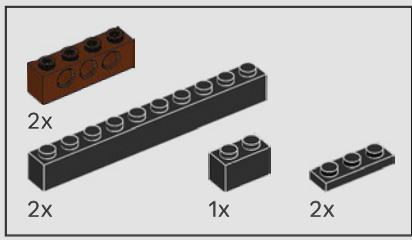

268

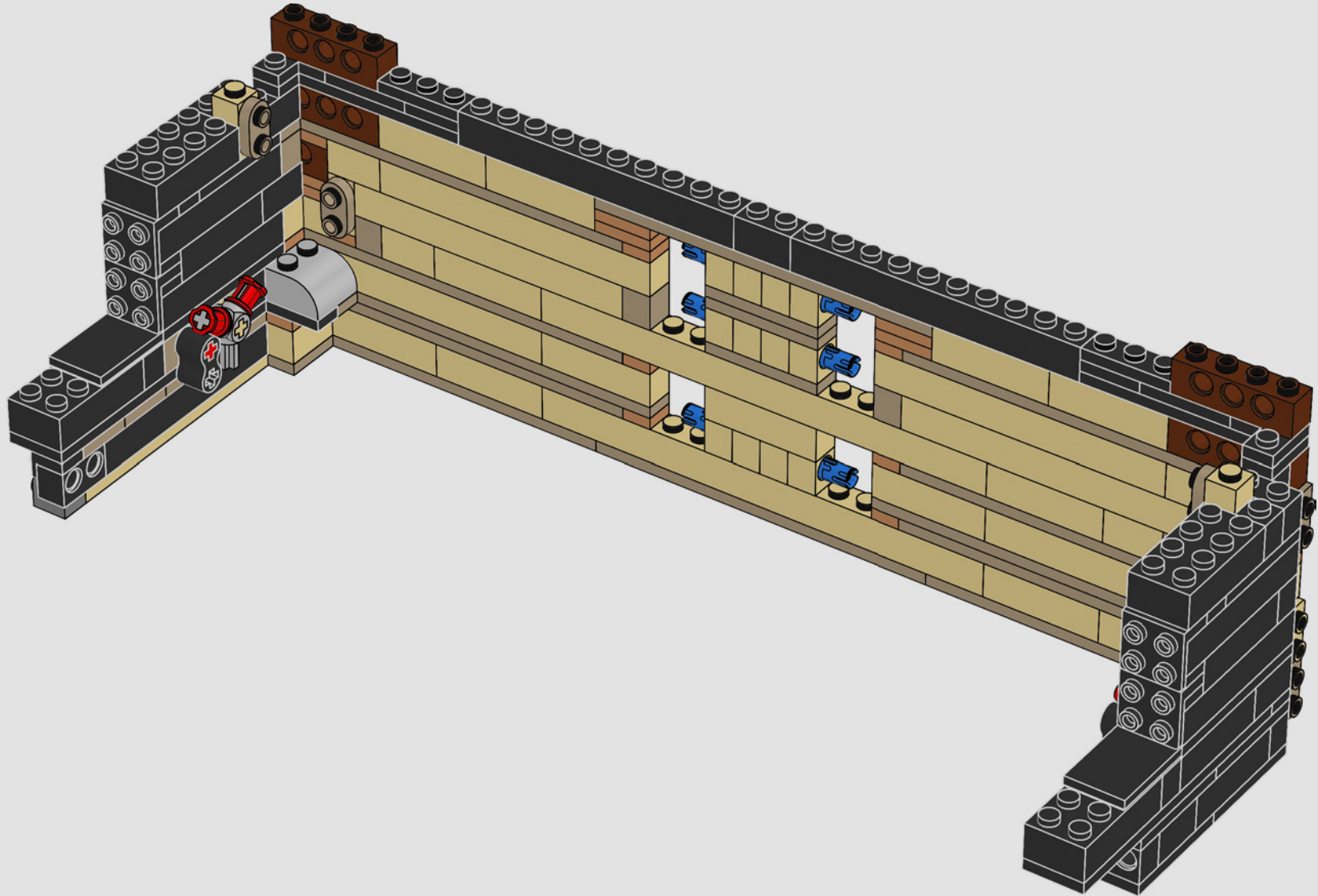

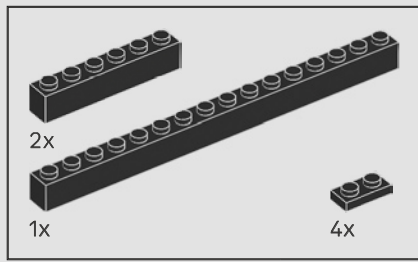

269

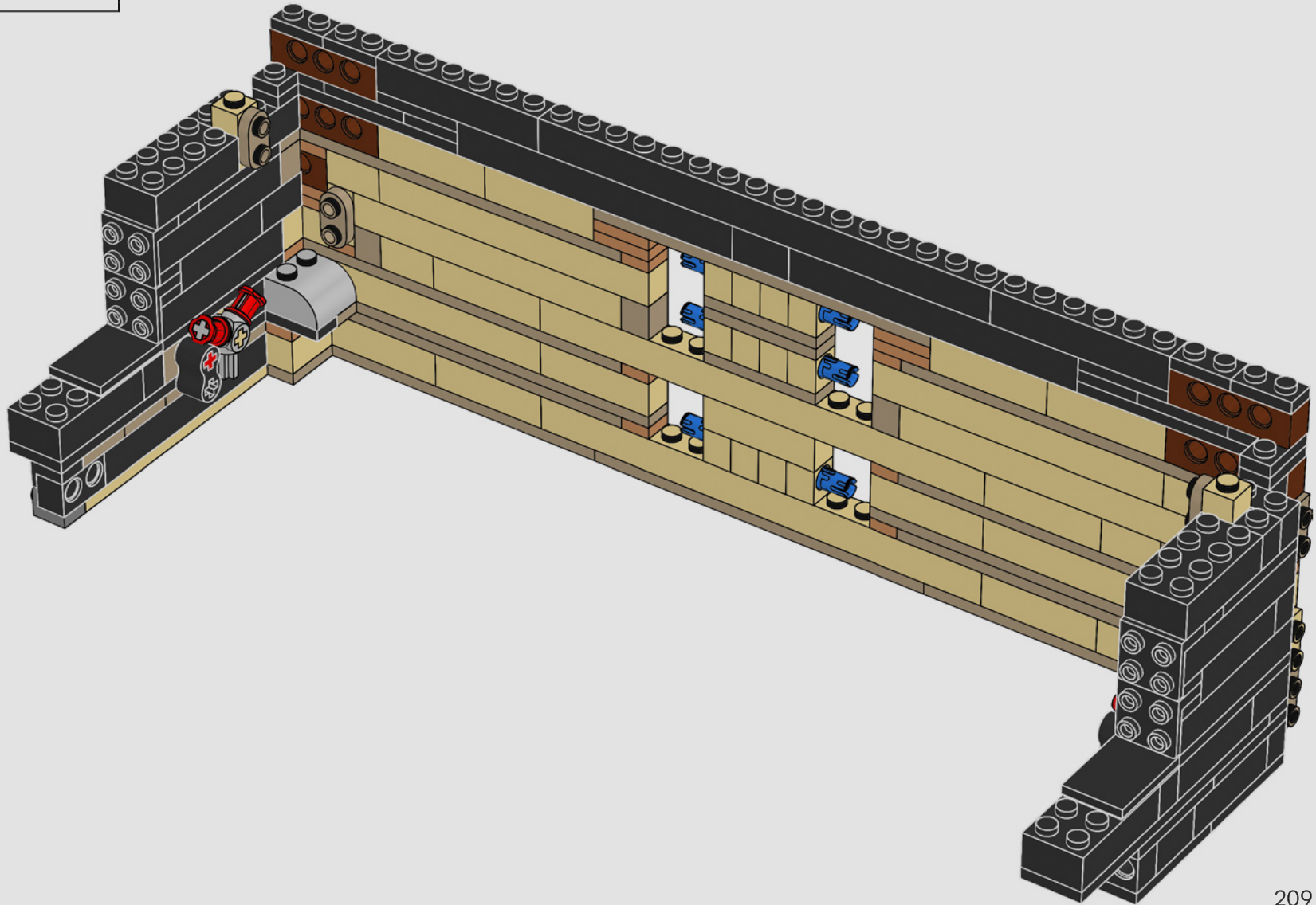

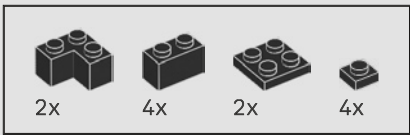

270

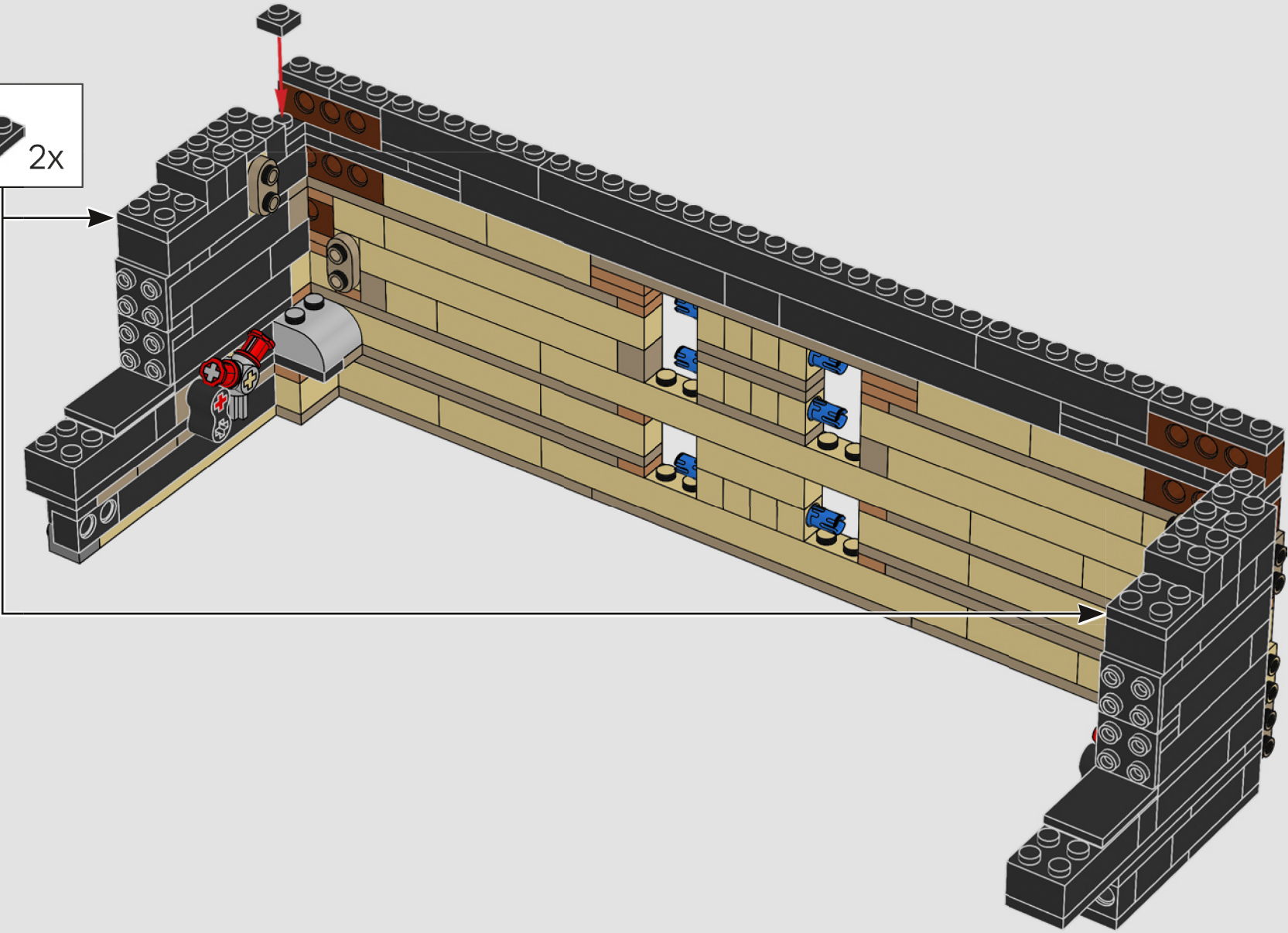
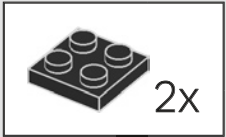

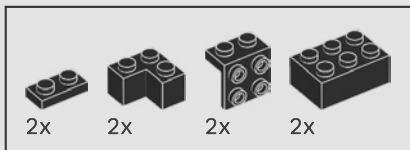

271

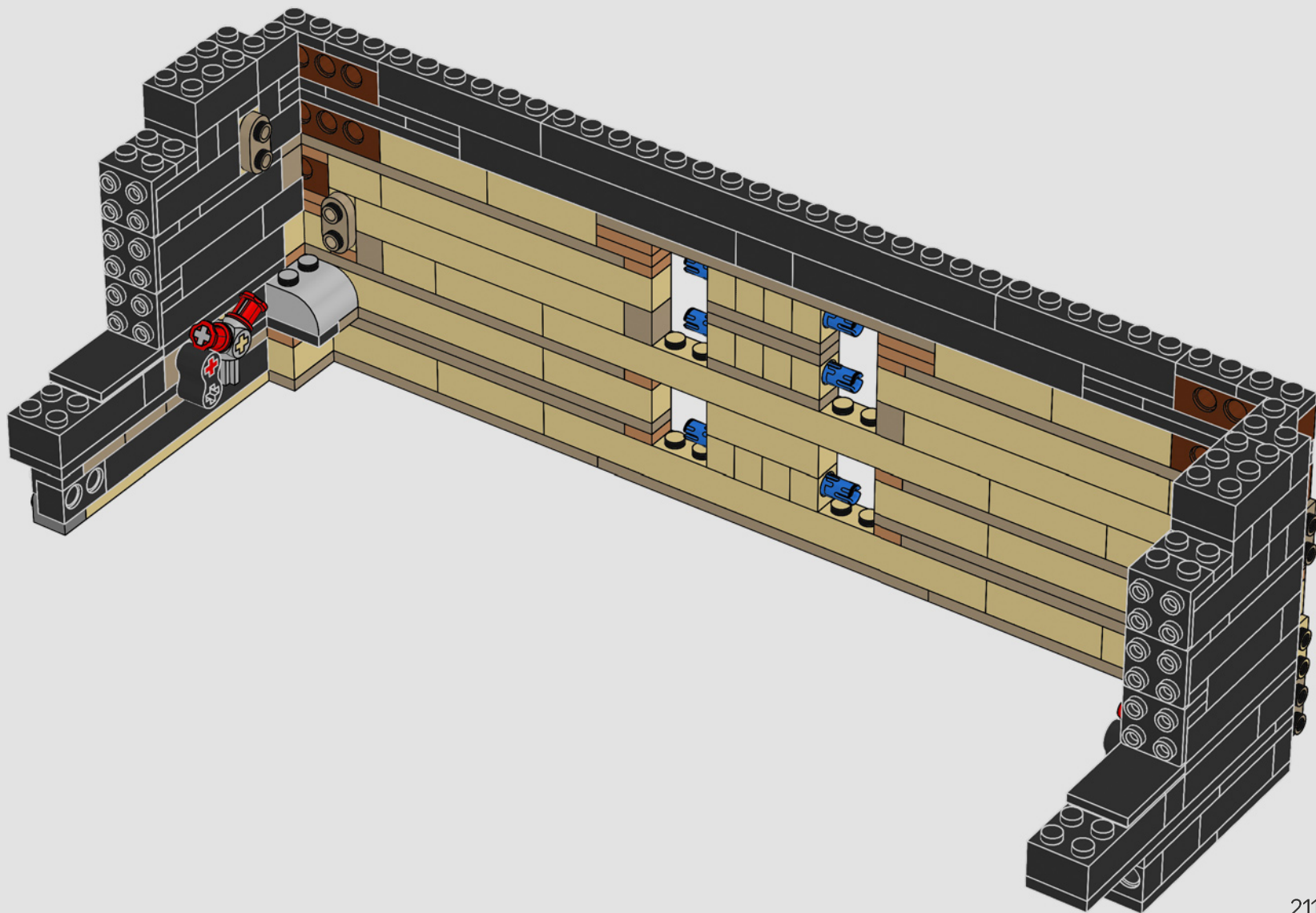

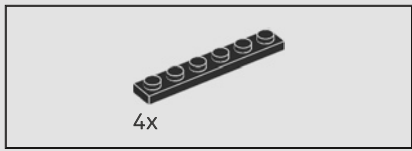

272

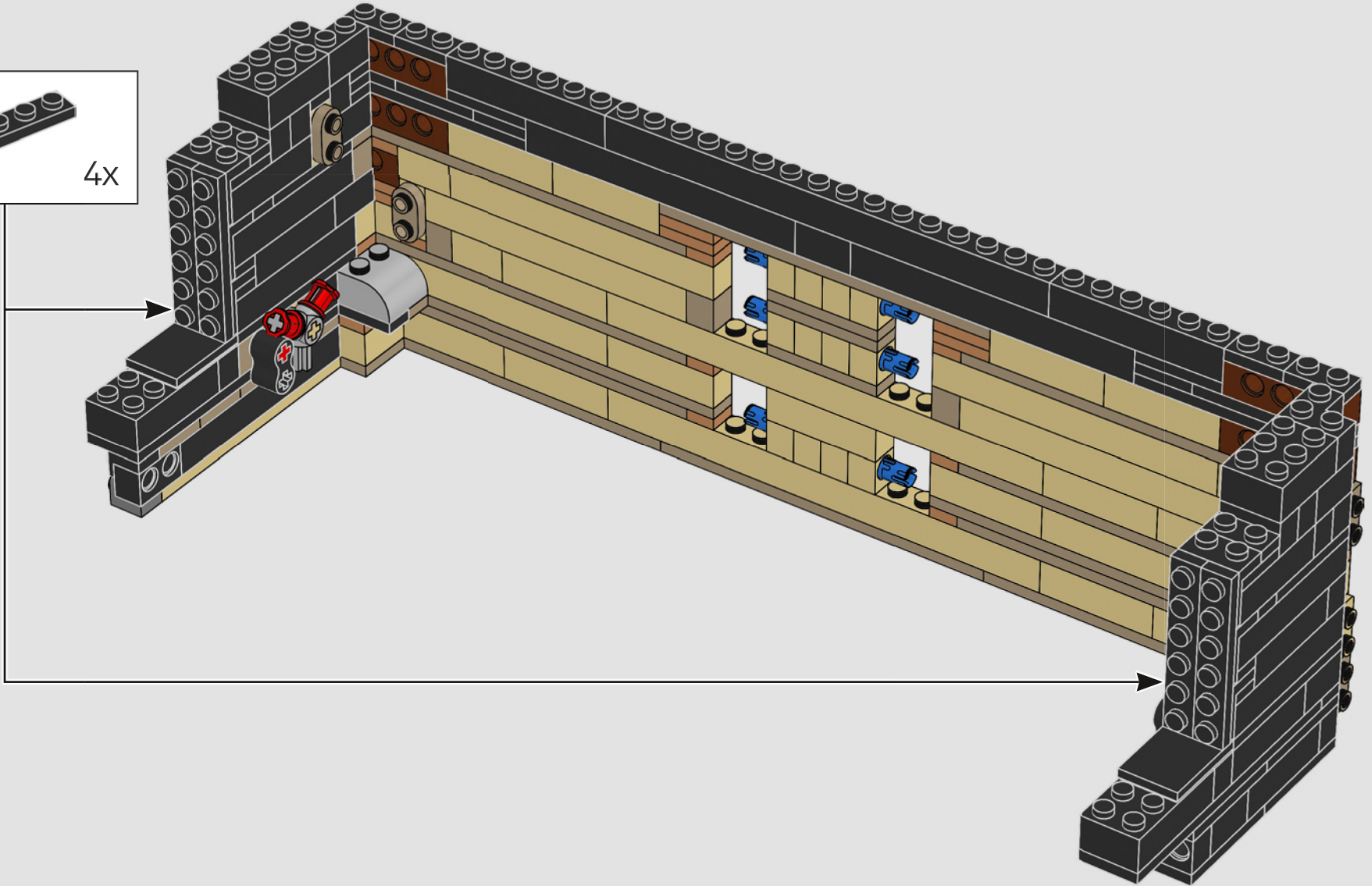
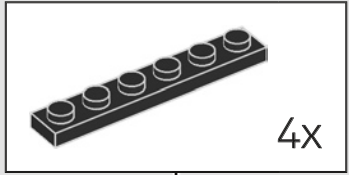

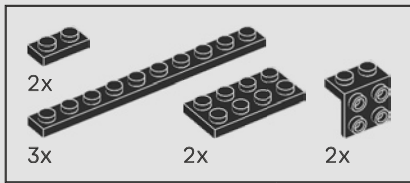

273

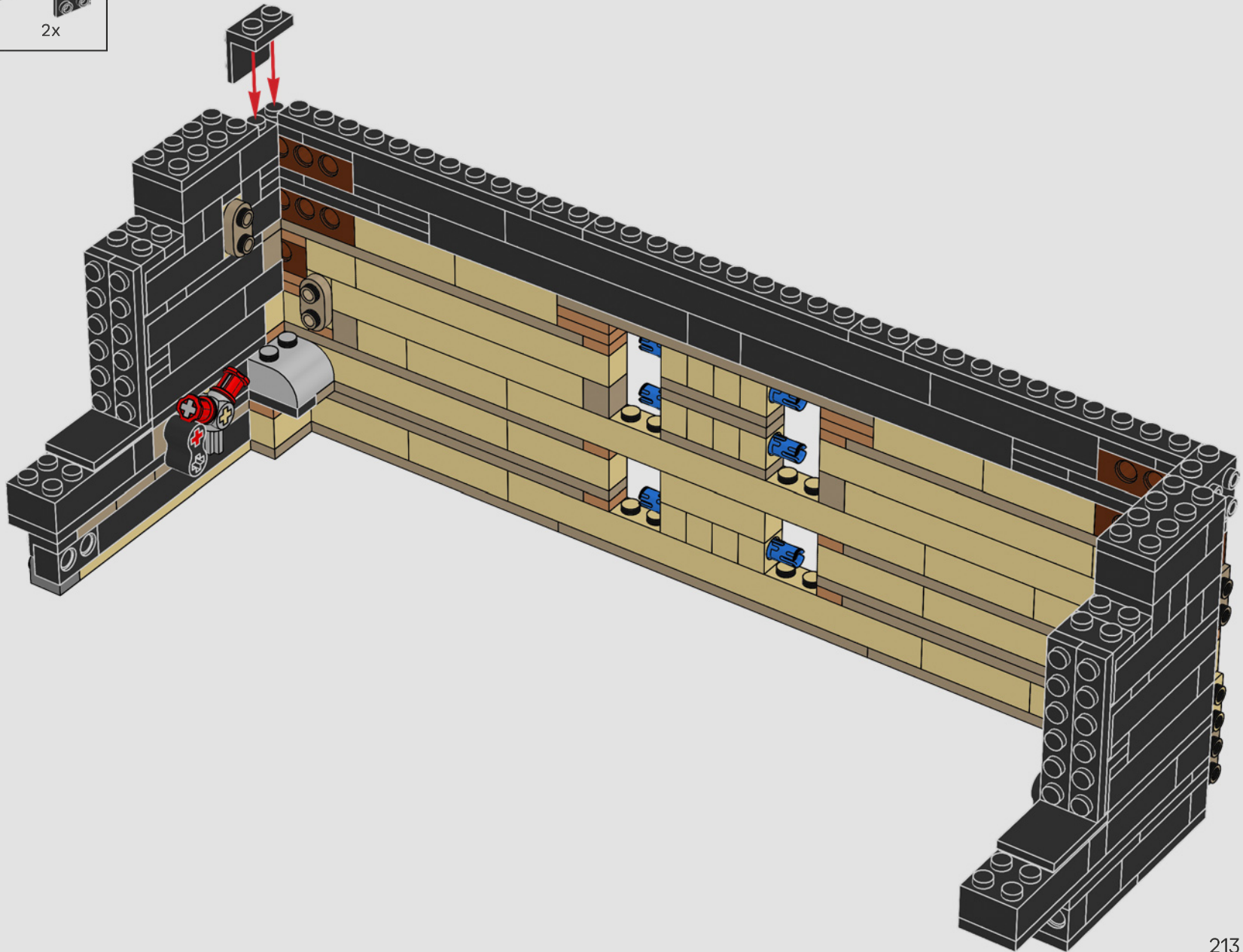

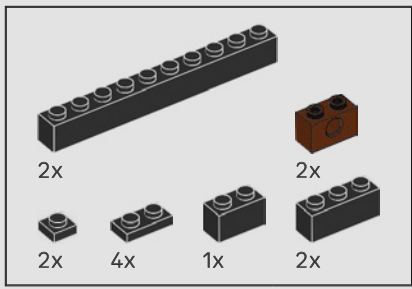

274

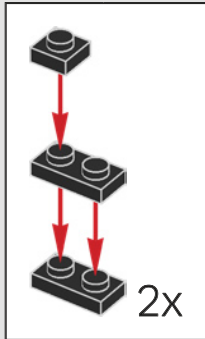
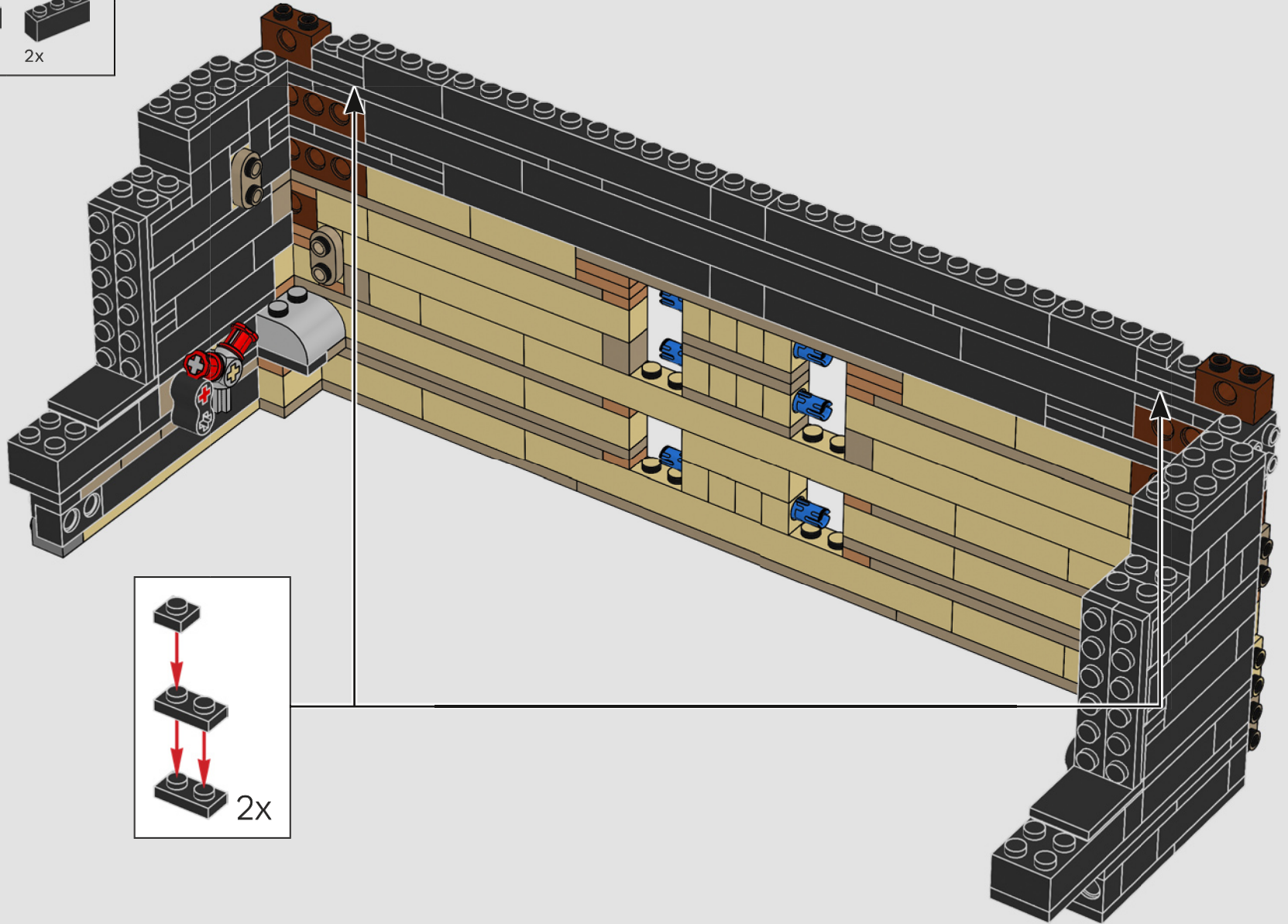

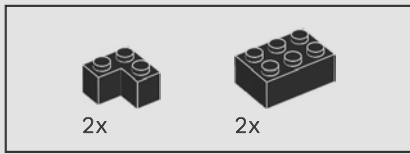

275

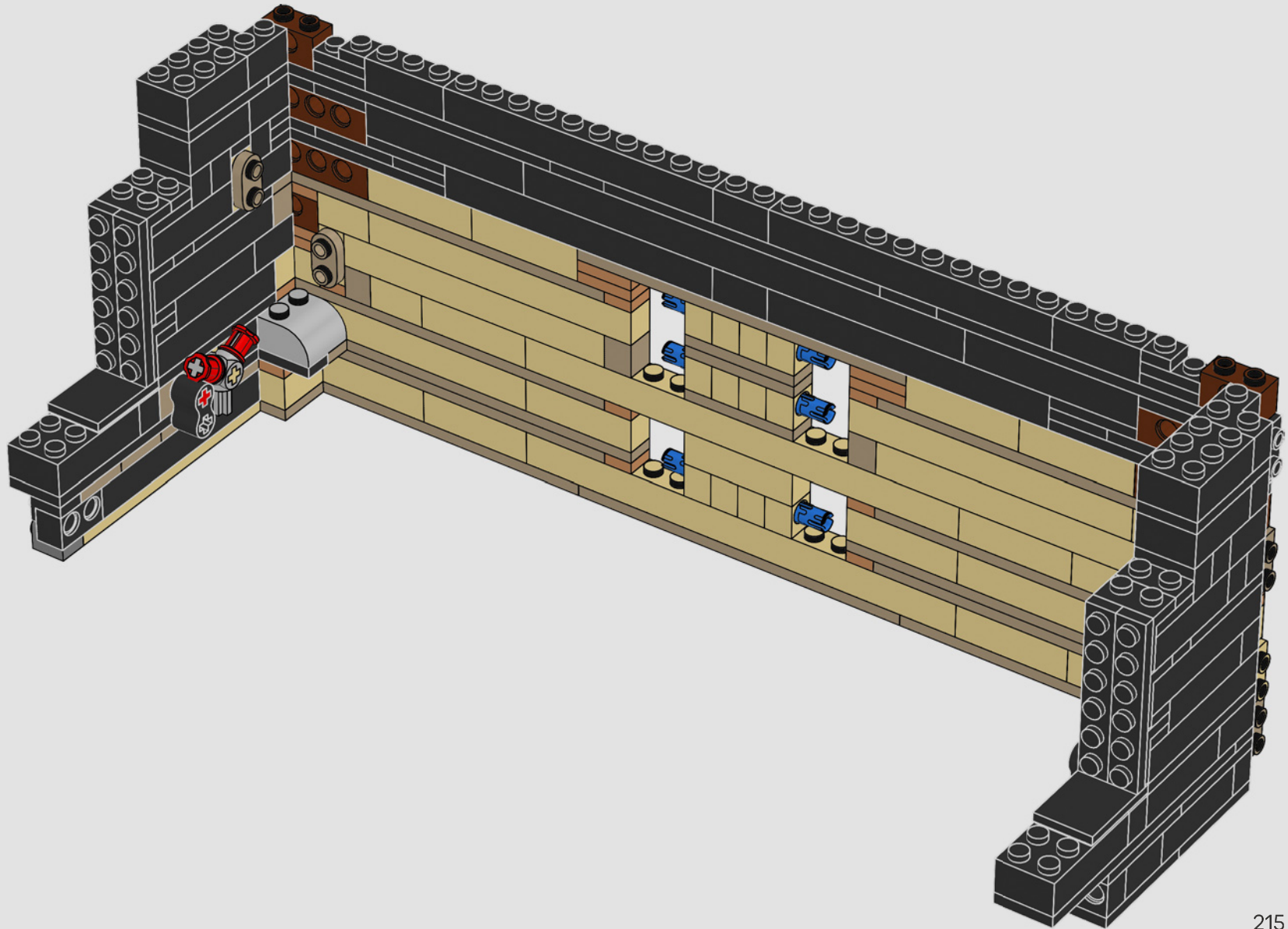

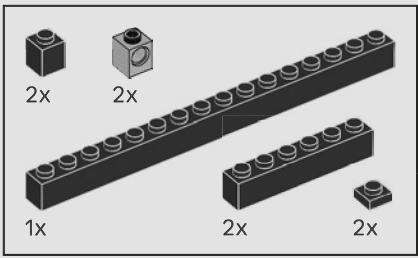

276

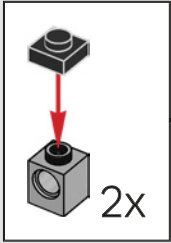
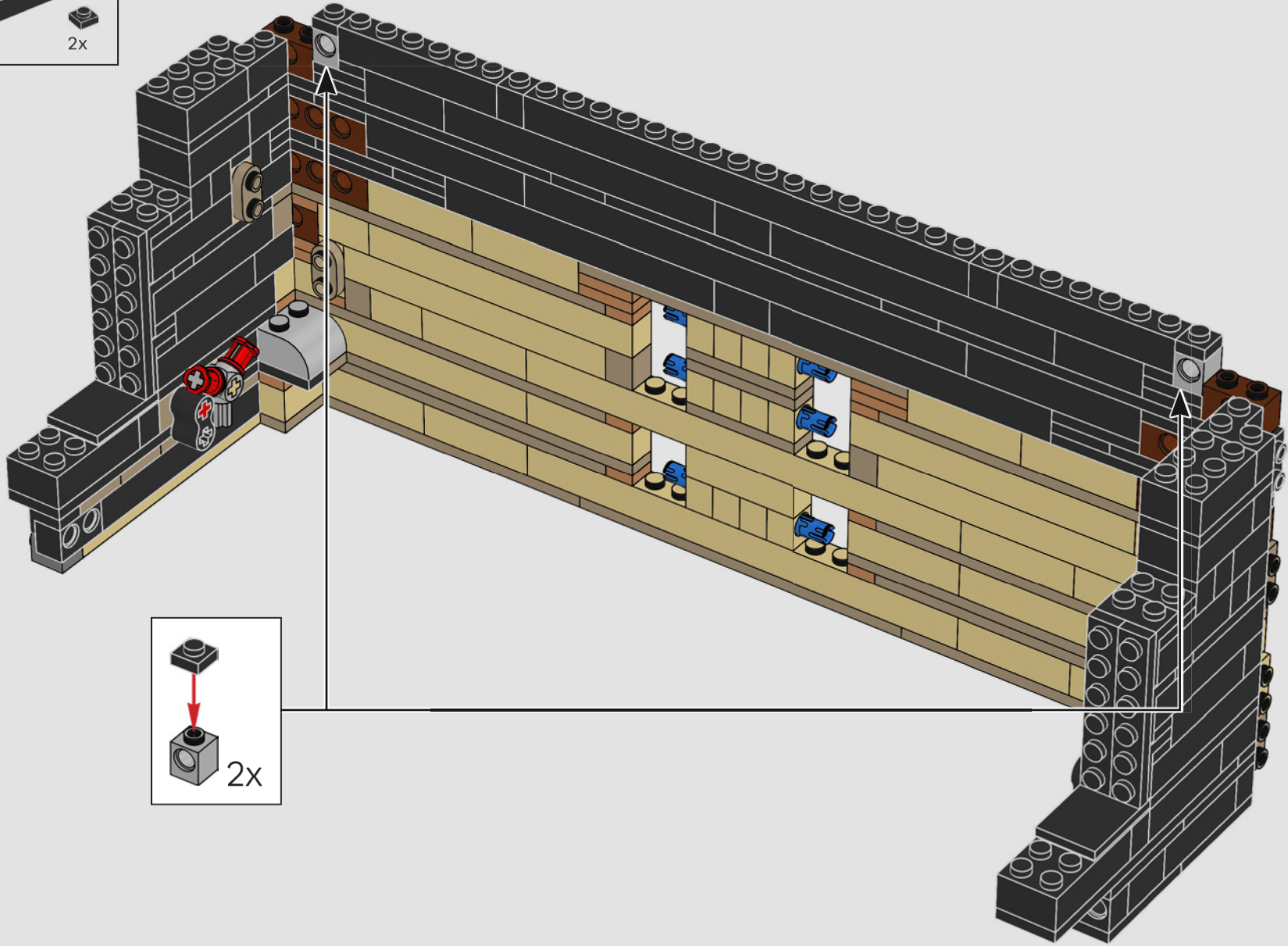

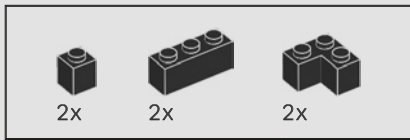

277

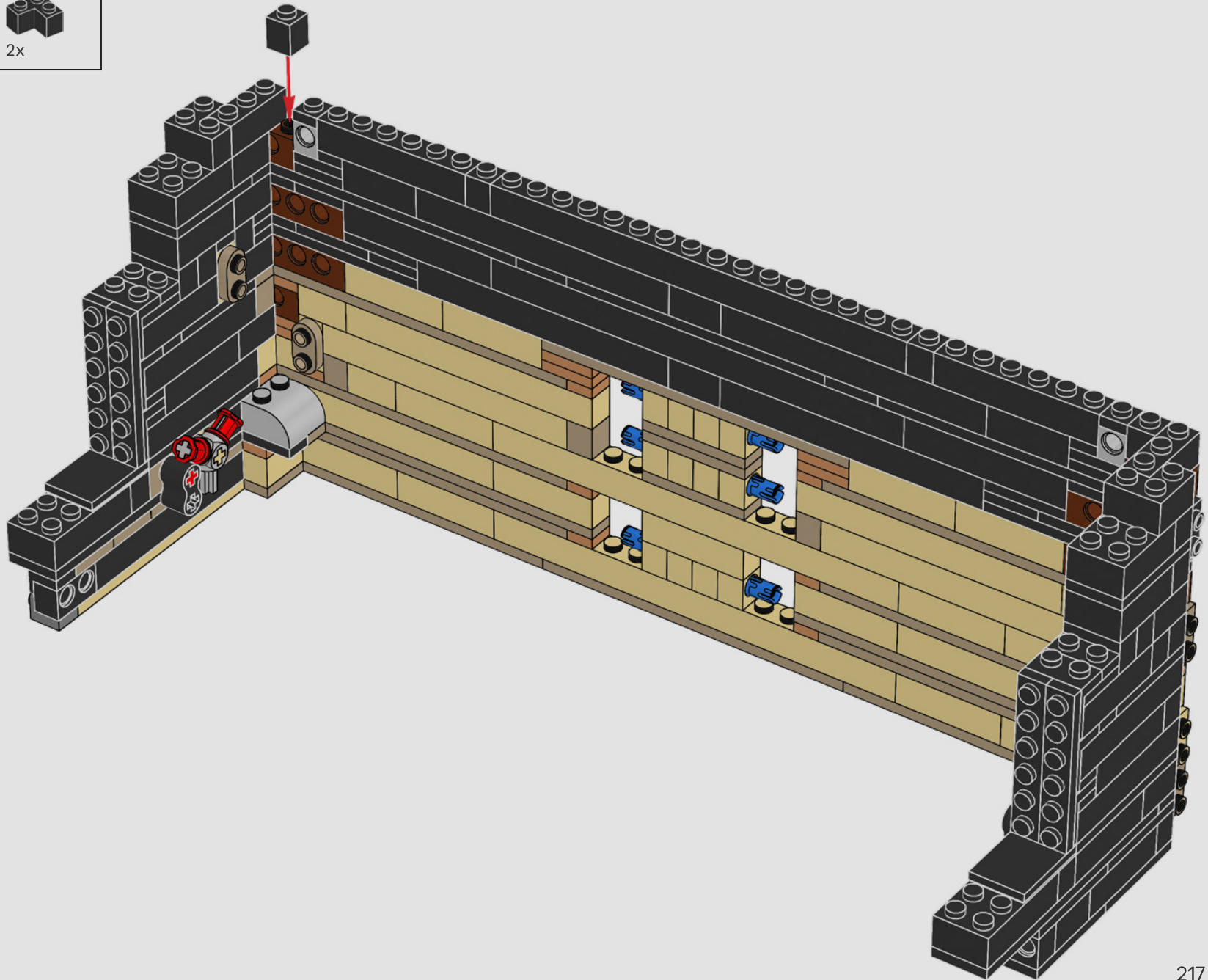

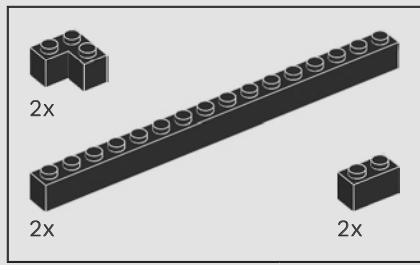

278

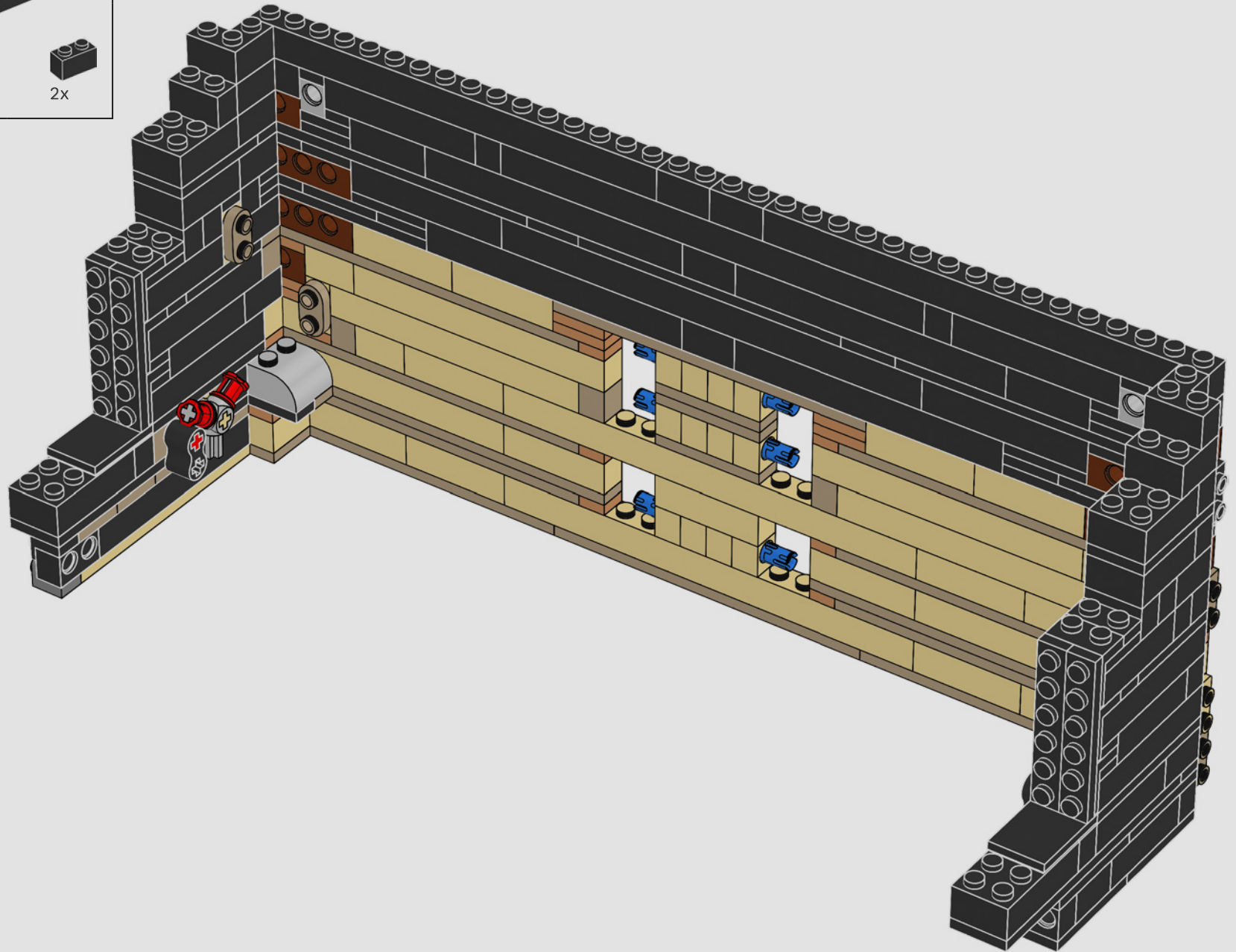

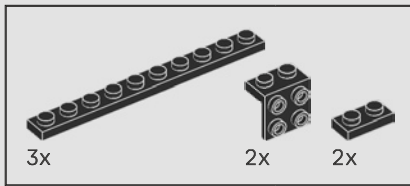

279

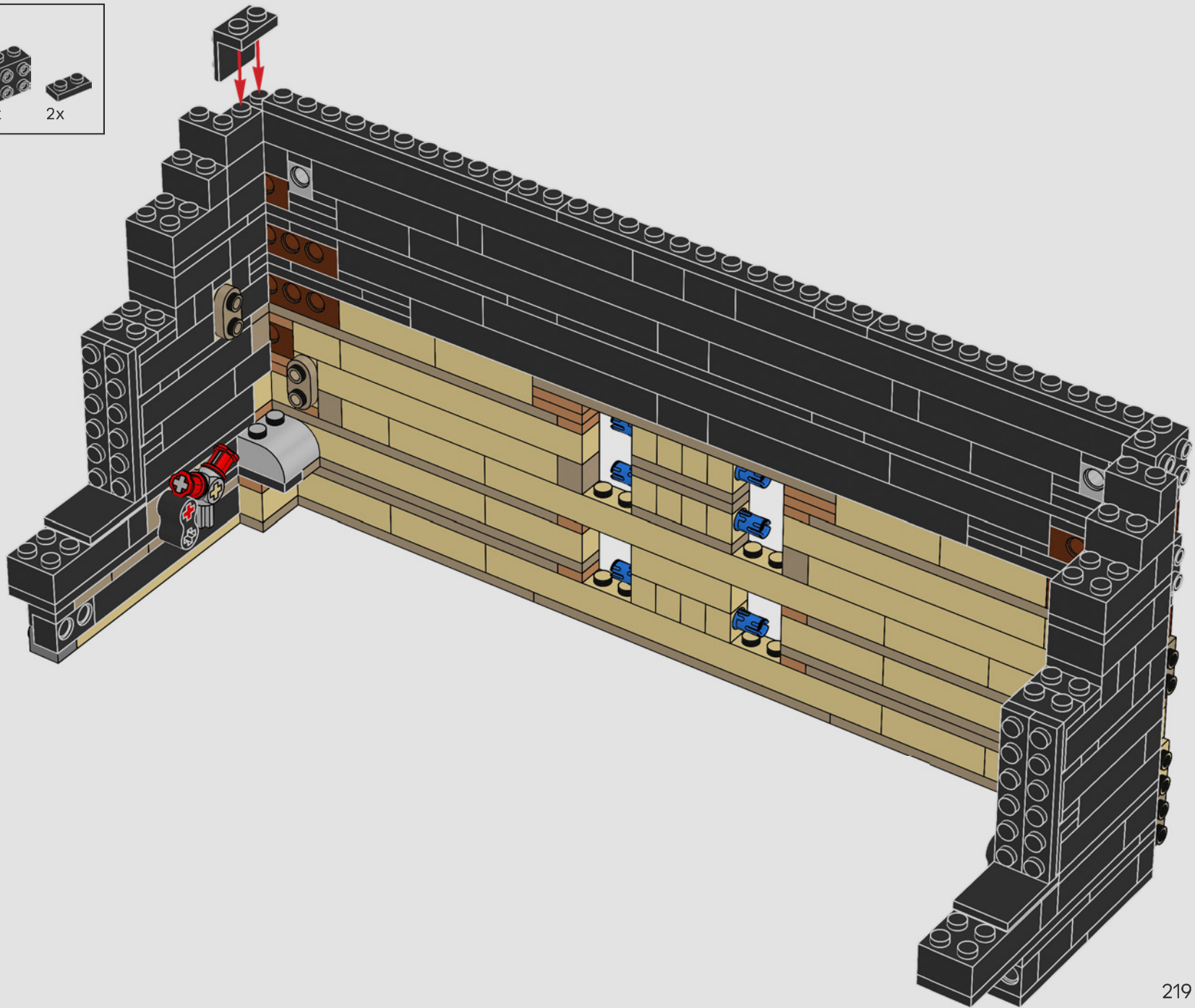

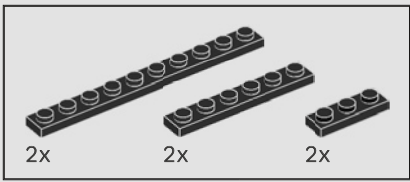

280

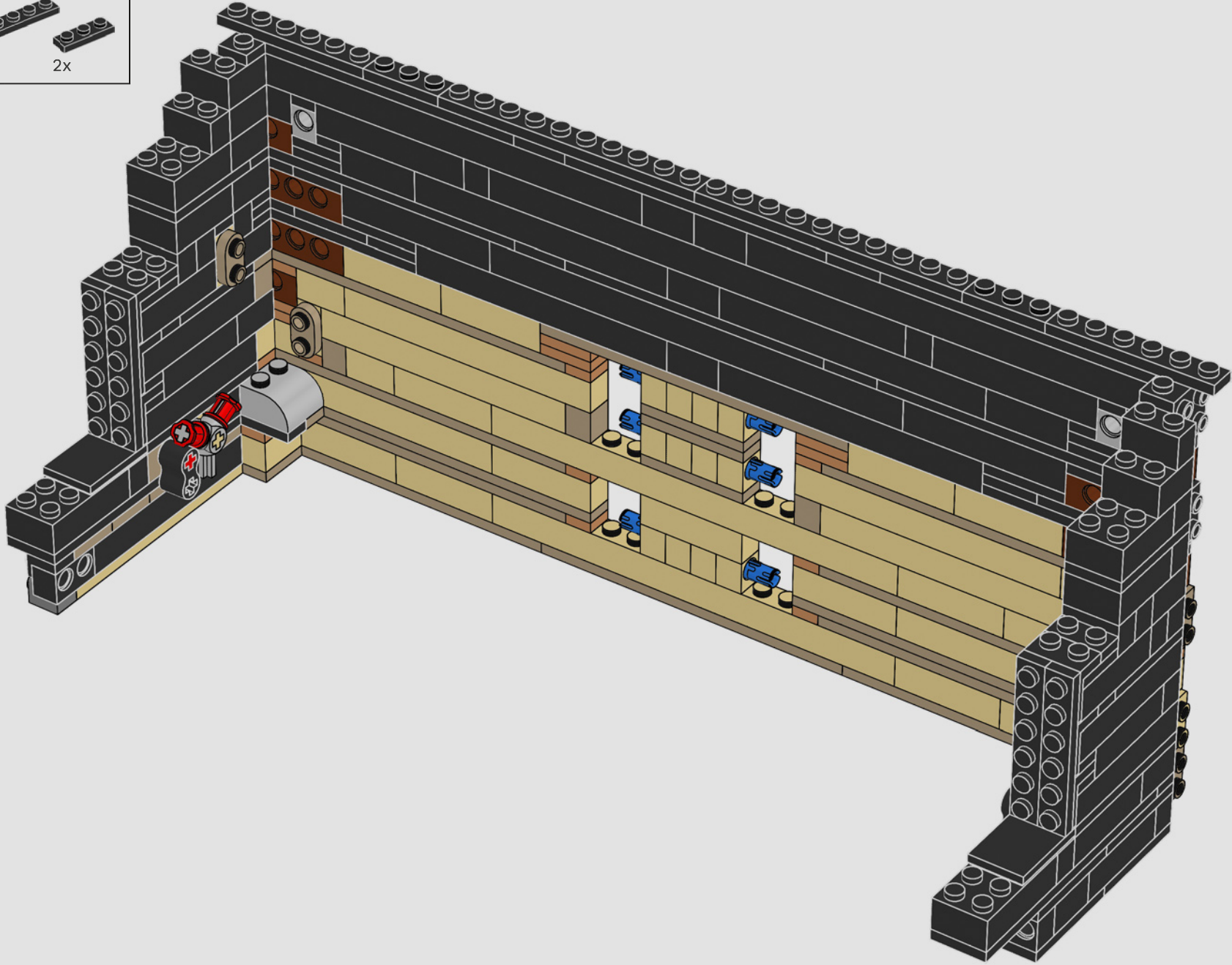

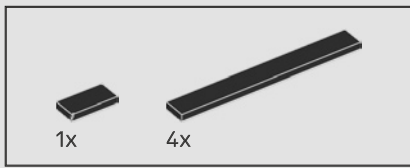

281

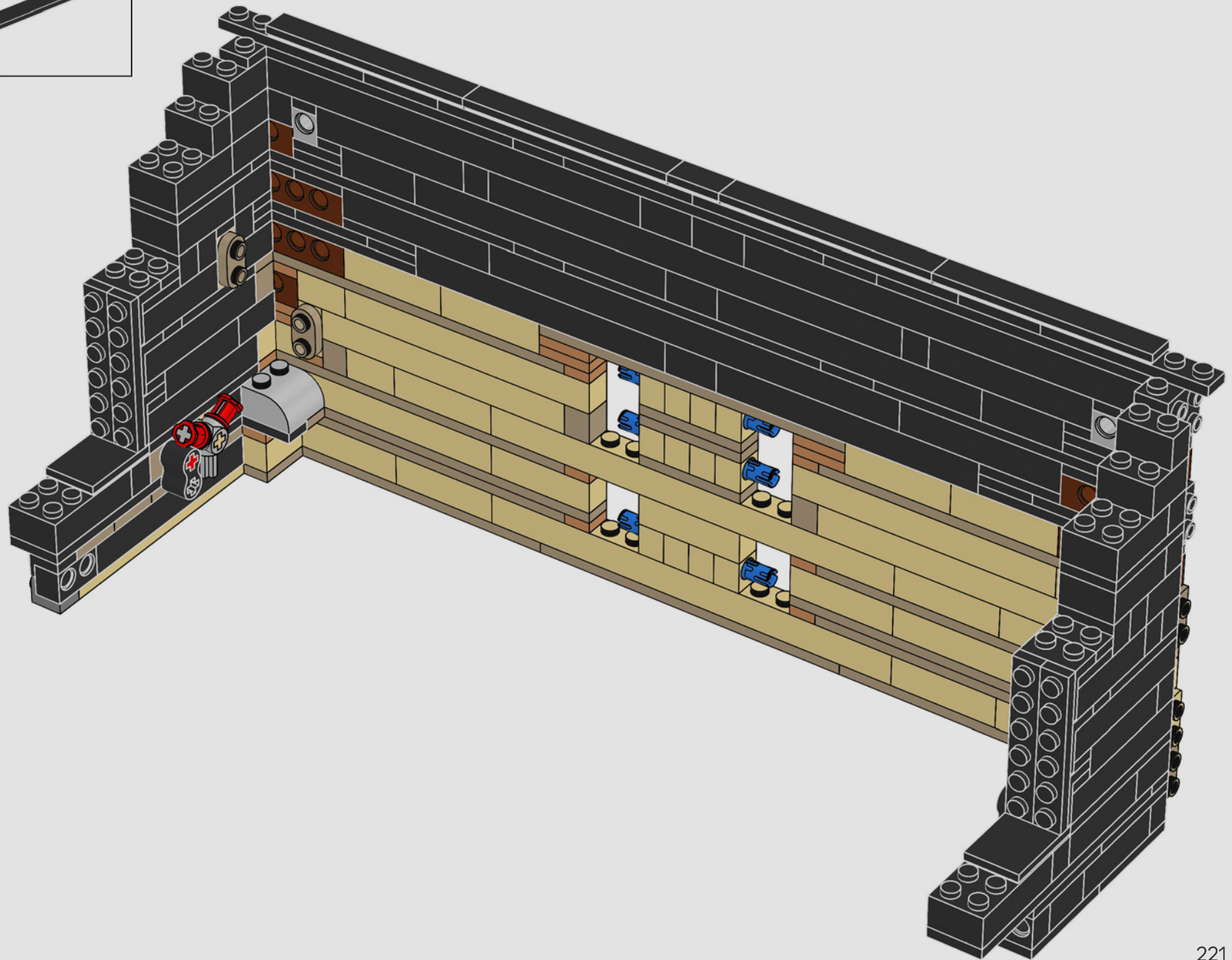

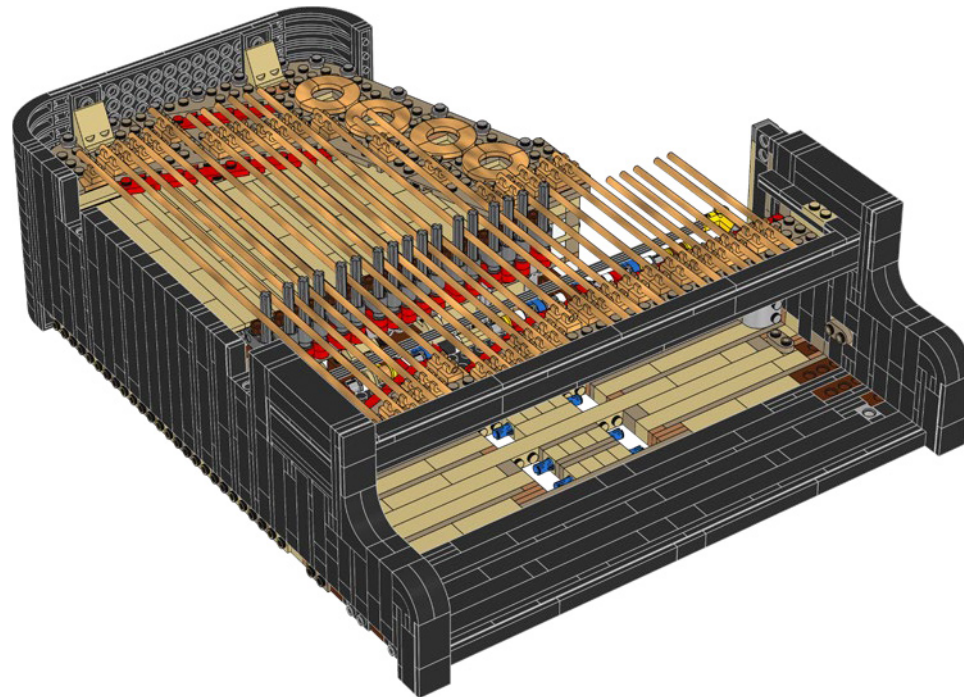
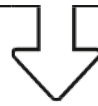
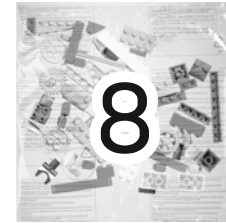
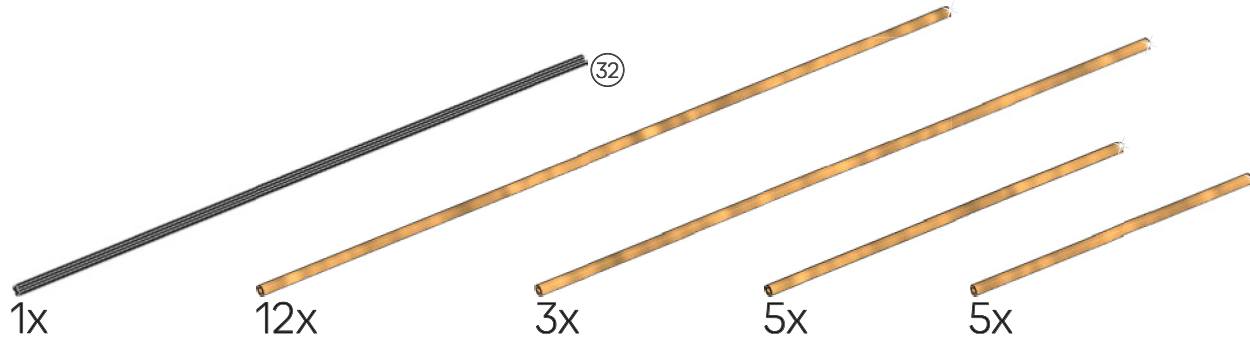

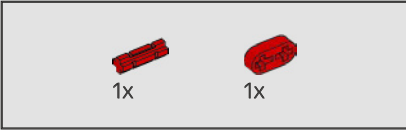
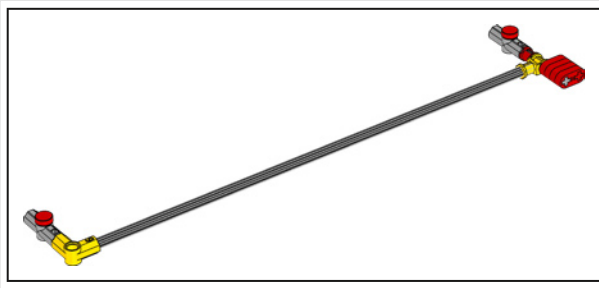

282

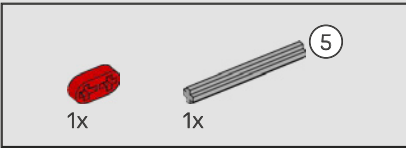

283

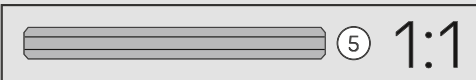
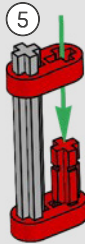

284

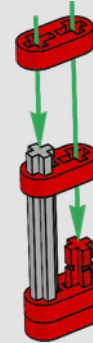

285

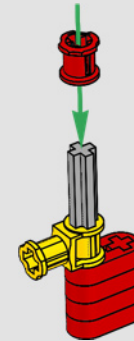

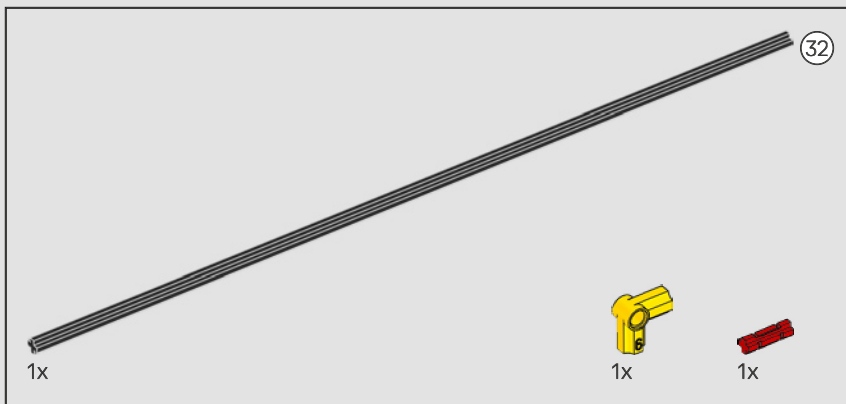

286

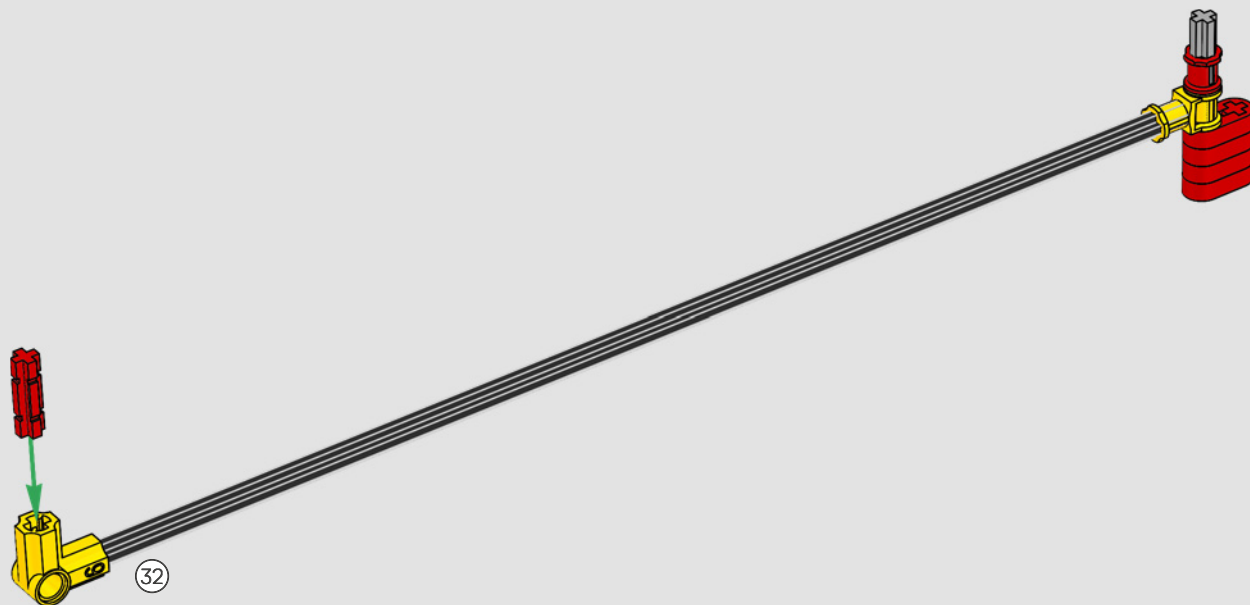



287

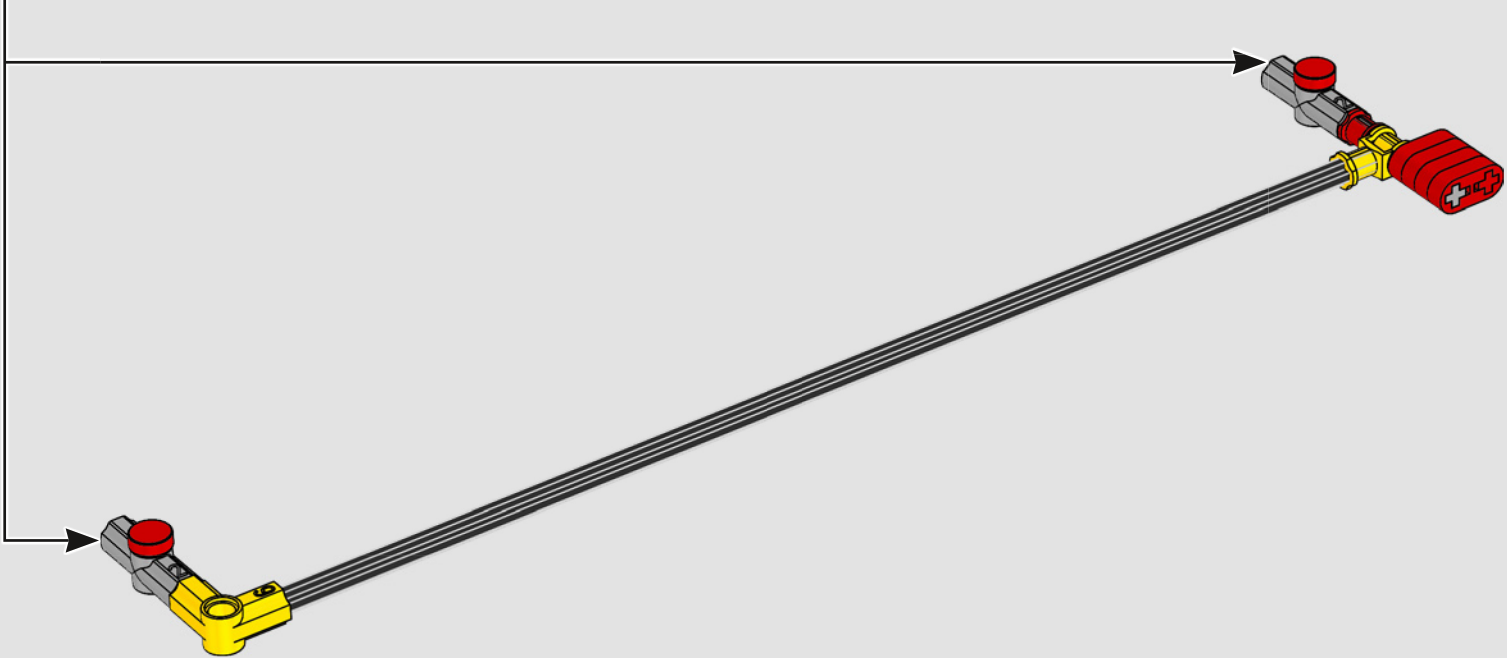
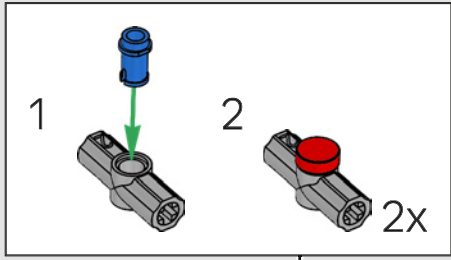

288

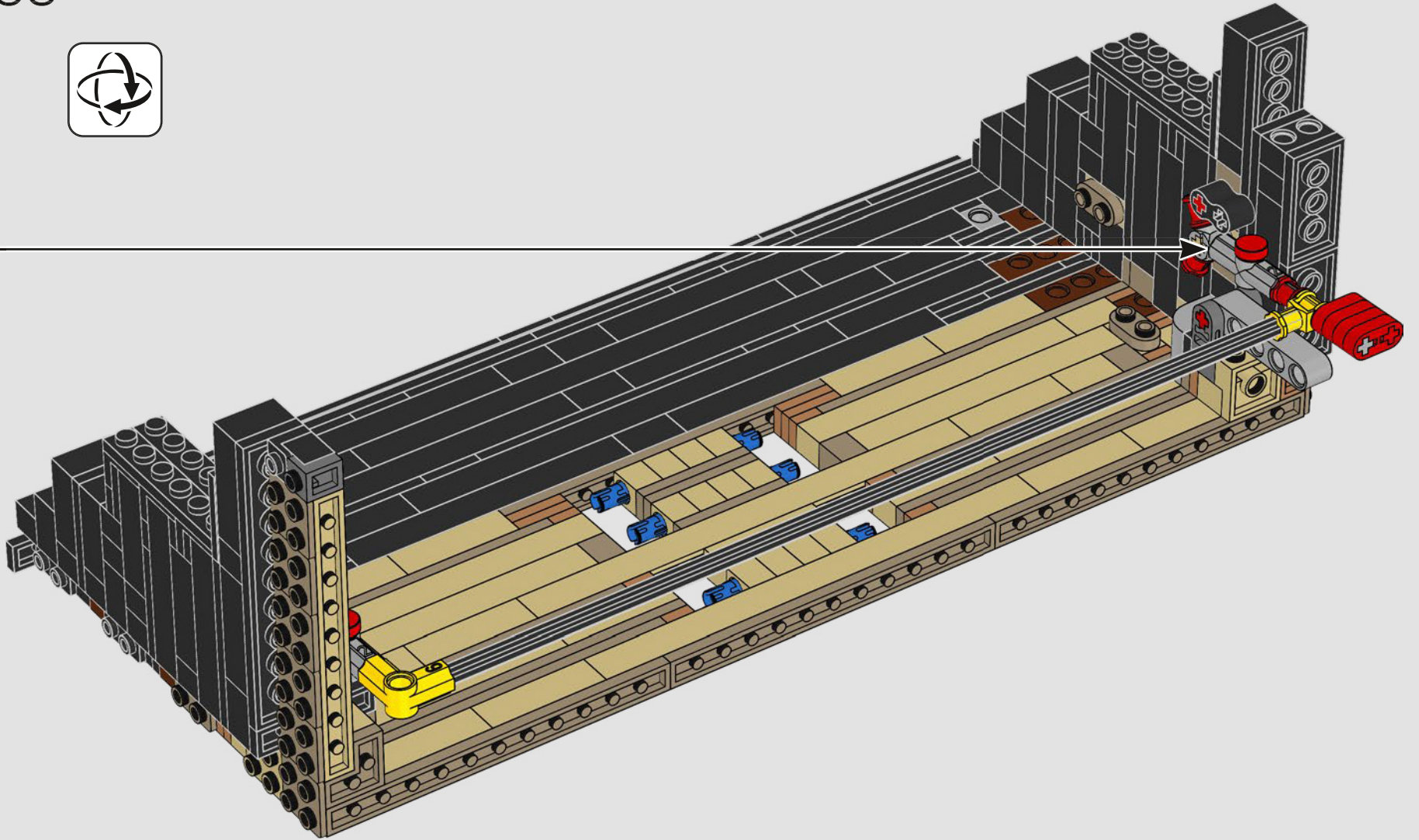

289

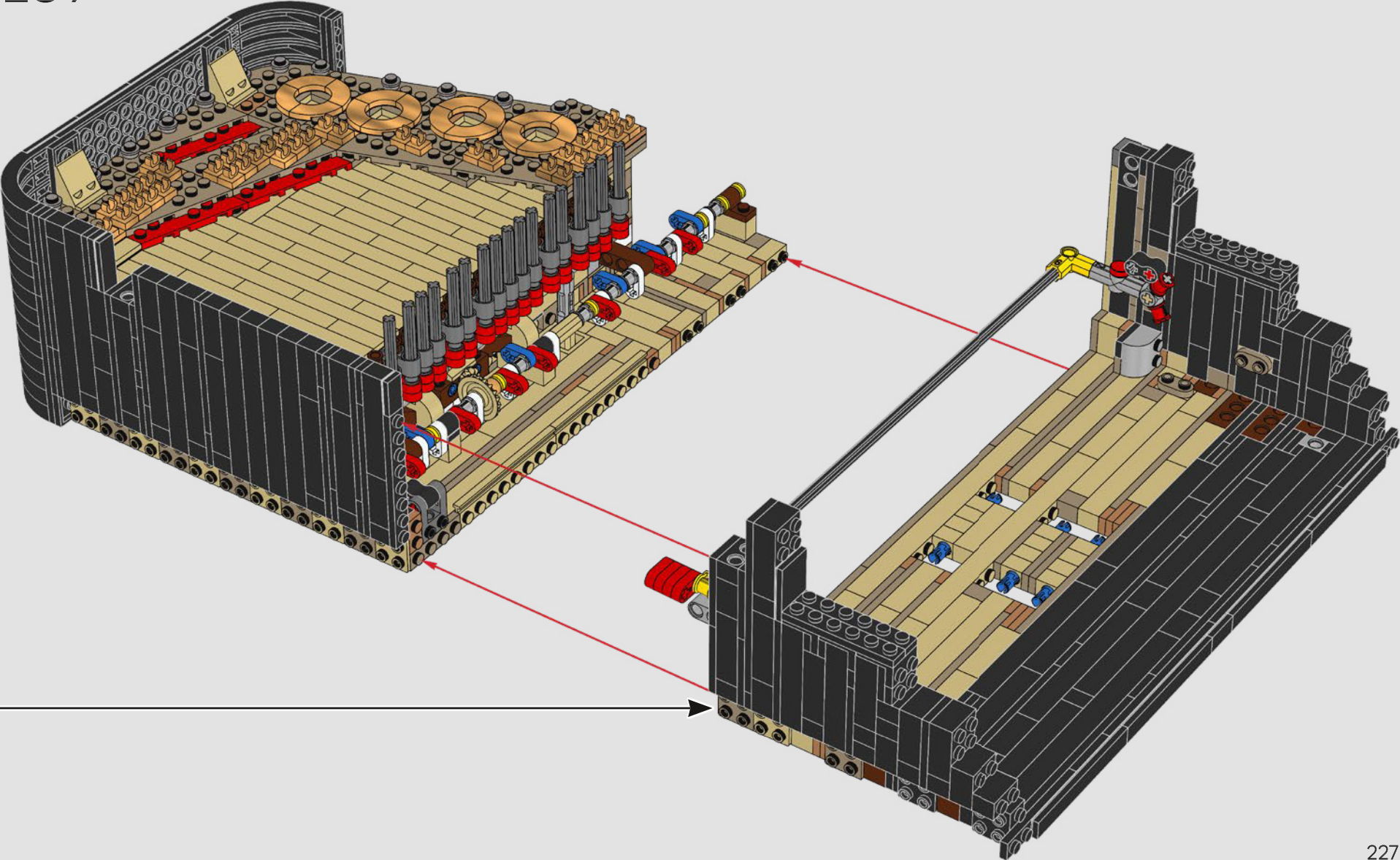

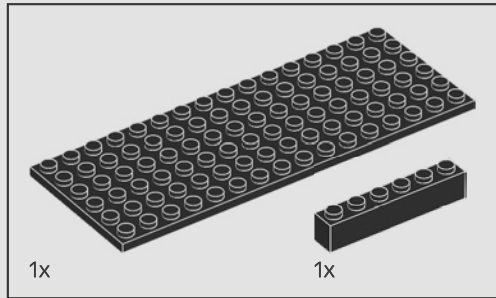
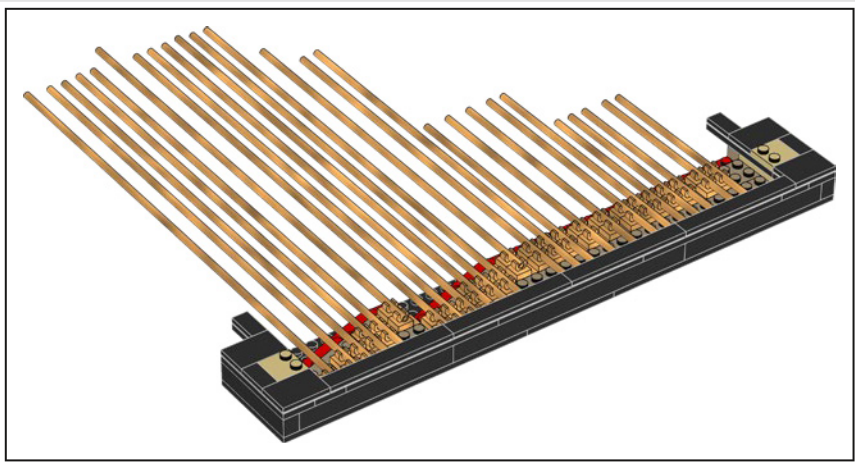

290

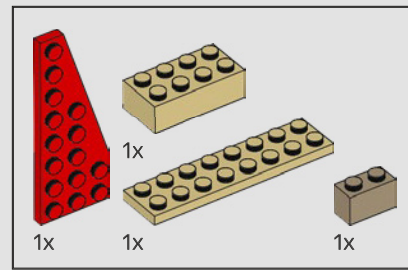
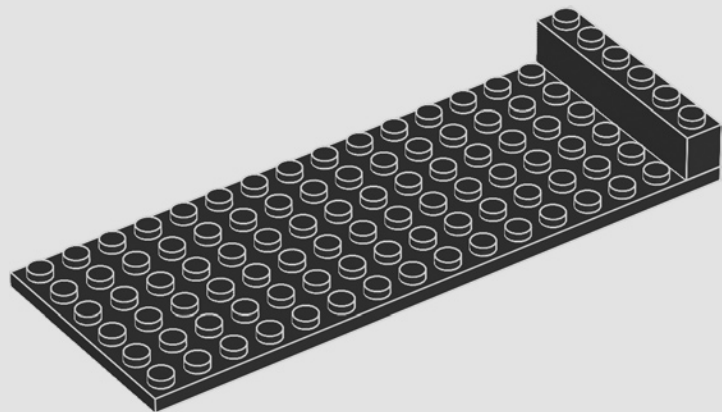

291

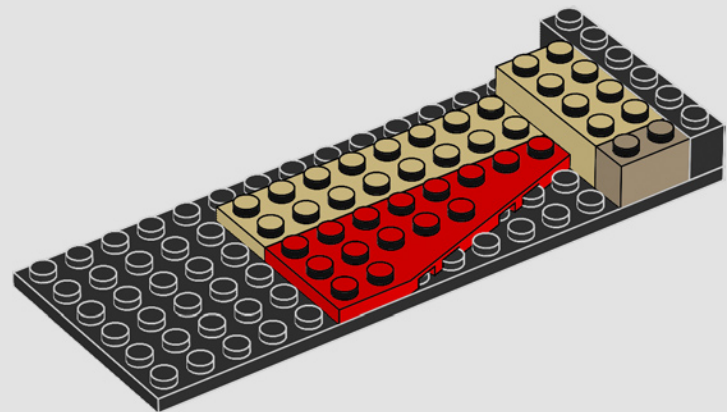

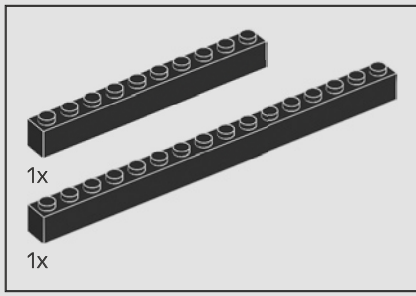

292

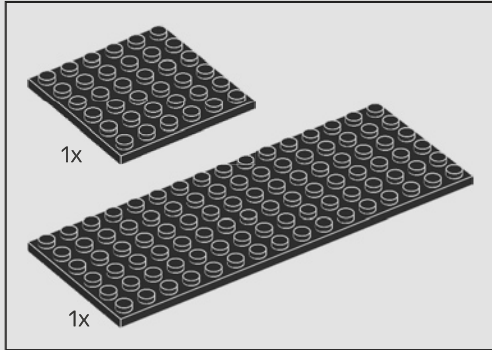
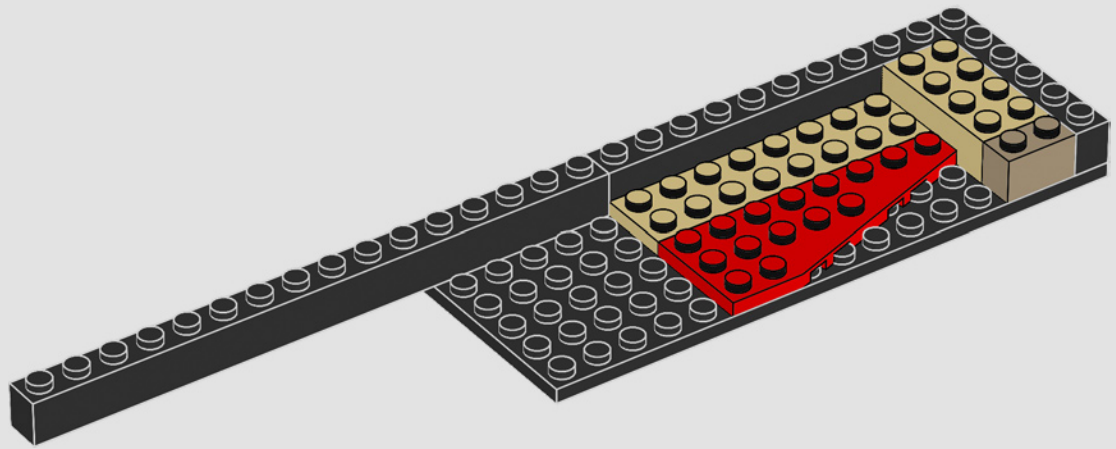

293

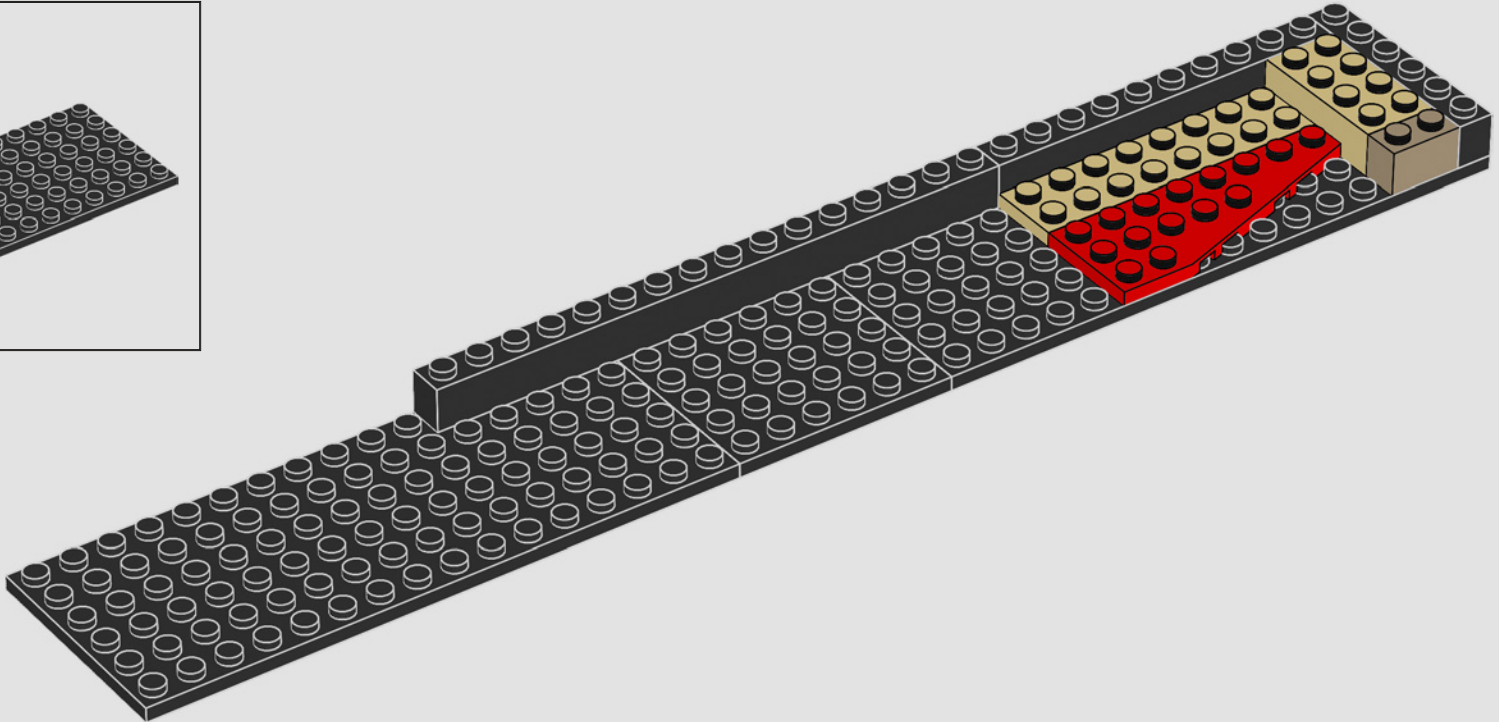

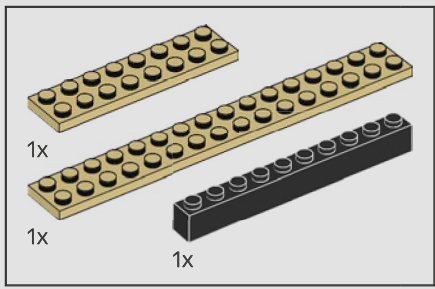

294

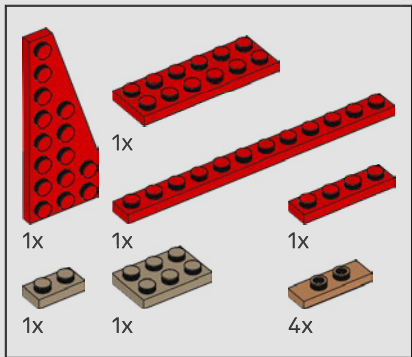
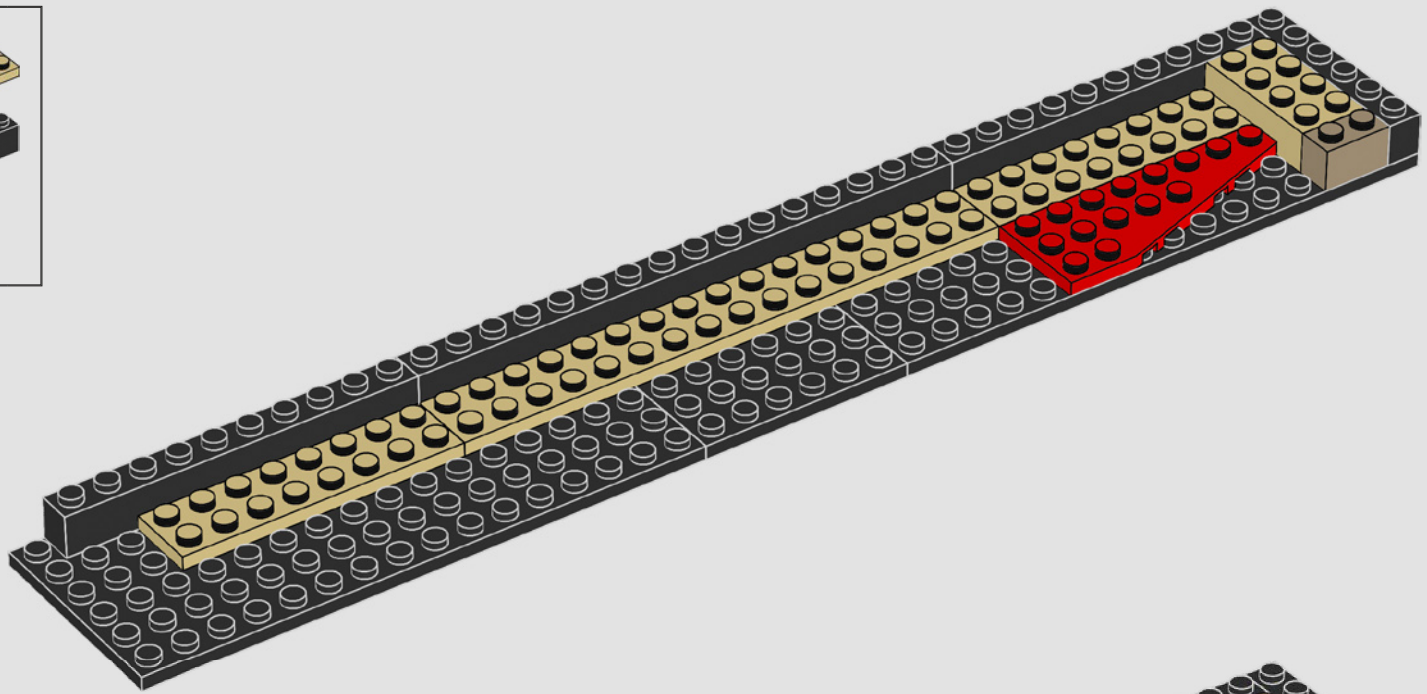

295

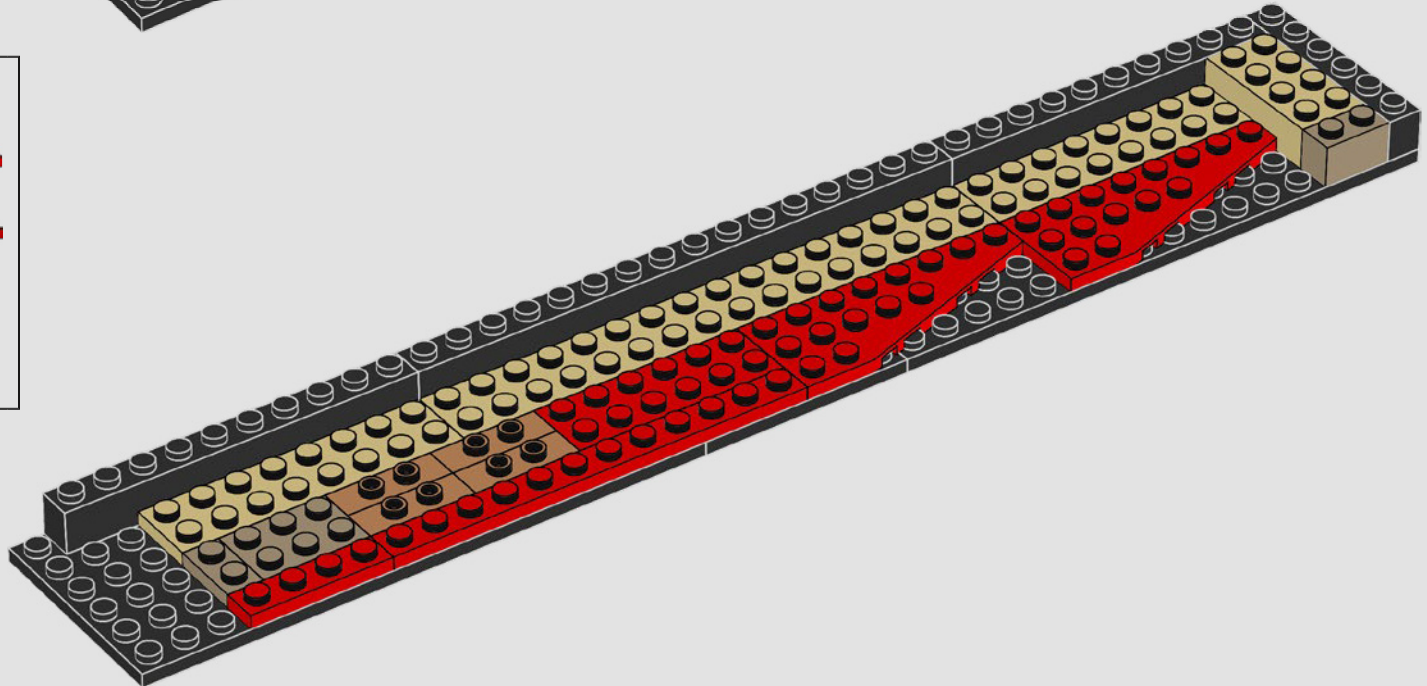

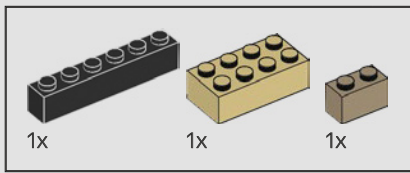

296

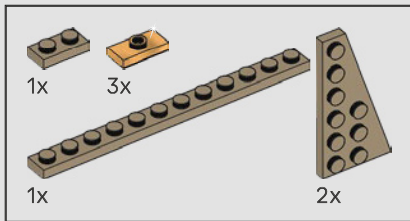
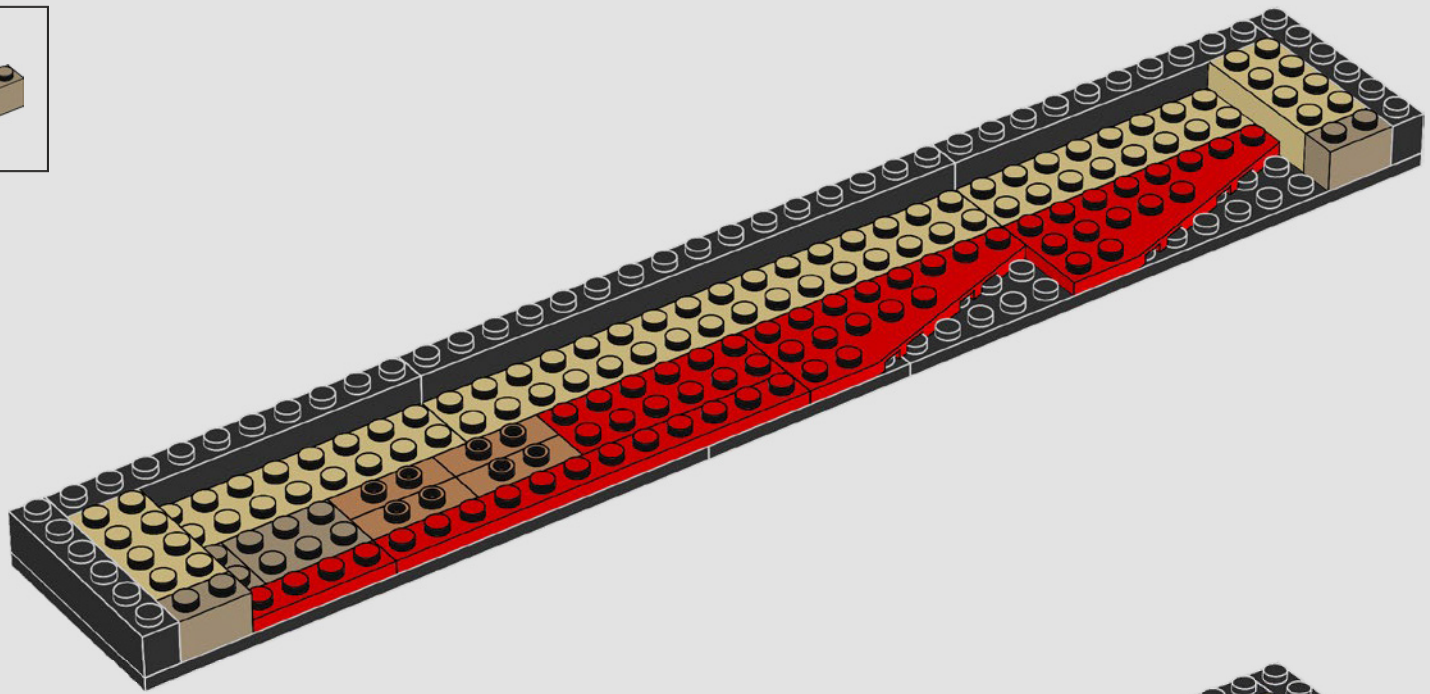

297

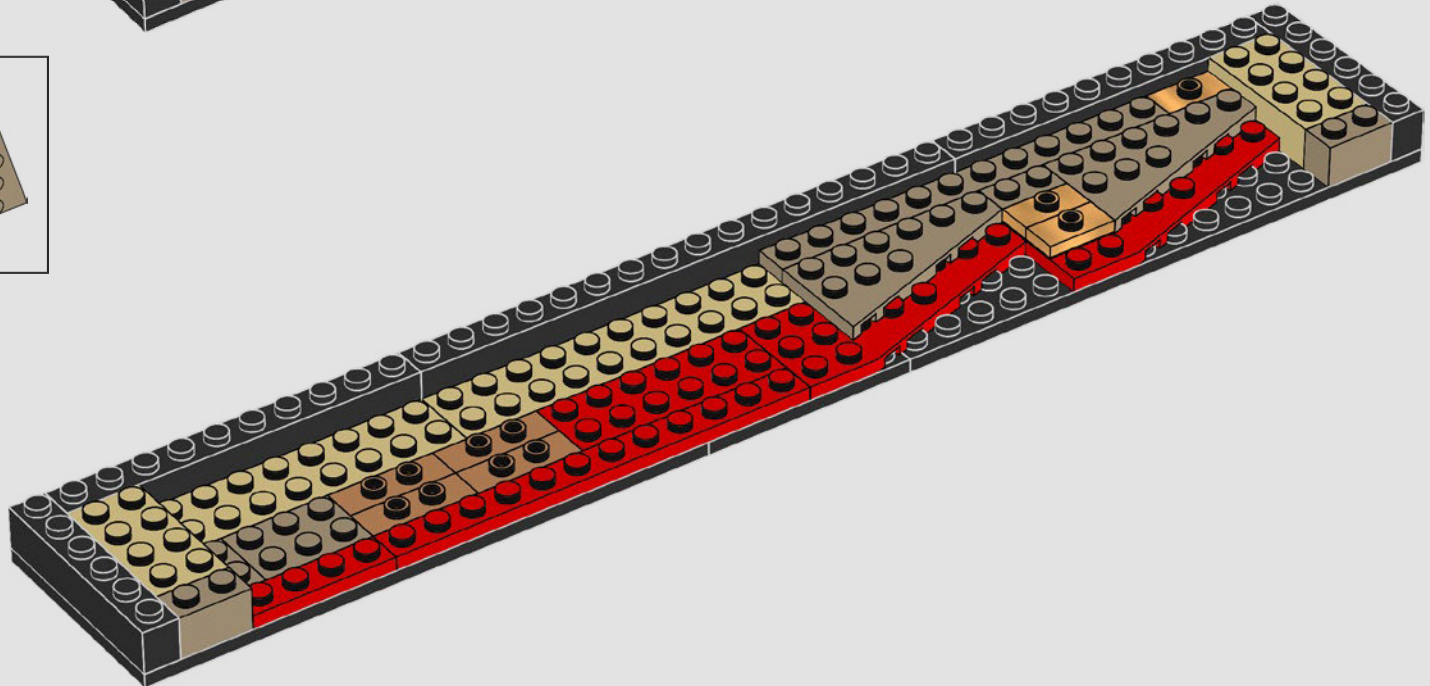

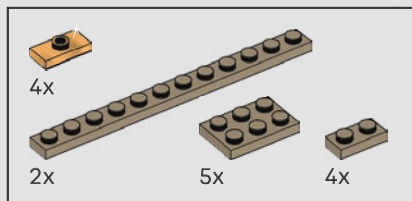

298

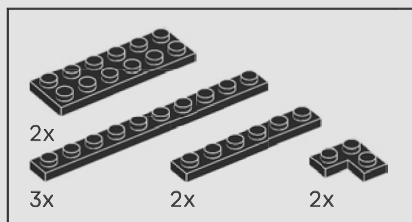
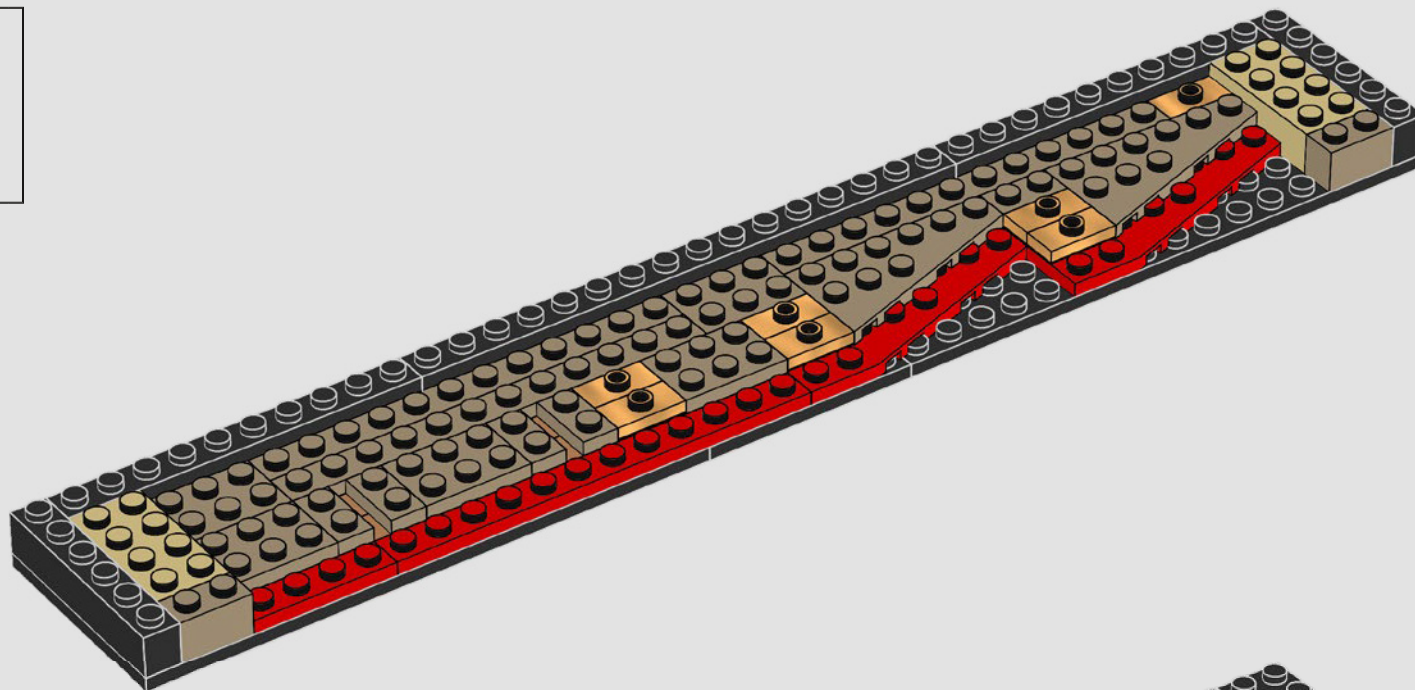

299

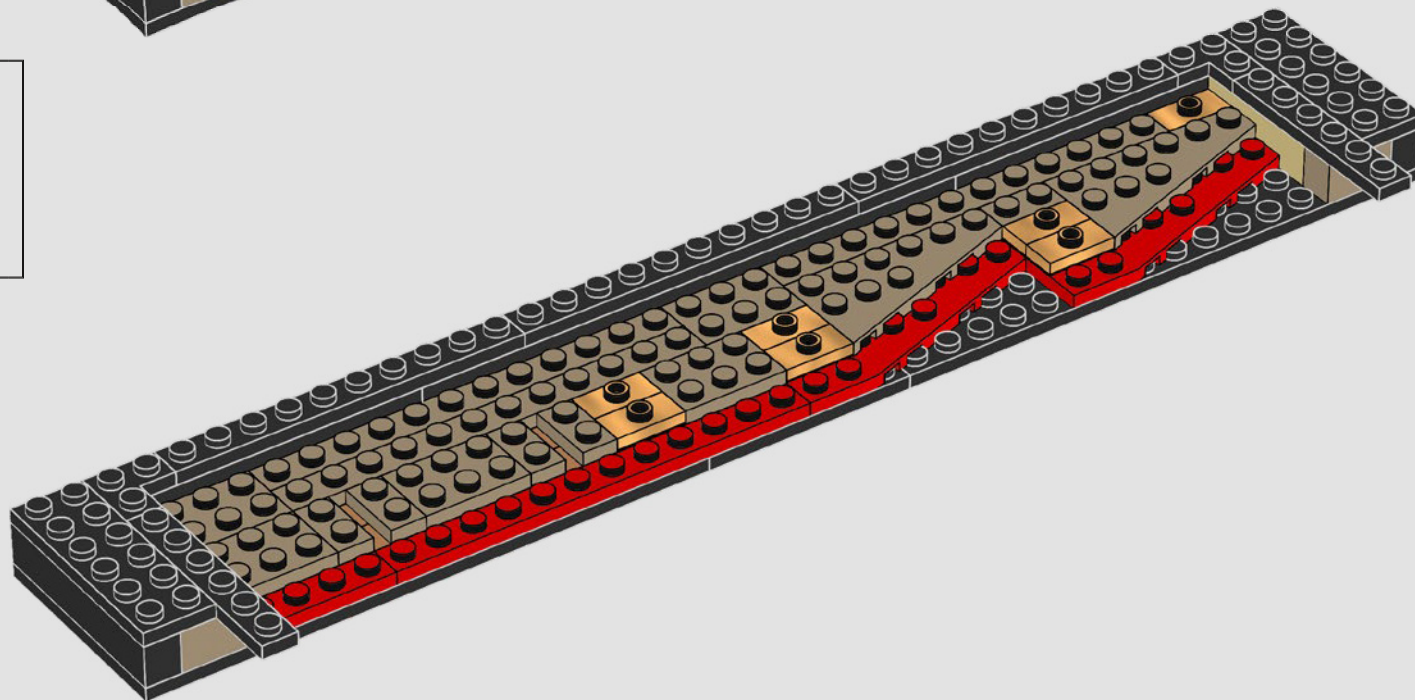

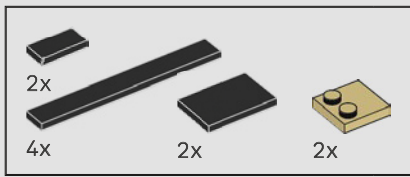

300

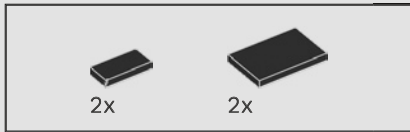
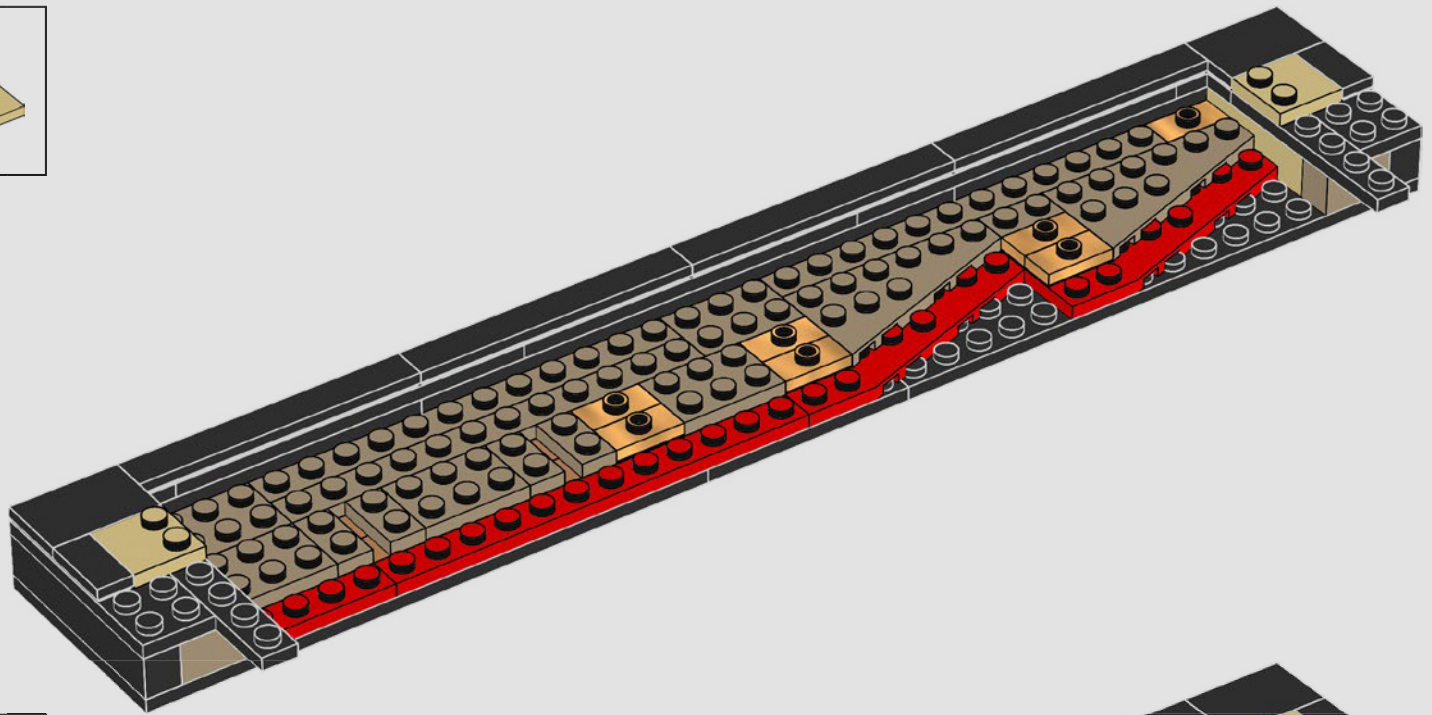

301

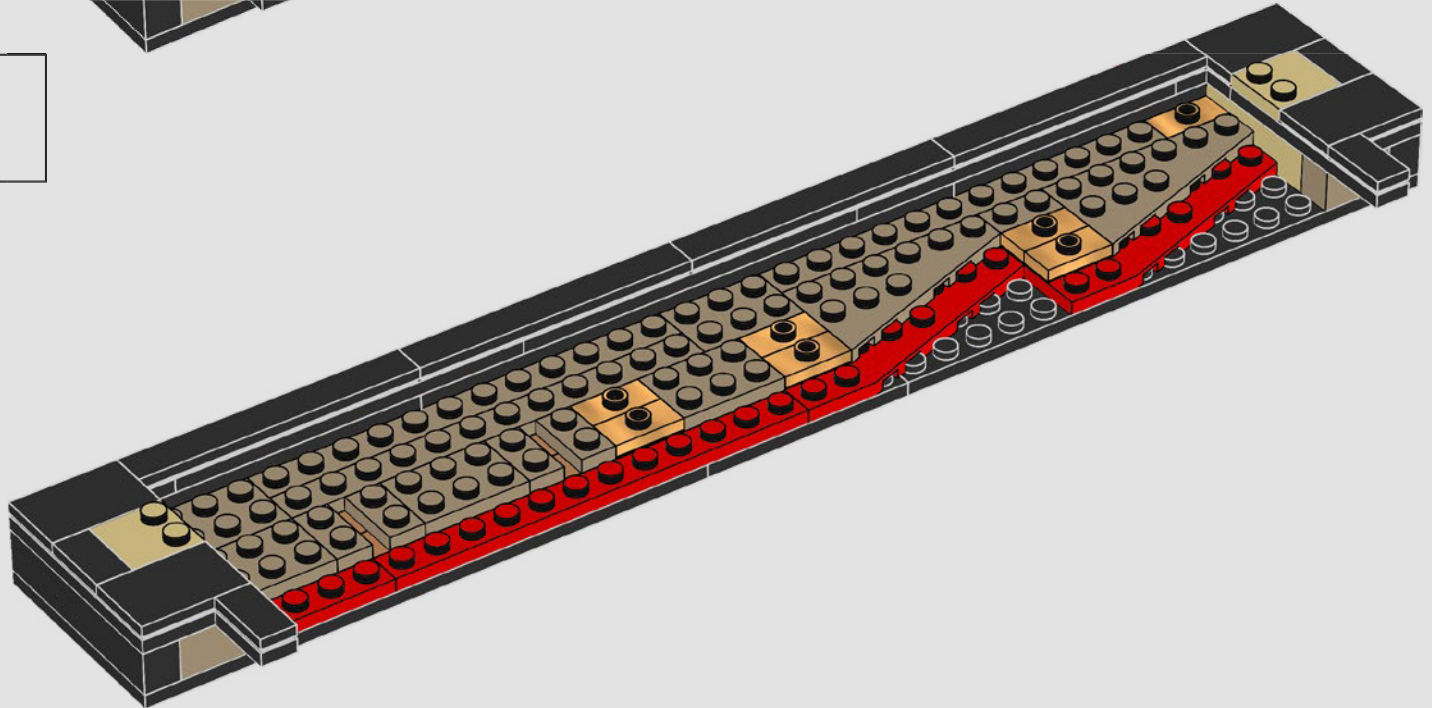



49x

302

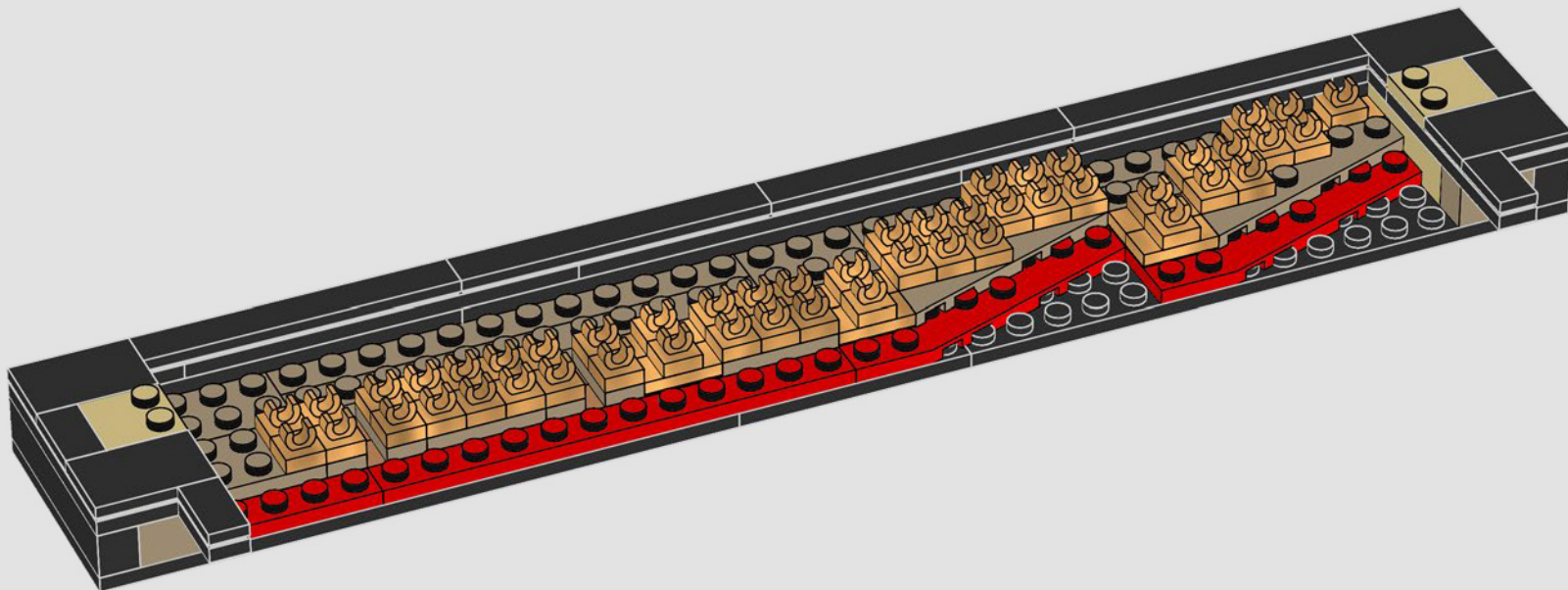



303

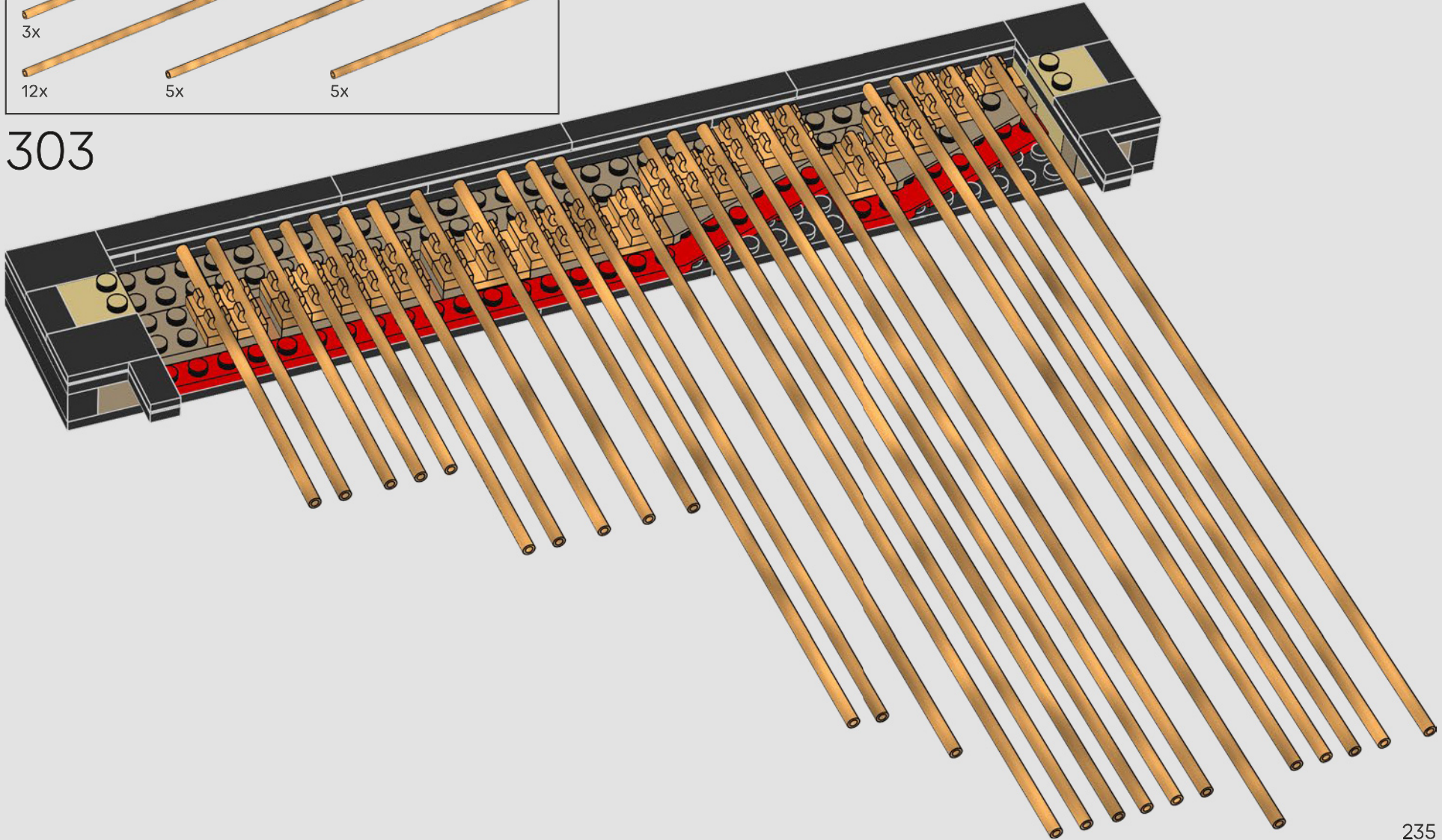

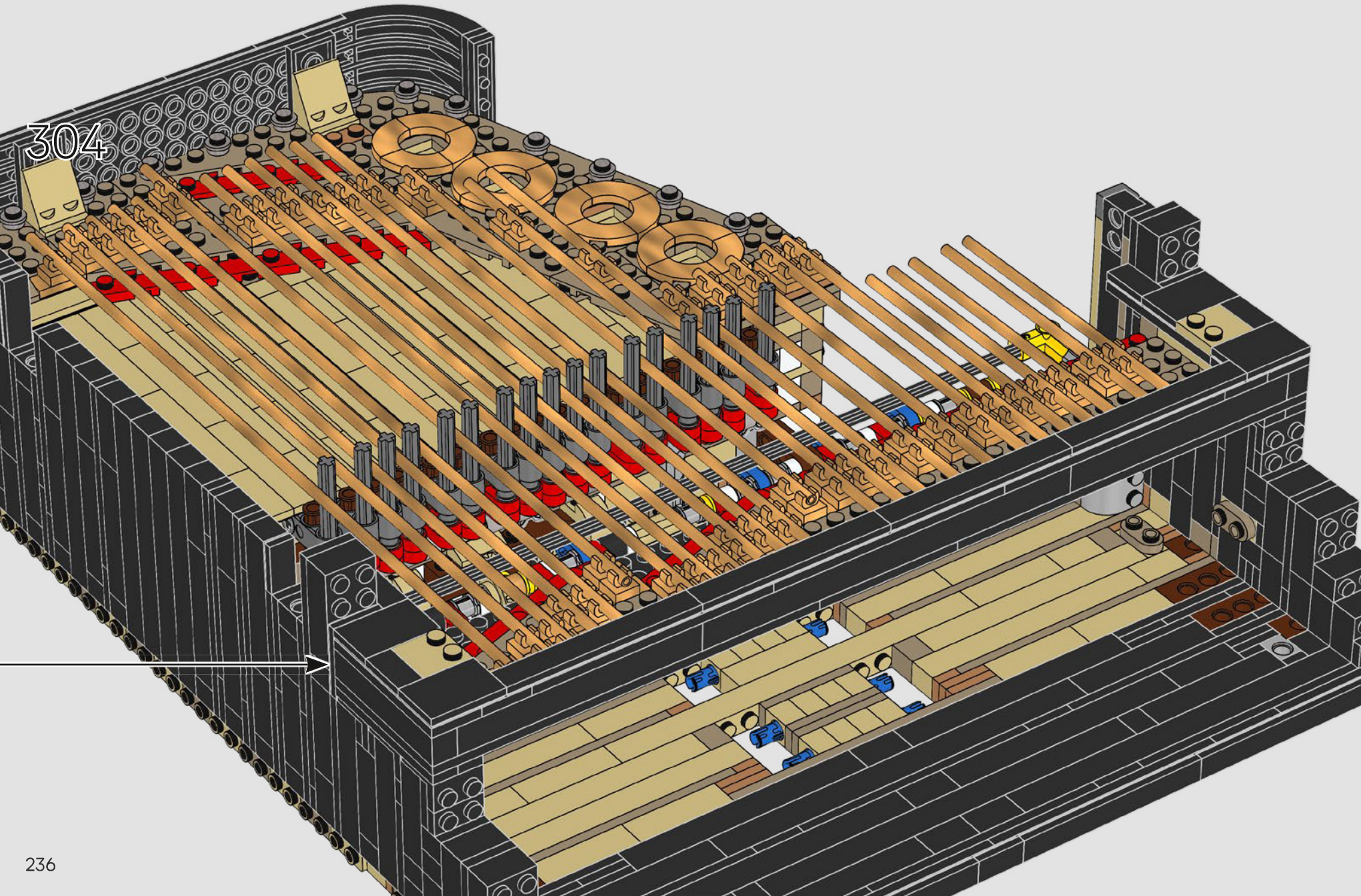

304

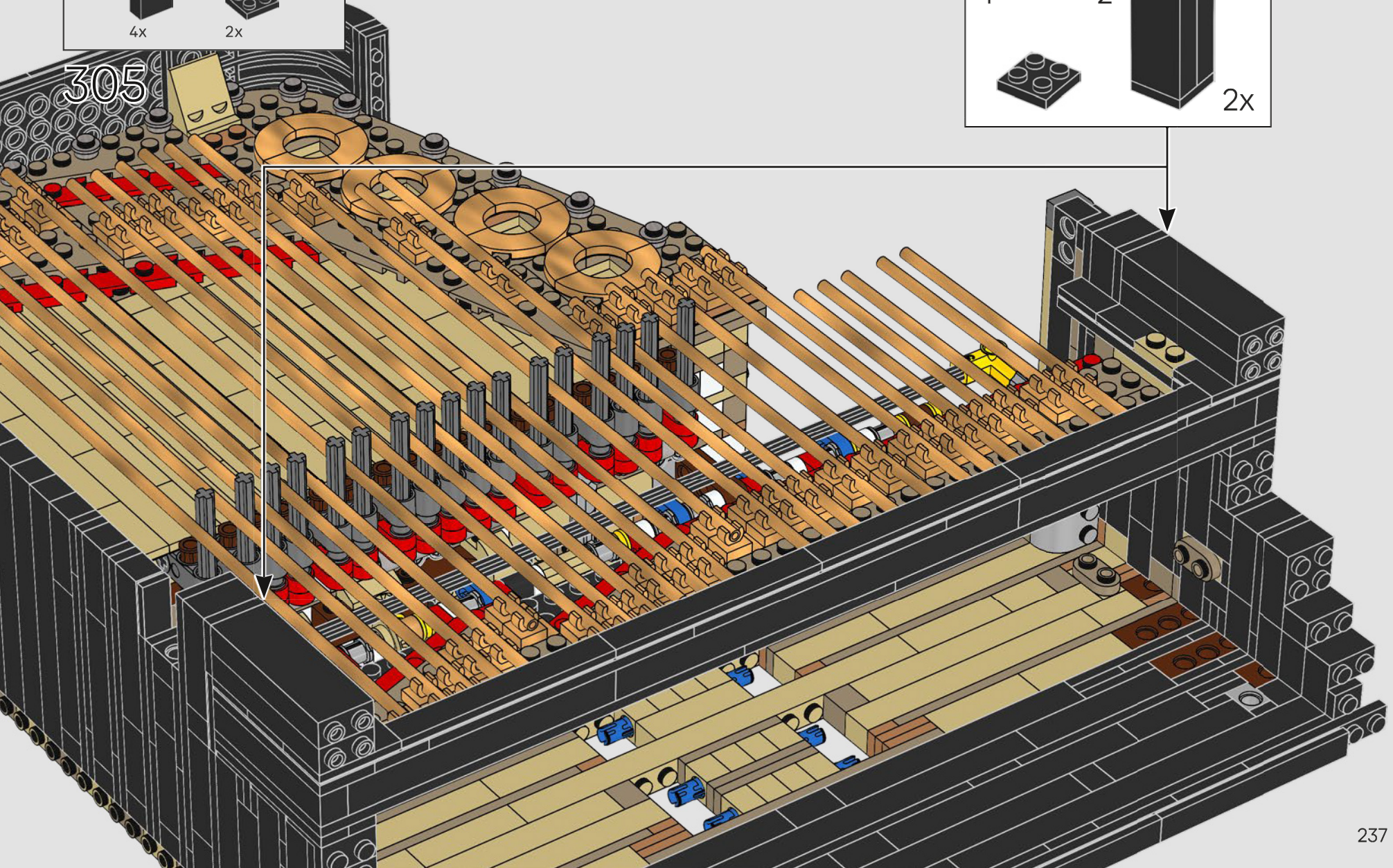
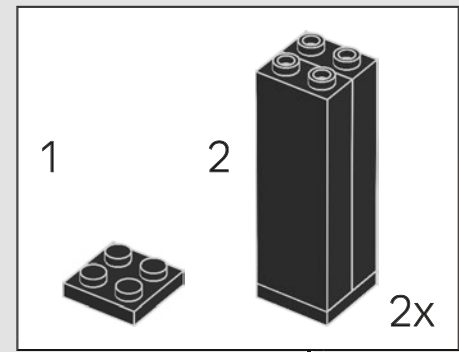
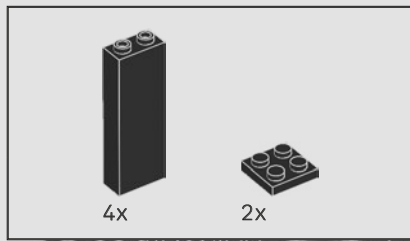

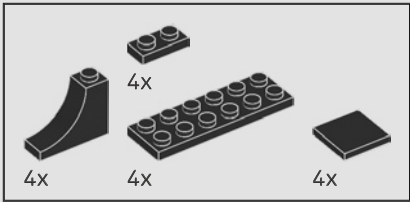
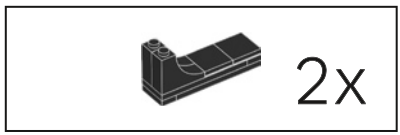

306

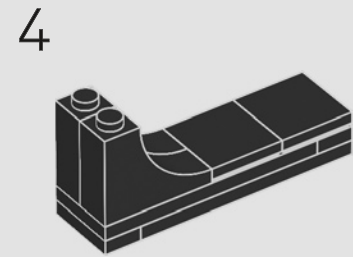
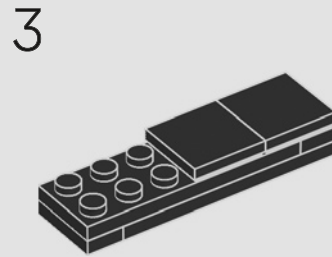
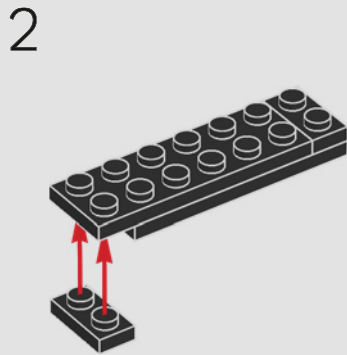
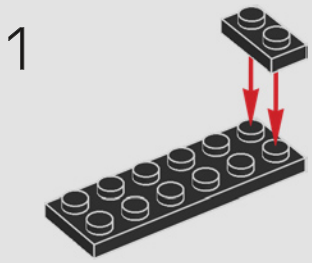

2x



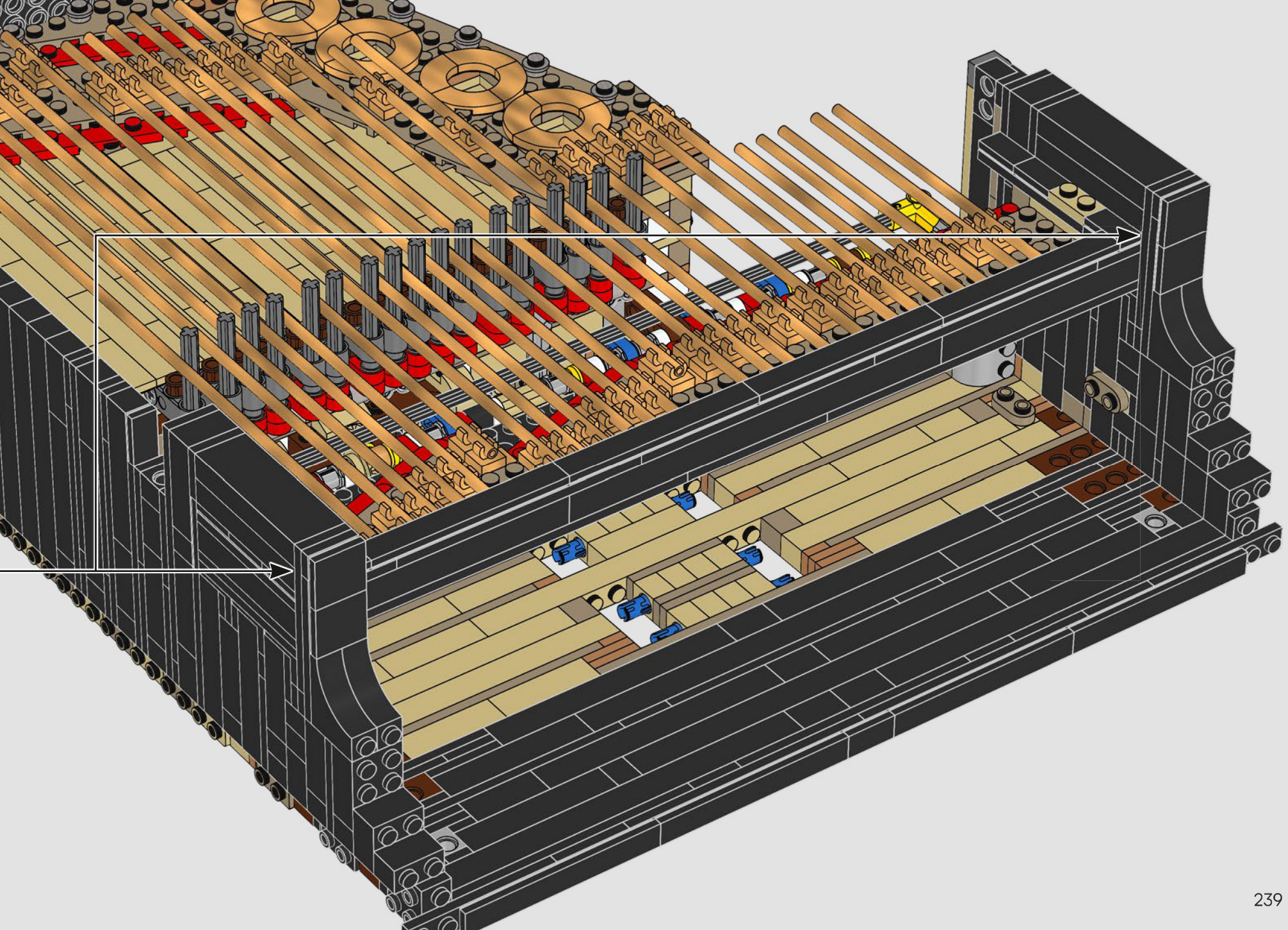



307

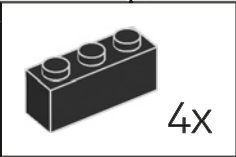
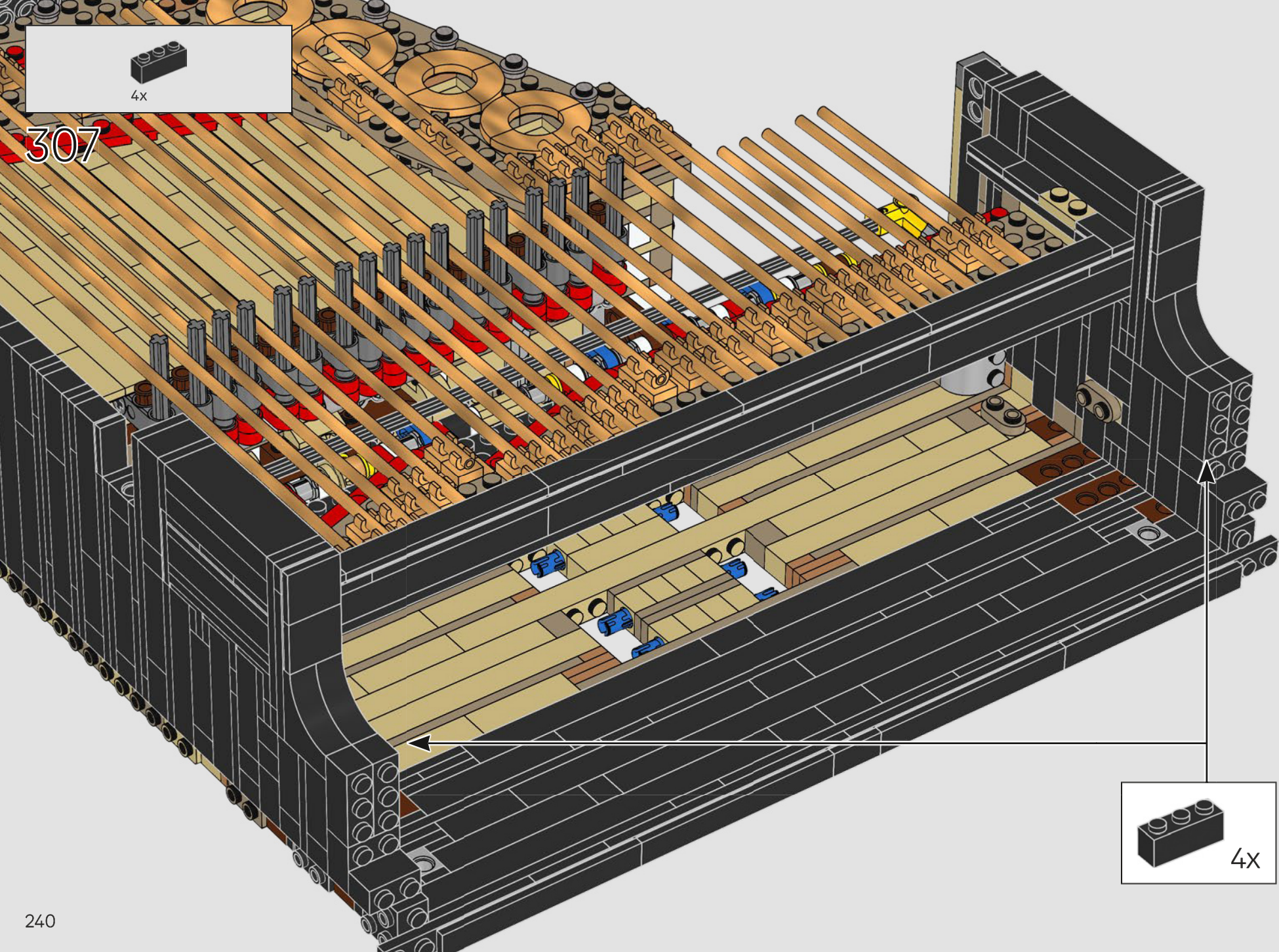

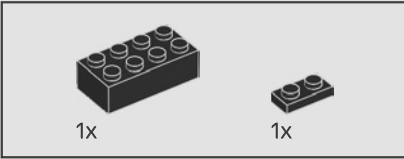
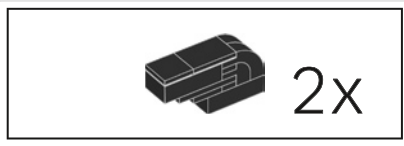

308

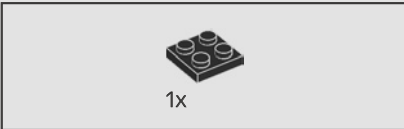
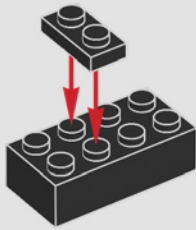

309

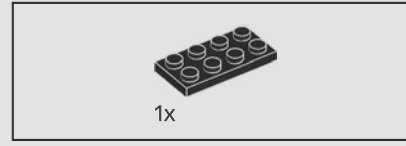
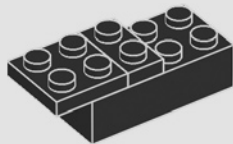

310

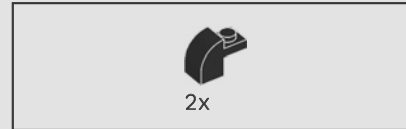
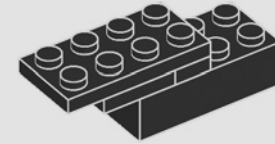

311

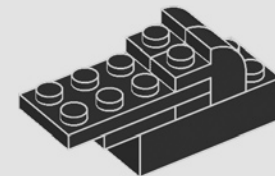

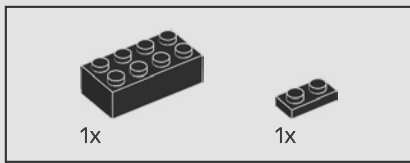

312

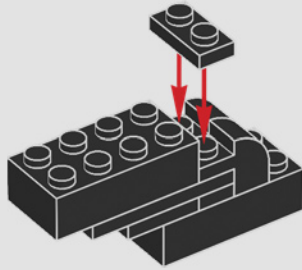

313

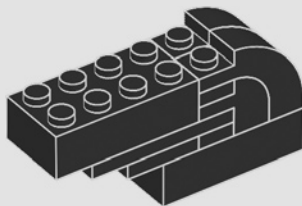

314

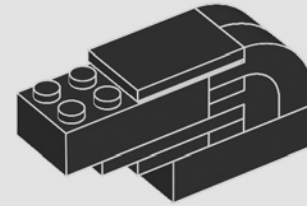

315

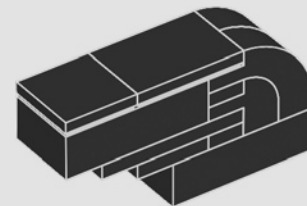

2x

316

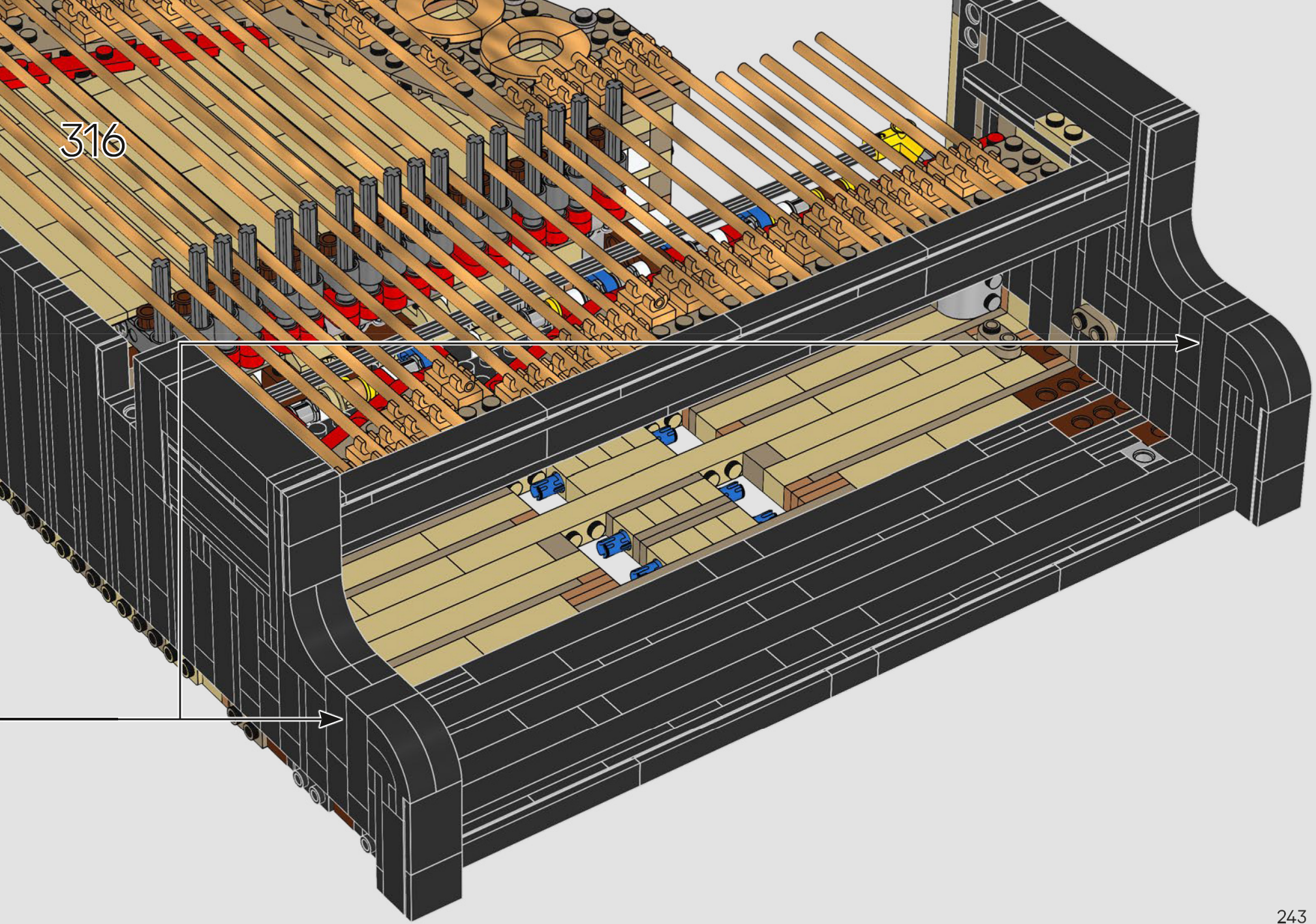

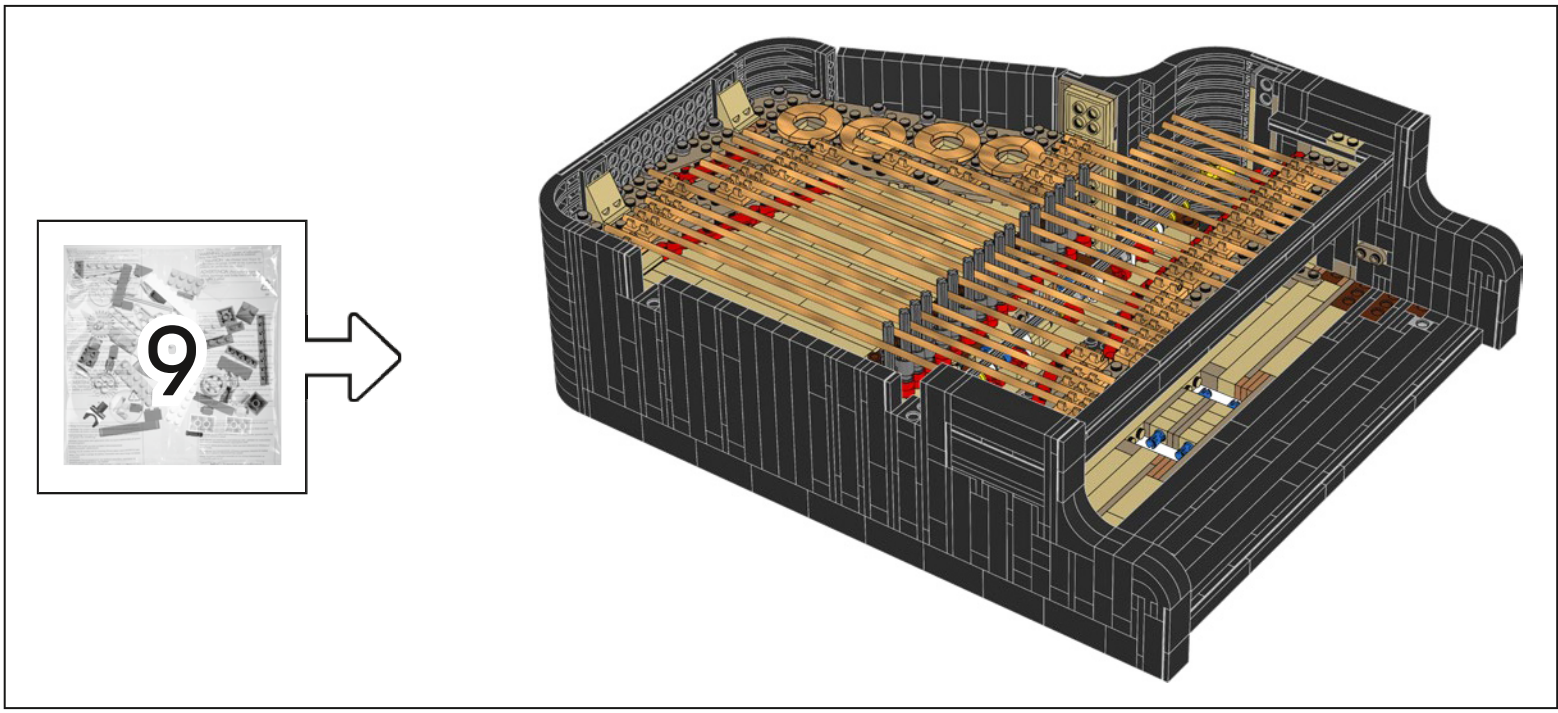

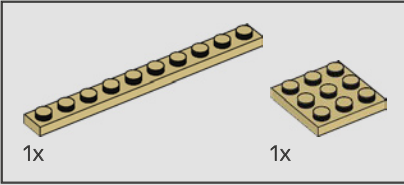
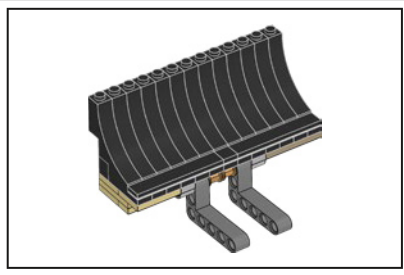

317

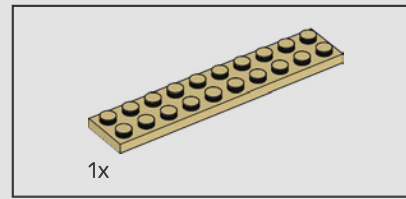
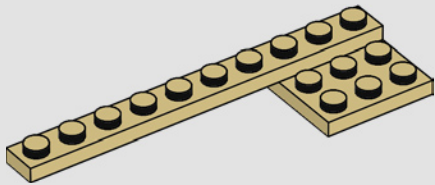

318

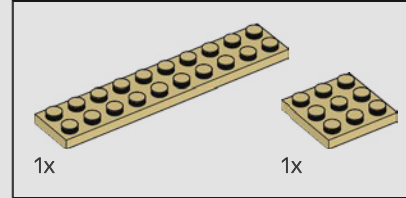
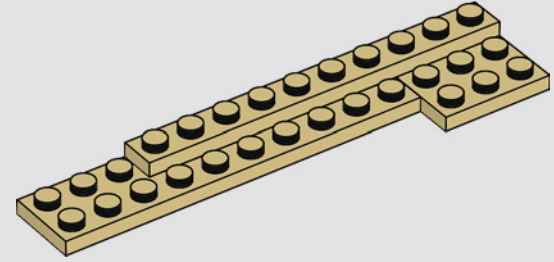

319

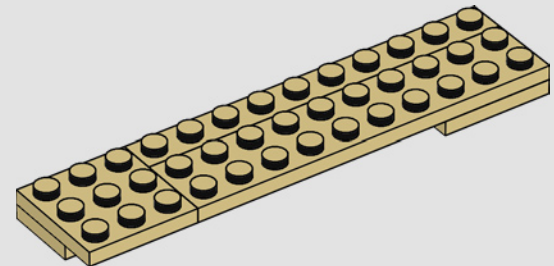

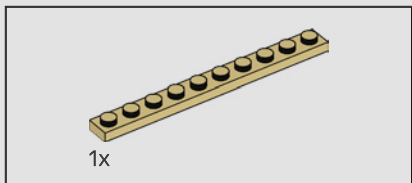

320

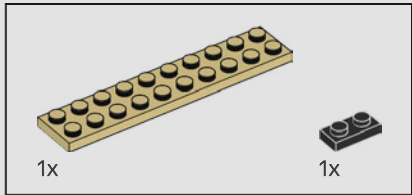
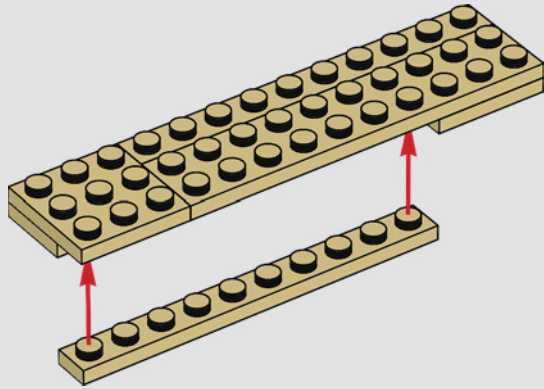

321

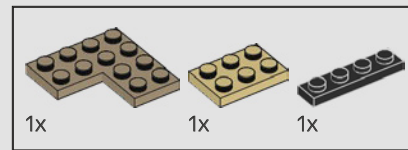
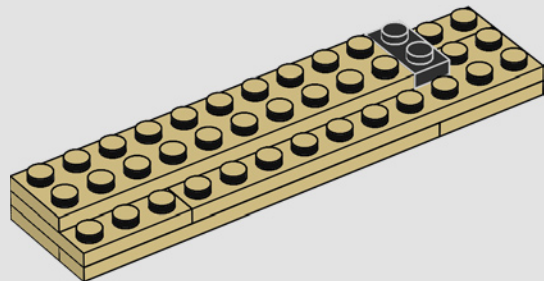

322

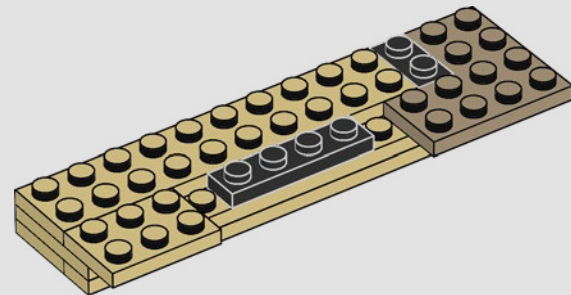

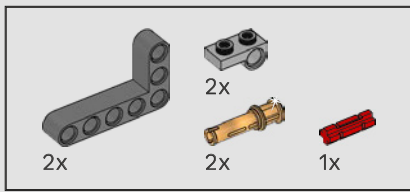

323

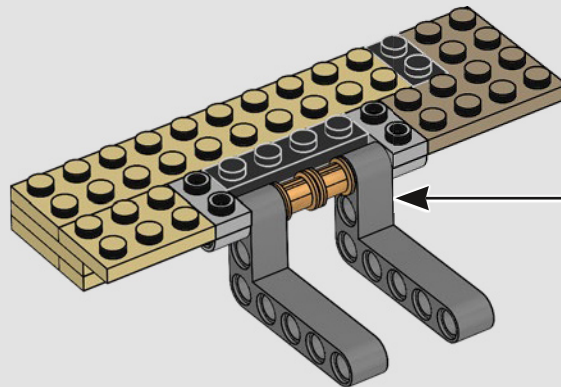
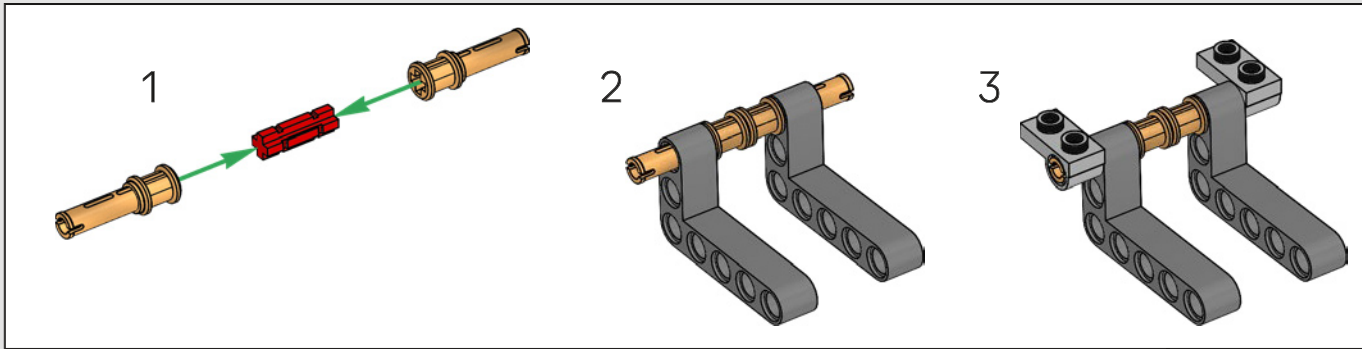

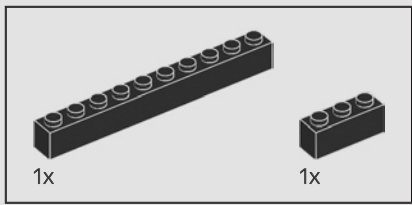

324

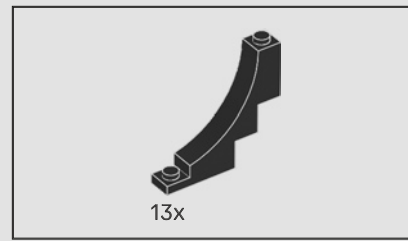
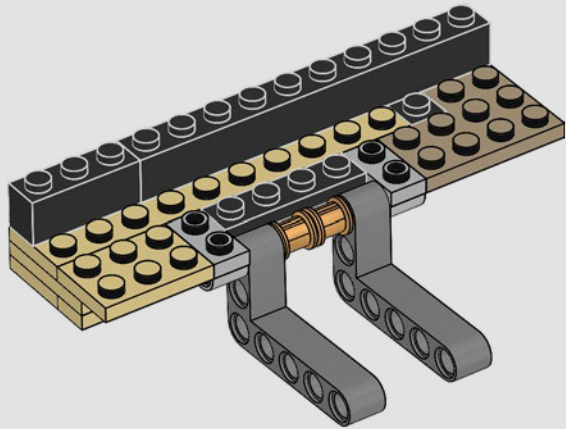

325

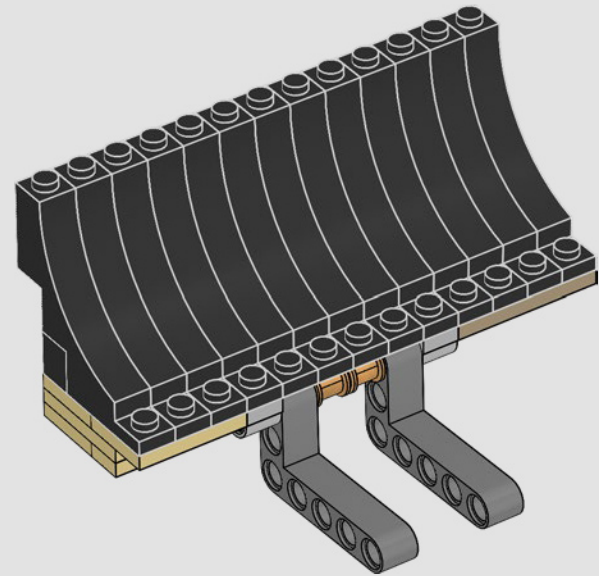

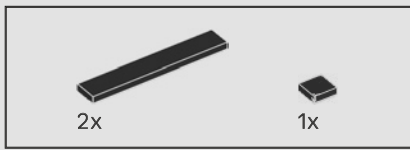

326

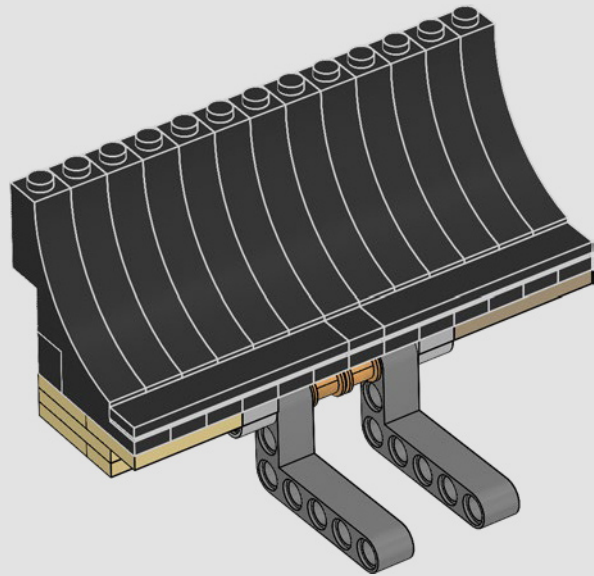

327

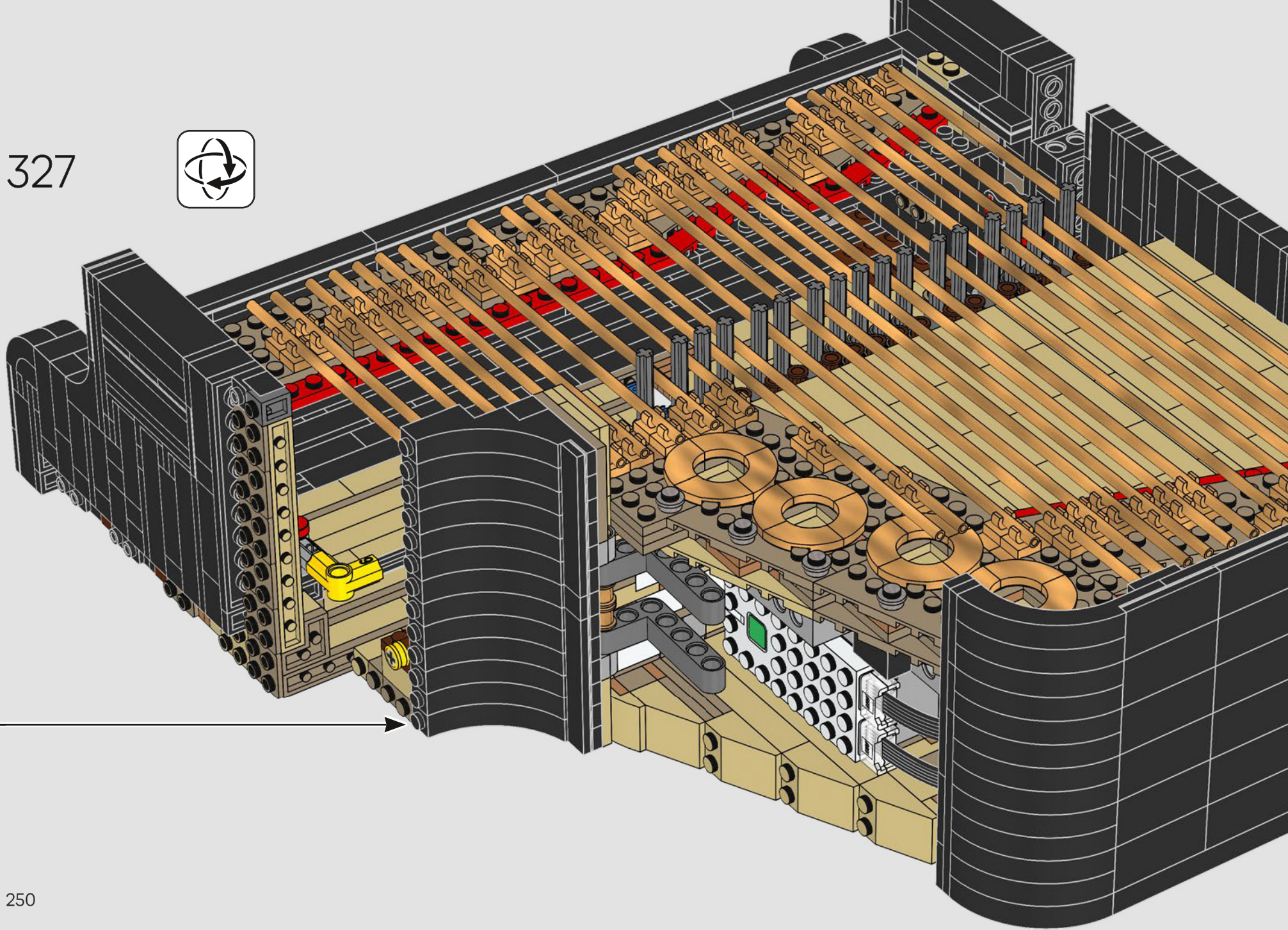

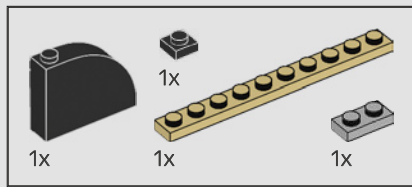

328

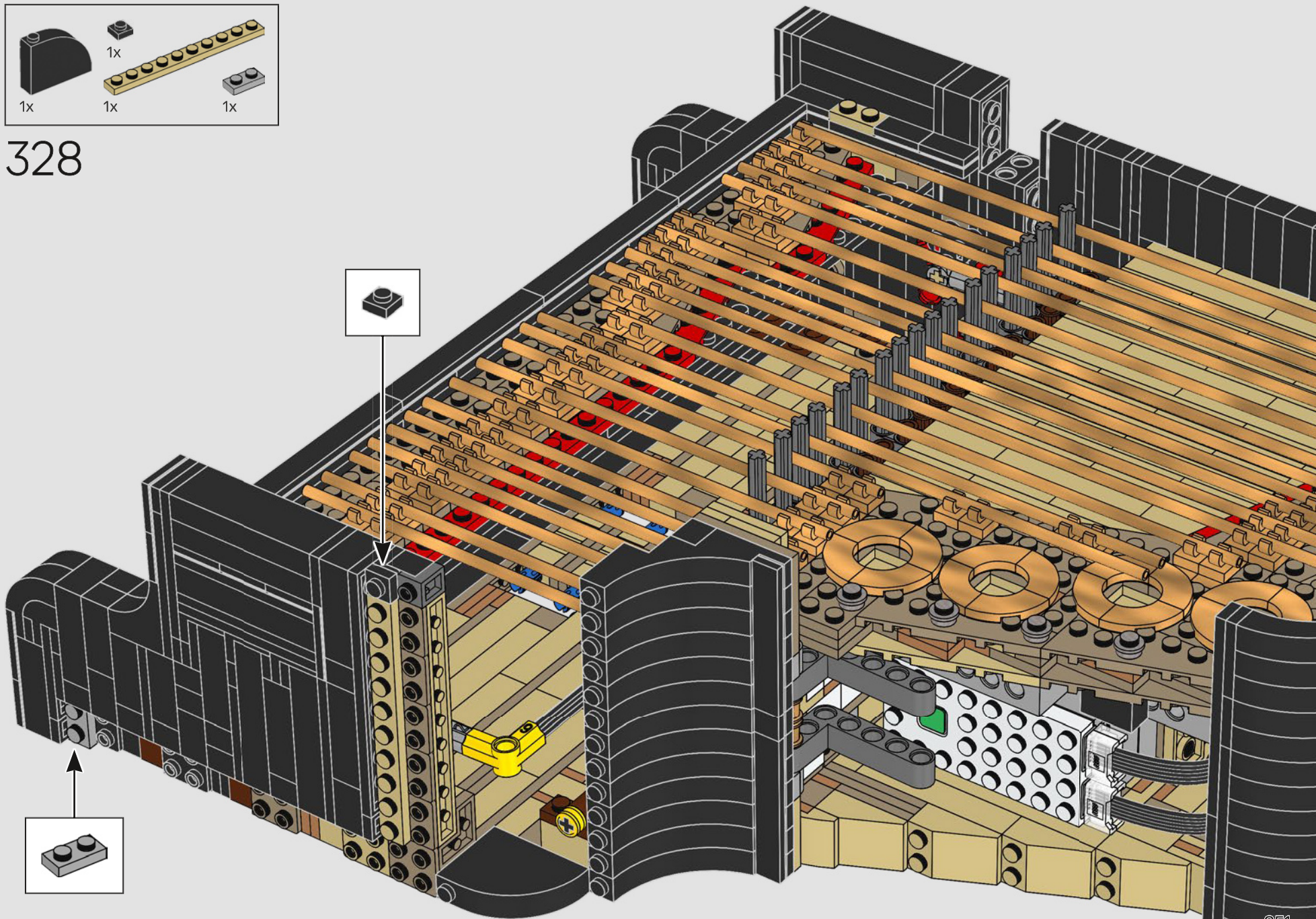

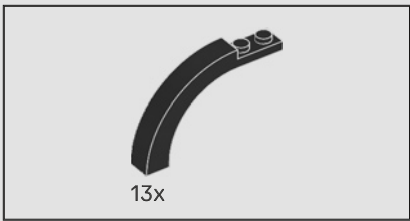

329

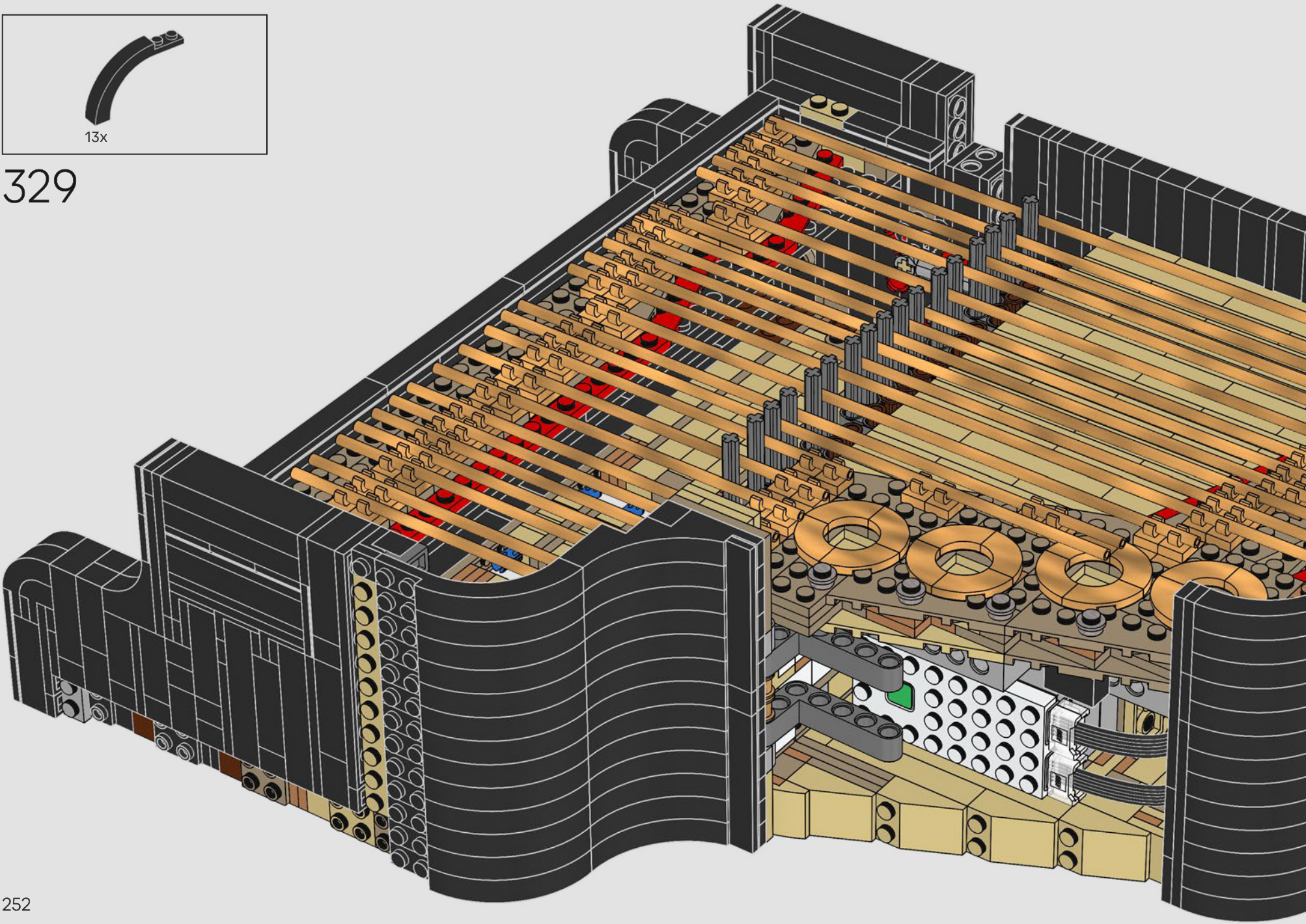

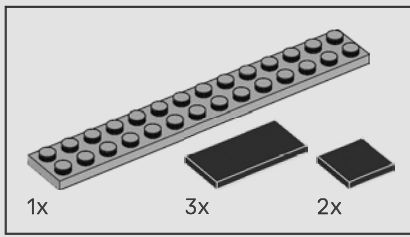

330

1

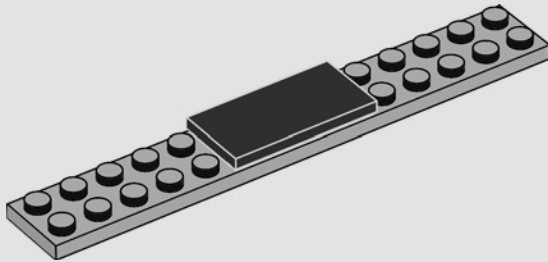

2

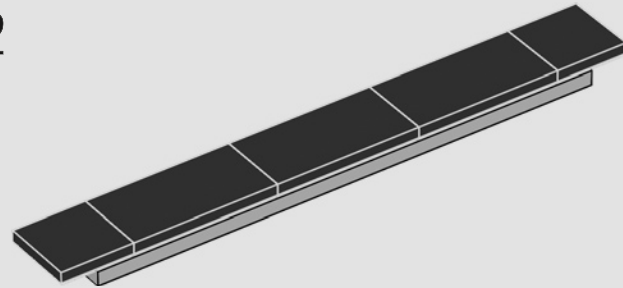

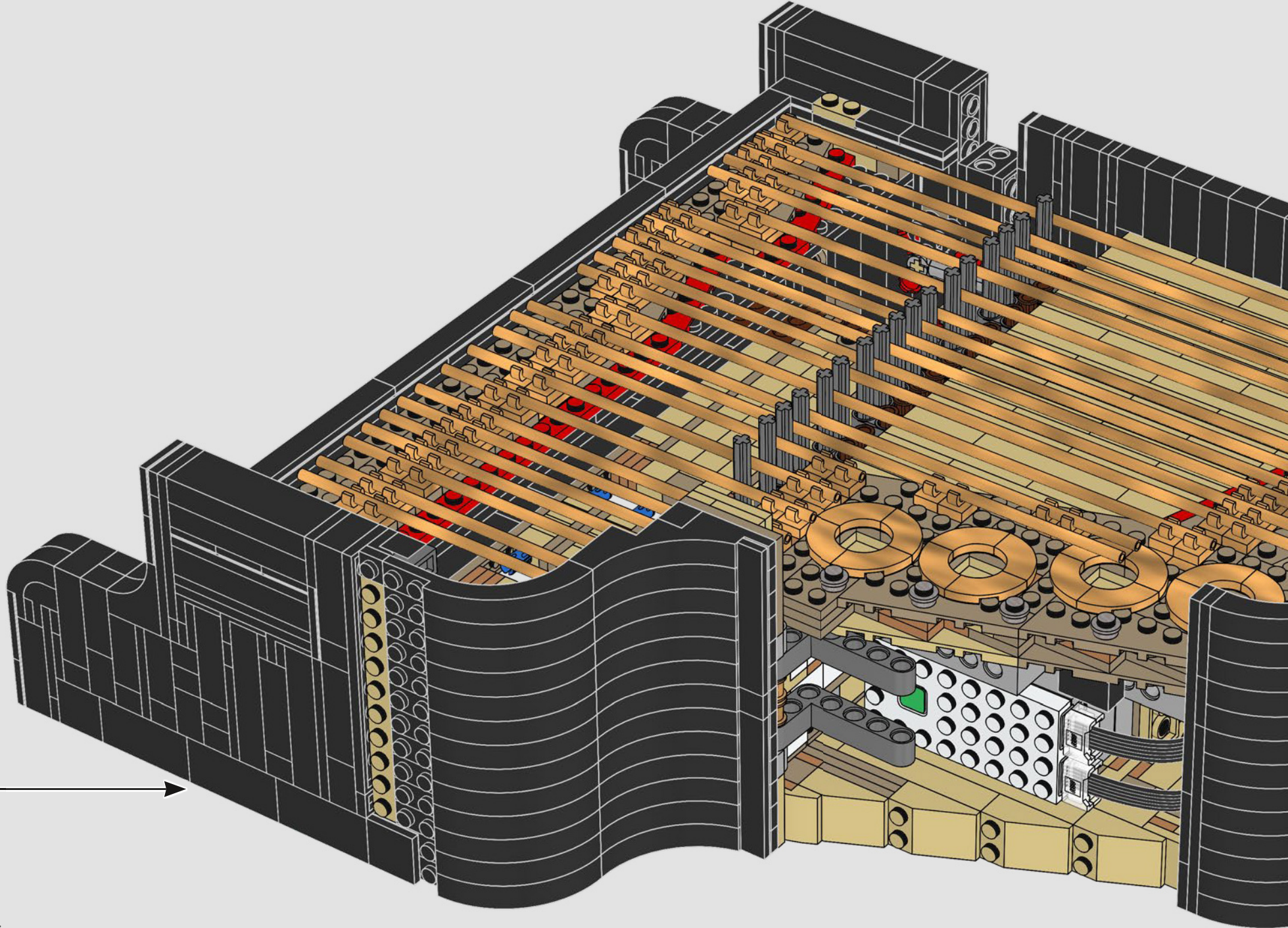

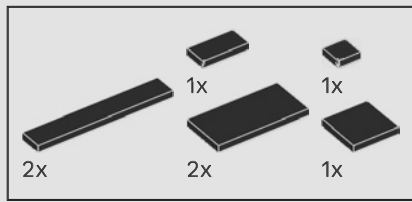

331

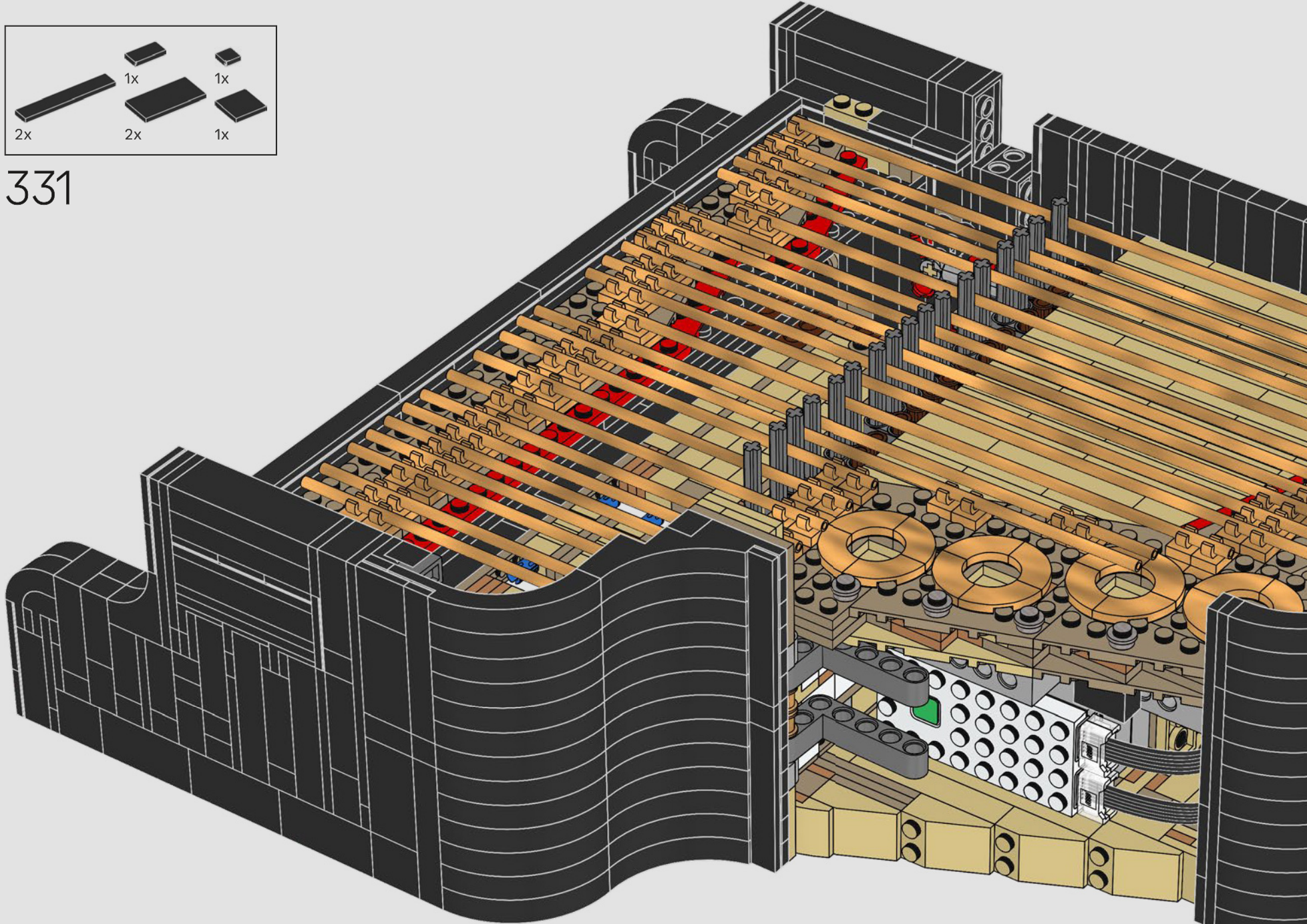

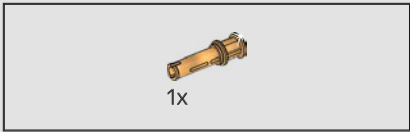

332

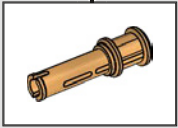
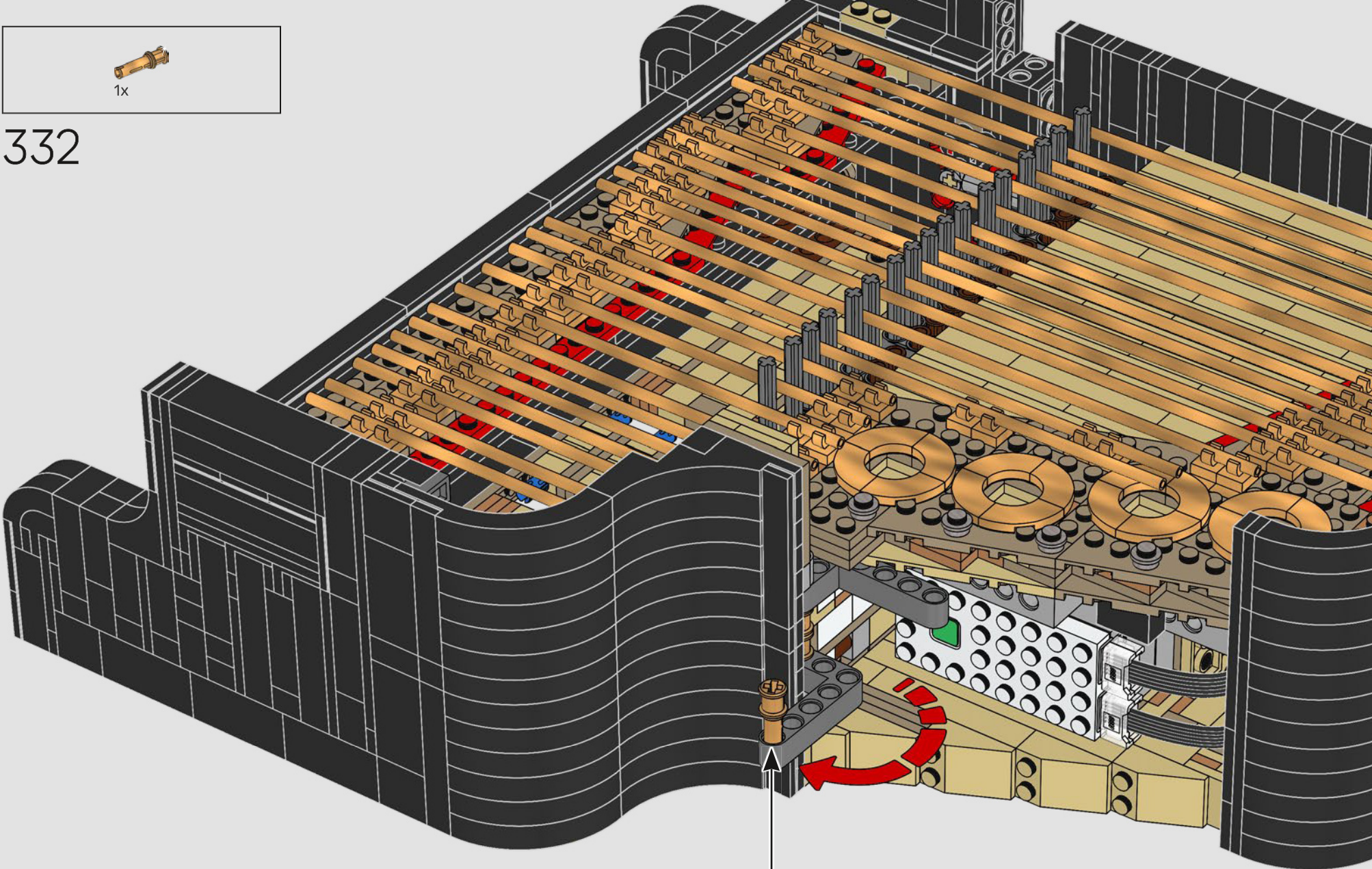

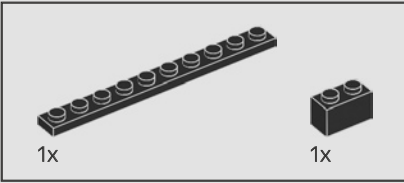
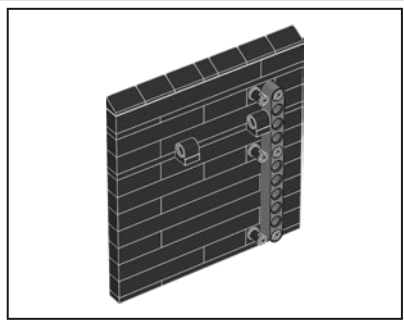

333

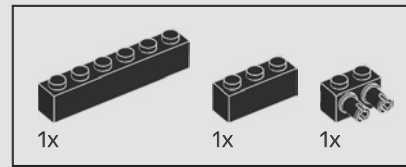
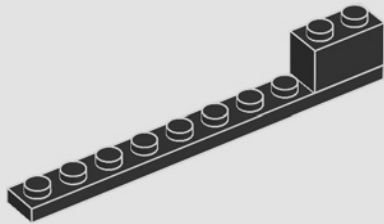

334

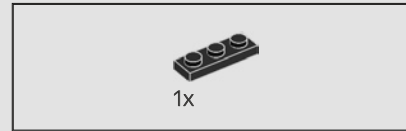
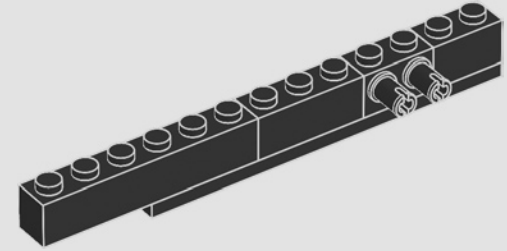

335

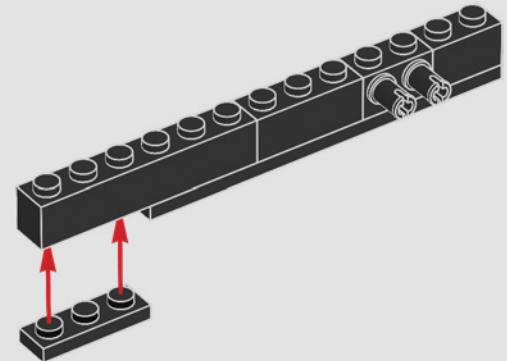

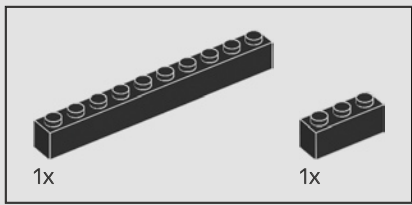

336

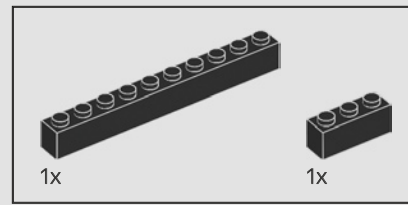
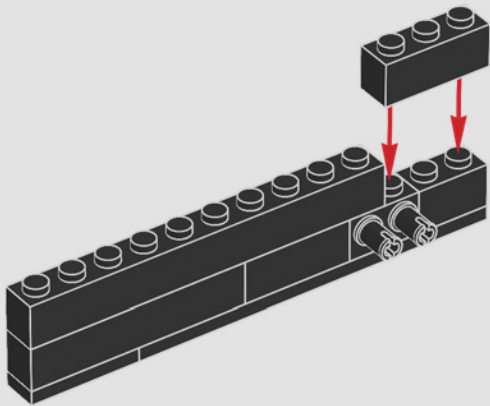

337

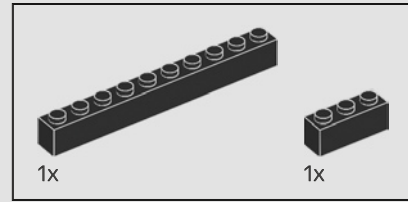
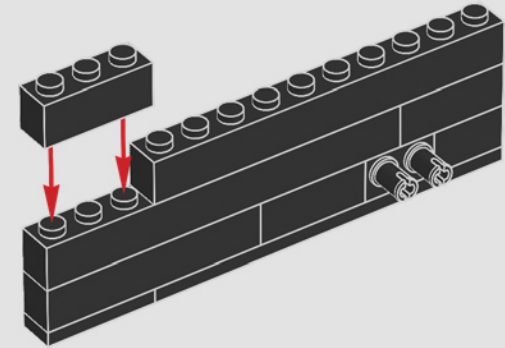

338

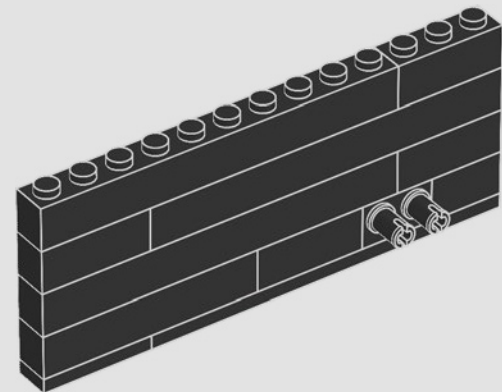

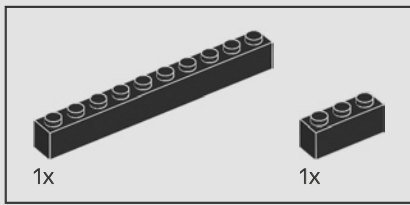

339

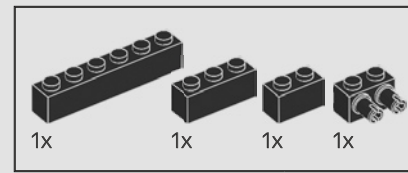
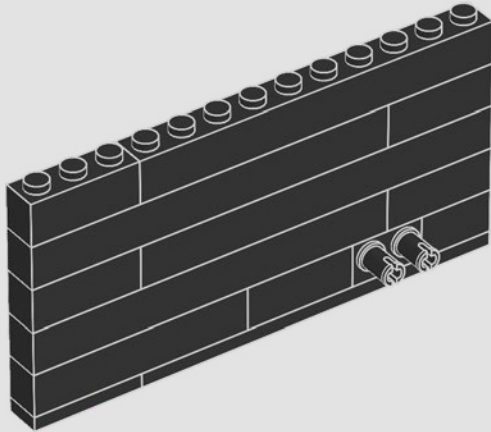

340

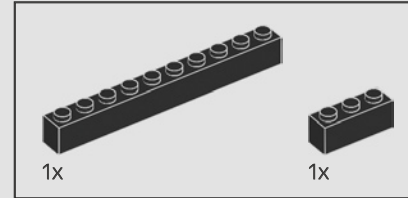
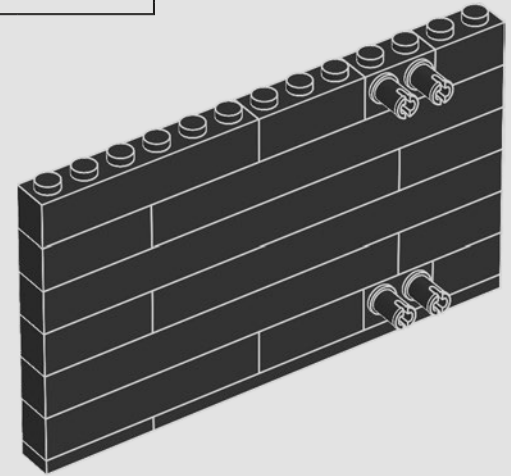

341

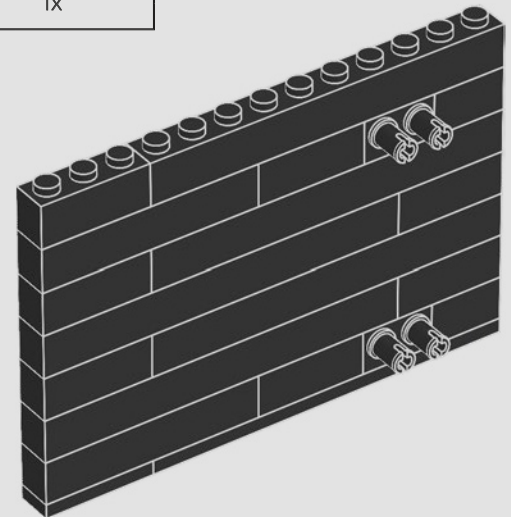

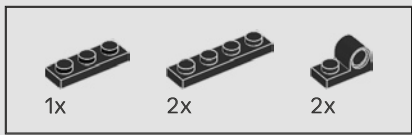

342

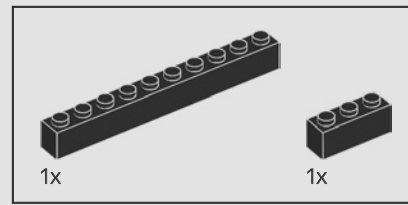
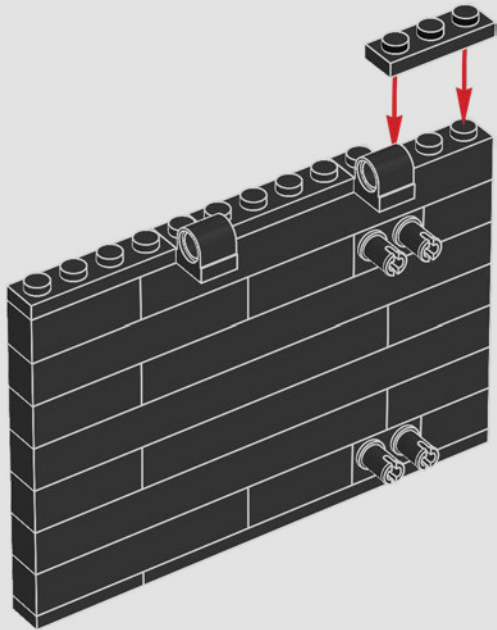

343

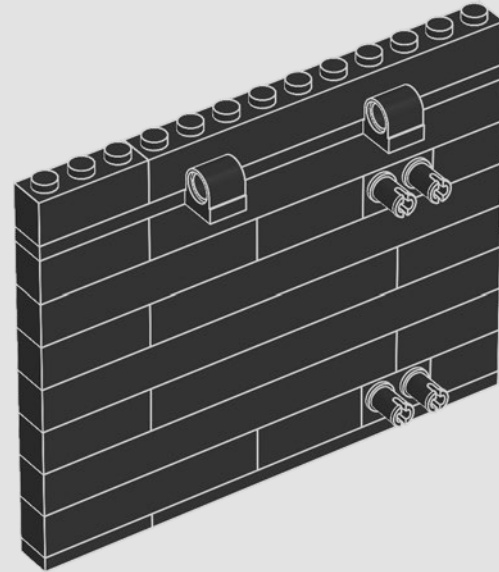

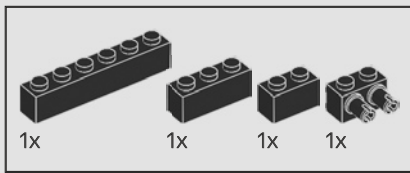

344

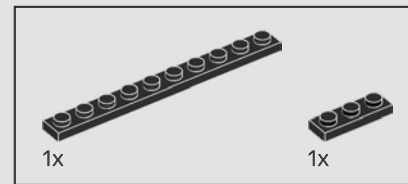
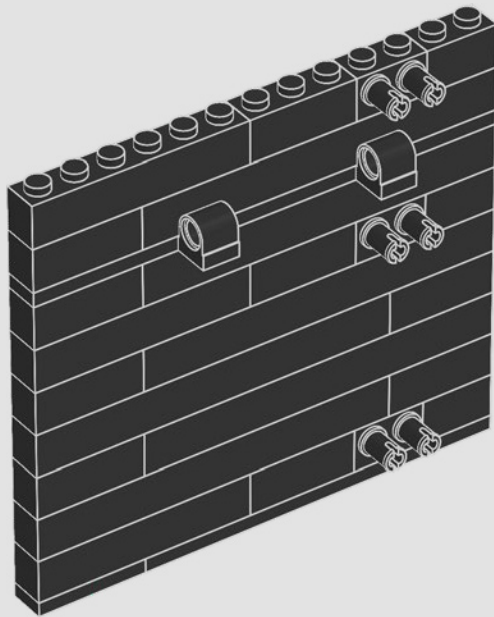

345

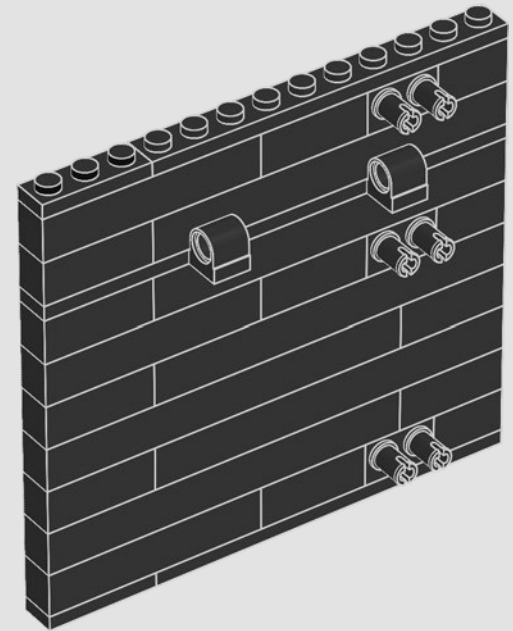

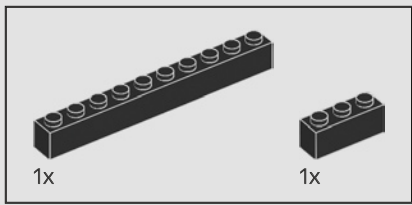

346

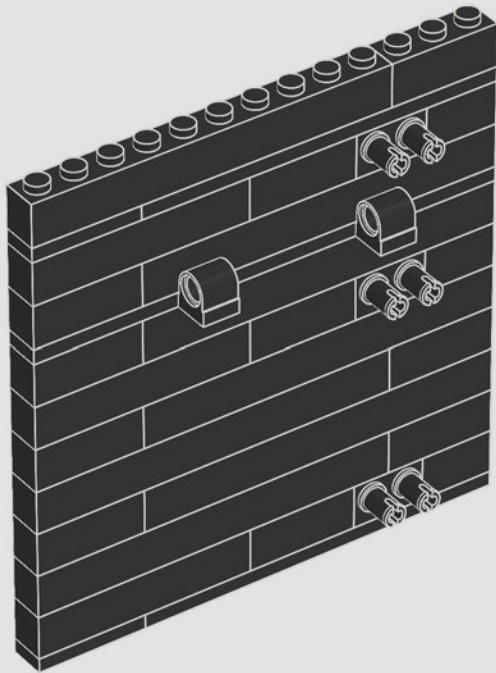

347

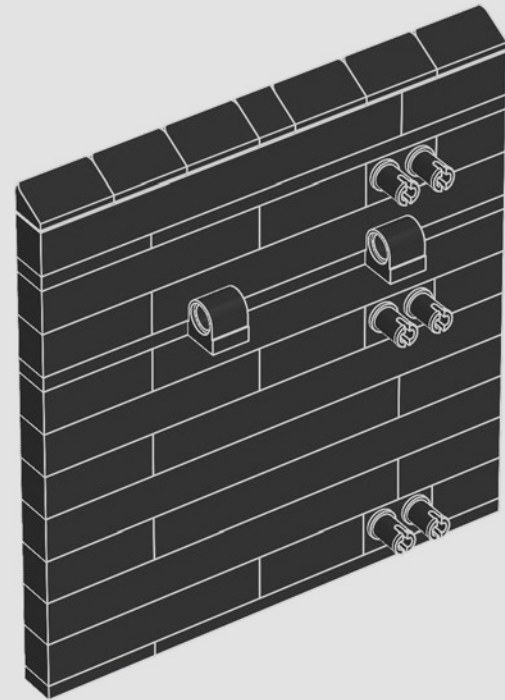

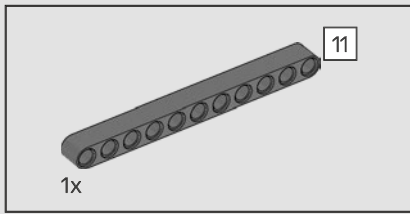

348

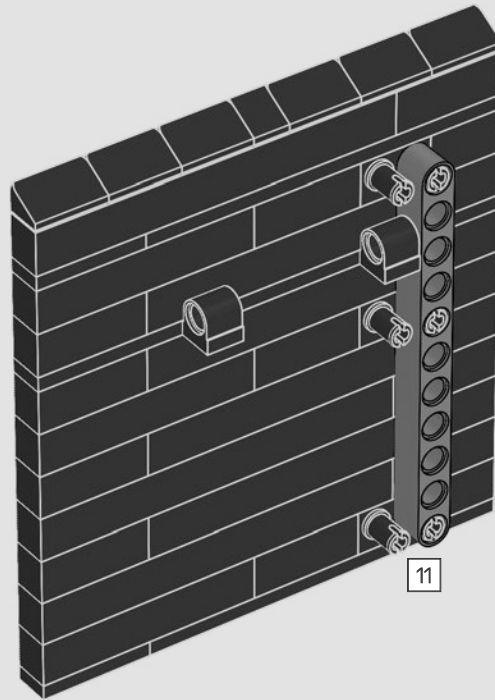

“ Music is the art which is most
nigh to tears and memories. ”

Oscar Wilde

349

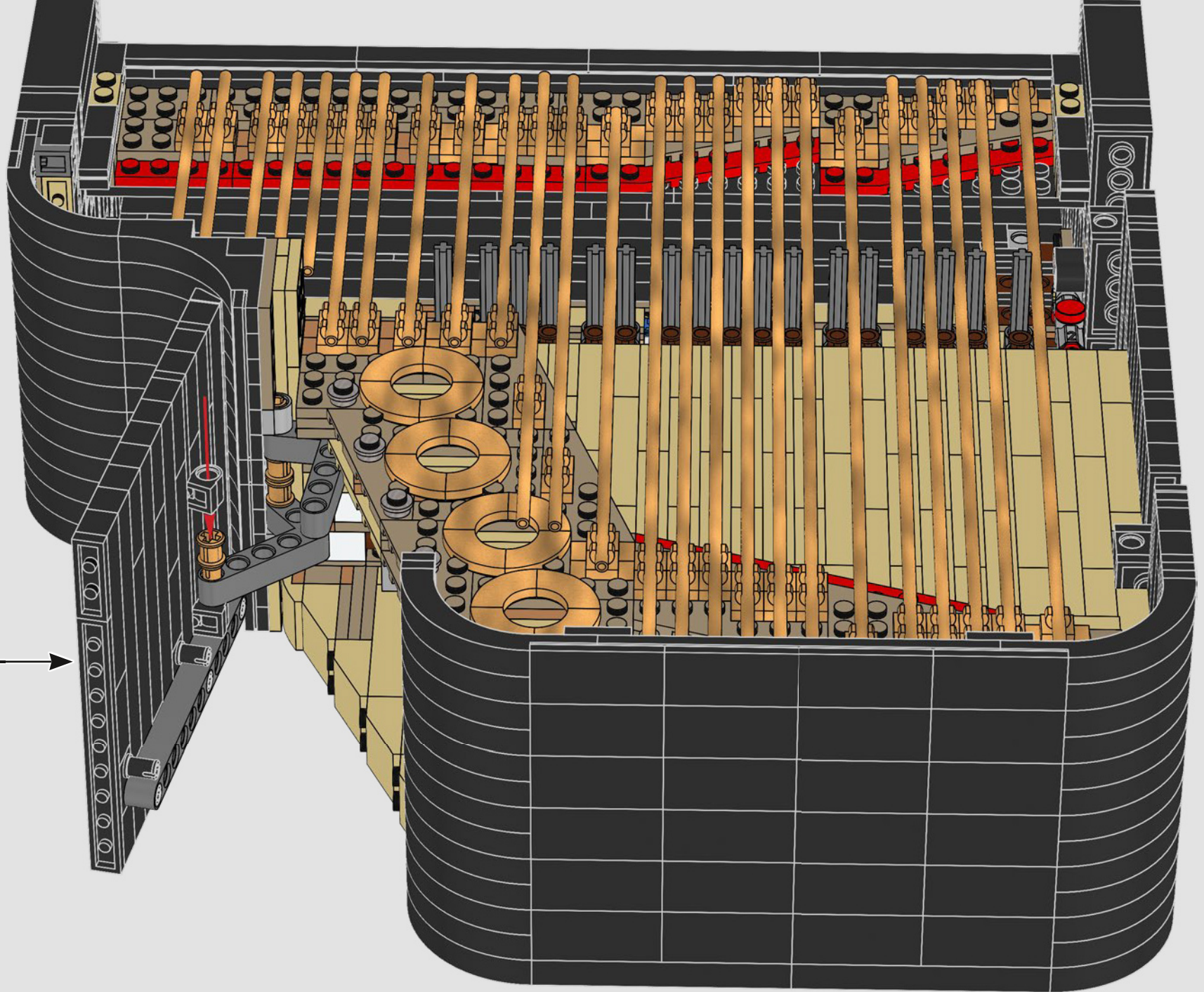

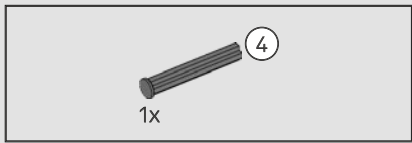

350

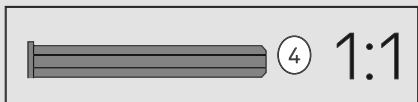
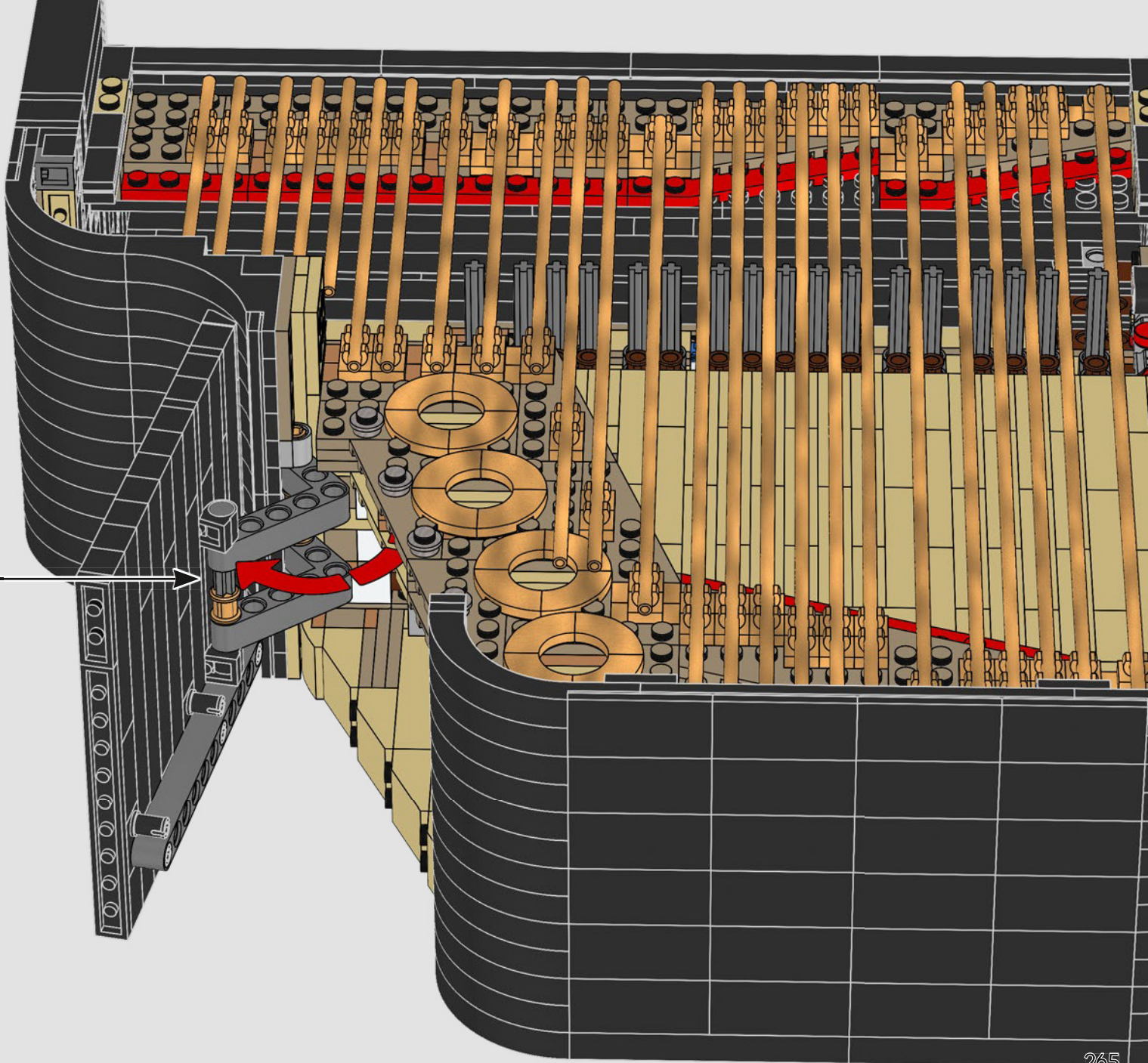
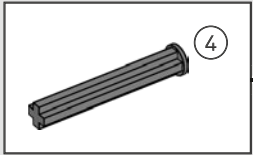

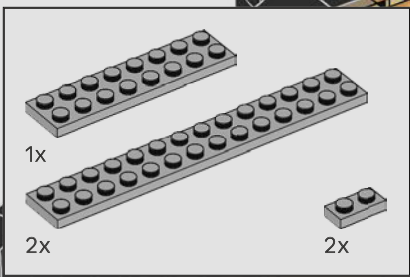

351

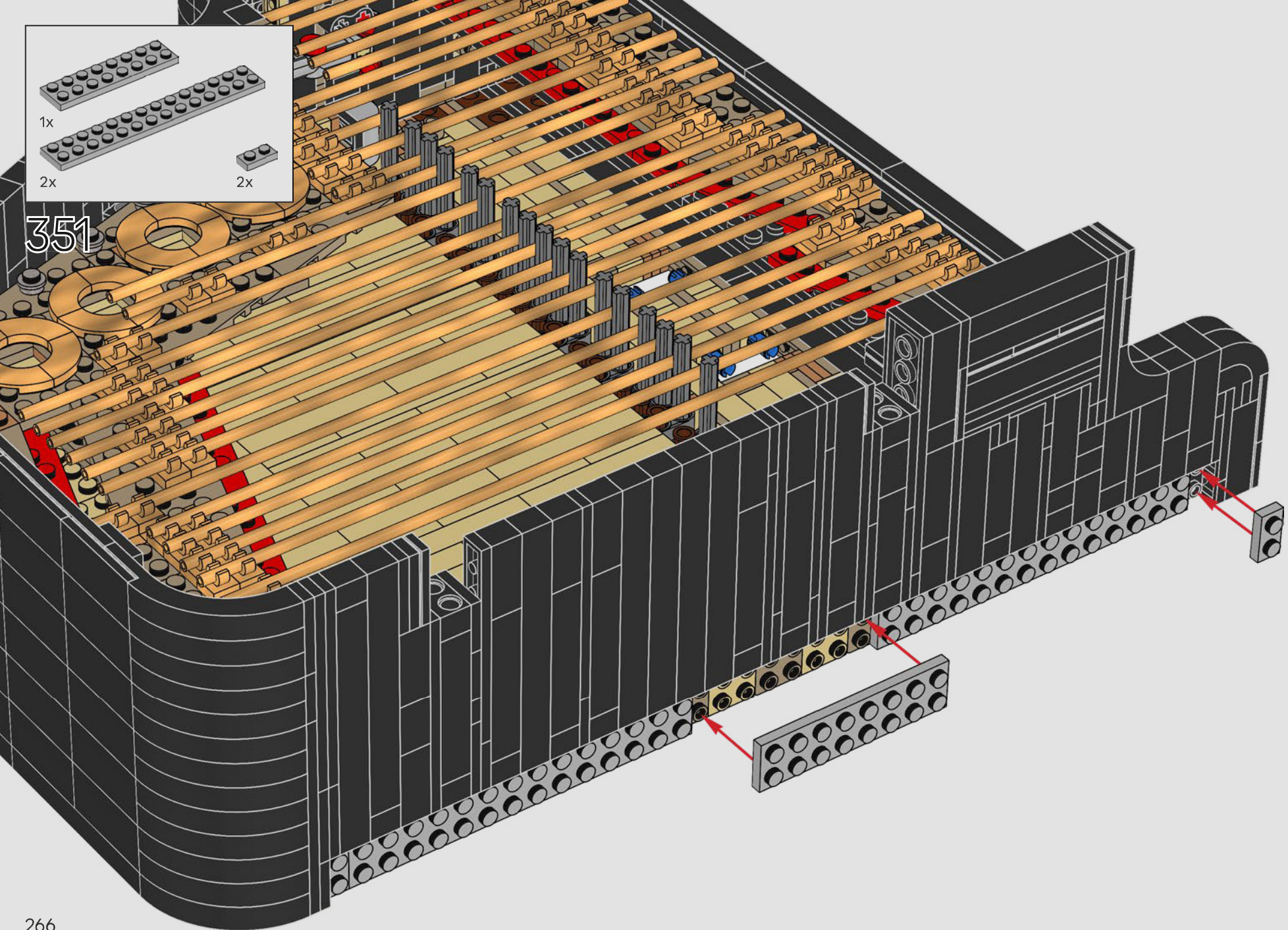

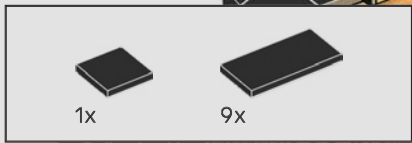

352

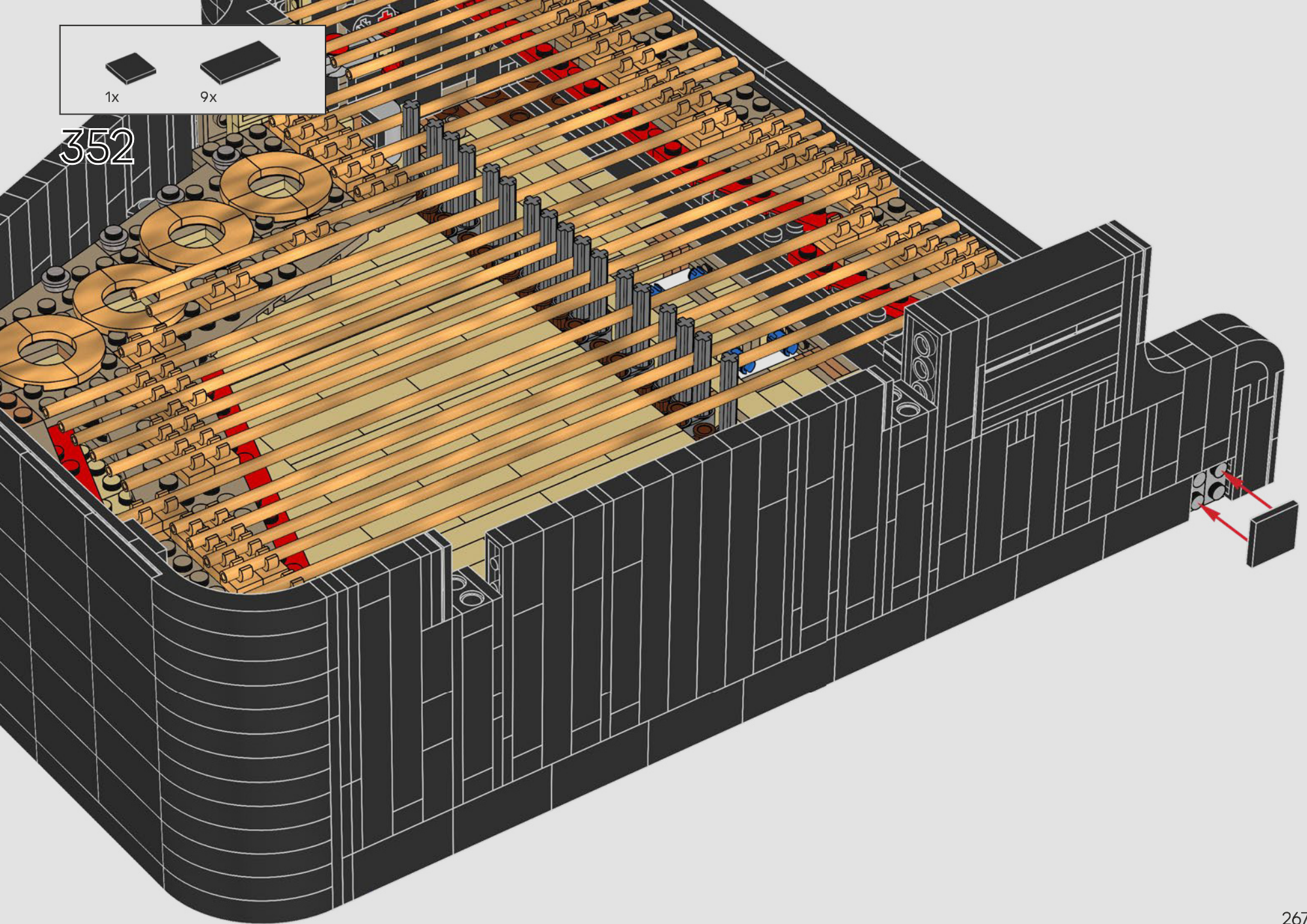

1

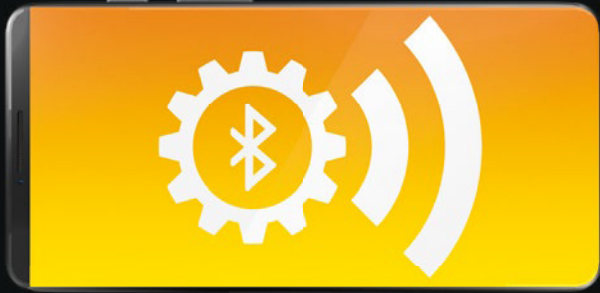
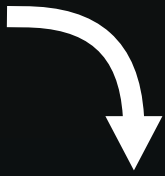

2



3

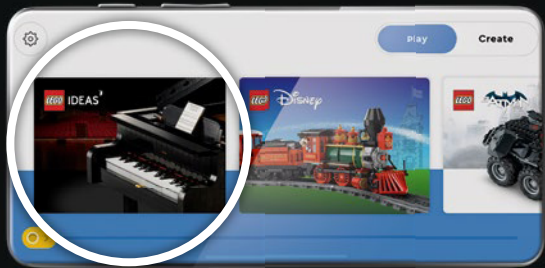

4



5



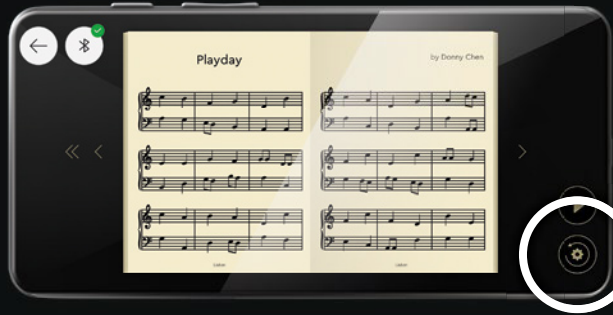

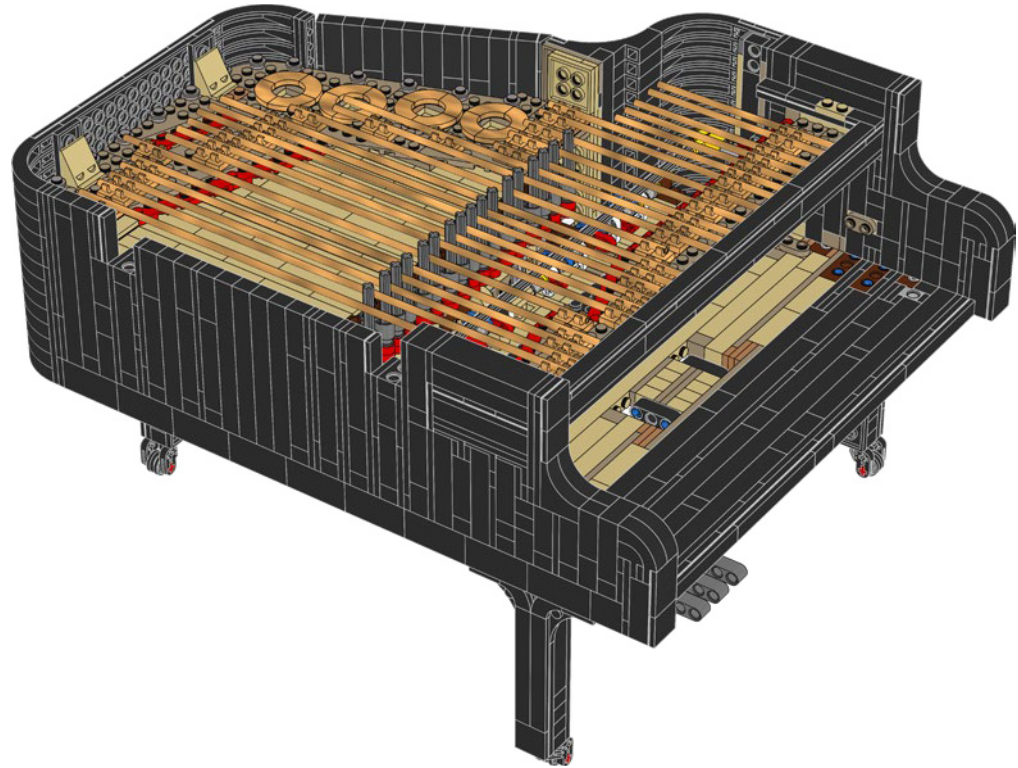
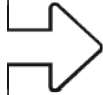

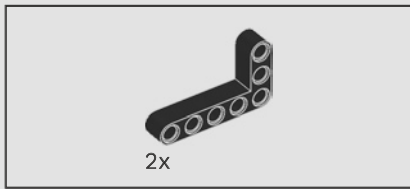

353

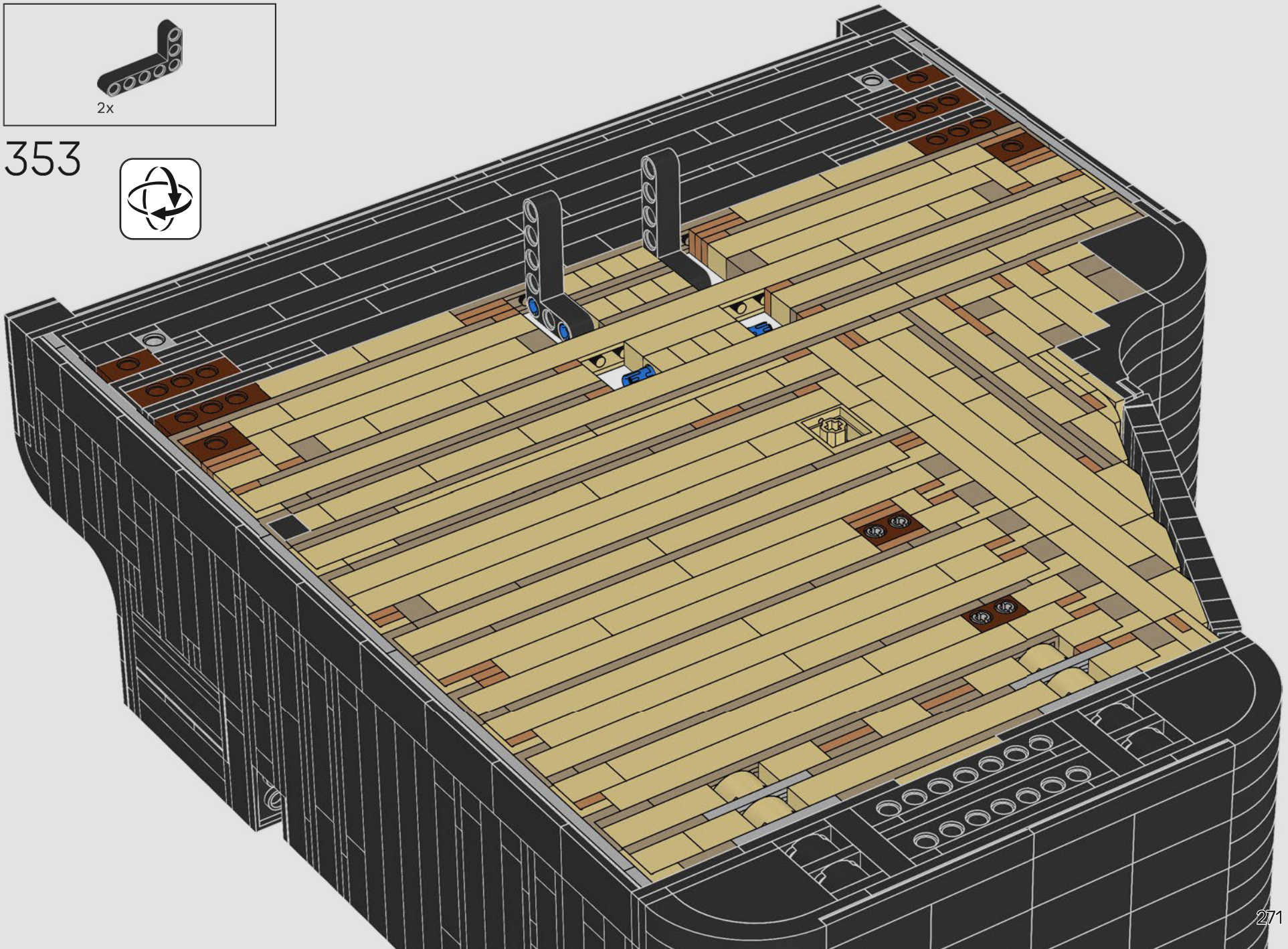



354

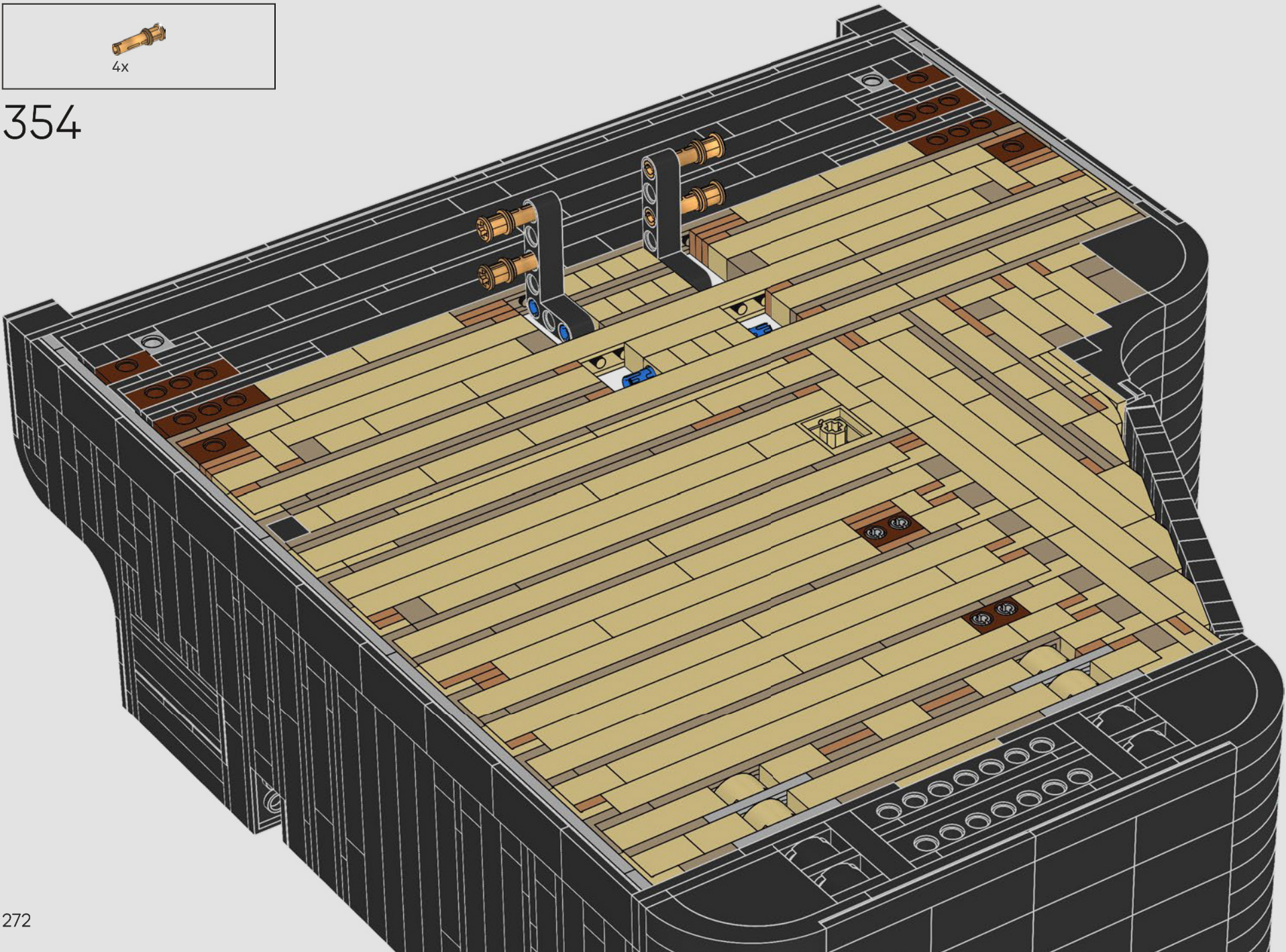

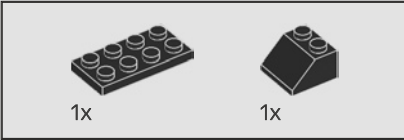
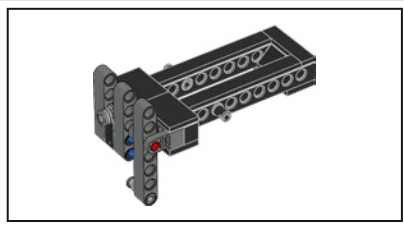

355

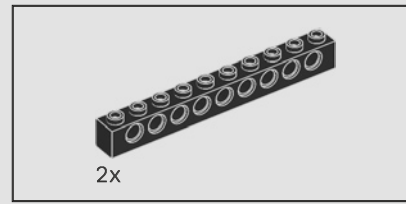
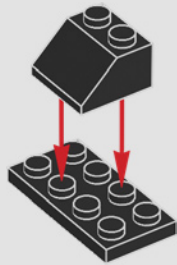

356

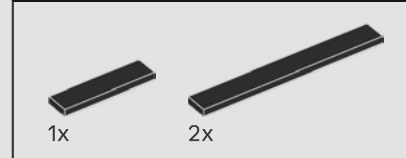
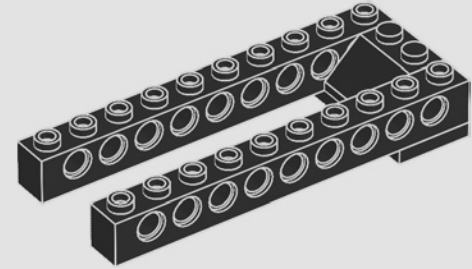

357

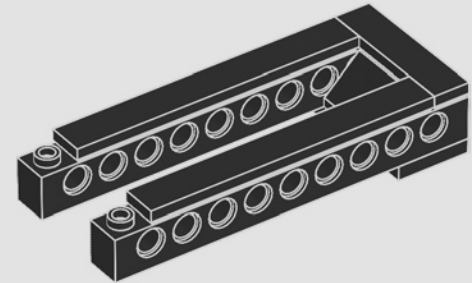

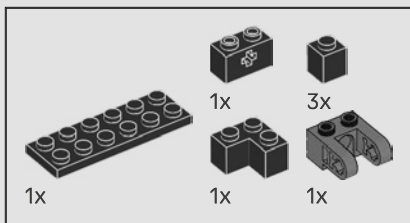

358

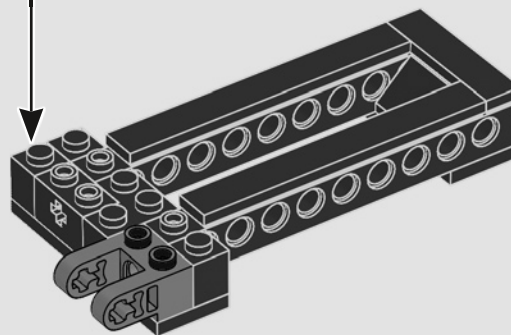
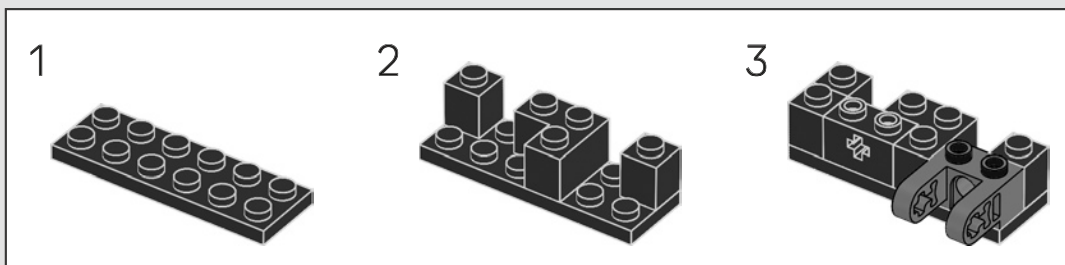

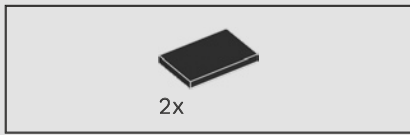

359

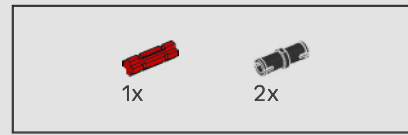
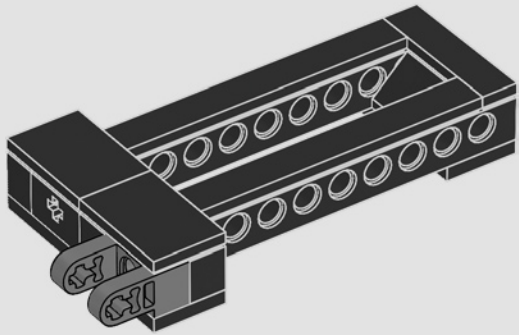

360

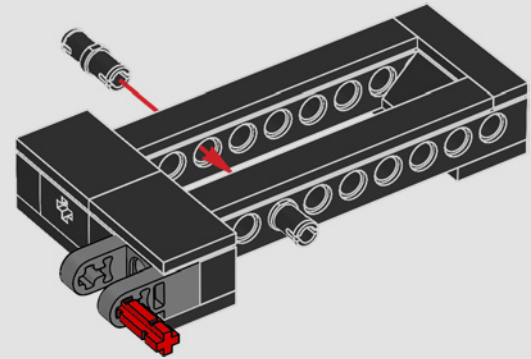

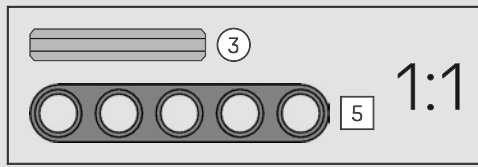
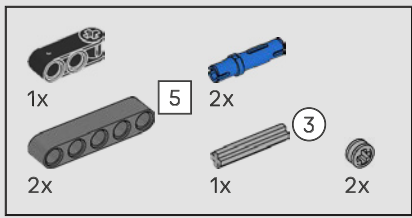

361

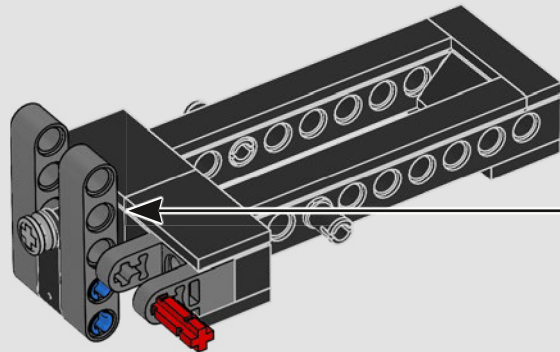
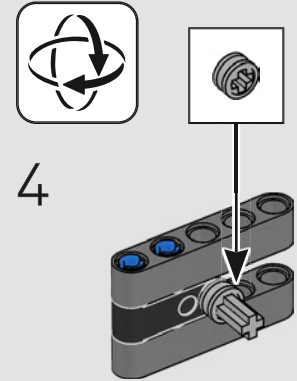
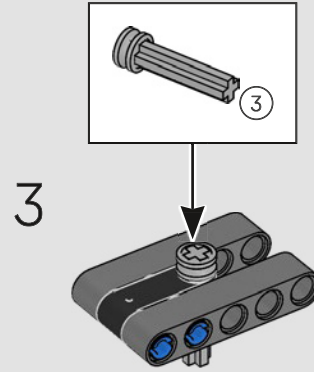
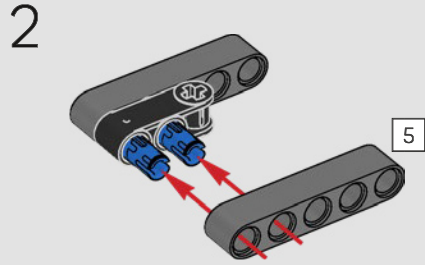
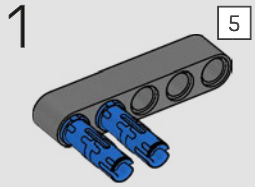

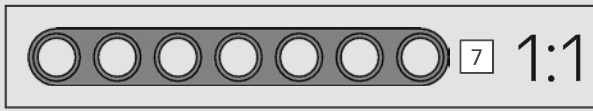
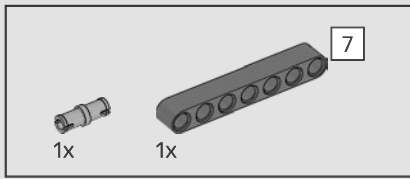

362

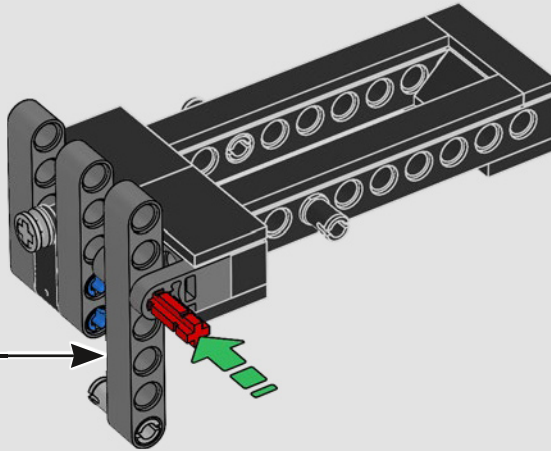
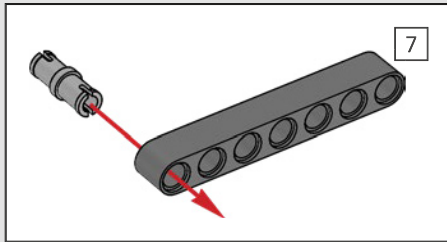

363

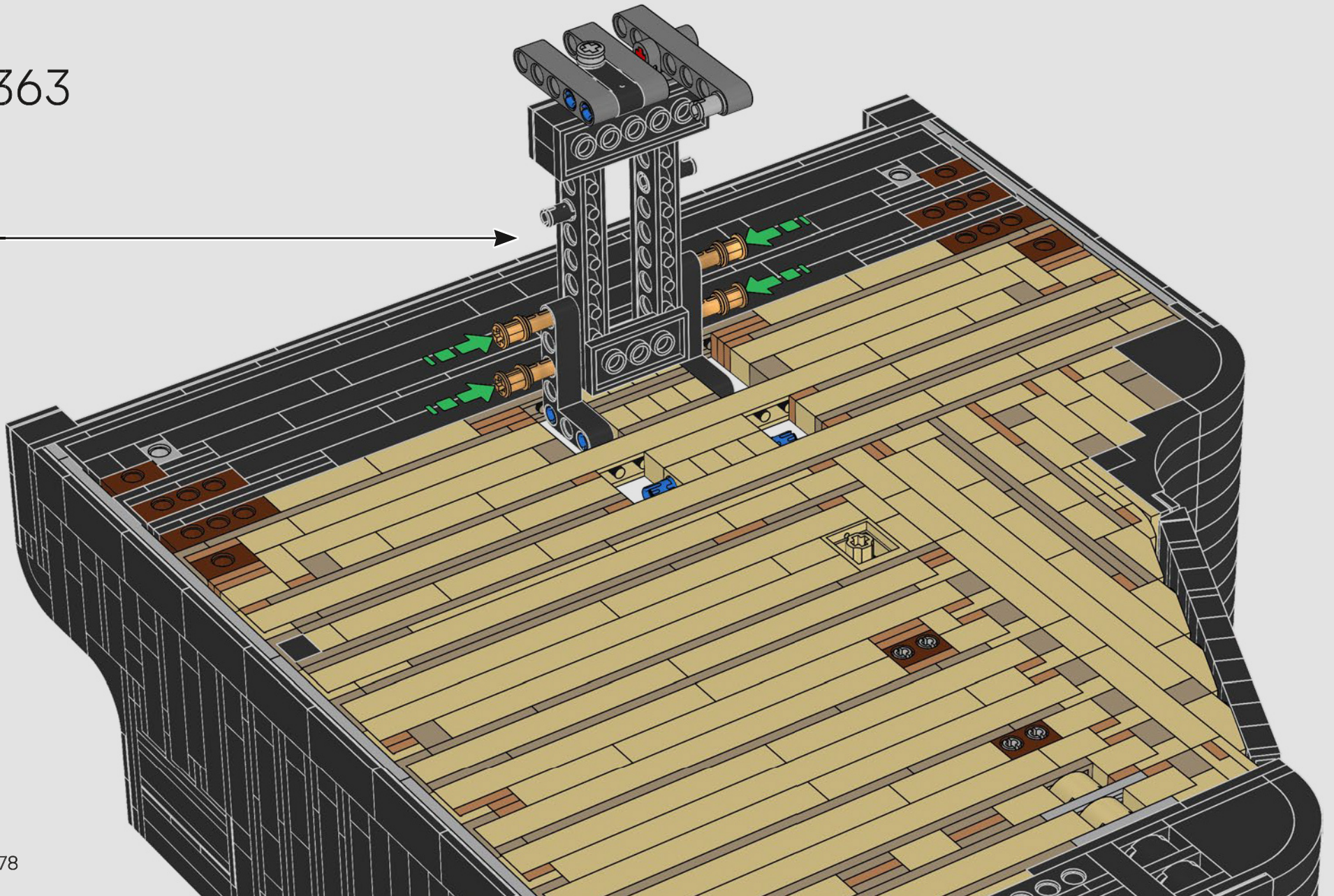

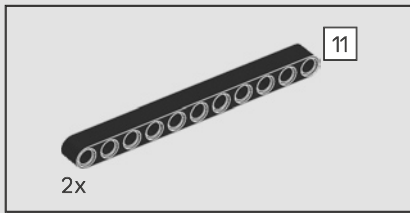

364

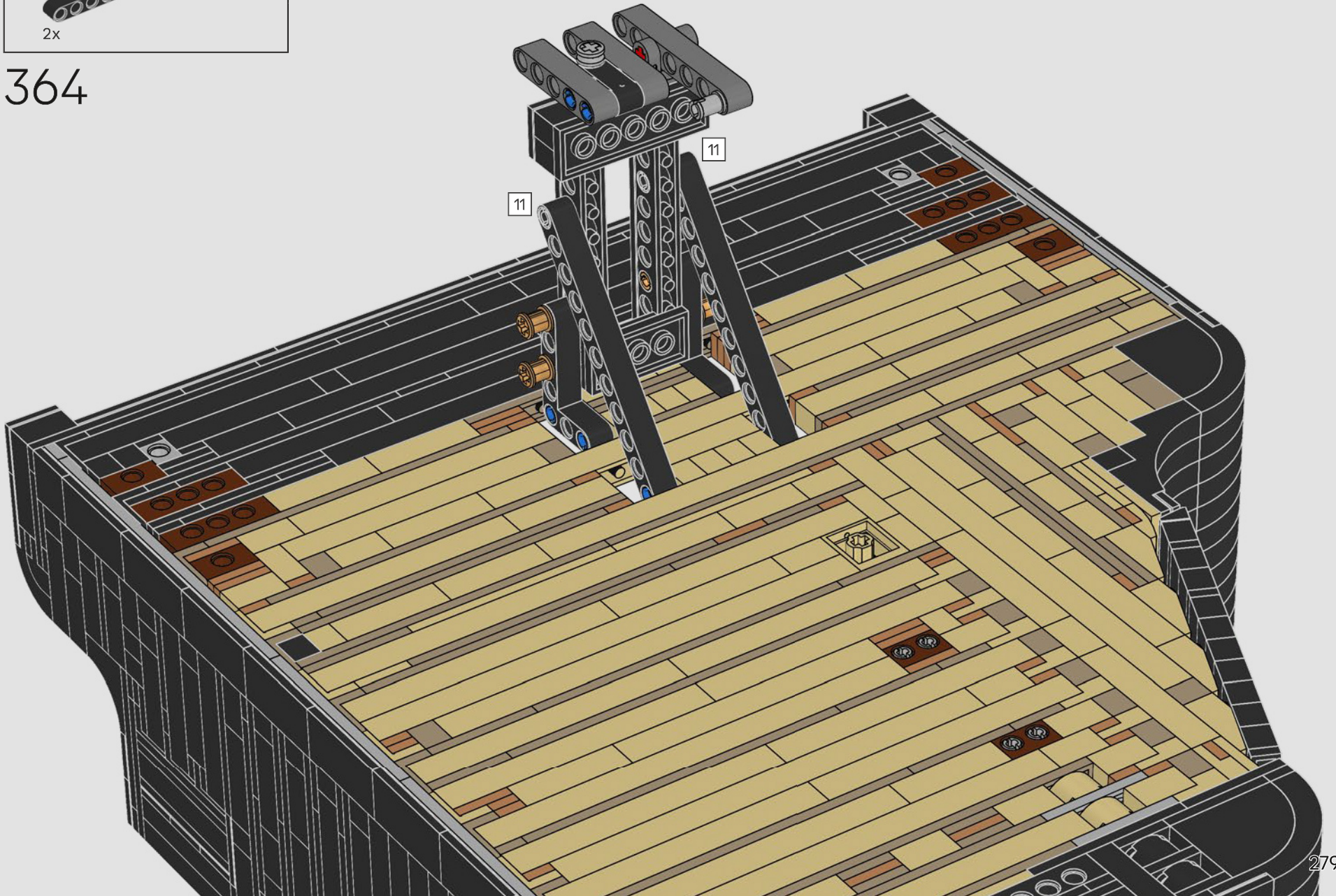

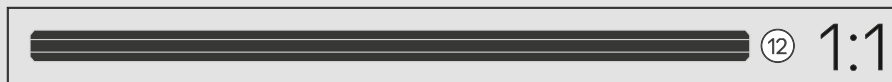
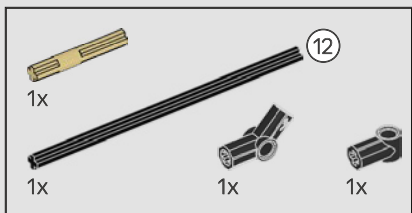

365

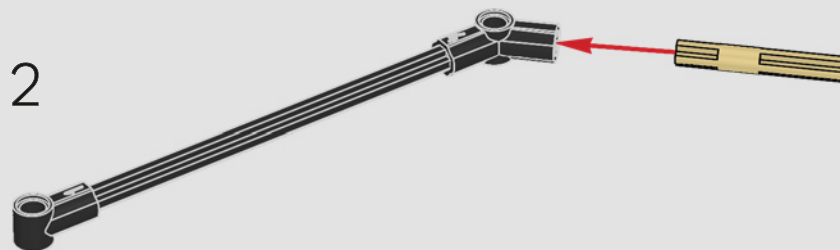
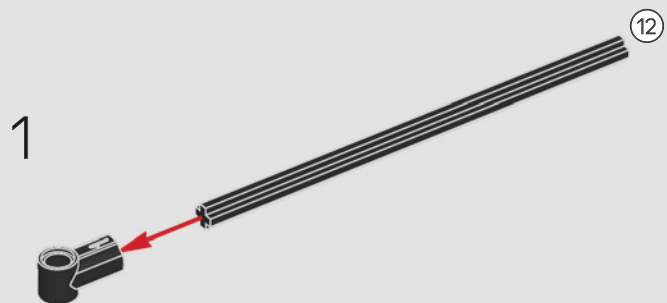

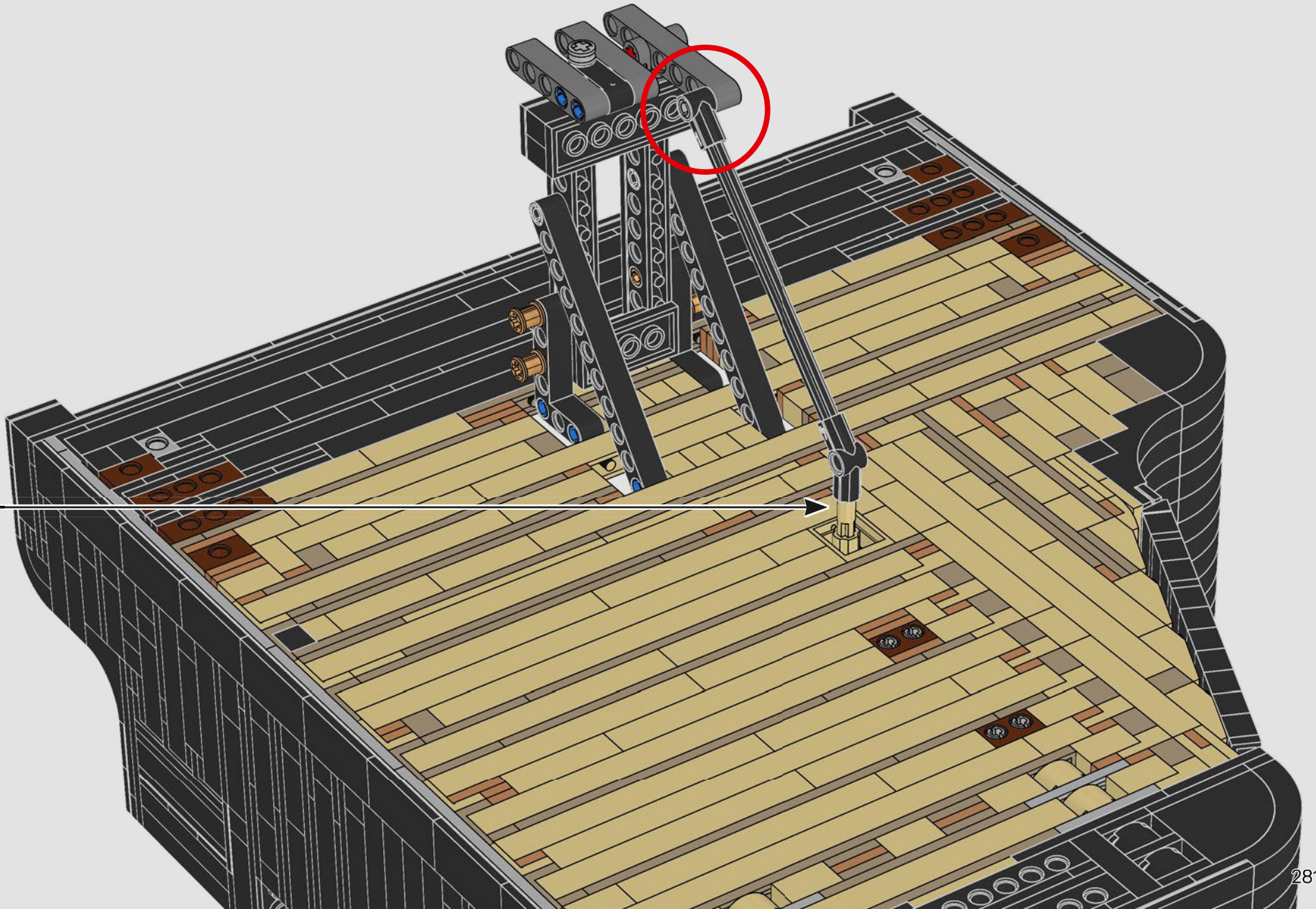

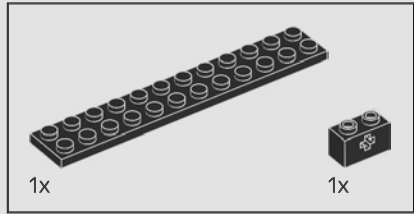
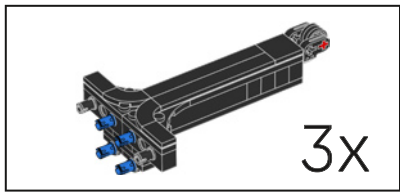

366

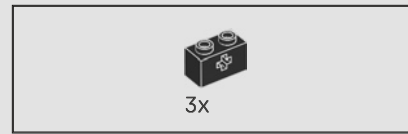
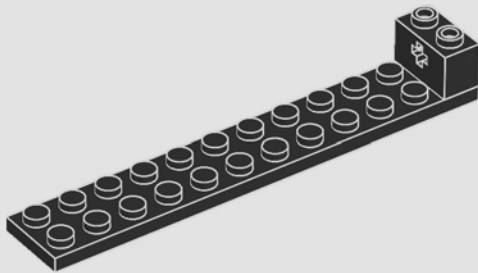

367

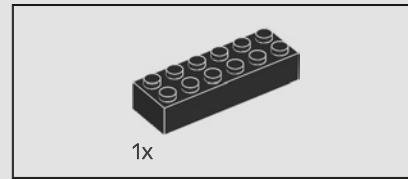
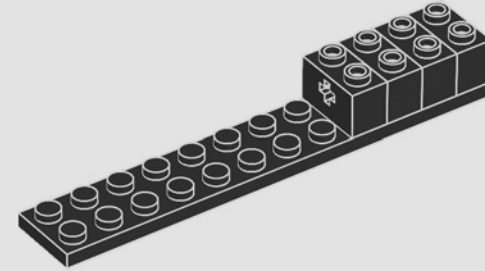

368

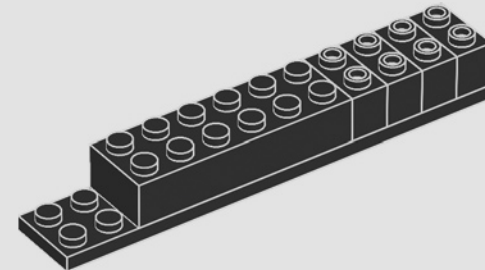

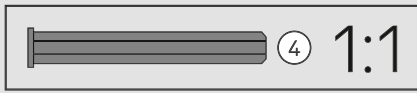
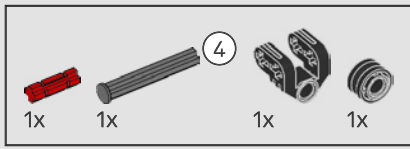

369

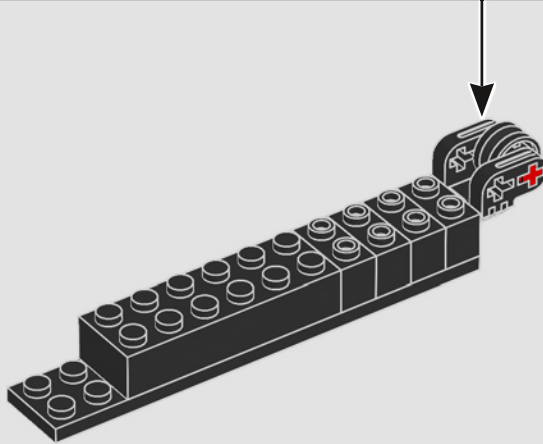
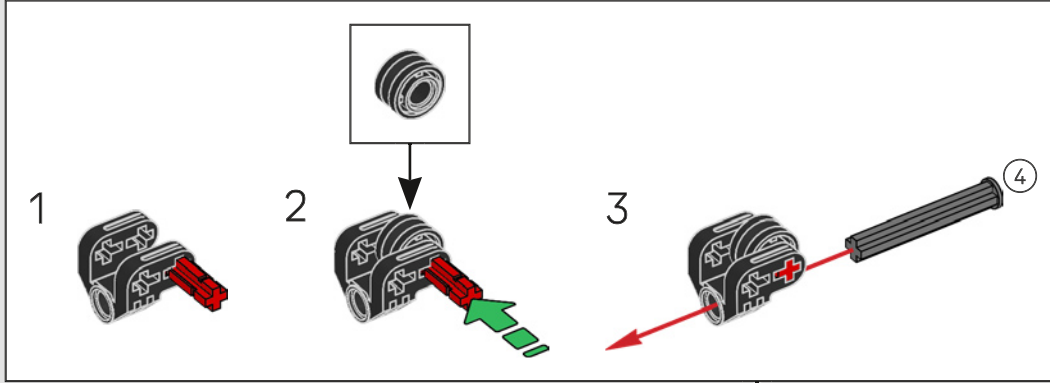

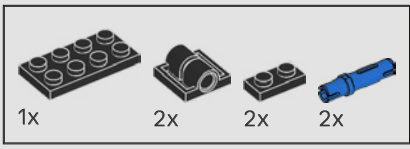

370

1

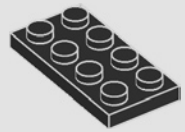

2

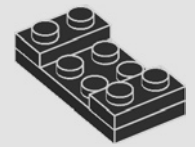

3

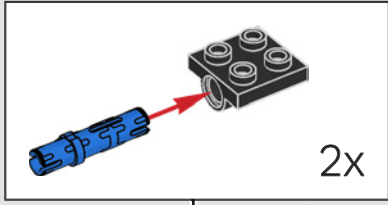
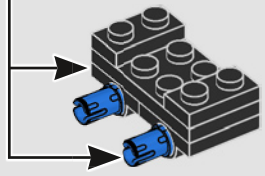

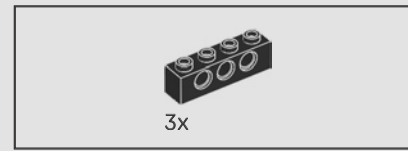
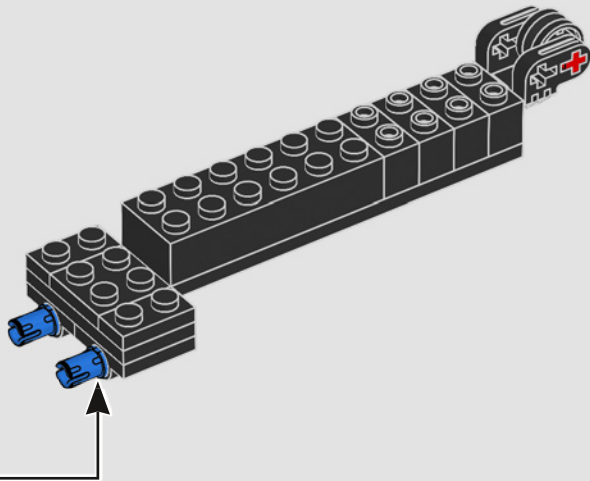

371

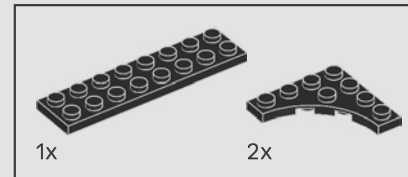
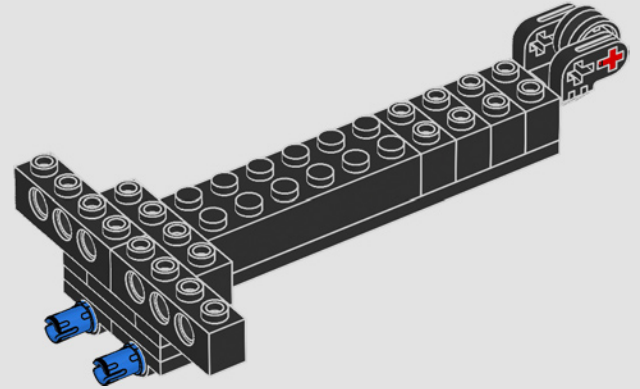

372

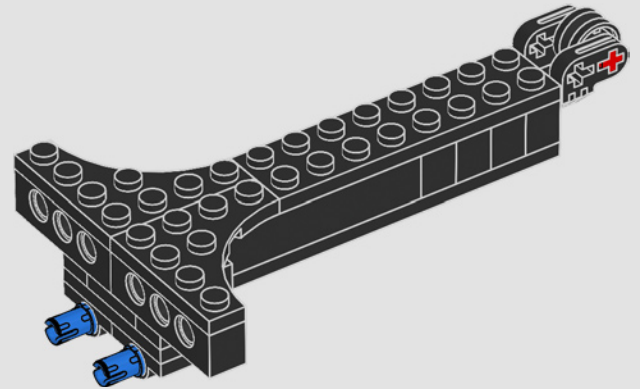

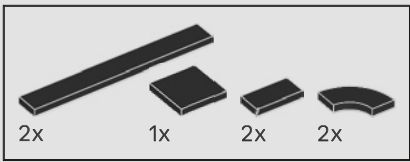

373

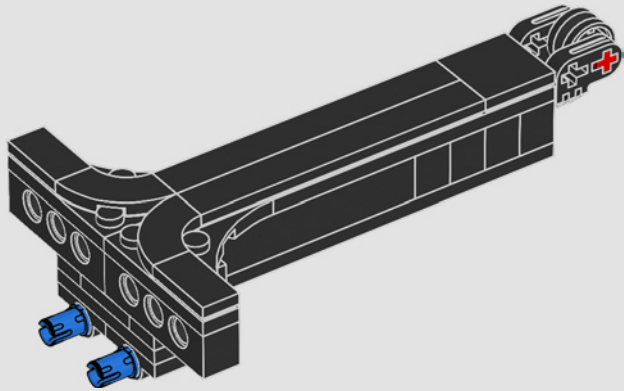

374

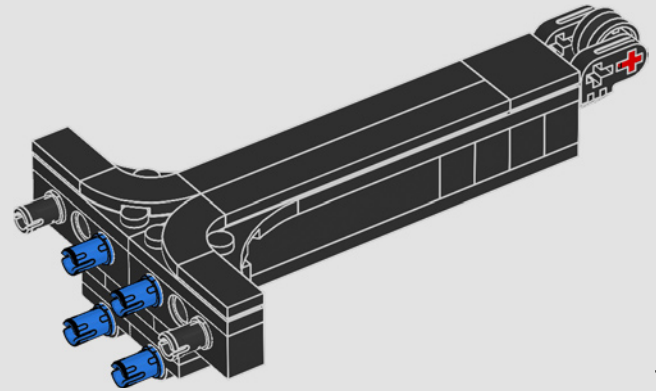

3x

375

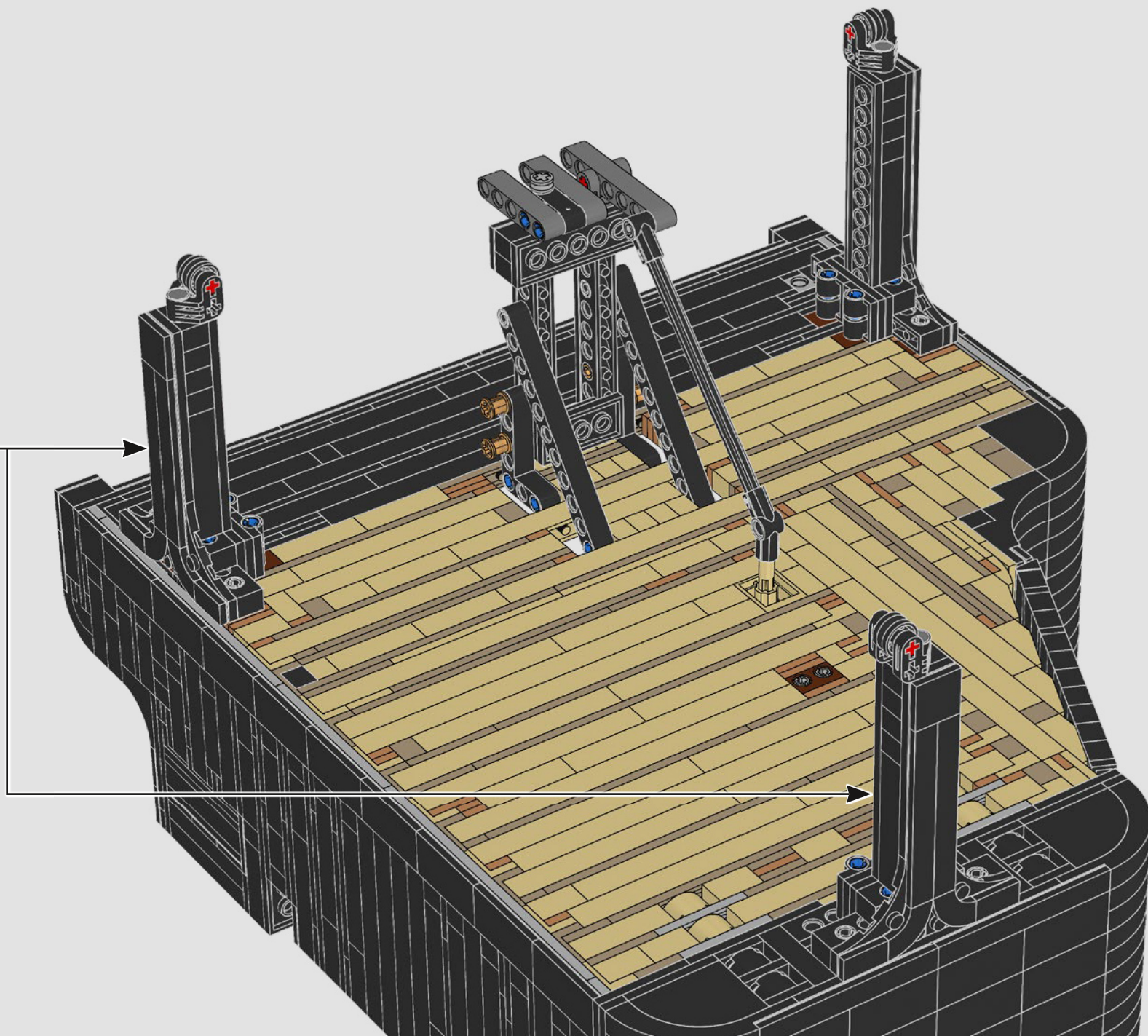

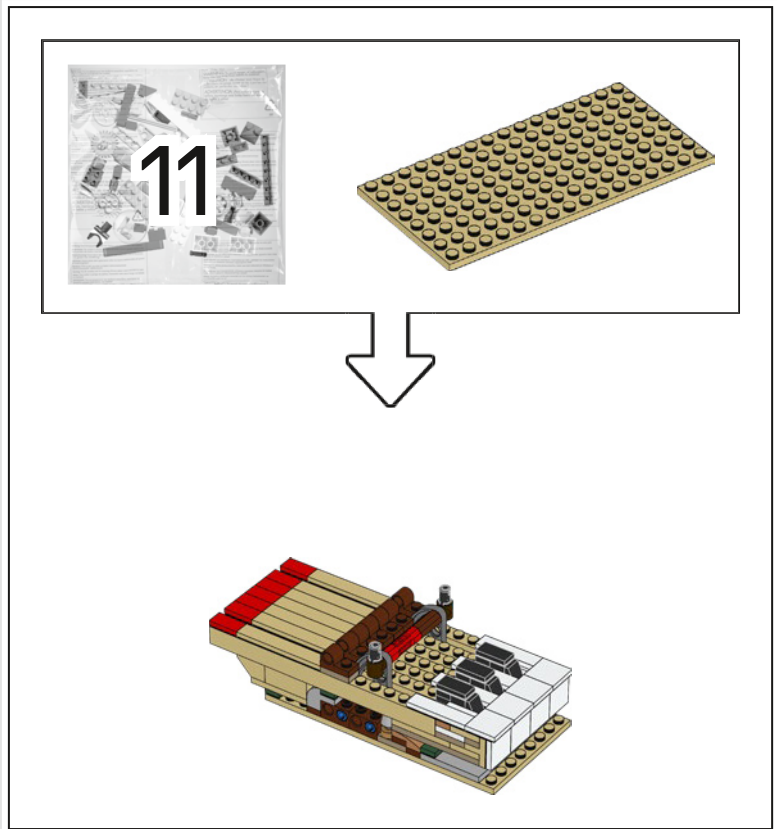

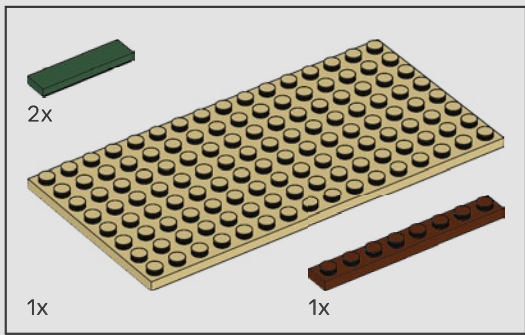

376

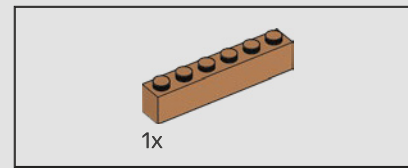
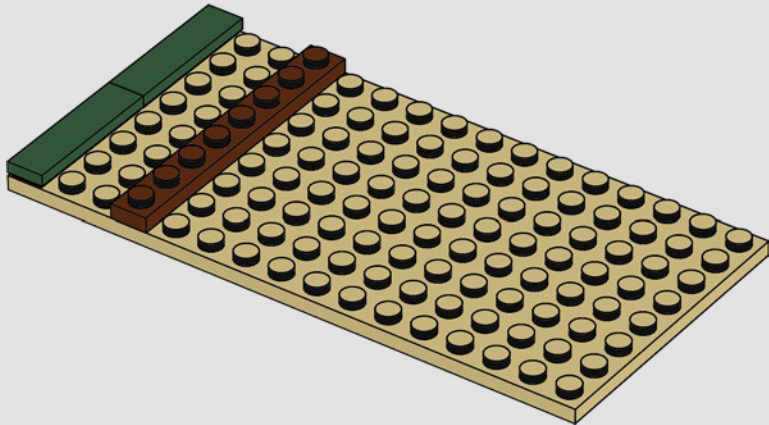

377

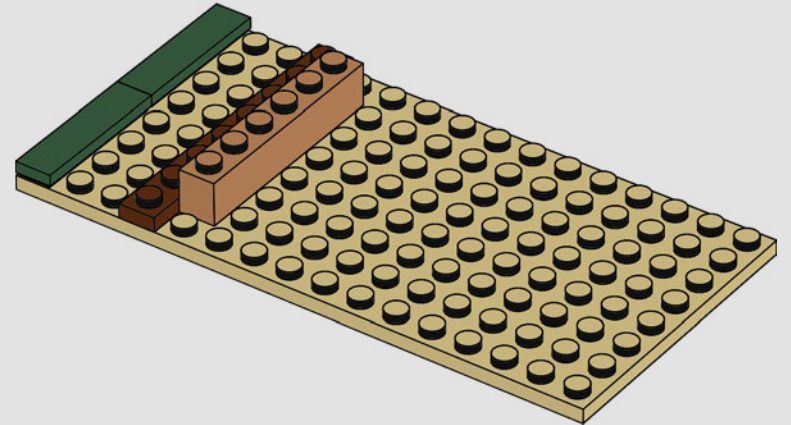

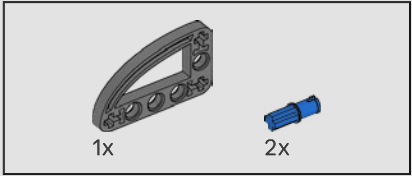
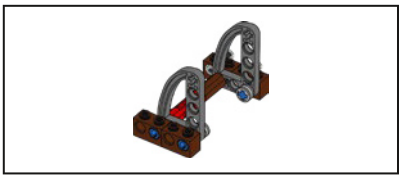

378

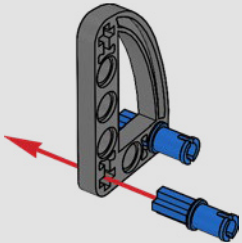

379

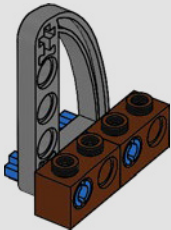

380

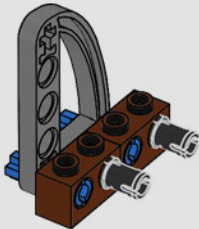

381

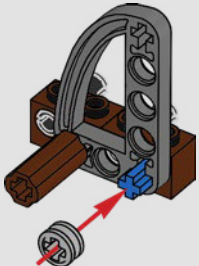

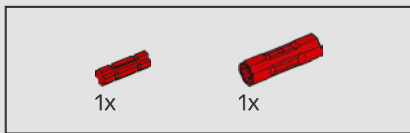

382

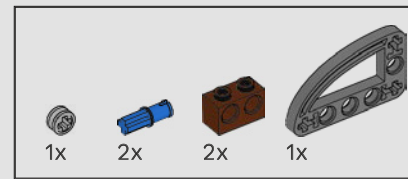
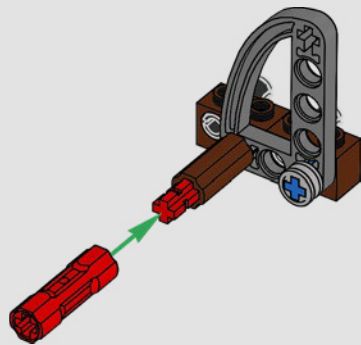

383

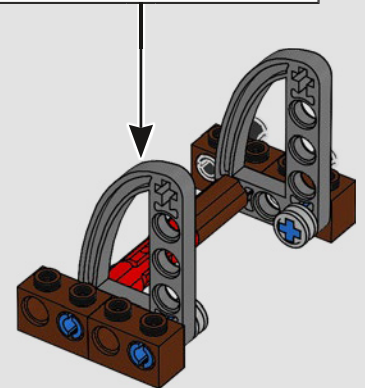
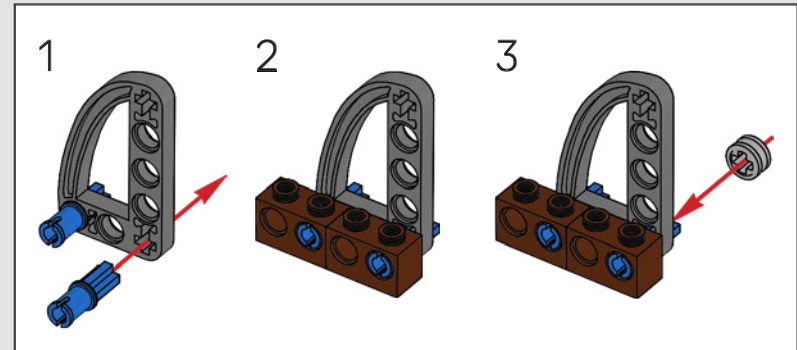

384

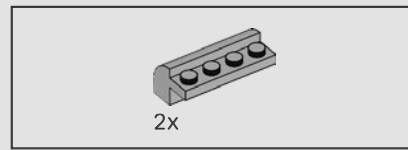
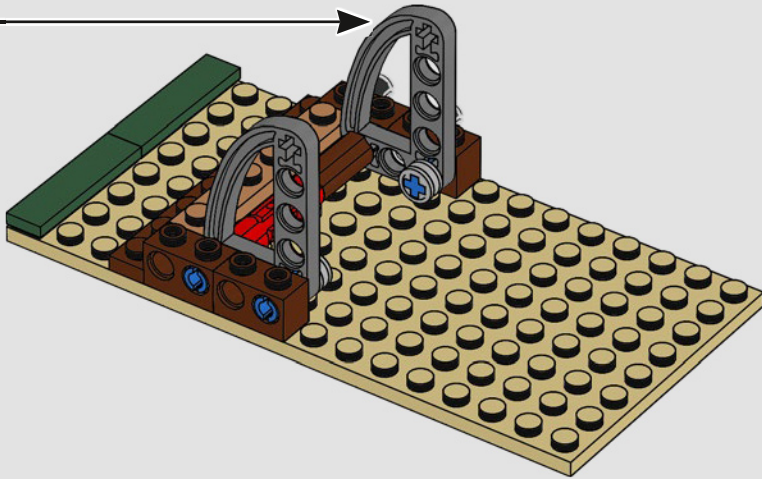

385

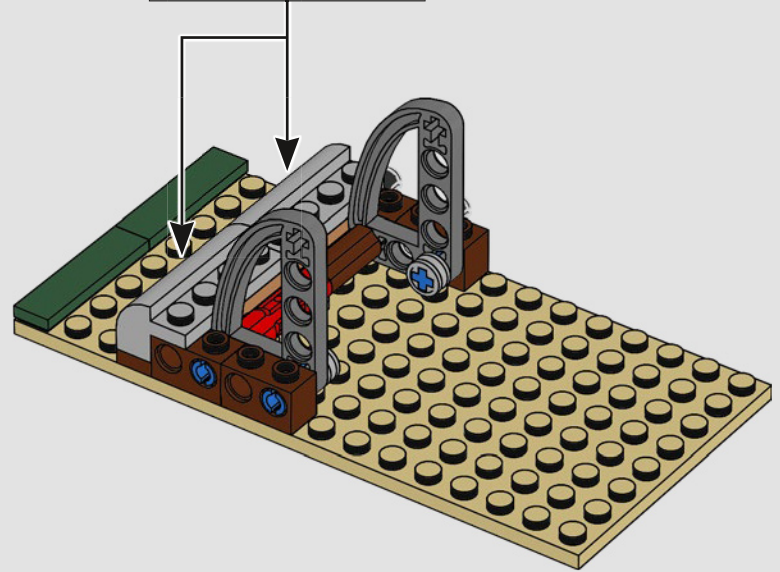
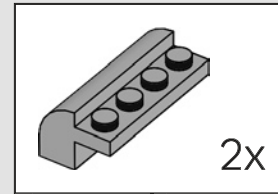

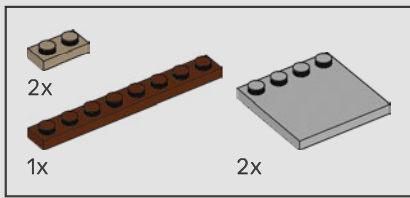

386

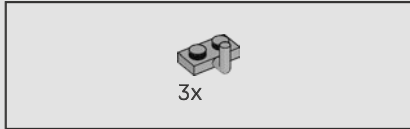
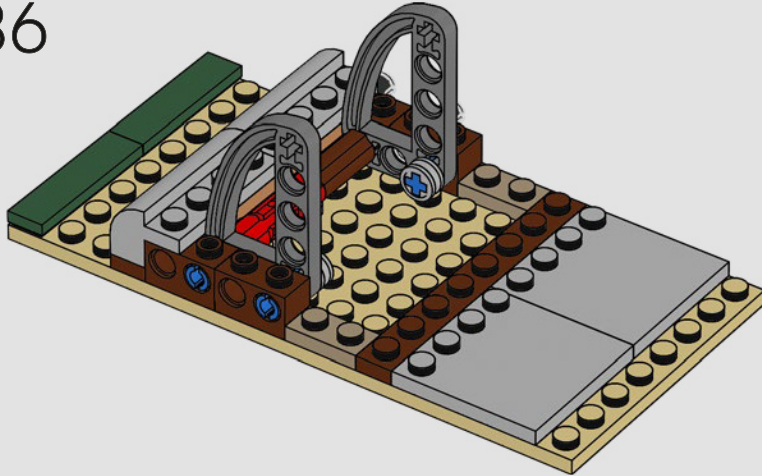

387

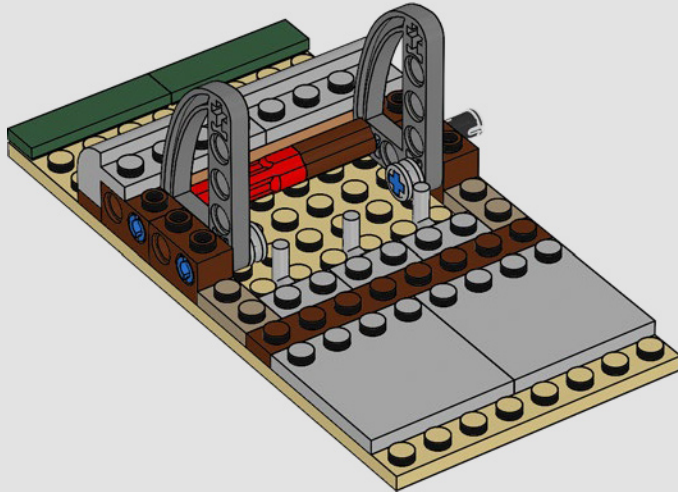

388

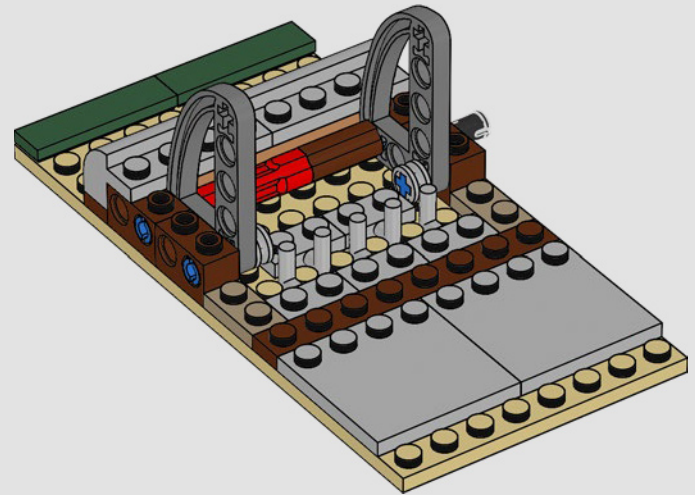

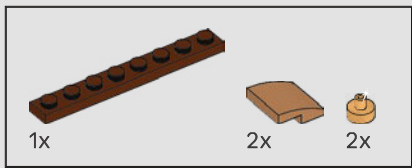

389

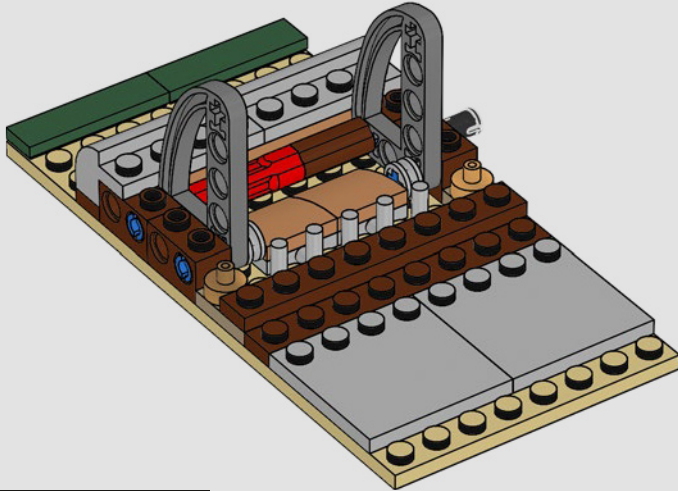

390

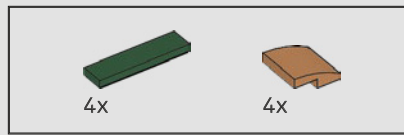
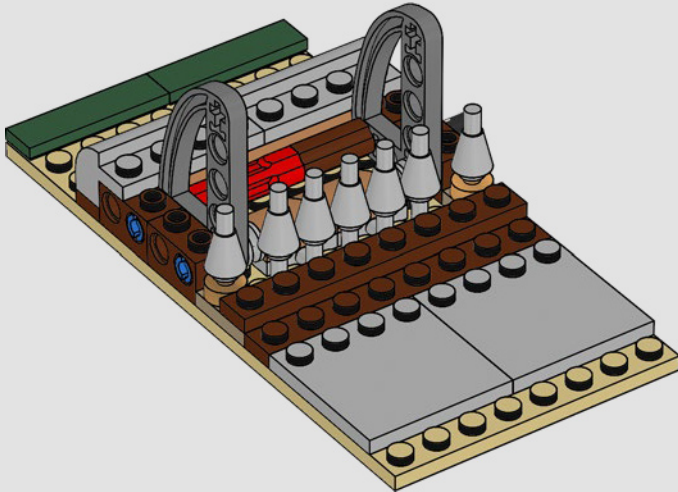

391

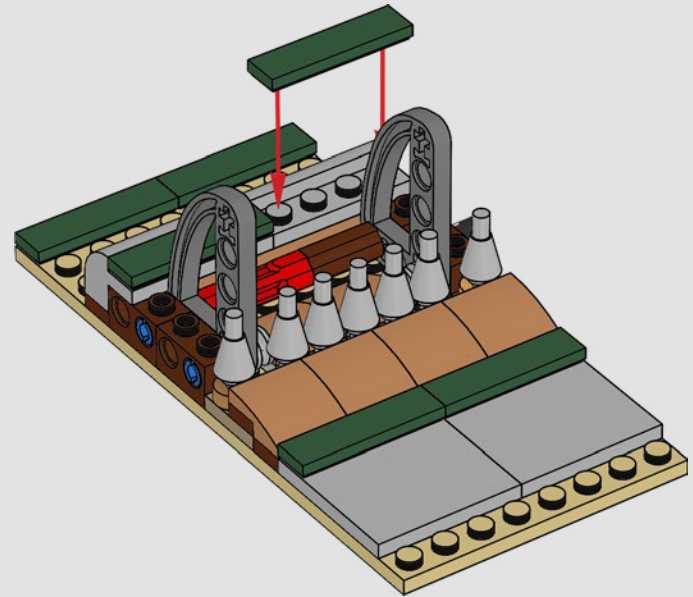

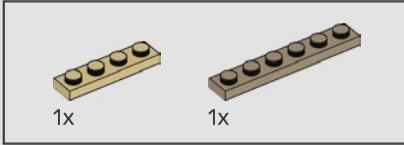
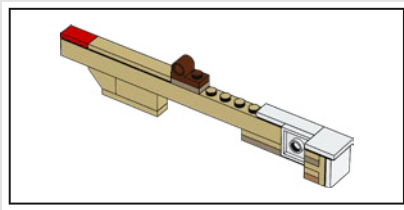

392

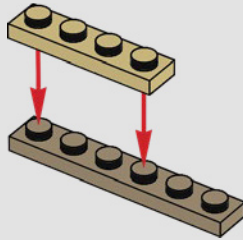

393

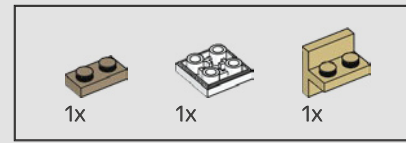
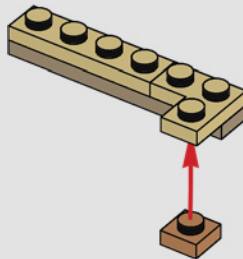

394

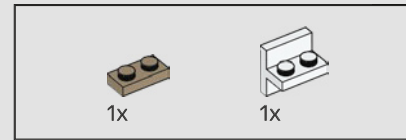
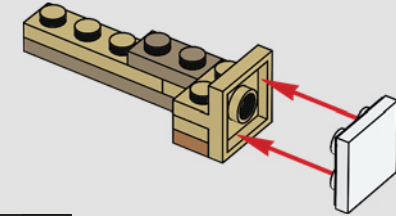

395

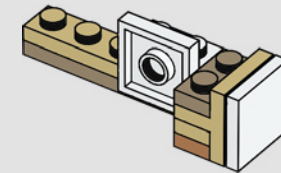

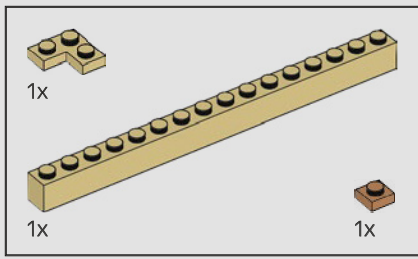

396

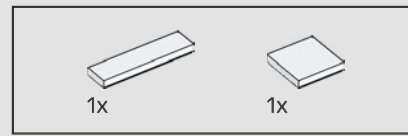
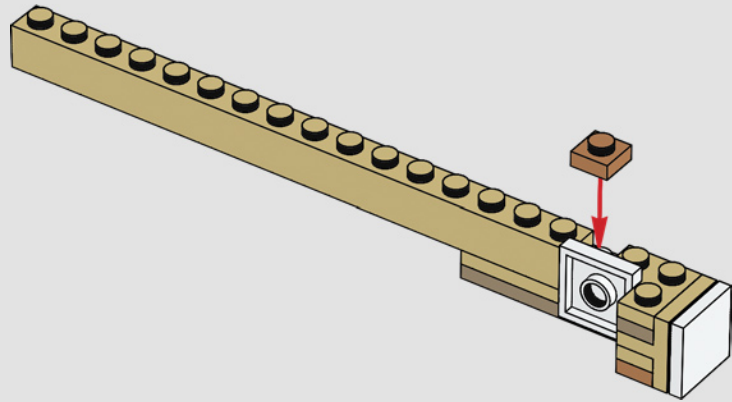

397

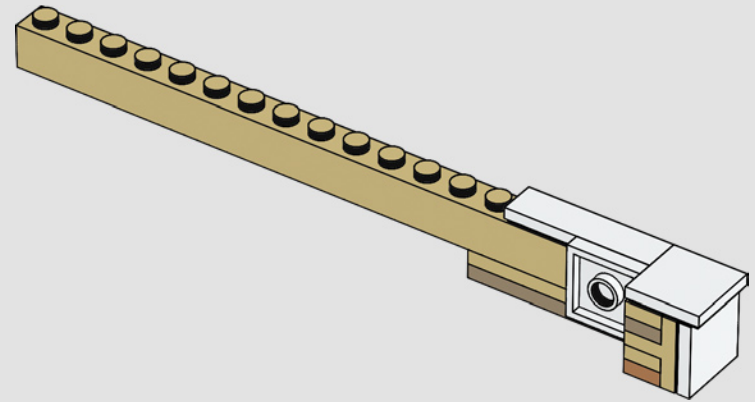

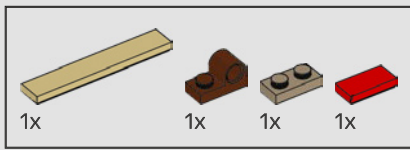

398

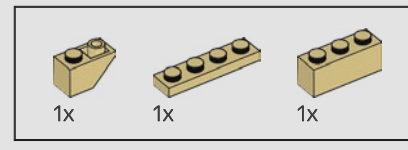
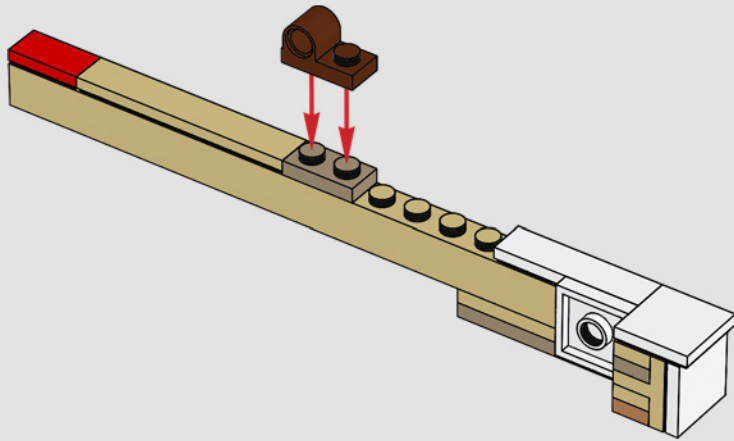

399

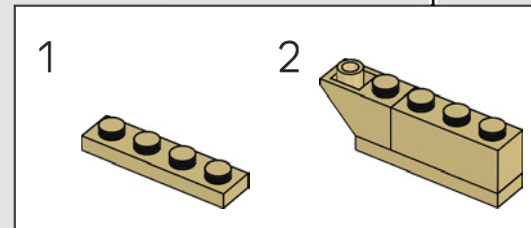
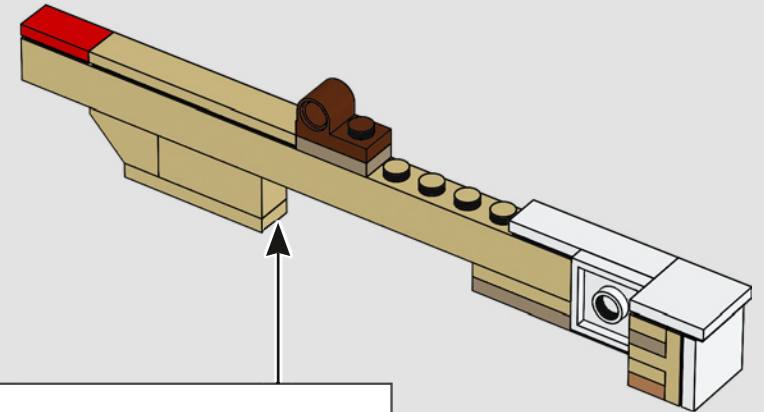



400

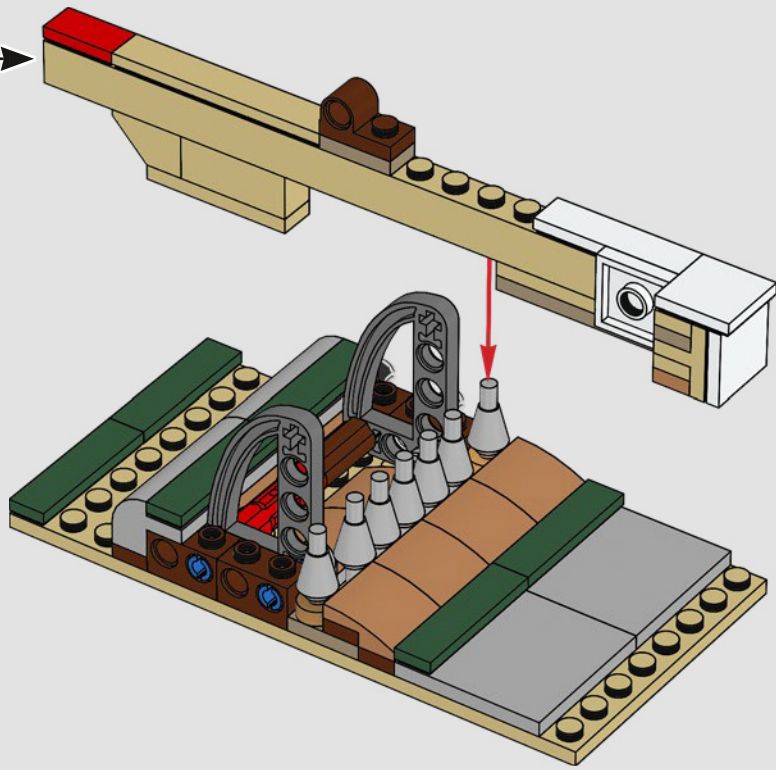

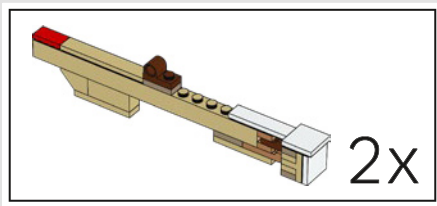

401

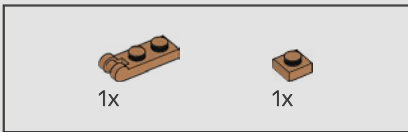
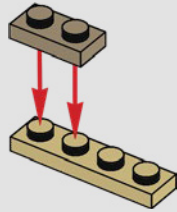

402

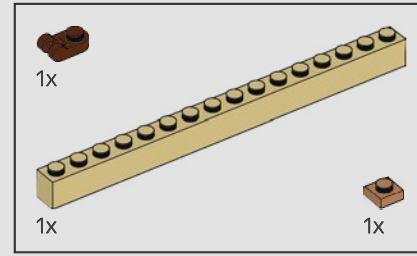
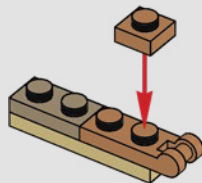

403

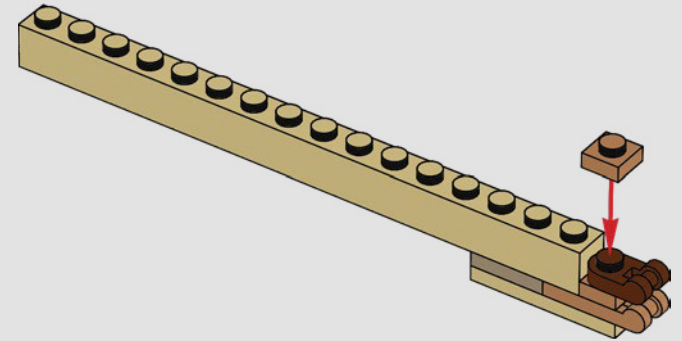

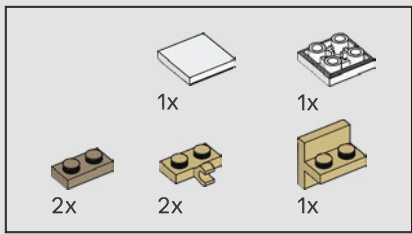

404

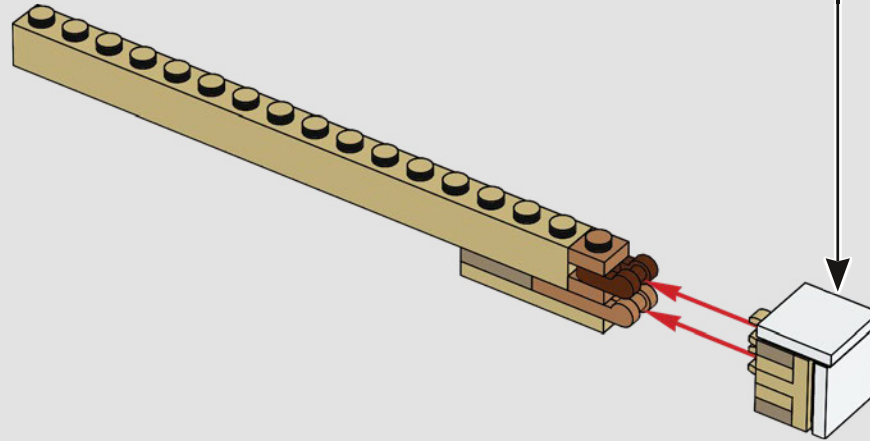
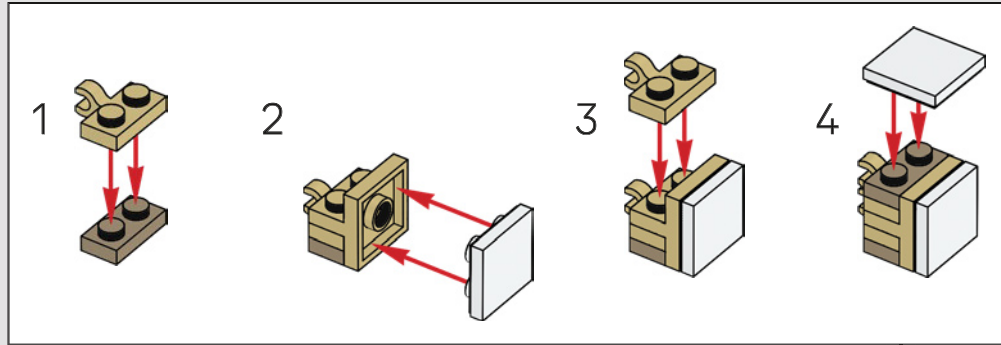

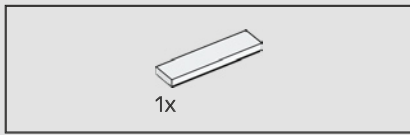

405

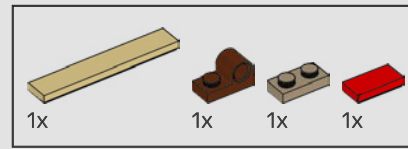
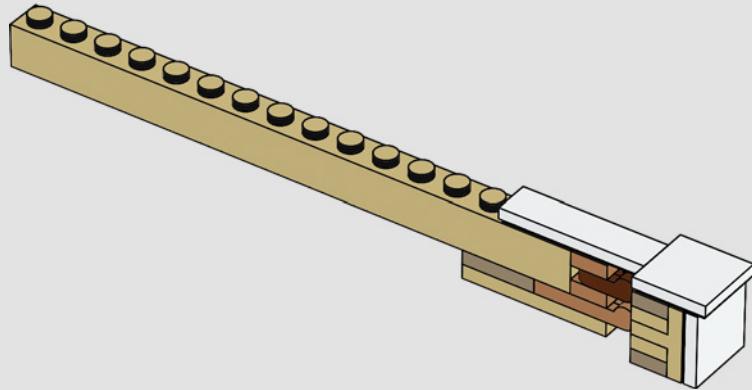

406

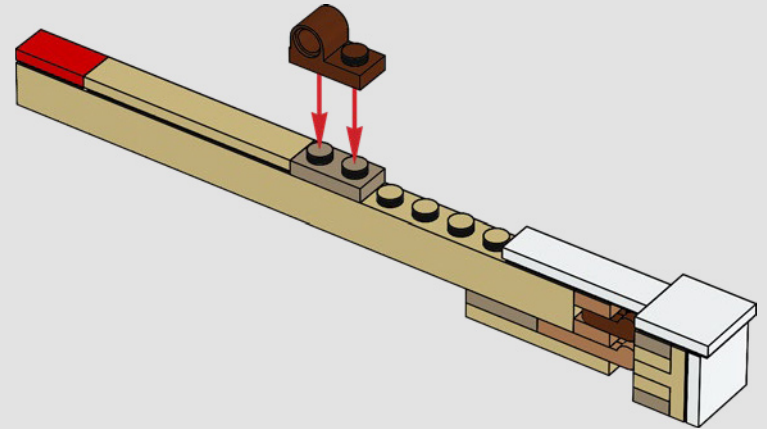

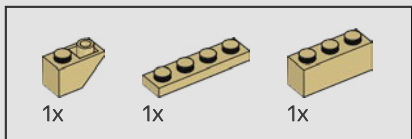

407

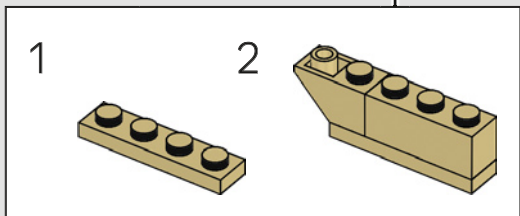
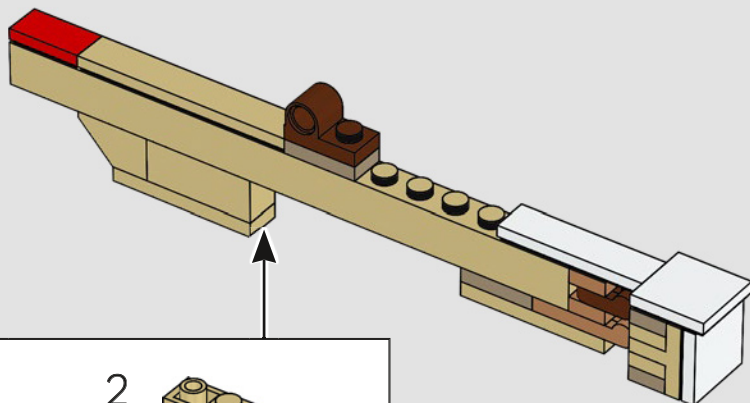

2x

408

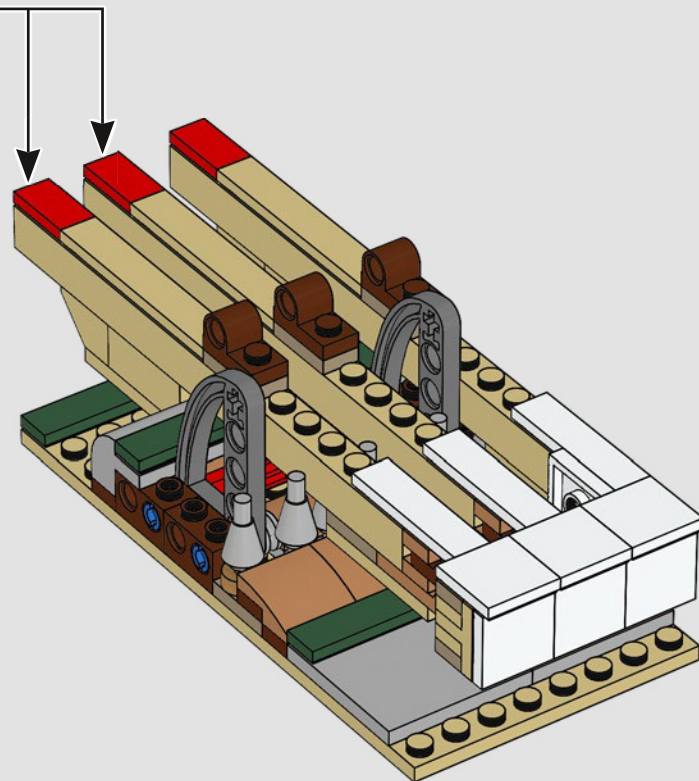

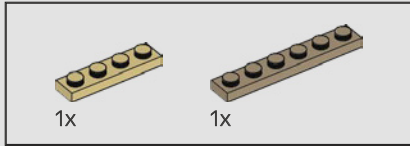
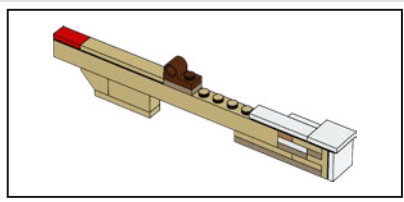

409

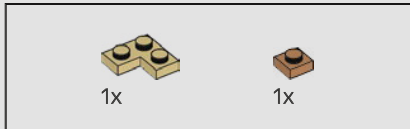
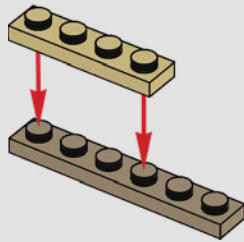

410

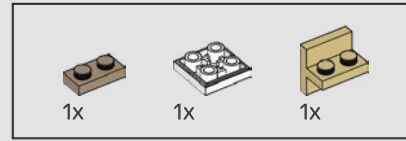
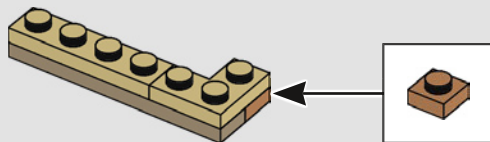

411

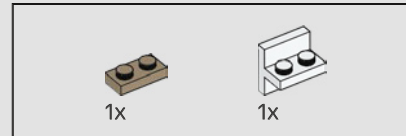
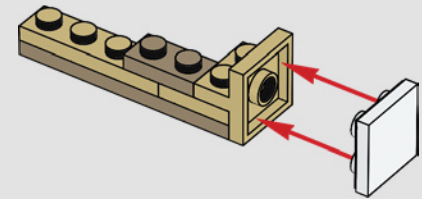

412

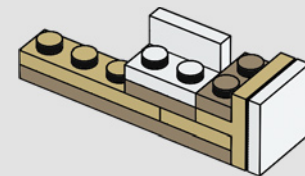

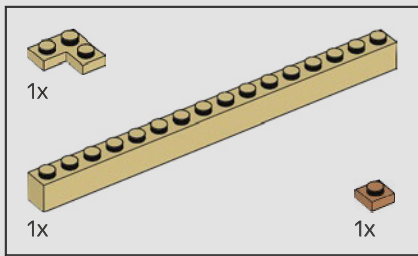

413

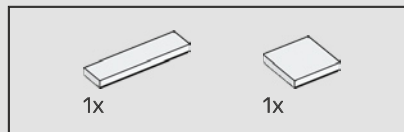
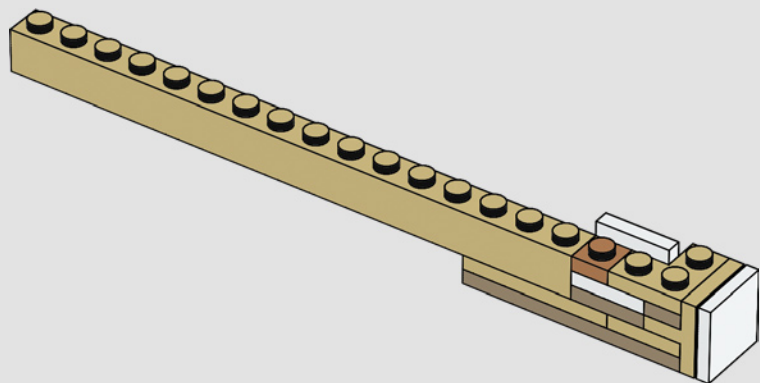

414

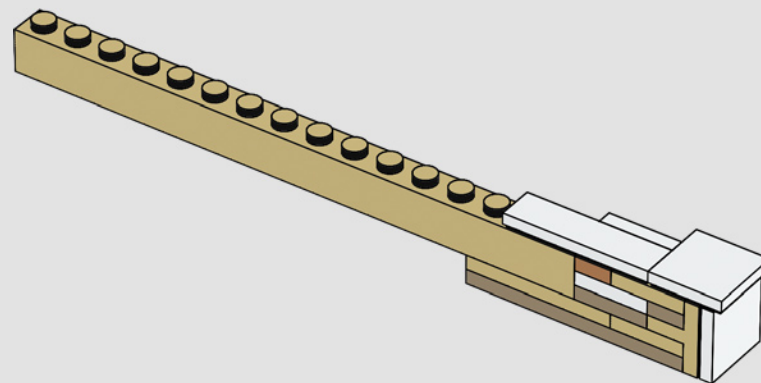

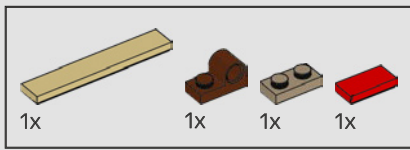

415

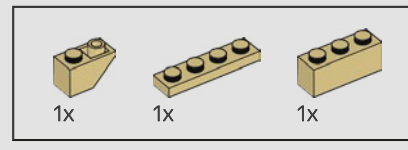
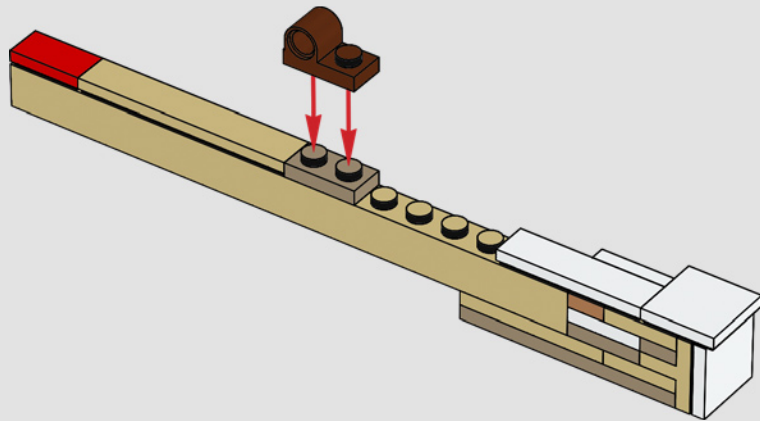

416

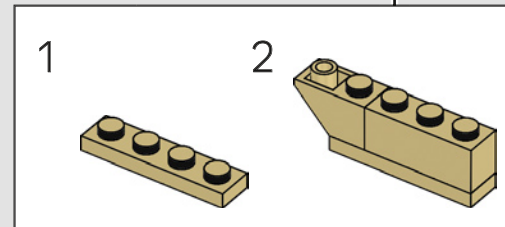
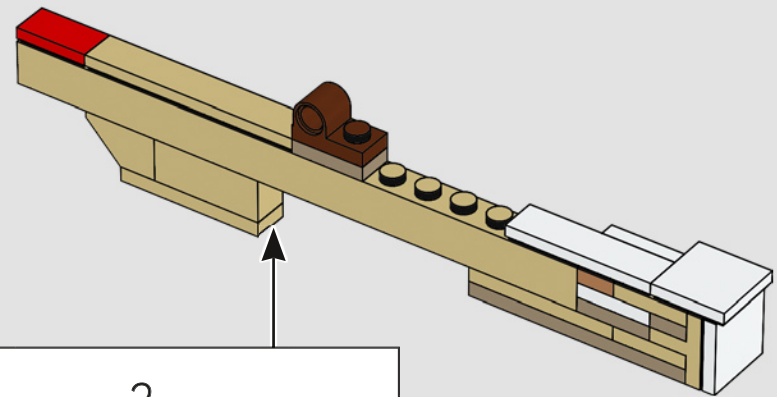

417

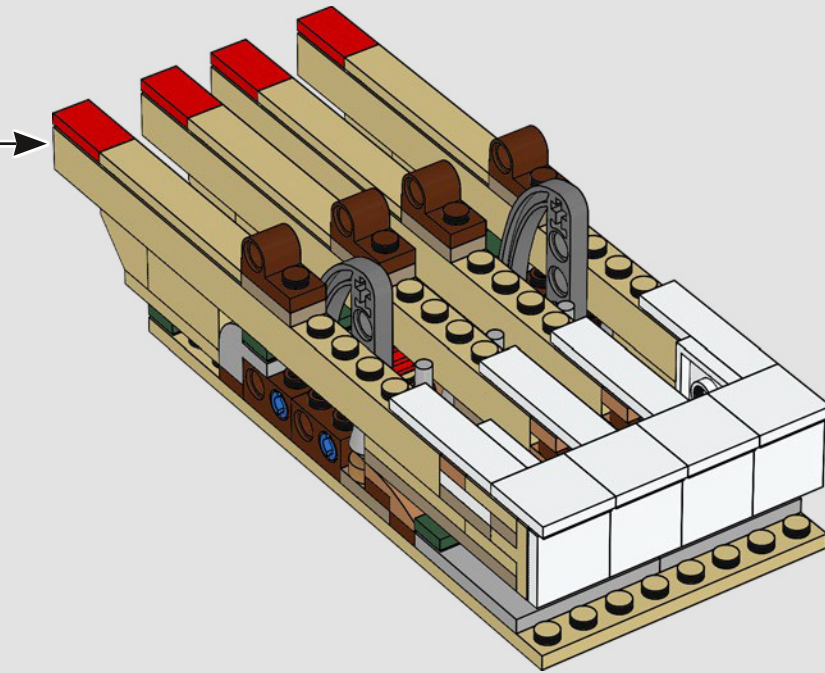

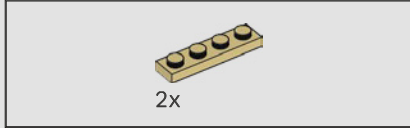
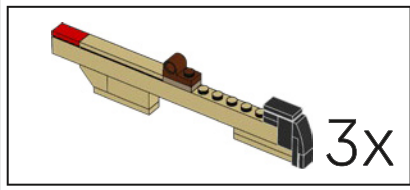

418

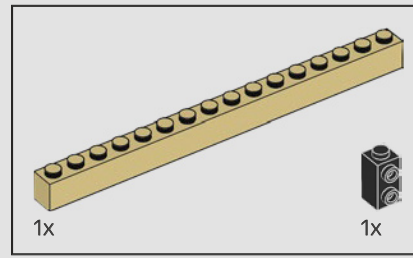
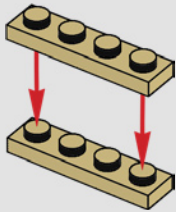

419

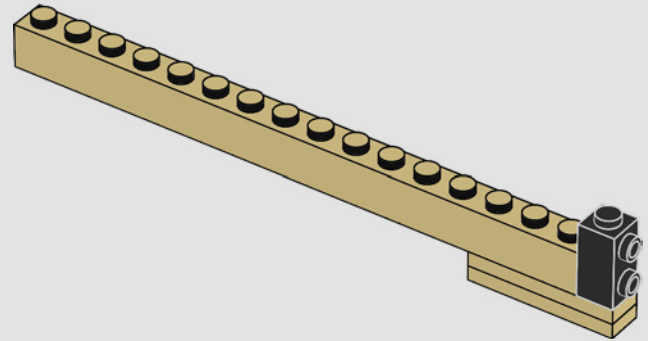

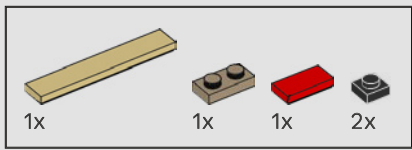

420

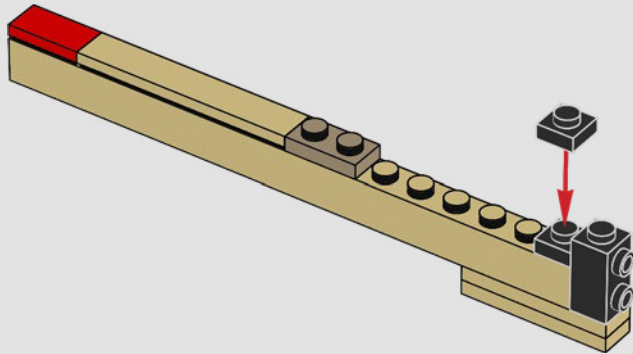

421

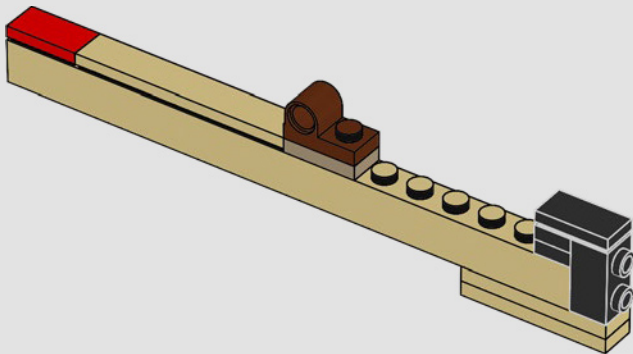

422

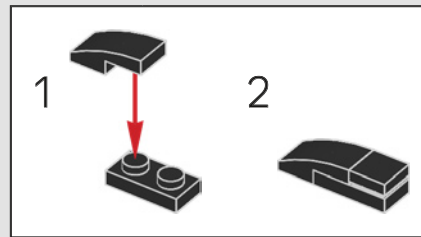
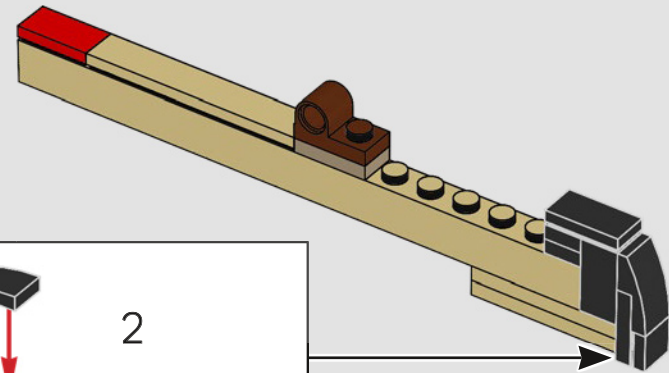

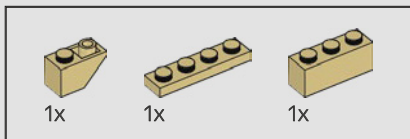

423

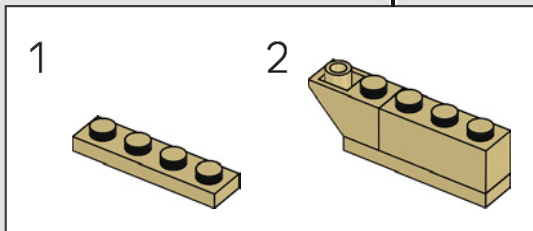
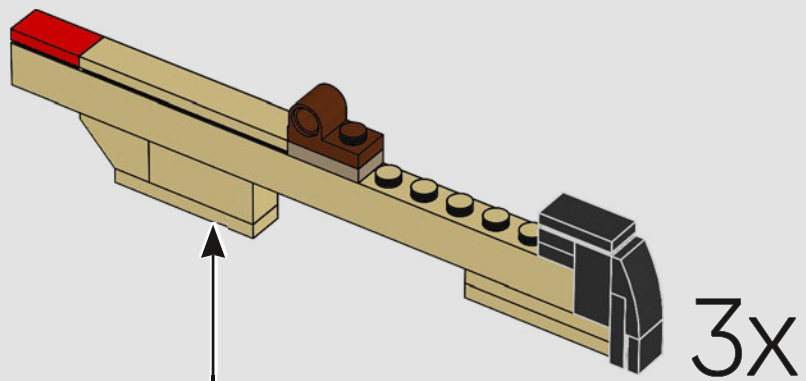

424

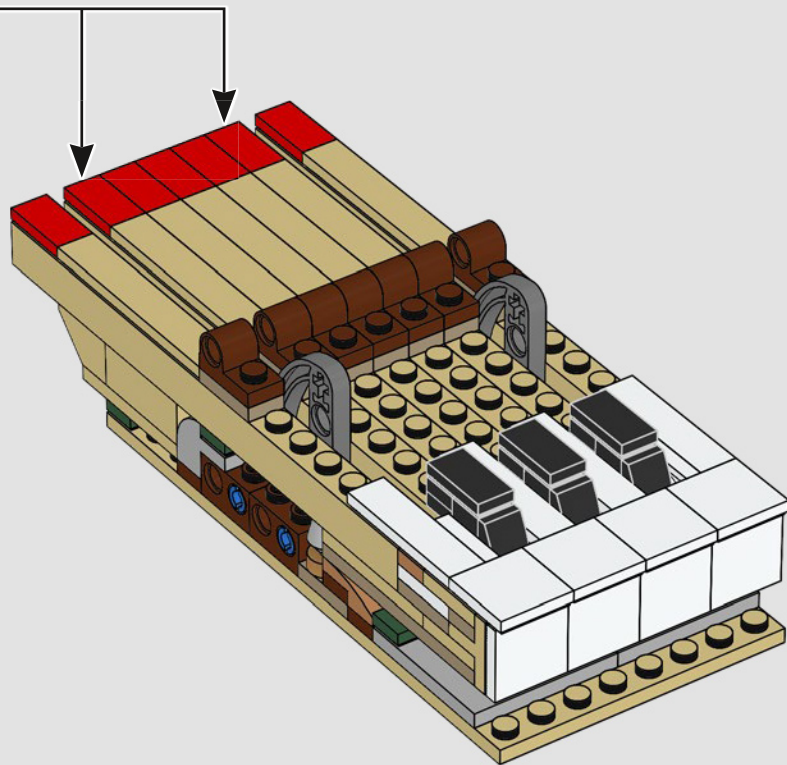

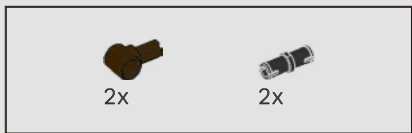

425

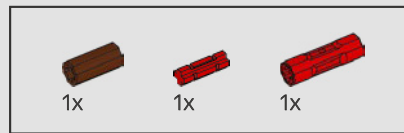
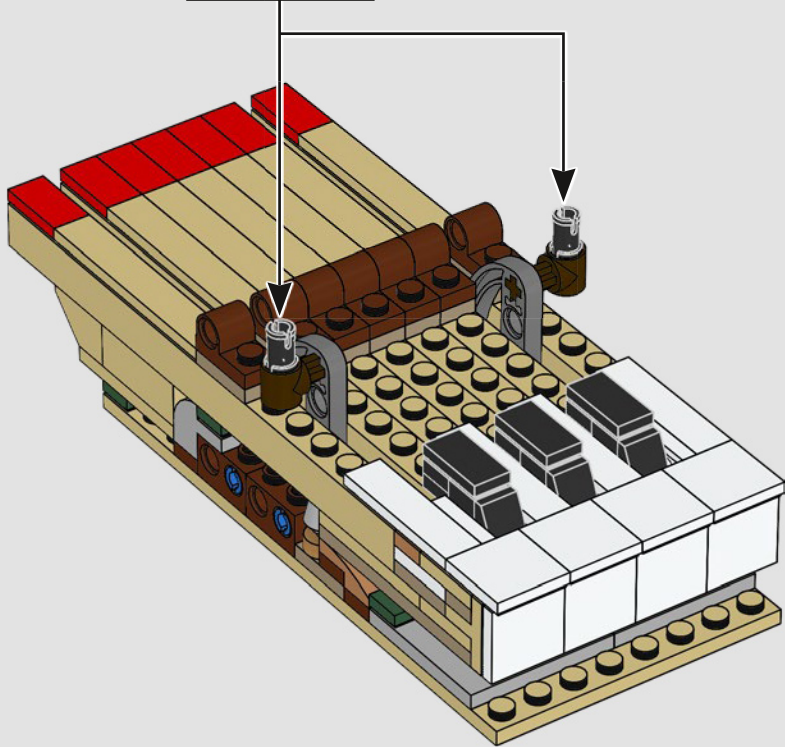
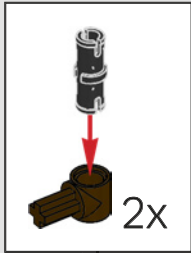

426

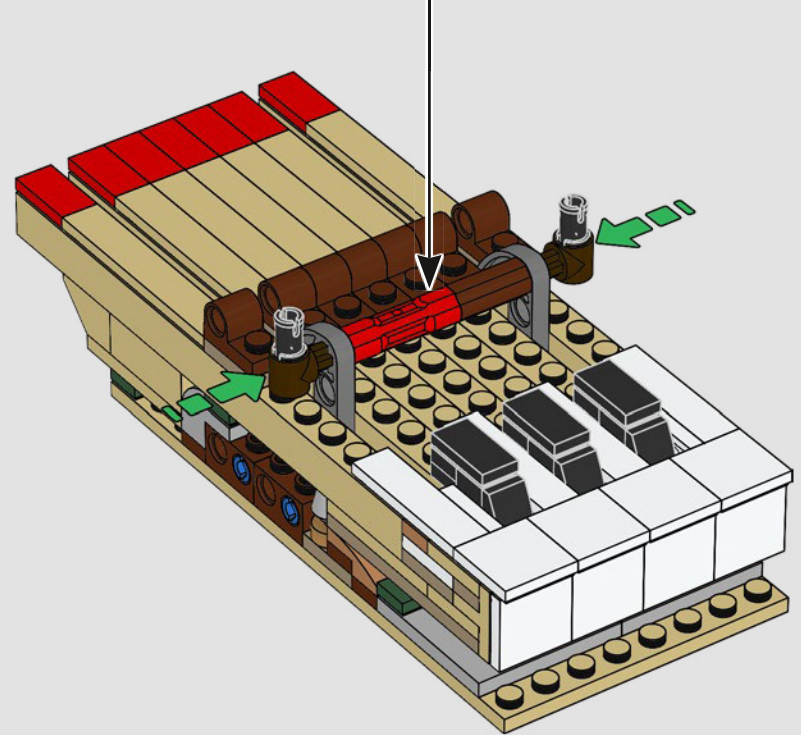
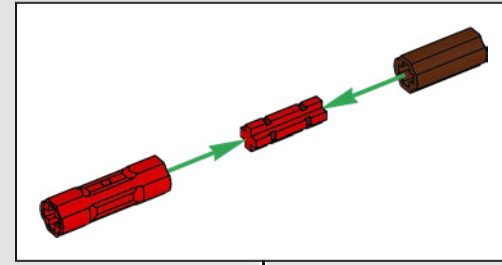

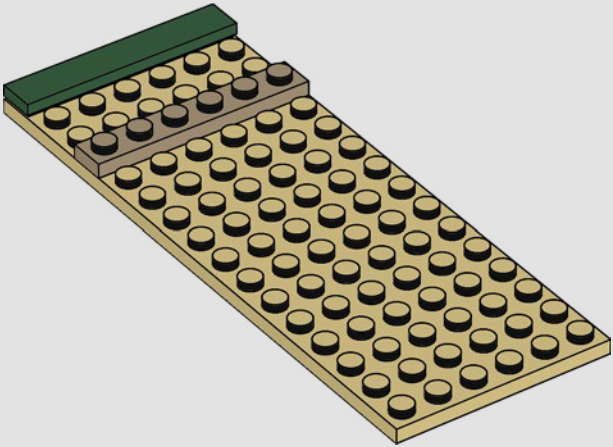
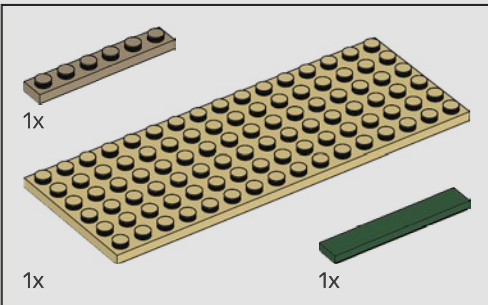
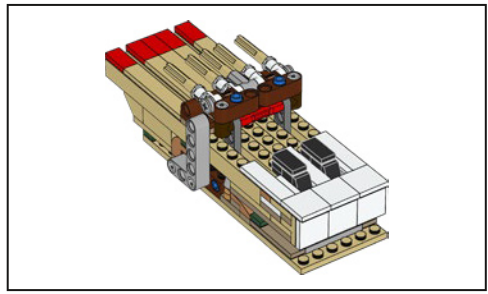
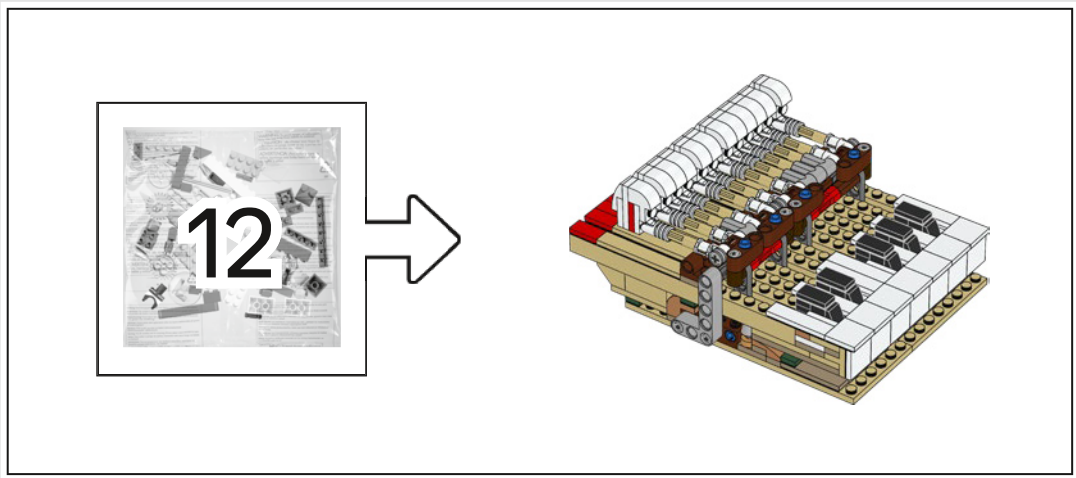

427

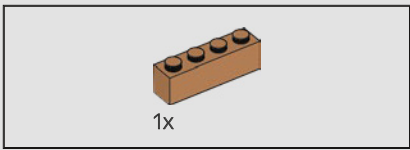

“ Music is well said to be the speech of angels. ”
Thomas Carlyle

428

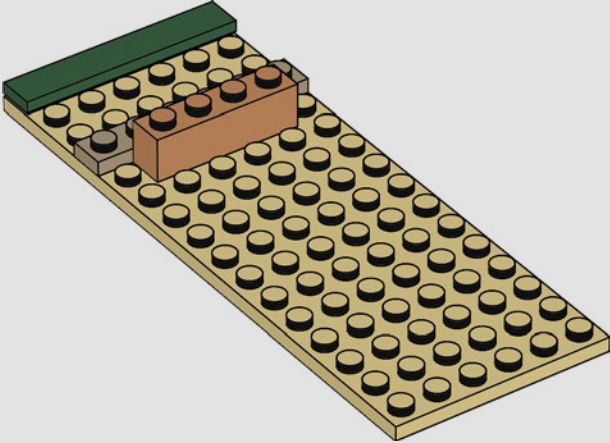

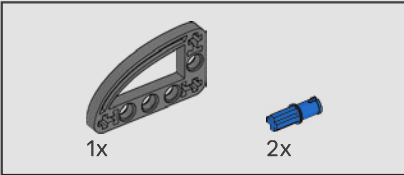
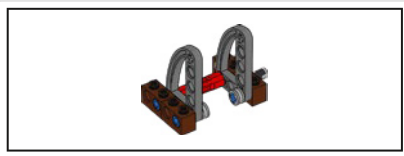

429

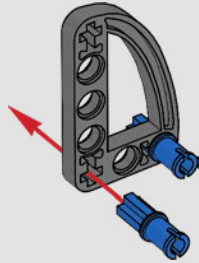

430

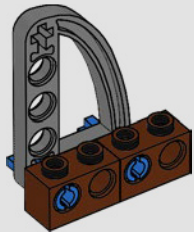

431

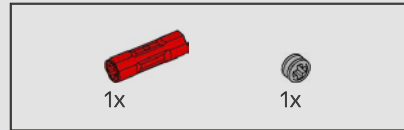
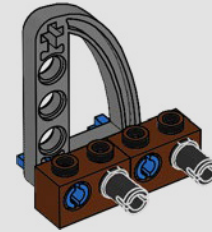

432

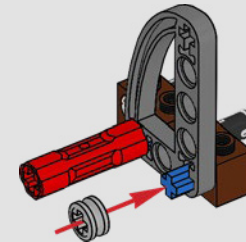
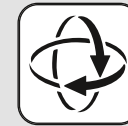

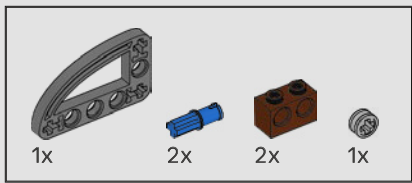

433

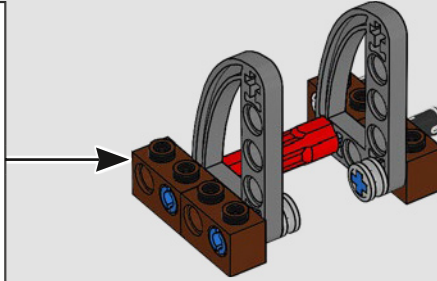
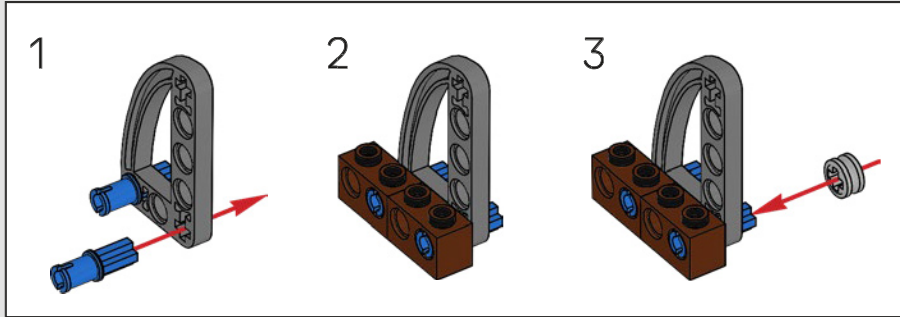

434

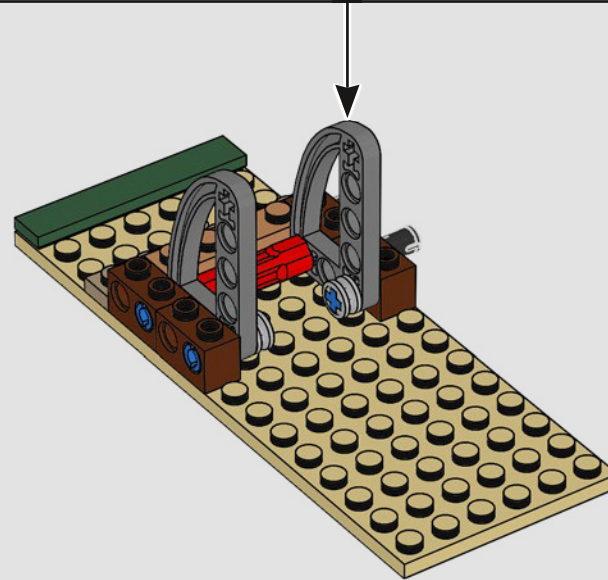

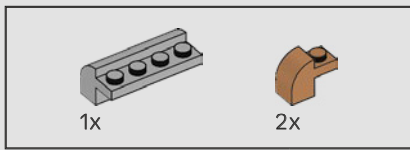

435

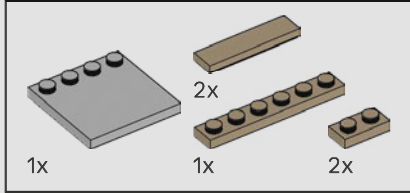
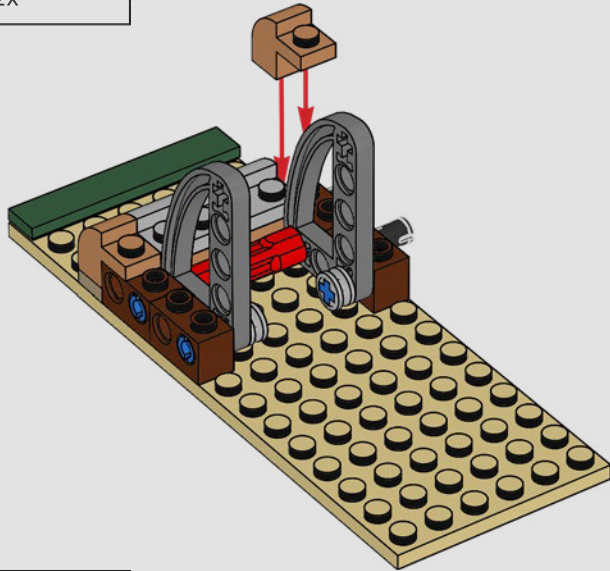

436

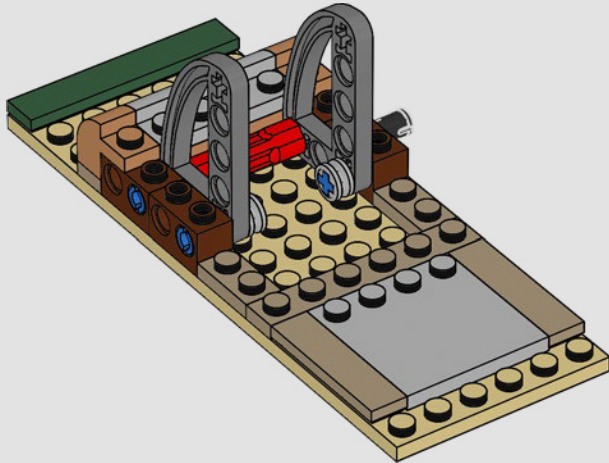

437

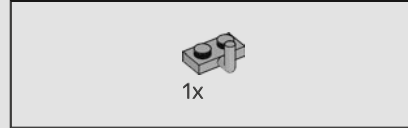
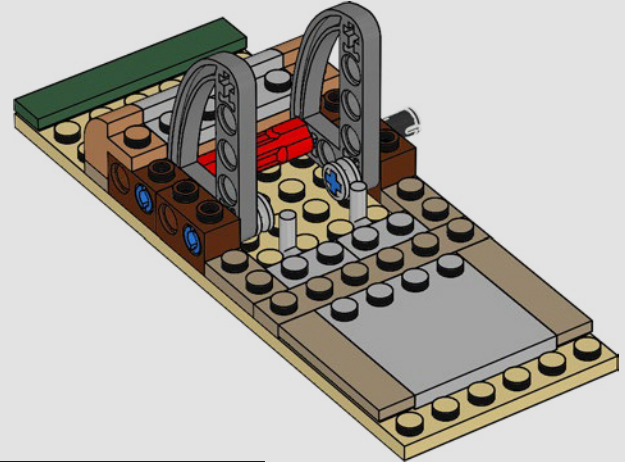

438

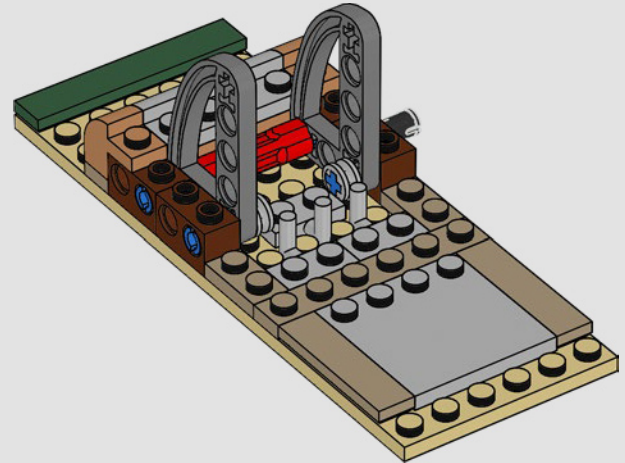

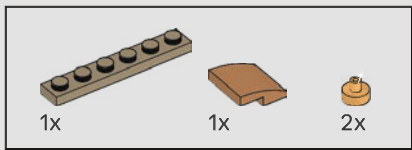

439

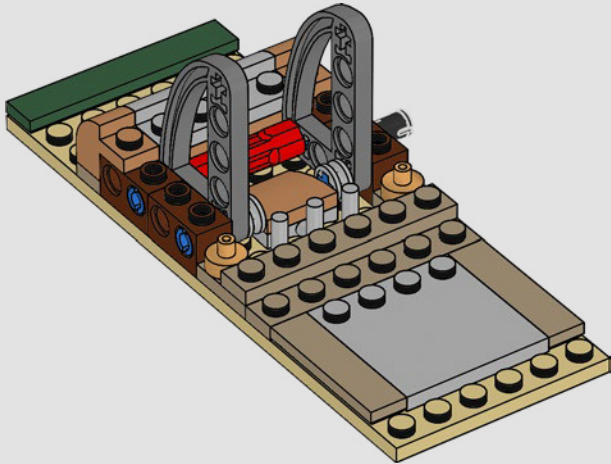

440

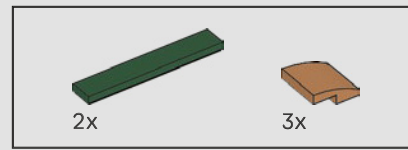
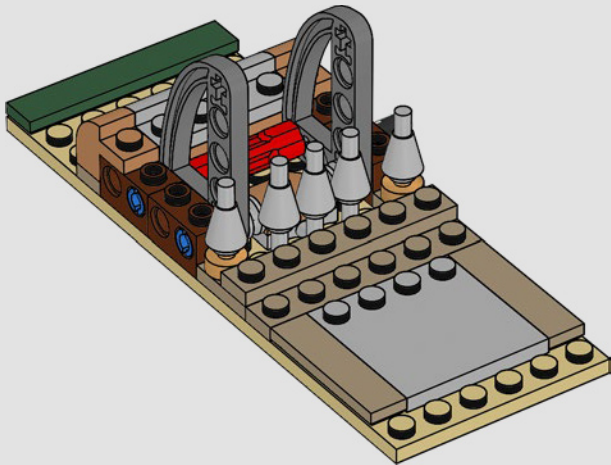

441

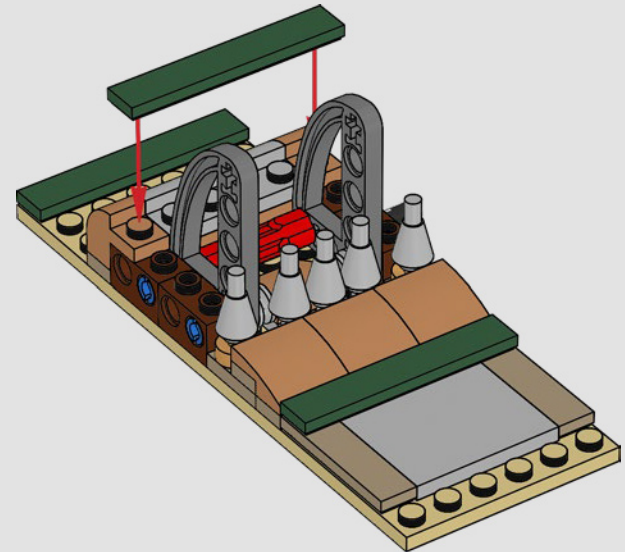

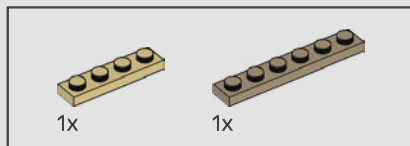
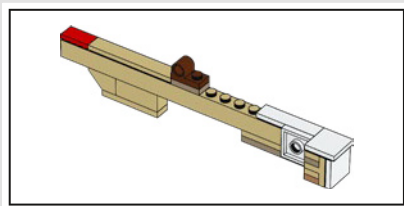

442

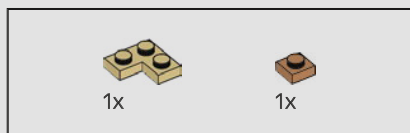
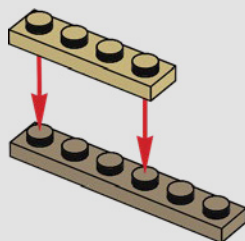

443

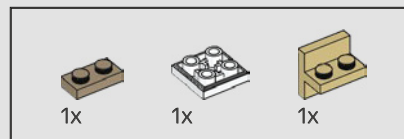
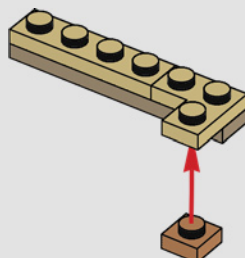

444

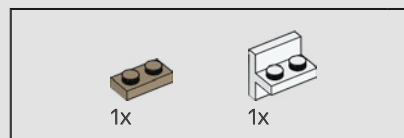
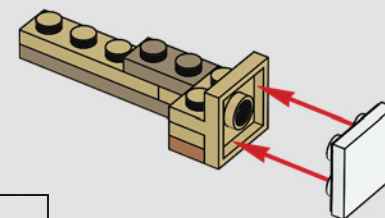

445

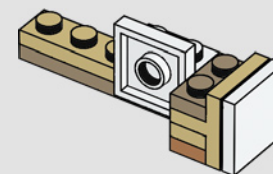

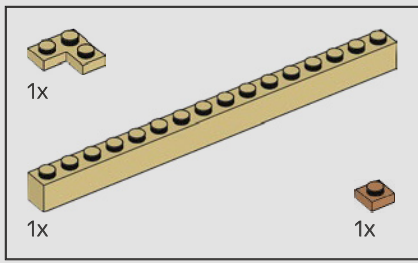

446

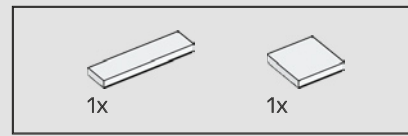
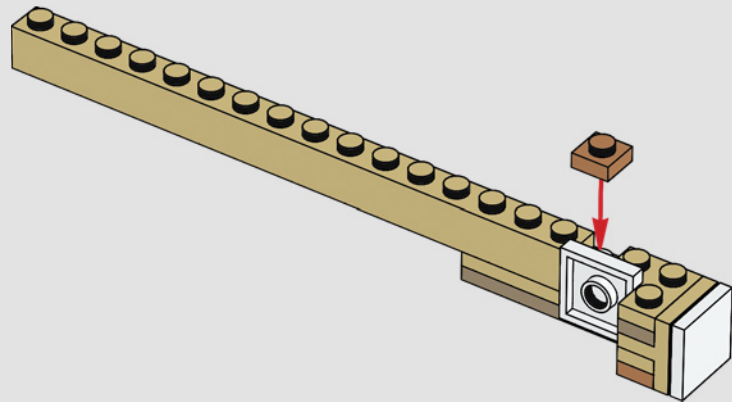

447

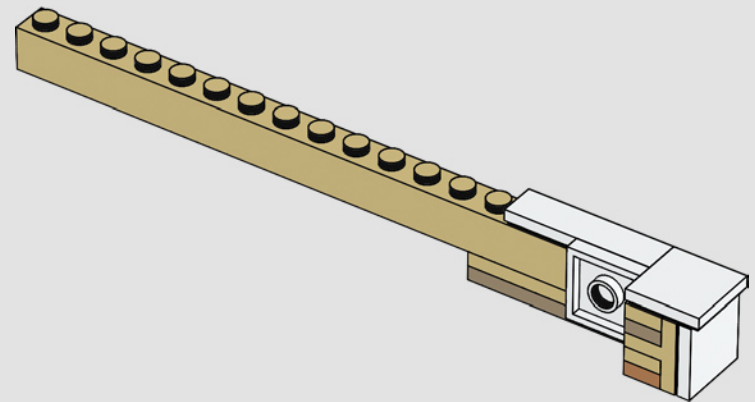

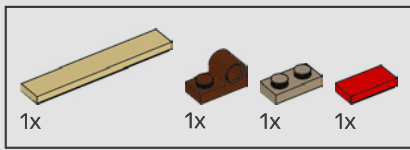

448

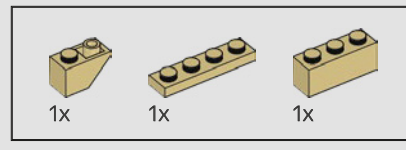
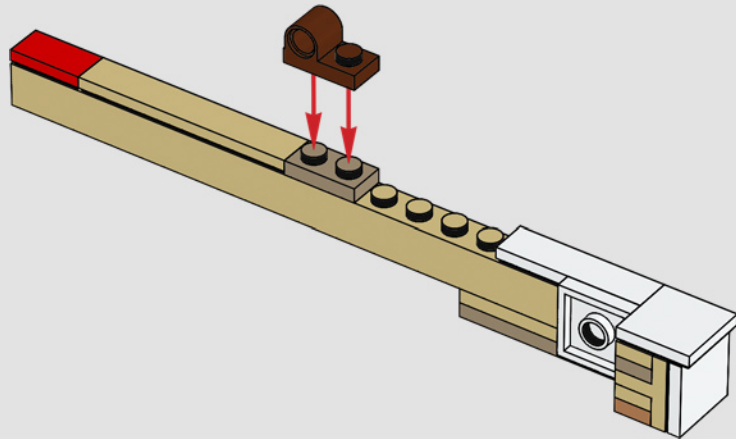

449

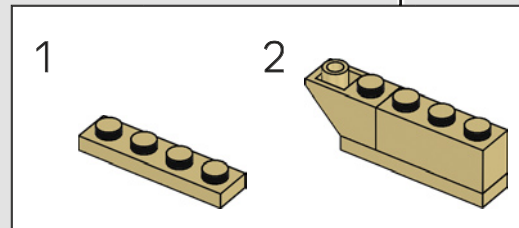
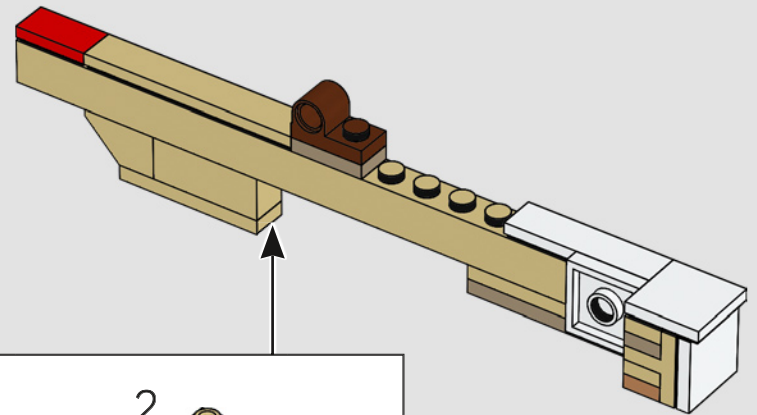



450

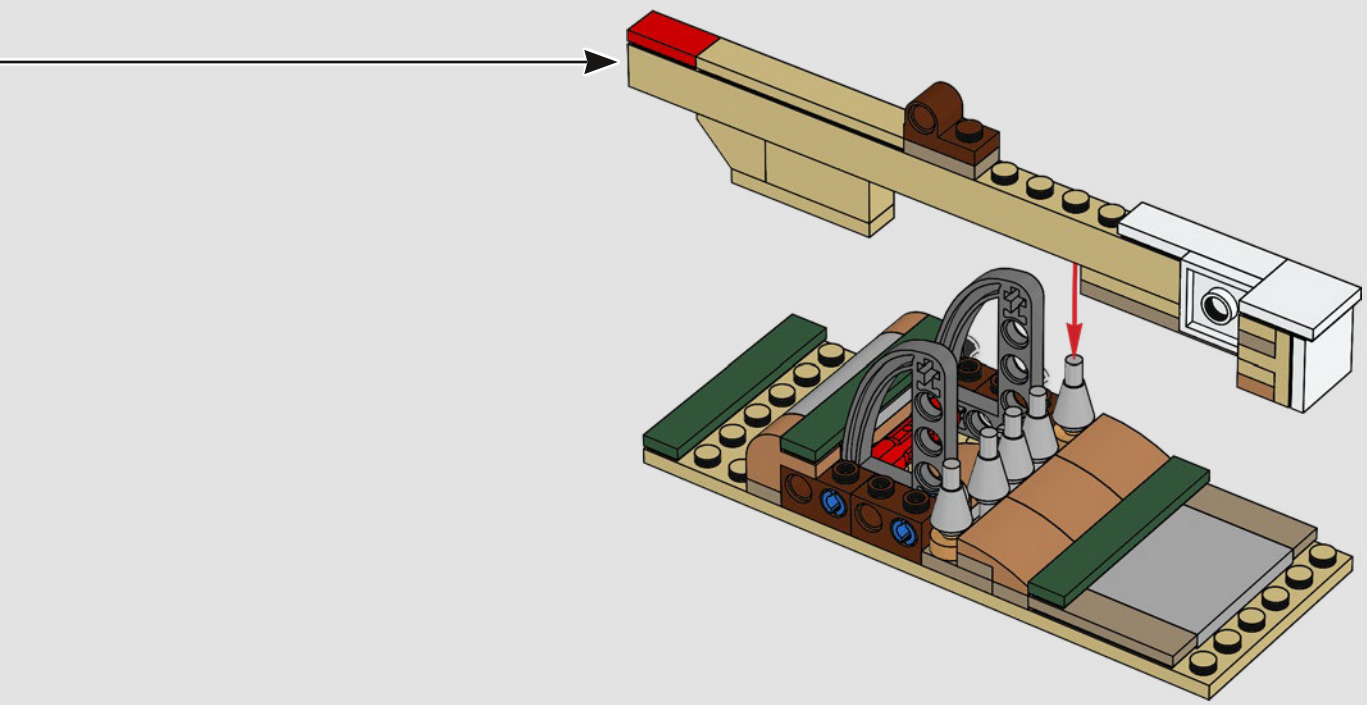

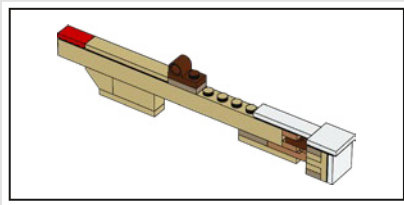

451

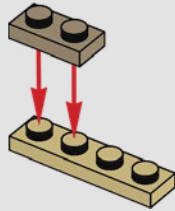

452

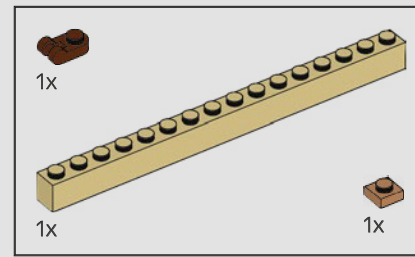
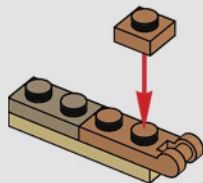

453

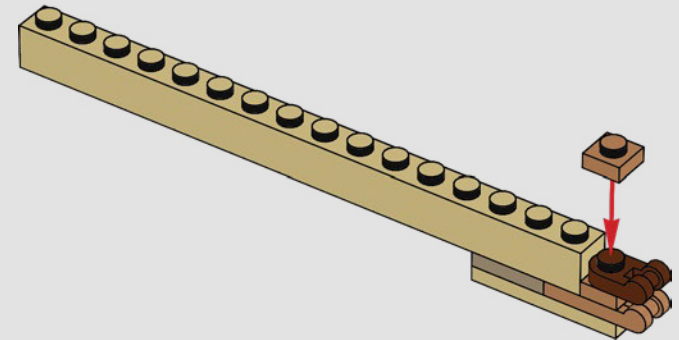

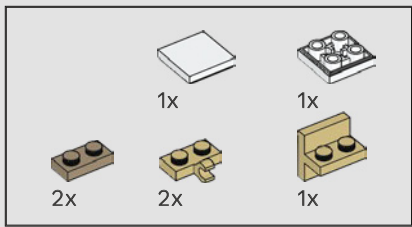

454

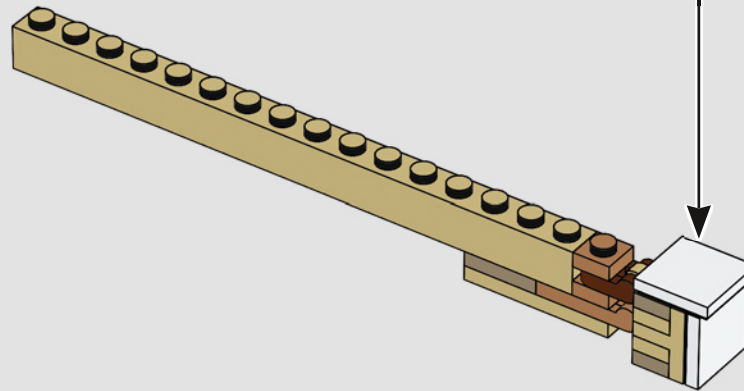
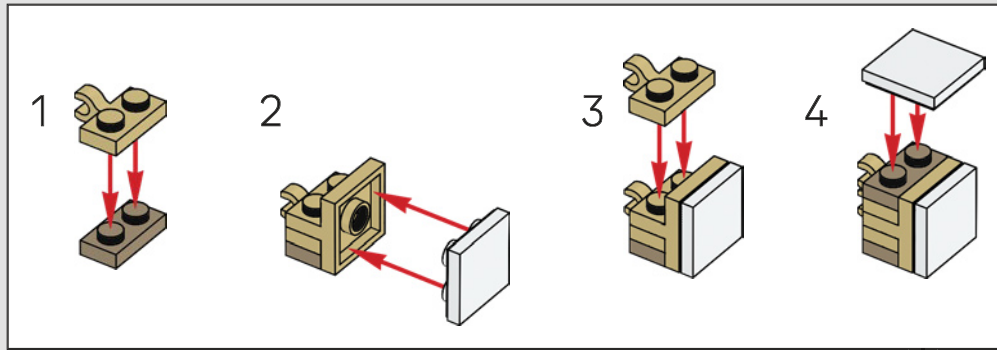

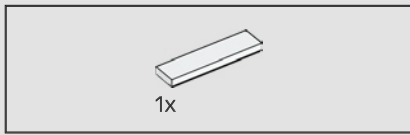

455

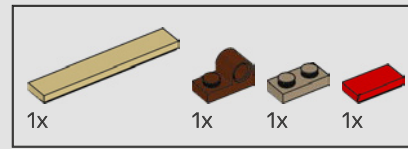
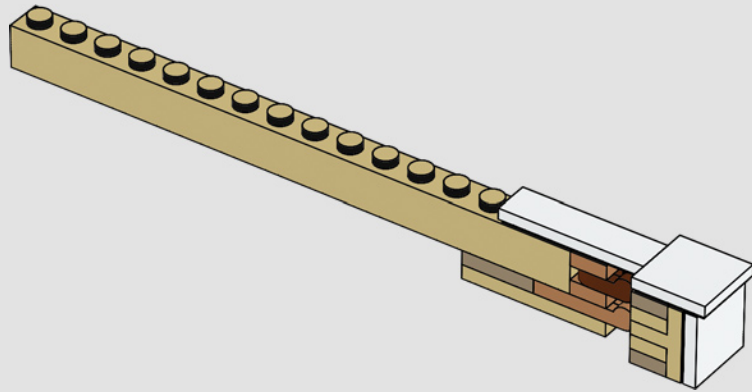

456

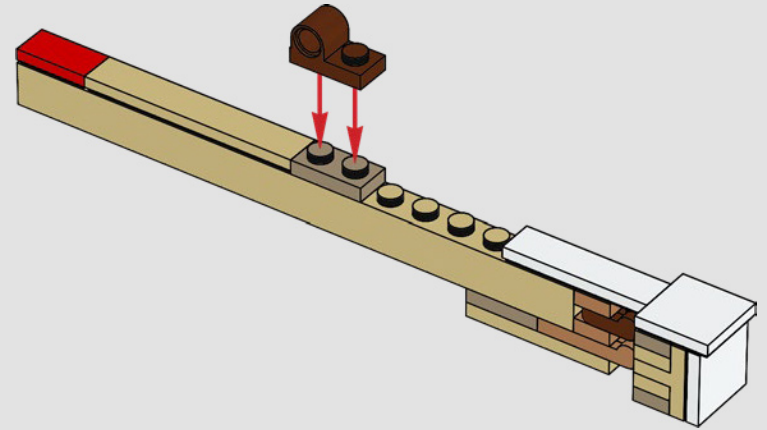

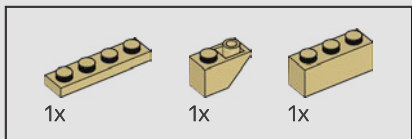

457

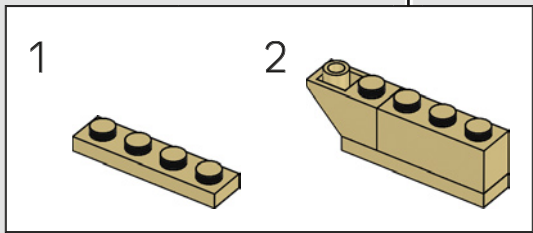
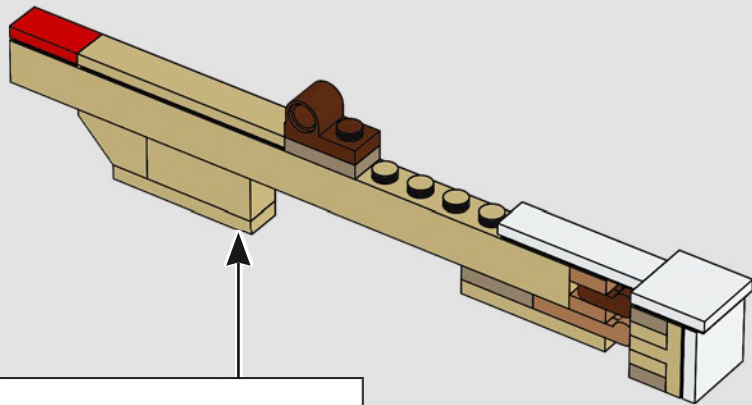

458

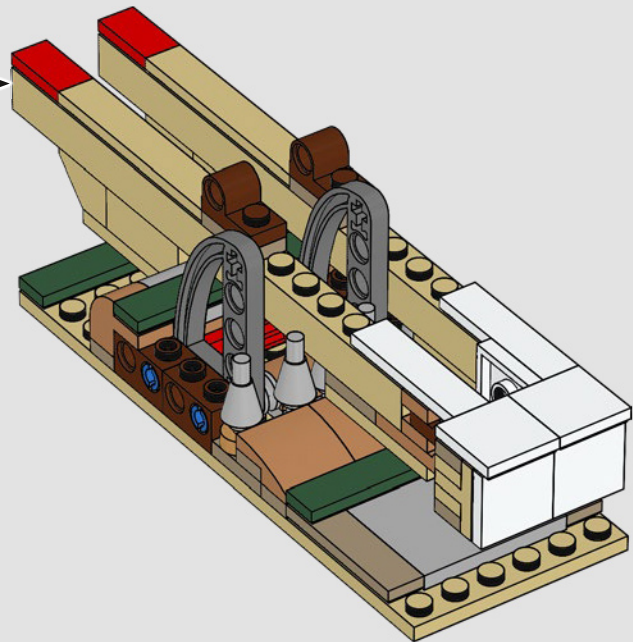

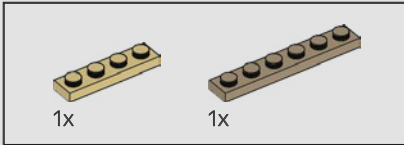
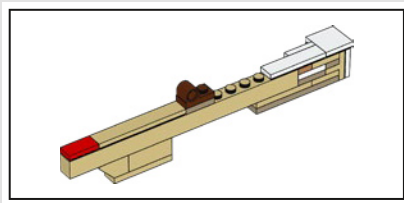

459

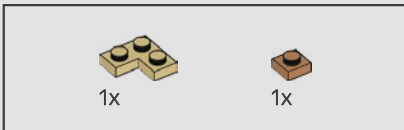
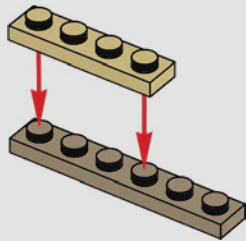

460

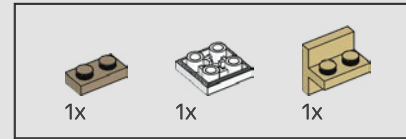
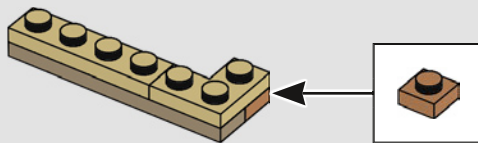

461

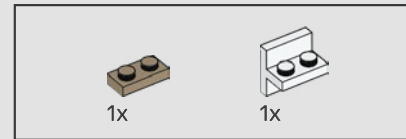
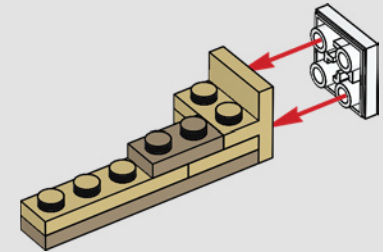

462

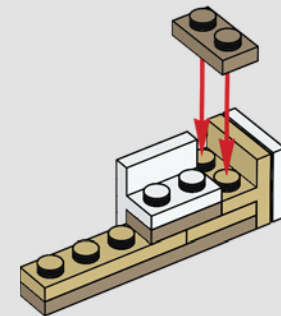

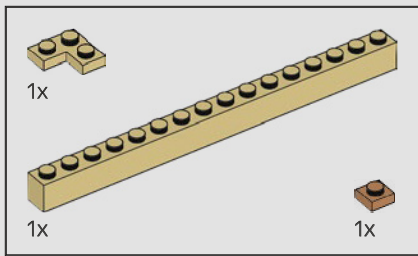

463

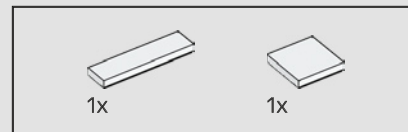
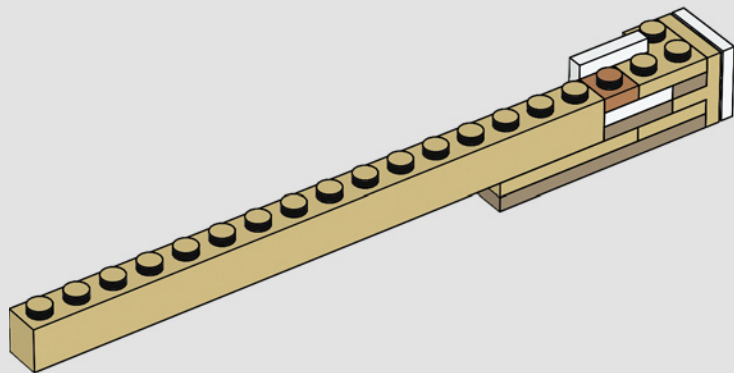

464

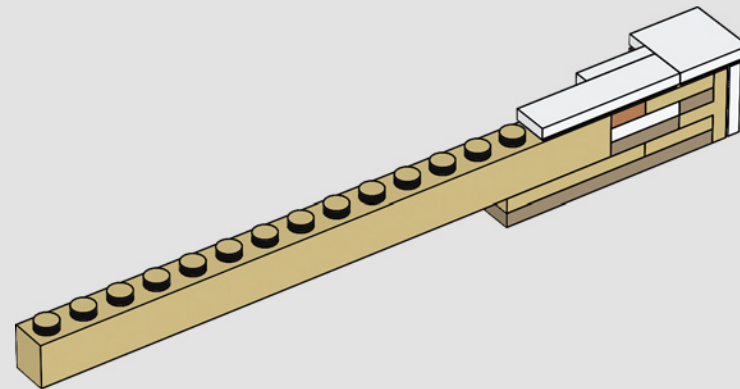

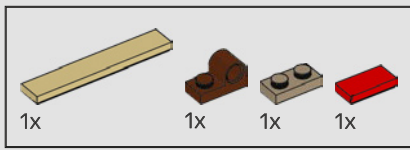

465

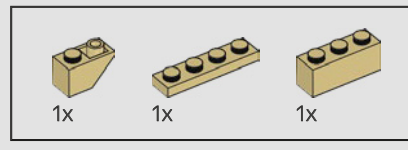
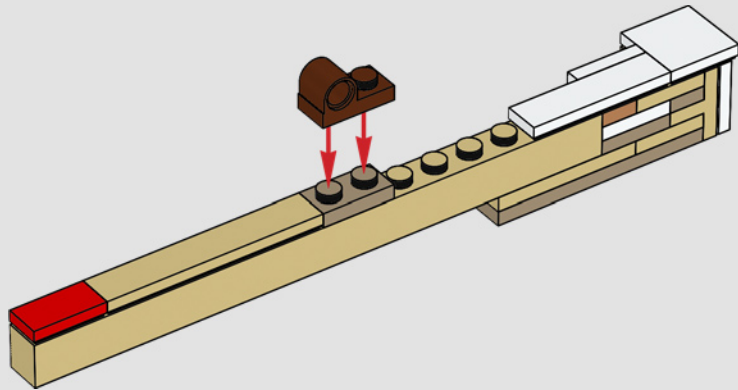

466

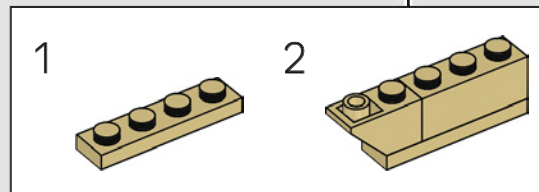
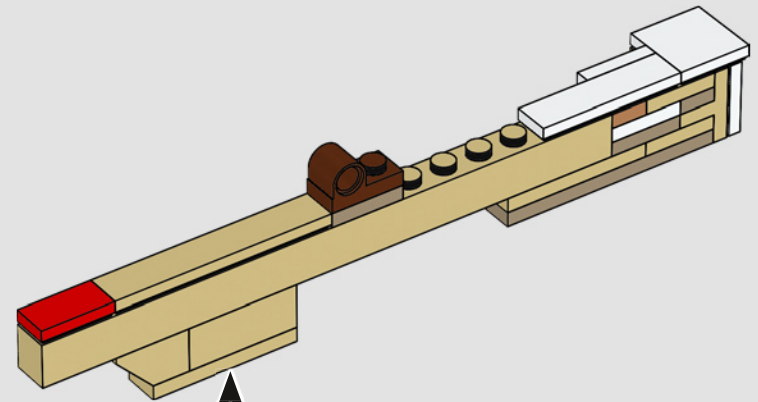

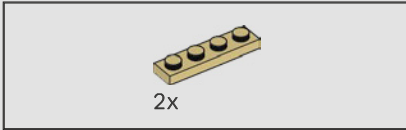
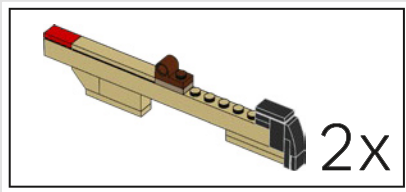

468

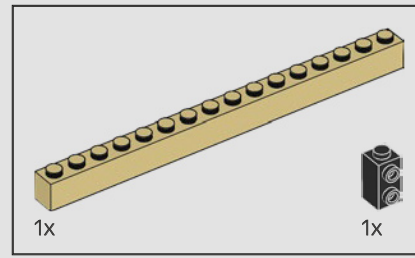
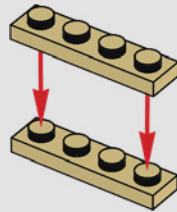

469

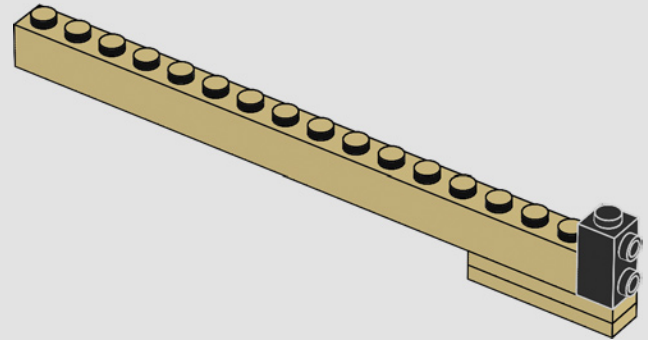

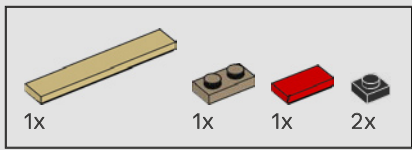

470

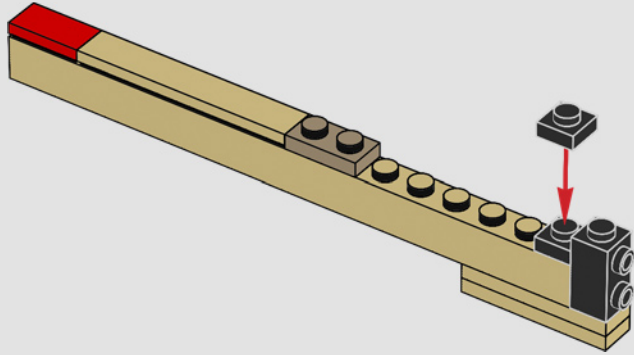

471

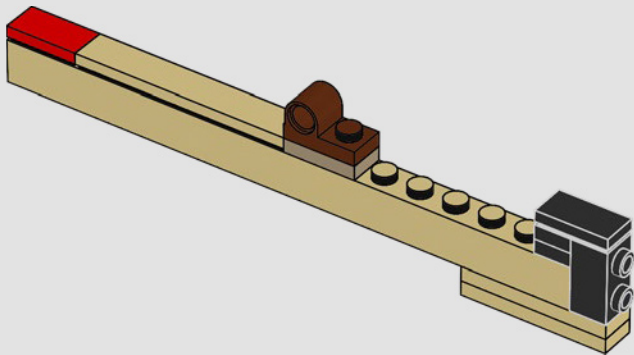

472

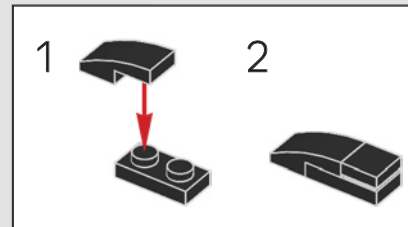
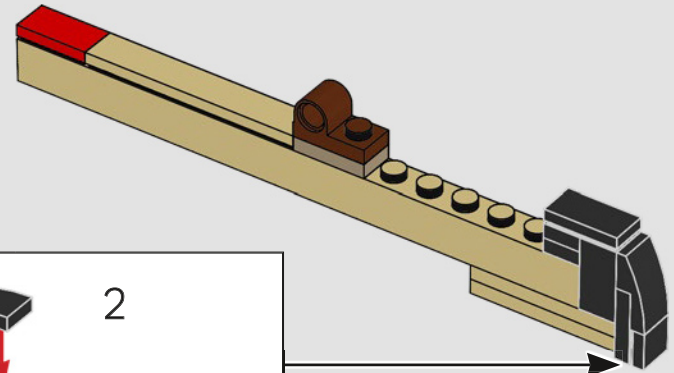

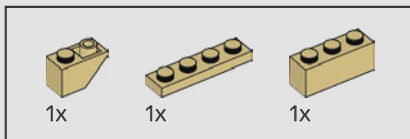

473

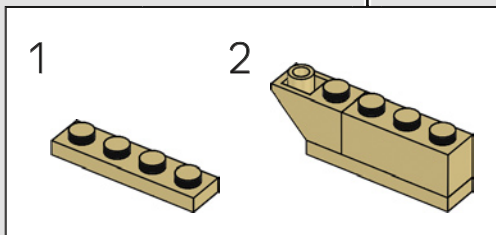
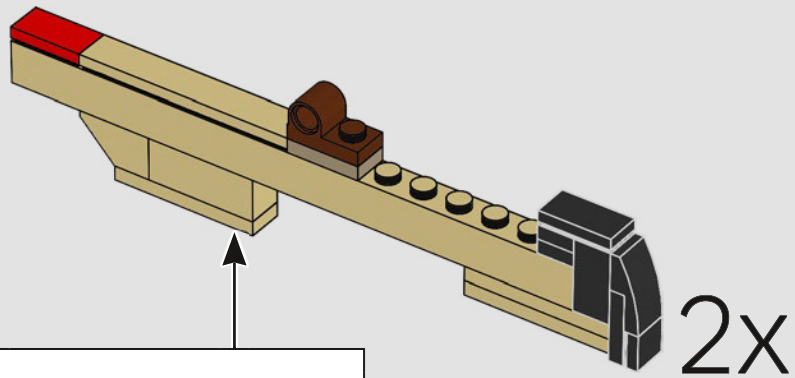

474

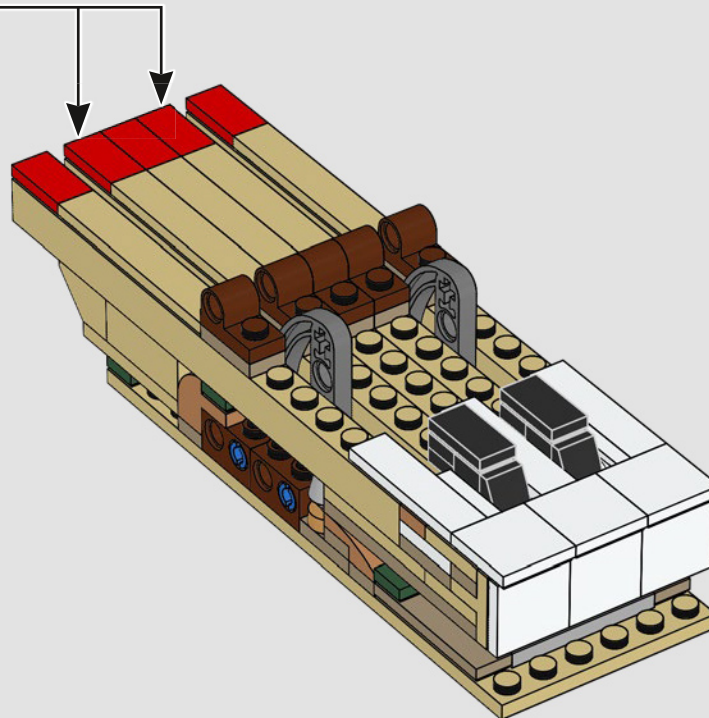

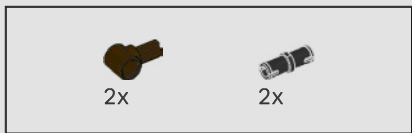

475

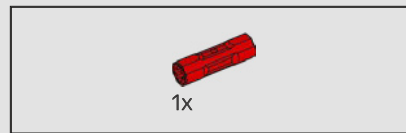
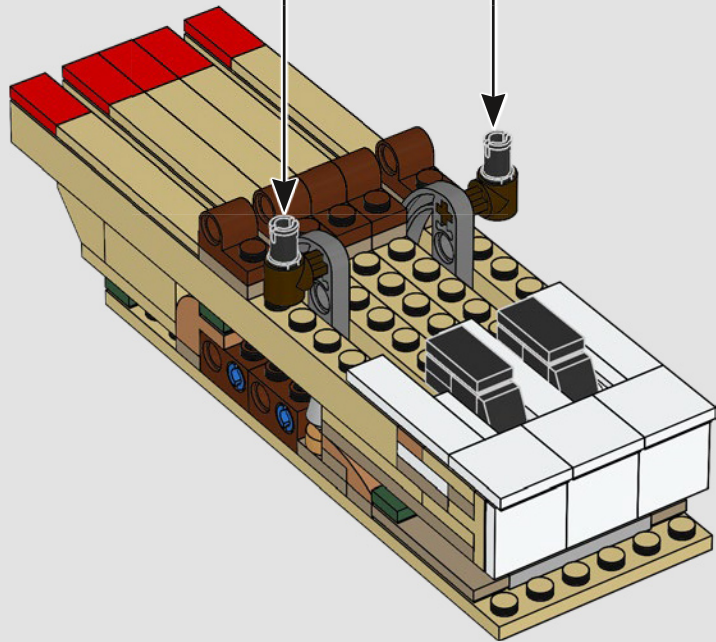
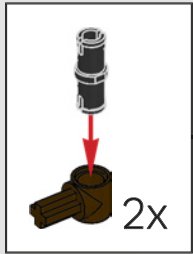

476

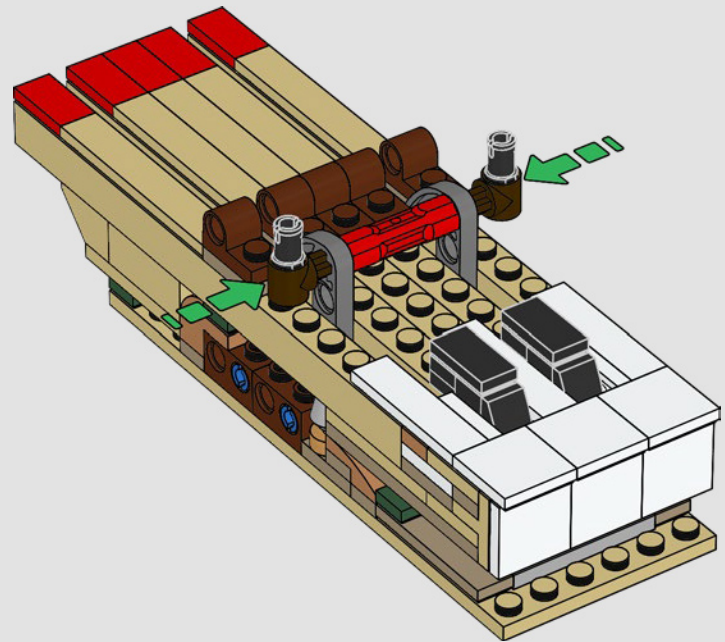

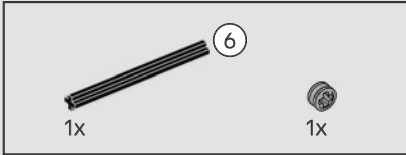
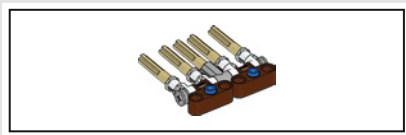

477

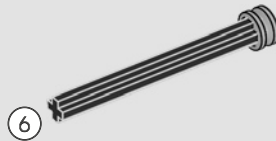

478

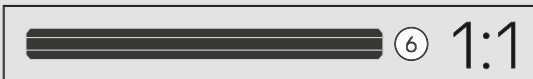
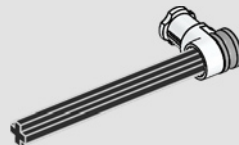

479

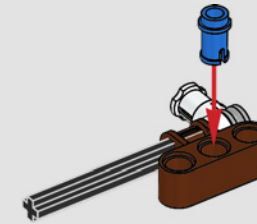

480

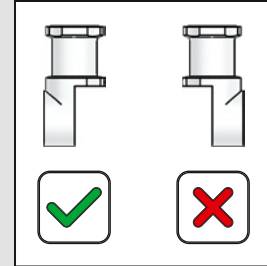
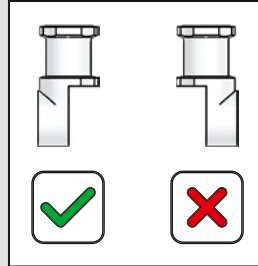
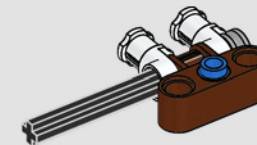



1x

481

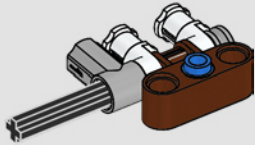

1x

482

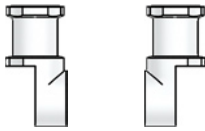
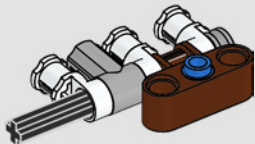

1x



1x

483

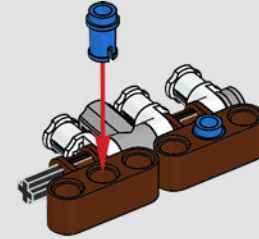

1x



1x

484

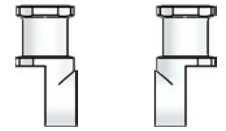
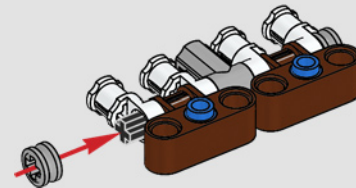

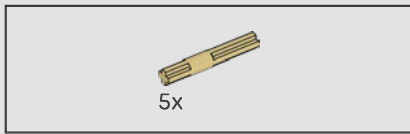

485

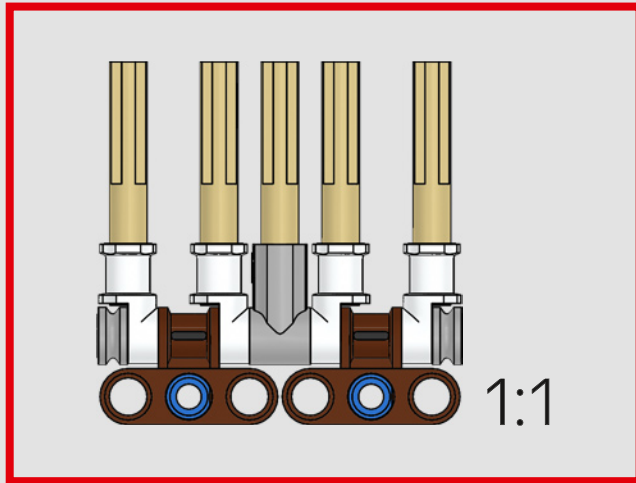
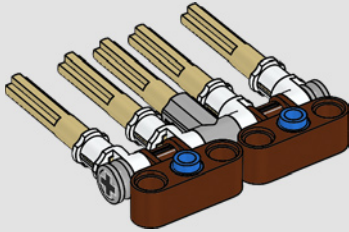

486

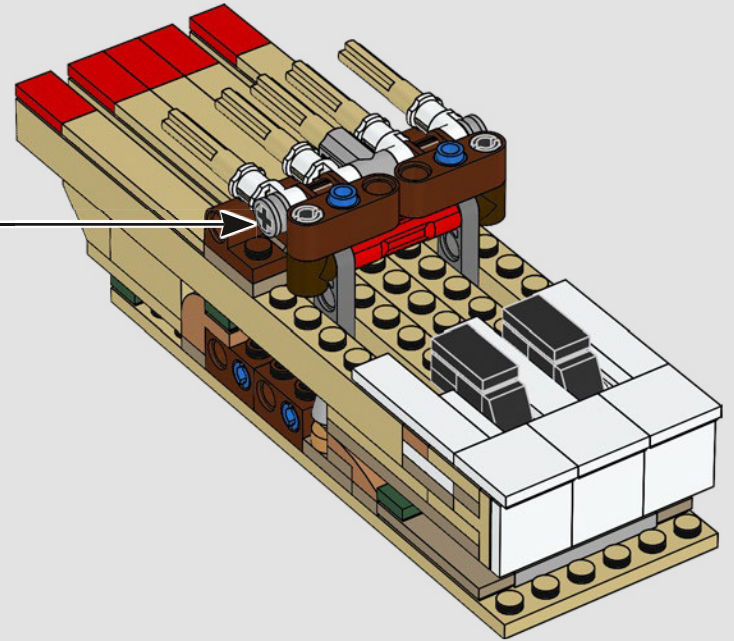

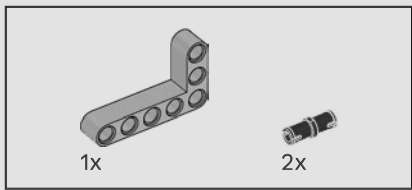

487

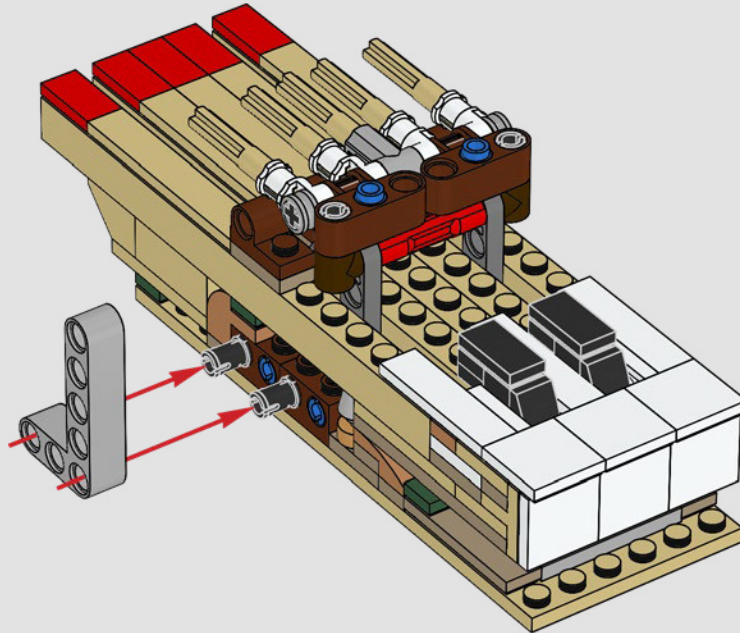

488

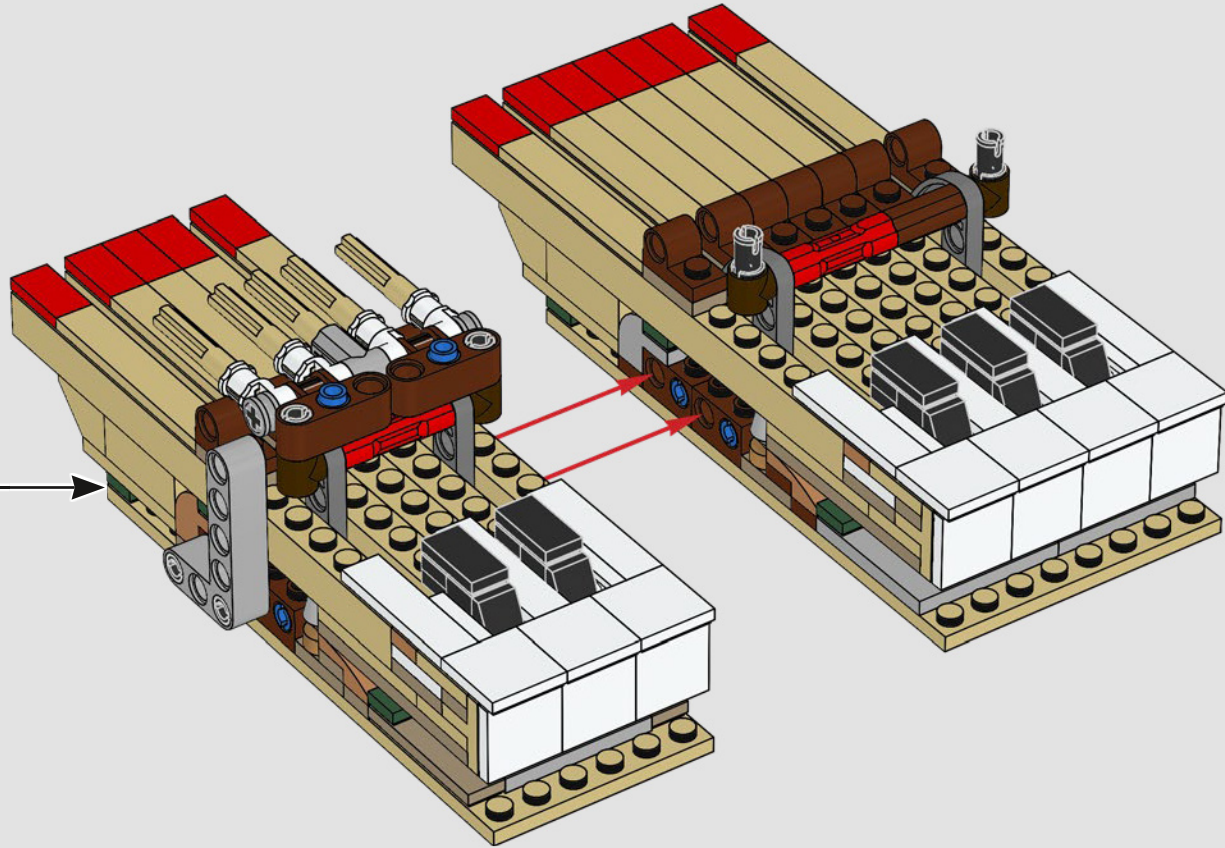

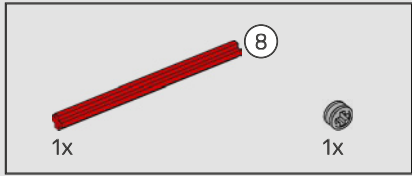
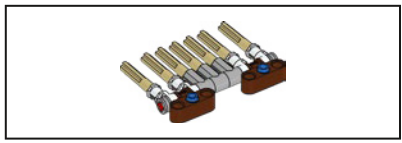

489

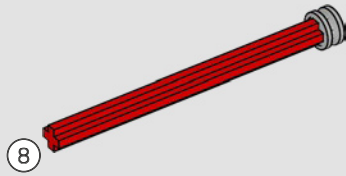

490

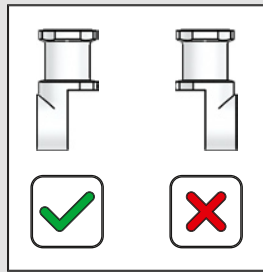
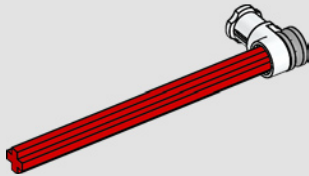

491

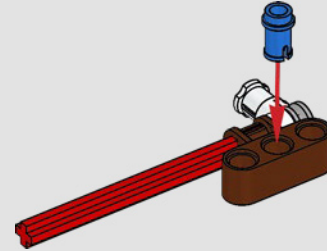

492

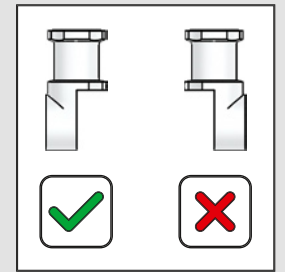
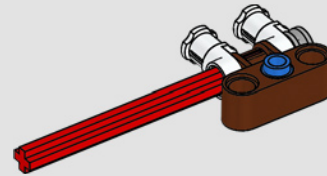



493

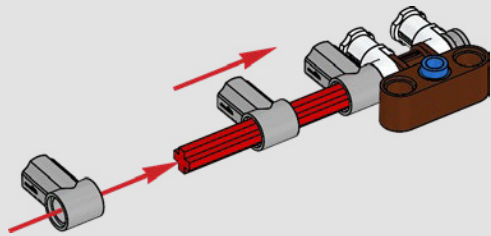

494

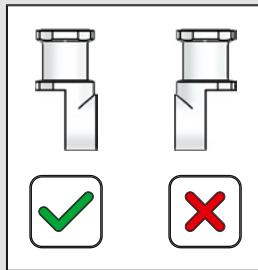
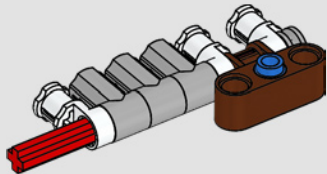

495

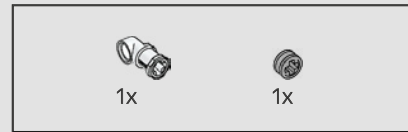
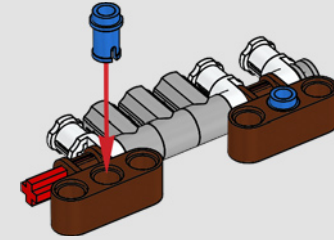

496

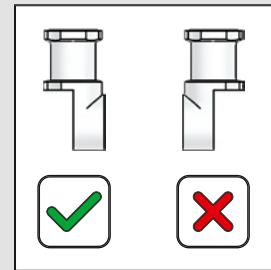
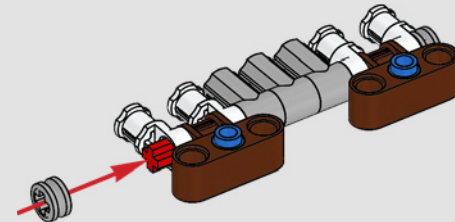

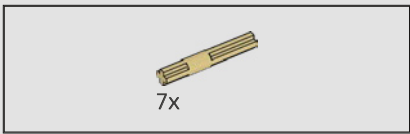

497

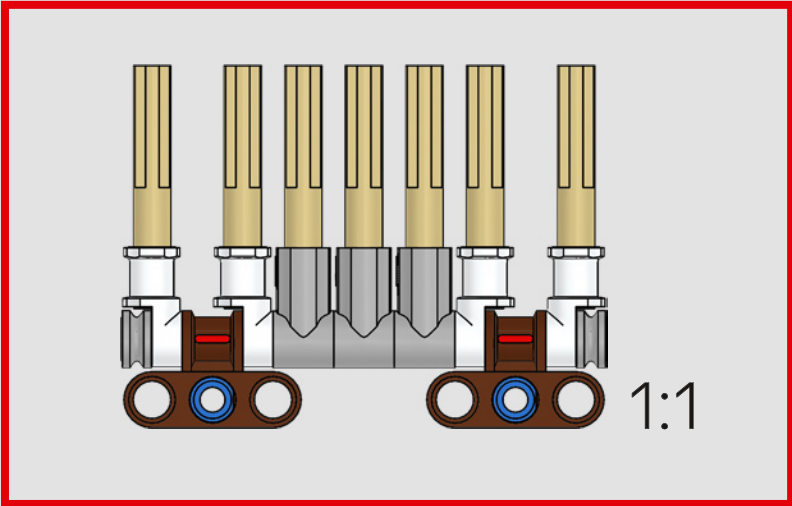
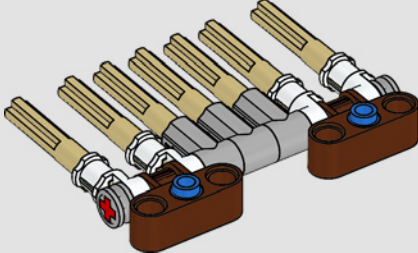

498

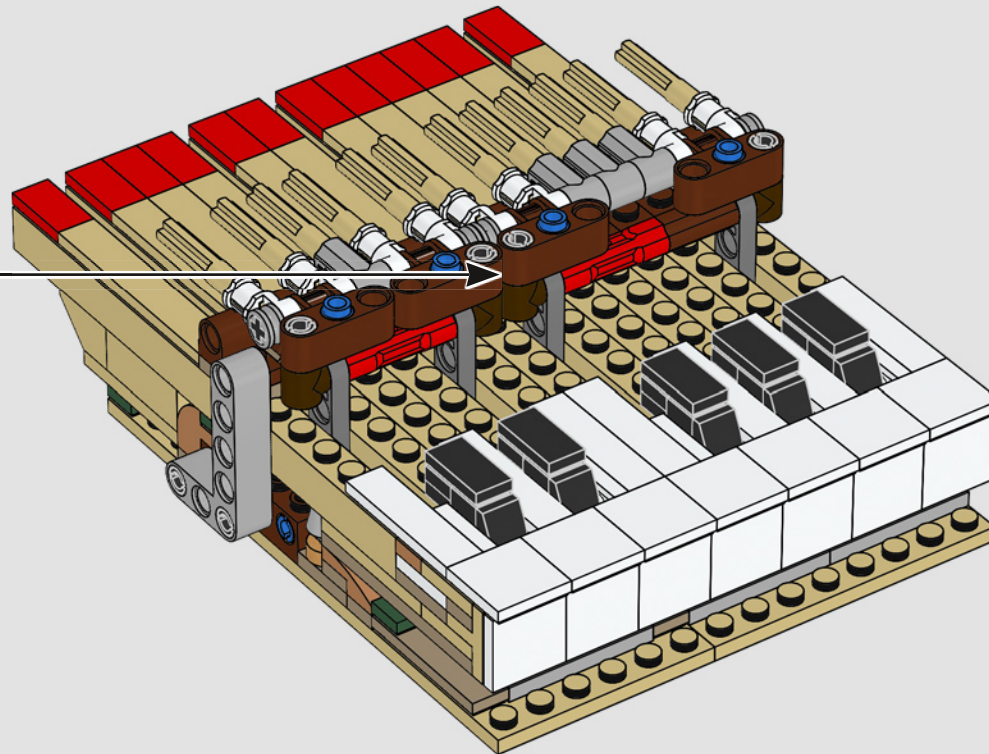



12x



12x



12x



12x



12x



12x



12x



12x

499

1

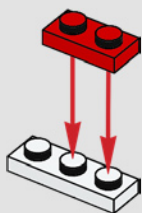

2

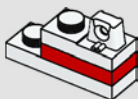

3

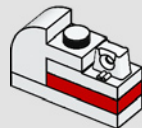

4

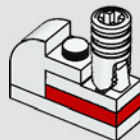

5

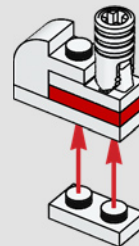

6

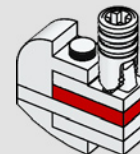

12x

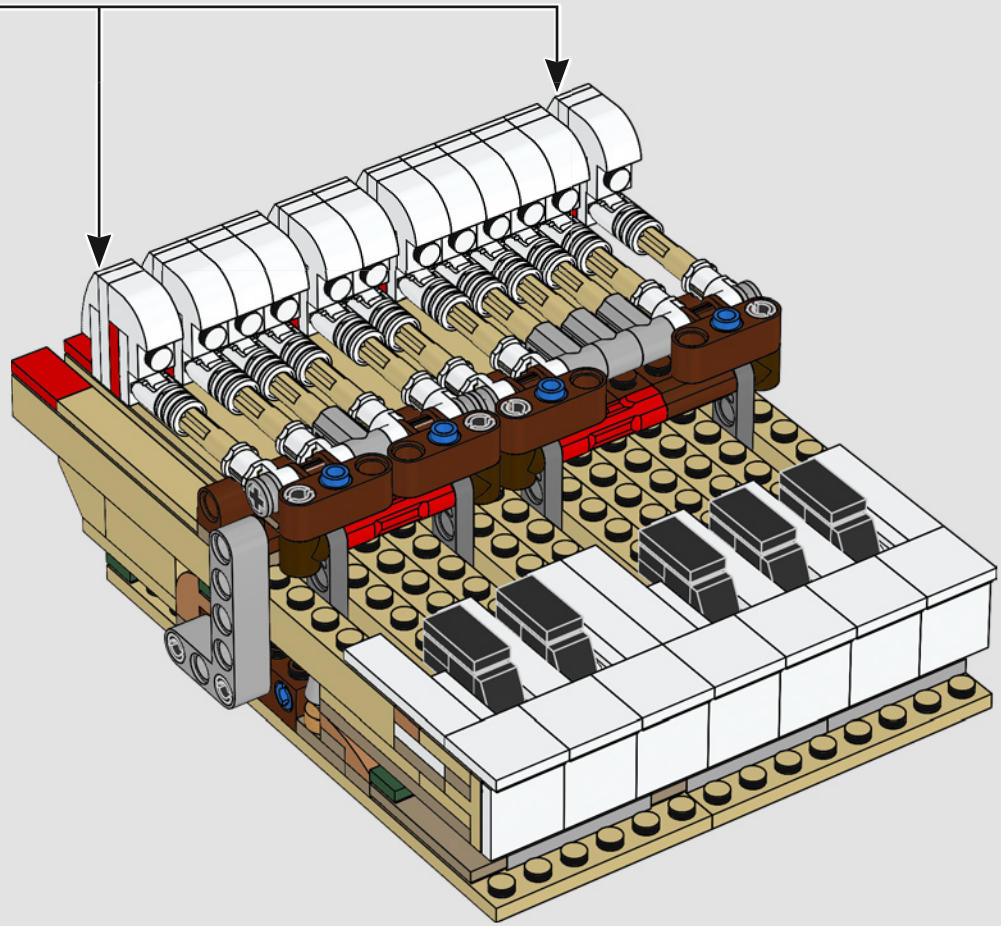

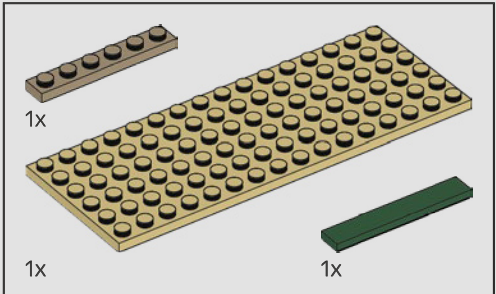
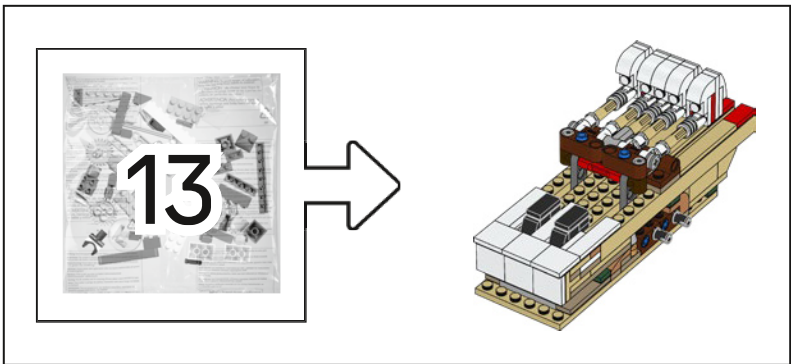

500

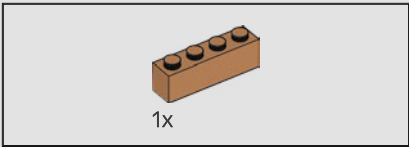
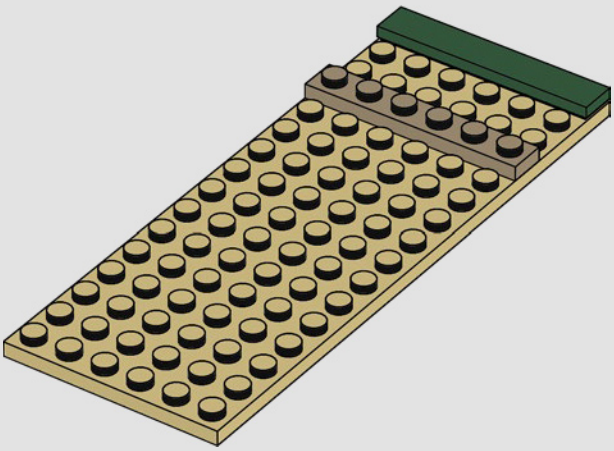

501

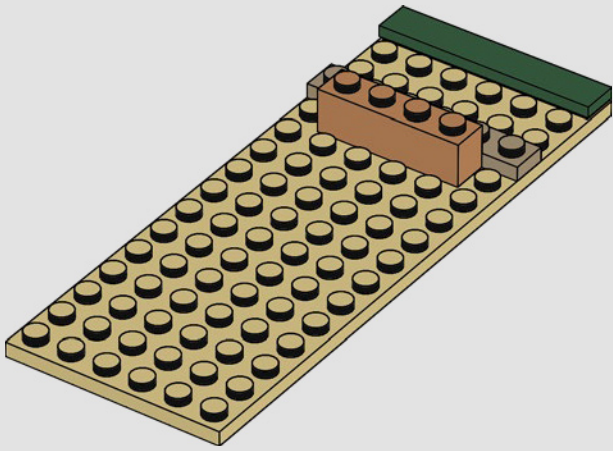

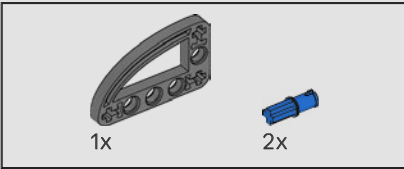
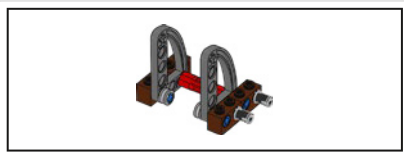

502

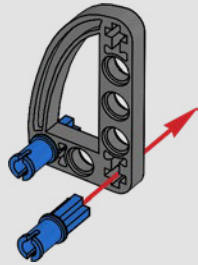

503

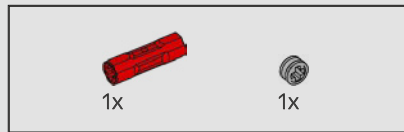
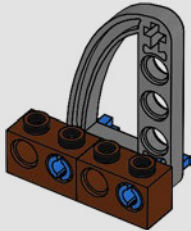

504

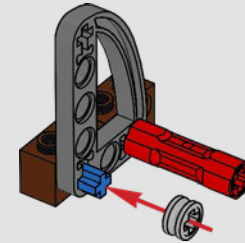
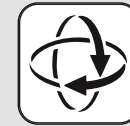

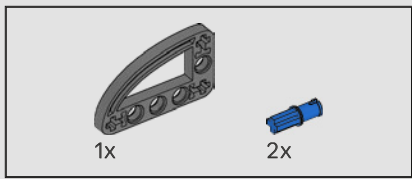

505

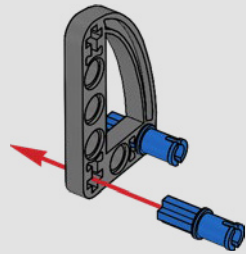

506

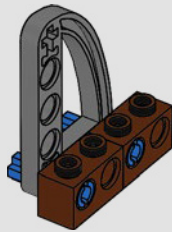

507

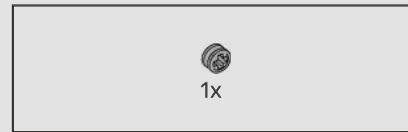
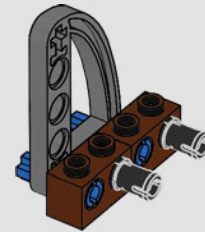

508

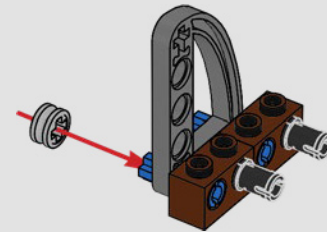

509

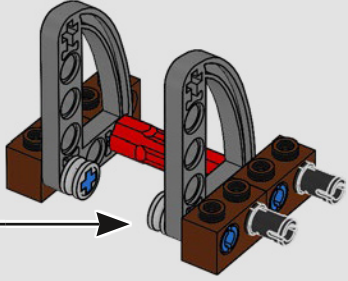

510

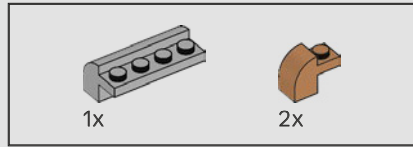
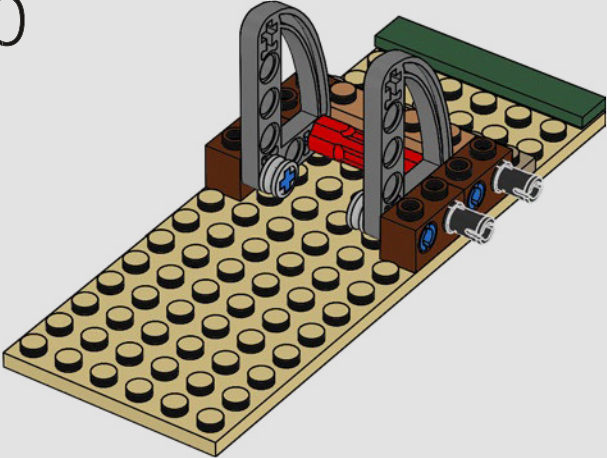

511

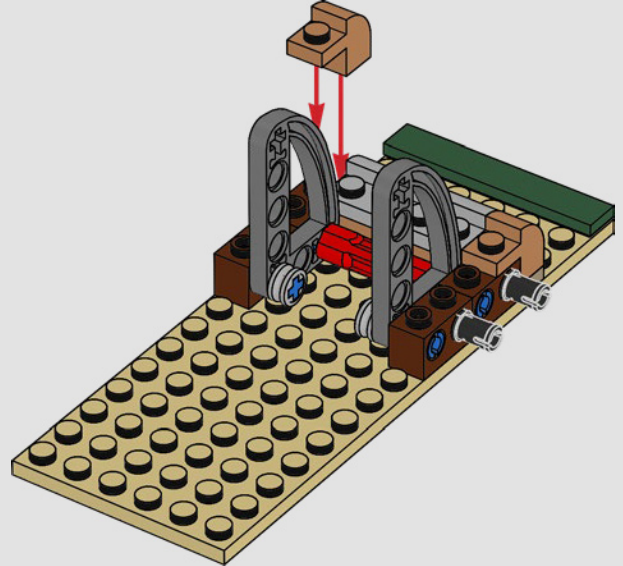

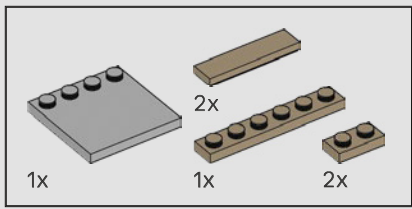

512

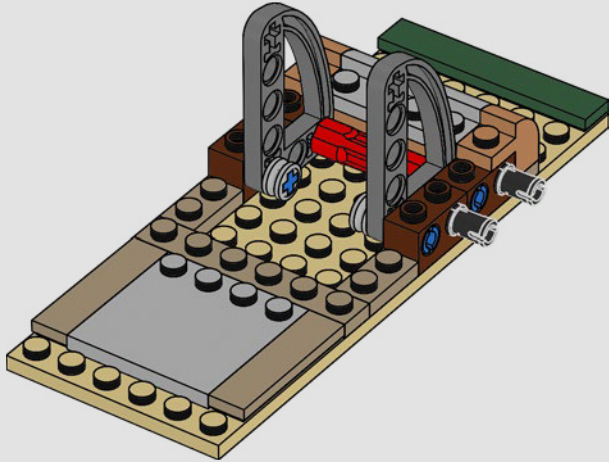

513

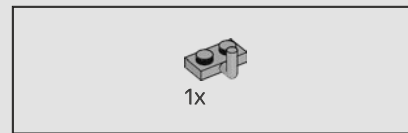
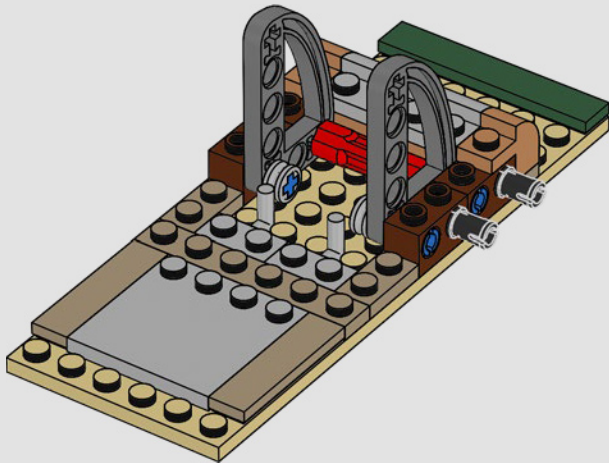

514

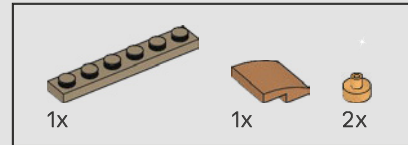
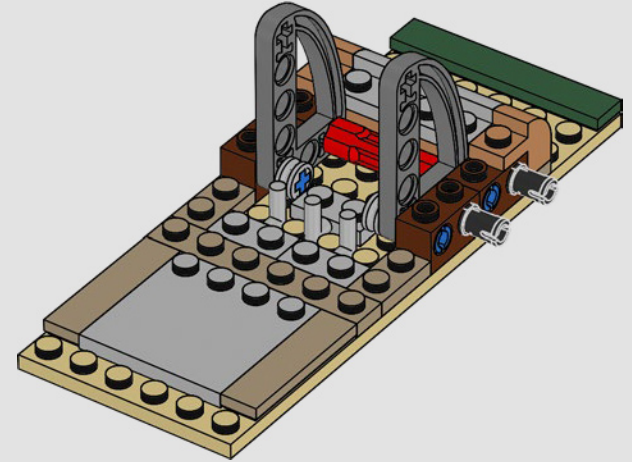

515

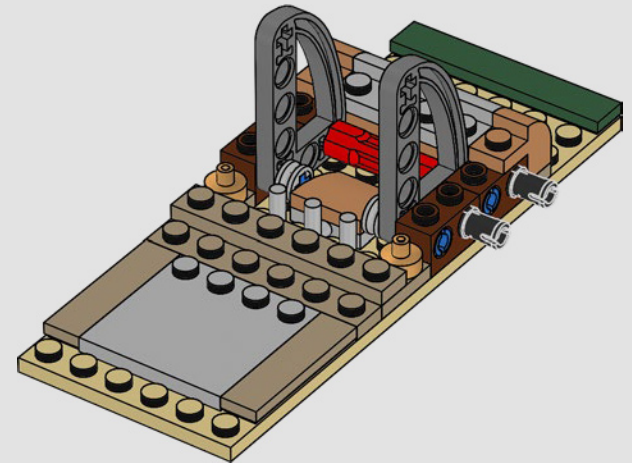



516

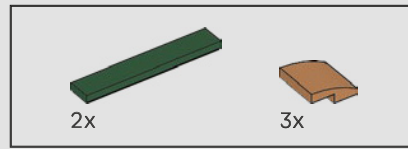
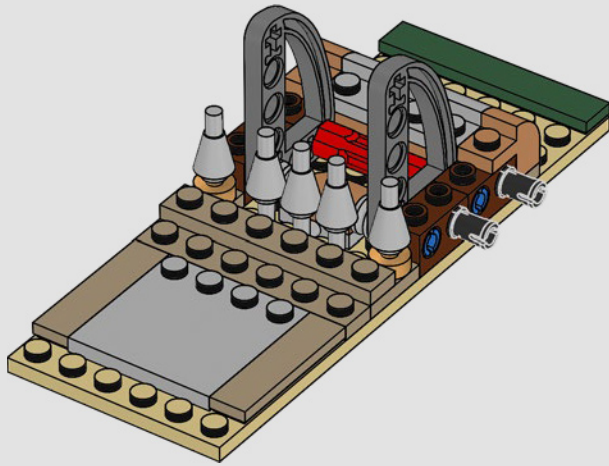

517

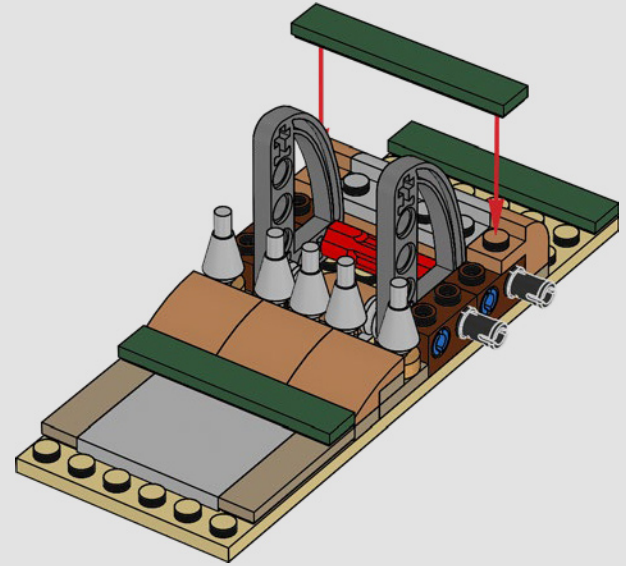

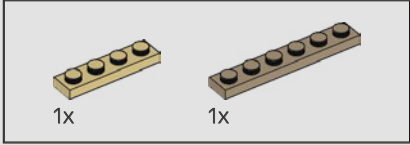
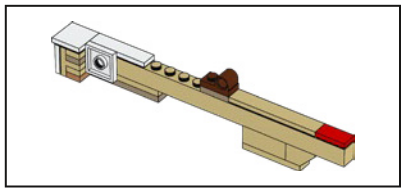

518

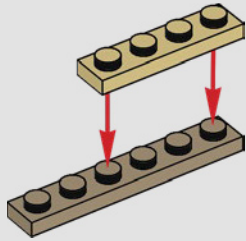

519

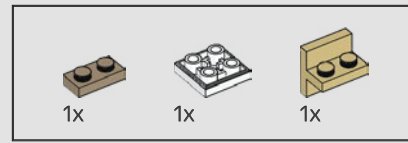
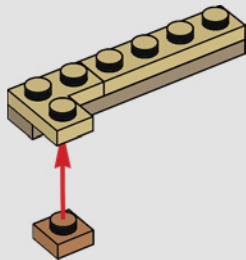

520

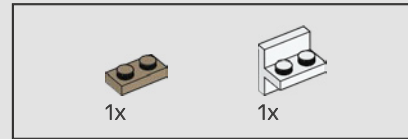
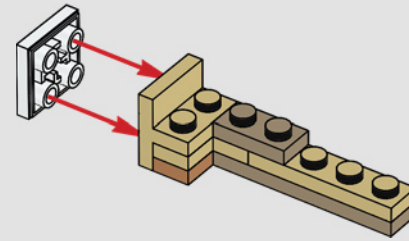

521

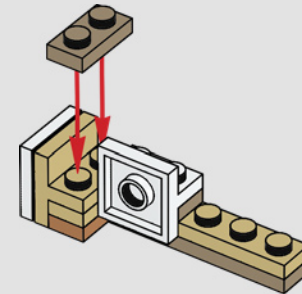

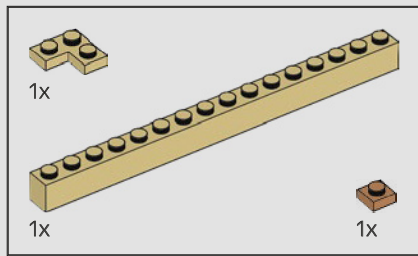

522

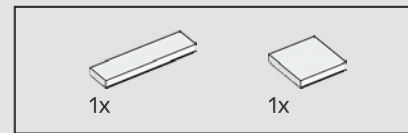
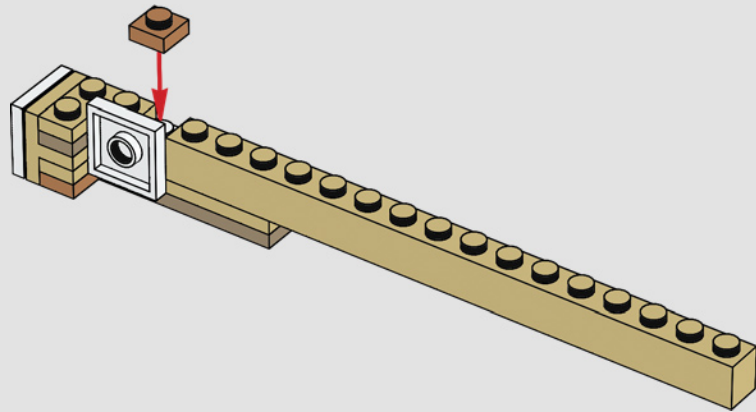

523

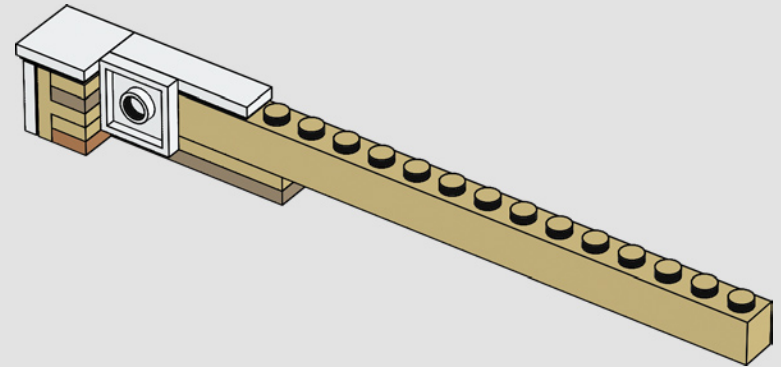

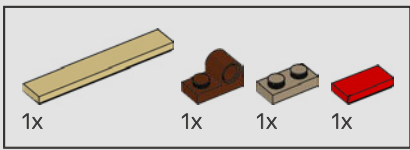

524

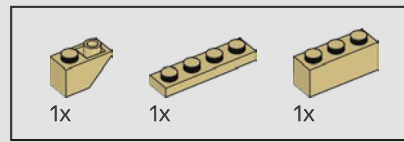
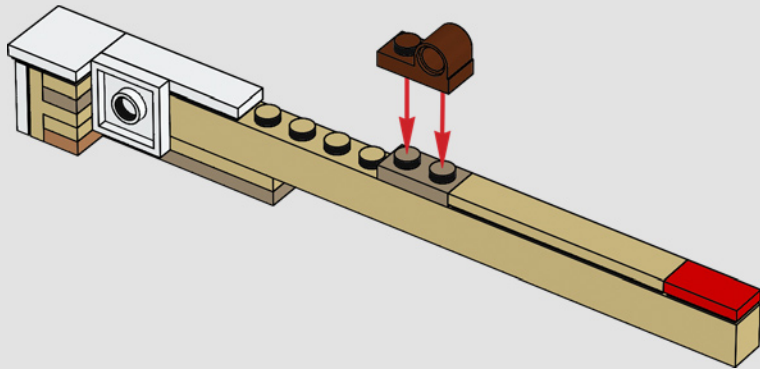

525

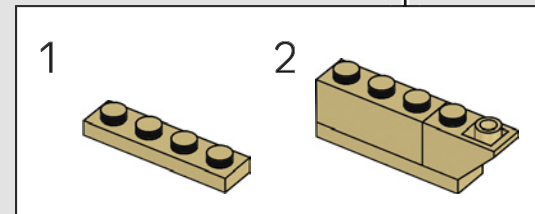
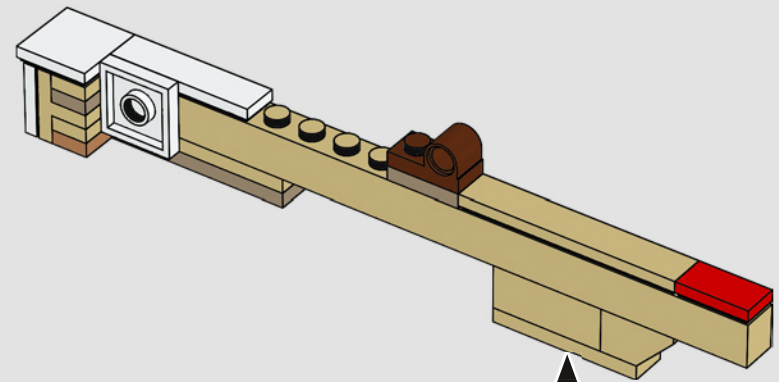

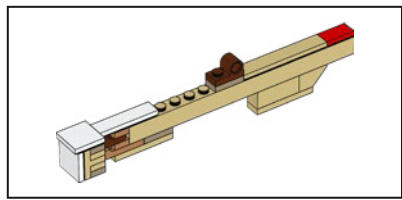

527

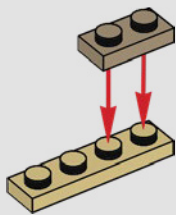

528

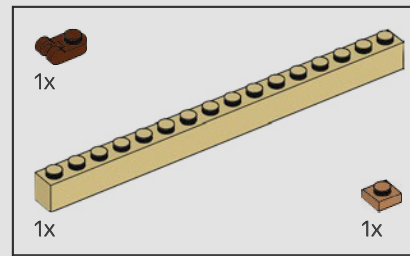
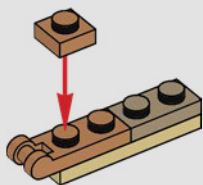

529

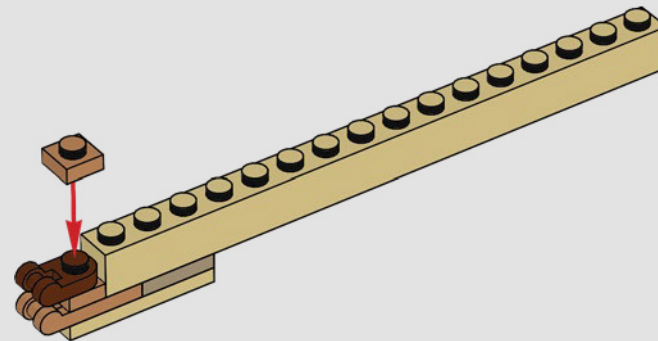

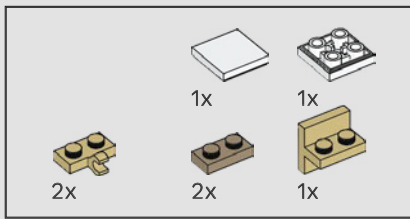

530

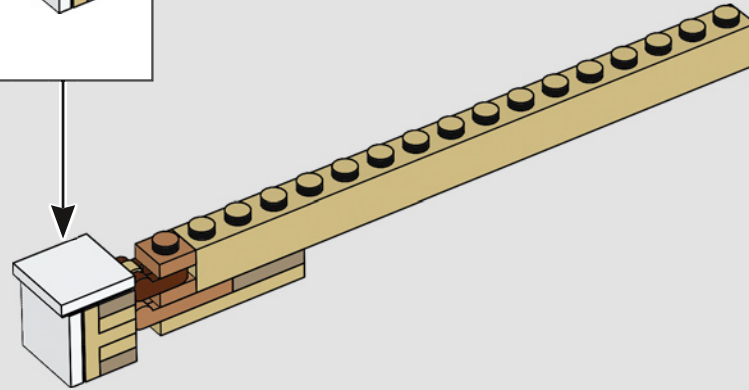
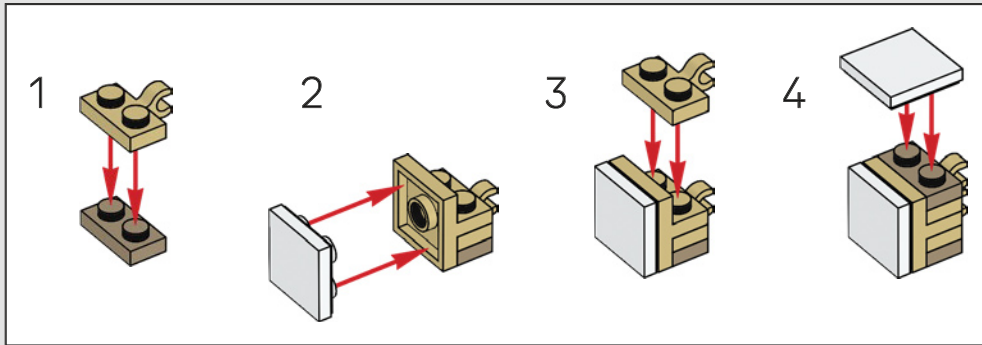

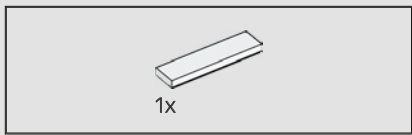

531

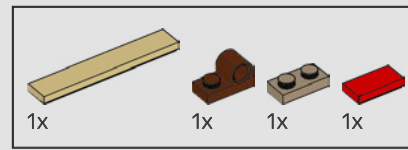
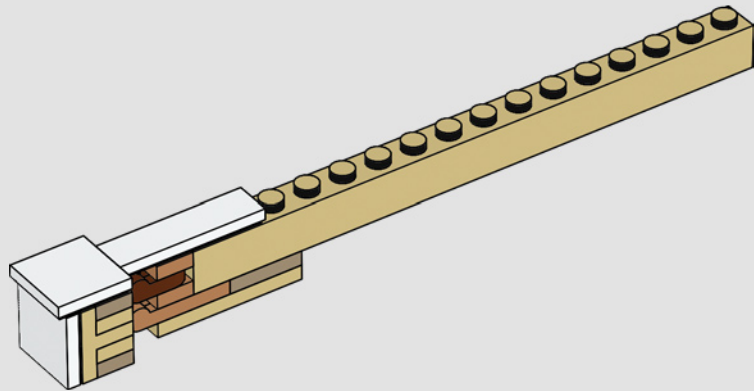

532

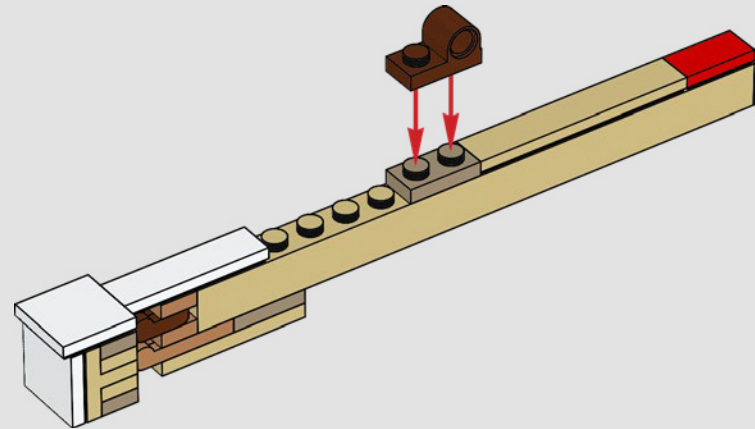

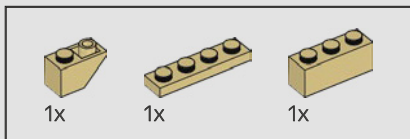

533

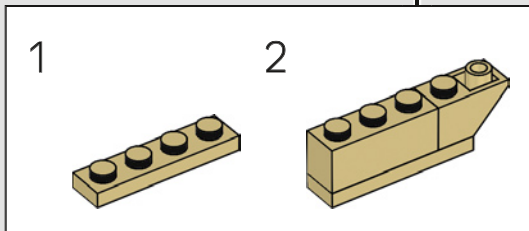
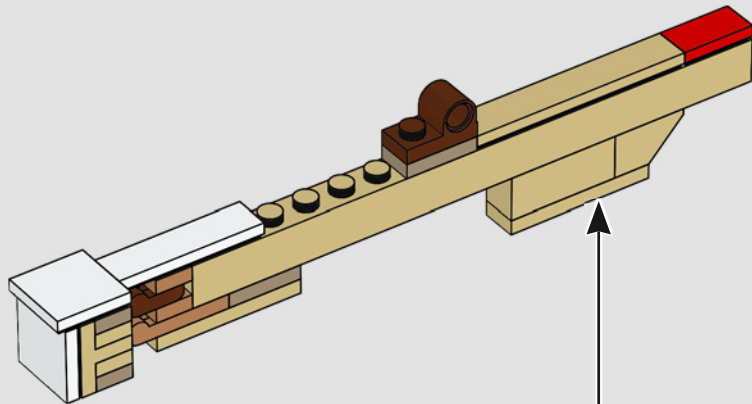

534

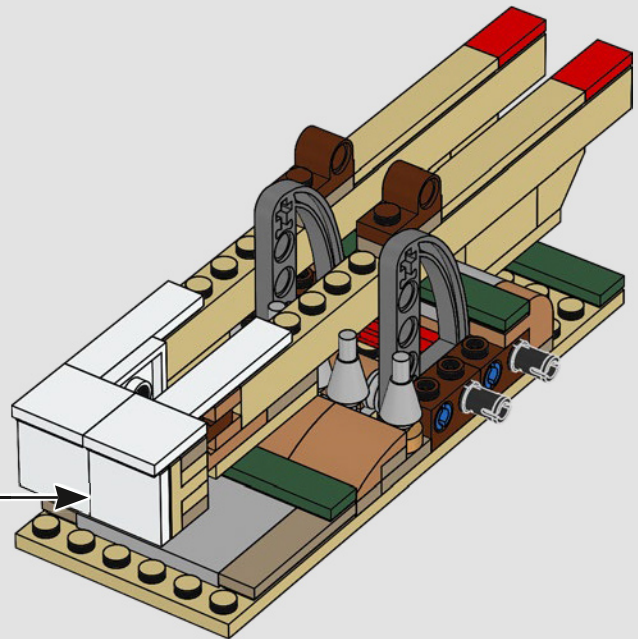

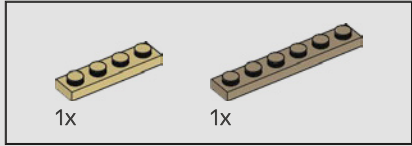
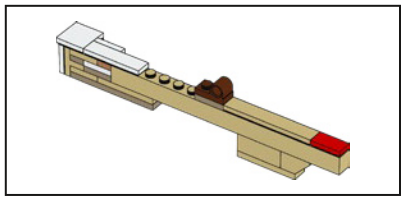

535

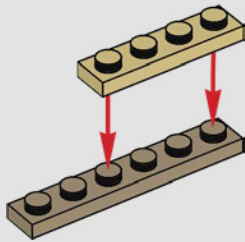

536

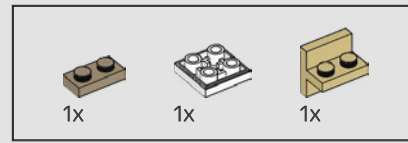
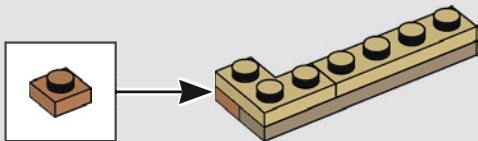

537

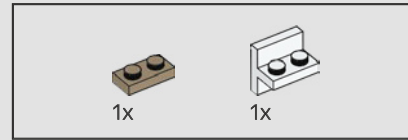
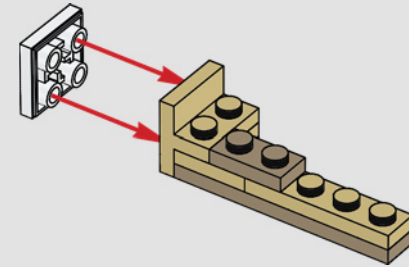

538

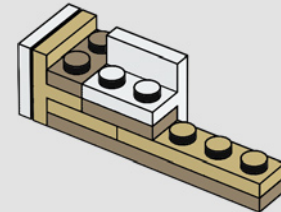

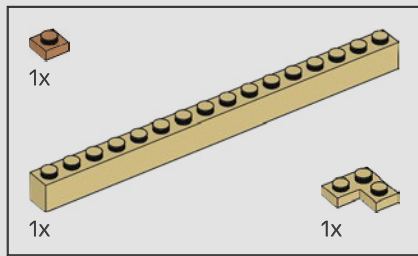

539

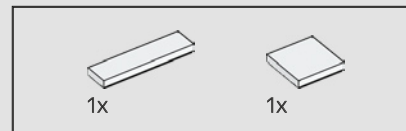
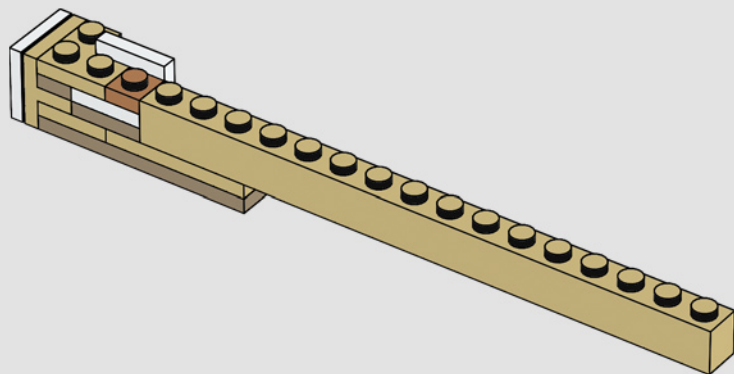

540

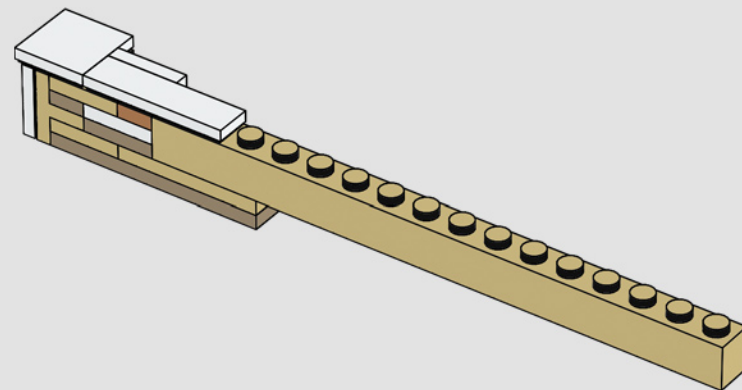

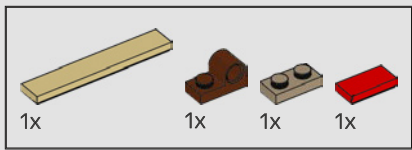

541

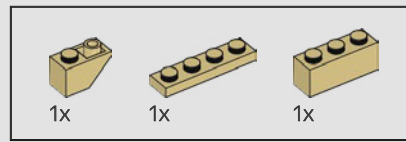
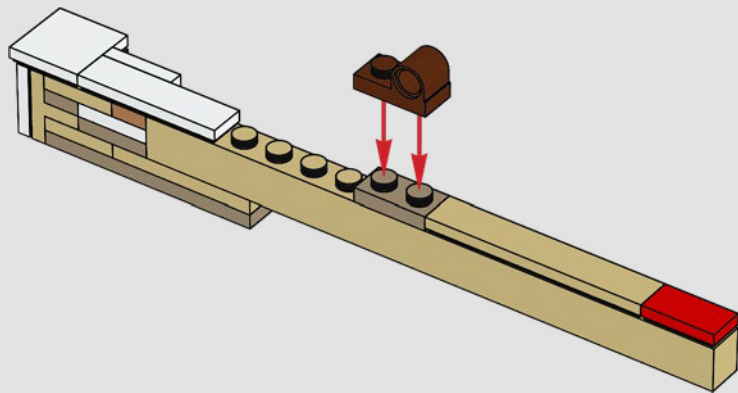

542

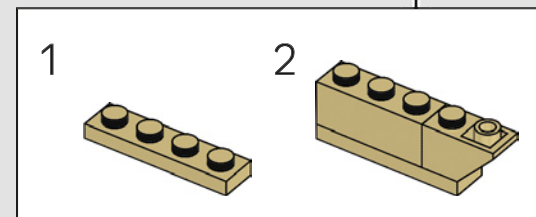
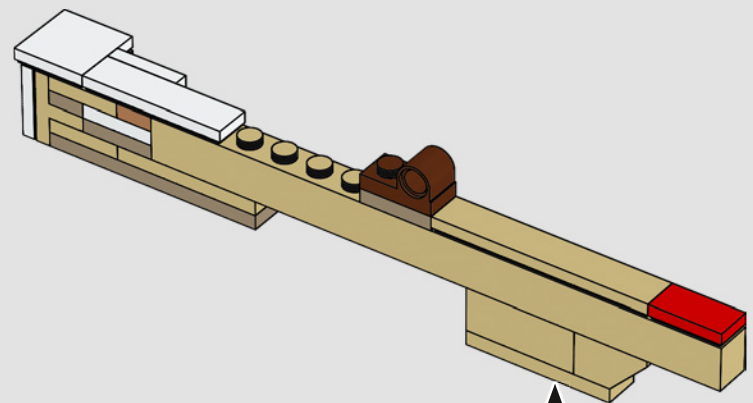

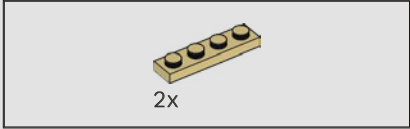
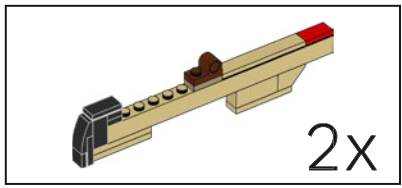

544

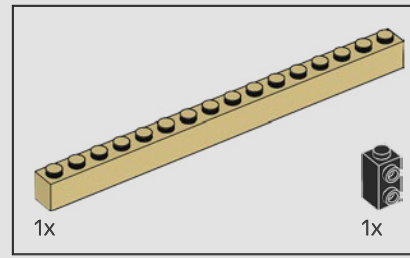
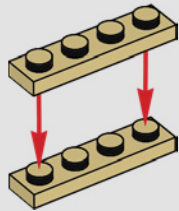

545

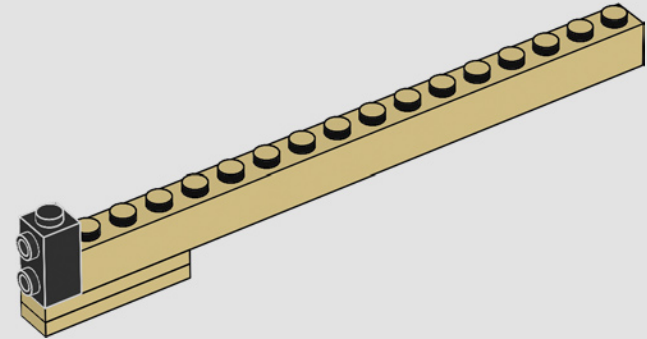

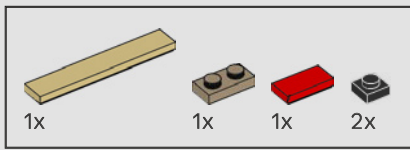

546

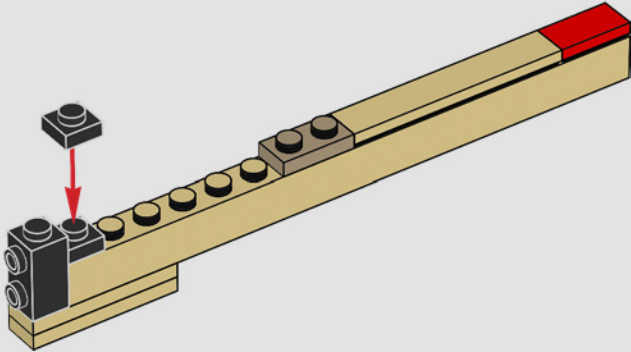

547

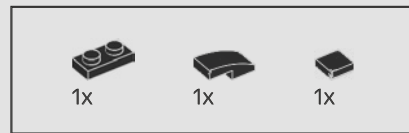
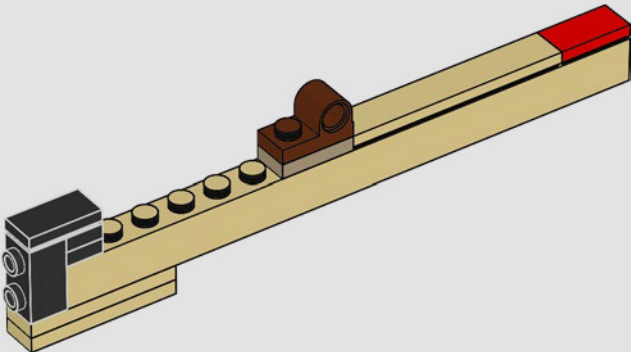

548

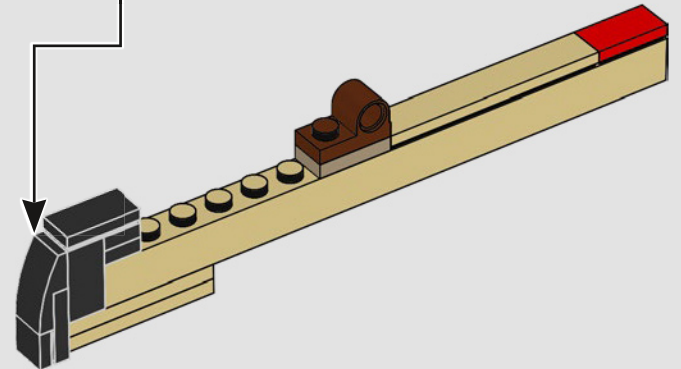
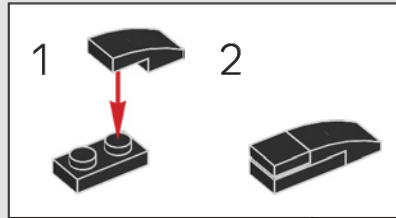

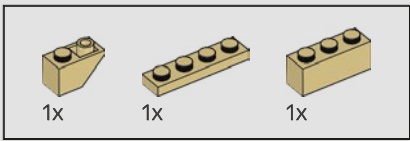

549

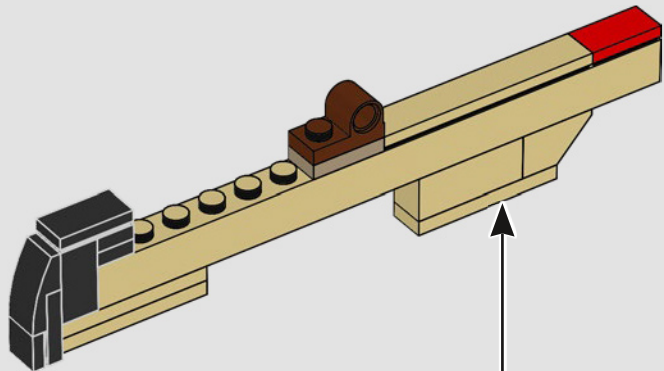

2x

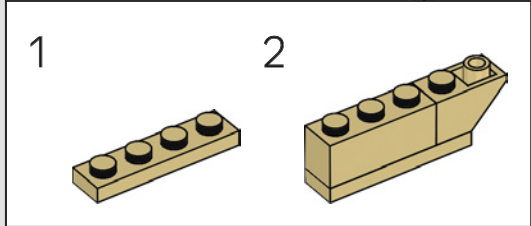

550

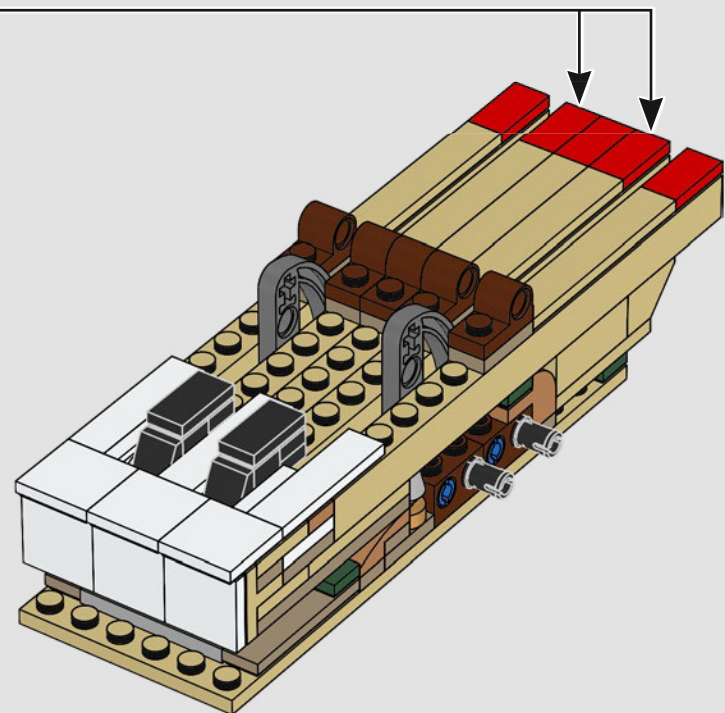



551

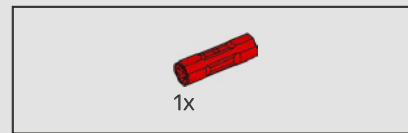
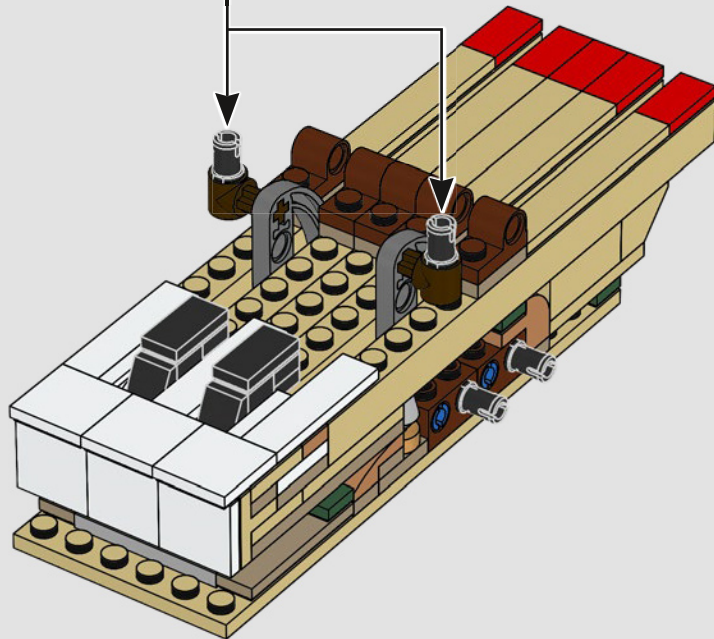
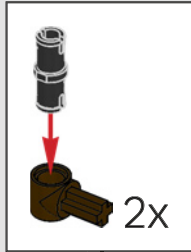

552

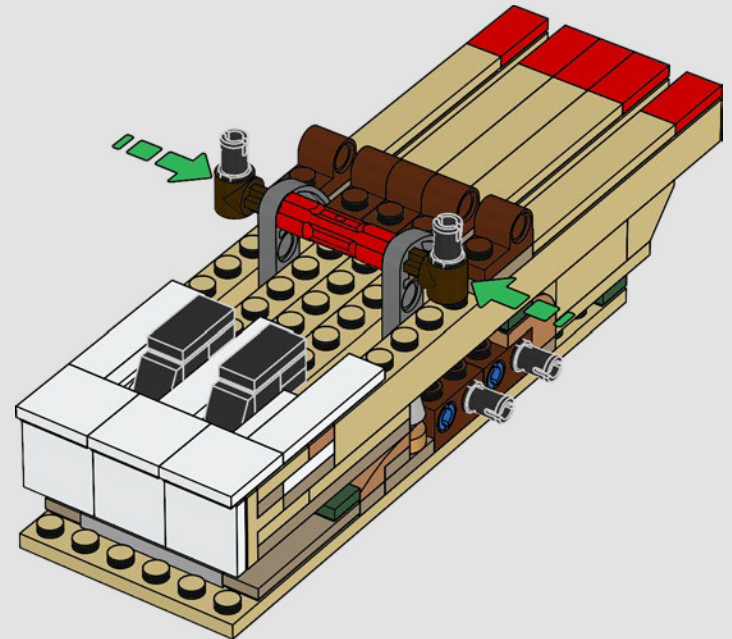

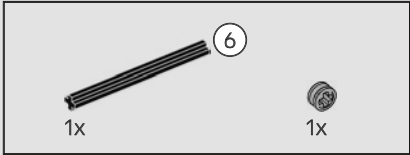
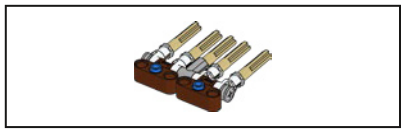

553

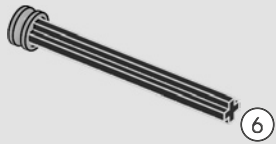

554

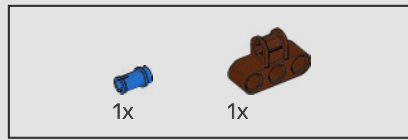
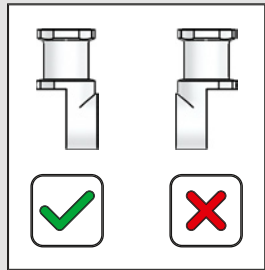
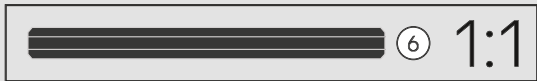
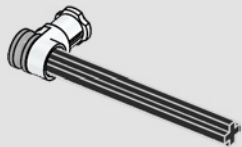

555

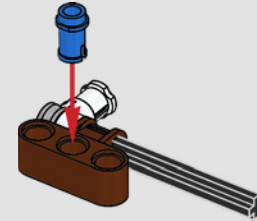

556

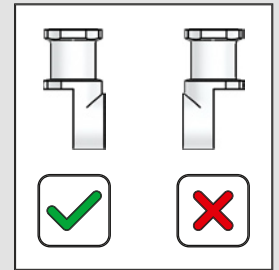
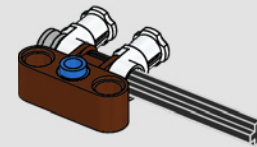



557

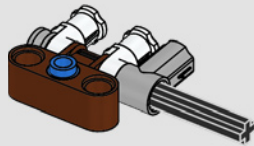

558

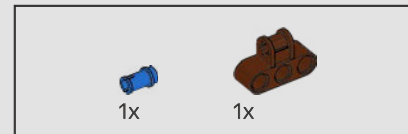
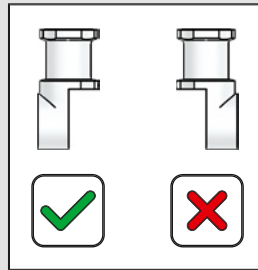
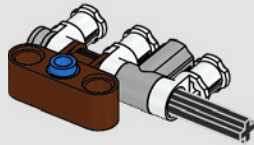

559

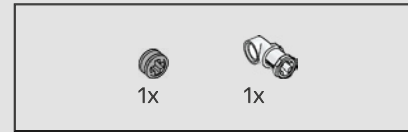
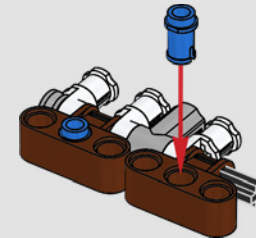

560

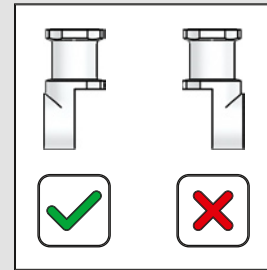
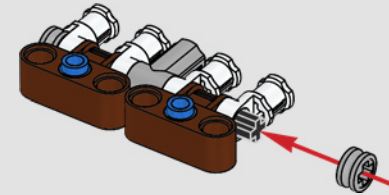

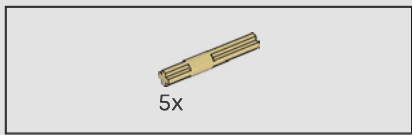

561

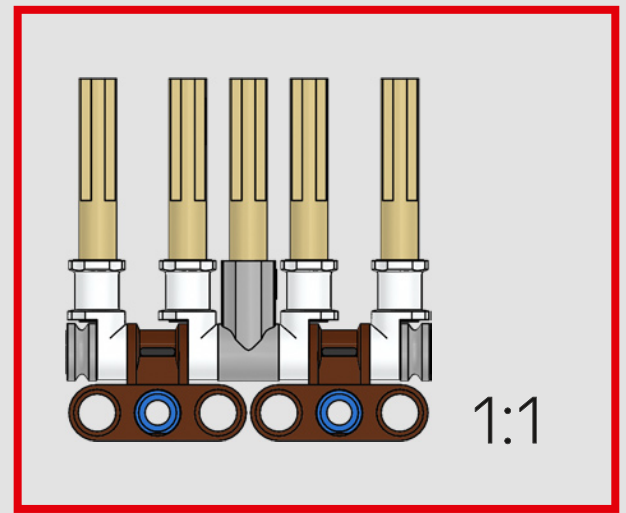
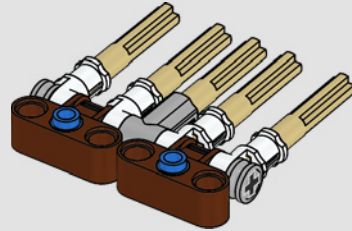

562

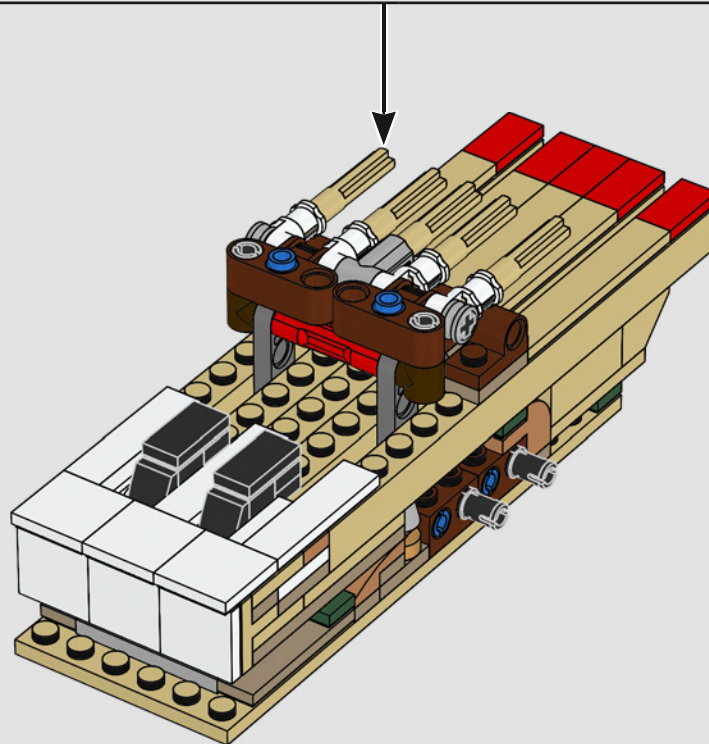

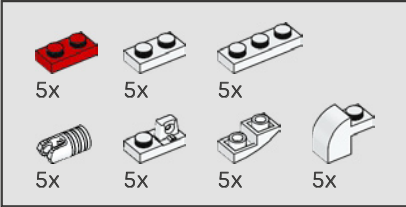
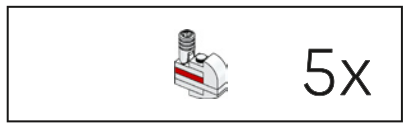

563

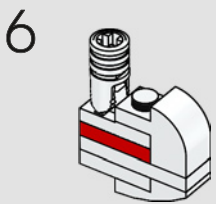
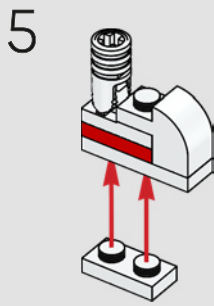
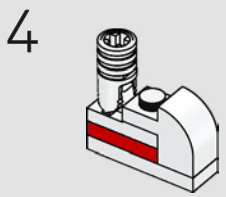
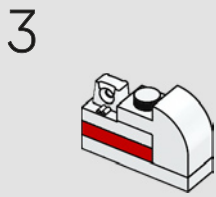
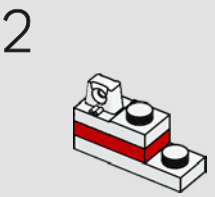
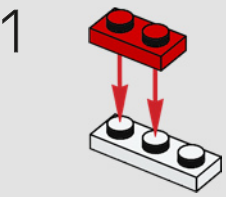

5x



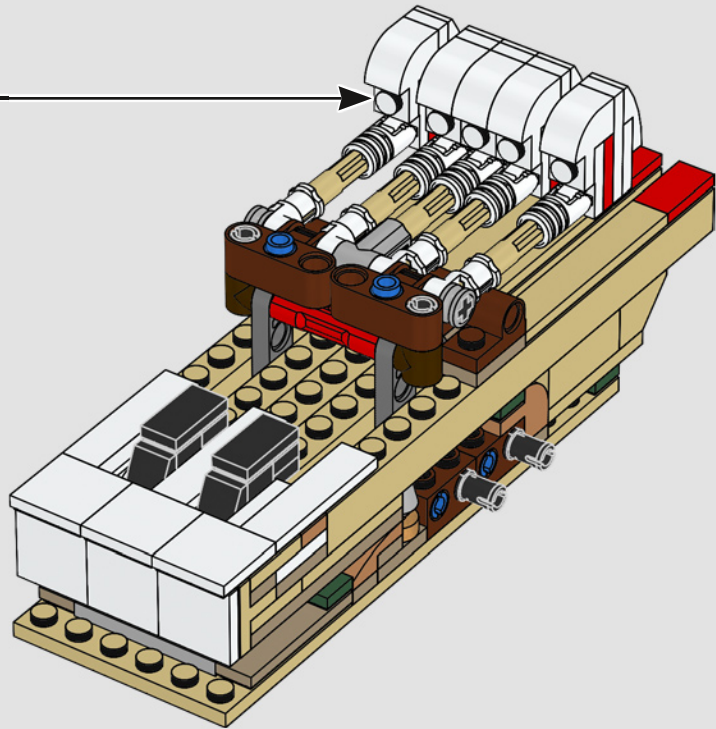

564

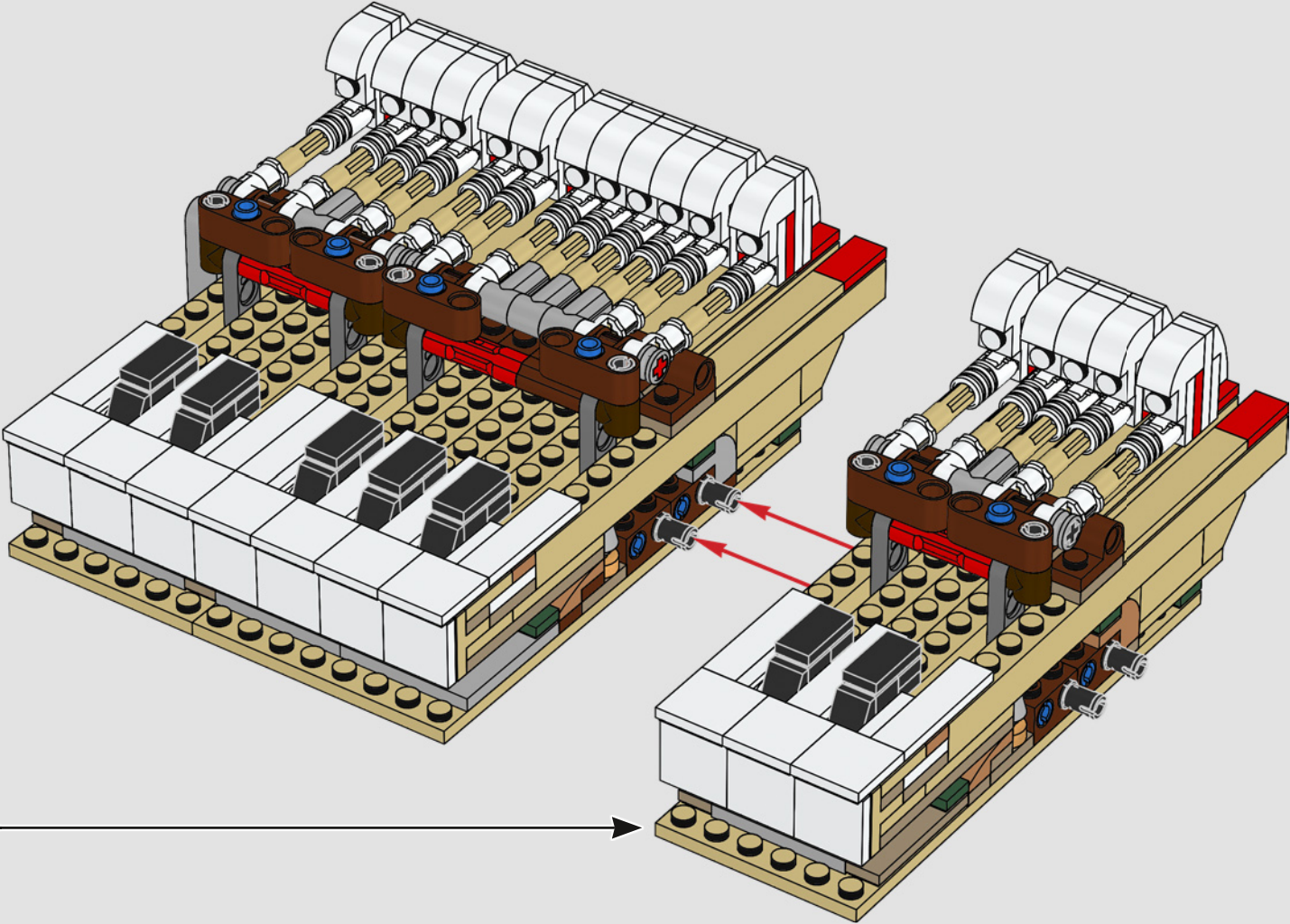

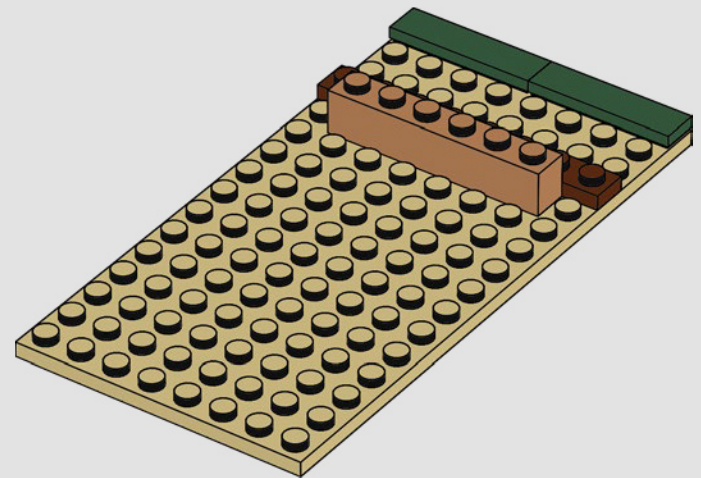
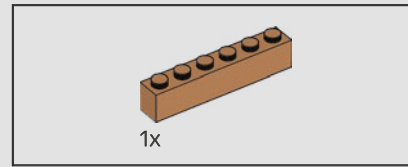
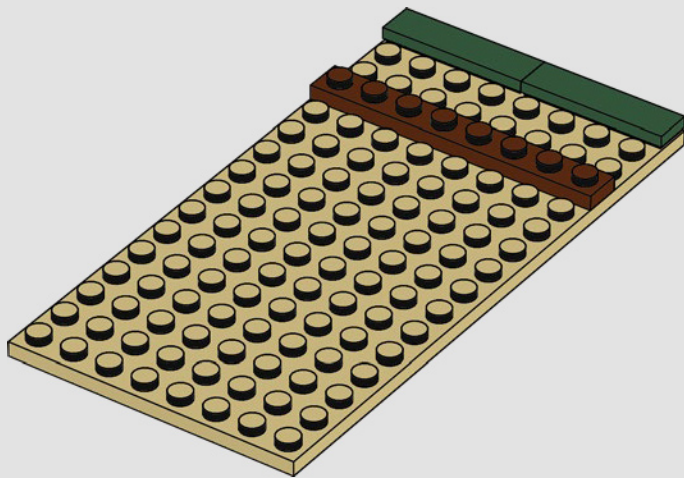
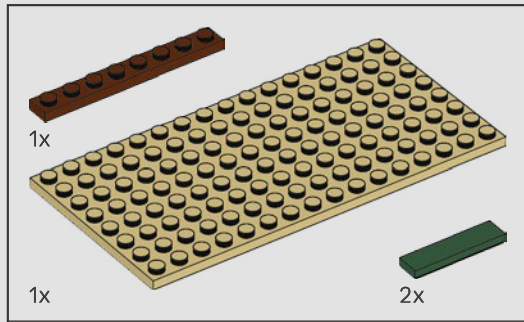
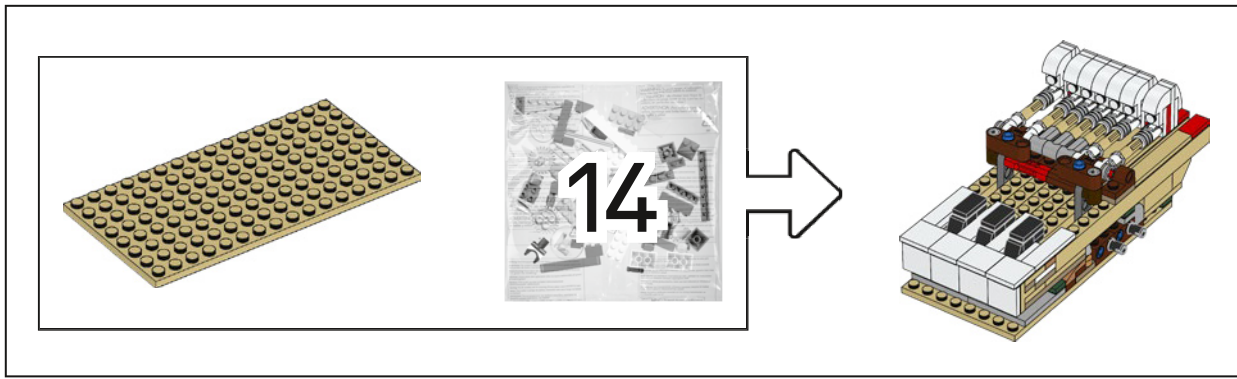

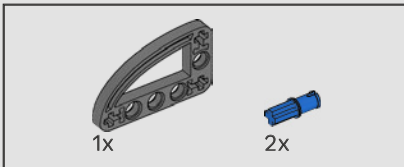
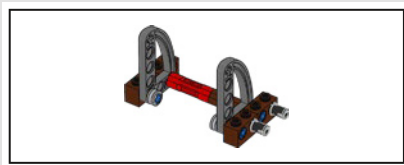

567

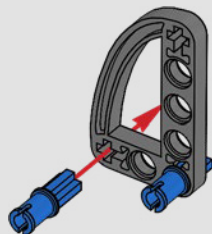

568

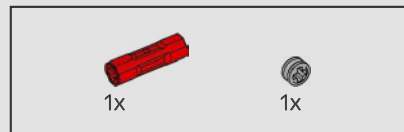
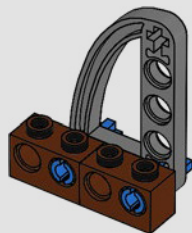

569

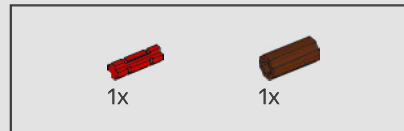
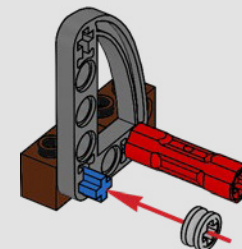
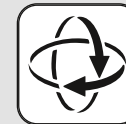

570

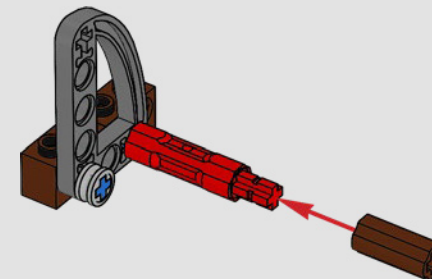

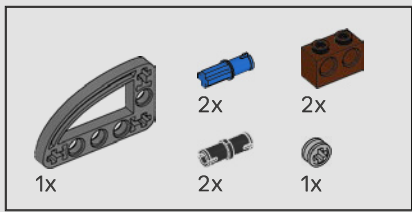

571

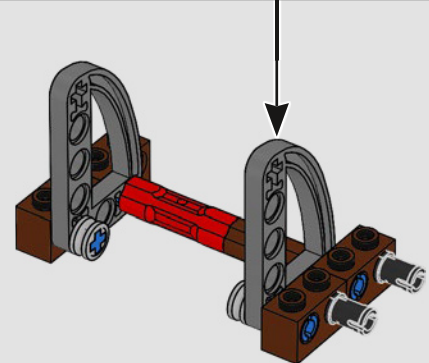
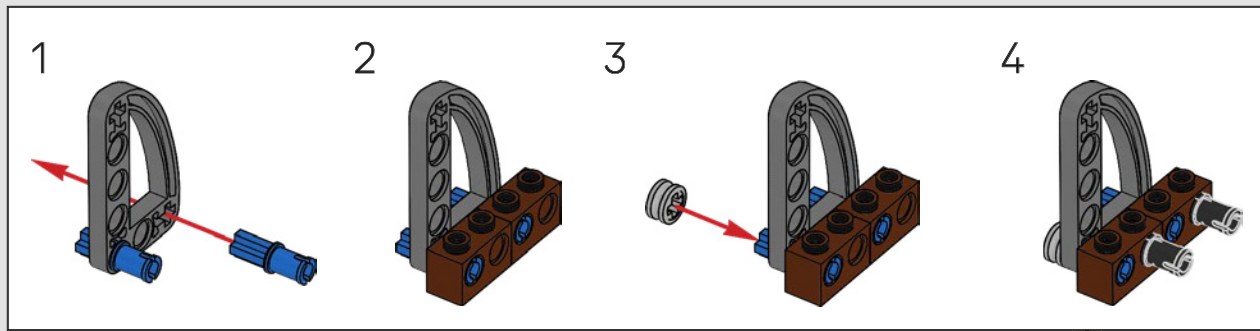

572

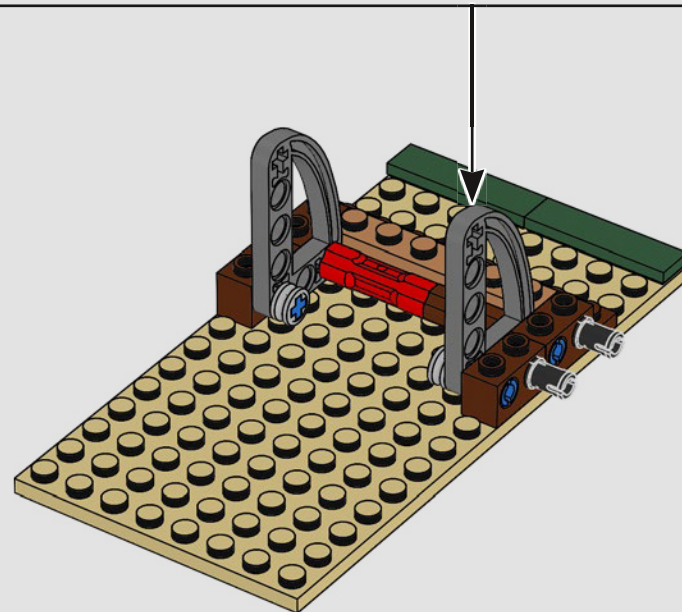

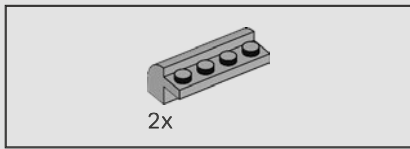

573

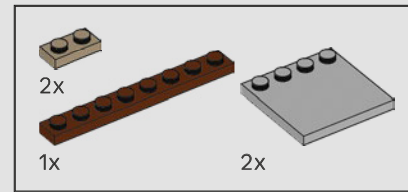
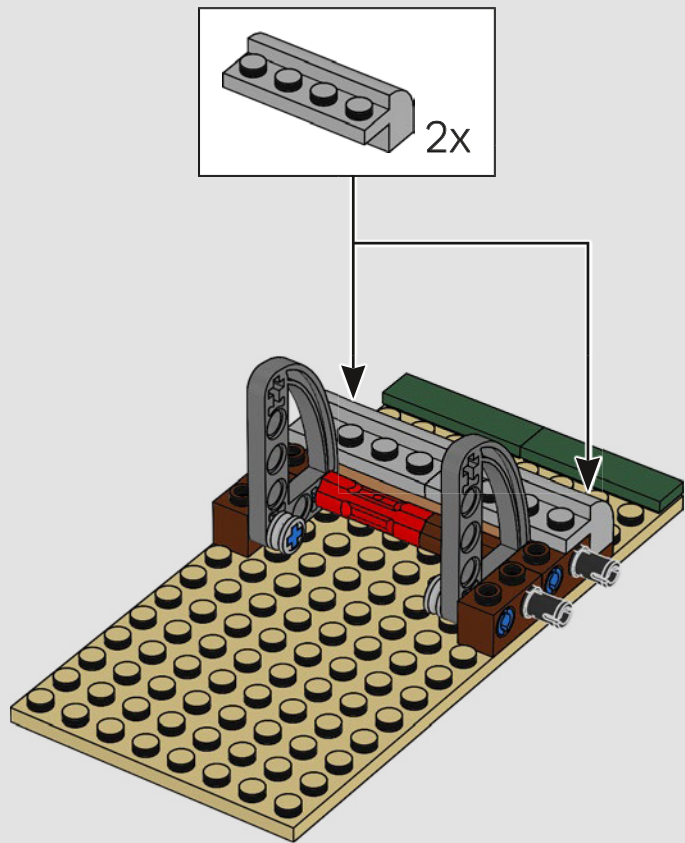

574

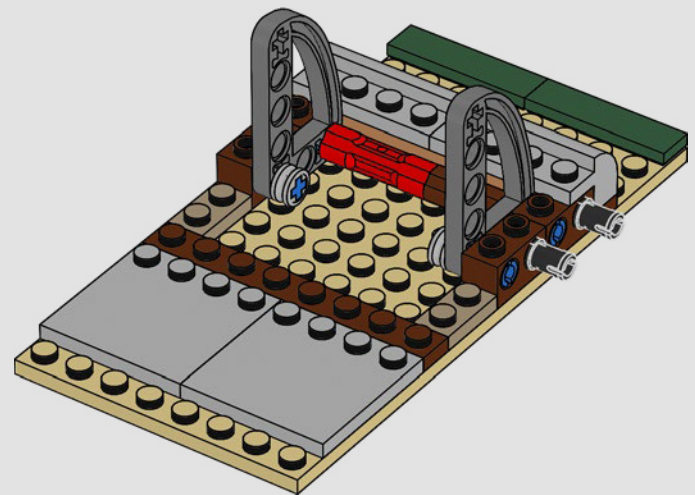



3x

575

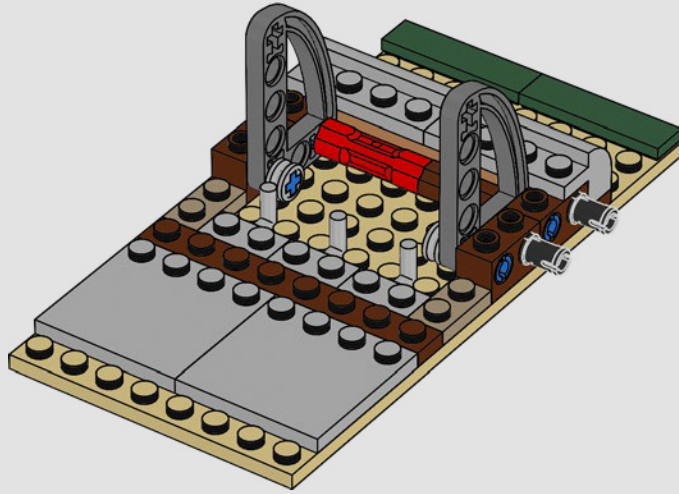

2x

576

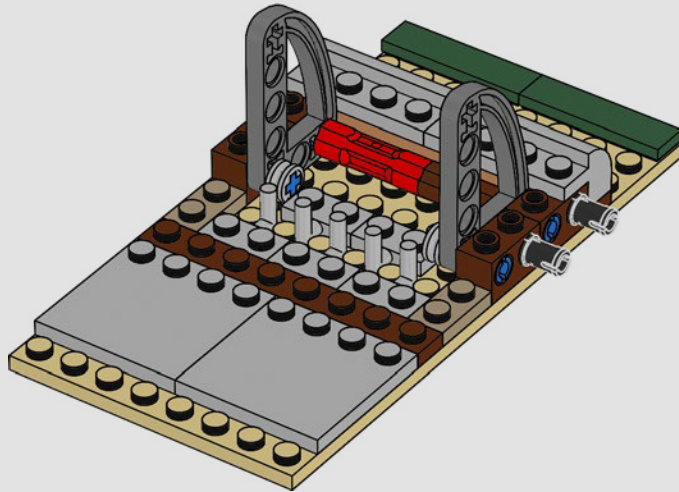

1x



2x



2x

577

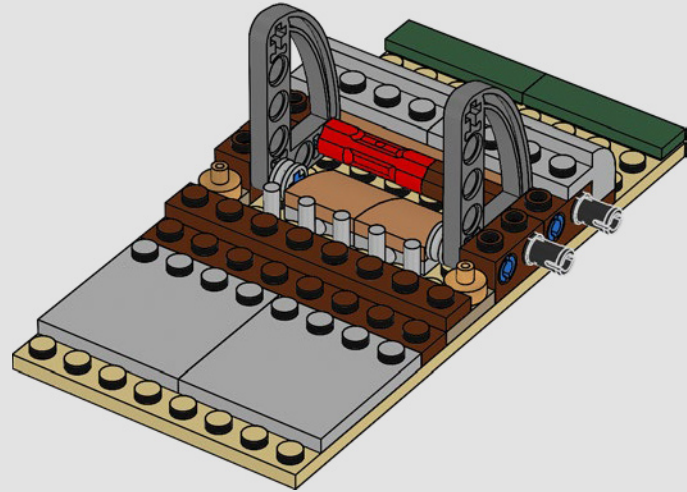



578

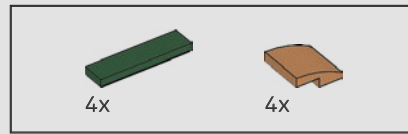
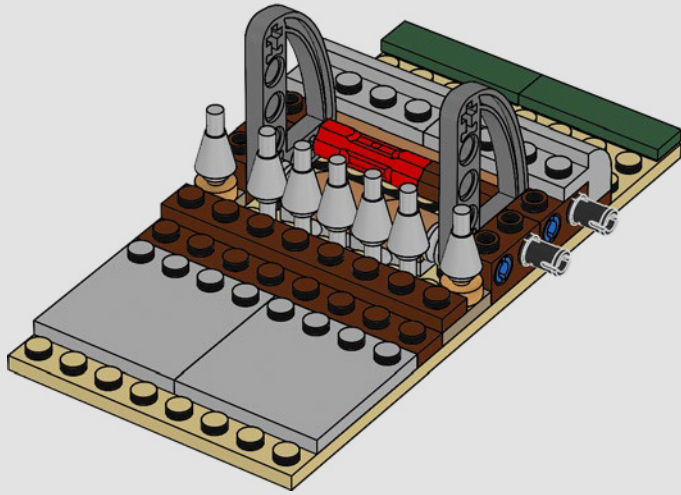

579

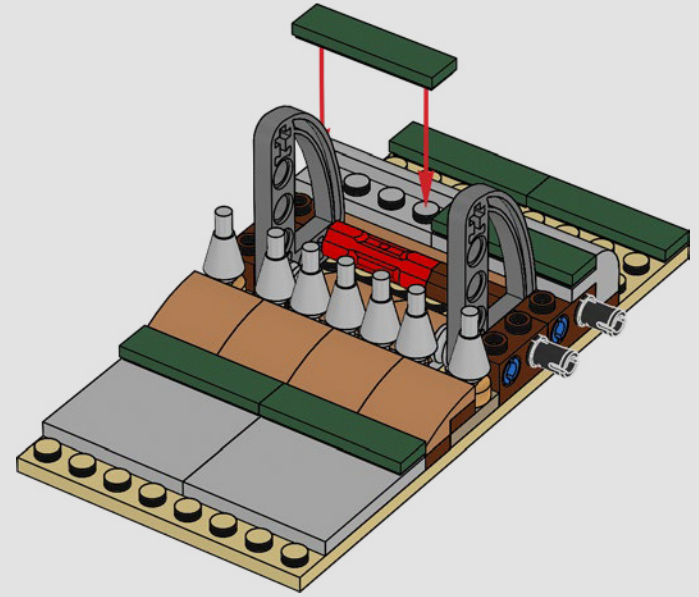

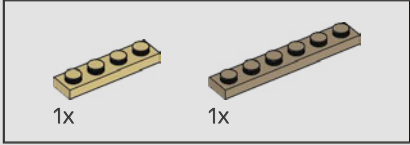
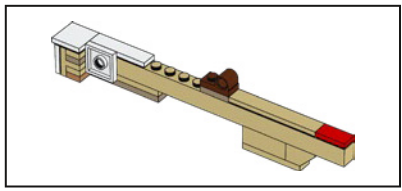

580

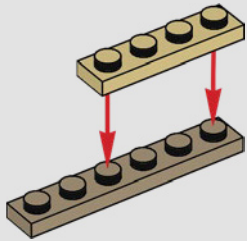

581

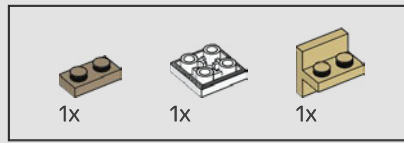
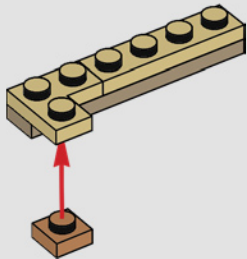

582

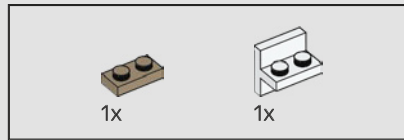
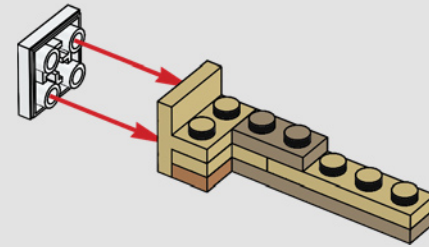

583

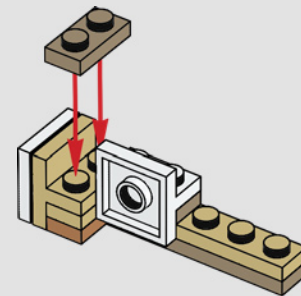

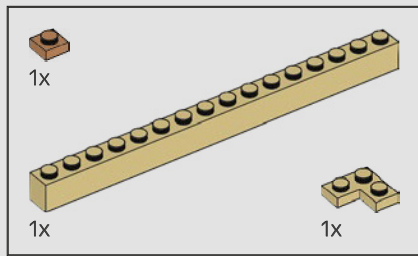

584

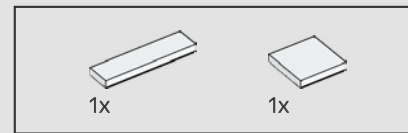
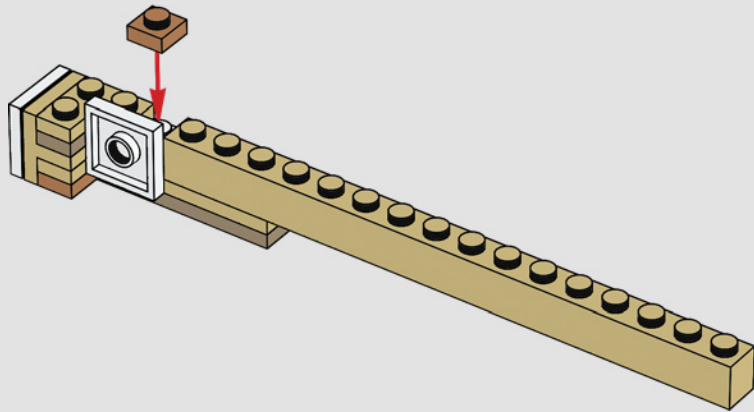

585

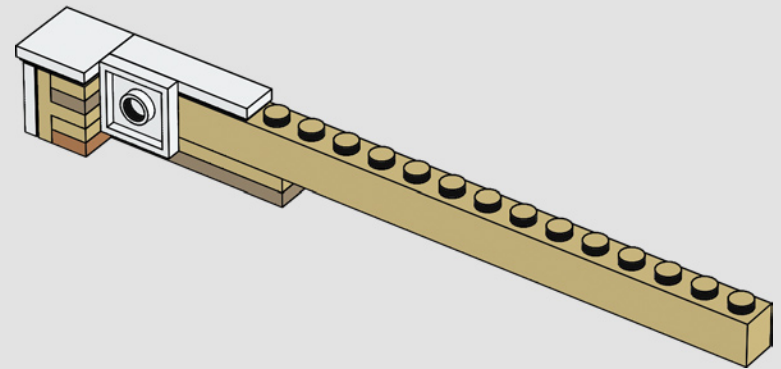

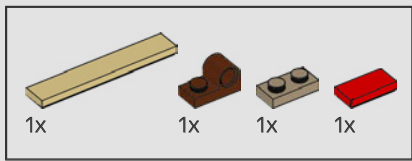

586

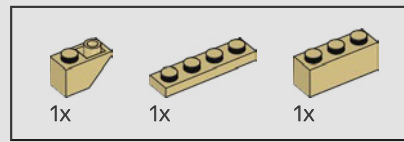
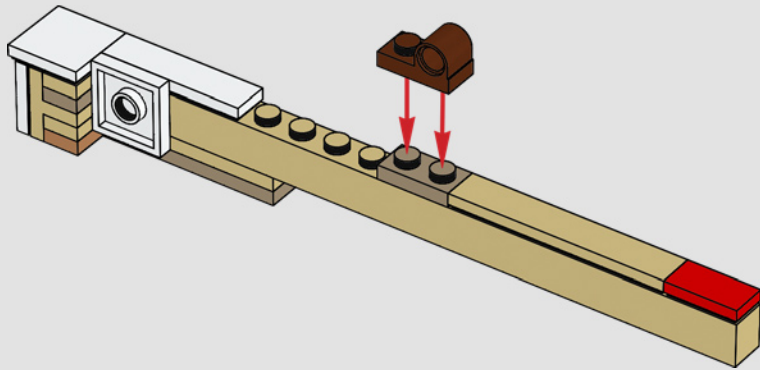

587

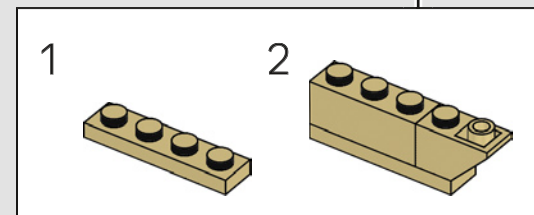
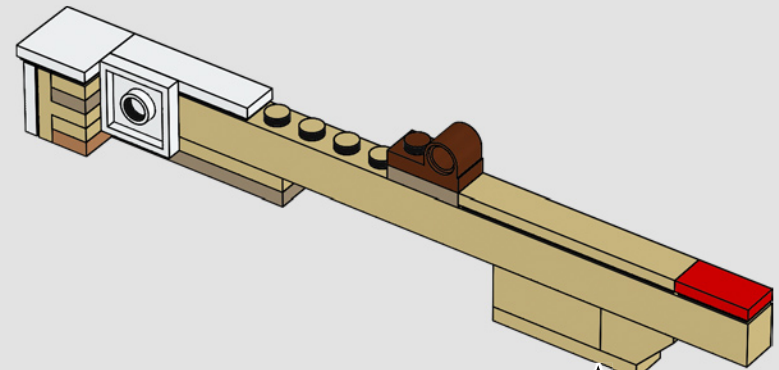

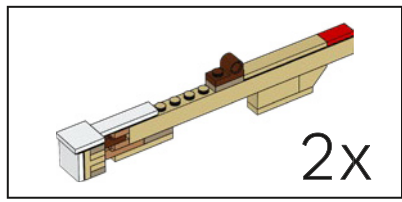

589

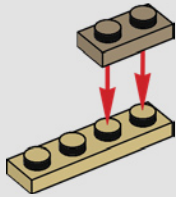

590

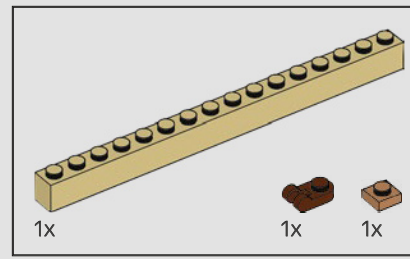
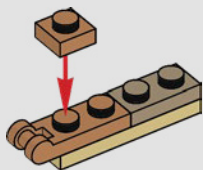

591

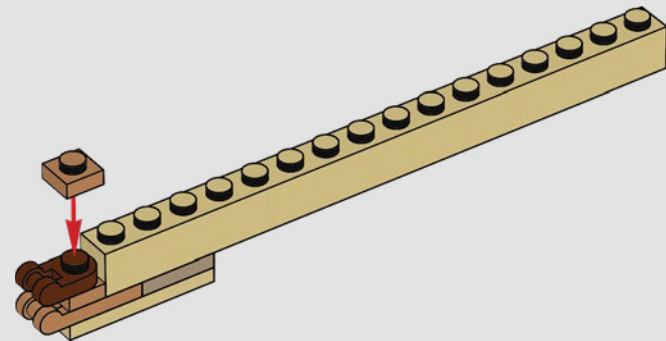

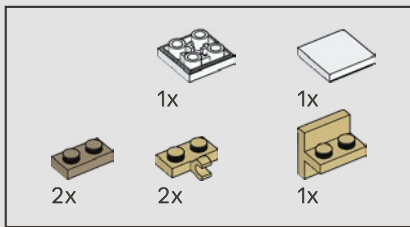

592

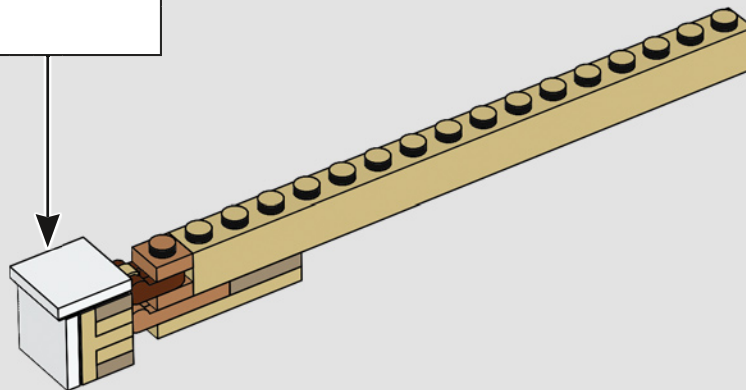
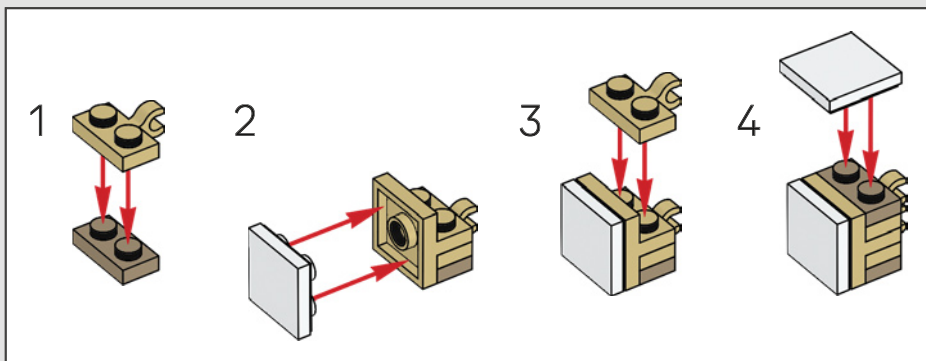

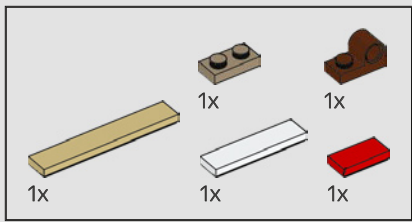

593

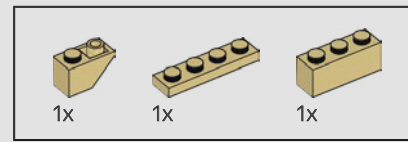
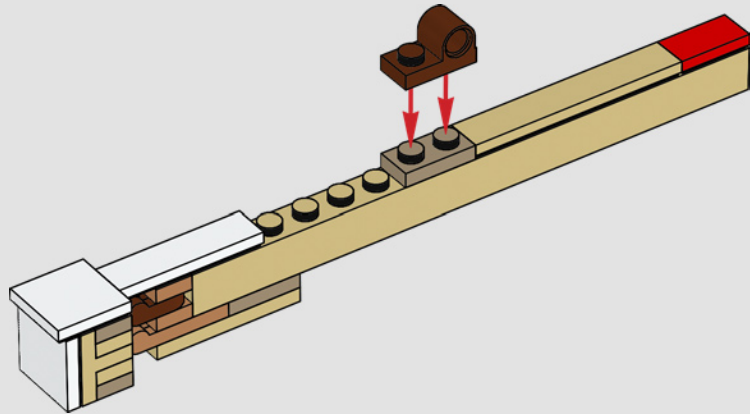

594

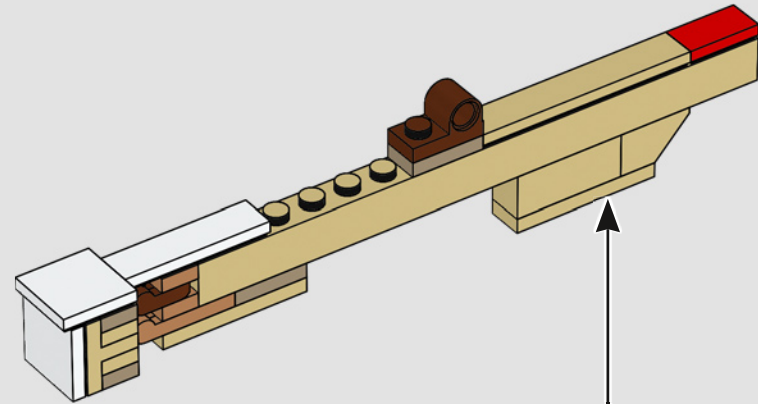

2x

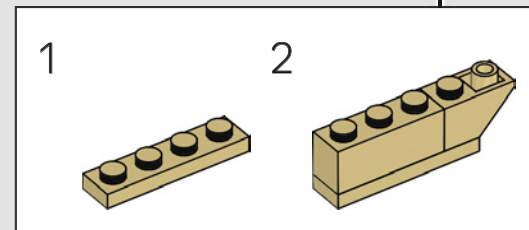

595

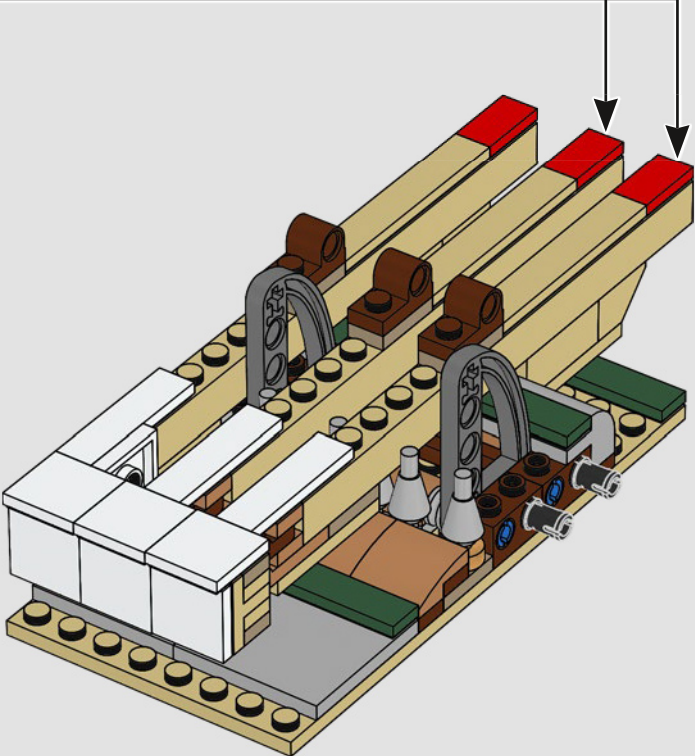

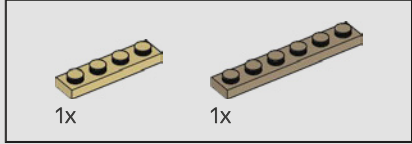
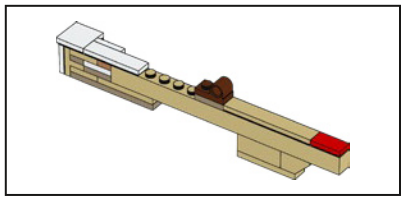

596

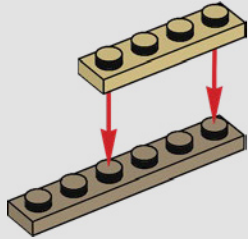

597

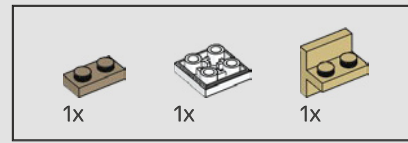
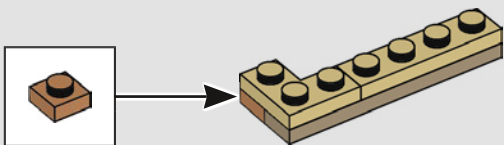

598

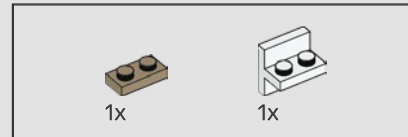
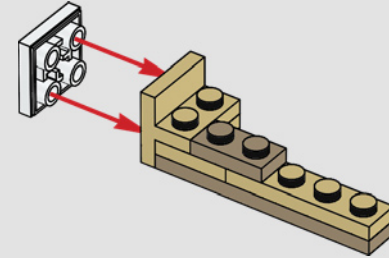

599

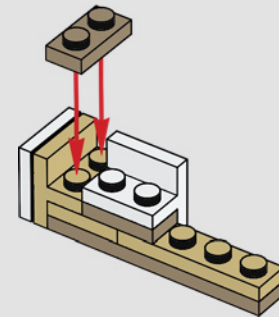

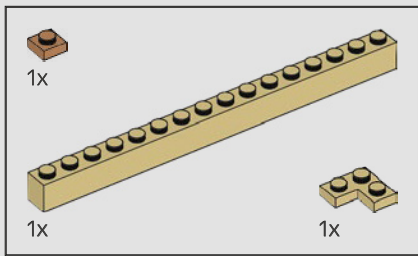

600

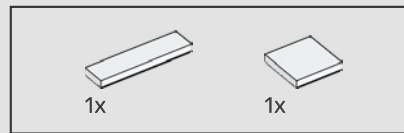
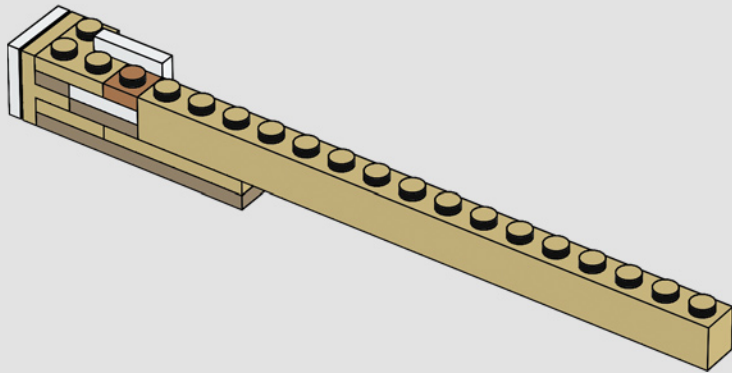

601

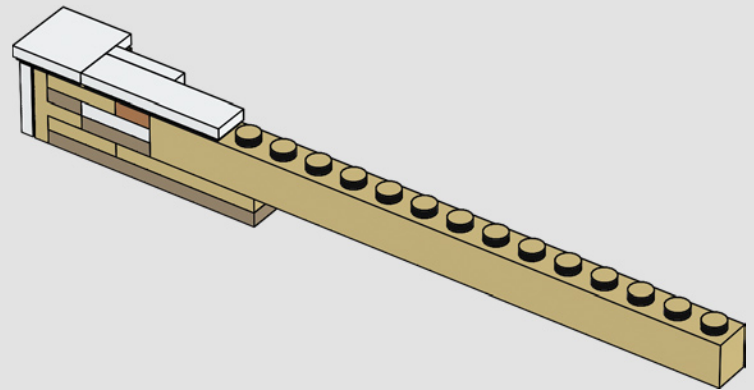

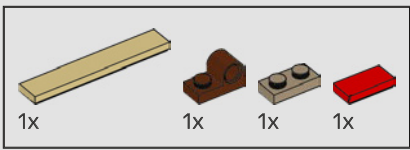

602

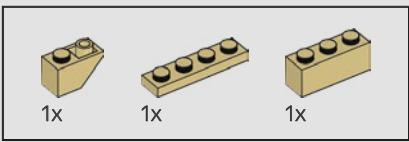
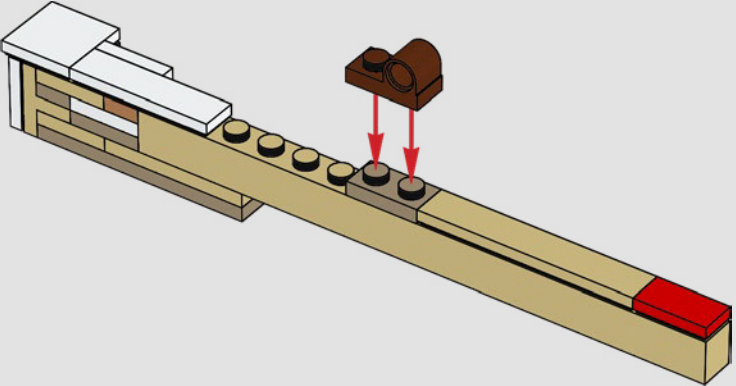

603

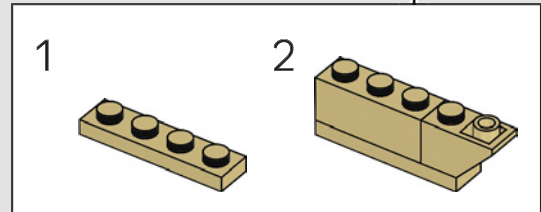
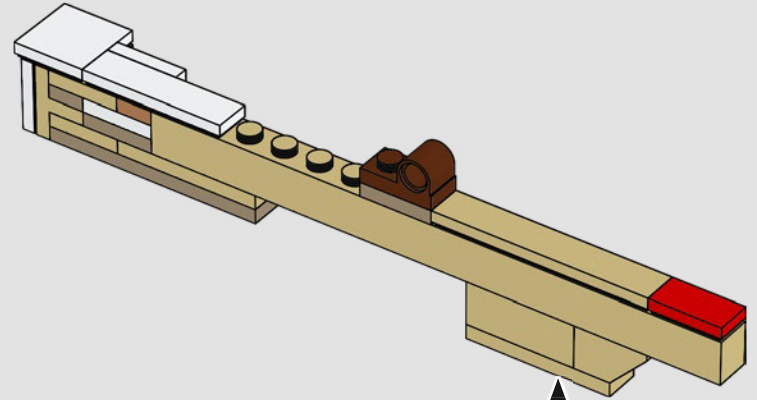

604

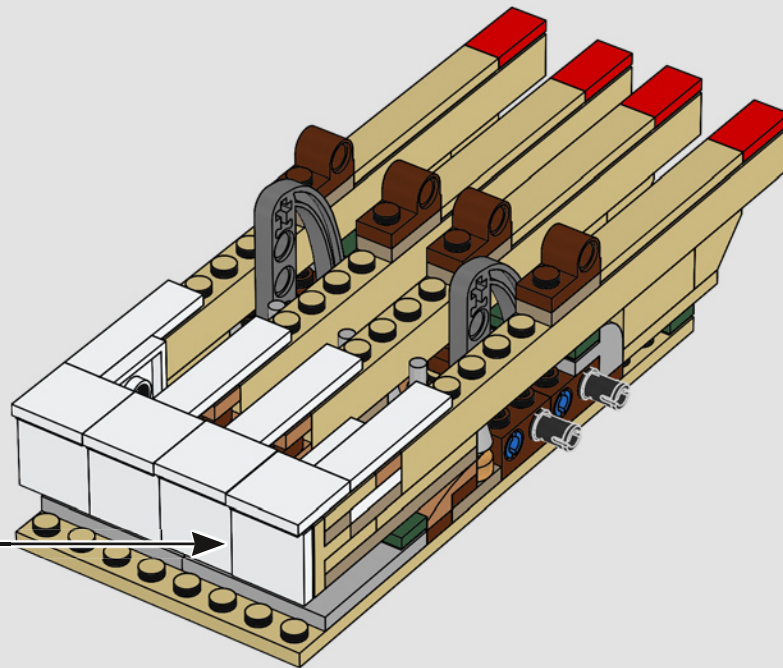

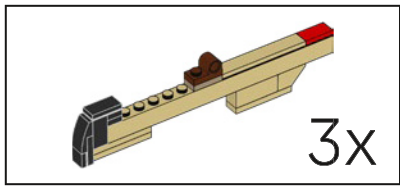

3x

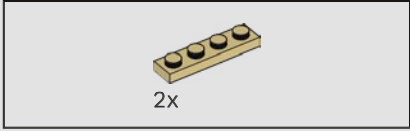

2x

605

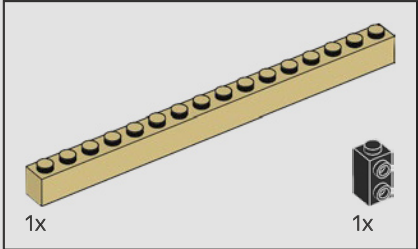
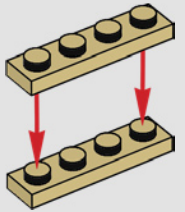

1x

1x

606

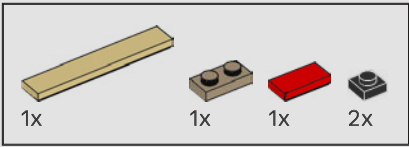
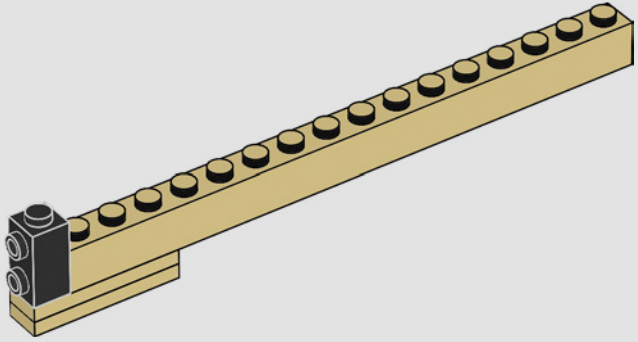

1x

1x

1x

2x

607

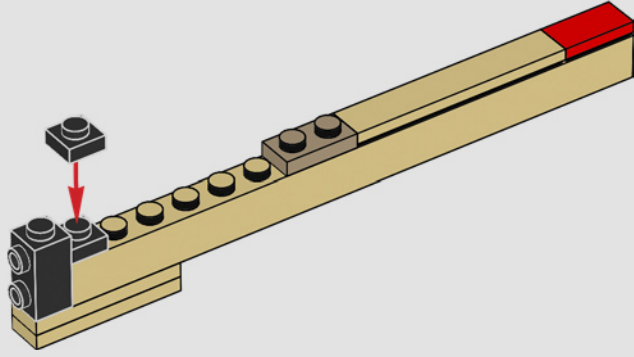

1x

1x

608

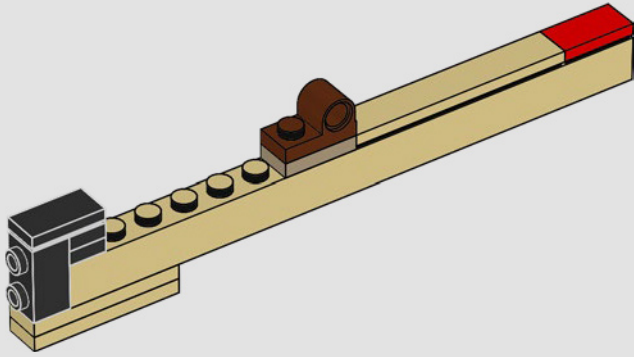

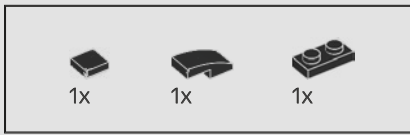

609

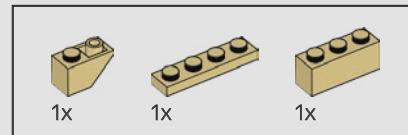
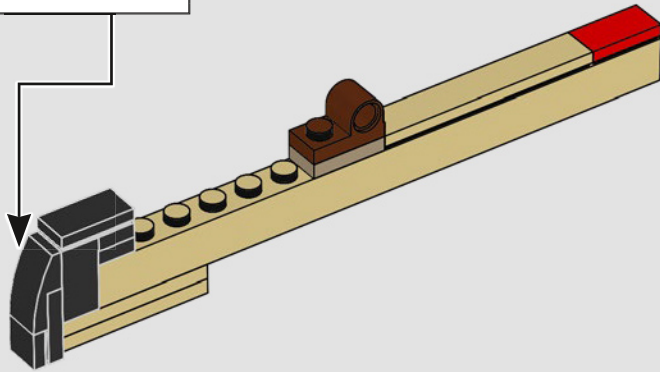
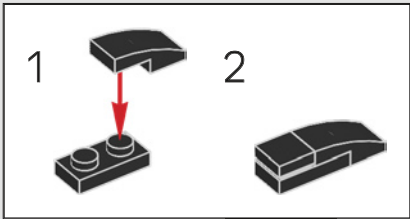

610

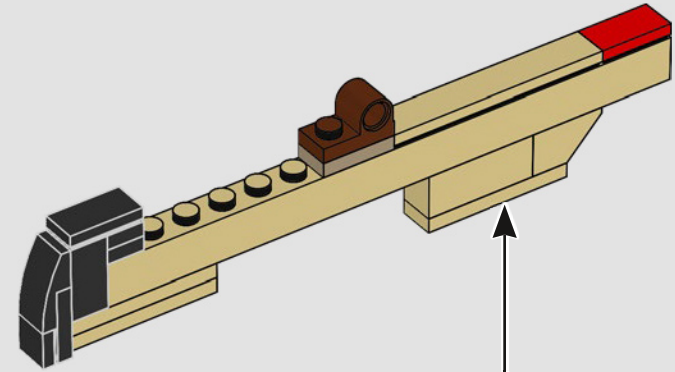

3x

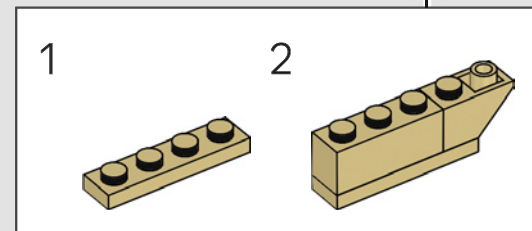

611

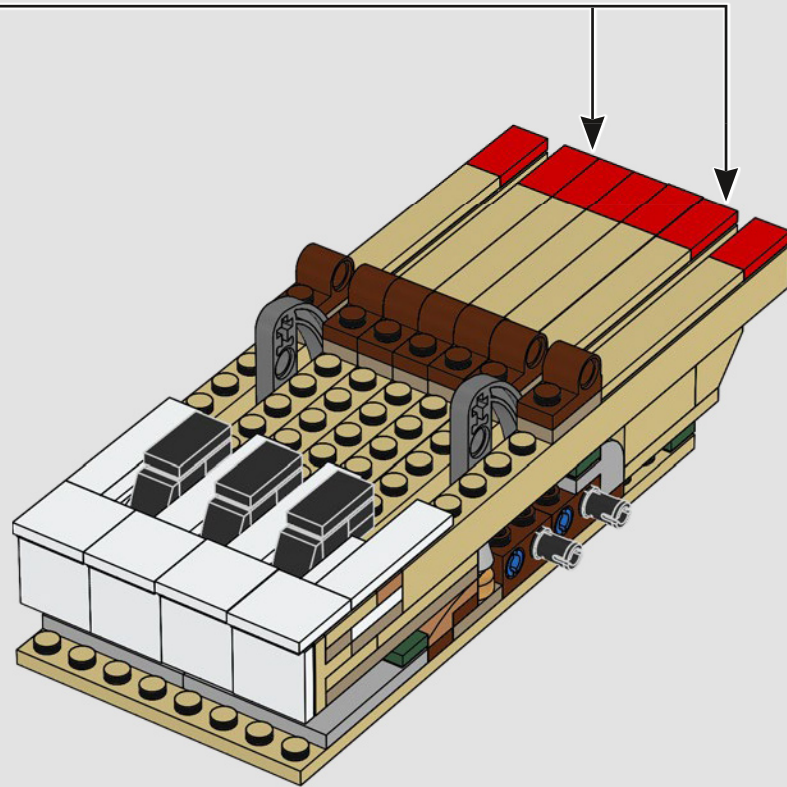



612

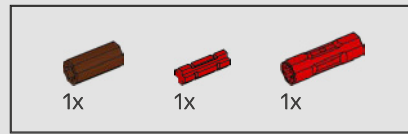
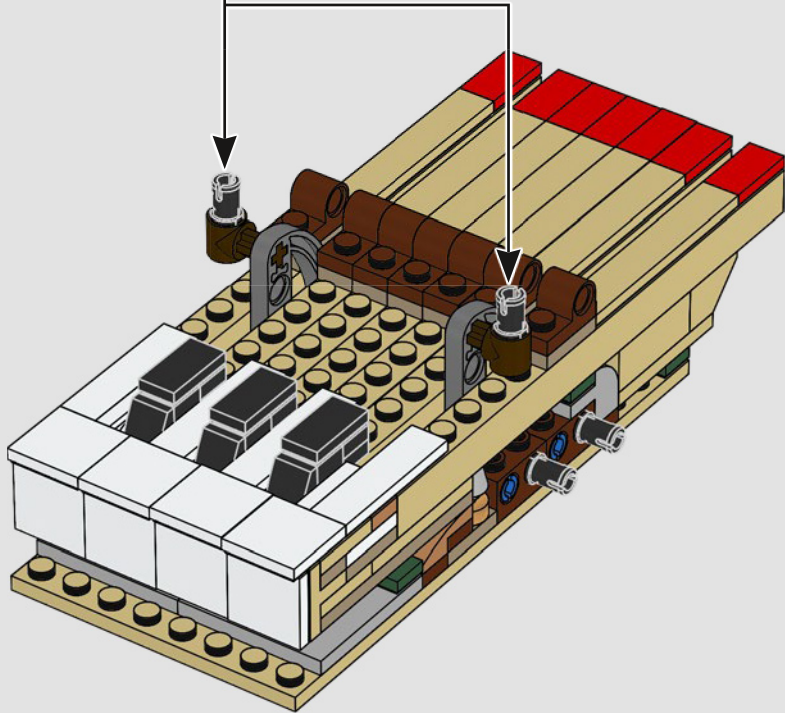
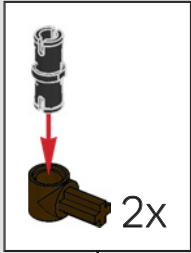

613

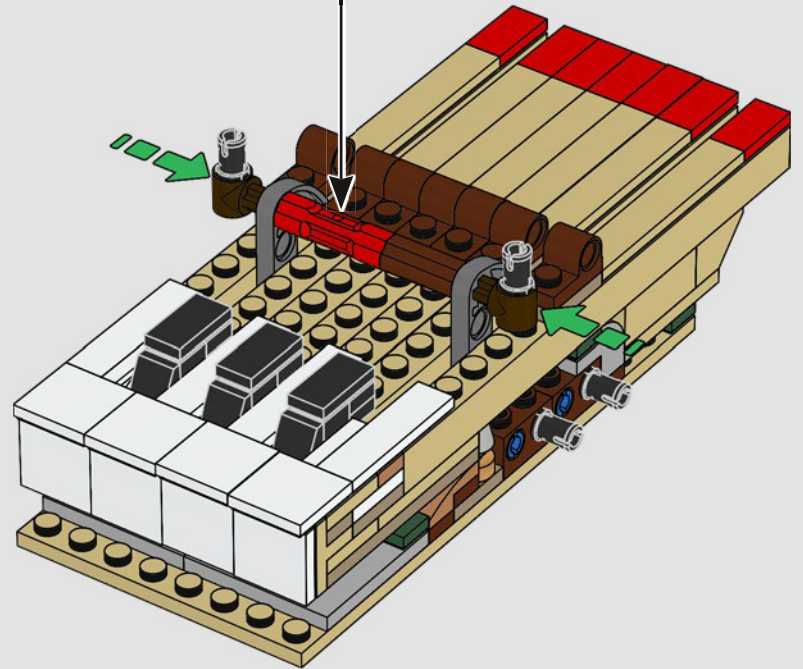
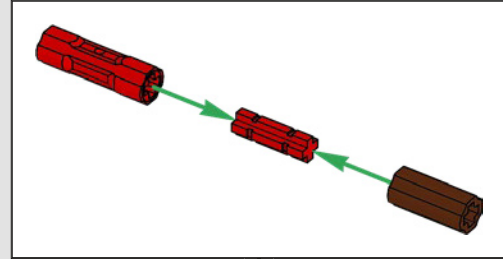

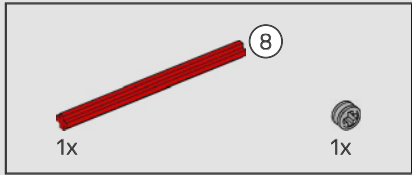
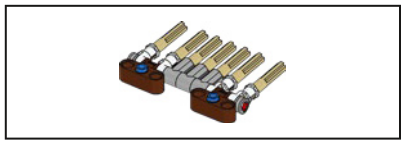

614

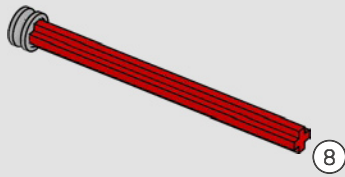

615

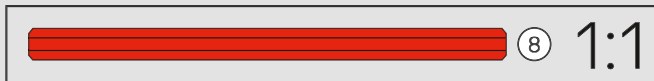
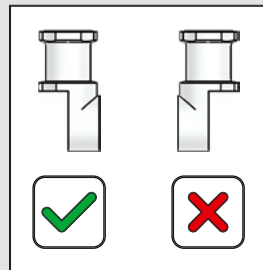
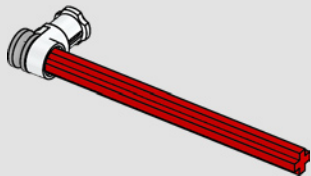

616

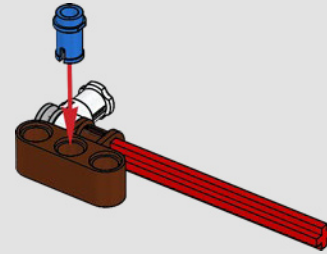

617

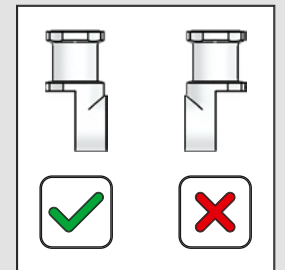
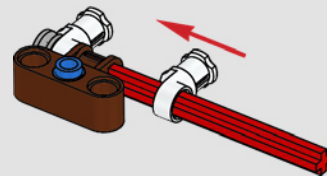



618

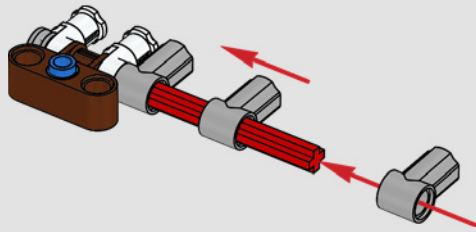

619

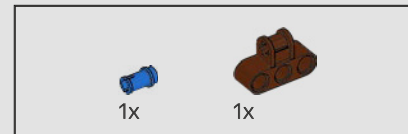
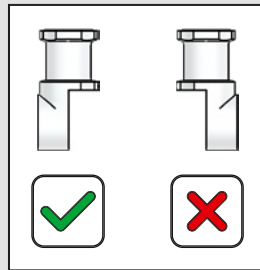
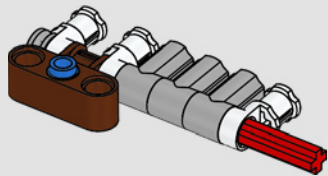

620

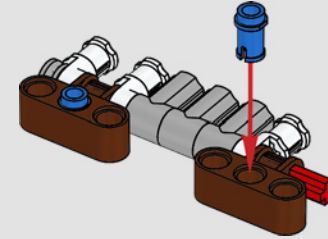

621

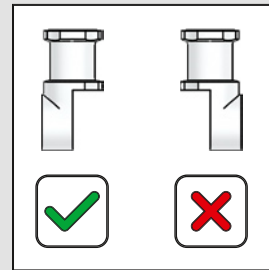
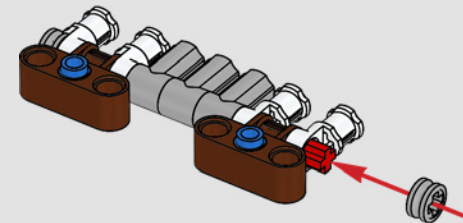

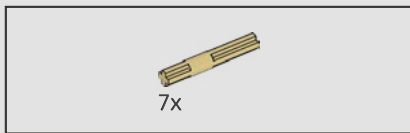

622

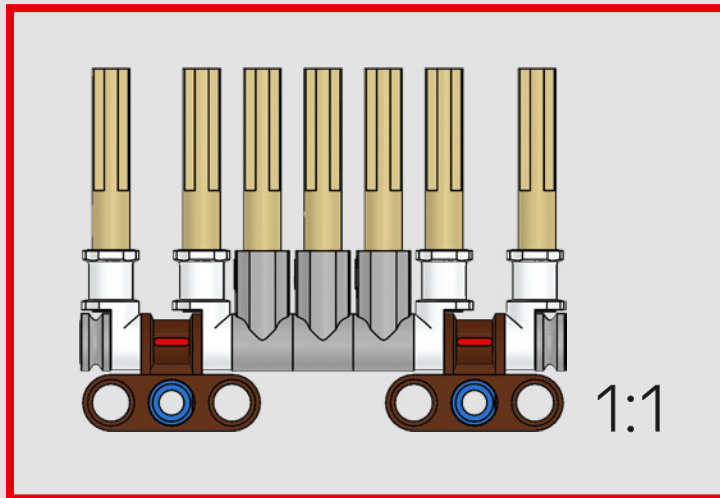
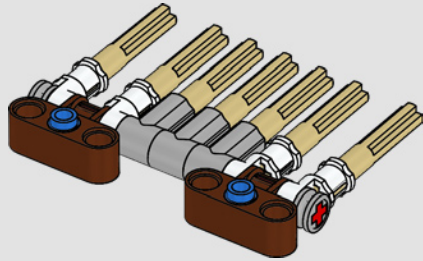

623

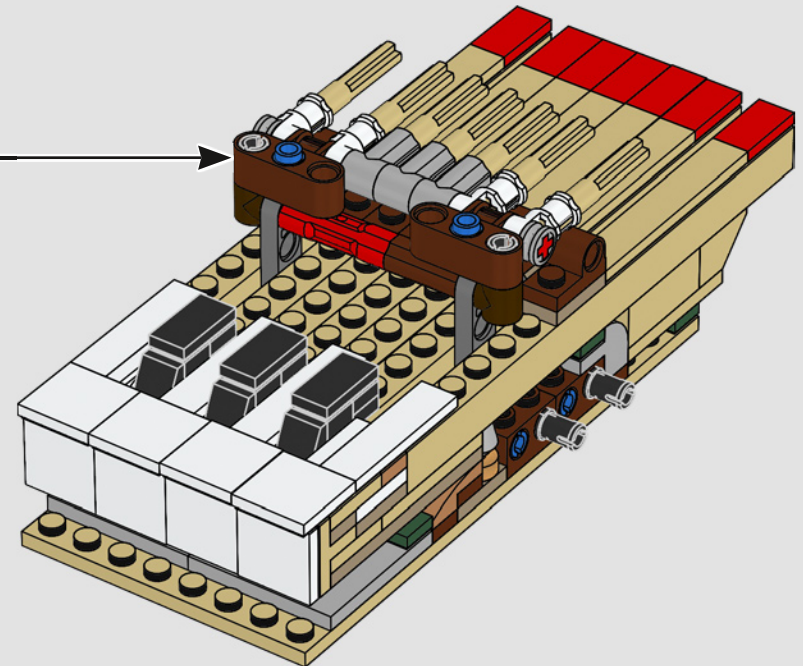

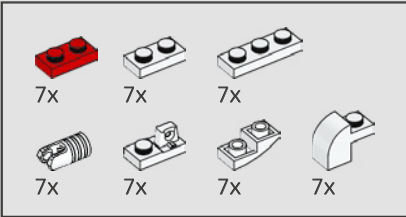
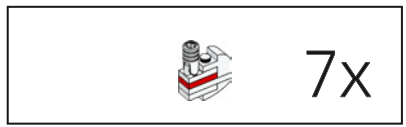

624

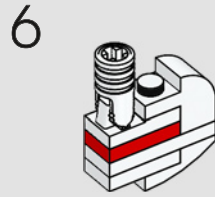
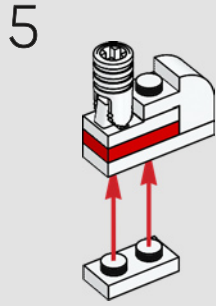
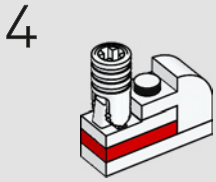
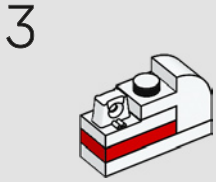
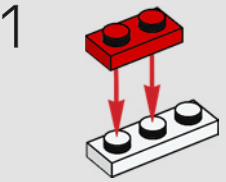

7x

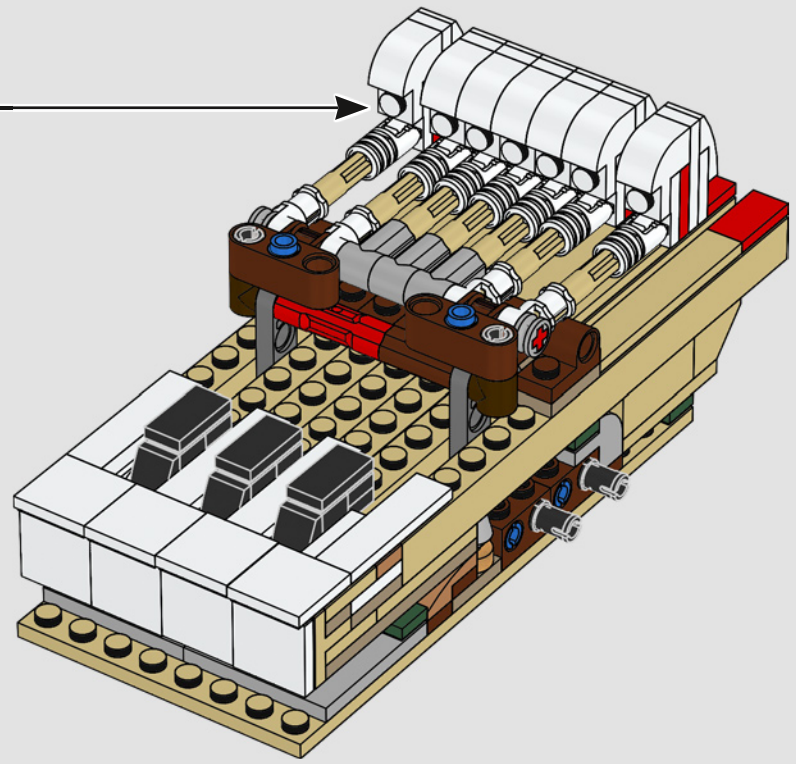



625

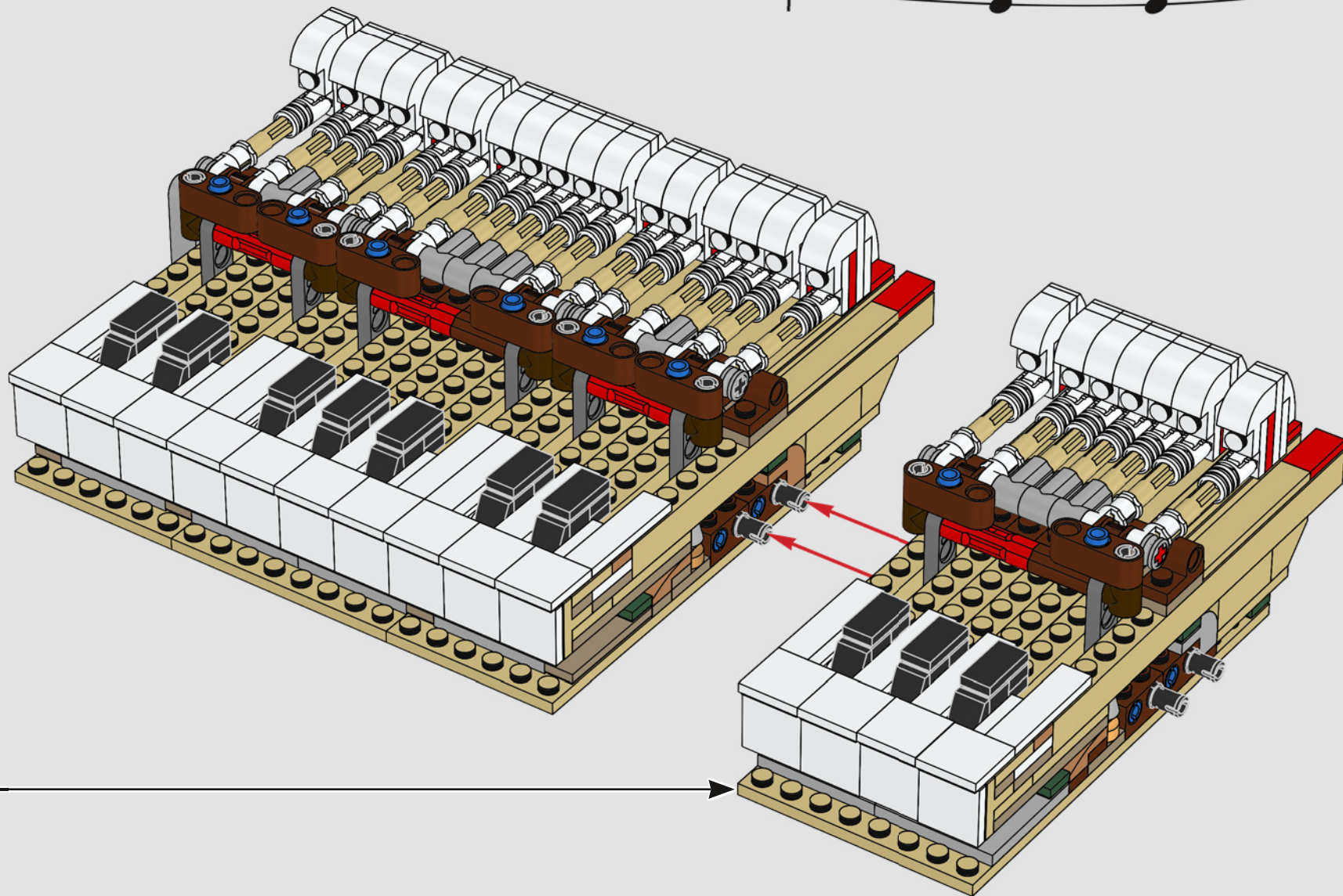

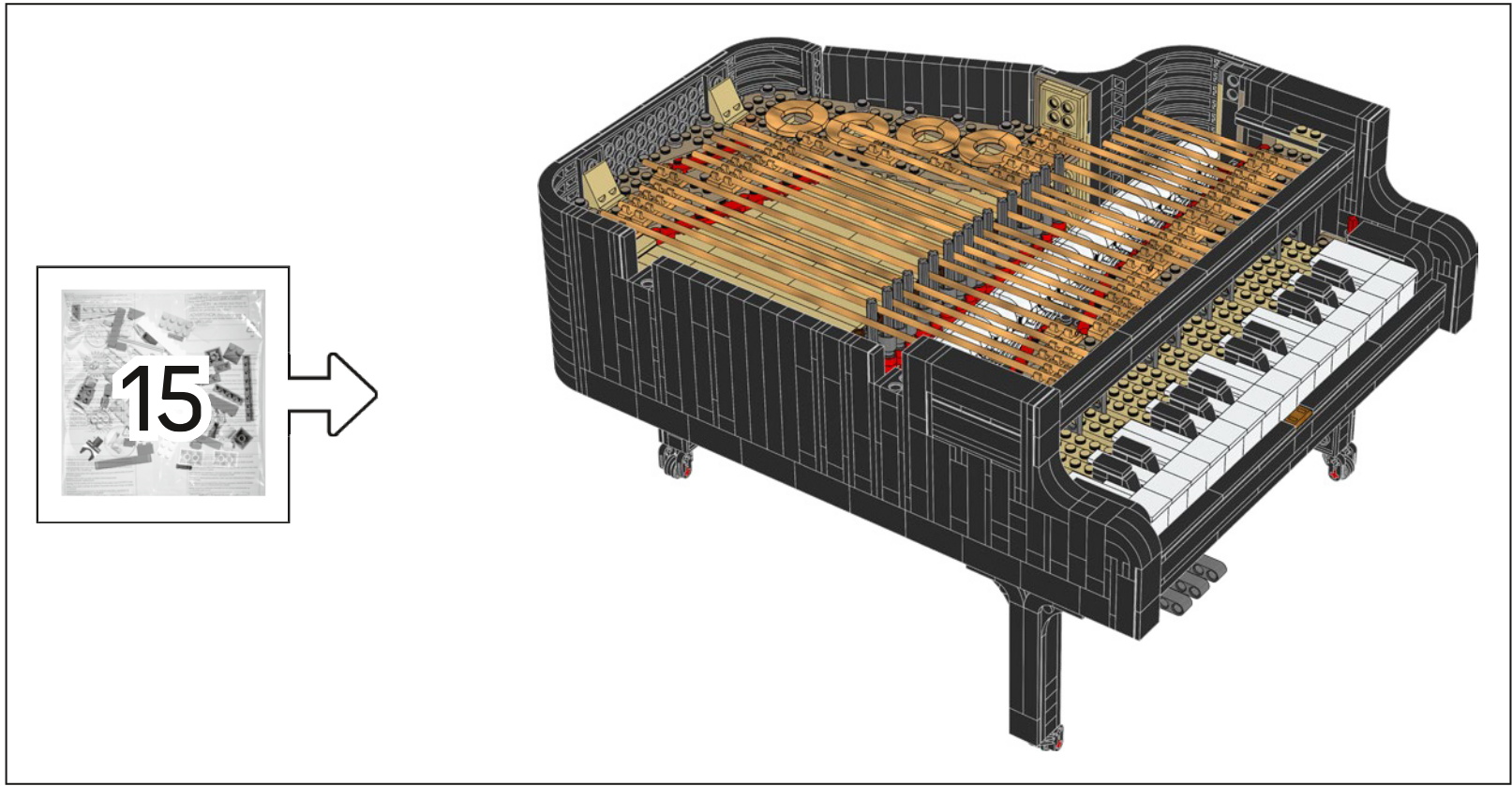

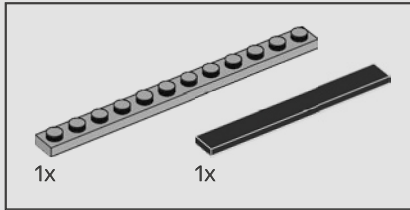
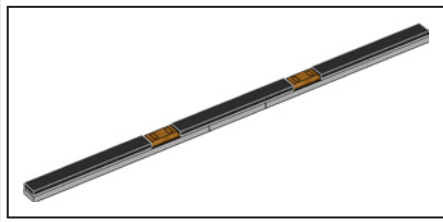

626

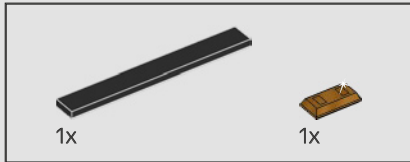
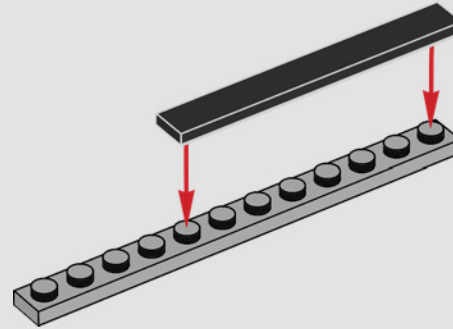

627

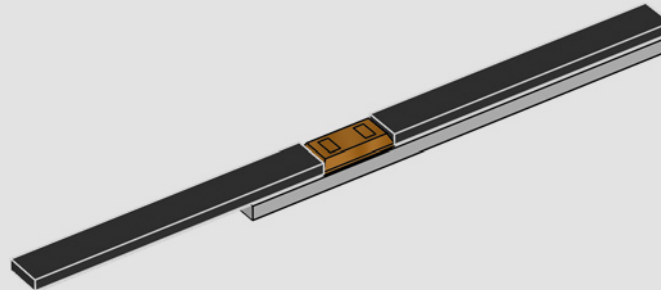

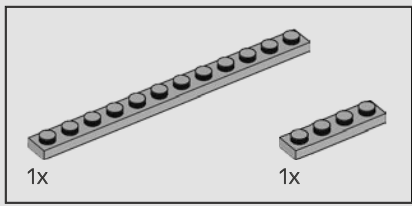

628

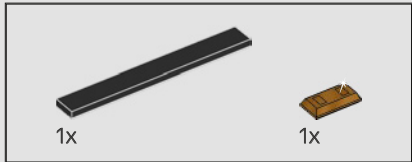
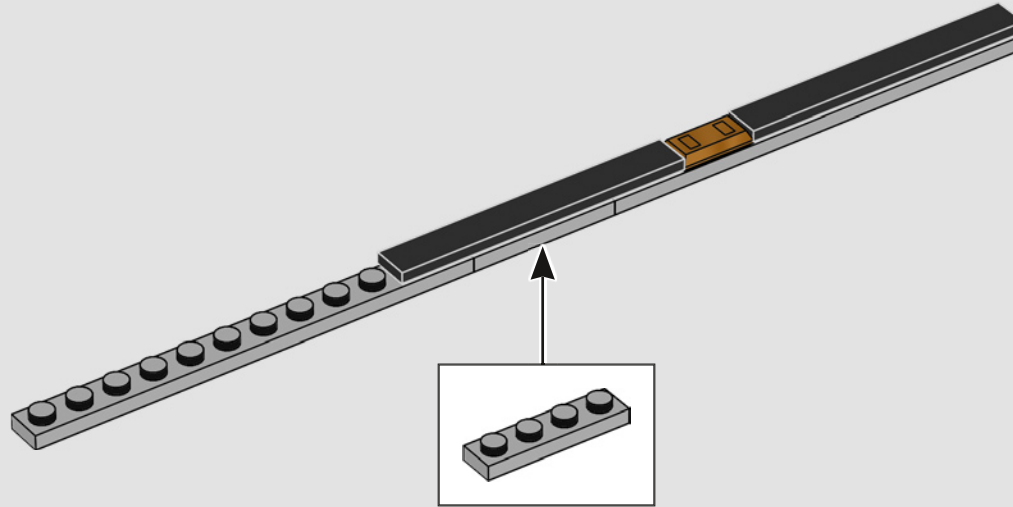

629

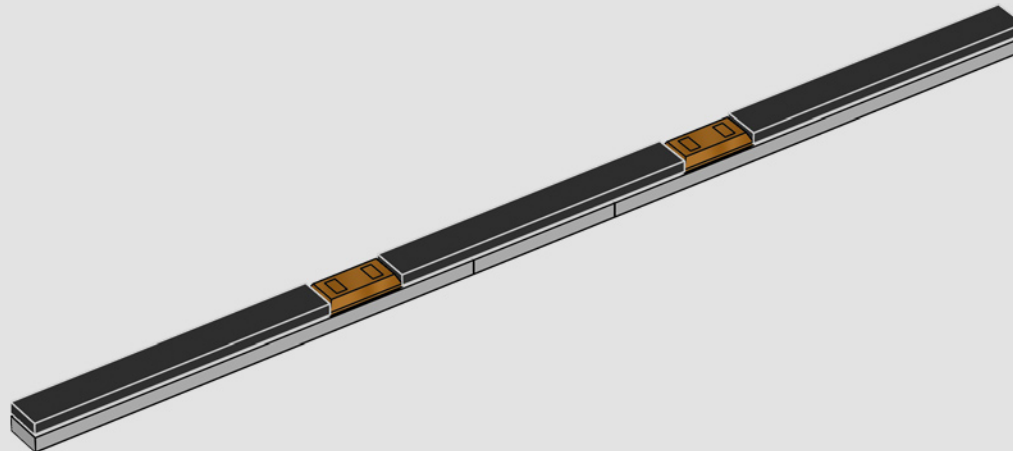

630

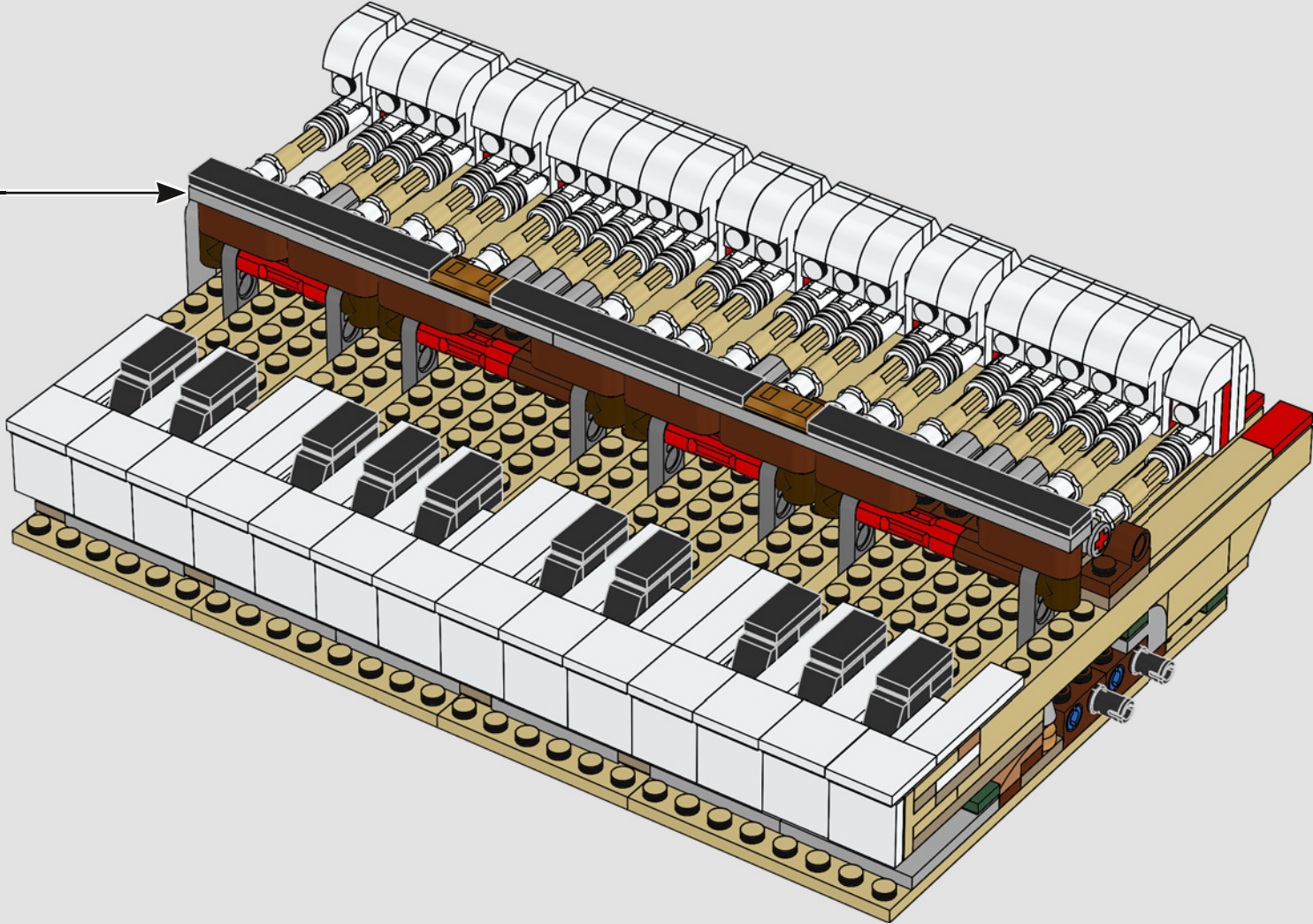

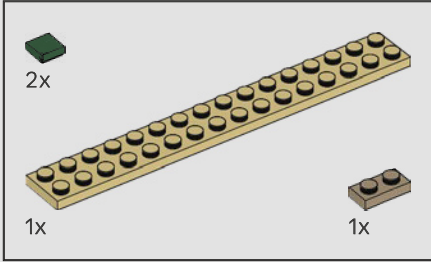
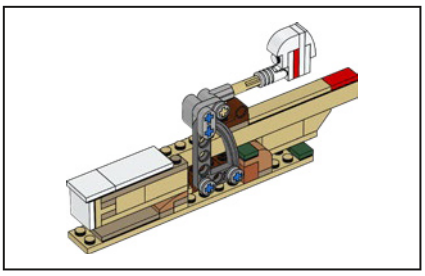

631

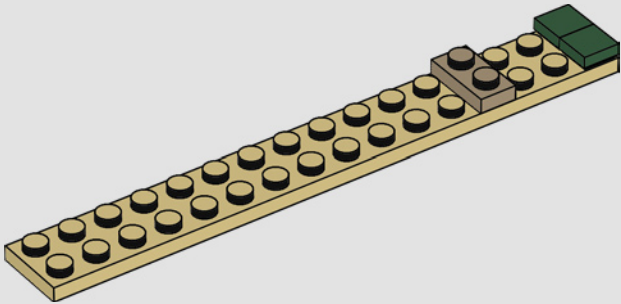

632

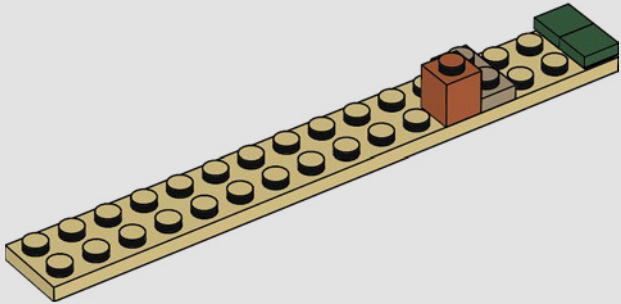

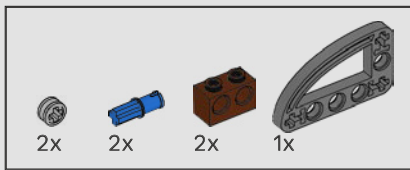

633

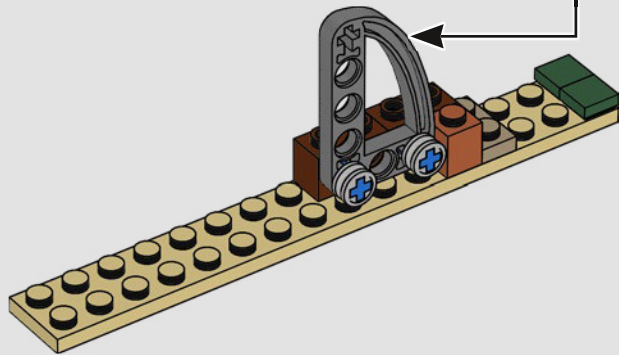
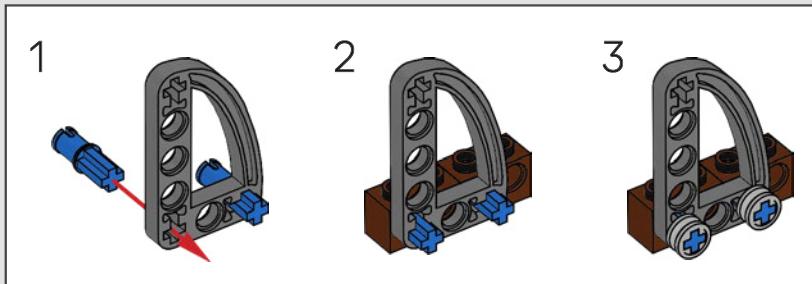

634

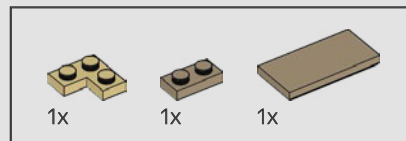
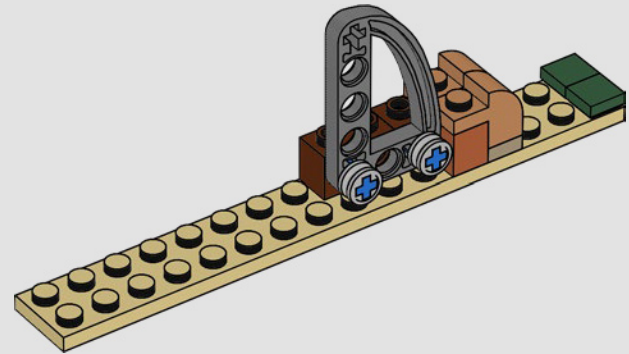

635

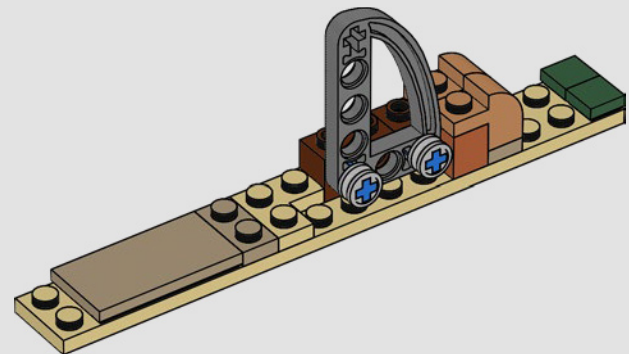

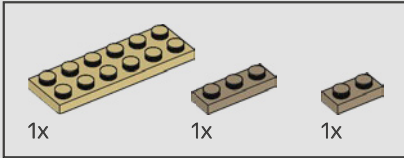
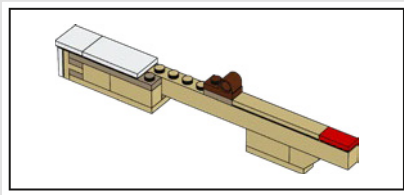

639

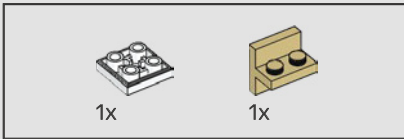
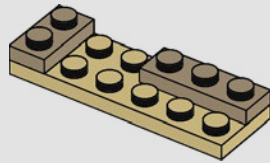

640

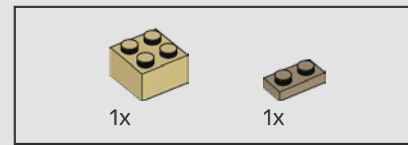
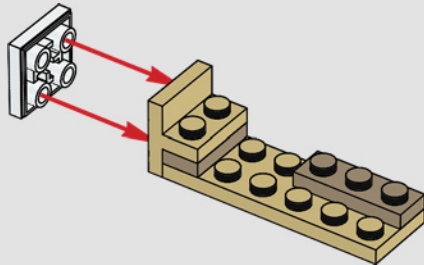

641

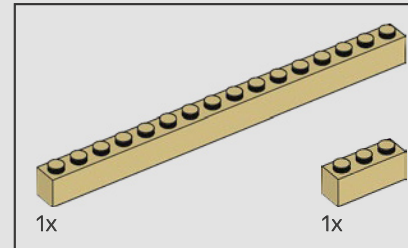
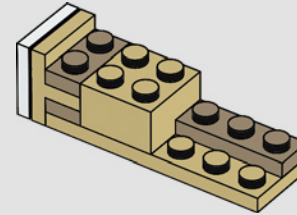

642

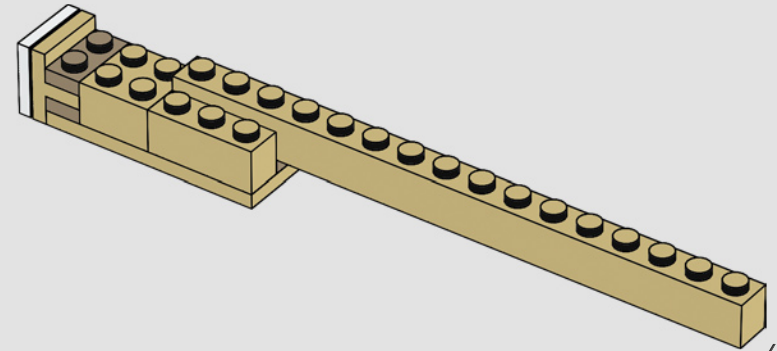

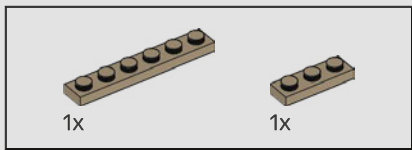

643

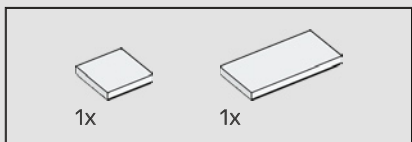
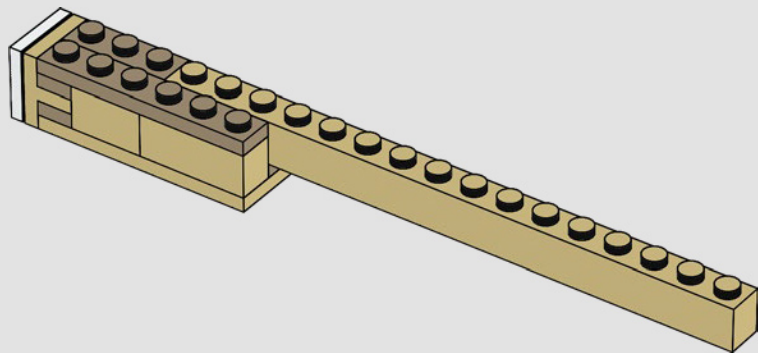

644

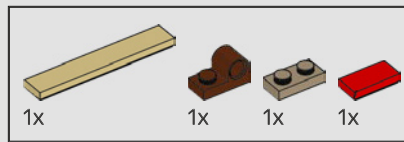
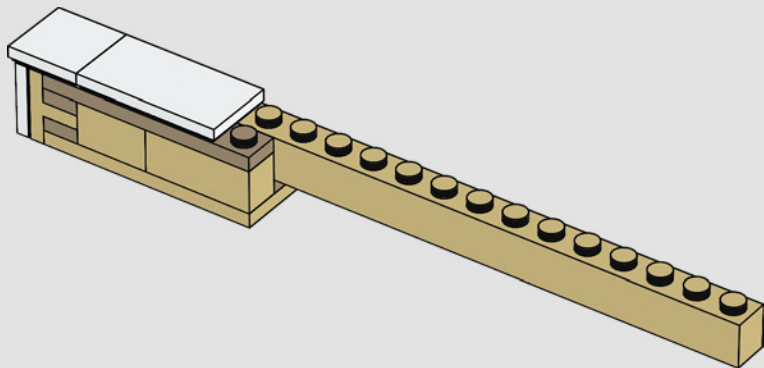

645

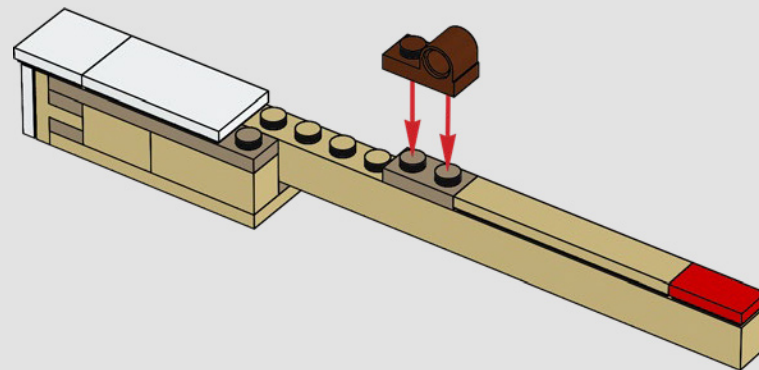

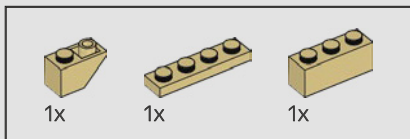

646

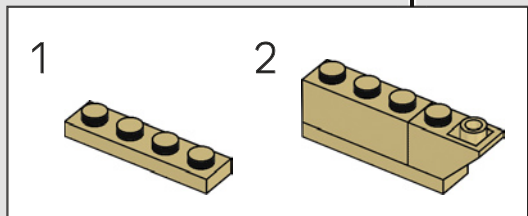
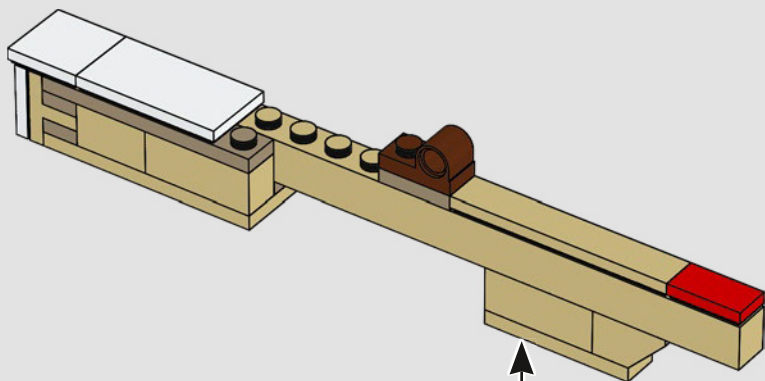

647

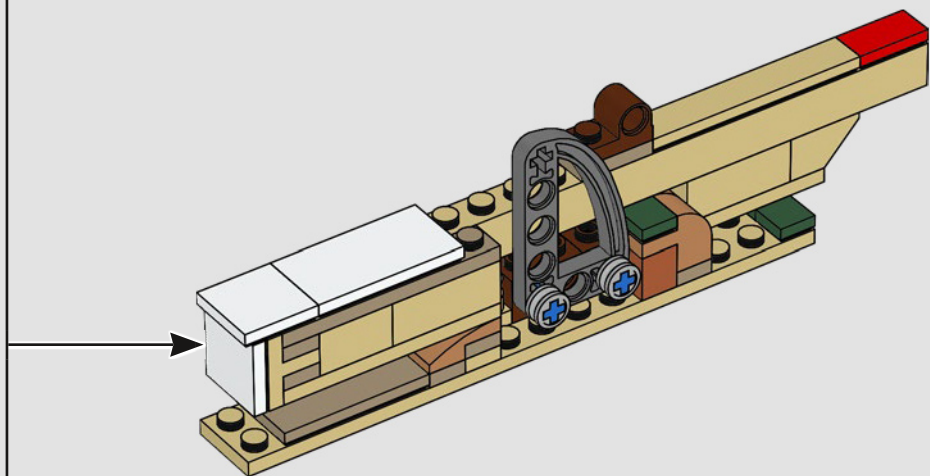

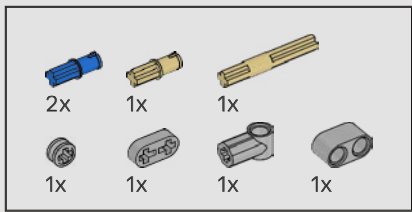

648

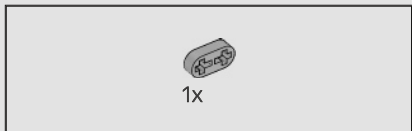
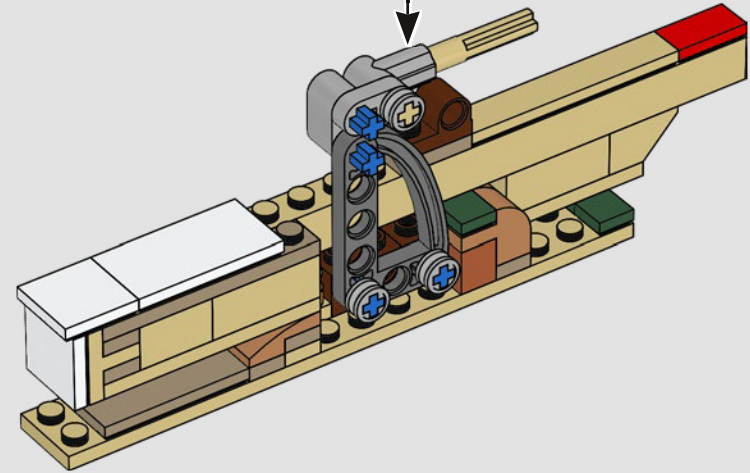
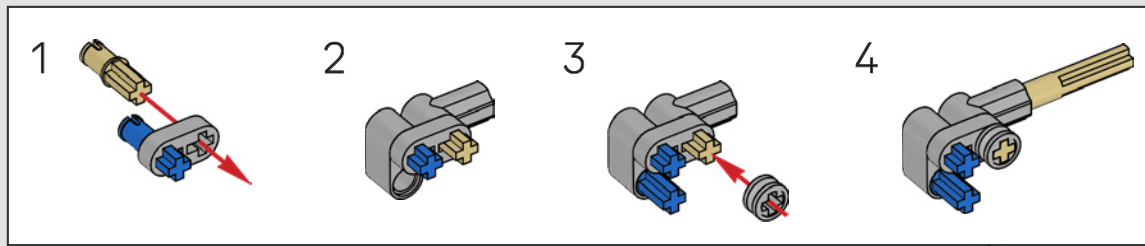

649

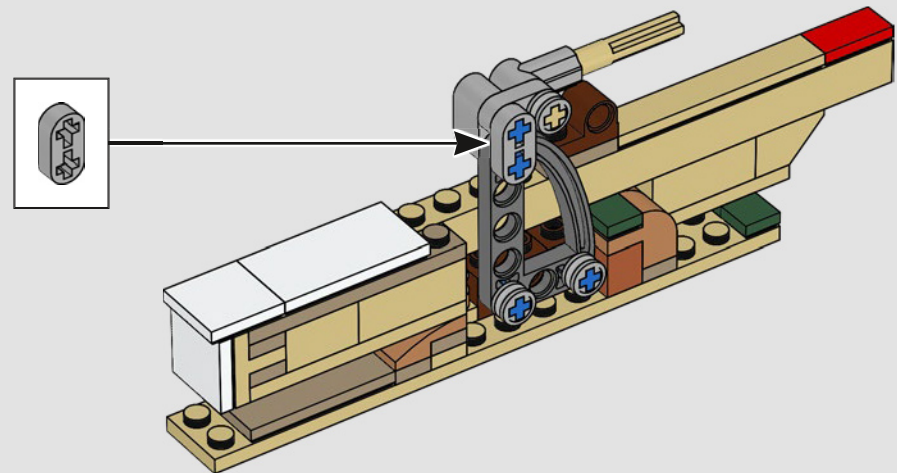

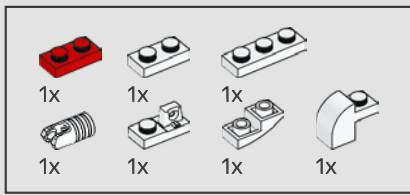

650

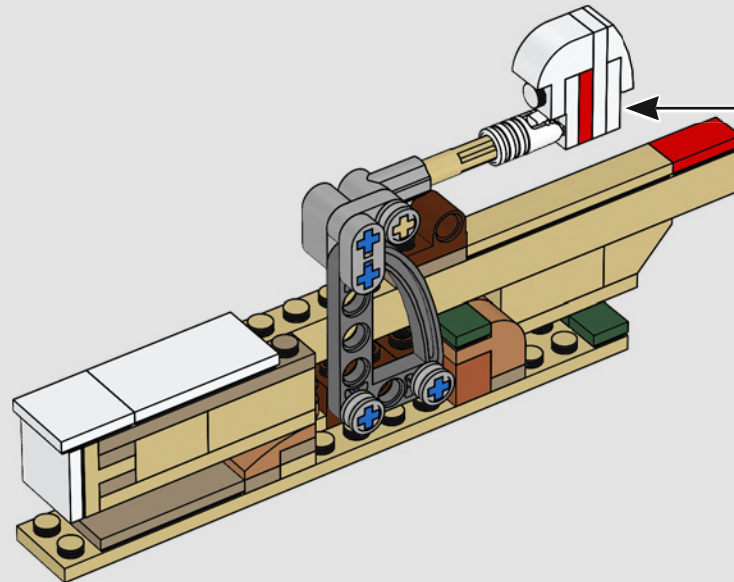
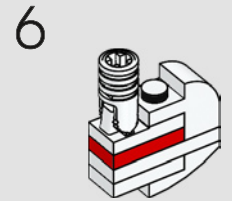
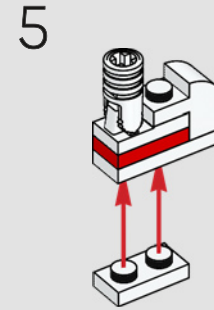
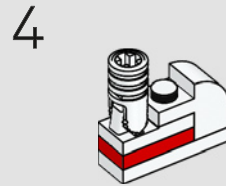
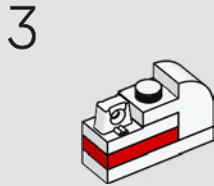
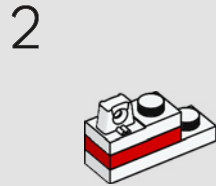
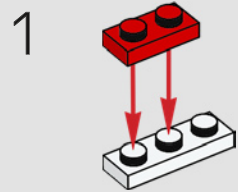



651

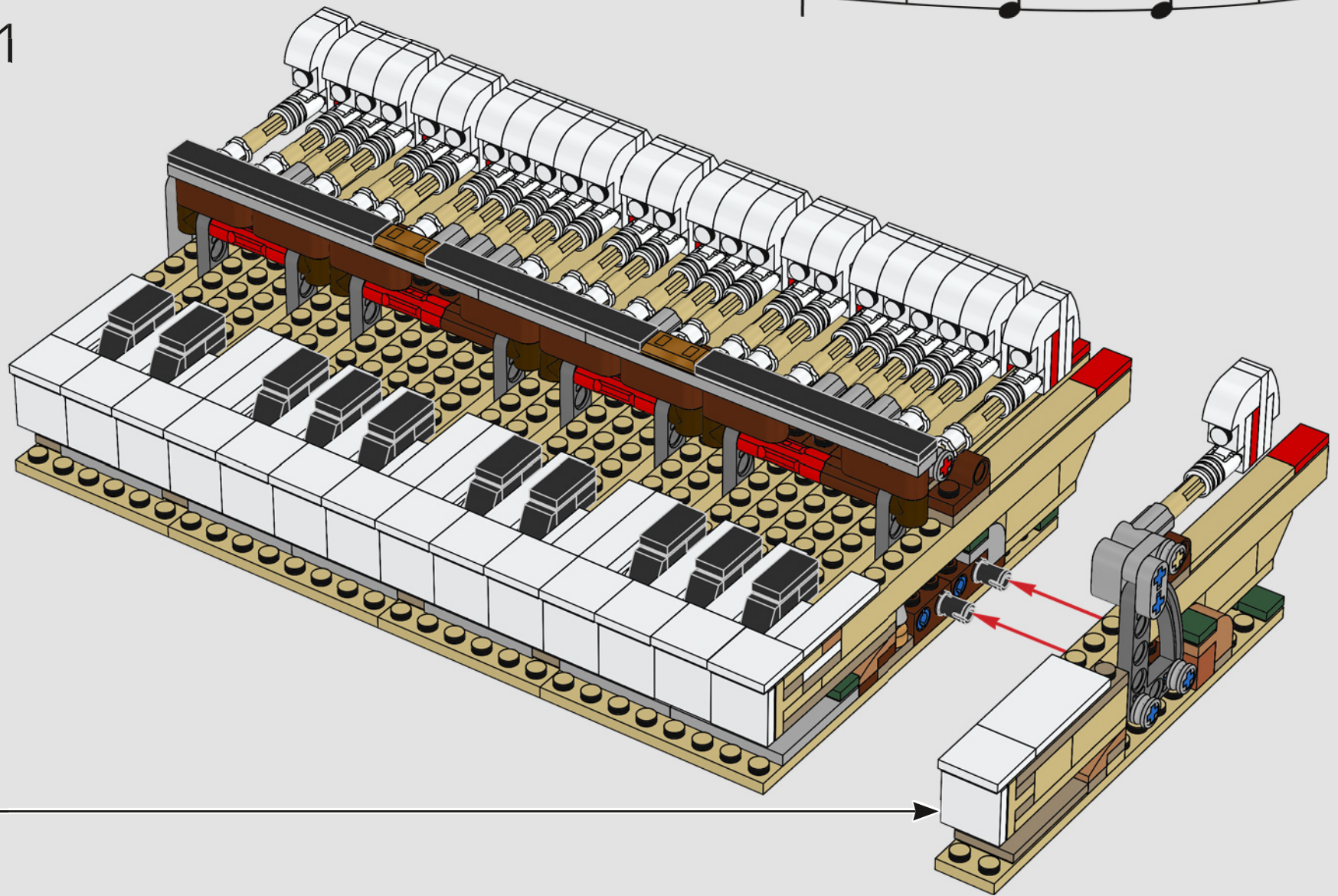

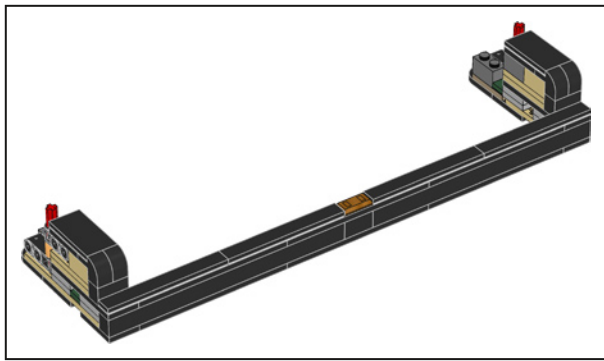

“ Music cleanses the understanding; inspires it and lifts it into a realm which it would not reach if it were left to itself. ”
Henry Ward Beecher

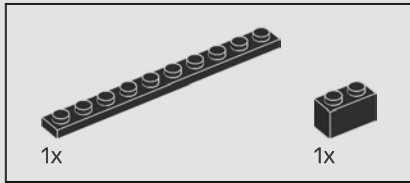

653

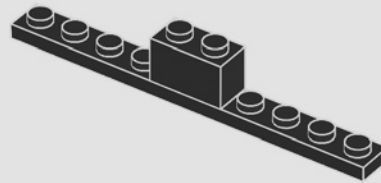

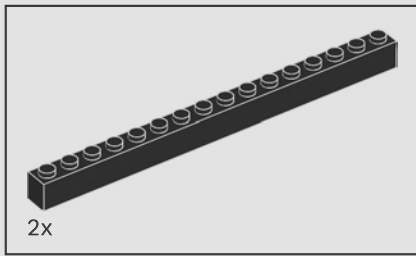

654

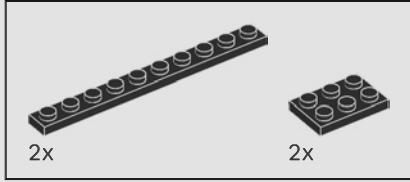
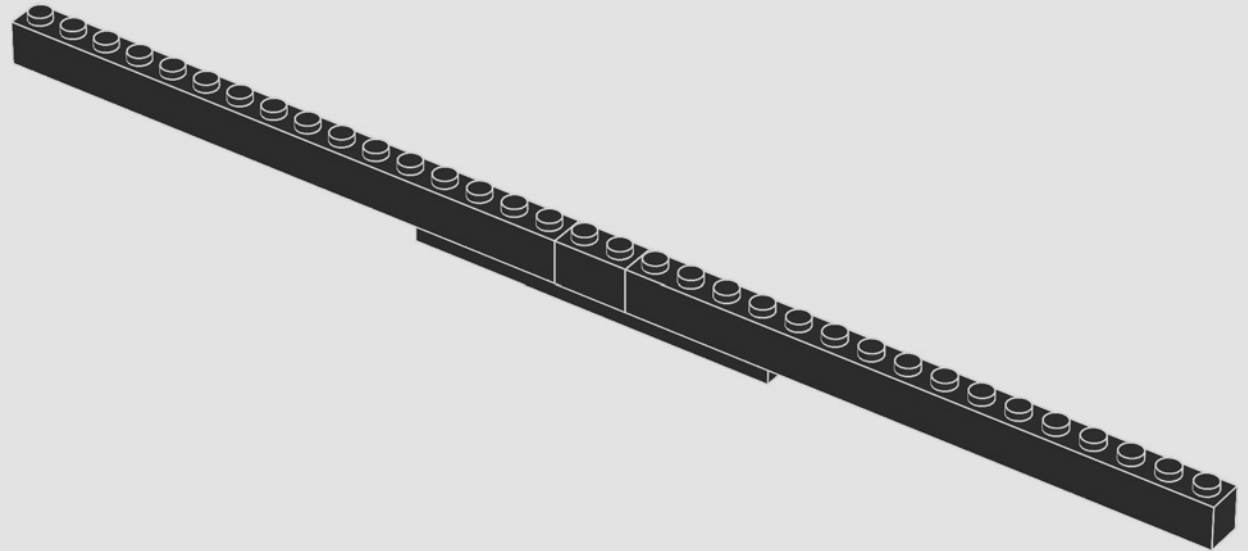

655

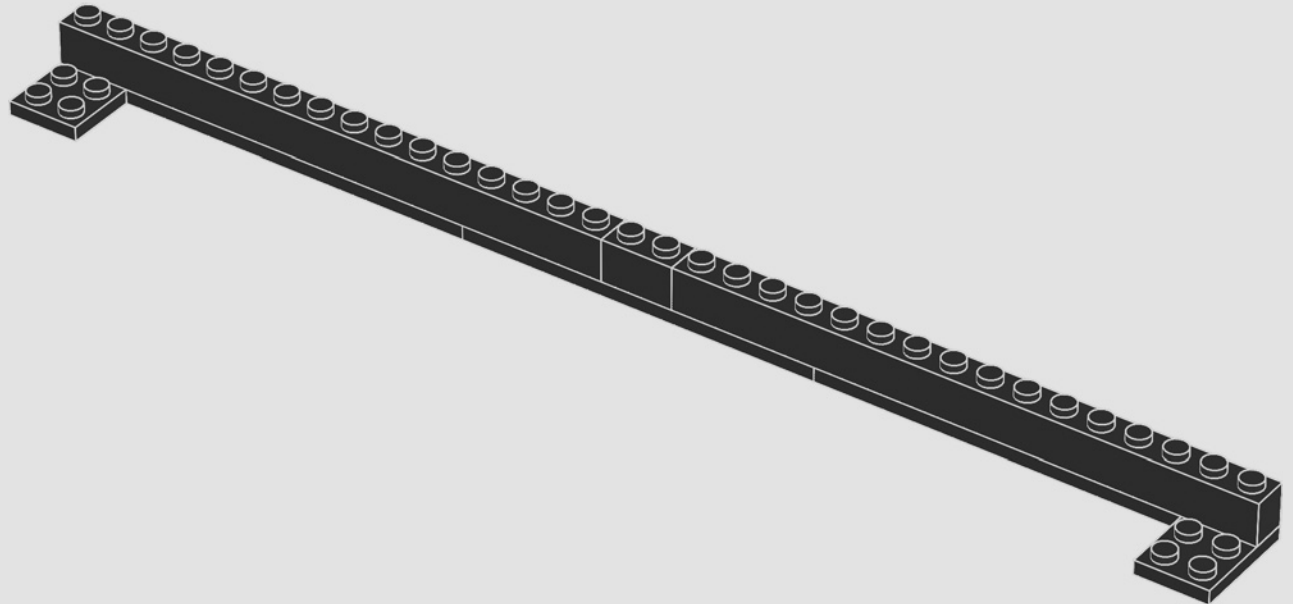

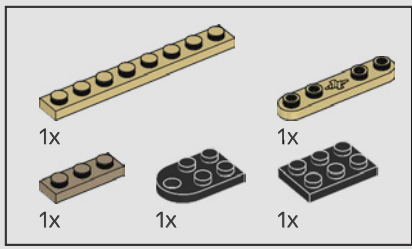

656

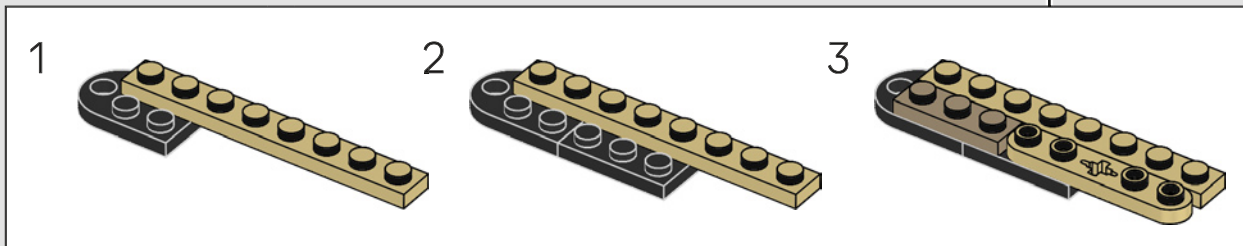
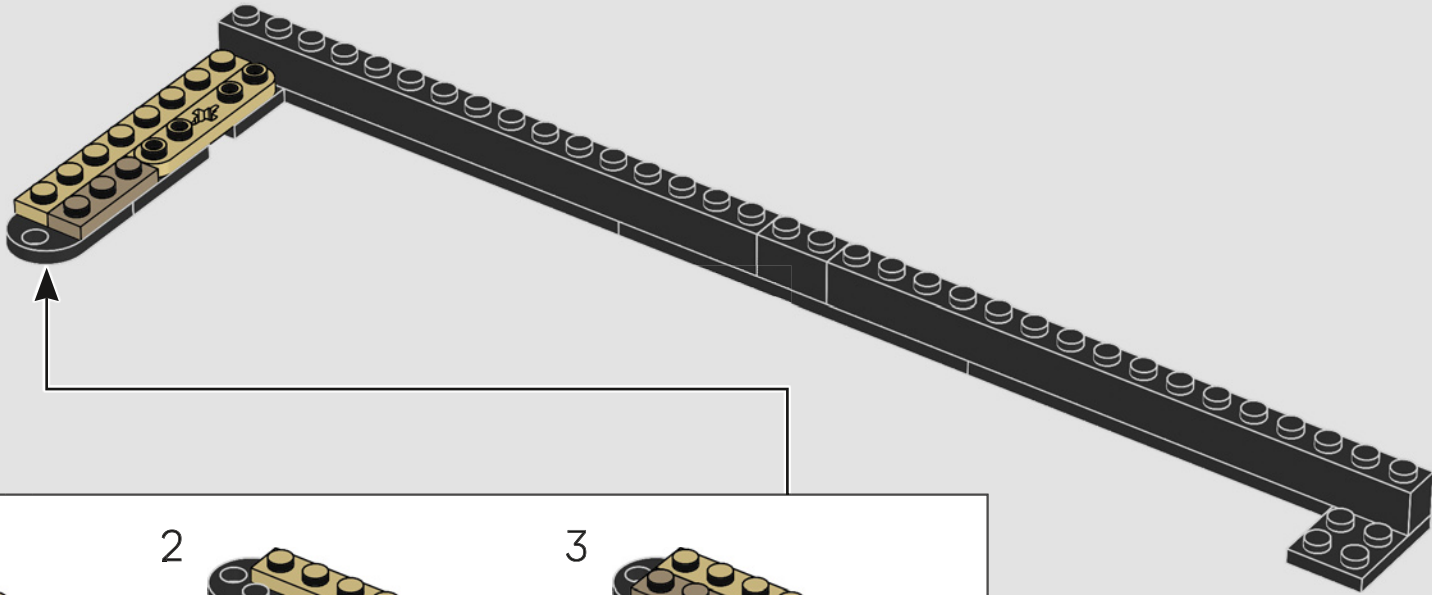

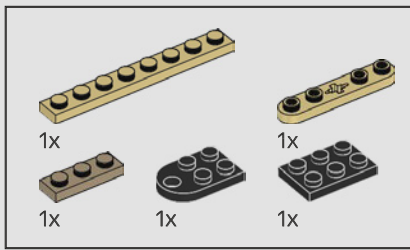

657

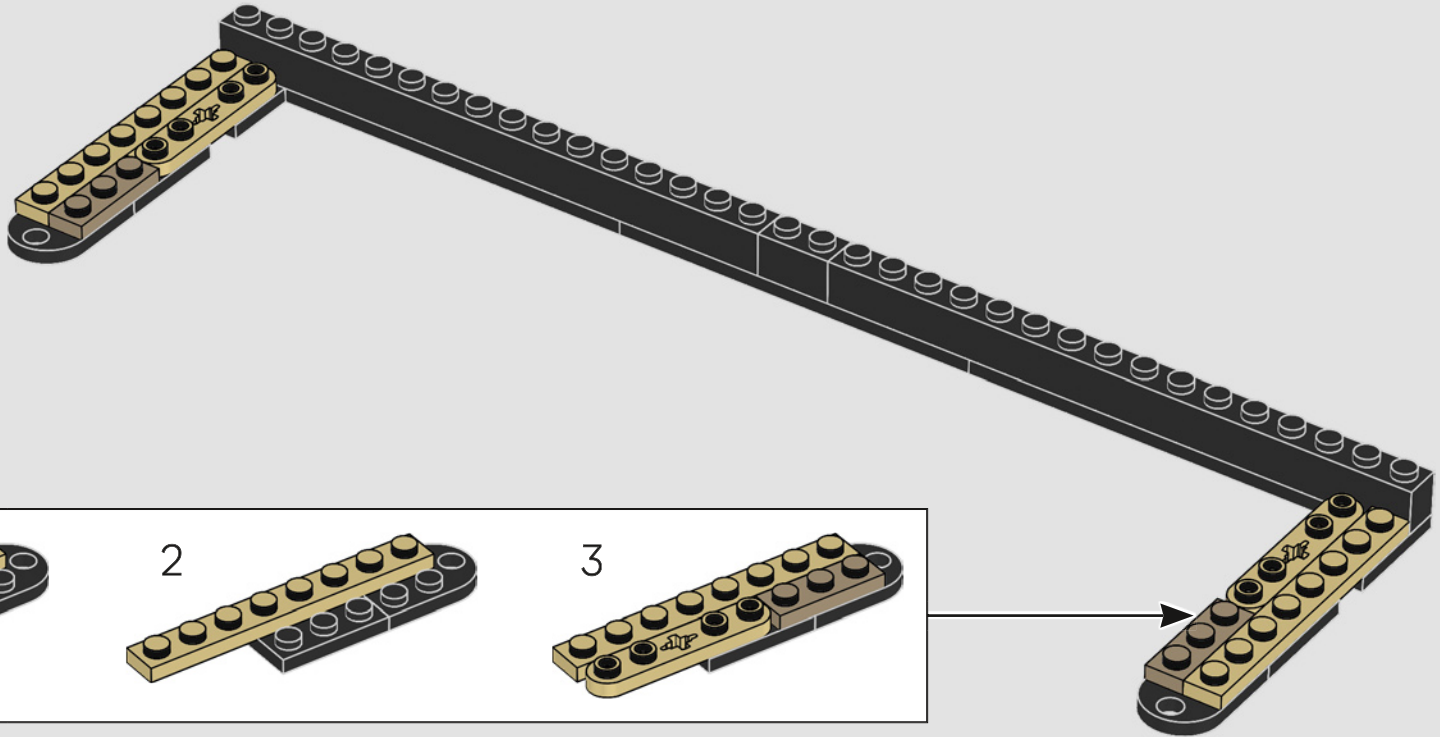

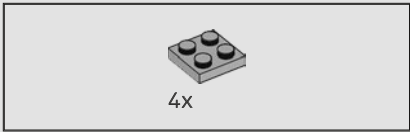

658

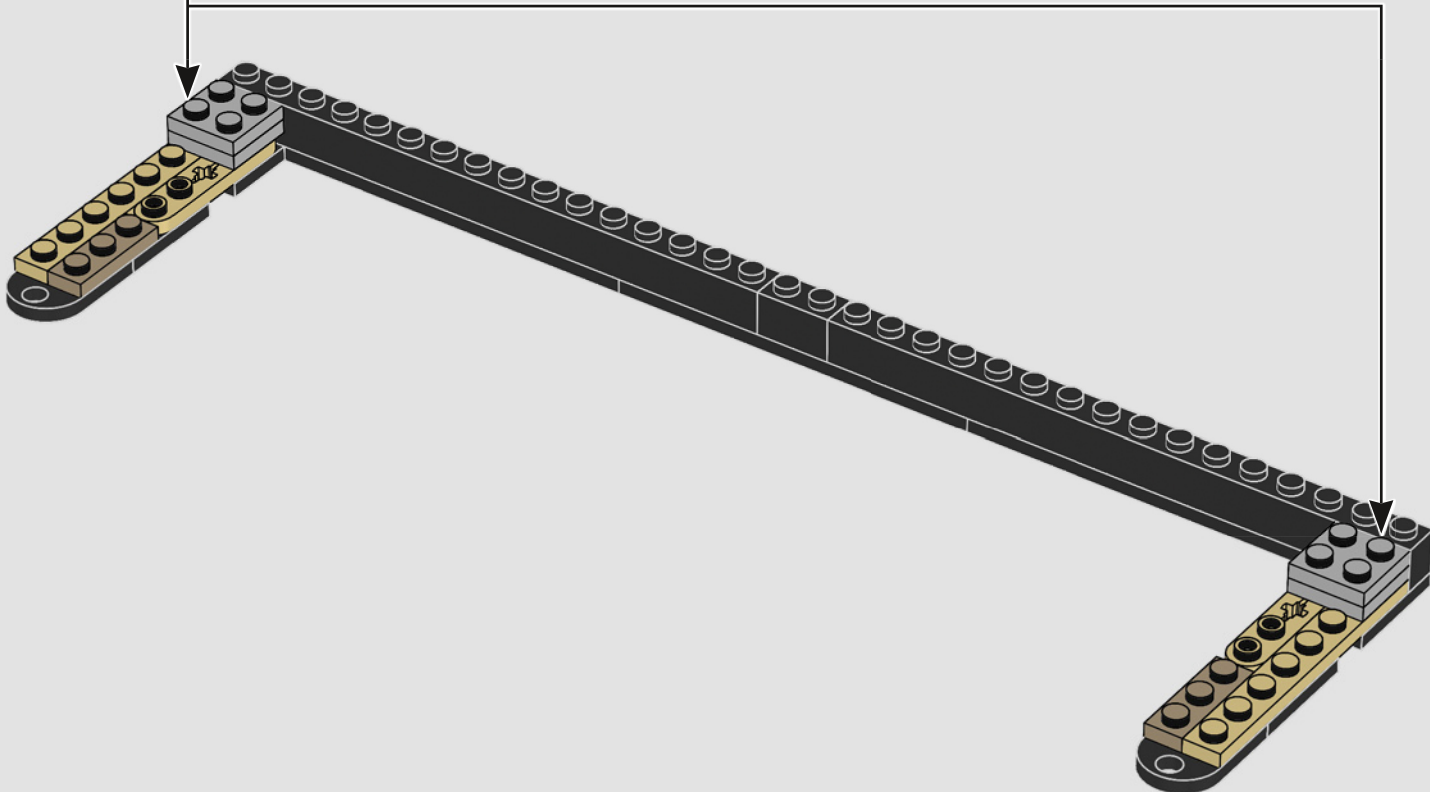
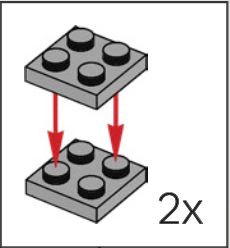



659

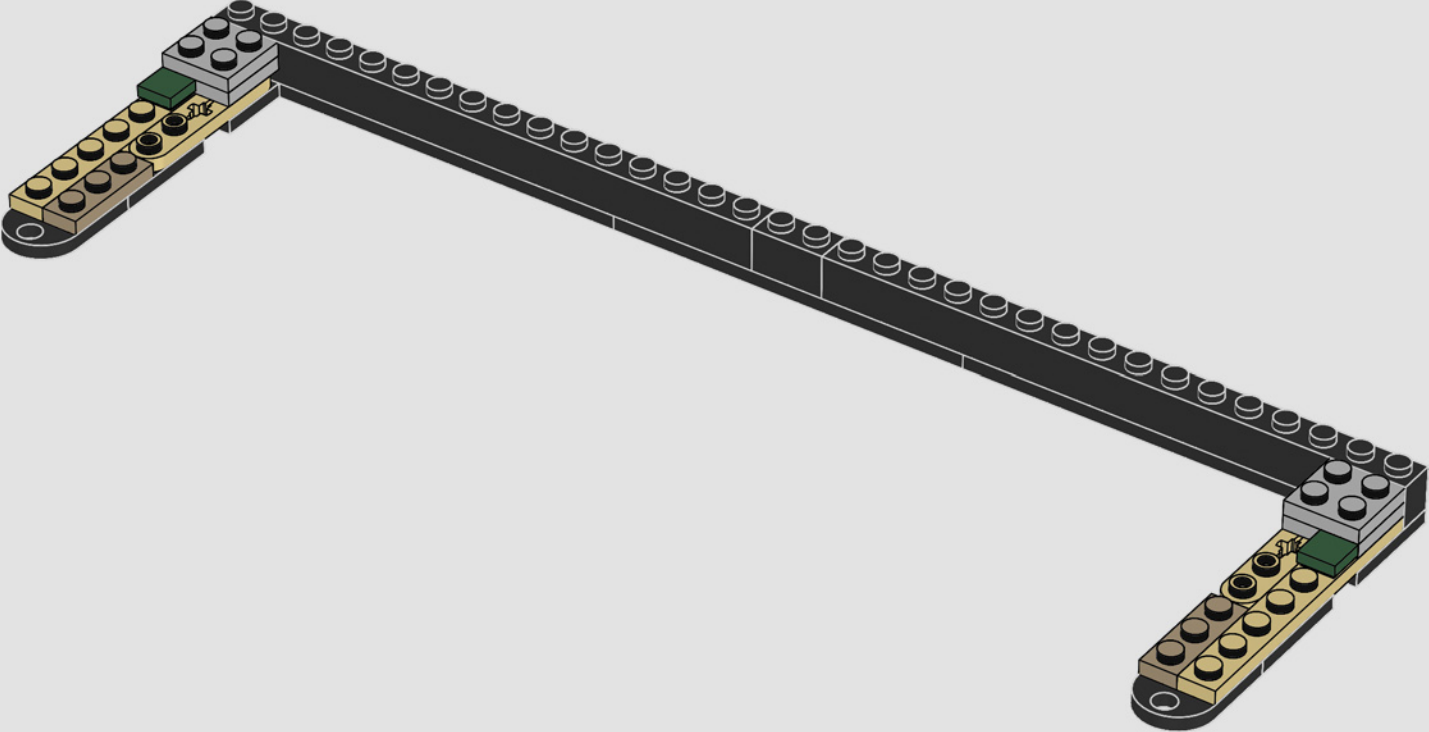

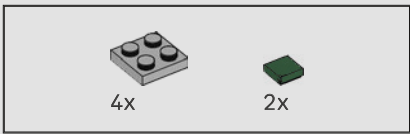

660

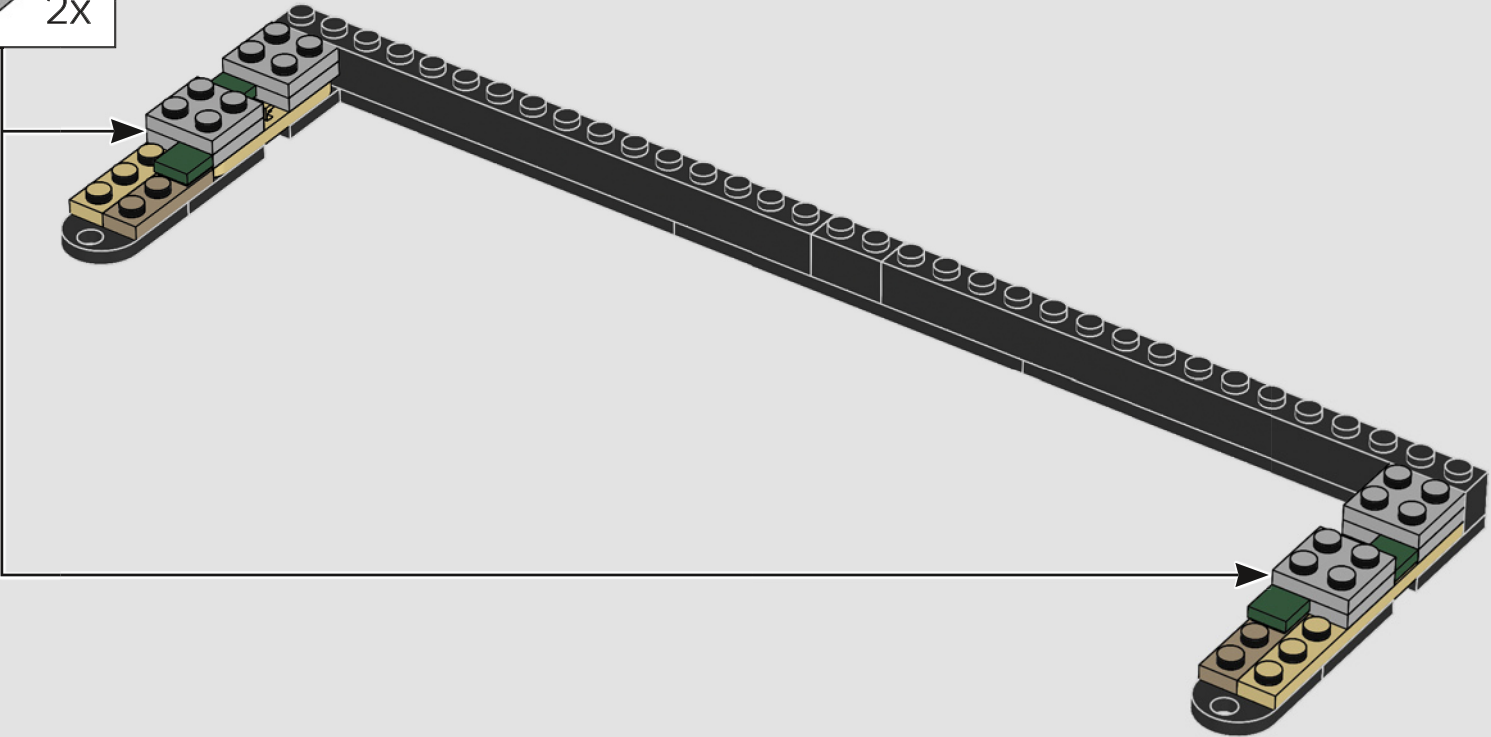
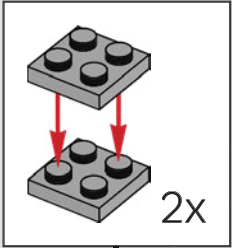

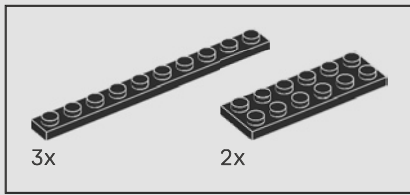

661

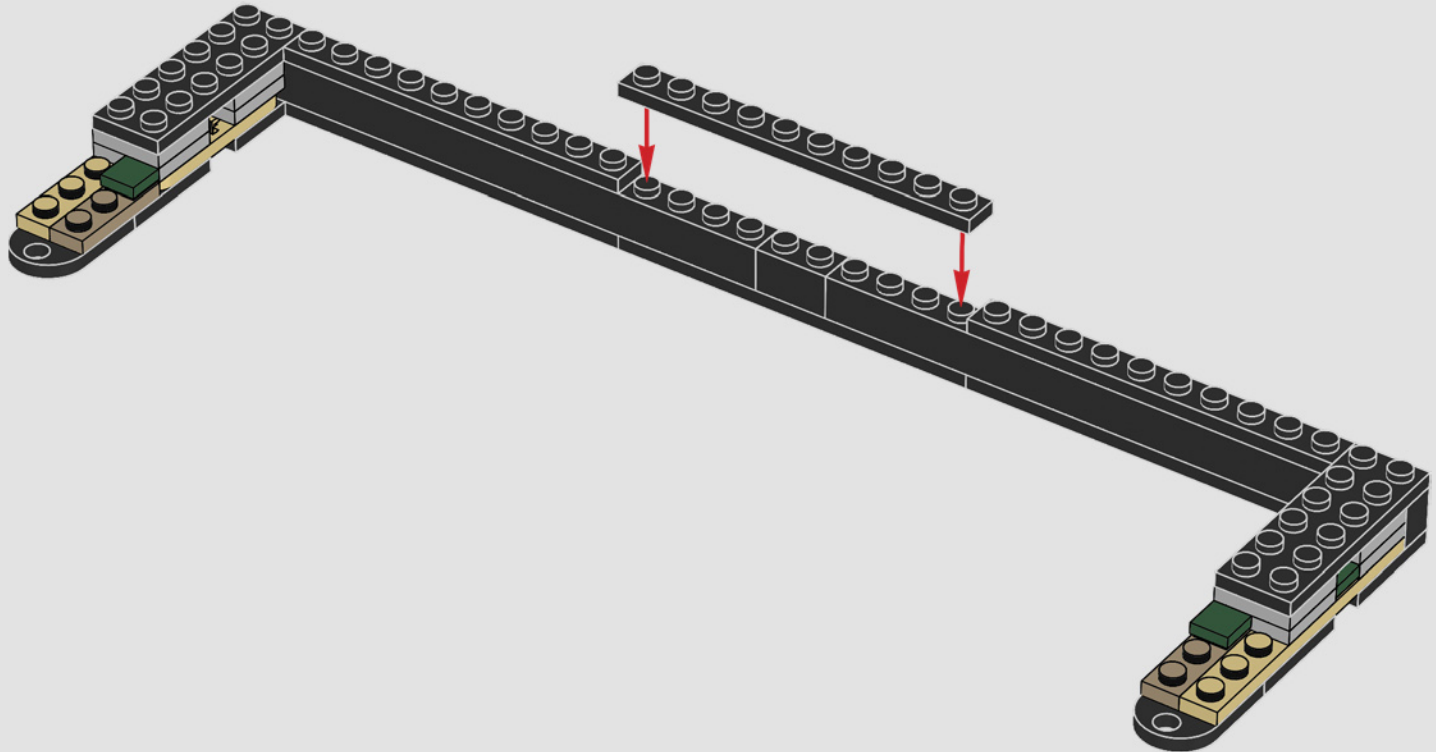

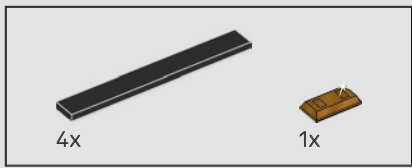

662

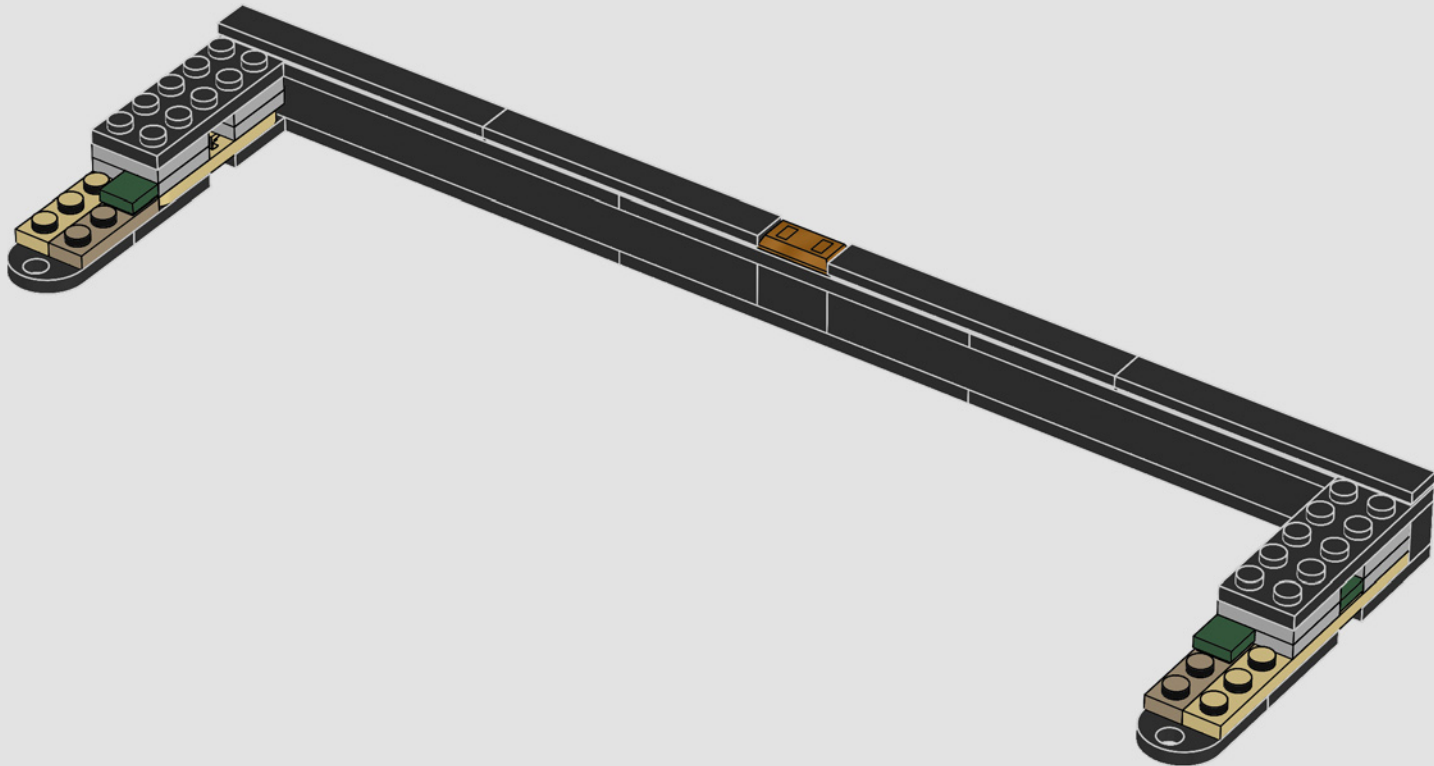

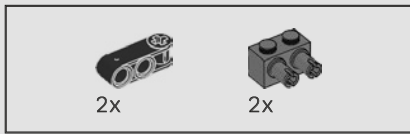

663

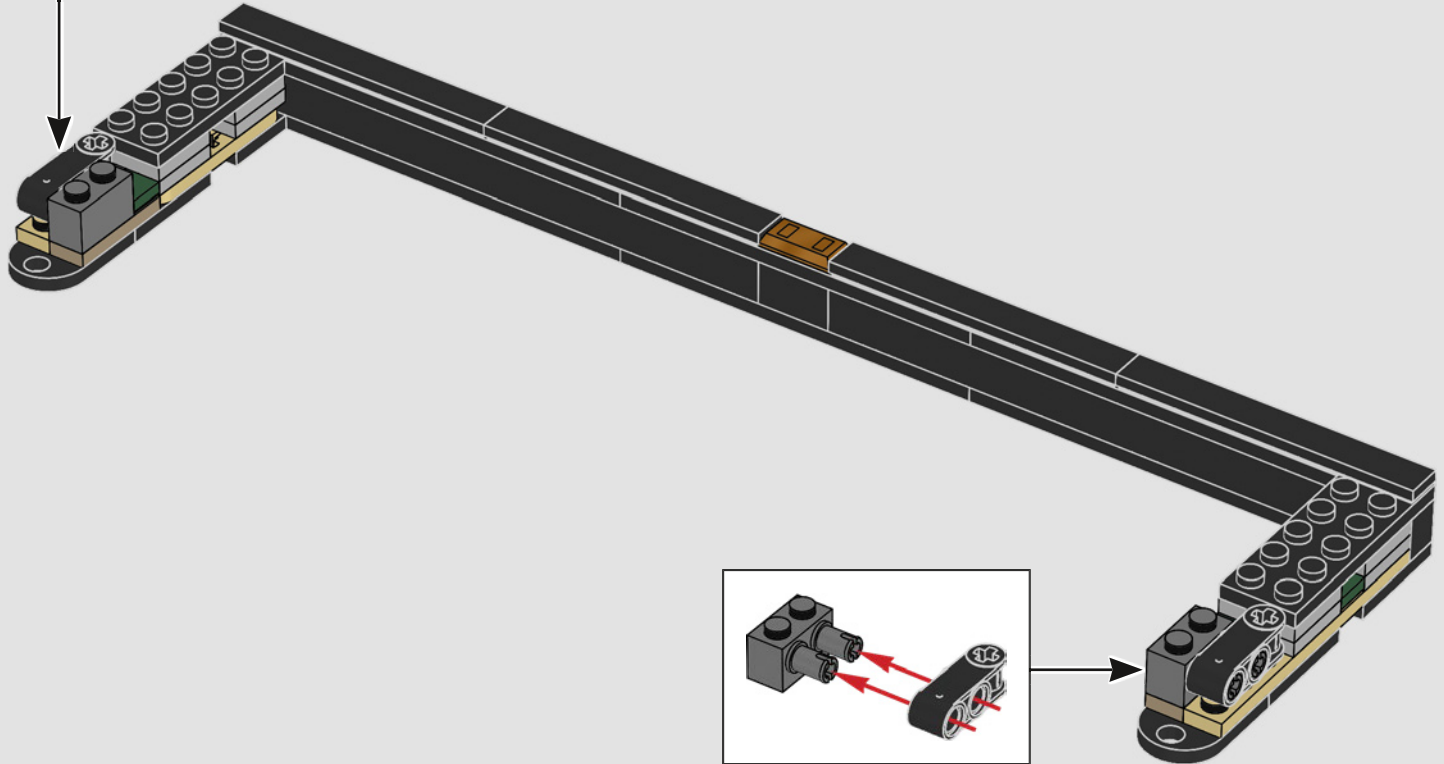
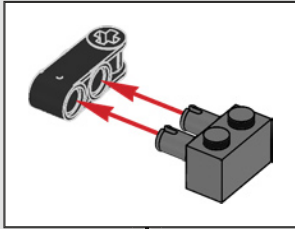



2x

664

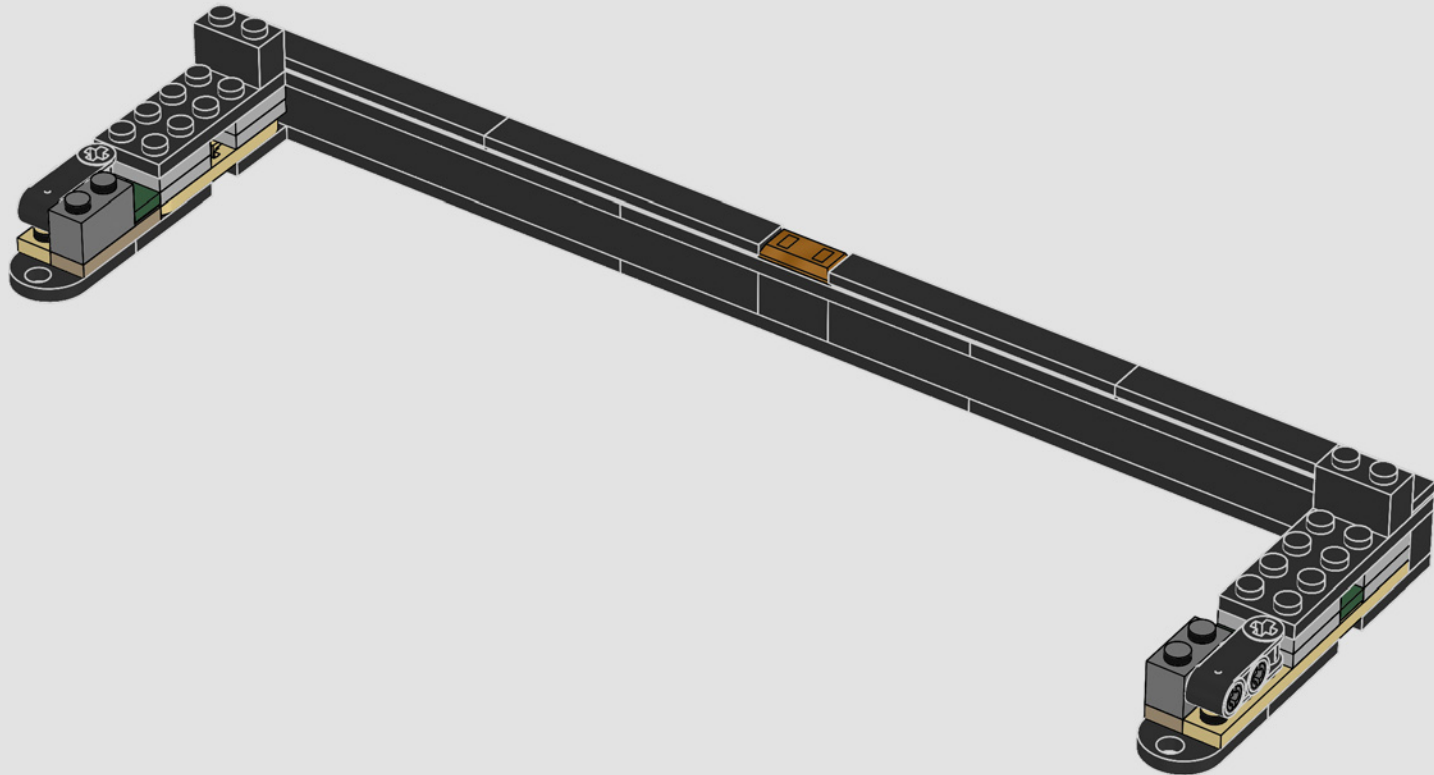

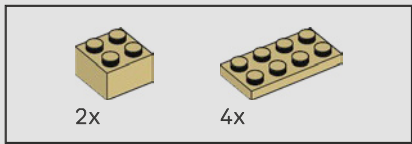

665

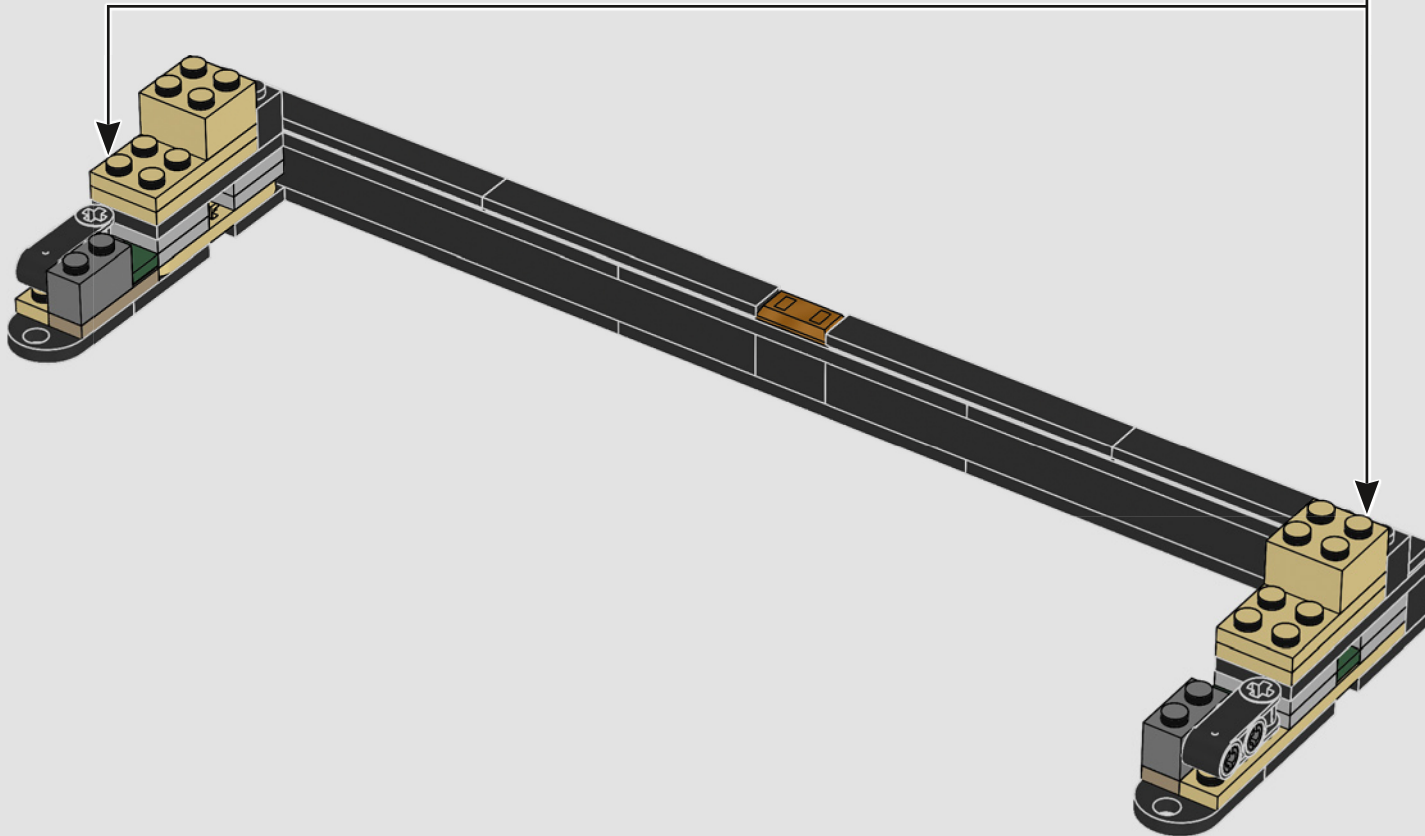
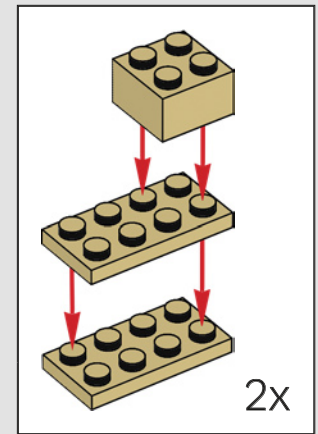

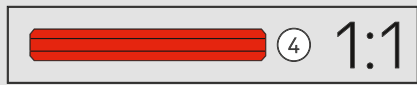
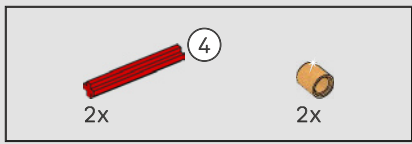

666

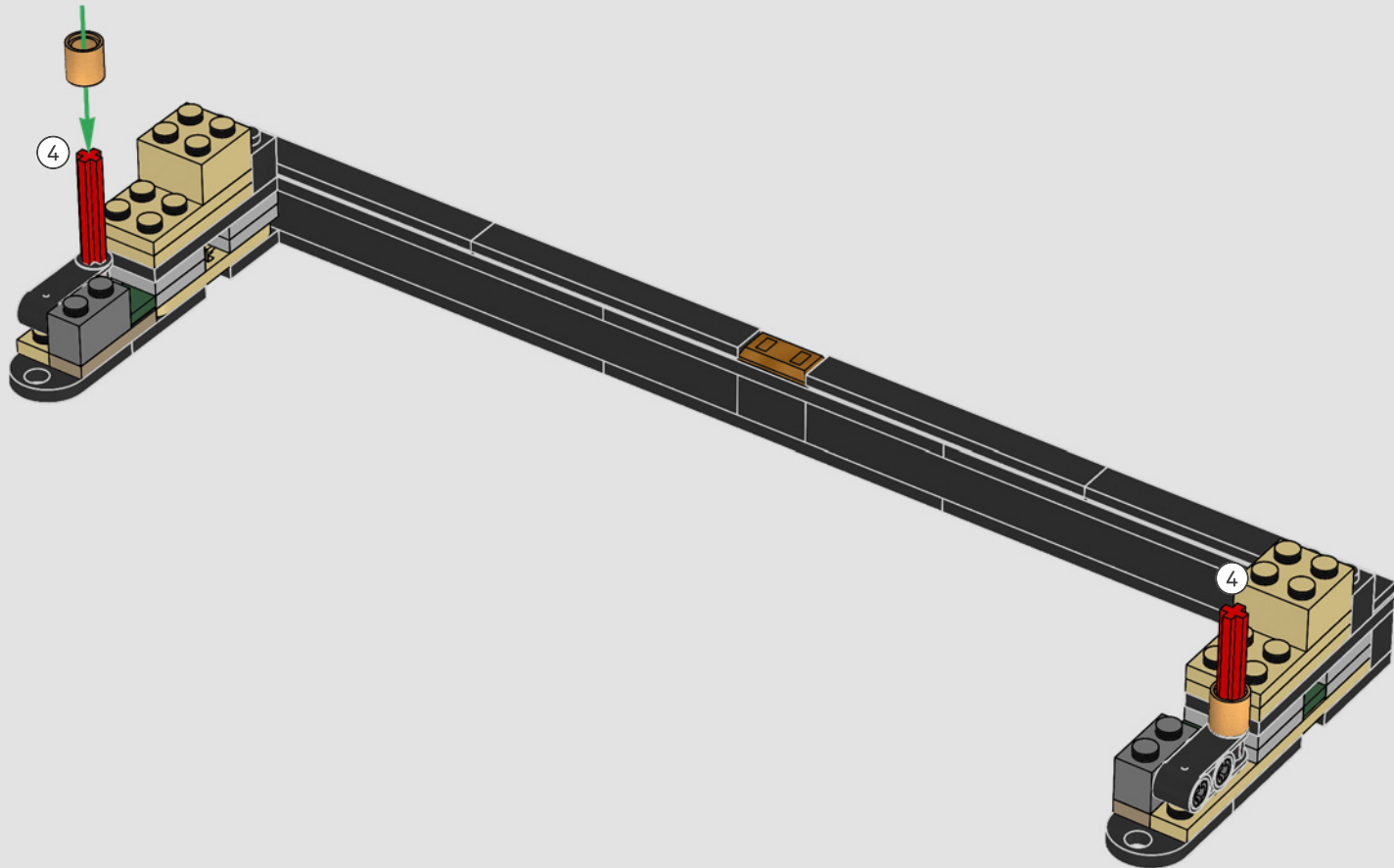

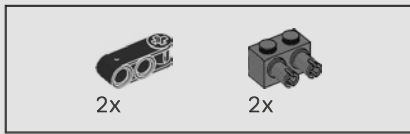

667

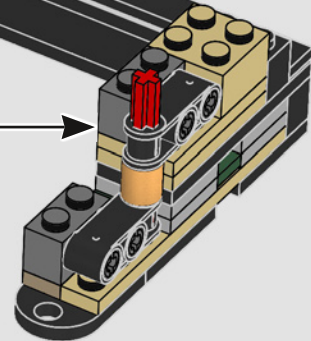
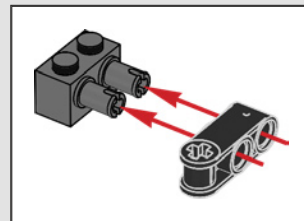
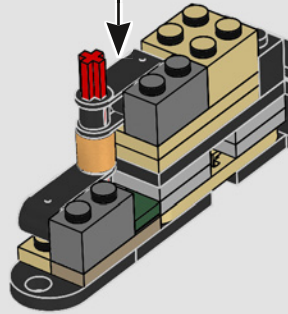
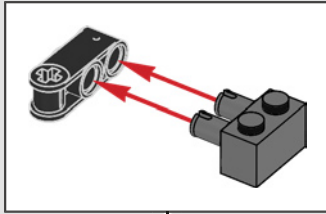



668

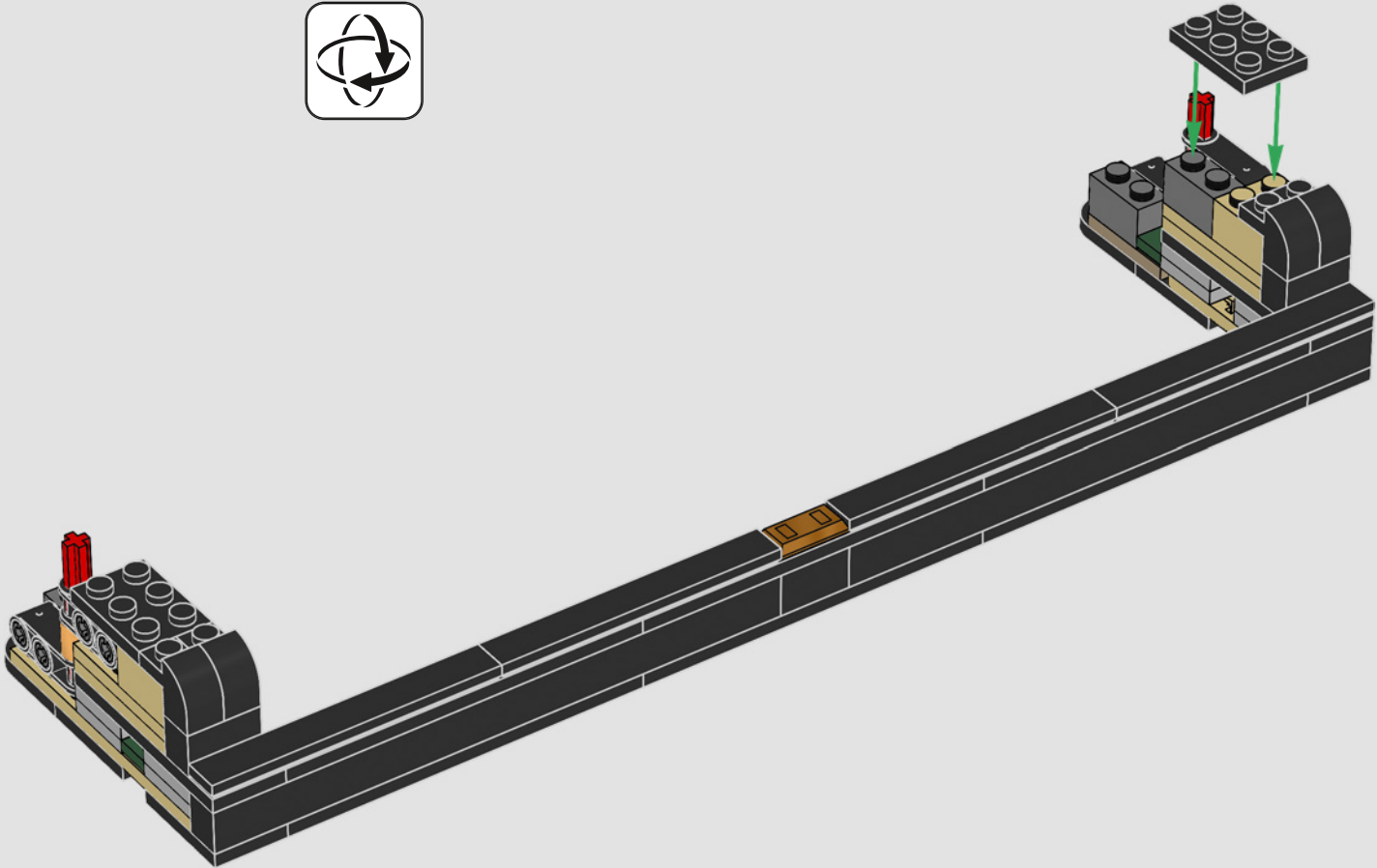

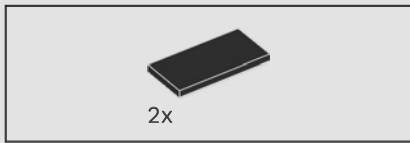

669

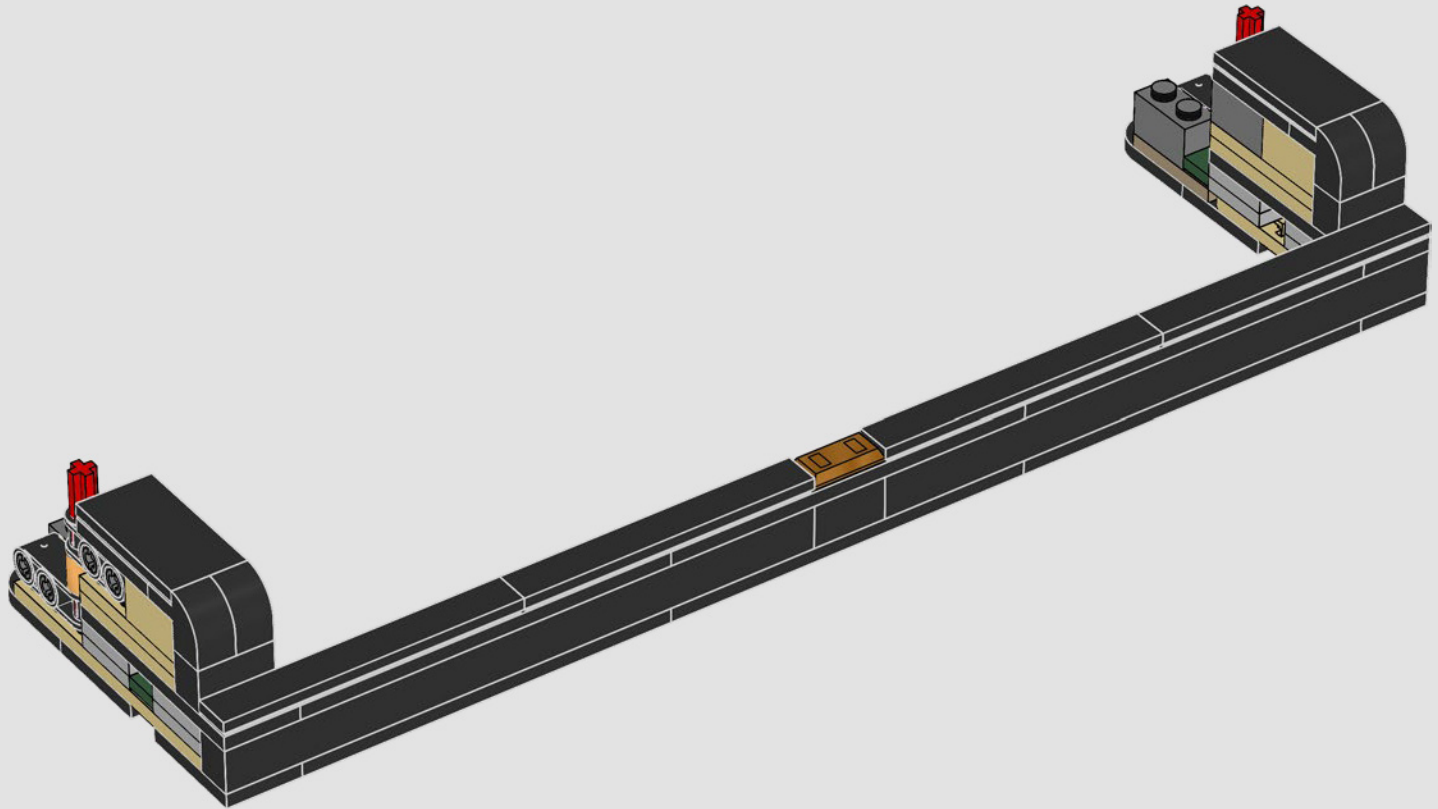

670

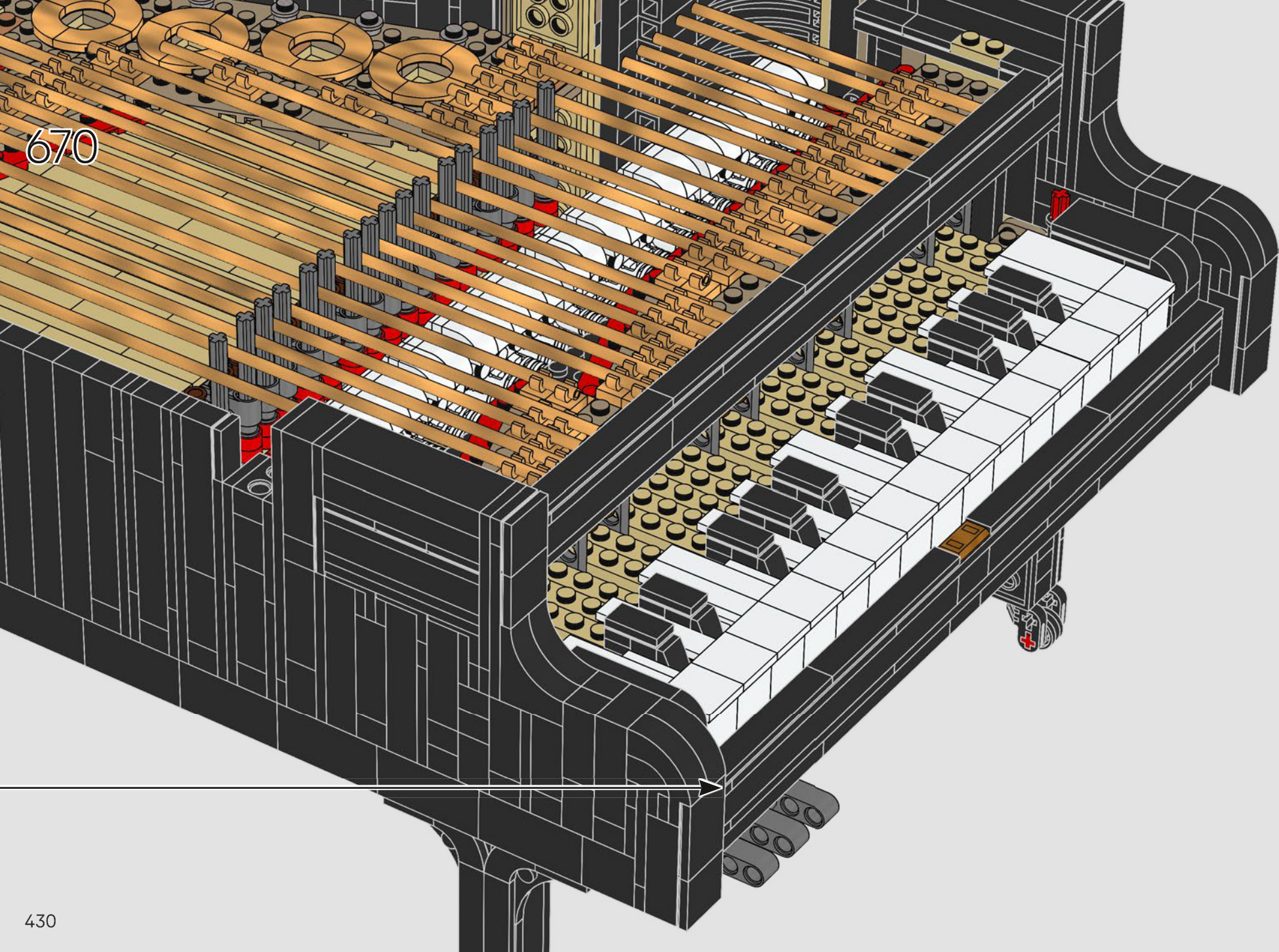

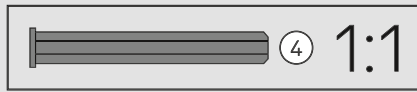
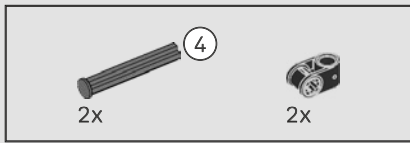

671

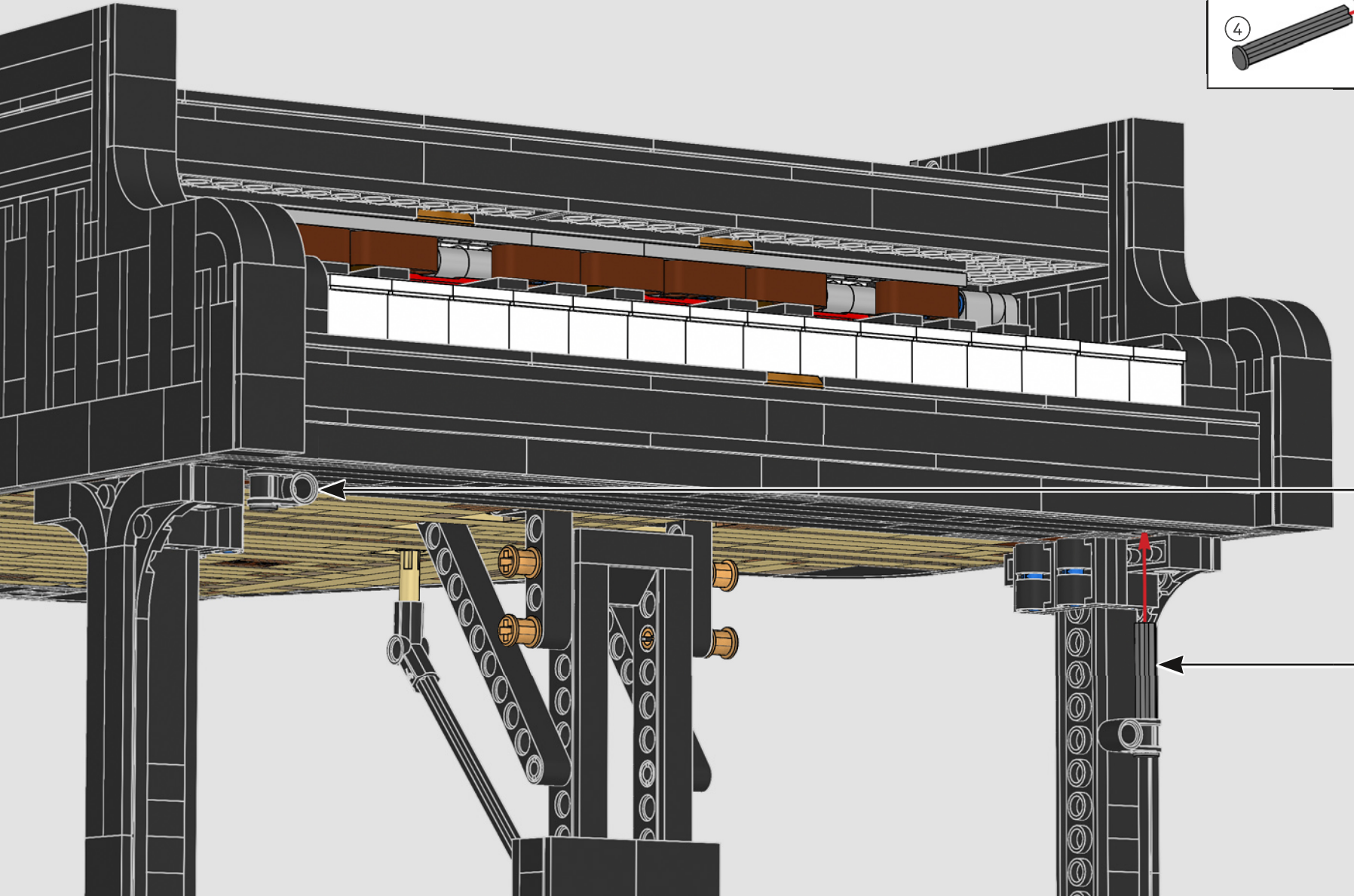
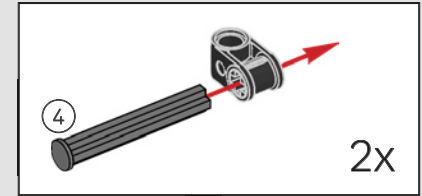

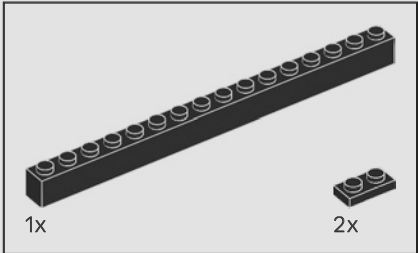
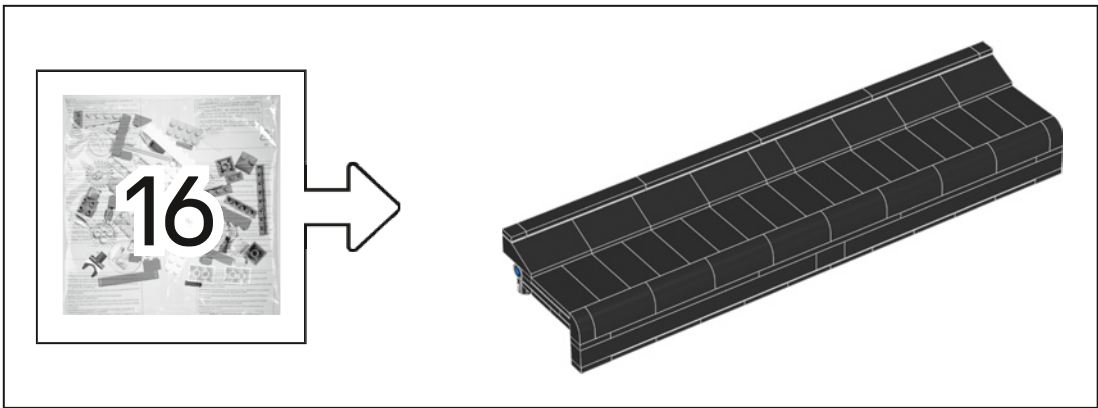

672

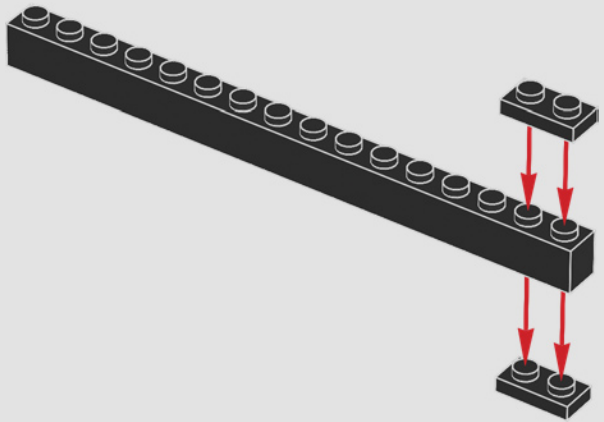

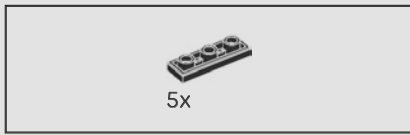

673

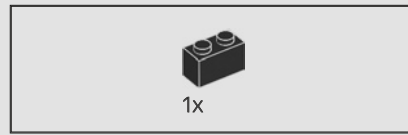
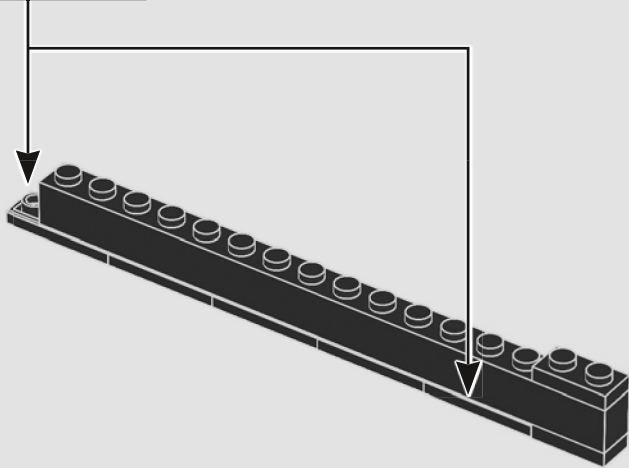

674

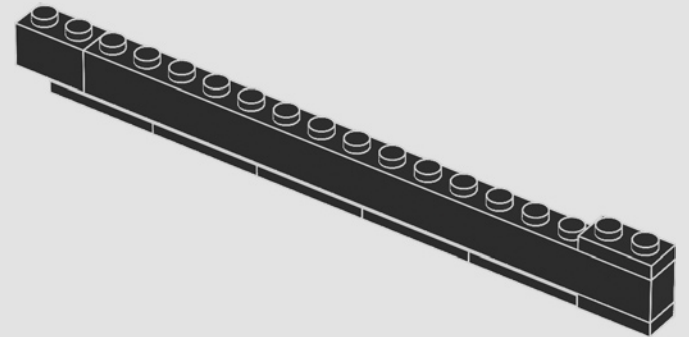

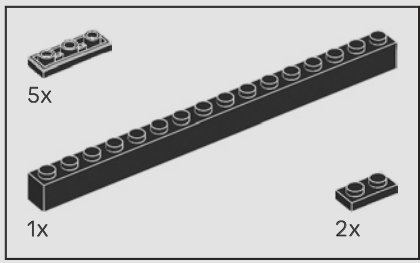

675

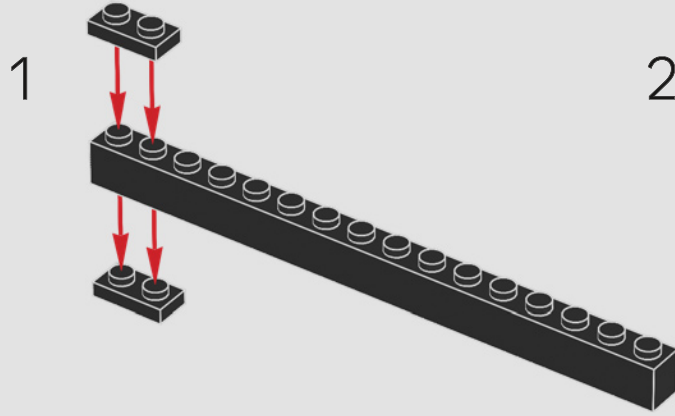

2

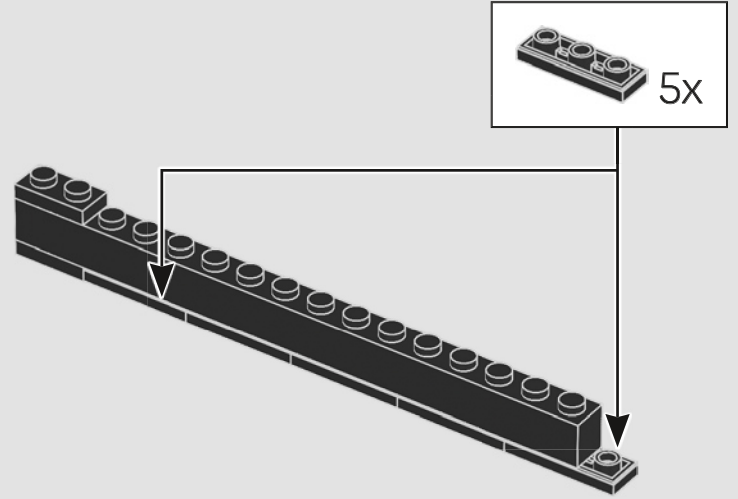

676

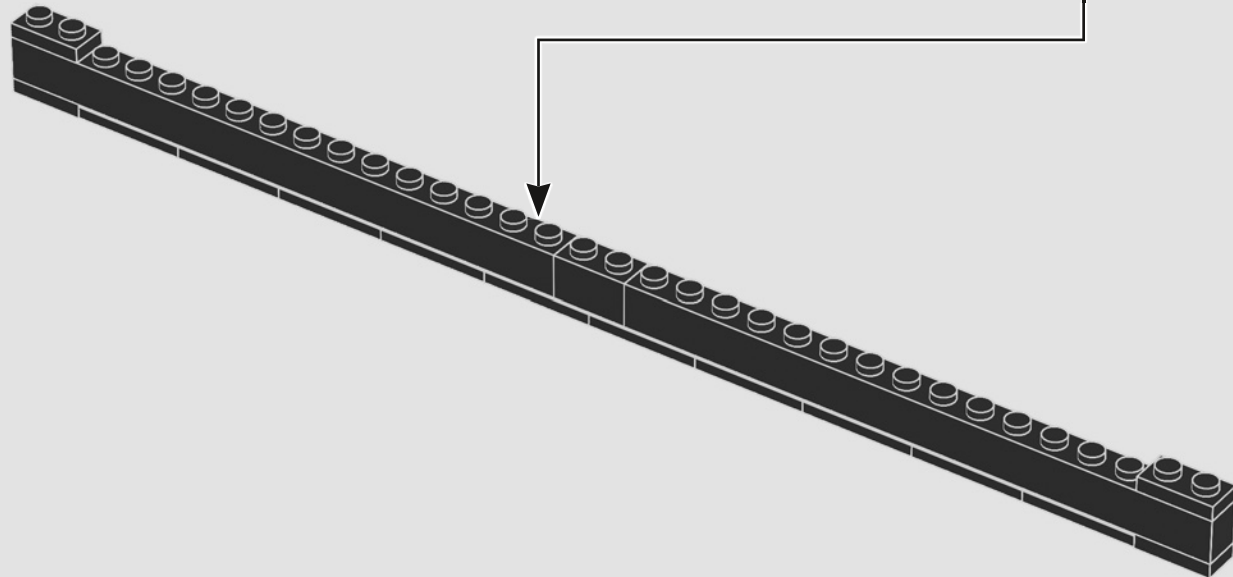

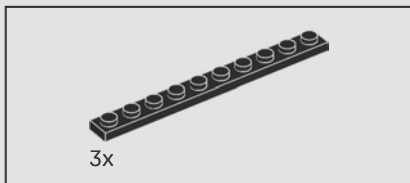

677

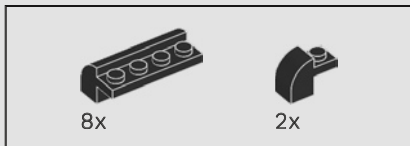
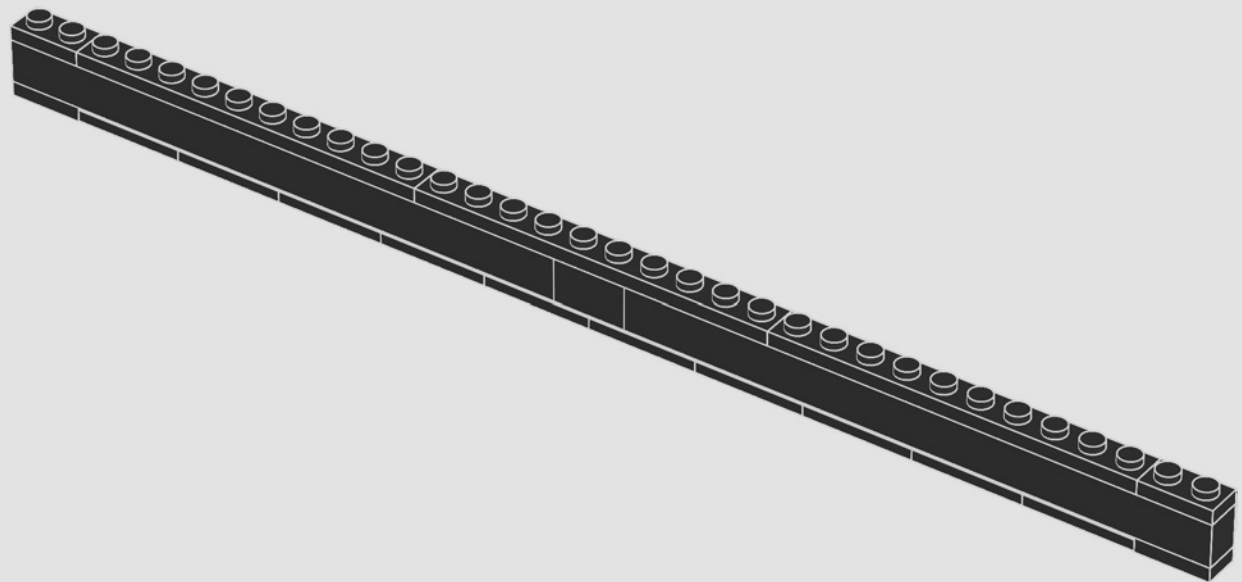

678

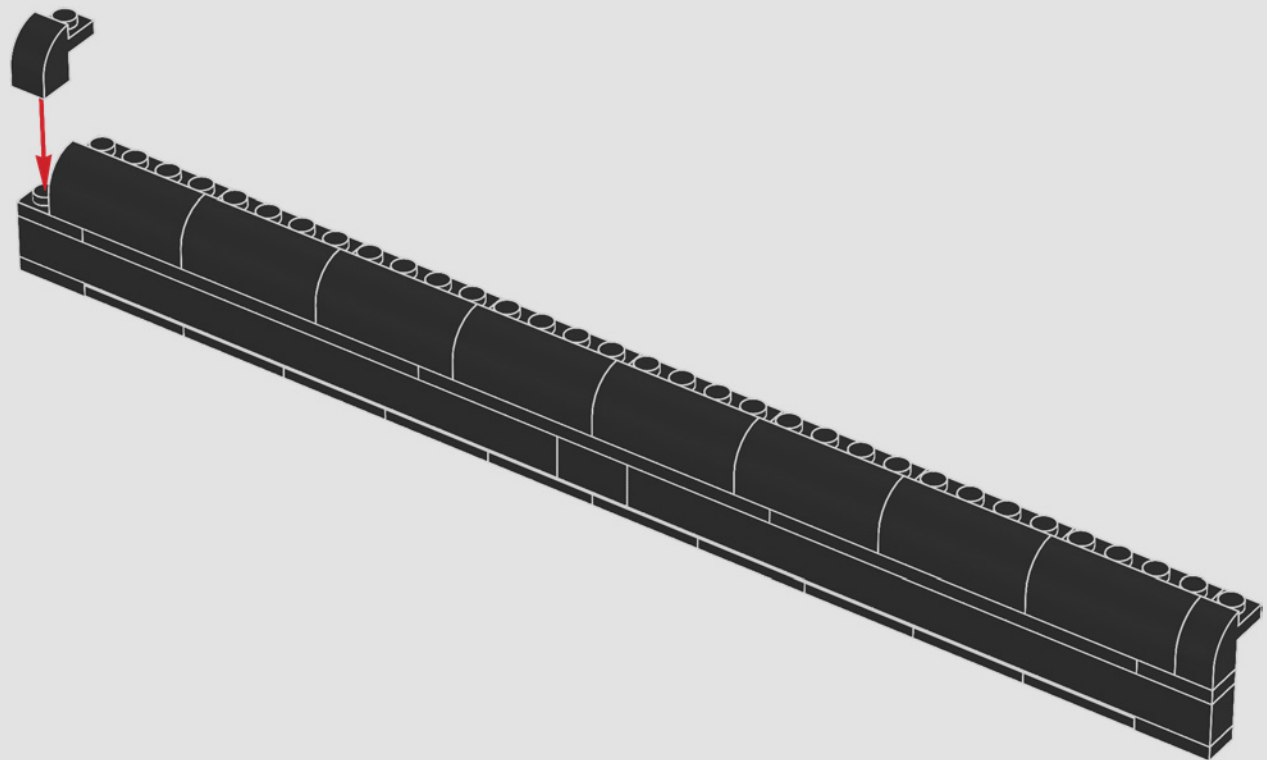

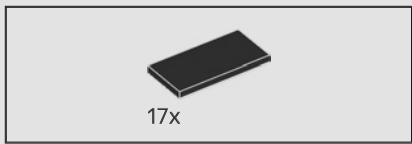

679

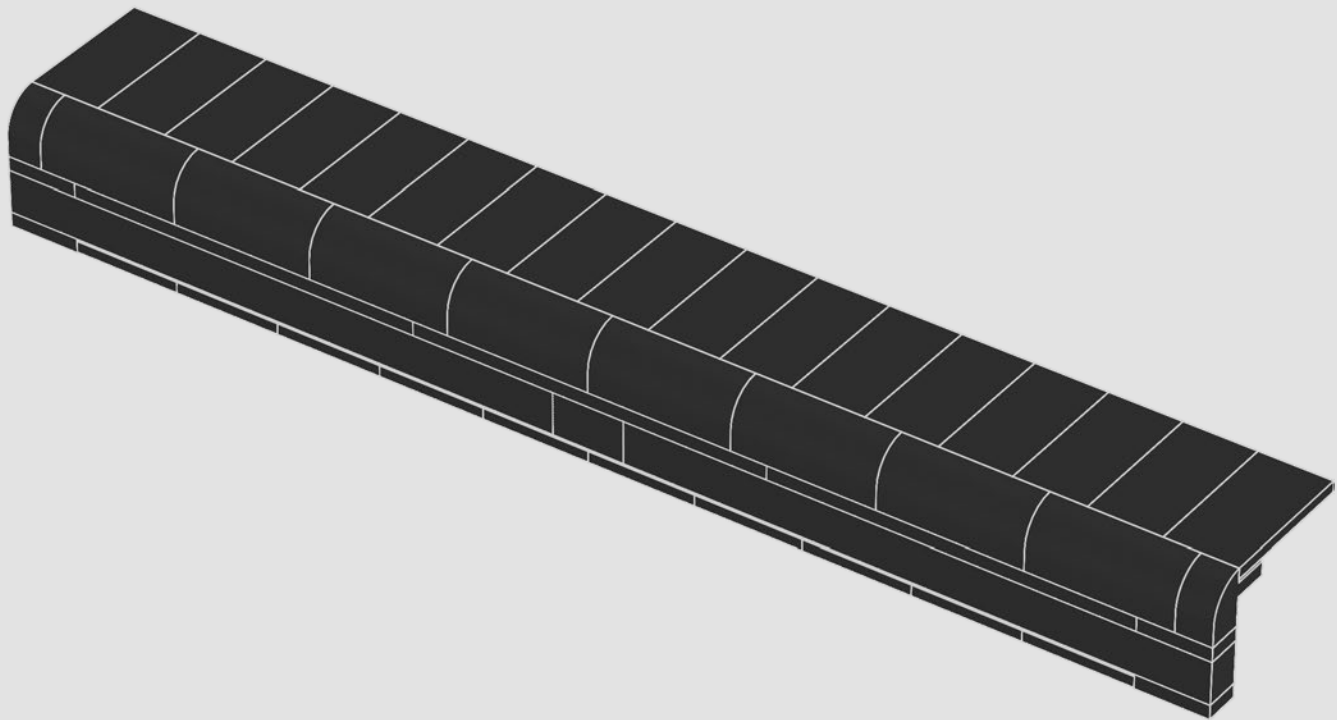

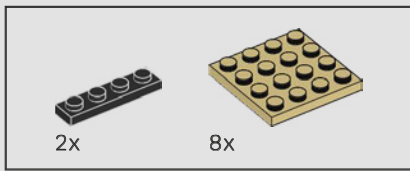

680

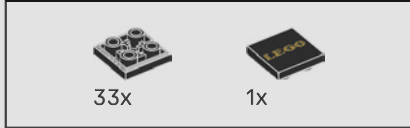
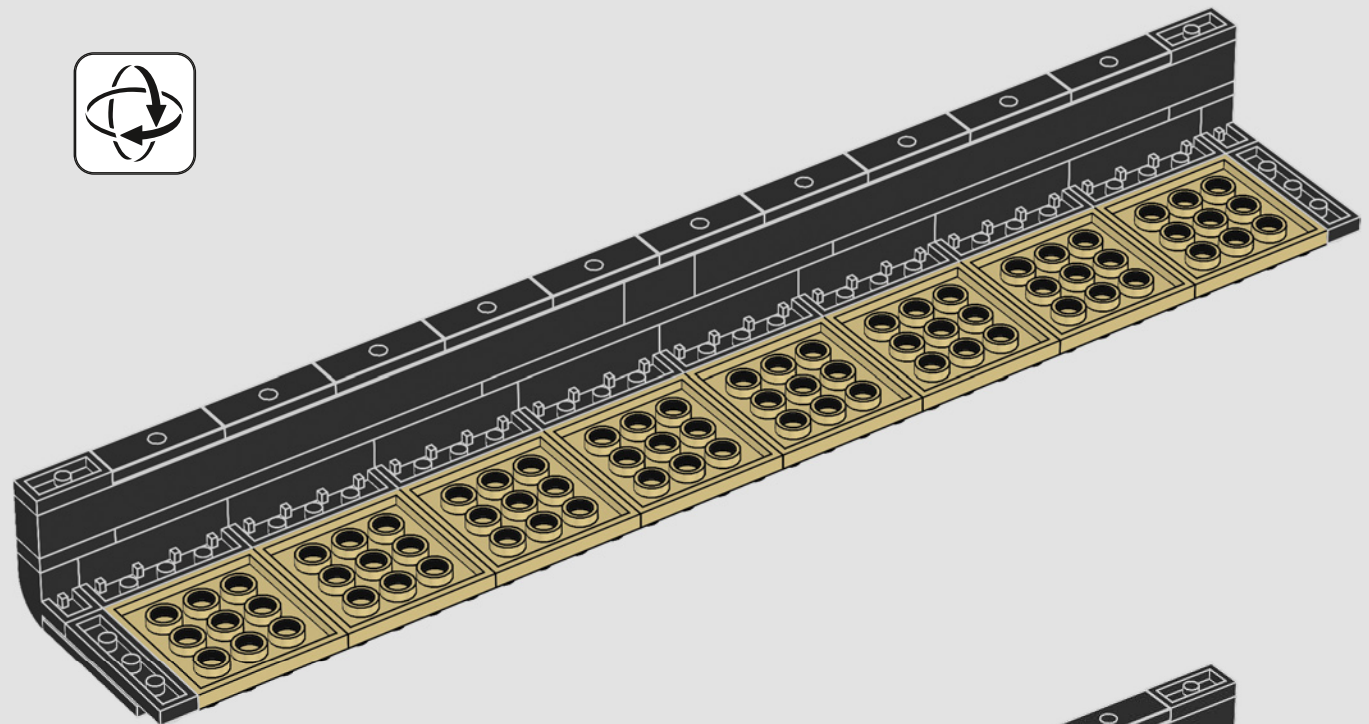

681

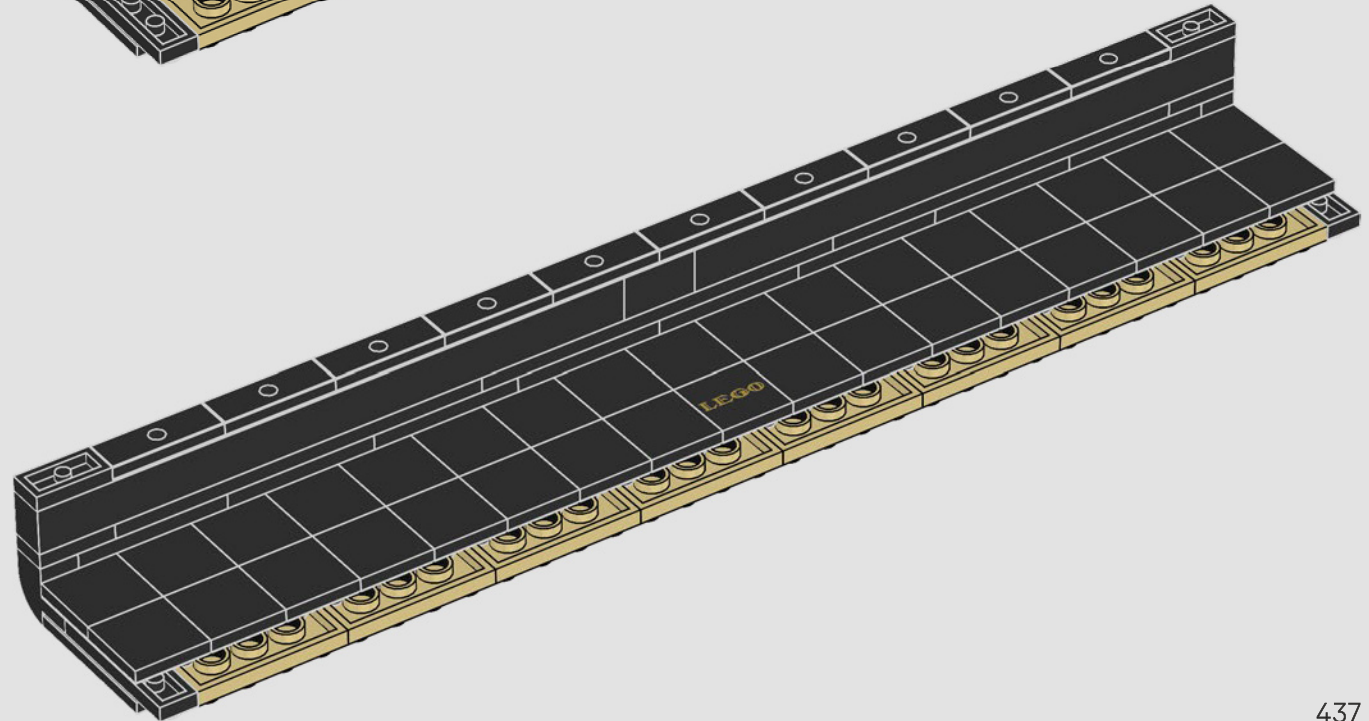

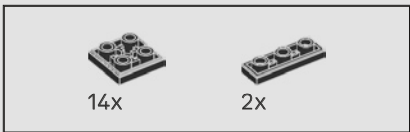

682

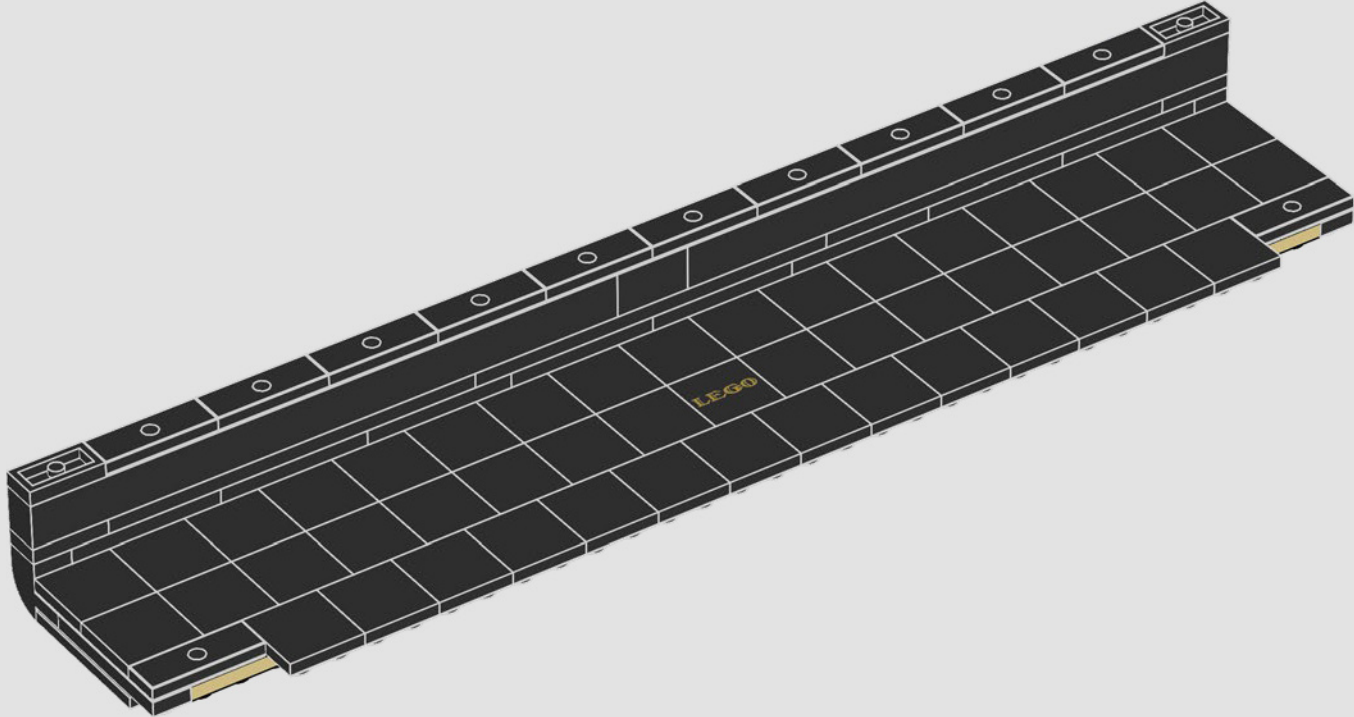

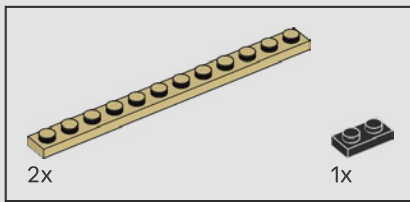

683

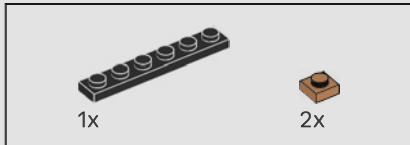
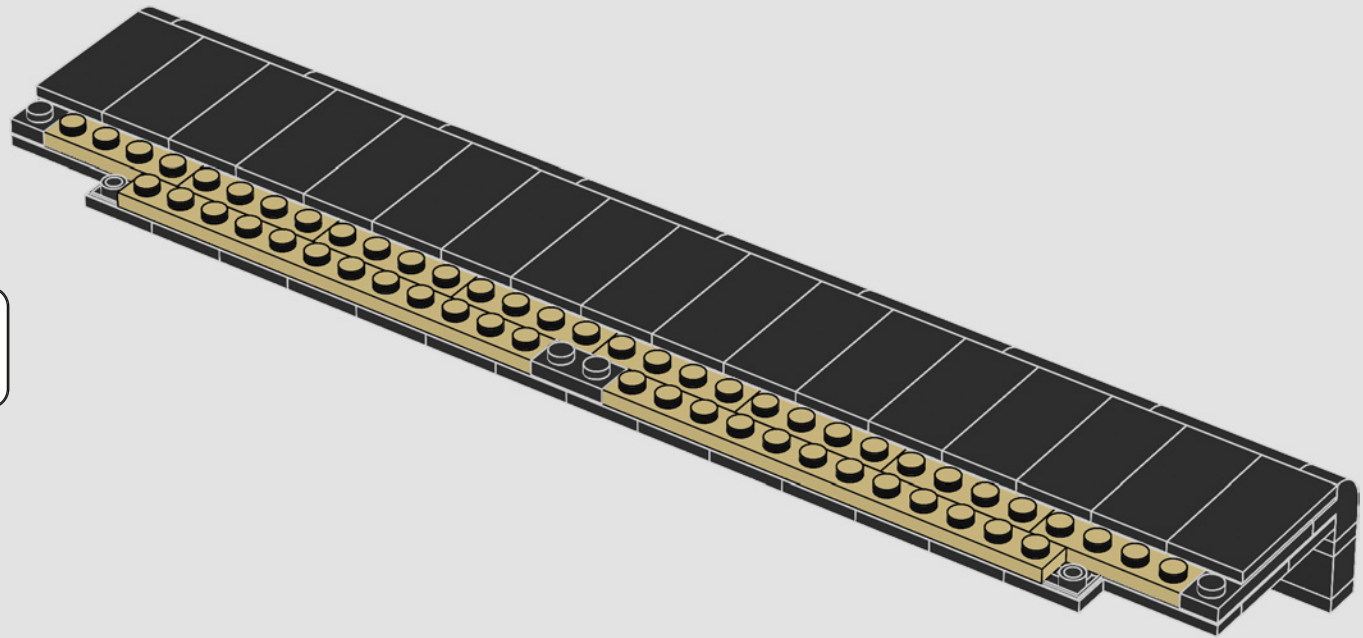

684

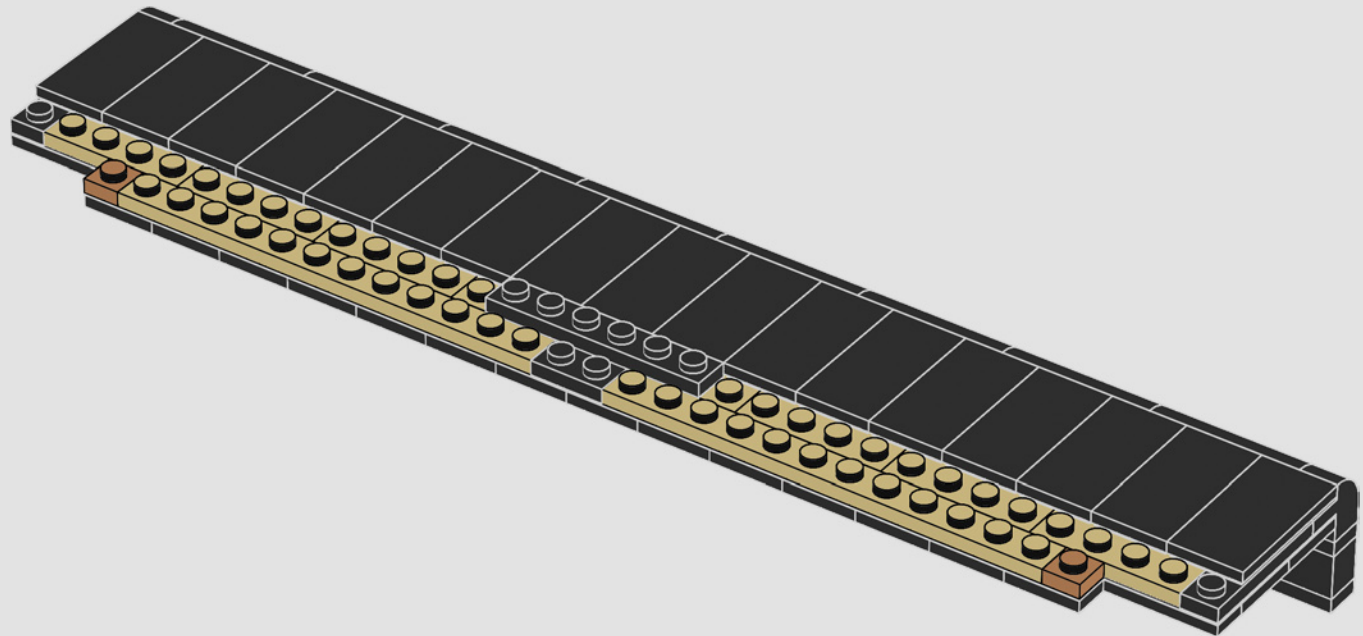



685

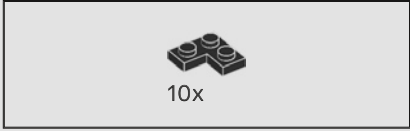
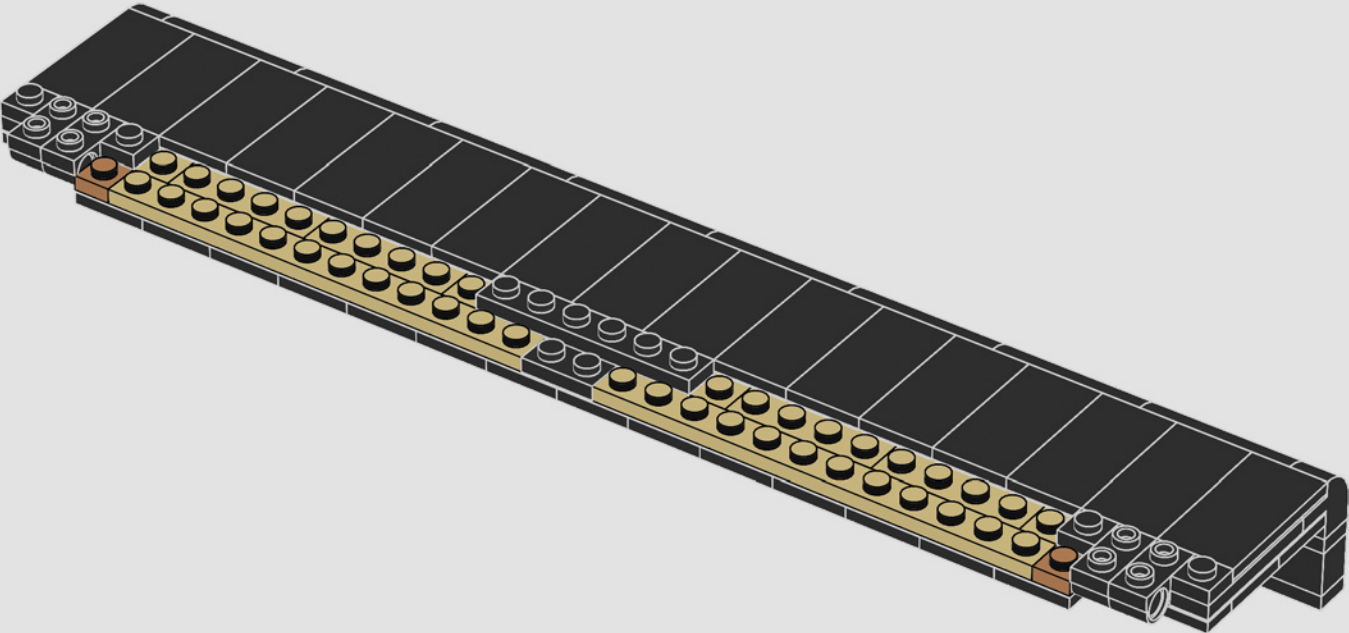

686

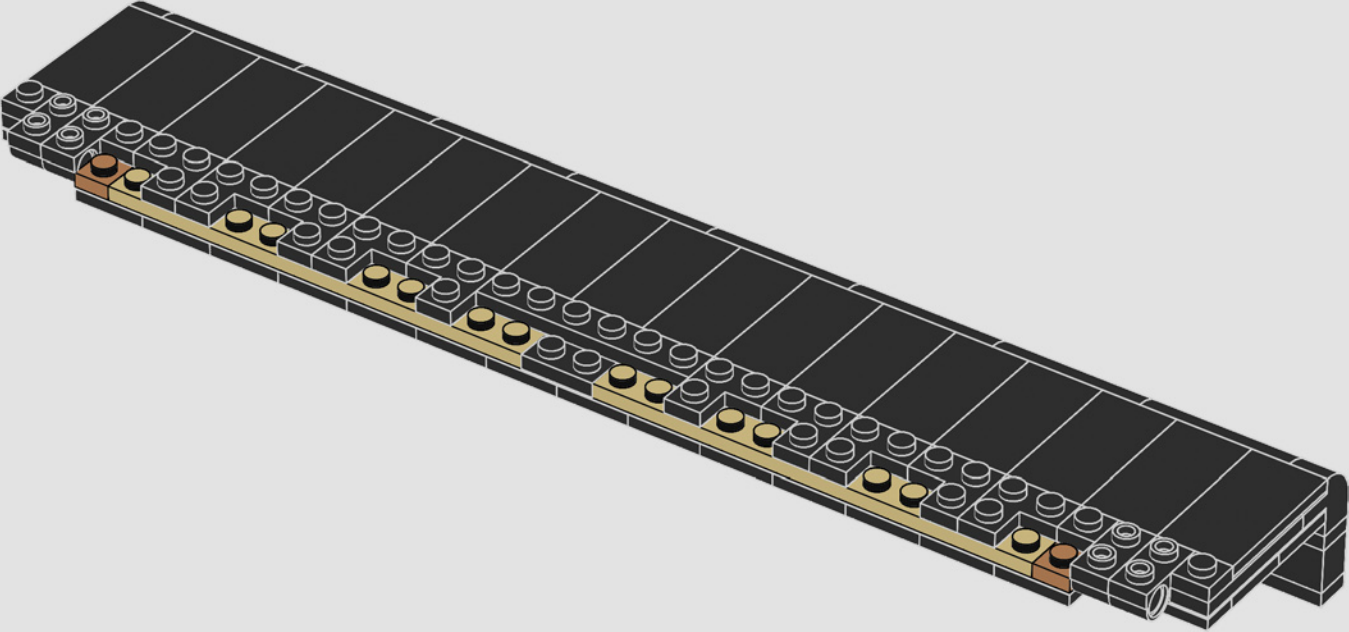

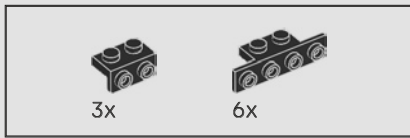

687

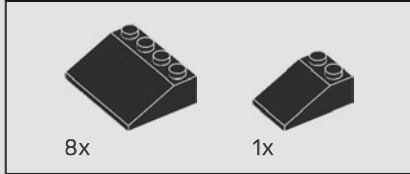
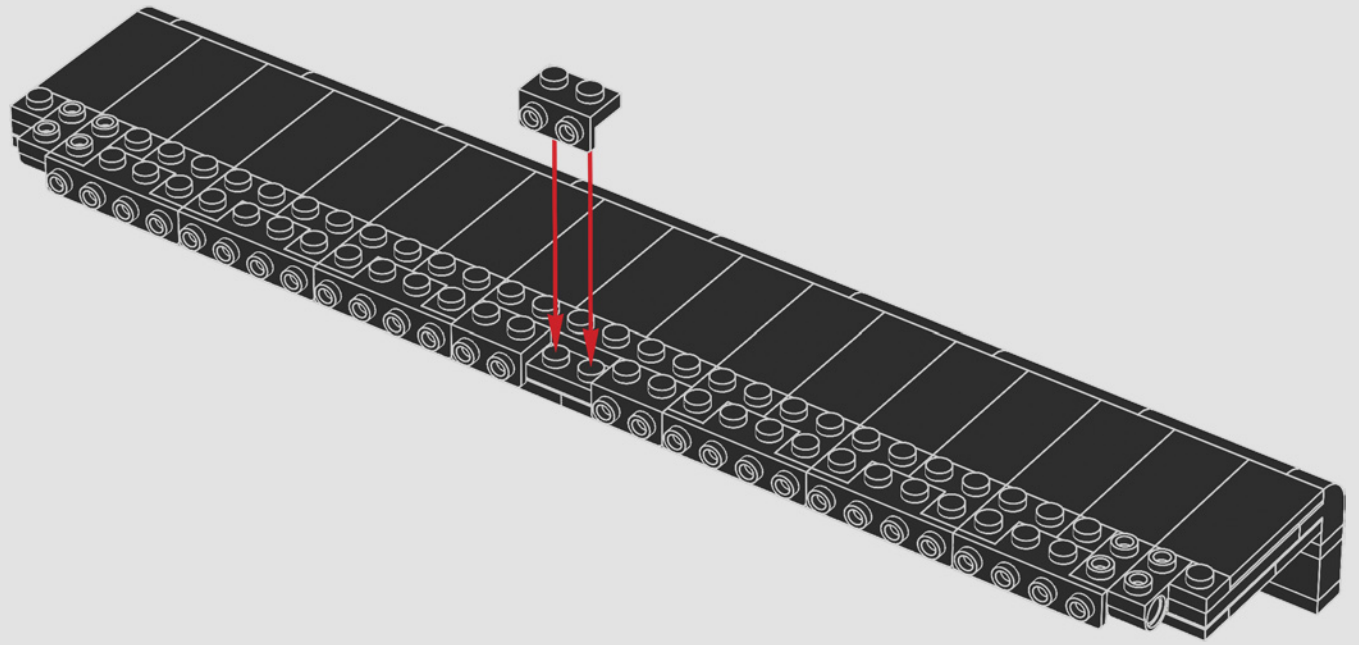

688

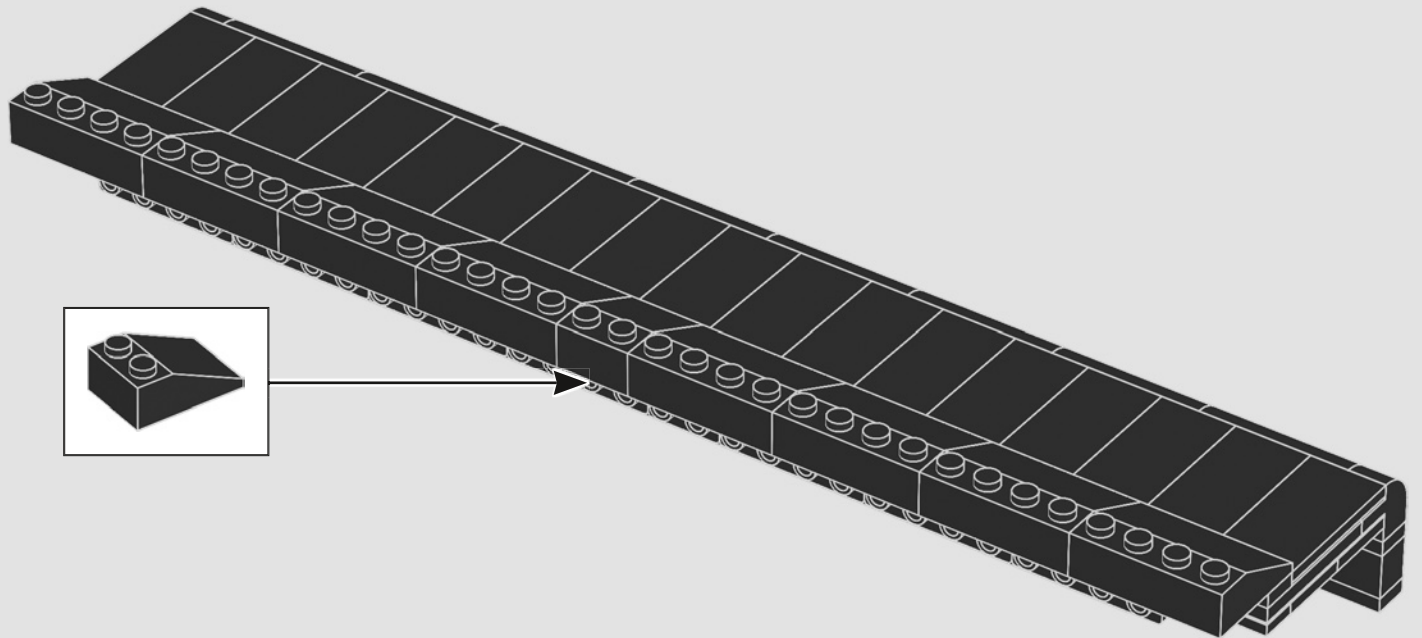

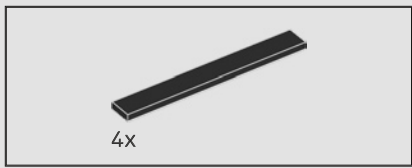

4x

689

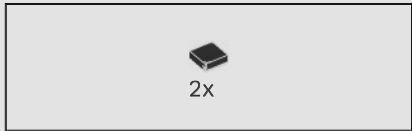
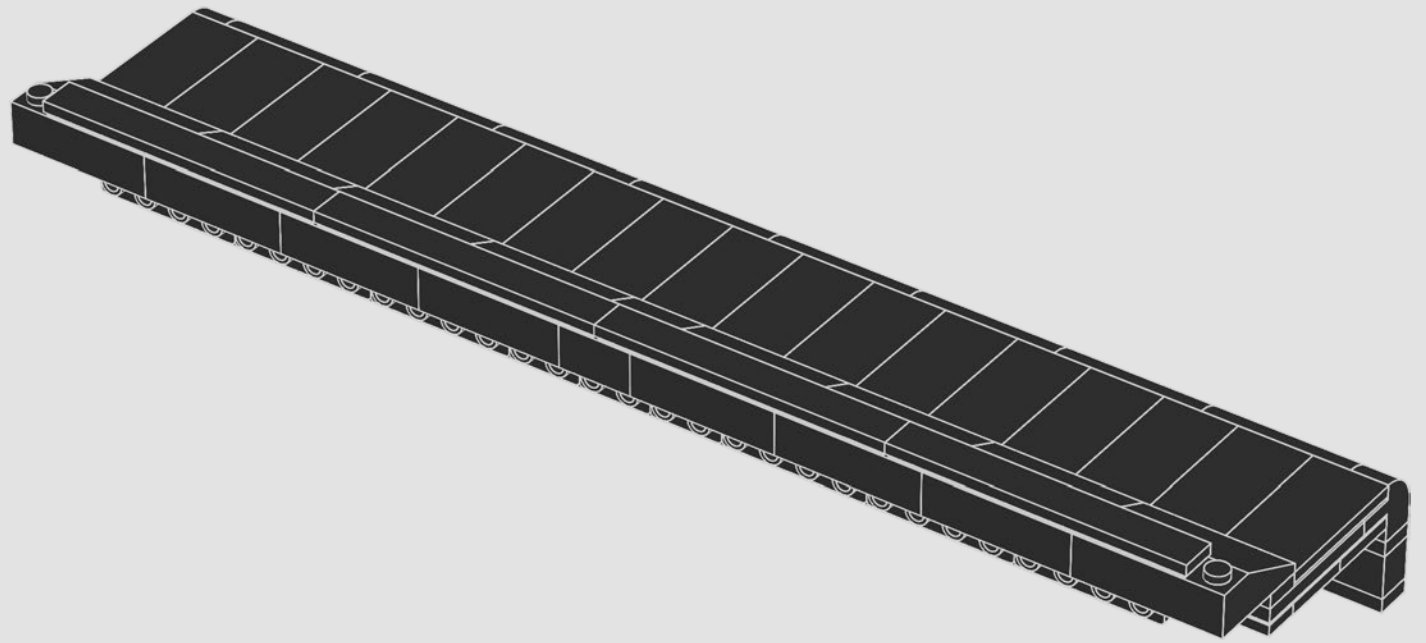

2x

690

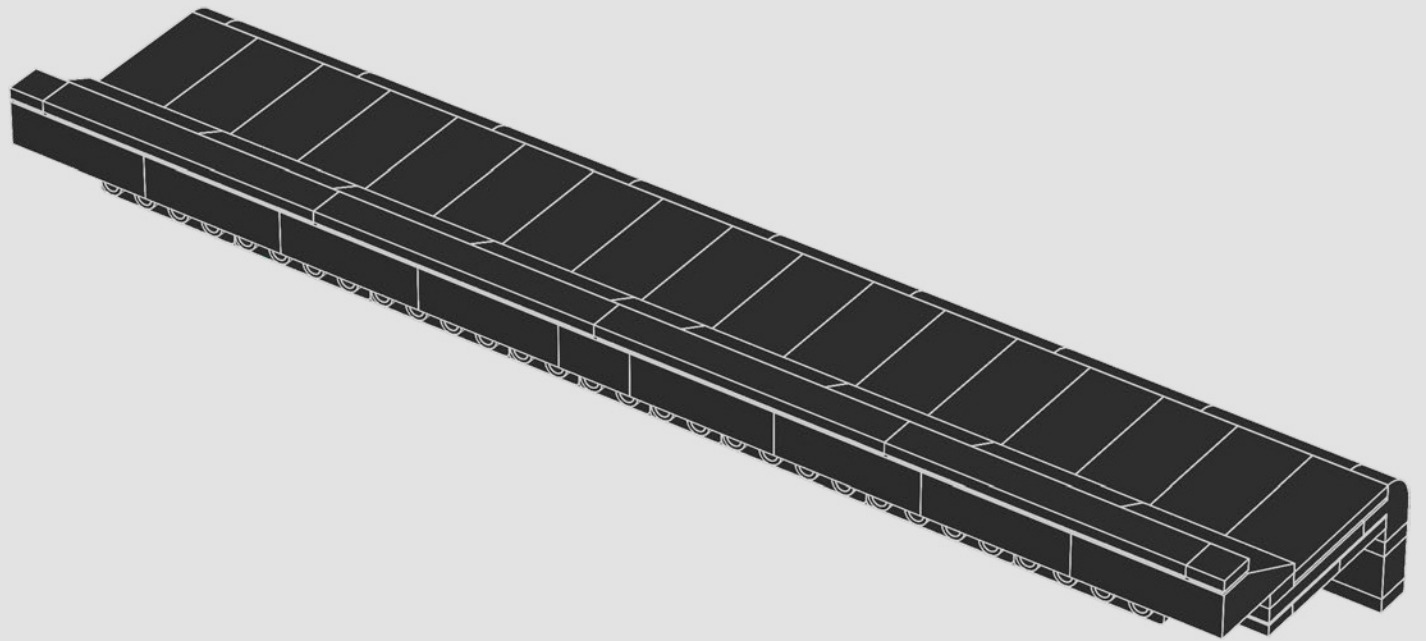



691

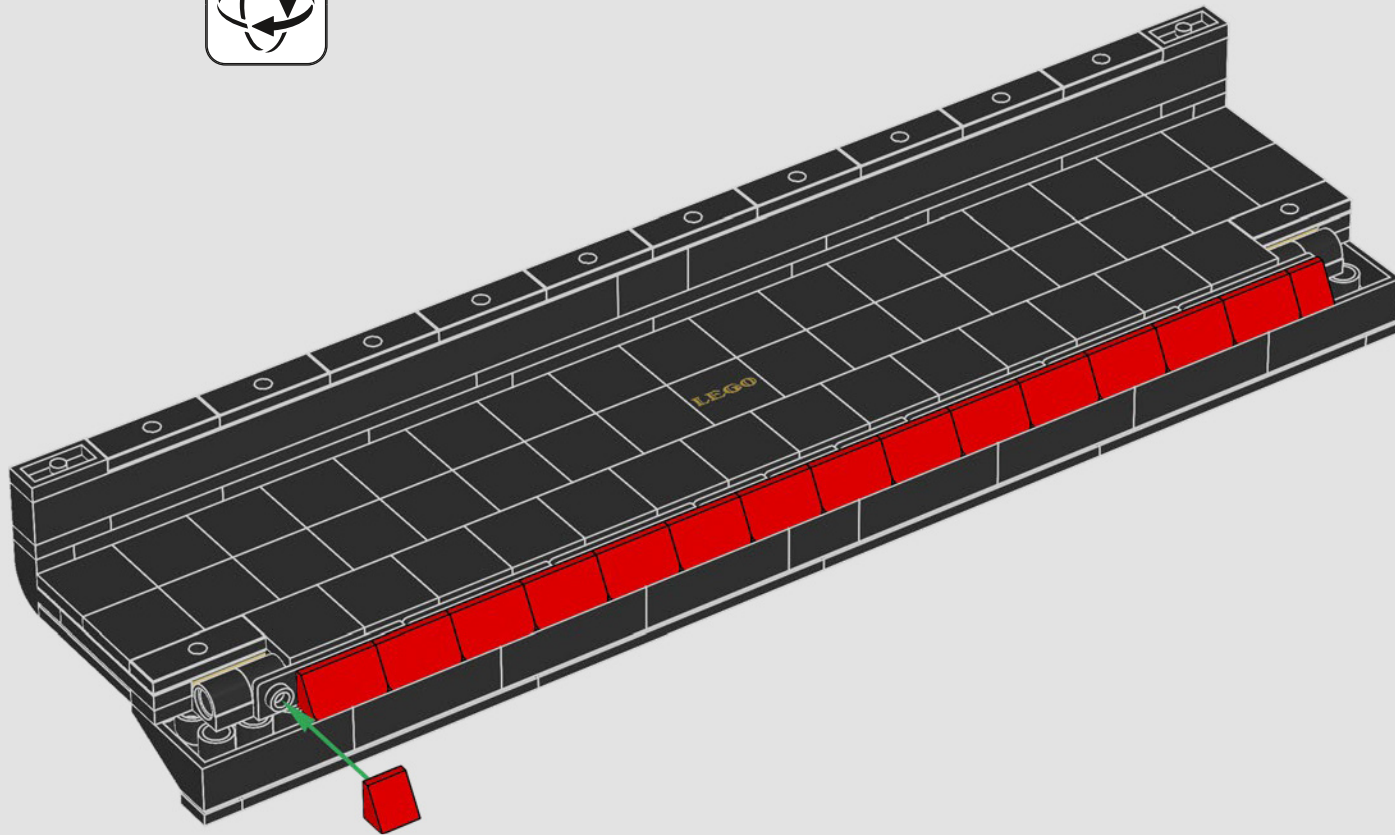

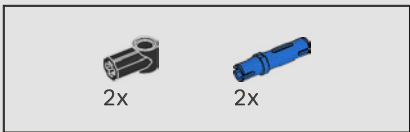

692

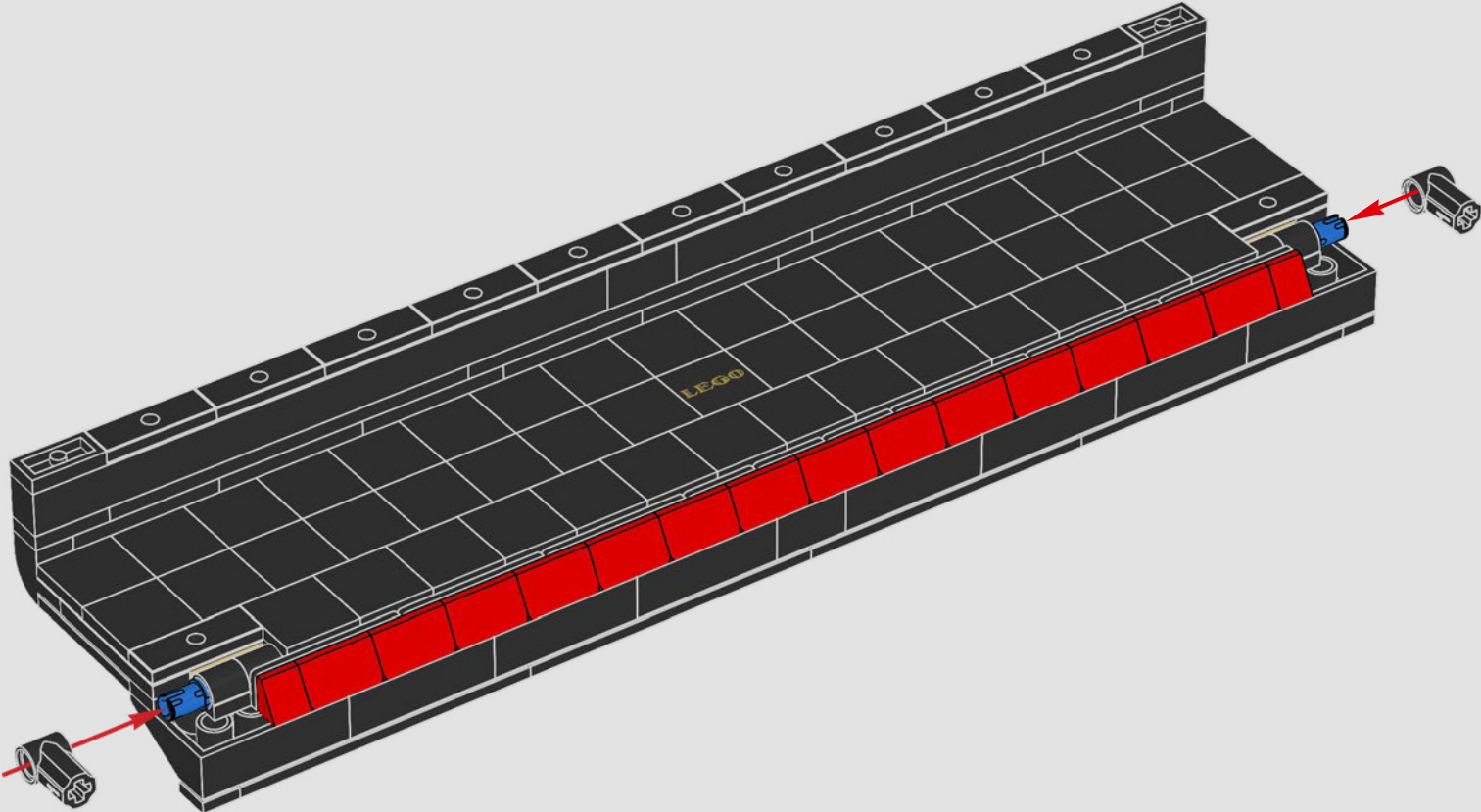

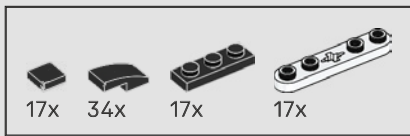

694

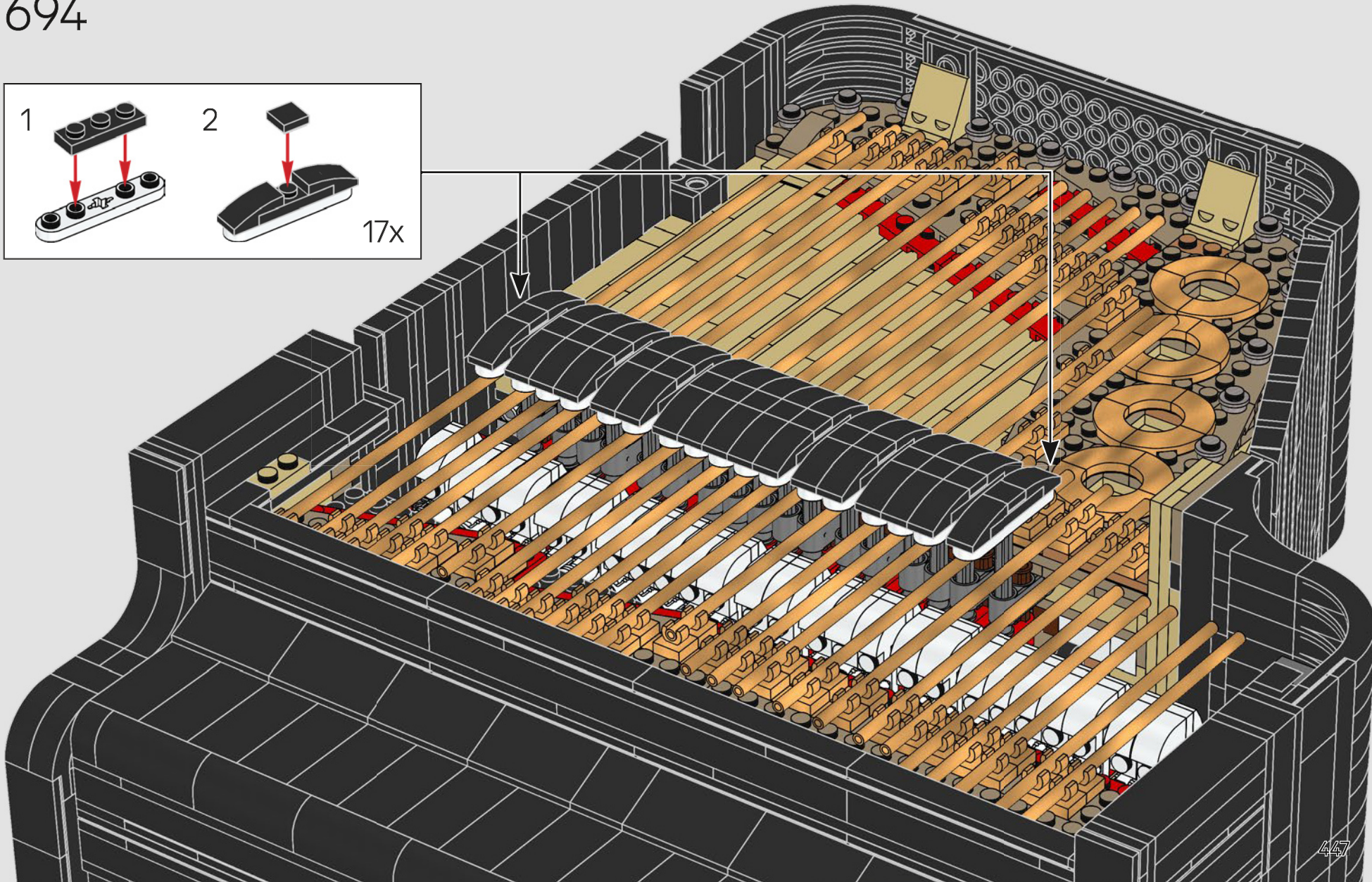
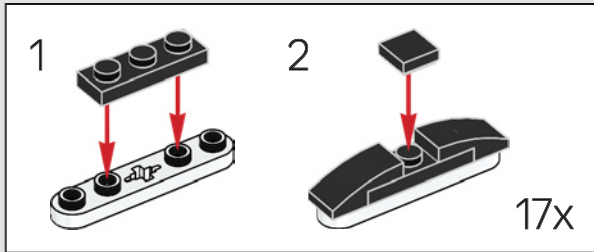

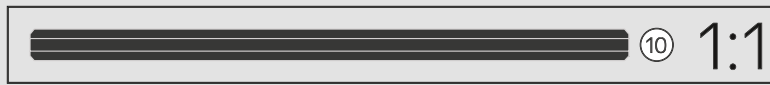
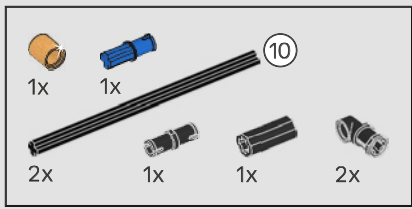

695

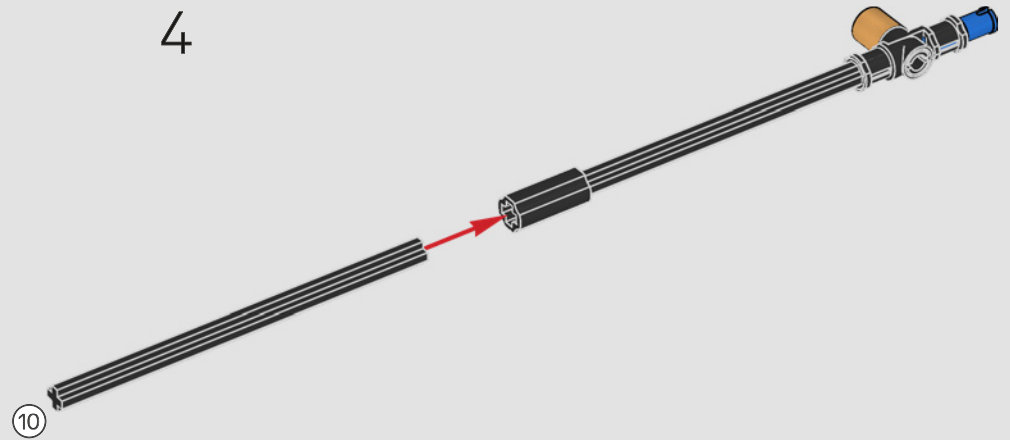
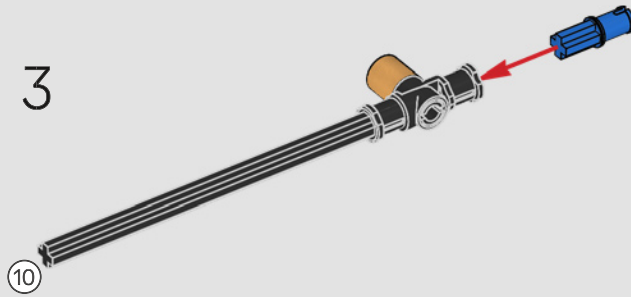
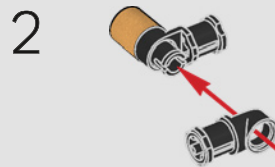
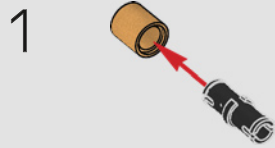

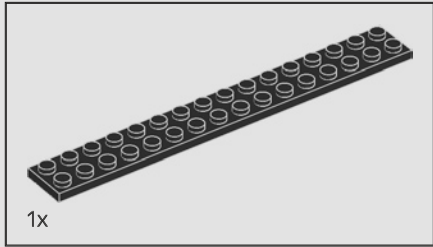
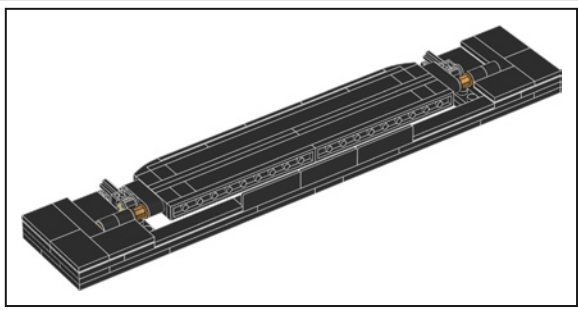

696

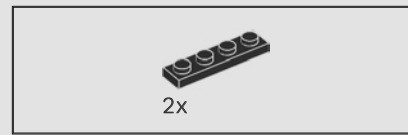
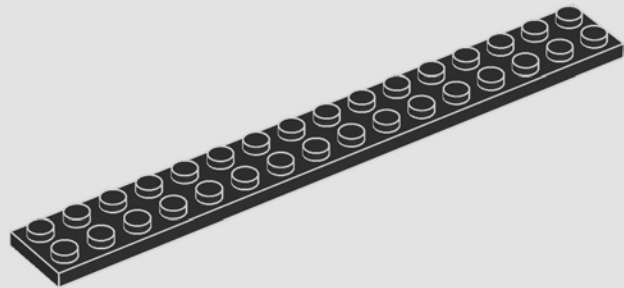

2x

697

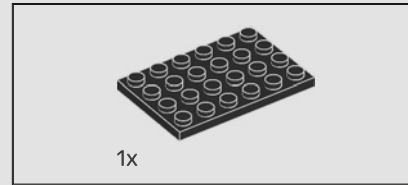
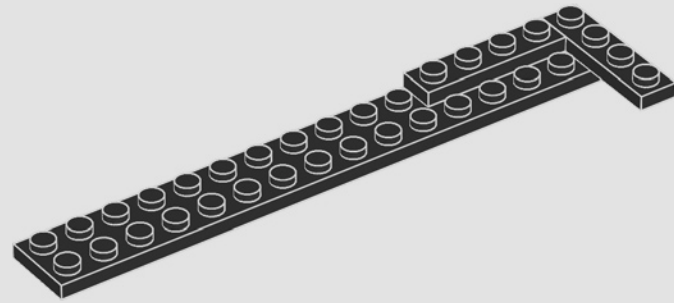

1x

698

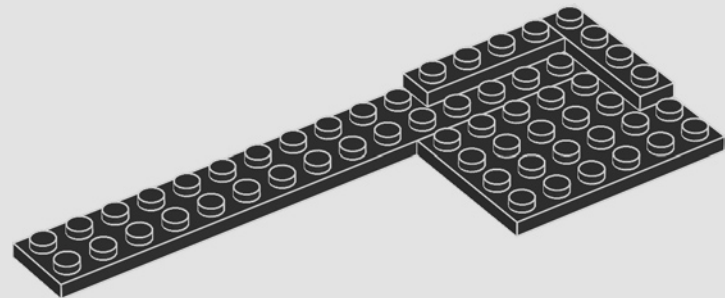

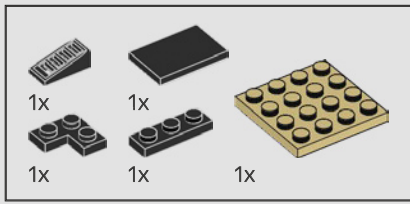

699

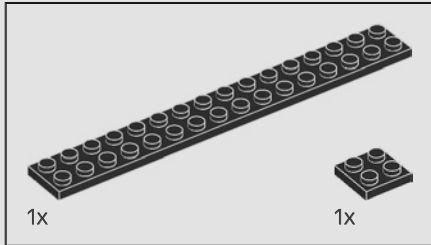
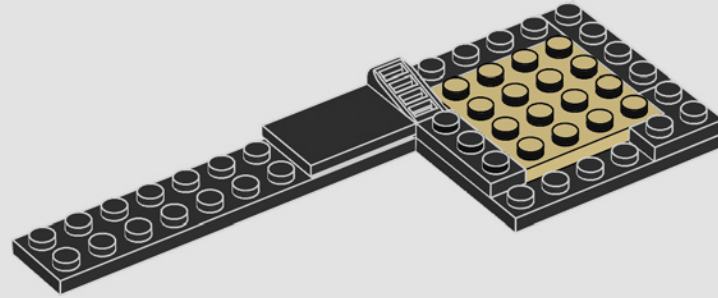

700

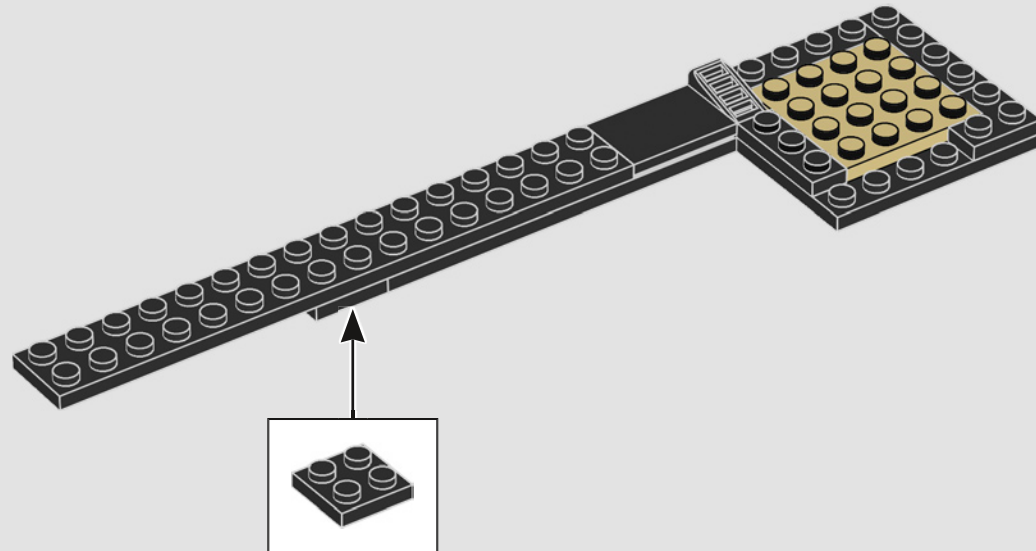

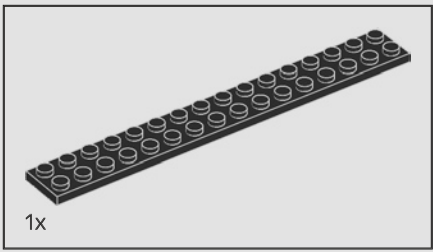

701

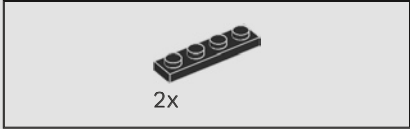
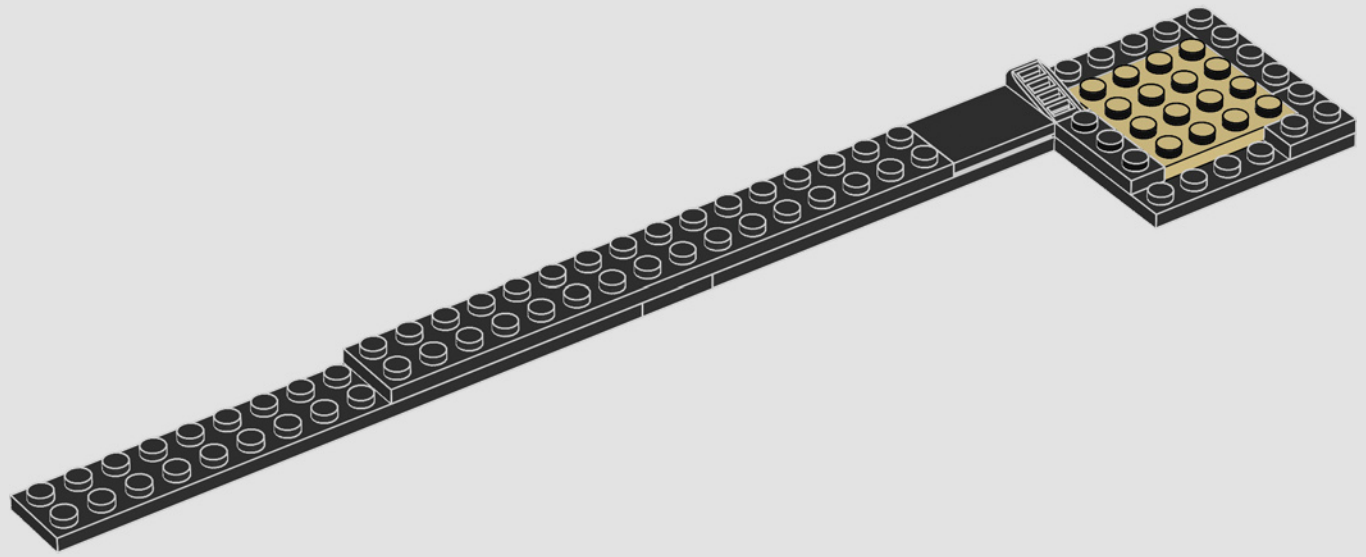

702

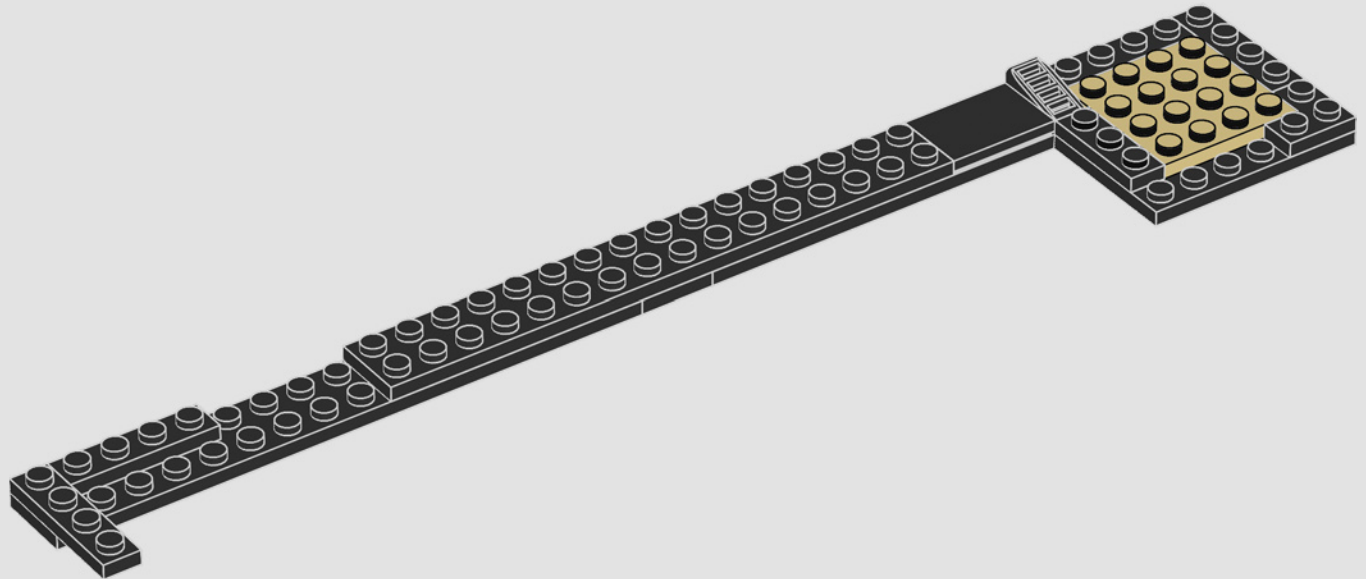

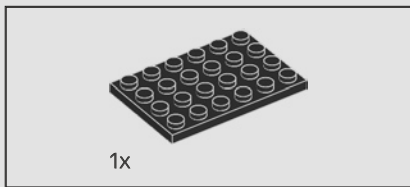

703

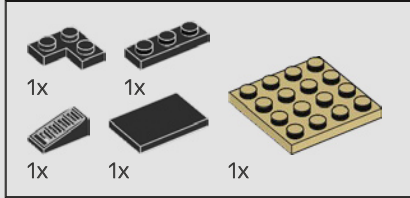
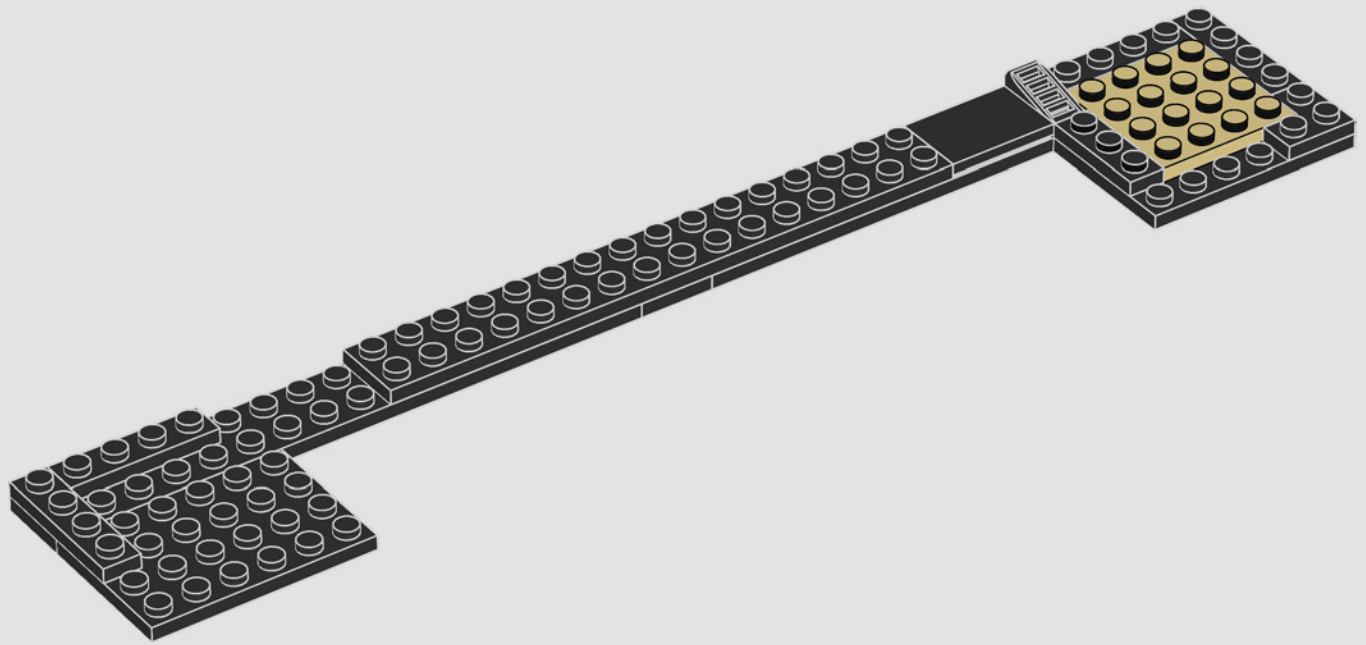

704

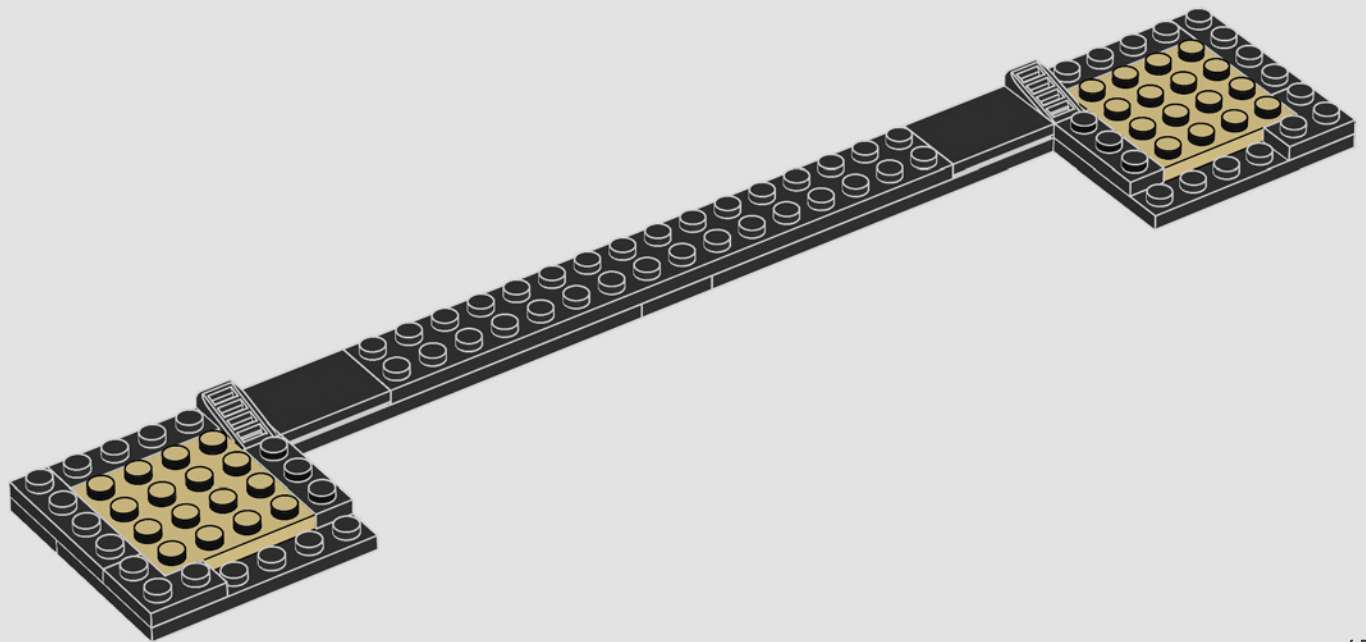

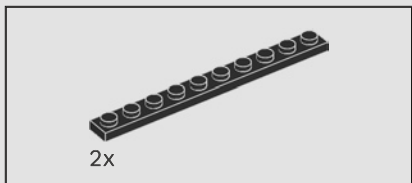

705

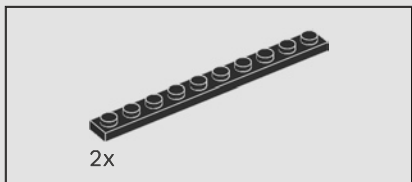
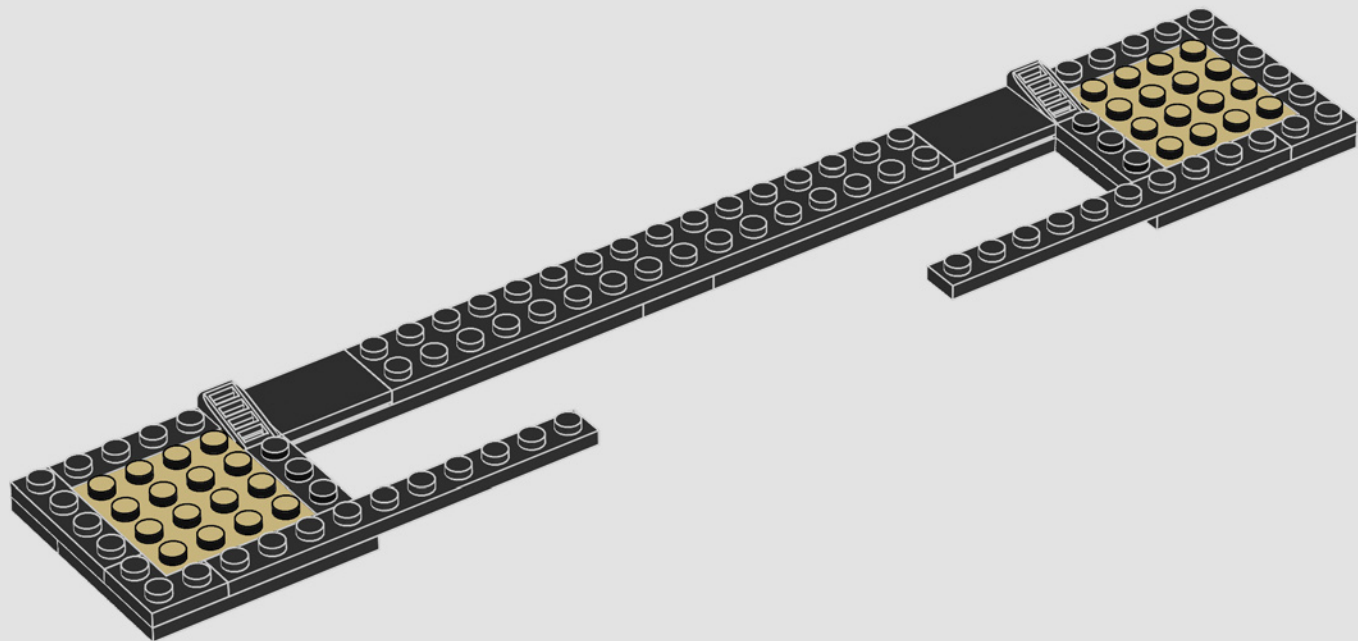

706

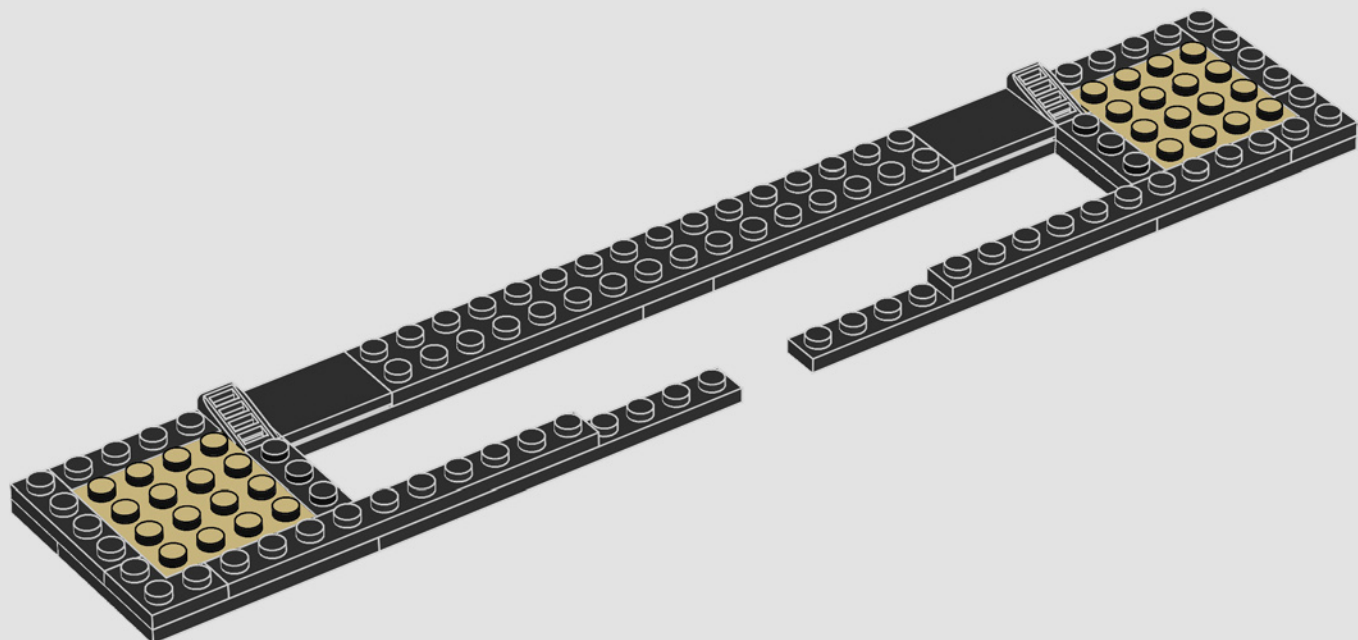

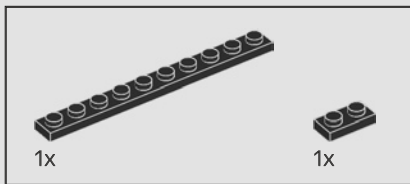

707

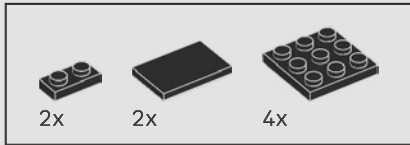
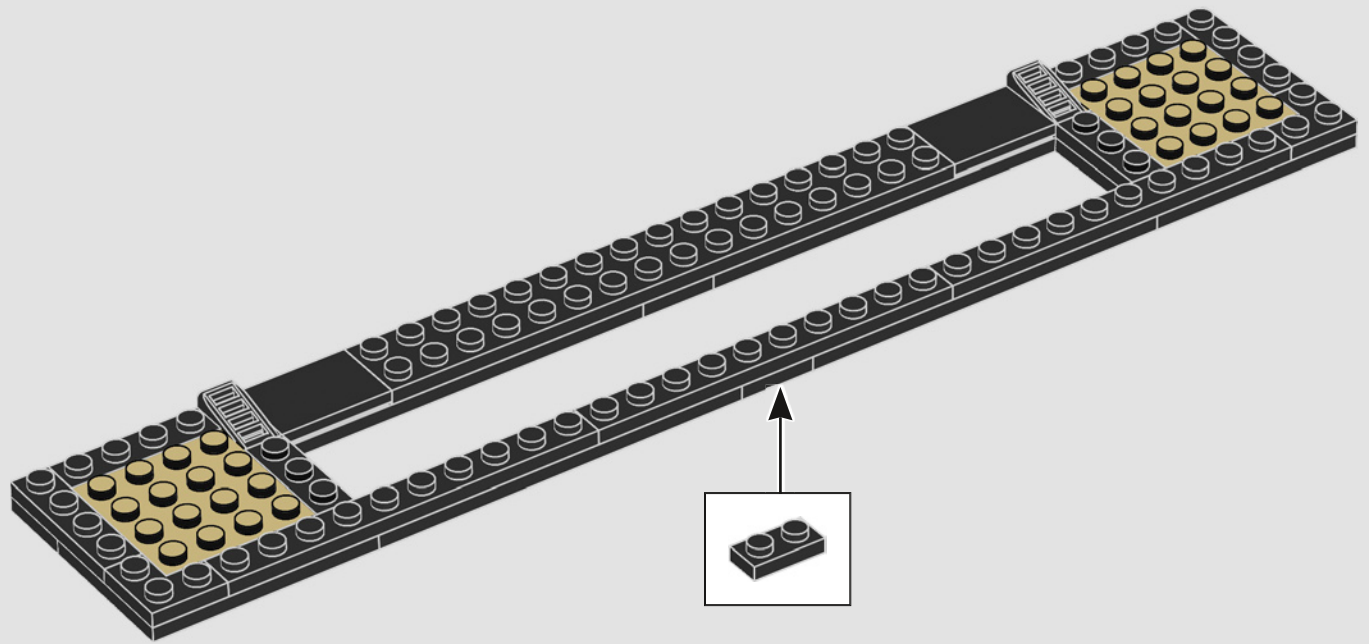

708

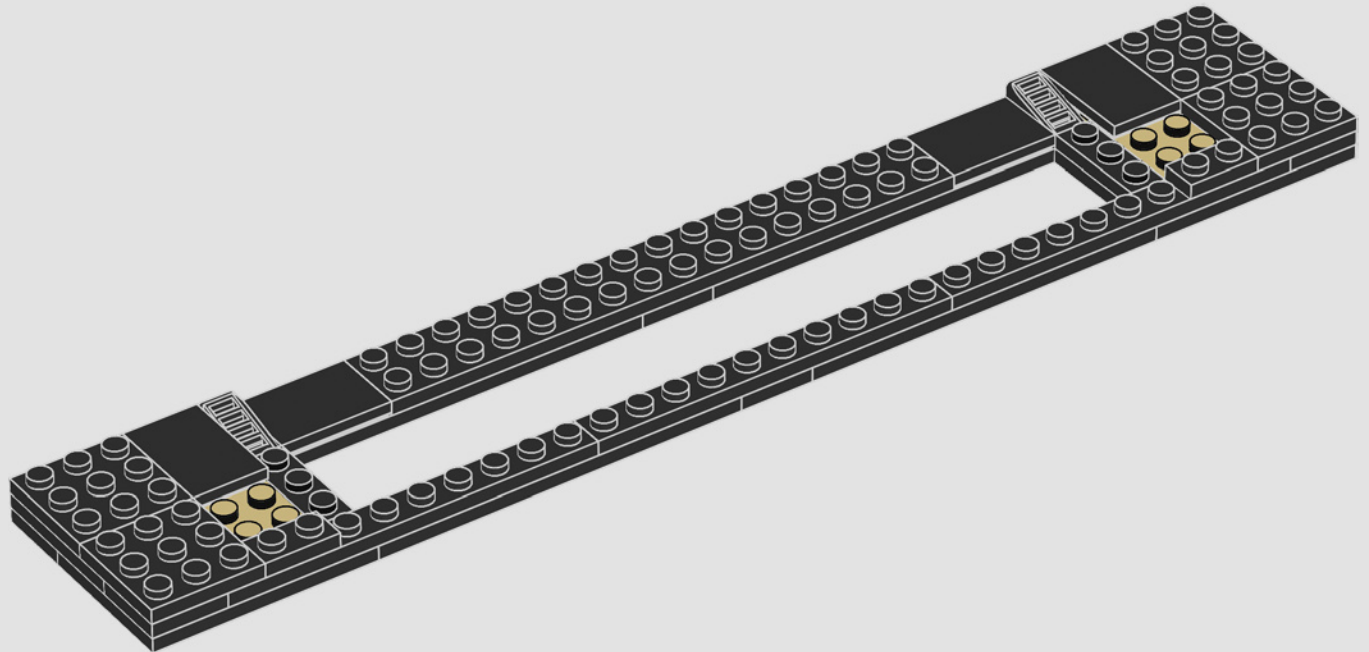

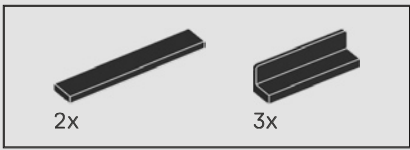

709

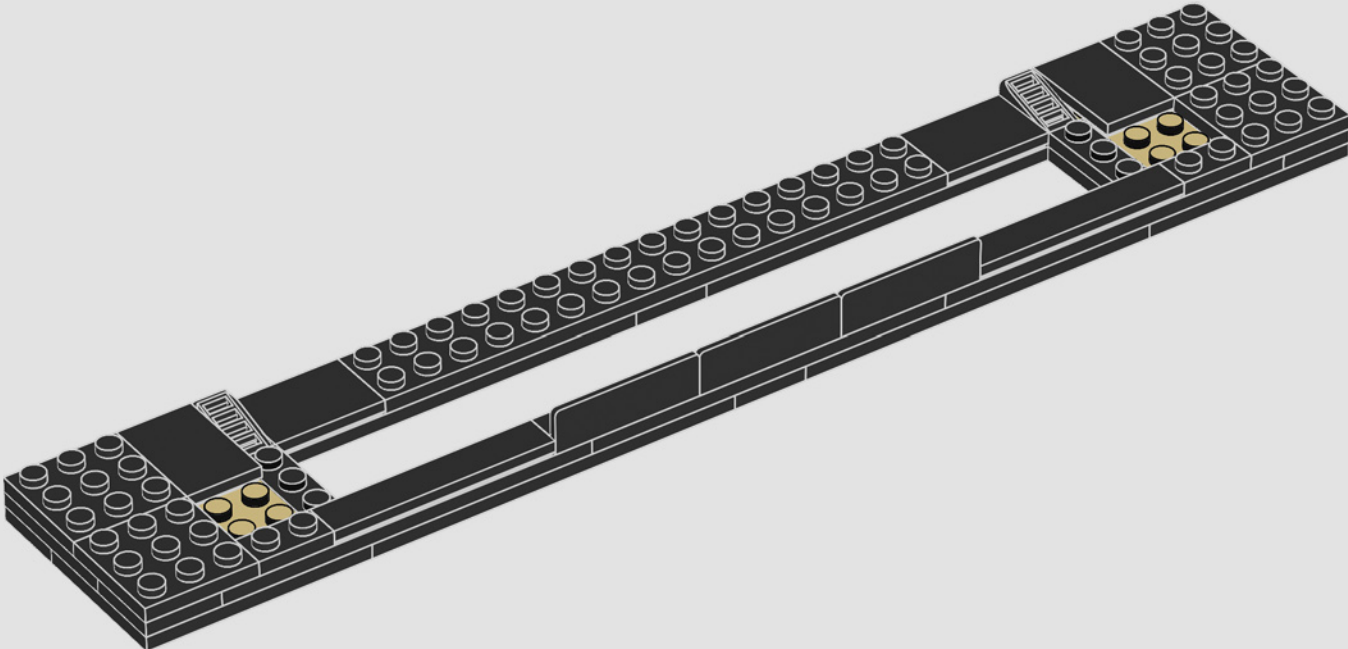

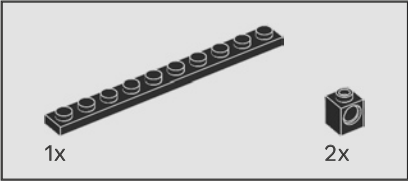
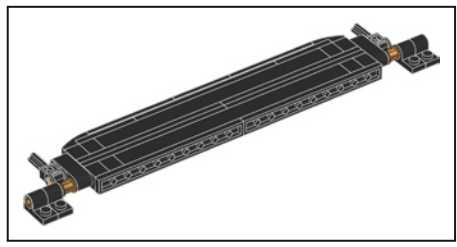

710

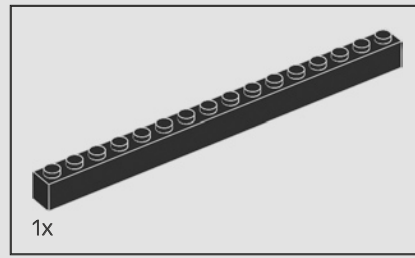
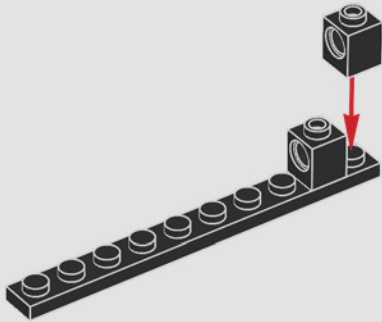

711

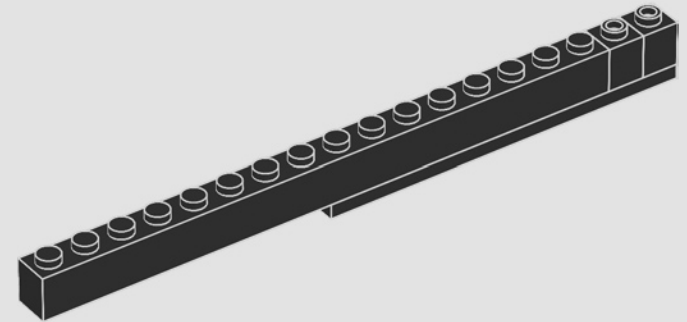

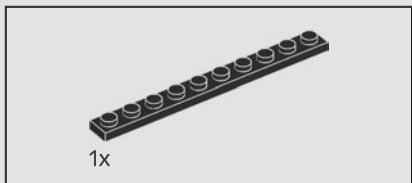

712

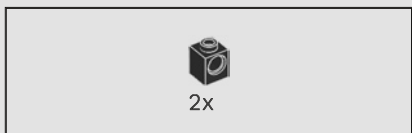
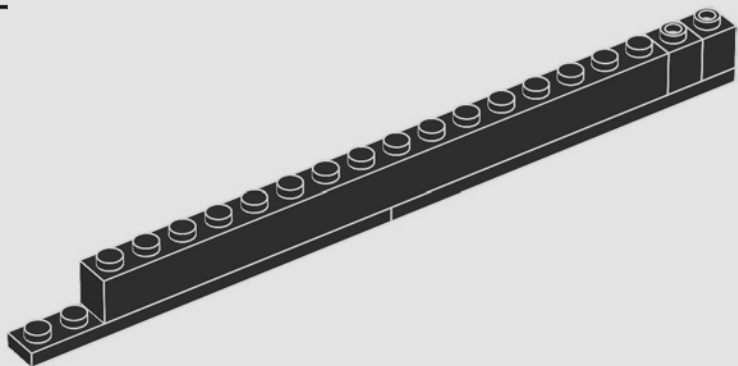

713

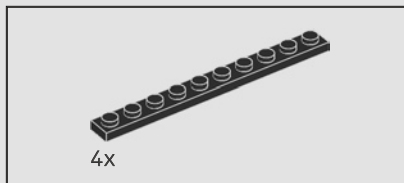
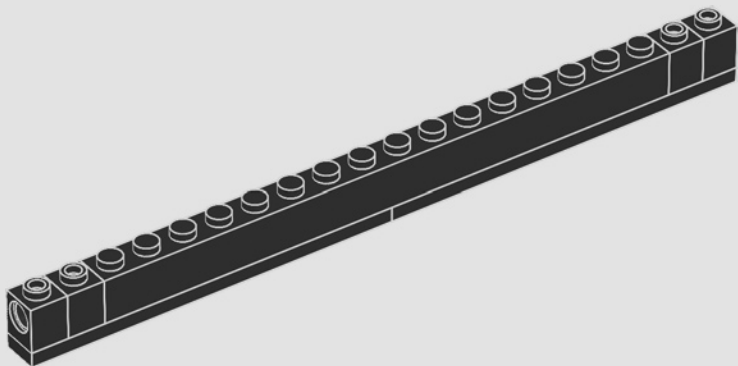

714

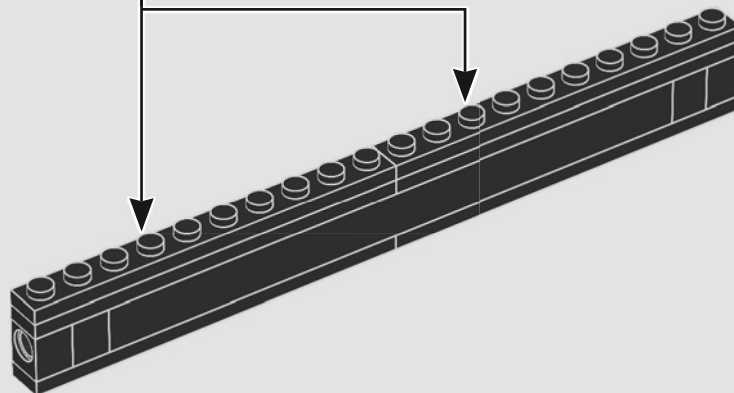
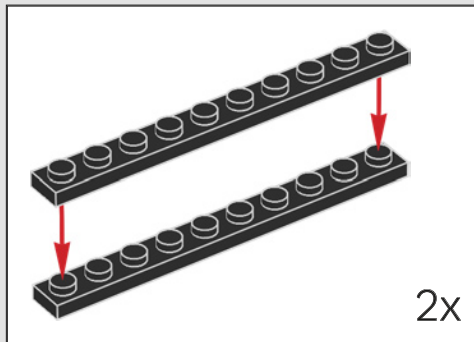

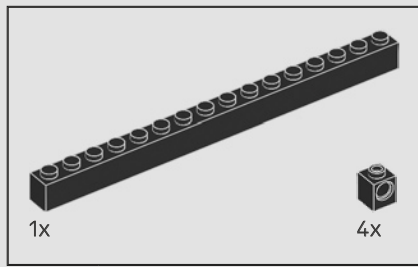

715

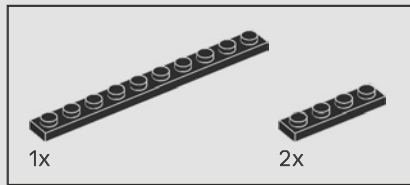
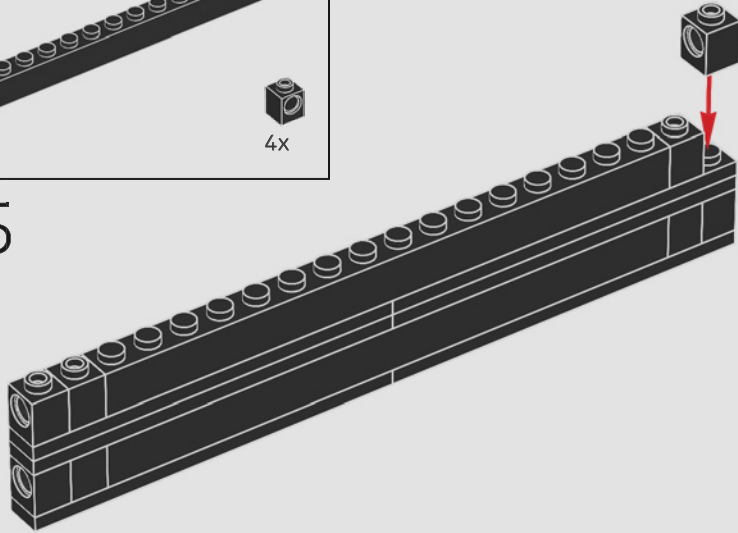

716

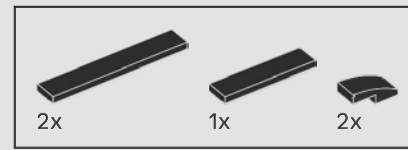
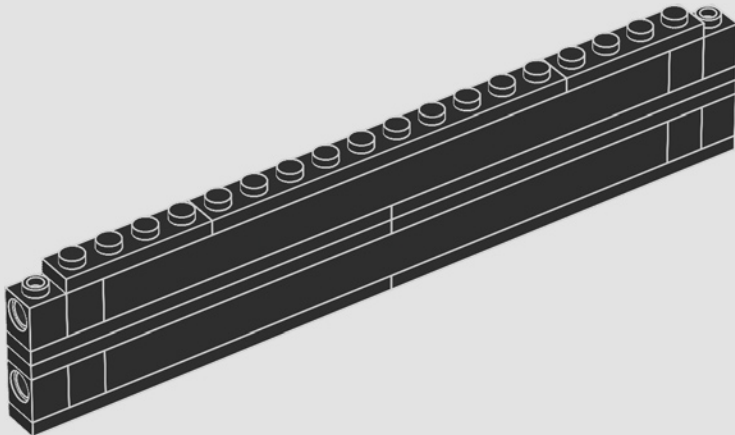

717

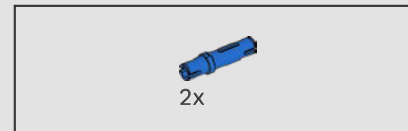
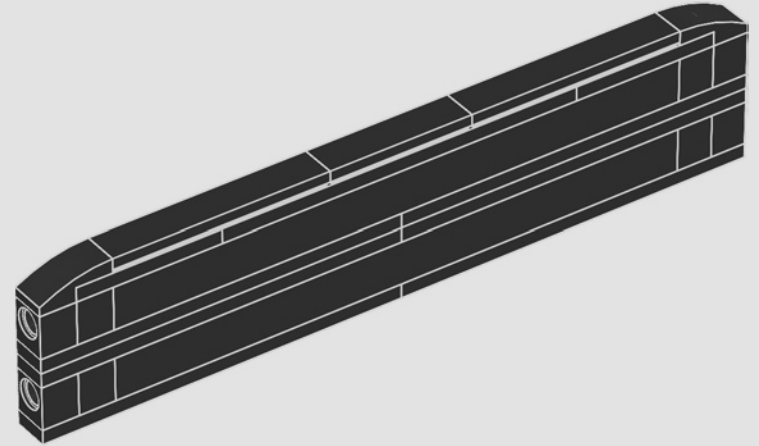

718

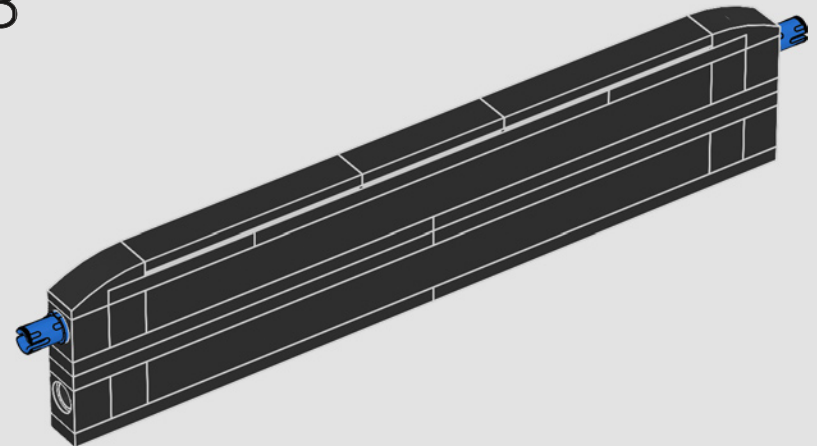

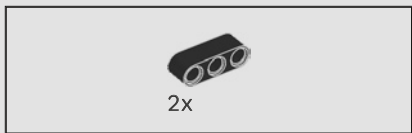

719

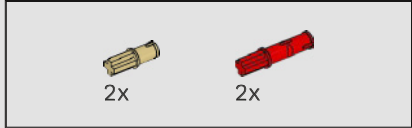
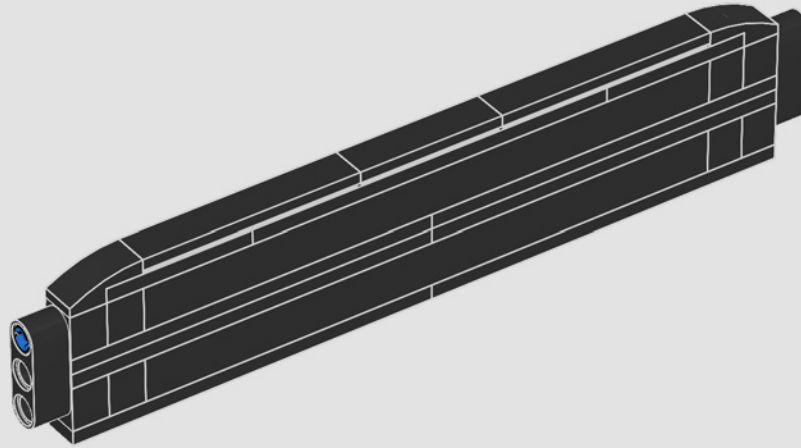

720

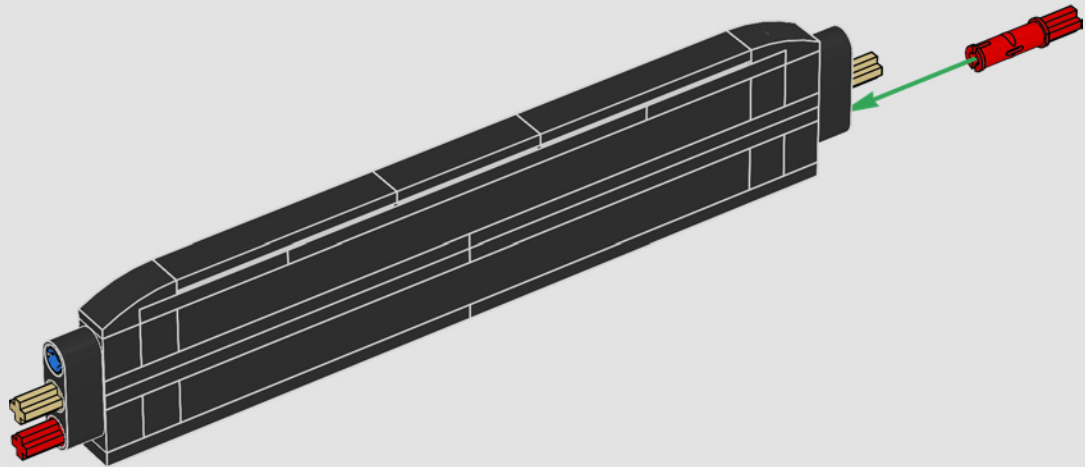

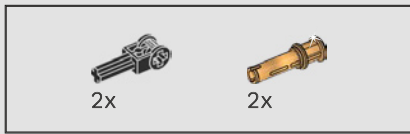

721

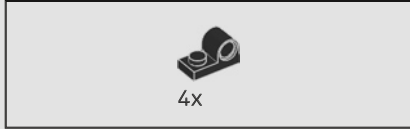
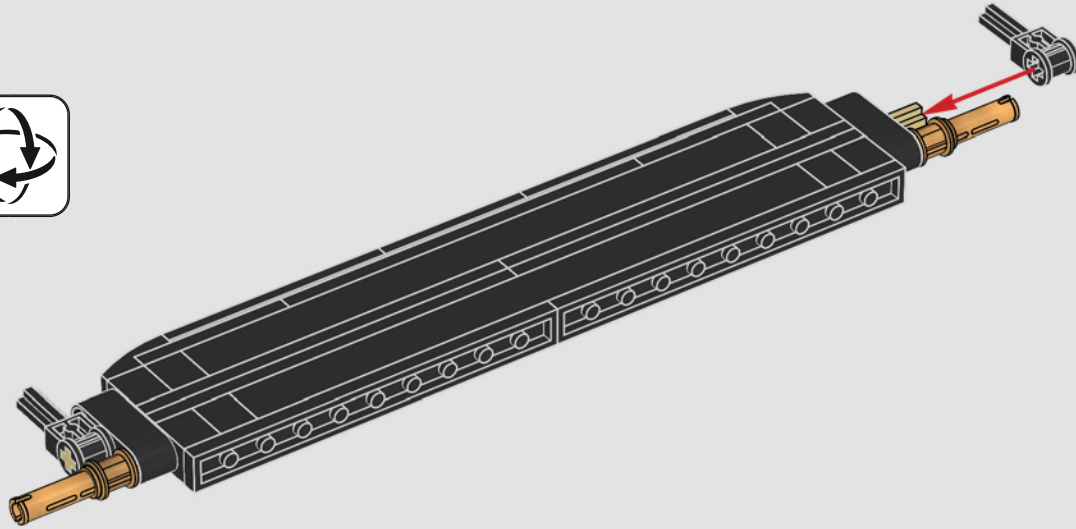

722

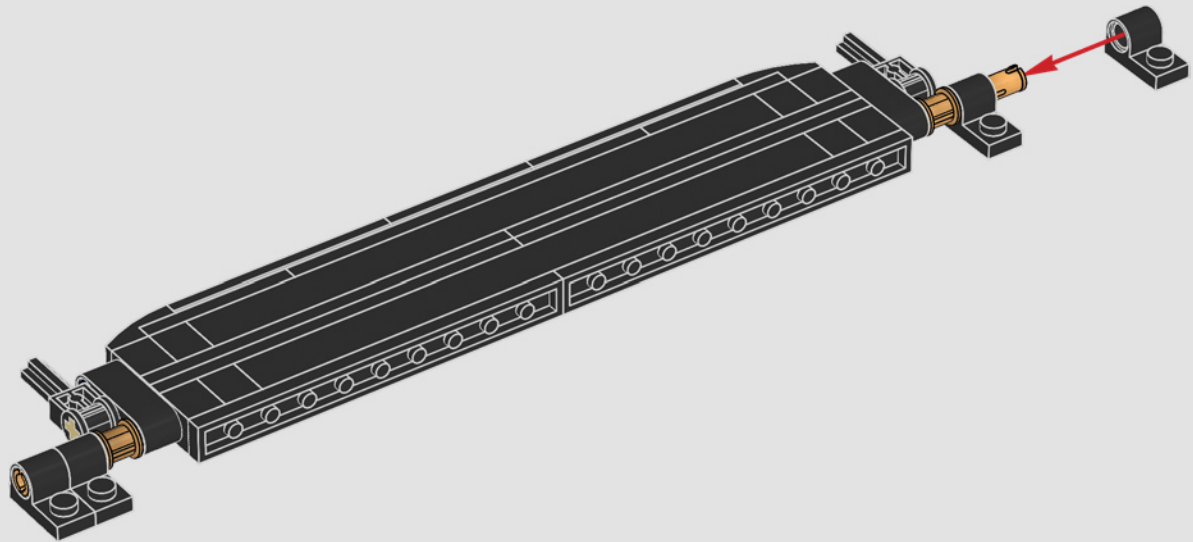

723

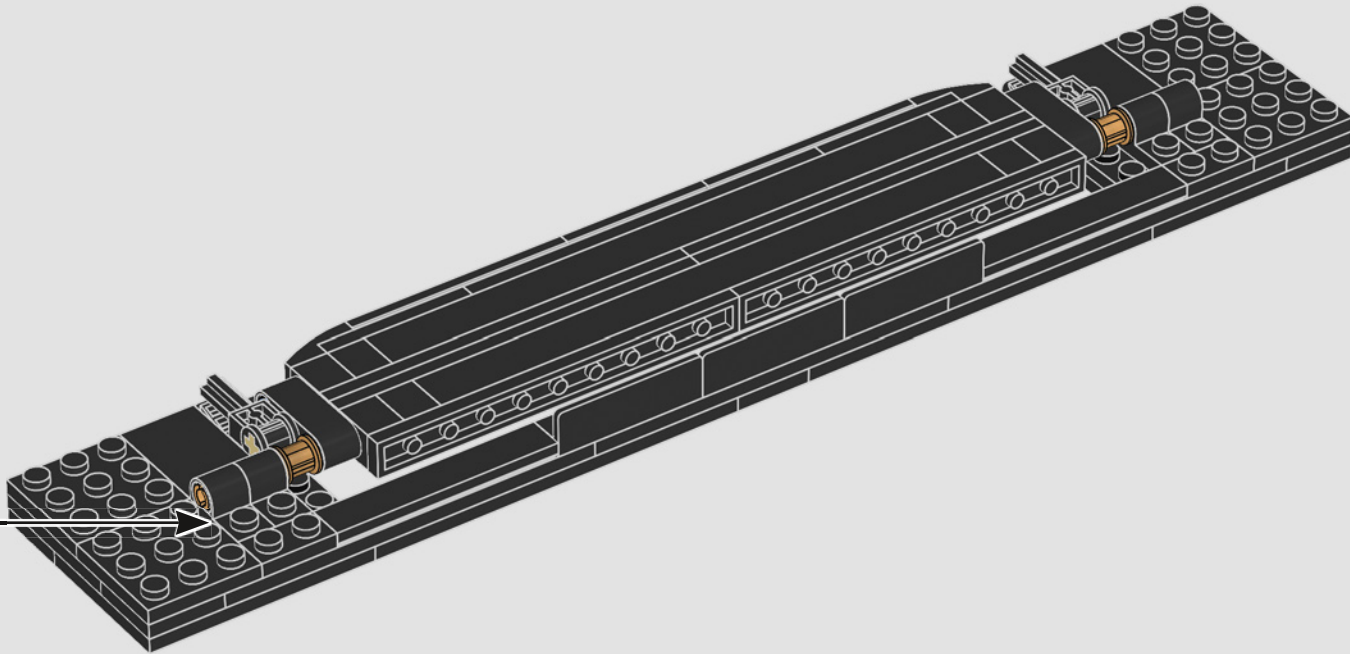

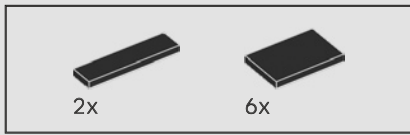

724

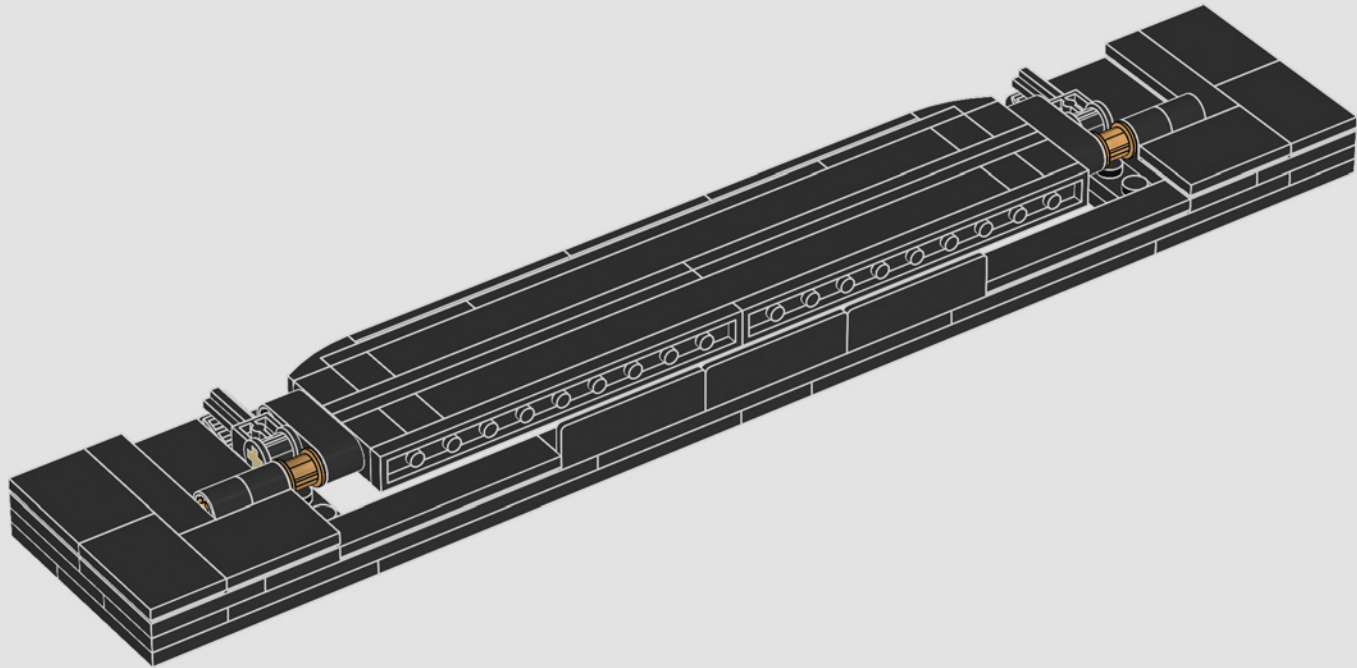

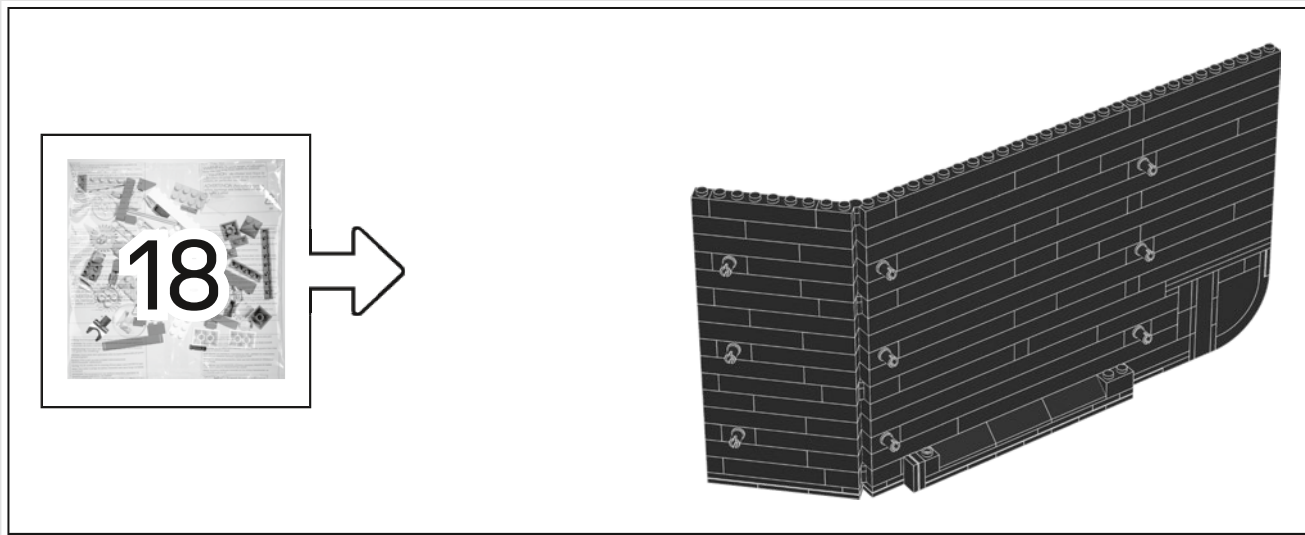

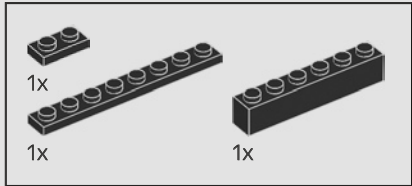
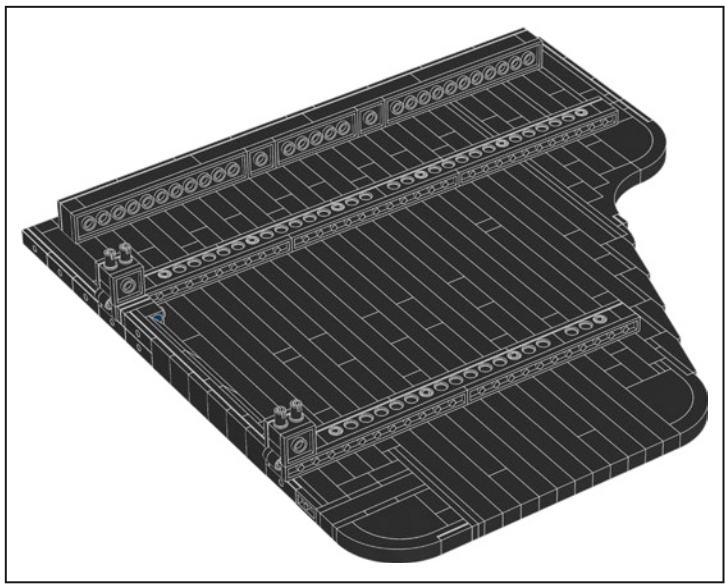

726

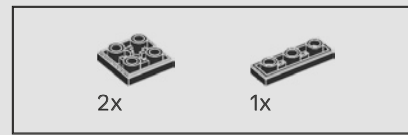
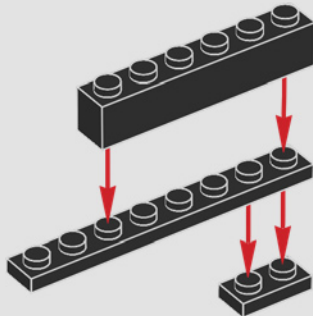

727

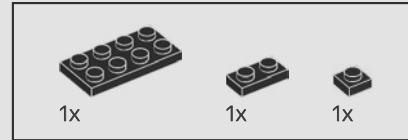
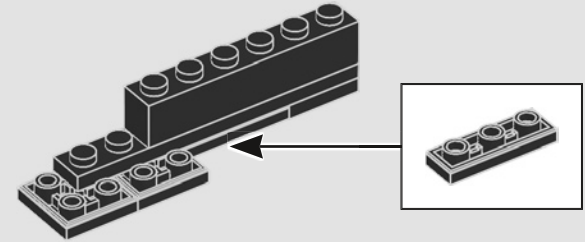

728

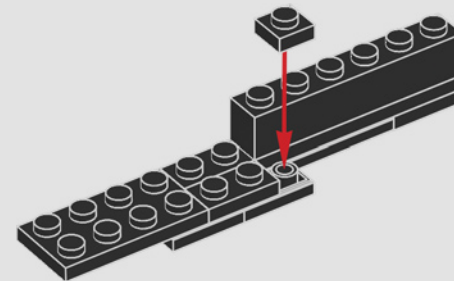

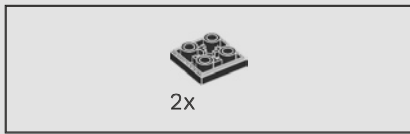

729

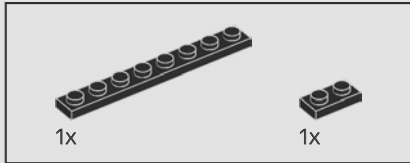
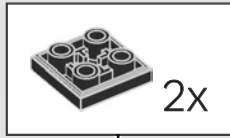
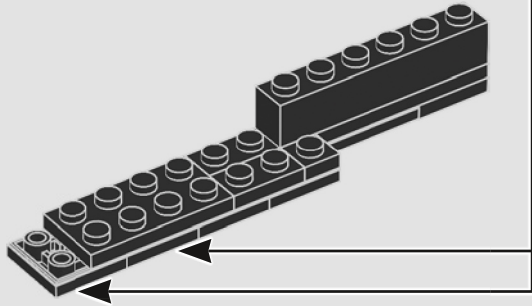

730

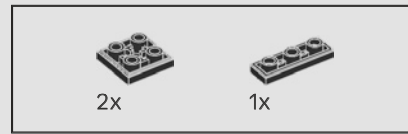
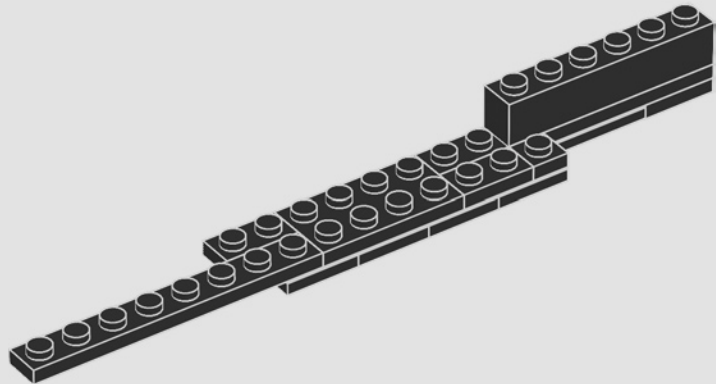

731

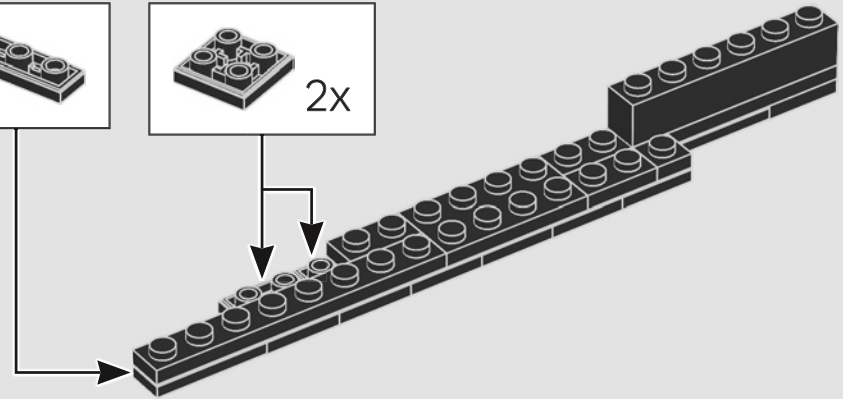
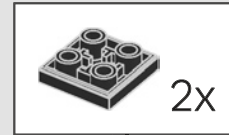

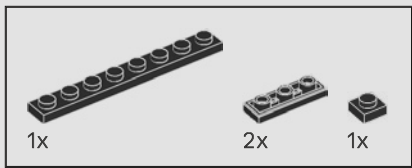

732

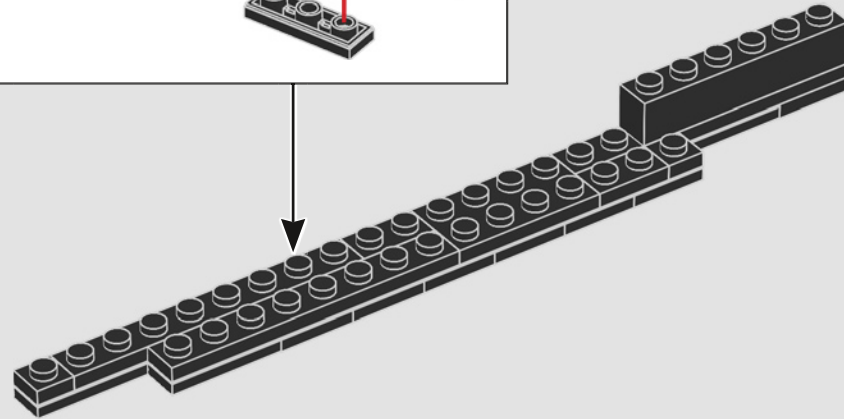
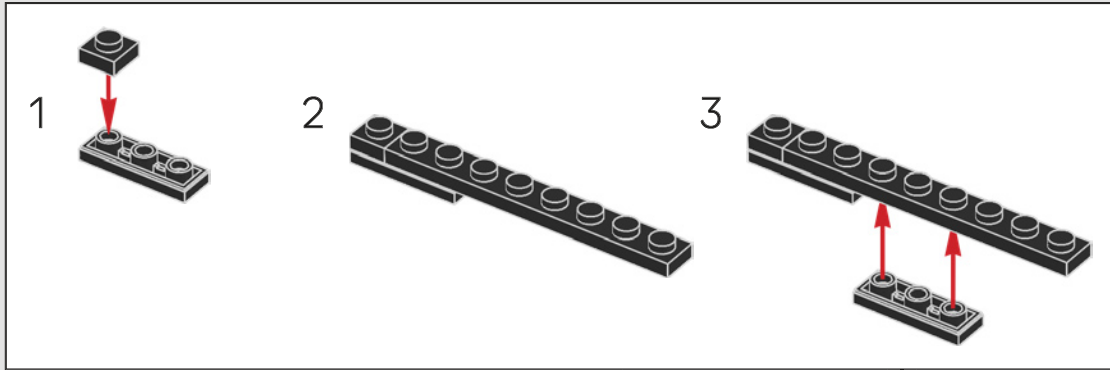

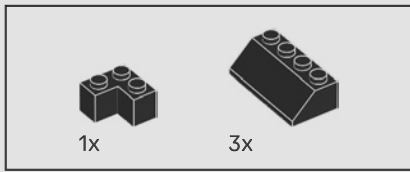

733

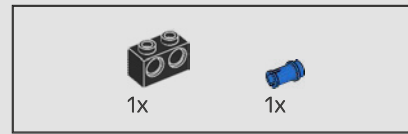
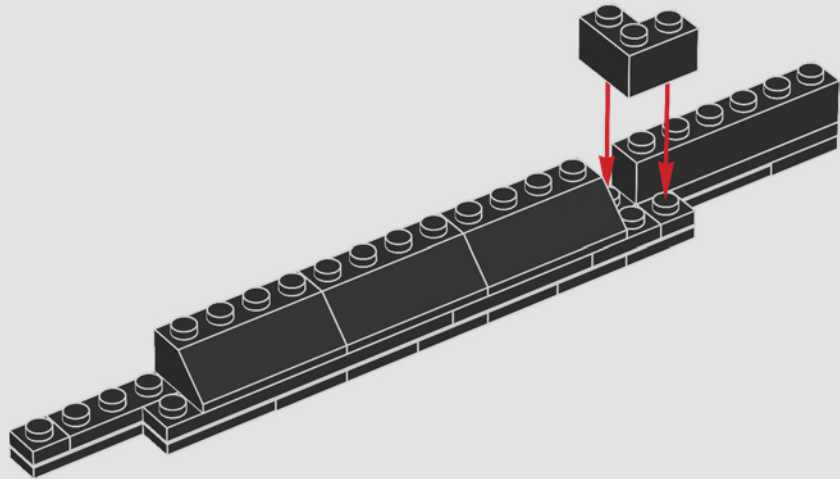

734

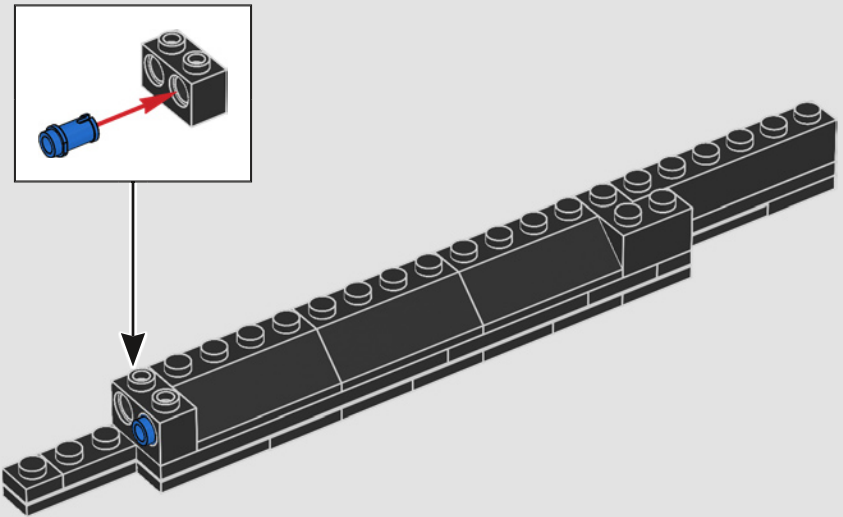

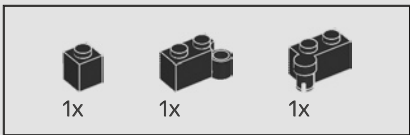

735

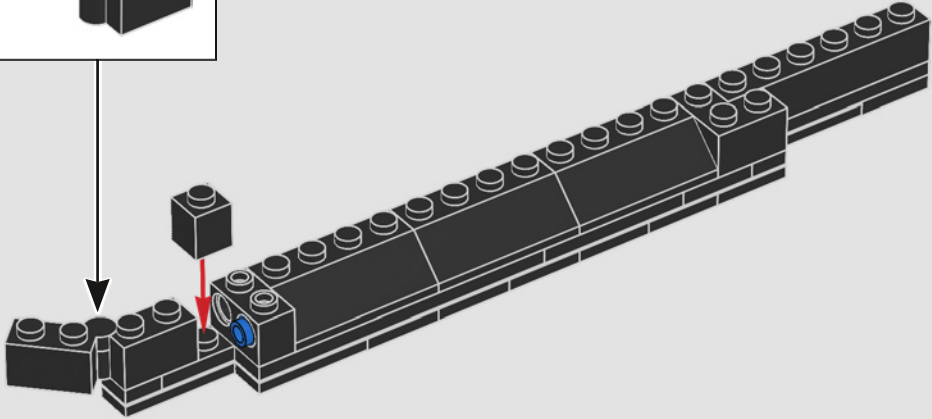
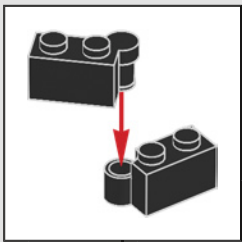

736

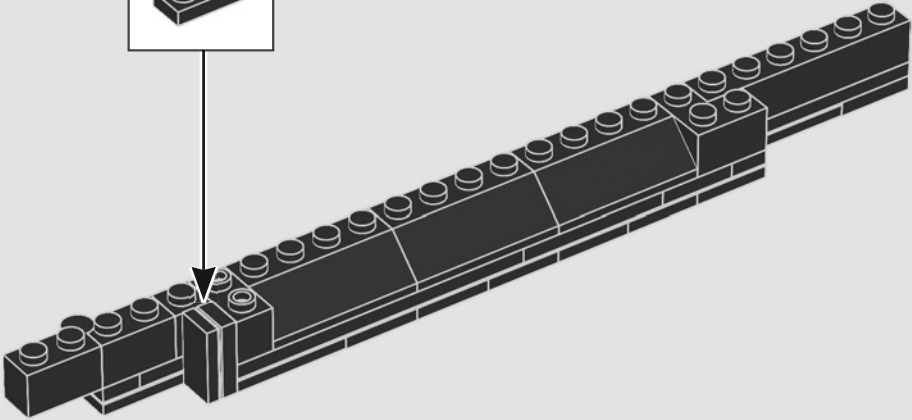
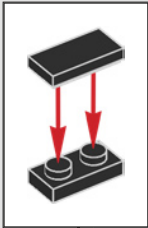

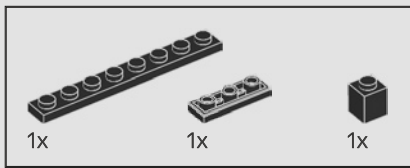

737

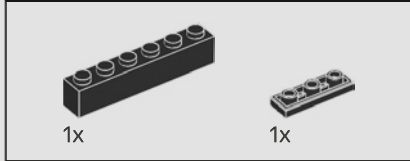
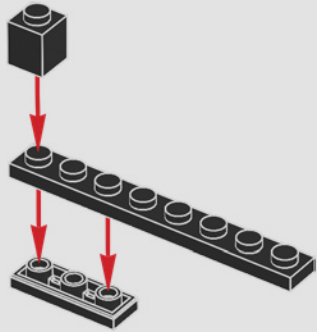

738

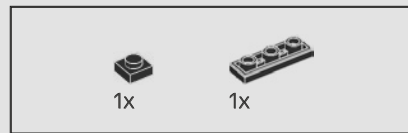
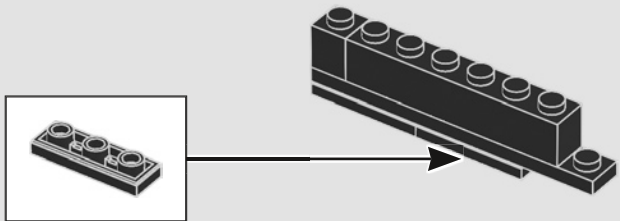

739

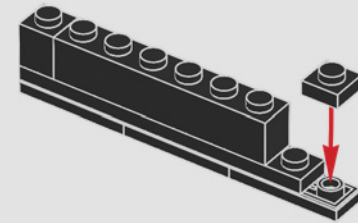



740

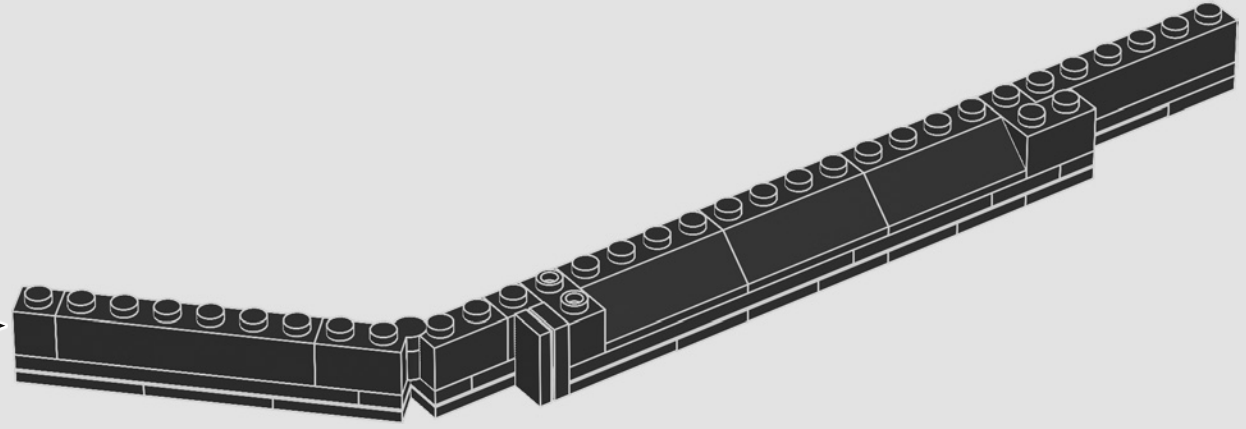

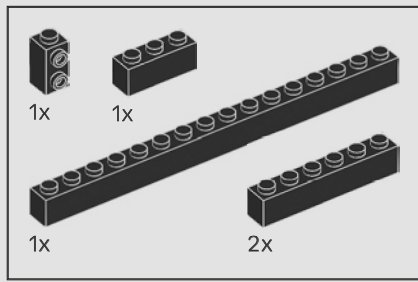

741

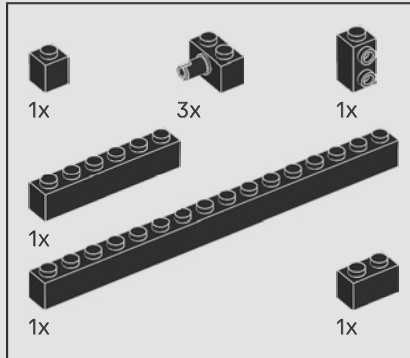
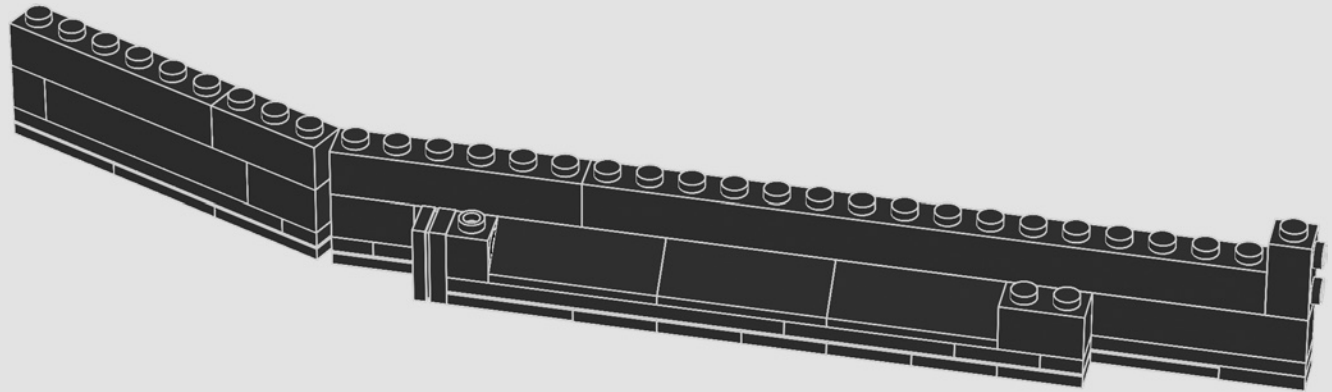

742

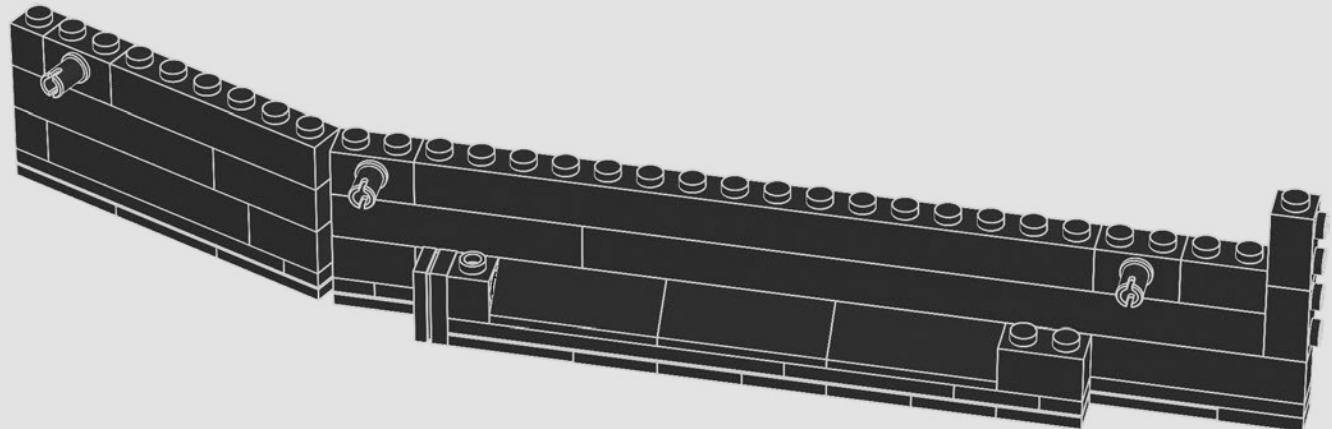

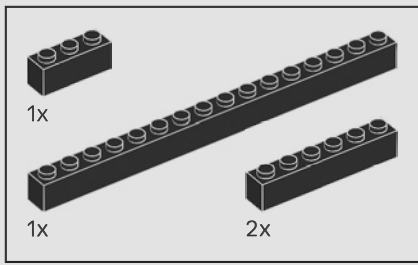

743

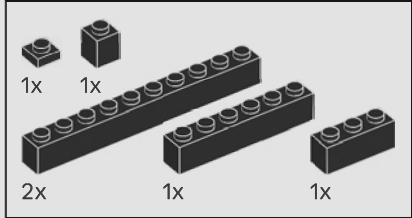
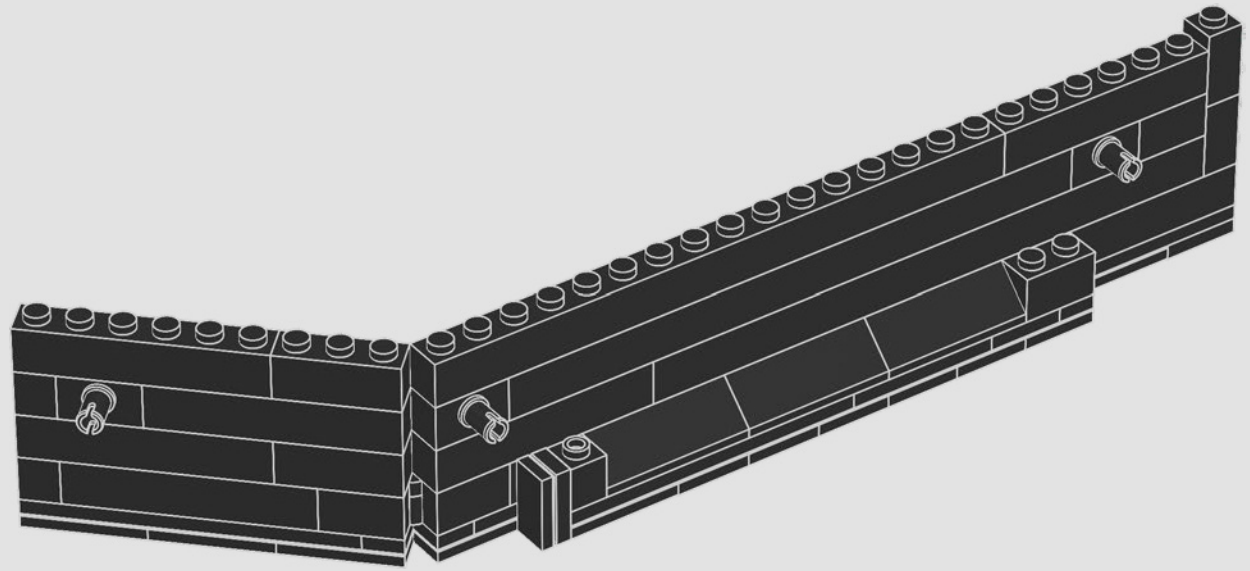

744

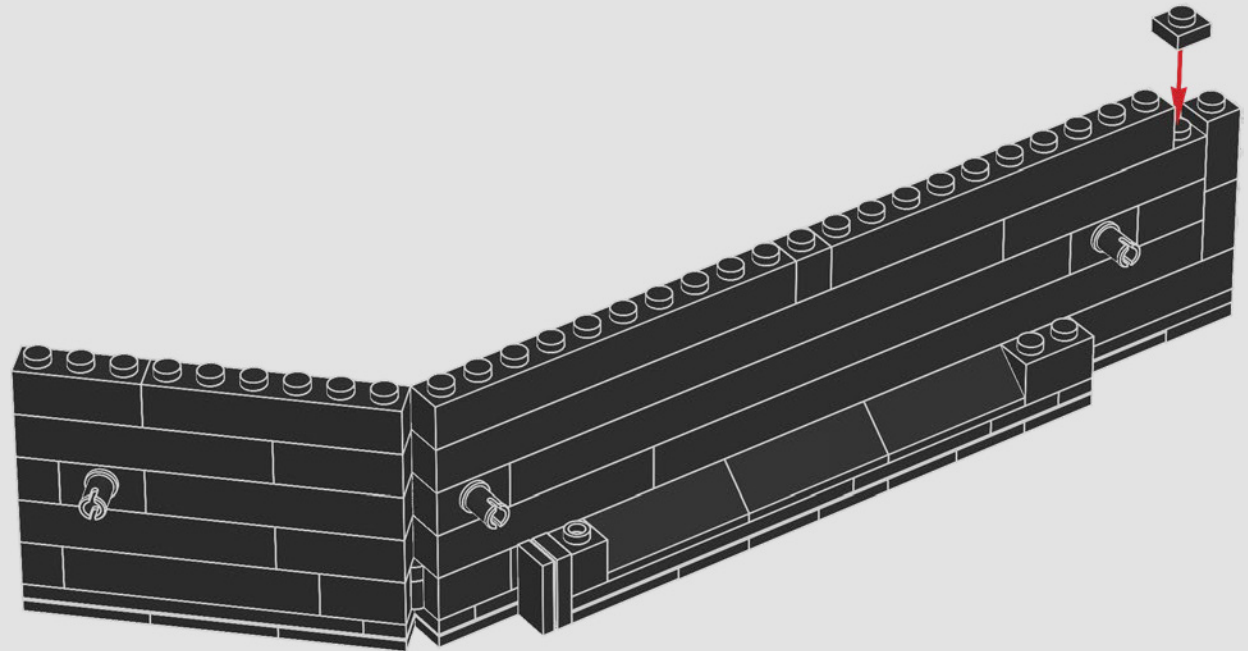

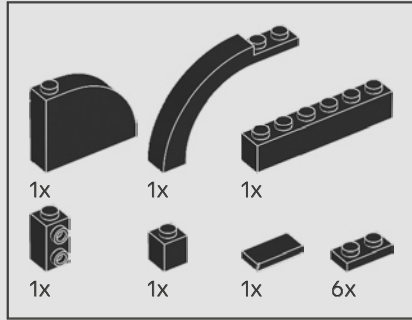
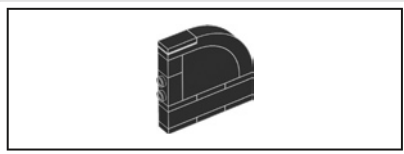

745

1

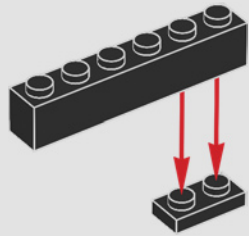

2

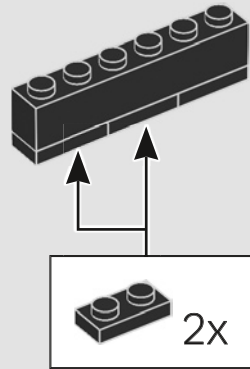

3

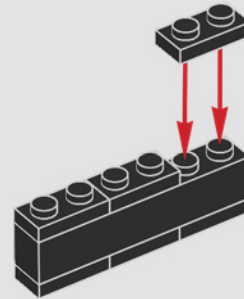

4

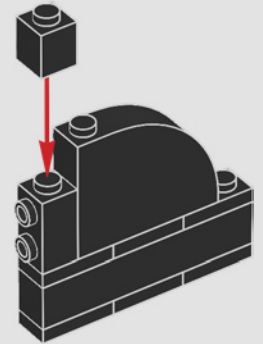

5

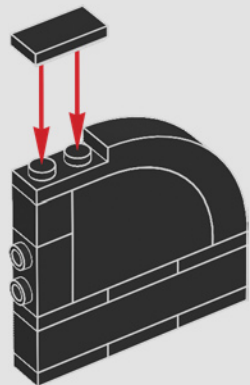

6

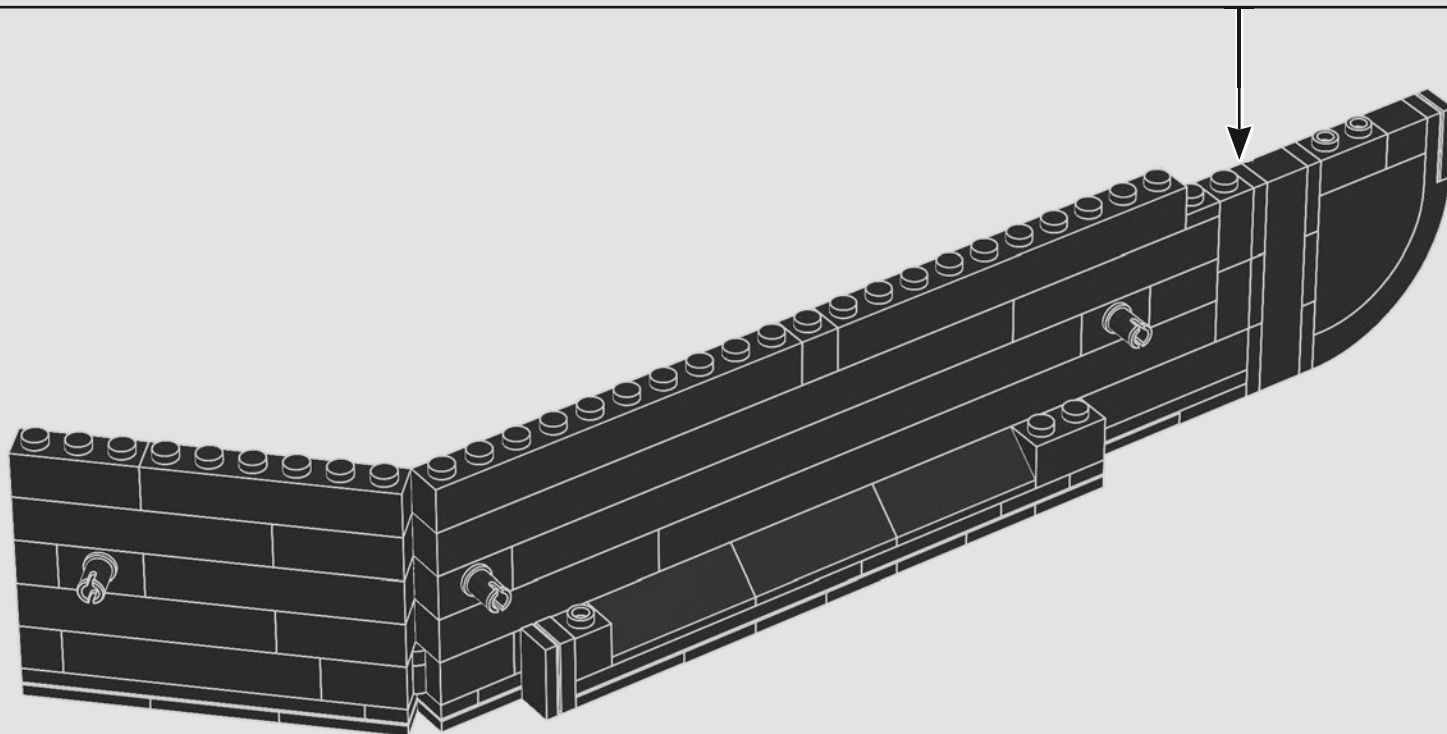
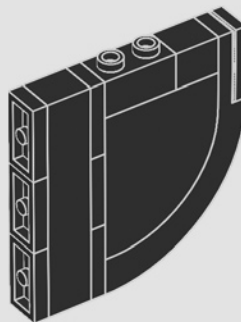

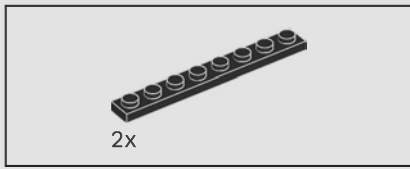

746

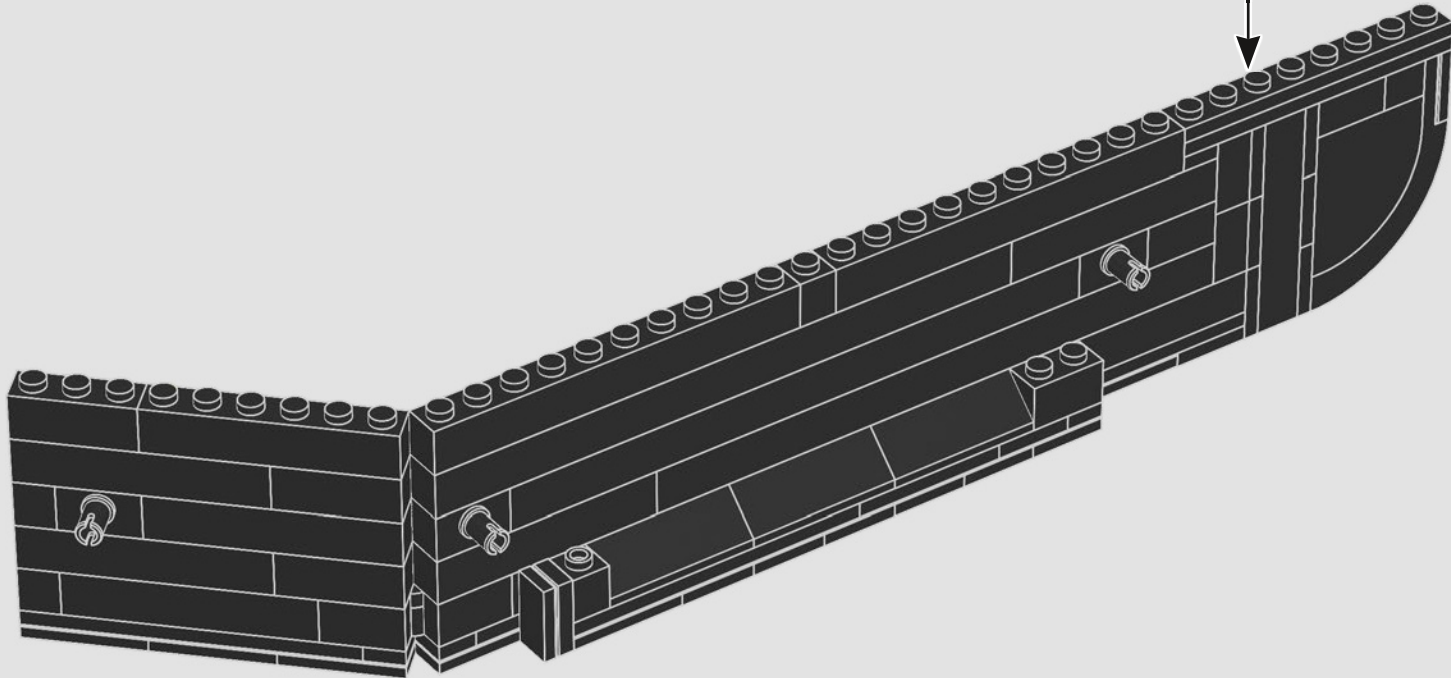
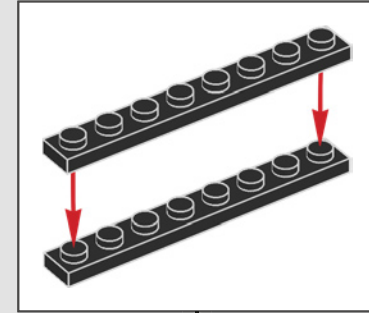

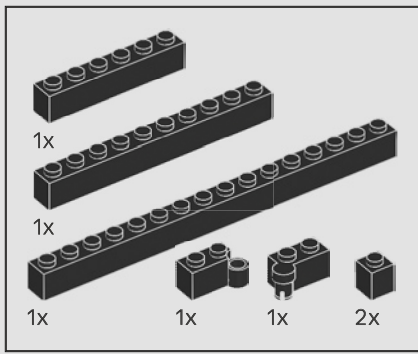

747

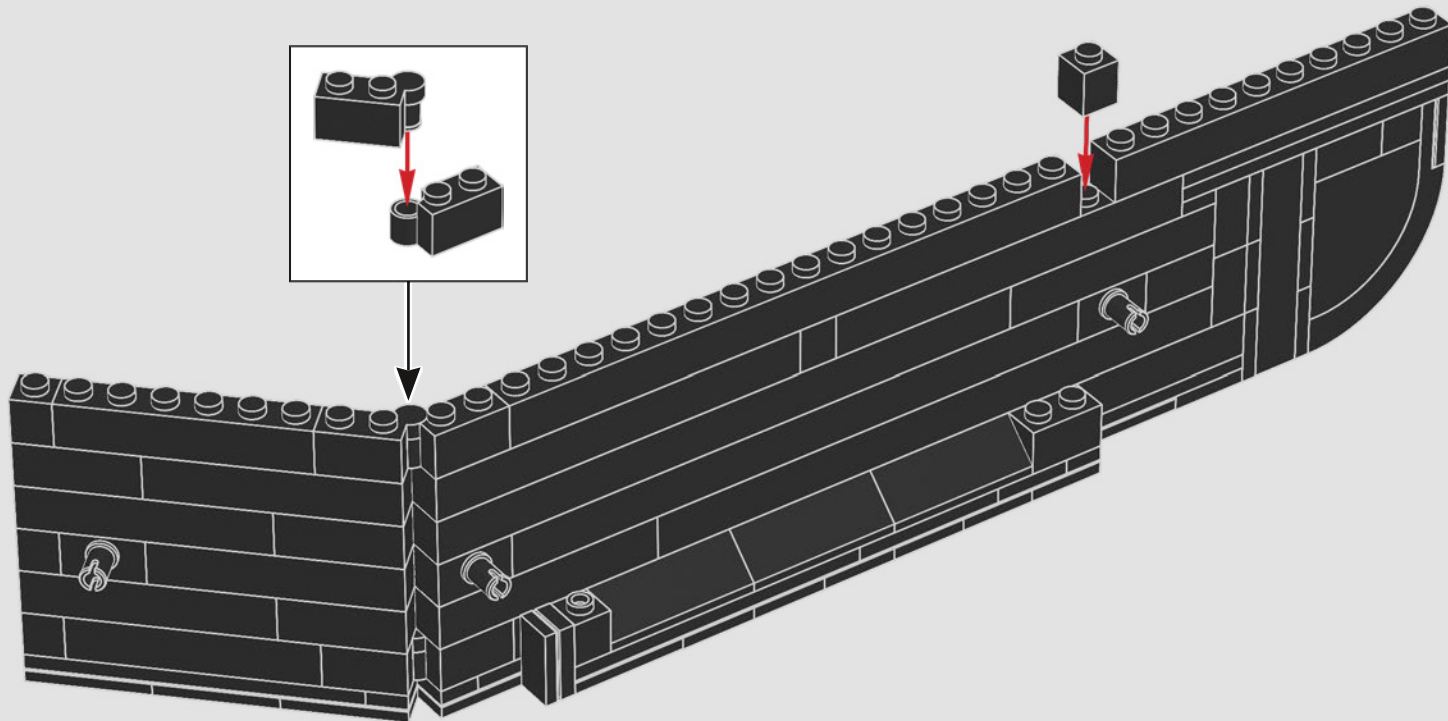

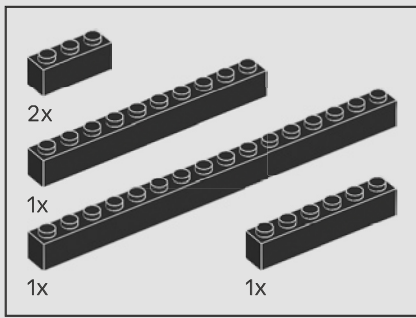

748

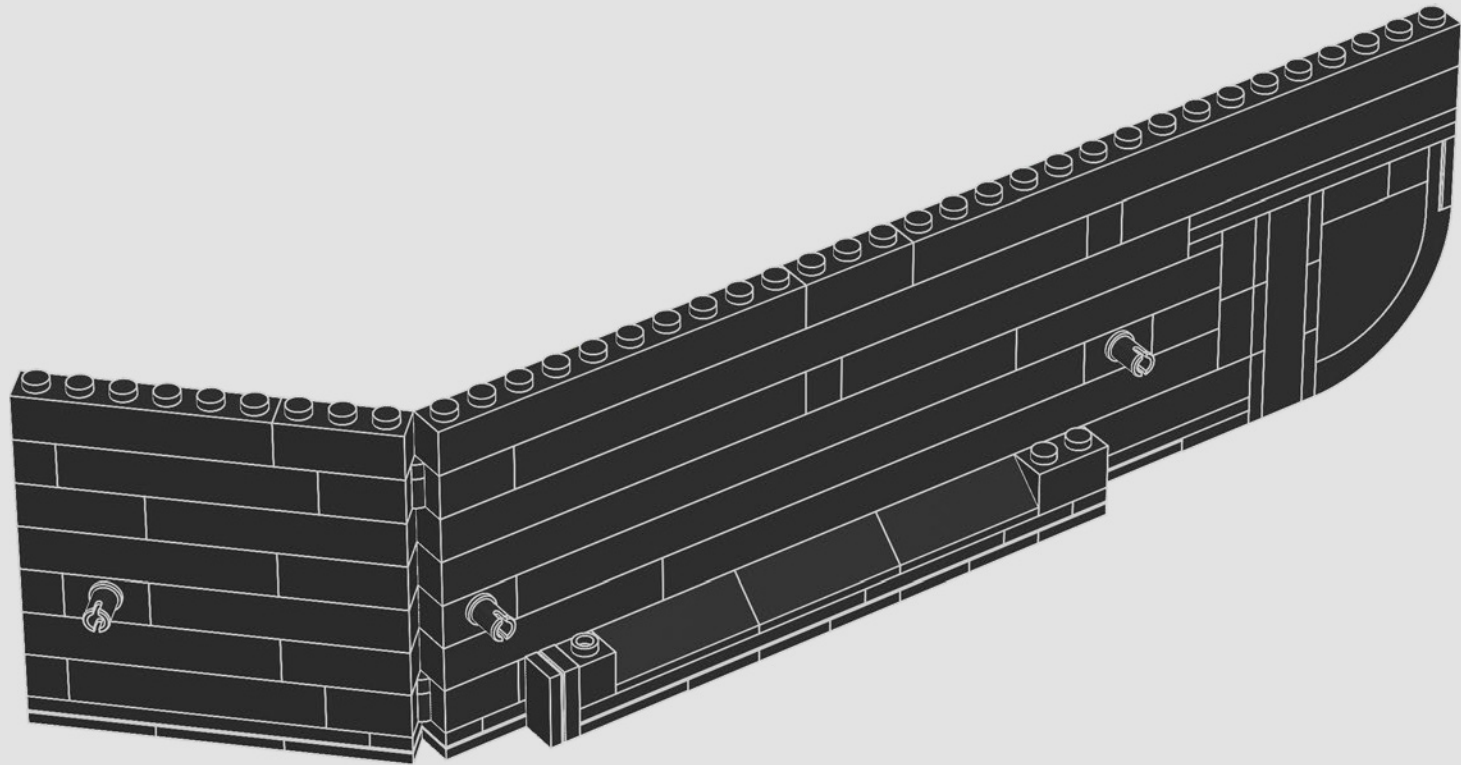

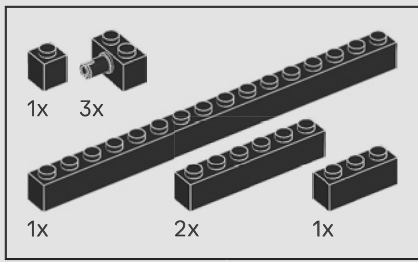

749

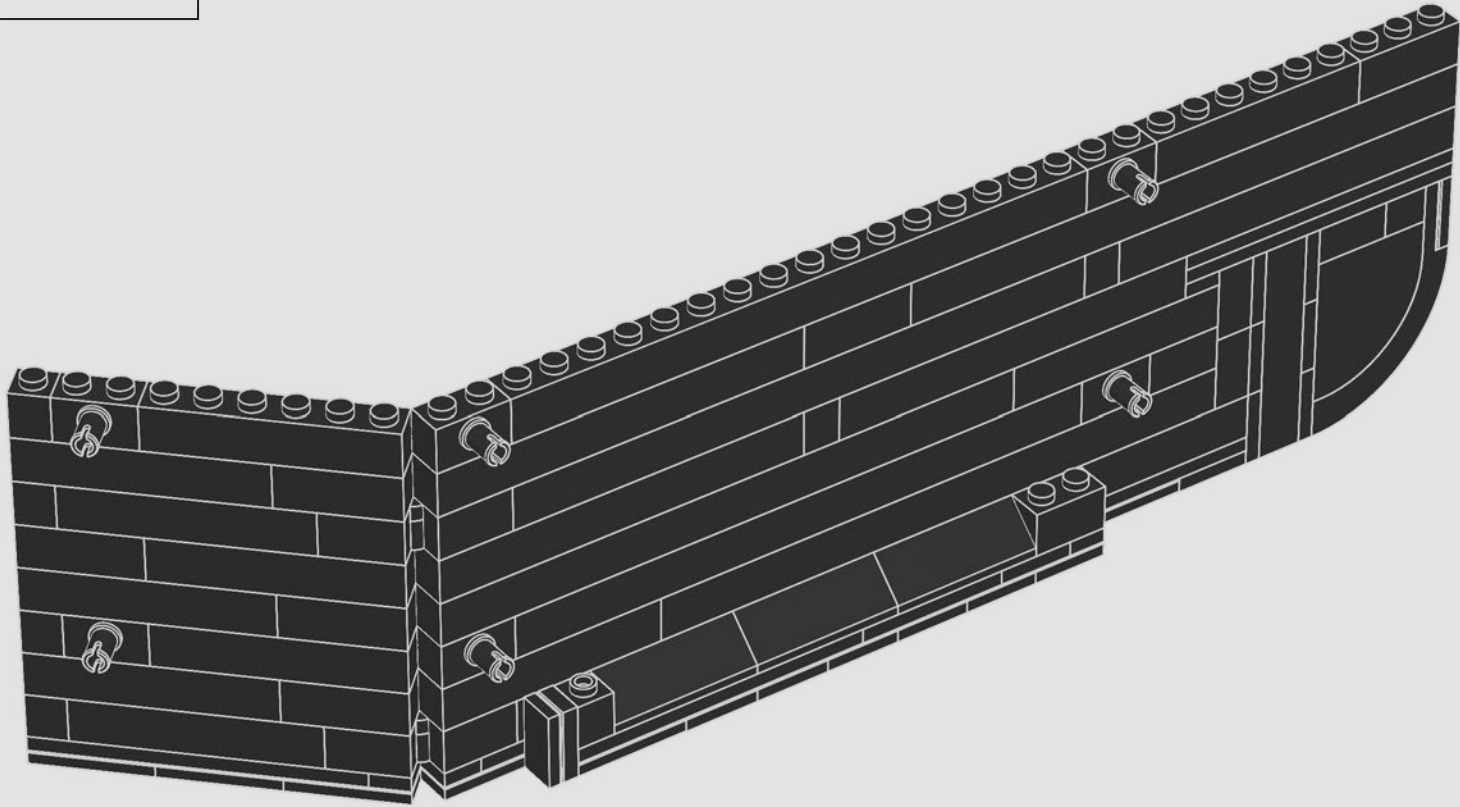

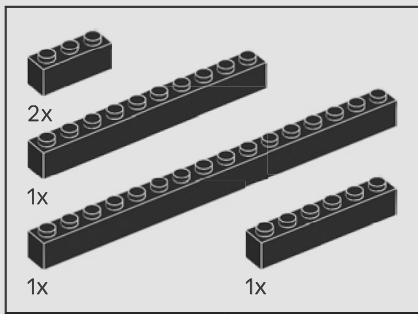

750

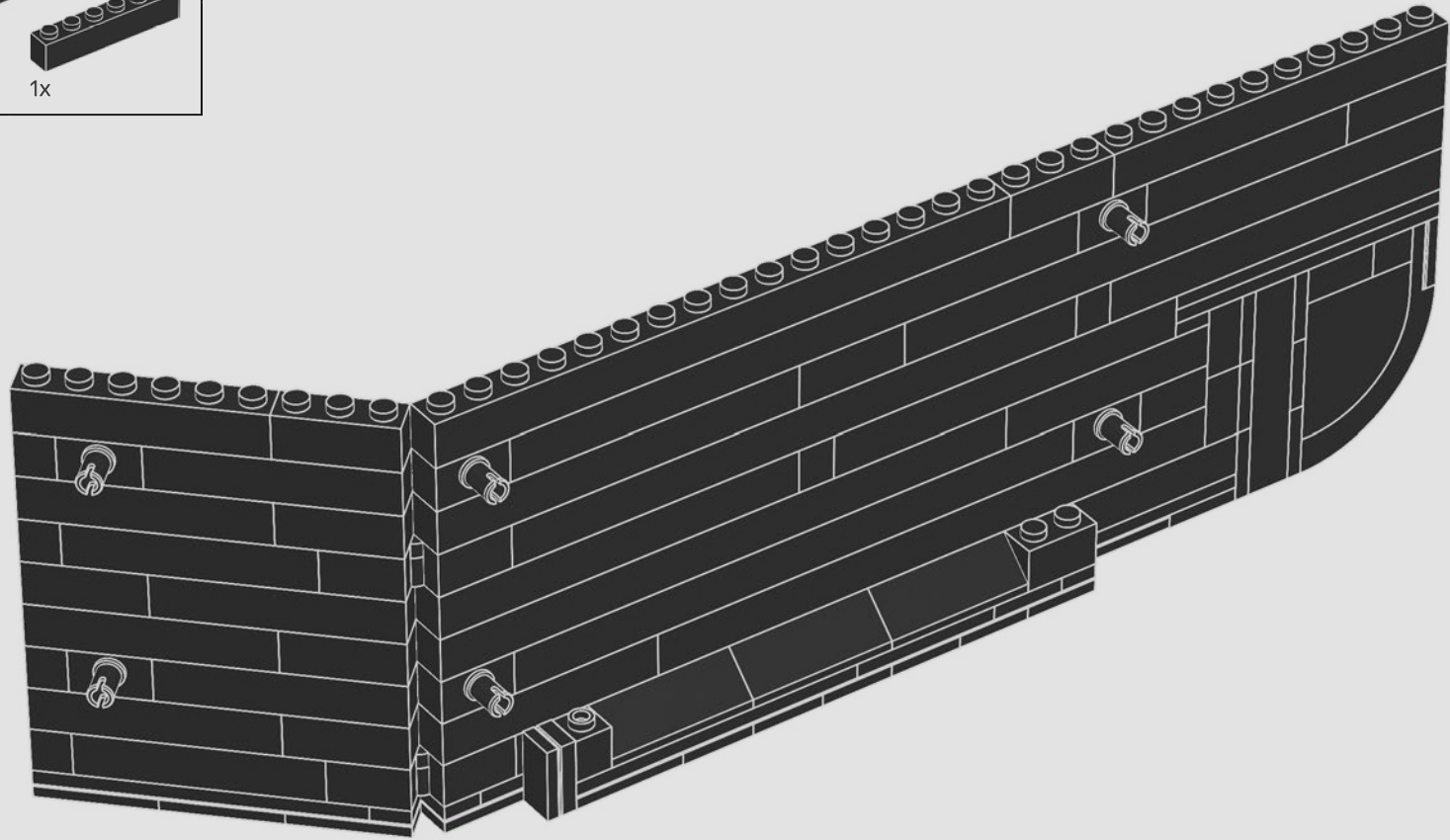

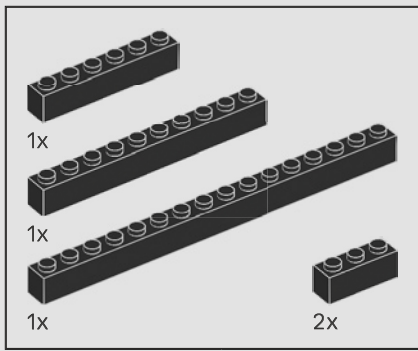

751

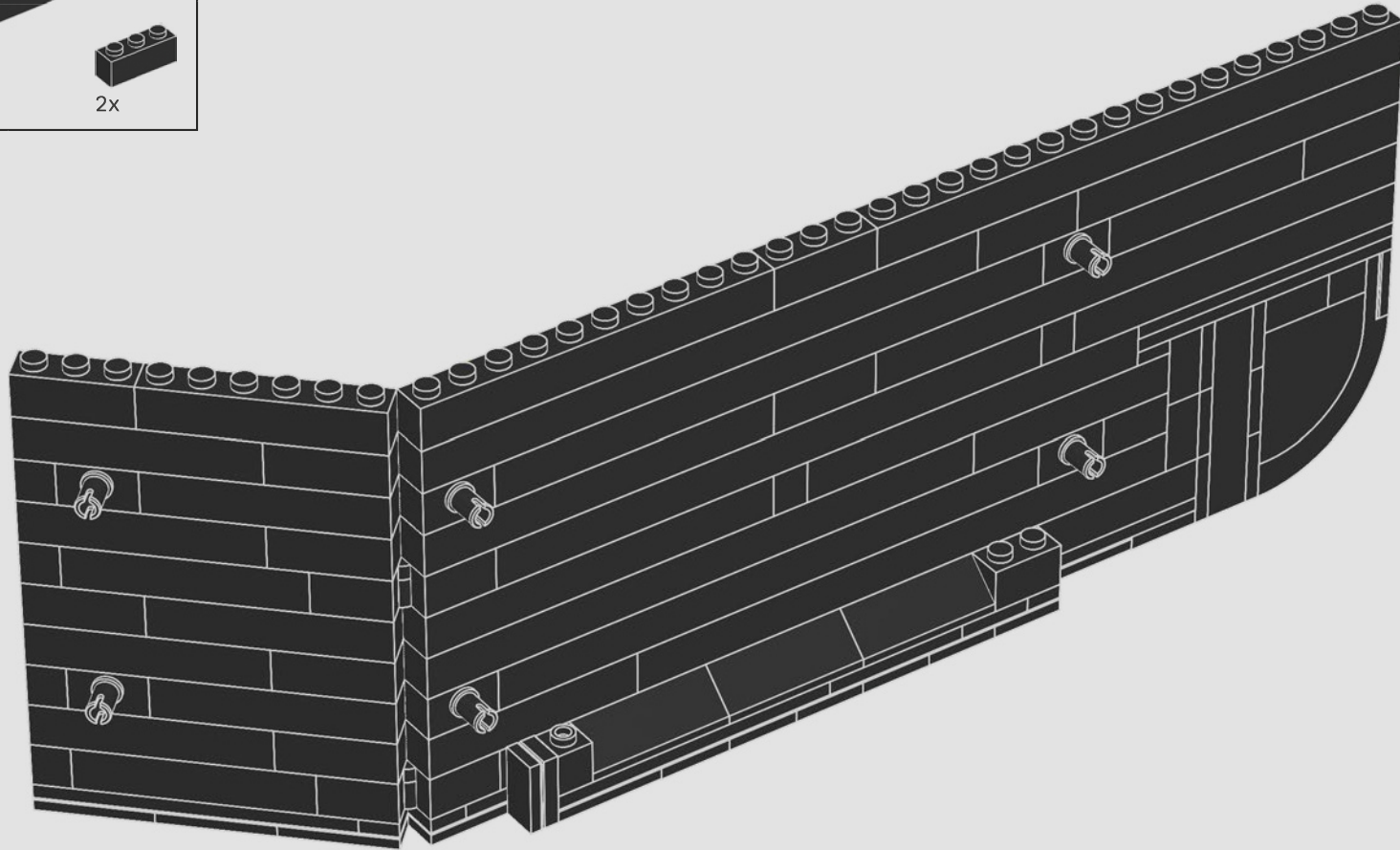

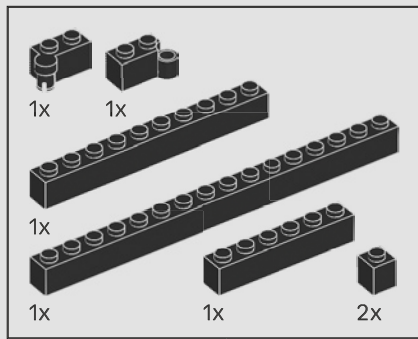

752

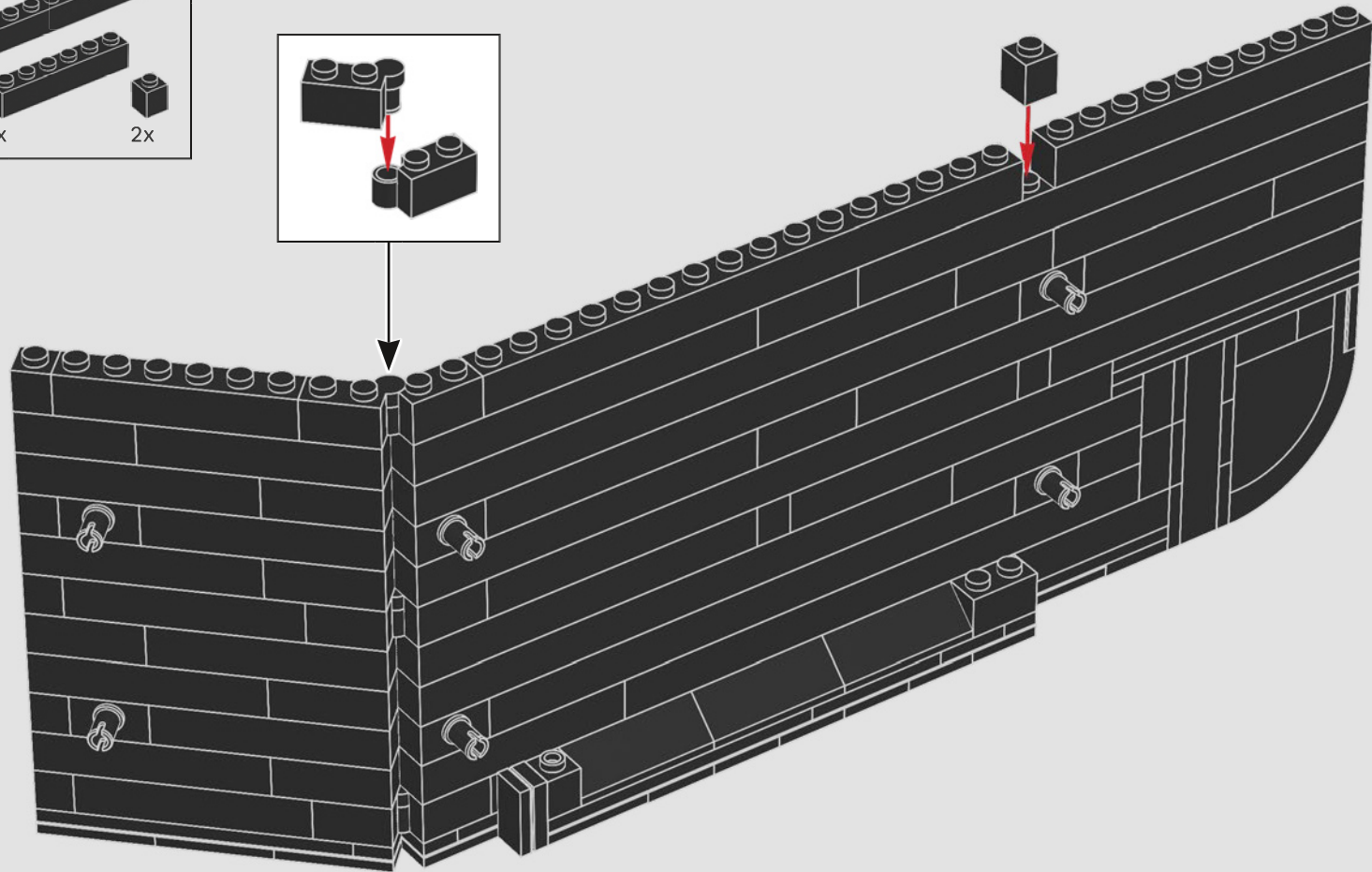
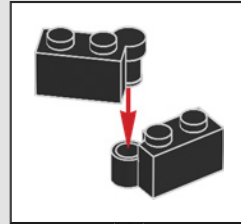

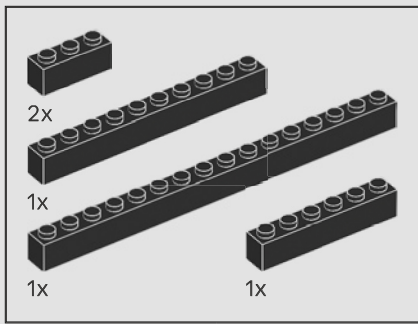

753

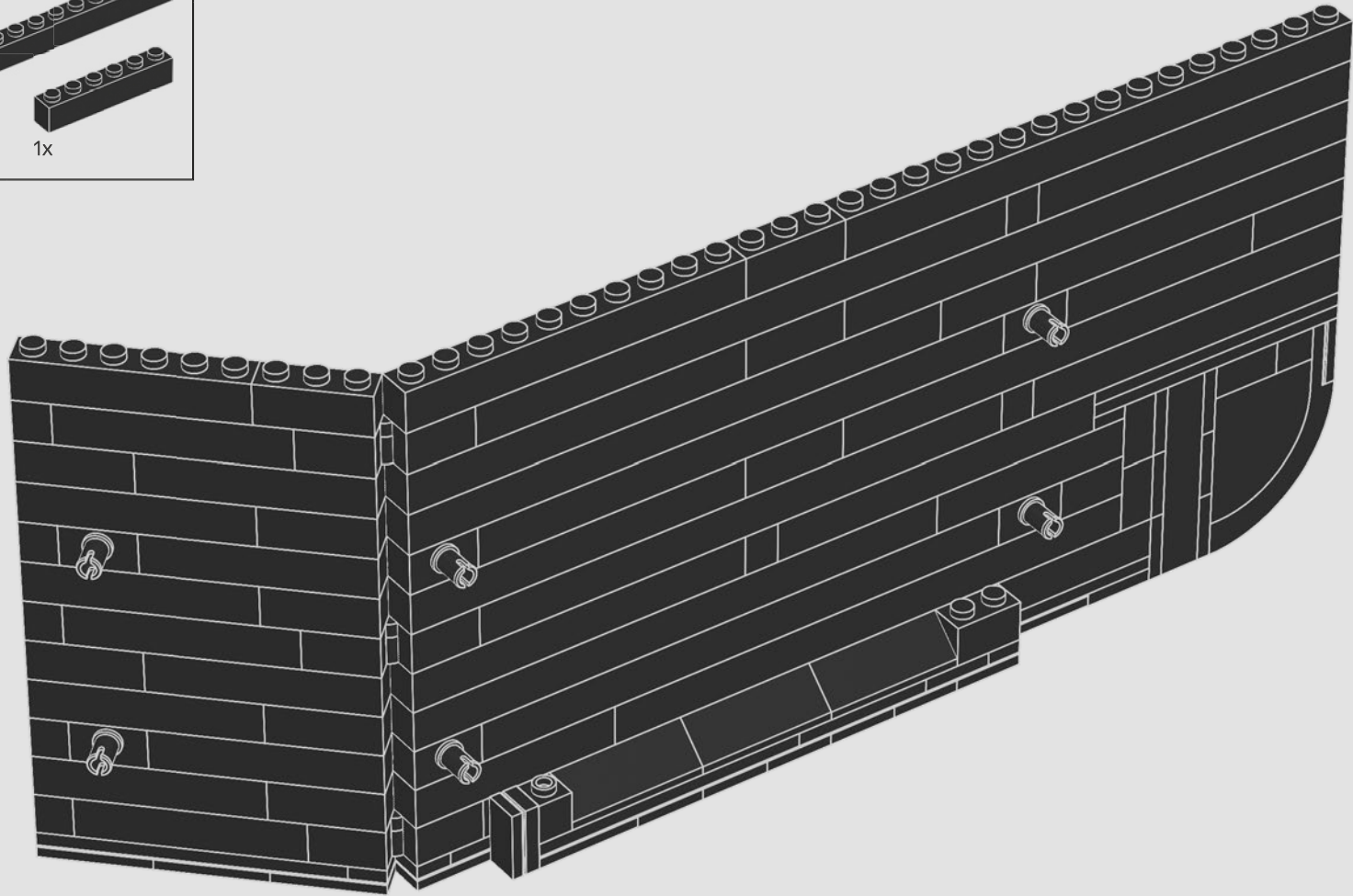

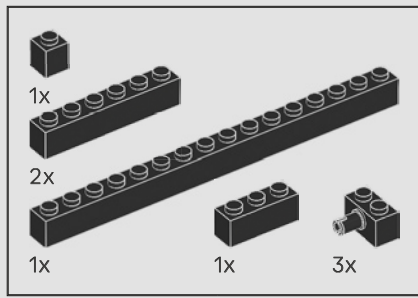

754

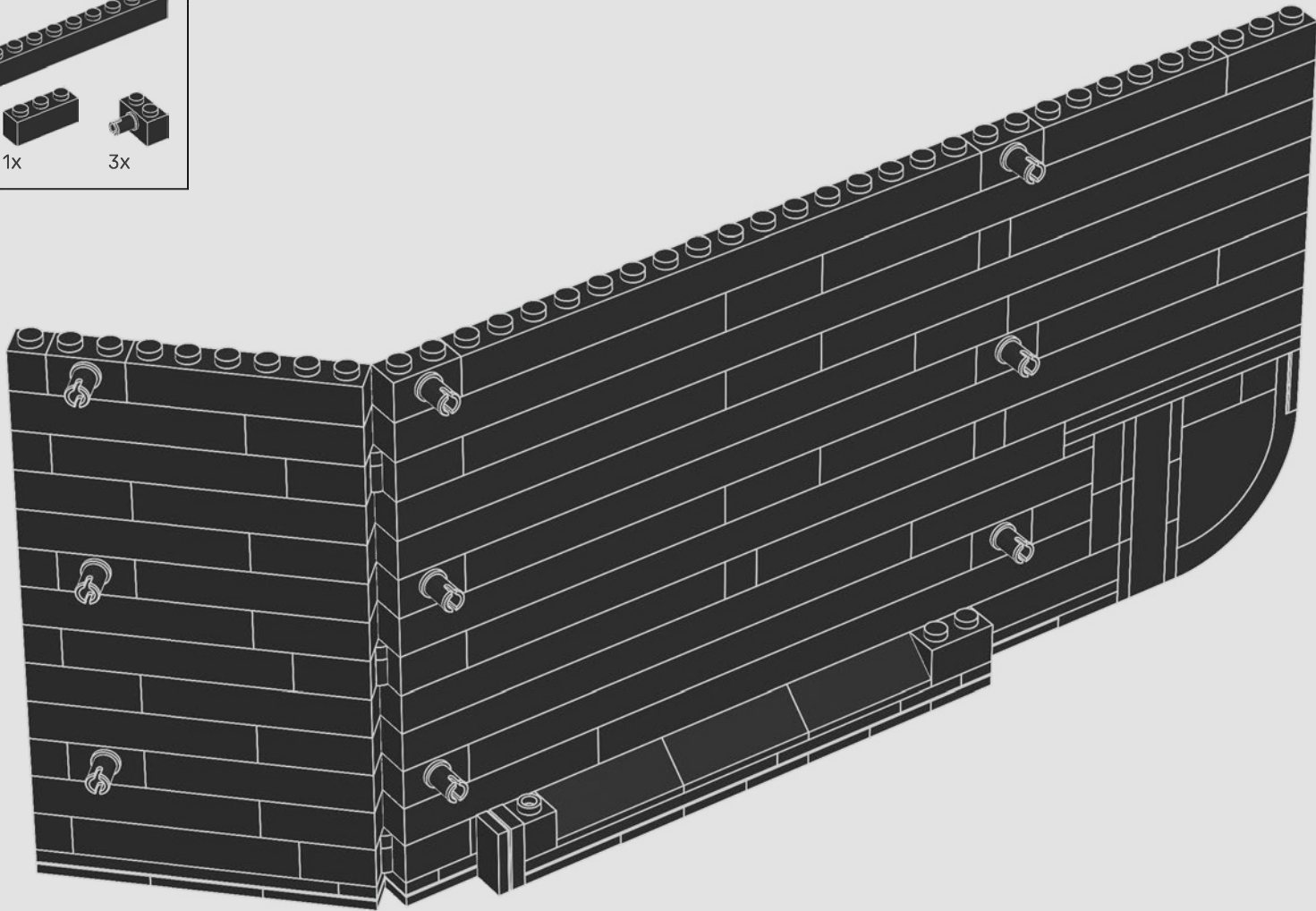

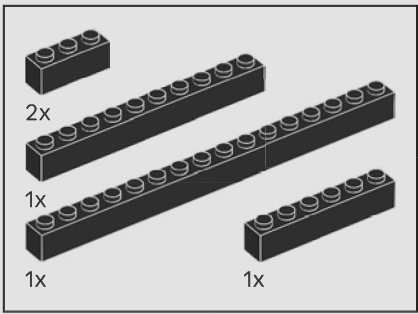

755

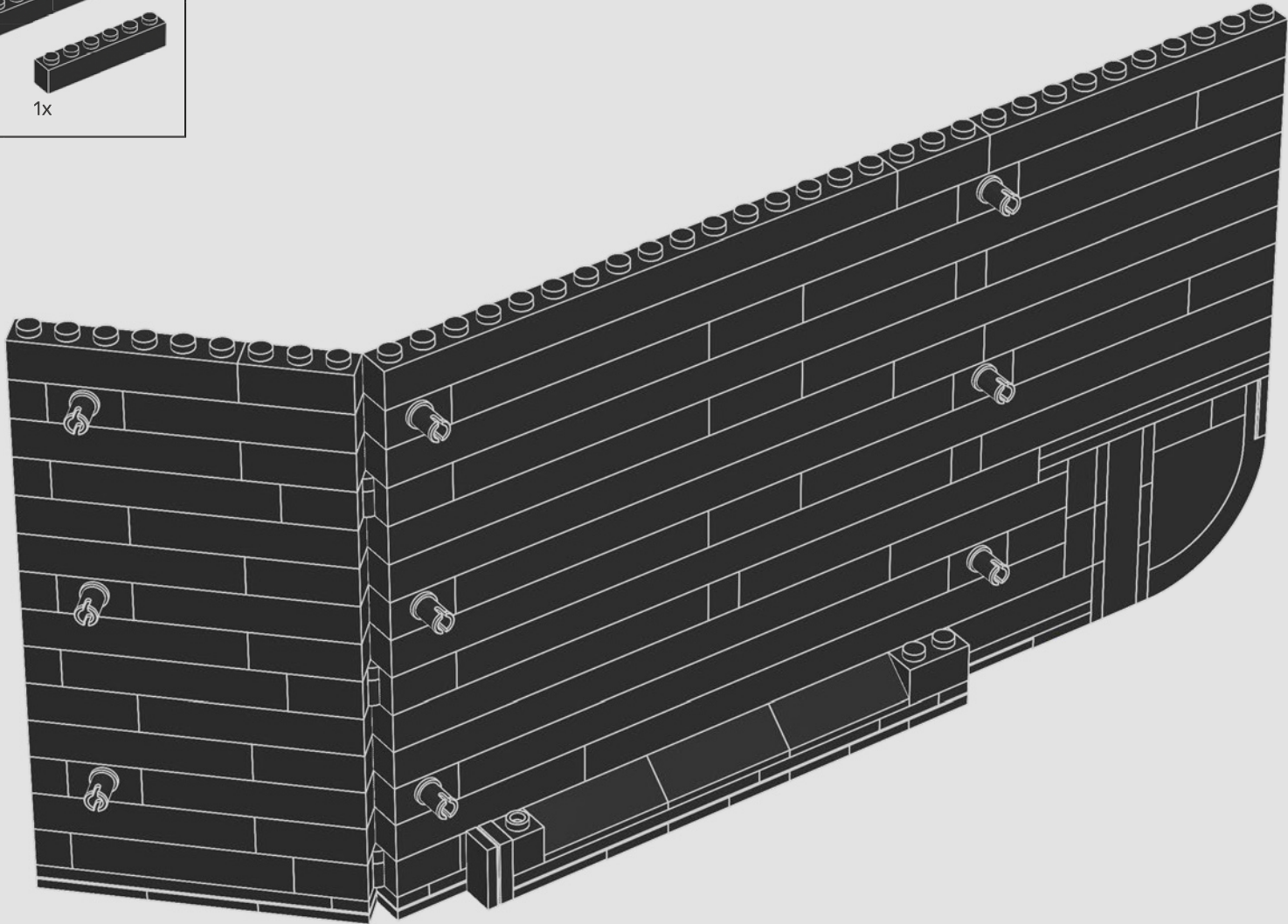

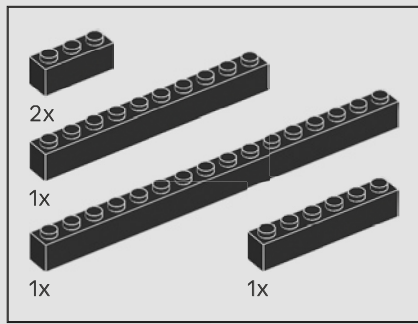

756

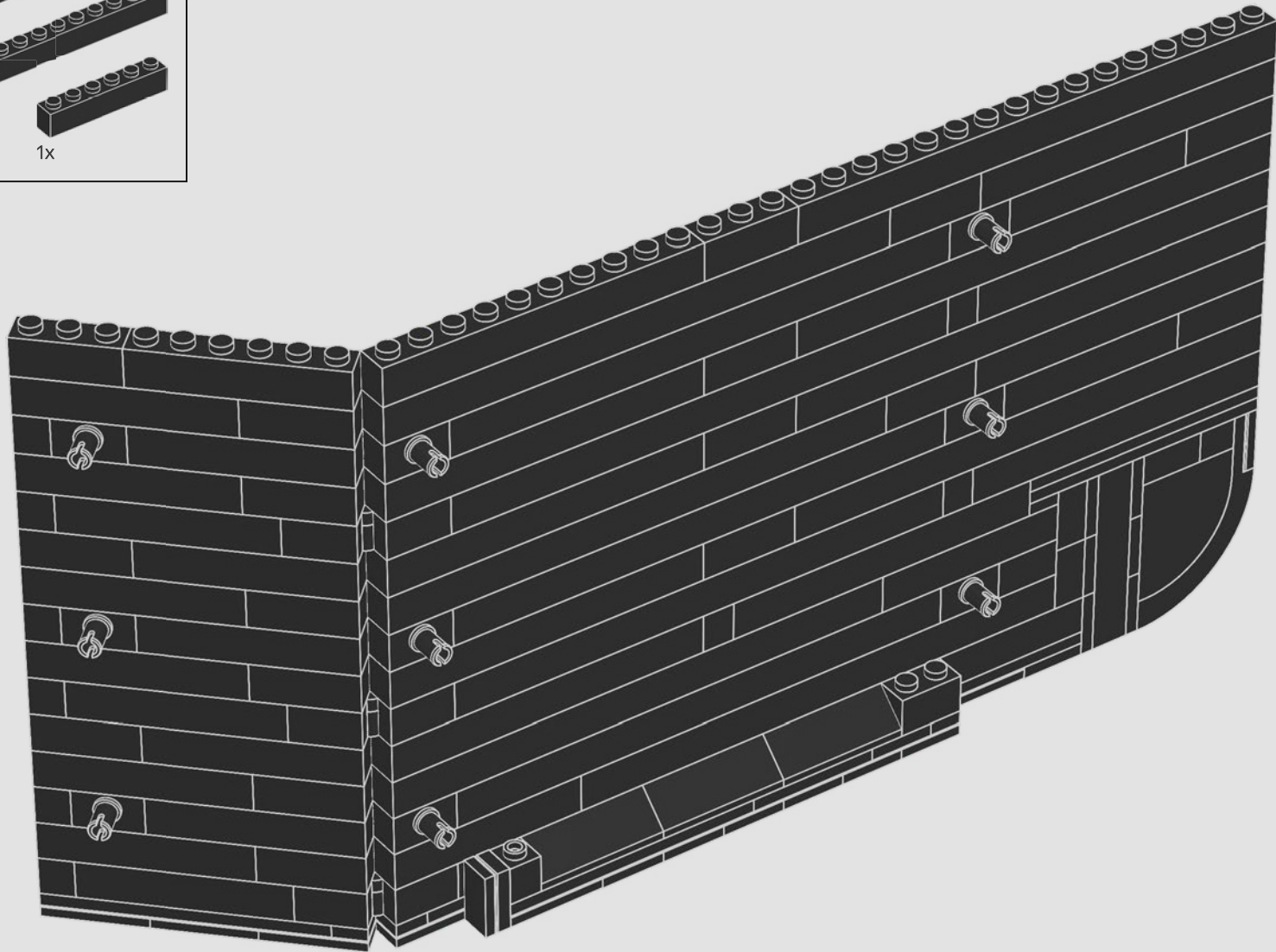

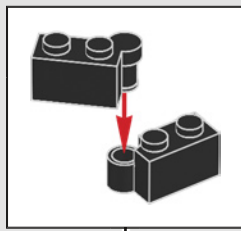
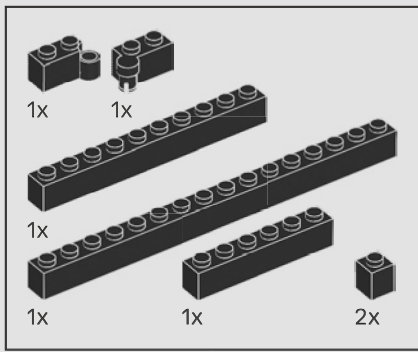

757

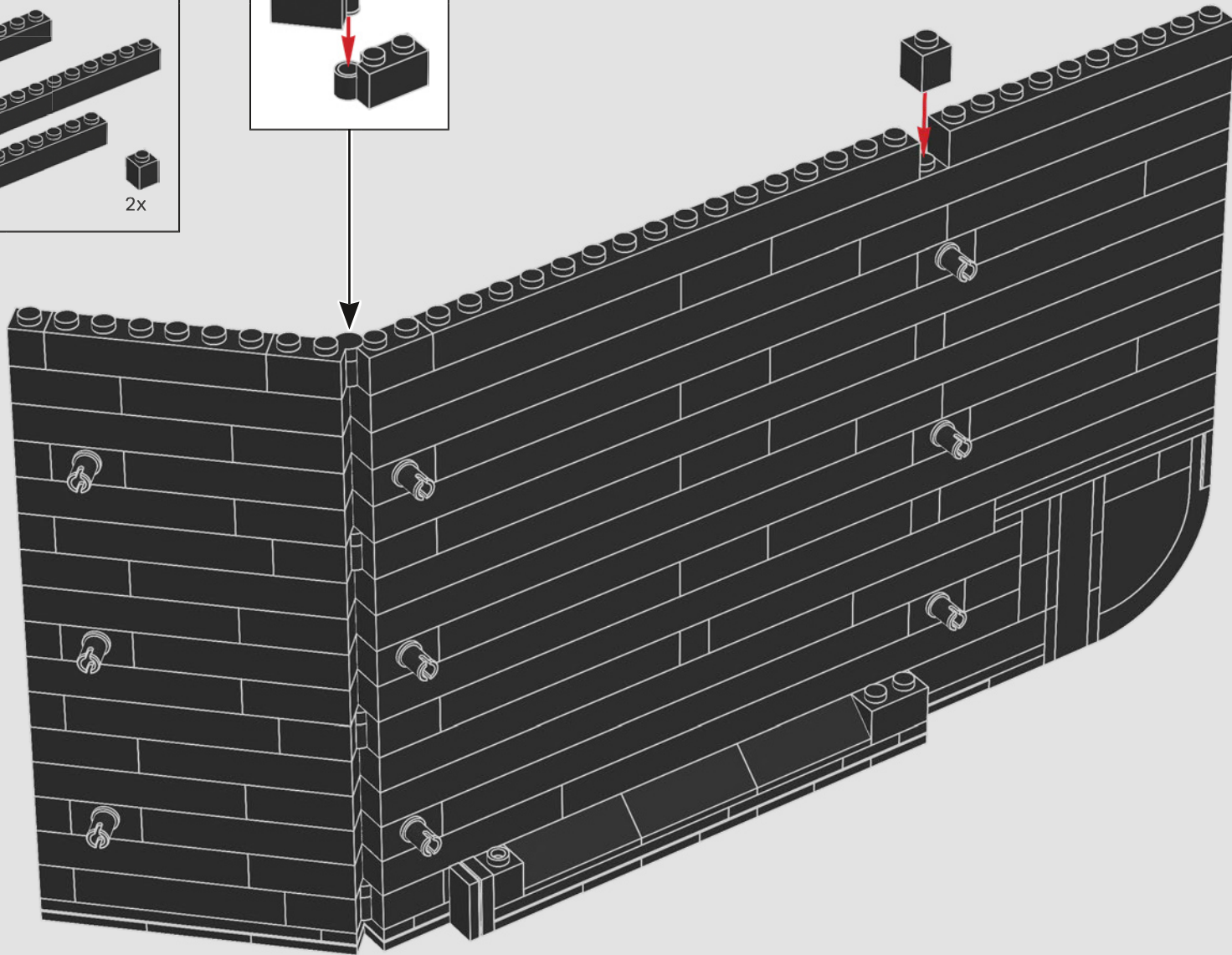

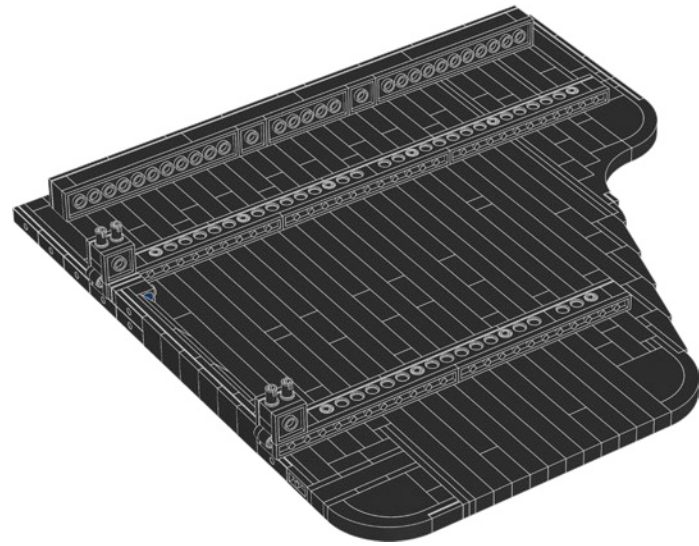
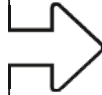

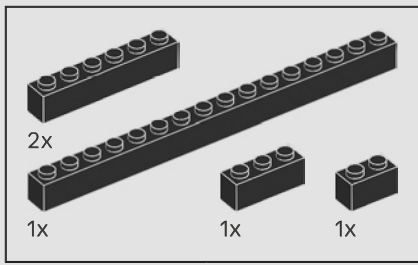

758

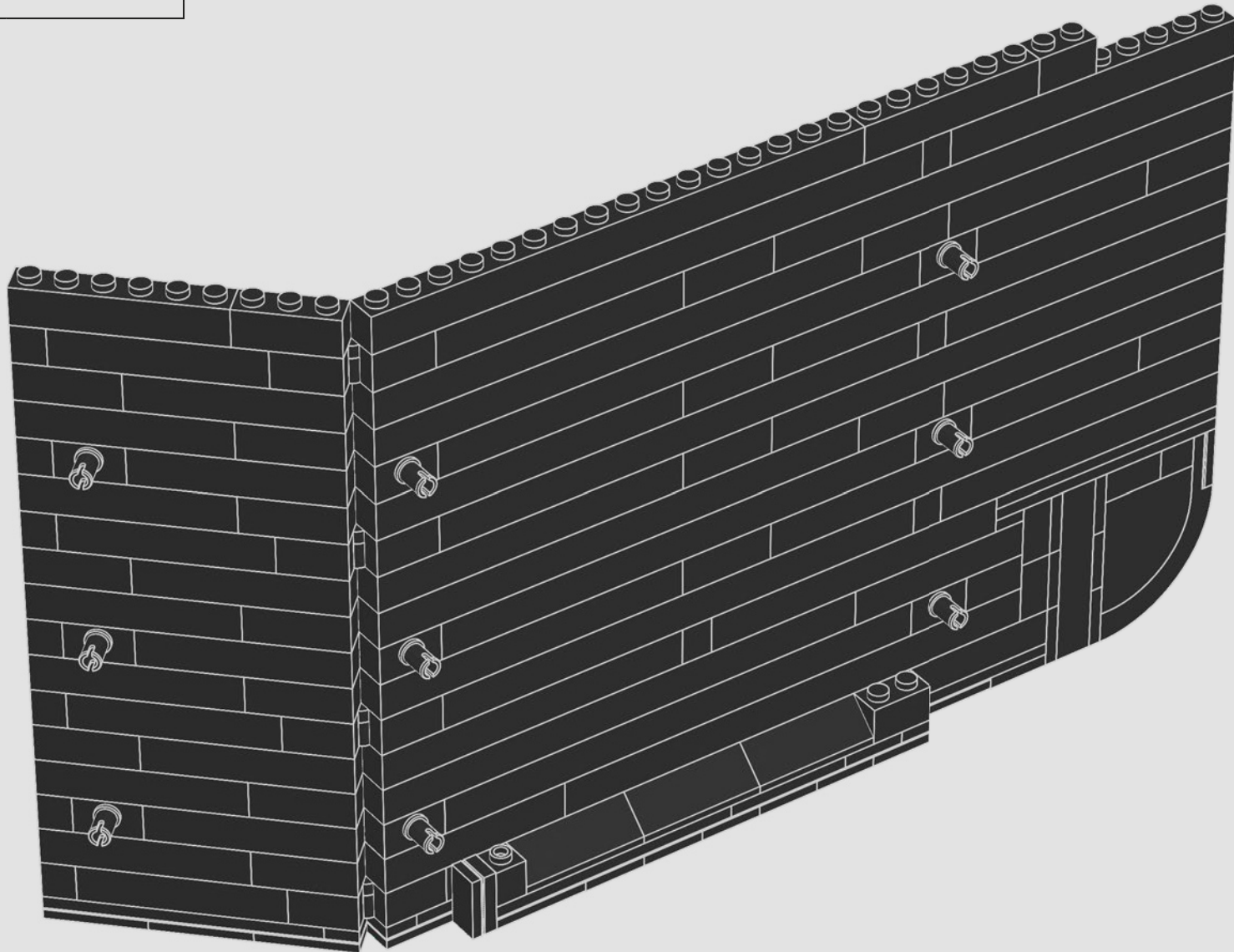

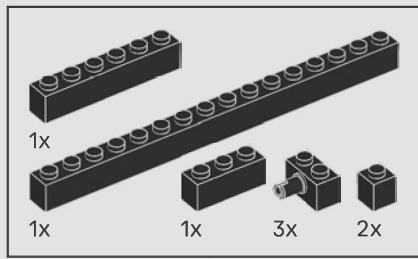

759

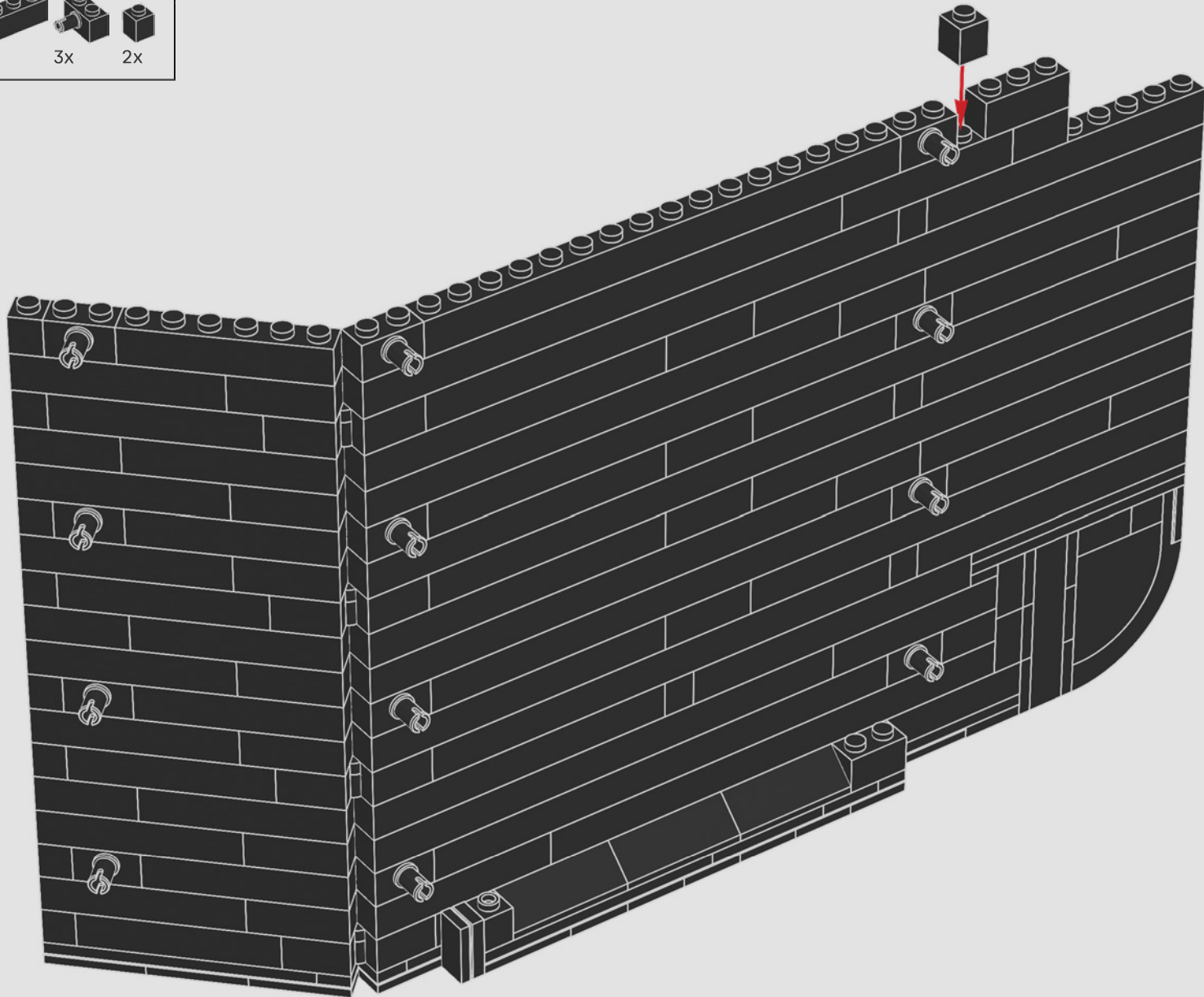

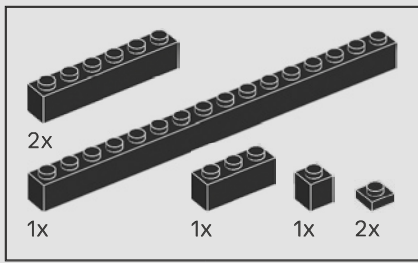

760

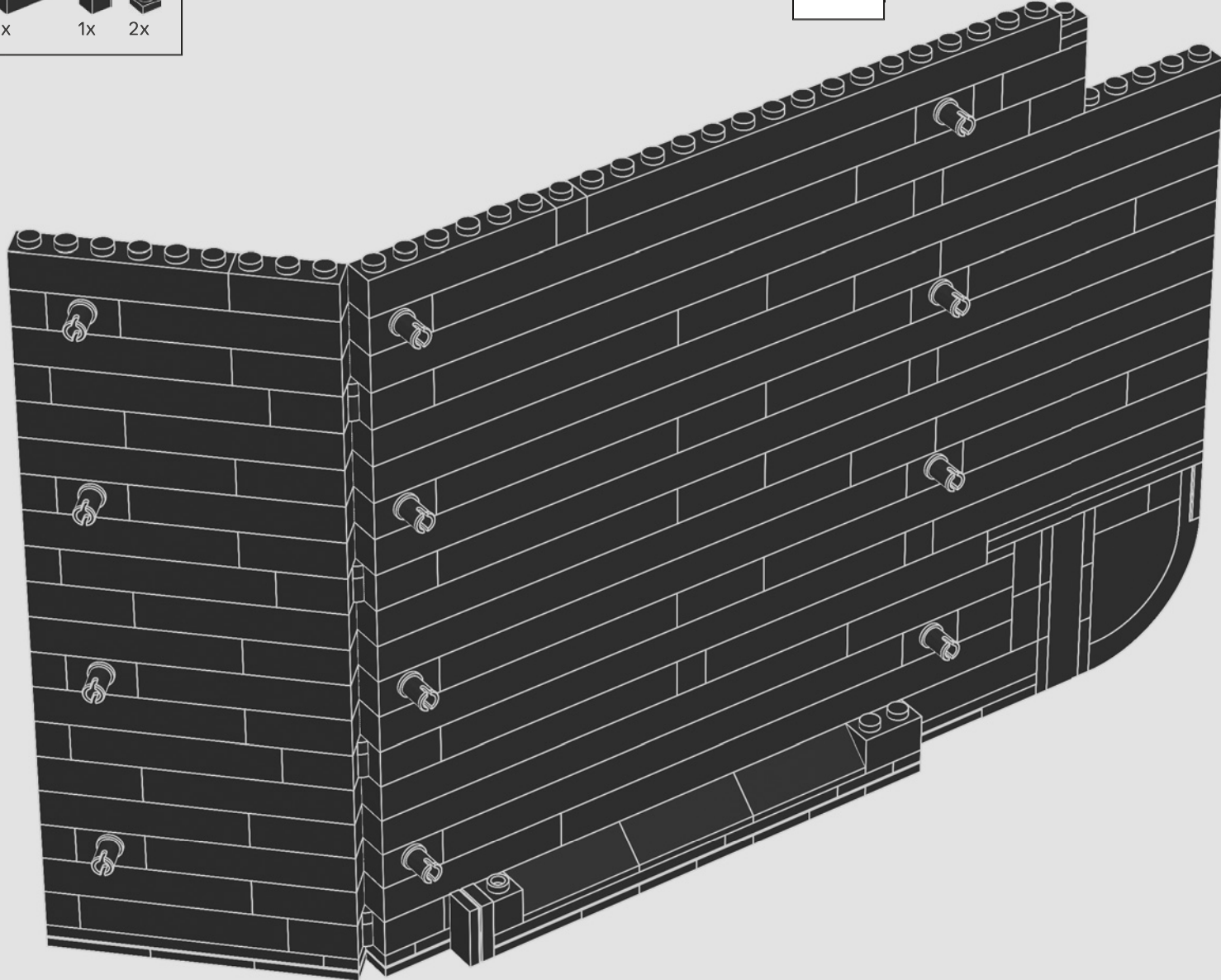
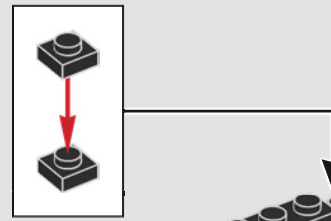

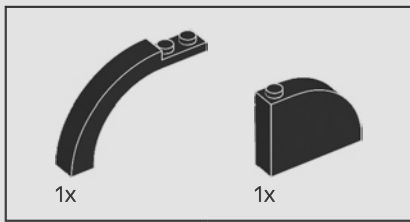

761

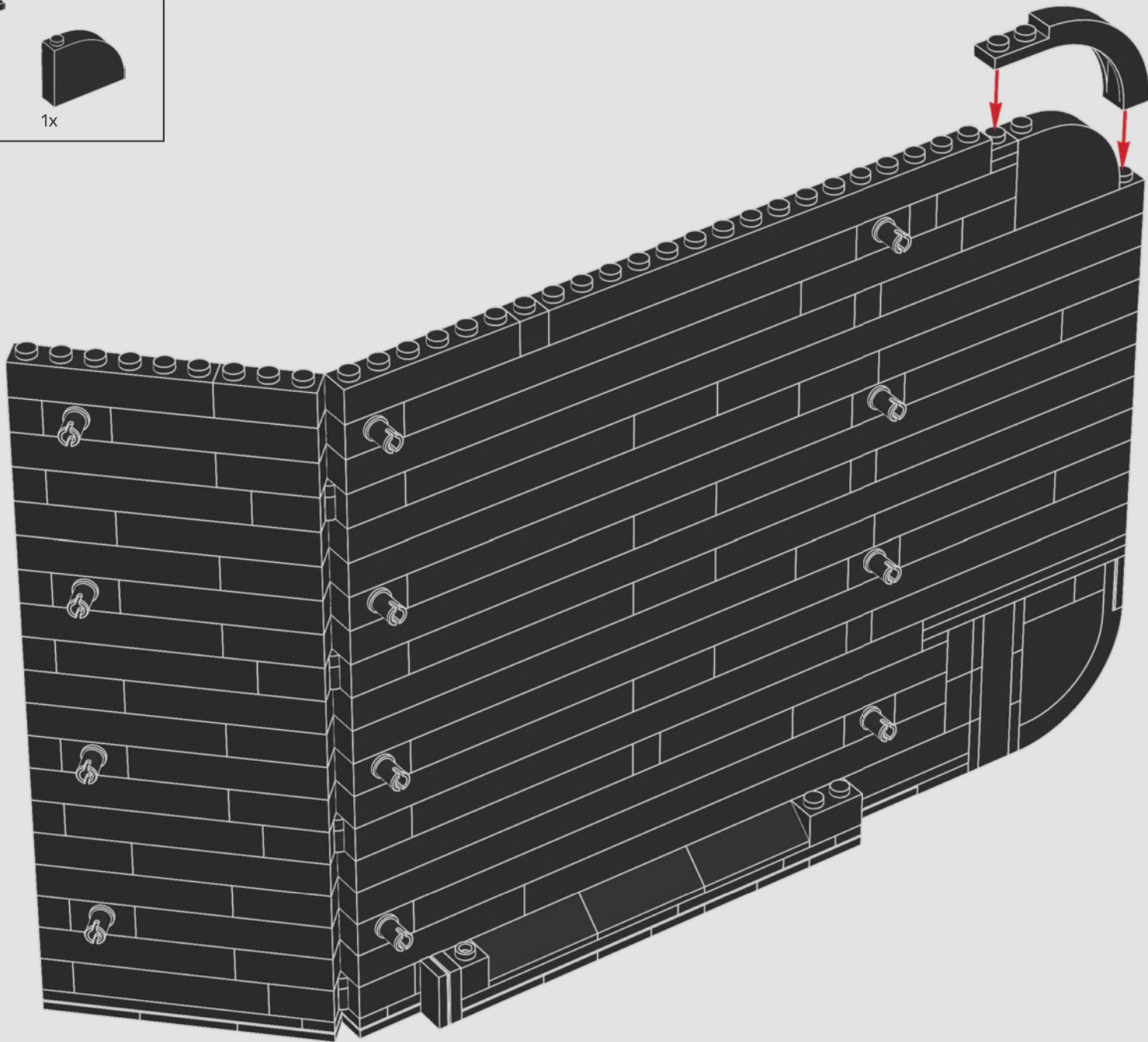

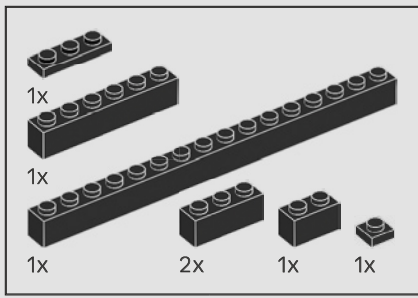

762

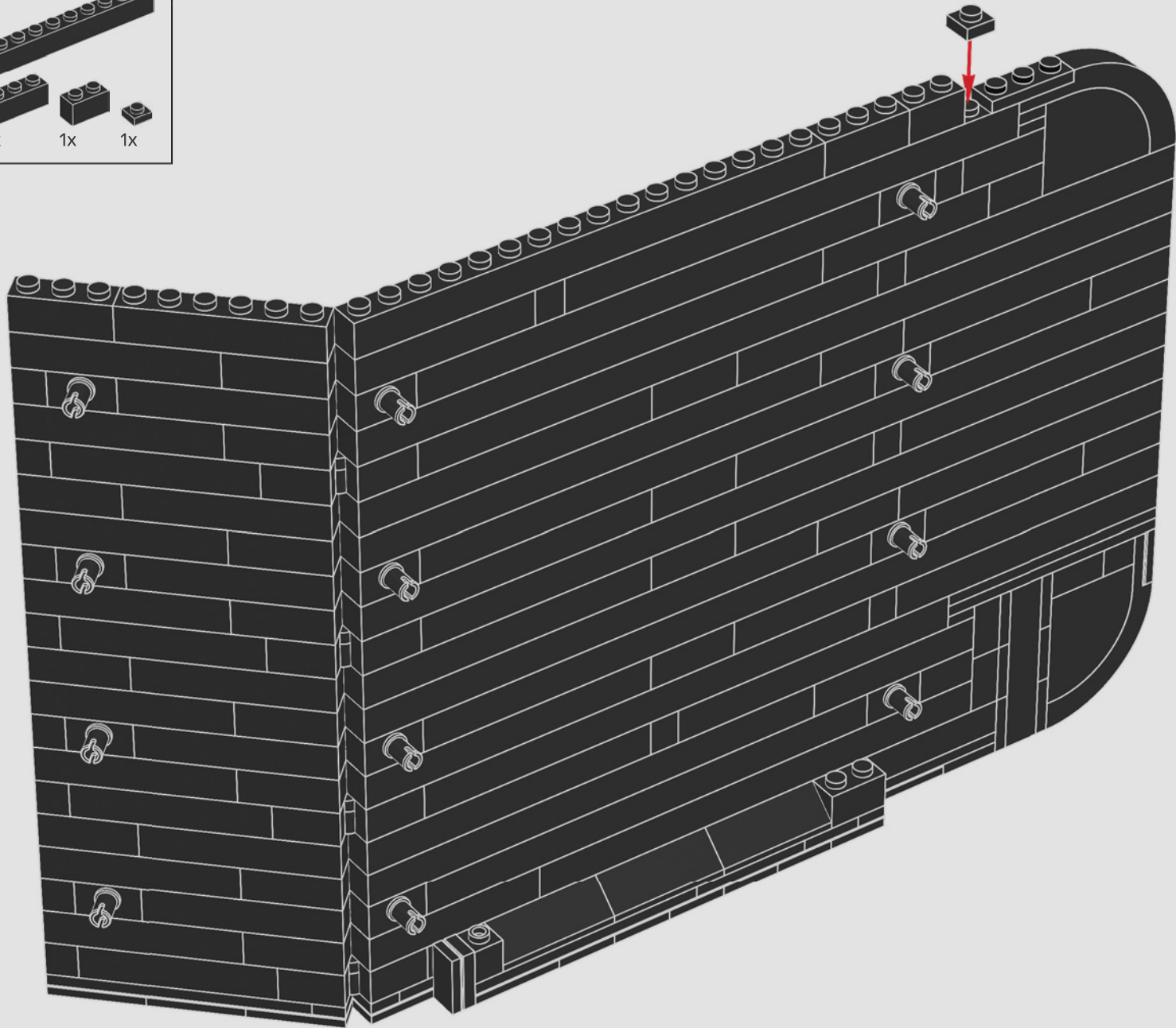

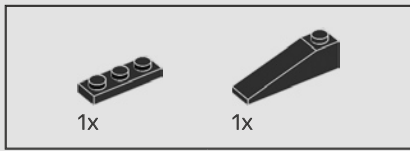

763

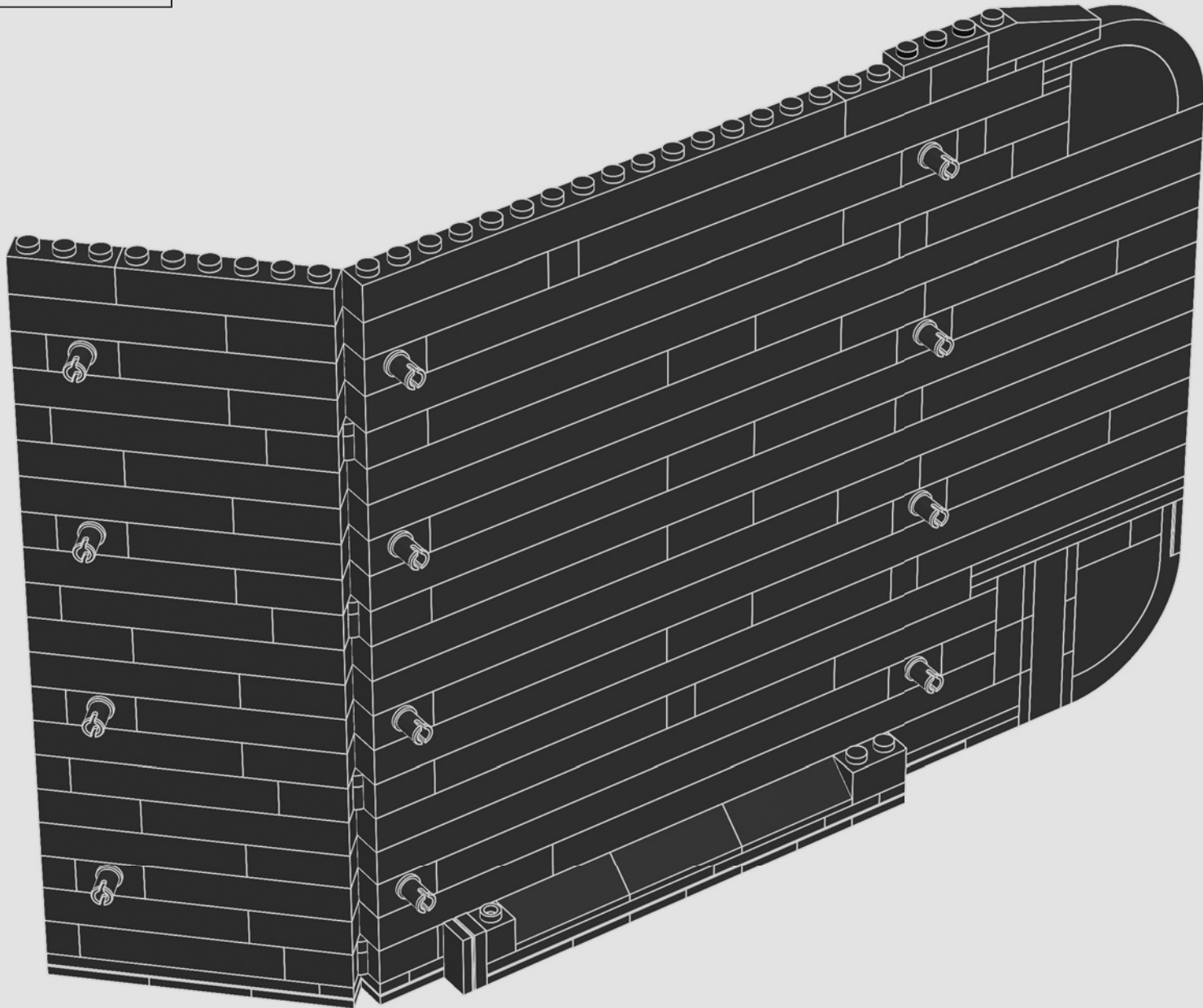

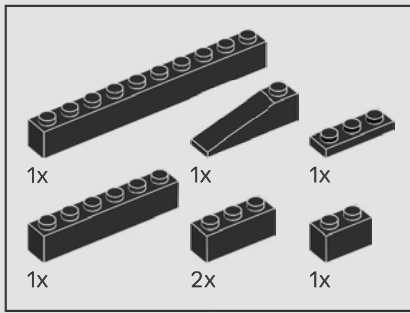

765

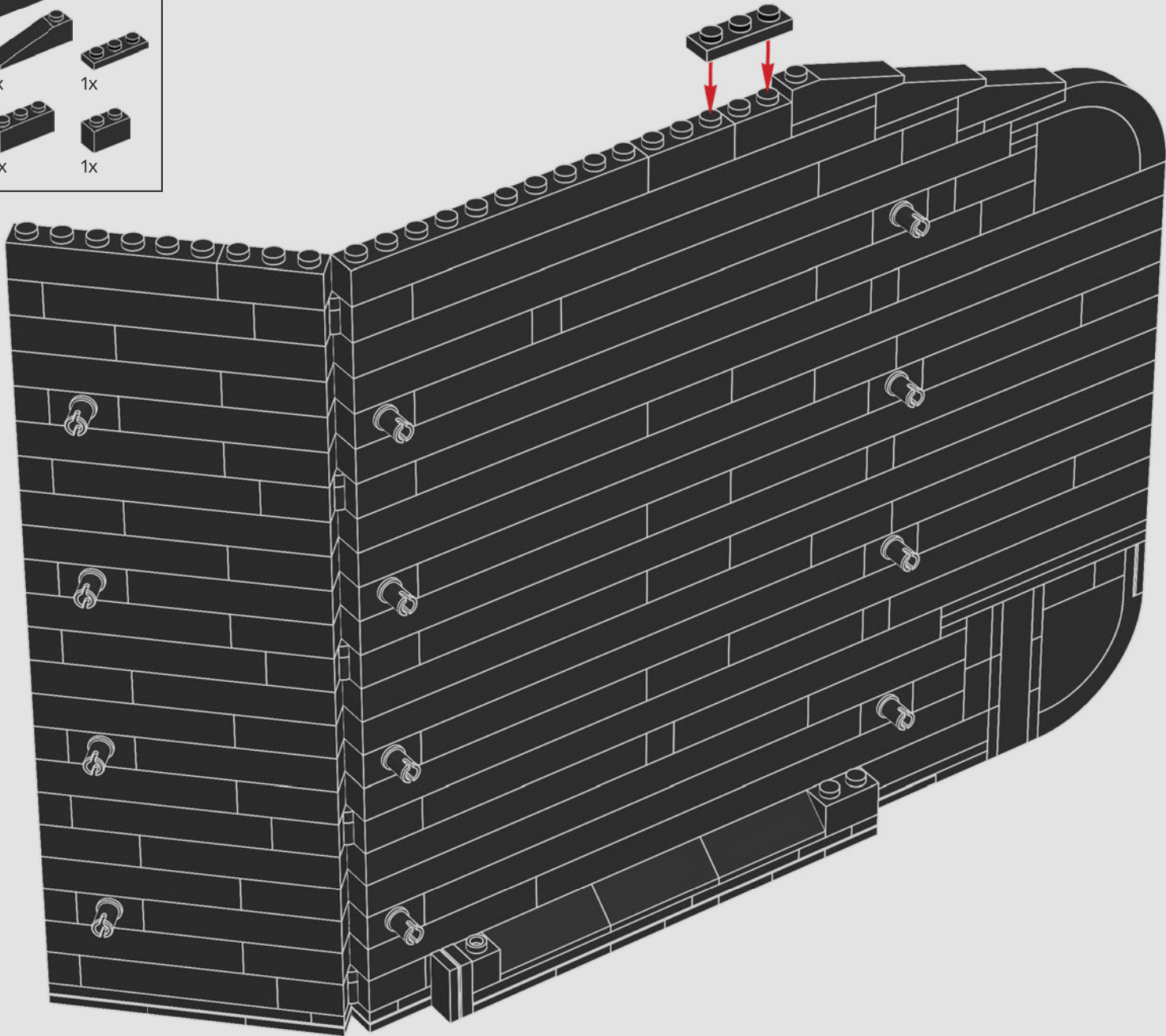

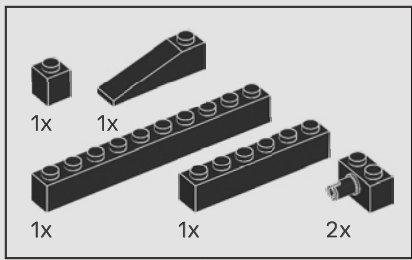

766

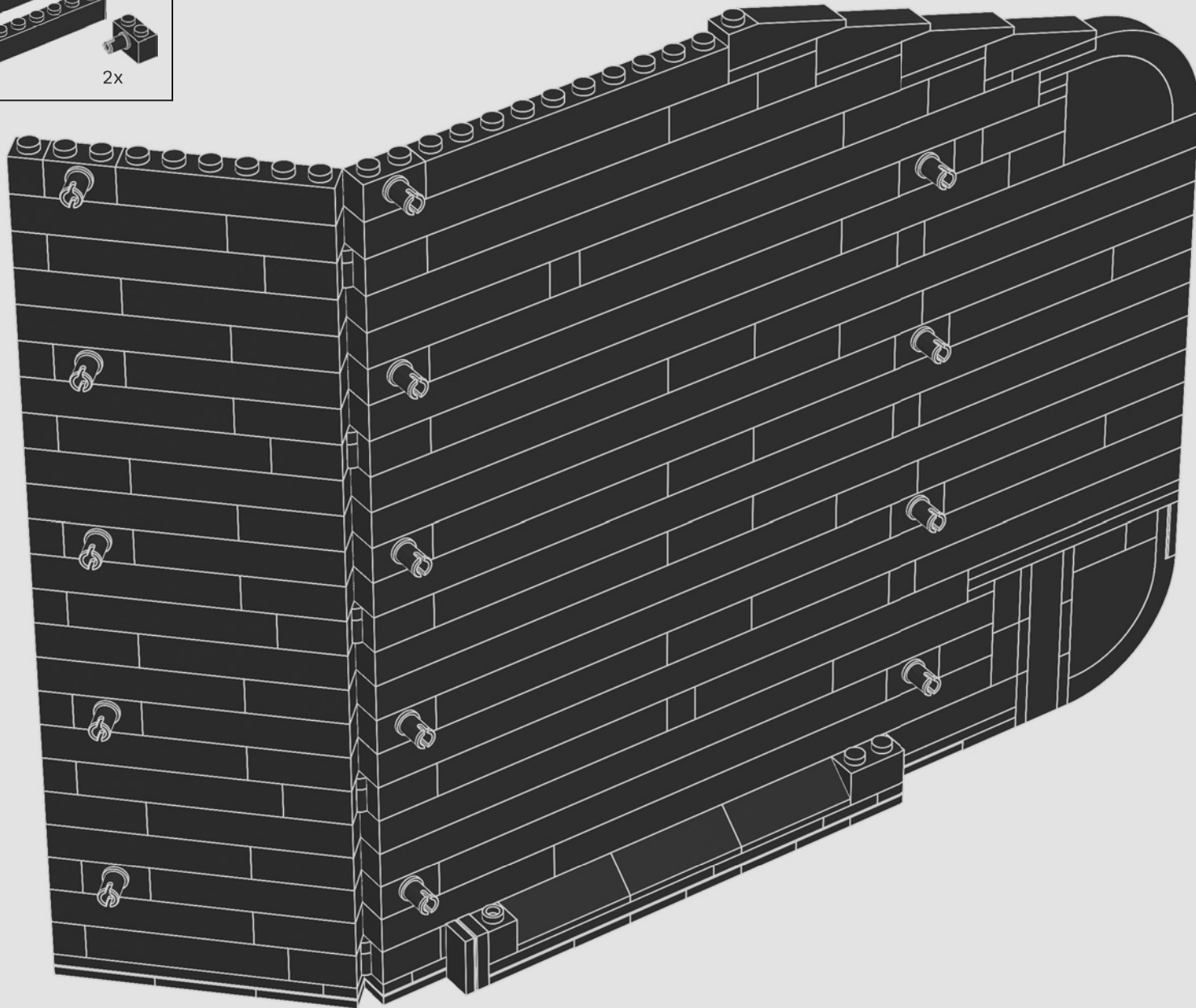

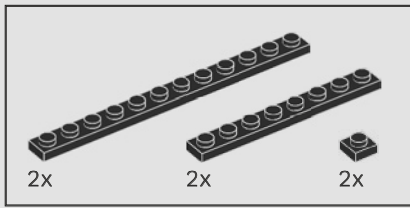

767

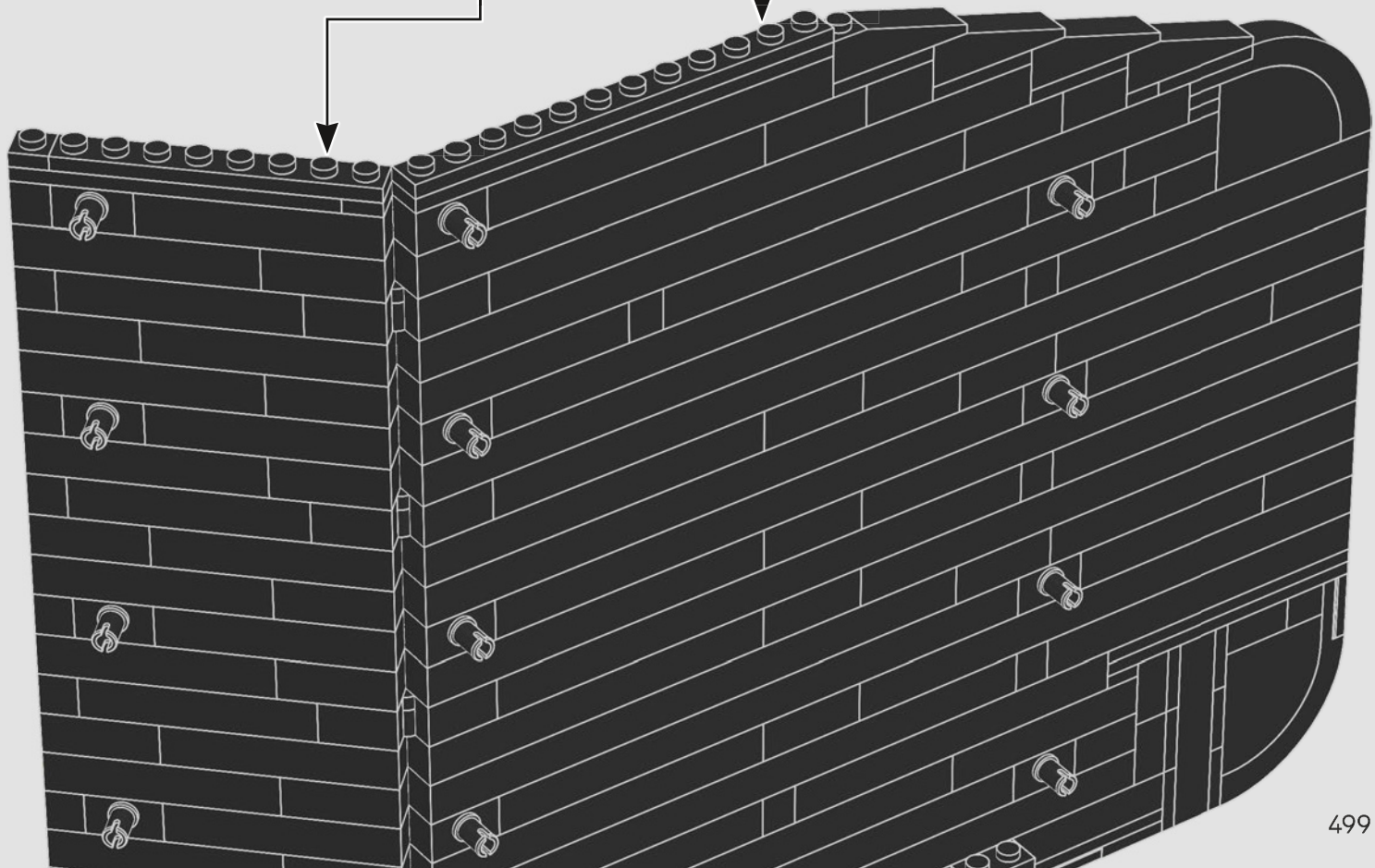
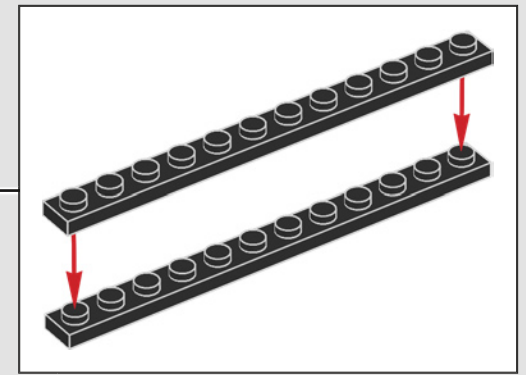
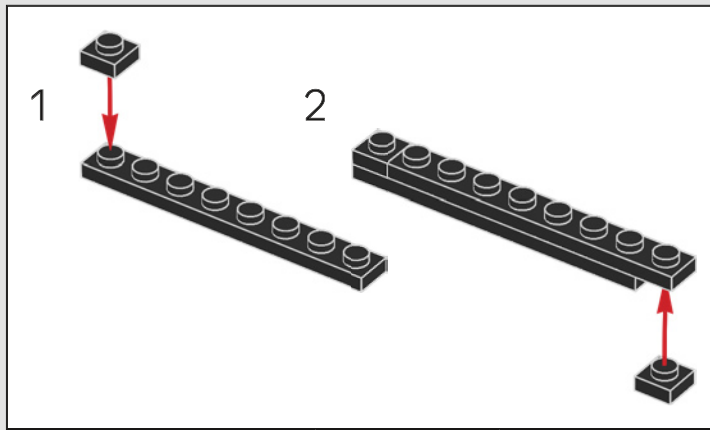

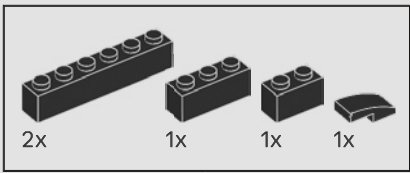

768

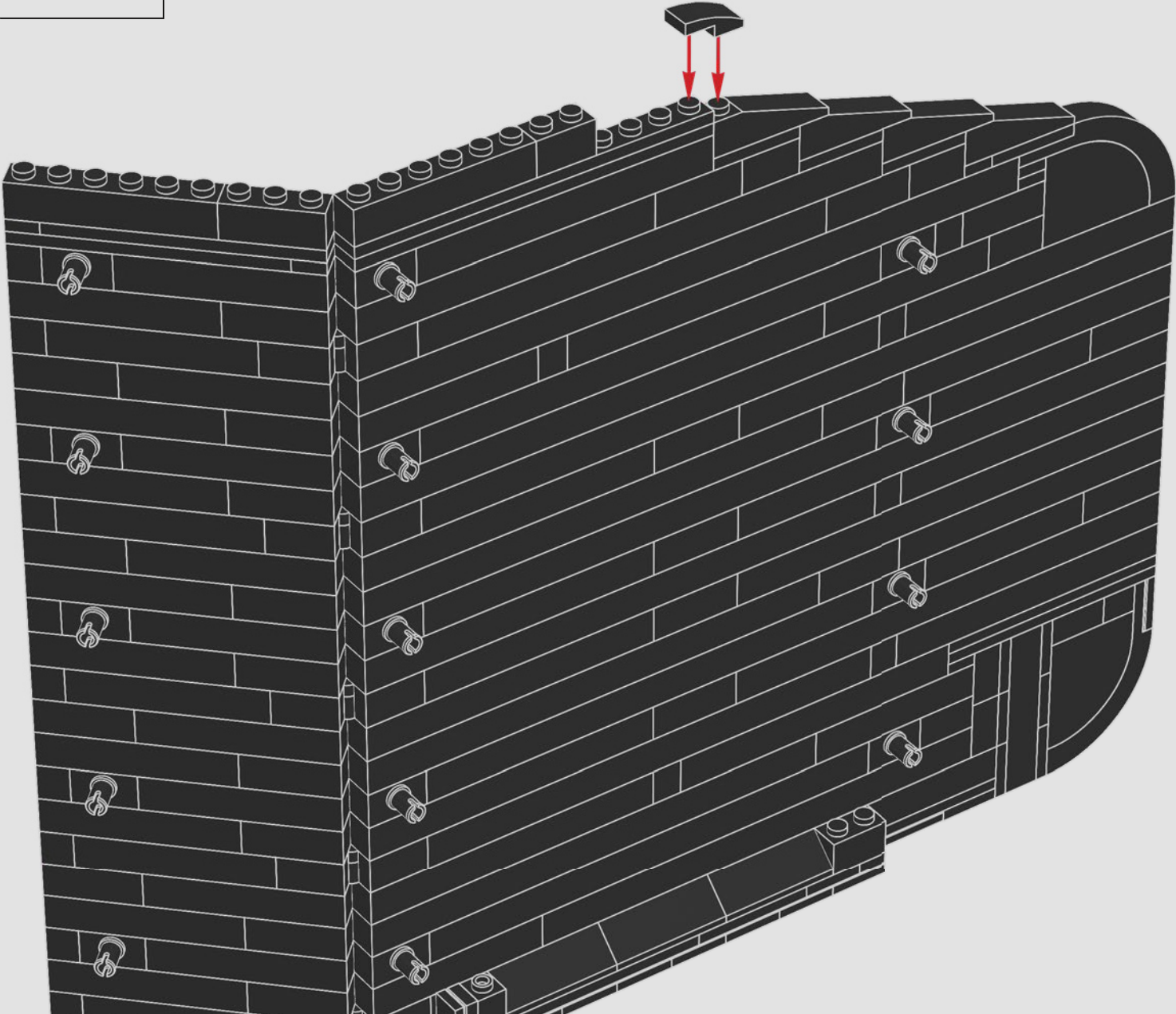

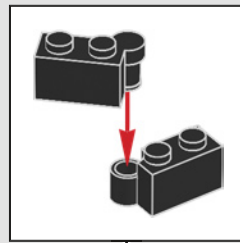
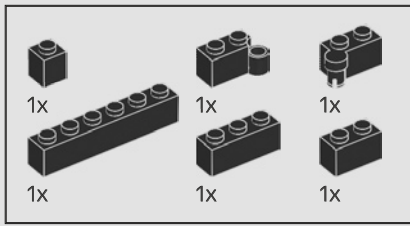

769

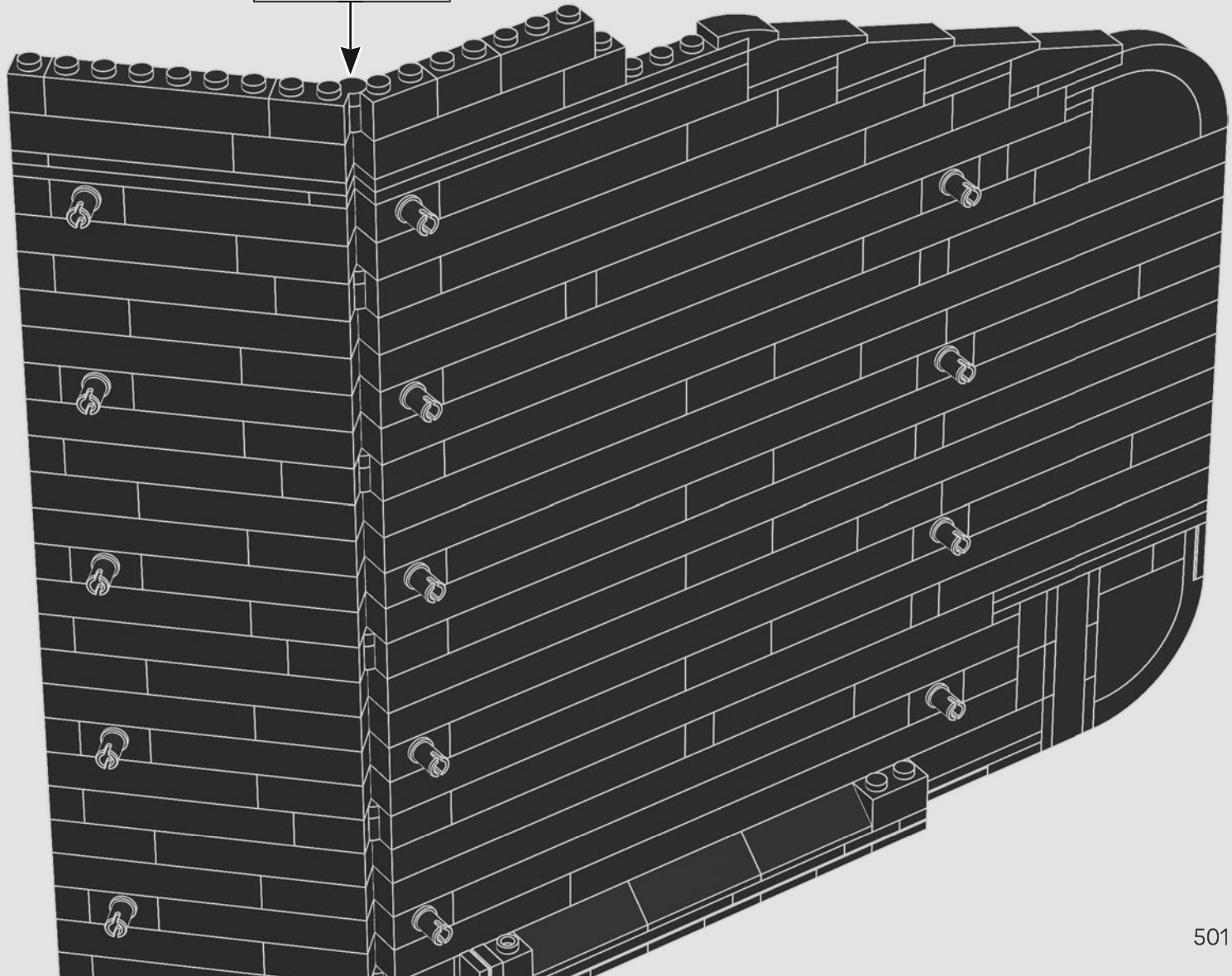

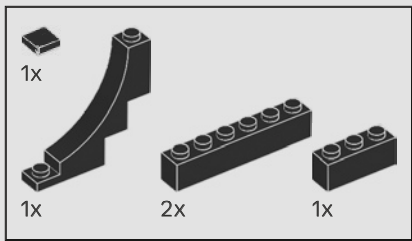

770

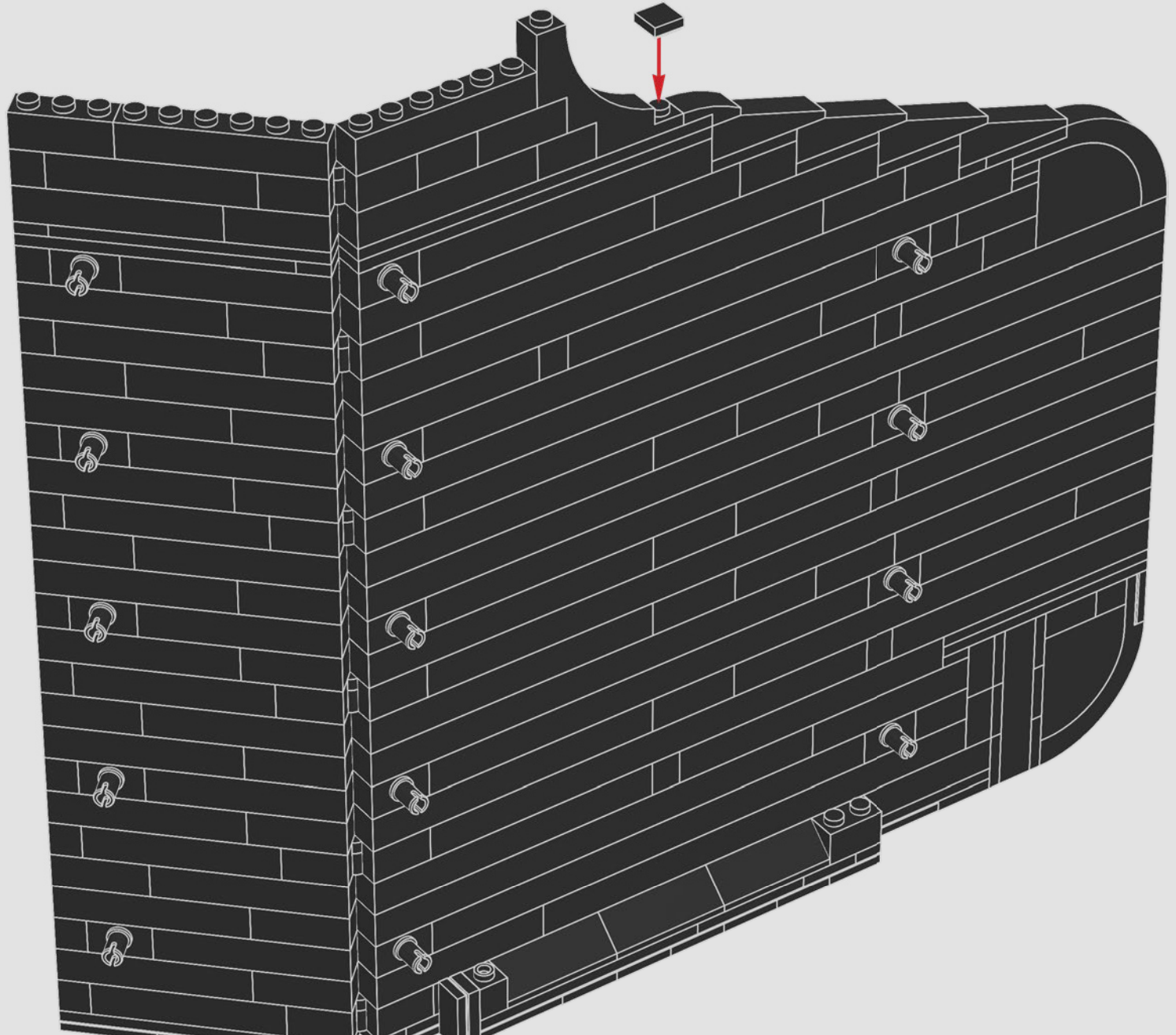

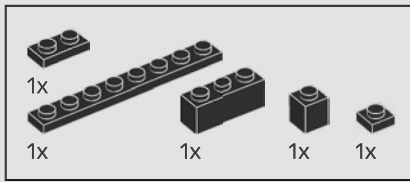

771

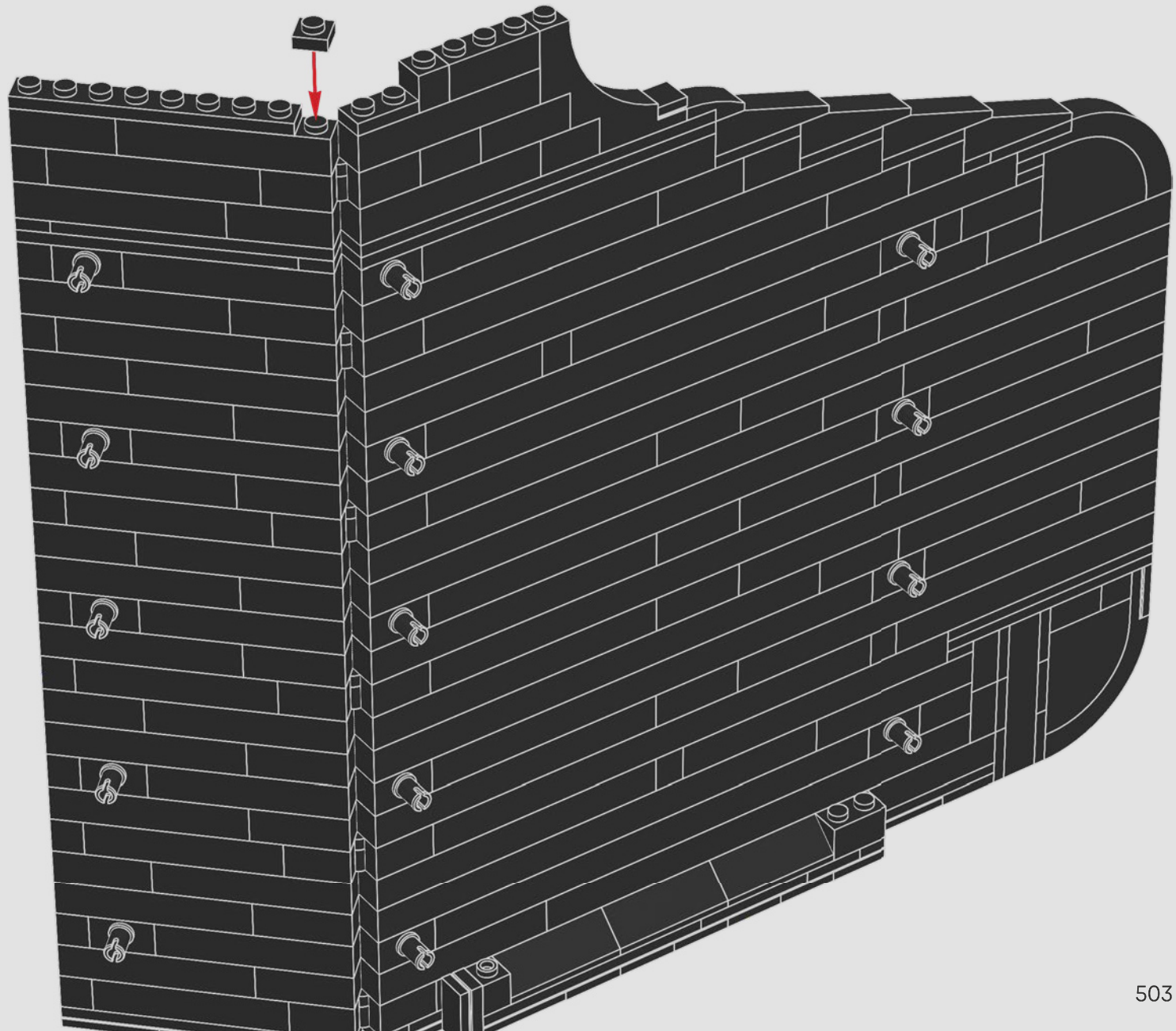

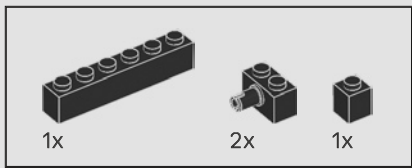

772

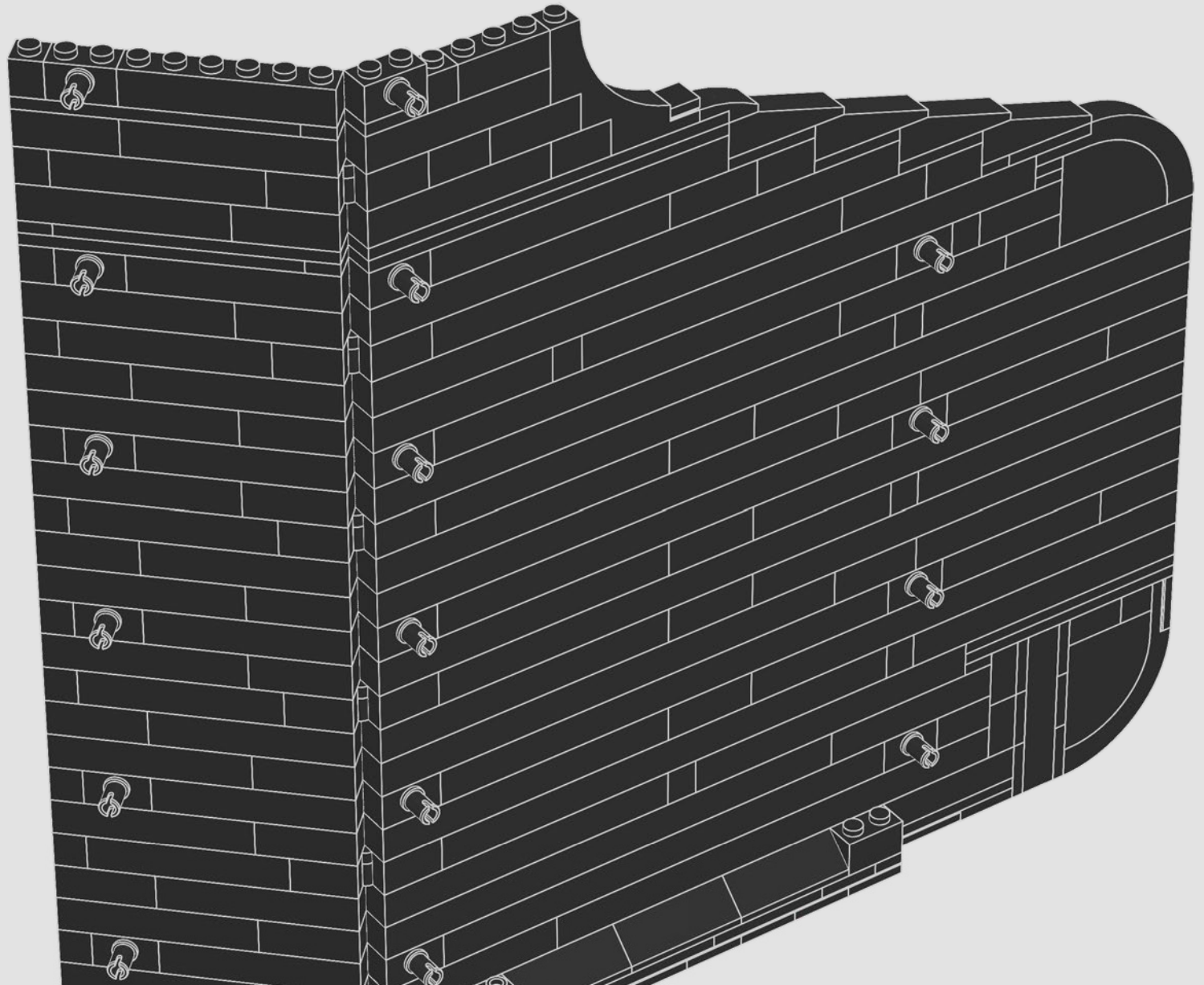

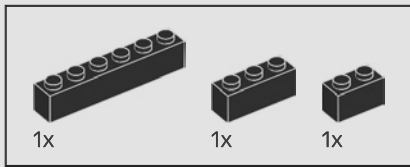

773

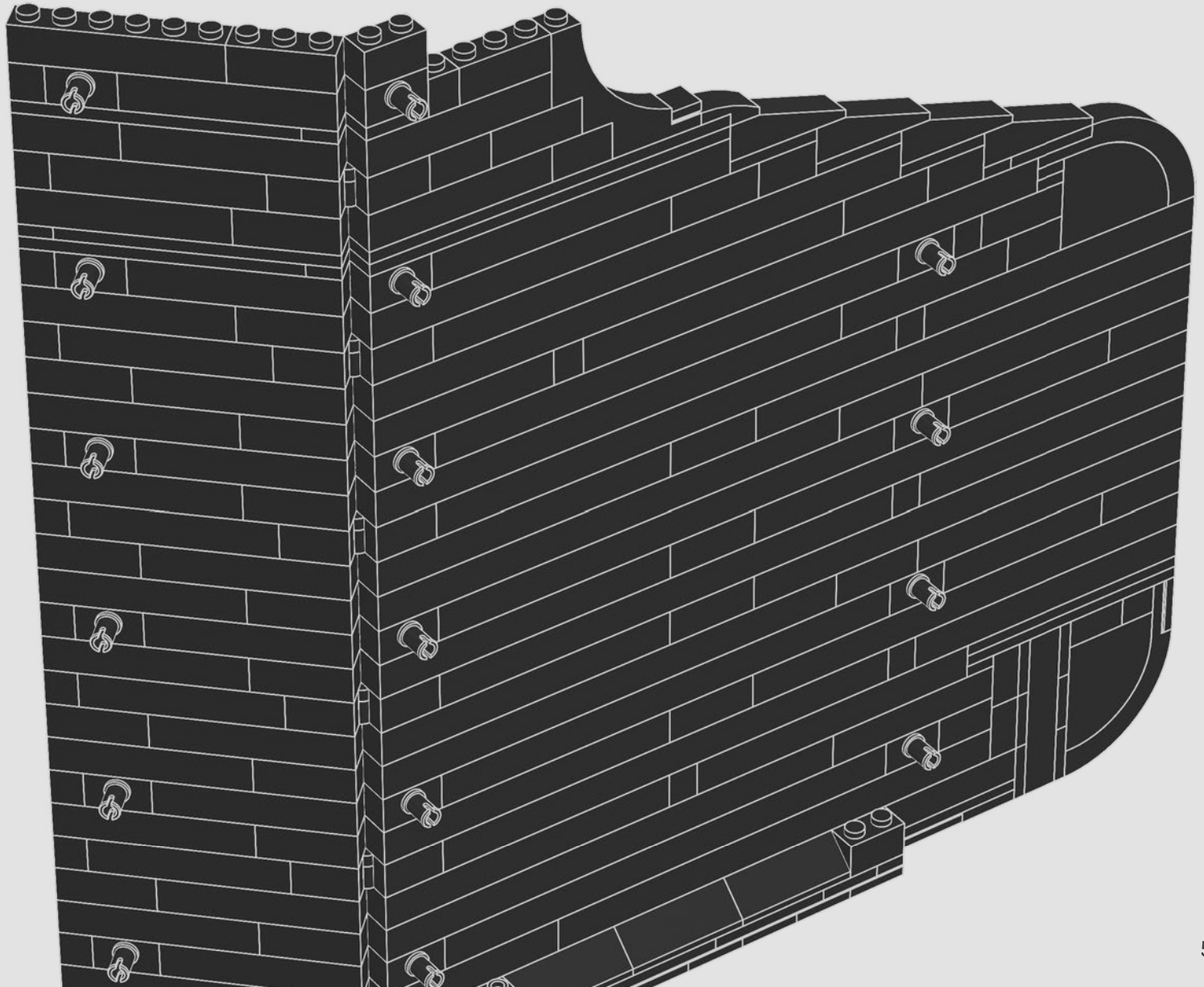

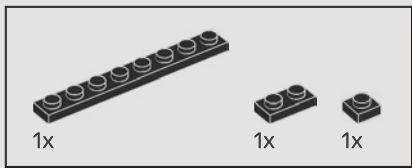

774

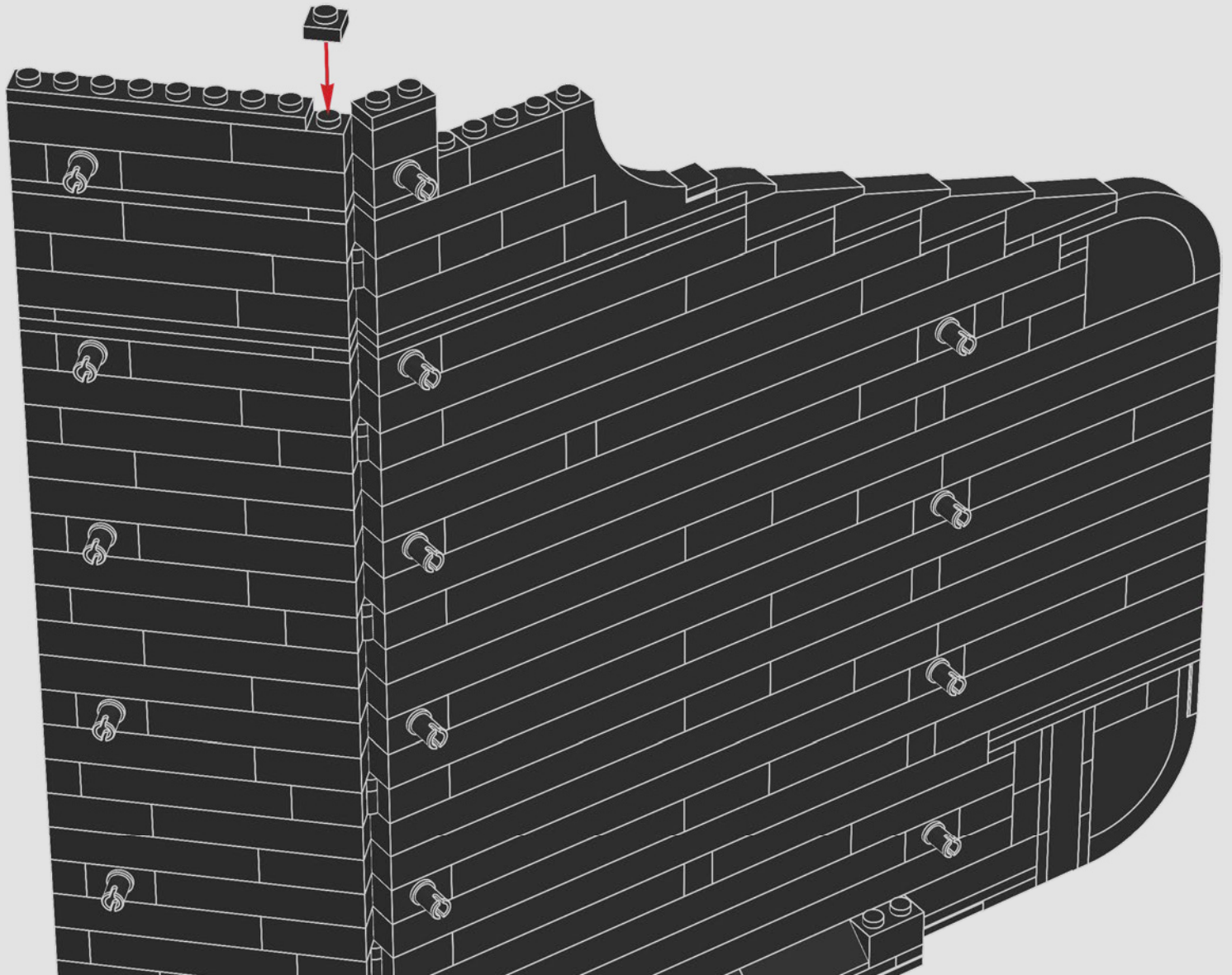

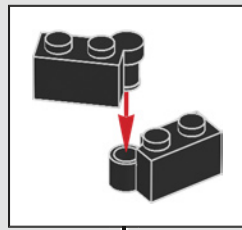
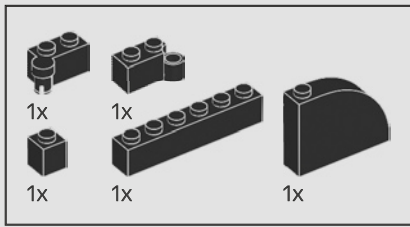

775

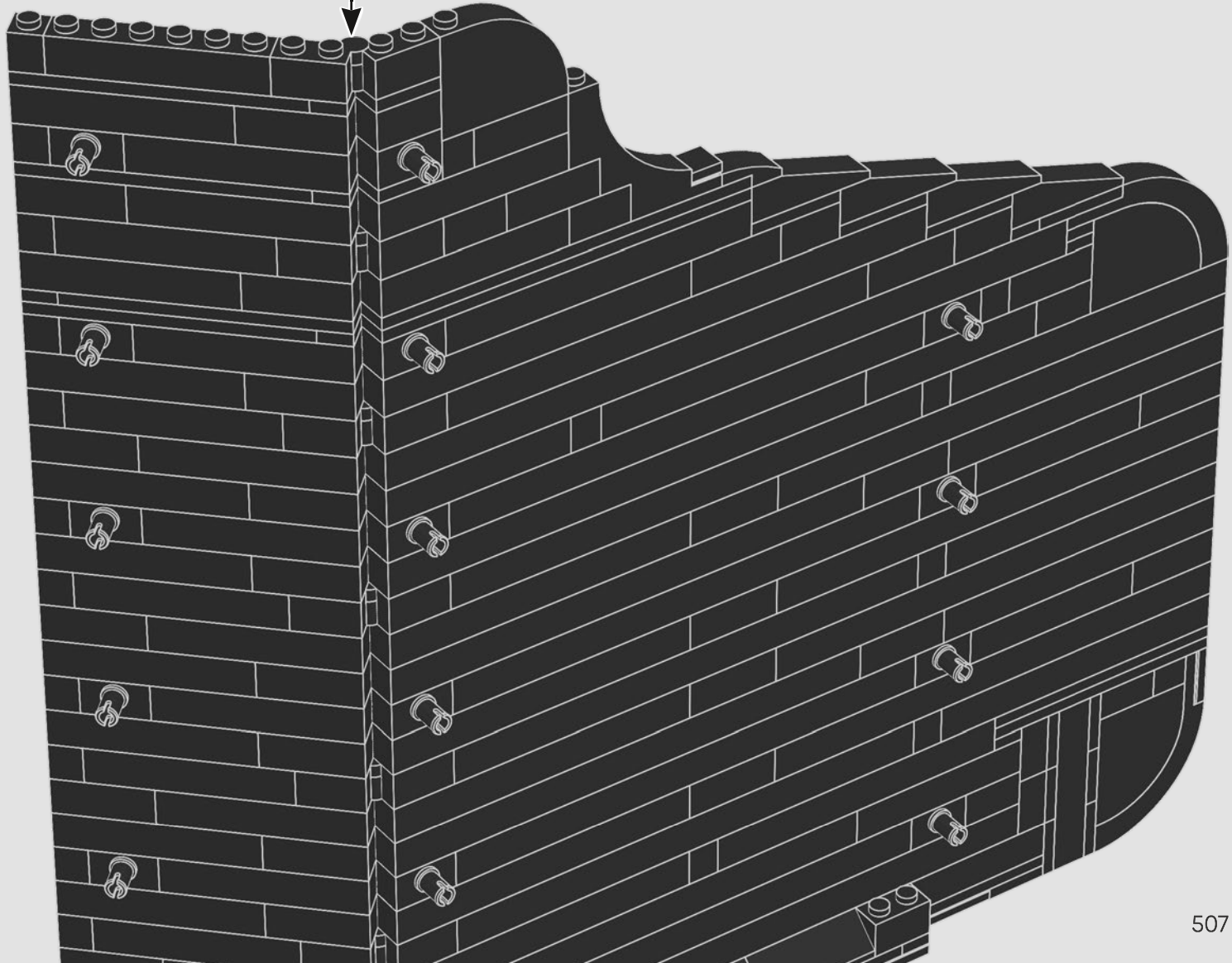

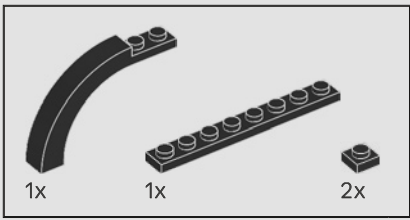

776

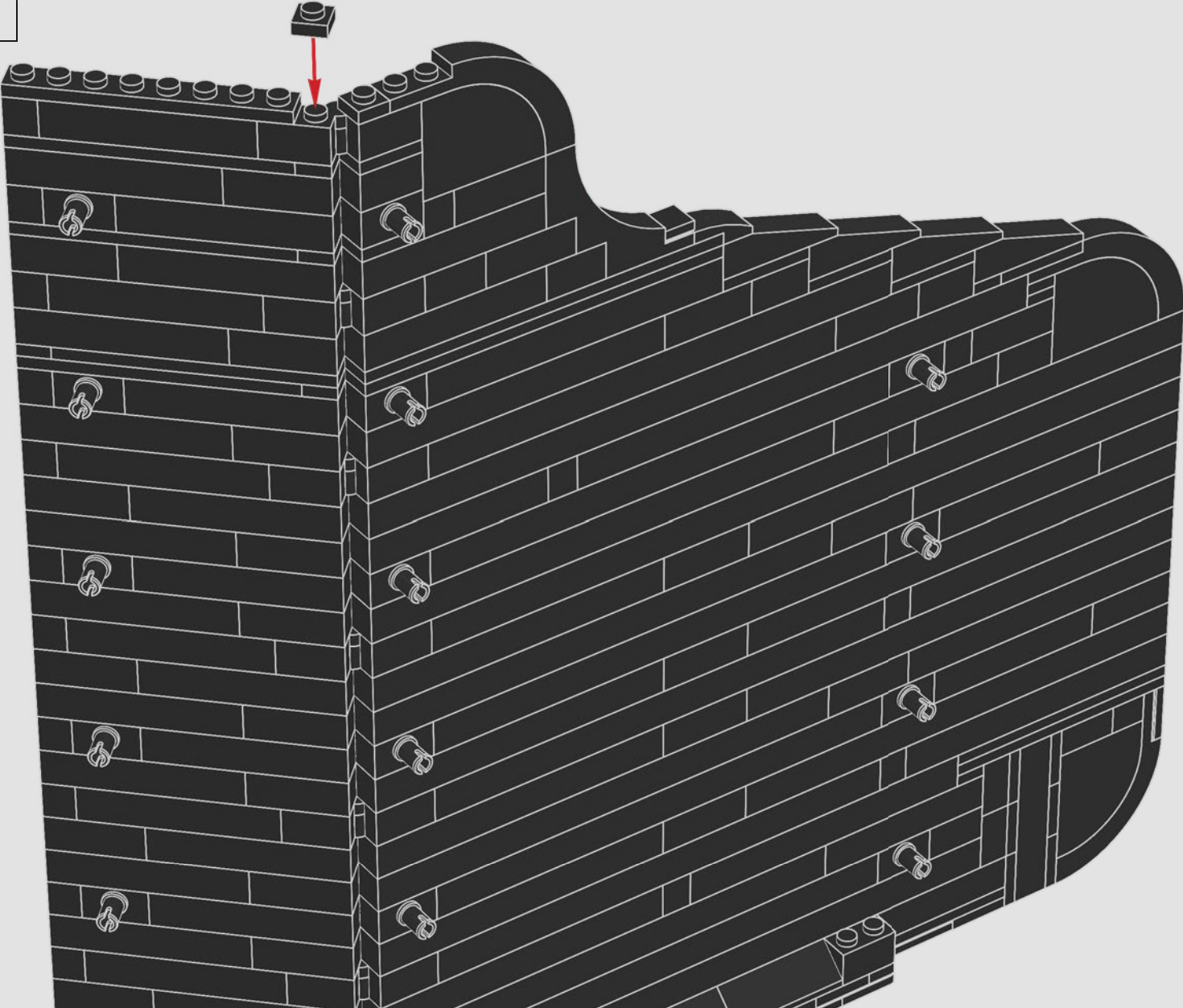

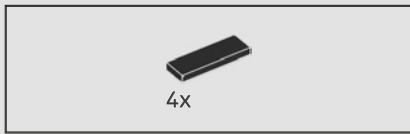

777

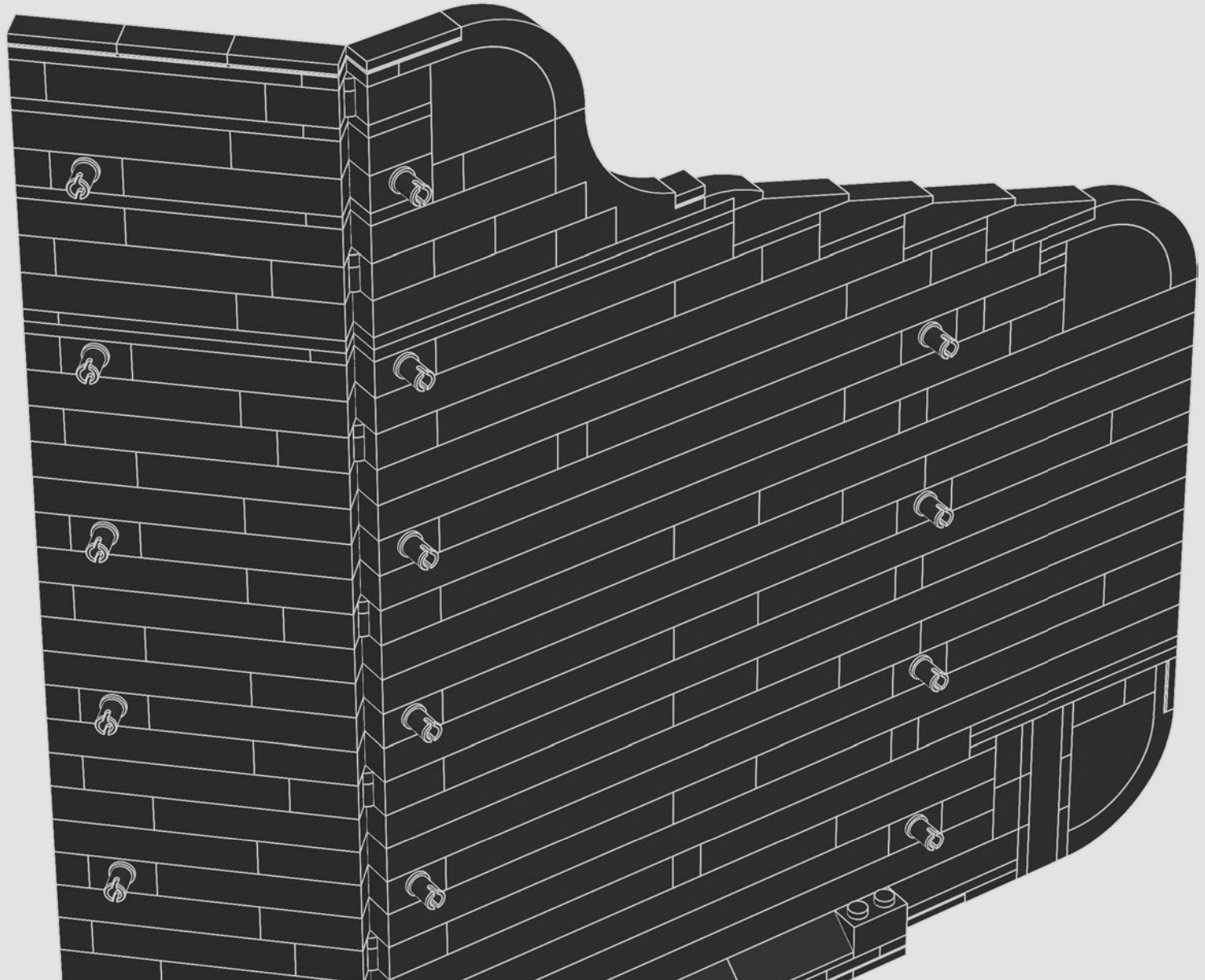

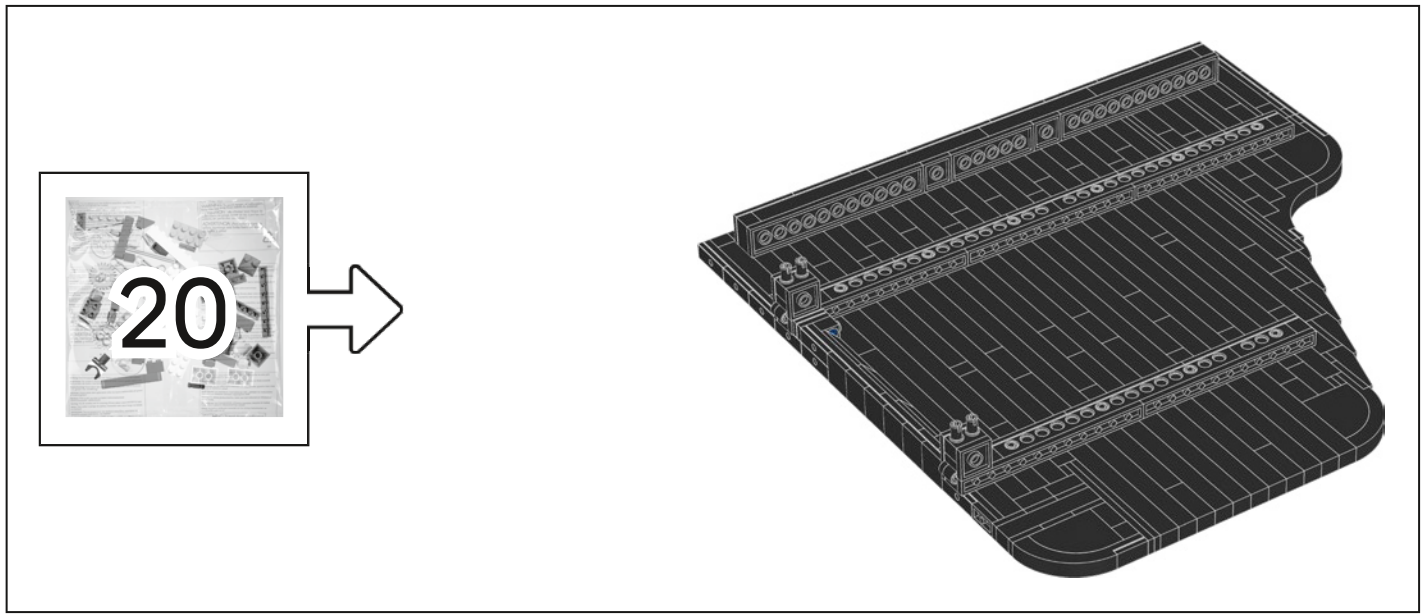

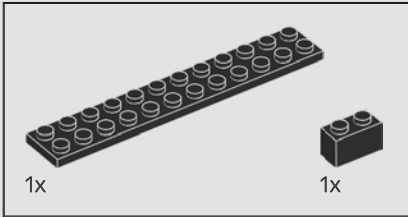
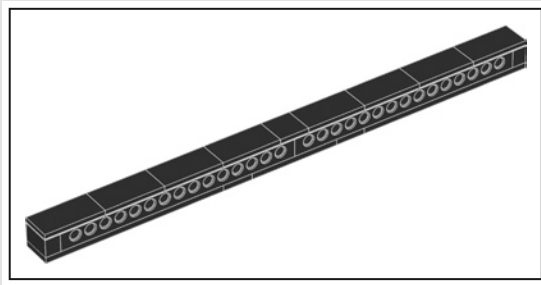

778

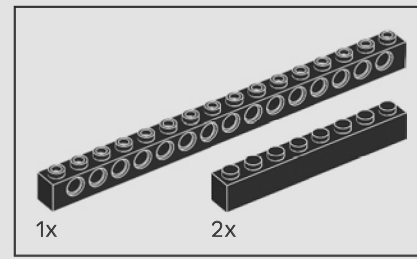
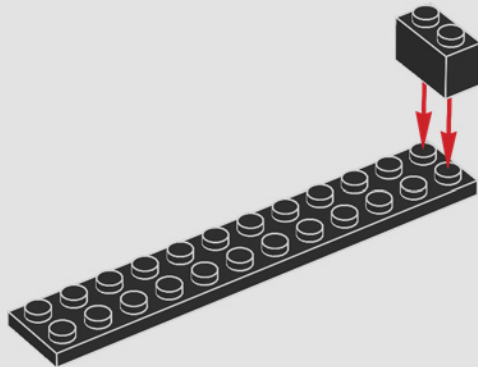

779

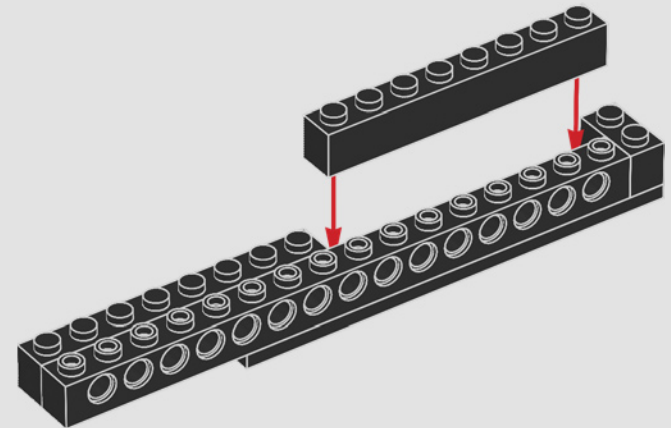

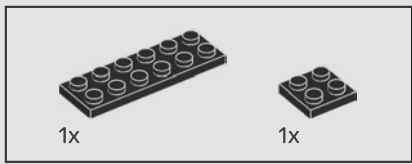

780

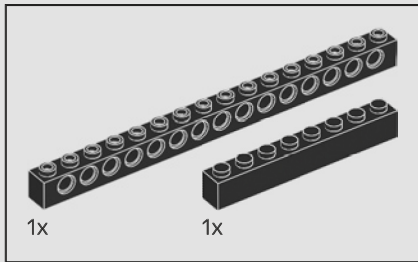
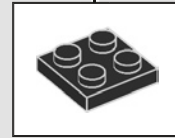
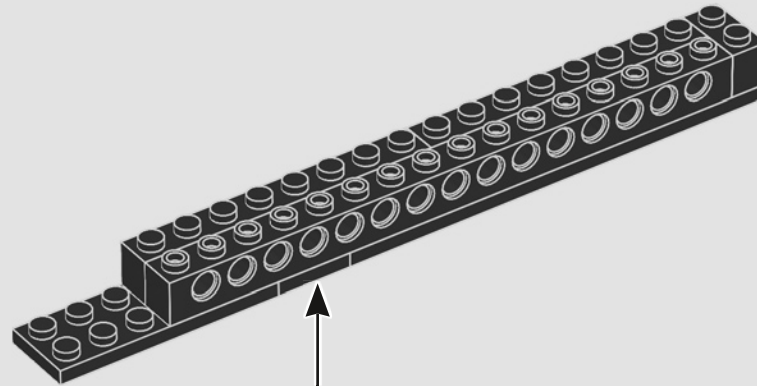

781

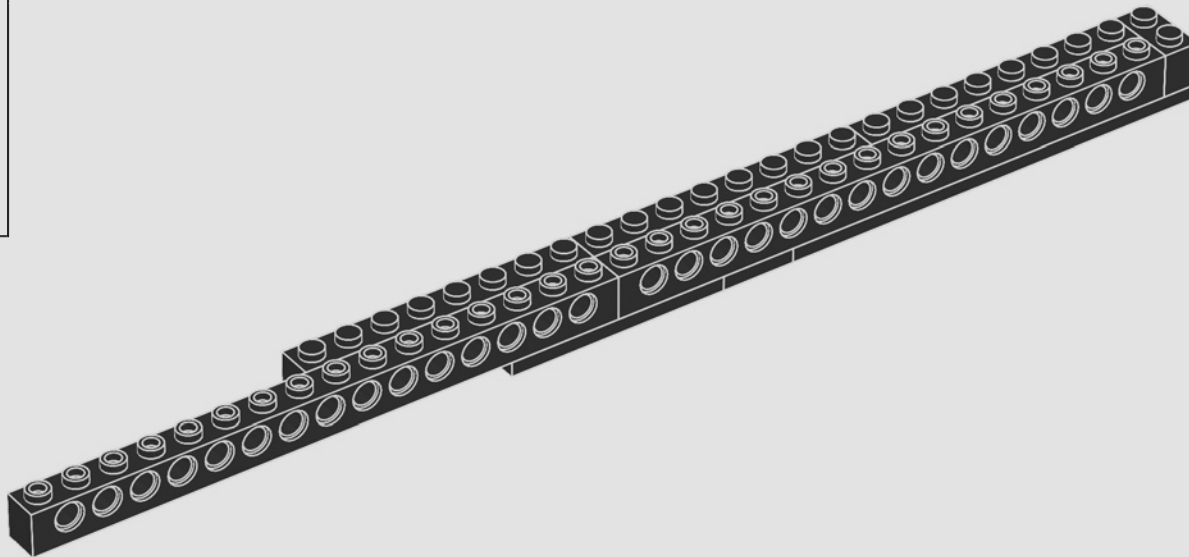

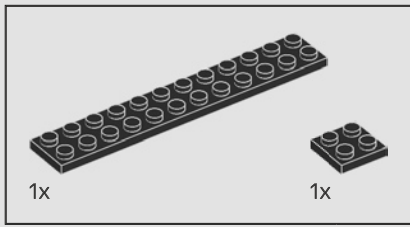

782

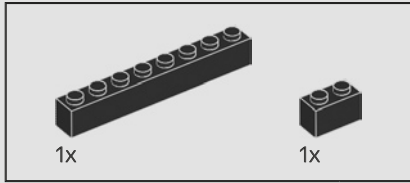
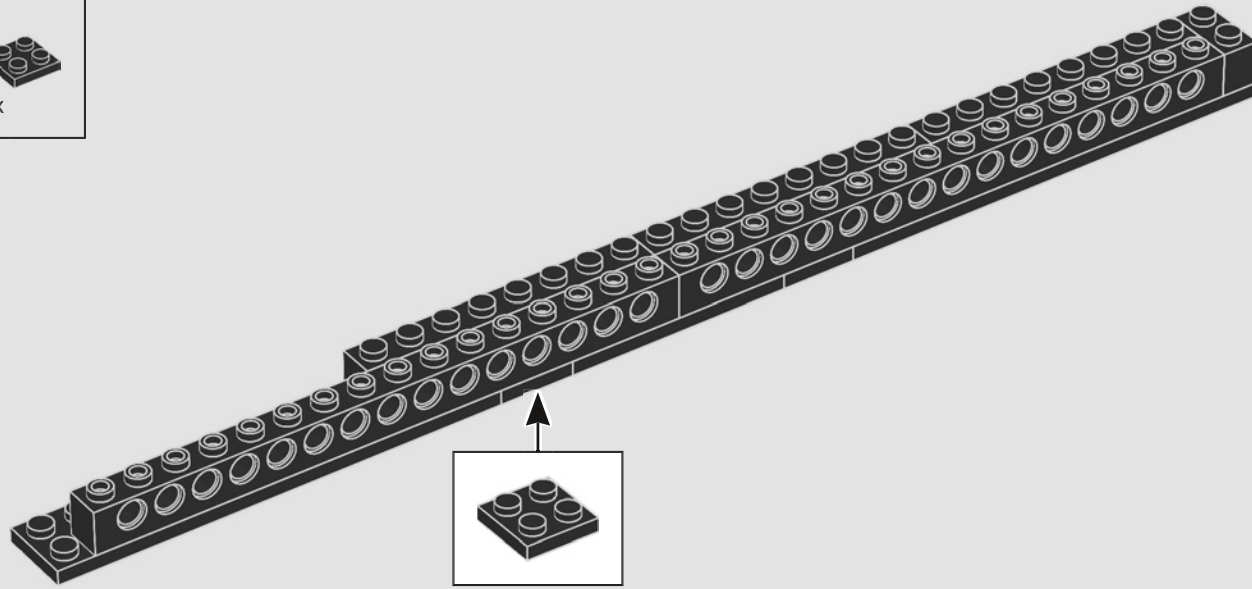

783

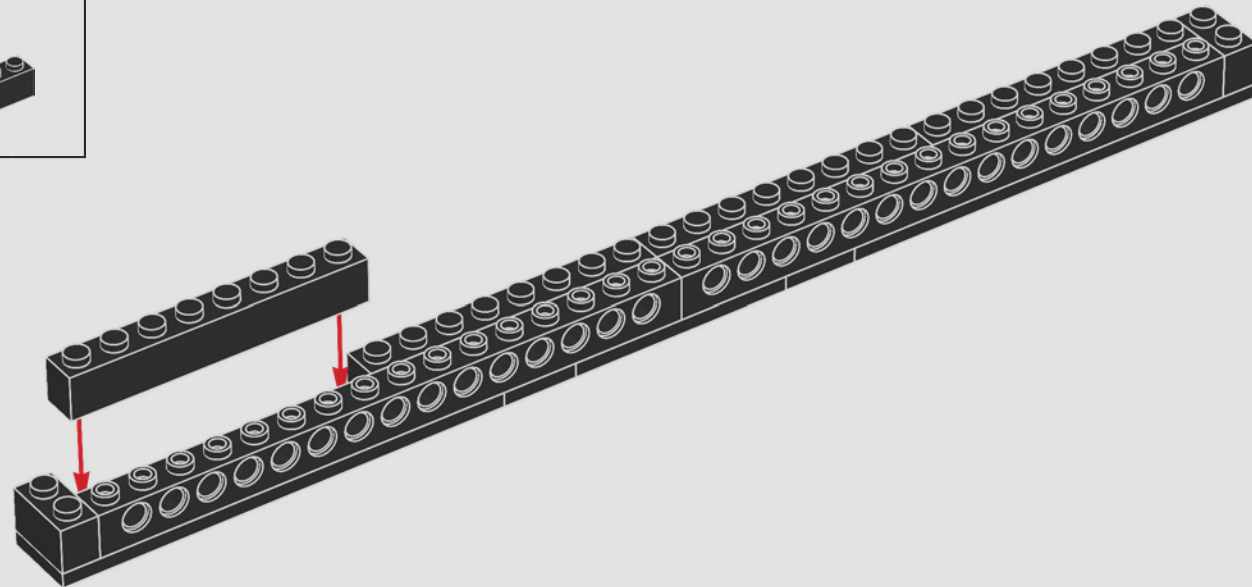

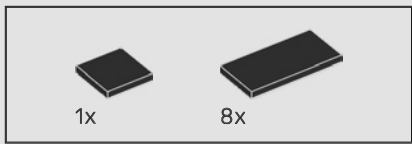

784

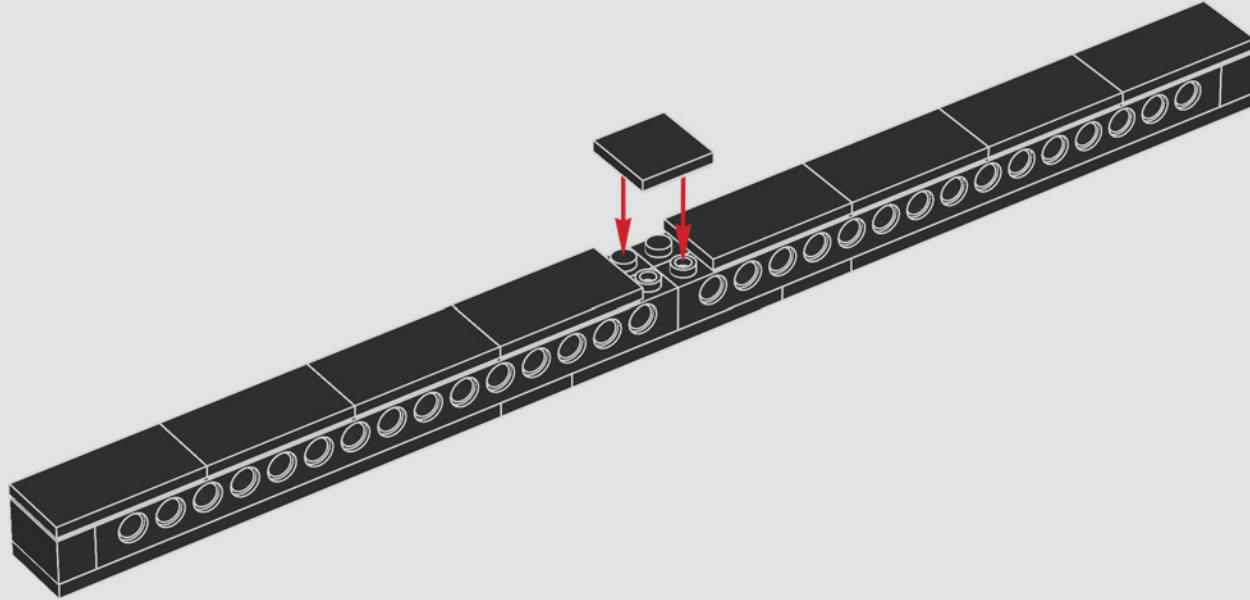

785

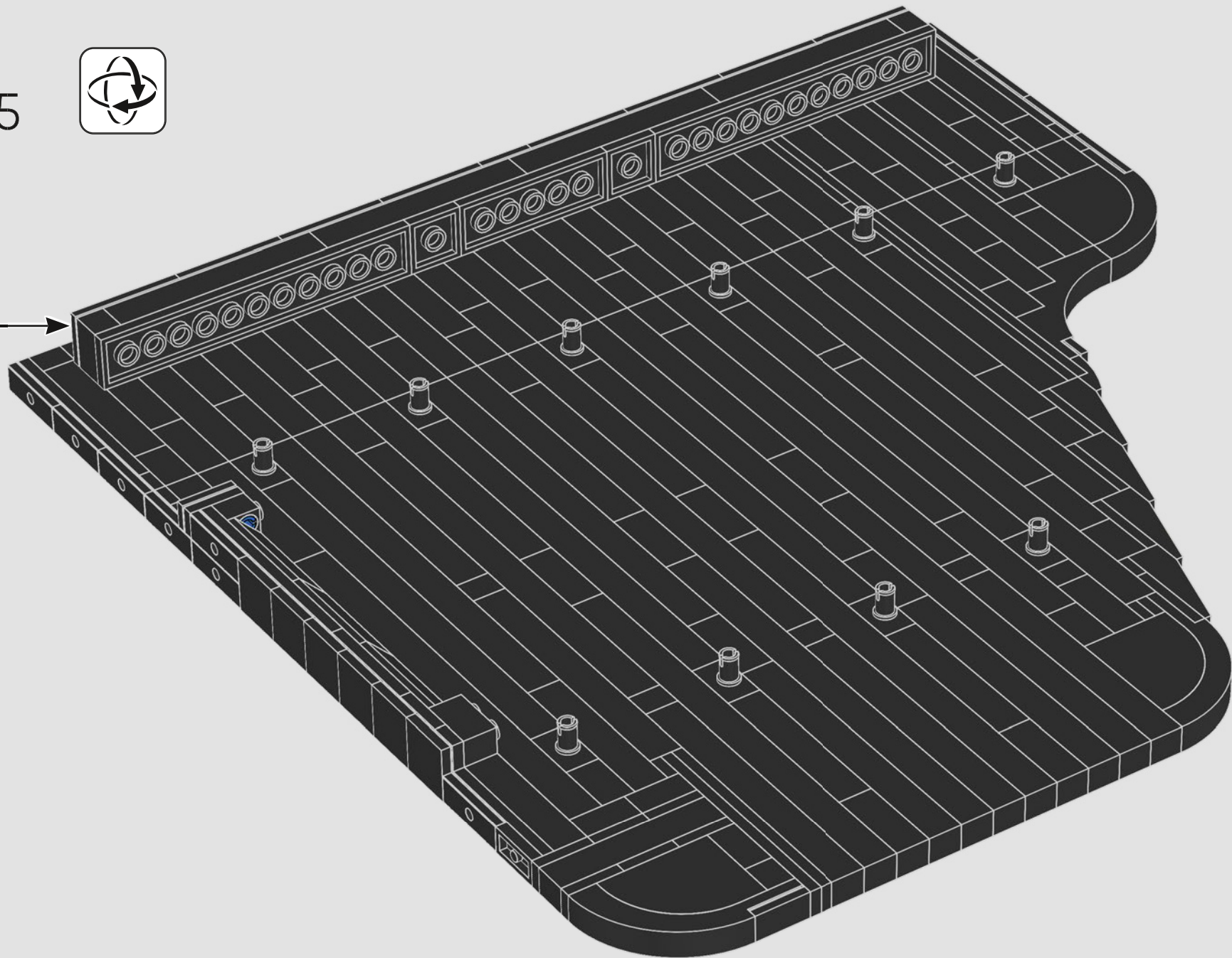

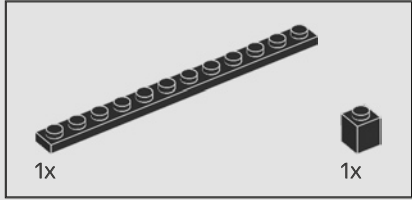
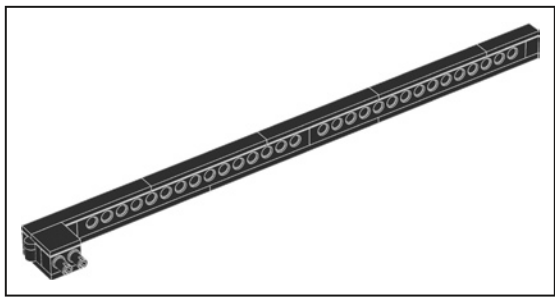

786

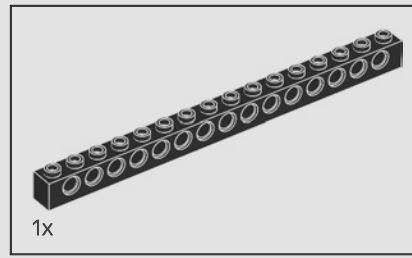
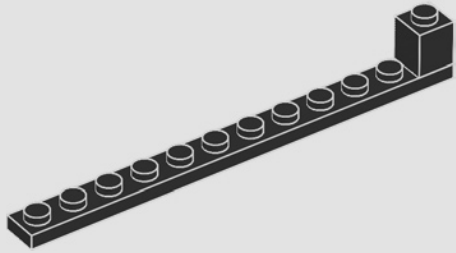

787

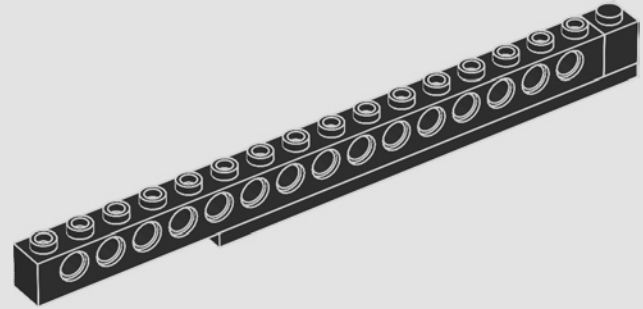

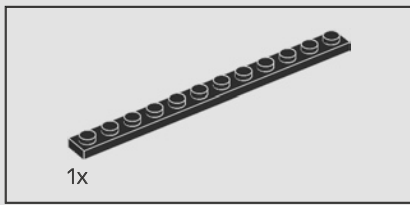

788

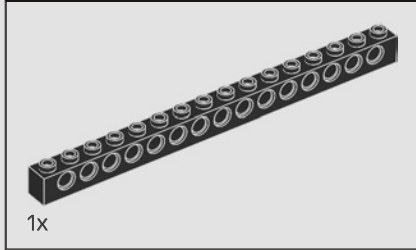
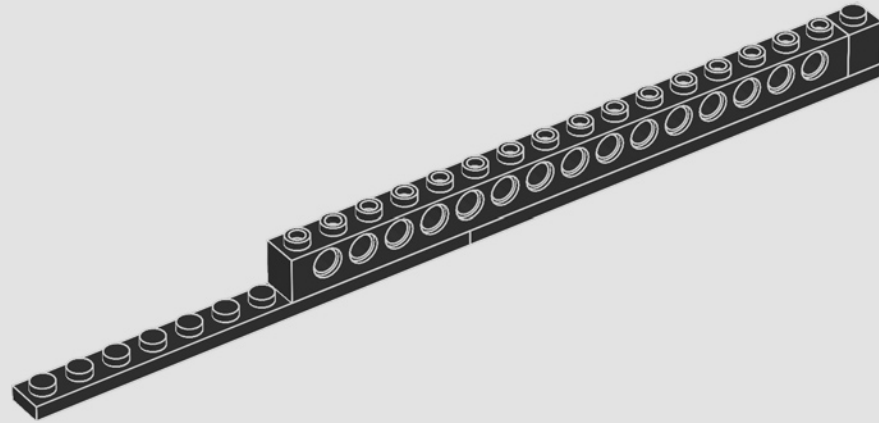

789

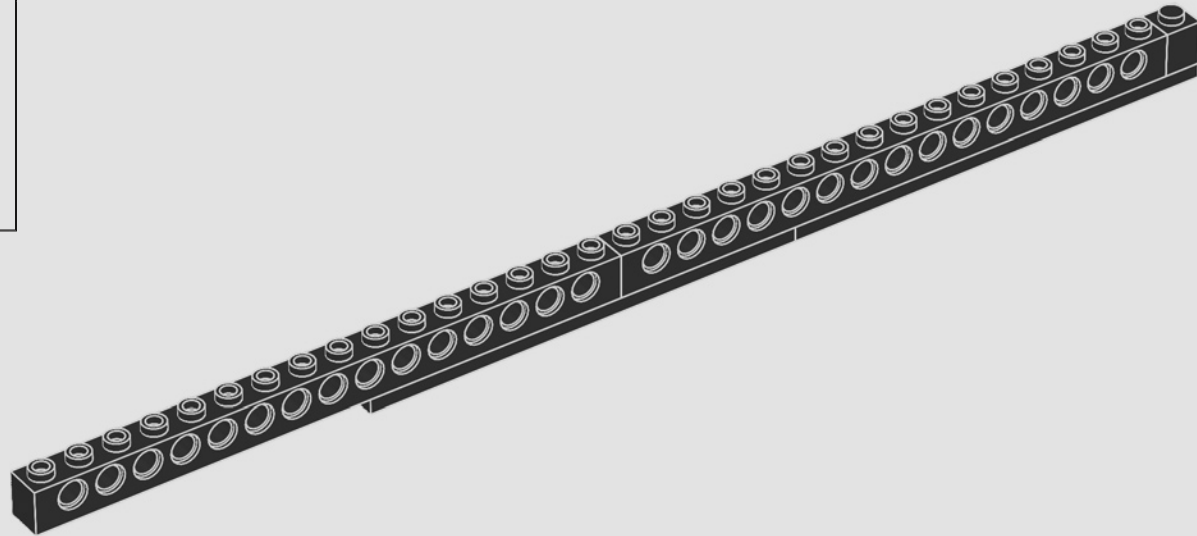

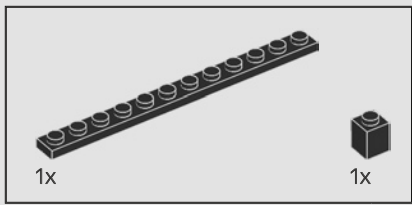

790

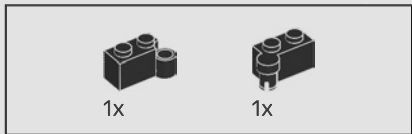
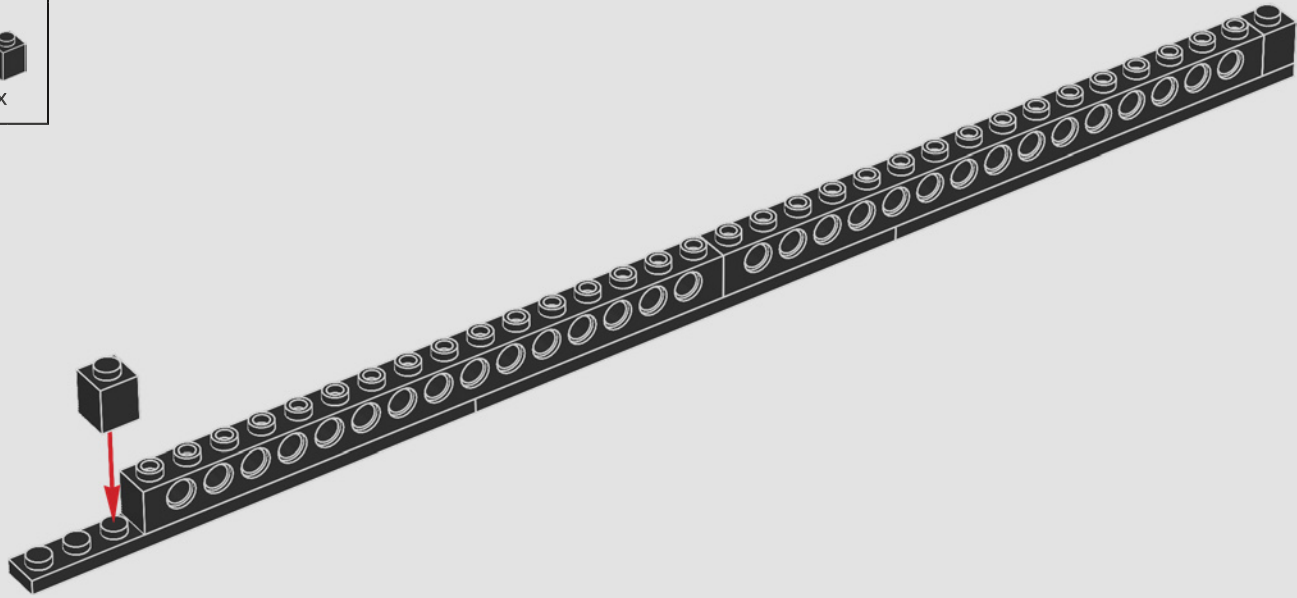

791

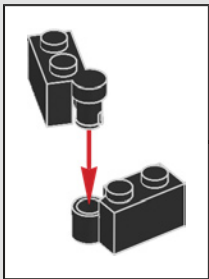
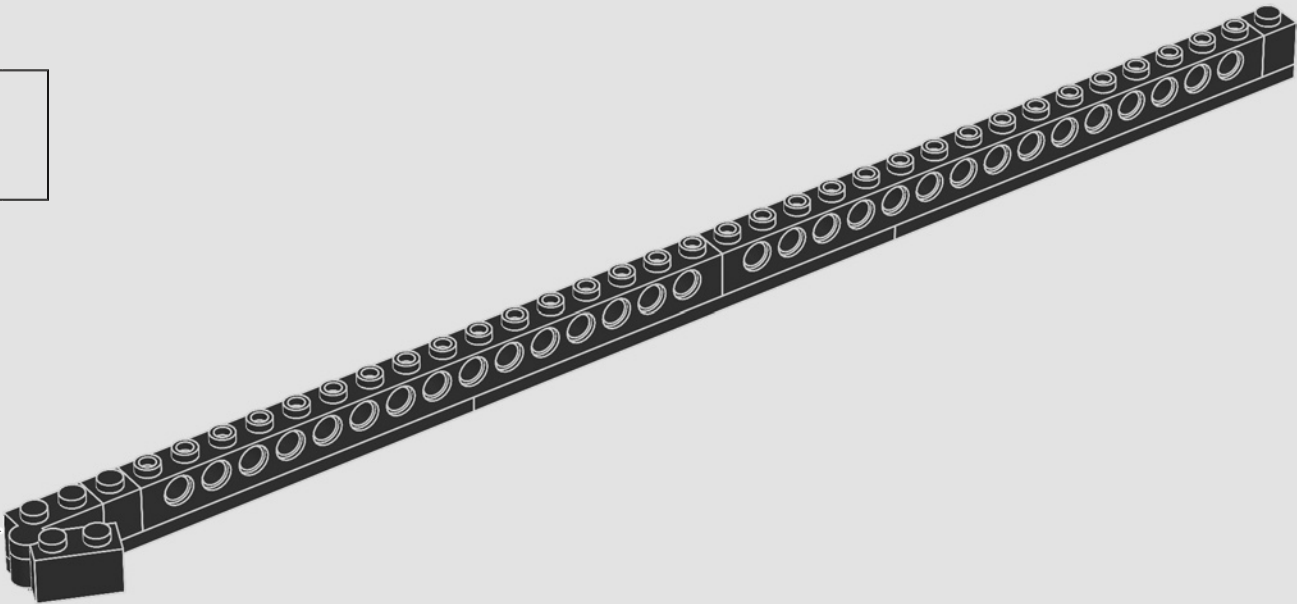

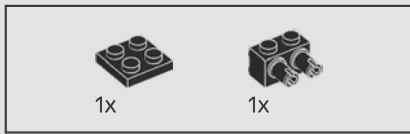

792

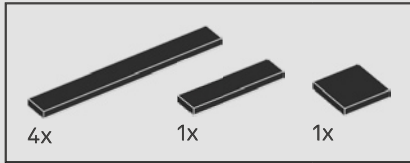
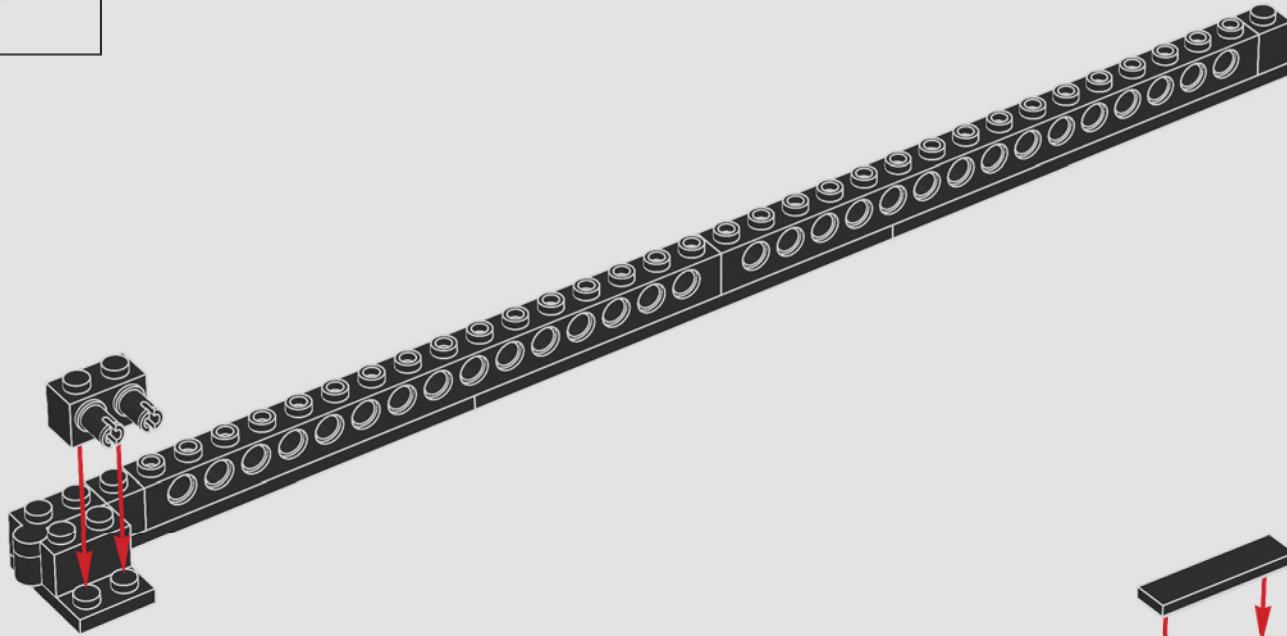

793

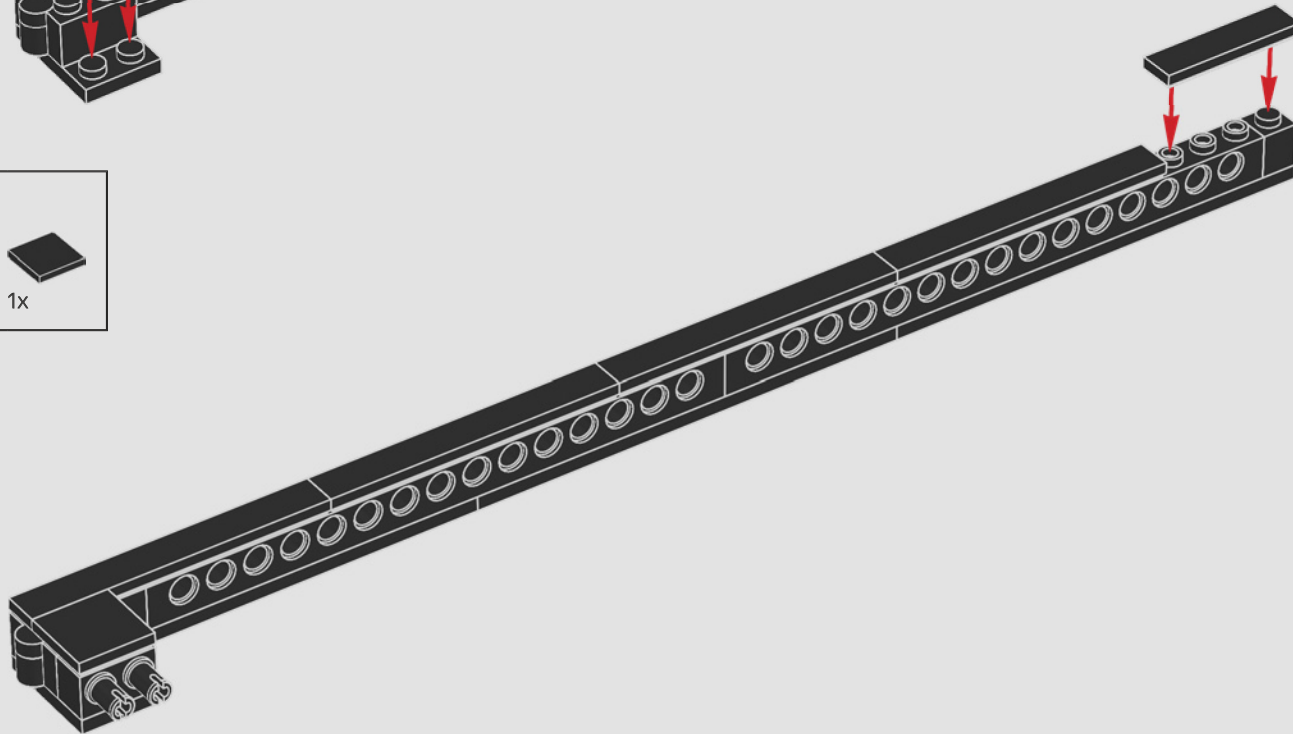

794

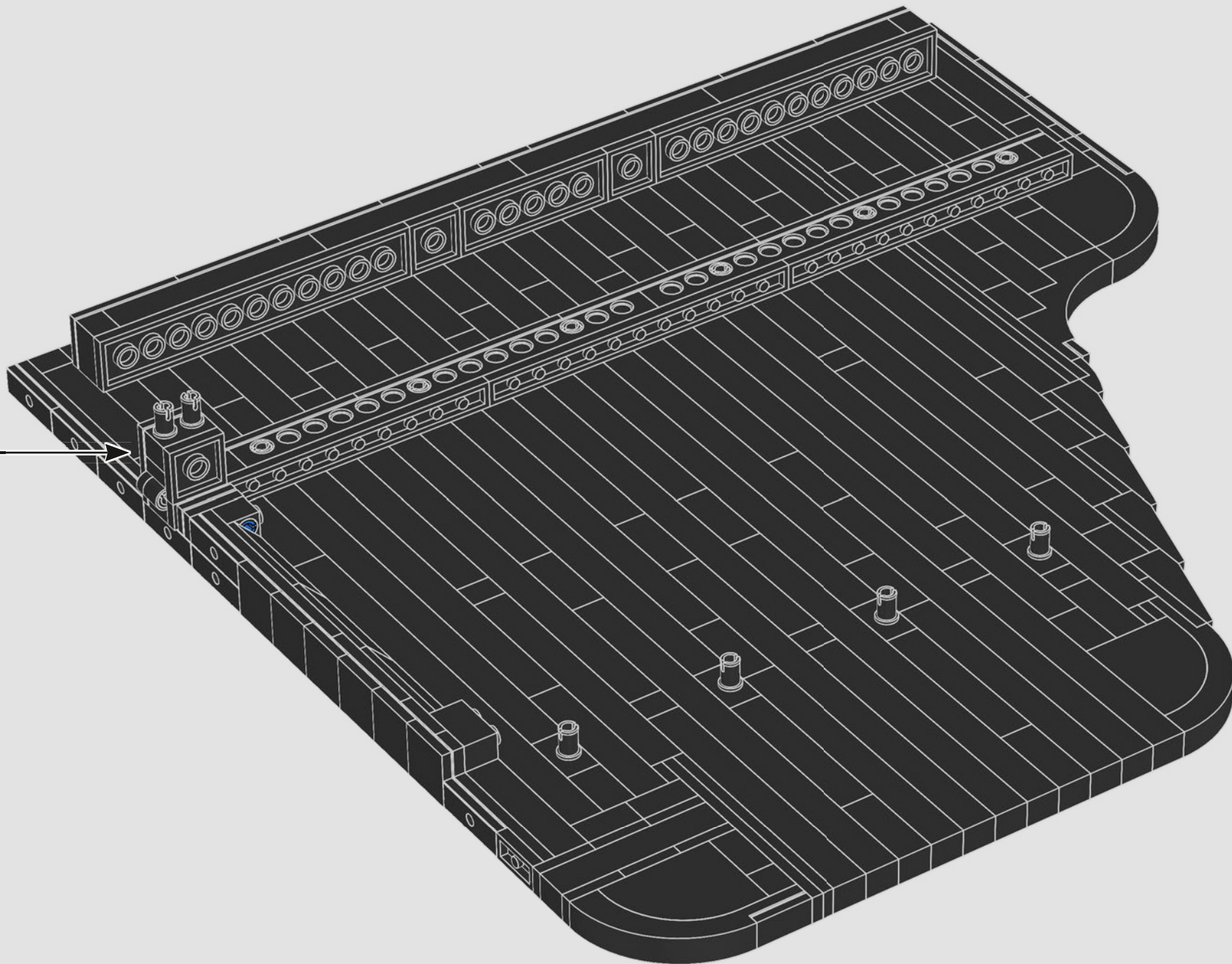

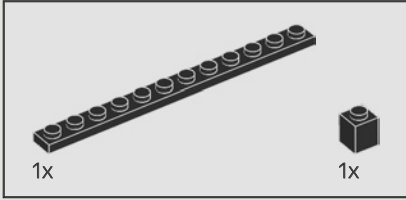
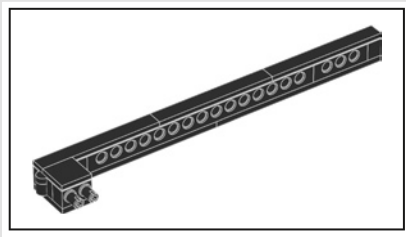

795

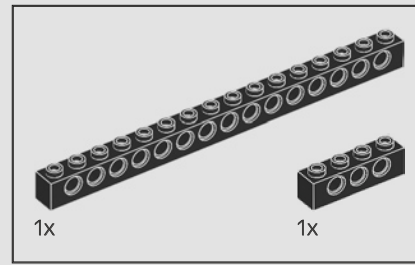
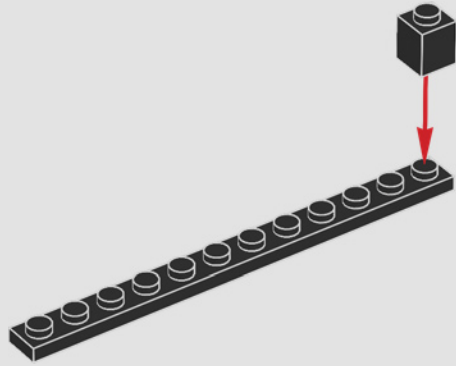

796

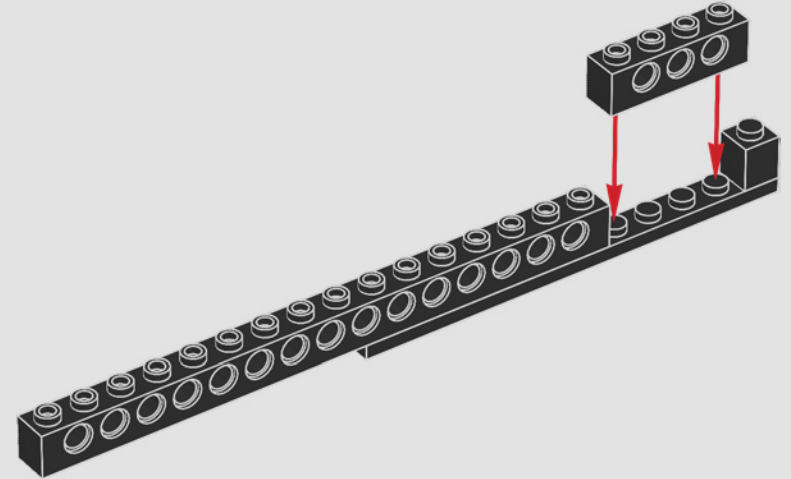

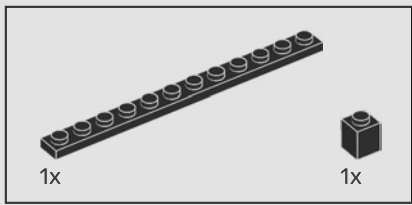

797

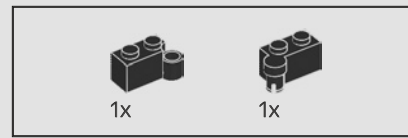
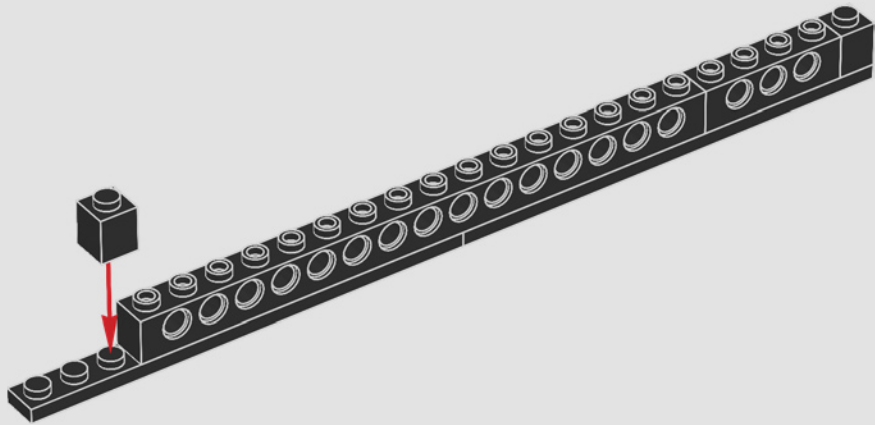

798

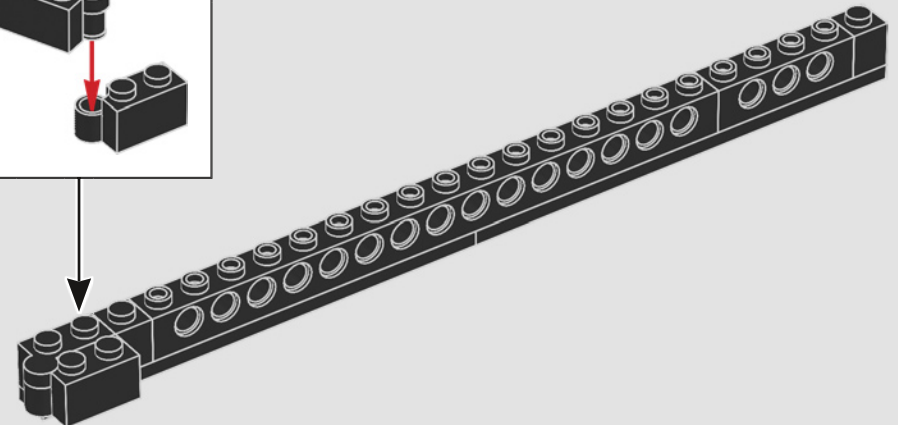
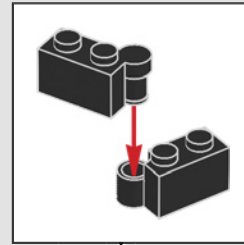

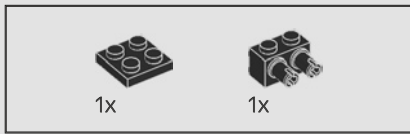

799

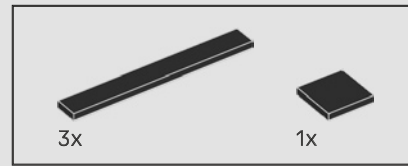
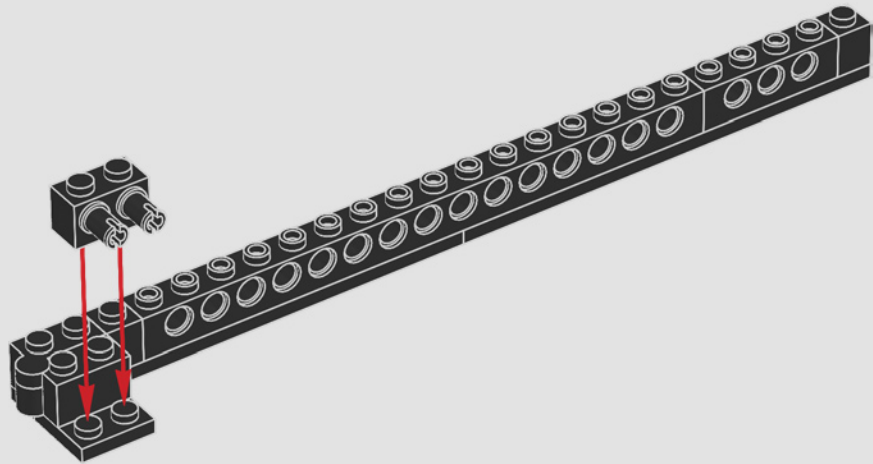

800

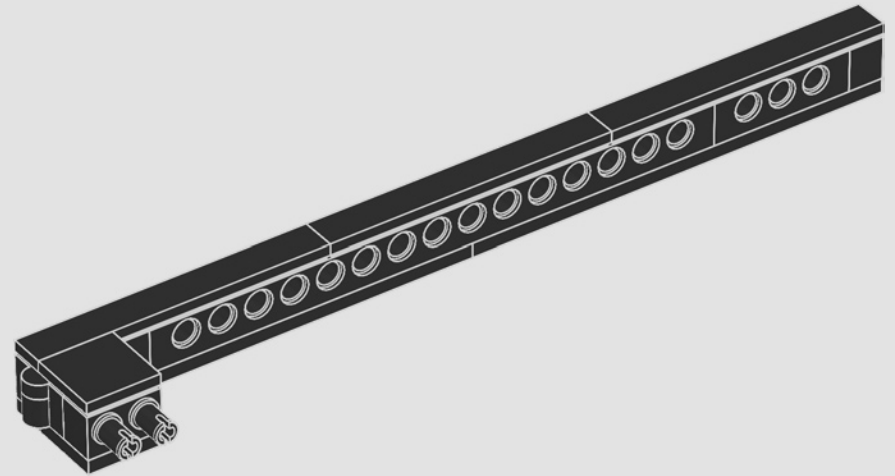

801

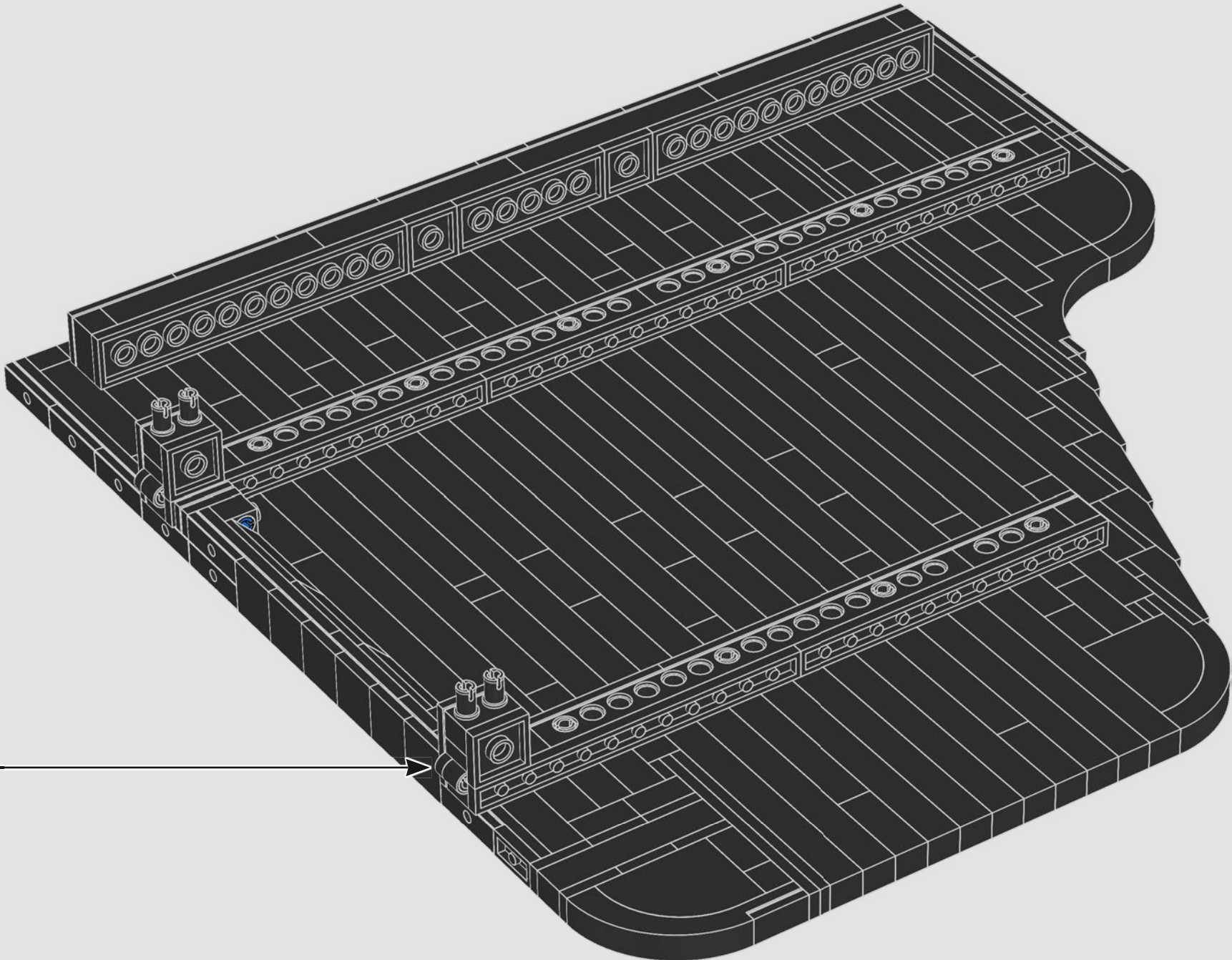

802

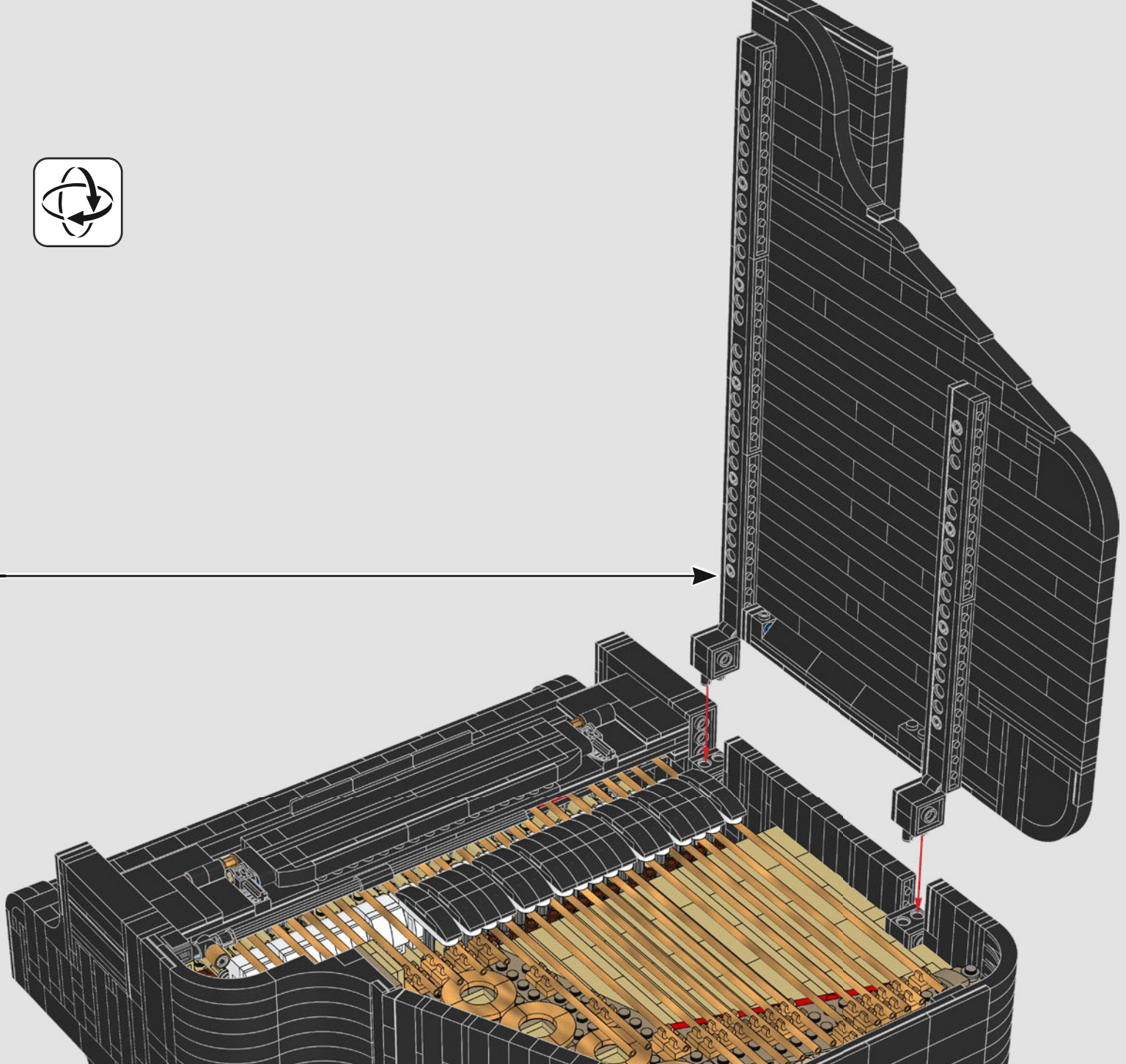

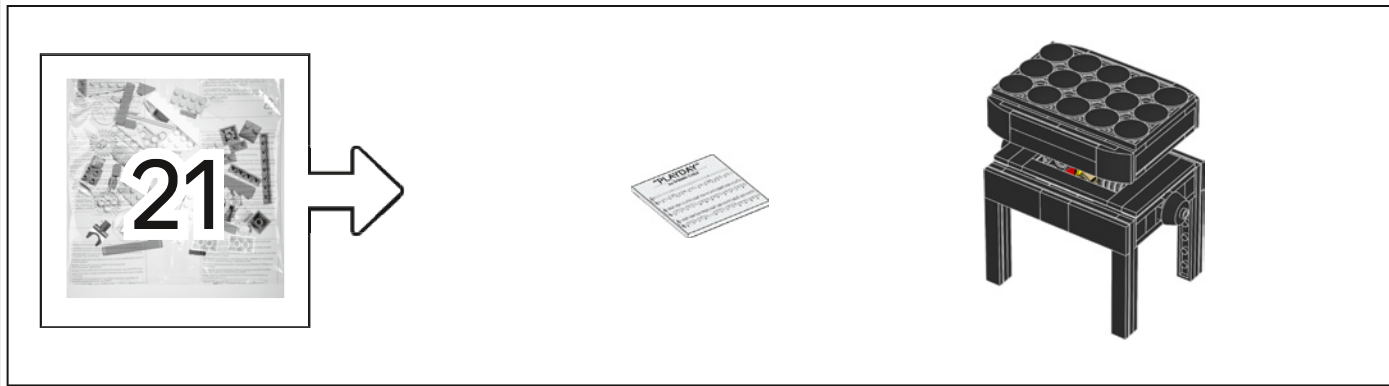

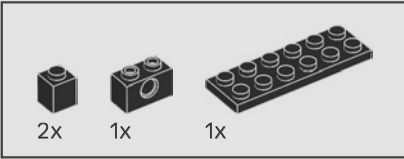
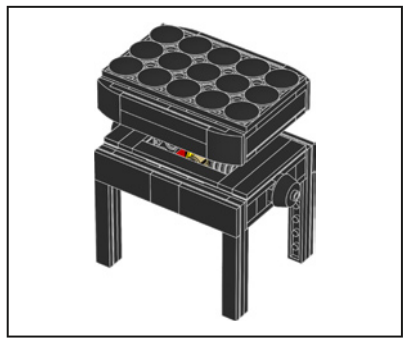

803

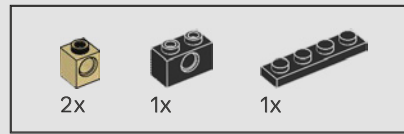
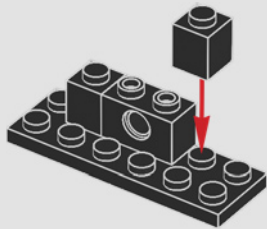

804

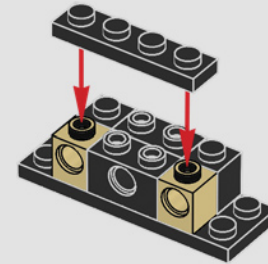

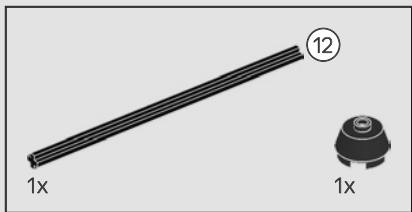

805

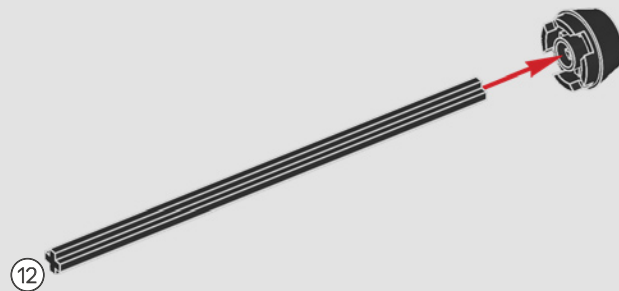
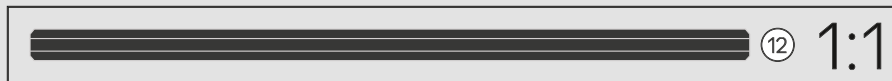

806

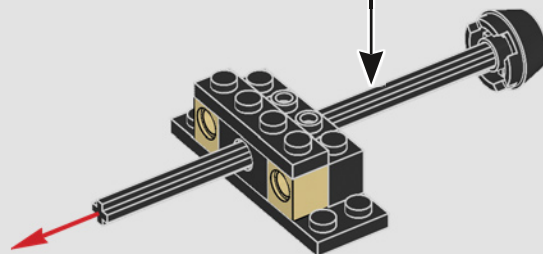

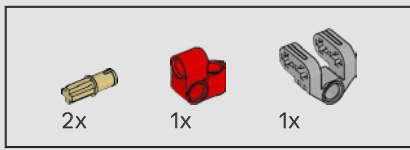

807

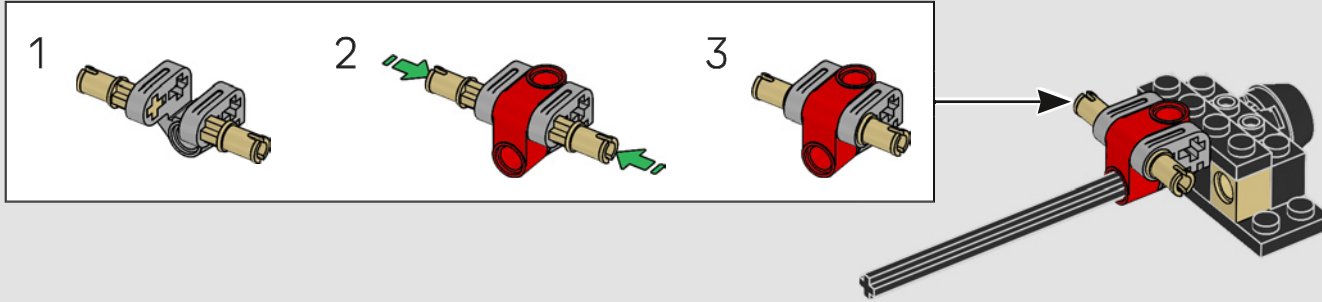

808

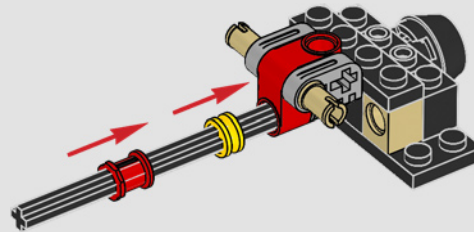



809

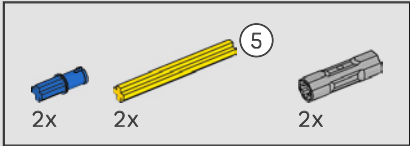
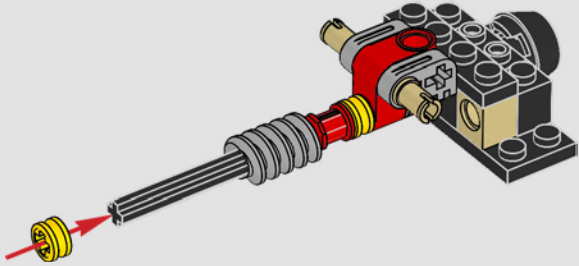

810

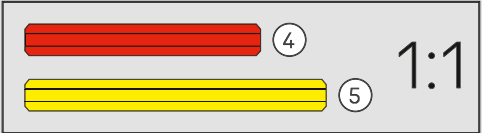
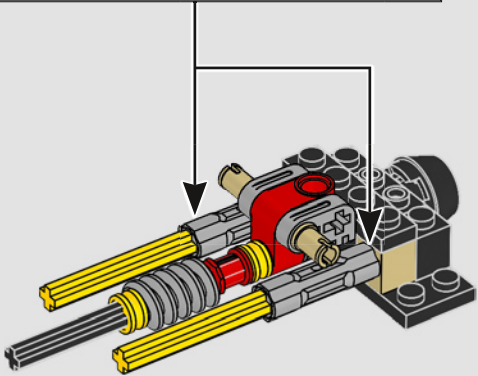
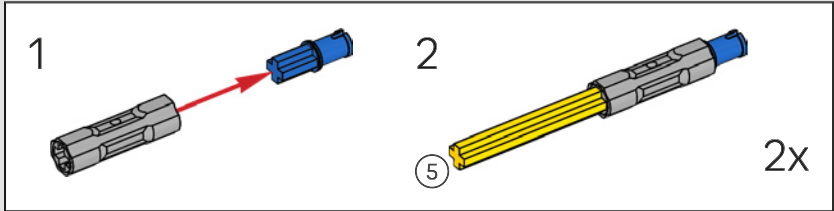

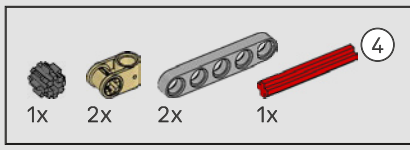

811

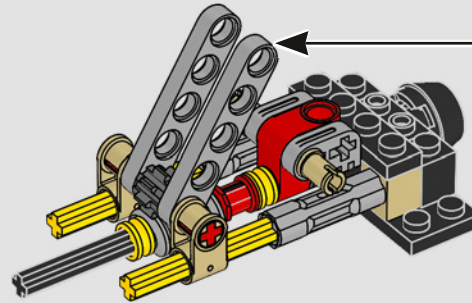
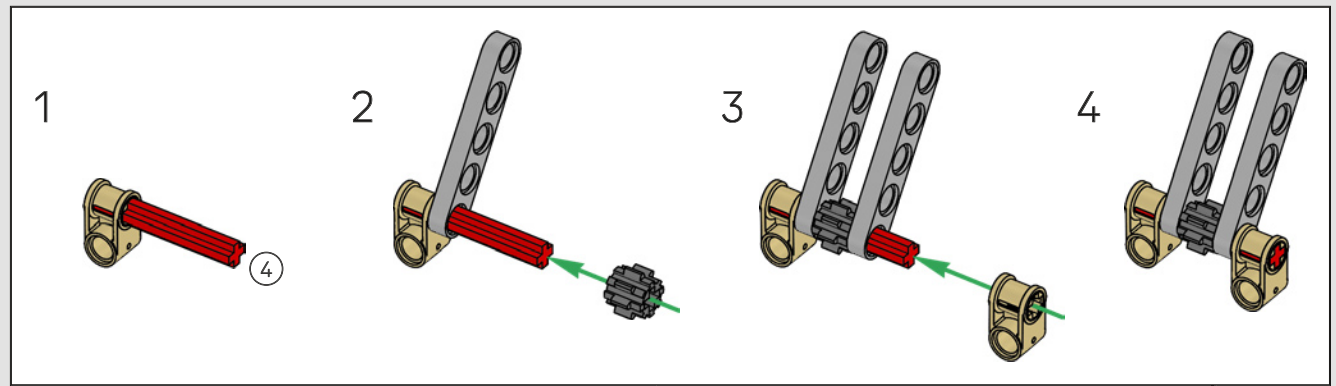

812

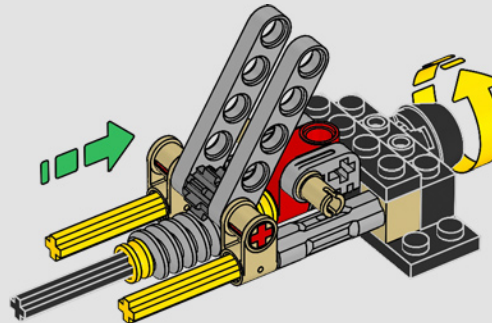

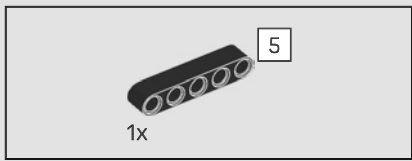

813

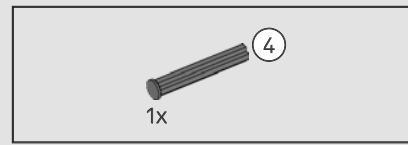
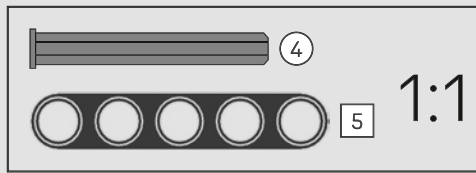
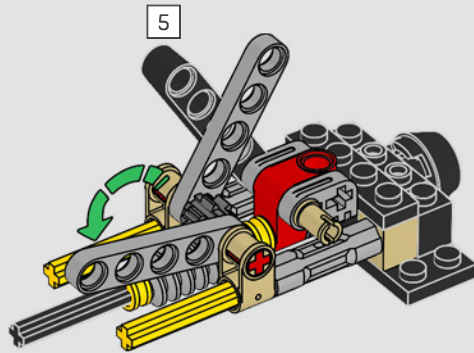

814

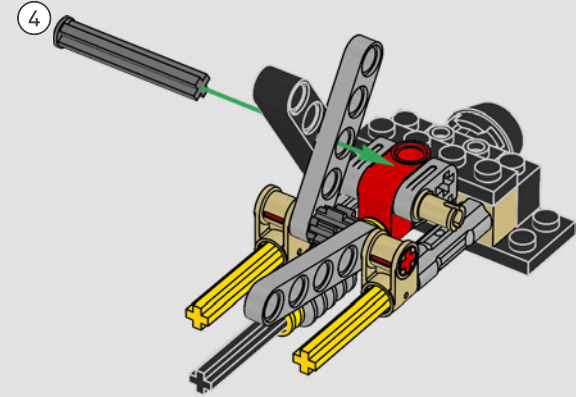

815

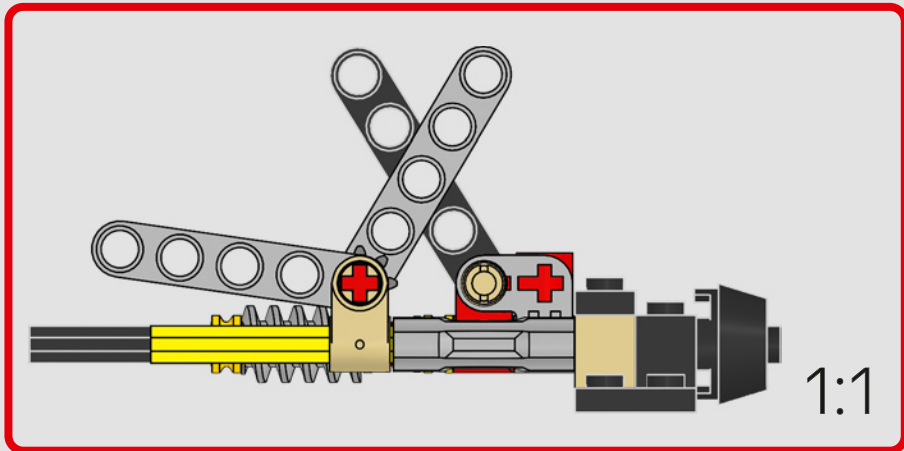
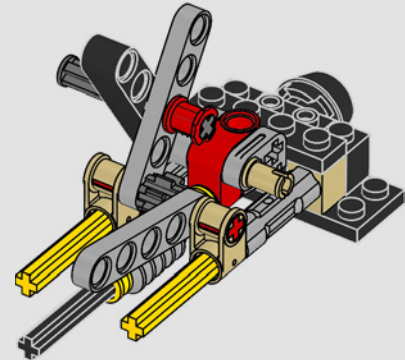

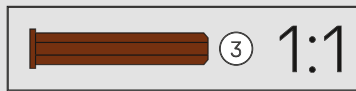
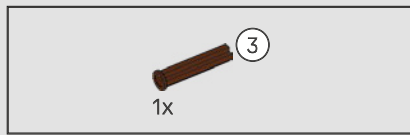

816

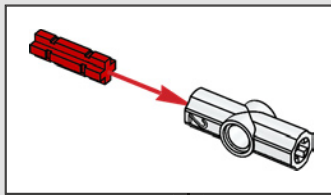
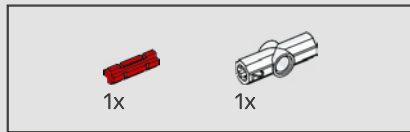
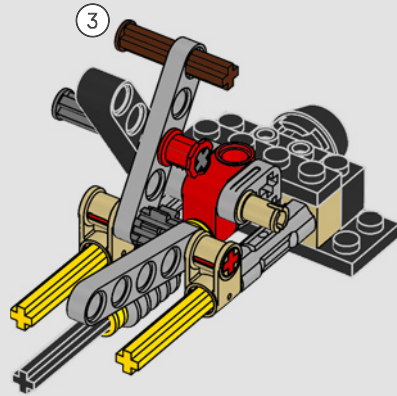

817

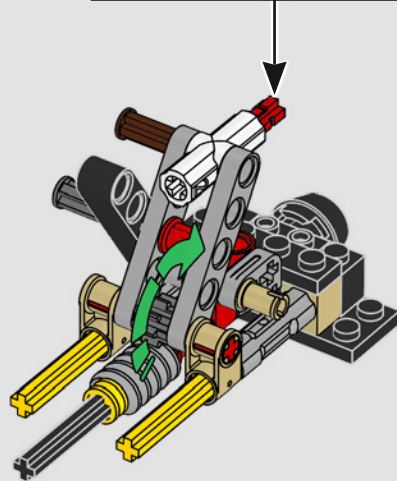

818

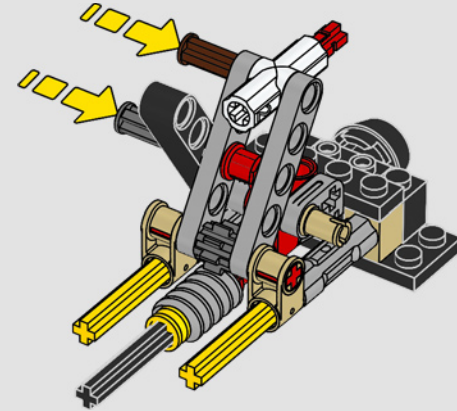

819

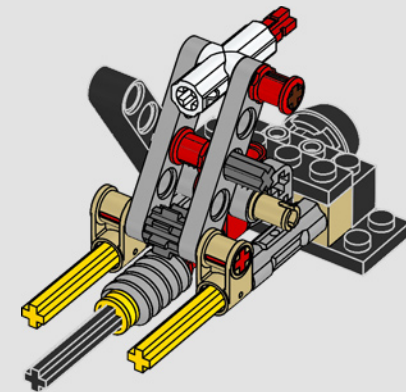

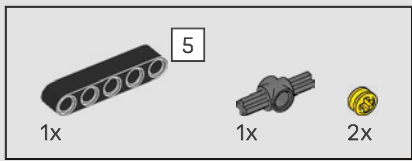

820

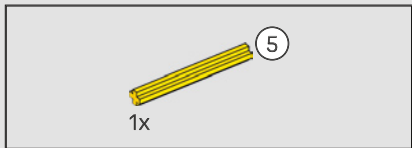
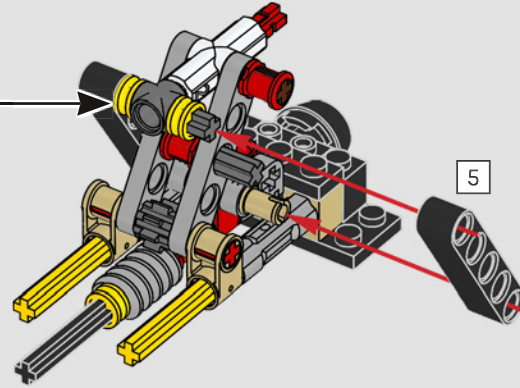
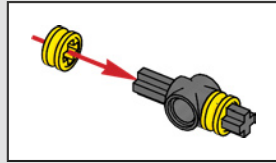
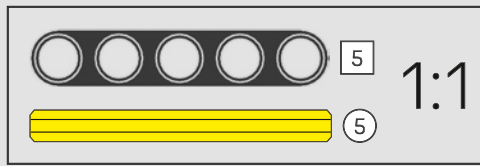

821

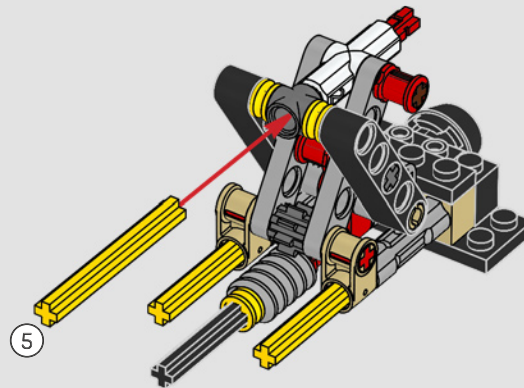

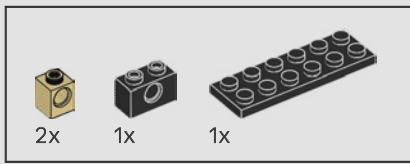

822

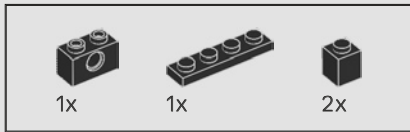
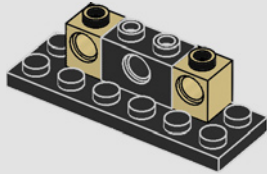

823

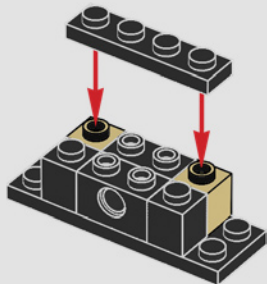

824

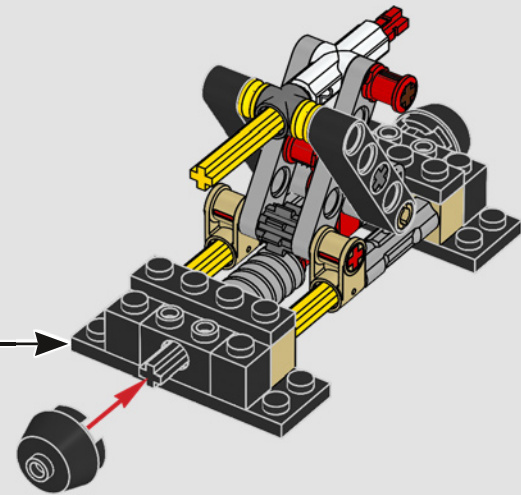

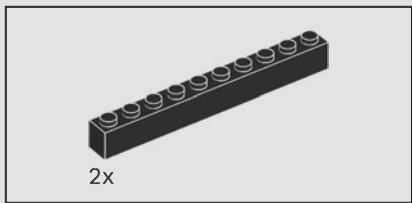

825

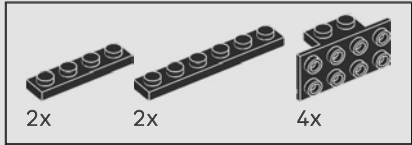
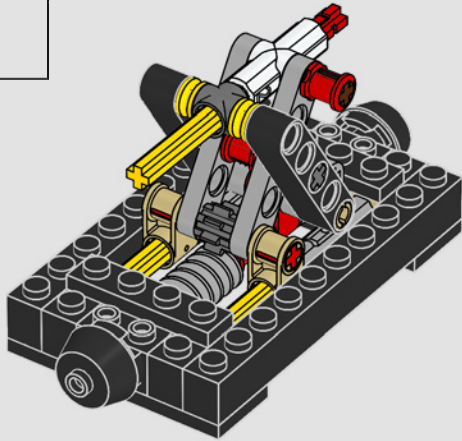

826

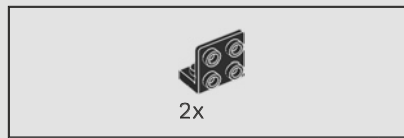
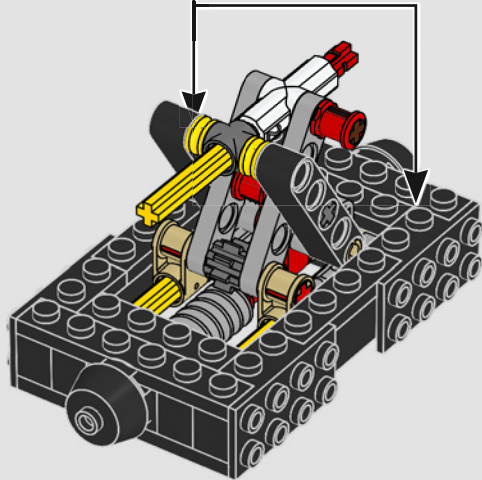
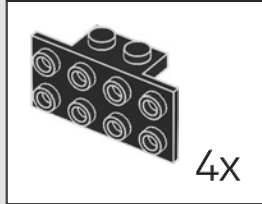

827

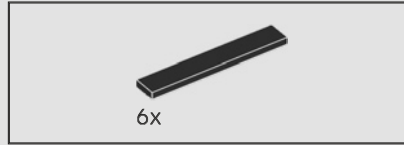
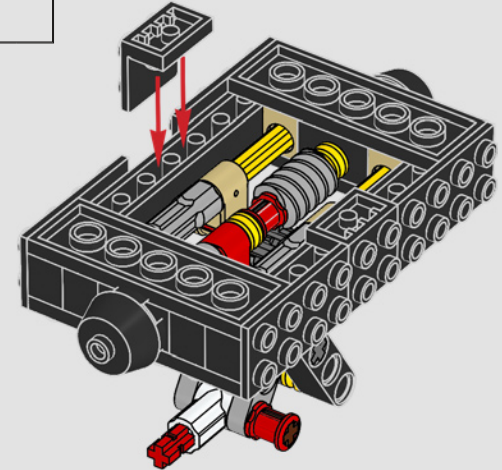

828

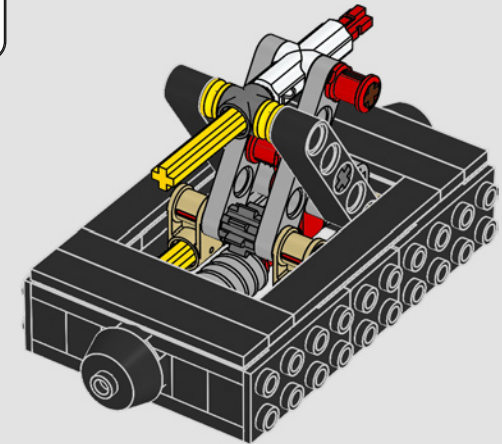

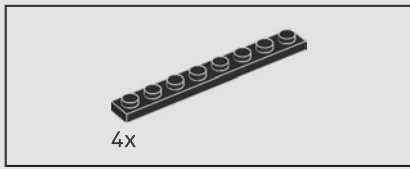

829

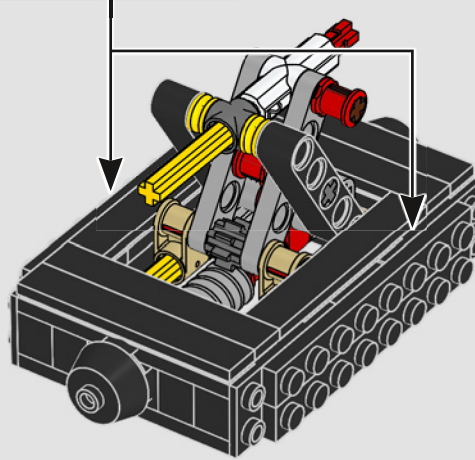
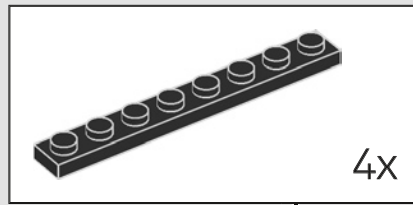

830

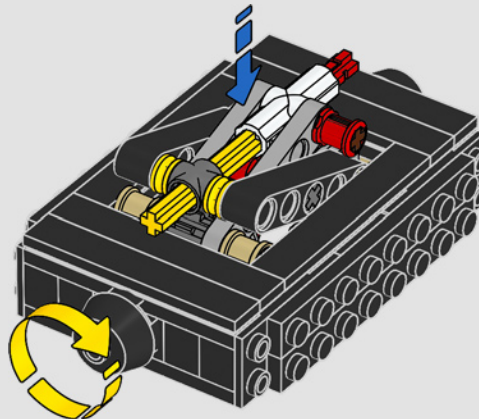

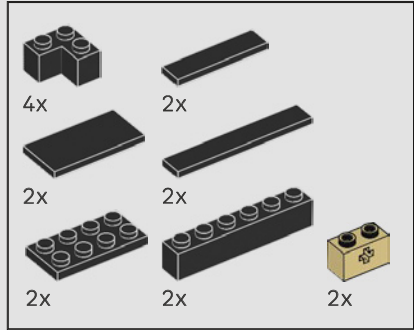
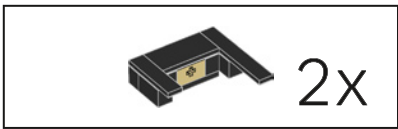

831

1

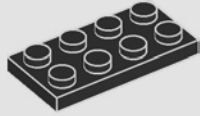

2

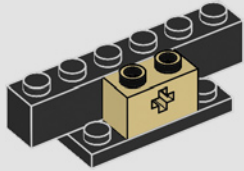

3

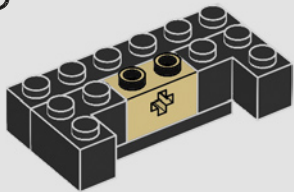

4

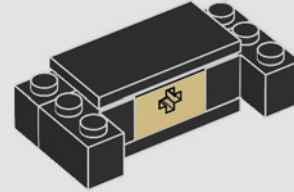

5

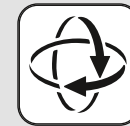
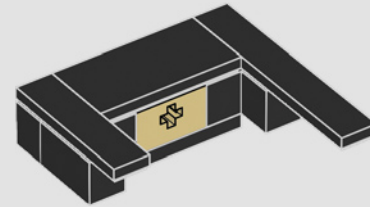

6

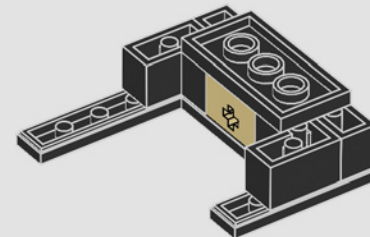

2x

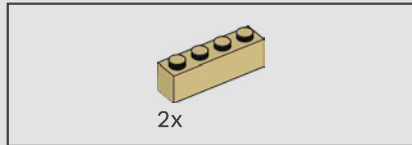
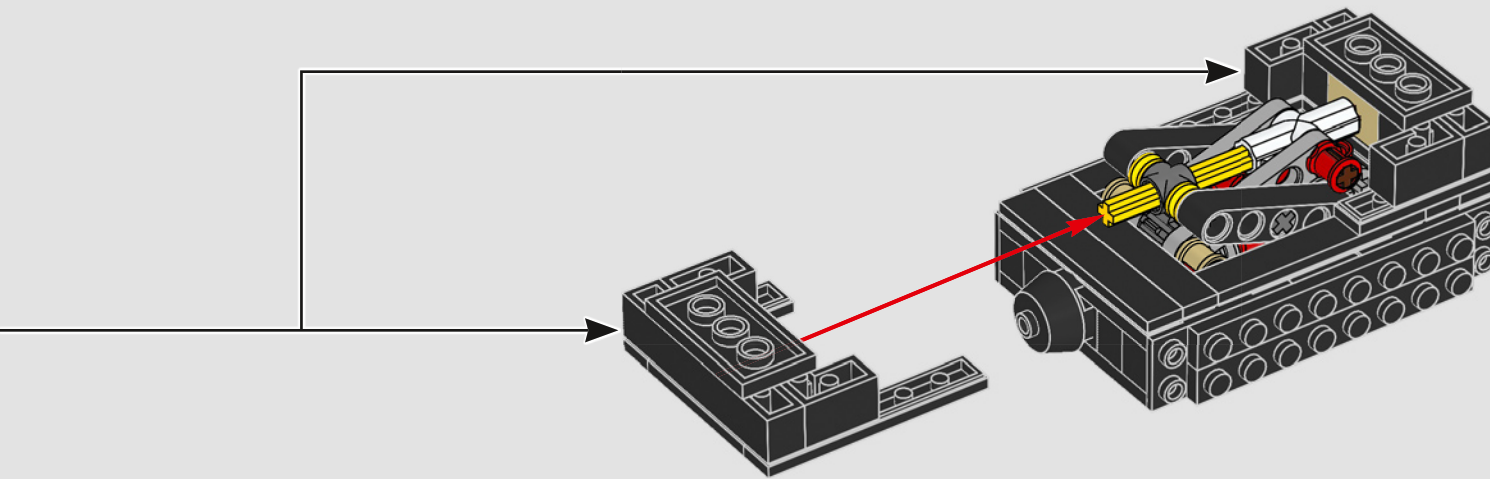

832

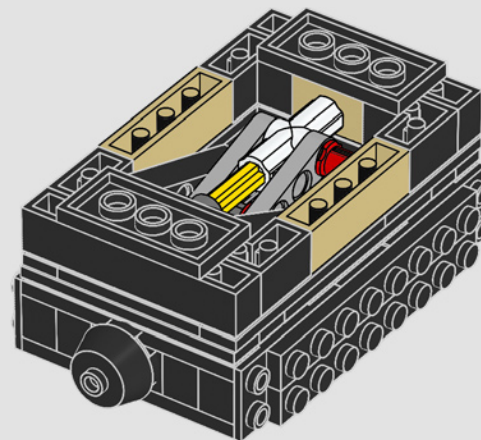



10x

833

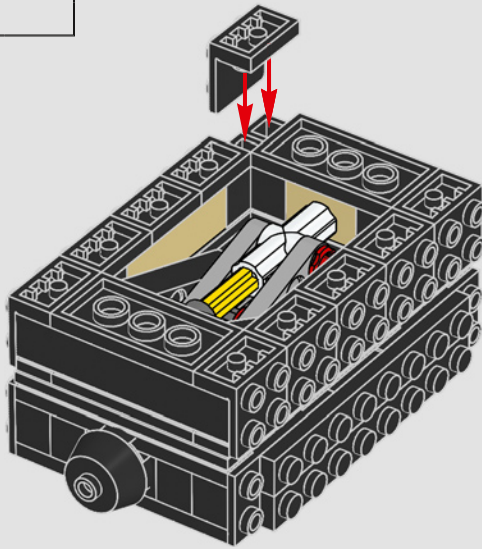

4x

834

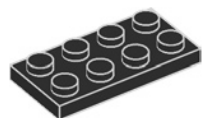

4x

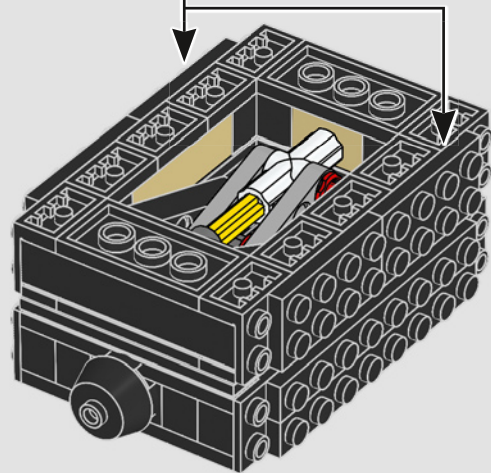

4x



4x

835



4x

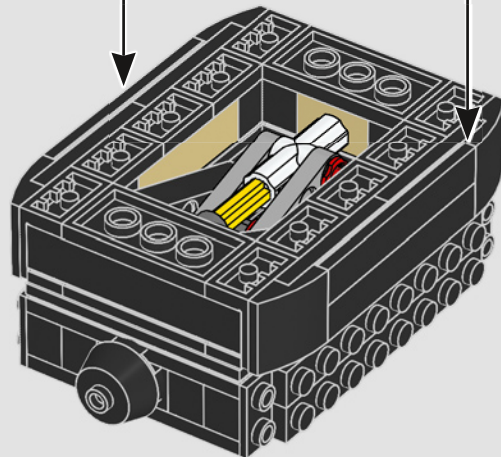

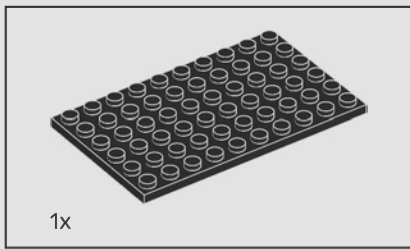

1x

836

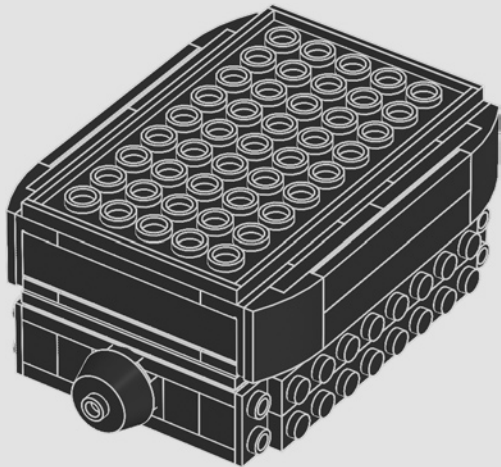

15x

837

“ Music is the electrical soil in which the spirit lives, thinks and invents. ”

Ludwig van Beethoven

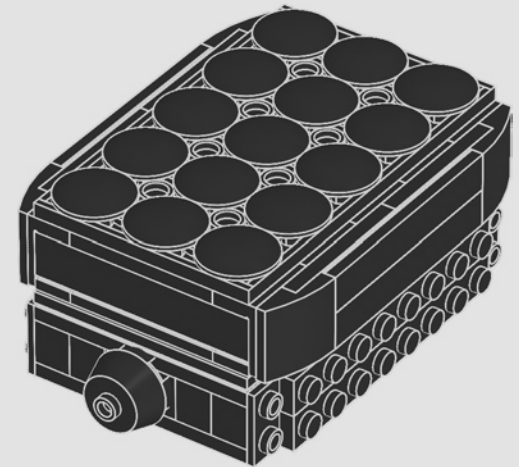

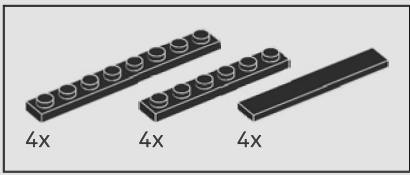

838

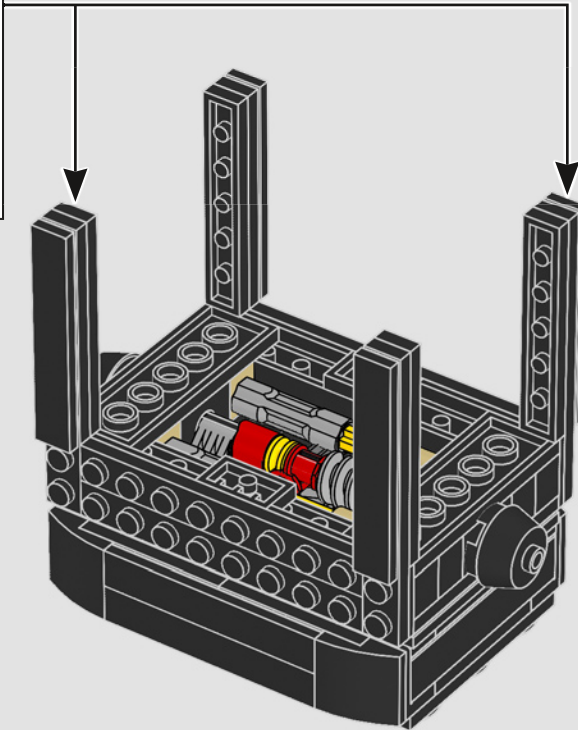
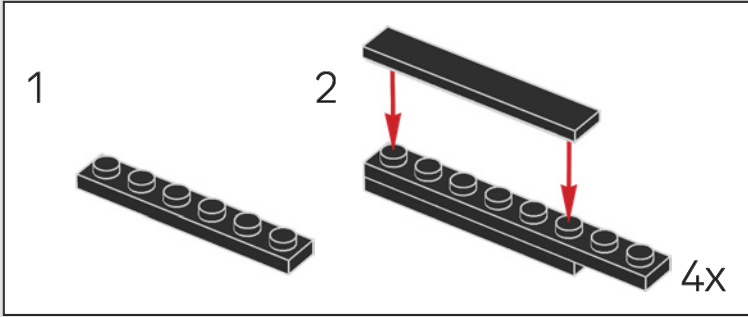

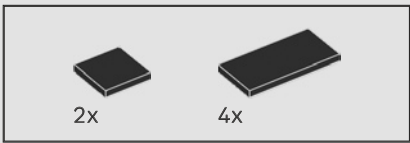

839

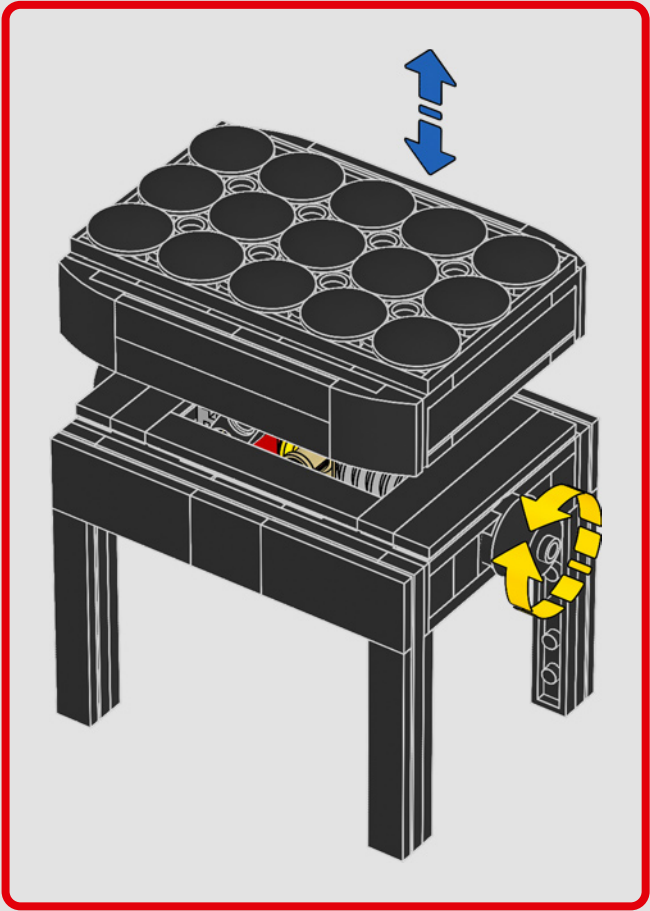
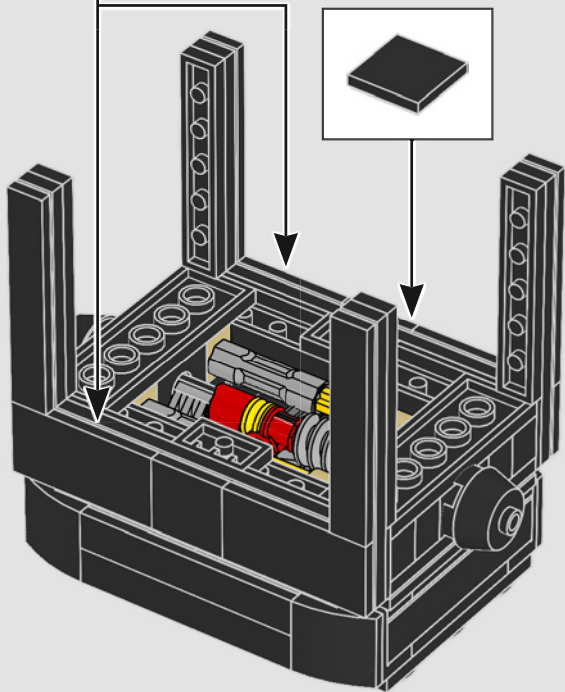
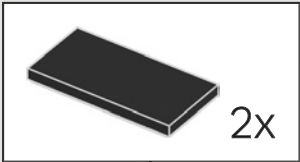

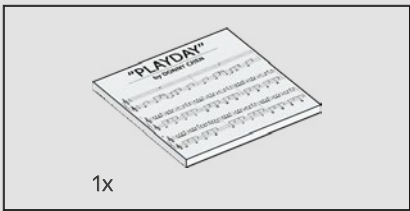

840

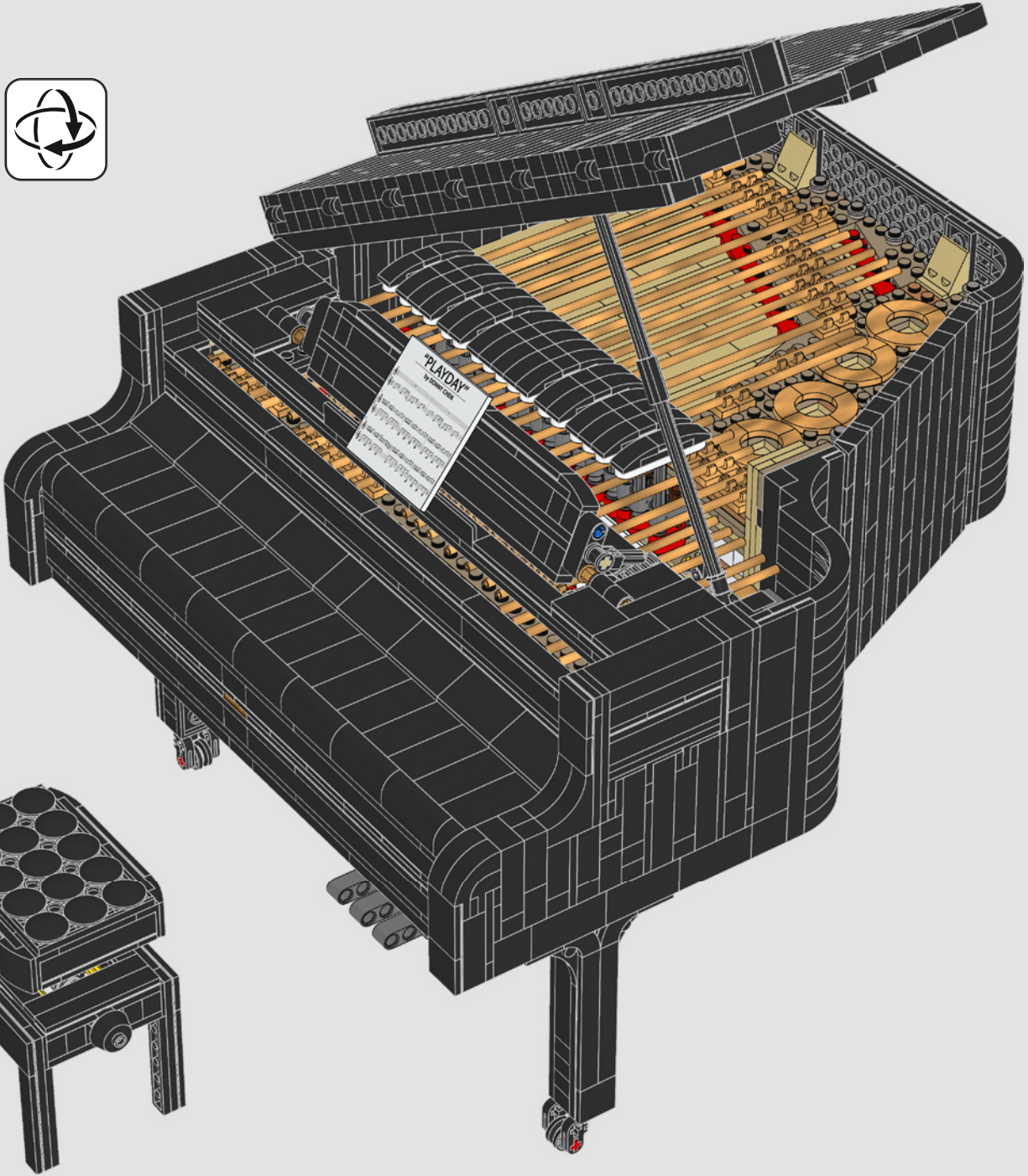



YOU COULD WIN



YOU COULD WIN

Your feedback will help shape the future development of this product series.

Visit:

DU KÖNNTEST GEWINNEN

Dein Feedback trägt zur Weiterentwicklung dieser Produktreihe bei.

Geh auf:

VOUS POURRIEZ GAGNER

Vos commentaires nous aideront à concevoir les futurs produits de cette gamme.

Visitez :

POTRESTI VINCERE TU

La tua opinione ci aiuterà a migliorare la creazione futura di questa linea di prodotti.

Visita:

PUEDES GANAR

Tu opinión contribuirá al futuro de esta serie de productos.

Visita:

轻松获奖

您的反馈将有助于我们在今后改进本产品系列。

请访问:

[LEGO.com/productfeedback](https://www.lego.com/productfeedback)

You also have the chance to win a LEGO® set.

Terms and conditions apply.*

Außerdem hast du die Chance, ein LEGO® Set zu gewinnen.

Es gelten die Teilnahmebedingungen.*

Vous pourriez également gagner un ensemble LEGO®.

Des conditions s'appliquent.*

Hai anche la possibilità di vincere un set LEGO®.

Termini e condizioni sono applicabili.*

También tienes la oportunidad de ganar un set LEGO®.

Aplican términos y condiciones.*

您还有机会赢取乐高®套装。

条款和条件适用。*

*[LEGO.com/productfeedback-terms](https://www.lego.com/productfeedback-terms)

Removable music stand which can be folded up or completely removed from the piano

Working piano lid which can be opened and folded back when the lid is raised

Working fall board or key cover which can be opened and closed, protecting the keys

Self-playing – Powered Up app function for self-playing feature

Removable keyboard with 25 independent working keys, connected to their own hammer

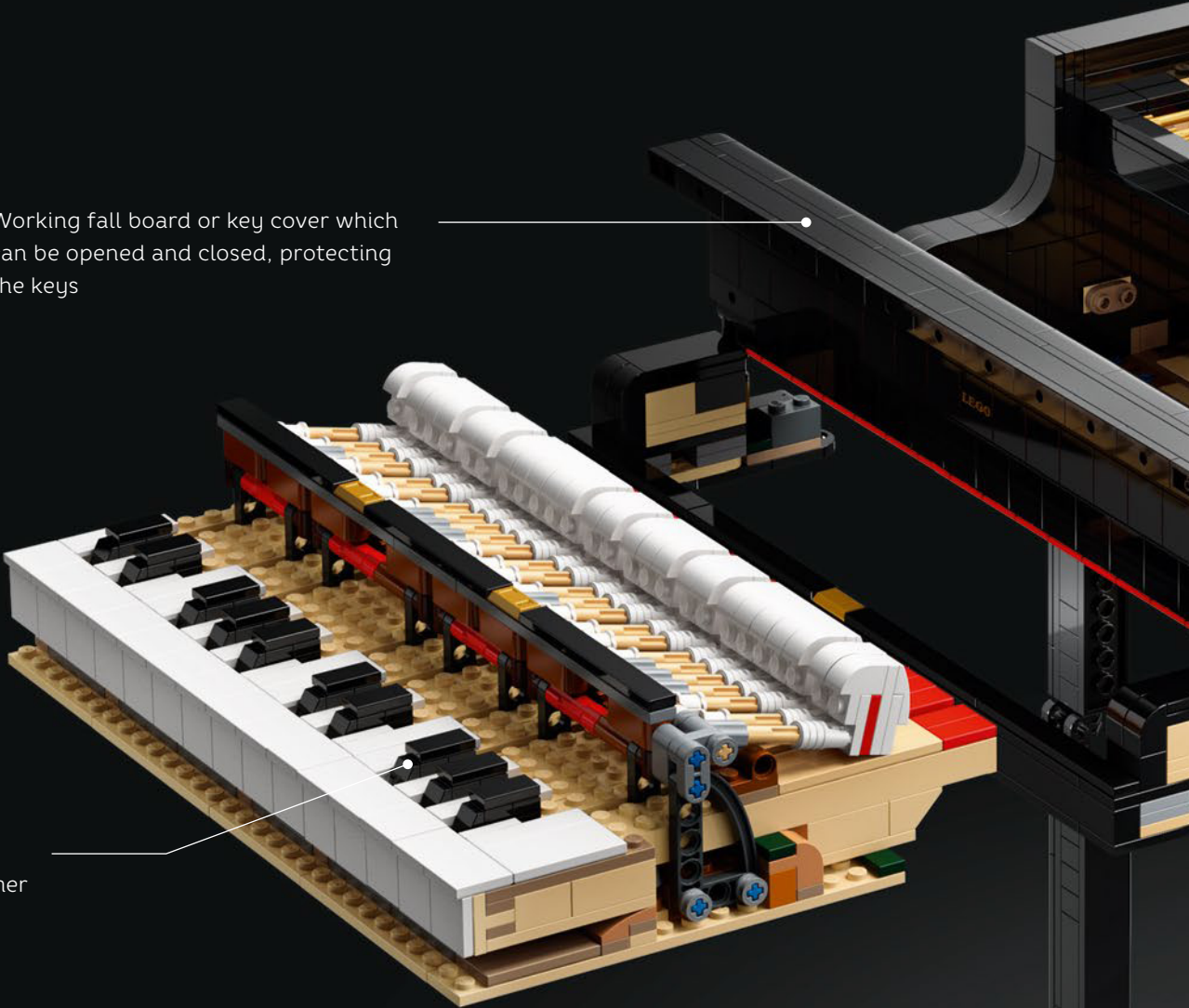



25 strings each corresponding to their own key

Working piano wheels

Height-adjustable piano bench

Moving pedal and damper

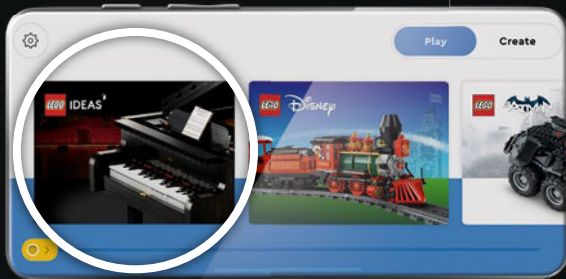

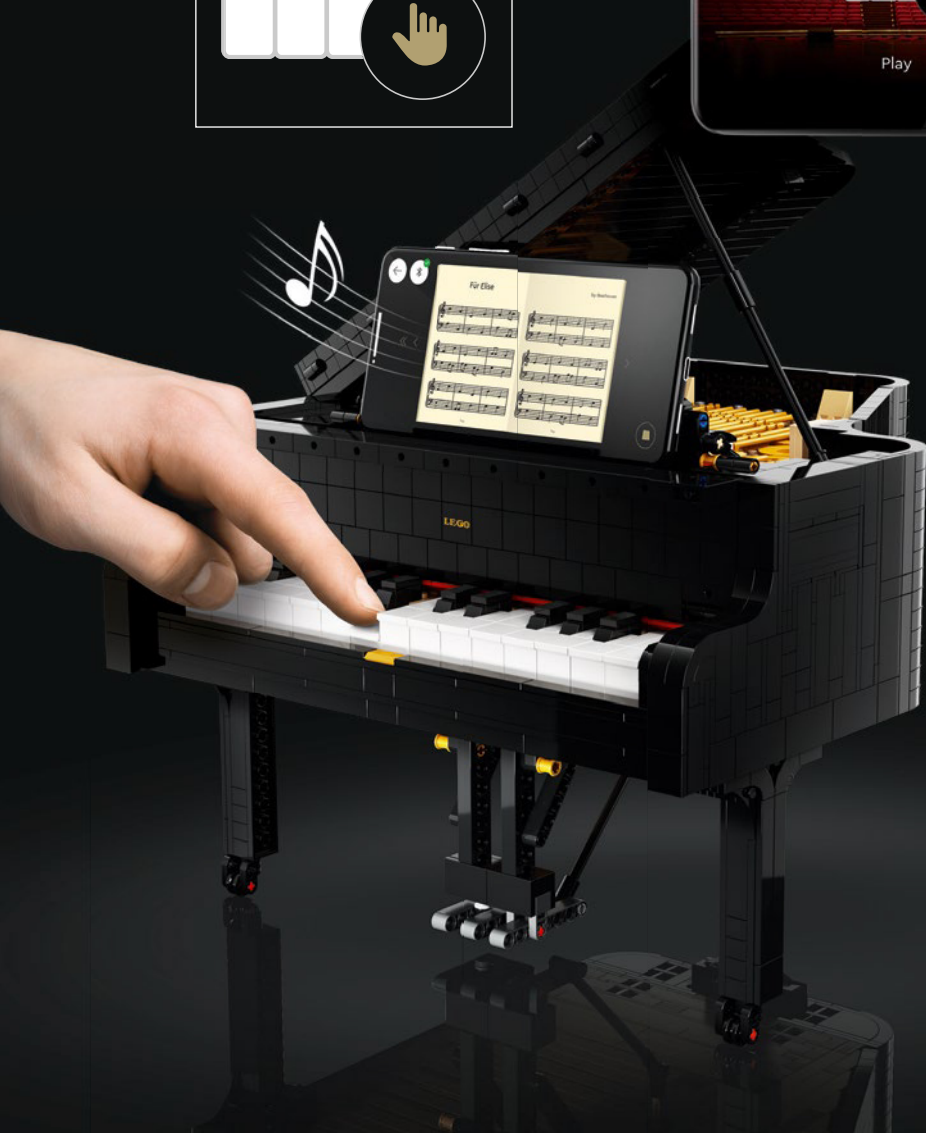
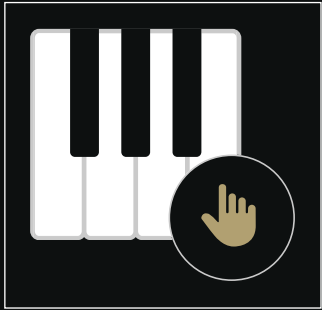

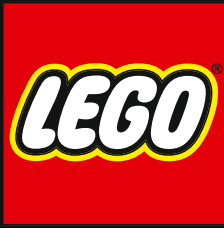

IDEAS

GATHER SUPPORT
HOL DIR UNTERSTÜTZUNG
RASSEMBLE DES VOTES
CHIEDI DI ESSERE SUPPORTATO
GANA APOYOS
OBTÉM APOIO
SZEREZZ TÁMOGATÁST
IEGŪSTI ATBALSTU
获得更多支持

SHARE YOUR IDEA
TEILE DEINE IDEE
PARTAGE TON IDÉE
CONDIVIDI LA TUA IDEA
COMPARTE TU IDEA
PARTILHA A TUA IDEIA
TEDD KÖZZÉ AZ ÖTLETED
DALIES AR SAVU IDEJU
分享您的观点

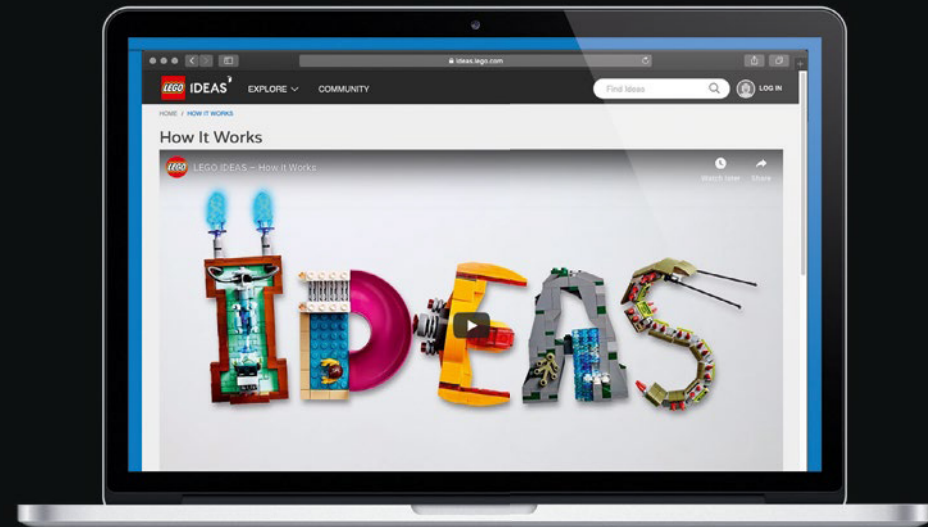
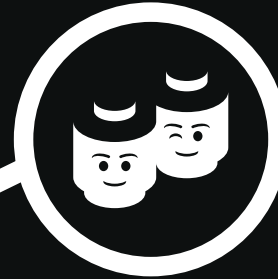

NEW LEGO® PRODUCT
NEUES LEGO® PRODUKT
NOUVEAU PRODUIT LEGO®
NUOVO PRODOTTO LEGO®
NUEVO PRODUCTO LEGO®
NOVO PRODUTO LEGO®
ÚJ LEGO® TERMÉK
JAUNS LEGO® PRODUKTS
新的乐高® 产品

LEGO® REVIEW
LEGO® PRÜFUNG
EXAMEN PAR LEGO®
REVIEW LEGO®
REVISIÓN DE LEGO®
AVALIAÇÃO LEGO®
LEGO® VÉLEMÉNYEZÉS
LEGO® RECENZIA
乐高® 评论

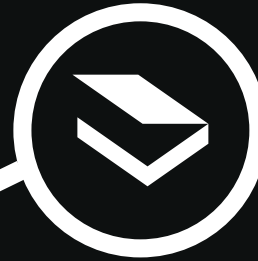

[LEGO.com/ideas](https://www.lego.com/ideas)

6x 1.5V LR 03 (AAA)
1:1

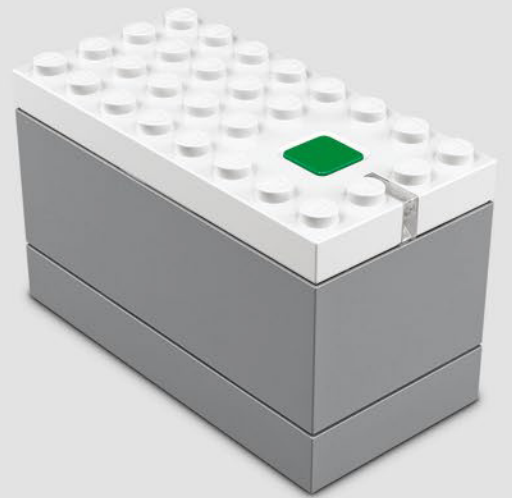
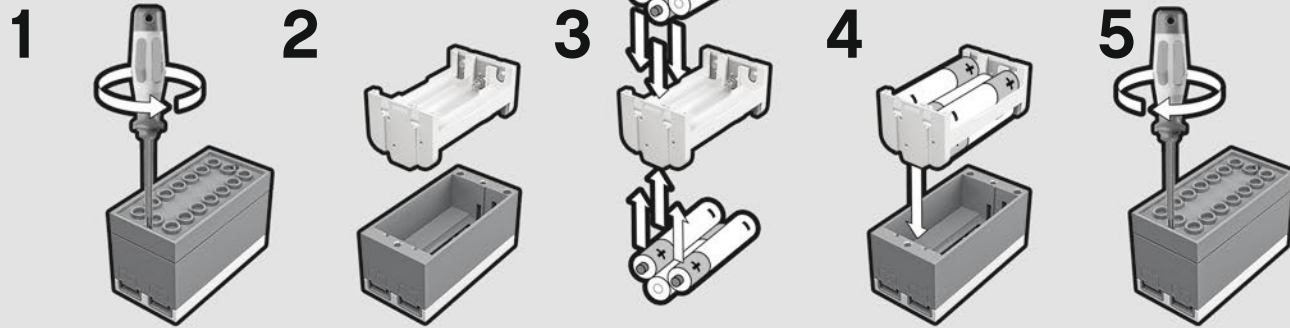

EN

Important information about batteries

Never use different types of batteries together, or a combination of old and new batteries. Always remove the batteries if the product is not to be used for a long time or if the batteries have run down. Never use damaged batteries. Only use alkaline type batteries. Insert the batteries so that the poles are correctly positioned. Never attempt to recharge non-rechargeable batteries. Never short-circuit the battery holder.

DE

Wichtige Informationen zu Batterien

Benutzen Sie niemals unterschiedliche Arten von Batterien oder alte und neue gleichzeitig. Nehmen Sie stets die Batterien heraus, wenn mit dem Modell längere Zeit nicht gespielt wird oder wenn die Batterien leer sind. Verwenden Sie niemals beschädigte Batterien. Verwenden Sie ausschließlich Alkali-Batterien. Achten Sie beim Einsetzen der Batterien auf die richtige Polung. Versuchen Sie unter keinen Umständen, „normale“ Batterien wieder aufzuladen. Schließen Sie das Batteriefach niemals kurz.

FR

Informations importantes concernant les piles

Ne jamais utiliser un mélange de différents types de piles, ou de piles neuves et de piles anciennes ou déjà utilisées. Toujours retirer les piles si le produit n'est pas utilisé durant une période prolongée ou si les piles sont vides. Ne jamais utiliser de piles endommagées. N'utiliser que des piles alcalines. En insérant les piles, respecter scrupuleusement le sens d'orientation des pôles (+/-). Ne jamais essayer de recharger des piles non rechargeables. Ne jamais court-circuiter le compartiment des piles.

IT

Importanti informazioni sulle batterie

Non usare mai contemporaneamente batterie di tipo diverso o batterie nuove e usate insieme. Rimuovere sempre le batterie qualora il prodotto non venga utilizzato per periodi prolungati, oppure se le batterie sono esauste. Non utilizzare mai batterie danneggiate. Utilizzare solo batterie di tipo alcalino. Inserire le batterie avendo cura che la loro polarità sia corretta. Non tentare mai di ricaricare batterie non ricaricabili. Non cortocircuitare mai il portabatterie.

NL

Belangrijke informatie over batterijen

Gebruik nooit verschillende soorten of een combinatie van oude en nieuwe batterijen tegelijkertijd. Verwijder de batterijen altijd als je het product lange tijd niet wilt gebruiken of als batterijen leeg zijn. Gebruik nooit beschadigde batterijen. Gebruik alleen alkalinebatterijen. Plaats de batterijen met de polen in de juiste richting. Probeer nooit niet-oplaadbare batterijen opnieuw op te laden. Laat de batterijhouder nooit kortsluiten.

ES

Información importante acerca de las pilas

No use pilas de diferentes tipos ni pilas nuevas y antiguas para alimentar el producto. Extraiga las pilas del producto si este va a permanecer sin uso durante un período prolongado de tiempo o aquellas se han agotado. No use pilas dañadas. Use solo pilas alcalinas. Inserte las pilas de modo que los polos queden situados en las posiciones correctas. No trate de cargar pilas no recargables. No cortocircuite el compartimento de las pilas.

DA

Vigtige oplysninger om batterier

Brug aldrig forskellige batterityper sammen eller en kombination af gamle og nye batterier. Fjern altid batterierne, hvis produktet ikke skal bruges i lang tid, eller hvis batterierne er flade. Brug aldrig beskadigede batterier. Brug kun alkaliske batterier. Sæt batterierne i, så polerne vender den rigtige vej. Forsøg aldrig at oplade ikke-genopladelige batterier. Kortslut aldrig batteriholderen.

IS

Mikilvægar upplýsingar um rafhlöður

Aldrei skal nota mismunandi gerðir rafhlaðna samtímis, né nýjar og eldri rafhlöður samtímis. Ef ekki á að nota tækidi í lengri tíma eða ef rafhlöðurnar eru orðnar tómar skal fjarlægja rafhlöðurnar. Aldrei skal nota rafhlöður sem hafa skemmt. Eingöngu má nota alkaline-rafhlöður. Setja skal rafhlöðurnar í þannig að plús- og mínusskaut þeirra snúi rétt. Aldrei skal reyna að endurhlaða rafhlöður sem ekki eru endurhlaðanlegar. Aldrei ætti að valda skammhlaupi í rafhlöðuhólfinu.

FI

Tärkeää tietoa paristoista

Älä koskaan käytä erityyppisiä paristoja yhdessä. Älä myöskään käytä samassa laitteessa sekä vanhoja että uusia paristoja. Poista paristot tuotteesta aina, kun se on pitemmän aikaa käyttämättä, tai kun paristot ovat tyhjentyneet. Älä koskaan käytä viallisia paristoja. Käytä vain alkaliaparistoja. Aseta paristot siten, että navat osoittavat oikeaan suuntaan. Älä koskaan aiheuta oikosulkuu pariston kosketinten välillä.

SV

Viktig information om batterier

Använd aldrig olika sorters batterier samtidigt, och inte heller en kombination av gamla och nya batterier. Ta alltid ur batterierna om produkten inte ska användas under en längre tid eller om batterierna är slut. Använd aldrig skadade batterier. Använd endast alkaliska batterier. Sätt i batterierna så att polerna hamnar i rätt läge. Försök aldrig ladda icke-laddningsbara batterier. Kortslut aldrig batteriutrymmets kontaktytor.

NO

Viktig informasjon om batterier

Bruk aldri ulike typer batterier sammen og heller aldri gamle og nye batterier sammen. Ta alltid ut batteriene hvis produktet ikke skal brukes på lang tid, eller hvis batteriene er brukt opp. Bruk aldri skadde batterier. Bruk bare alkaliske batterier. Sett inn batteriene med polene vendt riktig vei. Forsøk aldri å lade opp ikke-oppladbare batterier. Kortslett aldri batteriholderen.

PT

Informação importante sobre as pilhas

Nunca use diferentes tipos de pilhas em simultâneo, ou uma combinação de pilhas usadas e novas. Retire sempre as pilhas se o produto não for usado durante muito tempo ou se as pilhas já não tiverem carga. Nunca use pilhas danificadas. Use apenas pilhas alcalinas. Insira as pilhas de forma a que os polos fiquem corretamente posicionados. Nunca tente recarregar pilhas não recarregáveis. Nunca deixe o compartimento das pilhas entrar em curto-circuito.

EL

Σημαντικές πληροφορίες για τις μπαταρίες

Μην χρησιμοποιείτε ποτέ διαφορετικούς τύπους μπαταριών μαζί και μην συνδυάζετε παλιές και καινούργιες μπαταρίες. Αφαιρείτε πάντα τις μπαταρίες αν δεν σκοπεύετε να χρησιμοποιήσετε το προϊόν για αρκετό καιρό ή αν οι μπαταρίες έχουν αδείσει. Ποτέ μην χρησιμοποιείτε μπαταρίες που έχουν φθόρες. Χρησιμοποιείτε μόνο αλκαλικές μπαταρίες. Τοποθετήστε τις μπαταρίες με τους πόλους στη σωστή θέση. Μην επιχειρήσετε ποτέ να επαναφορτίσετε μη αναφορτιζόμενες μπαταρίες. Ποτέ μην βραχυκυκλώνετε τη θηκή των μπαταριών.

JA

電池取扱いに関する重要事項

異なるタイプの電池や古い電池を混ぜて使用しないでください。商品を長時間使用しないときや電池が切れたときは、電池を必ず取り外してください。不具合のある電池は絶対に使用しないでください。アルカリタイプの電池のみを使用してください。電極を確認して電池を正しい向きに入れてください。充電式ではない電池は絶対に充電しないでください。電池ホルダをショートさせないでください。

ZH

電池使用注意事項

请勿同时使用不同类型的电池，或把新旧程度不同的电池混合使用。如果产品将有很长时间不会使用，或者电池已经没电，请注意取出电池。切勿使用已破损的电池。仅可使用碱性电池。装入电池时请注意正负极。请勿尝试给非充电电池充电。切勿对电池仓进行短路连接。

KO

배터리 사용 시 주의사항

다른 종류의 배터리를 함께 사용하거나, 새 전지와 오래된 전지를 혼용하지 마세요. 배터리가 방전되었거나 장기간 제품을 작동하지 않을 때에는 반드시 배터리를 분리하세요. 파손된 배터리는 사용하지 마세요. 알칼라인 타입의 배터리만을 사용하세요. 양극과 음극의 위치를 잘 맞춰서 넣으세요. 일반 배터리는 충전해서 사용할 수 없습니다. 배터리 홀더의 접촉부에 배터리를 정확히 끼워서 사용하세요.

RU

Необходимая информация об элементах питания

Ни в коем случае не используйте одновременно элементы питания различных типов, а также элементы питания с разным сроком годности. В обязательном порядке вынимайте элементы питания из терминалов в случае, если вы не пользуетесь прибором в течение долгого времени, либо в случае, если в элементах питания закончился заряд. Ни в коем случае не используйте поврежденные элементы питания. Используйте только элементы питания щелочного типа. Установите элементы питания, соблюдая указанную полярность. Ни в коем случае не пытайтесь подзаряжать непerezаряжаемые элементы питания. Ни в коем случае не пытайтесь замкнуть полюса в устройстве для элементов питания.

PL

Ważne informacje dotyczące baterii

Nigdy nie należy stosować razem różnych rodzajów baterii ani stosować równocześnie starych i nowych baterii. Jeżeli produkt nie jest używany przez dłuższy czas lub jeżeli baterie się wyczerpały, należy wyjąć baterie. Nigdy nie należy stosować uszkodzonych baterii. Należy używać wyłącznie baterii alkalicznych. Przy wkładaniu baterii należy zwrócić uwagę na właściwe położenie biegunów. Nigdy nie należy próbować ładowania baterii jednorazowych. Nigdy nie należy doprowadzać do zwarcia w gnieździe baterii.

CZ

Důležitá informace o bateriích

Nikdy nepoužívejte najednou různé typy baterií nebo kombinaci starých a nových baterií. Nebude-li se výrobek delší dobu používat nebo jsou-li baterie vybité, vždy je vyjměte z výrobku. Nikdy nepoužívejte poškozené baterie. Používejte pouze alkaliccké baterie. Baterie instalujte se správnou orientací pólů. Nikdy se nesnažte nabíjet baterie, které nejsou nabíjitelné. Nikdy nezkratujte kontakty v prostoru pro baterie.

SK

Dôležitá informácia o batériách

Nikdy nepoužívajte naraz odlišné typy batérií ani nekombinujte staré batérie s novými. Batérie vždy vyberte, ak sa výrobok nebudе dlhšie používať, alebo ak sa batérie vybili. Nikdy nepoužívajte poškodené batérie. Používajte iba alkalické batérie. Batérie vkladajte so správnou orientáciou pólov. Nikdy sa nesnažte nabíjať batérie, ktoré nie sú nabíjateľné. Nikdy neskratuje kontakty v priestore pre batérie.

HU

Fontos tudnivalók az elemekről

Soha ne használjon különböző típusú elemeket, illetve ne használjon vegyesen új és használt elemeket. Mindig távolítsa el az elemeket, ha a készüléklet előre láthatóan hosszabb ideig nem fogják használni, vagy ha az elemek lemerültek. Soha ne használjon megrongálódott elemeket. Csak alkáli elemeket használjon! Az elemeket helyesen helyezze be, a polaritásuknak megfelelően. Soha ne próbálja meg feltölteni a nem tölthető elemeket. Soha ne hozzon létre rövidzárlatot az elemtartó kivezetésein.

UA

Необхідна інформація про батарейки

Ніколи не використовуйте одночасно батарейки різних типів або батарейки з різним терміном придатності. Обов'язково вилучайте батарейки з приладу, якщо довго не користуєтесь ним, або якщо в батарейках уже скінчився заряд. Ніколи не використовуйте пошкоджені батарейки. Використовуйте лише лужні батарейки. Вставляйте батарейки, враховуючи задану полярність. У будь-якому випадку не намагайтеся підзарядити батарейки, що не підлягають підзарядці. У будь-якому випадку не намагайтеся зробити коротке замикання в приладі для батарей.

HR

Važne obavijesti o bateriji

Nikada nemoj koristiti različite vrste baterija zajedno, isto tako ni kombinaciju starih i novih baterija. Uvijek izvadite baterije ako dugo nećeš koristiti proizvod ili ako su one potrošene. Nikada nemoj koristiti oštećene baterije. Upotrebļjavajte samo alkalne baterije. Umetni baterije pazeći da dobro okreneš polove. Nikada ne pokušavaj puniti baterije koje nisu predviđene za punjenje. Nikada ne izazivaj kratki spoj u držaču baterija.

SR

Важне информације о батеријама

Никада не користите различите типове батерија заједно нити комбинацију старих и нових батерија. Увек извадите батерије уколико производ нећете дуже време користити или уколико су батерије празне. Никада не користите оштећене батерије. Користите само алкалне батерије. Ставите батерије тако да су полови правилно позиционирани. Никада не покушавајте да пуните батерије које не могу да се пуне. Никада не изазивајте кратак спој у кућишту за батерије.

MK

Важни информации за батериите

Никогаш не користете различни типови батерии заедно или комбинација од стари и нови батерии. Секогаш отстранувајте ги батериите доколку не го користите производот подолго време или доколку се потрошиле. Никогаш не користете оштетени батерии. Користете само алкални батерии. Вметнете ги батериите така што точно ќе ги наместите половите. Никогаш не обидувајте се да ги полните батериите за еднократна употреба. Никогаш не предизвикувајте краток спој на држачот за батерии.

SL

Pomembne informacije o baterijah

Nikoli ne uporabljajte skupaj različnih baterij ali kombinacije starih in novih baterij. Vedno odstranite baterije, če izdelka dlje časa ne boste uporabljali ali če so iztrošene. Nikoli ne uporabljajte poškodovanih baterij. Uporabljajte le alkalne baterije. Baterije vstavite tako, da so njihovi poli pravilno obrnjeni. Nikoli ne poskušajte polniti baterij, ki niso akumulatorske. Pazite, da ležišč za baterije ne boste spravili v kratek stik.

RO

Informații importante despre baterii

Nu folosiți niciodată împreună tipuri diferite de baterii, sau o combinație de baterii vechi și noi. Îndepărtați întotdeauna bateriile dacă produsul nu este folosit timp îndelungat sau dacă bateriile s-au epuizat. Nu folosiți niciodată baterii deteriorate. Utilizați numai baterii de tip alcalin. Introduceți bateriile astfel ca polii să fie poziționați corect. Nu încercați niciodată să reîncărcați baterii nereîncărcabile. Nu scurtcircuiți niciodată suportul bateriei.

BG

Важна информация за батериите

Никога не използвайте едновременно различни типове батерии или комбинация от стари и нови батерии. Винаги изваждайте батериите, ако izdelието няма да се използва продължително време или ако батериите са се изтозили. Никога не използвайте повредени батерии. Използвайте само алкални батерии. Поставайте батериите така, че полюсите да са разположени правилно. Никога не опитвайте да зареждате батерии, които не са акумулаторни. Никога не свързвайте на късо контактите на отделението за батериите.

LV

Svarīga informācija par baterijām

Nekad vienlaikus nelietojiet dažādu tipu, kā arī vecas un jaunas baterijas. Vienmēr izņemiet baterijas, ja tās ir izlādējušas vai ja produkts ilgāku laiku netiek lietots. Nekad nelietojiet bojātas baterijas. Izmantojiet tikai sāрма tipa baterijas. Ievietojot baterijas, ievērojiet pareizu polaritāti. Nekad nemēģiniet uzlādēt baterijas, kas nav uzlādējamas. Nepieļaujiet issavienojumu bateriju nodalījumā.

ET

Oluline teave patareide kohta

Ära kunagi kasuta koos erinevat tüüpi patareisid, samuti vanu ja uusi patareisid. Kui mänguasja ei kasutata pika aja jooksul, võta patarei sellest välja. Ära kunagi kasuta kahjustatud patareisid. Kasuta ainult leelispatareisid. Pane patareid mänguasja sisse nii, et pluss- ja miinusklemmi asend oleks õige. Ära kunagi proovi akulaadijaga laadida tavalisi patareisid. Patareipesa klemmide vahel ei tohi tekkida lühis.

LT

Svarbi informacija apie elementus

Vienu metu nenaudokite skirtingų elementų, taip pat su naujais elementais nenaudokite senų. Jei nenaudosite gaminio ilgesnį laiką arba jei elementai išseko, visuomet išimkite juos iš gaminio. Niekada nenaudokite pažeistų elementų. Naudokite tik šarminius elementus. Elementus dėkite atsižvelgdami į jų poliškumą. Niekada nebandykite įkrauti vienkartinį elementų. Saugokitės, kad elementų įdėkle nesukeltumėte trumpojo jungimo.

TR

Piller hakkında önemli bilgiler

Hiçbir zaman farklı tipte pilleri ya da eski pillerle yeni pilleri bir arada kullanmayın. Ürün uzun süre kullanılmayacaksa ya da piller bitmişse, pilleri ürünün içinden çıkarın. Hiçbir zaman zedelenmiş piller kullanmayın. Sadece alkanil piller kullanın. Pilleri kutupları doğru konumda olacak şekilde yerleştirin. Hiçbir zaman, şarj edilebilir olmayan pilleri şarj etmeye çalışmayın. Hiçbir zaman pil kutusuna kısa devre yaptırmayın.

AR

معلومات مهمة عن البطاريات

يحظر استخدام أنواع مختلفة من البطاريات معا أو مزيج من البطاريات القديمة والجديدة. احرص دائما على نزع البطاريات في حال عدم استخدام المنتج لفترة طويلة أو إذا نفذت طاقة البطاريات. تجنب استخدام البطاريات التالفة. لا تستخدم إلا البطاريات القلوية فقط. قم بتكيب البطاريات بحيث تكون الأقطاب في موضعها الصحيح. يحظر إعادة شحن البطاريات غير القابلة لإعادة الشحن. تجنب إحداث دائرة قصر في حامل البطارية.

ID

Informasi penting tentang baterai

Jangan gunakan baterai yang jenisnya berlainan, atau mencampur baterai lama dan baterai baru. Lepas baterai jika produk tidak akan digunakan untuk waktu lama atau jika baterai sudah lemah. Jangan gunakan baterai yang rusak. Gunakan hanya baterai alkali. Masukkan baterai dengan posisi kutub yang tepat. Jangan pernah coba mengisi ulang baterai biasa. Jangan pernah membuat arus pendek pada dudukan baterai.

MS

Maklumat penting tentang bateri

Jangan guna jenis bateri yang berbeza bersama-sama, atau gabungan bateri baharu dan lama. Tanggalkan bateri jika produk tidak akan digunakan untuk tempoh masa yang lama atau jika bateri telah kehabisan kuasa. Jangan guna bateri yang rosak. Guna bateri jenis alkali sahaja. Selitkan bateri supaya paksi berada pada kedudukan yang betul. Jangan cuba untuk mengecas semula bateri yang tidak boleh dicaskan semula. Jangan pintas litar pemegang bateri.



EN

Protect the environment by not disposing of this product with your household waste. Check with your local authority for recycling advice and facilities. Penalties may apply for improper disposal.

DE

Schützen Sie die Umwelt und entsorgen Sie dieses Produkt nicht mit Ihrem Hausmüll. Informationen zu Recycling-Möglichkeiten erhalten Sie bei den örtlichen Behörden. Bei unsachgemäßer Entsorgung können Strafen verhängt werden.

FR

Protégez l'environnement : ne jetez pas ce produit avec vos autres déchets ménagers. Contactez les autorités locales pour obtenir des informations sur le recyclage et connaître les points de collecte. Des sanctions peuvent être appliquées en cas d'élimination inappropriée.



IT

Proteggi l'ambiente! Non smaltire questo prodotto con i rifiuti domestici. Per consulenza sul riciclaggio dei rifiuti e le strutture di riciclaggio, rivolgersi alle proprie autorità locali. Uno smaltimento improprio può comportare sanzioni.

NL

Bescherm het milieu: gooi dit product niet samen met het andere huisvuil weg. Raadpleeg de plaatselijke instanties voor locaties van milieustations en advies over hergebruik. In geval van onjuiste verwijdering kunnen boetes worden opgelegd.

ES

Proteja el medio ambiente no deshaciéndose de este producto junto con sus residuos domésticos. Solicite asesoramiento e información sobre instalaciones de reciclaje a las autoridades locales. La eliminación inadecuada puede ser objeto de sanciones.

DA

Beskyt miljøet! Smid ikke dette produkt ud sammen med husholdningsaffaldet. Få vejledning om genbrug og genbrugsstationer hos din kommune. Ukorrekt bortskaffelse kan medføre bøde eller straf.

IS

Stuðlið að umhverfisvernd með því að farga þessari vöru ekki með heimilisorpi. Leiðið upplýsinga um endurvinnslu- og förgunarstaði hjá yfirvöldum á hverjum stað. Viðurlögum kann að vera beitt ef förgun er ekki með réttum hætti.

FI

Tämä tuote on hävitettävä ympäristöstävällisesti ja erillään muusta talousjätteestä. Tietoja kierrätyksestä ja keräyspisteiden sijainnista saat paikallakuntasi teknisestä virastosta. Epäasianmukaisesta hävittämisestä saattaa aiheutua seuraamuksia.

SV

Skydda miljön genom att inte kasta denna produkt bland ditt hushållsavfall. Kontakta din kommun för frågor om återvinning och miljöstationer. Påföljder kan tillkomma för felaktig avyttring.

NO

Beskytt miljøet. Ikke kast dette produktet i husholdningsavfallet. Kontakt kommunen for veiledning om gjenbruk og miljøstasjoner. Feil avfallshåndtering kan være straffbart.

PT

Proteja o ambiente não eliminando este produto com o seu lixo doméstico. Consulte as autoridades locais para informação sobre reciclagem e sistemas de recolha. Podem ser aplicadas coimas por eliminação inadequada.

EL

Προστατέψτε το περιβάλλον. Μην πετάτε αυτό το προϊόν μαζί με τα συνηθισμένα οικιακά απορρίμματα. Επικοινωνήστε με τις τοπικές αρχές σχετικά με συμβουλές και εγκαταστάσεις ανακύκλωσης. Ενδέχεται να επιβάλλονται κυρώσεις για ακατάλληλη διάθεση απορριμμάτων.

JA

環境保護のため、本製品は家庭ごみとは別に処分してください。リサイクルに関する指示や施設については、お住まいの地方自治体にお問い合わせください。不適切な廃棄を行った場合、罰則が適用されることがあります。

ZH

注意保护环境，请勿将本产品与生活垃圾一起丢弃处理。请咨询当地相关部门，了解与回收相关的设施与建议。处理不当可能会导致处罚。

KO

환경 보호를 위해 이 제품을 생활폐기물과 함께 버리지 마십시오. 재활용 방법 및 시설에 관한 사항은 현지 관계 당국에 문의하십시오. 부적절하게 폐기할 경우 벌칙이 부과될 수 있습니다.

RU

Позаботьтесь об окружающей среде: не утилизируйте этот продукт вместе с бытовым мусором. Узнайте в органах местного самоуправления правила вторичной переработки и утилизации таких отходов. В случае ненадлежащей утилизации могут быть наложены штрафы.

PL

Aby chronić środowisko naturalne, nie należy wyrzucać tego produktu wraz z odpadkami z gospodarstwa domowego. W celu uzyskania wskazówek dotyczących recyklingu oraz adresów zakładów należy skontaktować się z lokalnym urzędem. Za nieprzestrzeganie zasad związanych z utylizacją odpadów grożą kary.

CZ

Nevyhazujte tento produkt do domácího odpadu, chraňte životní prostředí. Zjistěte si prosím u místních úřadů možnosti recyklace a dostupná zařízení. Nesprávná likvidace může být pokutována.

SK

Nevyhádzajte tento produkt do domáceho odpadu, chráňte životné prostredie. Zistite si na miestnych úradoch možnosti recyklácie a dostupné zariadenia. Za nesprávnu likvidáciu môžu byť uložené sankcie.

HU

Környezetet óvja, ha ettől a terméktől nem a háztartási hulladékkal együtt válik meg. Érdeklődjék a lakóhelyéhez közel eső hatóságnál az újrahasznosítás módjáról és lehetőségeiről. A nem megfelelő hulladékelhelyezésért büntetés járhat.

UA

Допоможіть захистити довкілля: не утилізуйте цей виріб разом із побутовим сміттям. Вказівки з утилізації та відомості про пункти прийому з'ясуєте в місцевих компетентних органах. У разі неналежної утилізації можуть застосовуватися штрафи.

HR

Zaštitite okoliš tako da ovaj proizvod ne odložite u otpad zajedno s kućanskim otpadom. Od lokalnih vlasti zatražite savjet ili informacije o pogonima za recikliranje. Moguća je kazna za nepropisno zbrinjavanje.

SR

Zaštite životnu sredinu tako što nećete da odložite ovaj proizvod sa kućnim otpadom. Raspitajte se kod lokalnog nadležnog organa o načinu reciklaže i o sabirnom centru. U slučaju nepravilnog odlaganja u otpad, mogu biti izrečene kazne.

MK

Zaštite je okolinata tako što nema da se oslobodite od proizvodot do domashinot otpad. Konsultirajte se so lokalnite vlasti za da doznaete za sovetite i objektite za recikliranje. Vozmojno e da bidat primeneti kazni za nepravilno iscfrañe.

SL

Zaščitite okolje! Okolje varujte tako, da tega izdelka ne zavržete skupaj z gospodinjiskimi odpadki. Pri krajevni upravi preverite, kakšne možnosti in kateri obrati za recikliranje obstajajo vaši okolici. Za nepravilno odlaganje odpadkov vas lahko doleti kazen.

RO

Protejați mediul înconjurător și nu vă debarașați de acest produs împreună cu deseurile menajere. Consultați autoritățile locale pentru îndrumări și facilități de reciclare. Dezafectarea necorespunzătoare poate atrage sancțiuni.

BG

Zaštite okolnata sreda i ne izhvřľajte tozi produkt zaedno s bitovite si otpadŕci. Svřřžete se s mestnite vlasti odnosno sŕveti i sŕorzhenia za reciklirane. Vŕzmojno e da ima globi za nepravilno izhvřľane.

LV

Lai saudzētu vidi, neizmetiet šo izstrādājumu kopā ar sadzīves atkritumiem. Vērsieties vietējas varas iestādēs, lai noskaidrotu, kur un kā tas nododams pārstrādei. Par neatbilstošu likvidēšanu var tikt piemērots sods.

ET

Keskonda saate kaitsta nii, et ei kõrvalda seda toodet koos olmejäätmetega. Nõuandeid toote taaskasutusse võtmise ja ümbertöötlemispunktide kohta saate asjaomaset kohalikut asutuselt. Nõutele mittevastav kasutuselt kõrvaldamine võib kaasa tuua trahvid.

LT

Saugokite aplinką: nemeskite šio produkto kartu su buitinėmis atliekomis. Atsižvelkite į savo vietos valdžios rekomendacijas dėl pakartotinio panaudojimo ir sąlygas. Už netinkamą šalinimą gali būti taikomos baudos.

TR

Bu ürünü, evsel atıklarla birlikte atmayarak çevreyi koruyun. Geri dönüşüm tavsiyeleri ve tesisler hakkında bilgi için yerel yönetimle iletişim kurun. Uygunsuz atılması durumunda cezalar uygulanabilir.

AR

احم البيئة بعدم التخلص من هذا المنتج مع المخلفات المنزلية. استشر السلطة المحلية لديك للحصول على نصح بخصوص إعادة تدوير المخلفات ومراقفة. قد يتم تطبيق عقوبات على التخلص غير السليم.

ID

Jagalah lingkungan dengan tidak membuang produk ini bersama sampah rumah tangga Anda. Periksa peraturan pemerintah setempat tentang saran dan fasilitas daur ulang. Pembuangan yang tidak sesuai ketentuan dapat dikenakan denda.

MS

Lindungi alam sekitar dengan tidak melupuskan produk ini bersama sisa isi rumah anda. Rujuk pihak berkuasa tempatan anda tentang nasihat dan kemudahan kitar semula. Penalti boleh dikenakan untuk pelupusan yang tidak wajar.

 **EN**
CAUTION: The substitution of firmware in this product with firmware not approved or supplied by the LEGO Group may cause unpredictable product behaviour, including damaged or overheated batteries, overheated element surfaces (e.g. motors or sensors), or other hazards.

DE
ACHTUNG: Der Austausch von Firmware in diesem Produkt durch nicht genehmigte oder mitgelieferte Firmware durch die LEGO Group kann zu unvorhersehbaren Situationen führen, einschließlich beschädigte oder überhitzte Batterien, überhitzte Elementoberflächen (z. B. Motoren oder Fühler), oder anderen Gefahren.

FR
ATTENTION : Toute substitution du microprogramme de ce produit avec un microprogramme non approuvé ou non fourni par le Groupe LEGO peut engendrer certains dangers ou situations imprévisibles, tels que l'endommagement ou la surchauffe des piles ou la surchauffe de certaines surfaces de l'élément (p. ex., moteurs ou capteurs).

IT
AVVERTENZA: la sostituzione del firmware di questo prodotto con un firmware non approvato o non fornito da The LEGO Group può causare condizioni imprevedibili, incluso danni o surriscaldamento delle batterie, surriscaldamento delle superfici degli elementi (per es. motori o sensori) o altri pericoli.

NL
VOORZICHTIG: als je de firmware van dit product vervangt door firmware die niet is goedgekeurd of aangeleverd door de LEGO Groep kan dit onvoorspelbare gevolgen hebben, zoals beschadigde of oververhitte batterijen, oververhitte elementoppervlakken (zoals bij motoren of sensoren) en andere gevaarlijke situaties.

ES
PRECAUCIÓN: La sustitución del firmware de este producto por una versión no autorizada o suministrada por The LEGO Group puede dar lugar a resultados impredecibles, como daños en las pilas o sobrecalentamiento de las mismas, sobrecalentamiento de la superficie de elementos como los motores o sensores, y otras situaciones peligrosas.

DA
ADVARSEL: Udsiftning af firmware i dette produkt med firmware, som ikke er godkendt eller leveret af LEGO Koncernen, kan medføre uforudsigelige forhold, herunder beskadigede eller overophedede batterier, overophedede elementoverflader (f.eks. motorer eller sensorer) eller andre farer.

IS
VARÚÐ: Skipti á fastbúnaði þessarar vöru fyrir fastbúnað sem ekki er samþykktur eða kemur ekki frá The LEGO Group geta valdið ófyrirsjáanlegum aðstæðum, þ.m.t. skemmdum rafhlöðum eða ofhitnun í rafhlöðum, of heitu yfirborði hluta (t.d. mótura eða skynjara) eða annarri hættu.

FI
VAROITUS: Tämän tuotteen laiteohjelmiston vaihtaminen sellaiseen laiteohjelmistoon, jota LEGO Group ei ole hyväksynyt tai toimittanut, voi aiheuttaa ennalta arvaamattomia tilanteita, kuten akkujen ja paristojen vaurioita tai ylikuumentumista, (esim. moottorien ja anturien) pintojen ylikuumentumista tai muita vaaratilanteita.

SV
VAR FÖRSIKTIG: Ersättning av firmware i denna produkt med firmware som inte är godkänd eller tillhandahålls av LEGO Koncernen kan orsaka oförutsägbara tillstånd, inklusive skadade eller överhettade batterier, överhettade elementytor (t.ex. motorer eller givare), eller andra faror.

NO
FORSIKTIG! Hvis fastvaren i dette produktet byttes ut med fastvare som ikke er godkjent av LEGO konsernet, kan det gi uforutsigbare resultater, inkludert batteriskade, overoppheting av batterier, overoppheting av elementoverflater (f.eks. motorer eller sensorer) eller annen fare.

PT
ATENÇÃO: A substituição do firmware neste produto por firmware que não tenha sido aprovado ou fornecido pelo LEGO Group pode causar situações imprevisíveis, incluindo pilhas danificadas ou sobreaquecidas, superfícies de elementos sobreaquecidas (por ex., motores ou sensores), ou outros perigos.

EL
ΠΡΟΣΟΧΗ: Η αντικατάσταση του firmware αυτού του προϊόντος με firmware το οποίο δεν έχει εγκριθεί ή παρασχεθεί από τον όμιλο LEGO Group μπορεί να προκαλέσει απρόβλεπτες συνθήκες, όπως βλάβη ή υπερθέρμανση μπαταριών, υπερθέρμανση των επιφανειών των στοιχείων (π.χ. κινητήρων ή αισθητήρων), ή άλλους κινδύνους.

JA
注意: 本製品のファームウェアを、LEGO Group が承認または供給した以外のファームウェアに交換すると、電池の損傷や加熱、パーツ表面の加熱 (例: モーター、センサー)、そのほかの危険など、不測の事態を引き起こす原因となる可能性があります。

ZH
注意事项: 使用非乐高集团准许或提供的固件替换本产品中的固件, 可能会导致不可预知的情况, 包括电池损坏或过热、元素表面过热 (如电机或传感器) 或其它危险。

KO
주의: 레고 그룹에서 승인하거나 제공하지 않은 펌웨어를 이용해 이 제품의 펌웨어를 교체할 경우, 배터리의 손상이나 과열, 장치 표면의 과열 (예: 모터 또는 센서) 또는 기타 위험 요소를 포함하여 예측할 수 없는 결과가 유발될 수 있습니다.

RU
ВНИМАНИЕ! Замена встроенного ПО данного изделия на ПО сторонних поставщиков, не одобренное The LEGO Group, может привести к непредсказуемым последствиям, в том числе к повреждению или перегреву аккумуляторных батарей, перегреву поверхностей элементов (например, моторов или датчиков) и иным потенциально опасным ситуациям.

PL
UWAGA: zastąpienie firmowego oprogramowania w tym produkcie oprogramowaniem, które nie zostało zatwierdzone lub dostarczone przez Grupę LEGO, może przynieść nieprzewidywalne skutki, jak uszkodzenie i przegrzanie baterii, przegrzanie elementów powierzchniowych (np. silników lub czujników) oraz innych niebezpiecznych sytuacji.

CZ
POZOR: Přehrání firmwaru v tomto zařízení firmwarem, který nebyl schválen či dodán společností LEGO Group, může způsobit nepředvídatelné okolnosti, včetně poškození nebo přehřátí baterií, přehřátí povrchu zařízení a jeho částí (např. motorů nebo senzorů), nebo jiná rizika.

SK
VAROVANIE: Nahradenie firmvéru v tomto produkte firmvérom, ktorý neschválila alebo nedodala spoločnosť LEGO Group, môže spôsobiť nepredvídateľné podmienky vrátane poškodenia alebo prehriatia batérií, prehriatia povrchov prvkov (napr. motorov alebo snímačov) alebo iných rizik.

HU
VIGYÁZAT! Ha ennek a terméknek a firmware szoftverét nem jóváhagyott vagy nem a LEGO Csoport által adott firmware-re cserélik ki, akkor ez kiszámíthatatlan állapotokat, többek között az akkumulátor károsodását vagy túlmelegedését, az alkotóelemek (pl. motorok vagy érzékelők) felületének túlmelegedését, vagy más veszélyes helyzeteket okozhat.

UA
ЗАСТЕРЕЖЕННЯ: Заміна мікропрограми продукту на мікропрограми сторонніх виробників, не схвалені компанією The LEGO Group, може спричинити непередбачувані наслідки, зокрема пошкодження чи перегрівання батарейок, перегрівання зовнішньої поверхні деталей (наприклад, двигунів чи датчиків) та інші небезпечні ситуації.

HR
OPREZ: Zamjena firmvera u ovom proizvodu firmverom koji nije odobrio ili isporučio LEGO Group može dovesti do nepredvidljivih stanja, uključujući oštećenje ili pregrijavanje baterija, pregrijavanje površina elementa (npr. motora ili senzora) ili drugih opasnosti.

SR
OPREZ: Zamena sistemskog softvera u ovom proizvodu sistemskim softverom koji nije odobrila ili isporučila kompanija The LEGO Group može da dovede do nepredvidljivih uslova, uključujući oštećenje ili pregrejane baterije, pregrejane površine elemenata (npr. motora ili senzora) i drugih opasnosti.



МК
ВНИМАНИЕ: Замената на системскиот софтвер во овој производ со системски софтвер којшто не е одобрен или снабден од страна на LEGO Group може да предизвика непредвидливи услови, вклучувајќи оштетени или прегреани батерии, прегреани површини на елементите (пр. на моторите или сензорите), како и други опасности.

SL
POZOR: Zamenjava tjestine programske opreme tega izdelka s strojno programsko opremo, ki je ni odobrila ali dobavila skupina The LEGO Group, lahko povzroči nepredvidljive pogoje, vključno s poškodovanjem ali pregrevanjem baterij, pregrevanjem površin elementov (npr. motorjev ali senzorjev) in druge nevarnosti.

RO
ATENȚIE: Înclocuirea firmware-ului din acest produs cu un firmware neautorizat sau nefurnizat de The LEGO Group poate cauza situații imprevizibile, inclusiv deteriorarea sau supraîncălzirea bateriilor, supraîncălzirea suprafețelor (de ex. la motoare sau senzori), sau alte pericole.

BG
ВНИМАНИЕ: Замяната на фърмуера в този продукт с фърмуер, който не е одобрен или предоставен от LEGO Group, може да доведе до непредсказуеми условия, включително повреда или прегряване на батериите, прегряване на повърхностите на елементите (напр. двигатели или сензори), или до други опасности.

LV
UZMANĪBU! Aizstājot šajā produktā iekļauto aparātprogrammatūru ar tādu aparātprogrammatūru, ko nav apstiprinājis vai piegādājis LEGO Group, var rasties iepriekš neparedzami apstākļi, tostarp akumulatoru bojājums vai pārkaršana, elementu vīrsmu (piemēram, motoru vai sensoru) pārkaršana vai citi bīstami apstākļi.

ET
ETTEVAATUST! Selle toote püsivara asendamine püsivaraga, mis pole LEGO Groupi poolt heaks kiidetud või tarnitud, võib põhjustada ettearvamatuid olukordi, sealhulgas kahjustatud või ülekuumenenud patareisid, ülekuumenenud elementide pindu (nt mootorid või andurid) või muid ohte.

LT
ATSARGIAI! Šio gaminio programinės aparatinės įrangos pakeitimas LEGO Group nepatvirtinta arba netiekiamo programine aparatine įranga gali lemti nenumatytas pasekmes, pvz., gali sugesti arba perkaisti baterijas, perkaisti komponentų (pvz., variklių arba jutiklių) paviršiai arba kilti kitų pavojų.

TR
UYARI: Bu üründeki aygıt yazılımının LEGO Group tarafından onaylanmamış ya da sağlanmamış aygıt yazılımıyla değiştirilmesi, pillerin hasar görmesi ya da aşırı ısınması, eleman yüzeylerinin aşırı ısınması (örn. motorlar veya sensörler) ya da başka tehlikeler dahil öngörülemez koşullara neden olabilir.

AR

تنبيه: قد يتسبب استبدال البرنامج الثابت في هذا المنتج ببرنامج ثابت لم تعتمده مجموعة LEGO Group أو توفره إلى ظهور حالات غير متوقعة، بما في ذلك تلف البطاريات أو زيادة سخونتها. أو زيادة سخونة أسطح المكونات (مثل المحركات أو المستشعرات)، أو غيرها من الأخطار.

ID
HATI-HATI: Mengganti firmware dalam produk ini dengan firmware yang belum disetujui atau tidak dipasok oleh LEGO Group dapat mengakibatkan kondisi yang tak terduga, seperti baterai rusak atau kepanasan, permukaan elemen (misalnya motor atau sensor) kepanasan, atau bahaya lainnya.

MS
PERINGATAN: Penggantian perisian tegar dalam produk ini dengan perisian tegar yang tidak diluluskan atau dibekalkan oleh The LEGO Group mungkin mengakibatkan keadaan luar jangkaan, termasuk kerosakan bateri atau bateri terlampau panas, permukaan elemen terlampau panas (seperti motor atau sensor), atau bahaya lain.

EN Please retain the leaflet and packaging as they contain important information
DE Broschüre und Verpackung bitte aufbewahren, sie enthalten wichtige Informationen
FR Veuillez conserver le dépliant et l'emballage, car ils contiennent des informations importantes
IT Conserva l'opuscolo e la confezione in quanto contengono informazioni importanti
NL Bewaar a.u.b. de folder en verpakking: die bevatten belangrijke informatie
ES Conserve el folleto y el embalaje; contienen información importante
DA Gem hæftet og emballagen, da de indeholder vigtige oplysninger
IS Geymið bæklinginn og umbúðirnar þar sem þau innihalda mikilvægar upplýsingar
FI Säilytä esite ja pakkaus, koska ne sisältävät tärkeää tietoa
SV Spara broschyren och förpackningen eftersom de innehåller viktig information
NO Heftet og emballasjen inneholder viktig informasjon og skal beholdes
PT Por favor guarde o folheto e a embalagem, pois contém informação importante
EL Κρατήστε το φυλλάδιο και τη συσκευασία γιατί περιέχουν σημαντικές πληροφορίες
JA 説明書とパッケージには重要な情報が含まれていますので保管しておいてください
ZH 说明书和包装均包含重要信息，请妥善保存
KO 중요한 정보가 담겨 있으므로 리플릿과 포장물 보관해두세요
RU Пожалуйста, сохраните эту брошюру и упаковку, поскольку они содержат важную информацию
PL Prosimy zachować ulotkę i opakowanie, ponieważ zawierają one ważne informacje
CZ Ponechte si prosím leták i obal, neboť obsahují důležité informace
SK Ponechajte si prosím leták aj obal, pretože obsahujú dôležité informácie
HU Kérjük, őrizze meg a szórólapot és a csomagolást, mert fontos tudnivalókat tartalmaznak
UA Будь ласка, зберігайте вкладиш та упаковку, оскільки вони містять важливу інформацію
HR Spremite letak i ambalažu jer sadrže važne obavijesti
SR Молимо да сачувате упутство и паковање јер се на њима налазе важне информације
МК Чувајте ги брошурата и амбалажата бидејќи содржат важна информација
SL Prosimo, da brošurico in embalažo shranite, saj vključujeta pomembne informacije
RO Vă rugăm să păstrați prospectul și ambalajul întrucât conțin informații importante
BG Запазете листовката и опаковката, тъй като съдържат важна информация
LV Lūdzu, saglabājiet bukletu un iepakojumu, jo uz tā ir norādīta svarīga informācija
ET Hoidke infoleht ja pakend alles, sest nendele on märgitud oluline teave
LT Išsaugokite informacinį lapelį ir pakuotę, nes ant jų pateikiama svarbi informacija
TR Önemli bilgiler içerdiği için broşürü ve ambalajı saklayın
AR الرجاء الاحتفاظ بالنشرة والغلاف لاحتوائهما على معلومات هامة
ID Harap simpan brosur dan kemasan ini karena berisi informasi penting
MS Sila simpan risalah dan pembungkusan kerana ia mengandungi maklumat penting

LEGO System A/S
Aastvej 1
DK-7190 Billund

EN CAUTION: Risk of explosion if the battery is replaced by an incorrect type.
DE ACHTUNG: Es besteht Explosionsgefahr, wenn die Batterie durch einen ungeeigneten Batterietyp ersetzt wird.
FR ATTENTION : Risque d'explosion si la pile est remplacée par un modèle incompatible.
IT ATTENZIONE: rischio di esplosione se la batteria è sostituita con una di tipo errato.
NL VOORZICHTIG: Explosiegevaar indien de batterij wordt vervangen door een onjuist type.
ES PRECAUCIÓN: Sustituir la batería por otra de tipo incorrecto representa un riesgo de explosión.
DA ADVARSEL: Der er risiko for eksplosion, hvis batteriet udskiftes med en forkert type.
IS VARÚÐ: Hætta á sprengingu ef rafhlöðunni er skipt úr fyrir rafhlöðu af rangri gerð.
FI VAROITUS: Räjähdyksvaara, jos pariston tilalle vaihdetaan väärän tyyppinen paristo.
SV VARNING: Explosionsrisk om batteriet byts ut mot ett batteri av fel typ.
NO FORSIKTIG: Kan eksplodere hvis batteriet skiftes ut med feil type batteri.
PT ATENÇÃO: Risco de explosão se as pilhas forem substituídas por um tipo incorreto.
EL ΠΡΟΣΟΧΗ: Κίνδυνος έκρηξης εάν η μπαταρία αντικατασταθεί με μια άλλη λανθασμένου τύπου.
JA 注意: 誤った種類の電池を挿入すると爆発する恐れがあります。
ZH 注意事项: 如果所更换的电池类型不正确, 则存在爆炸的风险。
KO 주의: 출고 시 규격 이외의 배터리로 교체할 경우 폭발의 위험이 있습니다.
RU ВНИМАНИЕ! Установка элемента питания неправильного типа может привести к его взрыву.
PL UWAGA: Zastosowanie nieprawidłowego typu baterii stwarza zagrożenie wybuchem.
CZ POZOR: V případě nahrazení baterie nesprávným typem hrozí riziko výbuchu.
SK VAROVANIE: Ak batériu nahradíte nesprávnym typom, hrozí riziko výbuchu.
HU VIGYÁZAT! Robbanásveszély, ha az akkumulátort nem megfelelő típusúra cserélik.
UA ОБЕРЕЖНО! Якщо вставити невідповідний тип батарейки, може статися вибух.
HR OPREZ: Opasnost od eksplozije ako se baterija zamijeni vrstom koja nije propisana.
SR OPREZ: Opasnost od eksplozije ako se baterija zamjeni neodgovarajućom vrstom.
МК ВНИМАНИЕ: Има ризик од експлозија, ако батеријата е заменета со погрешен тип.
SL POZOR: Če vstavite baterijo napačnega tipa, tvegate, da bo eksplodirala.
RO ATENȚIE: risc de explozie dacă bateria este înlocuită cu una de un tip incorect.
BG ВНИМАНИЕ: Има риск от експлозия, ако батерията бъде заменена с такава от неправилен тип.
LV UZMANĪBU! Ja baterija tiek nomainīta ar nepareiza tipa bateriju, pastāv sprādziena risks.
ET ETTEVAATUST! Plahvatusoht, kui patarei asendatakse vale tüüpi patareiga.
LT ATSARGIAI! Įstačius netinkamo tipo elementą, gali kilti sprogimo pavojus.
TR UYARI: Yanlış türde pil kullanılırsa patlama riski bulunur.
AR تنبيه: خطر الانفجار في حالة استبدال البطارية بنوع غير صحيح.
ID HATI-HATI: Risiko ledakan dapat timbul jika baterai diganti dengan jenis yang berbeda.
MS PERINGATAN: Risiko letupan jika bateri ditukarkan dengan jenis bateri yang salah.

EN

The LEGO Group hereby declares that above product/products comply with the essential requirements and other relevant provisions of Directive 2014/53/EU. Complete declaration on www.LEGO.com/compliance

DE

Hiermit erklärt die LEGO Gruppe, dass das oben genannte Produkt/die oben genannten Produkte den notwendigen Anforderungen und weiteren relevanten Bestimmungen der Richtlinie 2014/53/EU entspricht bzw. entsprechen. Vollständige Erklärung auf www.LEGO.com/compliance.

FR

Par la présente, le Groupe LEGO déclare que le(s) produit(s) mentionné(s) ci-dessus est/sont conforme(s) aux exigences essentielles et aux autres dispositions pertinentes de la Directive 2014/53/UE. Déclaration complète sur www.LEGO.com/compliance

IT

Con la presente, LEGO Group dichiara che il prodotto/prodotti di cui sopra sono conformi ai requisiti essenziali e alle altre disposizioni pertinenti stabiliti dalla Direttiva 2014/53/UE. Dichiarazione completa su www.LEGO.com/compliance

NL

De LEGO Groep verklaart bij dezen dat het bovenstaande product/de bovenstaande producten voldoet/voldoen aan de essentiële eisen en overige relevante bepalingen van Richtlijn 2014/53/EU. De volledige verklaring is te vinden op www.LEGO.com/compliance

ES

The LEGO Group declara que el producto o los productos anteriores satisfacen los requisitos fundamentales y demás disposiciones correspondientes de la Directiva 2014/53/UE. La declaración completa está disponible en www.LEGO.com/compliance

DA

LEGO Koncernen erklærer hermed, at produktet/produkterne nævnt ovenfor opfylder de væsentlige krav og andre relevante bestemmelser i direktiv 2014/53/EU. Komplet erklæring på www.LEGO.com/compliance

IS

LEGO Group lýsir því hér með yfir að ofangreind vara uppfyllir grundvallarkröfur og samræmist öðrum viðeigandi ákvæðum tilskipunar nr. 2014/53/ESB. Yfirlýsinguna í heild er að finna á www.LEGO.com/compliance

FI

LEGO Group vakuuttaa täten, että edellä mainittu yksiy tai useampi tuote on direktiivin 2014/53/EU oleellisten vaatimusten ja ehtojen mukainen. Täydellinen vaatimustenmukaisuusvakuutus on osoitteessa www.LEGO.com/compliance

SV

LEGO Koncernen intygar härmed att ovanstående produkt/produkter uppfyller de väsentliga kraven och andra relevanta bestämmelser i direktiv 2014/53/EU. Fullständig förklaring på www.LEGO.com/compliance

NO

LEGO konsernet erklærer herved at ovennevnte produkt/produkter oppfyller de obligatoriske kravene og andre relevante bestemmelser i Europaparlaments- og rådsdirektiv 2014/53/EU. Hele erklæringen ligger på www.LEGO.com/compliance

PT

O LEGO Group declara que o/os produto(s) acima mencionado(s) está/estão em conformidade com os requisitos essenciais e outras disposições relevantes da Diretiva 2014/53/UE. Declaração completa em www.LEGO.com/compliance

EL

Δια της παρούσης ο Όμιλος LEGO Group δηλώνει ότι το/τα παραπάνω προϊόν/προϊόντα συμμορφώνεται/ονται με τις ουσιαστικές απαιτήσεις και άλλες σχετικές διατάξεις της Οδηγίας 2014/53/ΕΕ. Η πλήρης δήλωση βρίσκεται στο www.LEGO.com/compliance

JA

LEGO Group による上記の製品はすべて、2014 年 EU 指令 (2014/53/EU) の基本的な要求事項およびその他の関連規定に準拠しております。準拠宣言の全文はこちら: www.LEGO.com/compliance

ZH

乐高集团特此声明，上述产品符合欧盟 2014/53/EU 指令的基本要求和其它有关规定。请访问 www.LEGO.com/compliance 网站查看完整声明

KO

레고 그룹은 상기 제품이 2014/53/EU 지침의 필수 요건 및 기타 관련 조항을 준수함을 선언합니다. 자세한 내용은 www.LEGO.com/compliance에서 확인할 수 있습니다.

RU

Настоящим LEGO Group заявляет, что указанные выше товары отвечают основополагающим требованиям и иным применимым положениям Директивы 2014/53/ЕС. Полный текст см. на сайте www.LEGO.com/compliance.

PL

Grupa LEGO niniejszym oświadcza, że wymienione produkty są zgodne z zasadniczymi wymaganiami oraz innymi właściwymi postanowieniami dyrektywy 2014/53/UE. Pełna treść deklaracji na stronie www.LEGO.com/compliance

CZ

LEGO Group tímto prohlašuje, že všechny výše uvedené produkty odpovídají základním požadavkům a všem příslušným ustanovením směrnice 2014/53/EU. Kompletní prohlášení na www.LEGO.com/compliance

SK

LEGO Group týmto vyhlasuje, že hore uvedené produkty zodpovedajú základným požiadavkám a všetkým príslušným ustanoveniam smernice 2014/53/EU. Kompletné prehlásenie na www.LEGO.com/compliance

HU

A LEGO Csoport ezennel kijelenti, hogy a fenti termék/termékek megfelelnek a 2014/53/EU irányelv alapvető követelményeinek és egyéb vonatkozó rendelkezésének. A nyilatkozat teljes szövege itt olvasható: www.LEGO.com/compliance

UA

LEGO Group заявляє, що цей продукт чи продукти відповідають головним вимогам та іншим відповідним положенням Директиви 2014/53/EU. Повний текст заяви можна переглянути на сайті www.LEGO.com/compliance

HR

LEGO Group ovim izjavljuje da su gore navedeni proizvod/proizvodi sukladni bitnim zahtjevima i drugim odgovarajućim odredbama direktive 2014/53/EU. Cjelovita izjava nalazi se na www.LEGO.com/compliance

SR

Компанија LEGO Group овим путем изјављује да је/су горенаведени производ/-и усклађен/-и са основним захтевима и другим релевантним одредбама Директиве 2014/53/EU. Комплетну изјаву можете пронаћи на адреси www.LEGO.com/compliance

MK

LEGO Group со ова изјавува дека производот/производите погоре се во согласност со основните барања и другите релевантни одредби на директивата 2014/53/ЕС. Целосна декларација на www.LEGO.com/compliance

SL

LEGO Group izjavlja, da izdelek ustreza osnovnim zahtevam in drugim relevantnim določilom Direktive 2014/53/ES. Celotna deklaracija je na spletni strani www.LEGO.com/compliance

RO

Grupul LEGO declară prin prezenta că produsul/produsele de mai sus se conformează cerințelor esențiale și altor prevederi relevante ale Directivei 2014/53/UE. Declarația completă pe www.LEGO.com/compliance

BG

LEGO Group декларира, че посочените продукти по-горе съответстват на основните изисквания и други съответни разпоредби на Директива 2014/53/ЕС. Пълна декларация на www.LEGO.com/compliance

LV

Ar šo LEGO Group paziņo, ka iepriekšminētās(i) produkts(i) atbilst Direktīvas 2014/53/ES būtiskajām prasībām un citiem saistītajiem noteikumiem. Pilns deklarācijas teksts pieejams vietnē www.LEGO.com/compliance

ET

Käesolevaga teatab LEGO Group, et eespool nimetatud toode/tooted vastavad direktiivi 2014/53/EL olulistele nõuetele ja muudele asjakohastele sätetele. Täielik deklaratsioon on saadaval aadressil www.LEGO.com/compliance

LT

Šiuo dokumentu „LEGO Group“ deklaruoja, kad anksčiau nurodytas (-i) produktas (-ai) atitinka svarbiausius reikalavimus ir kitas 2014/53/ES direktyvos sąlygas. Visa deklaraciją rasite www.LEGO.com/compliance

TR

LEGO Group işbu belge ile yukarıdaki ürünün/ürünlerin 2014/53/EU sayılı direktifin temel gereksinimlerine ve diğer ilgili hükümlerine uygun olduğunu beyan eder. Beyanın tam metnine www.LEGO.com/compliance adresinden ulaşabilirsiniz.

AR

تعلم مجموعة LEGO Group بموجب هذه الوثيقة أن المنتج/المنتجات تتوافق مع المتطلبات الأساسية والأحكام الأخرى ذات الصلة بالتوجيه 2014/53/UE. التصريح كاملاً على الموقع www.LEGO.com/compliance

ID

LEGO Group dengan ini menyatakan bahwa produk di atas sesuai dengan persyaratan penting dan ketentuan terkait lainnya dalam Directive 2014/53/EU. Pernyataan selengkapnya tersedia di www.LEGO.com/compliance

MS

LEGO Group dengan ini mengumumkan bahawa produk di atas mematuhi keperluan asas dan peruntukan relevan lain dalam Directive 2014/53/EU. Pengisytiharan lengkap di www.LEGO.com/compliance



This device complies with part 15 of the FCC Rules. Operation is subject to the following two conditions:

- (1) This device may not cause harmful interference, and
- (2) this device must accept any interference received, including interference that may cause undesired operation.

NOTE: This equipment has been tested and found to comply with the limits for a Class B digital device, pursuant to part 15 of the FCC Rules. These limits are designed to provide reasonable protection against harmful interference in a residential installation. This equipment generates, uses and can radiate radio frequency energy and, if not installed and used in accordance with the instructions, may cause harmful interference to radio communications. However, there is no guarantee that interference will not occur in a particular installation. If this equipment does cause harmful interference to radio or television reception, which can be determined by turning the equipment off and on, the user is encouraged to try to correct the interference by one or more of the following measures:

- Reorient or relocate the receiving antenna.
- Increase the separation between the equipment and receiver.
- Connect the equipment into an outlet on a circuit different from that to which the receiver is connected.
- Consult the dealer or an experienced radio/TV technician for help.

Caution: changes or modifications not expressly approved by the party responsible for compliance could void the user's authority to operate the equipment.

This device contains licence-exempt transmitter(s)/receiver(s) that comply with Innovation, Science and Economic Development Canada's licence-exempt RSS(s). Operation is subject to the following two conditions:

- (1) This device may not cause interference.
- (2) This device must accept any interference, including interference that may cause undesired operation of the device.

L'émetteur/récepteur exempt de licence contenu dans le présent appareil est conforme aux CNR d'Innovation, Sciences et Développement économique Canada applicables aux appareils radio exempts de licence. L'exploitation est autorisée aux deux conditions suivantes :

- (1) L'appareil ne doit pas produire de brouillage;
- (2) L'appareil doit accepter tout brouillage radioélectrique subi, même si le brouillage est susceptible d'en compromettre le fonctionnement.

CAN ICES-3 (B)/NMB-3(B)

取得審驗證明之低功率射頻器材，非經核准，公司、商號或使用者均不得擅自變更頻率、加大功率或變更原設計之特性及功能。低功率射頻器材之使用不得影響飛航安全及干擾合法通信；經發現有干擾現象時，應立即停用，並改善至無干擾時方得繼續使用。前述合法通信，指依電信管理法規定作業之無線電通信。低功率射頻器材須忍受合法通信或工業、科學及醫療用電波輻射性電機設備之干擾。

台灣樂高貿易股份有限公司
台北市信義區忠孝東路四段555-1號11樓B室



La operación de este equipo está sujeta a las siguientes dos condiciones:

- (1) es posible que este equipo o dispositivo no cause interferencia perjudicial y
- (2) este equipo o dispositivo debe aceptar cualquier interferencia, incluyendo la que pueda causar su operación no deseada.

Este equipamento não tem direito à proteção contra interferência prejudicial e não pode causar interferência em sistemas devidamente autorizados.

产品中有害物质的名称及含有信息表										
部件名称	有害物质									
	Pb	Hg	Cd	Cr(VI)	PBB	PBDE	DEHP	BBP	DBP	DIBP
印刷电路板组件	X	○	○	○	○	○	○	○	○	○
注1: ○: 表示该有害物质在该部件所有均质材料中的含量均不超出电器电子产品有害物质限制使用国家标准要求。 X: 表示该有害物质至少在该部件的某一均质材料中的含量超出电器电子产品有害物质限制使用国家标准要求。 注2: 以上未列出的部件，表明其有害物质含量均不超出电器电子产品有害物质限制使用国家标准要求。										



9x 4163533
16x 6323918
25x 6271540
25x 302301
25x 6285777
25x 6172927
9x 300401
25x 6265695
8x 6250019
15x 306801
15x 6013866
9x 300301
1x 6271870
25x 362301
14x 243101
560

17x 6280386
1x 4560178
1x 6322624
18x 4179771
2x 4125253
13x 6232135
1x 4565452
2x 6261379
7x 4666579
4x 4125220
4x 6262188
2x 6219794
24x 4109995
1x 4578107

25x 4159196
2x 4273526
1x 6031962
8x 6174925
15x 6253003
1x 6056274
3x 6221467
2x 6046924
4x 4185177
13x 4114306
7x 4124455
17x 4114077
17x 6132769

39x 4162465
21x 6131896
12x 6313119
1x 4118790
4x 6020375
2x 4500453
26x 4666999
1x 4159739
59x 4113233
4x 4201062
23x 4113916
2x 4578109
2x 6115031

4x 6311104
13x 4114309
9x 4114319
58x 4157277
3x 6223291
10x 4243824
9x 4181134
5x 4113993
2x 4114324
2x 4161443
2x 4113988

7x 4143409
23x 4166138
3x 4249019
2x 6294678
2x 6156462
1x 6037834
35x 4295313
5x 6030980

5x 6096262
2x 4609726
2x 6284574
11x 6271820
2x 4504379
45x 4186678
1x 6008527
14x 4651524
20x 4142865
25x 306921
25x 302321
2x 6059013

3x 6170834
2x 6209519
8x 6273211
3x 6129995
1x 371021
1x 379521
3x 6130004
1x 4514843
24x 4514553
11x 4143005
5x 4186834
37x 4206482

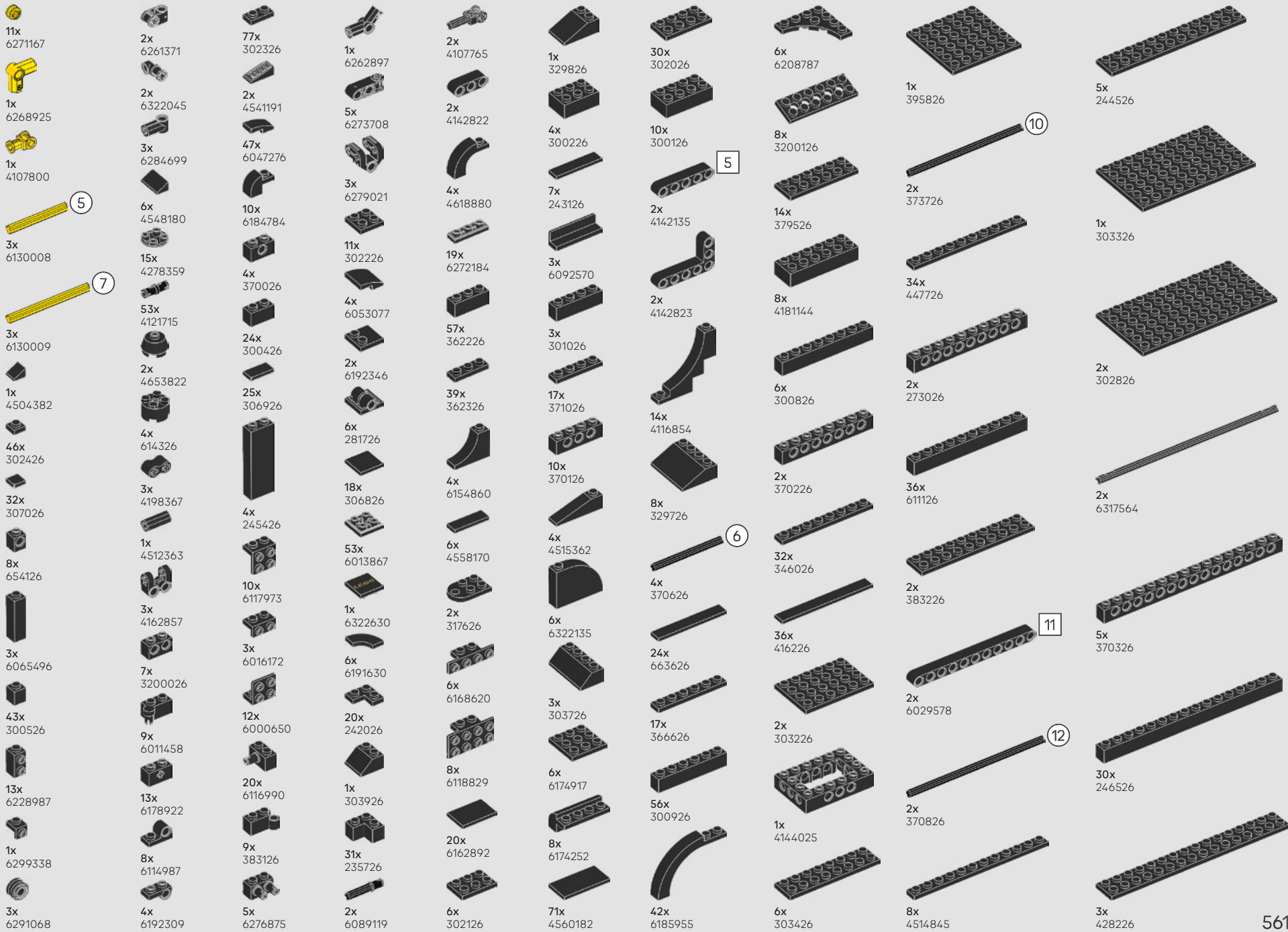

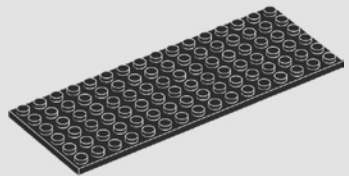

2x
302726

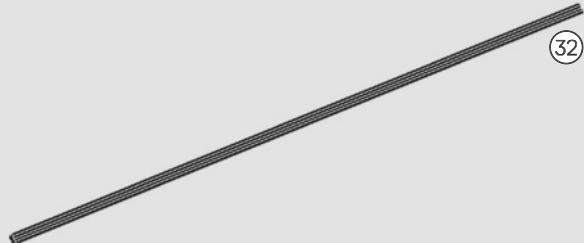

32

1x
6210821



1x
6254484



1x
6265128

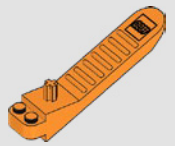

1x
6240515



2x
4549436



14x
6001824



4x
6231386



3x
6170313



1x
6101254



2x
6310833
562



15x
6310835



2x
4521914



78x
4528604



20x
6275485



7x
6002849



4x
6002851



8x
6047415



12x
4550168



2x
4255416



4x
6132768



30x
6035540



4x
6175927



22x
4626904



1x
6164288



27x
6015424



1x
6151537



4x
4570451



7x
4550329



4x
4246957



21x
6275088

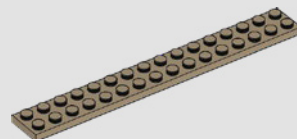

3x
6316277



2x
4211535



2x
4211741



9x
6296859



1x
4211807



1x
6123815



1x
6185471



1x
4211862



4x
6043656



2x
6168633



3x
4211398



16x
6261353



2x
4502595



7x
6276874



1x
6279023



8x
4211397



1x
4211815



2x
4211567



3x
6273212



2x
4217918



1x
4211445



2x
4503416



6x
4260409



2x
4211639



4x
4211444



1x
4211713



1x
4211651



6x
4211837



1x
4211374

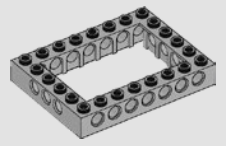

6x
4211848



2x
4514846

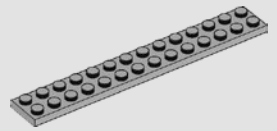

3x
4662161



25x
6167667



21x
6271165

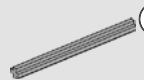

2x
4211805



1x
4211406



9x
6275844

5

7

5

3

8x
6055171

12x
4543949

6x
6216880

1x
6012451

1x
6225494

4x
6276873

6x
4210659

4x
6123814

17x
6273715

1x
6167281

3x
6324639

9x
6327165

7x
6083620

2x
4210753

2x
4210686

17x
4508553

1x
4210917

1x
4495931

1x
4603472

1x
4256828

4x
4531751

26x
6151461

26x
6138664

8x
4211252

18x
6135494

8x
6179615

6x
4267994

2x
6096217

2x
4211201

2x
6179636

6x
4216945

6x
6153863

9x
6186672

4x
6256803

88x
6071259

14x
6092594

16x
6173654

11x
6285441

5x
6267914

5x
6173281

3x
6322139

12x
6322138

8x
6134197

52x
6215606

73x
6218360

6x
6167645

21x
6312473

6x
6167699

6x
6292145

2x
6223183

2x
6099341

5x
6245499

3x
6294492

14x
6051507

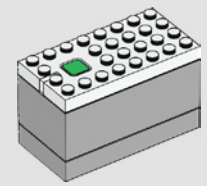

1x
6262033

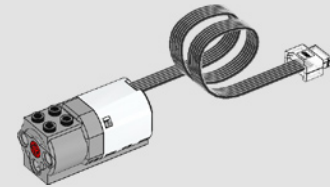

1x
6290182

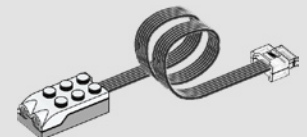

1x
6299496

Customer Service
Kundenservice
Service Consommateurs
Servicio Al Consumidor

LEGO.com/service or dial



: 00800 5346 5555

: 1-800-422-5346

