



Harry Potter

76453



LEGO® Builder



LEGO.com/sustainable-packaging



FR

DONNEZ
OU
RECYCLEZ



OU



OU



ASSOCIATION

MAGASIN

DÉCHÈTERIE

Adresses sur quefairedemesdechets.fr



🔍 LEGO® Builder

BUILDER



Apple and the Apple logo are trademarks of Apple Inc., registered in the U.S. and other countries and regions. App Store is a service mark of Apple Inc. Google Play and the Google Play logo are trademarks of Google LLC. Tencent and the Tencent logo are trademarks of Tencent Inc.

🔍 LEGO.com/devicecheck

EN Ask parents' permission before going online | DE Eltern um Erlaubnis bitten, bevor du online gehst | FR Demande l'autorisation d'un parent avant d'aller en ligne | IT Chiedi il permesso ai tuoi genitori prima di andare online | ES Pídeles permiso a tus papás antes de conectarte a Internet | PT Peça autorização aos pais antes de acederes online | ZH 上网前应先征得父母的同意 | PL Poproś rodziców o zgodę, zanim wejdiesz do Internetu | CS Než půjdeš na internet, požádej rodiče o svolení | SK Skôr než pôjdeš na internet, vypýtaj si povolenie od rodičov | HU Kérj szülői engedélyt, mielőtt online csatlakoznál! | RO Cere permisiunea părinților înainte de a te conecta online | BG Поискайте разрешение от родител, преди да влезете онлайн | LV Pirms došanās tiešsaistē palūdz atļauju vecākiem | ET Enne Interneti kasutamist küsi vanematelt luba | LT Prieš prisijungdami prie interneto, atsklauskite tėvų

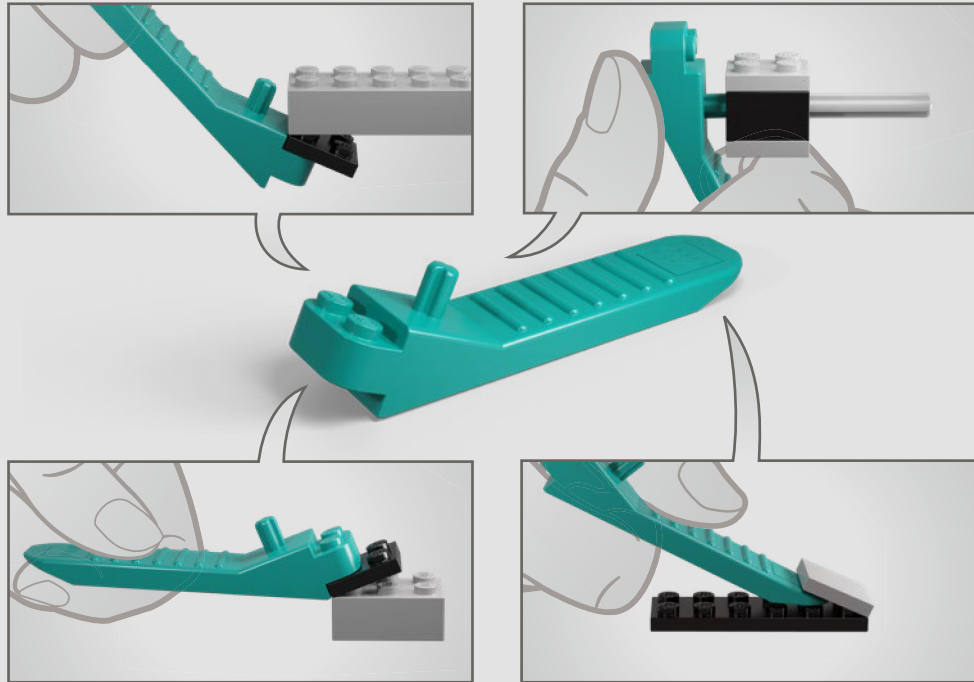

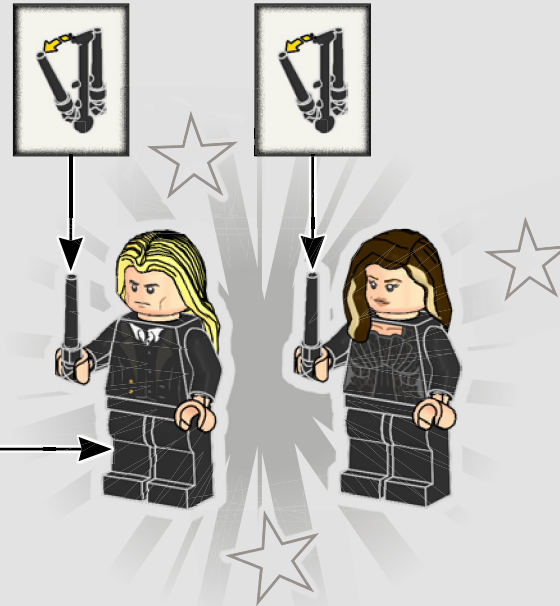
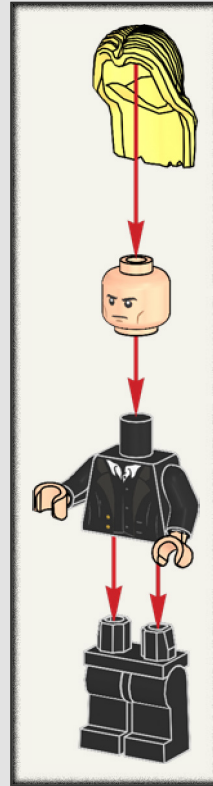

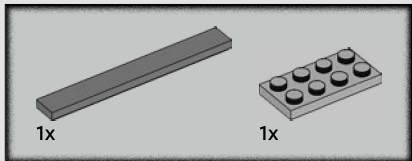
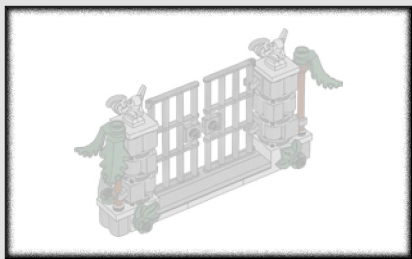

1

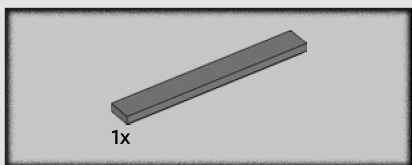
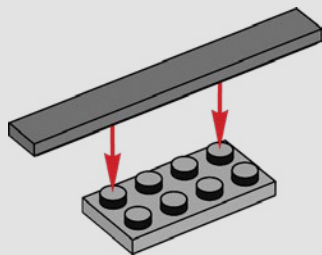

2

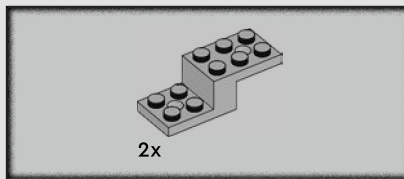
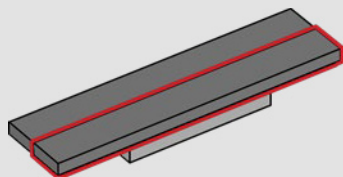

3

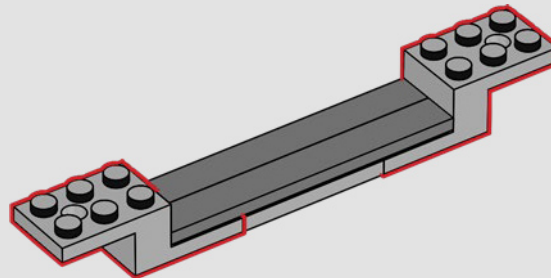

4

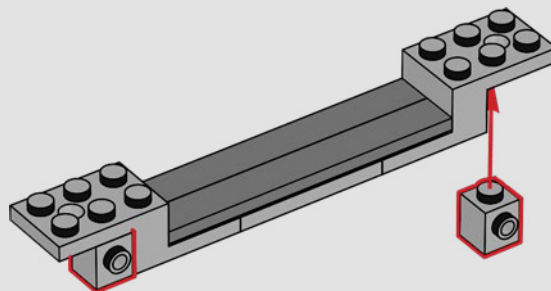

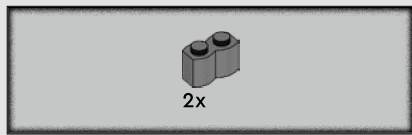

5

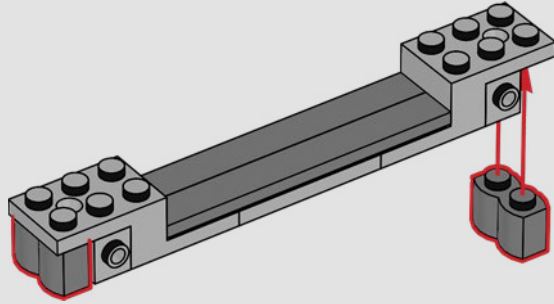

6

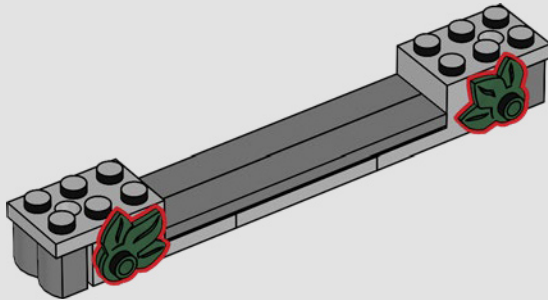

7

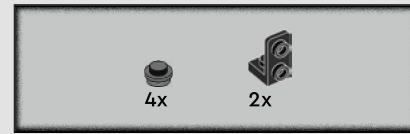
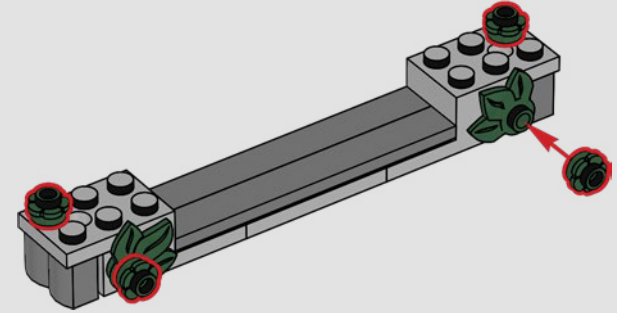

8

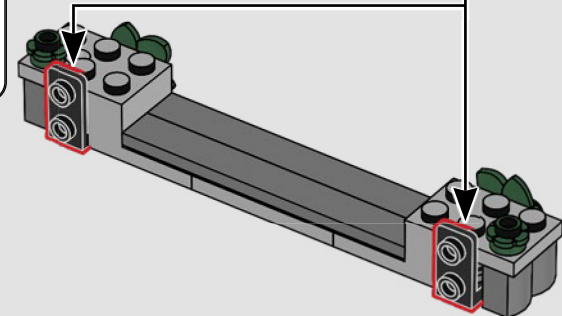
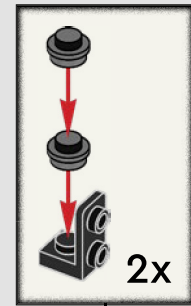
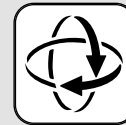

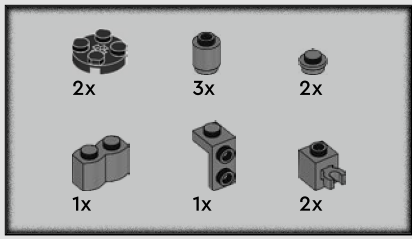

9

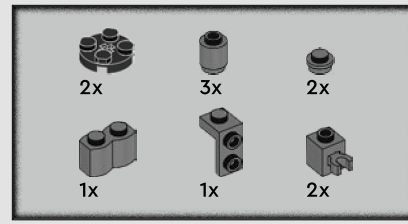
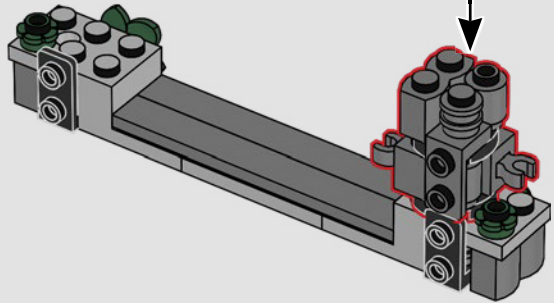
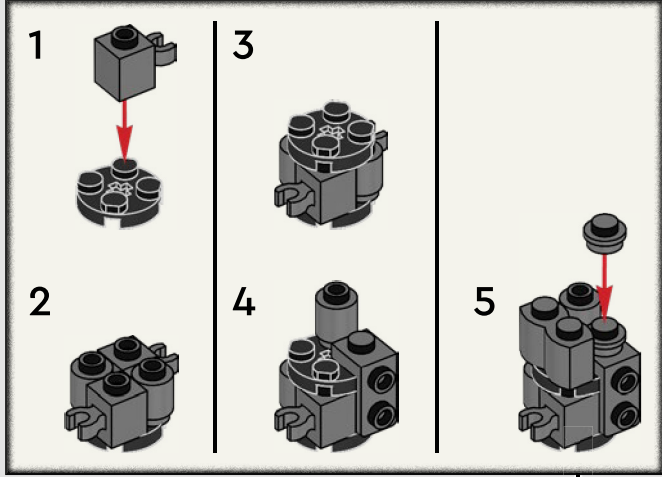

10

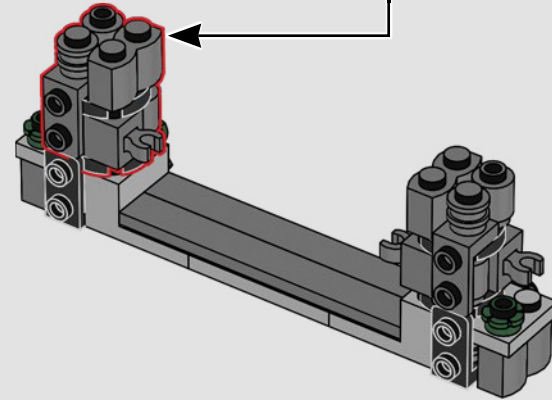
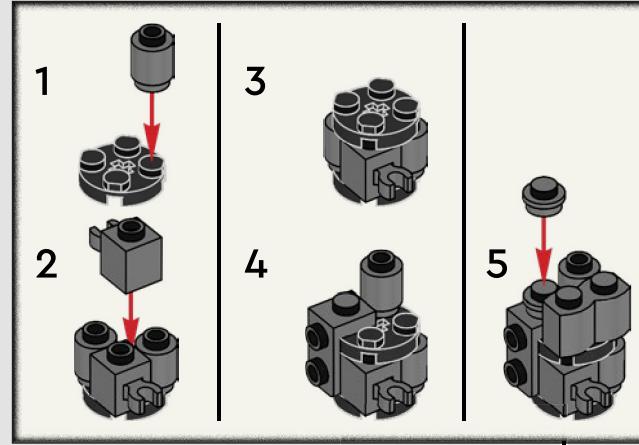

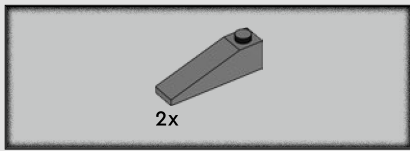

11

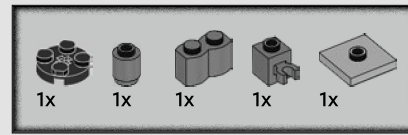
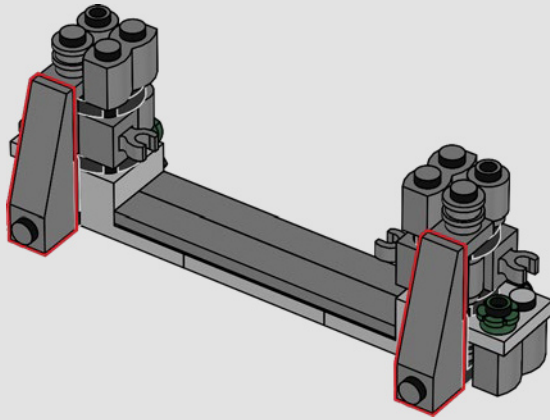

12

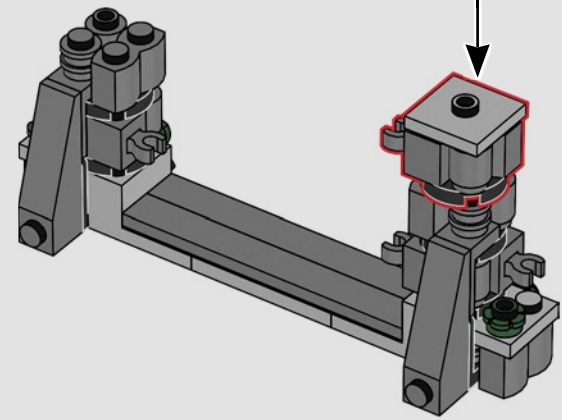
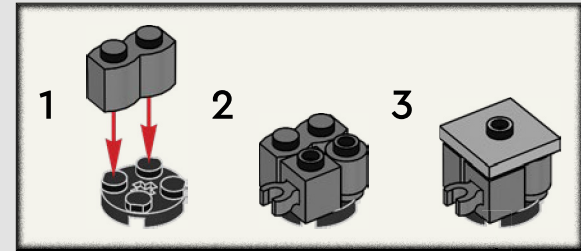

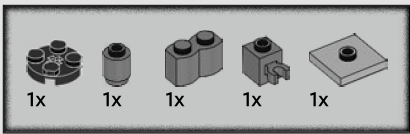

13

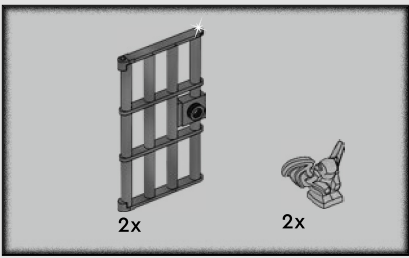
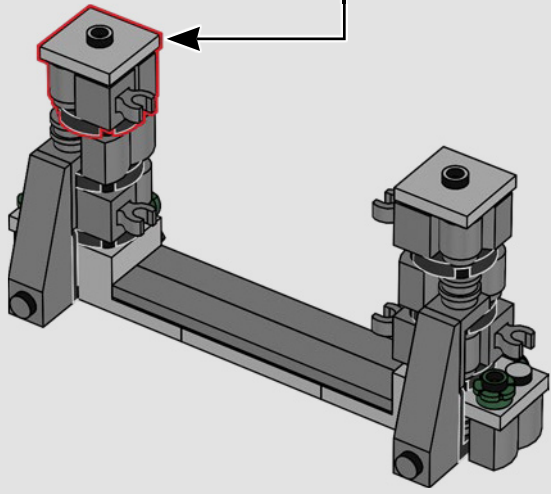
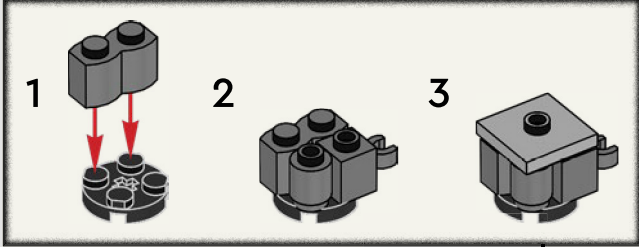

14

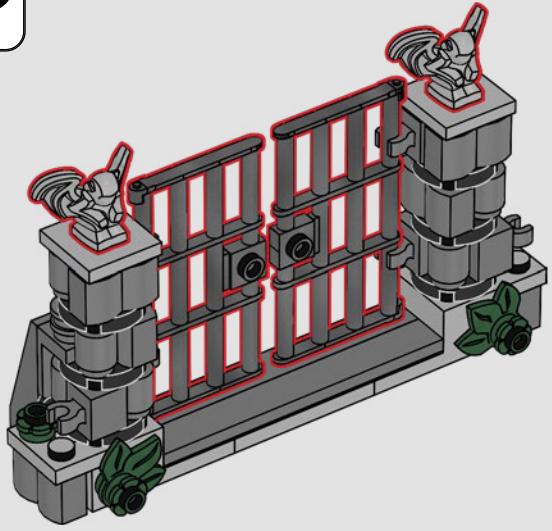
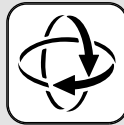

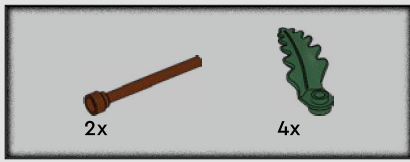

15

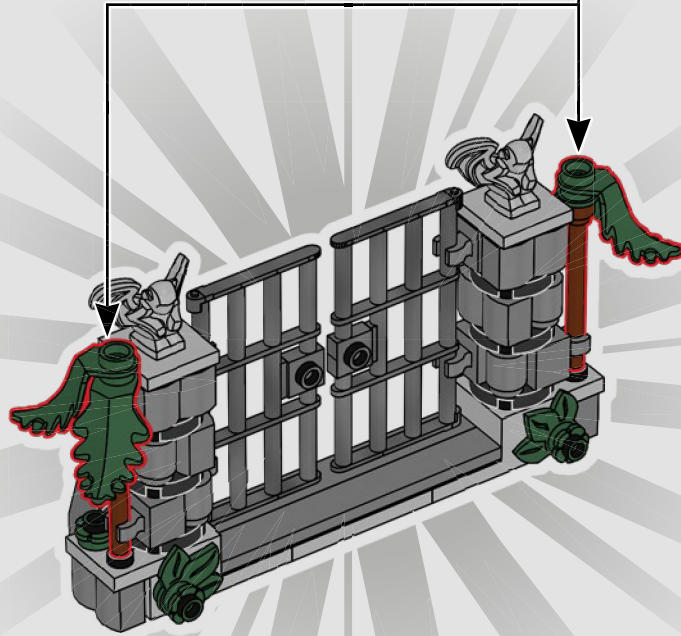
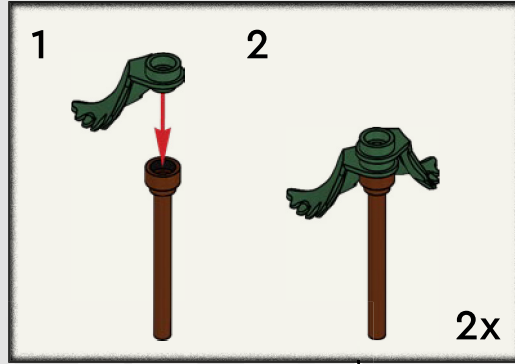

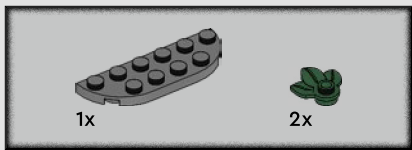

1

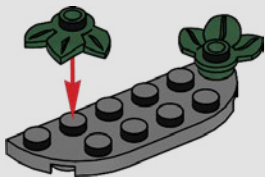

2

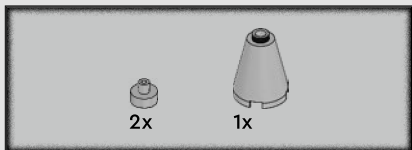
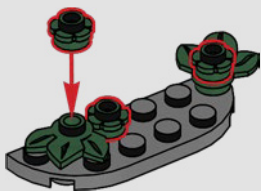

3

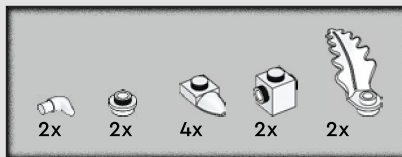
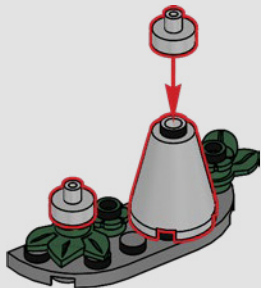

4

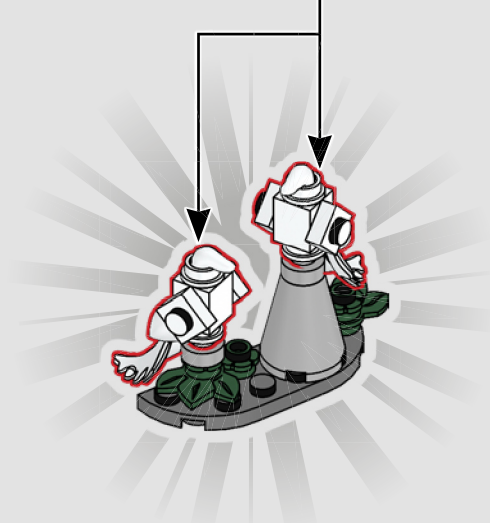
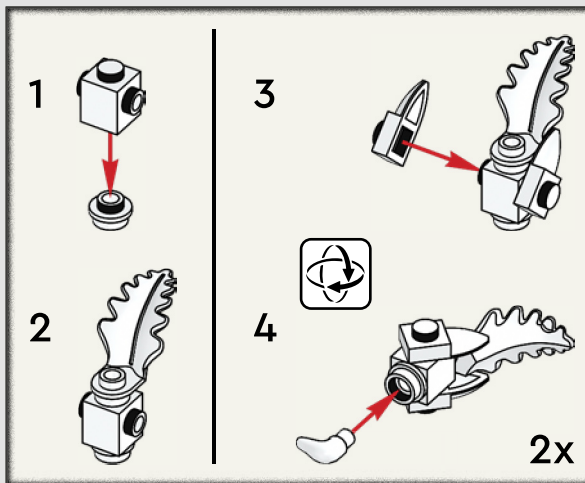

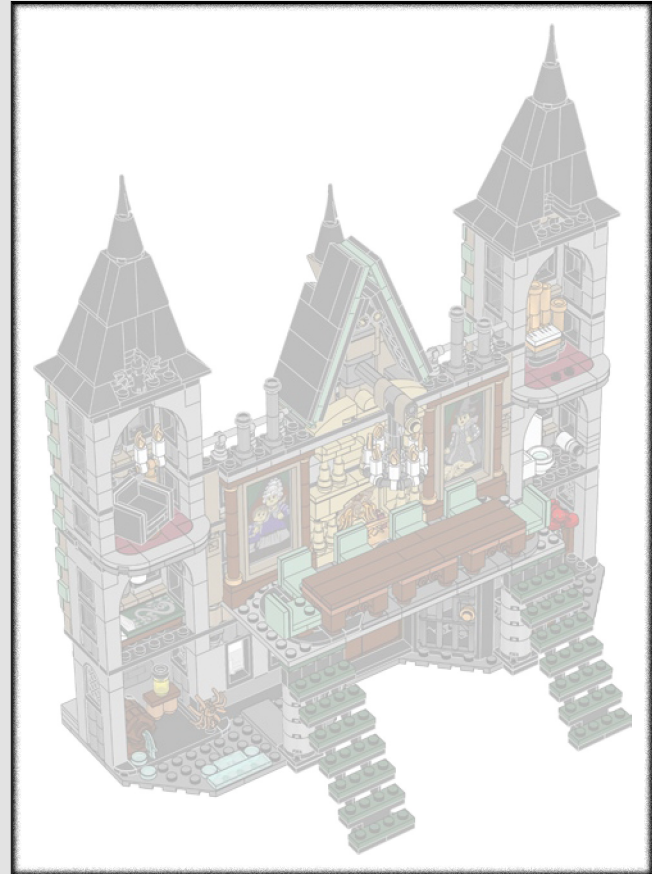

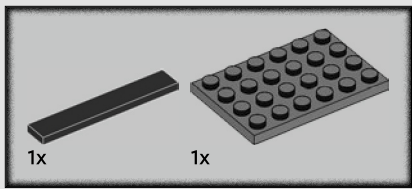

1

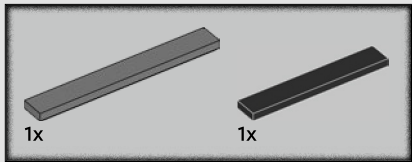
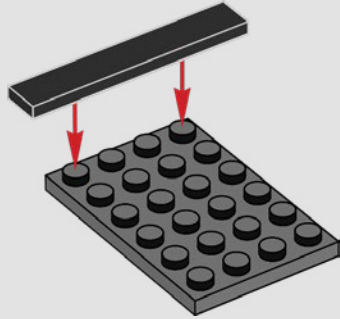

2

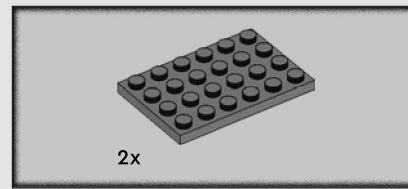
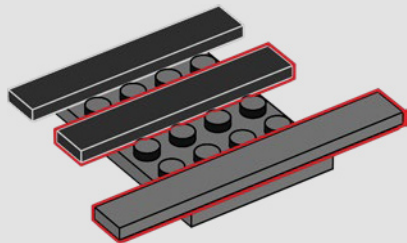

3

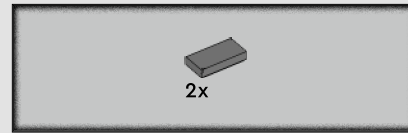
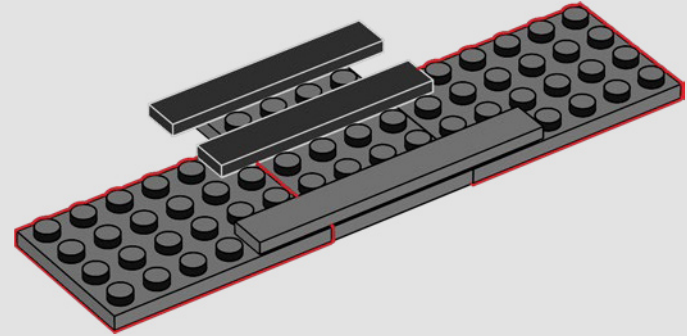

4

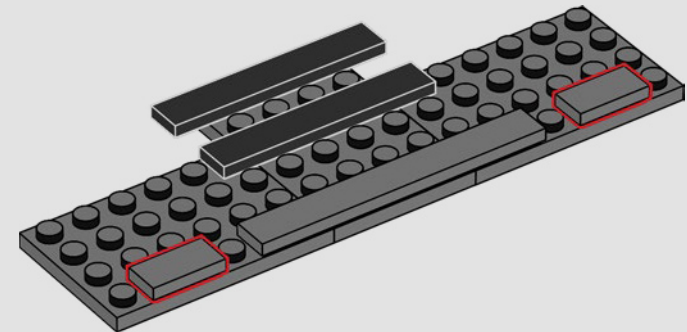

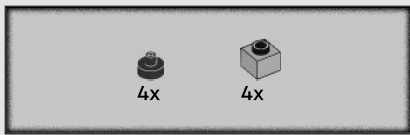

5

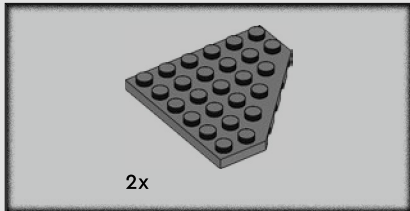
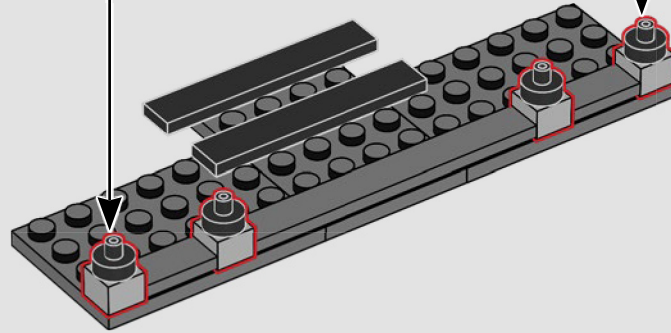
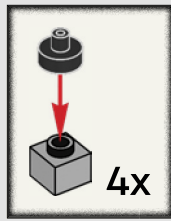

6

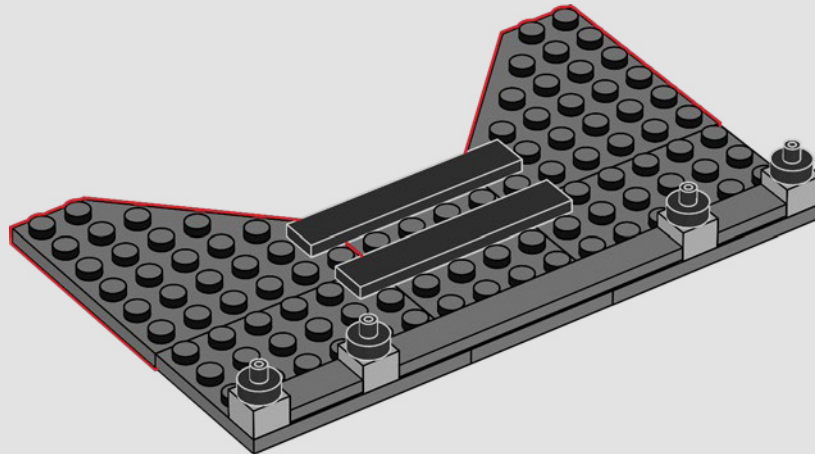

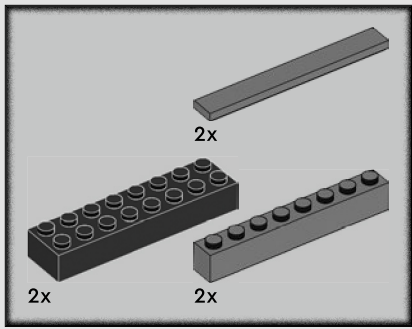

7

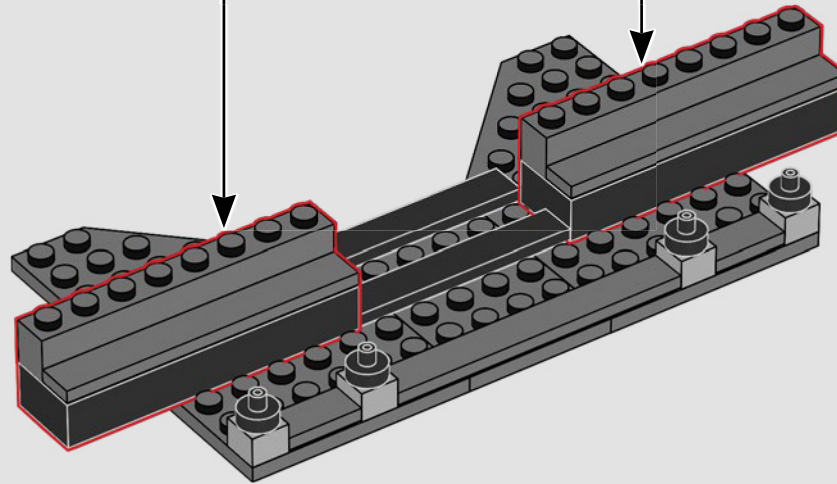
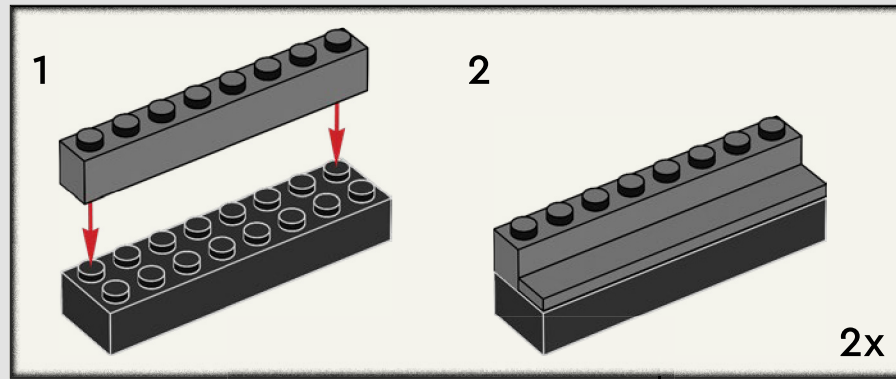

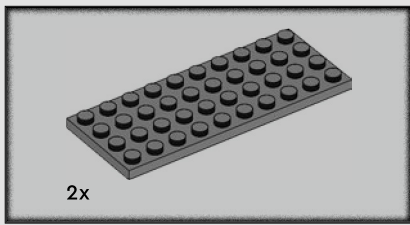

8

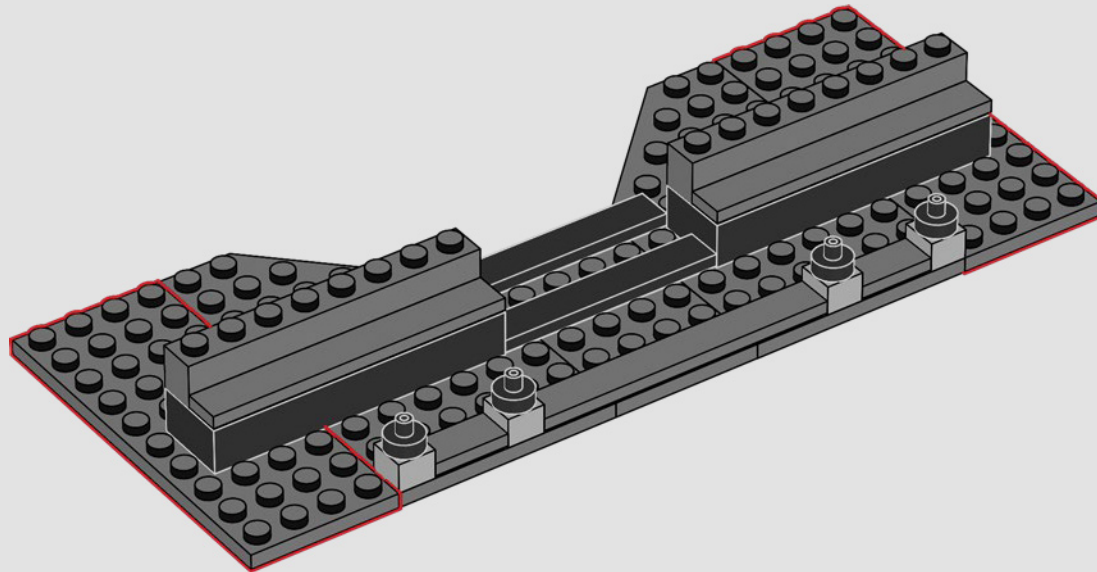

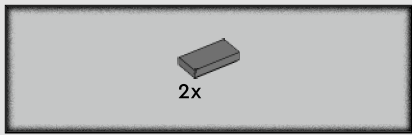

9

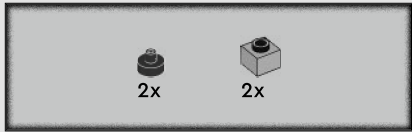
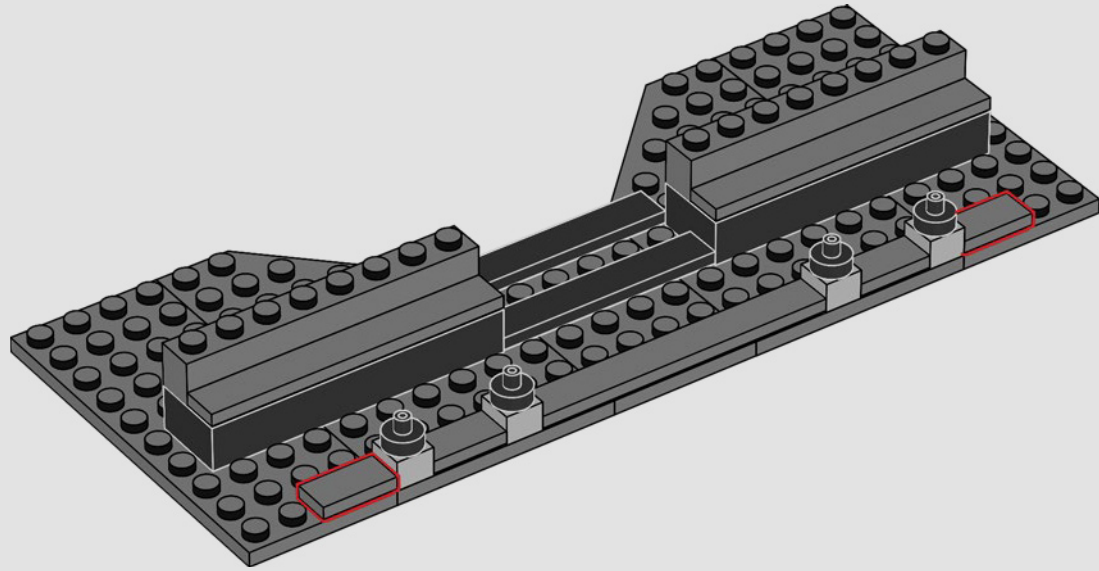

10

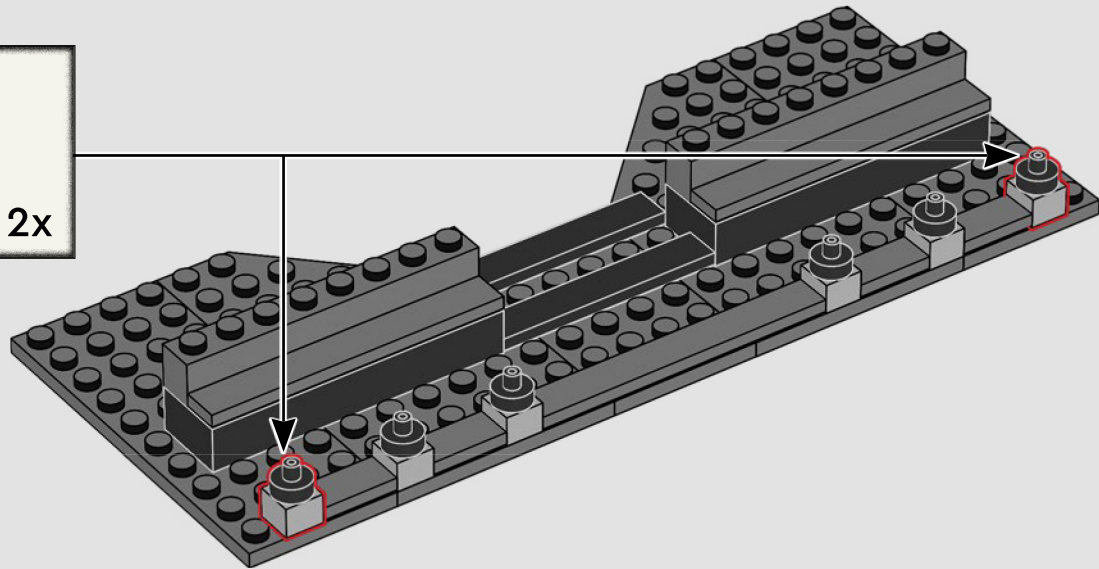
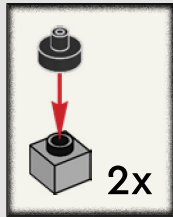

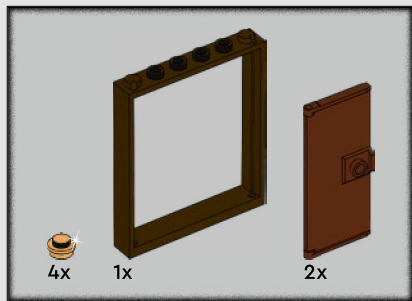

11

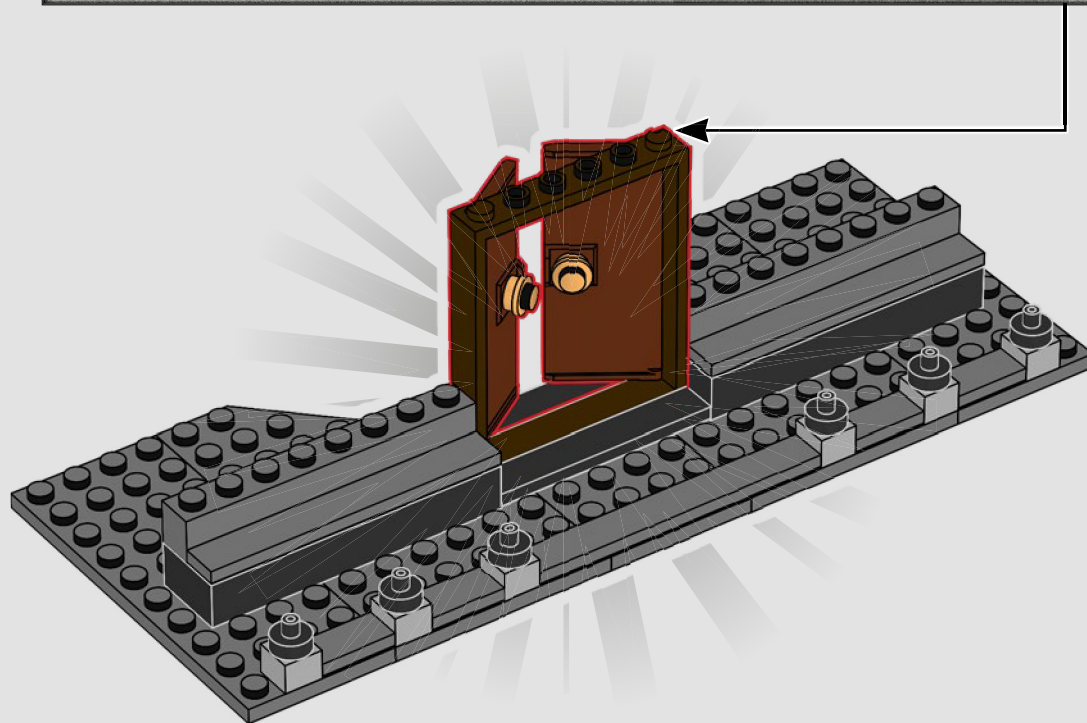
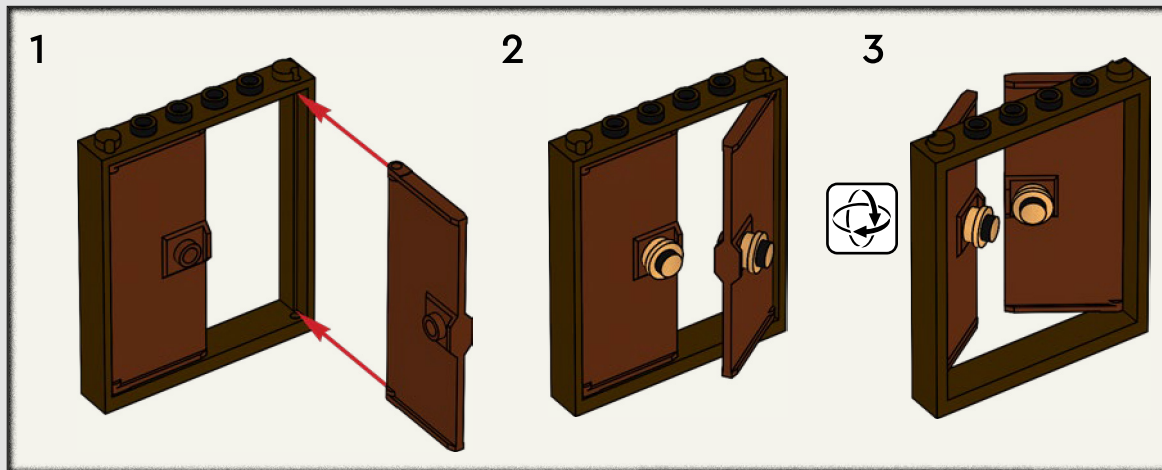

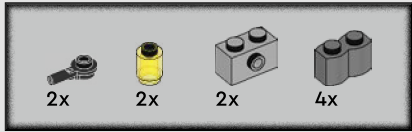
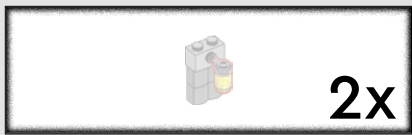

12

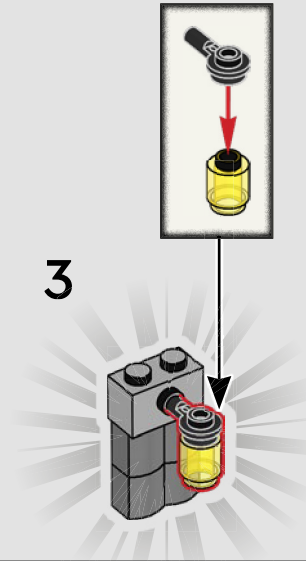
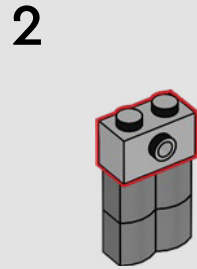
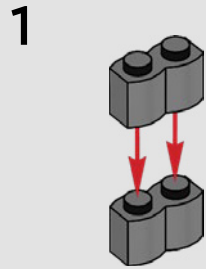

2x

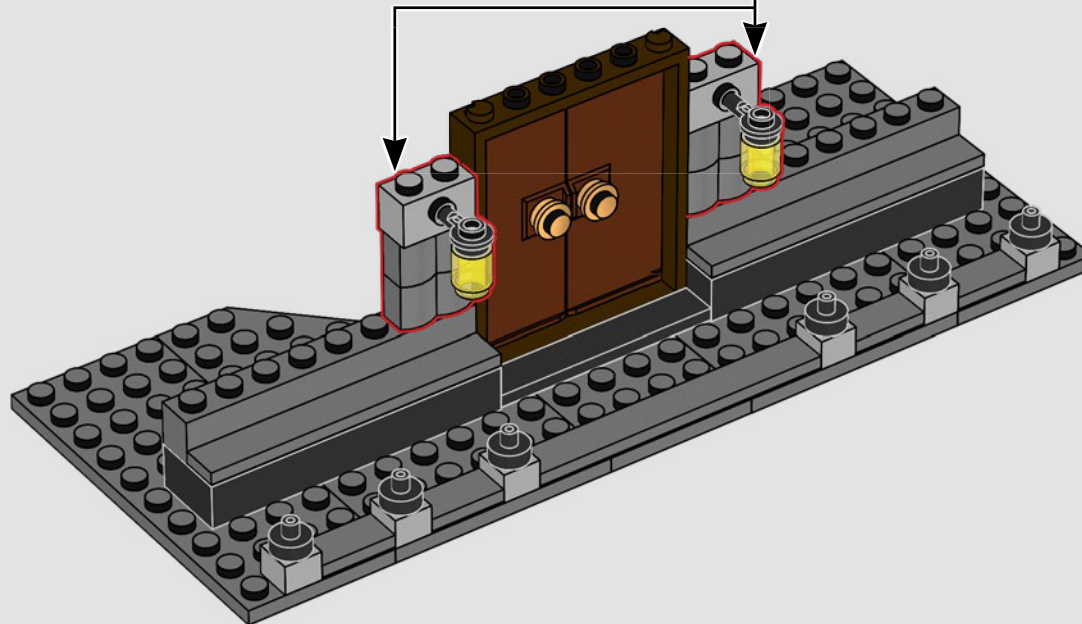

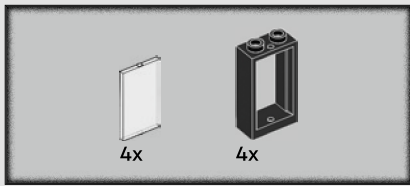

13

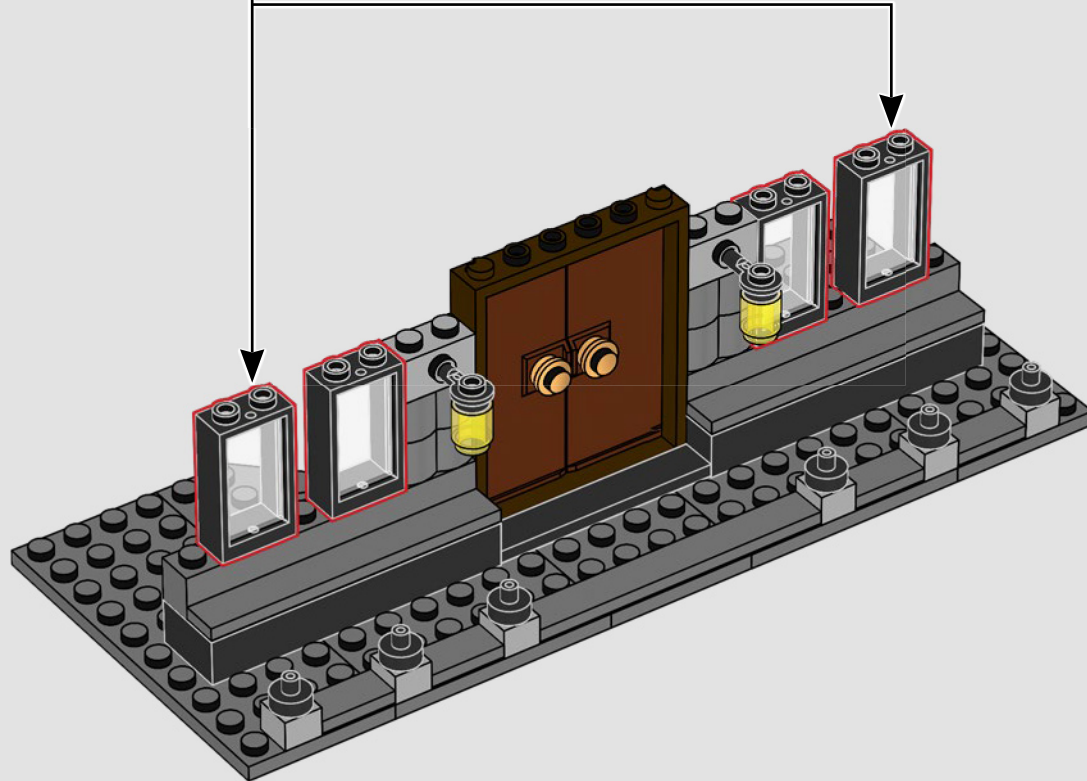
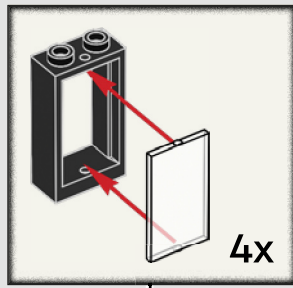



2x

14

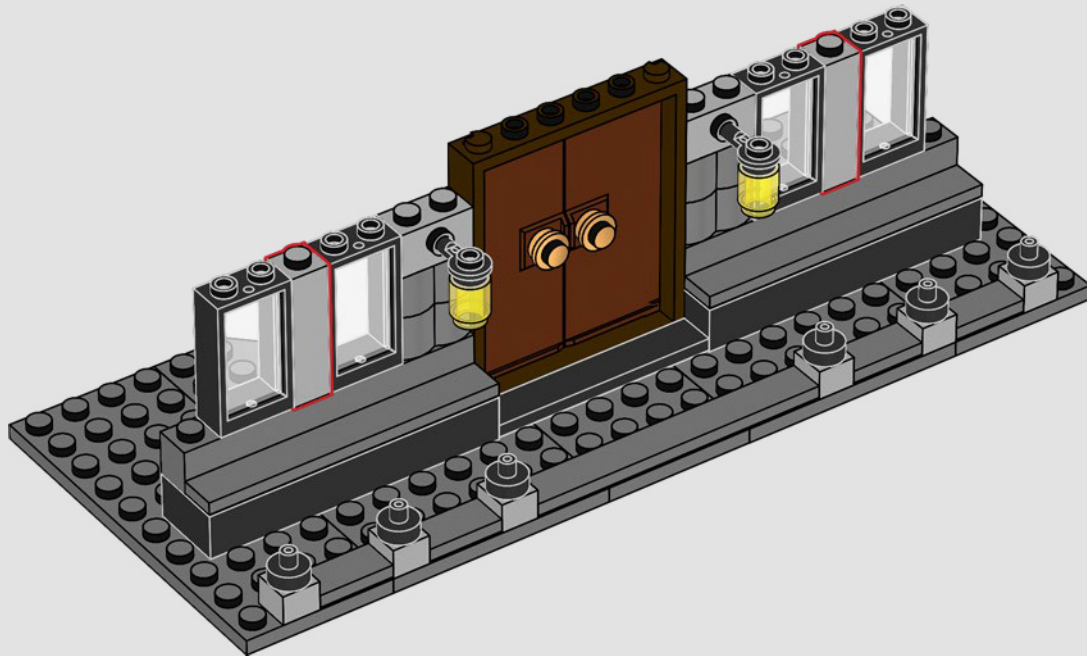

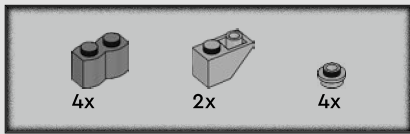

15

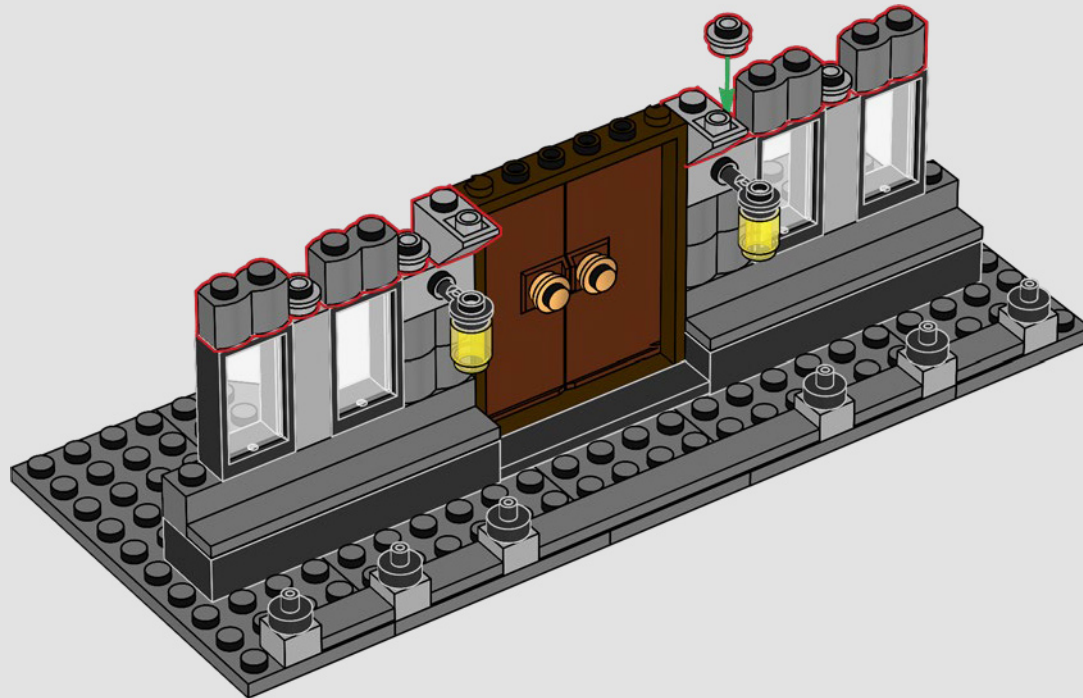

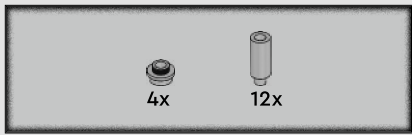

16

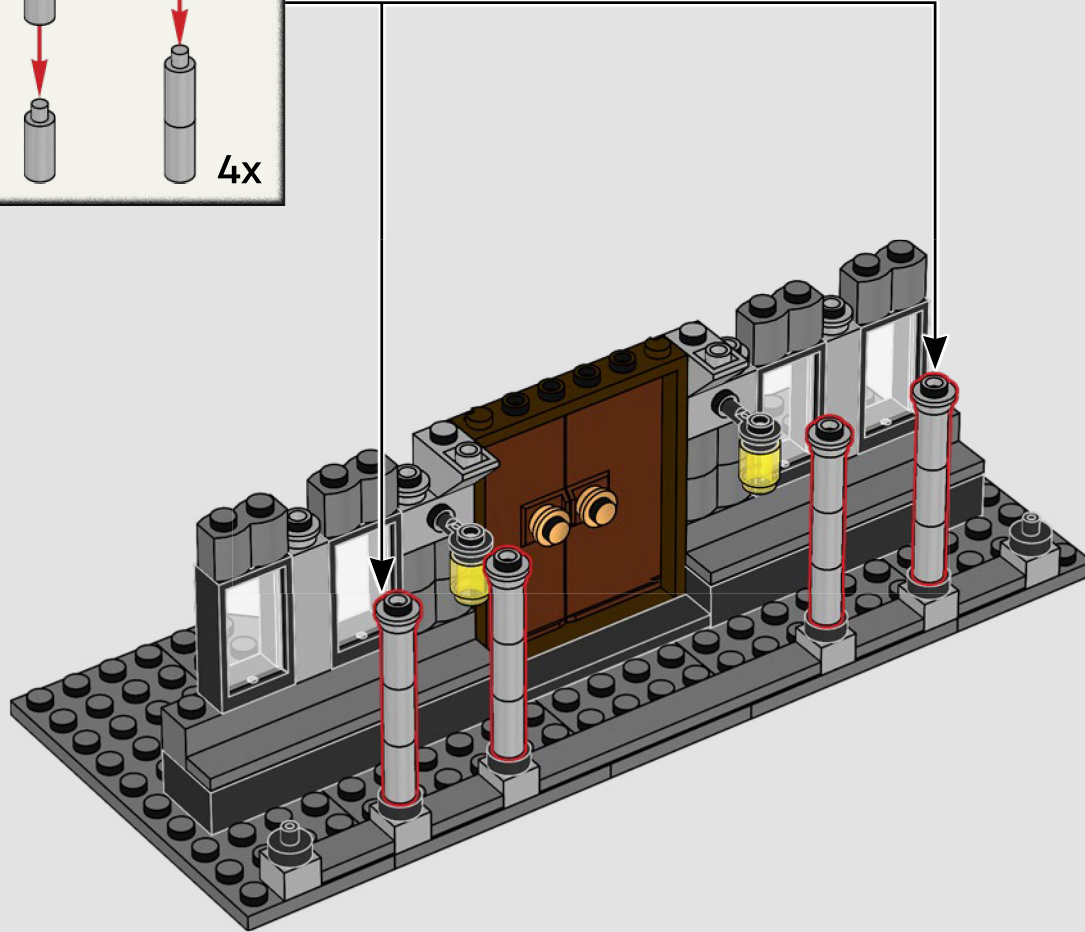
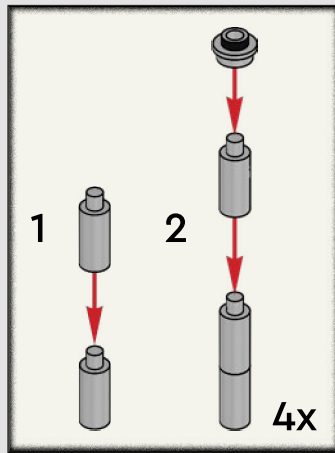

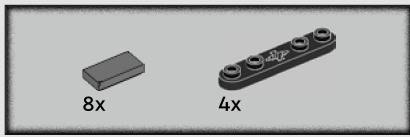

17

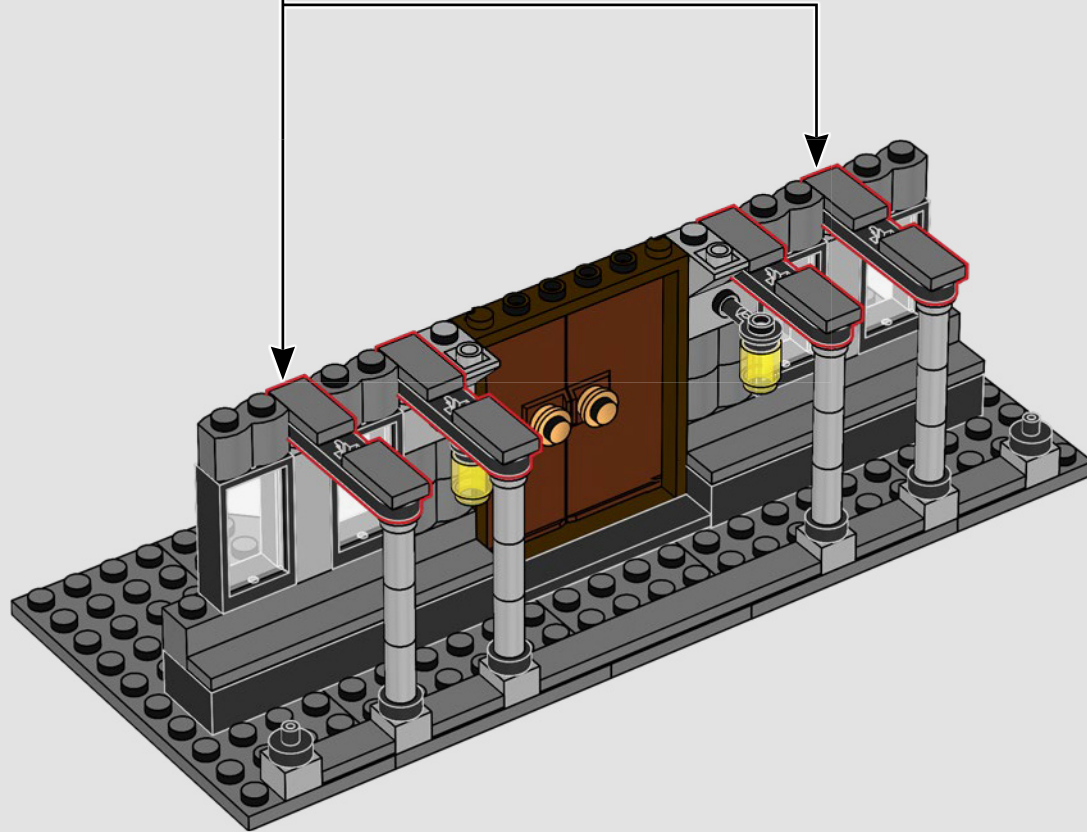
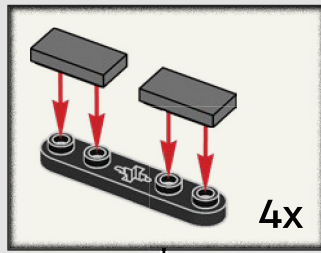

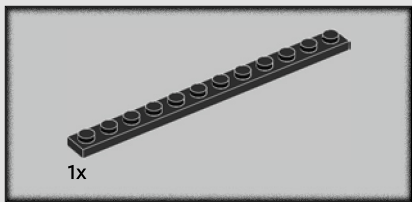

18

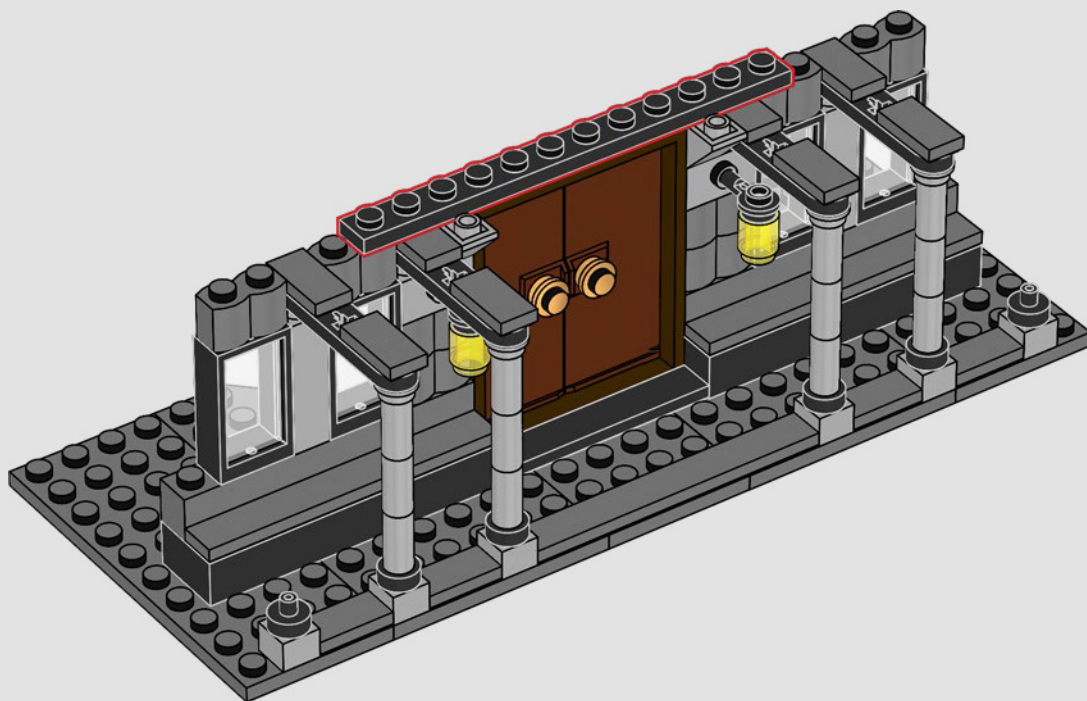

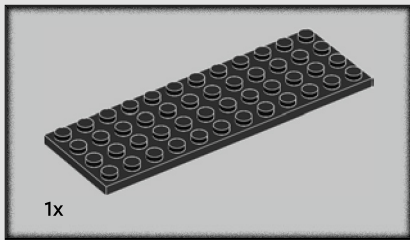

19

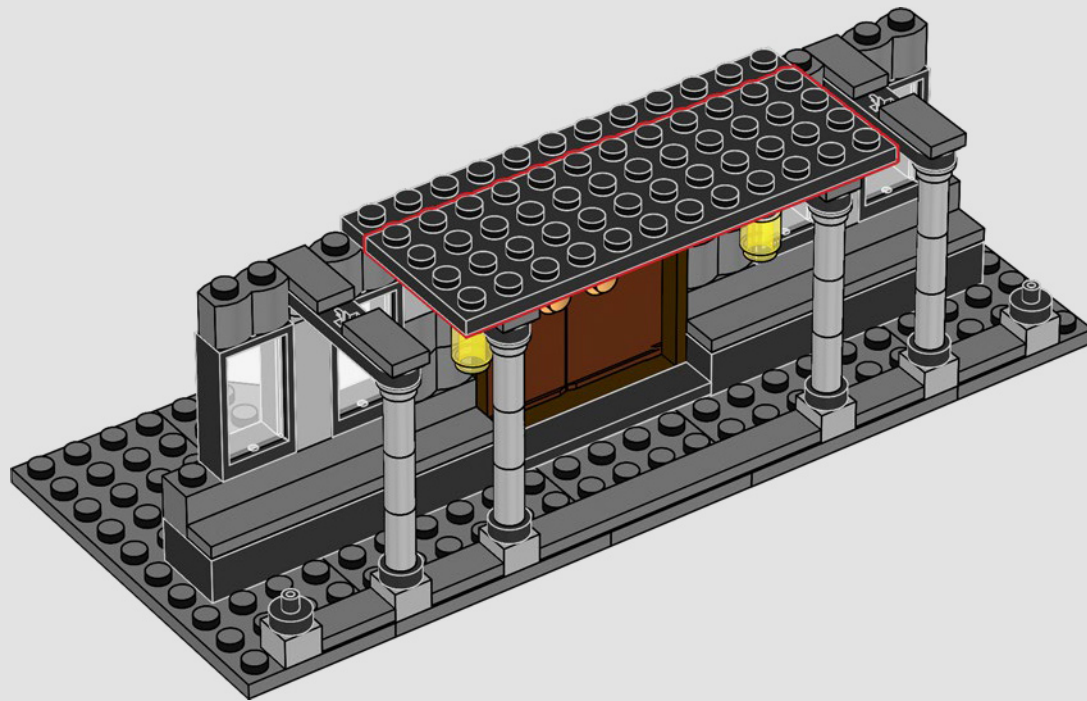

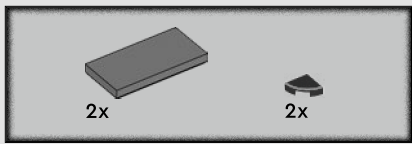

20

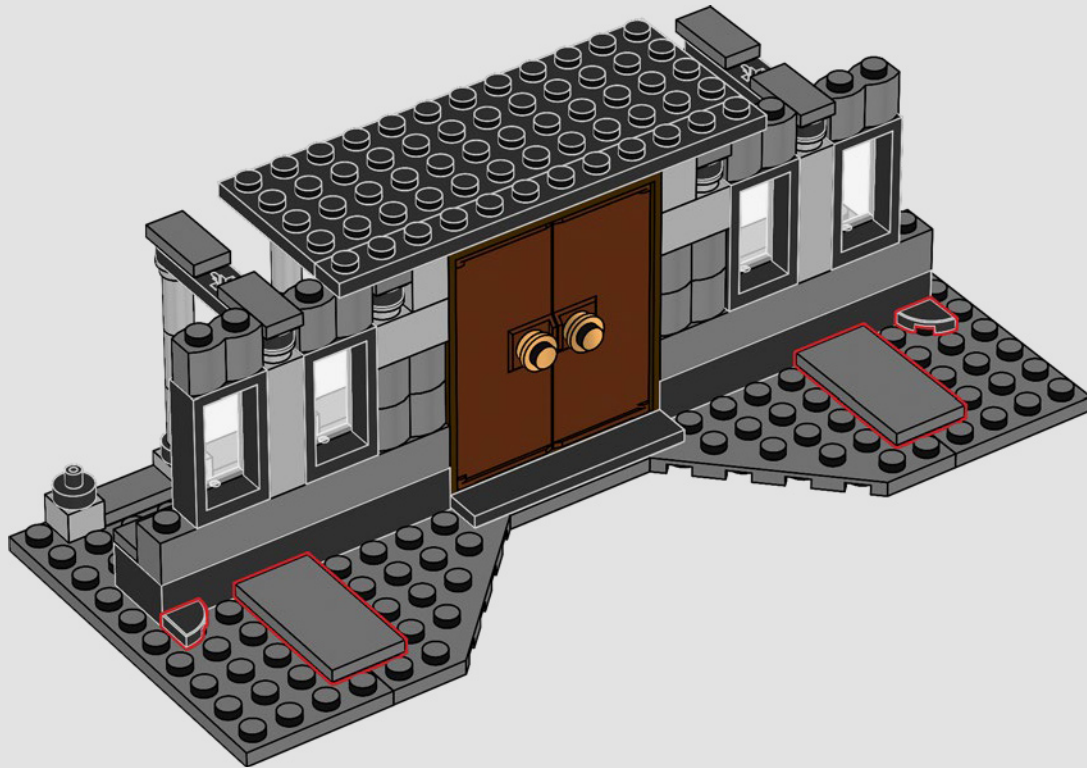

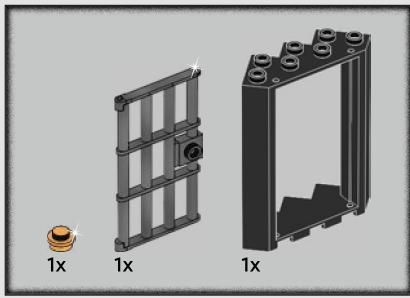

21

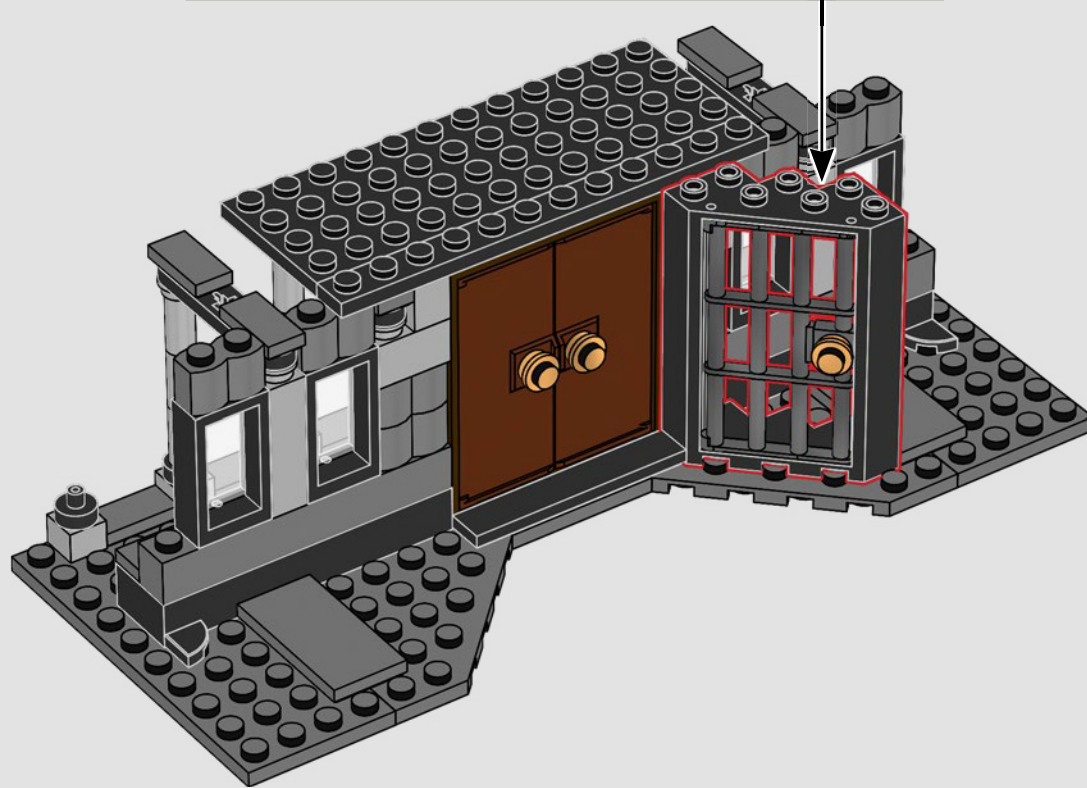
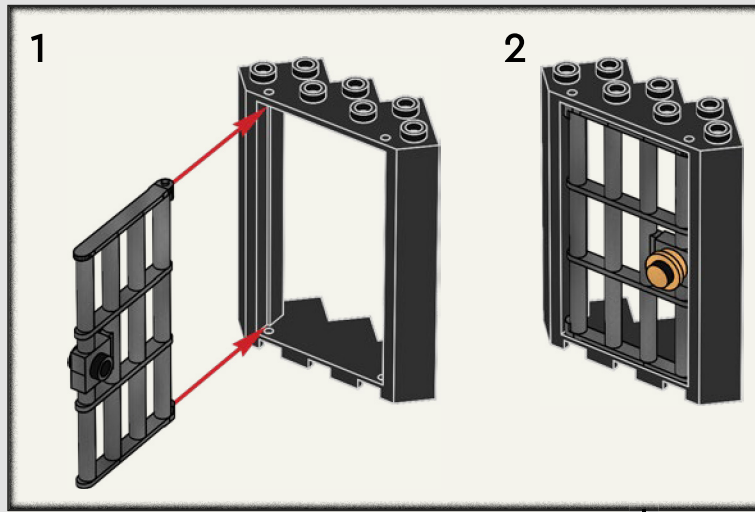

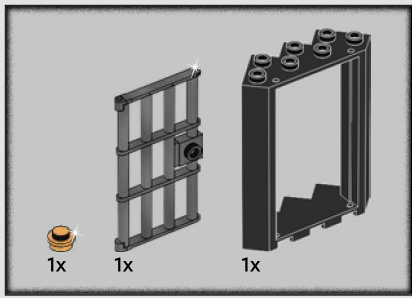

22

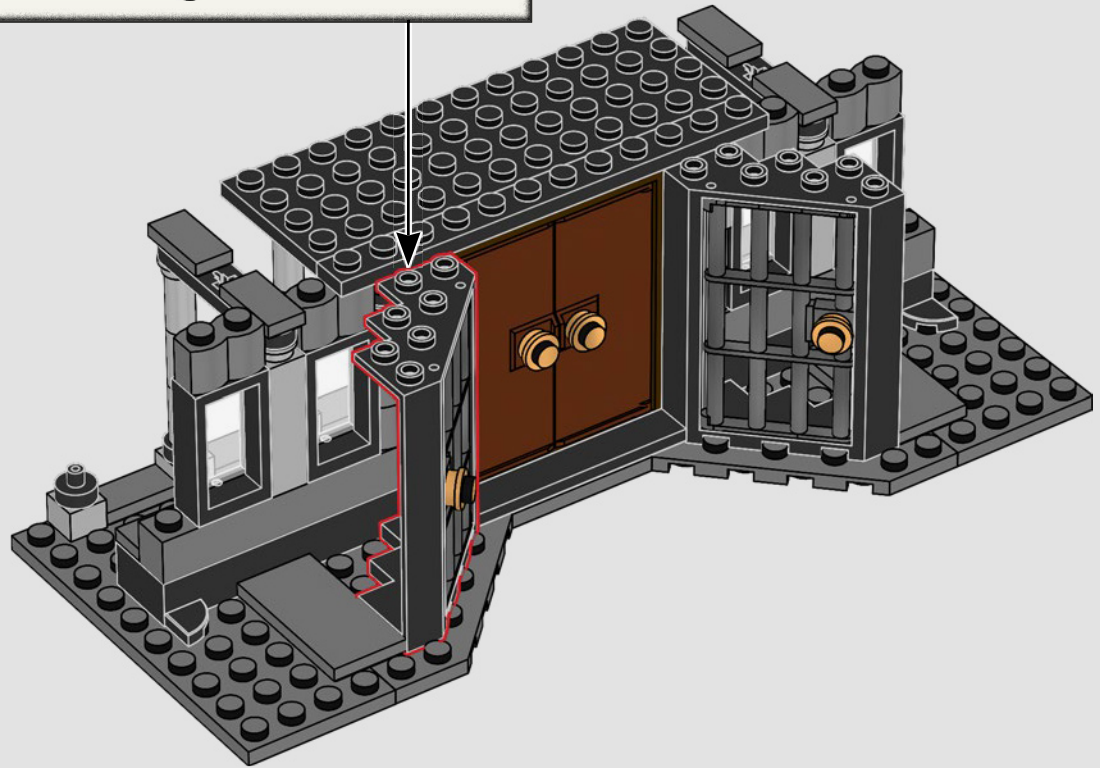
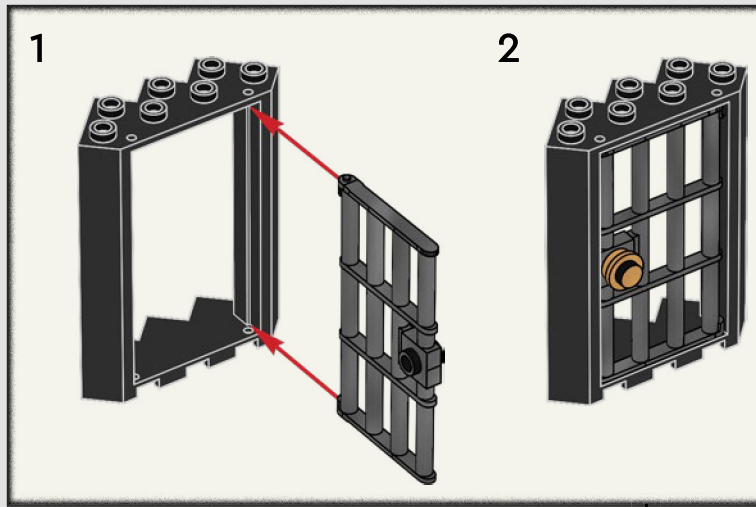

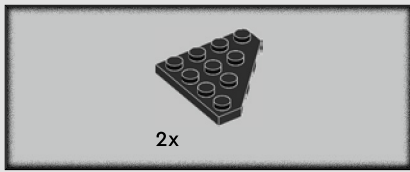

23

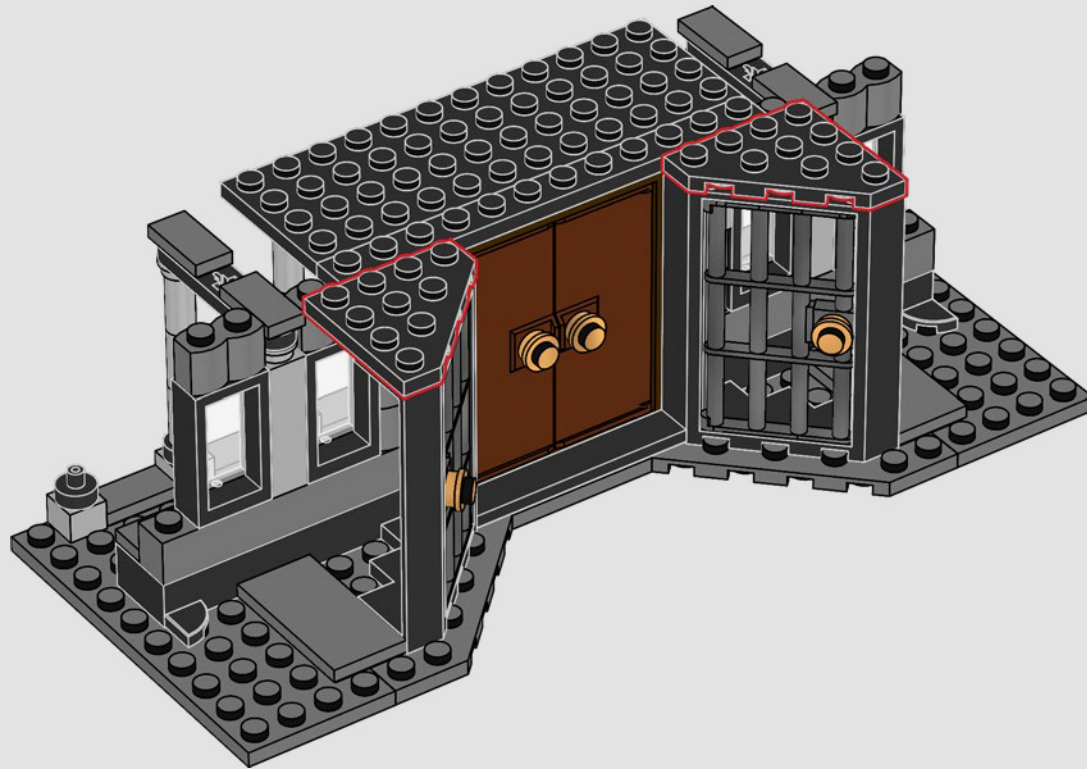



2x

24

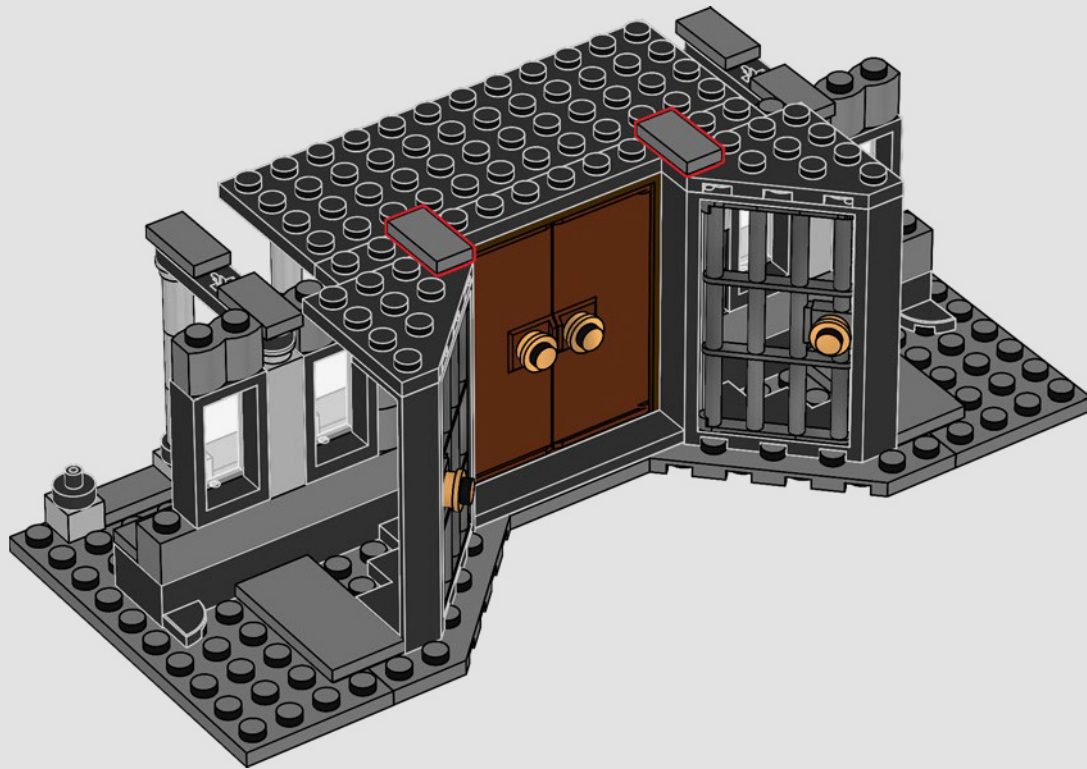

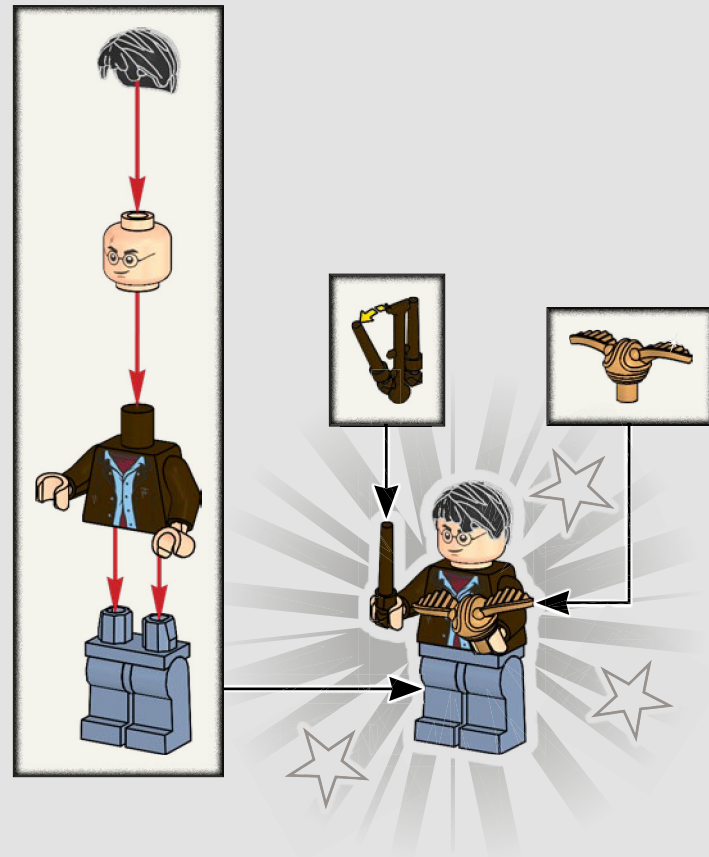

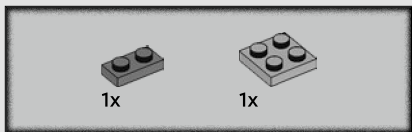

25

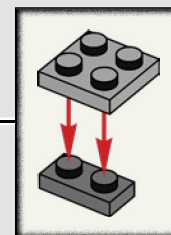
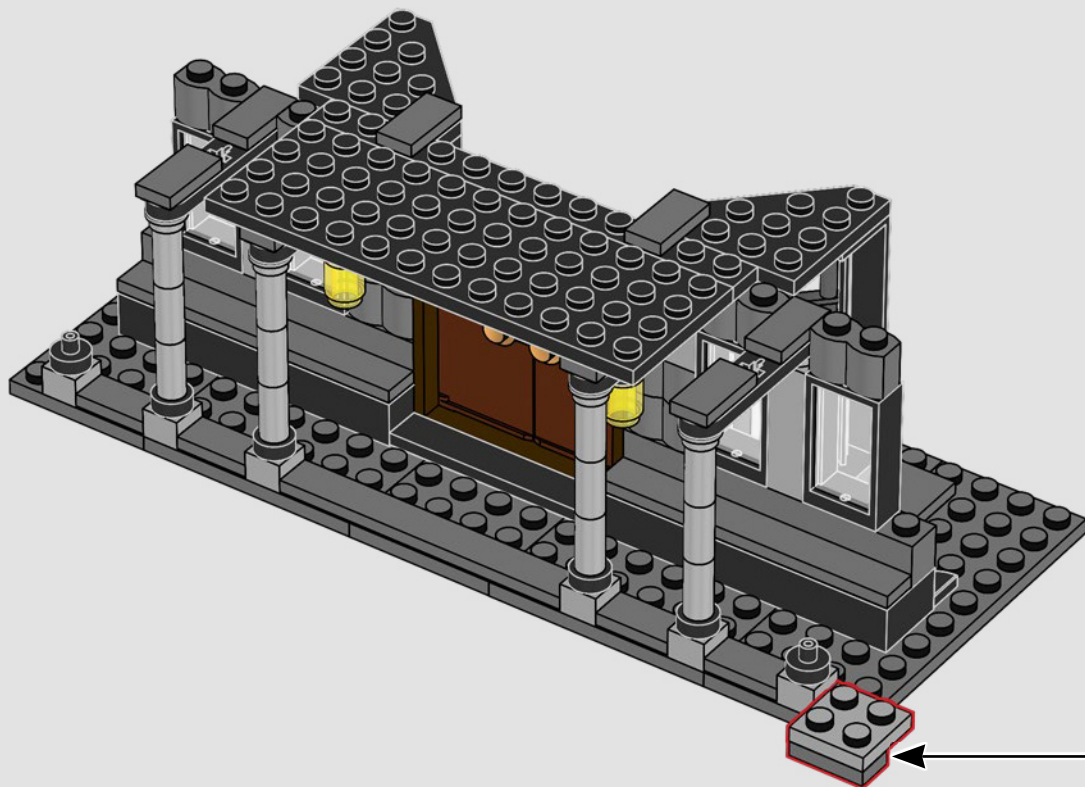

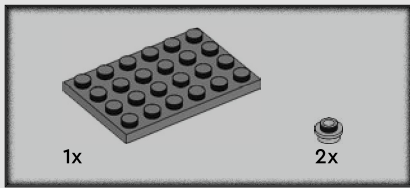

26

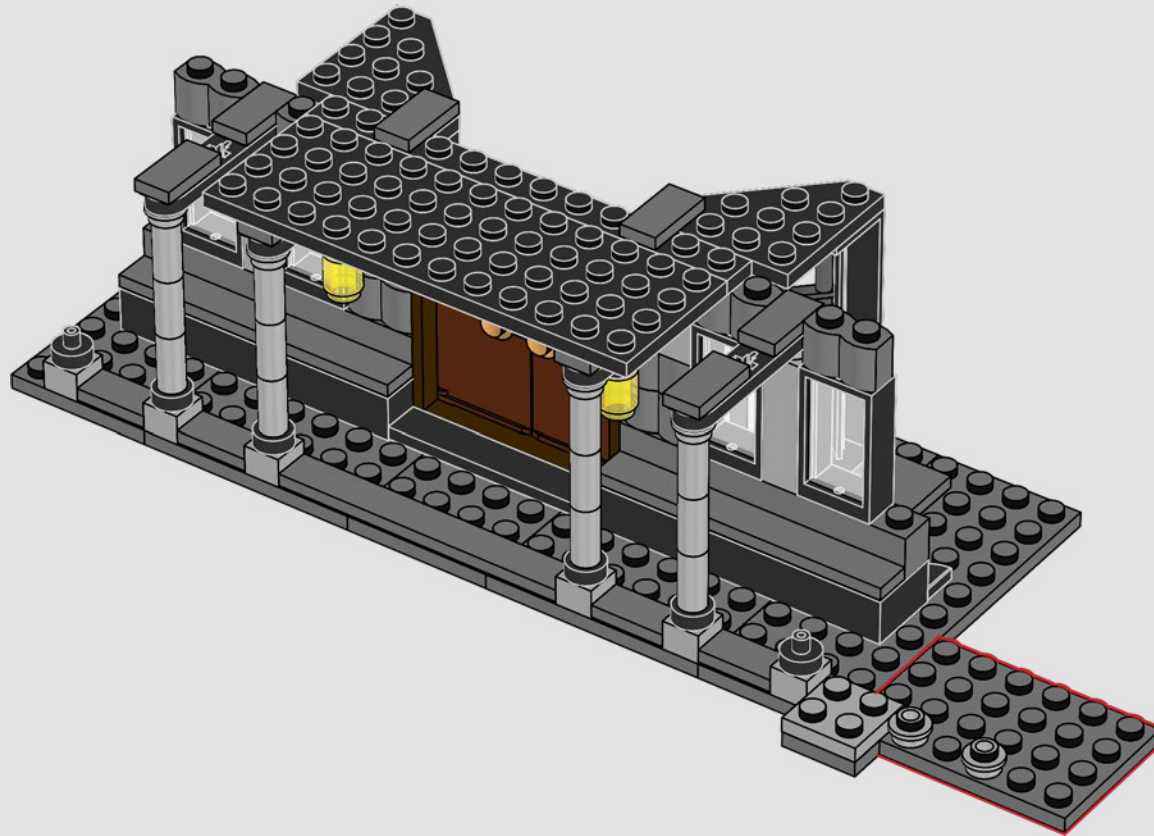

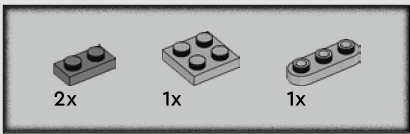

27

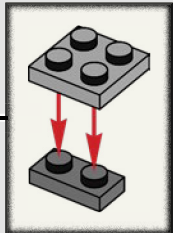
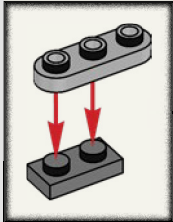
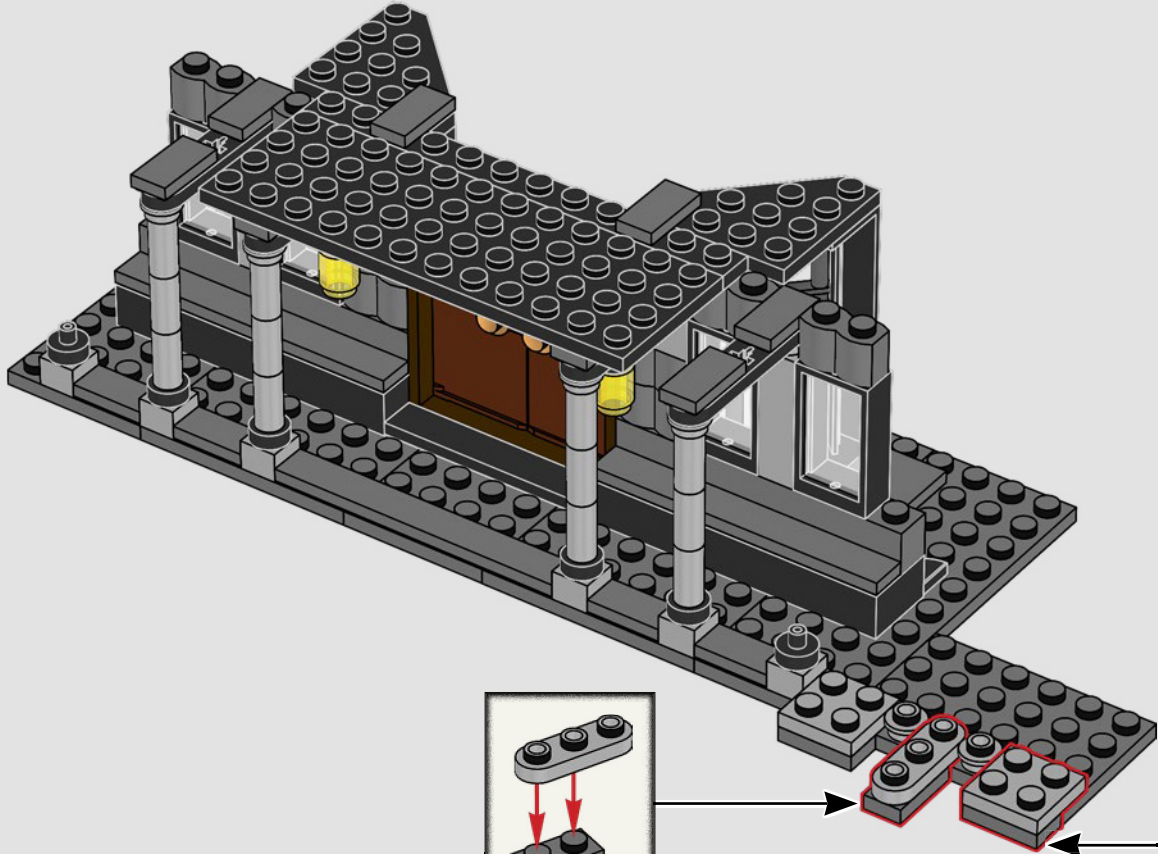

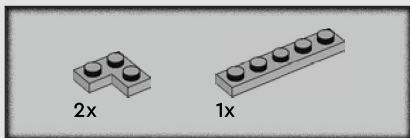

28

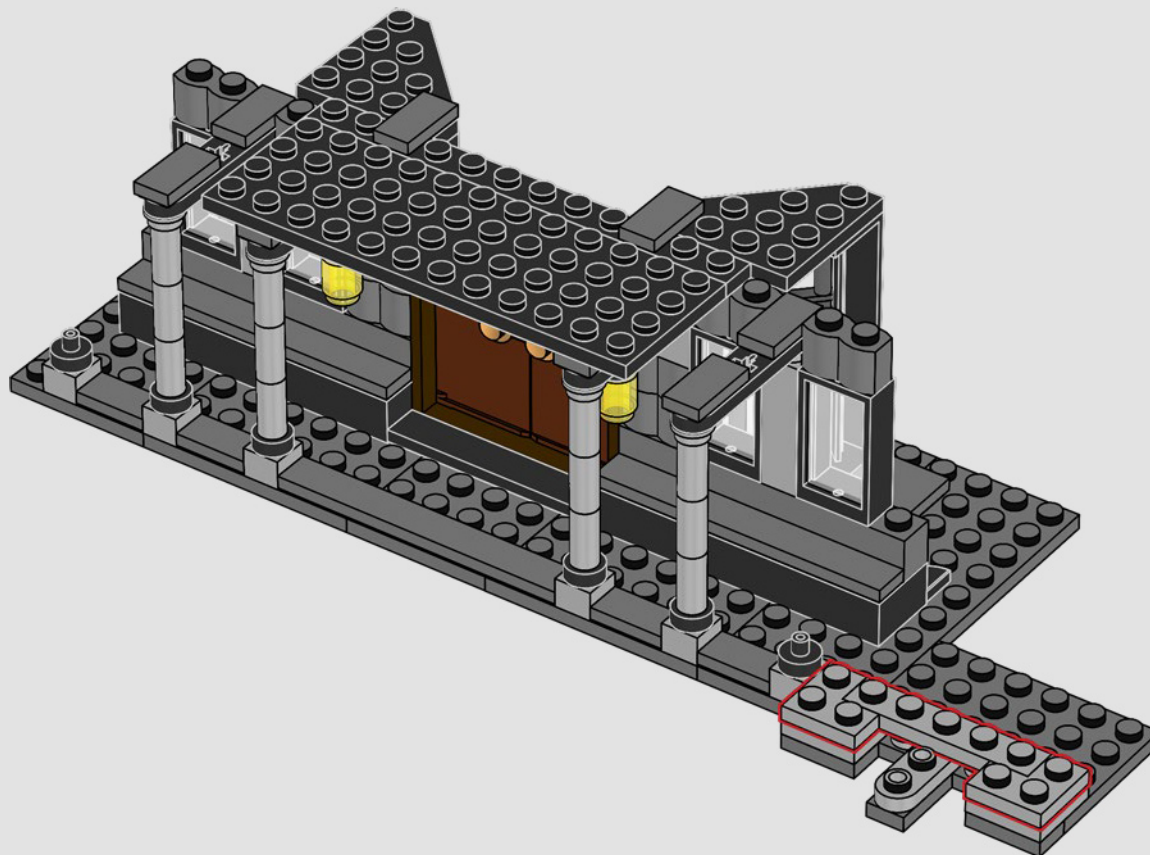

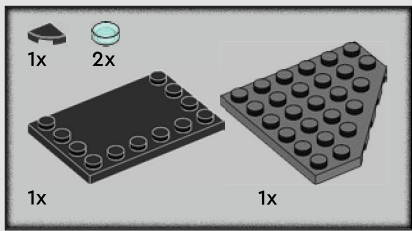

29

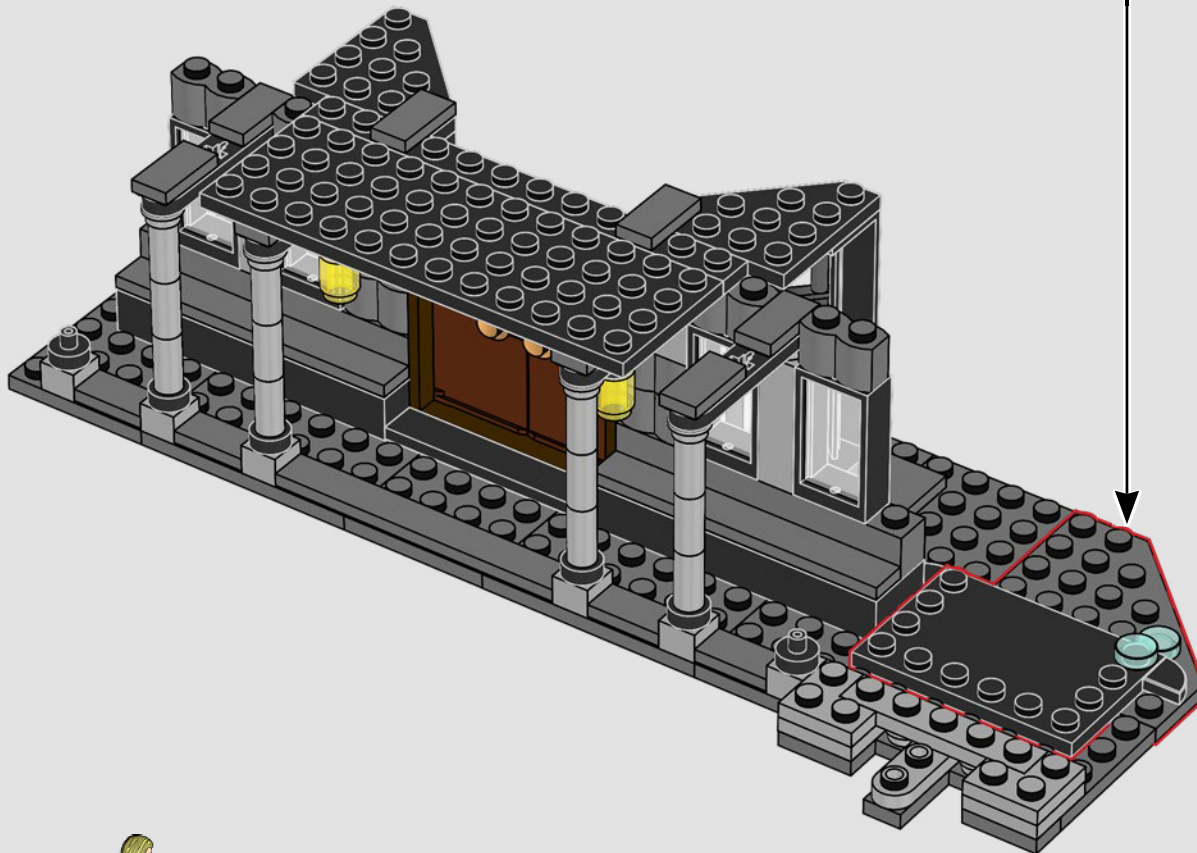
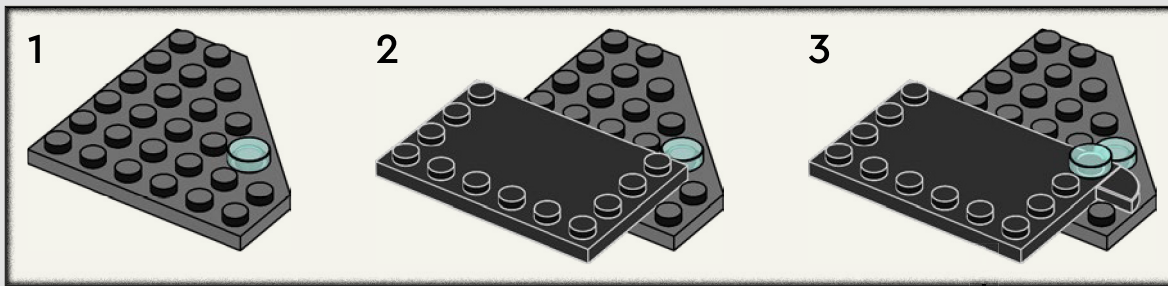

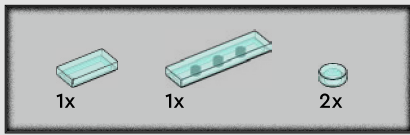

30

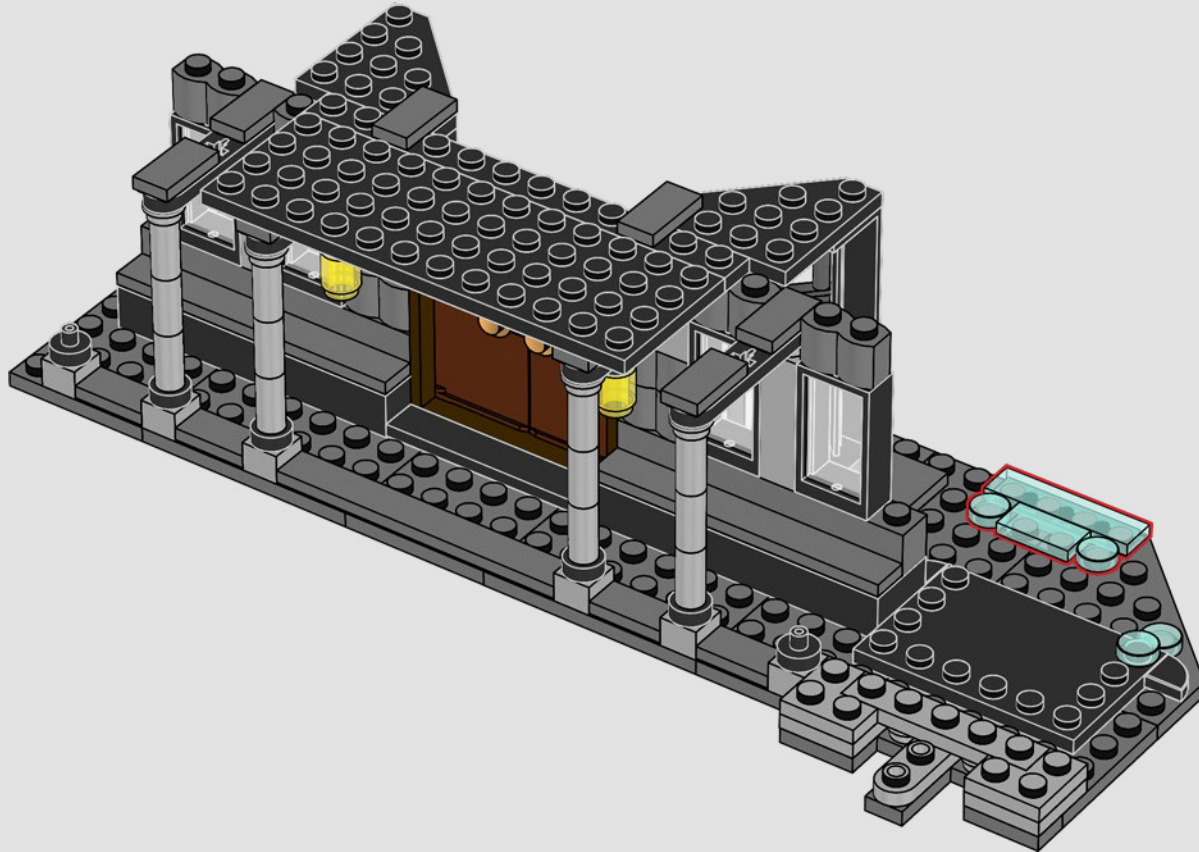

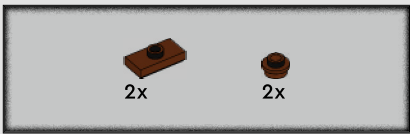

31

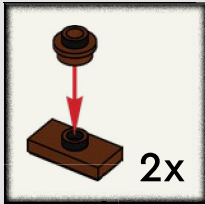
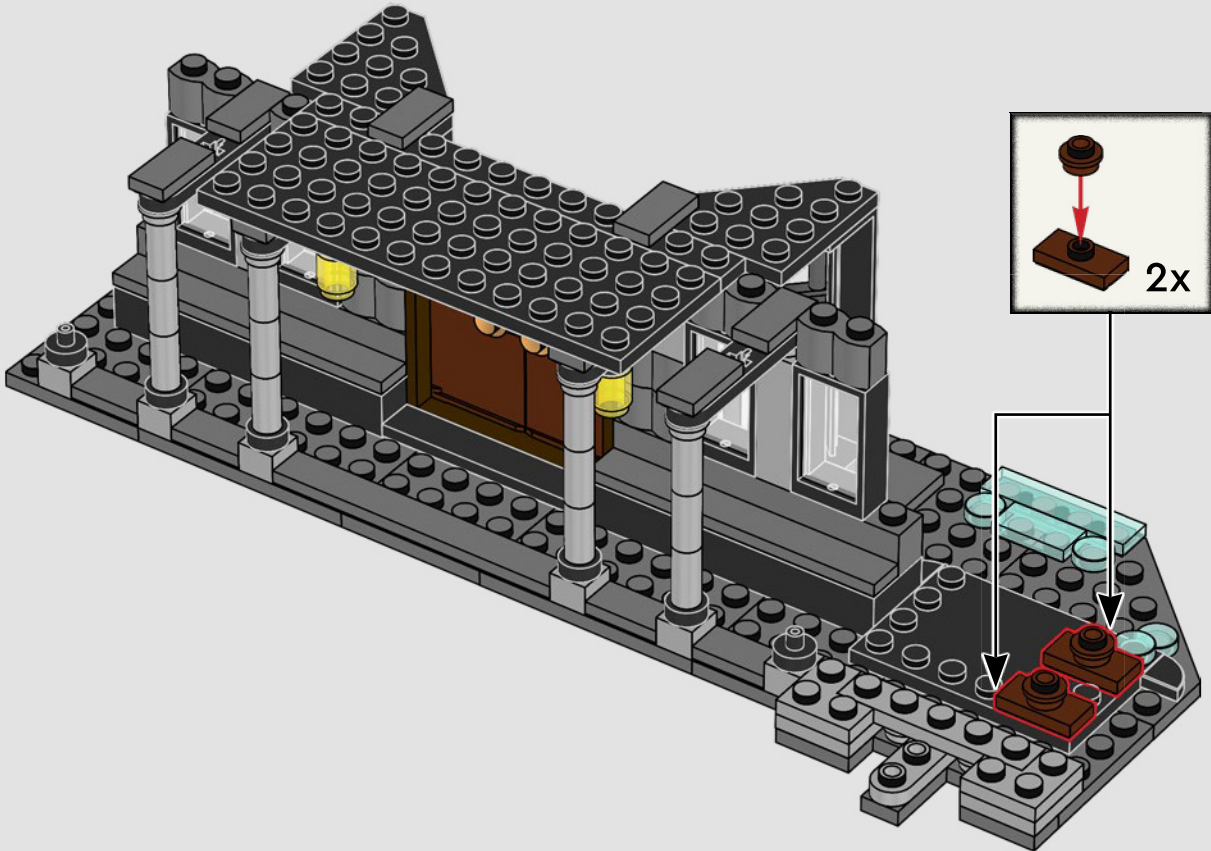

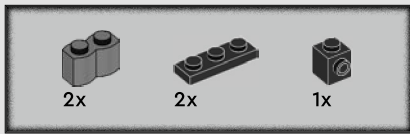

32

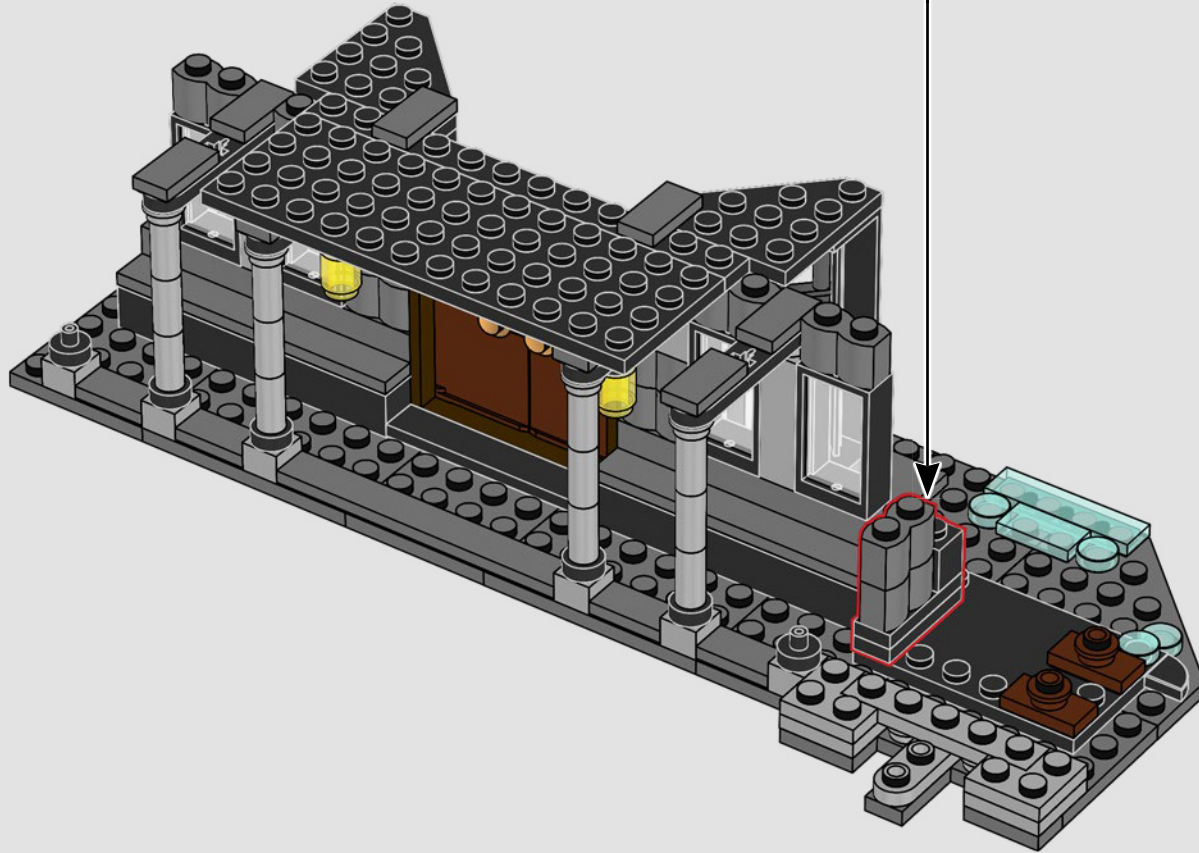
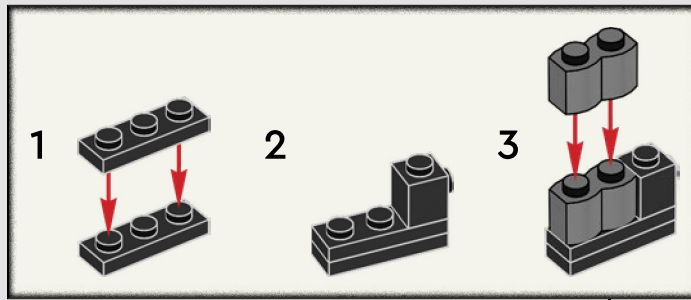



33

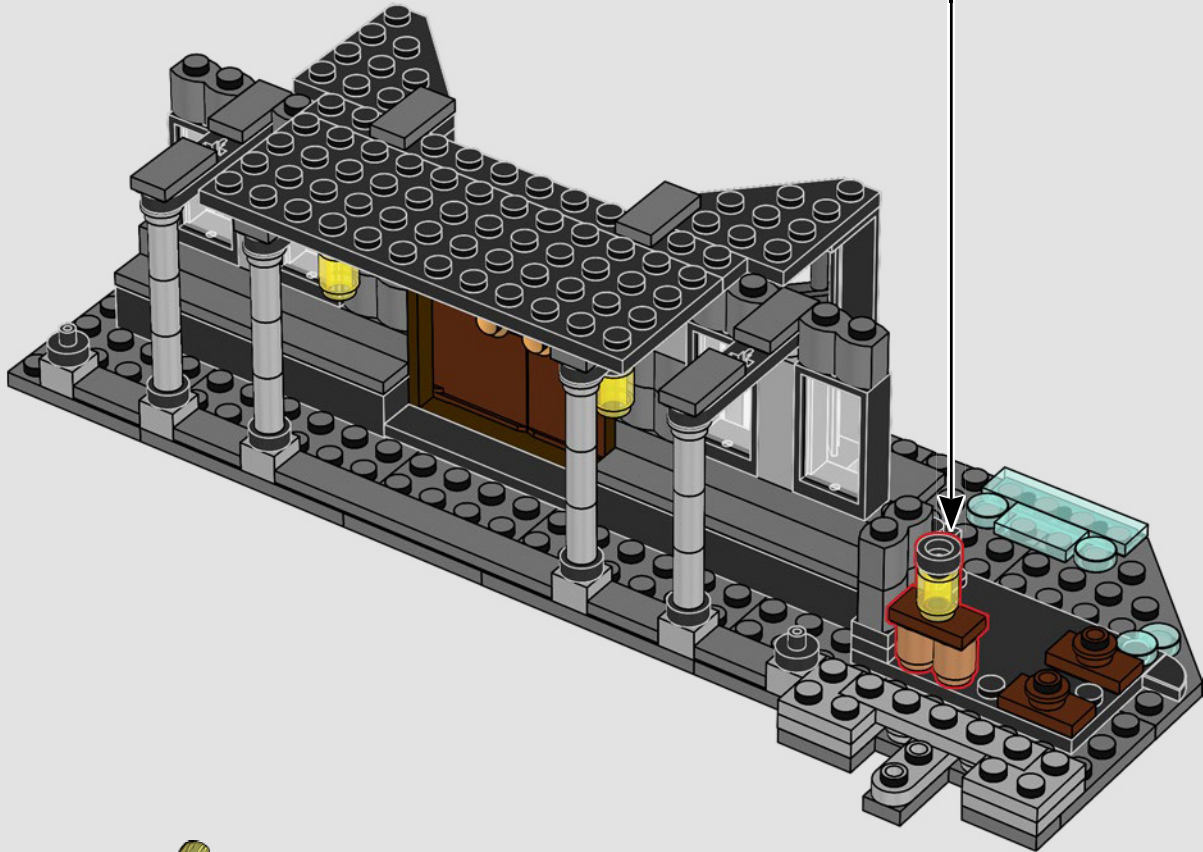
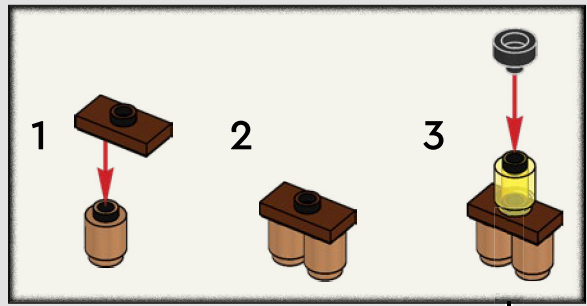



34

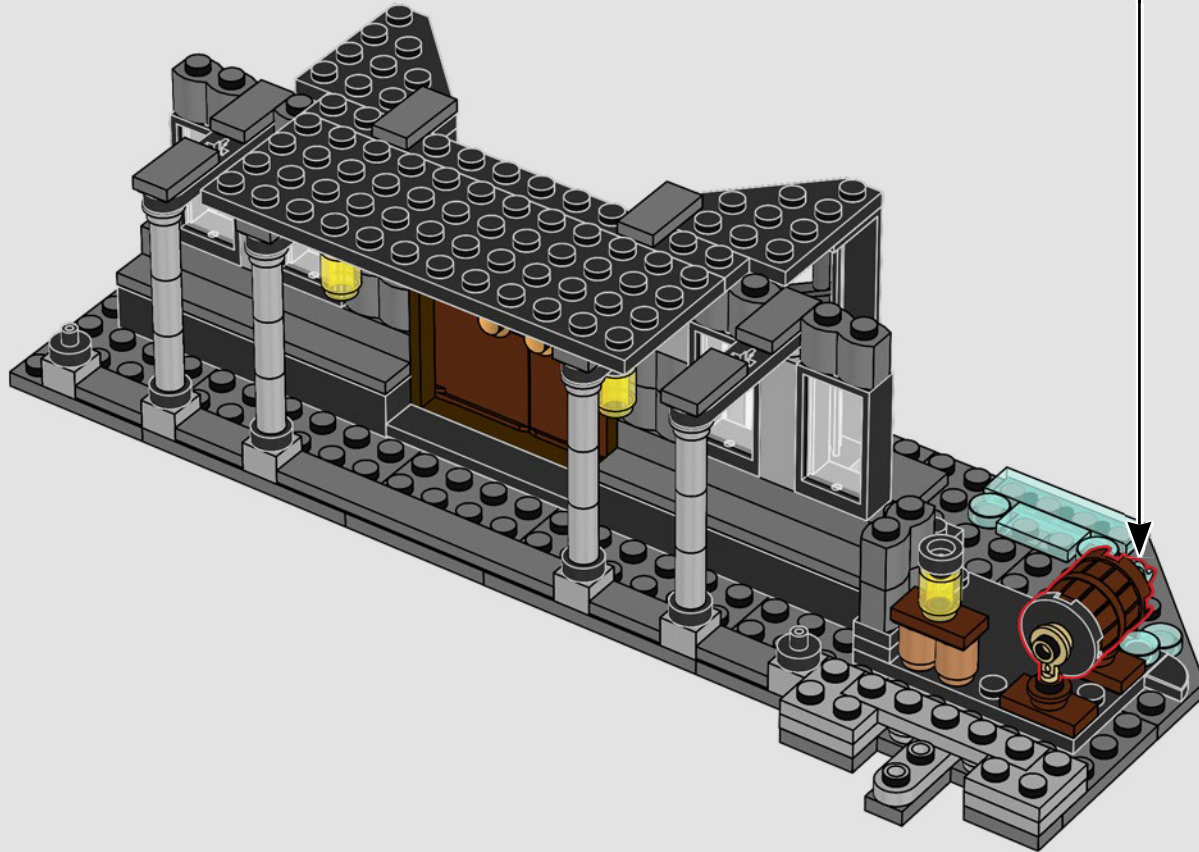
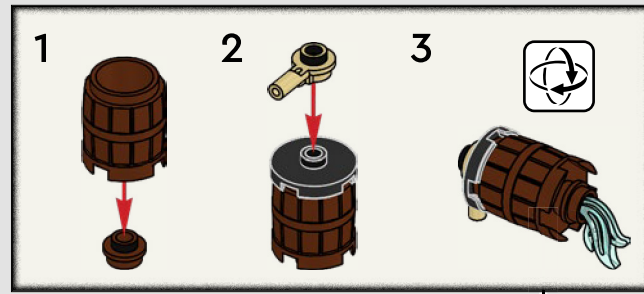

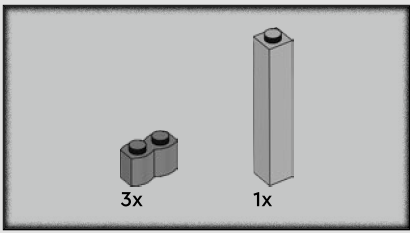

35

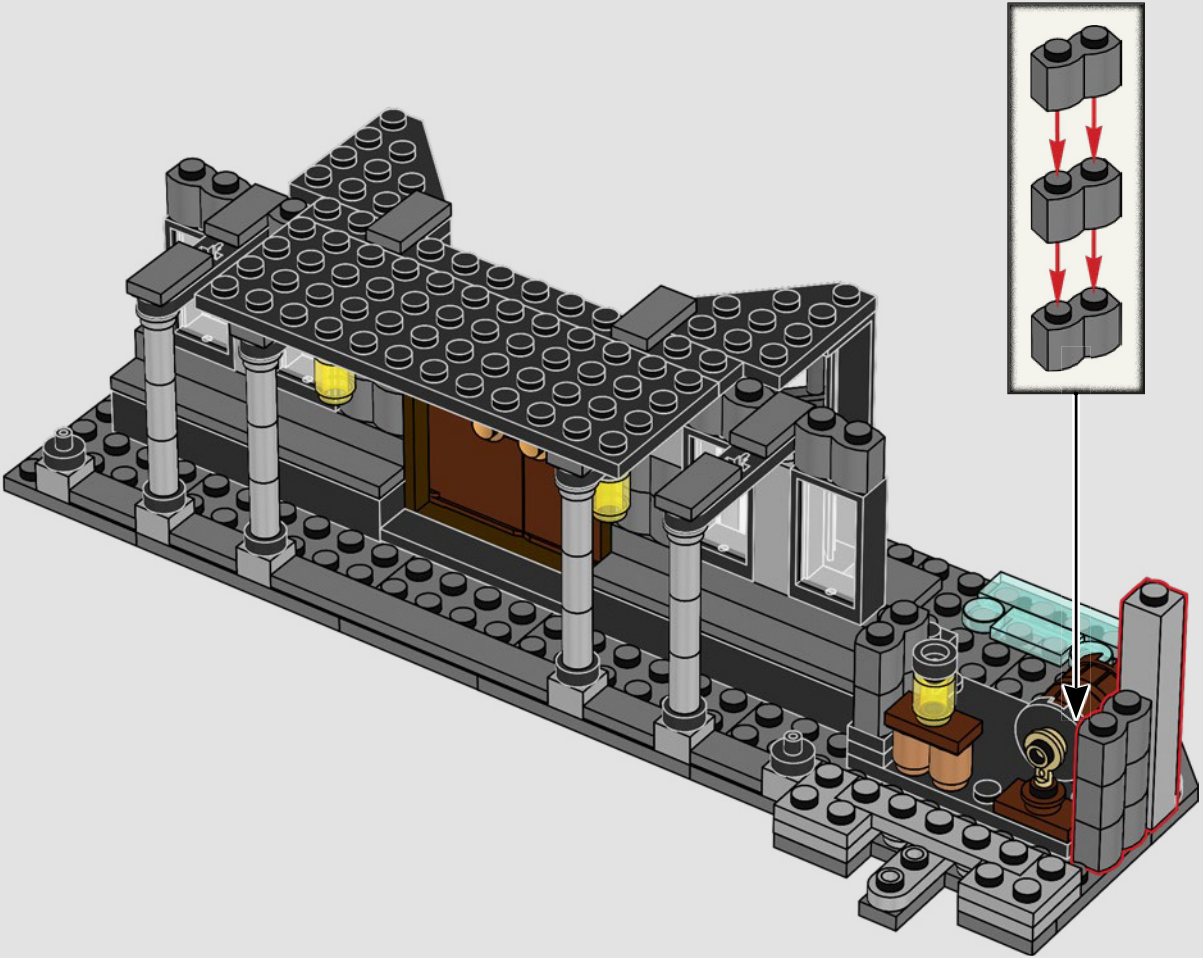

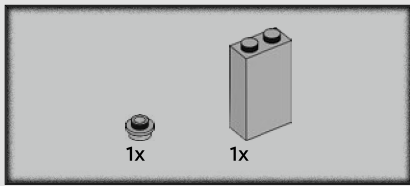

36

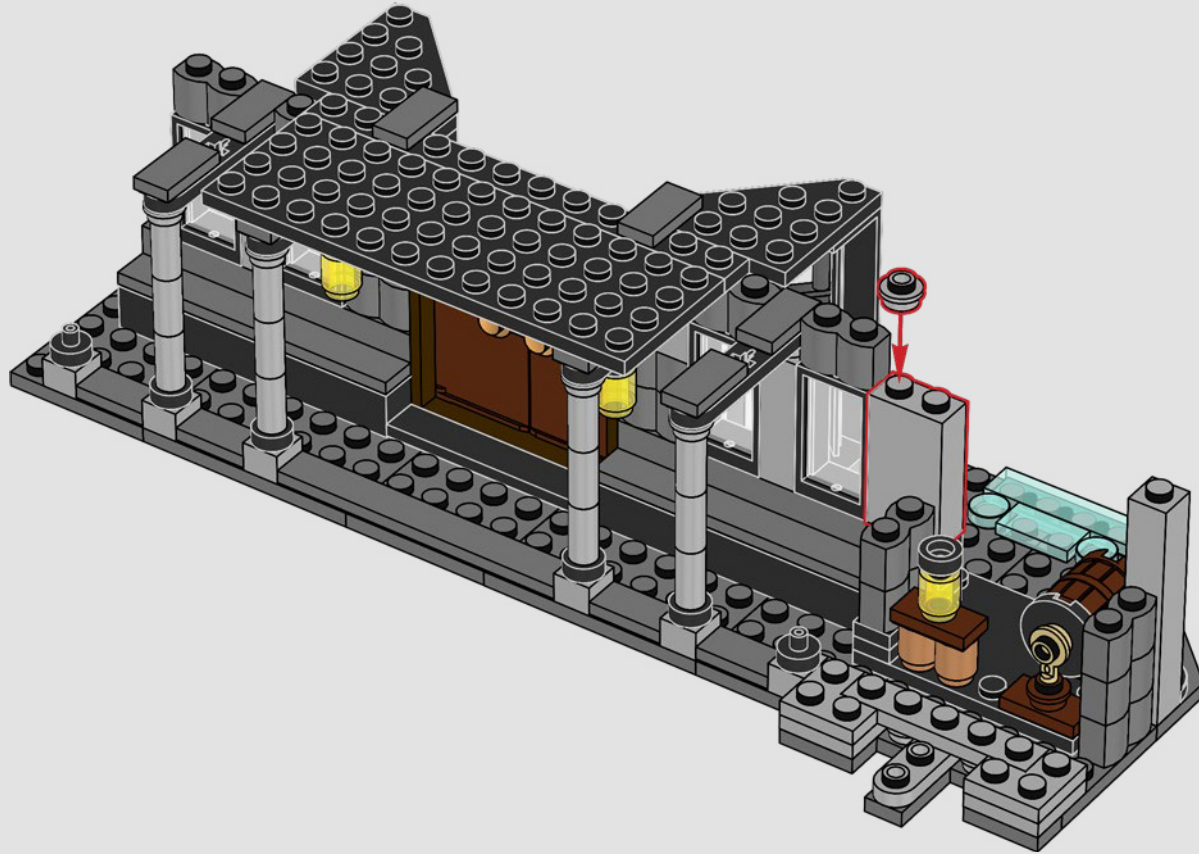

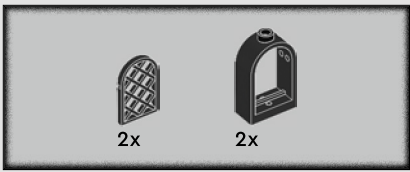

37

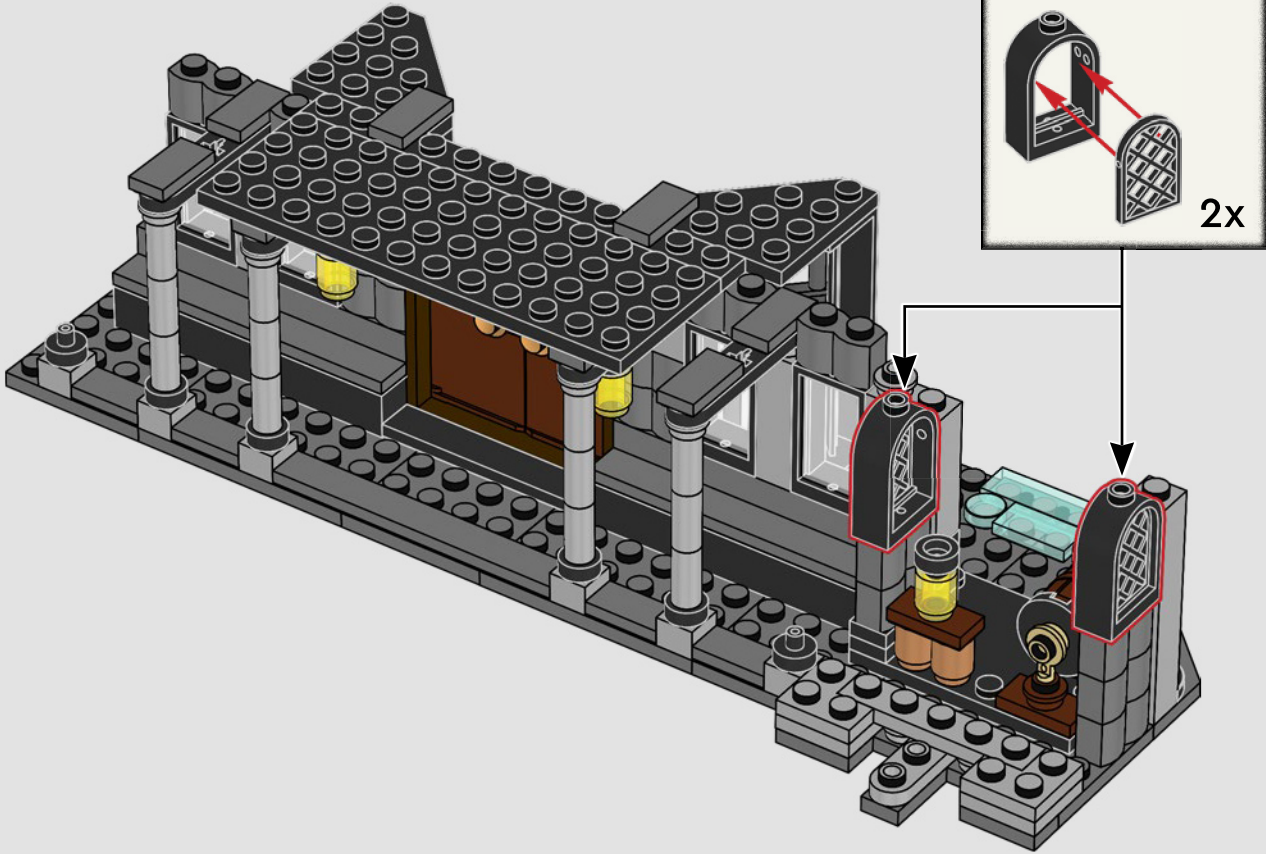

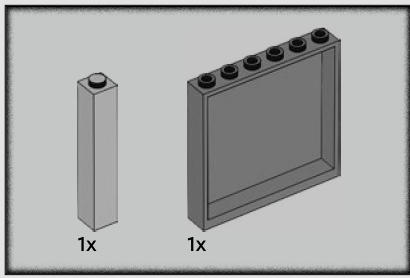

38

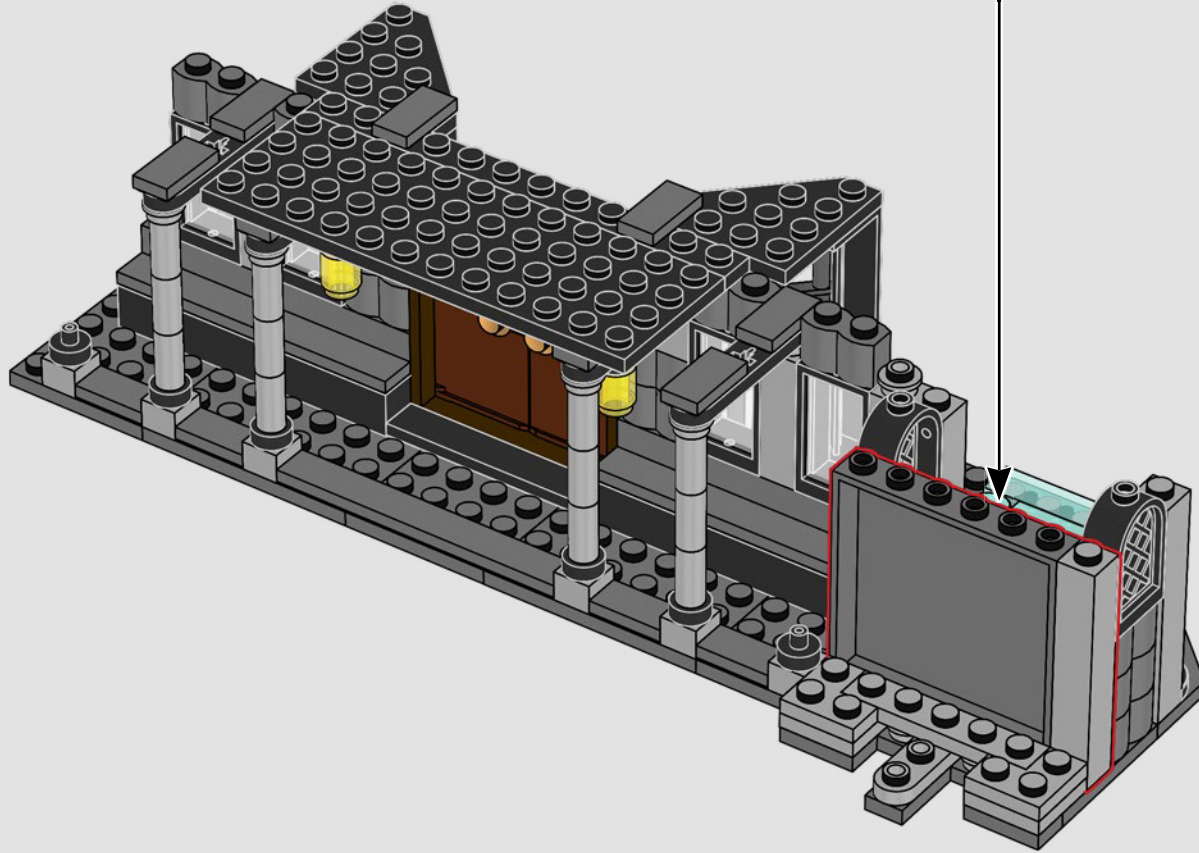
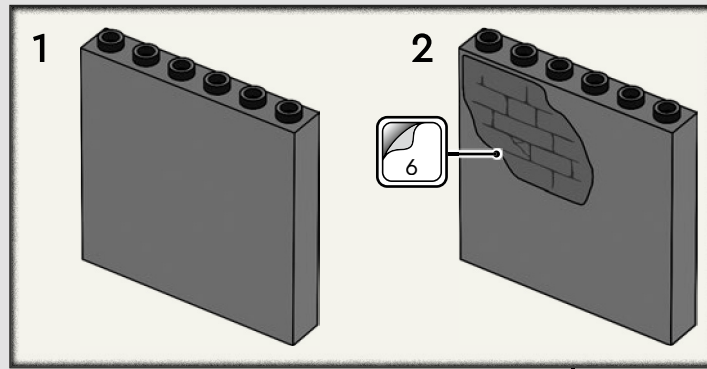

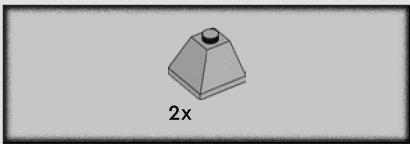

39

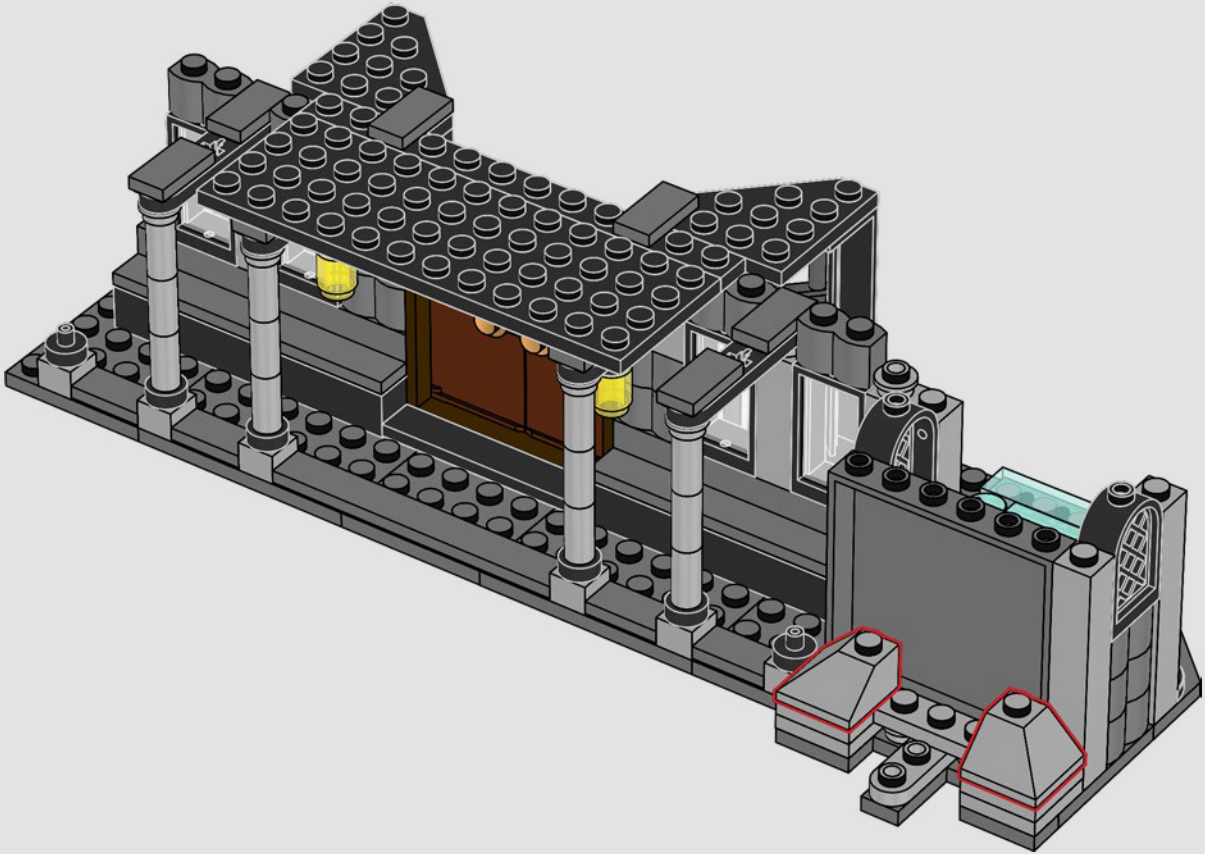

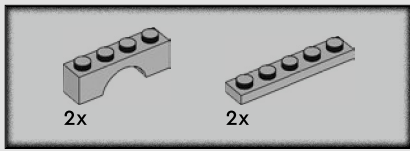

40

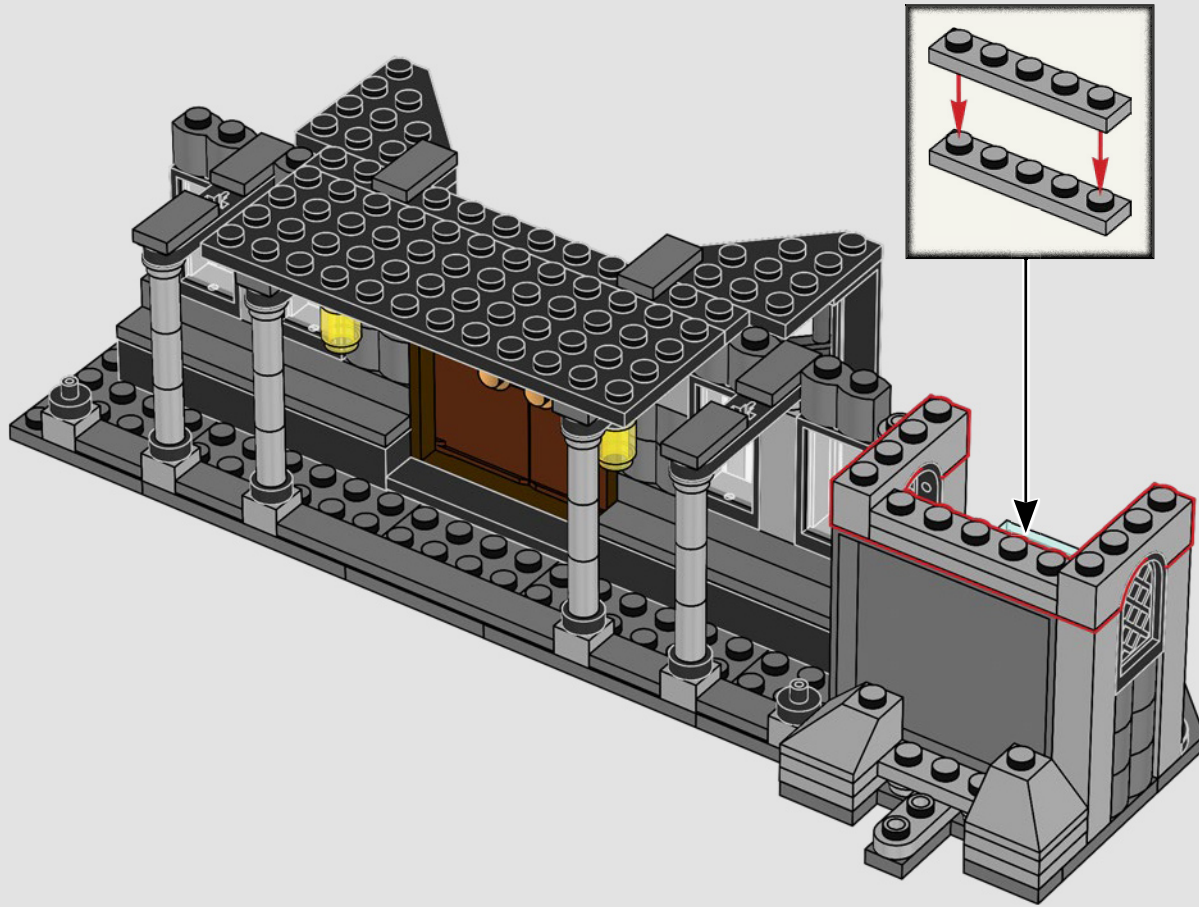

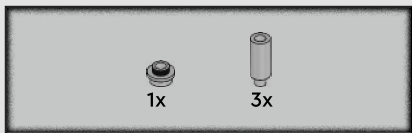

41

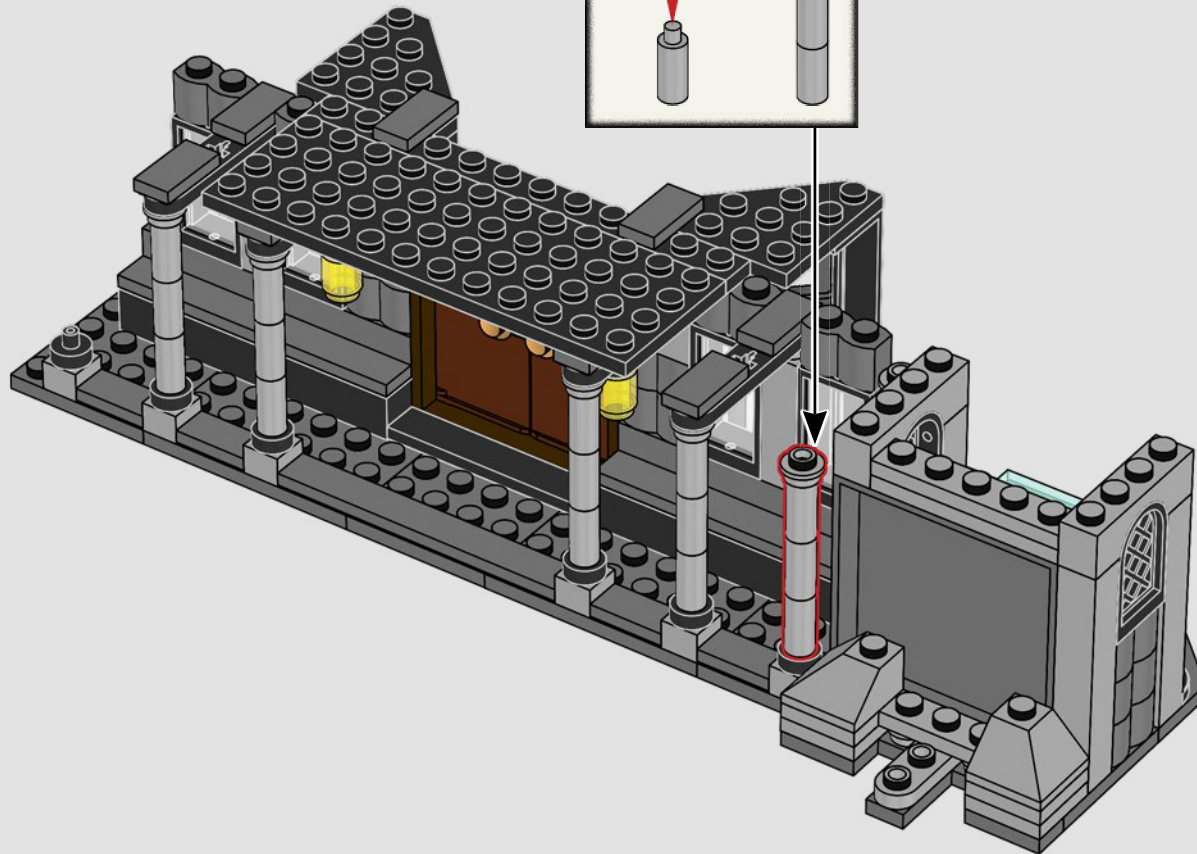
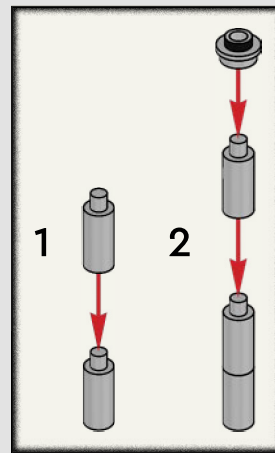

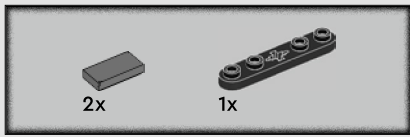

42

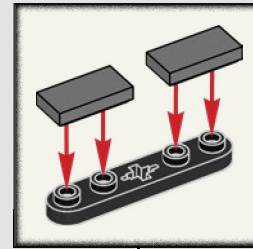
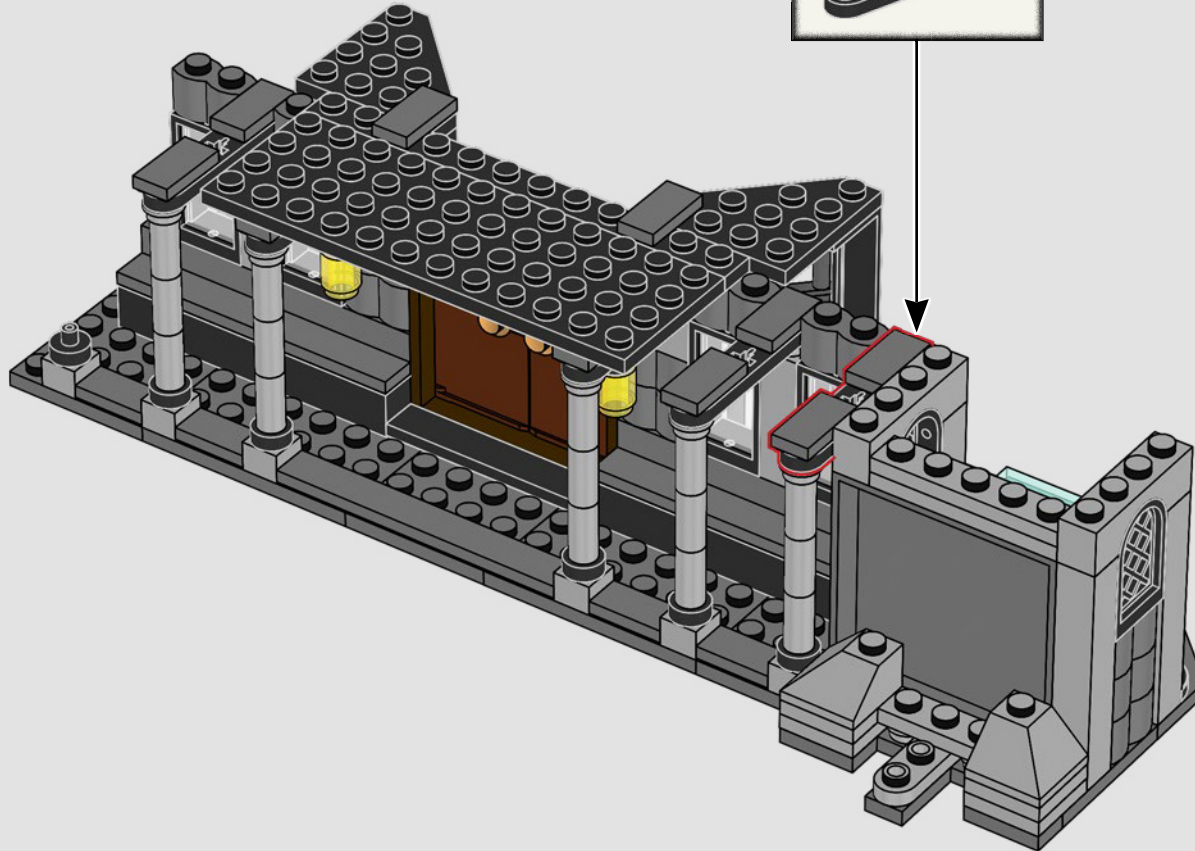

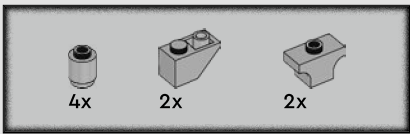

43

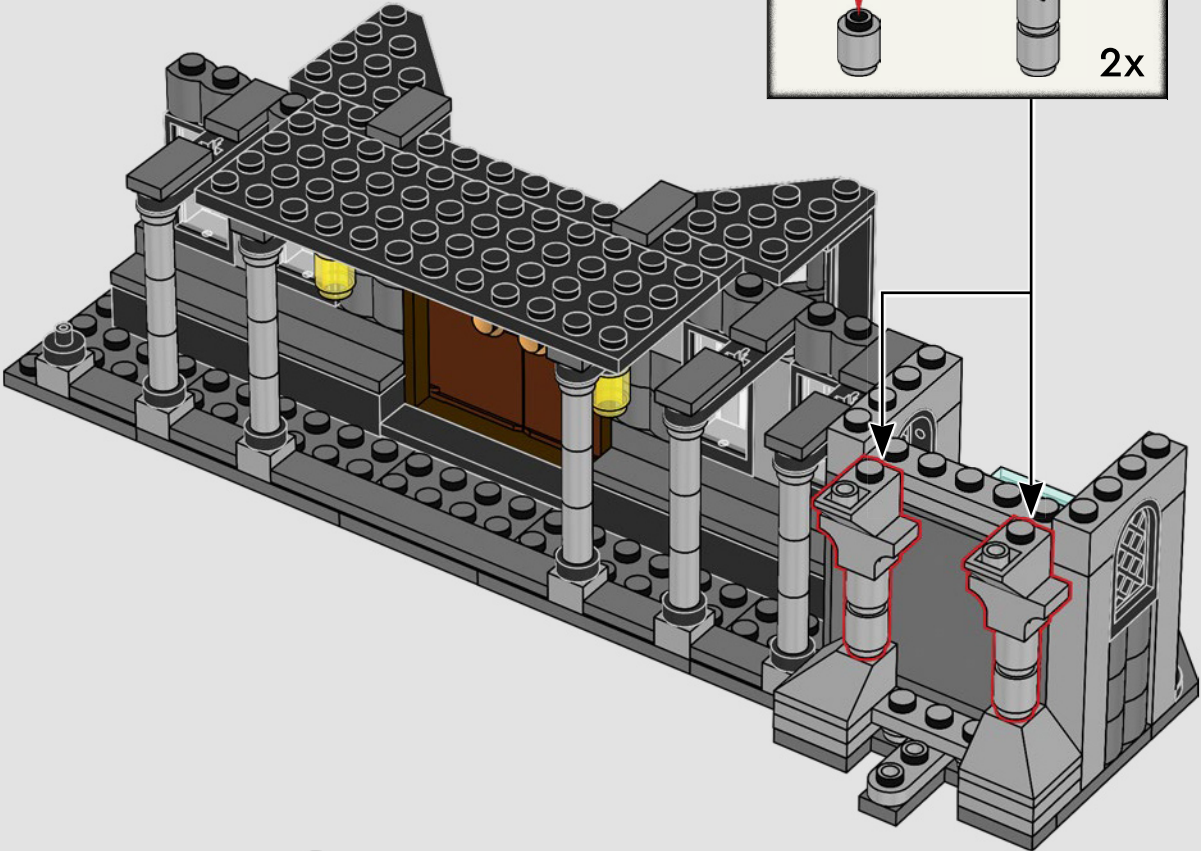
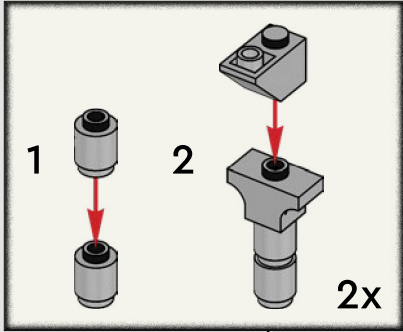



44

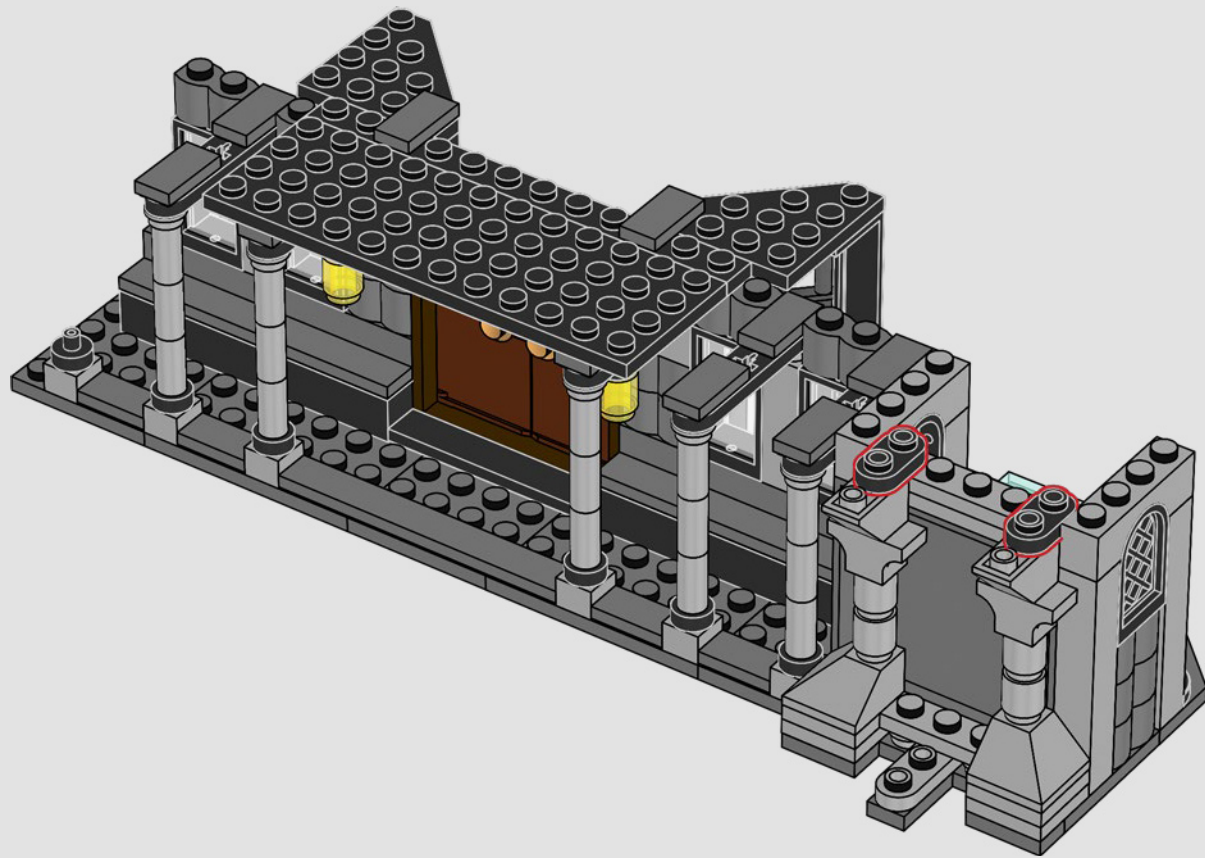

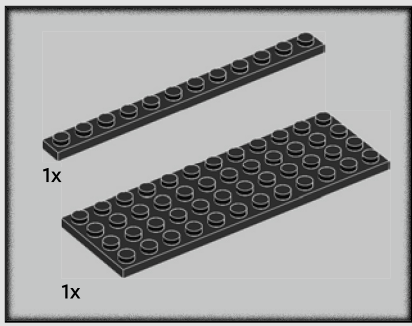

45

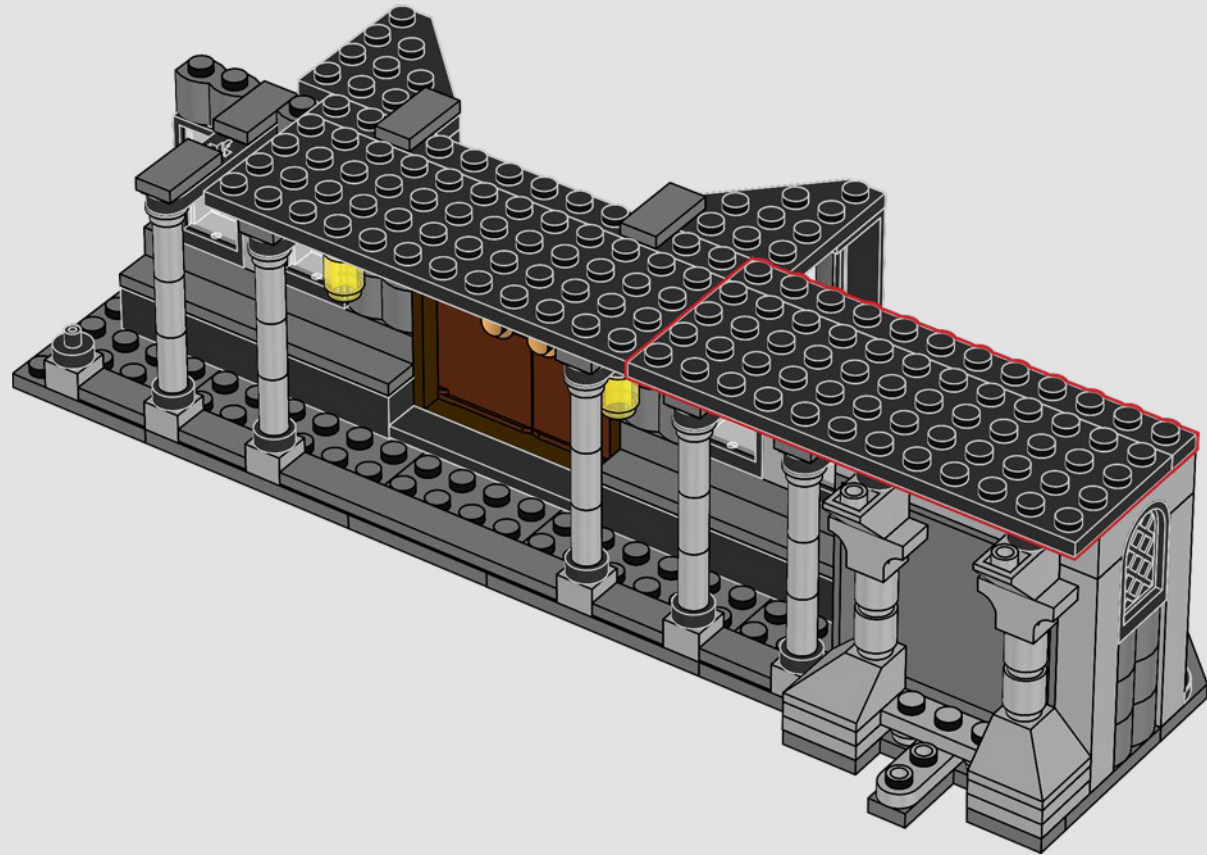

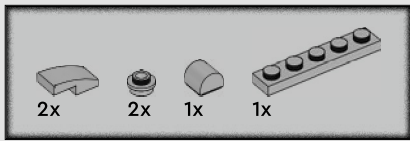

46

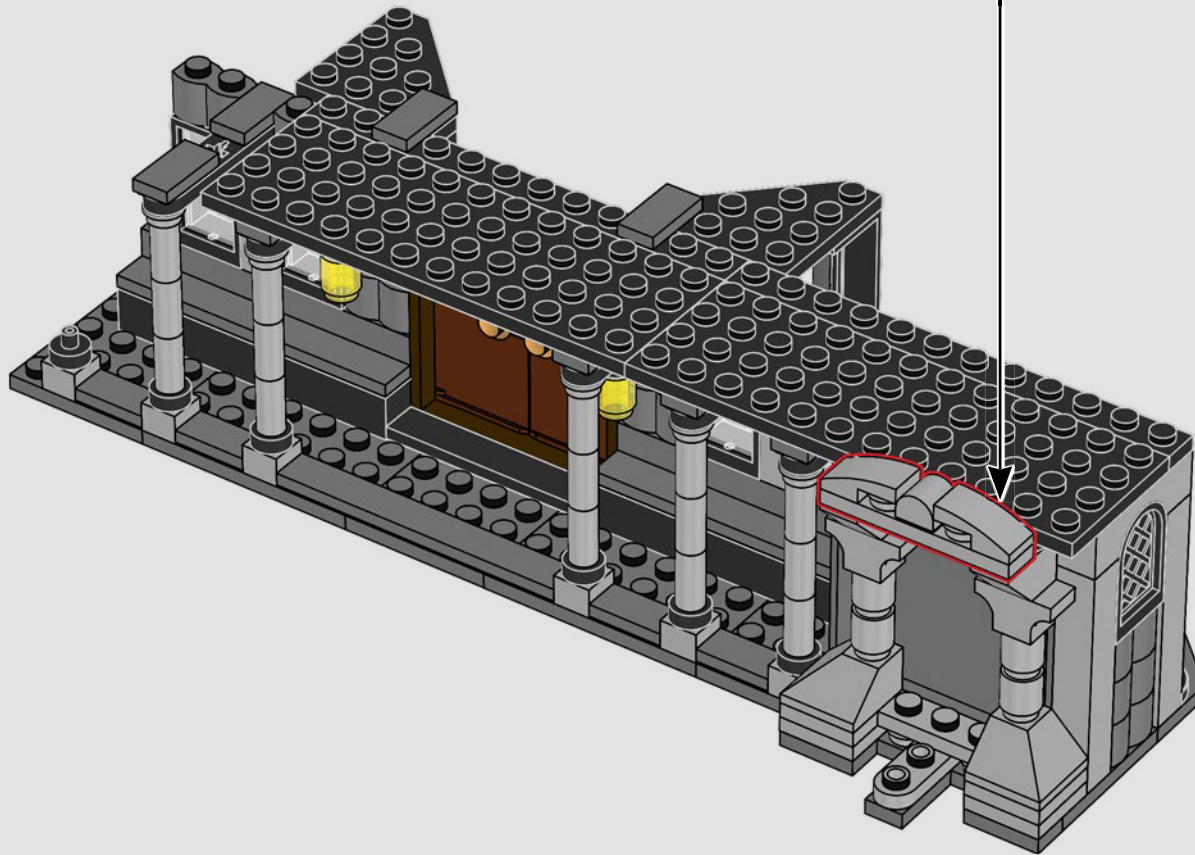
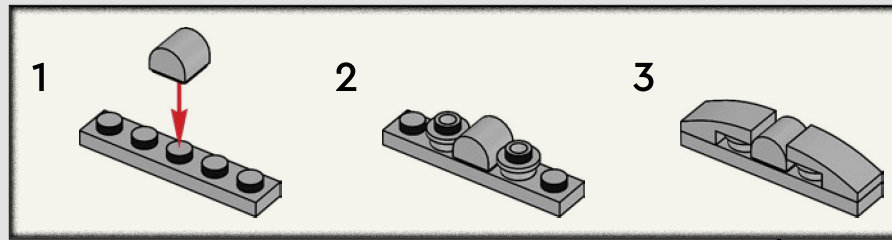

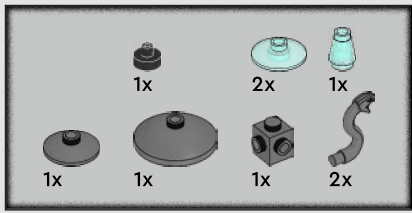

47

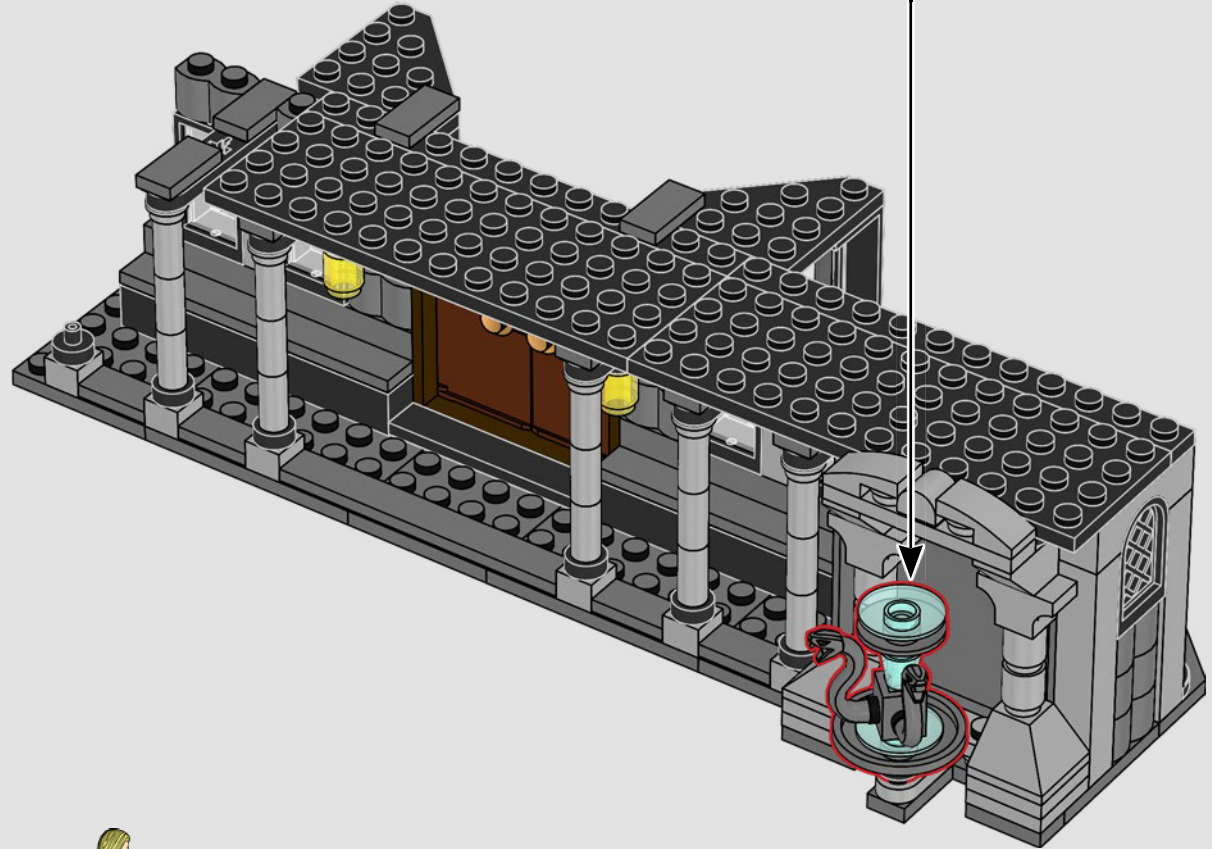
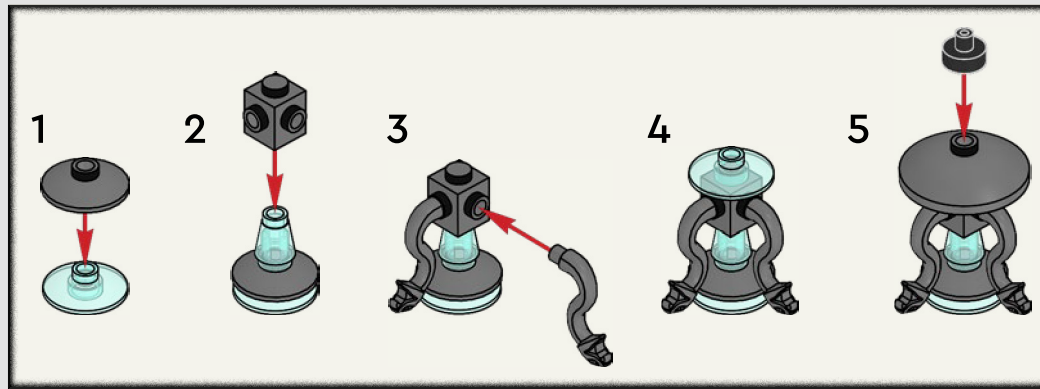

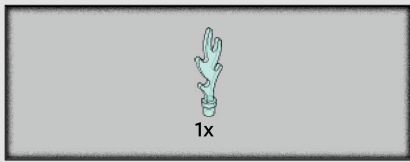

48

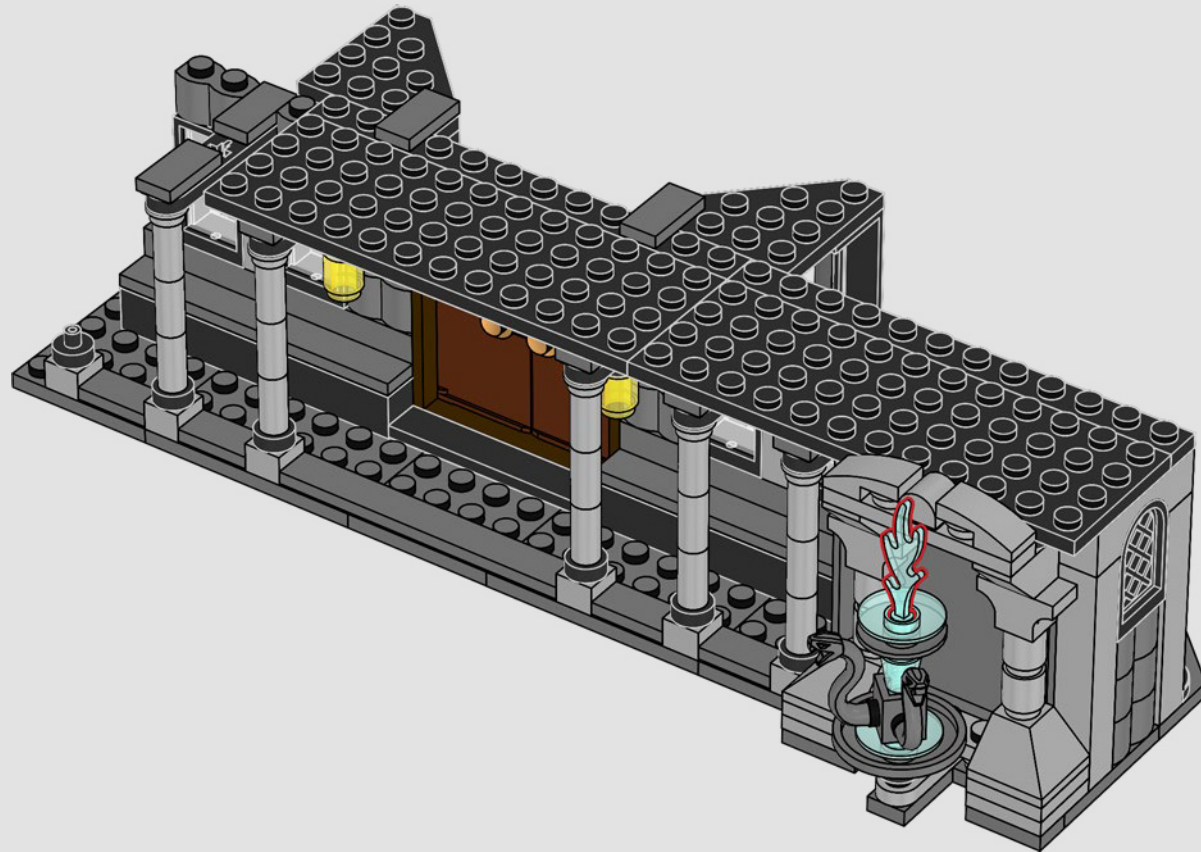



49

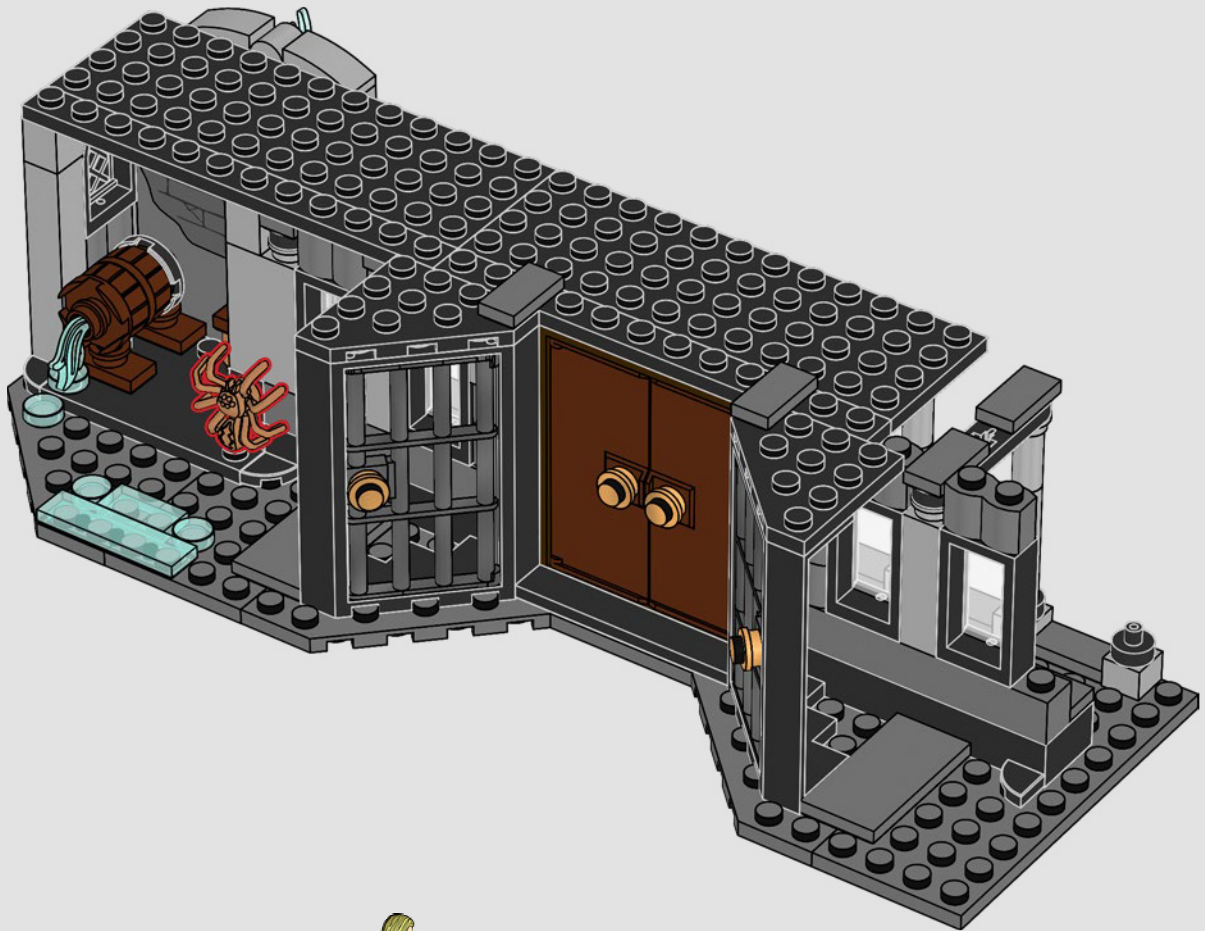



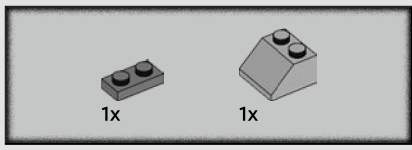

50

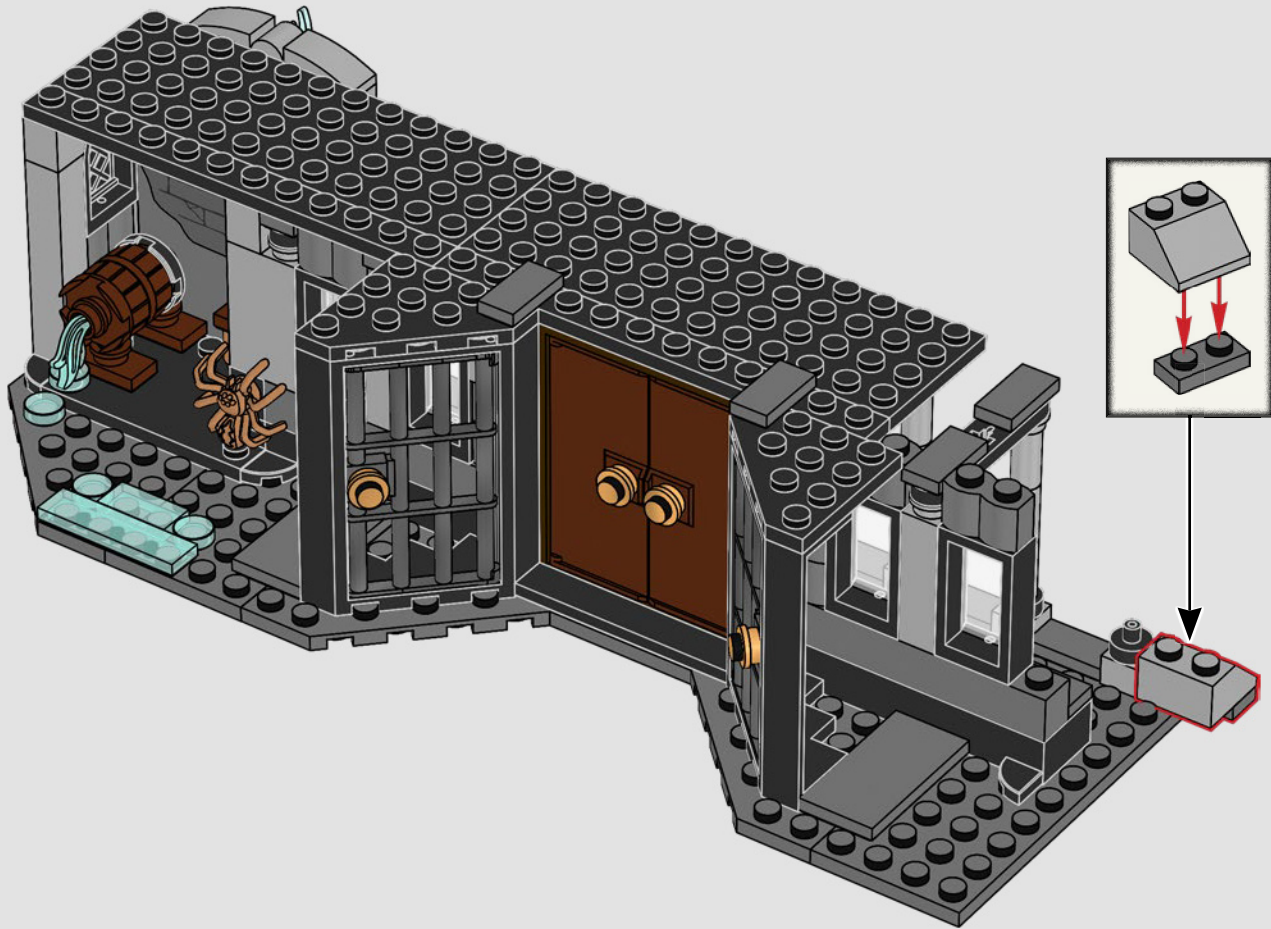

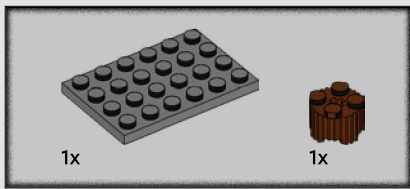

51

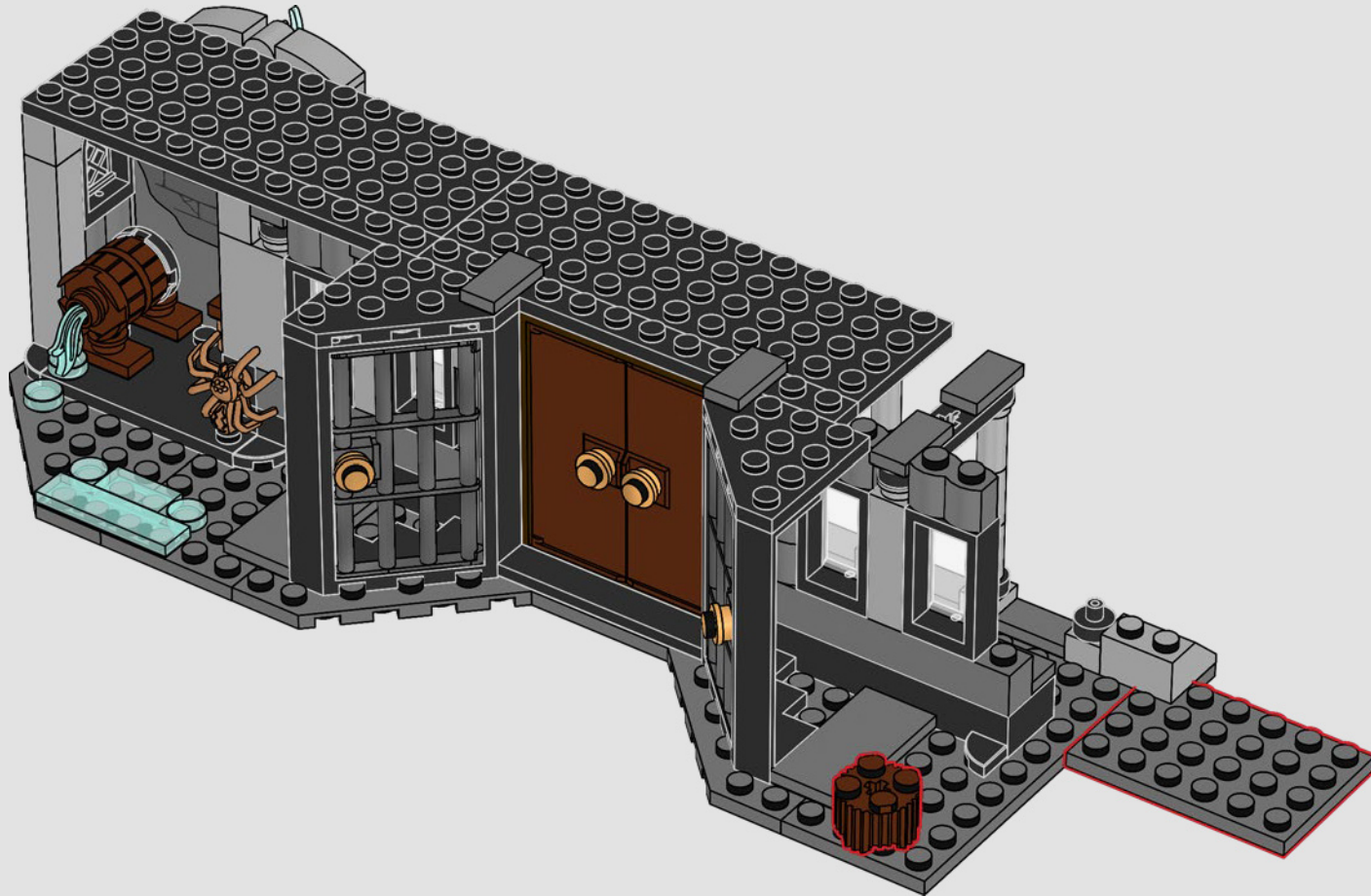

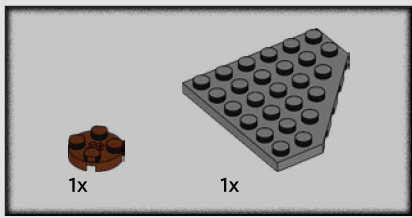

52

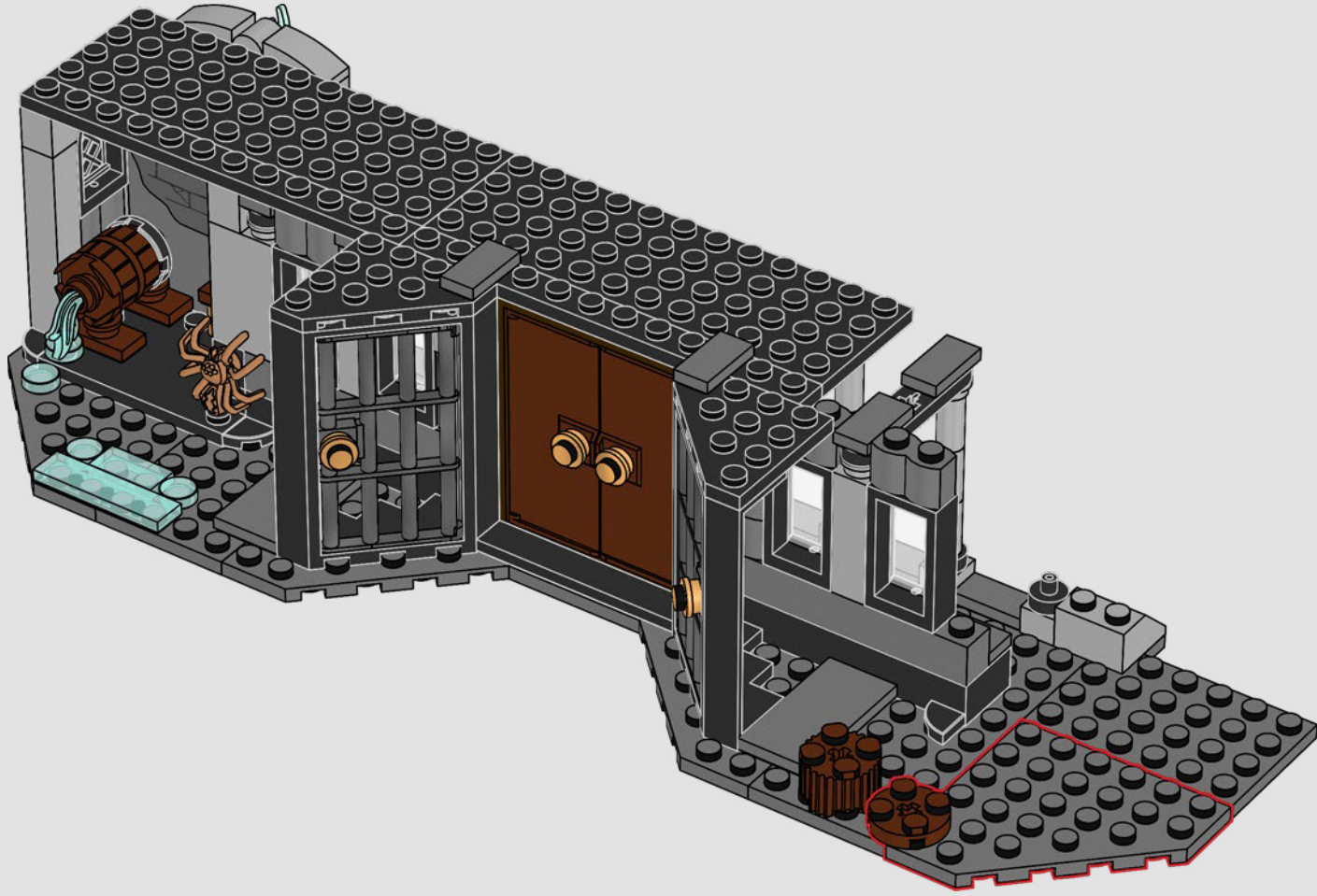

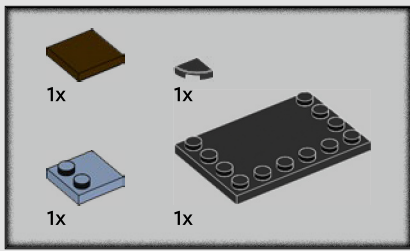

53

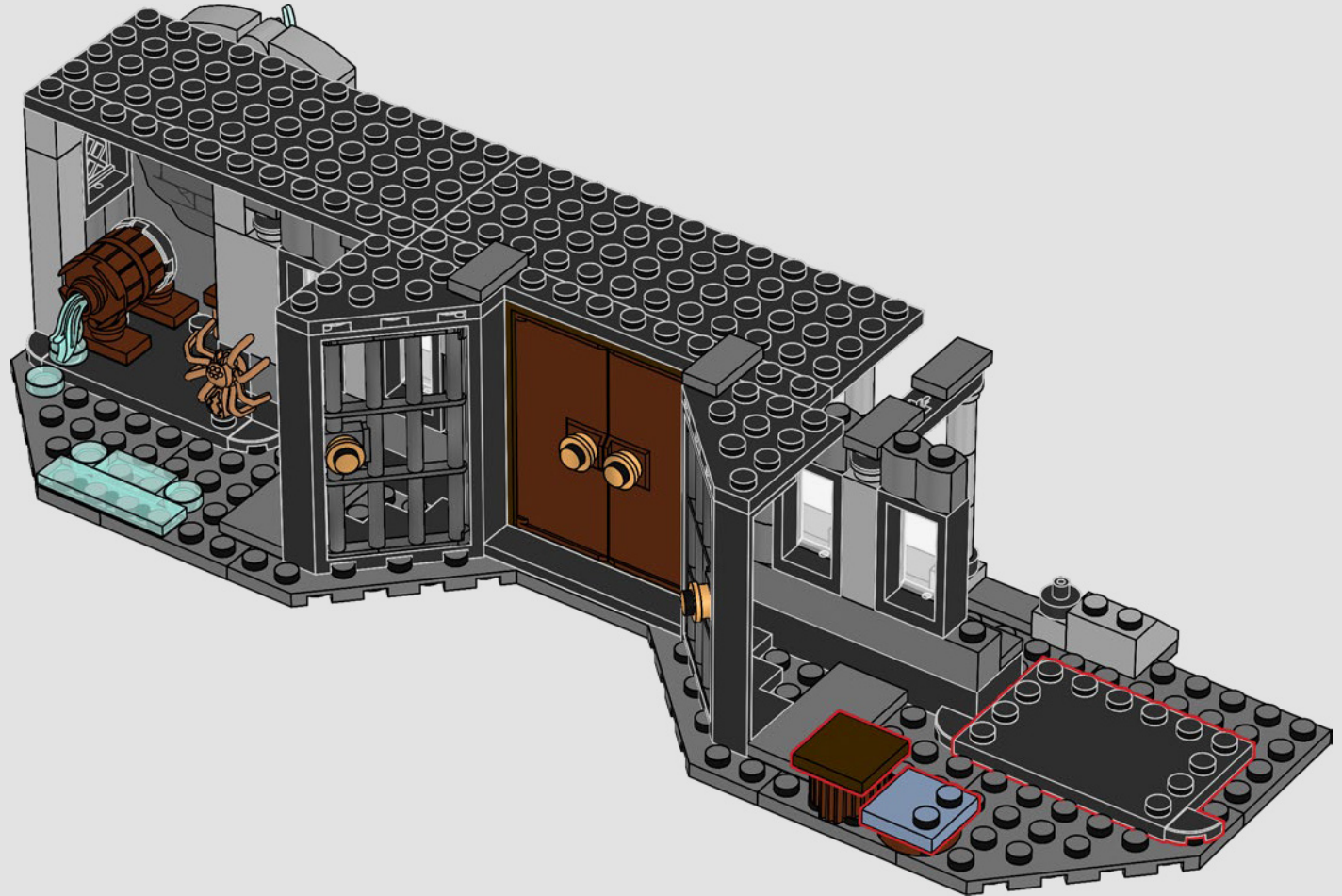

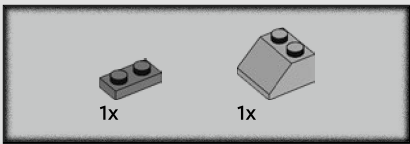

54

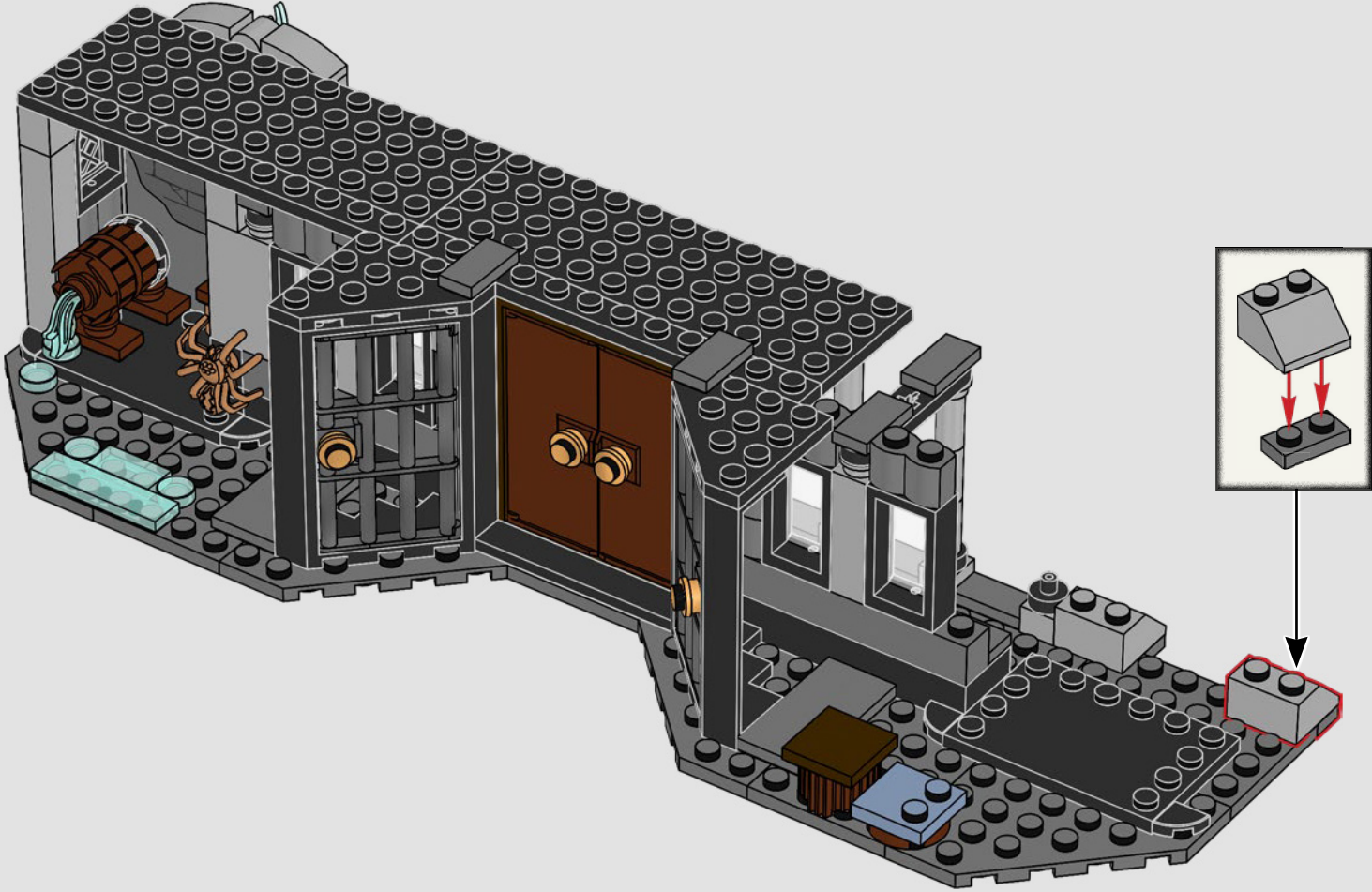

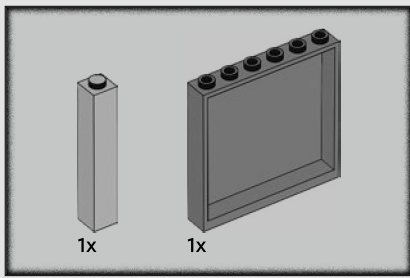

55

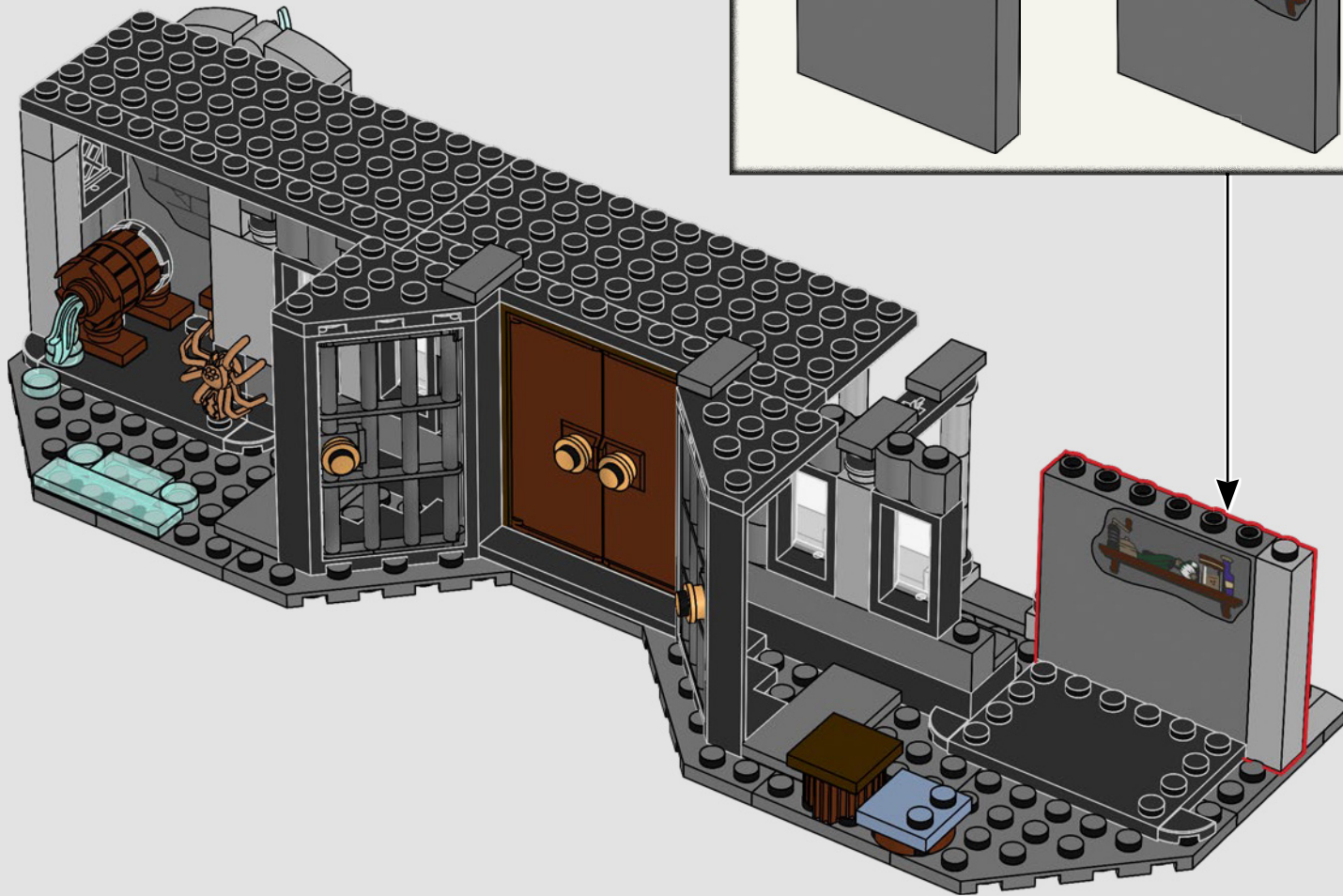
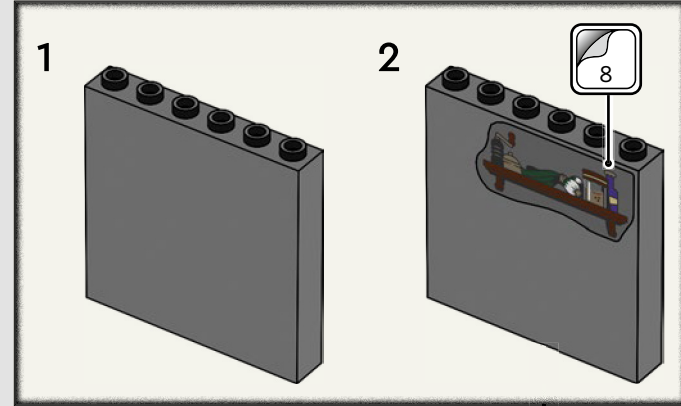

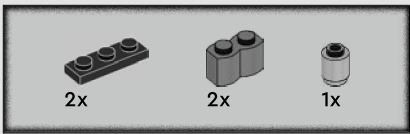

56

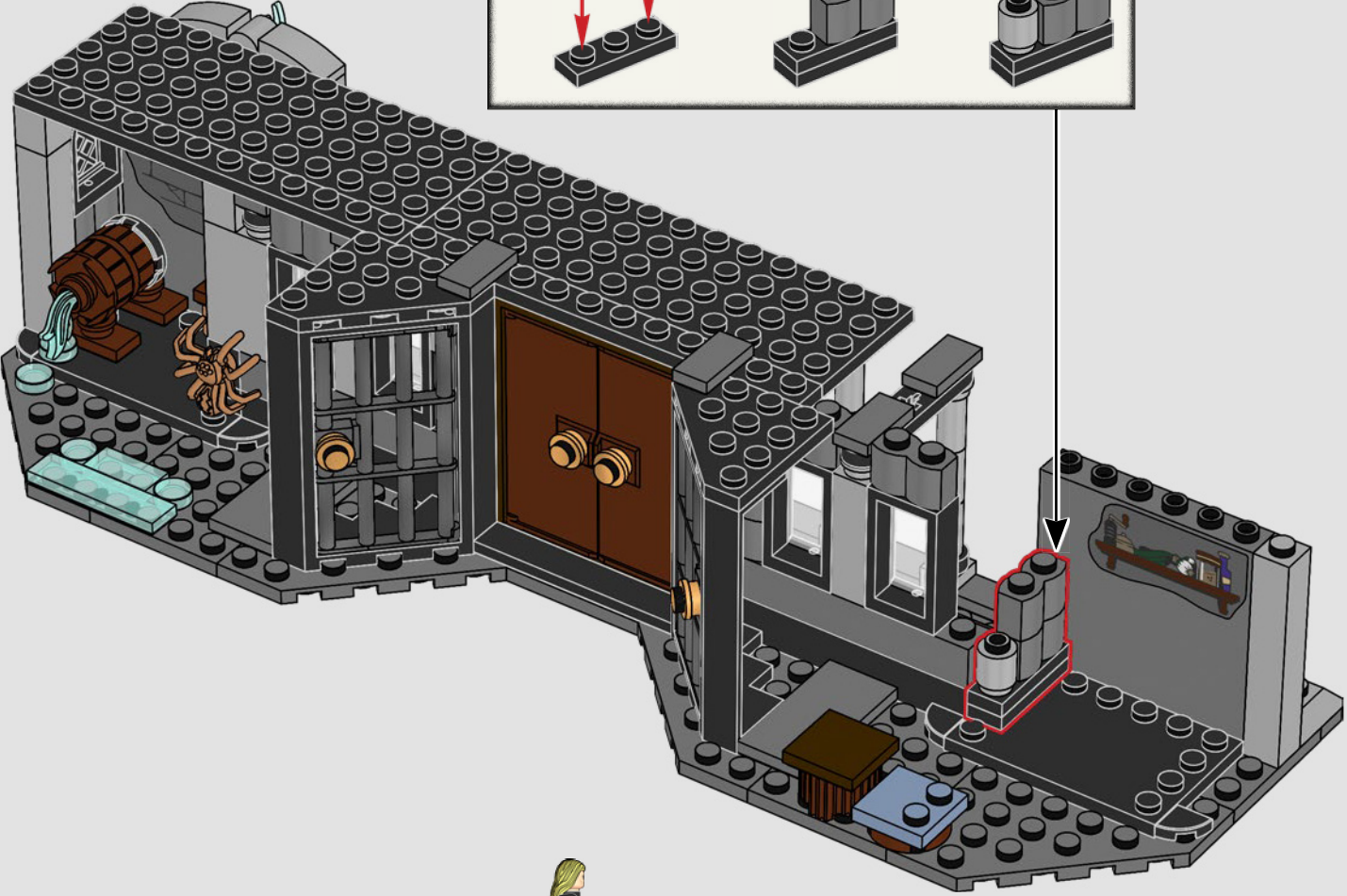
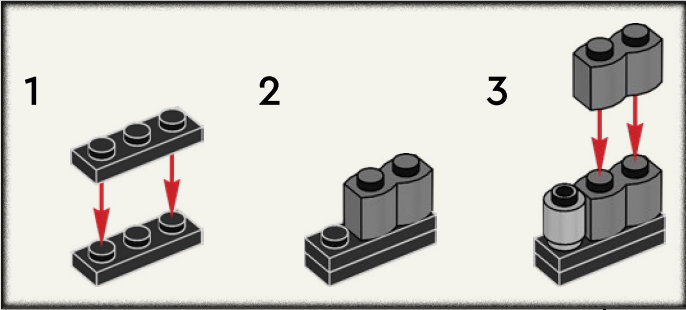

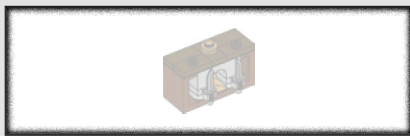

57

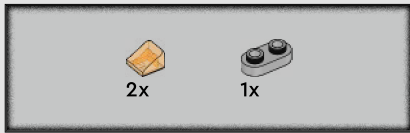
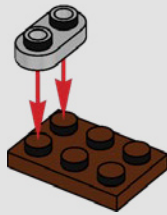

58

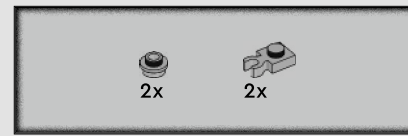
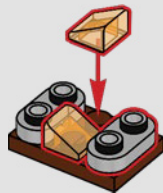

59

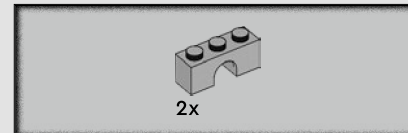
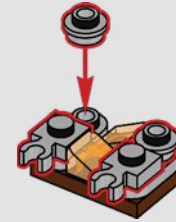

60

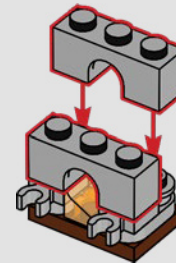

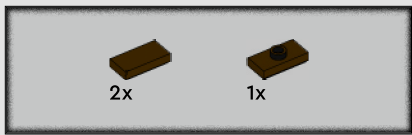

61

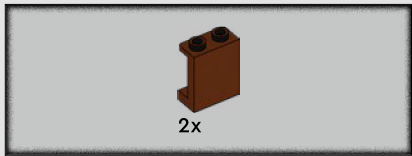
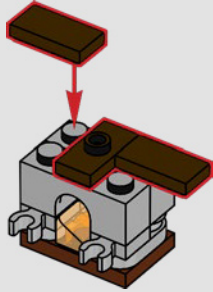

62

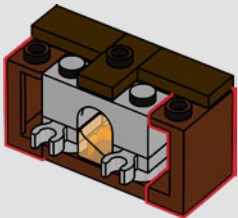

63

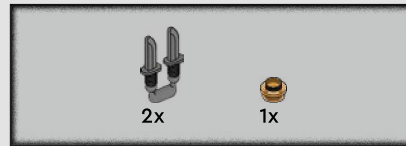
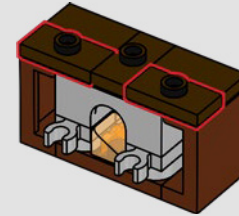

64

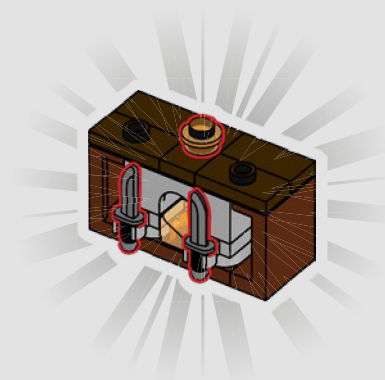

65

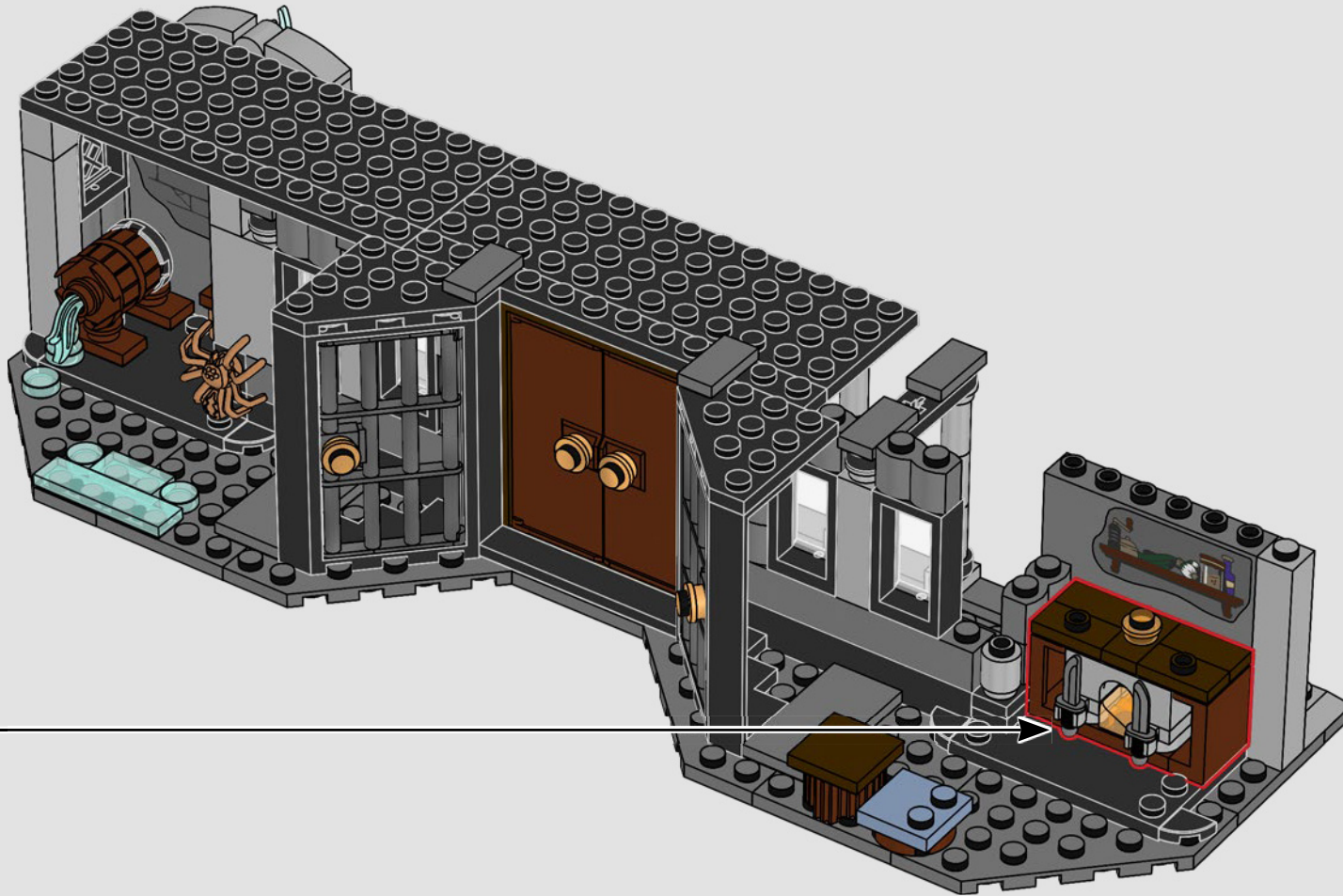



66



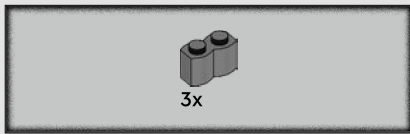

67

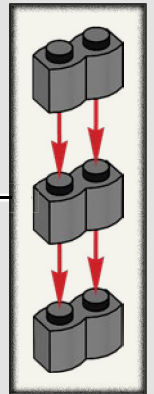
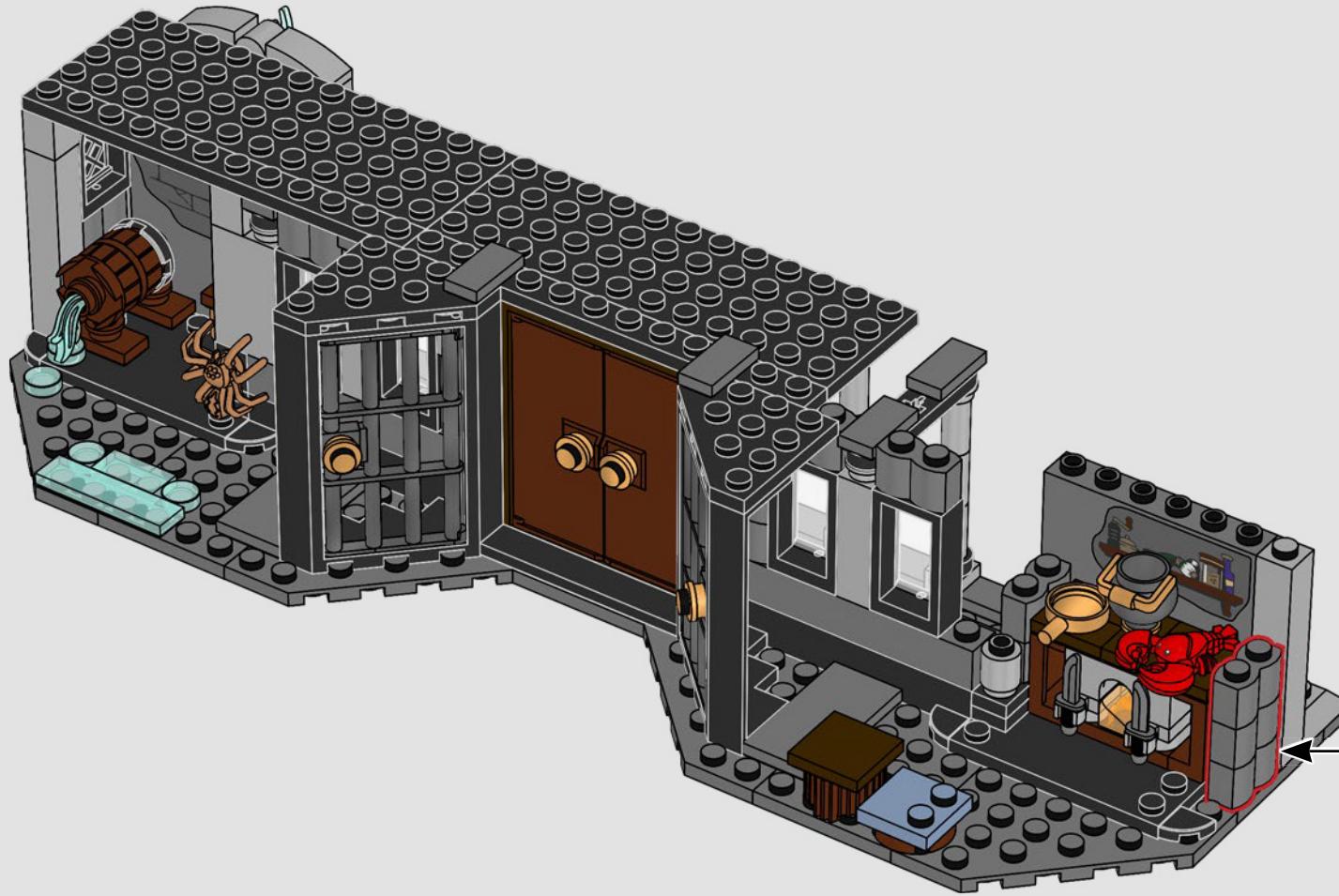

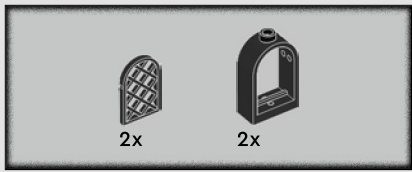

68

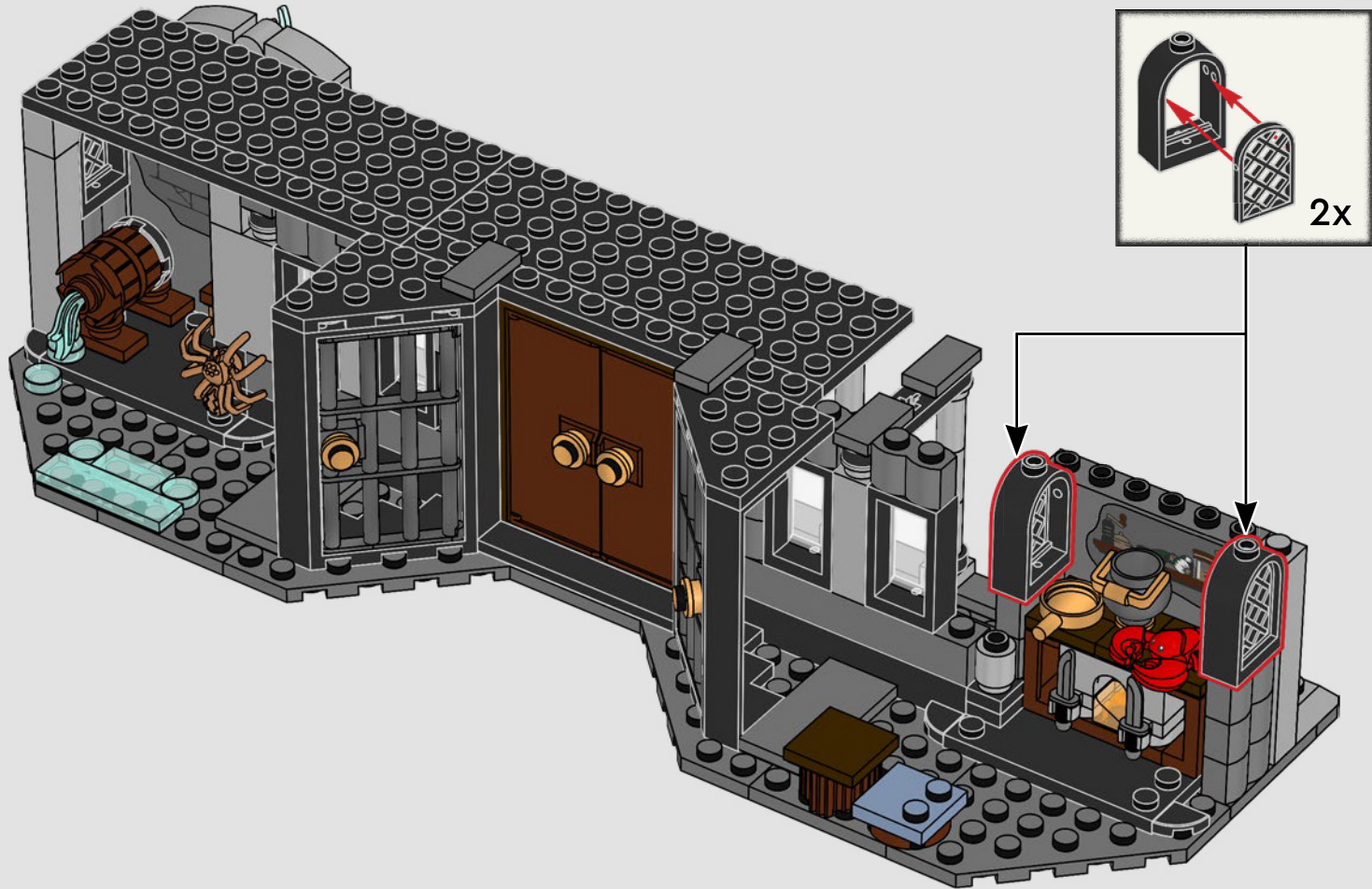

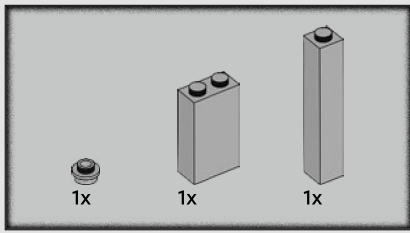

69

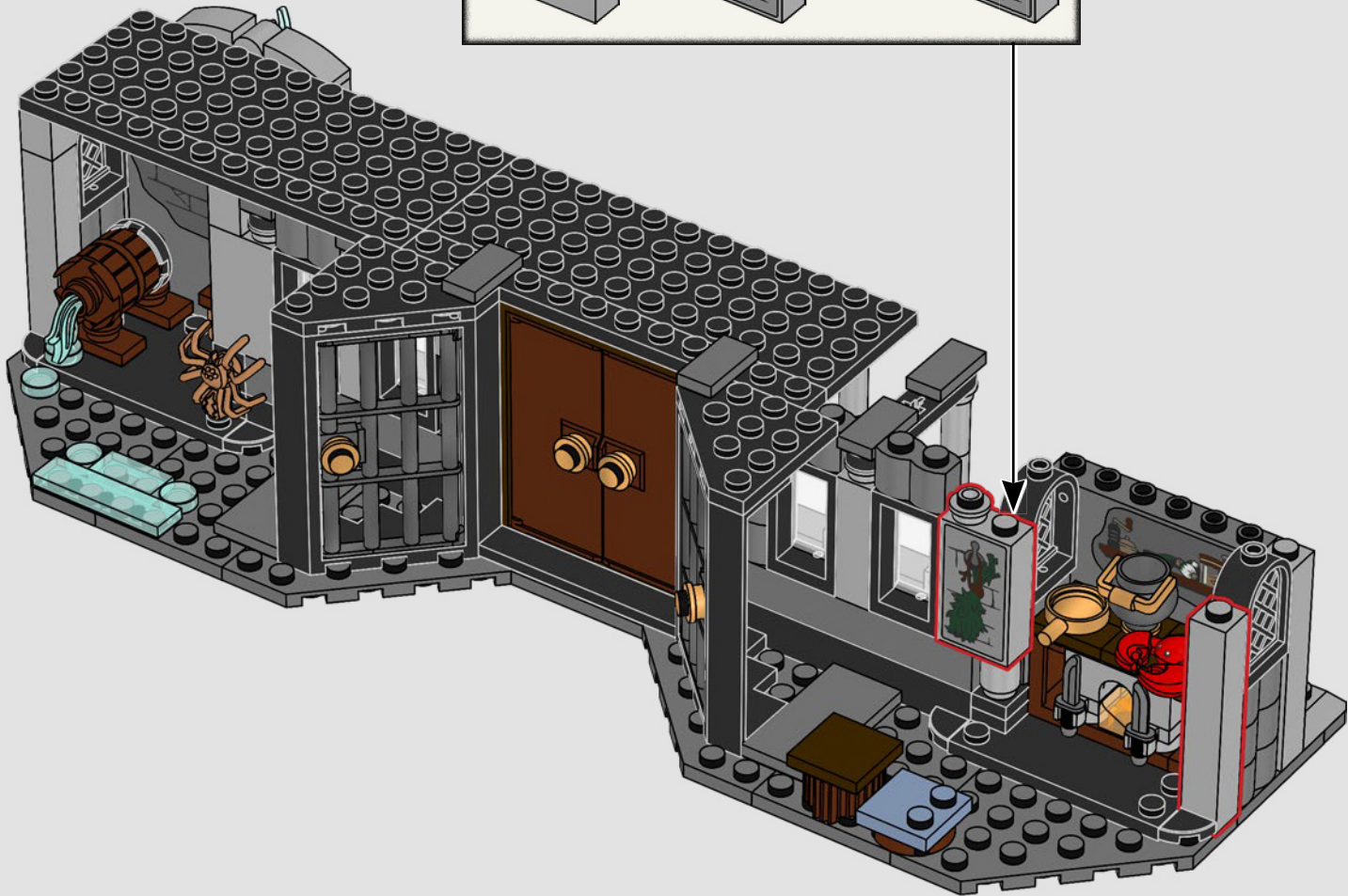
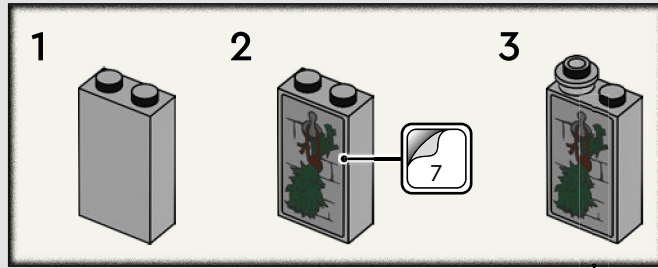

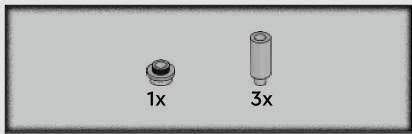

70

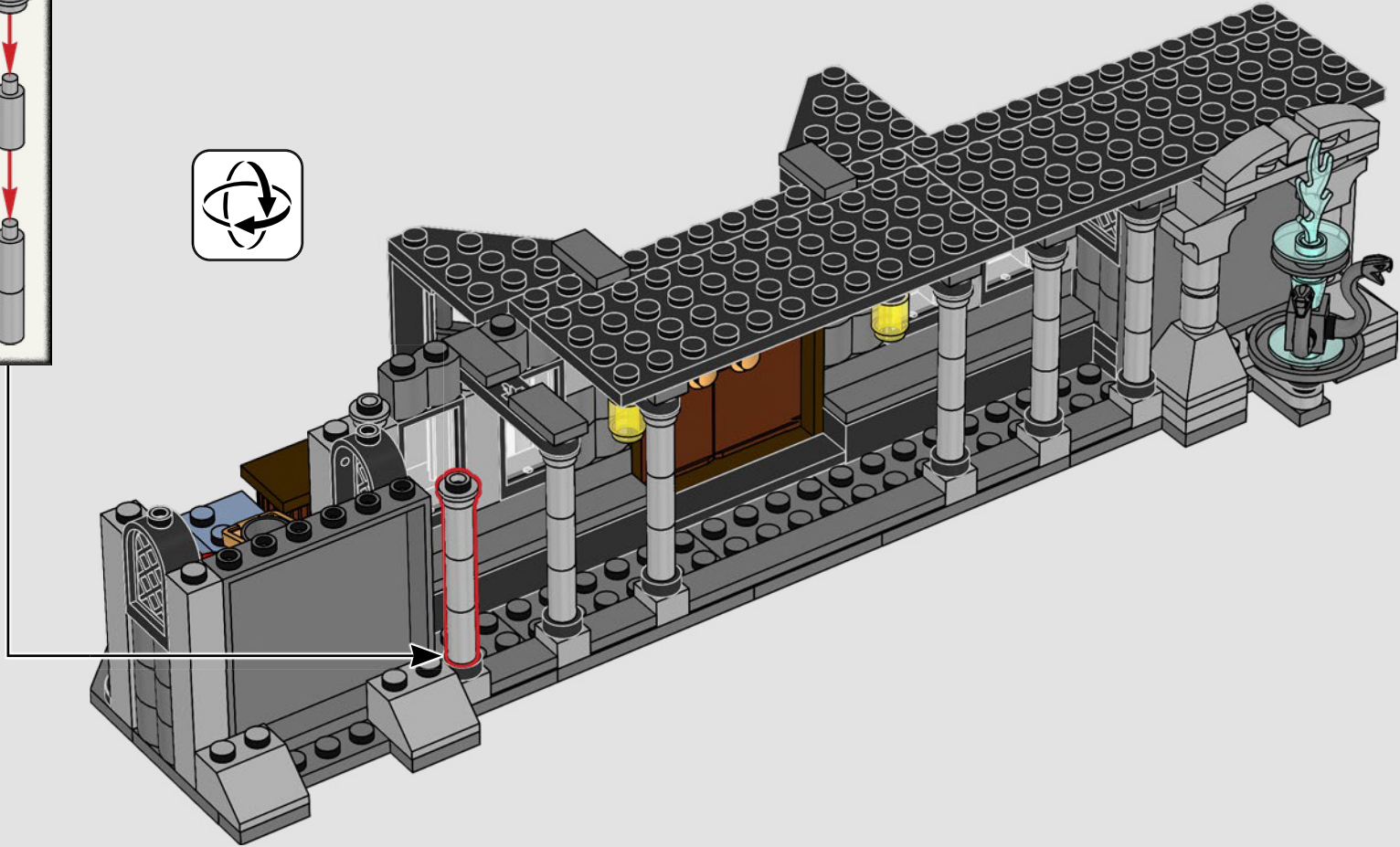
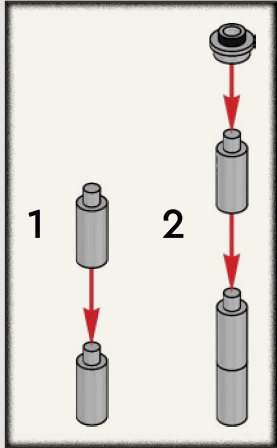

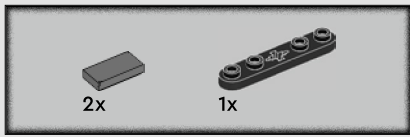

71

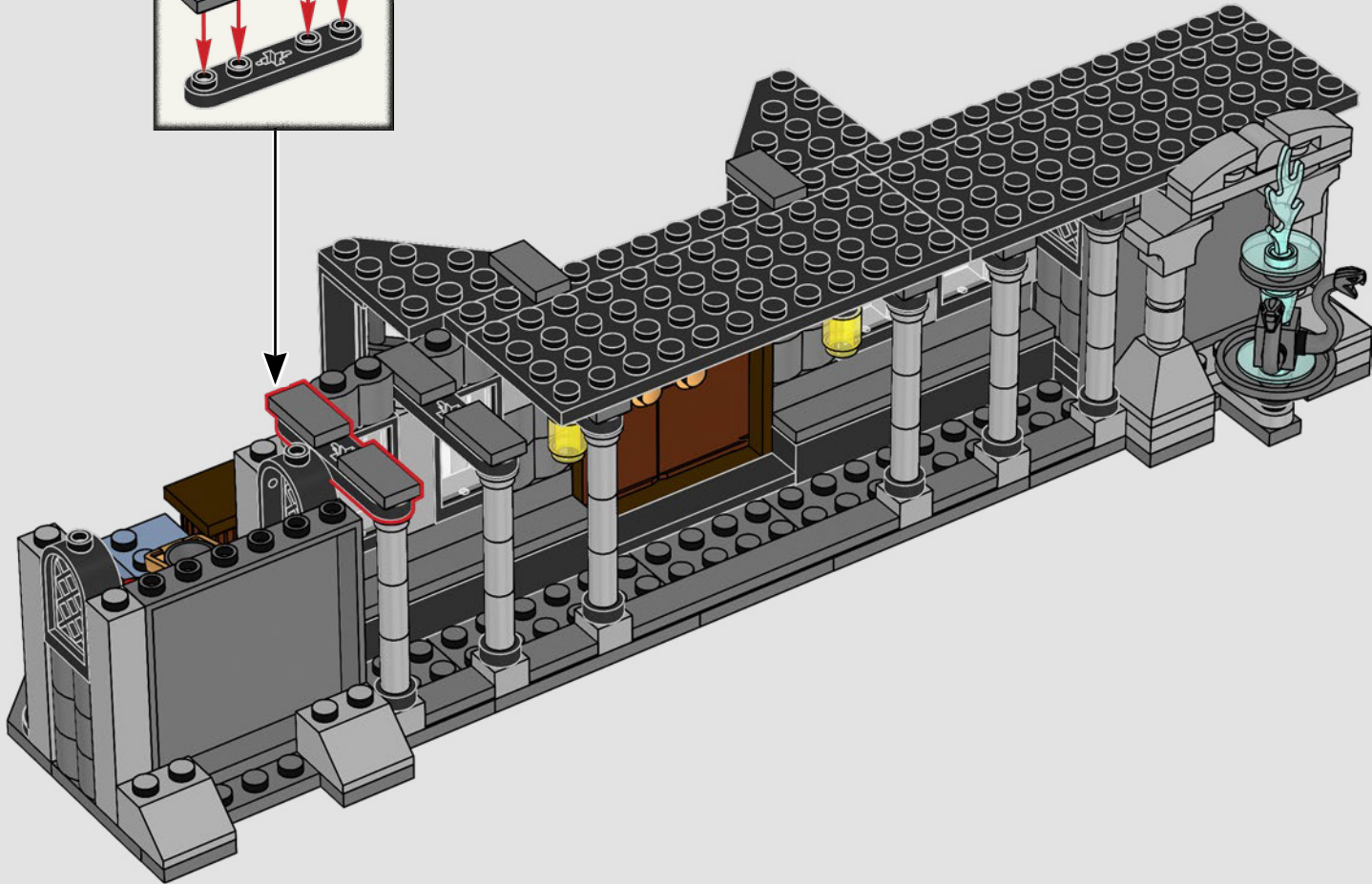
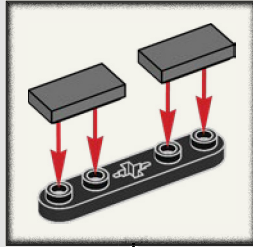

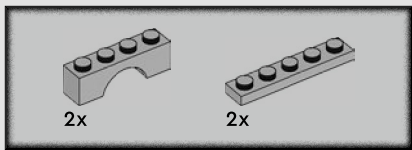

72

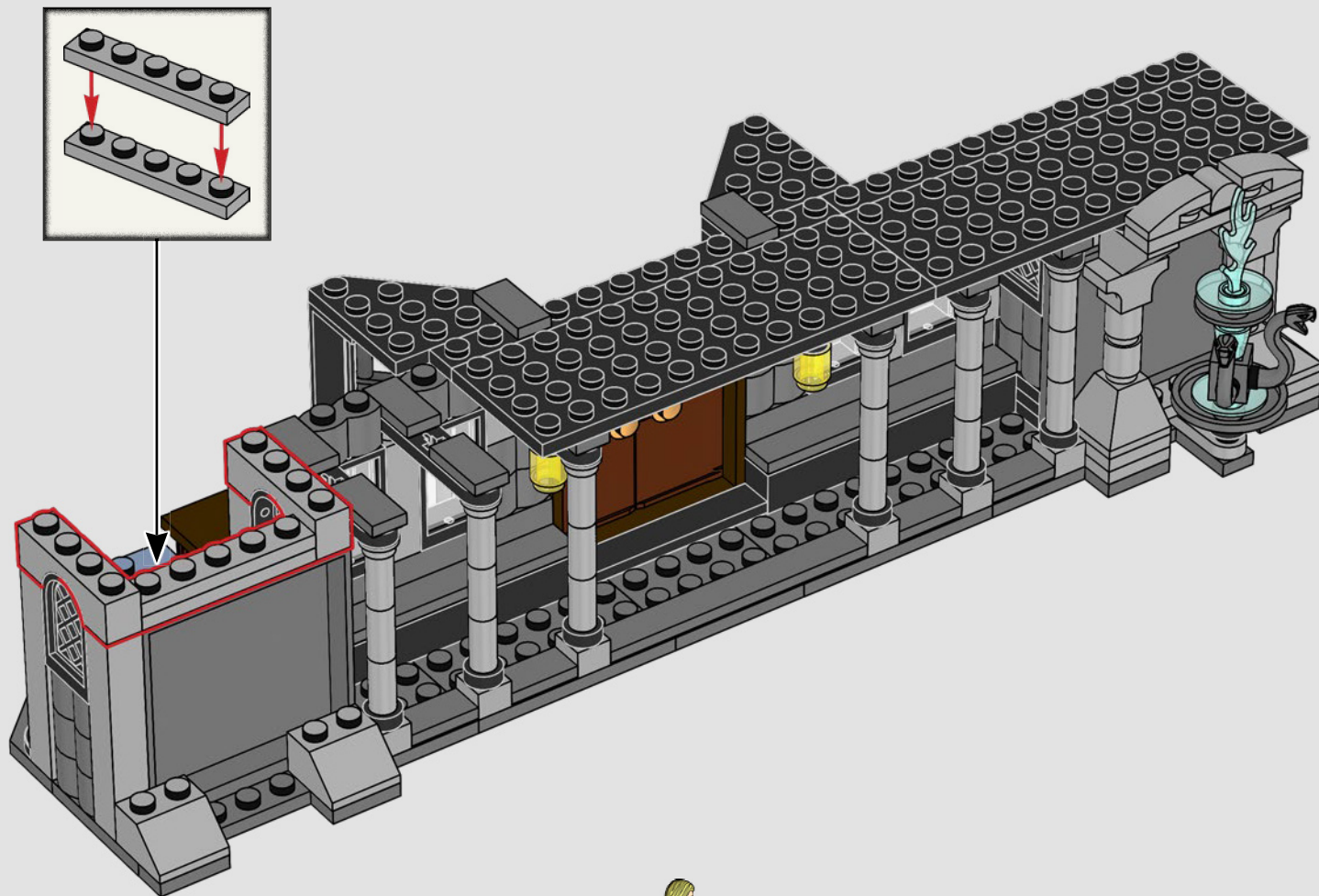



73

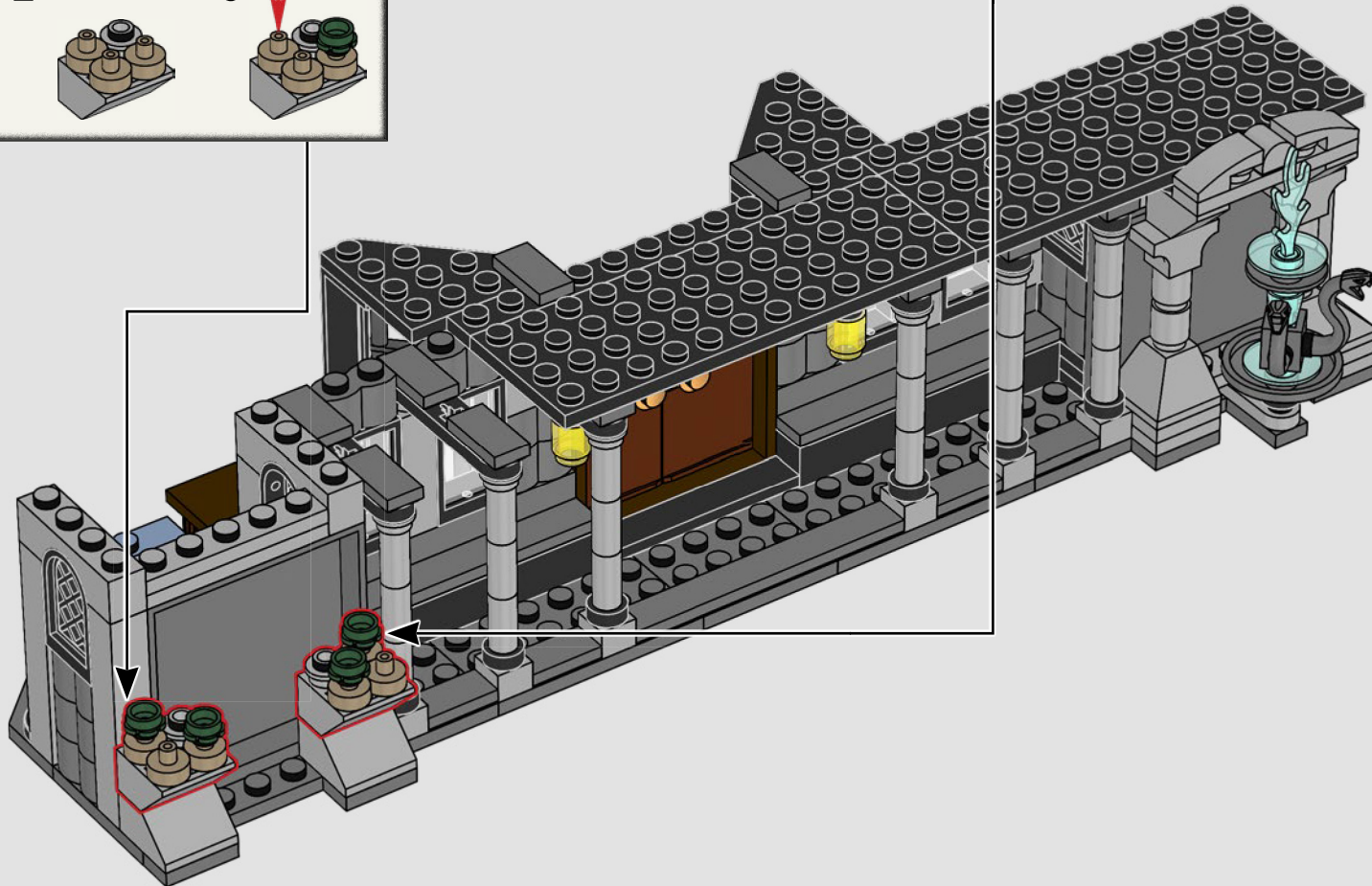
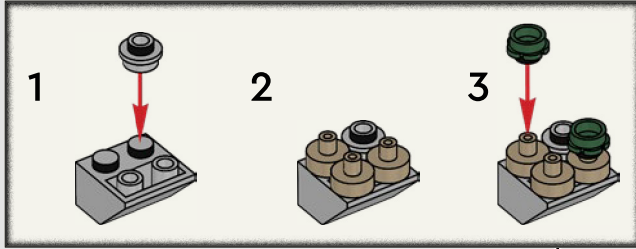
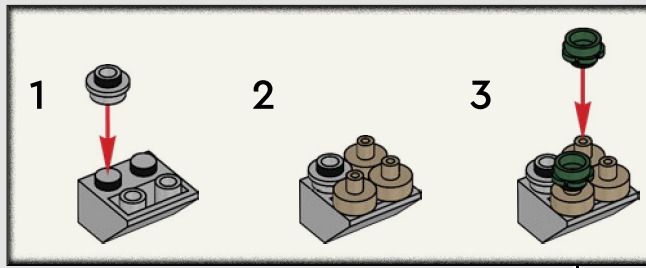

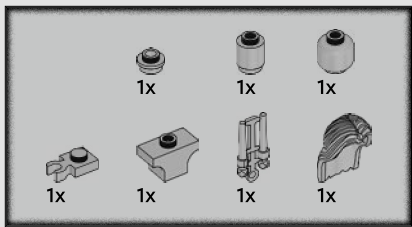

74

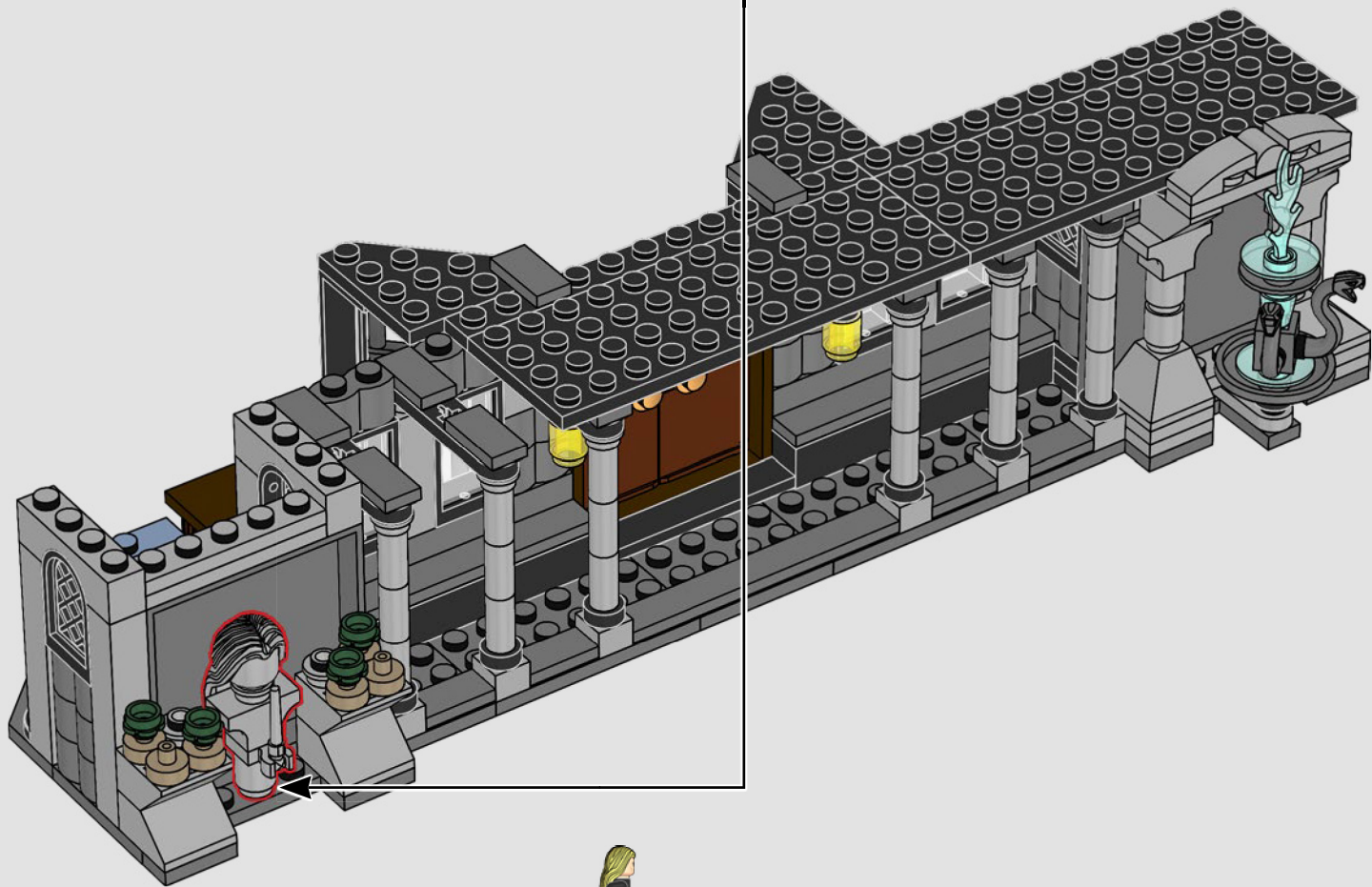
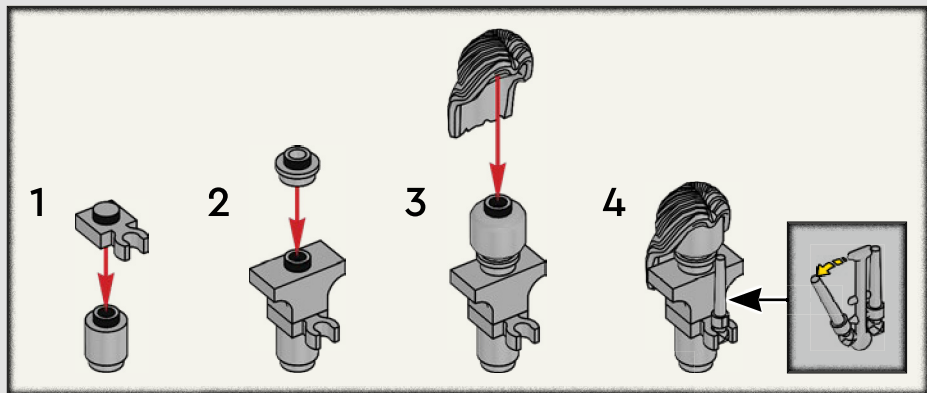

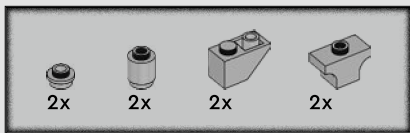

75

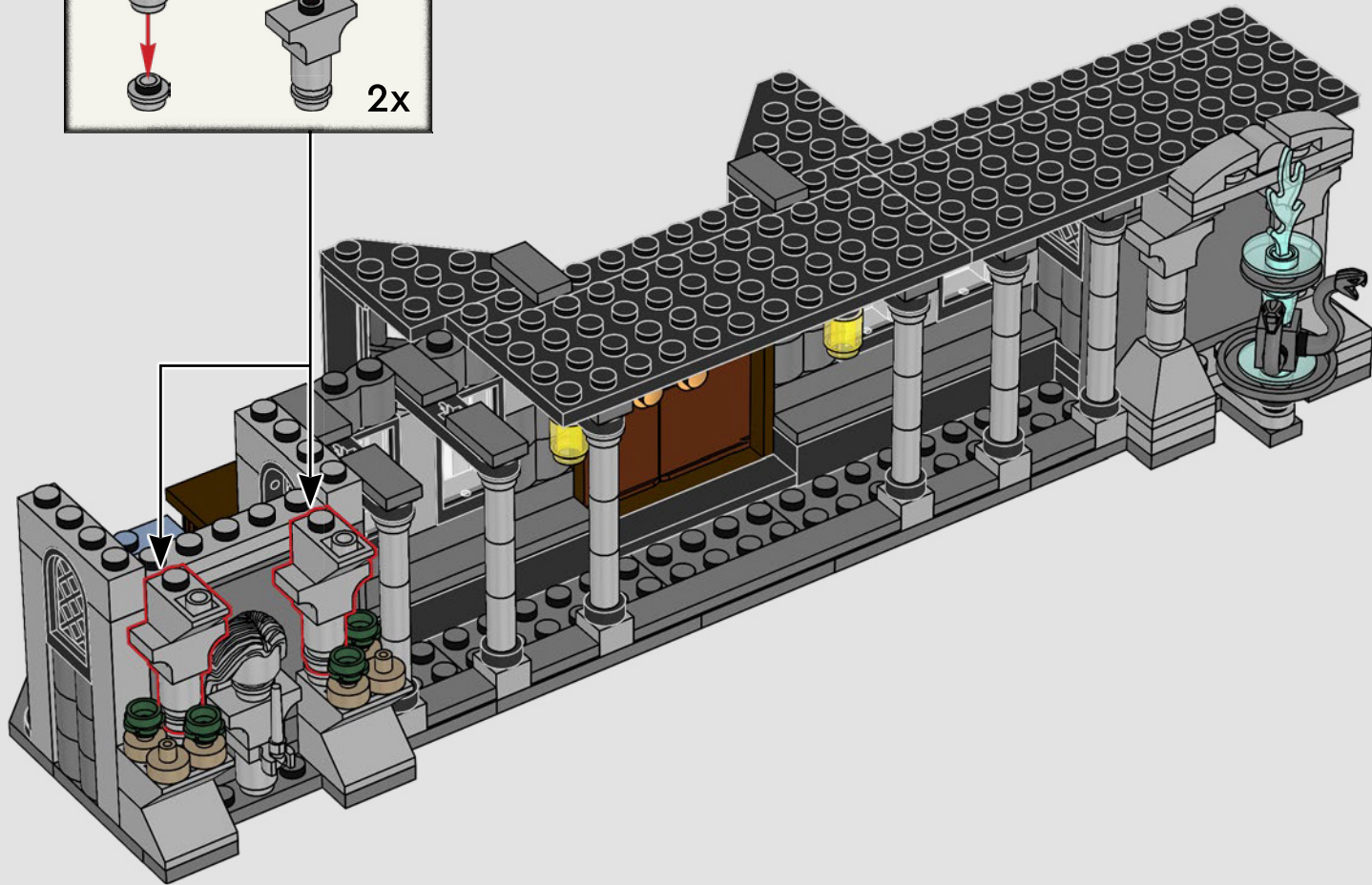
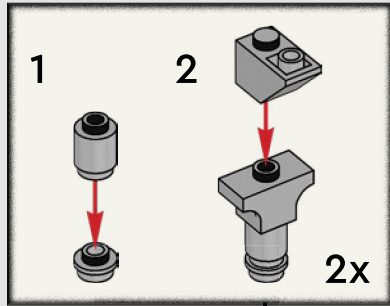

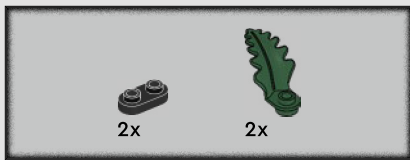

76

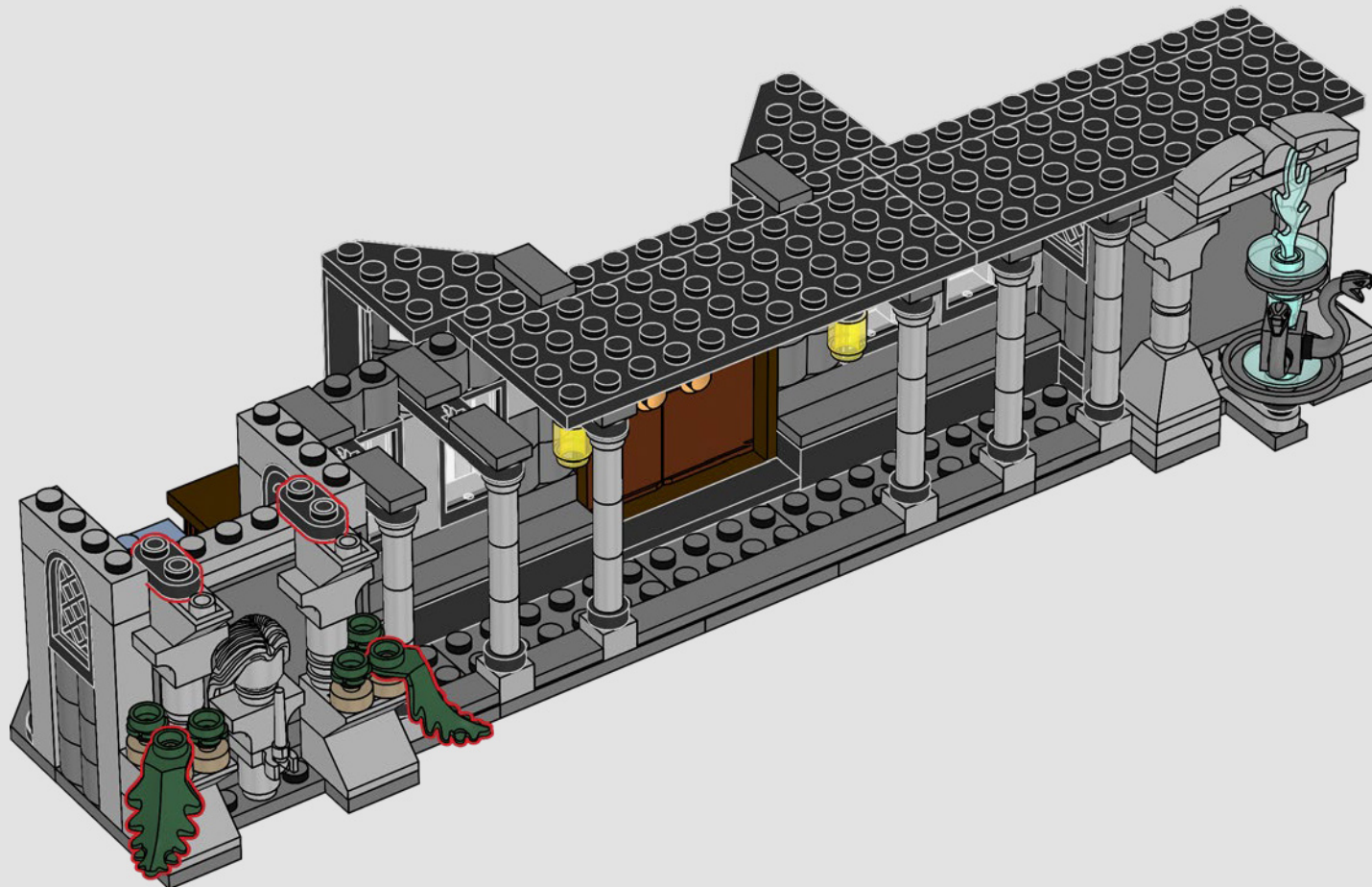

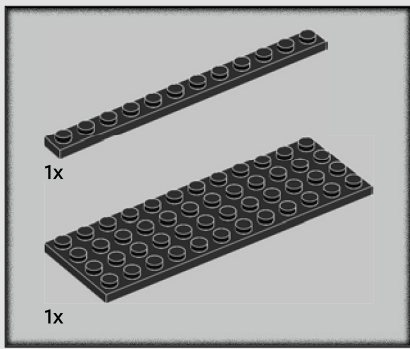

77

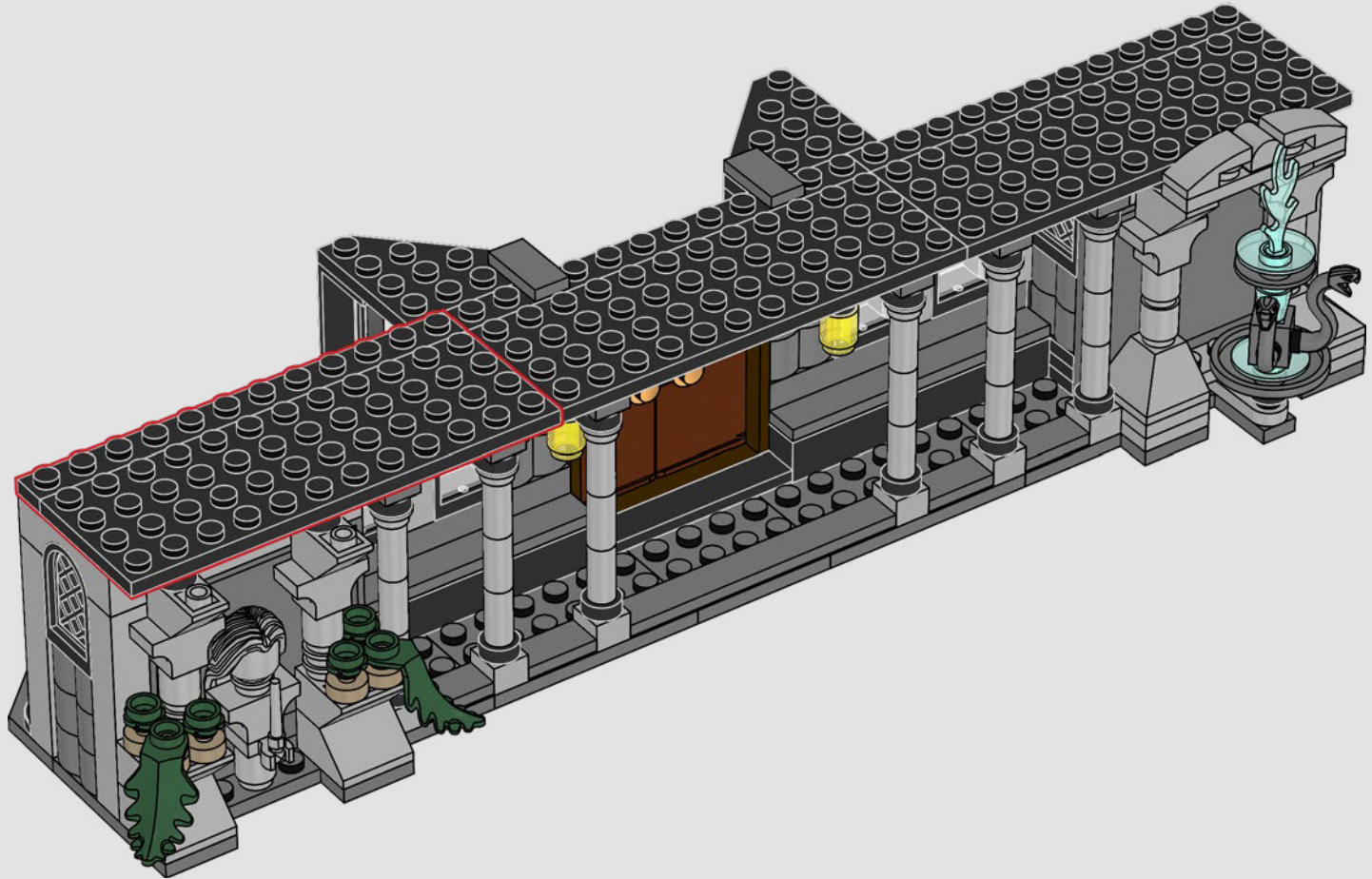

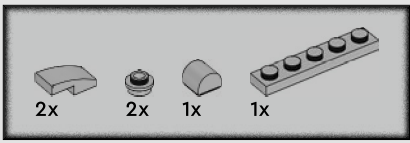

78

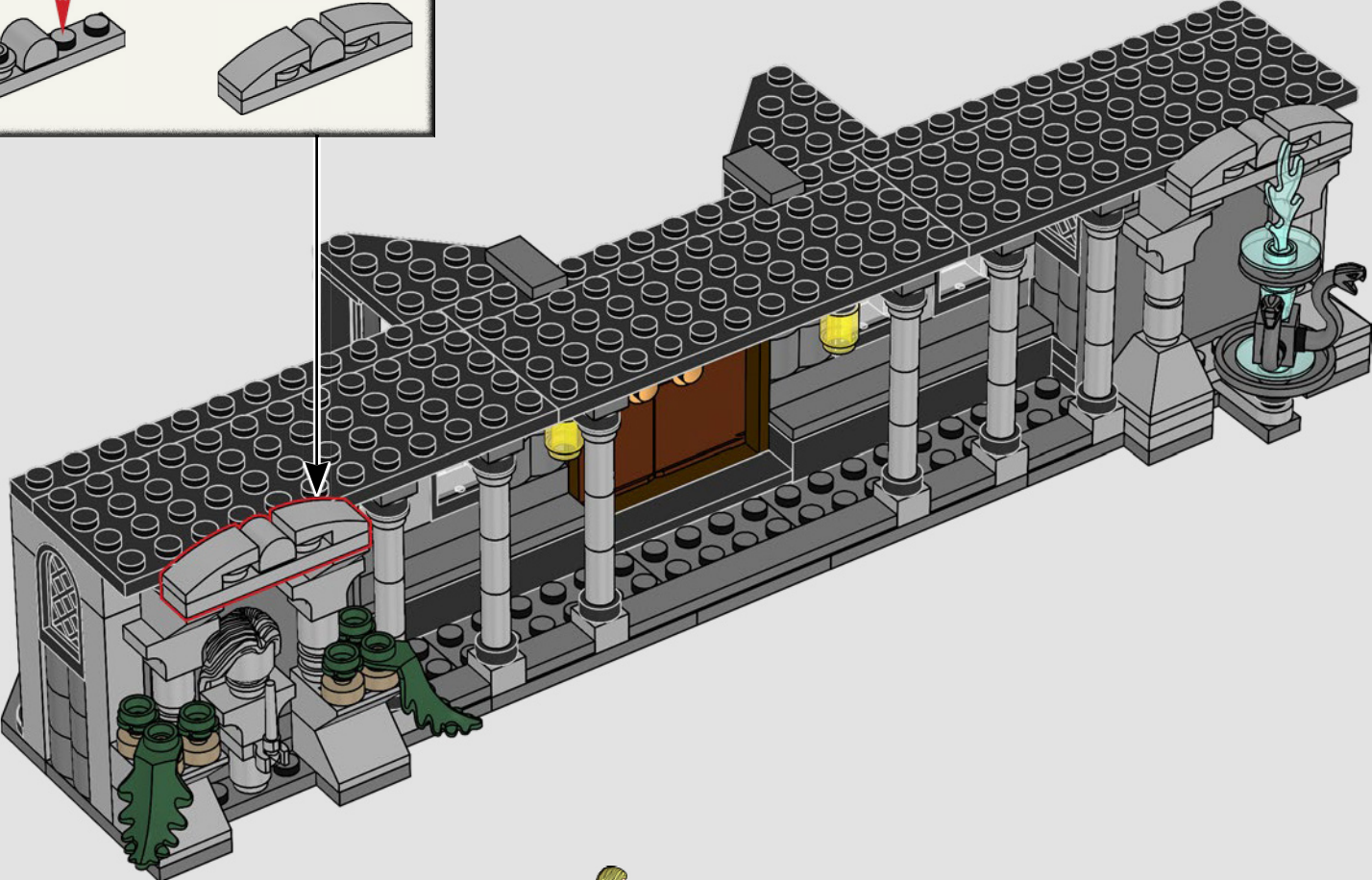
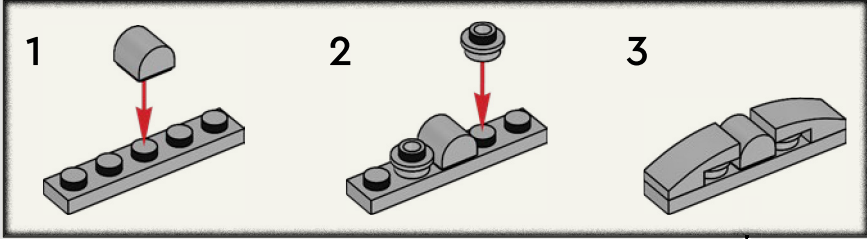

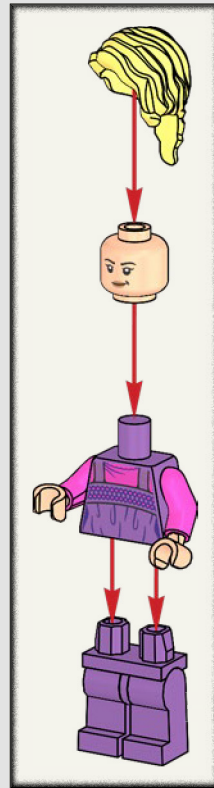



2x

79



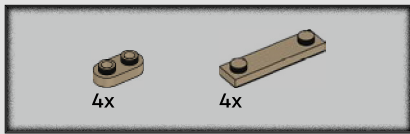

80

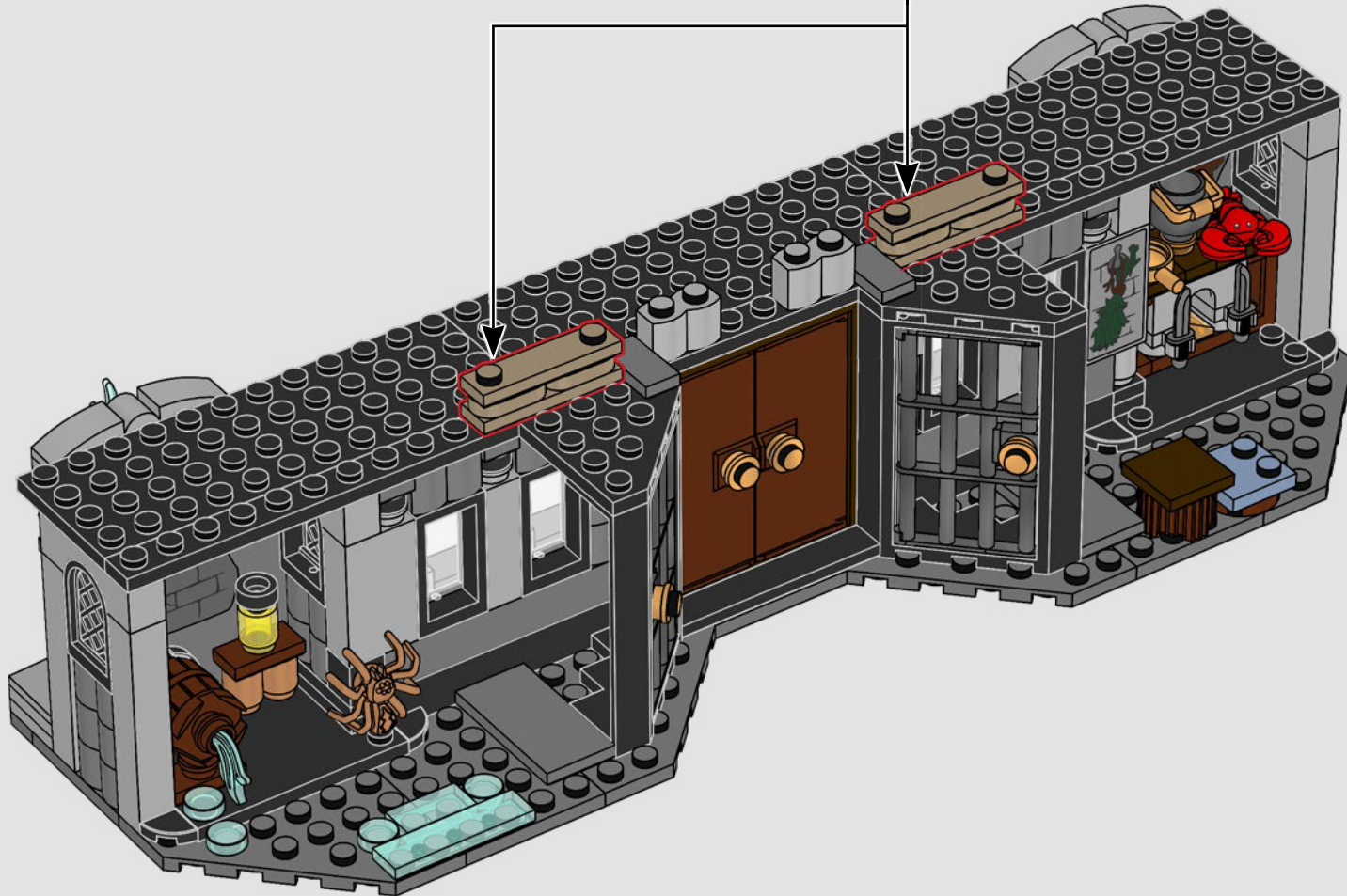
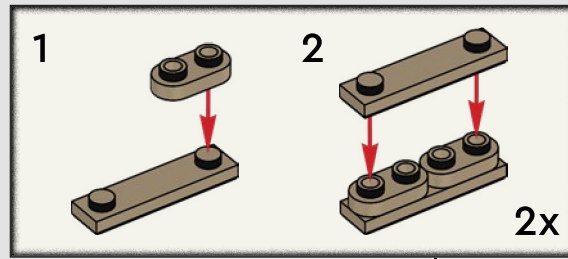



81

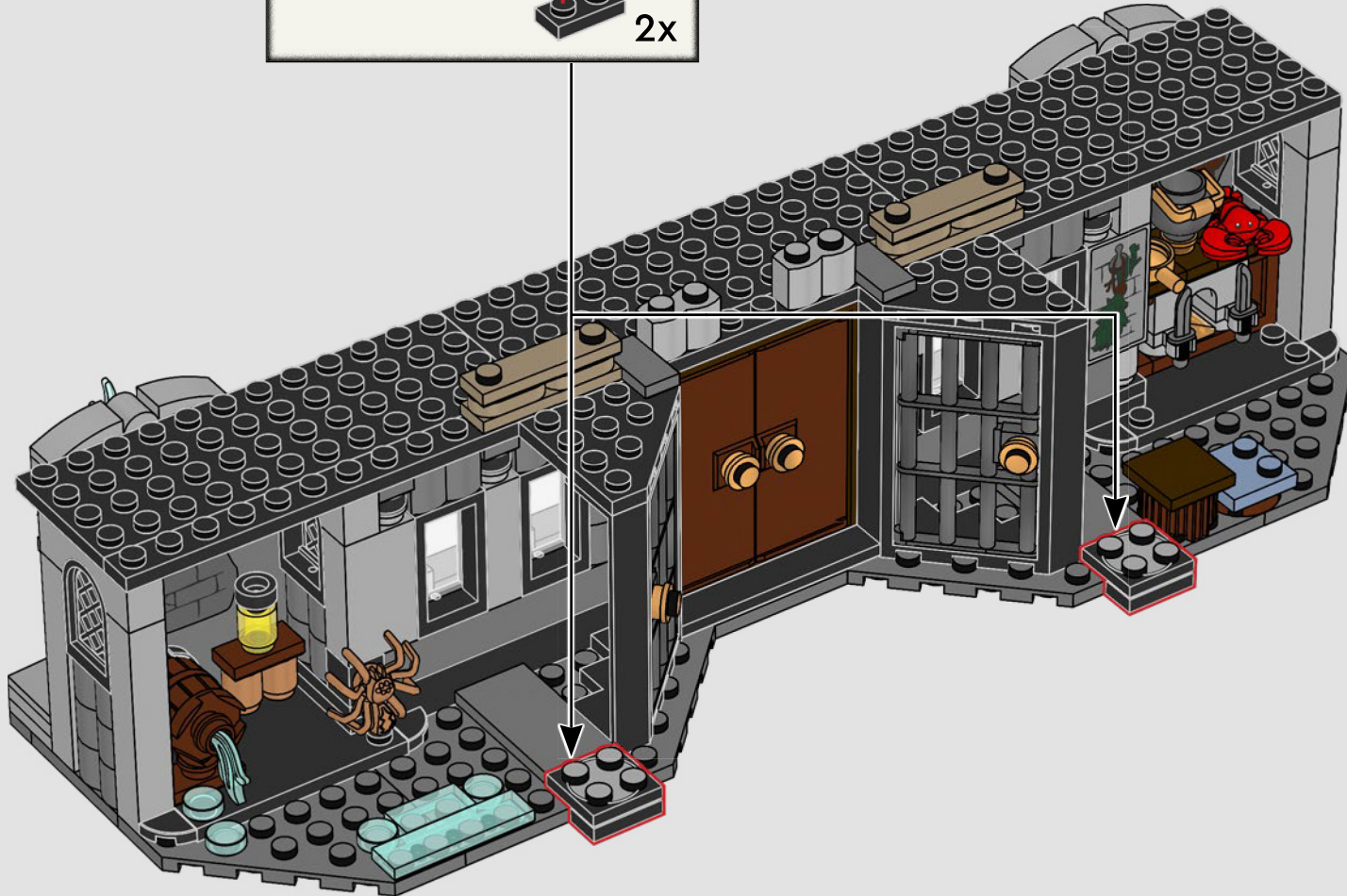
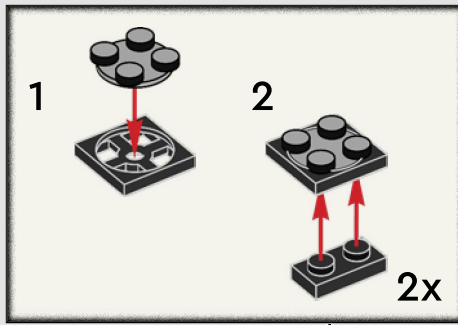

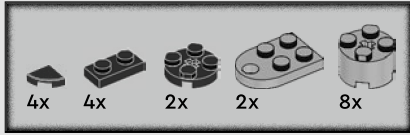
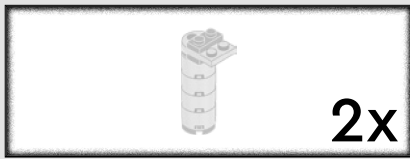

82

1

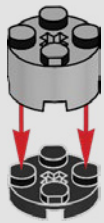

2

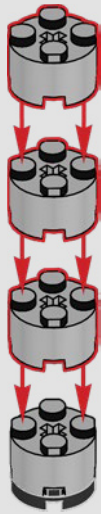

3

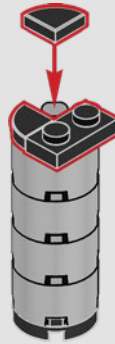

4

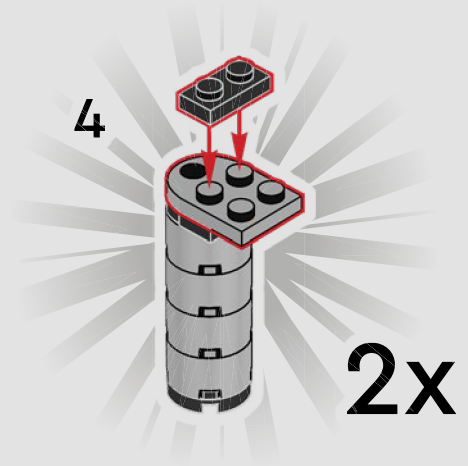

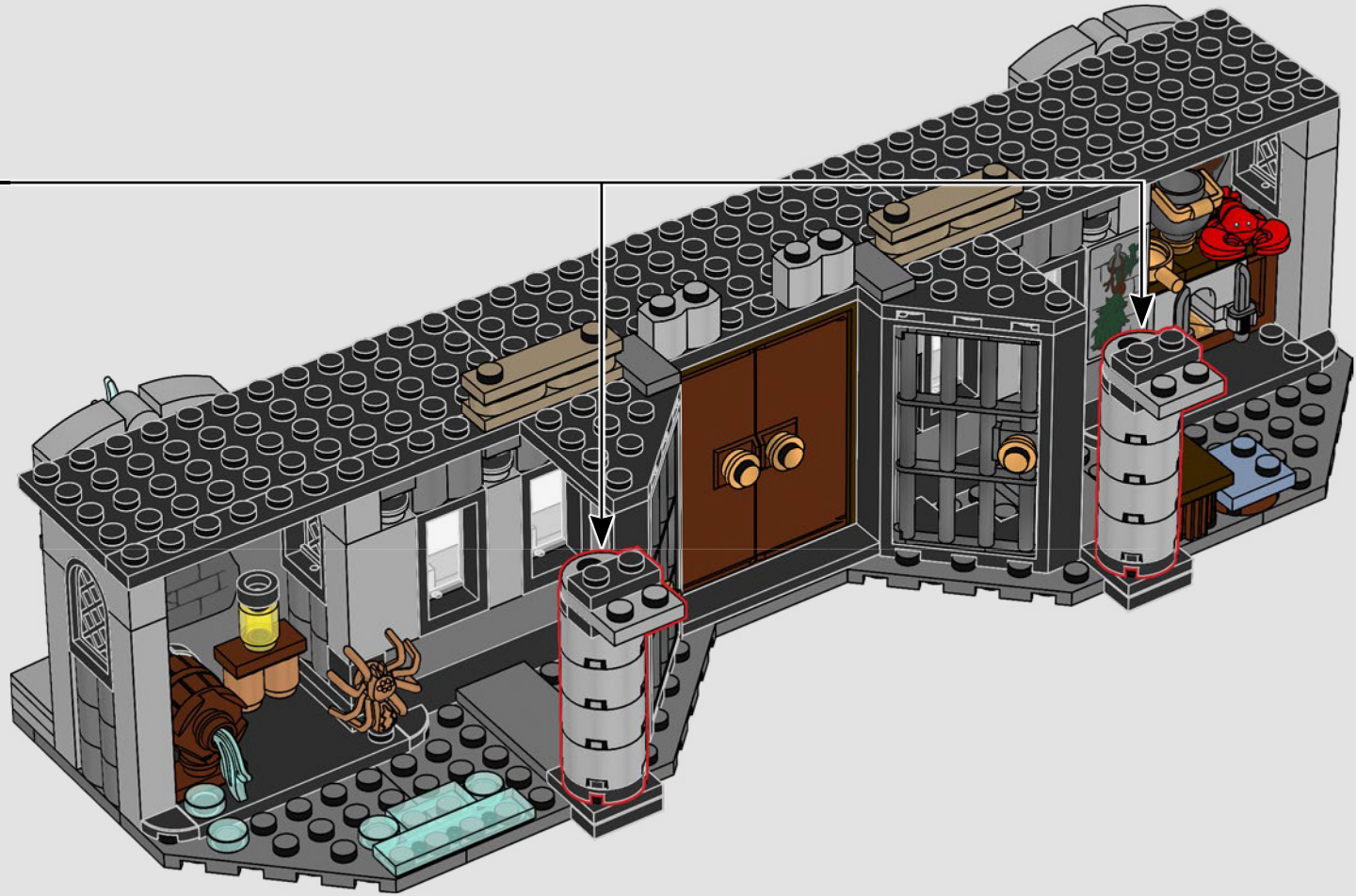

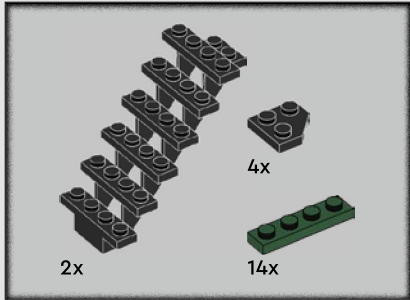
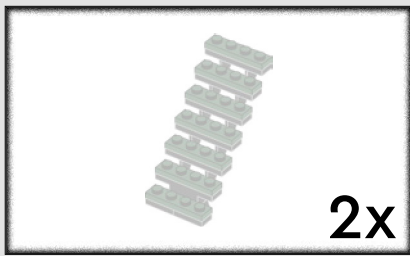

83

1

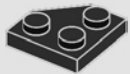

2

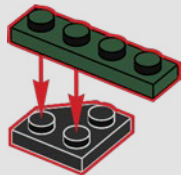

3

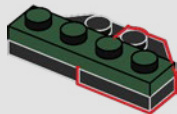

4

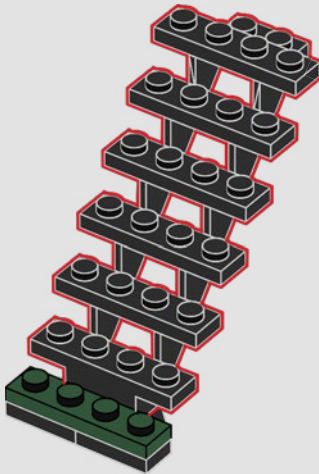

5

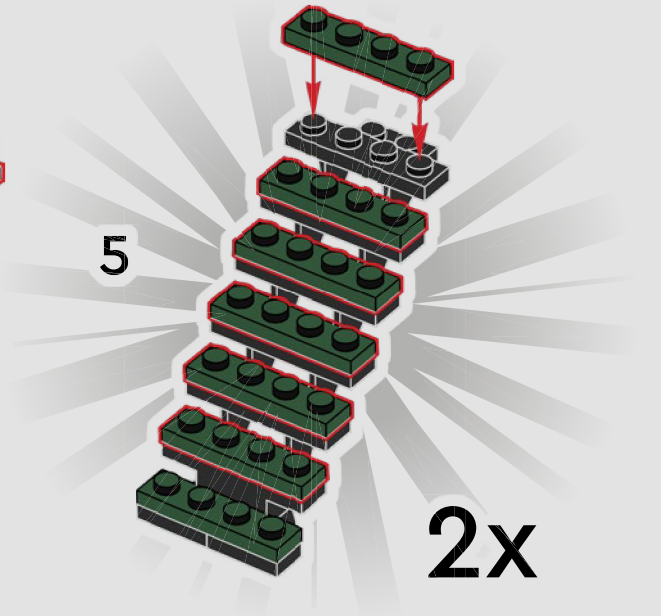



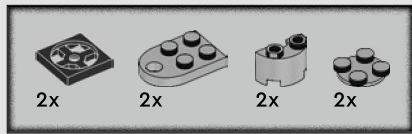

84

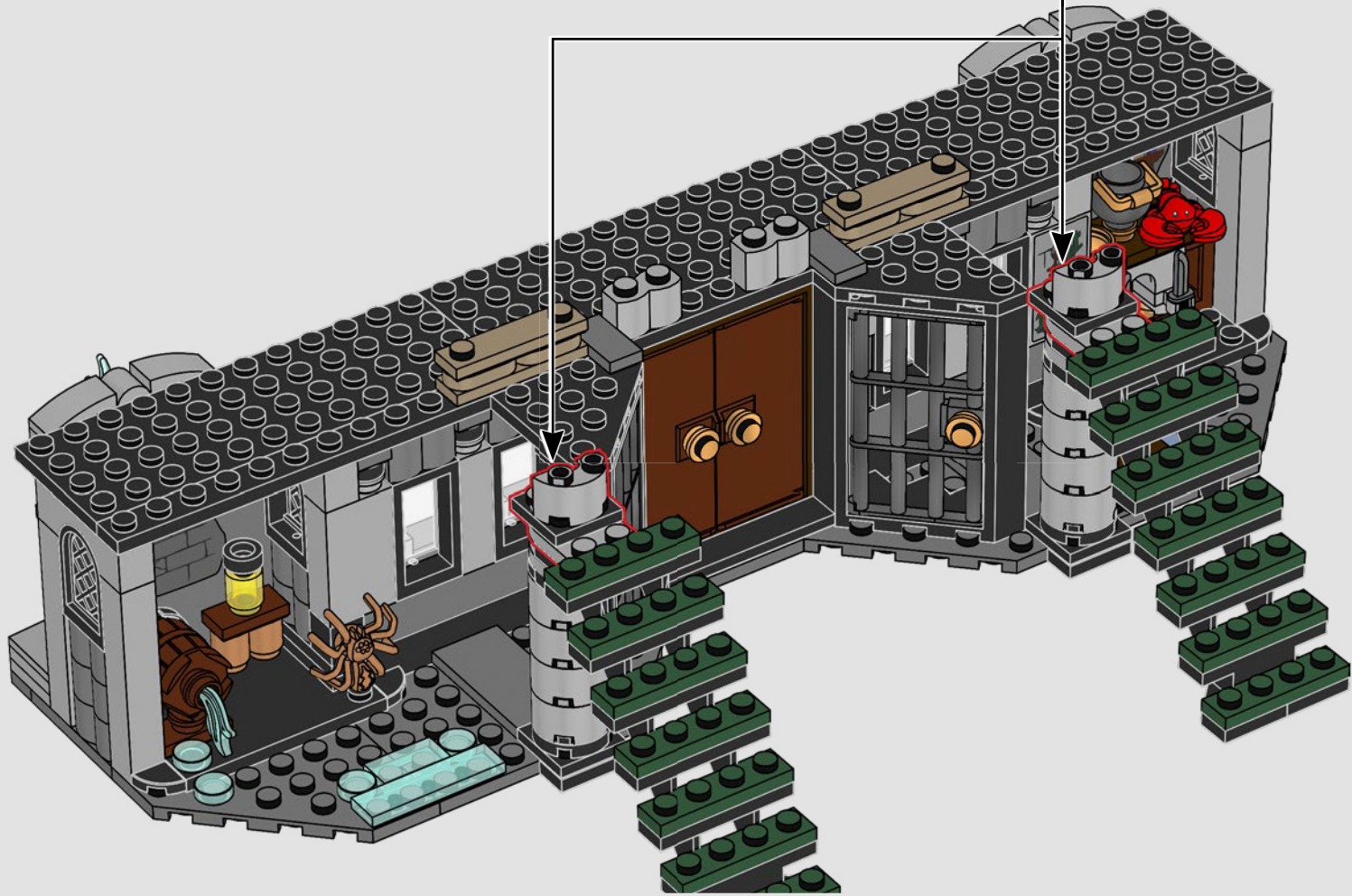
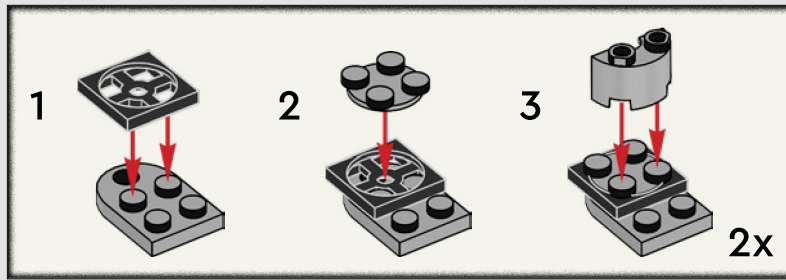

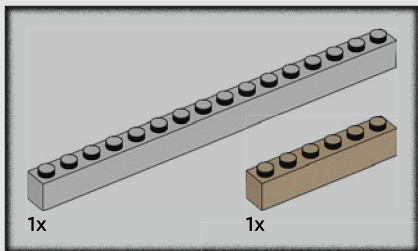

85

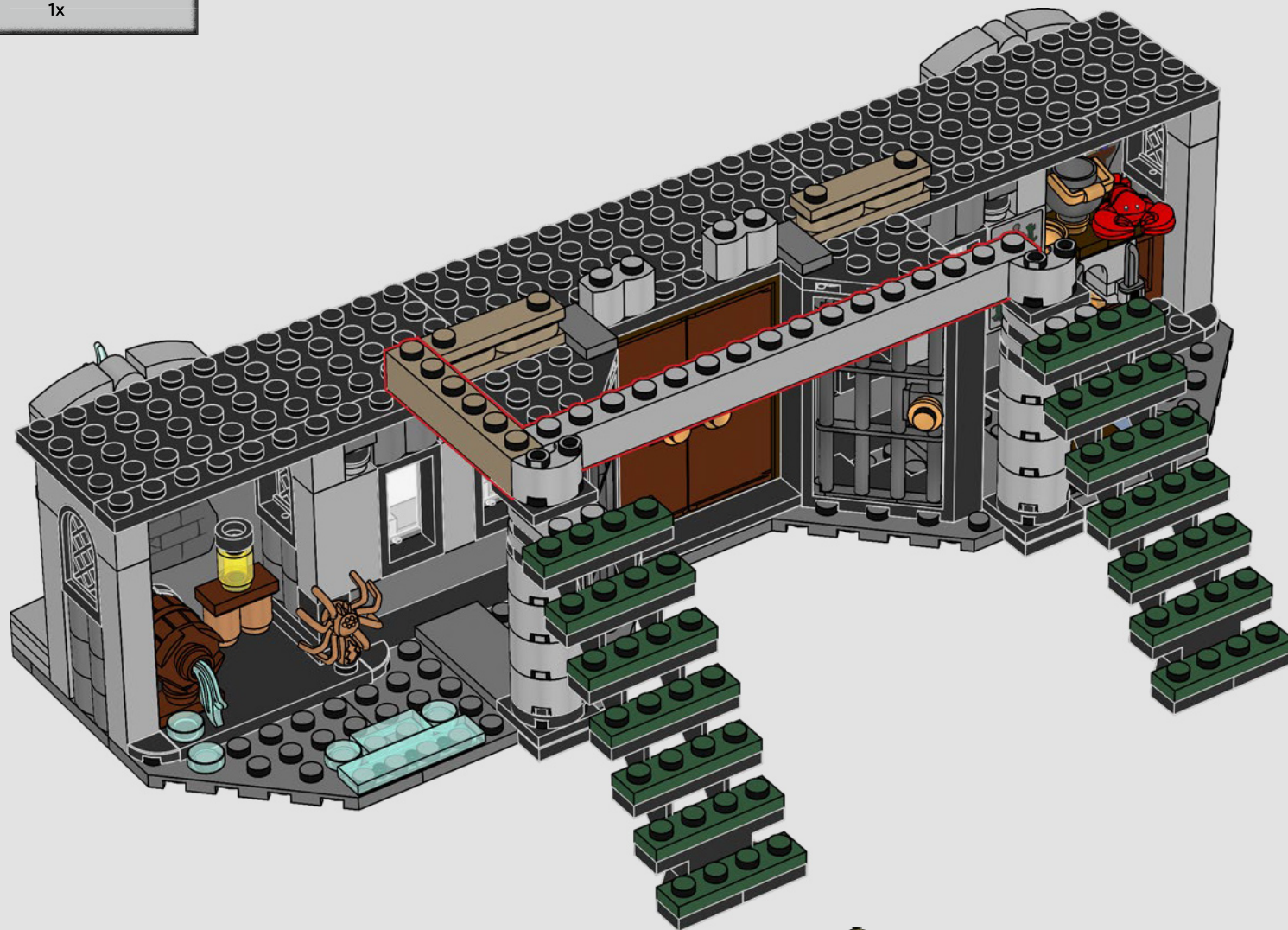

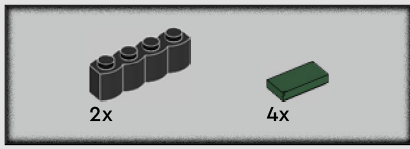

86

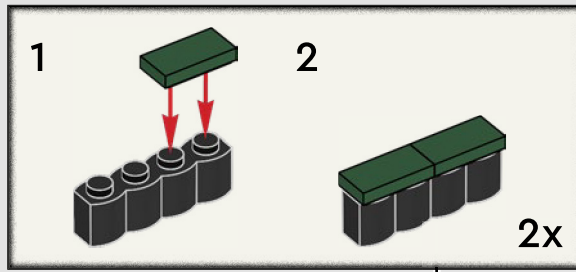

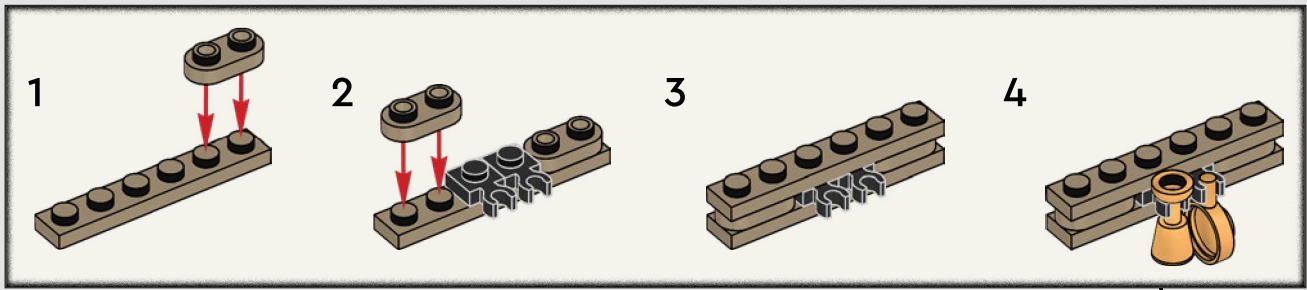
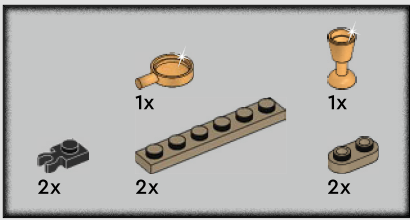

87



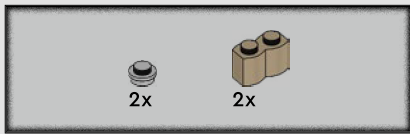

88

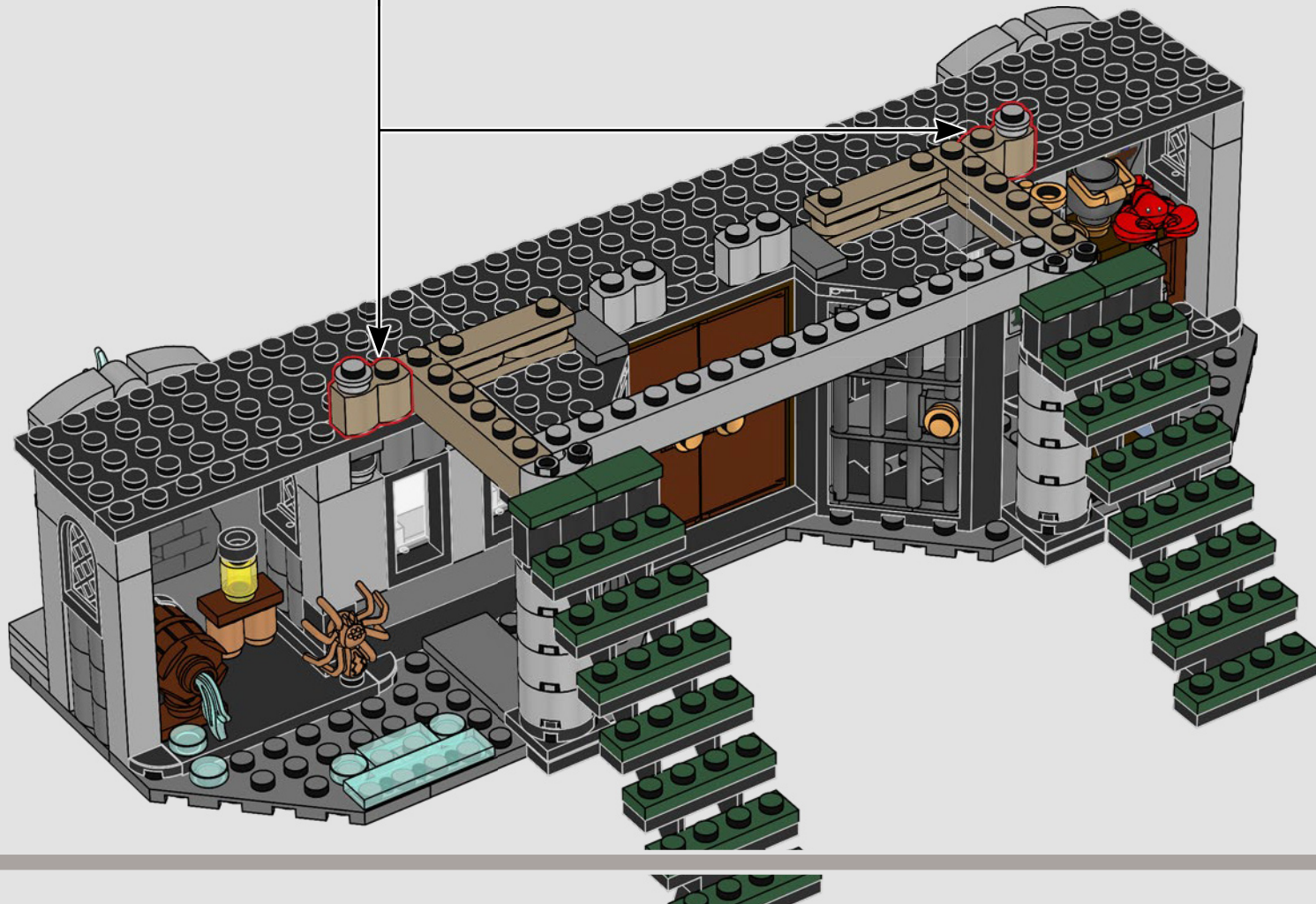
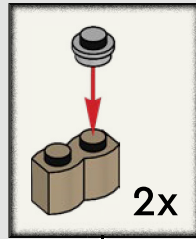

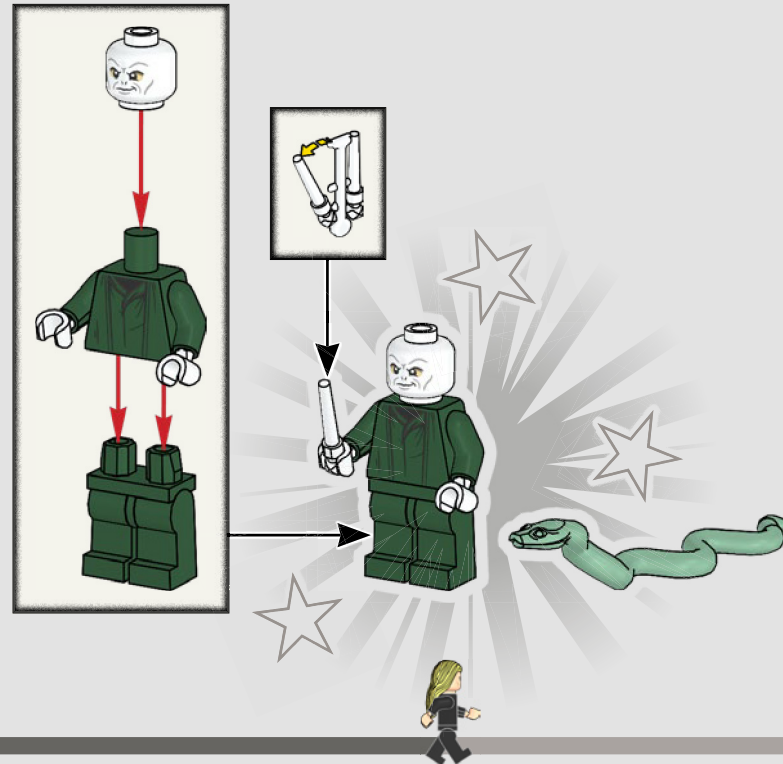

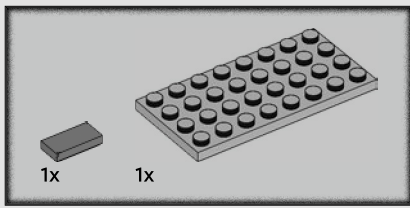

89

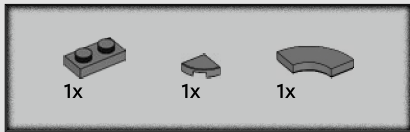
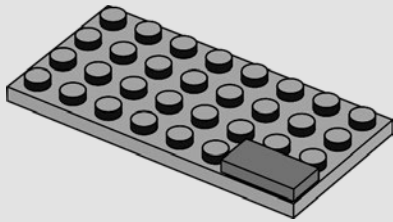

90

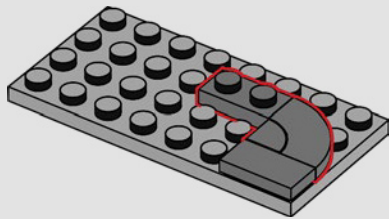

91

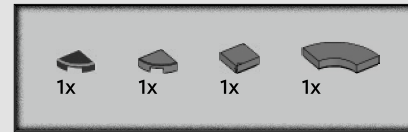
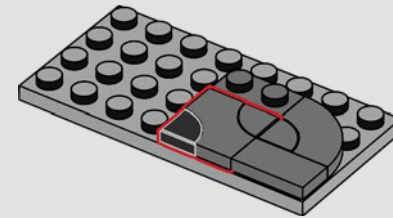

92

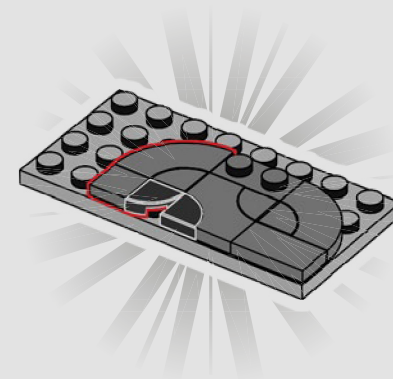

93



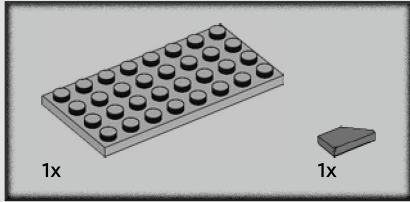
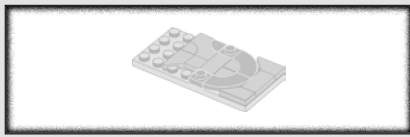

94

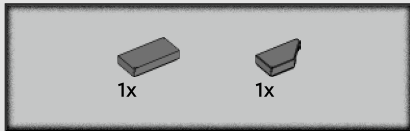
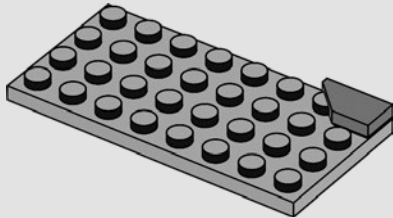

95

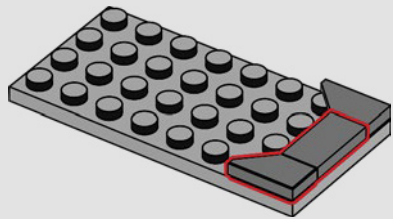

96

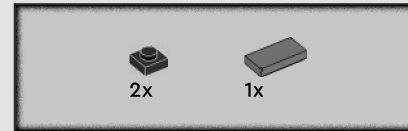
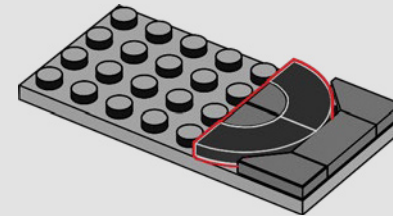

97

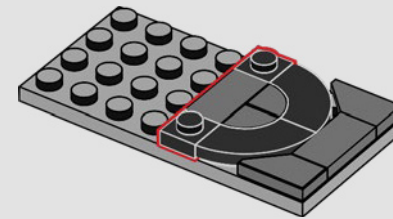

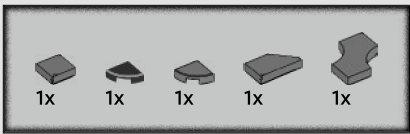

98

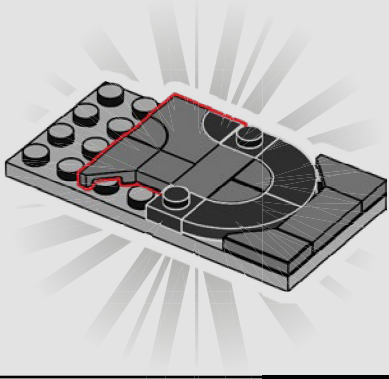

99

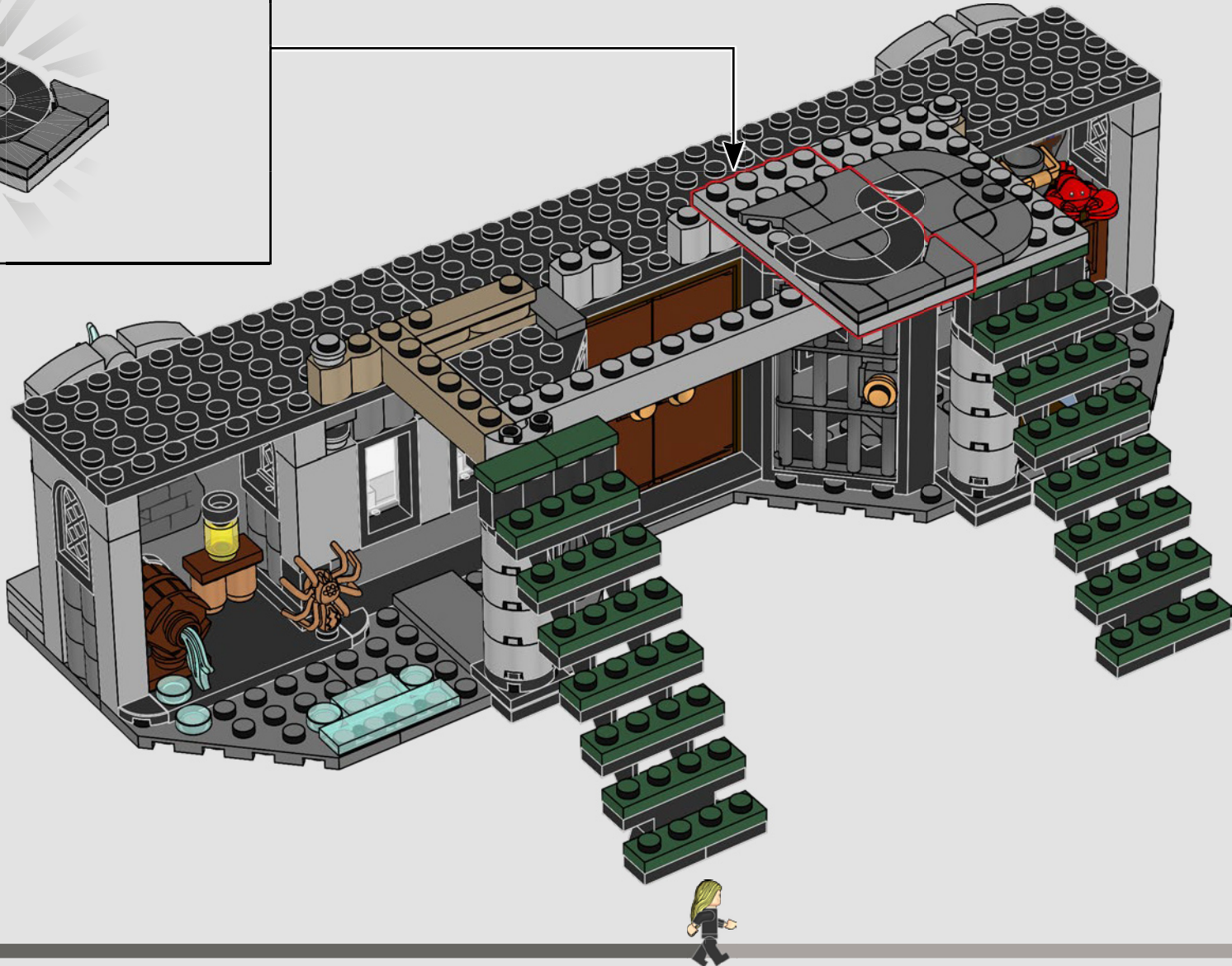

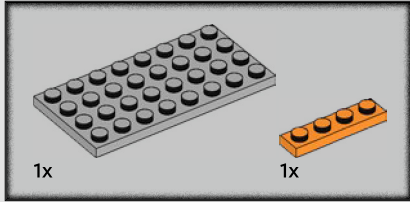
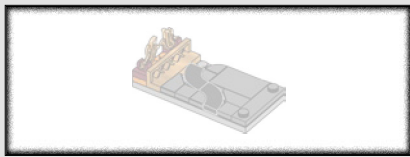

100

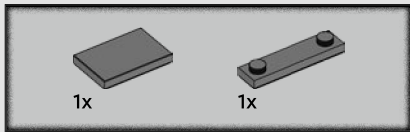
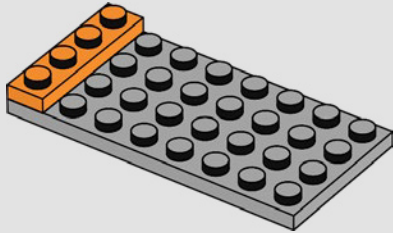

101

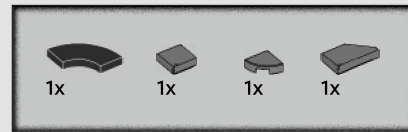
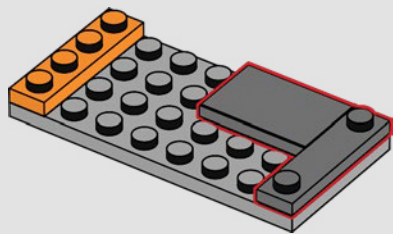

102

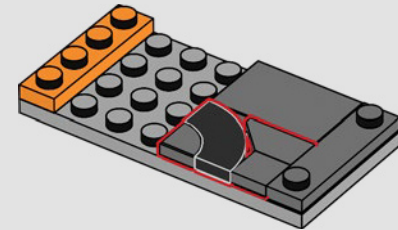

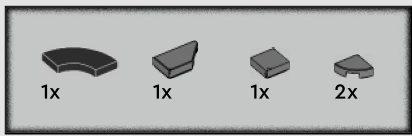

103

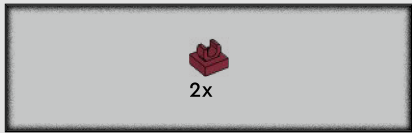
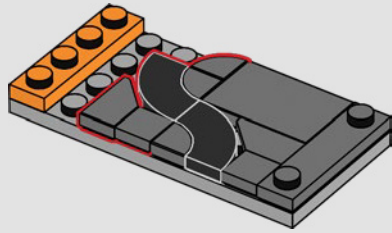

104

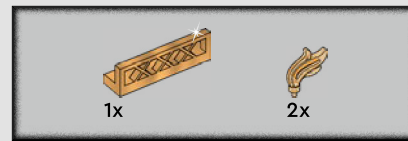
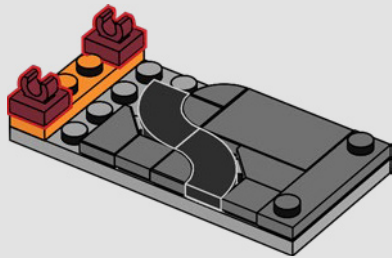

105

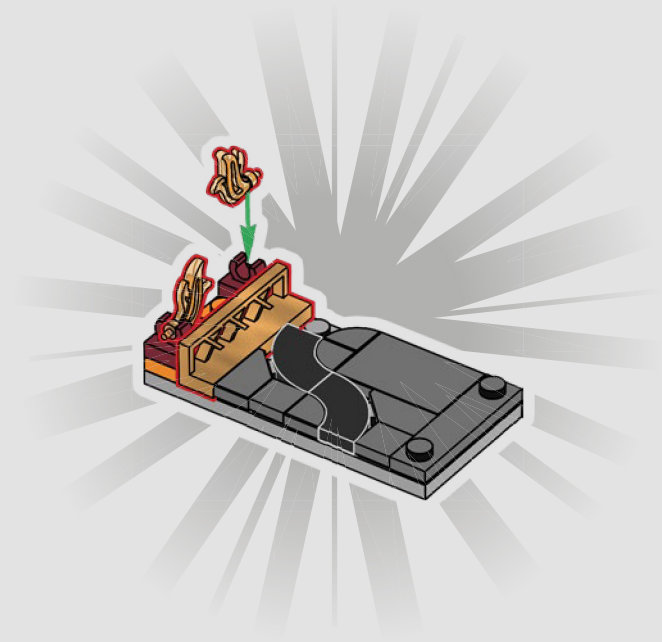

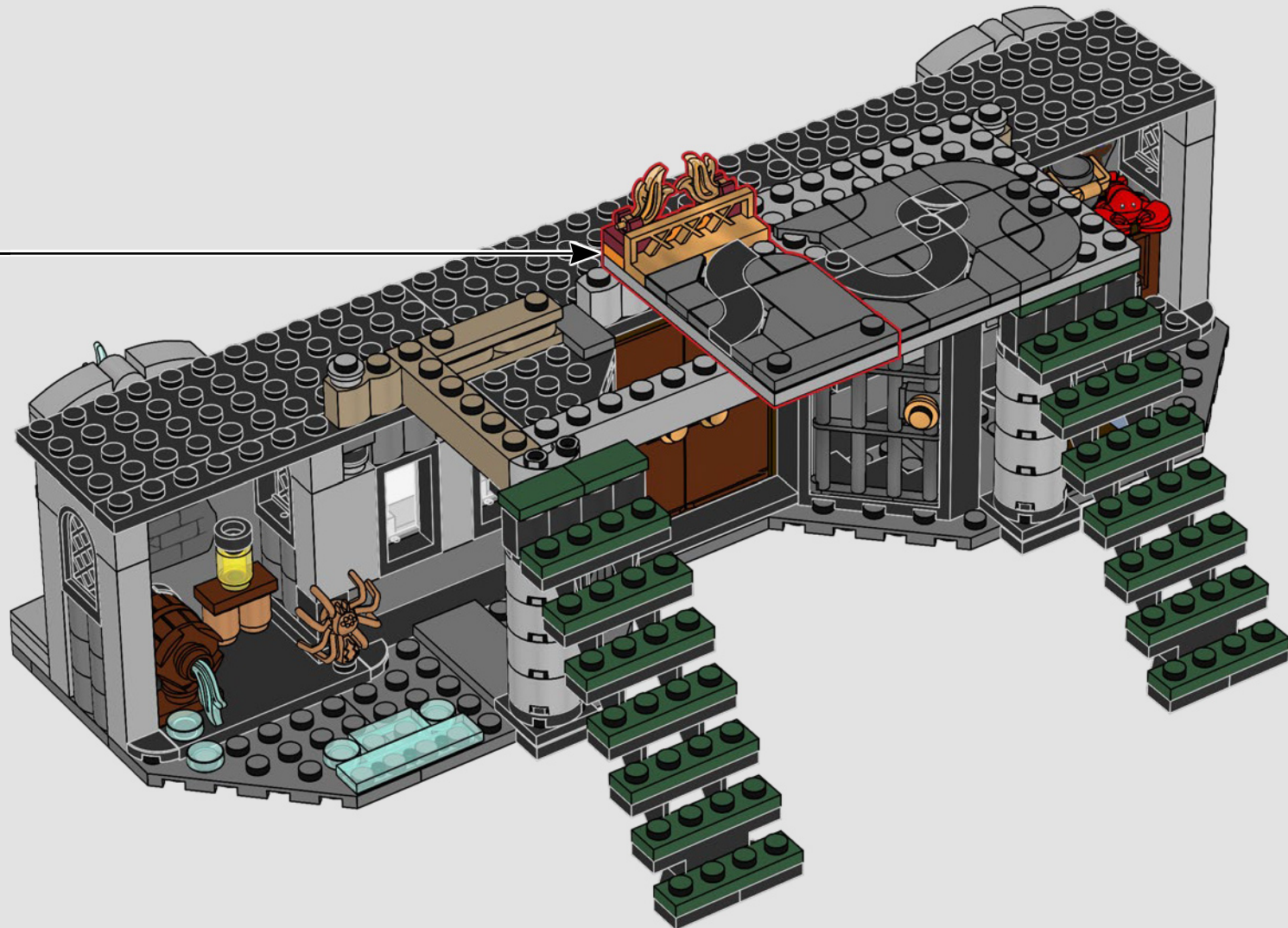

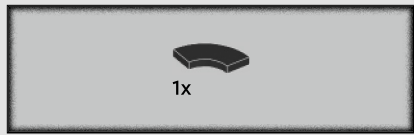

107

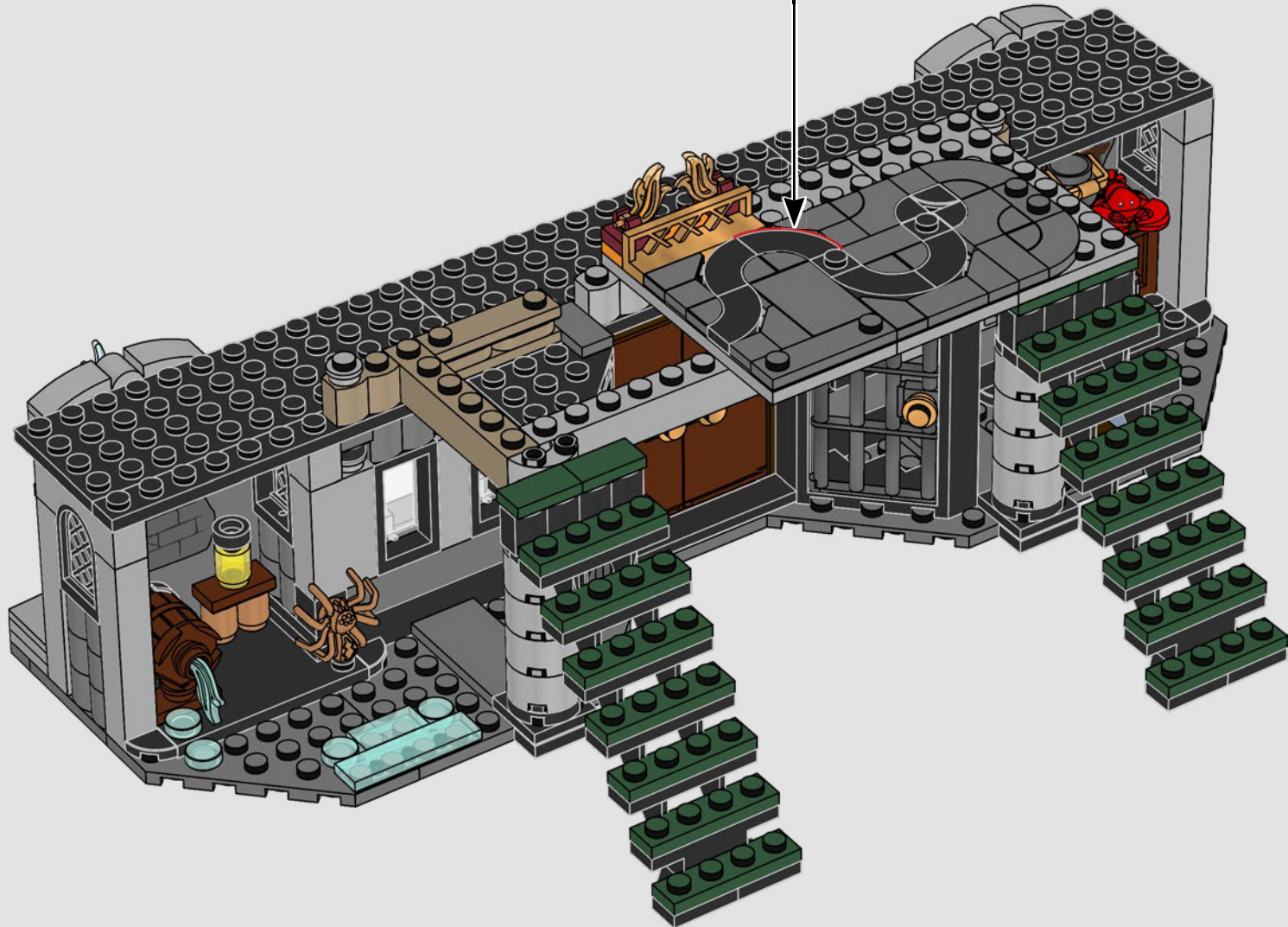

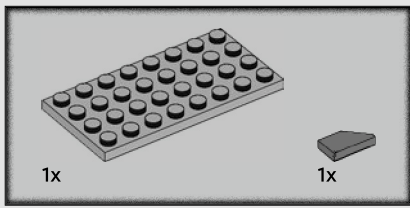

108

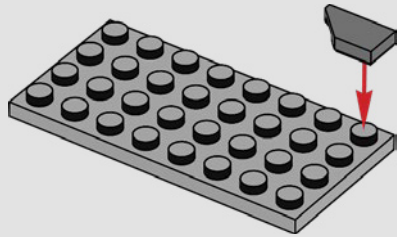

109

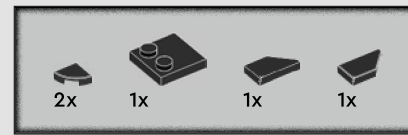
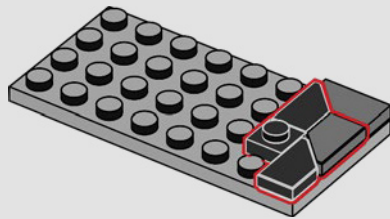

110

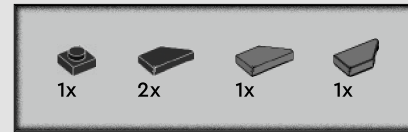
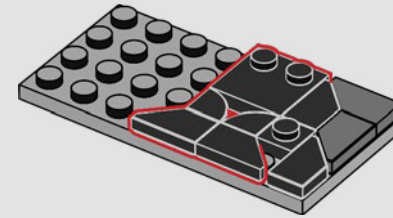

111

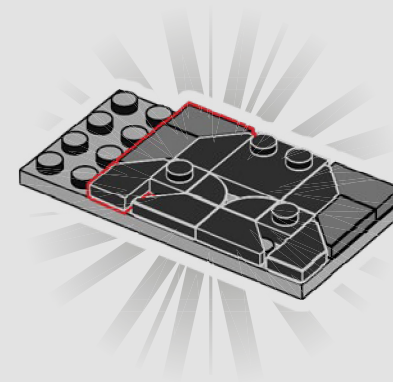

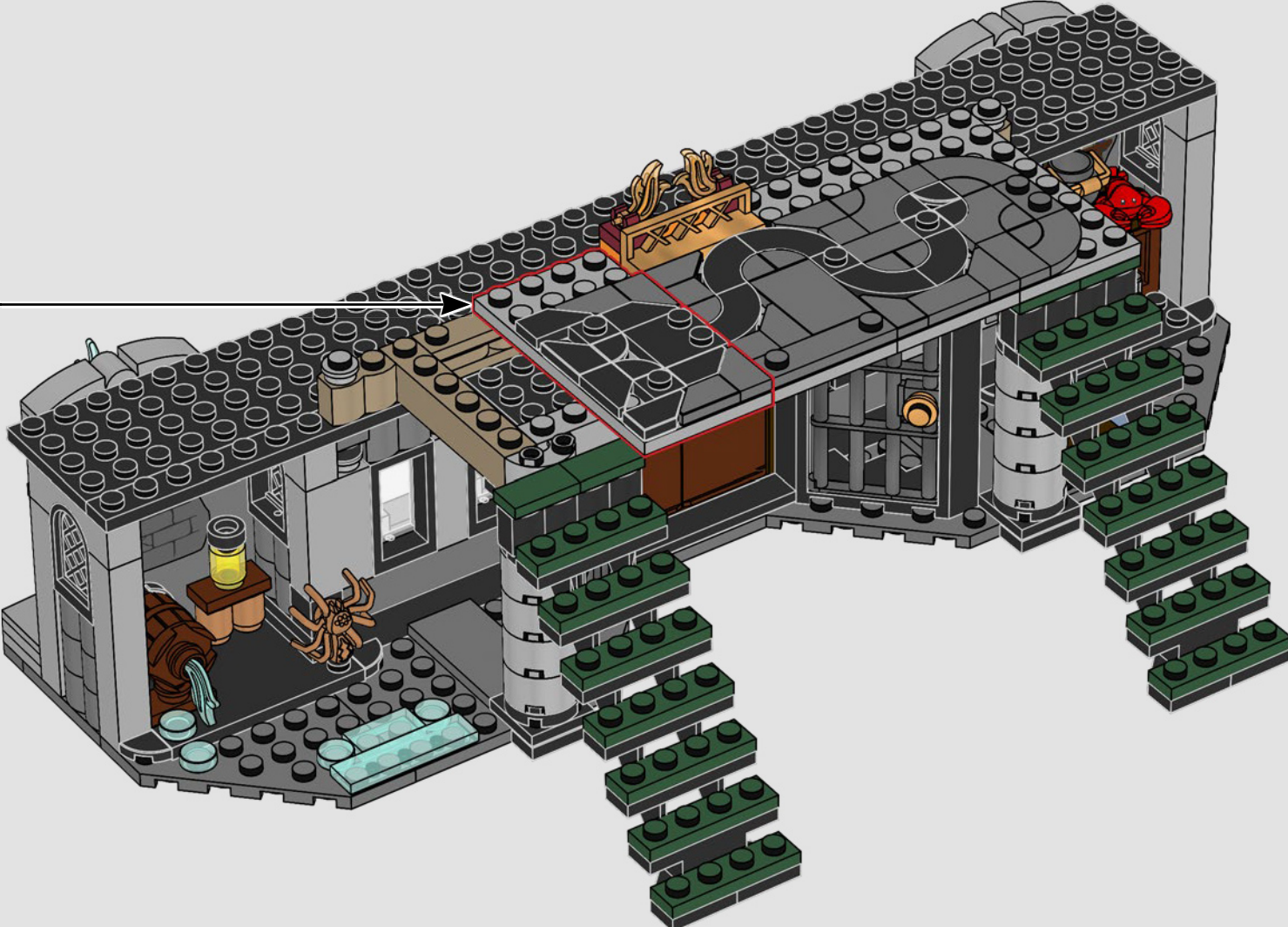

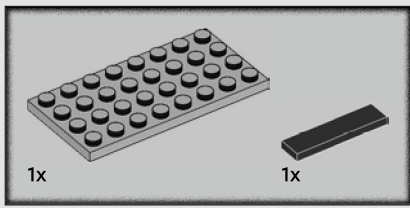

113

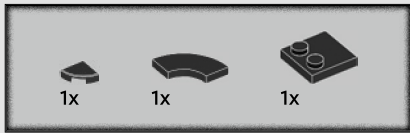
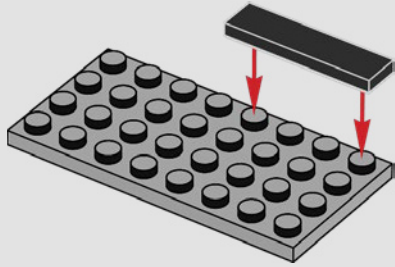

114

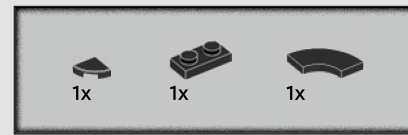
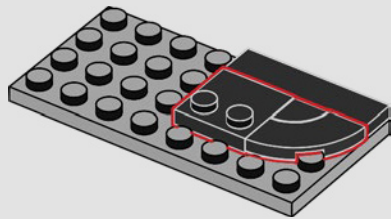

115

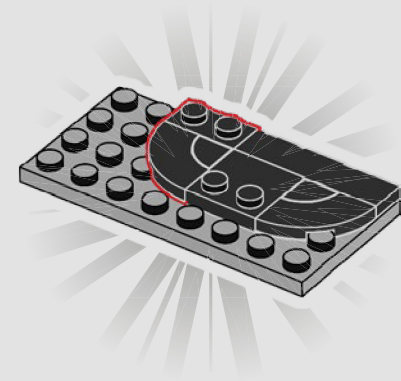

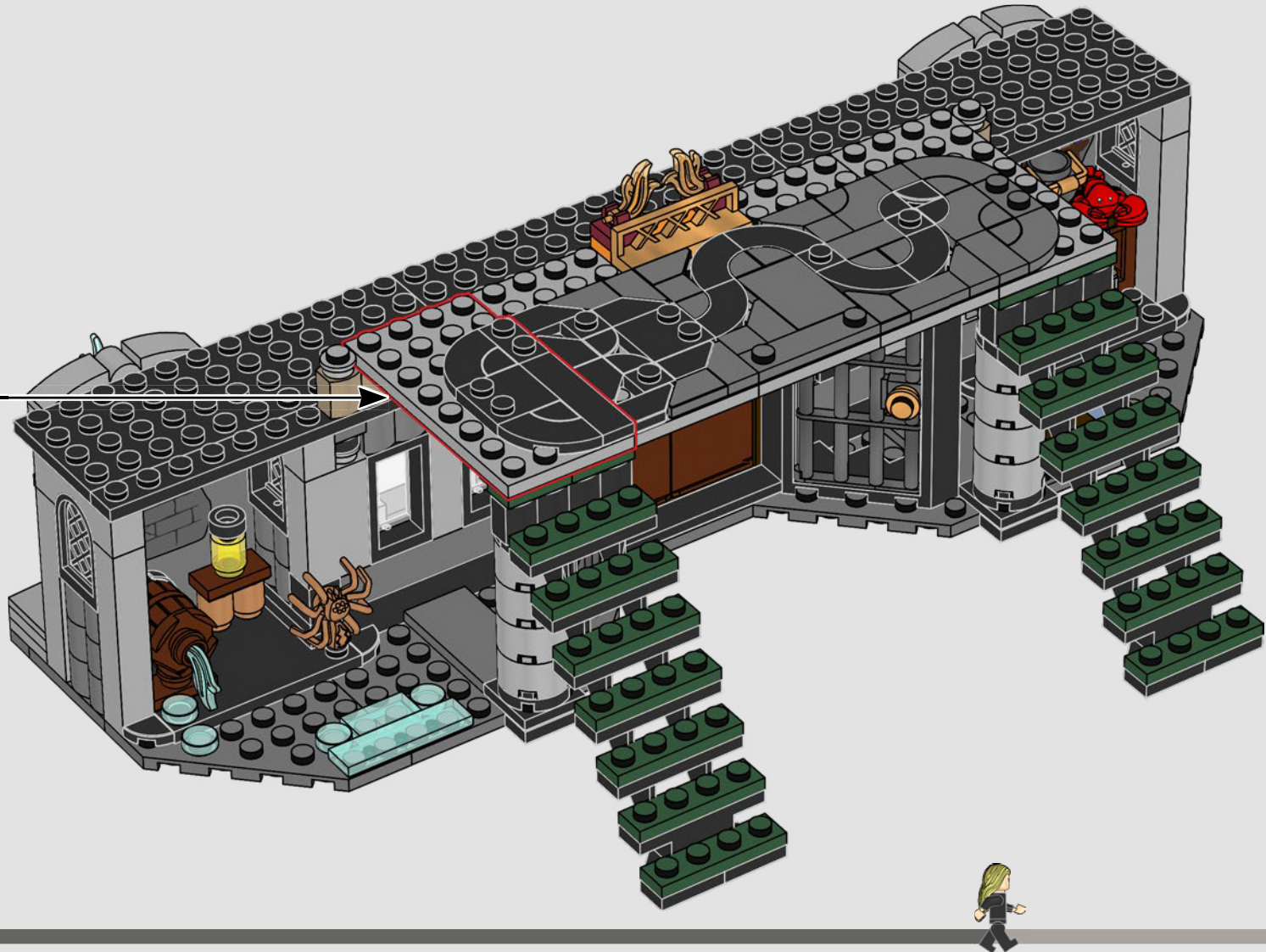

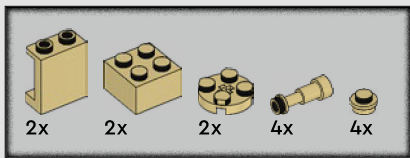

117

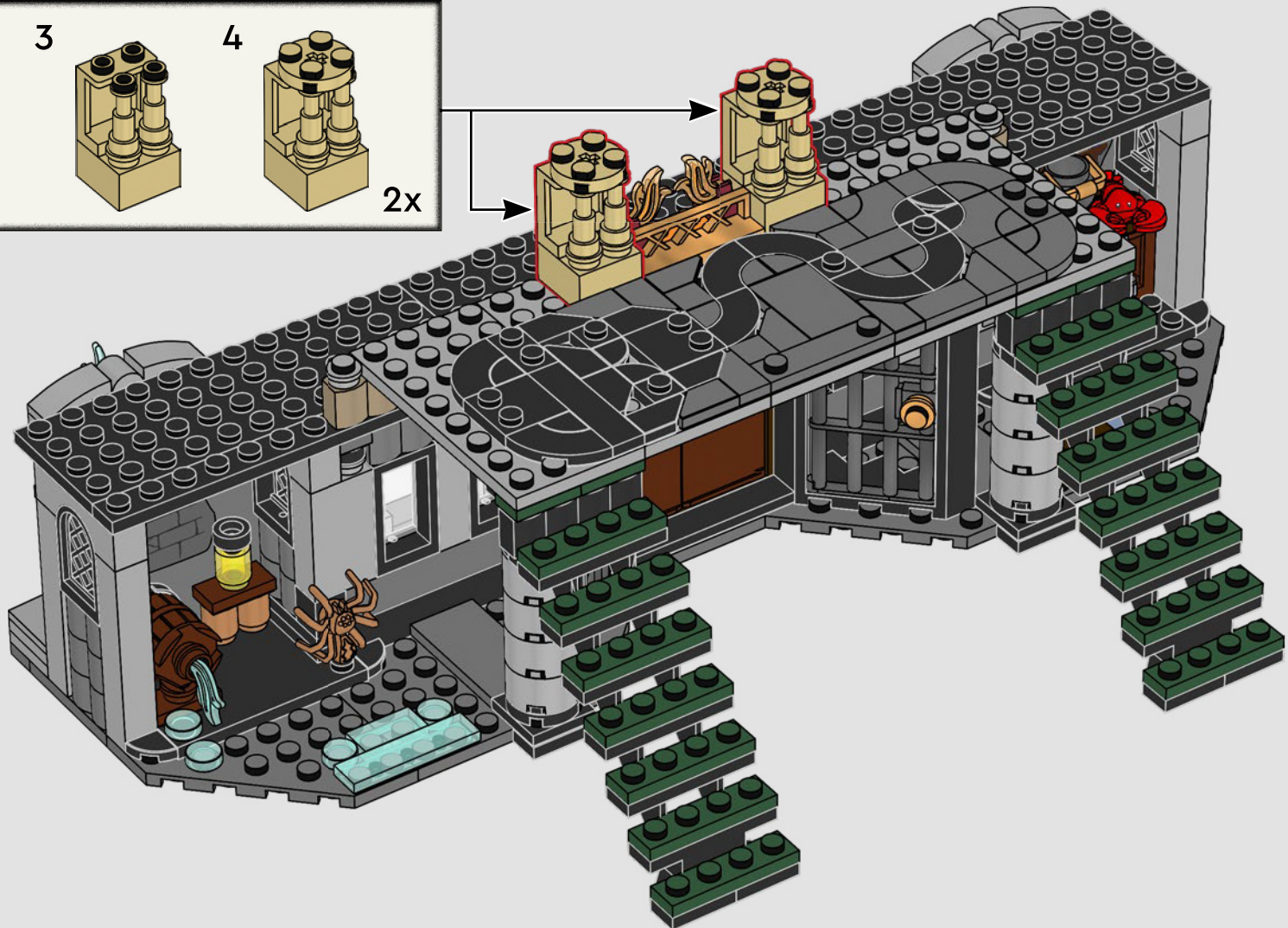
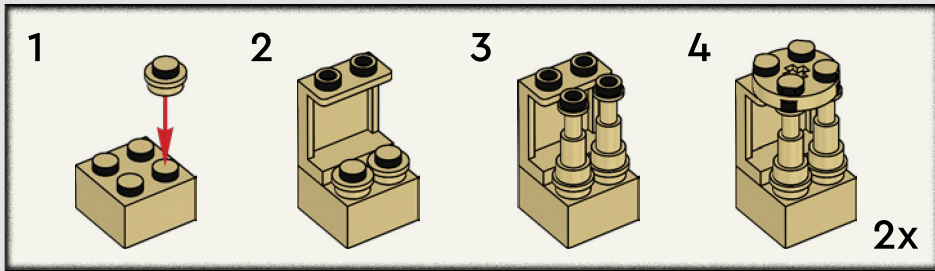

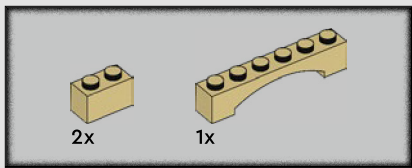

118

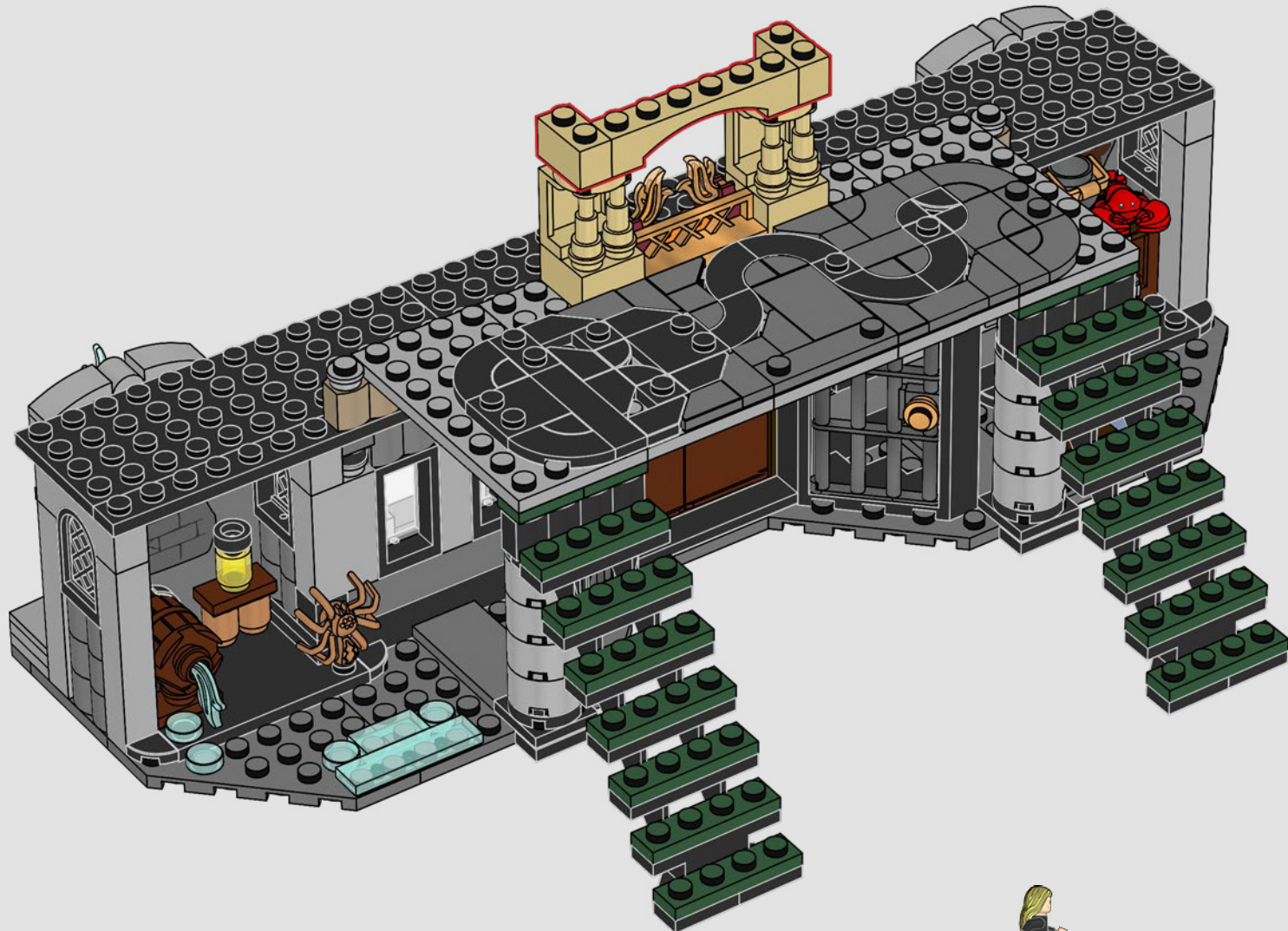

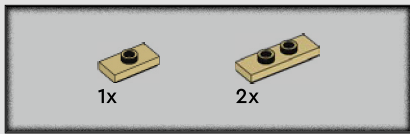

119

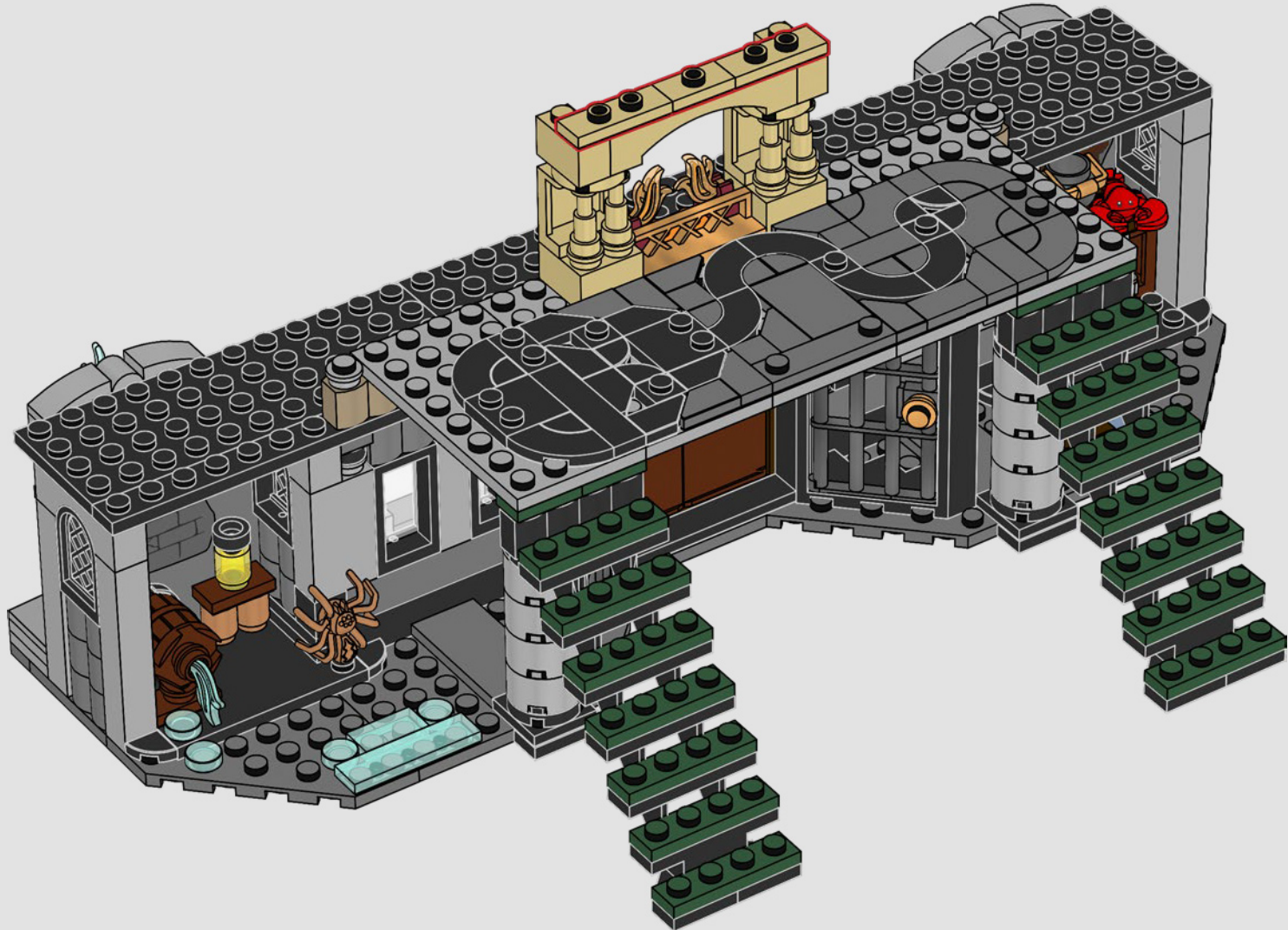

5x

120

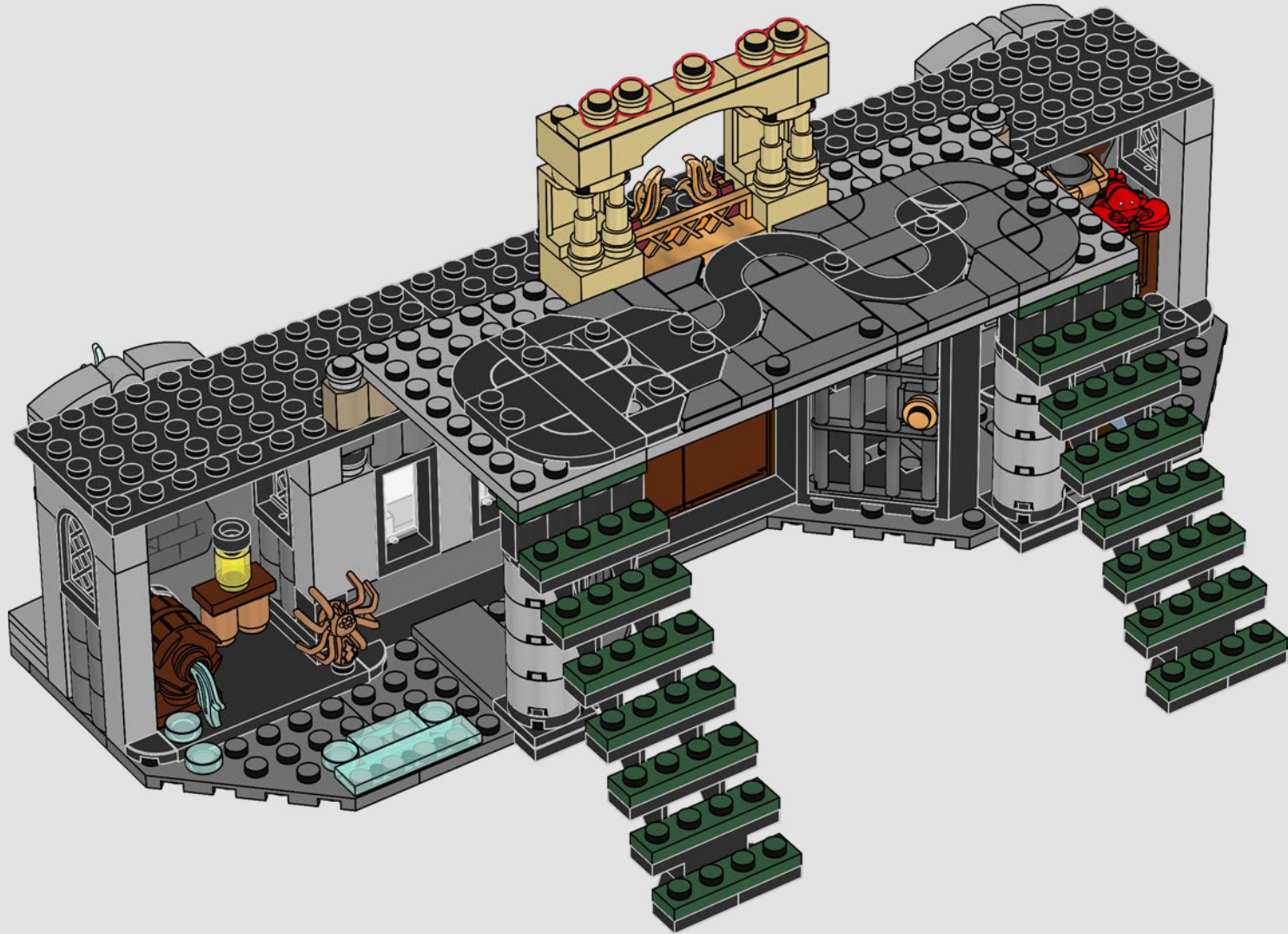



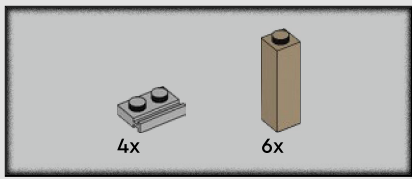

121

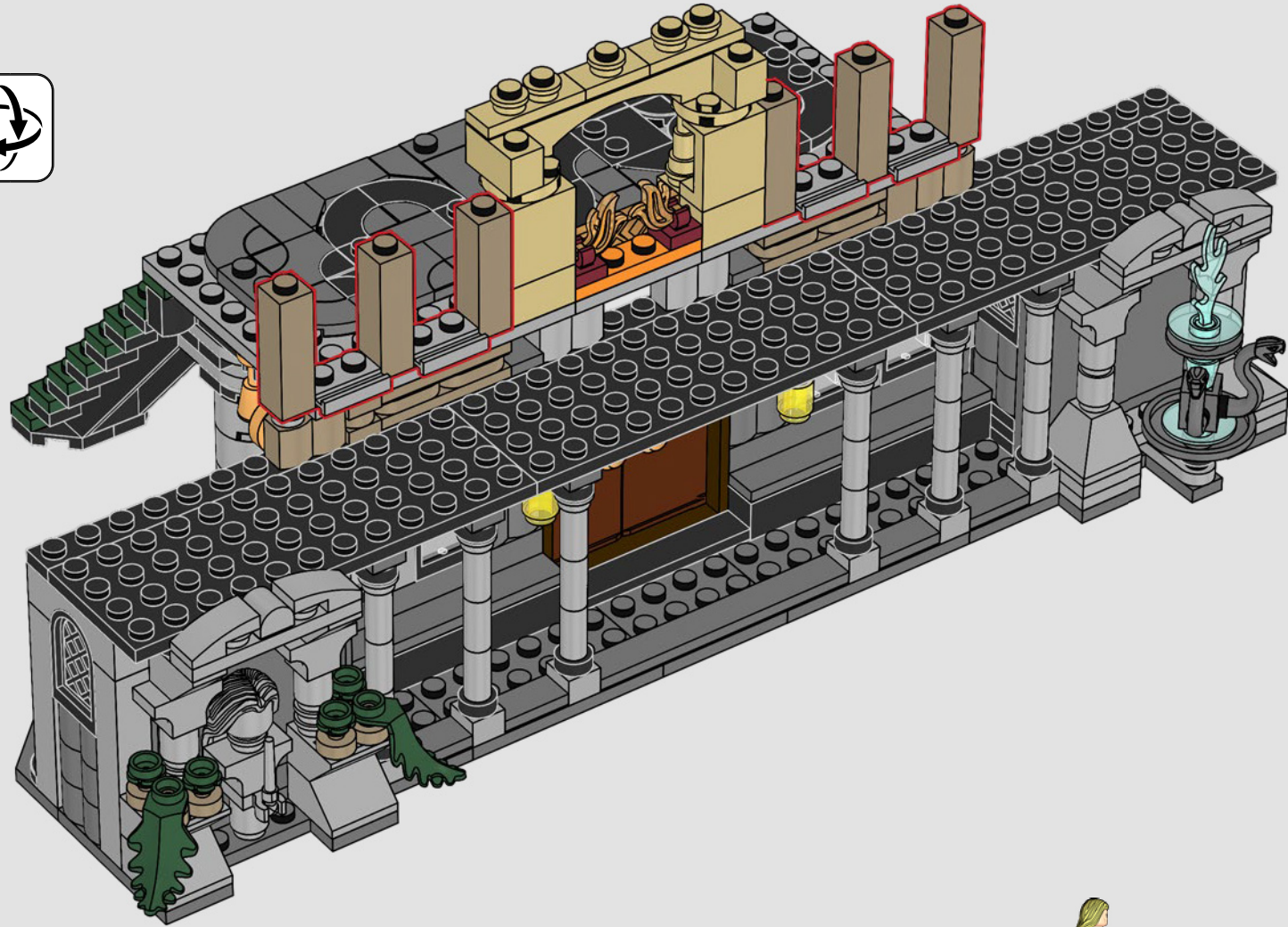

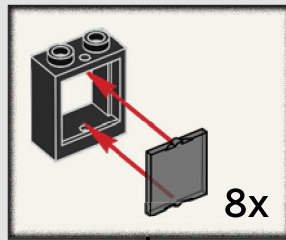
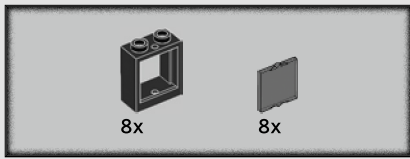

122

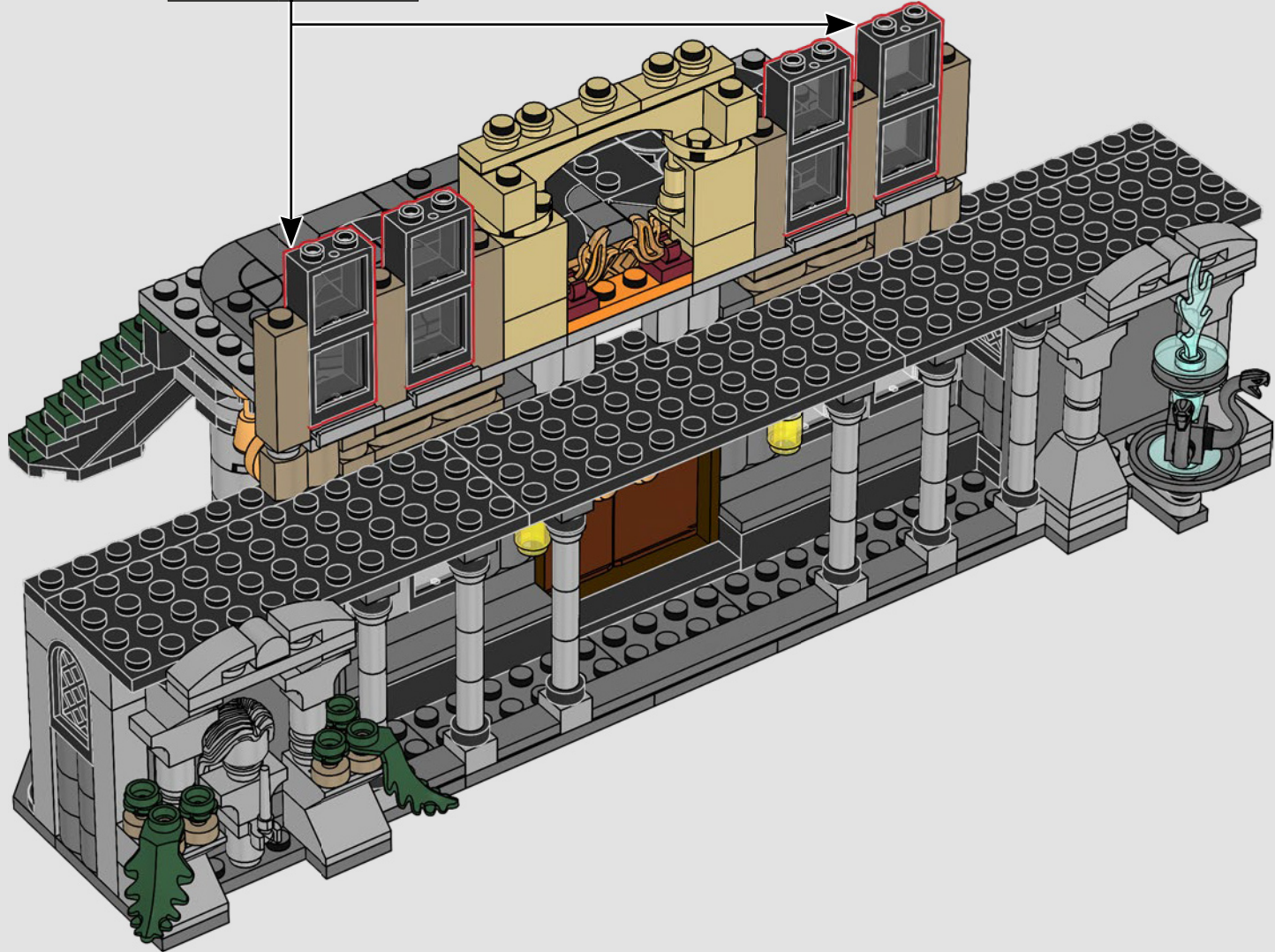

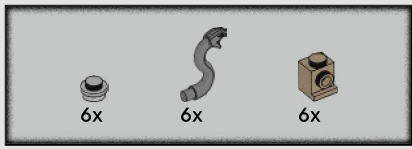

123

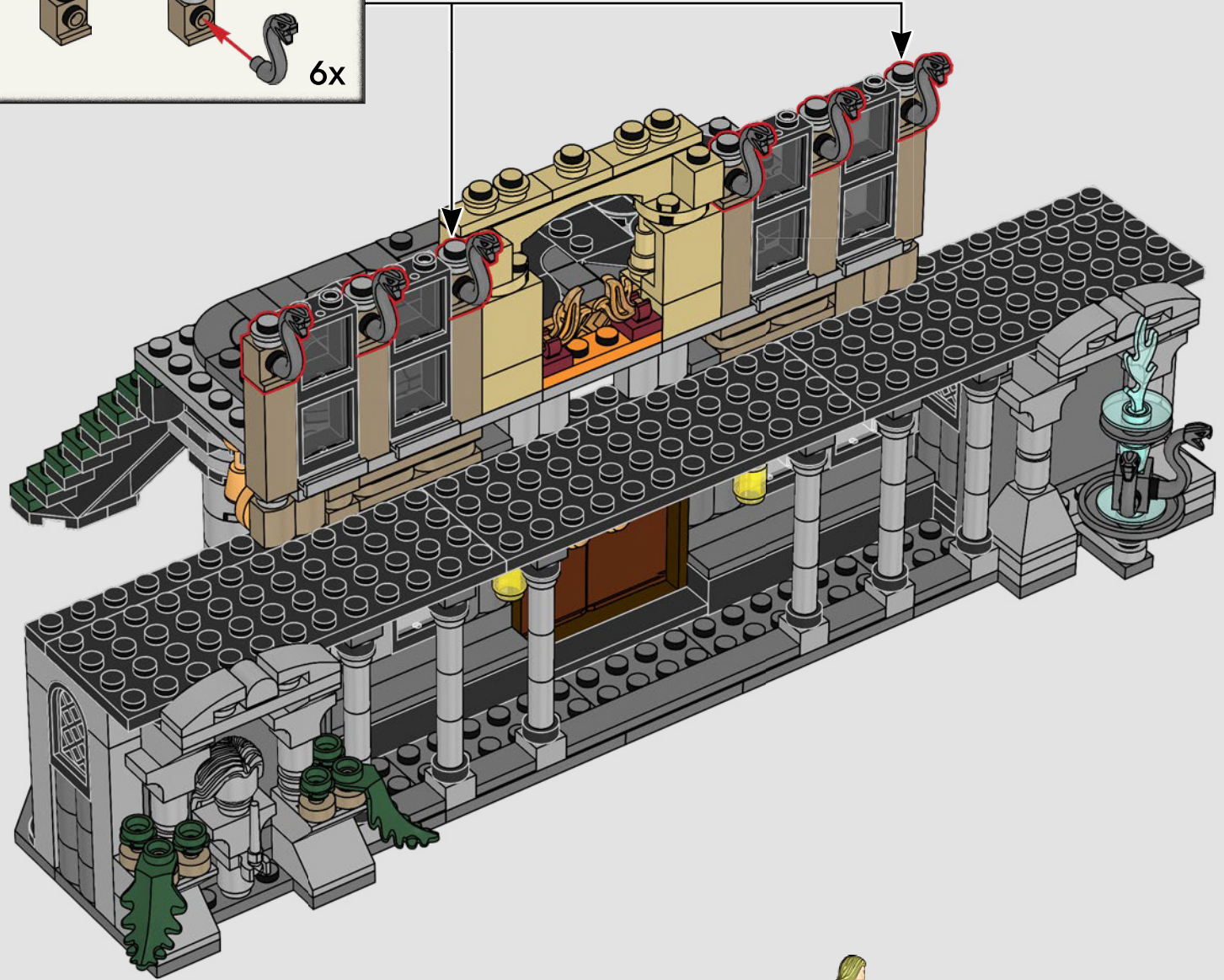
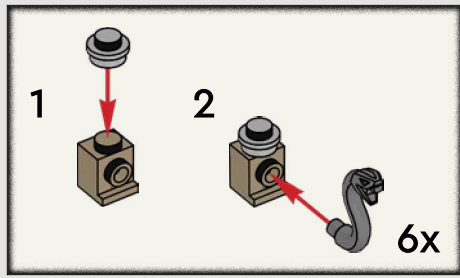

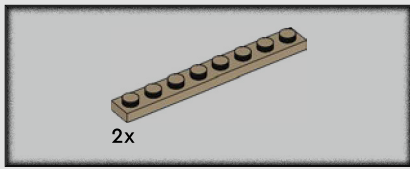

124

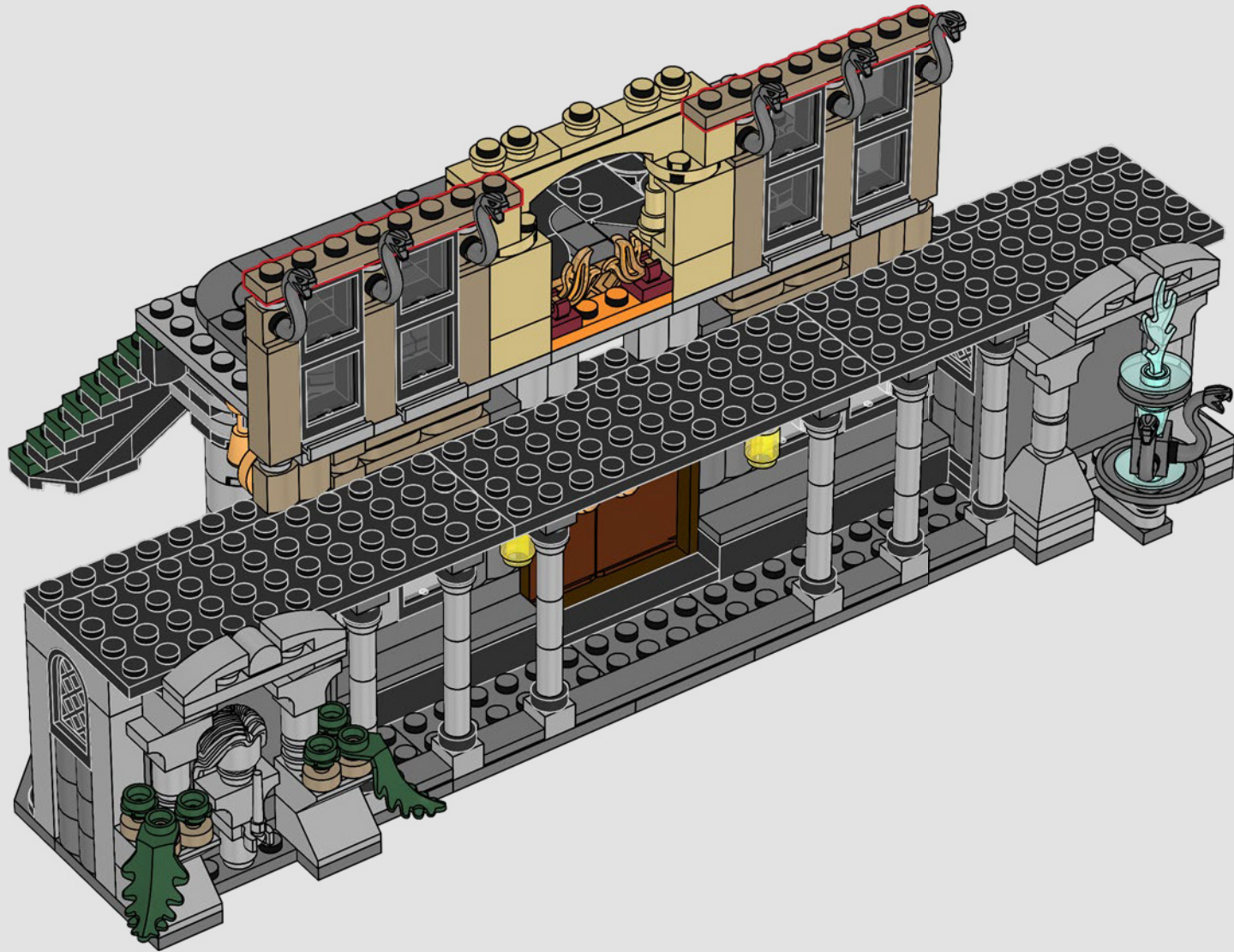

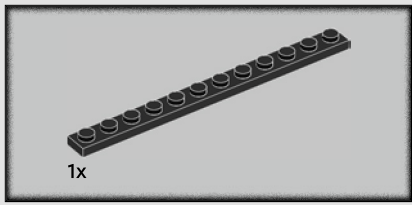

125

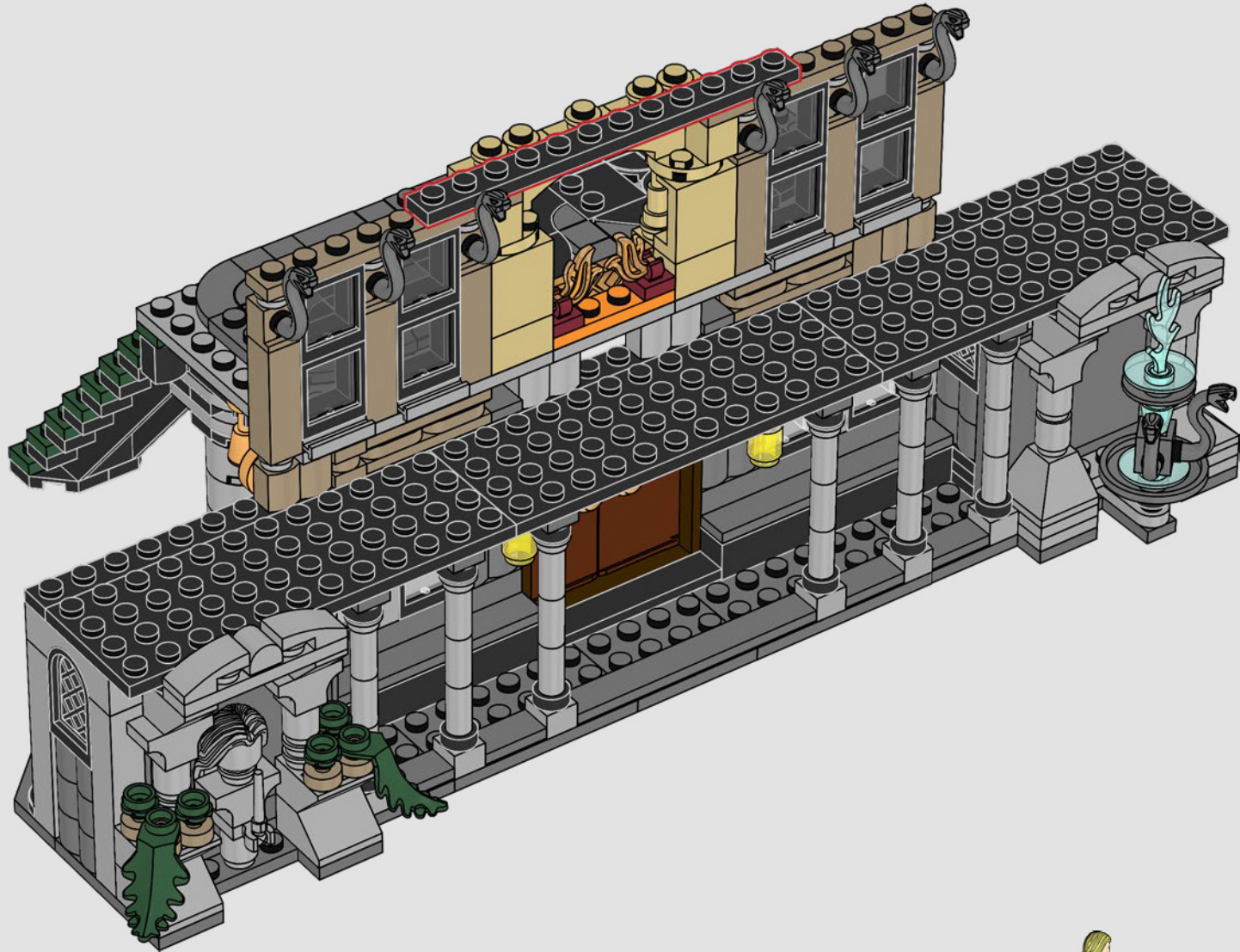

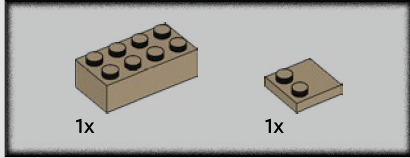
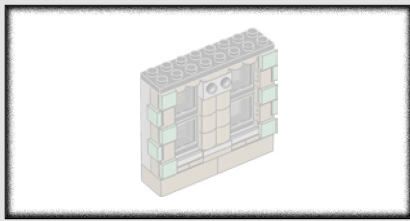

126

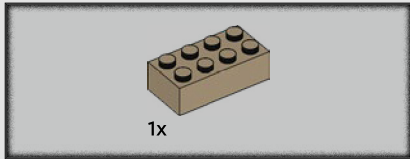
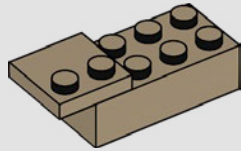

127

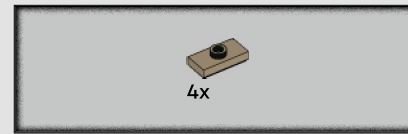
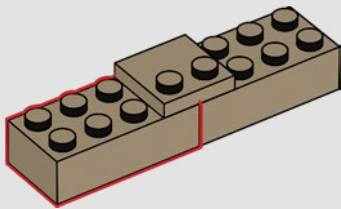

128

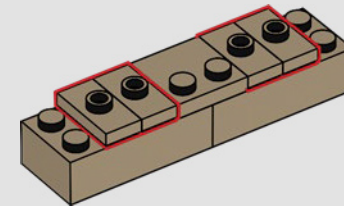

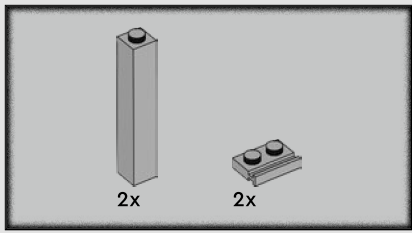

129

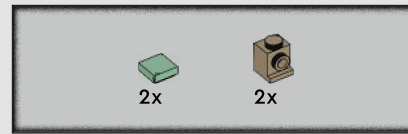
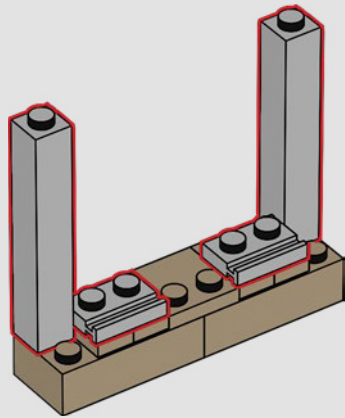

130

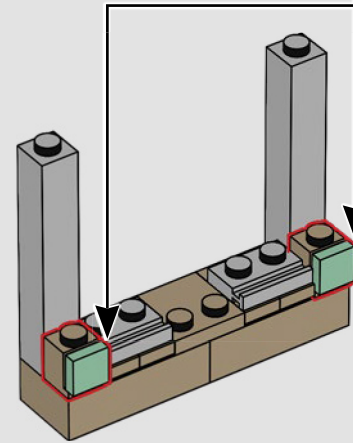
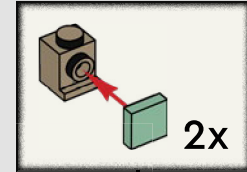

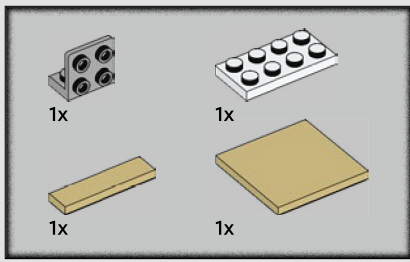

131

1

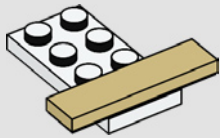

2

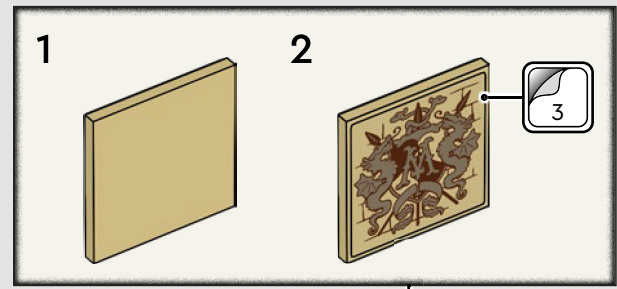
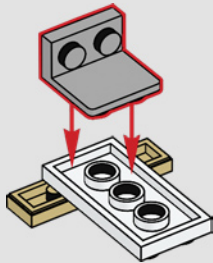

3

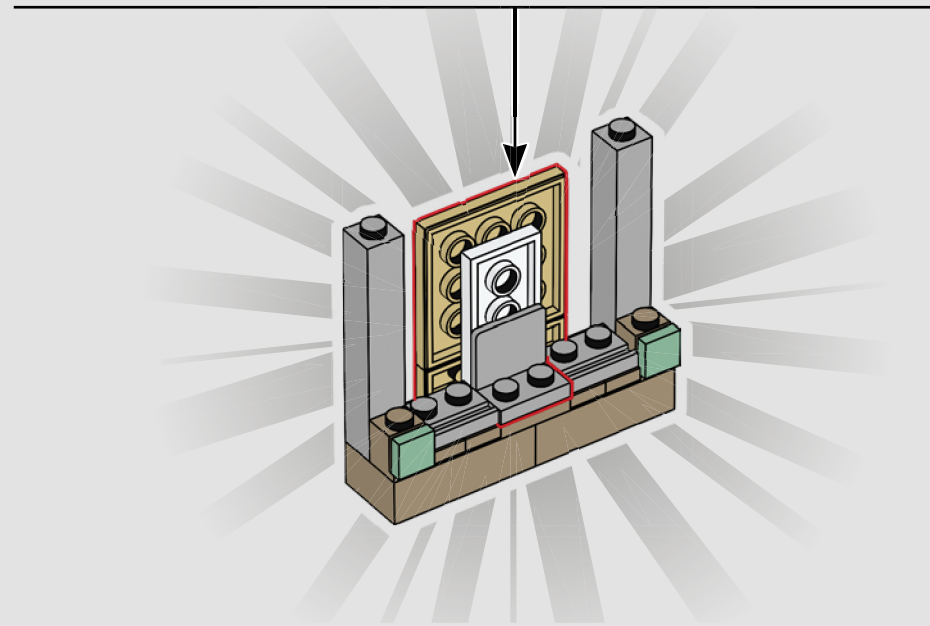
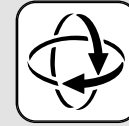

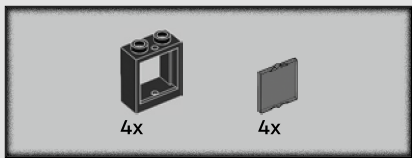

132

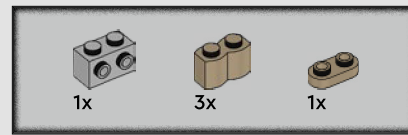
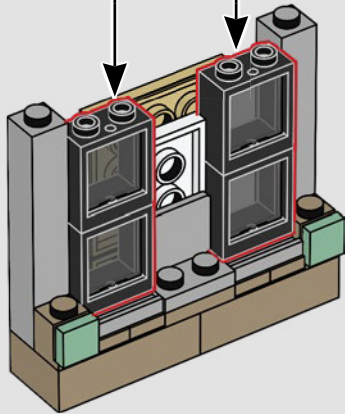
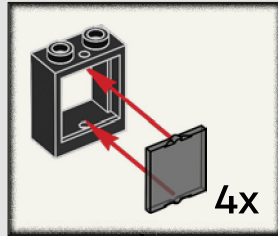

133

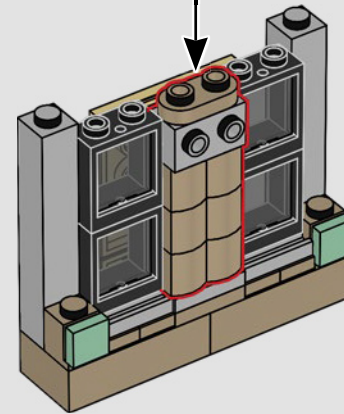
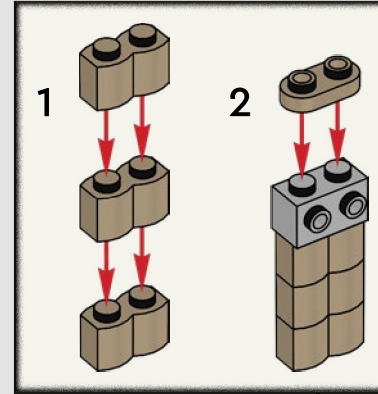

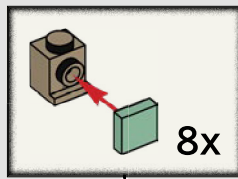
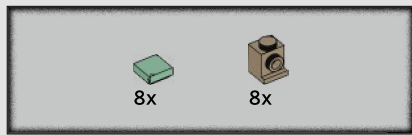

134

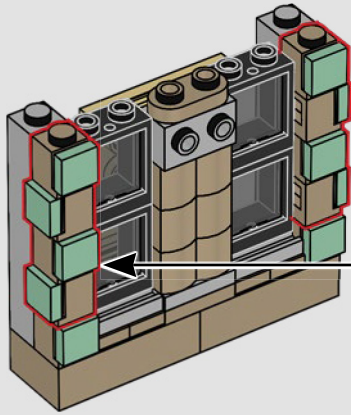

135

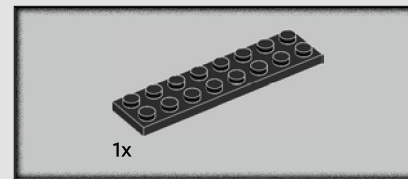
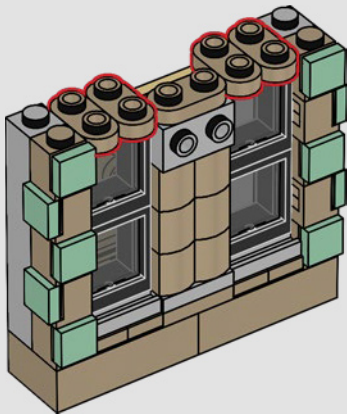

136

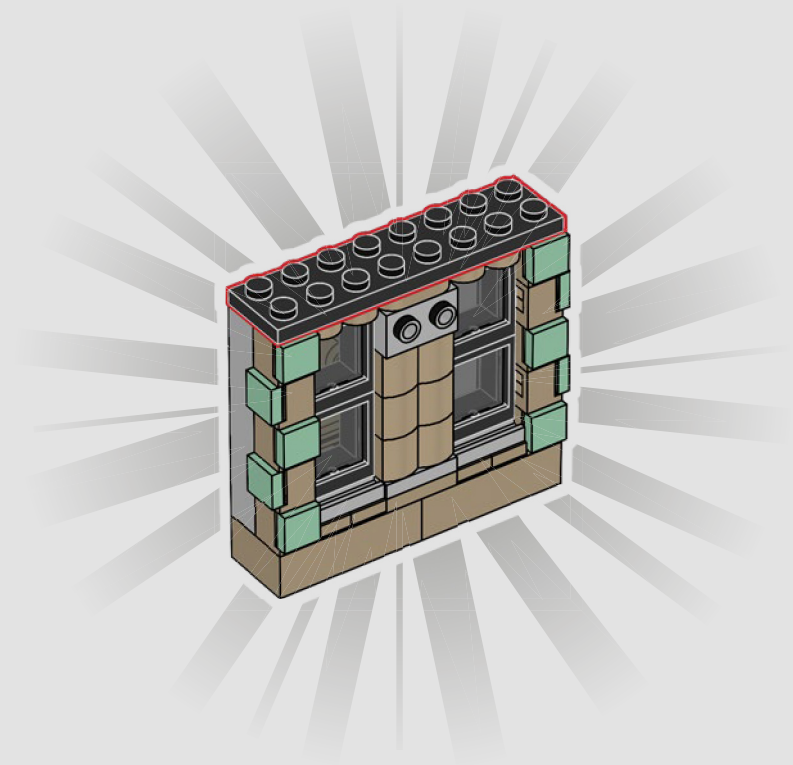

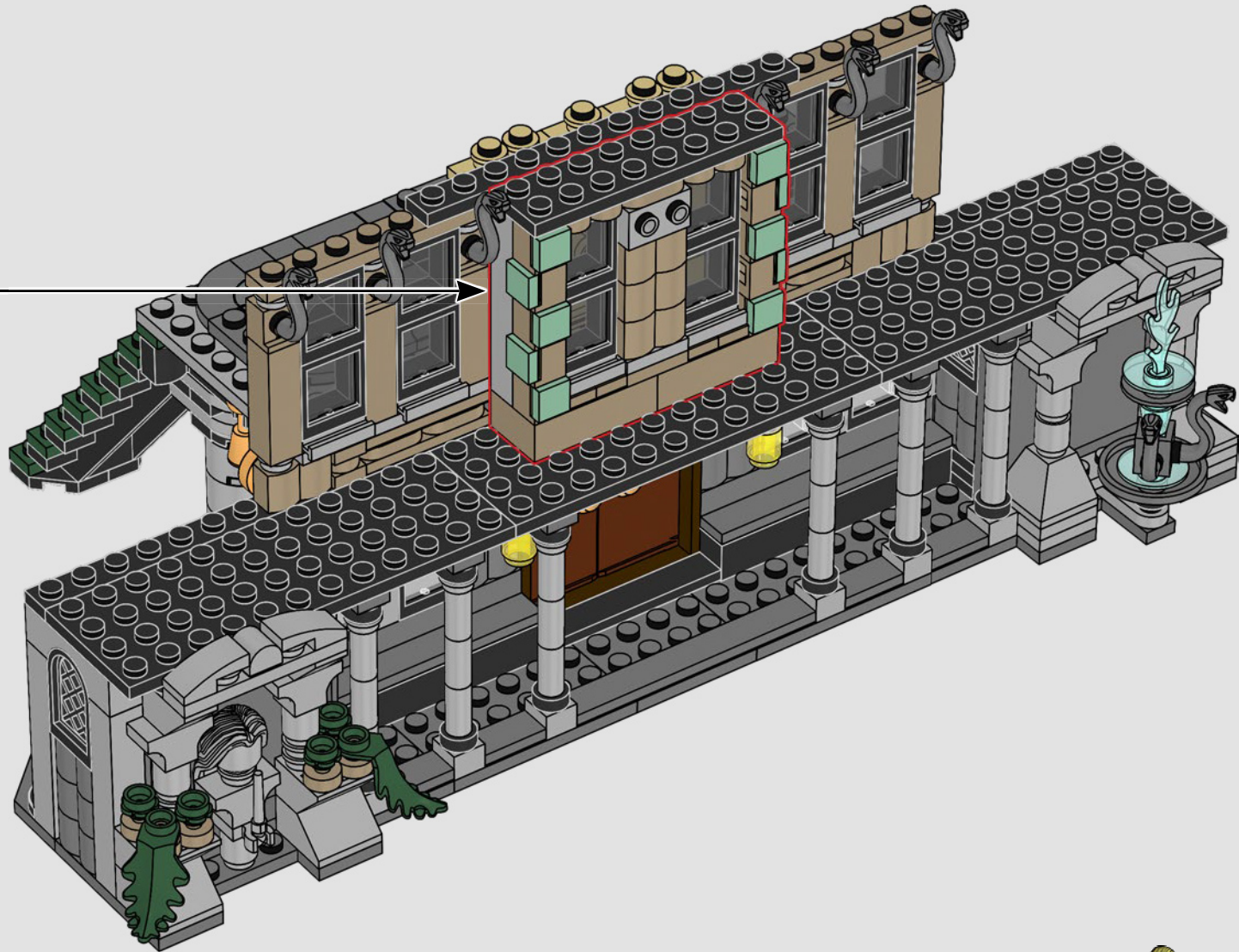

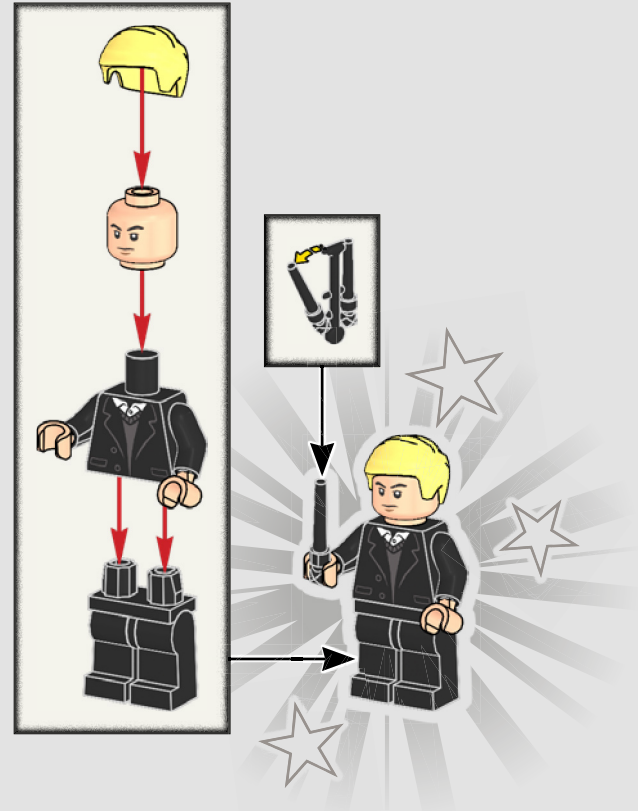

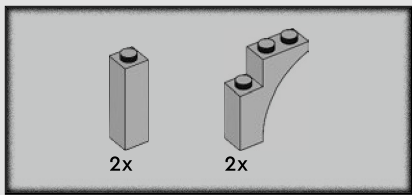

138

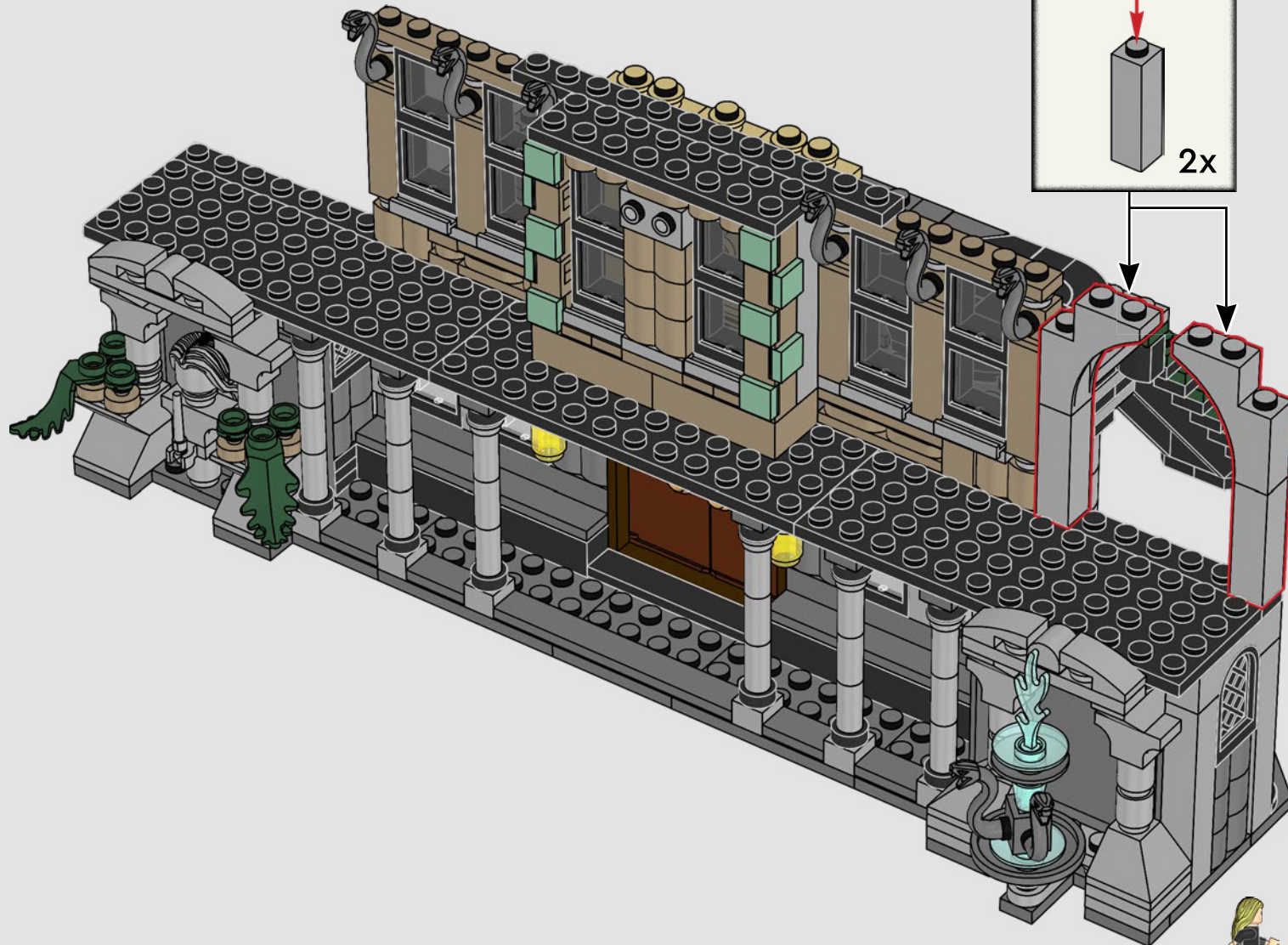
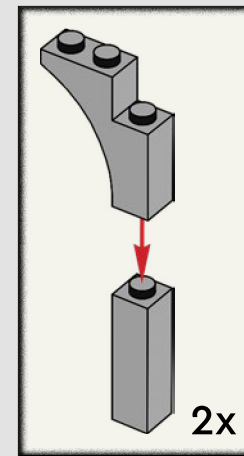

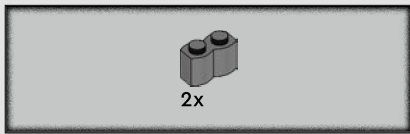

139

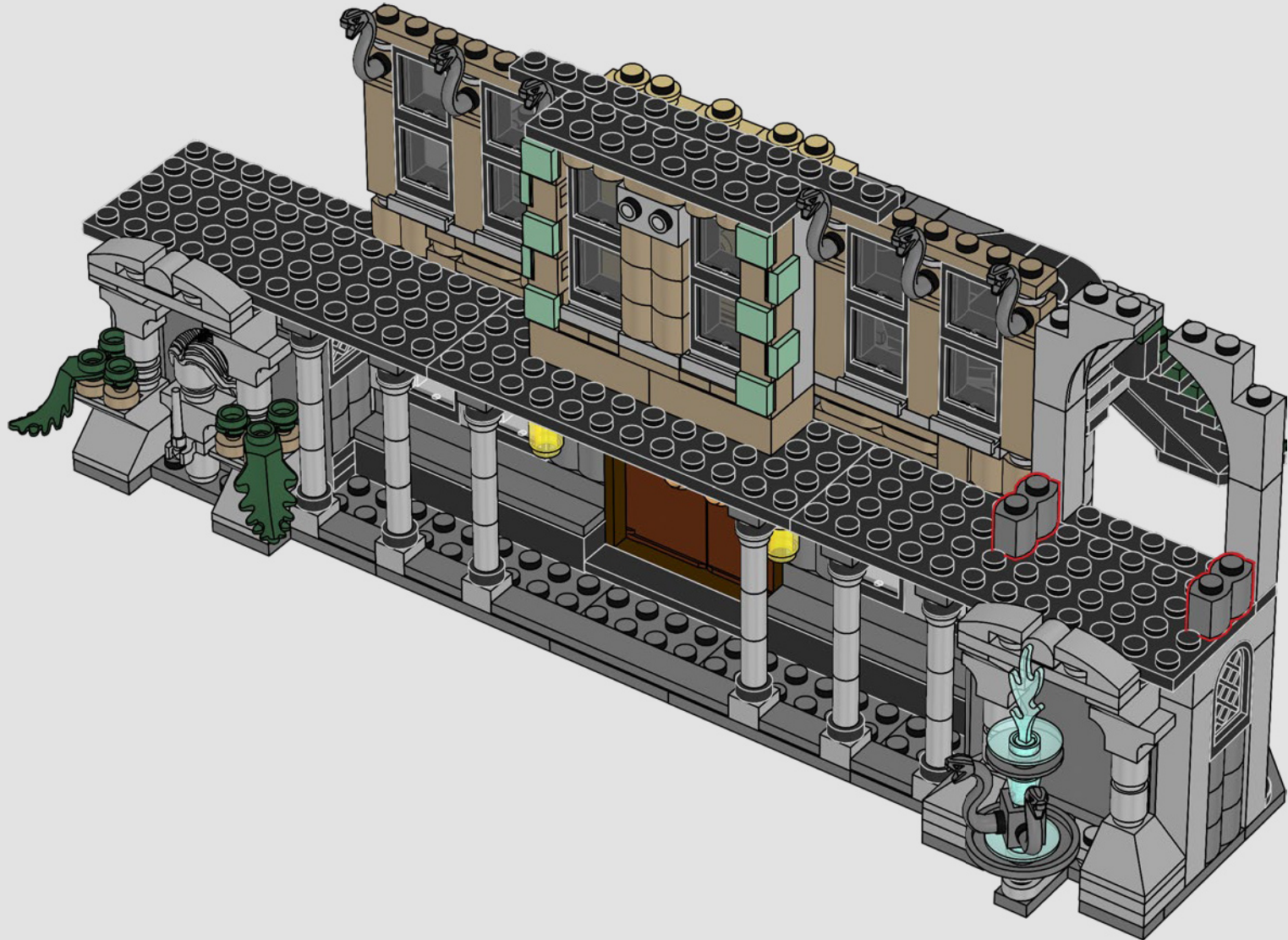

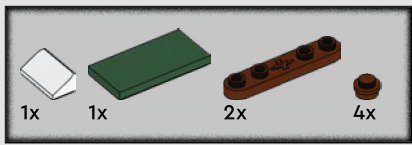

140

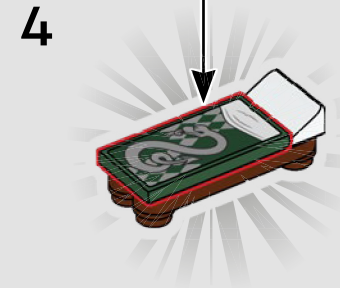
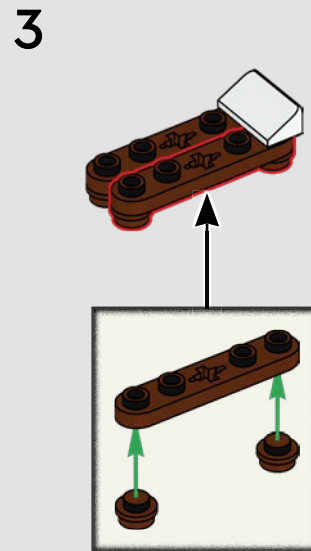
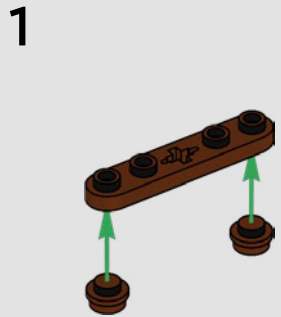
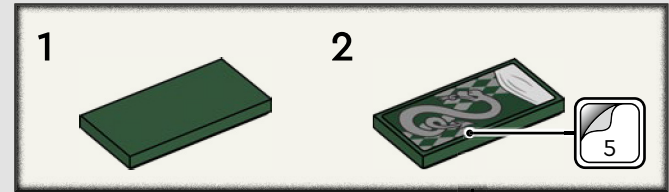

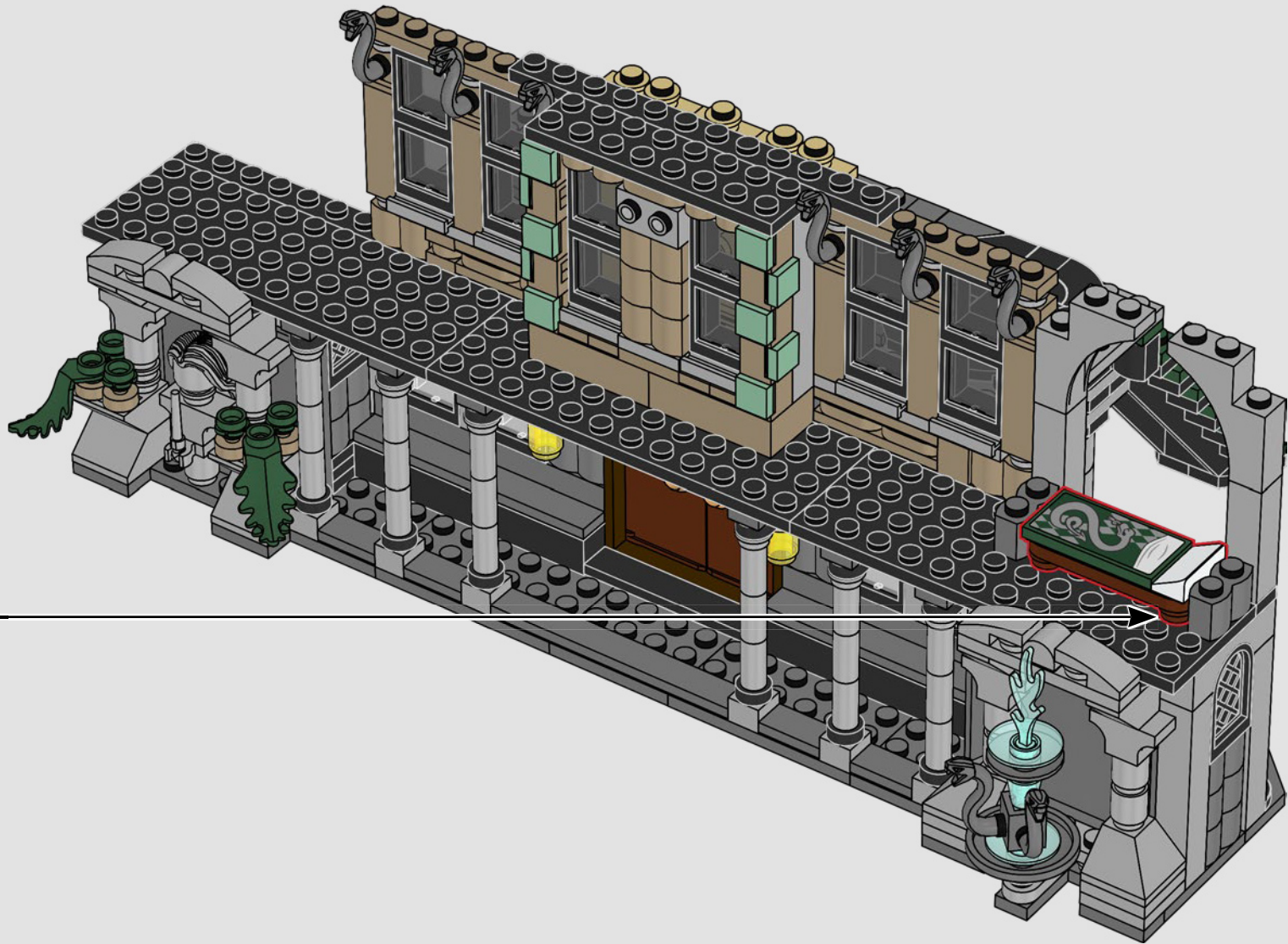

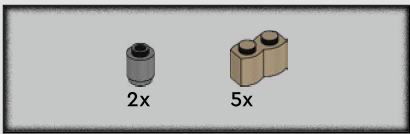

141

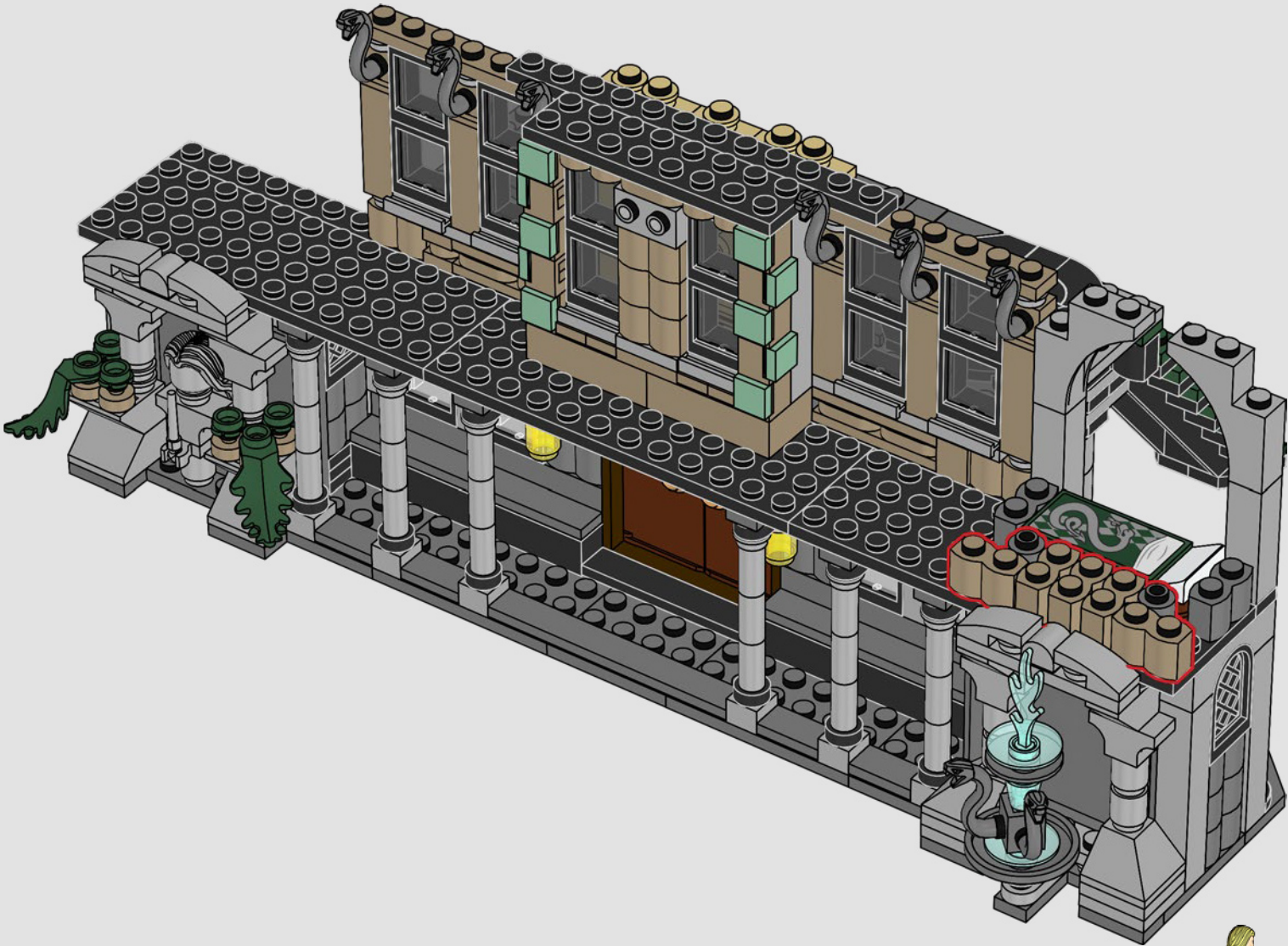

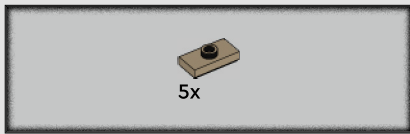

142

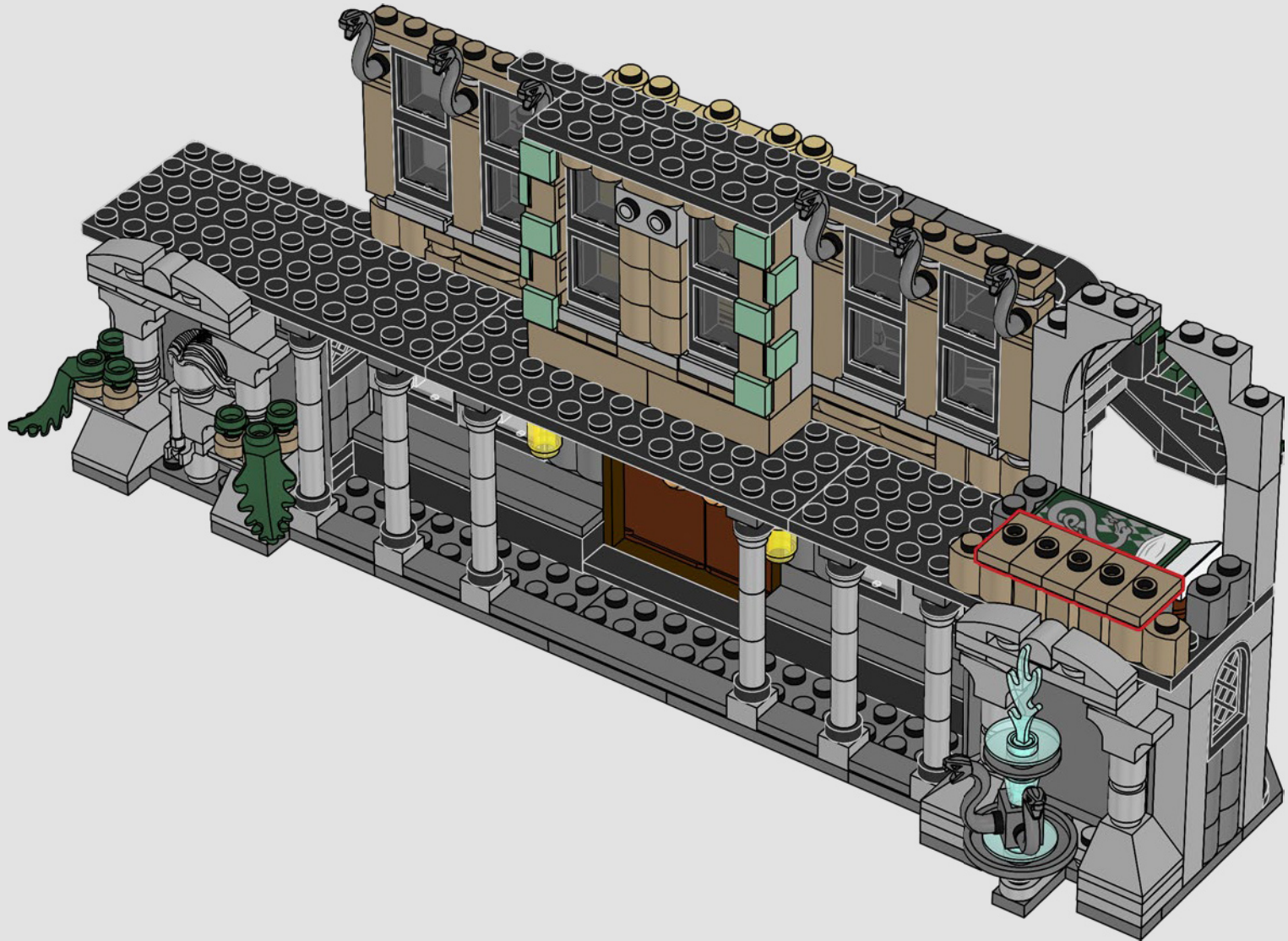

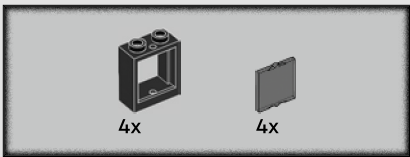

143

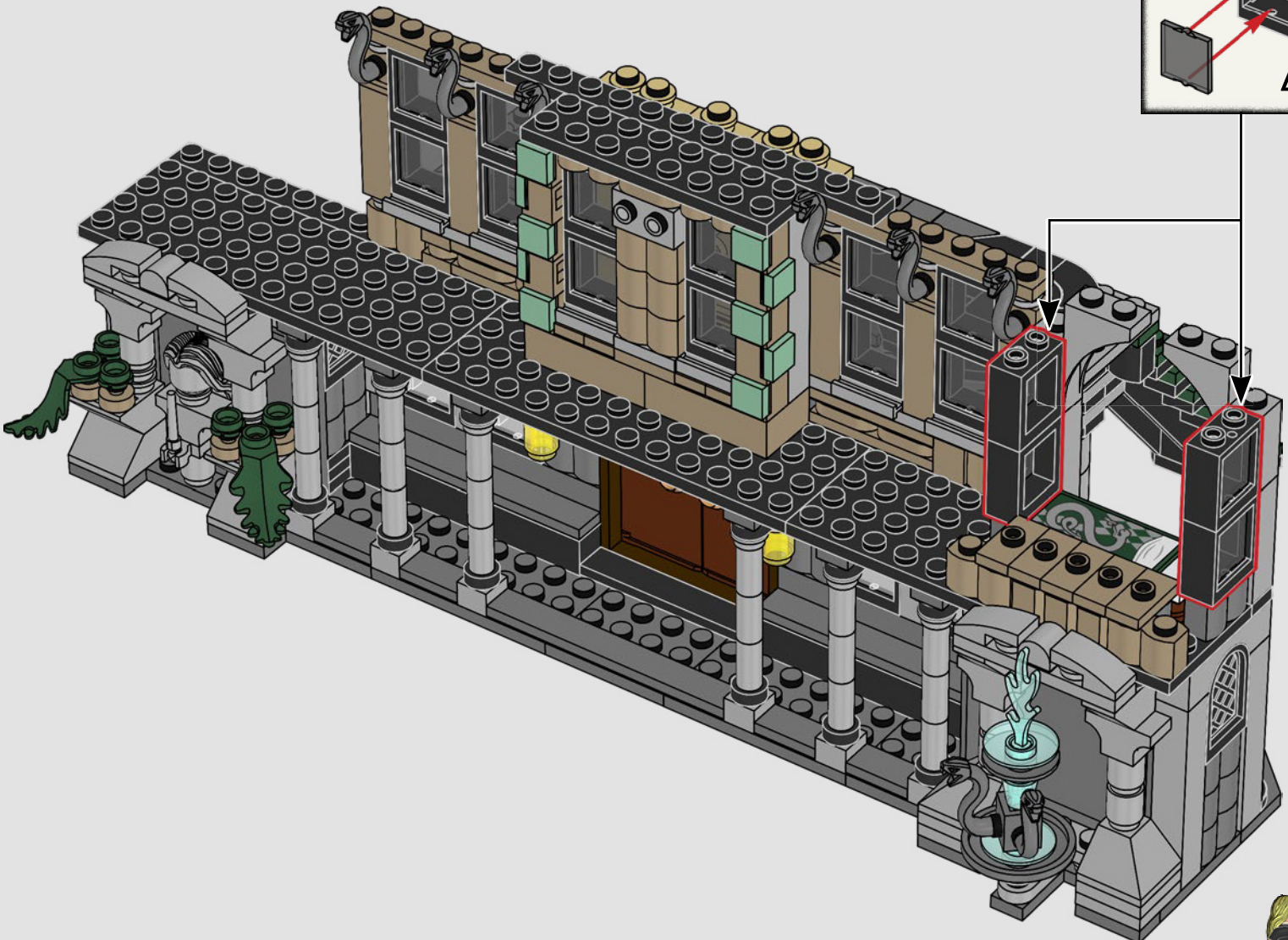
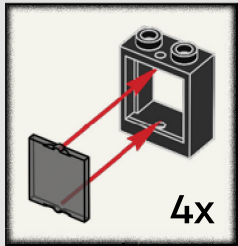

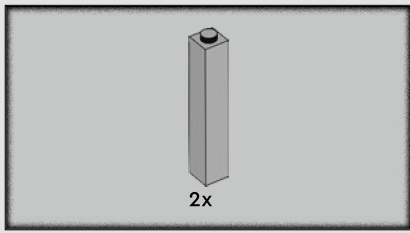

144

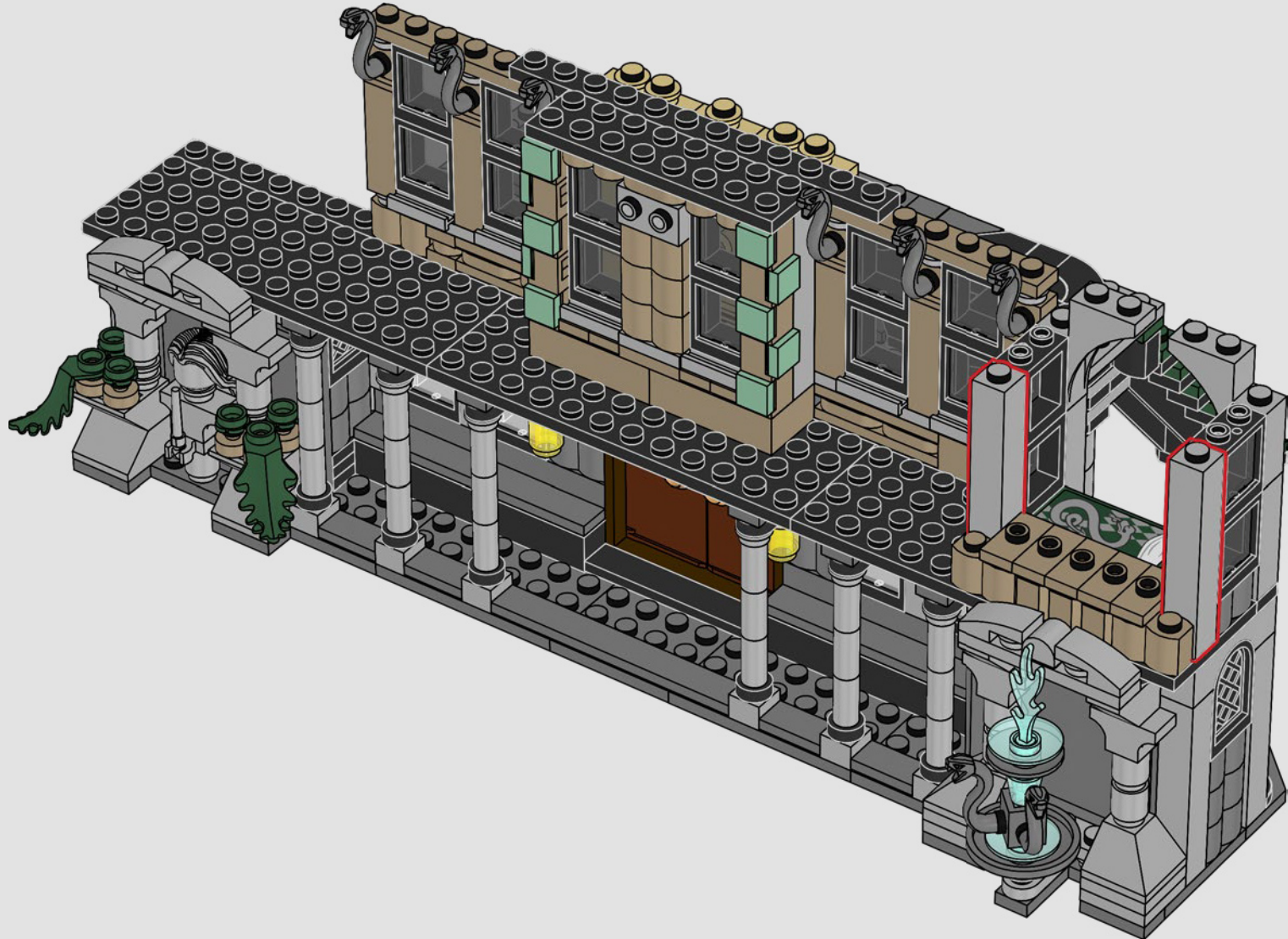

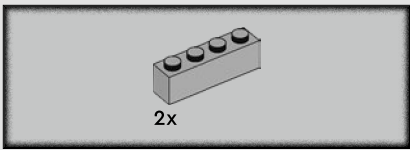

145

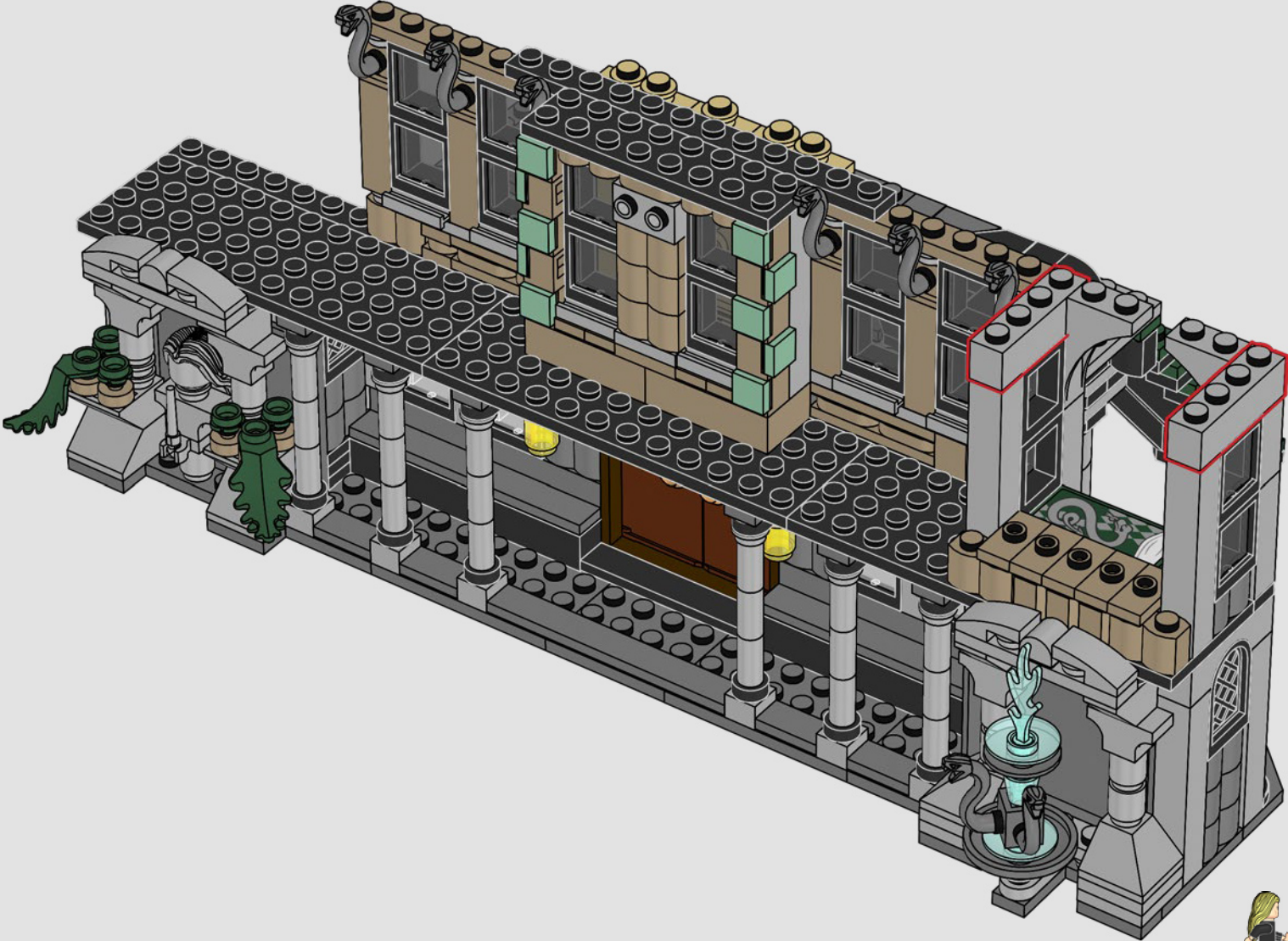

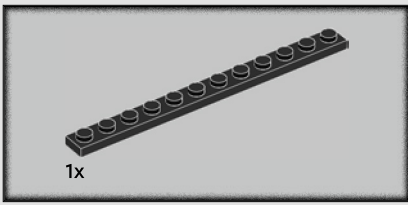

146

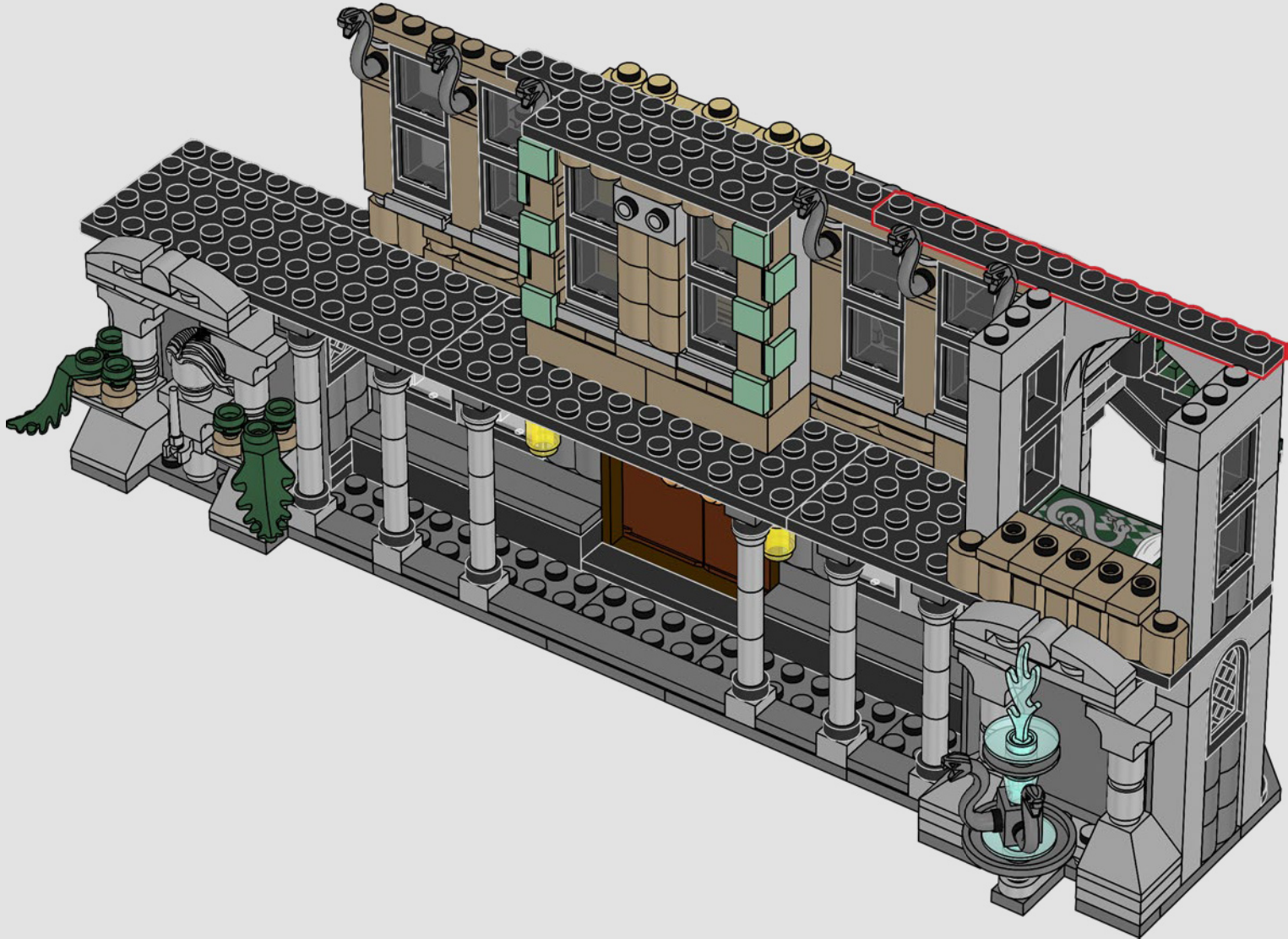

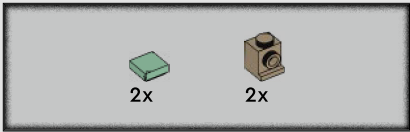

147

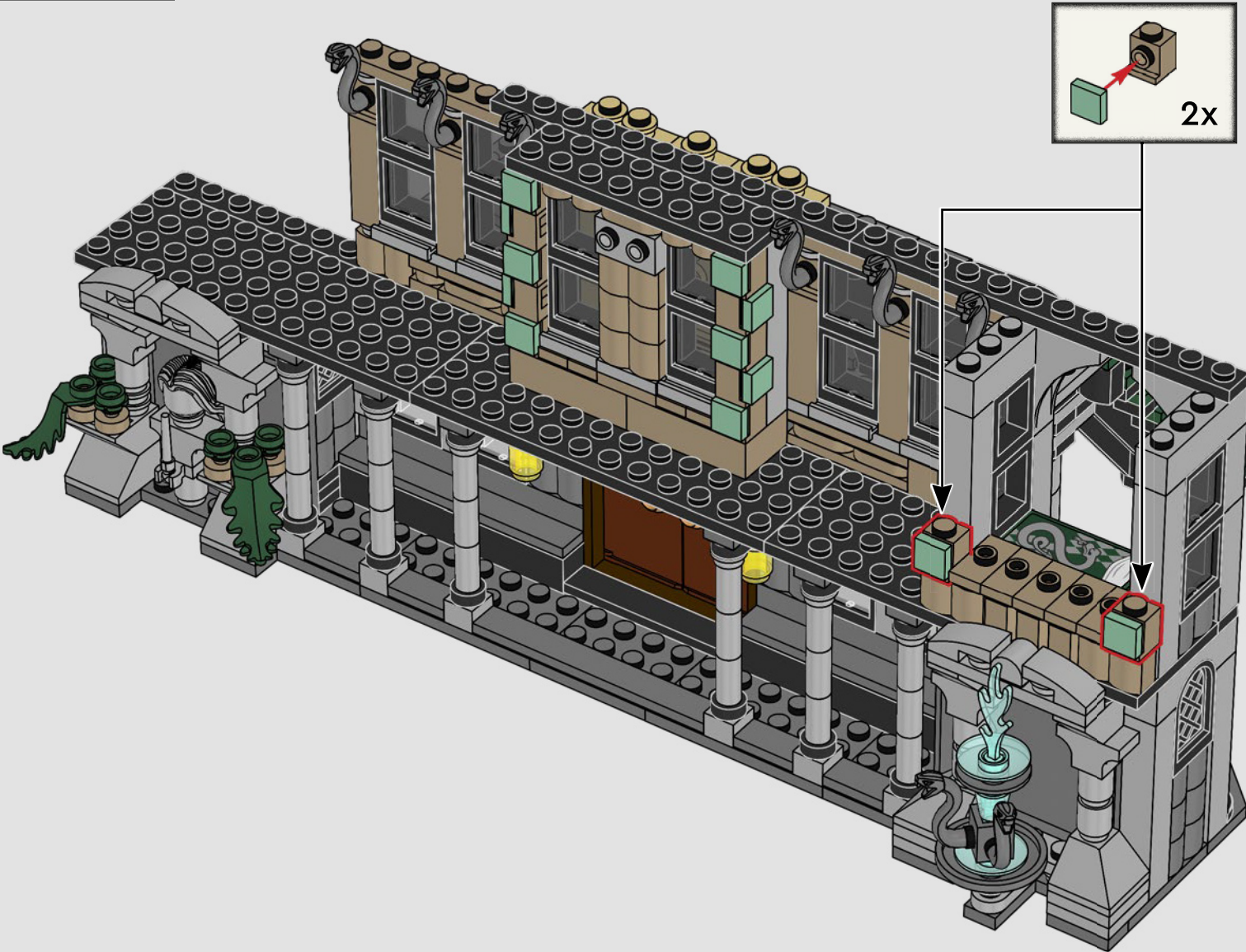

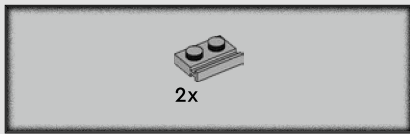

148



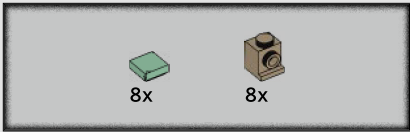

149

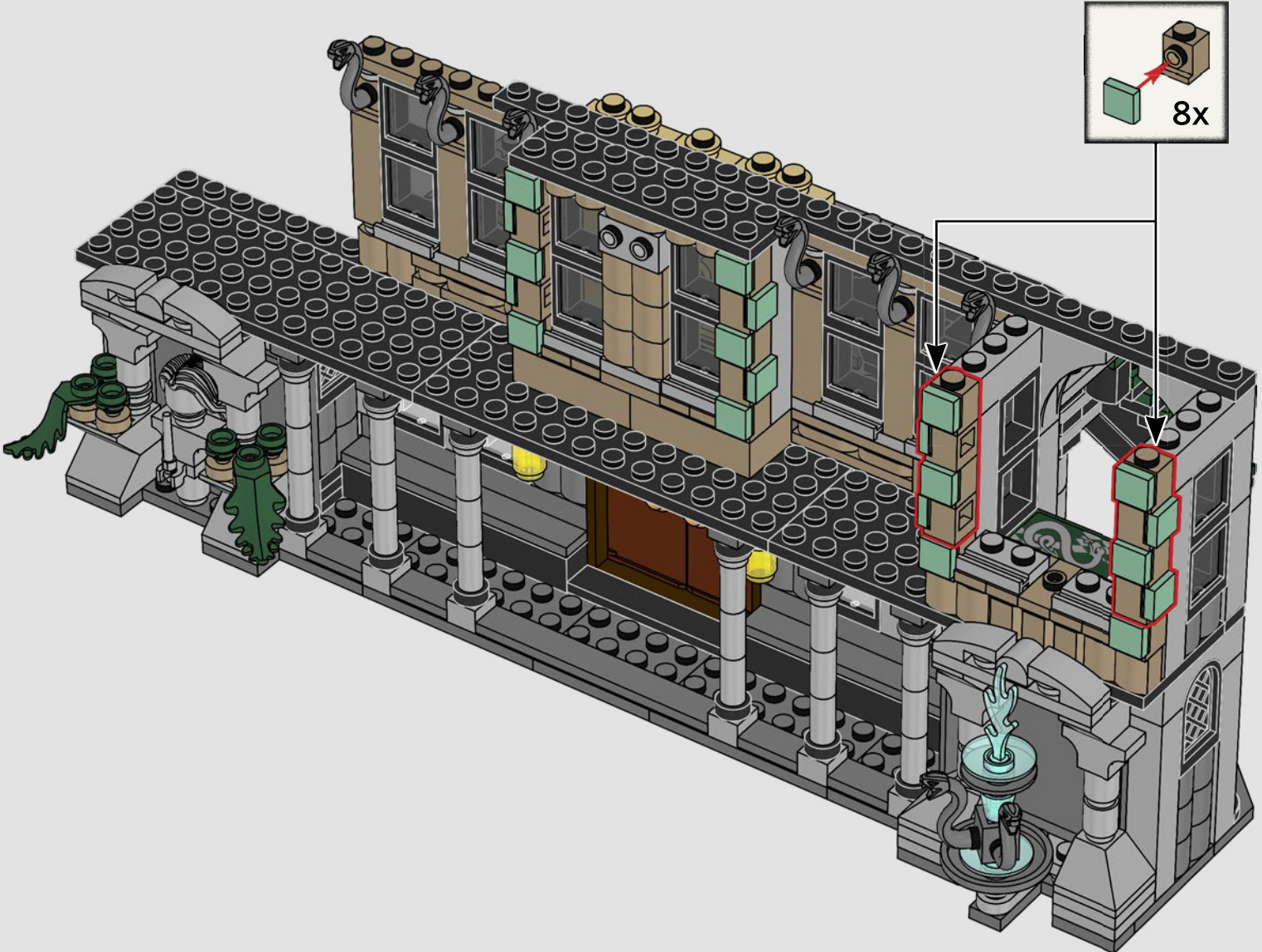

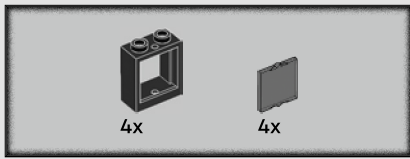

150

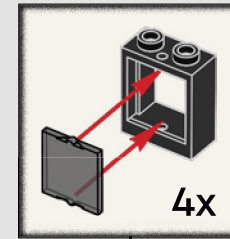
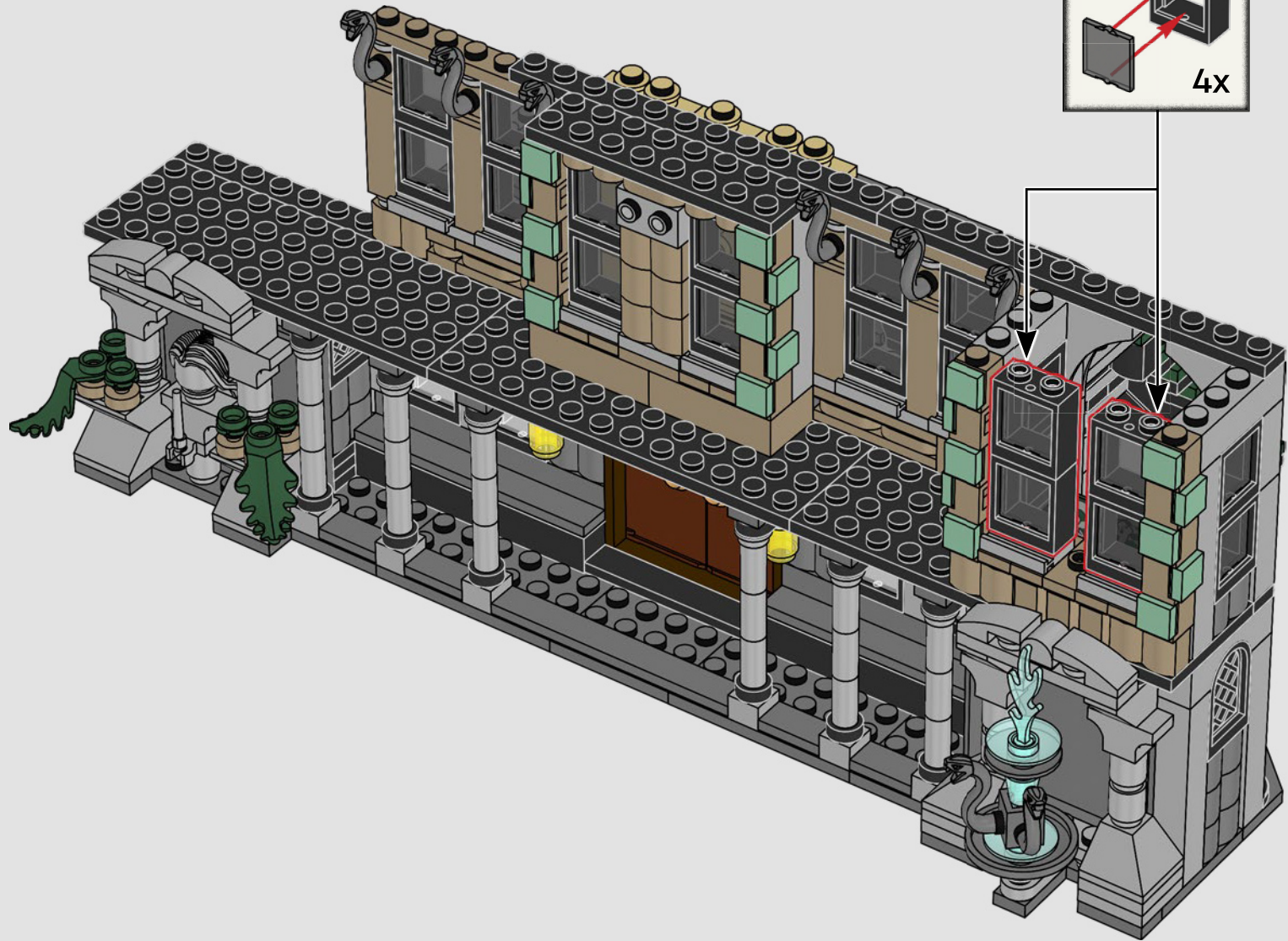

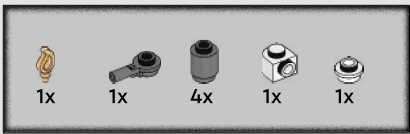

151

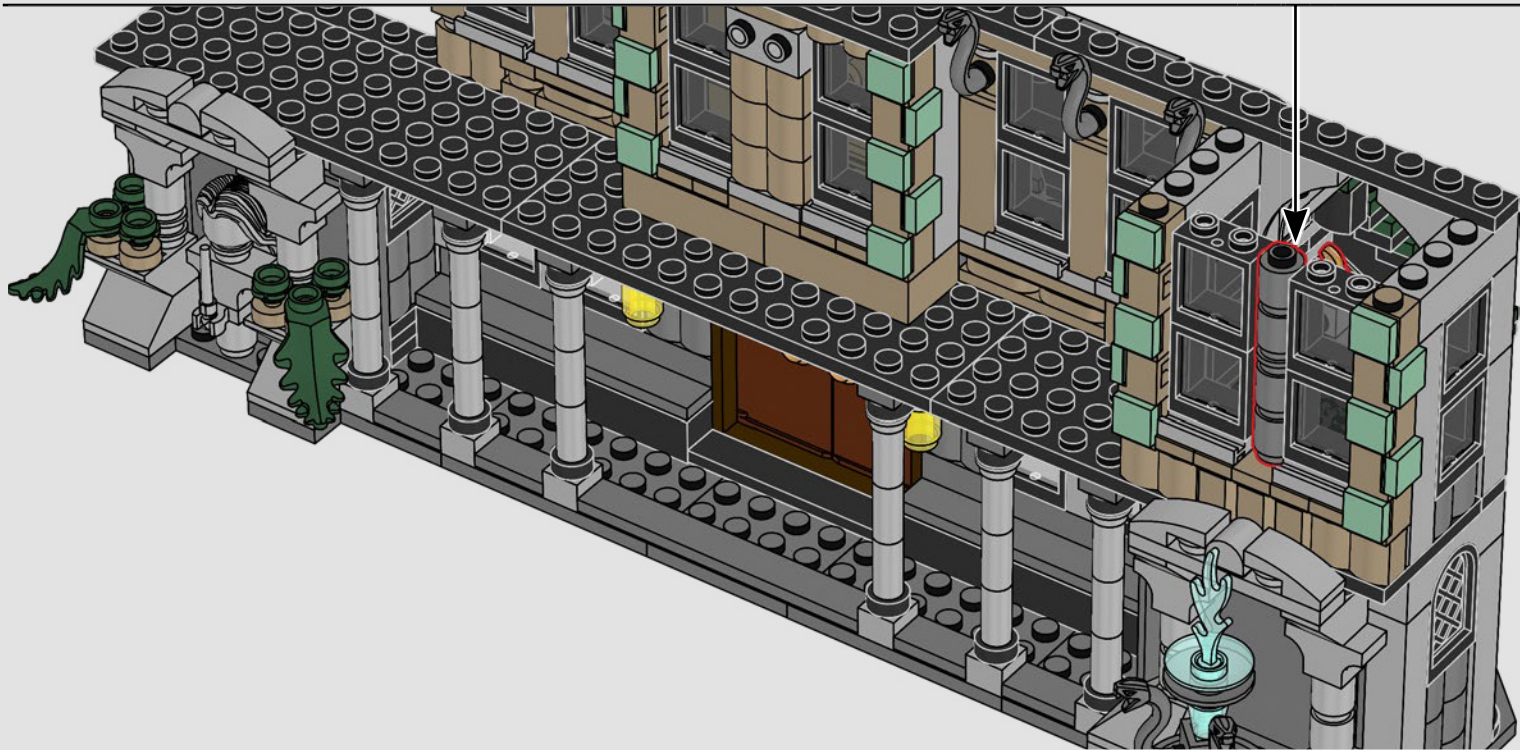
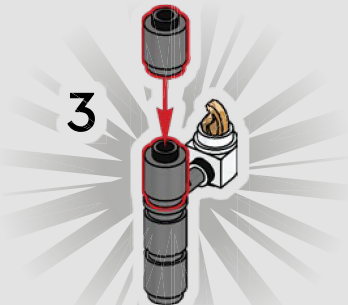
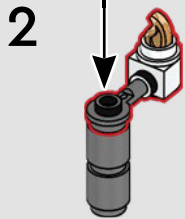
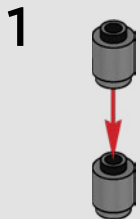
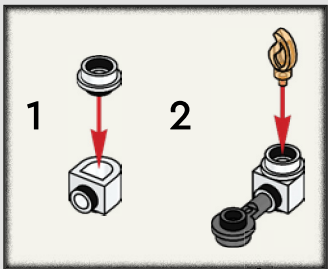



152

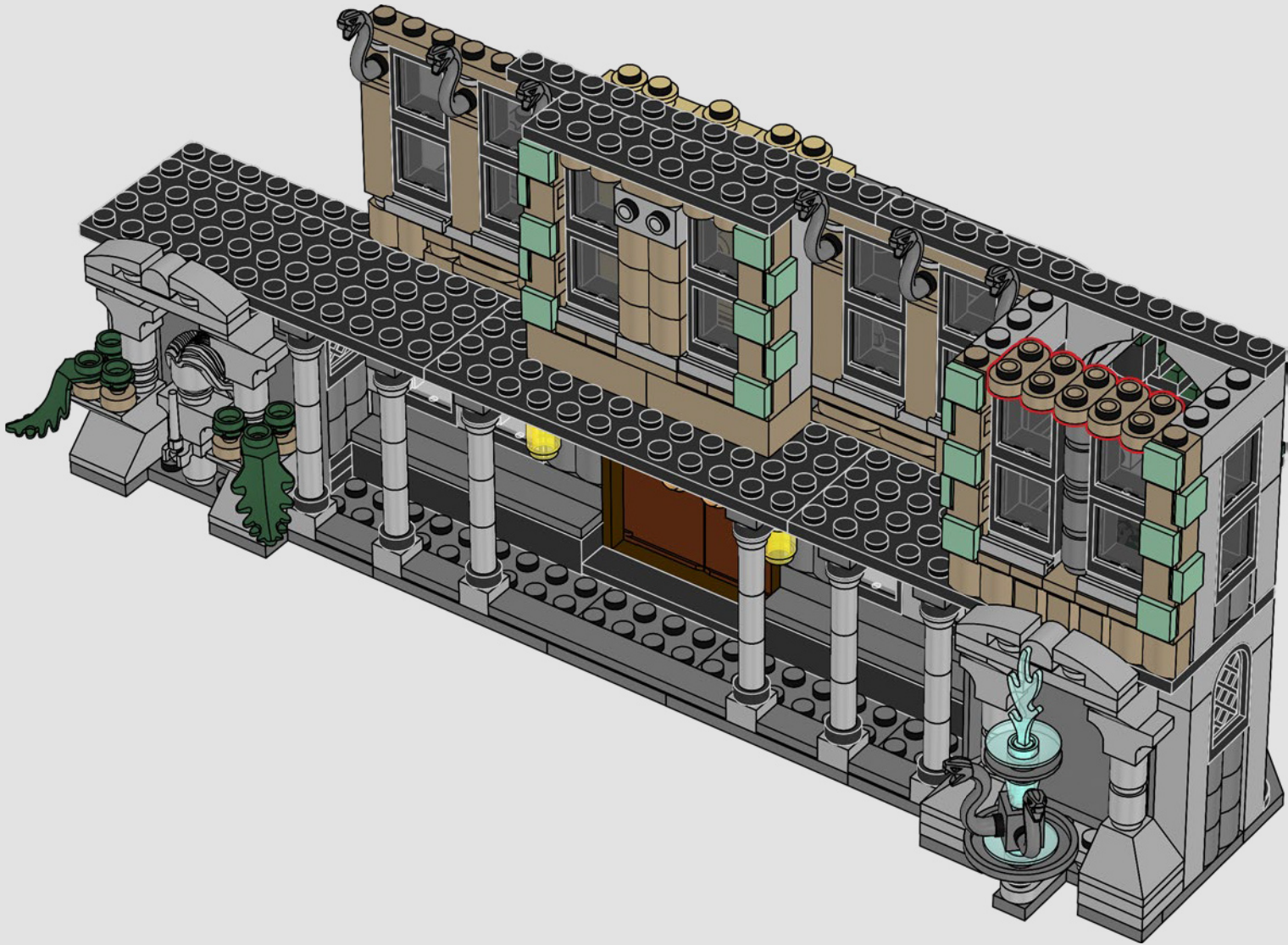

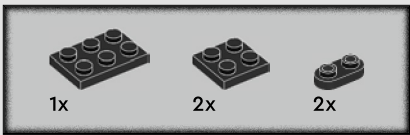

153



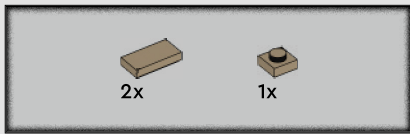

154



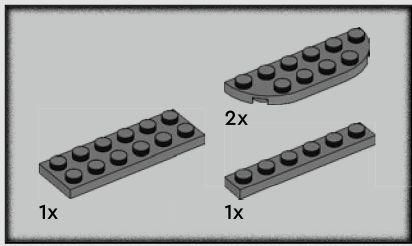

155

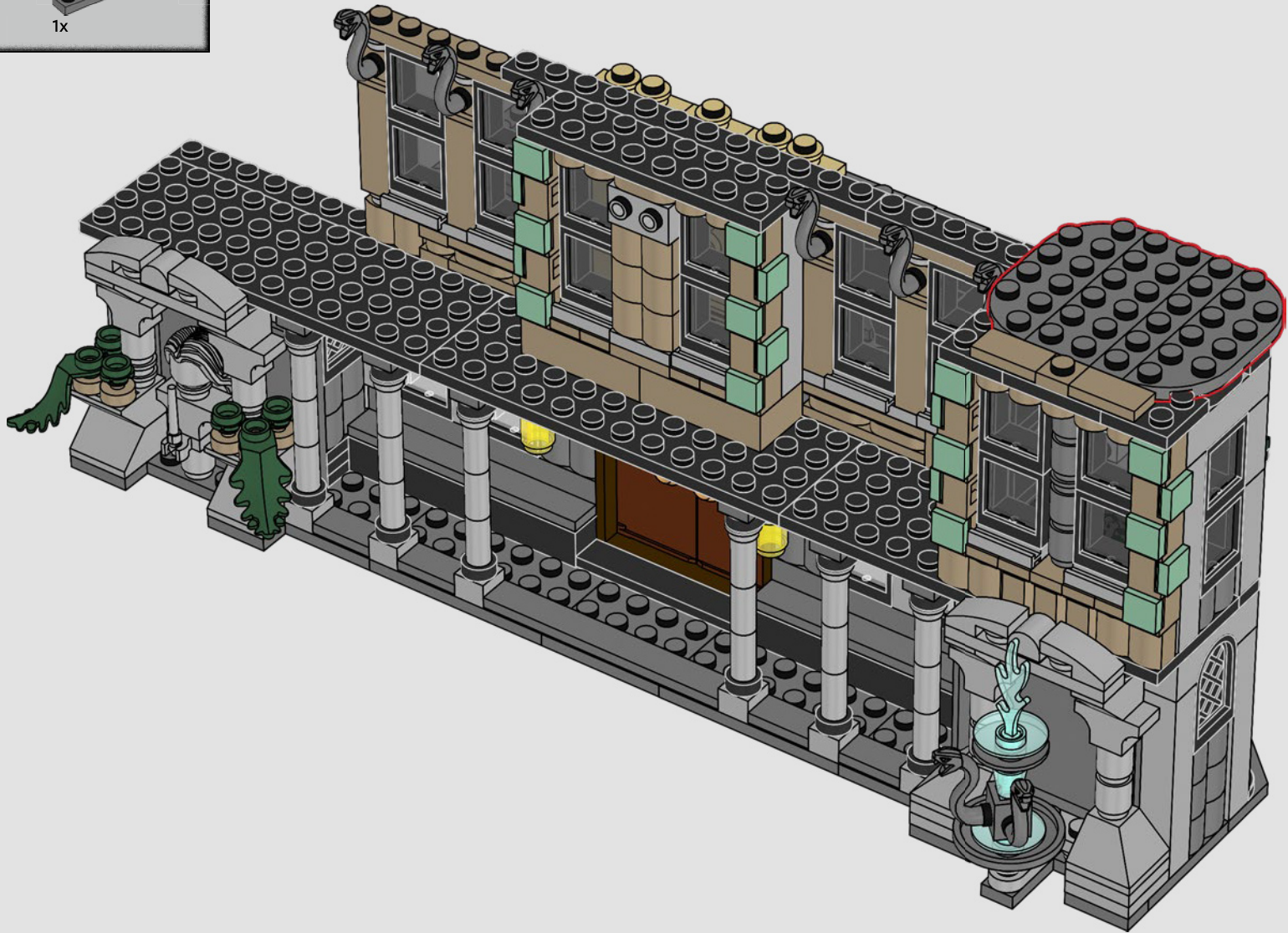

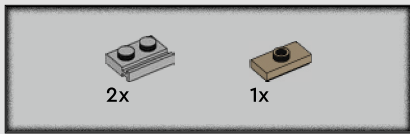

156



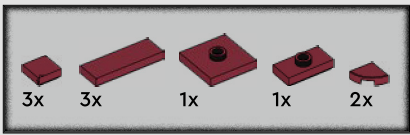

157

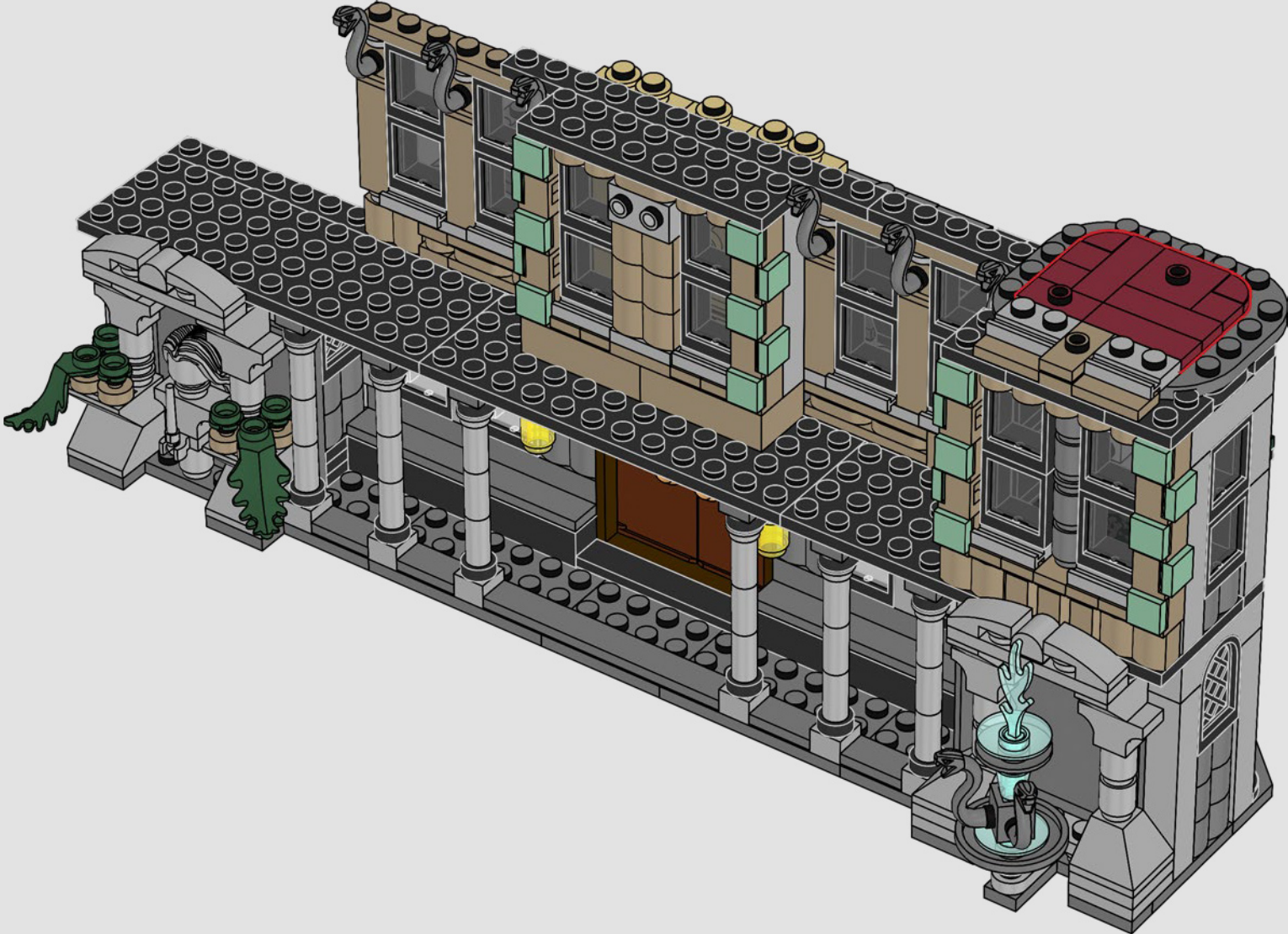

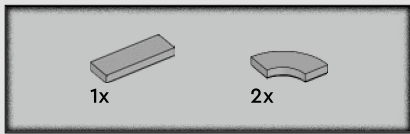

158



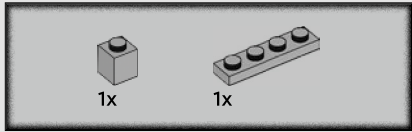
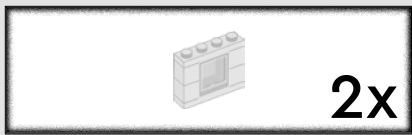

159

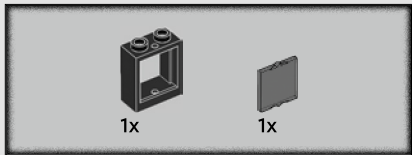
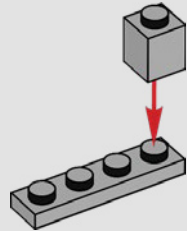

160

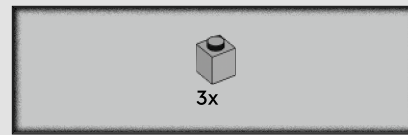
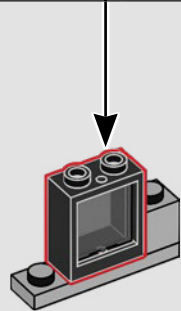
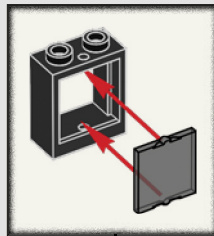

161

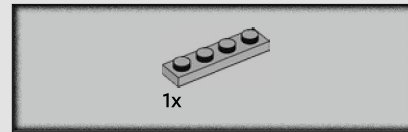
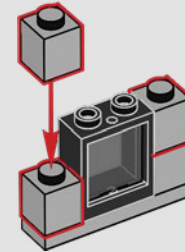

162

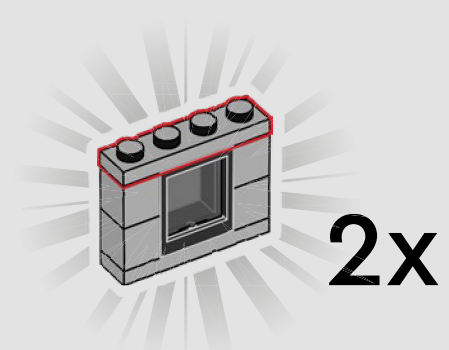

163

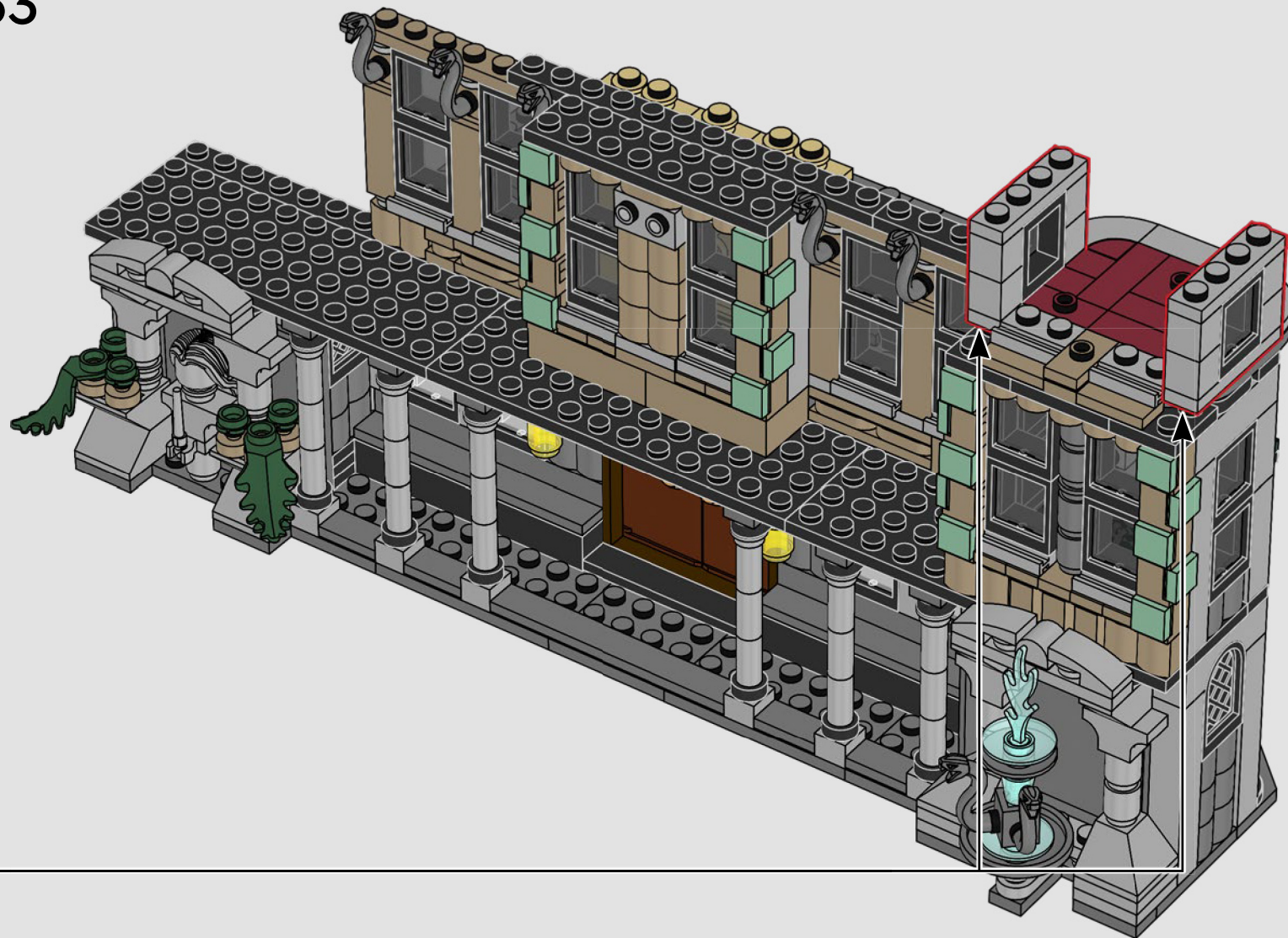

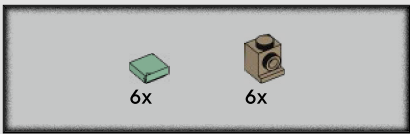

164

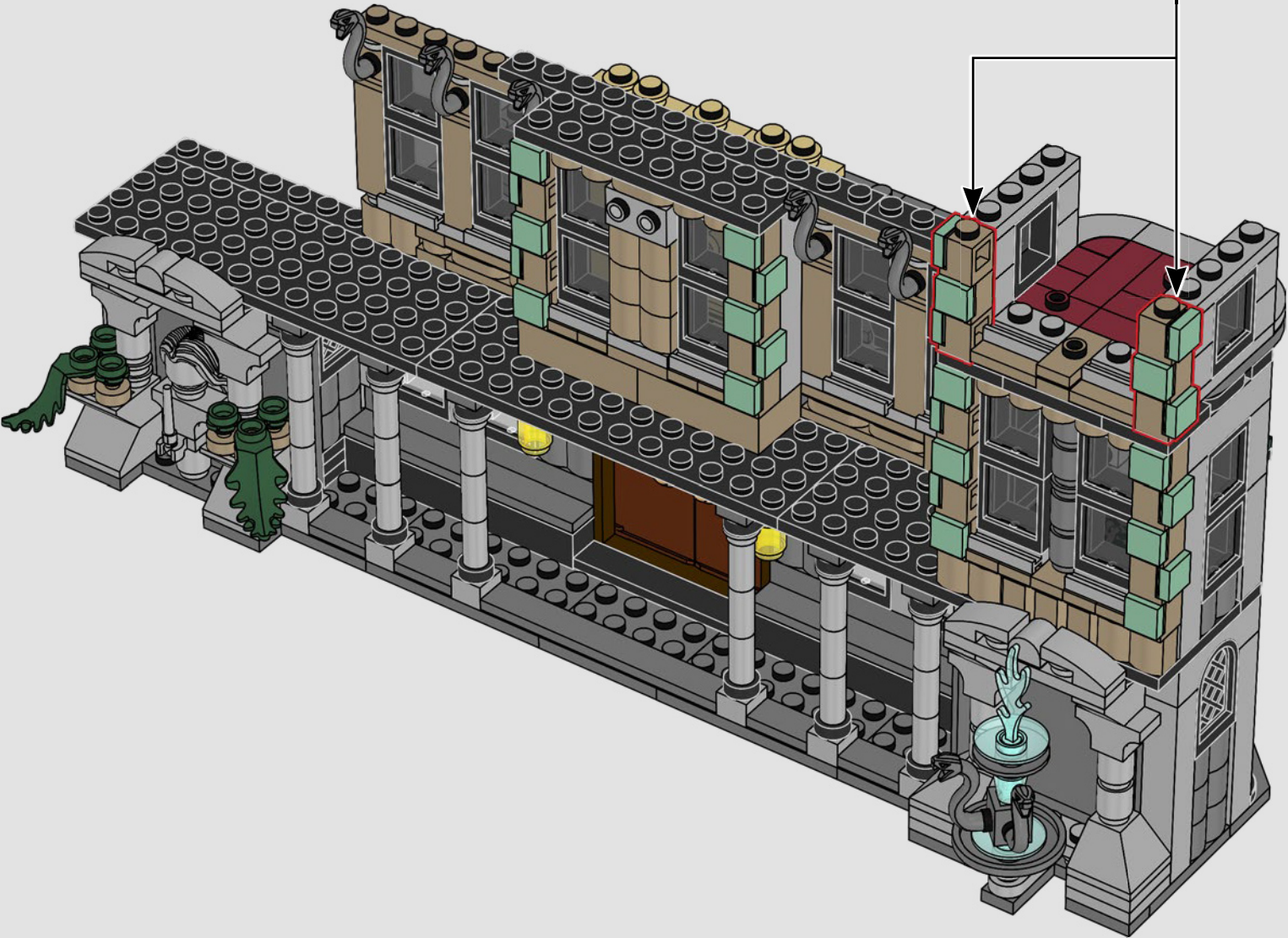
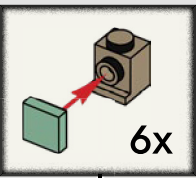

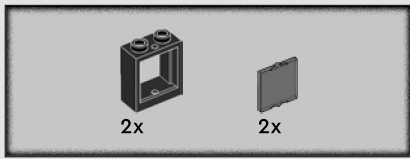

165

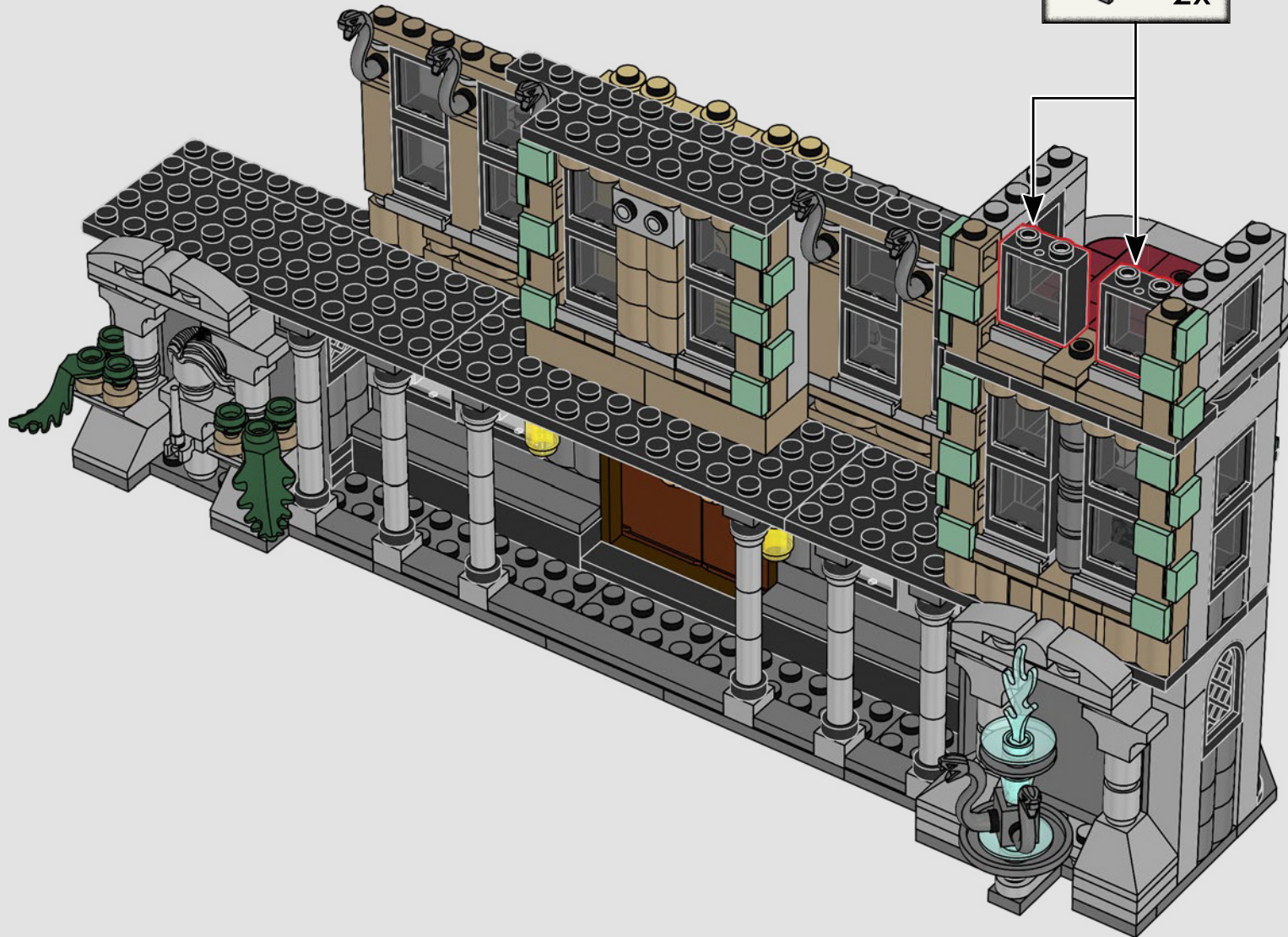
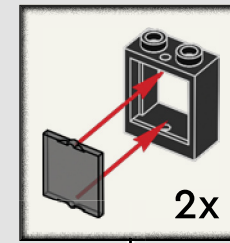



2x

166

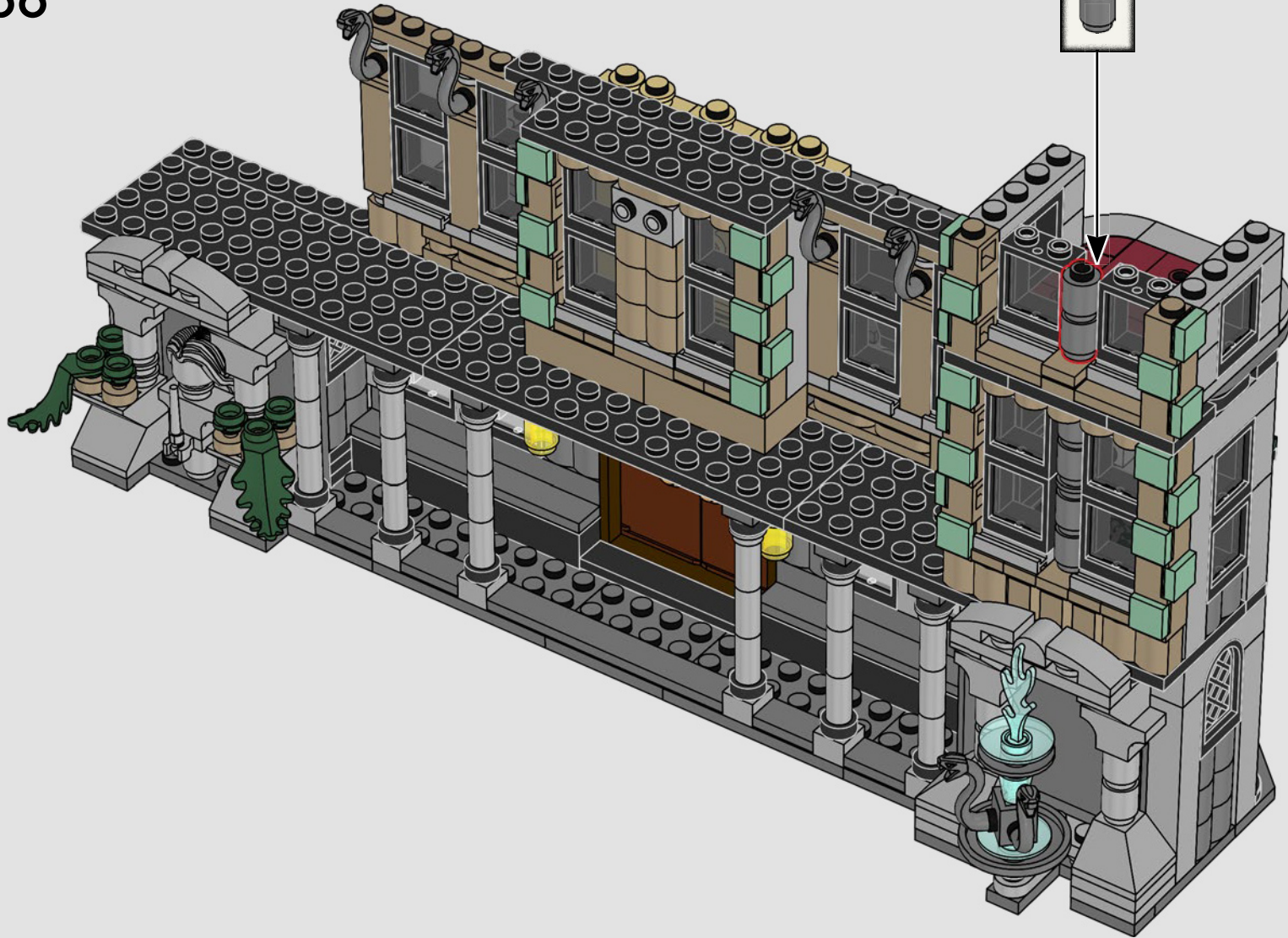



167

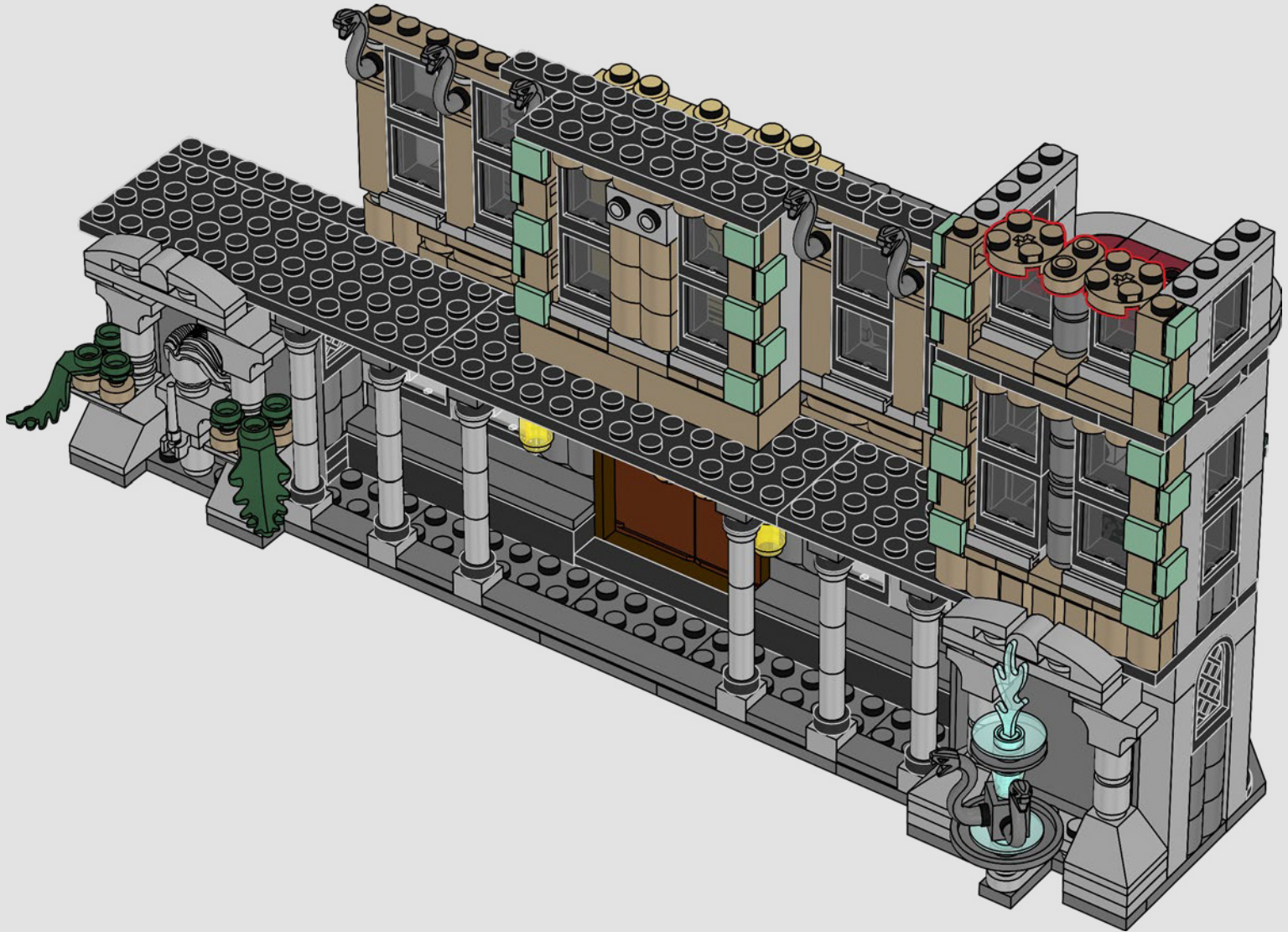

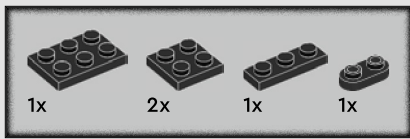

168

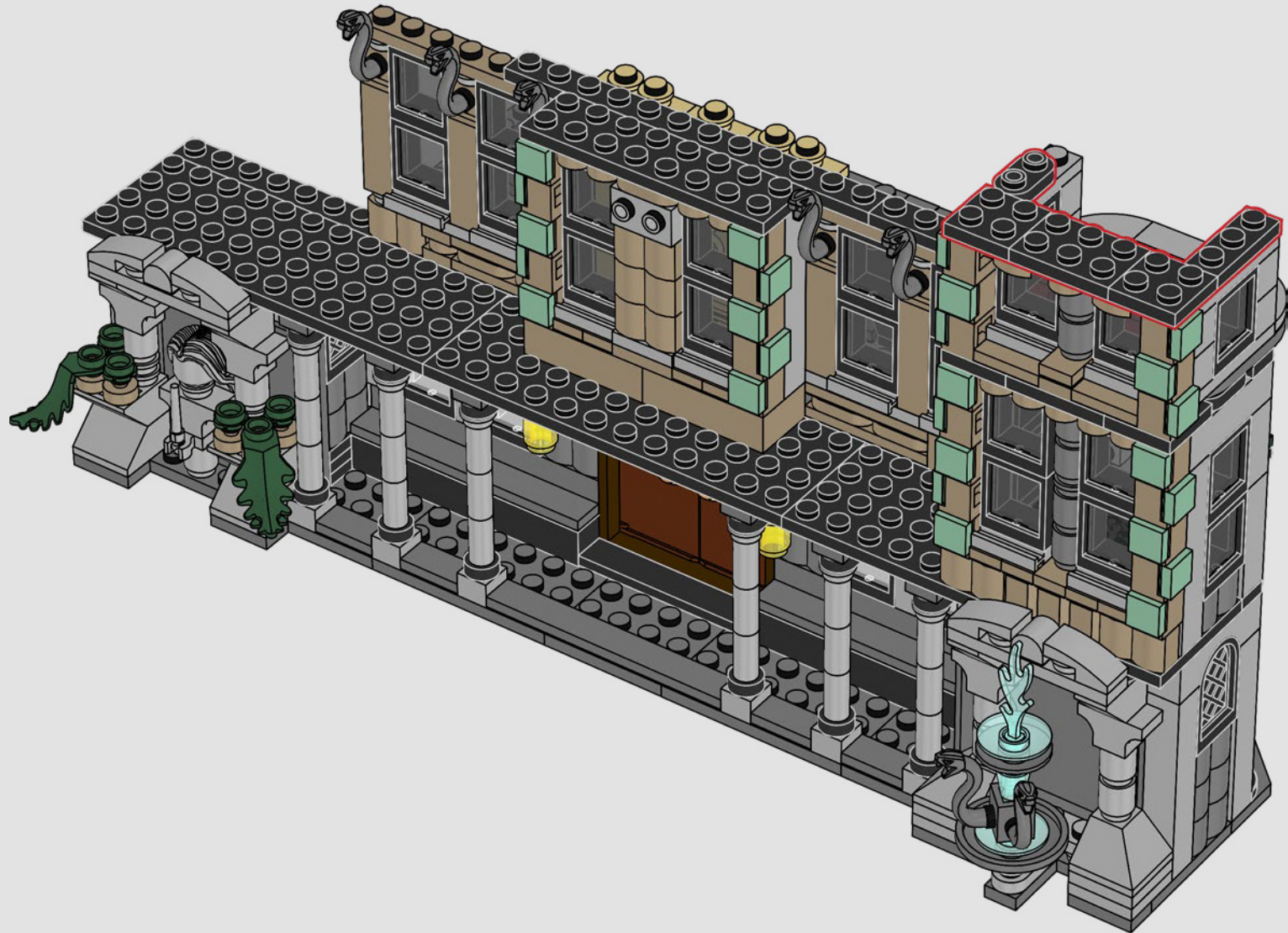



169

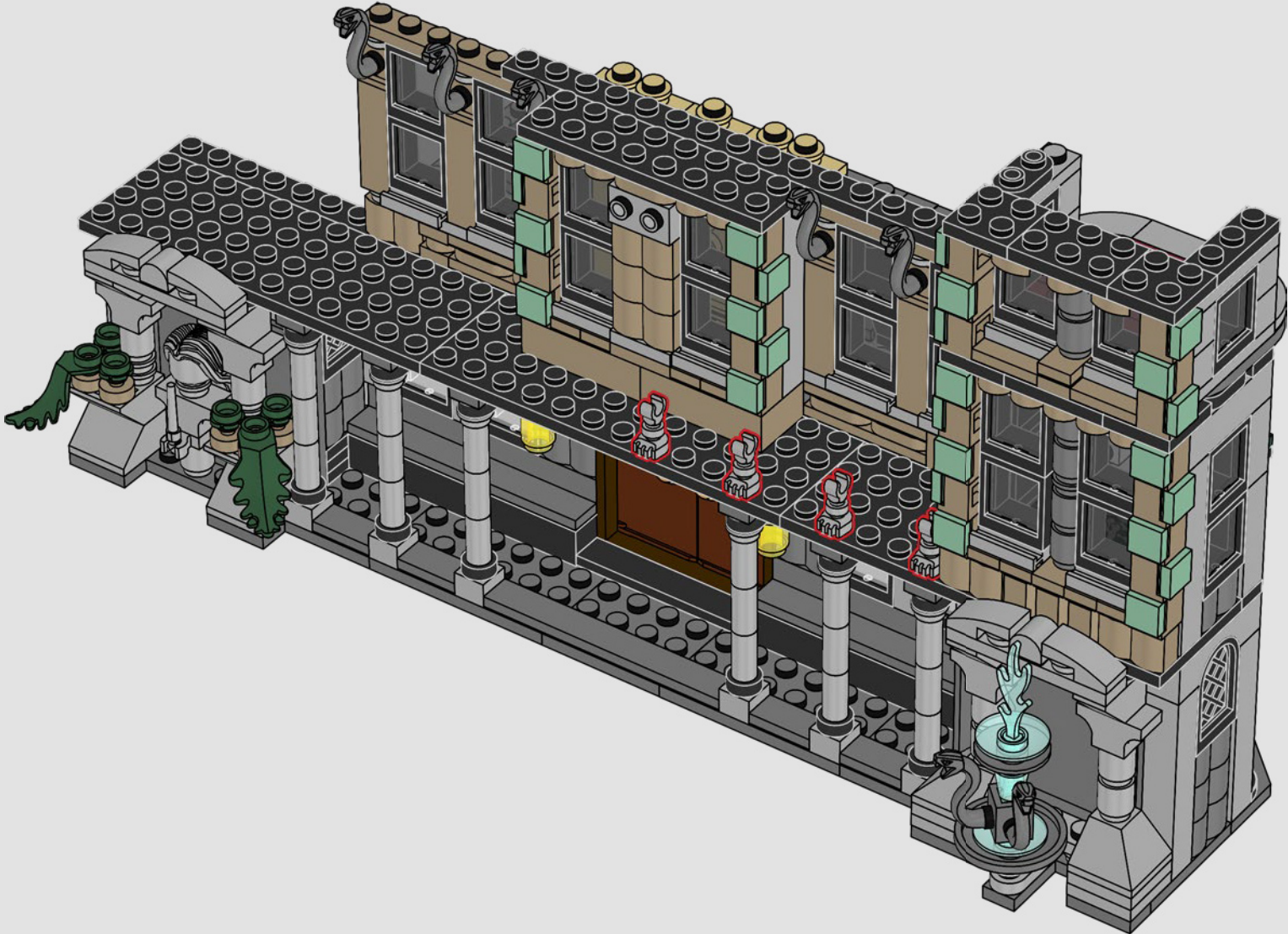

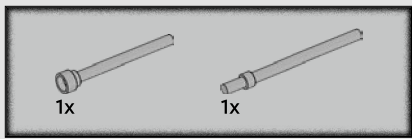

170

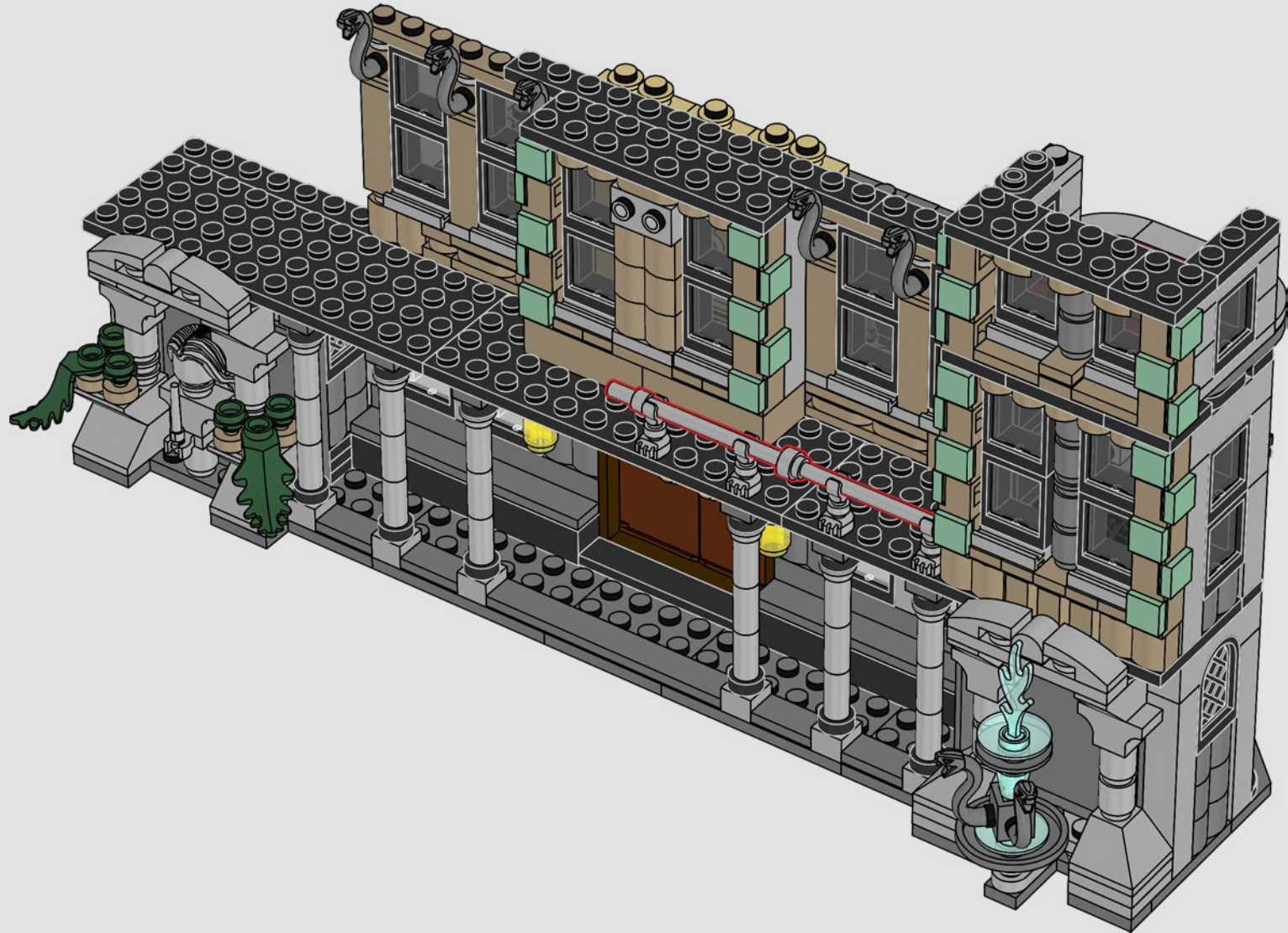



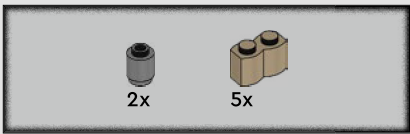

171

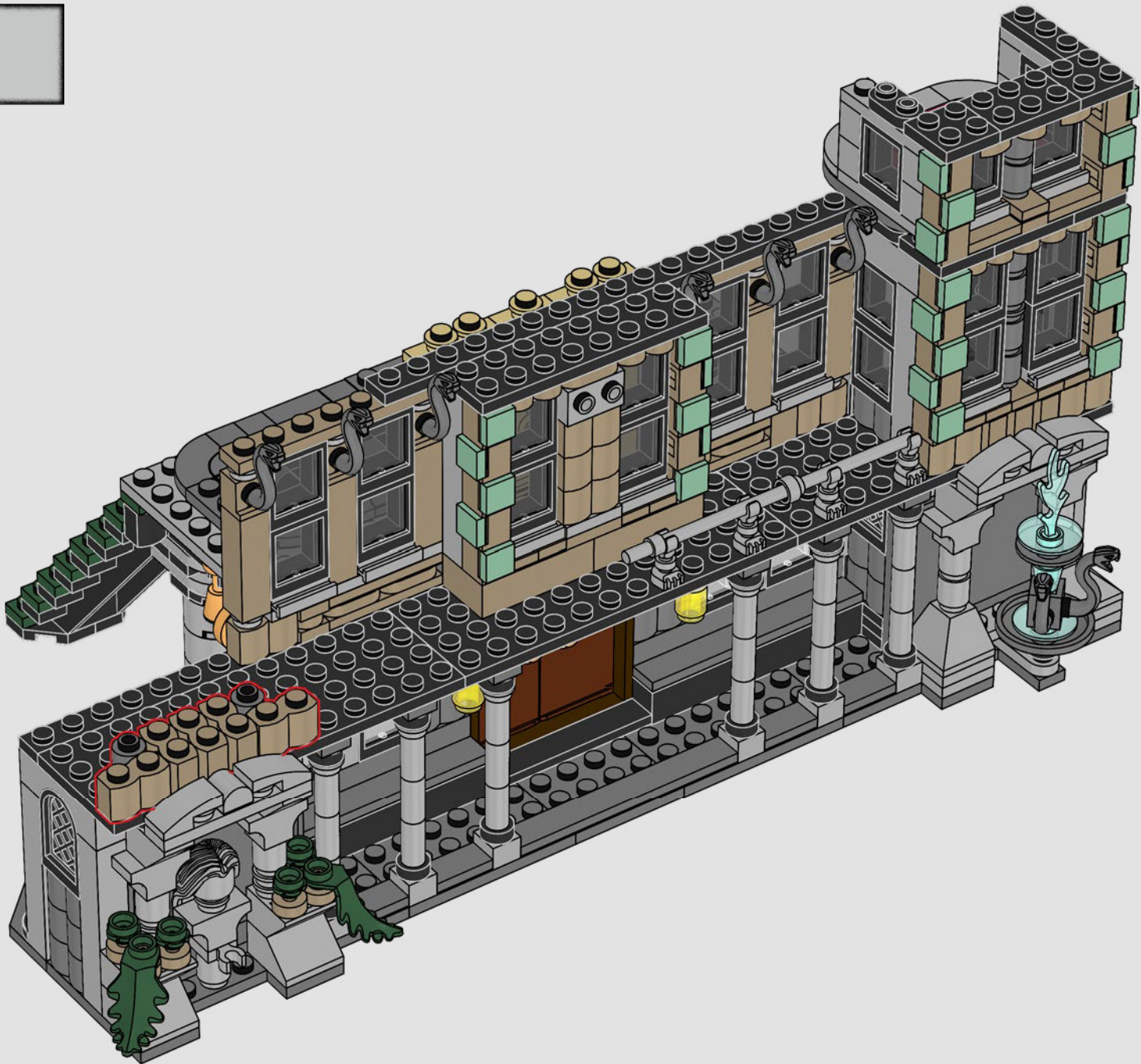

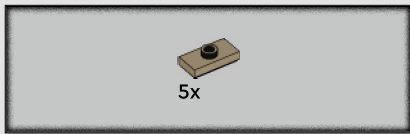

172

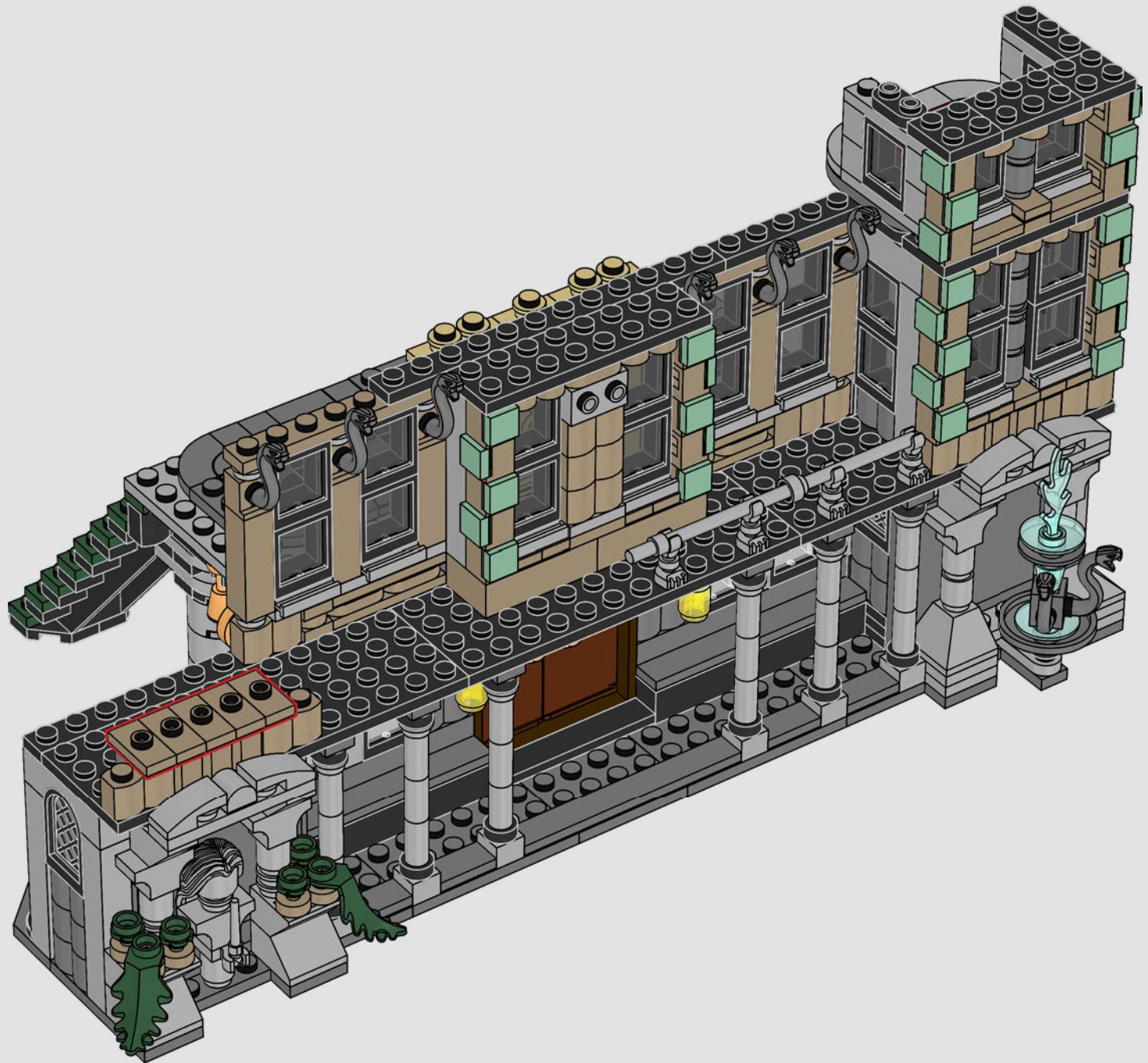



2x

173

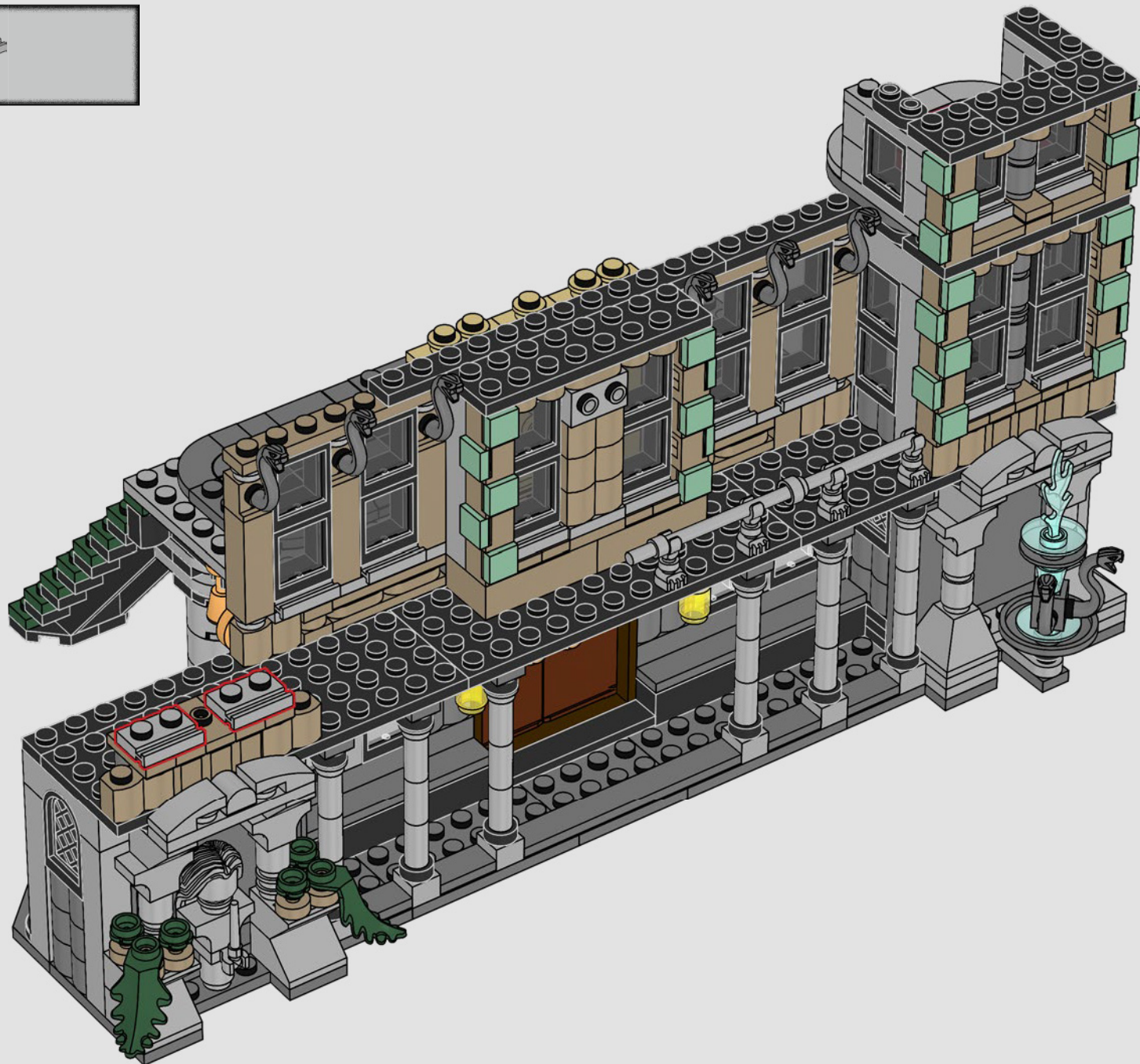

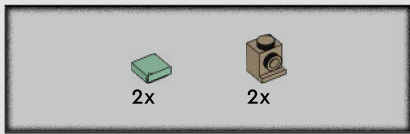

174

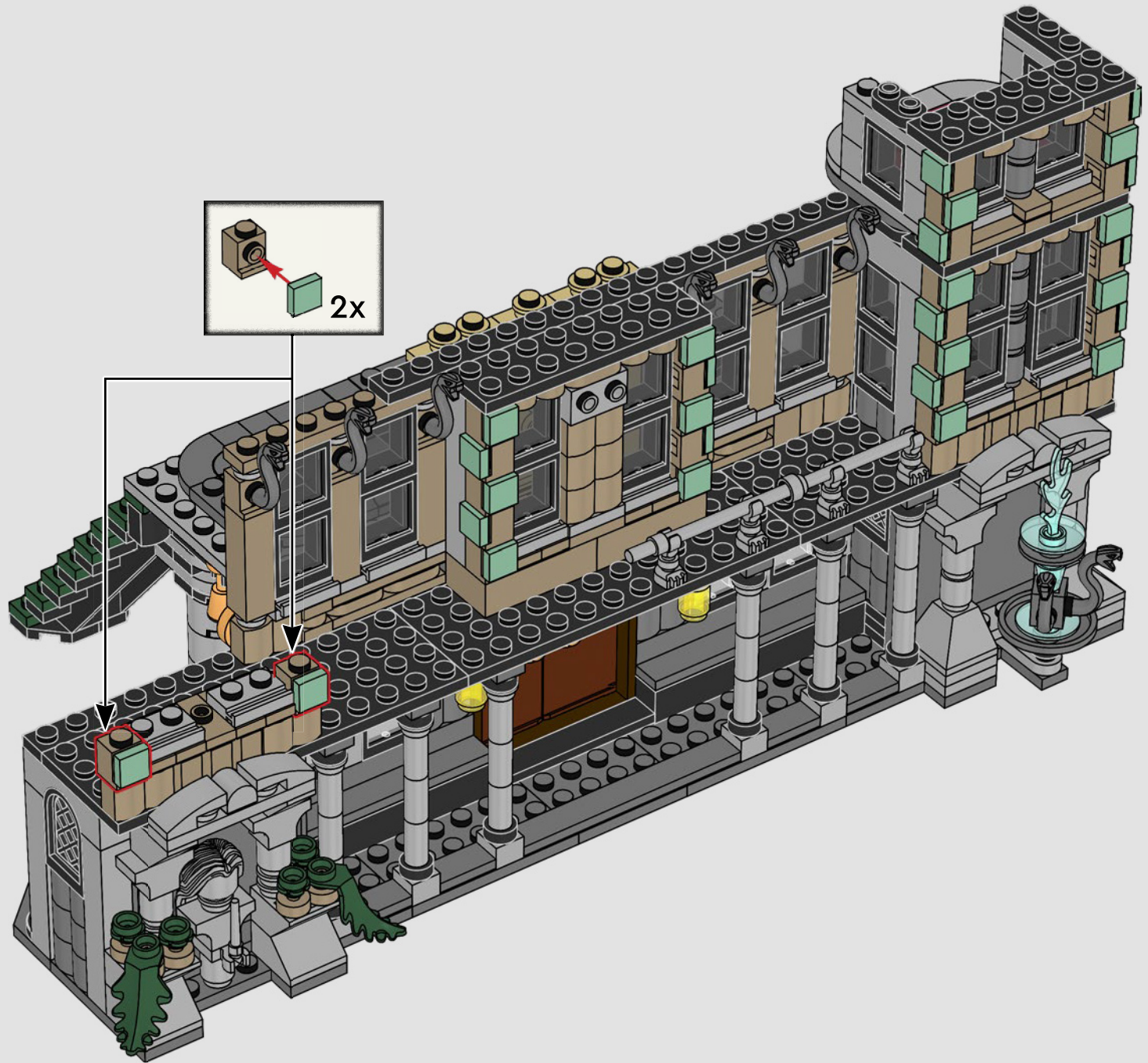

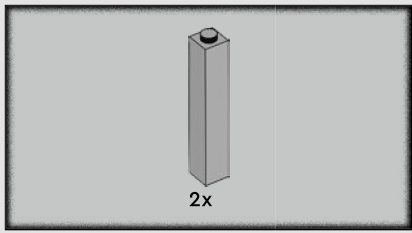

175

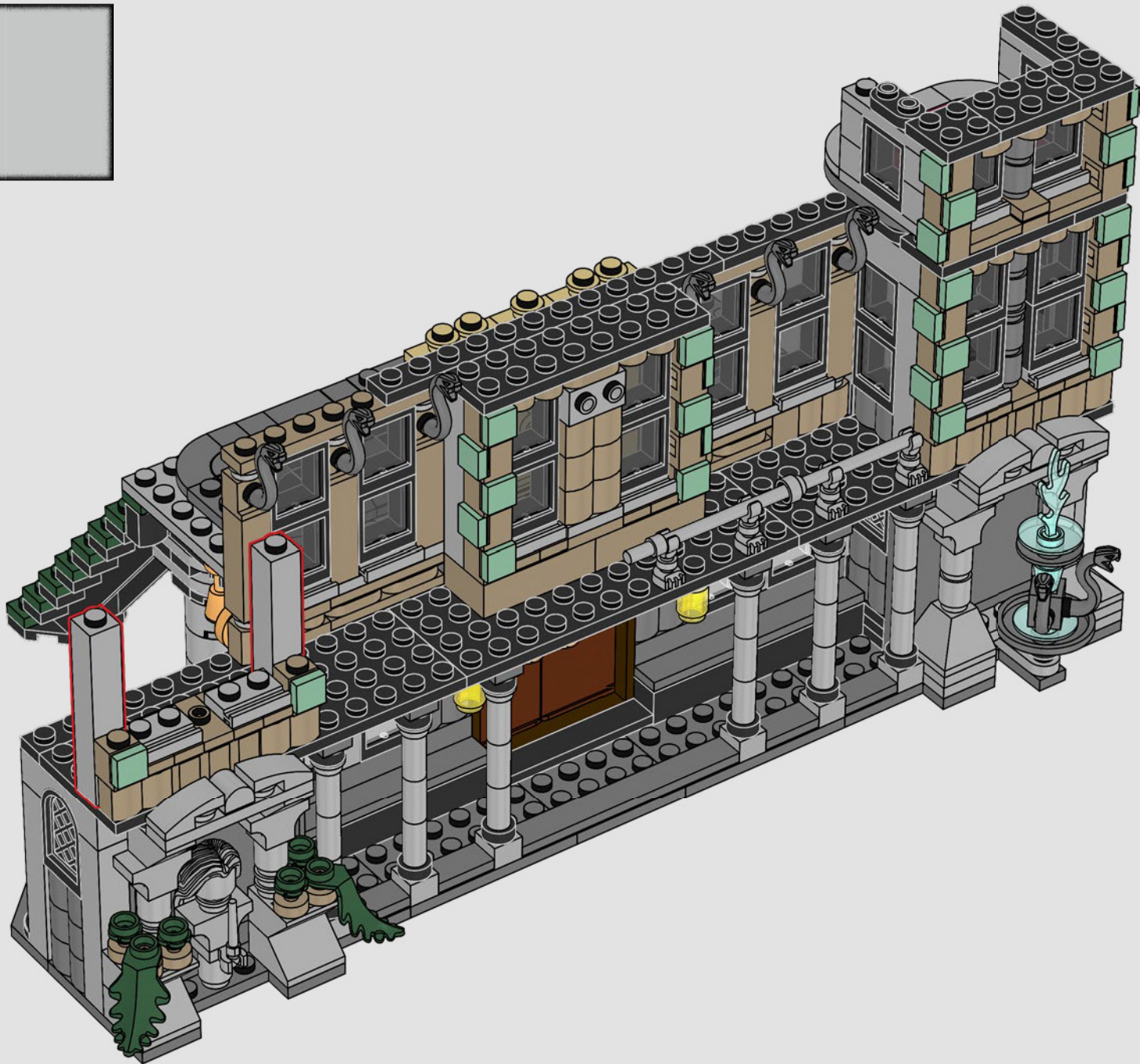

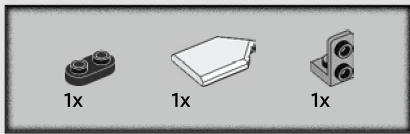

176

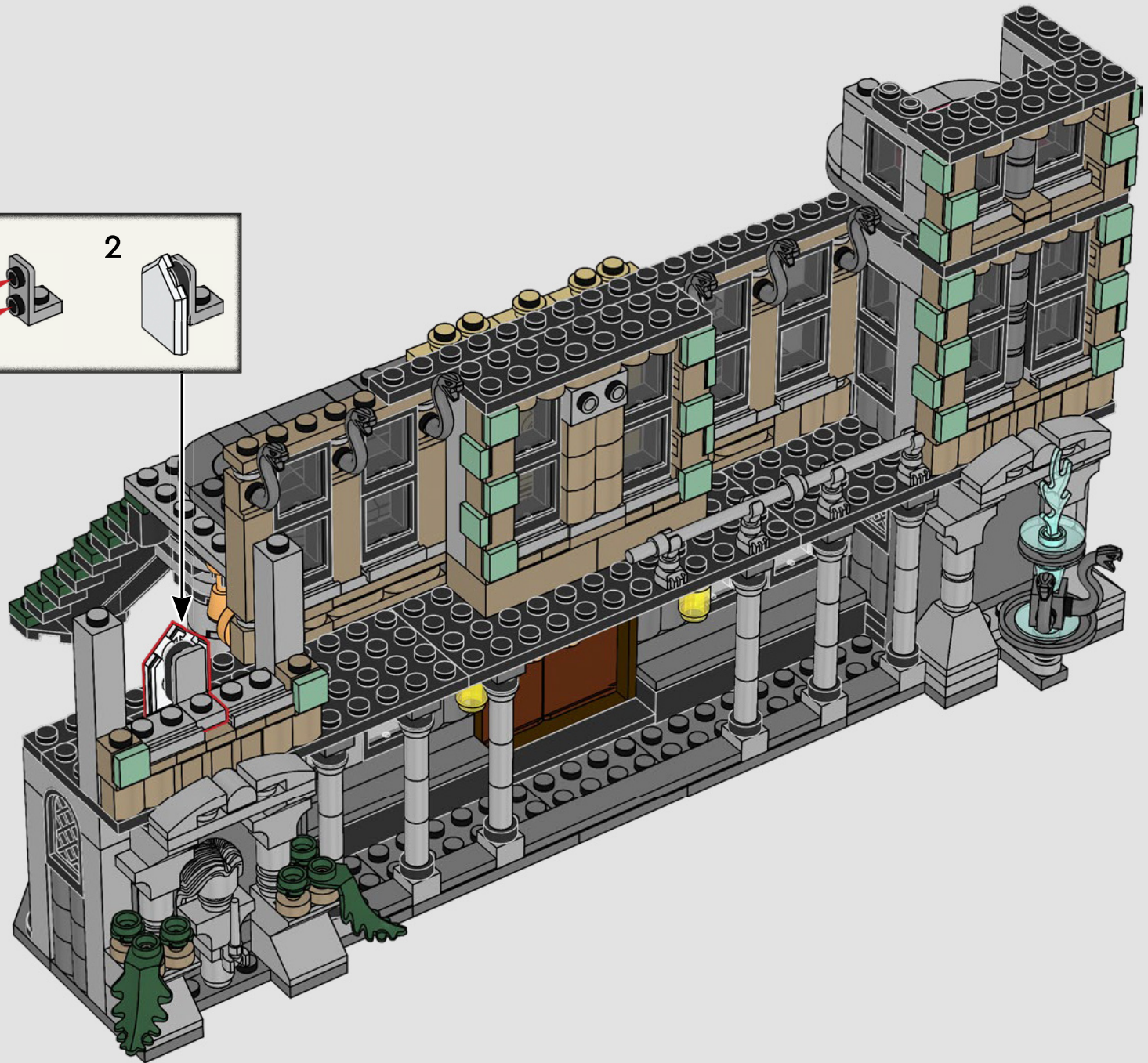
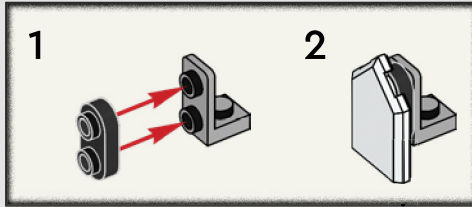

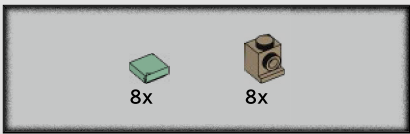

177

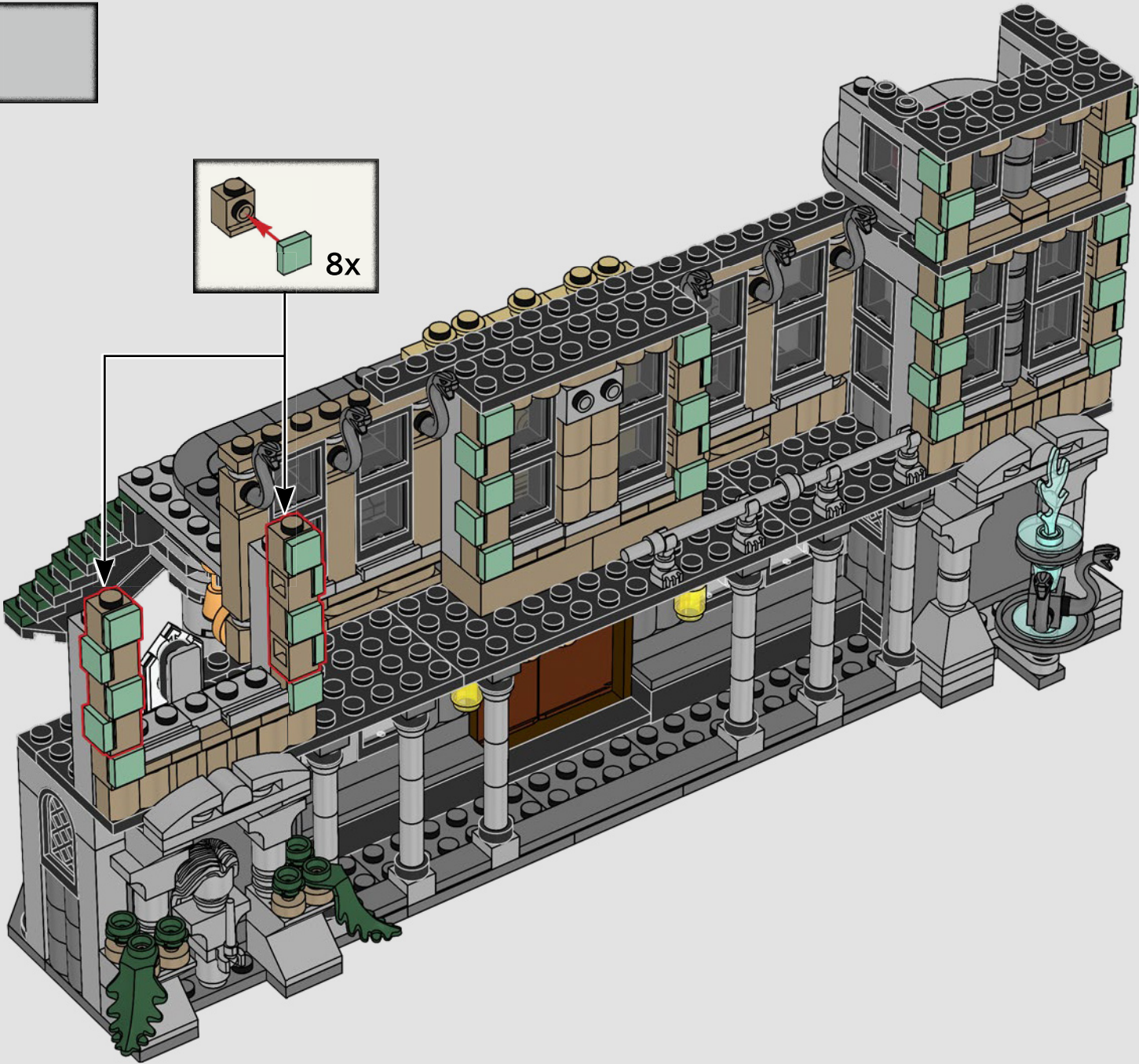
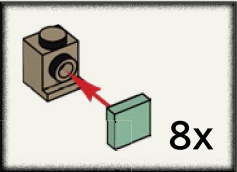

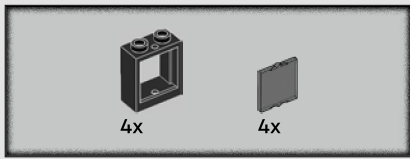

178

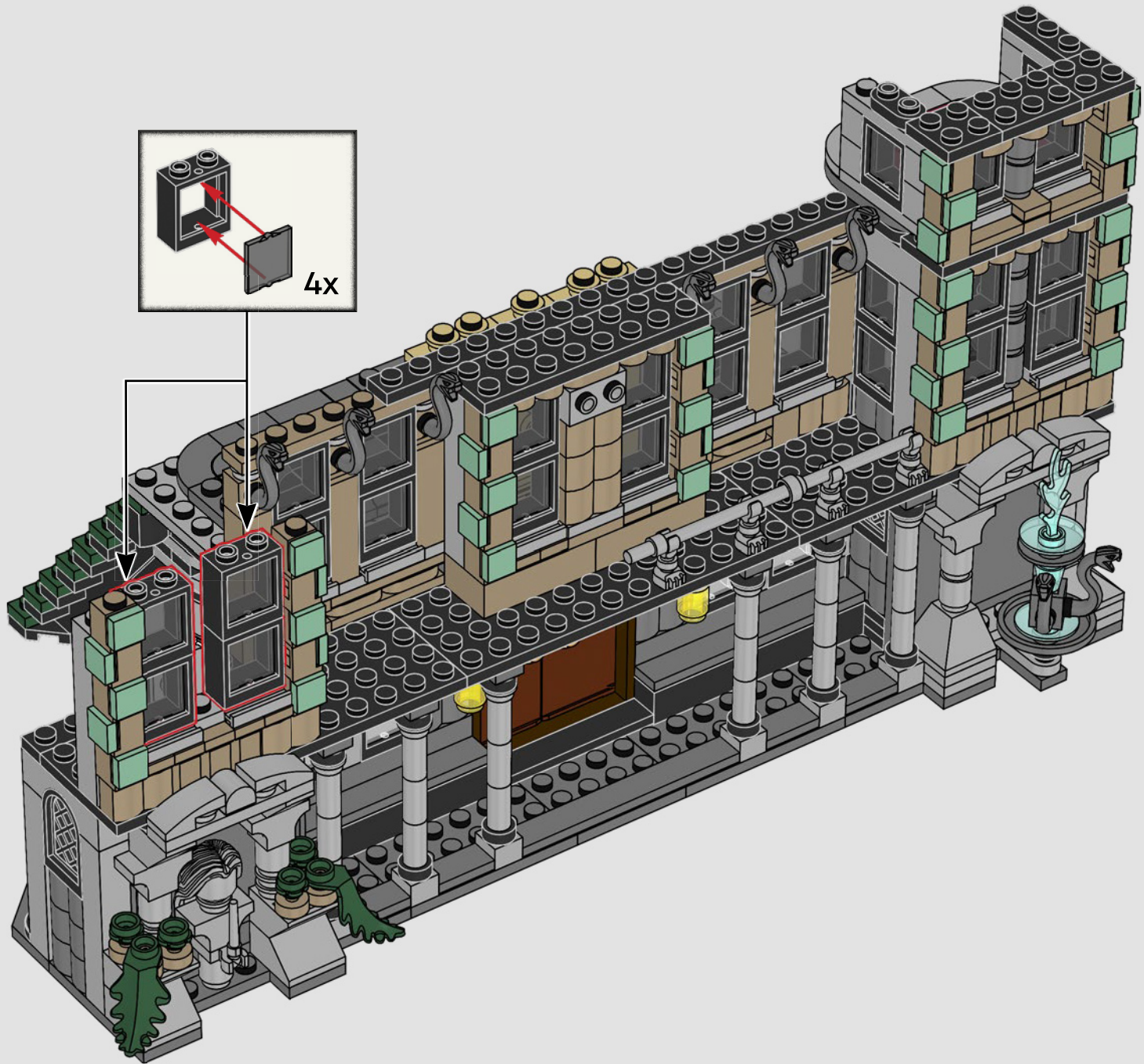
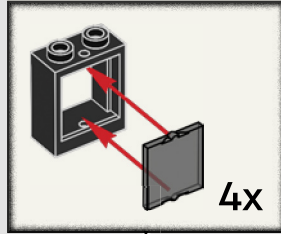

4x

179

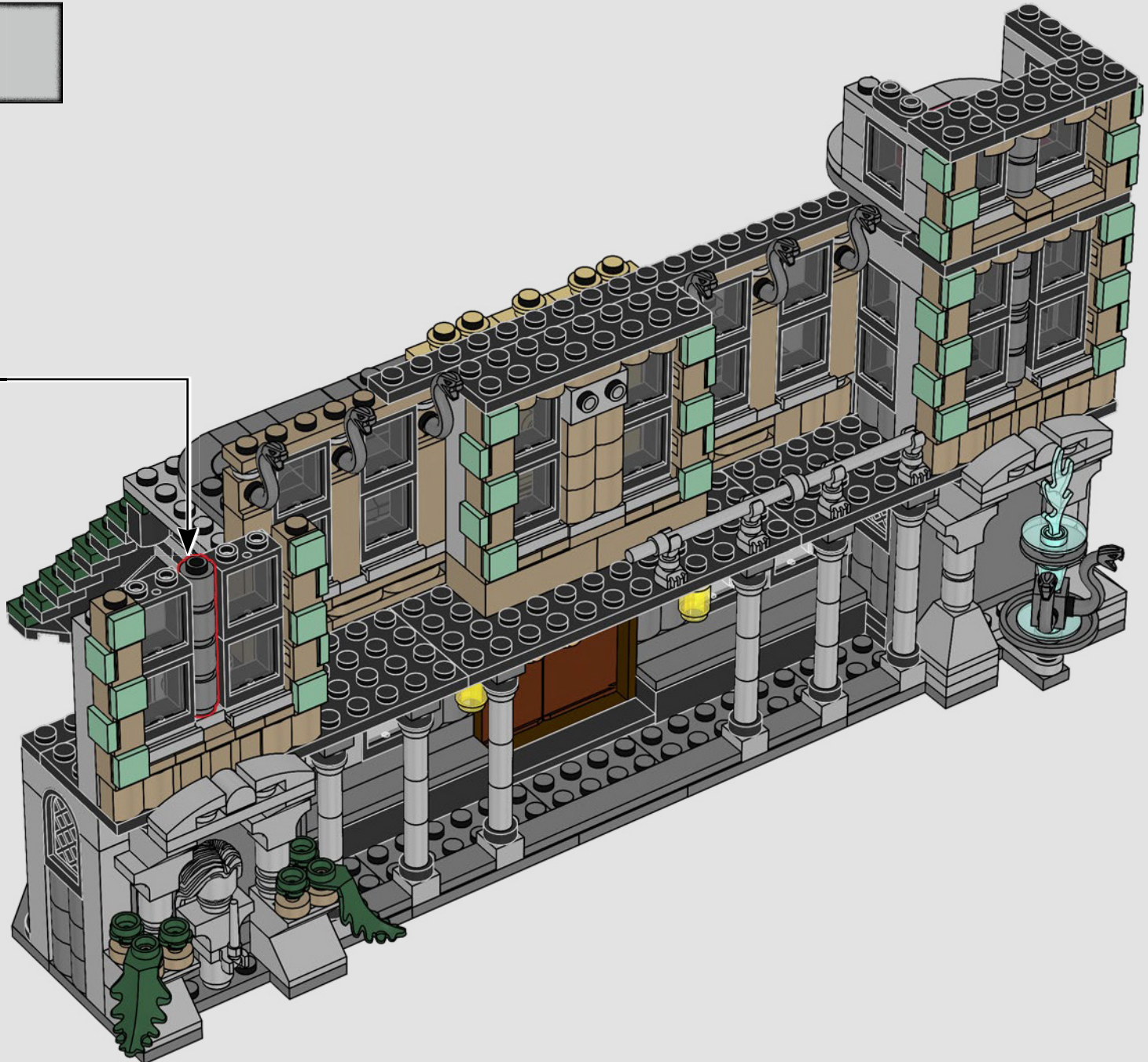
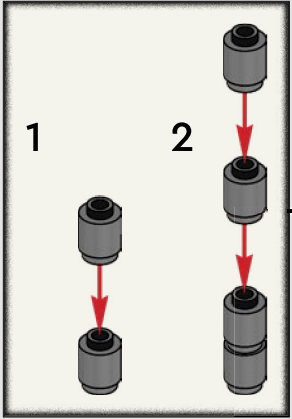

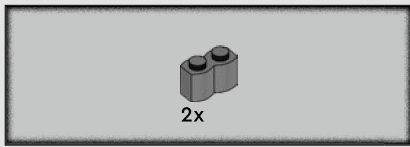

180

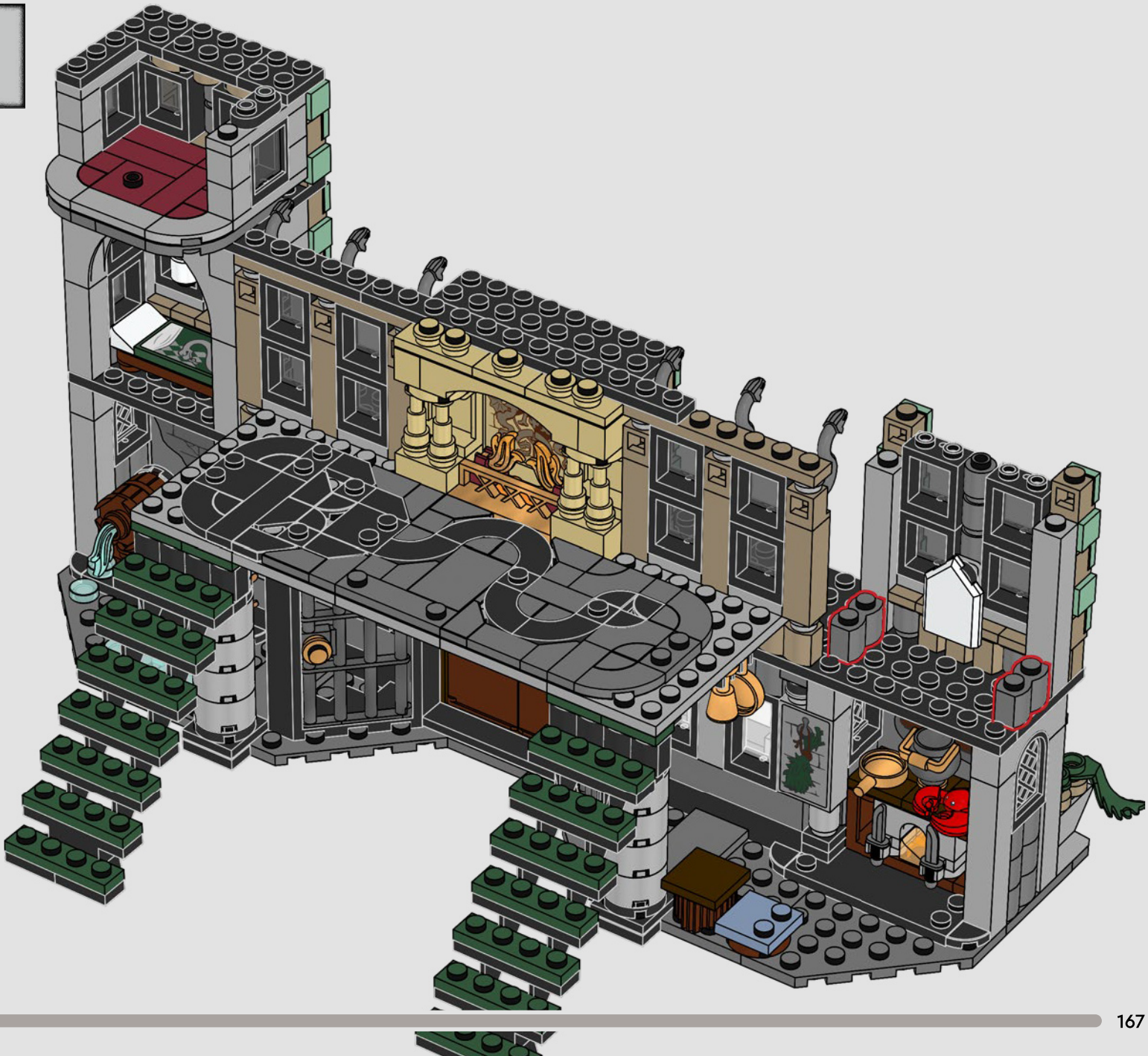

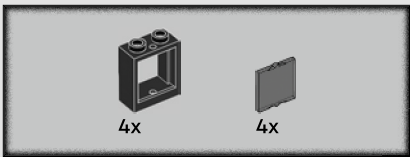

181

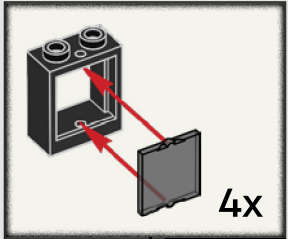
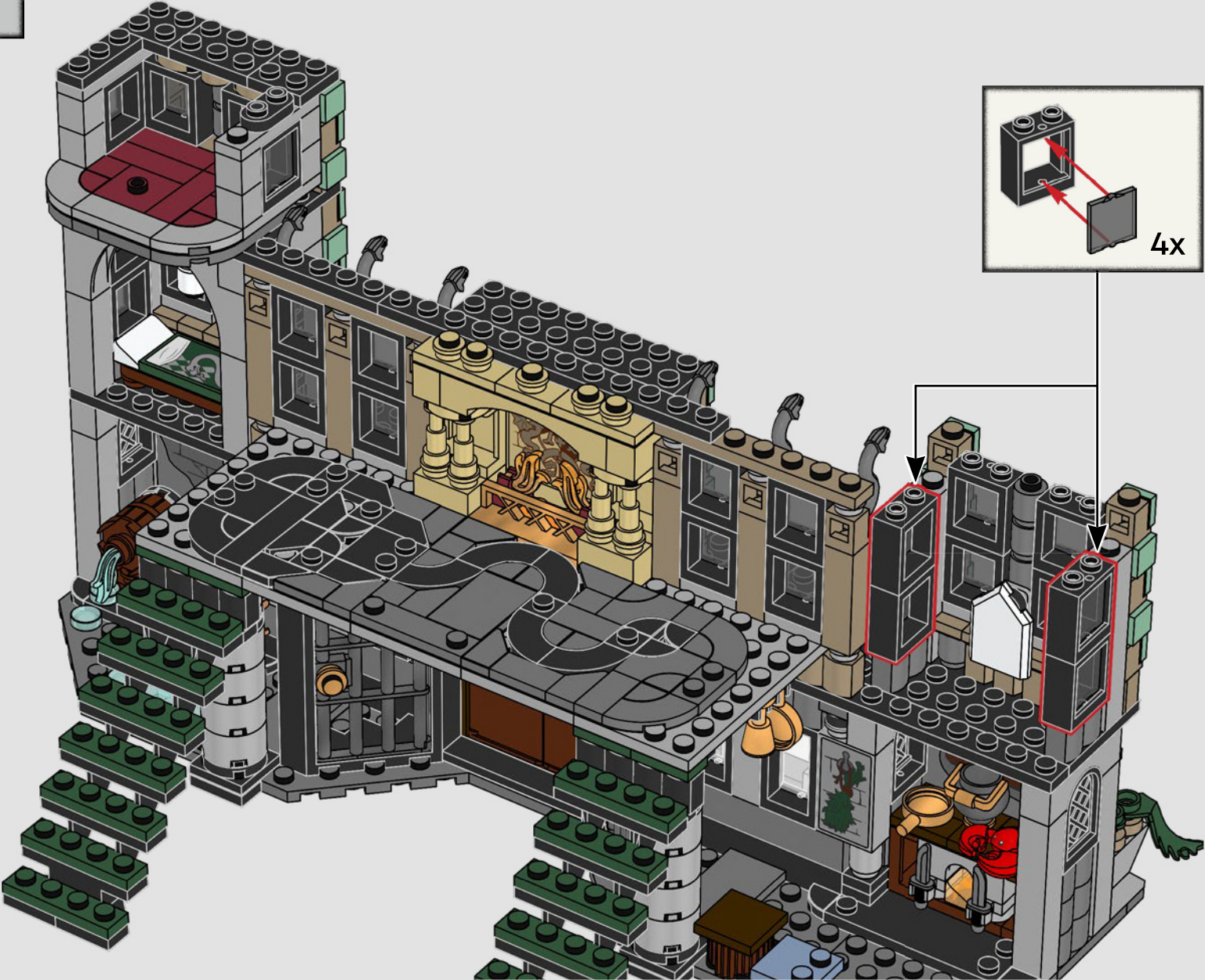

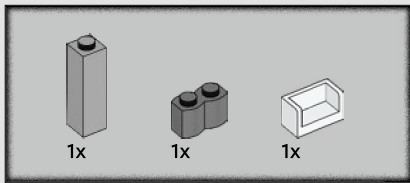

182

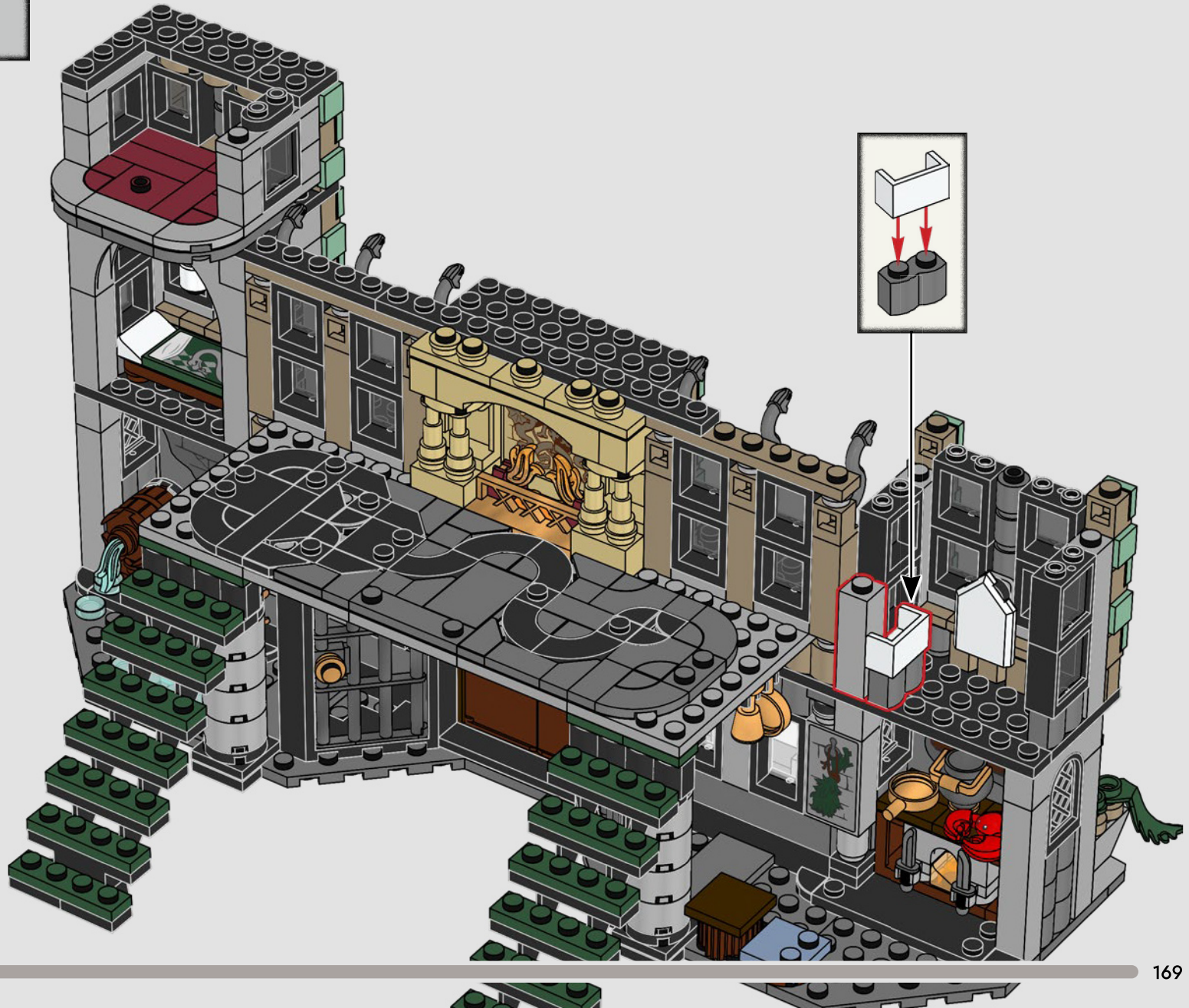

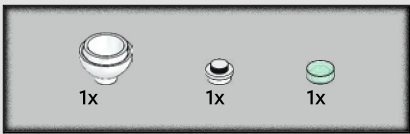

183

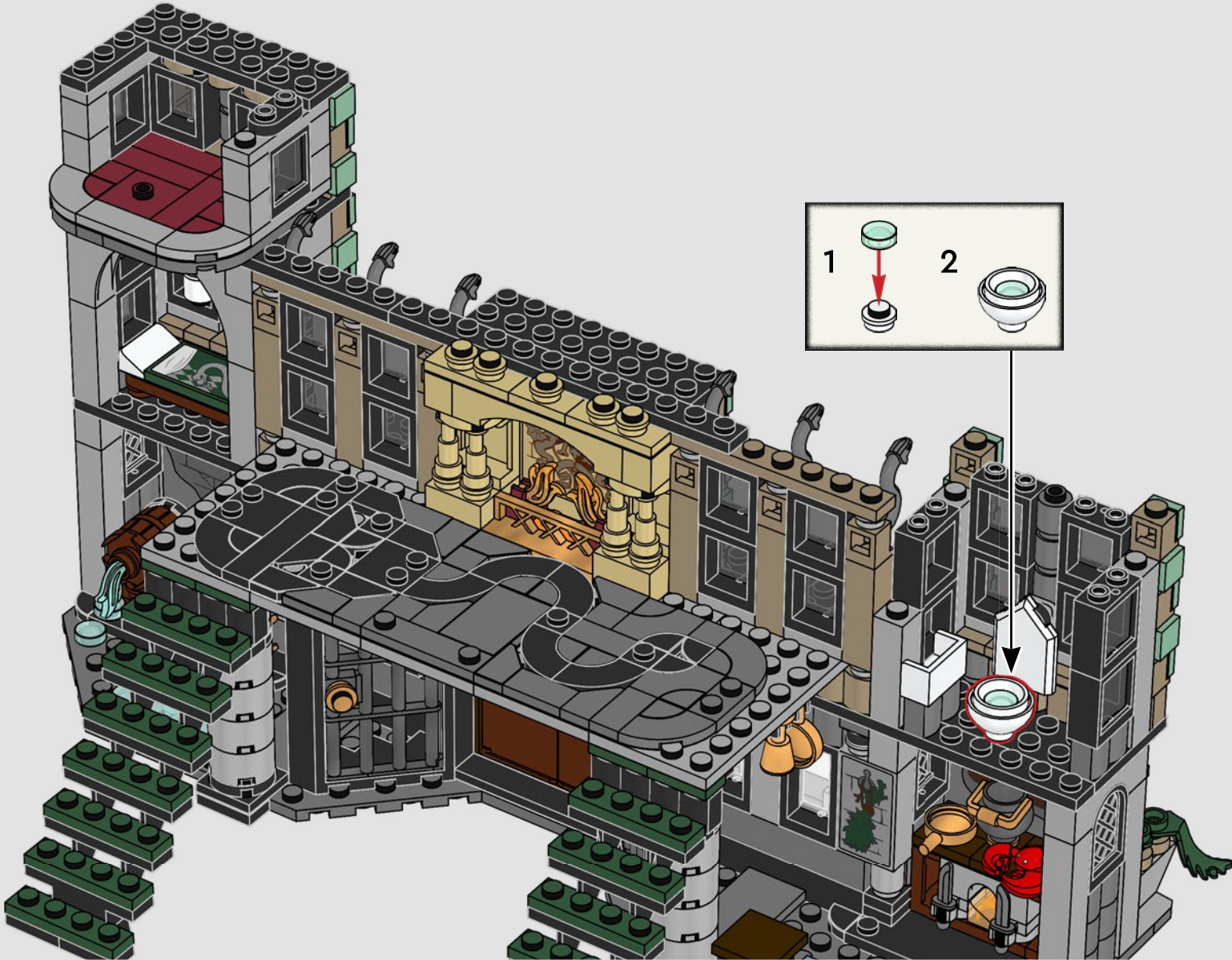

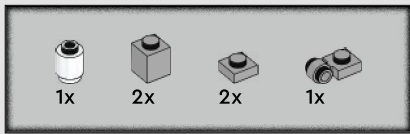

184

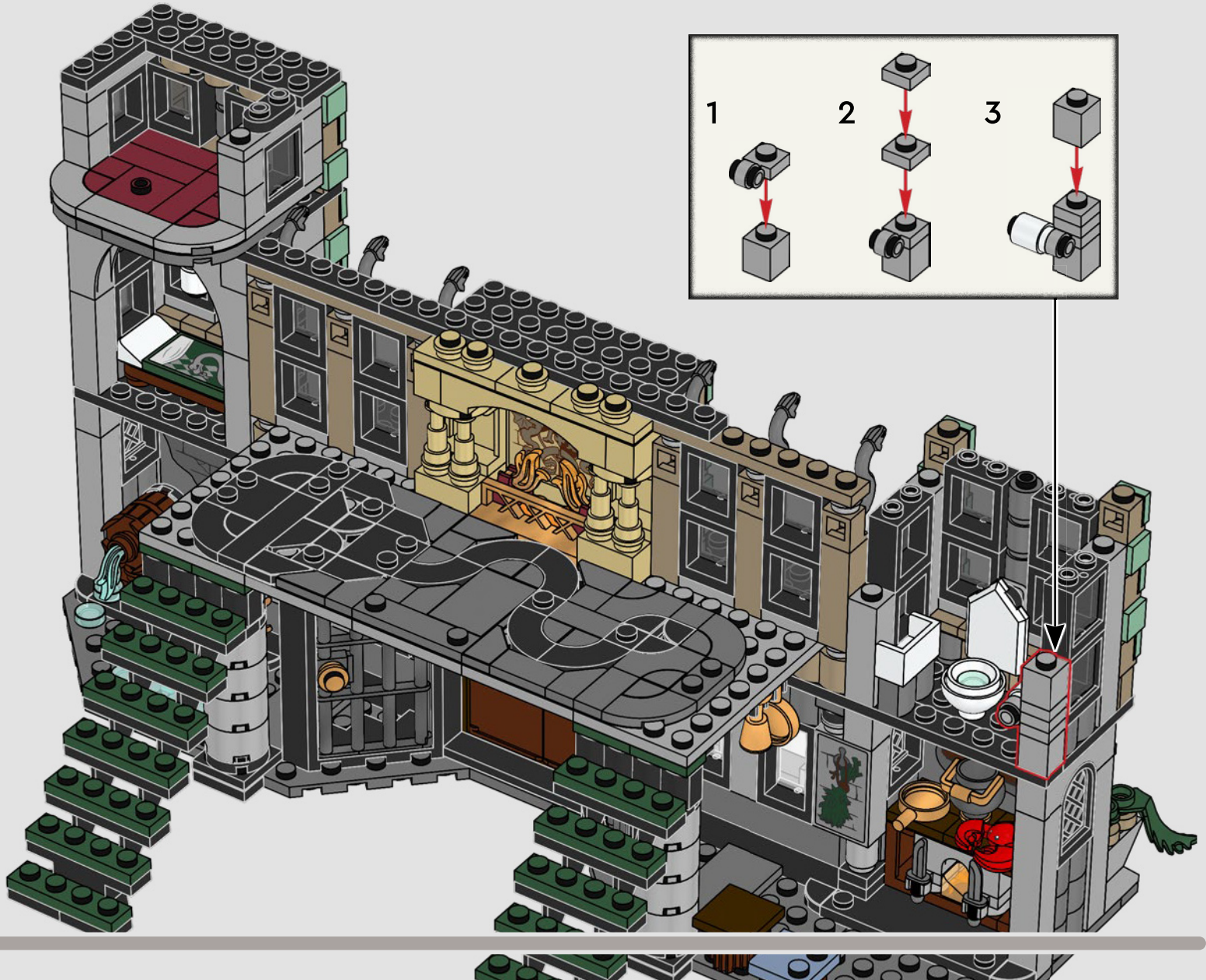

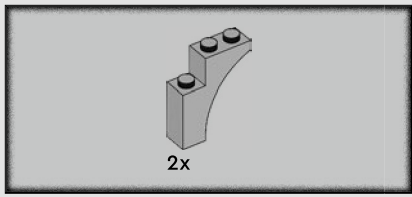

185

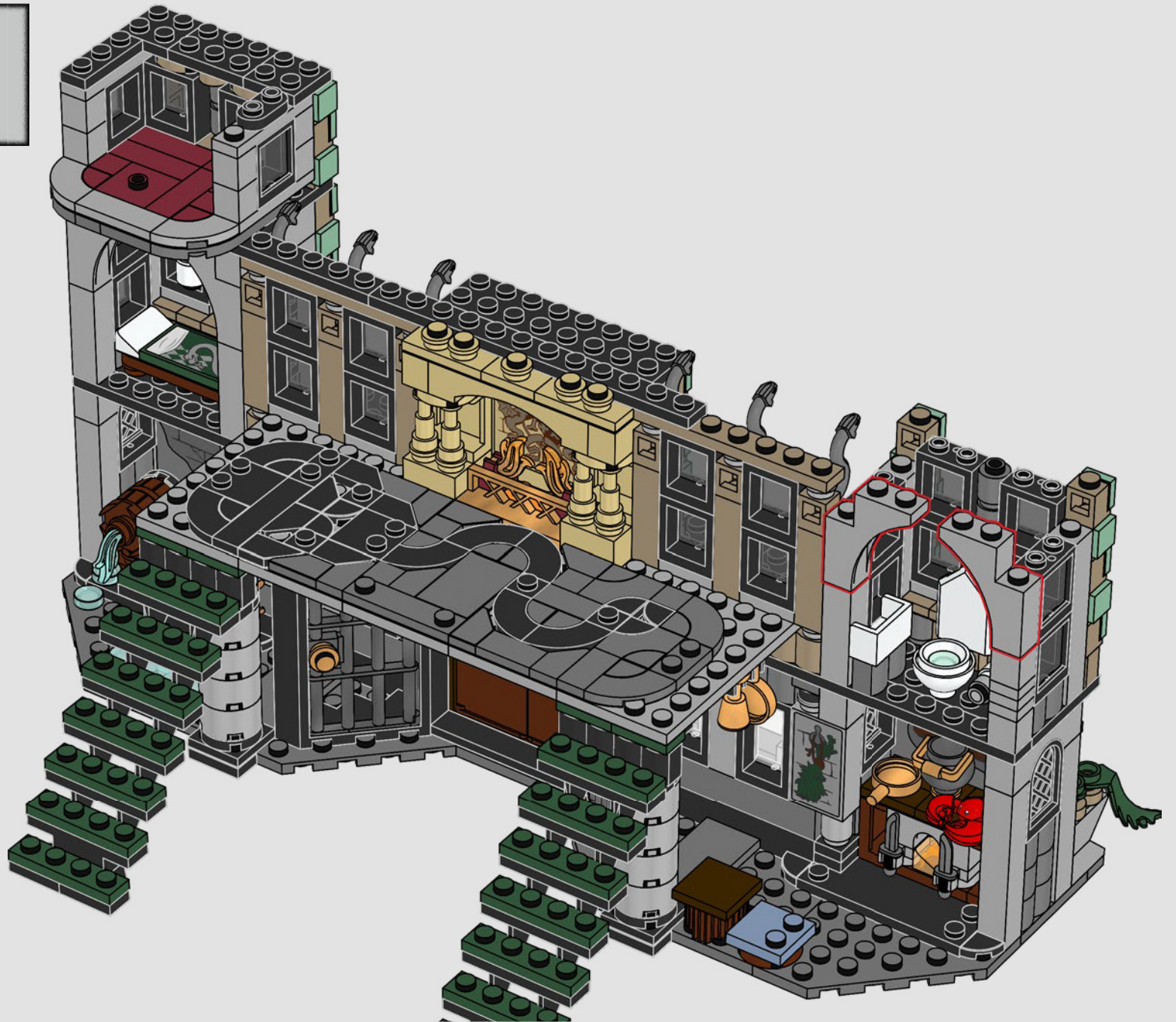

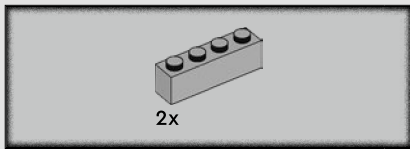

186



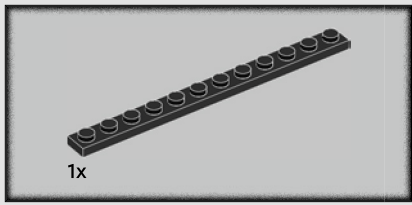

187





188



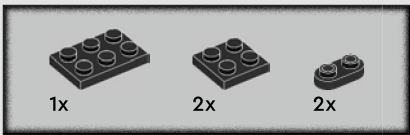

189

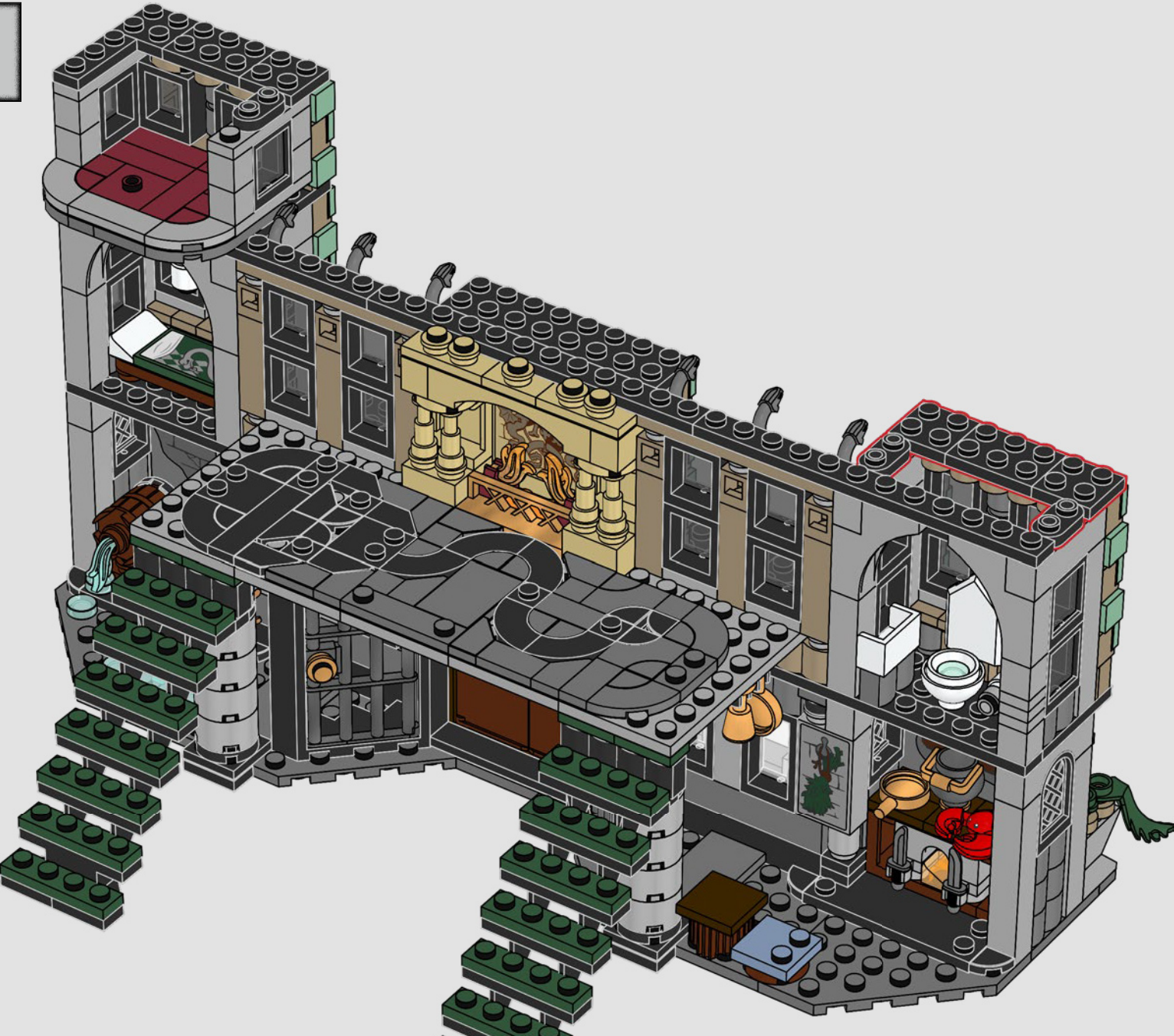

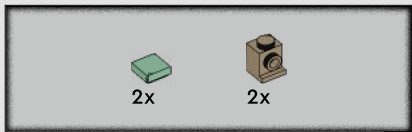

190

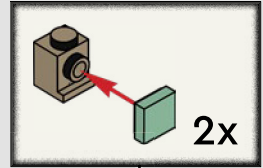

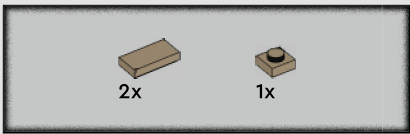

191



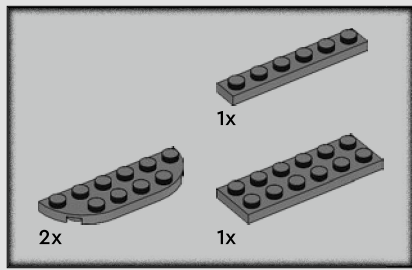

192



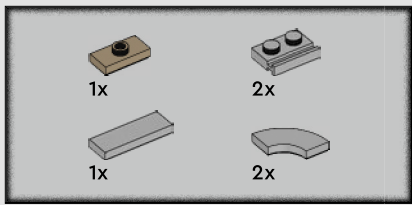

193



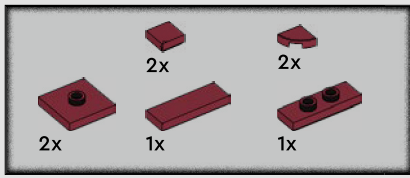

194



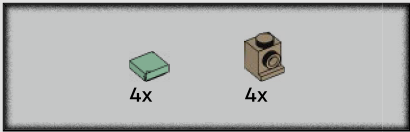

195

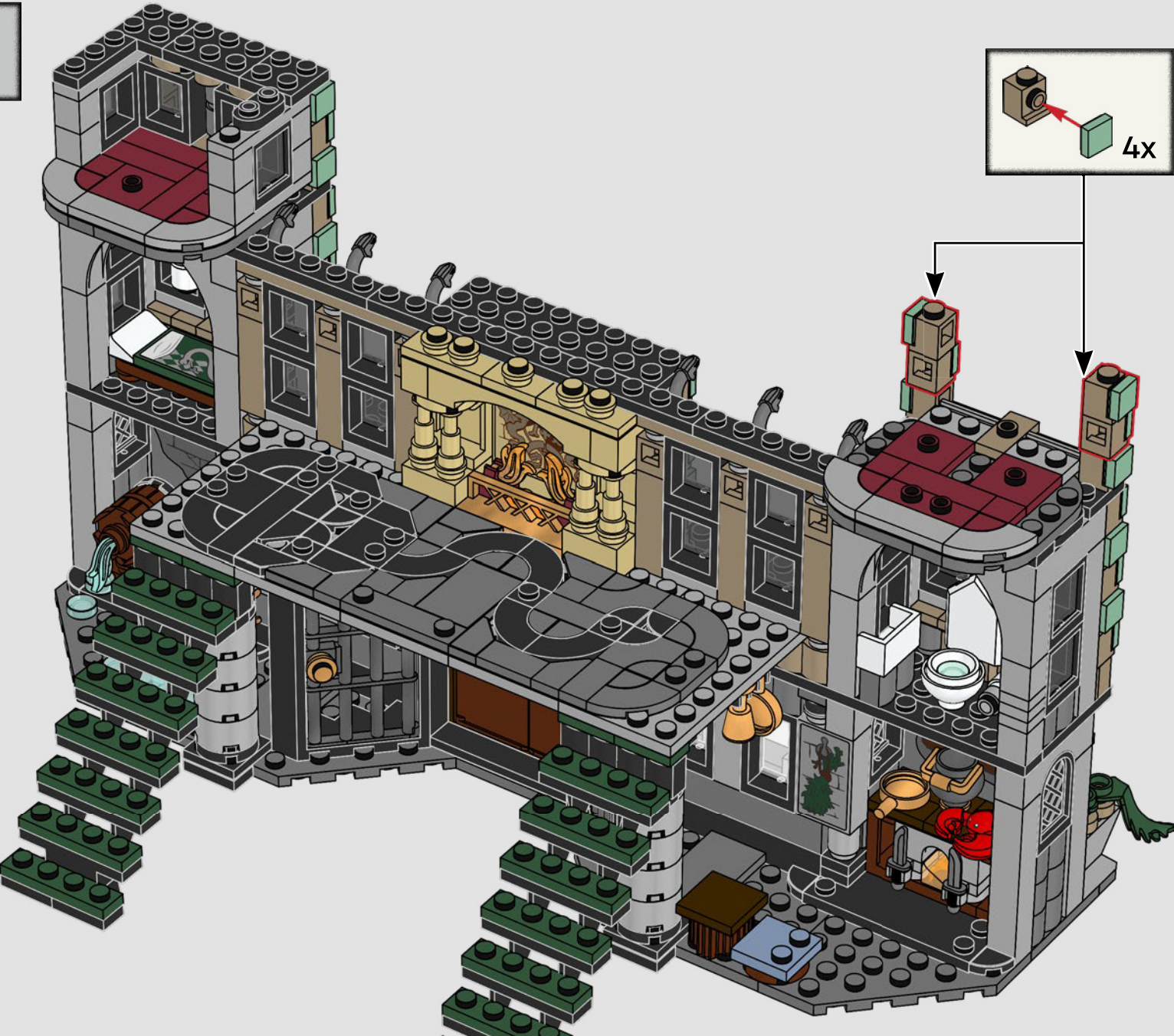
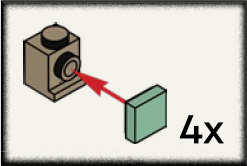

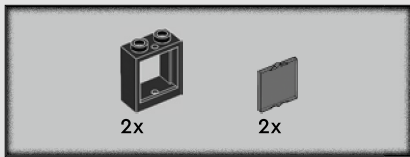

196

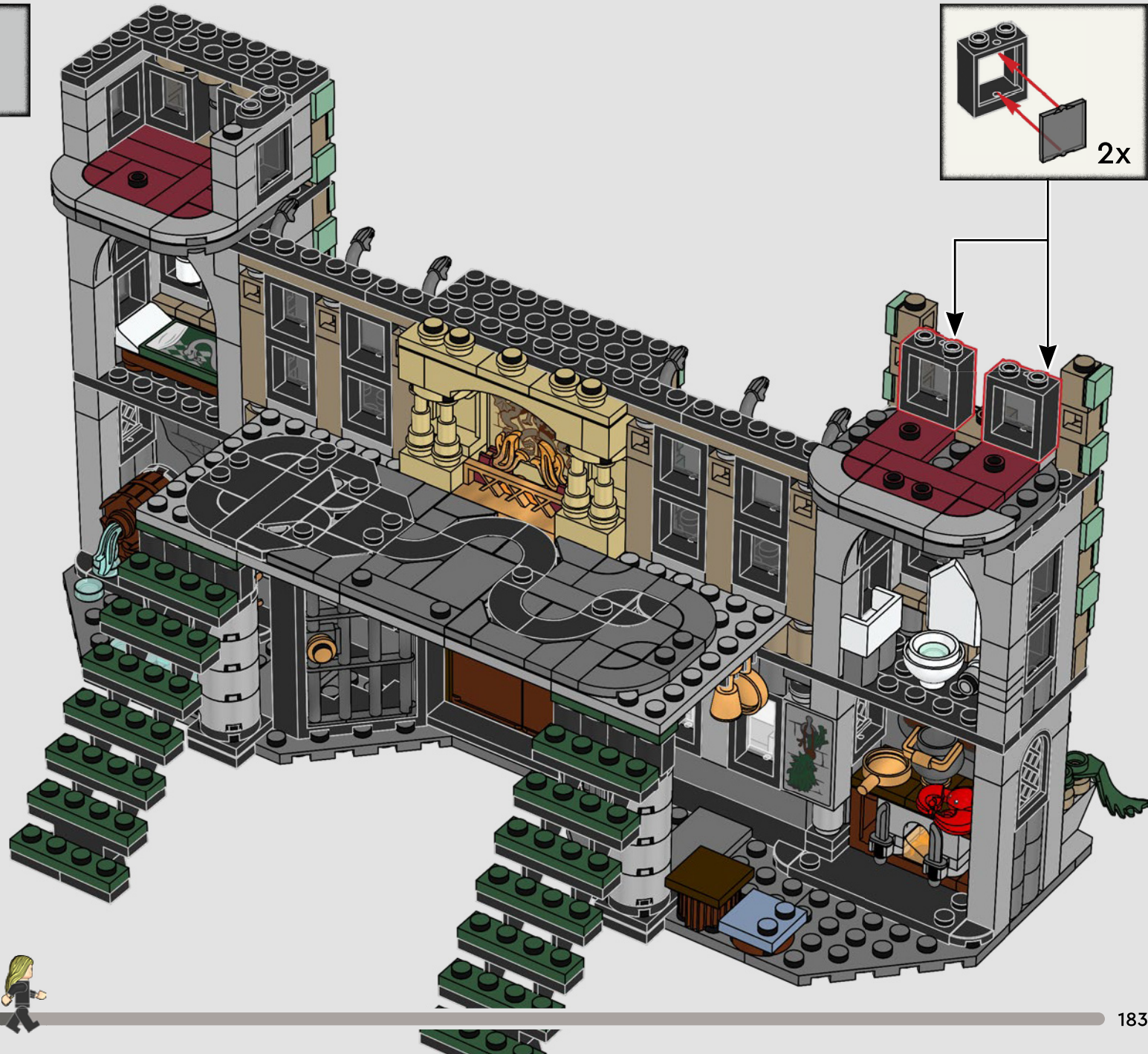
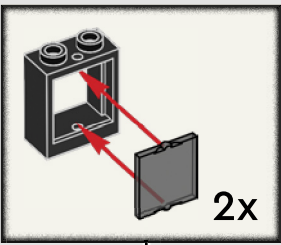



2x

197

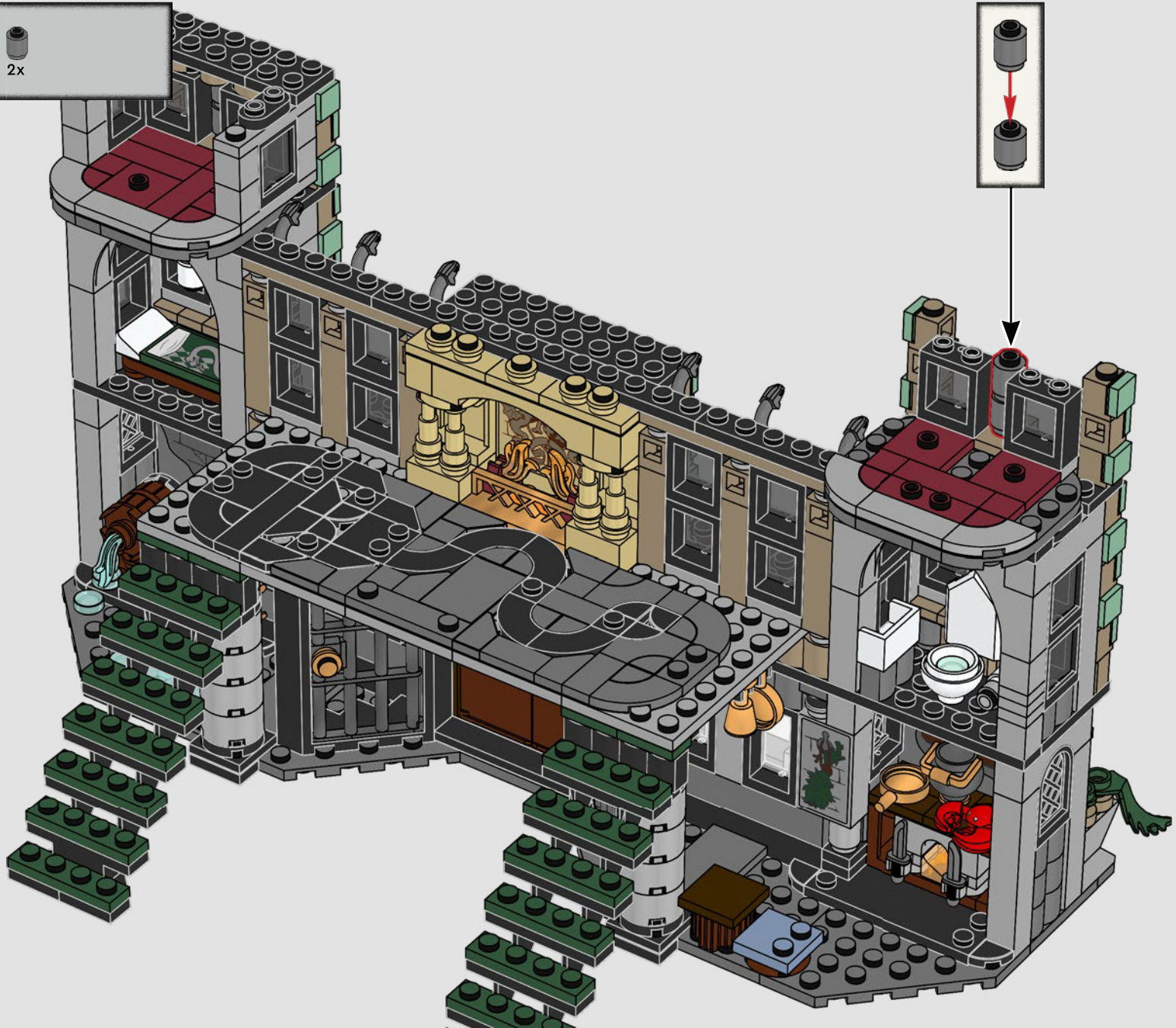

The diagram shows a multi-level LEGO Technic building. The main structure is grey with a red roof. A central courtyard area is covered with grey Technic plates. To the right, there is a kitchen area with a red stove and a white sink. Below the kitchen is a bathroom with a white toilet. The building has several windows and a staircase on the left side. A red circle highlights a hole on the roof where a pin should be inserted. An arrow points from the pin diagram above to this hole.

184

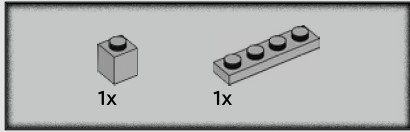
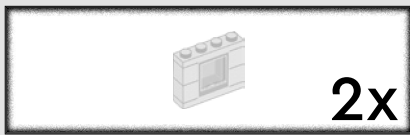

198

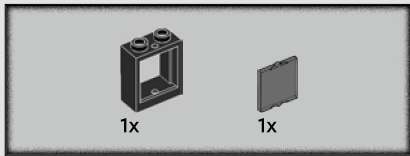
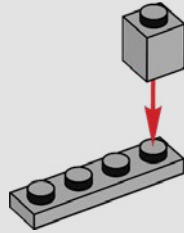

199

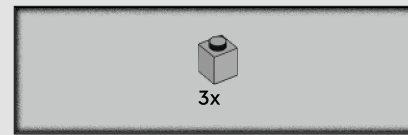
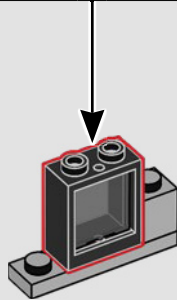
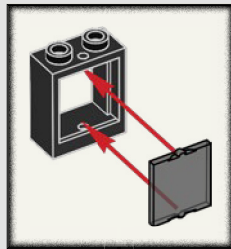

200

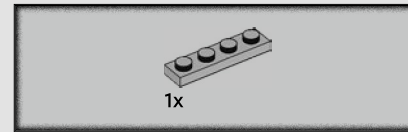
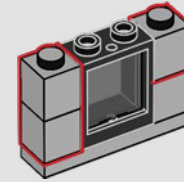

201

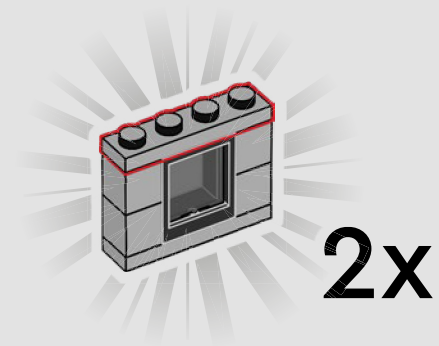

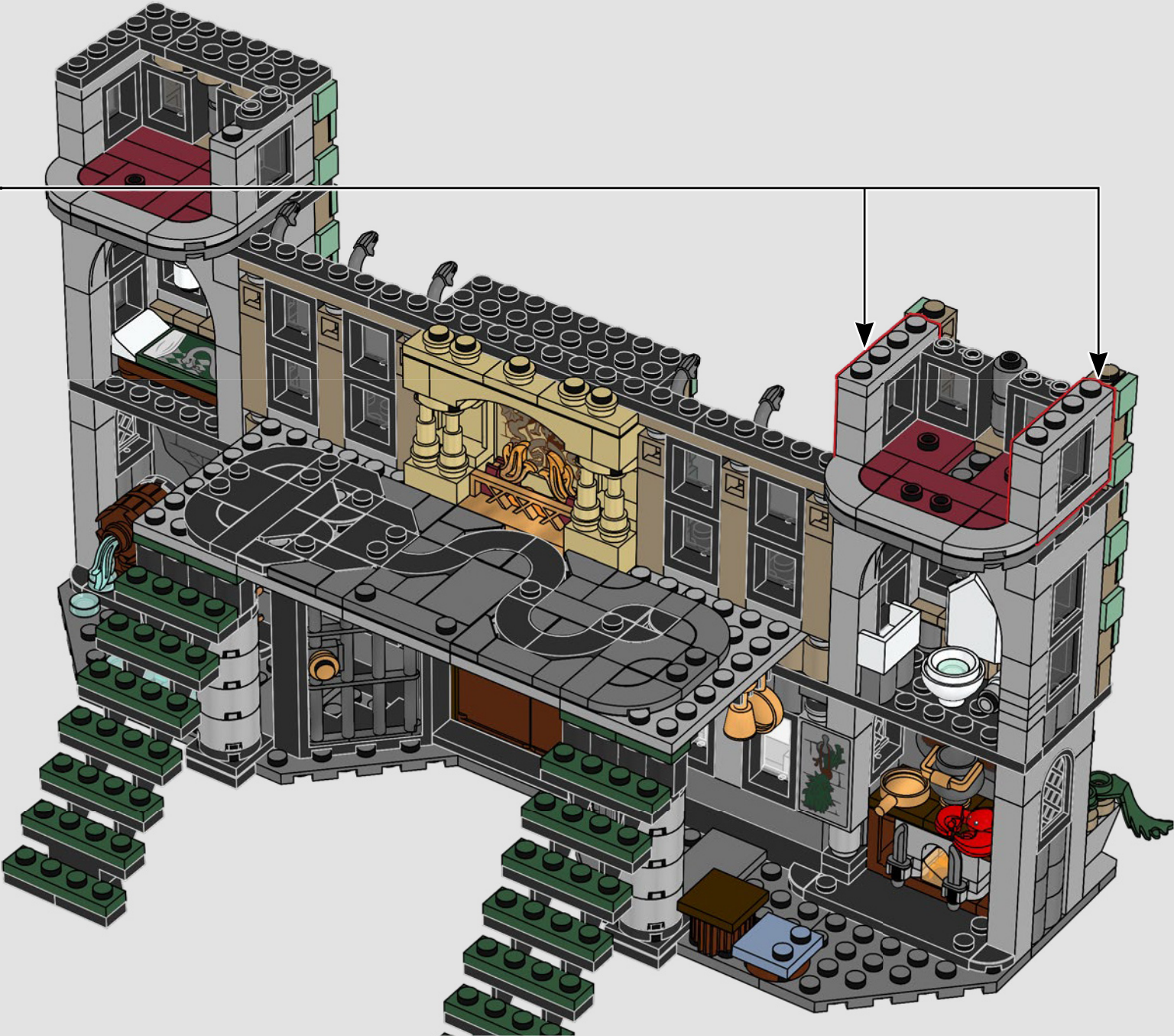



203



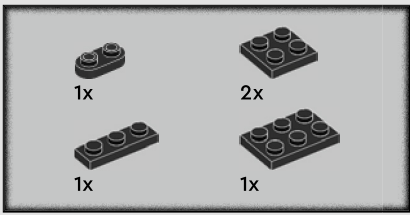

204





205

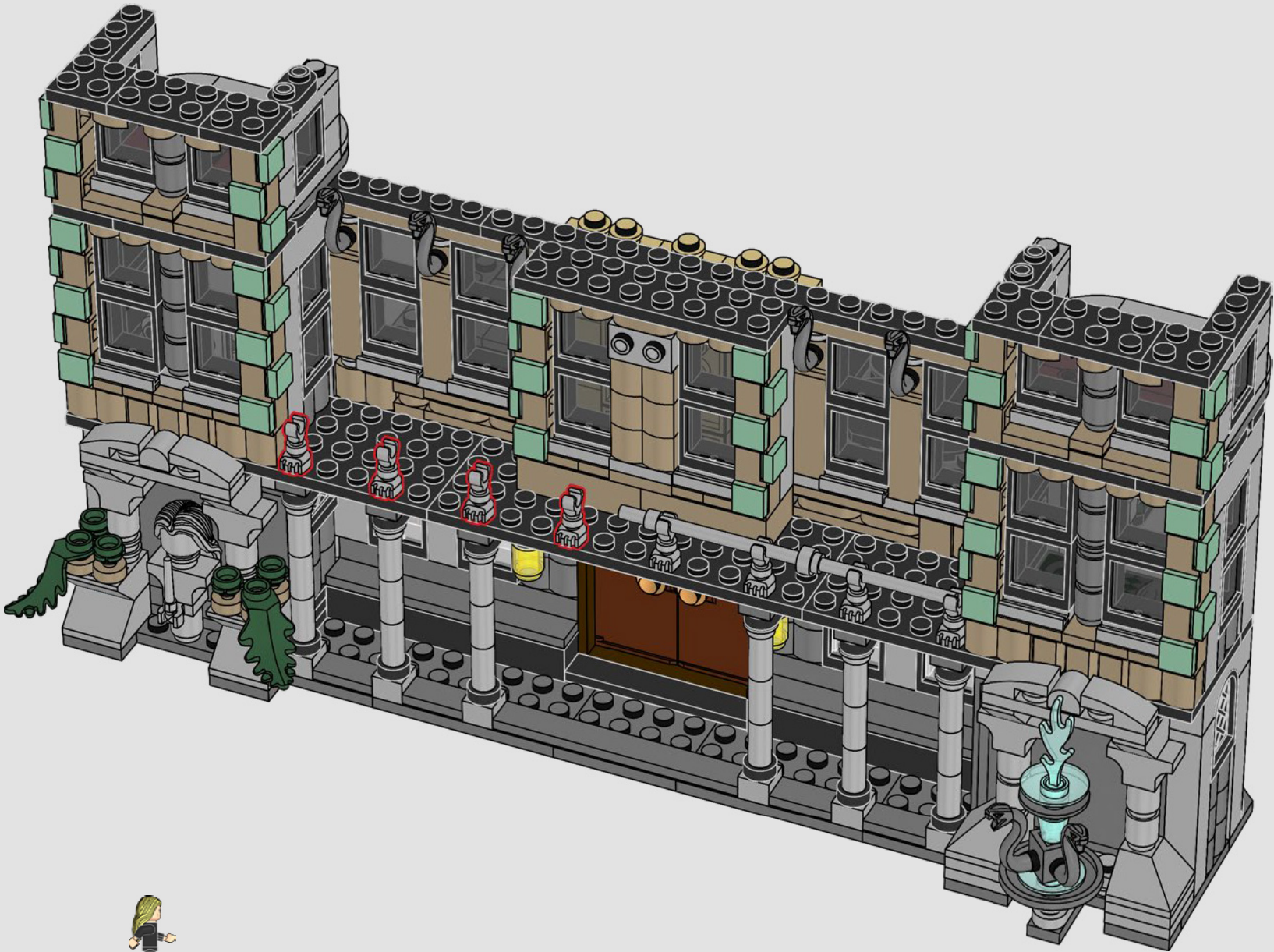

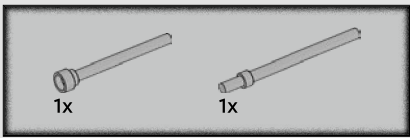

206

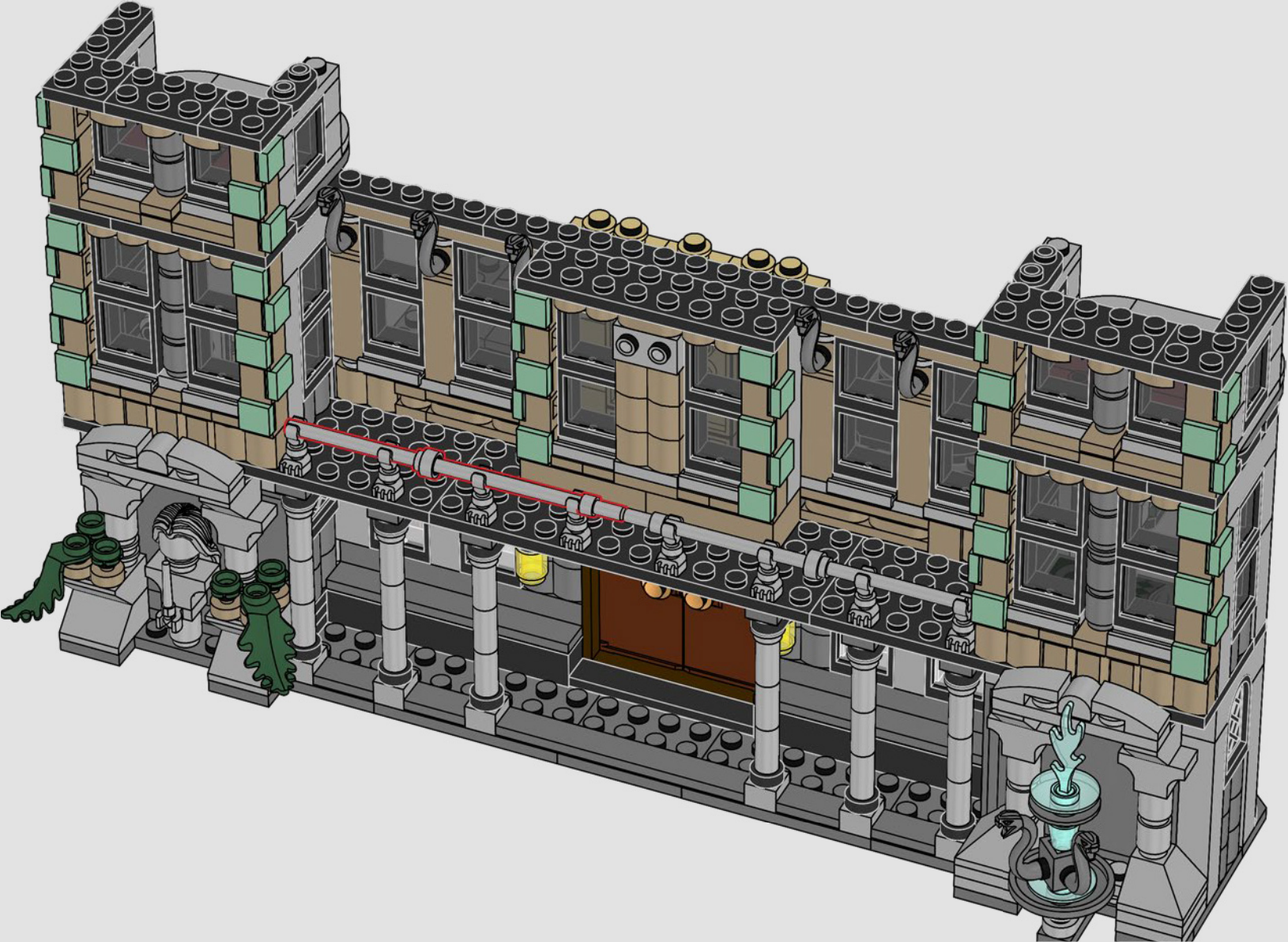



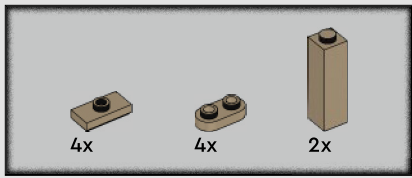

207

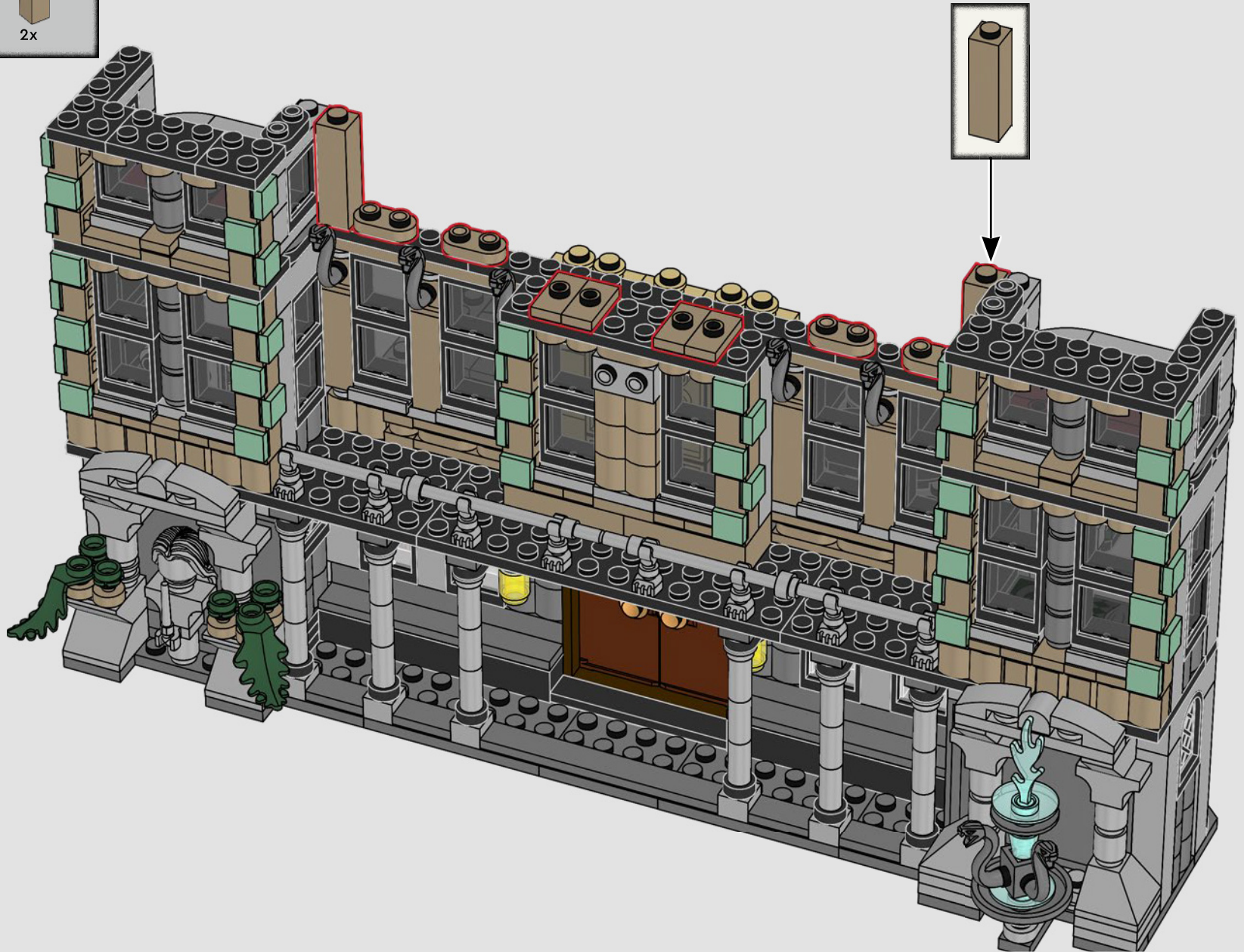



208



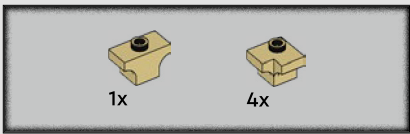

209



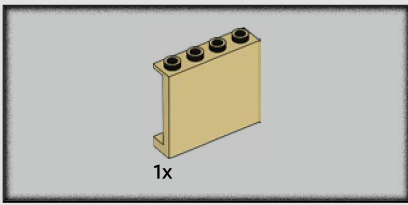

210





6x

211



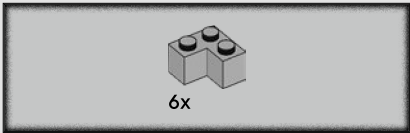

212

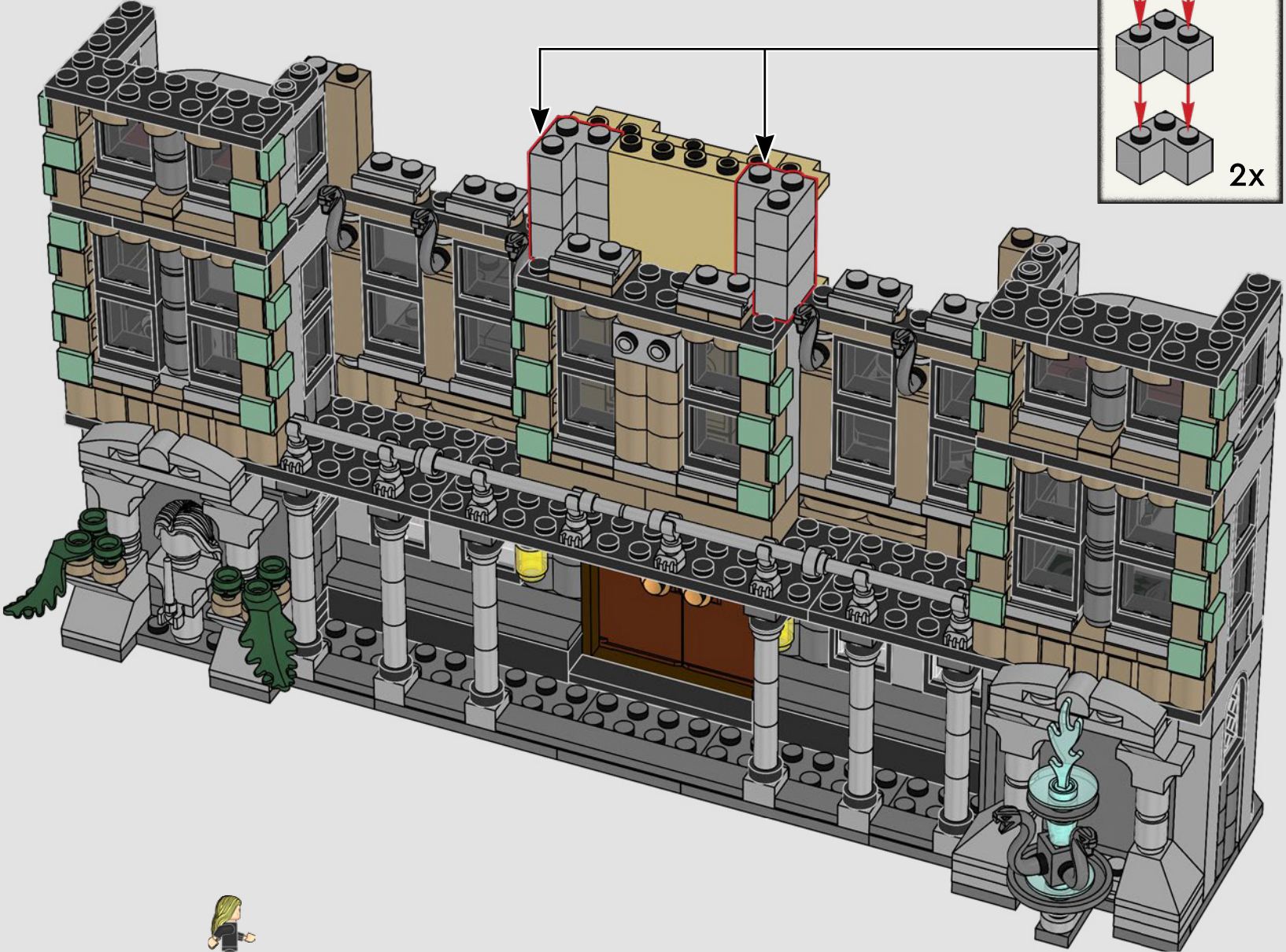



4x

213

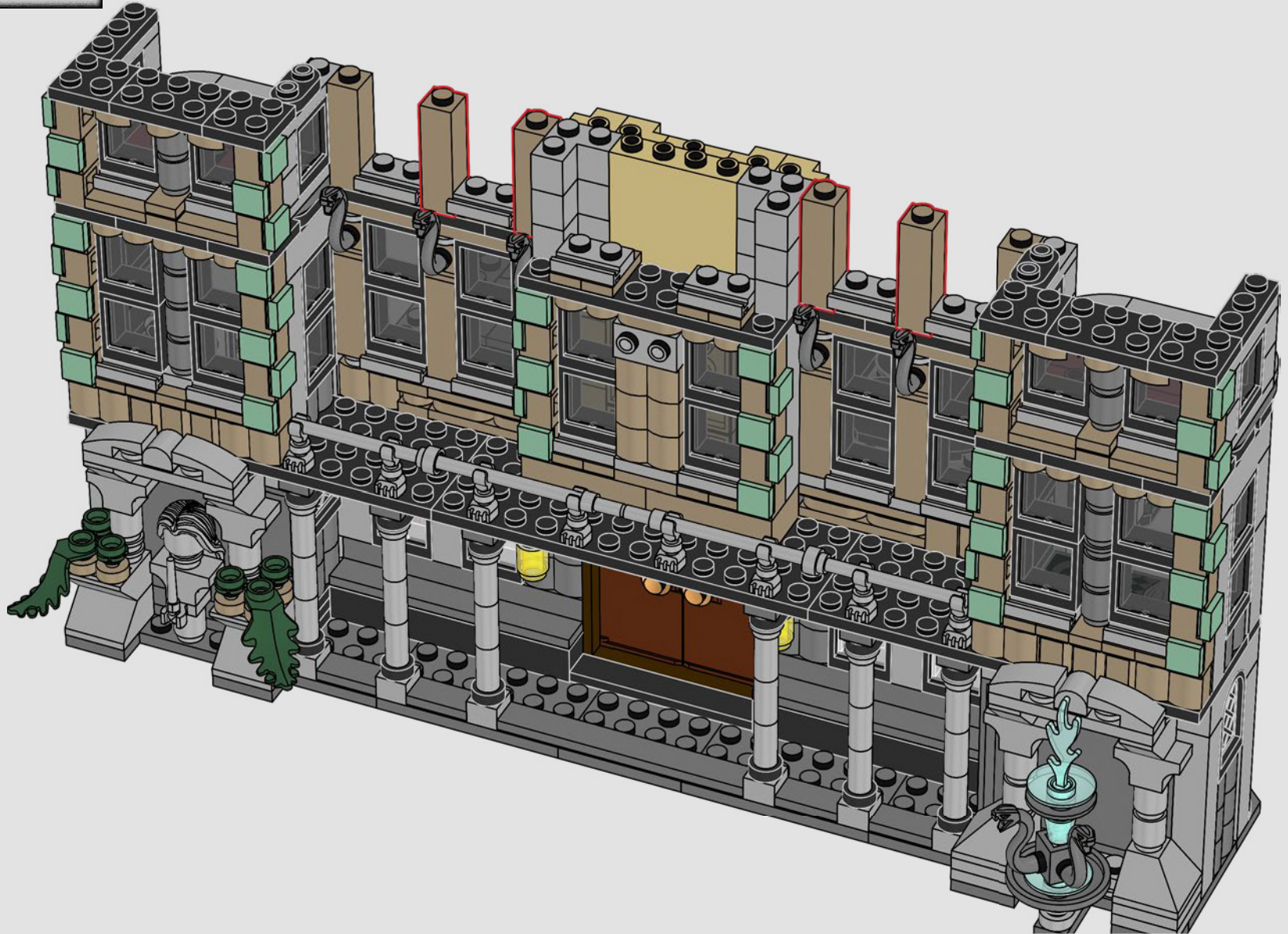

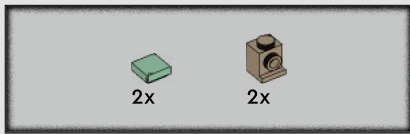

214

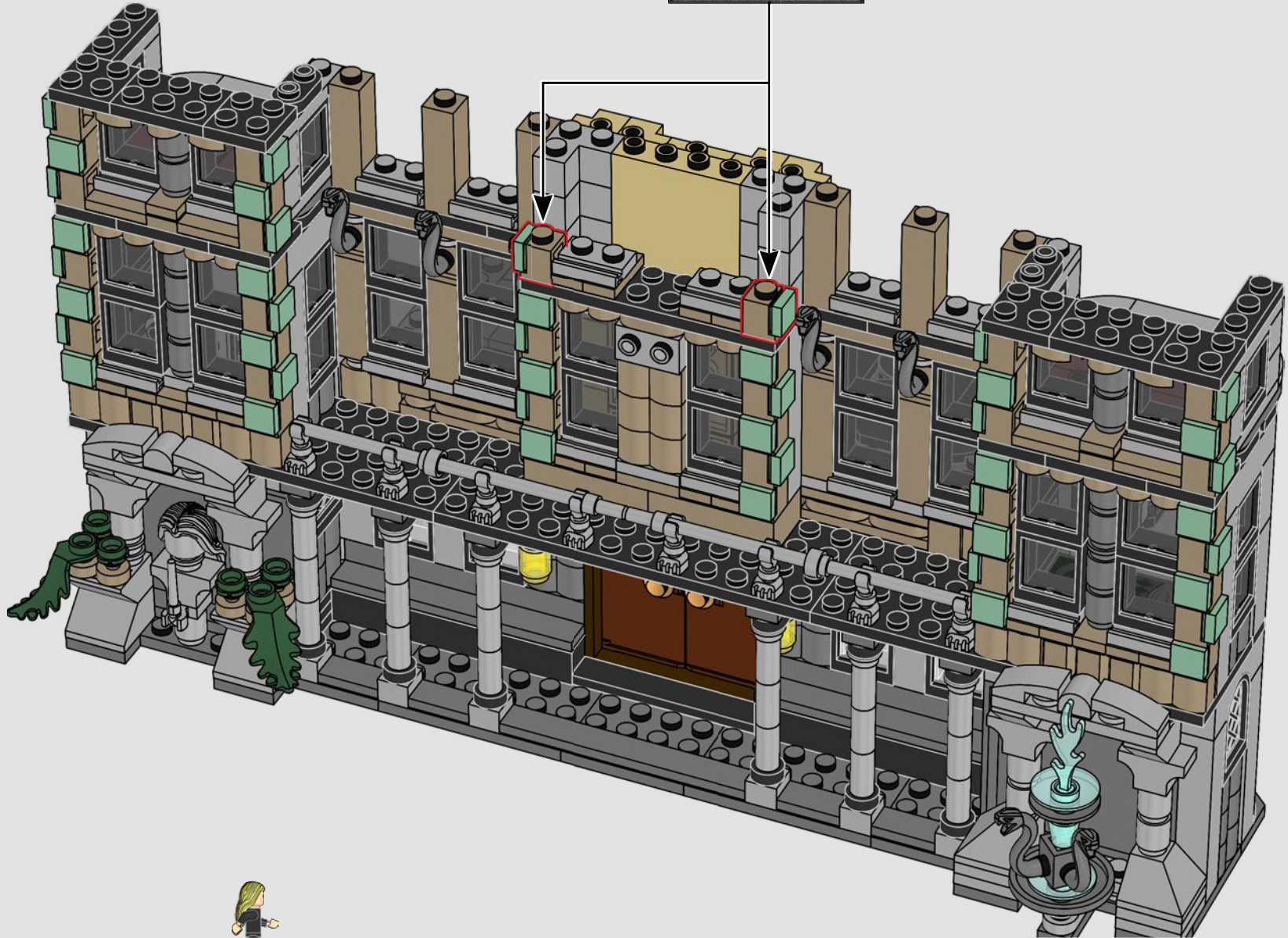
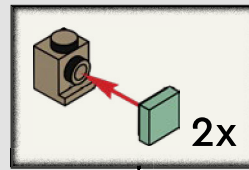

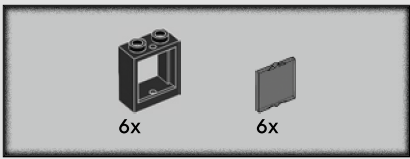

215

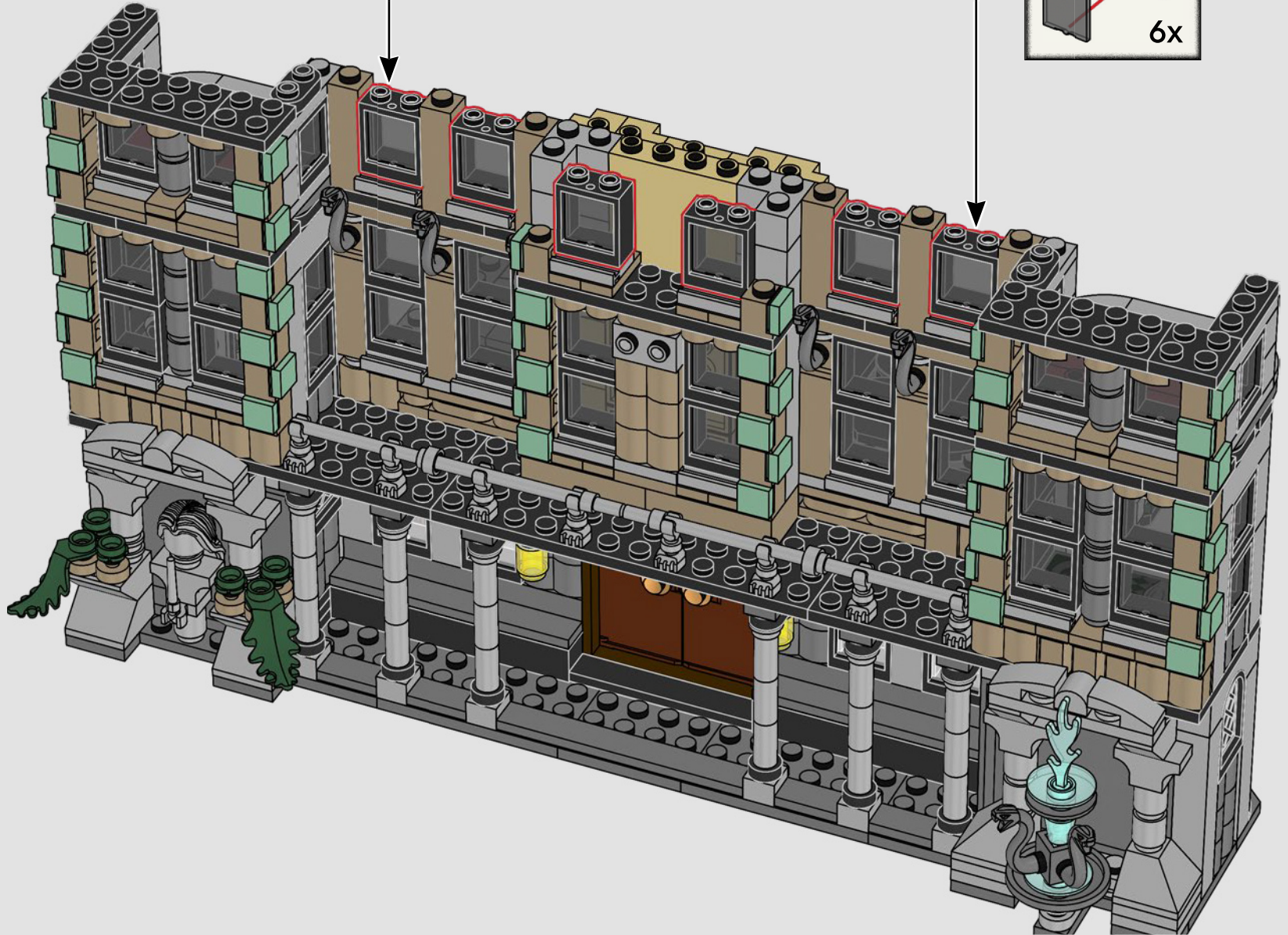
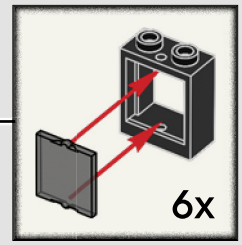

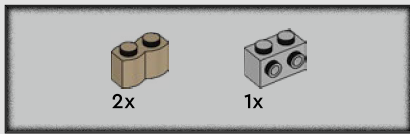

216

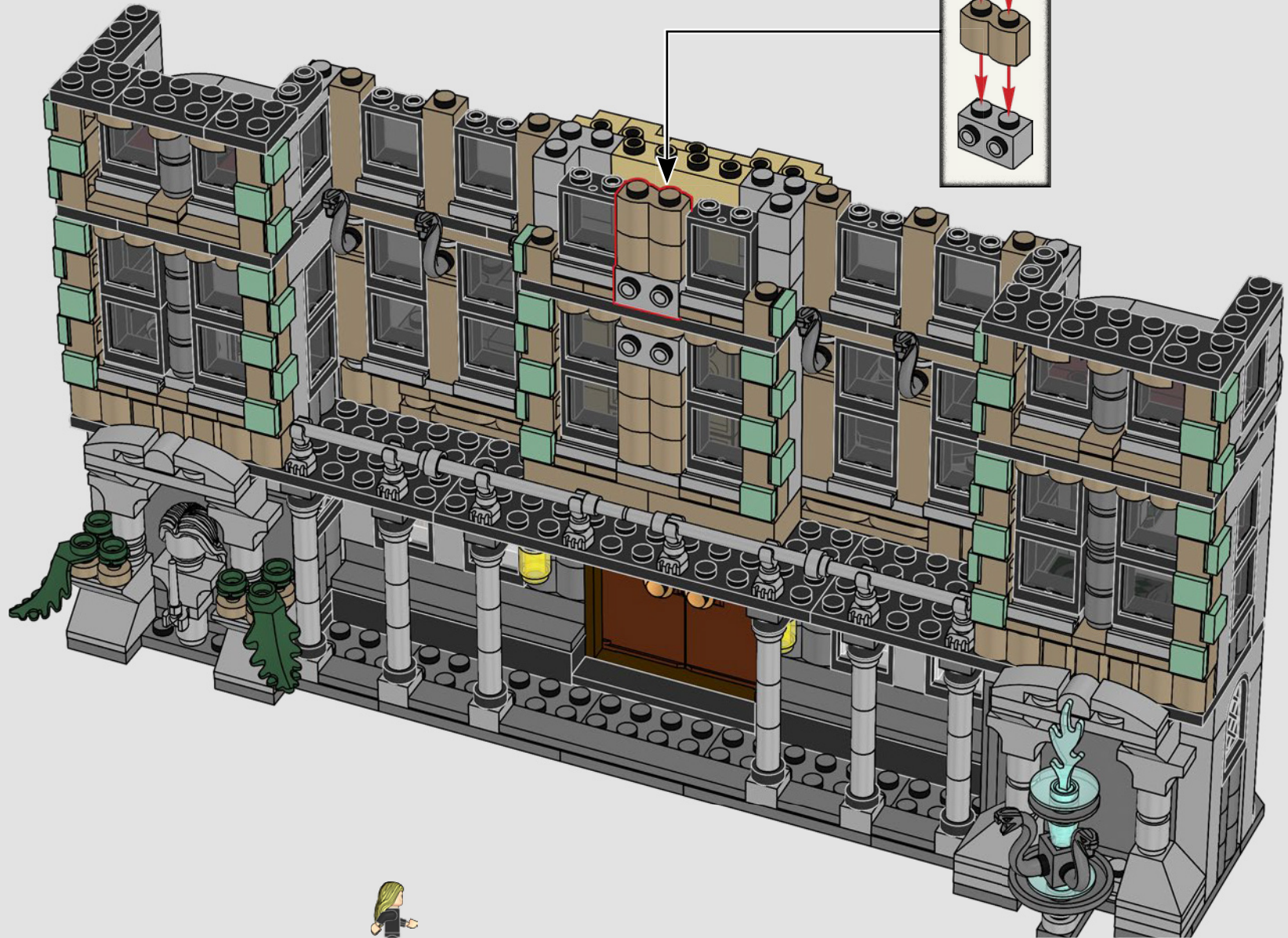

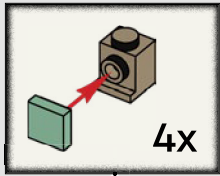
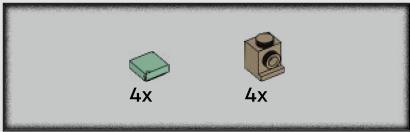

217

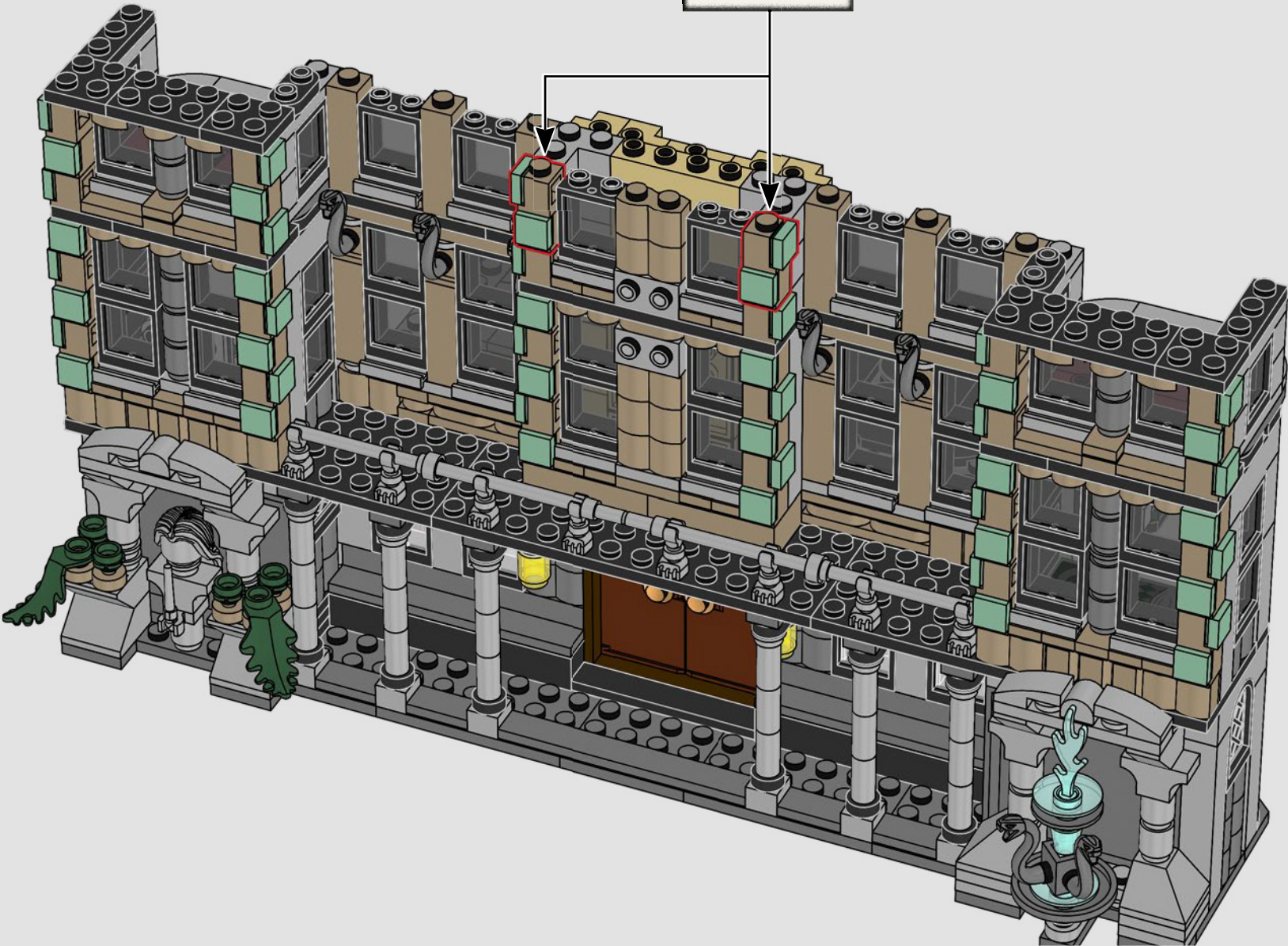

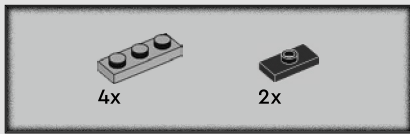

218

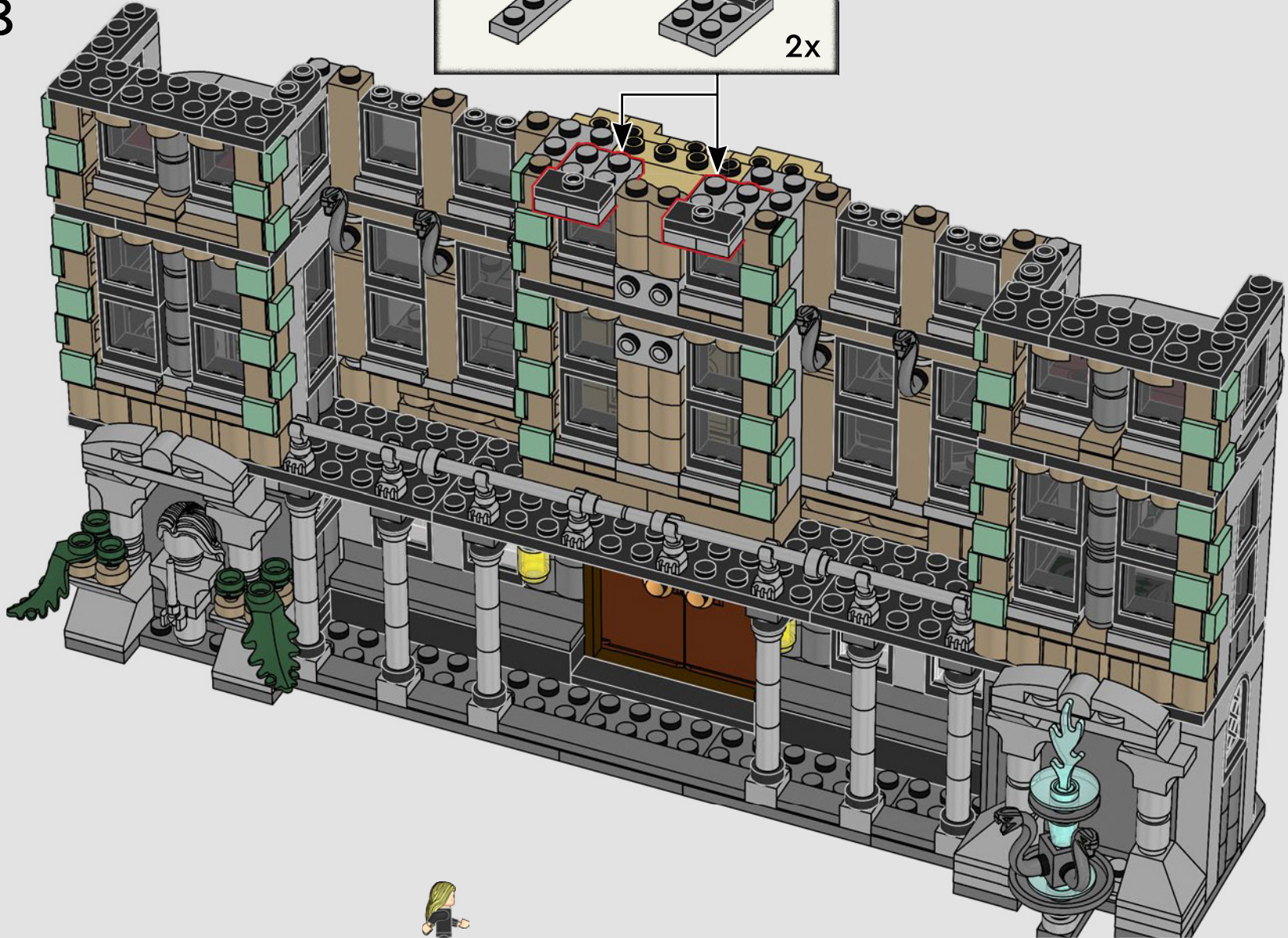
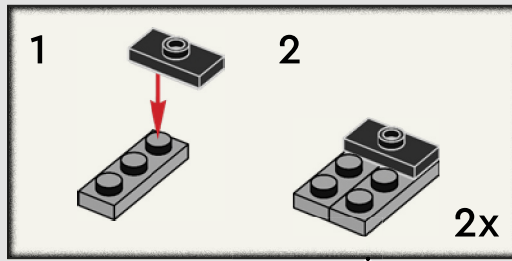

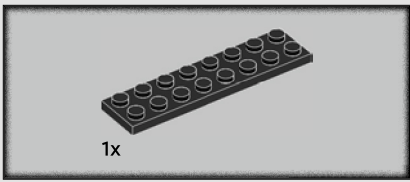

219

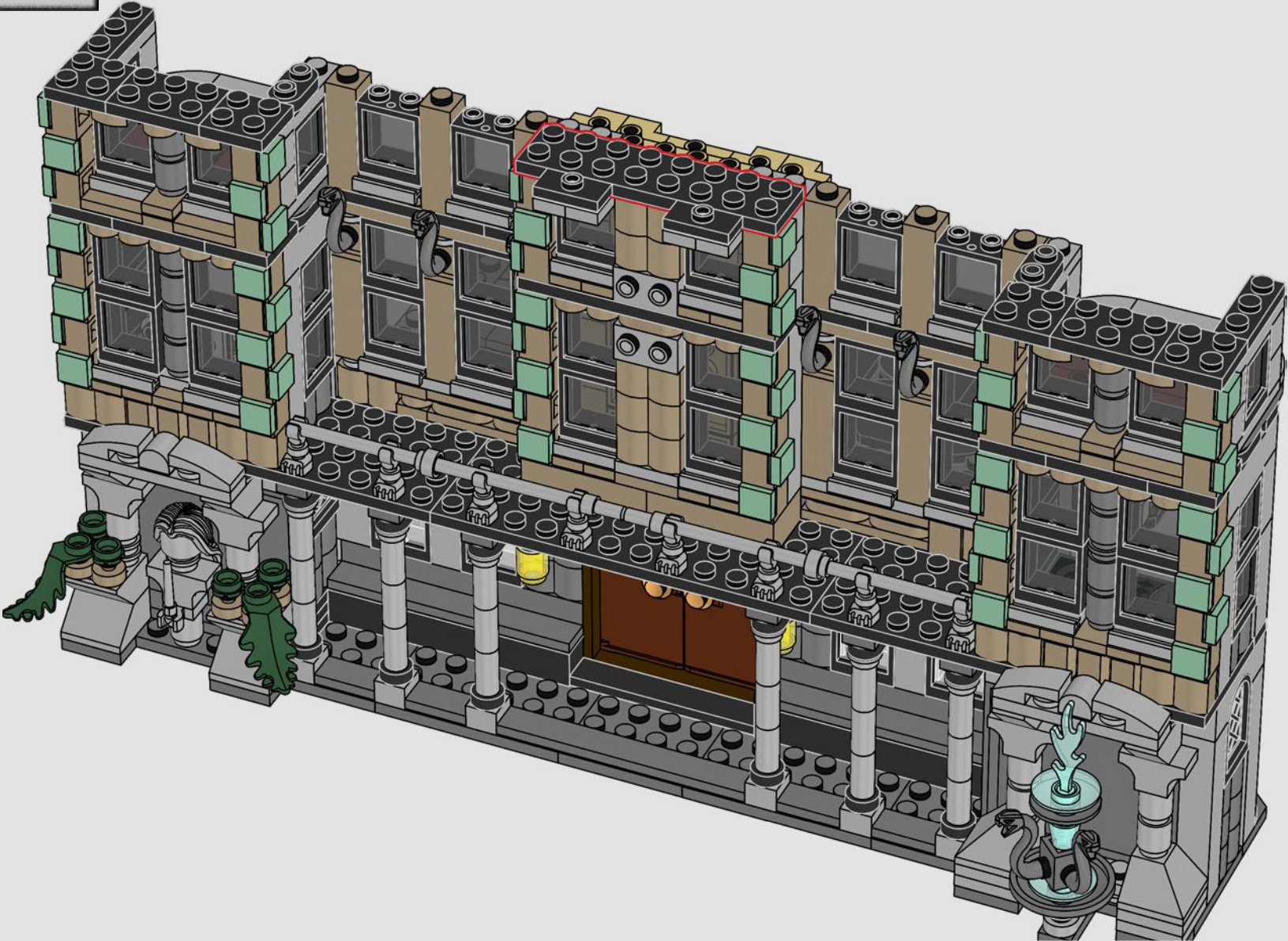

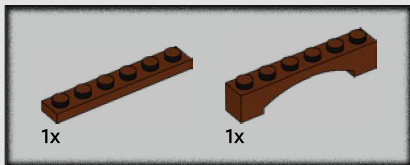

220

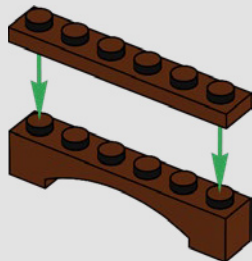

221

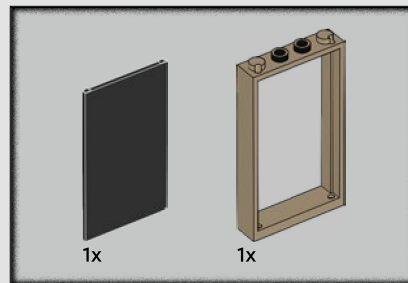
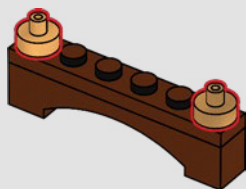

222





223

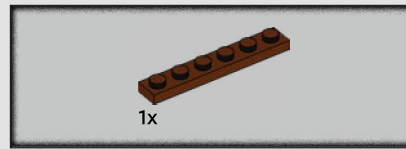
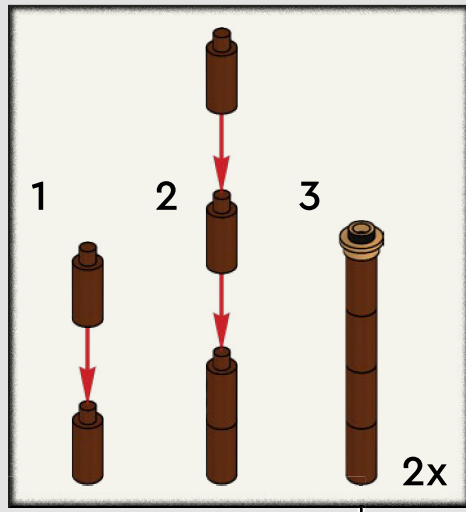

224



225



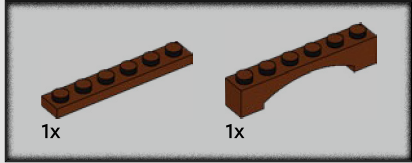

226

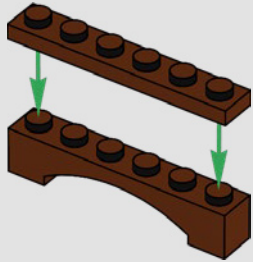

227

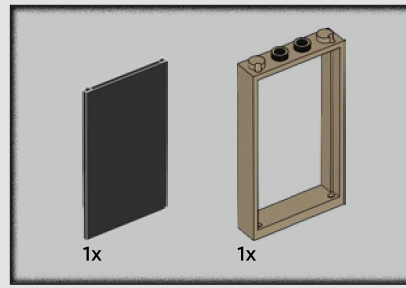
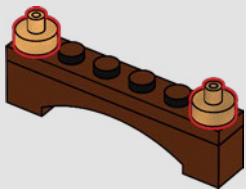

228





229

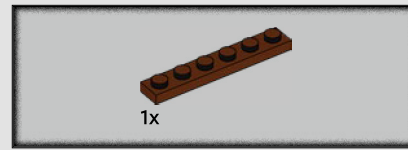
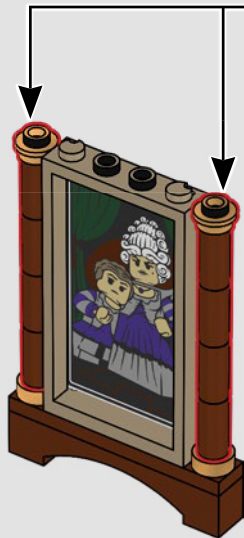
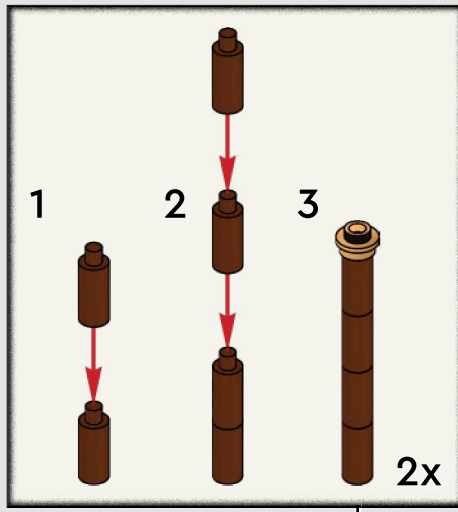

230





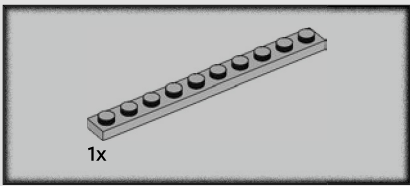

232



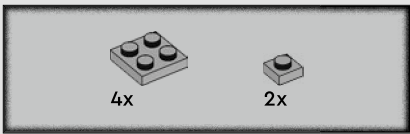

233



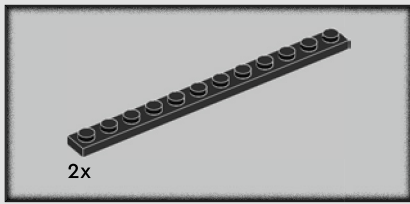

234



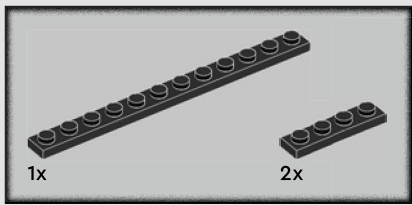

235





236

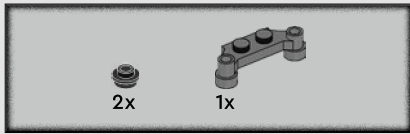
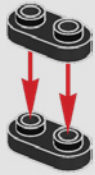

237

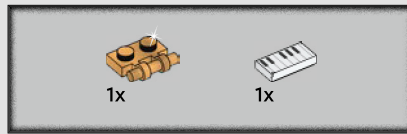
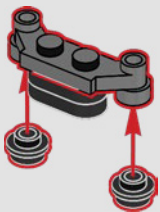

238

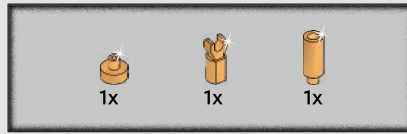

239

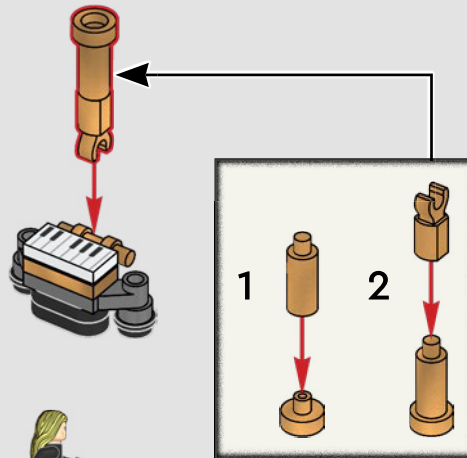

240

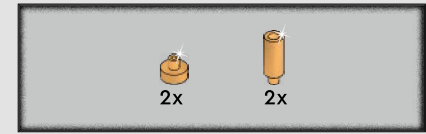
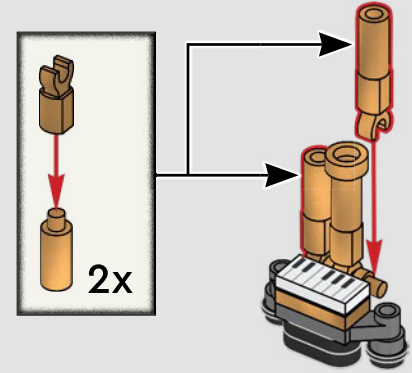

241

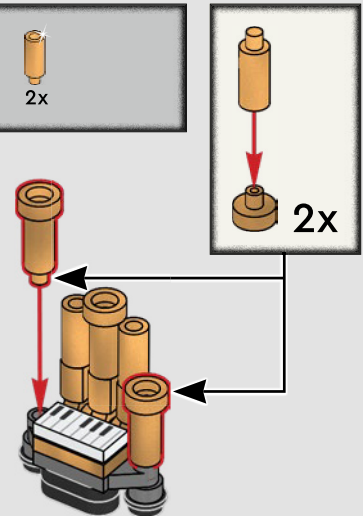





243

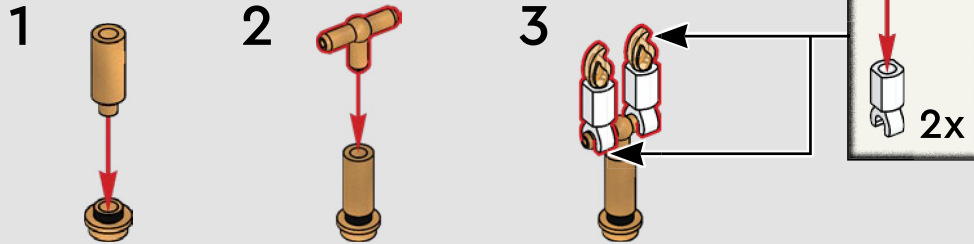

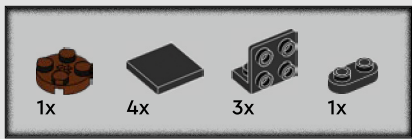

244

1

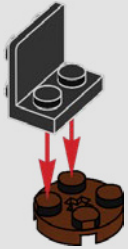

2



3

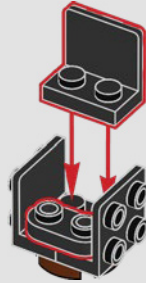

4

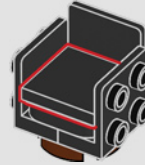

5

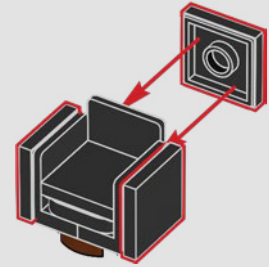

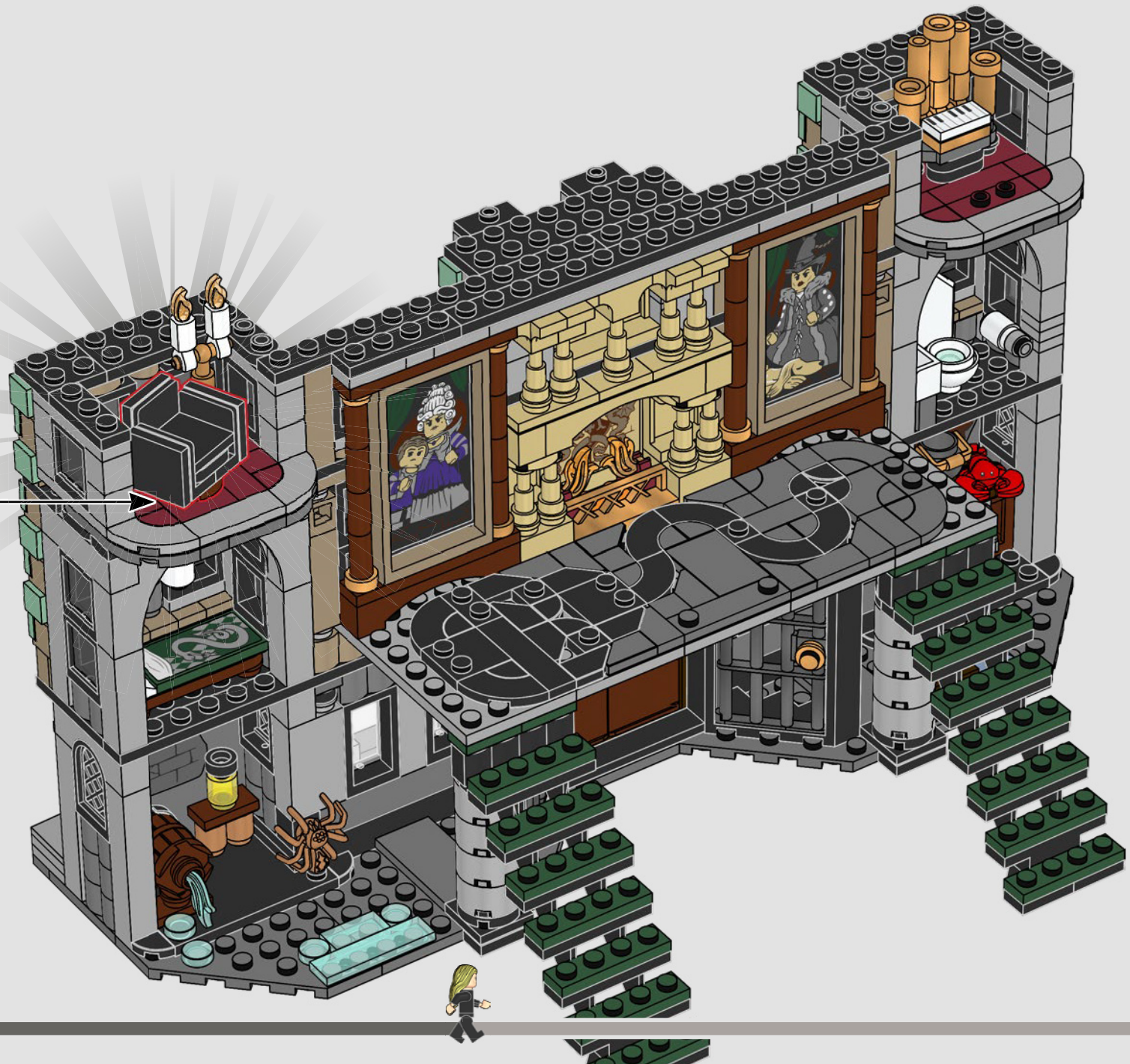

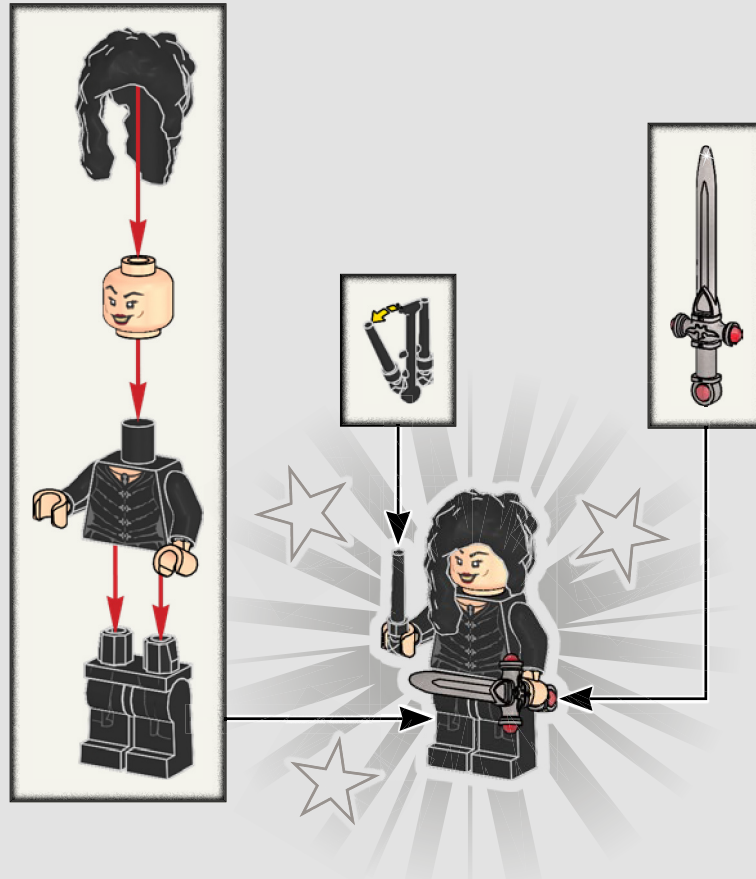

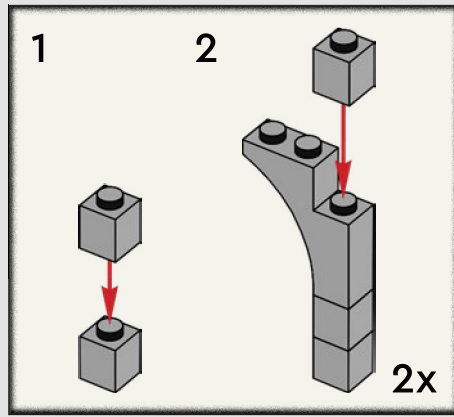
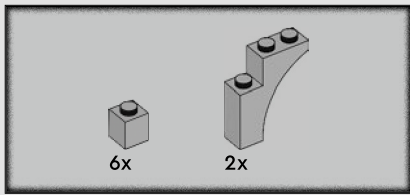

245

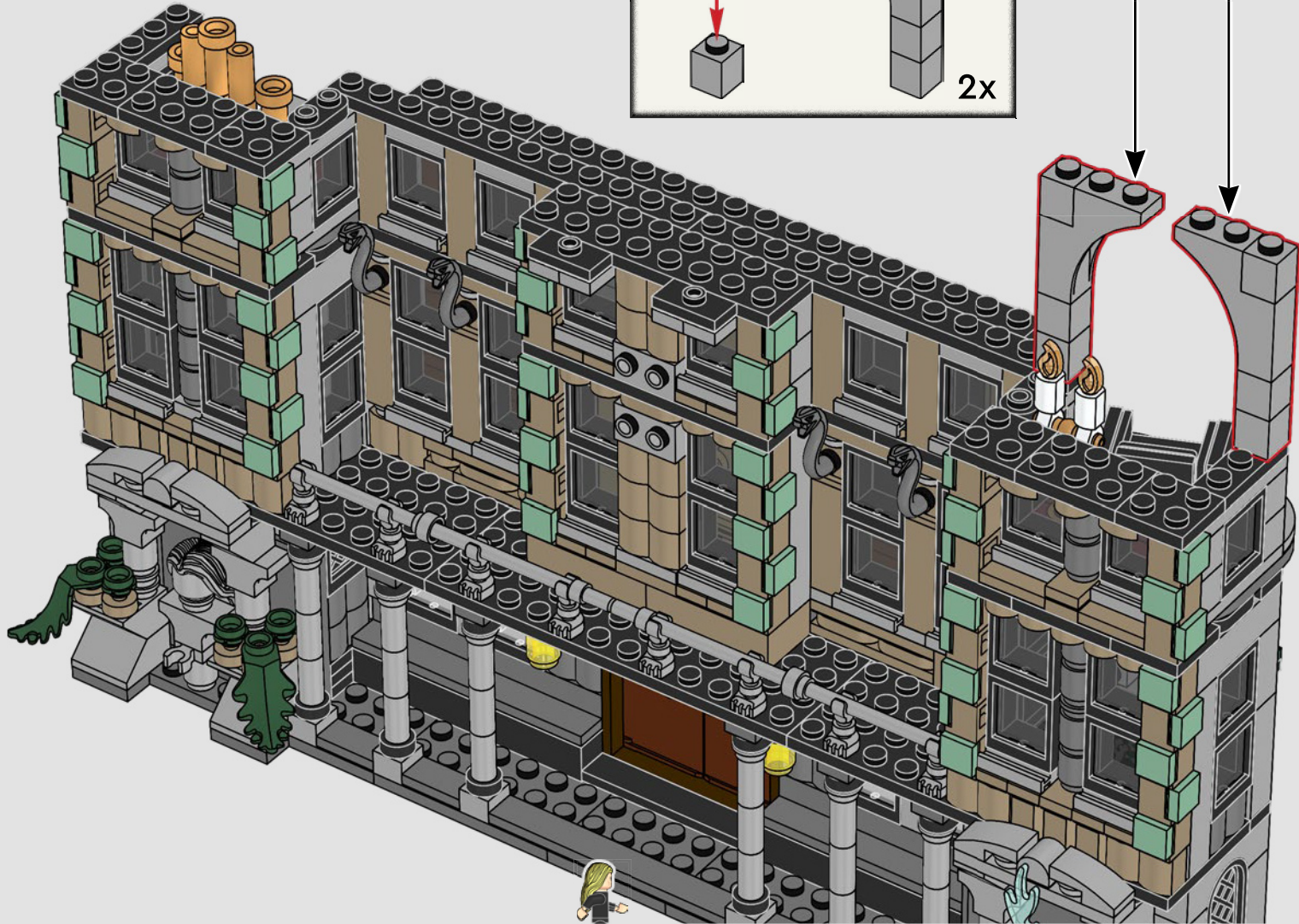



2x

246

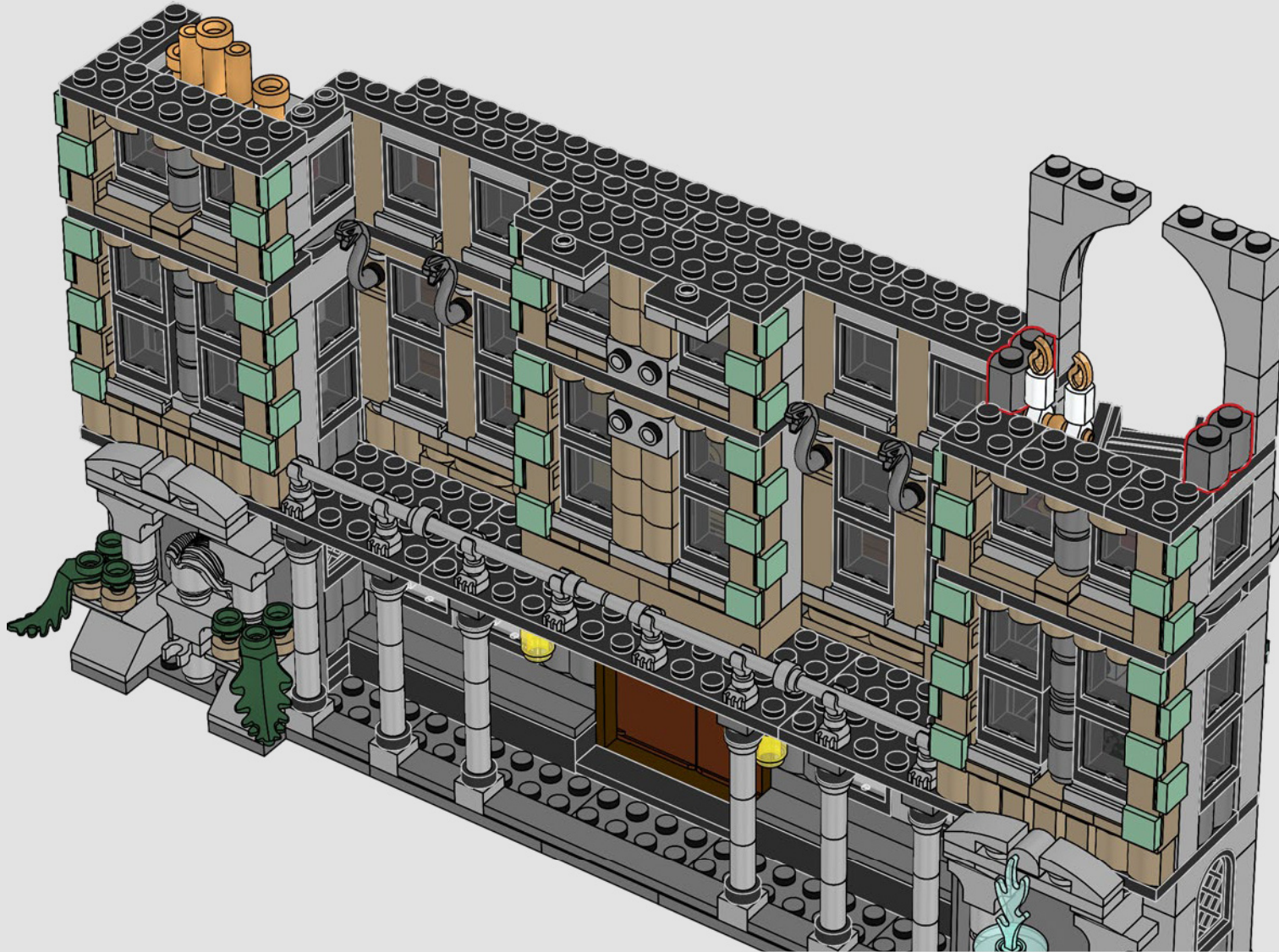

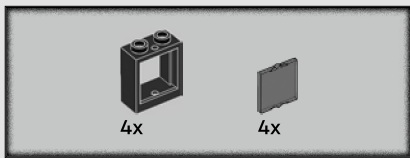

247

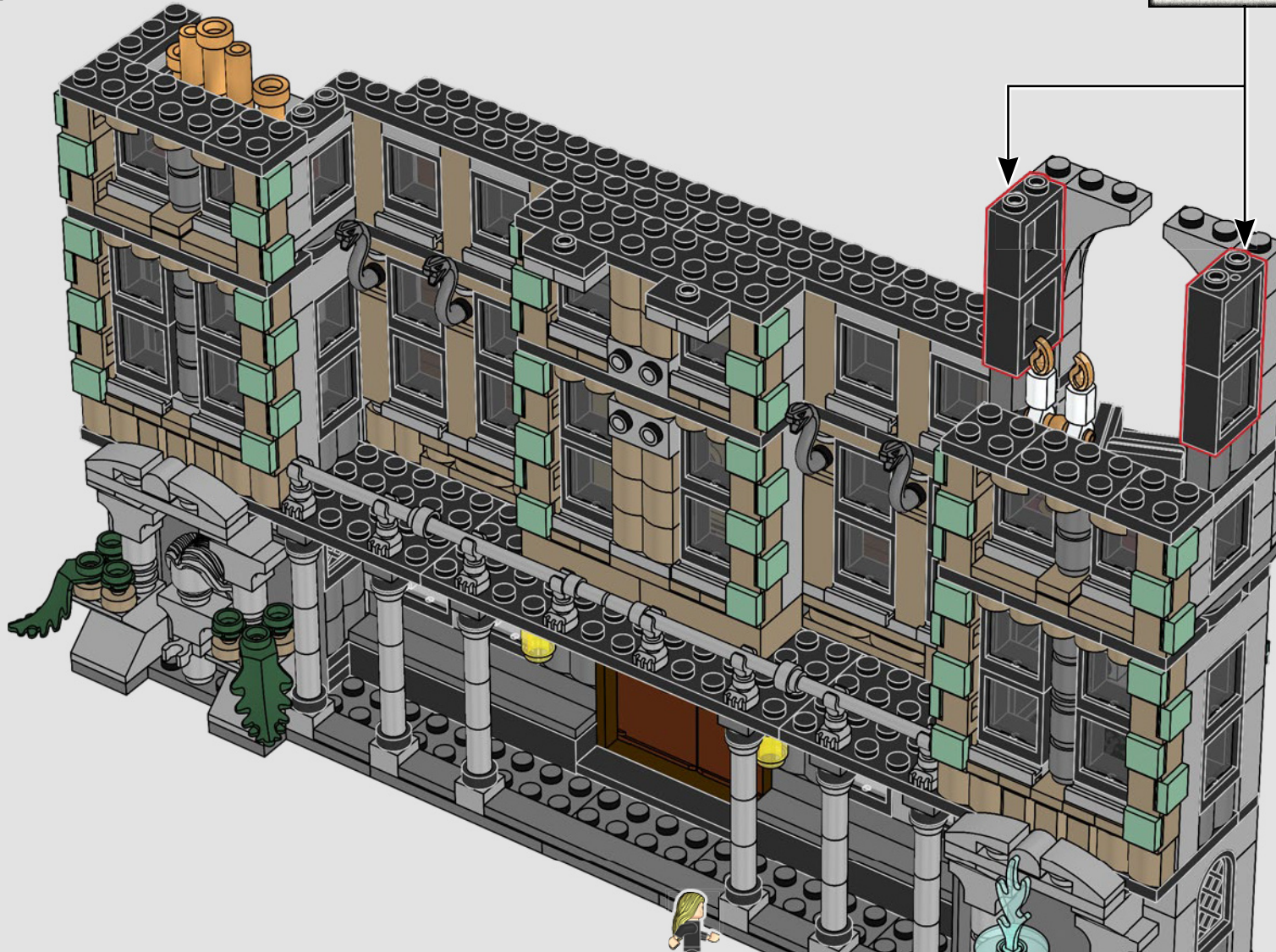
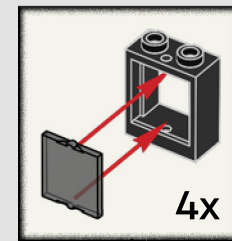



5x

248

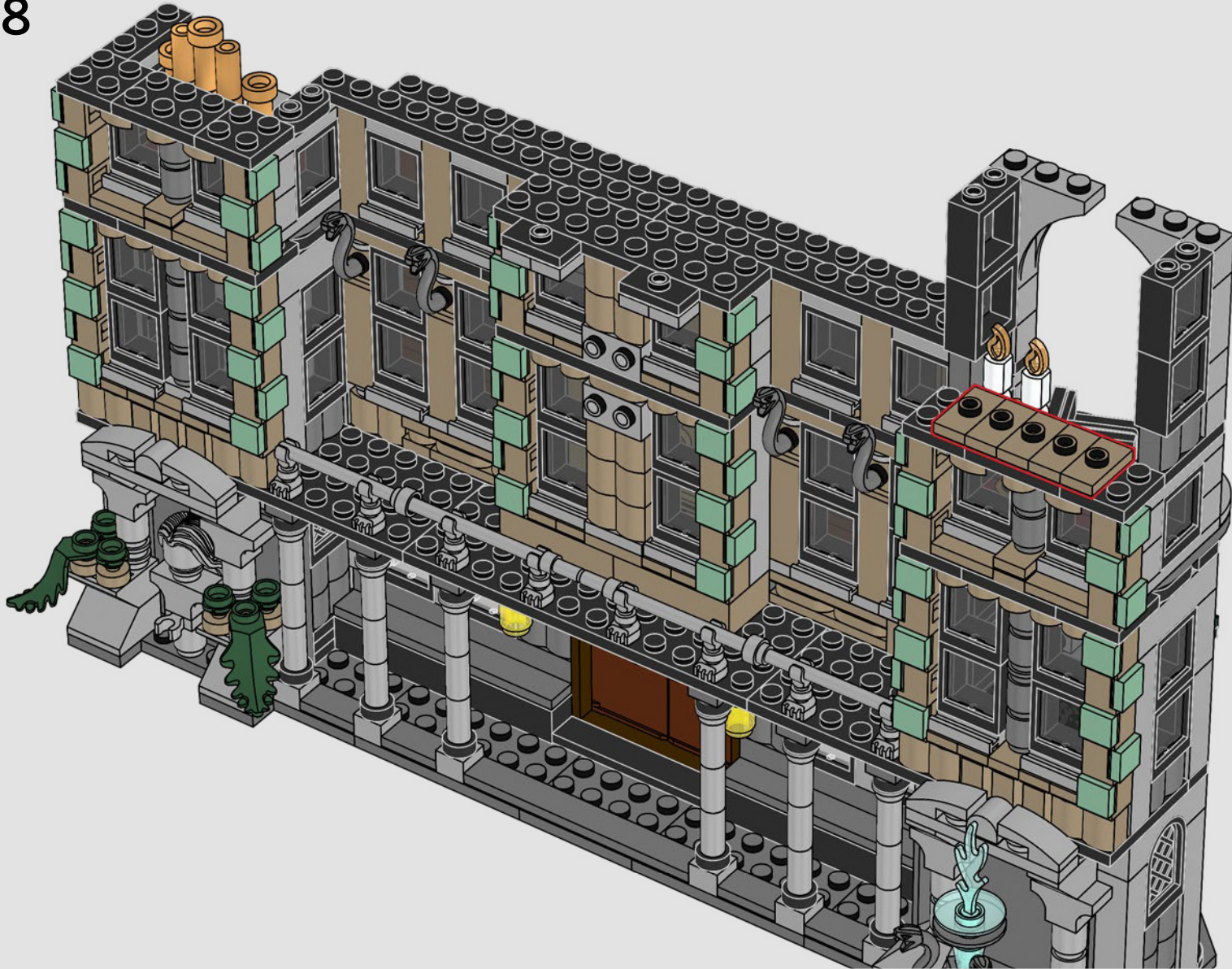

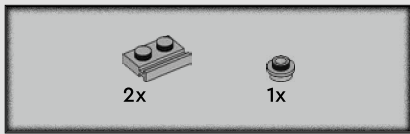

249





2x

250



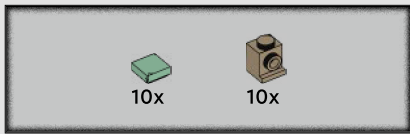

251

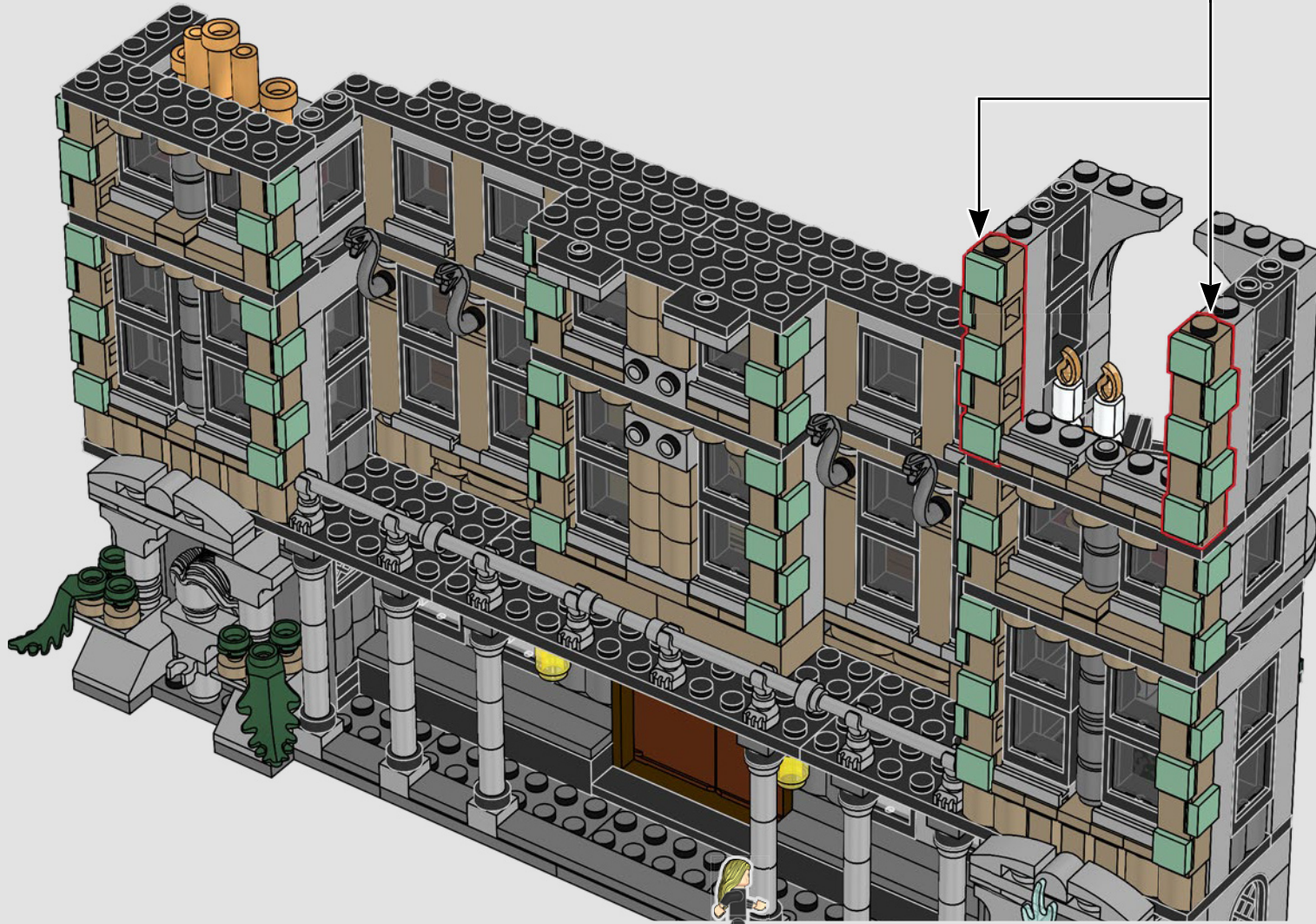
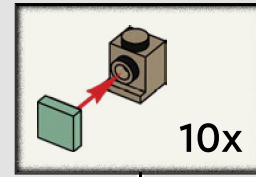

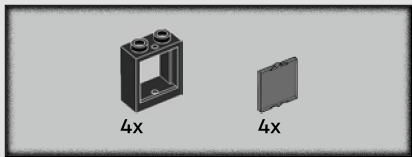

252

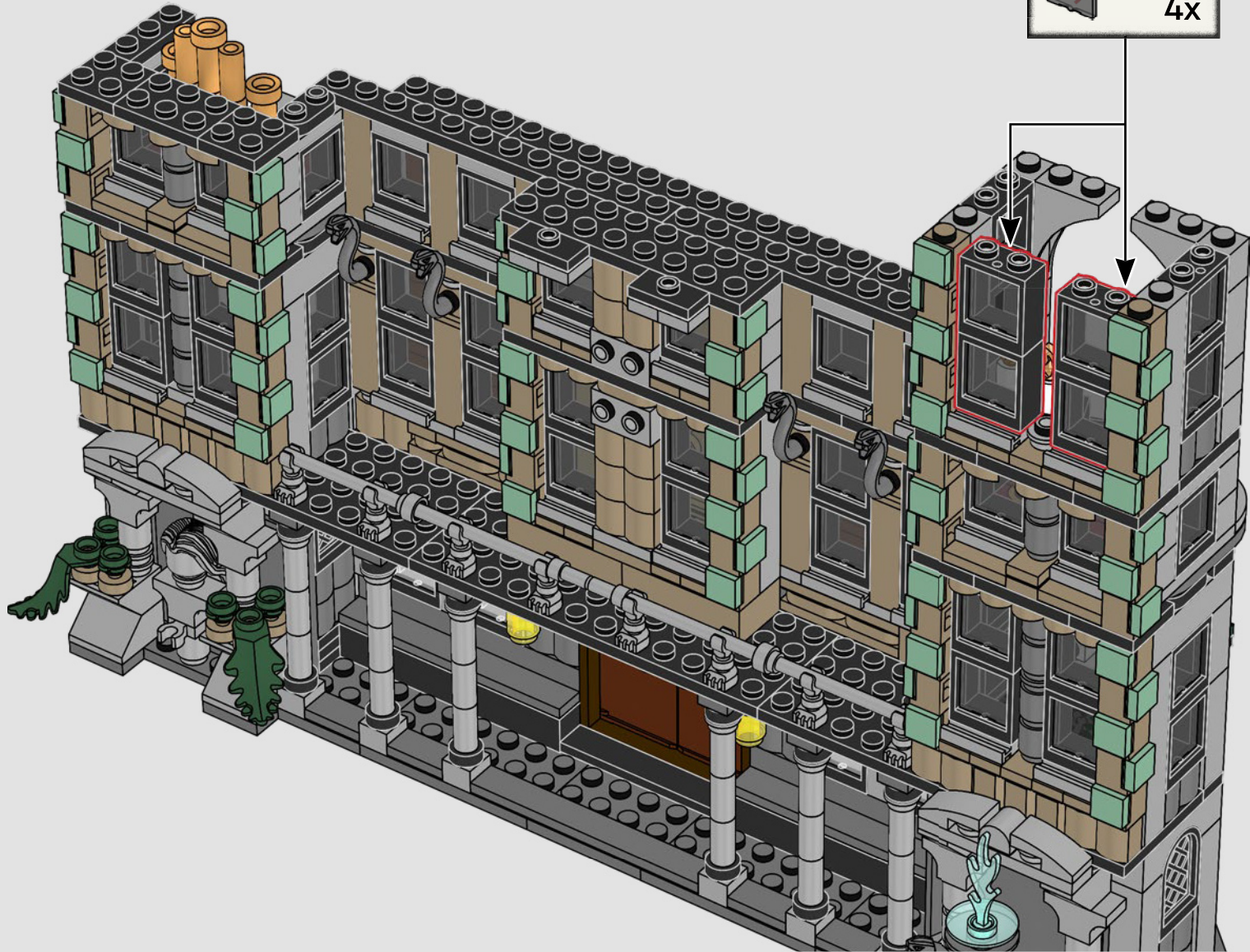
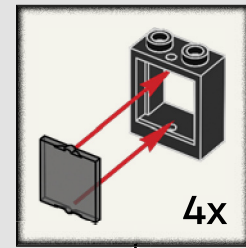

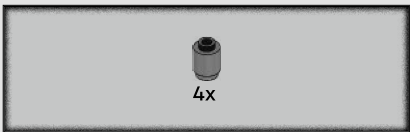

253

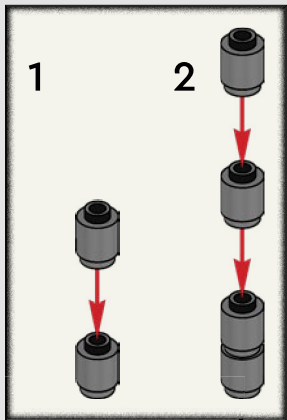
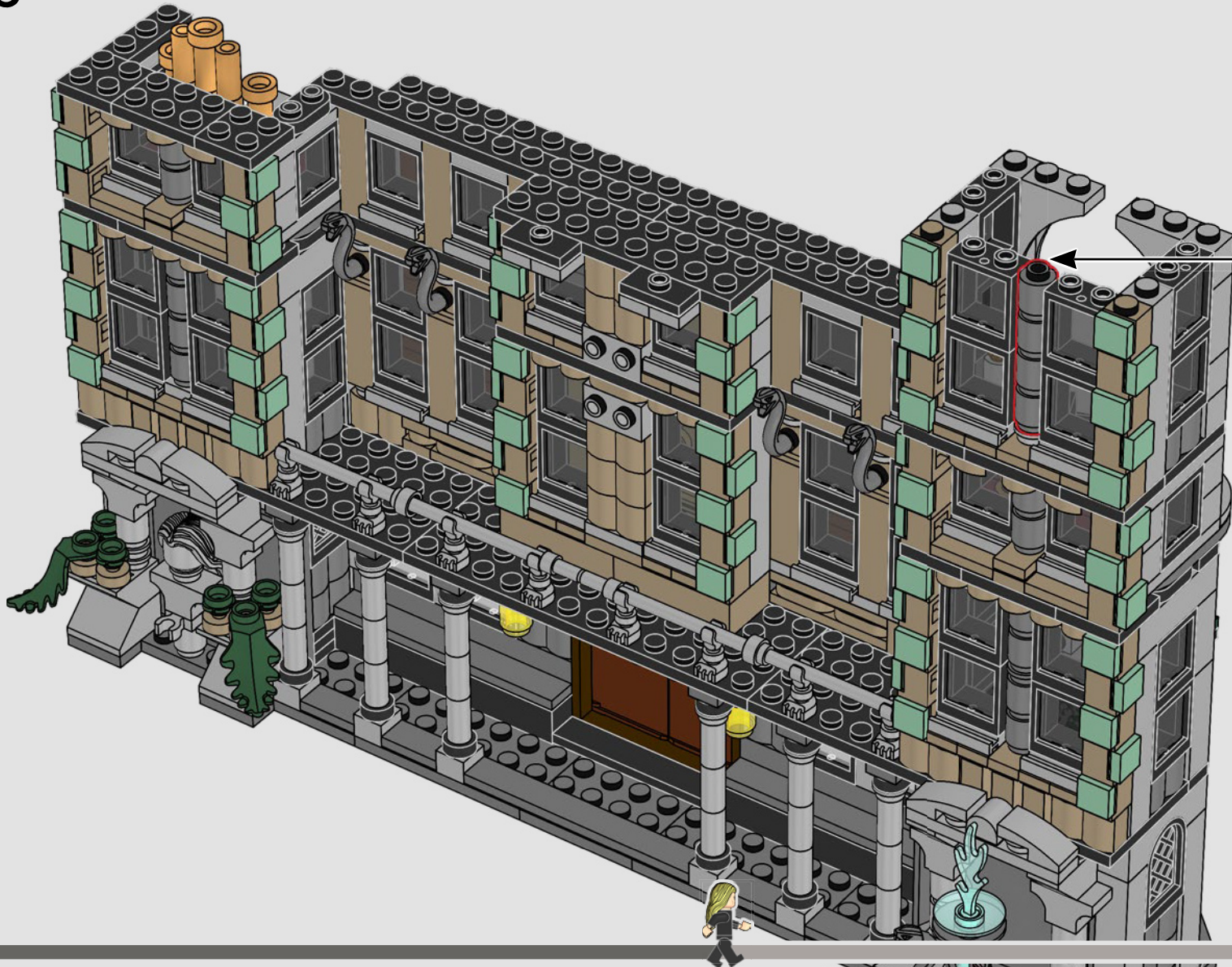



5x

254

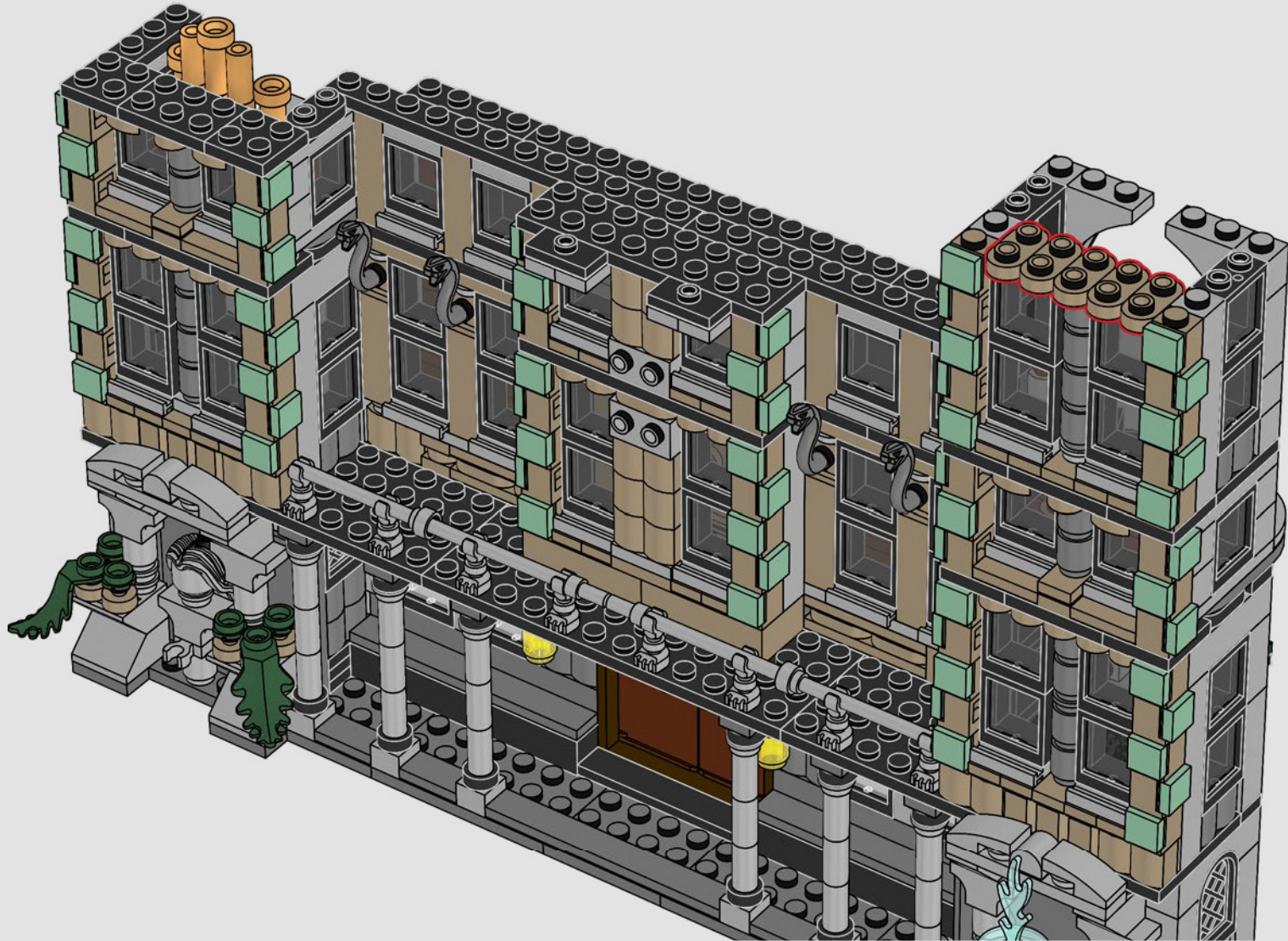

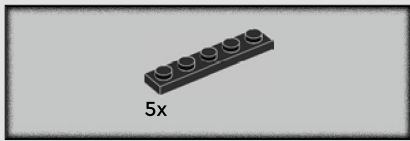

255

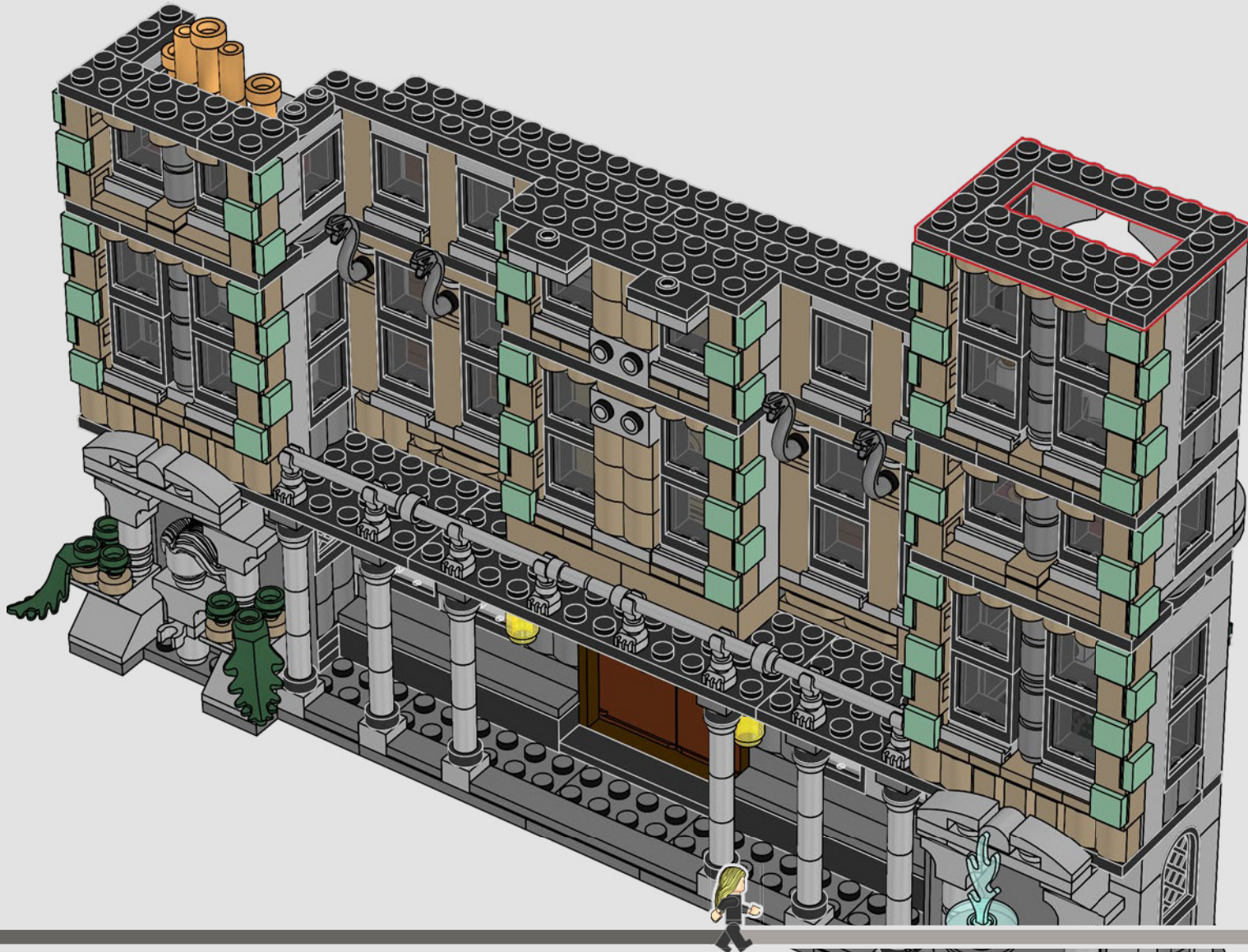

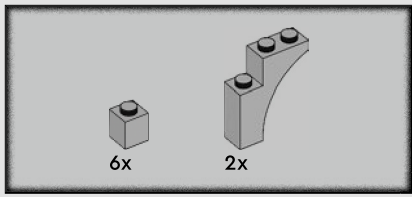

256

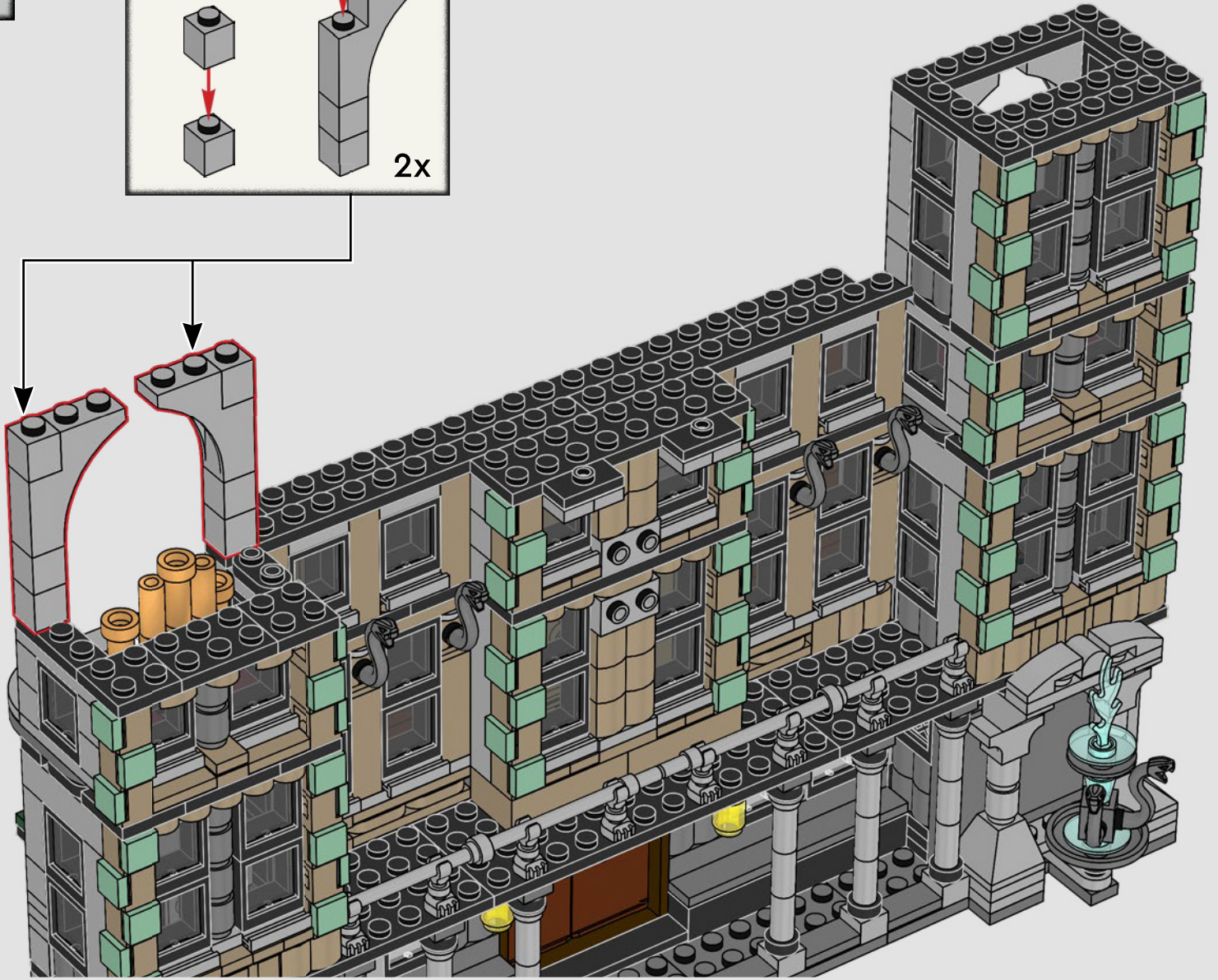
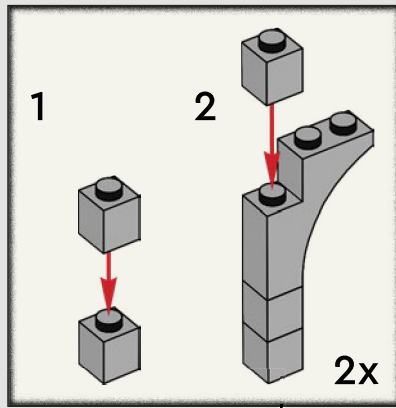

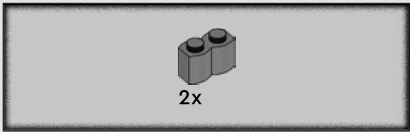

257

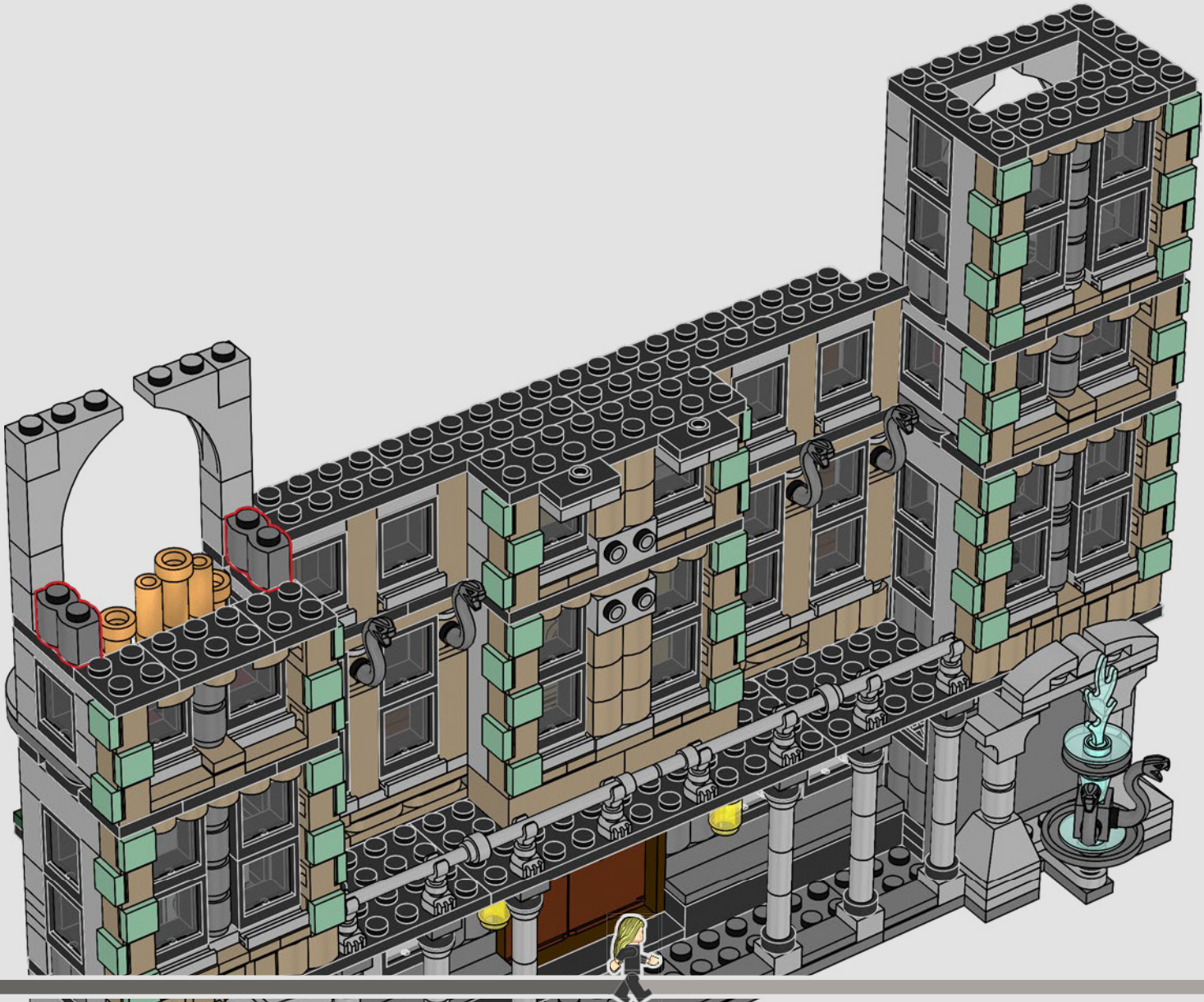

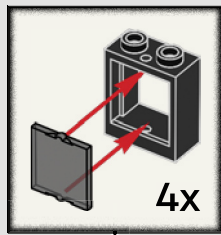
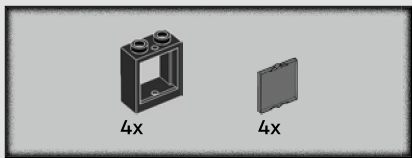

258

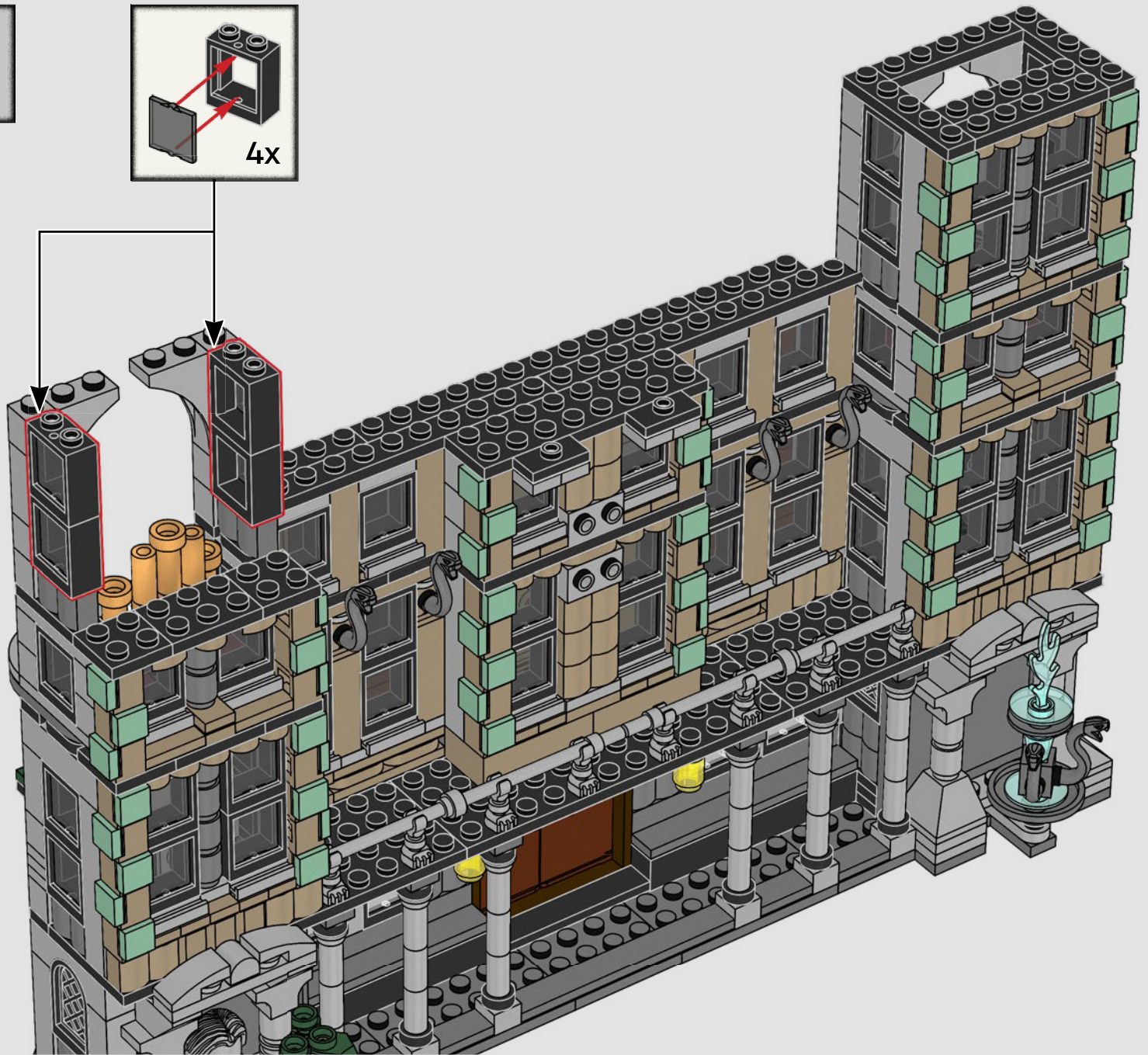

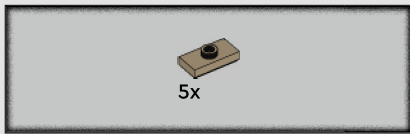

259



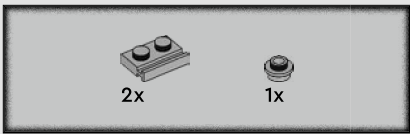

260

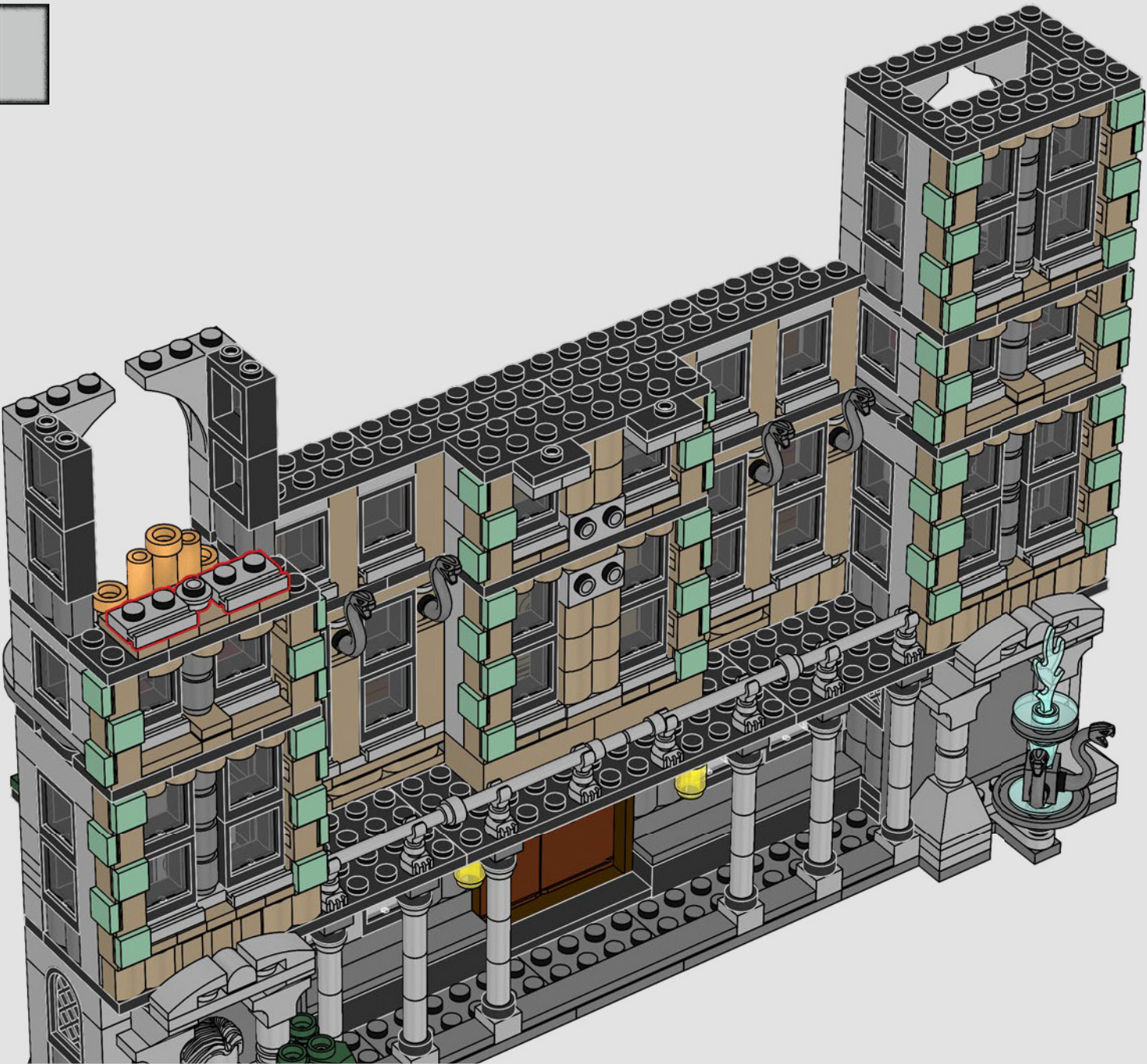

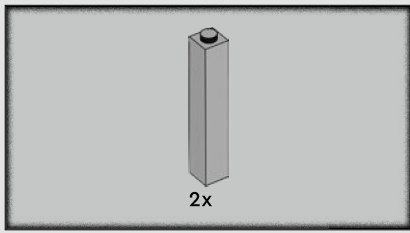

261



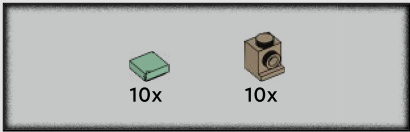

262

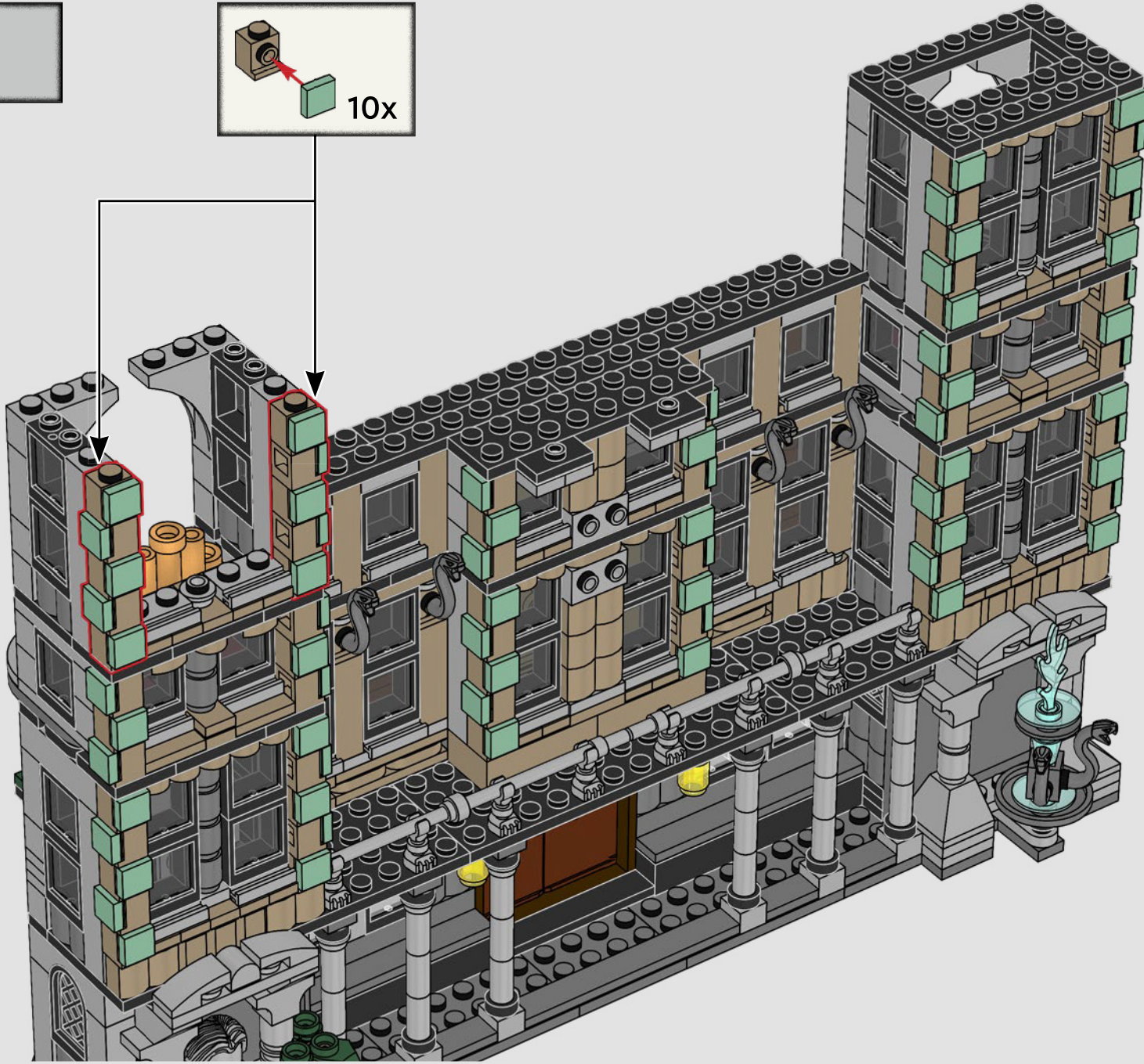
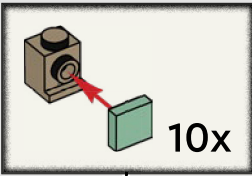

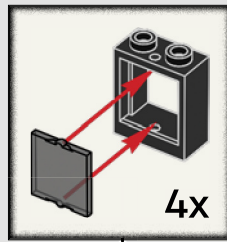
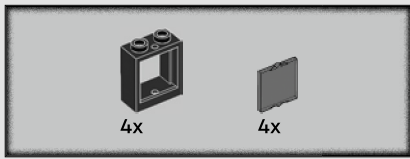

263

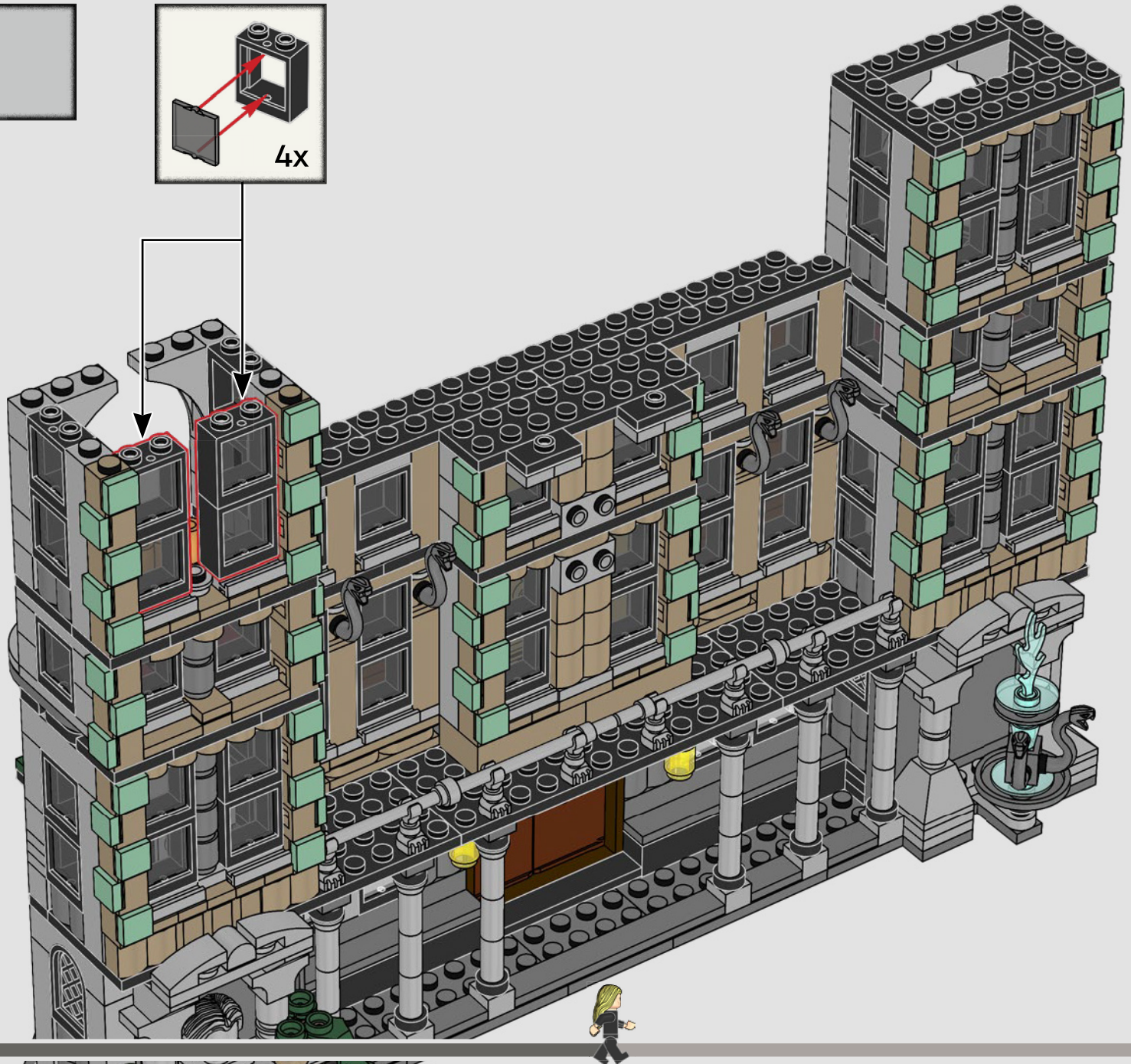

4x

264

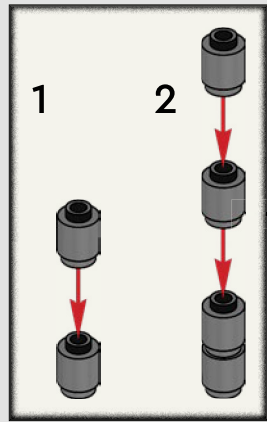



265



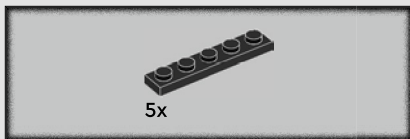

266



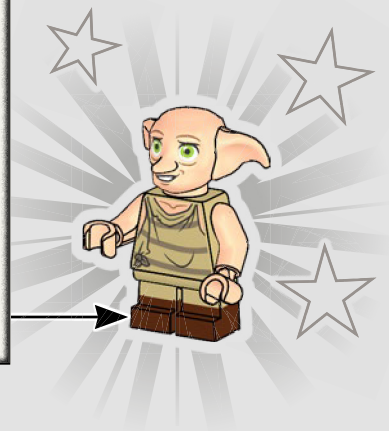
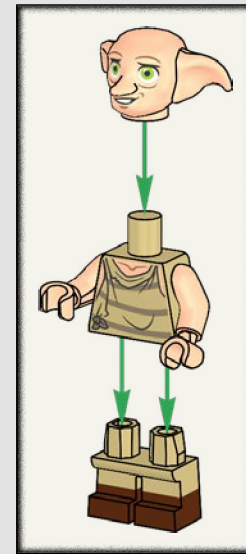

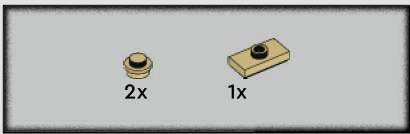

267



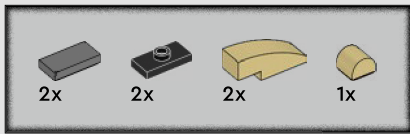

268



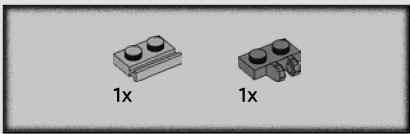

269

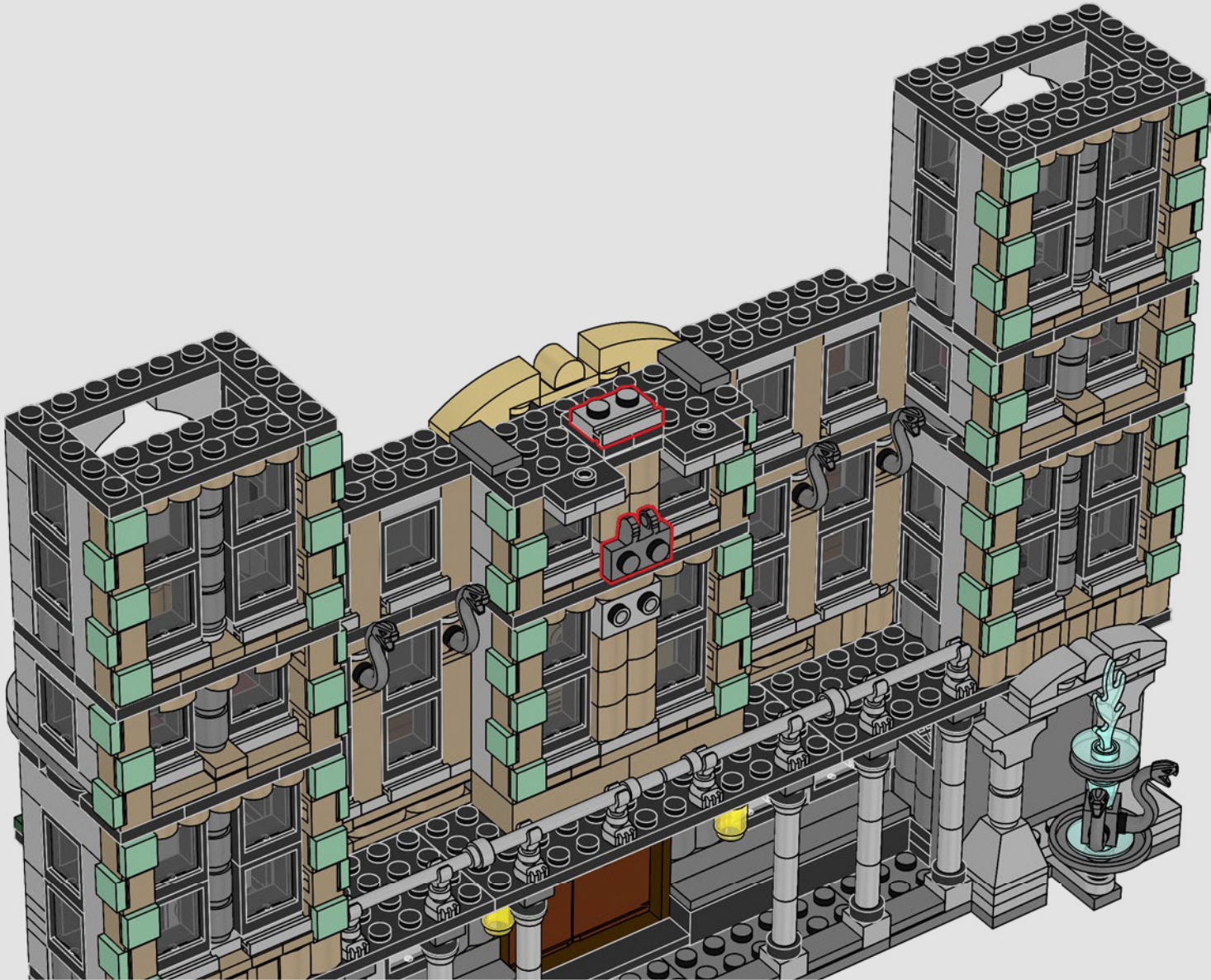

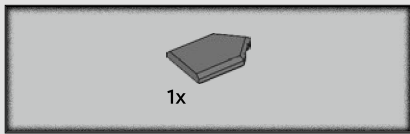

270

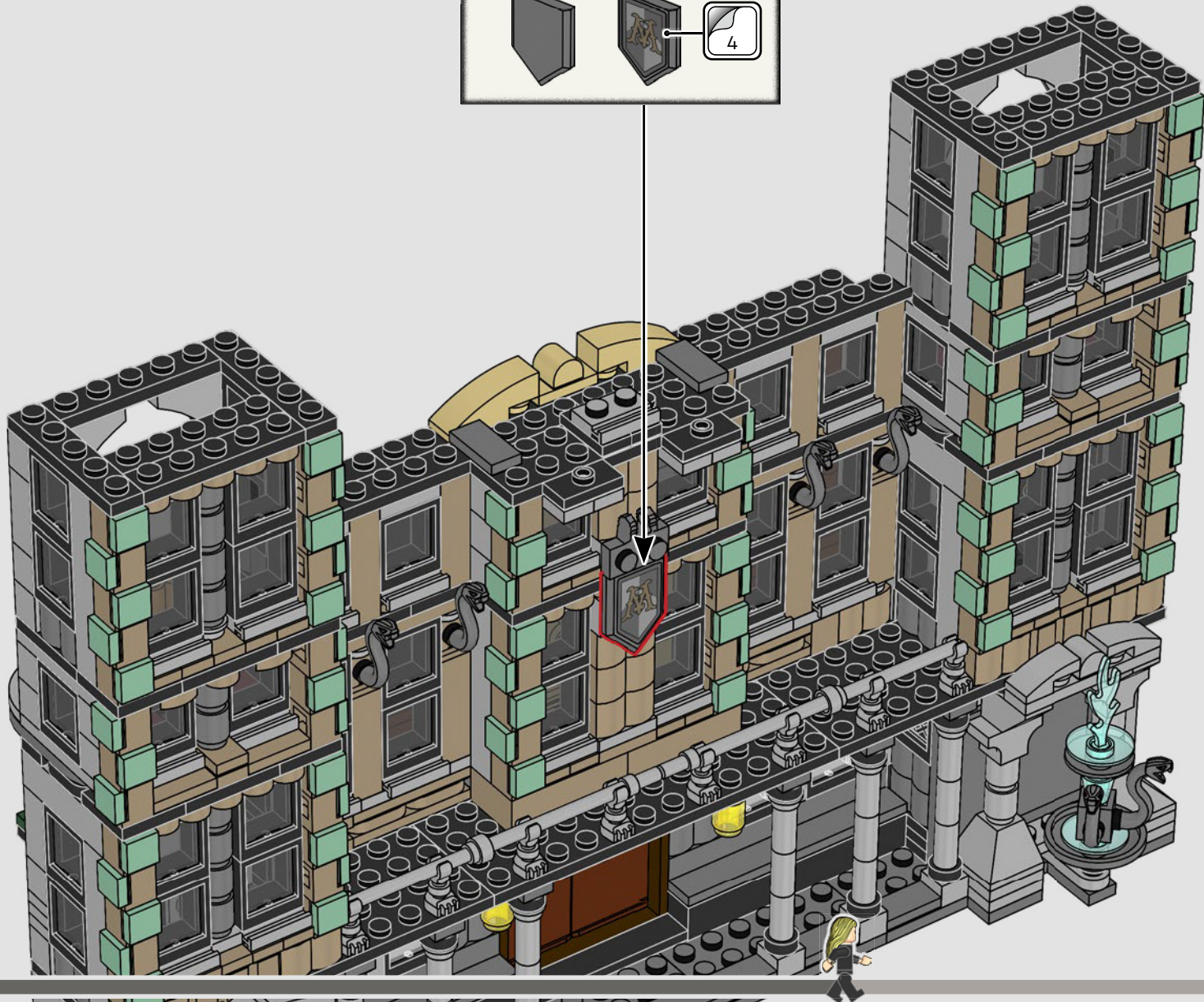
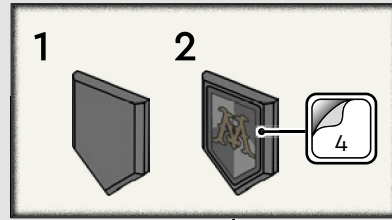

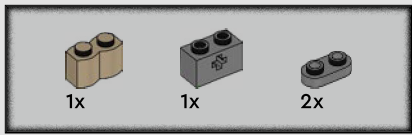

271

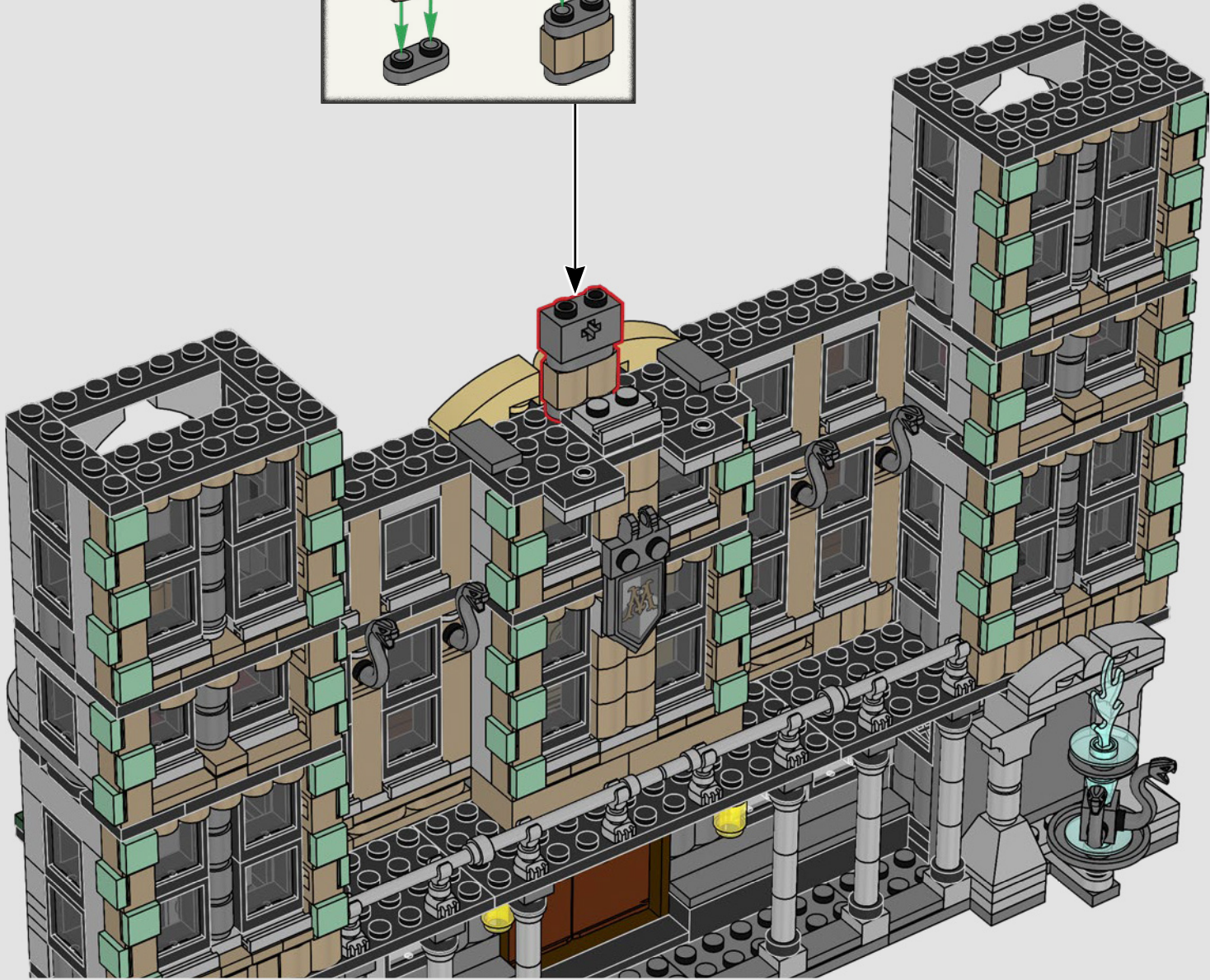
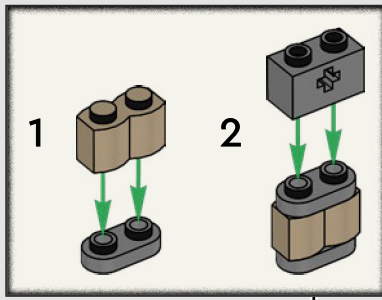

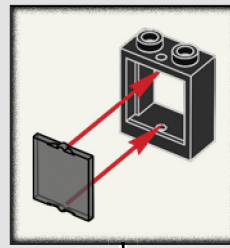
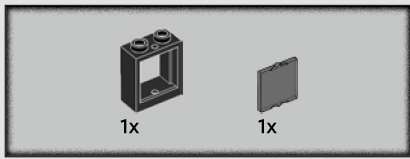

272

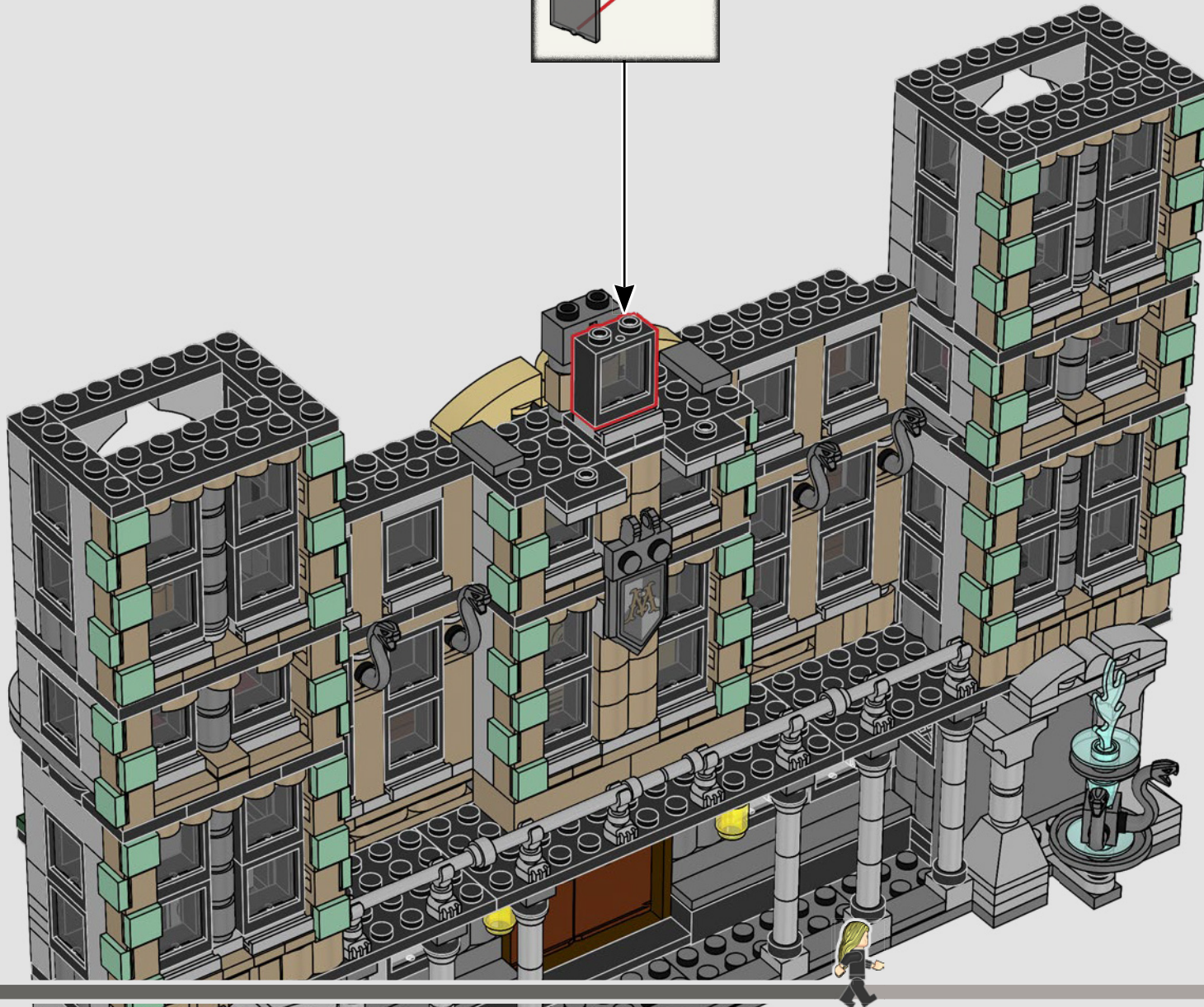



4x

273



2x

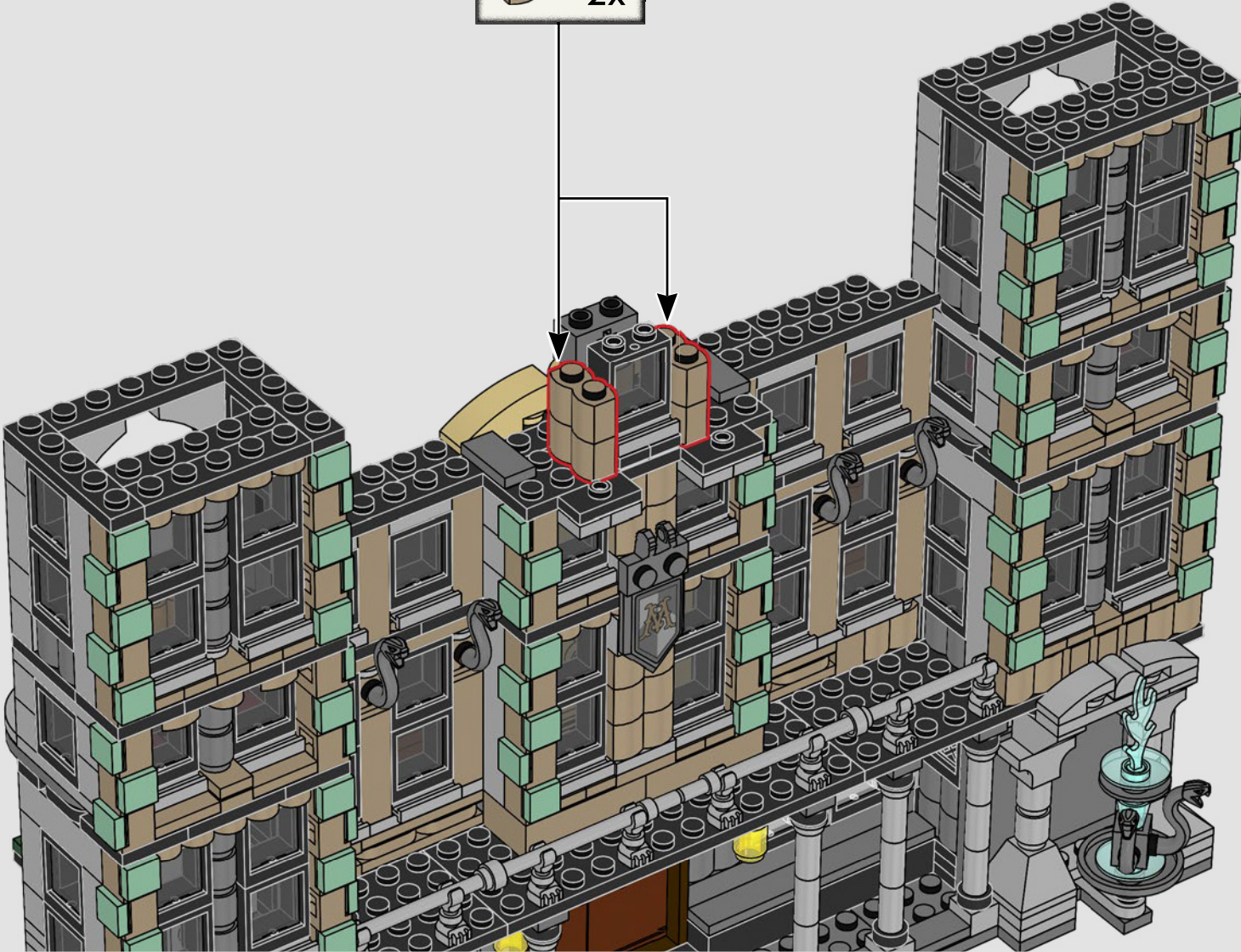

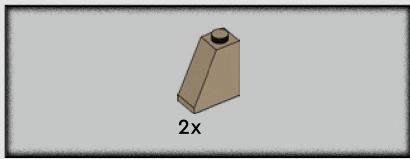

274





275

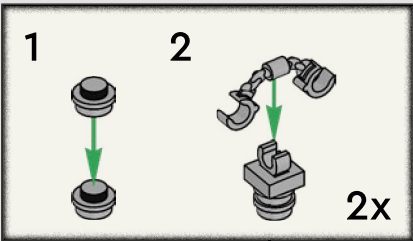

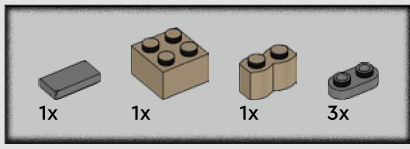

276

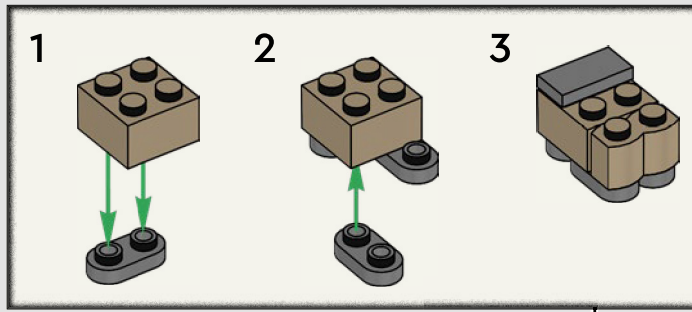



4x

277

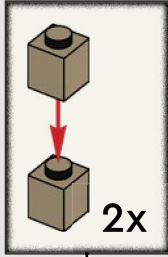

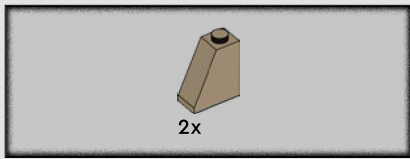

278

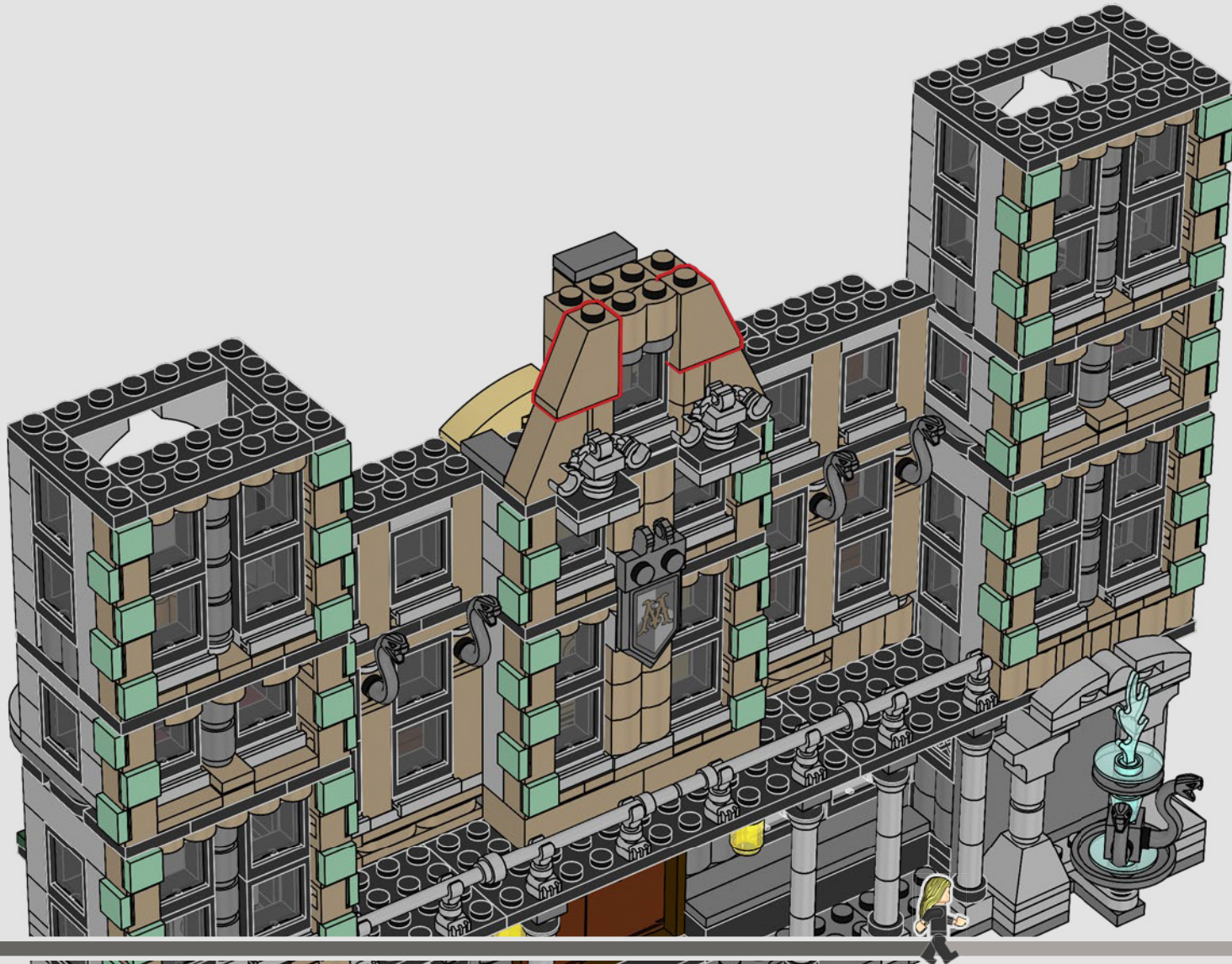

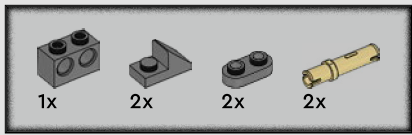

279

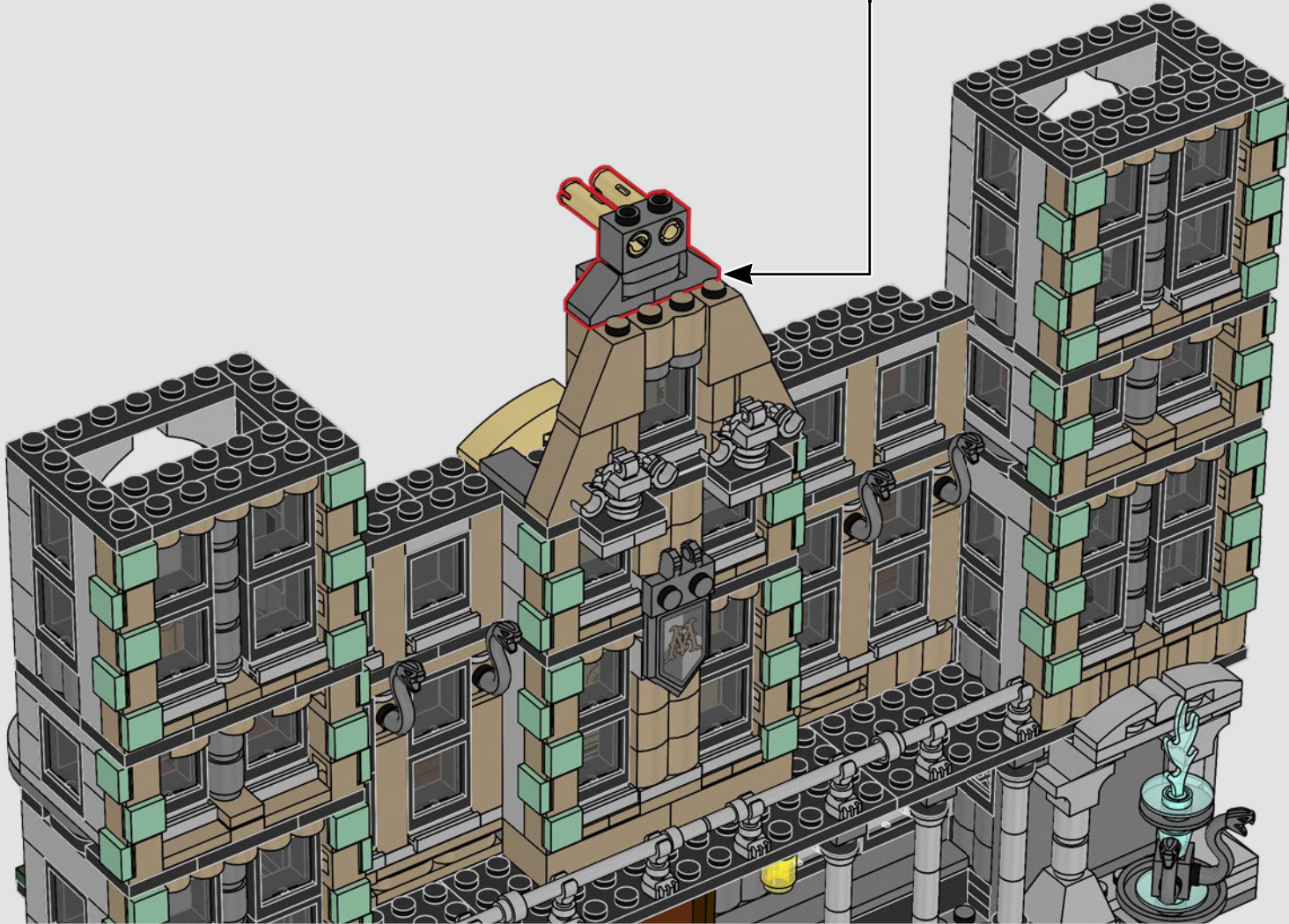
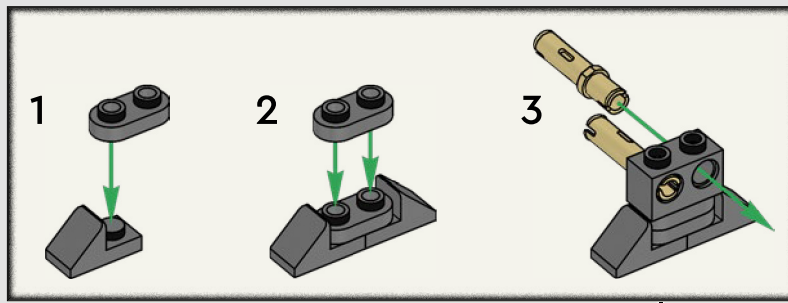

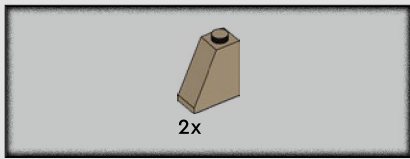

280



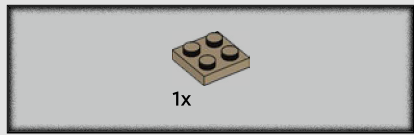

281

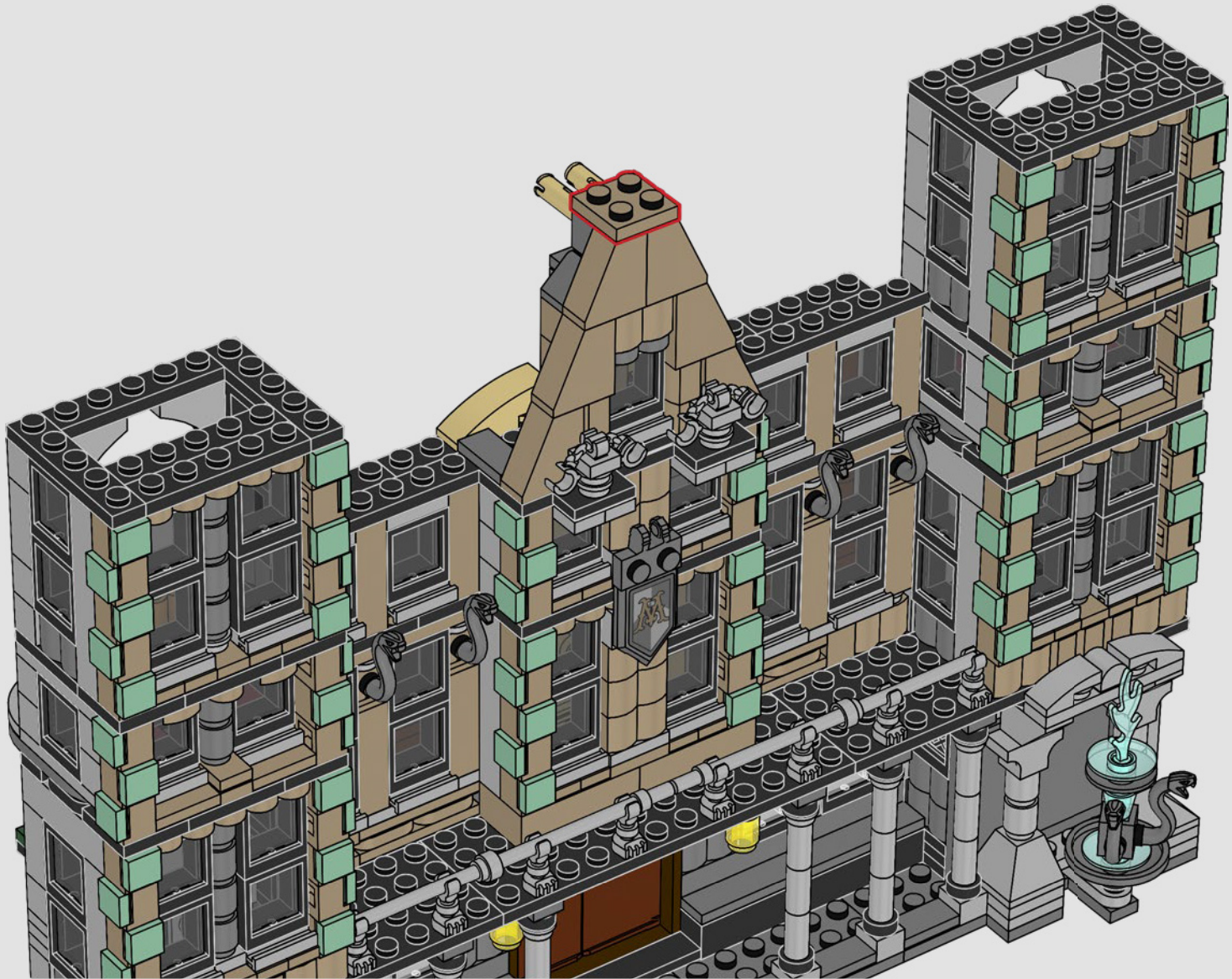

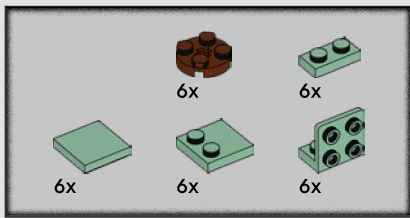

282

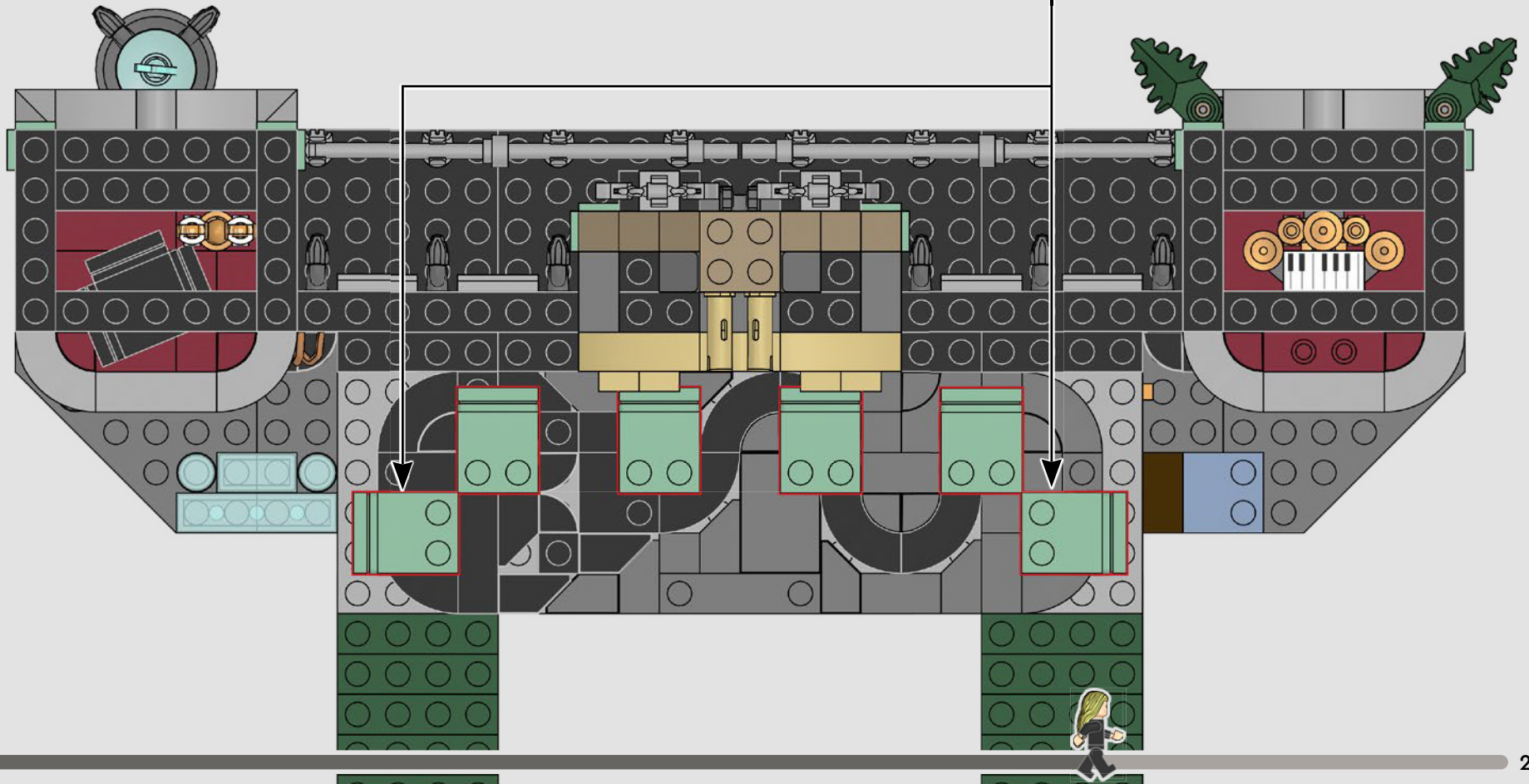
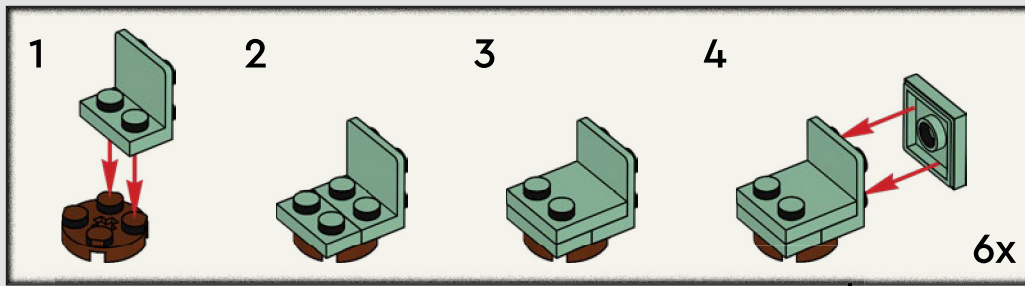

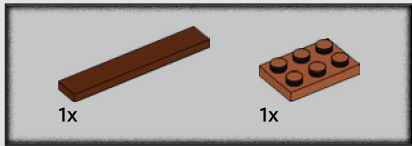
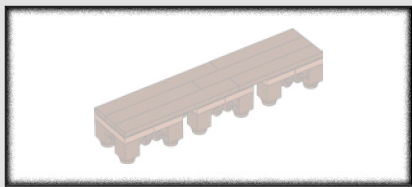

283

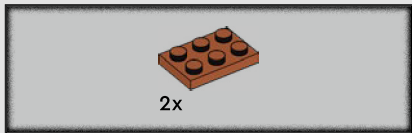
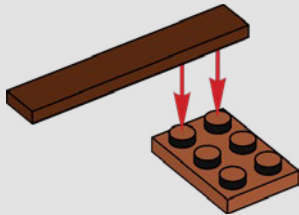

284

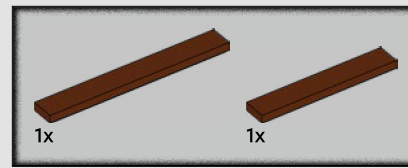
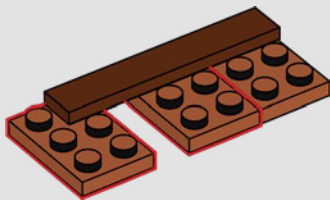

285

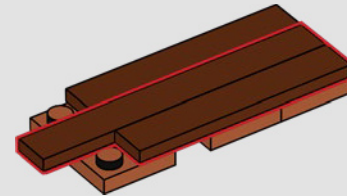

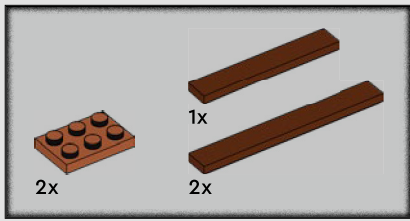

286

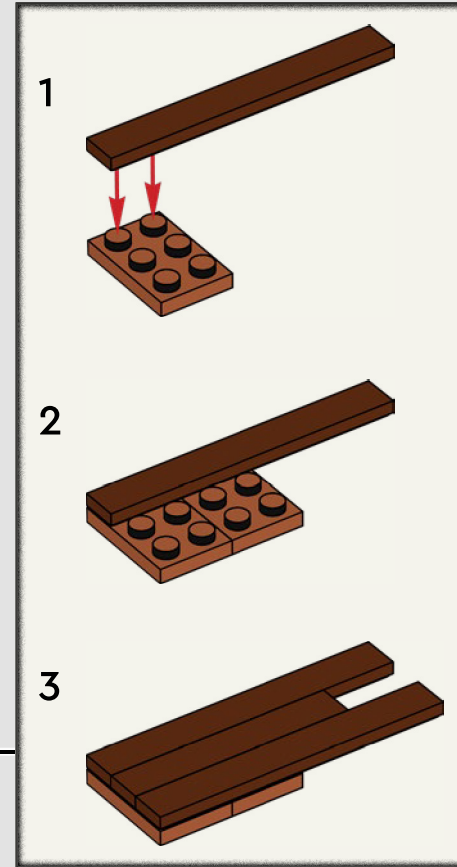
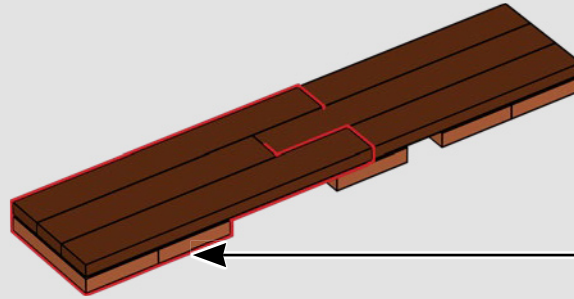

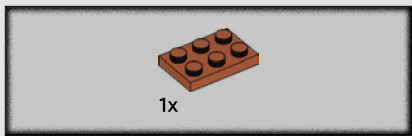

287

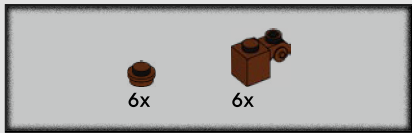
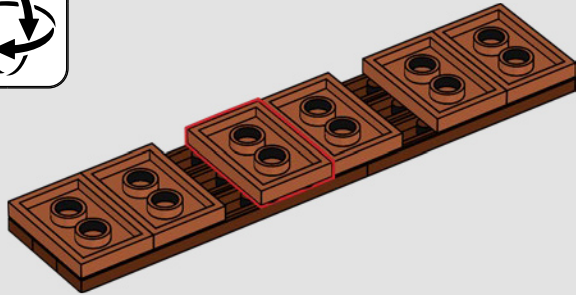

288

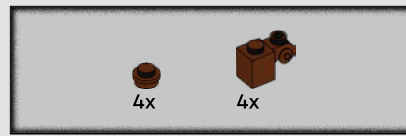
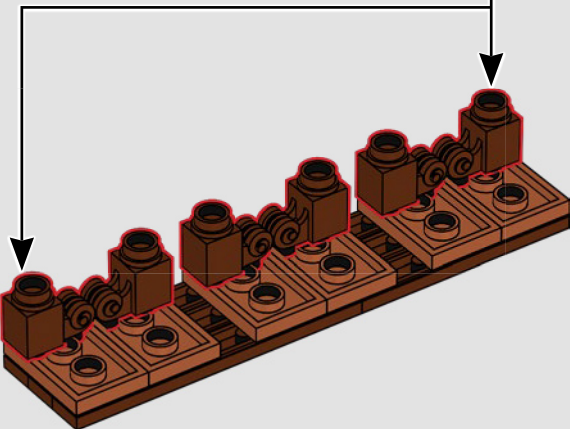
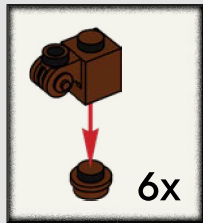

289

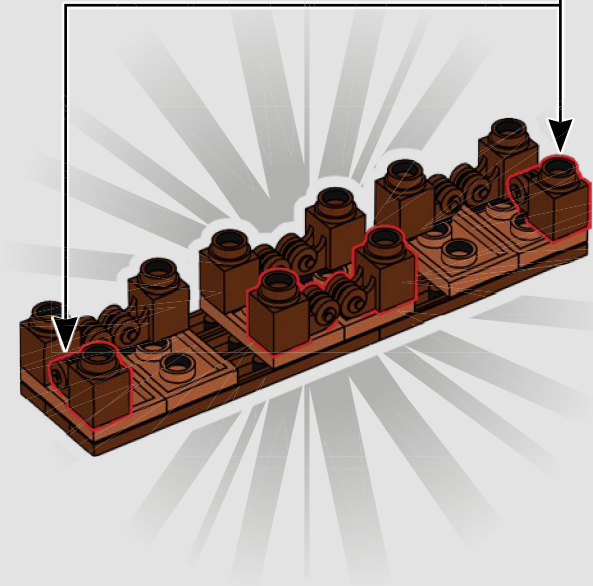
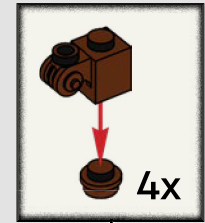

290



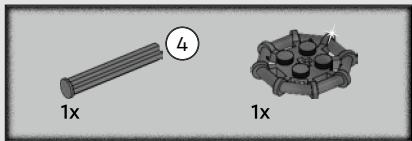
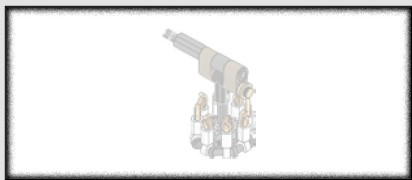

291

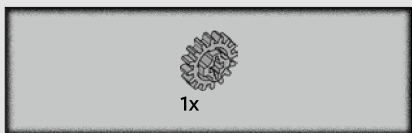
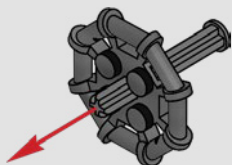

292

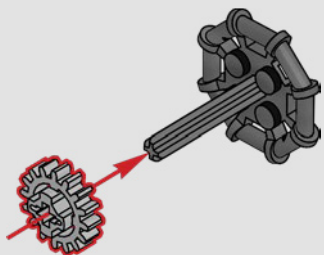

293

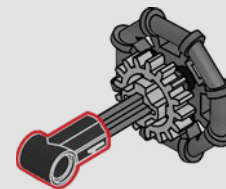

294

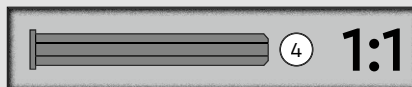
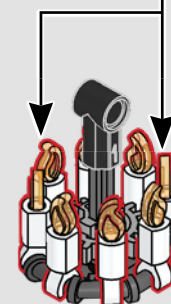
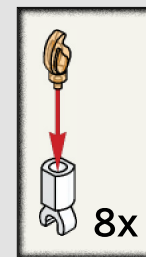

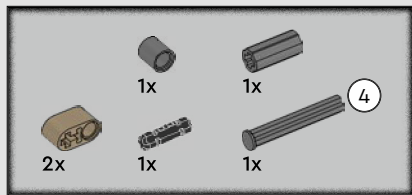

295

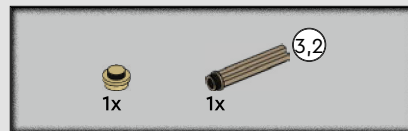
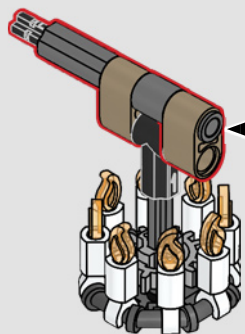
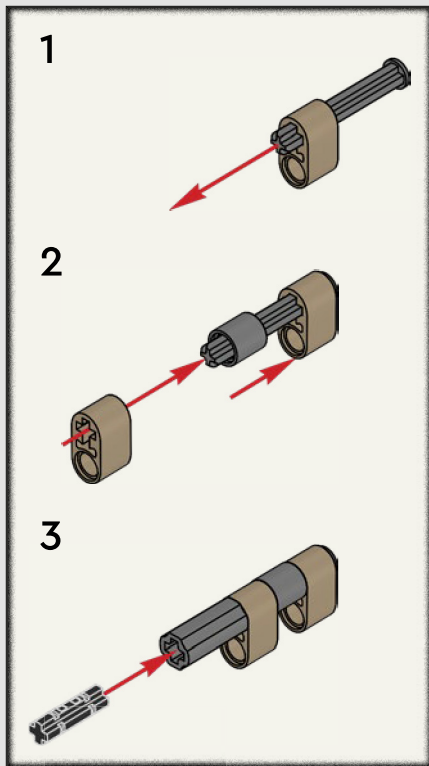

296

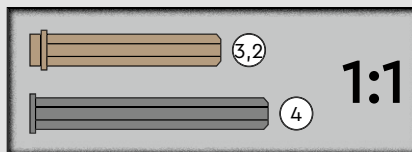
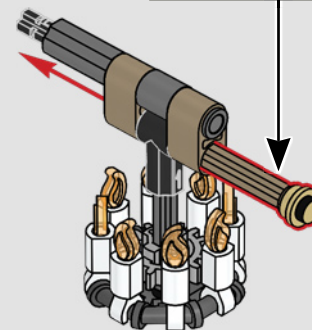
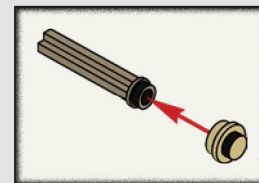





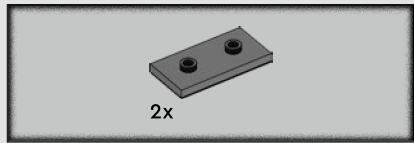

298



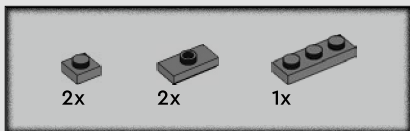

299

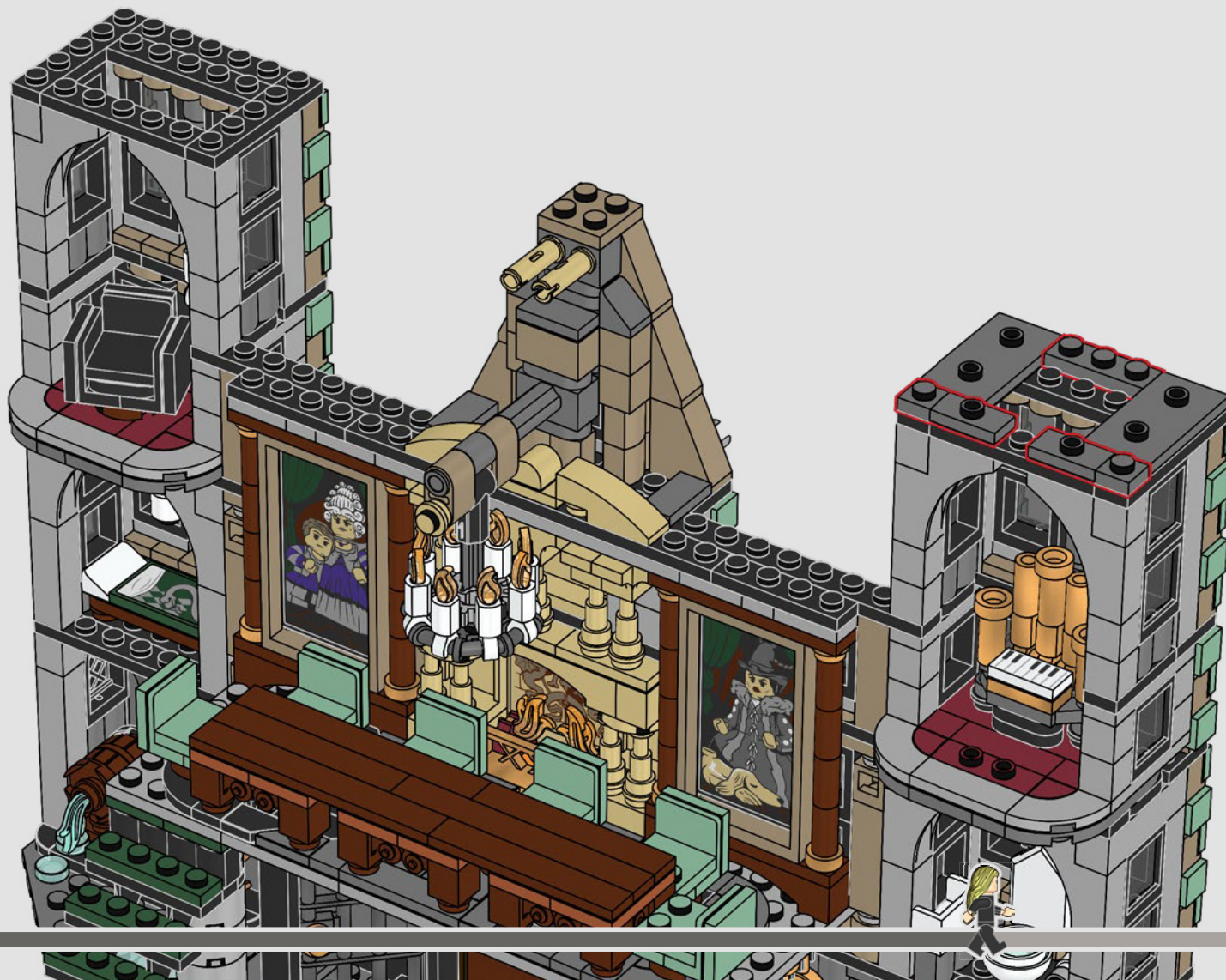

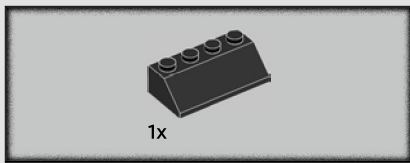

300

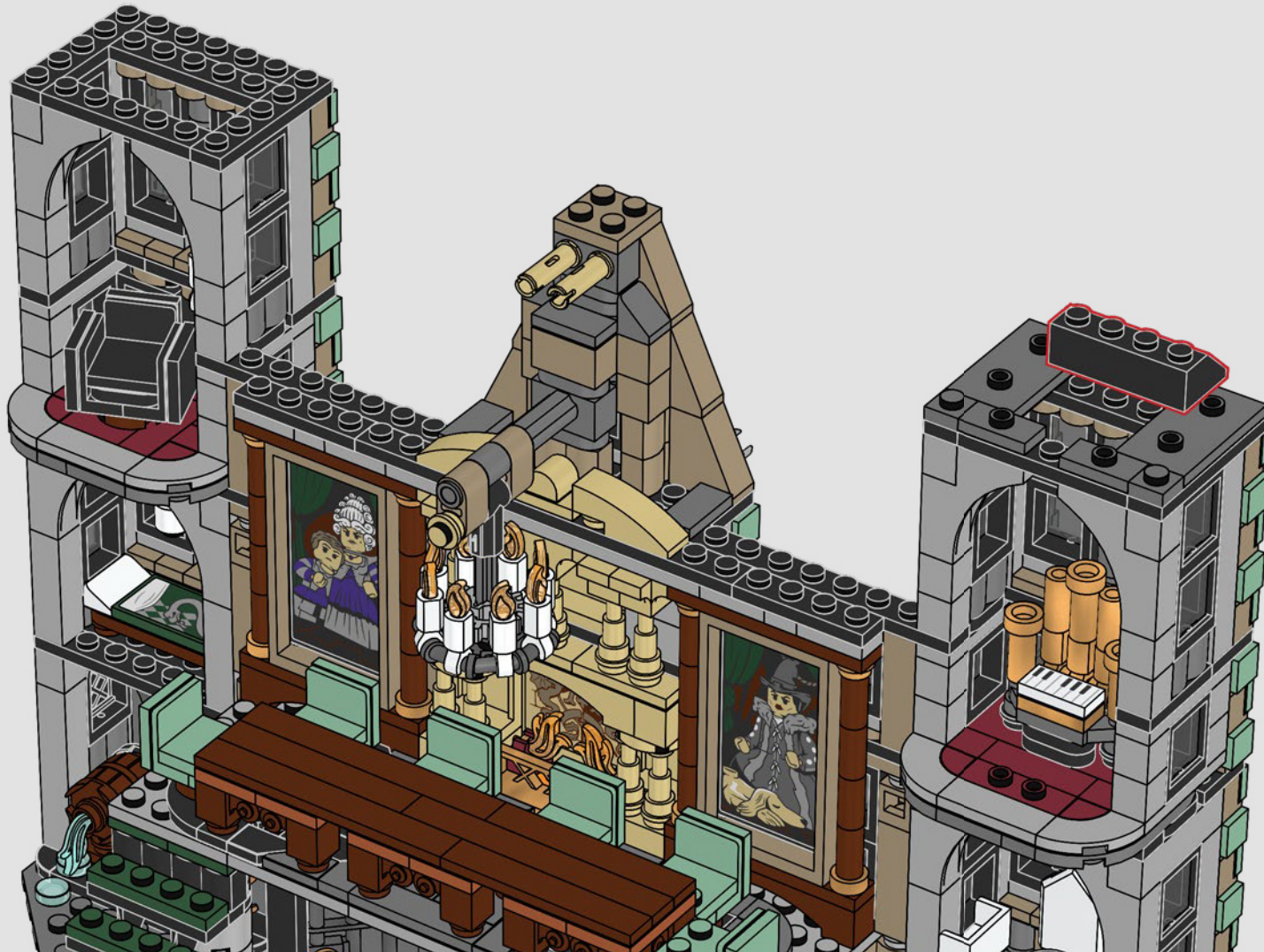

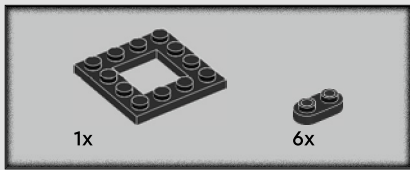

301

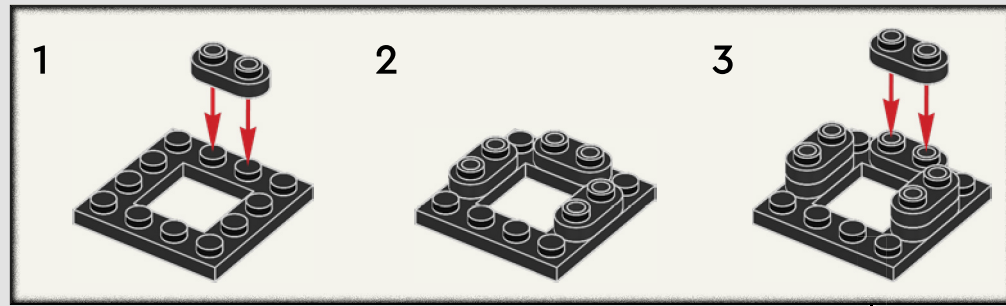

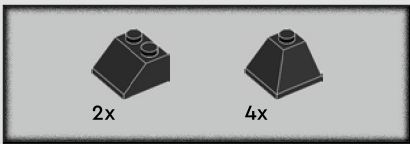

302

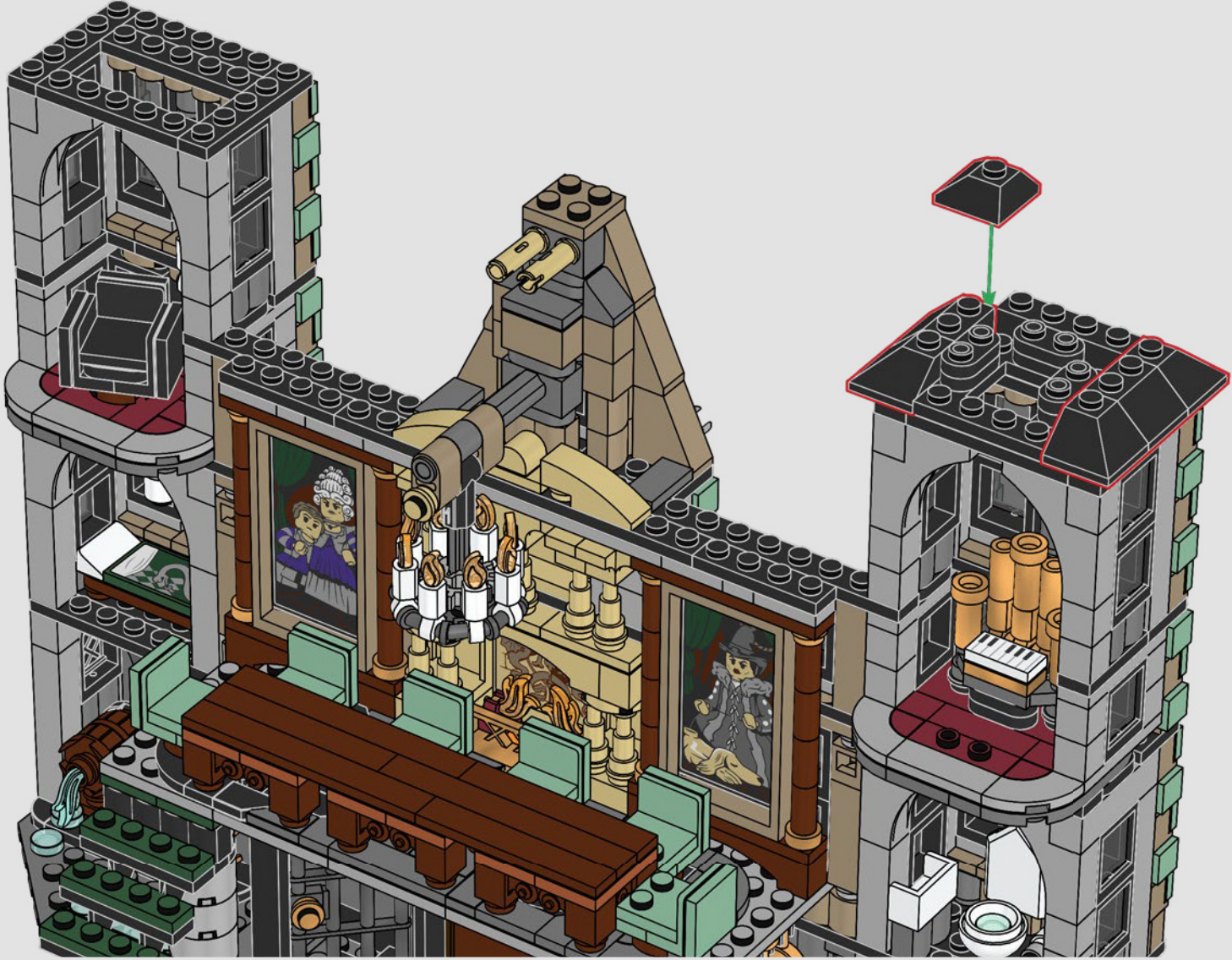

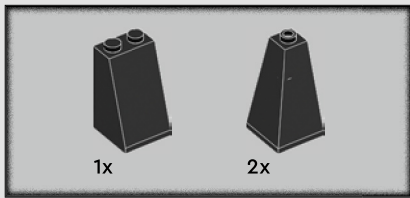

303



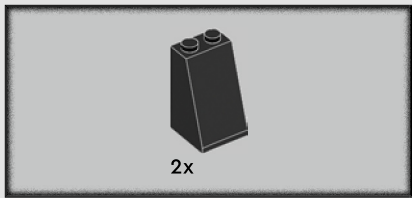

304



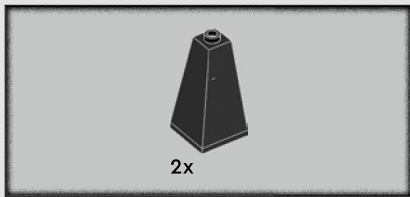

305



2x

306



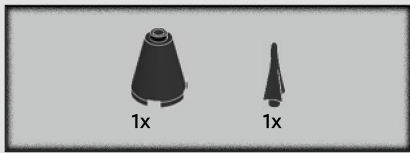

307

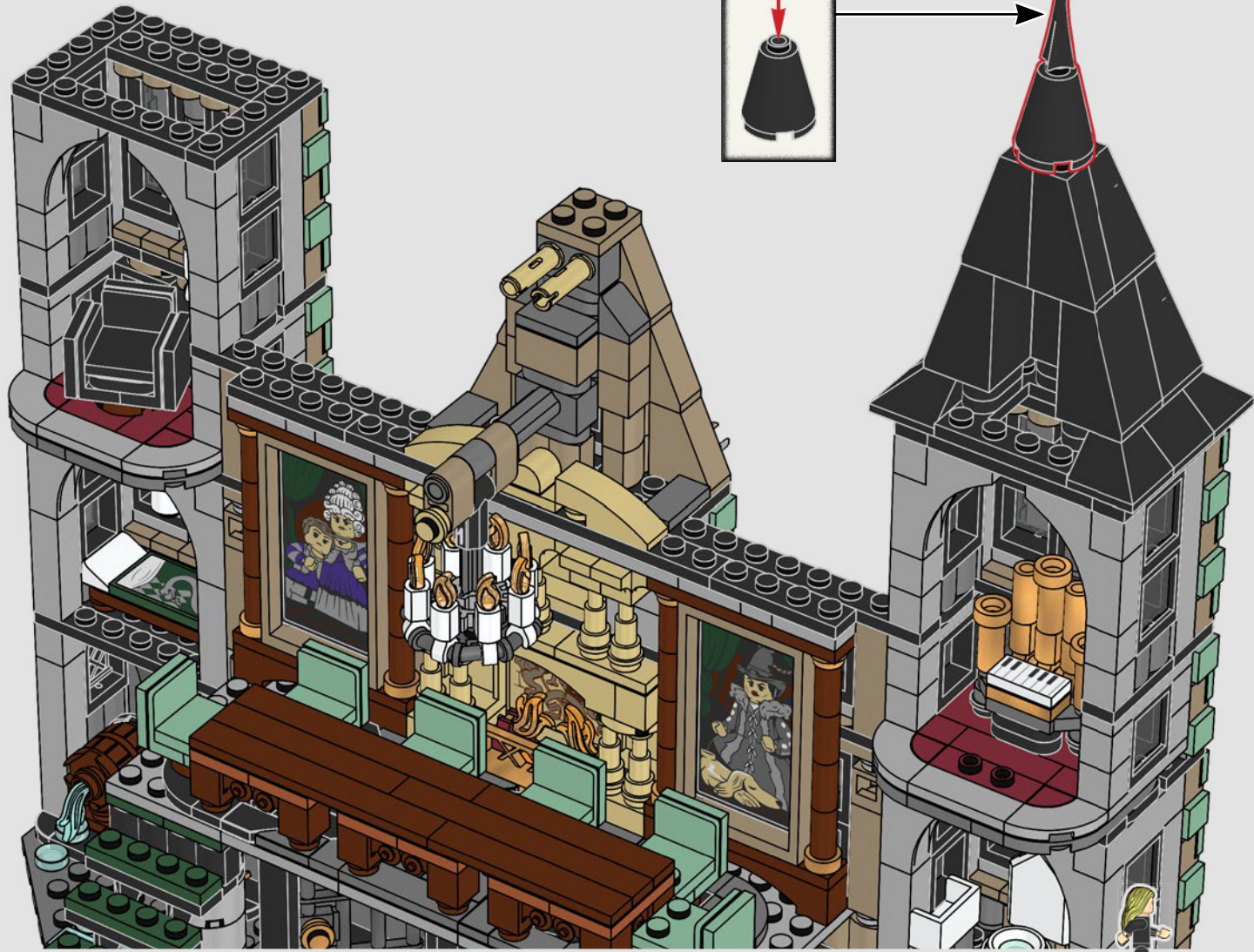
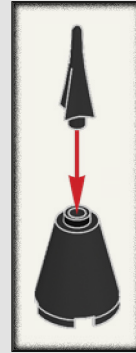

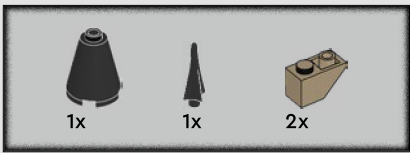

308

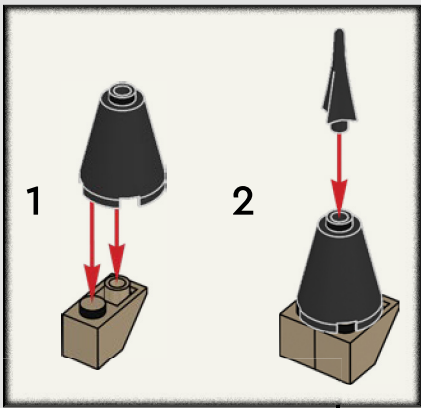

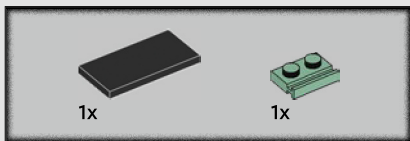
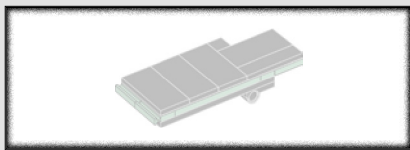

309

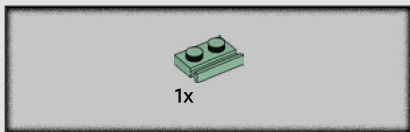
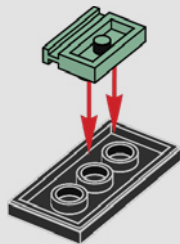

310

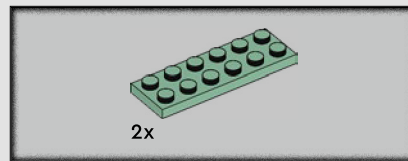
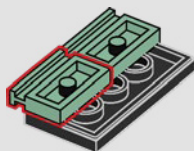

311

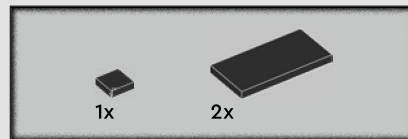
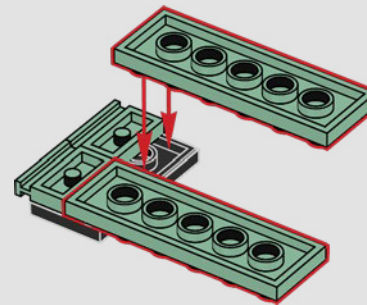

312

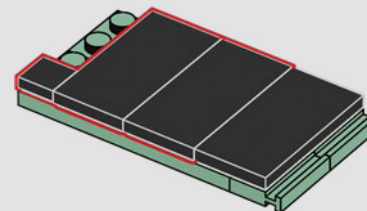

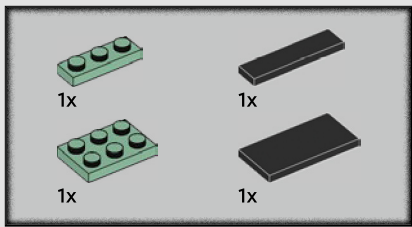

313

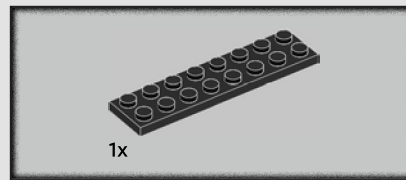
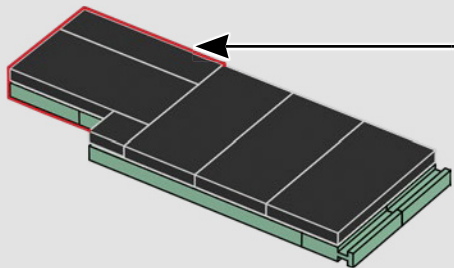
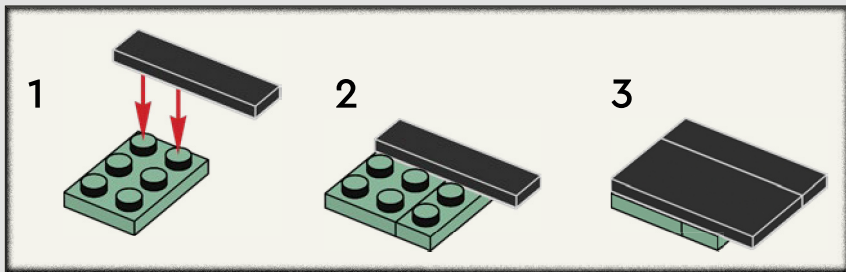

314

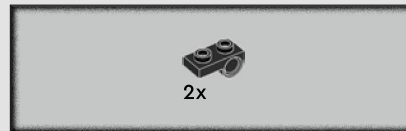
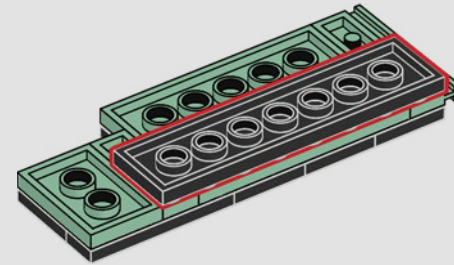
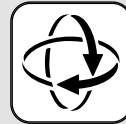

315

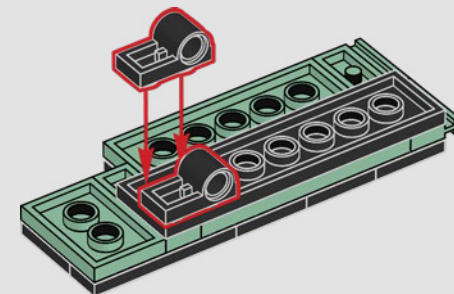

316



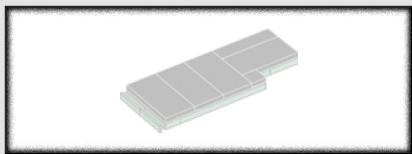

317

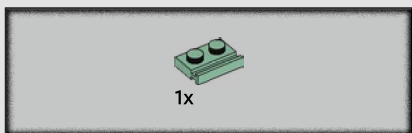
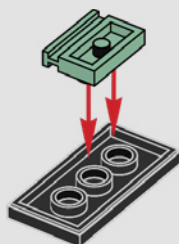

318

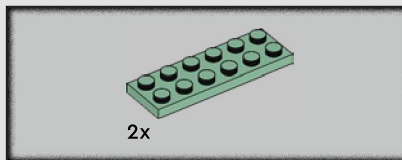
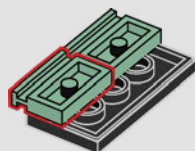

319

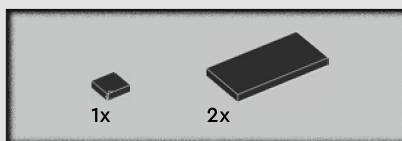
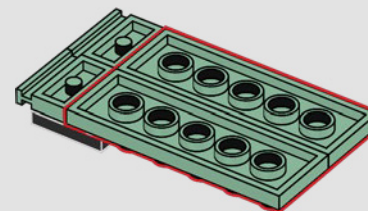

320

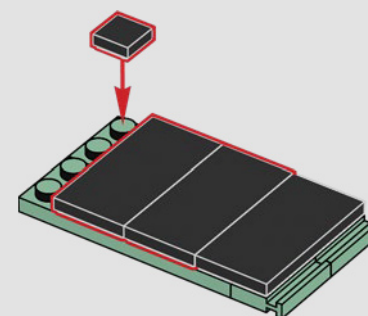

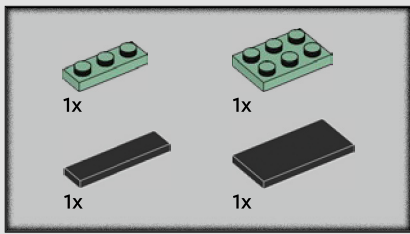

321

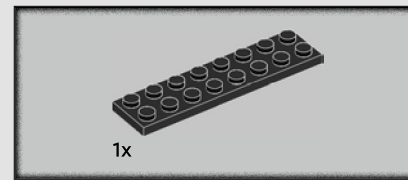
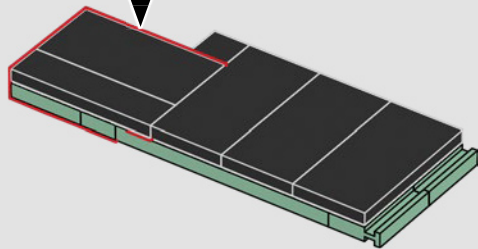
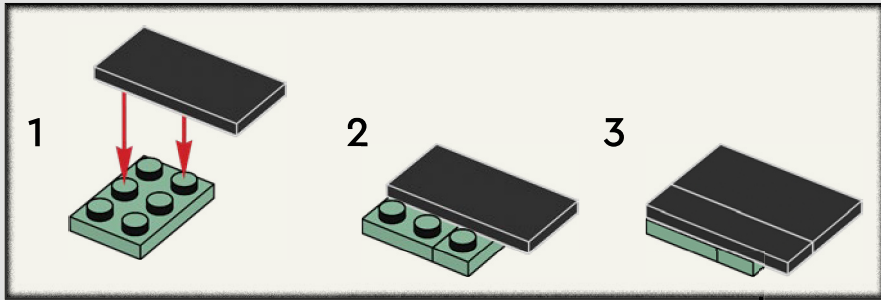

322

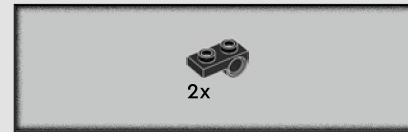
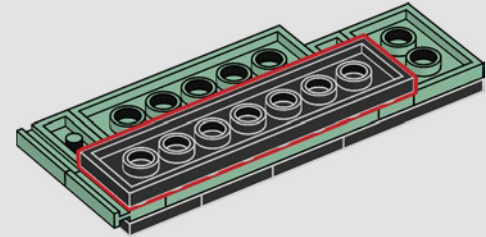
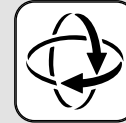

323

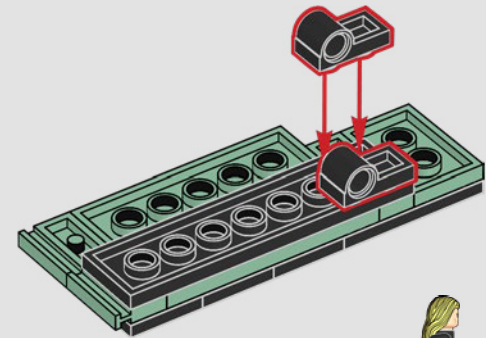

324





6x

325

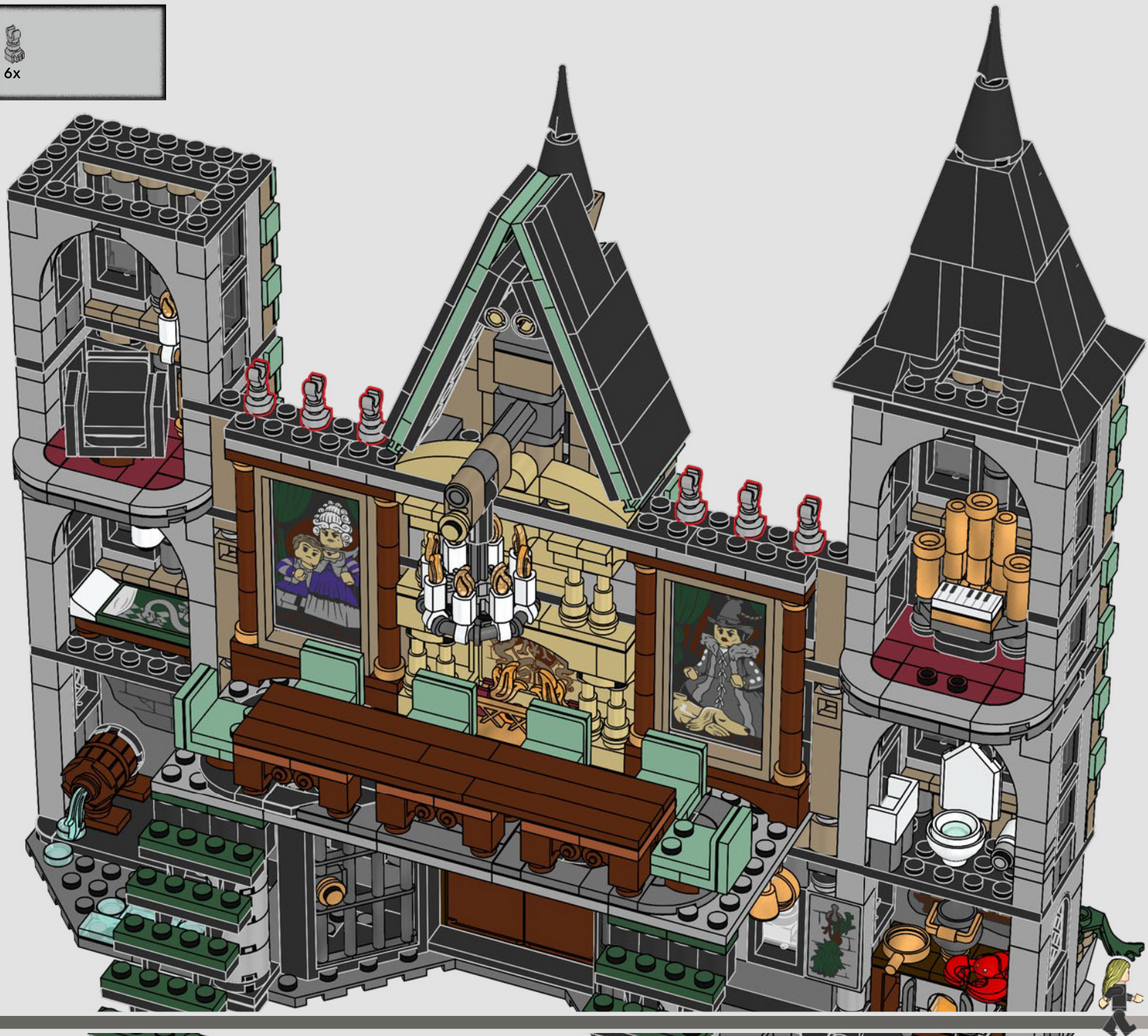

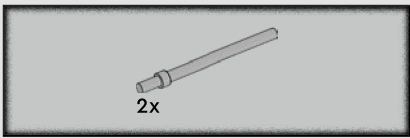

326

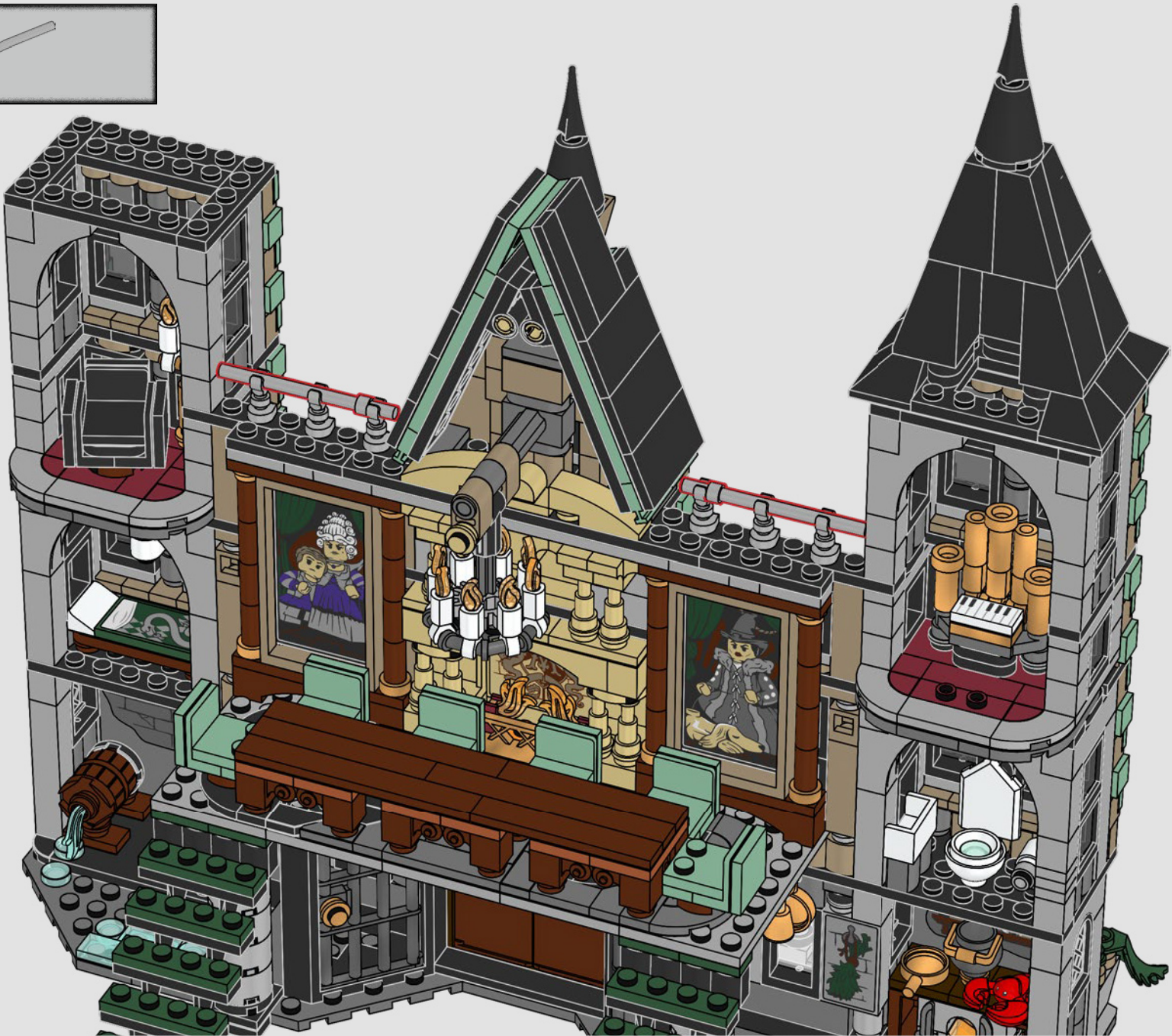



327

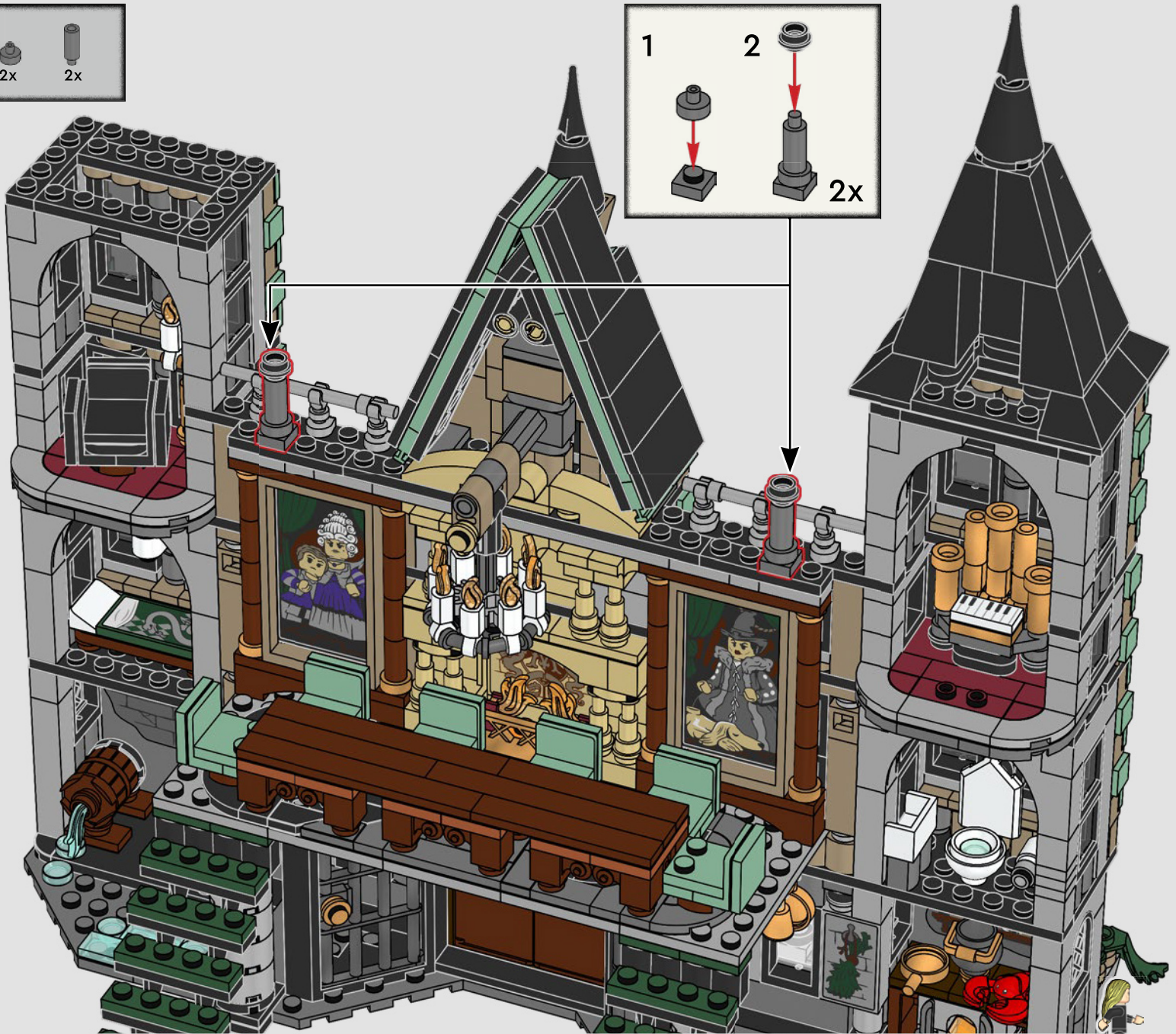
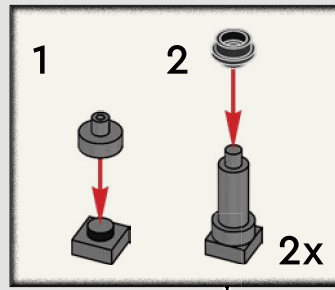

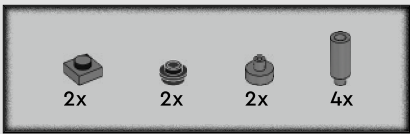

328

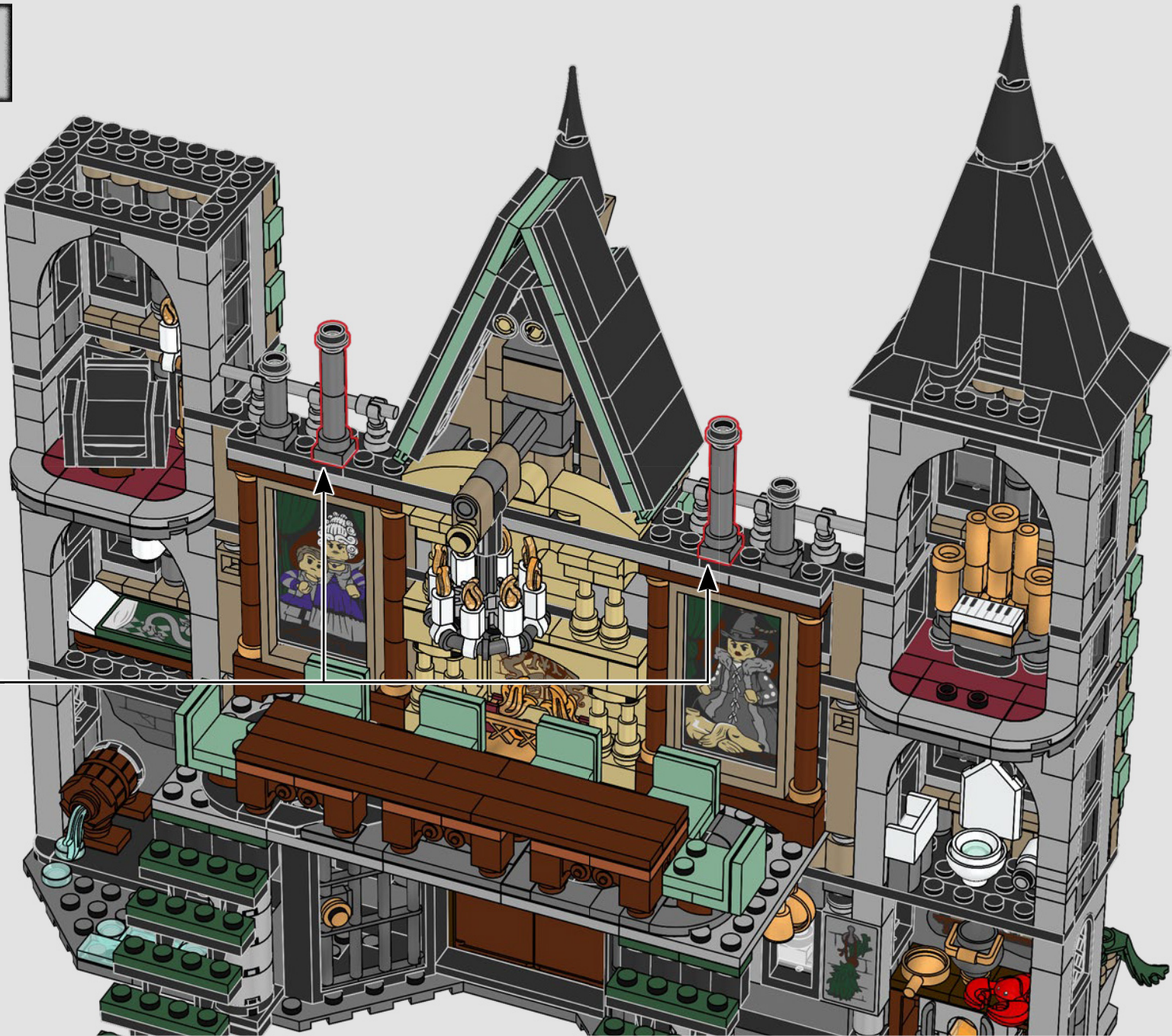
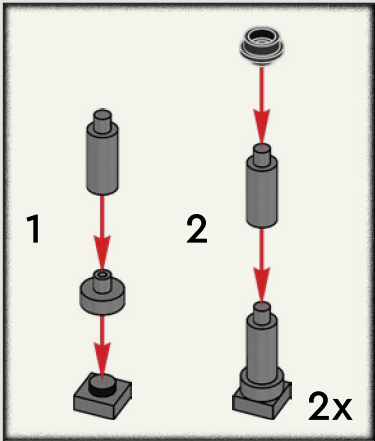

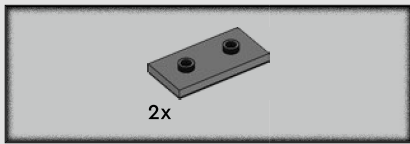

329



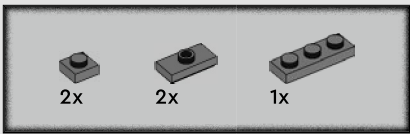

330



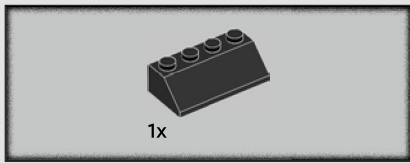

331



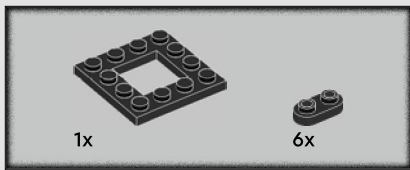

332

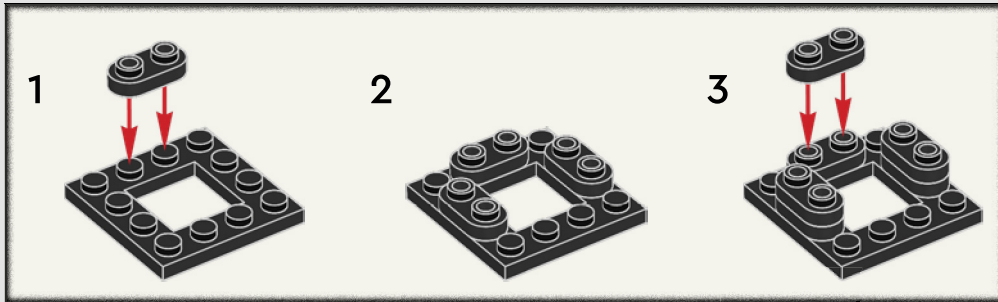

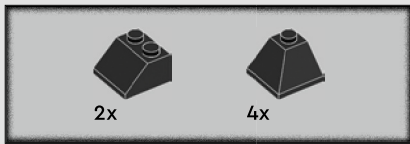

333



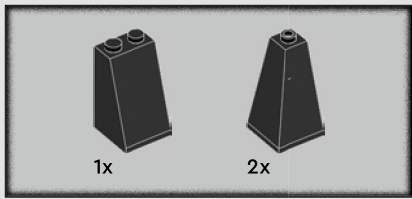

334

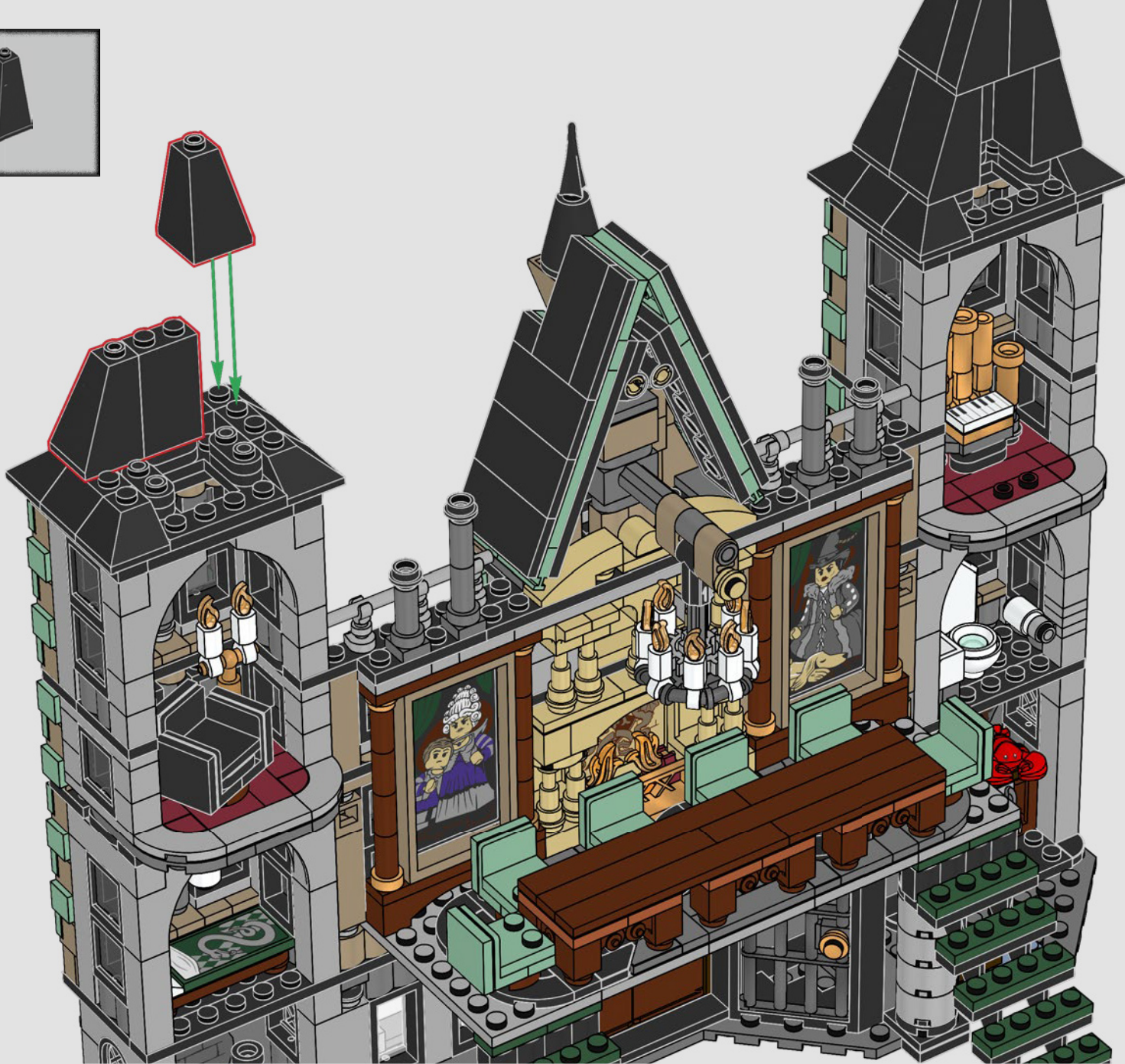

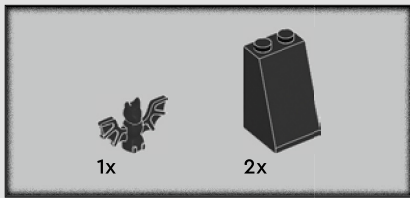

335



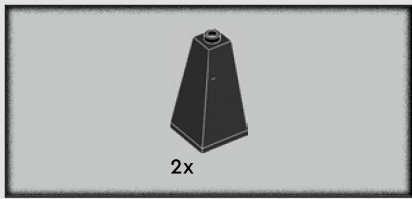

336



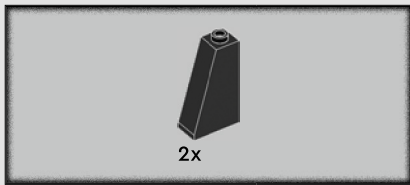

337



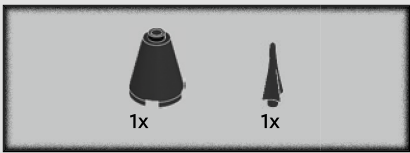

338

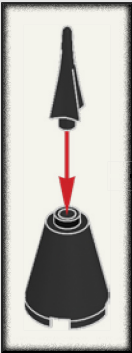





Harry Potter



76435



Build the most detailed HOGWARTS™ CASTLE



76447



76426

Baue das detailreiche Schloss Hogwarts™ / Construisez le château de Poudlard le plus détaillé / Costruisci il Castello di Hogwarts™ più dettagliato di sempre / Construye el Castillo de Hogwarts™ más detallado / Construa o mais detalhado Castelo de Hogwarts™ / 拼搭精美的霍格沃茨™城堡 / Zbuduj najbardziej szczegółowy zamek Hogwart™ / Postavte si ten najdetailnejší Bradavický hrad / Postavte si najdetailnejší Rokfortský hrad / Építsd meg a legrészletgazdagabb Roxfort™ kastélyt! / Construieste cel mai detaliat Castel Hogwarts™ / Постройте наиболее-детальную версию на замка Хогвортс / Uzbūve visdetalizētāko Čūkkārpas pili / Pane kokku kõige üksikasjalikum Sigatüüka™ loss / Sukonstruokite nepaprastai detalią Hogwartso pilį

Each set sold separately and available for different periods of time / Jedes Set ist separat und in unterschiedlichen Zeiträumen erhältlich. / Chaque set est vendu séparément et sera disponible à des périodes différentes. / Ogni set è venduto separatamente ed è disponibile per periodi di tempo diversi. / Cada set se vende por separado y está disponible durante un cierto período de tiempo. / Os sets são vendidos separadamente e estão disponíveis por diferentes períodos de tempo. / 每款套装于不同时间段单独出售。 / Zestawy są sprzedawane osobno i są dostępne w różnym czasie / Každá stavebnice se prodává samostatně a je k dispozici v různých časových obdobích / Každá stavebnice sa predáva samostatne a je k dispozícii v rôznych časových obdobiach / Minden egyes készlet külön-külön és más-más időszakban kapható. / Seturile se vând separat și sunt disponibile pentru perioade diferite de timp / Всеки комплект се продава отделно и е наличен за различен период от време. / Katsr komplekts tiek pārdots atsevišķi, un to pieejamības periodi atšķiras. / Kõik komplektid on müügil eraldi ja saadaval erinevates ajavahemikes. / Kiekvienas rinkinys parduodamas atskirai ir tik ribotą laiką



Harry Potter



76442

Baue das detailreichste Schloss Hogwarts™ / Construisez le château de Poudlard le plus détaillé / Costruisci il Castello di Hogwarts™
più dettagliato di sempre / Construye el Castillo de Hogwarts™ más detallado / Construa o mais detalhado Castelo de Hogwarts™ /
拼搭精美的霍格沃茨™城堡 / Zbuduj najbardziej szczegółowy zamek Hogwart™ / Postavte si ten nejdetajnější Bradavický hrad / Postavte
si najdetailnejší Rokfortský hrad / Építsd meg a legrészletgazdagabb Roxfort™ kastélyt! / Construíeste cel mai detaliat Castel Hogwarts™ /
Постройте най-детайlnата версия на замъка Хогортс / Uzbūvē visdetalizētāko Čūkkārpas pili / Pane kokku kõige üksikasjalikum
Sigatüüka™ loss / Sukonstruokite nepaprastai detalią Hogwartso pilį

Each set sold separately and available for different periods of time / Jedes Set ist separat und in unterschiedlichen Zeiträumen erhältlich. /
Chaque set est vendu séparément et sera disponible à des périodes différentes. / Ogni set è venduto separatamente ed è disponibile per periodi
di tempo diversi. / Cada set se vende por separado y está disponible durante un cierto período de tiempo. / Os sets são vendidos separadamente
e estão disponíveis por diferentes períodos de tempo. / 每款套装于不同时间段单独出售。 / Zestawy są sprzedawane osobno i są dostępne
w różnym czasie / Každá stavebnice se prodává samostatně a je k dispozici v různých časových obdobích / Každá stavebnice sa predáva
samostatne a je k dispozícii v rôznych časových obdobiach / Minden egyes készlet külön-külön és más-más időszakban kapható. / Seturile
se vând separat și sunt disponibile pentru perioade diferite de timp / Всеки комплект се продава отделно и е наличен за различен
период от време. / Katrs komplekts tiek pārdots atsevišķi, un to pieejamības periodi atšķiras. / Kõik komplekid on müügil eraldi ja saadaval
erinevates ajavahemikes. / Kiekvienas rinkinys parduodamas atskirai ir tik ribotą laiką



Build the most detailed HOGWARTS™ CASTLE



76435



76441



76431



**Rebuild
the
World™**



10x 6341465	1x 302001	1x 6532697	4x 6173105	4x 6468344	6x 6007896	4x 302126		1x 6167739	4x 6001824
1x 306201	12x 4161734		1x 4526110	59x 6382697		2x 6230228		1x 6326099	2x 4549436
3x 6168642	1x 6286329	1x 6146877	2x 6335317	4x 6408578	8x 6312358		2x 4279270	1x 6245307	37x 6231386
1x 614101	1x 6286492	1x 4550324	3x 6510139	4x 6408578	4x 368026	2x 4160025		2x 6245307	4x 6454938
1x 6270029	2x 4140562	1x 4618876	26x 6210270	7x 302326	4x 303926	3x 243126	2x 4100378	1x 6514224	23x 4520257
1x 6446788	4x 6236425	1x 6488487	2x 6196548	4x 6092585	8x 4189064	2x 371026	2x 6037390	1x 6510178	2x 6344864
2x 6328195	1x 6532419	1x 6533358	2x 6330189	4x 446026	4x 306826	6x 6280168	2x 303426	3x 6514236	30x 6092591
1x 6523444	2x 6063943	1x 6269965	1x 4109810	4x 446026	4x 306826	2x 303726	4x 303426	1x 4118782	6x 6354068
2x 4626882	2x 4109995	8x 6186675	3x 6092664	4x 6192309	6x 362326	8x 4560182	9x 4514845	1x 6254100	2x 6121959
4x 4224792	2x 6092587	6x 6168646	8x 403226	4x 6174243		10x 6350415		2x 4267425	4x 4496699
1x 6050914	1x 6236423	4x 6270027	1x 6195325	3x 6000650	2x 6256051		3x 302926	1x 6398673	1x 4255416
1x 4547489	9x 6060850	1x 6284699	1x 6310823	1x 6532706	1x 6532709		6x 6359717	6x 6300320	1x 6396392
2x 6439714	2x 4114306	15x 6172383	3x 6510125	1x 6416513	1x 6532709	2x 6177156		1x 6270031	1x 6047415
1x 6248490	2x 6321305	1x 4558954	3x 9339	8x 302226	1x 6533035	2x 663626	4x 6252258	74x 6273590	1x 6031821
1x 6293665	2x 4624088	2x 307026	1x 6308975	7x 6191630	1x 6374765		1x 6514027	1x 6031821	4x 6257599
1x 6245249	2x 6211966	4x 302426		2x 6192346			4x 6514192		

- 2x 6262970
- 2x 4247145
- 1x 4247151
- 2x 6015424
- 2x 6156492
- 11x 6446790
- 4x 6400754
- 6x 6447541
- 1x 4226869
- 4x 6326011
- 1x 6533067
- 14x 6020923
- 1x 6440430
- 68x 6223913
- 6x 4655080
- 6x 6526069
- 4x 6222362
- 6x 6423384
- 6x 6133896
- 2x 6069257
- 2x 6184348
- 4x 6194726
- 1x 6546650
- 5x 4550169
- 4x 6311890
- 2x 6360079
- 1x 6092597
- 3x 4613761
- 4x 4583299
- 1x 6208727
- 11x 6514274
- 1x 6514059
- 2x 6245265
- 2x 6314353
- 16x 6422088
- 14x 4216581
- 3x 6215659
- 1x 6270028
- 1x 6036503
- 1x 6278989
- 8x 4211159
- 10x 6172757
- 2x 6064188
- 3x 6092590
- 1x 6266075
- 2x 6510228
- 1x 4211189
- 2x 6280388
- 2x 4538252
- 4x 4221590
- 2x 4655611
- 3x 4211204
- 3x 4585337
- 18x 6436421
- 14x 6423983
- 27x 6168647
- 8x 4211412
- 12x 4211525
- 2x 6258831
- 1x 6526067
- 1x 6454730
- 5x 6061702
- 30x 4211389
- 4x 4211399
- 6x 6401023
- 2x 6308012
- 2x 6262085
- 2x 4558953
- 14x 4211362
- 1x 6345639
- 2x 6311384
- 2x 6248890
- 3x 6296894
- 1x 6236162
- 1x 6404367
- 1x 6281998
- 4x 4540203
- 8x 4211526
- 2x 4550325
- 1x 4640536
- 2x 6383177
- 2x 6170387
- 5x 6429026
- 2x 6015344
- 6x 4211437
- 4x 6028813
- 2x 6492553
- 1x 4654580
- 25x 4211568
- 2x 4641048
- 1x 6446028
- 6x 4211349
- 2x 4211410
- 2x 6435857
- 4x 6163990
- 6x 4211397
- 2x 4211353
- 2x 4216250
- 2x 6126082
- 8x 6225228
- 2x 4558169
- 4x 4211429
- 2x 4645397
- 4x 4211419
- 4x 4211435
- 4x 4211394
- 8x 4211445
- 2x 4211473
- 1x 4211395
- 7x 6372029
- 4x 6170418
- 2x 6028811
- 1x 4251149
- 5x 4211407
- 1x 4211366
- 1x 6514199
- 6x 6388120
- 32x 4211090
- 8x 4210633
- 4x 6271752
- 1x 6100030
- 9x 6199549
- 4x 4210848
- 8x 4210719
- 1x 6332045
- 1x 4542586
- 2x 6435043
- 4x 6510145
- 2x 6526068
- 8x 6234583

6x 6321350
1x 6388118
7x 6221607
1x 4211010
33x 4211095
5x 6510131
1x 4516546
24x 4211052
6x 4211063
4x 6092572
1x 6178919
1x 6342558
2x 6069164
1x 4210762
2x 6265306
1x 4210865
1x 6335316

2x 4211133
1x 6531970
1x 6302647
1x 6187008
2x 6083620
1x 6257592
2x 4535930
2x 4560184
4x 6307616
5x 6388294
2x 4211056
2x 4505068
2x 4211002

4

4x 6262023
5x 4211008
2x 4211099
5x 4211115
2x 4211122
1x 6309172
1x 6323492
1x 6529039
1x 6364632
1x 6476878
1x 6163442
1x 6523442
1x 6192171

1x 6523436
1x 6258524
1x 6530642
6x 6290401
3x 6252838
5x 6190252
6x 4523159
1x 4505990
7x 6186672
1x 6245278
1x 6452472
2x 6138068
1x 6342678
1x 6279731
1x 4536675

1x 6270032
1x 6523446
3x 6404033
2x 4566688
1x 6179803
1x 6531966
1x 6430932
2x 6300103
1x 6234805
1x 6167628
1x 6532225

1x 6503228
1x 6363146
4x 6037634
1x 6197967
59x 6491420



 [LEGO.com/service](https://www.LEGO.com/service)

YOU COULD

WIN



Scan this QR code or go to **LEGO.COM/PRODUCTFEEDBACK** and give us your short feedback about this LEGO® set for a chance to win a cool LEGO prize.

Terms and Conditions apply*

EN: YOU COULD WIN. Terms and Conditions apply* **DE: Du könntest GEWINNEN.** Es gelten die Teilnahmebedingungen* **FR: Tu pourrais GAGNER.** Des conditions s'appliquent* **IT: Potresti VINCERE tu.** Termini e condizioni sono applicabili* **ES: Puedes GANAR.** Aplican términos y condiciones* **PT: Poderá GANHAR.** Aplicam-se termos e condições* **ZH: 轻松获奖. 条款和条件适用*** **PL: Szansa na WYGRANĄ.** Obowiązują warunki korzystania* **CS: Máte šanci VYHRÁT.** Platí všeobecné smluvní podmínky* **SK: Máte šancu VYHRAŤ.** Platia všeobecné zmluvné podmienky* **HU: TE IS NYERHETSZ.** Felhasználási feltételek érvényesek* **RO: Ai putea CÂȘTIGA.** Se aplică termenii și condițiile* **BG: Можете да СПЕЧЕЛИТЕ.** Има определени правила и условия* **LV: Tu vari LAIMĒT.** Ir spēkā noteikumi un nosacījumi.* **ET: Sul on võimalus VÕITA.** Kehtivad tingimused* **LT: Jūs galite LAIMĖTI.** Taikomos sąlygos*

*[LEGO.com/productfeedback-terms](https://www.lego.com/productfeedback-terms)

LEGO and the LEGO logo are trademarks of the LEGO Group. ©2025 The LEGO Group.

All HARRY POTTER characters and elements © & ™ Warner Bros. Entertainment Inc. Publishing Rights © JKR. (s25)