



MARVEL

76311



2

3

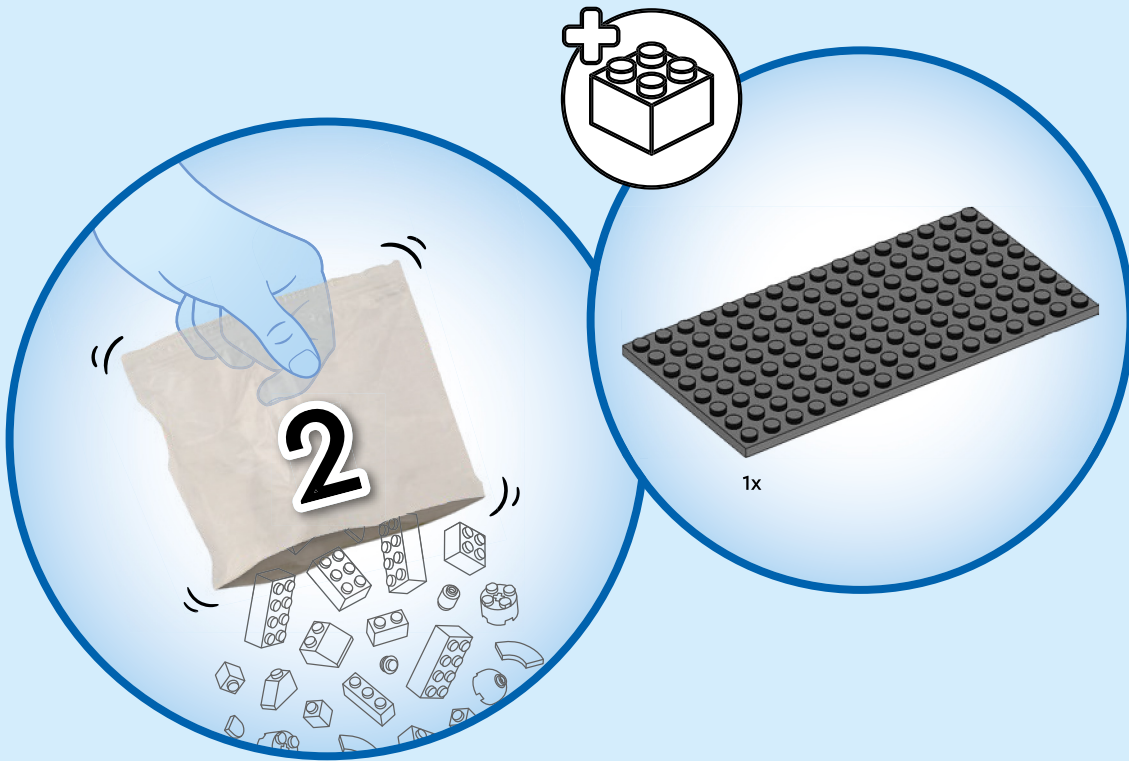

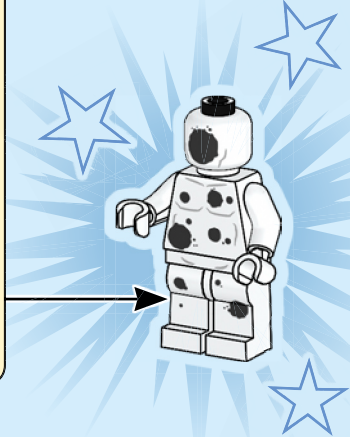
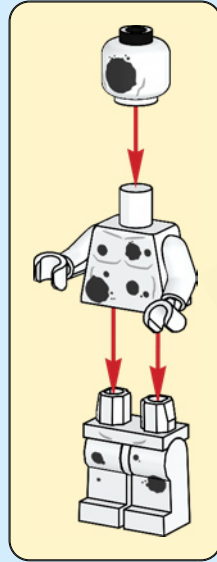
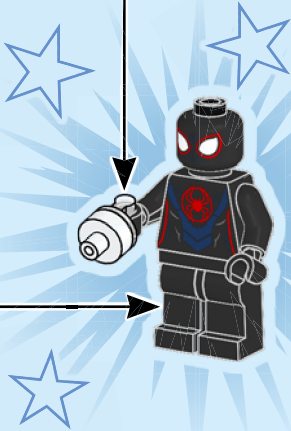
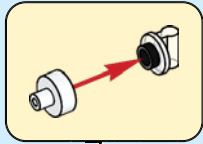
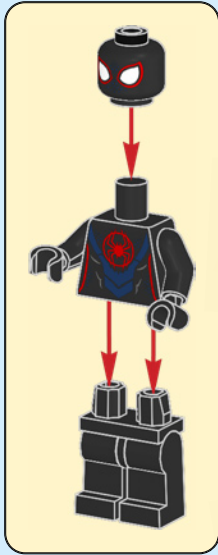
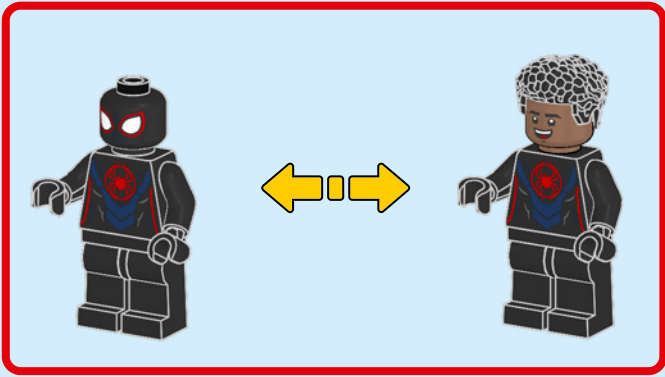

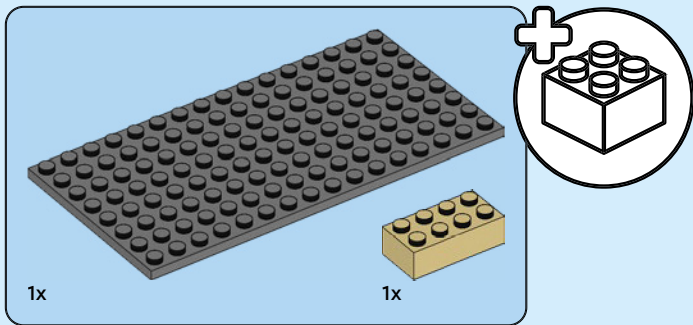

1

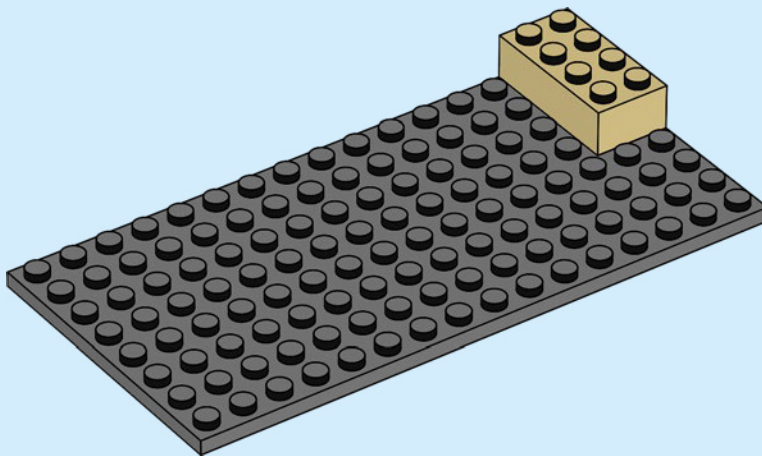



1x



1x

2

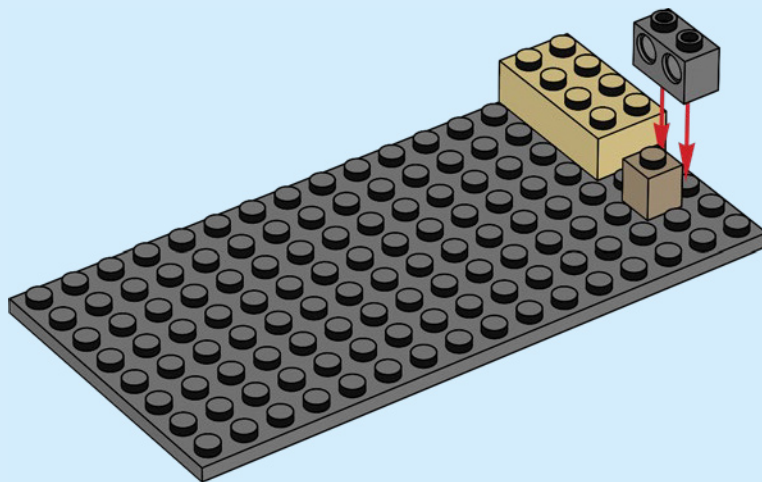

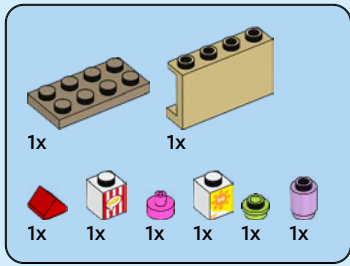

3

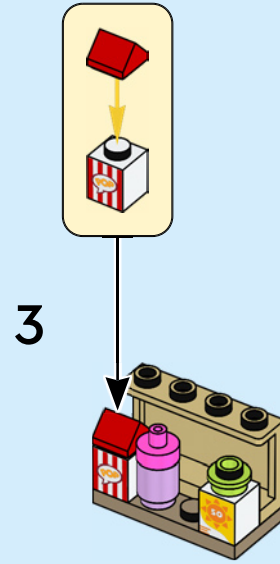
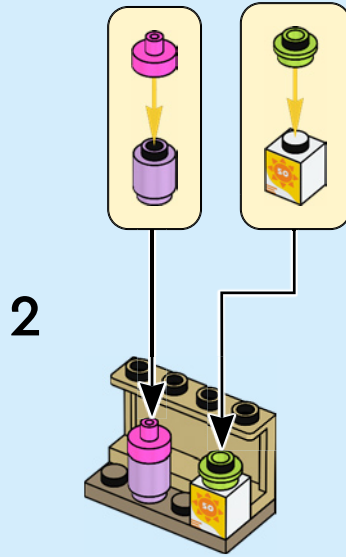
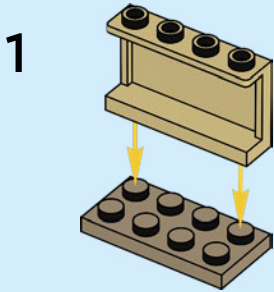

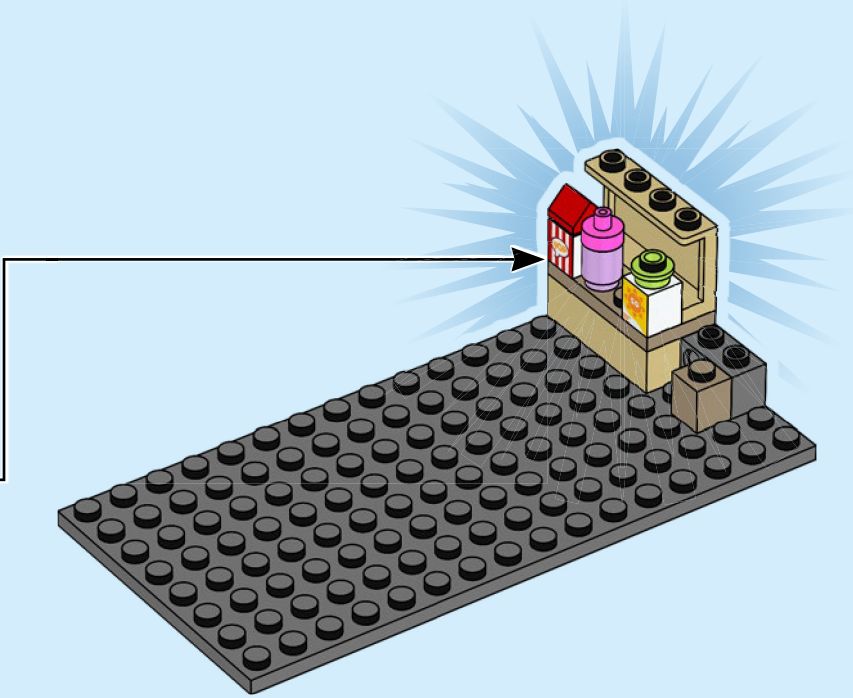

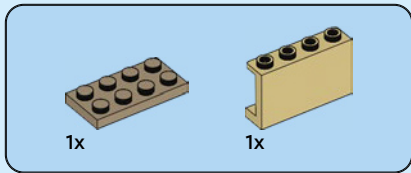

4

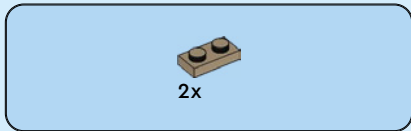
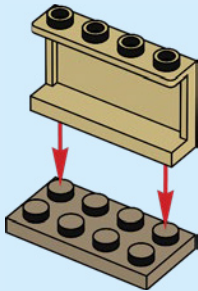

5

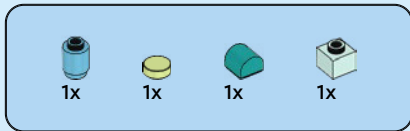
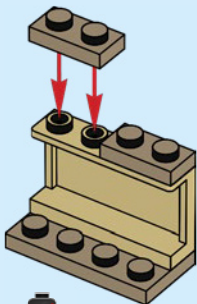

6

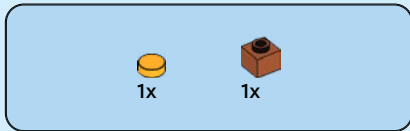
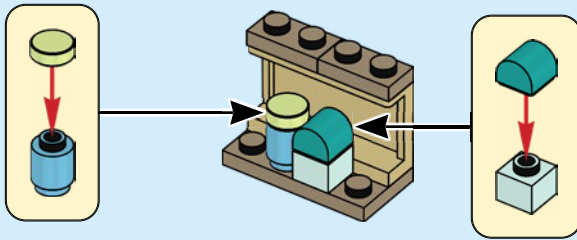

7

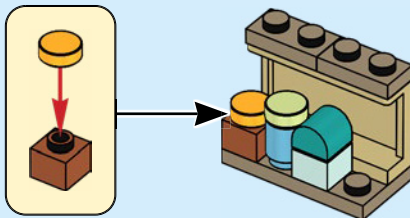

8

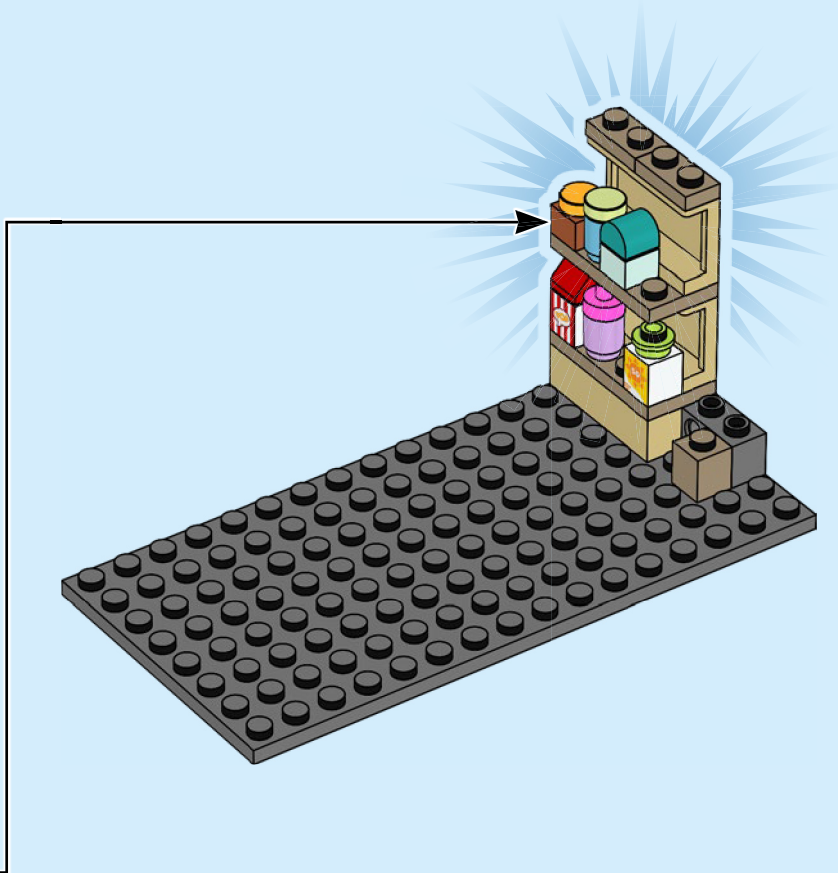

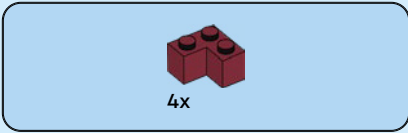

9

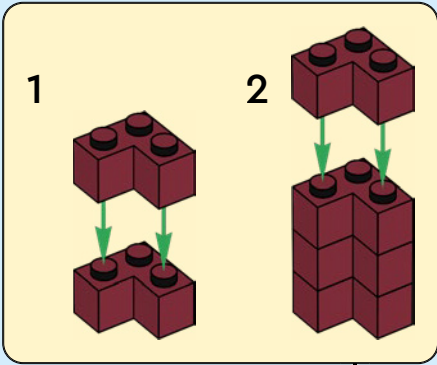

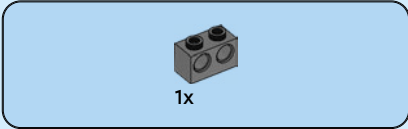
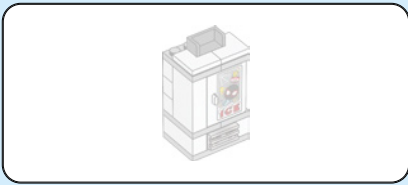

10

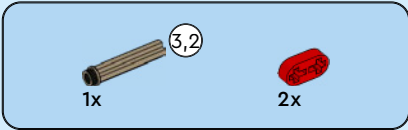
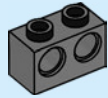

11

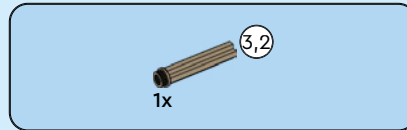
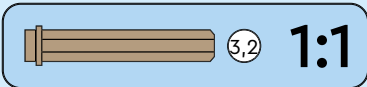
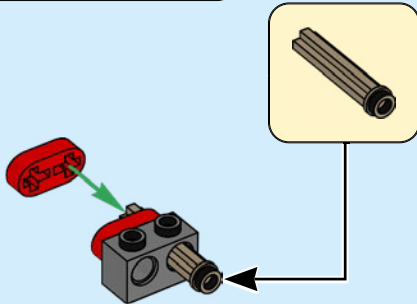

12

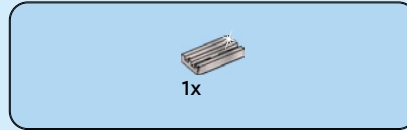
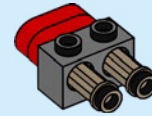

13

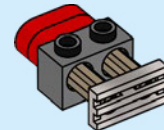

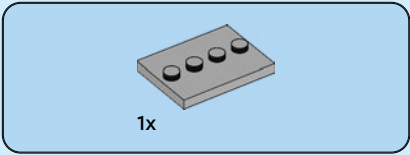

14

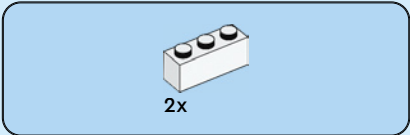
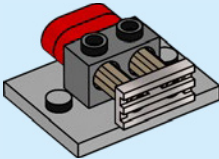

15

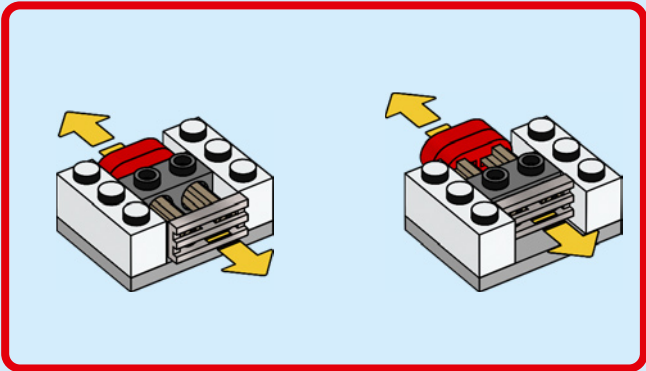
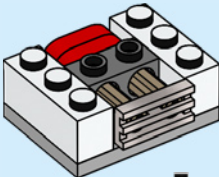

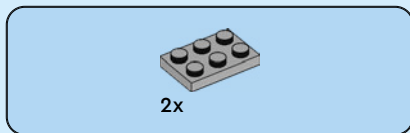

16

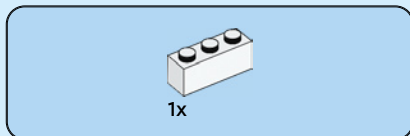
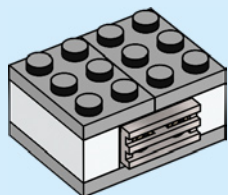

17

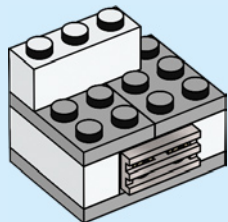

18

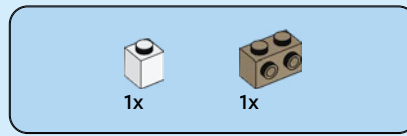
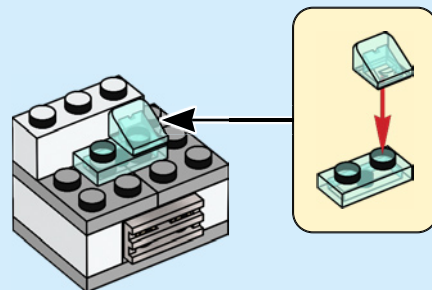

19

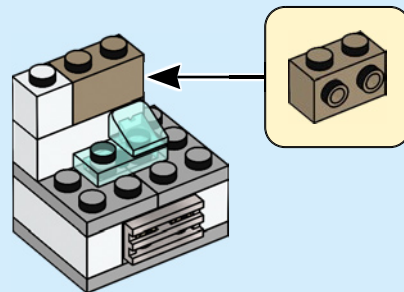



1x

20

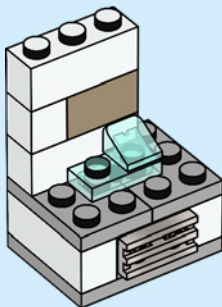

2x

21

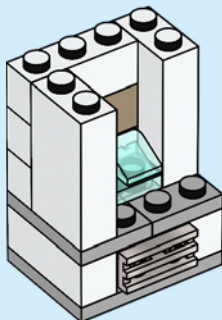

1x

22

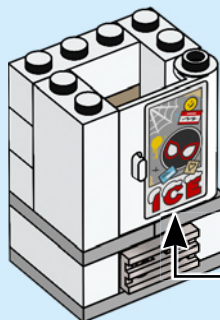

1



2

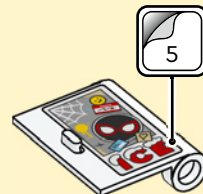



2x

23



2x

24



1x

25

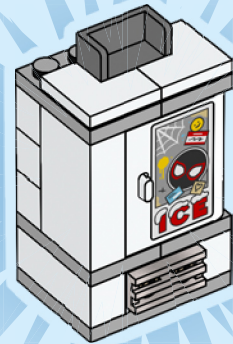

26



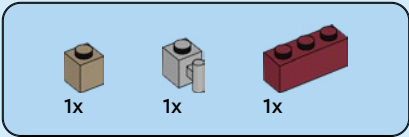

27

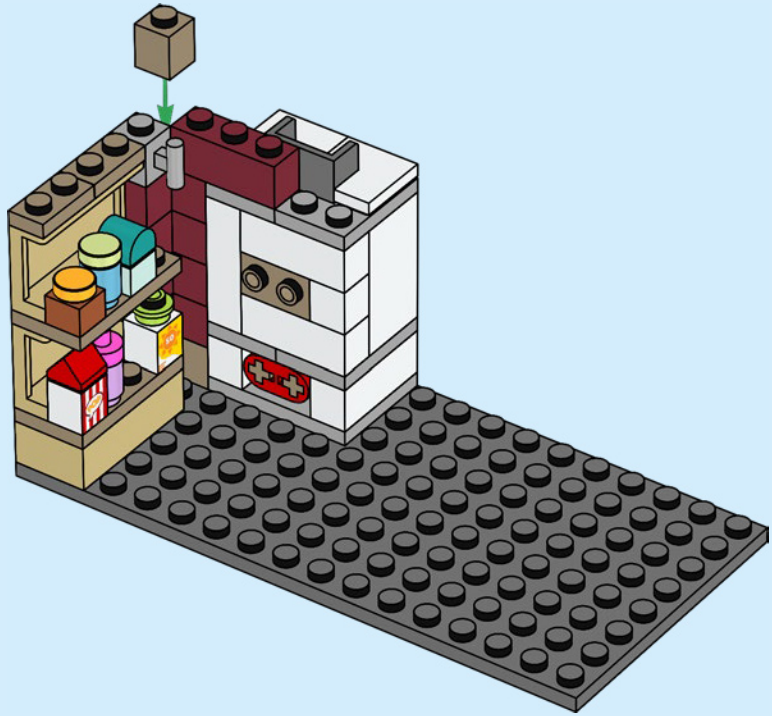



1x



3x

28



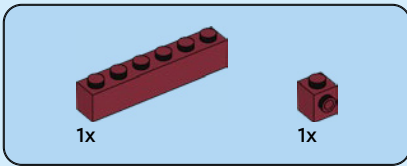

29





2x

30

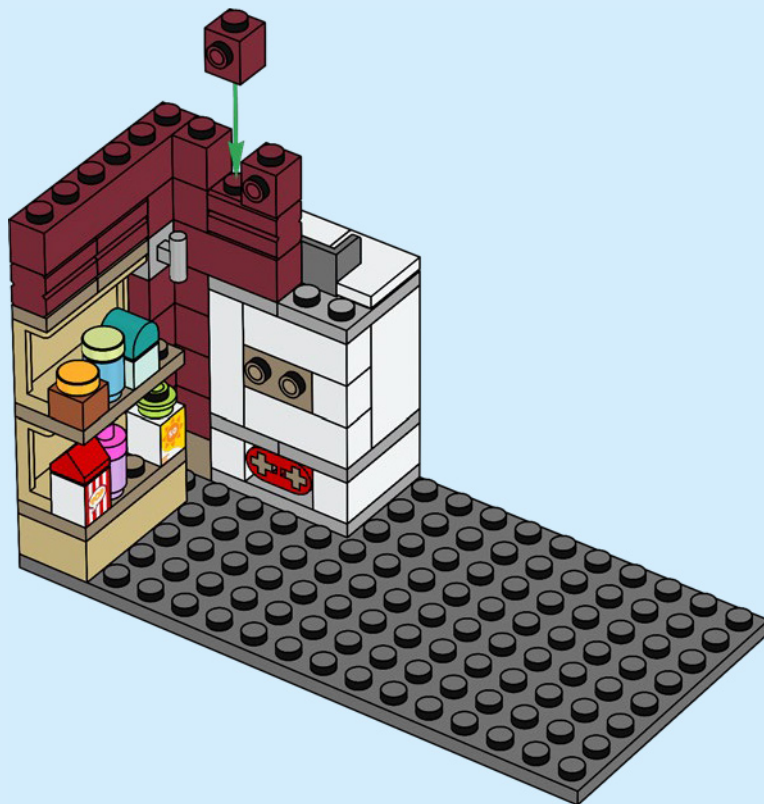



1x

31

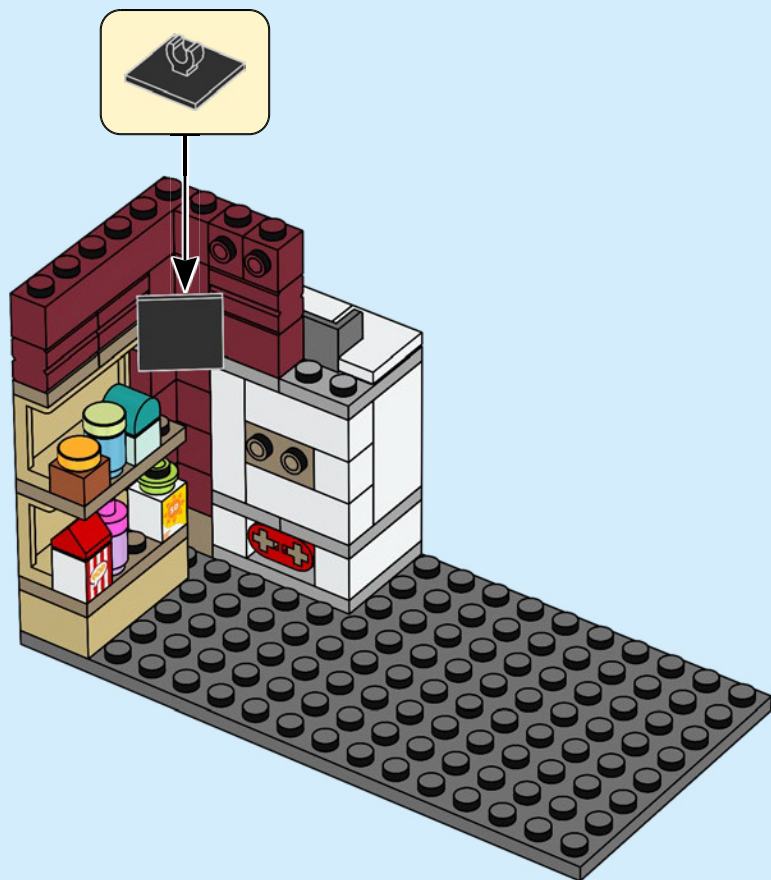

32



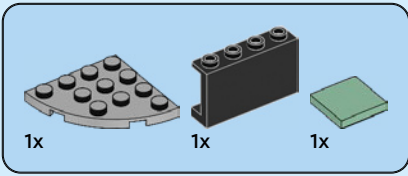

33





2x



1x

34





1x

35



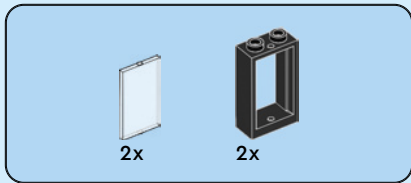

36

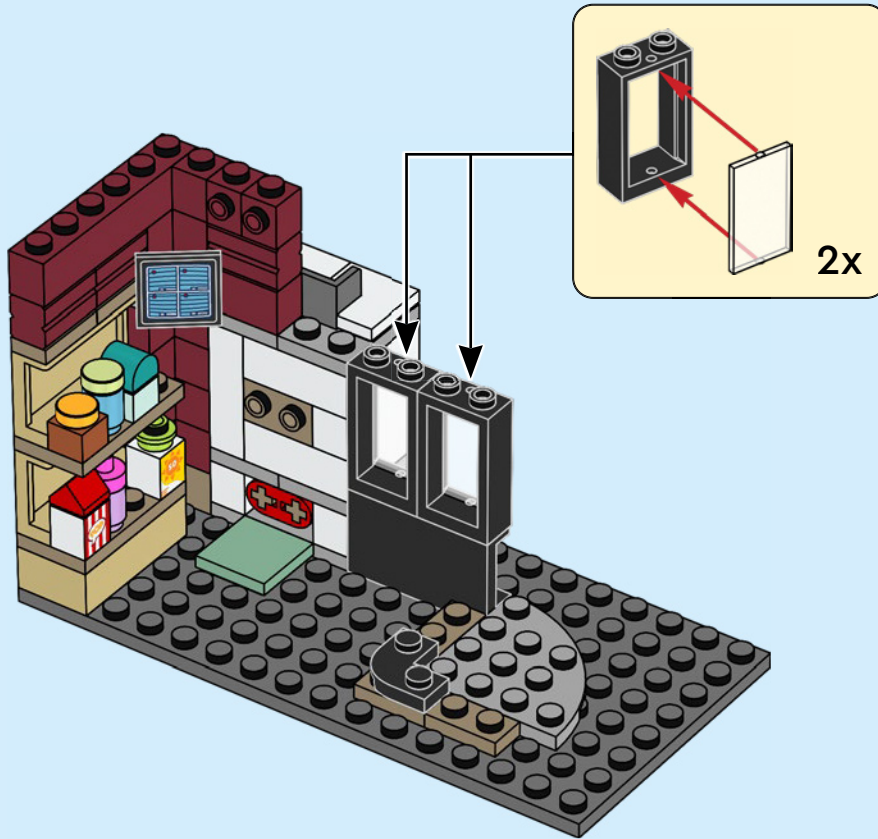

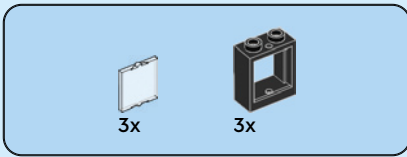

37

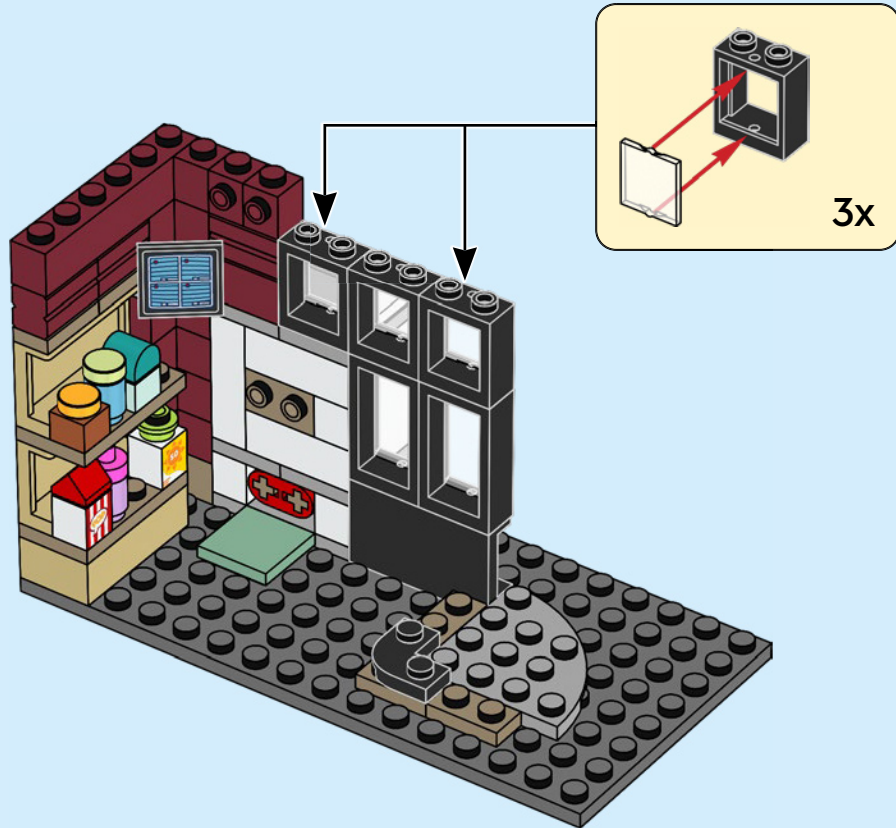

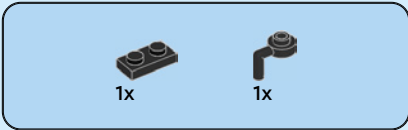

38



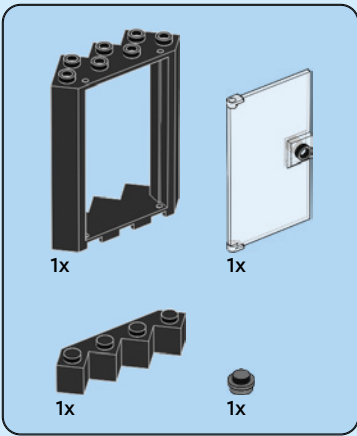

39

1

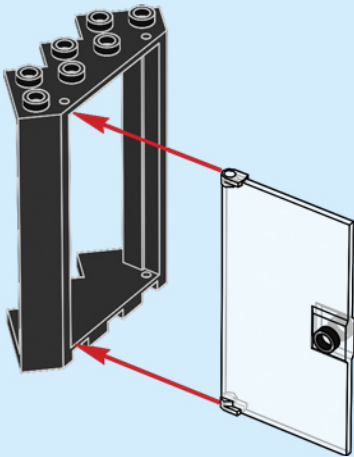

2

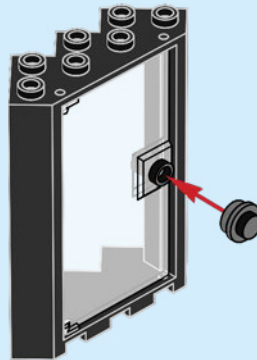

3

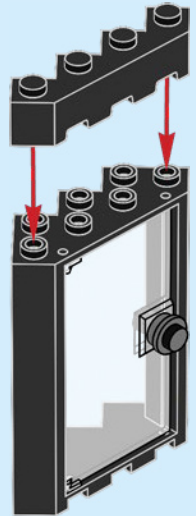

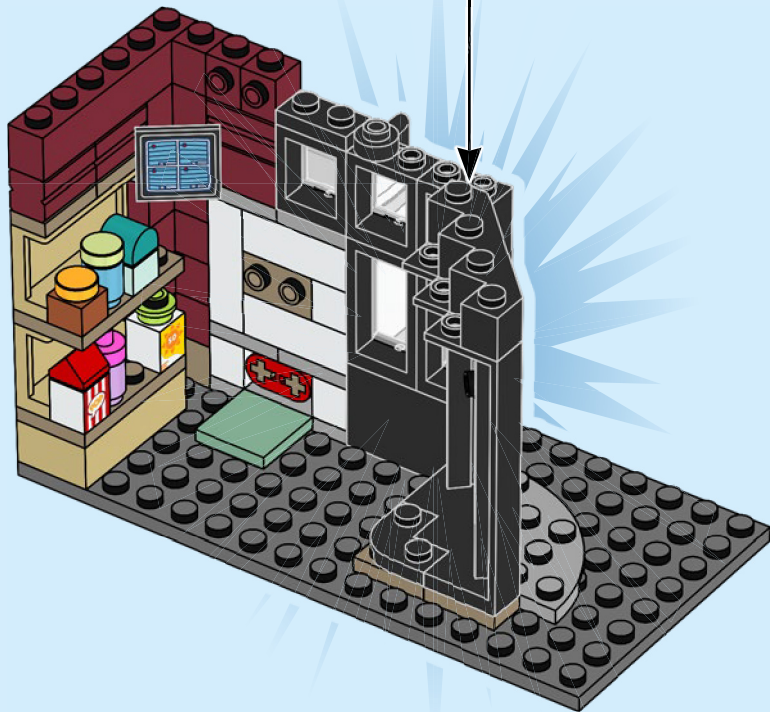

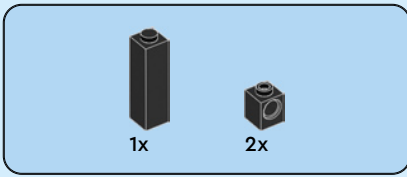

40





1x

41

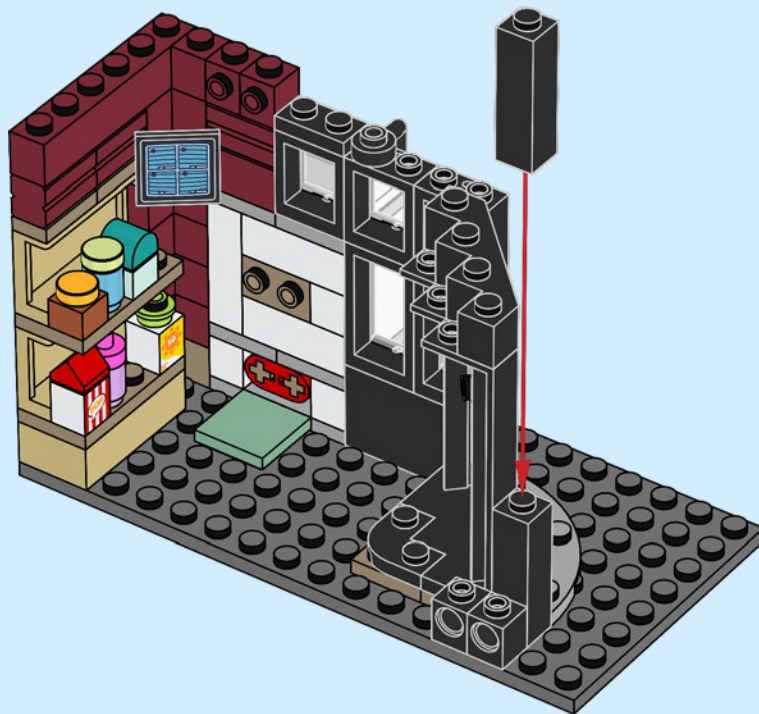

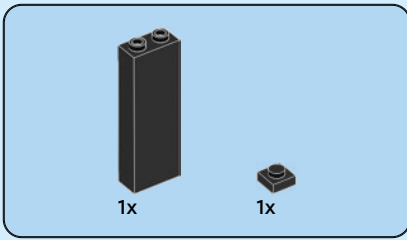

42

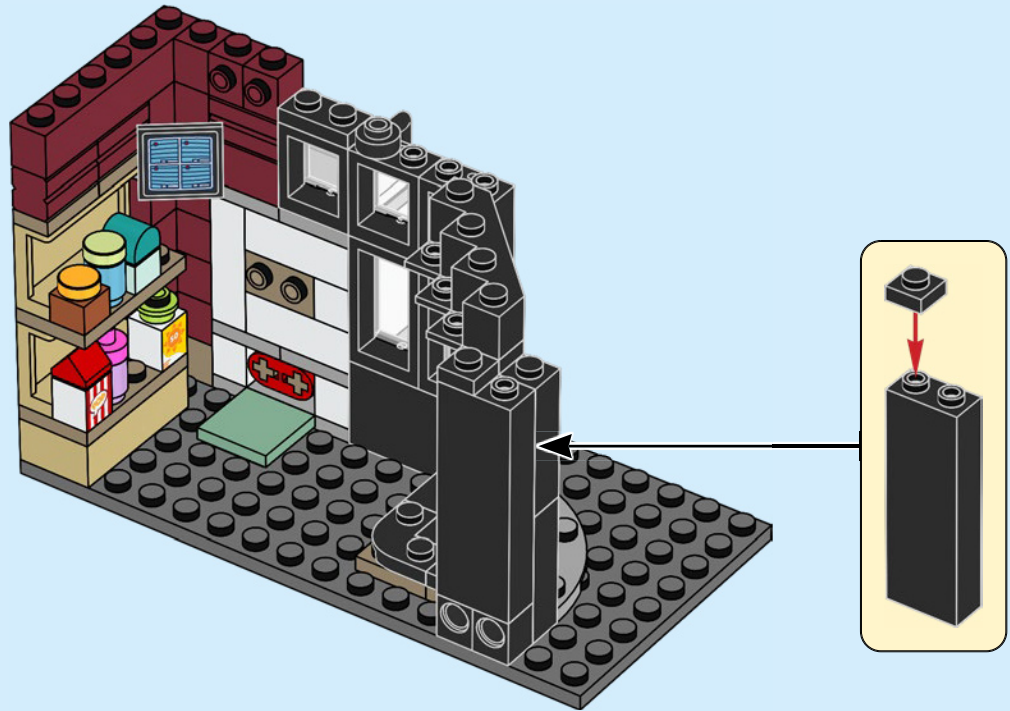

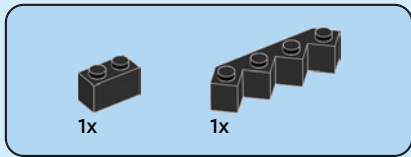

43



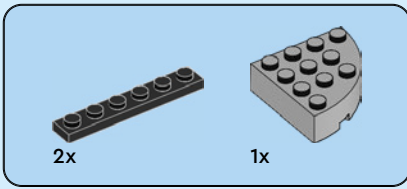

44

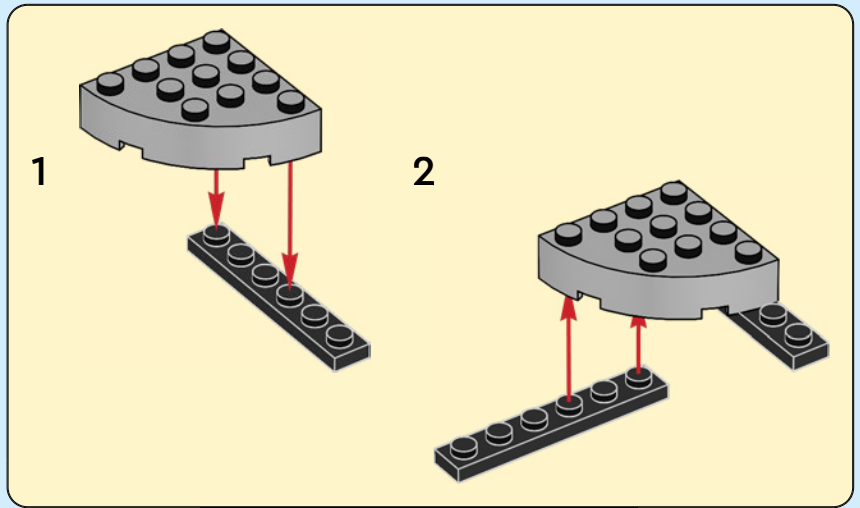

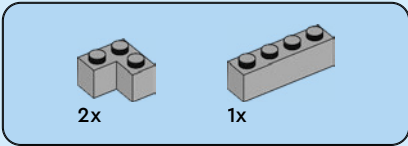

45

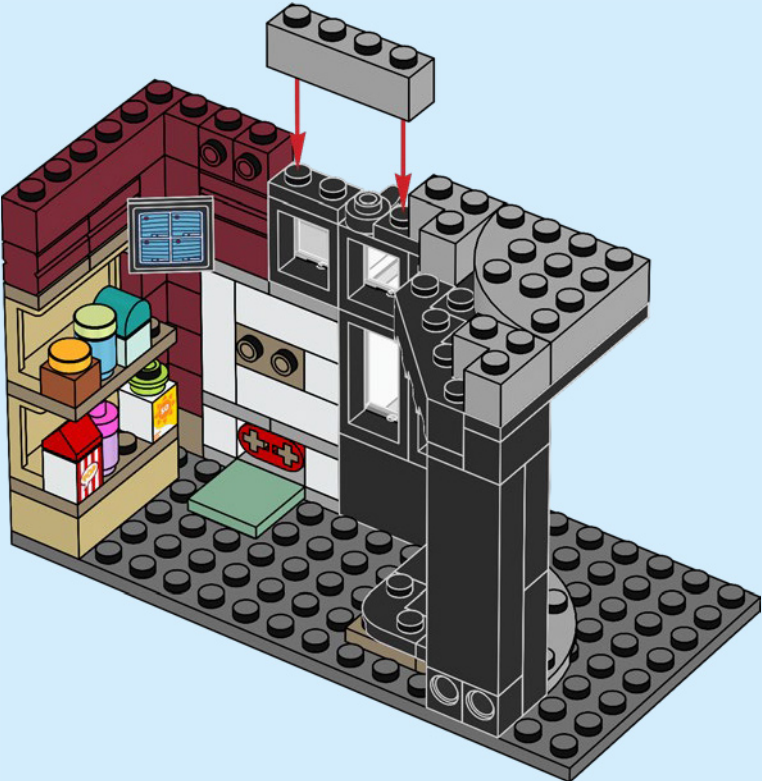

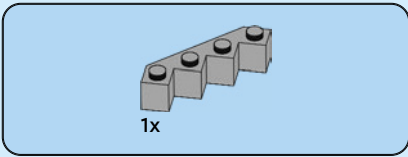

46



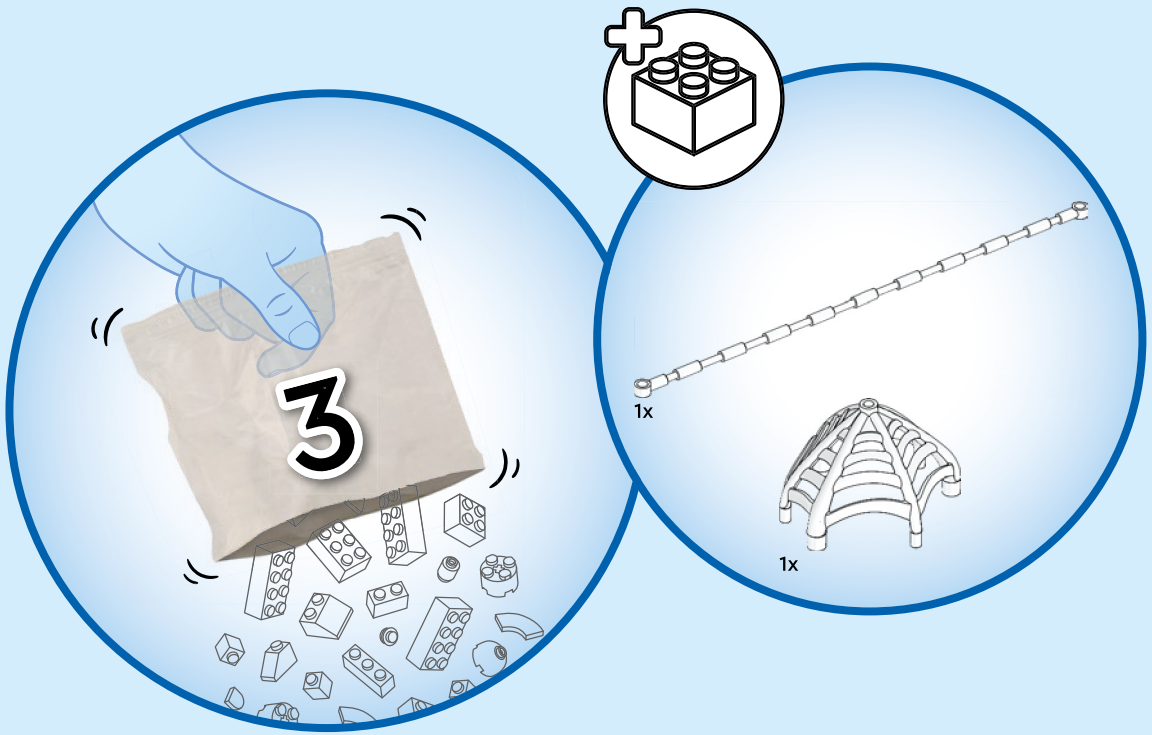

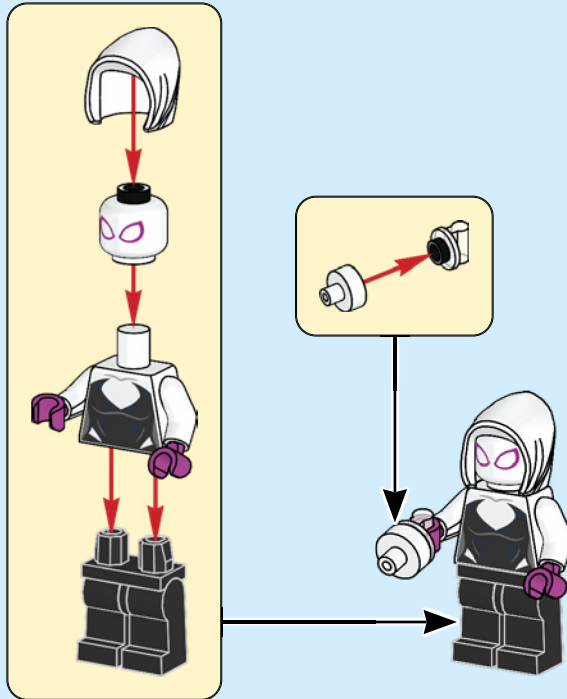
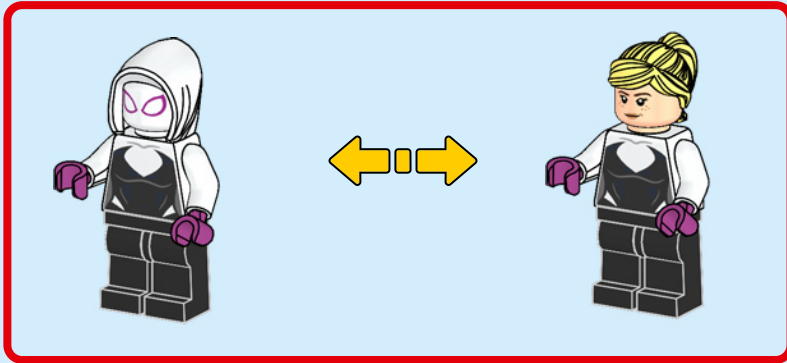

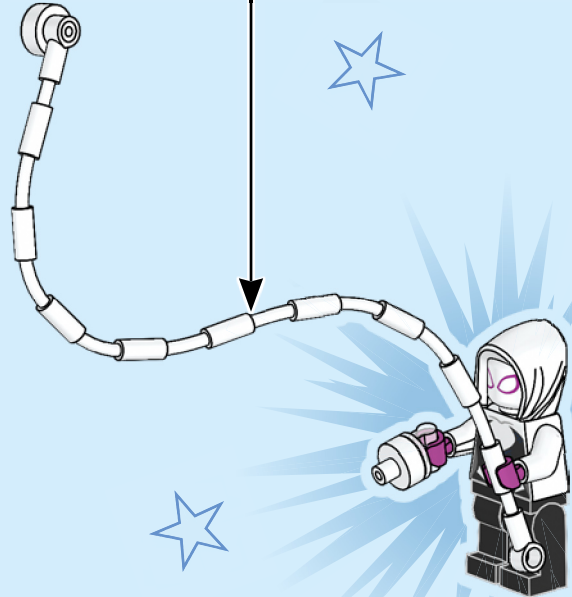
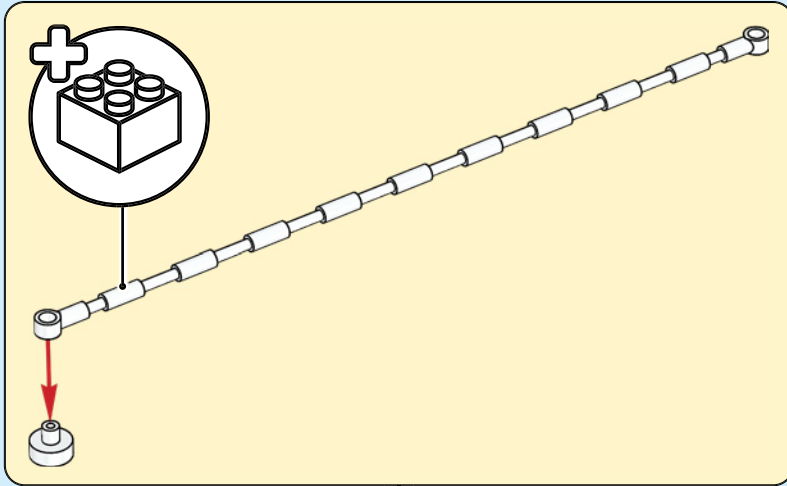

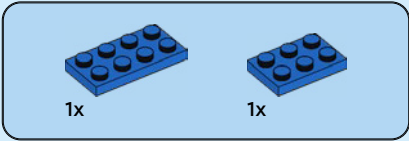

47

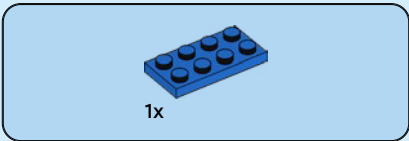
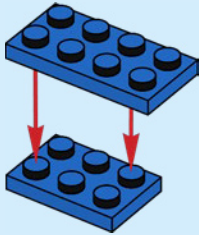

48

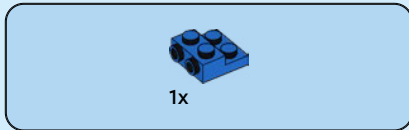
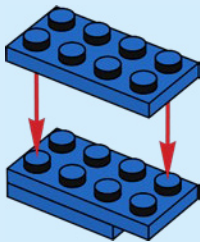

49

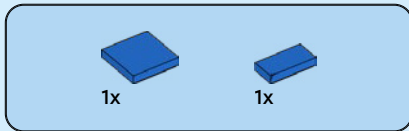
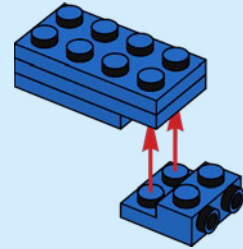

50

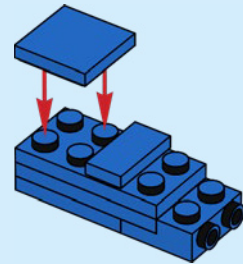



51

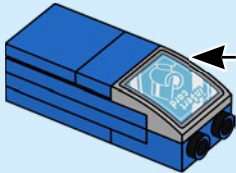
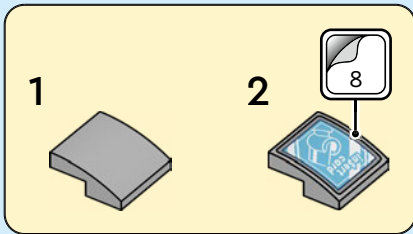

52

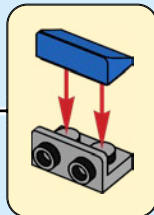
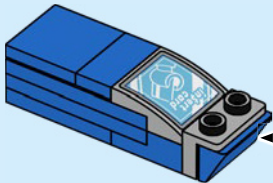

53

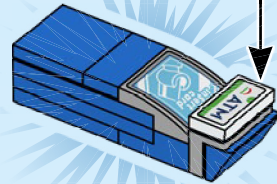
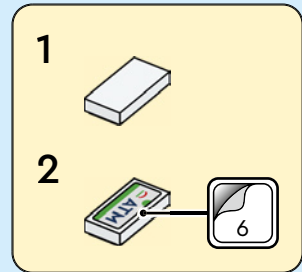

54

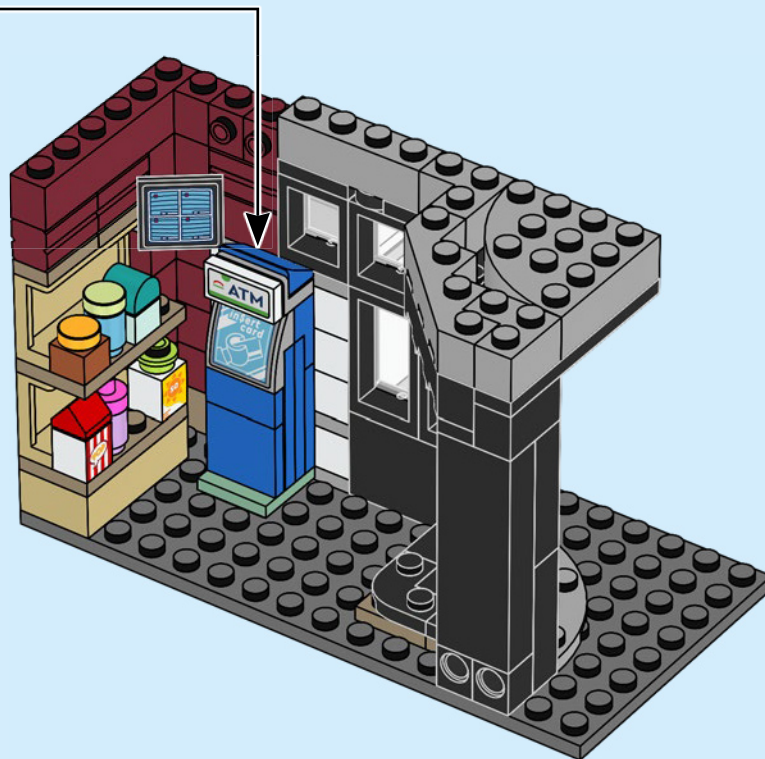

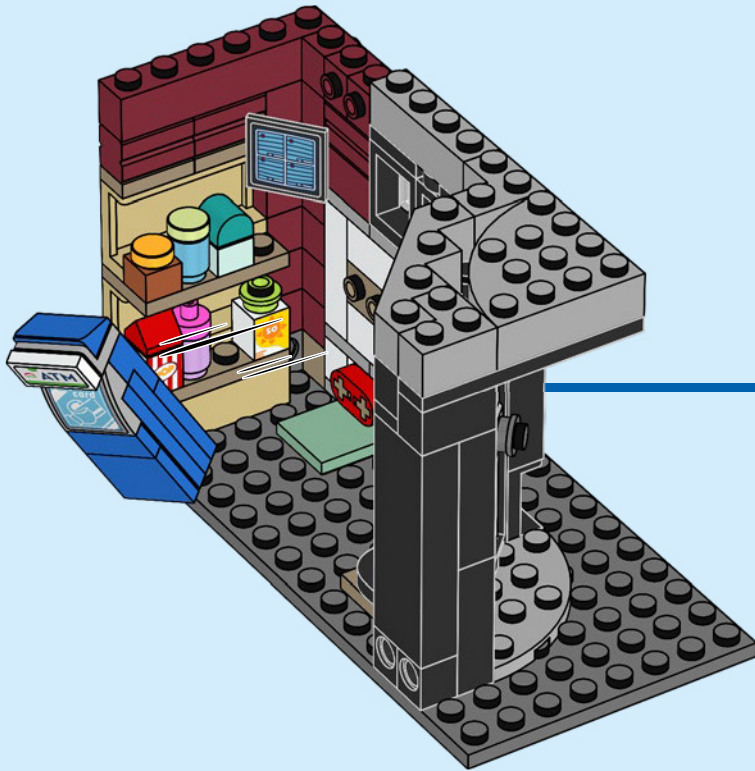

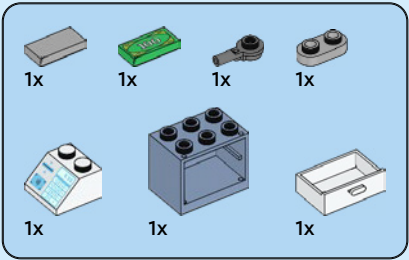

55

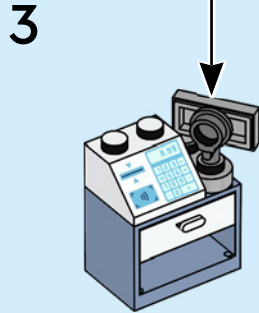
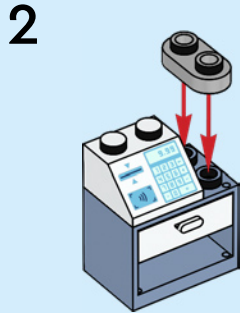
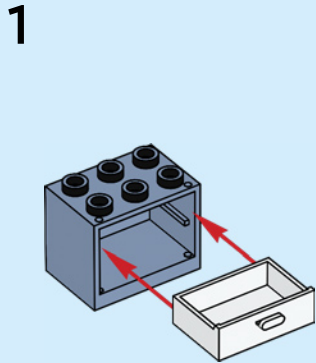
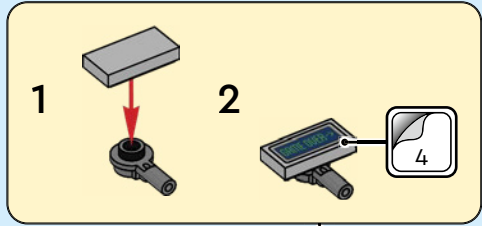

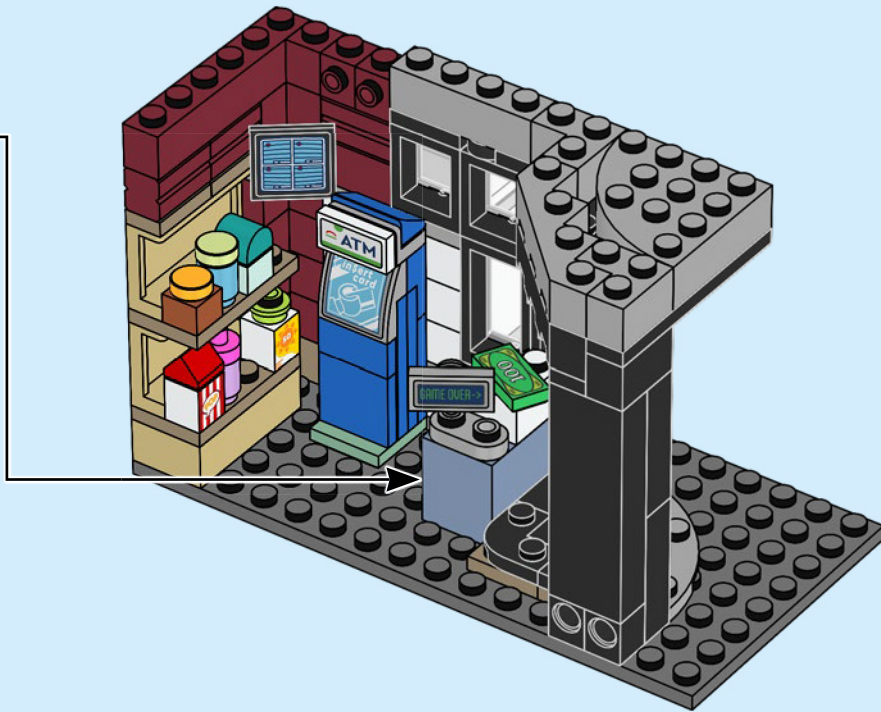

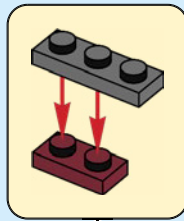
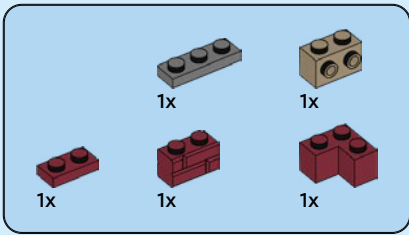

56

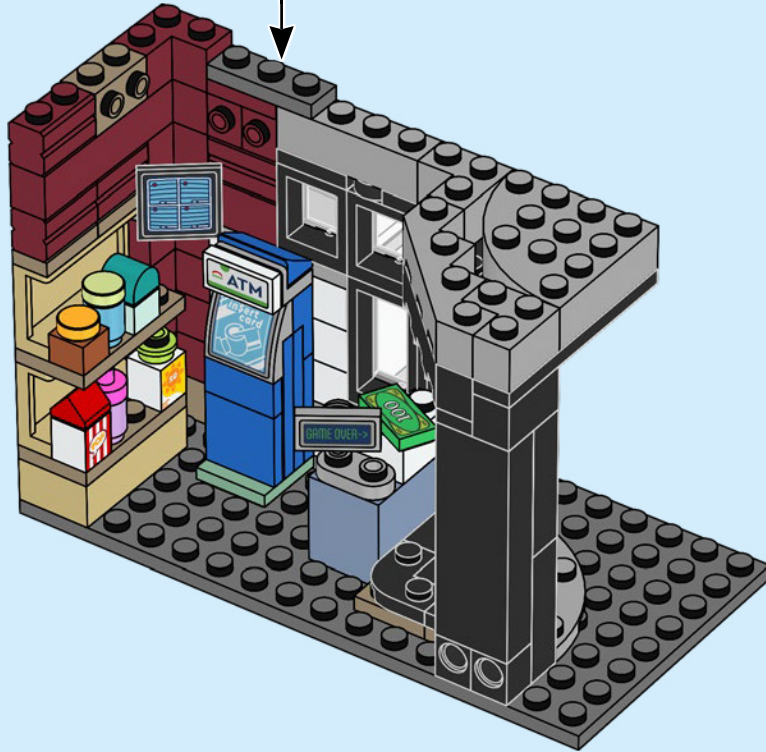

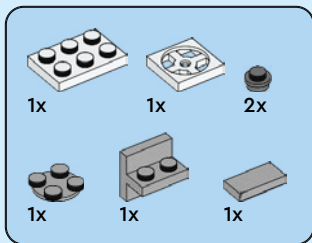

57

1

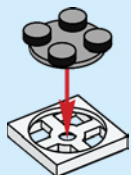

2

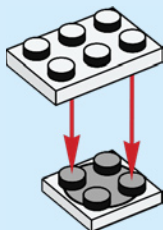

3

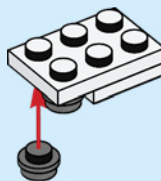

4

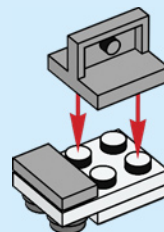

58

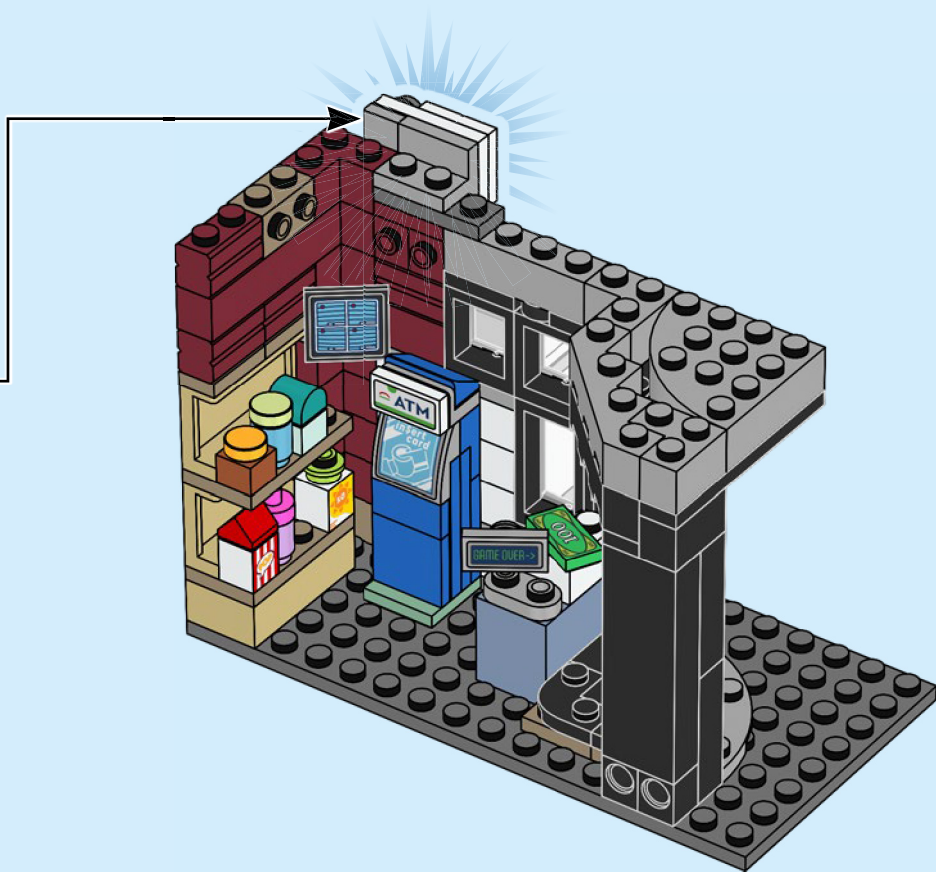

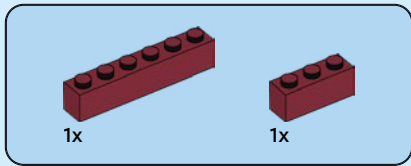

59



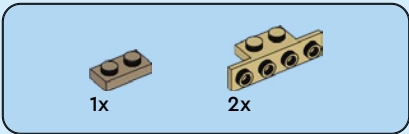

60



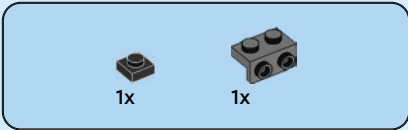

61



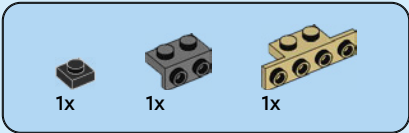

62



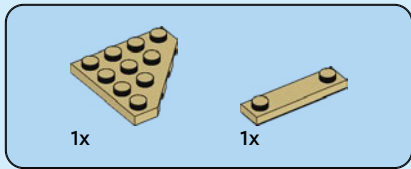

63





3x



3x

64



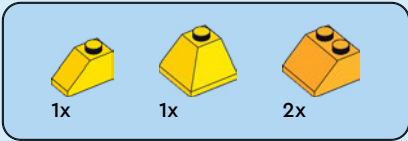

65





1x



2x

66





3x

67



3x



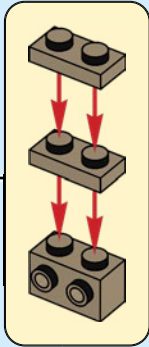
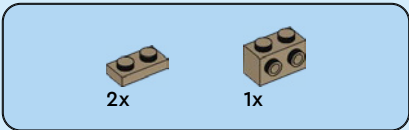

68





1x



1x

69





1x



1x

70



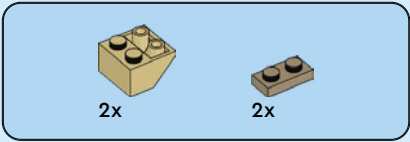

71

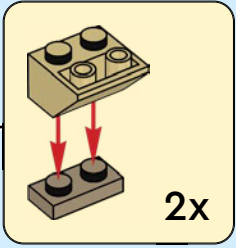



2x



2x

72



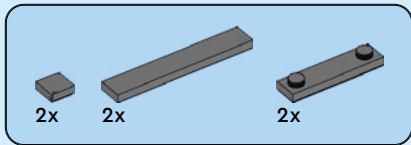

73





2x

74



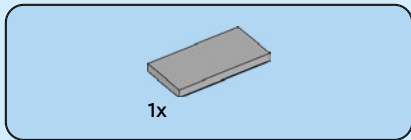

75

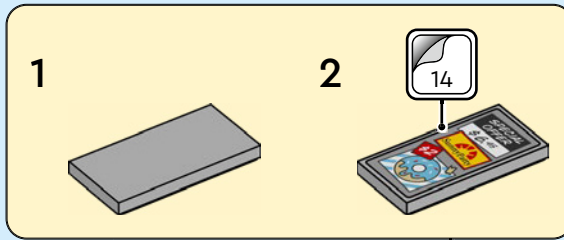

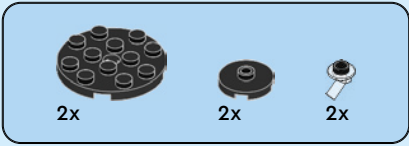

76

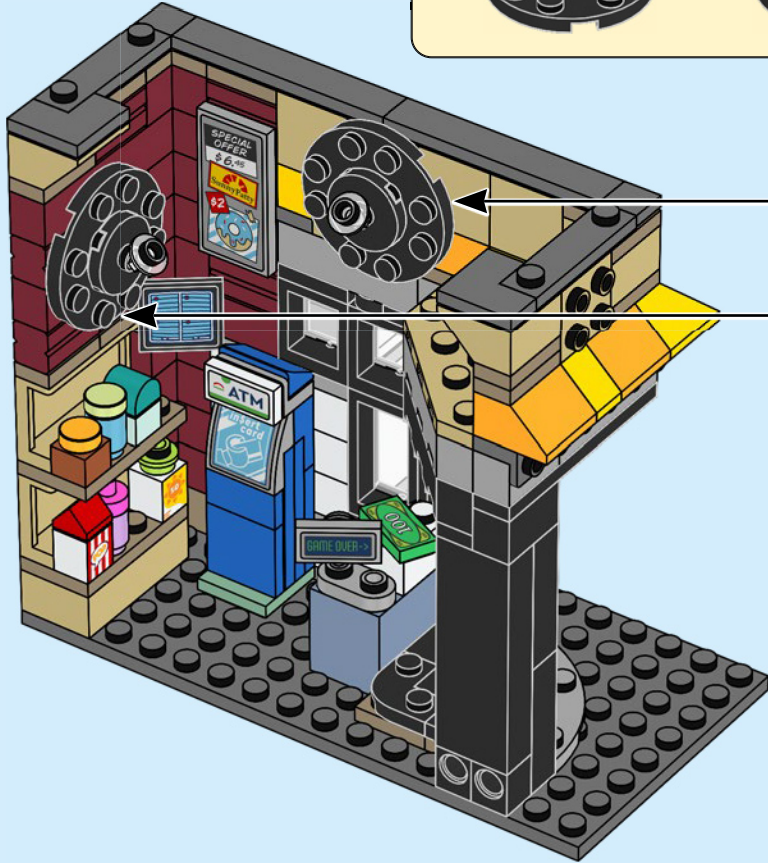
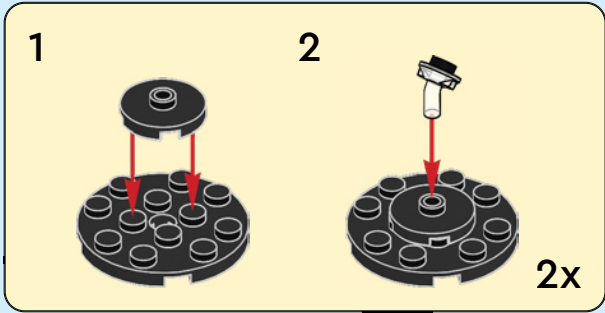



3x



2x

77

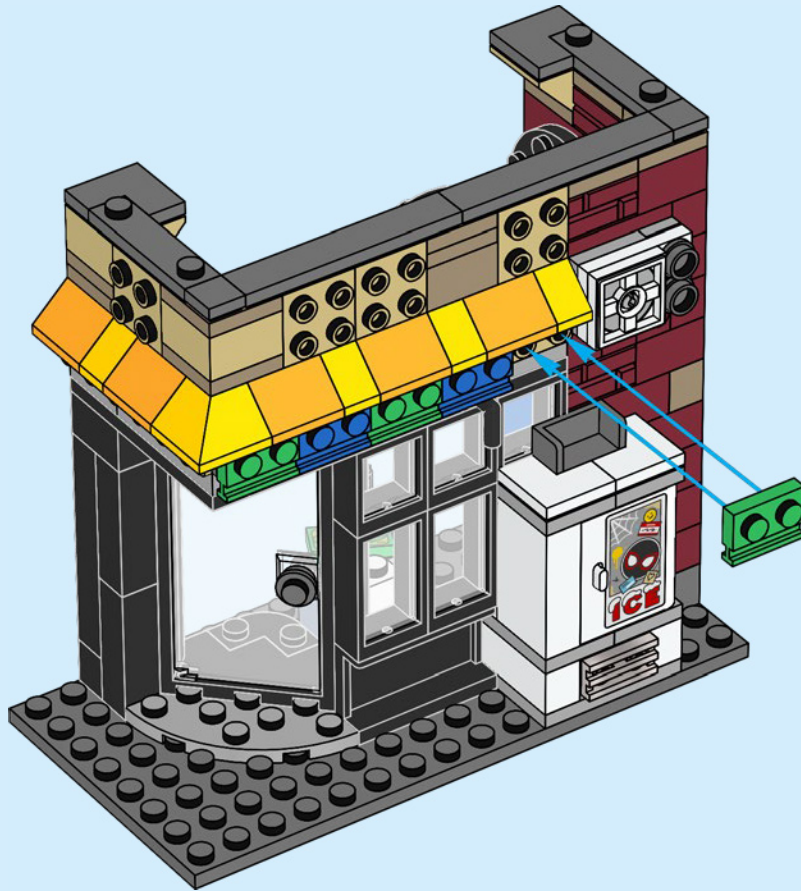



1x



1x

78

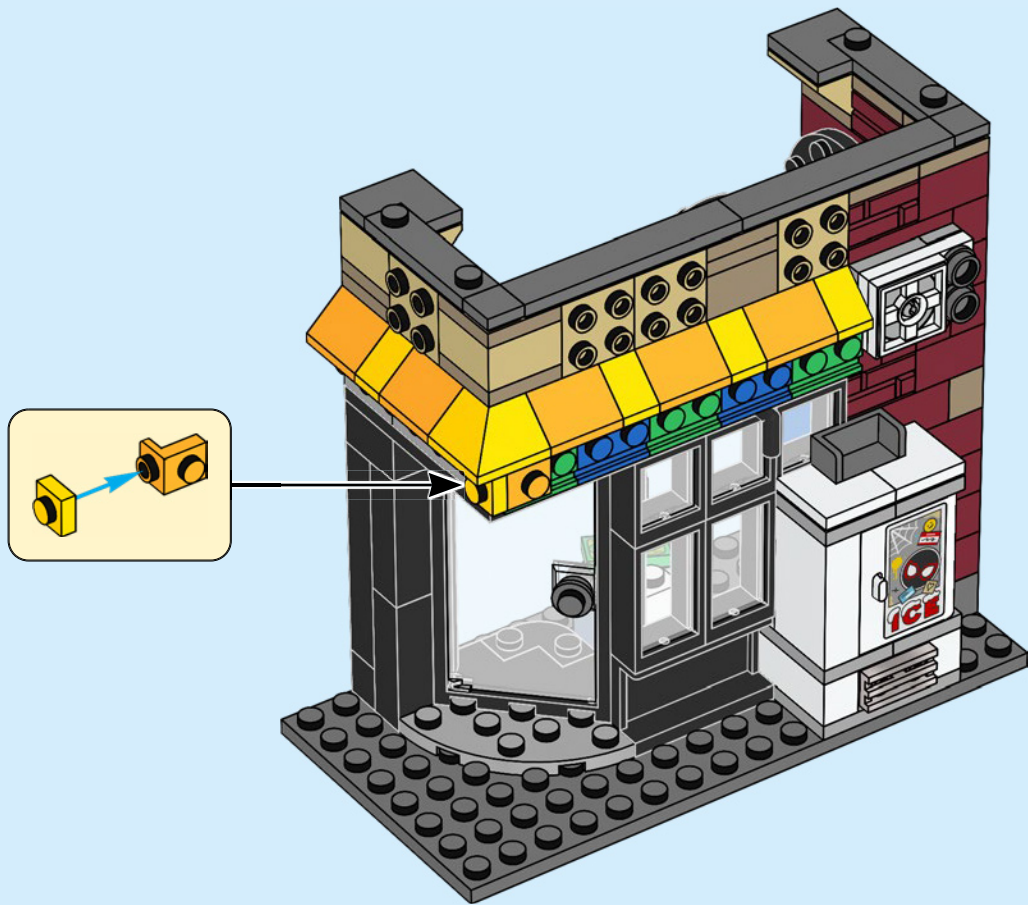

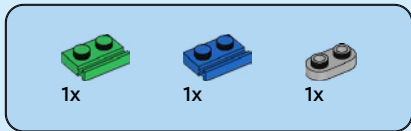

79

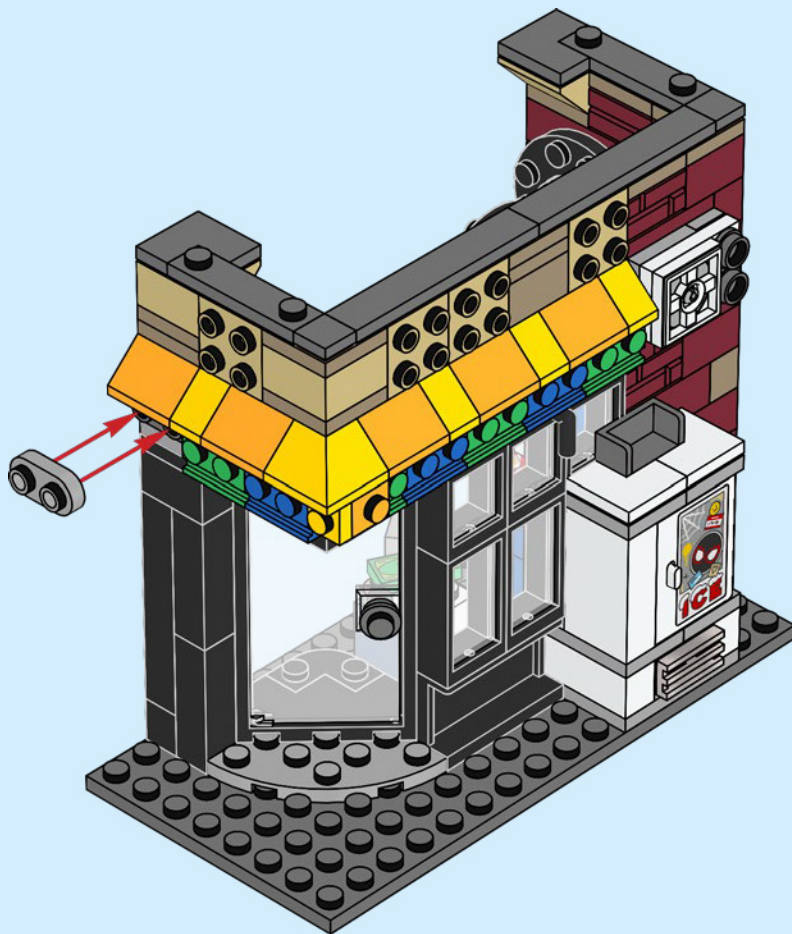

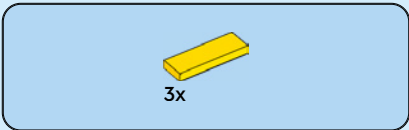

80

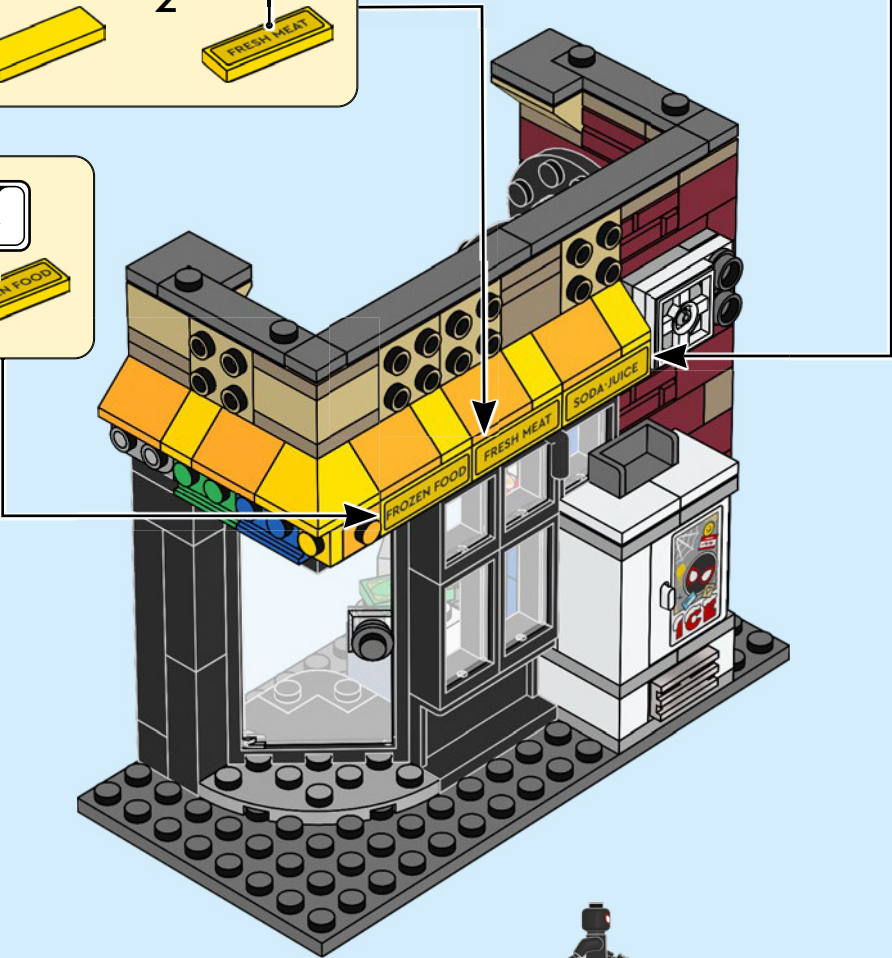
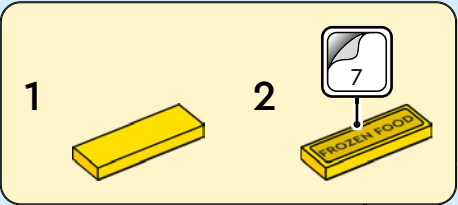
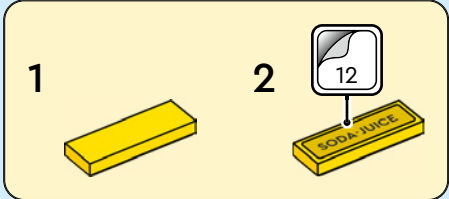
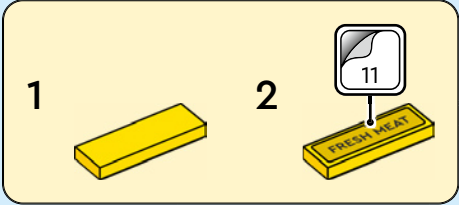

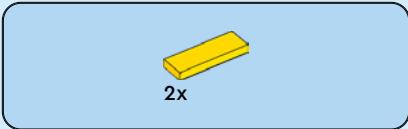

81

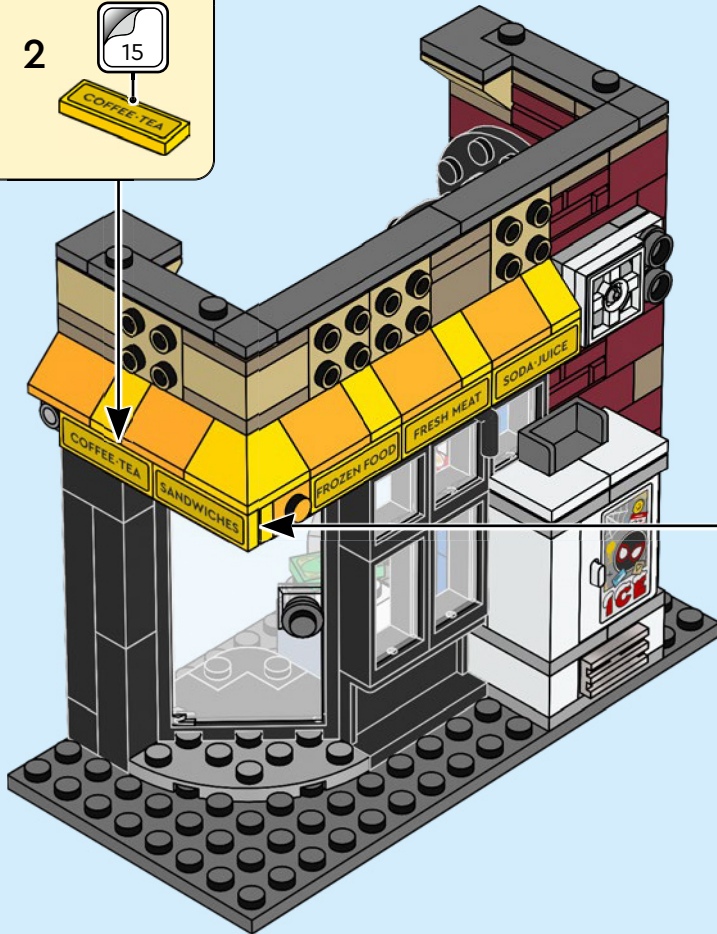
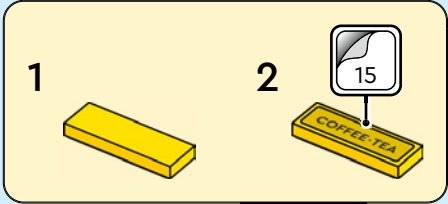
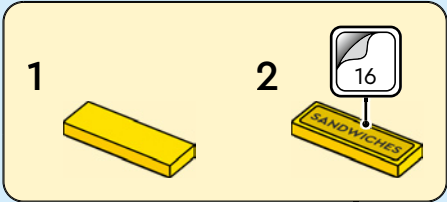



1x

82

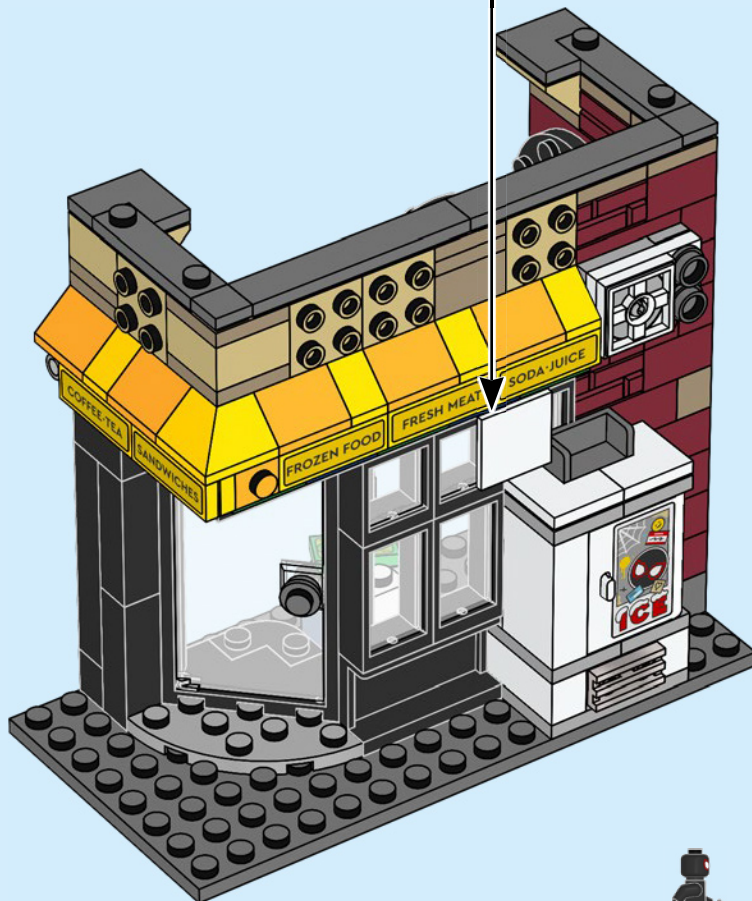
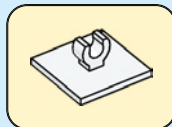

83

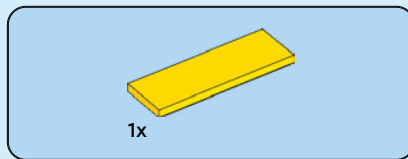
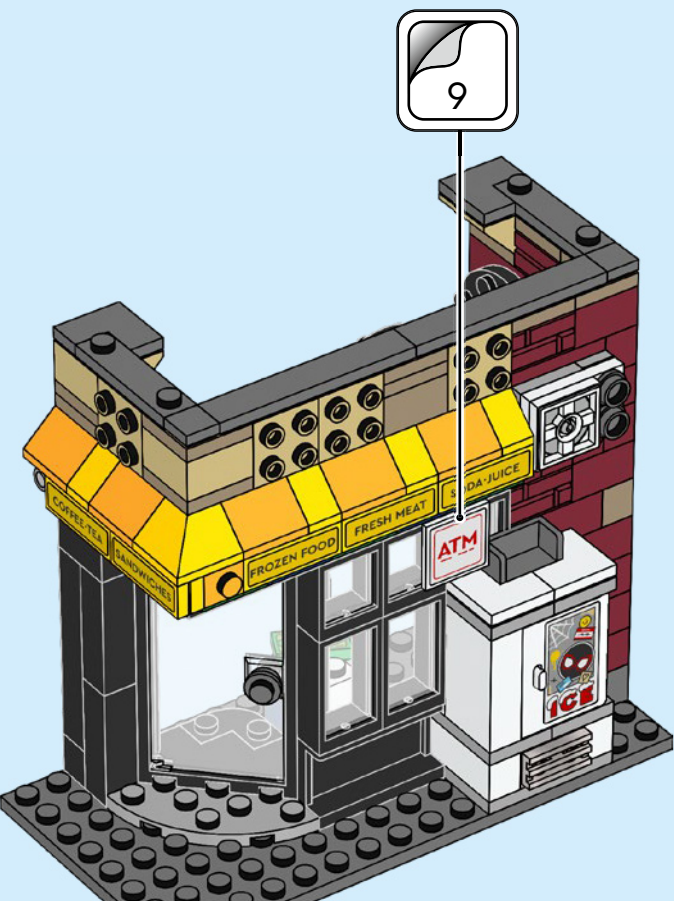

84

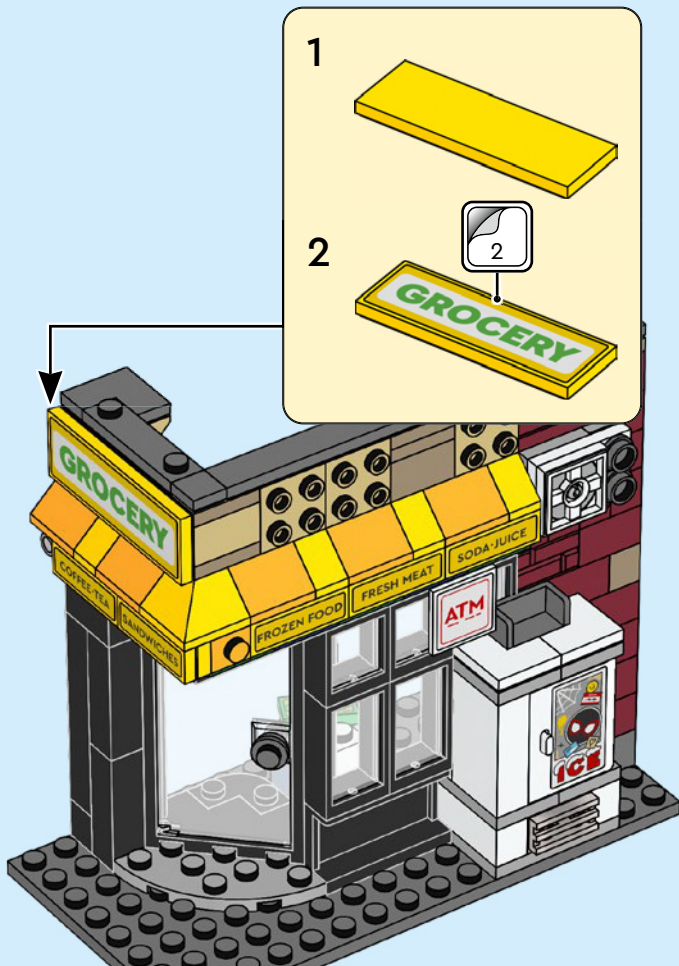

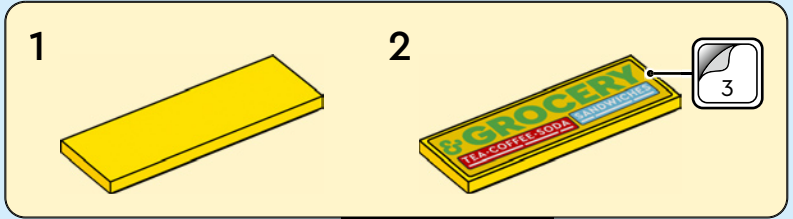
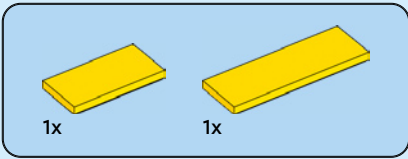

85

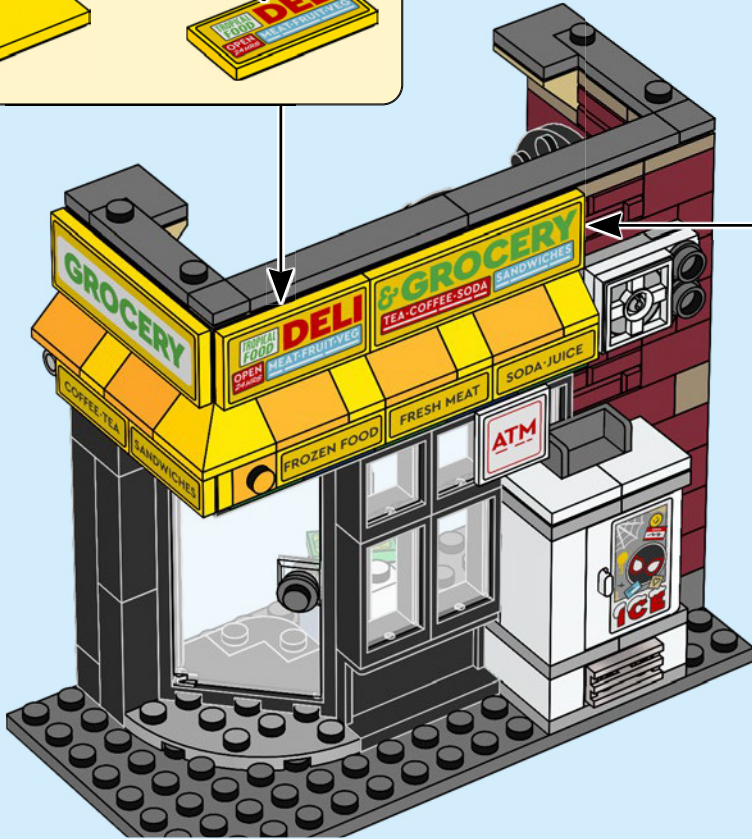
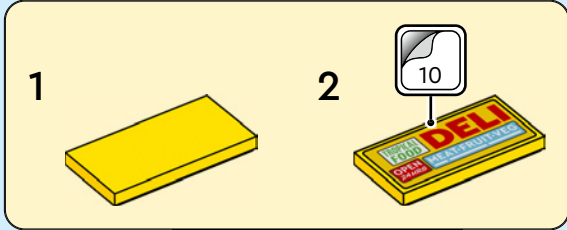

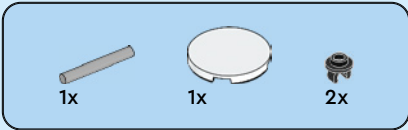

86

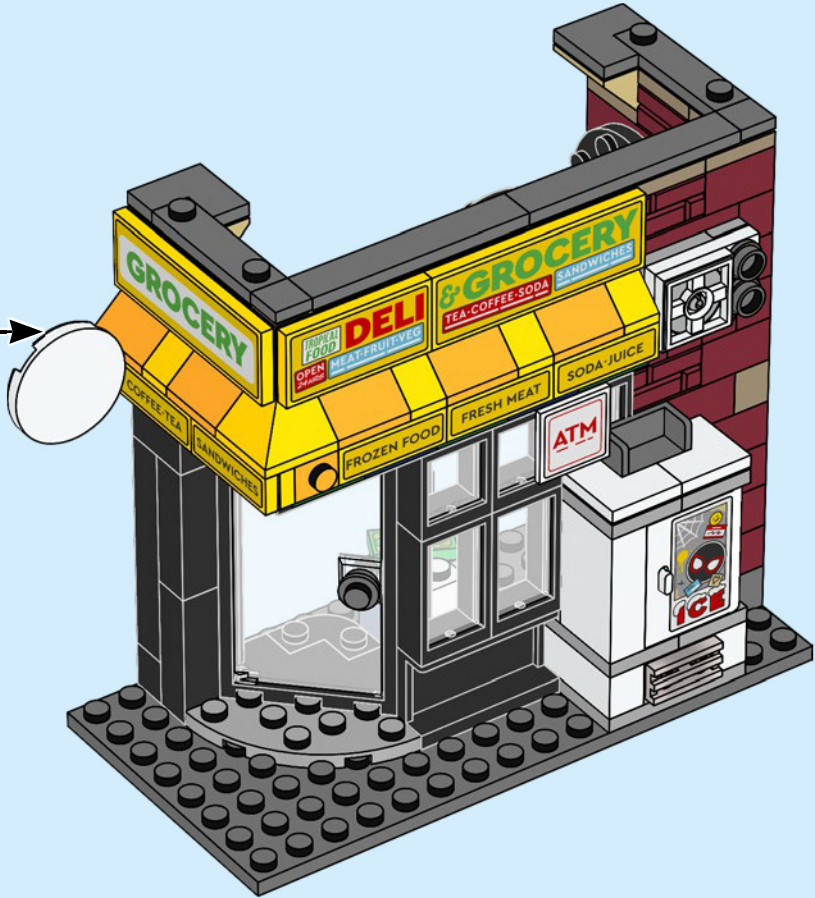
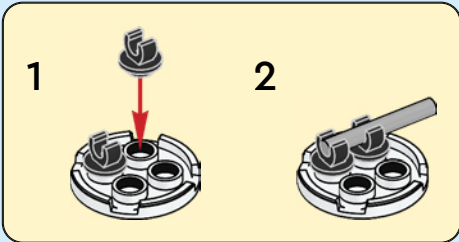



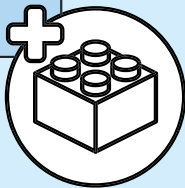
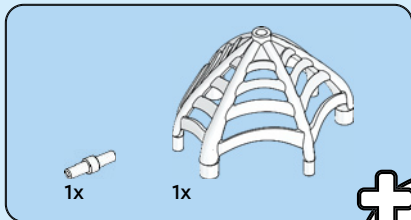

88

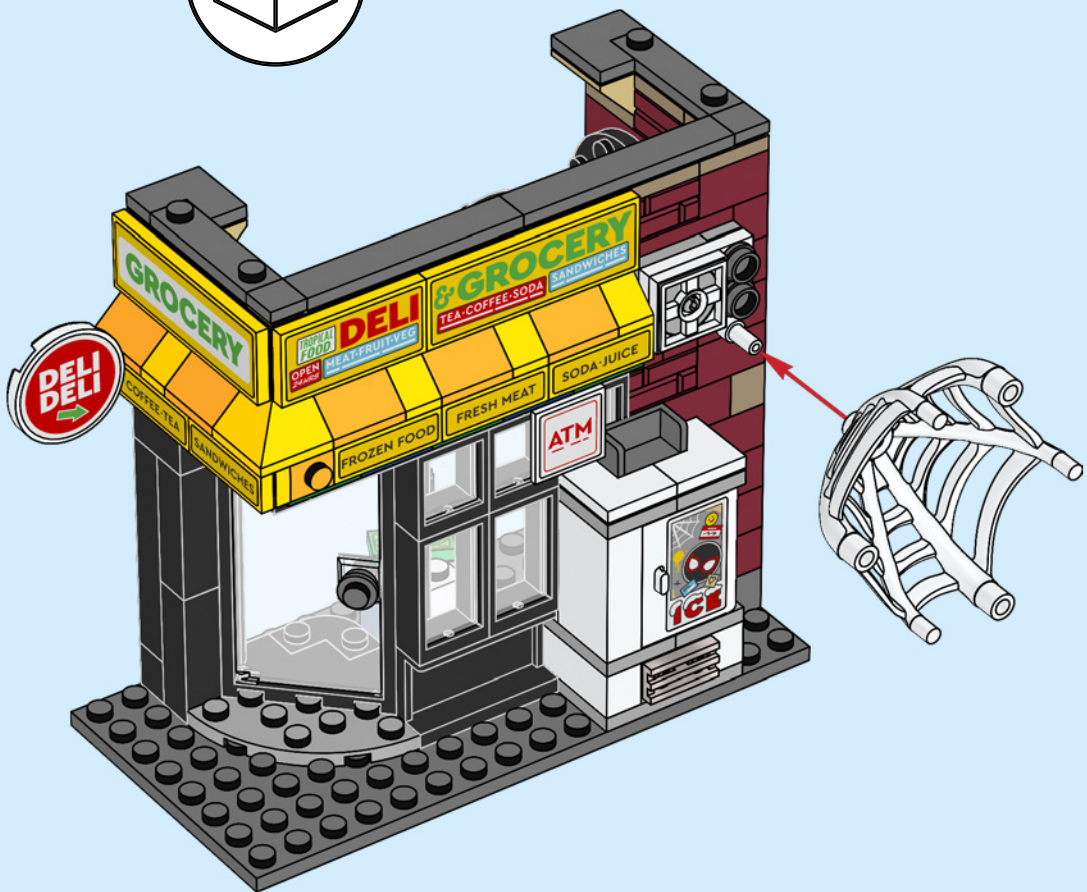

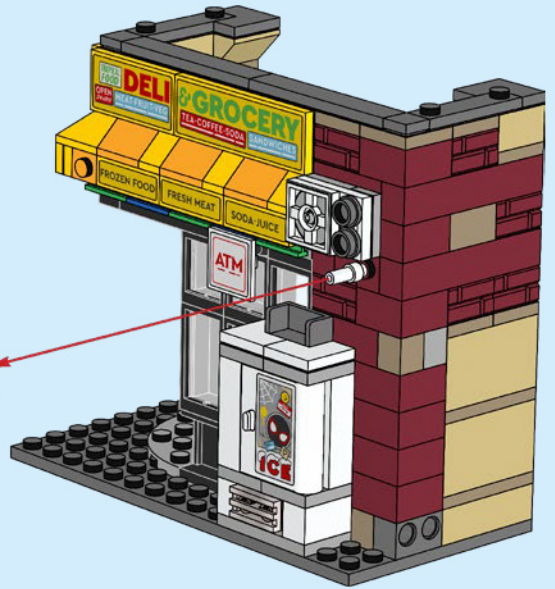
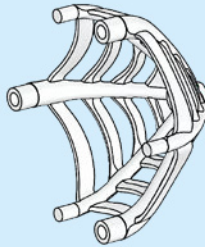
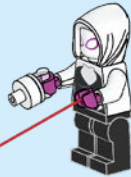
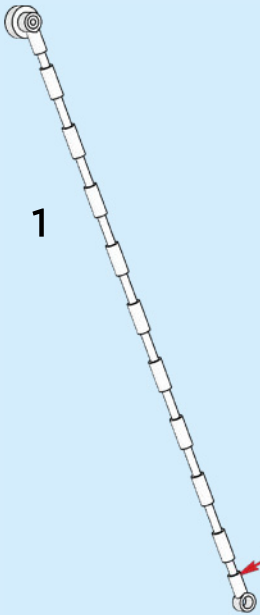

2

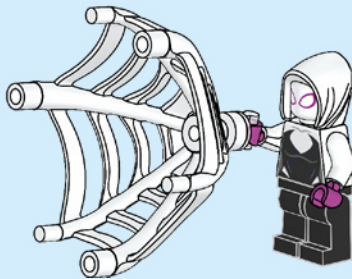
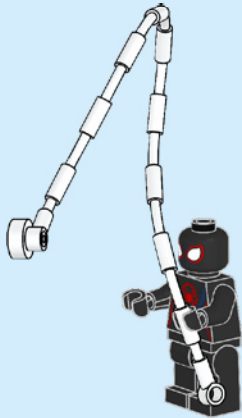





MARVEL

SPIDER-MAN

ACROSS THE SPIDER-VERSE



76308



76311



76309

MARVEL
SPIDER-MAN

3x 6186681	2x 300401	1x 6538162	1x 6538019	1x 6224794	1x 6224666	2x 6195325
1x 6526084	2x 302301	1x 6535676		2x 6371442	5x 4558172	2x 9339
1x 6252946	6x 6034044	1x 4520636		1x 4651236	1x 4560181	2x 6468344
1x 6435173	2x 6070698	1x 302101	1x 6409728	1x 306923	2x 6329869	3x 6382697
1x 6253658	1x 4519345	4x 243101	4x 6214334	3x 6179330	1x 73587	1x 300426
5x 300501	1x 6347287	2x 418866	2x 418866	1x 306823	6x 6534180	1x 302326
4x 6242241	1x 6428803	4x 6293776	1x 4124455	1x 6469450	1x 6526052	1x 6313116
6x 6337079	1x 6329696	2x 300901	3x 6318084	3x 302123	2x 654126	1x 4226995
1x 6323185	2x 6058329	2x 663601	2x 6195544	2x 302023	2x 6065496	4x 6288175
1x 6357680	1x 368001	2x 617901	1x 6257600	1x 302424	5x 302426	2x 6347310
1x 6546711	4x 242001	1x 6519729	2x 6195544	1x 614324	2x 4504382	2x 6347310
1x 6526086	2x 6047220	1x 6519729	1x 6034852	1x 6185994	1x 6508269	1x 245426
2x 6153776	1x 6300017	1x 6519729	1x 6034852	4x 4121965	1x 6323189	1x 245426
4x 306901	4x 362201	1x 4646574	1x 4114319	1x 6185994	1x 6525742	4x 6029208
82				1x 6378402		

- | | | | | | | | | |
|---------------|---------------|----------------|---------------|---------------|---------------|---------------|---------------|---------------|
| 1x
6430580 | 2x
6369923 | 2x
6514220 | 1x
4162916 | 2x
6248890 | 1x
6451128 | 1x
6309059 | 2x
6132422 | 1x
6192171 |
| 1x
6394979 | 2x
366626 | 2x
6514192 | 1x
6133896 | 1x
4540203 | 1x
4560183 | 1x
4211133 | 1x
6092833 | 1x
4619636 |
| 2x
6469445 | 1x
4295260 | 1x
6245277 | 1x
633896 | 2x
4211414 | 1x
4211395 | 1x
4211105 | 1x
6307633 | 1x
6526090 |
| 1x
6535661 | 4x
4272665 | 1x
6514007 | 3x
6212007 | 3x
4211398 | 1x
4211395 | 2x
6257592 | 1x
6307633 | 1x
6481909 |
| 1x
6535692 | 1x
6382577 | 1x
6295358 | 6x
6093908 | 1x
4539097 | 1x
6015344 | 2x
4210651 | 1x
6526091 | 1x
6209673 |
| 1x
6116604 | 2x
6510217 | 1x
6190251 | 1x
4539097 | 7x
4541379 | 2x
6227184 | 2x
4210651 | 1x
6284598 | 1x
6284598 |
| 2x
302126 | 1x
6510188 | 1x
6404592 | 2x
6264025 | 2x
4541379 | 1x
6004990 | 1x
6079461 | | |
| 1x
6115117 | 4x
6245250 | 2x
6001824 | 2x
4541528 | 1x
6264025 | 1x
6258820 | 1x
4579294 | | |
| 2x
4515350 | 3x
6514136 | 12x
4528604 | 5x
6514005 | 1x
6093527 | 1x
4620909 | 1x
4654613 | | |
| 1x
6177156 | 2x
6252258 | 3x
6310835 | 1x
6322822 | 4x
4211349 | 3x
4210633 | 2x
6184484 | | |
| 2x
6039347 | 2x
6514001 | 4x
4550168 | 1x
6359040 | 1x
6102357 | 2x
4210848 | 2x
6097861 | | |
| | 1x
6514119 | 2x
6031821 | 5x
6020181 | 2x
4211353 | 1x
6388118 | 2x
6361988 | | |
| | 2x
6514189 | 2x
4267874 | 8x
4211399 | 4x
4211396 | 2x
4210762 | 2x
6361985 | | |
| | | 1x
6055306 | 1x
6170569 | 1x
4211394 | 1x
6275131 | | | |
| | | | | | 2x
6214341 | | | |
| | | | | | 2x
6247784 | | | |

 [LEGO.com/service](https://www.LEGO.com/service)

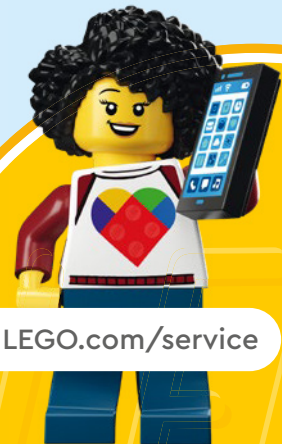

YOU COULD **WIN**



Scan this QR code or go to **LEGO.COM/PRODUCTFEEDBACK** and give us your short feedback about this LEGO® set for a chance to win a cool LEGO prize.

Terms and Conditions apply*



EN: YOU COULD WIN. Terms and Conditions apply* **DE: Du könntest GEWINNEN.** Es gelten die Teilnahmebedingungen* **FR: Tu pourrais GAGNER.** Des conditions s'appliquent* **IT: Potresti VINCERE tu.** Termini e condizioni sono applicabili* **ES: Puedes GANAR.** Aplican términos y condiciones* **PT: Poderá GANHAR.** Aplicam-se termos e condições* **ZH: 轻松获奖. 条款和条件适用*** **PL: Szansa na WYGRANĄ.** Obowiązują warunki korzystania* **CS: Máte šanci VYHRÁT.** Platí všeobecné smluvní podmínky* **SK: Máte šancu VYHRAŤ.** Platia všeobecné zmluvné podmienky* **HU: TE IS NYERHETSZ.** Felhasználási feltételek érvényesek* **RO: Ai putea CÂȘTIGA.** Se aplică termeni și condiții* **BG: Можете да СПЕЧЕЛИТЕ.** Има определени правила и условия* **LV: Tu vari LAIMĒT.** Ir spēkā noteikumi un nosacījumi.* **ET: Sul on võimalus VÕITA.** Kehtivad tingimused* **LT: Jūs galite LAIMĖTI.** Taikomos sąlygos*

*[LEGO.com/productfeedback-terms](https://www.lego.com/productfeedback-terms)