



MARVEL

76310



LEGO® Builder



LEGO.com/sustainable-packaging



 ^{FR} **DONNEZ**
OU
RECYCLEZ

 OU  OU 

ASSOCIATION MAGASIN DÉCHÈTERIE

Adresses sur quefairedemesdechets.fr

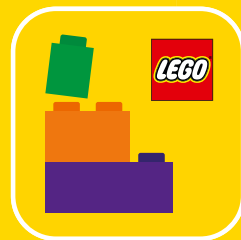

Q LEGO® Builder

BUILDER



Apple and the Apple logo are trademarks of Apple Inc., registered in the U.S. and other countries and regions. App Store is a service mark of Apple Inc. Google Play and the Google Play logo are trademarks of Google LLC. Tencent and the Tencent logo are trademarks of Tencent Inc.

Q [LEGO.com/devicecheck](https://www.lego.com/devicecheck)

EN Ask parents' permission before going online | DE Eltern um Erlaubnis bitten, bevor du online gehst | FR Demande l'autorisation d'un parent avant d'aller en ligne | IT Chiedi il permesso ai tuoi genitori prima di andare online | ES Pídeles permiso a tus papás antes de conectarte a Internet | PT Pede autorização aos pais antes de acederes online | ZH 上网前应先征得父母的同意 | PL Poproś rodziców o zgodę, zanim wejdiesz do Internetu | CS Než půjdeš na internet, požádej rodiče o svolení | SK Skôr než pôjdeš na internet, vypýtaj si povolenie od rodičov | HU Kérj szülői engedélyt, mielőtt online csatlakoznál! | RO Cere permisiunea părinților înainte de a te conecta online | BG Поискайте разрешение от родител, преди да влезете онлайн | LV Pirms došanās tiešsaistē palūdz atļauju vecākiem | ET Enne Interneti kasutamist küsi vanematelt luba | LT Prieš prisijungdami prie interneto, atsiklauskite tėvų

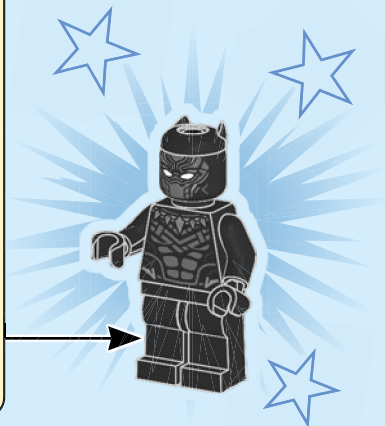
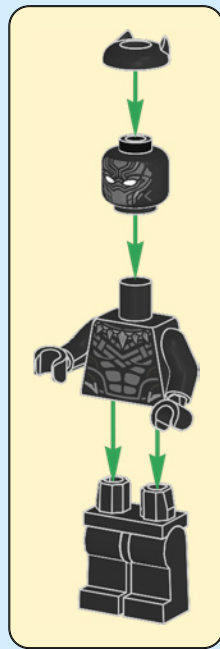

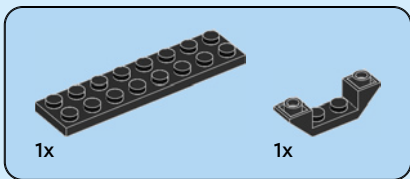
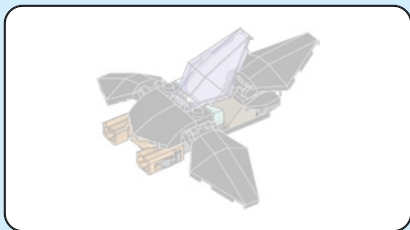

1

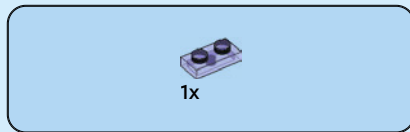
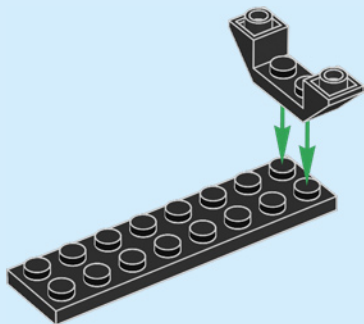

2

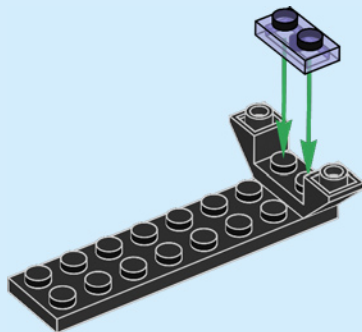

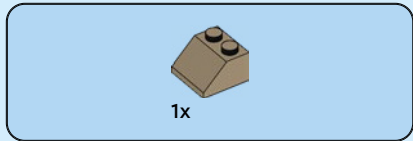

3

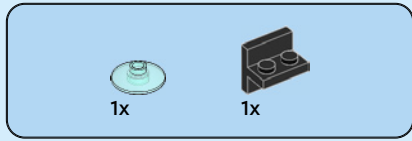
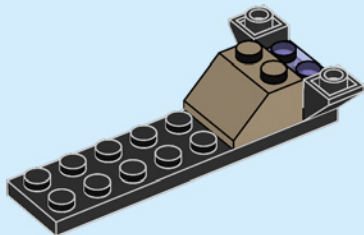

4

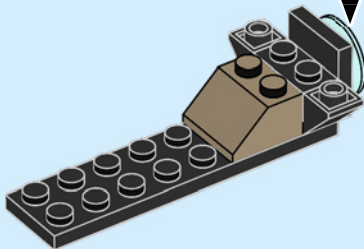
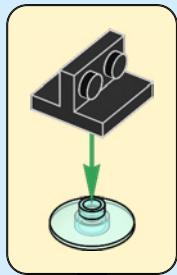



1x



1x



2x

5

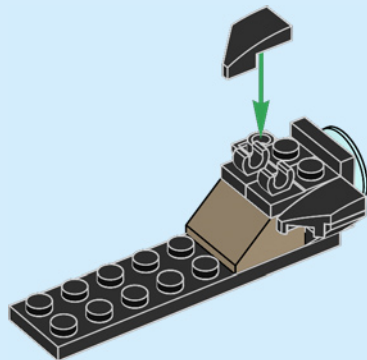

2x



2x

6

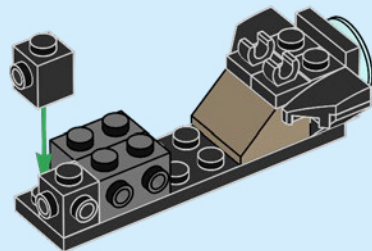

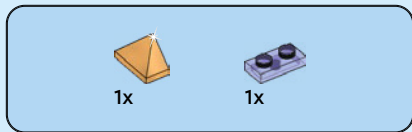

7

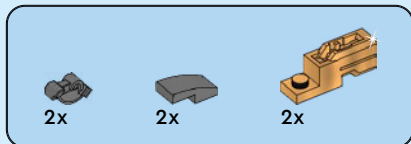
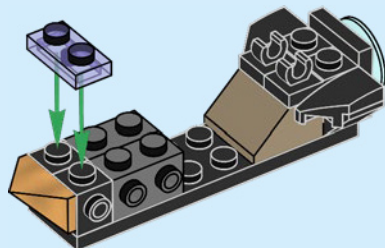

8

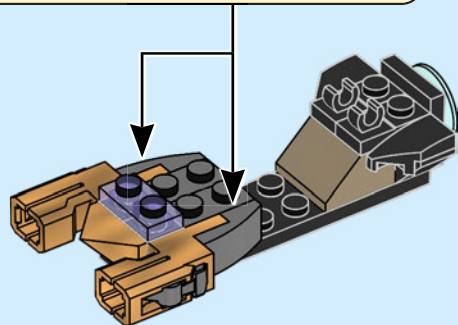
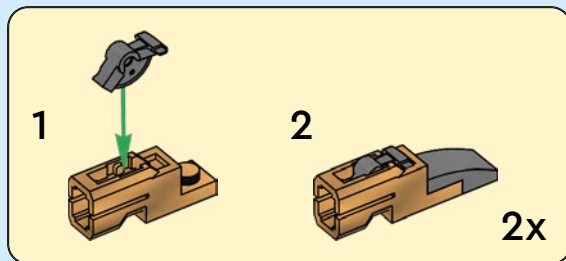

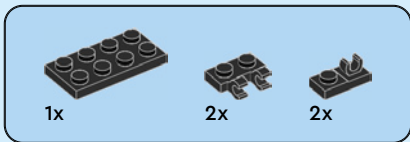

9

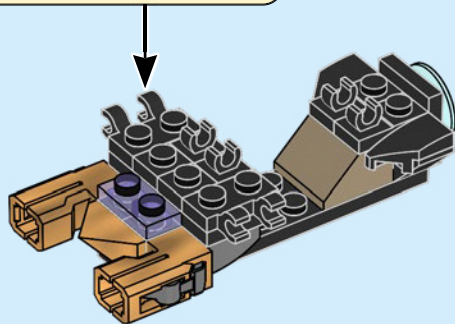
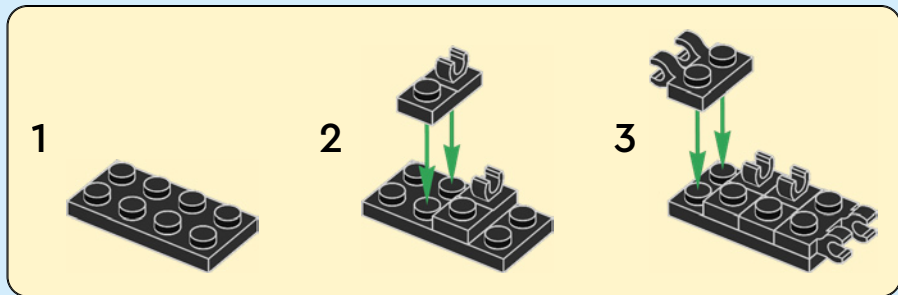

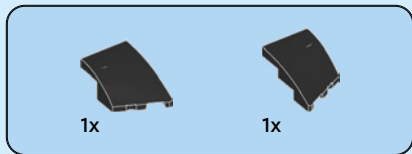

10

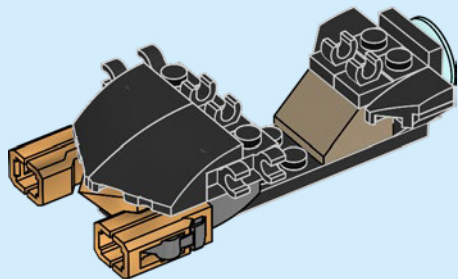

11

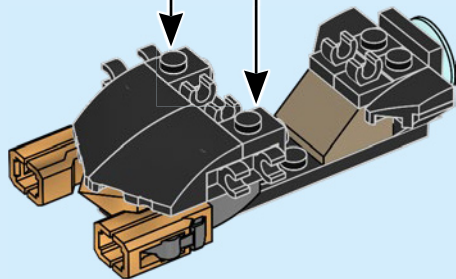



2x

12

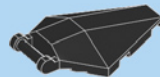
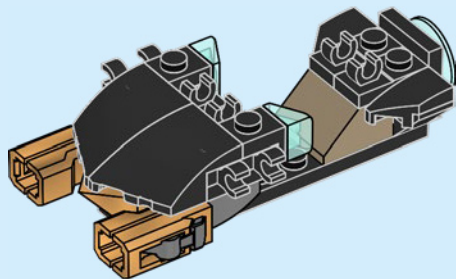

3x

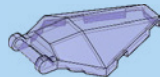

1x

13

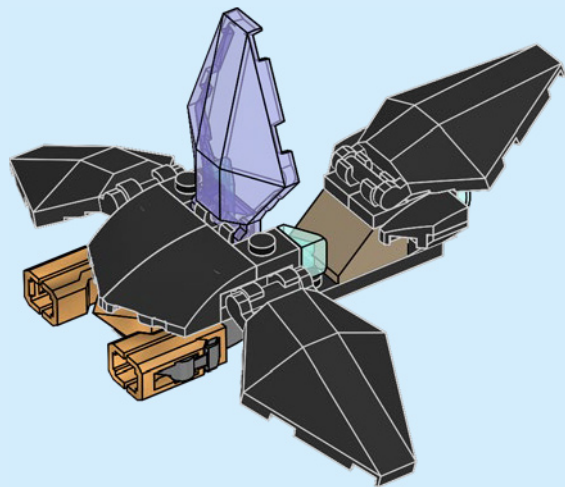

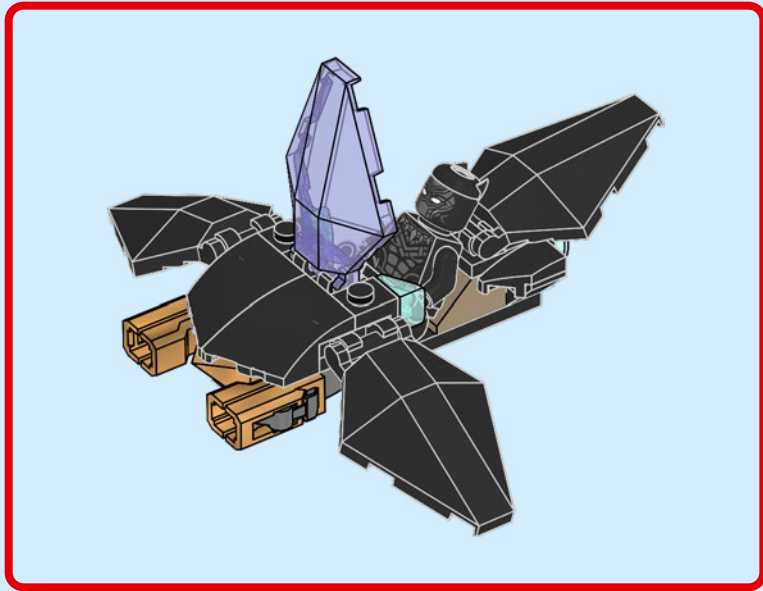



4x



14

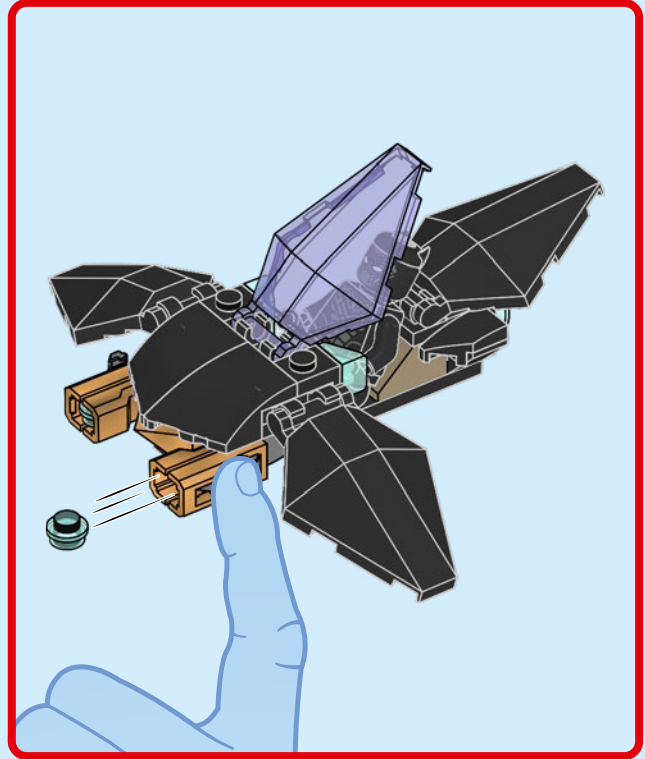
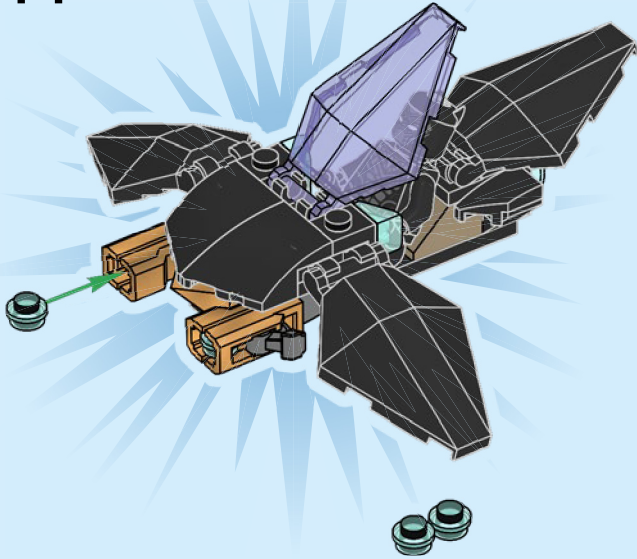

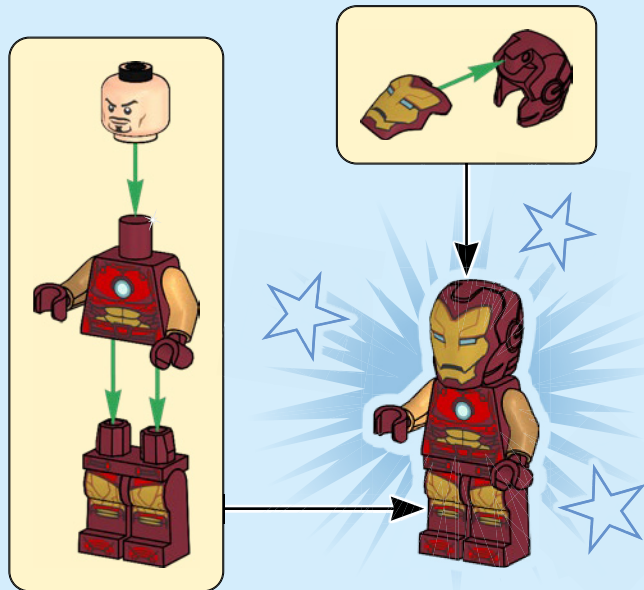

1



2

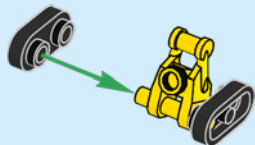

3

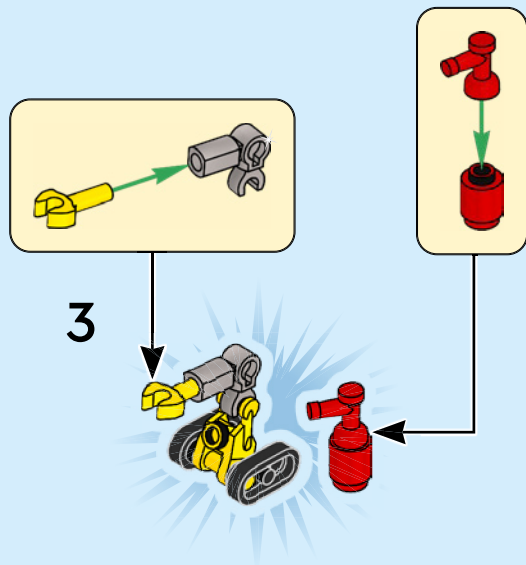

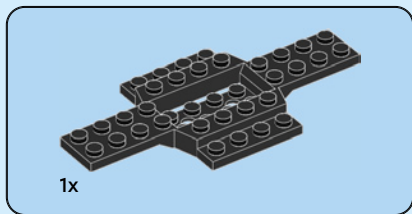
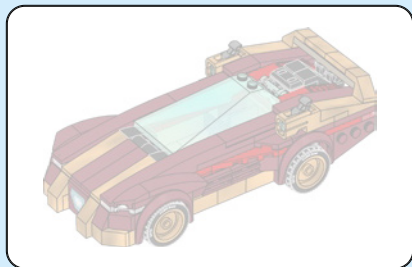

1

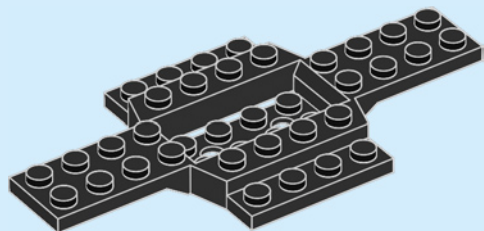



1x



1x

2

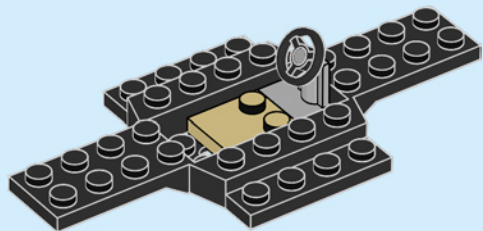

1x

3

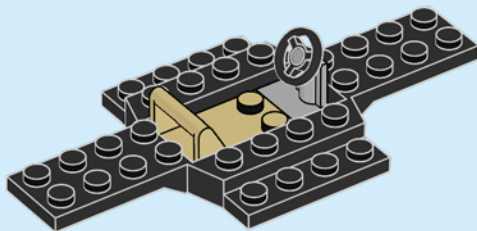

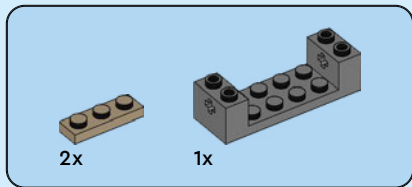

4

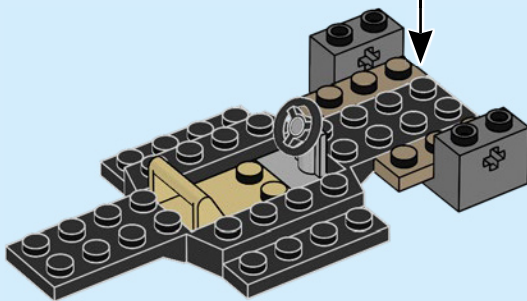
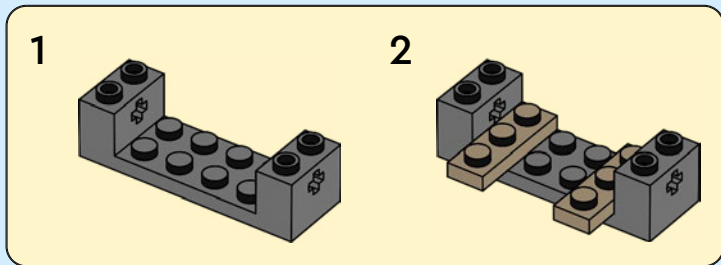

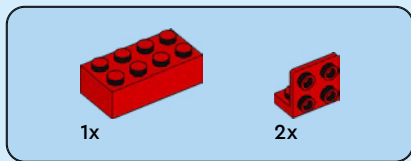

5

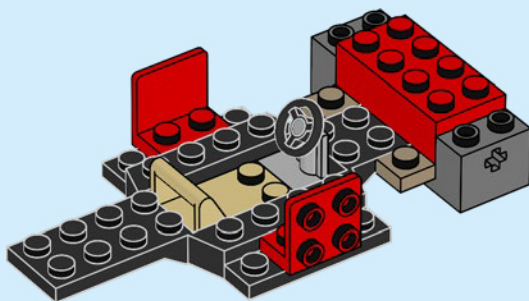

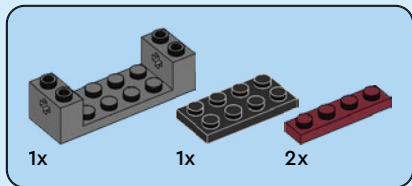

6

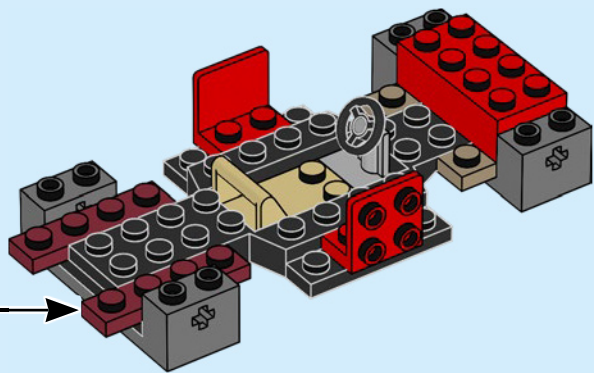
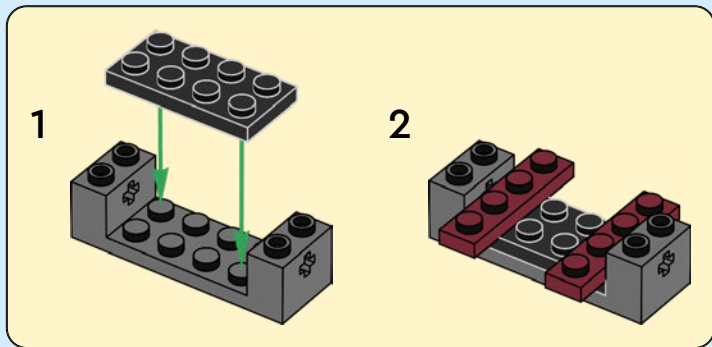

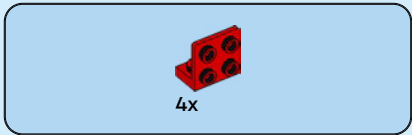

7

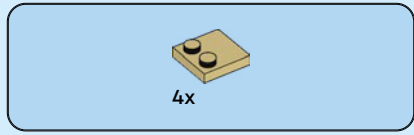
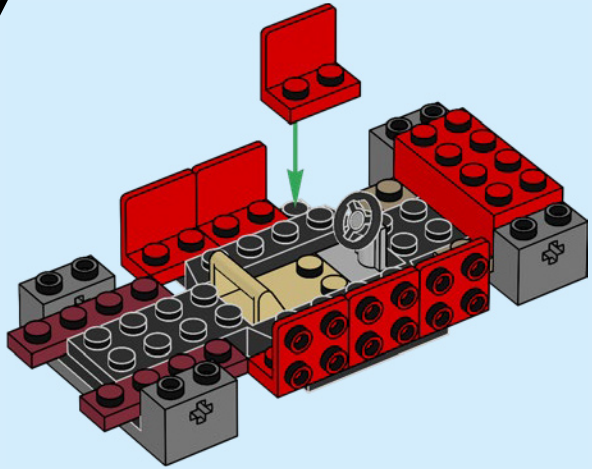

8

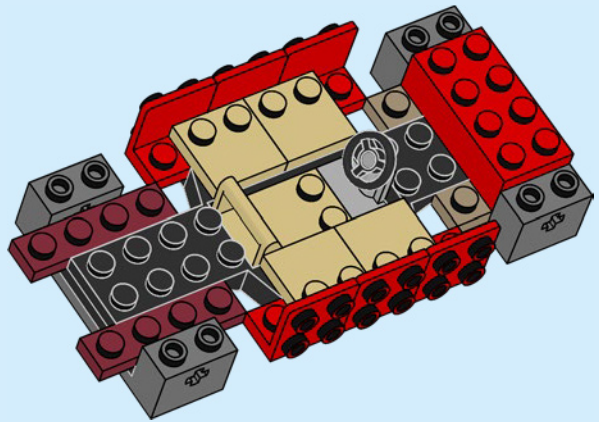

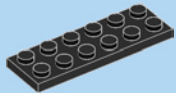

2x

9

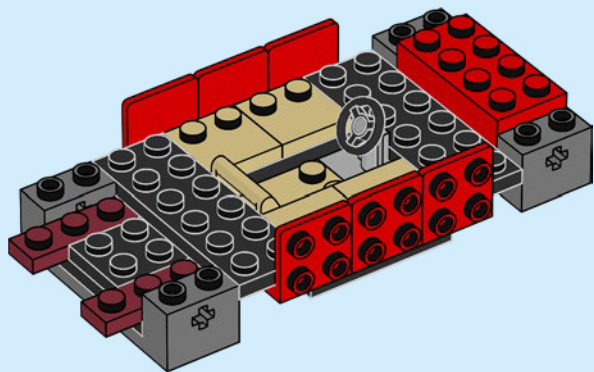

2x

10

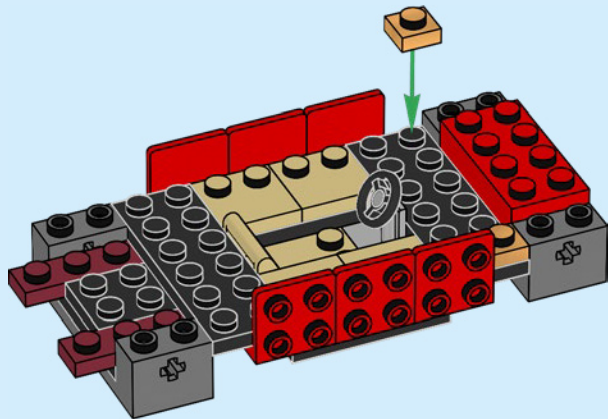

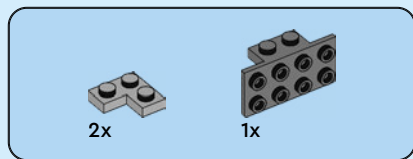

11

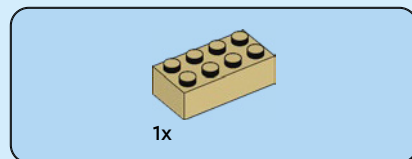
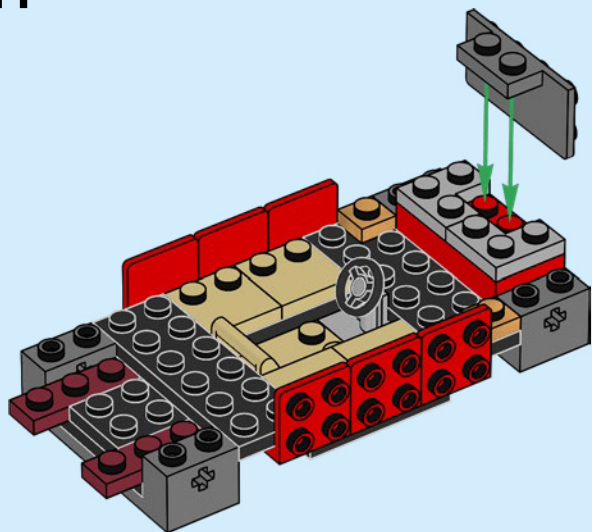

12

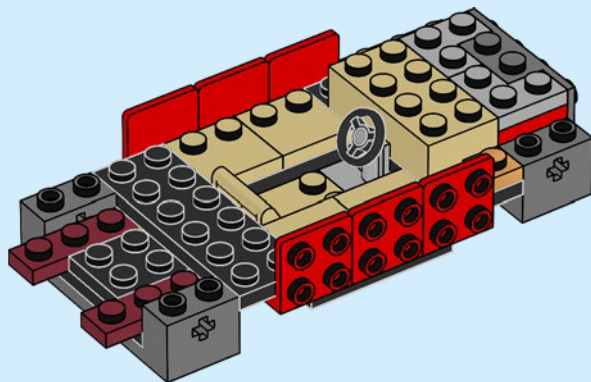



2x

13

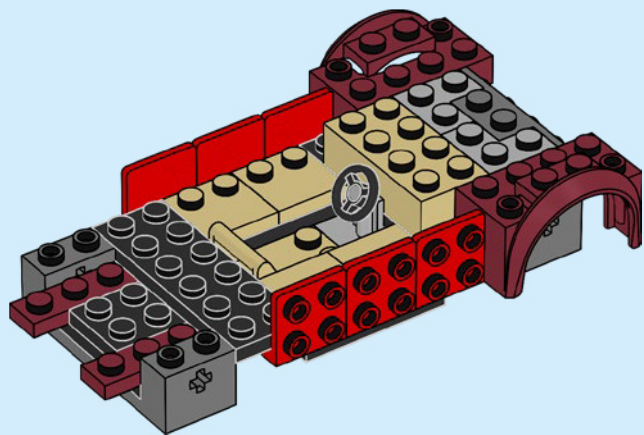

2x

14

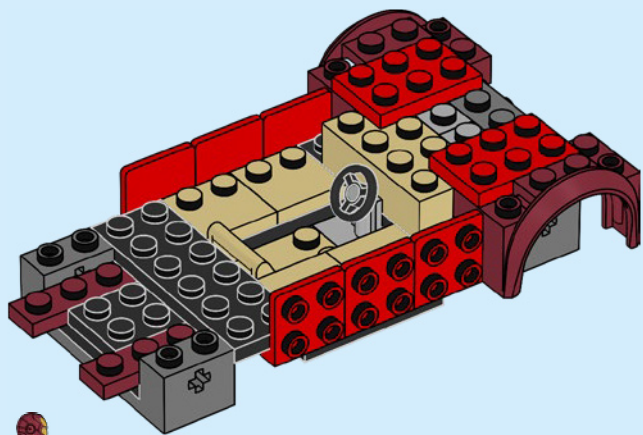

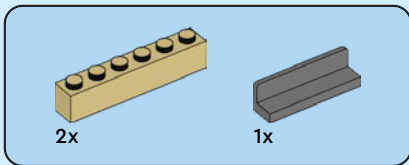

15

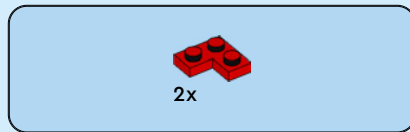
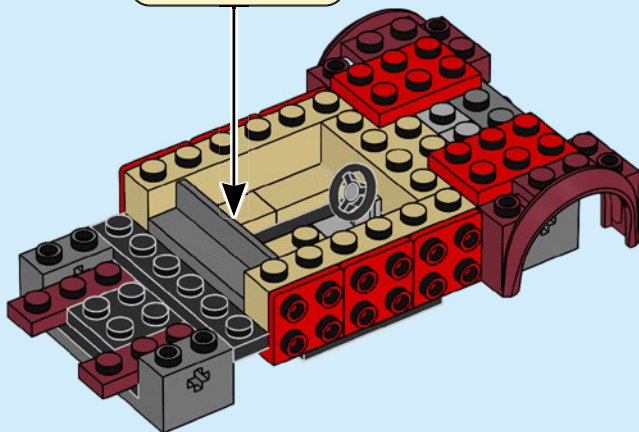
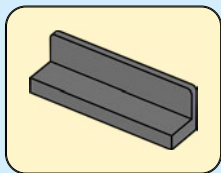

16

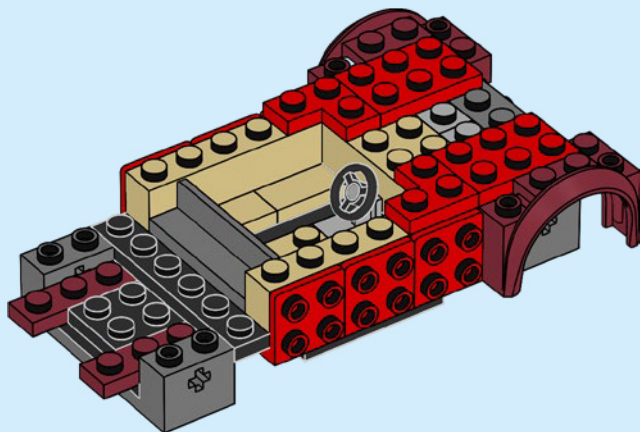



2x

17

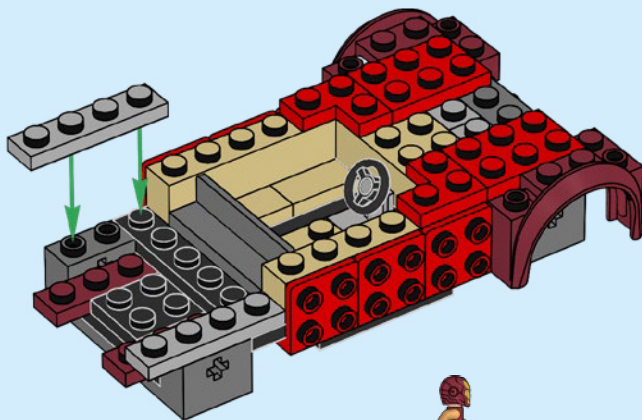

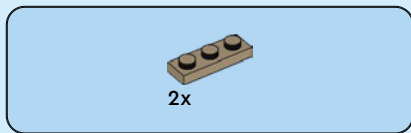

18

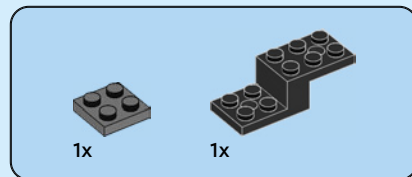
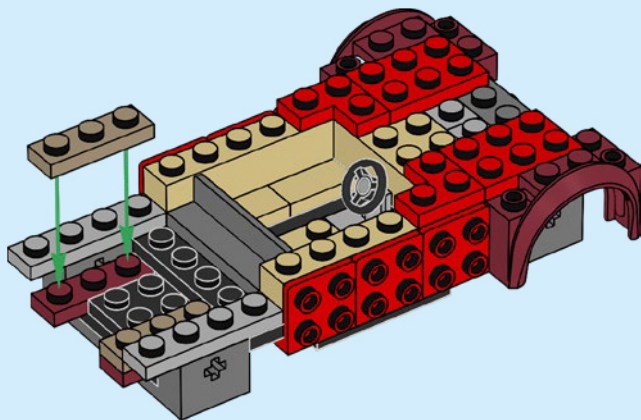

19

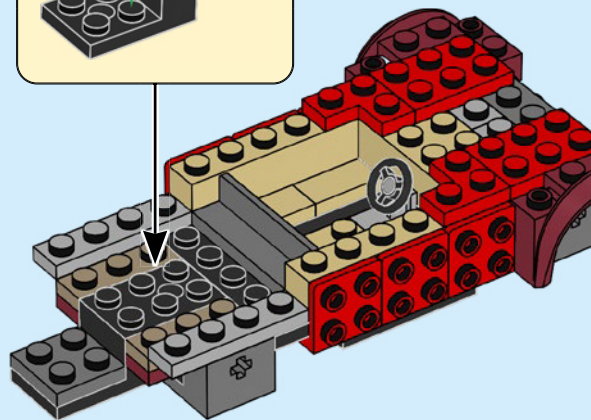
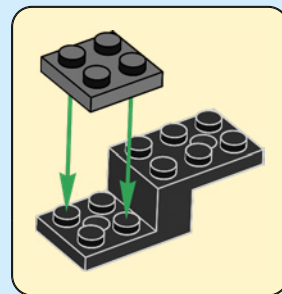



2x



2x

20

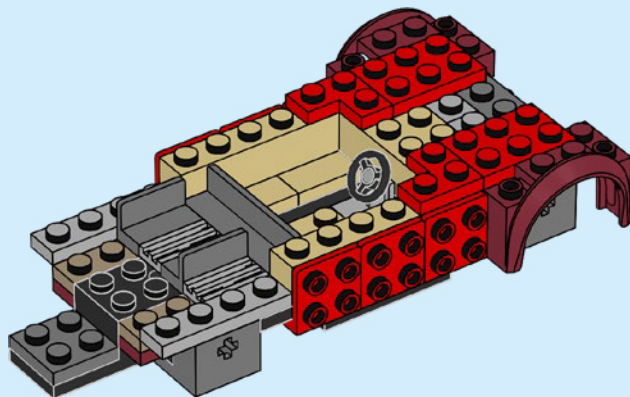



2x

21

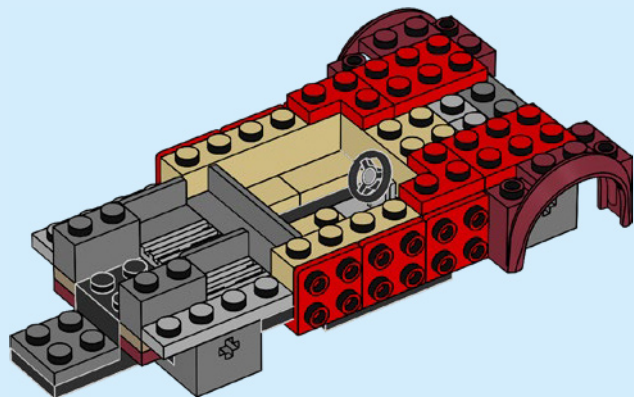

3x

22

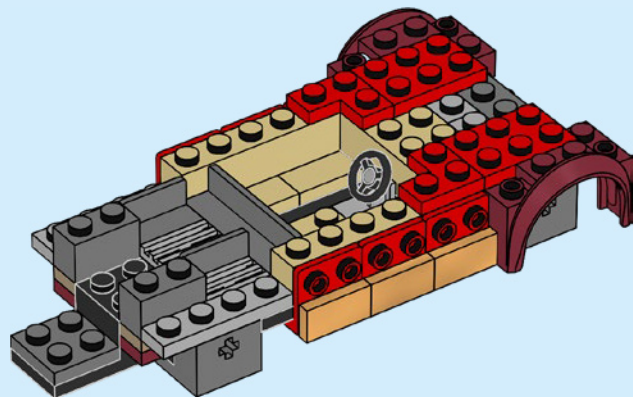



2x



2x

23



2x

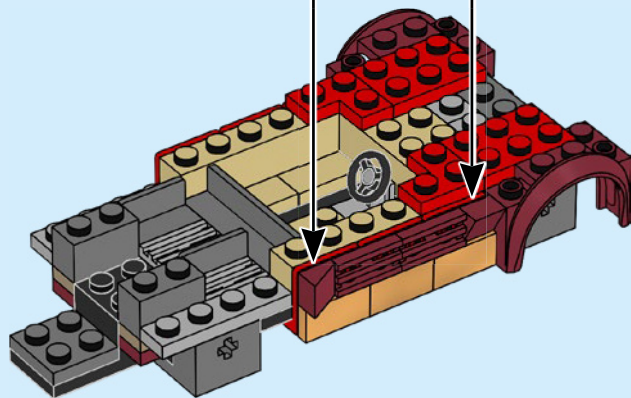



3x

24

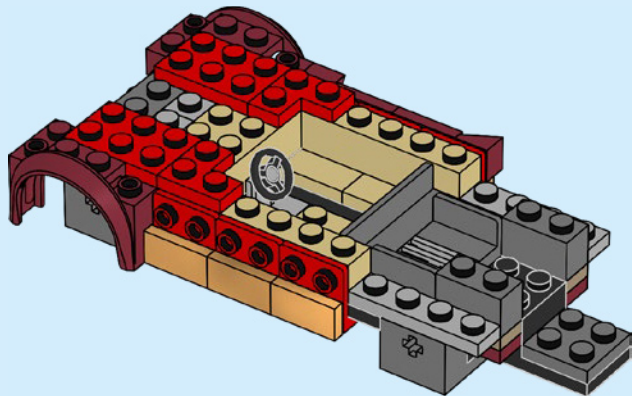

2x



2x

25



2x

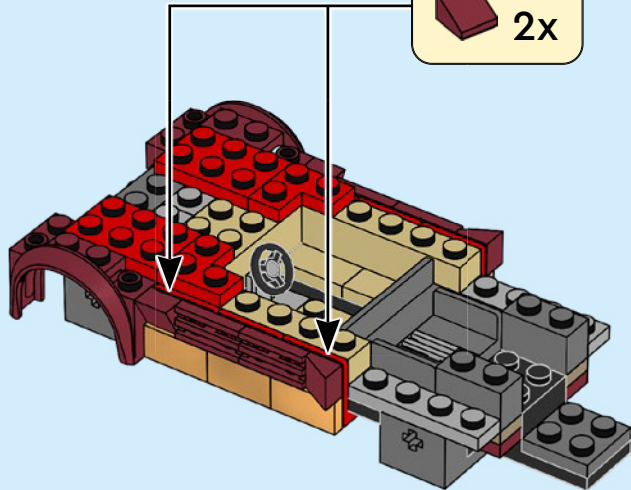



2x



1x



1x

26

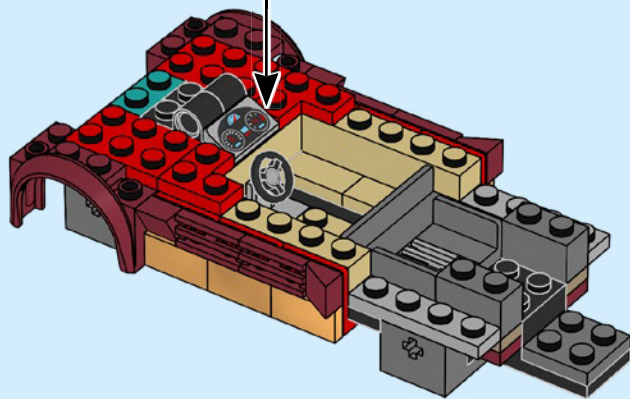



2x



2x

27

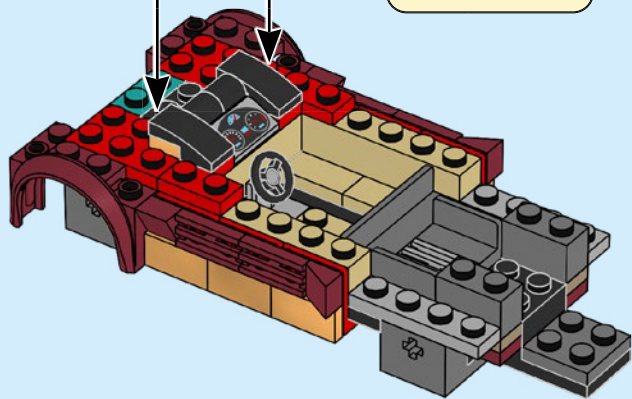
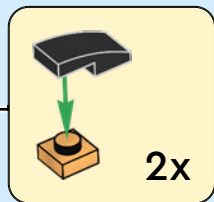

1x

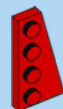

1x

28

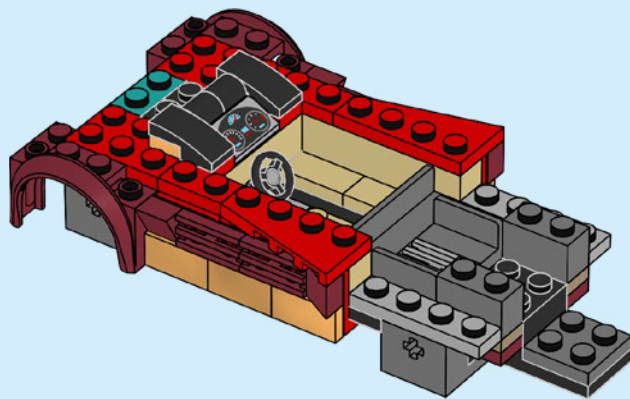

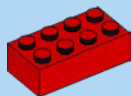

1x

29

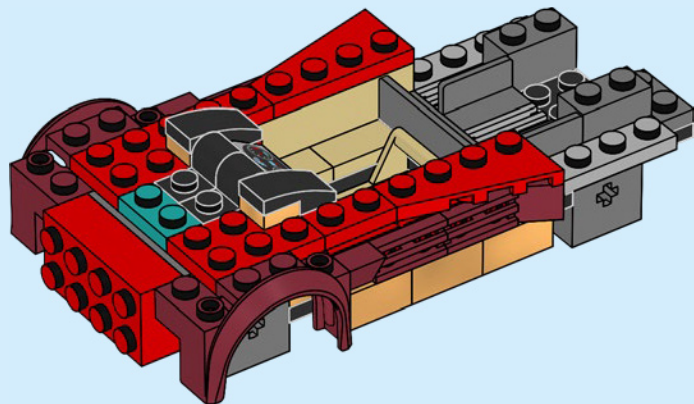

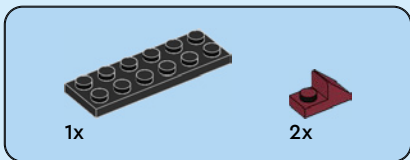
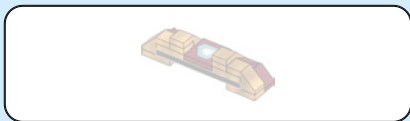

30

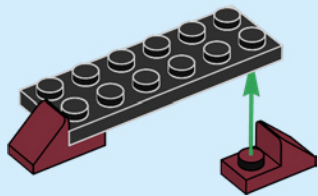

31

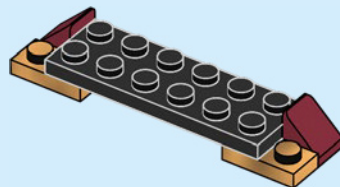



1x

32

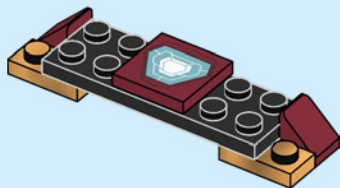

2x

33

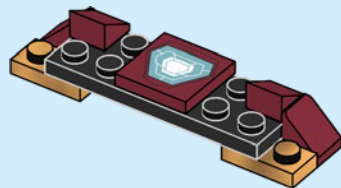



2x

34

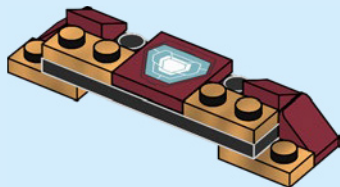

2x



2x

35

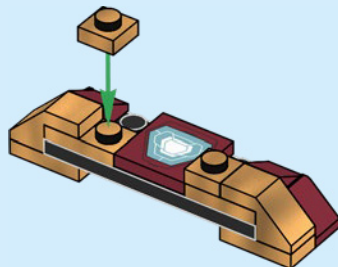



2x

36

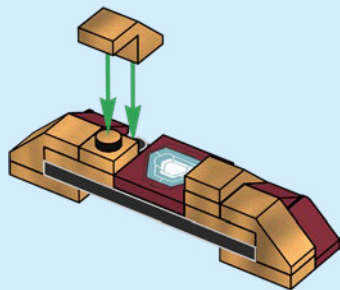

37

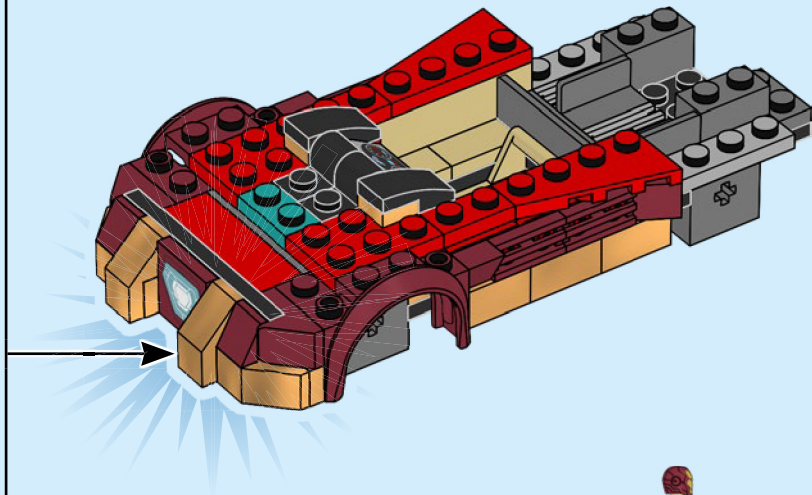



2x



1x



1x

38

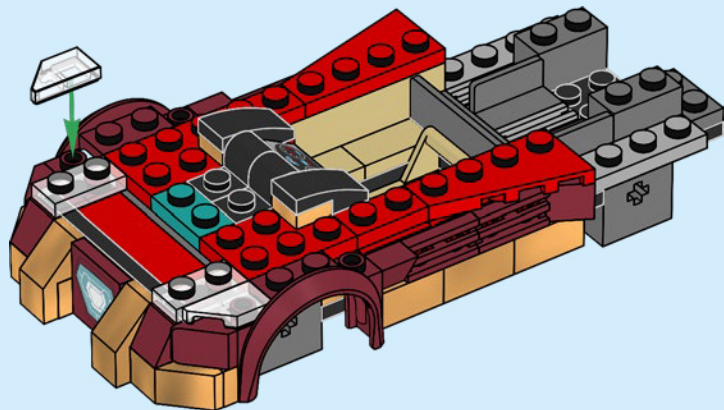

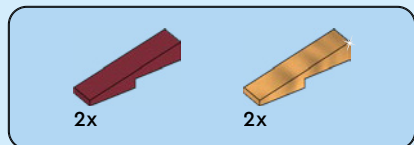

39

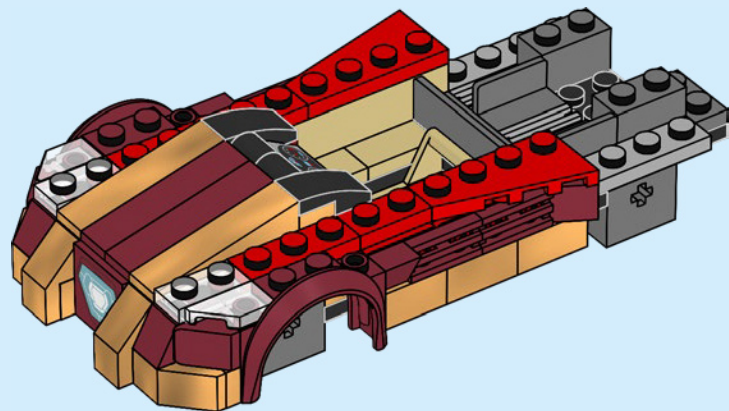

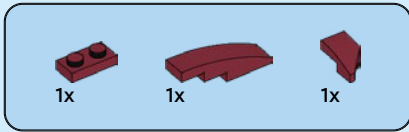

40

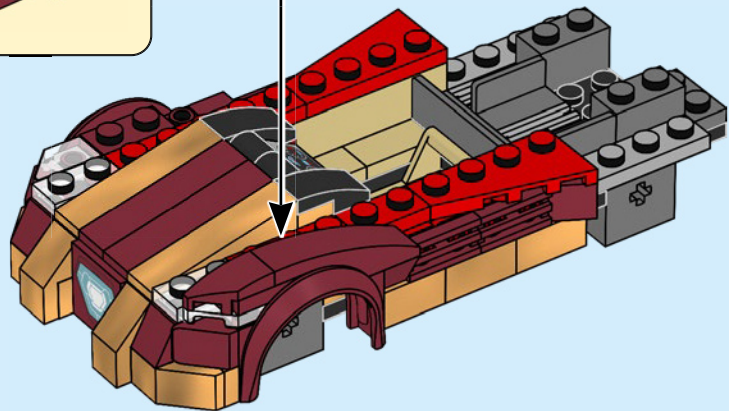
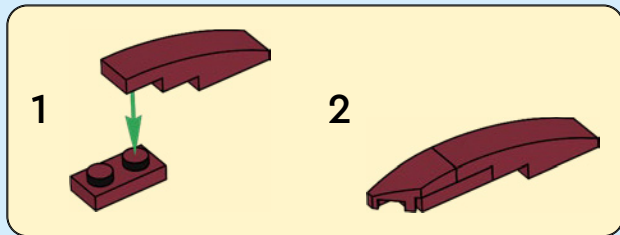

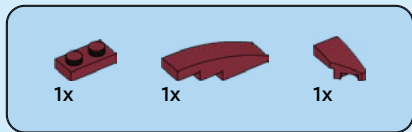

41

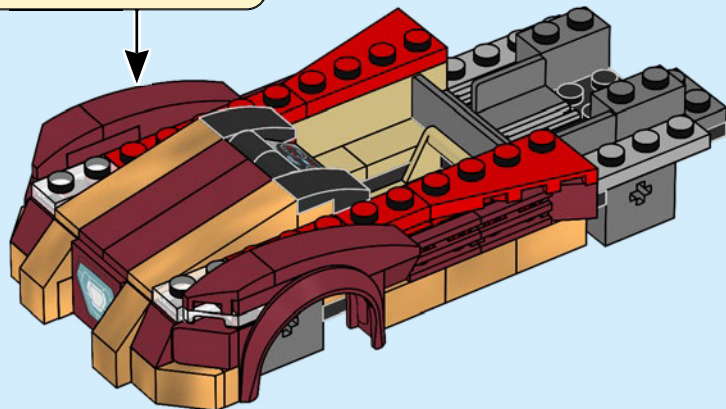
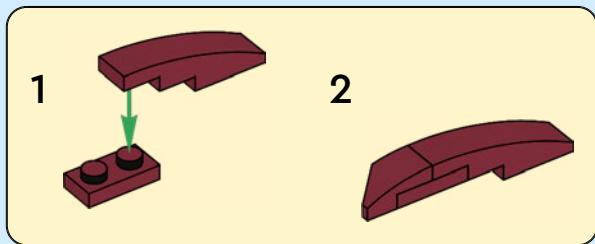

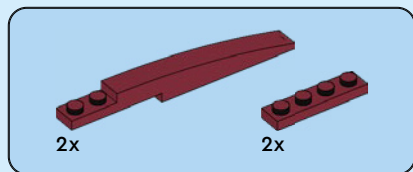

42

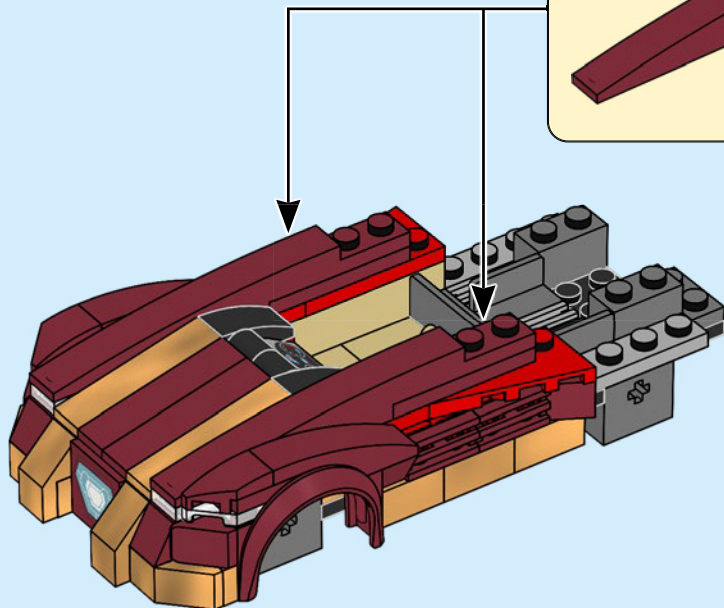
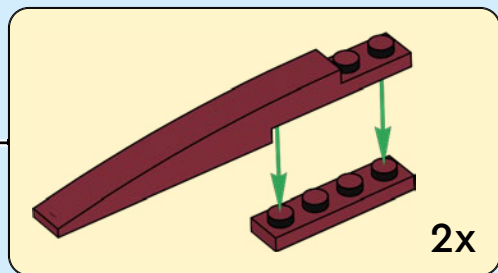

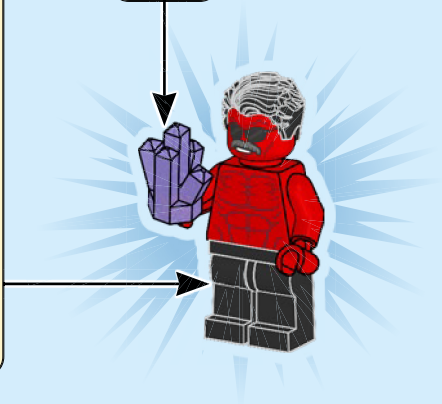
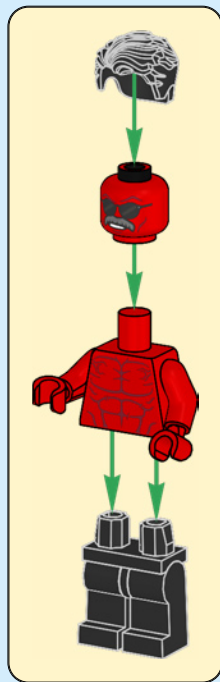

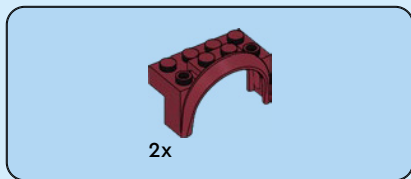

43

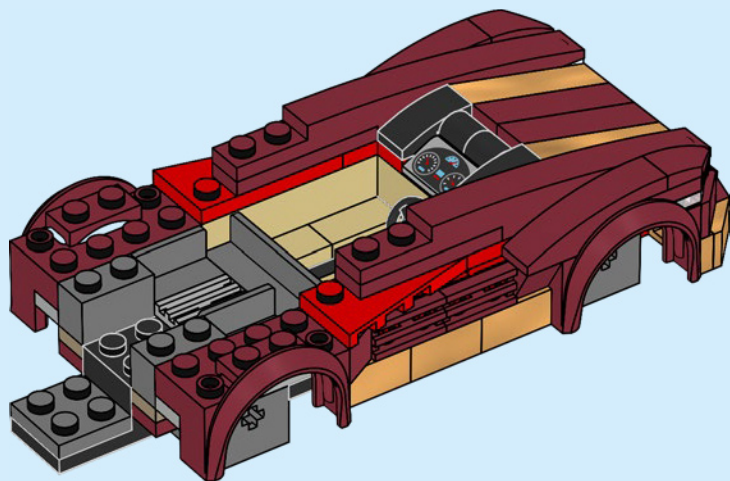



1x



1x

44

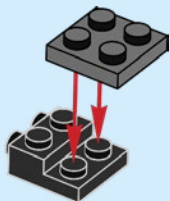

1x

45

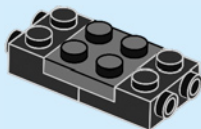

2x



2x

46

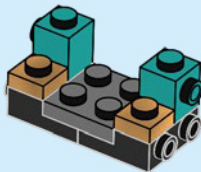



1x

47

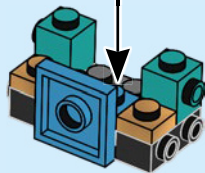
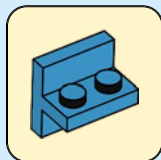

1x



1x

48

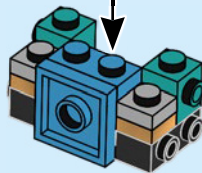
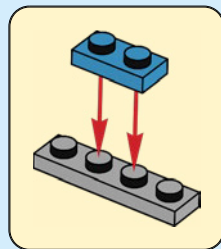

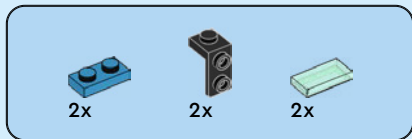

49

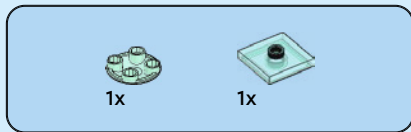
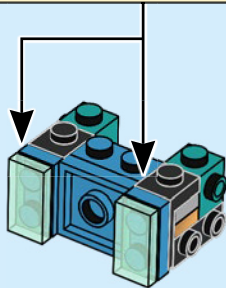
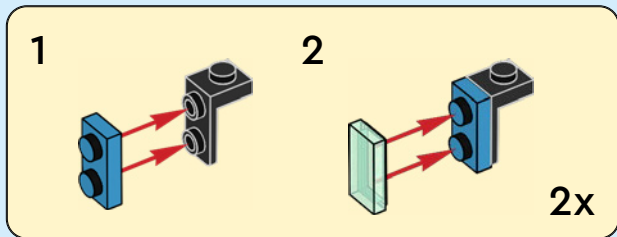

50

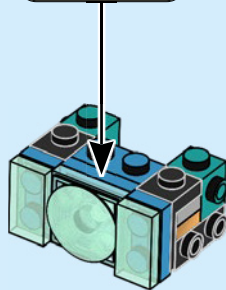
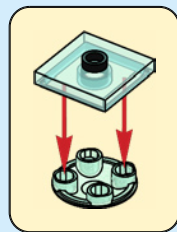

51

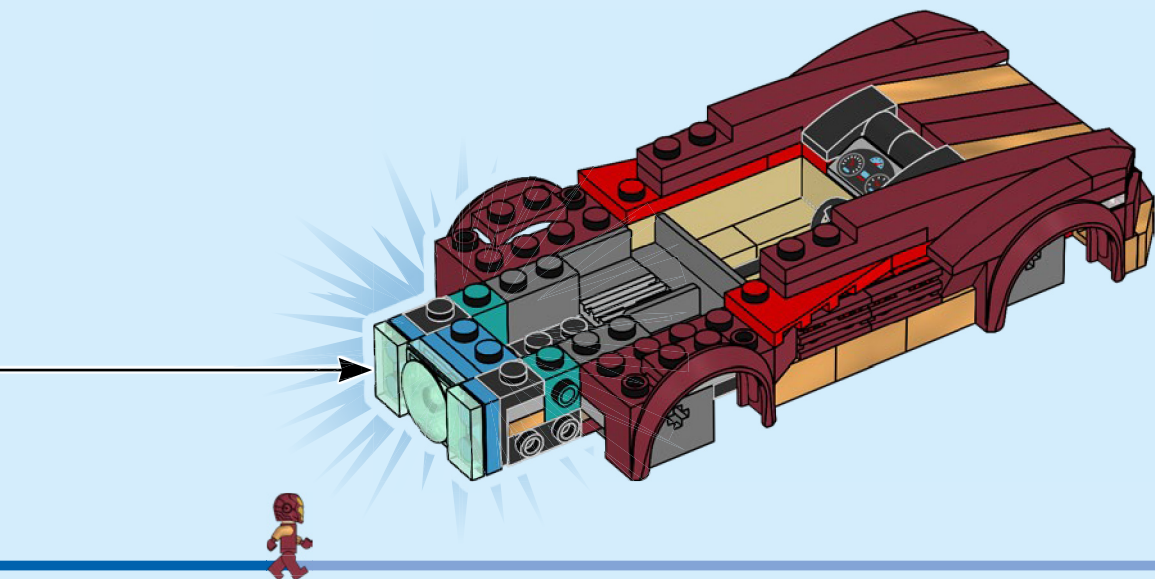



1x

52

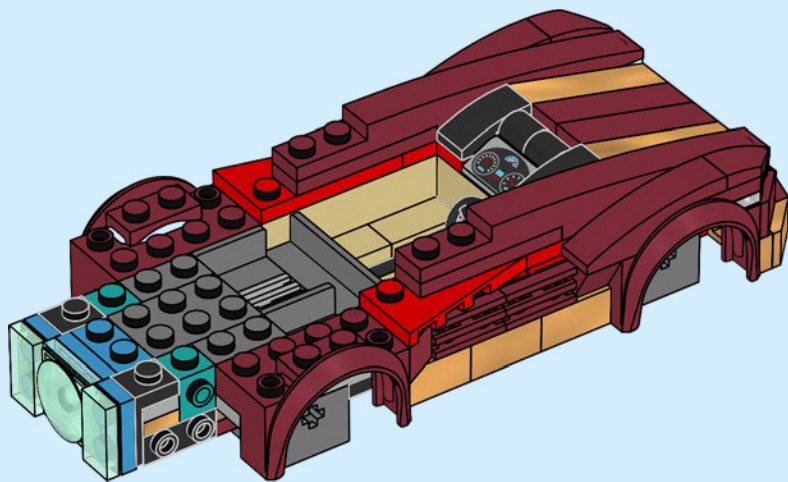

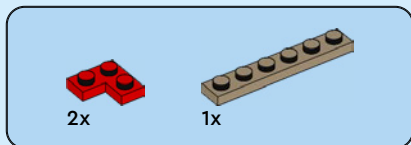

53

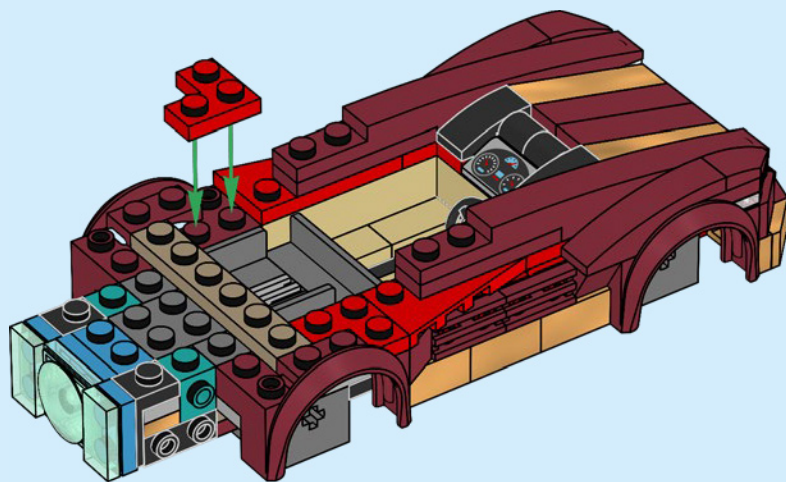

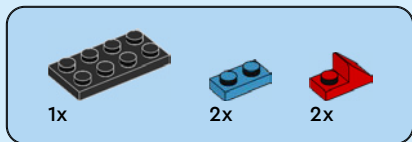

54

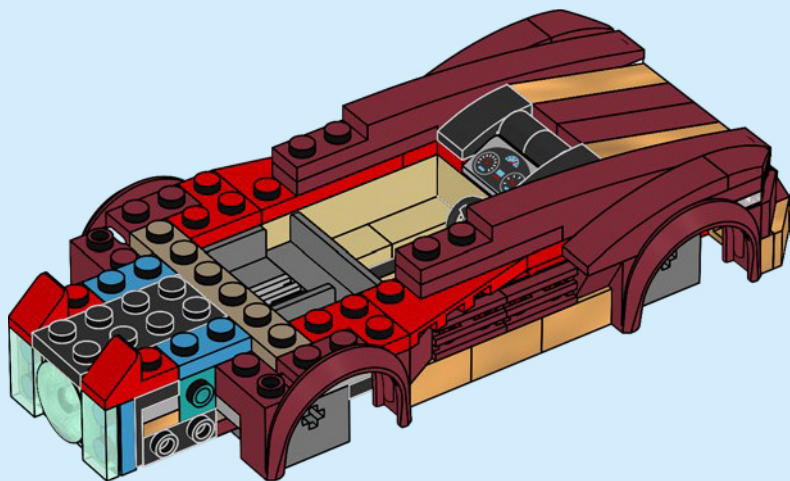

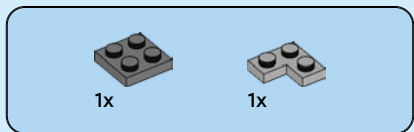

55

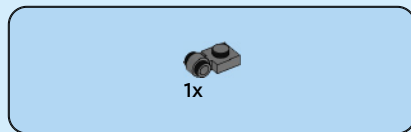
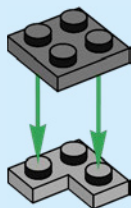

56

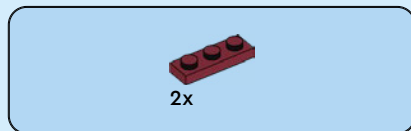
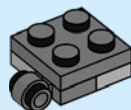

57

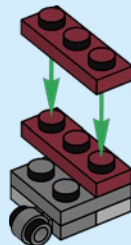



1x



1x

58

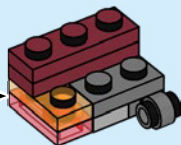
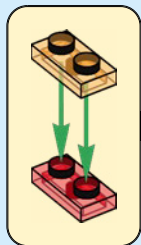
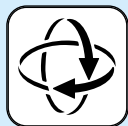

1x



1x

59

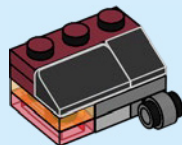



1x

60

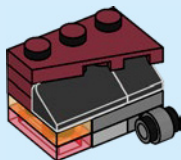

1x

61

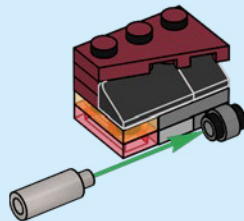

62

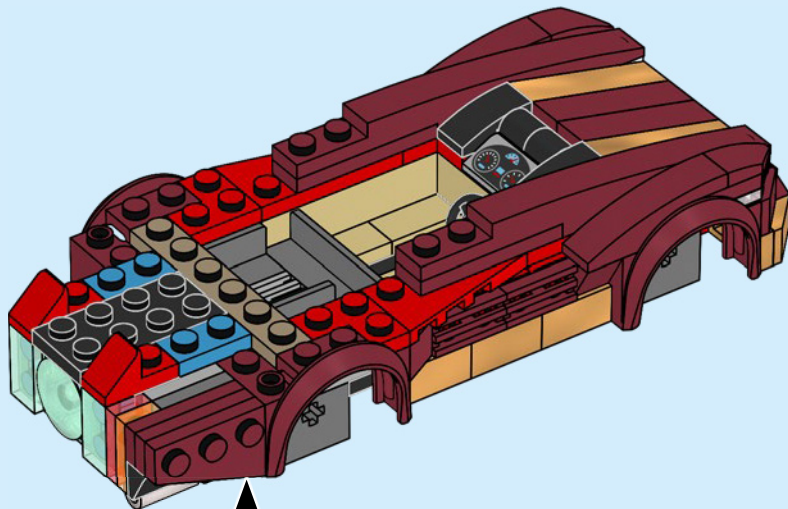



1x



1x

63

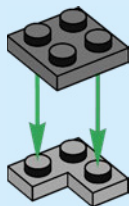

1x

64

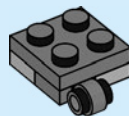

2x

65

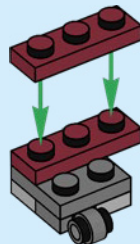



1x



1x

66

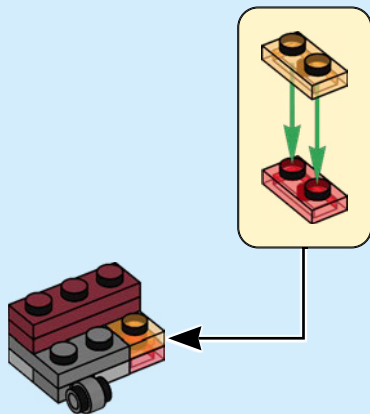

1x



1x

67

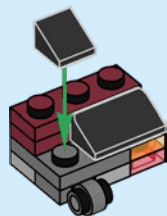



1x

68

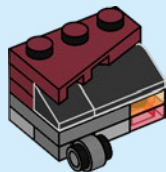

1x

69

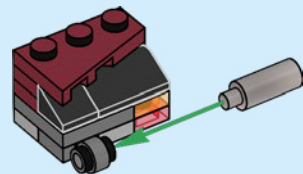

70

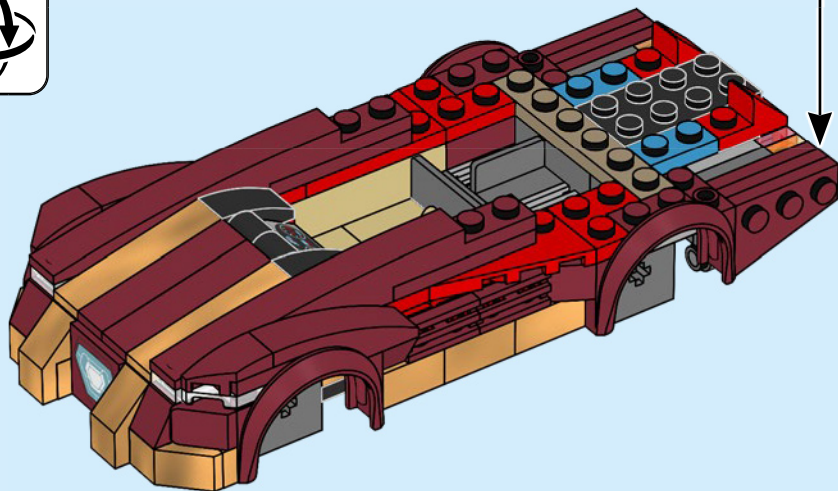
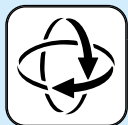



2x



2x

71

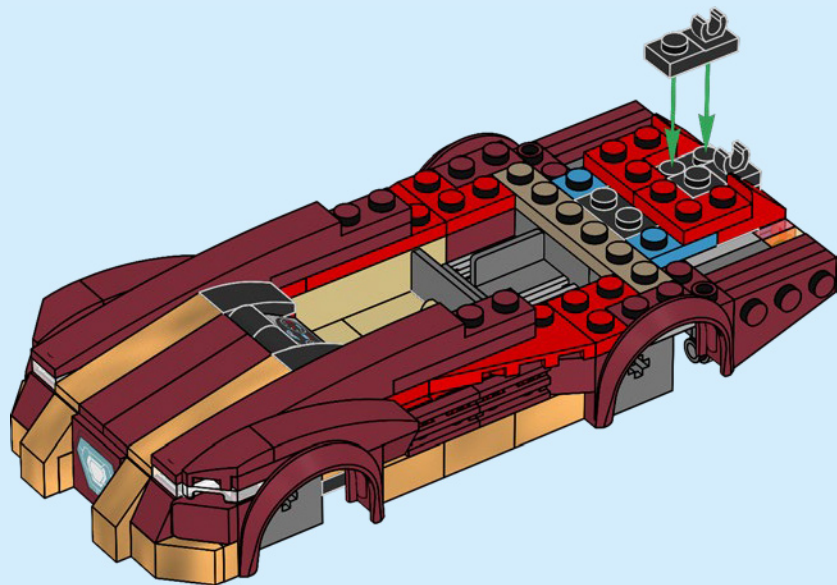

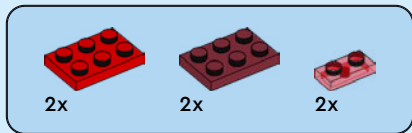

72

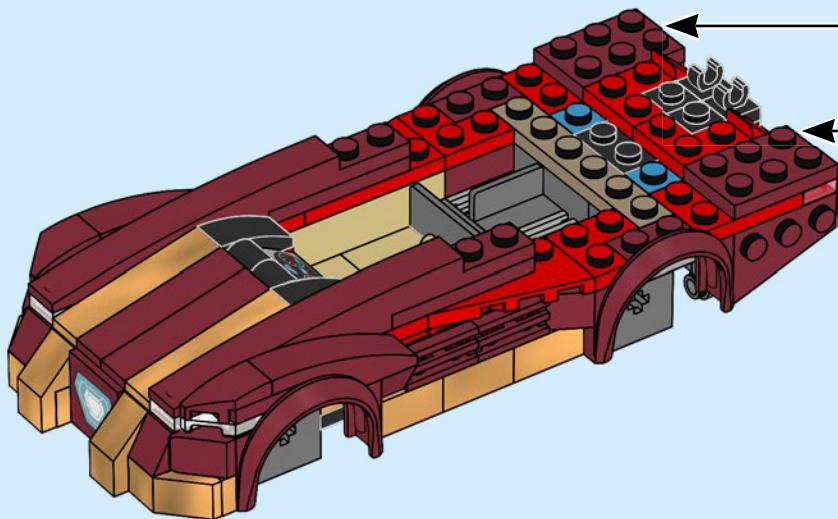
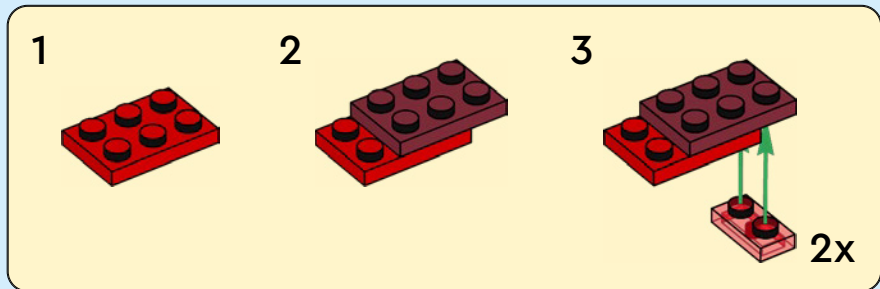

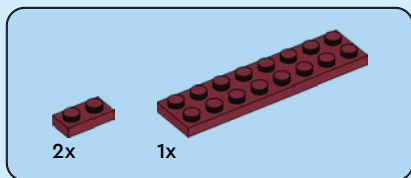

73

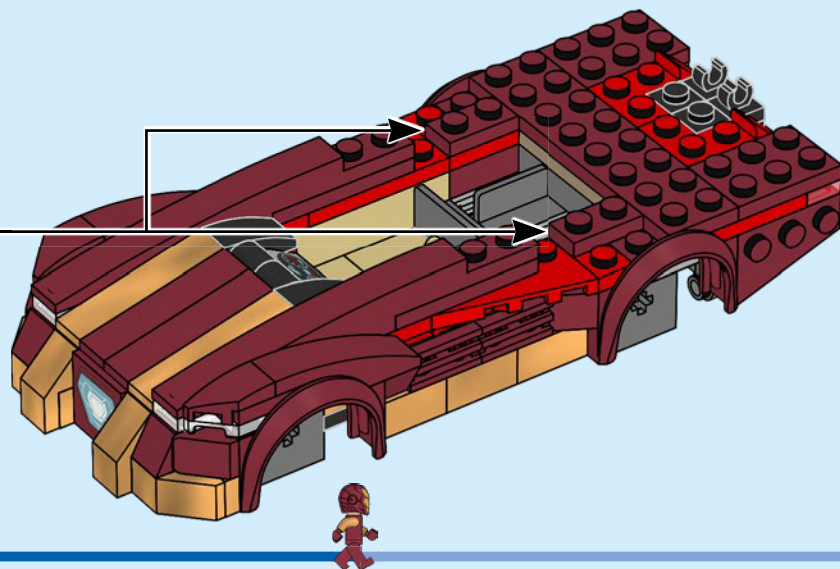



2x



2x

74

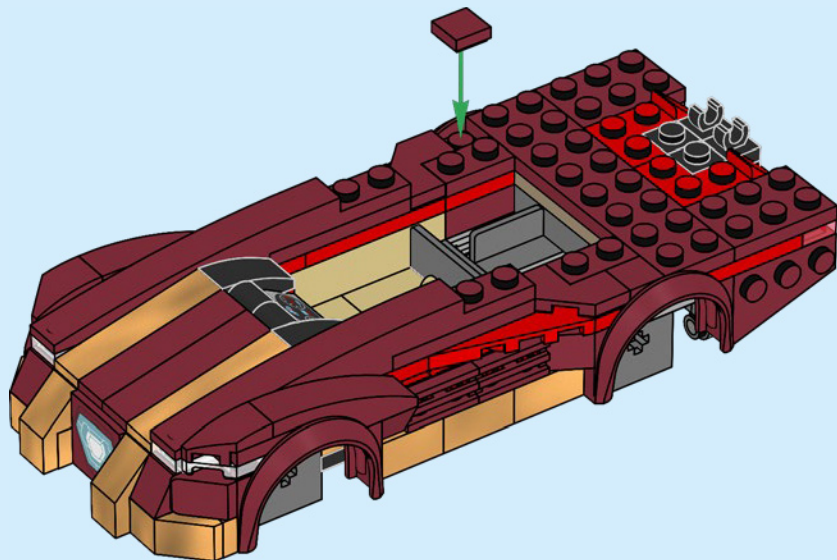



1x



2x

75

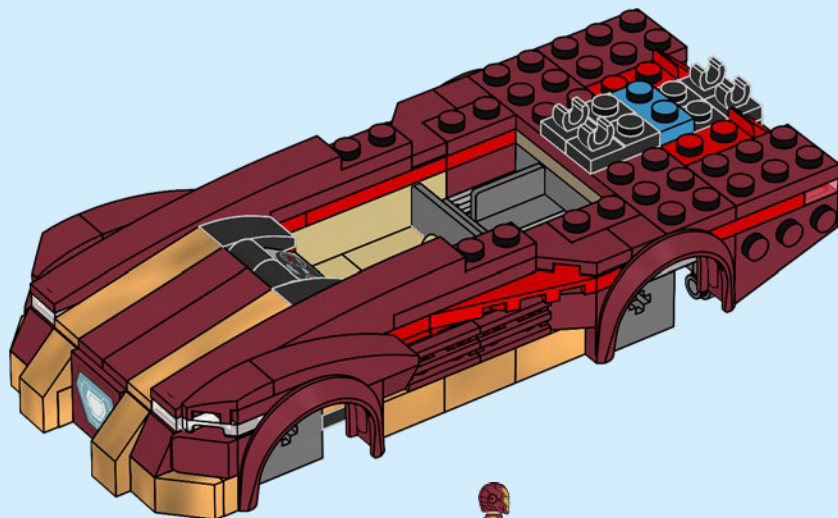



1x

76

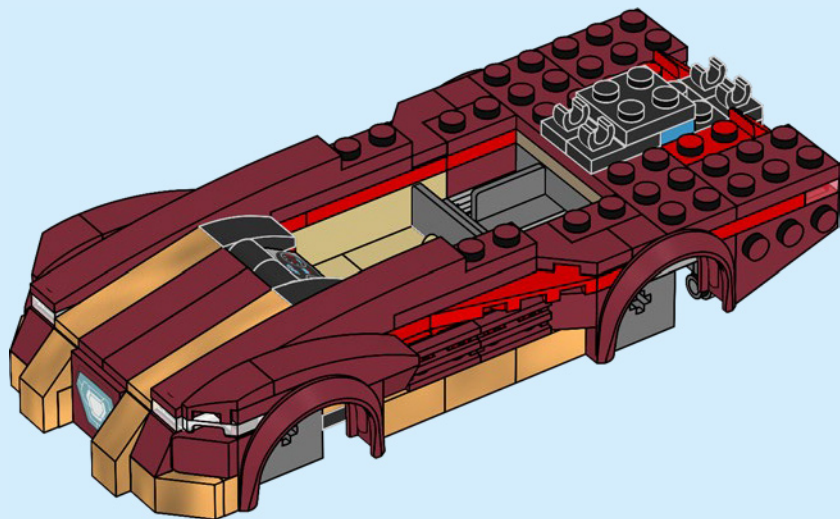



1x



2x

77

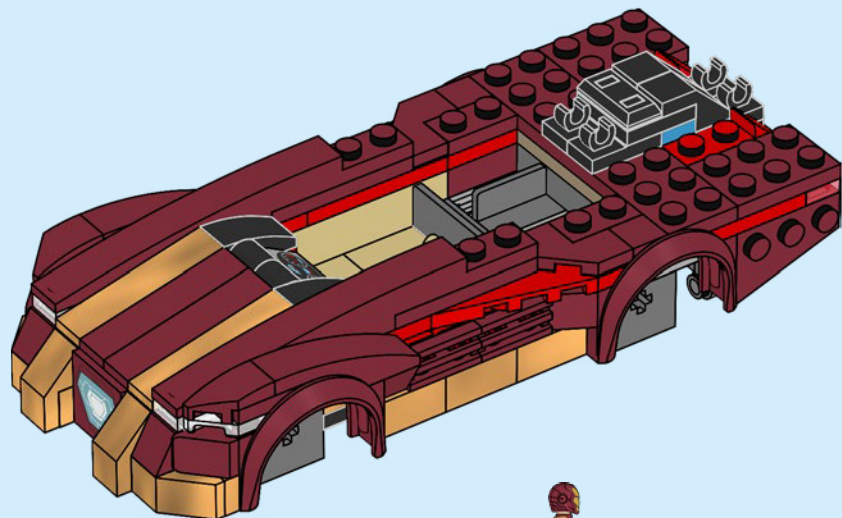



2x

78

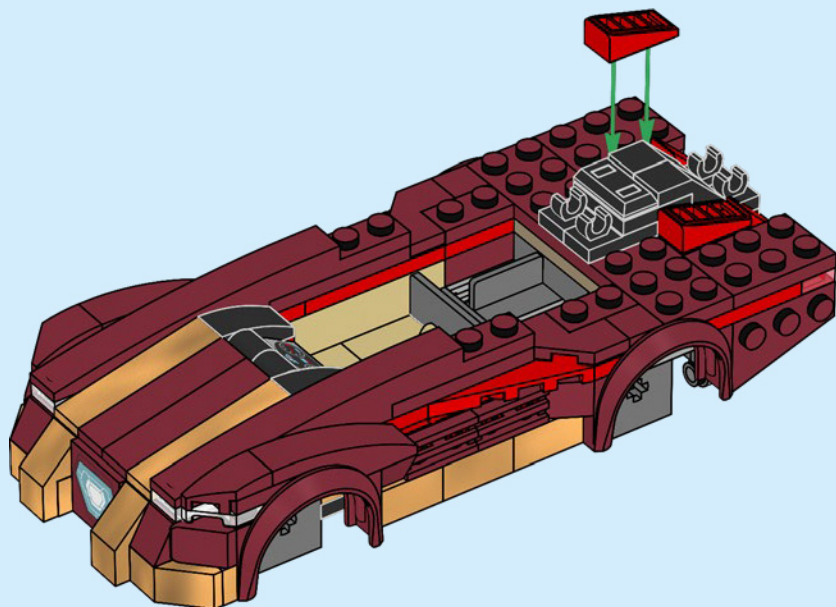

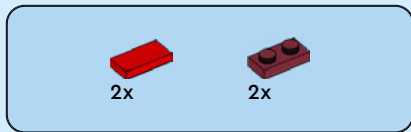

79

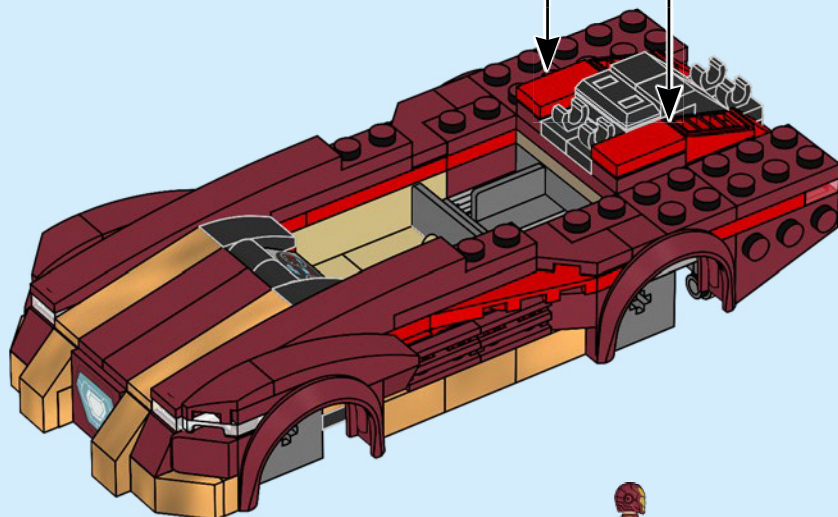
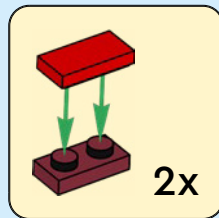

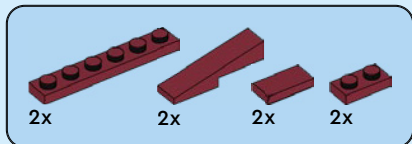

80

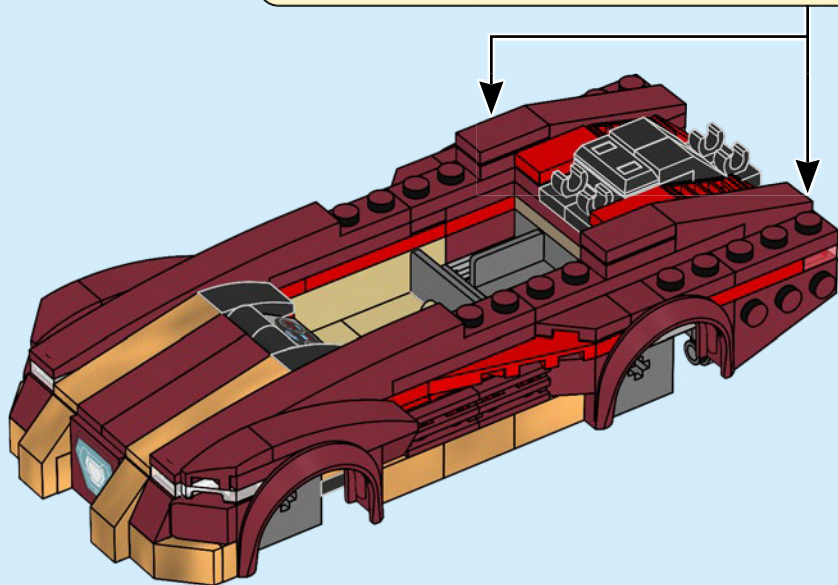
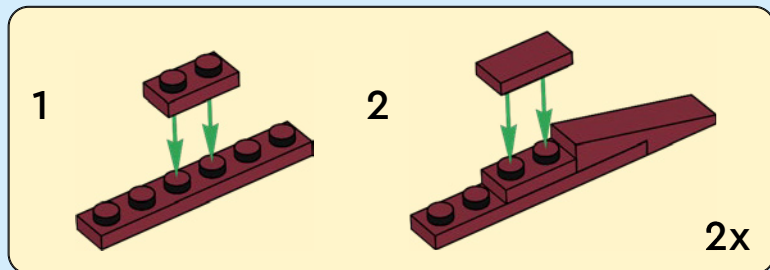



2x

81

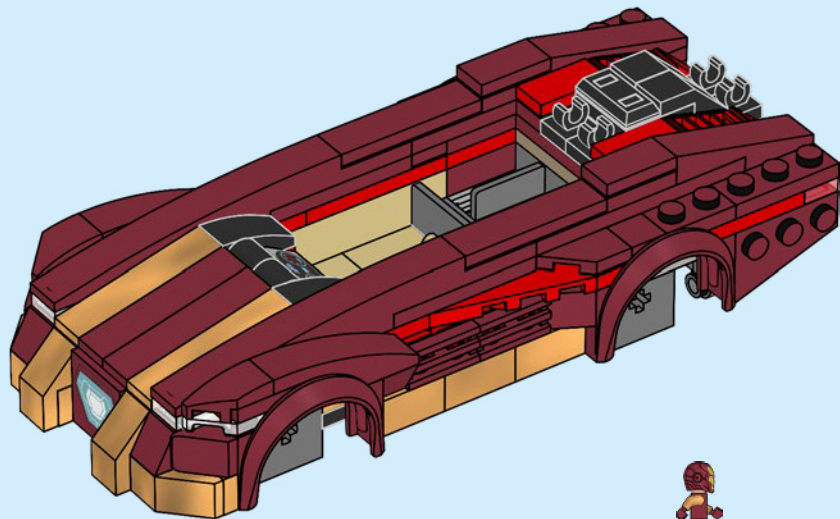

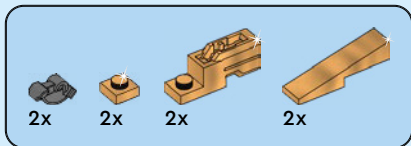

82

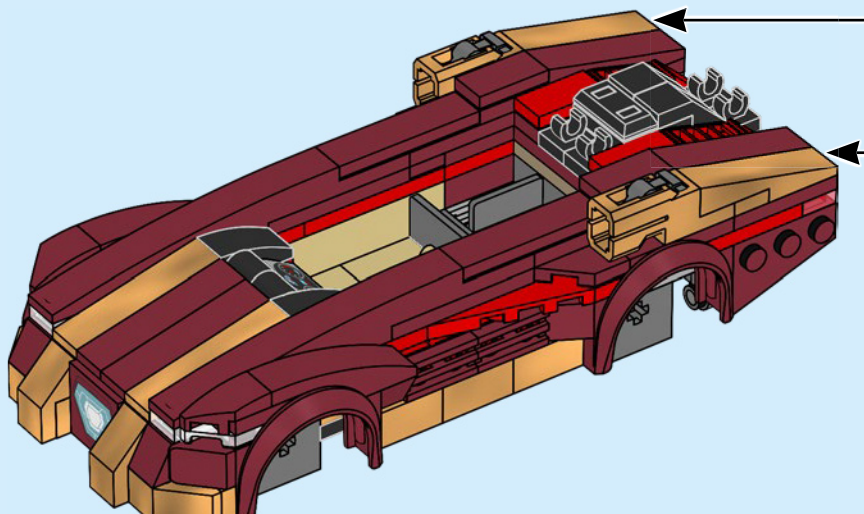
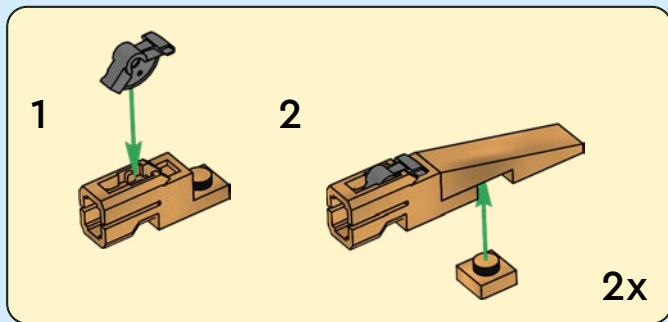

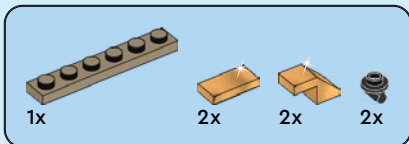

83

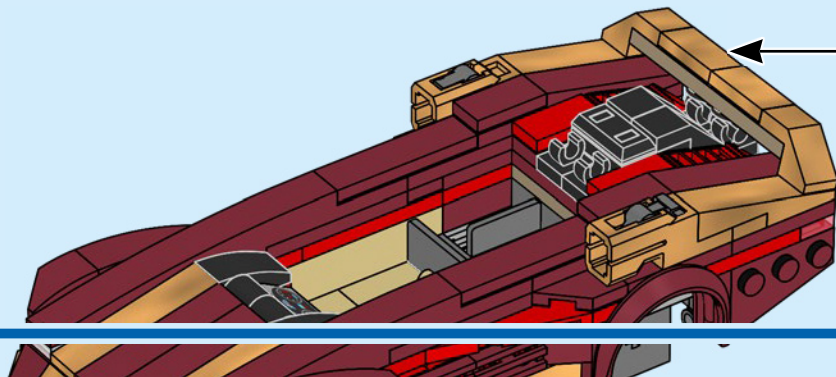
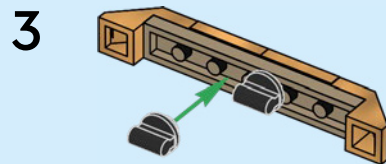
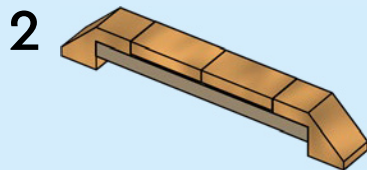
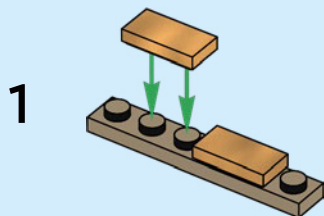

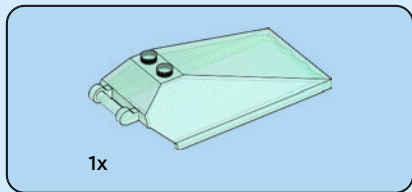

84

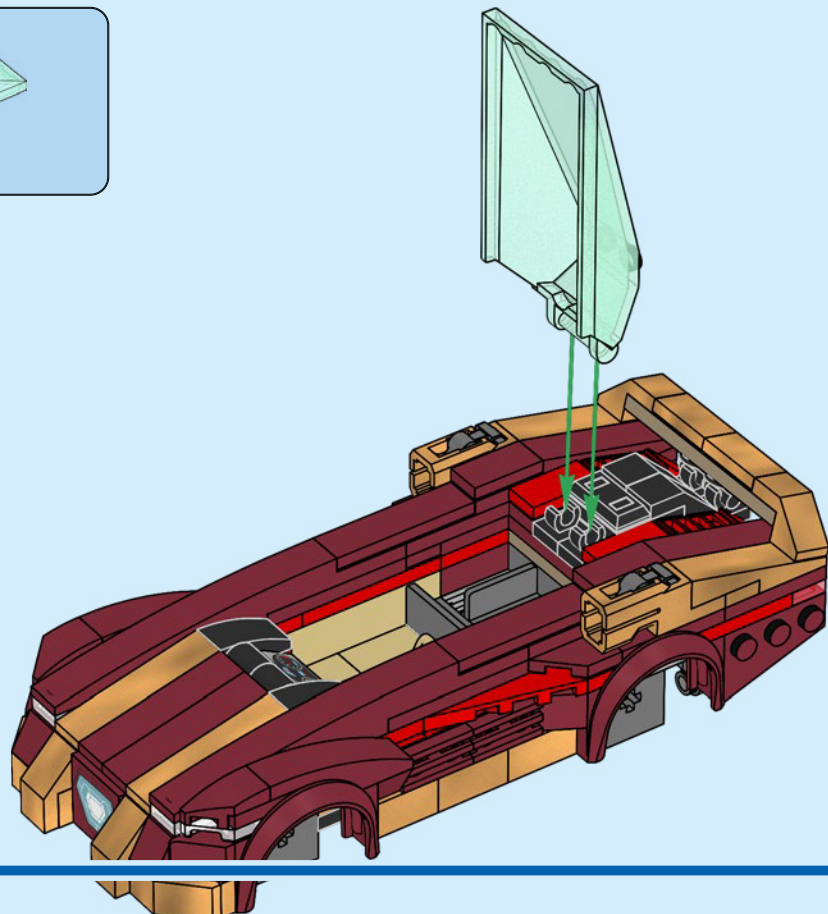

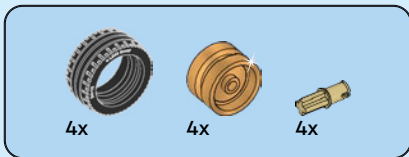

85

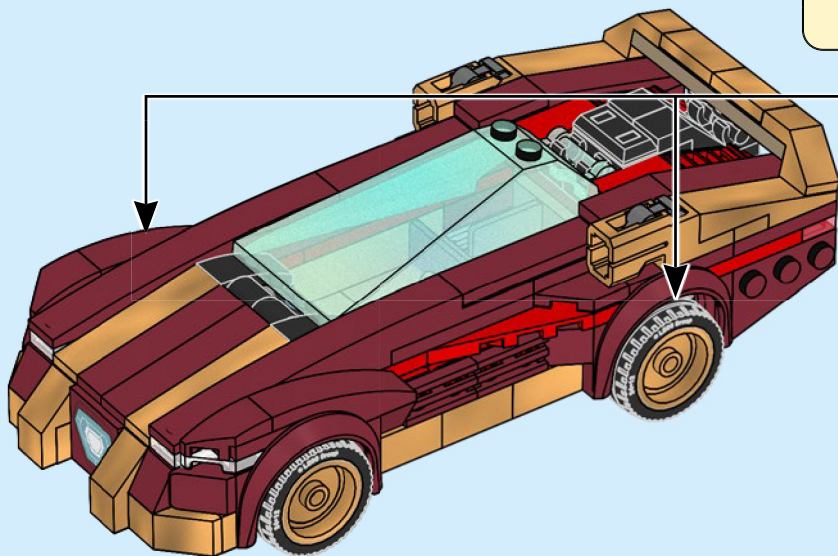
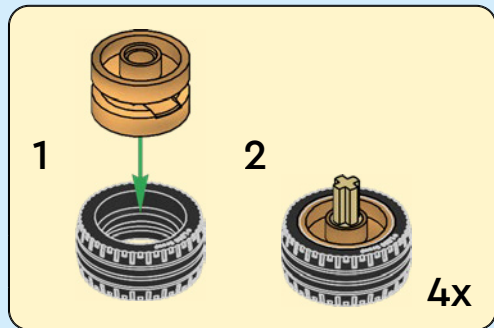

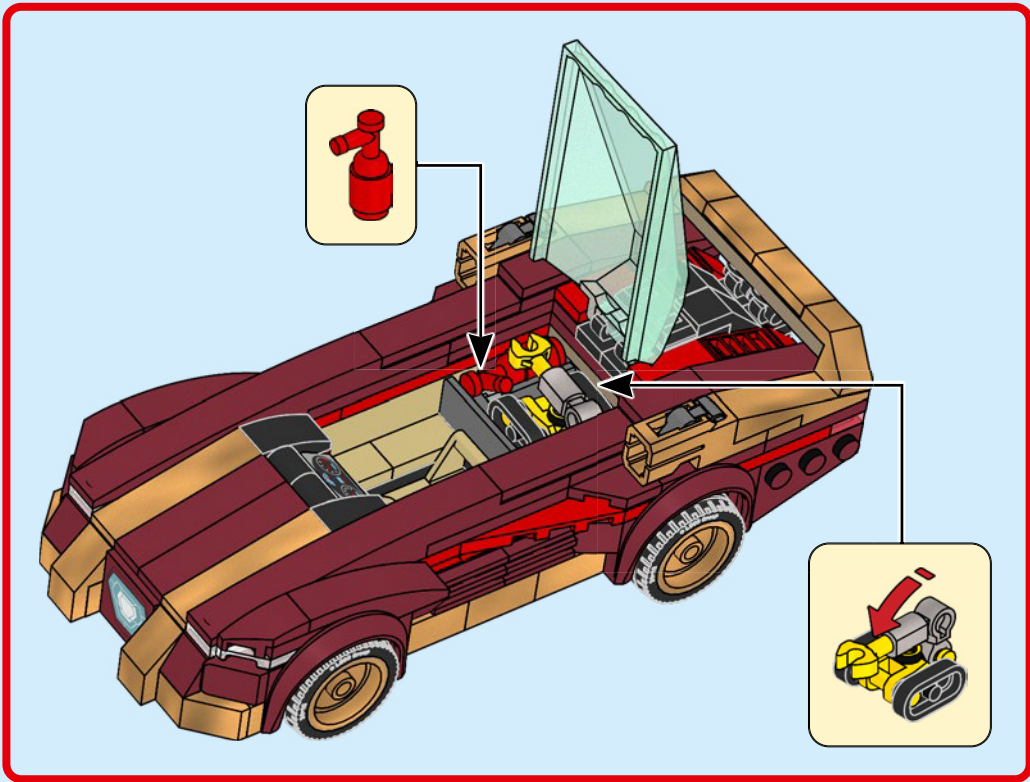

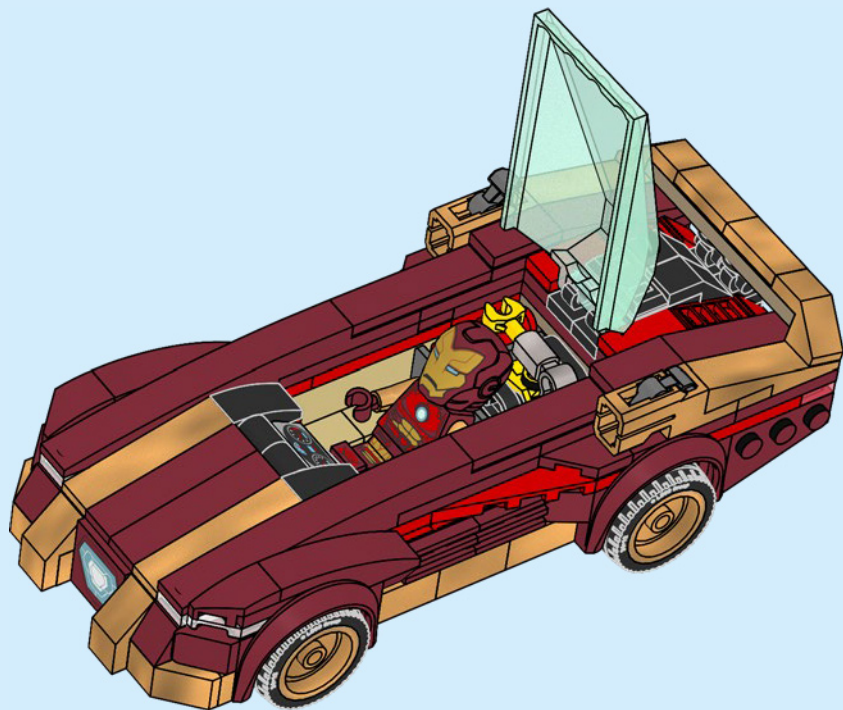



4x

86

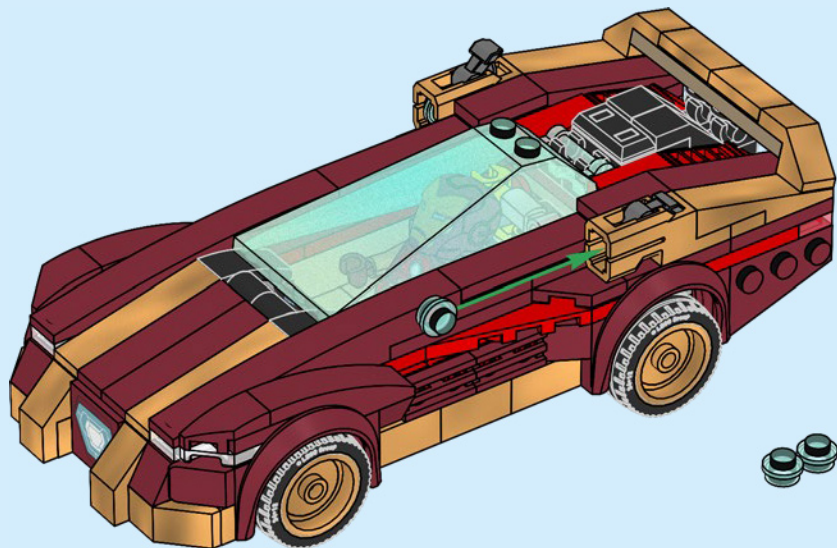

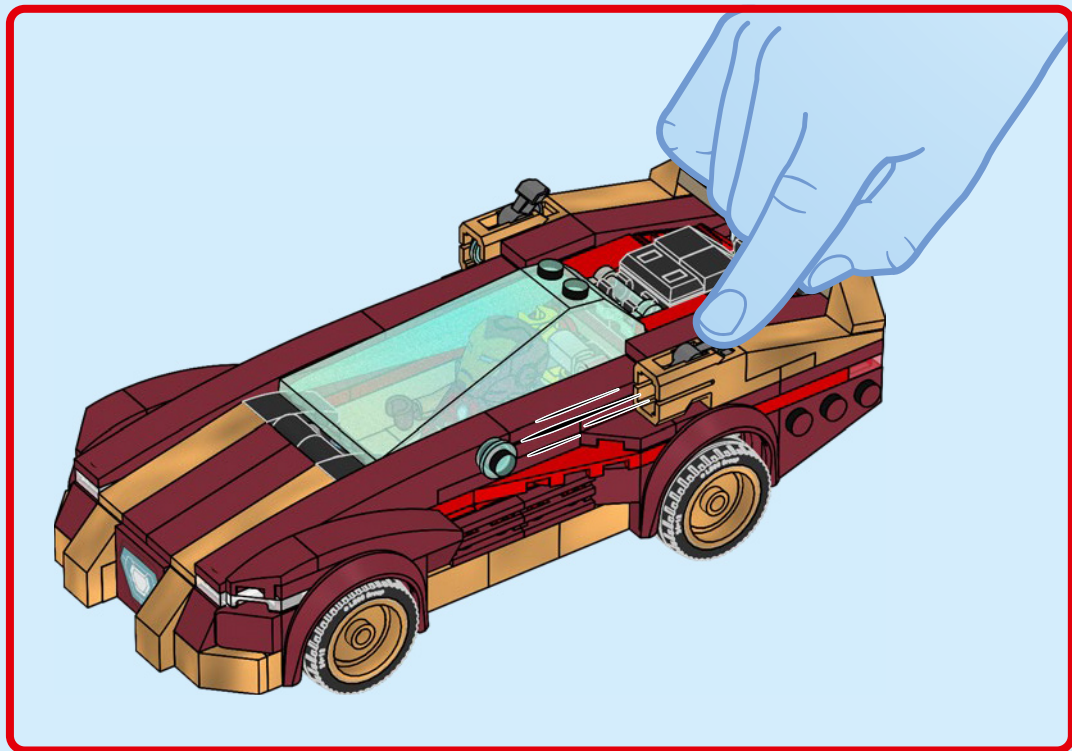

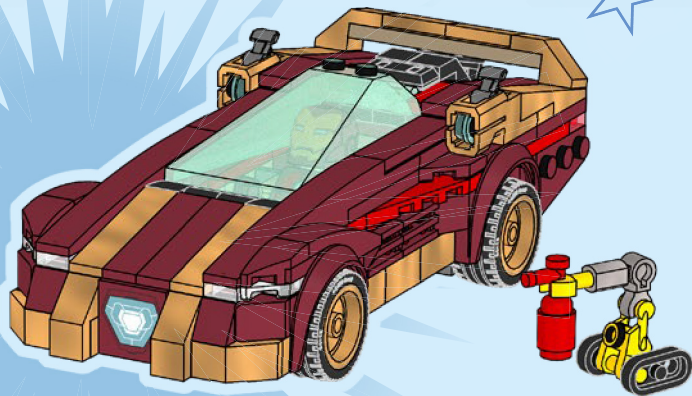
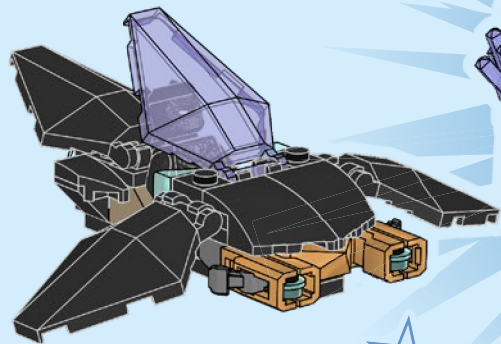



MARVEL



76313



76314



76310



76307

MARVEL
AVENGERS

 4x 4666579	 1x 4160866	 1x 6439051	 1x 6134617	 2x 6047276	 1x 6267482	 1x 6515311	 1x 6529658
 1x 6021208	 2x 6053011	 1x 6449913	 2x 6210270	 2x 6310268	 3x 302026	 1x 6515310	 1x 6184880
 5x 6221467	 2x 306921	 2x 6510216	 1x 6181713	 1x 6250020	 1x 6533639	 2x 6514001	 4x 6132768
 1x 4114319	 2x 4540382	 1x 6526044	 2x 4548180	 1x 302226	 1x 6533639	 4x 6514003	 4x 6132768
 1x 4112982	 6x 6001806	 1x 6527202	 2x 9339	 1x 6390748	 3x 6494547	 8x 6240225	 2x 6015424
 2x 306221	 6x 242021	 2x 4504382	 2x 6267487	 2x 6469445	 3x 379526	 2x 6245277	 2x 4550169
 1x 6526042	 1x 6534604	 1x 6181720	 8x 6347310	 1x 6533906	 1x 303426	 1x 6499141	 6x 4531415
 1x 459921	 4x 302121	 2x 6187572	 1x 4226995	 4x 6102596	 1x 303426	 2x 6213781	 1x 6219658
 1x 4161329	 2x 300121	 2x 6380236	 2x 6114987	 1x 6390749	 1x 6170384	 1x 6213777	 1x 6526663
 1x 4161329	 2x 300121	 2x 6299338	 1x 6156991	 1x 6390749	 1x 6170384	 2x 6514009	 1x 6398321



1x
6267490



1x
6267492



1x
6219657



1x
6448822



8x
4539097



2x
4539090



4x
4541506



2x
6251611



1x
6526664



2x
6364638



4x
4539076



1x
6453200



2x
6264030



4x
4539061



2x
4539060



4x
6505207



2x
6042953



4x
6525793



2x
4539062



1x
6152321



2x
6293875



2x
6514005



1x
6329152



2x
4211350



4x
4211353



3x
4211445



4x
6360675



2x
6281996



2x
4211088



2x
6146225



2x
6230233



2x
6029948



4x
4211094



1x
6118832



1x
4211105



1x
6092649



2x
6454959



1x
6221340



10x
6069887



1x
6075079



6x
6287530



4x
6218047



8x
6107197



4x
6365808



4x
6345949



4x
6522889



2x
6336564



1x
6338570



6x
4653988



1x
6424641



1x
6507866



1x
6350385



2x
6514227



1x
6530837



 [LEGO.com/service](https://www.lego.com/service)

YOU COULD **WIN**

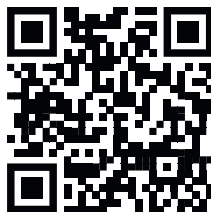

Scan this QR code or go to **LEGO.COM/PRODUCTFEEDBACK** and give us your short feedback about this LEGO® set for a chance to win a cool LEGO prize.

Terms and Conditions apply*



EN: YOU COULD WIN. Terms and Conditions apply* **DE: Du könntest GEWINNEN.** Es gelten die Teilnahmebedingungen* **FR: Tu pourrais GAGNER.** Des conditions s'appliquent* **IT: Potresti VINCERE tu.** Termini e condizioni sono applicabili* **ES: Puedes GANAR.** Aplican términos y condiciones* **PT: Poderá GANHAR.** Aplicam-se termos e condições* **ZH: 轻松获奖. 条款和条件适用*** **PL: Szansa na WYGRANĄ.** Obowiązują warunki korzystania* **CS: Máte šanci VYHRÁT.** Platí všeobecné smluvní podmínky* **SK: Máte šancu VYHRAŤ.** Platia všeobecné zmluvné podmienky* **HU: TE IS NYERHETSZ.** Felhasználási feltételek érvényesek* **RO: Ai putea CÂȘTIGA.** Se aplică termenii și condiții* **BG: Можете да СПЕЧЕЛИТЕ.** Има определени правила и условия* **LV: Tu vari LAIMĒT.** Ir spēkā noteikumi un nosacījumi.* **ET: Sul on võimalus VÕITA.** Kehtivad tingimused* **LT: Jūs galite LAIMĖTI.** Taikomos sąlygos*

*[LEGO.com/productfeedback-terms](https://www.lego.com/productfeedback-terms)