

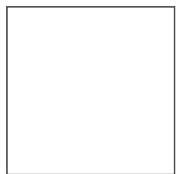

21062



Booklet available in English
Heft in deutscher Sprache erhältlich
Livret disponible en français
Libretto disponibile in italiano
Folleto disponible en español
如需中文版手册





LEGO.com/sustainable-packaging



FR
**DONNEZ
OU
RECYCLEZ**



ASSOCIATION

OU



MAGASIN

OU



DÉCHÈTERIE

Adresses sur quefairedemesdechets.fr



BUILDER



Apple and the Apple logo are trademarks of Apple Inc., registered in the U.S. and other countries and regions. App Store is a service mark of Apple Inc. Google Play and the Google Play logo are trademarks of Google LLC. Tencent and the Tencent logo are trademarks of Tencent Inc.

LEGO.com/devicecheck



LEGO® Builder



WHEN IN ROME / FONTANA DI TREVI

Since its completion in 1762, the Trevi Fountain in its current form has generously carried its well of rich Roman history and architectural heritage through the centuries. The site of the fountain has long played a significant role in the city's growth and prosperity. Since 19 BCE, its natural spring water has flowed through one of the oldest Roman aqueducts, the Acqua Vergine (Virgin Waters).

A breathtaking work of Baroque art, the fountain manifests Roman resourcefulness with a cornucopia of sculptures and symbolic tributes to ancient deities, Roman legends and visionaries, and the abundance of the natural world. Its name, derived from *tre vie* (three roads), highlights its strategic location at the intersection of three ancient streets, once guiding pilgrims and citizens – and now around 10 million visitors a year.

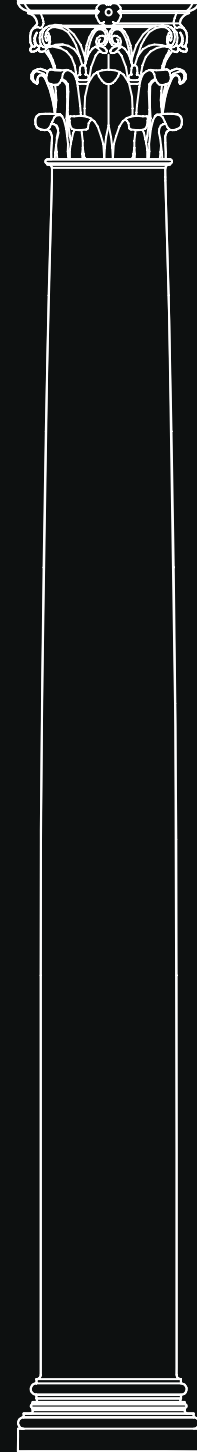

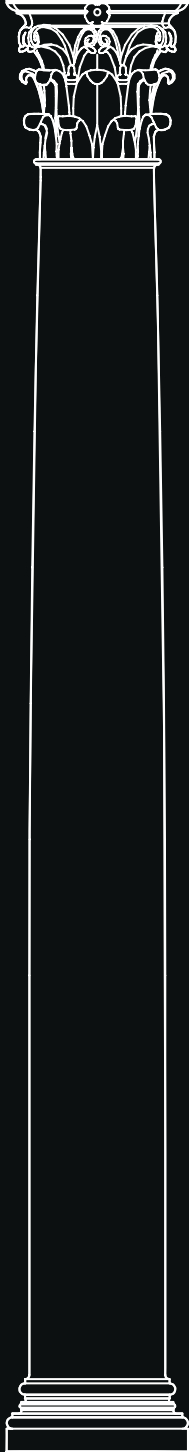

FROM THE LEGO® ARCHITECTURE DESIGN TEAM

More than a visual gem, as a cultural icon the Trevi Fountain has inspired countless works of art, literature and even films. Following the popular 2014 LEGO® Architecture Trevi Fountain (21020) set, this version revisits the site at a grander scale as an interpretation of the real-life structure, with some details abstracted to fit the scene.

The main goal was to capture the Baroque ambience and atmosphere in Rome on a summer's day, with the vibrant-coloured buildings surrounding the Trevi Fountain reflecting a warm light over the piazza. The depths within the facade cast shadows upon themselves and the basin, creating subtle variances in the surface colours. Using hues of pink, tan, grey and white, we wanted to capture the essence of these intricate nuances in the building, statues, water and rockwork.

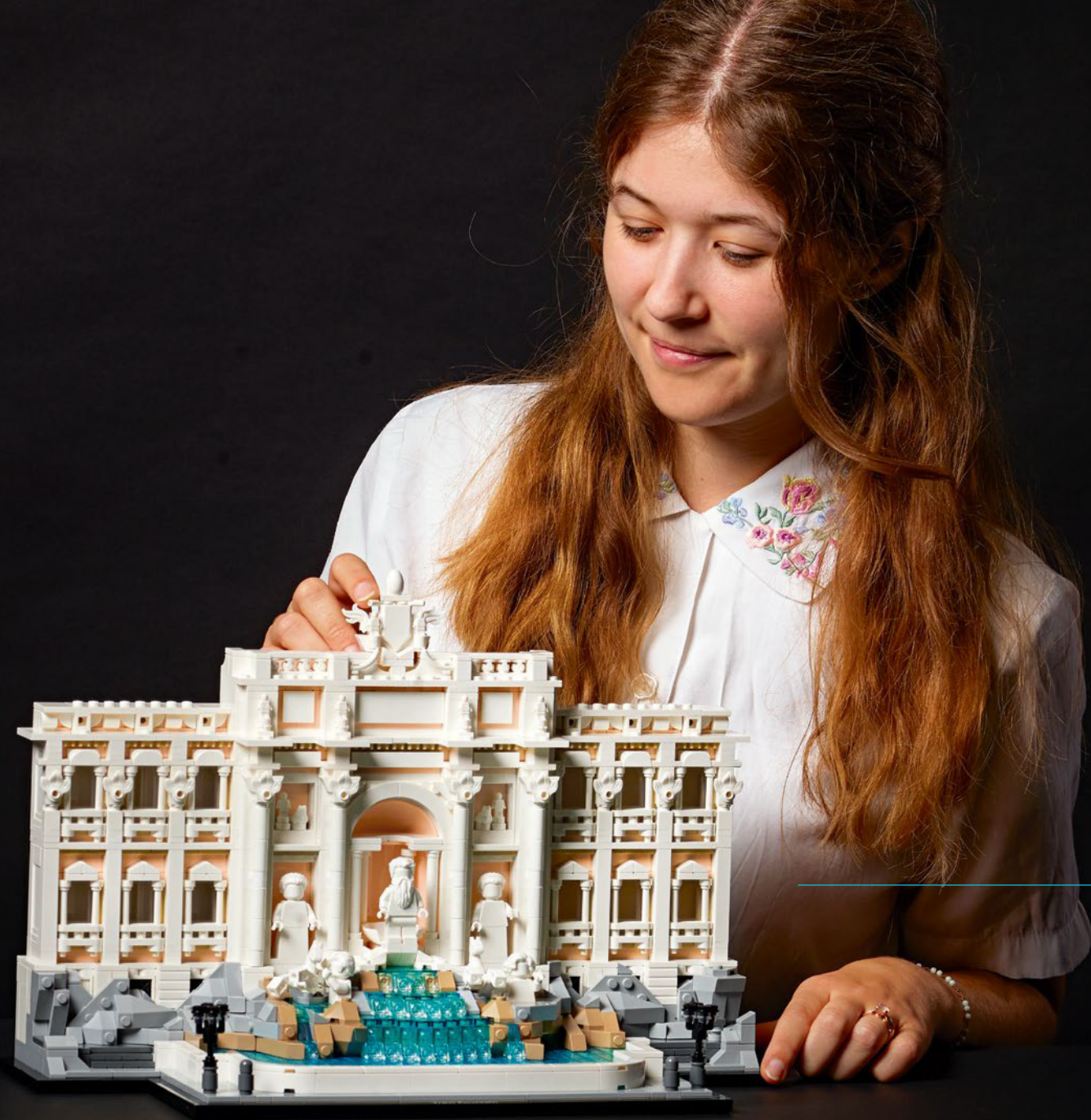

Mary Wilson
LEGO® Architecture Designer



PALAZZO POLI

The coat of arms of Pope Clemens XII, who commissioned the Trevi Fountain, is flanked by four statues representing fruits and crops fertilised by the water.



OCEANUS (NEPTUNE)

The god of the seas, riding a shell-shaped chariot pulled by mythical hippocampi (sea-horses), symbolising Roman engineering expertise in controlling water through aqueducts.

AGRIPPA

Roman general and architect Marcus Vipsanius Agrippa (63-12 BCE) is shown approving the plans for the original aqueduct's construction.



THE VIRGIN

A tribute to the young girl who, according to myth, pointed out the spring to Roman soldiers millennia ago.



SALUBRITY (SALUS)

The goddess of health holds a cup to allow a snake to drink, symbolising the purity and healing powers of the water.



ABUNDANTIA

The goddess of abundance pours water from a large urn, symbolising the flow of water from the aqueducts and the fertility it brings to the land.



TRITONS

Mythical half-man, half-fish sea creatures. One struggles to control a wild hippocampus (the turbulent nature of the sea), the other guides a calm hippocampus (the waters under Roman control).



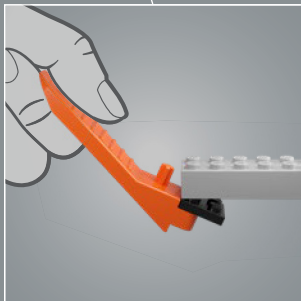
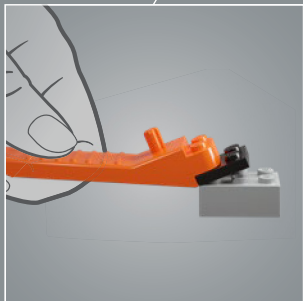
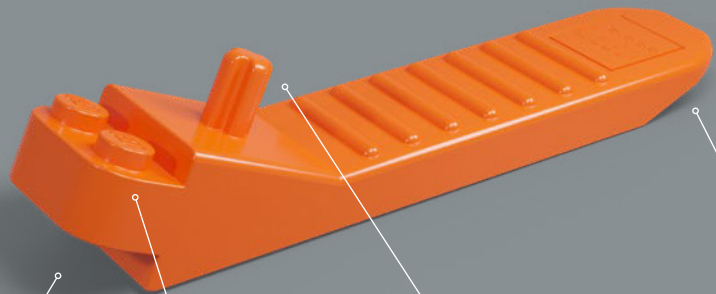



Designed by Nicola Salvi, the Fontana di Trevi took 30 years to build and was completed by his friend – the sculptor, Pietro Bracci – in 1762, 11 years after Salvi's death.

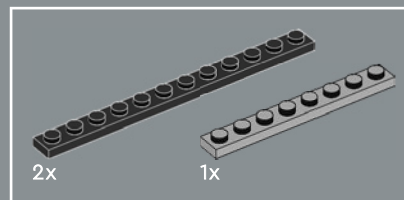

1

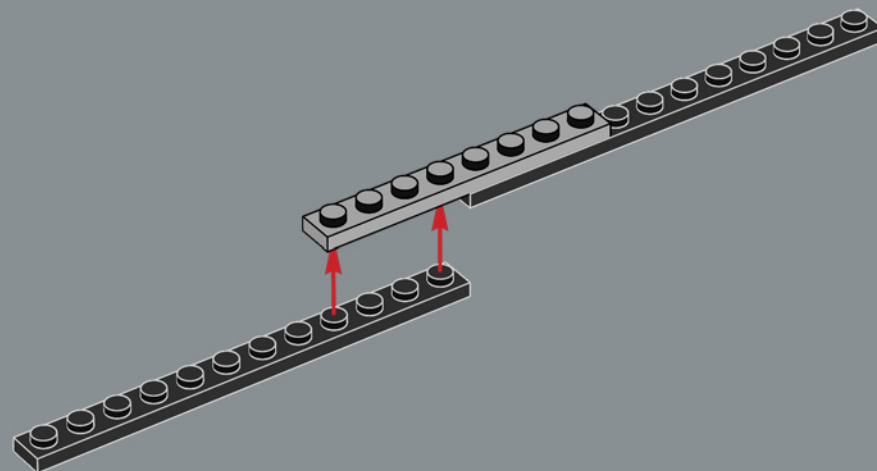

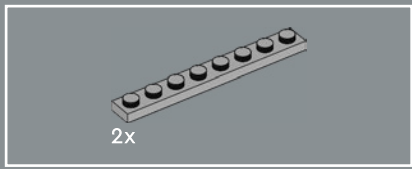

2

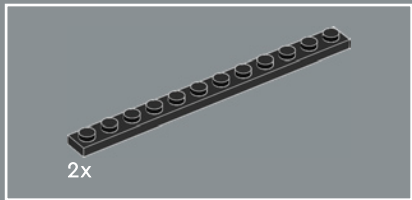
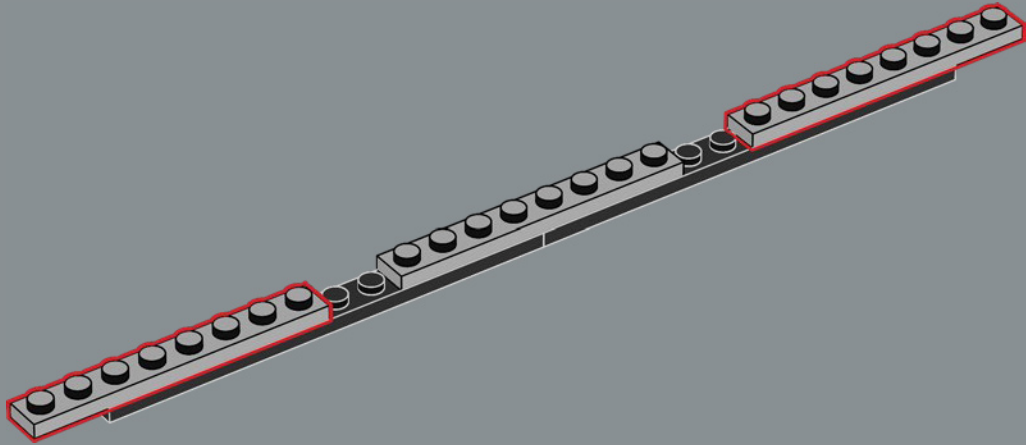

3

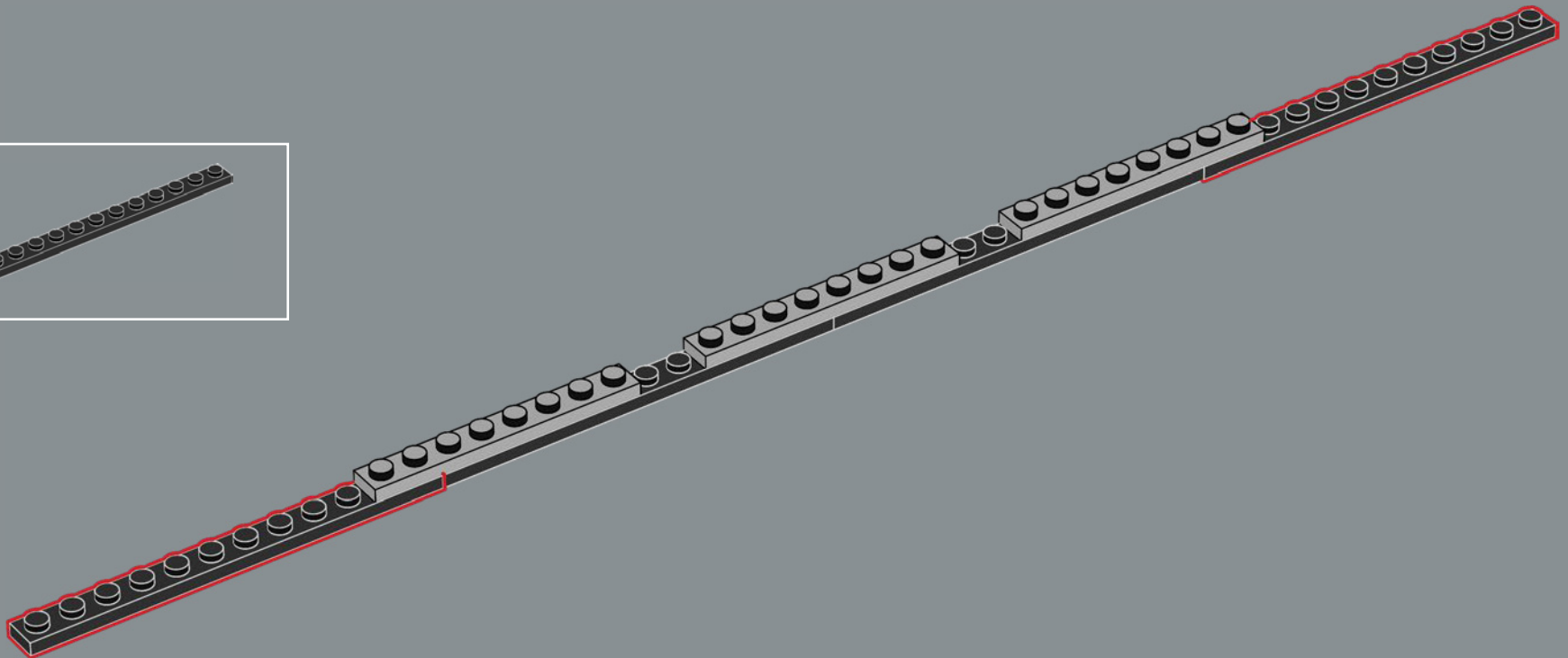

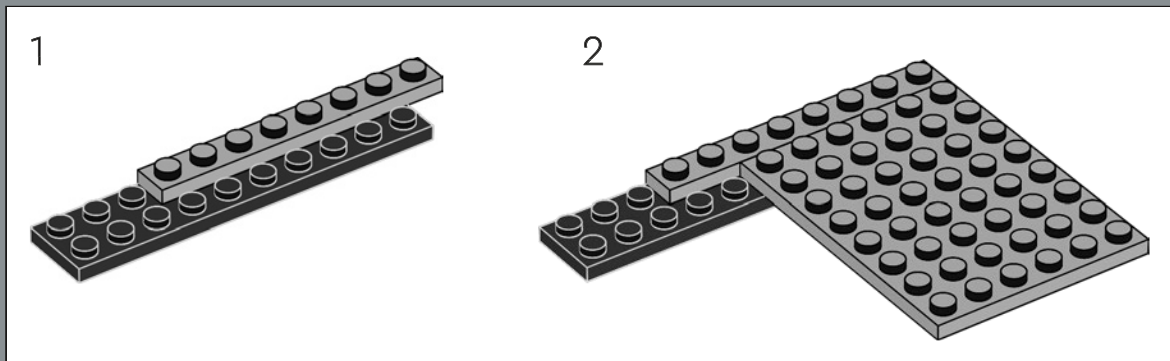
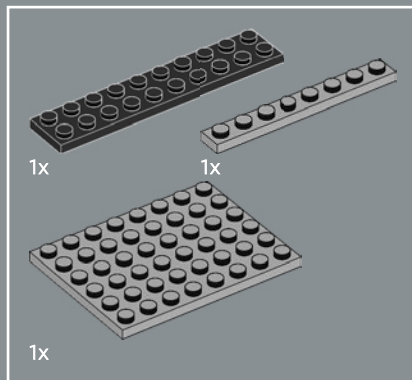

4

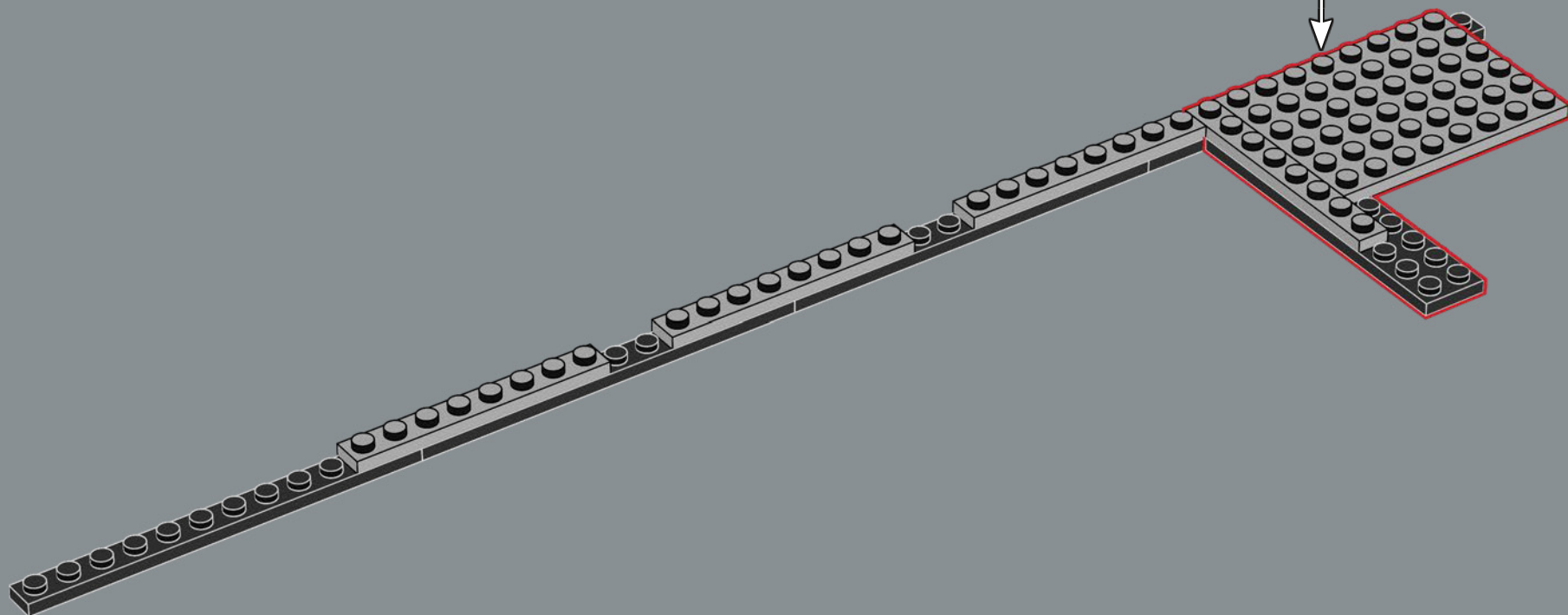

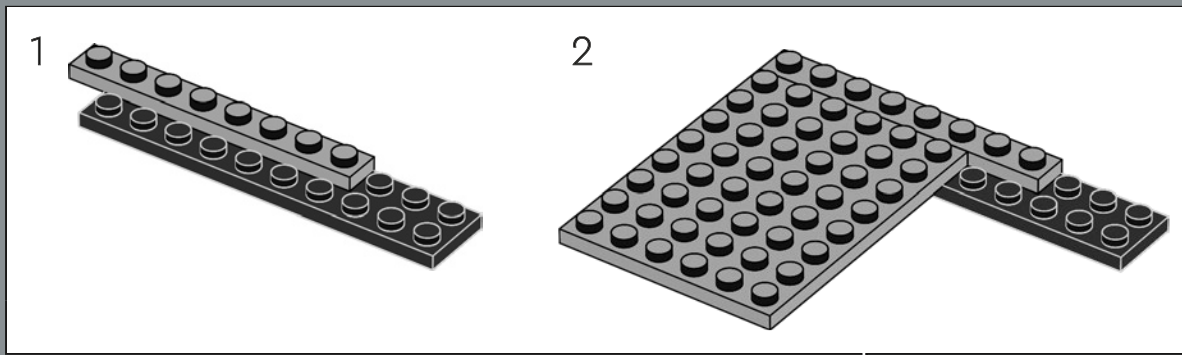
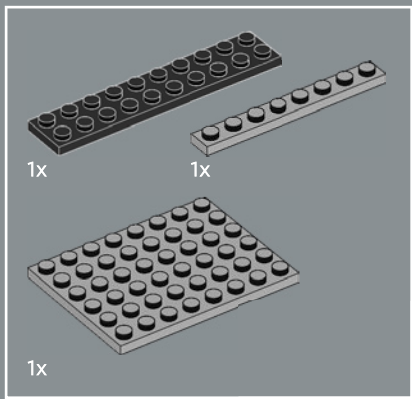

5

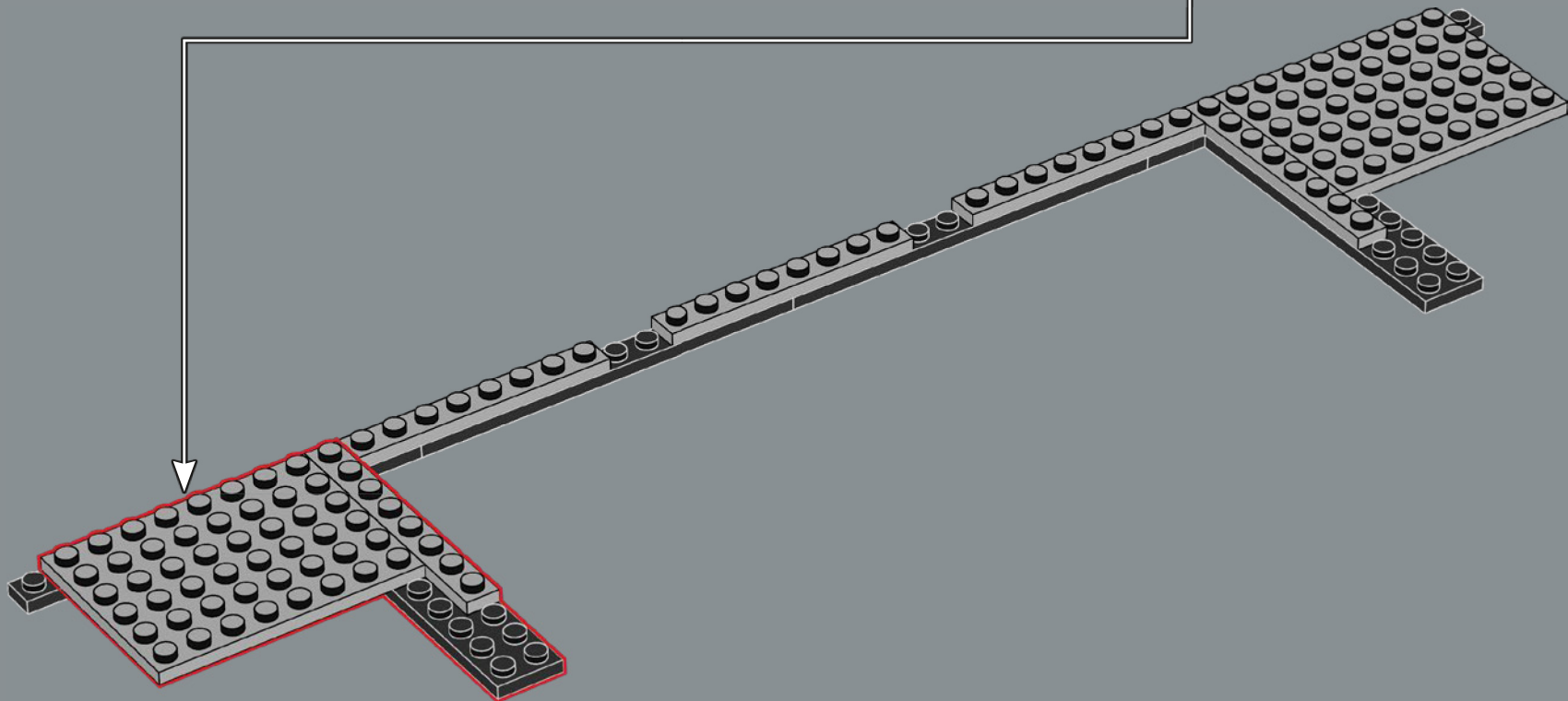

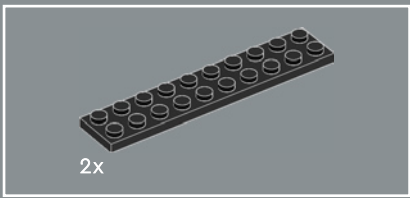

6

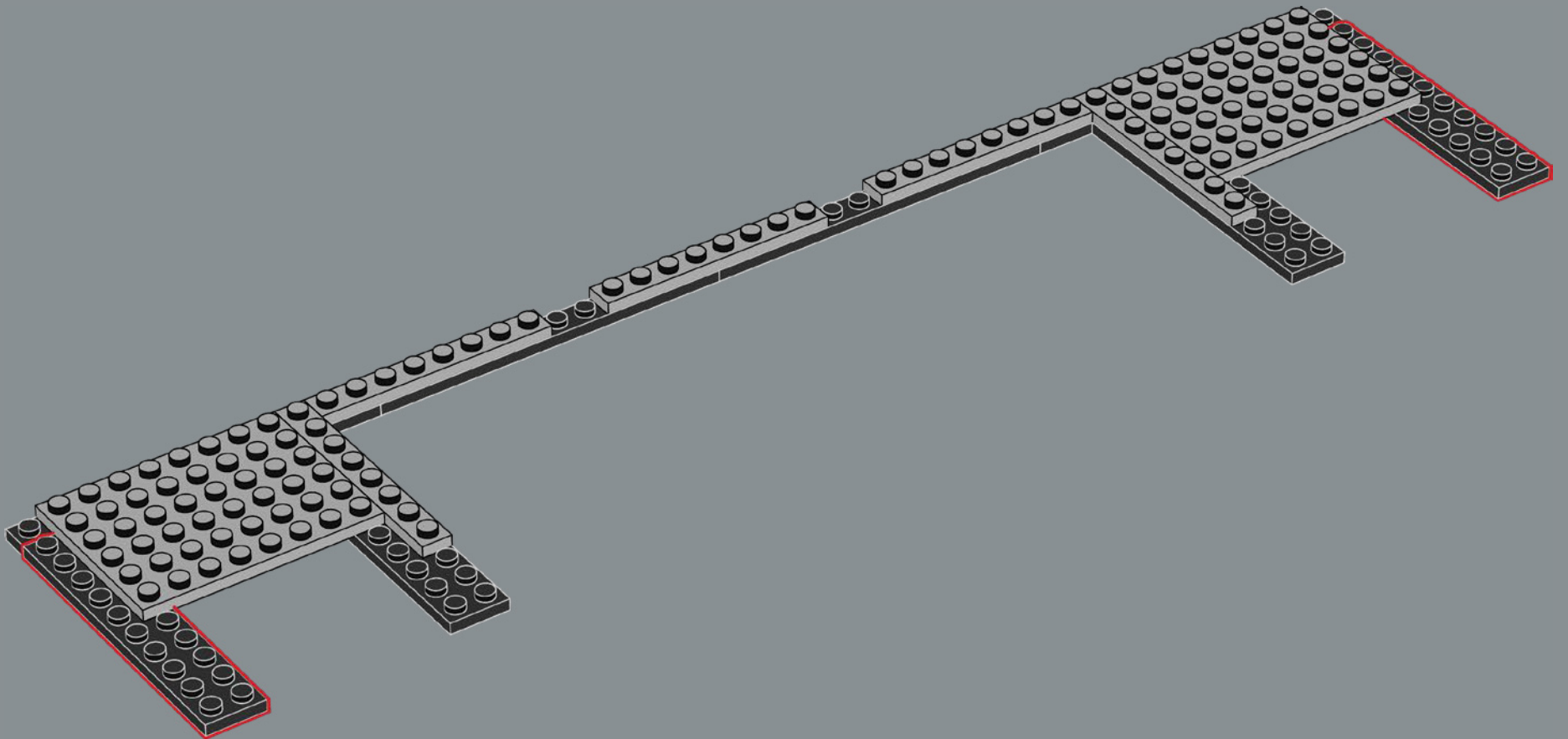

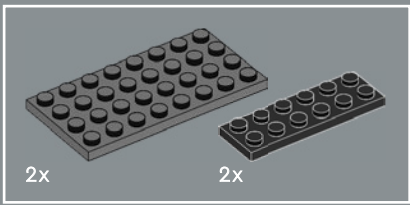

7

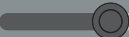
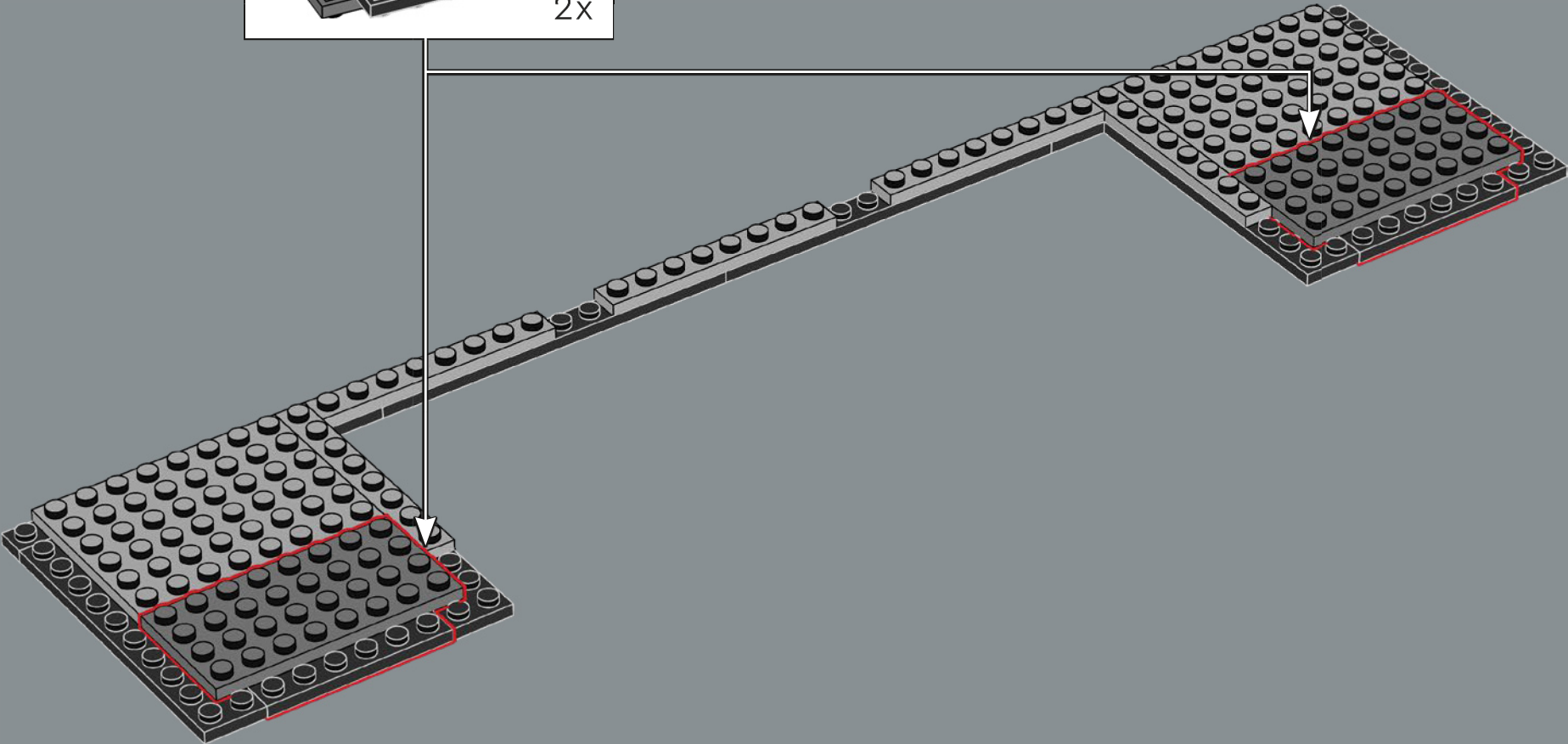
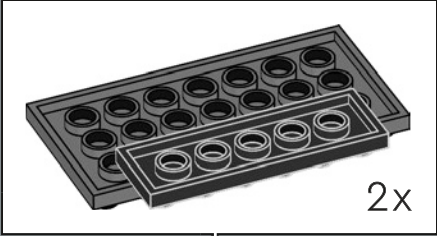



8

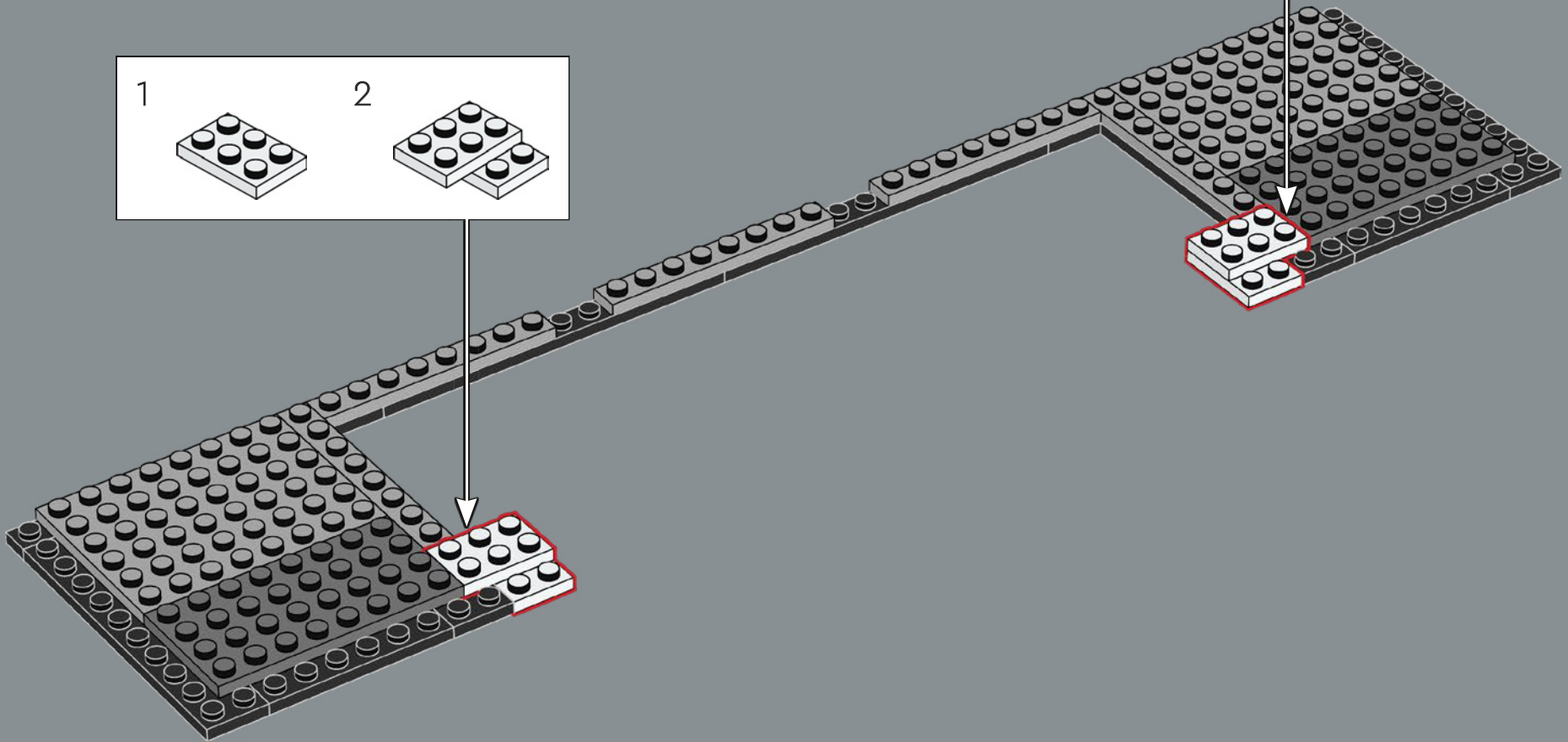
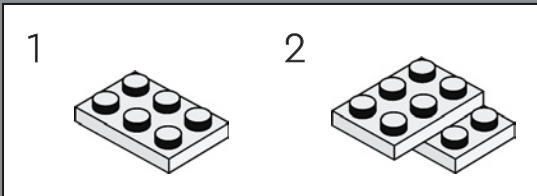
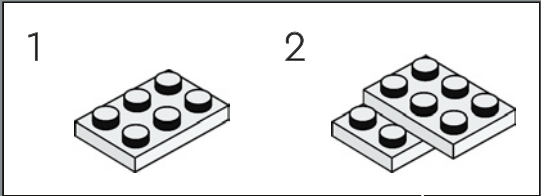

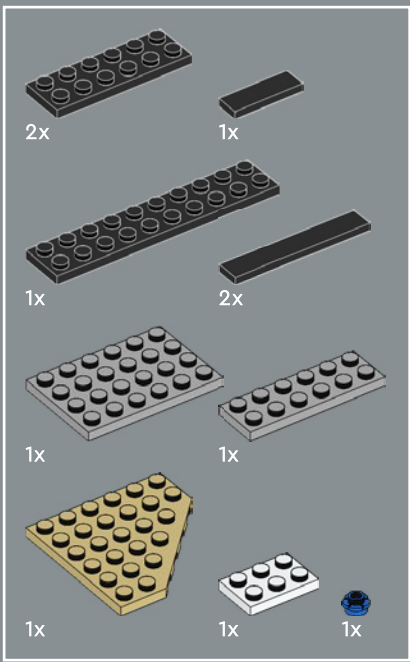

9

1

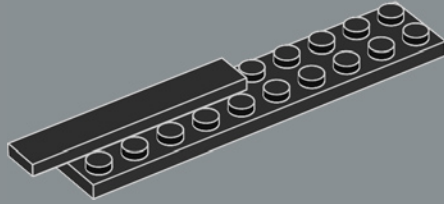

2

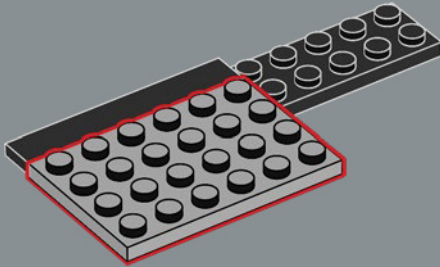

3

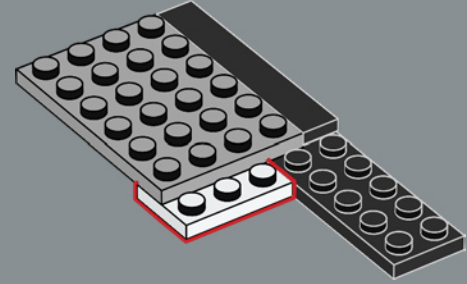

4

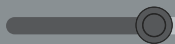
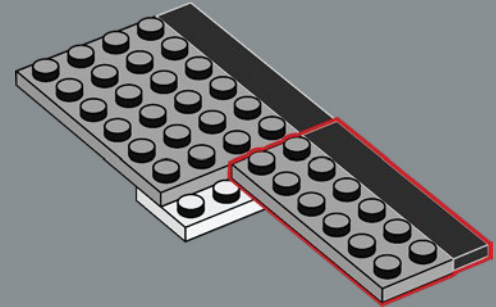

5

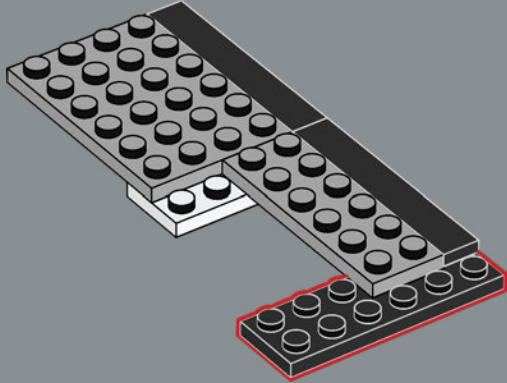

6

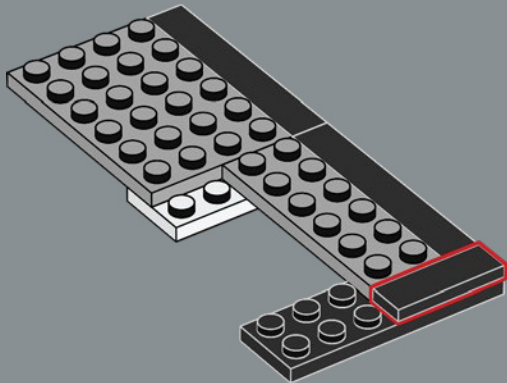

7

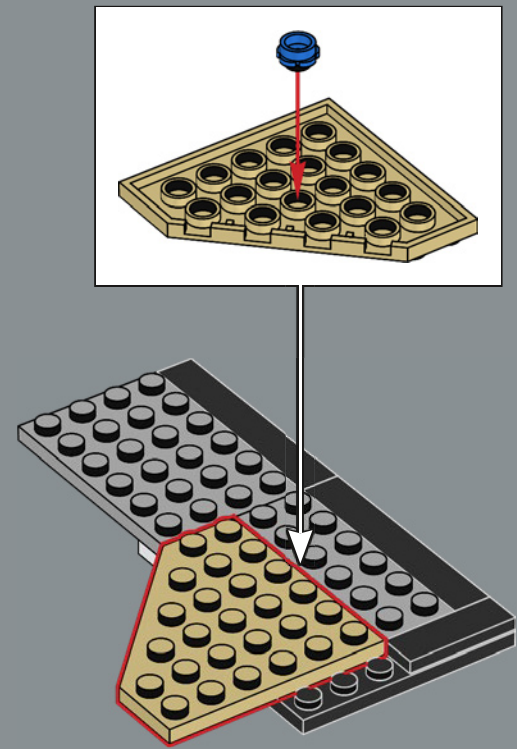

8

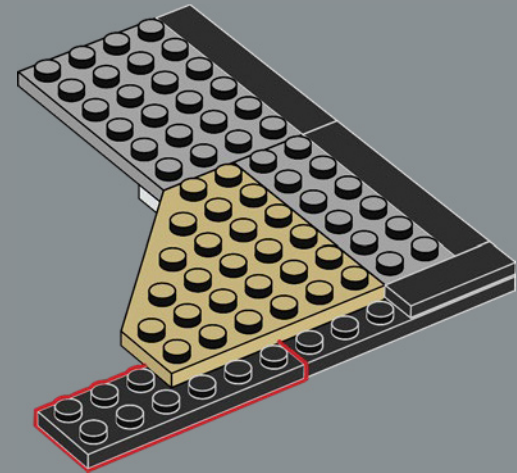

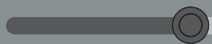
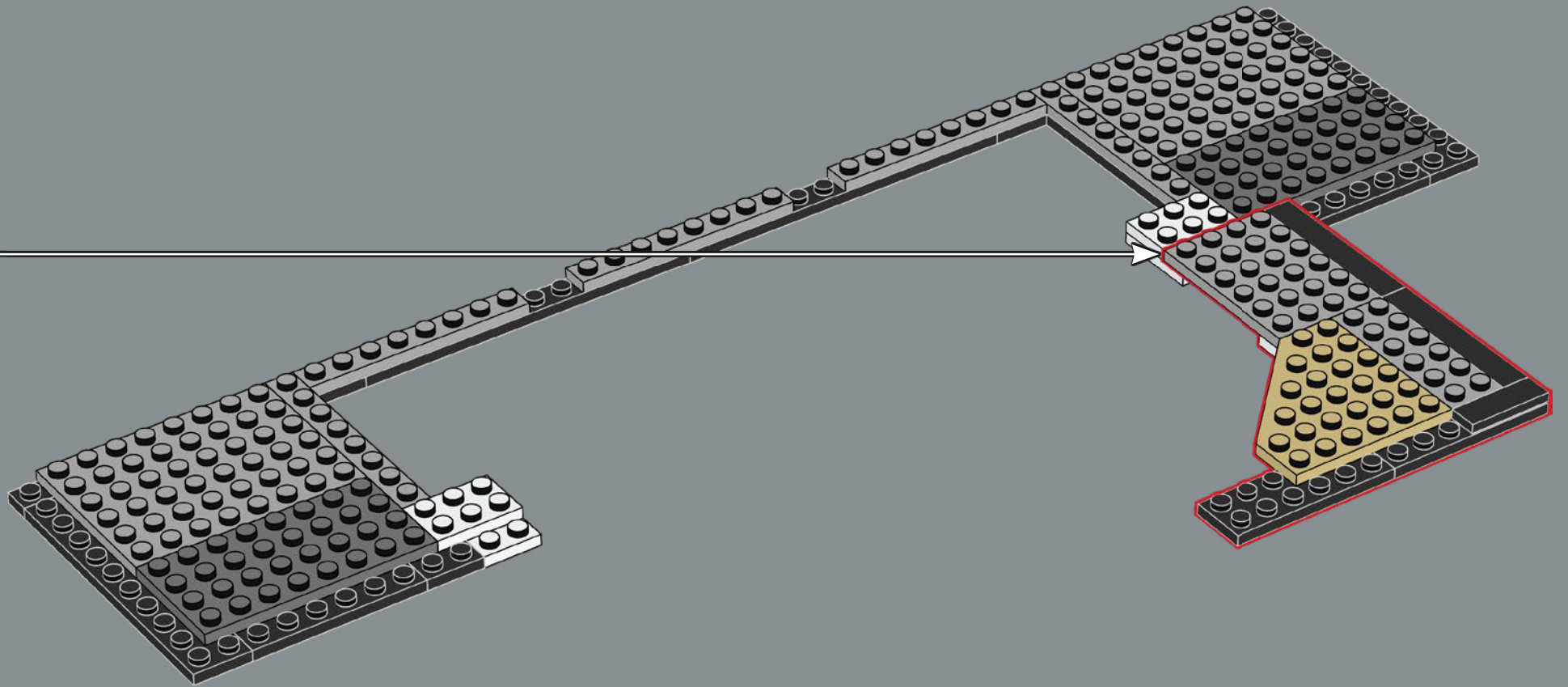

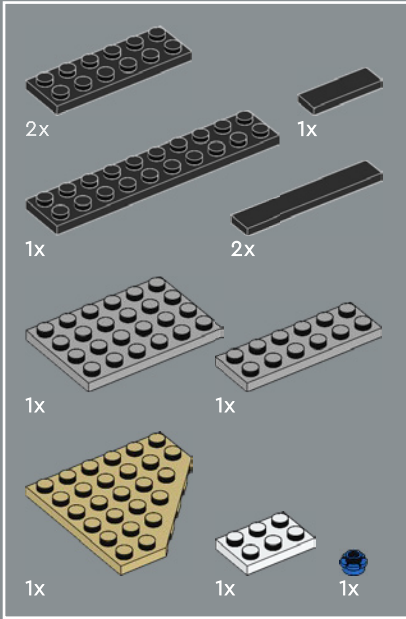
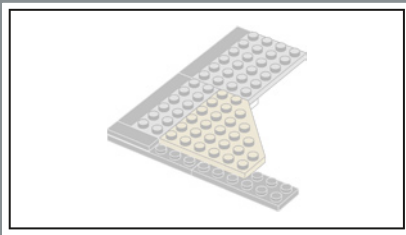

10

1

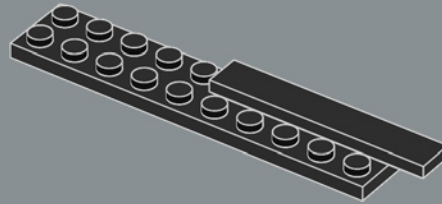

2

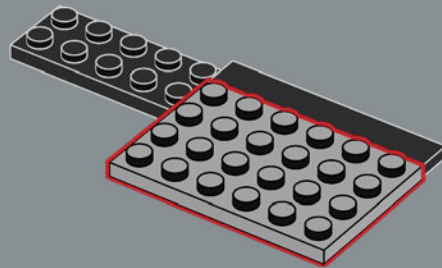

3

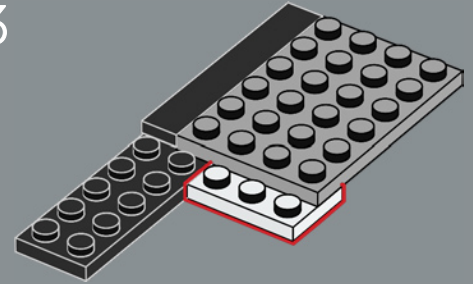

4

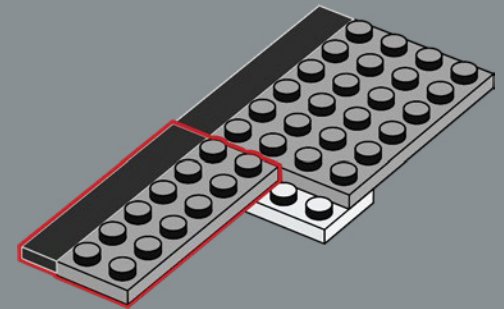

5

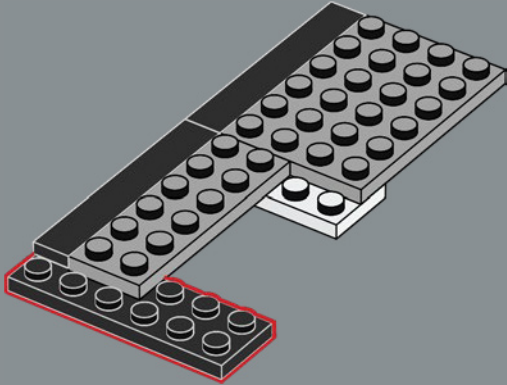

6

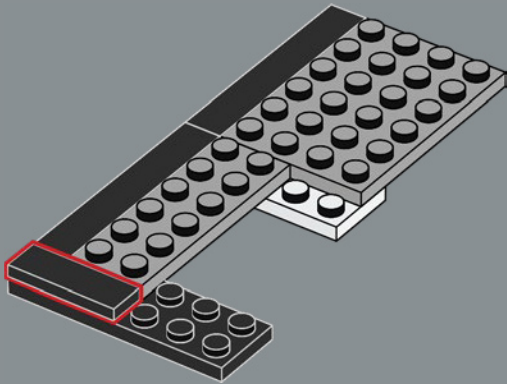

7

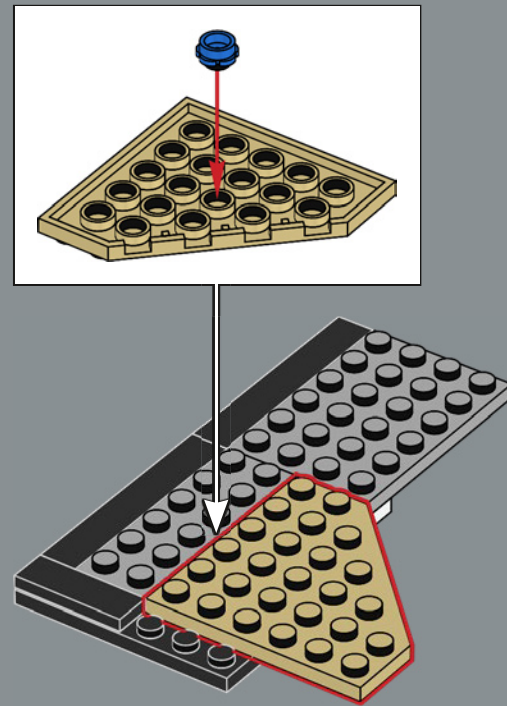

8

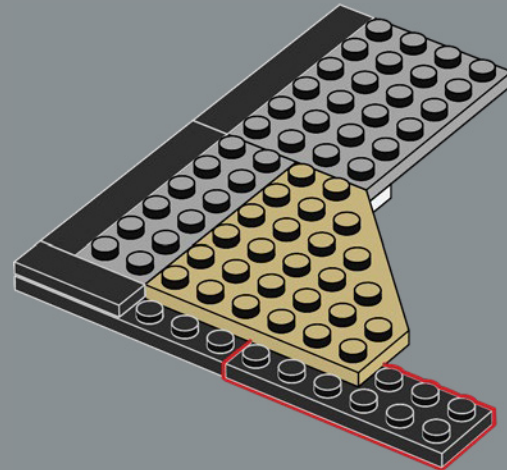

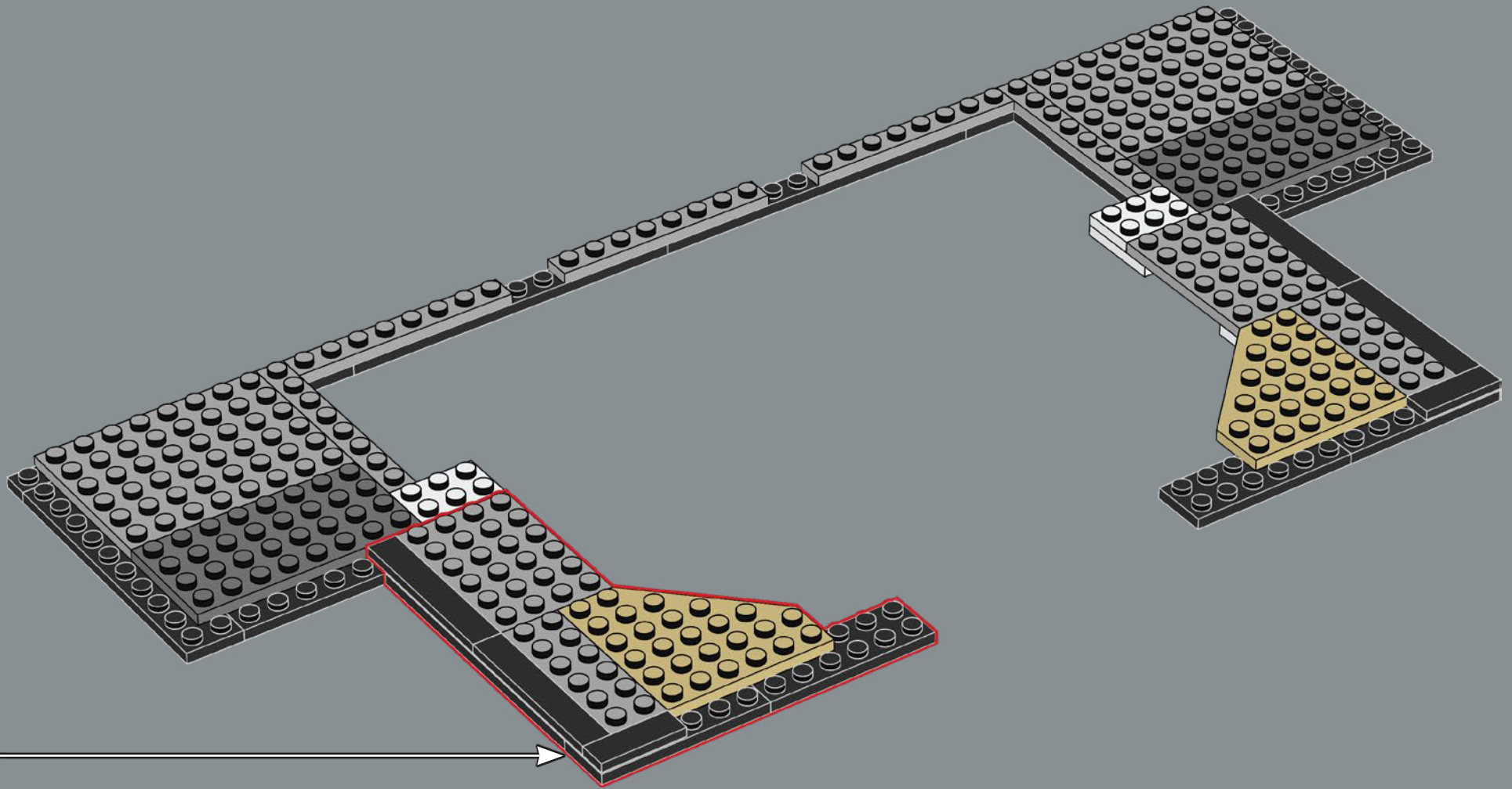

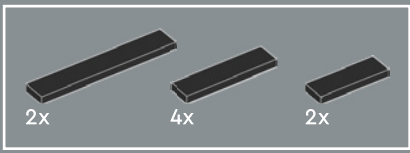

11

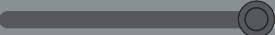
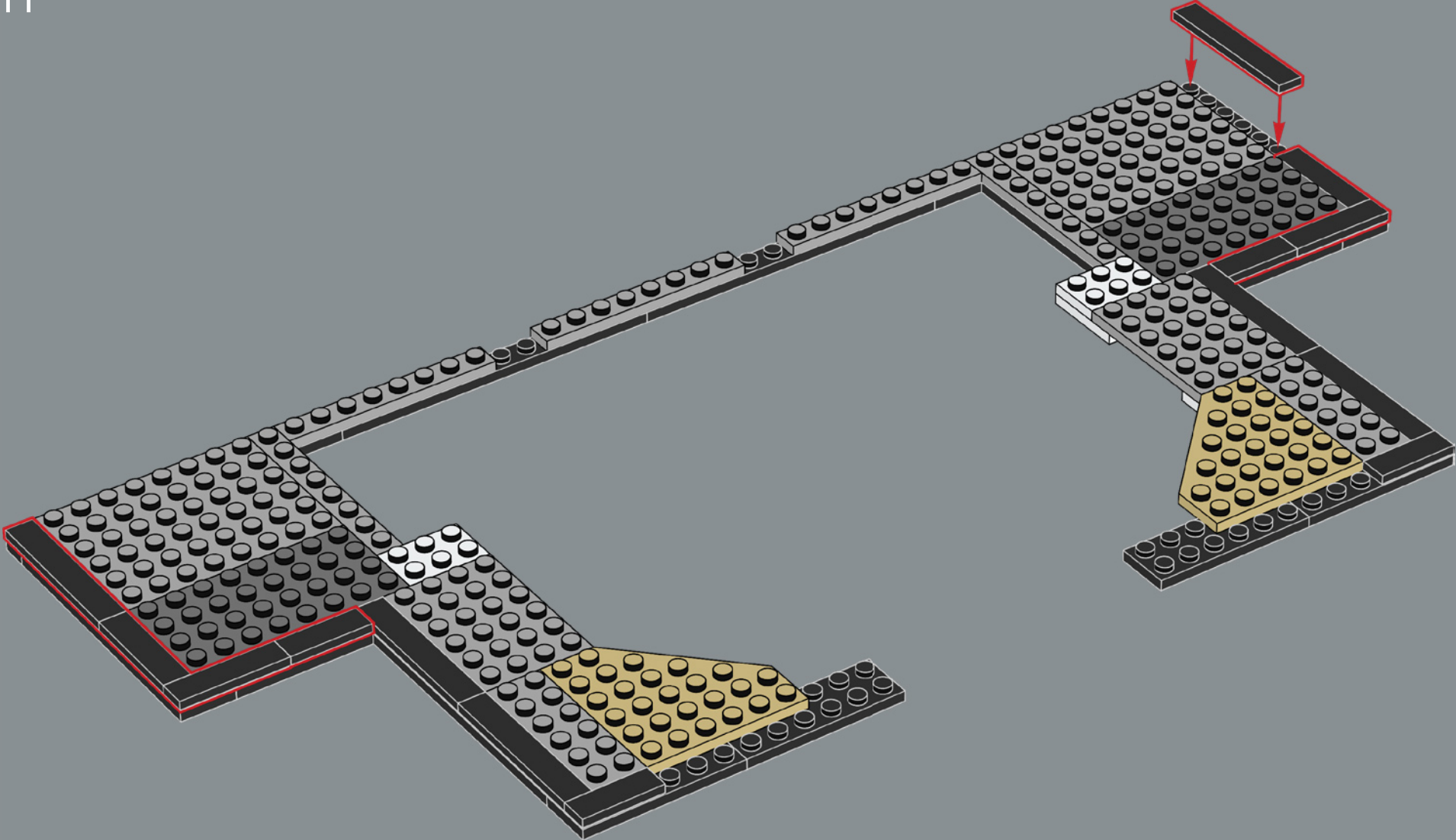

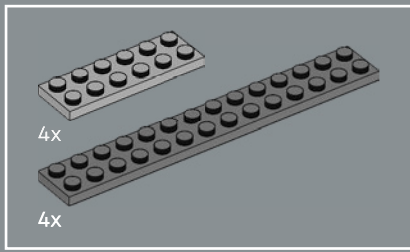

12

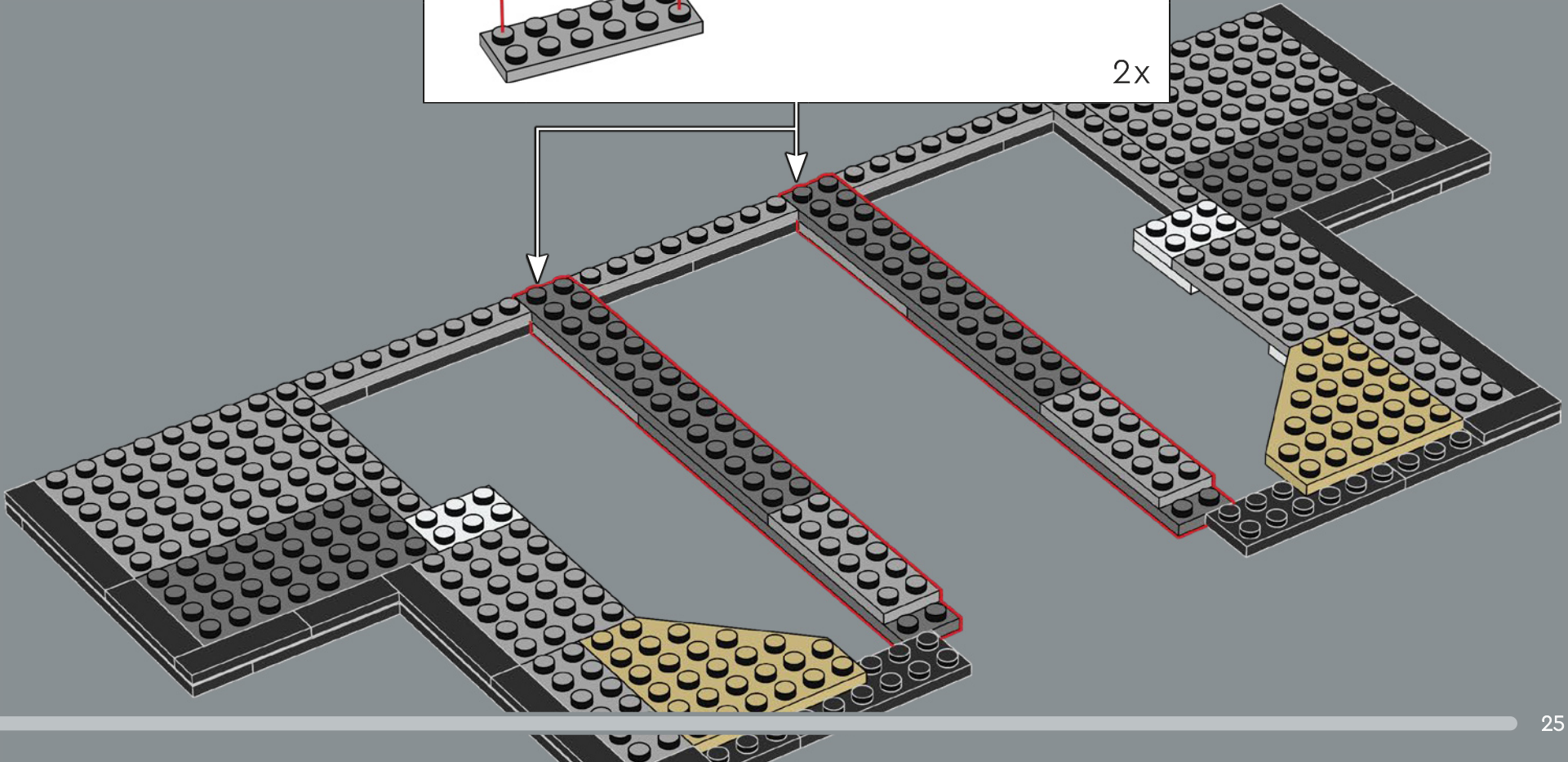
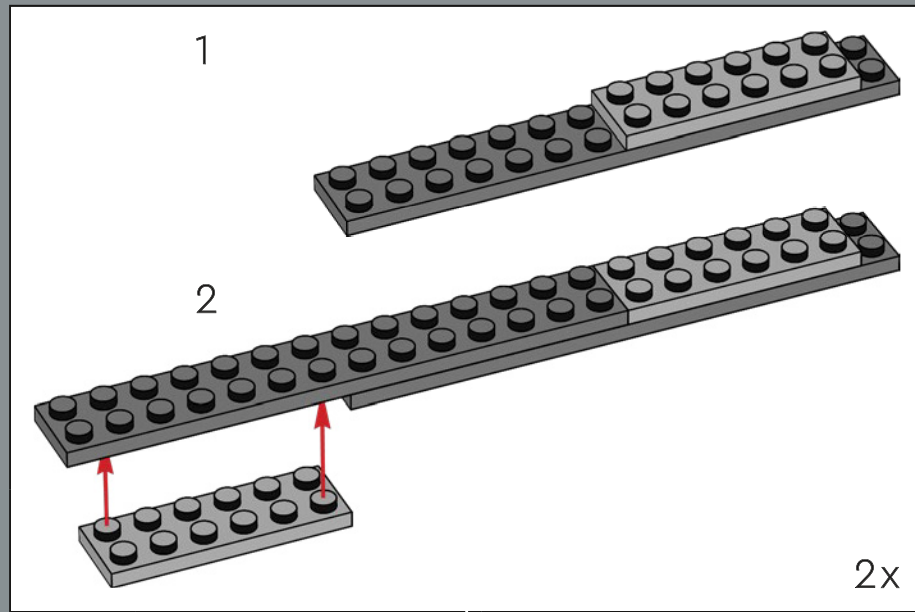

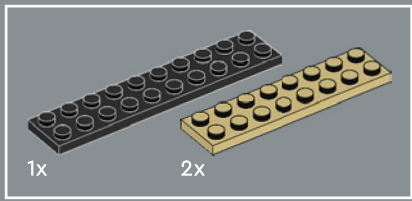

13

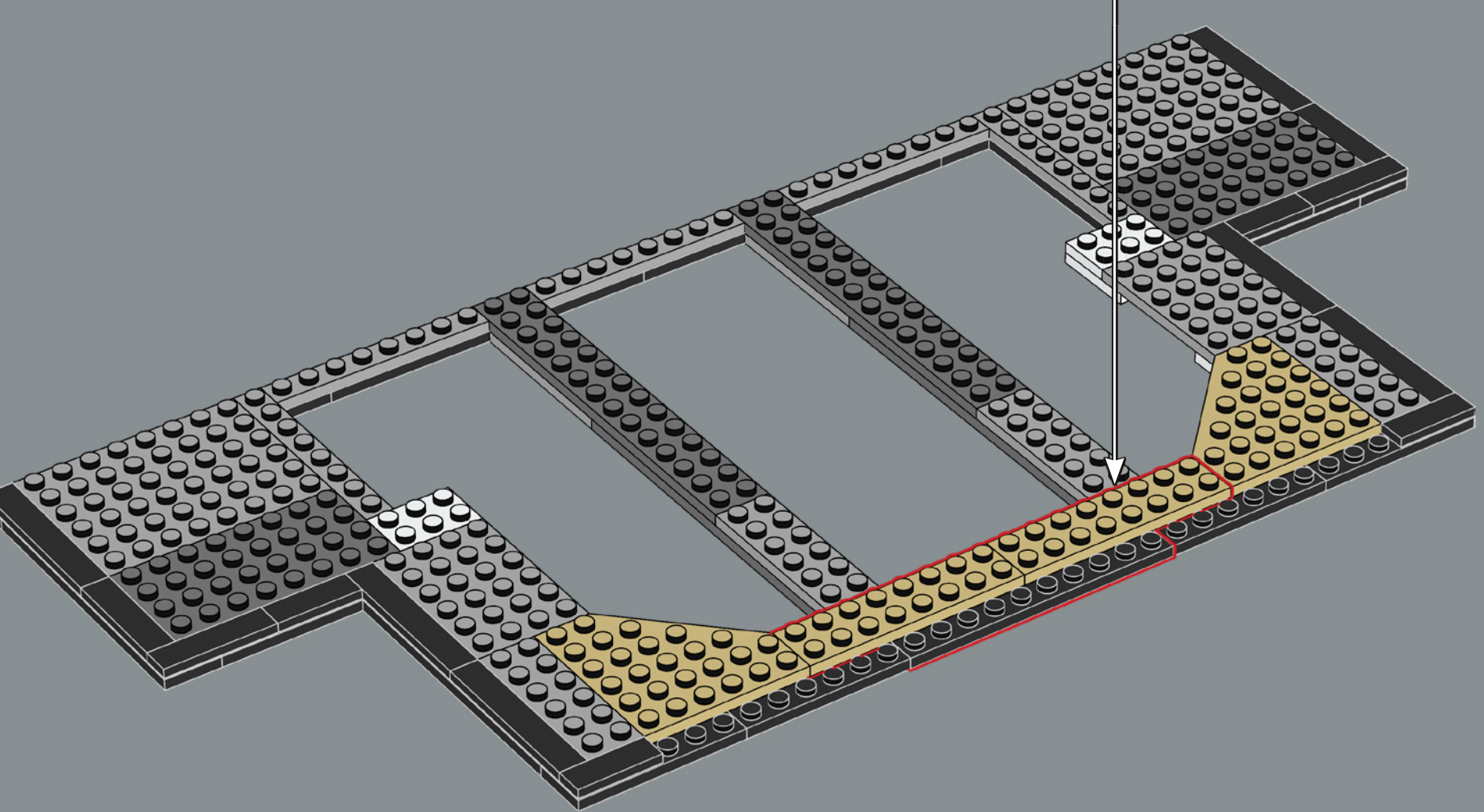
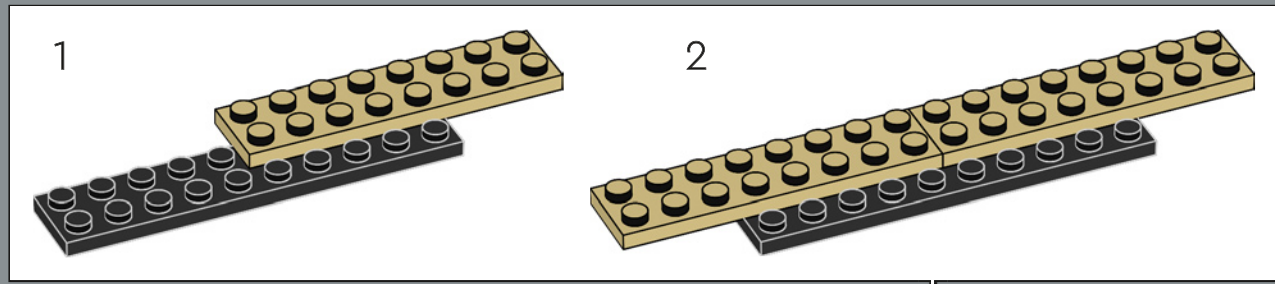

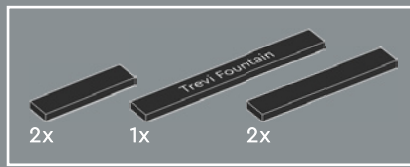

Over the centuries, the 'three roads' that led to and inspired the name of the Trevi Fountain have expanded. Five roads now lead to the famous piazza.

14

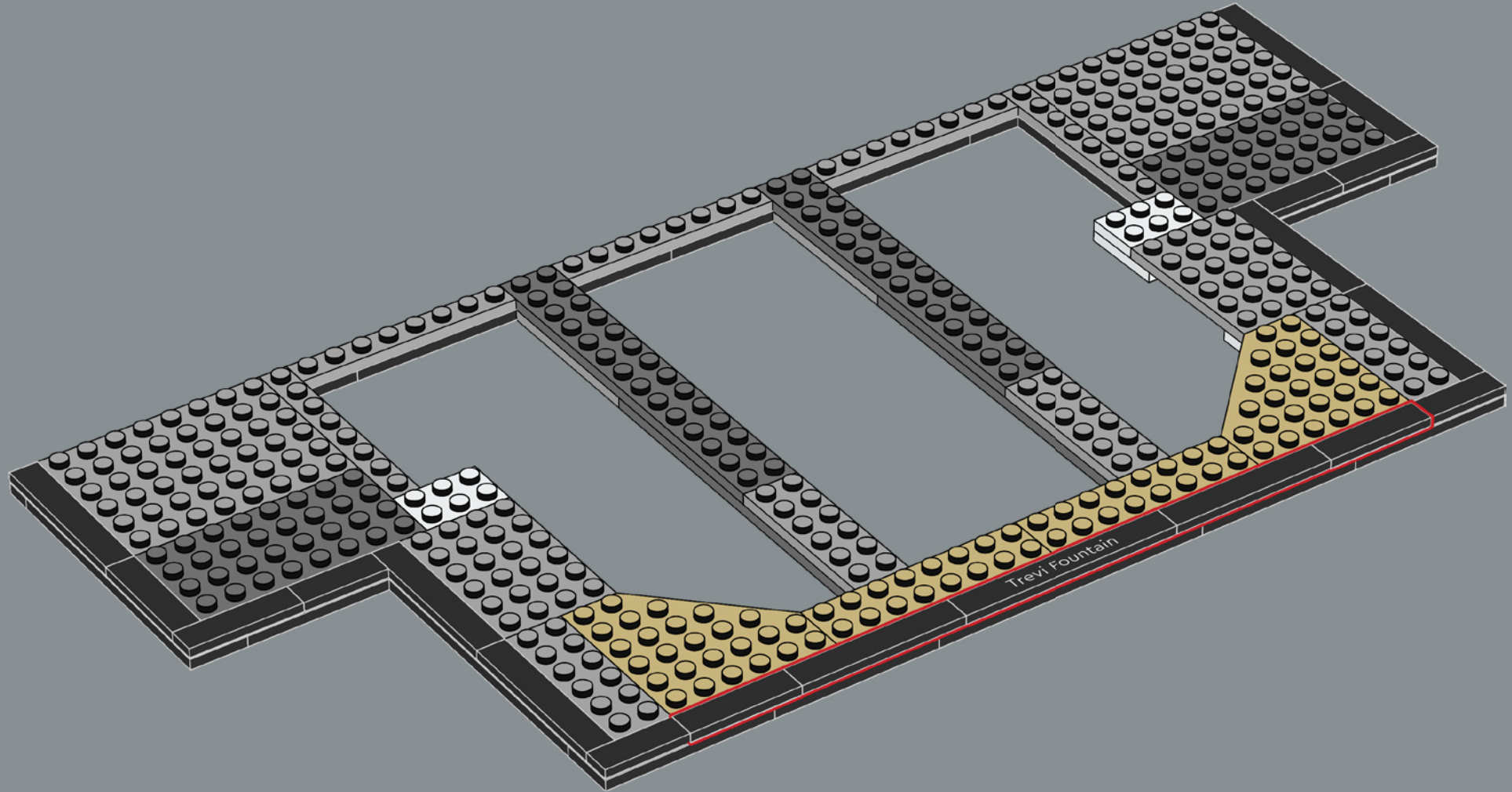

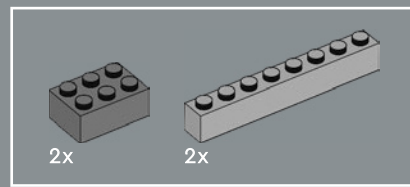

15

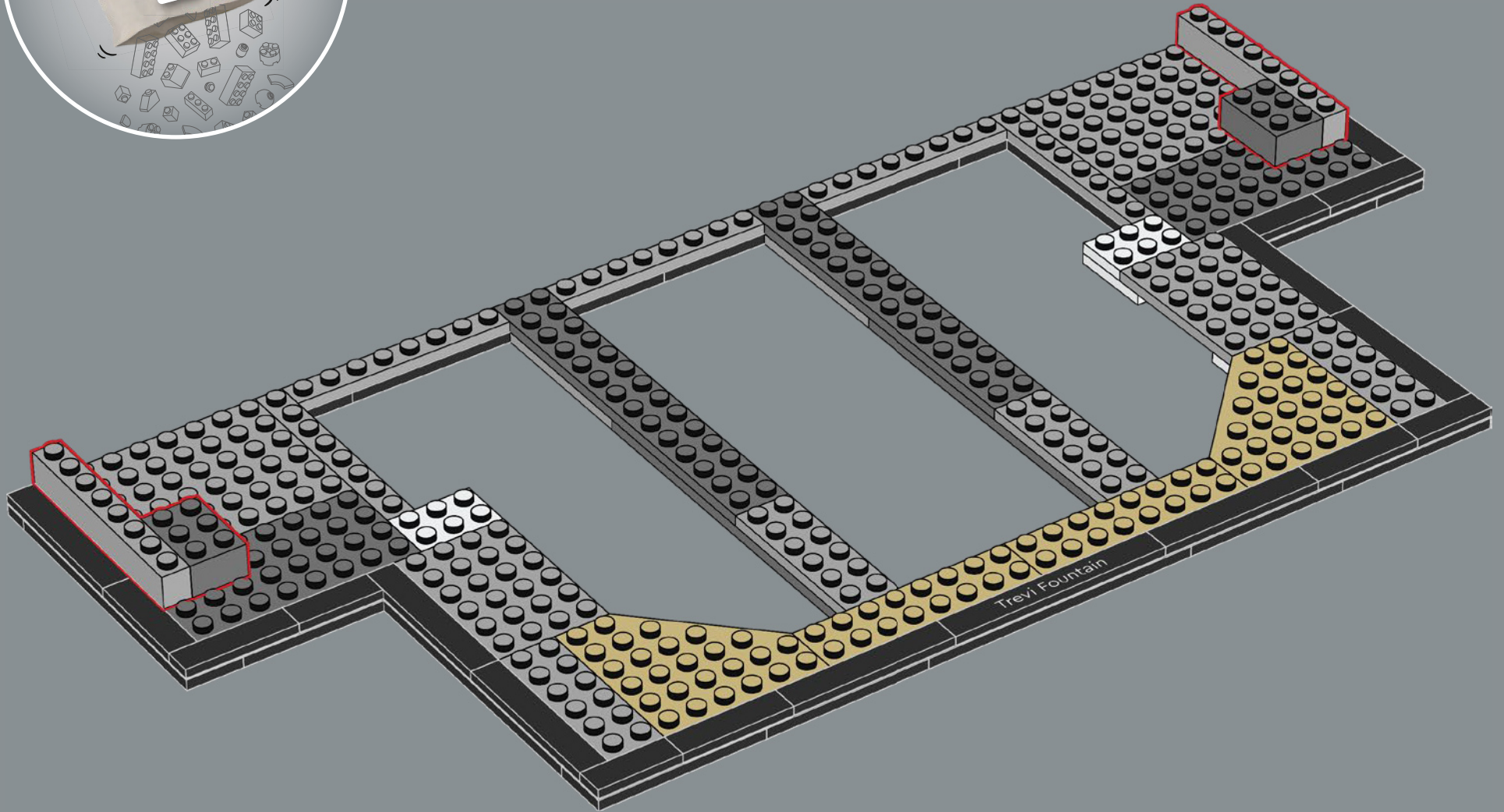

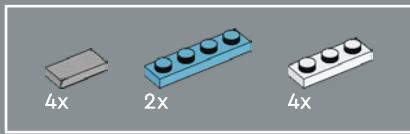

16

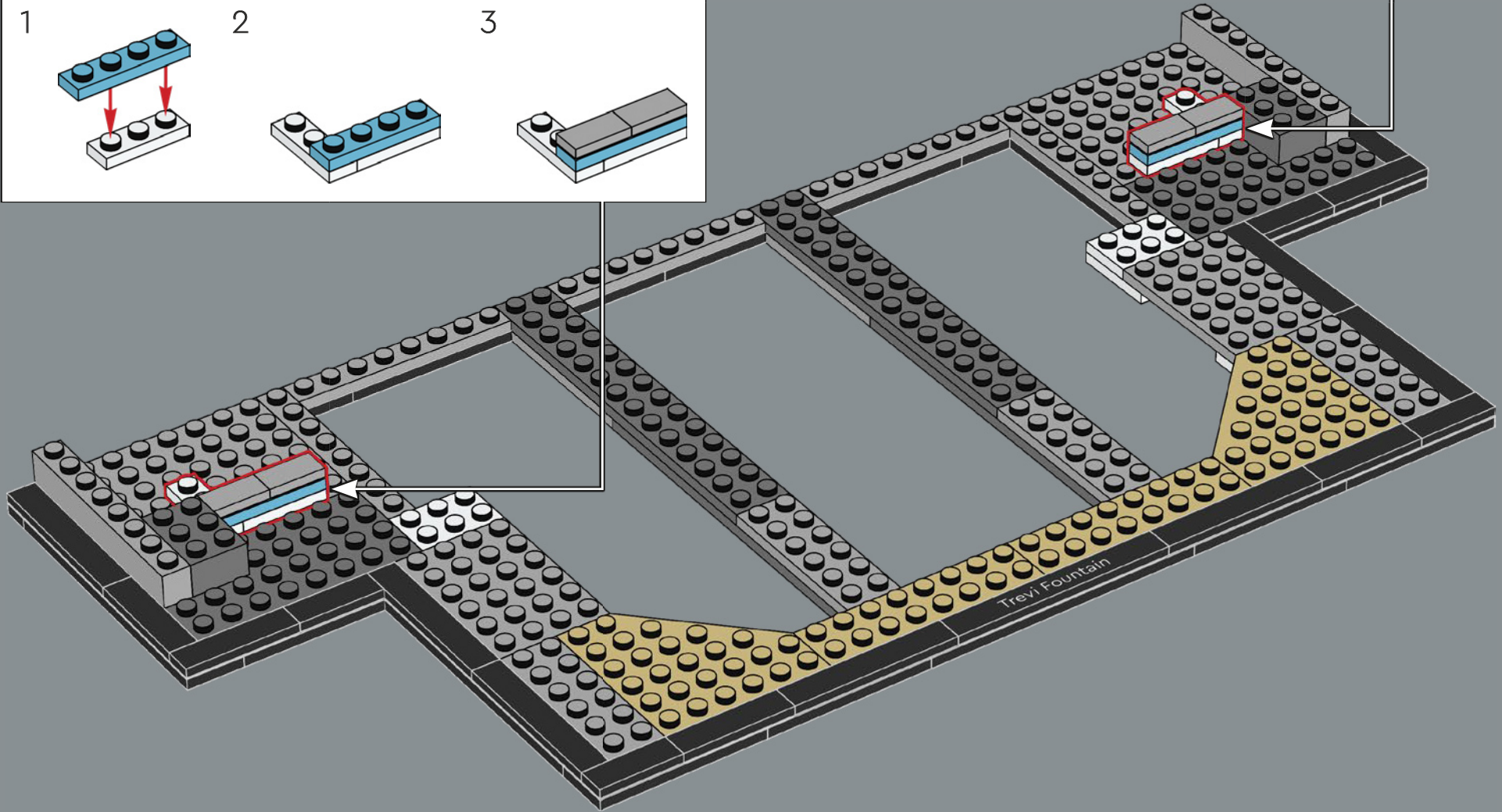
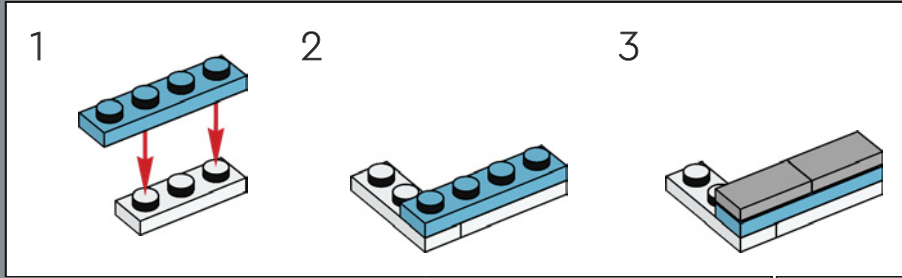
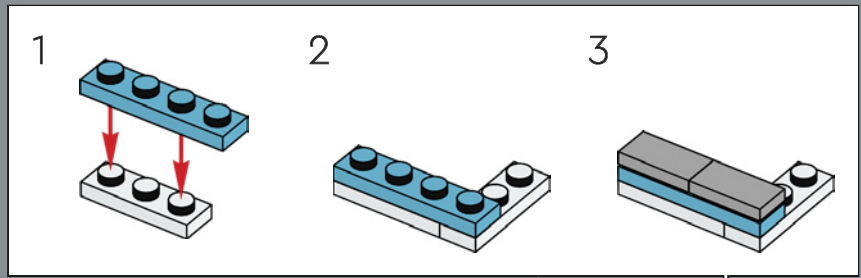

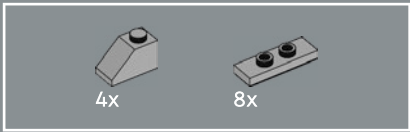

17

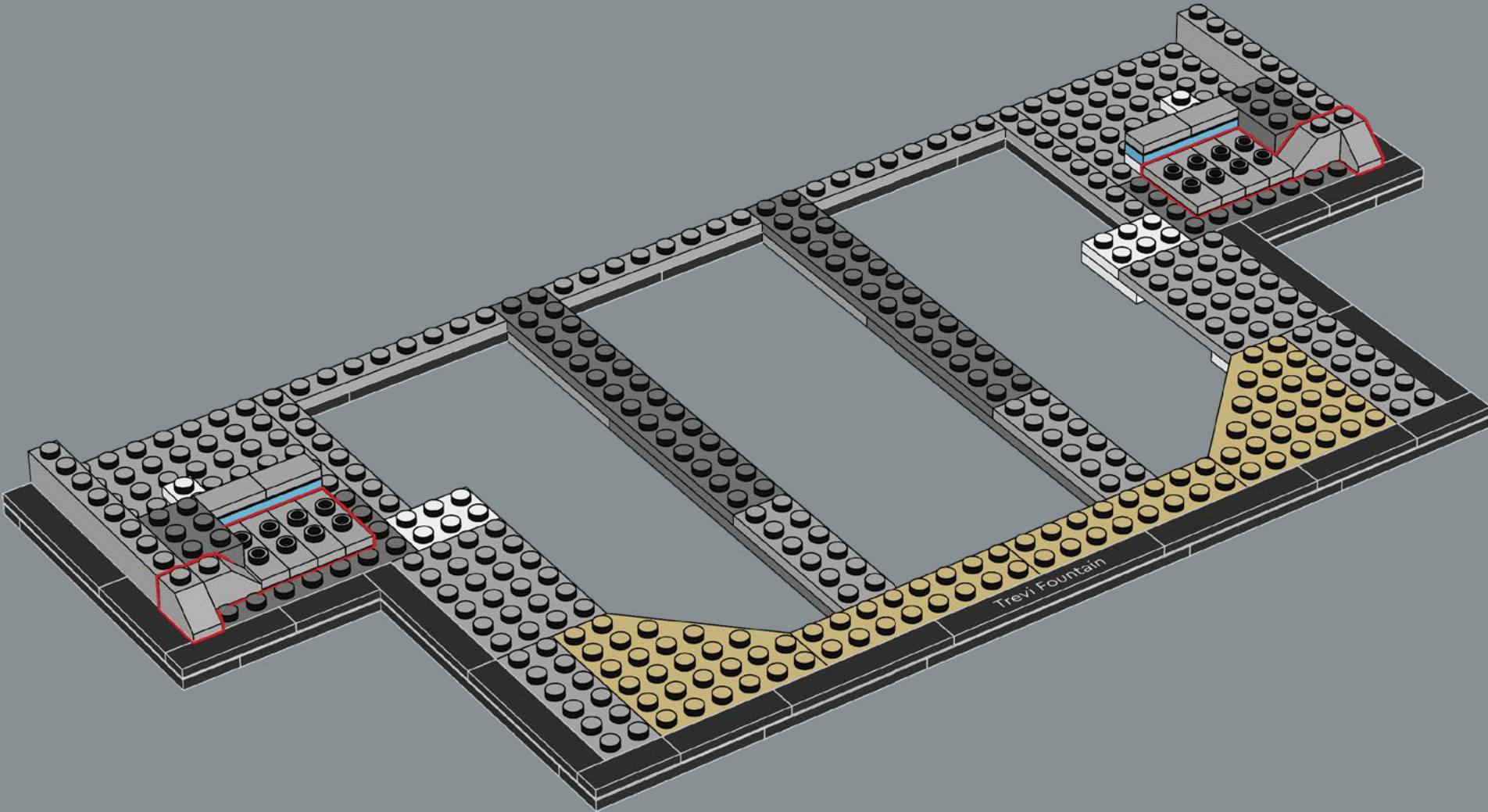

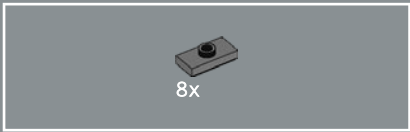

18

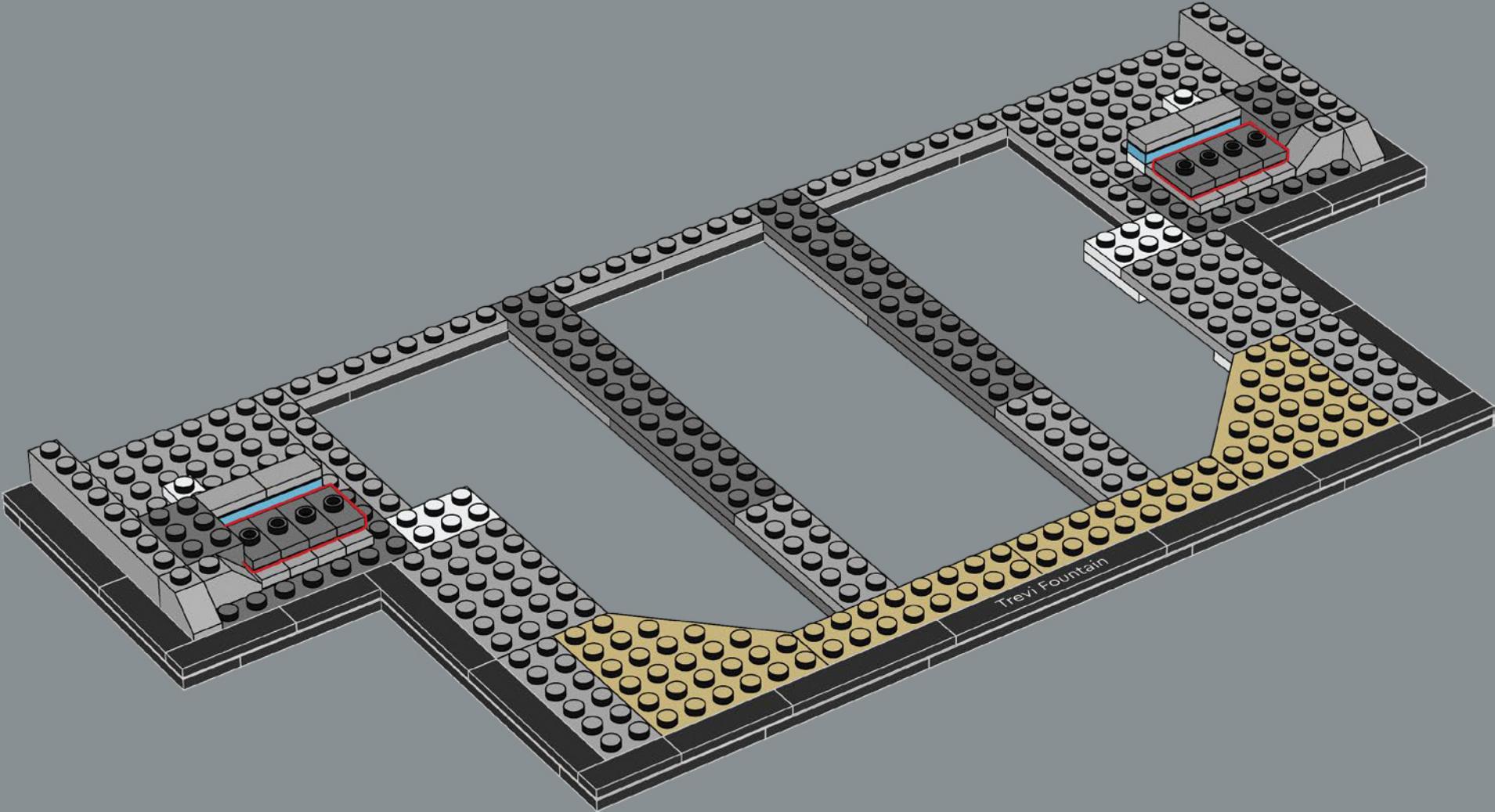



8x

19

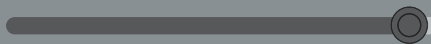
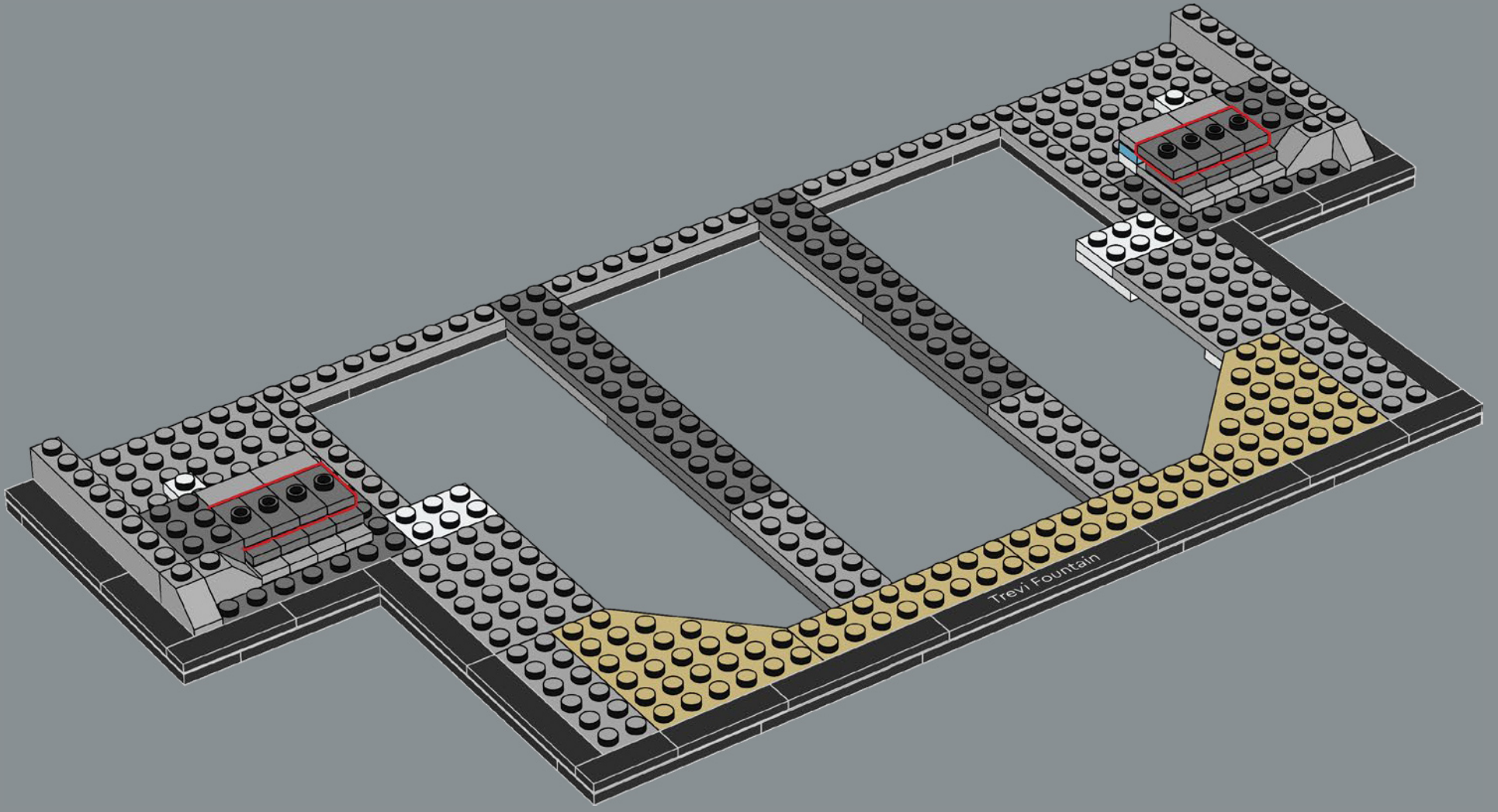

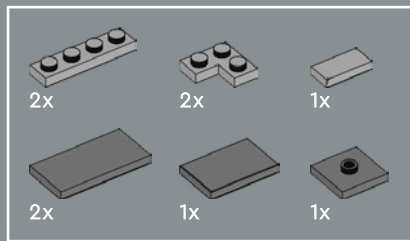

The sheer amount of foot traffic to the monument also contributes to the gradual discolouration of the pavement, steps and lower rockwork.

20

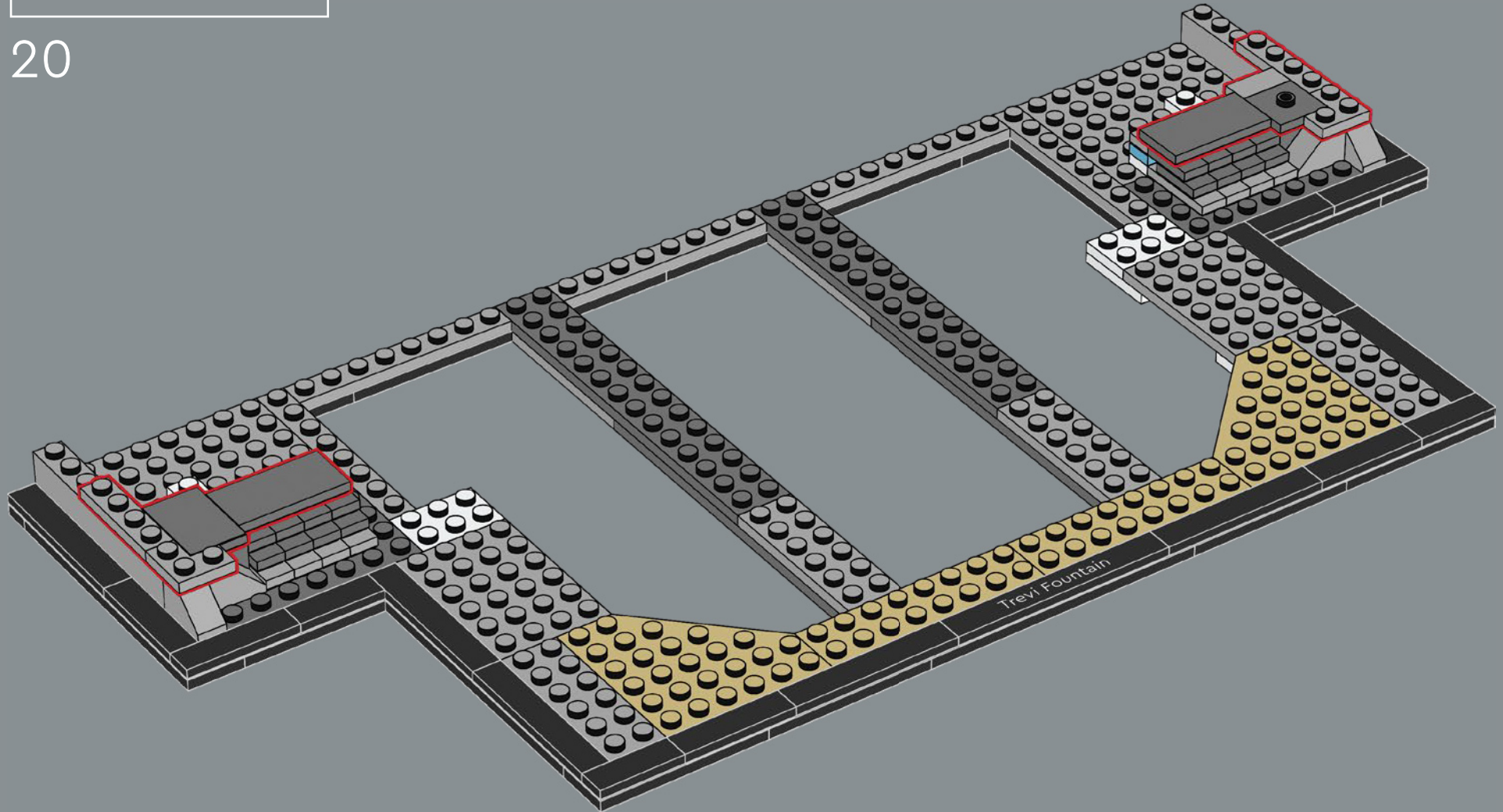

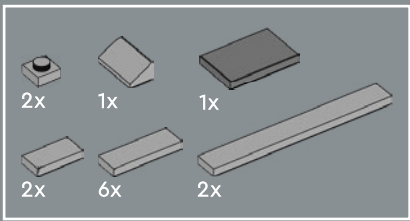

21

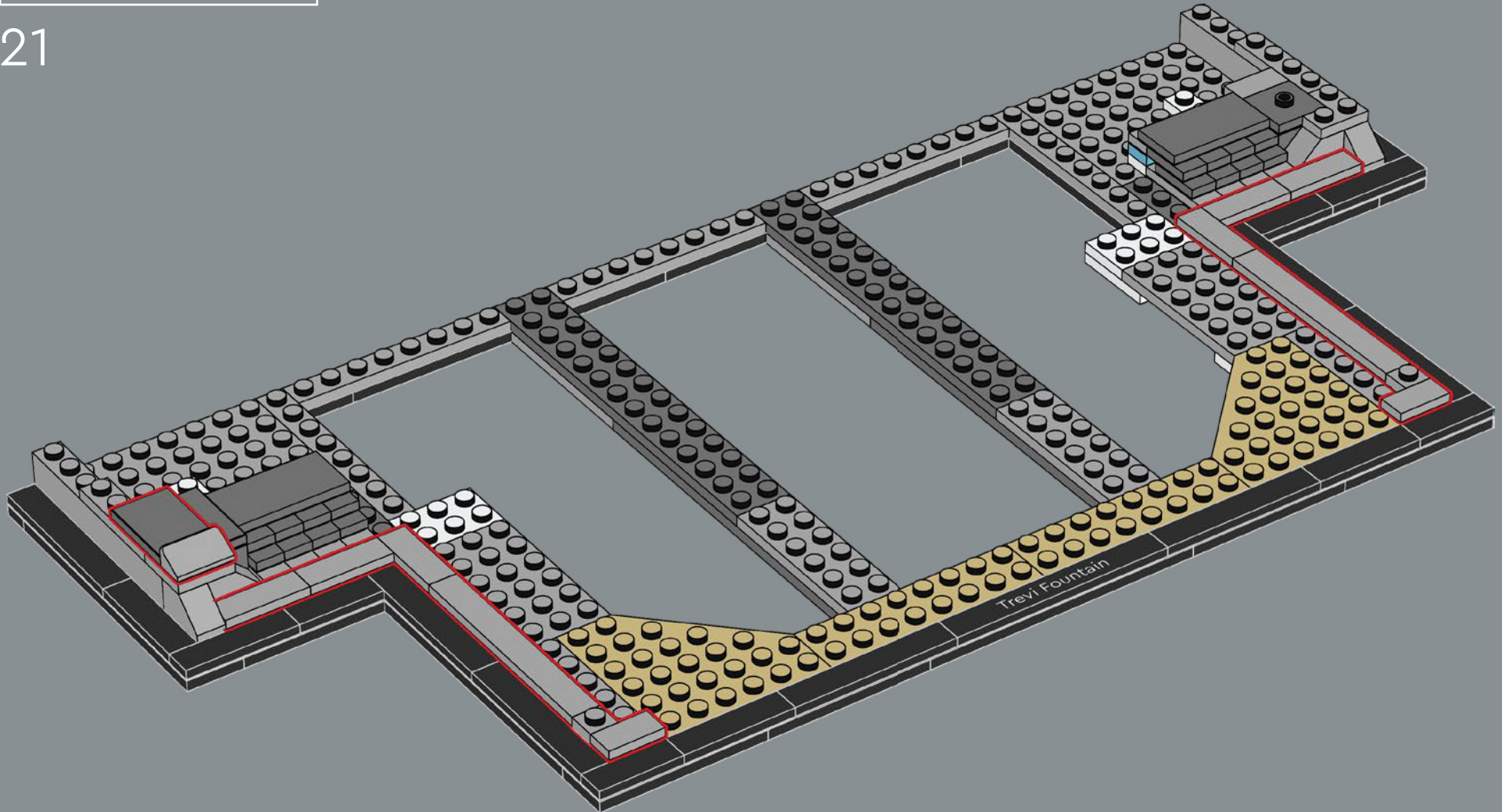

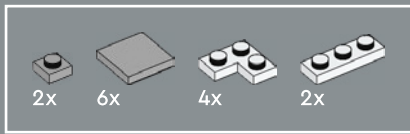

22

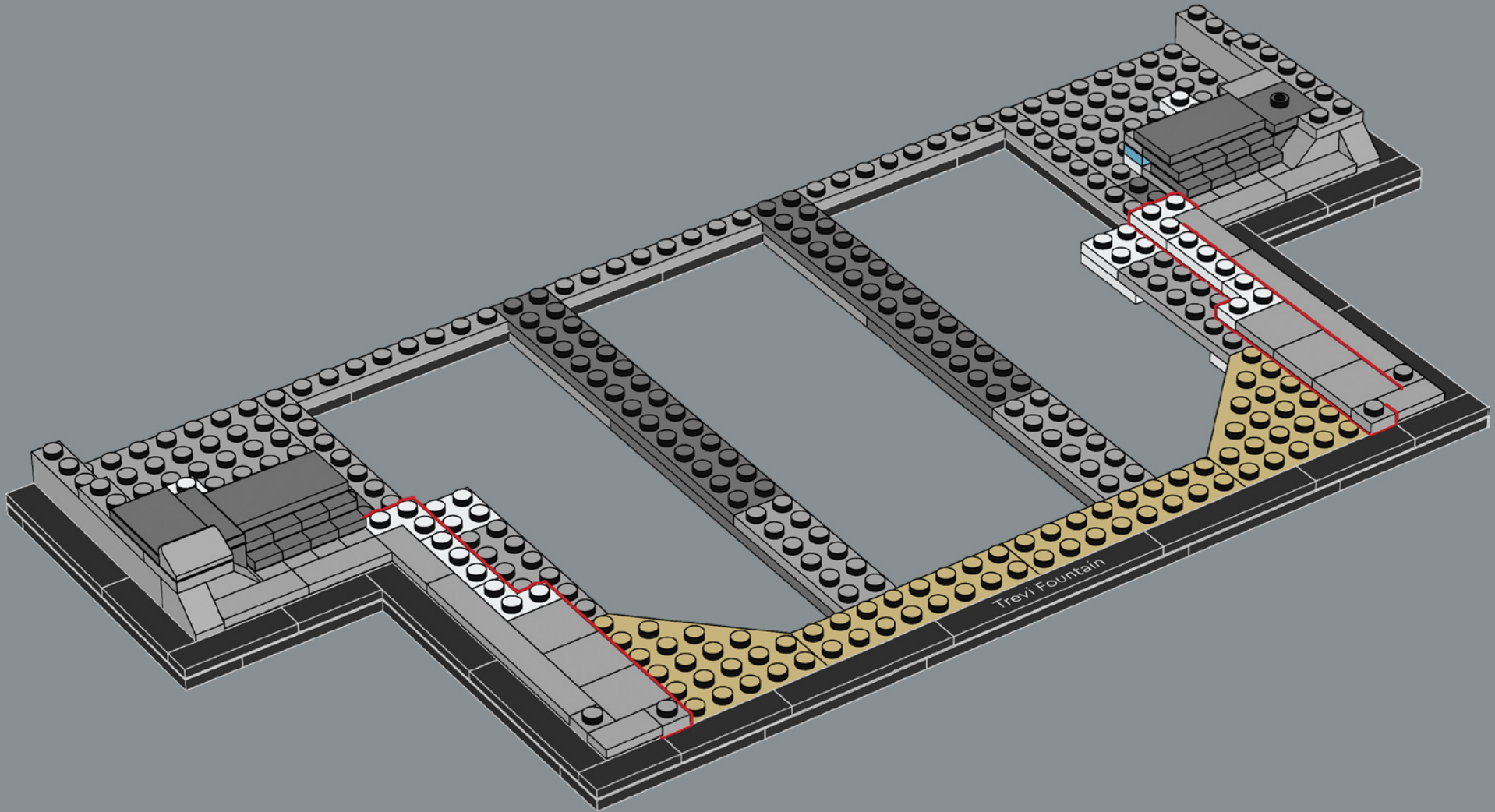

The Piazza di Trevi hosts around 10 million visitors each year, making it one of the most popular tourist destinations in Italy.

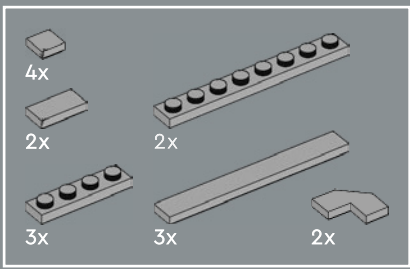

23

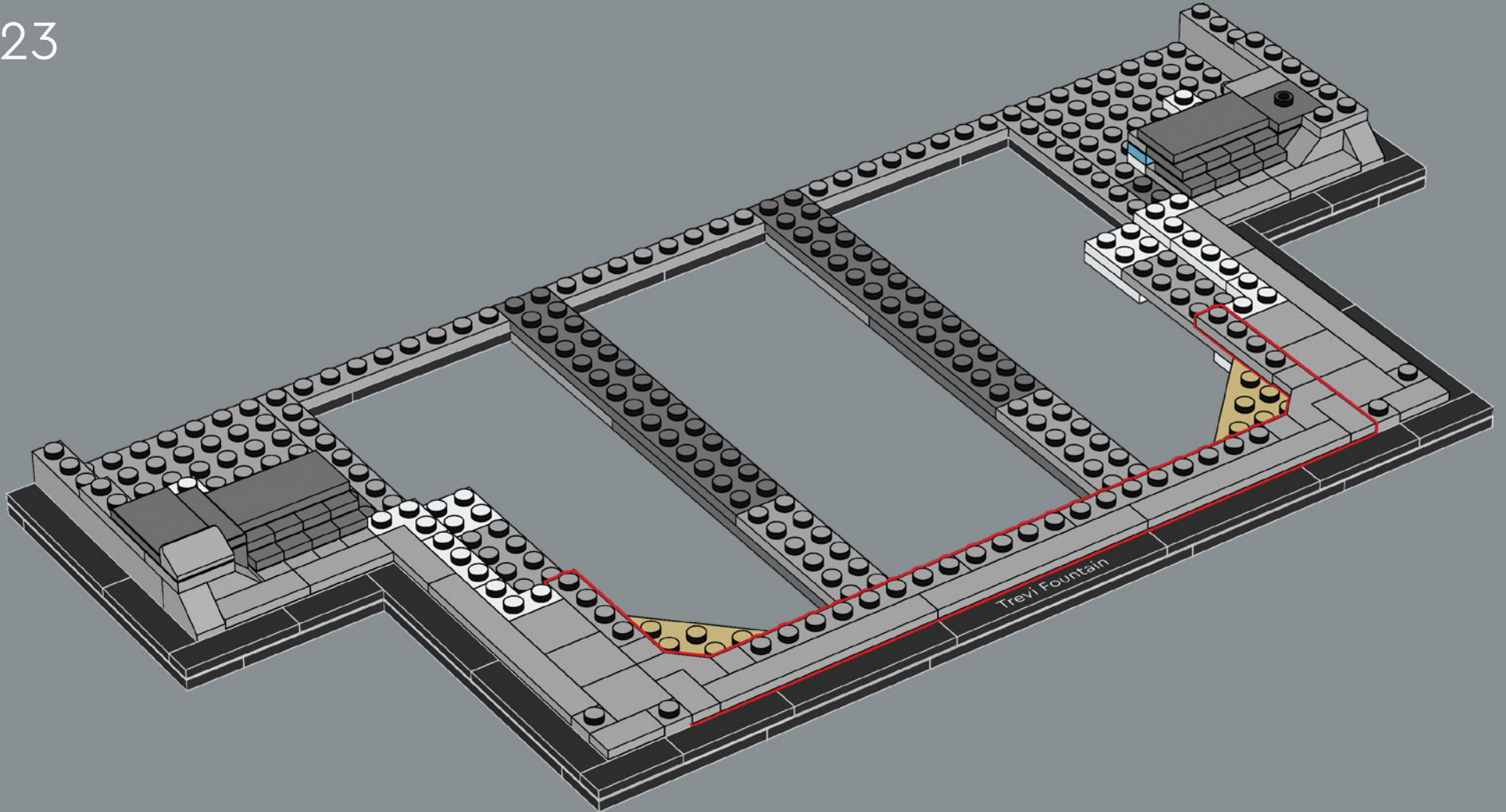

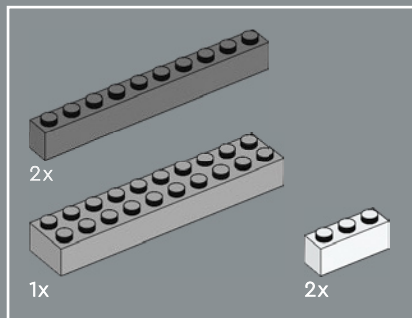

24

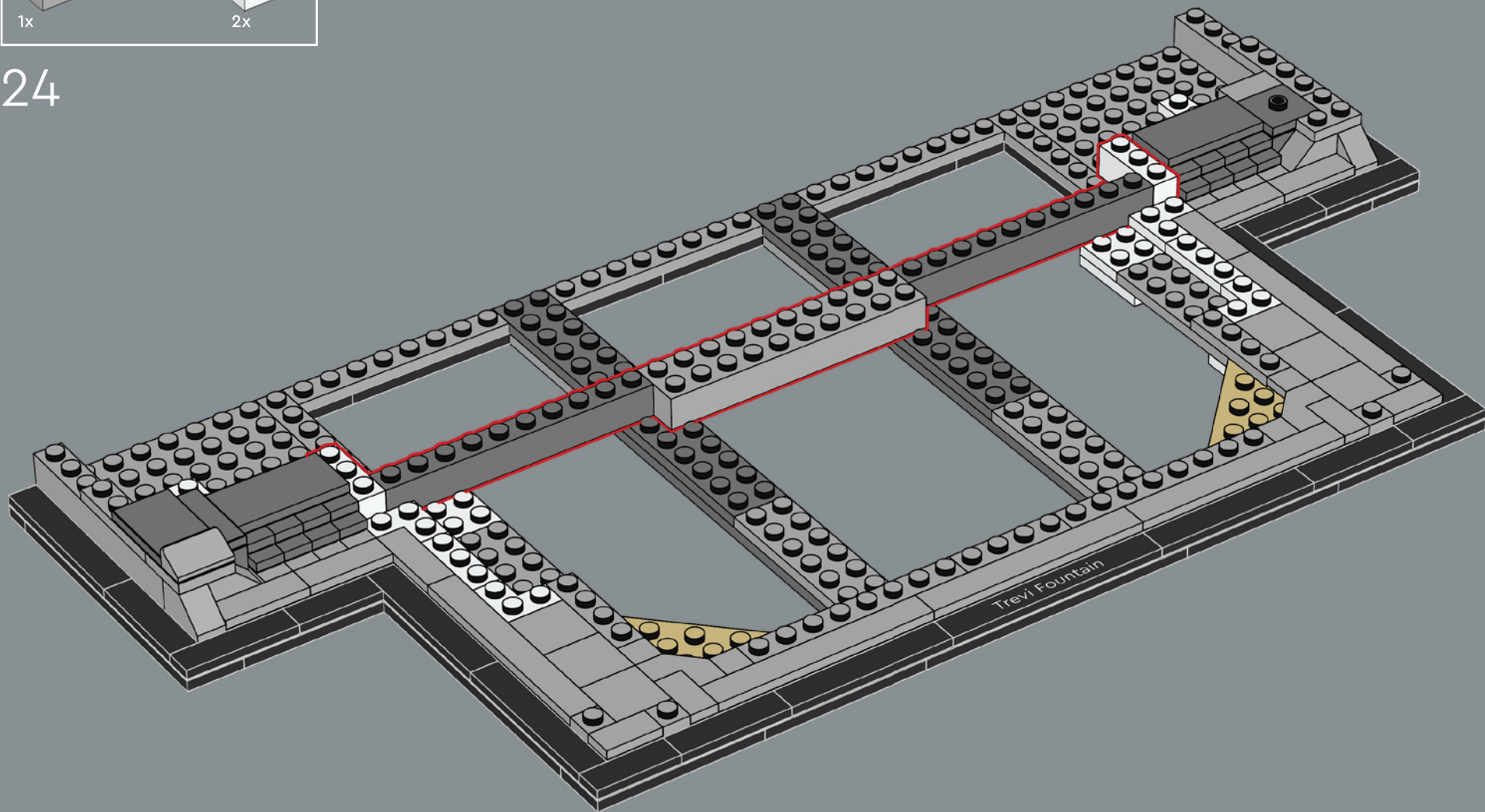

2x

25

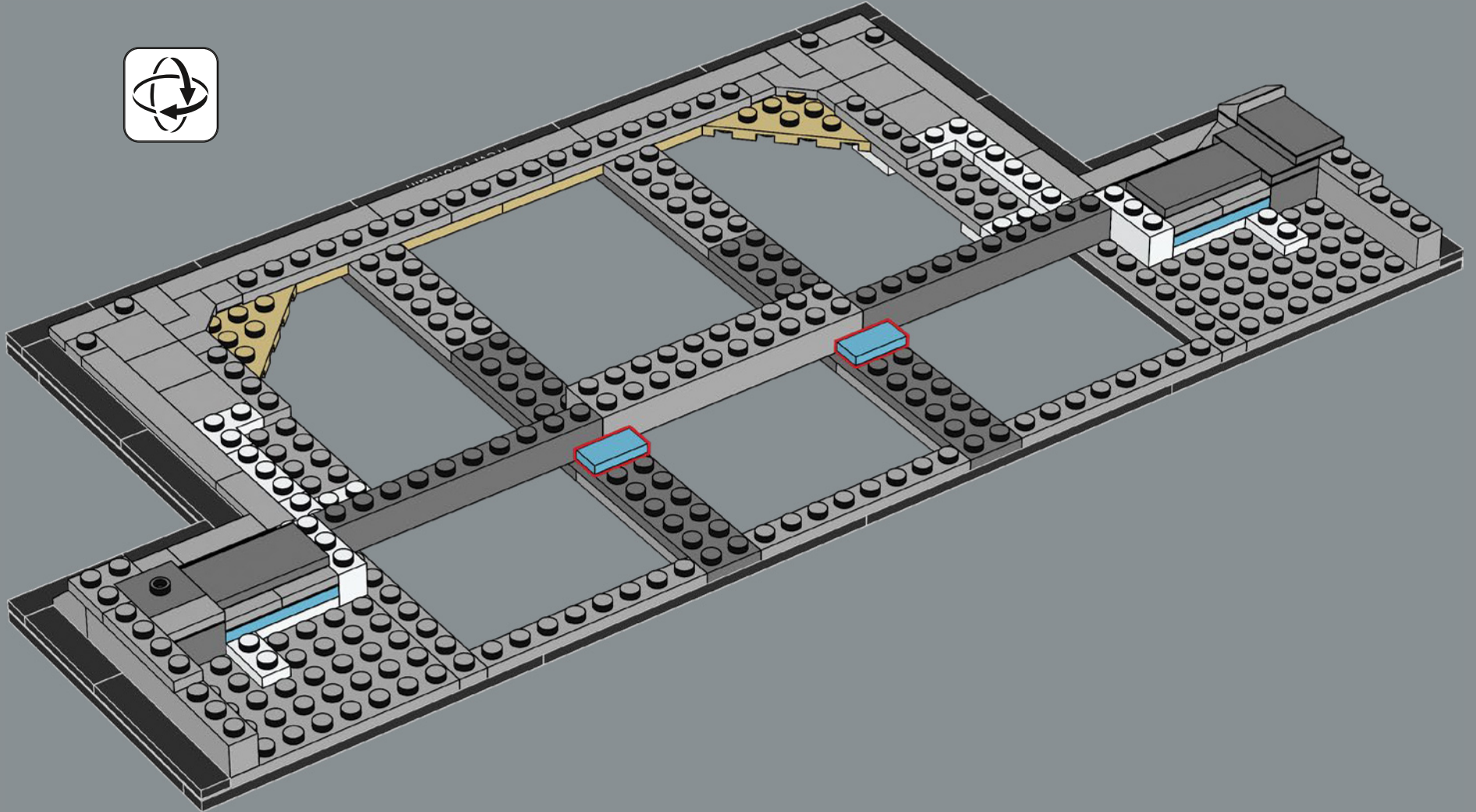

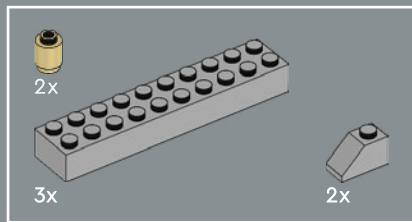

26

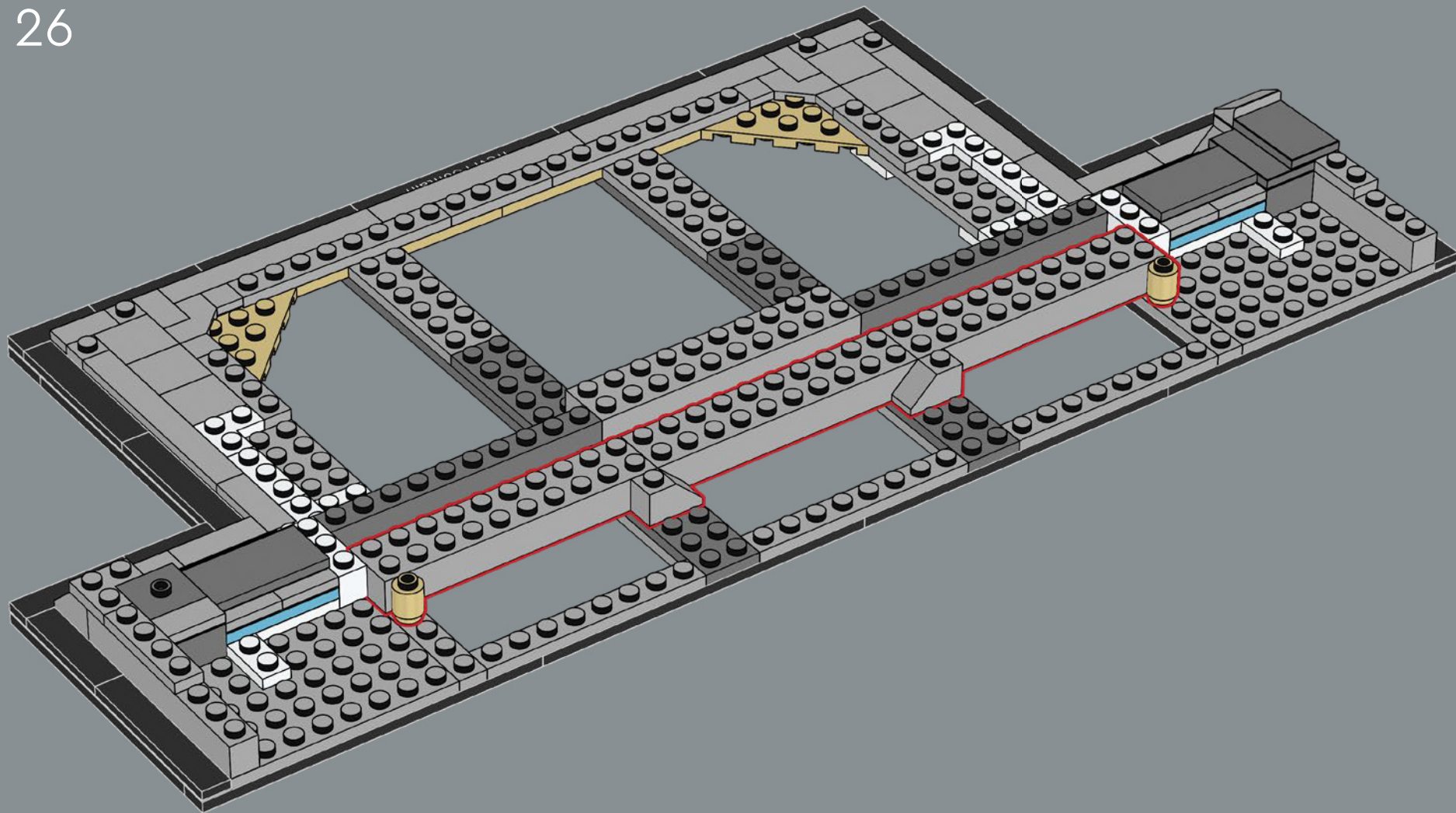

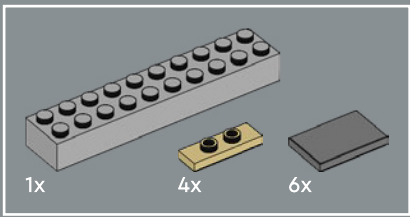

27

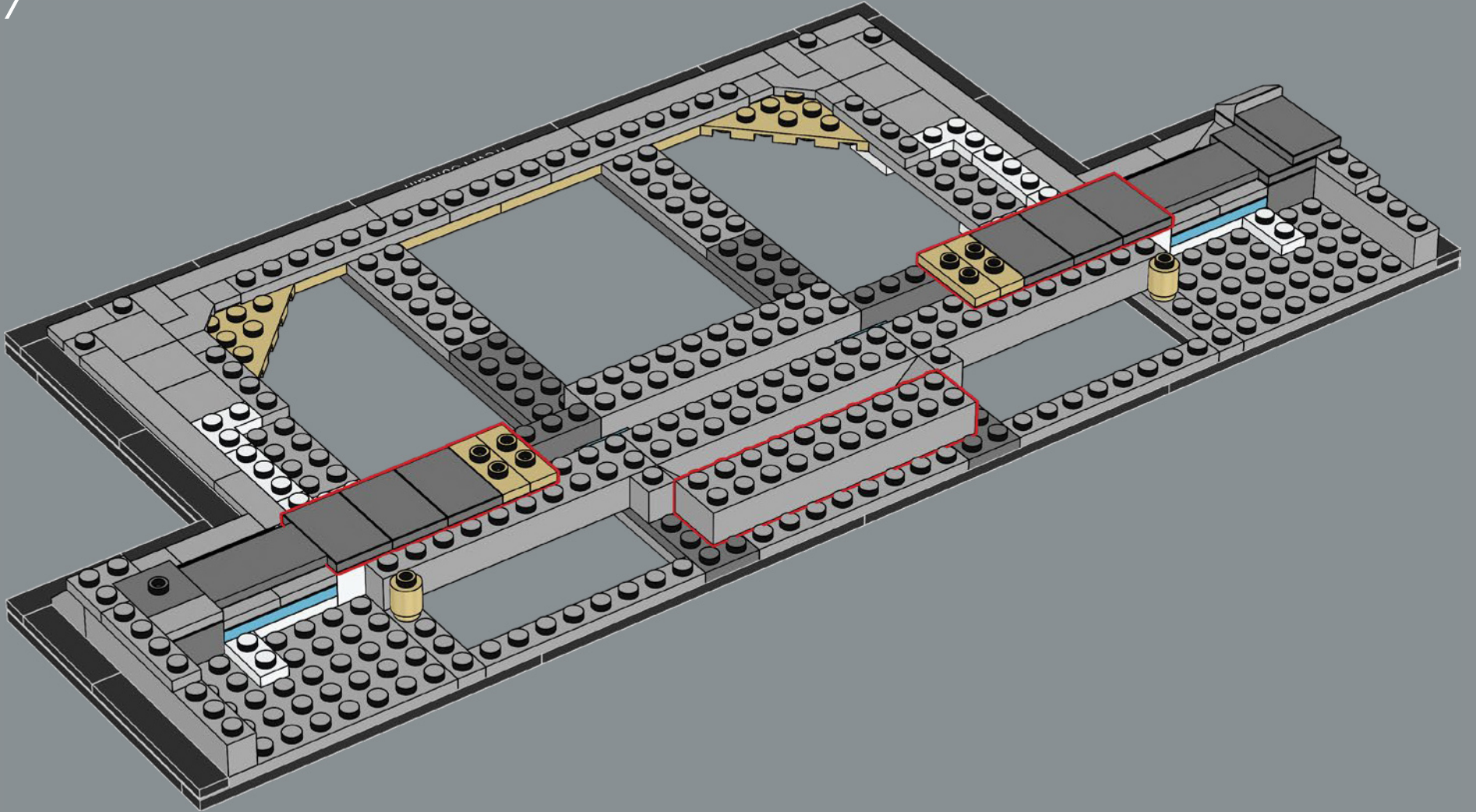

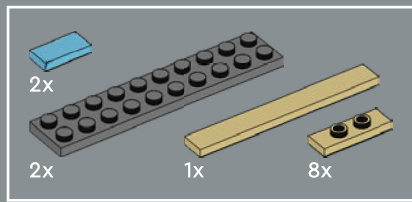

28

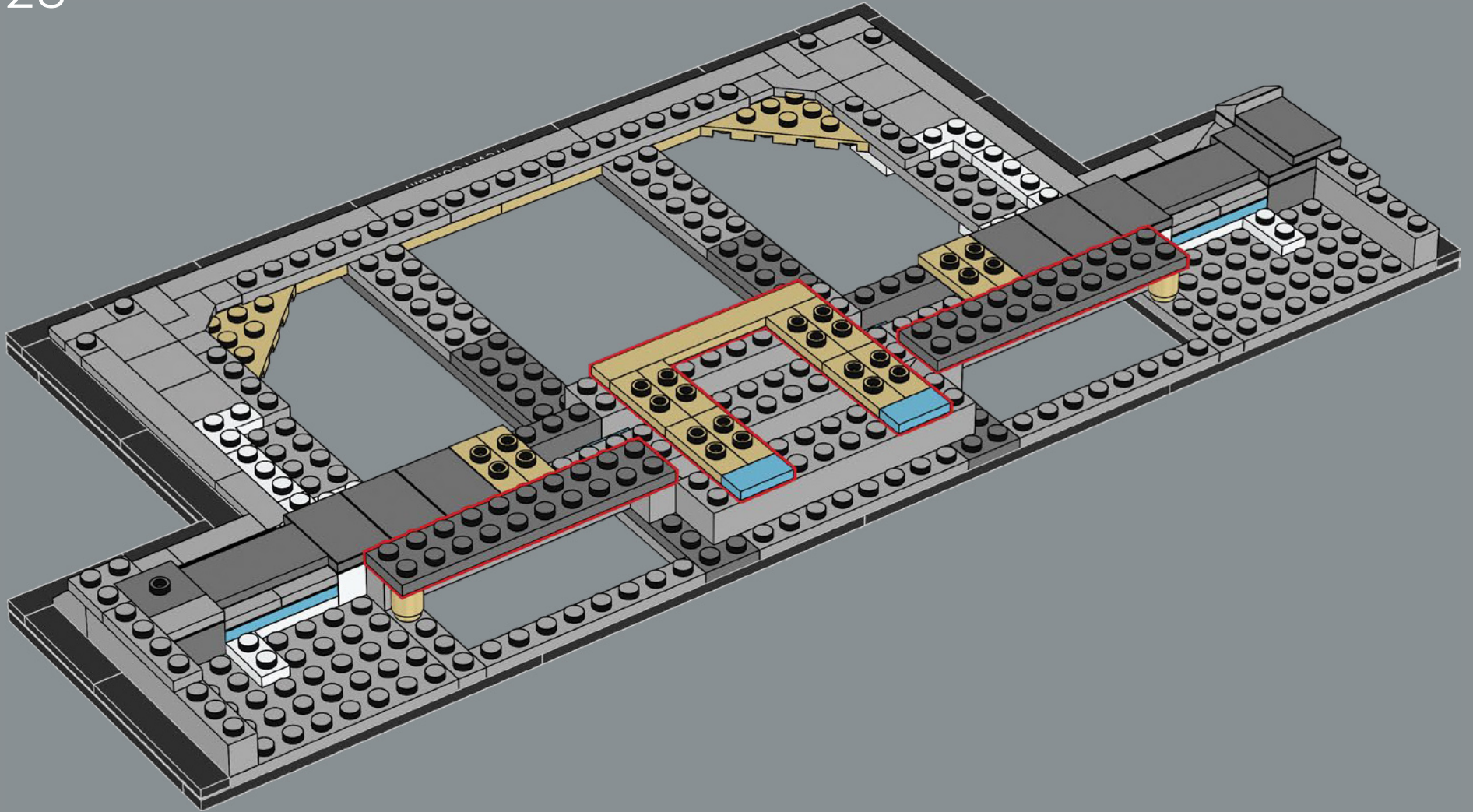

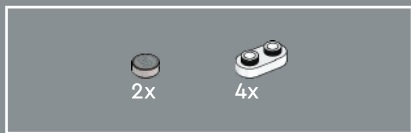

29

A local legend says that if you toss one coin into the fountain, you are bound to return to Rome. Two coins, and you will fall in love with a person you meet at the fountain, and if you offer three coins, you might be together forever!

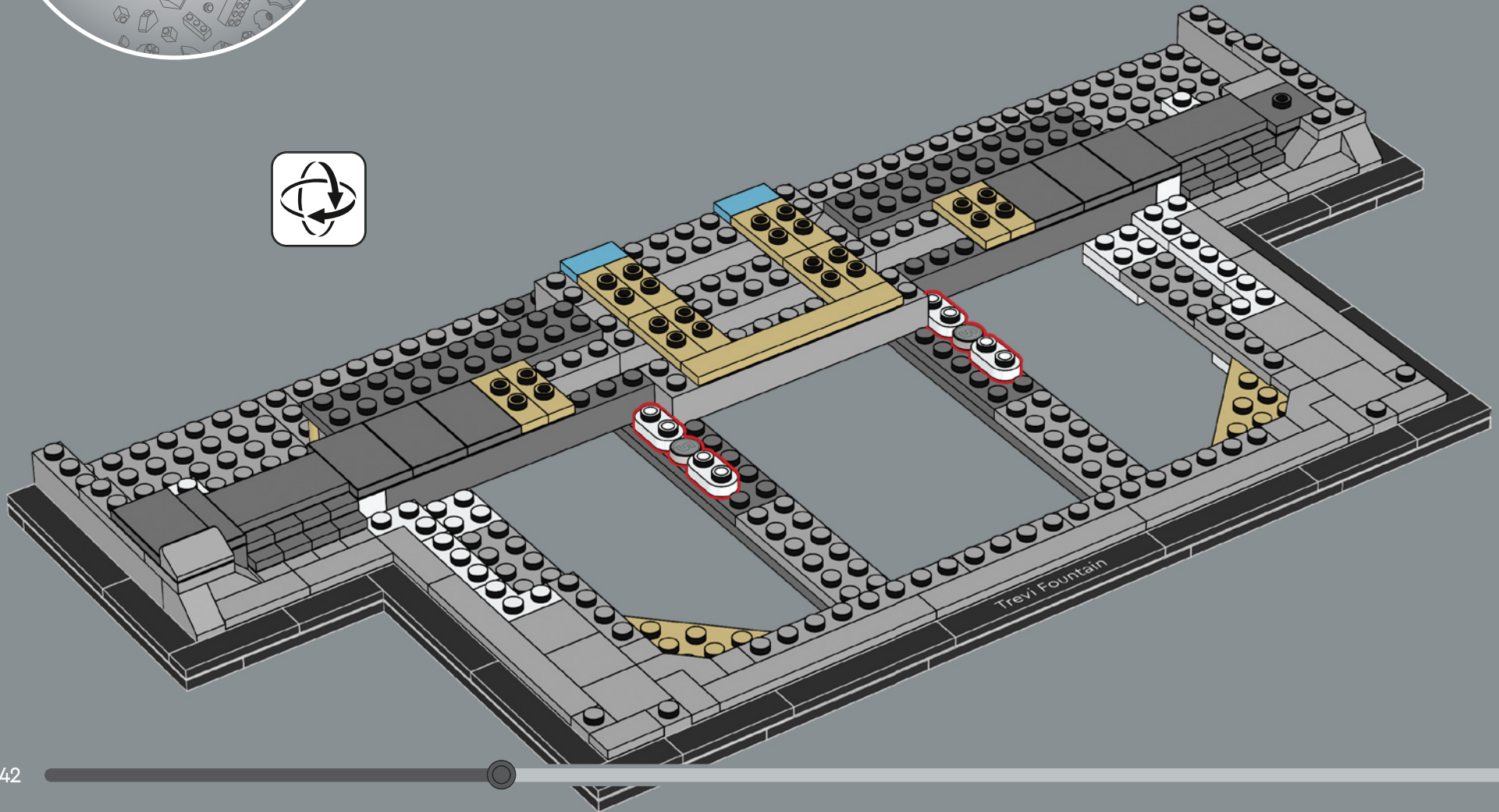

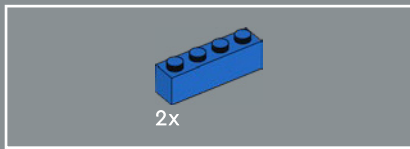

30

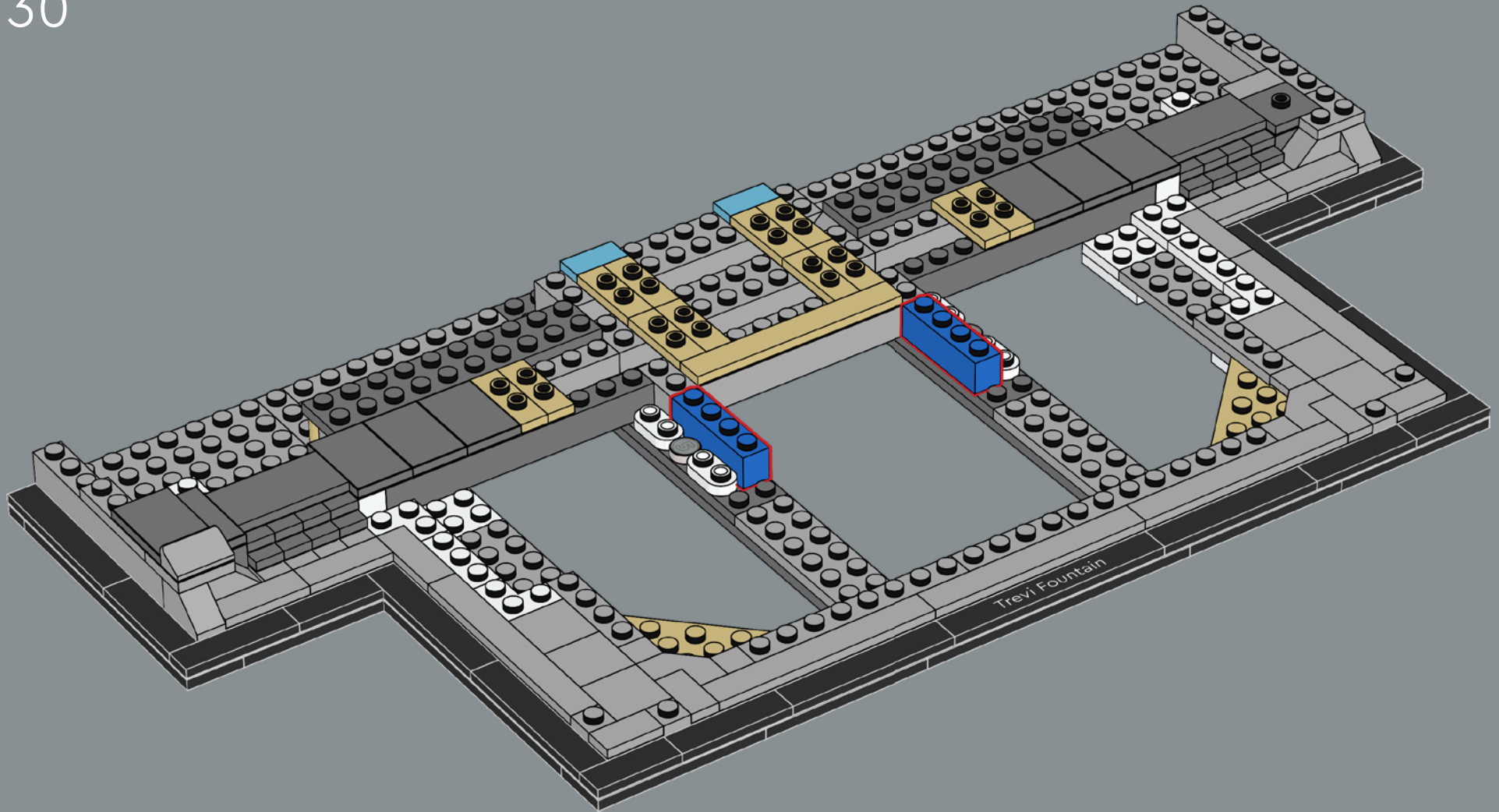

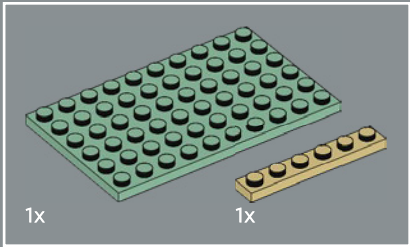
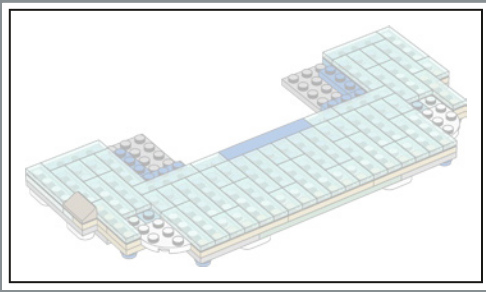

31

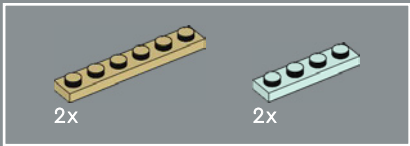
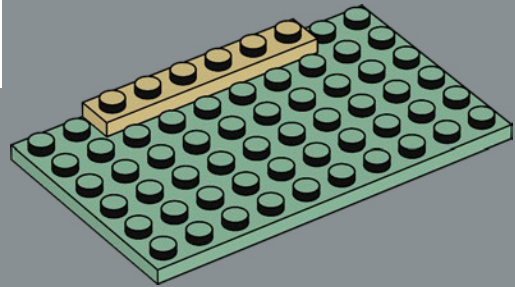

32

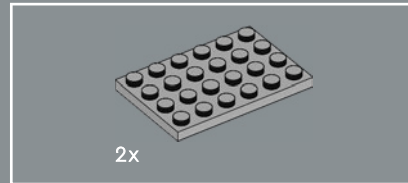
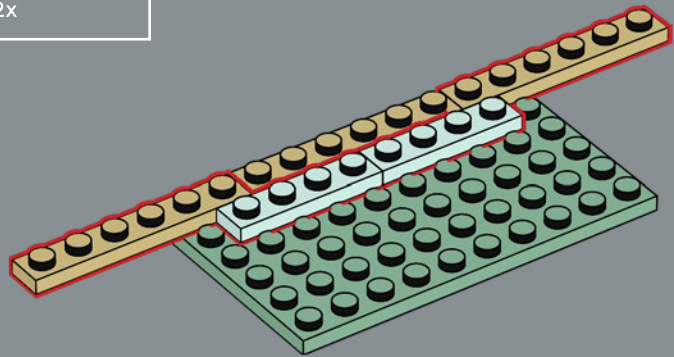

33

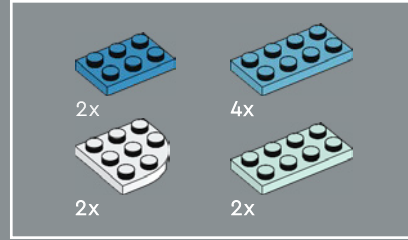
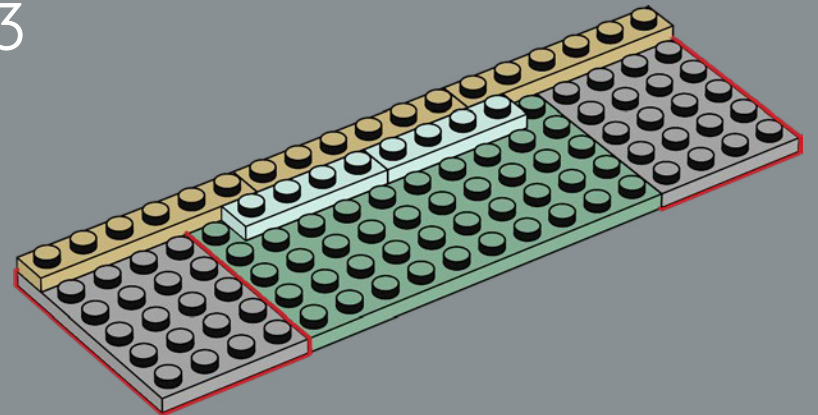

34

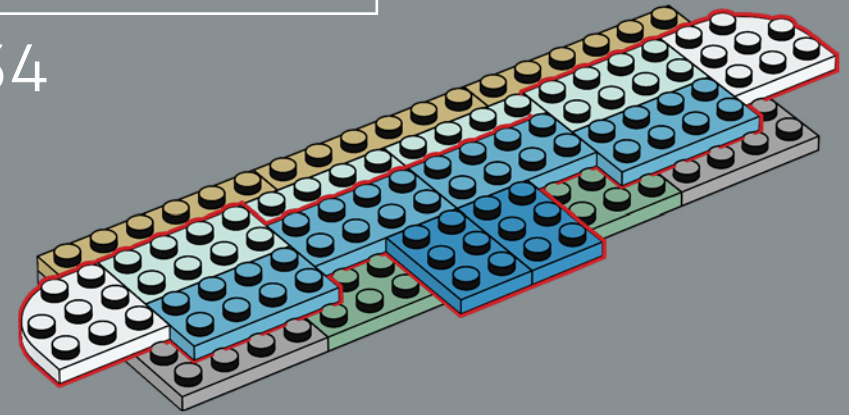

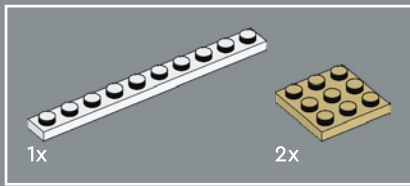

35

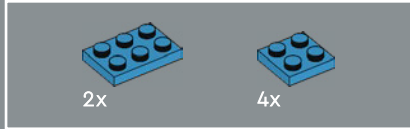
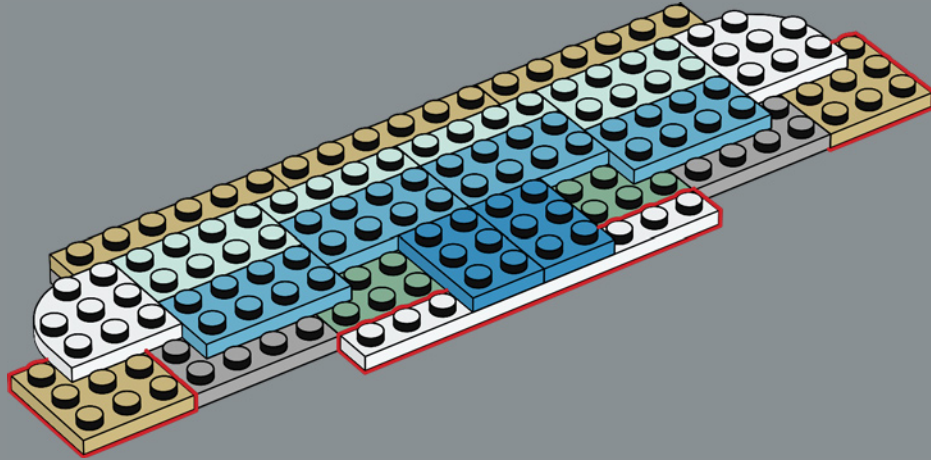

36

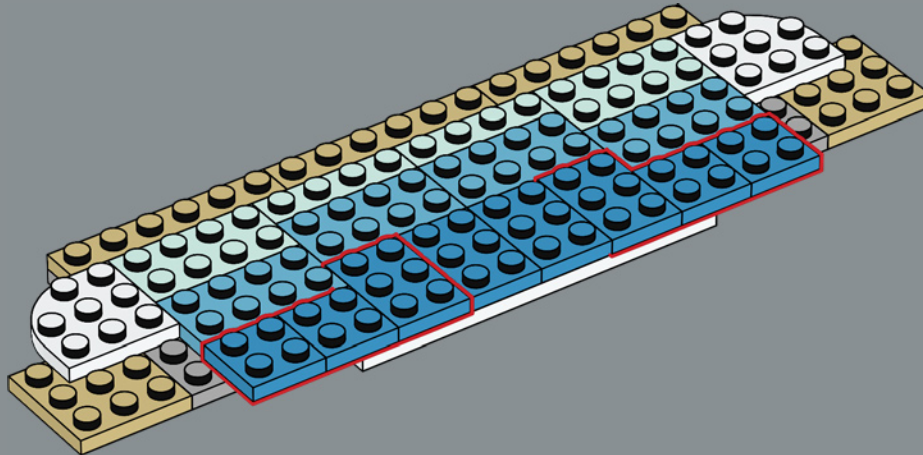

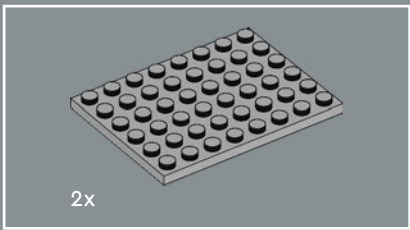

37

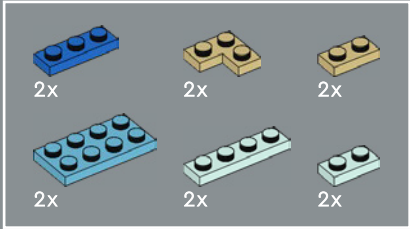
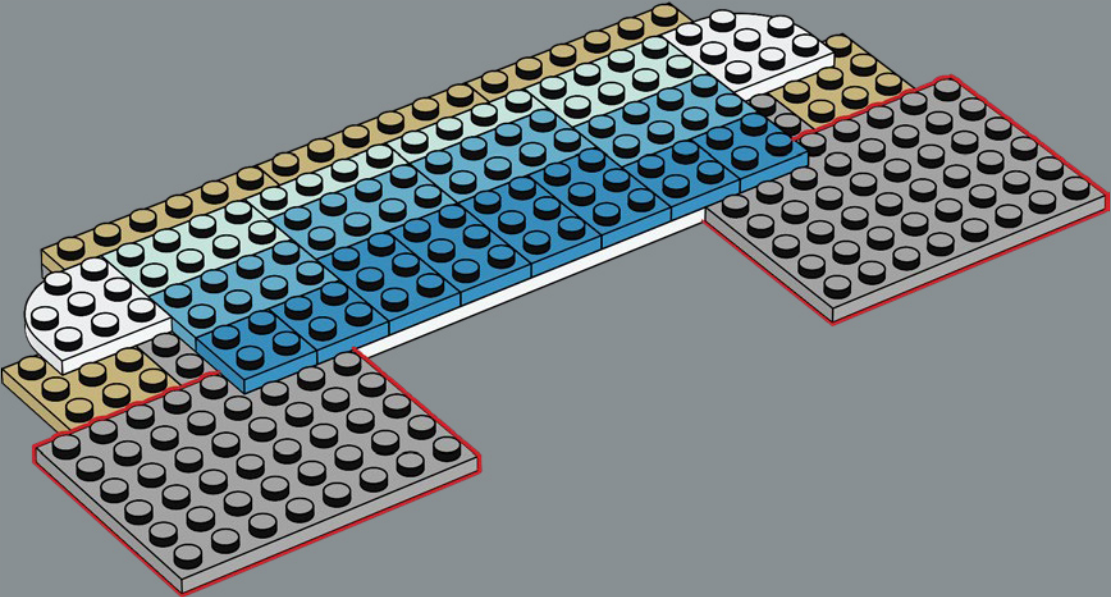

38

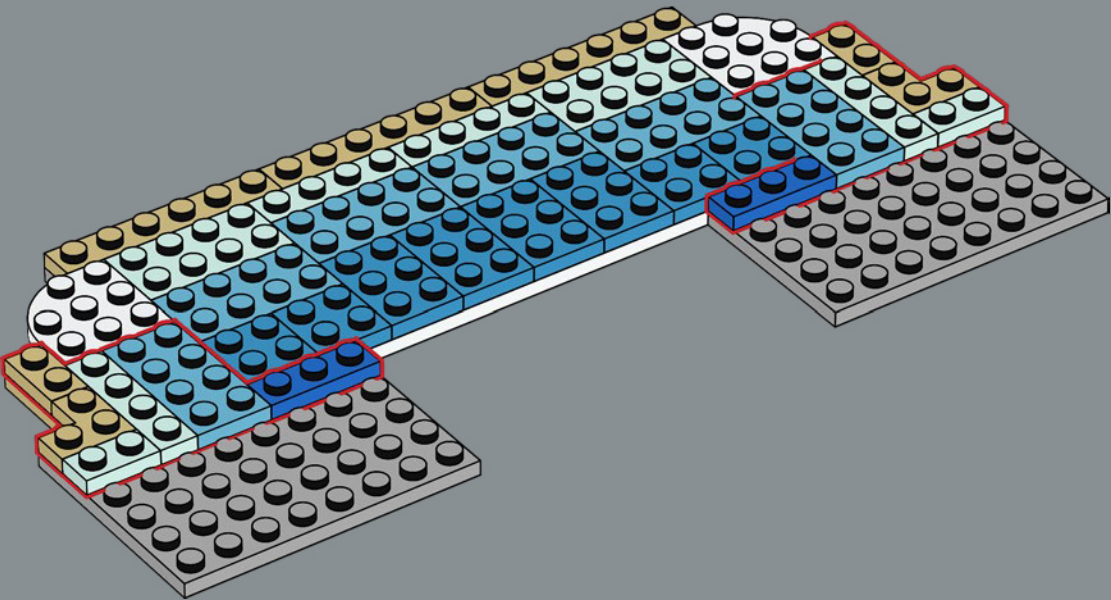

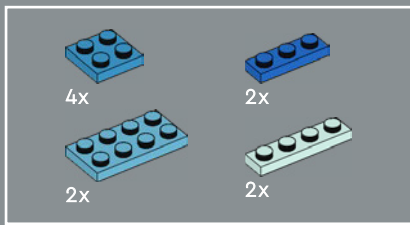

39

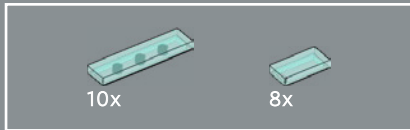
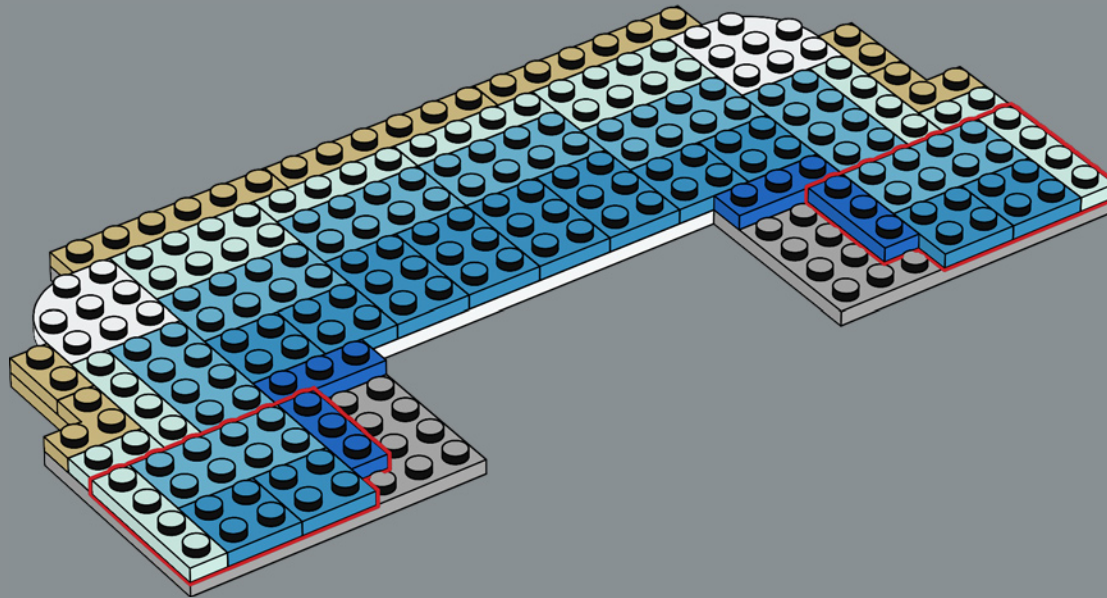

40

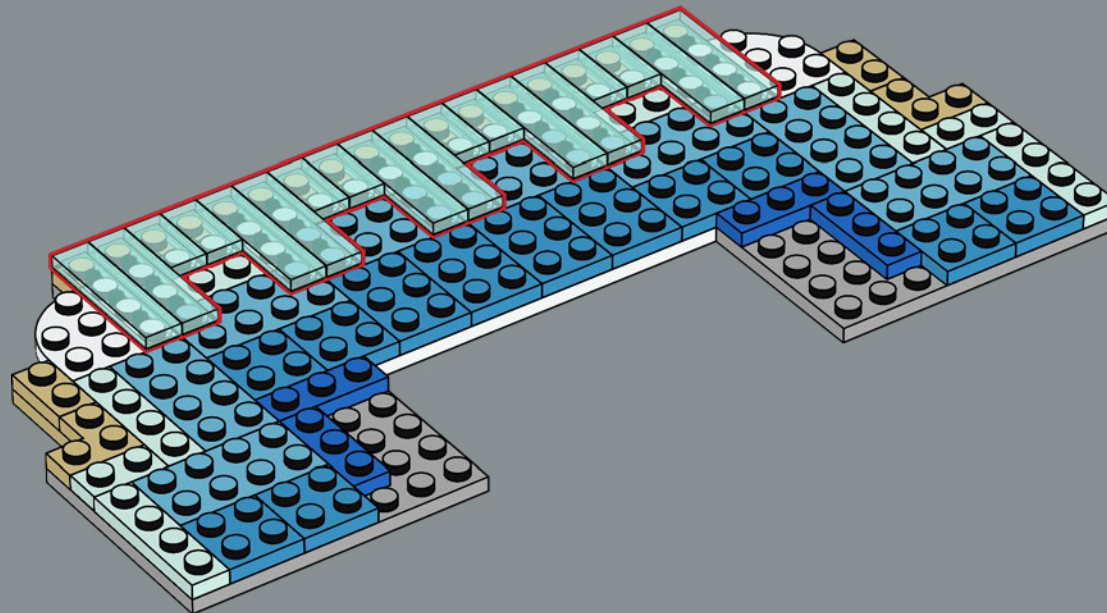

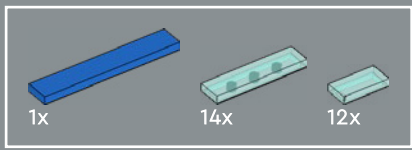

41

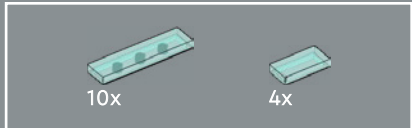
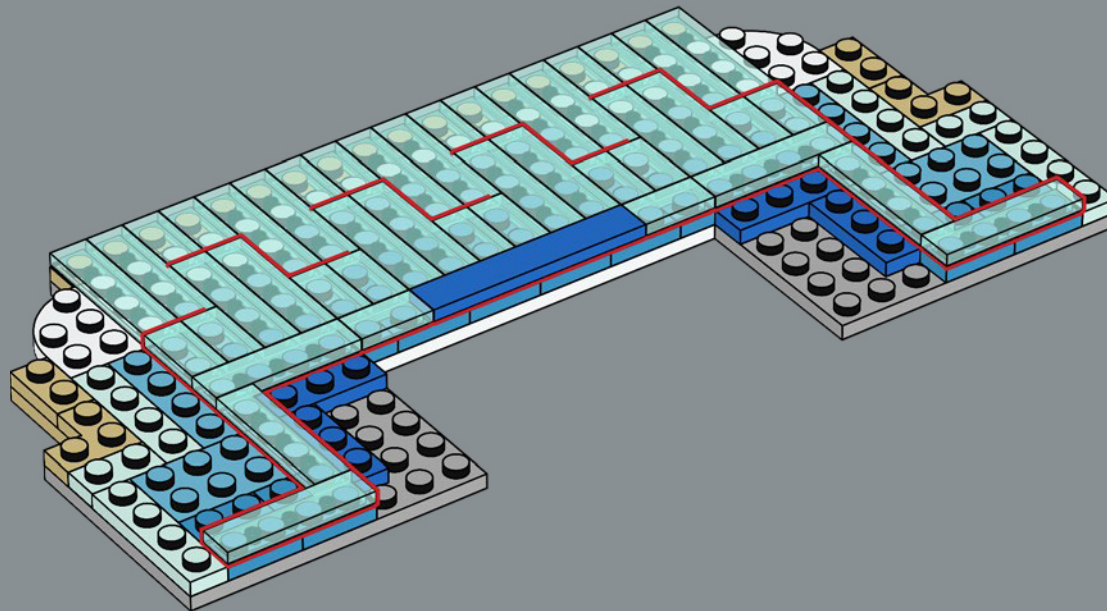

42

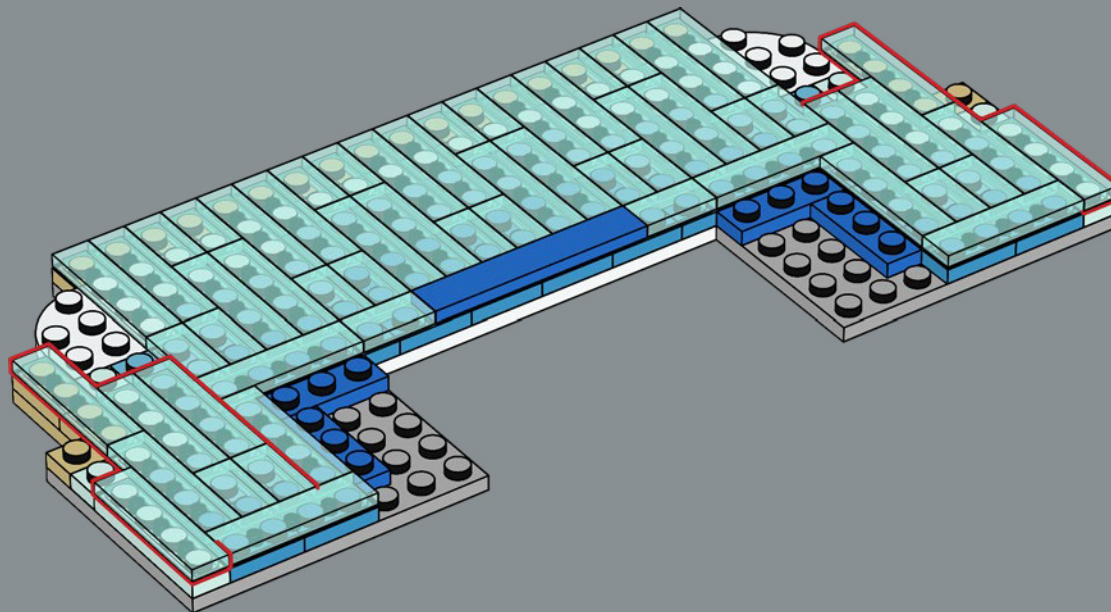

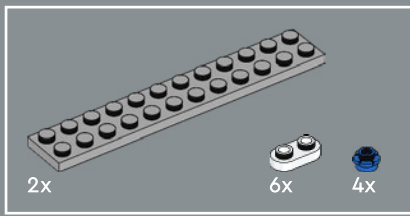

43

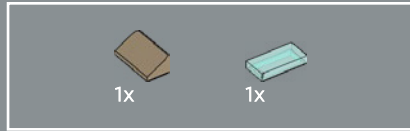
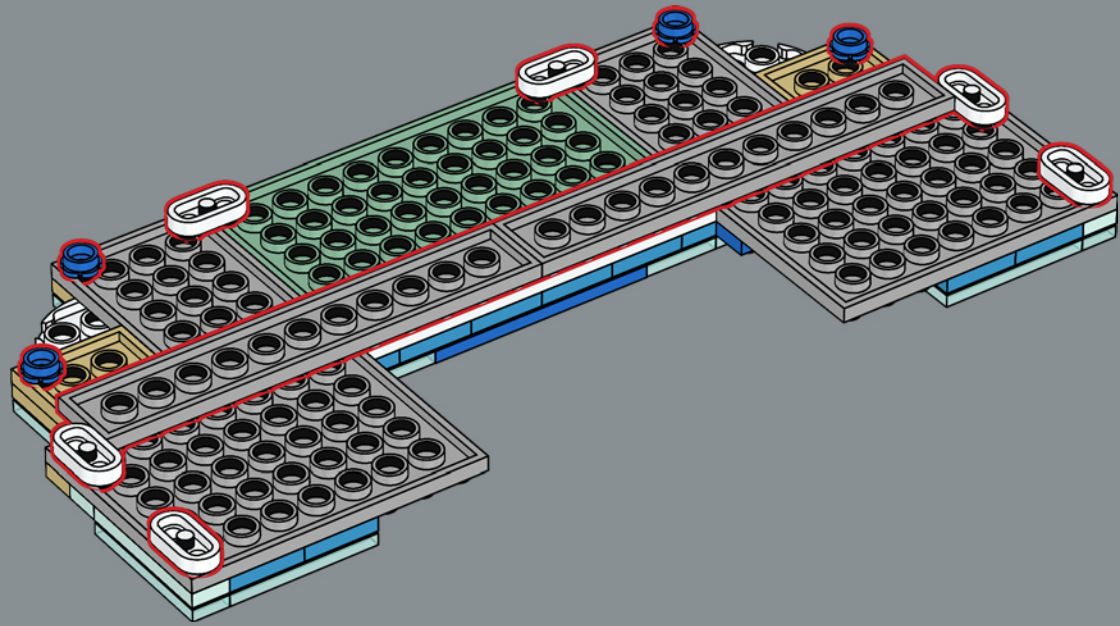

44

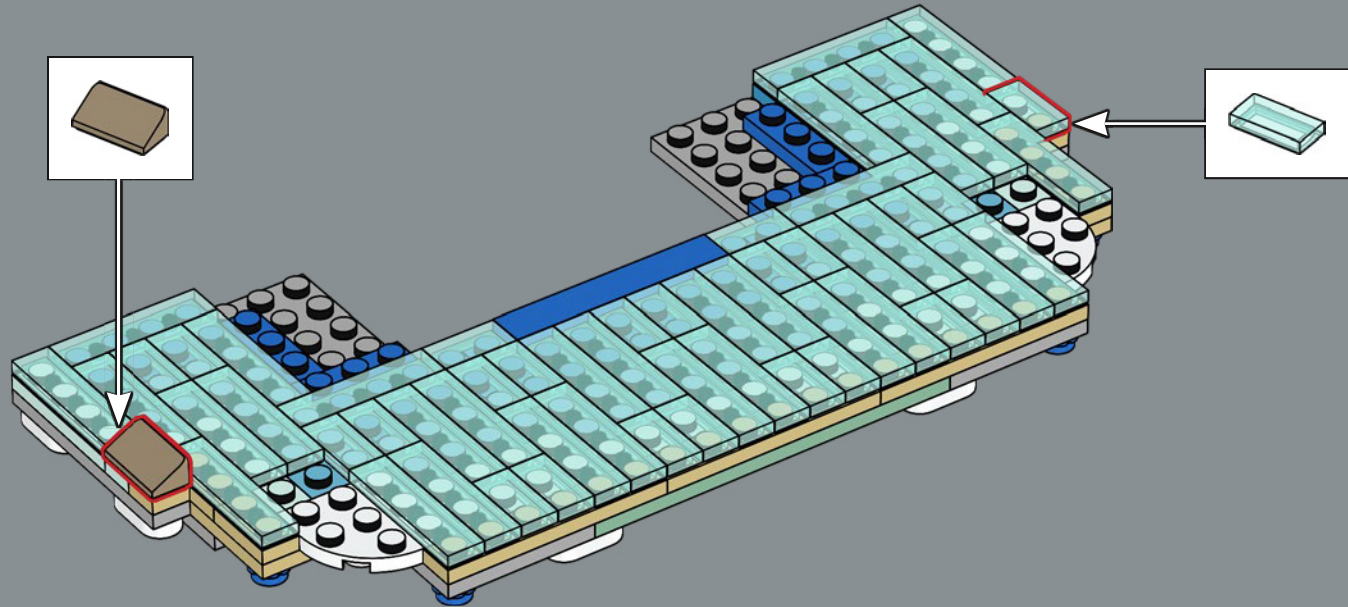

Roughly €3,000/\$3,200 worth of coins are tossed into the fountain daily. They are collected at the end of the day, and a large portion of the offerings is donated to charities.

45

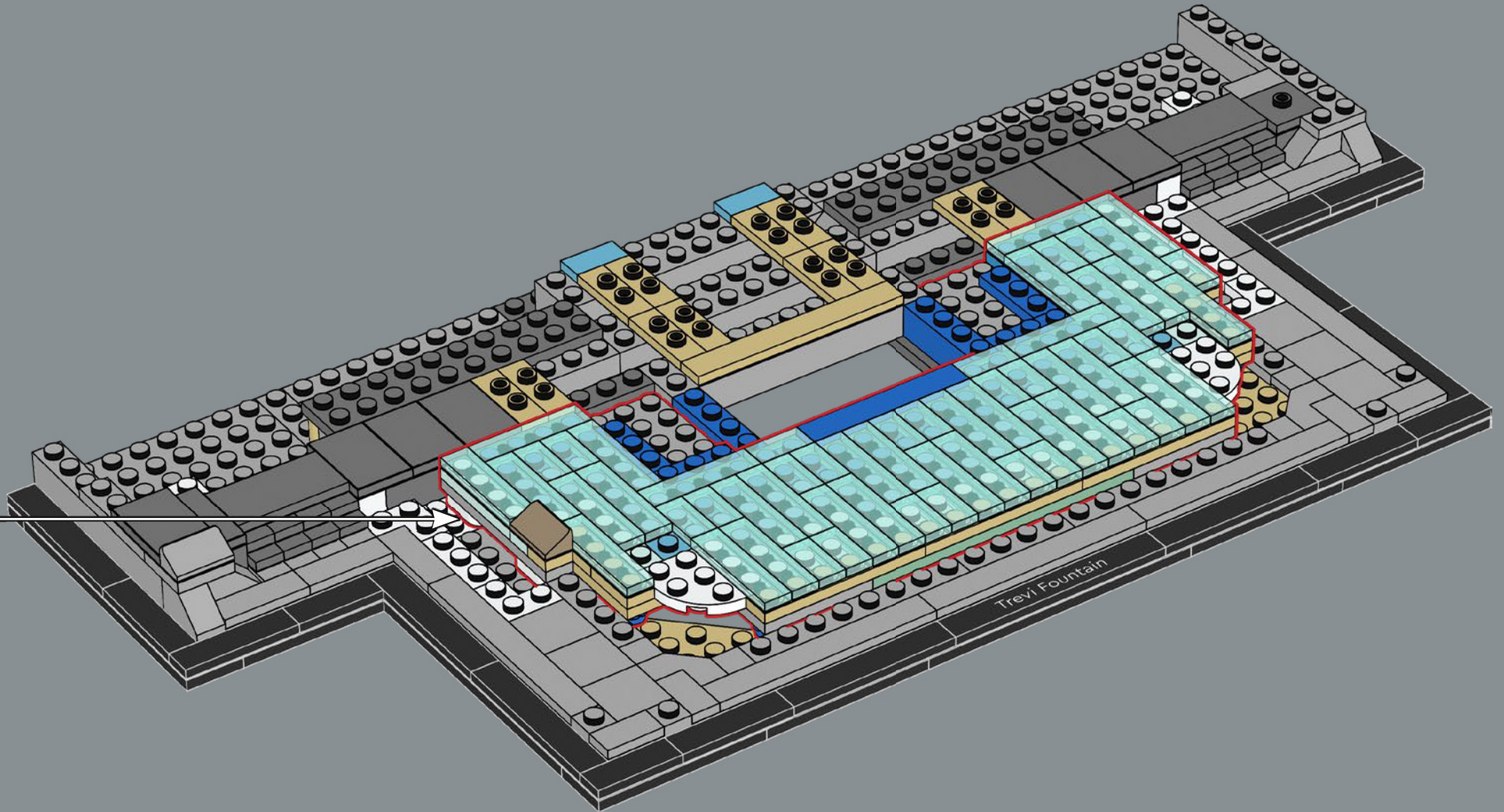



46

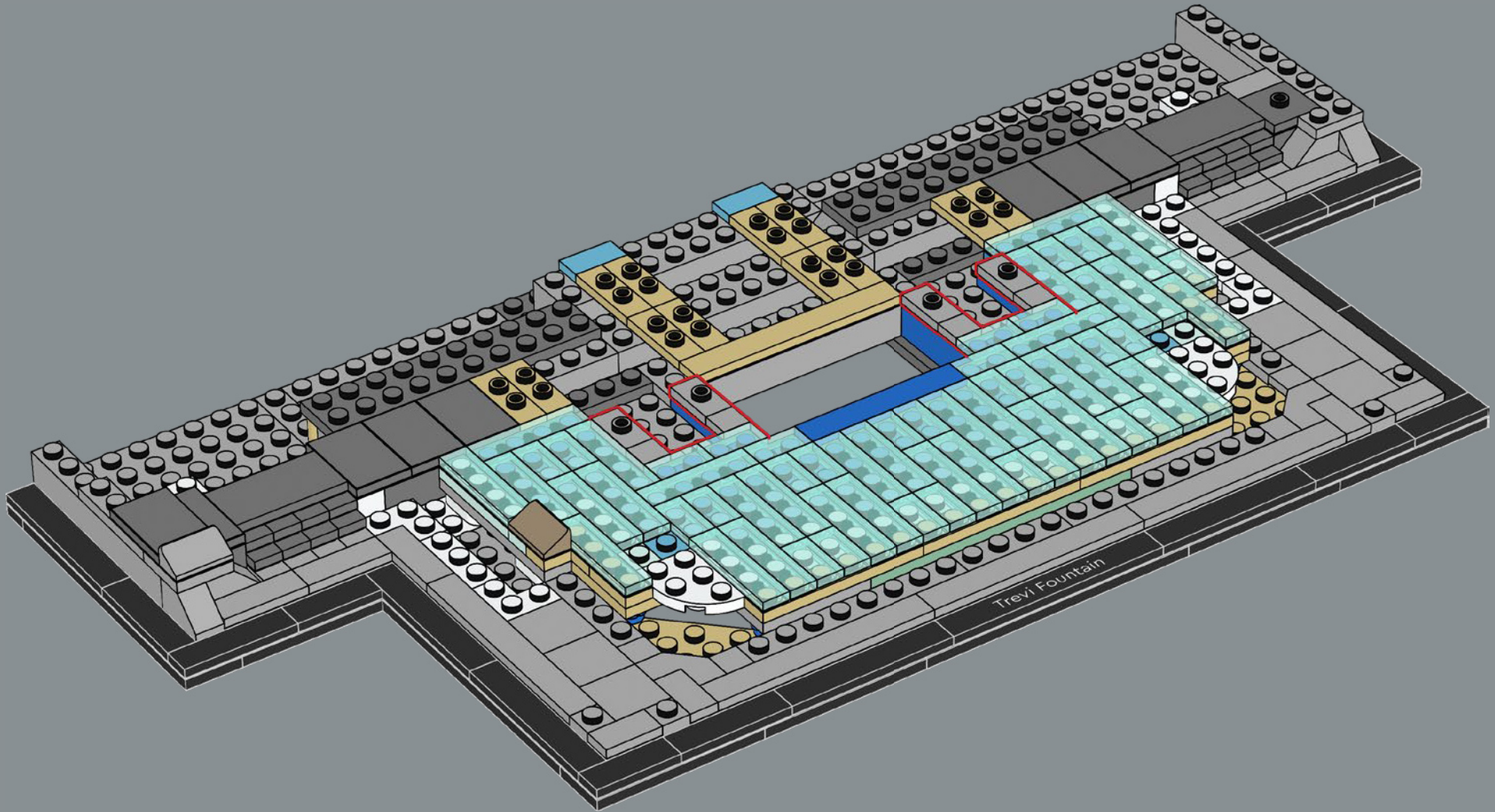

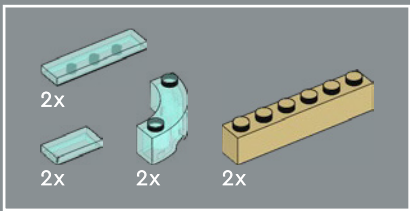

47

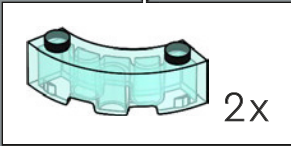
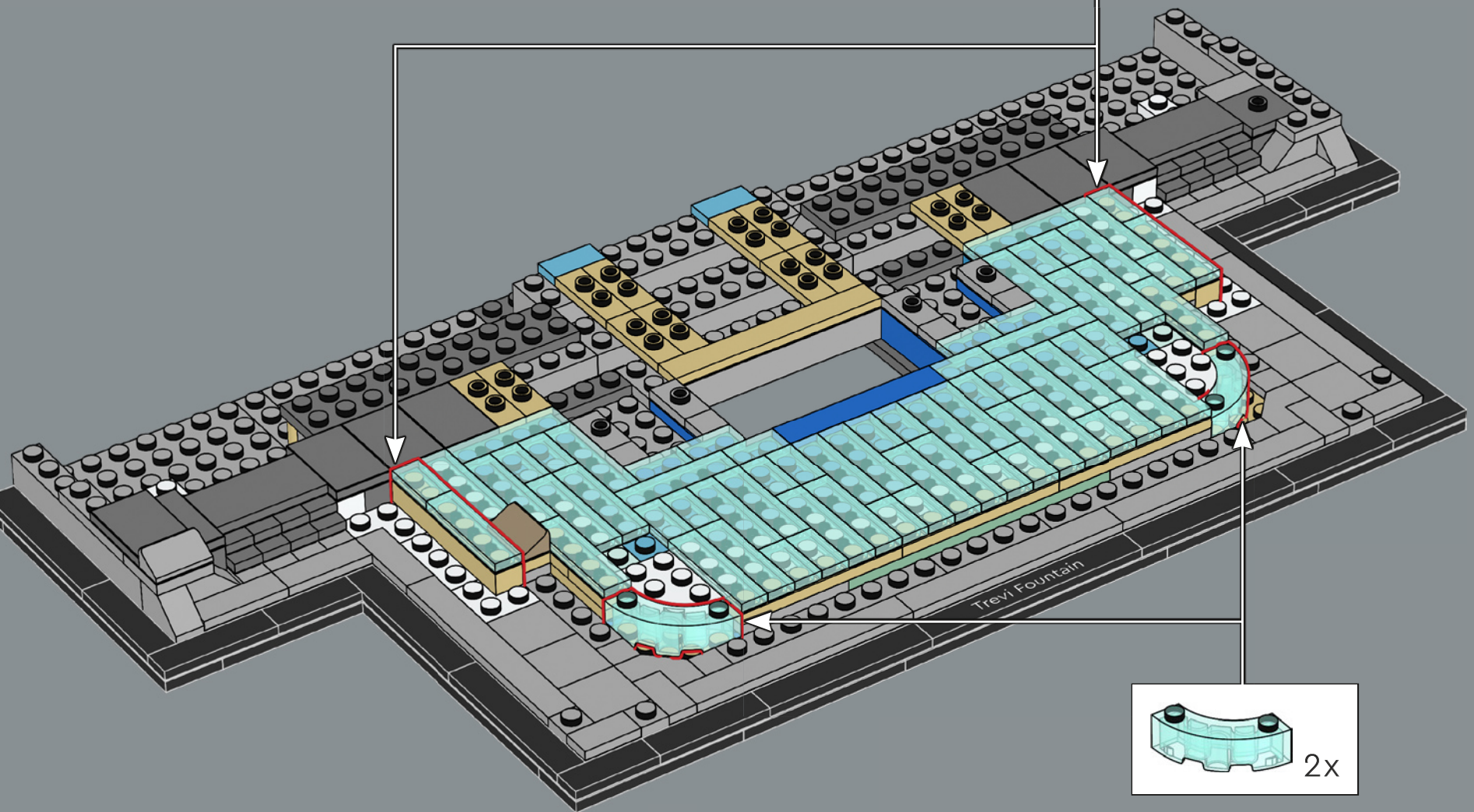
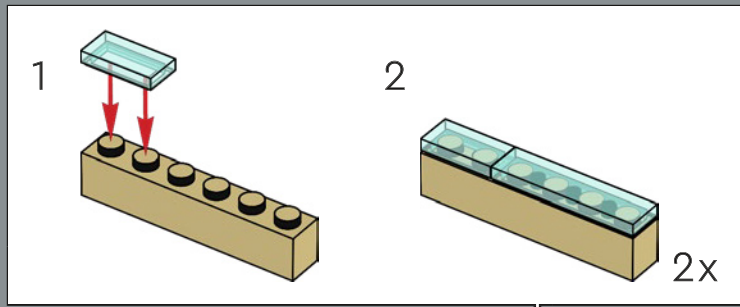

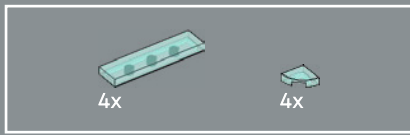

48

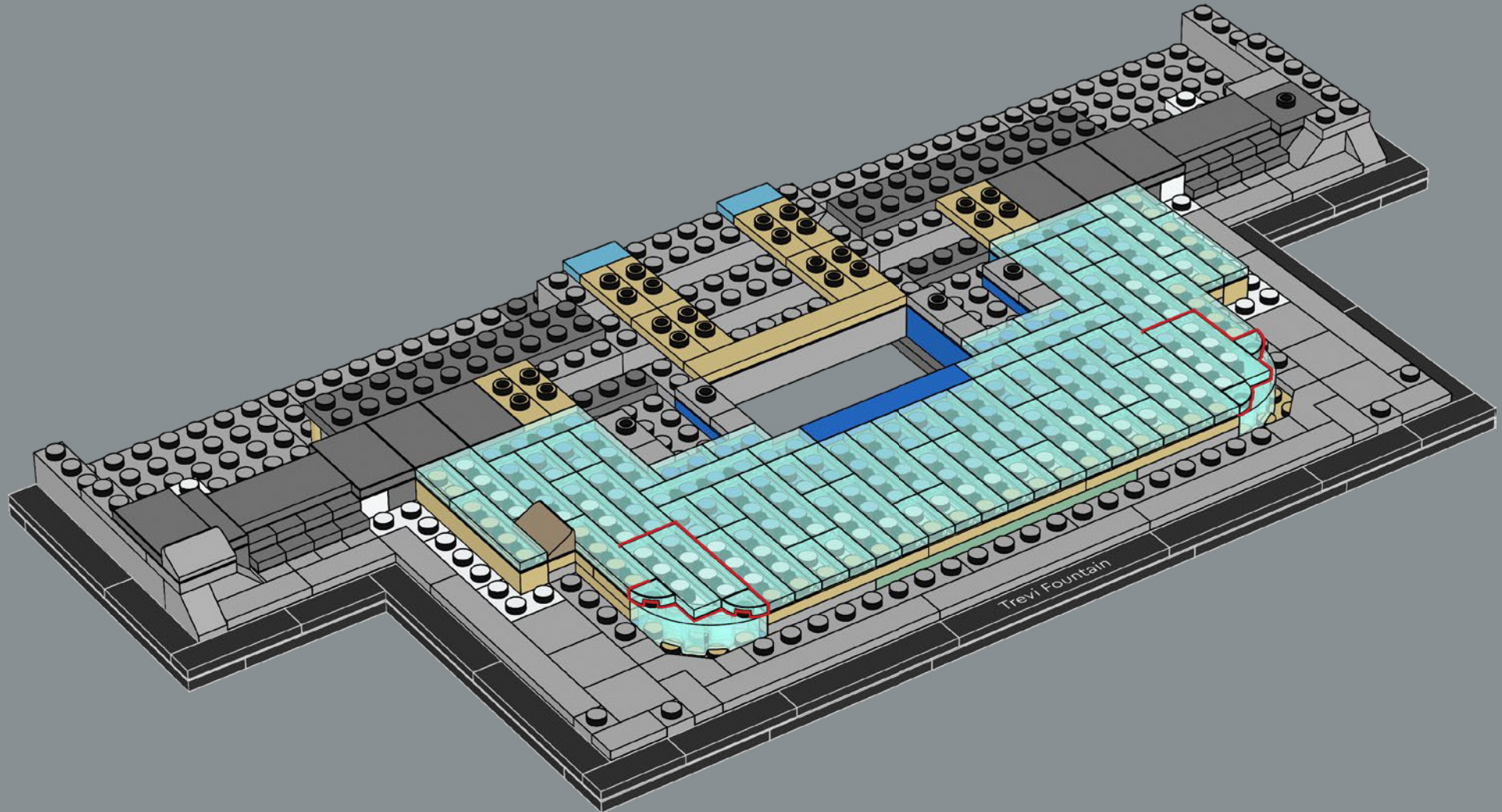

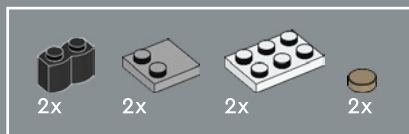

49

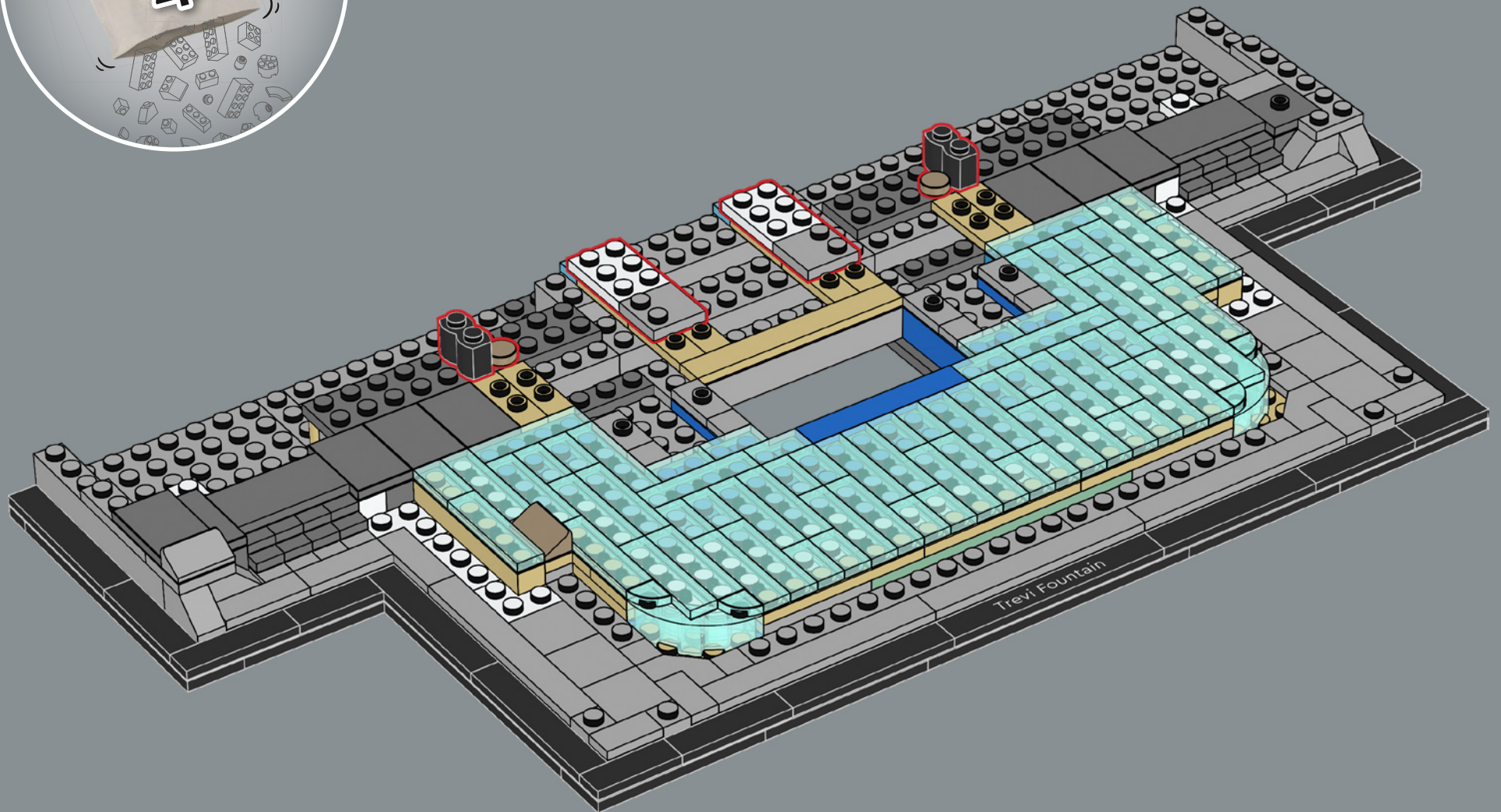

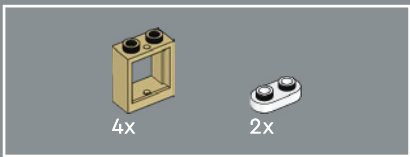

50

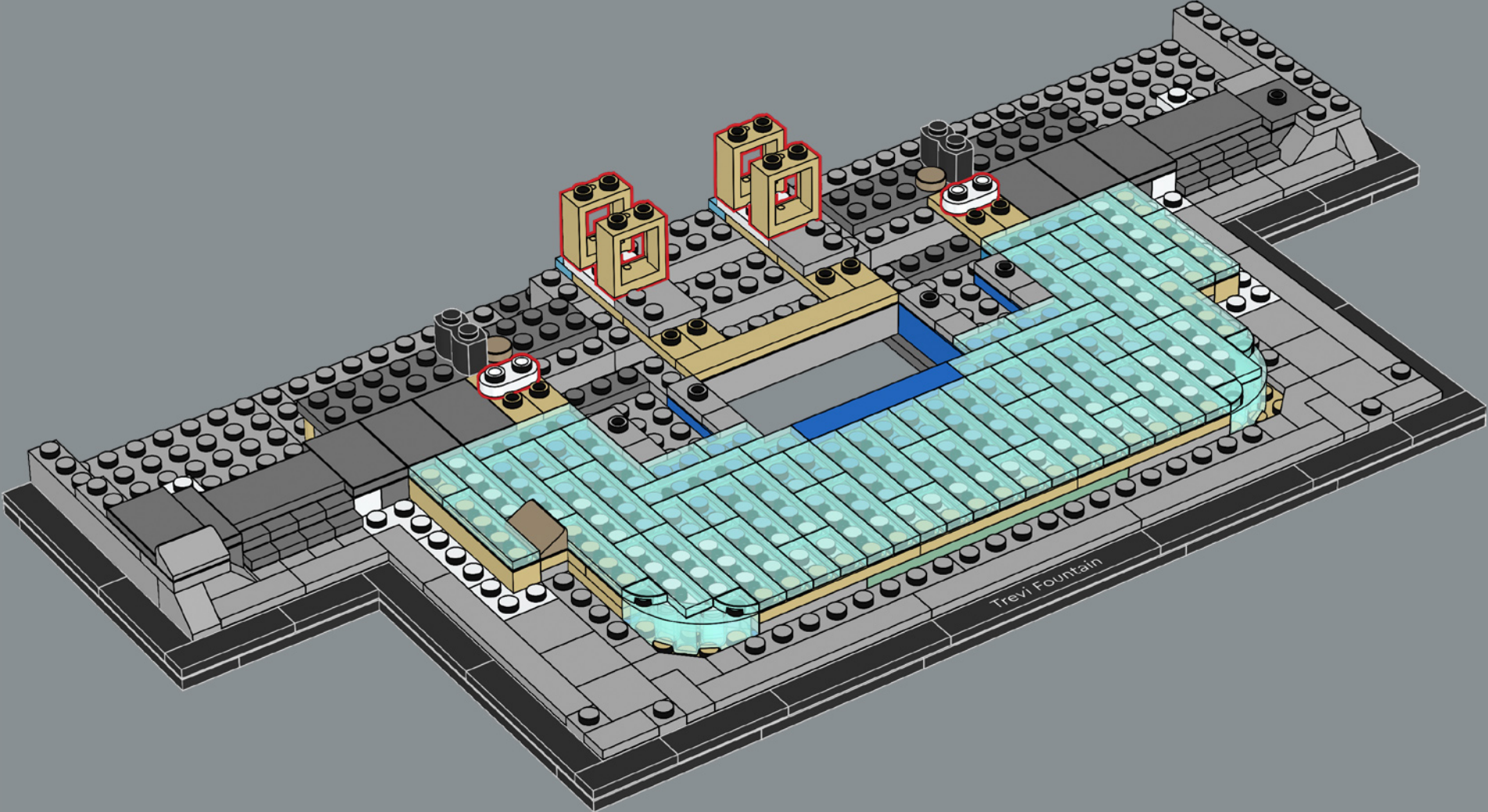

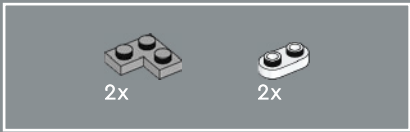

51

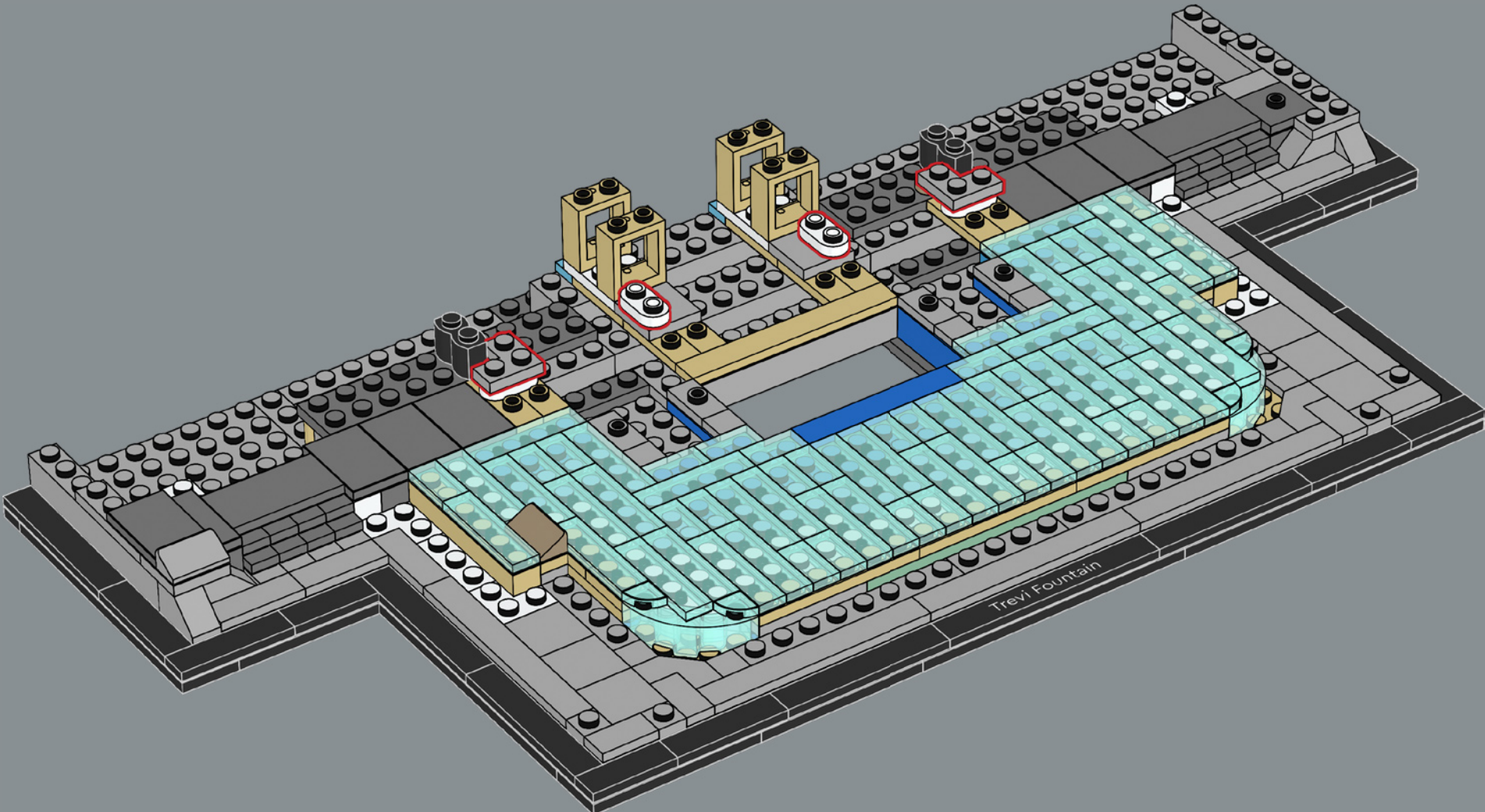

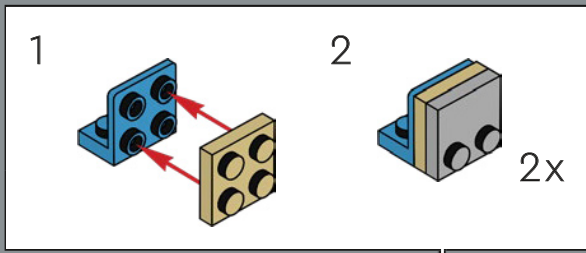
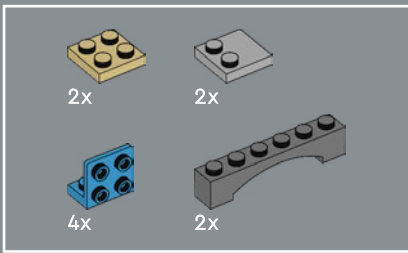

52

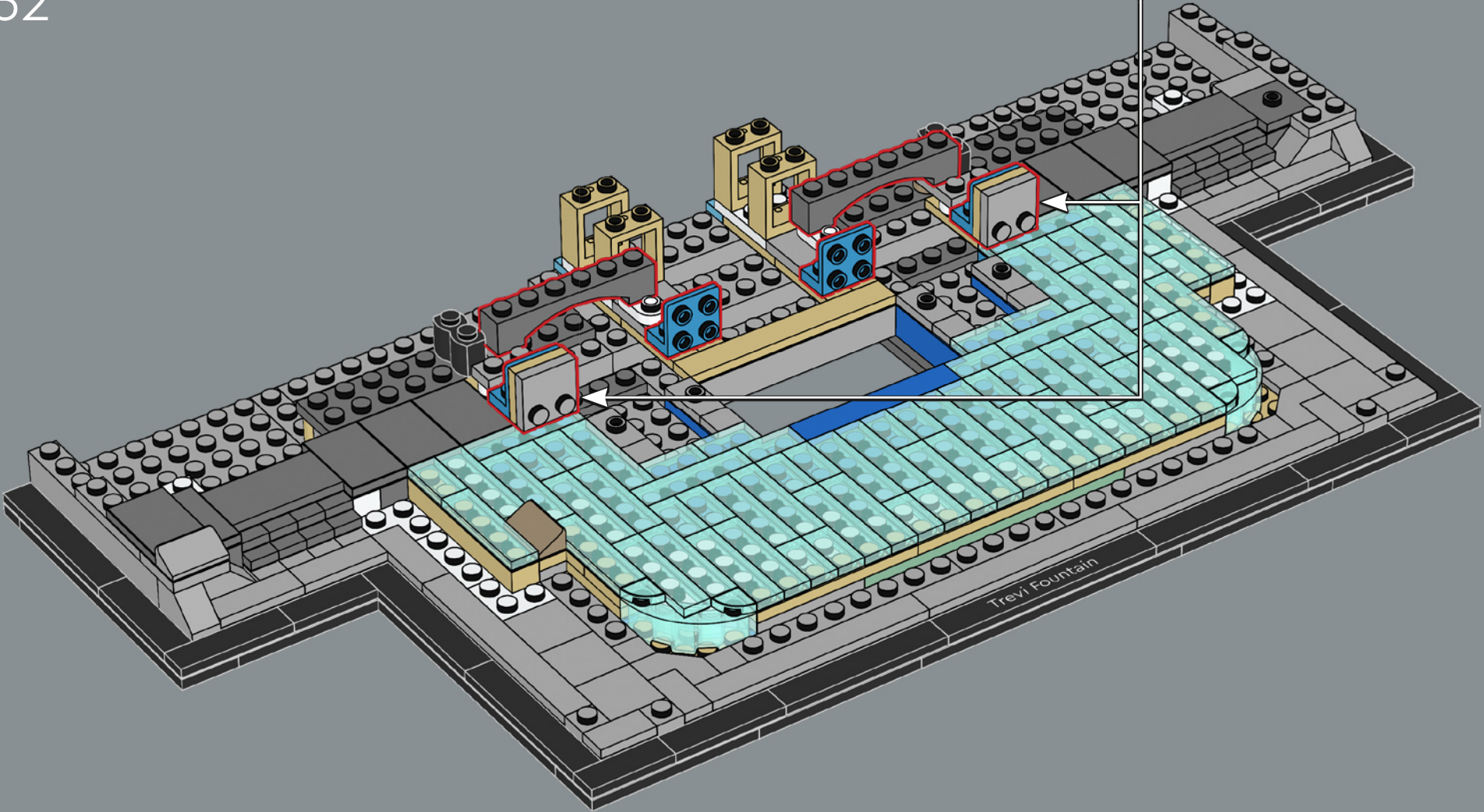

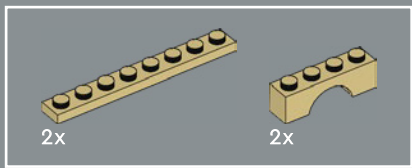

53

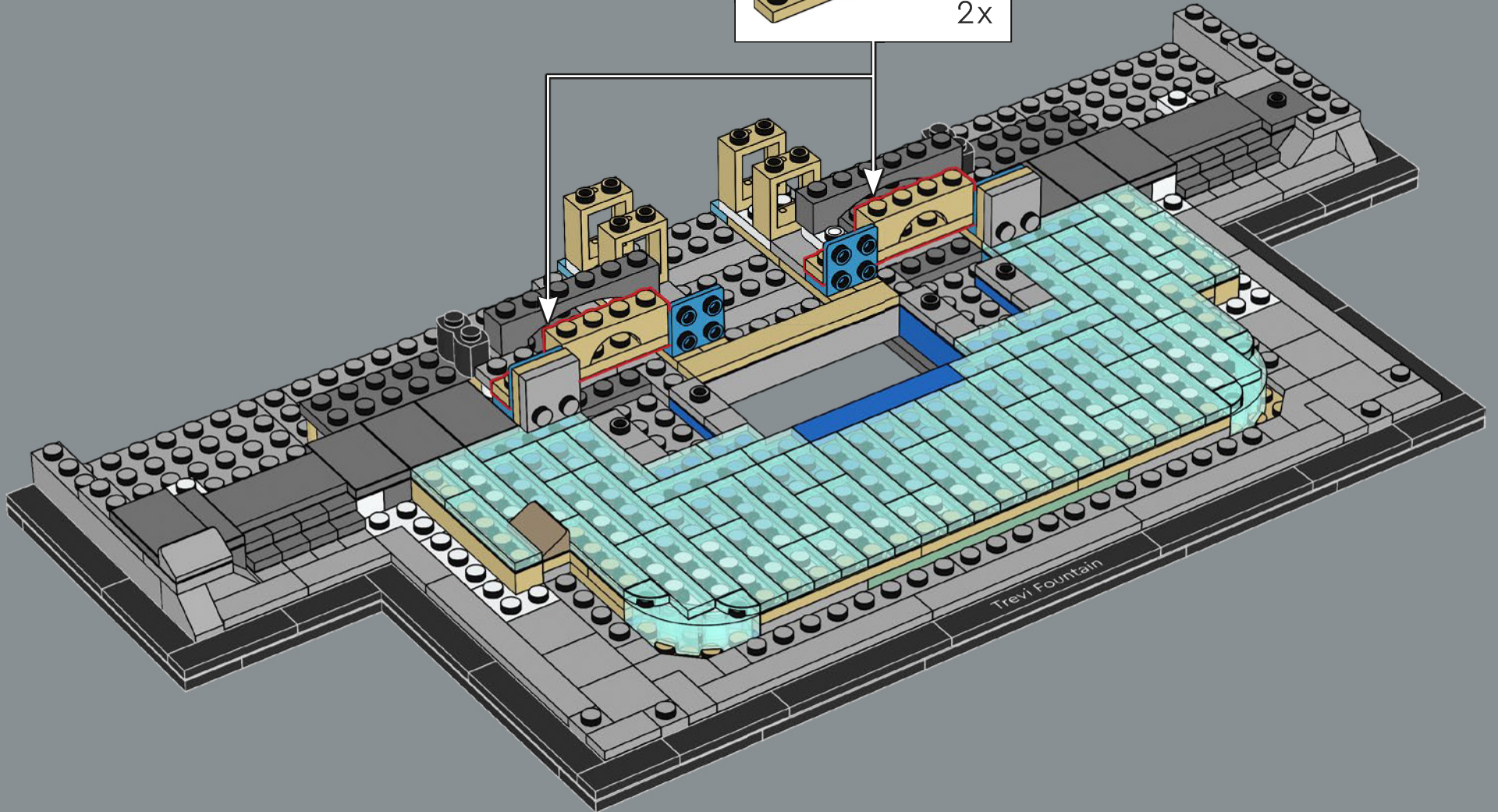
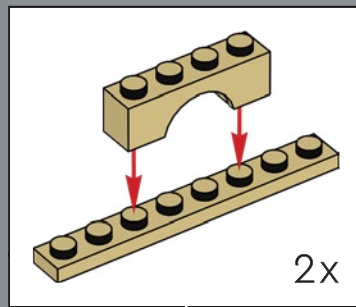

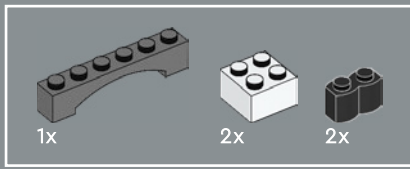

54

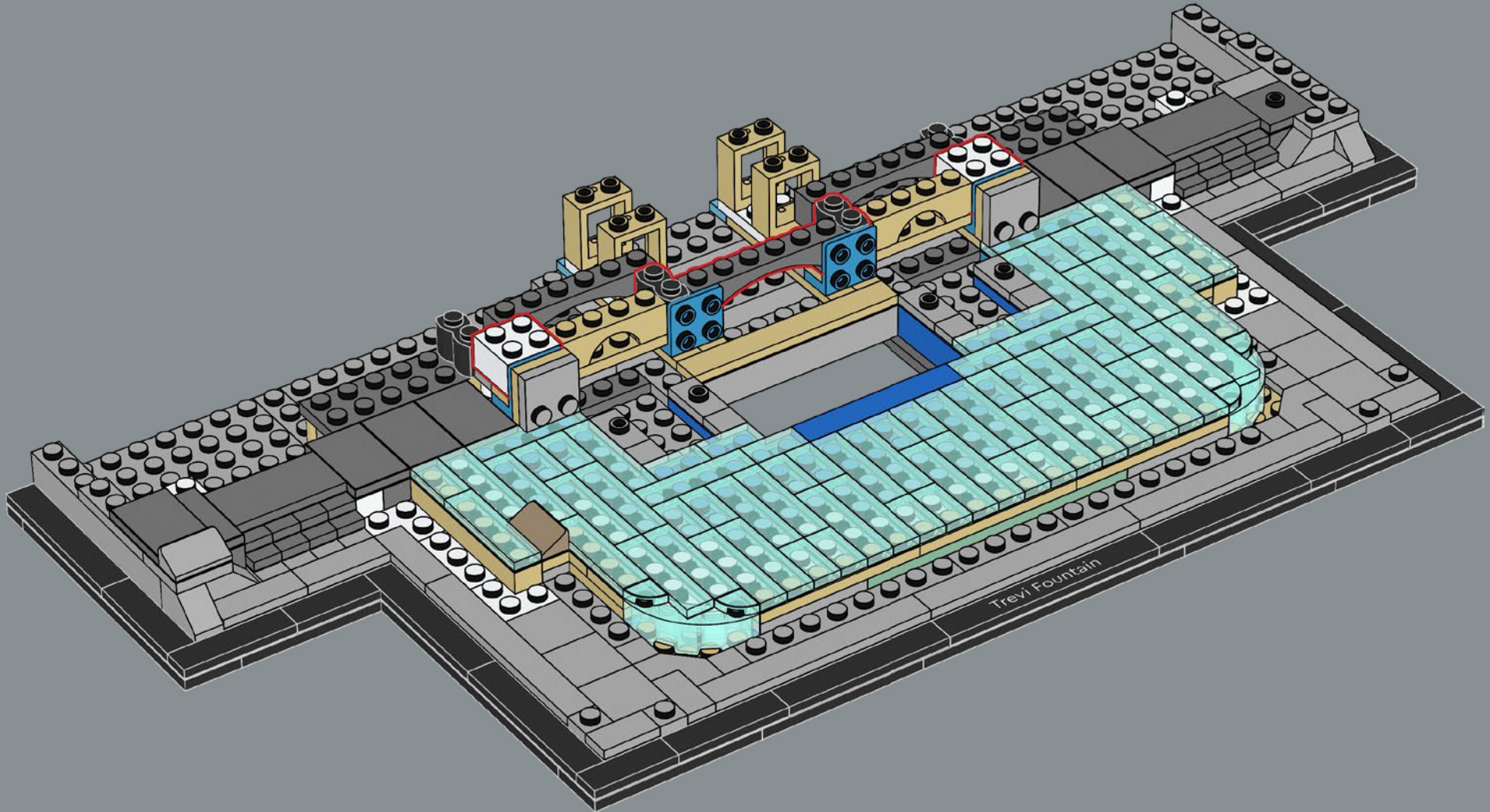

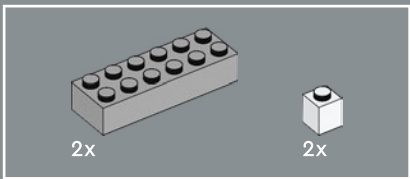

55

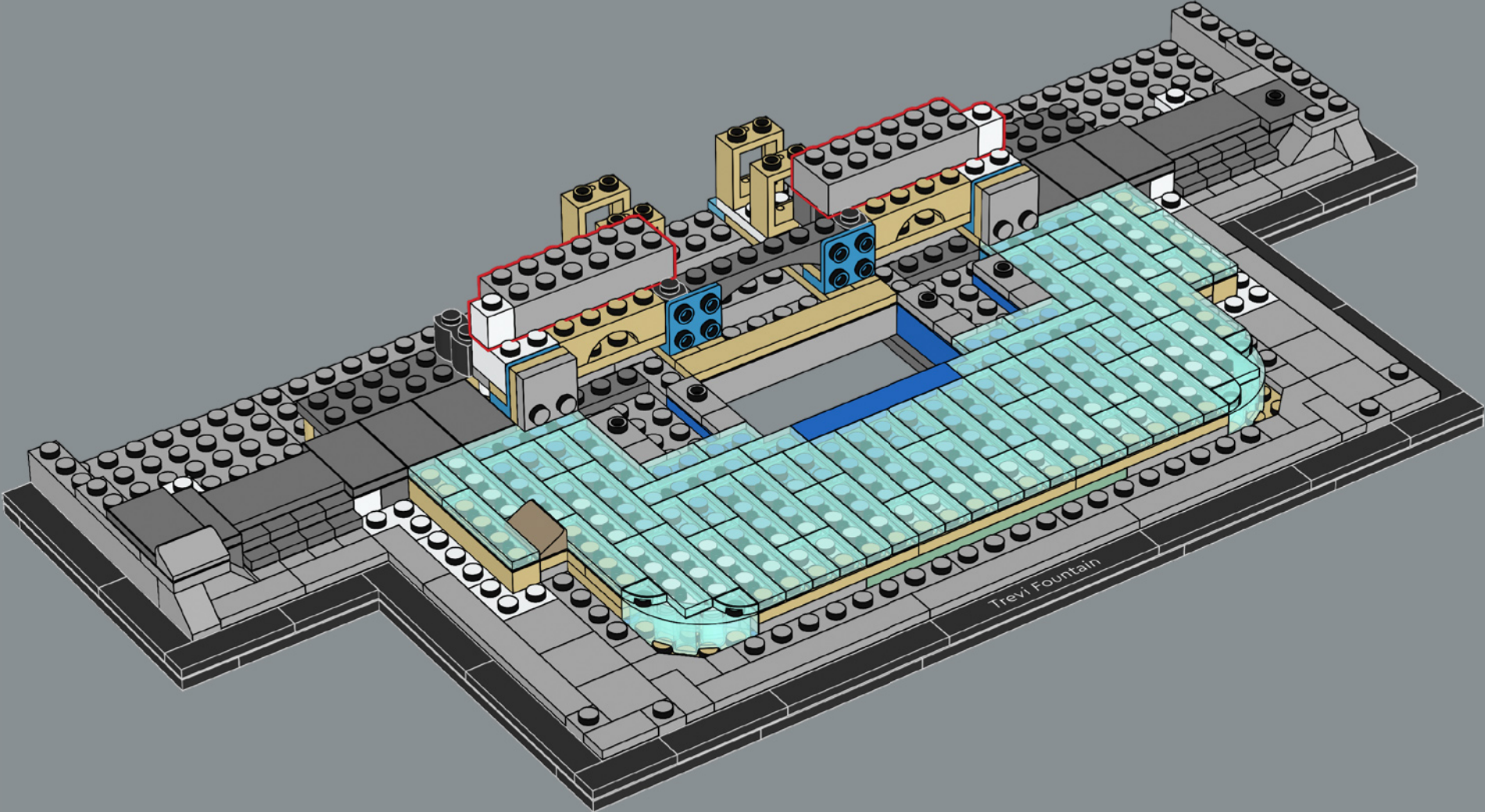

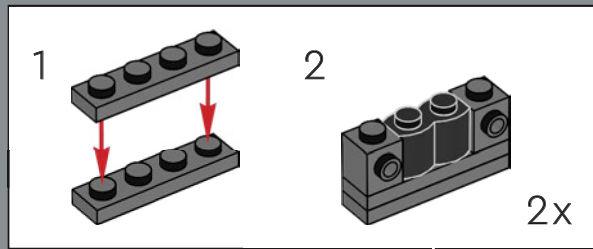
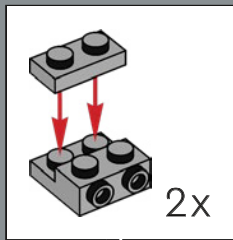
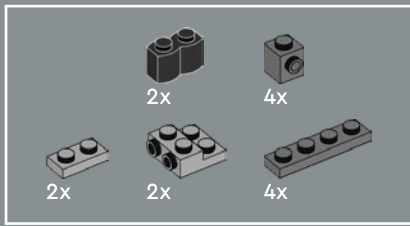

56

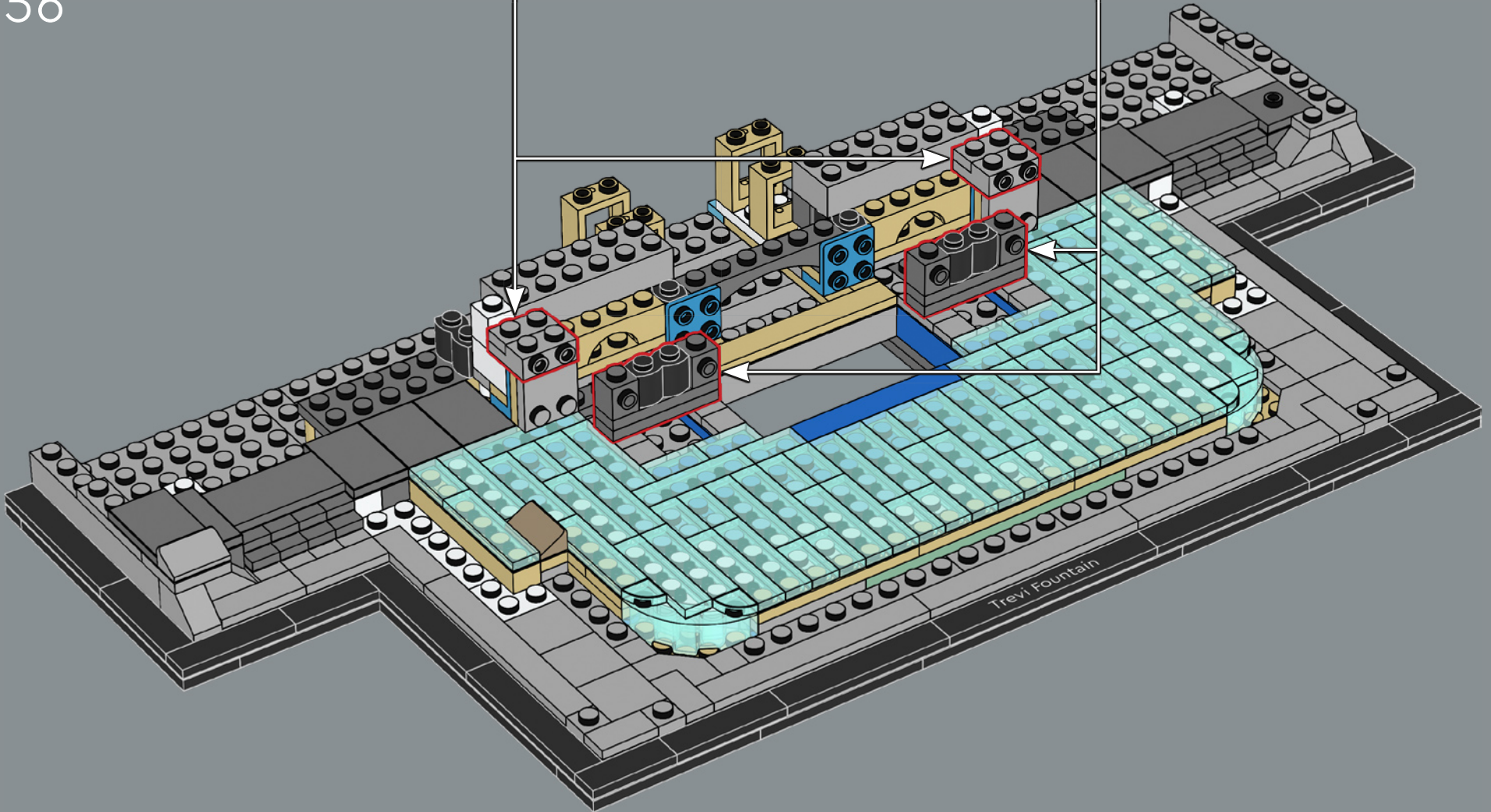

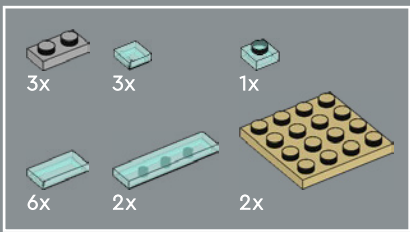

57

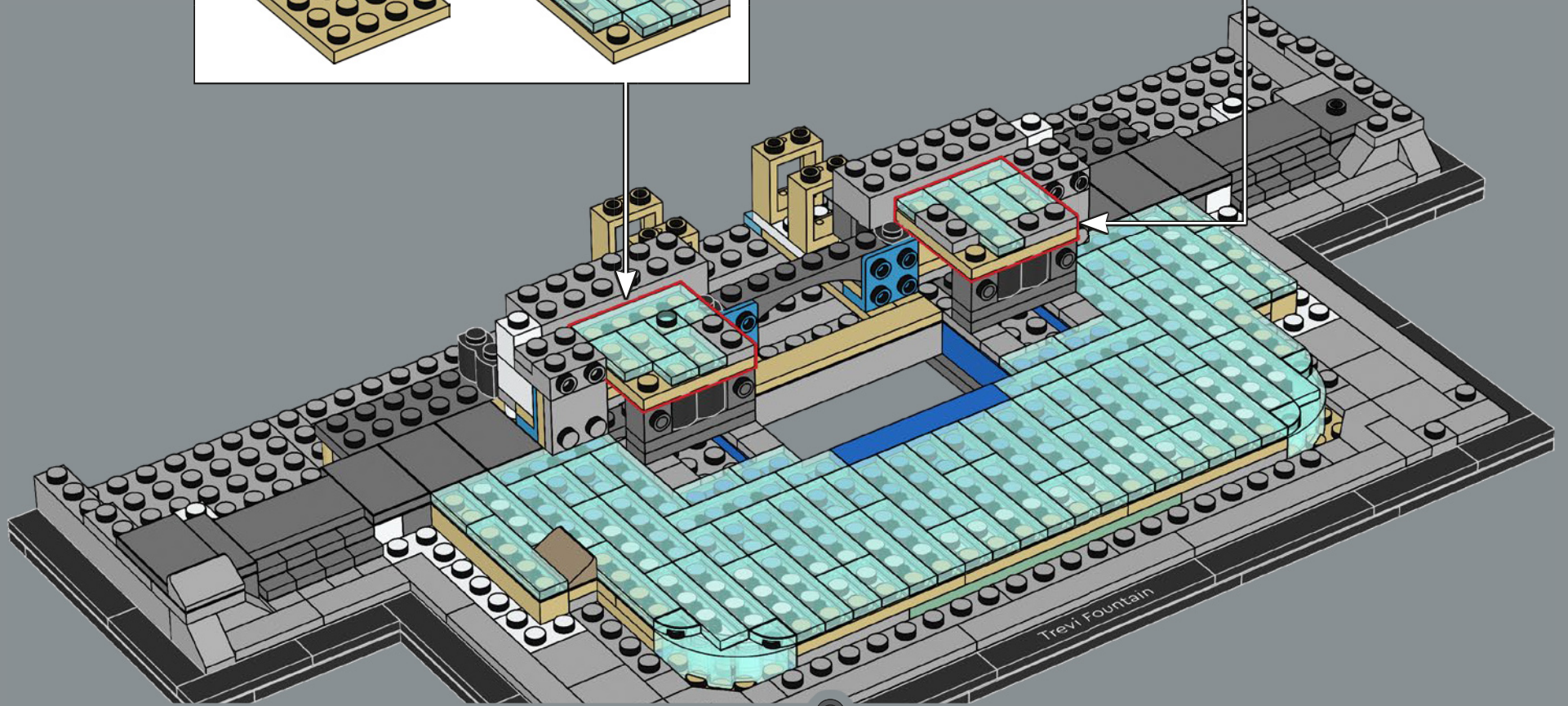
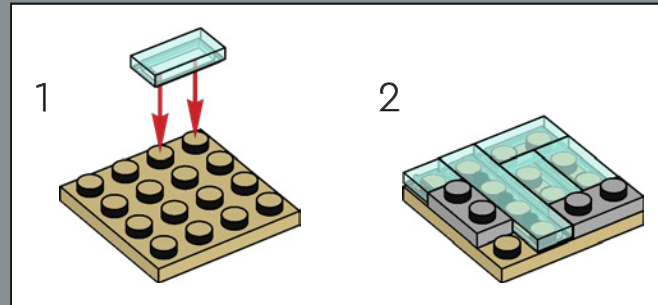
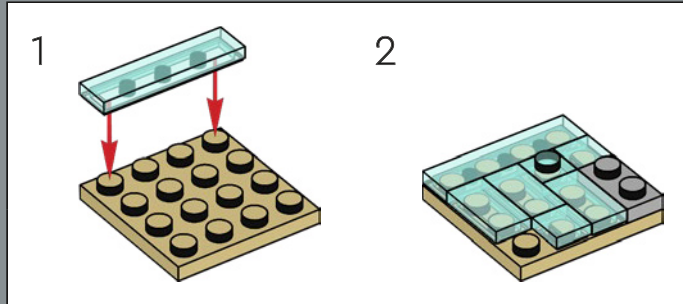

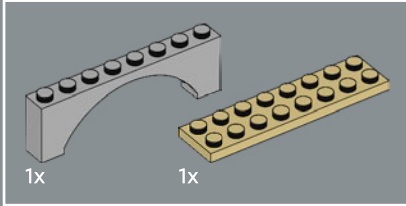
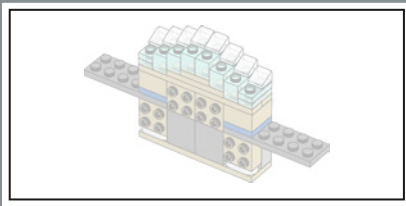

58

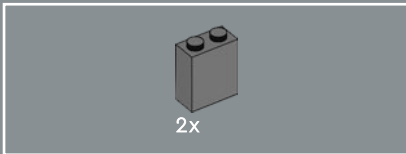
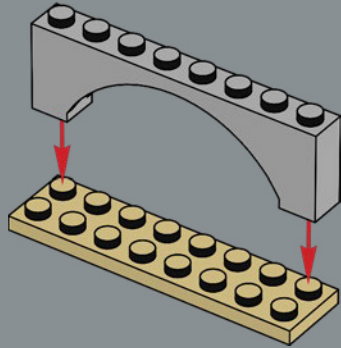

59

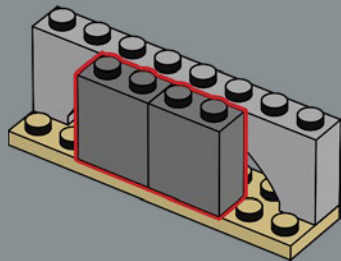

60

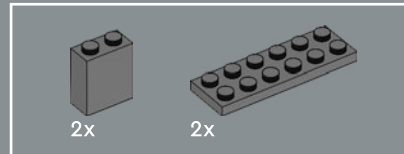
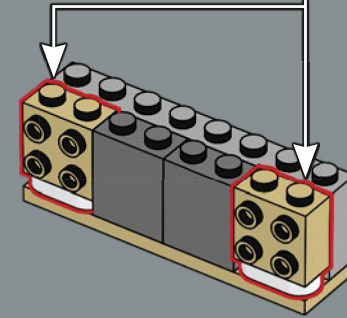
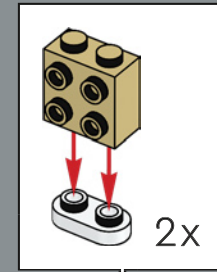

61

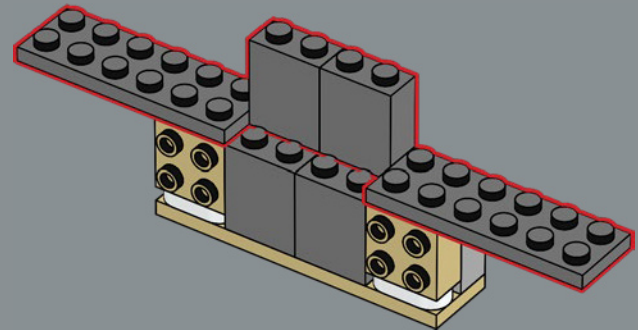

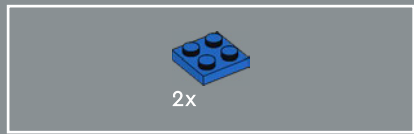

62

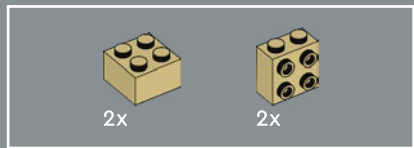
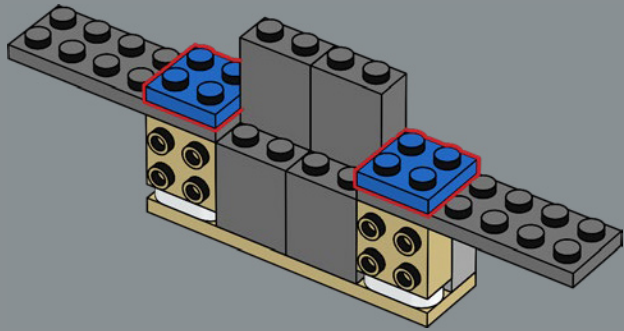

63

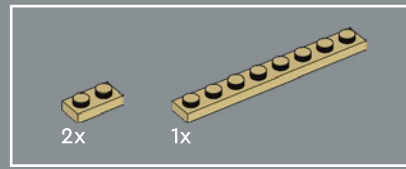
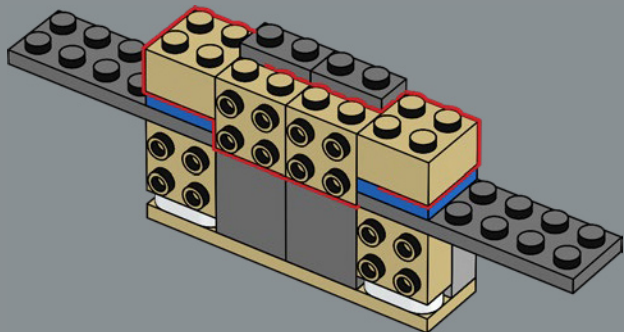

64

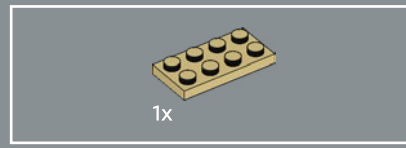
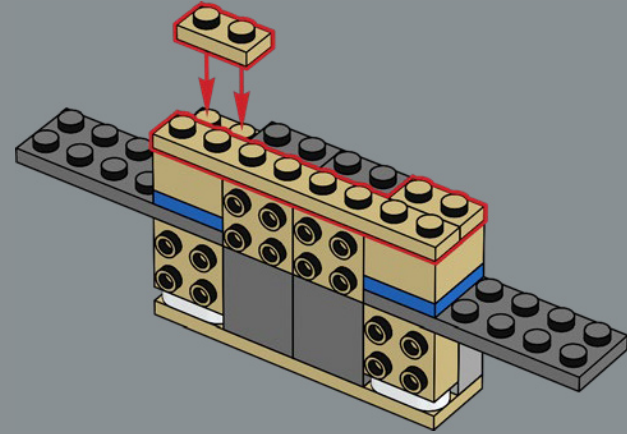

65

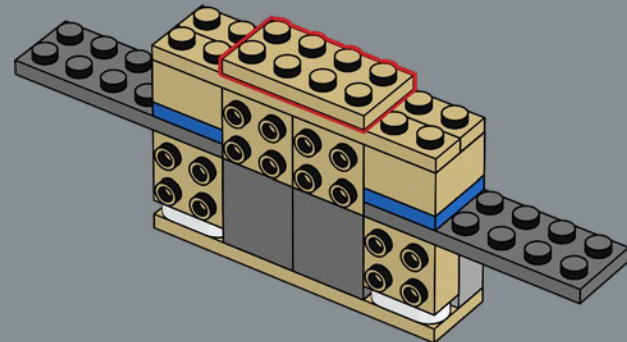

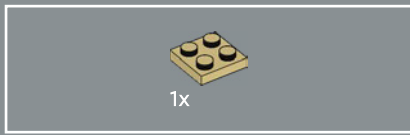

66

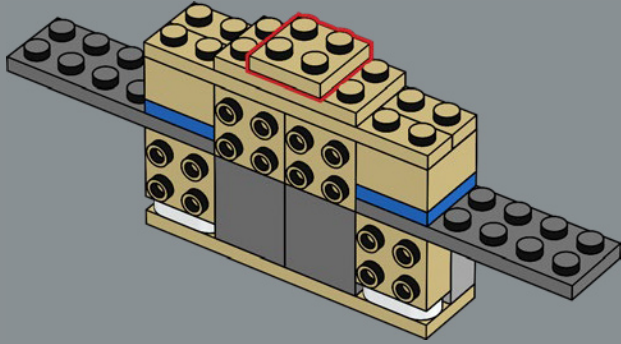

67

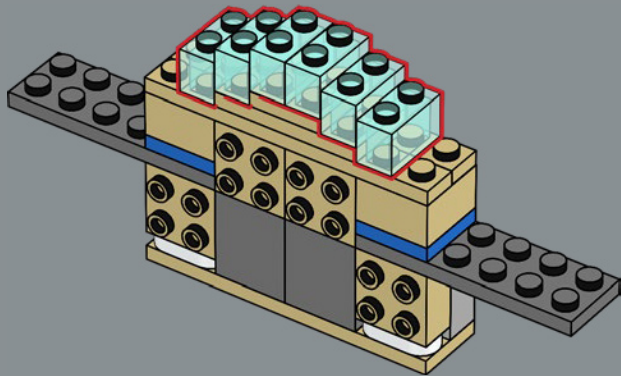

68

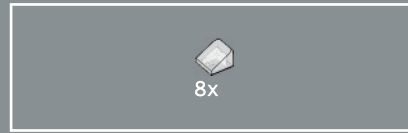
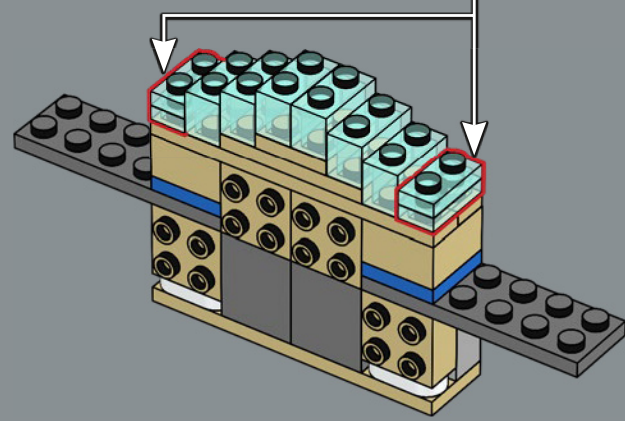
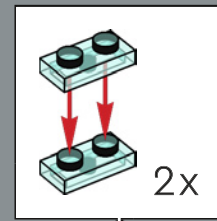

69

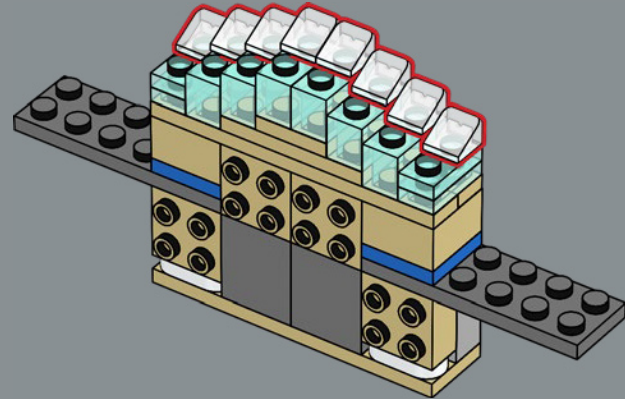

The Trevi Fountain was built at the end of the ancient Acqua Vergine, and aqueducts continue to supply the fountain today.

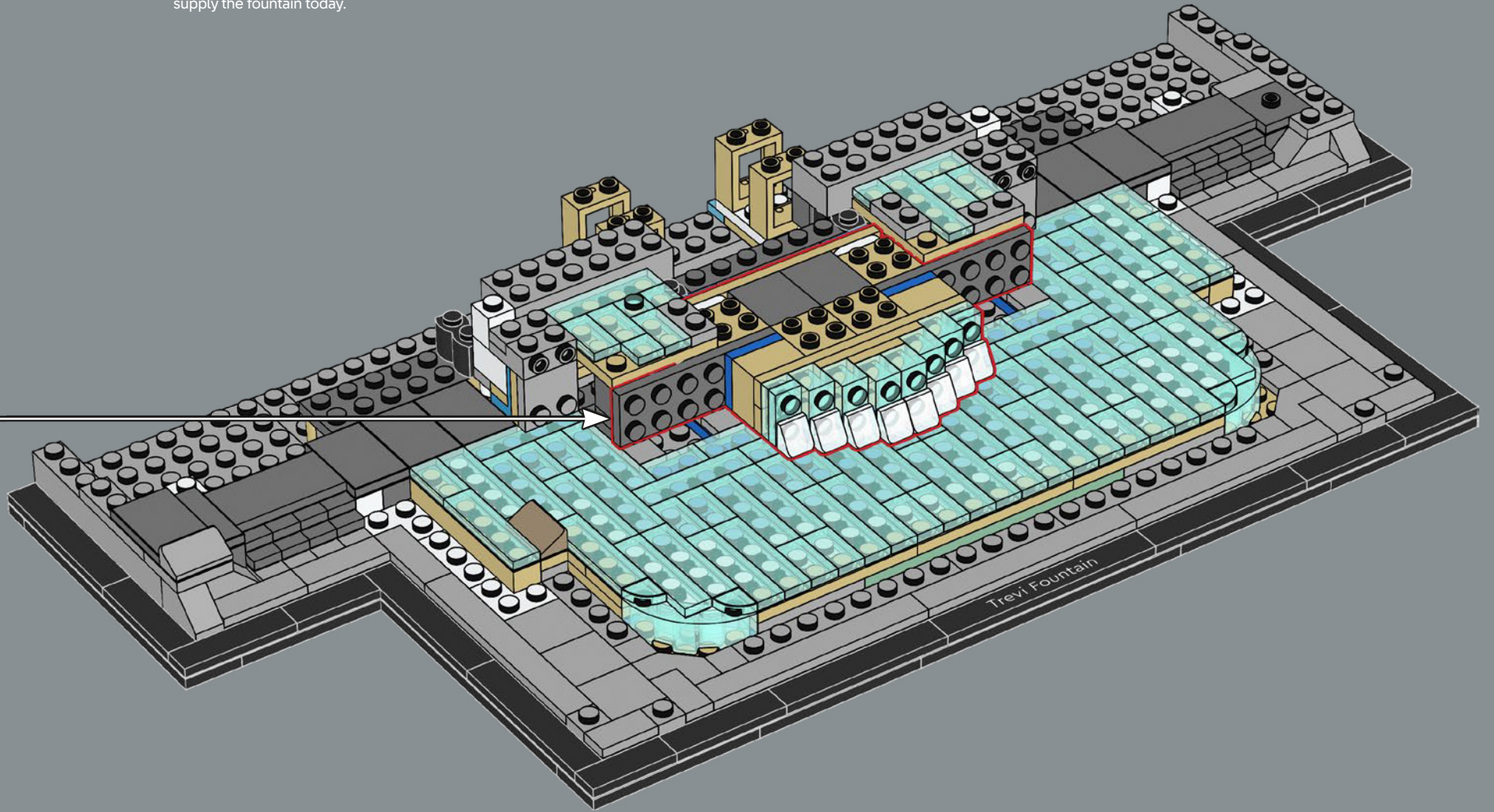

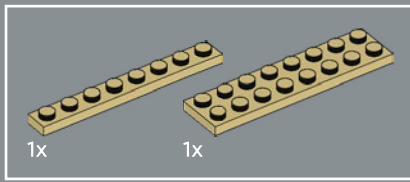

71

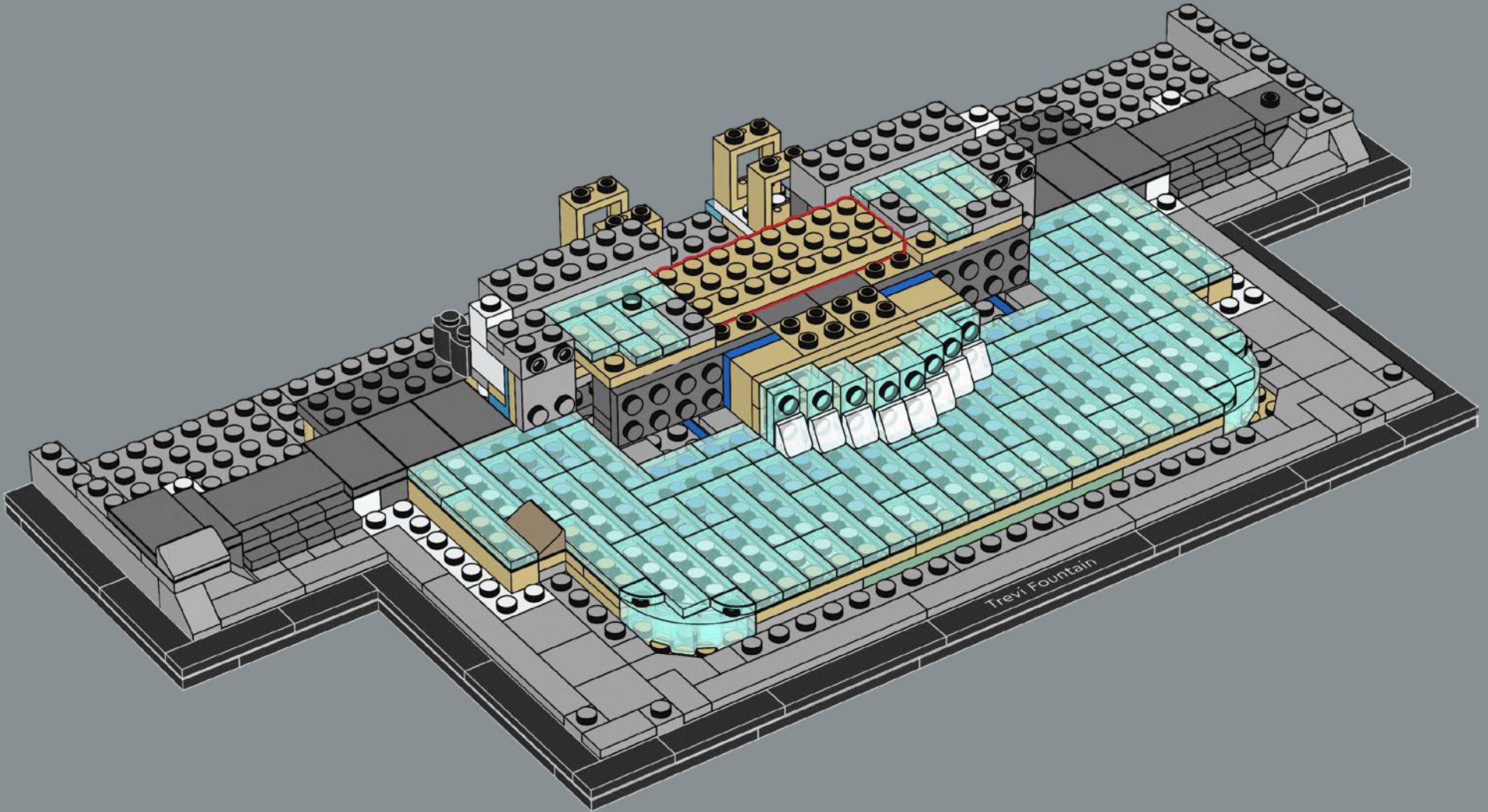

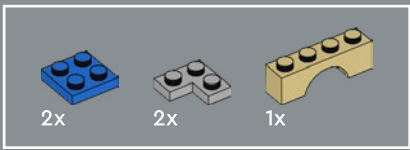

72

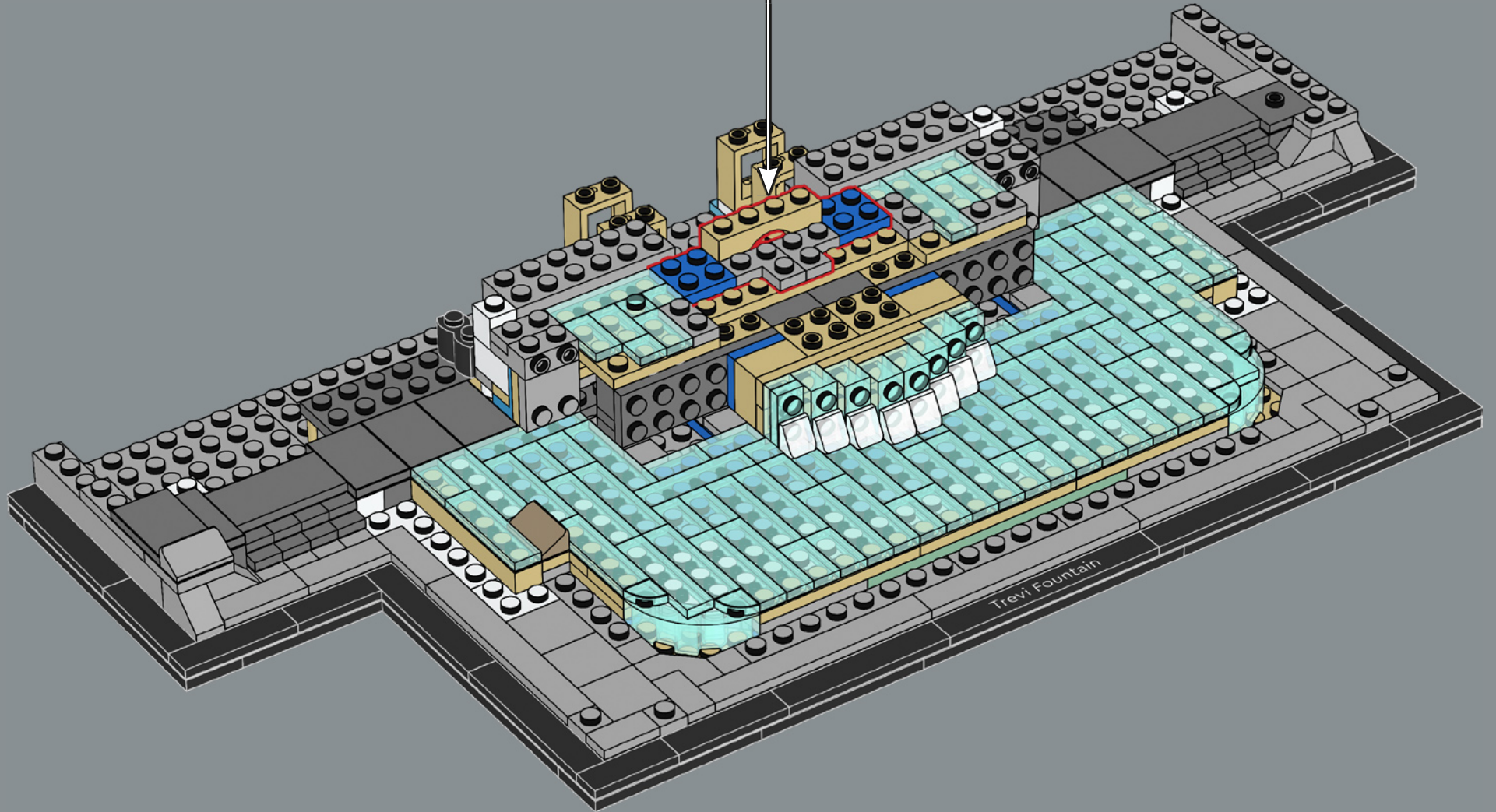
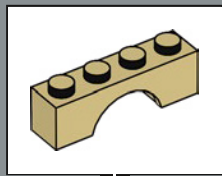

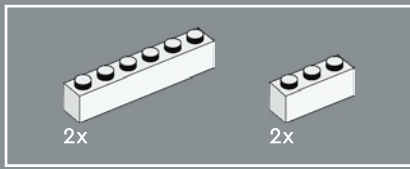

73

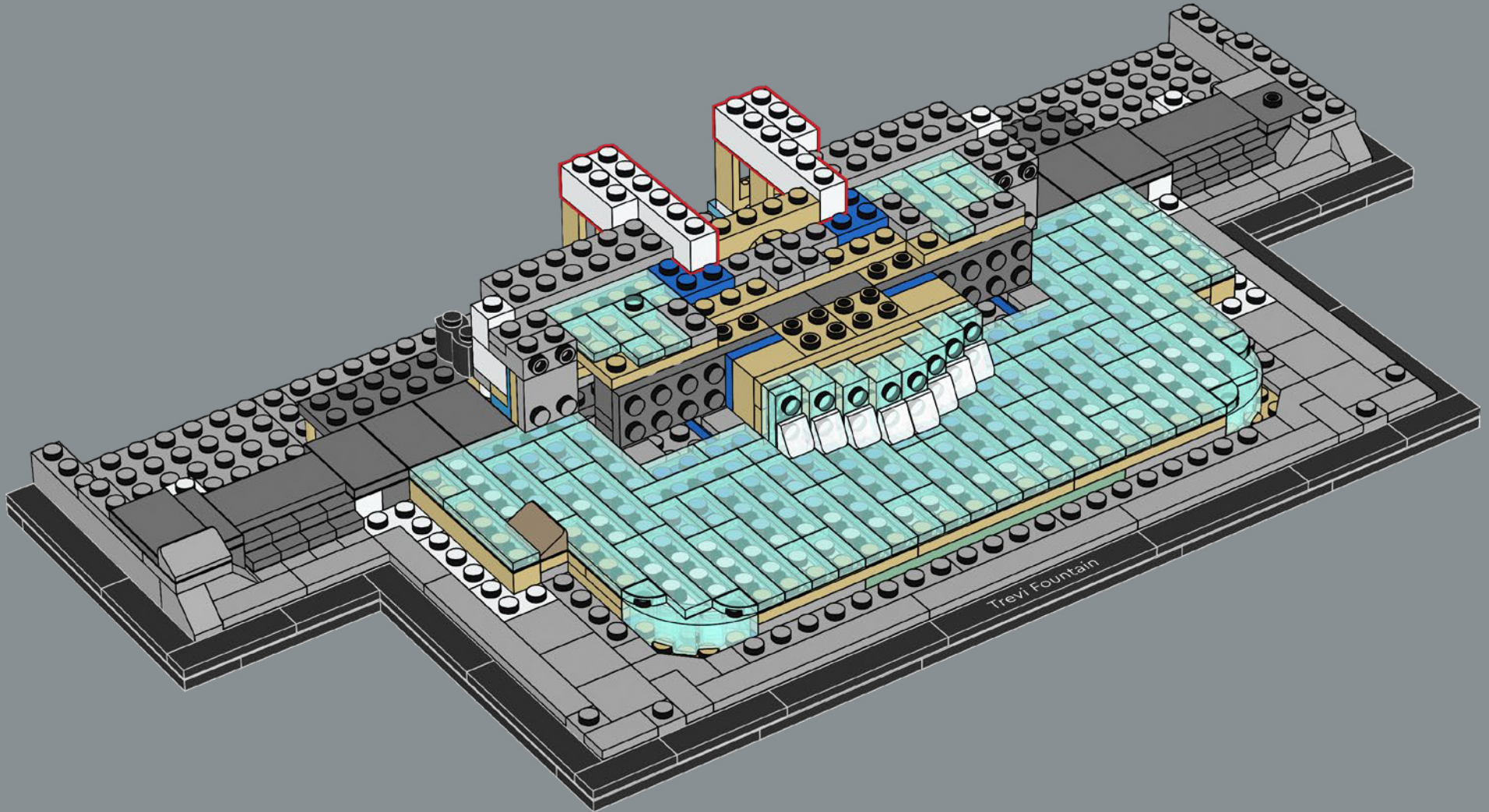

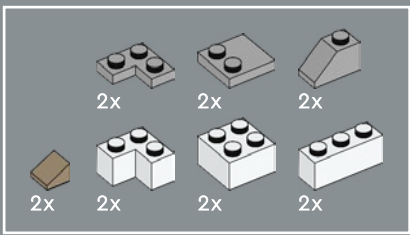

74

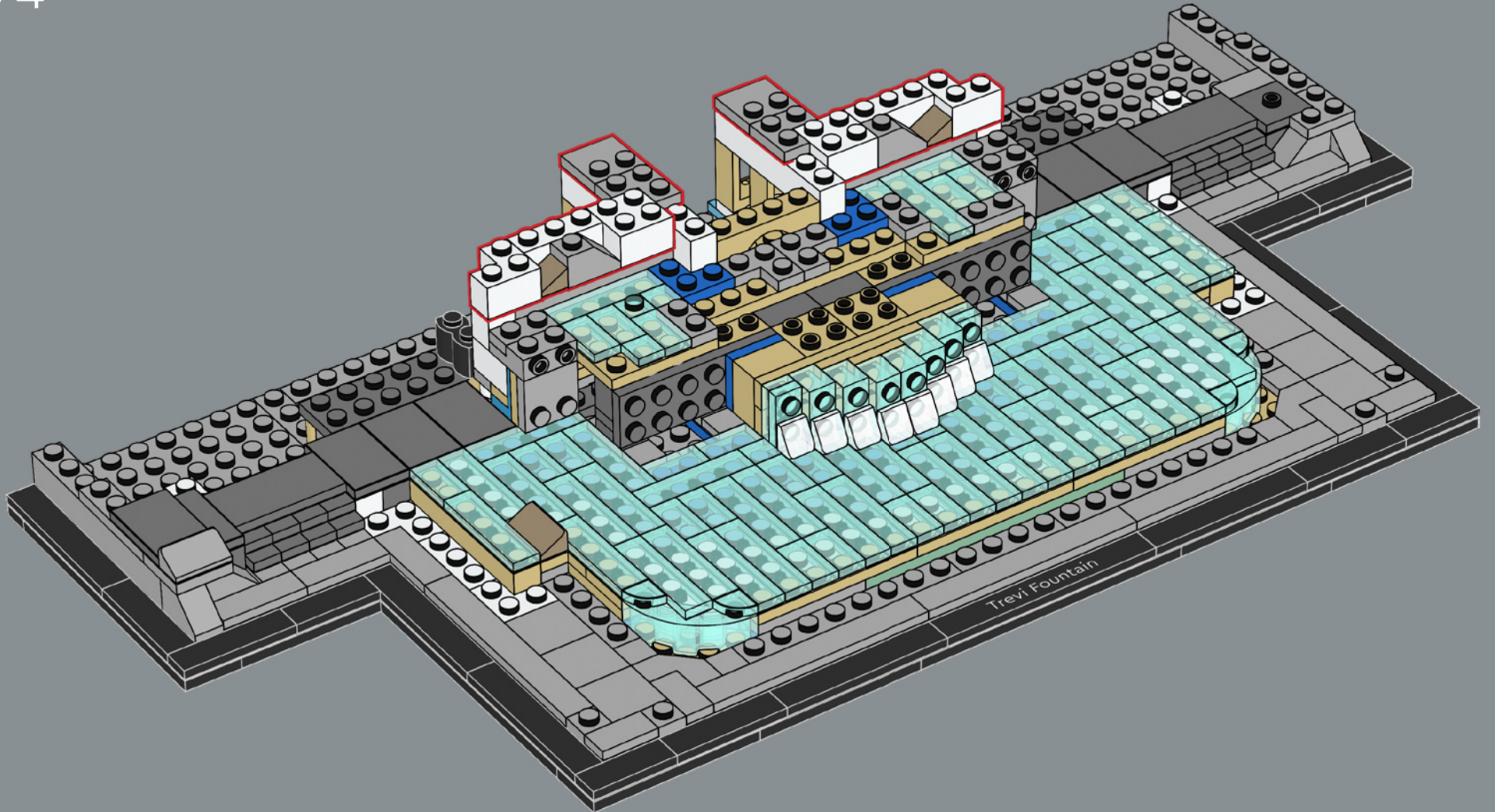

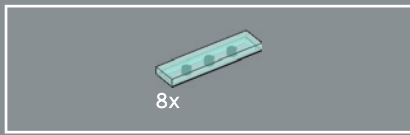

75

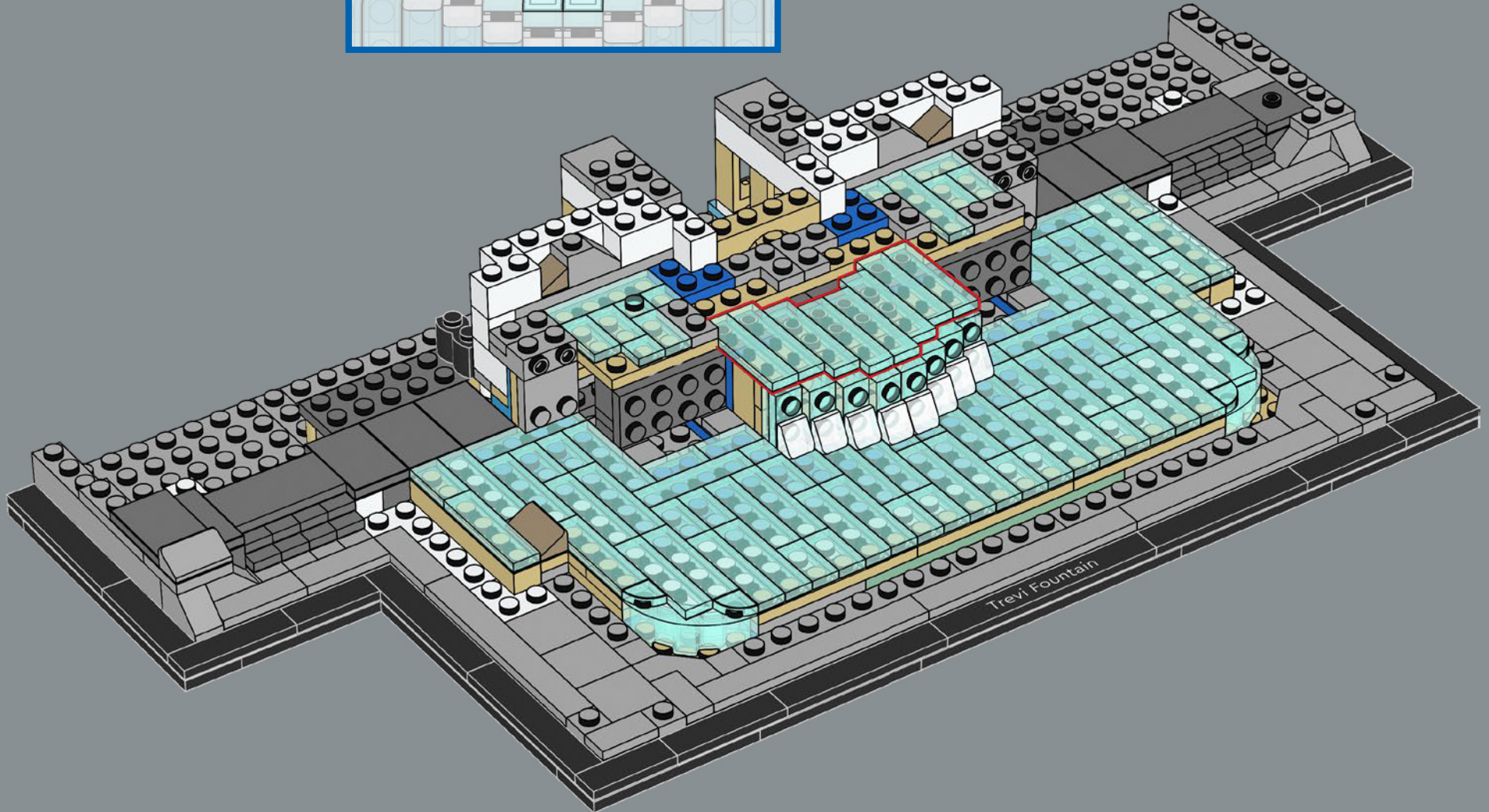
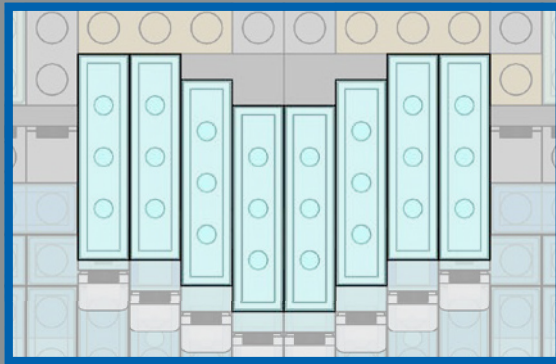

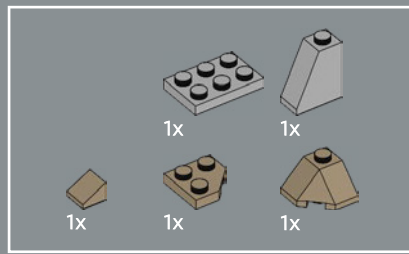

76

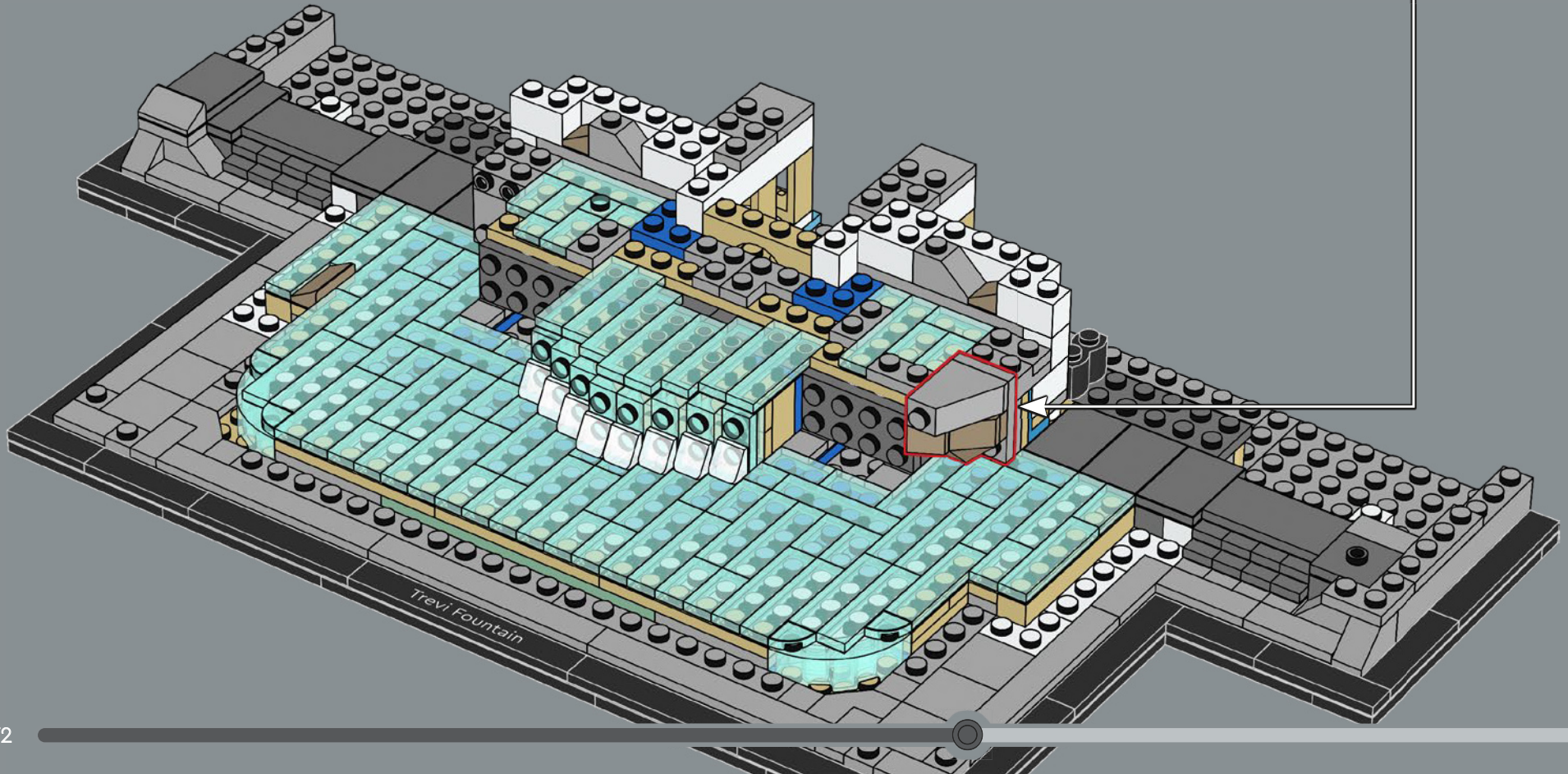
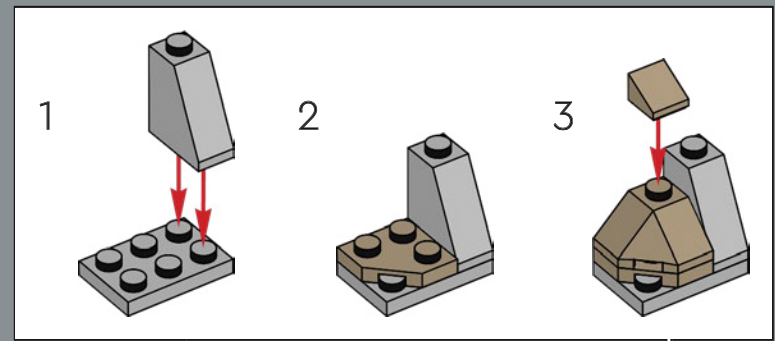

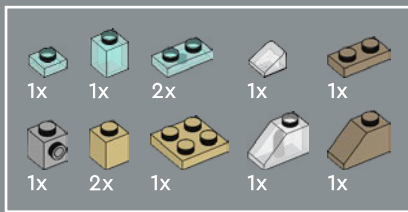

77

1

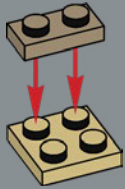

2

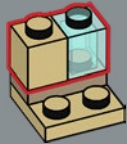

3

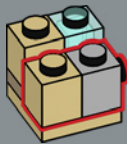

4



5



6

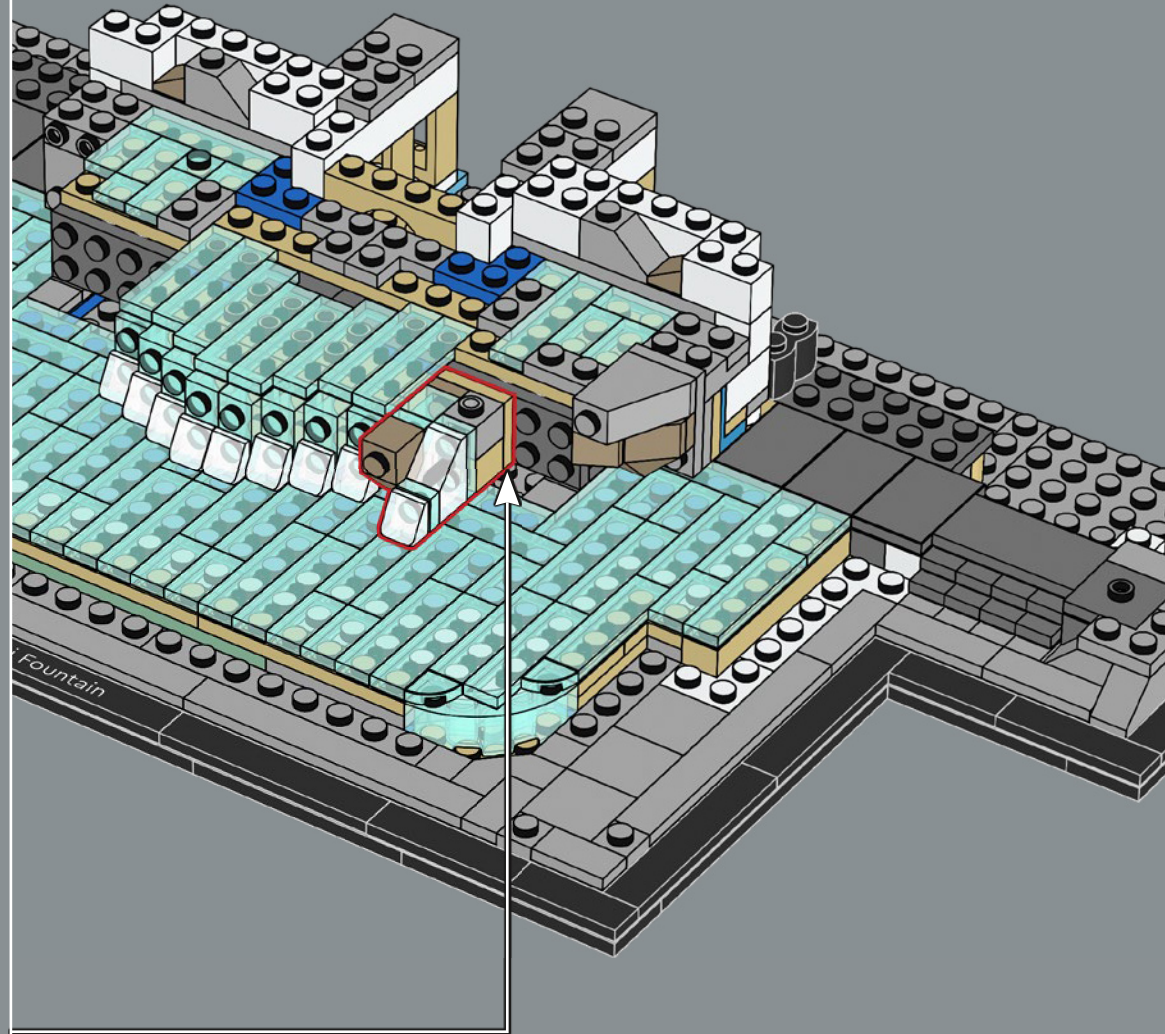

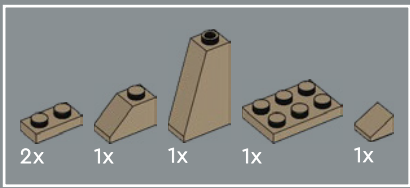

78

1

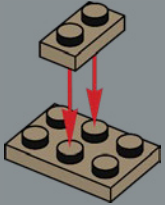

2

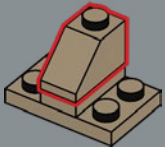

3

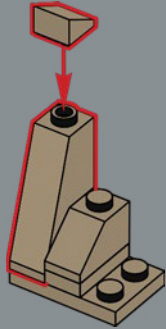

4

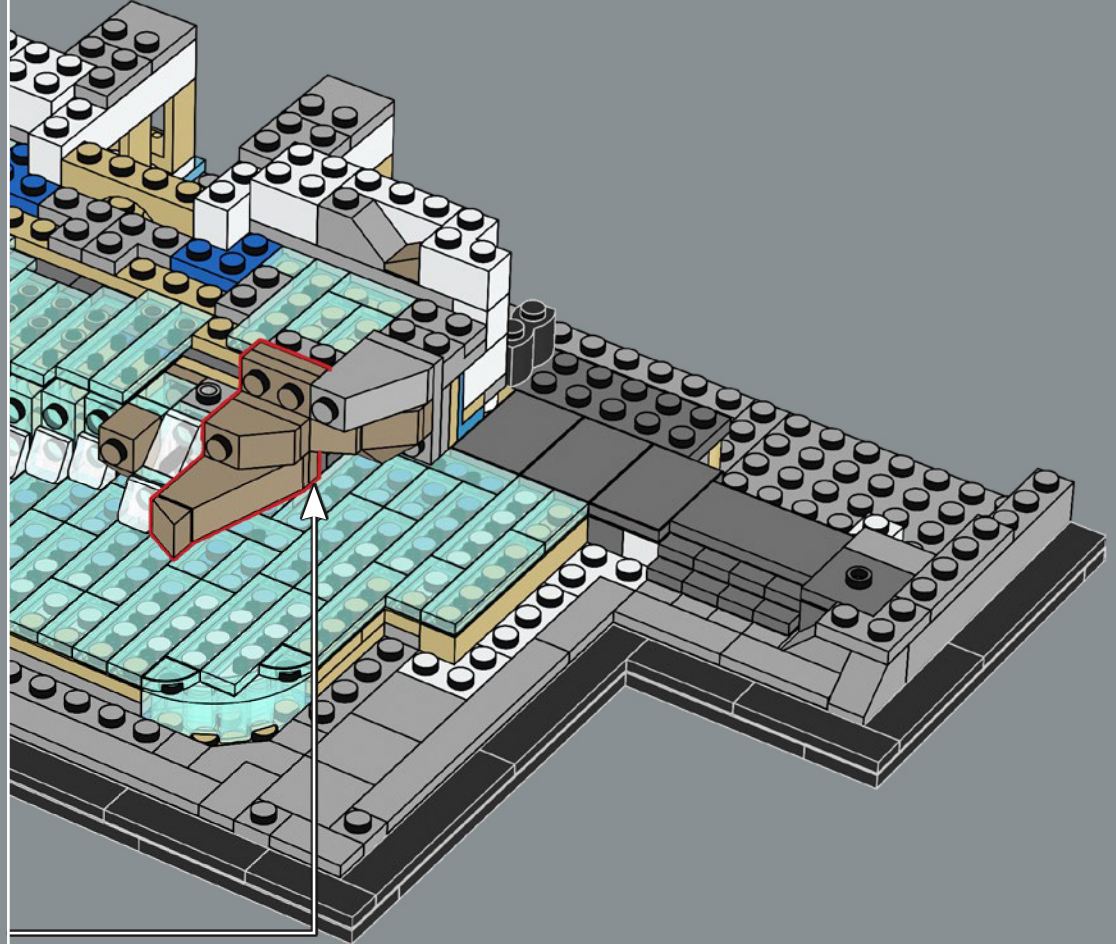
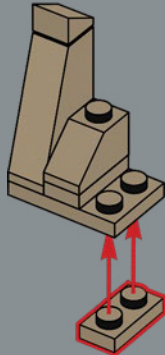

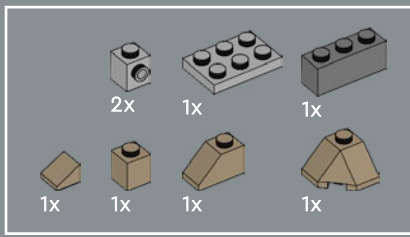

79

1

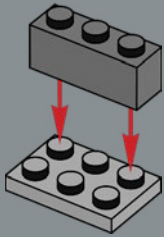

2

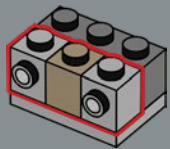

3

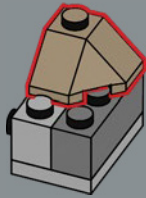

4

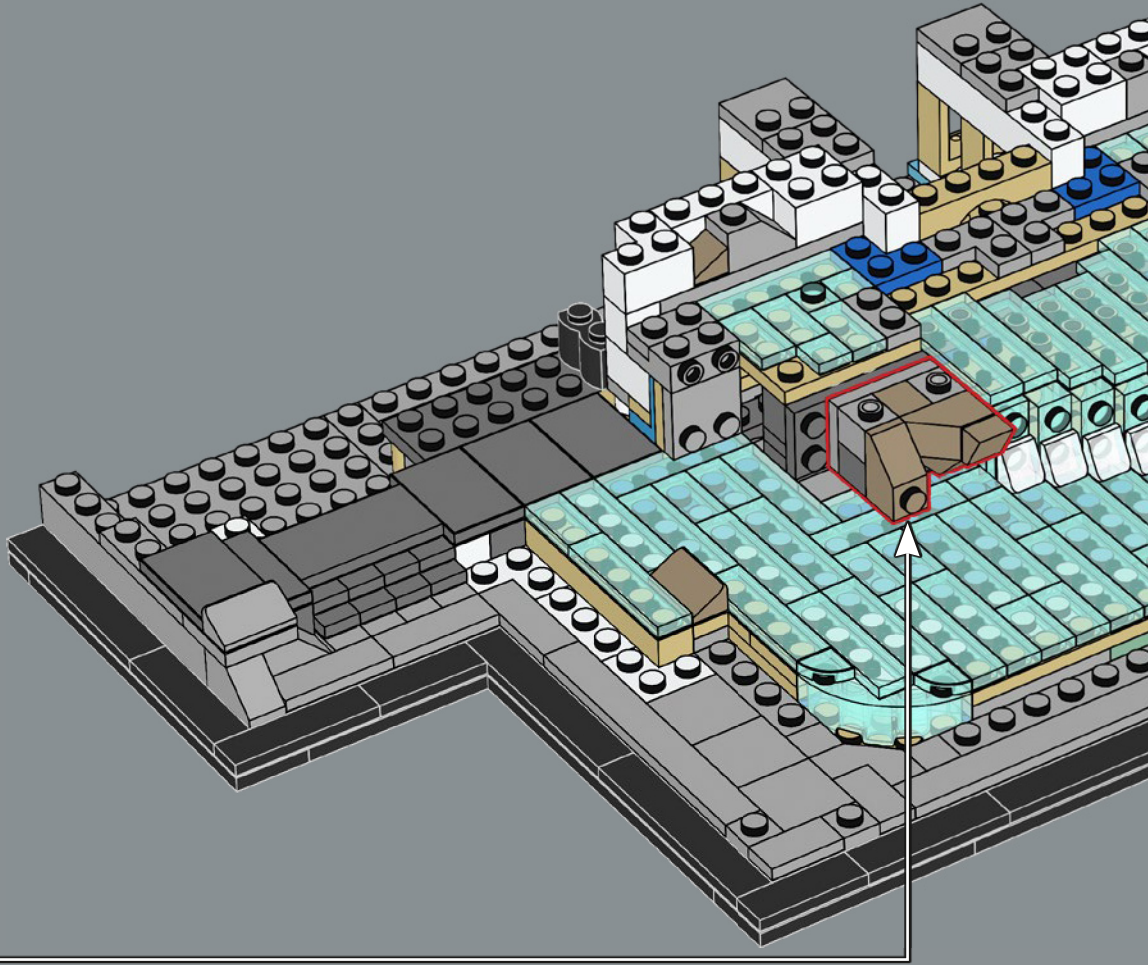
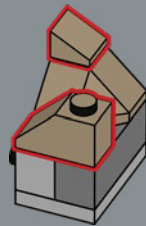

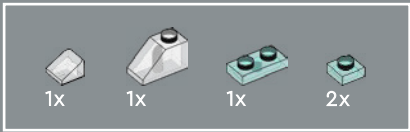

80

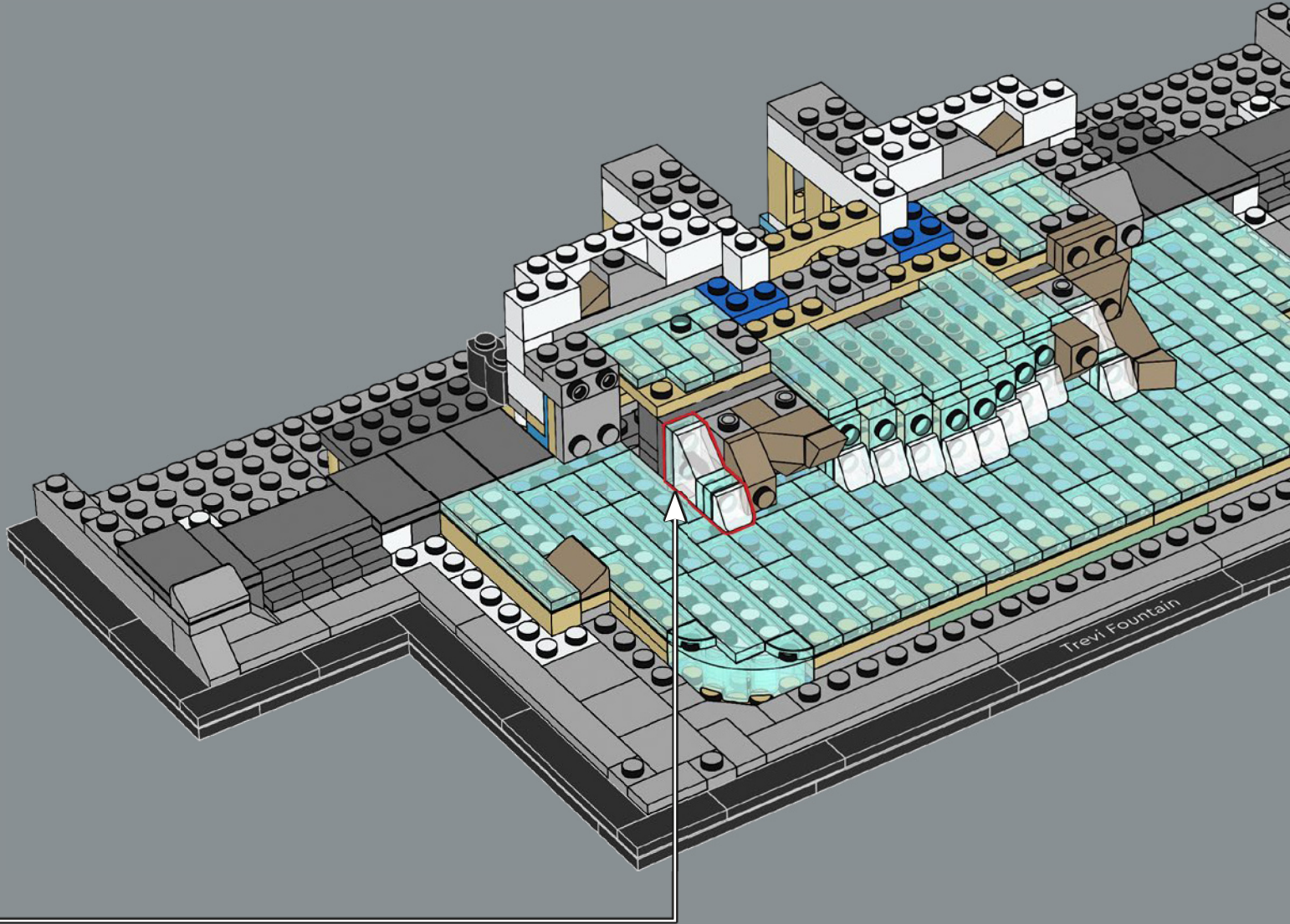
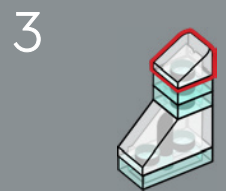
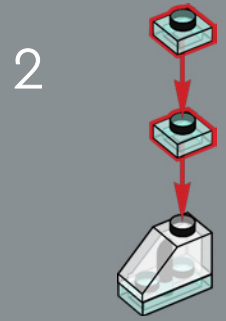
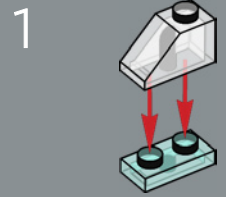

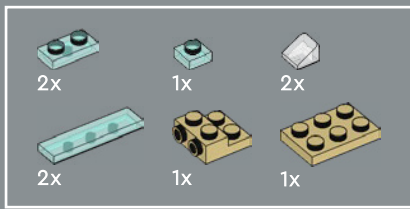

81

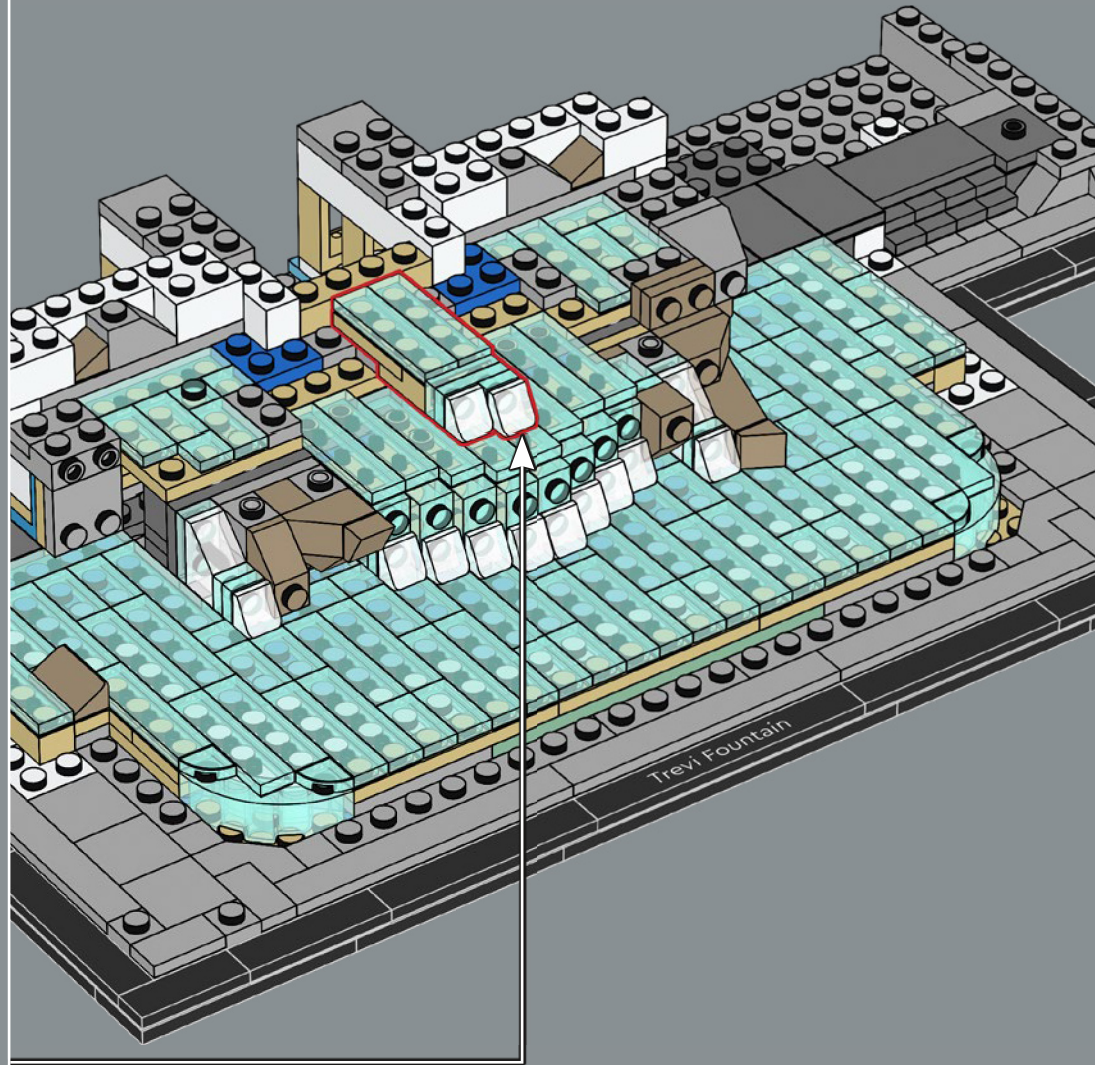
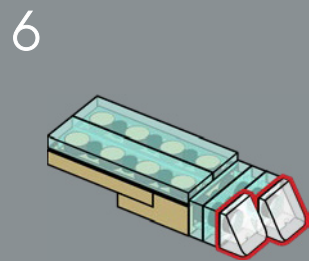
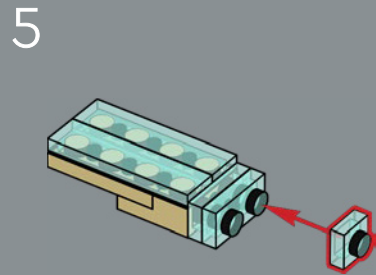
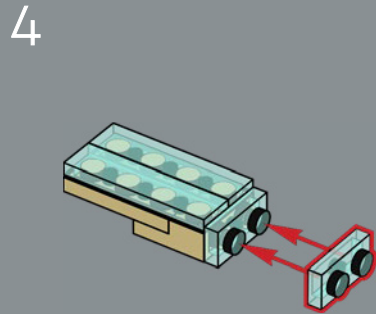
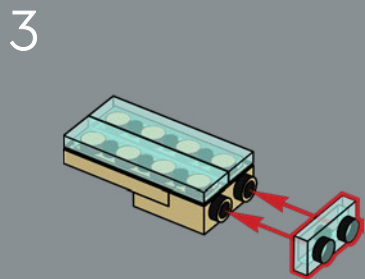
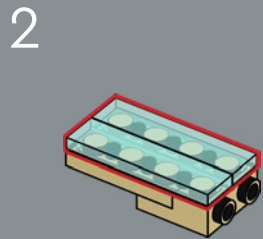
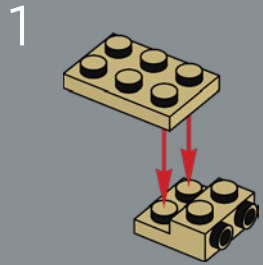

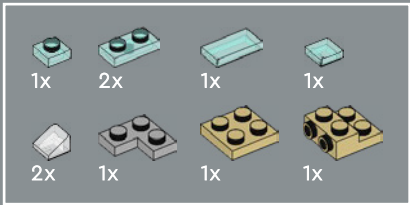

82

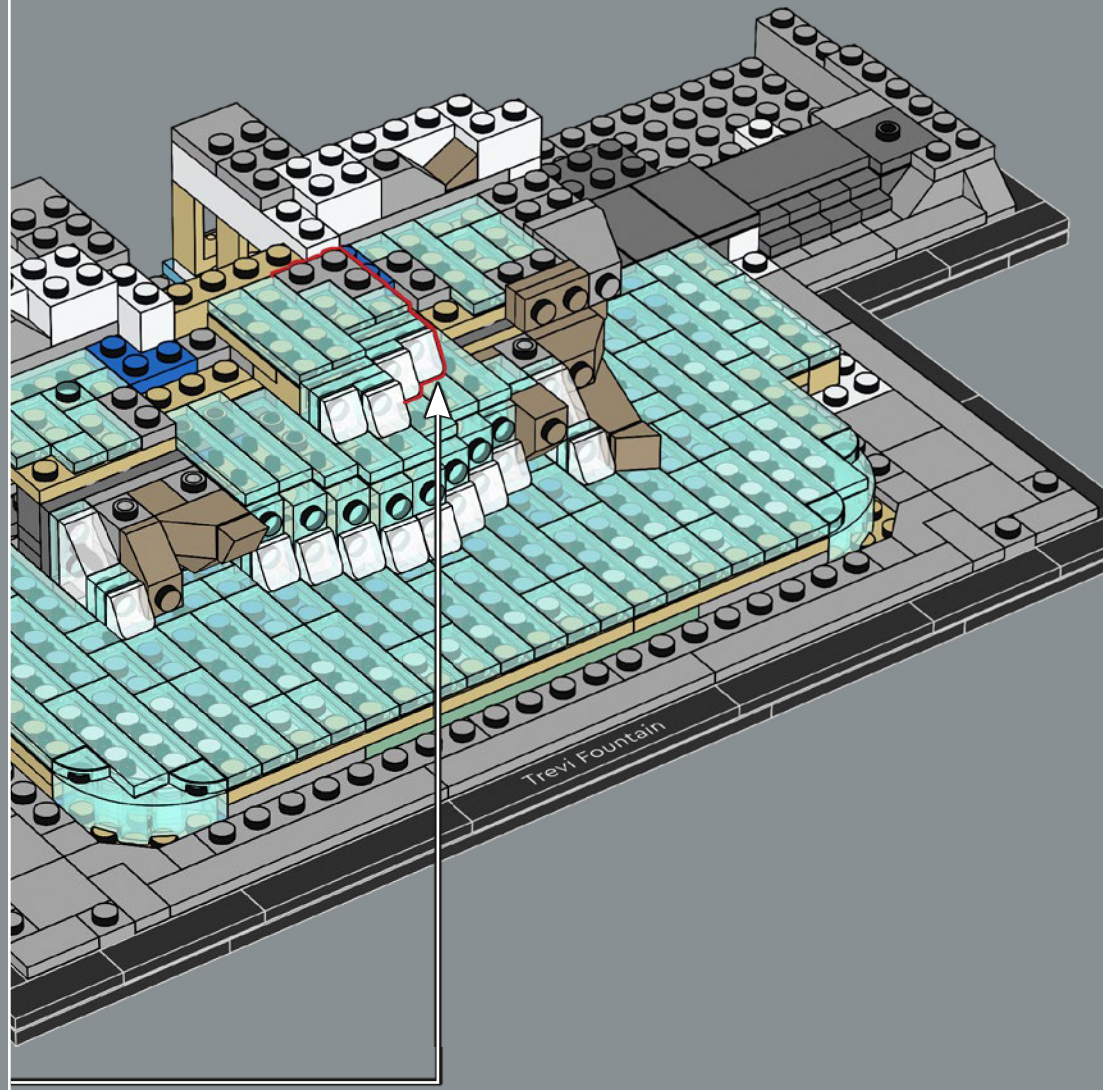
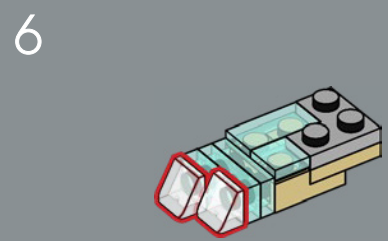
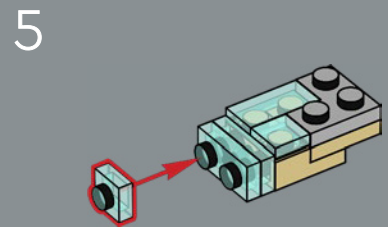
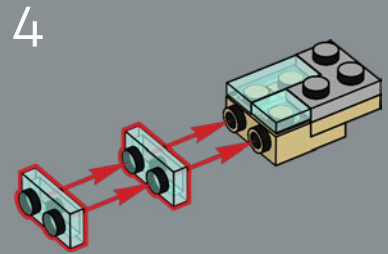
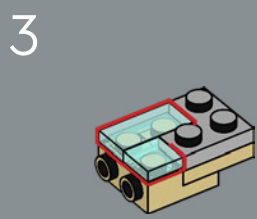
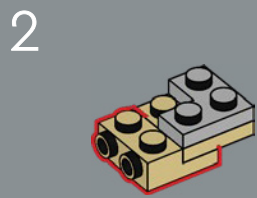
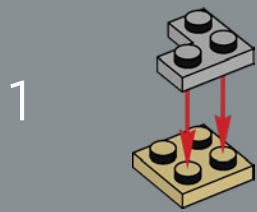

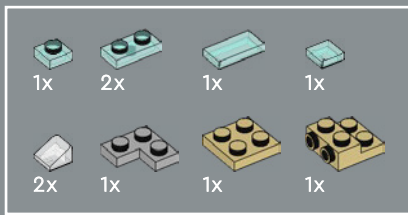

83

1

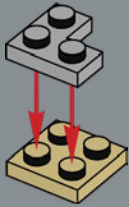

2

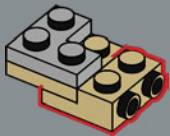

3

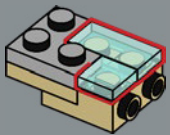

4

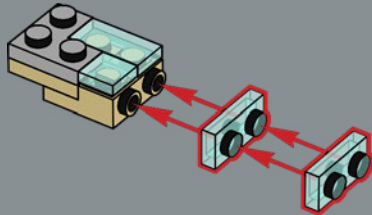

5

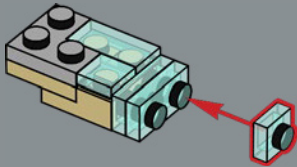

6

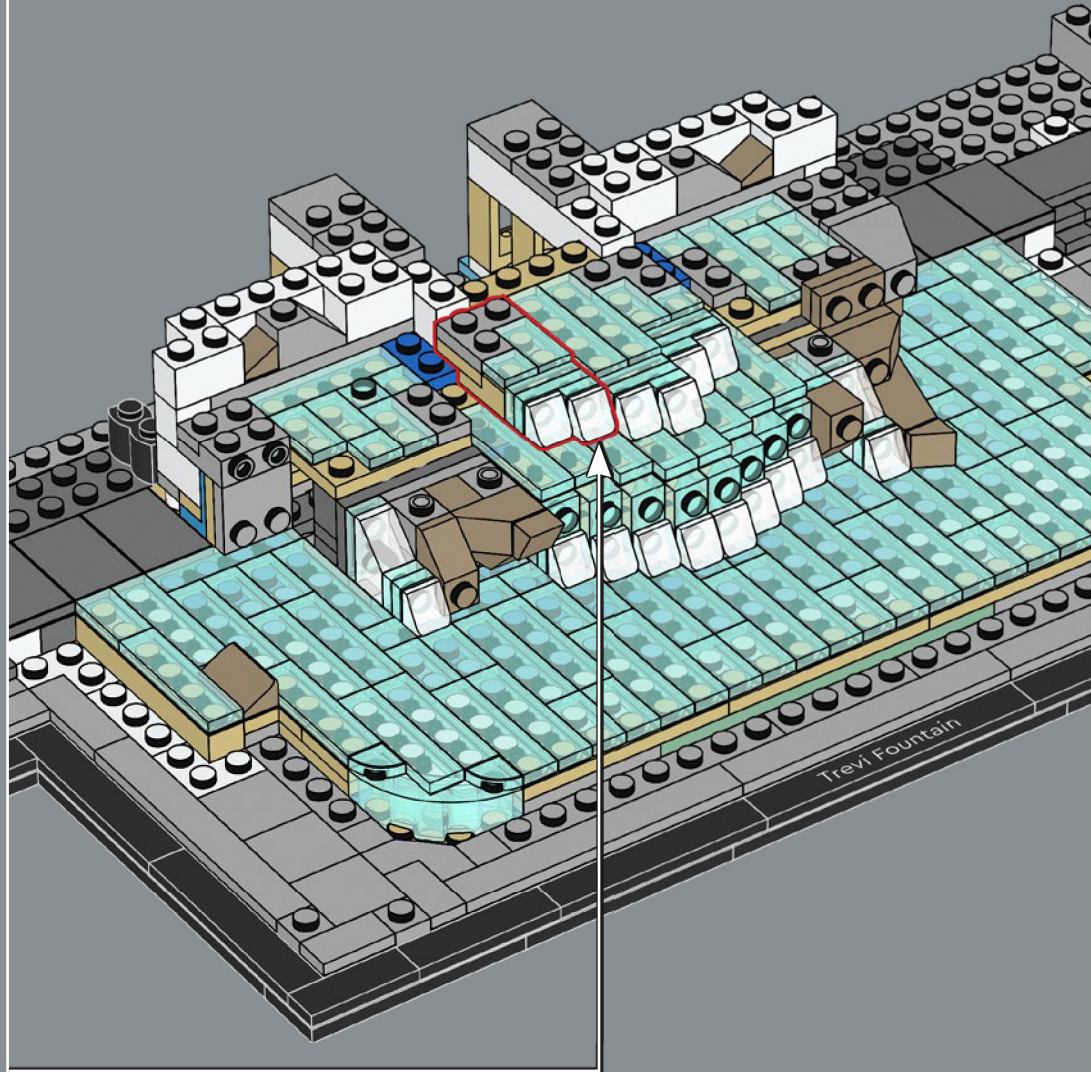
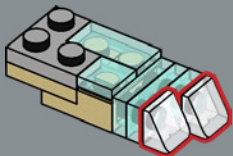

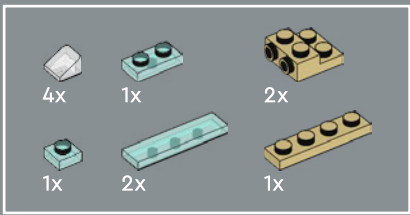

84

1

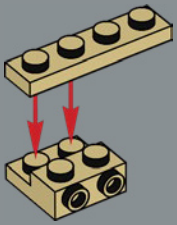

2

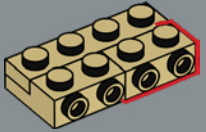

3

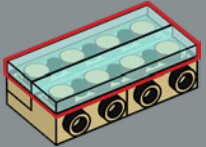

4

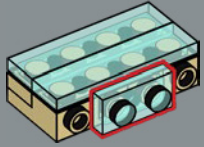

5

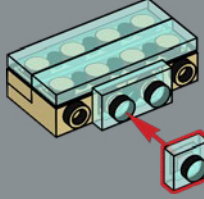

6

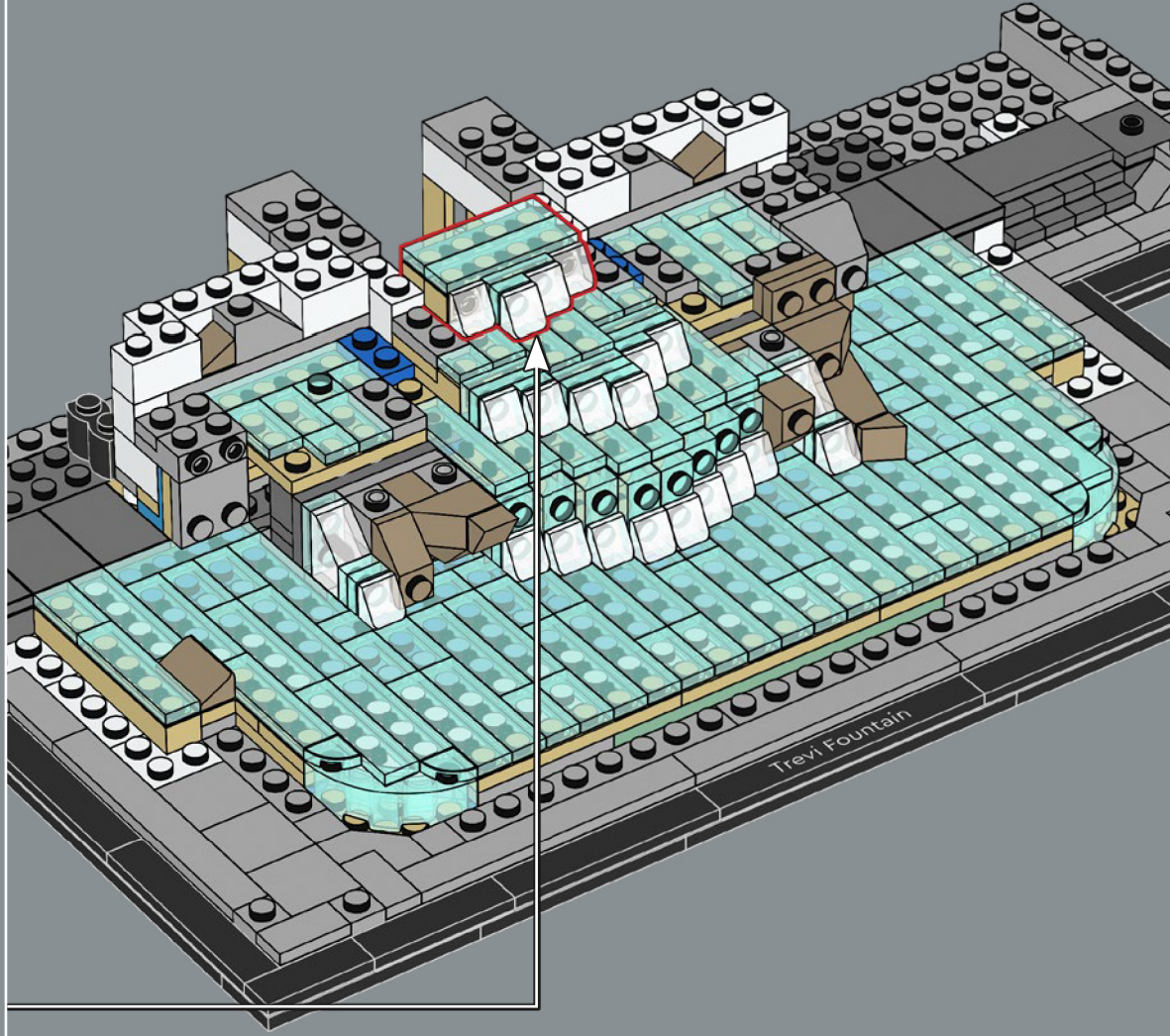
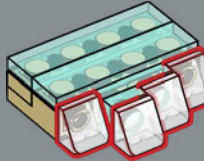

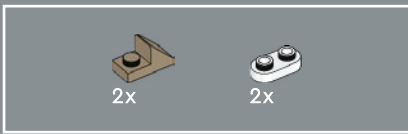

The colour under the transparent blue reflects that of real life. In the upper portions, the water streams thinly over the rock, exposing the stone colour beneath, but lower in the pool, the depth is indicated with darker shades of blue.

85

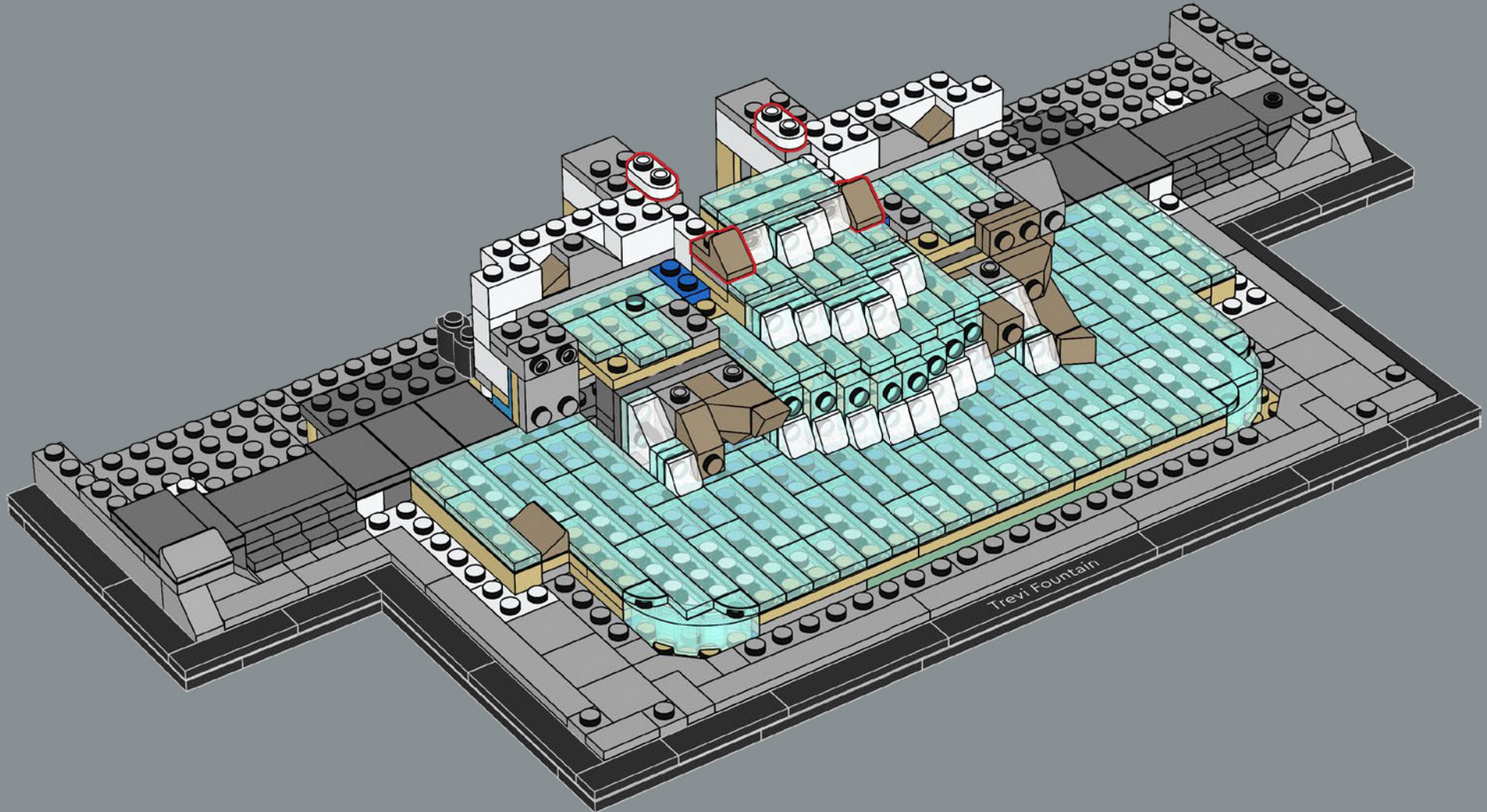

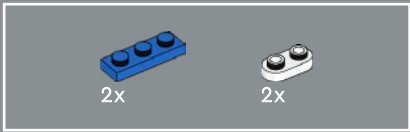

86

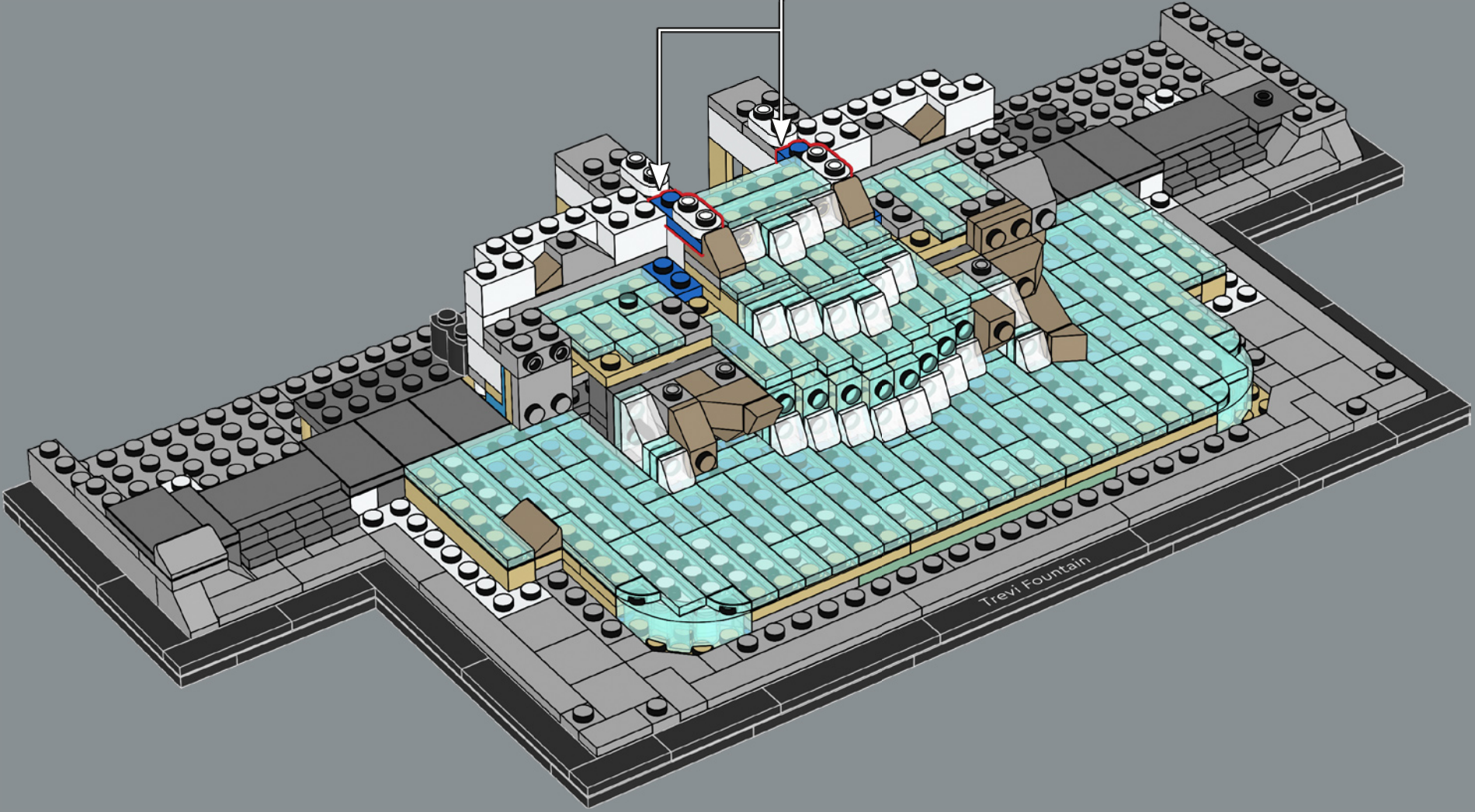
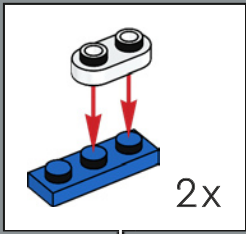

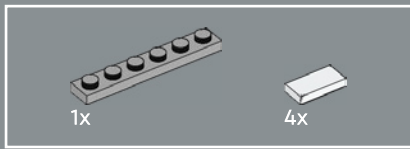

87

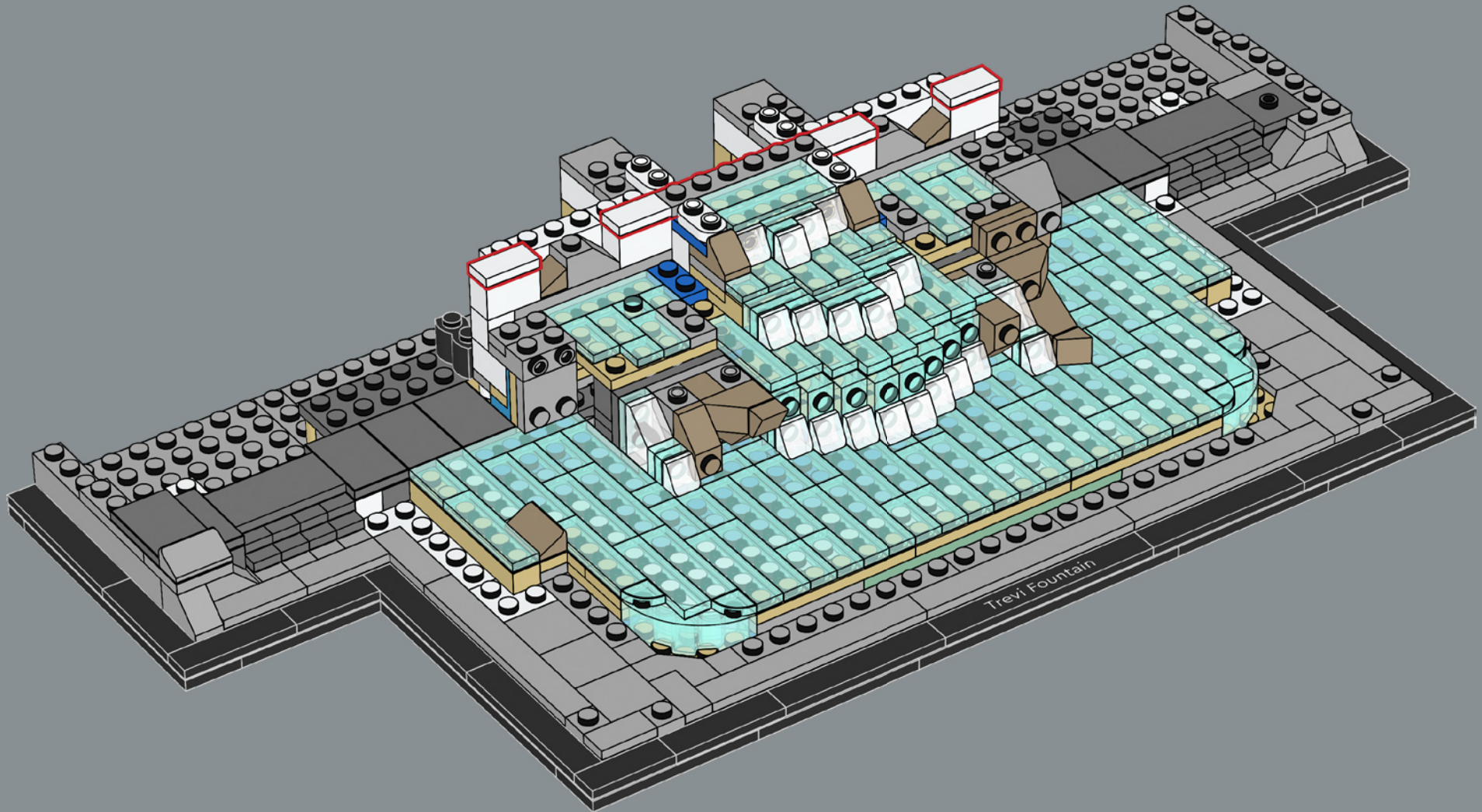

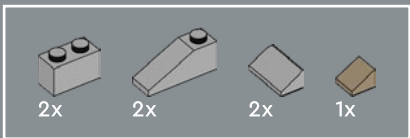

88

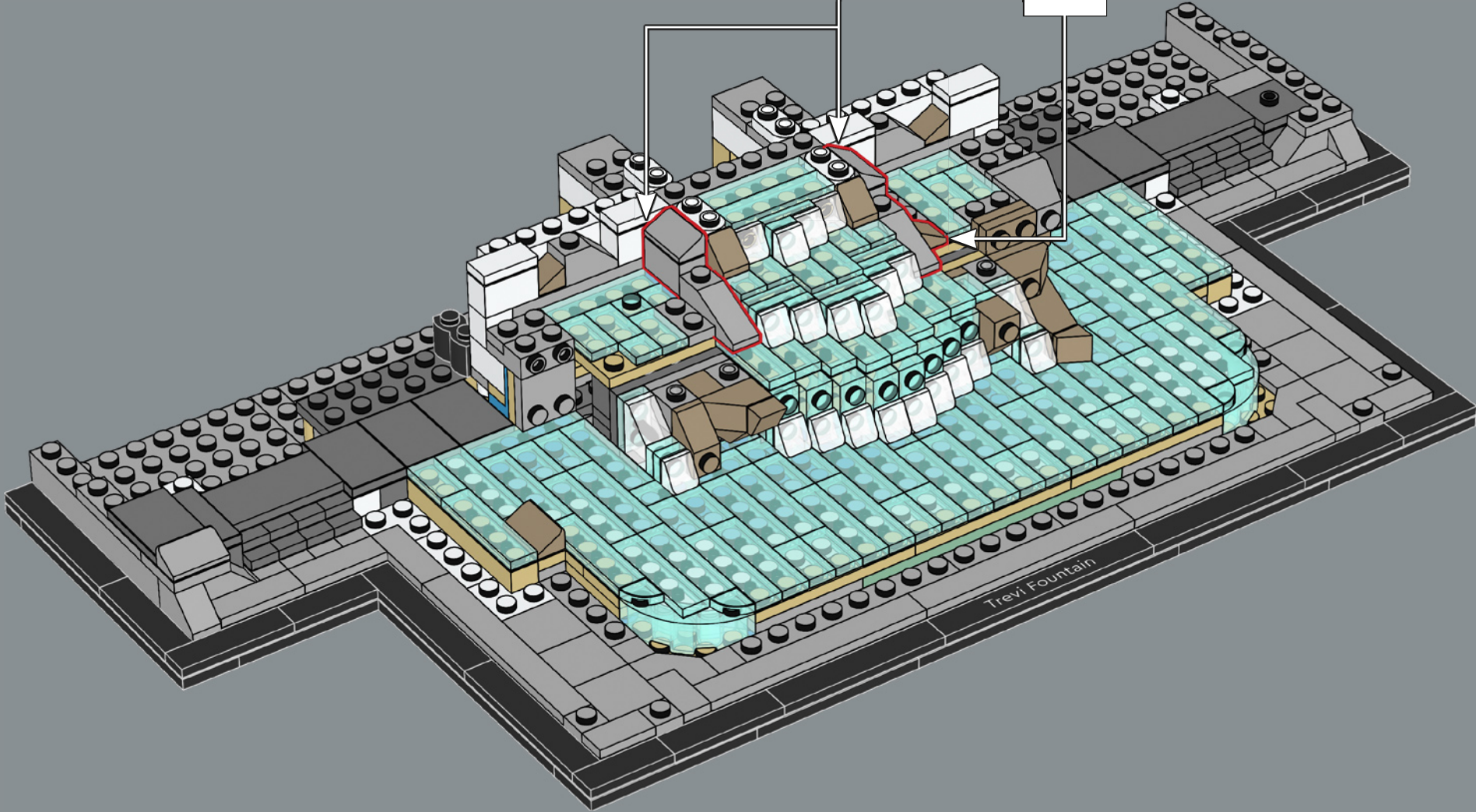
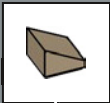
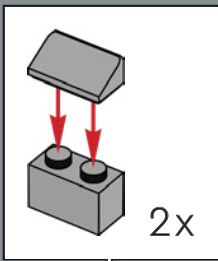

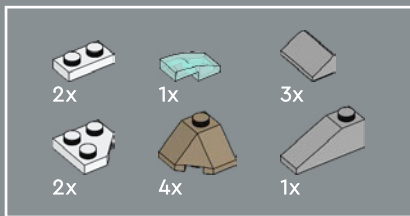

89

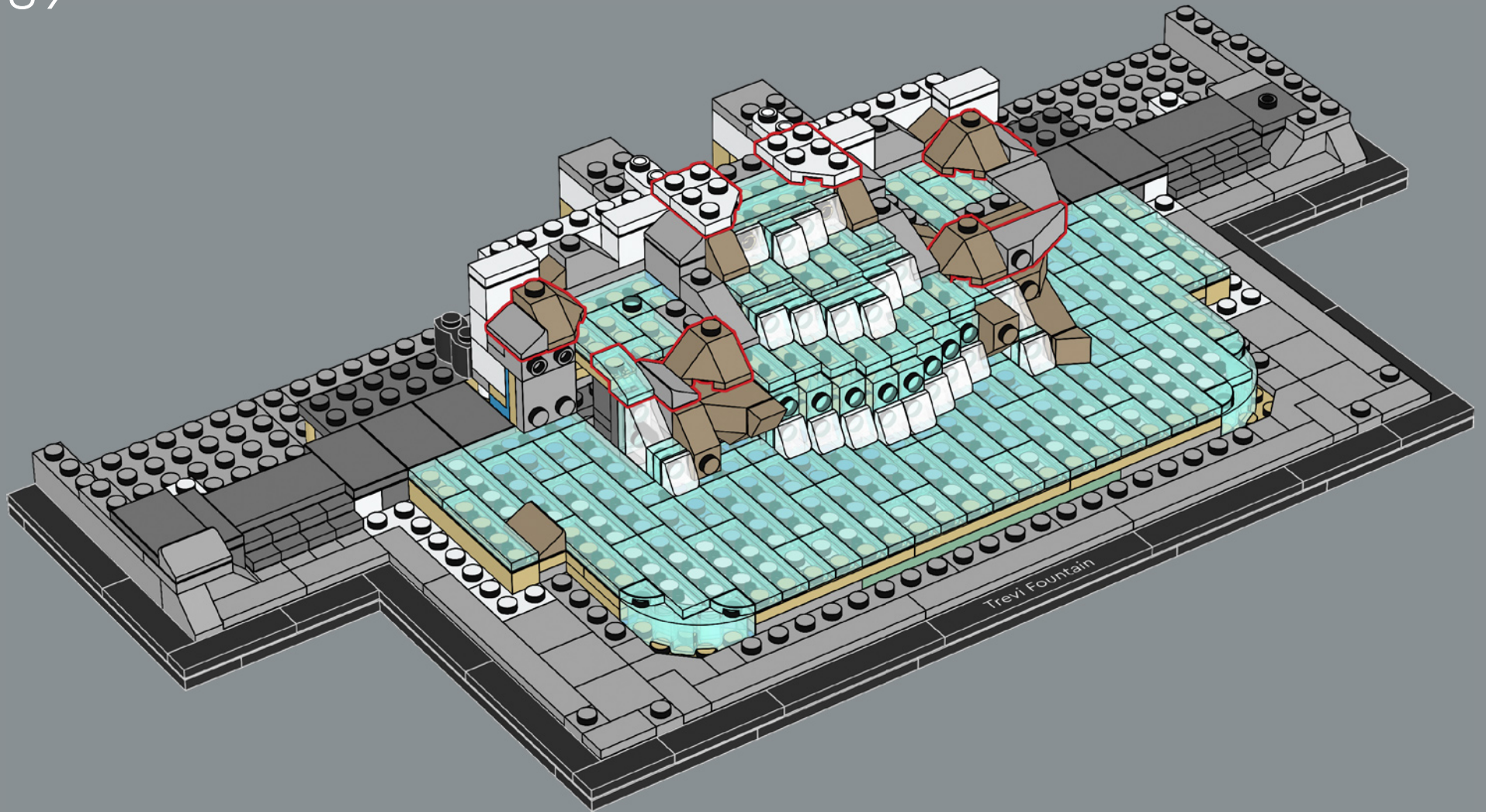

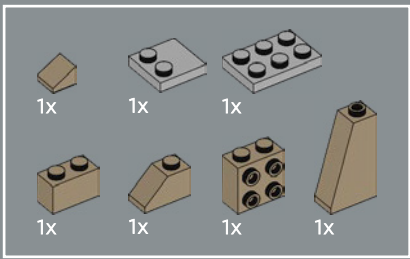

90

1

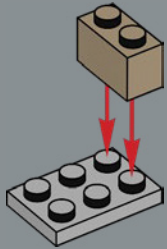

2

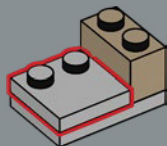

3

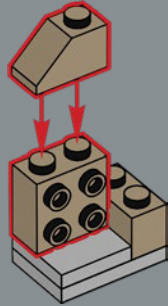

4

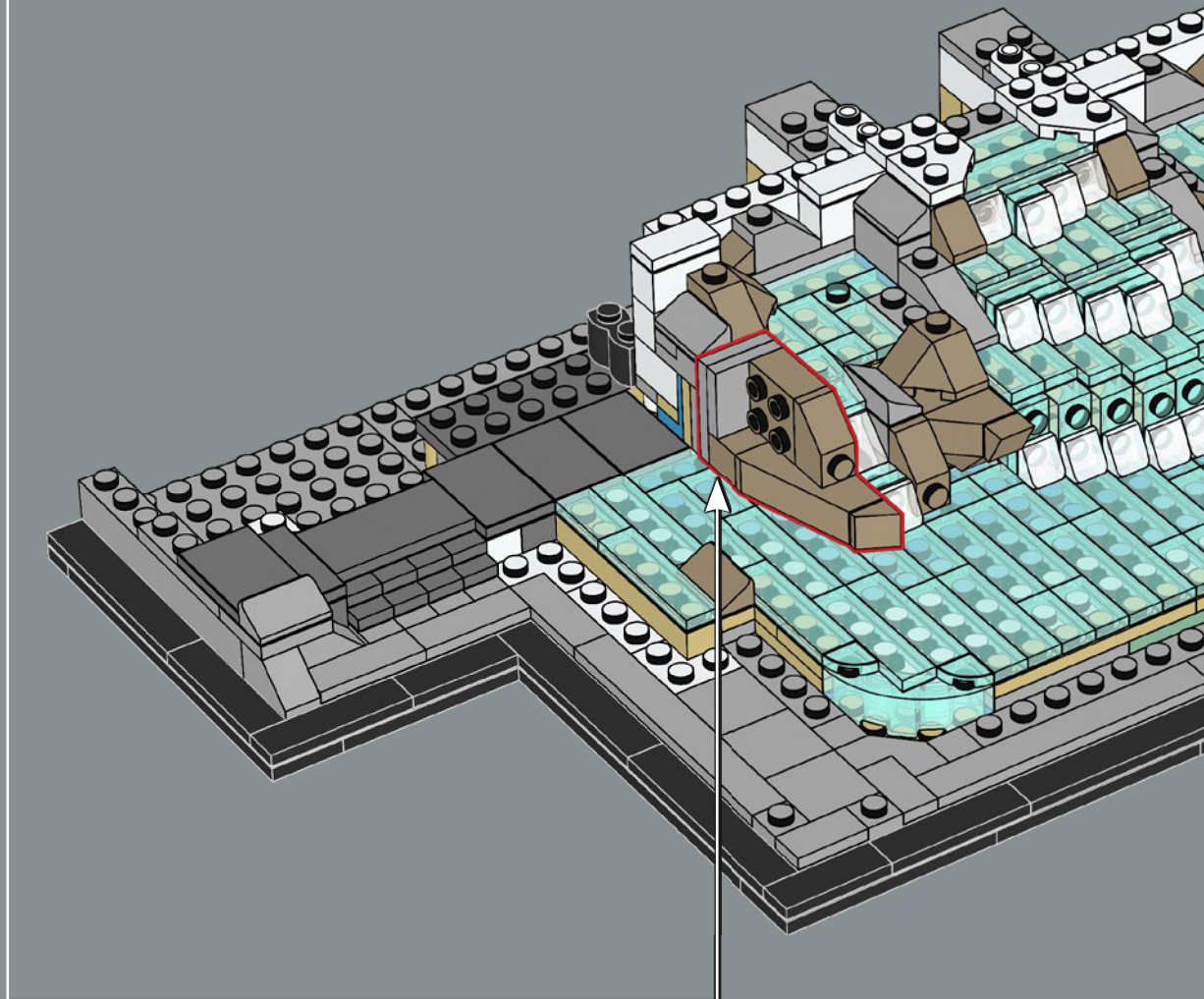
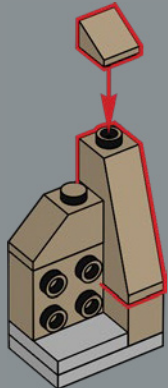

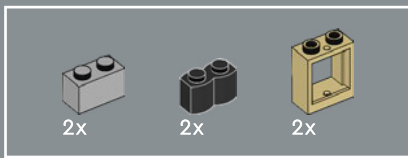

91

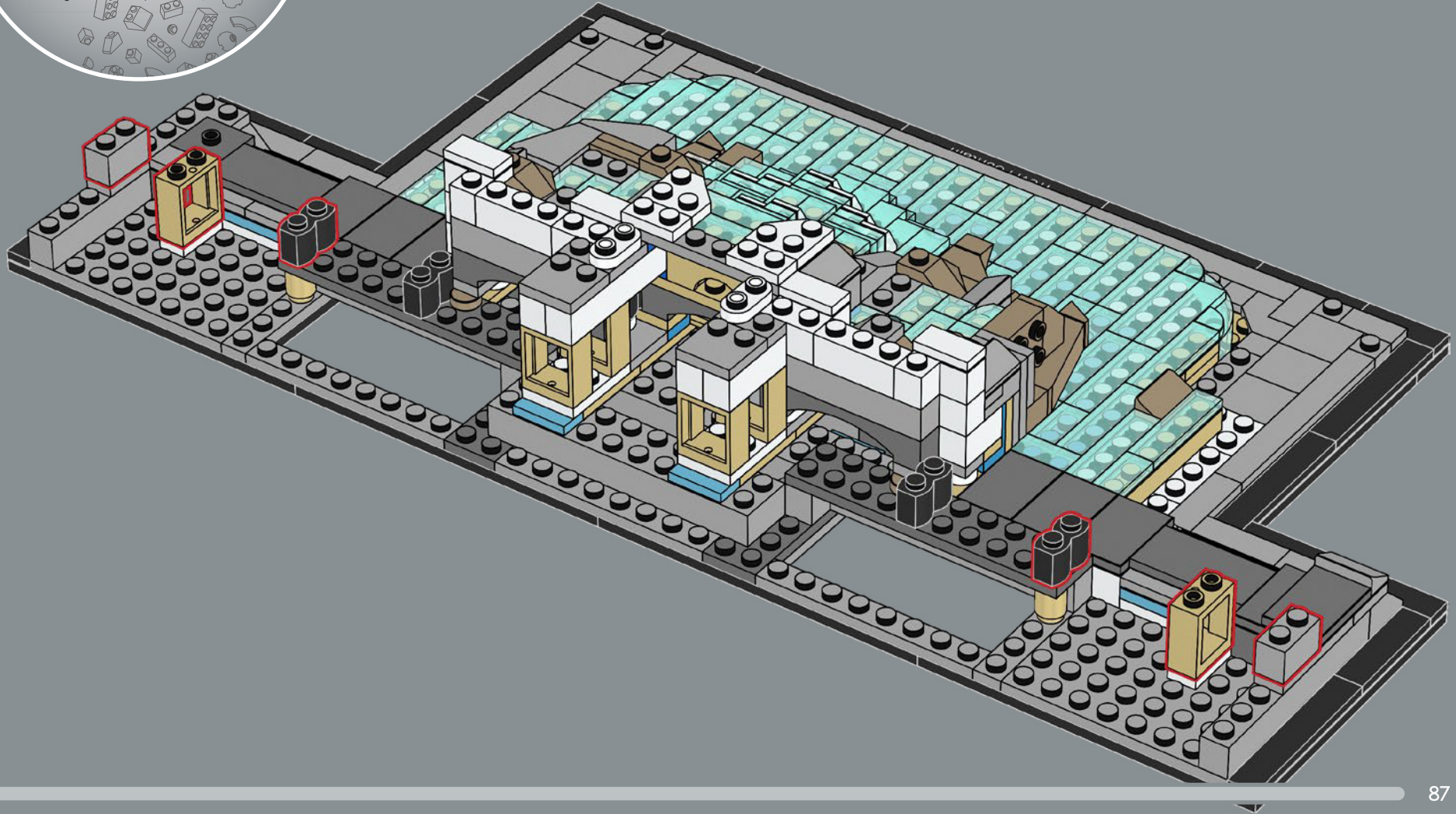

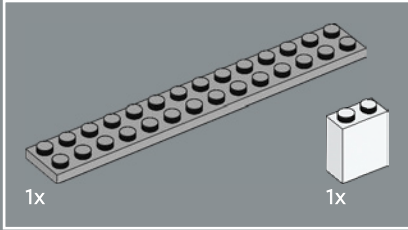
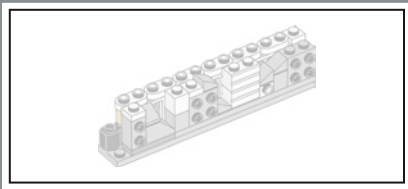

92

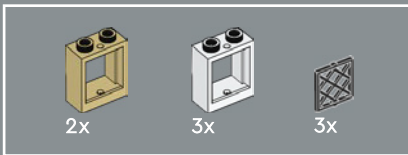
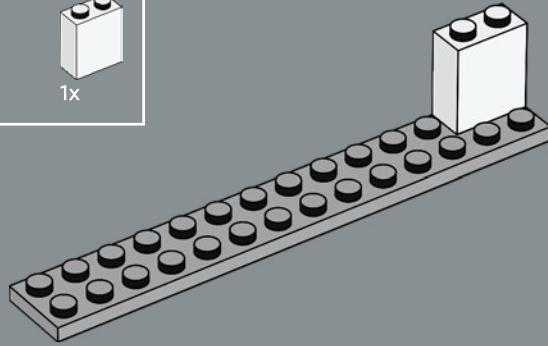

93

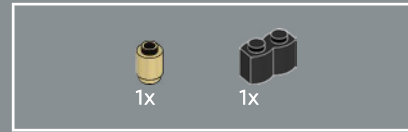
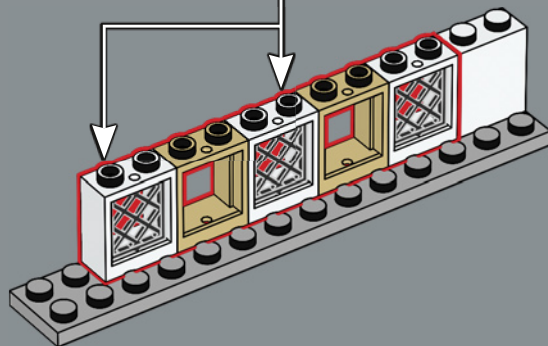
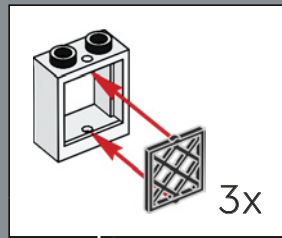

94

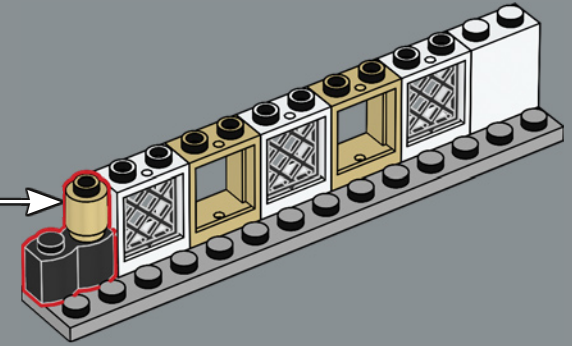
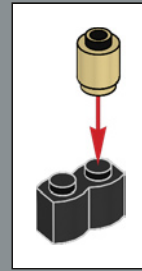

95

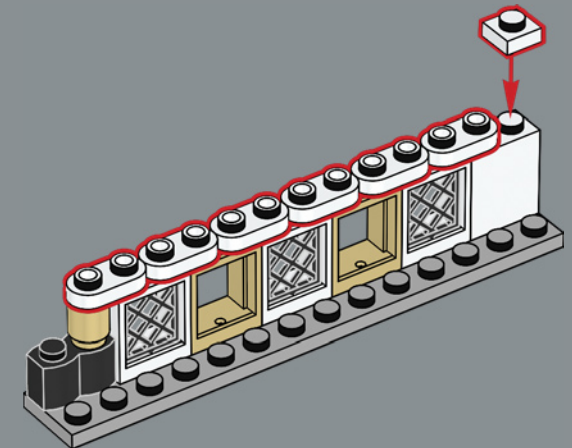

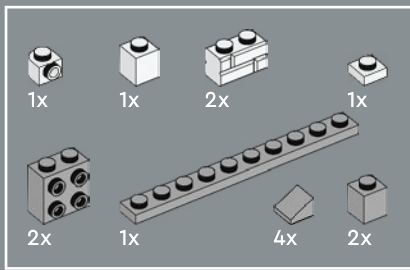

96

Behind these windows lie the channels of water from the aqueducts that pour through the waterfall.

1

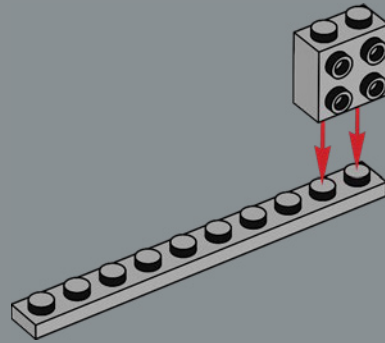

2

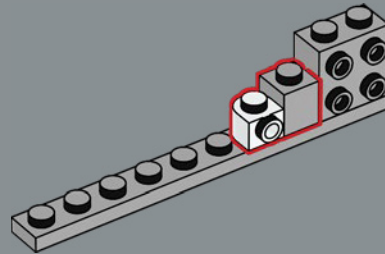

3

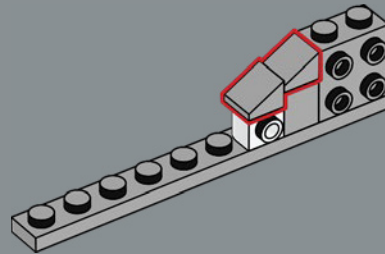

4

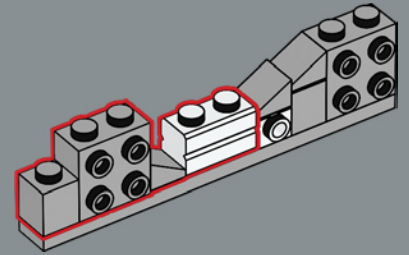

5

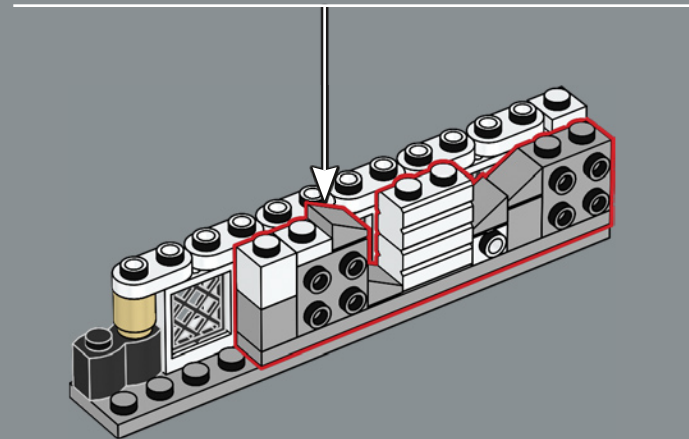
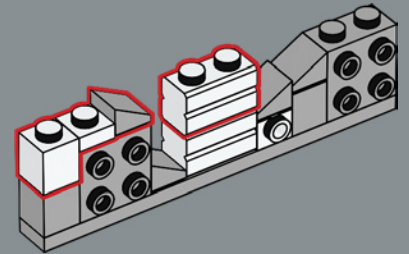

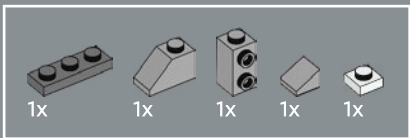

97

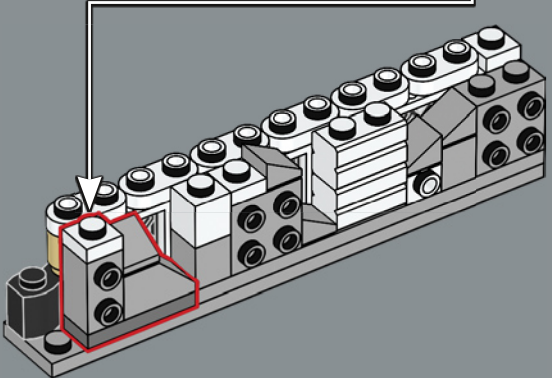
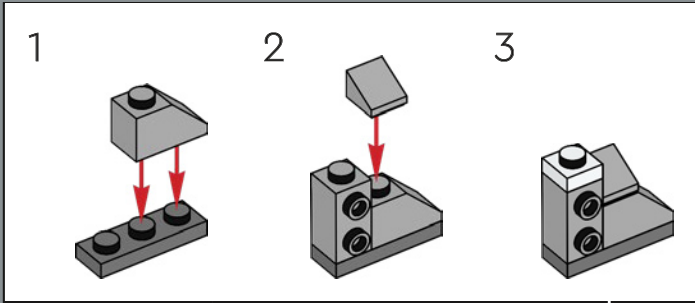

98

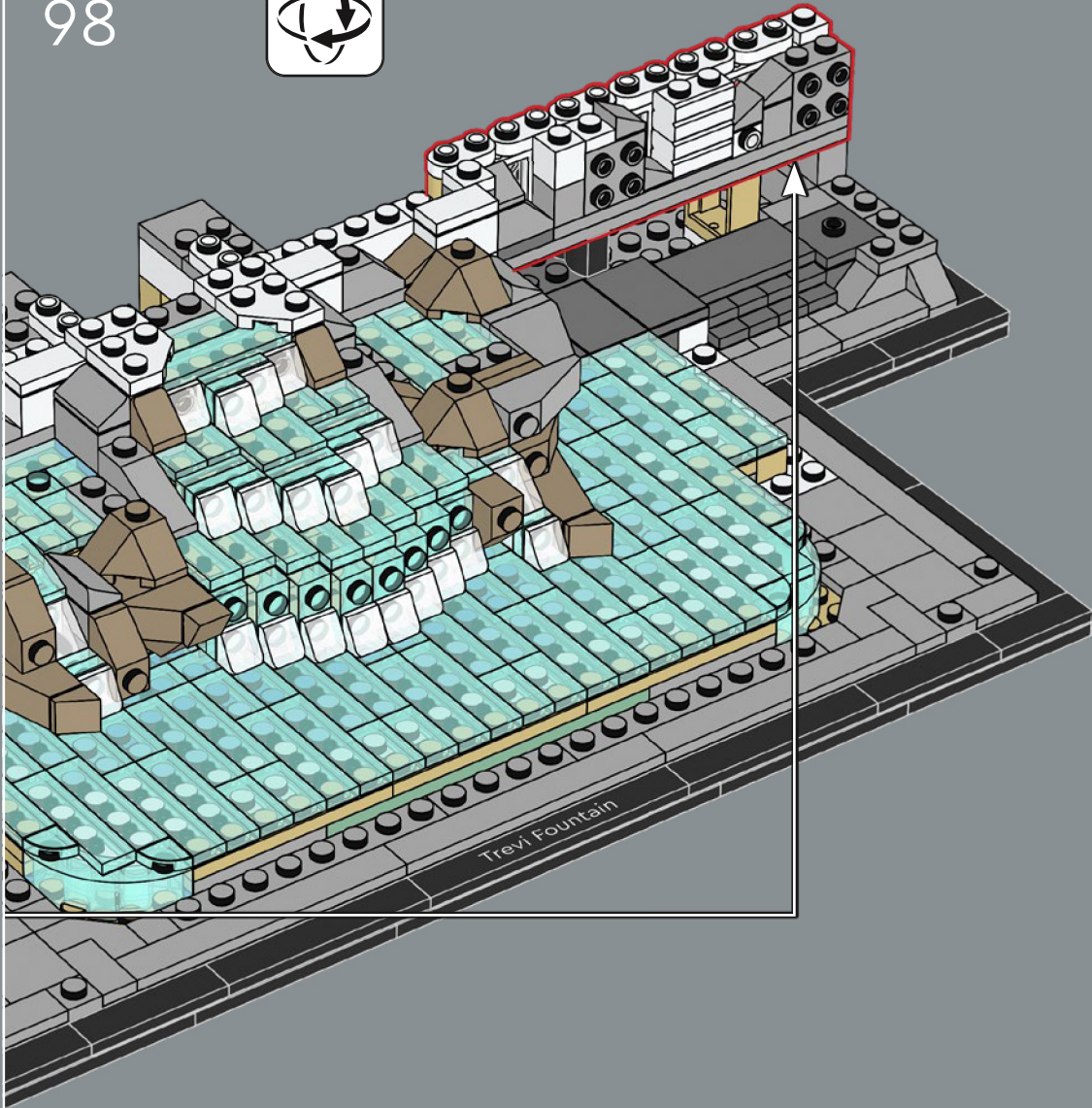

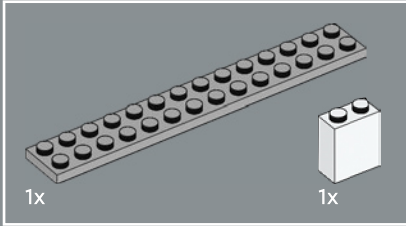
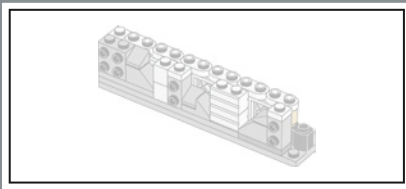

99

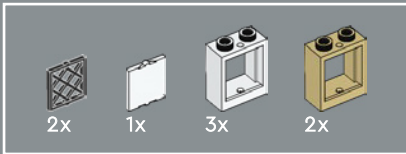

100

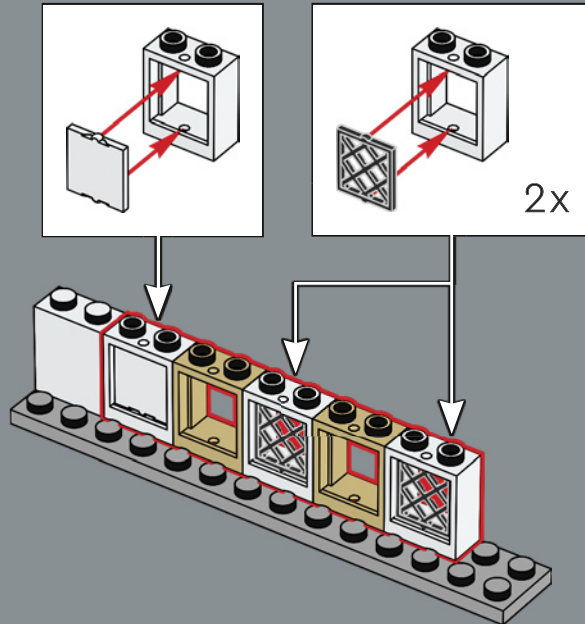
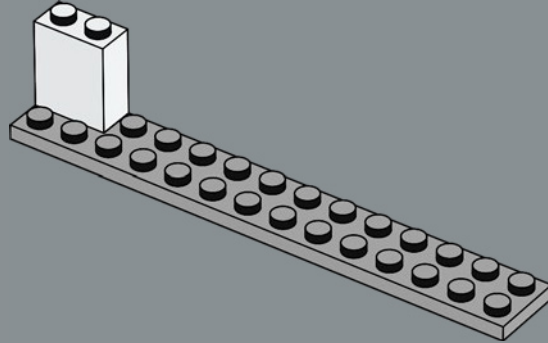

101

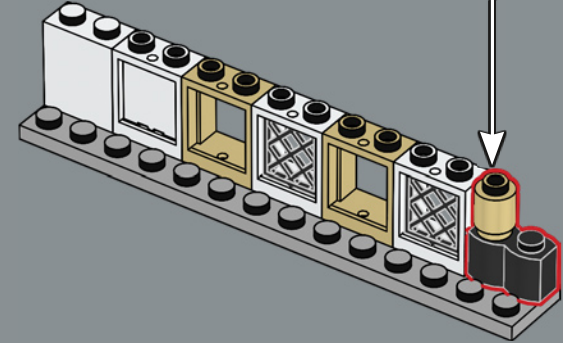
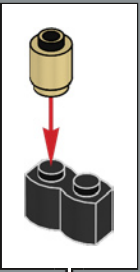

102

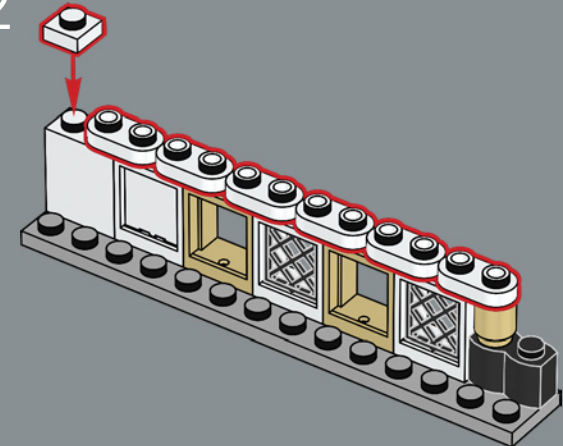

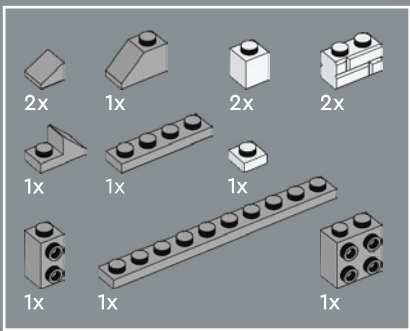

103

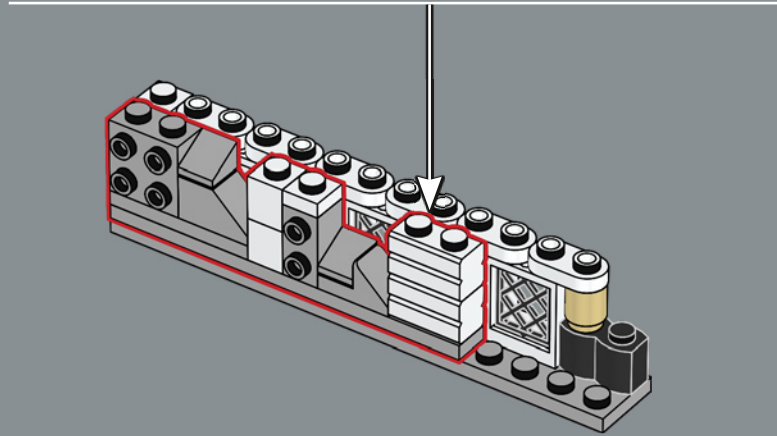
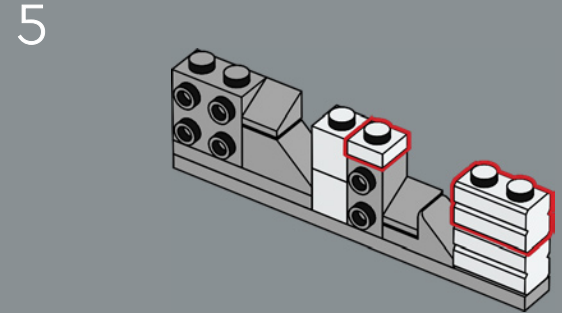
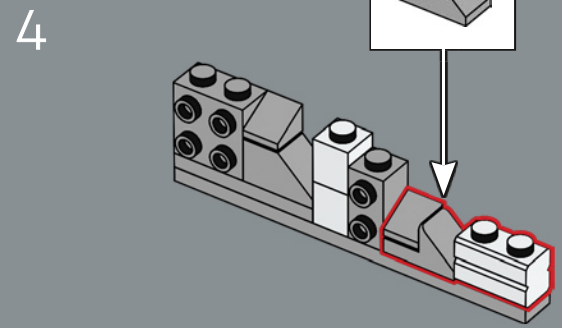
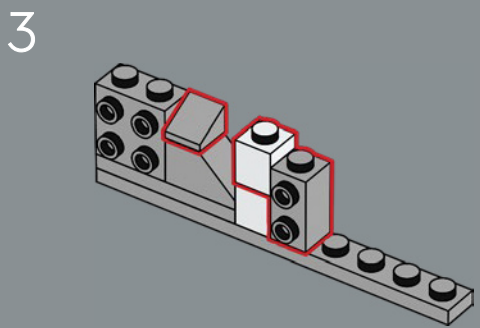
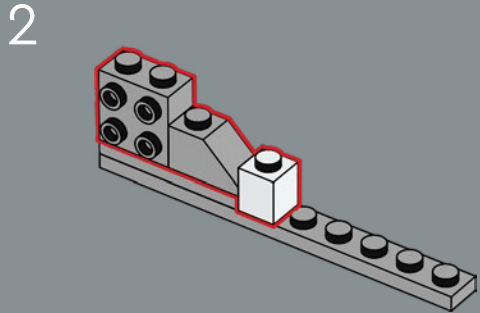
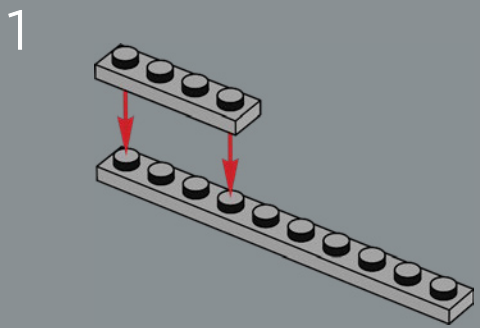

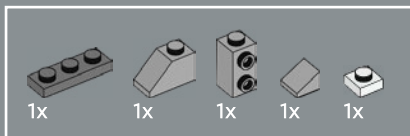

104

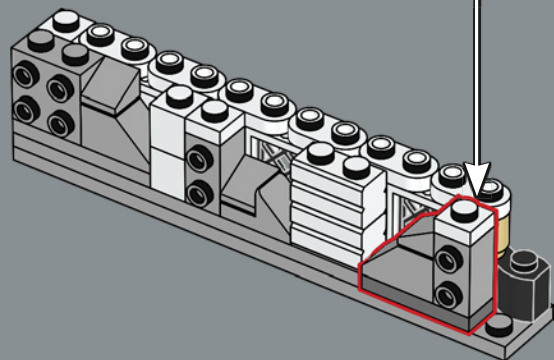
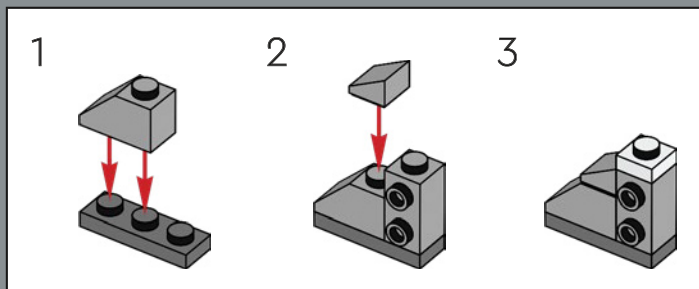

105

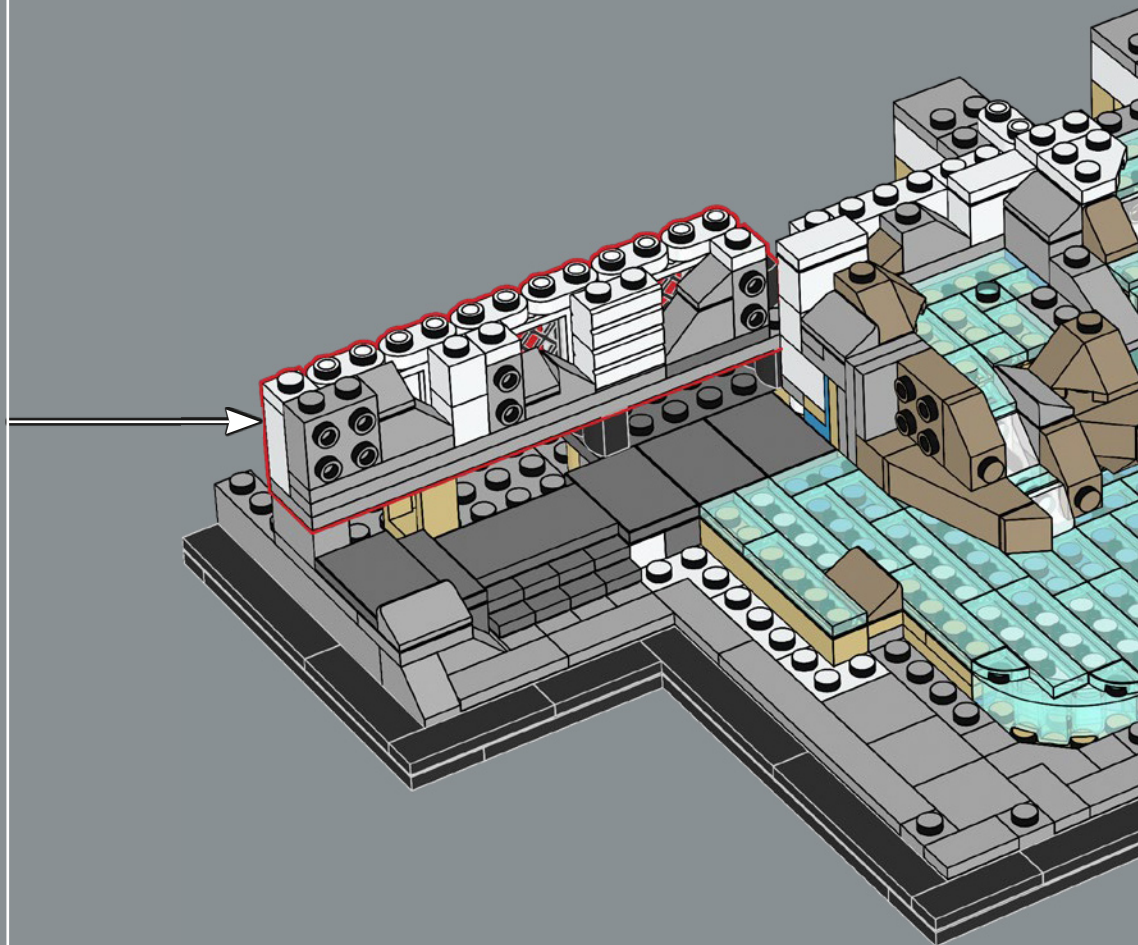

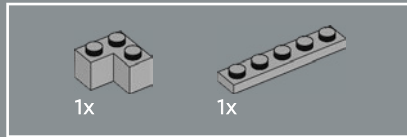
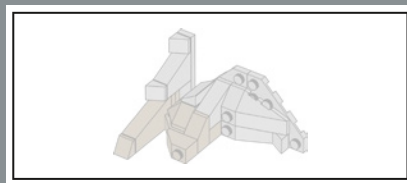

106

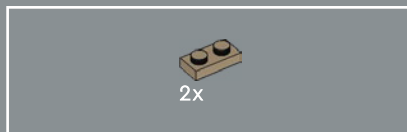
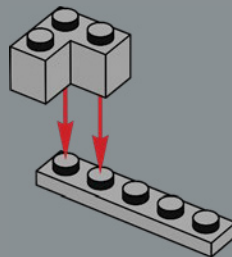

107

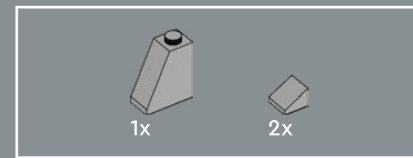
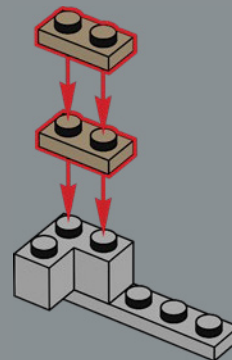

108

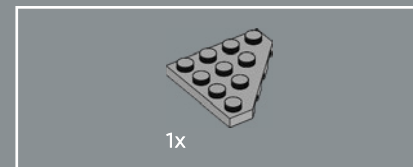
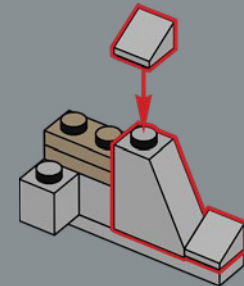

109

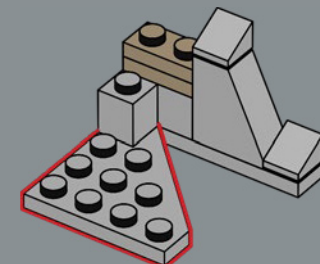

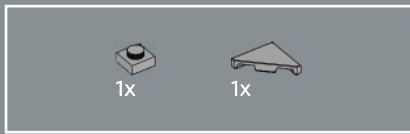

110

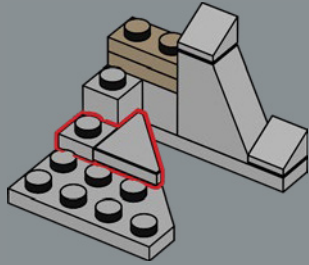

112

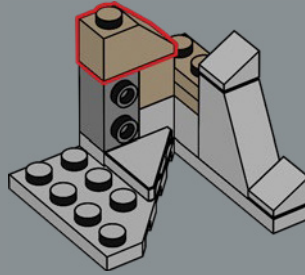

114

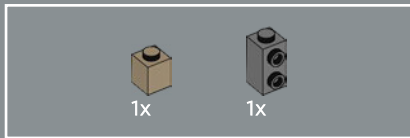
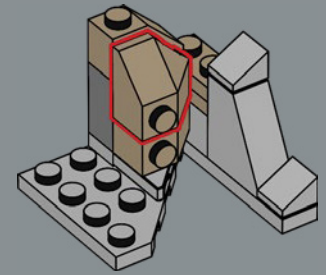

111

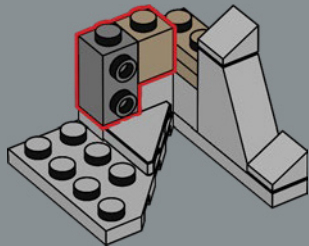

113

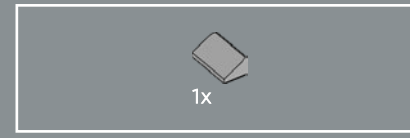
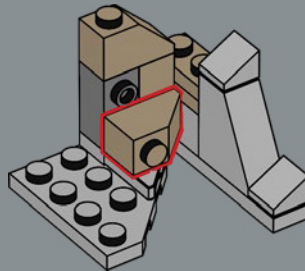

115

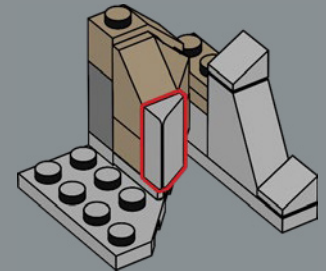

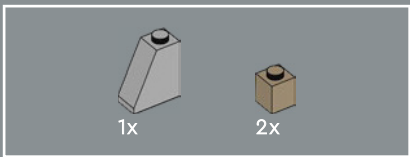

116

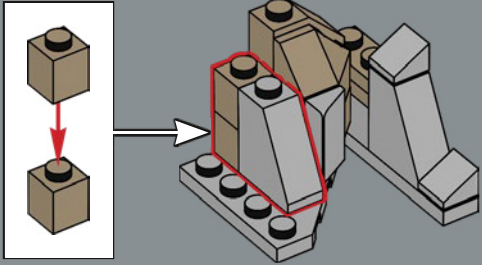

117

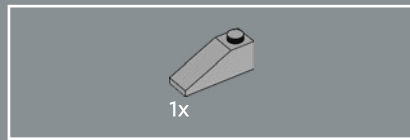
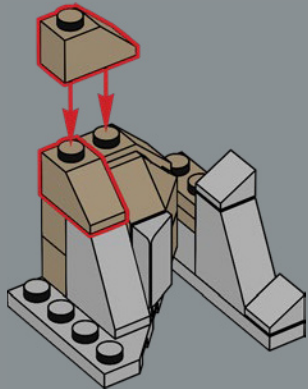

118

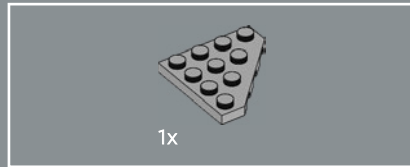
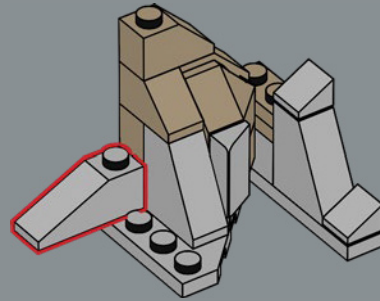

119

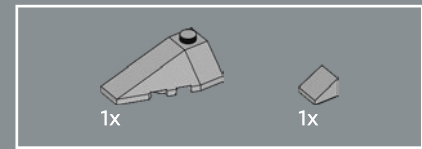
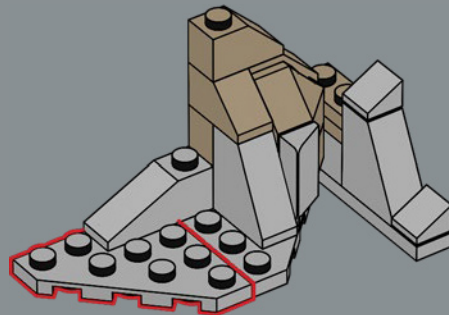

120

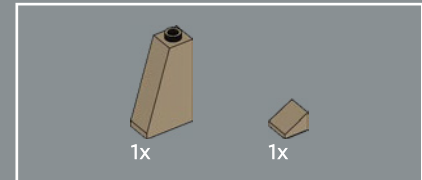
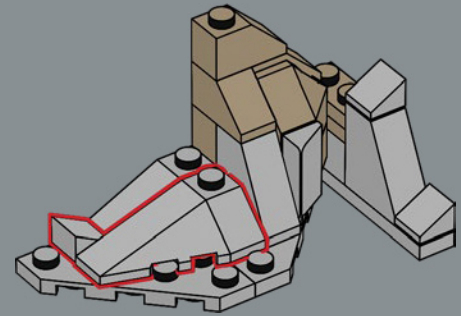

121

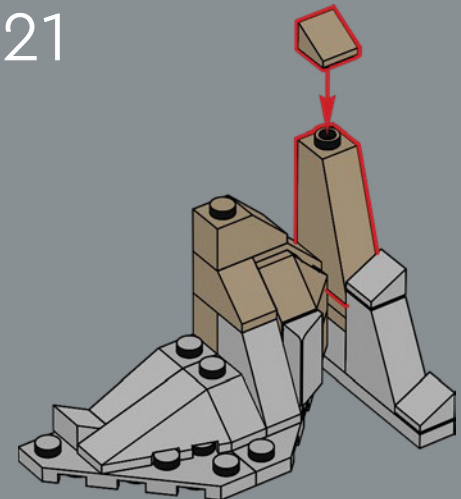

The rockwork is one of the few details that disrupts the overall symmetry of the Baroque structure, while adding a stunning contrast to the rest of the facade with its organic shapes.

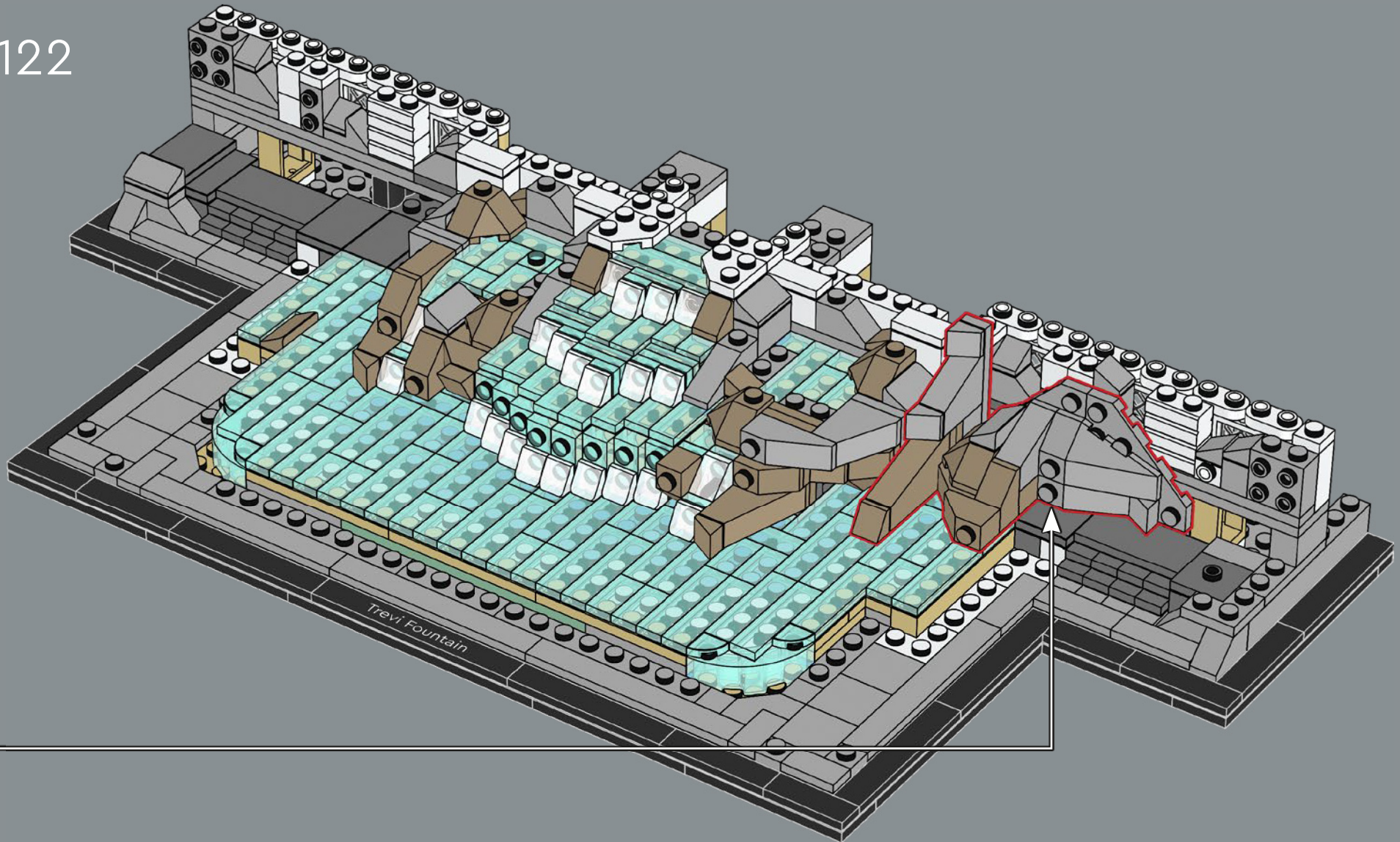

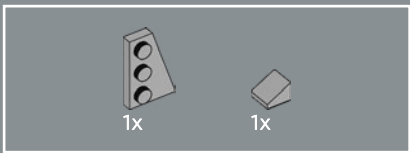

123

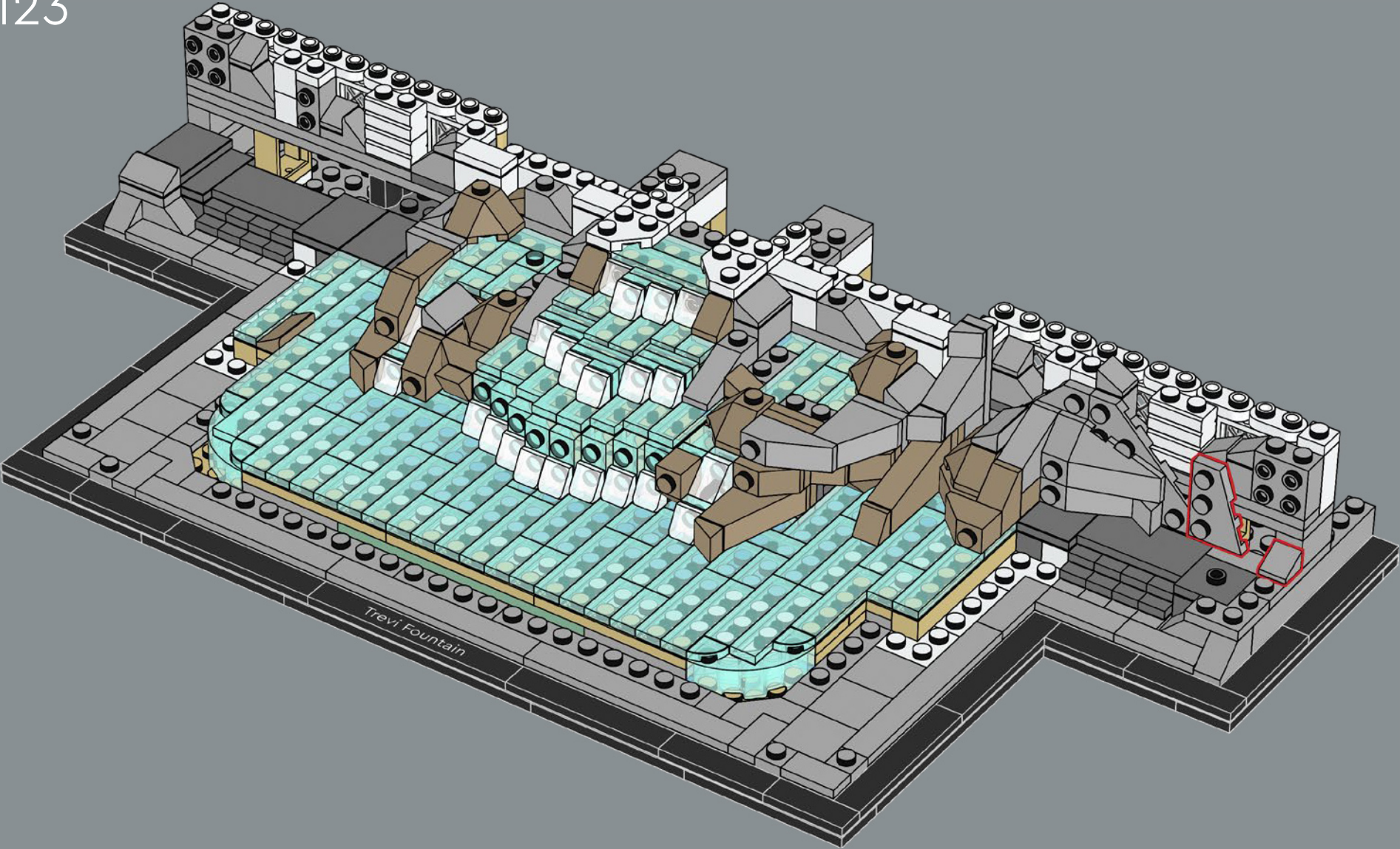

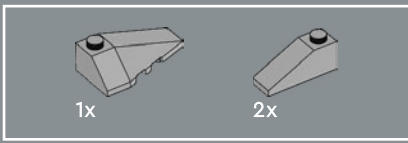

124

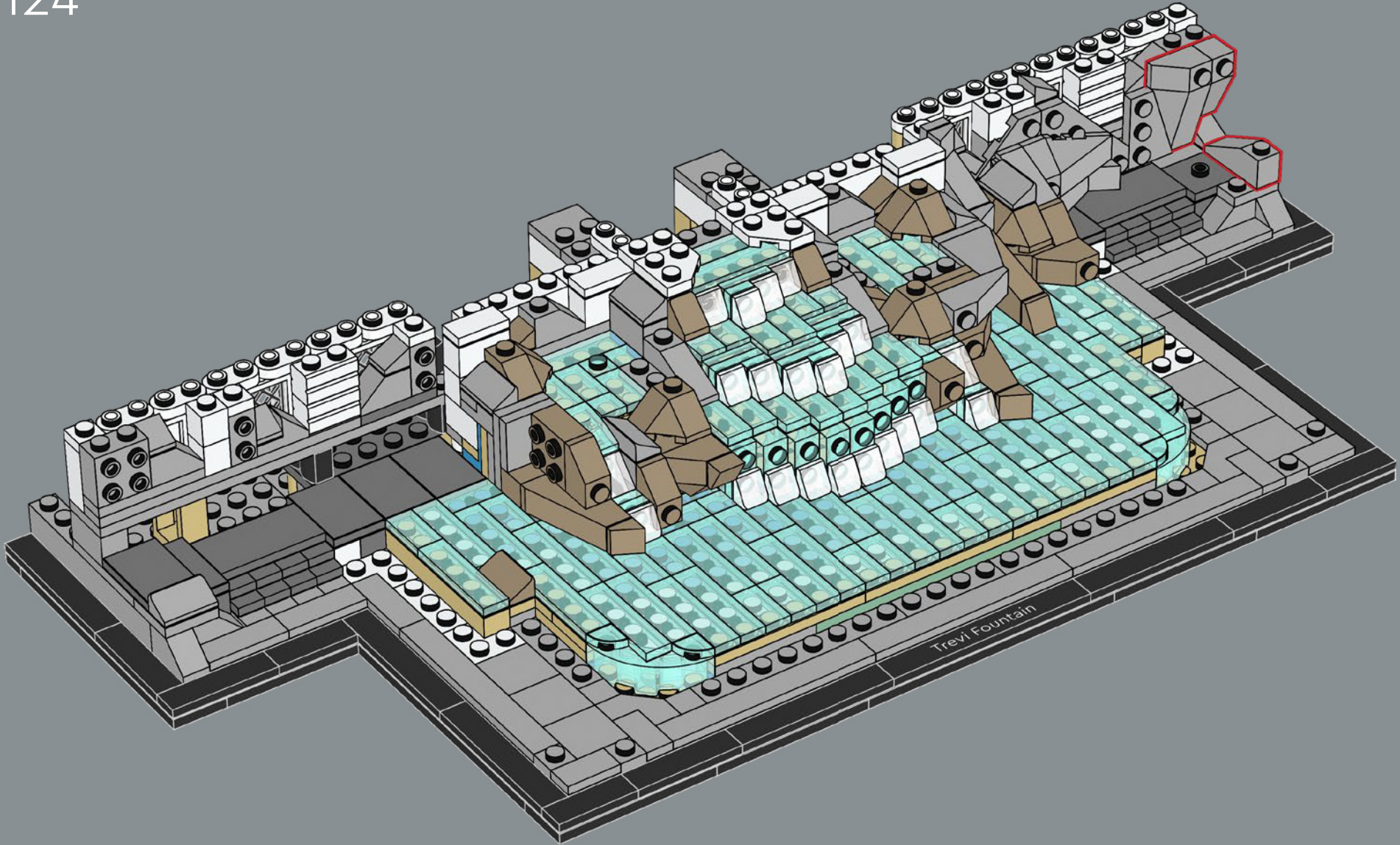

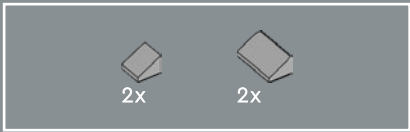

125

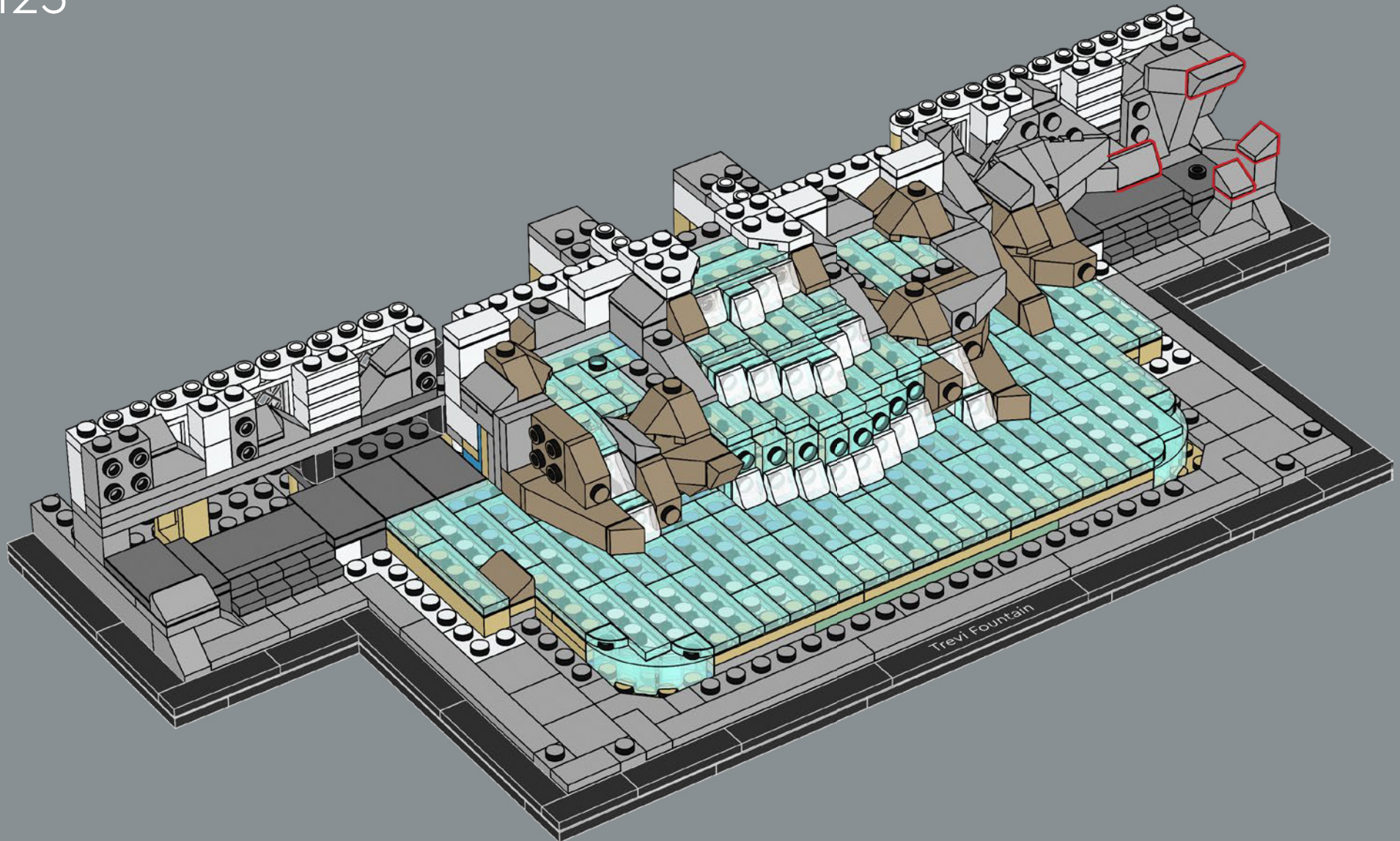

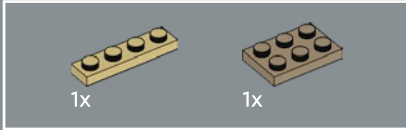
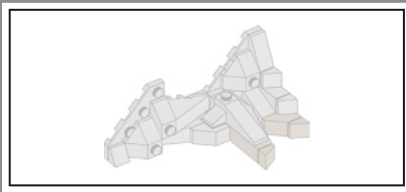

126

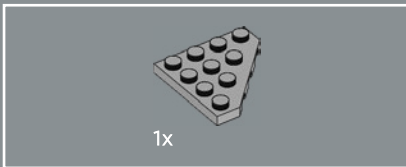
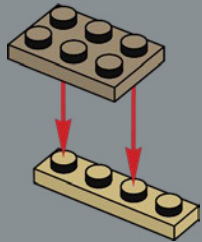

127

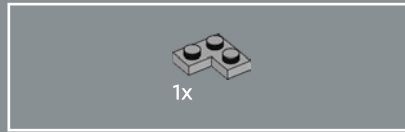
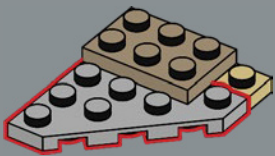

128

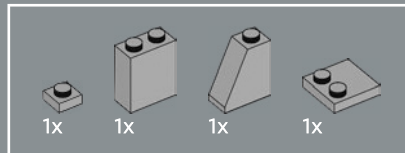
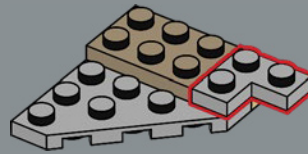

129

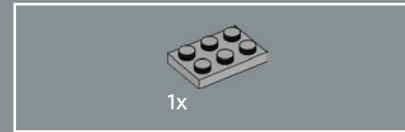
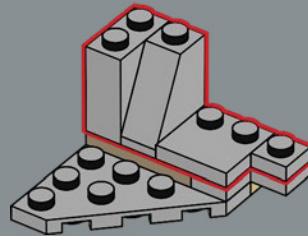

130

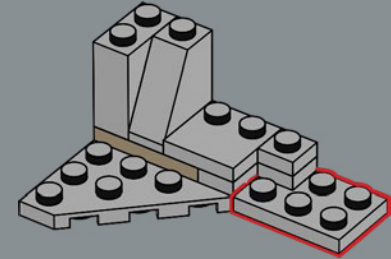

131

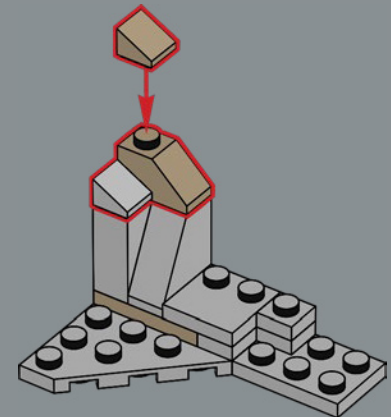



132

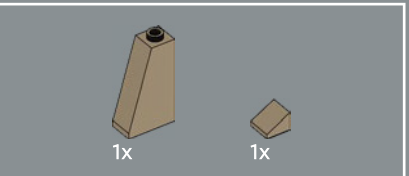
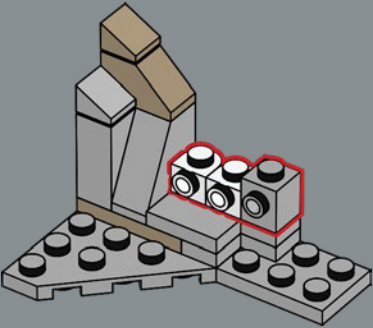

134

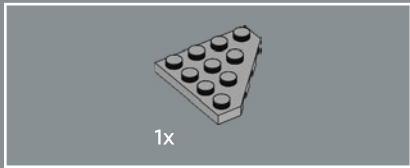
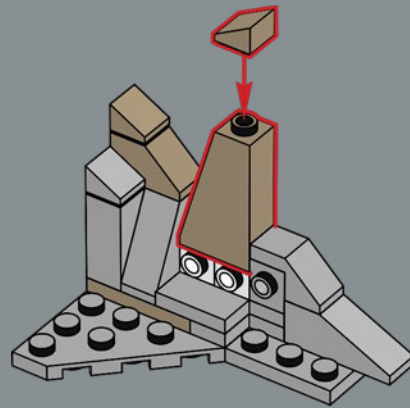

136

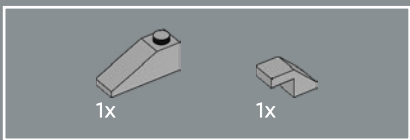
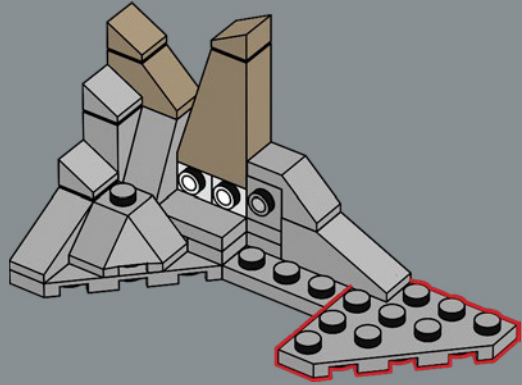

133

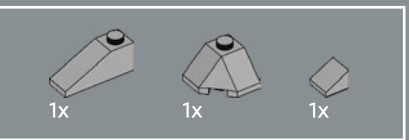
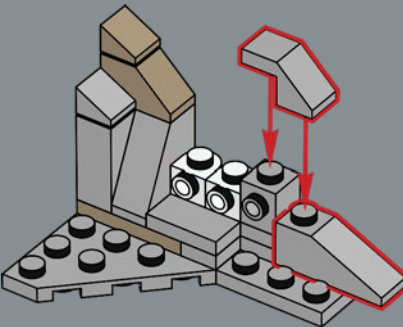

135

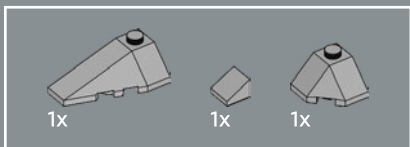
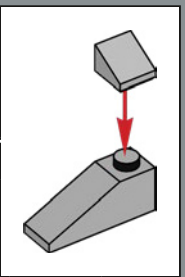
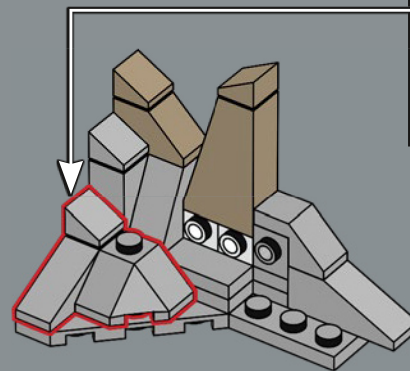

137

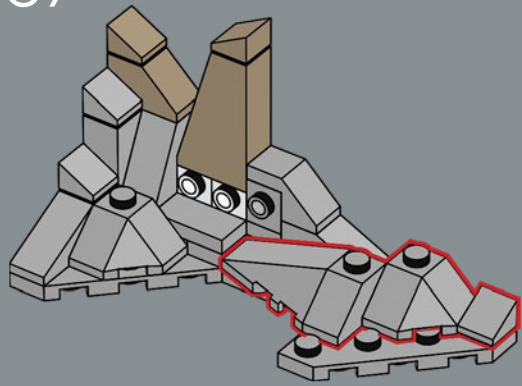

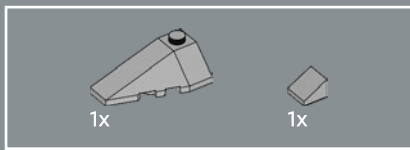

138

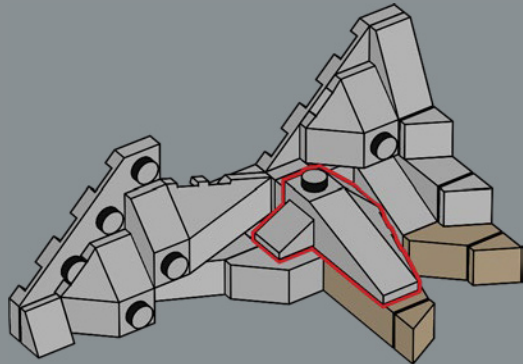

139

Even the wear and tear of the fountain plays a role in how it is viewed. Environmental degradation catches in the nooks and crannies of the carved facade, leaving even shallow engravings darker in colour than the surrounding rock.

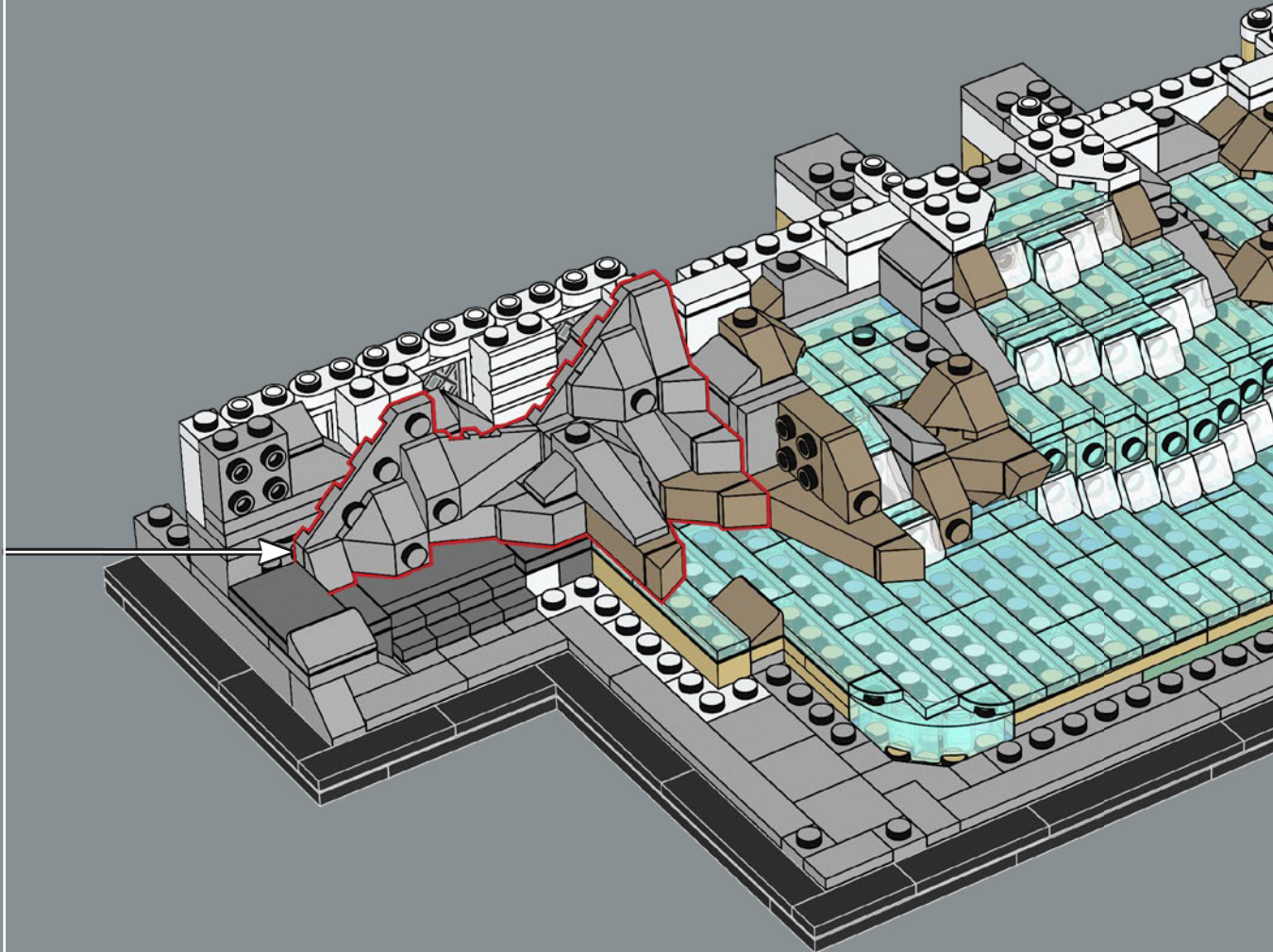

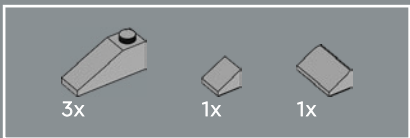

140

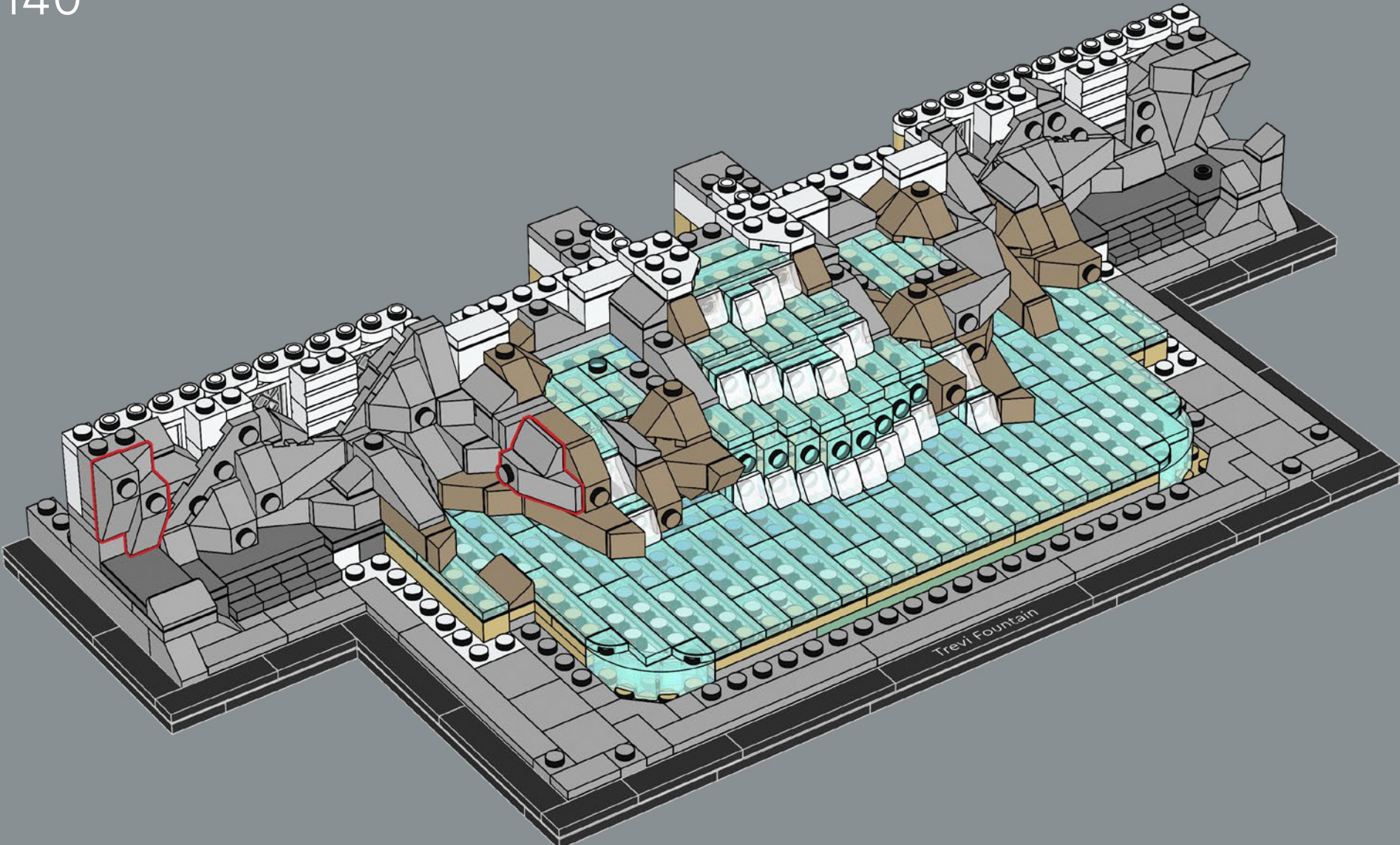

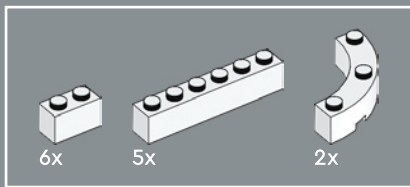

141

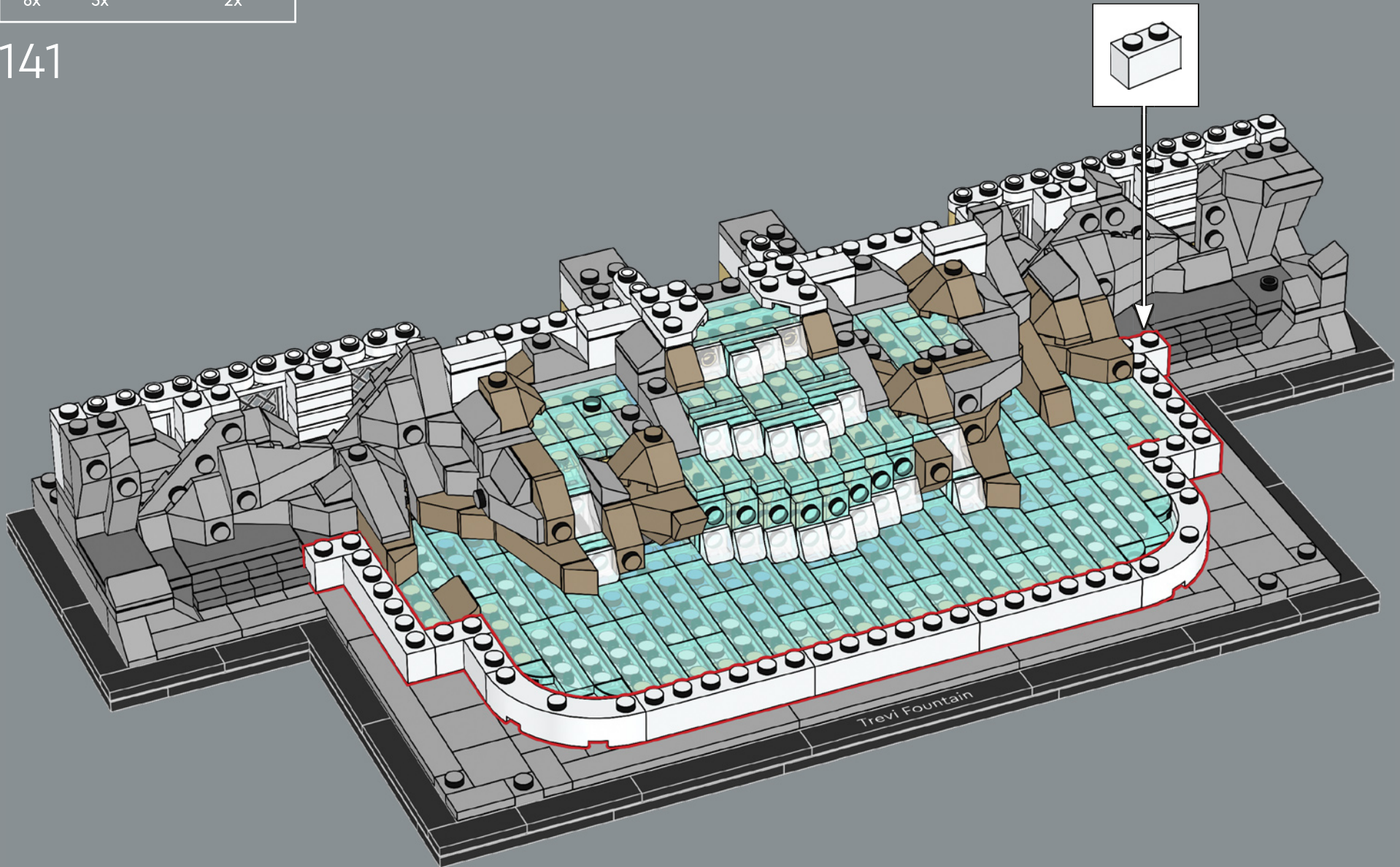

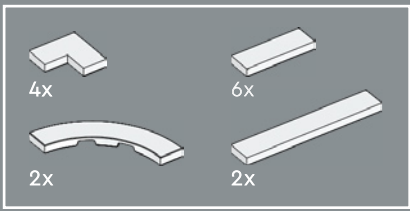

142

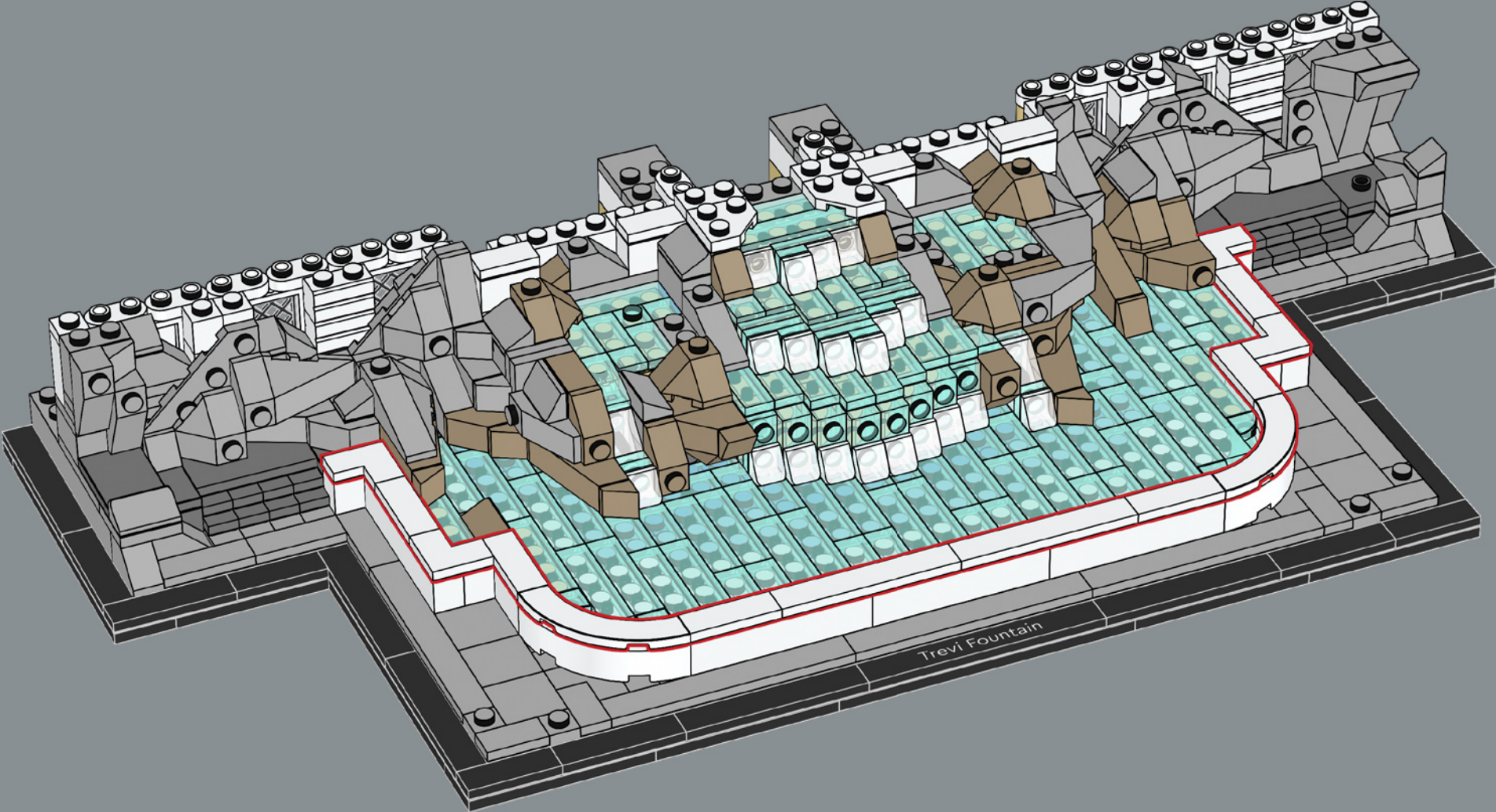

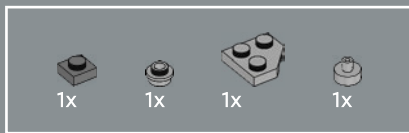

143

This small fountain is coined the Fontanella degli Innamorati (Fountain of Love) due to its crossing water jets. Legend says that if two lovers drink from this fountain, they will remain forever faithful to each other.

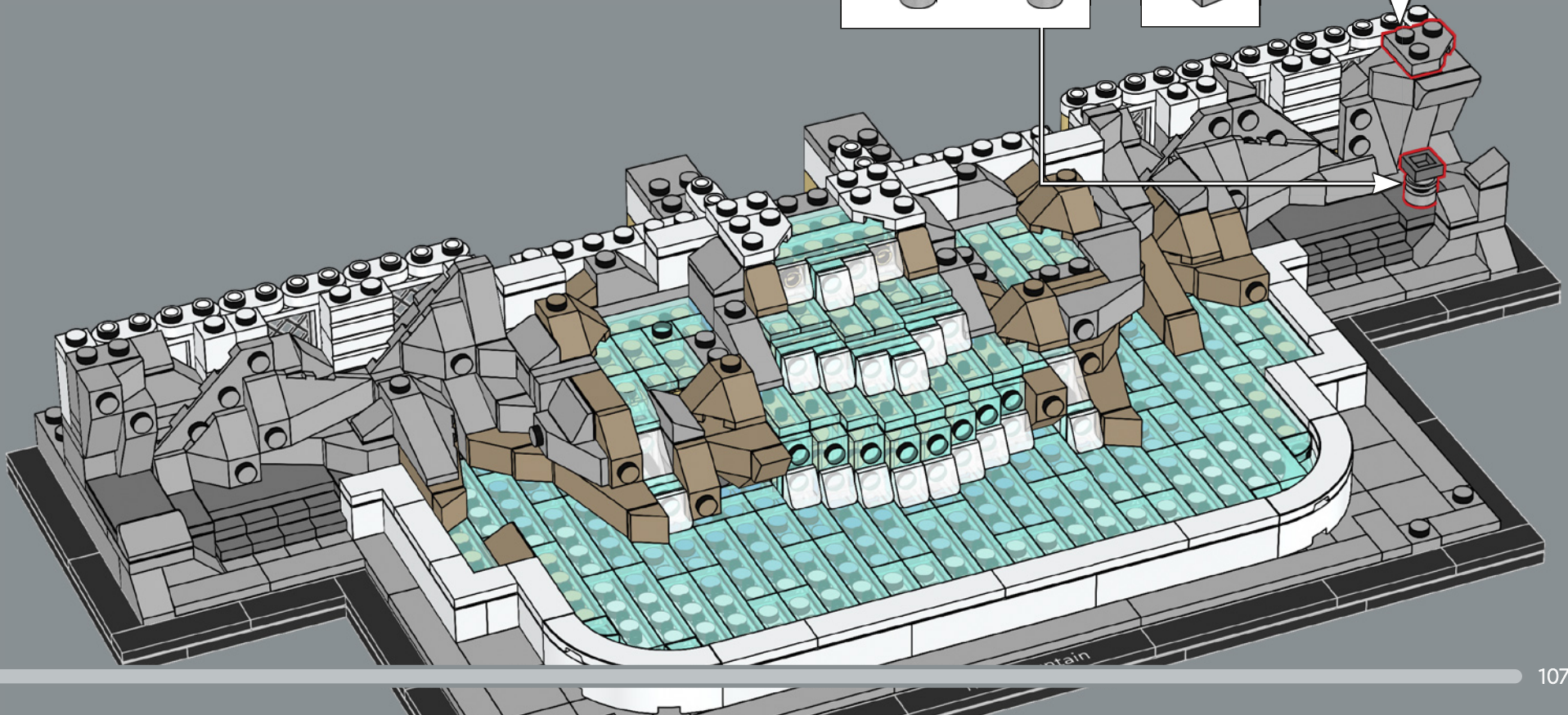
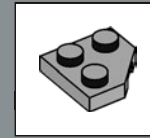
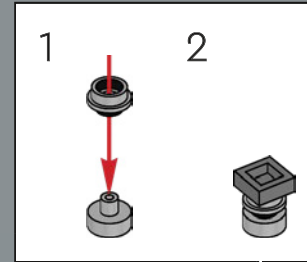

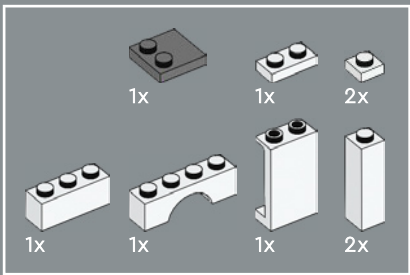

144

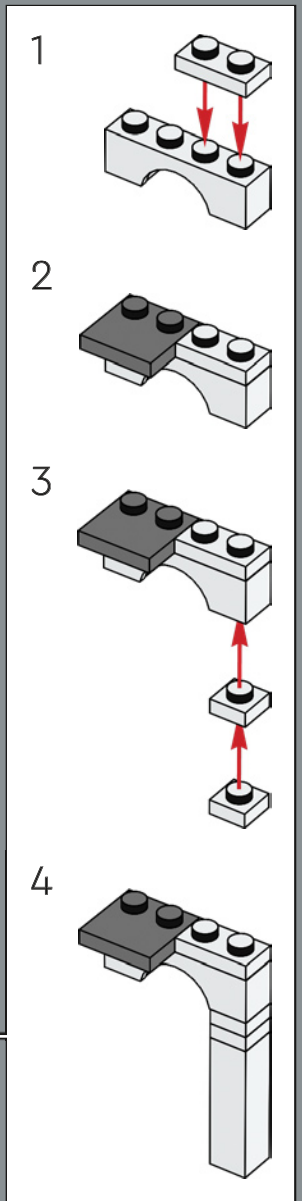
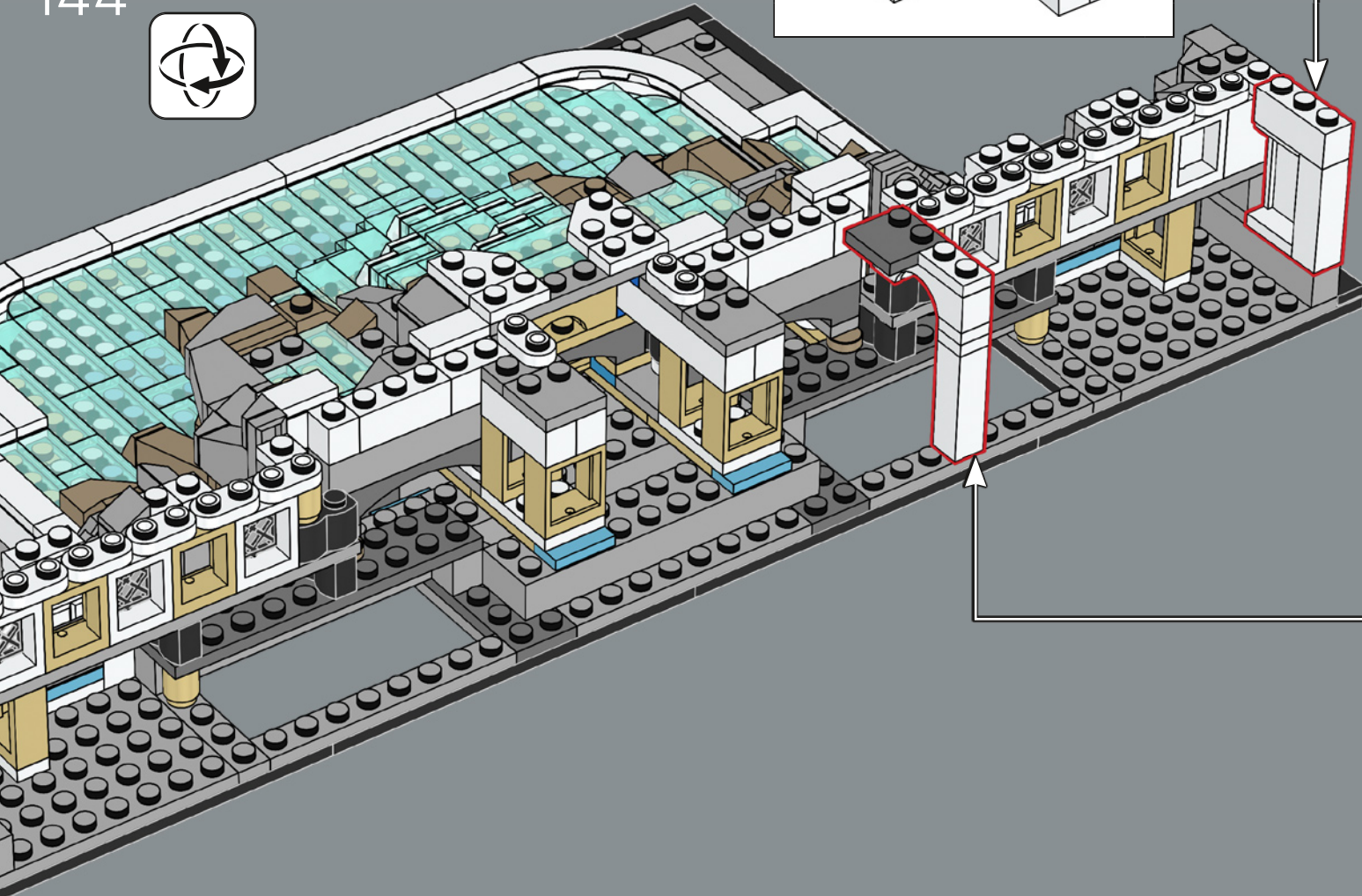
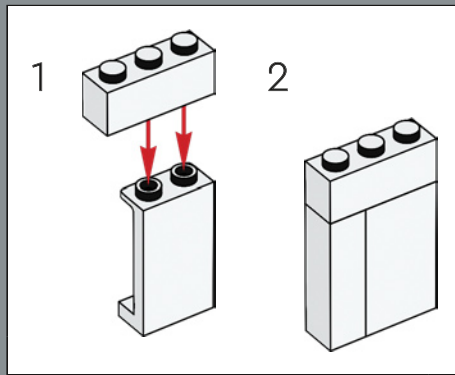

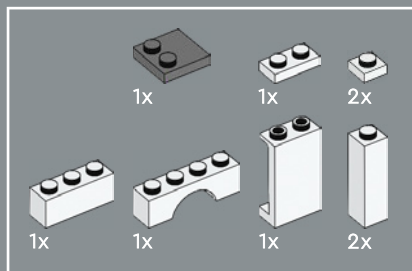

145

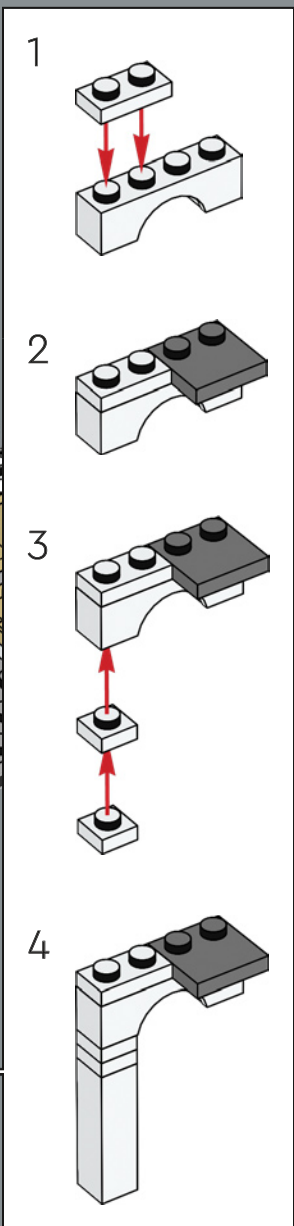
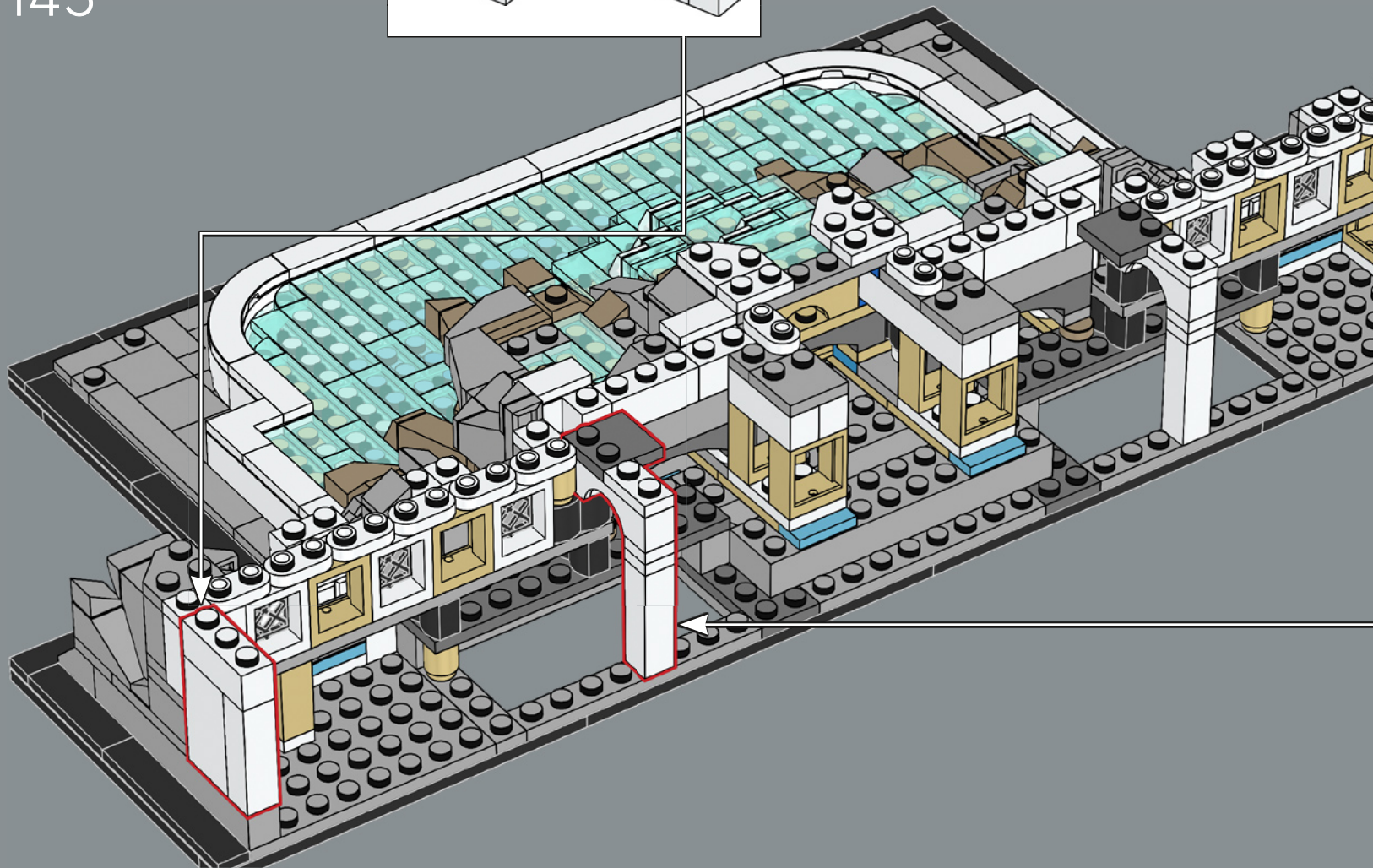
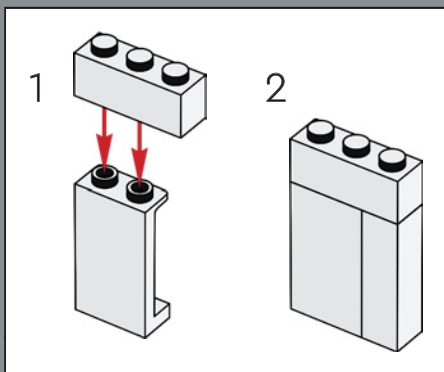

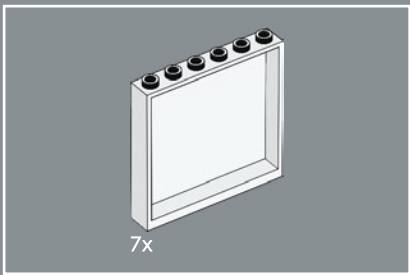

146

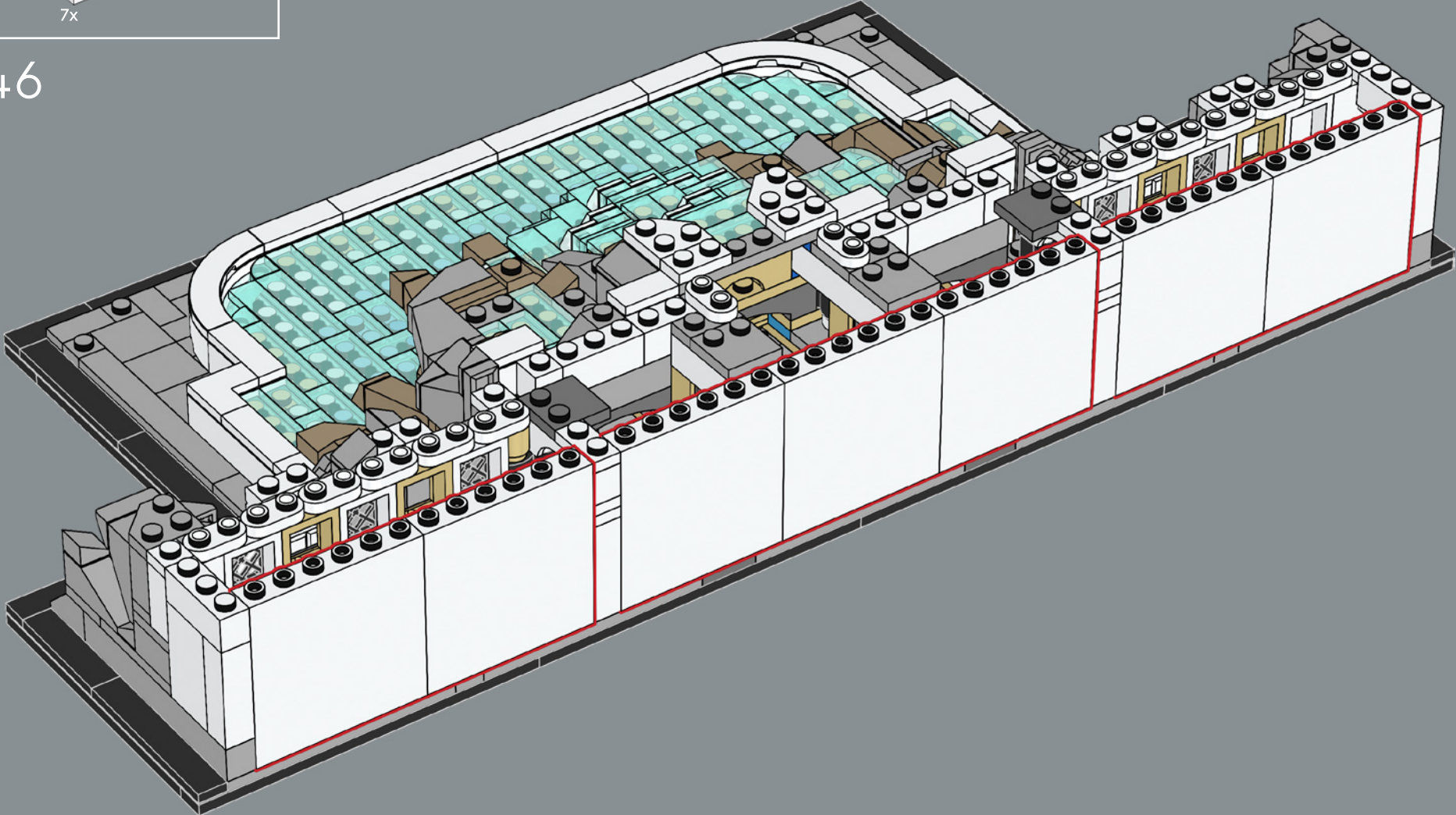

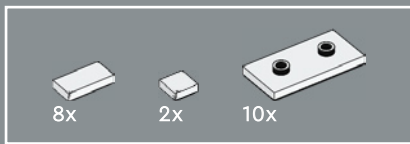

147

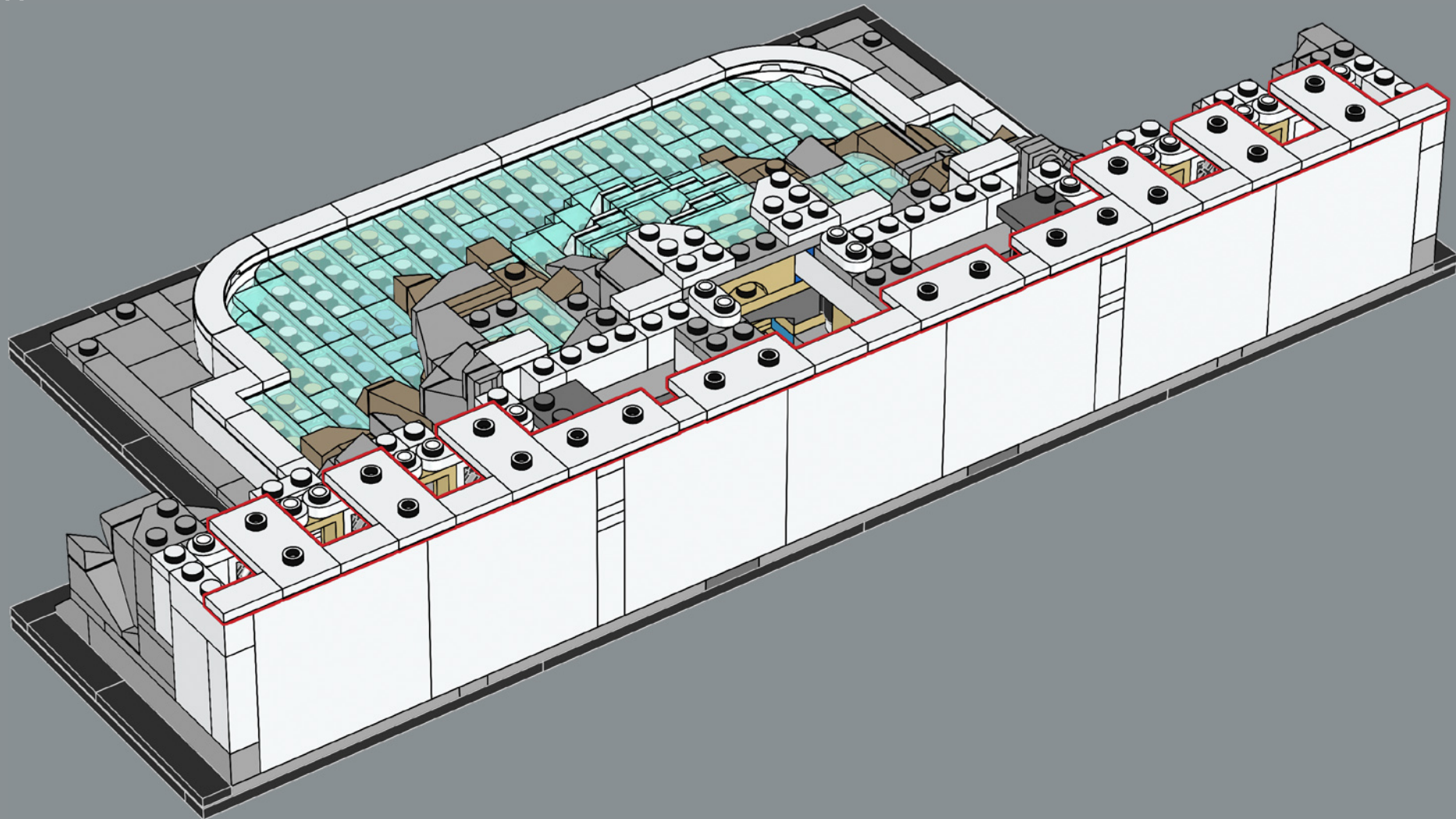

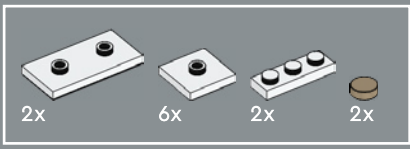

148

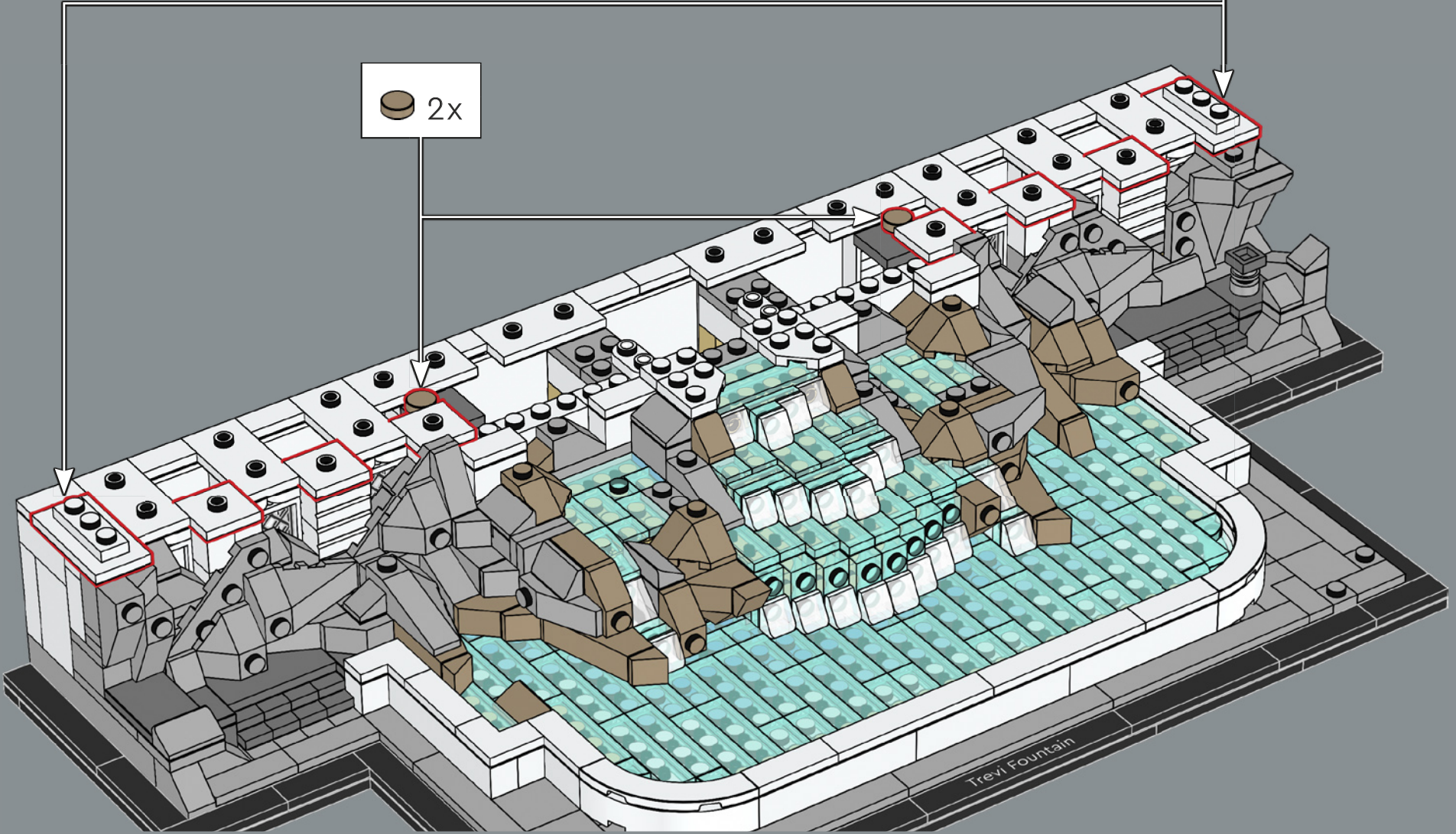
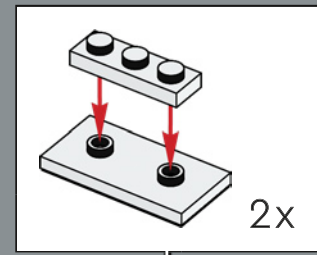

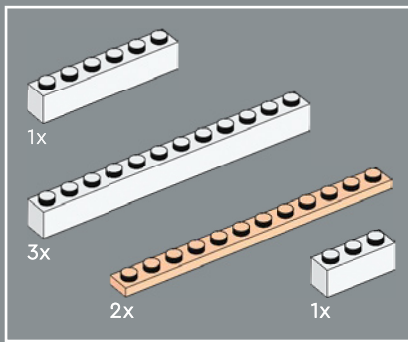

To properly capture the details and spacing in the overhangs and offset portions of the facade, we jumped back and forth between the standard LEGO® grid and 1/2 plate off the grid. This helped us create a smooth building flow and a strong construction.

149

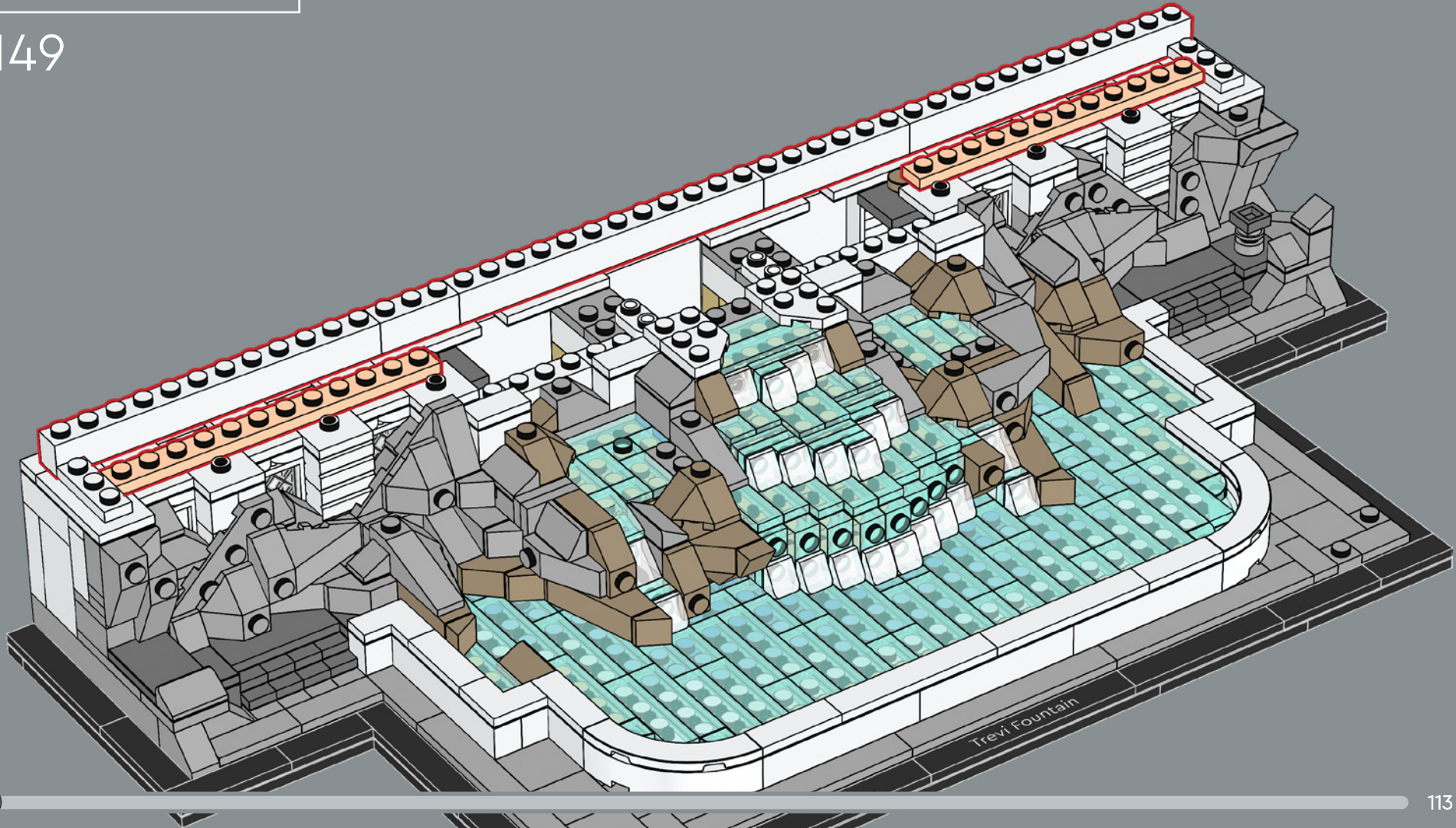



6x

150



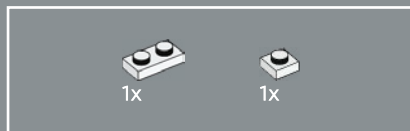
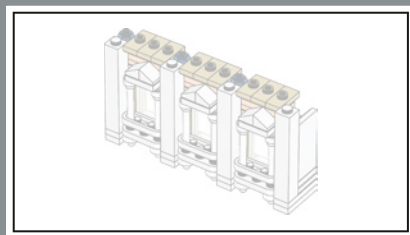

151

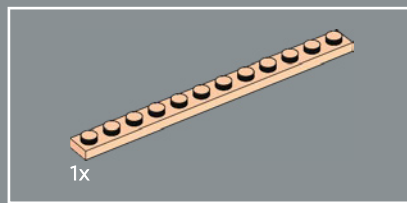
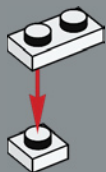

152

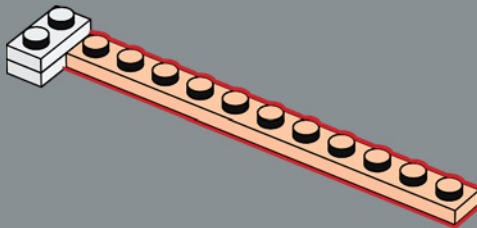

153

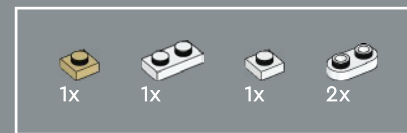
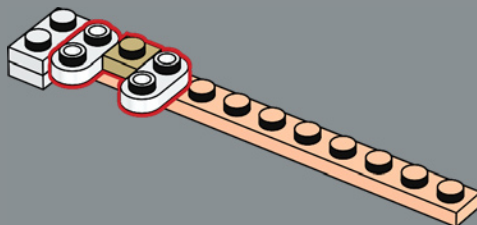

154

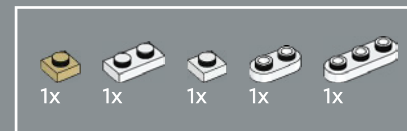
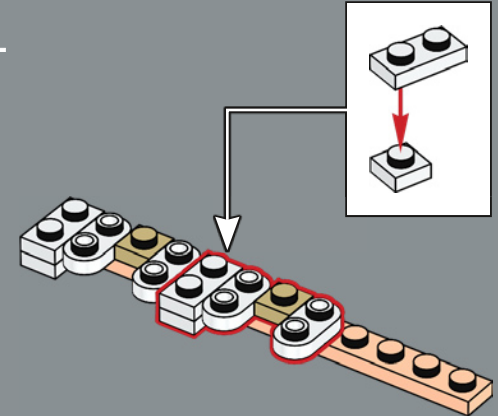

155

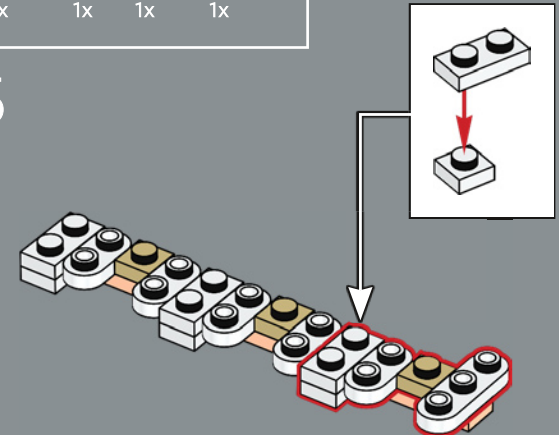

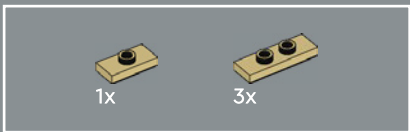

156

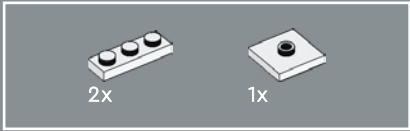
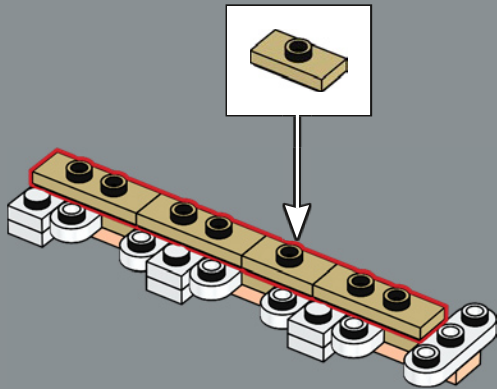

157

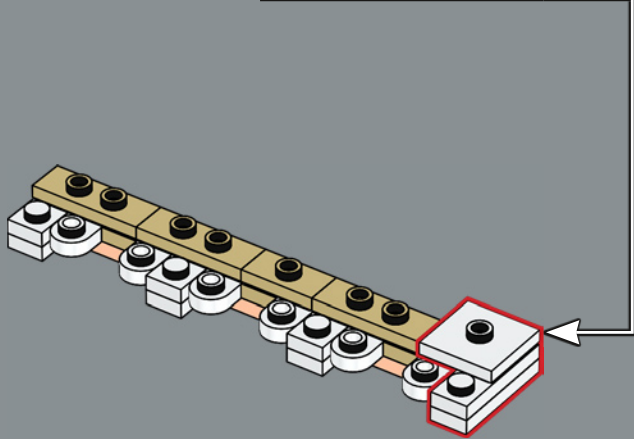
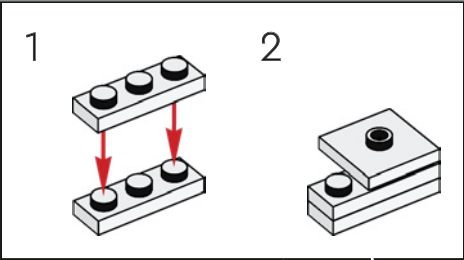

158

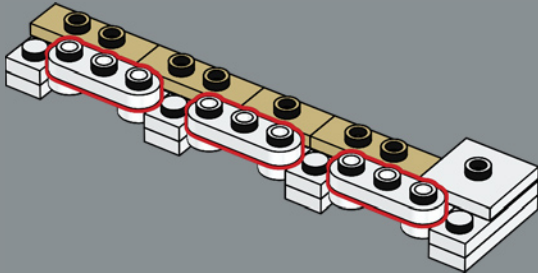

159

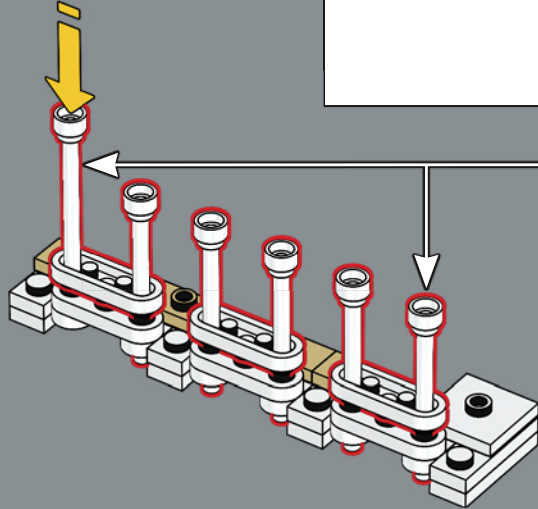
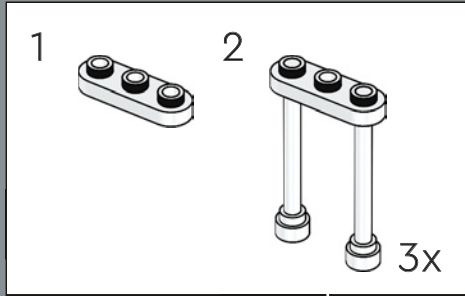

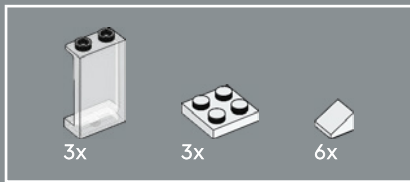

160

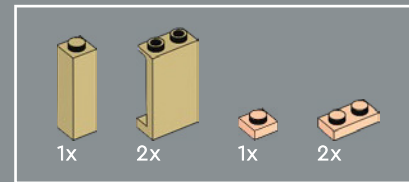
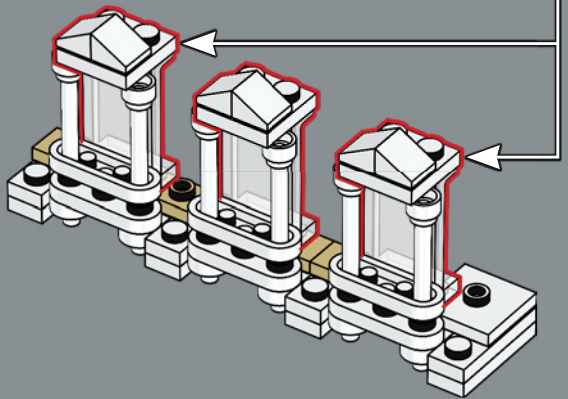
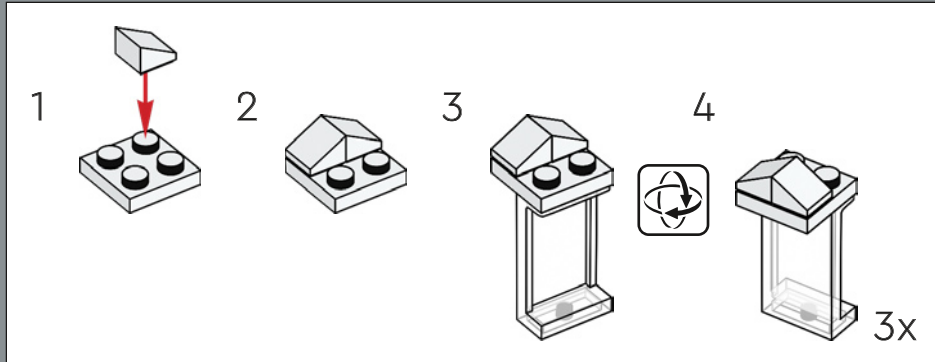
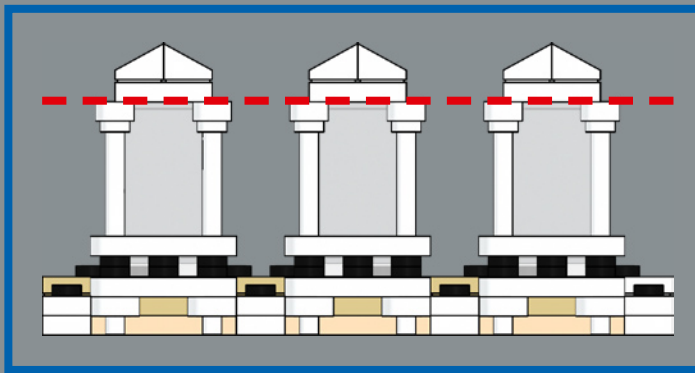

161

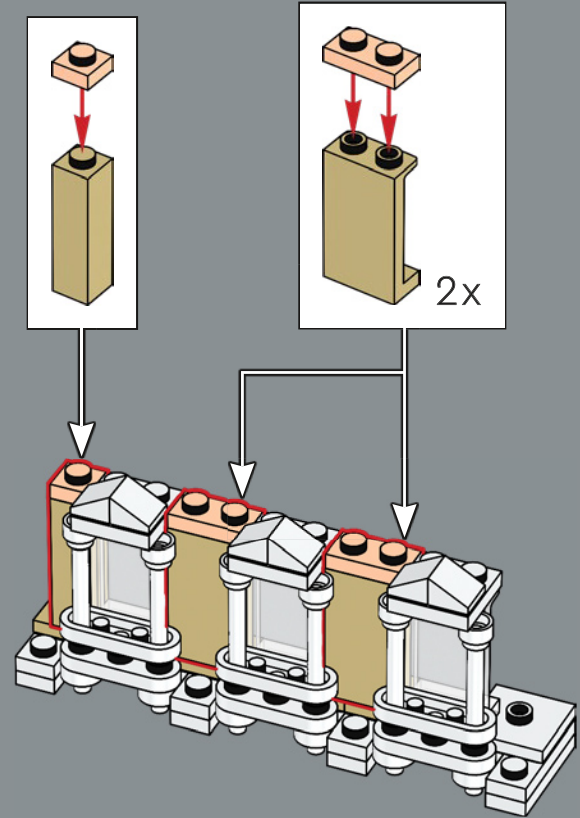

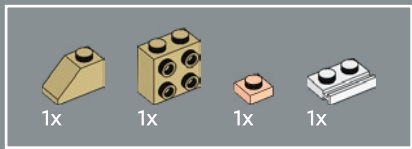

162

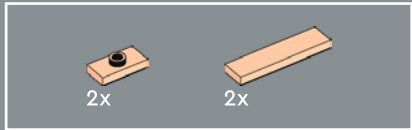
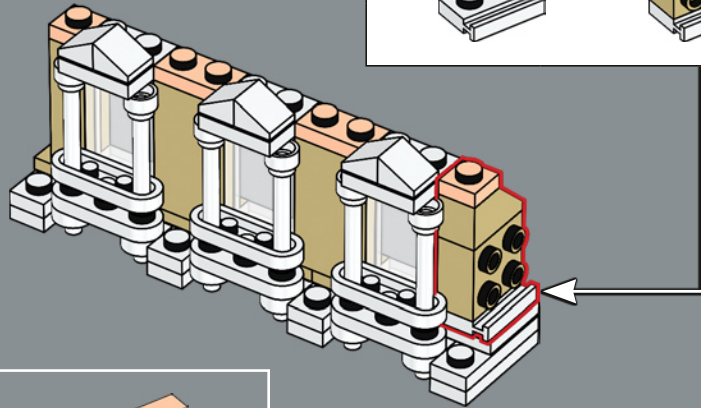
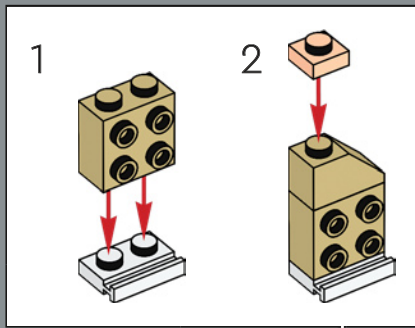

163

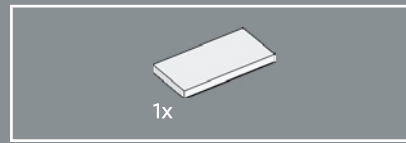
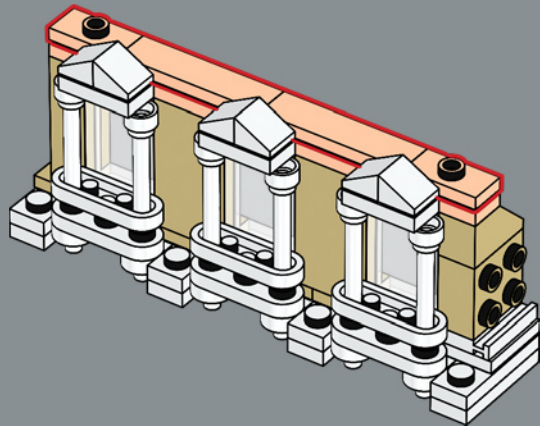

164

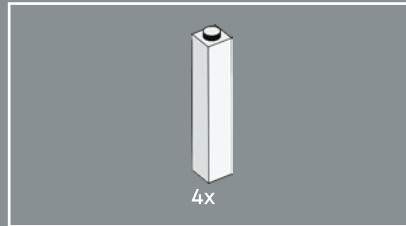
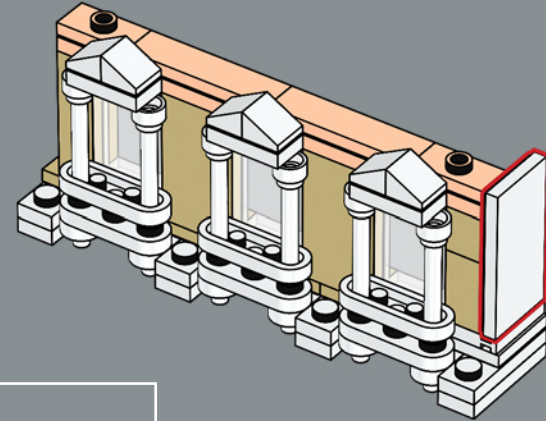

165

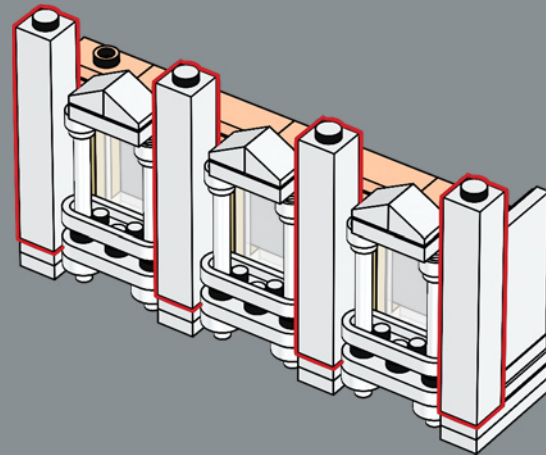

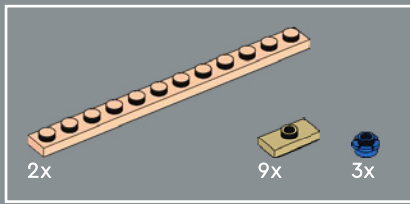

166

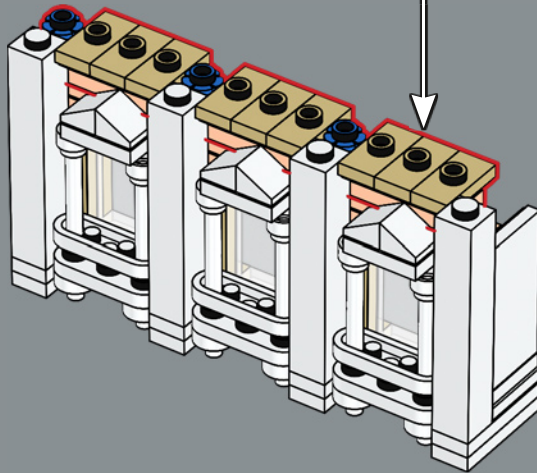
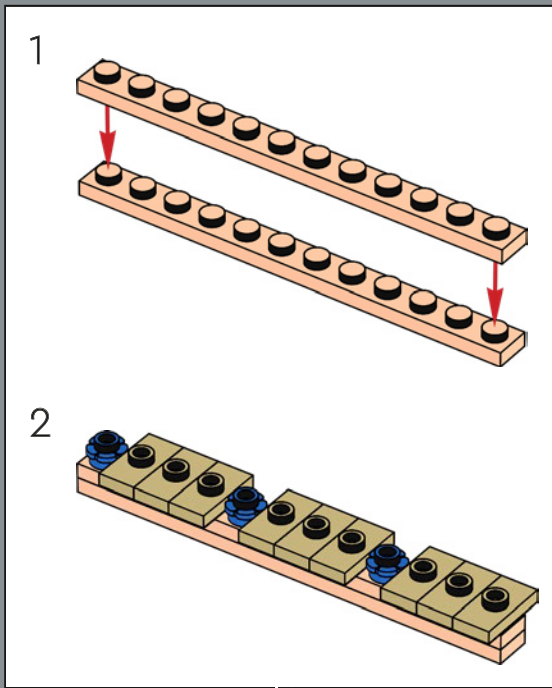

167

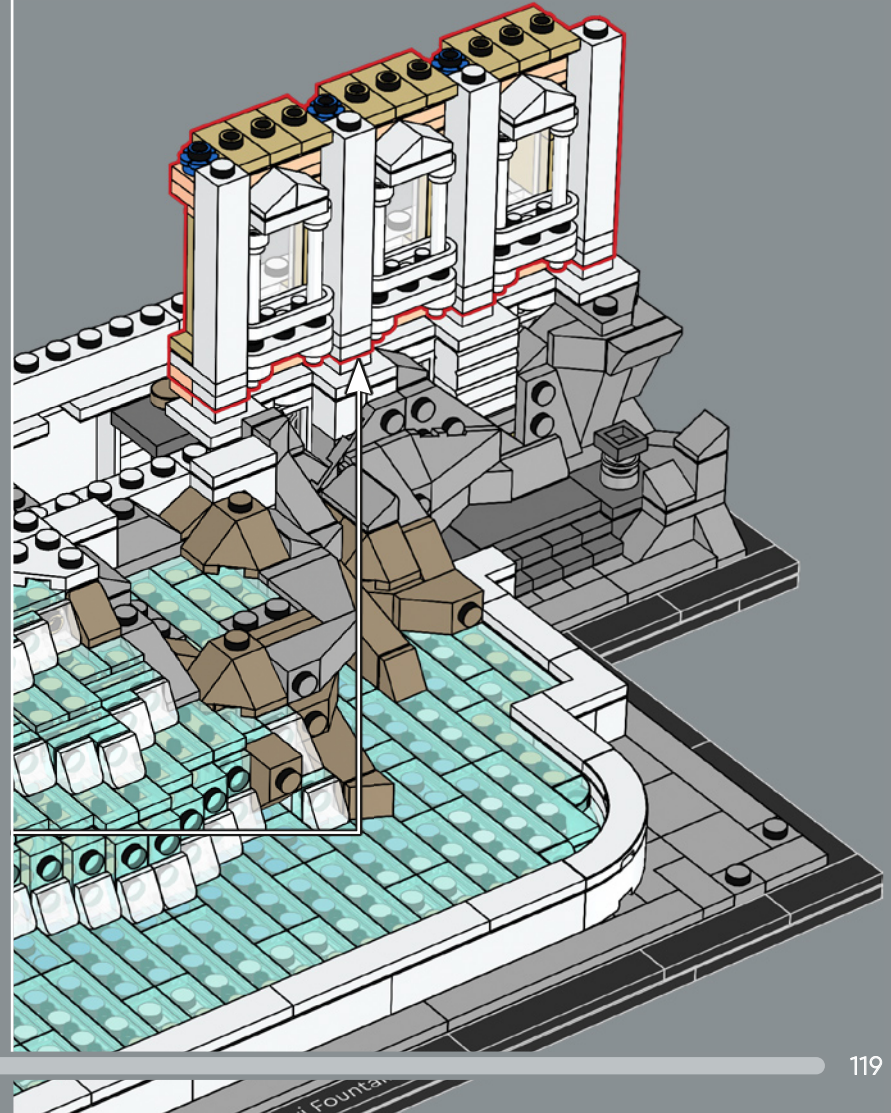

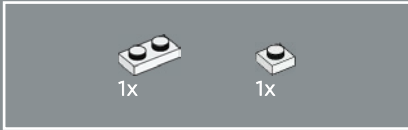
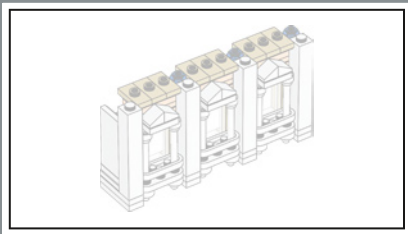

168

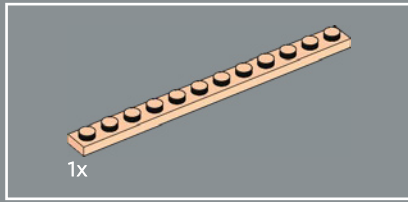
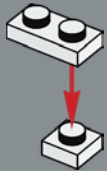

169

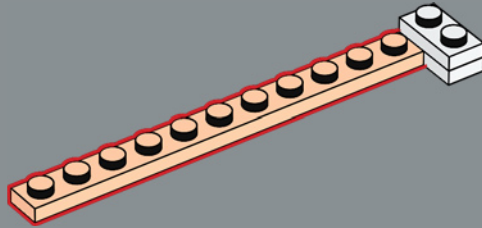

170

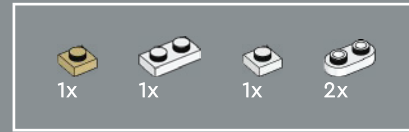
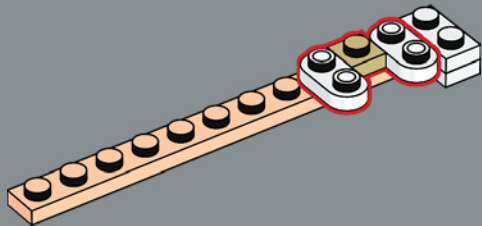

171

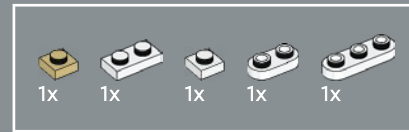
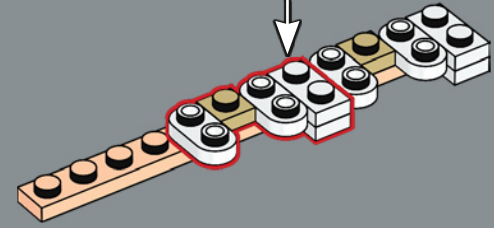
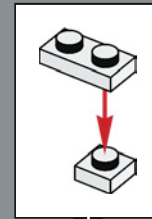

172

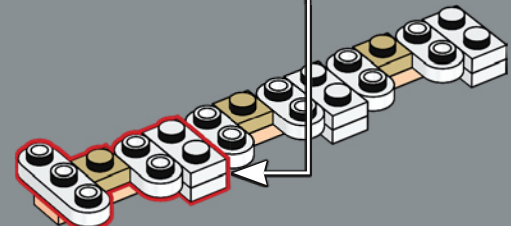
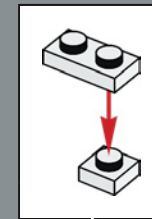

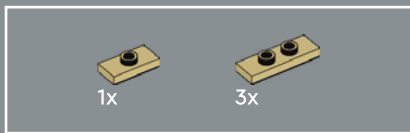

173

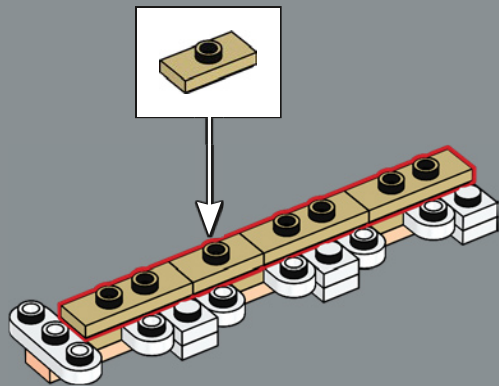

174

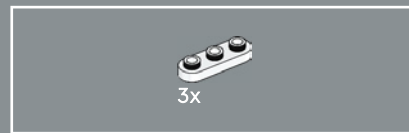
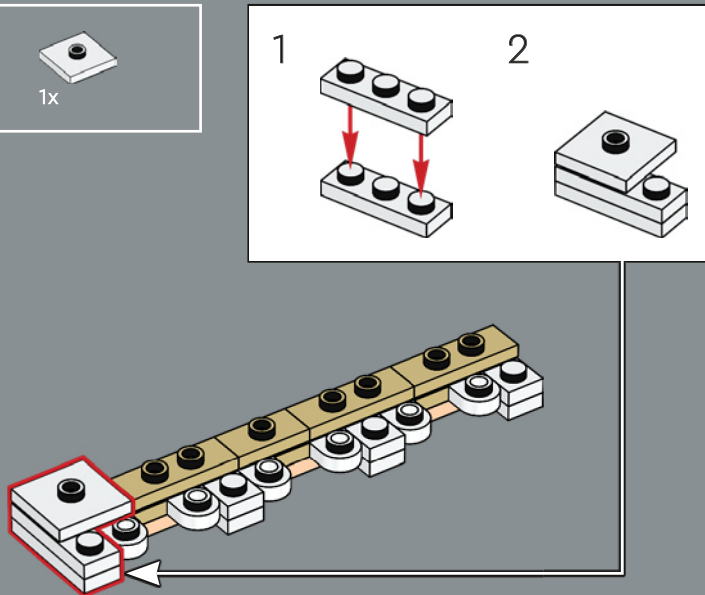

175

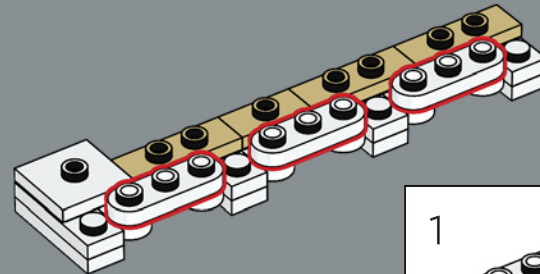

176

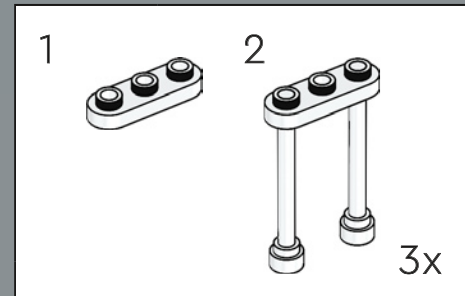
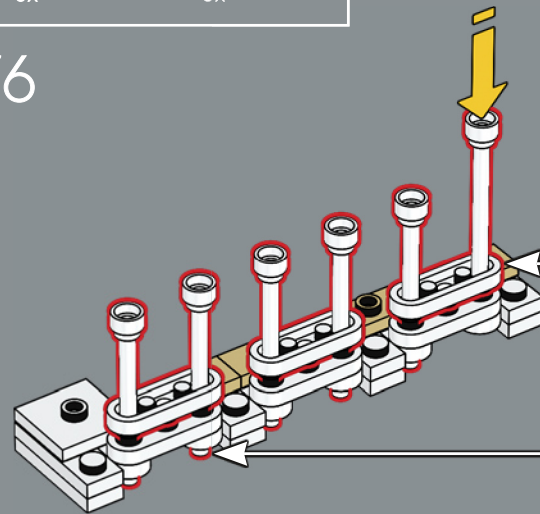

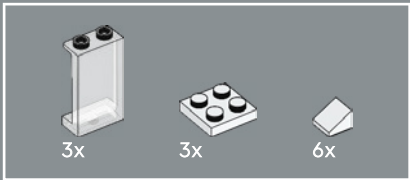

177

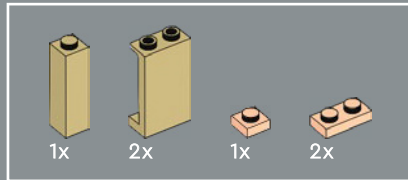
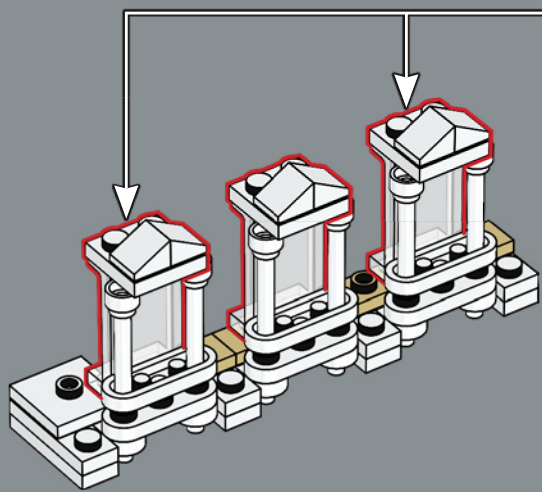
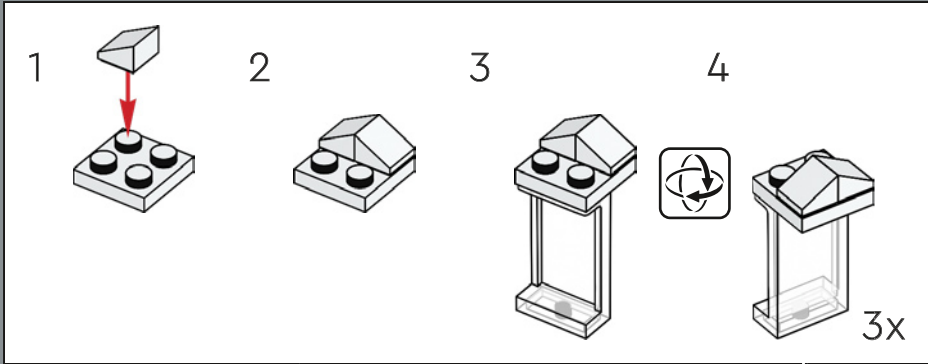
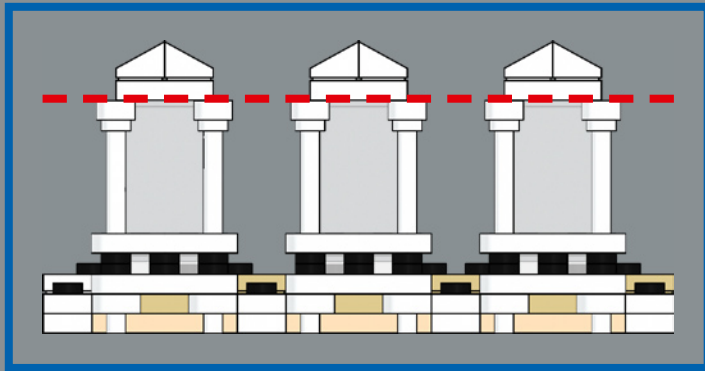

178

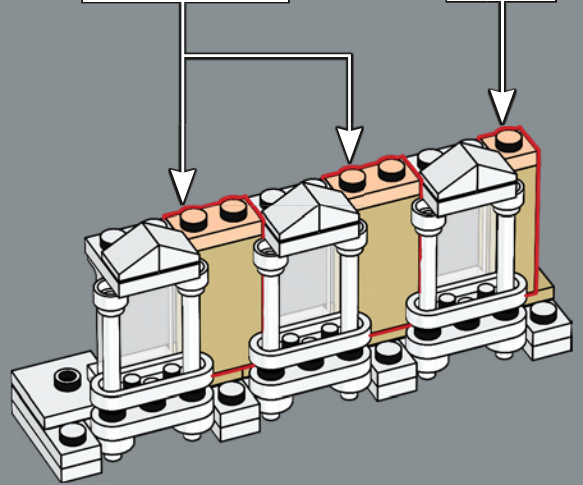
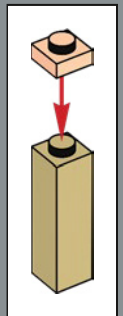
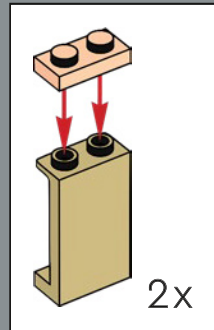

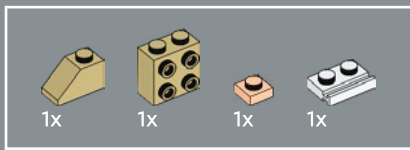

179

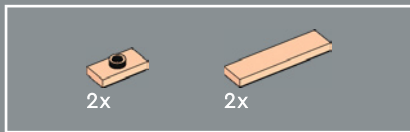
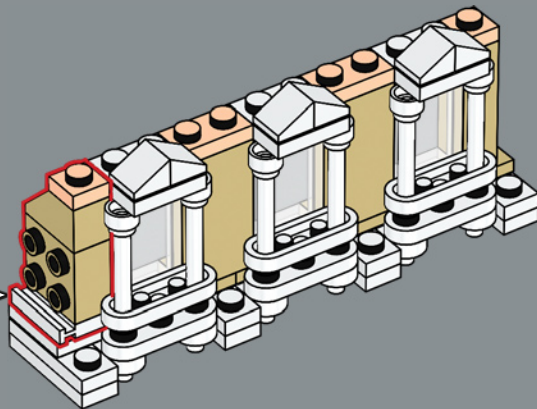
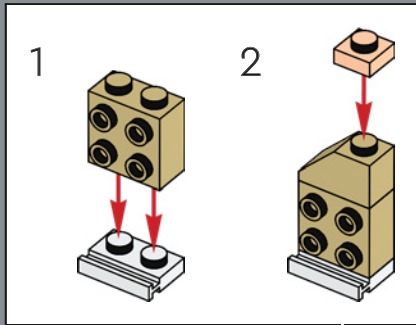

180

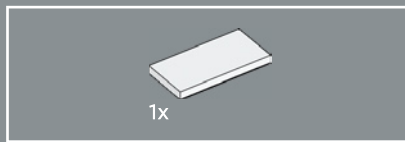
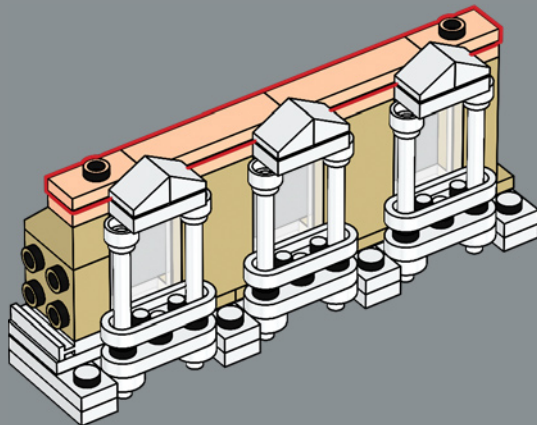

181

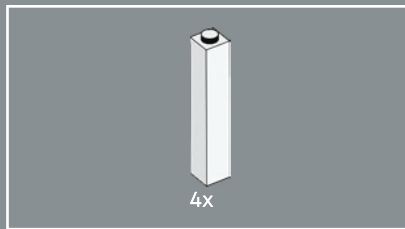
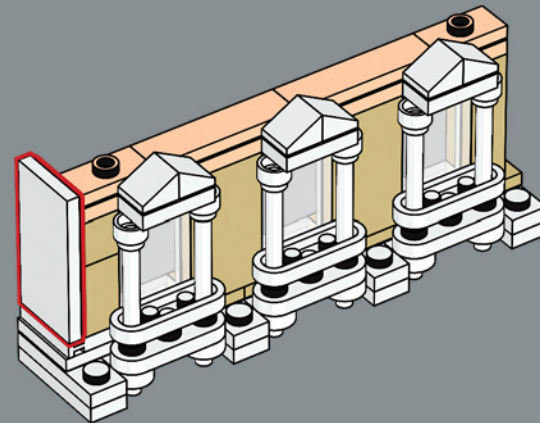

182

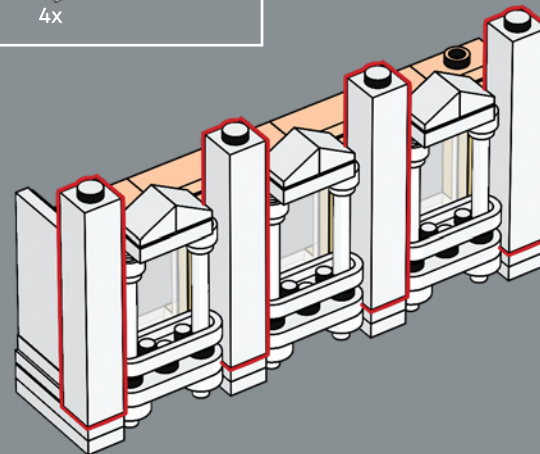

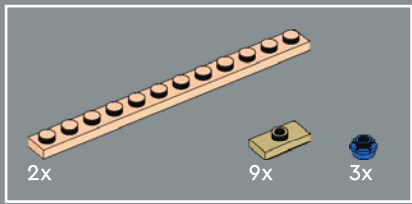

183

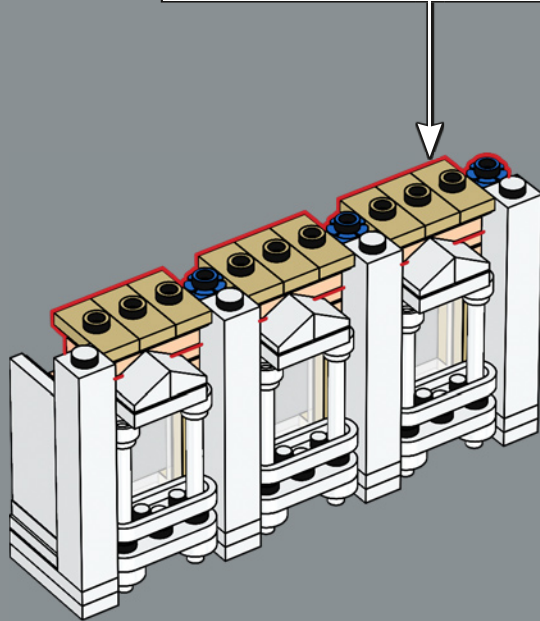
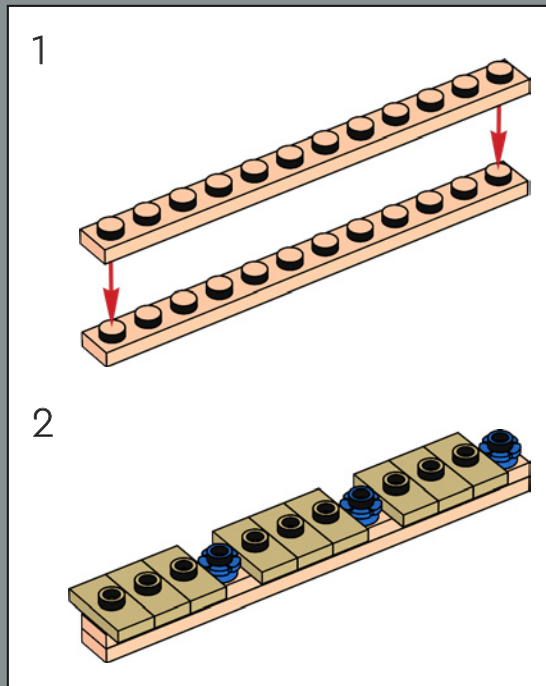

184

The sand colour is reserved for the most shadowed areas of the fountain, beneath the overhangs and behind the window trim.

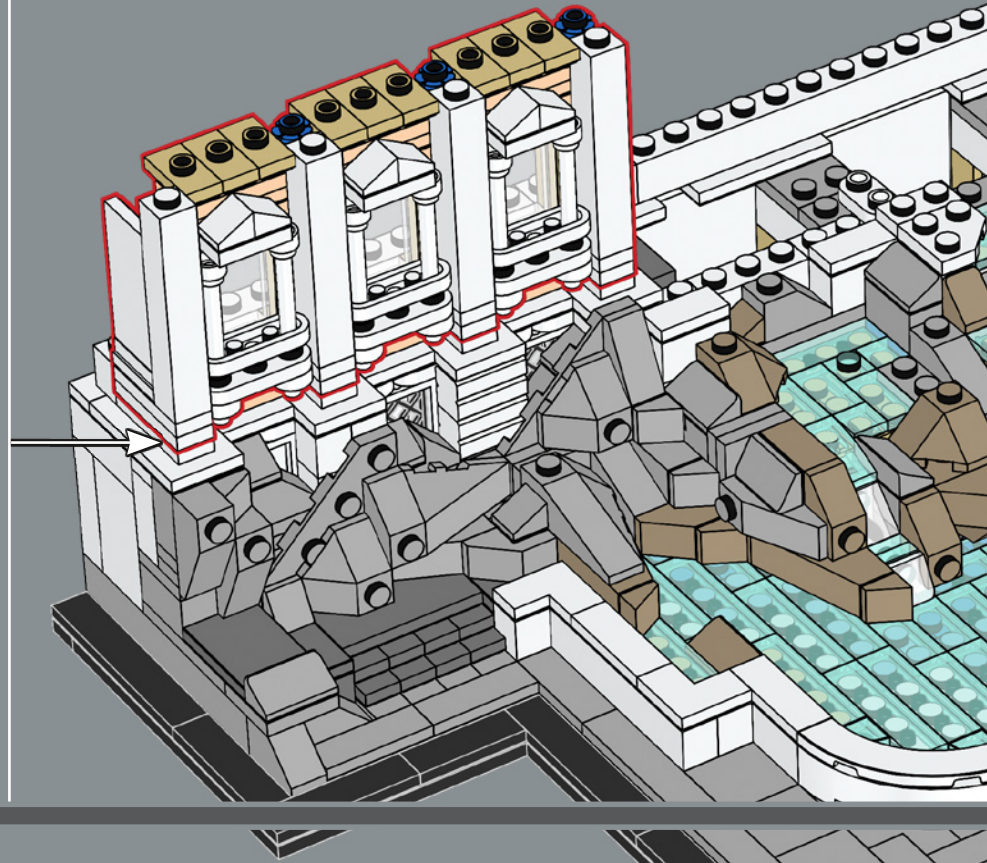

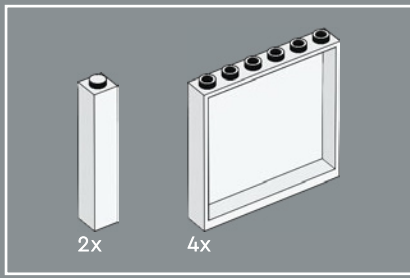

185

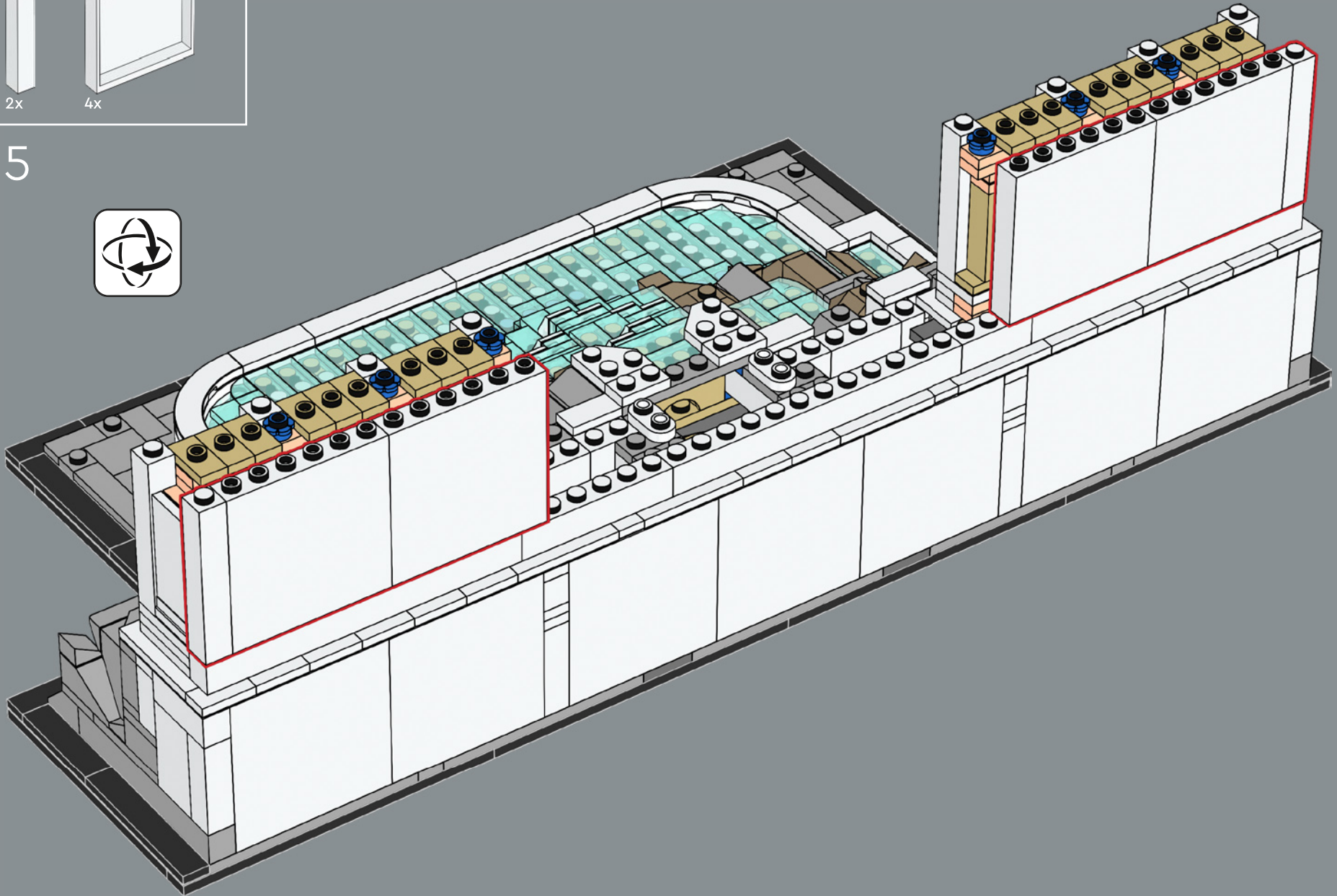

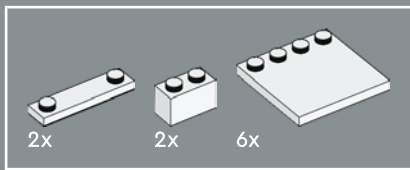

186

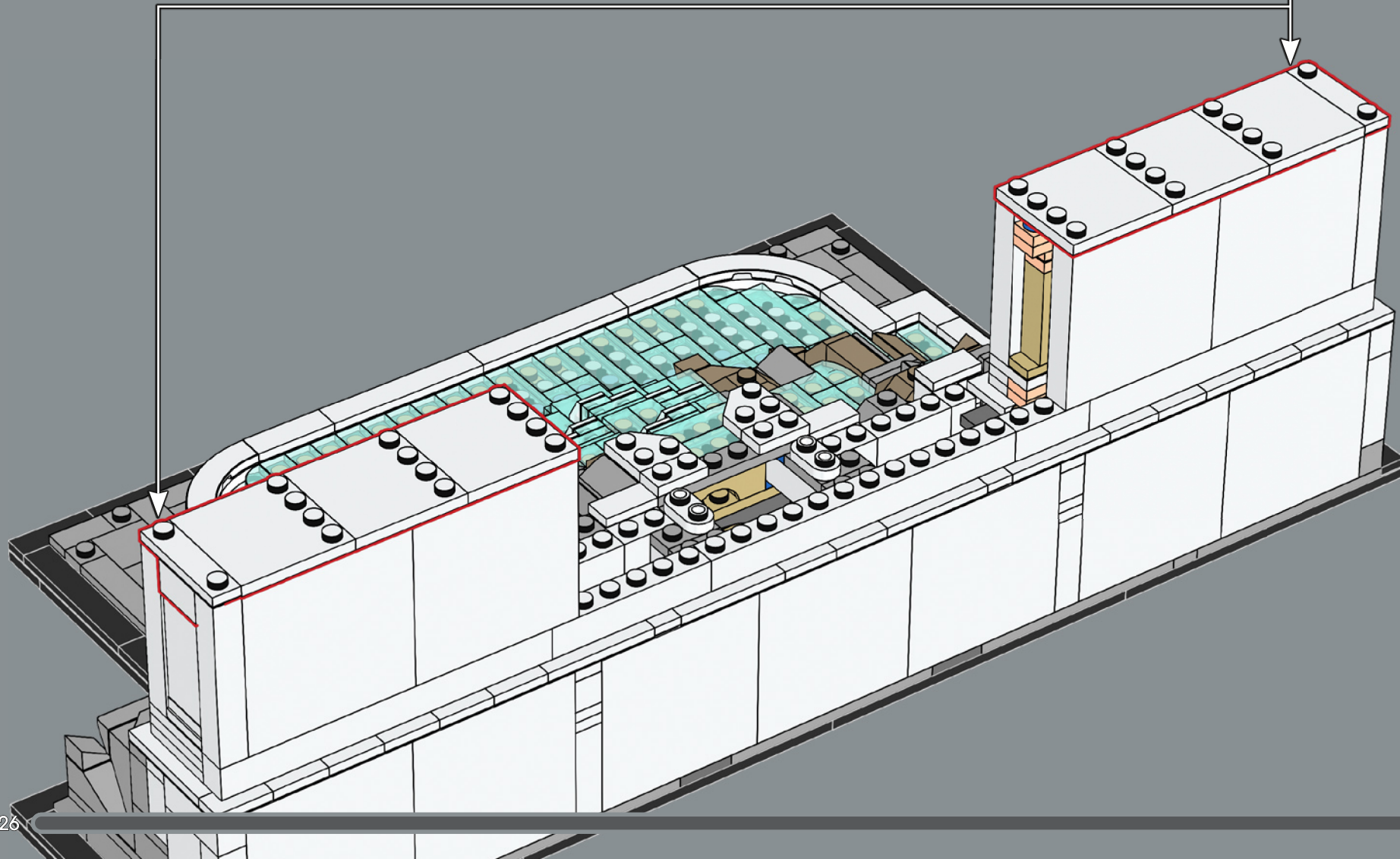
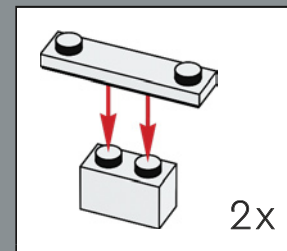

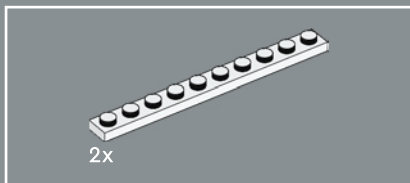

187

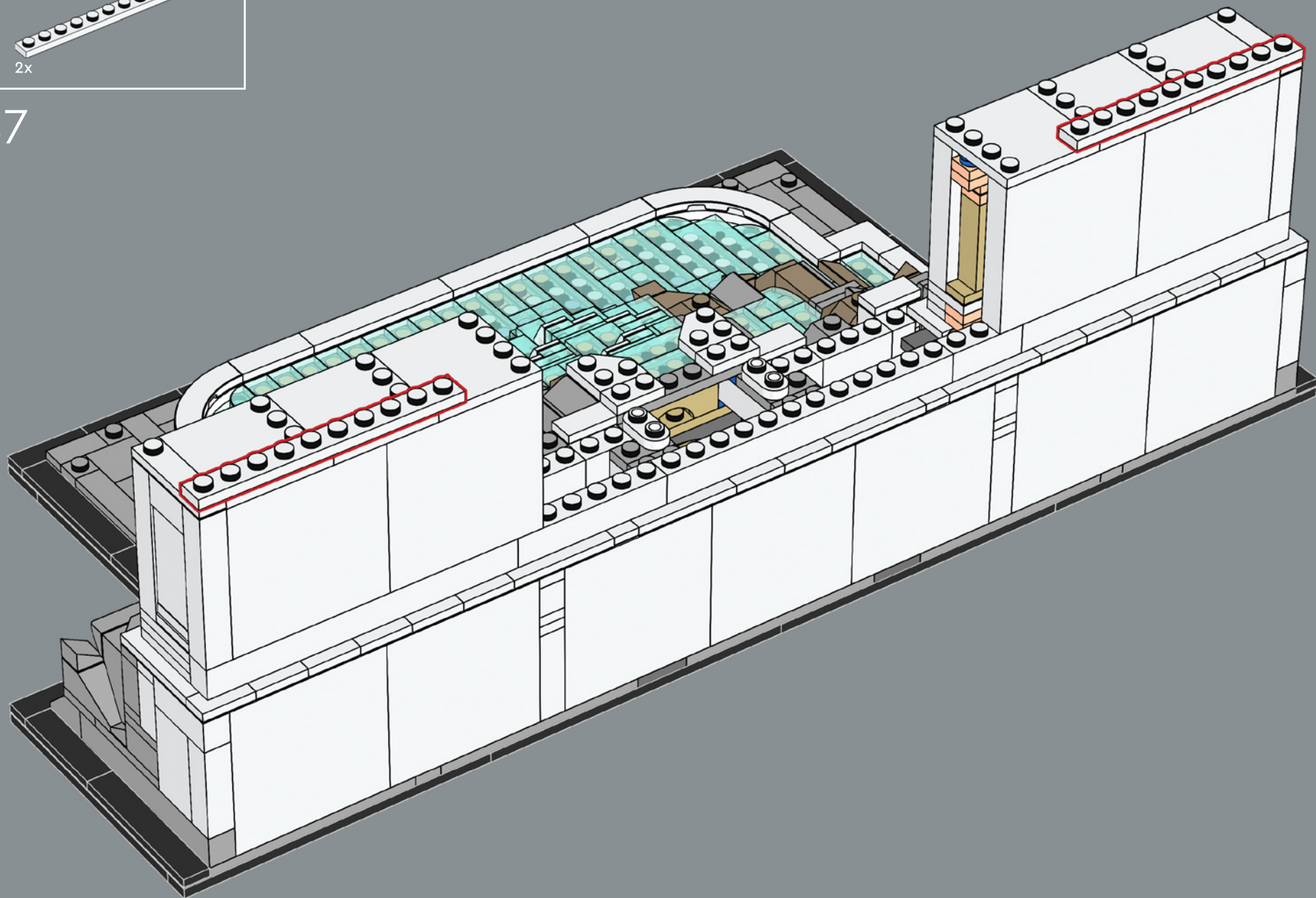

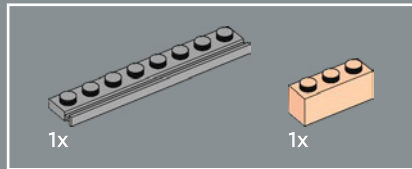
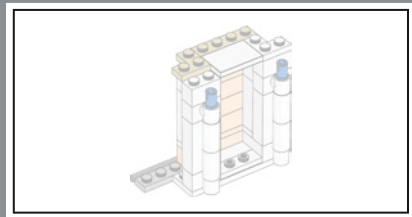

188

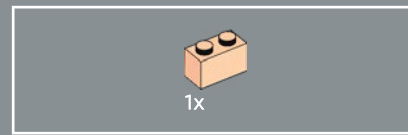
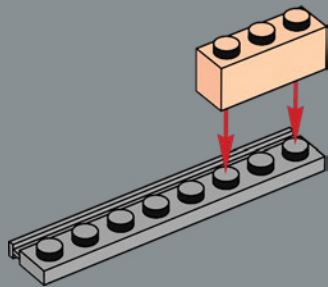

189

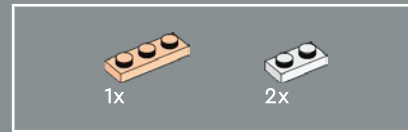
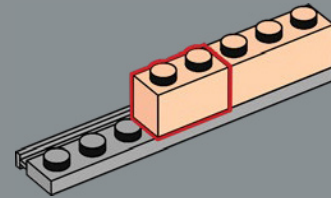

190

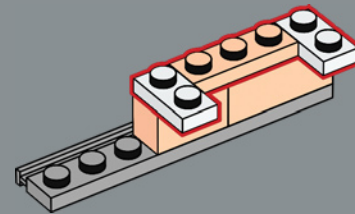

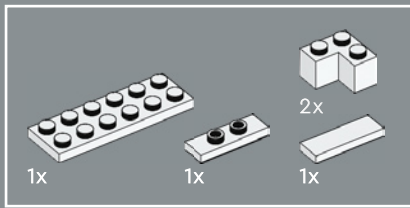

191

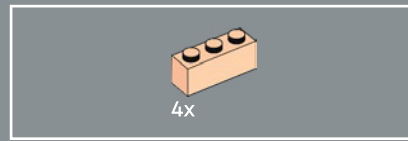
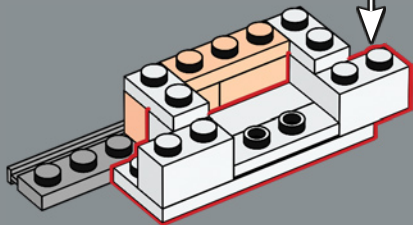
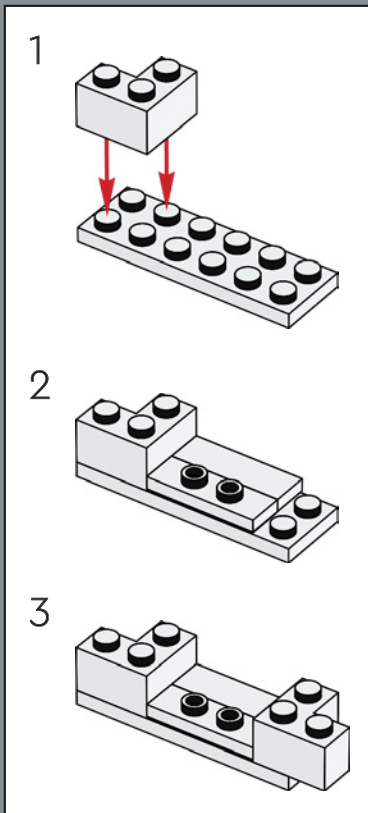

192

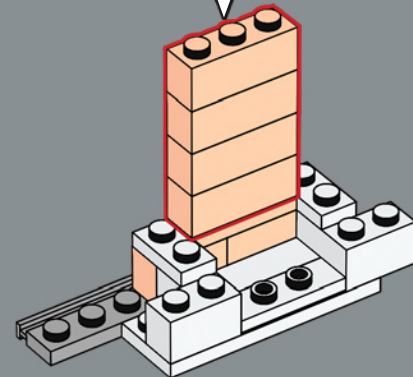
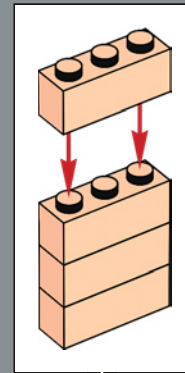

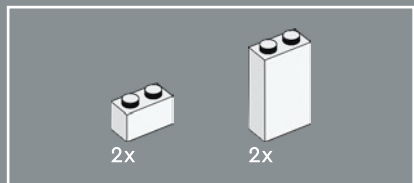

193

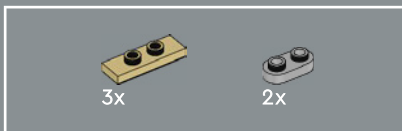
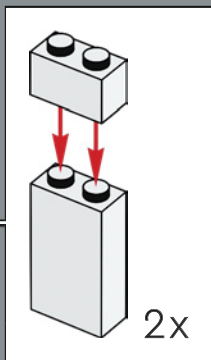
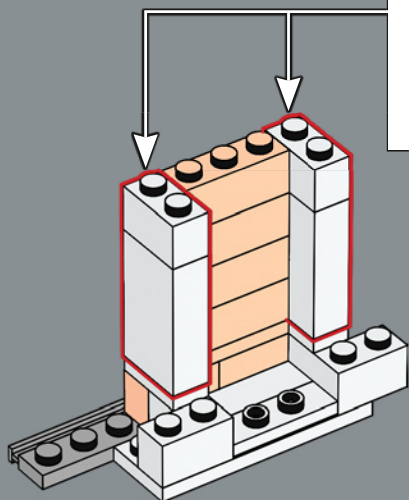

195

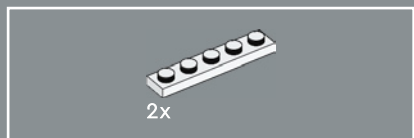
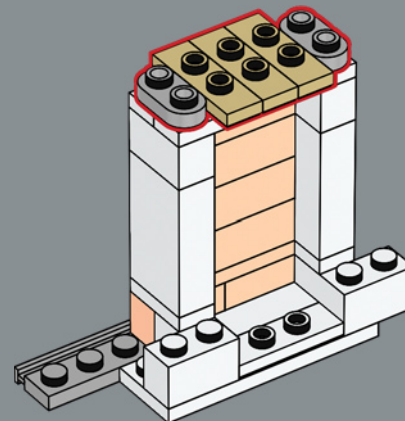

194

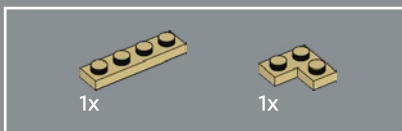
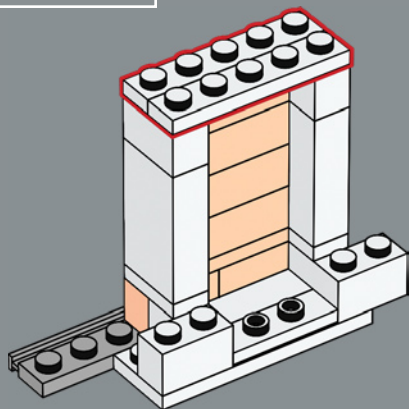

196

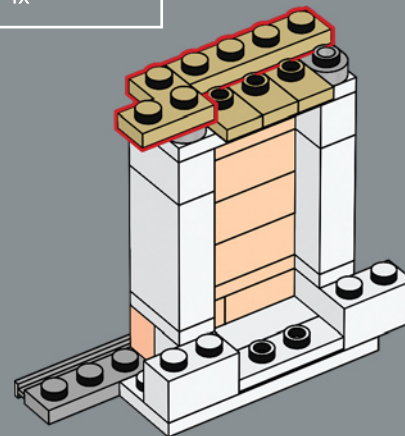

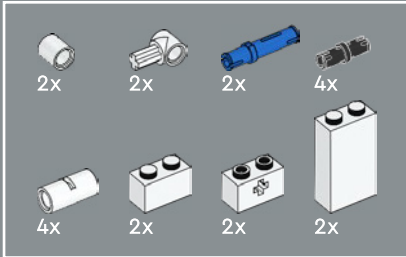
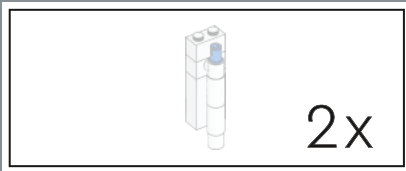

197

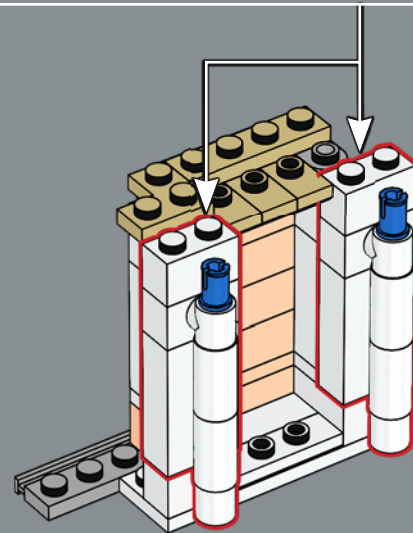
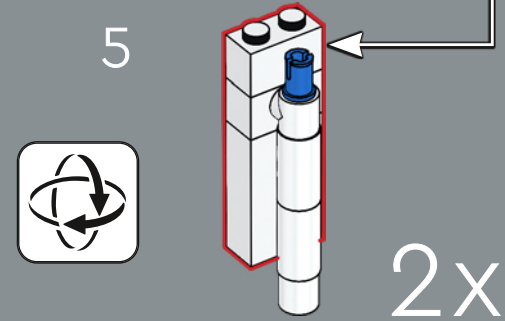
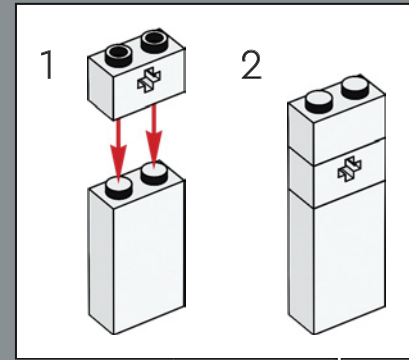
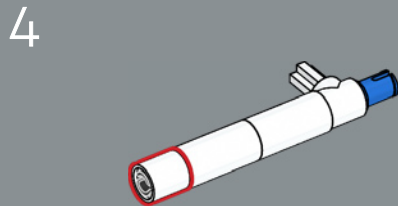
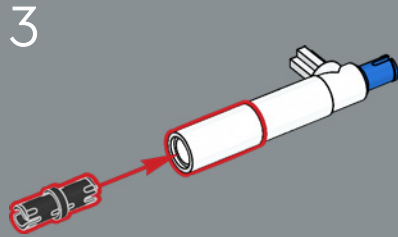
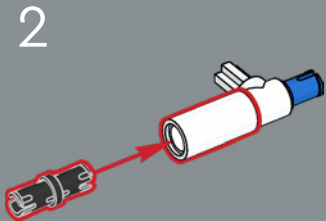
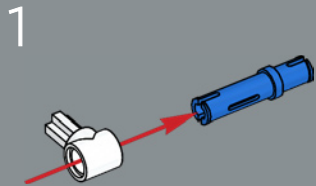

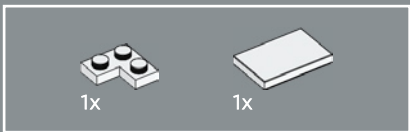

198

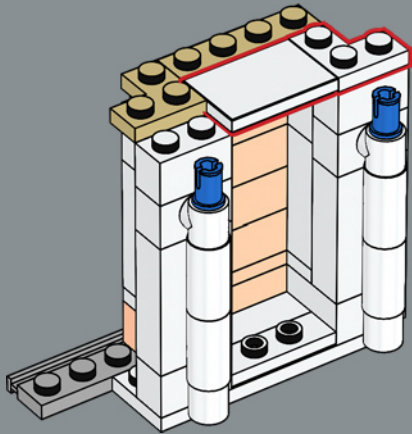

199

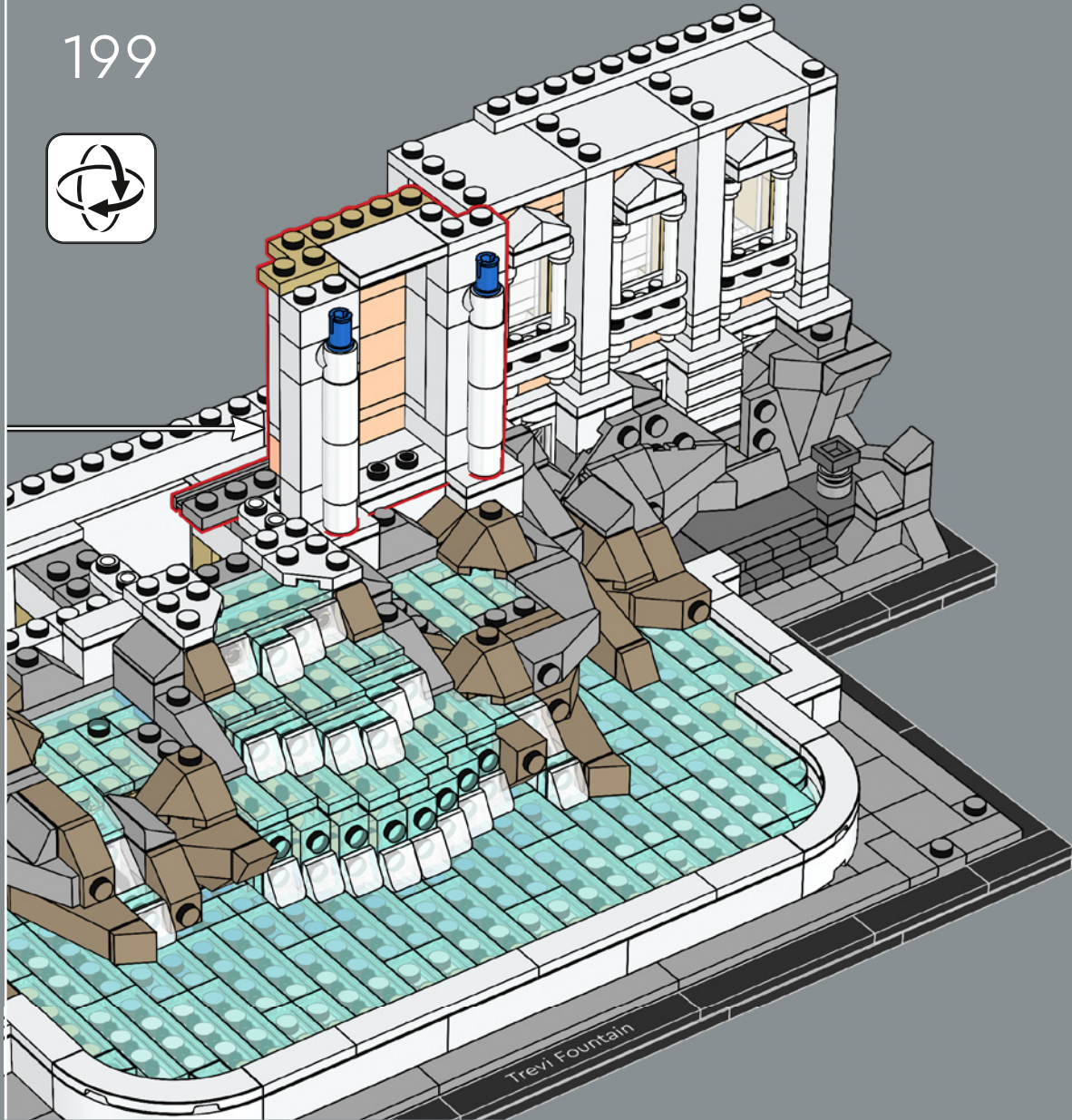

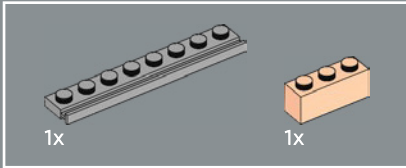
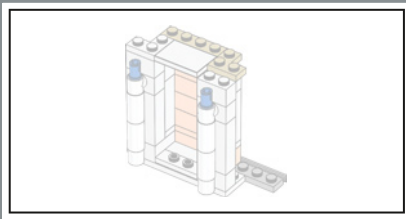

200

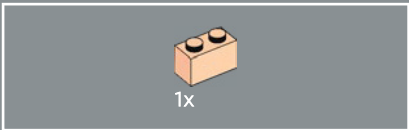
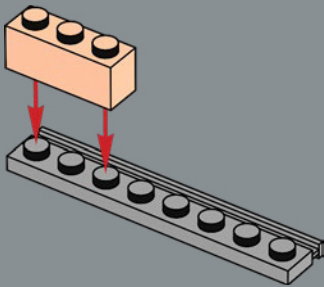

201

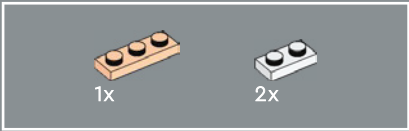
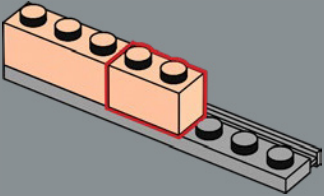

202

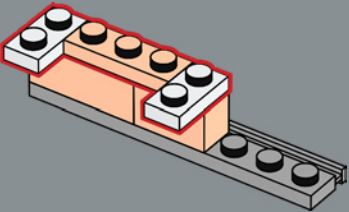

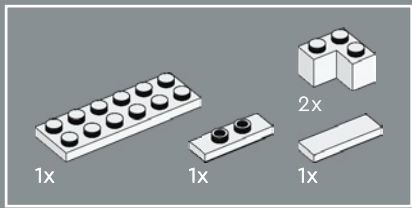

203

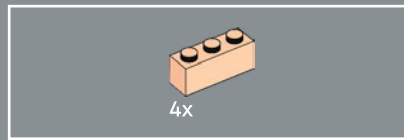
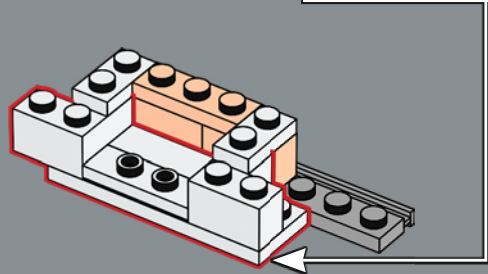
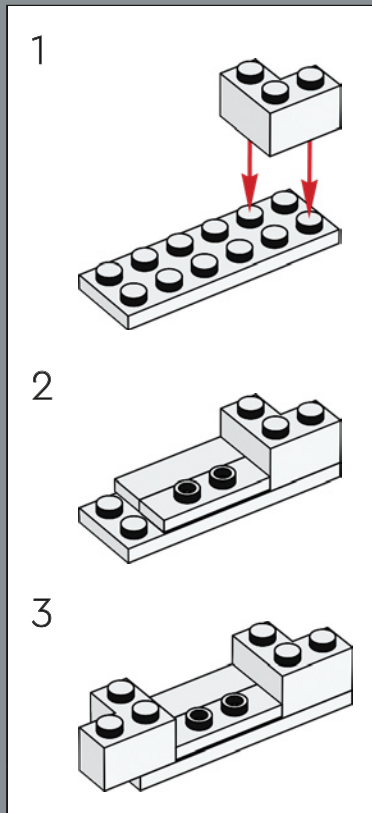

204

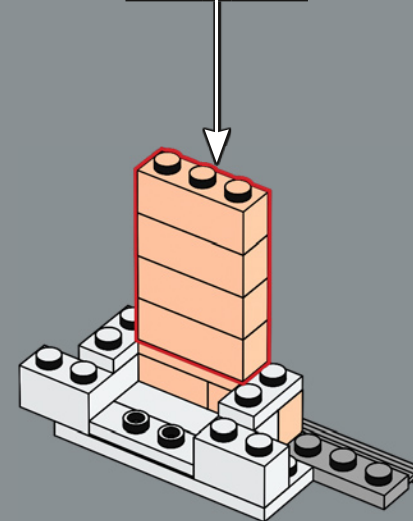
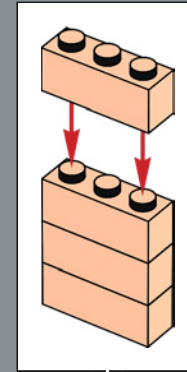

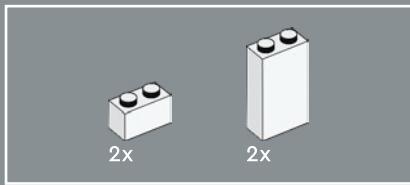

205

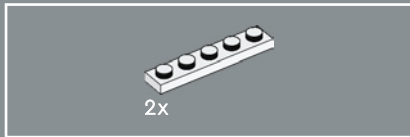
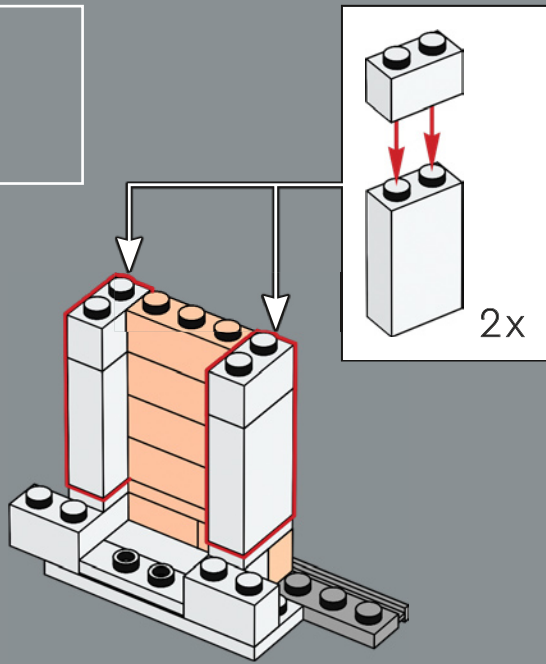

206

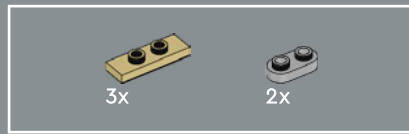
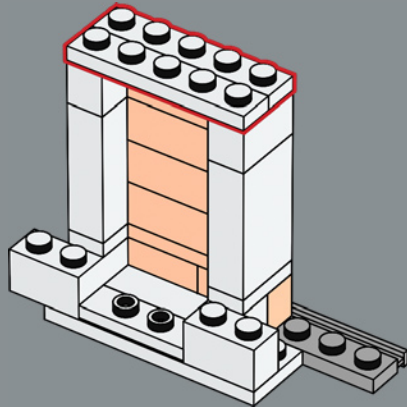

207

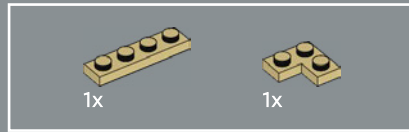
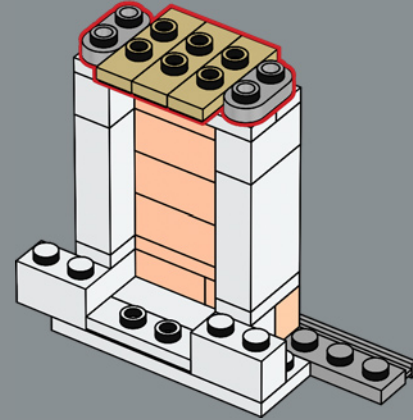

208

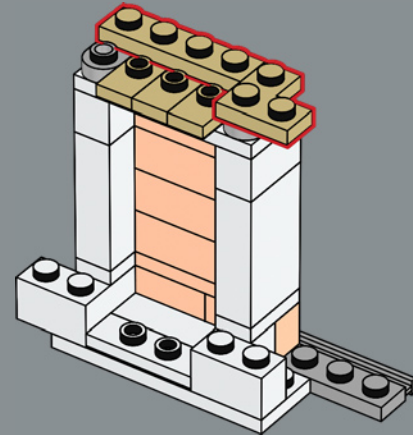

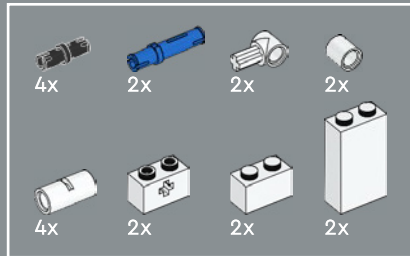
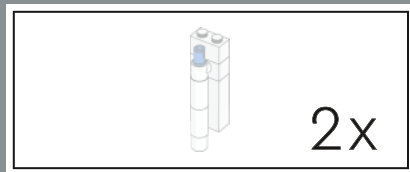

209

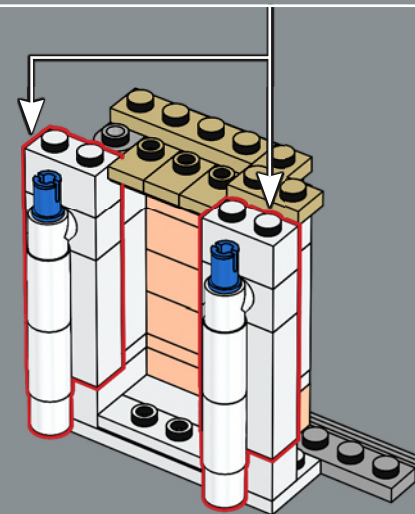
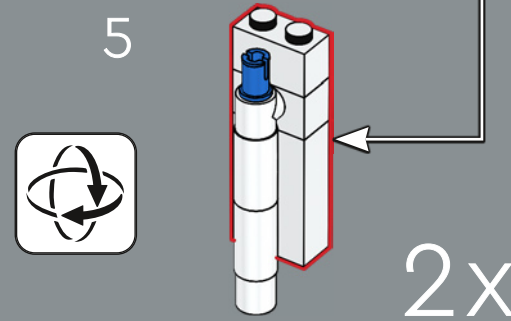
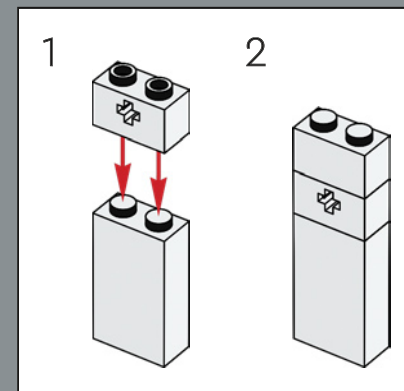
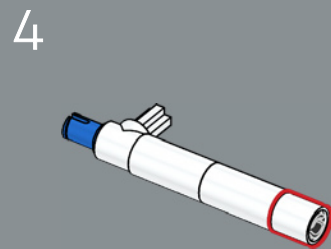
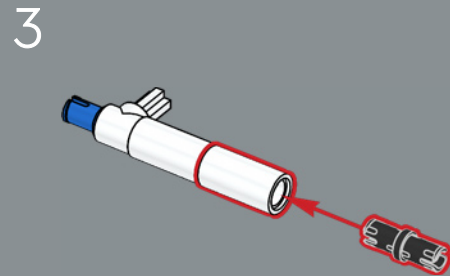
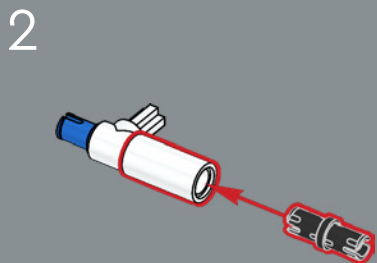
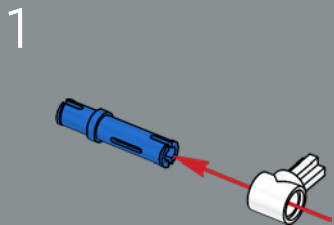

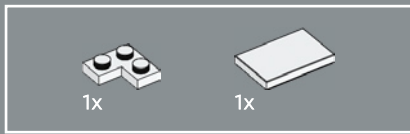

210

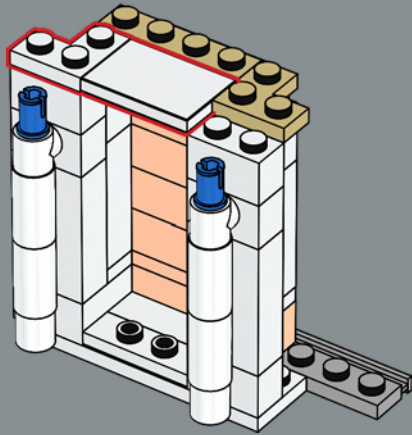

211

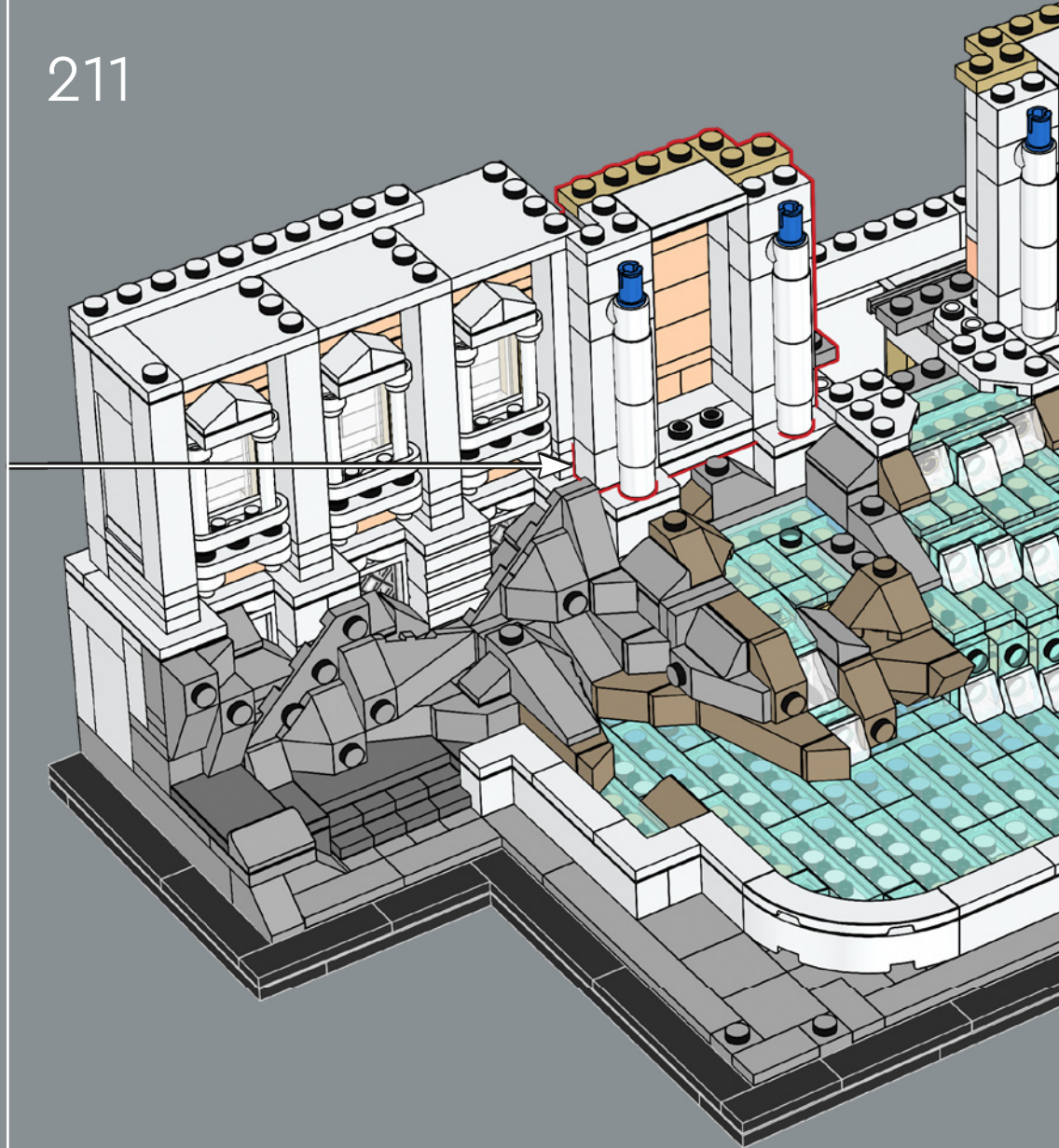

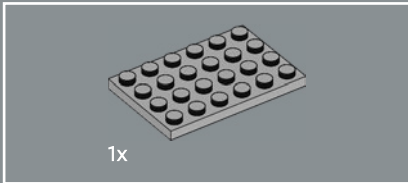
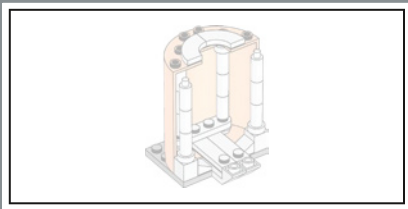

1x

212

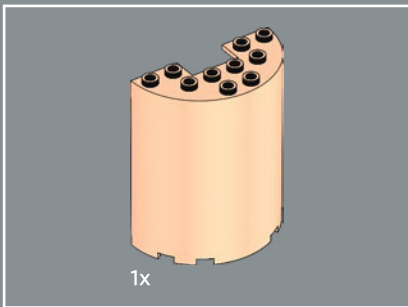
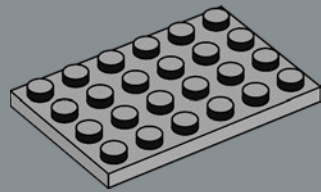

1x

213

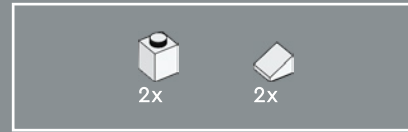
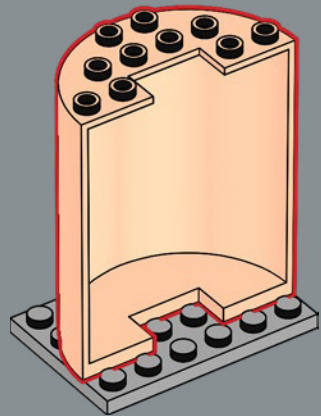

2x

2x

214

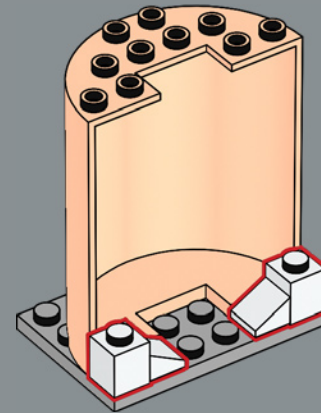

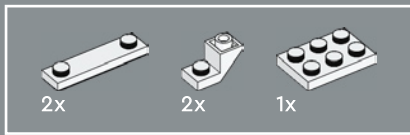

215

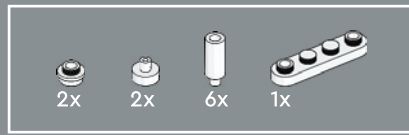
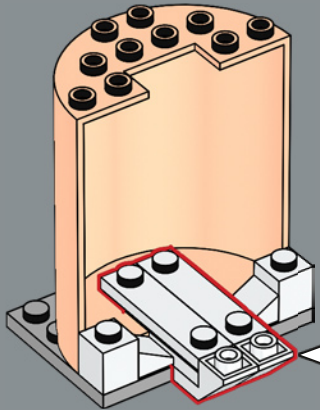
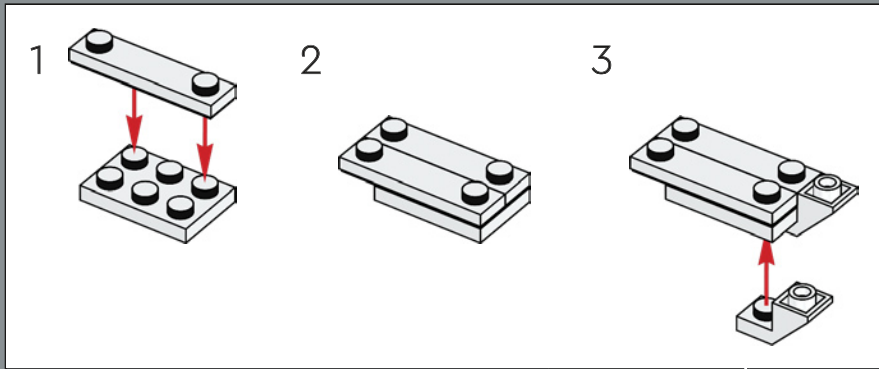

216

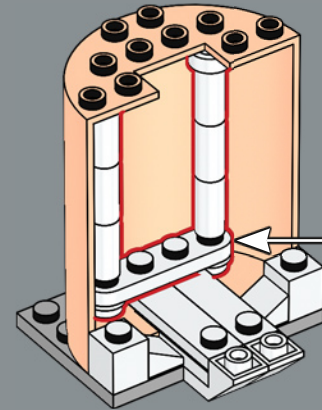
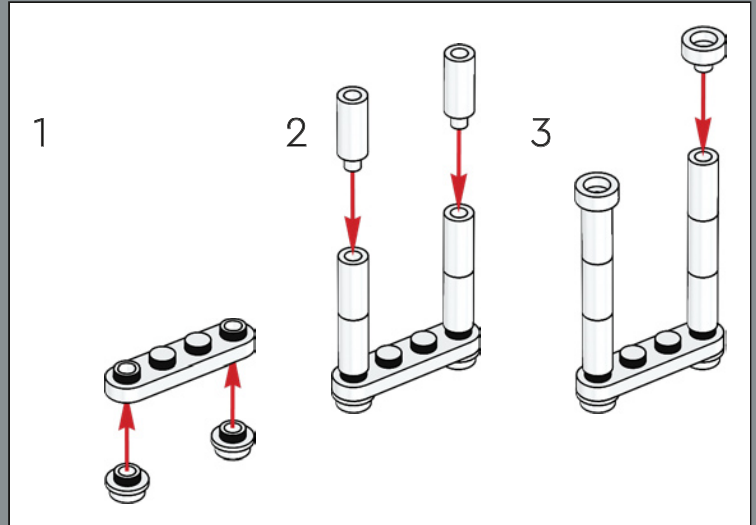



217

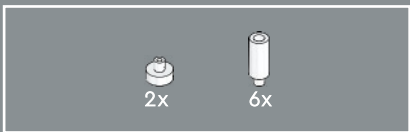
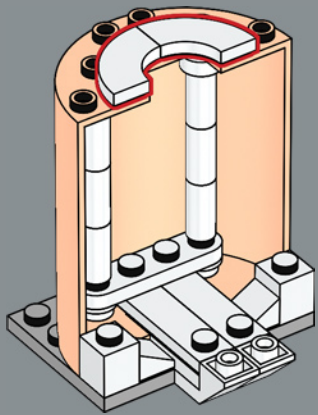

218

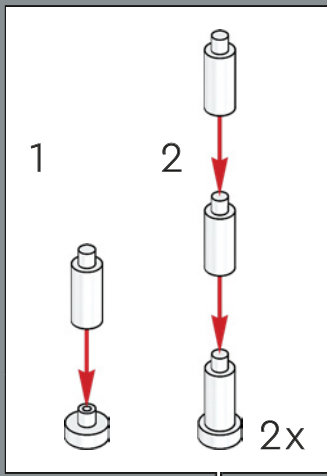
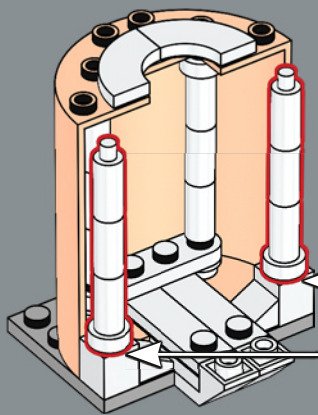

219

The entire facade is split into nine vertical sections allowing for the middle focal point. Replicating this in LEGO® bricks called for an odd number of modules and jumper plates to centre the main archway.

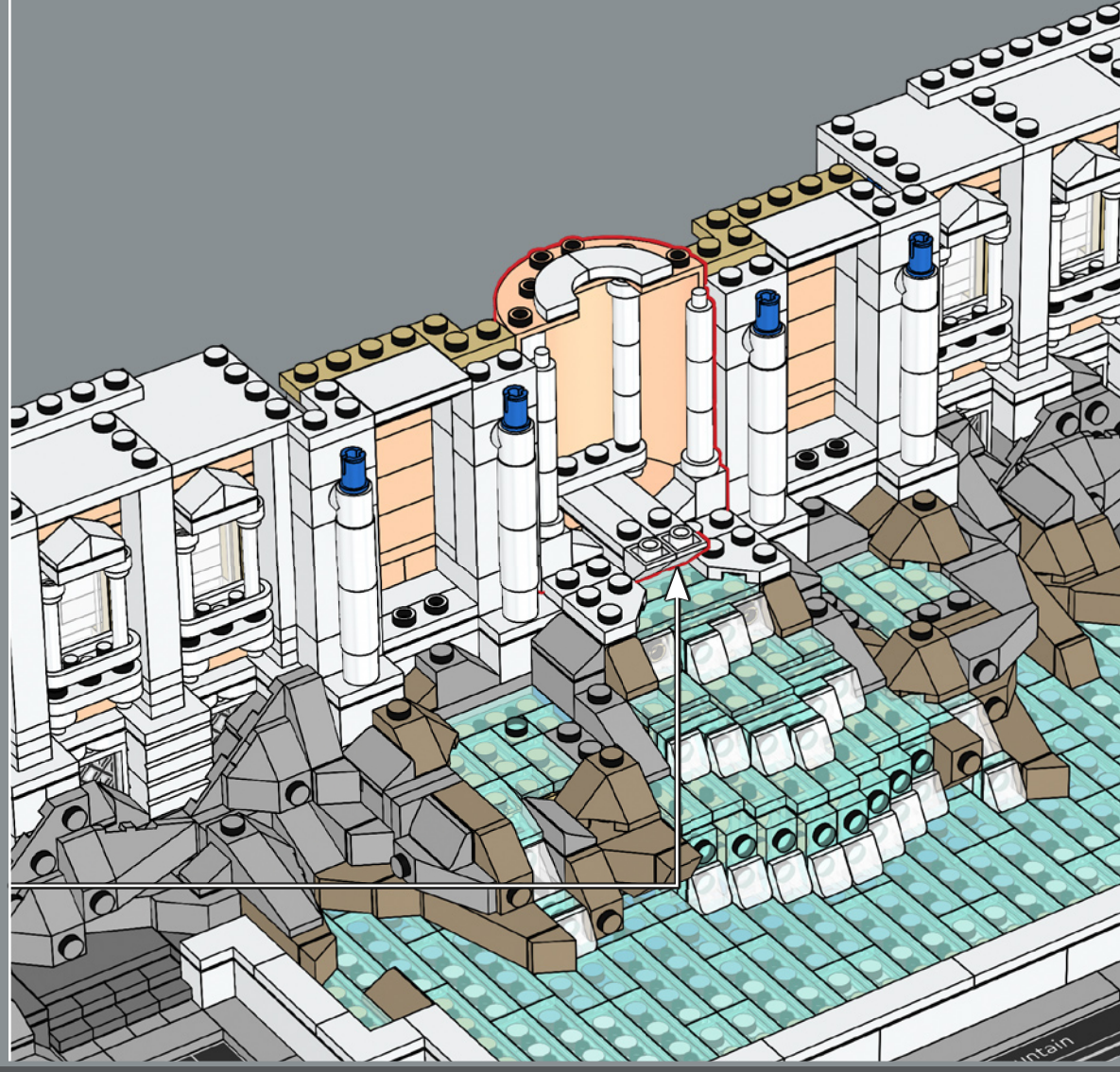

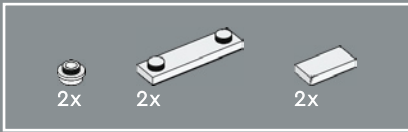

220

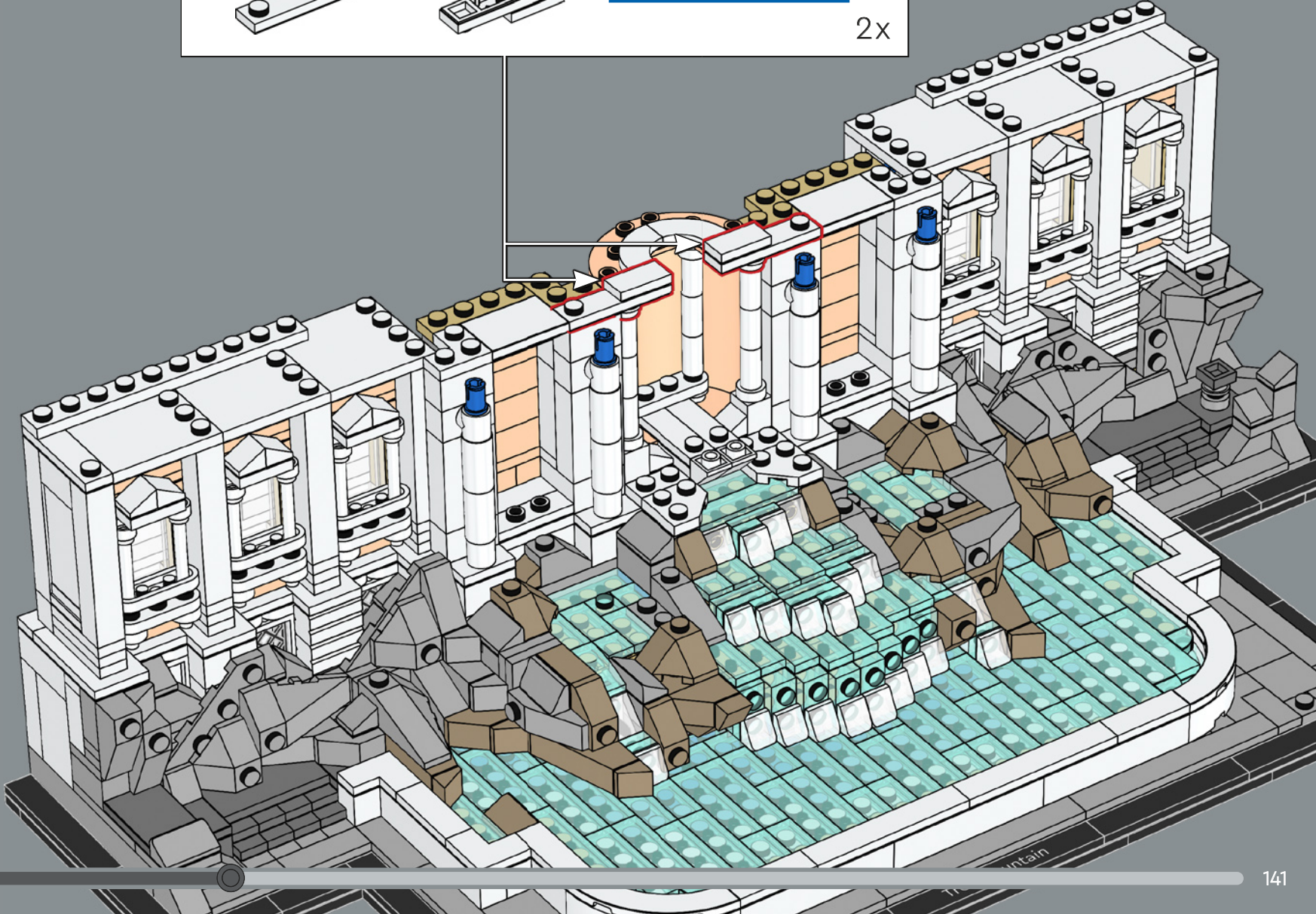
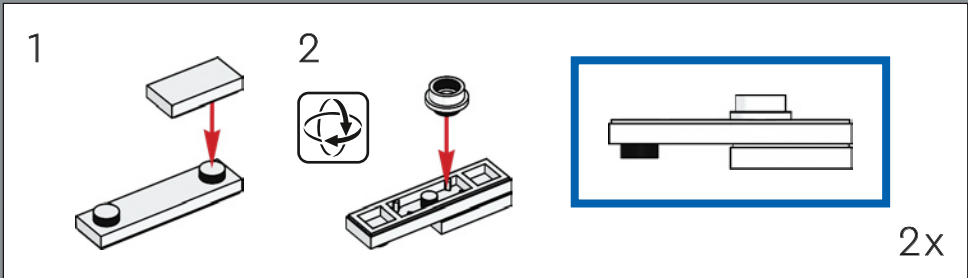

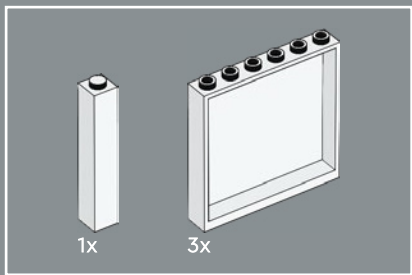

221

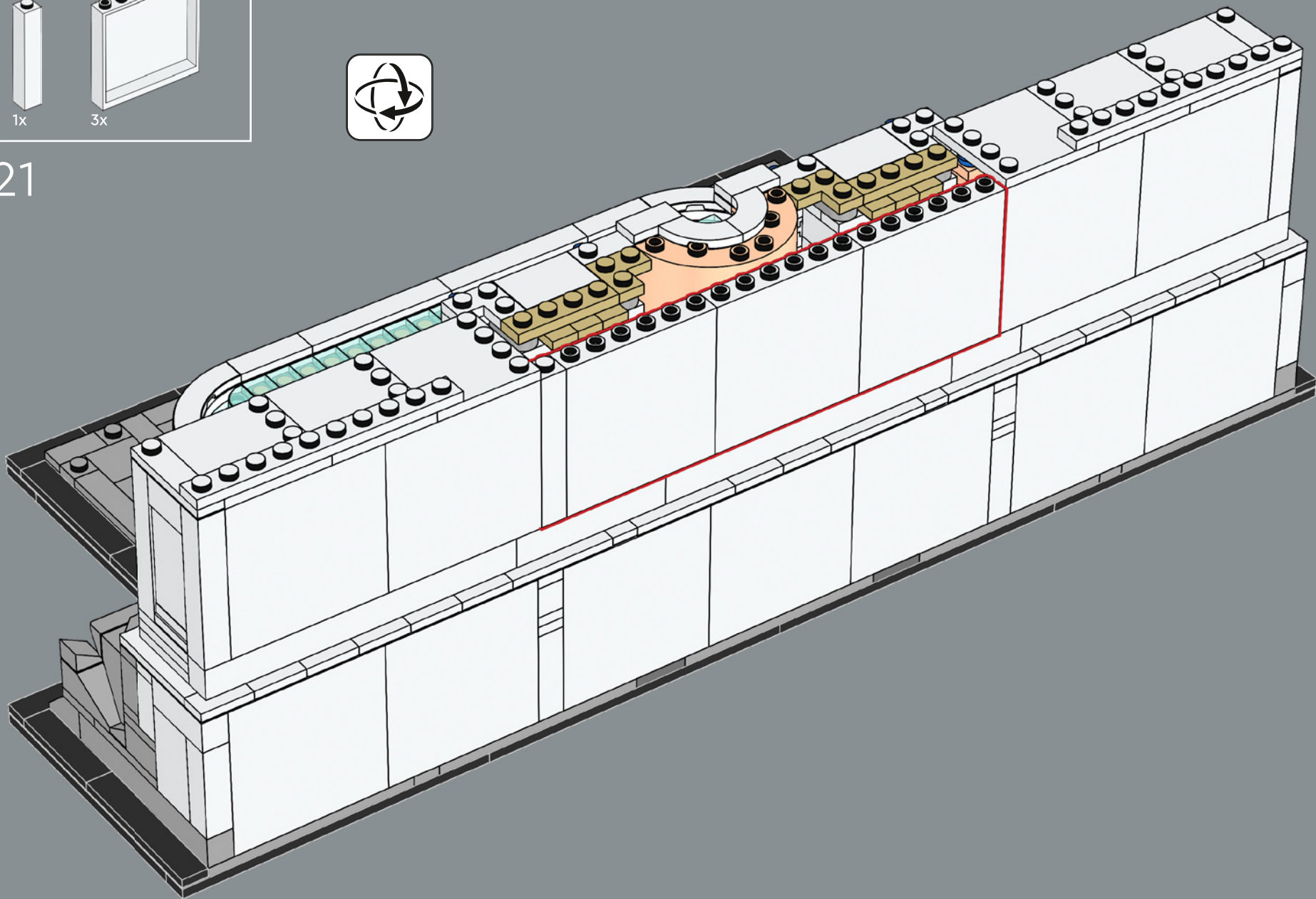

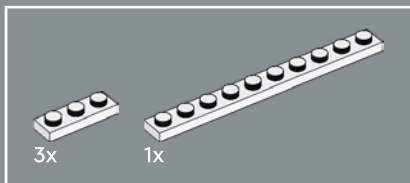

222

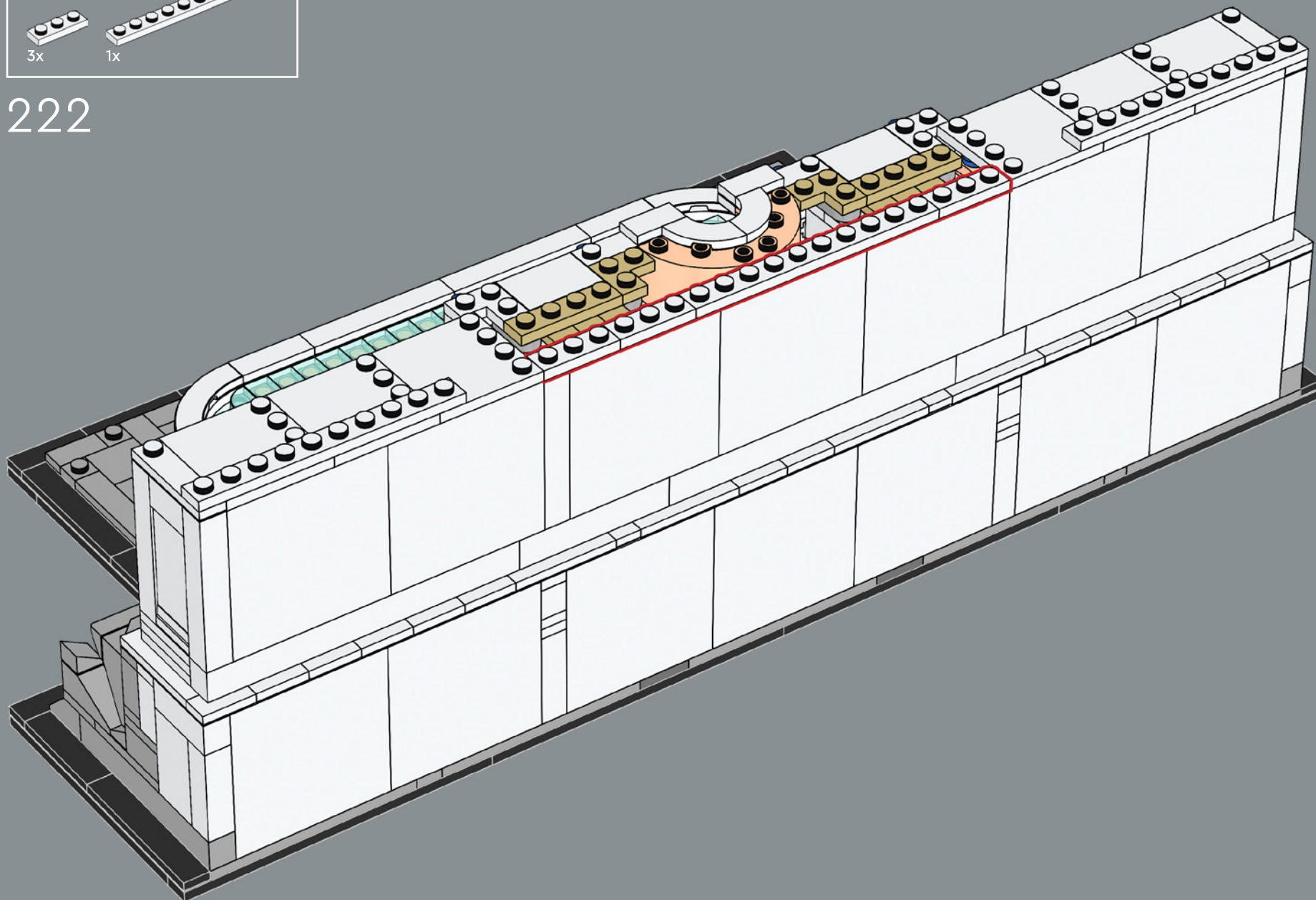

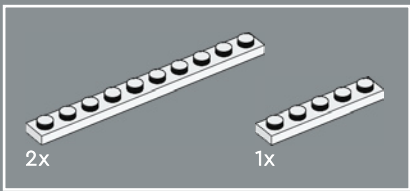

223

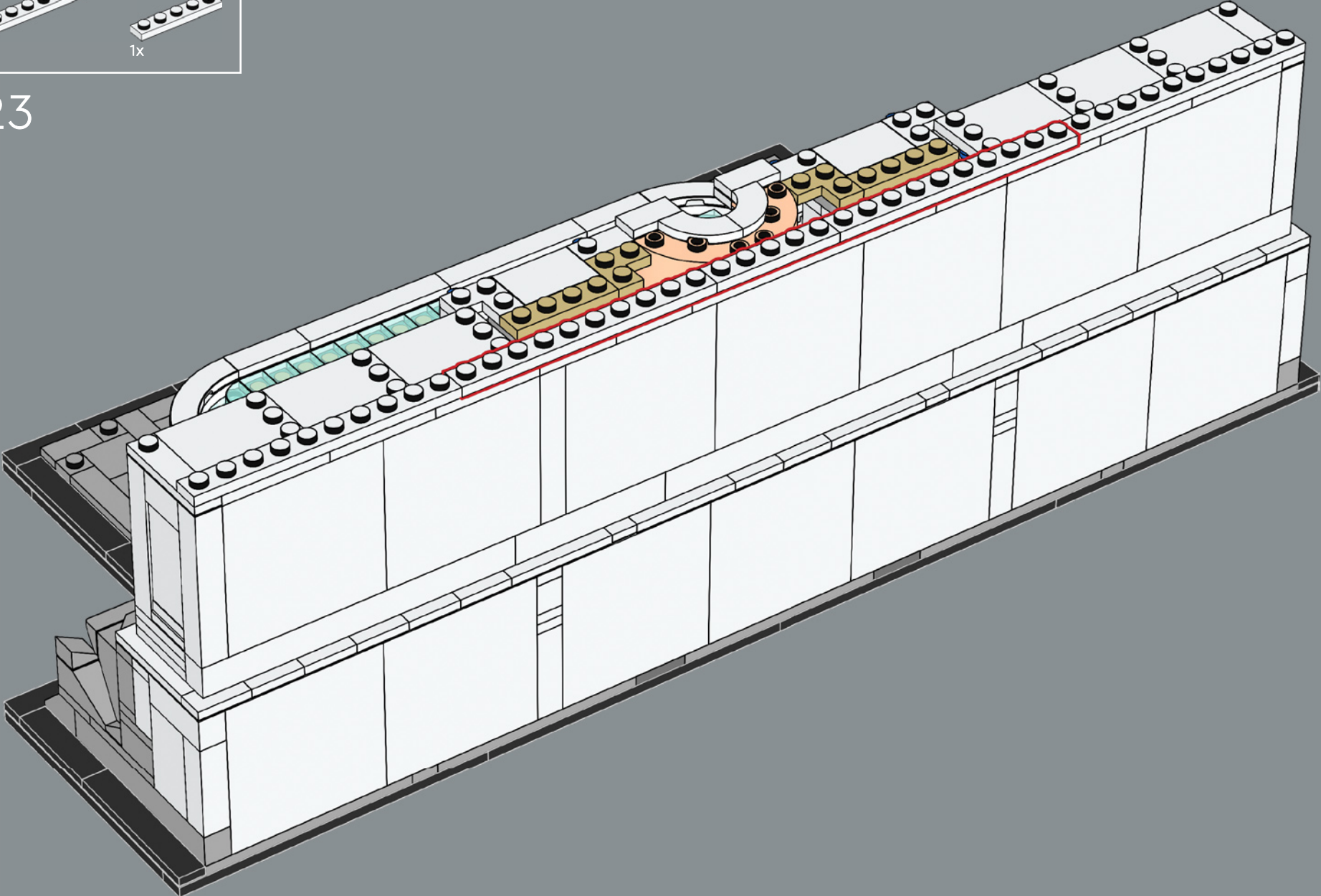

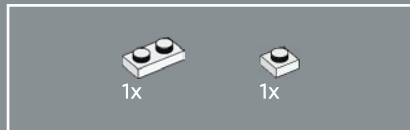
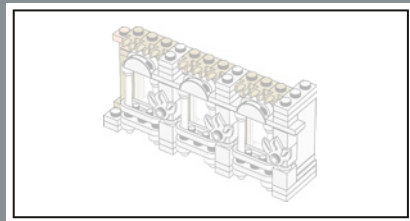

224

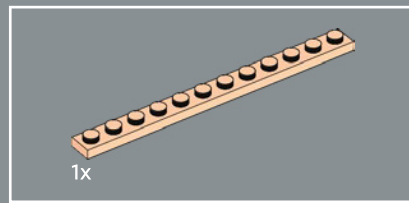
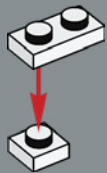

225

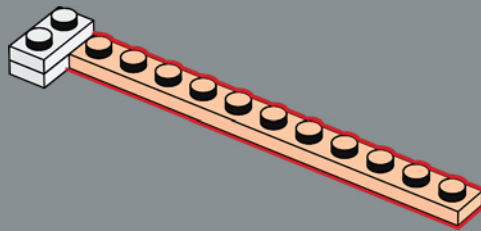

226

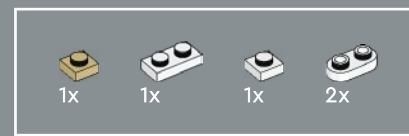
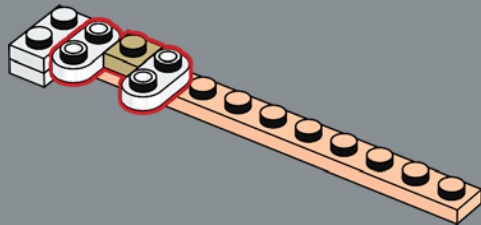

227

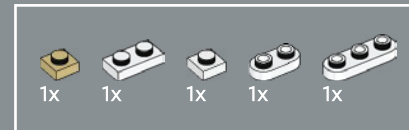
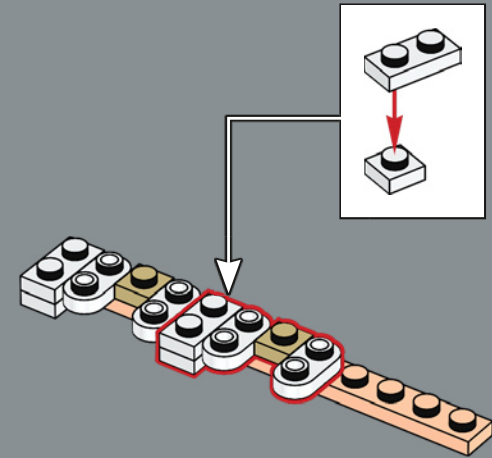

228

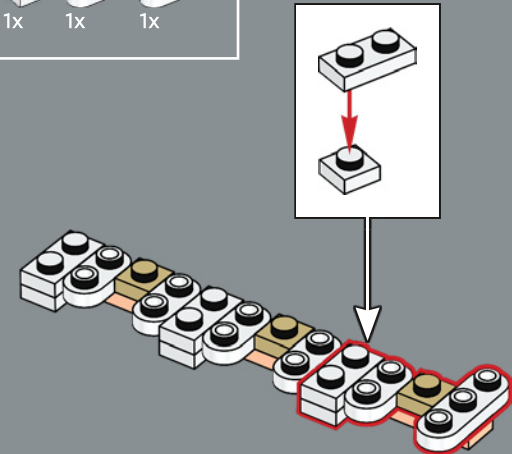

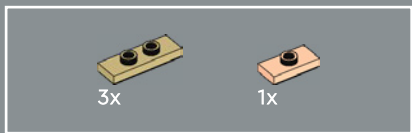

229

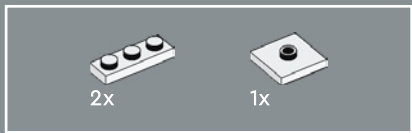
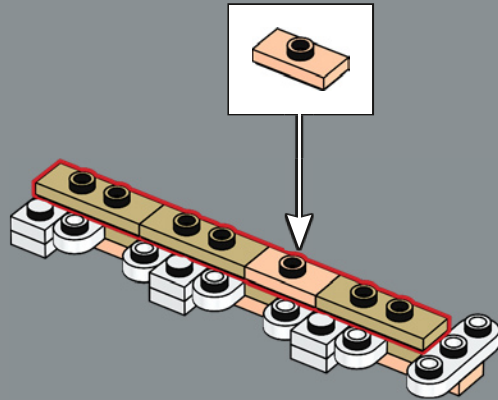

230

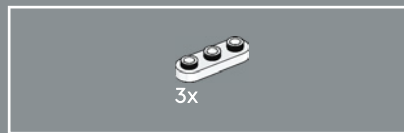
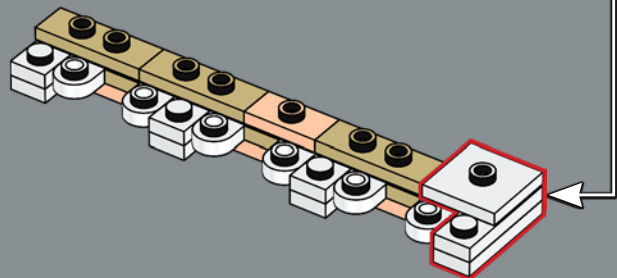
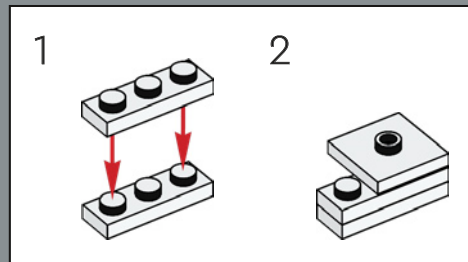

231

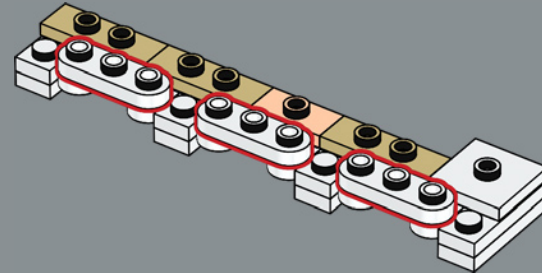

232

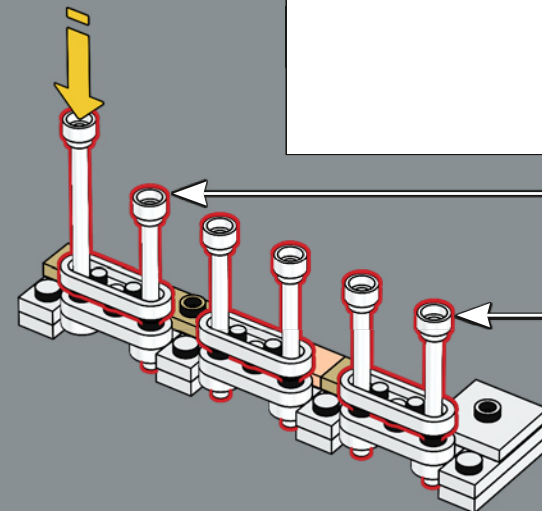
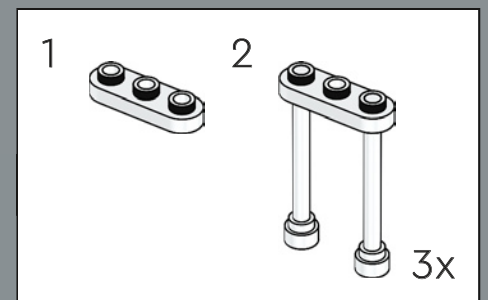

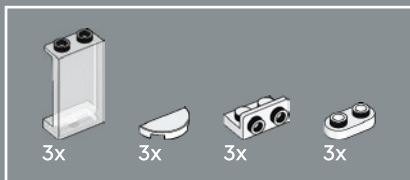

233

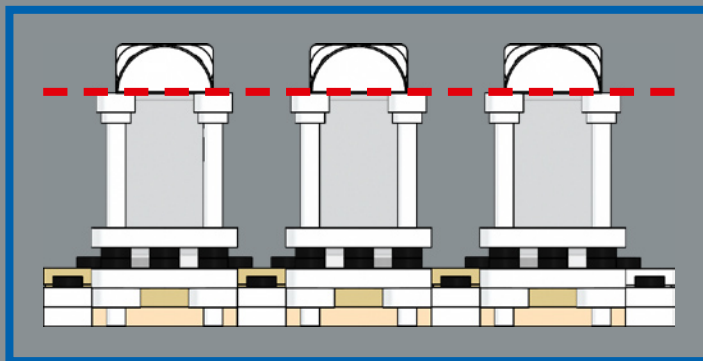

The farthest right 'window' is actually just a wall painted to resemble the other 11 windows.

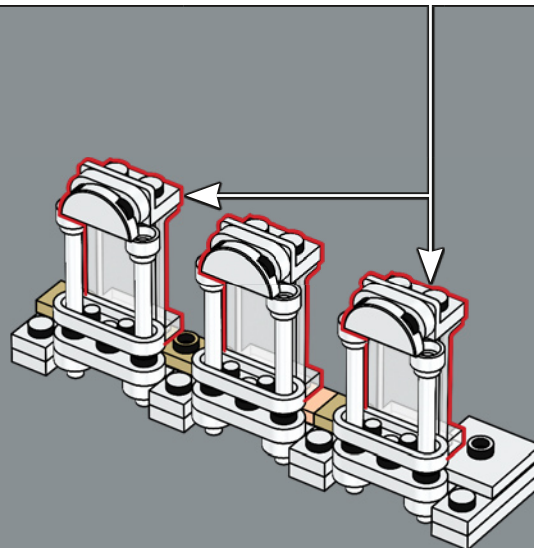
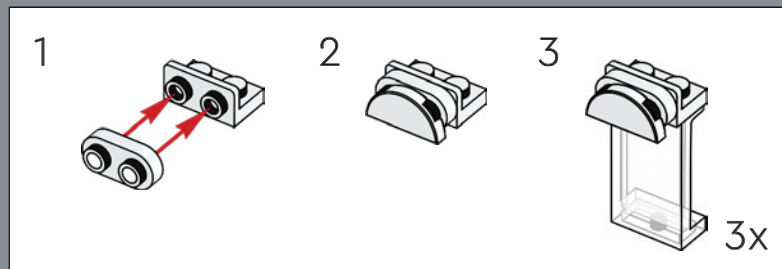

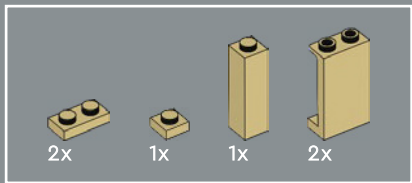

234

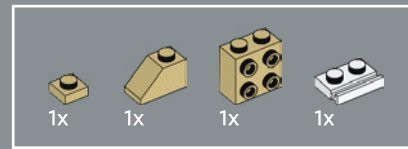
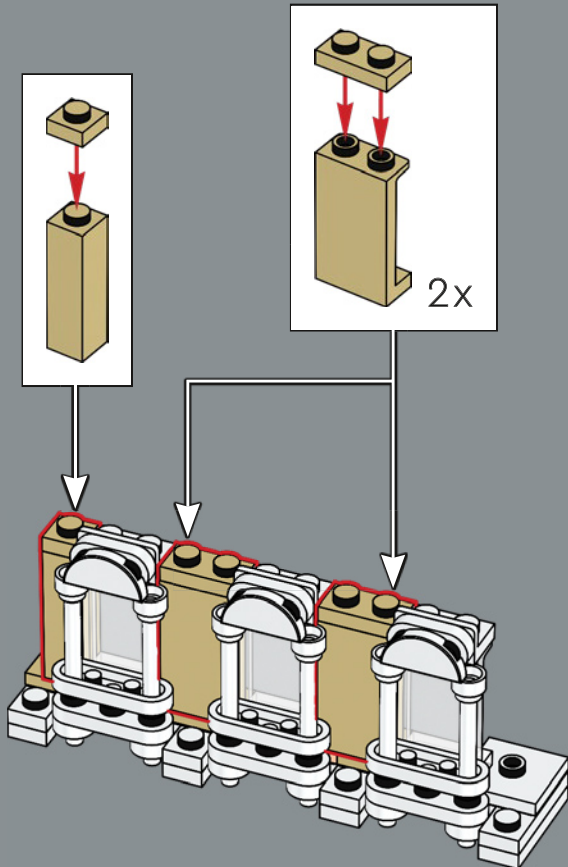

235

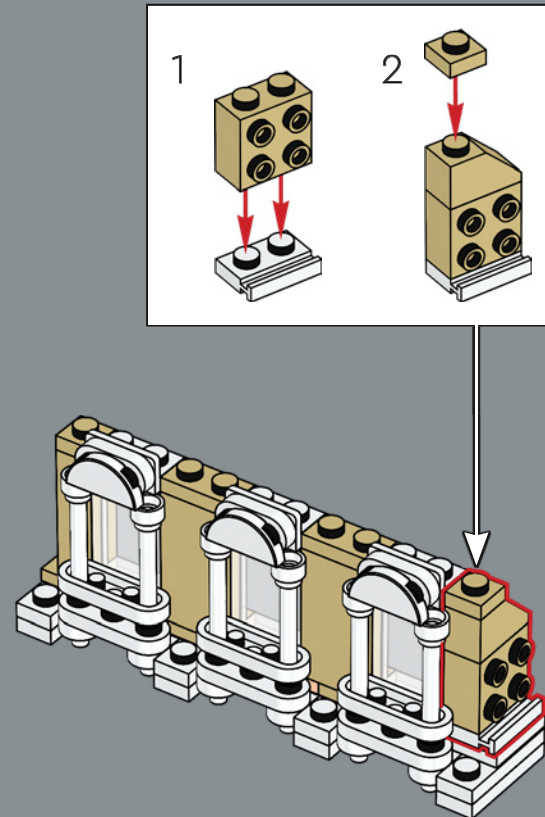

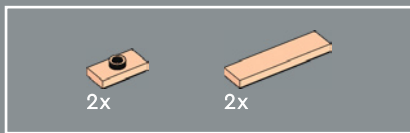

236

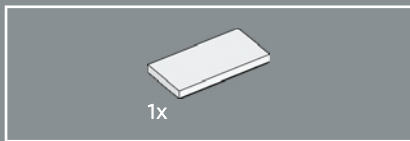
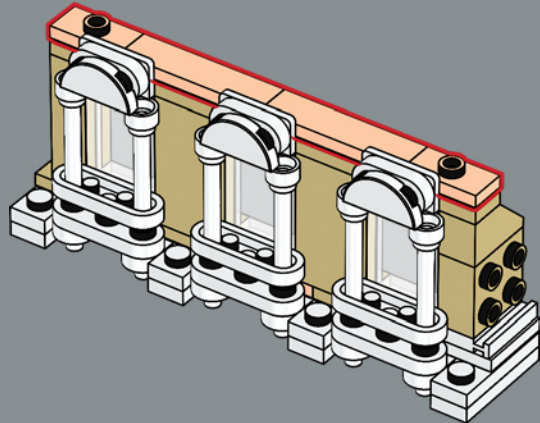

237

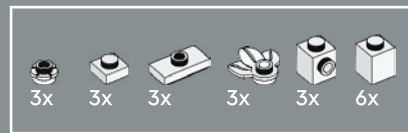
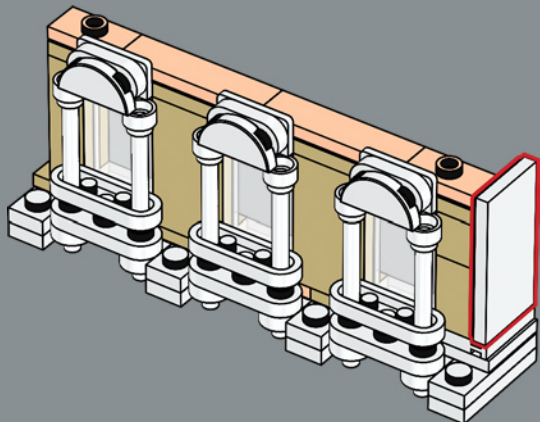

238

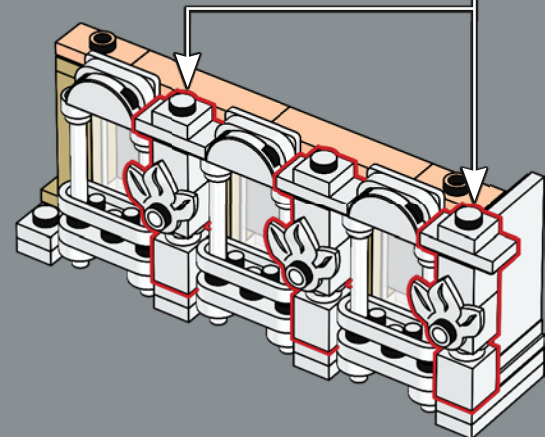
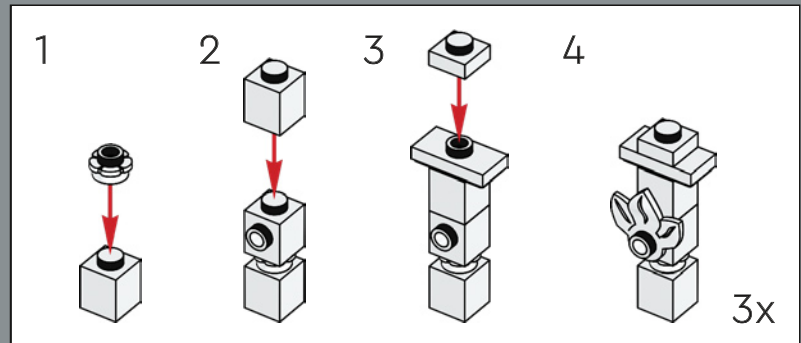

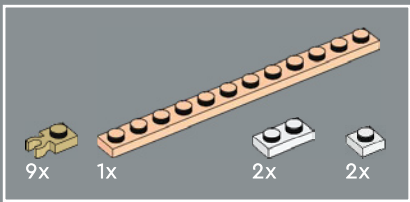

239

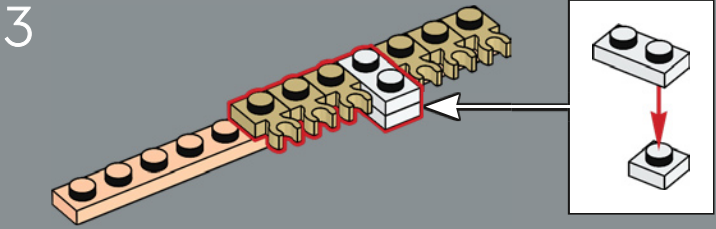
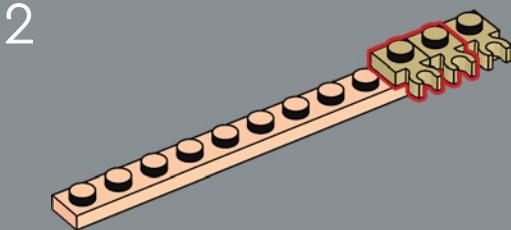
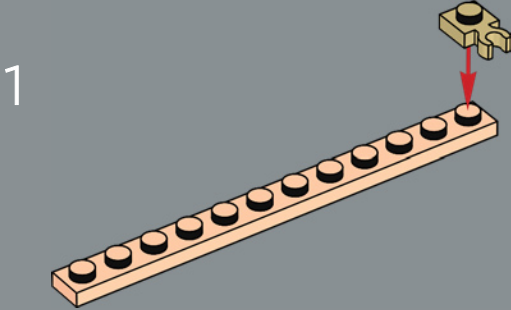

4

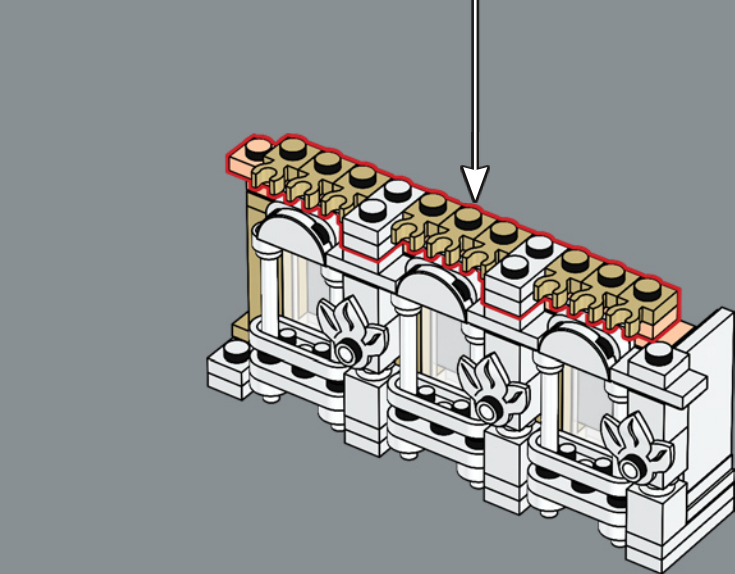
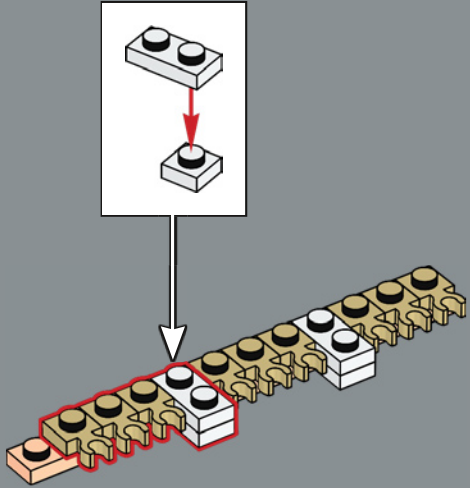

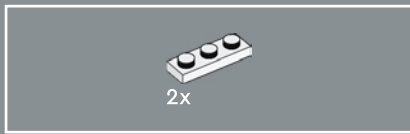

240

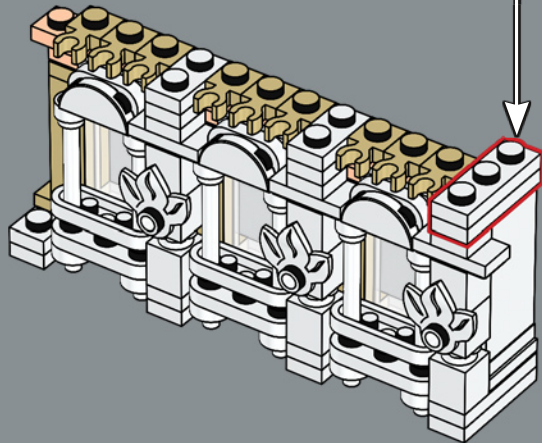
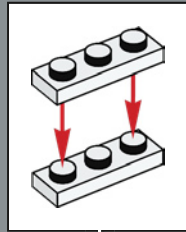

241

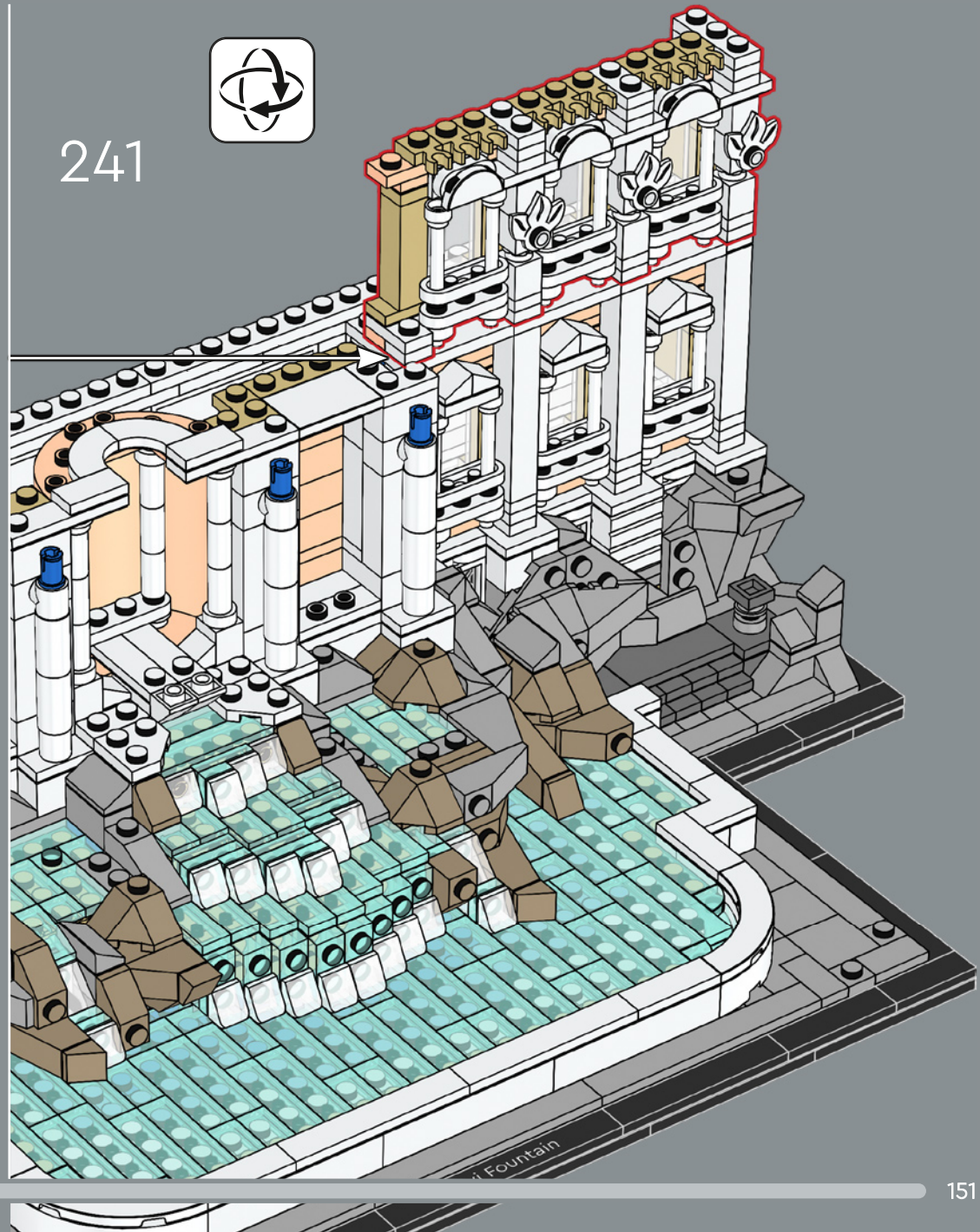

Fountain

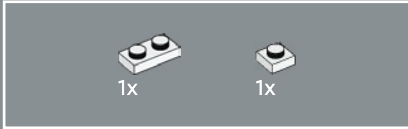
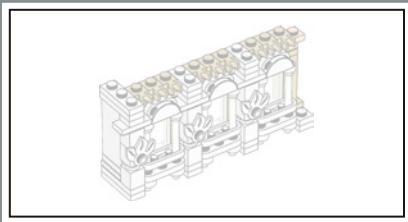

242

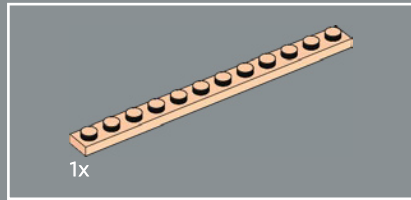
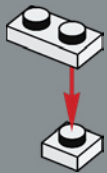

243

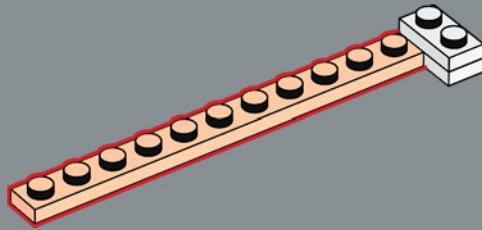

244

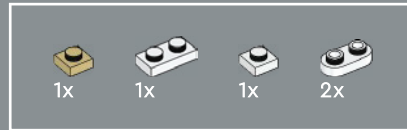
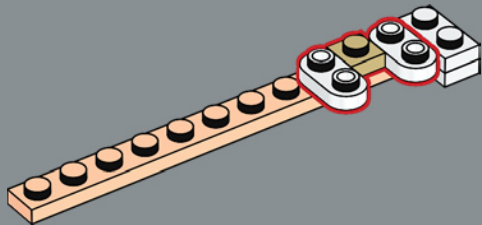

245

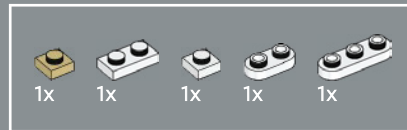
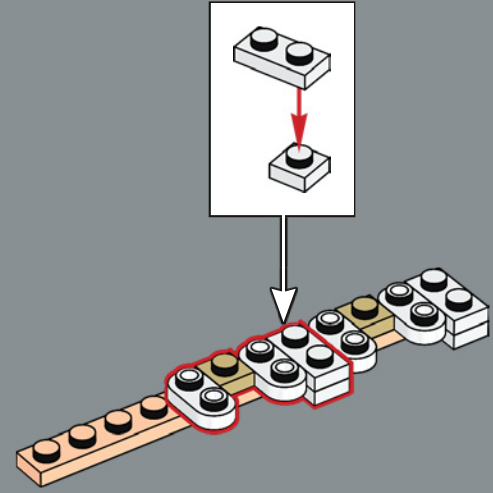

246

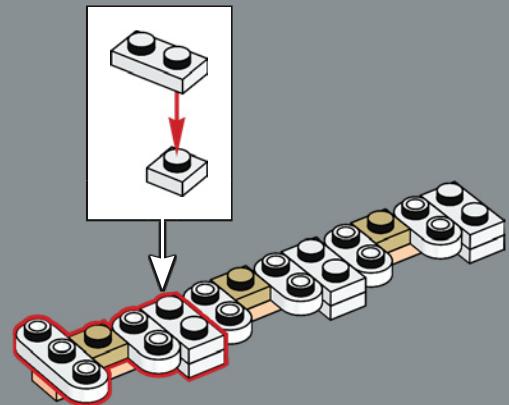

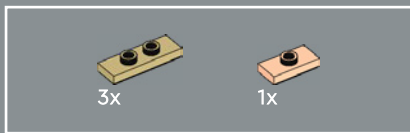

247

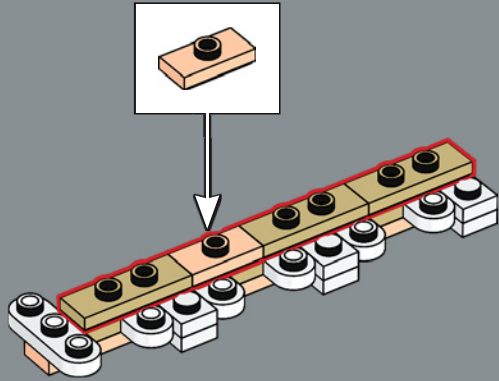

248

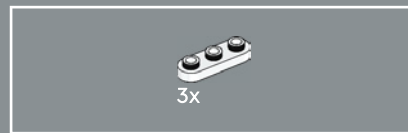
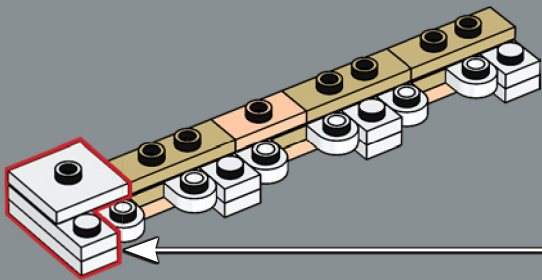
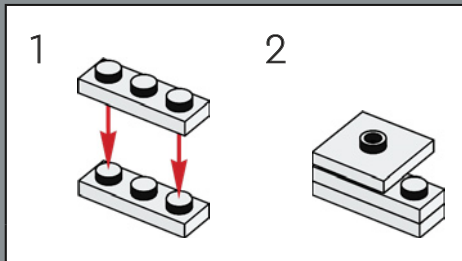

249

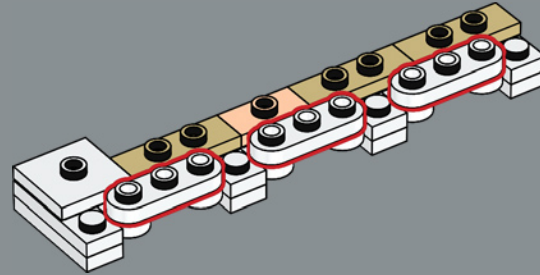

250

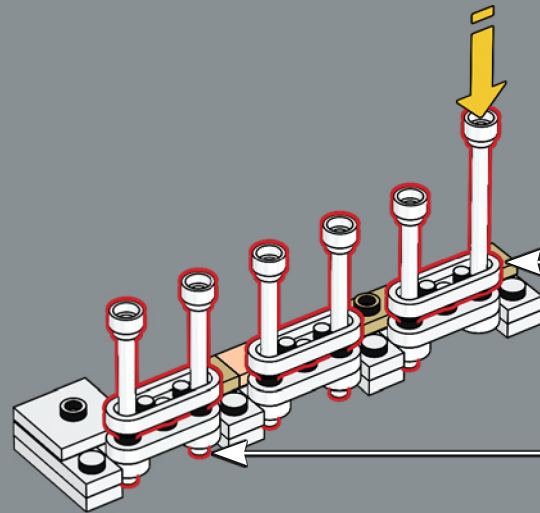
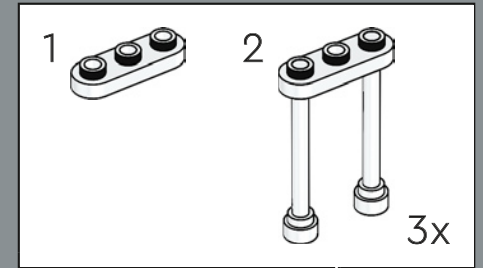

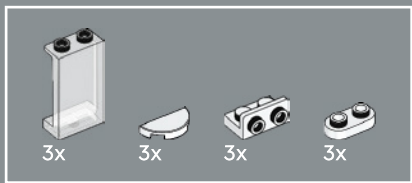

251

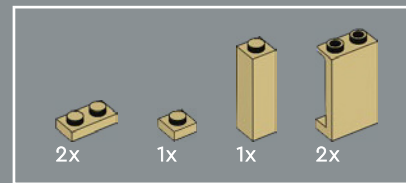
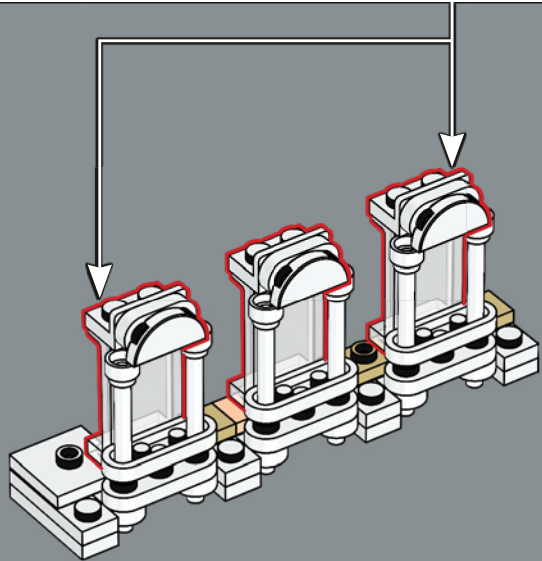
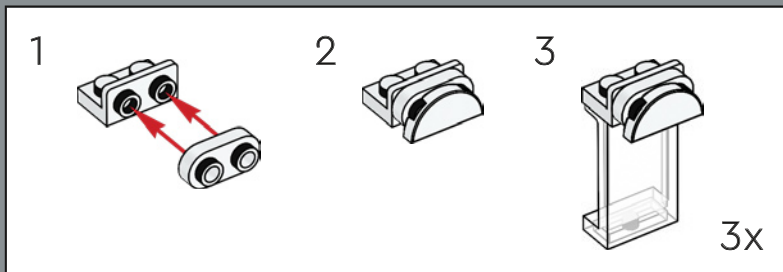
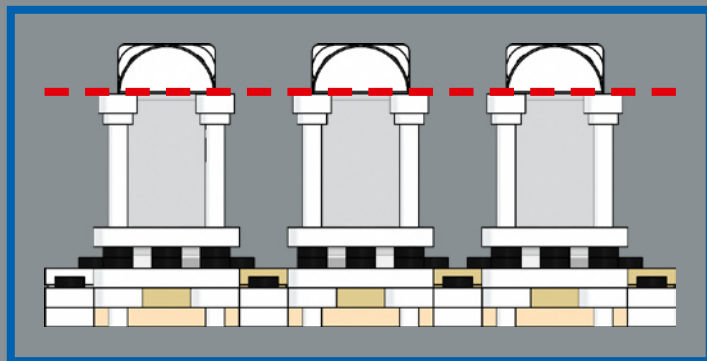

252

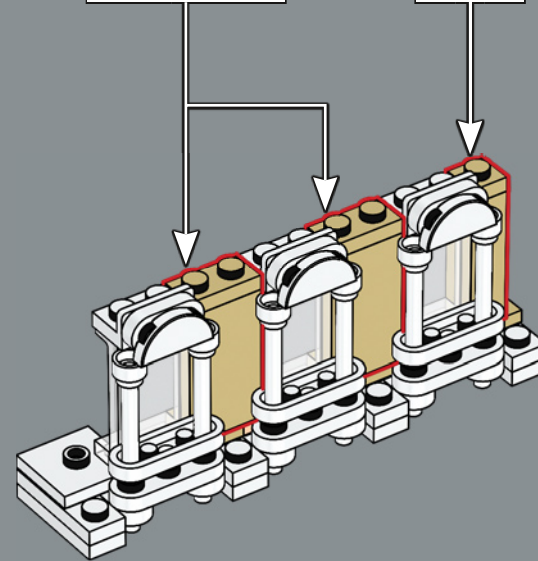
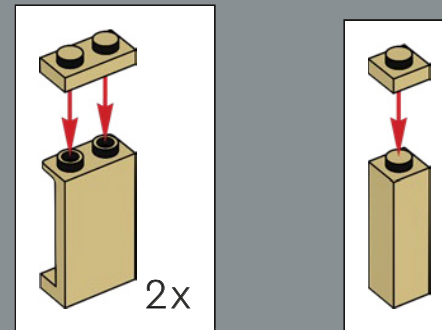

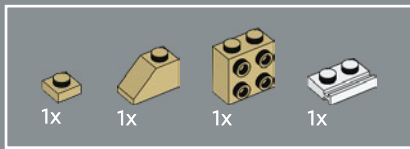

253

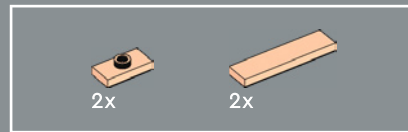
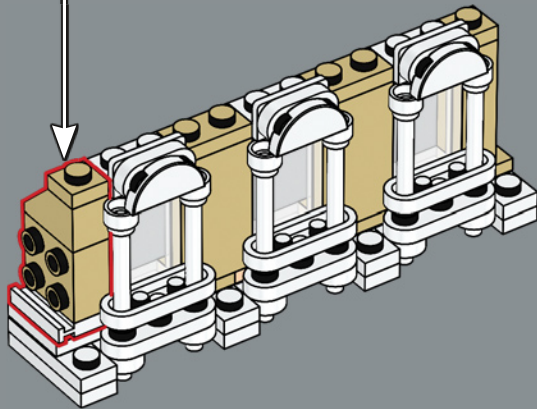
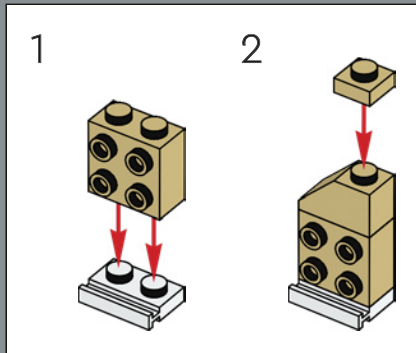

254

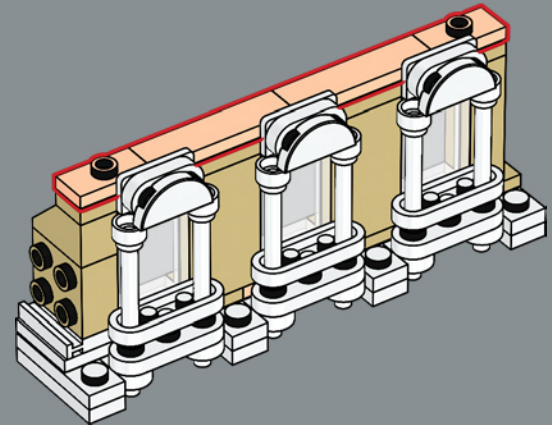

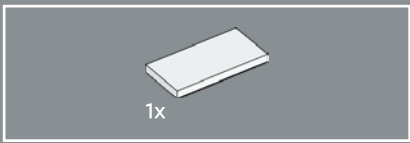

255

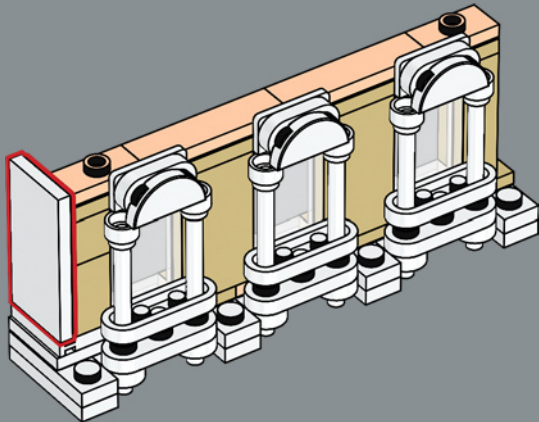

256

The LEGO® leaf elements used here help create the capitals of the Corinthian pillars.

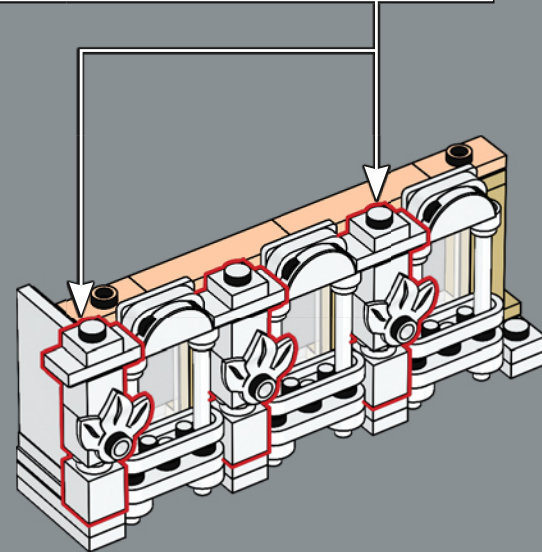
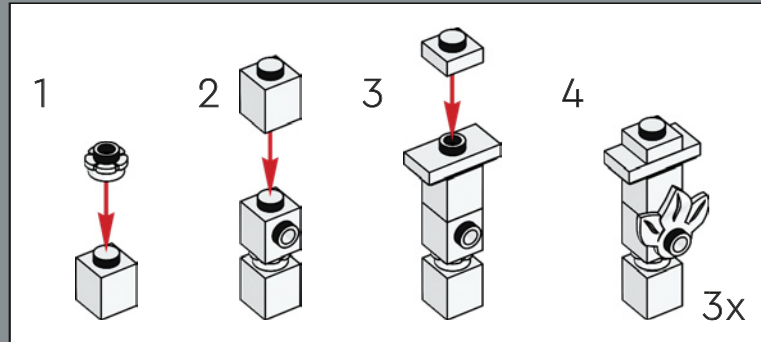

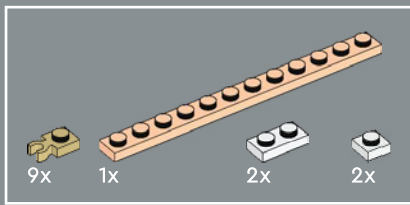

257

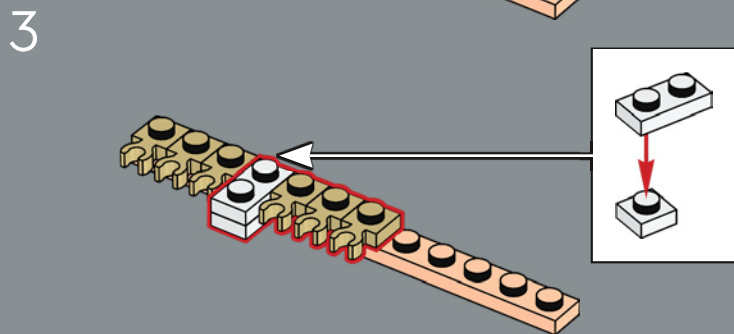
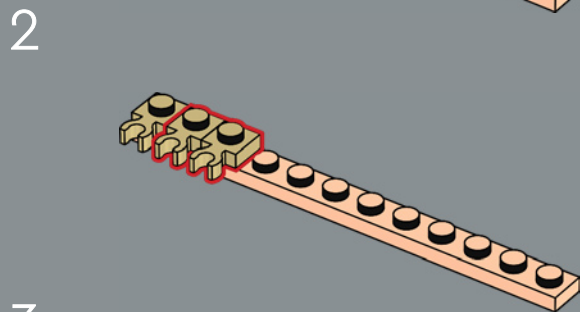
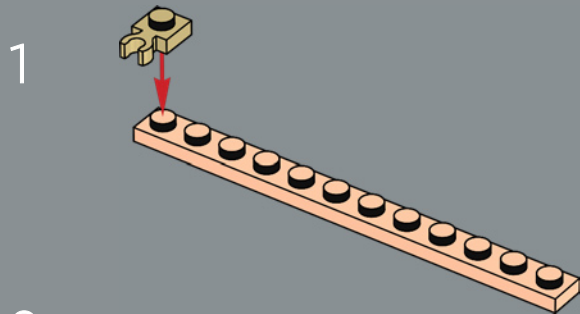

4

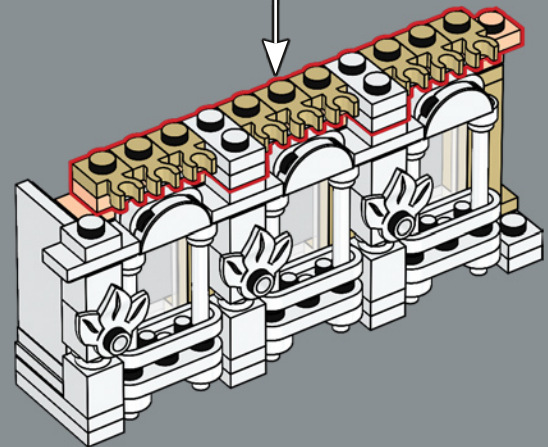
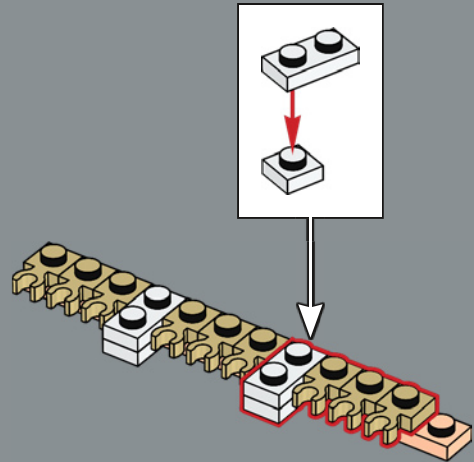



258

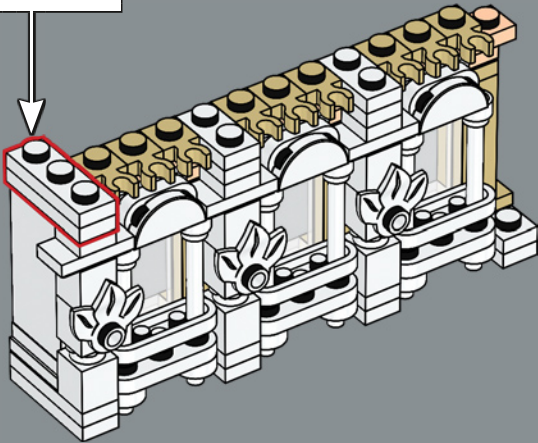
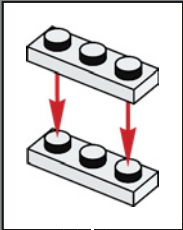

259

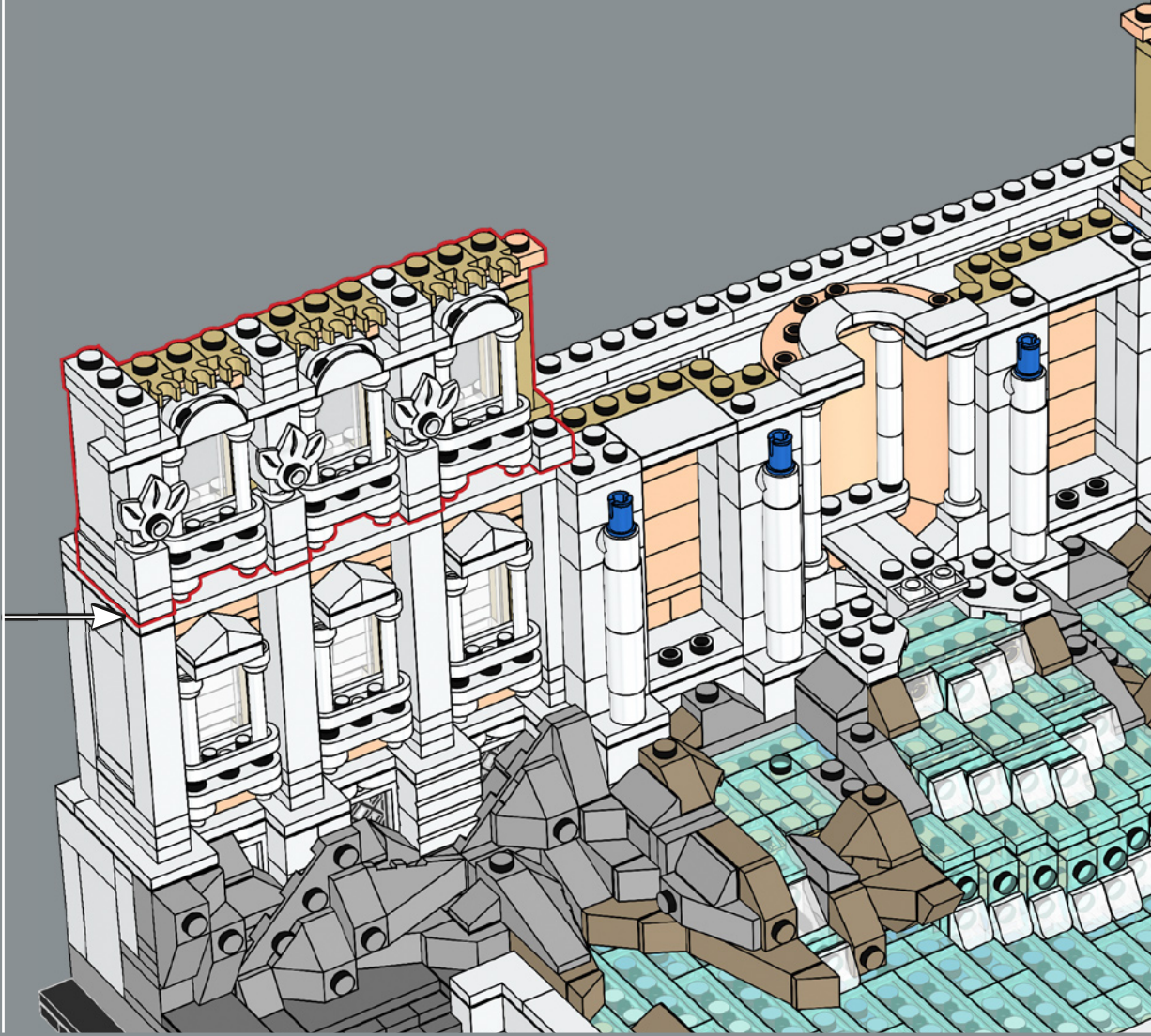

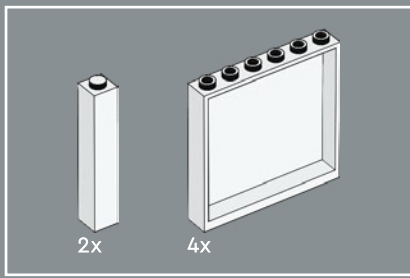

260

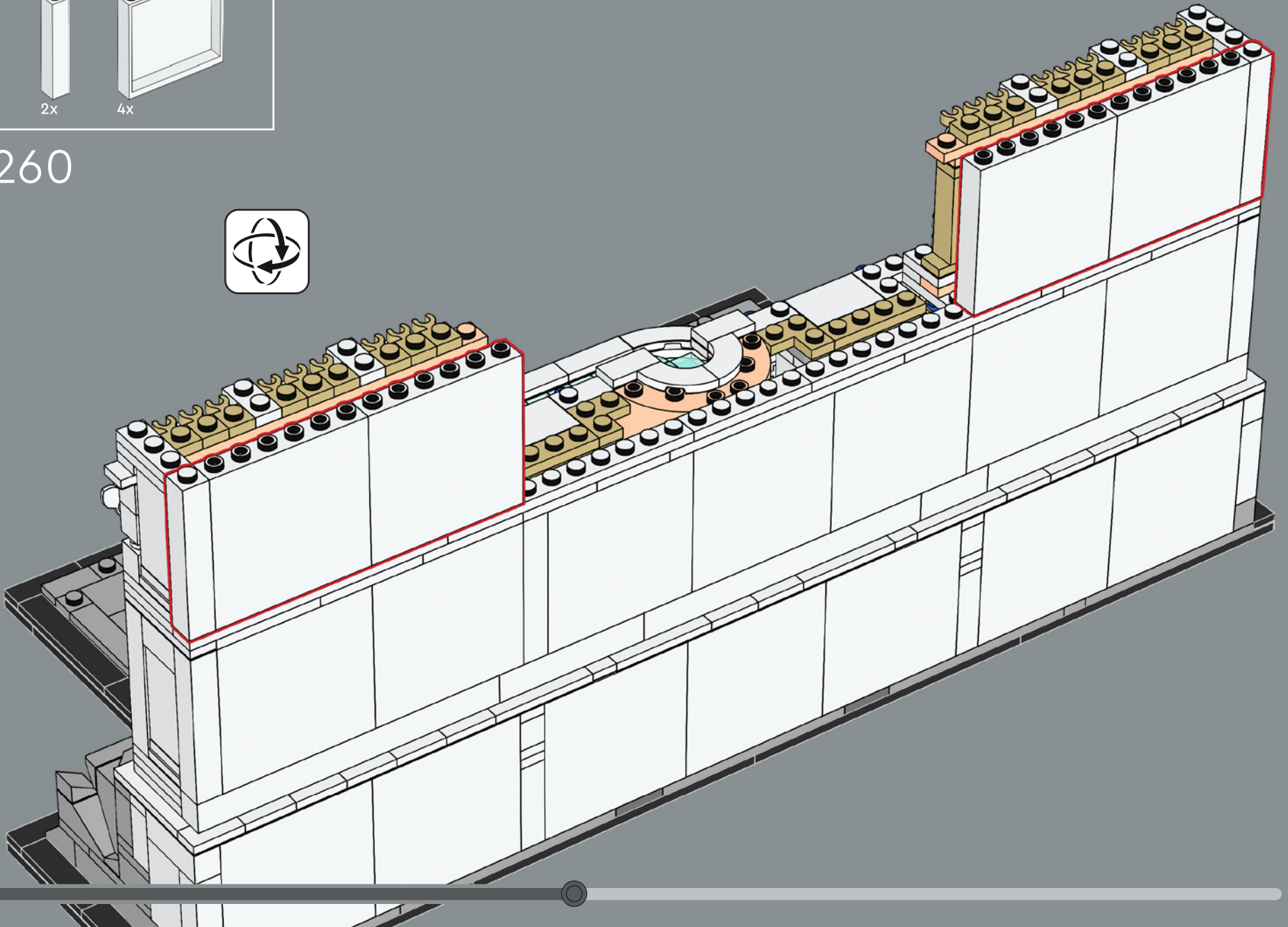



261

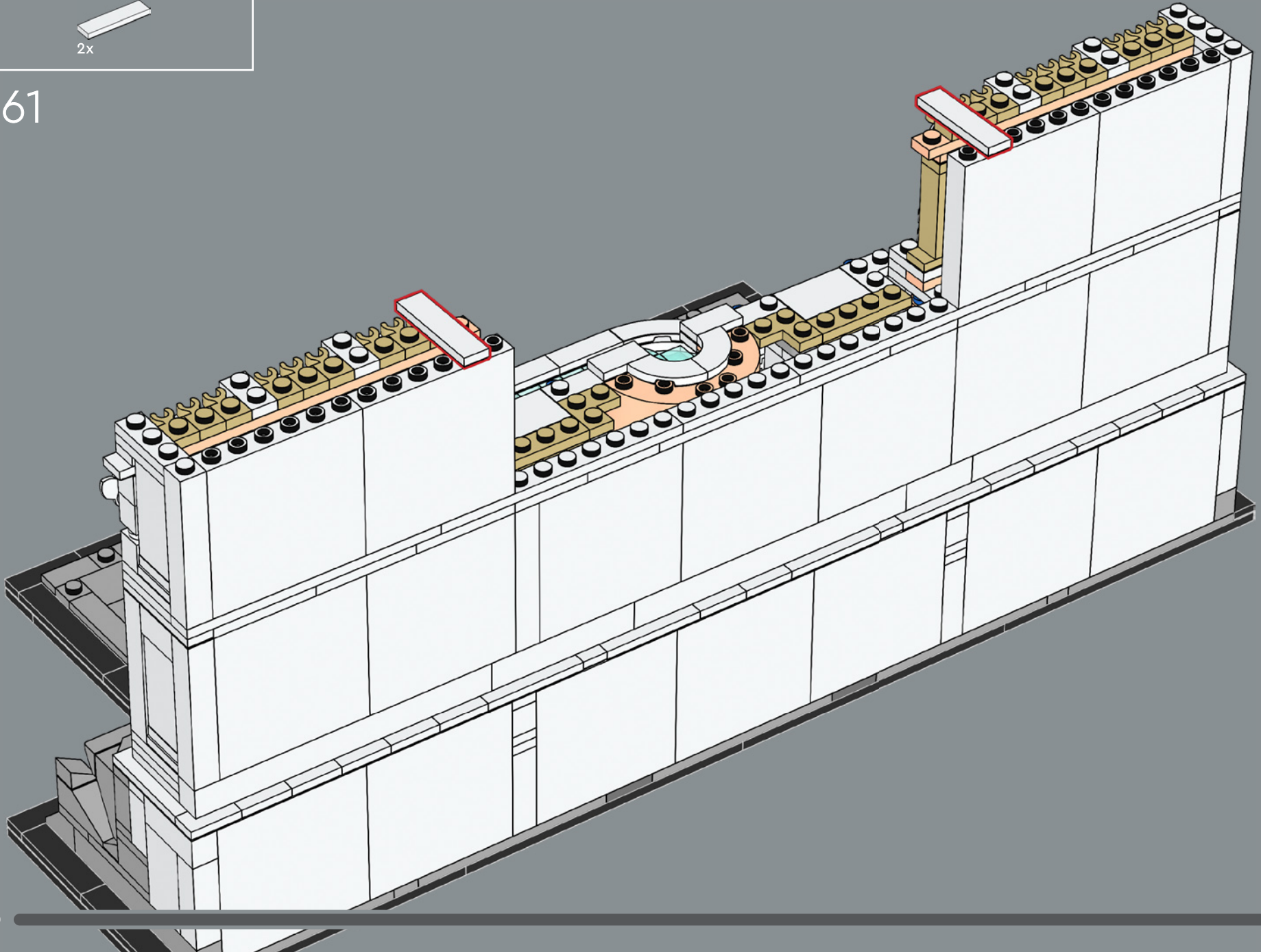

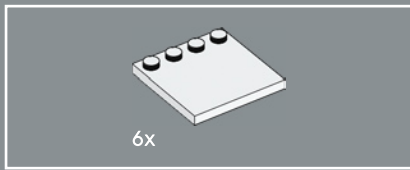

262

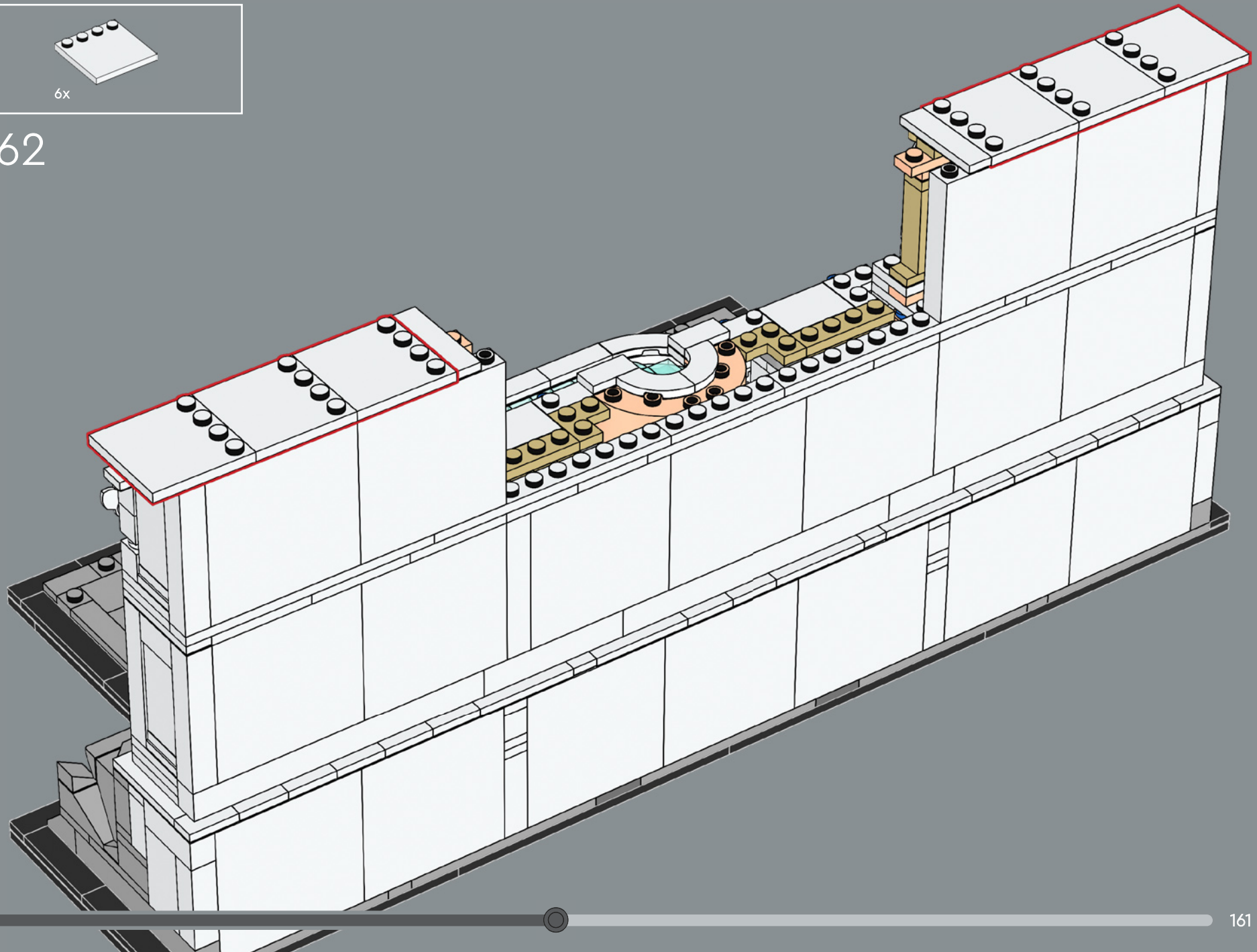

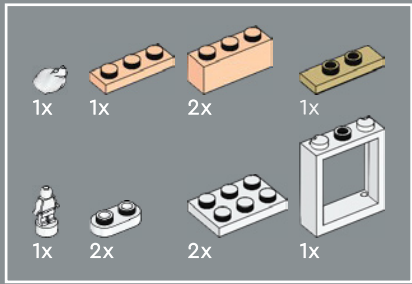

263

1

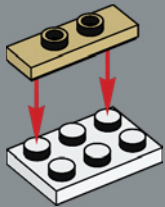

2

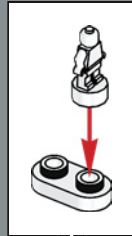
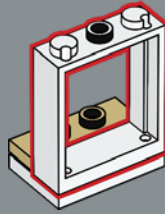

3

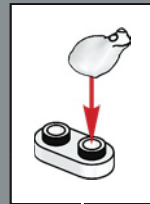
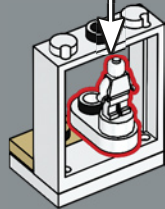

4



1

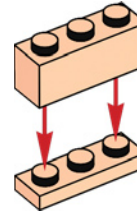

2

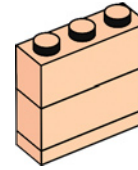

5



6



Both the left and right reliefs include a standing and a kneeling figure, represented here by a LEGO® minifigure trophy and a frog.

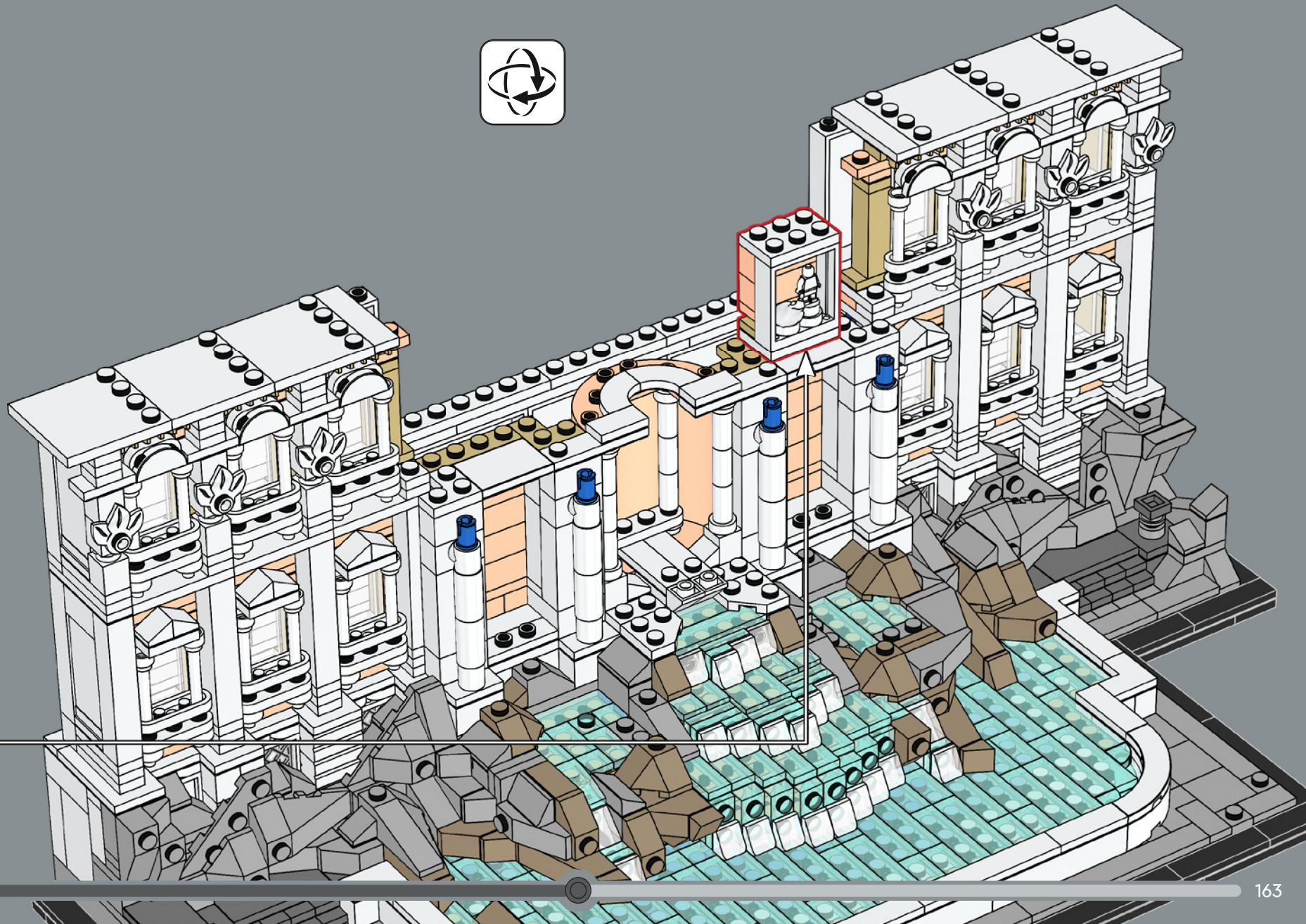

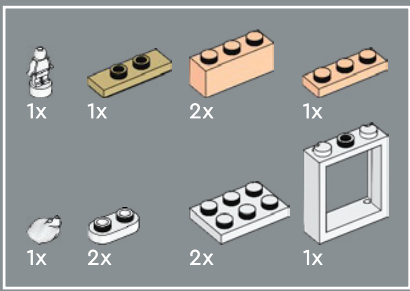

264

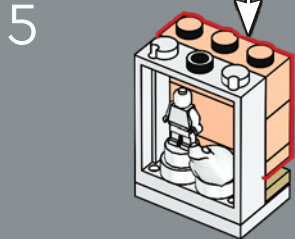
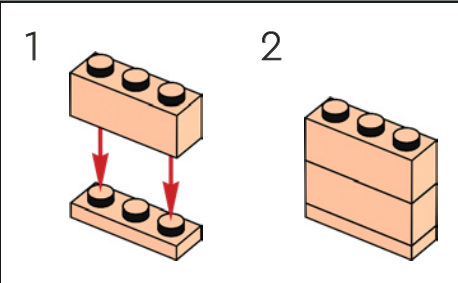
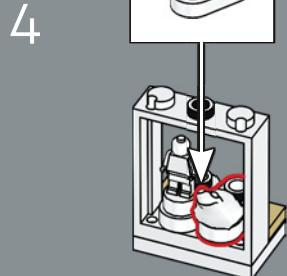
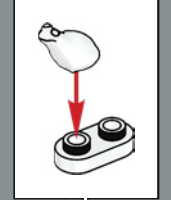
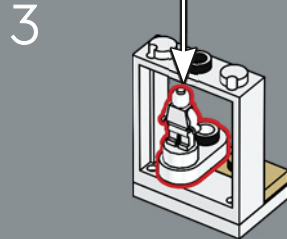
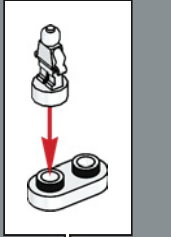
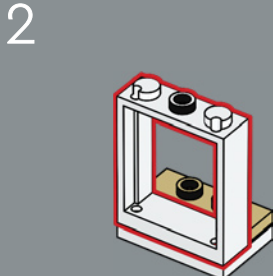
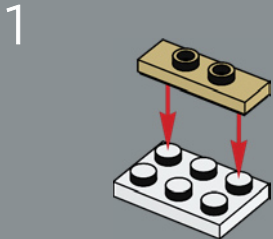

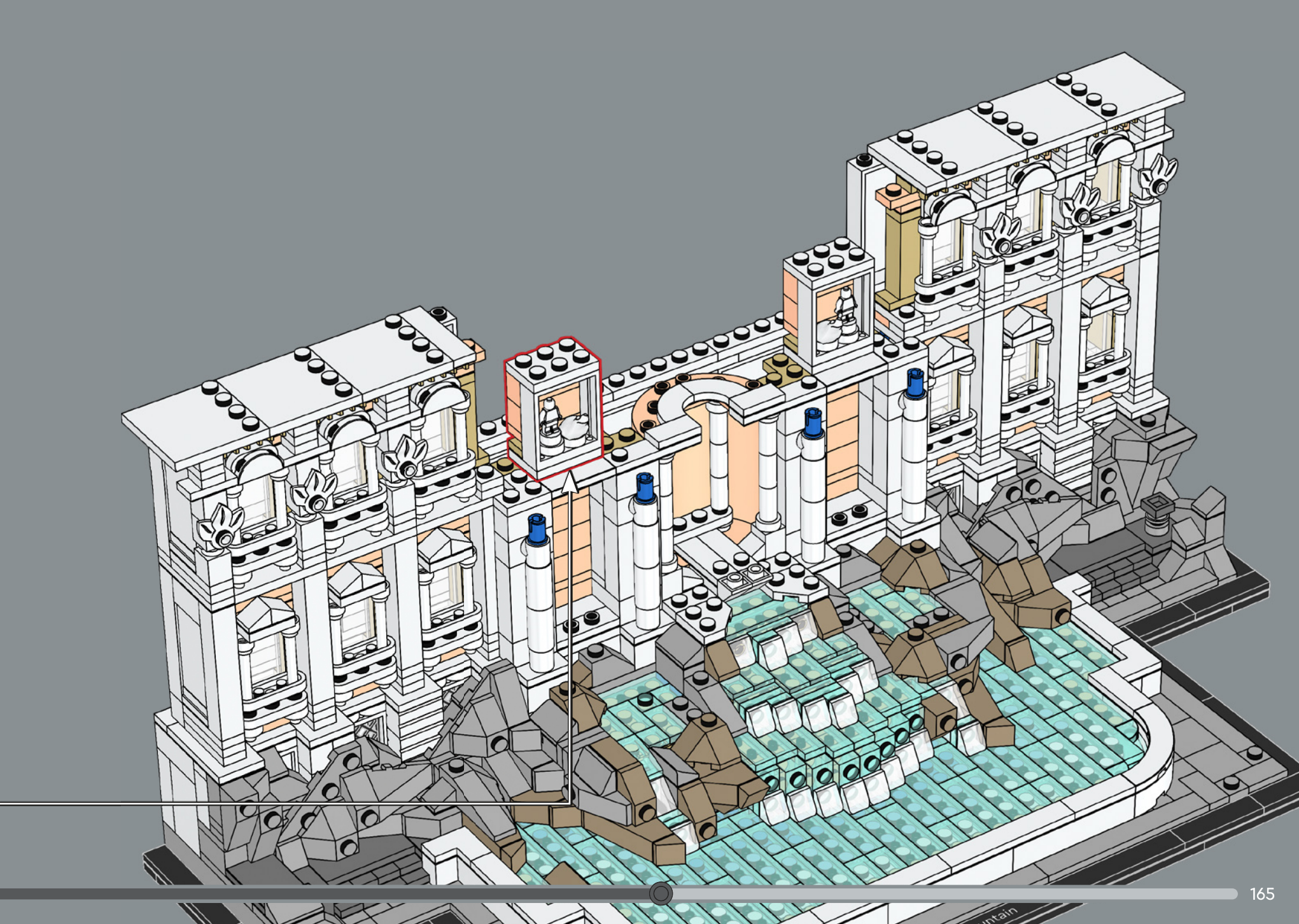

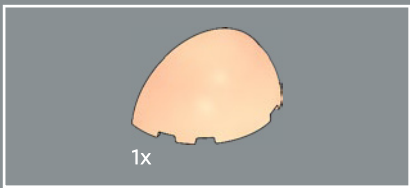

265

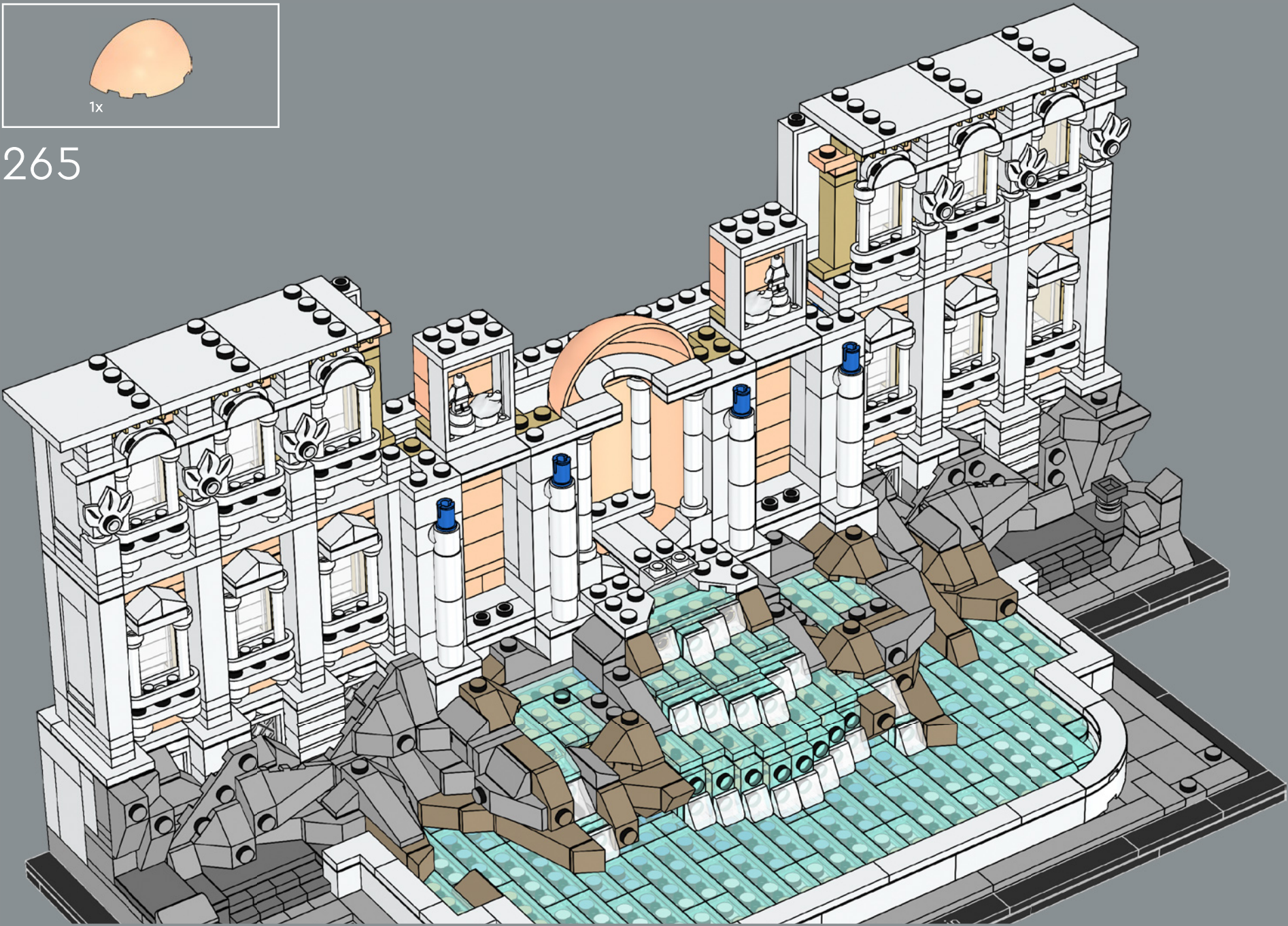

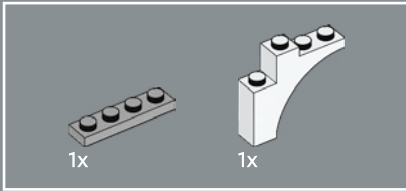
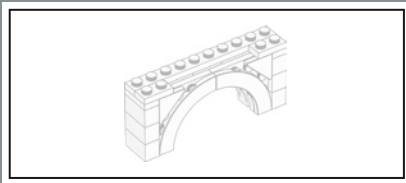

266

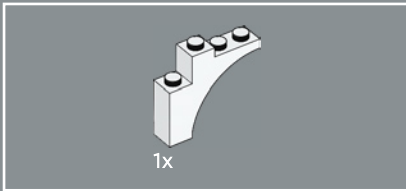
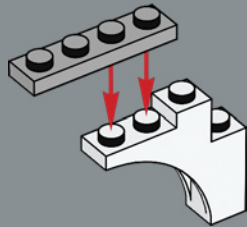

267

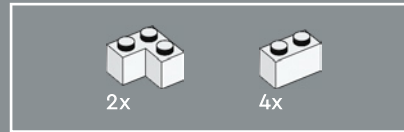
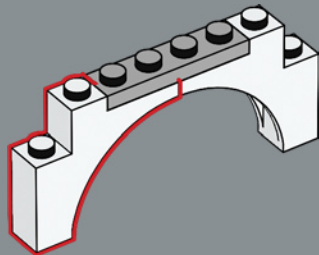

268

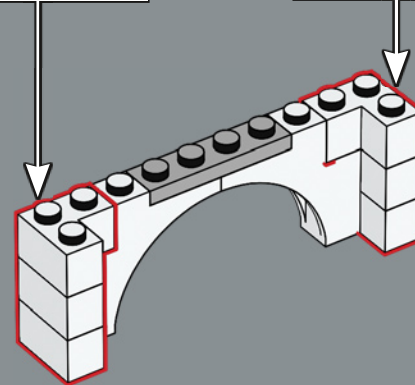
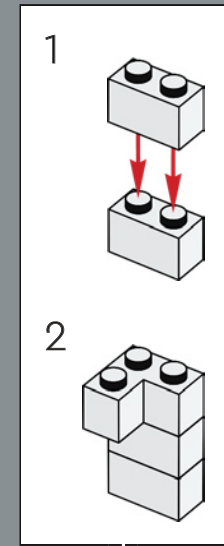
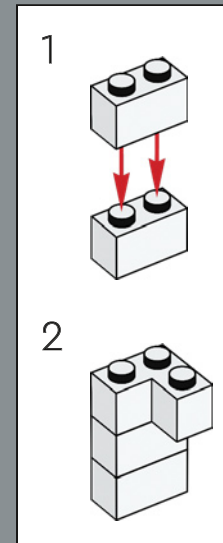

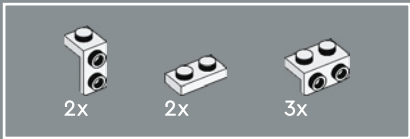

269

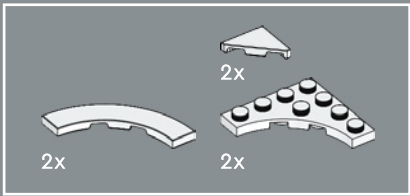
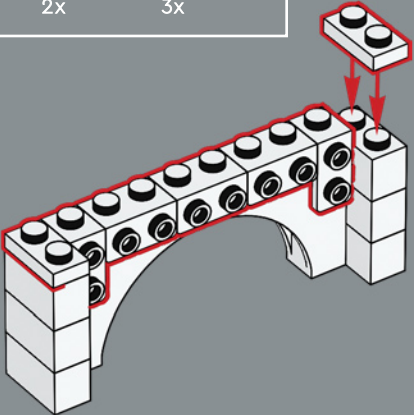

270

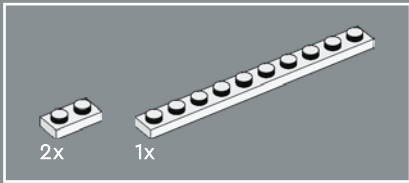
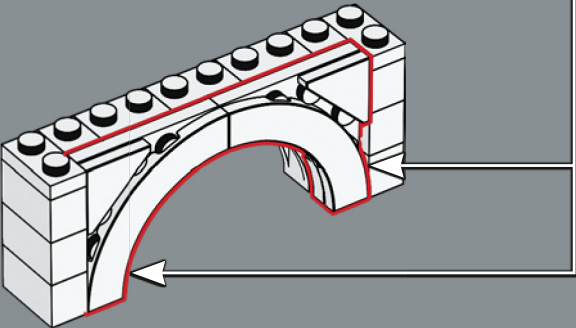
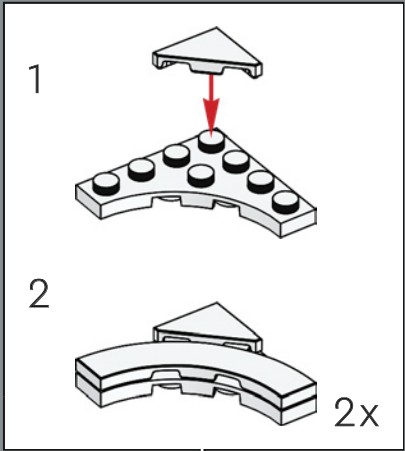

271

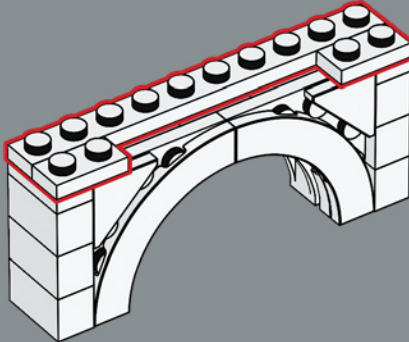

272

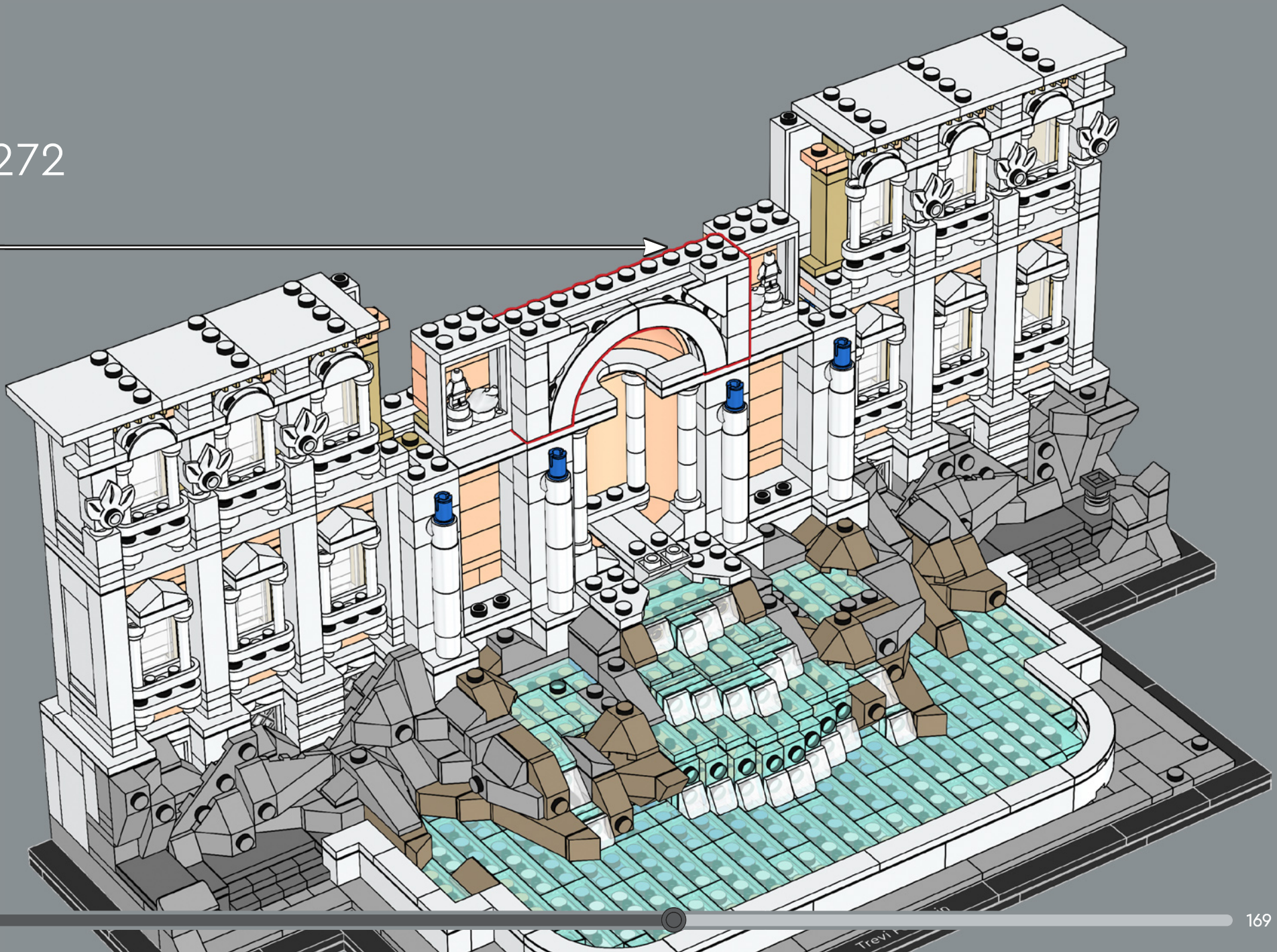

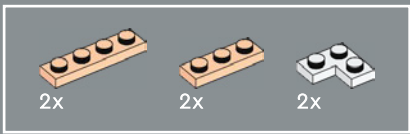

273

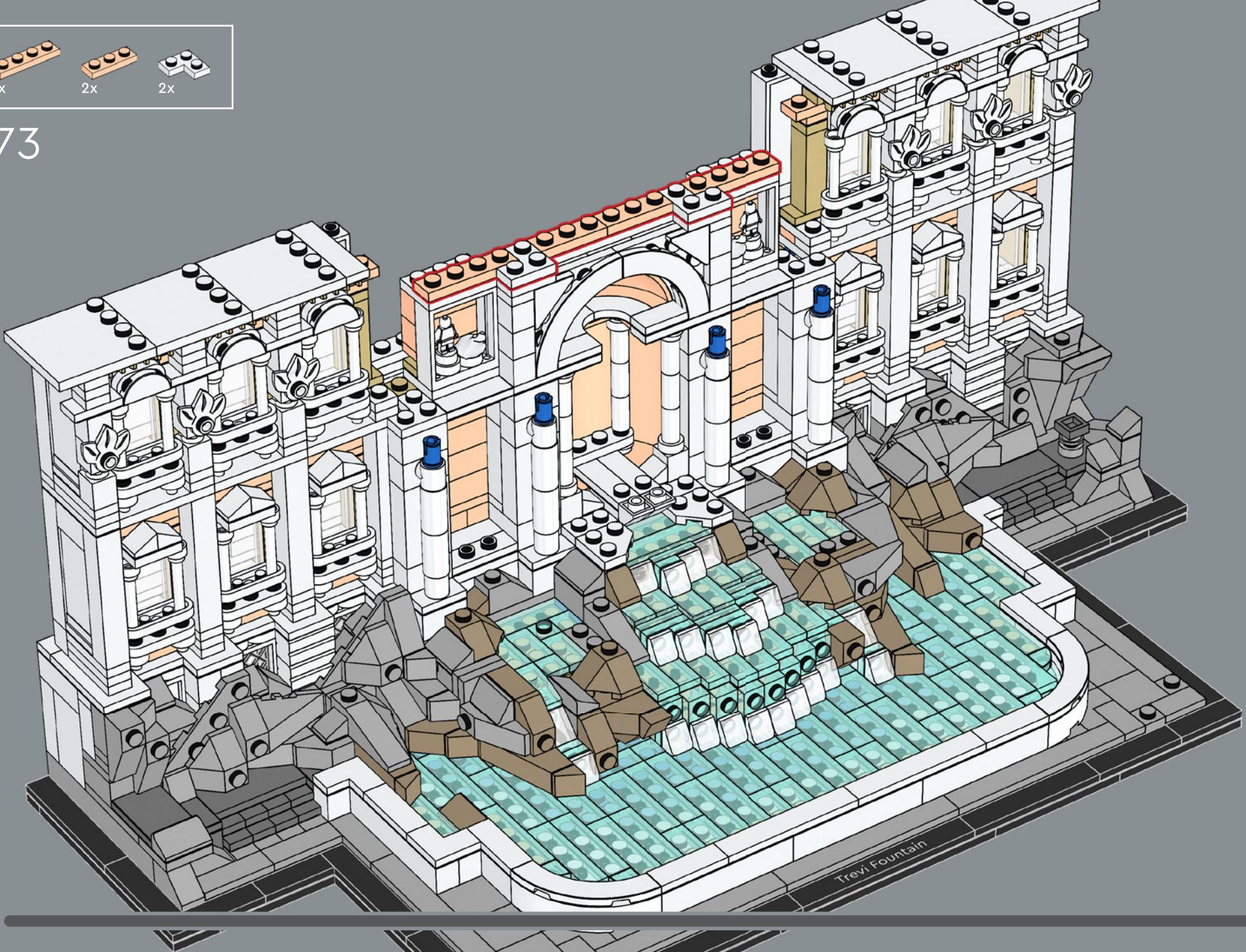

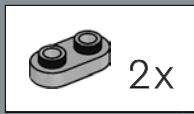
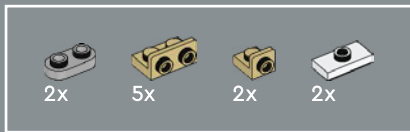

274

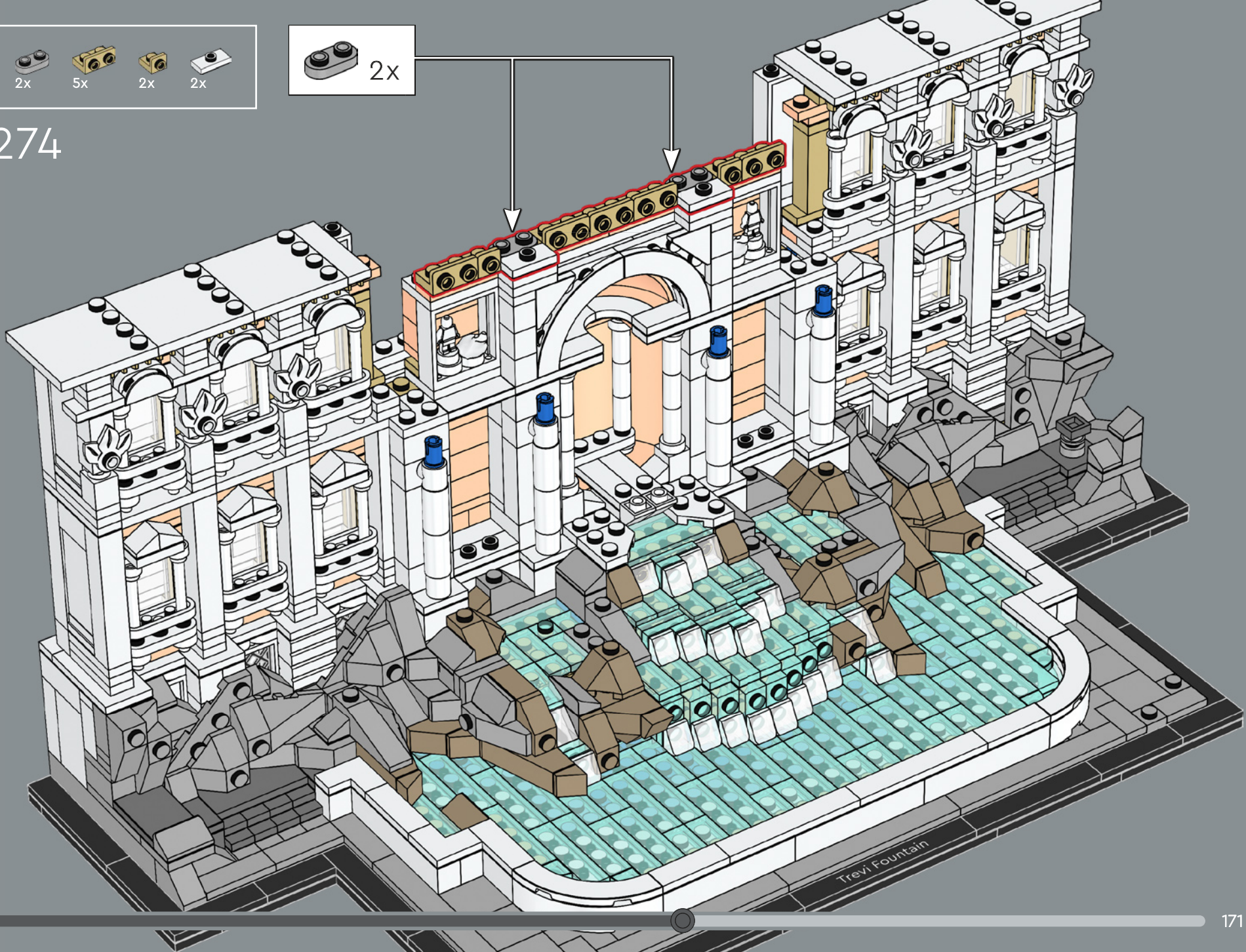

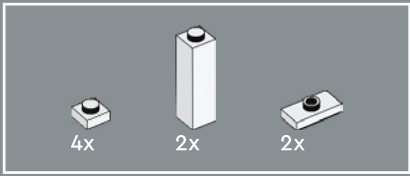

275

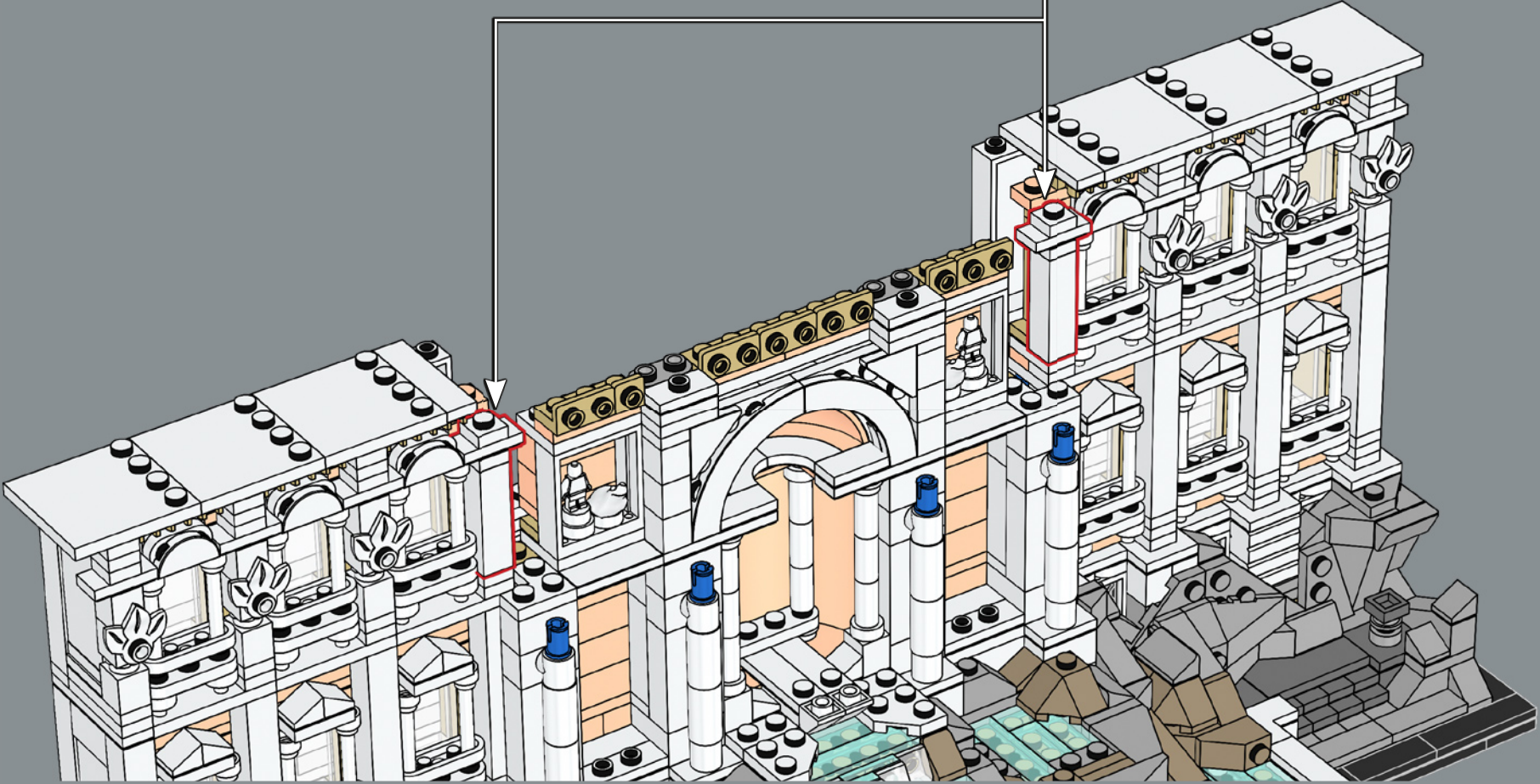
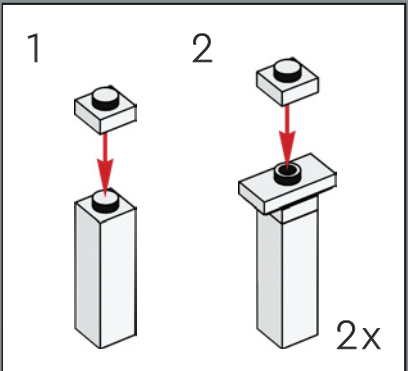

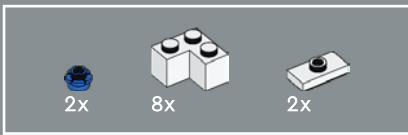

276

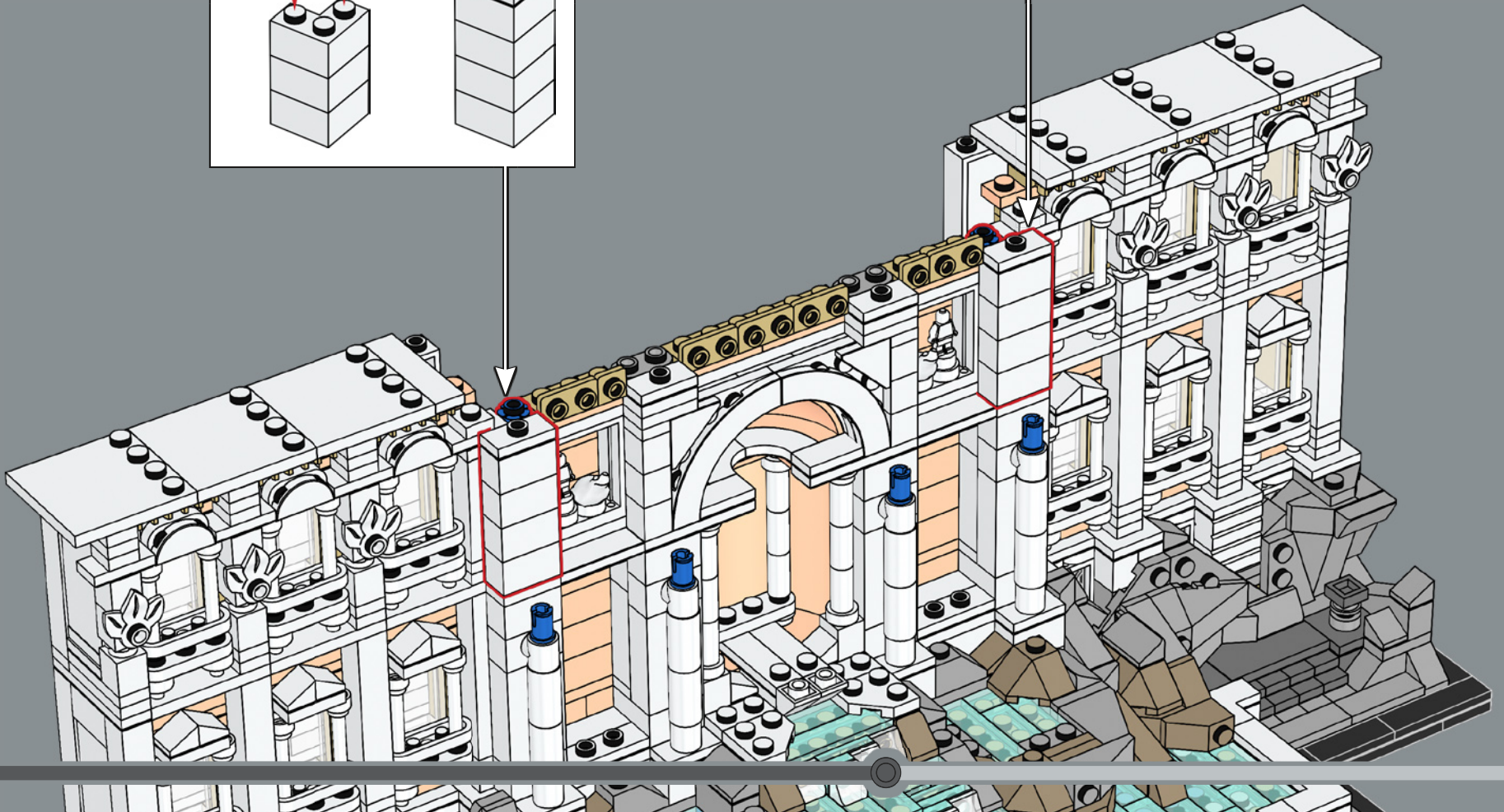
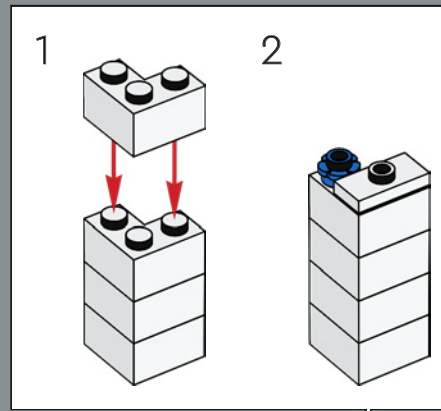
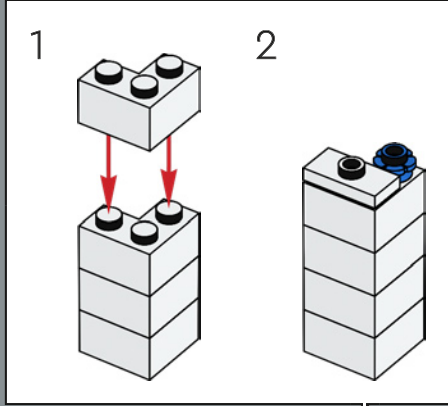



2x



277

1



3



2



4



5

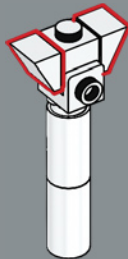

6

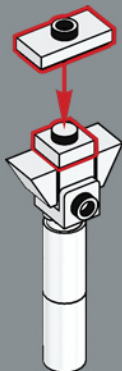

7

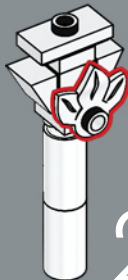

2x

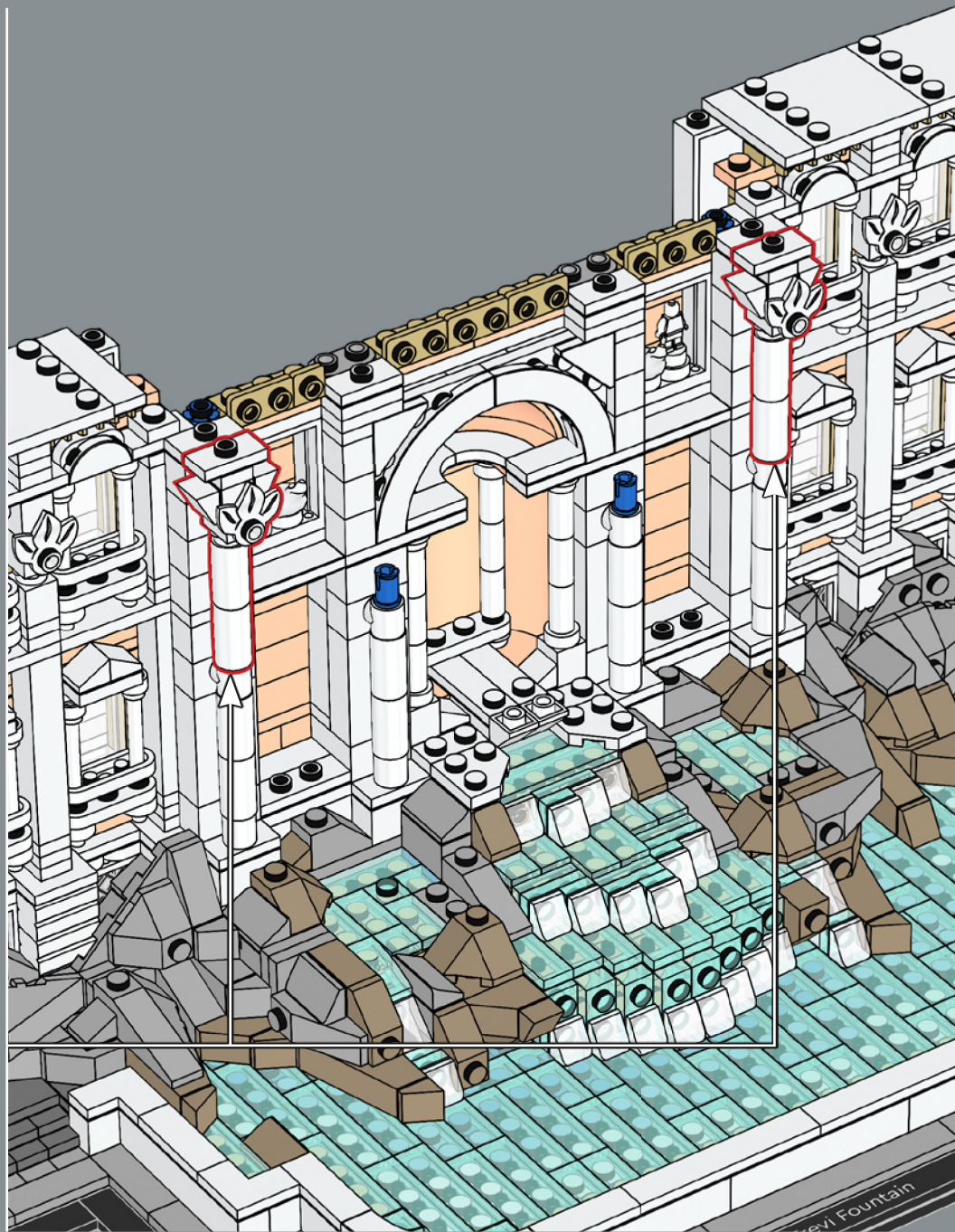

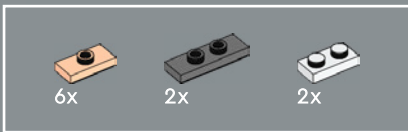

278

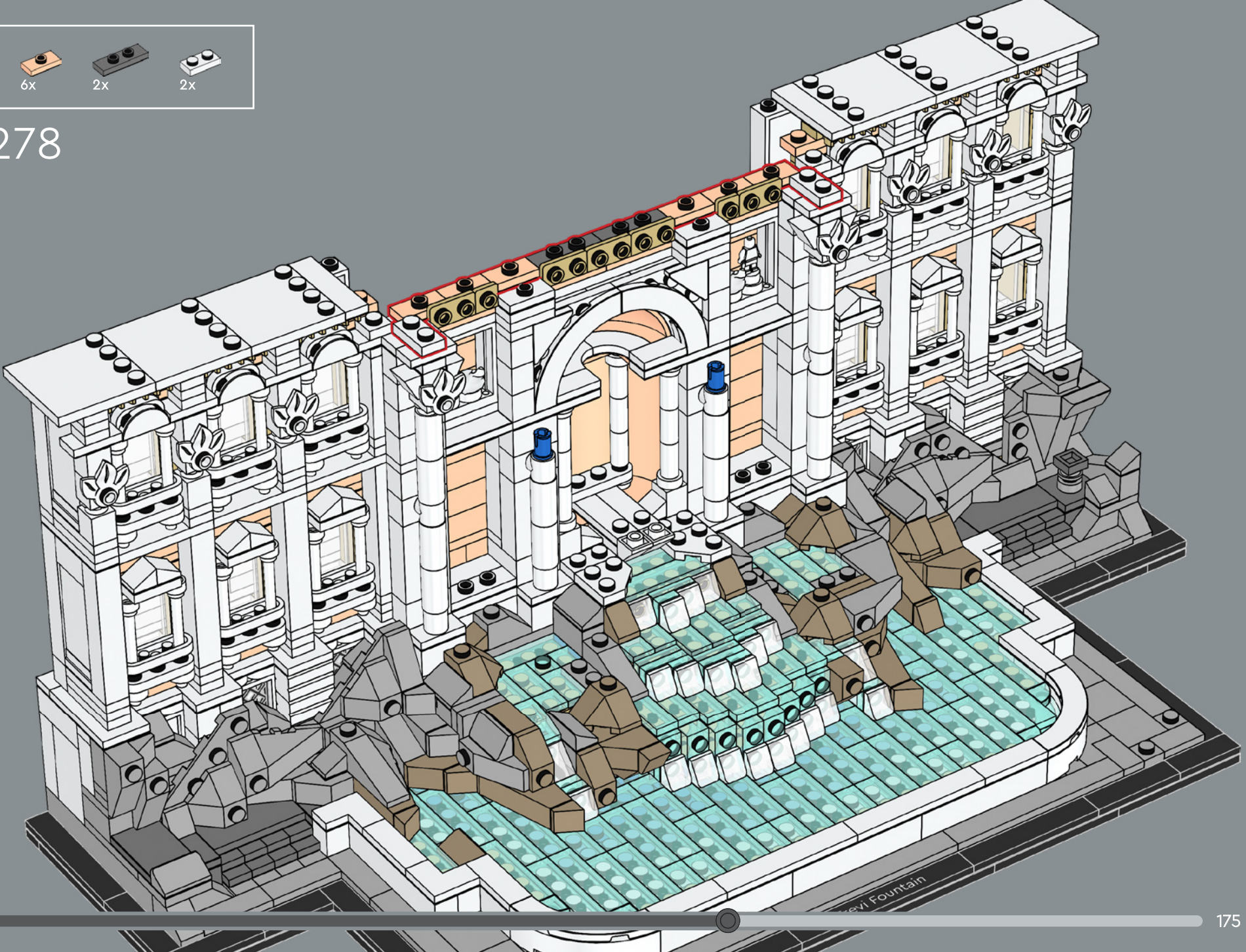

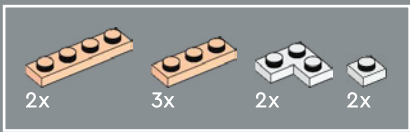

279

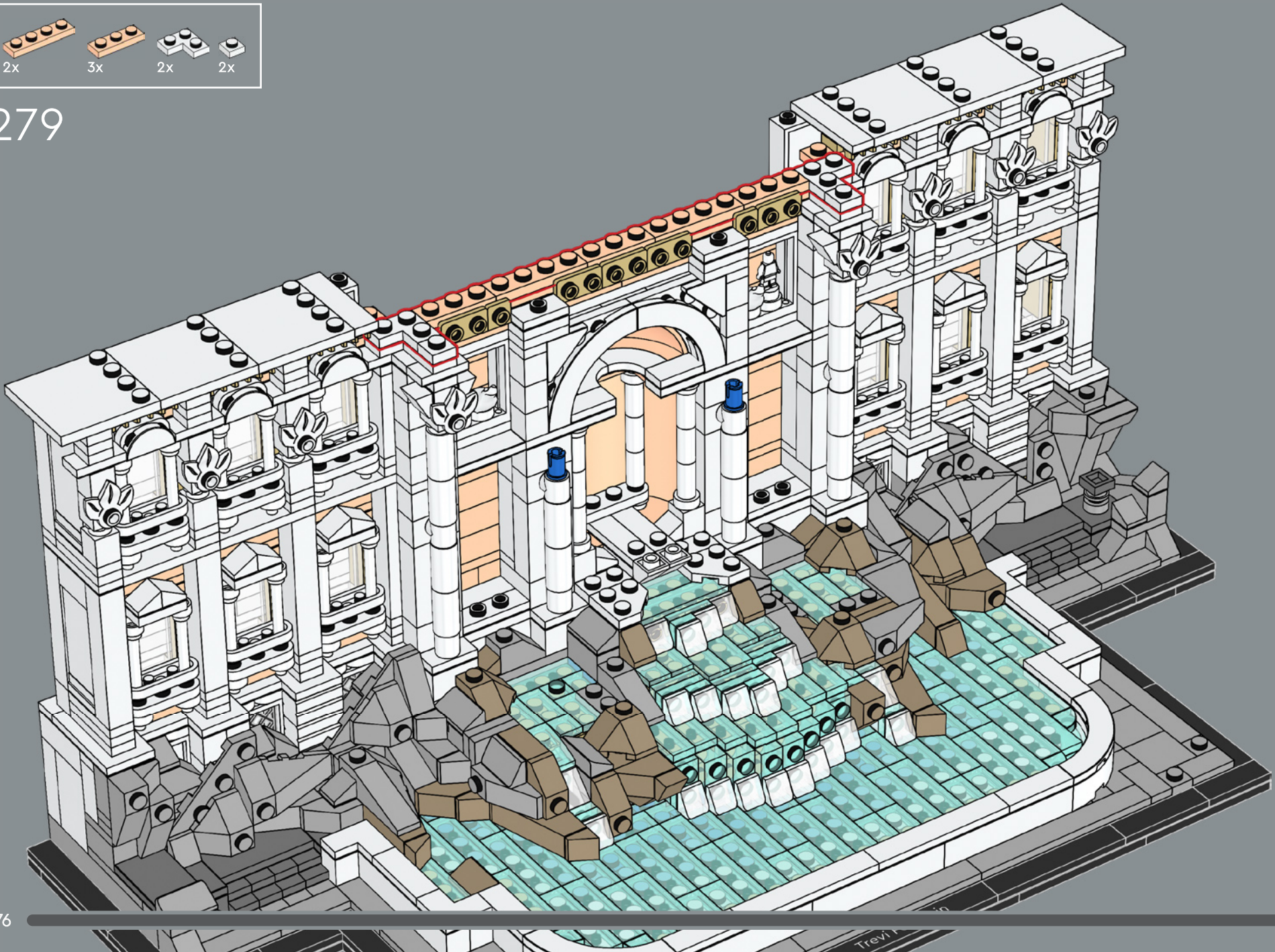

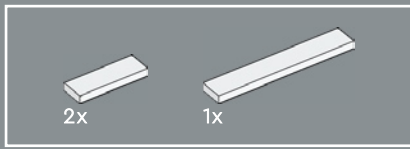

280

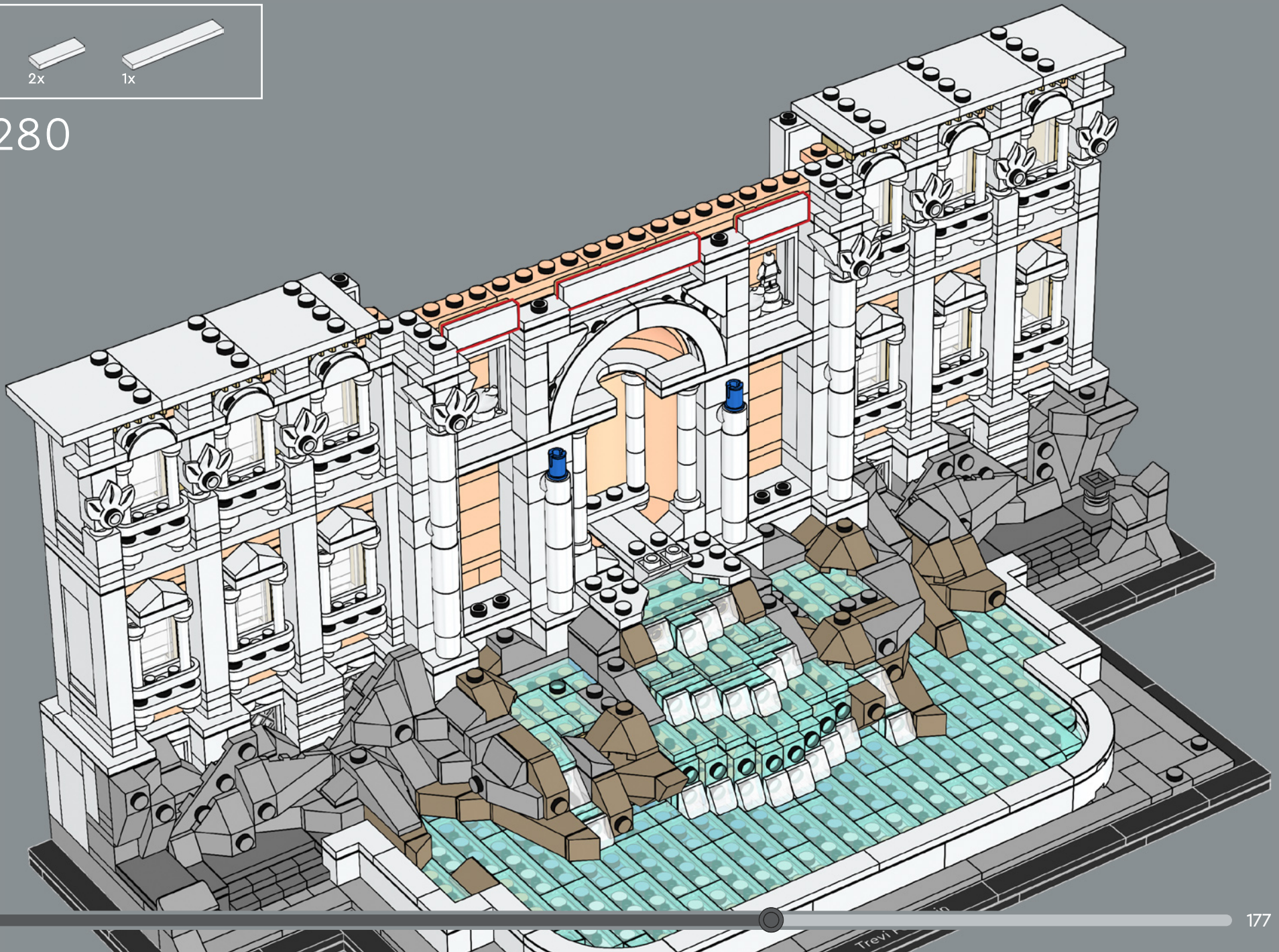



2x



281

1



2



3



4



5

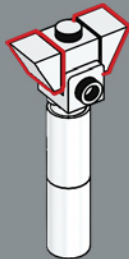

6

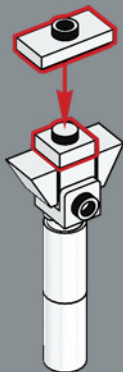

7

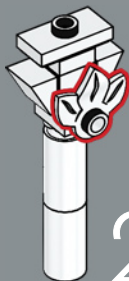

2x

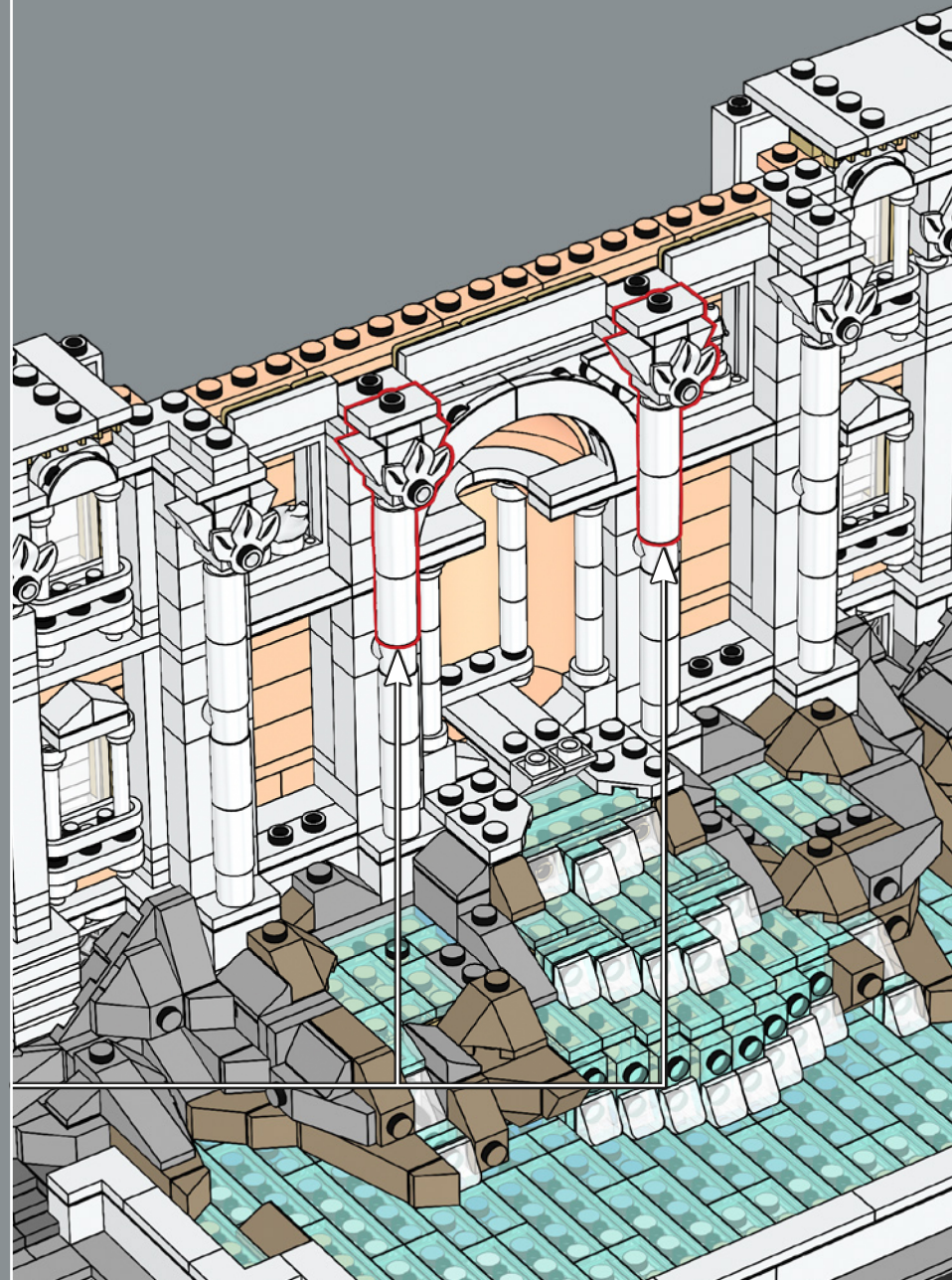

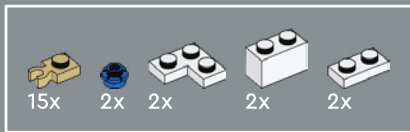

282



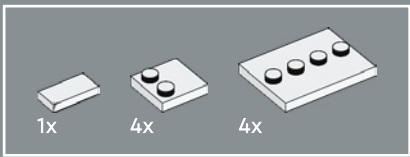

283

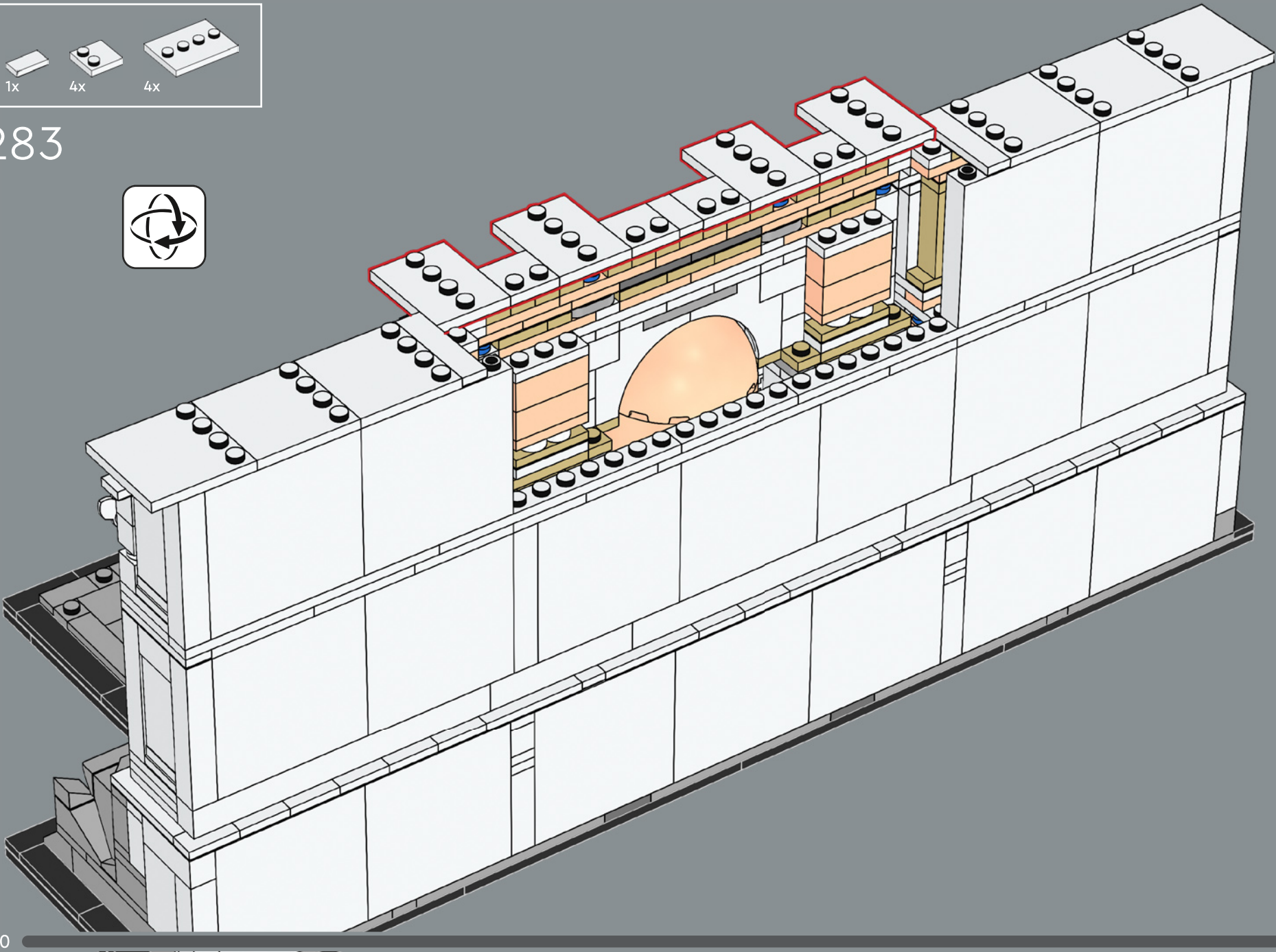

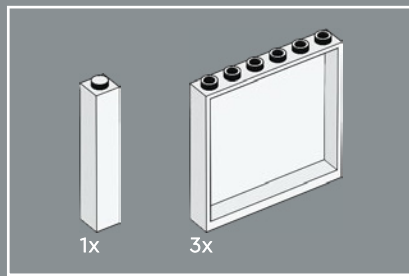

284

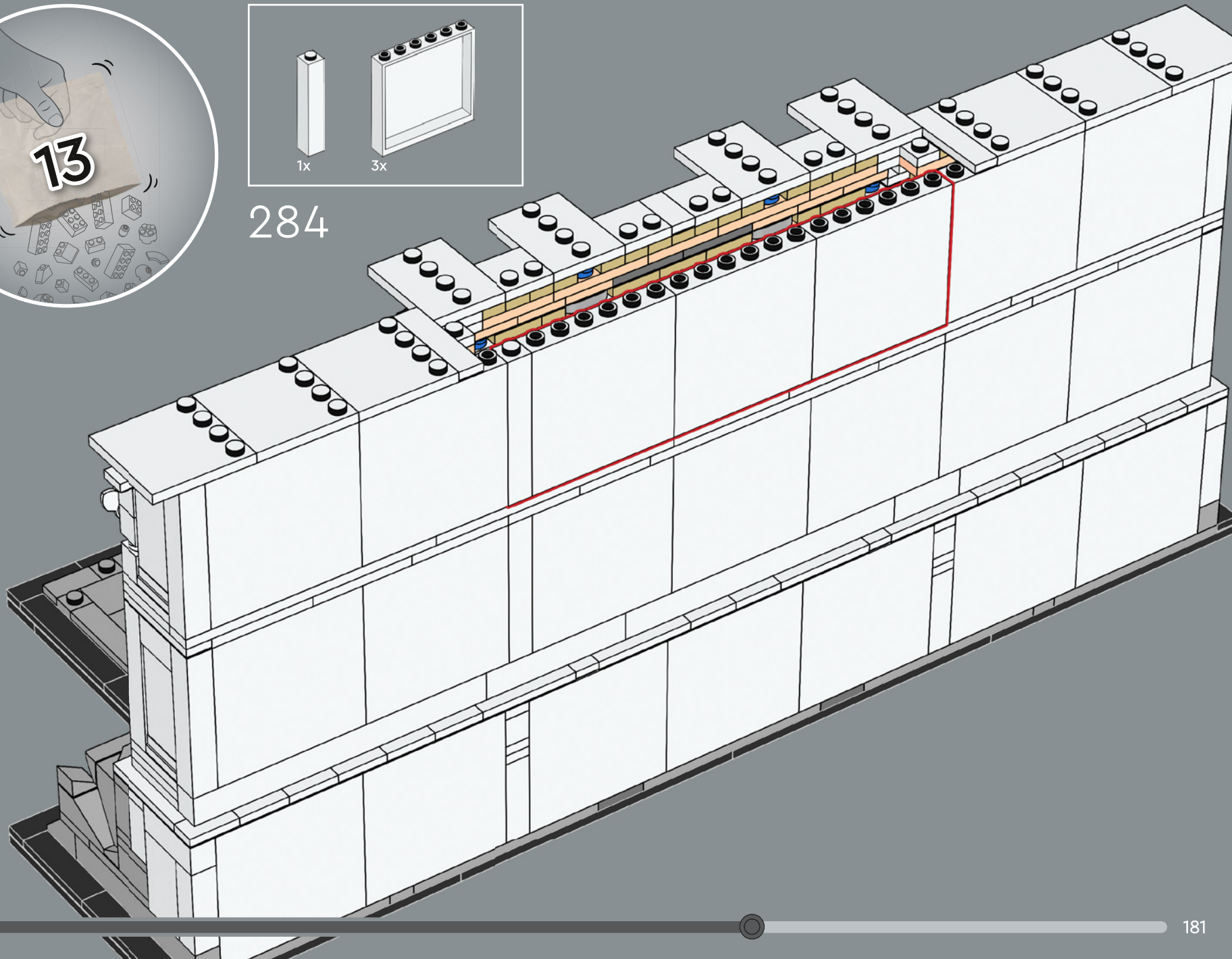

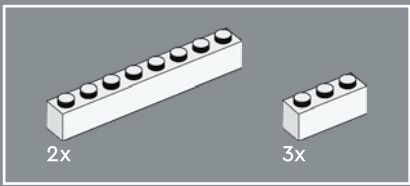

In real life, the Trevi Fountain is the facade of the Palazzo Poli, a former papal residence that now houses a museum. The building continues backwards with architecture that matches the surrounding buildings rather than the Baroque style of the fountain.

285

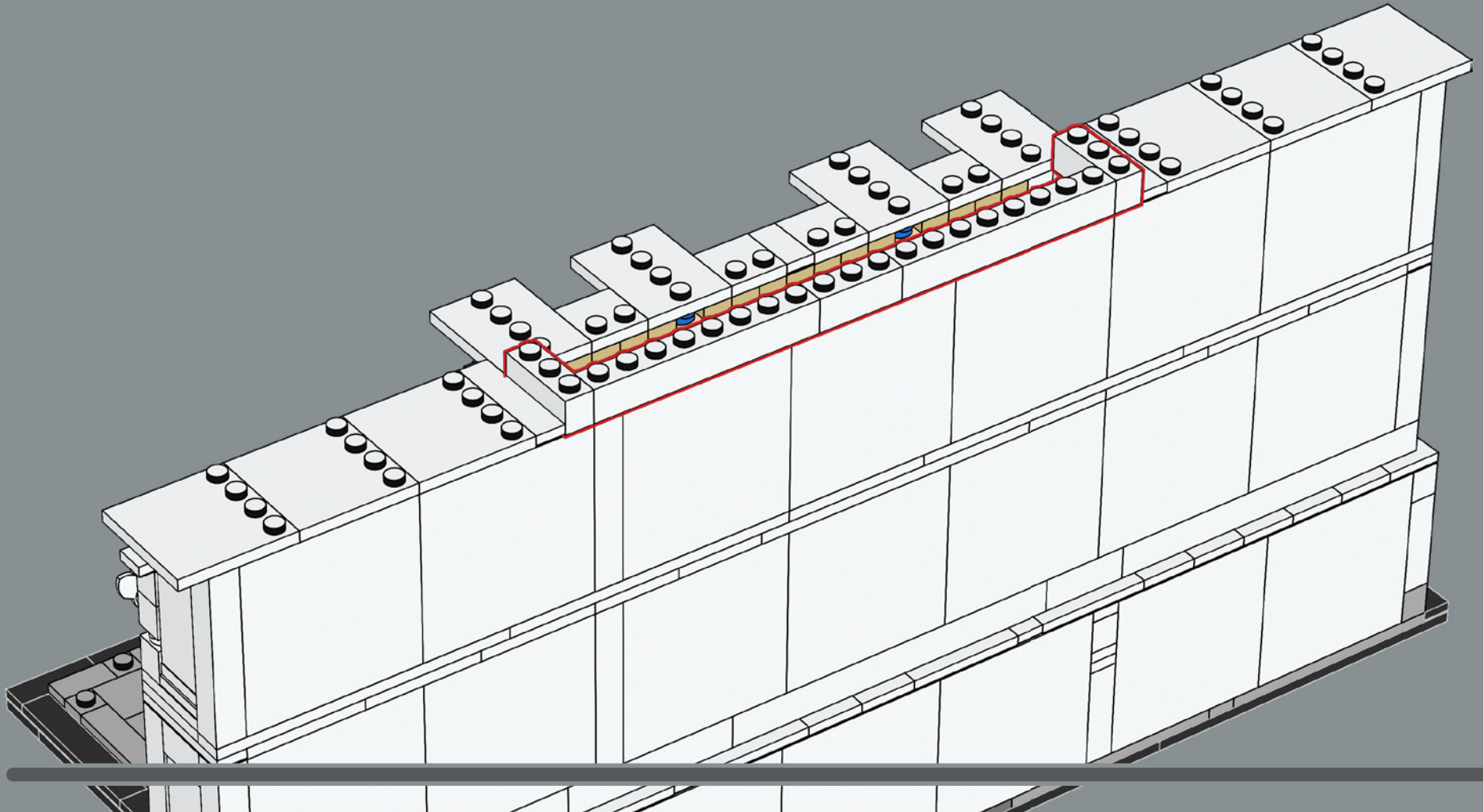

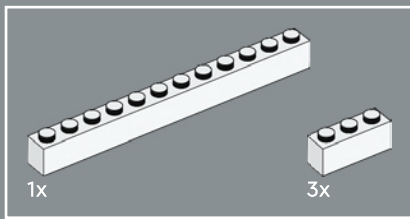

286

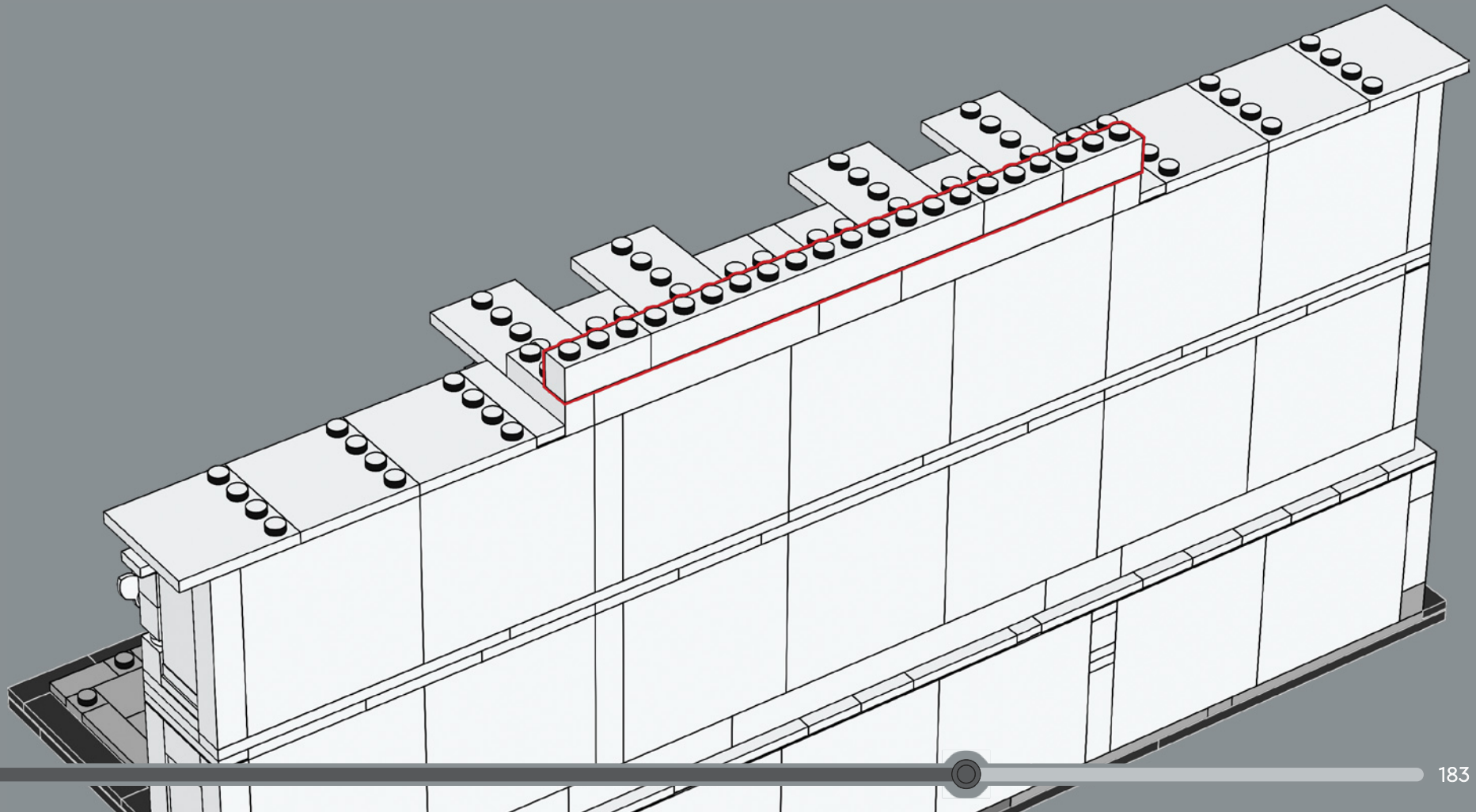

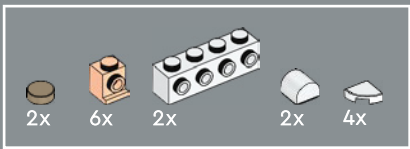

287

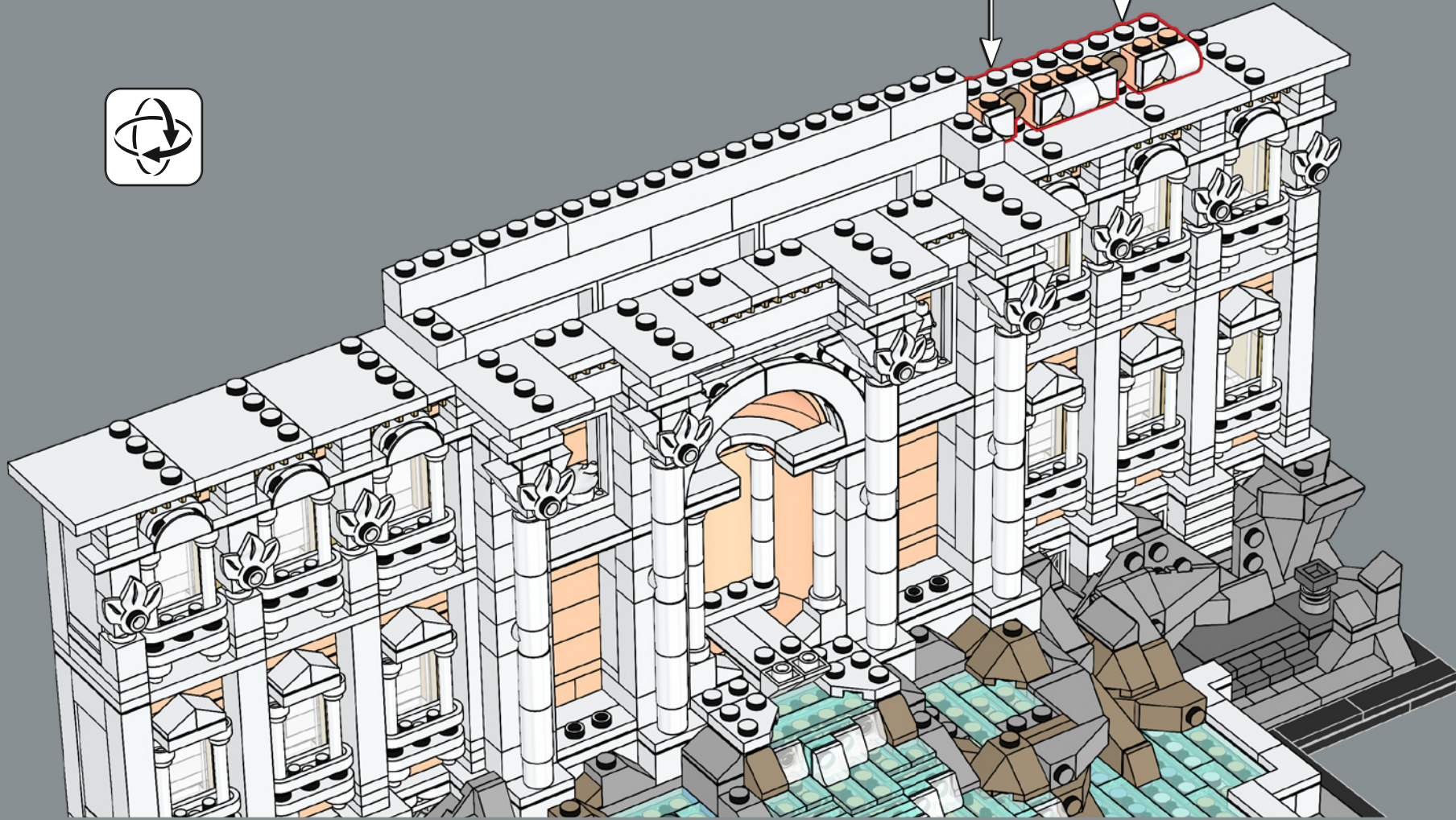
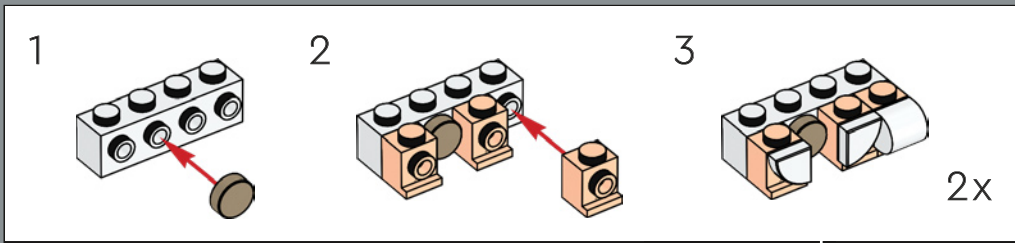

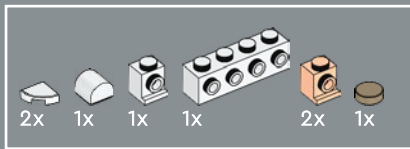

288

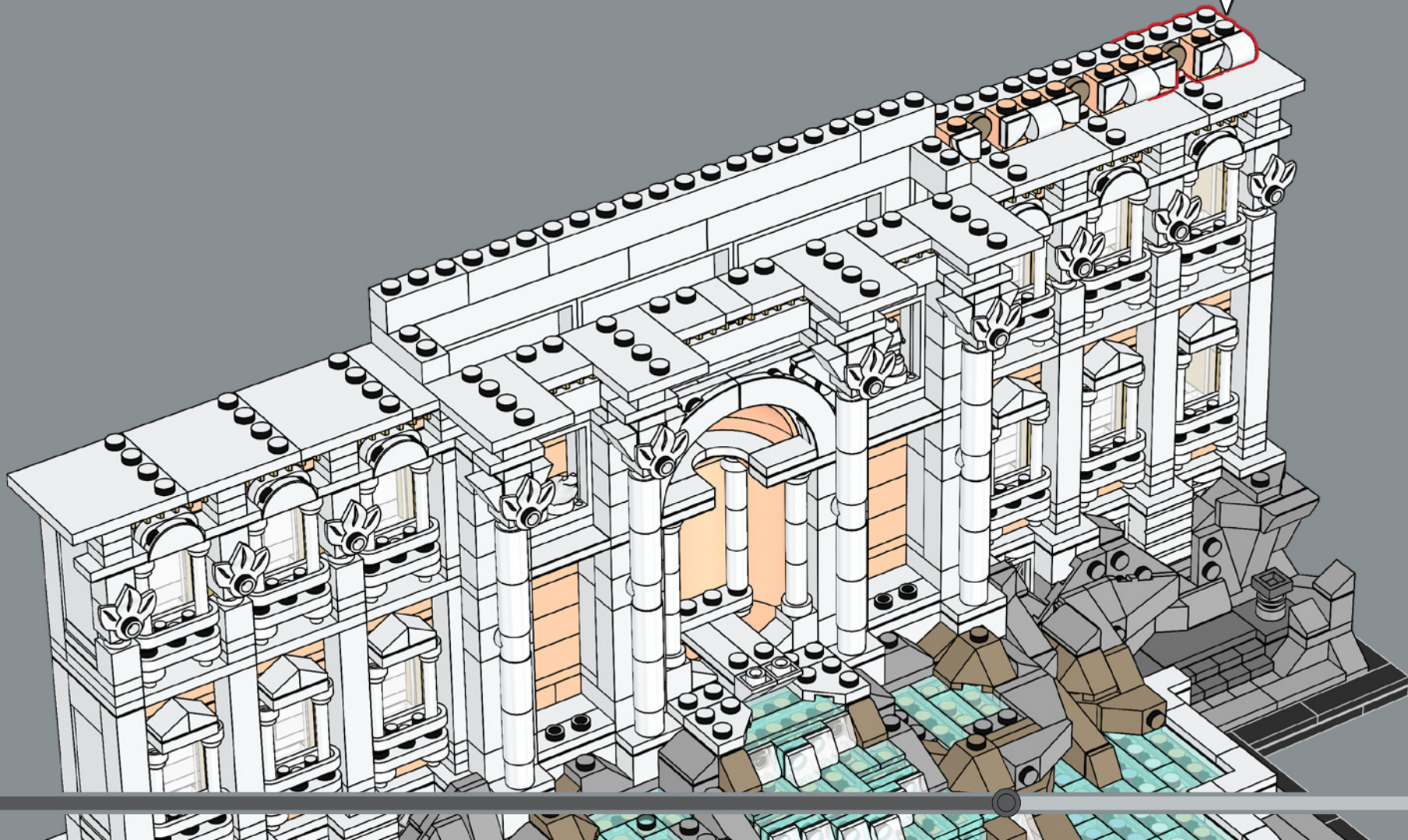
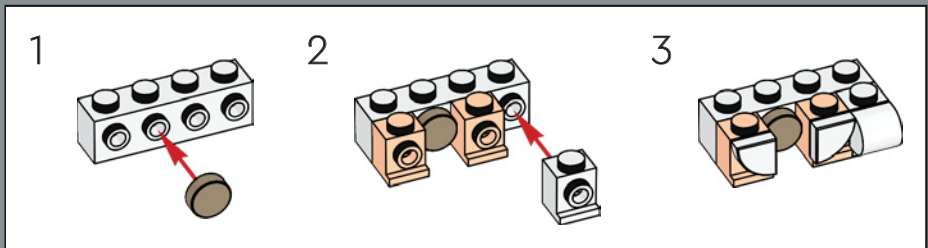

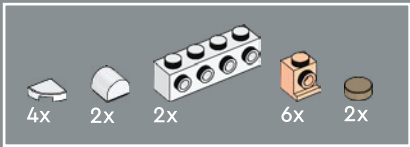

289

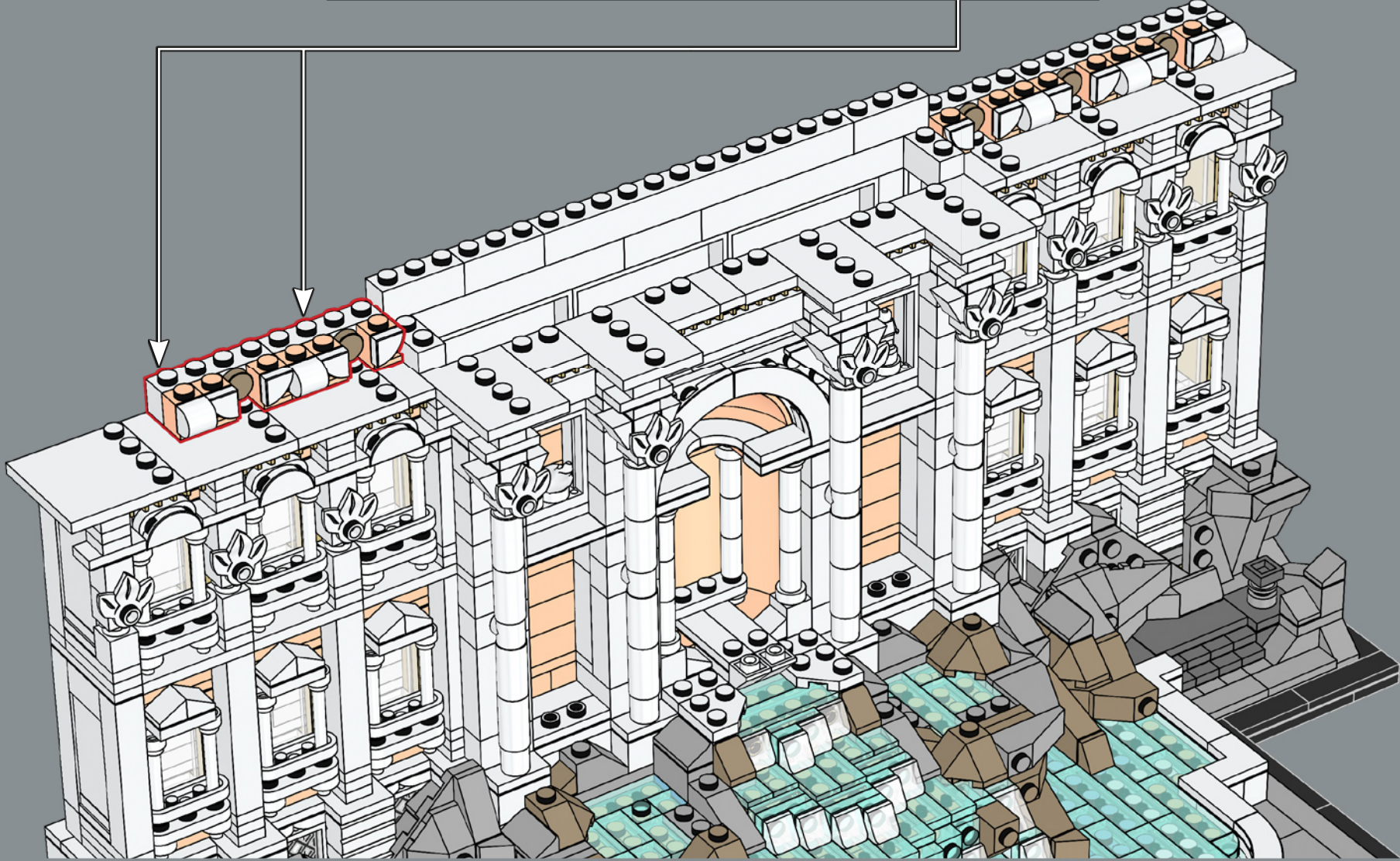
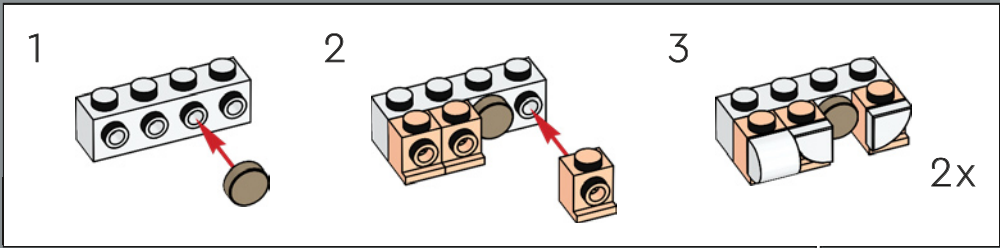

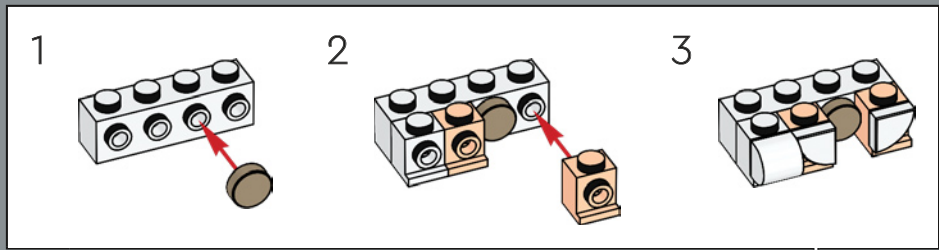
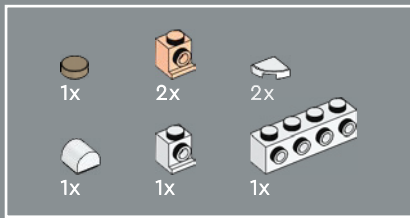

290

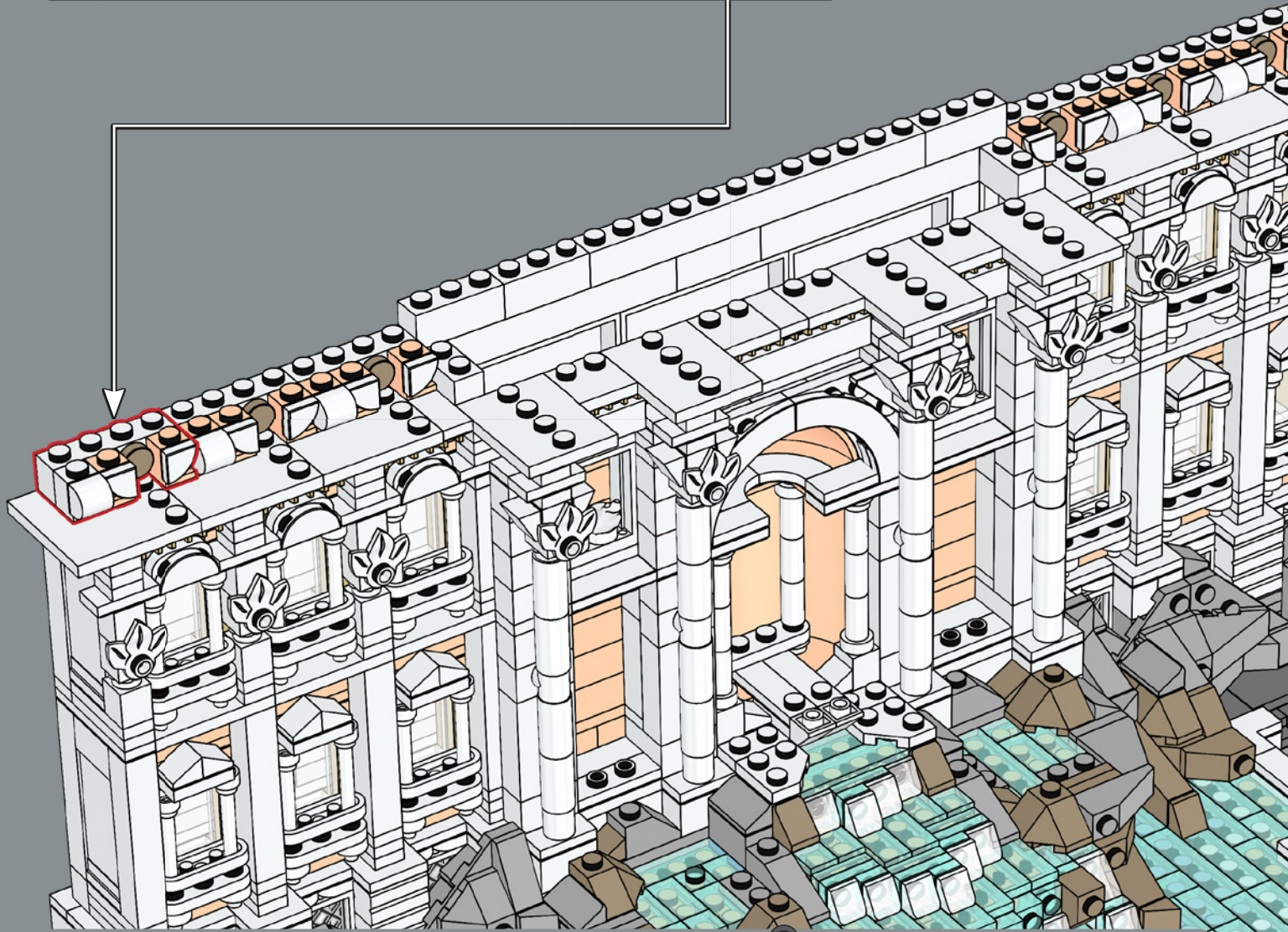



6x

291

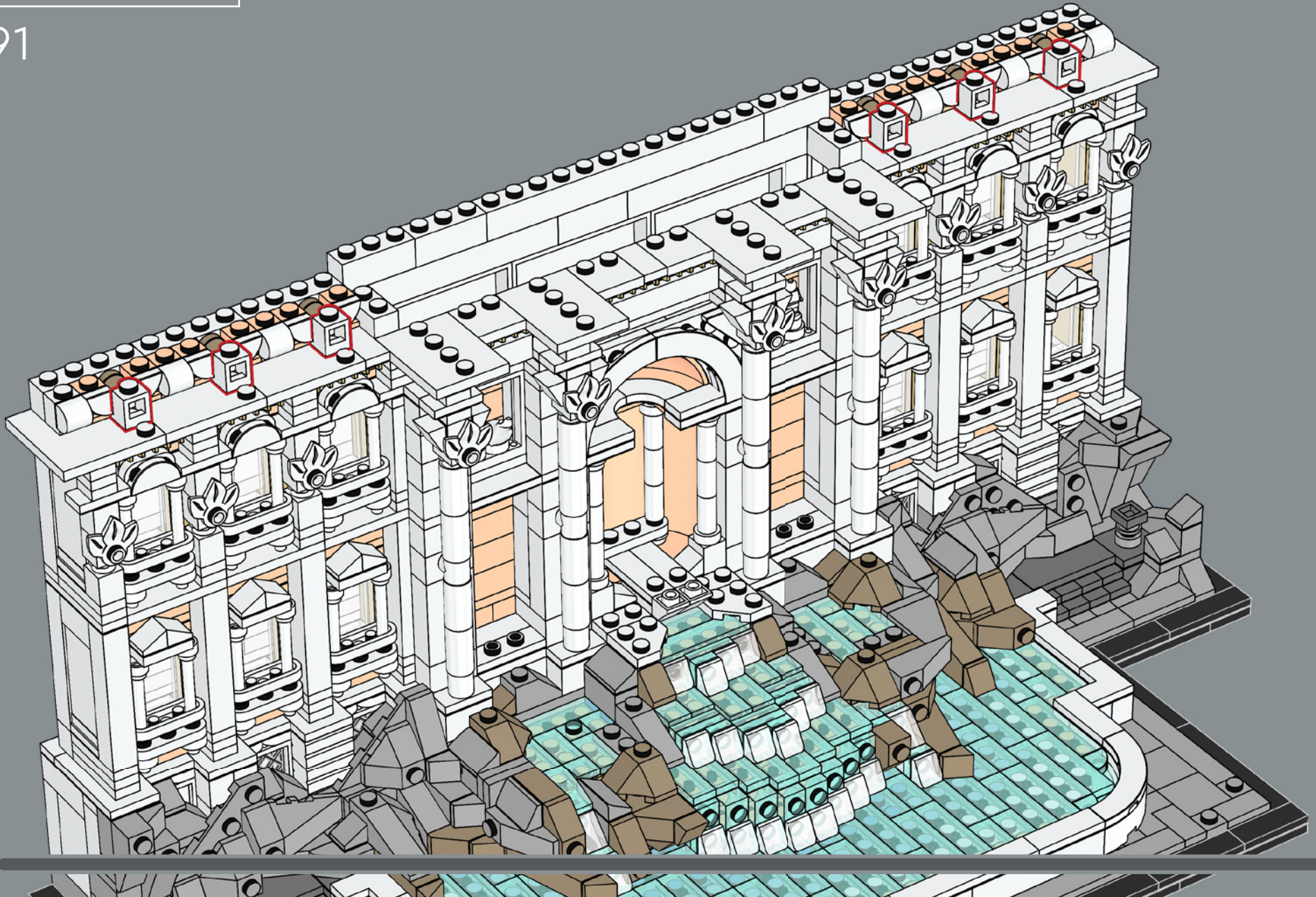

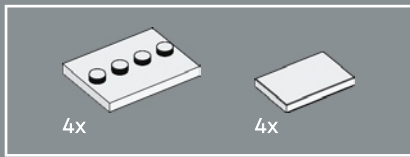

292

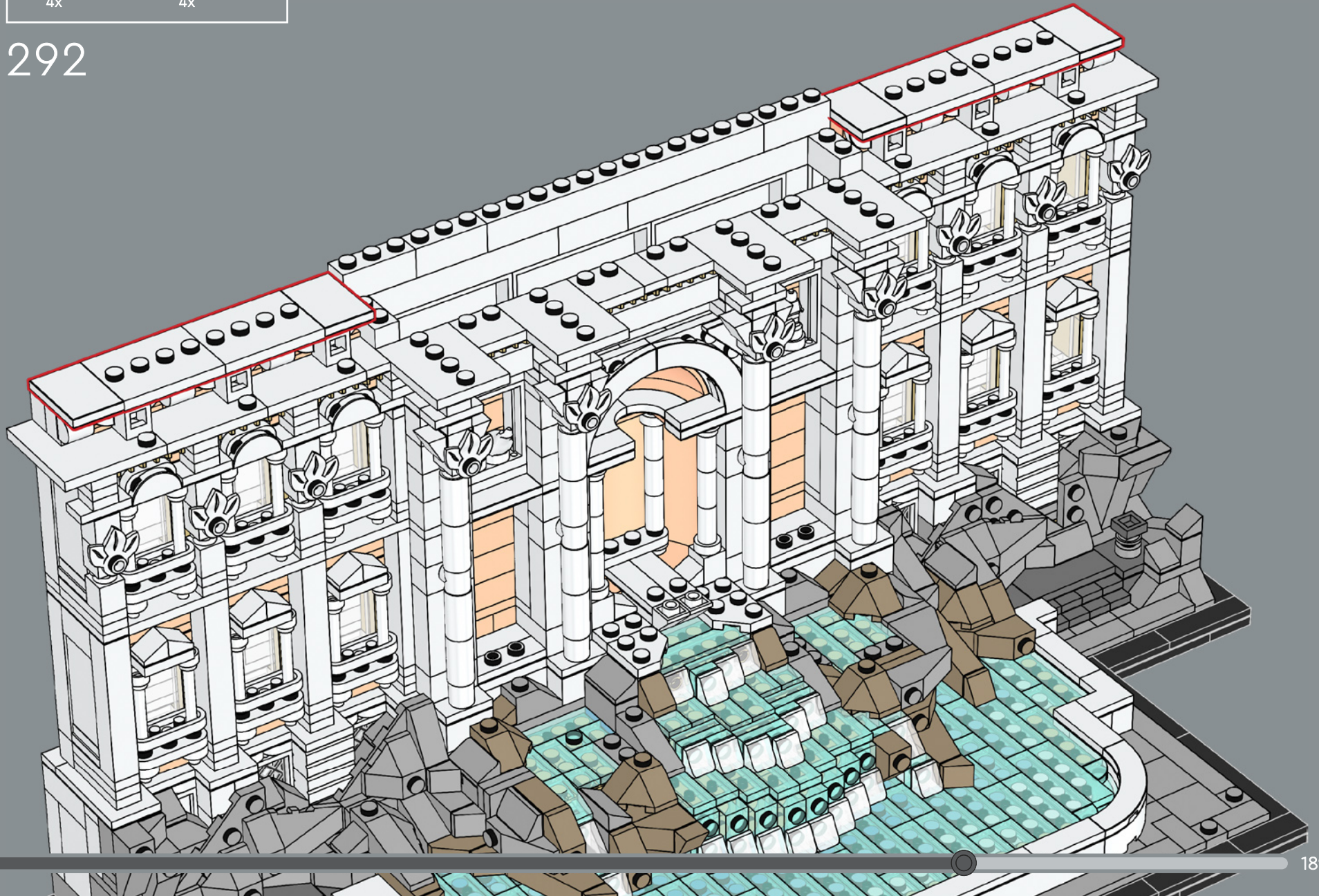

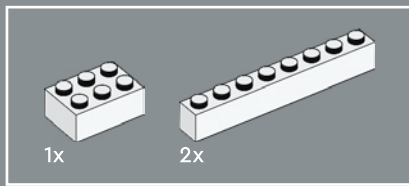

293

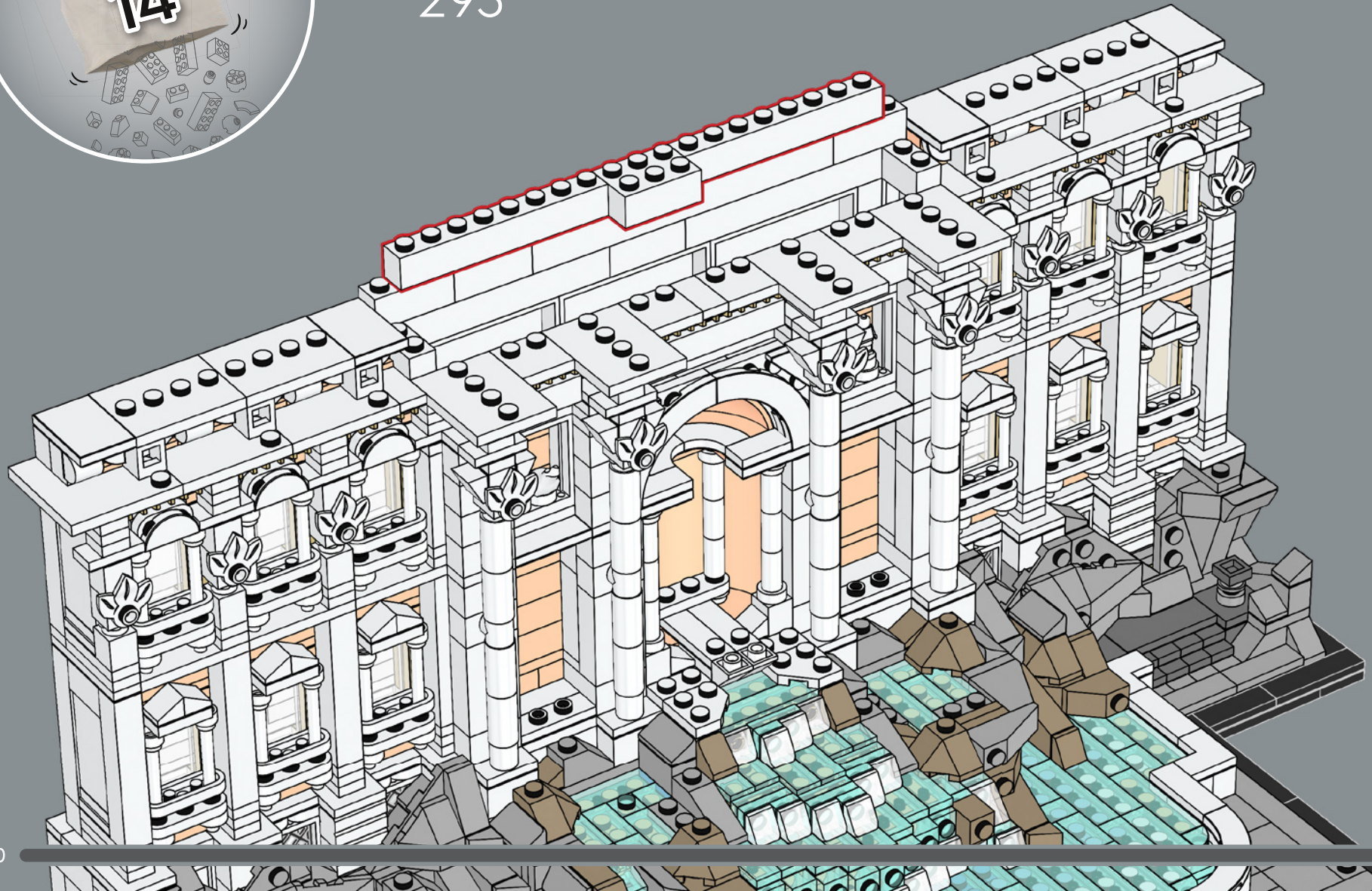

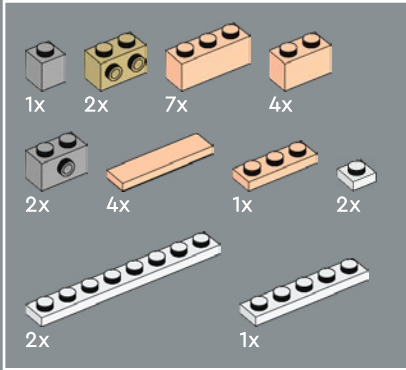
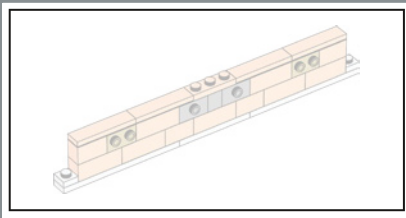

294

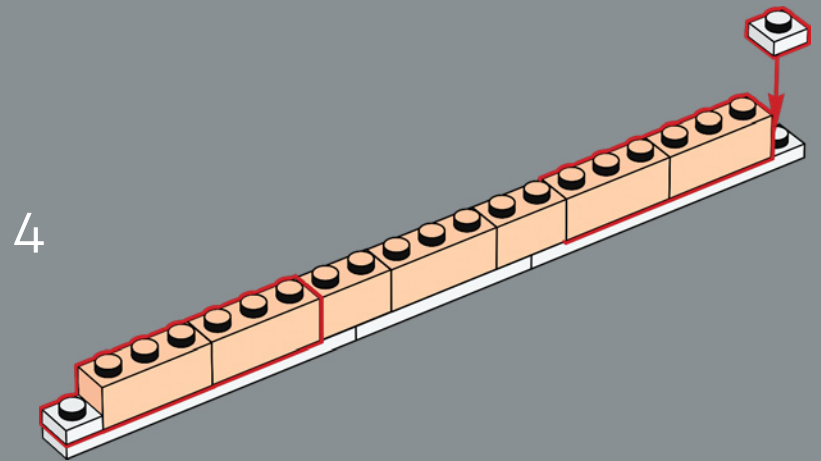
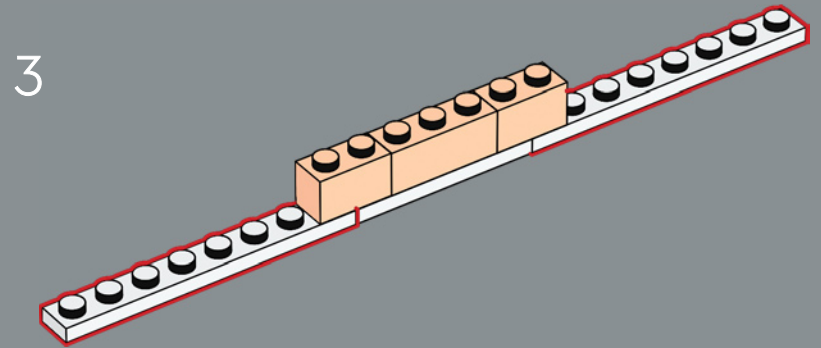
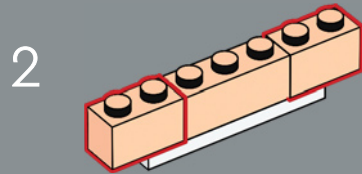
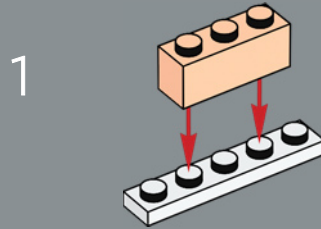

5

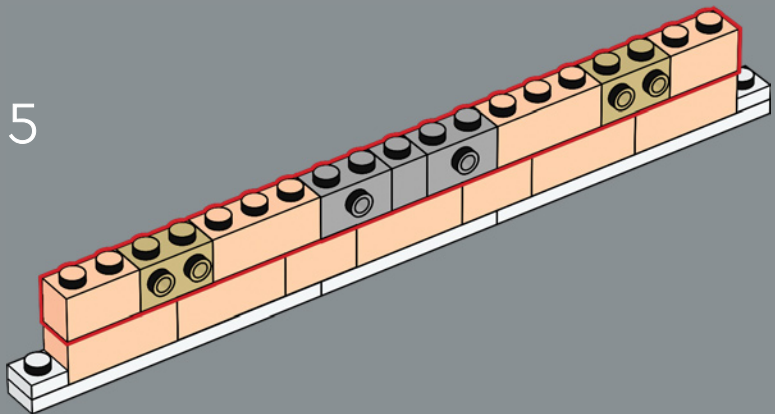

6

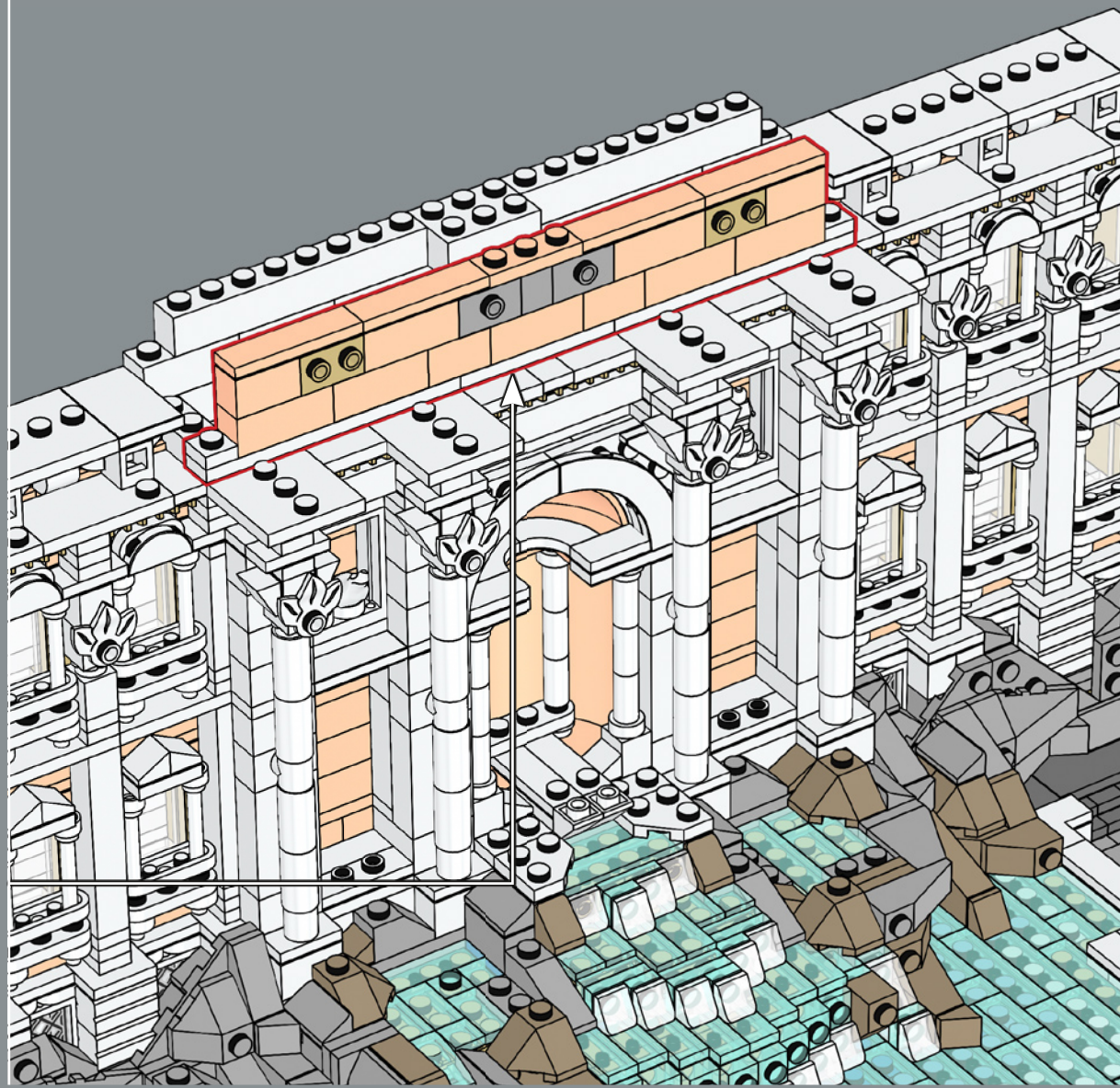
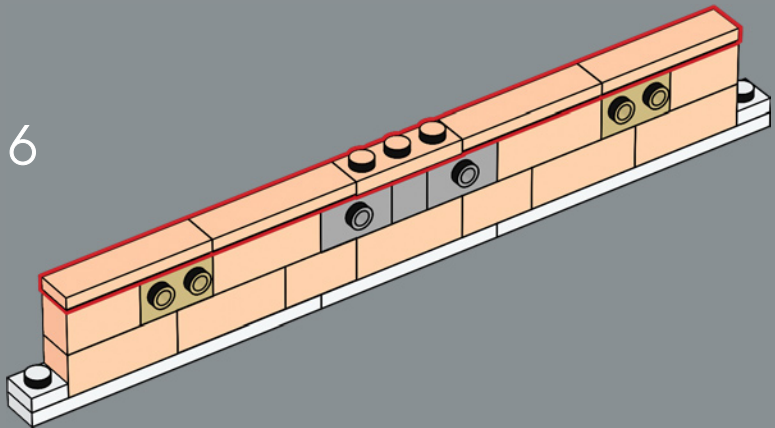

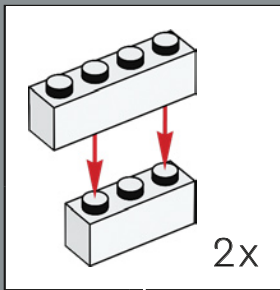
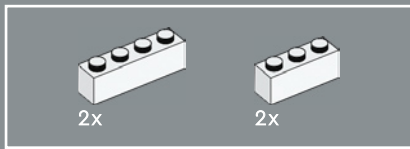

295

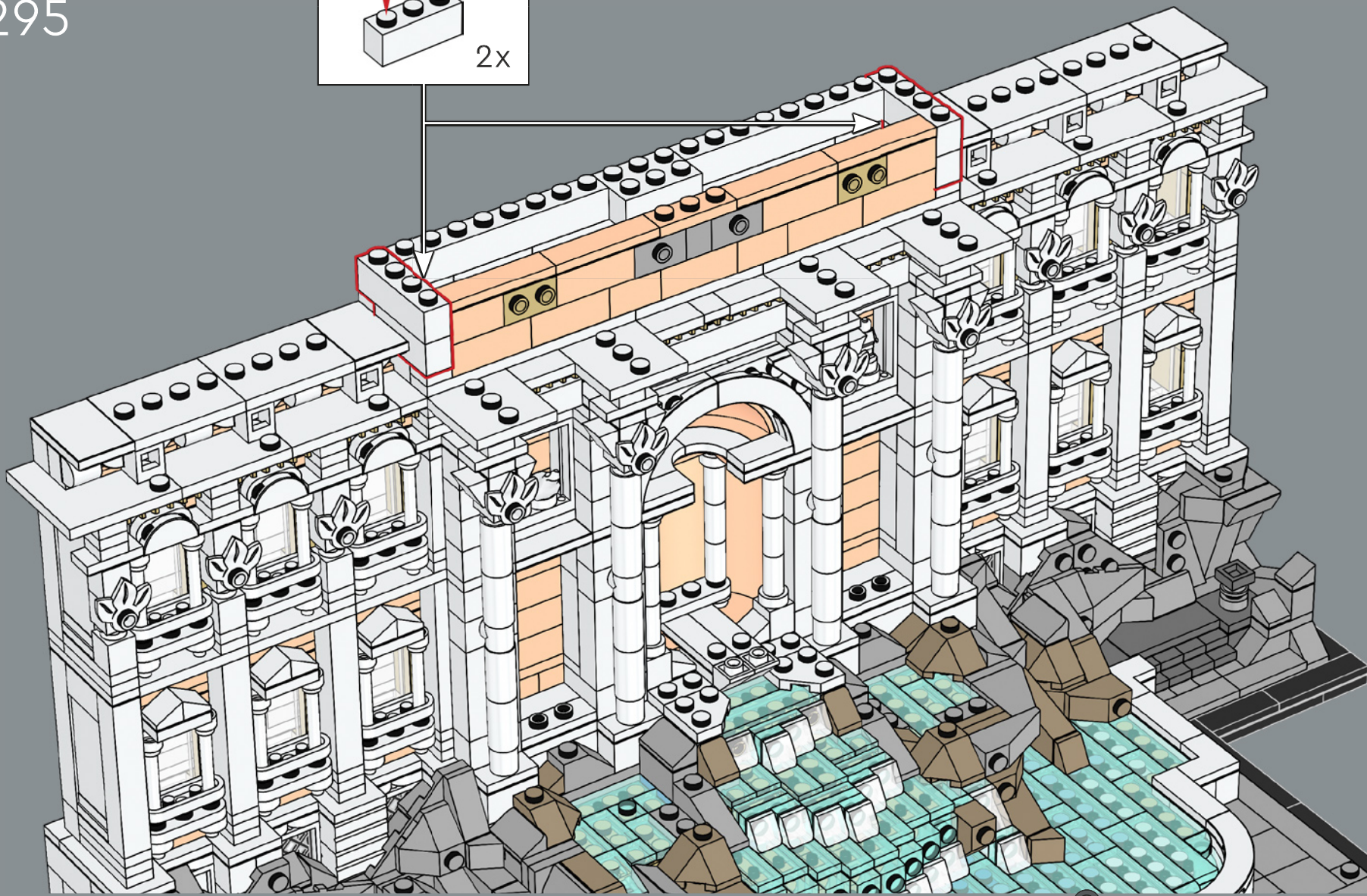

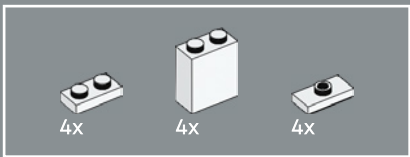

296

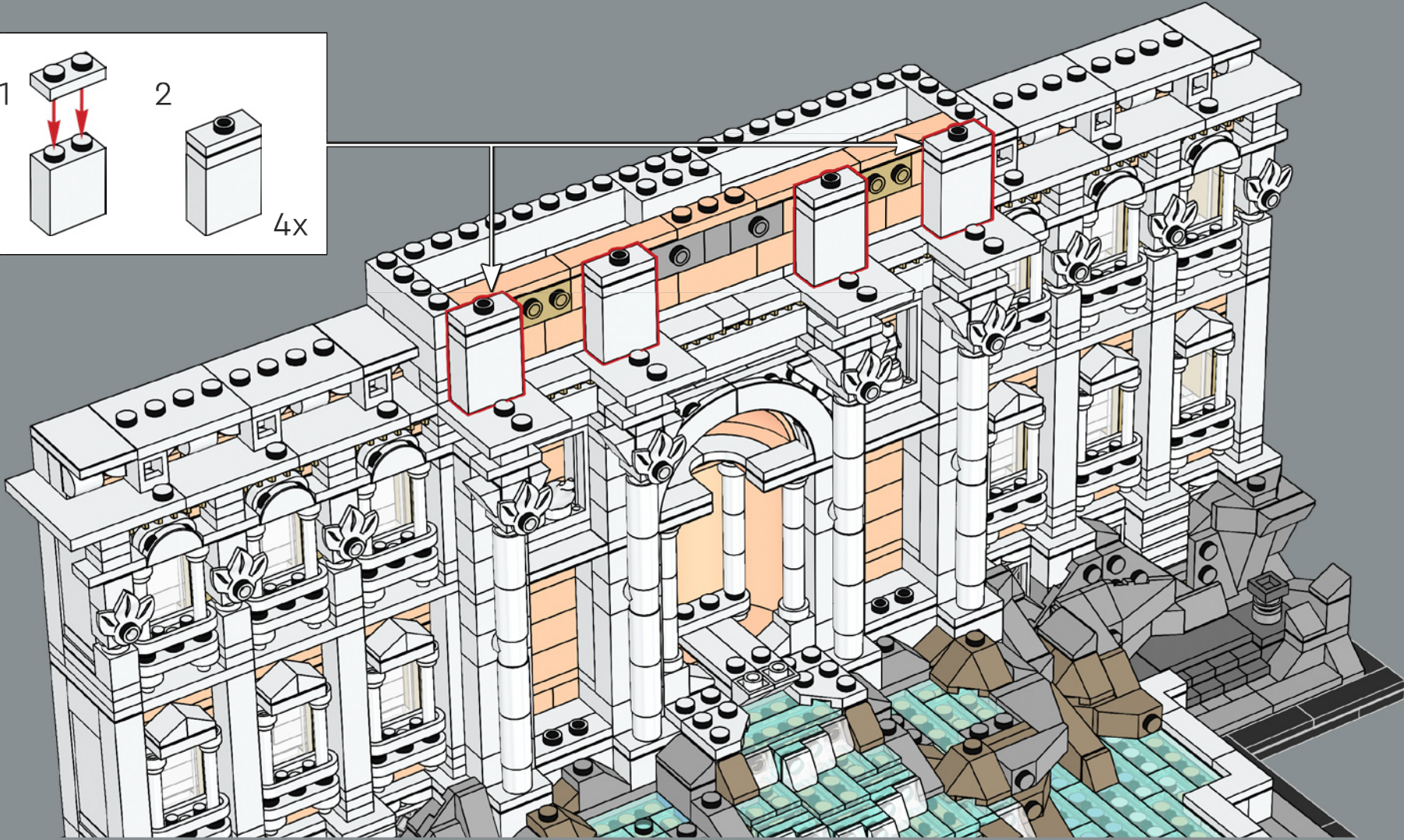
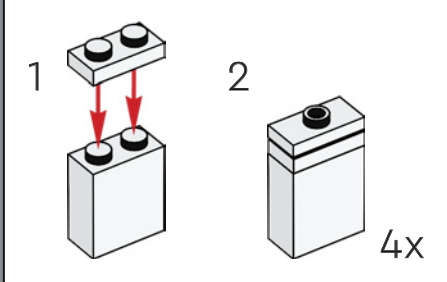

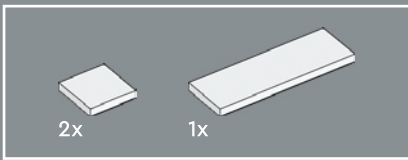

297

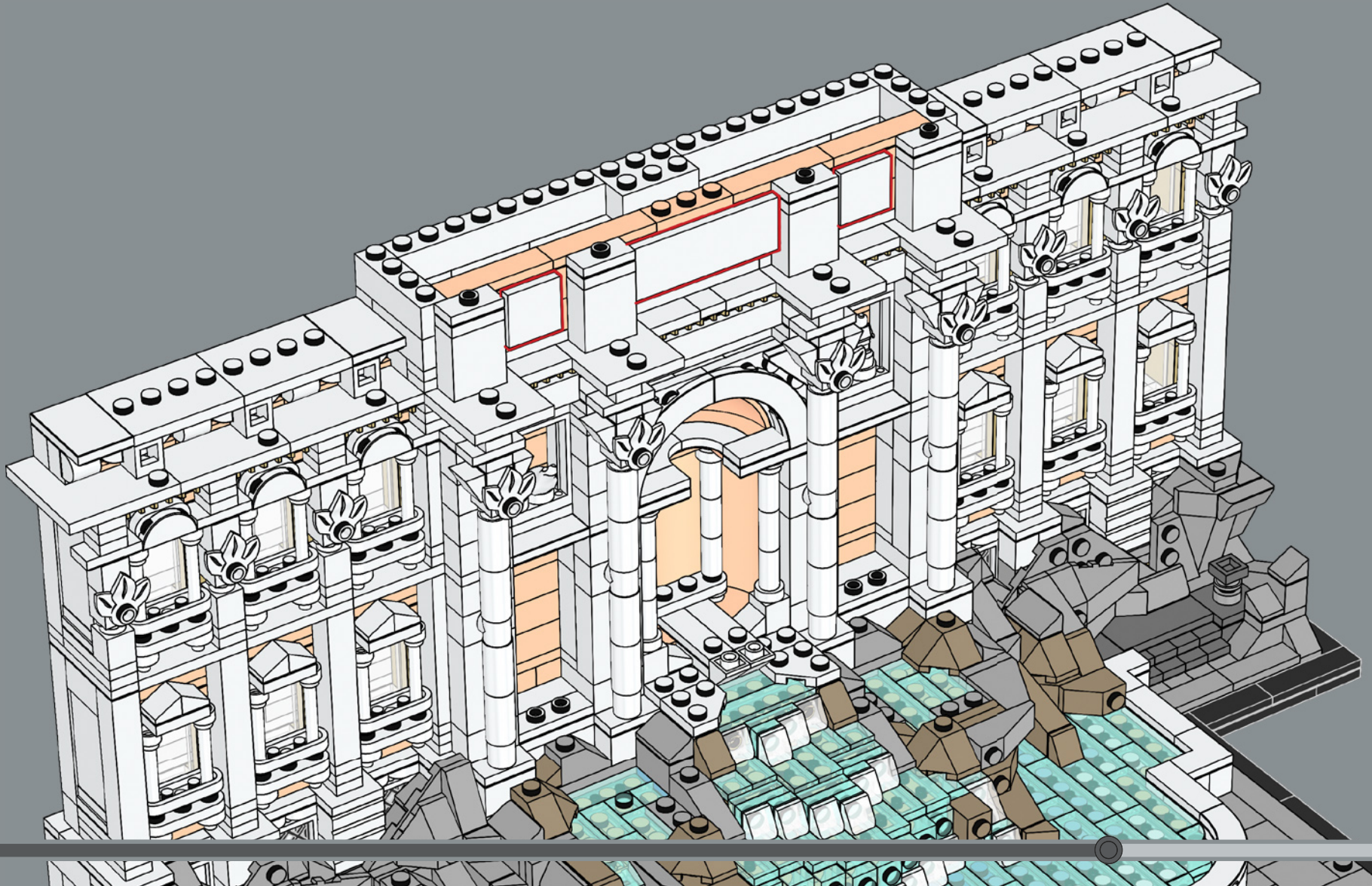

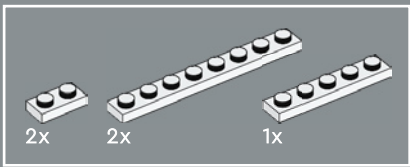

298

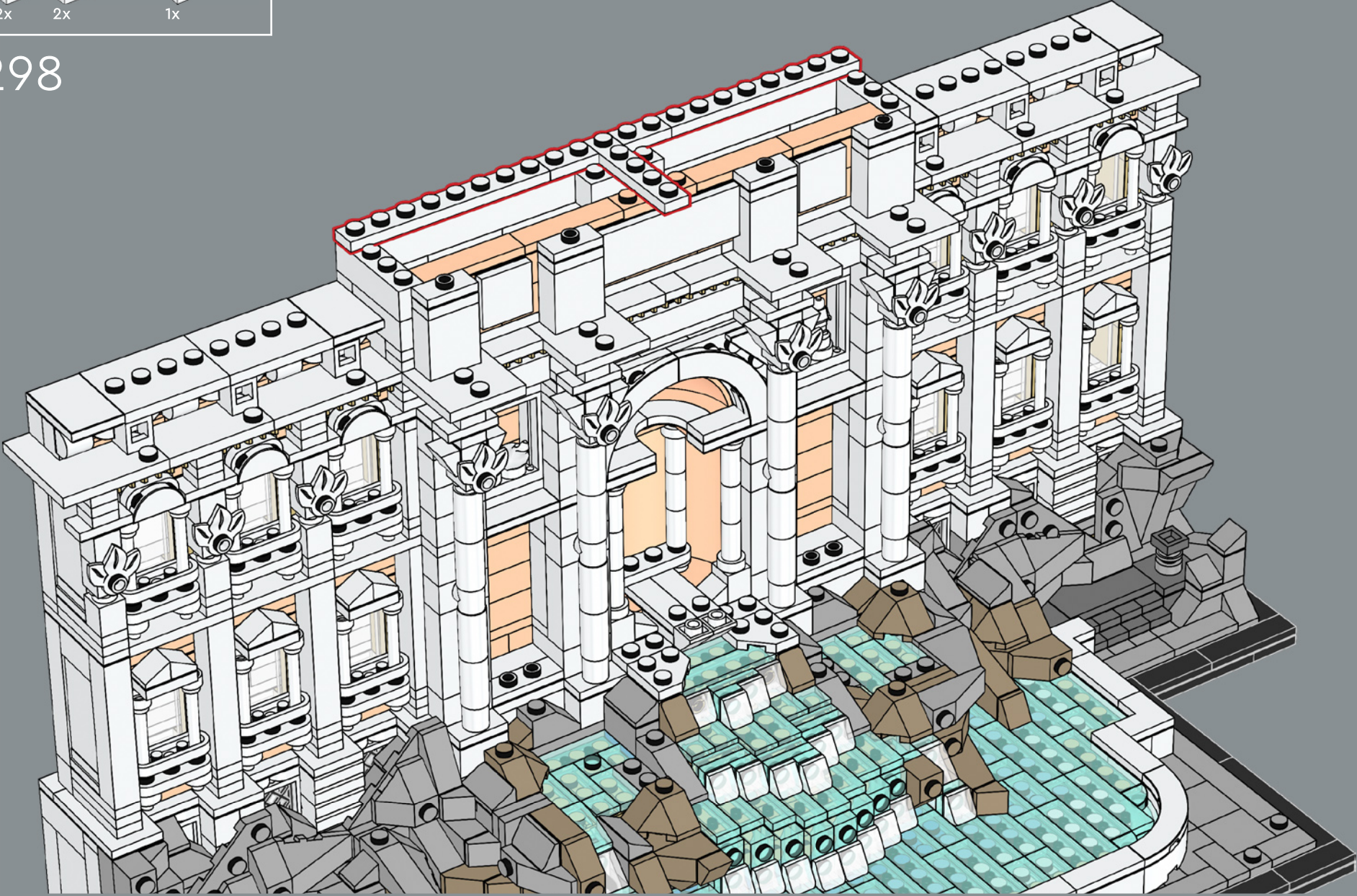

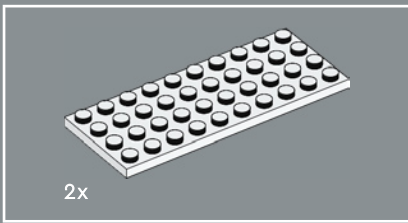

299

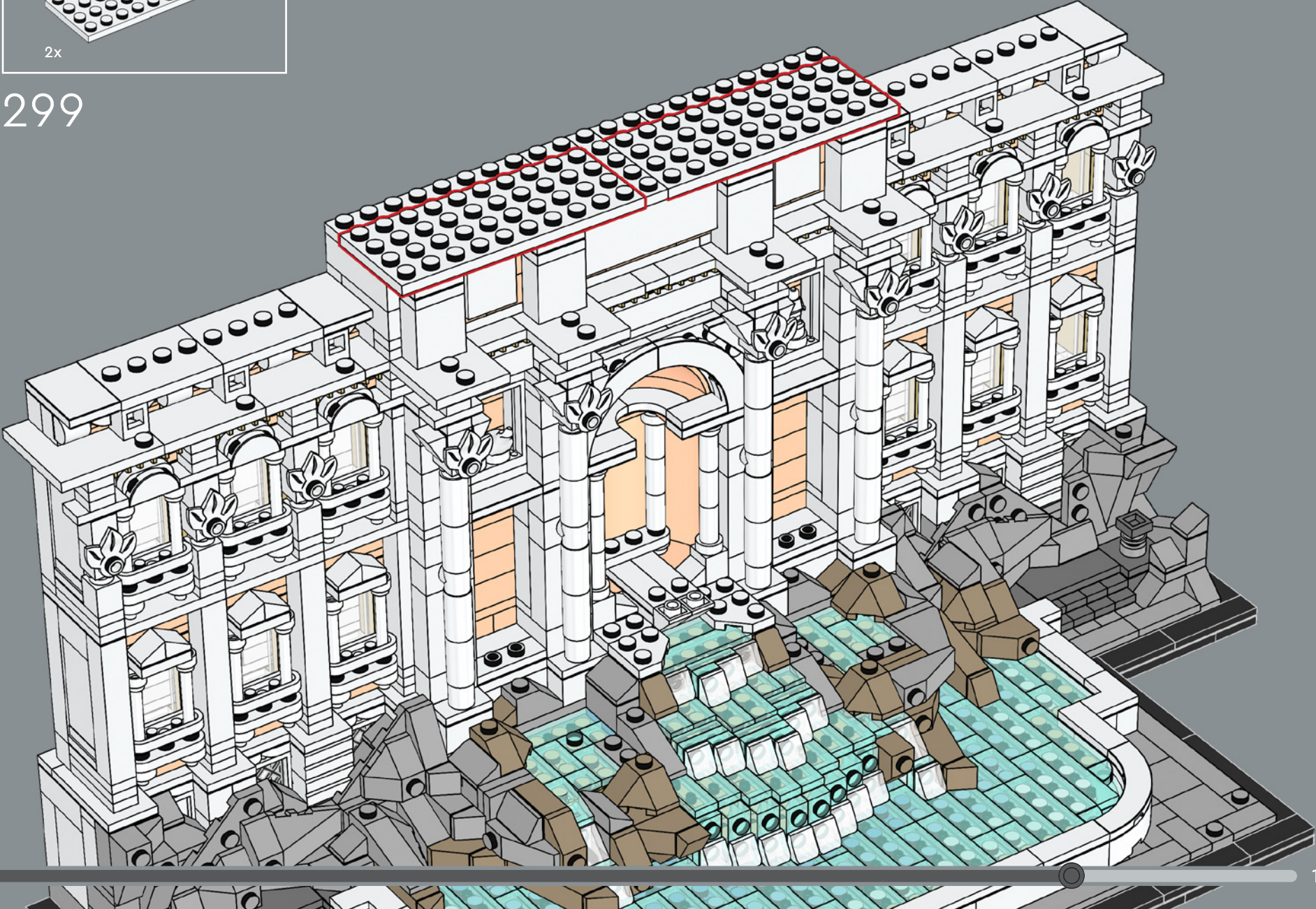

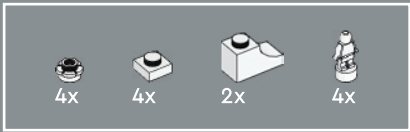

These statues represent the four seasons: Abundance of Fruit, Fertility of the Fields, the Gifts of Autumn and the Amenities of Meadows and Gardens.

300

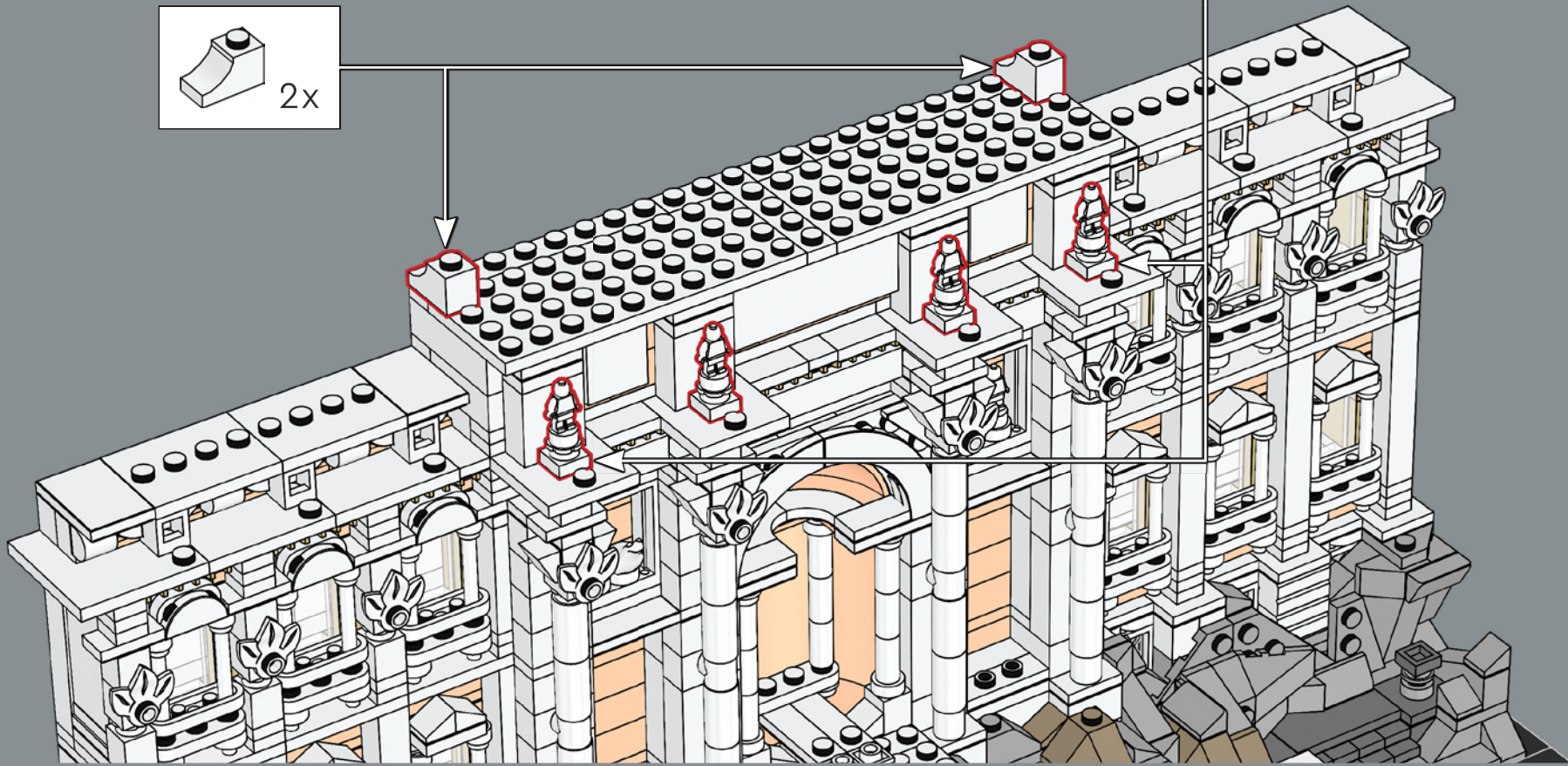
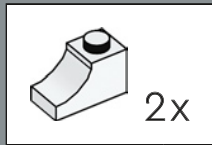
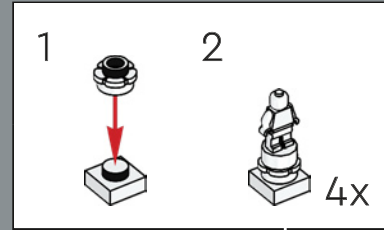

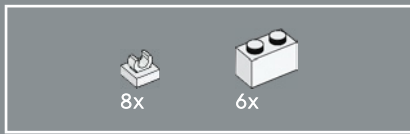

301

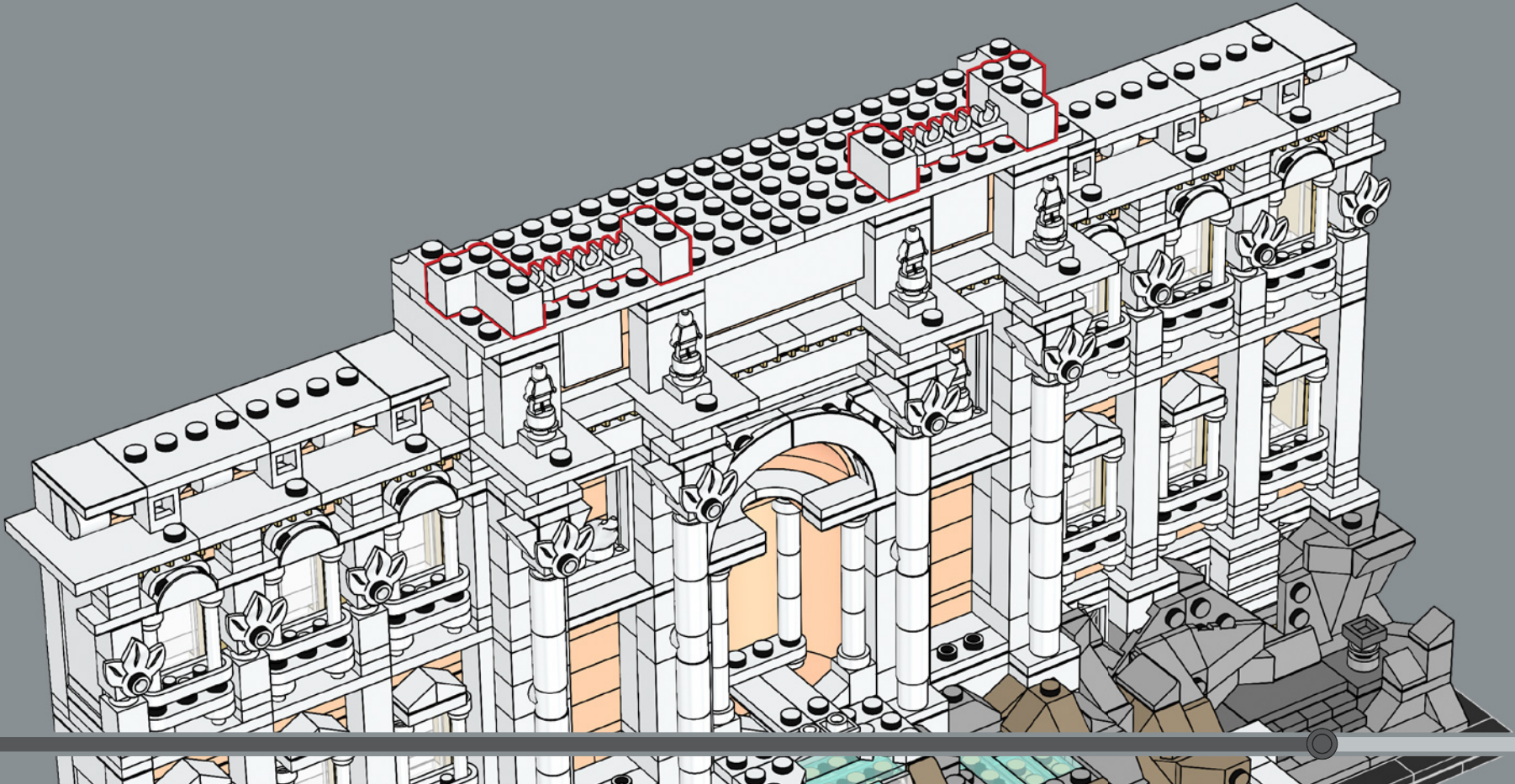



2x



1x



2x

302

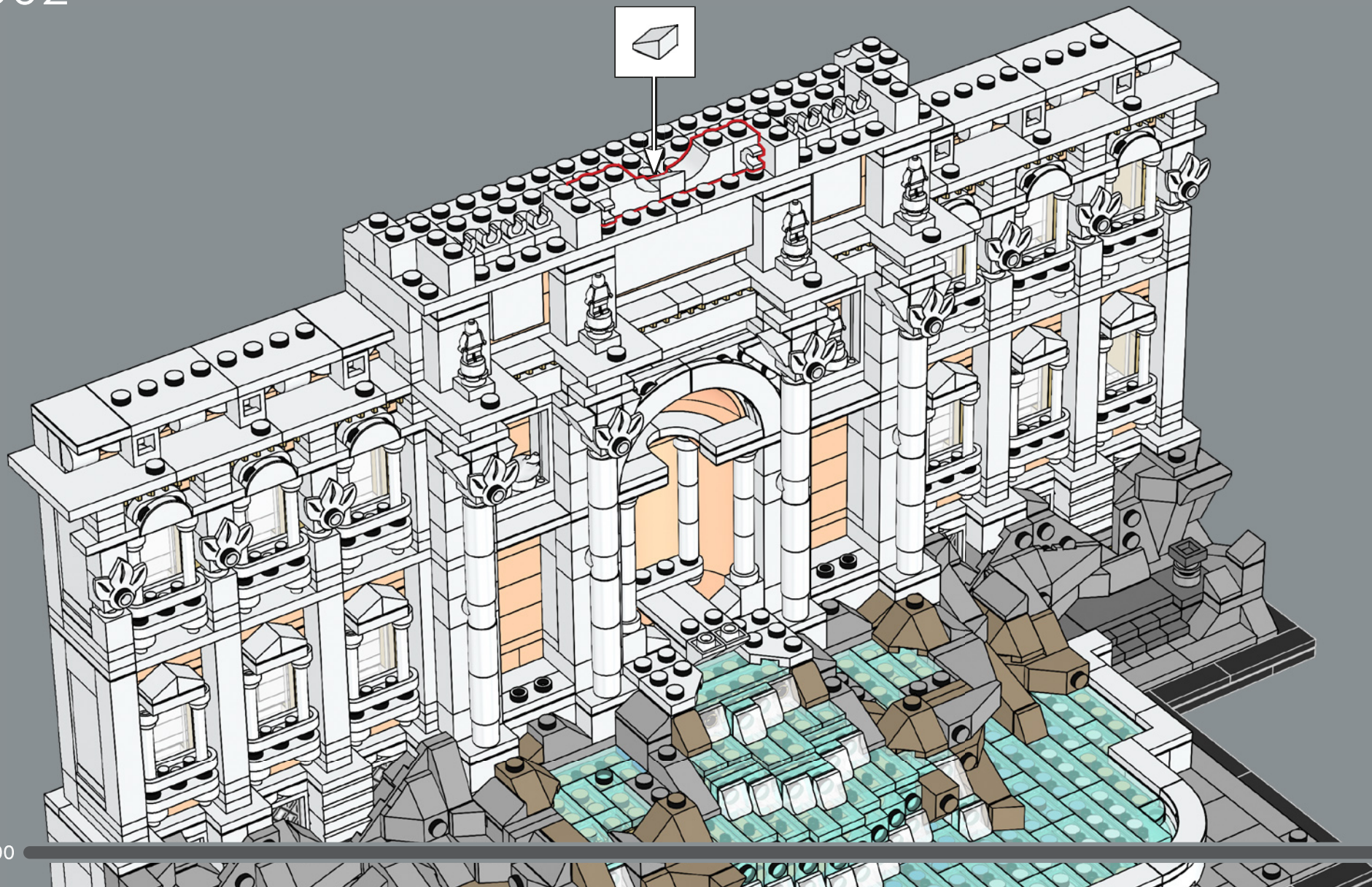

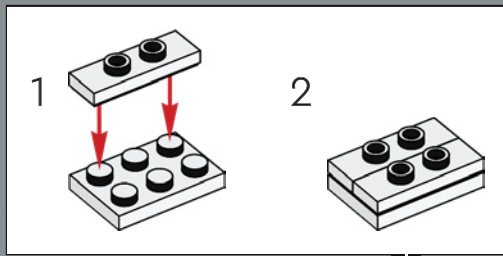
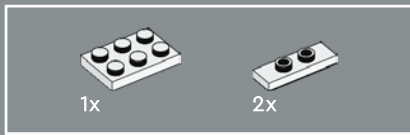

303

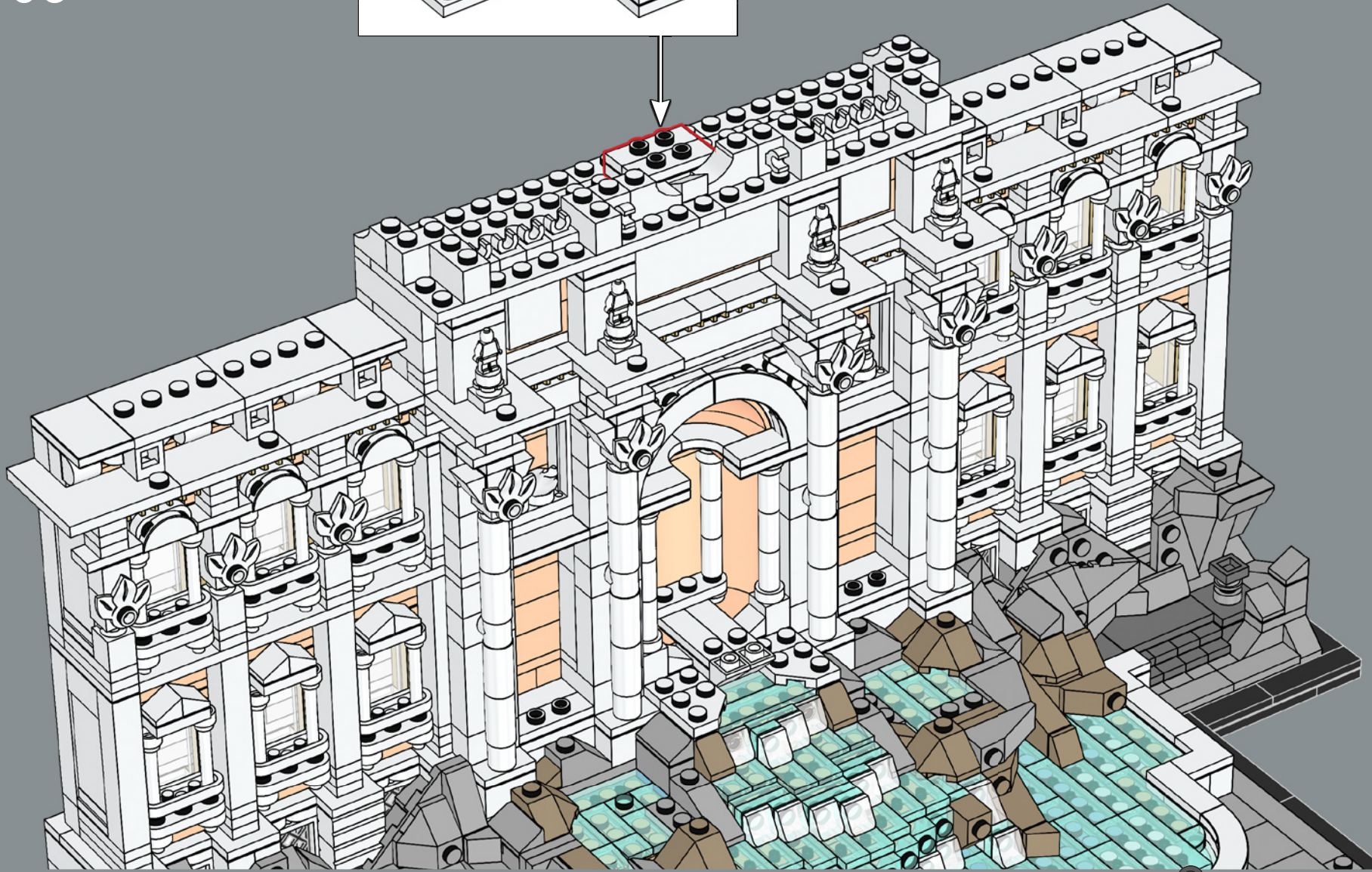

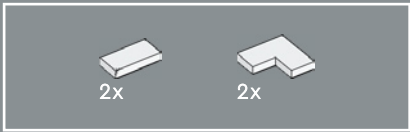

304

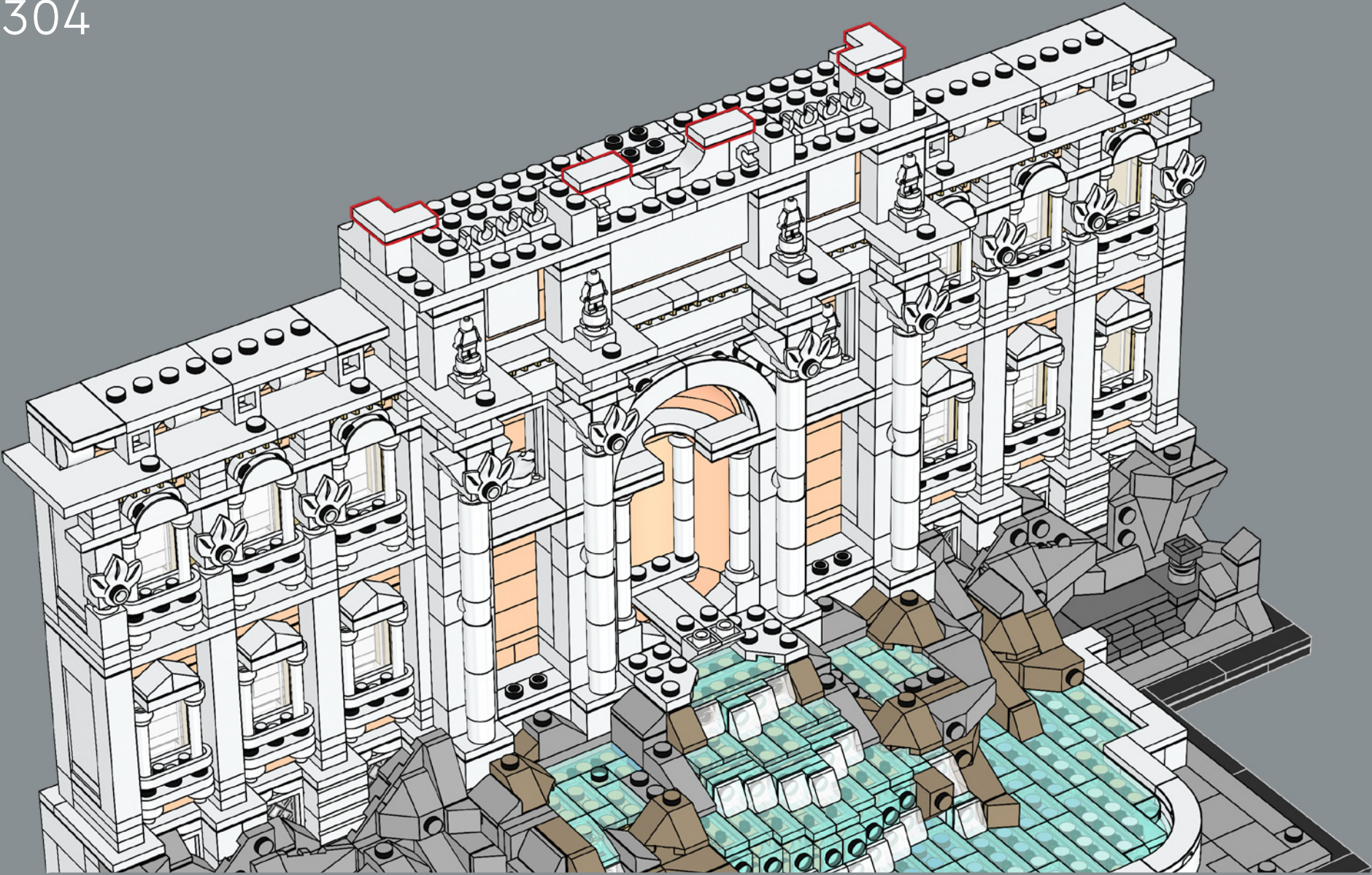

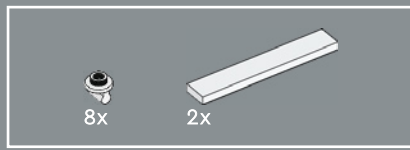

305

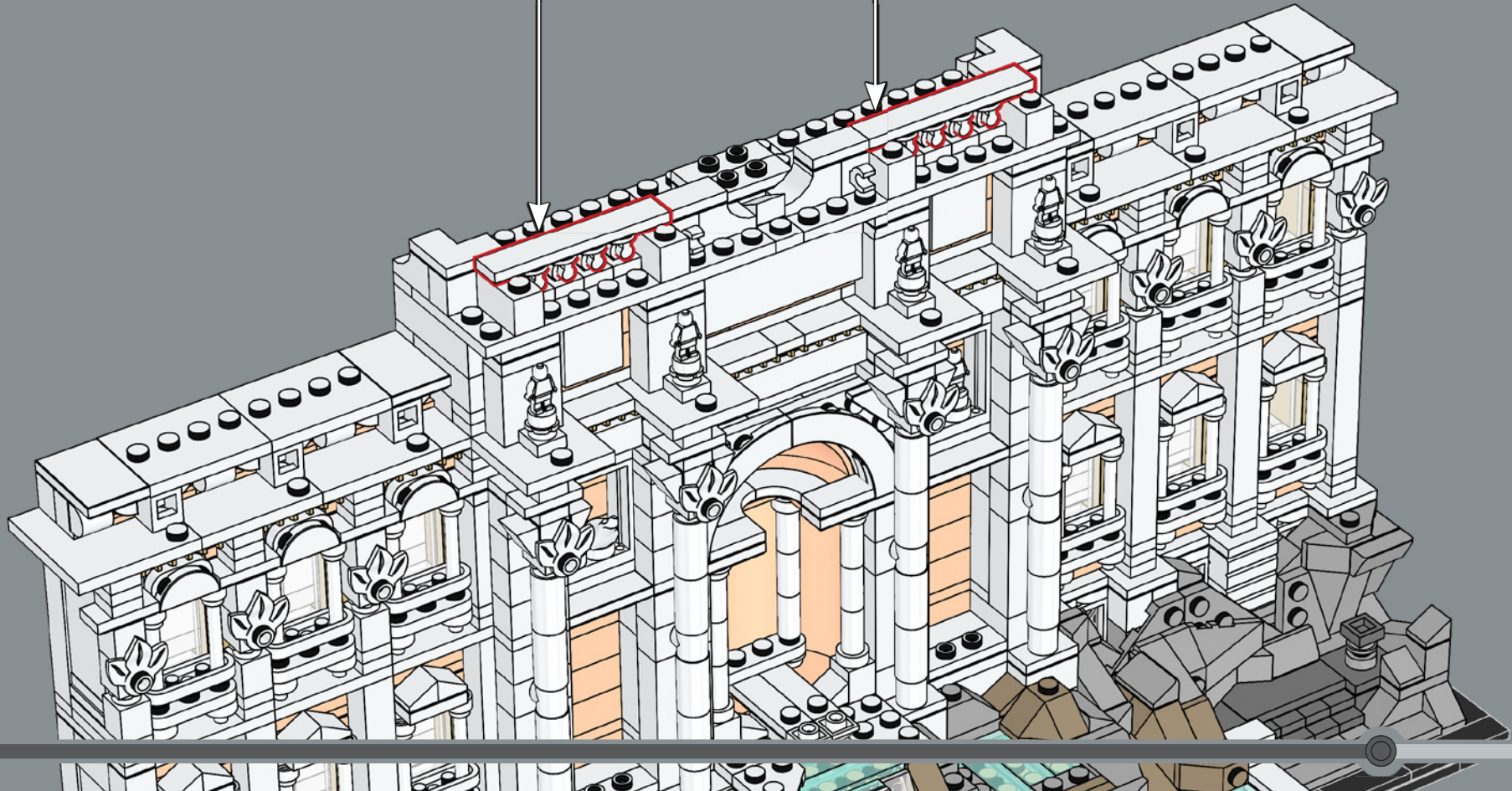
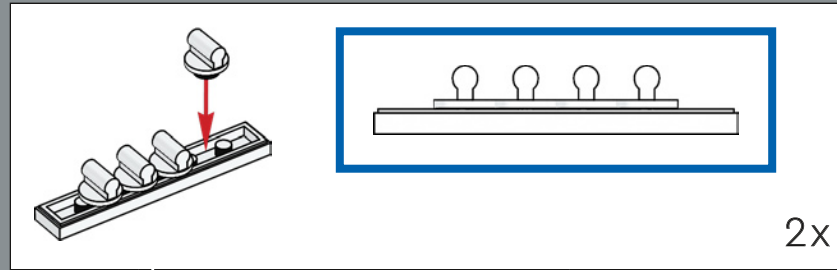

4x  2x 

306

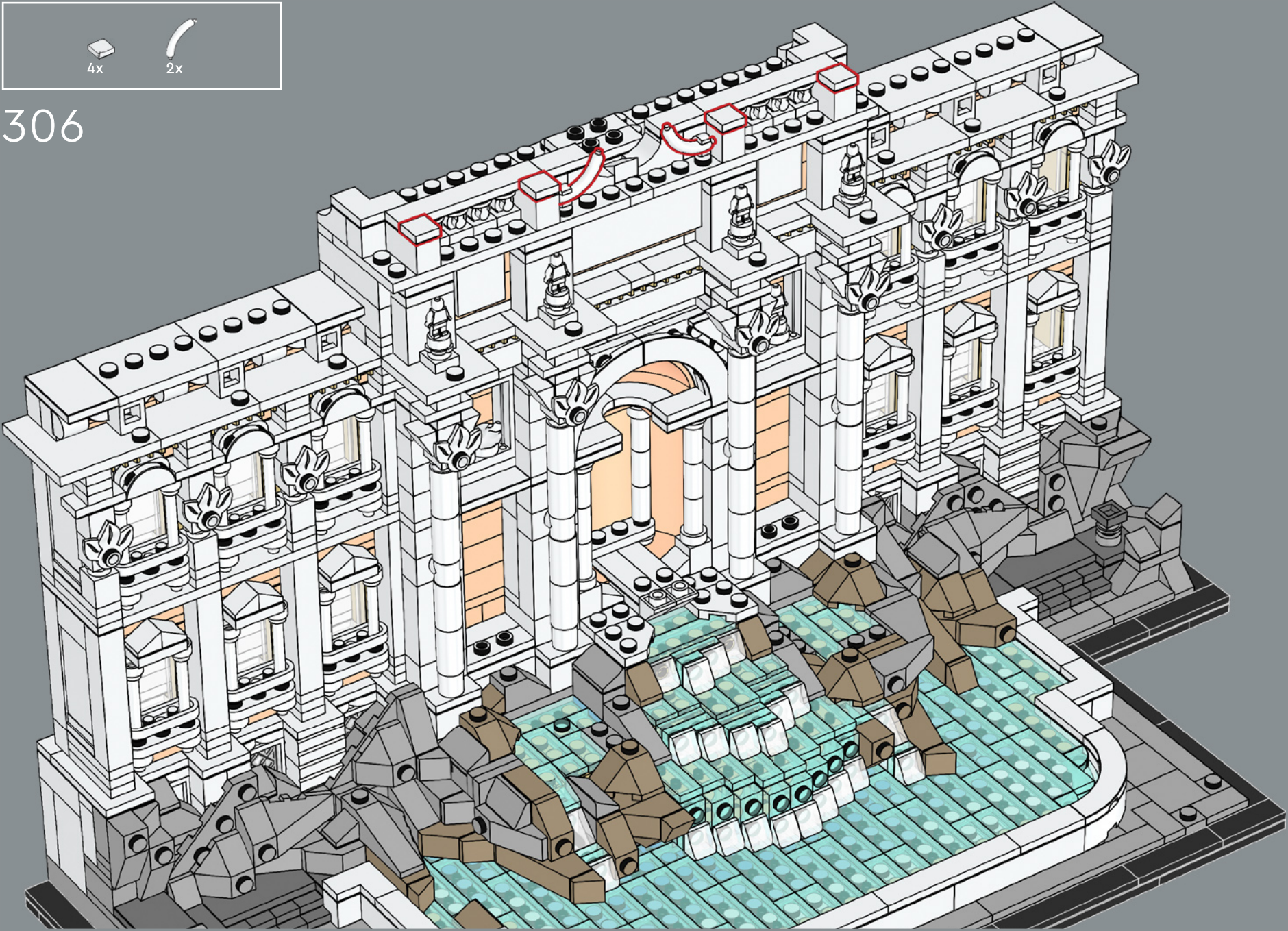

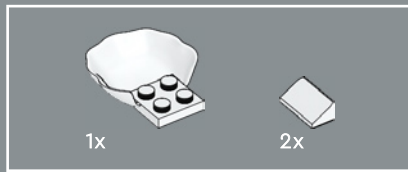

307



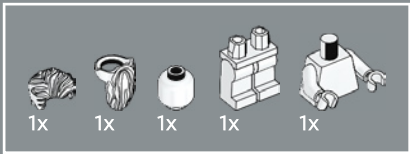

308

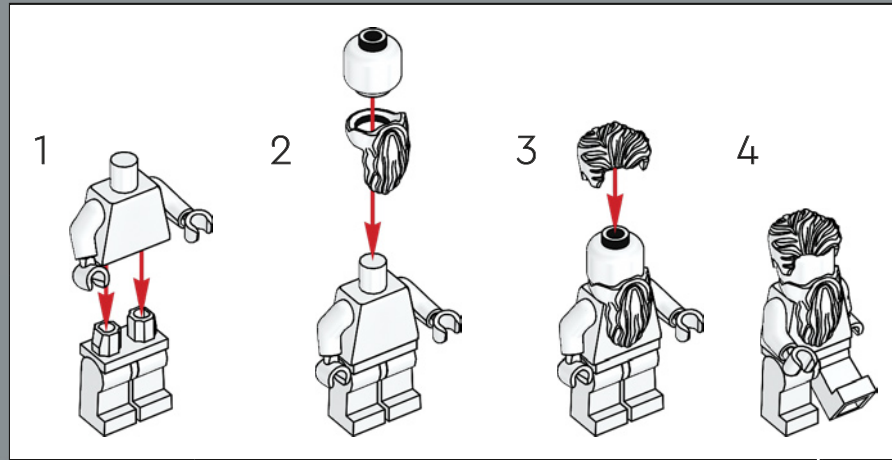

This is the first time a minifigure has appeared in a LEGO® Architecture set.

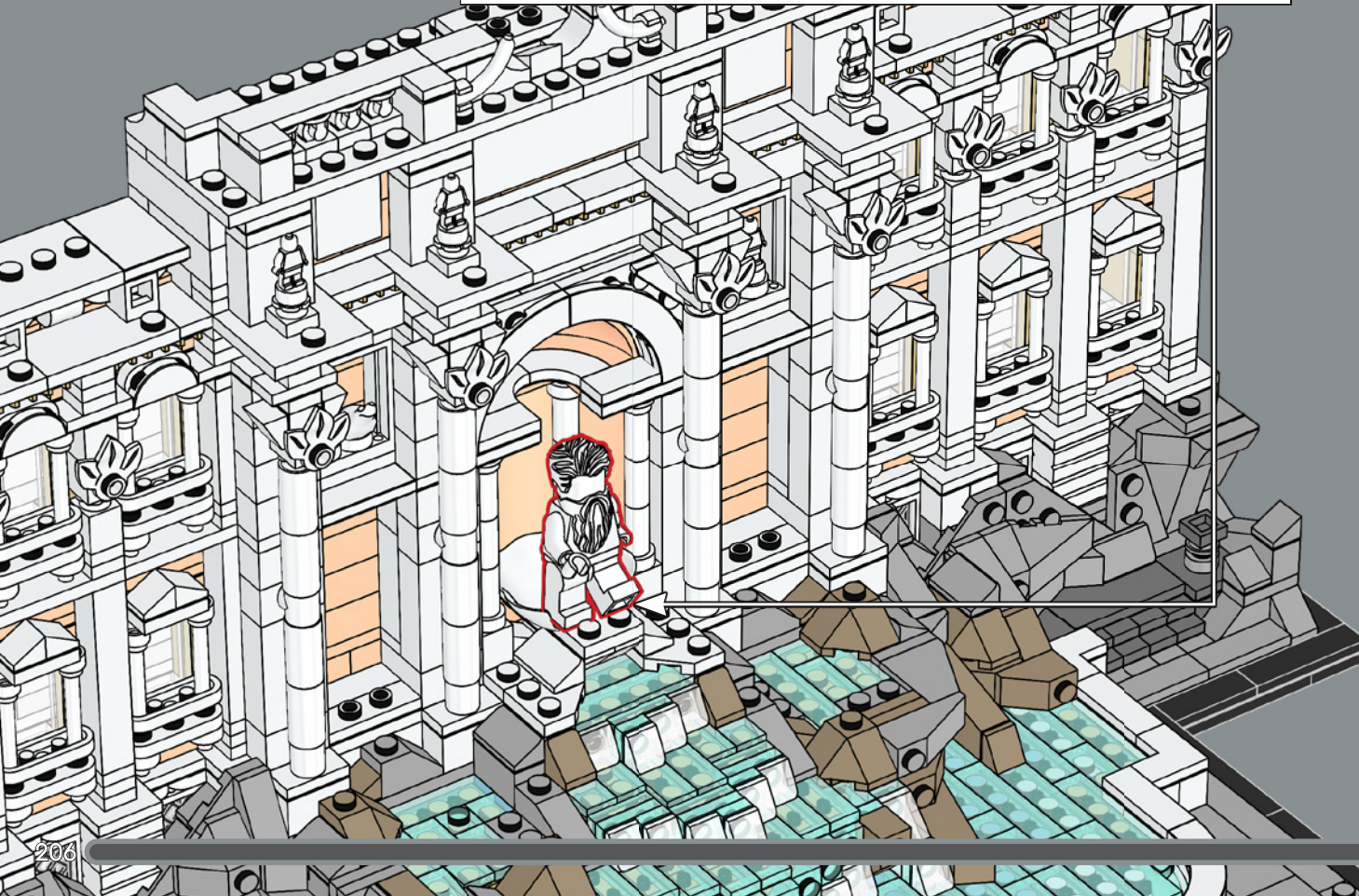

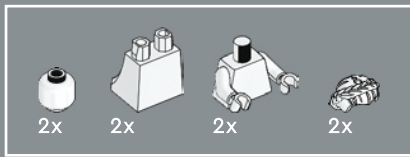

309

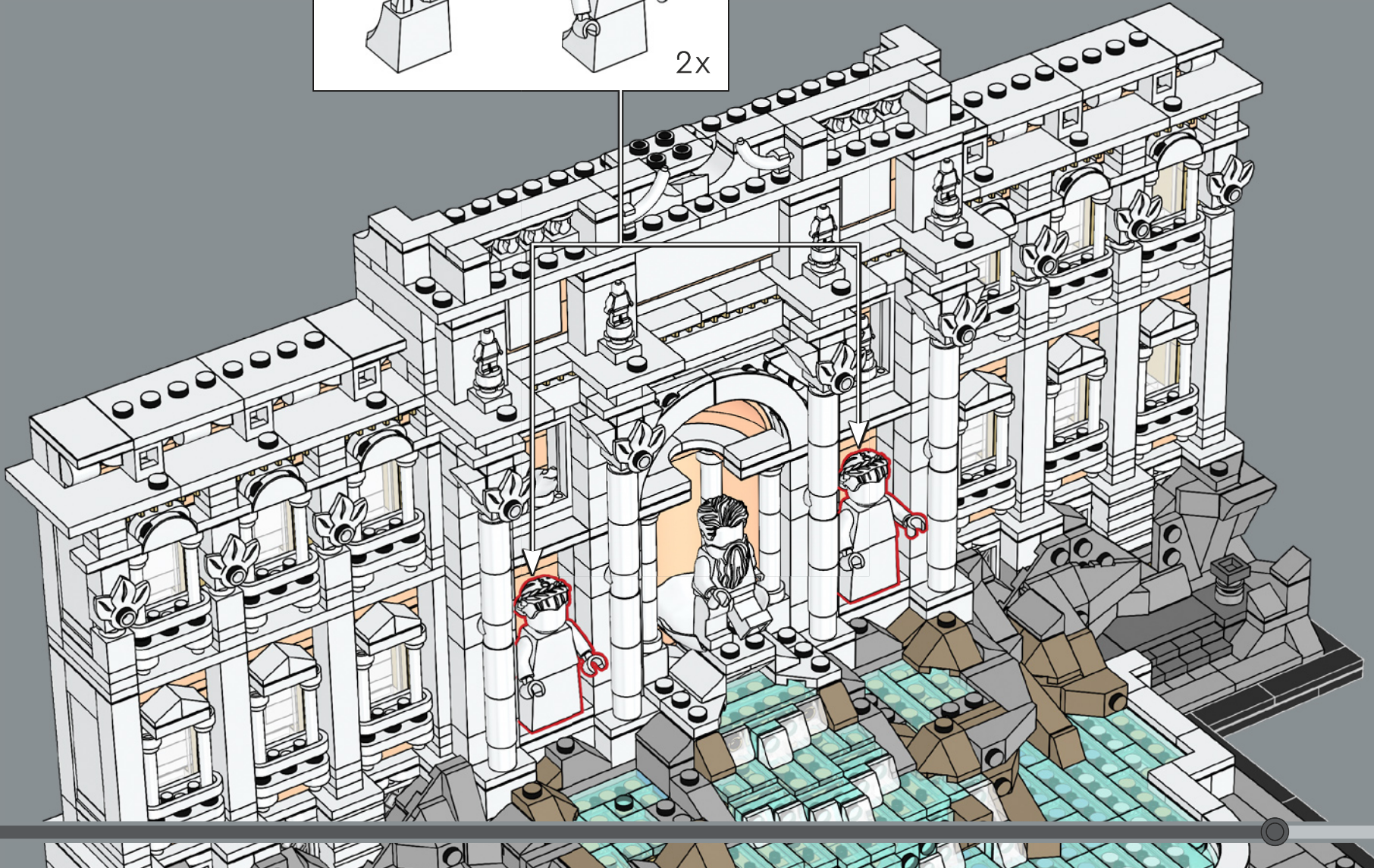
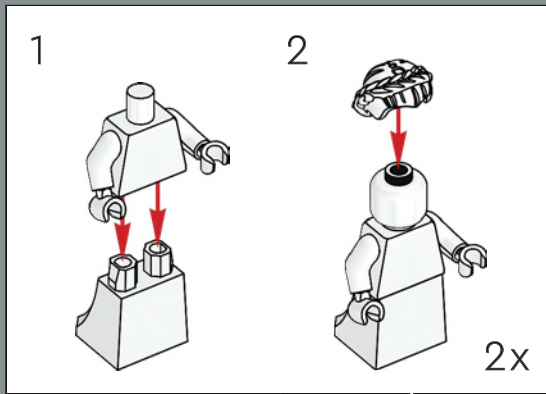

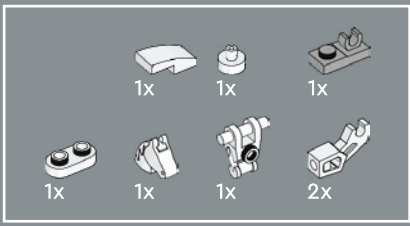

310

The LEGO® horse head returns from a LEGO Minifigures collectible series to provide detail to the hippocampi, or mythical sea-horses.

1



2

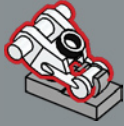

3

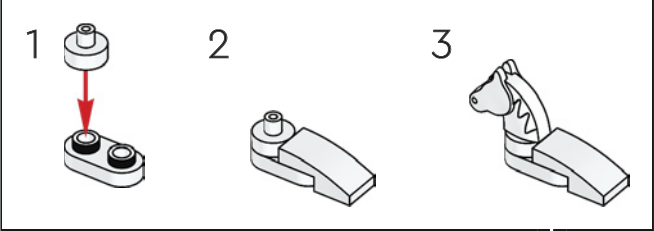
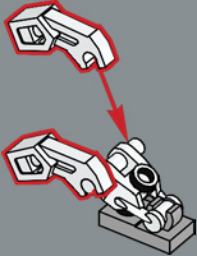

4

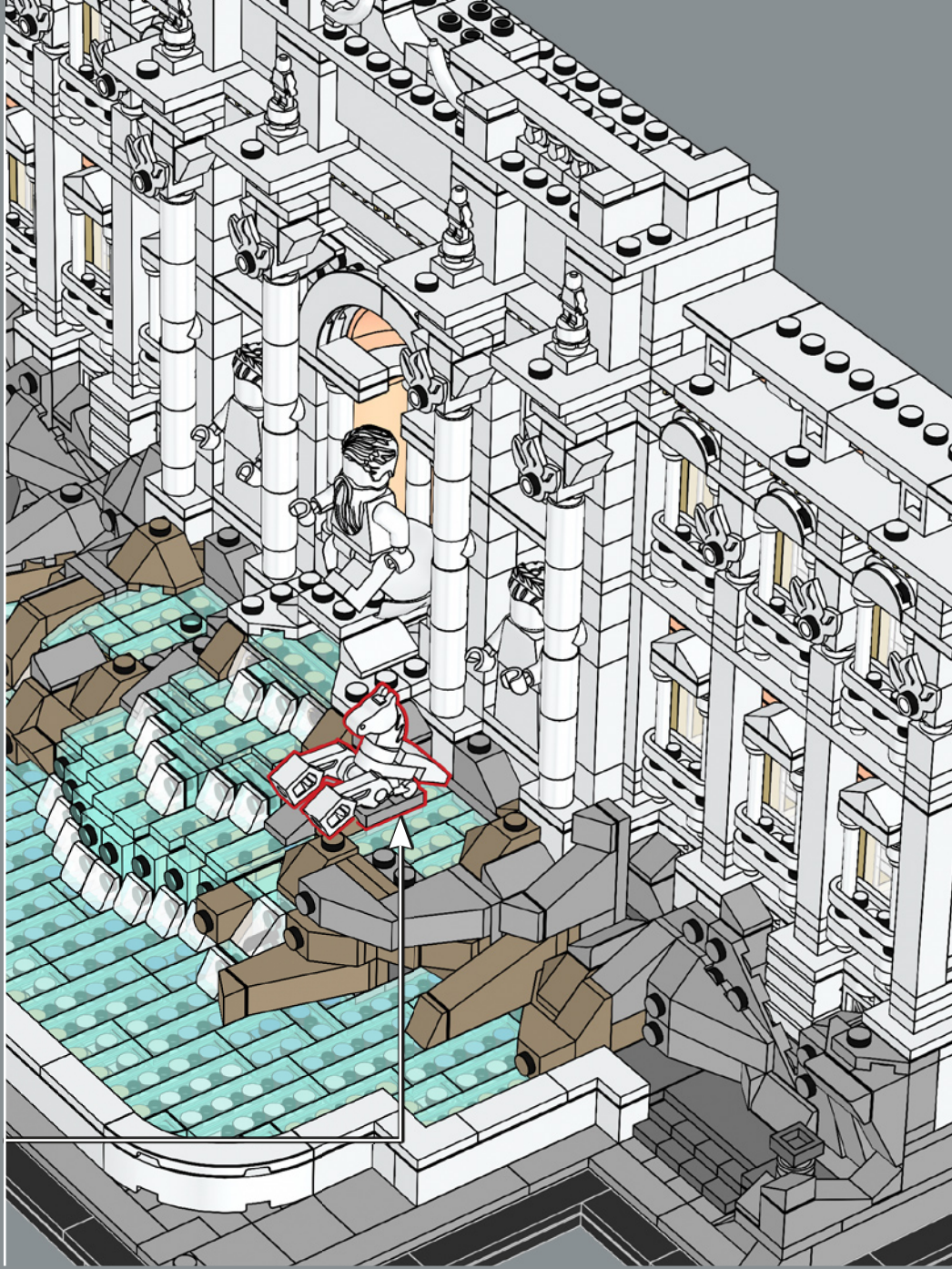
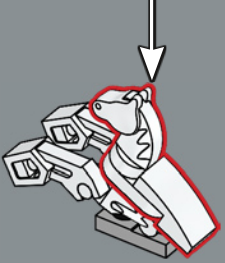



311

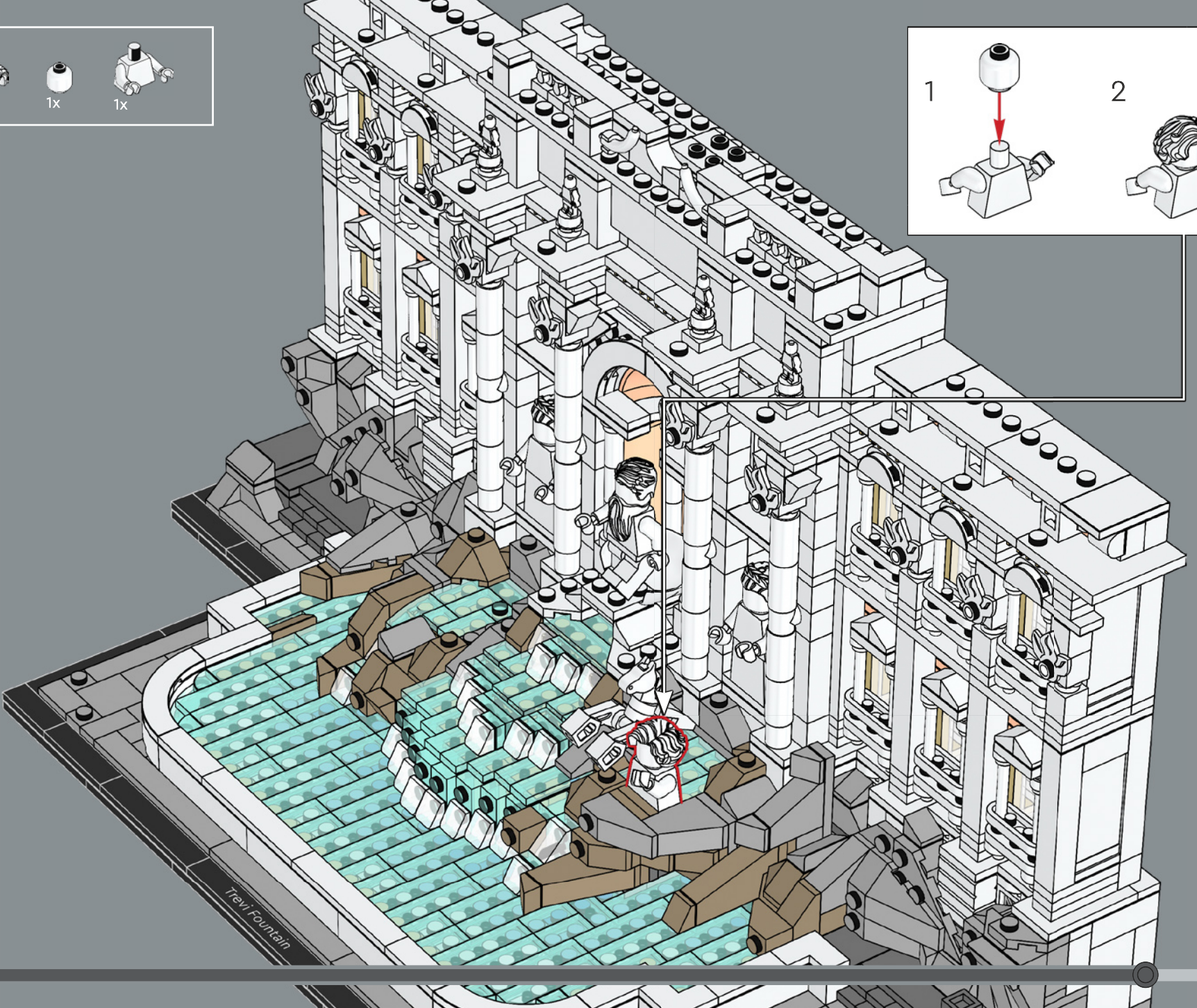
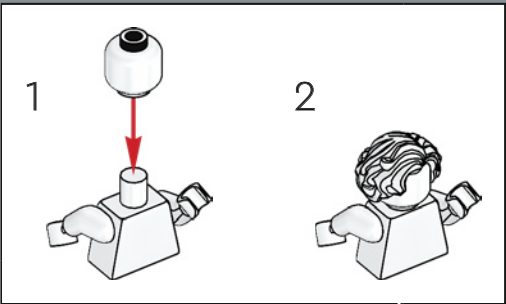

Trevi Fountain



312

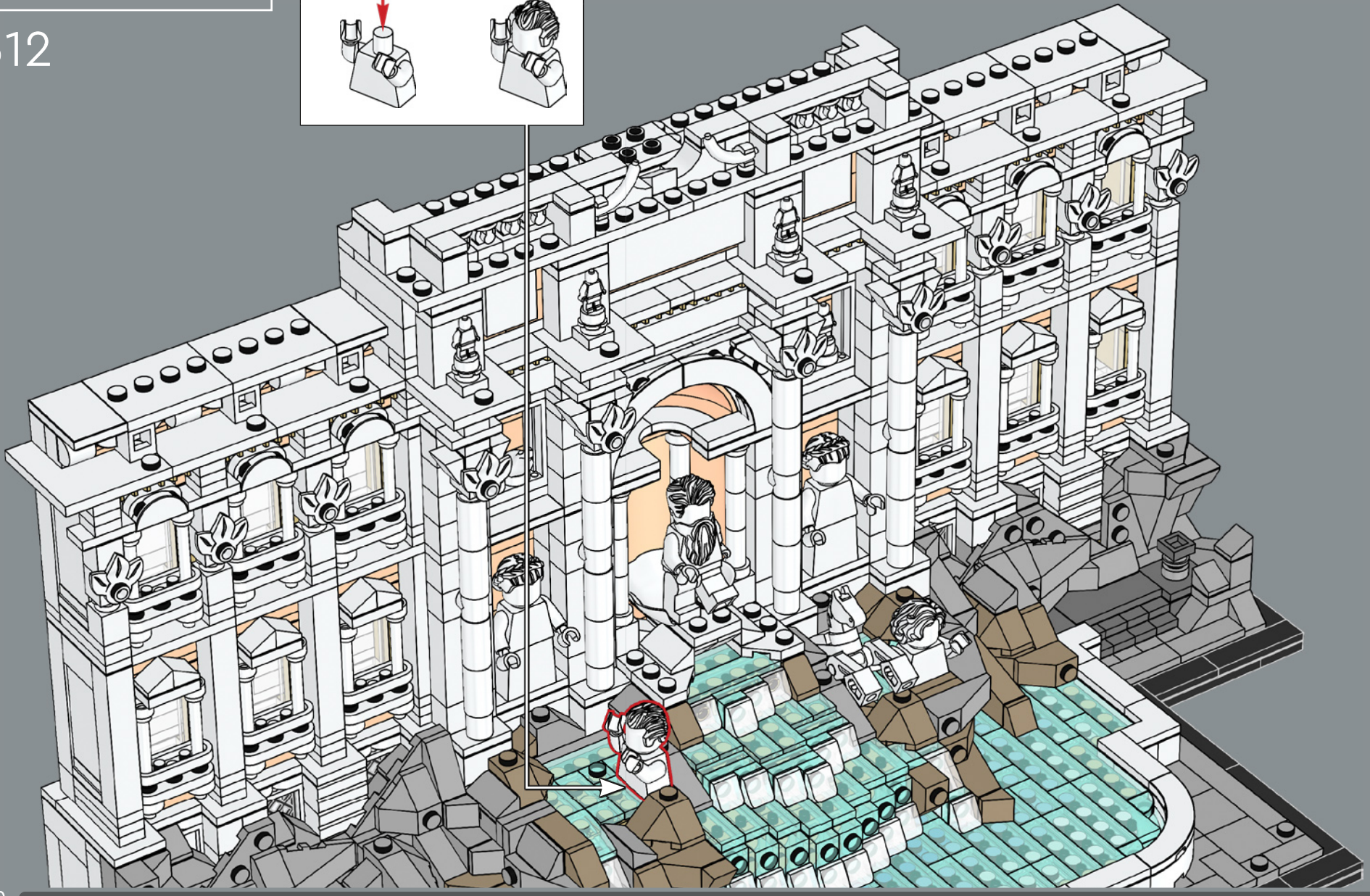
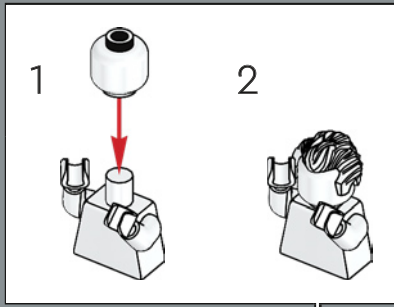

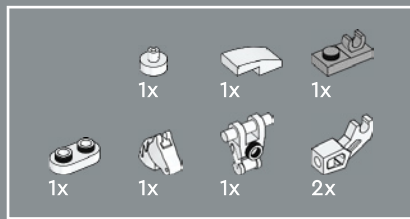

313

1



2

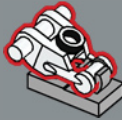

3

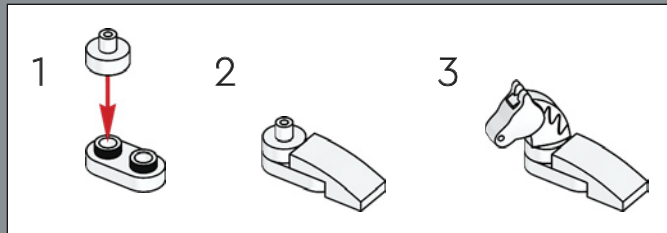
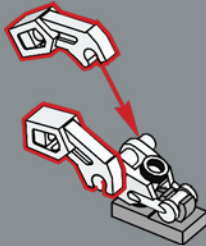

4

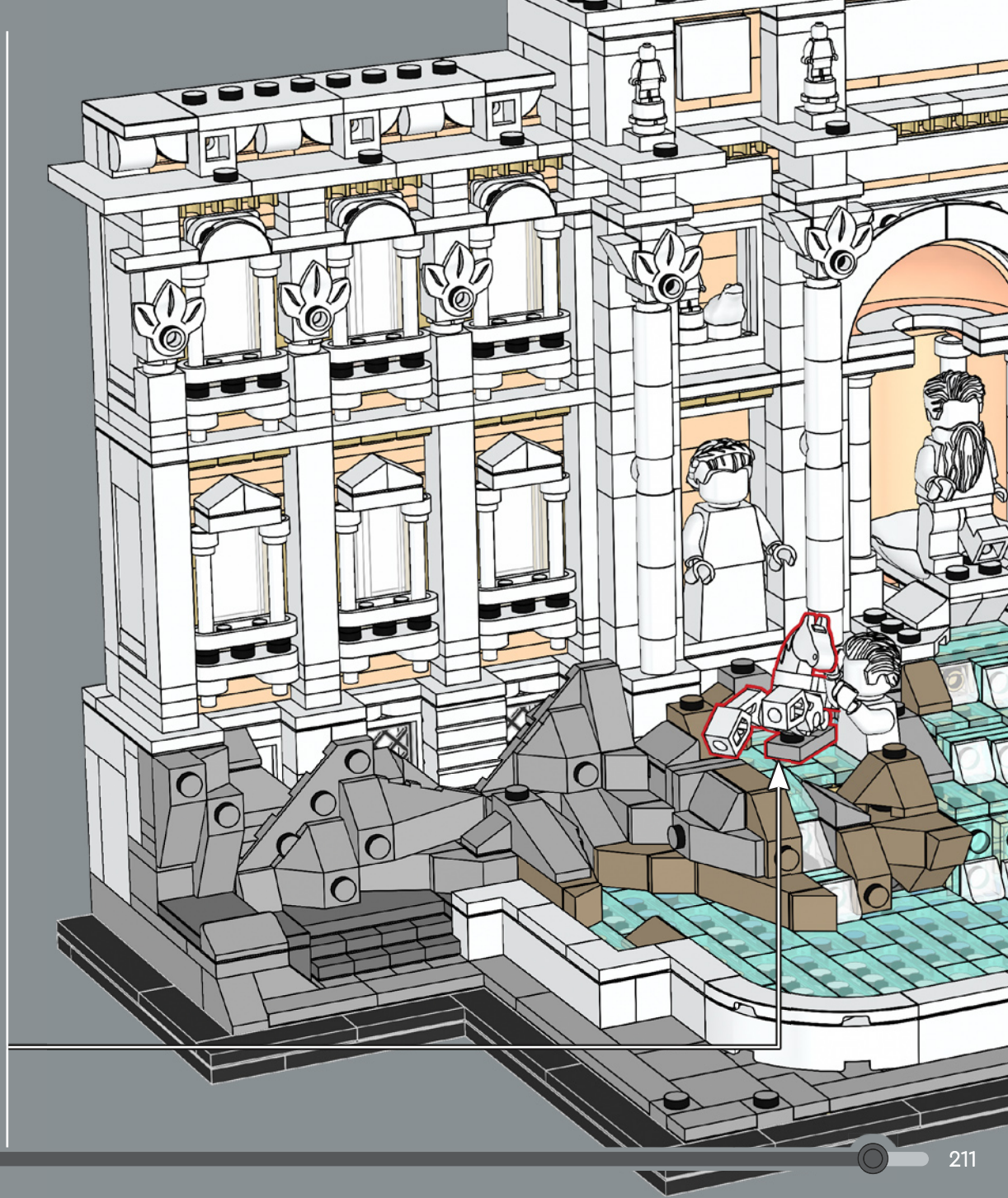
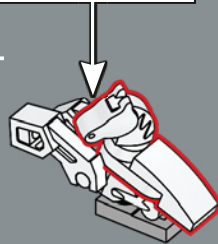

2x 2x

314

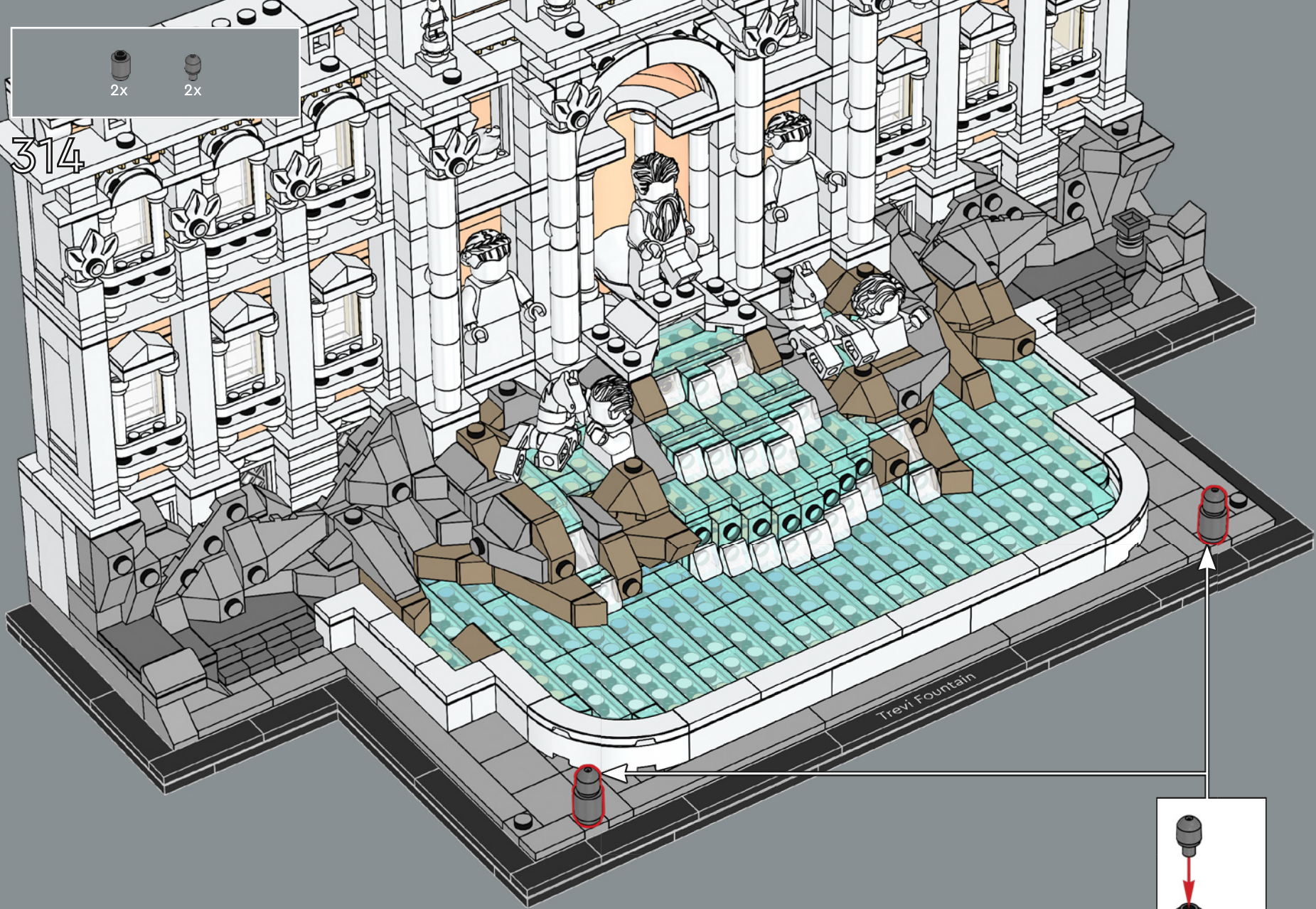

Trevi Fountain

2x

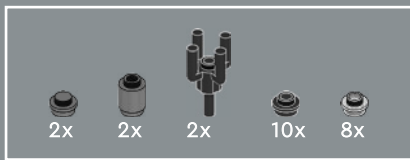

315

1

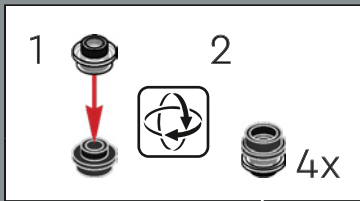
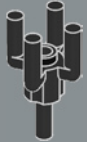

2

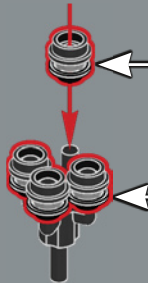

3

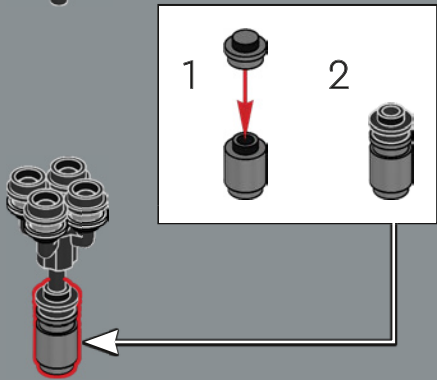

2x

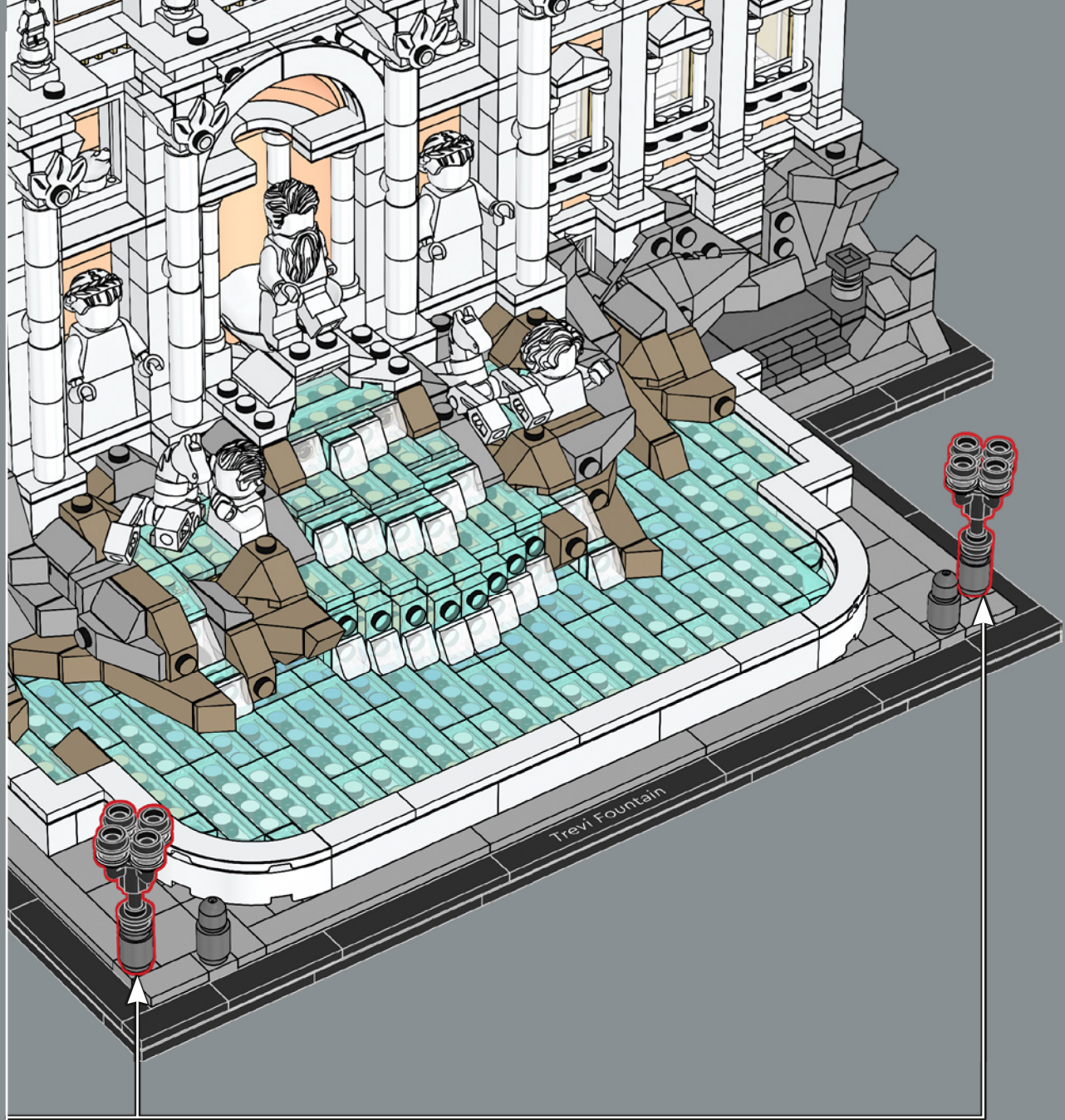

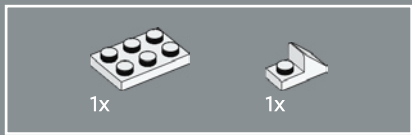

316

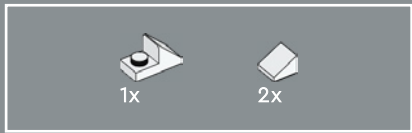
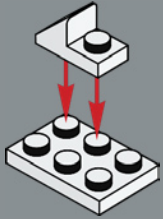

317

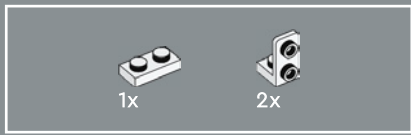
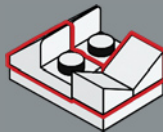

318

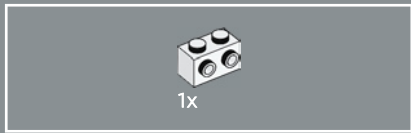
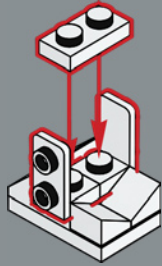

319

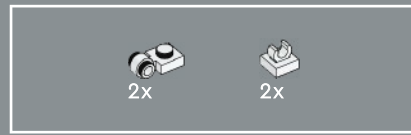
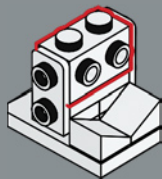

320

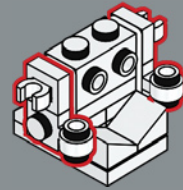

321

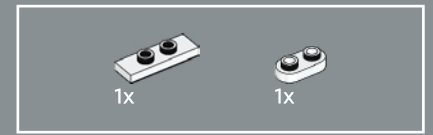
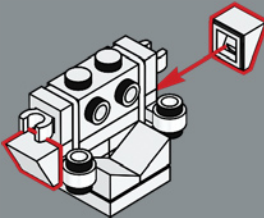

322

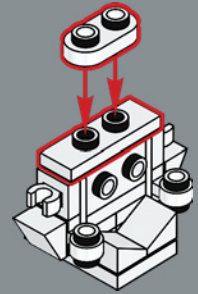

323

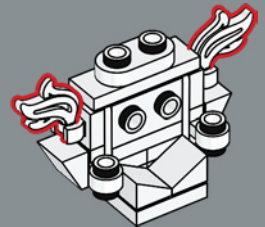



2x

324

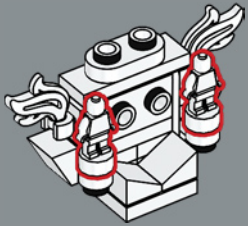

1x

325

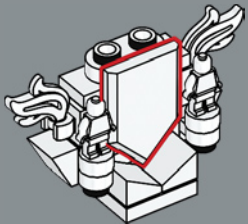

2x

326

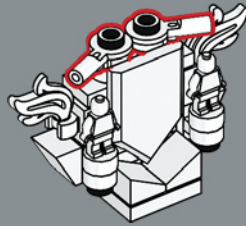

1x



1x

327

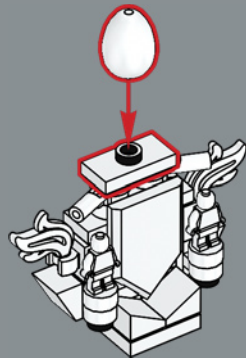

328

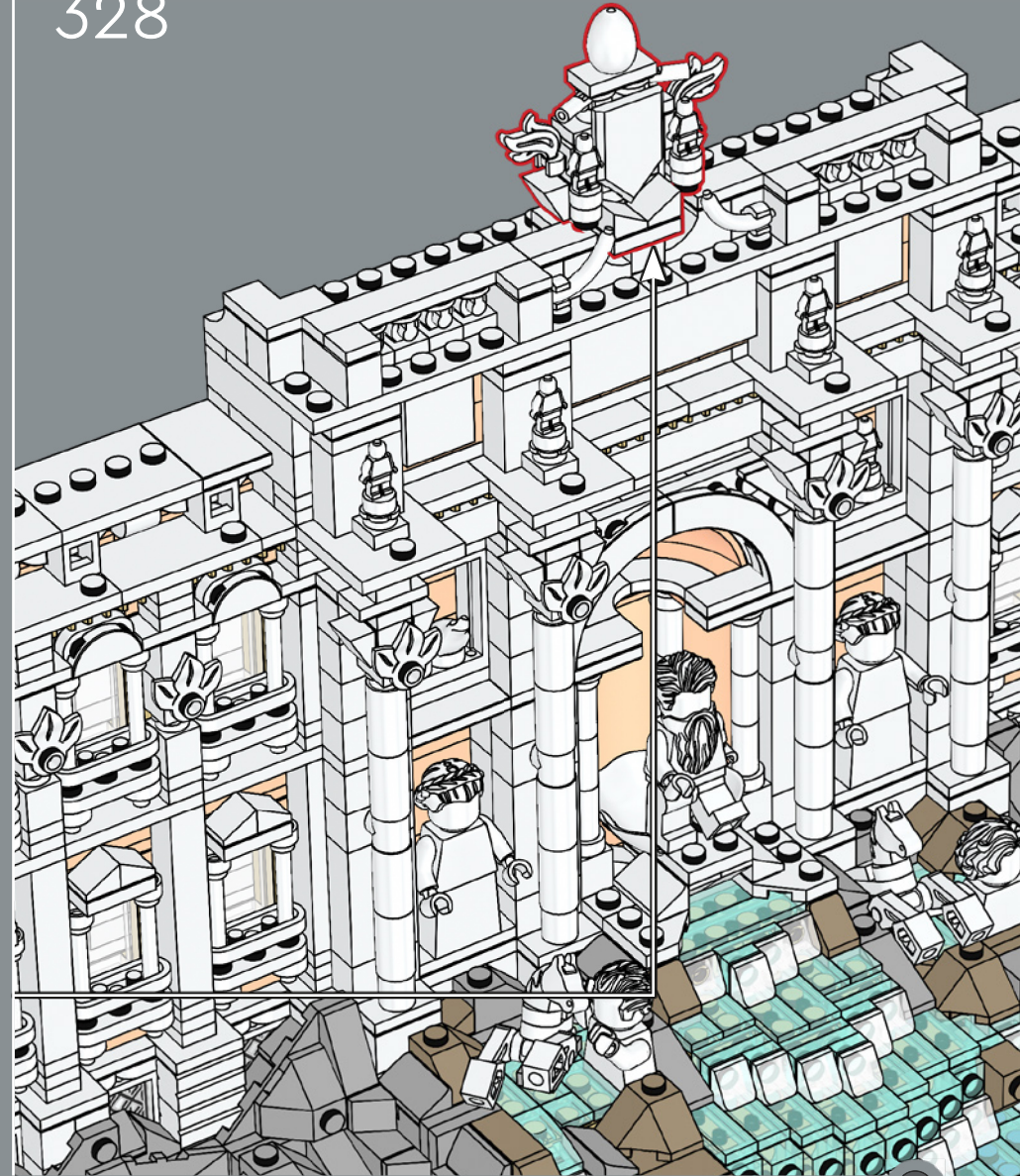

The Trevi Fountain, carved from Travertine stone, has been the backdrop for many classic films, including Federico Fellini's *La Dolce Vita* (1960).

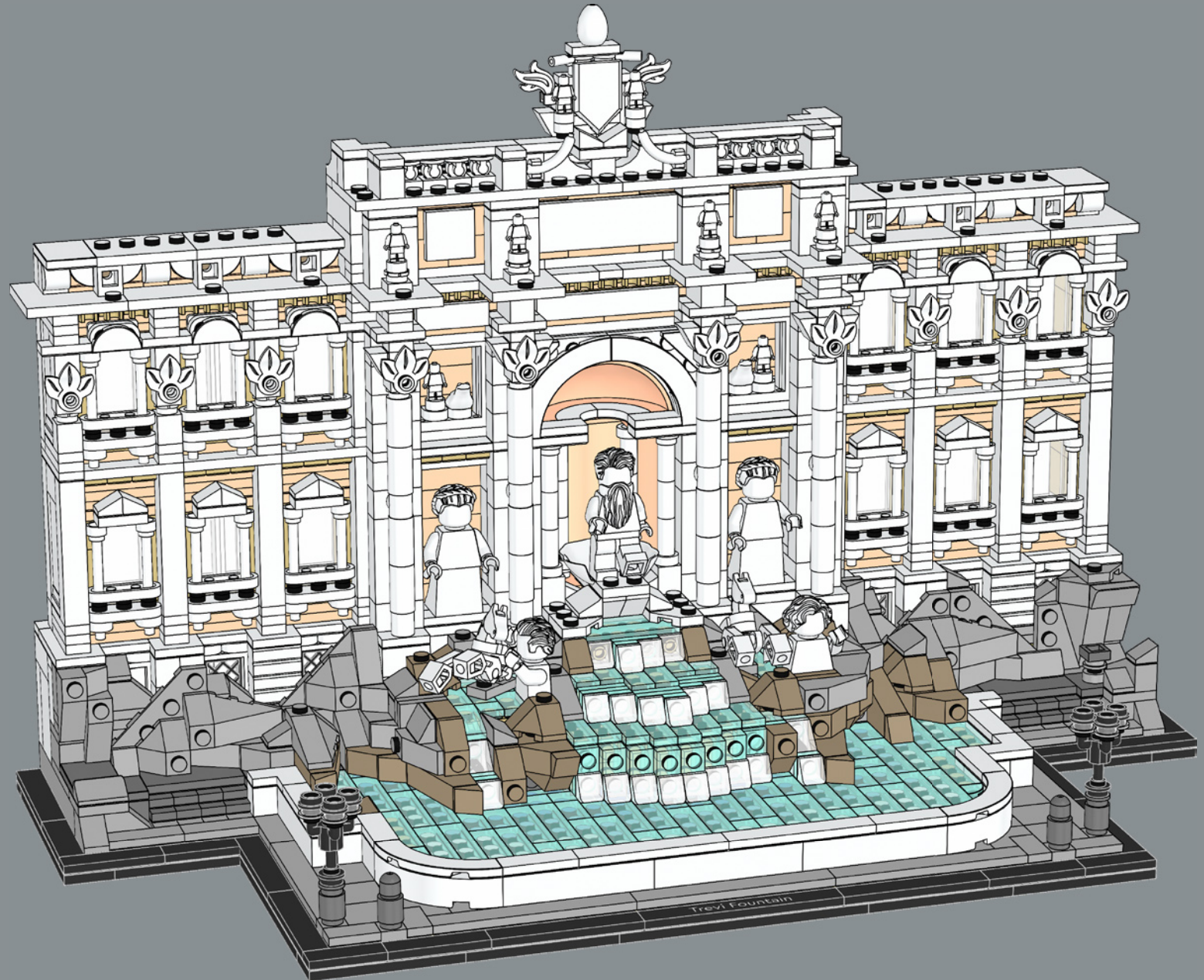

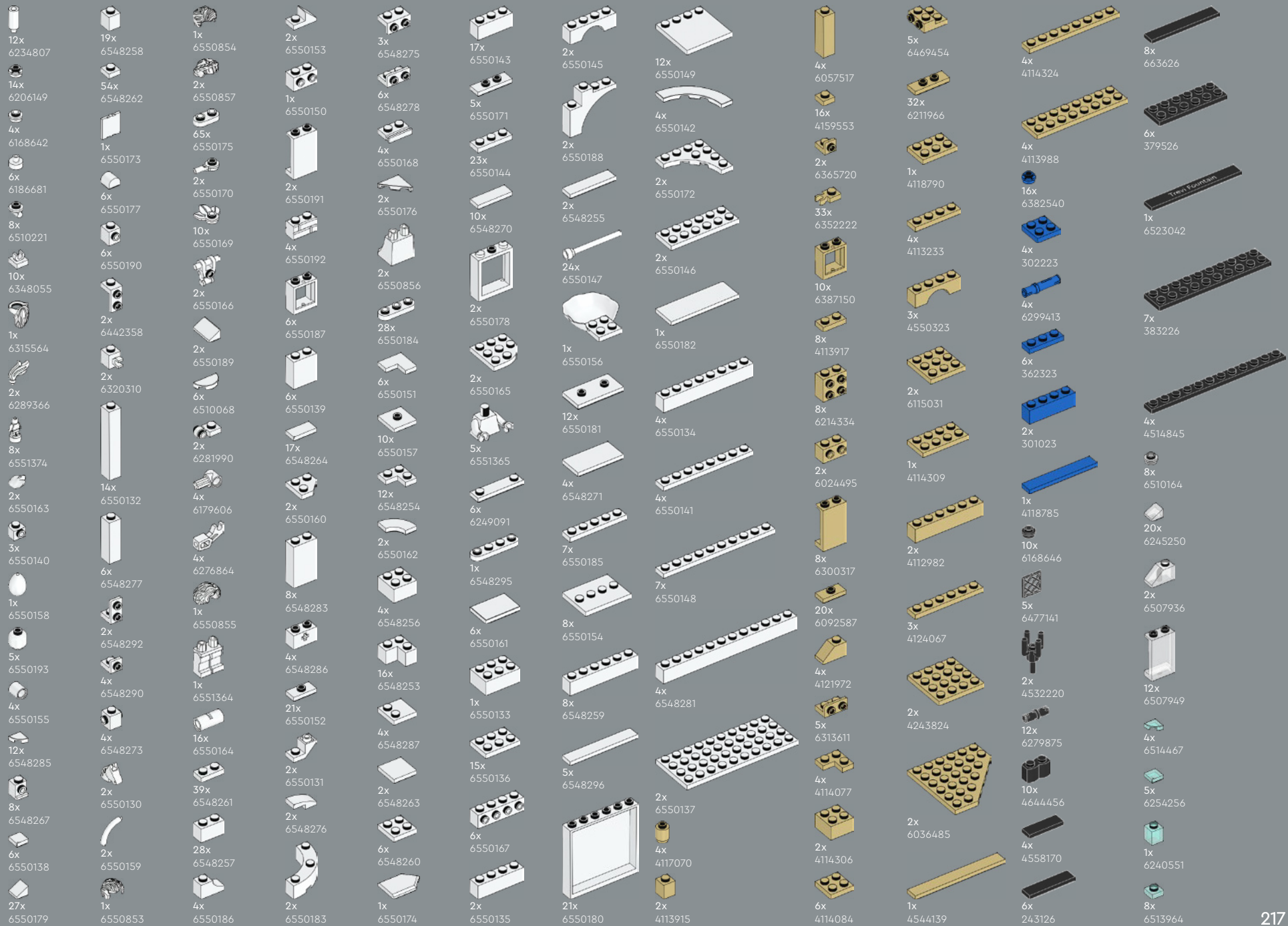

- 2x 6537848
- 14x 6514007
- 39x 6514224
- 6x 6514268
- 1x 6508249
- 54x 6510178
- 1x 6240515
- 10x 6322841
- 4x 6001824
- 9x 4530678
- 5x 4528604
- 4x 4653509
- 1x 6449563
- 1x 4521914
- 2x 6093064
- 1x 6228921
- 7x 6331865
- 2x 6035540
- 10x 6040126
- 1x 6015449
- 1x 6168647
- 1x 6258831
- 3x 4211389
- 19x 4521921
- 3x 6225242
- 6x 4211399
- 8x 4211415
- 4x 4558953
- 6x 6248890
- 1x 4211791
- 10x 4568637
- 1x 6213378
- 1x 6186657
- 3x 6123809
- 4x 4515374
- 11x 4211614
- 4x 6066097
- 9x 4211414
- 4x 4211388
- 1x 6093859
- 1x 4211564
- 5x 4211398
- 2x 6326078
- 2x 6383177
- 1x 6217876
- 1x 4211349
- 2x 6177078
- 6x 4211413
- 2x 6034676
- 8x 6212077
- 11x 4211353
- 2x 6469440
- 11x 4211488
- 6x 4558169
- 8x 6211969
- 4x 4211396
- 4x 4160560
- 7x 4211445
- 1x 4180418
- 3x 4180408
- 1x 6372029
- 1x 4211438
- 6x 4211452
- 2x 4211795
- 7x 4211425
- 2x 4211392
- 5x 4211481
- 1x 6313653
- 5x 4211404
- 1x 4210719
- 16x 6092572
- 4x 4210978
- 1x 6126083
- 2x 6309059
- 2x 4211133
- 1x 4211104
- 2x 6343852
- 8x 6187008
- 2x 4211105
- 4x 4211001
- 2x 4560184
- 3x 4620760
- 2x 4211002
- 2x 4211498
- 2x 4251149
- 5x 4617862
- 4x 4211408
- 2x 4211360
- 2x 4662161
- 1x 6528242
- 2x 6344216
- 4x 4211090
- 2x 4210633
- 4x 6395635
- 1x 6228923
- 4x 4558955
- 2x 4211107
- 2x 4211061
- 2x 4210678
- 4x 6000970
- 16x 6426347
- 4x 6357797
- 6x 6369189
- 16x 6329282
- 4x 6369188
- 21x 6357794
- 10x 6501239
- 4x 6440965
- 12x 6424071
- 1x 6541427
- 1x 6537849
- 12x 6537846
- 2x 6329604
- 4x 6439745
- 8x 6206809
- 4x 6144149
- 4x 4649741
- 2x 6070757
- 8x 4655256
- 2x 6146701
- 6x 6141592
- 2x 6138662



 [LEGO.com/service](https://www.LEGO.com/service)



YOU COULD WIN



YOU COULD WIN

Your feedback will help shape the future development of this product series.

Visit:

DU KÖNNTEST GEWINNEN

Dein Feedback trägt zur Weiterentwicklung dieser Produktreihe bei.

Geh auf:

VOUS POURRIEZ GAGNER

Vos commentaires nous aideront à concevoir les futurs produits de cette gamme.

Visitez :

POTRESTI VINCERE TU

La tua opinione ci aiuterà a migliorare la creazione futura di questa linea di prodotti.

Visita:

PUEDES GANAR

Tu opinión contribuirá al futuro de esta serie de productos.

Visita:

轻松获奖

您的反馈将有助于我们在今后改进本产品系列。

请访问:

LEGO.com/productfeedback

You also have the chance to win a LEGO® set.

Terms and conditions apply.*

Außerdem hast du die Chance, ein LEGO® Set zu gewinnen.

Es gelten die Teilnahmebedingungen.*

Vous pourriez également gagner un ensemble LEGO®.

Des conditions s'appliquent.*

Hai anche la possibilità di vincere un set LEGO®.

Termini e condizioni sono applicabili.*

También tienes la oportunidad de ganar un set LEGO®.

Aplican términos y condiciones.*

您还有机会赢取乐高®套装。

条款和条件适用。*

*LEGO.com/productfeedback-terms

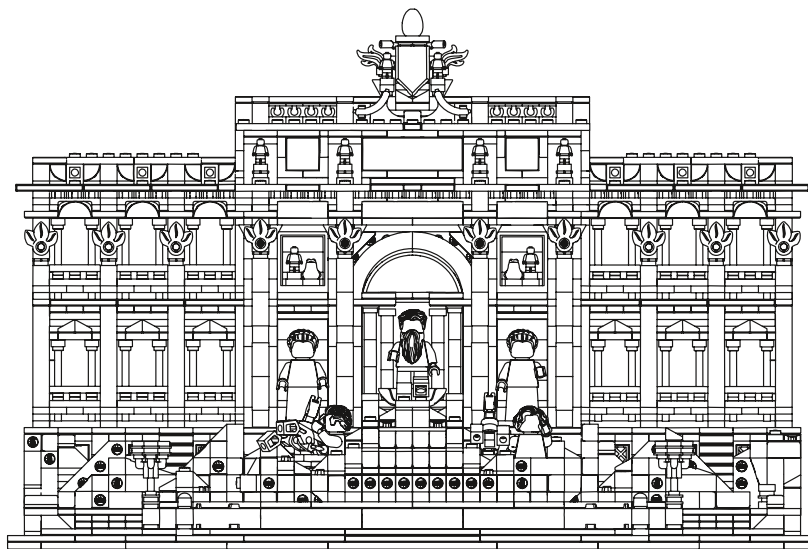

LEGO and the LEGO logo are trademarks of the LEGO Group. ©2025 The LEGO Group. 6566165
Adam Reed Tucker is the co-developer of the LEGO® Architecture product line.