



80117



LEGO® Builder



 **1-3**
Builders

Build Together

Download now



Q LEGO® Builder



Apple and the Apple logo are trademarks of Apple Inc., registered in the U.S. and other countries and regions. App Store is a service mark of Apple Inc. Google Play and the Google Play logo are trademarks of Google LLC. Tencent and the Tencent logo are trademarks of Tencent Inc.

Q LEGO.com/devicecheck

Construire Ensemble

Télécharger

1-3 constructeurs

Construye En Compañía

Descargar ahora

1-3 constructores





福 (fú) is a Chinese character with deep significance, embodying centuries of tradition and values. An important word which is symbolic of good luck, prosperity and well-being, it is deeply rooted in traditional Chinese culture as a sentiment of positive energy and good fortune, especially during festivals and celebrations. It contains the eternal yearning and ideals of hundreds of millions of Chinese people from ancient times to modern times. Not only does 福 (fú) embody people's pursuit of a happy life, but also reflects people's expectations for a better future. You can see the pursuit and love of this character all over China, and the rest of the world, especially during the Spring Festival. People always express their hope for a good fortune in a variety of ways, such as Spring Festival couplets, persimmons, gold ingots, magpies, lucky fruits, etc., each endowed with deep symbolic meanings and the yearning for a happy life in the new year.

福 (fú) est un caractère chinois très significatif qui représente des siècles de tradition et de valeurs. Symbole de chance, de prospérité et de bien-être, ce mot important est profondément ancré dans la culture traditionnelle chinoise comme un vecteur d'énergie positive et de bonne fortune, en particulier lors des festivals et des célébrations. Il renferme les aspirations et les idéaux éternels de centaines de millions de Chinois, de l'antiquité à nos jours. Non seulement 福 (fú) exprime la quête d'une vie heureuse, mais il reflète également les attentes d'un avenir meilleur. On peut observer la quête et l'amour de ce caractère dans toute la Chine et dans le reste du monde, en particulier lors du festival du printemps. Les gens manifestent toujours leur espoir de bonne fortune de diverses manières, comme les distiques du festival de printemps, les kakis, les lingots d'or, les pies, les fruits porte-bonheur, etc., tous porteurs de significations symboliques profondes et de l'aspiration à une vie heureuse dans la nouvelle année.

福 (fu) es un sinograma con una profunda trascendencia que expresa siglos de tradición y valores. Este importante carácter que simboliza la buena suerte, la prosperidad y el bienestar está profundamente arraigado en la cultura tradicional china como un sentimiento de energía positiva y buena fortuna, sobre todo en las fiestas y celebraciones. Encierra los anhelos e ideales eternos de cientos de millones de chinos y chinas desde los tiempos antiguos hasta la actualidad. 福 (fu) no solo representa la búsqueda de una vida feliz por parte de las personas, sino que también refleja sus esperanzas de un futuro mejor. Puedes ver la admiración y el cariño que existe por este carácter en toda China, y en el resto del mundo, especialmente durante la Fiesta de la Primavera. La gente siempre manifiesta su deseo de buena suerte de las formas más variadas, como en los versos pareados de la Fiesta de la Primavera o con caquis, lingotes de oro, urracas, frutas de la suerte, etc., cada una cargada de gran significado simbólico y el anhelo de una vida feliz en el nuevo año.





Get excited about our new packaging!

We're switching from plastic to paper-based packaging. That's why you might find a mix of paper and plastic in our boxes!

Nos nouveaux emballages vous emballeront !

Nous passons des emballages en plastique aux emballages à base de papier. C'est pourquoi vous pourriez trouver un mélange de papier et de plastique dans nos boîtes !

¡Te presentamos nuestros nuevos empaques!

Estamos sustituyendo las bolsas de plástico por bolsas con base de papel. ¡Por eso, puedes encontrar una mezcla de papel y de plástico en nuestras cajas!

[LEGO.com/sustainable-packaging](https://www.lego.com/sustainable-packaging)

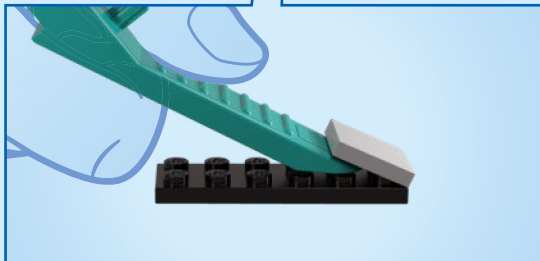
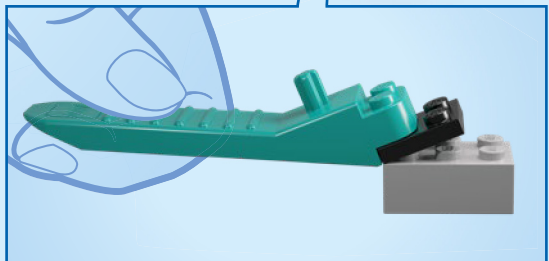
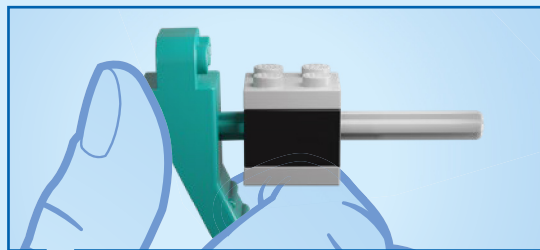
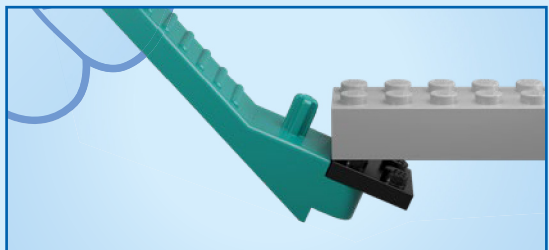

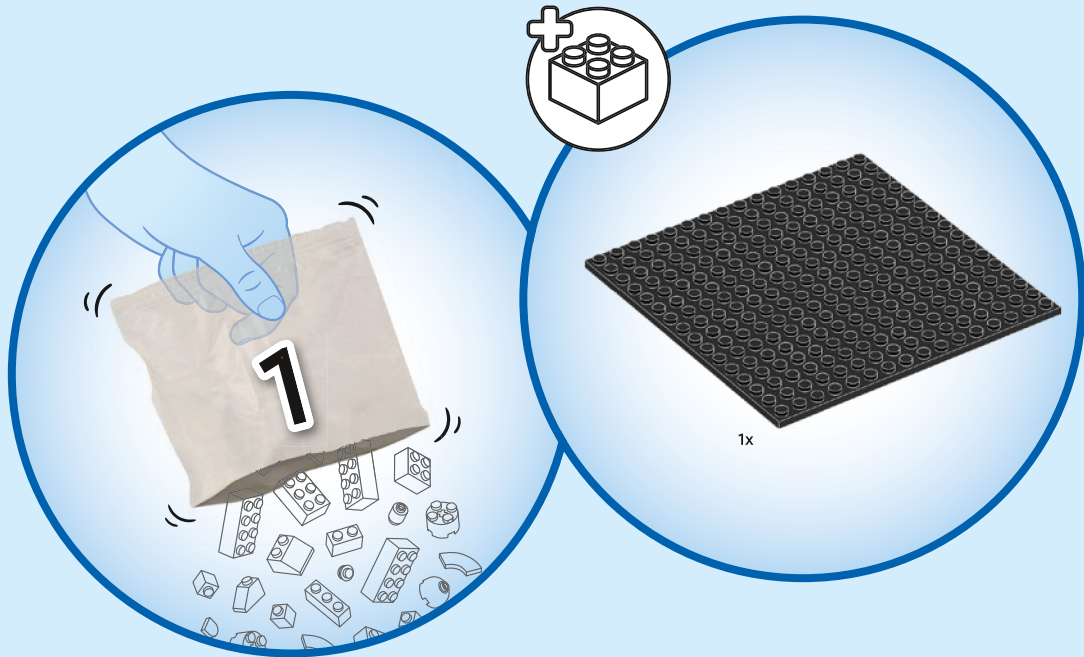

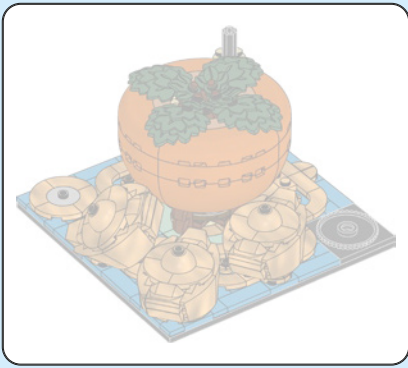

1

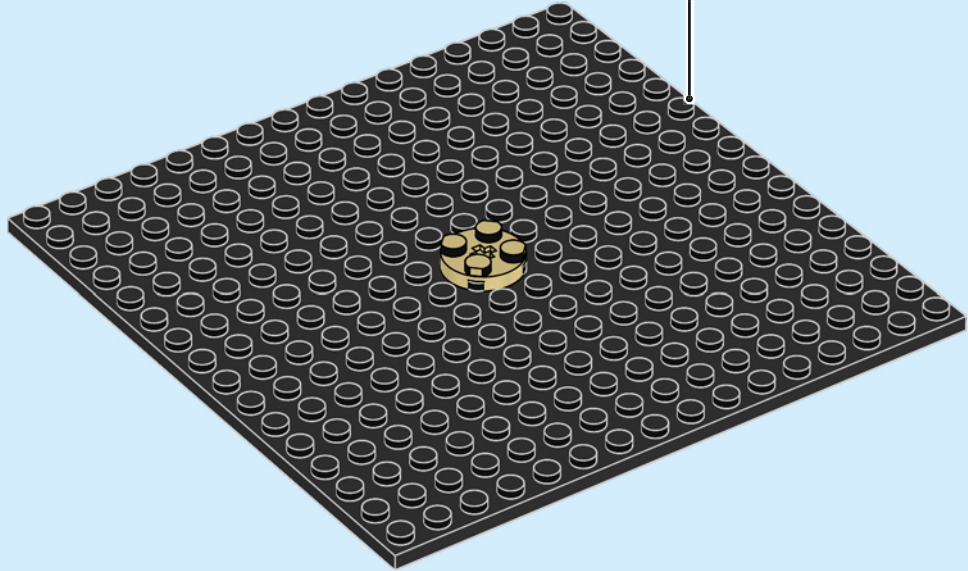
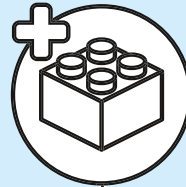

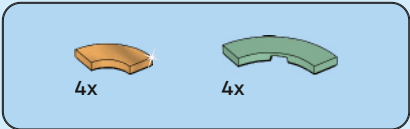

2

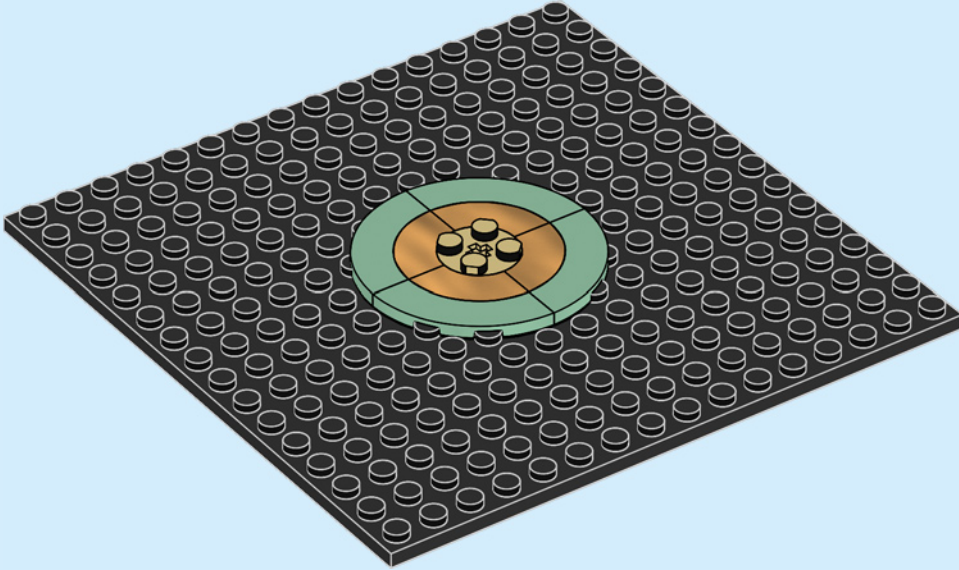

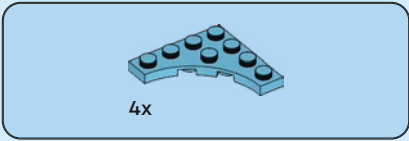

3

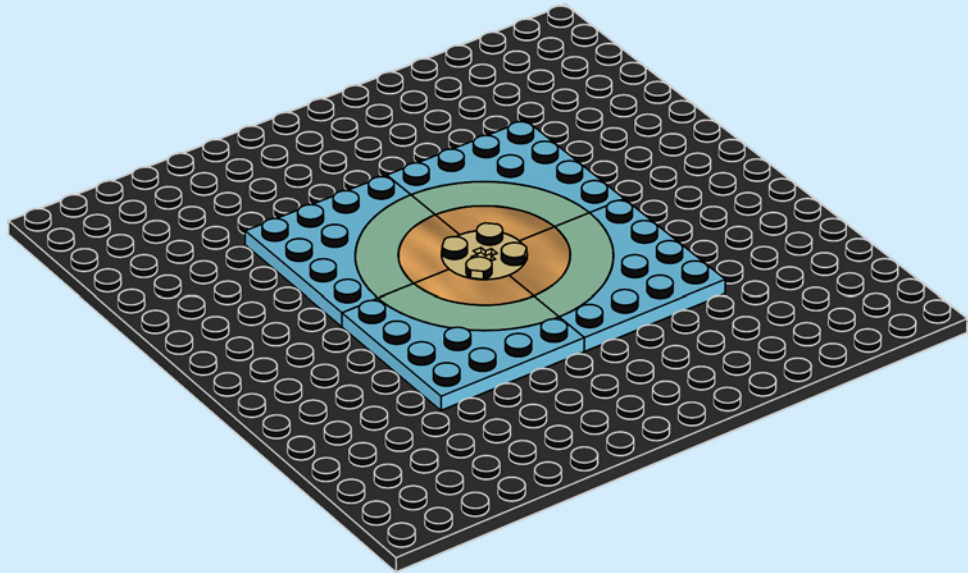

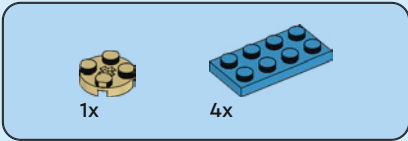

4

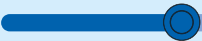
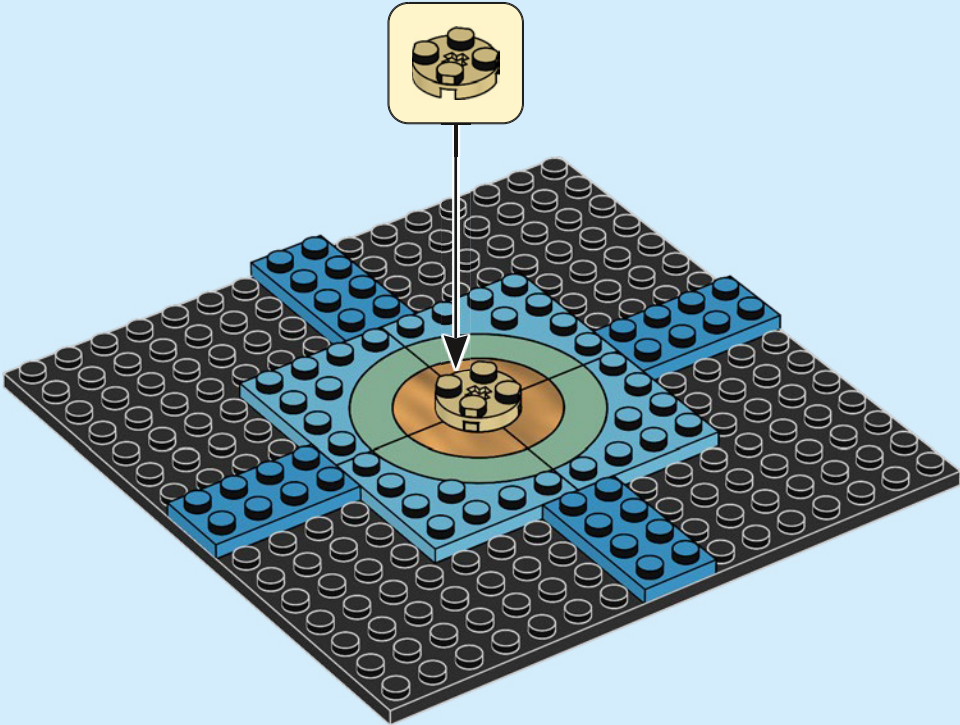

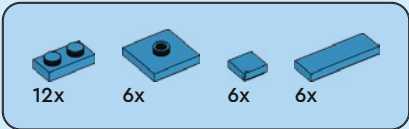

5

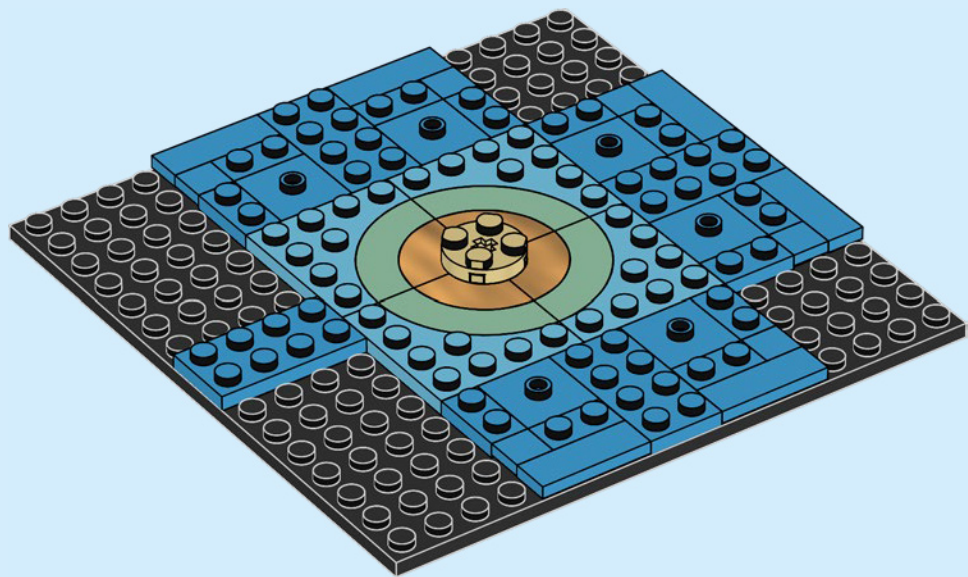

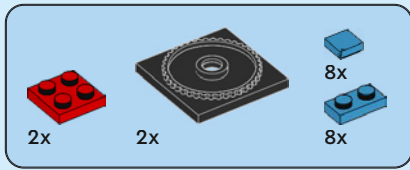

6

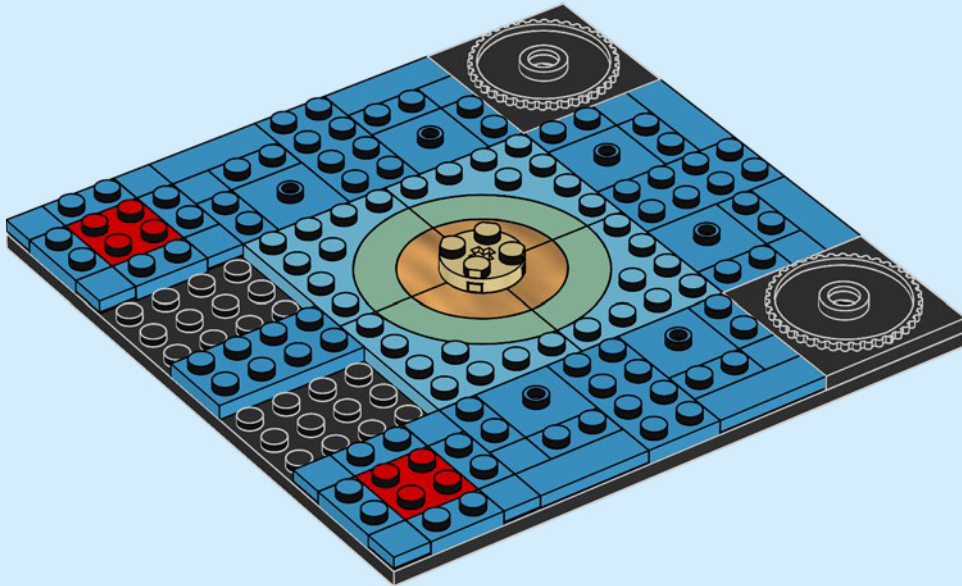

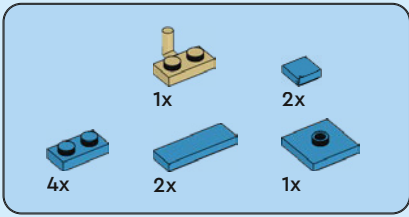

7

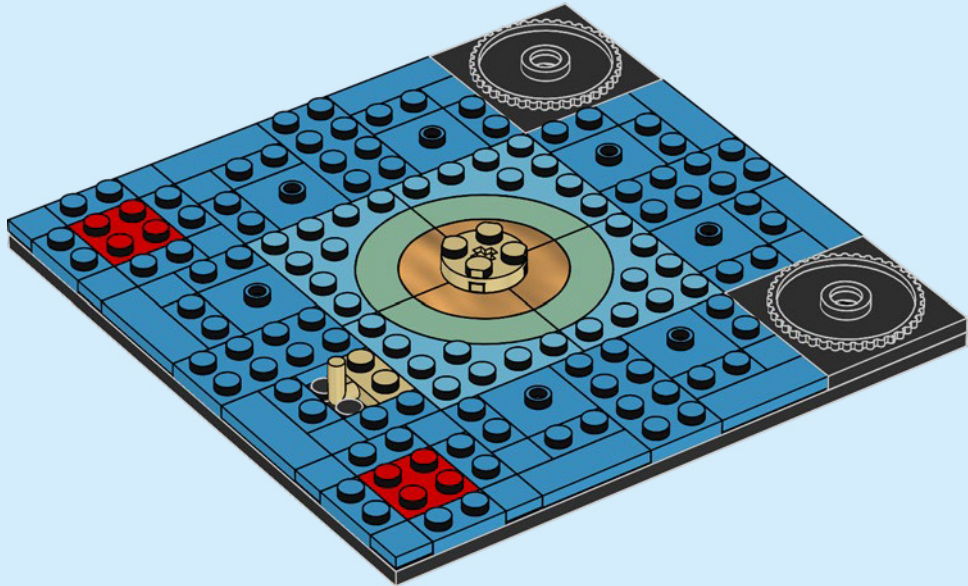



7x

8





8x

9

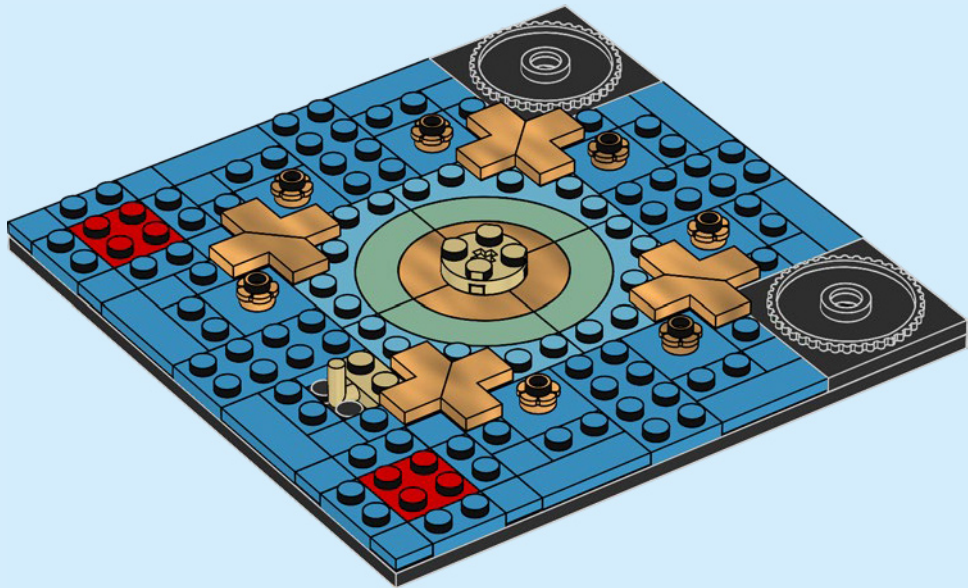



10

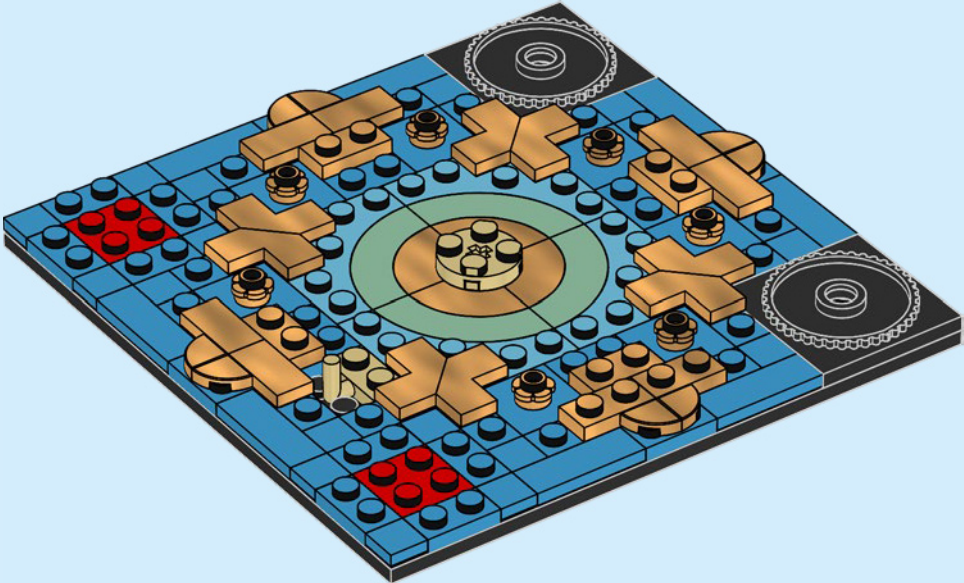



16x

11

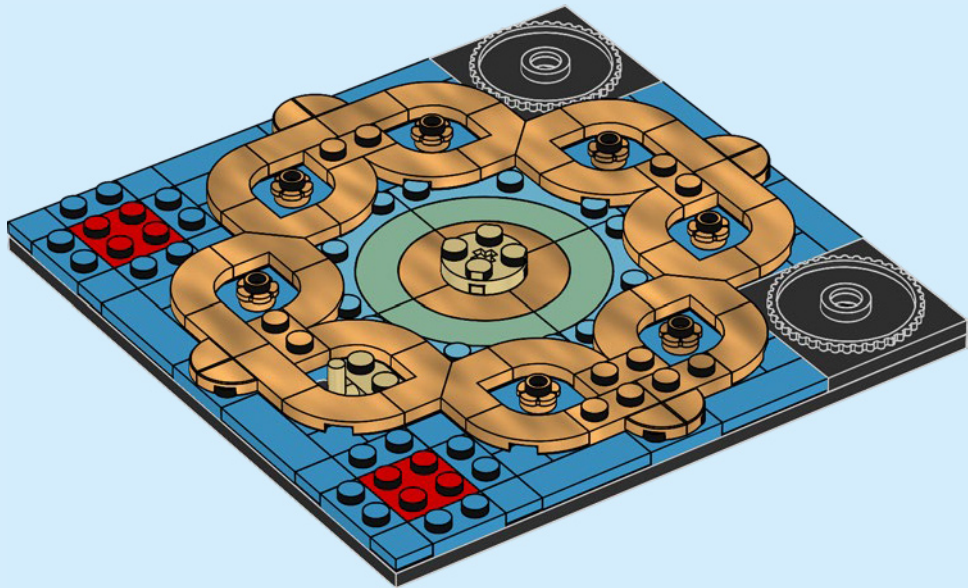



12

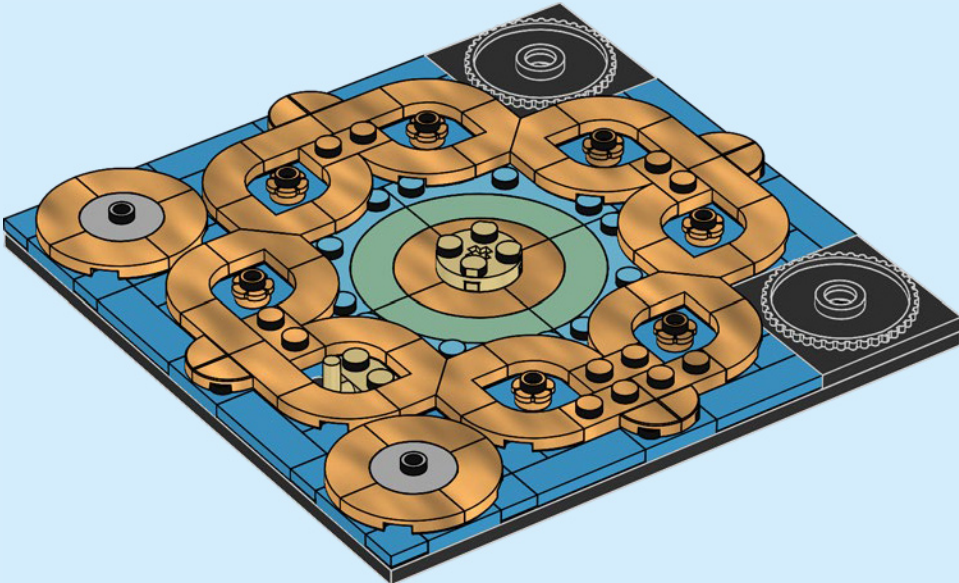

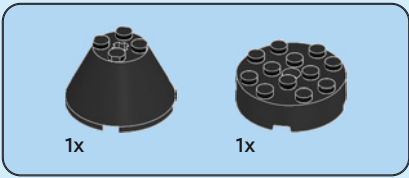

13

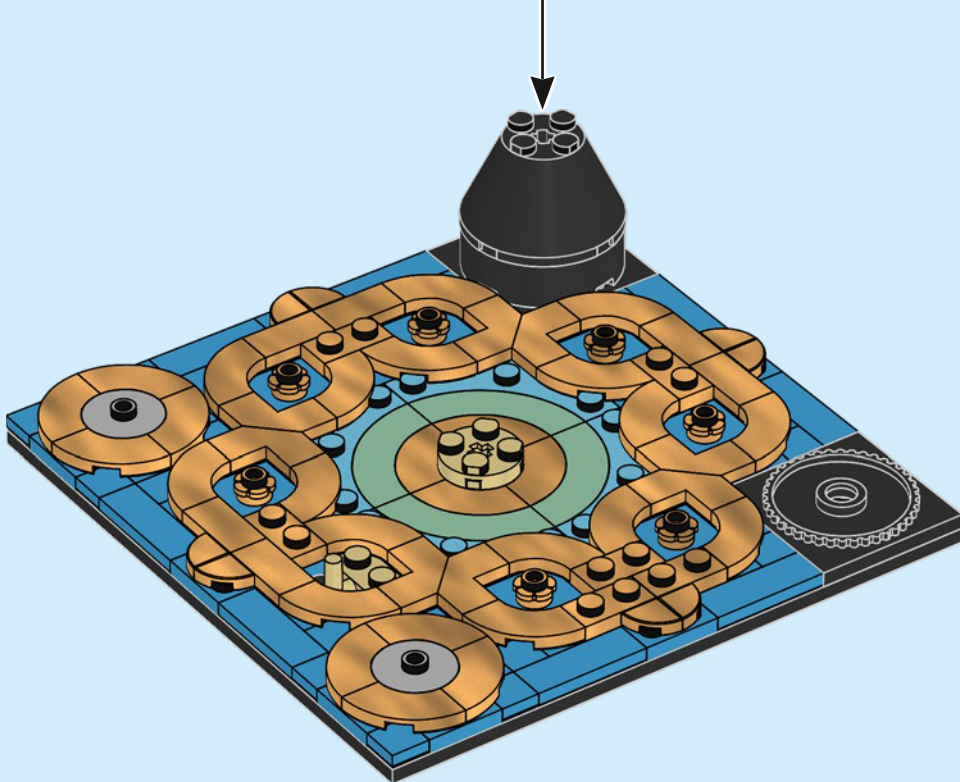
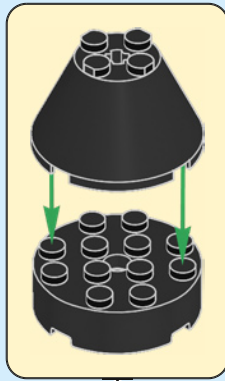

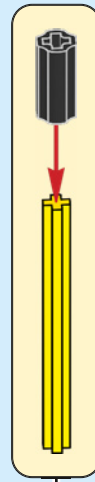
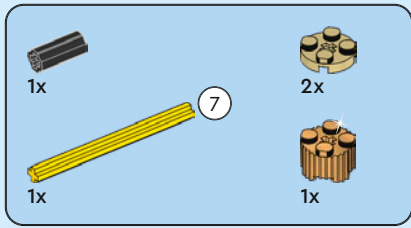

14

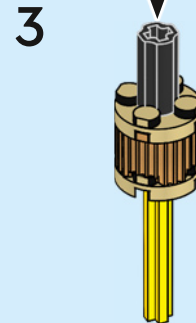
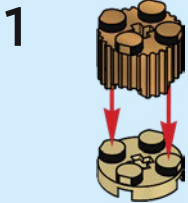

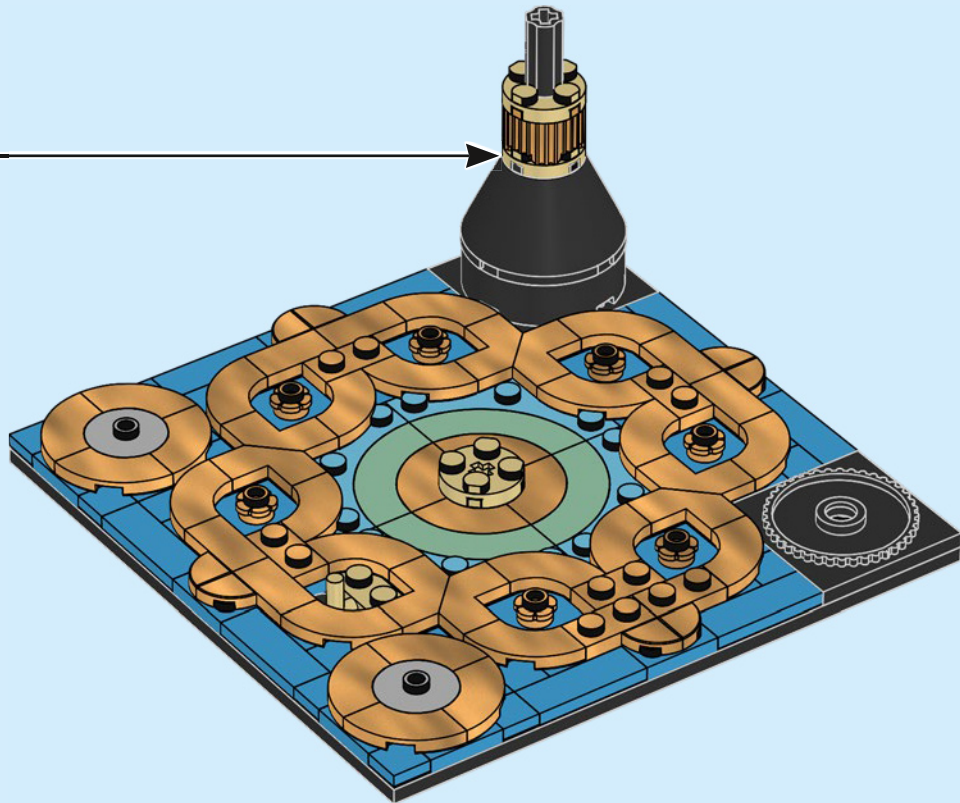

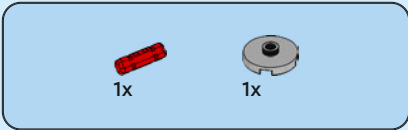

15





1x



1x

16





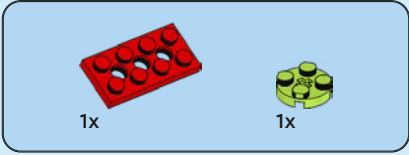

17

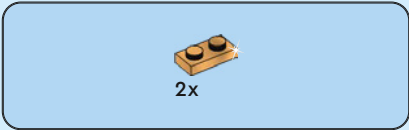
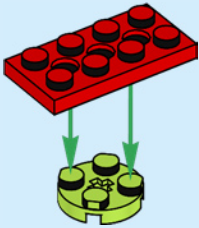

18

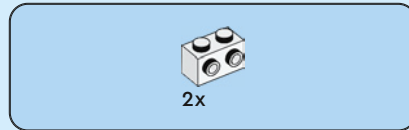
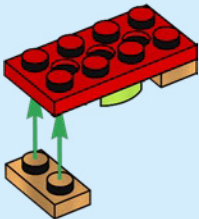

19

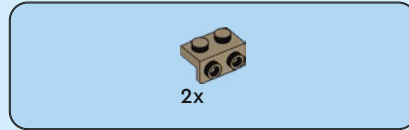
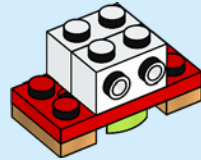

20

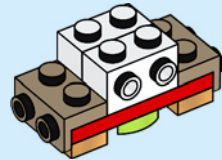



2x

21

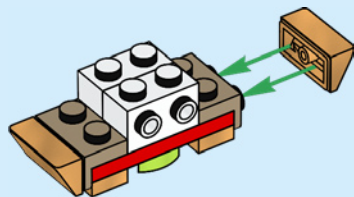

2x

22

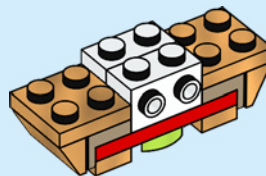



2x

23

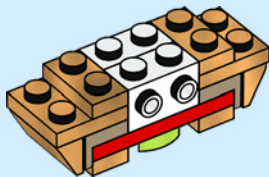

1x



2x

24

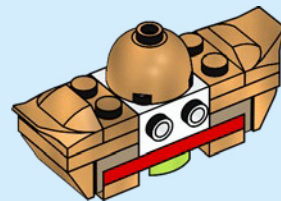

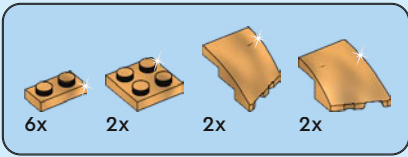

25

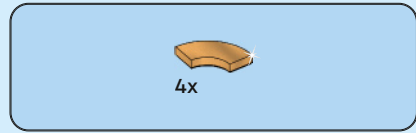
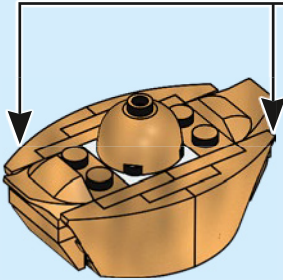
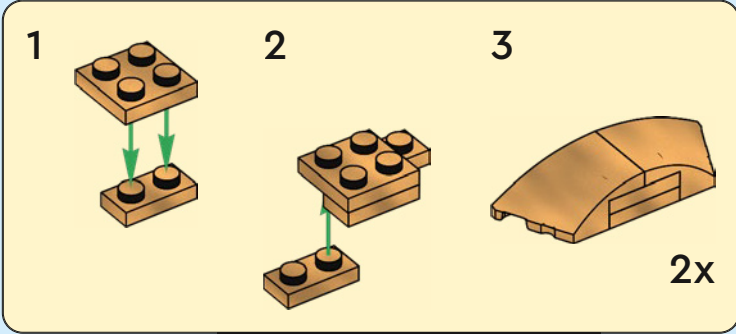

26

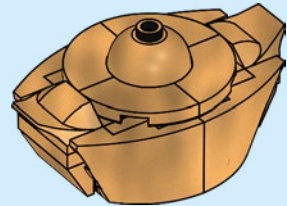

3x

27

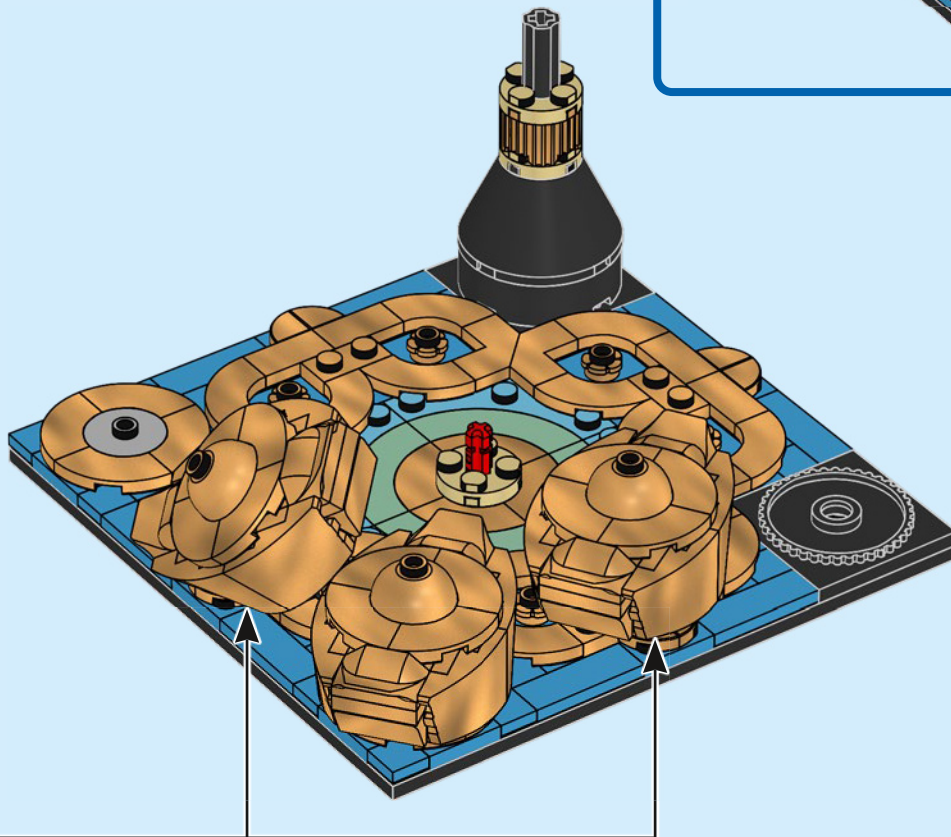
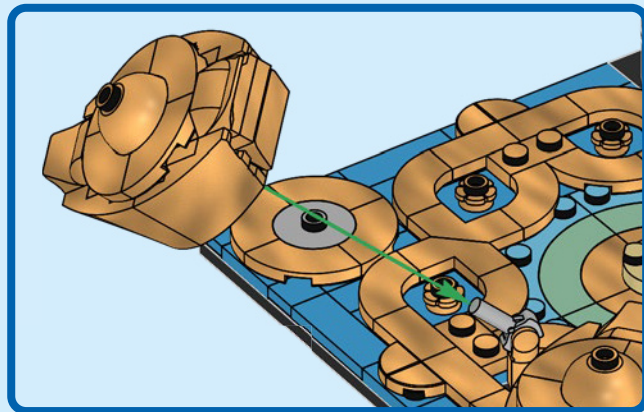



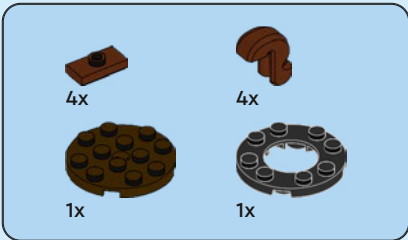

28

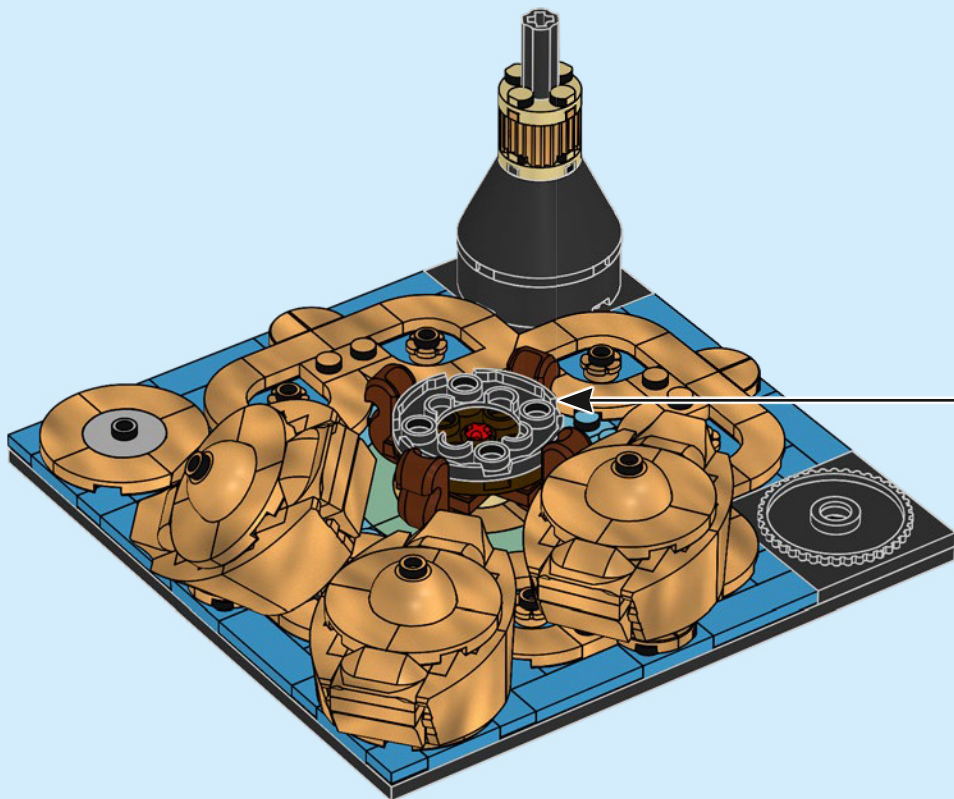
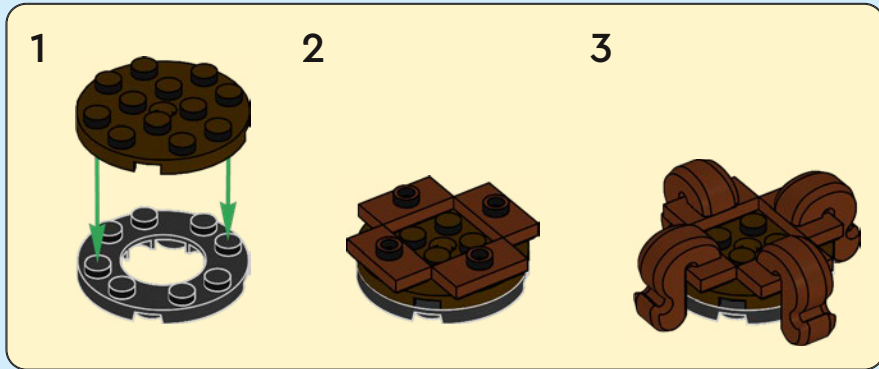

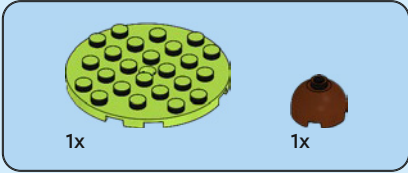
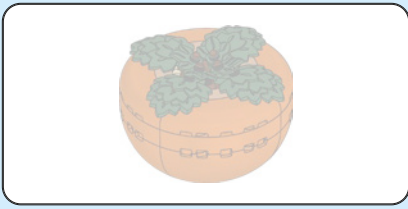

29

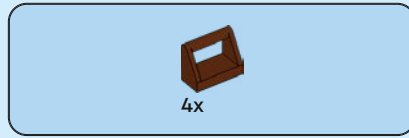
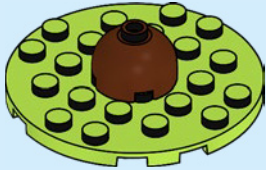

30

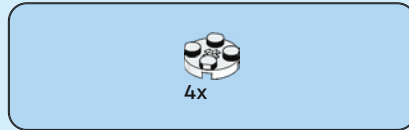
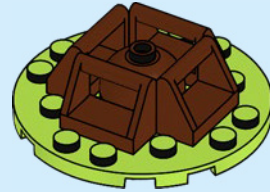

31



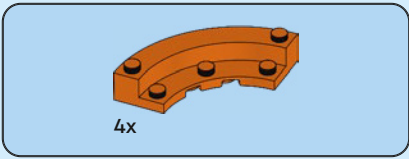

32

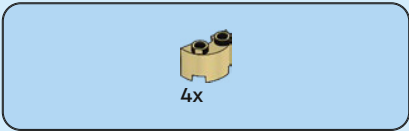
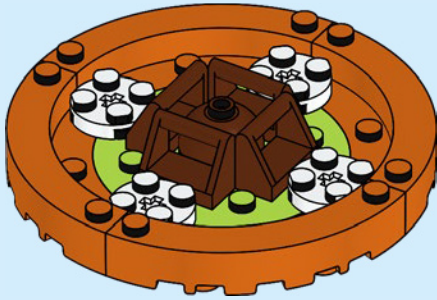

33

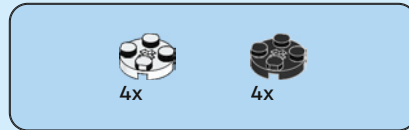
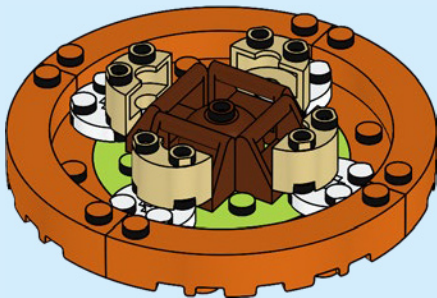

34

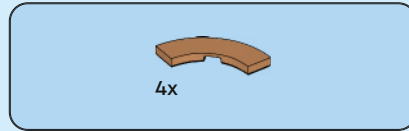
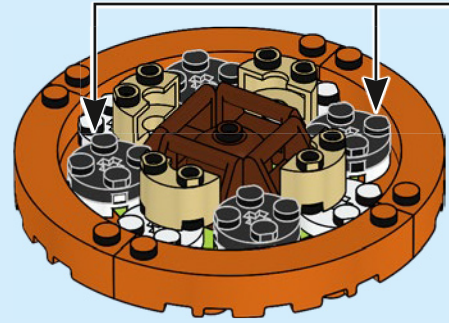
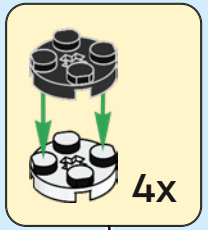

35

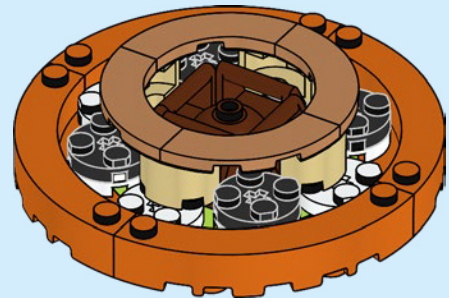

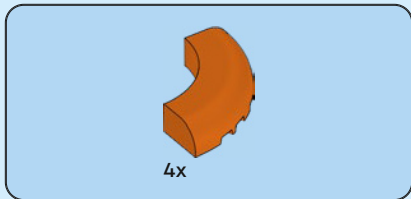

36

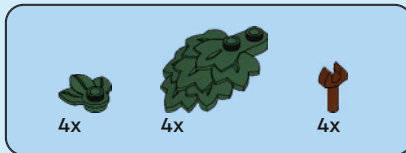
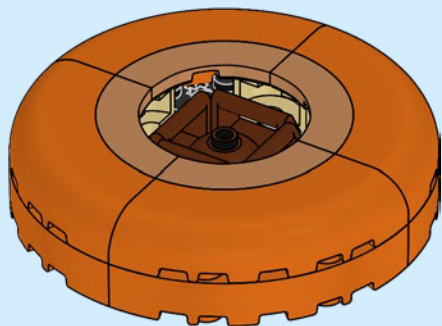

37

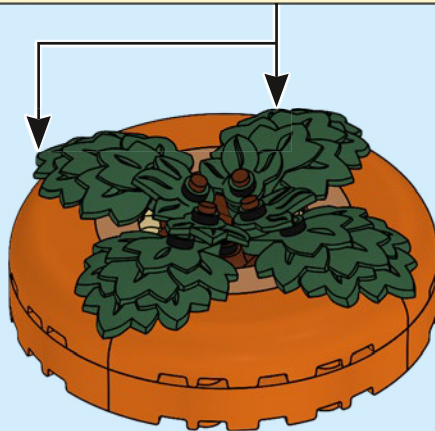
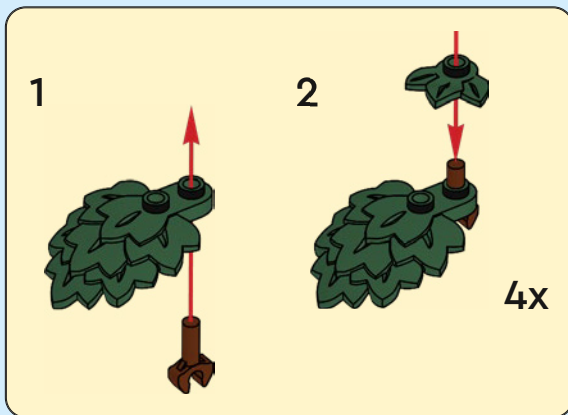

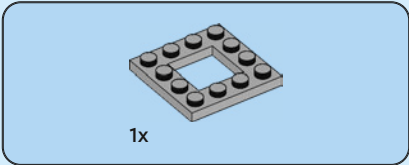
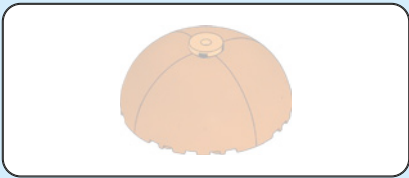

38

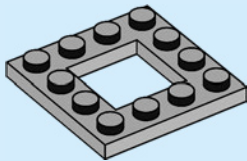

39

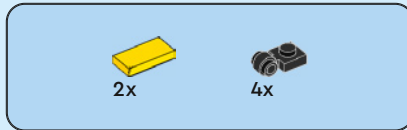
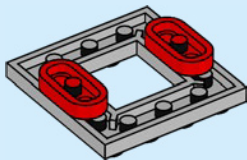

40

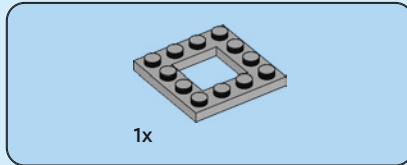
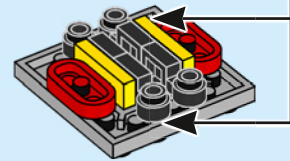
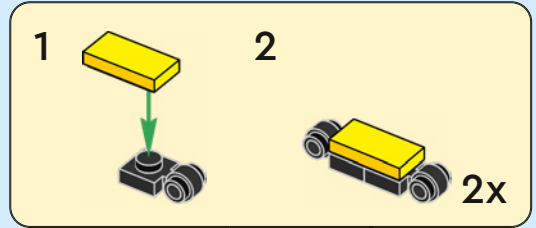

41

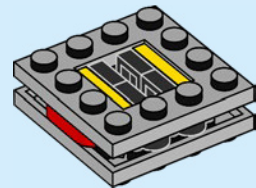

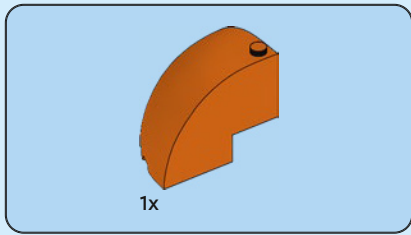

42

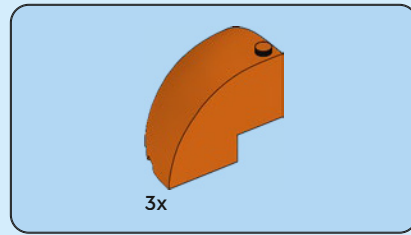
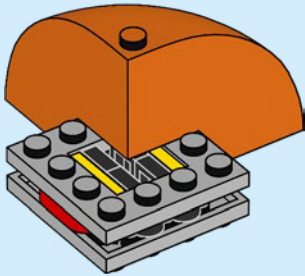

43

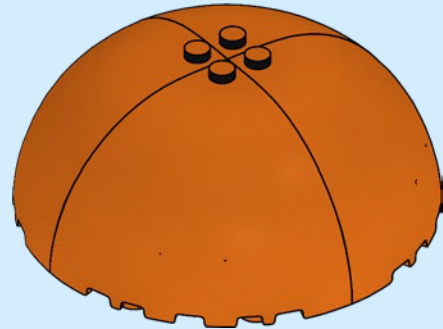

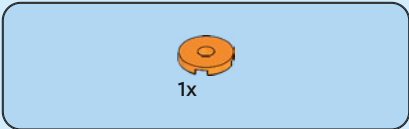

44

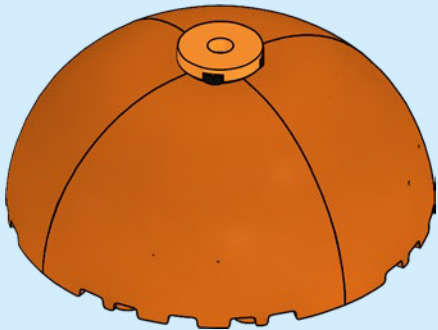

45

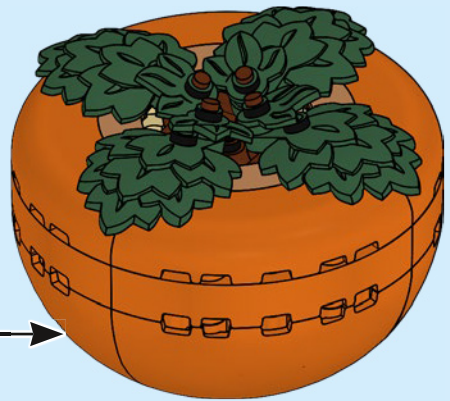

46

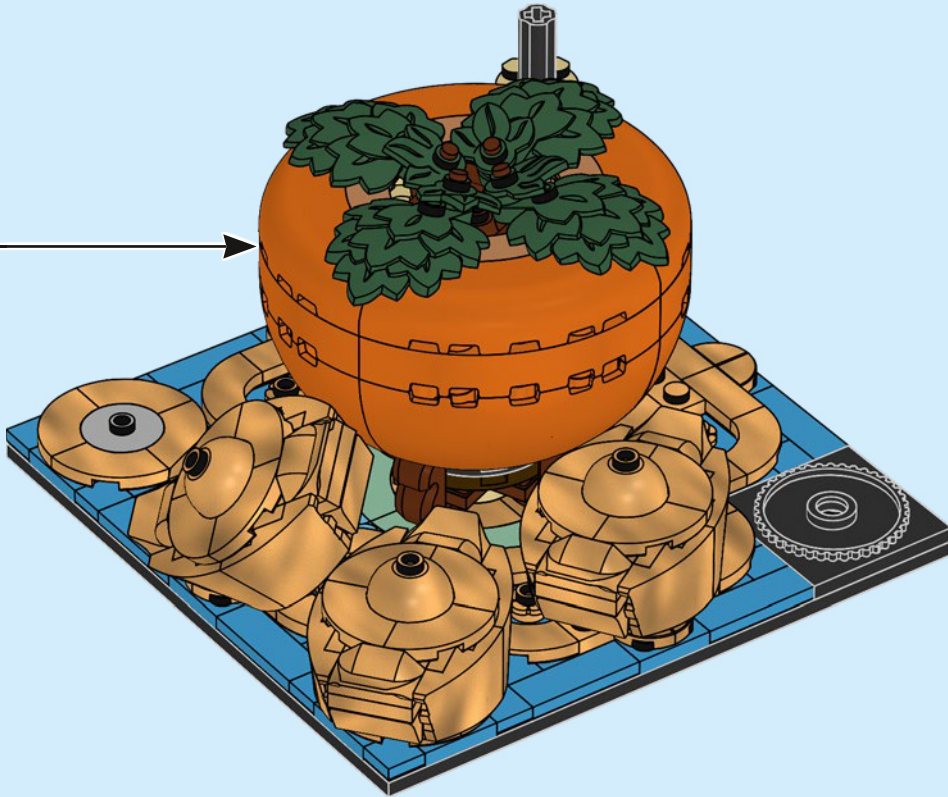



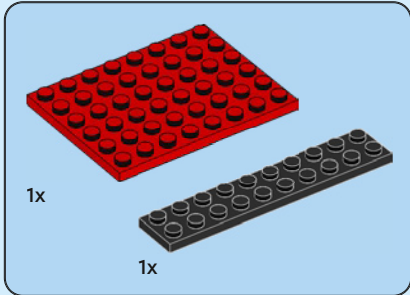
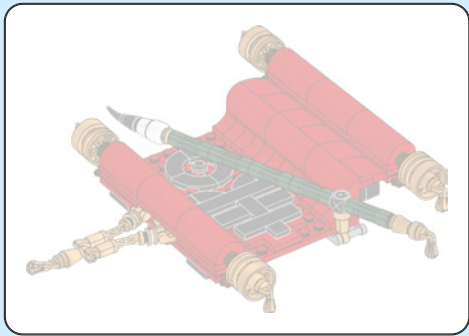

47

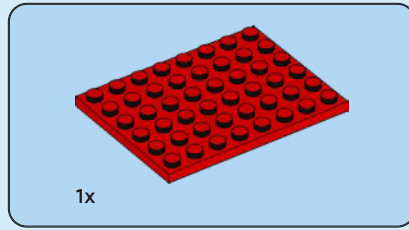
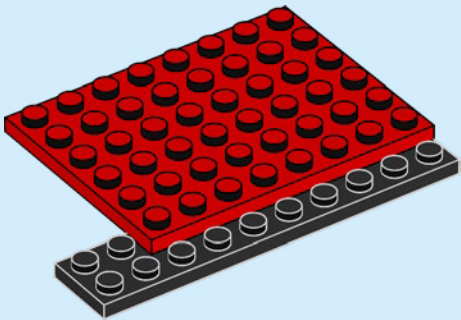

48

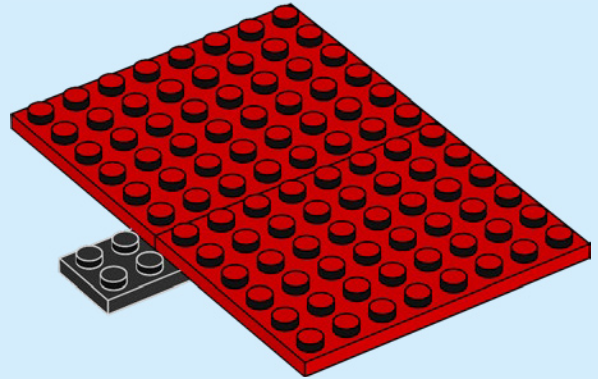

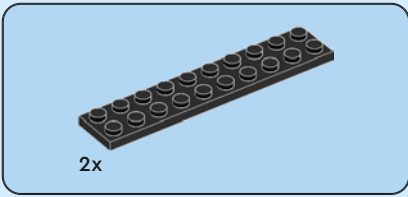

49

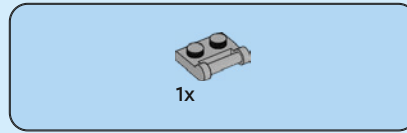
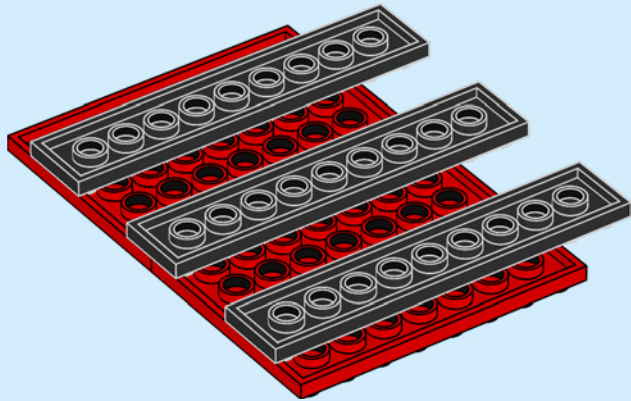

50

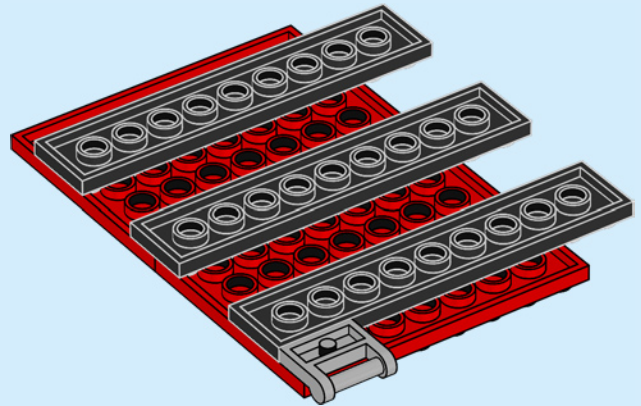

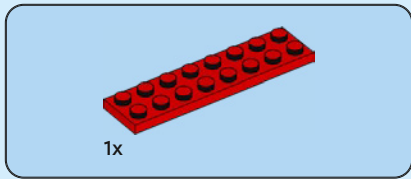

51

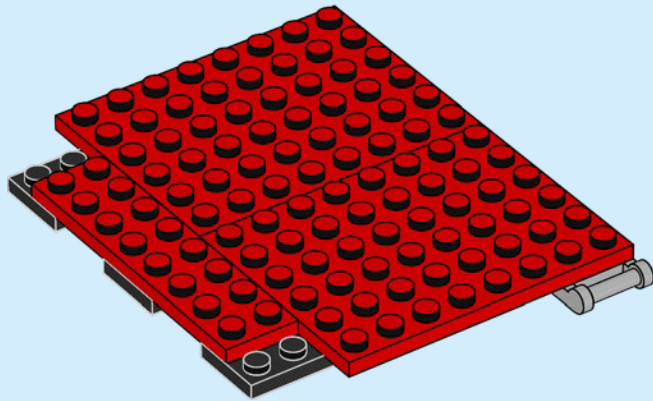

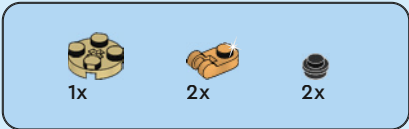

52

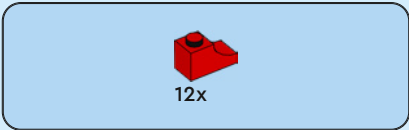

53



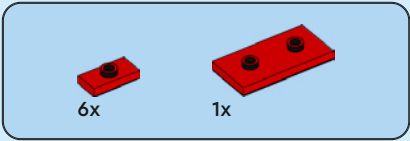

54



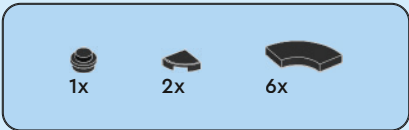

55

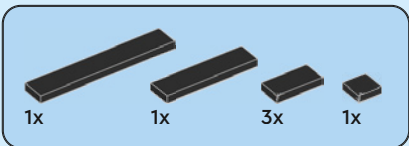

56

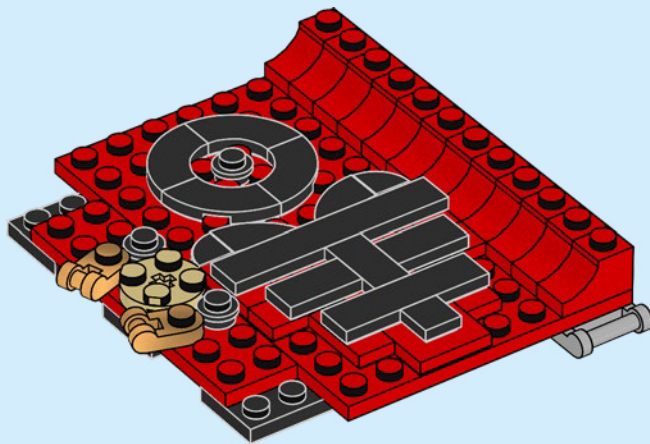

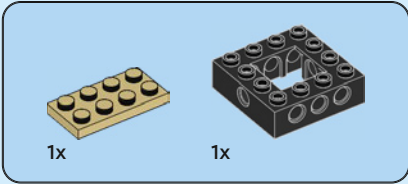
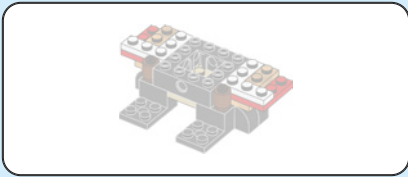

57

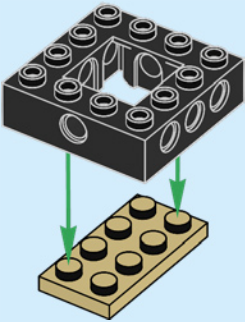

58

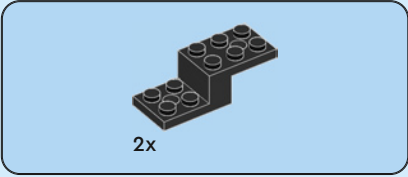
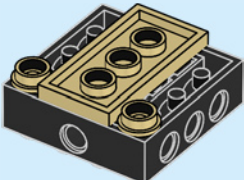

59

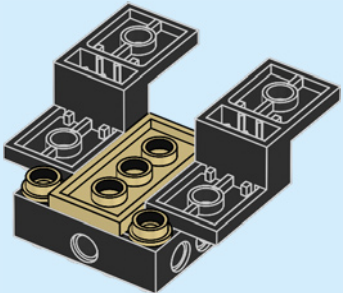

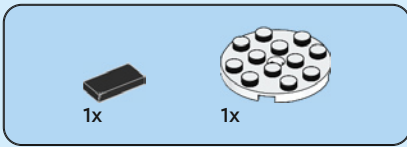

60

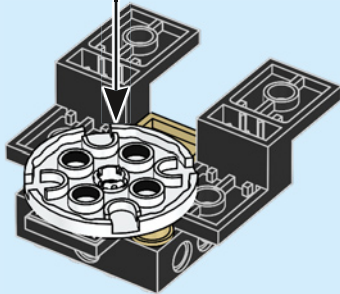
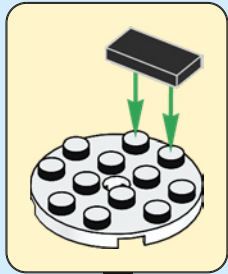

61

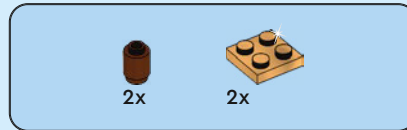
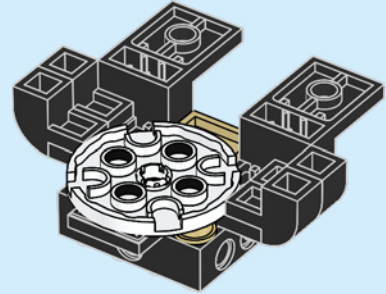

62

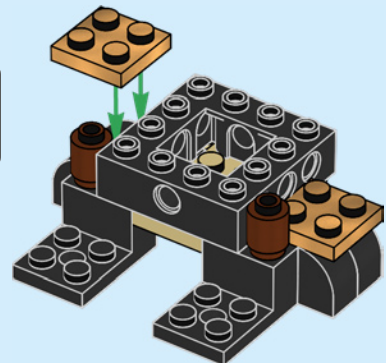

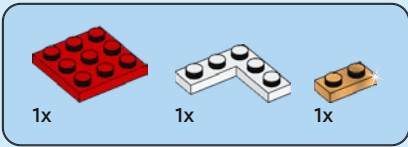

63

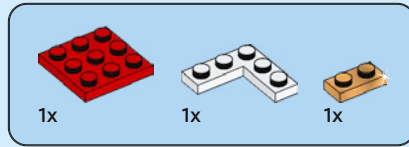
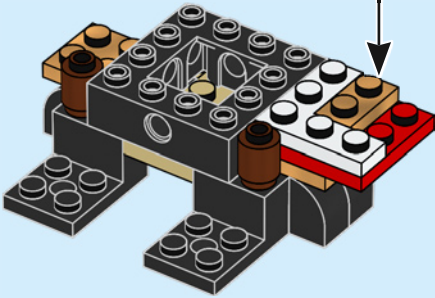
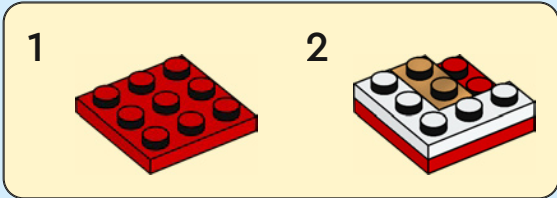

64

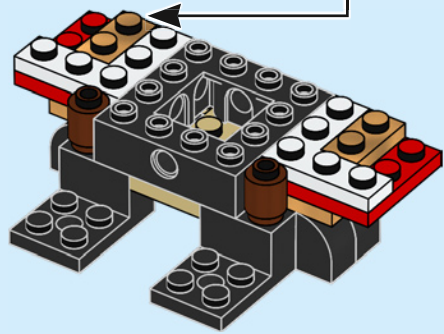
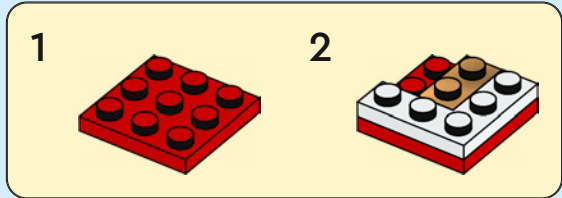

65

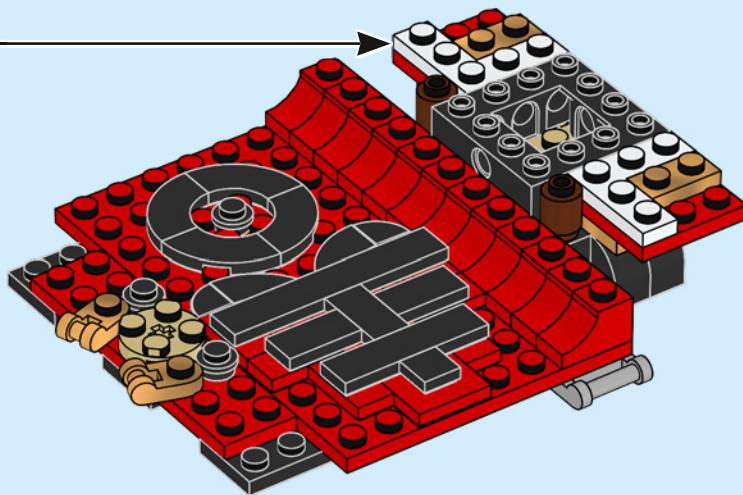

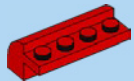

3x

66

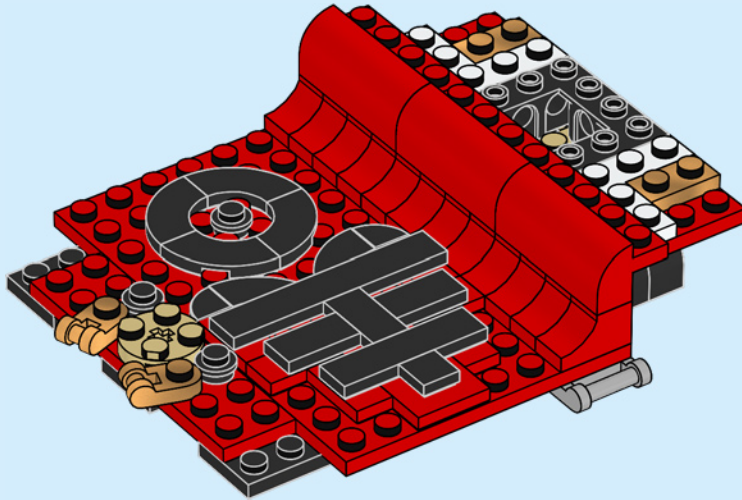



4x

67

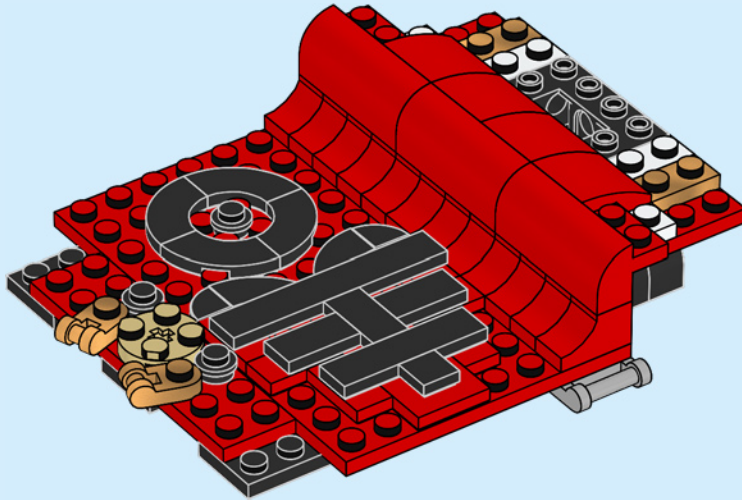

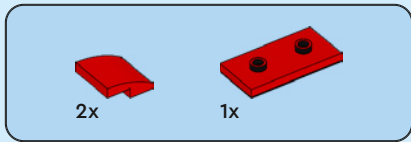

68

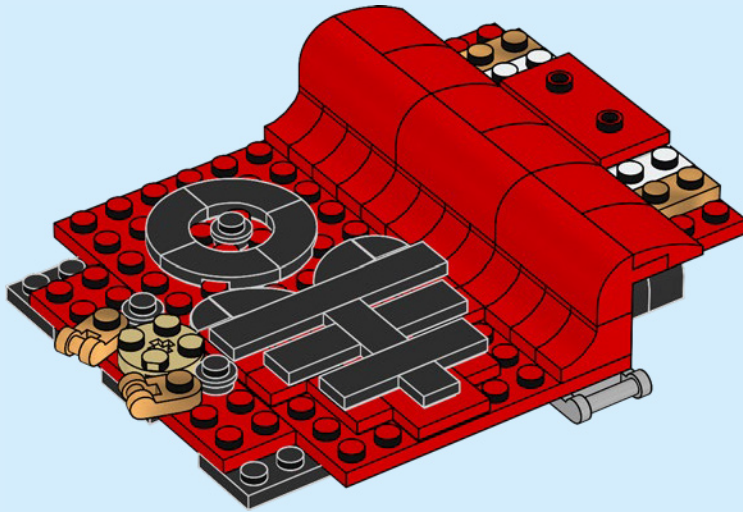

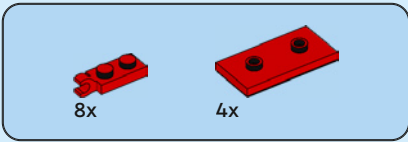

69

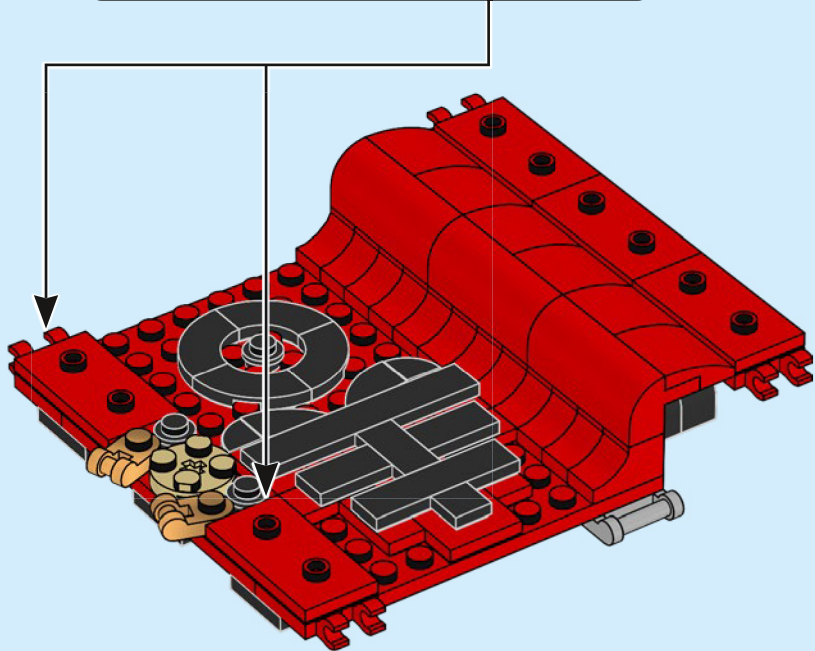
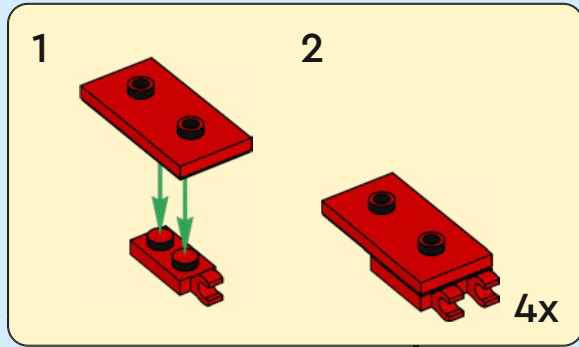

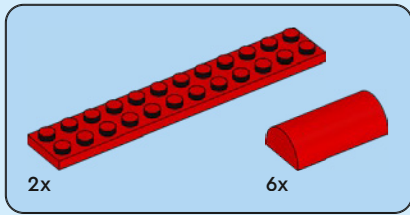

70

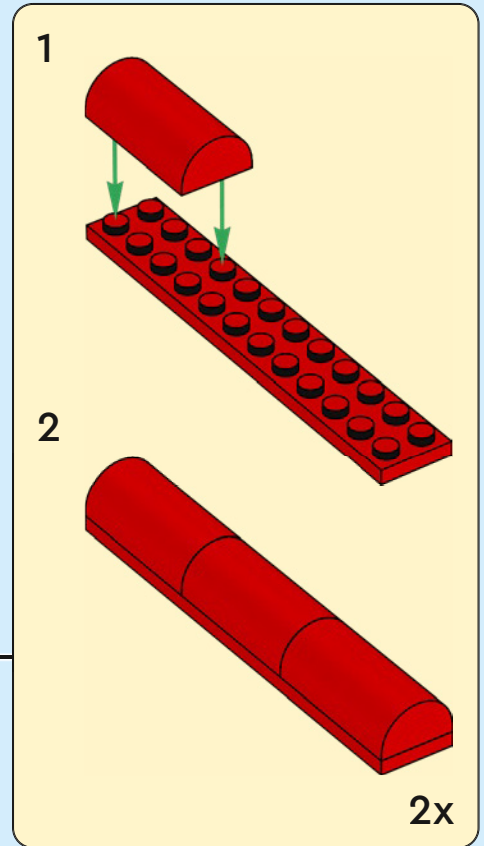
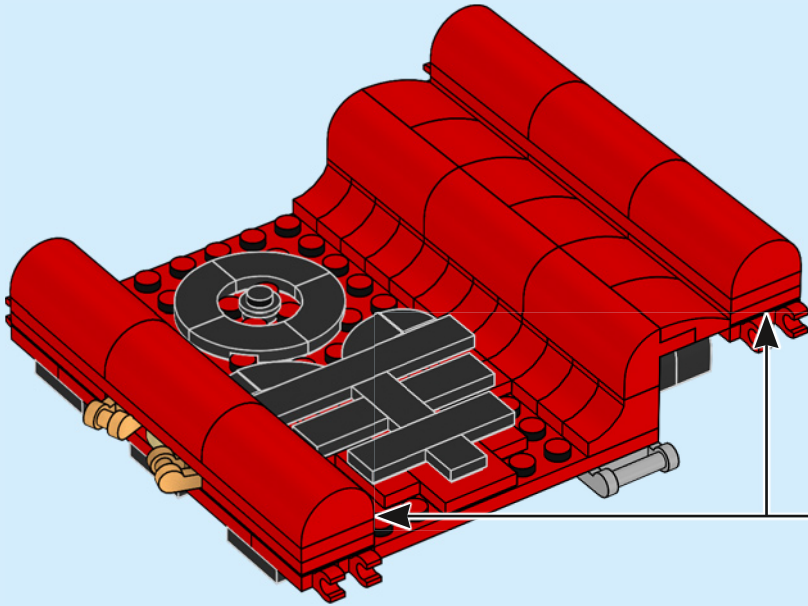

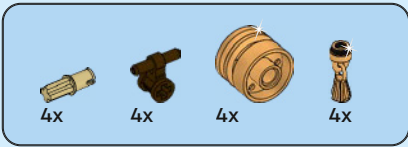

71

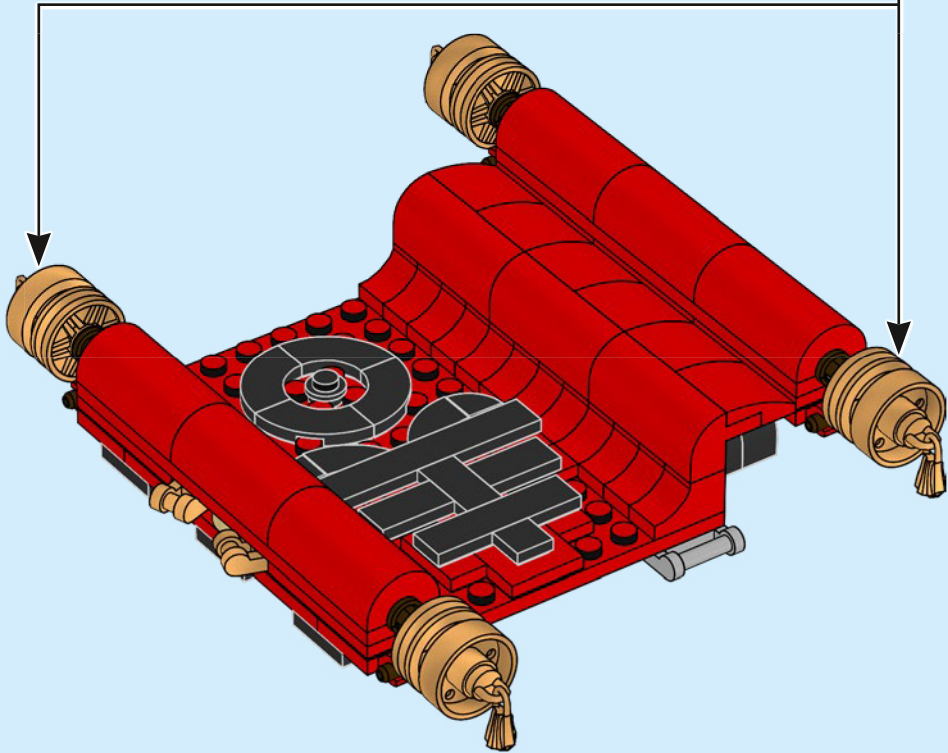
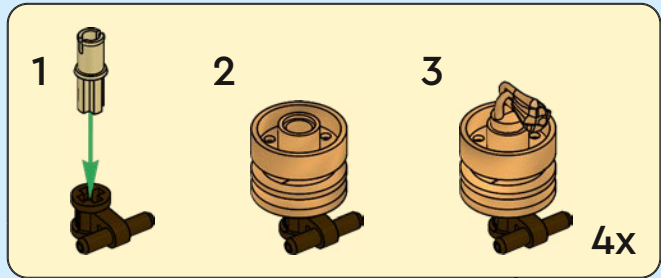



1x



1x

72

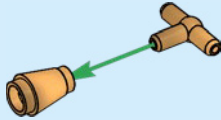

1x

73



2x

74

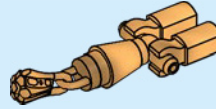

2x



2x



2x

75

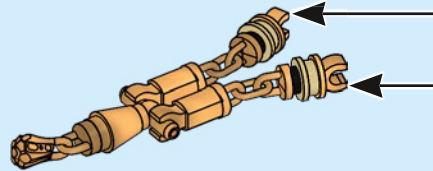
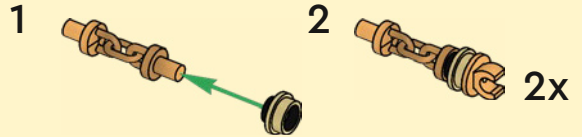

76

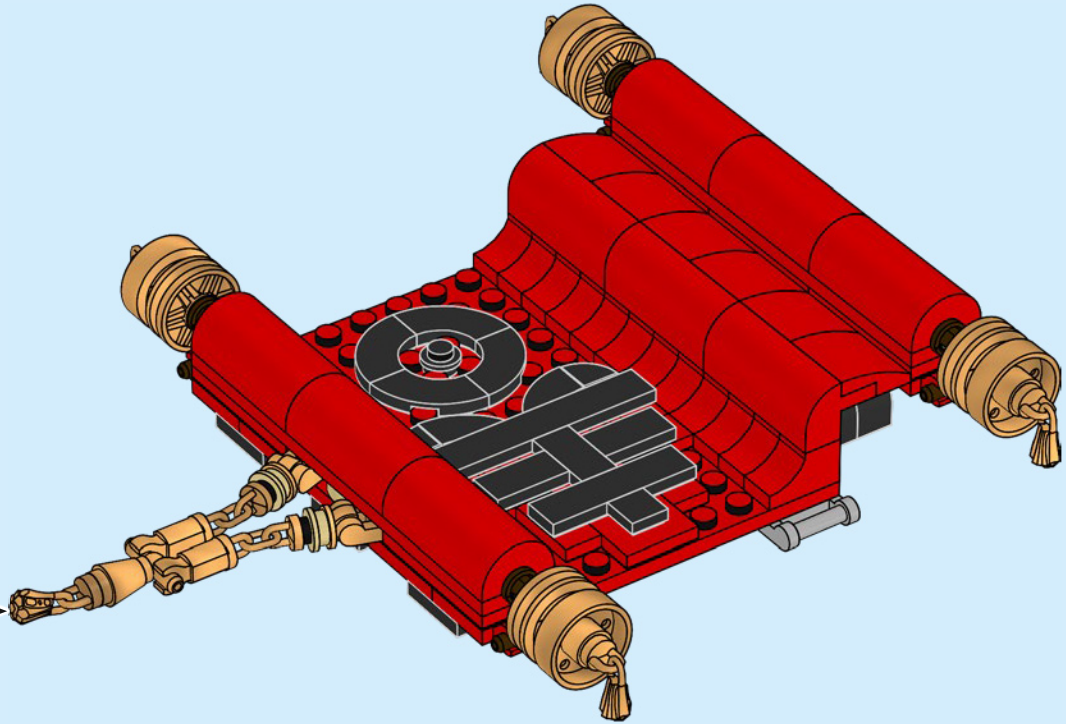

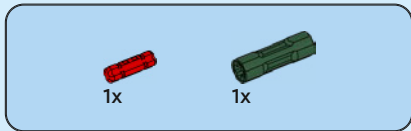
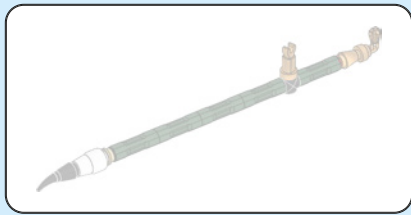

77

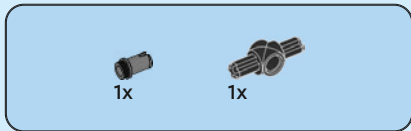
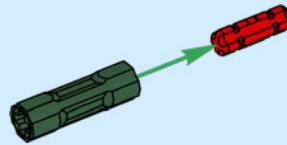

78

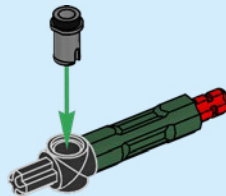



1x



1x

79

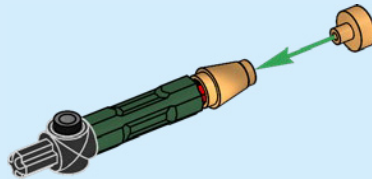

1x

80

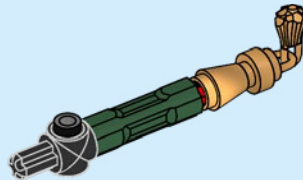



1x

81

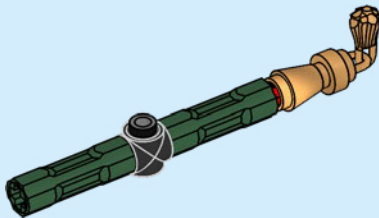

1x



1x

82

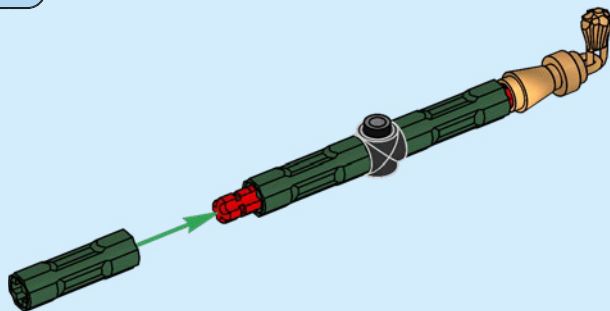

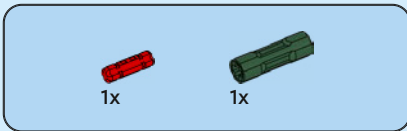

83

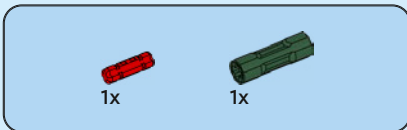
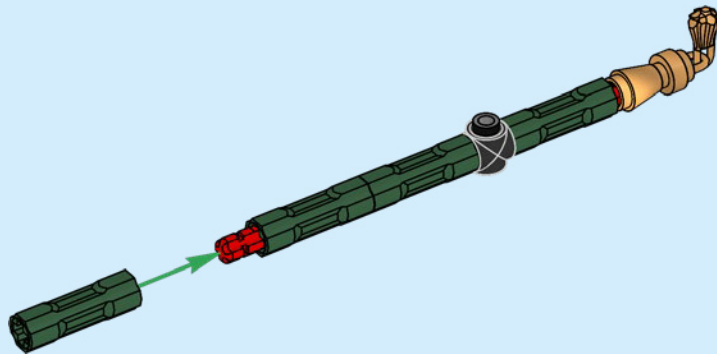

84

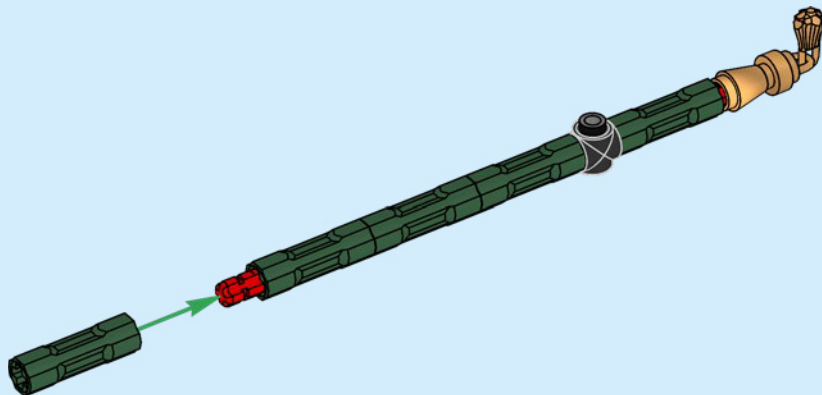



1x



1x

85

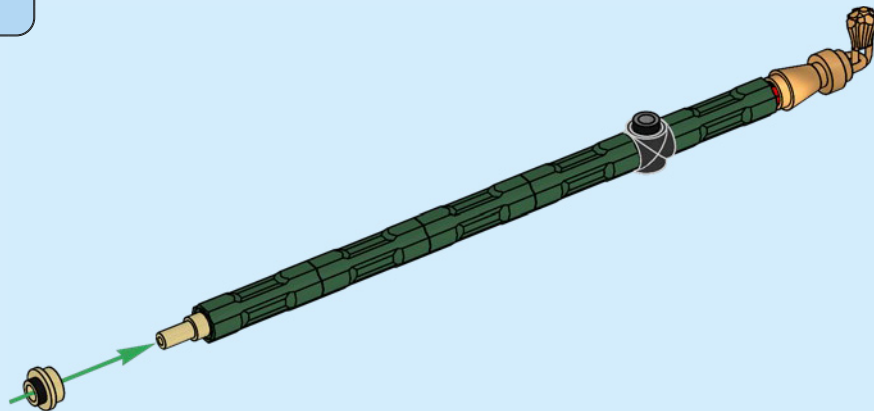

1x



1x

86

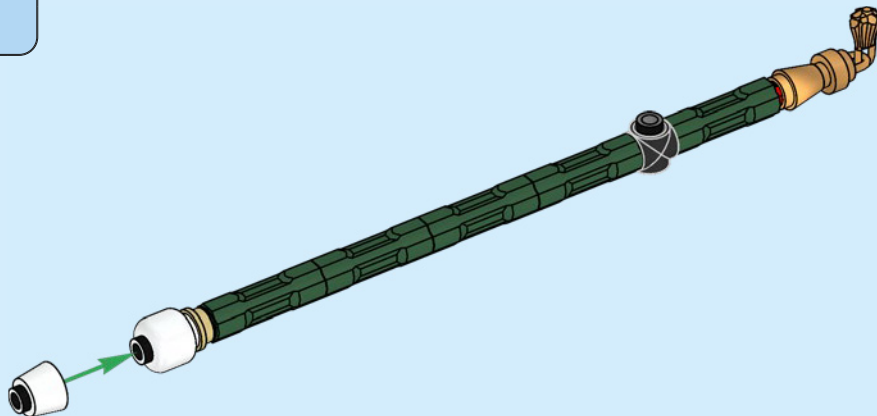



1x



1x

87

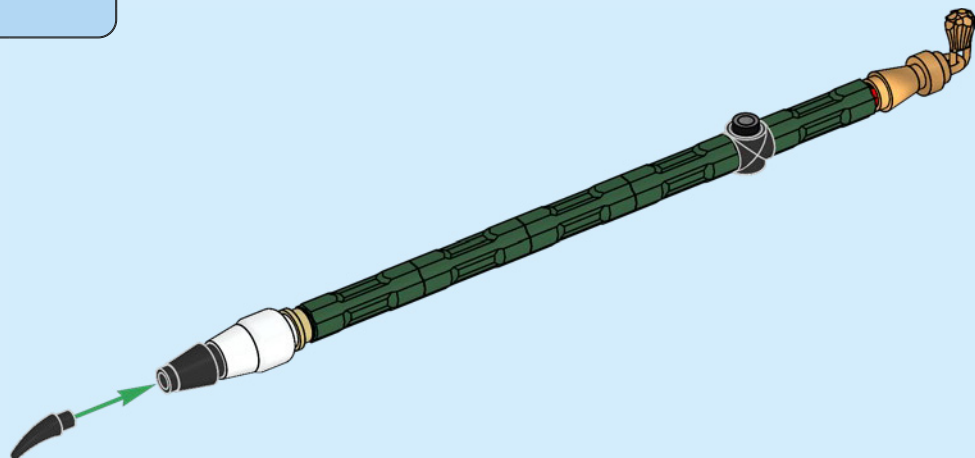

1x



1x

88

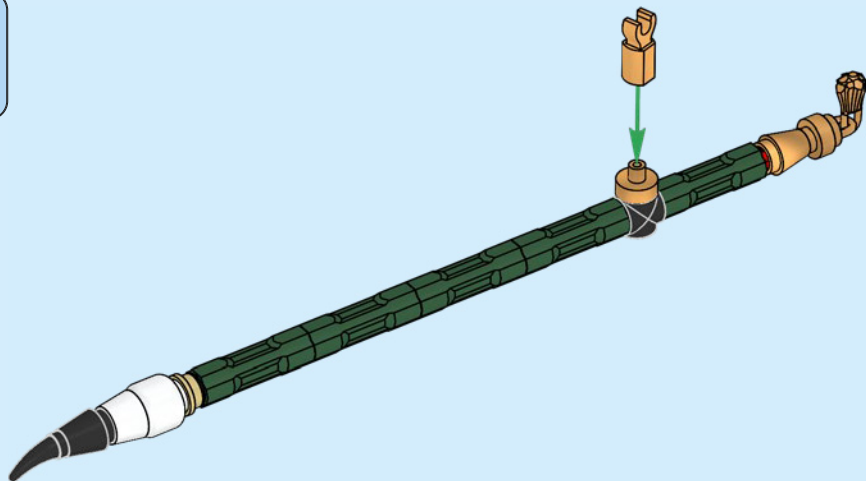

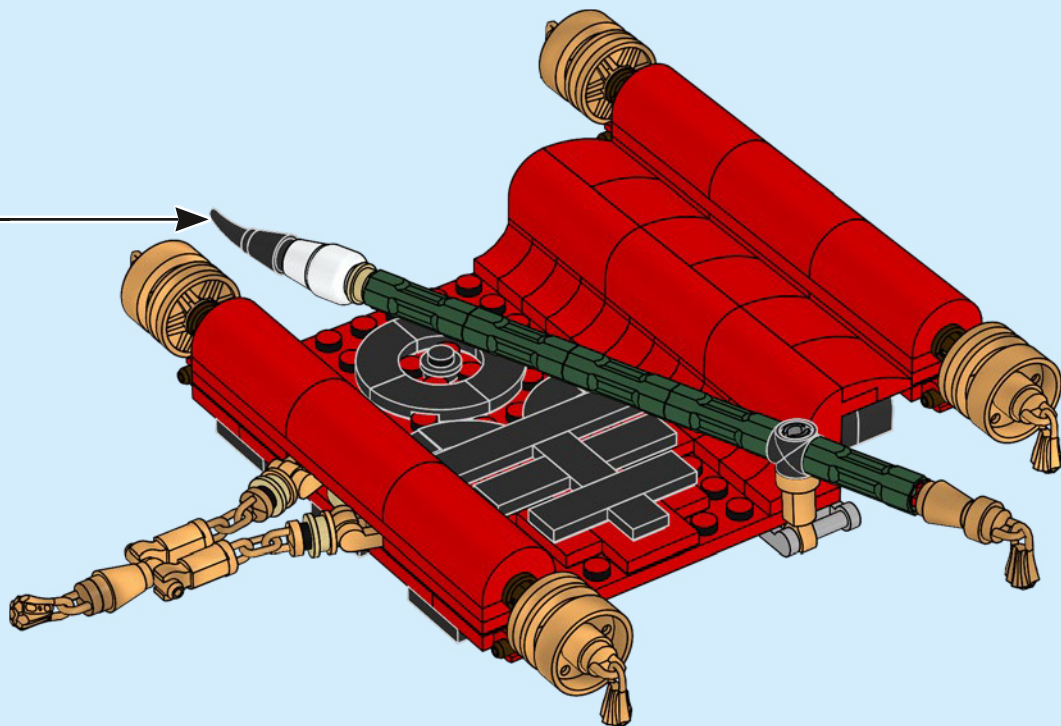

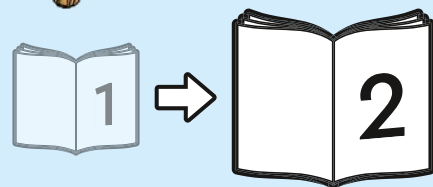
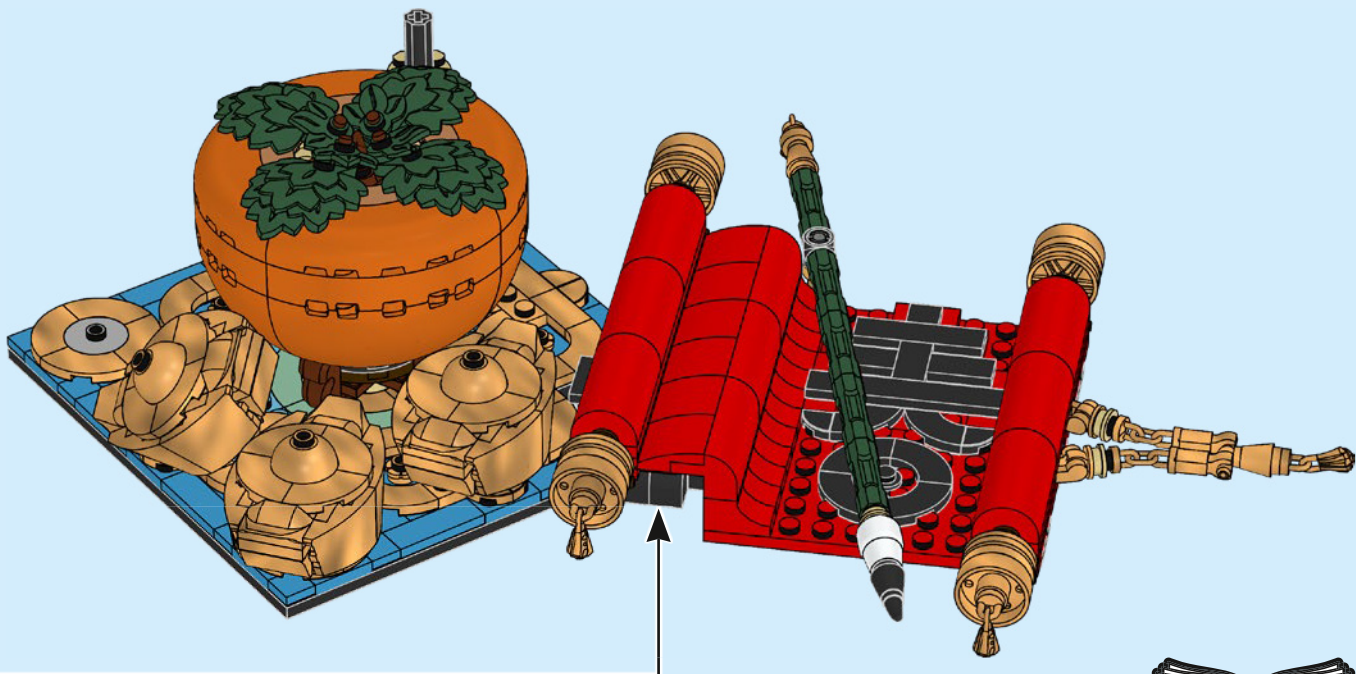

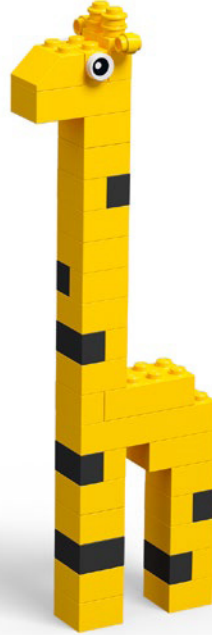

Rebuild
the
World™

