

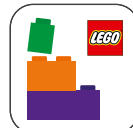

10345



Booklet available in English  
Livret disponible en français  
Folleto disponible en español



LEGO® Builder

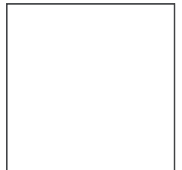

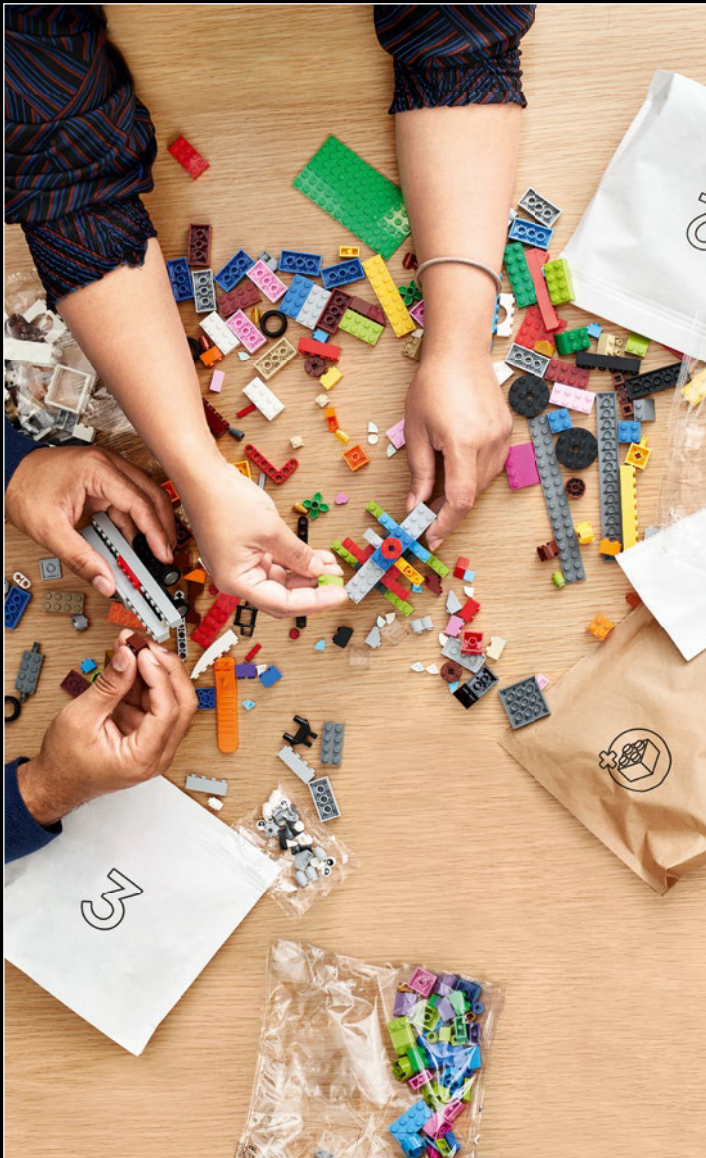

## WE'RE MAKING OUR PACKAGING MORE SUSTAINABLE

We're transitioning from single-use plastic to paper-based packaging. As we progress, you may find a mix of paper and plastic in our boxes.

## NOUS RENDONS NOS EMBALLAGES PLUS DURABLES

Nous passons des emballages en plastique à usage unique aux emballages à base de papier. Durant la transition, vous pourriez trouver un mélange de papier et de plastique dans nos boîtes.

## QUEREMOS HACER MÁS SUSTENTABLES NUESTROS MATERIALES DE EMBALAJE

Estamos cambiando las bolsas de plástico desechables por bolsas con base de papel. Conforme avanzamos en este propósito, puedes encontrar una mezcla de papel y de plástico en nuestras cajas.

[LEGO.com/sustainable-packaging](https://LEGO.com/sustainable-packaging)



# BUILDER



Apple and the Apple logo are trademarks of Apple Inc., registered in the U.S. and other countries and regions. App Store is a service mark of Apple Inc. Google Play and the Google Play logo are trademarks of Google LLC. Tencent and the Tencent logo are trademarks of Tencent Inc.

LEGO.com/devicecheck



LEGO® Builder



**BUILD IT  
YOUR  
WAY**



**CONSTRUISEZ À VOTRE FAÇON  
CONSTRÚYELO A TU MANERA**



## A GIFT OF CREATIVE NATURE

The LEGO® Botanicals collection opens a door to a colorful field of creative possibilities. With sets inspired by flora from all over the world, nature lovers can indulge in a cheerful take on 'forever flowers'. For this set, we curated a balanced composition of popular bouquet elements in an elegant white pedestal vase – with built-in versatility.

## UN CADEAU DE NATURE CRÉATIVE

La collection LEGO® Botanique ouvre la porte à un champ coloré de possibilités créatives. Grâce à des ensembles inspirés par la flore du monde entier, les amoureux de la nature peuvent profiter d'une charmante interprétation des « fleurs éternelles ». Pour cet ensemble, nous avons créé une composition équilibrée d'éléments de bouquet populaires dans un élégant vase blanc à piédestal – avec une polyvalence intégrée.

## UN REGALO DE NATURALEZA CREATIVA

La colección LEGO® Botanical abre las puertas de un colorido campo lleno de posibilidades creativas. De la mano de sets inspirados en flora de todos los rincones del mundo, los amantes de la naturaleza podrán consentirse con una alegre interpretación de las *flores eternas*. Para este set, seleccionamos cuidadosamente una serie de elementos muy populares en los ramos, creamos una equilibrada composición con ellos y los colocamos en un jarrón blanco... con versatilidad integrada.



*Camellia x williamsii*

### **Night Rider camellia**

*Originally bred in the UK, this compact evergreen shrub with glossy, dark leaves is adorned with dark maroon, semi-double flowers that bloom in late winter and early spring. In gardens, it can grow up to about 5 ft. (1.5 m) tall and wide.*

### **Camélia « Night Rider »**

*Cultivé à l'origine au Royaume-Uni, cet arbuste compact à feuilles persistantes, brillantes et foncées est orné de fleurs semi-doubles marron foncé qui fleurissent à la fin de l'hiver et au début du printemps. Dans les jardins, il peut atteindre 1,5 m de haut et de large.*

### **Camelia Night Rider**

*Cultivado originalmente en el Reino Unido, este tupido arbusto de hoja perenne con follaje brillante de color verde oscuro está adornado con flores semidobles en rojo carmesí que florecen a finales del invierno y al comienzo de la primavera. En los jardines, puede alcanzar hasta 1,5 m de altura y anchura.*

## Itoh Peony

Intersectional peonies were first cultivated in Japan in the 1940s. As hybrids between trees and herbaceous peonies, their flowers grow up to about 7.87 in. (20 cm) wide. Not typically suitable as a container plant, this LEGO® version, however, is guaranteed to blossom all year.

## Pivoine Itoh

La pivoine intersectionnelle a été cultivée pour la première fois au Japon dans les années 1940. Croisement improbable entre une pivoine herbacée et une pivoine arbustive, cette plante présente des fleurs pouvant mesurer jusqu'à 20 cm de large. Elle n'est généralement pas adaptée pour la mise en pot, mais cette version LEGO® fleurira tout au long de l'année.

## Peonía Itoh

Las peonías intersectionales se cultivaron por primera vez en Japón en la década de 1940. Resultado del cruce entre peonías herbáceas y arbóreas, las flores de estos híbridos crecen hasta tener unos 20 cm de anchura. Aunque no es, generalmente, una planta adecuada para su cultivo en maceta, esta versión LEGO® florecerá durante todo el año con total seguridad.

Peonía Itoh



Hydrangea arborescens

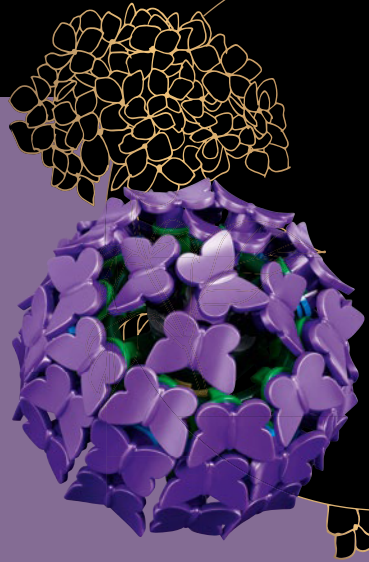

## Hydrangea

Native to Asia, North and South America, over 70 species of these majestic shrubs have found their way to gardens worldwide. The blossoms vary in color based on the pH value in the soil, from blue (acidic) to pink (alkaline) and white (neutral).

## Hydrangée arborescente

Originnaire d'Asie, d'Amérique du Nord et d'Amérique du Sud, cet arbuste majestueux compte plus de 70 espèces qui se sont imposées dans les jardins du monde entier. La couleur des fleurs varie en fonction du pH du sol, du bleu (acide) au rose (alcalin) en passant par le blanc (neutre).

## Hortensia

Autóctonos de Asia, Norteamérica y Sudamérica, más de 70 especies de estos majestuosos arbustos se han ganado un lugar en los jardines de todo el mundo. Sus flores varían de color en función del pH del suelo, y adquieren desde tonos azules (ácido) hasta rosas (alcalino) y blancos (neutro).

### Baby's breath

A popular staple in floral arrangements around the world, baby's breath is light as a summer cloud. As a symbol of everlasting love, it adds an air of grace to a bouquet or centerpiece, even dried in vases or wreaths.

### Souffle de bébé

Populaire élément de base des compositions florales dans le monde entier, le souffle de bébé est aussi léger qu'un nuage d'été. Symbole de l'amour éternel, il ajoute une touche de grâce à un bouquet ou à un centre de table, même séché dans des vases ou des couronnes.

### Nube

Un básico en los arreglos florales de todo el mundo y de ligereza semejante a una nube de verano. Símbolo del amor eterno, esta delicada planta aporta un aire de elegancia a cualquier ramo o centro de mesa, incluso seca en jarrones o en coronas.

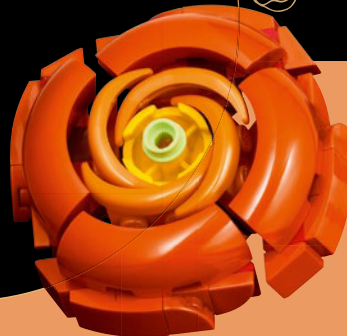

*Ranunculus*

### Persian buttercup

A tuberous perennial, the Persian buttercup can grow up to about 1.97 ft. (60 cm) tall. With its densely layered petals in soft or bright colors, this lavish and long-lasting cut flower brightens any space, indoors or in your garden.

### Renoncule

Plante vivace tubéreuse, la renoncule peut atteindre jusqu'à 60 cm de haut. Avec ses pétales densément stratifiés aux couleurs douces ou vives, cette fleur coupée somptueuse et durable illumine n'importe quel espace, à l'intérieur ou dans votre jardin.

### Ranúnculo

El ranúnculo, una planta herbácea perenne de raíces tuberosas, puede crecer hasta unos 60 cm de altura. De pétalos densamente agrupados en colores suaves o intensos, esta flor cortada exuberante y duradera ilumina cualquier espacio, ya sea en interiores o en tu jardín.





Bouvardia

### Hummingbird flower

*Like a miniature bouquet in every stem, each flower erupts into a delightful little star – inspiring its other familiar names: 'firecracker bush' or 'trumpetellia'. Originating from Central America, some of its family members can also be found in Europe and Canada.*

### Fleur de colibri

*Tel un bouquet miniature dans chaque tige, chaque fleur éclate en une jolie petite étoile. Cette plante est d'ailleurs également surnommée « buisson de feu d'artifice » ou « petite trompette ». Originaire d'Amérique centrale, ce genre de plantes à fleurs est également présent en Europe et au Canada.*

### Flor de colibrí

*Como un ramillete en miniatura en cada tallo, la flor se abre en una encantadora estrellita que inspira otro de sus nombres comunes: trompetilla. Originaria de Centroamérica, también pueden encontrarse algunos miembros de la familia en Europa y Canadá.*



### Lily flower

*With between 80 and 100 species, and almost as many color variations, lilies captivate us with their pleasant aroma and glowing intensity. Symbols of timeless elegance and purity, they are a cherished choice for celebrations and heartfelt gestures.*

### Fleur de lys

*Comptant entre 80 et 100 espèces, et presque autant de variations de couleurs, le lys nous envoûte par son arôme agréable et l'intensité de son éclat. Symbole d'élégance et de pureté intemporelles, il est un excellent choix pour les célébrations et les gestes sincères.*

### Azucena

*Con 80-100 especies y casi el mismo número de variaciones de color, las azucenas nos cautivan con su agradable aroma y encendida intensidad. Símbolos de elegancia atemporal y pureza, son una opción muy apreciada para celebraciones y gestos sinceros.*

Lilium





## PLANT A SEED OF INSPIRATION

Building a LEGO® Botanicals Flower Arrangement is just the beginning. Anytime you feel inspired to rearrange your display, just switch the flower heads between the stems, or mix and match more sets to create all-new bouquets. Whichever complements the seasons, your mood and your interior decor. If you are already a seasoned LEGO florist, why not branch out and rebuild your set into different species, too!

## PLANTEZ UNE GRAINE D'INSPIRATION

Construire une composition florale LEGO® Botanique n'est que le début. Lorsque vous avez envie de changement, il vous suffit d'invertir les fleurs entre les tiges, ou de mélanger et d'assortir d'autres ensembles pour créer de nouveaux bouquets. Vous pouvez ainsi adapter votre composition aux saisons, à votre humeur et à votre décor. Si vous êtes déjà un fleuriste LEGO chevronné, pourquoi ne pas reconstruire votre ensemble en différentes espèces ?

## PLANTA UNA SEMILLA DE INSPIRACIÓN

Construir el Arreglo Floral LEGO® Botanical es solo el comienzo. Cada vez que desees darle una nueva expresión a tu pieza ornamental, cambia las flores de un tallo a otro o mezcla varios sets para crear ramos totalmente nuevos: lo que combine mejor con las estaciones, tu estado de ánimo o la decoración de tu hogar. Si ya se te dan bien las flores LEGO, ¡reconstruye tu set para convertirlo en una especie diferente también!





Discover more blooming  
creative tips with your  
LEGO® Insiders account on

Découvrez d'autres astuces  
créatives fleuries avec votre  
compte LEGO® Insiders sur

Descubre más consejos  
creativos con tu cuenta  
LEGO® Insiders en



[LEGO.com/Botanicals-exclusive](https://LEGO.com/Botanicals-exclusive)



Combine with 10342. Sold separately.  
À combiner avec 10342. Vendus séparément.  
Combínalo con 10342. De venta por separado.

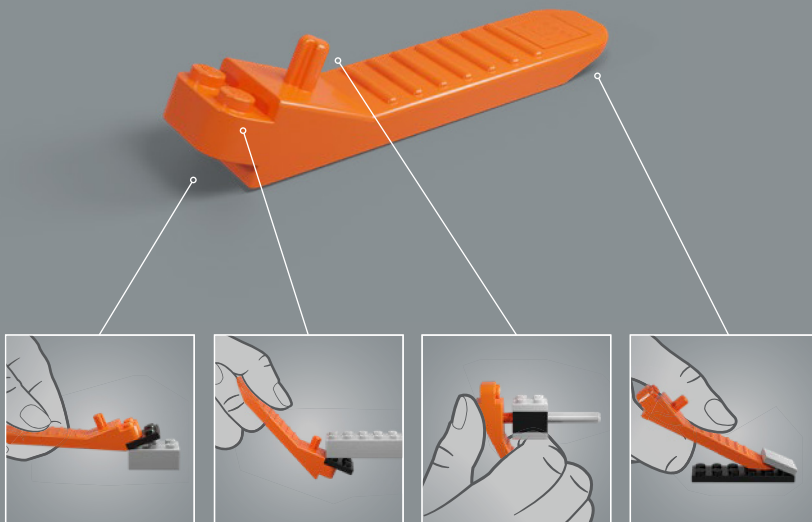

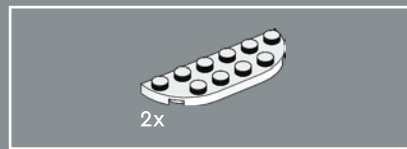

2

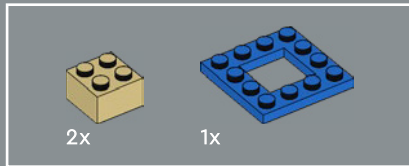
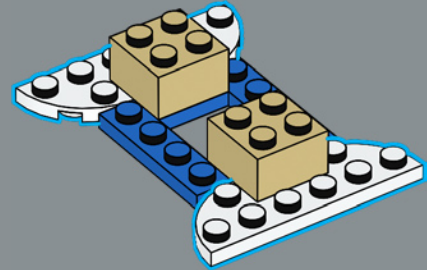

1

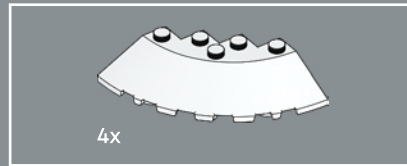
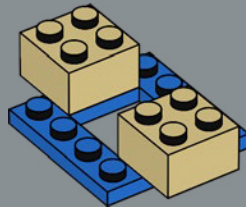

3

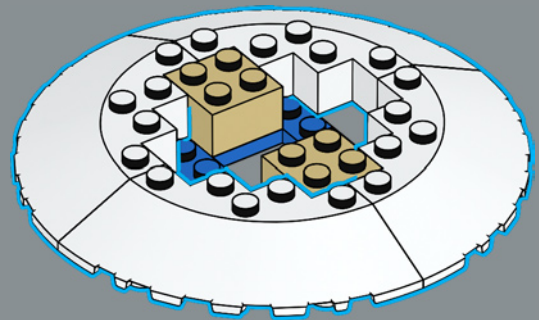

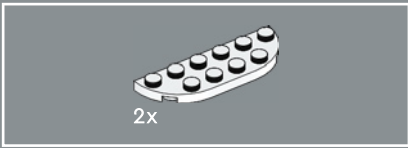

4

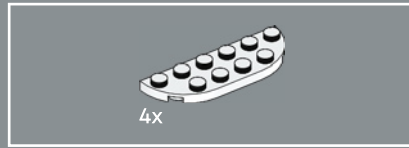
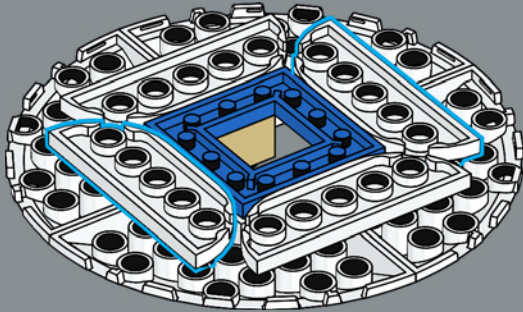

5

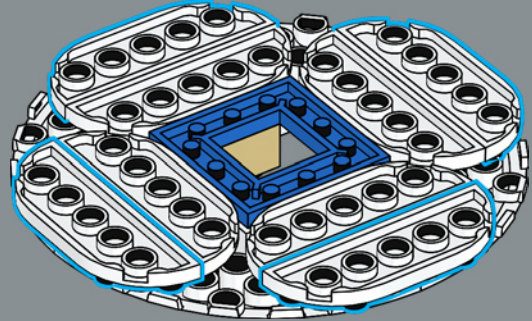



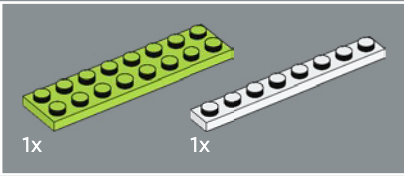
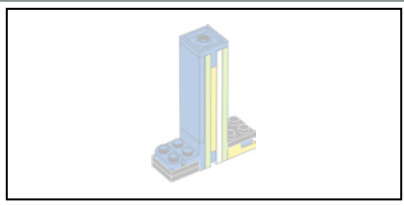

6

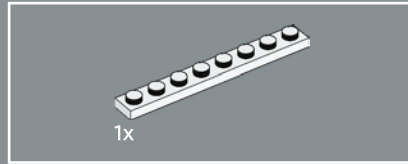
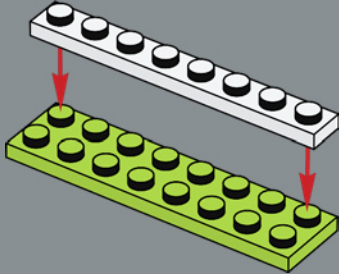

7

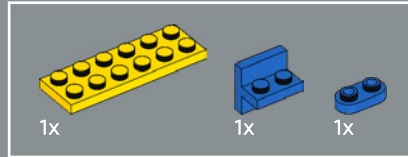
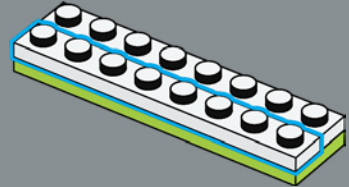

8

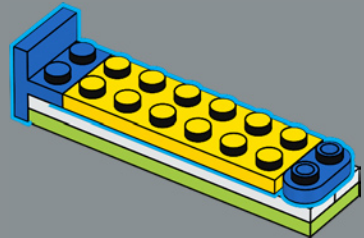

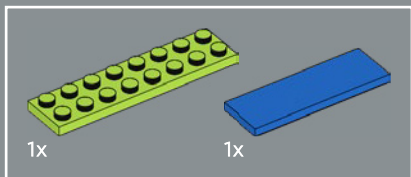

9

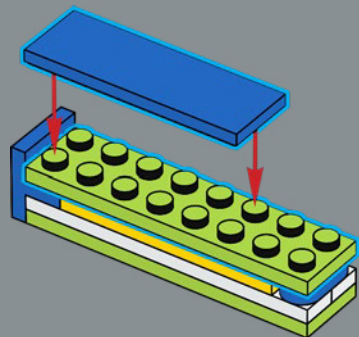

10

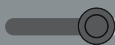
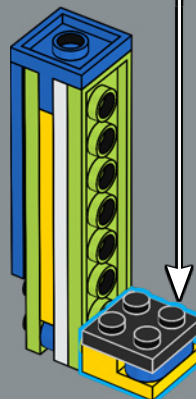
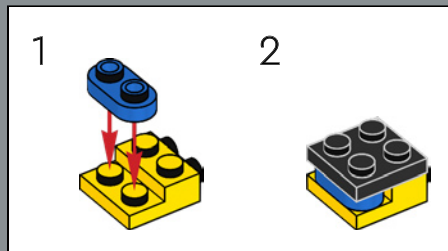

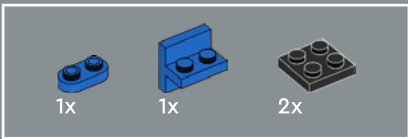

11

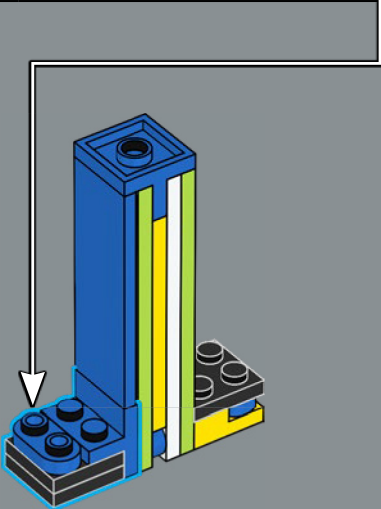
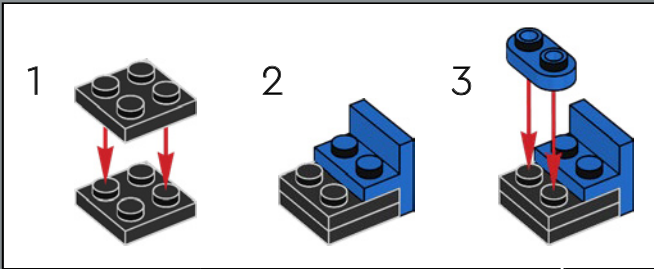

12

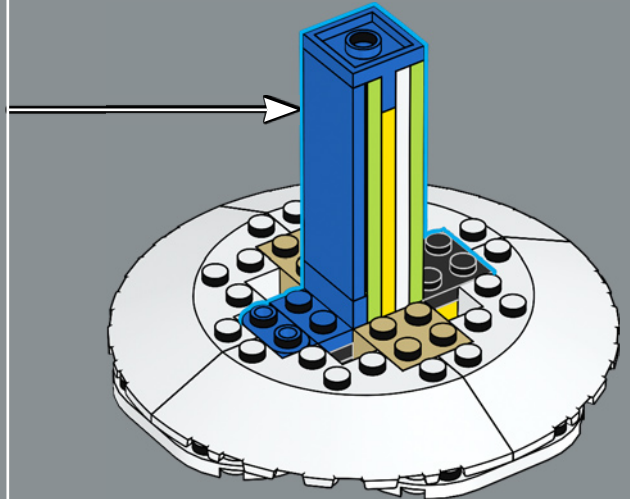

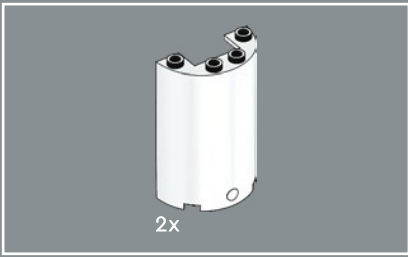

13

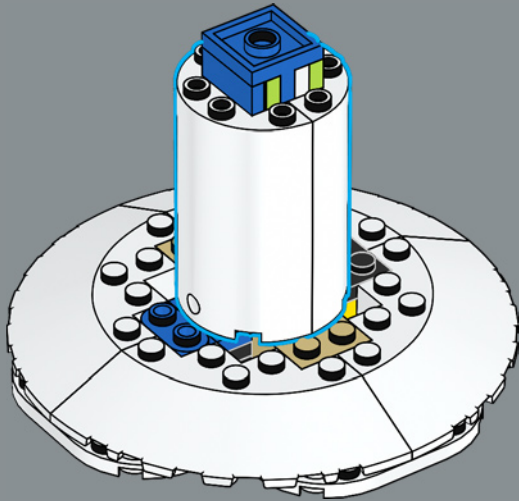

14

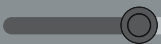
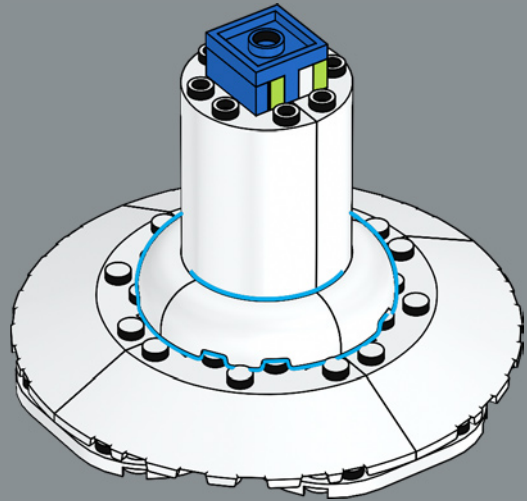

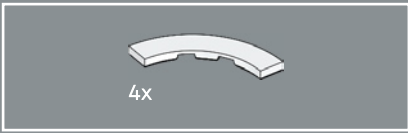

15

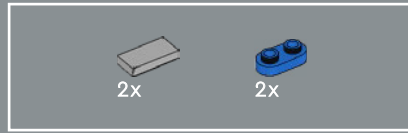
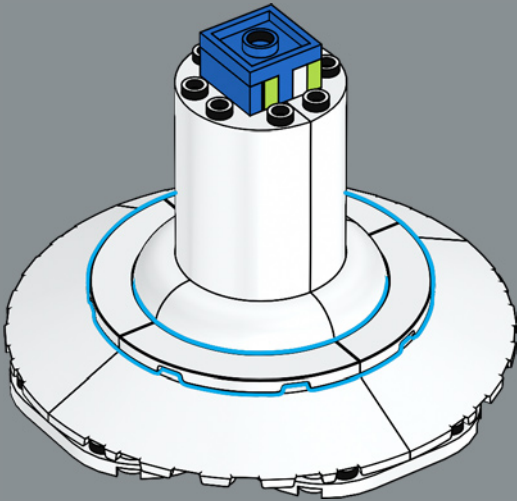

16

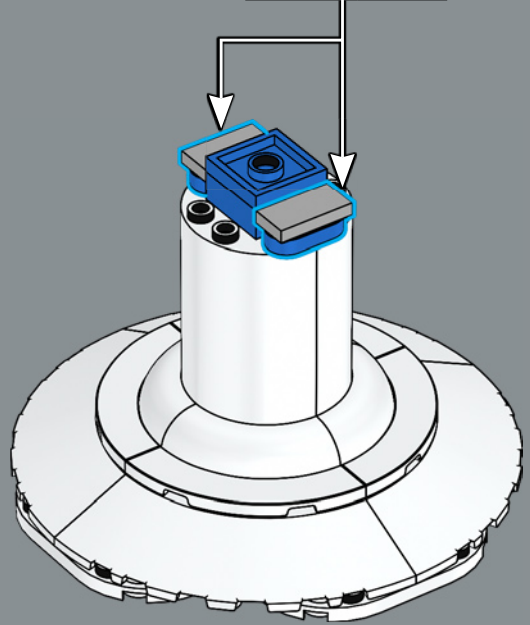
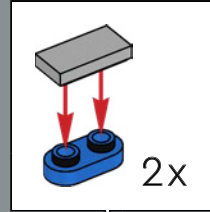



17

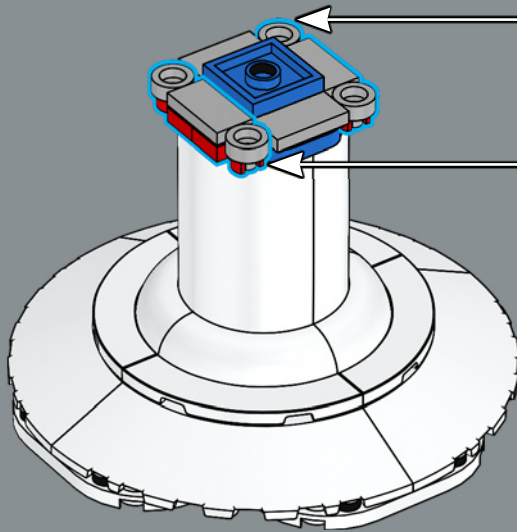
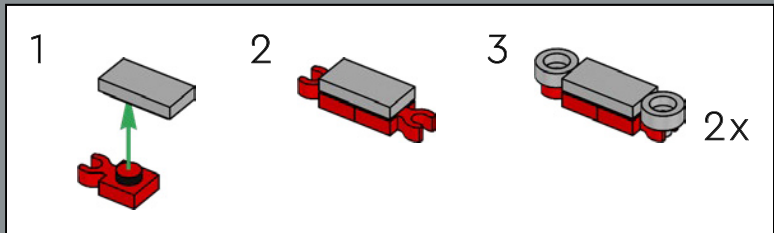

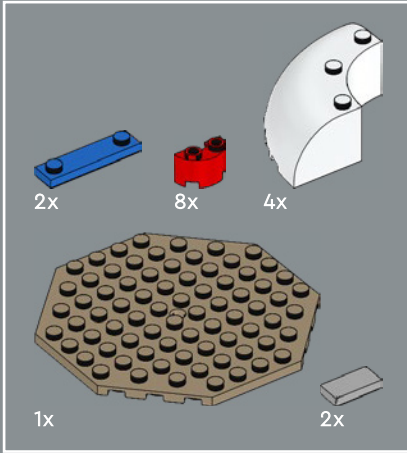
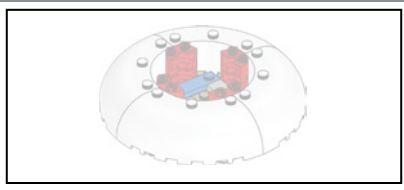

18

1

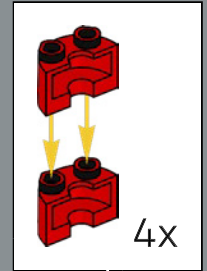
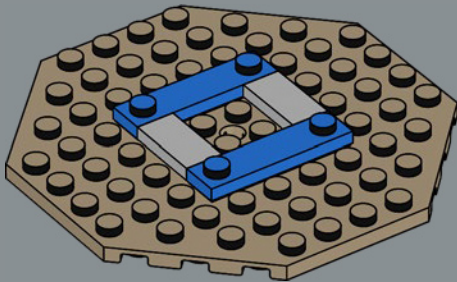

2

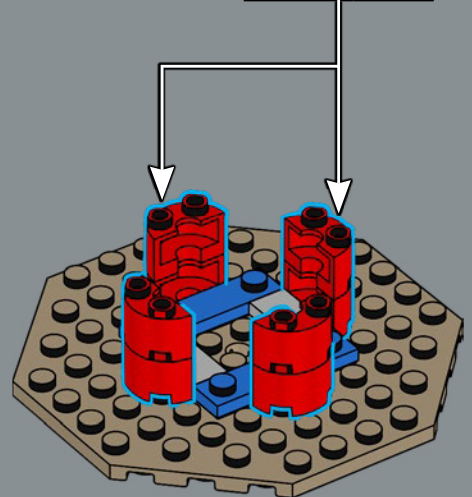

3

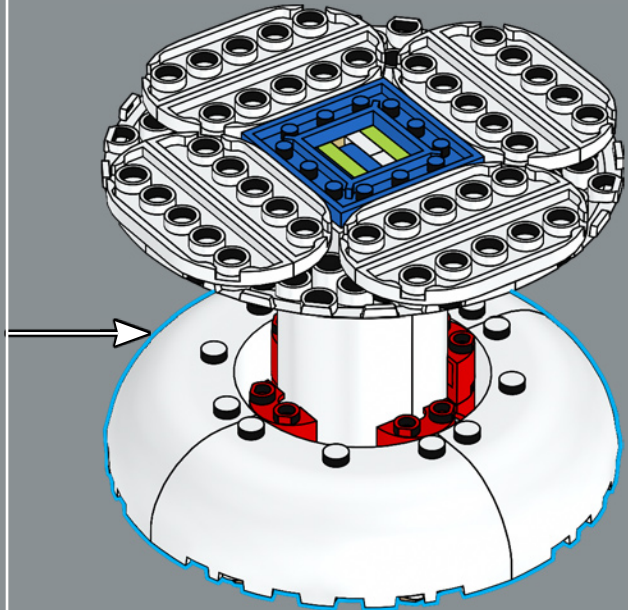
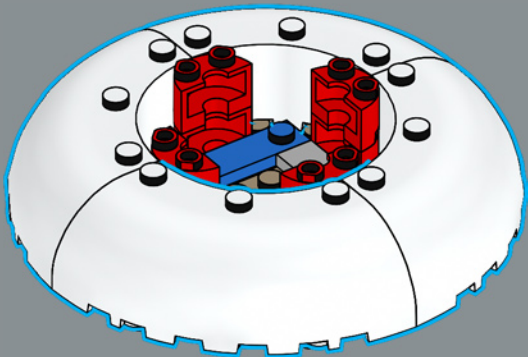





19

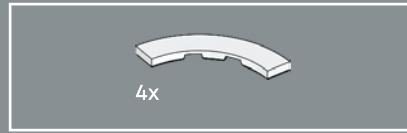
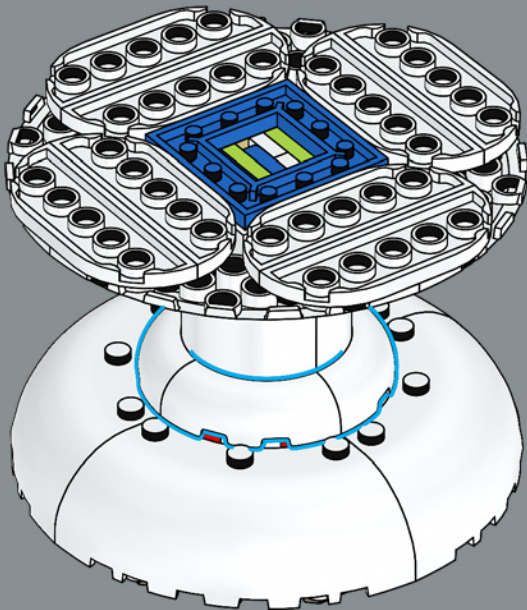

20

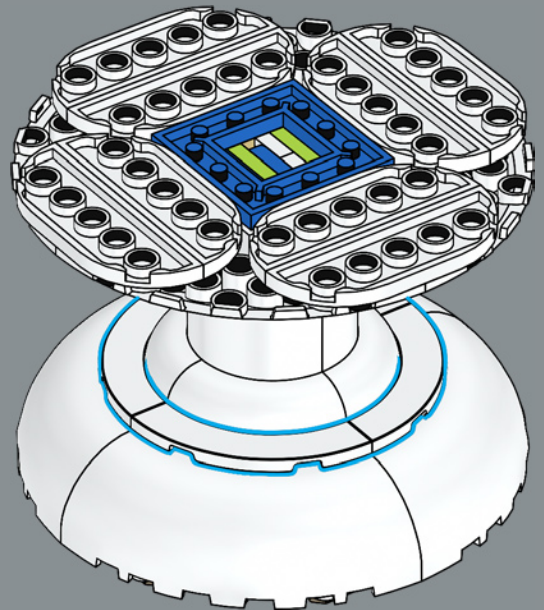



21

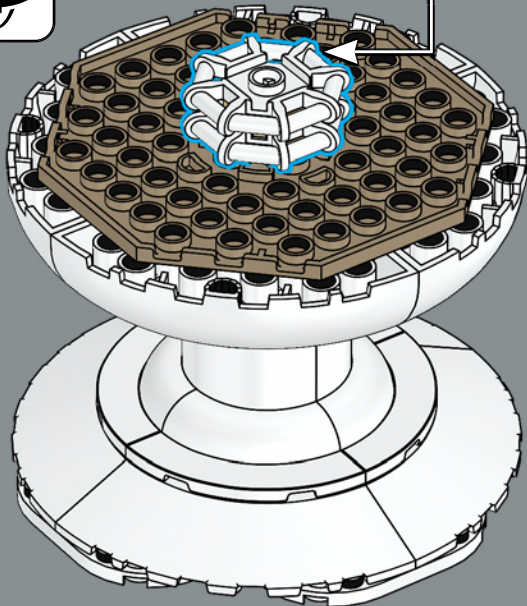
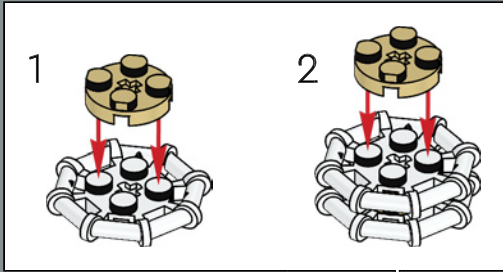

22

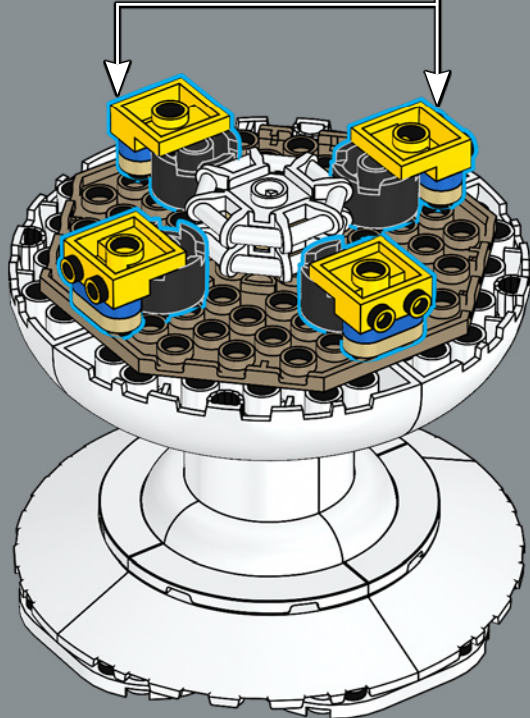
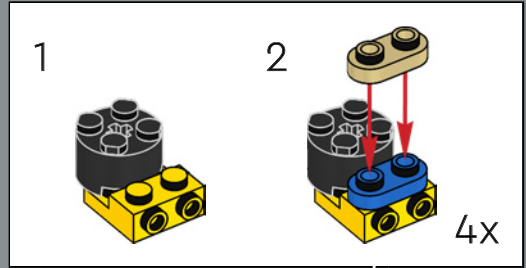

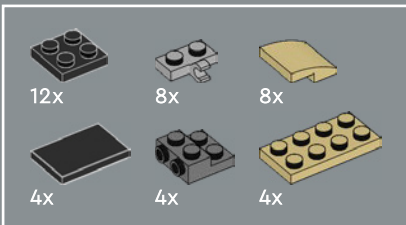
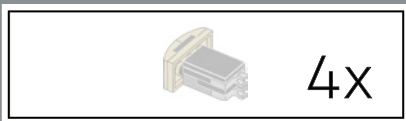

23

1

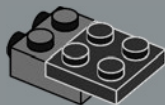

2

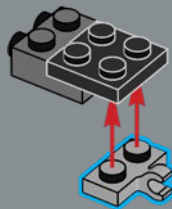

3

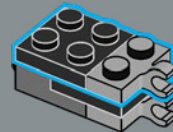

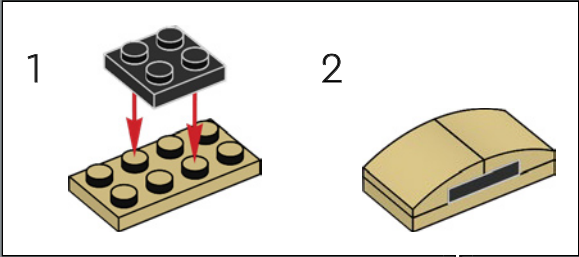

4

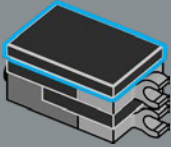

5

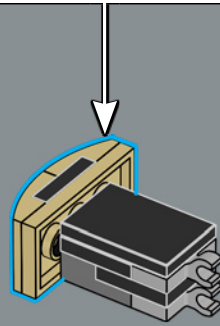

4X

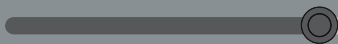

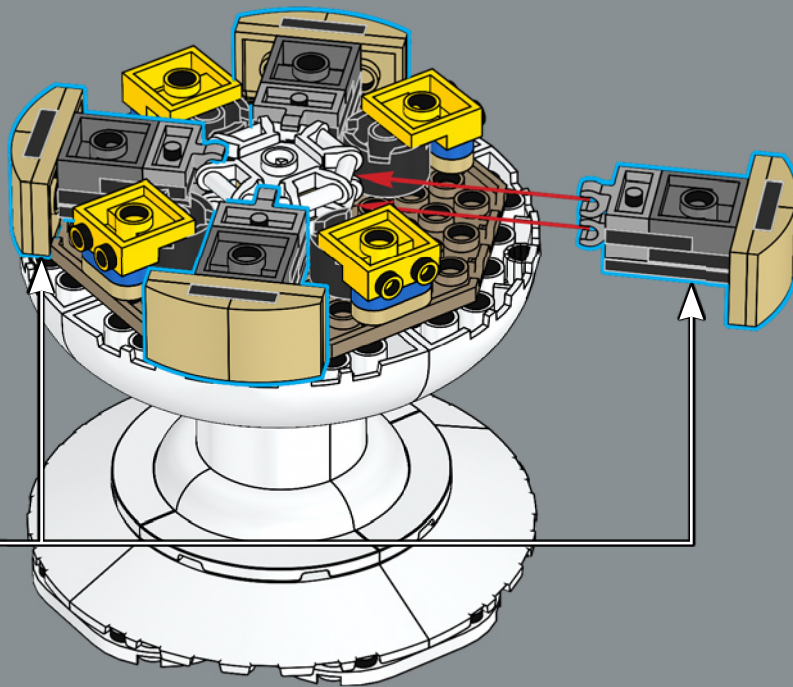

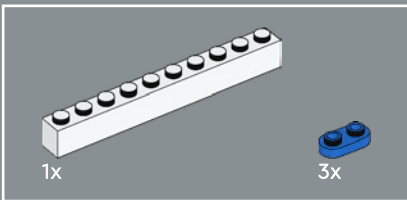
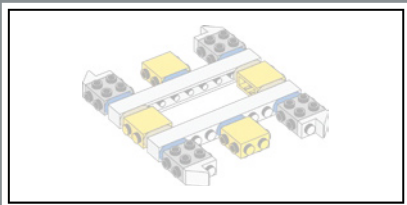

24

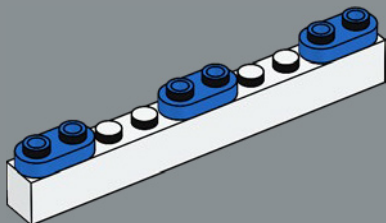

25

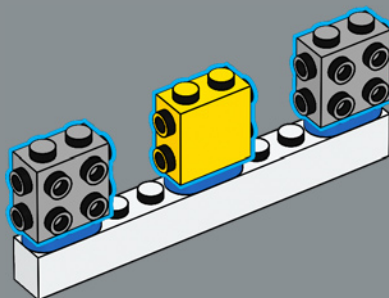

26

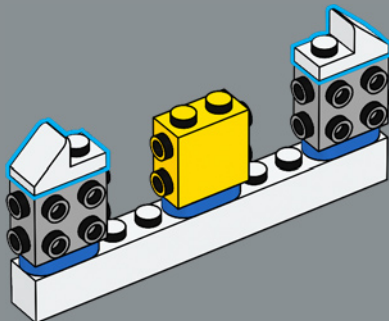



27

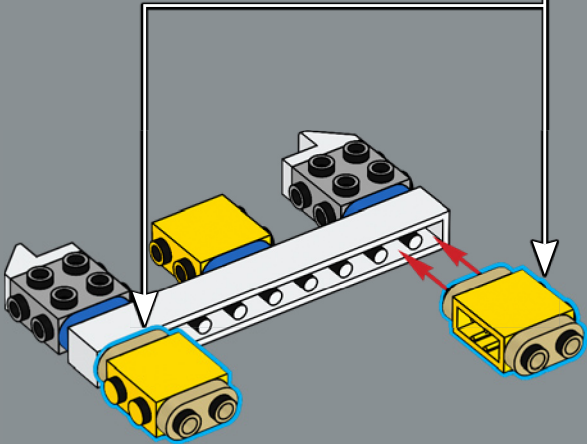
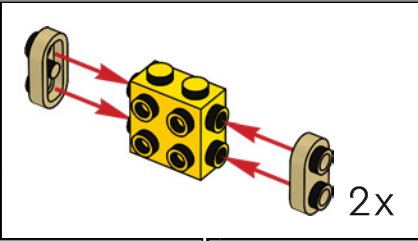

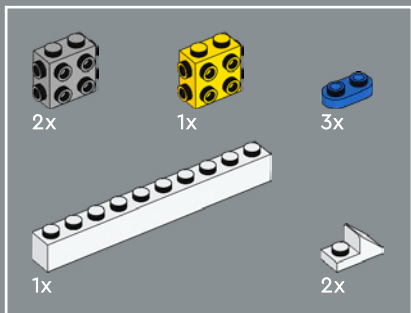

28

1

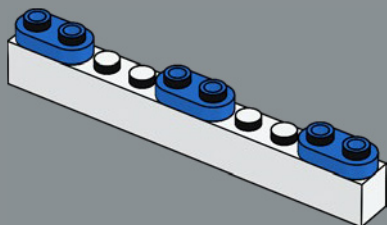

2

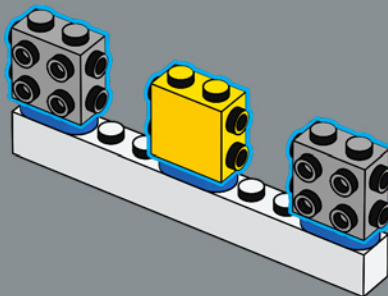

3

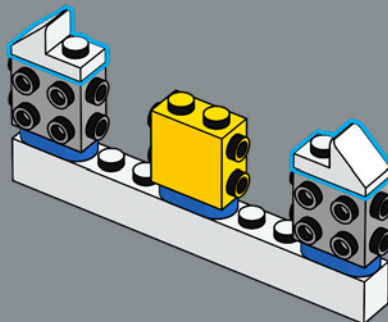



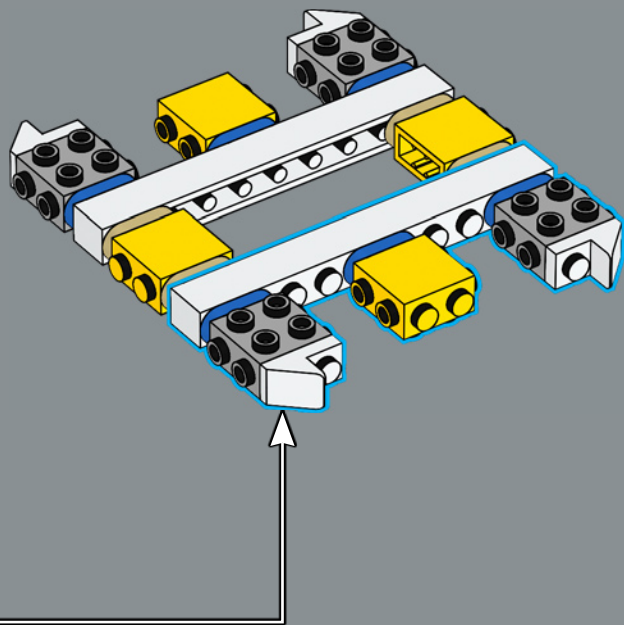

29

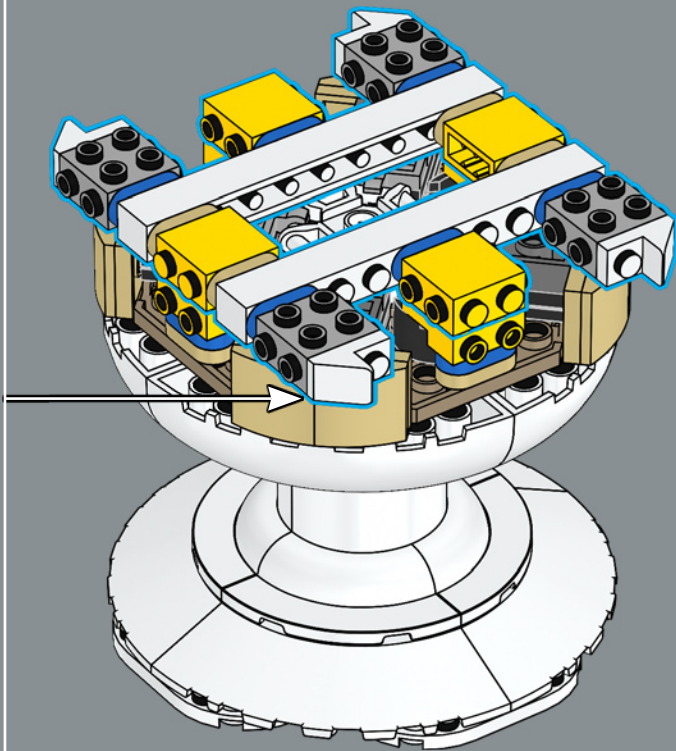

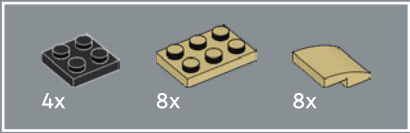

30

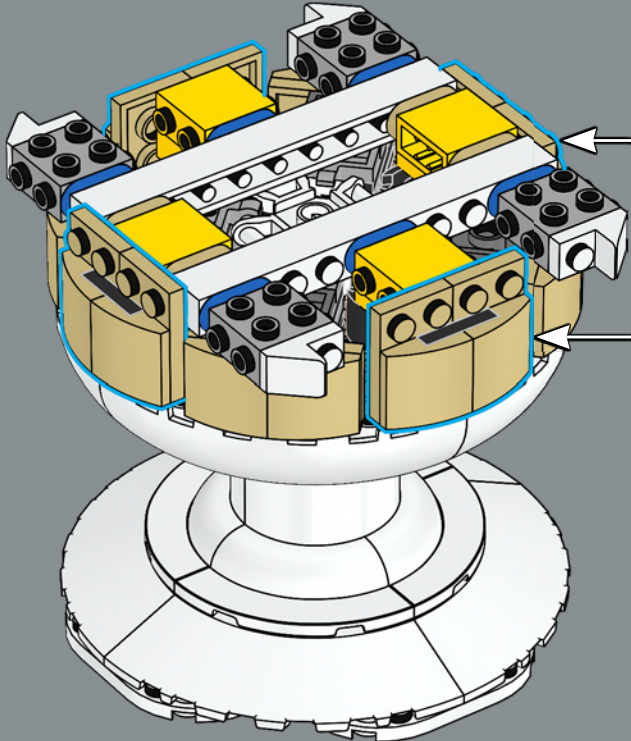
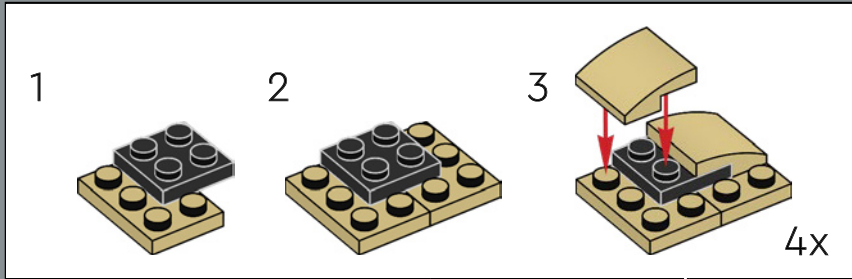

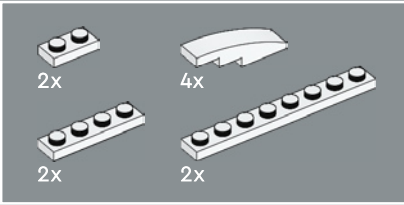
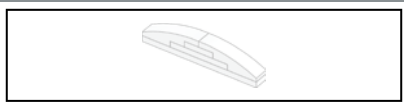

31

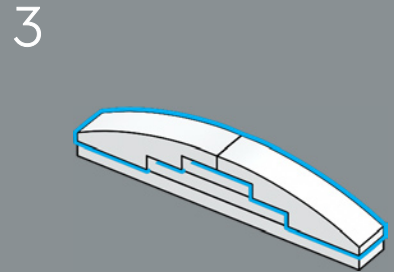
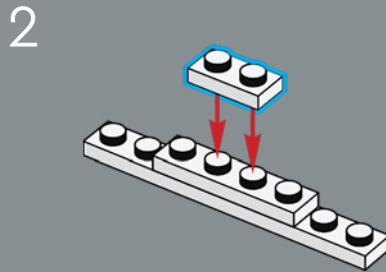
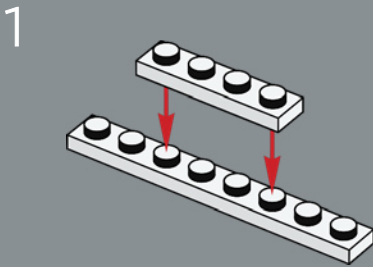

2x

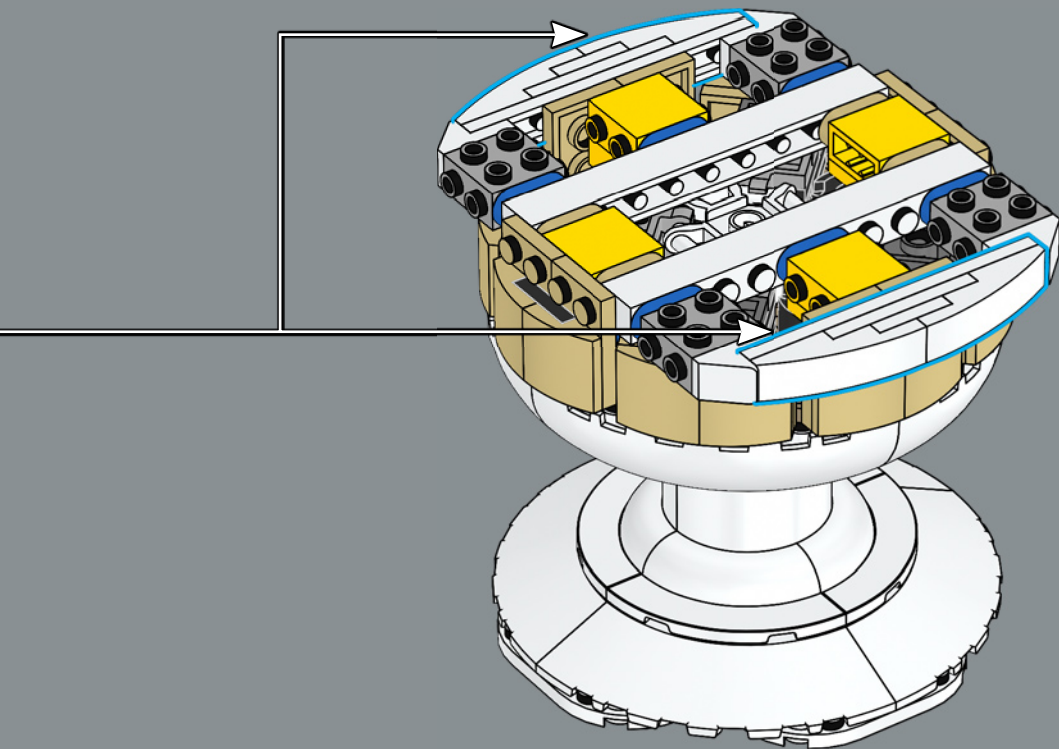

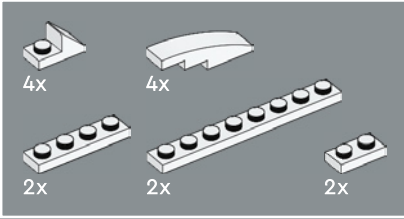
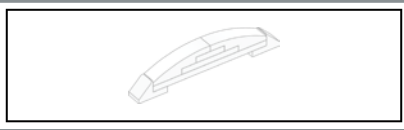

32

1

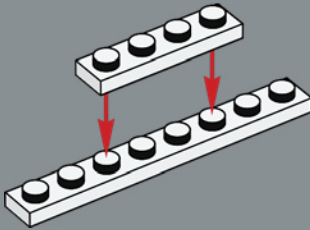

2

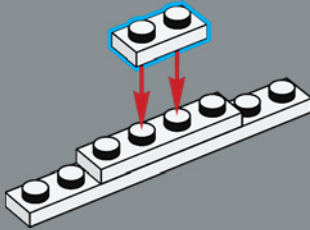

3

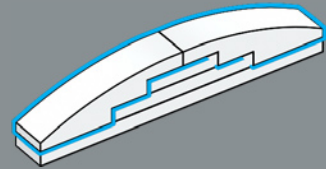

4

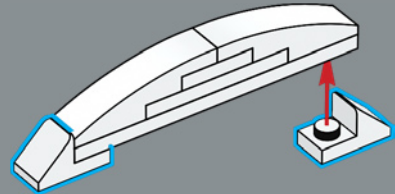

2x

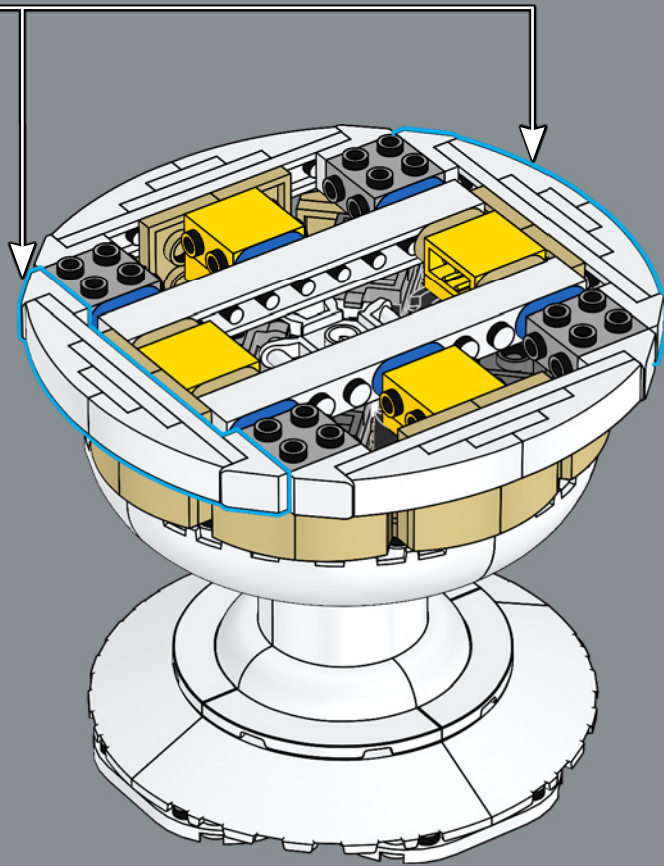

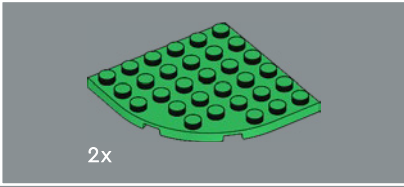
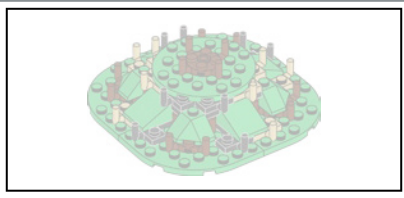

33

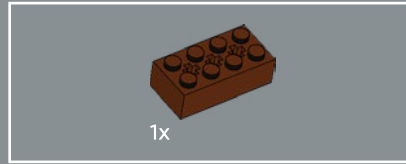
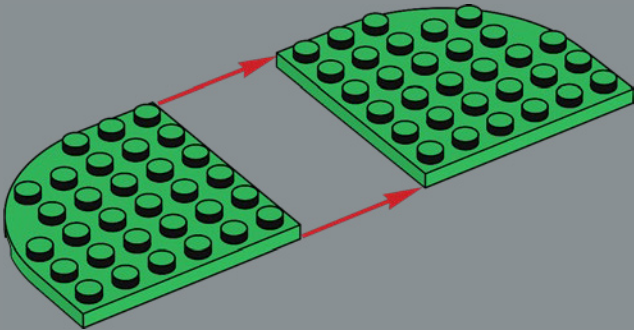

34

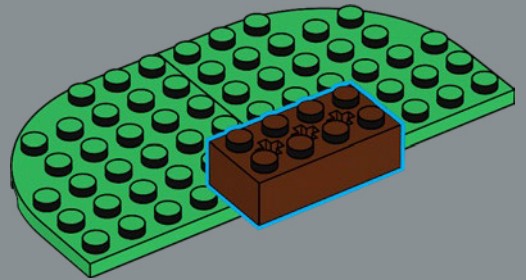

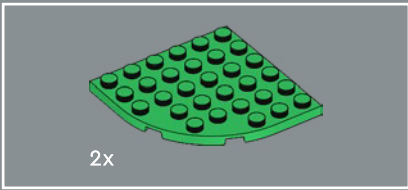

35

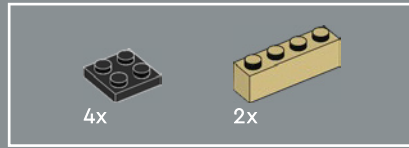
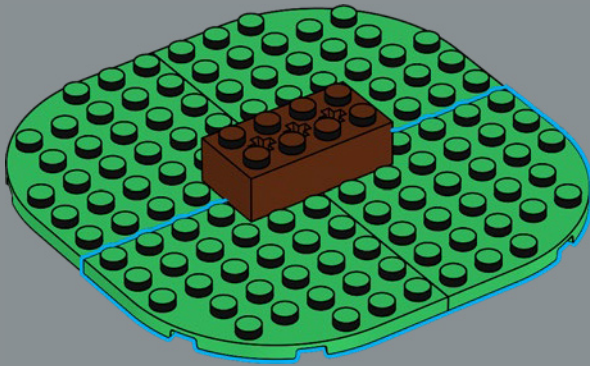

36

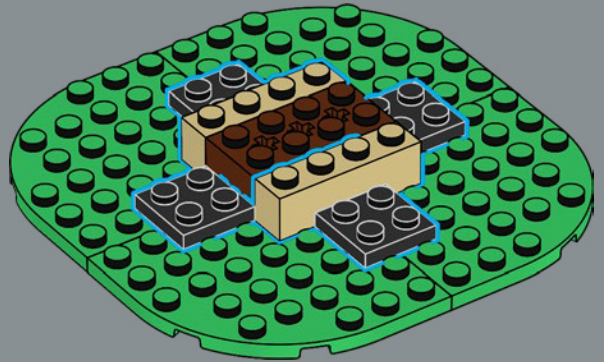





37

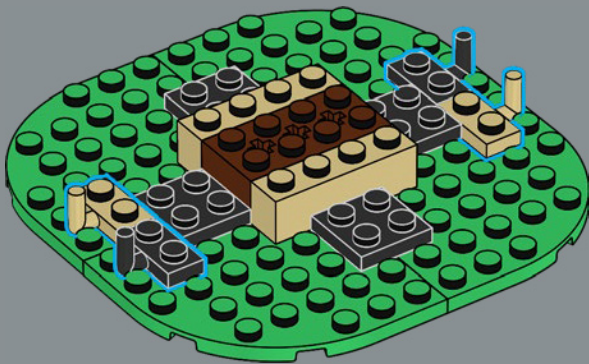

38

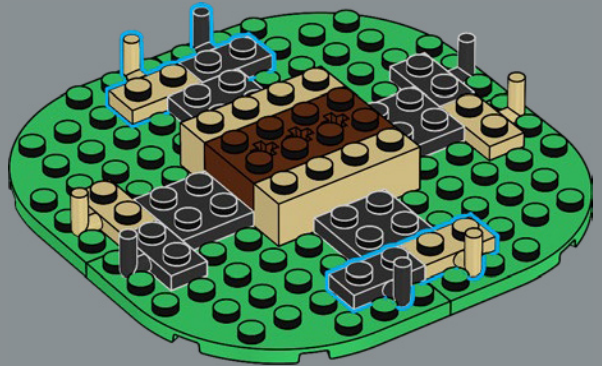



39

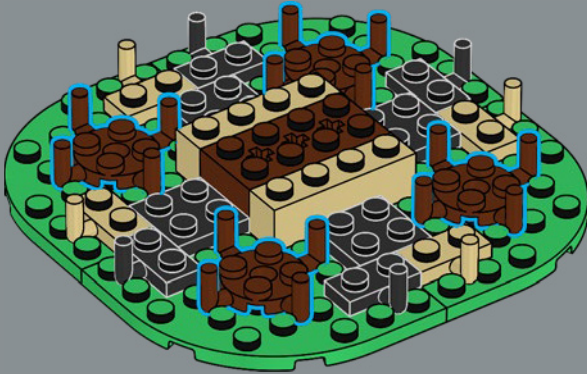

40

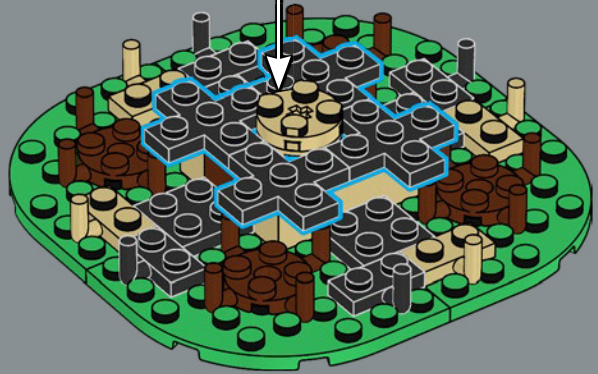
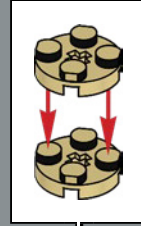

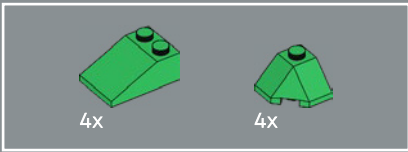

41

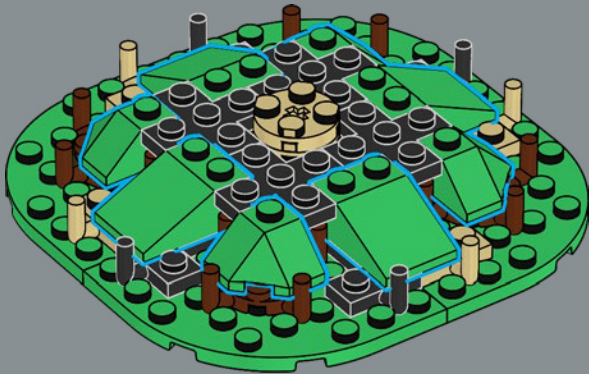

42

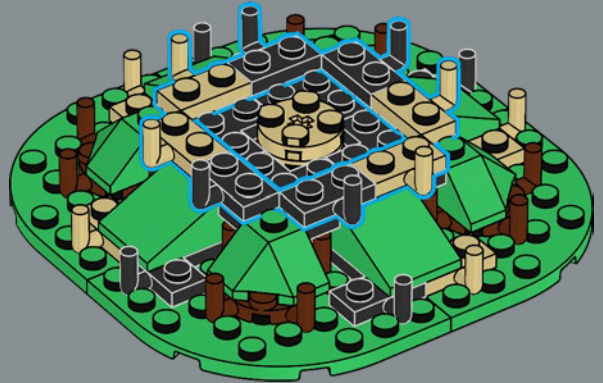

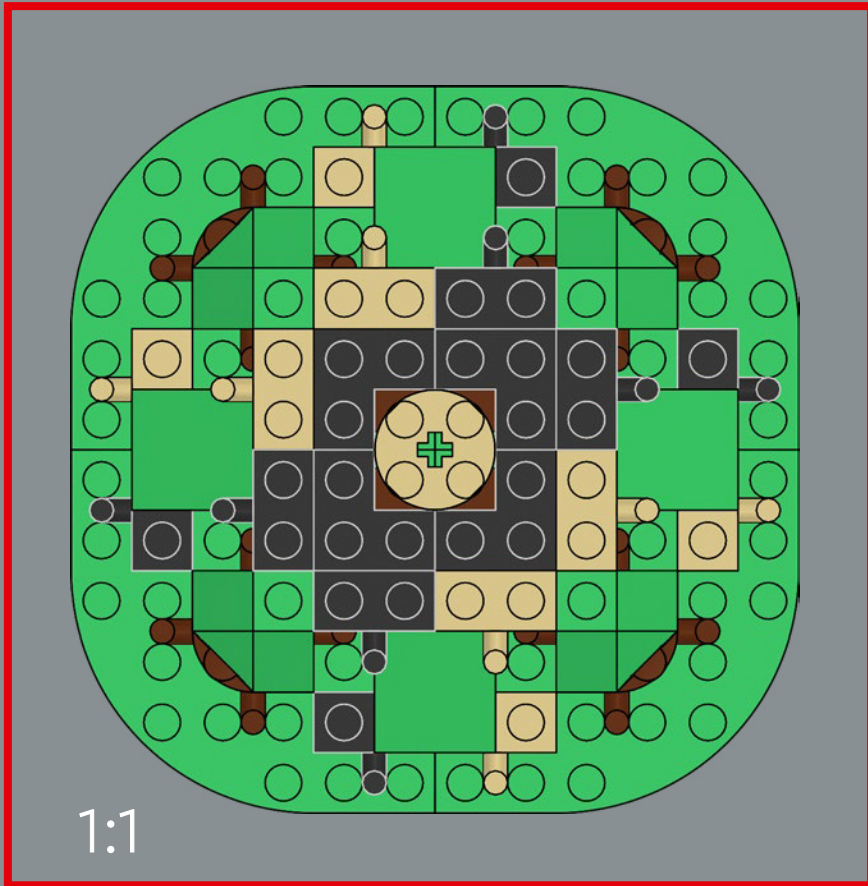

1:1



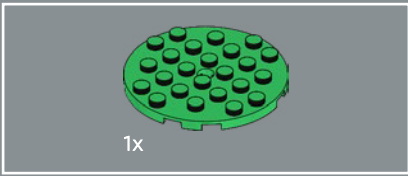

43

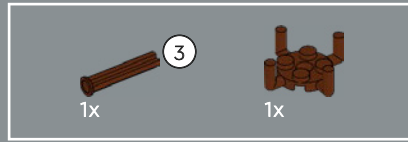
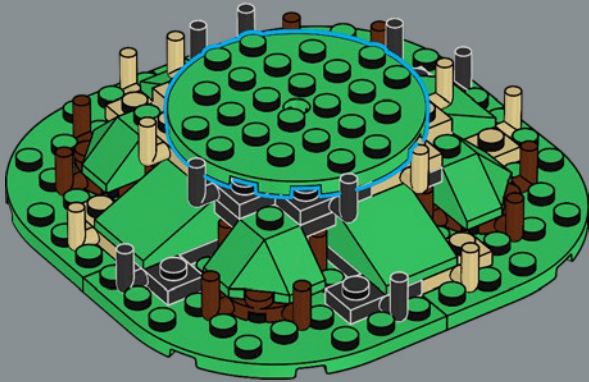

44

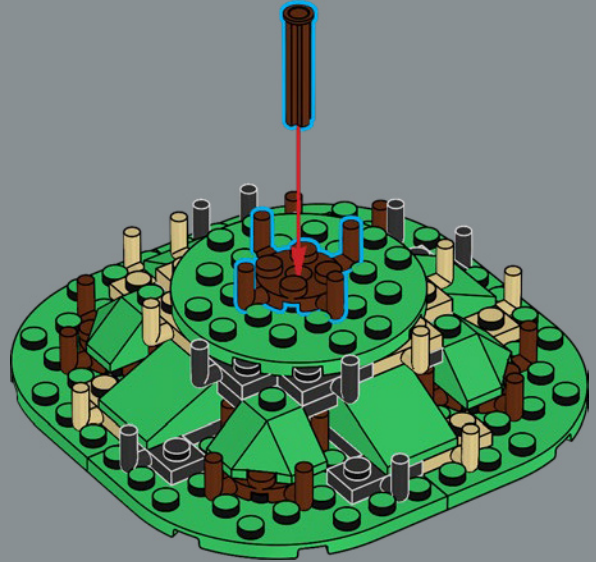

45



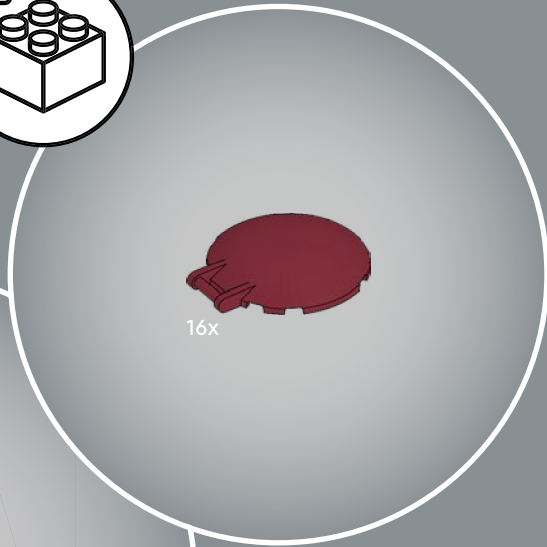
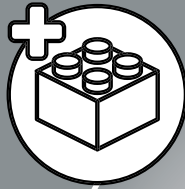

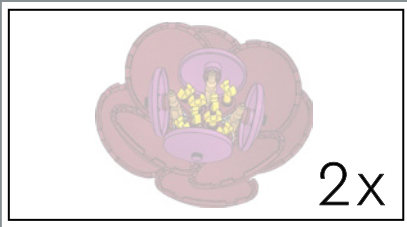

46

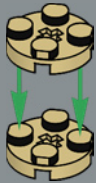

47



48







49

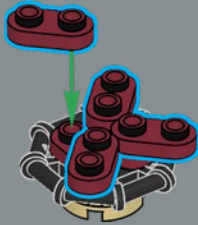

Need a hand building this flower? In this case, the core is actually made with a few LEGO® robot hand elements!

Besoin d'un coup de main pour construire cette fleur ? Ici, le centre est en fait formé de quelques éléments de main de robot LEGO® !

¿Necesitas una mano para construir esta flor? En este caso, ¡el centro está formado por unos cuantos elementos LEGO® que representan manos robóticas!



50

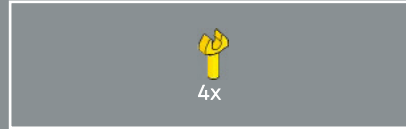

51

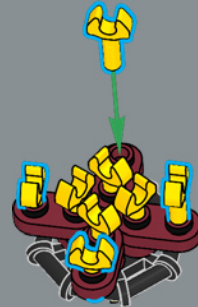

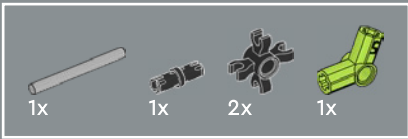

52

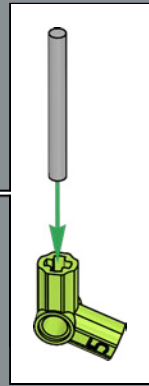
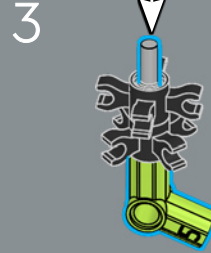
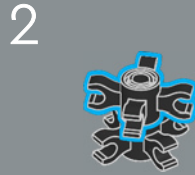
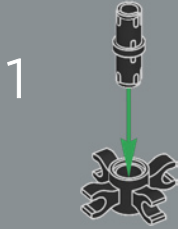



53

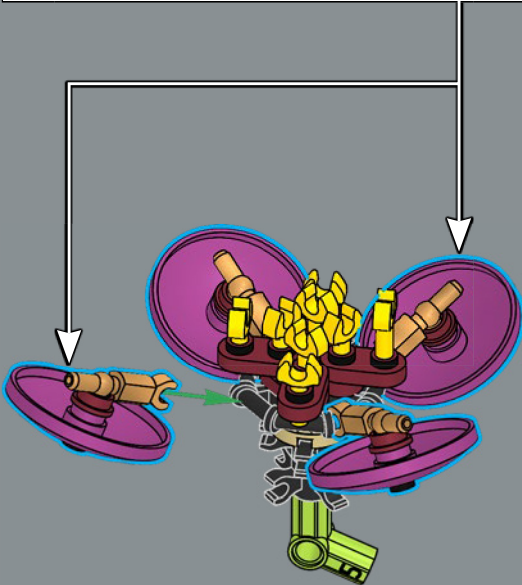
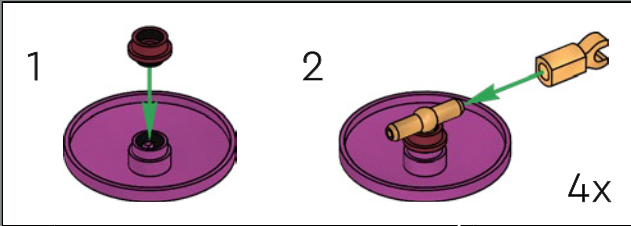

54

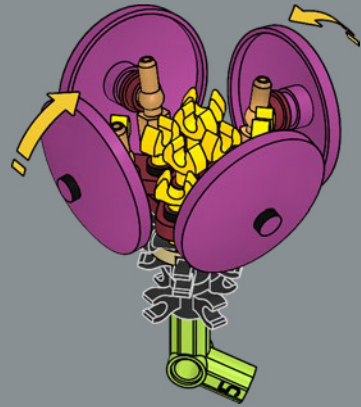

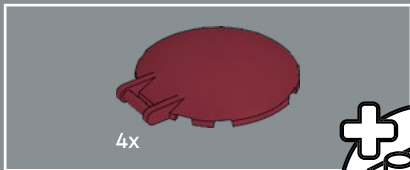

55

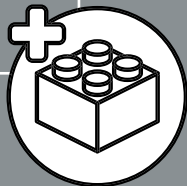

Night Rider camellia: These dark red petals have often been used (in other colors) in cockpits in various LEGO® vehicles.

Camélia « Night Rider » : Ces pétales rouge foncé font souvent office (dans d'autres couleurs) d'habitacle pour divers véhicules LEGO®.

Camelia Night Rider: Estos pétalos de color rojo oscuro se han usado con frecuencia (en otros colores) en las cabinas de varios vehículos LEGO®.

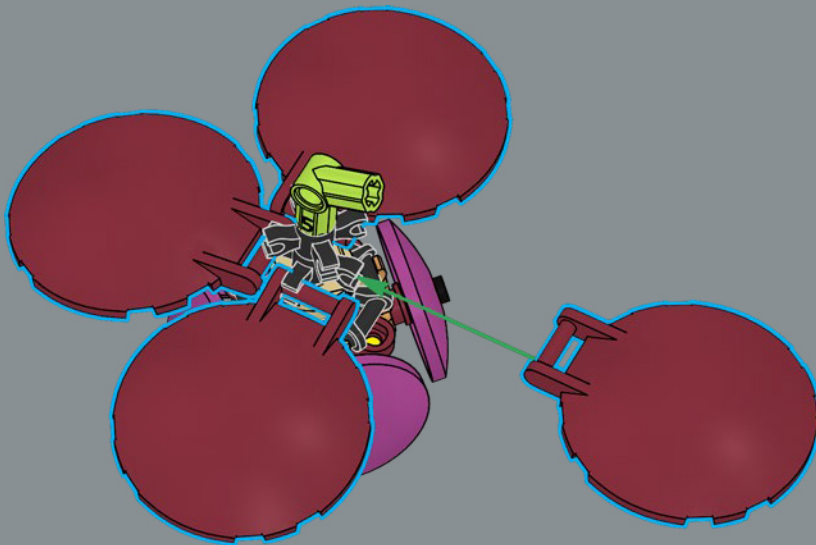

56

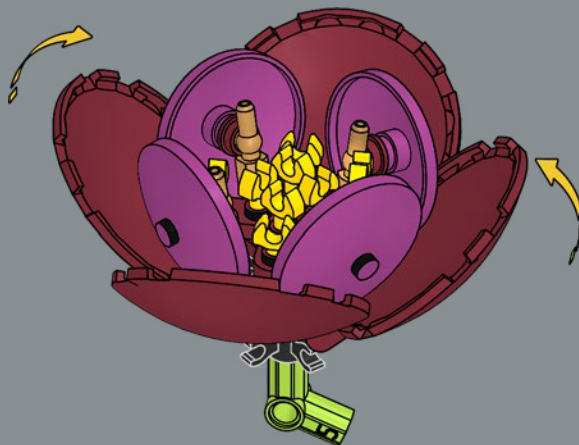

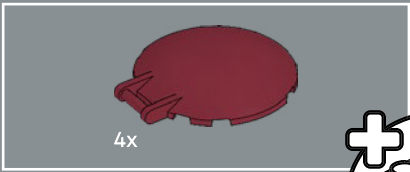

57

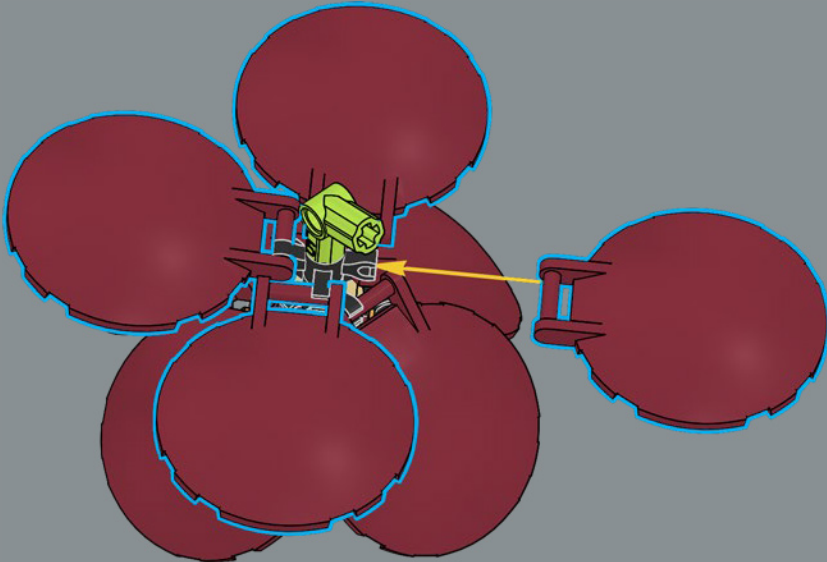
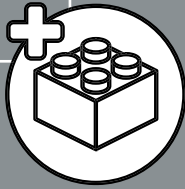

2x



58

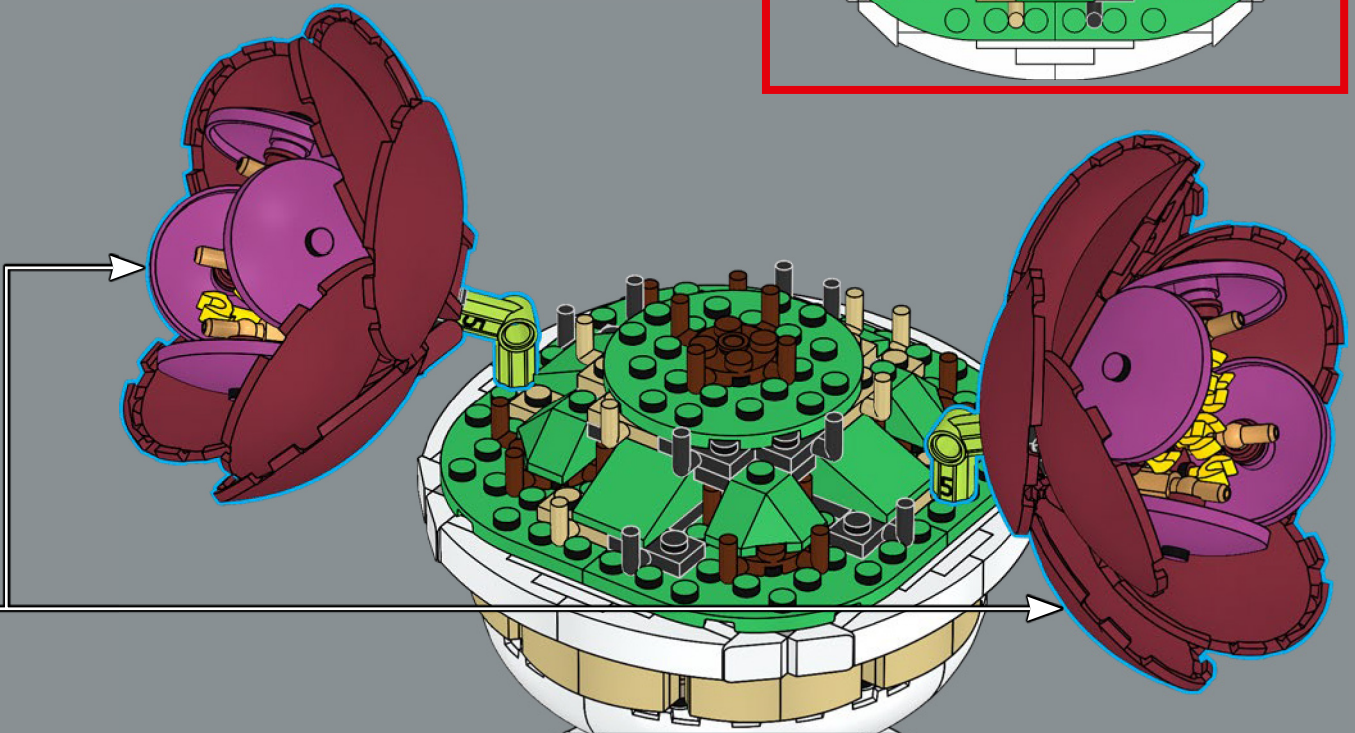
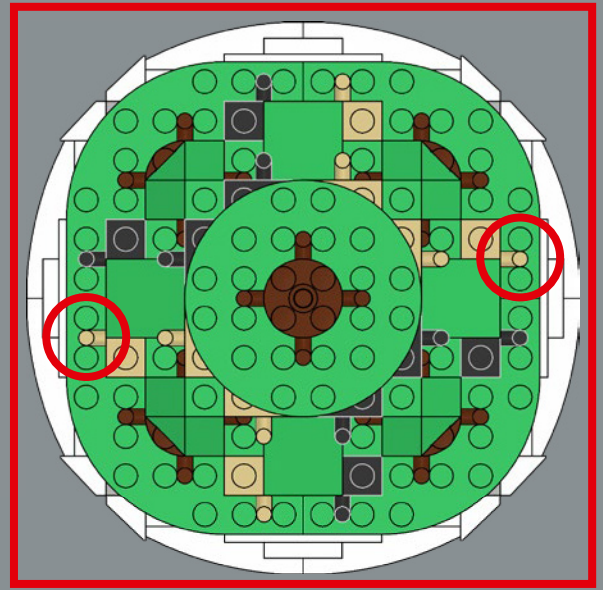

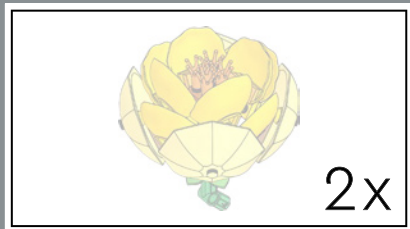

59

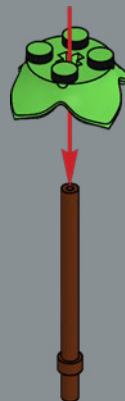

60







61

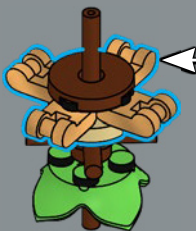
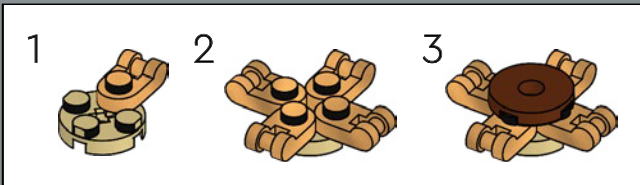

62

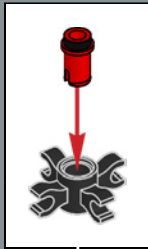



63

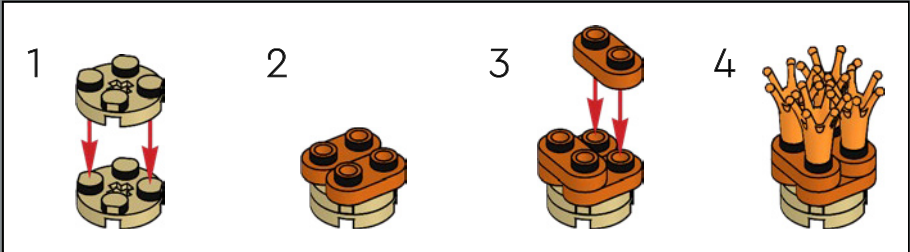



64

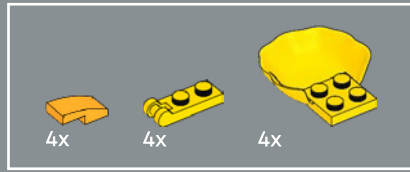

65

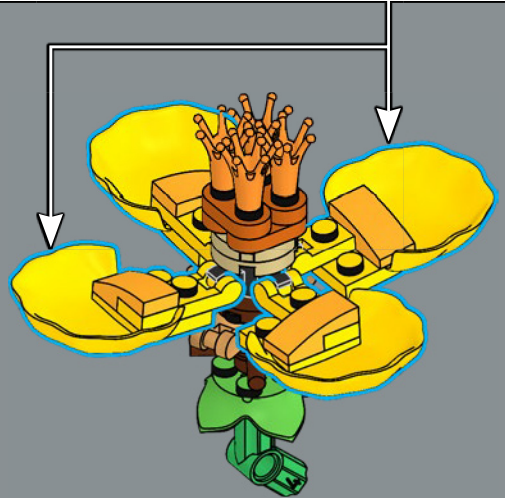
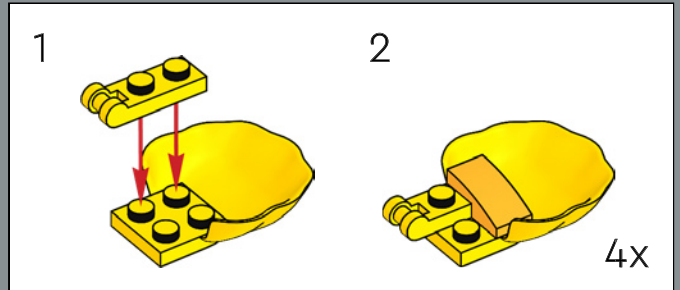

66

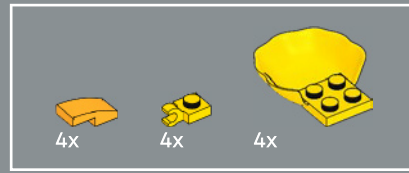
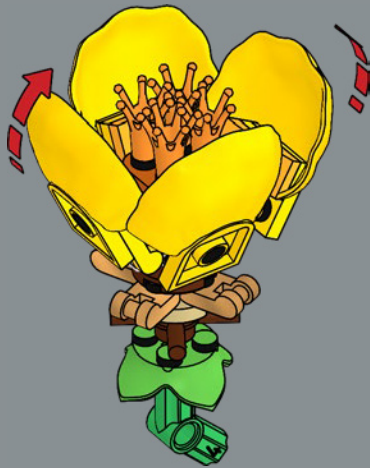

67

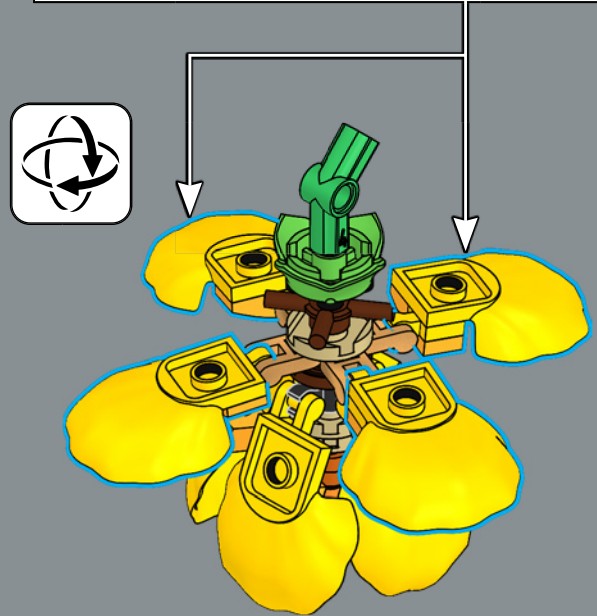
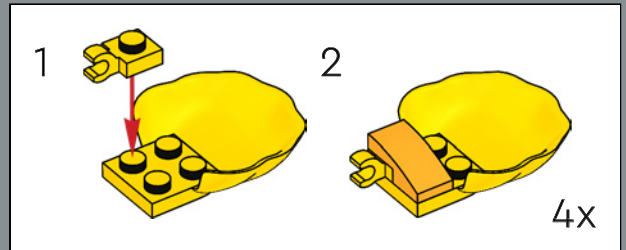

68

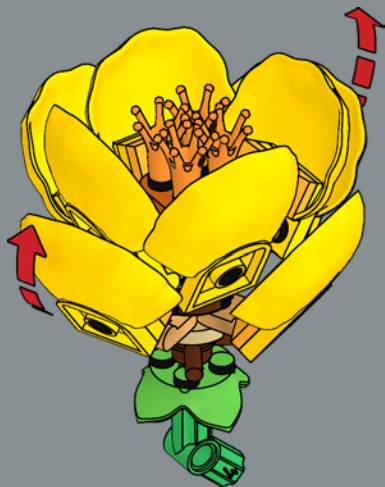

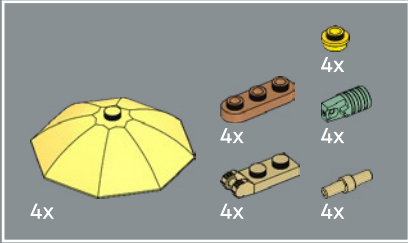
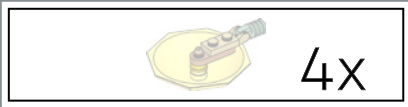

69

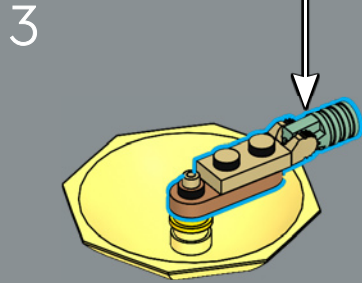
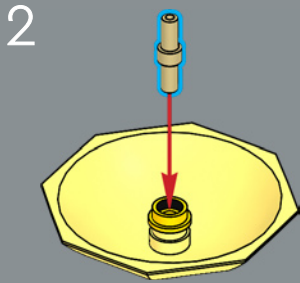
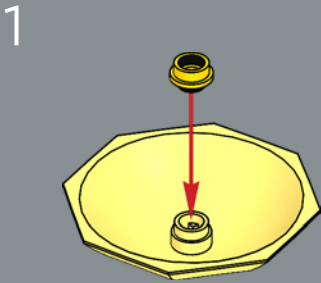
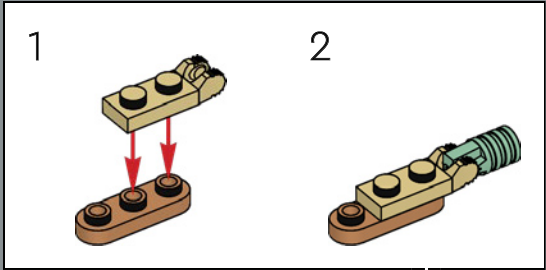

4x



Itoh peony: Did you just get a sudden urge to go to the beach? Maybe you're just realizing that this peony is made up of LEGO® parasols, seashells – and even a few crowns!

Pivoine Itoh : Vous avez soudainement envie d'aller à la plage ? Vous venez peut-être de réaliser que cette pivoine est composée de parasols, de coquillages et même de quelques couronnes LEGO® !

Peonía Itoh : ¿De repente te dieron ganas de ir a la playa? Tal vez estás dándote cuenta ahora mismo de que esta peonía se compone de sombrillas y conchas marinas LEGO®, ¡e incluso de algunas coronas!

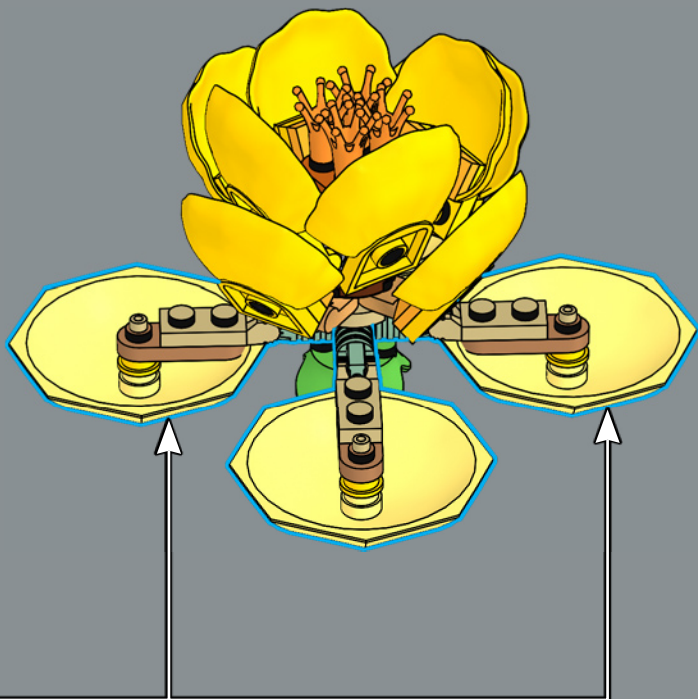

70

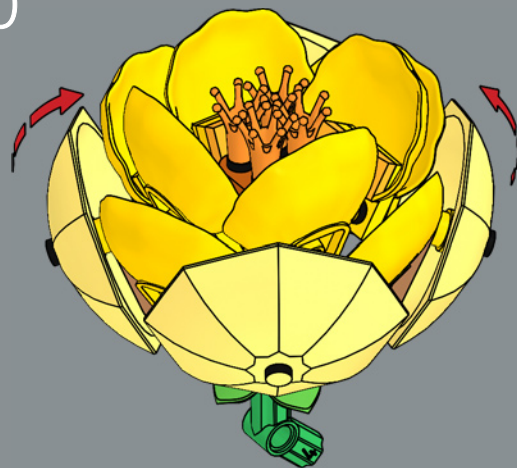

2x

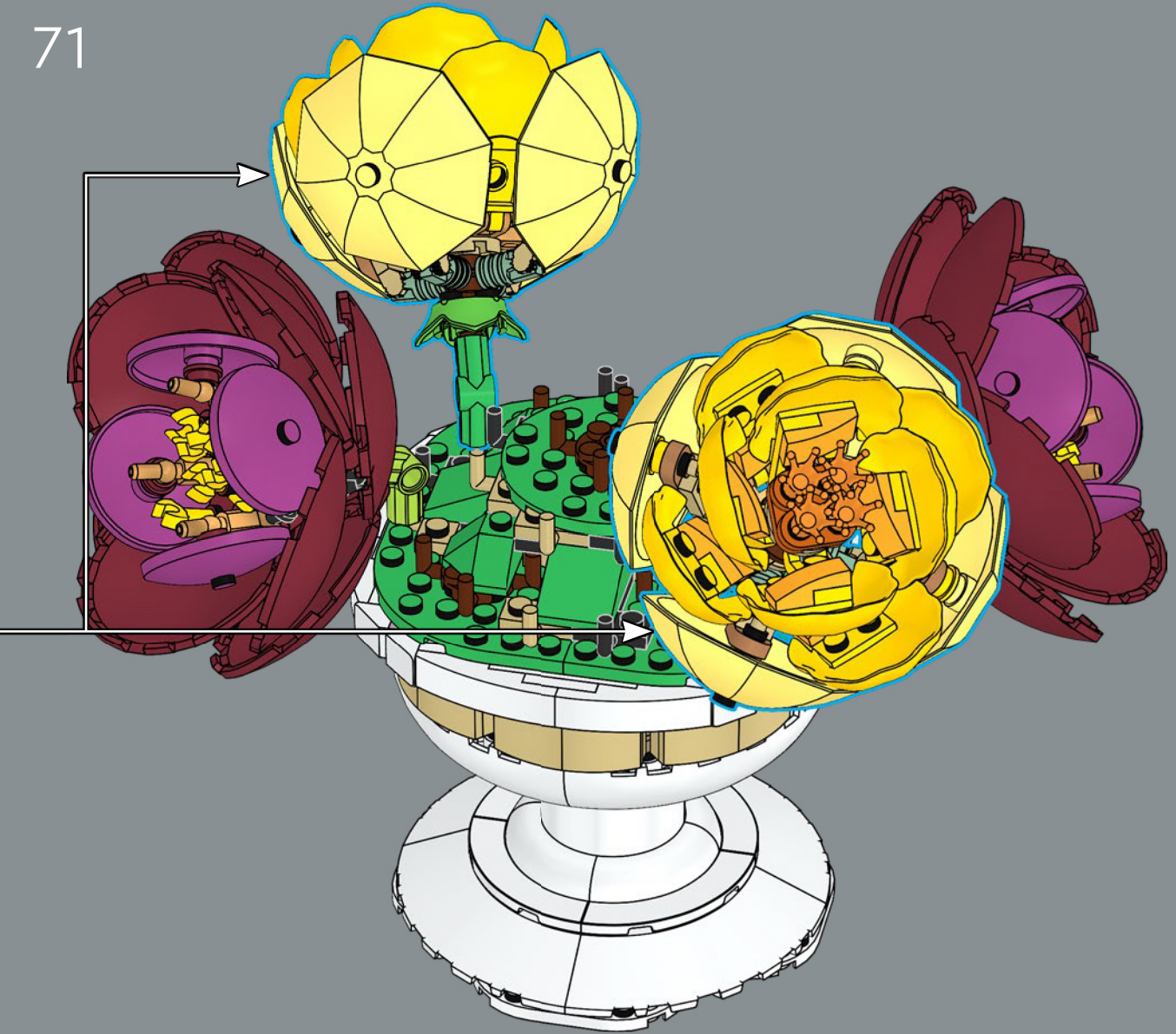



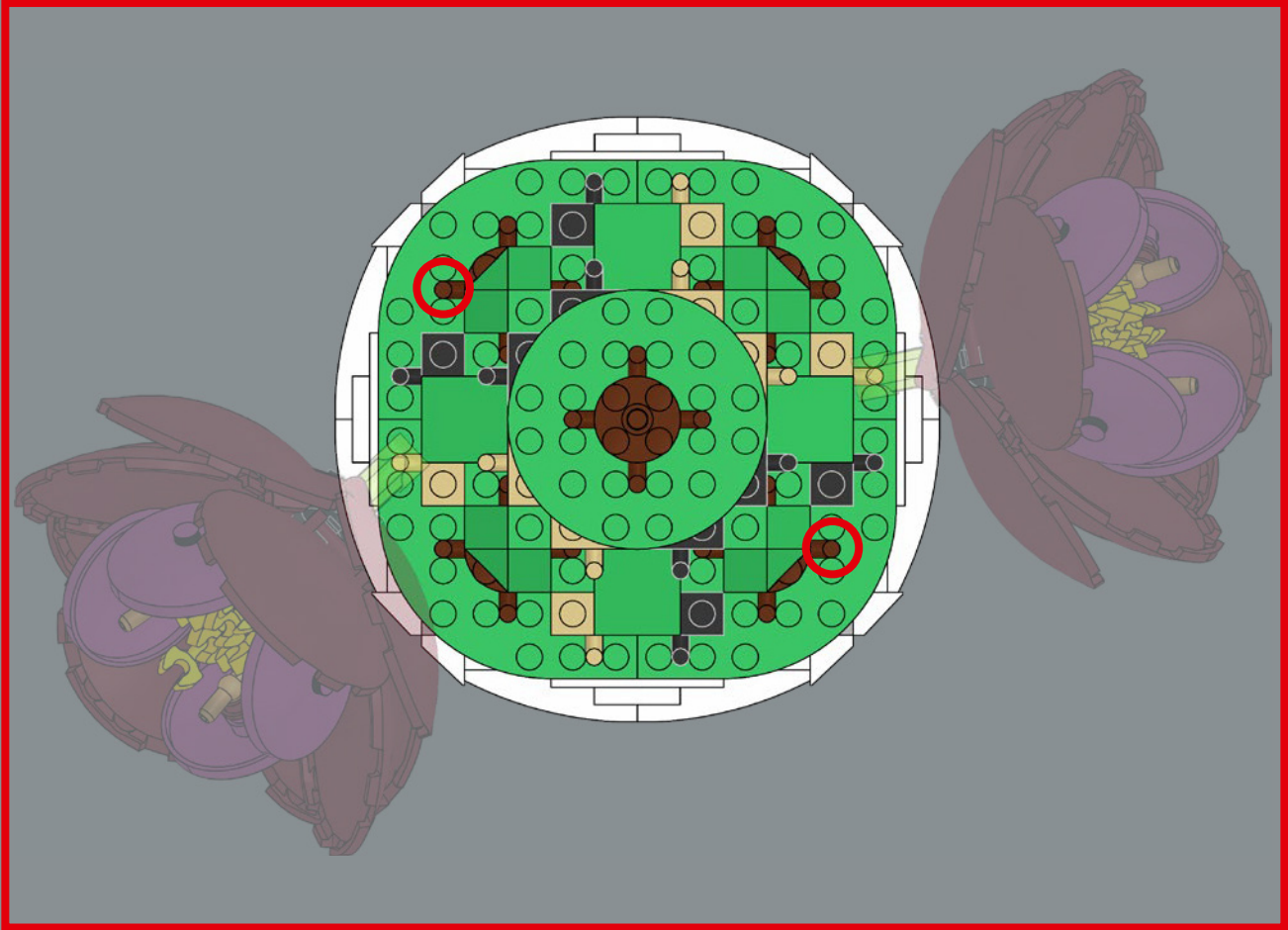

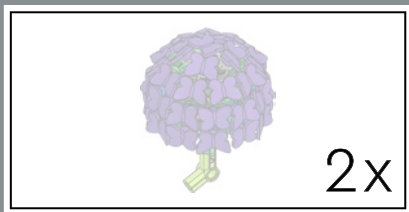

72

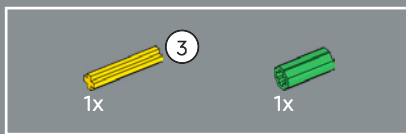

73

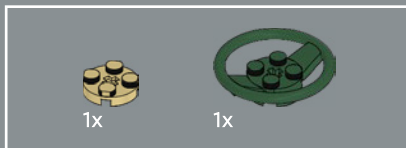
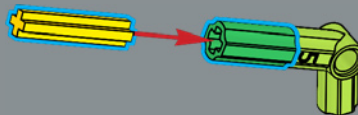

74

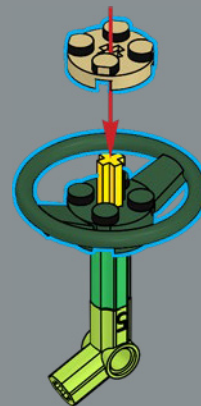

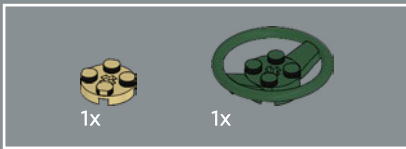

75

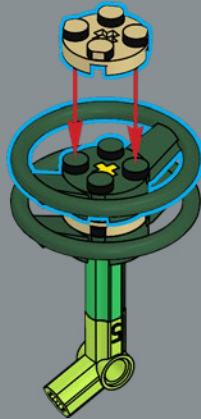

Put creativity at the wheel! This steering wheel, designed for large-scale LEGO® cars, now constructs the center of our LEGO flowers.

La créativité prend les commandes ! Ce volant, conçu pour les voitures LEGO® de grande taille, constitue désormais le centre de nos fleurs LEGO.

¡Pon la creatividad a dirigir el rumbo! Este volante, diseñado para autos LEGO® a gran escala, ahora conforma el centro de nuestras flores LEGO.

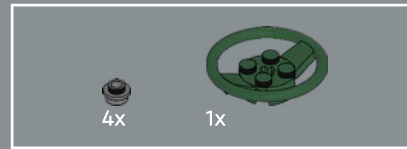

76

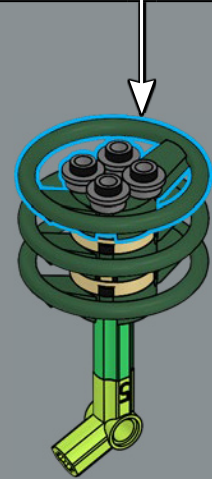
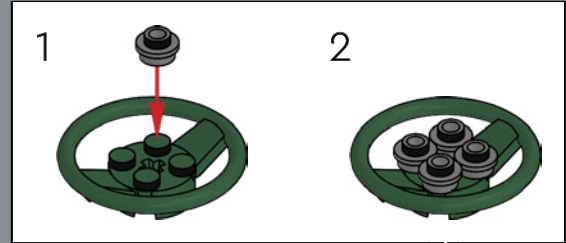

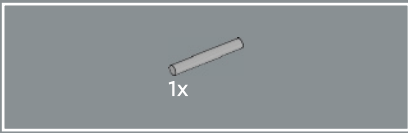

77

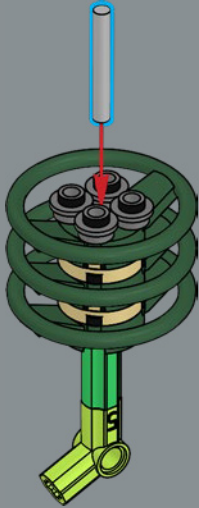

78

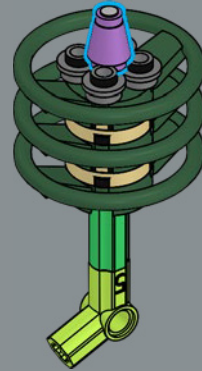

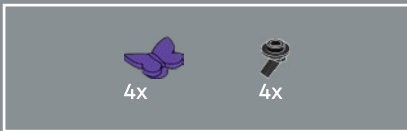

79

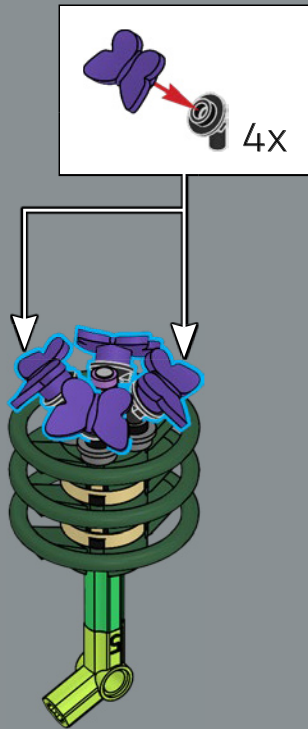

80



Hydrangea: Can you feel the flutters? We have flown in dozens of tiny LEGO® butterflies to create the textured globe of this hydrangea.

Hydrangée arborescente : Vous entendez les battements d'ailes ? Nous avons utilisé des dizaines de petits papillons LEGO® pour créer le globe texturé de cette hydrangée.

Hortensia: ¿Sientes el aleteo? Trajimos volando decenas de minúsculas mariposas LEGO® para crear el globo texturizado de esta hortensia.



81

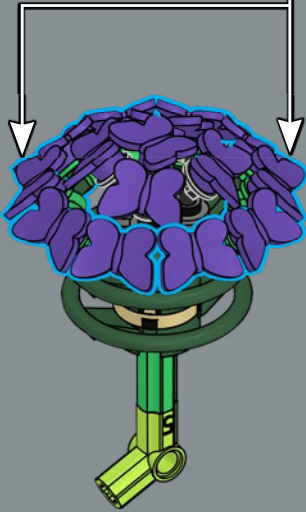
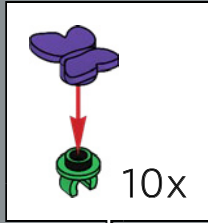

82

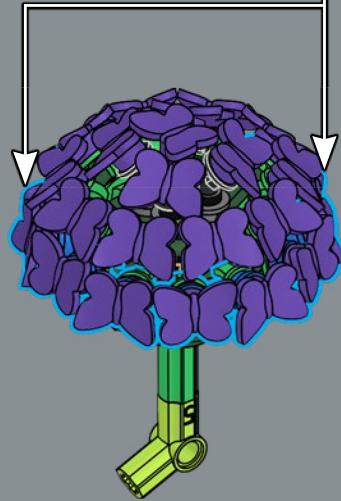
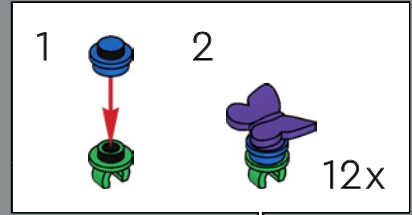

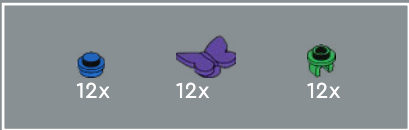

83

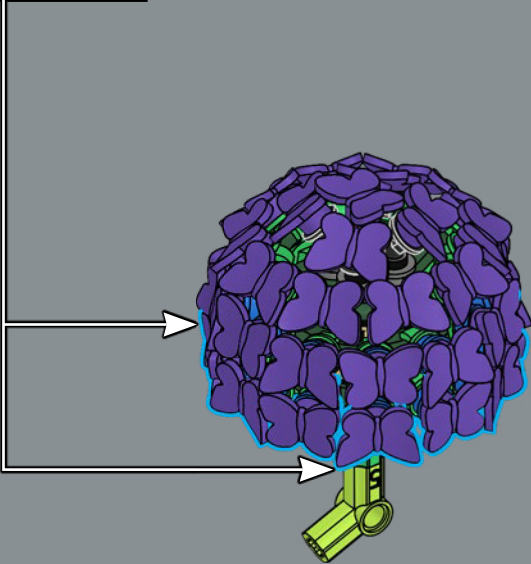
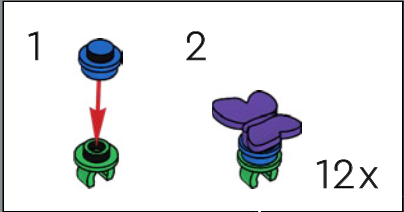

2x

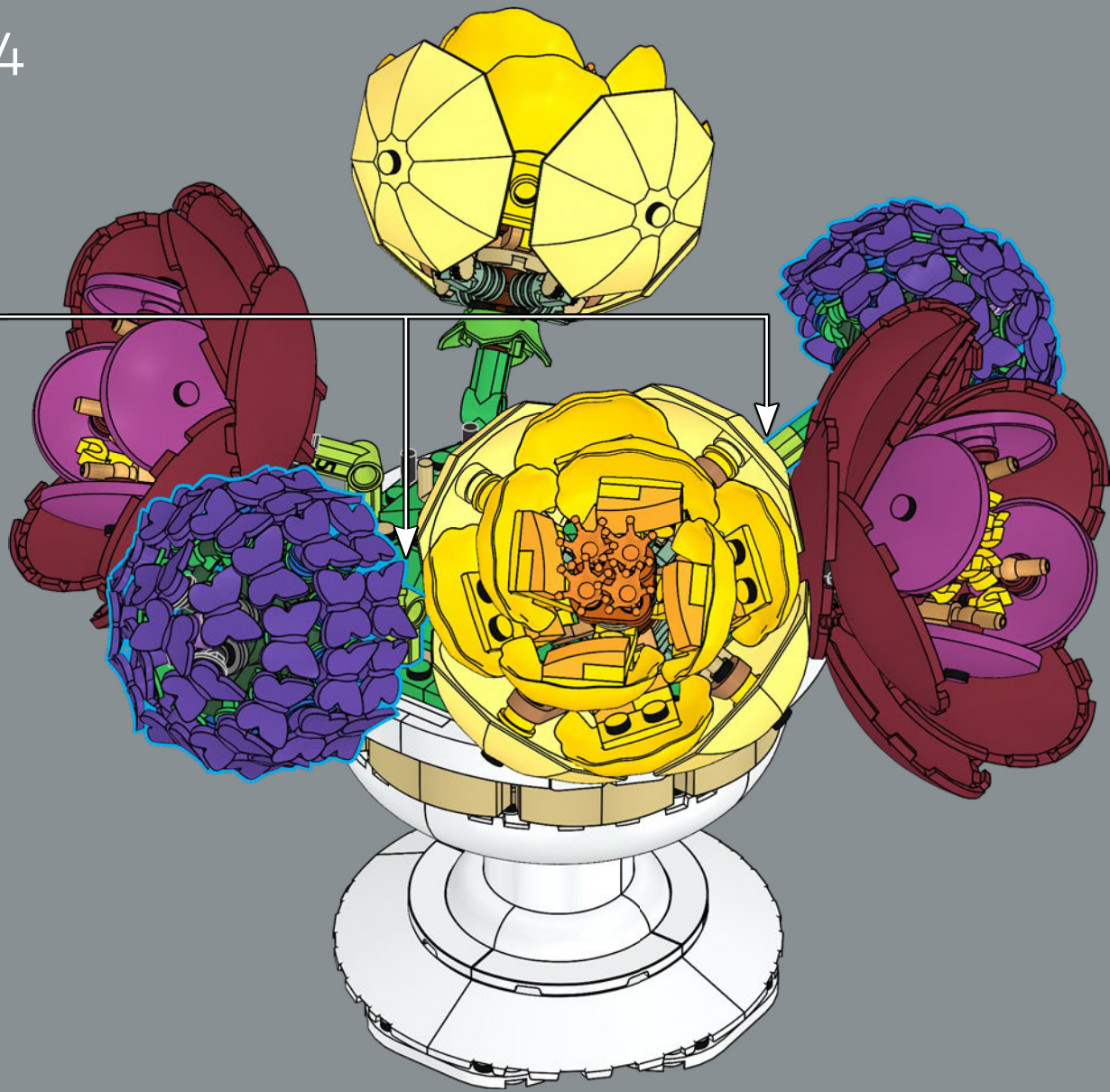



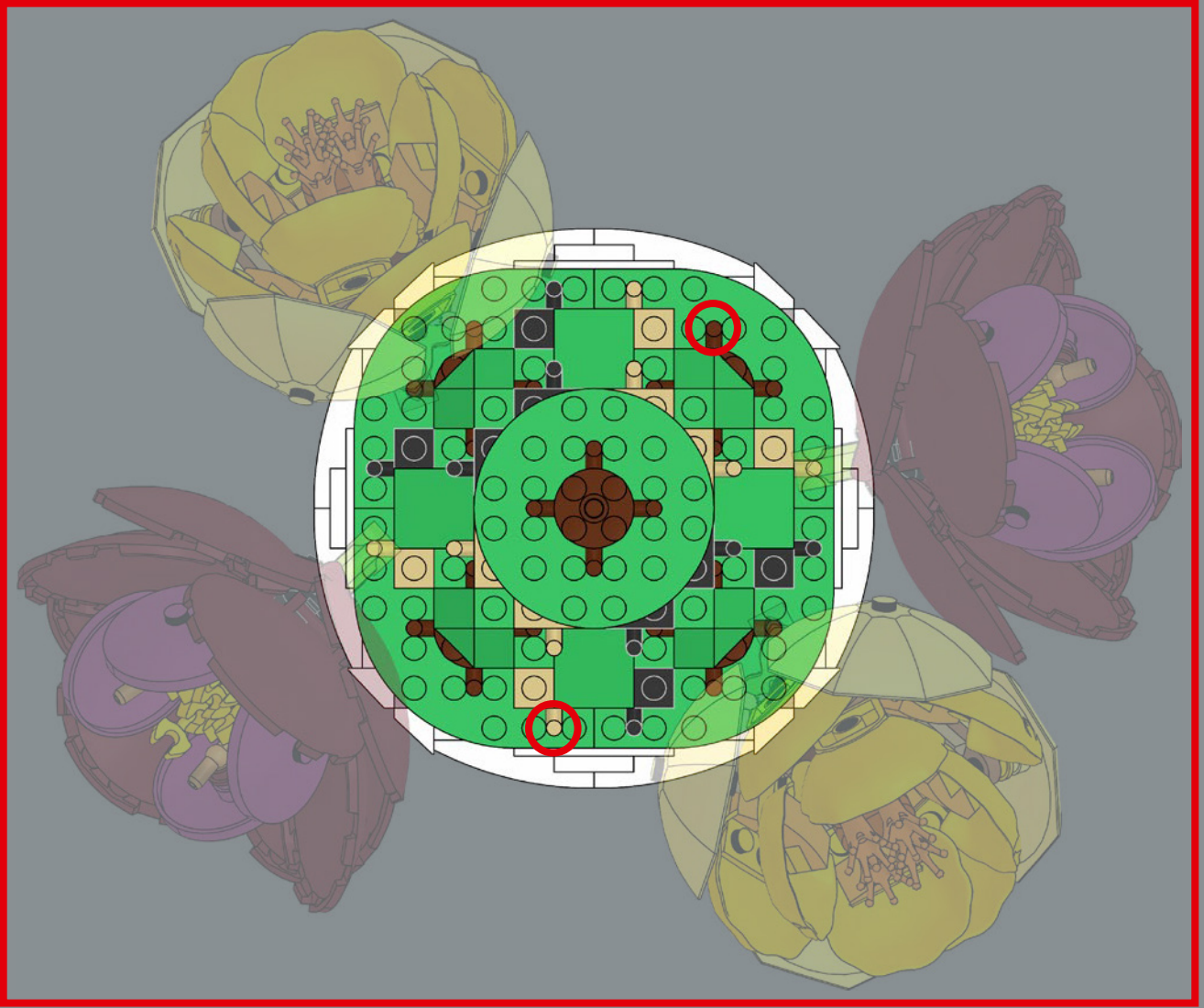

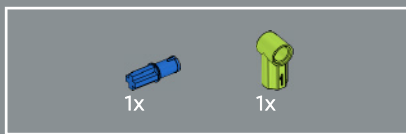
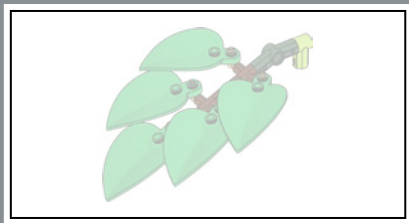

85

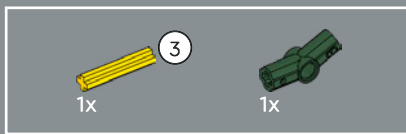
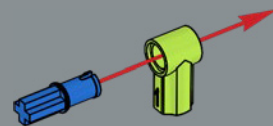

86

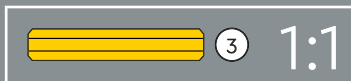
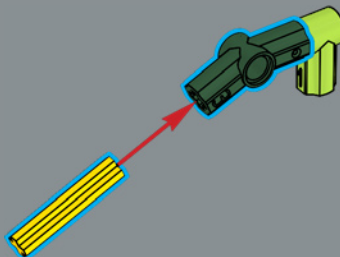



87

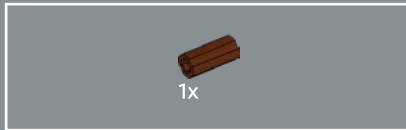
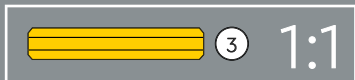
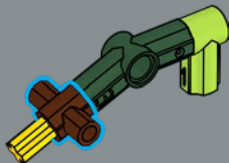

88

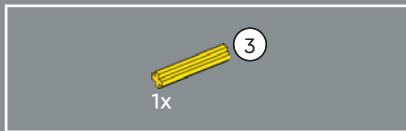
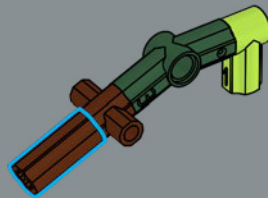

89

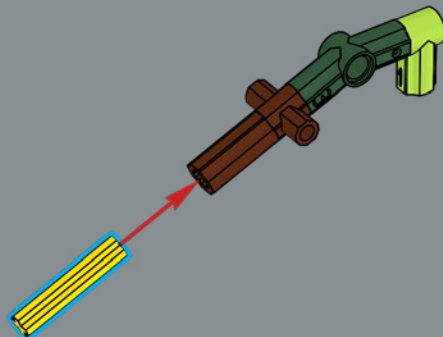



90

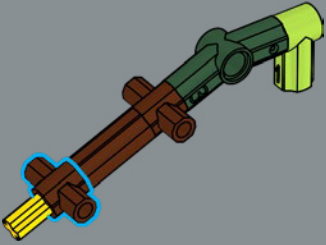

91

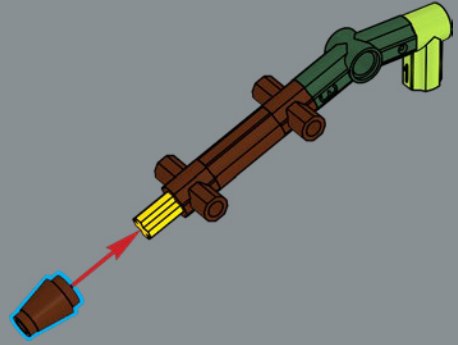



5x

92

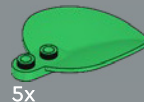
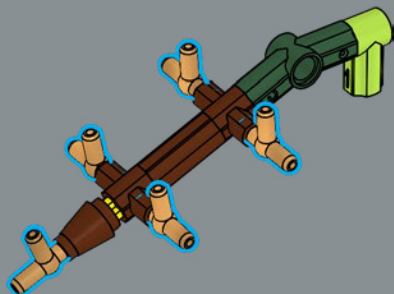

5x

93

Leaves: Turning a new leaf? These green leaves are new elements designed for some of our 2025 sets in the LEGO® Botanicals series, including the 10342 Pretty Pink Flower Bouquet.

Feuilles : Vous avez le pouce vert ? Ces feuilles vertes sont de nouveaux éléments conçus pour certains de nos ensembles 2025 de la série LEGO® Botanique, notamment Le joli bouquet de fleurs roses (10342).

Hojas: ¿Borrón y hoja nueva? Estas hojas verdes son elementos nuevos diseñados para algunos de nuestros sets de 2025 de la serie LEGO® Botanical, incluido el Ramo de Flores Fantasía en Rosa (10342).

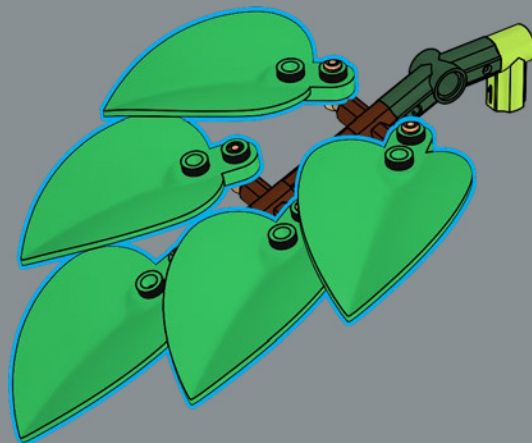



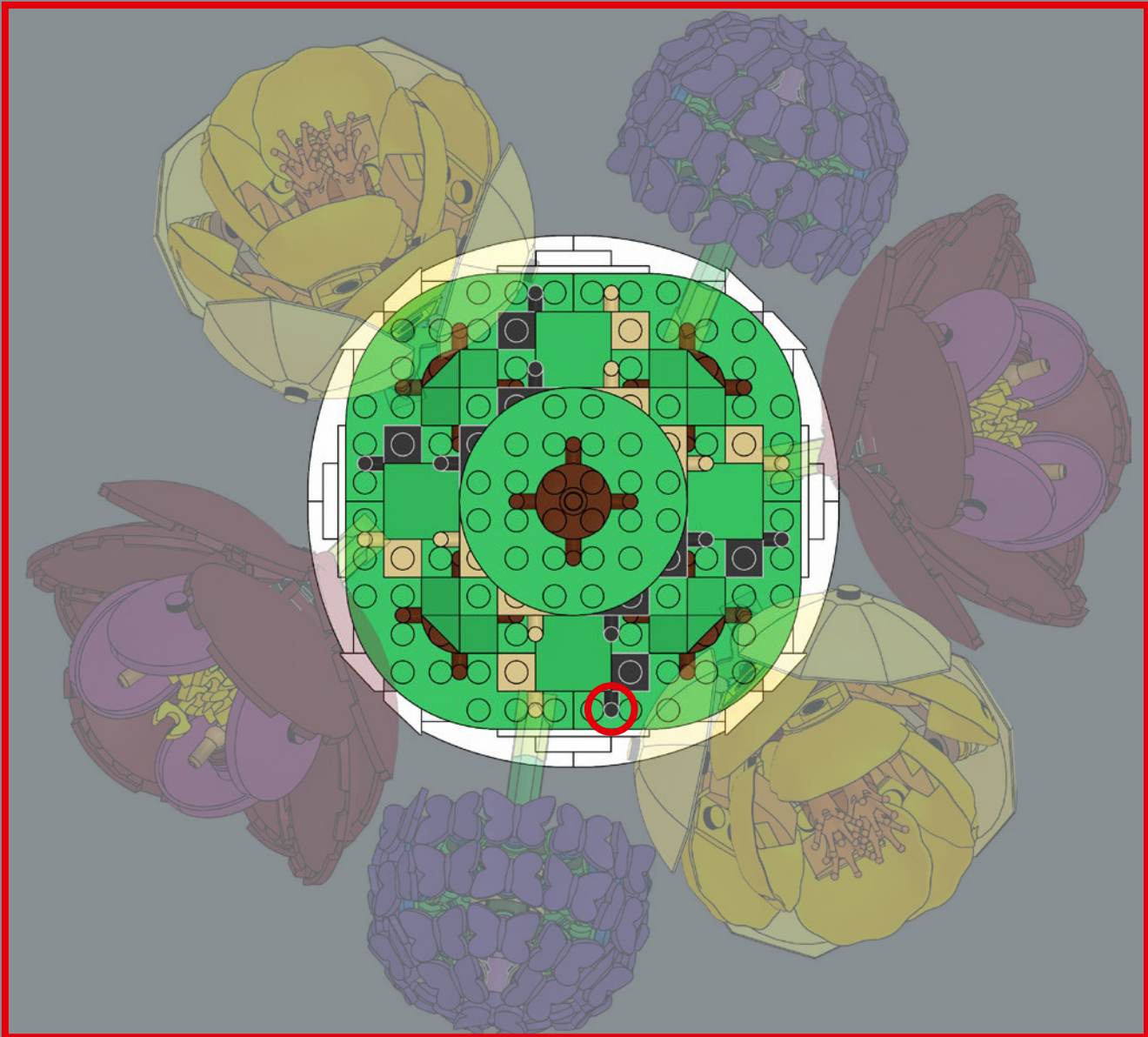

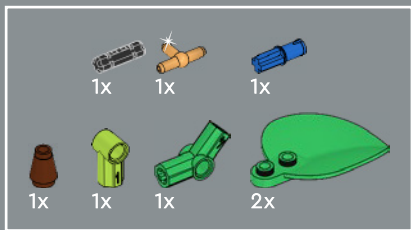

95

1

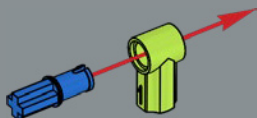

2

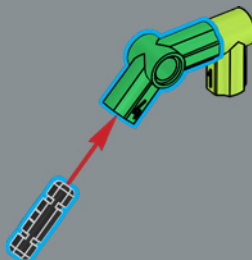



3

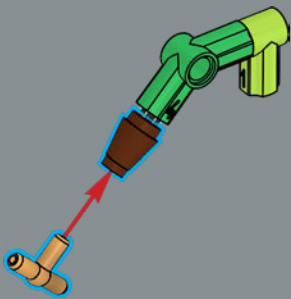

4

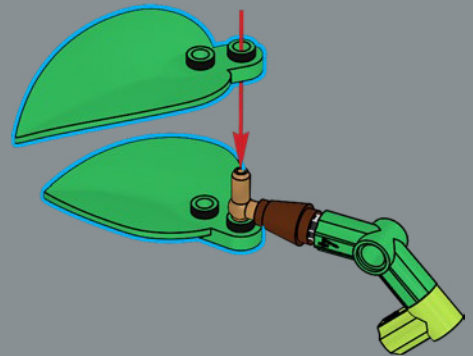

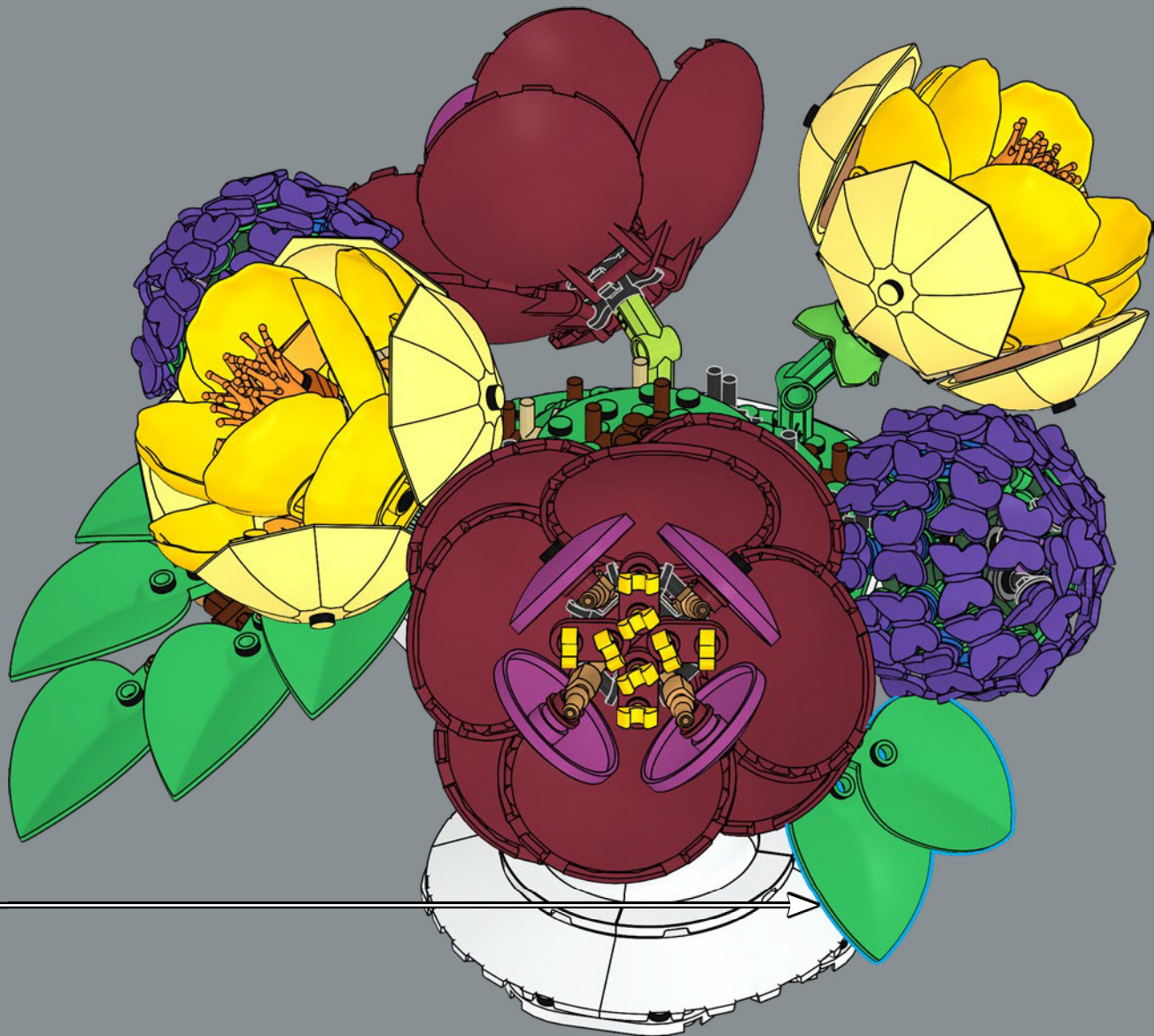

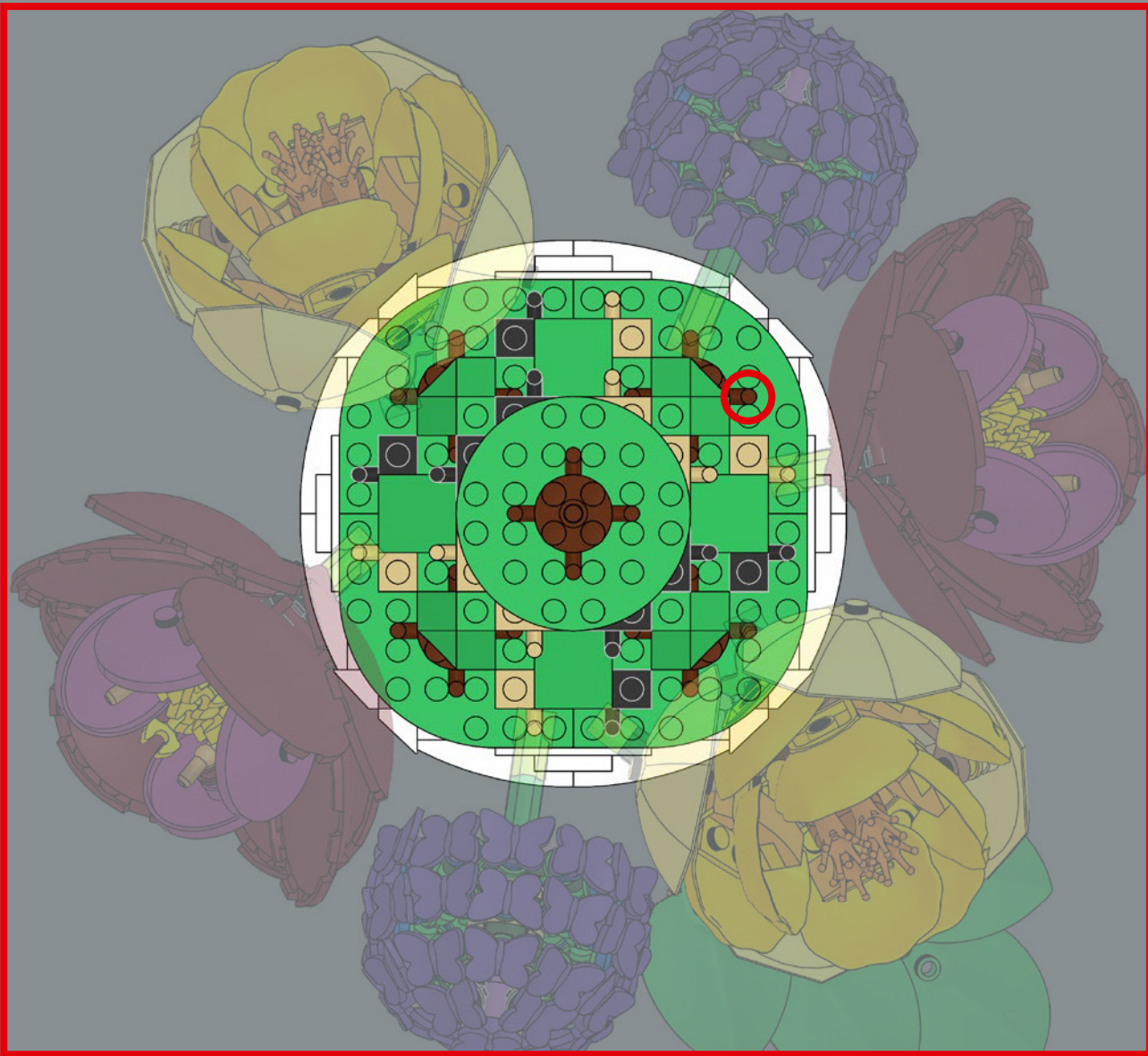

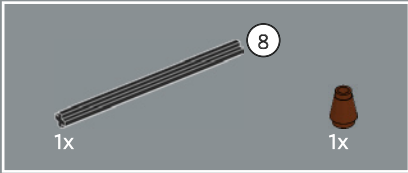
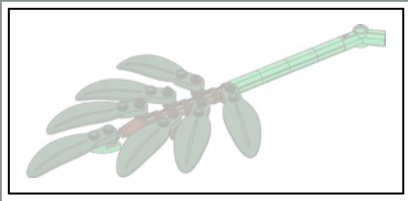

96

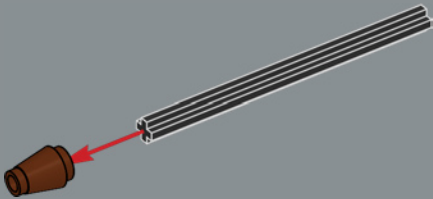

97

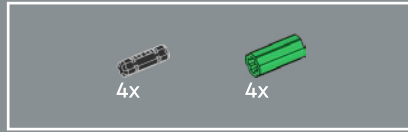
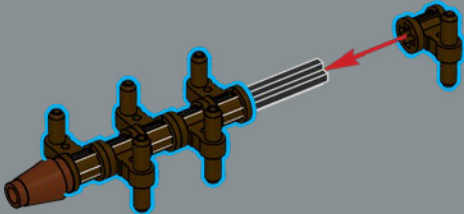

98

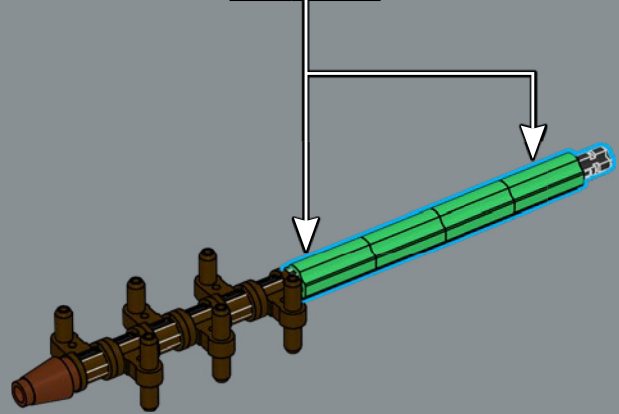
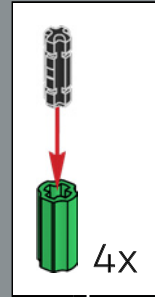

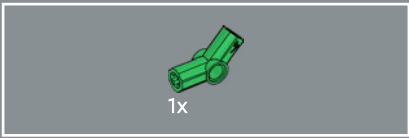

99

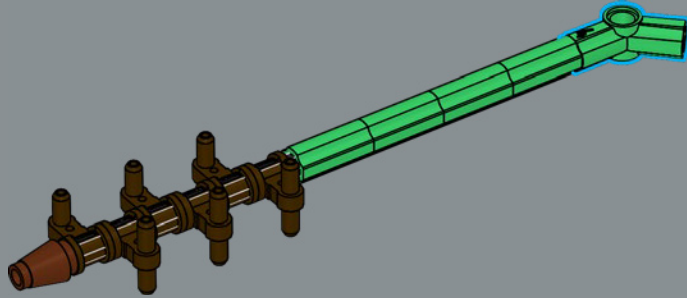

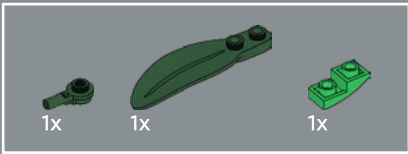

100

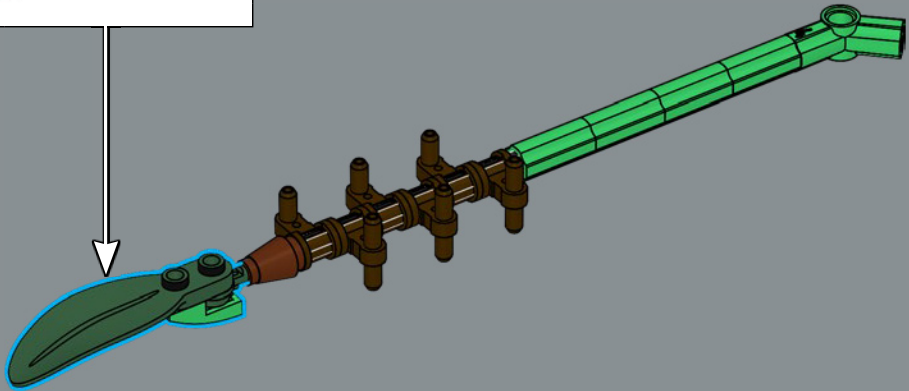
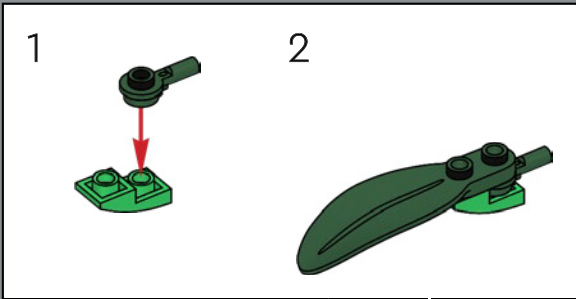

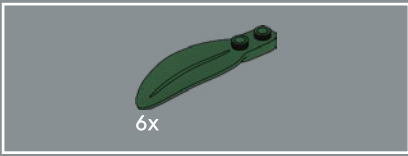

101

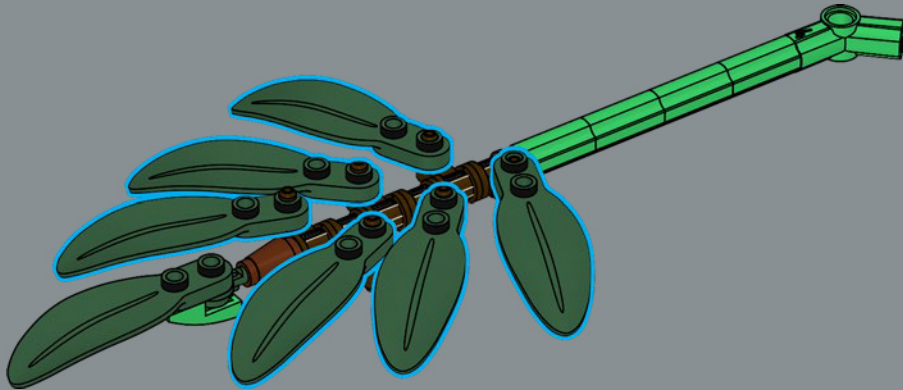





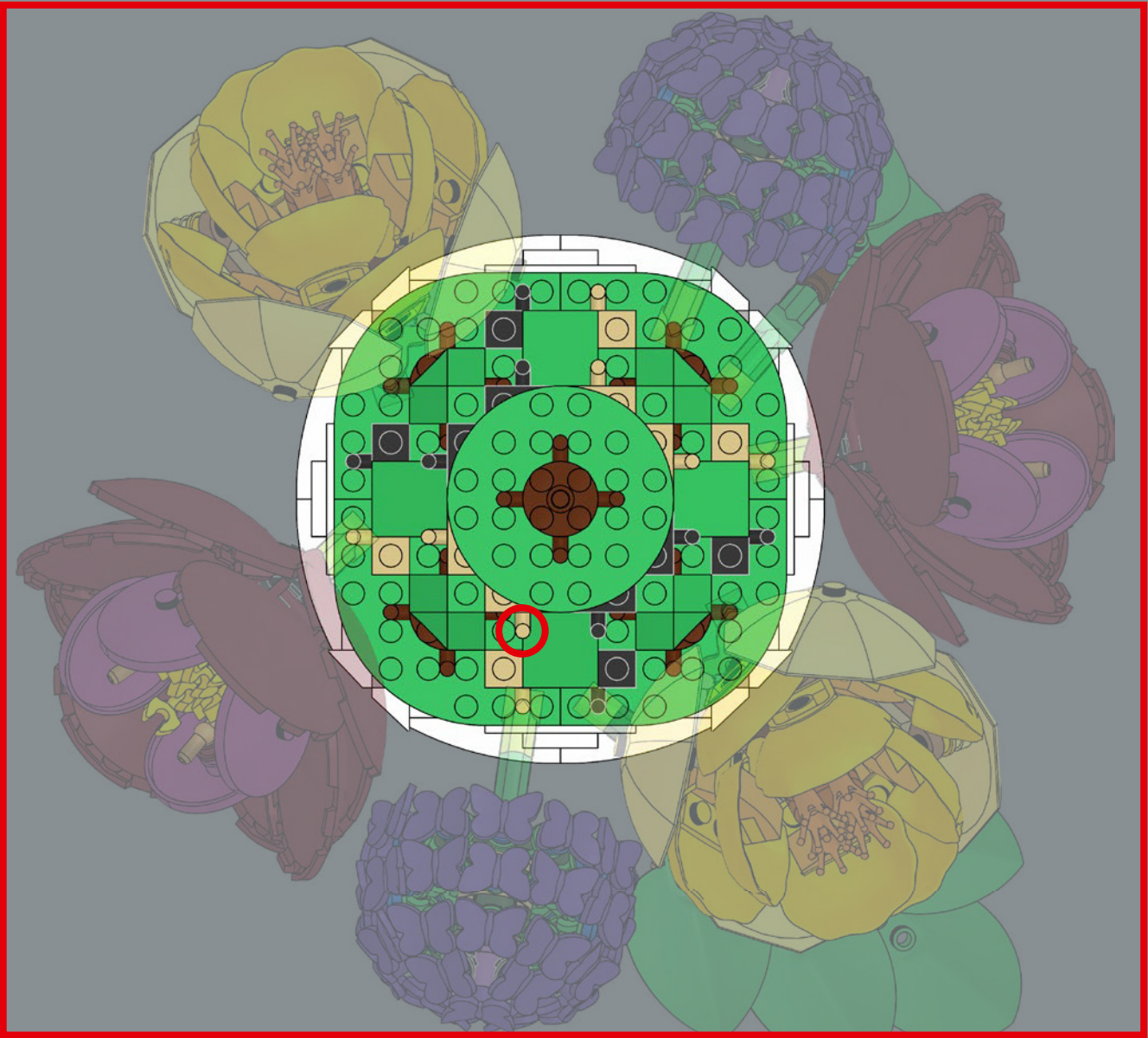

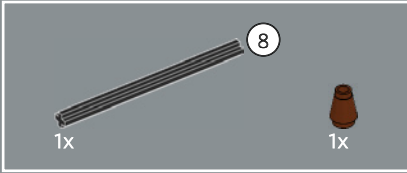

103

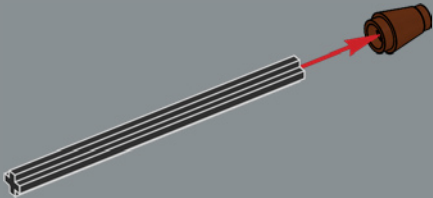

104

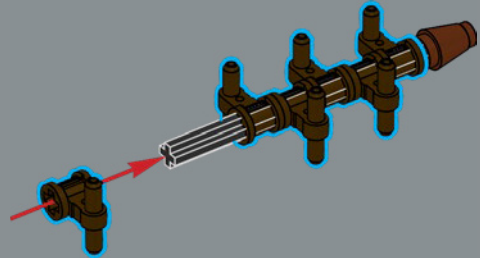



105

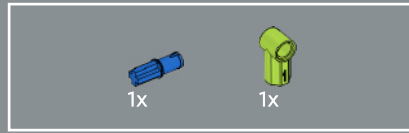
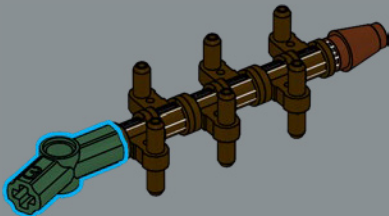

106

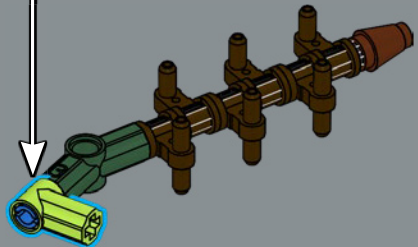
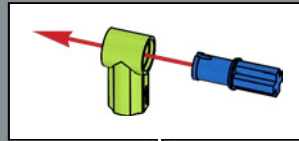

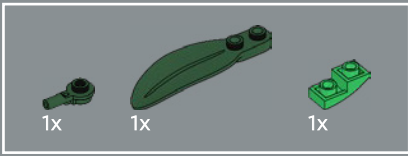

107

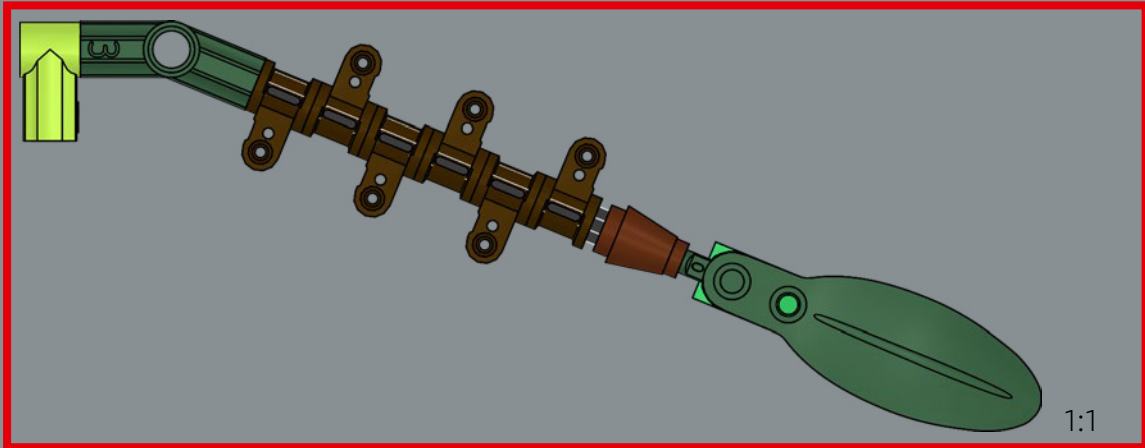
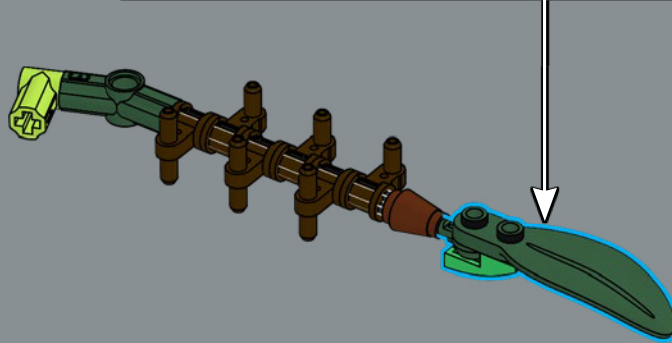
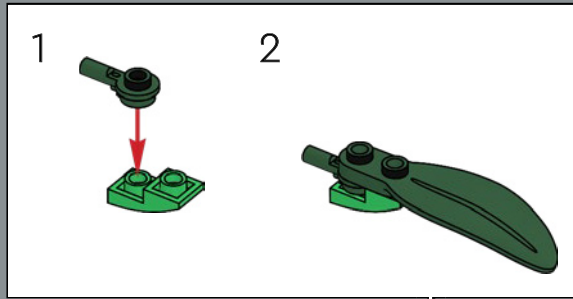

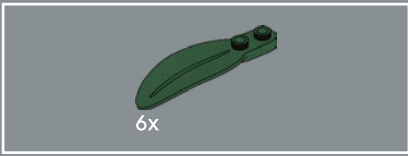

108



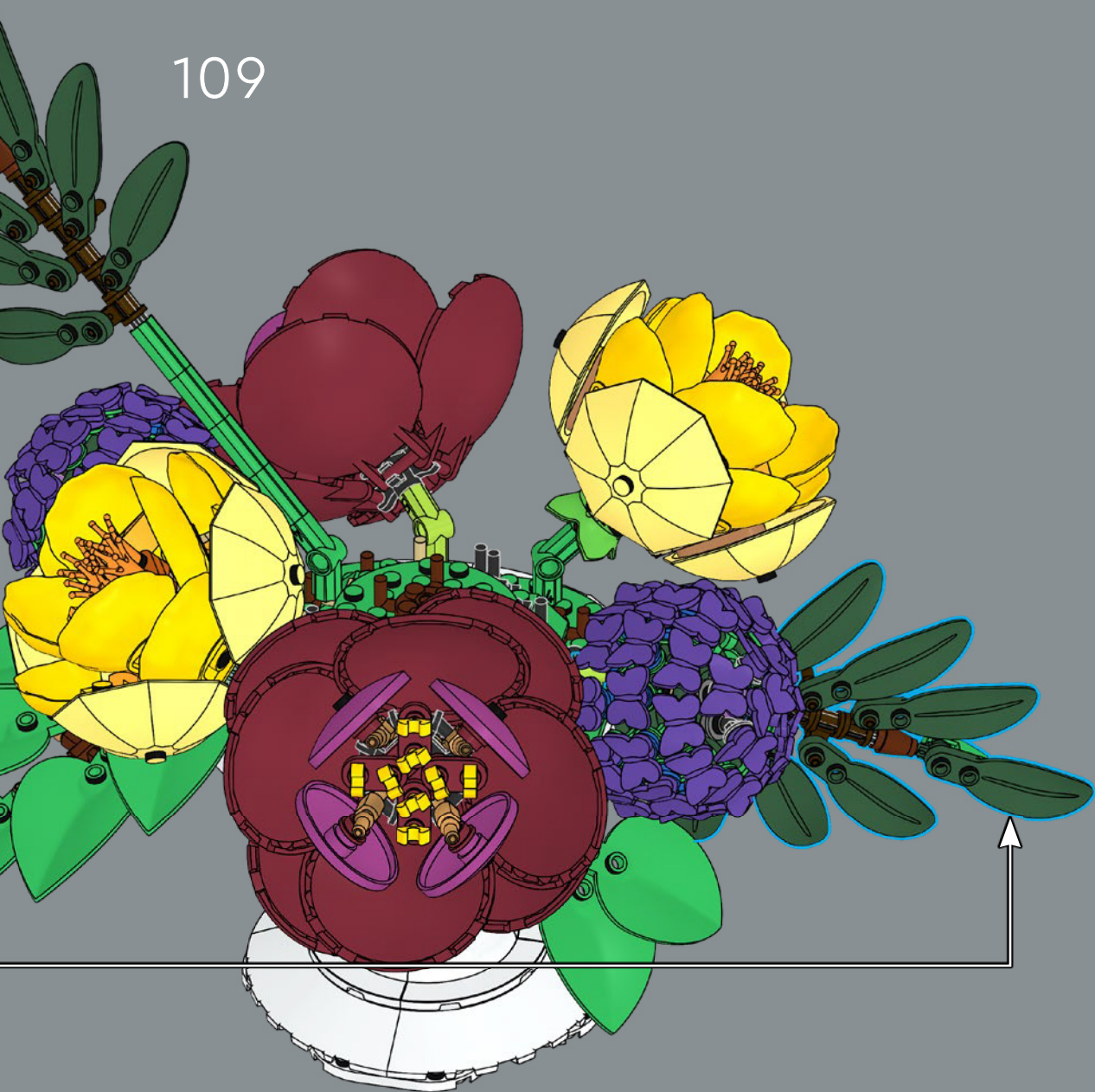

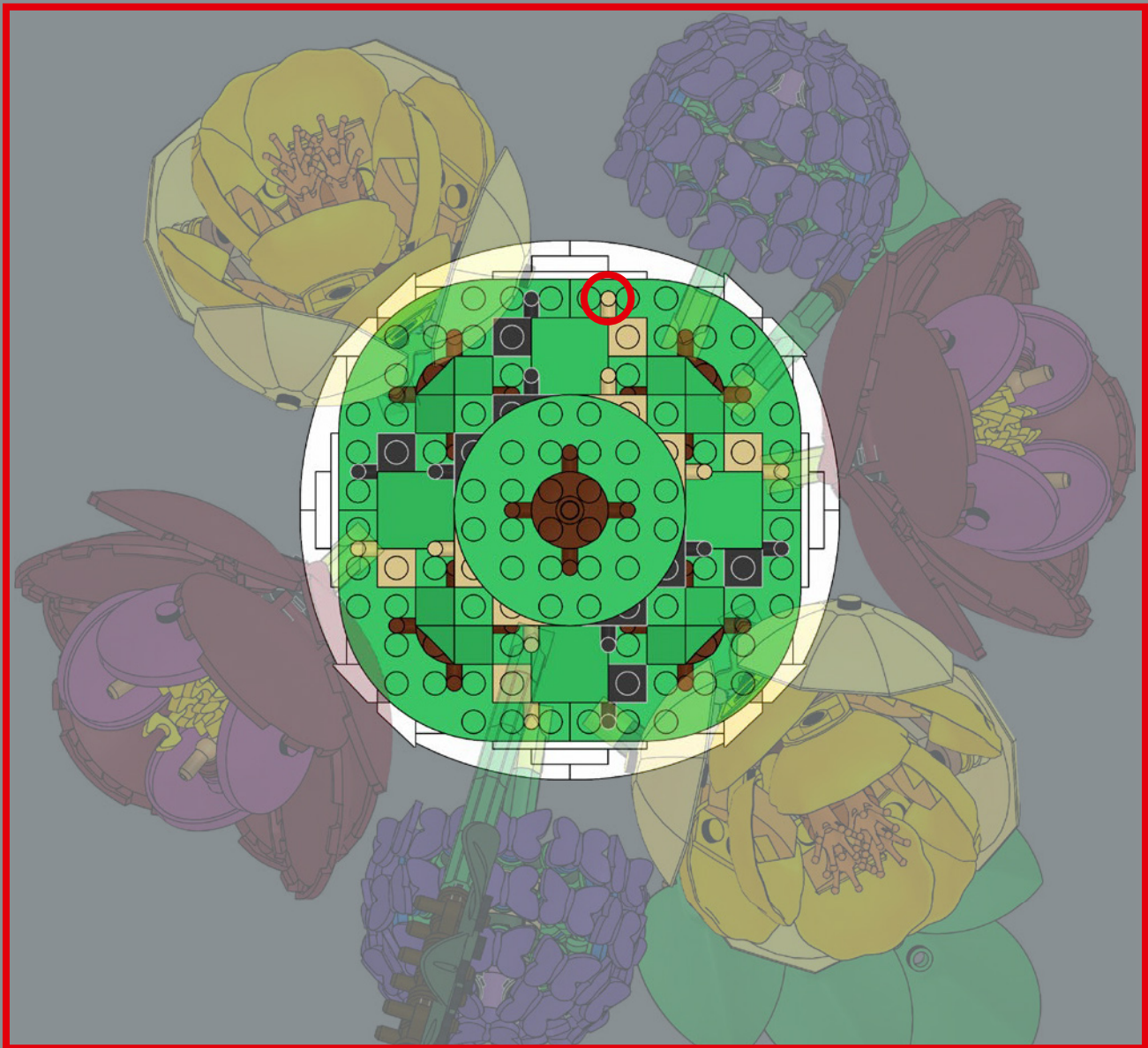

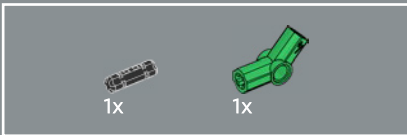
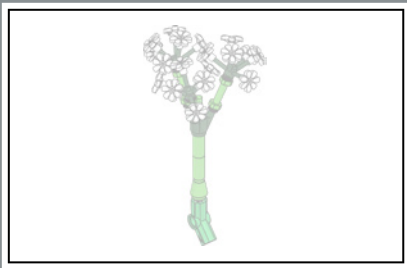

110

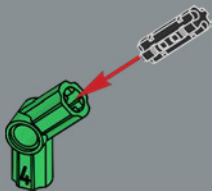

111

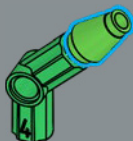

112

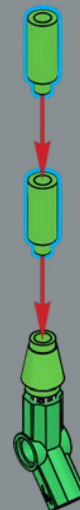



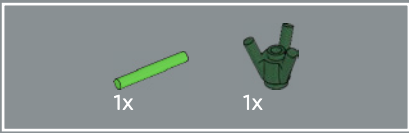

113

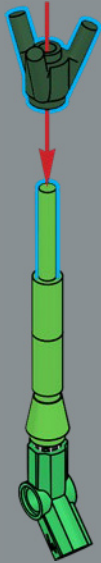

114

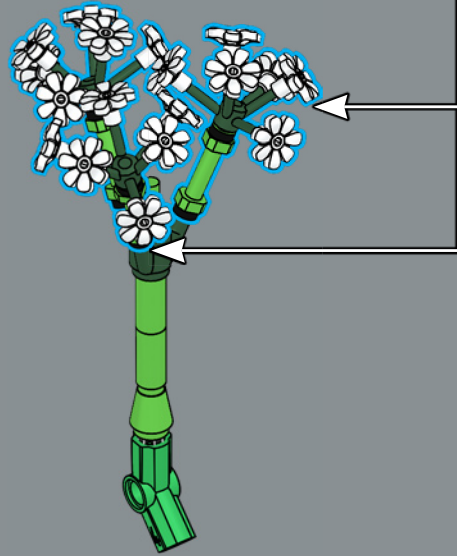
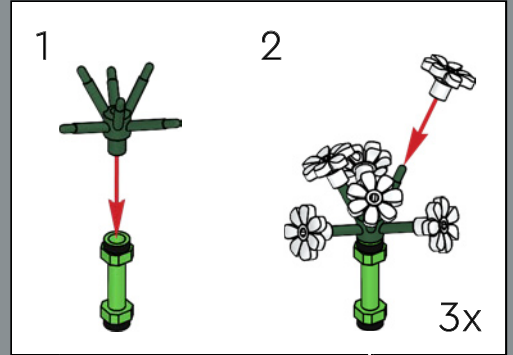

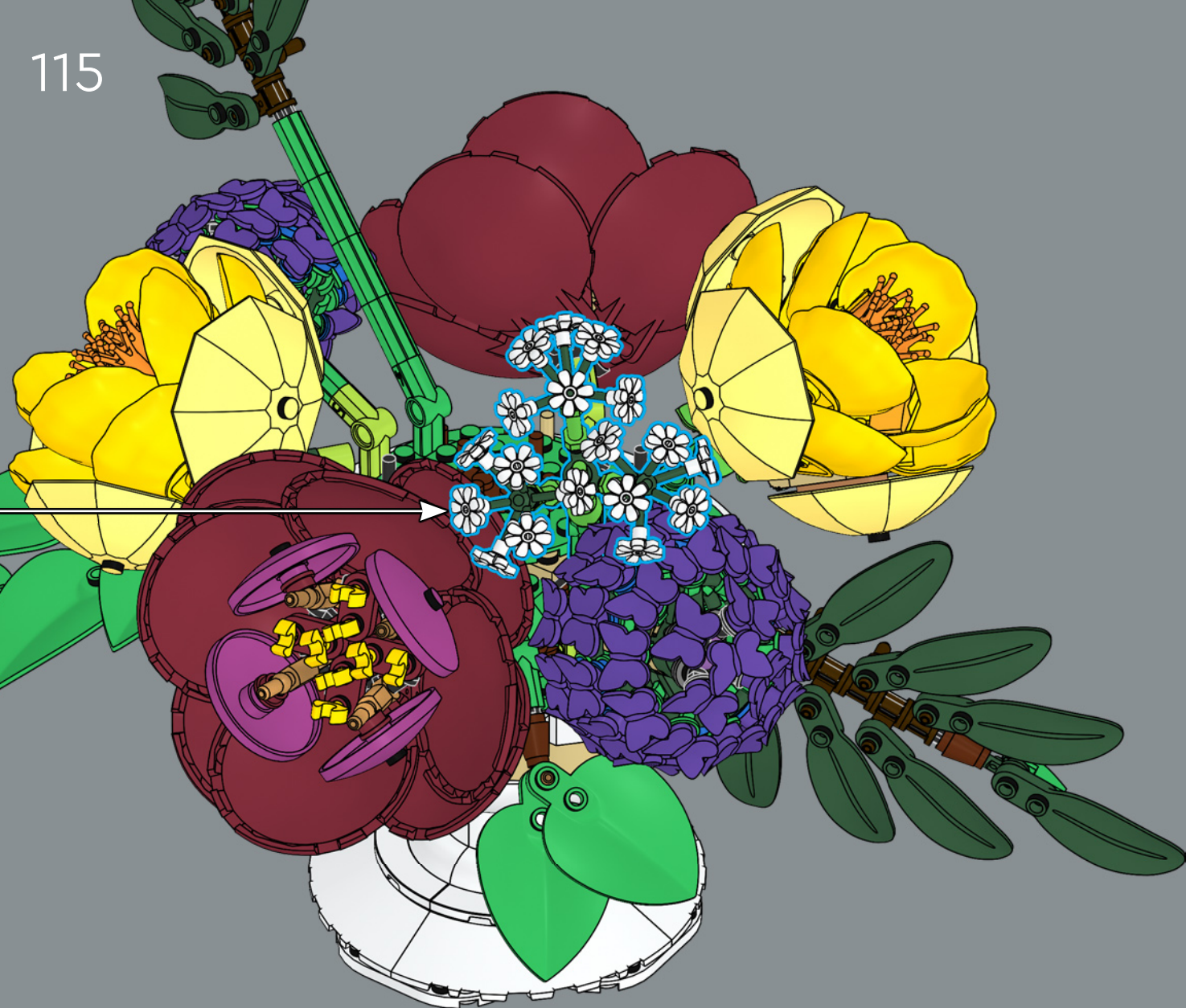

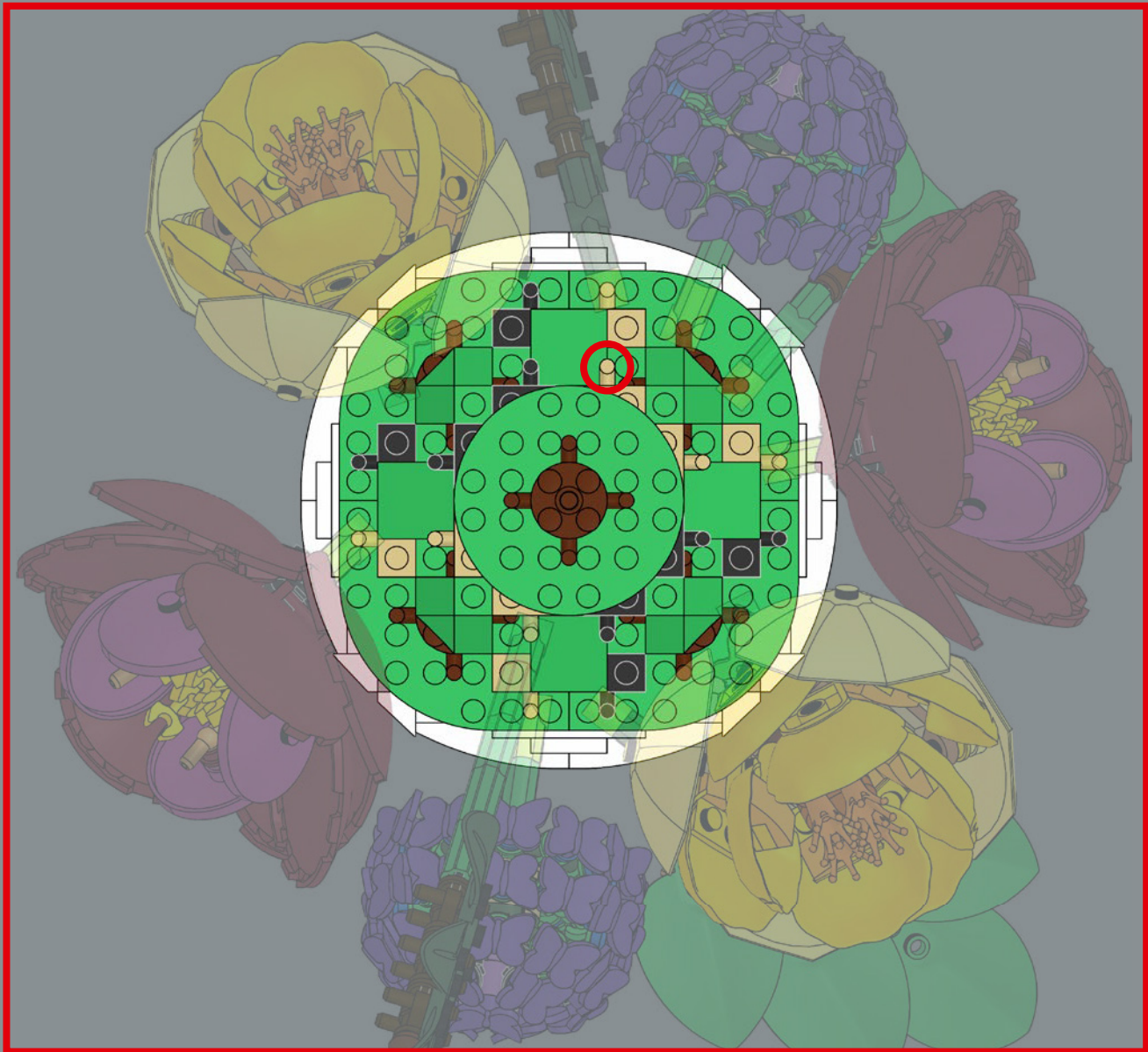

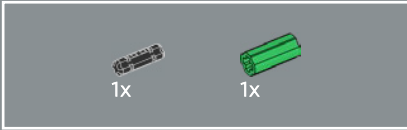
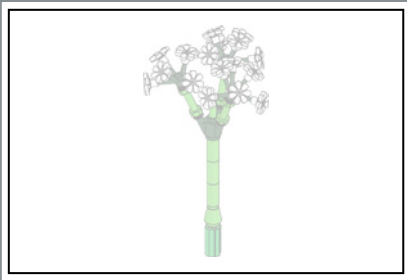

116

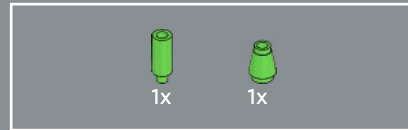

117

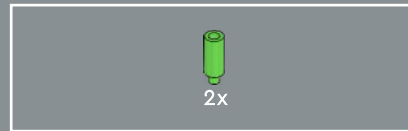

118



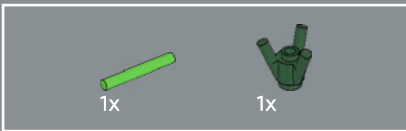

# 119

Baby's breath: Say cheese! The stem is made of tripod elements that were originally designed to help LEGO® minifigures steady their cameras. Now they hold bunches of baby's breath. This might be a good time to take a selfie to document your progress.

Souffle de bébé : Souriez ! La tige est composée d'éléments de trépied qui ont été conçus à l'origine pour aider les figurines LEGO® à stabiliser leur appareil photo. Maintenant, ils tiennent des grappes de souffle de bébé. C'est peut-être le moment de prendre un égoportrait pour montrer vos progrès.

Nube: ¡Sonríe! El tallo está hecho de elementos que representan trípodes y que se diseñaron originalmente para ayudar a las minifiguras LEGO® a mantener firmes sus cámaras. Ahora, sostienen ramilletes de delicada nube. Este podría ser un buen momento para tomarse una selfie y documentar cuánto avanzaste.

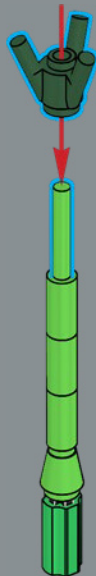

# 120

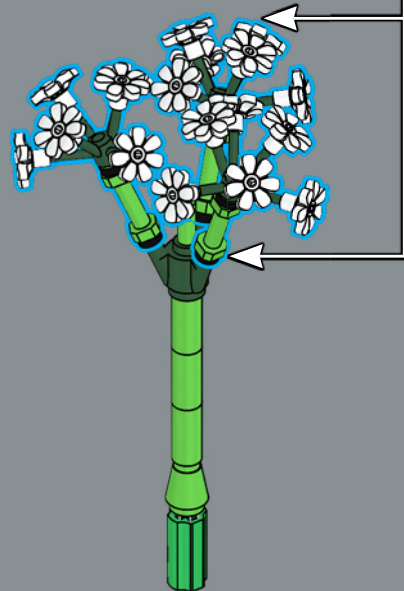
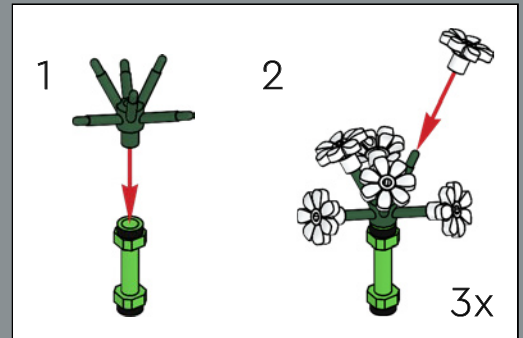



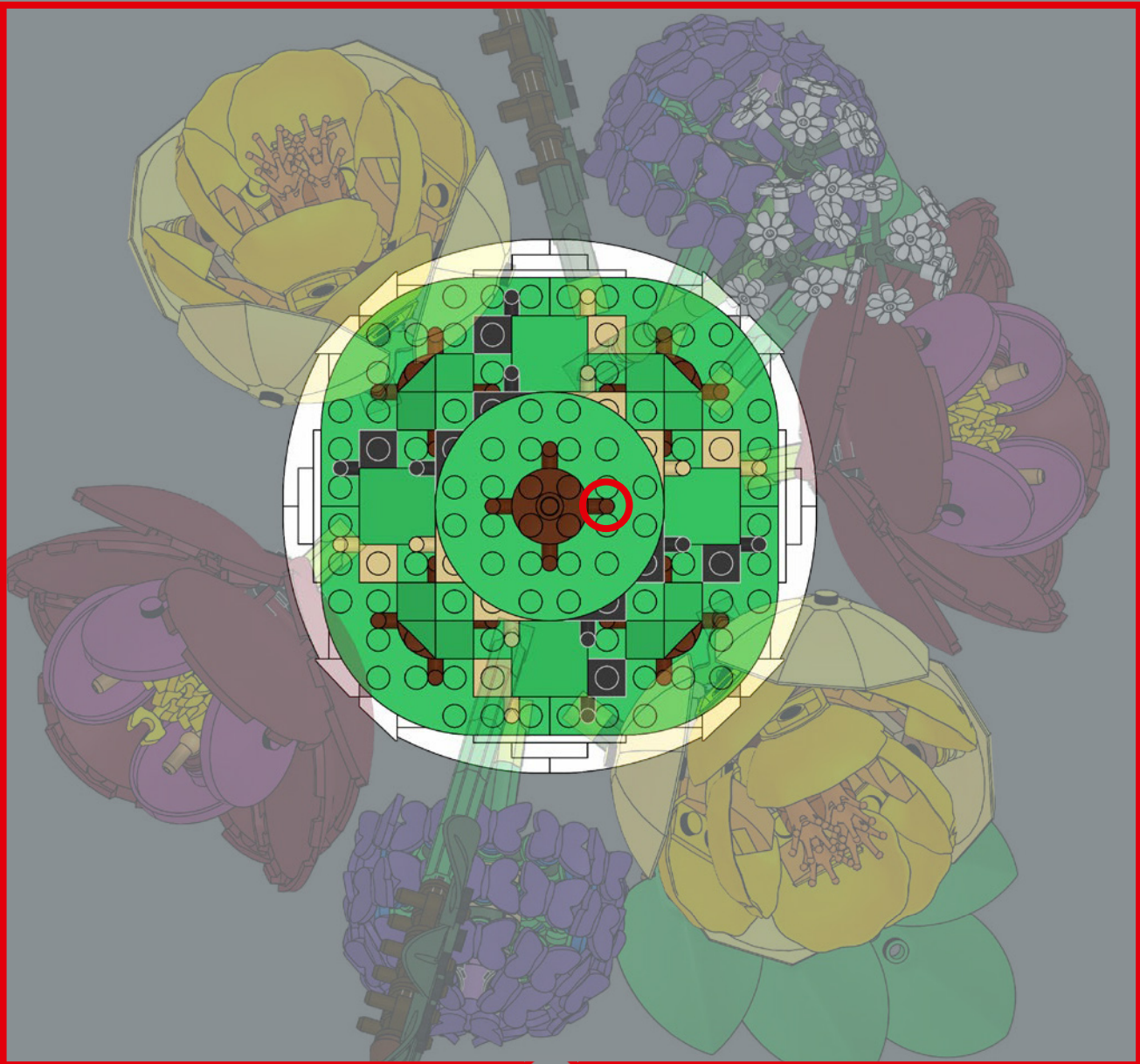

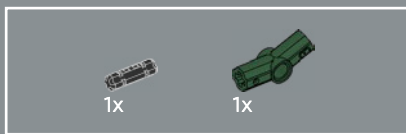
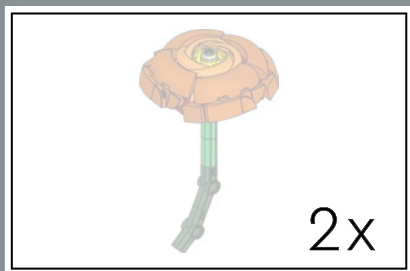

122

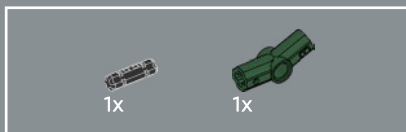

123

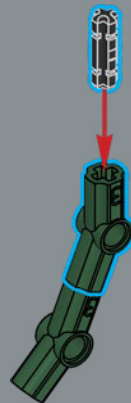



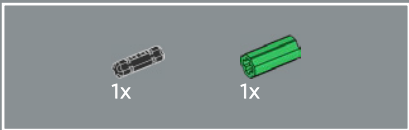

124

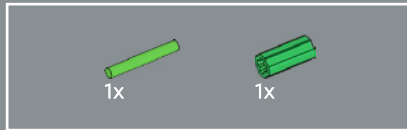
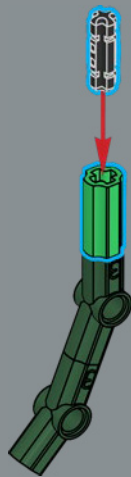

125

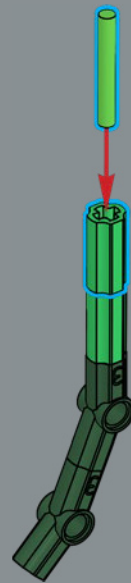



126

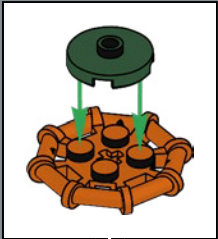

127



128



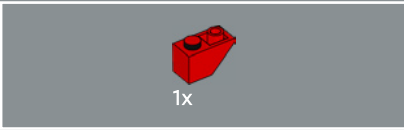

129

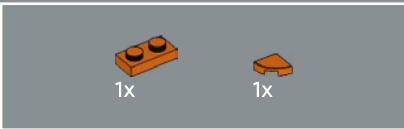
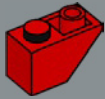

130

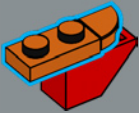

131

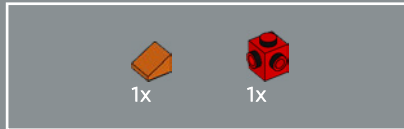
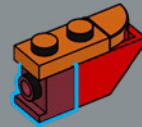

132

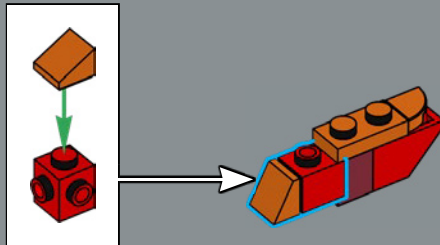

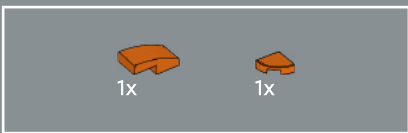

133

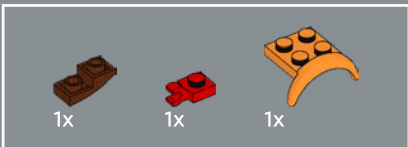
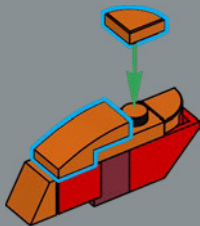

134

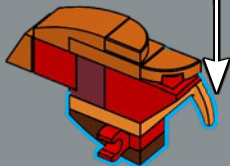
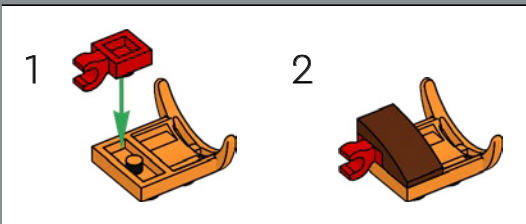

4x

135

*Ranunculus:* You can always trust LEGO® car elements to drive the details home. This flower's core features four mudguard elements to create the effect of folded petals.

Renoncule : Pas besoin de réinventer la roue avec les éléments de voiture LEGO®. Le centre de cette fleur comporte quatre éléments de garde-boue pour créer l'effet de pétales pliés.

Ranúnculo: Siempre puedes confiar en los elementos LEGO® que representan piezas de autos para dar forma a un sinfín de detalles distintos. El centro de esta flor lleva cuatro salpicaderas para crear el efecto de pétalos cerrados.

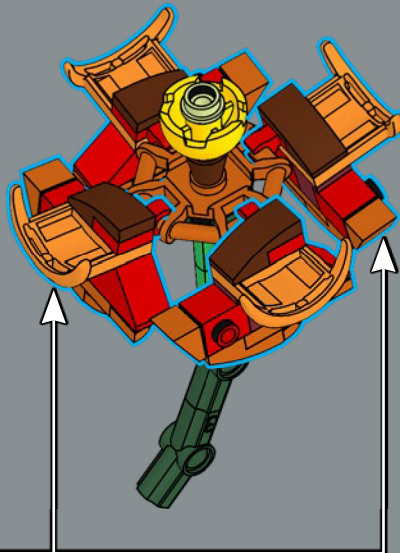

136

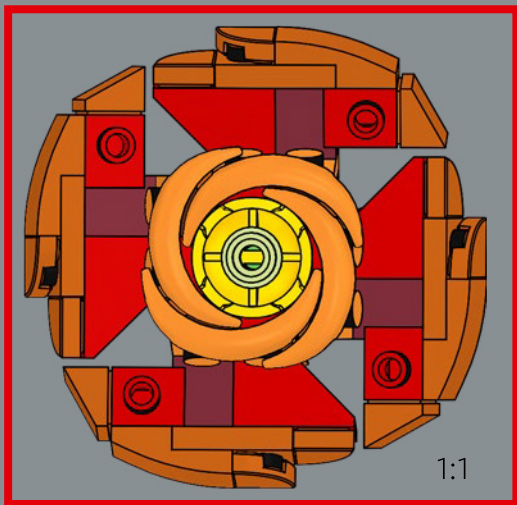
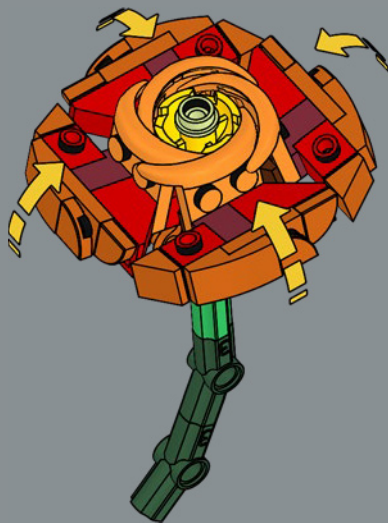

1:1

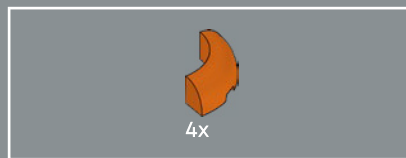

4x

137

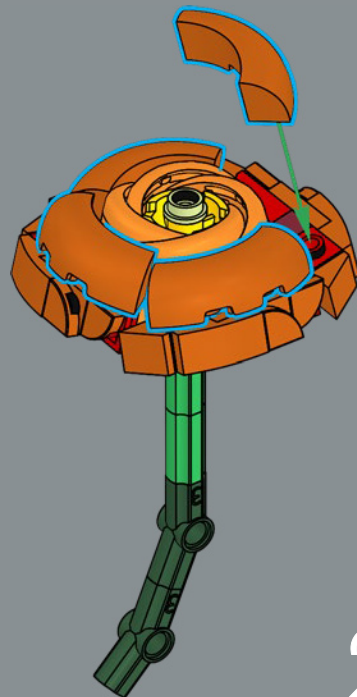

2x





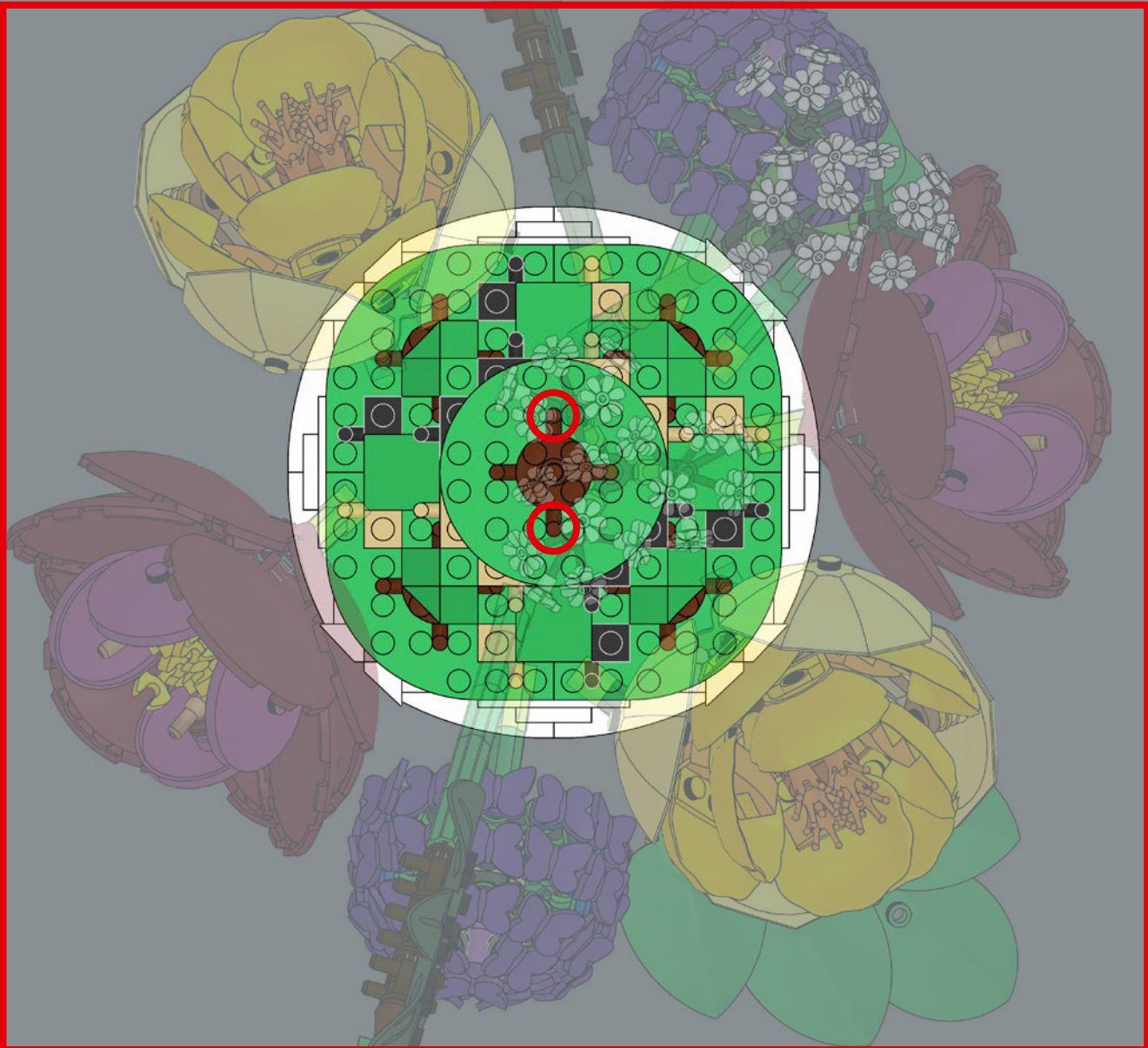

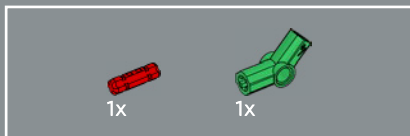
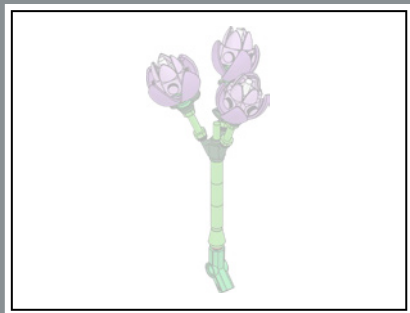

139

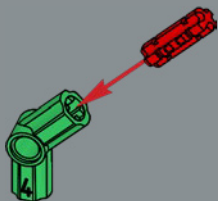

140

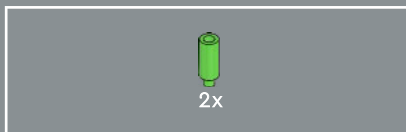
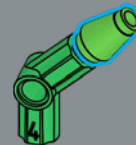

141

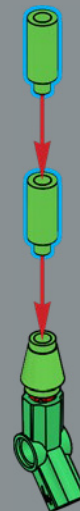



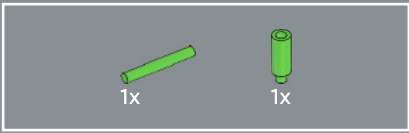

142

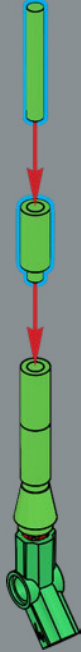

143

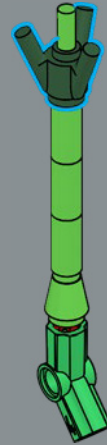

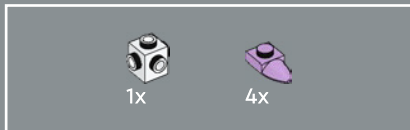

144

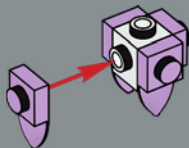

145

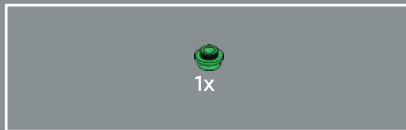

146

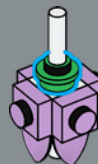

147

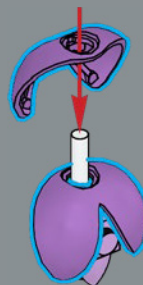



148

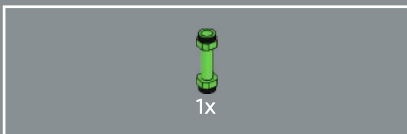
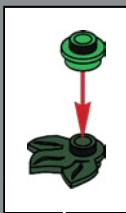

149

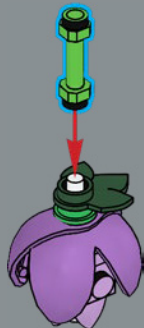

3x

150

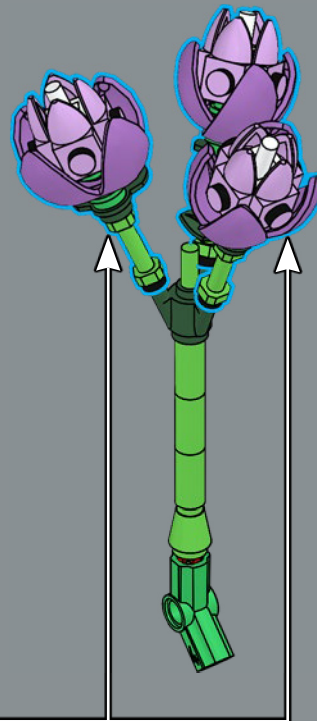

*Bouvardia*: These parts of the flower were originally designed as wings for a LEGO® ladybug.

Fleur de colibri : Ces parties de la fleur étaient à l'origine des ailes pour une coccinelle LEGO®.

Flor de colibrí: Estas partes de la flor se diseñaron originalmente para crear las alas de una catarina LEGO®.





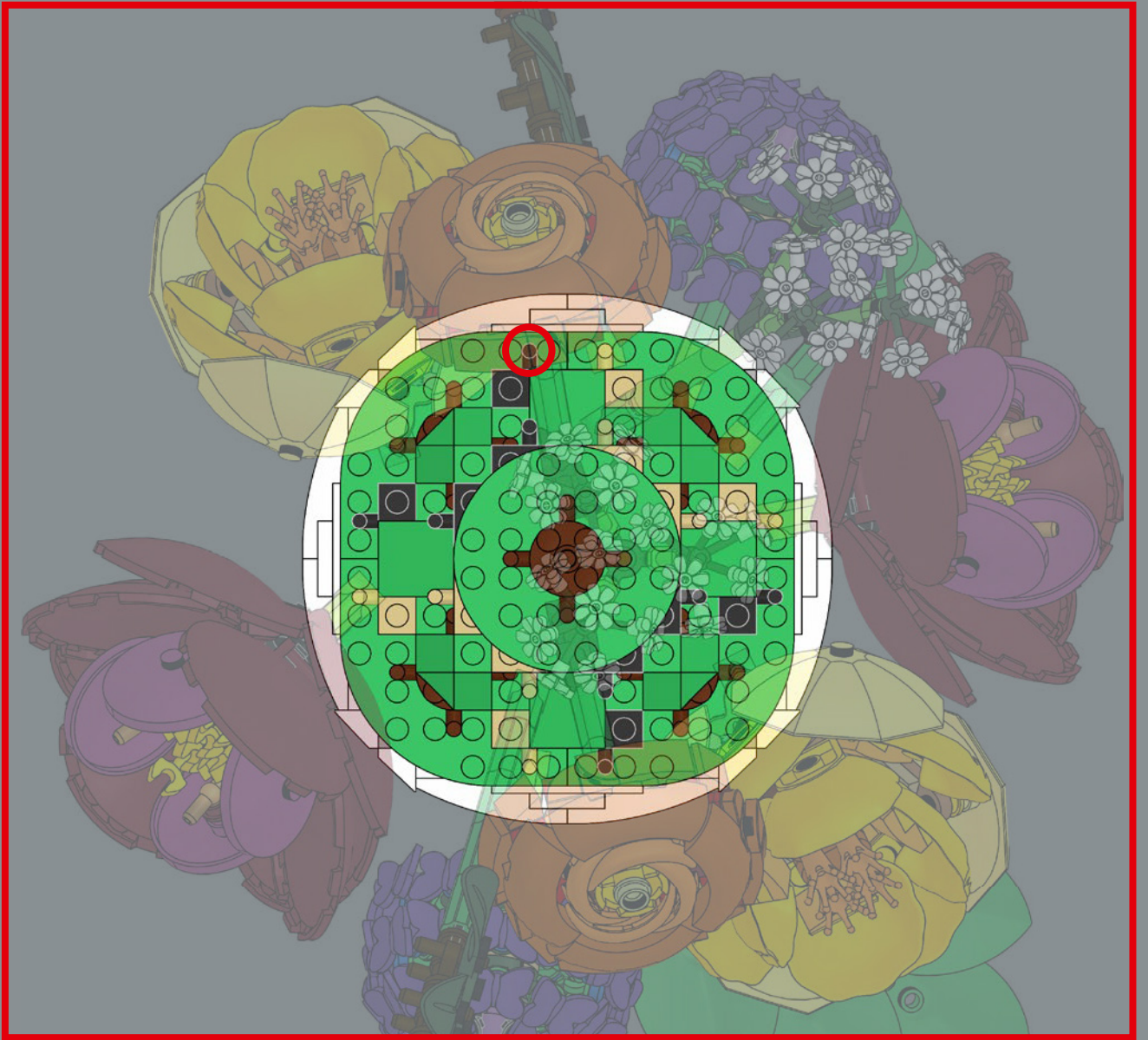

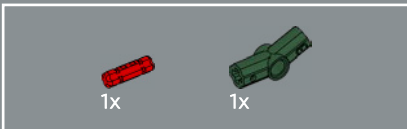
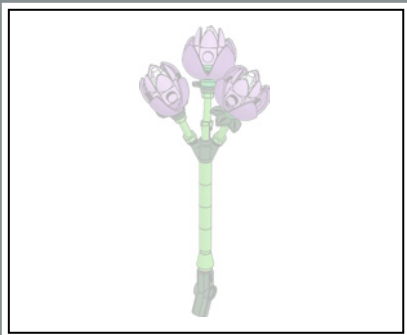

152



153

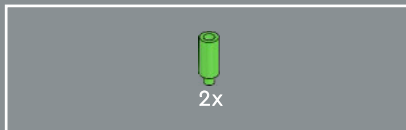

154

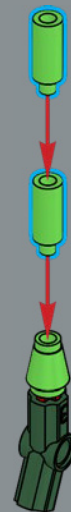

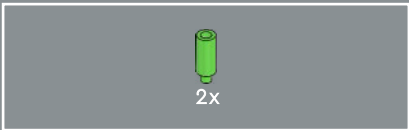

155

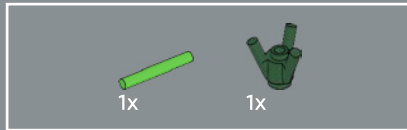

156

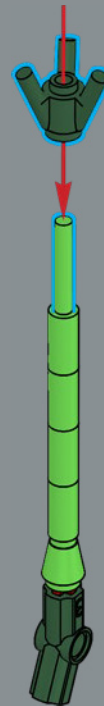

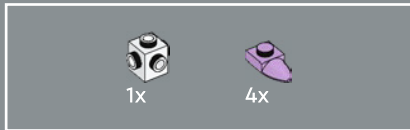

157

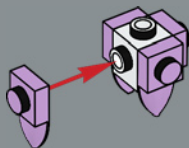

158

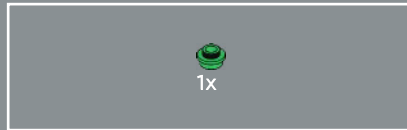

159

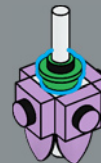

160

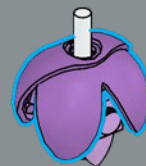



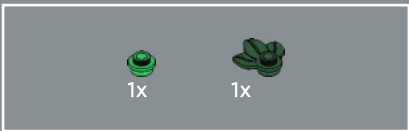

161

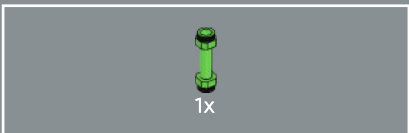
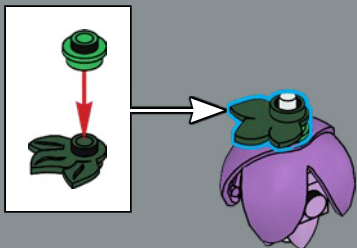

162

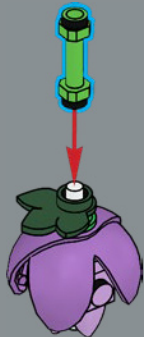

3x

163

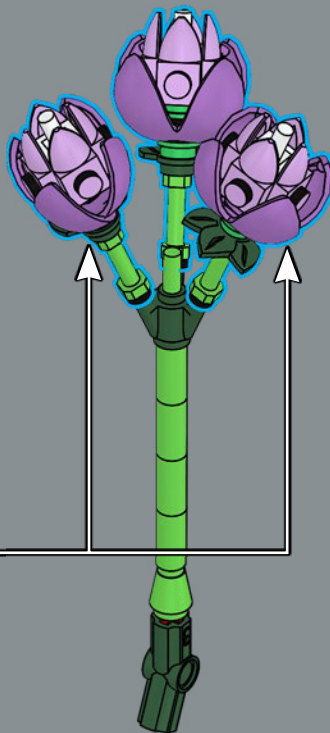



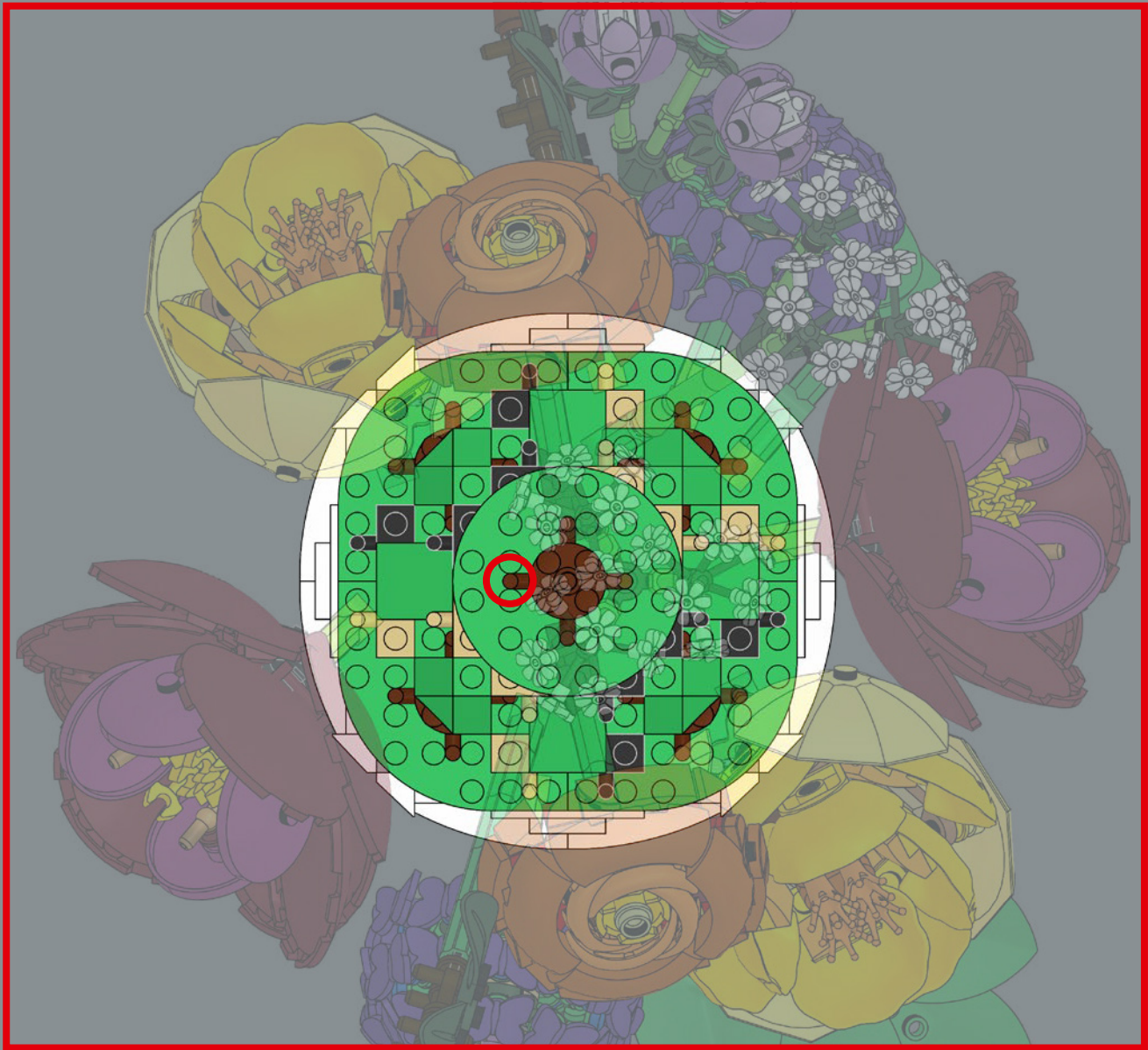

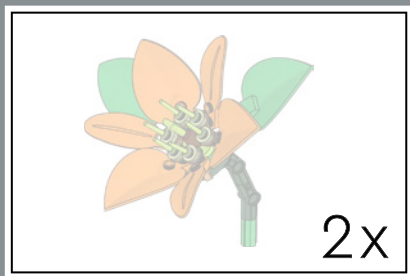

165

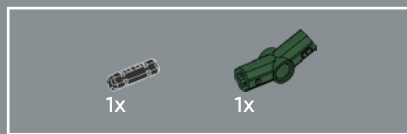
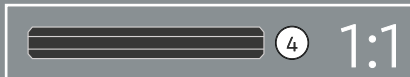

166

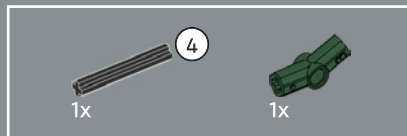
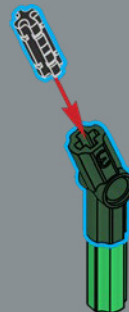

167

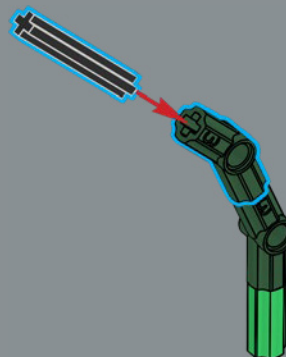

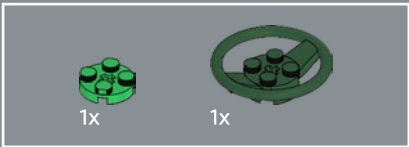

168

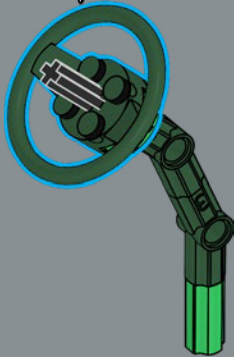
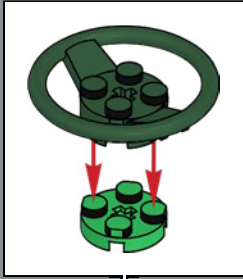

169

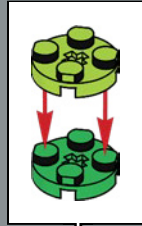

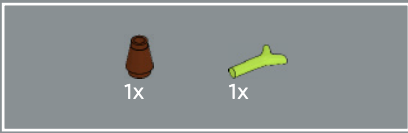

170

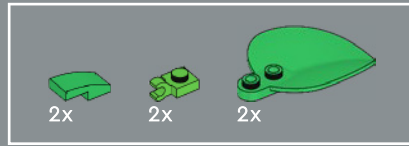
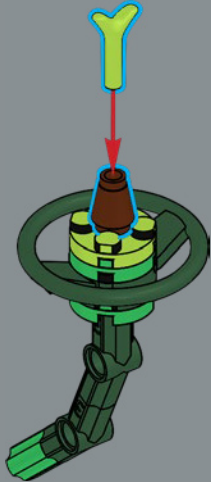

171

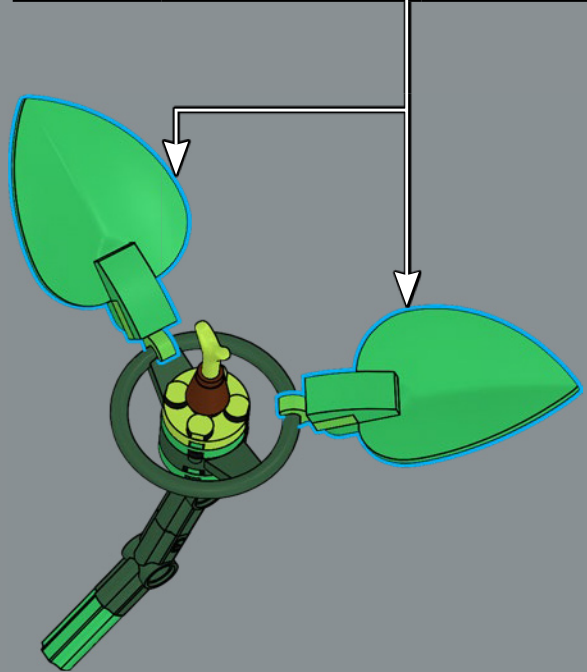
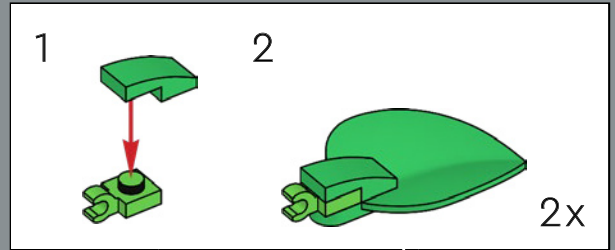



Lily: Watch out, this flower might cast a spell on you!  
The stamens are made from six LEGO® wands.

Lys : Attention, cette fleur pourrait vous jeter un sort ! Les  
étamines sont réalisées à partir de six baguettes LEGO®.

Azucena: Cuidado, ¡esta flor podría lanzarte un hechizo!  
Los estambres están hechos a partir de seis varitas LEGO®.

172

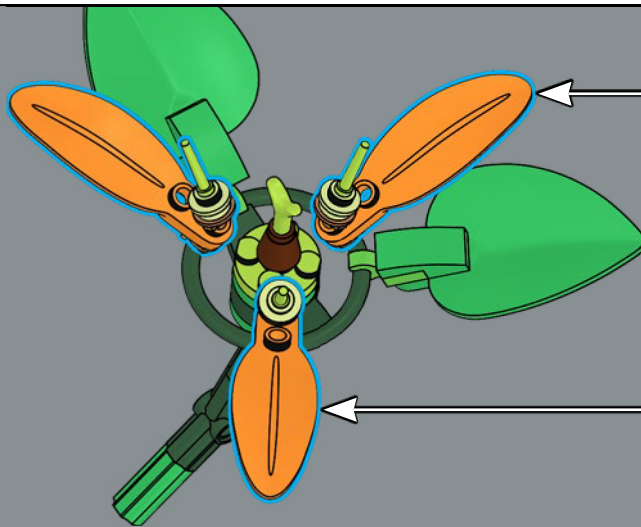
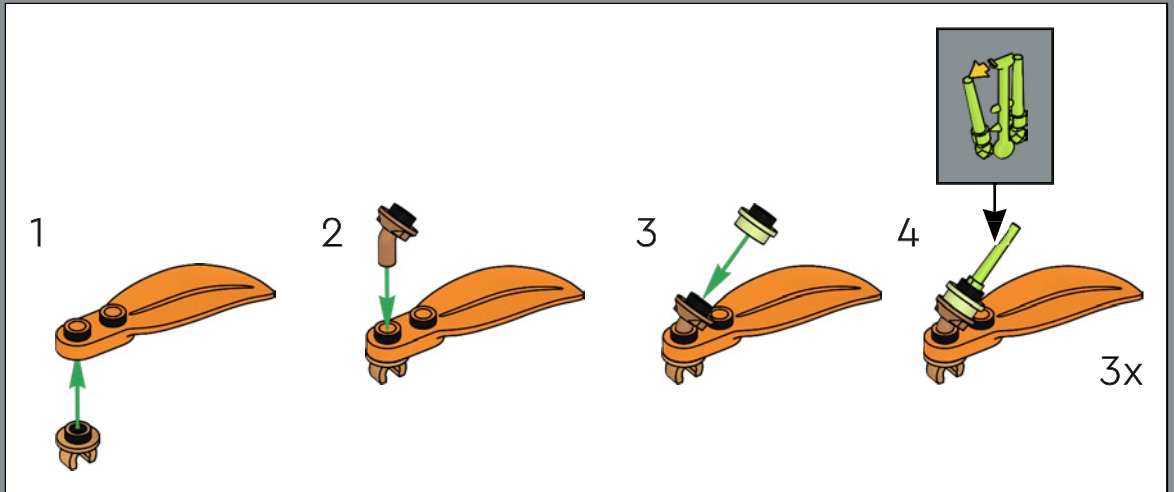



173

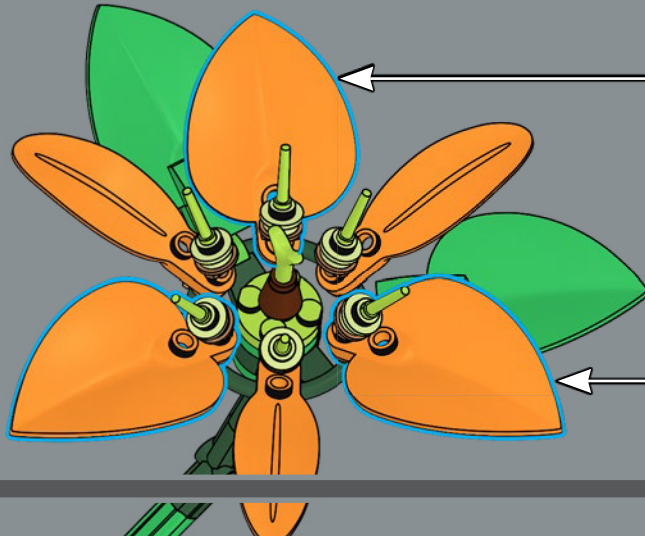
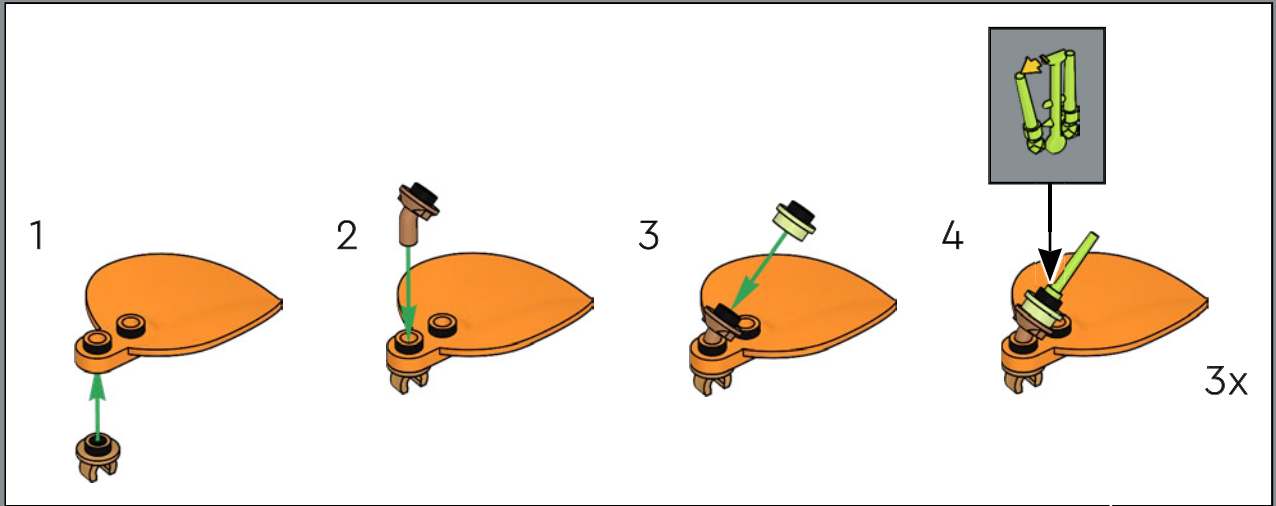



174

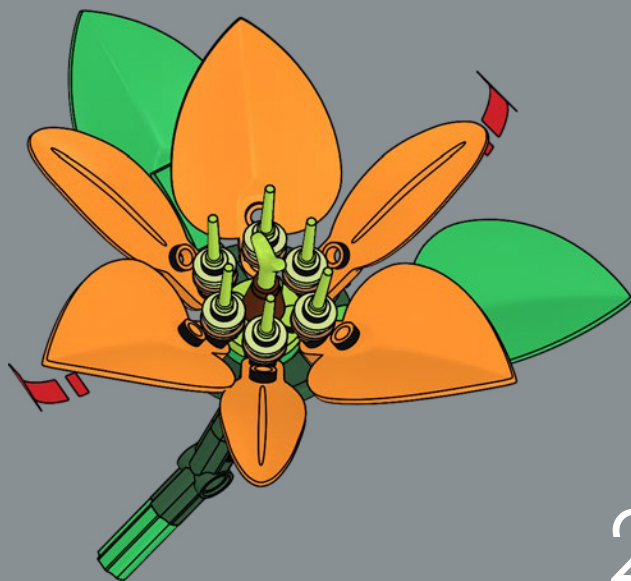

2x



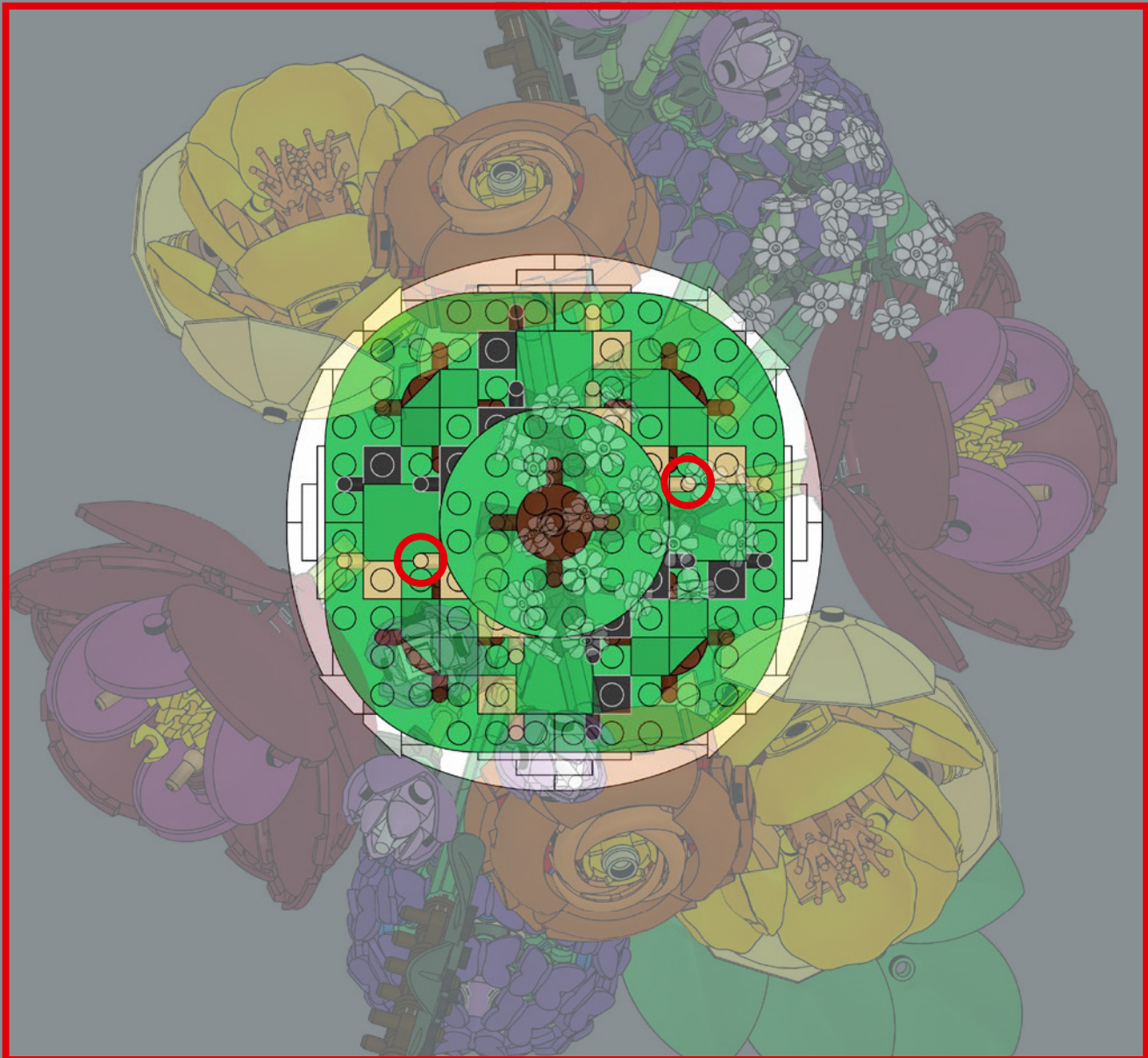



Discover more blooming creative tips  
with your LEGO® Insiders account on  
[LEGO.com/Botanicals-exclusive](https://LEGO.com/Botanicals-exclusive)

Découvrez d'autres astuces créatives fleuries  
avec votre compte LEGO® Insiders sur  
[LEGO.com/Botanicals-exclusive](https://LEGO.com/Botanicals-exclusive)

Descubre más consejos creativos  
con tu cuenta LEGO® Insiders en  
[LEGO.com/Botanicals-exclusive](https://LEGO.com/Botanicals-exclusive)



2x  
6009016



6x  
4111971



8x  
6294351



4x  
6488780



4x  
6250286



8x  
6069002



8x  
6045936



4x  
302301



4x  
371001



6x  
6116602



6x  
346001



2x  
611101



8x  
6147792



8x  
6457244



2x  
6246885



36x  
6452532



2x  
4114306



2x  
4113916



16x  
6046924



8x  
4118790



4x  
4114309



8x  
6261357



8x  
6485745



8x  
6212758



18x  
4140562



8x  
6447501



8x  
6473603



8x  
366521



8x  
6335377



4x  
6337002



8x  
6525850



2x  
6378120



2x  
4142865



2x  
6292291



1x  
6339313

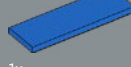

1x  
6410028



2x  
6446707



48x  
614123



15x  
6315482



3x  
4206482



4x  
6310247



2x  
6429054

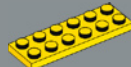

1x  
379524



8x  
6347294



5x  
6469455



8x  
4515367



8x  
6168644



16x  
6527030



16x  
6439051



4x  
6130007



4x  
614326



23x  
302226



4x  
6162892



8x  
6261348



2x  
6018805



4x  
6097283



8x  
6510193



19x  
4109810



2x  
6279875



6x  
6320293



2x  
370526



2x  
370726



4x  
6297286



4x  
6226928



2x  
6505133



4x  
6047426



4x  
403228



1x  
6097413



4x  
6021999



11x  
6529199



68x  
6527025



13x  
6374076



6x  
6420635



4x  
6331100



4x  
6347296



2x  
6345196



6x  
6161772



12x  
6328327



12x  
6468078



12x  
6338221



6x  
6529198



6x  
6529197



8x  
6527031



8x  
6527032

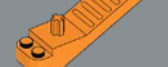

1x  
6240515



2x  
6440107



2x  
6314224



10x  
6527028



2x  
6420268



3x  
6332867



4x  
6322194



8x  
6527036

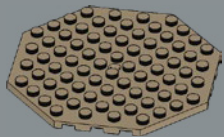

1x  
6288246



2x  
6392974



2x  
6512536



6x  
6400754



6x  
6398343



14x  
6510113



8x  
6329283



4x  
6525927



11x  
6344177



8x  
6348250



8x  
4539092



8x  
6168645



12x  
6212040



16x  
6527035



16x  
6099728



1x  
6365882



8x  
4529242



8x  
6172922



5x  
6313506



2x  
6092568



2x  
6170468



2x  
6459423



1x  
4531751



2x  
6316697



1x  
6135494



4x  
6301870



6x  
4211414



4x  
6258831



8x  
6313114



2x  
6093527



2x  
6116608



4x  
6469463



8x  
6231765



8x  
6527029



78x  
6468346



8x  
6212377



8x  
6252838



12x  
6520665



14x  
6452472



12x  
6265670



8x  
6492538



12x  
6510192



2x  
6482110



12x  
6534648



14x  
6256092



24x  
6468342



8x  
6527034



8x  
6473212



8x  
6468286



8x  
6466720



2x  
6510511



16x  
6492073



8x  
6527033

 [LEGO.com/service](https://www.LEGO.com/service)



# YOU COULD WIN



## YOU COULD WIN

Your feedback will help shape the future development of this product series.

Visit:

## DU KÖNNTEST GEWINNEN

Dein Feedback trägt zur Weiterentwicklung dieser Produktreihe bei.

Geh auf:

## VOUS POURRIEZ GAGNER

Vos commentaires nous aideront à concevoir les futurs produits de cette gamme.

Visitez :

## POTRESTI VINCERE TU

La tua opinione ci aiuterà a migliorare la creazione futura di questa linea di prodotti.

Visita:

## PUEDES GANAR

Tu opinión contribuirá al futuro de esta serie de productos.

Visita:

## 轻松获奖

您的反馈将有助于我们在今后改进本产品系列。

请访问：

---

# LEGO.com/productfeedback

---

You also have the chance to win a LEGO® set.

Terms and conditions apply.\*

Außerdem hast du die Chance, ein LEGO® Set zu gewinnen.

Es gelten die Teilnahmebedingungen.\*

Vous pourriez également gagner un ensemble LEGO®.

Des conditions s'appliquent.\*

Hai anche la possibilità di vincere un set LEGO®.

Termini e condizioni sono applicabili.\*

También tienes la oportunidad de ganar un set LEGO®.

Aplican términos y condiciones.\*

您还有机会赢取乐高®套装。

条款和条件适用。\*

\*LEGO.com/productfeedback-terms



LEGO and the LEGO logo are trademarks of the/sont des marques de commerce du/son marcas registradas de LEGO Group.  
©2025 The LEGO Group. 6560442