



JURASSIC WORLD

76967



WARNING: CHOKING HAZARD.
Toy contains small parts and a small ball.
Not for children under 3 years.



LEGO® Builder



Get excited about our new packaging!

We're switching from plastic to paper-based packaging. That's why you might find a mix of paper and plastic in our boxes!

Nos nouveaux emballages vous emballeront !

Nous passons des emballages en plastique aux emballages à base de papier. C'est pourquoi vous pourriez trouver un mélange de papier et de plastique dans nos boîtes !

¡Te presentamos nuestros nuevos empaques!

Estamos sustituyendo las bolsas de plástico por bolsas con base de papel. ¡Por eso, puedes encontrar una mezcla de papel y de plástico en nuestras cajas!

[LEGO.com/sustainable-packaging](https://www.lego.com/sustainable-packaging)

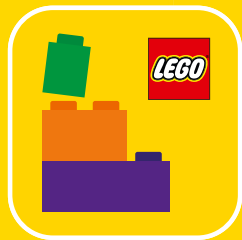

Q LEGO® Builder

BUILDER



Apple and the Apple logo are trademarks of Apple Inc., registered in the U.S. and other countries and regions. App Store is a service mark of Apple Inc. Google Play and the Google Play logo are trademarks of Google LLC. Tencent and the Tencent logo are trademarks of Tencent Inc.

Q [LEGO.com/devicecheck](https://www.lego.com/devicecheck)

EN Ask parents' permission before going online | DE Eltern um Erlaubnis bitten, bevor du online gehst | FR Demande l'autorisation d'un parent avant d'aller en ligne | IT Chiedi il permesso ai tuoi genitori prima di andare online | ES Pídeles permiso a tus papás antes de conectarte a Internet | PT Pede autorização aos pais antes de acederes online | ZH 上网前应先征得父母的同意 | PL Poproś rodziców o zgodę, zanim wejdiesz do Internetu | CS Než půjdeš na internet, požádej rodiče o svolení | SK Skôr než pôjdeš na internet, vypýtaj si povolenie od rodičov | HU Kérj szülői engedélyt, mielőtt online csatlakoznál! | RO Cere permisiunea părinților înainte de a te conecta online | BG Поискайте разрешение от родител, преди да влезете онлайн | LV Pirms došanās tiešsaistē palūdz atļauju vecākiem | ET Enne Interneti kasutamist küsi vanematelt luba | LT Prieš prisijungdami prie interneto, atsiklauskite tėvų

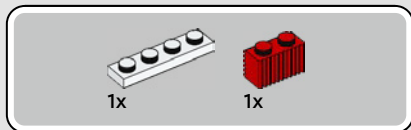

1

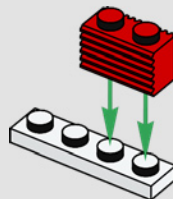

AVERTISSEMENT : RISQUE D'ÉTOUFFEMENT.

Le jouet contient des petites pièces ainsi qu'une petite boule. Il ne convient pas aux enfants de moins de 3 ans.



ADVERTENCIA: PELIGRO DE ASFIXIA.

Juguete que contiene partes pequeñas y una pelota pequeña. No recomendado para niños menores de 3 años.





1x



1x

2

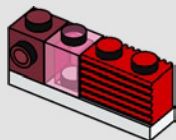

1x

3

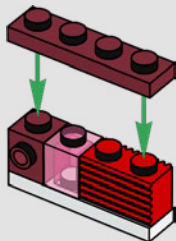

1x



1x

4

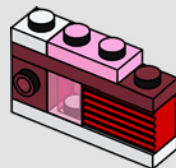

1x

5

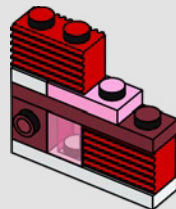



1x

6

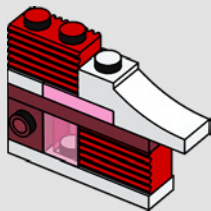

2x

7

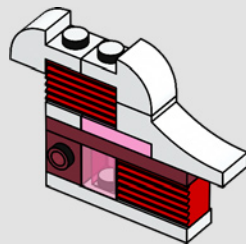

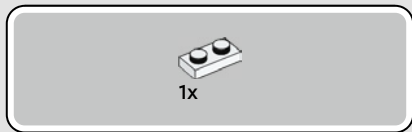

8

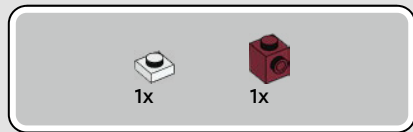
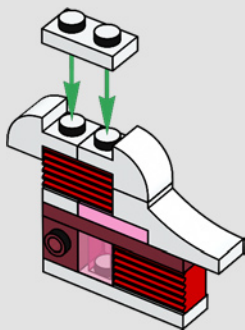

9

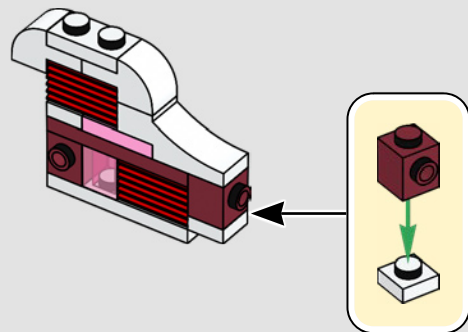



2x



1x

10

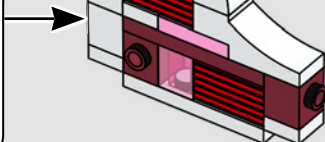
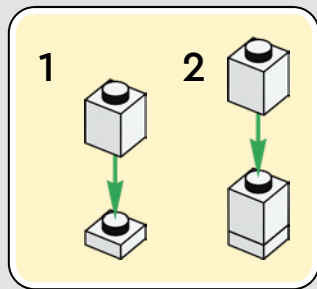

1x

11

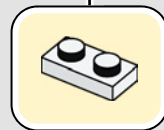
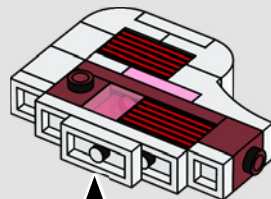



2x

12

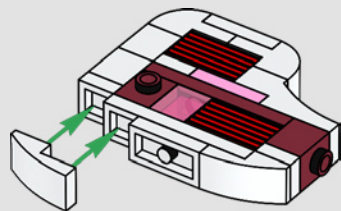

1x



1x



1x

13

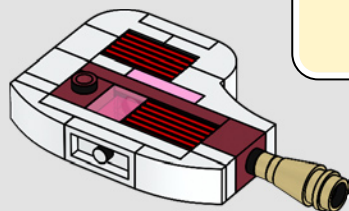

1



2



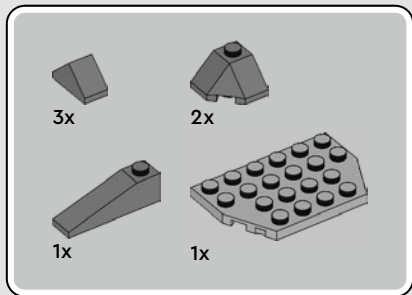

14

1

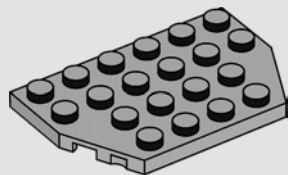

2

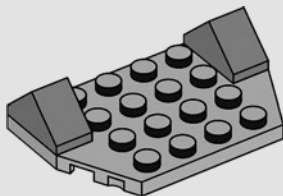

3

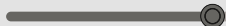
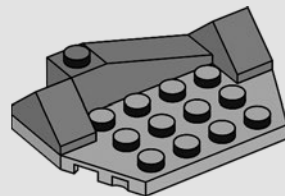

4

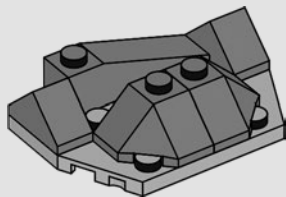

5

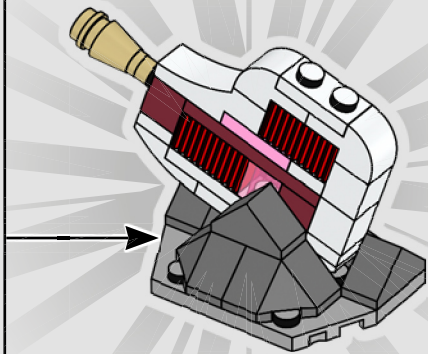
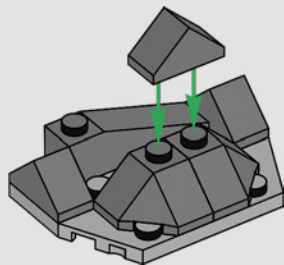

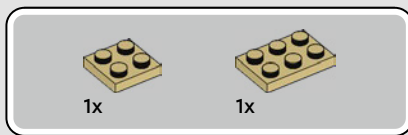
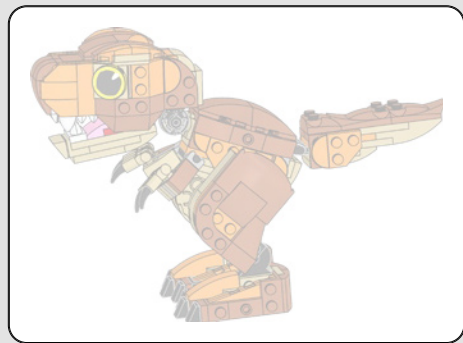

1

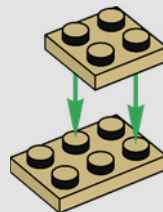

2

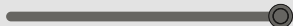
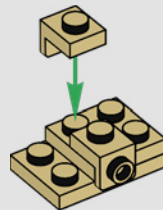

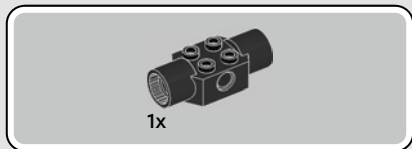

3



4

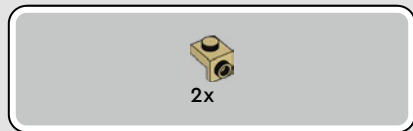
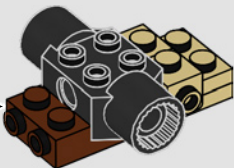

5

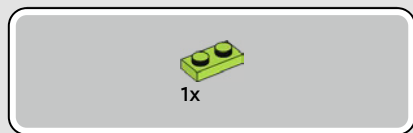
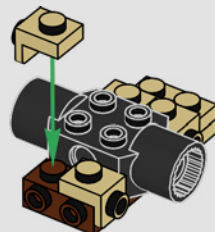

6

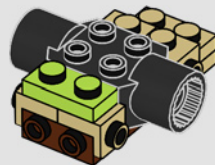

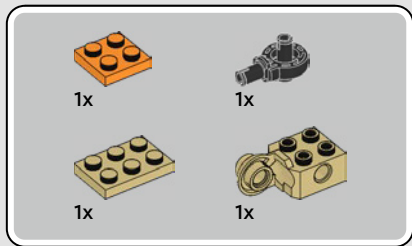

7

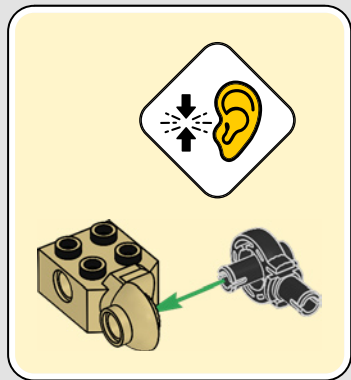

1



2



3

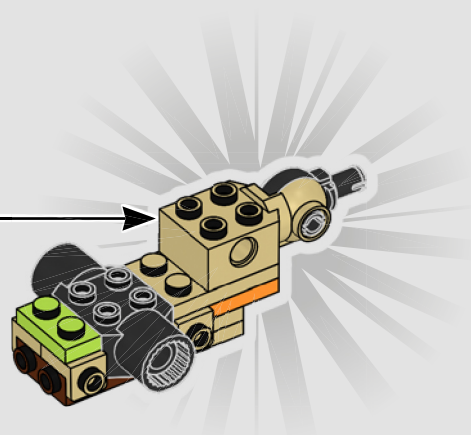
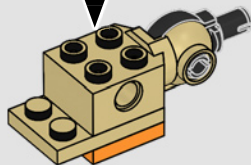



2x

8

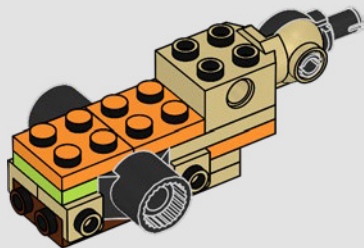

1x

9

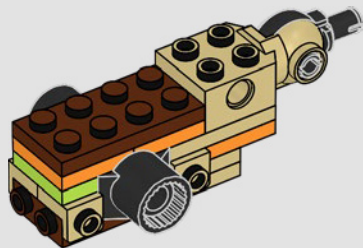



1x



2x

10

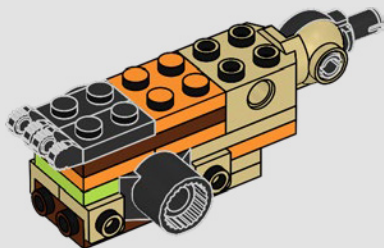

2x



4x

11

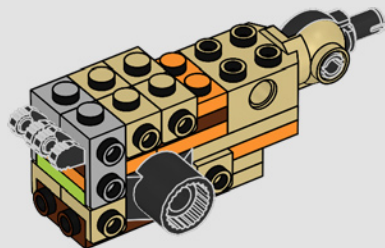

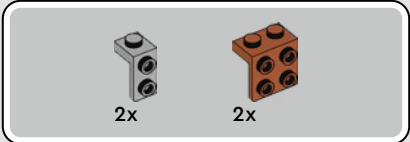

12

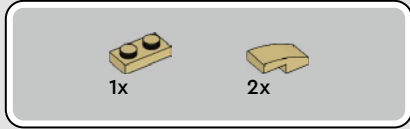
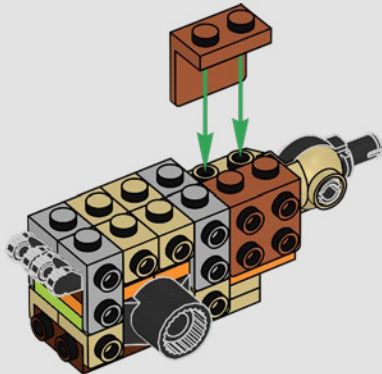

13

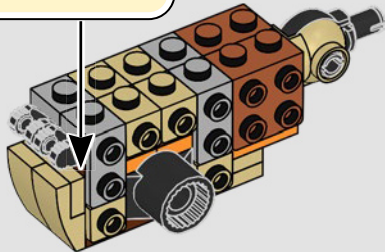
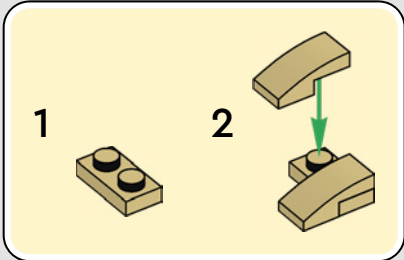

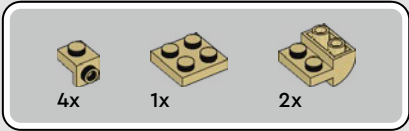

14

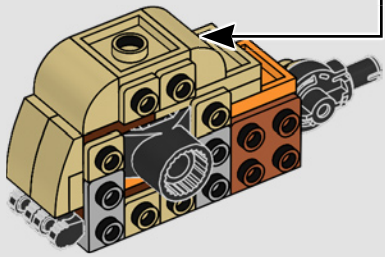
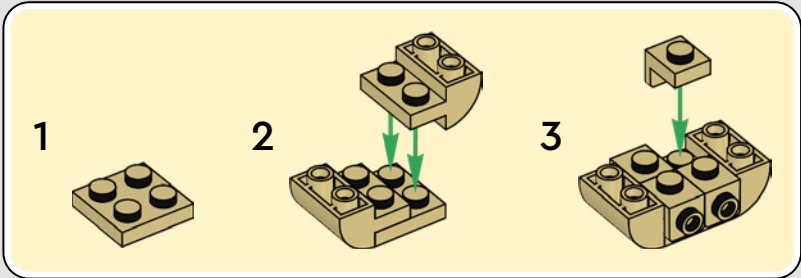

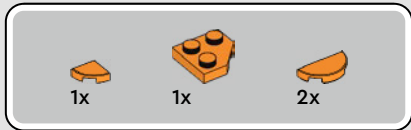

17

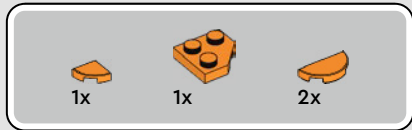
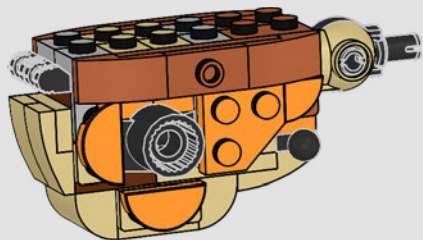

18

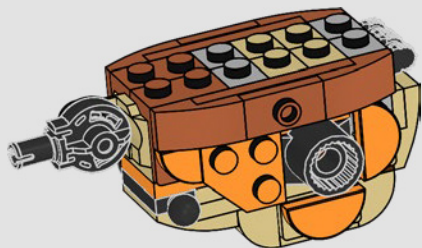

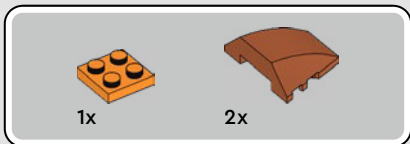

19

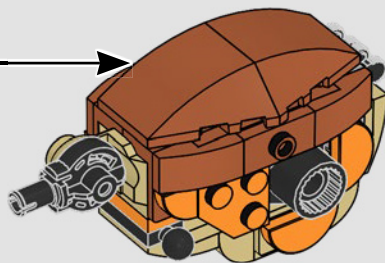
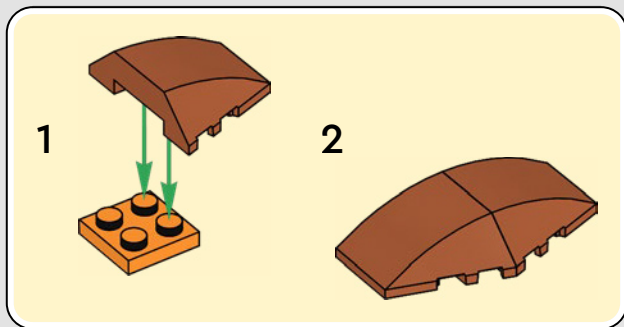

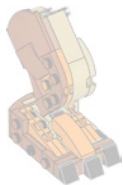

1x

20



1x



1x

21

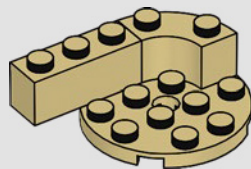

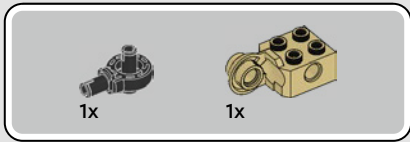

22

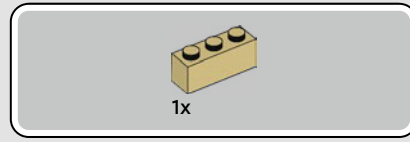
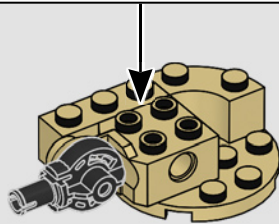
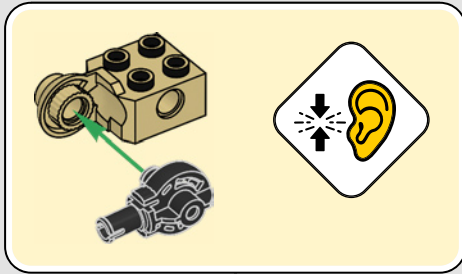

23

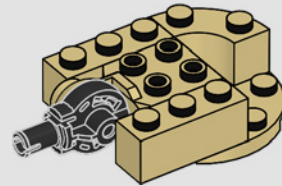

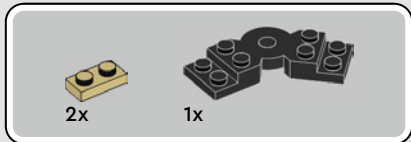

24

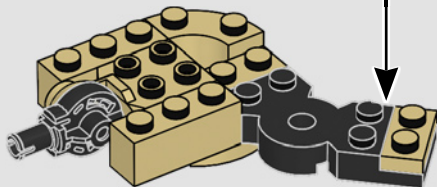
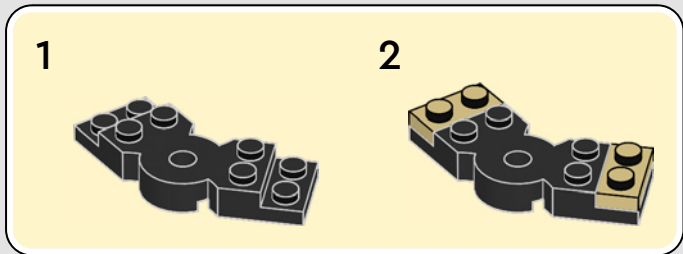

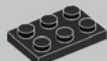

1x

25

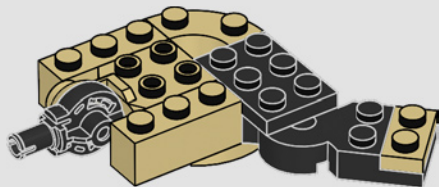

1x



1x

26

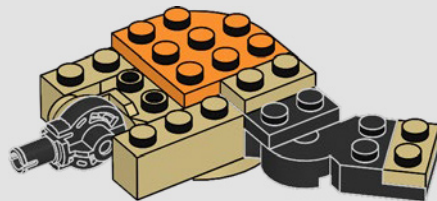



2x

27

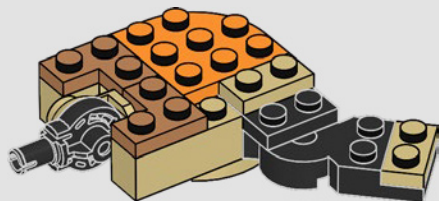

1x



1x



1x

28

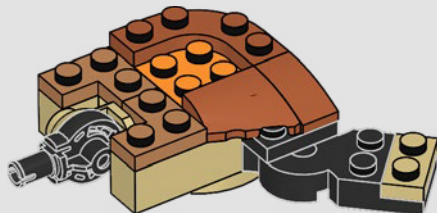

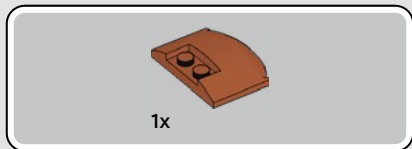

29

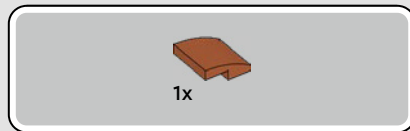
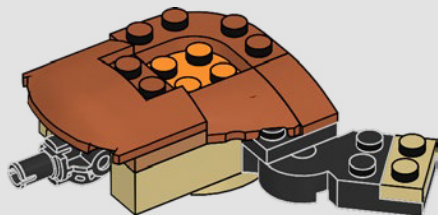

30

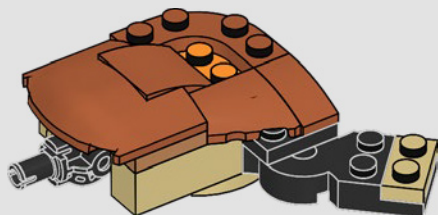

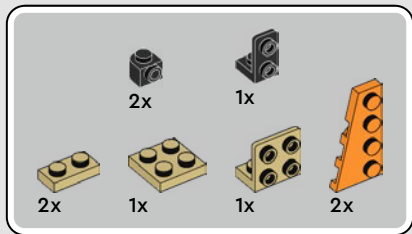

31

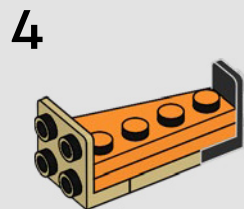
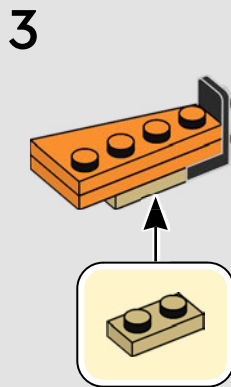
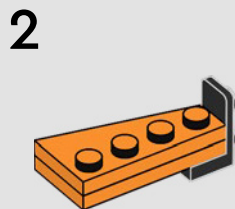
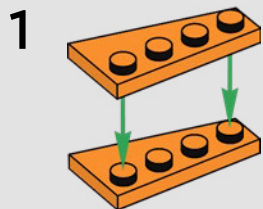

5

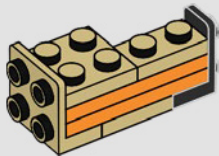

6

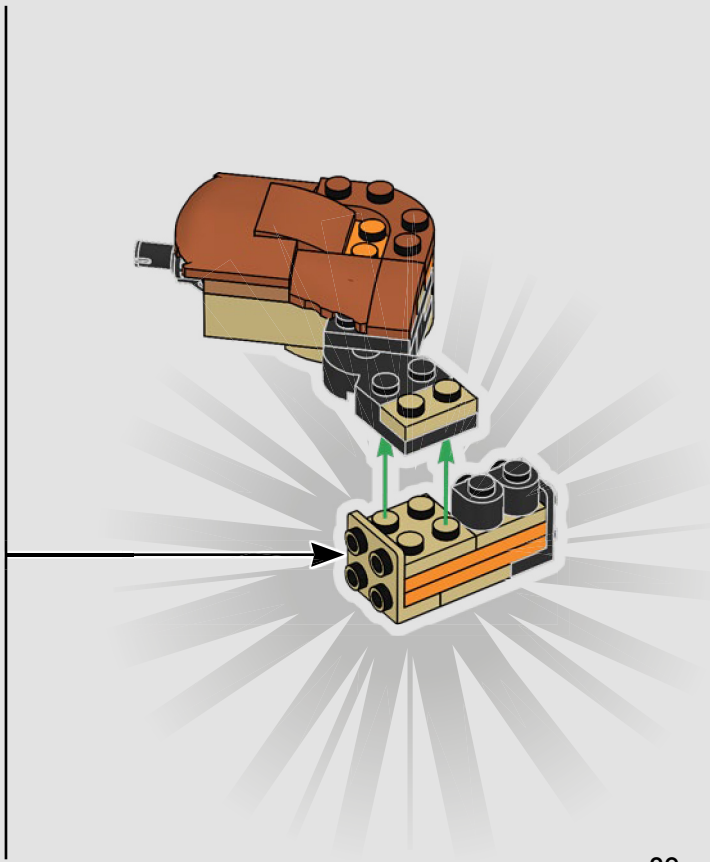
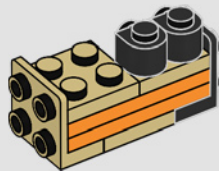



1x



1x

32

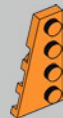
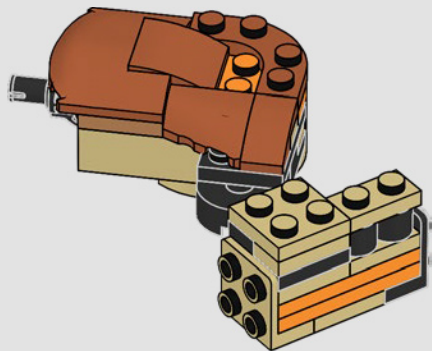

2x

33

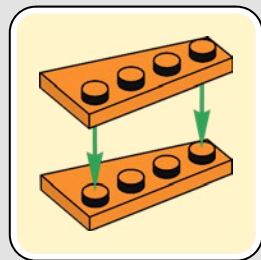
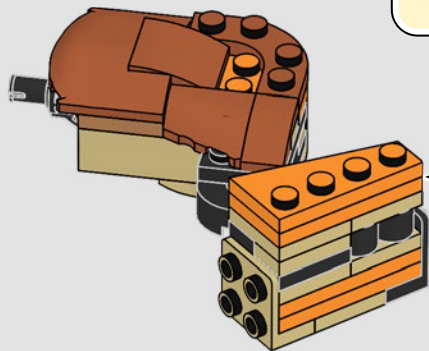

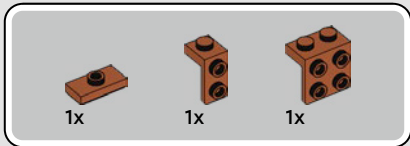

34

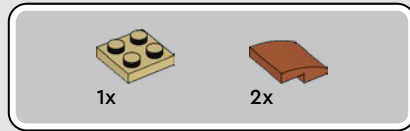
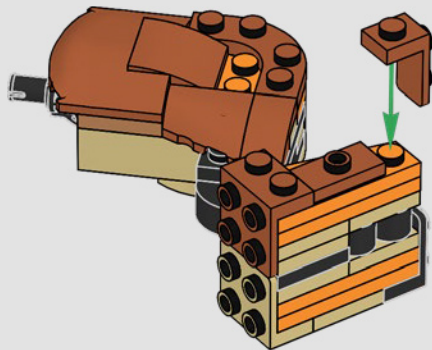

35

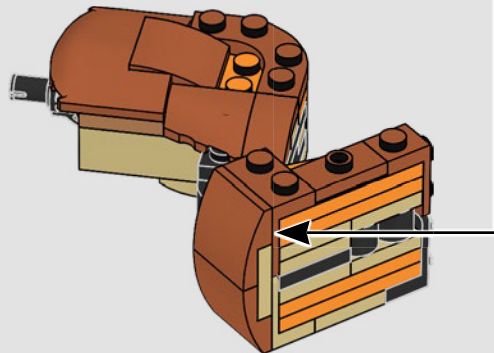
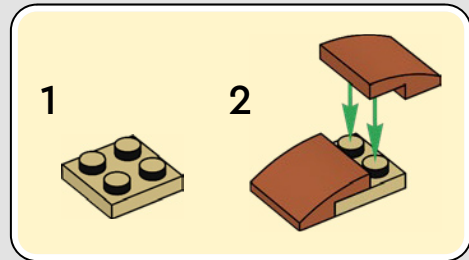

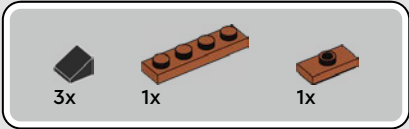

36

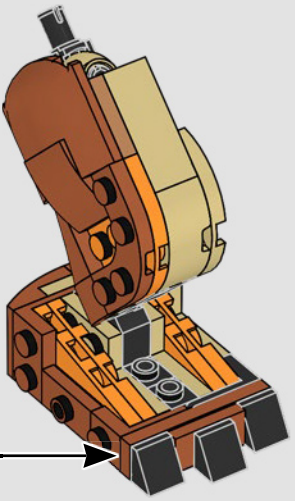
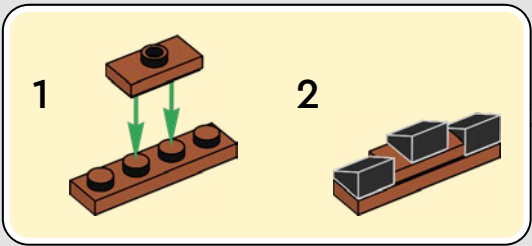



1x



1x

37

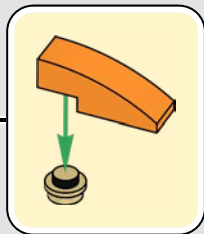
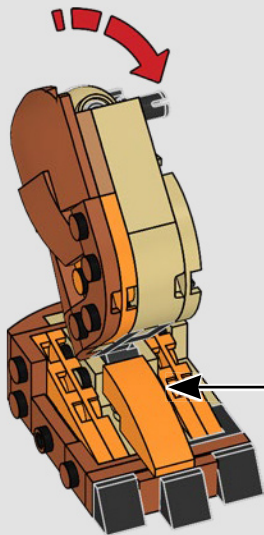

38

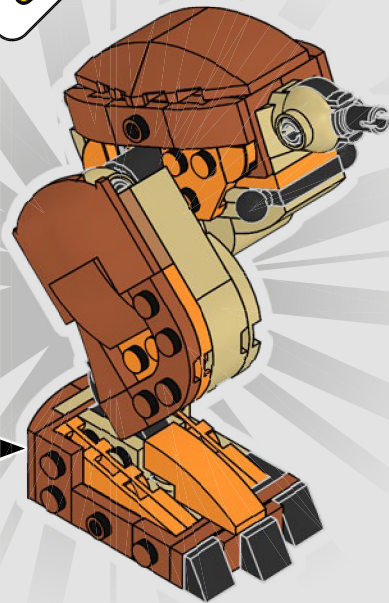

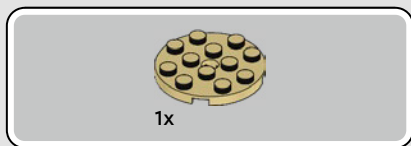
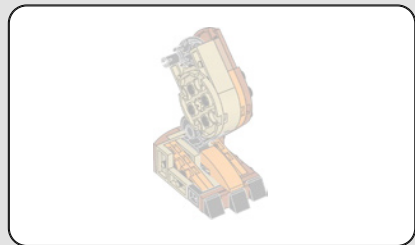

39

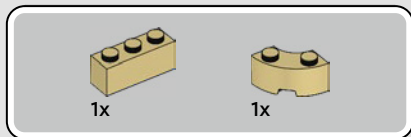

40

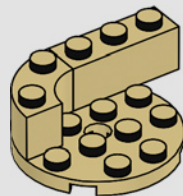

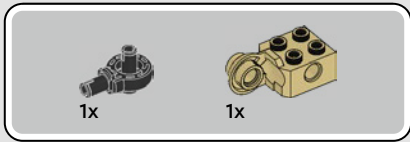

41

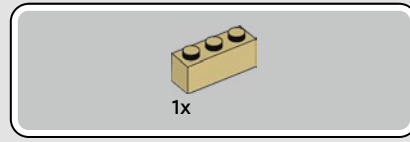
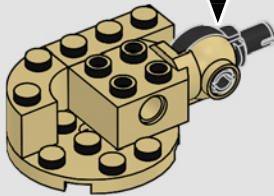
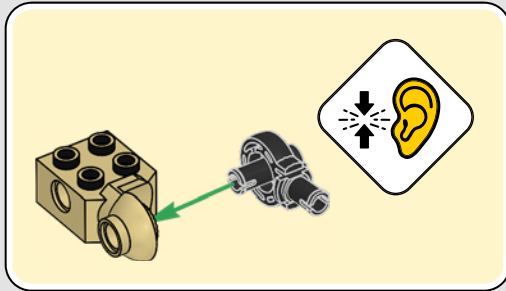

42

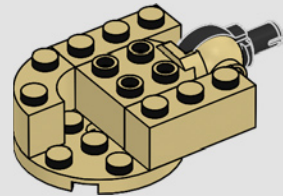

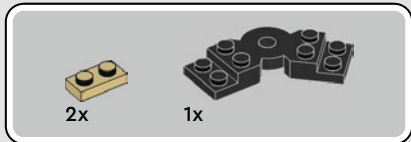

43

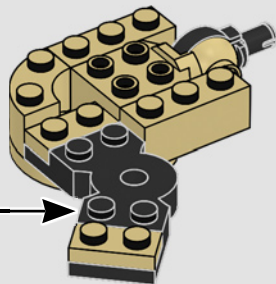
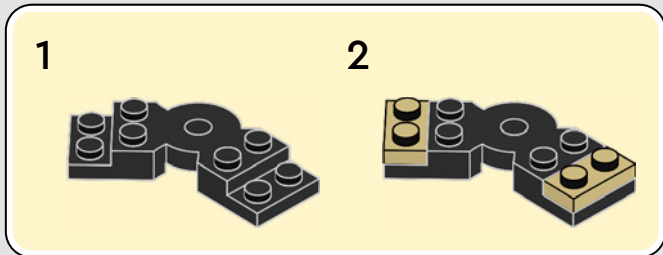

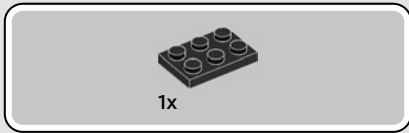

44

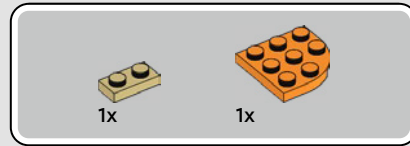
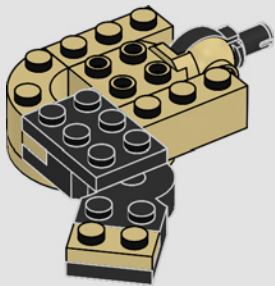

45

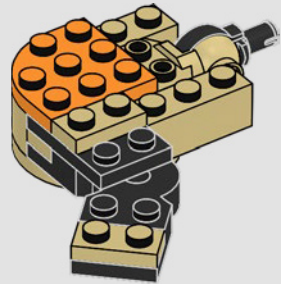

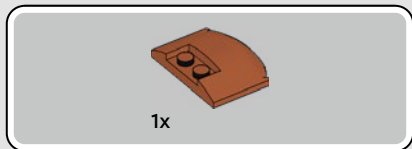

48

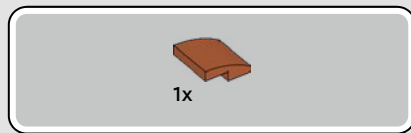
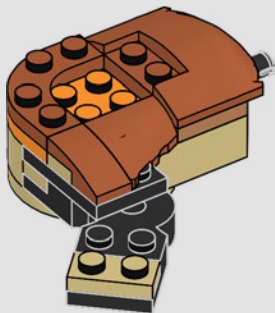

49

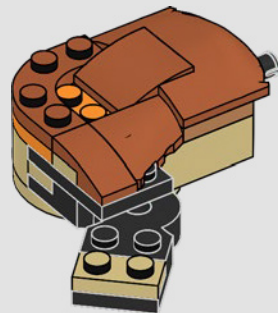

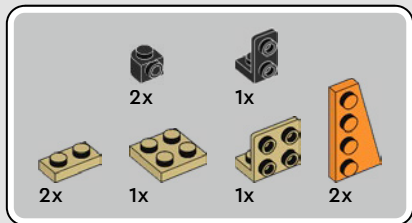

50

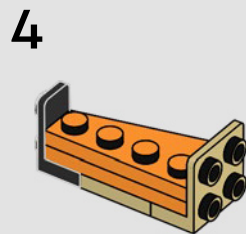
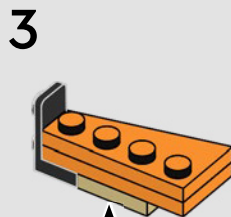
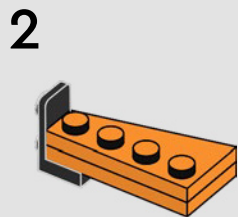
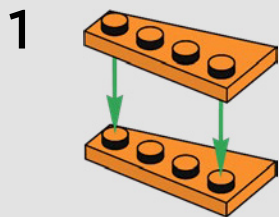

5

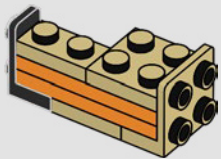

6

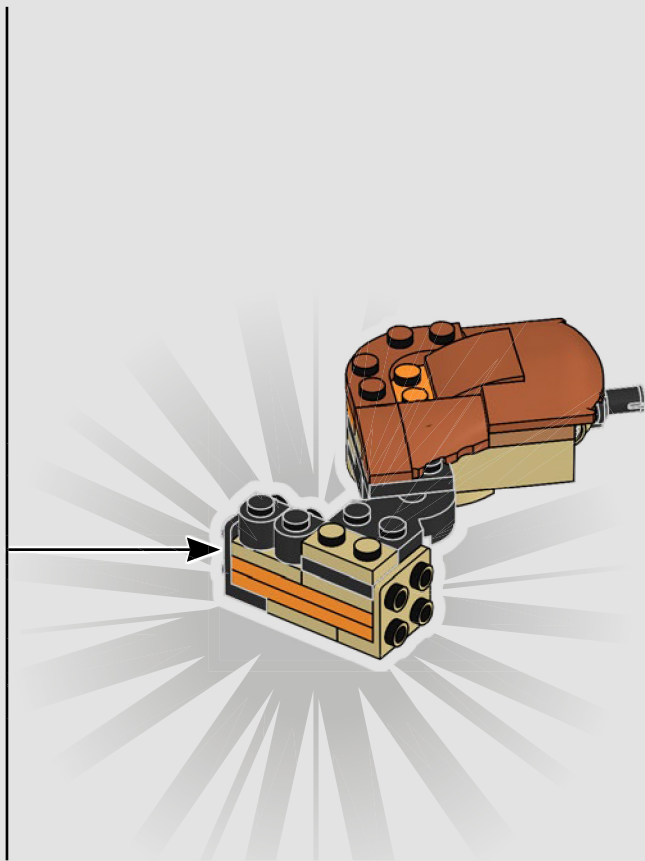
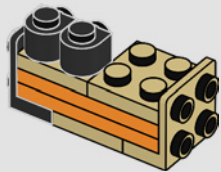

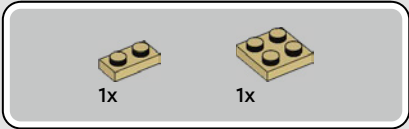

51

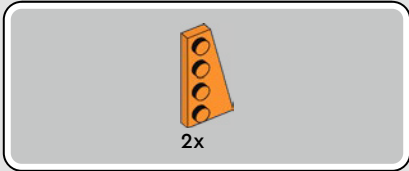
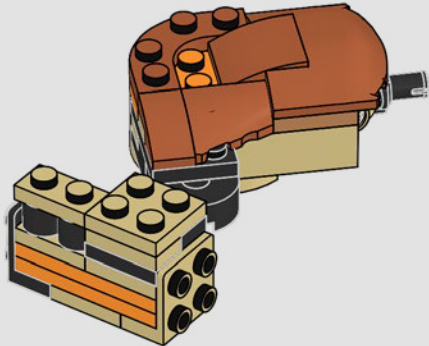

52

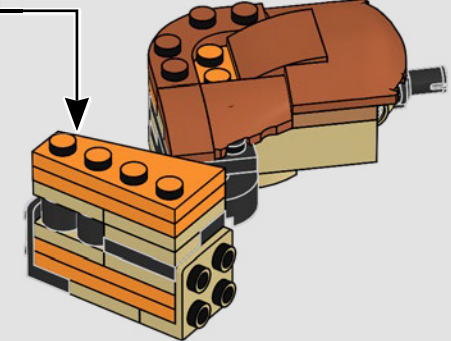
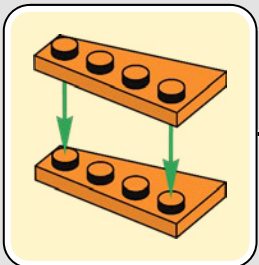

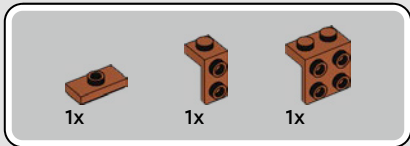

53

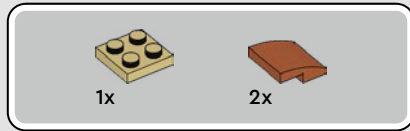
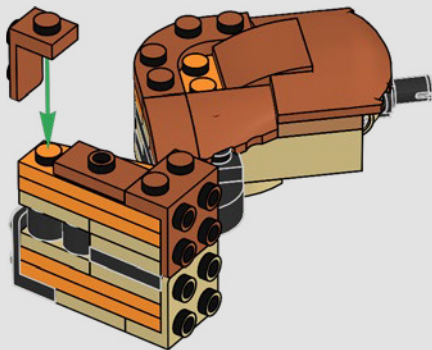

54

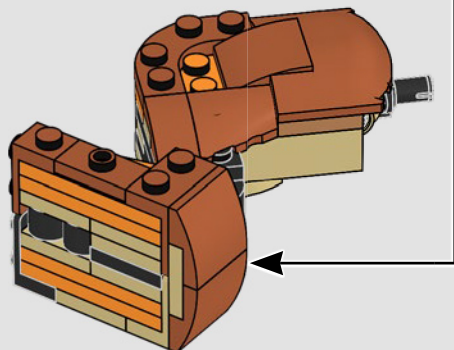
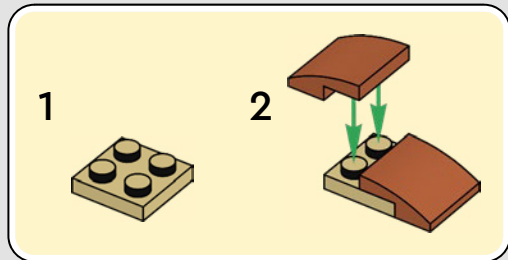

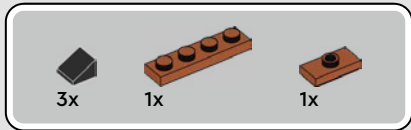

55

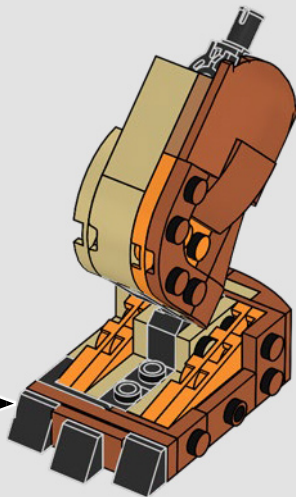
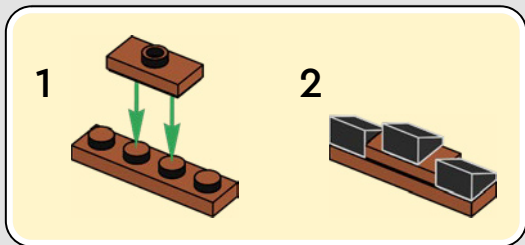



1x



1x

56

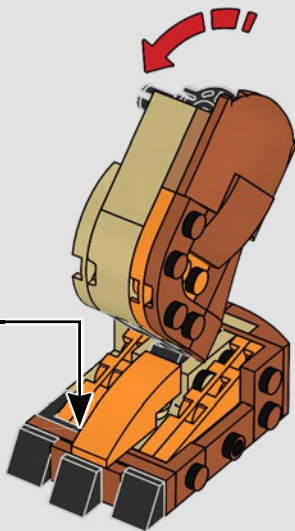
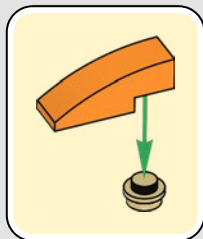

57

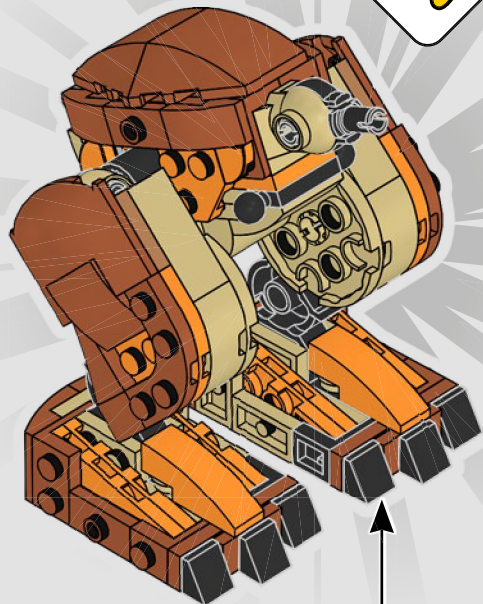

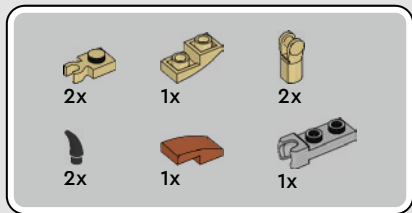

58

1



2

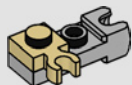

3

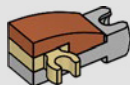

4

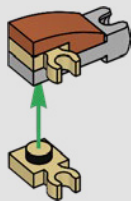

5

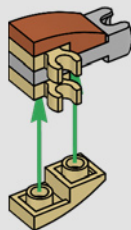

6

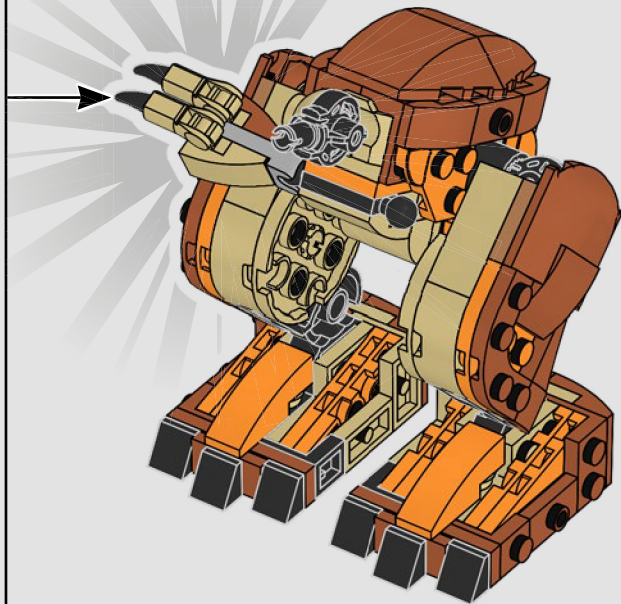
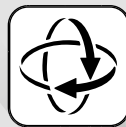
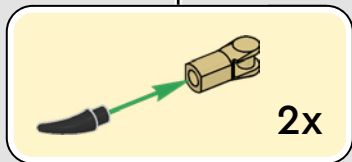
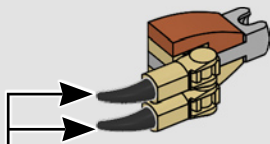

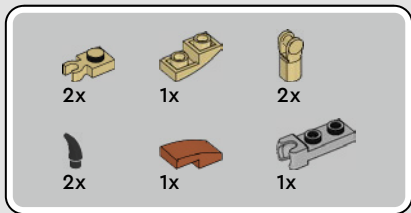

59

1

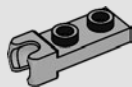

2

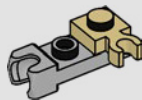

3

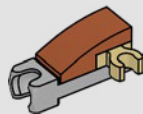

4

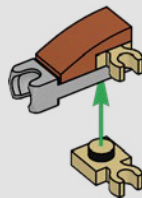

5

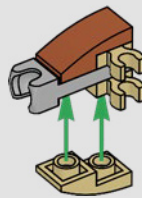

6

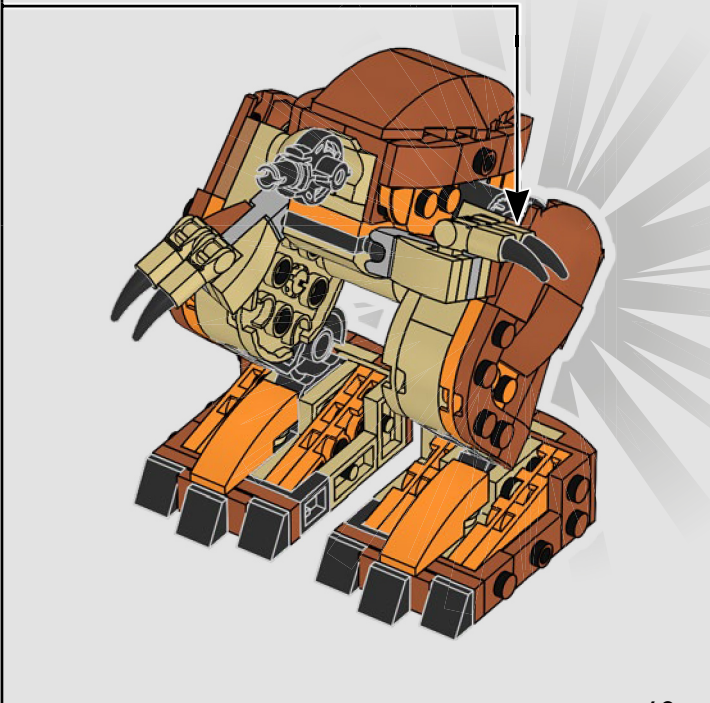
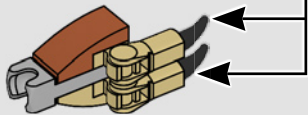
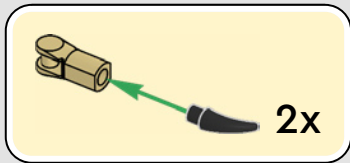

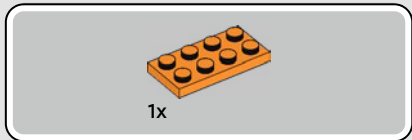
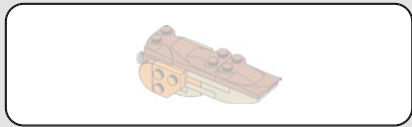

60

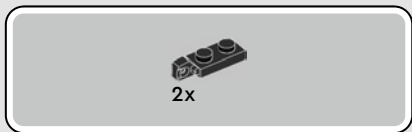

61

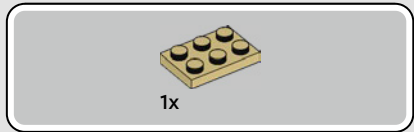
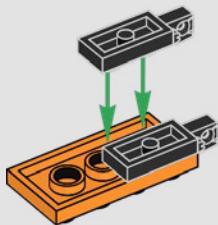

62

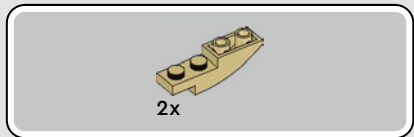
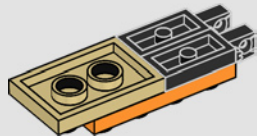

63

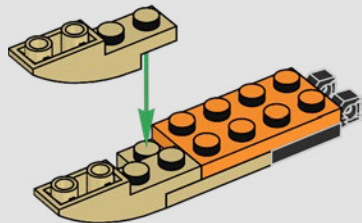



1x

64

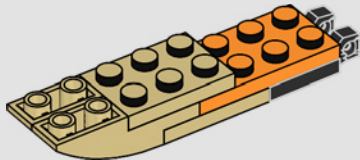

2x

65

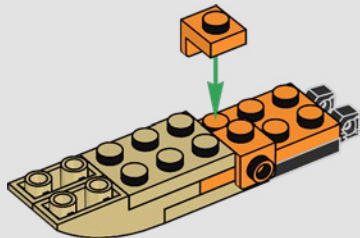

1x



1x

66

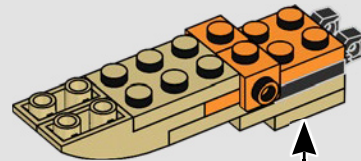

1

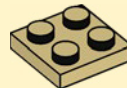

2

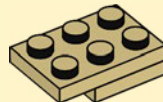



2x

67

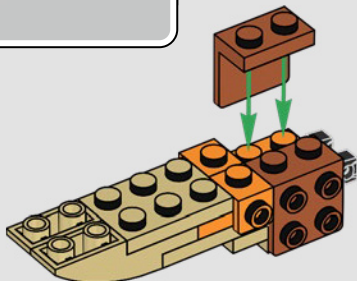

2x

68

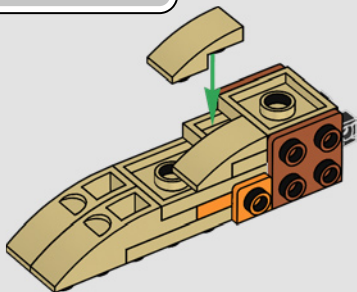

1x

69

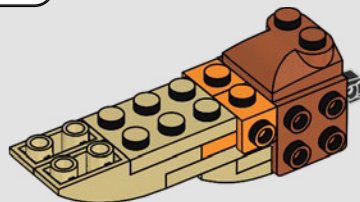



2x

70

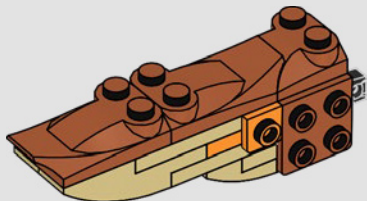

1x



1x

71

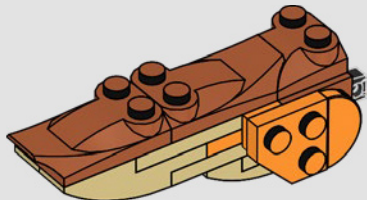

1x



1x

72

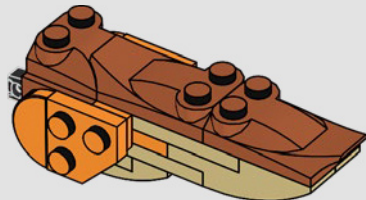

73

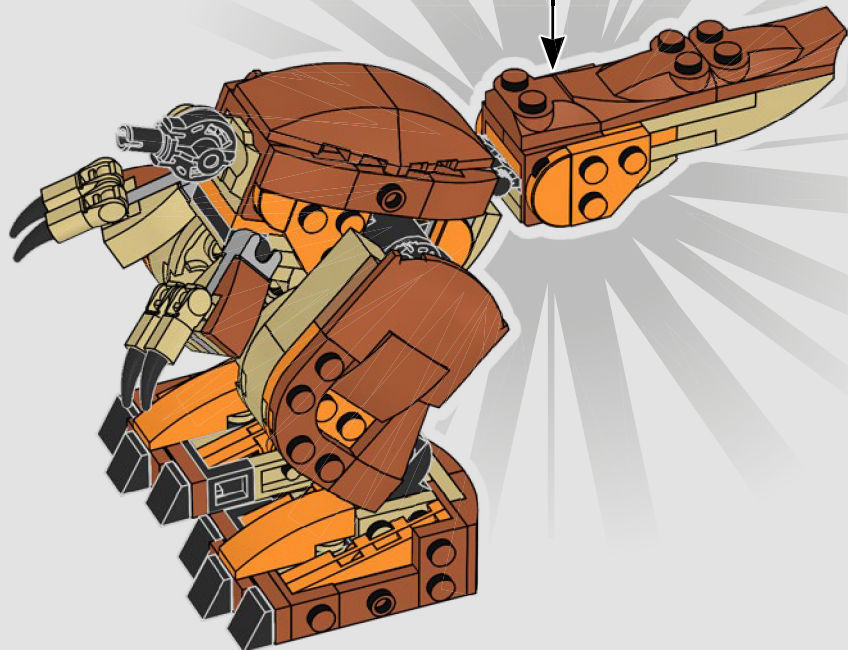

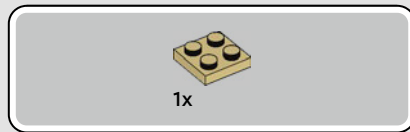
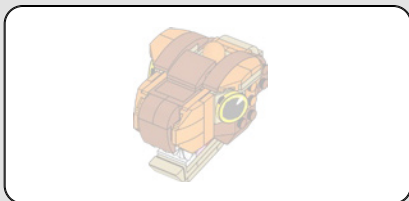

74

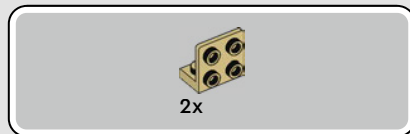

75

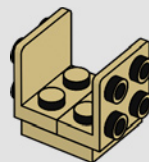



1x

76

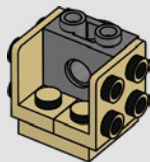

1x



2x



1x



1x

77

1



2

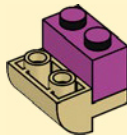

3

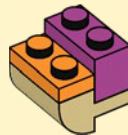

4

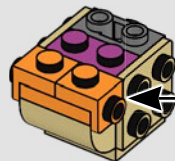
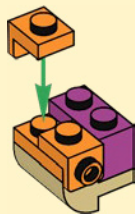



1x



1x

78

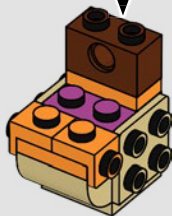
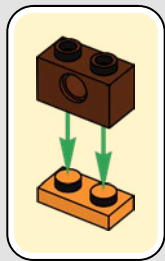

2x

79

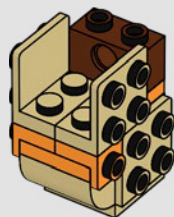

1x

80

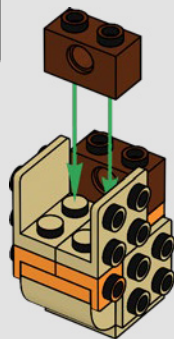

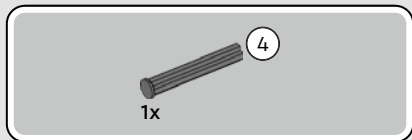

81

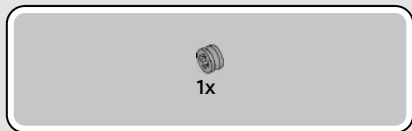
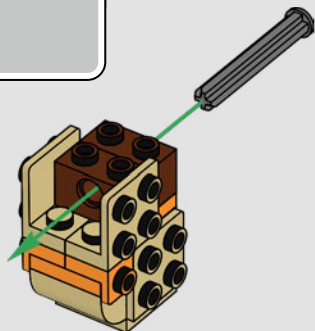

82

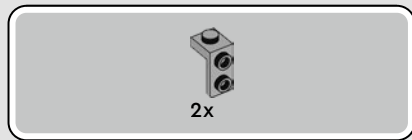
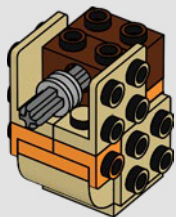

83

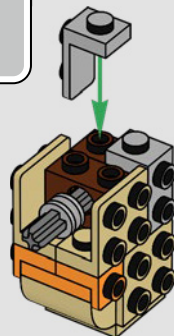

84

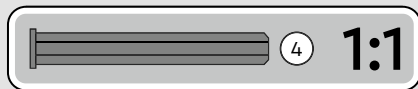
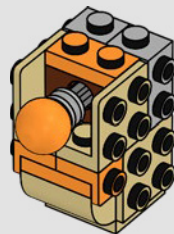

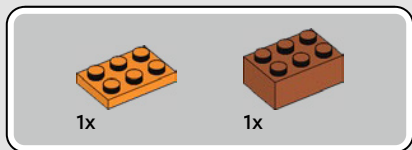

85

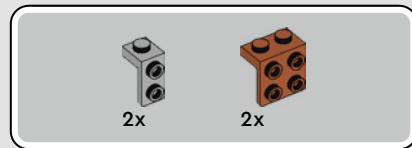
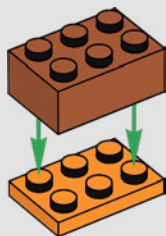

86

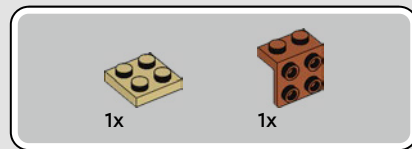
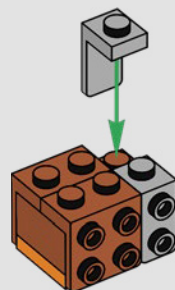

87

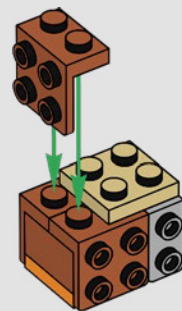



1x

88

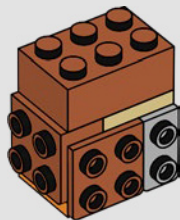

2x



2x

89

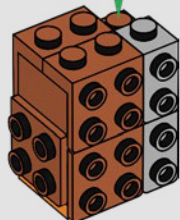

1x



1x

90

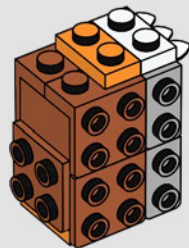

2x

91

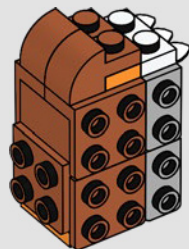



1x

92

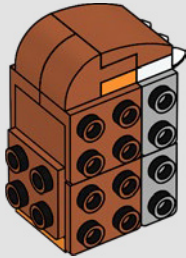

1x



1x



1x

93

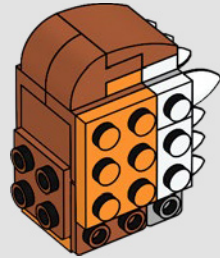

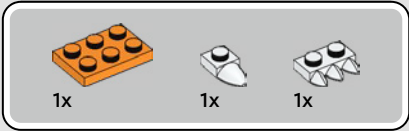

94

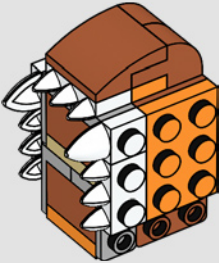

95

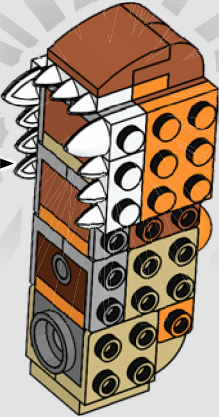

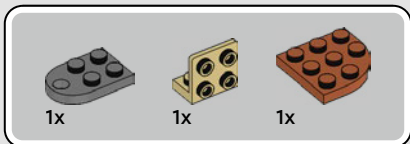

96

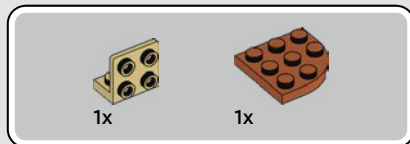
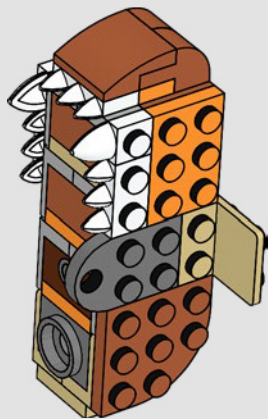

97

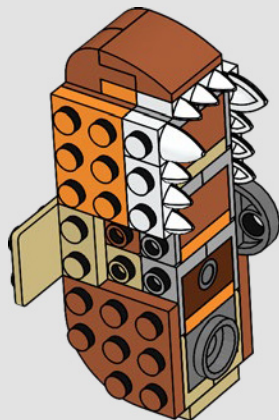



1x

98

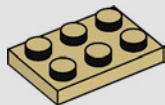

1x

99

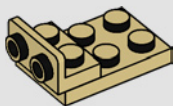

1x

100

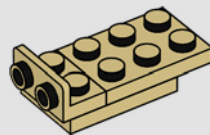



2x

101

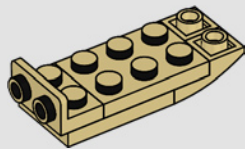

2x

102

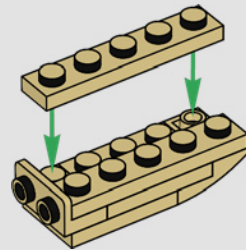



1x

103

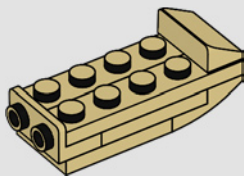

2x

104

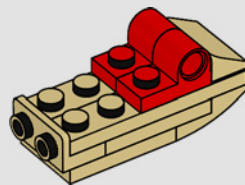



1x



1x

105

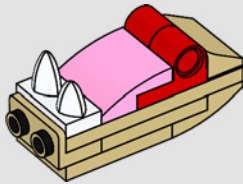

1x

106

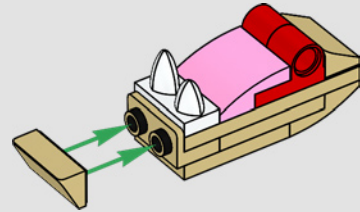



2x

107

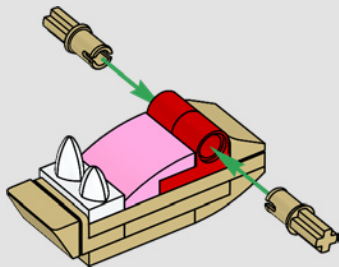

108

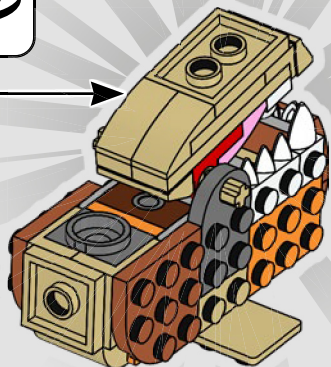



1x

109

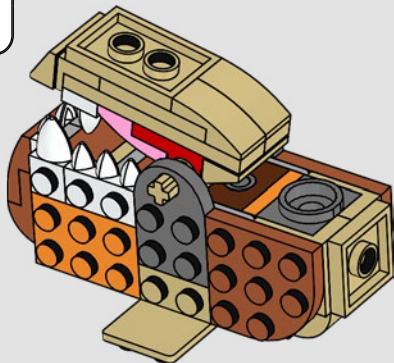
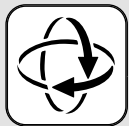

1x



1x



1x

110

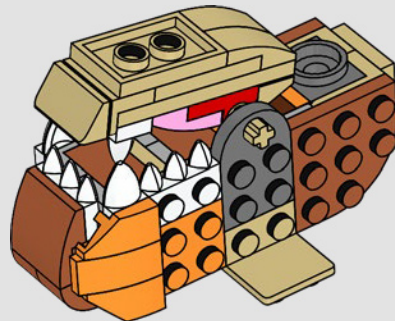



1x

111

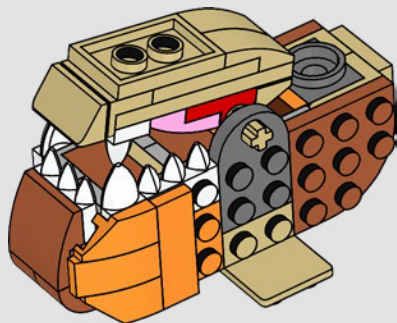

1x



1x

112

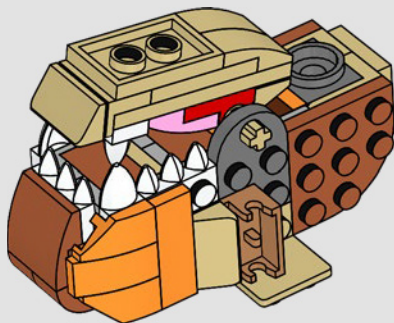



1x



1x

113

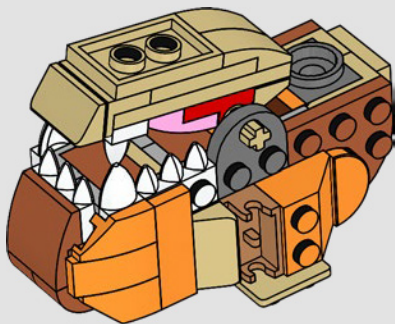

1x

114

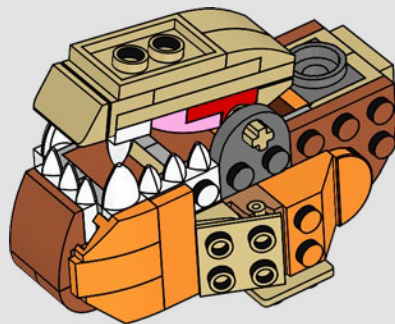

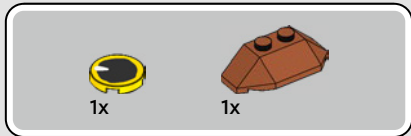

115

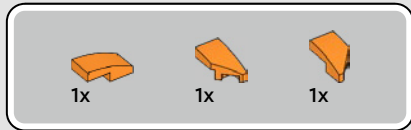
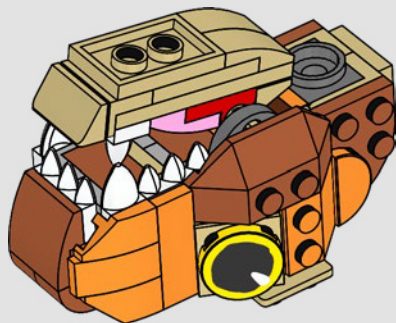

116

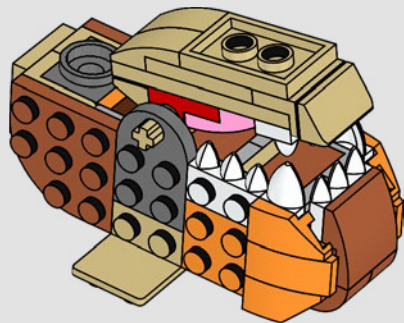



1x

117

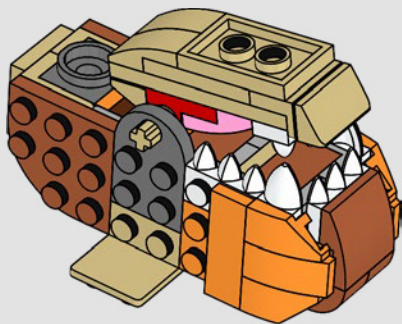

1x



1x

118

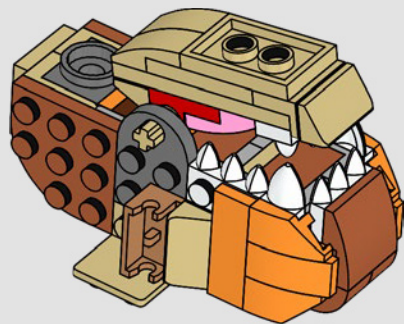

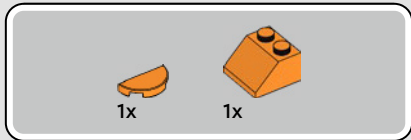

119

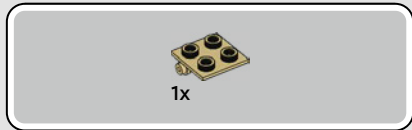
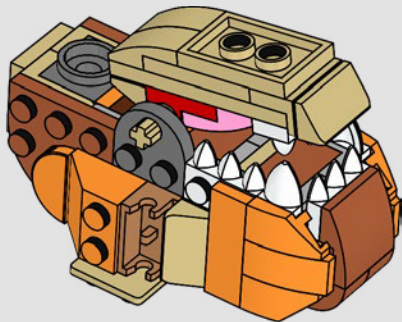

120

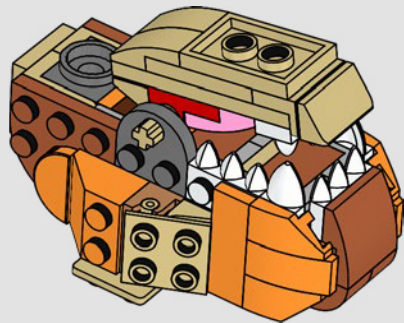



1x



1x

121

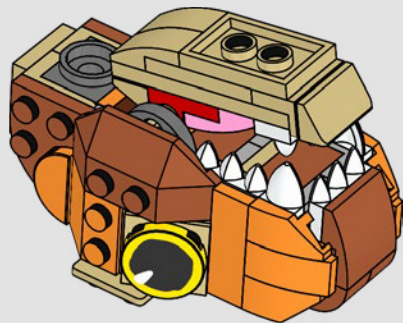



1x



1x

122

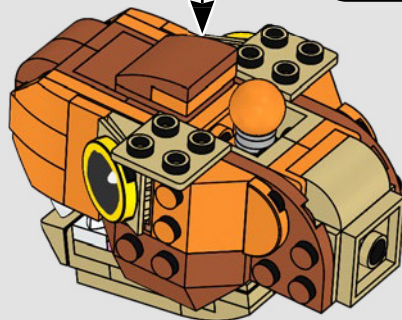
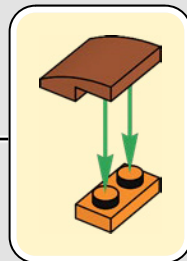

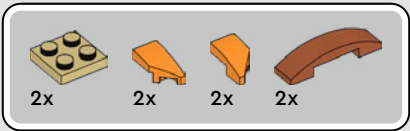

123

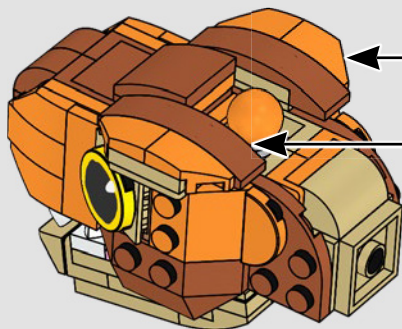
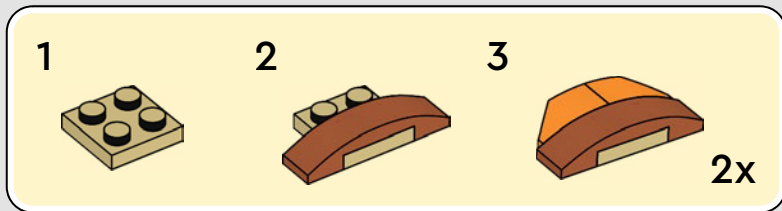

124

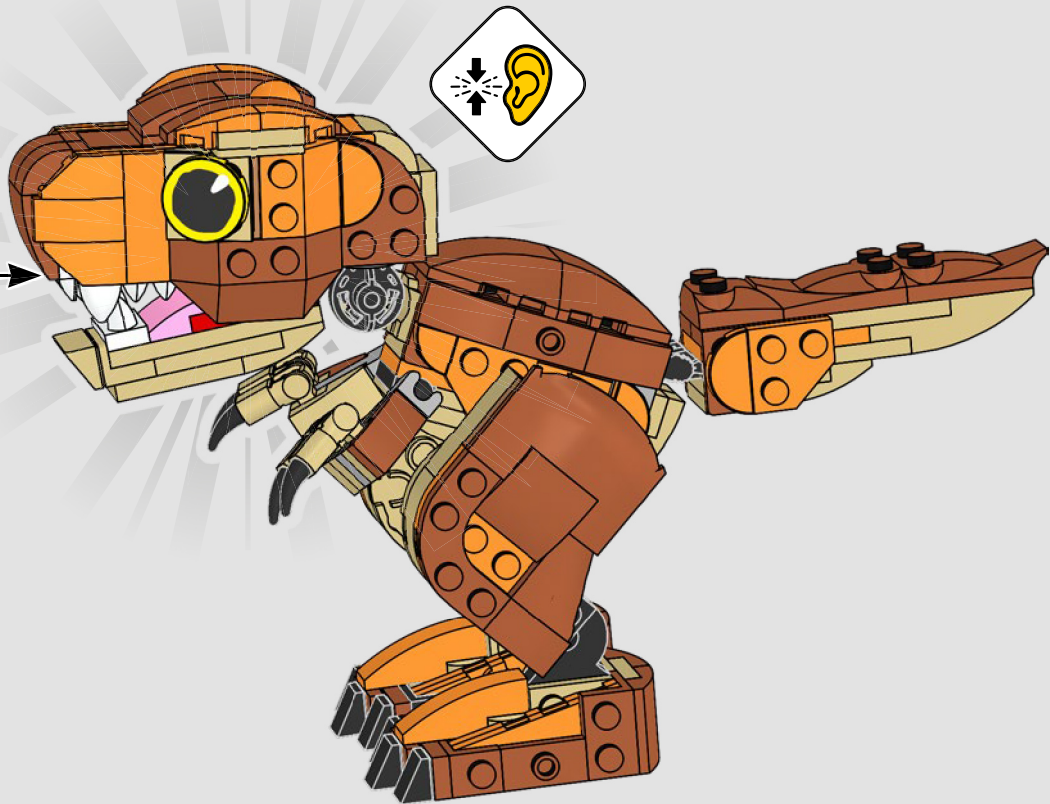

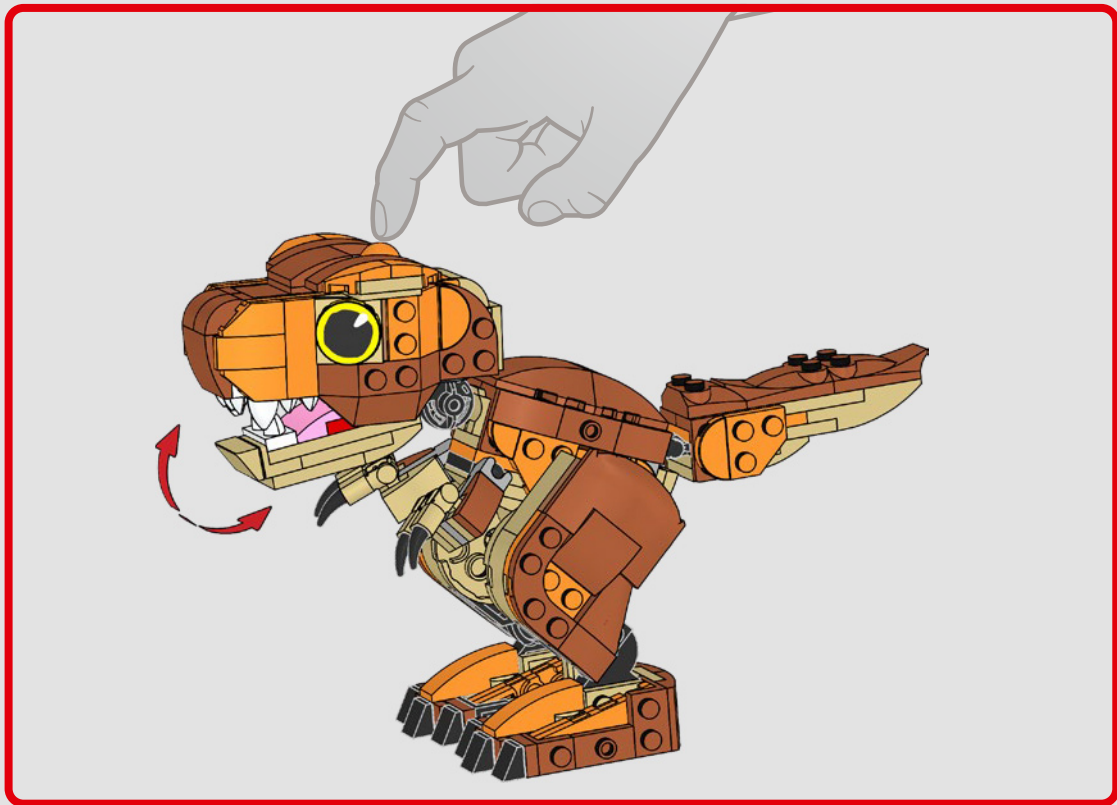

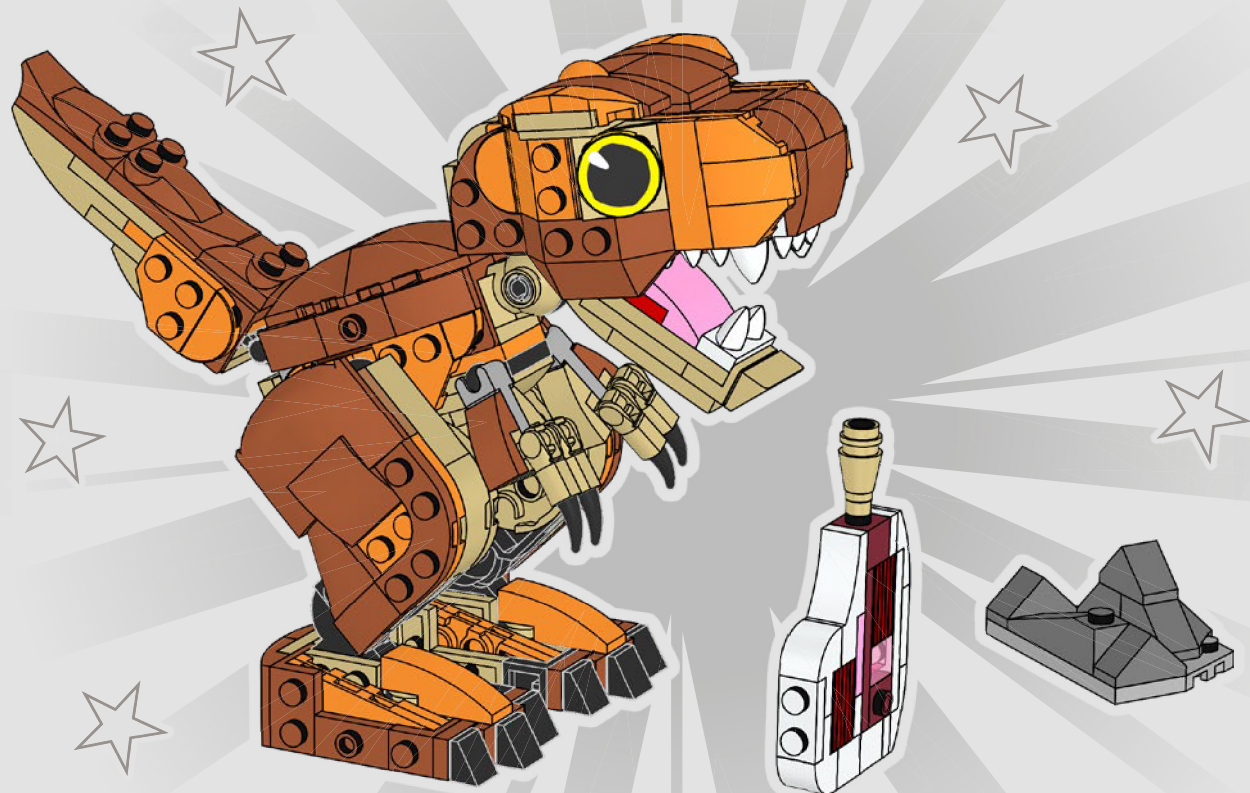





2x
300501



2x
6519988



2x
6172927



1x
6357598



3x
302401



2x
302301



1x
371001



2x
4224792



1x
6046384



3x
6046381



1x
4529237



4x
4624086



6x
6251252



2x
6046922



2x
6055868



4x
4162465



3x
6375375



3x
6485743



1x
6517736



3x
4161734



12x
6374192



4x
6352222



8x
6174925



13x
4113917



1x
6313611



13x
4114084



7x
4118790



2x
6273851



2x
6351905



2x
6302268



1x
6447501



4x
6458391



2x
4666579



2x
6487881



2x
6219677



2x
6099736



2x
6523604



3x
4213374



1x
6296186



6x
4504382



4x
6270103



4x
6424674



2x
6335317



2x
6266224



2x
6267045



1x
6416838



2x
302126



2x
6469080



1x
4519195



2x
6536259



2x
6536264



1x
6536270



1x
6536271



8x
6104344



2x
6536282



2x
6536269



6x
6092602



4x
6074892



2x
6536263



8x
6186009



2x
6515558



11x
6536278



2x
6359697



2x
6339915



2x
6468071



1x
6536266



2x
6536268



2x
6055069



2x
4251969



1x
6307452



5x
4177932



5x
4159007



2x
4620693



3x
4125278



1x
4158355



4x
6177499



4x
6403225



4x
6177490



2x
6173925



8x
6510077



2x
4118828



4x
6433114



4x
6433119



4x
6218367



2x
6220713



2x
6212007



1x
4539061



2x
4211252



1x
4211186



1x
6470170



1x
6271165



10x
6362975



2x
6043639



1x
4211725



1x
4164037



1x
6398662



3x
4226221



2x
6227909



1x
4535930



2x
4225733



1x
6083620

4



1x
6230082



1x
4654128



4x
6177535



2x
6167642



1x
6240553



LEGO.com/service

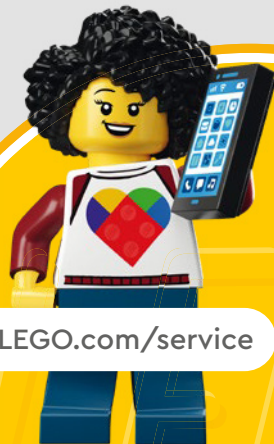

YOU COULD
WIN

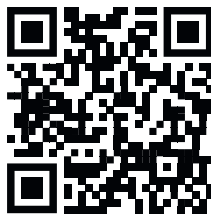

Scan this QR code or go to
LEGO.COM/PRODUCTFEEDBACK and give
us your short feedback about this LEGO® set
for a chance to win a cool LEGO prize.

Terms and Conditions apply*

EN: YOU COULD WIN. Terms and Conditions apply* **DE: Du könntest GEWINNEN.** Es gelten die Teilnahmebedingungen* **FR: Tu pourrais GAGNER.** Des conditions s'appliquent* **IT: Potresti VINCERE tu.** Termini e condizioni sono applicabili* **ES: Puedes GANAR.** Aplican términos y condiciones* **PT: Poderá GANHAR.** Aplicam-se termos e condições* **ZH: 轻松获奖. 条款和条件适用*** **PL: Szansa na WYGRANĄ.** Obowiązują warunki korzystania* **CS: Máte šanci VYHRÁT.** Platí všeobecné smluvní podmínky* **SK: Máte šancu VYHRAŤ.** Platia všeobecné zmluvné podmienky* **HU: TE IS NYERHETSZ.** Felhasználási feltételek érvényesek* **RO: Ai putea CÂȘTIGA.** Se aplică termenii și condiții* **BG: Можете да СПЕЧЕЛИТЕ.** Има определени правила и условия* **LV: Tu vari LAIMĒT.** Ir spēkā noteikumi un nosacījumi.* **ET: Sul on võimalus VÕITA.** Kehtivad tingimused* **LT: Jūs galite LAIMĖTI.** Taikomos sąlygos*

*[LEGO.com/productfeedback-terms](https://www.lego.com/productfeedback-terms)

LEGO and the LEGO logo are trademarks of the/son des marques de commerce du/son marcas registradas de LEGO Group. ©2025 The LEGO Group.

Jurassic World franchise © Universal City Studios LLC and Amblin Entertainment, Inc. Series © DreamWorks Animation LLC. All Rights Reserved.

6560060