



Disney

43275



3



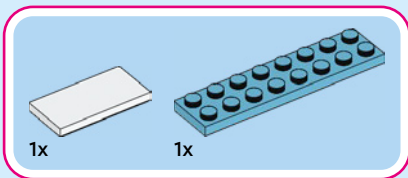
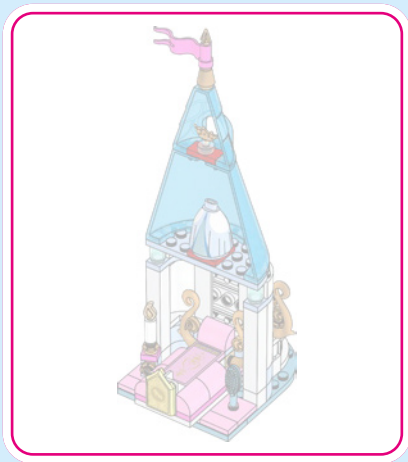

1

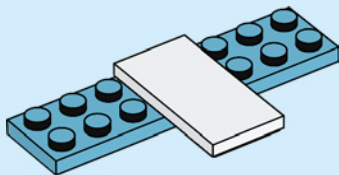

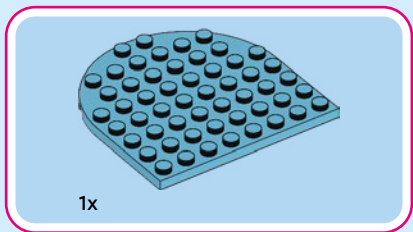

2

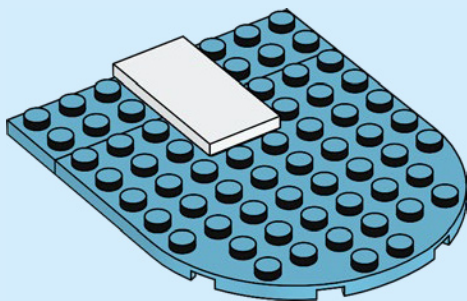



2x

3

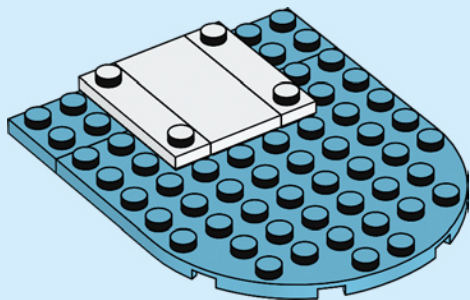



2x



2x

4

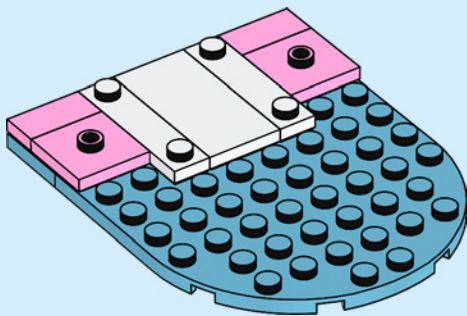



1x



2x

5

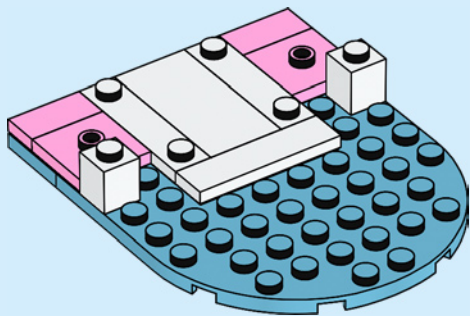

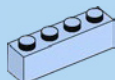

1x



2x

6

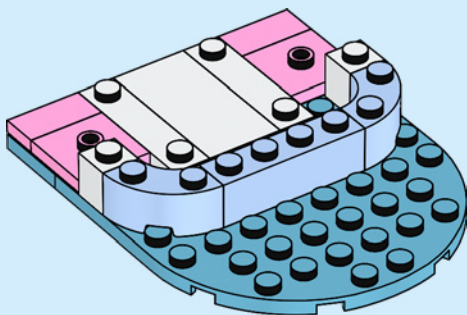



1x



2x

7

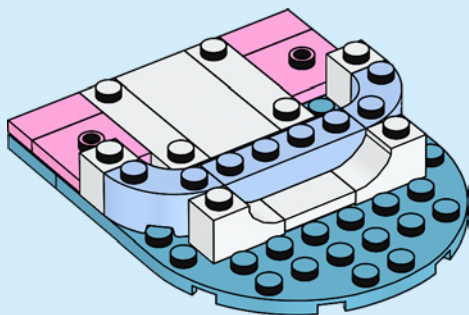



2x



1x

8

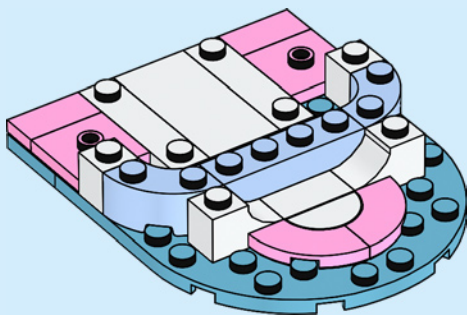

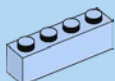

1x



2x

9

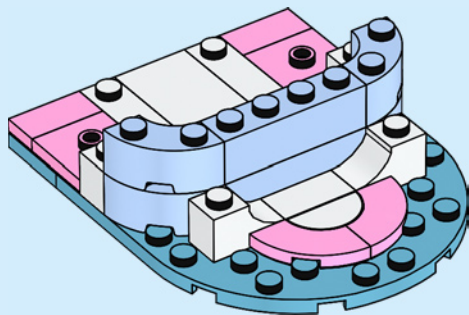



2x

10

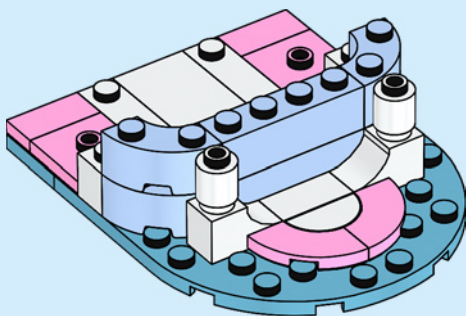



2x

11

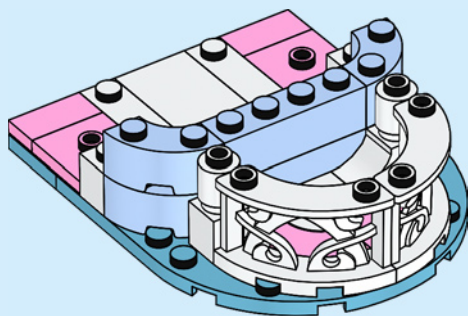



2x

12

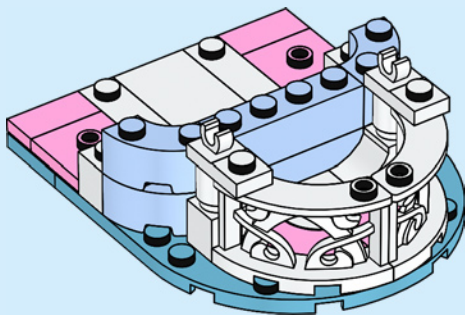



4x

13

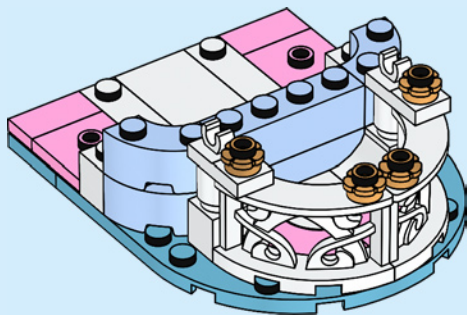

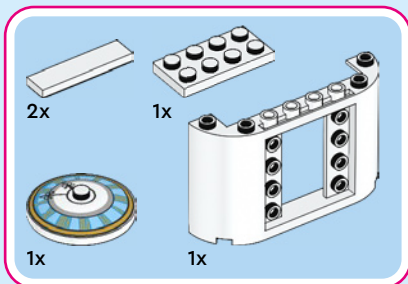
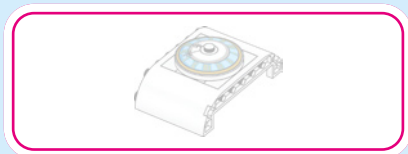

14

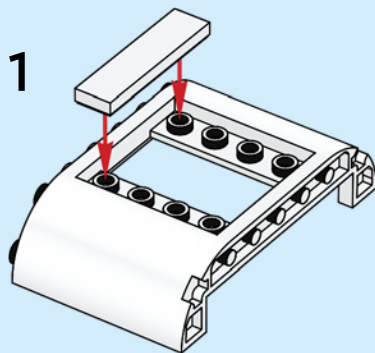

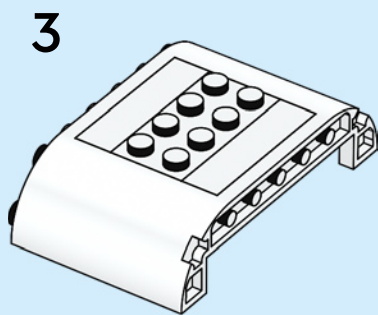
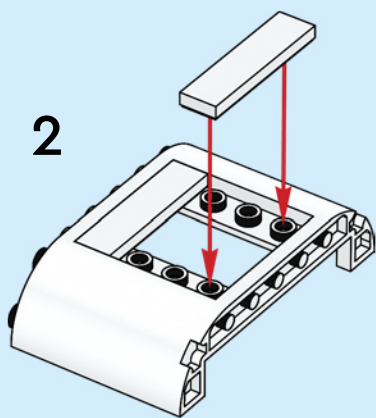

4

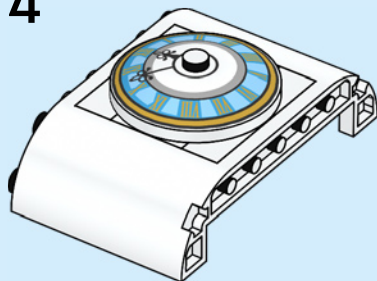

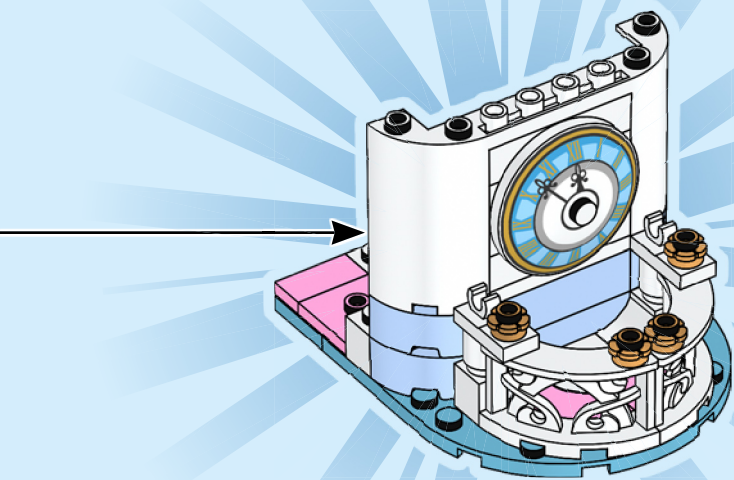



2x

15

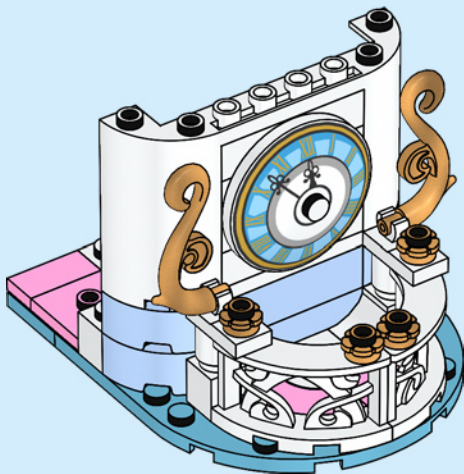

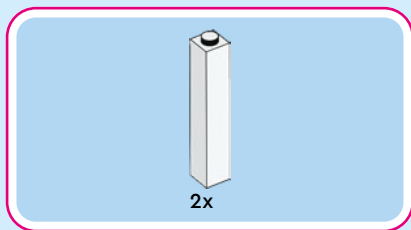

16

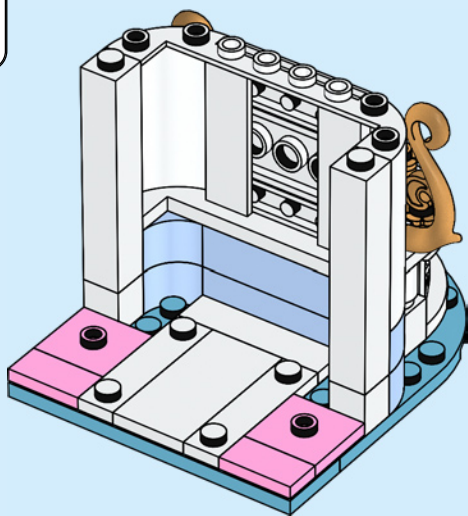



1x



2x

17

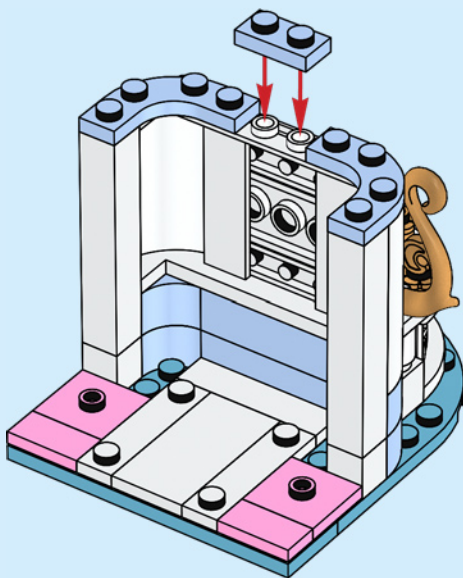

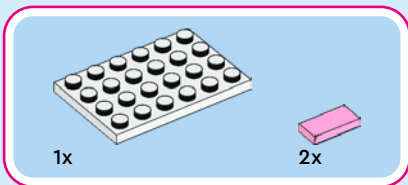
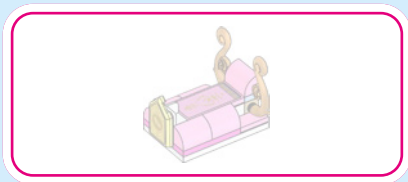

18

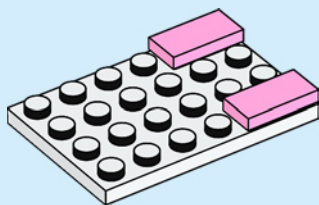



2x

19

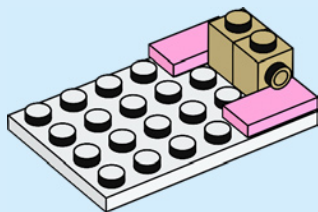



2x

20

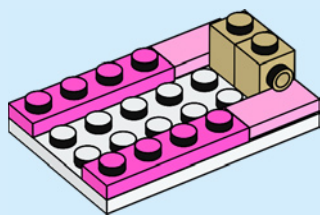



1x



1x

21

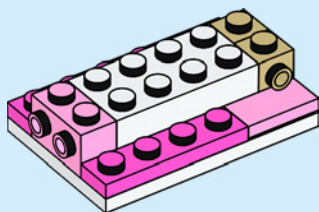



1x

22

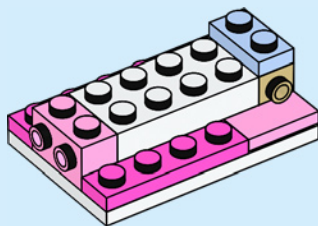



1x

23

1

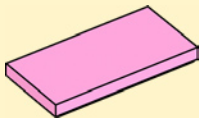

2

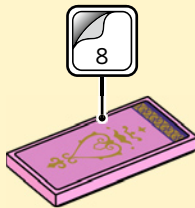



4x

24





1x



1x

25

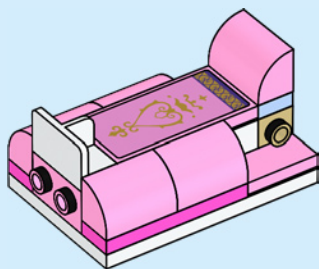



2x

26

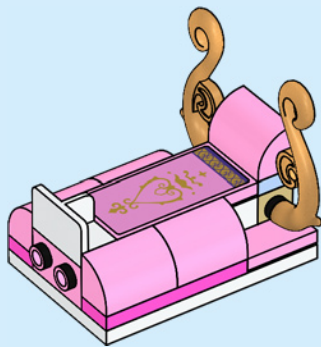



1x

27

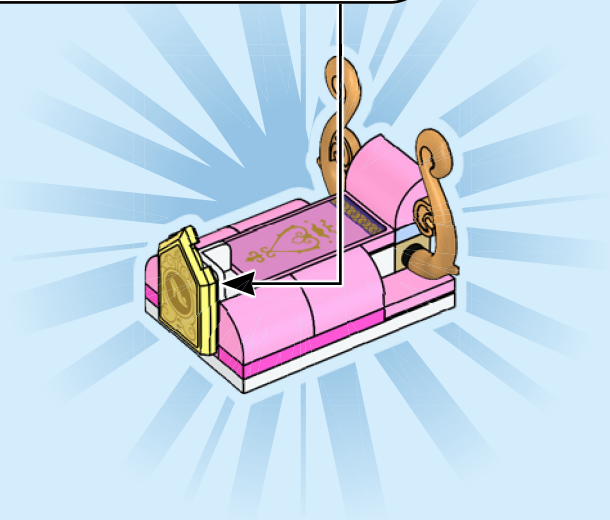
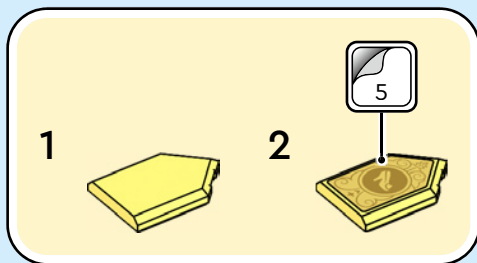

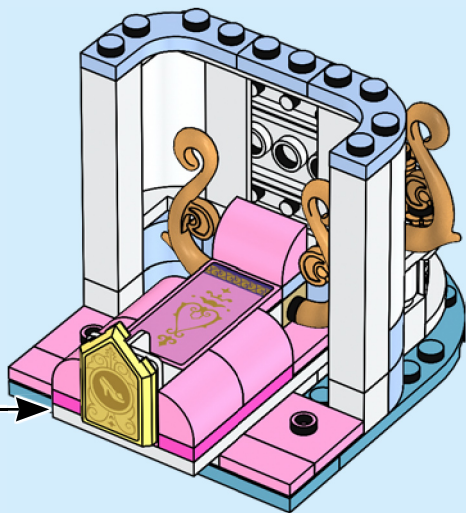



2x



1x



1x



1x



1x

29

1



2



3

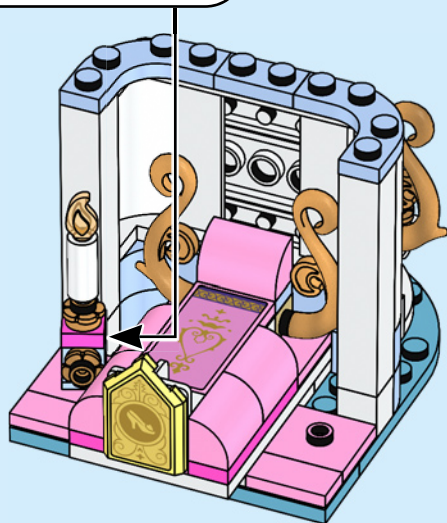



1x

30

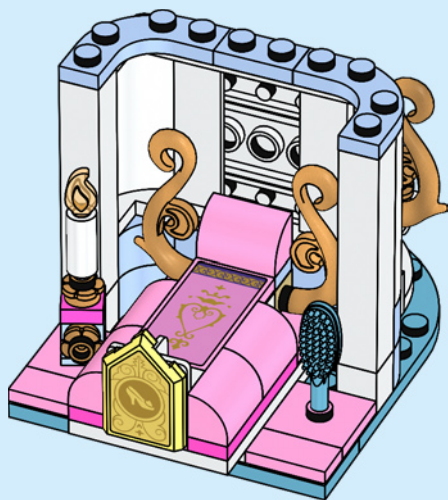



1x

31

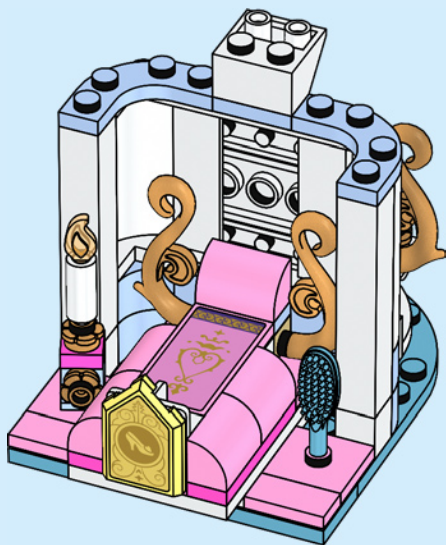



2x



4x

32

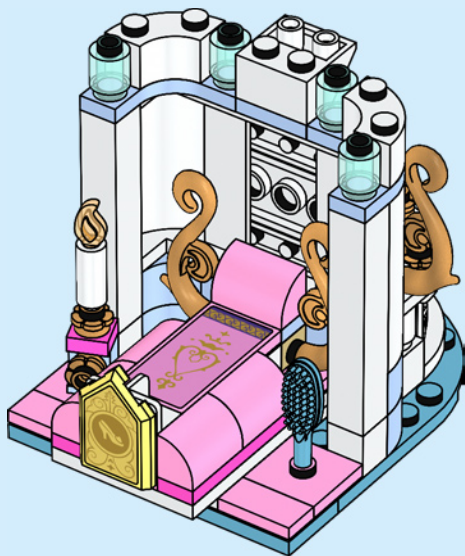

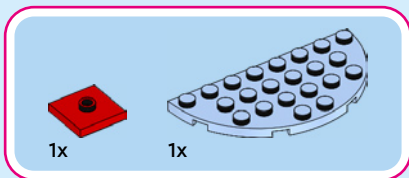

33

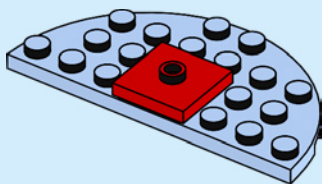

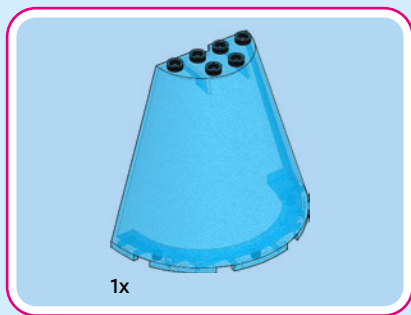

34

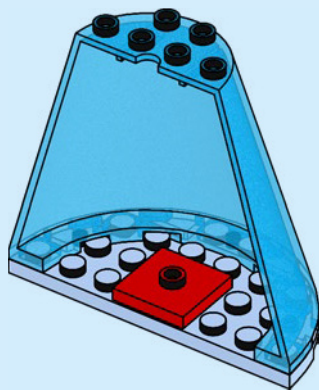



1x



1x

35

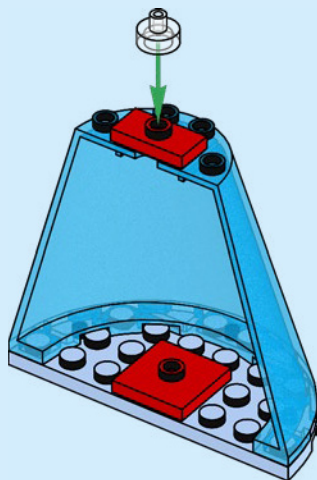



1x

36

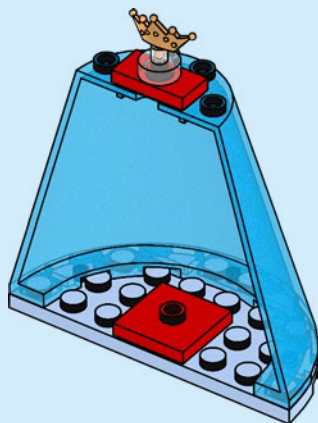



1x

37

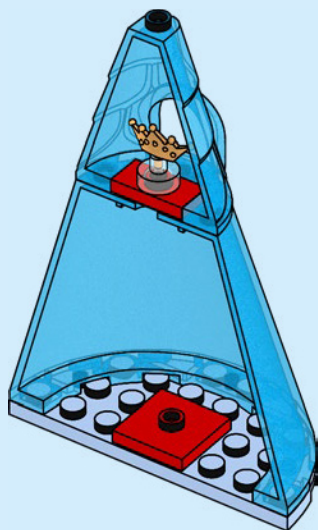



1x



1x



1x

38

1

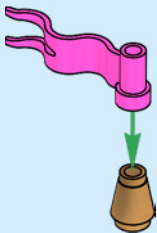

2

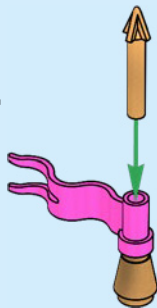

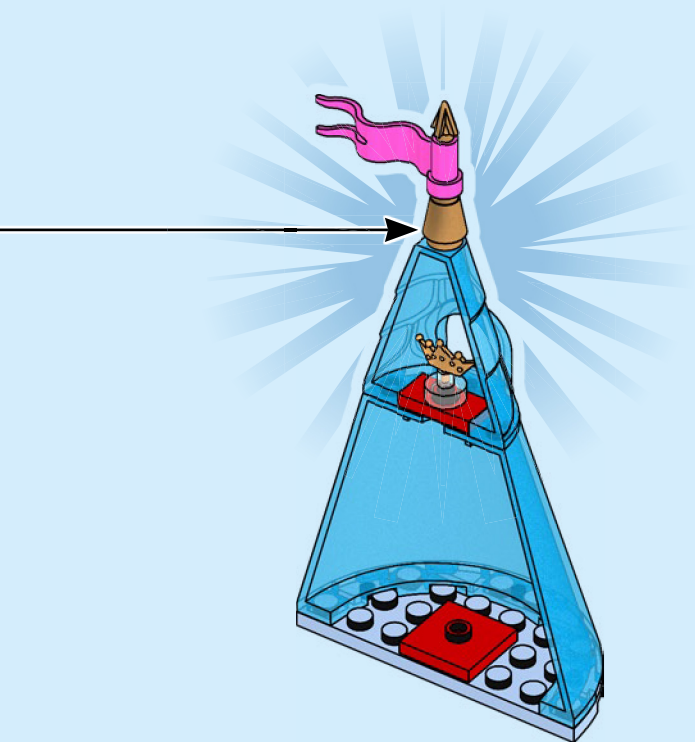



1x

41

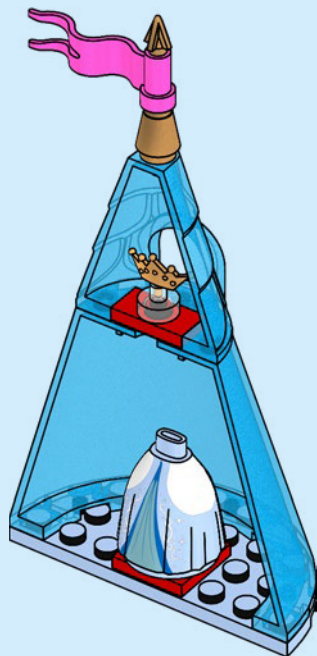

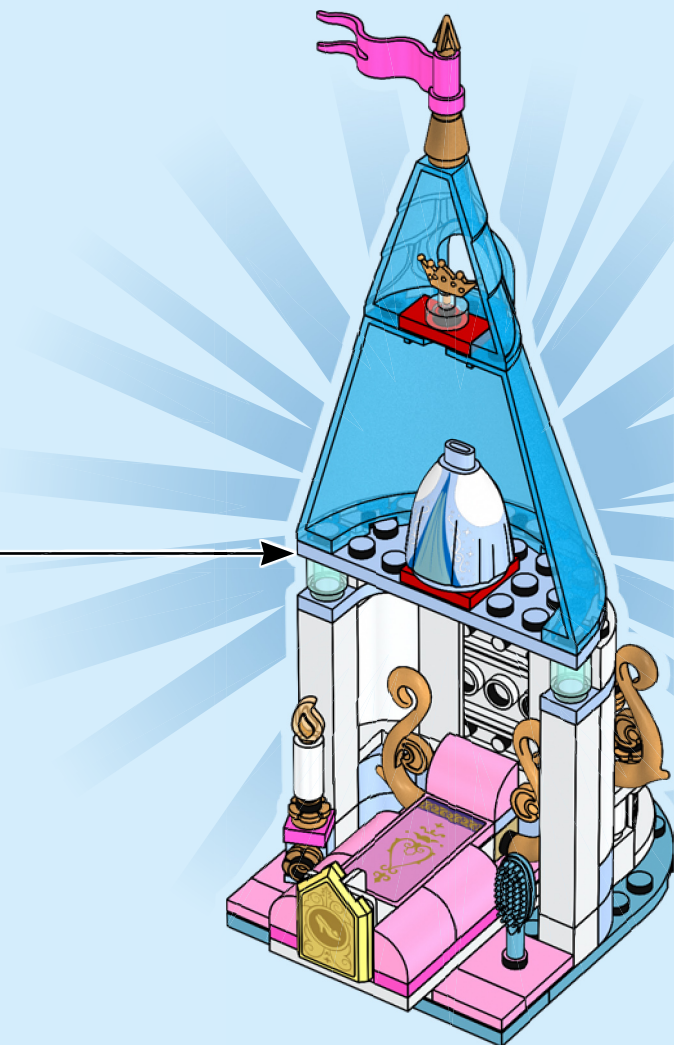

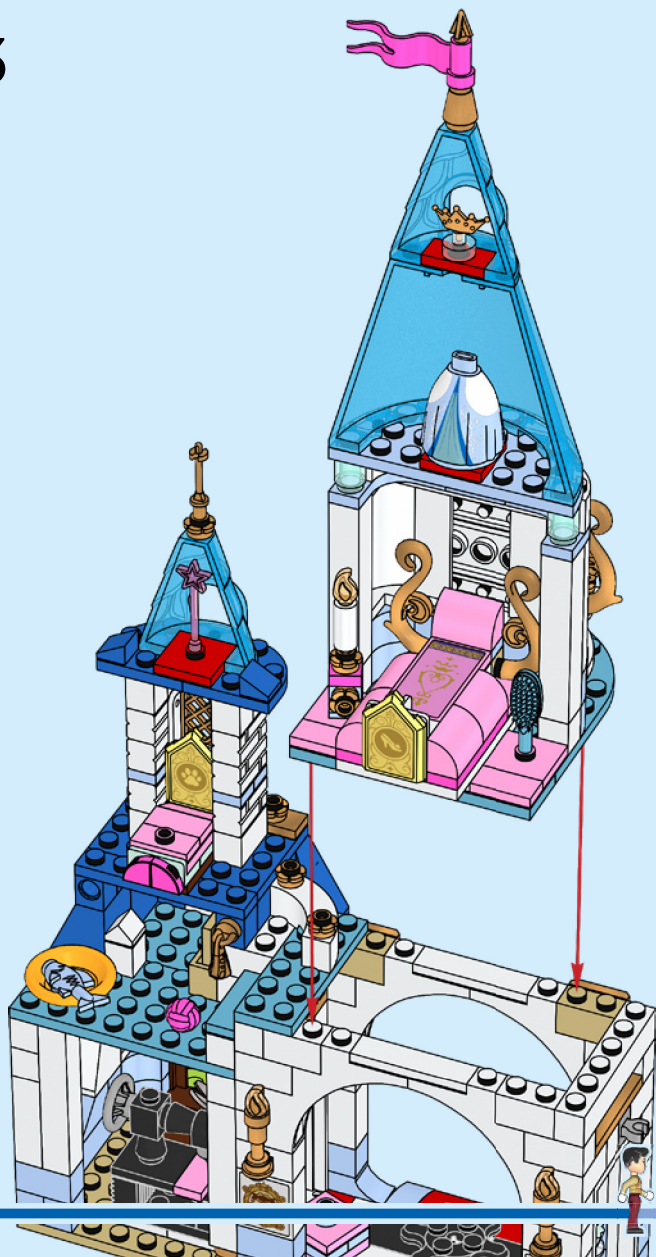

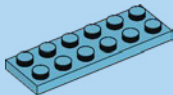

1x

44

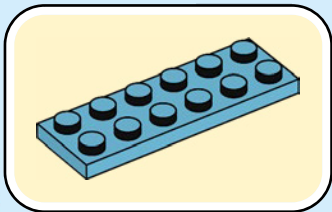

43



3



4



LEGO

Disney

Disney
ENCANTO

43261



Disney
PRINCESS

43259



Disney
MOANA 2

43260



43270



[LEGO.com/disney](https://www.lego.com/disney)

Disney
PRINCESS

43275



Disney
FROZEN

43265



43256



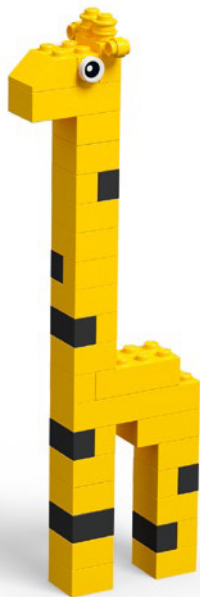
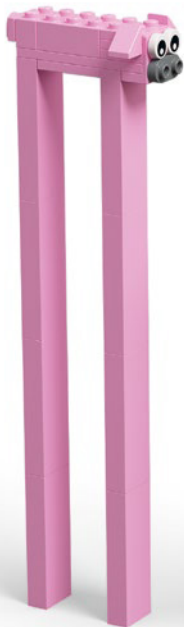

Rebuild
the
World™



LEGO and the LEGO logo are trademarks of the LEGO Group.
©2025 The LEGO Group. 6559854
©Disney