



MARVEL

76314



Q LEGO® Builder



Get excited about our new packaging!

We're switching from plastic to paper-based packaging. That's why you might find a mix of paper and plastic in our boxes!

Nos nouveaux emballages vous emballeront !

Nous passons des emballages en plastique aux emballages à base de papier. C'est pourquoi vous pourriez trouver un mélange de papier et de plastique dans nos boîtes !

¡Te presentamos nuestros nuevos empaques!

Estamos sustituyendo las bolsas de plástico por bolsas con base de papel. ¡Por eso, puedes encontrar una mezcla de papel y de plástico en nuestras cajas!

[LEGO.com/sustainable-packaging](https://www.lego.com/sustainable-packaging)



BUILDER



Apple and the Apple logo are trademarks of Apple Inc., registered in the U.S. and other countries and regions. App Store is a service mark of Apple Inc. Google Play and the Google Play logo are trademarks of Google LLC. Tencent and the Tencent logo are trademarks of Tencent Inc.



EN Ask parents' permission before going online | **DE** Eltern um Erlaubnis bitten, bevor du online gehst | **FR** Demande l'autorisation d'un parent avant d'aller en ligne | **IT** Chiedi il permesso ai tuoi genitori prima di andare online | **ES** Pídeles permiso a tus papás antes de conectarte a Internet | **PT** Peça autorização aos pais antes de acederes online | **ZH** 上网前应先征得父母的同意 | **PL** Poproś rodziców o zgodę, zanim wejdiesz do Internetu | **CS** Než půjdeš na internet, požádej rodiče o svolení | **SK** Skôr než pôjdeš na internet, vypýtaj si povolenie od rodičov | **HU** Kérj szülői engedélyt, mielőtt online csatlakoznál! | **RO** Cere permisiunea părinților înainte de a te conecta online | **BG** Поискайте разрешение от родител, преди да влезете онлайн | **LV** Pirms došanās tiešsaistē palūdz atļauju vecākiem | **ET** Enne Interneti kasutamist küsi vanematelt luba | **LT** Prieš prisijungdami prie interneto, atsiklauskite tėvų



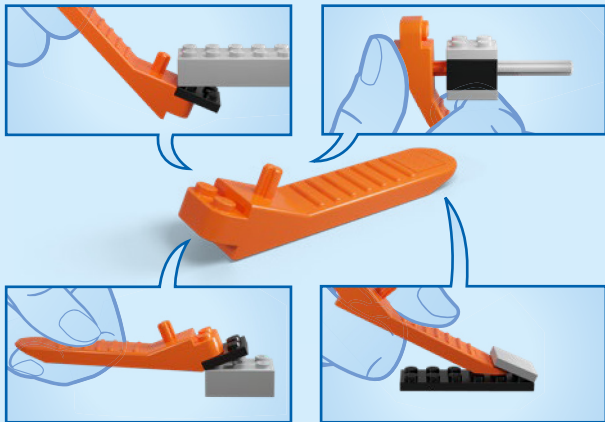



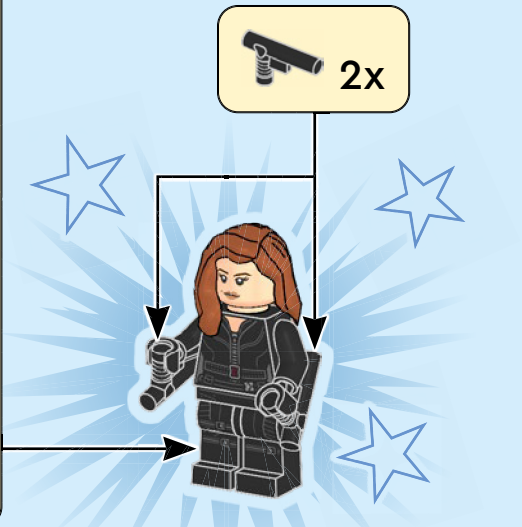
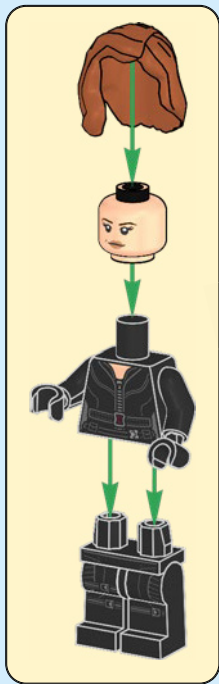

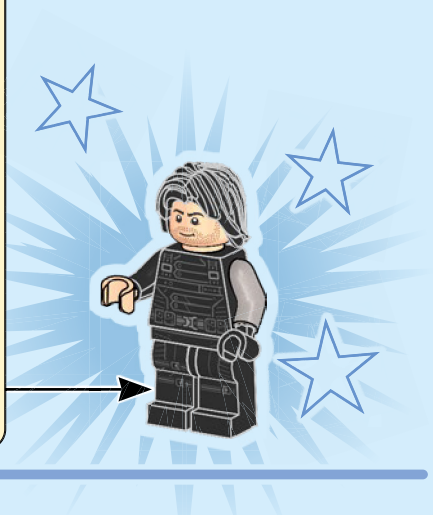
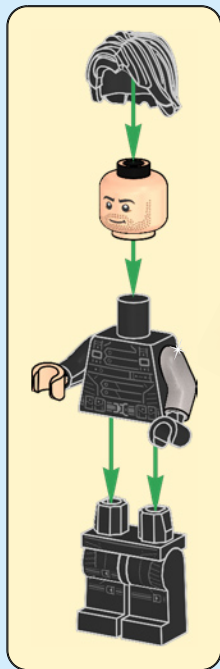

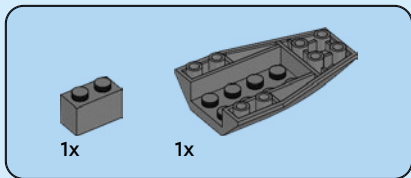

1

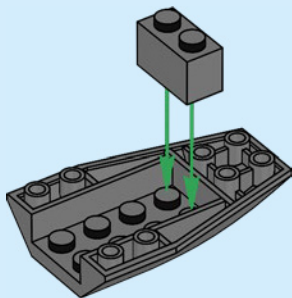

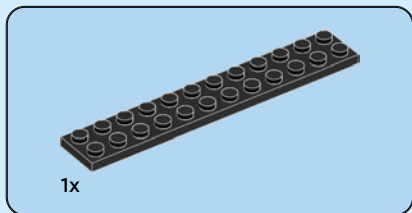

2

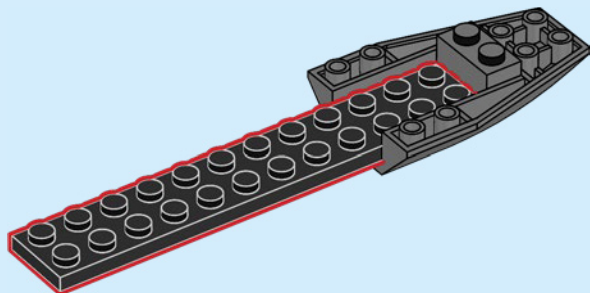



2x



2x

3



2x

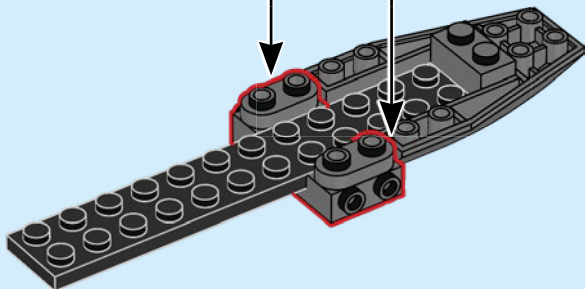

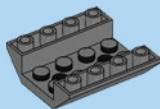

1x

4

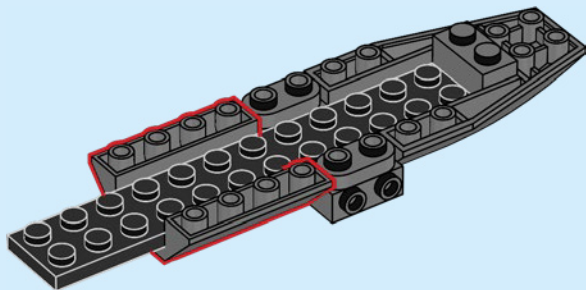



2x

5

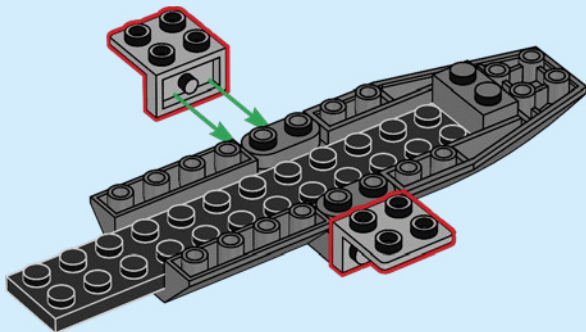

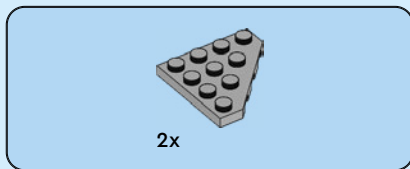

6

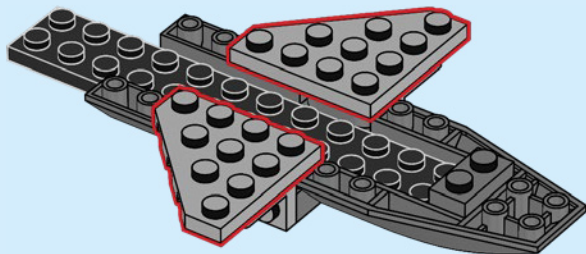

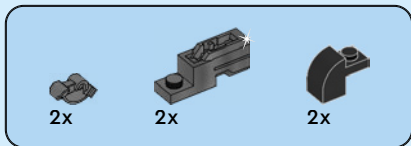

7

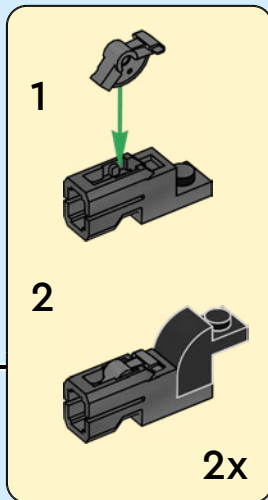
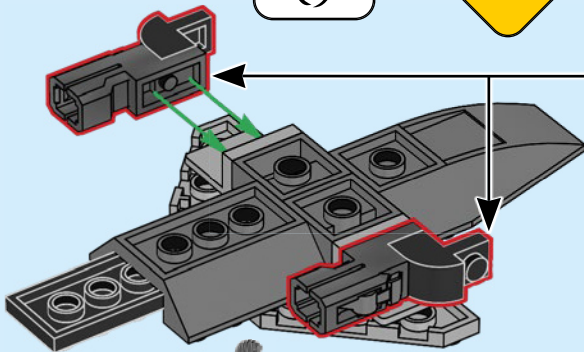



2x

8

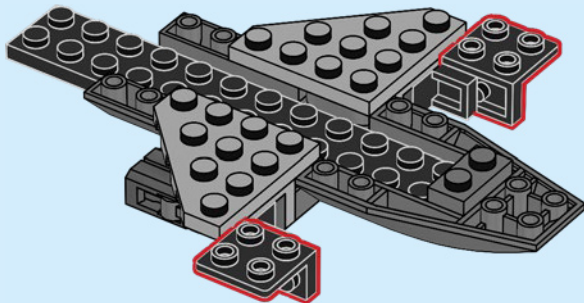

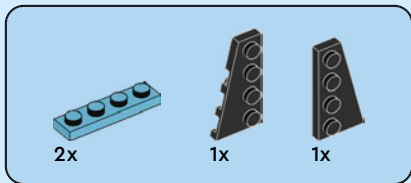

9

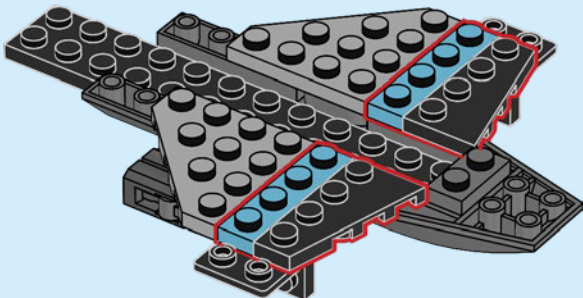



1x

10

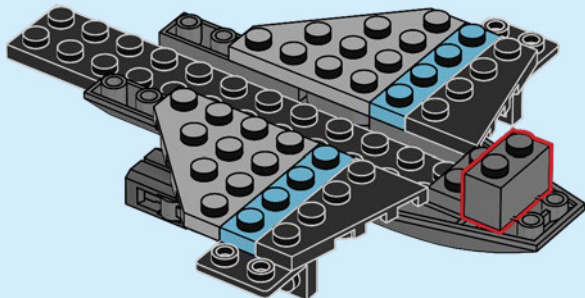



2x

11

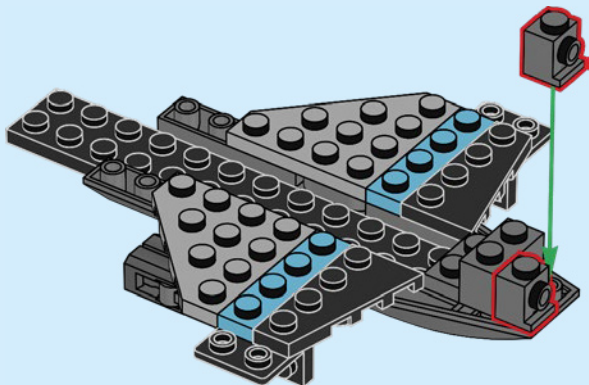



2x

12

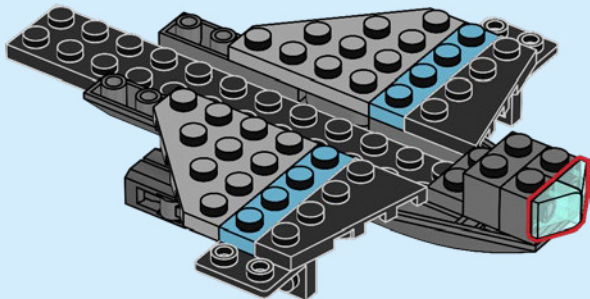



1x

13

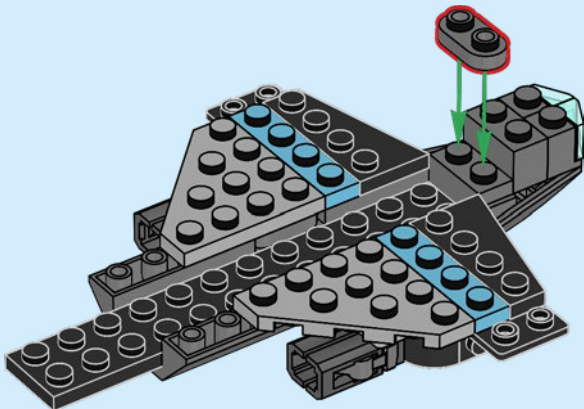



1x

14

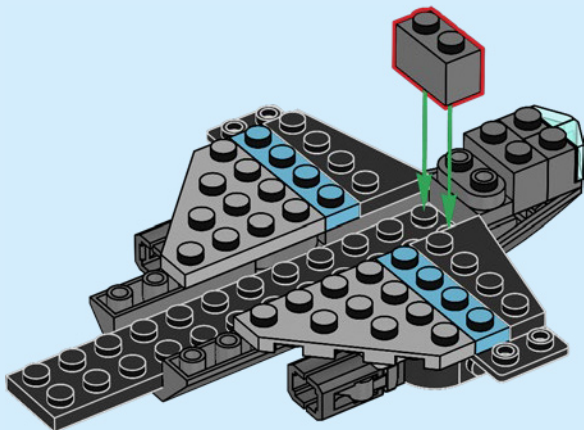



3x

15

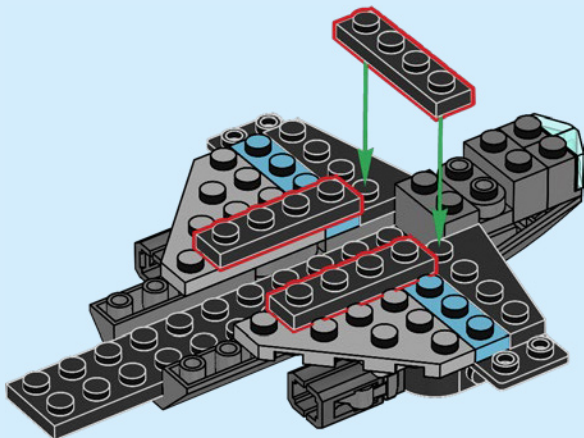



1x



1x

16

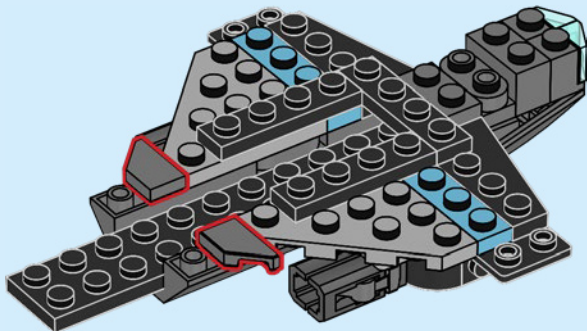



2x



1x



1x

17

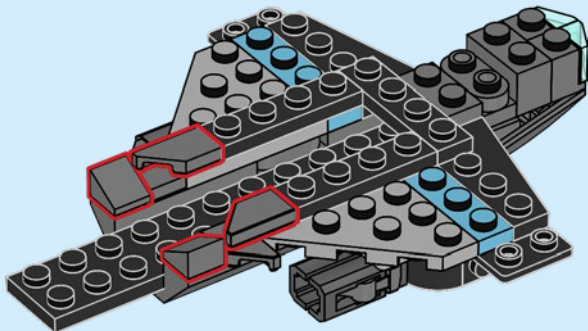



2x



2x

18

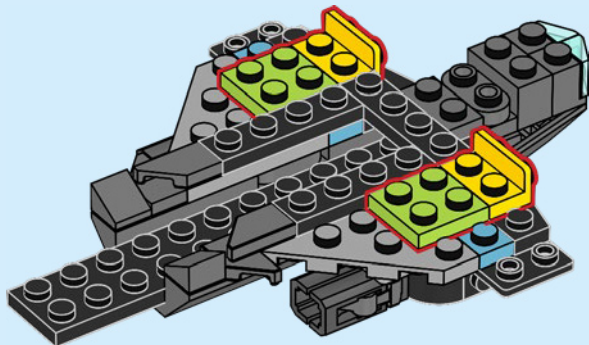



2x

19

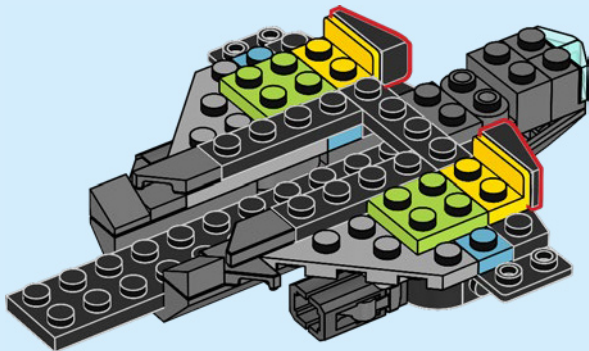

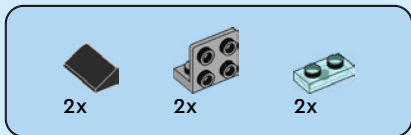

20

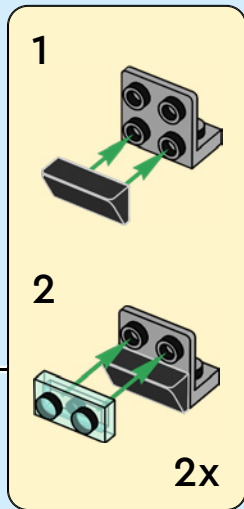
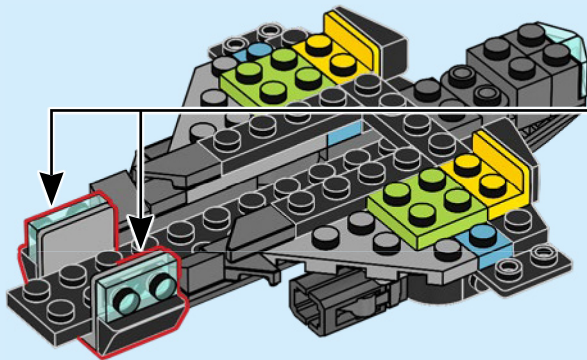



2x



1x



1x

21

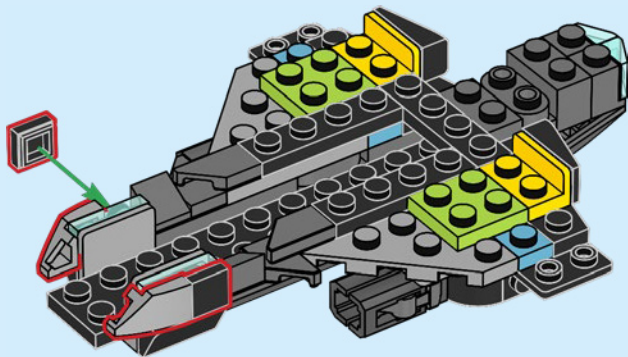



1x

22

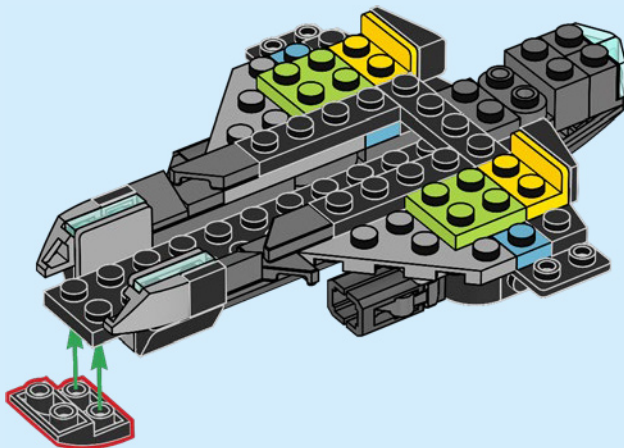



1x

23

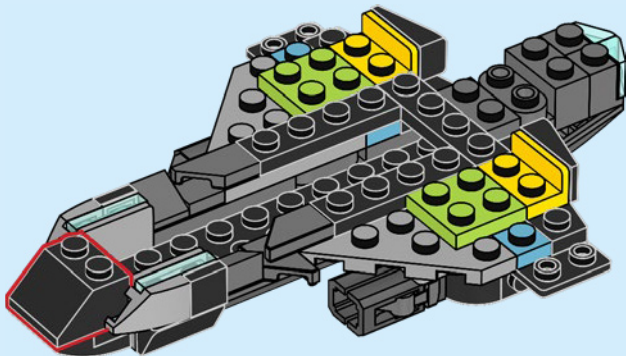

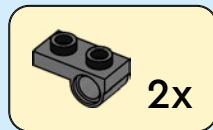
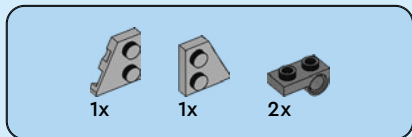

24

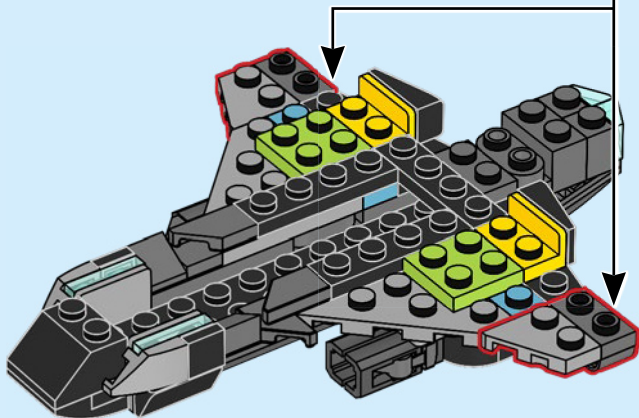



2x

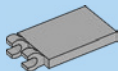

2x

25

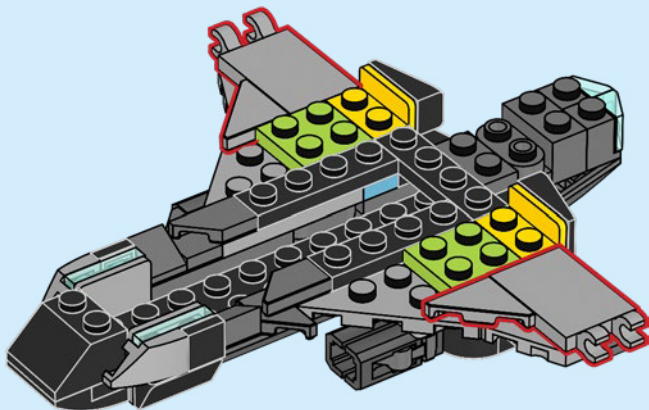

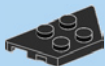

1x



1x

26

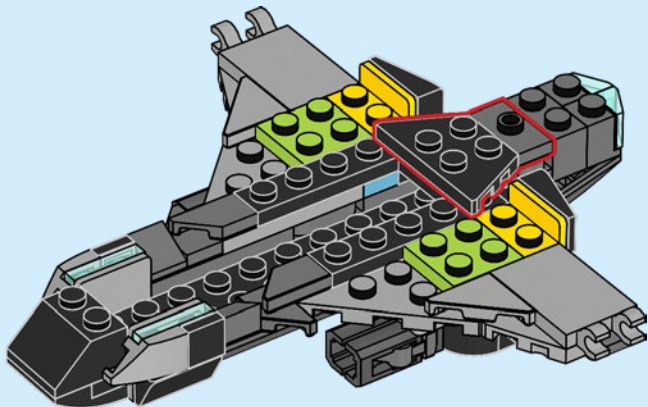



1x



2x

27

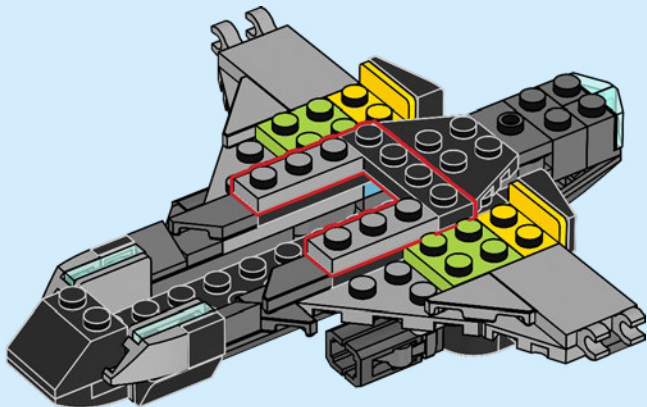



2x

28

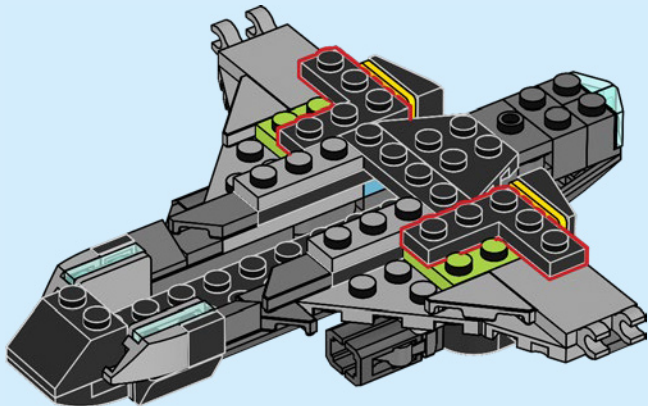



2x

29

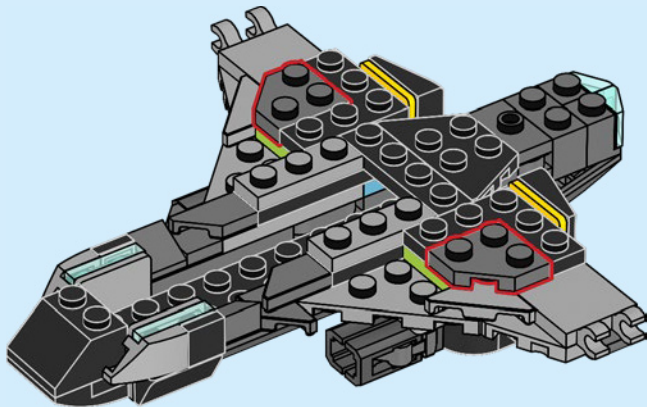



2x



2x

30

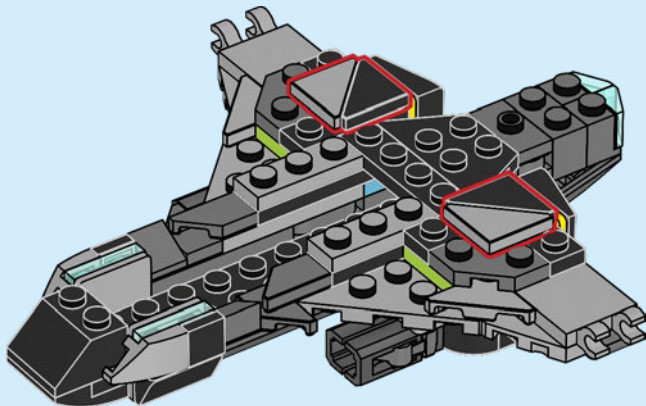

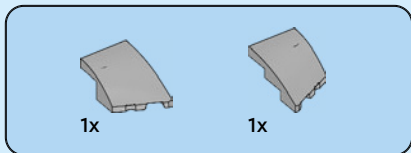

31

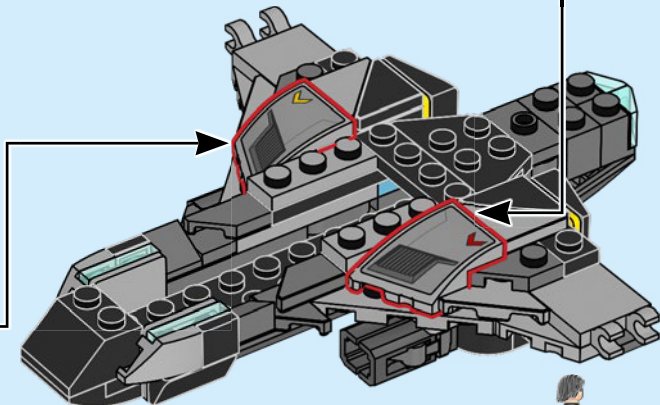
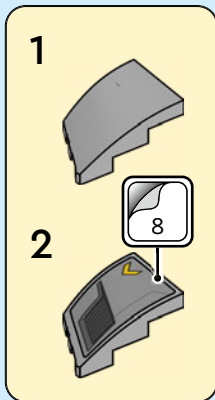
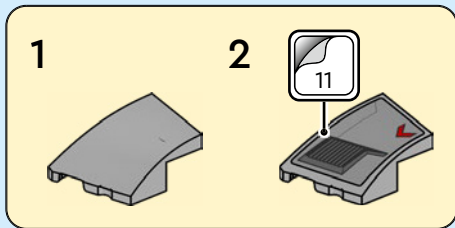



2x

32

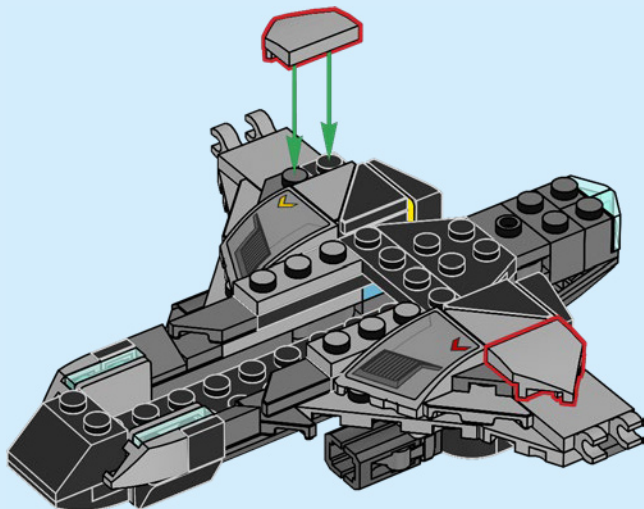

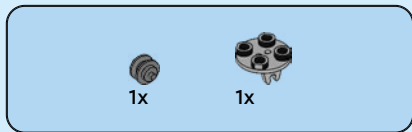

33

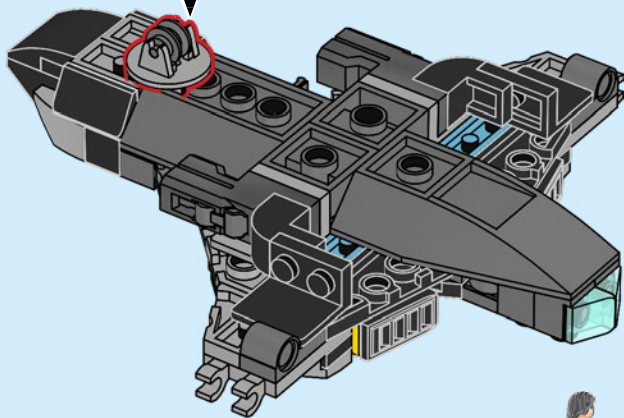
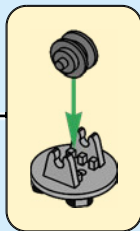
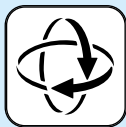



1x

34

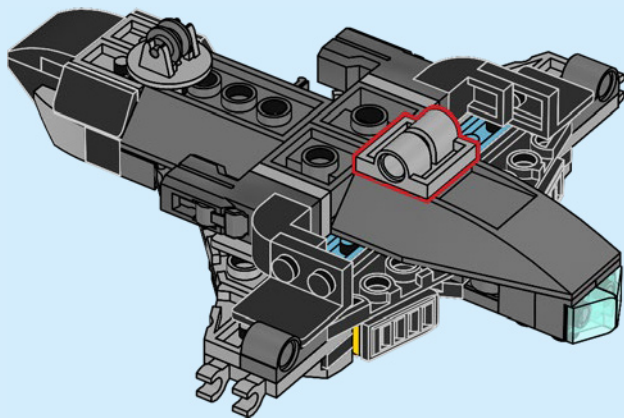

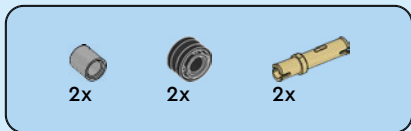

35

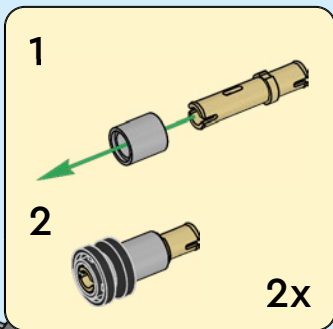
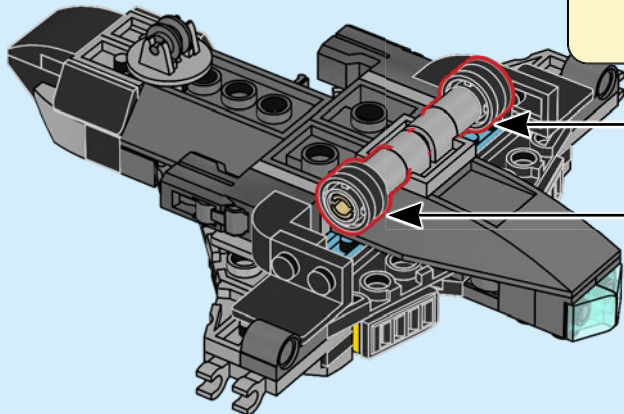



1x

36

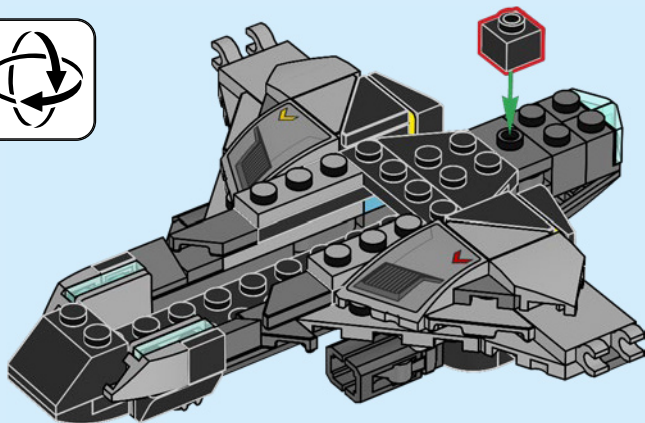



1x

37

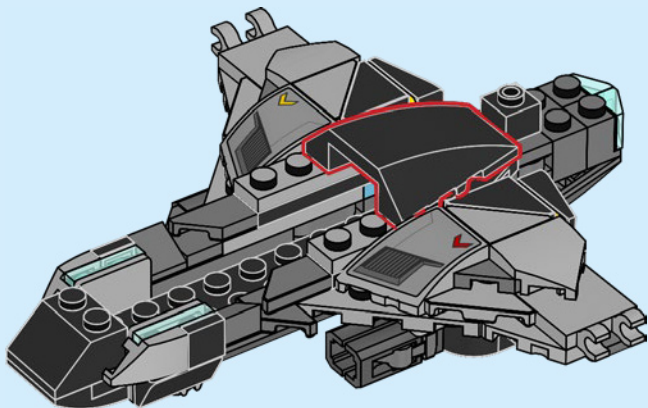



2x

38

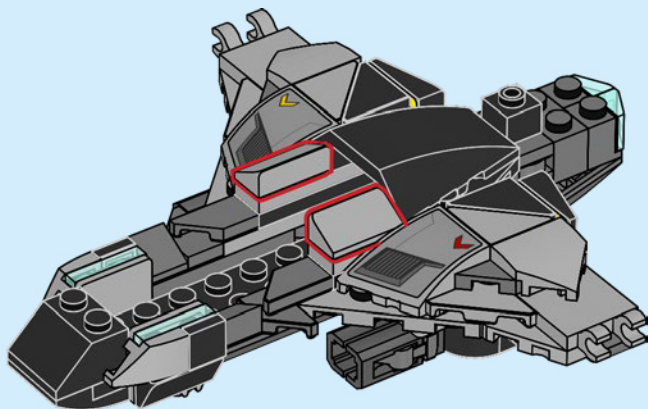



1x



1x

39

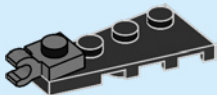



1x



1x

40



1x

41

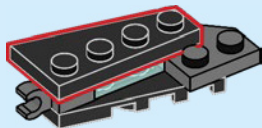



1x



1x

42

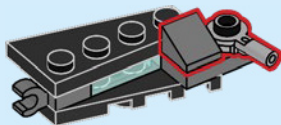



1x



1x

43

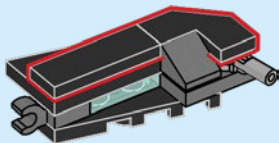

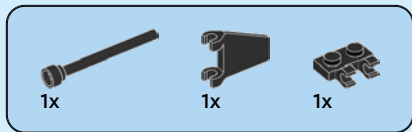

44

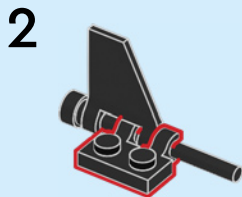
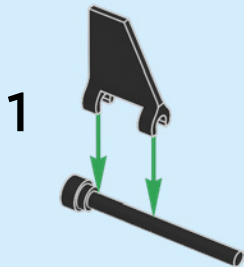

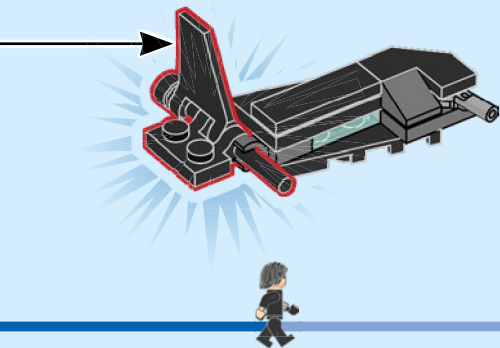

45

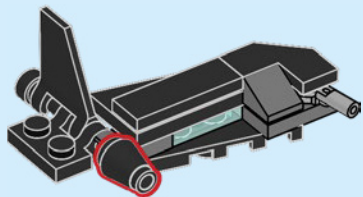

46

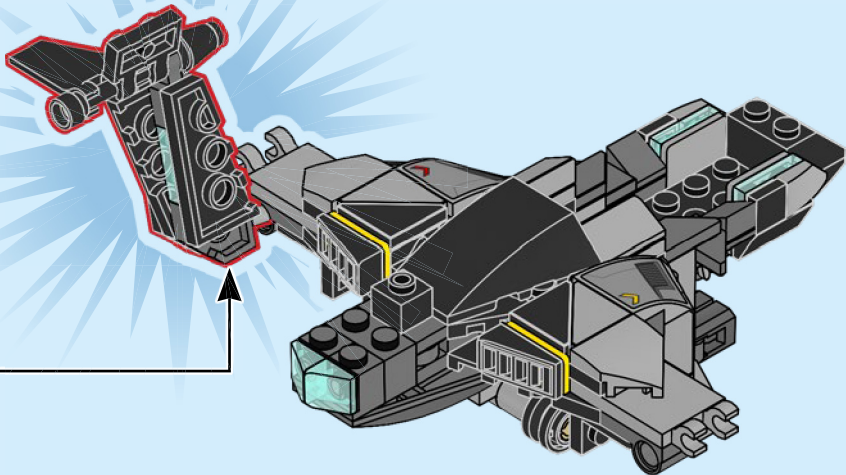

47

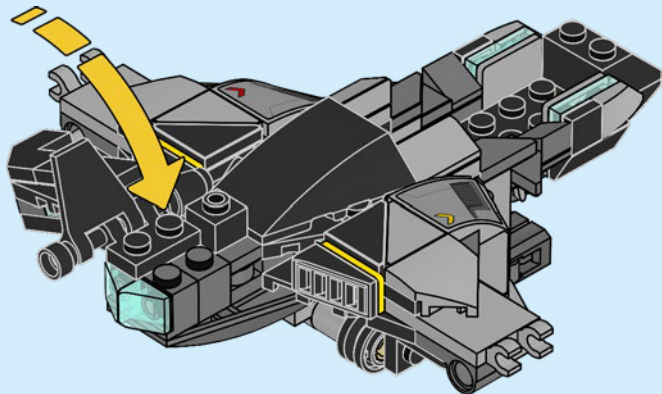



48

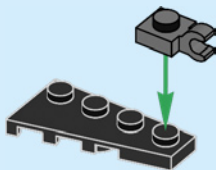



1x



1x

49

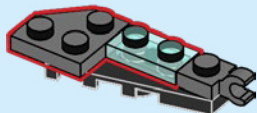

1x

50

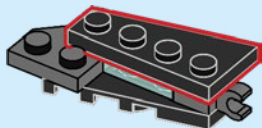



1x



1x

51

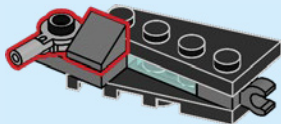



1x



1x

52

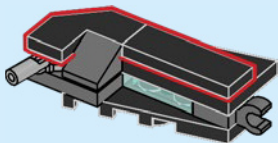



1x



1x



1x

53

1

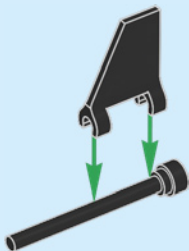

2



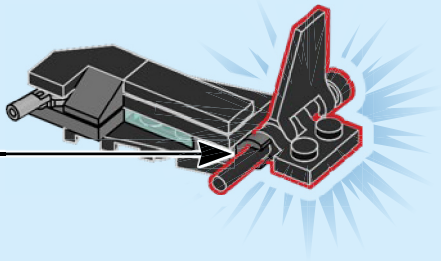



1x

54

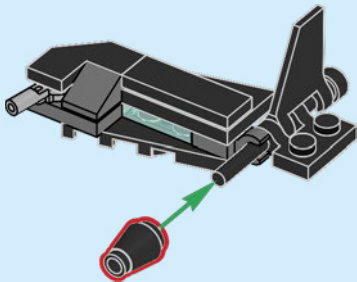

55

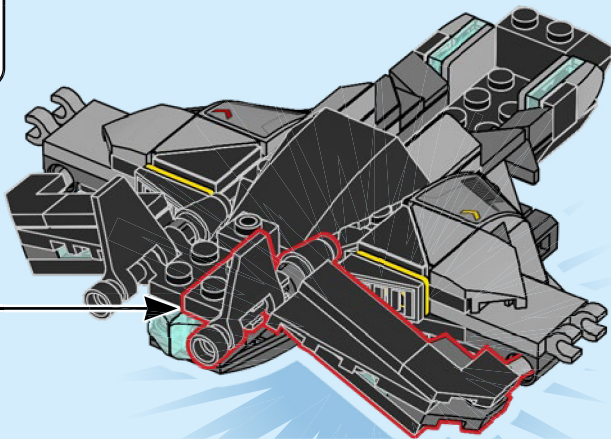
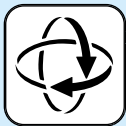



1x



1x

56

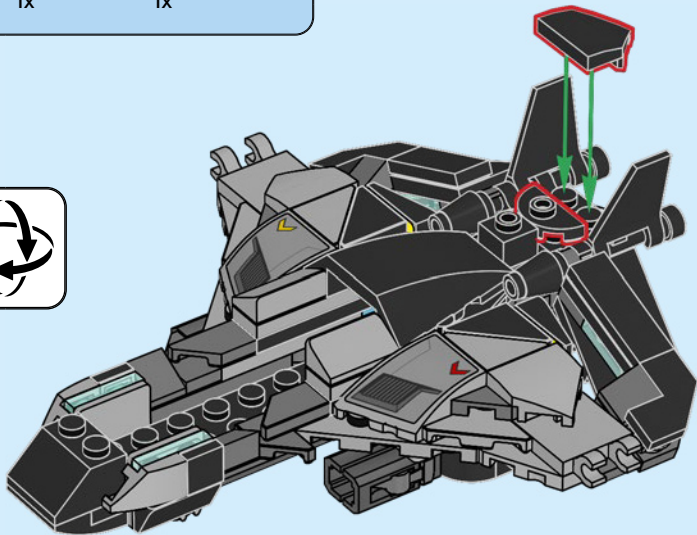
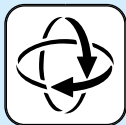



1x

57

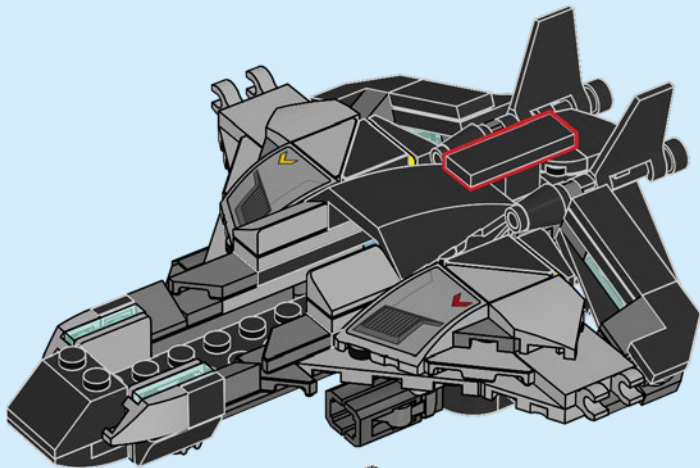

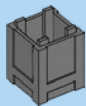

1x

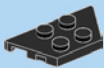

1x

58

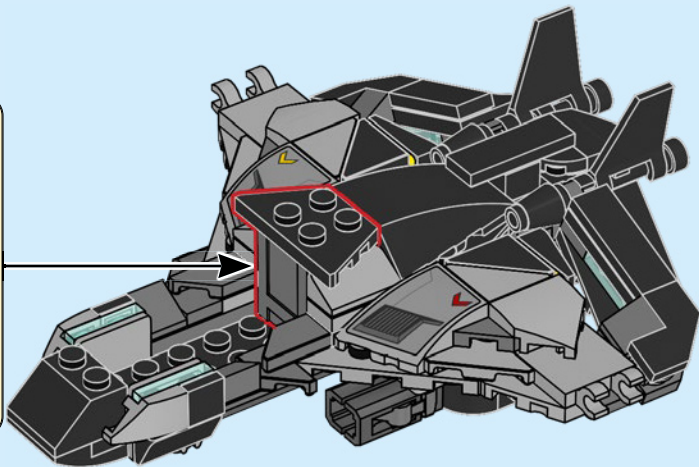
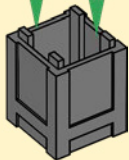
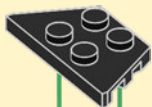

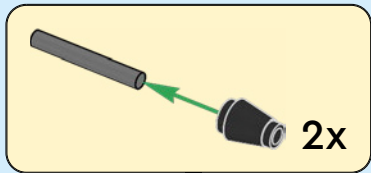
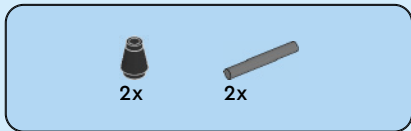

59

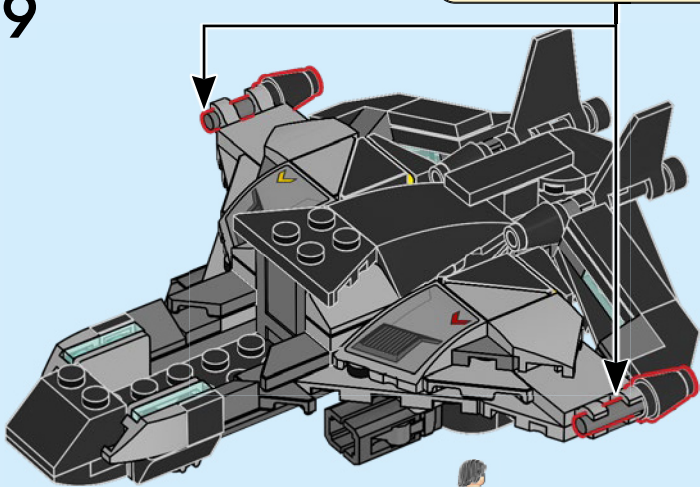

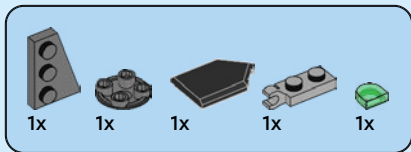

60

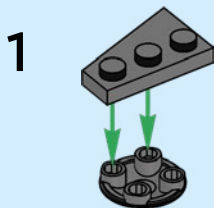

2



3

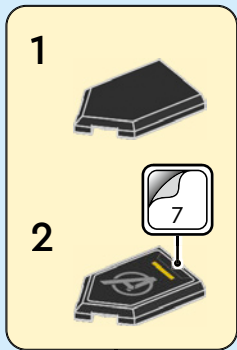
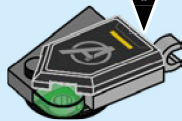

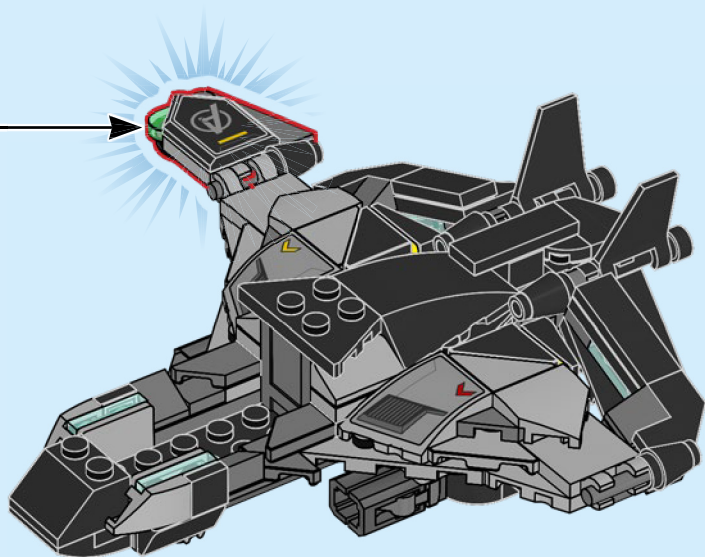



1x



1x



1x



1x



1x

61

1

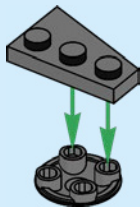

2

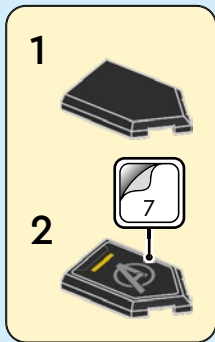
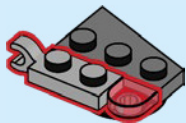

3



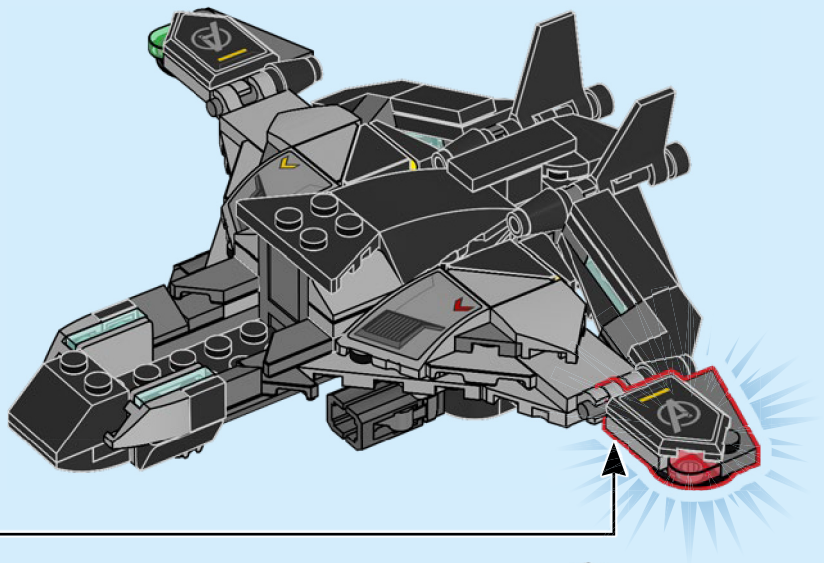

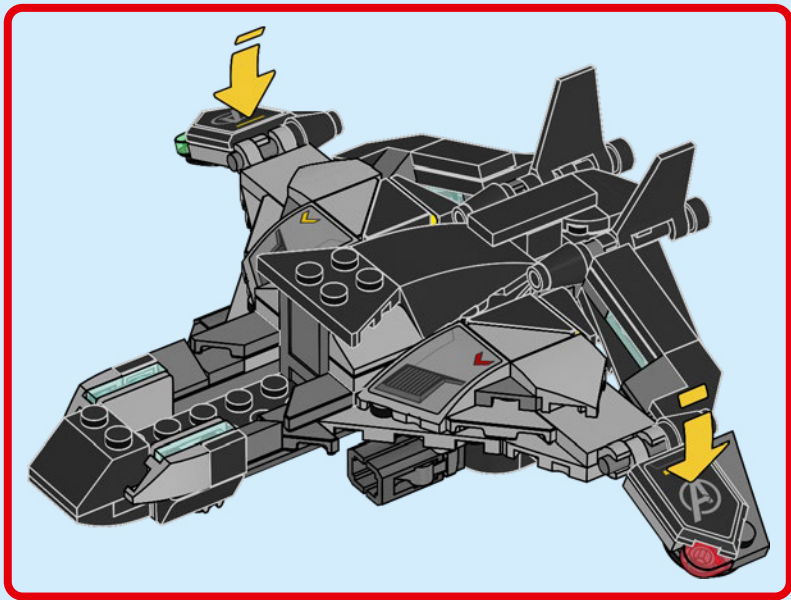

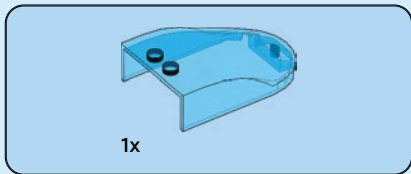

62

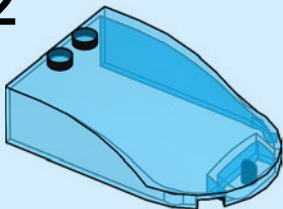

63

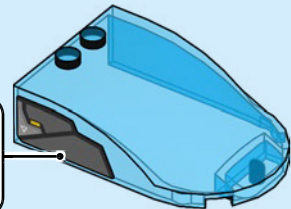

64

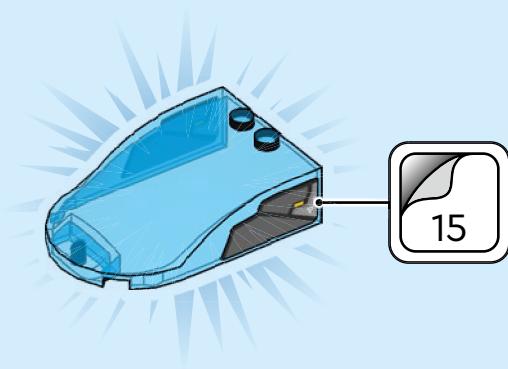

65

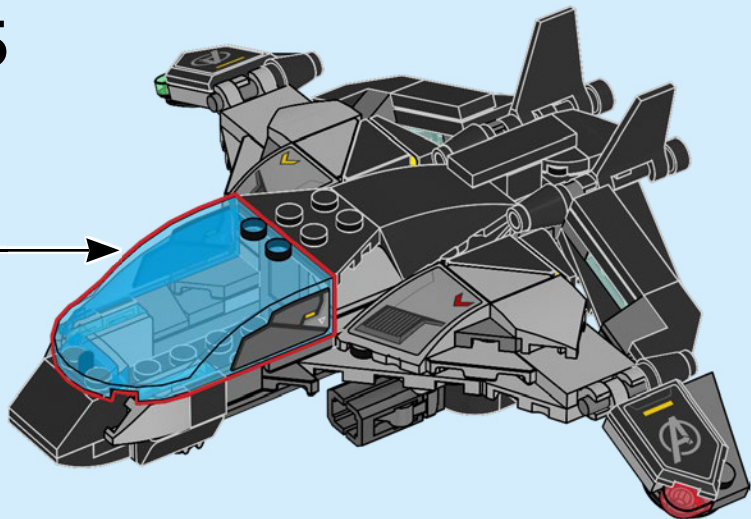



4x

66

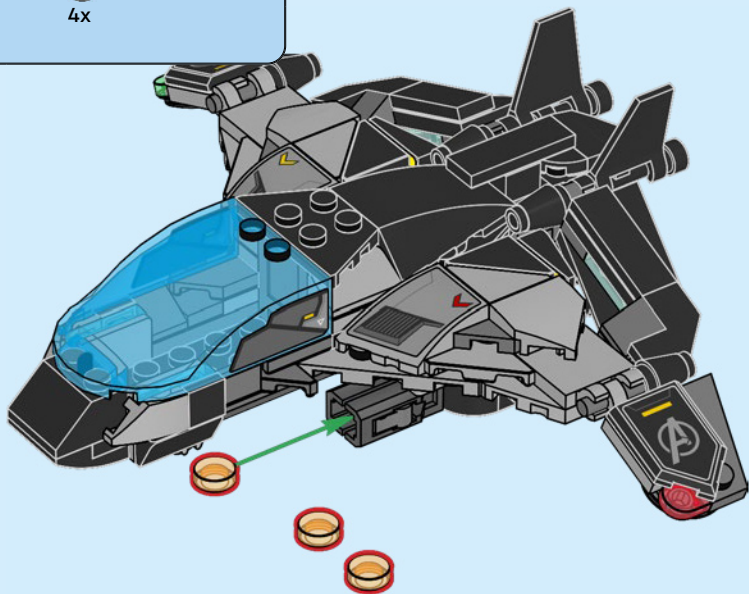

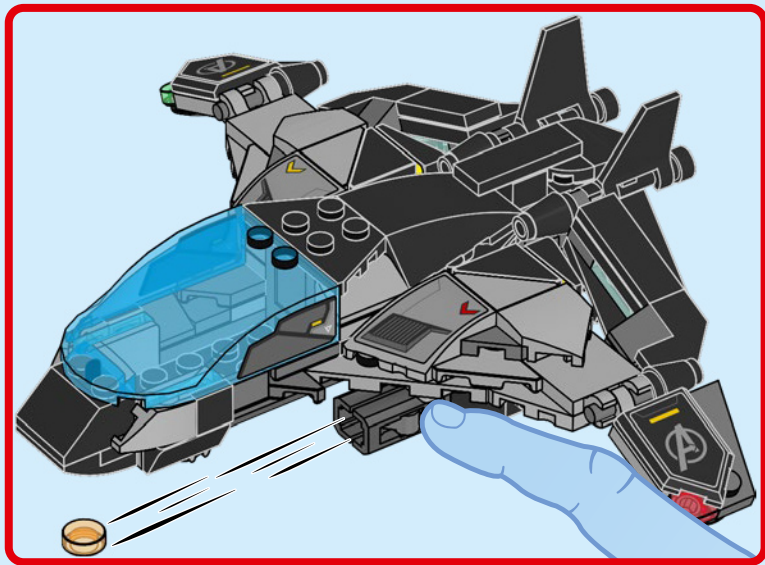

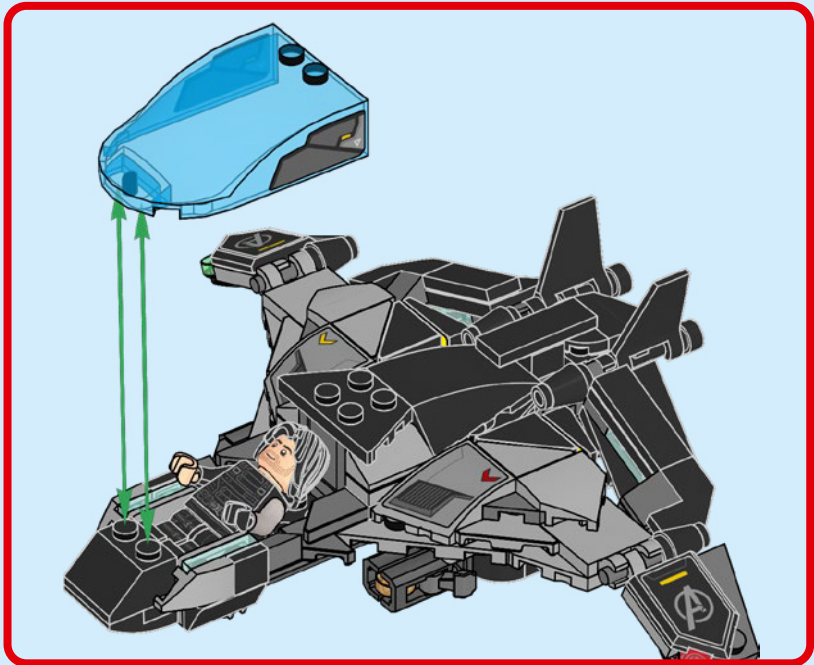

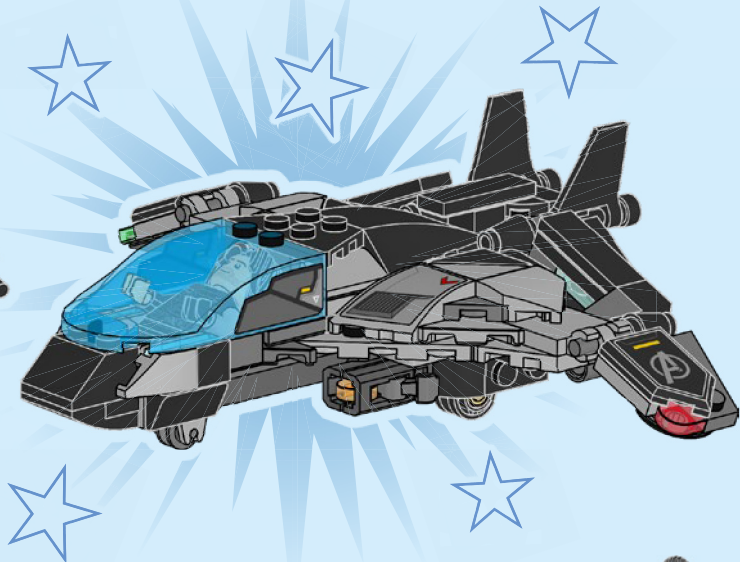



LEGO and the LEGO logo are trademarks of the/son des marques de commerce du/
son marcas registradas de LEGO Group. ©2025 The LEGO Group. 6559656

© 2025 MARVEL

**Rebuild
the
World** 