



MARVEL

76311



LEGO® Builder



Get excited about our new packaging!

We're switching from plastic to paper-based packaging. That's why you might find a mix of paper and plastic in our boxes!

Nos nouveaux emballages vous emballeront !

Nous passons des emballages en plastique aux emballages à base de papier. C'est pourquoi vous pourriez trouver un mélange de papier et de plastique dans nos boîtes !

¡Te presentamos nuestros nuevos empaques!

Estamos sustituyendo las bolsas de plástico por bolsas con base de papel. ¡Por eso, puedes encontrar una mezcla de papel y de plástico en nuestras cajas!

[LEGO.com/sustainable-packaging](https://www.lego.com/sustainable-packaging)

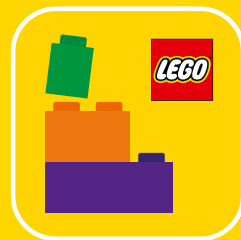

Q LEGO® Builder

BUILDER



Apple and the Apple logo are trademarks of Apple Inc., registered in the U.S. and other countries and regions. App Store is a service mark of Apple Inc. Google Play and the Google Play logo are trademarks of Google LLC. Tencent and the Tencent logo are trademarks of Tencent Inc.

Q [LEGO.com/devicecheck](https://www.lego.com/devicecheck)

EN Ask parents' permission before going online | DE Eltern um Erlaubnis bitten, bevor du online gehst | FR Demande l'autorisation d'un parent avant d'aller en ligne | IT Chiedi il permesso ai tuoi genitori prima di andare online | ES Pídeles permiso a tus papás antes de conectarte a Internet | PT Pede autorização aos pais antes de acederes online | ZH 上网前应先征得父母的同意 | PL Poproś rodziców o zgodę, zanim wejdiesz do Internetu | CS Než půjdeš na internet, požádej rodiče o svolení | SK Skôr než pôjdeš na internet, vypýtaj si povolenie od rodičov | HU Kérj szülői engedélyt, mielőtt online csatlakoznál! | RO Cere permisiunea părinților înainte de a te conecta online | BG Поискайте разрешение от родител, преди да влезете онлайн | LV Pirms došanās tiešsaistē palūdz atļauju vecākiem | ET Enne Interneti kasutamist küsi vanematelt luba | LT Prieš prisijungdami prie interneto, atsiklauskite tėvų

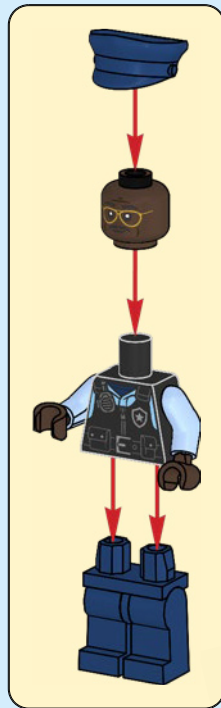
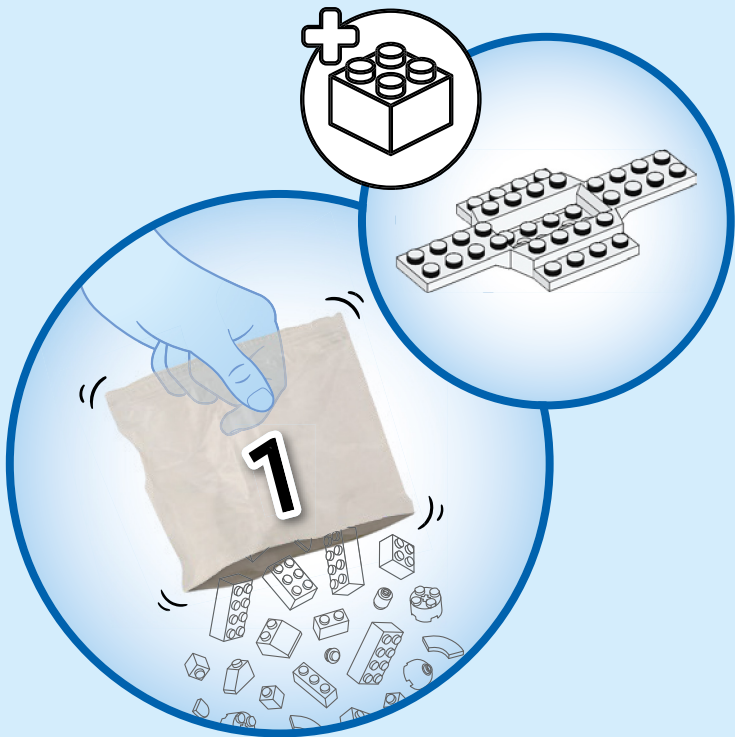

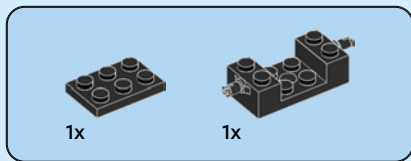

1

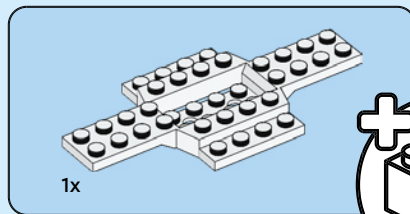
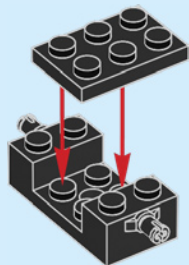

2

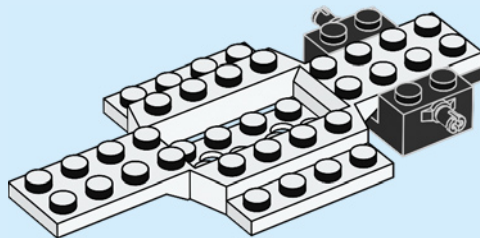
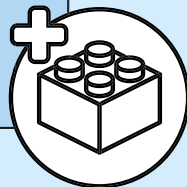

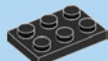

1x

3

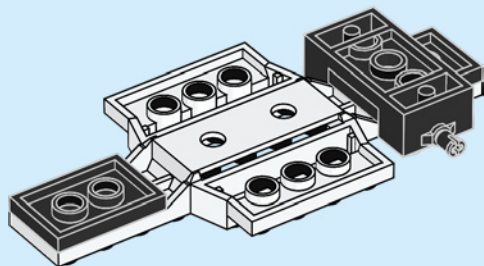
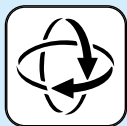

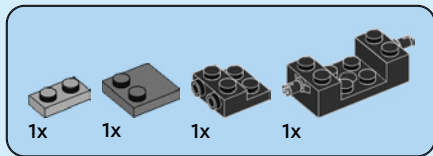

4

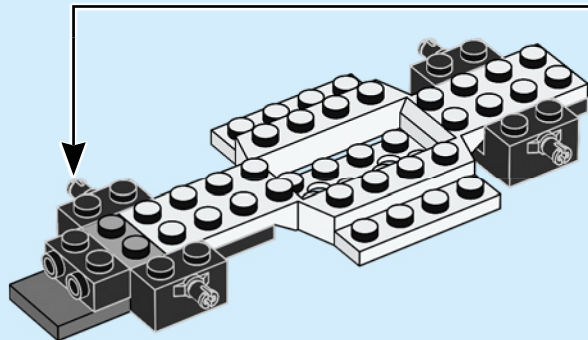
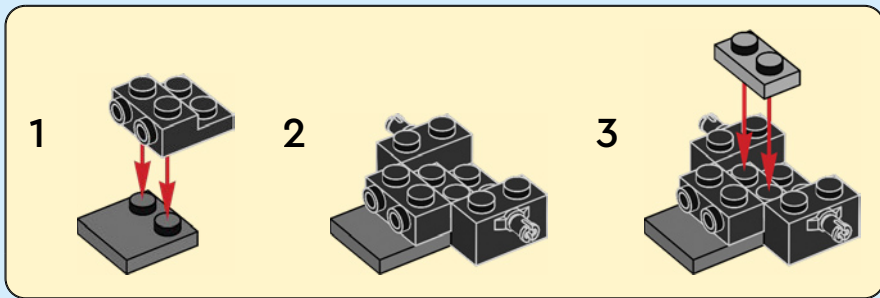



1x

5

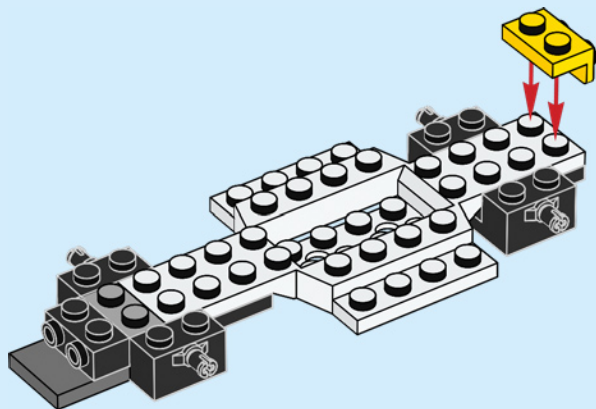



1x



1x

6

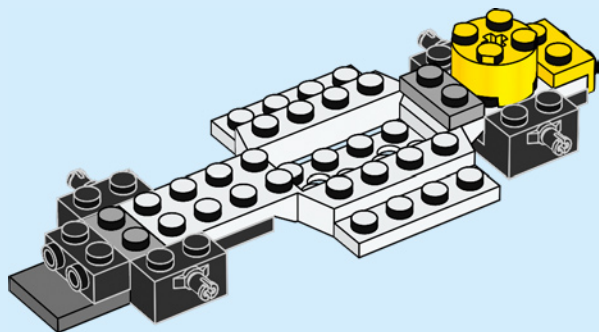

2x

7

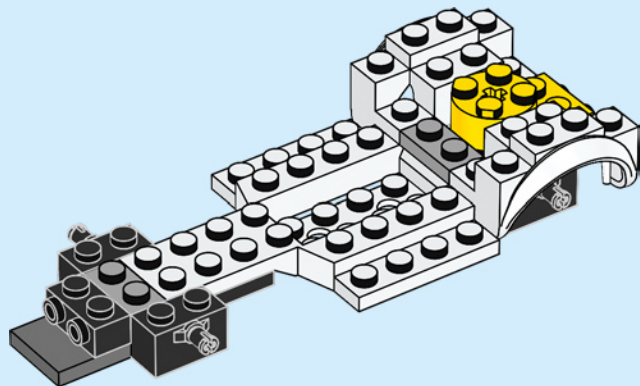

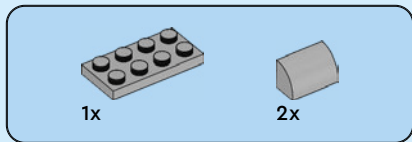

8

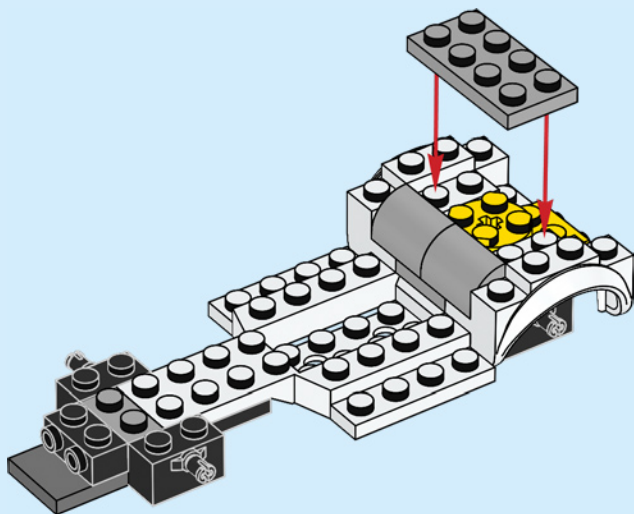

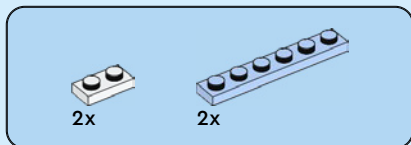

9

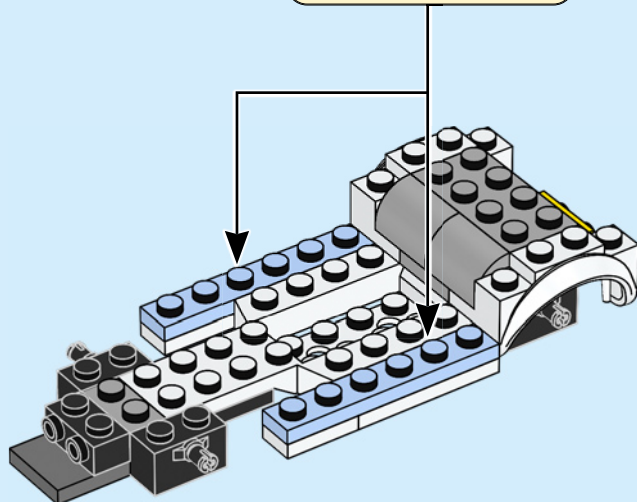
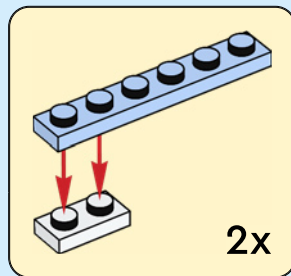



1x

10

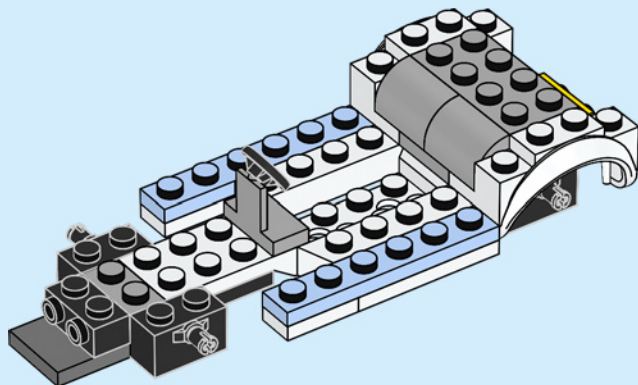



2x

11

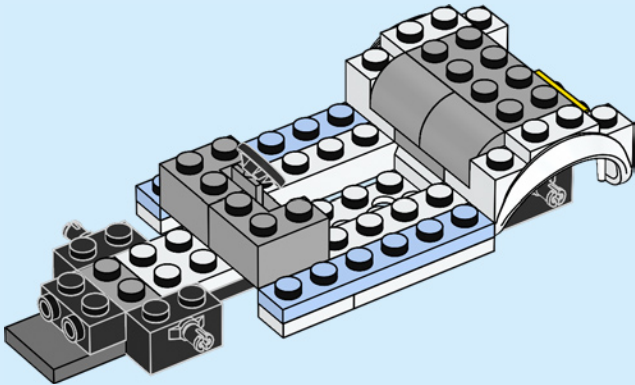

1x



1x

12

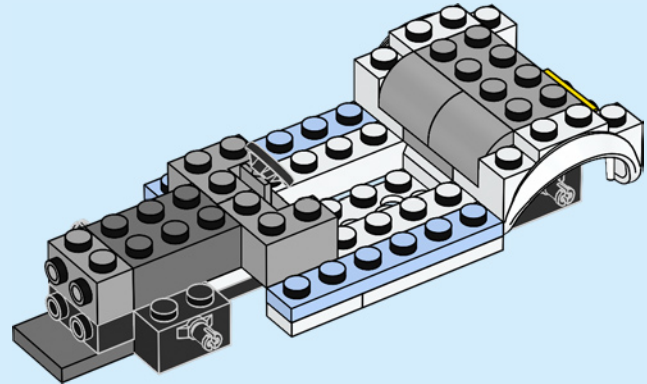

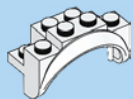

2x

13

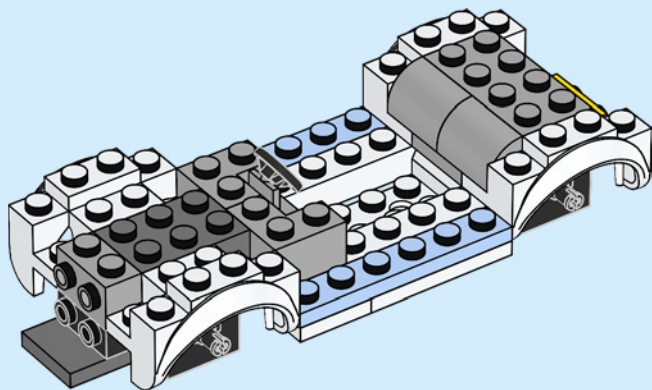



2x

14

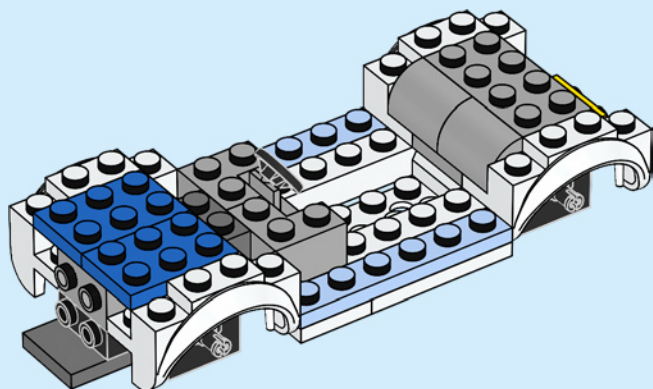

2x

15

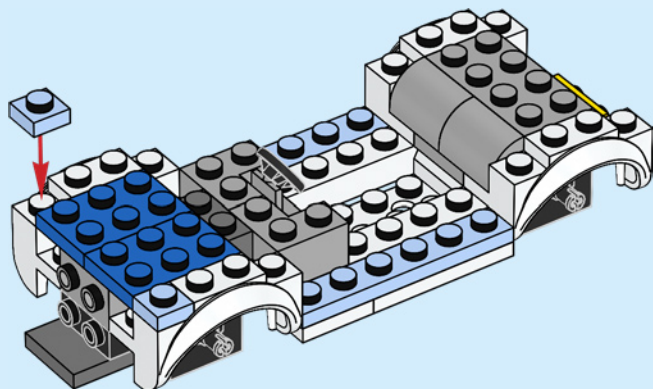

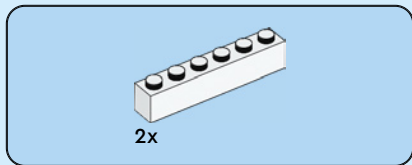

16

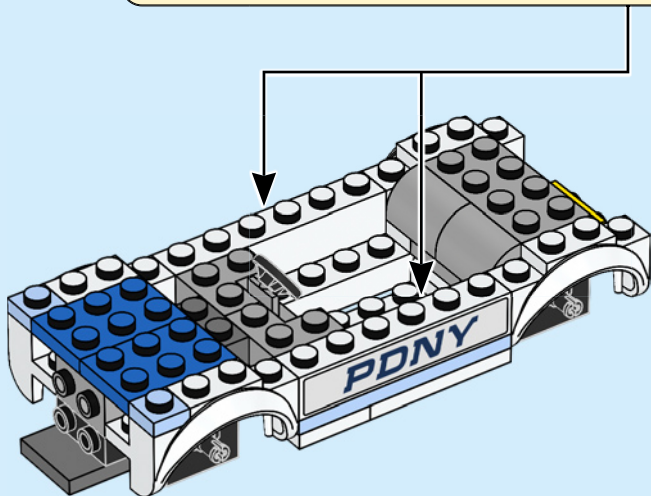
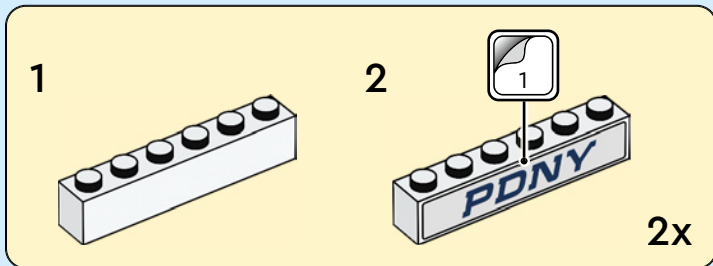



2x

17

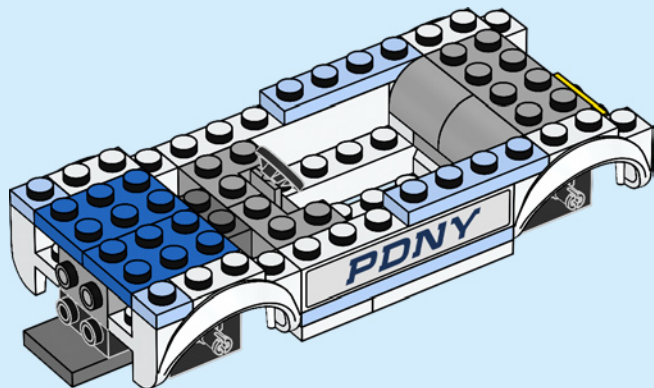

2x

18

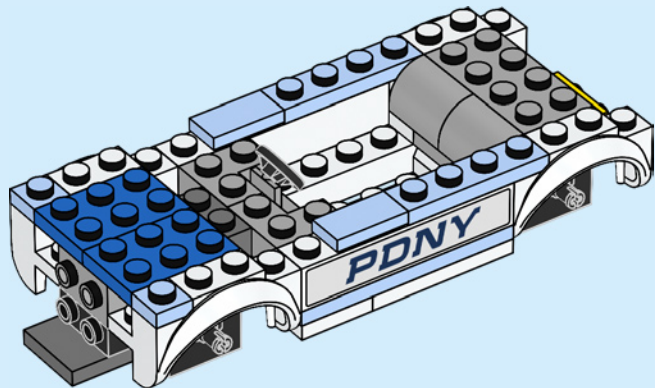

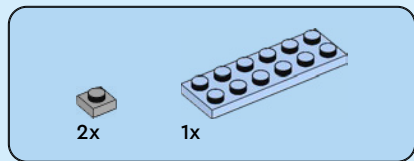

19

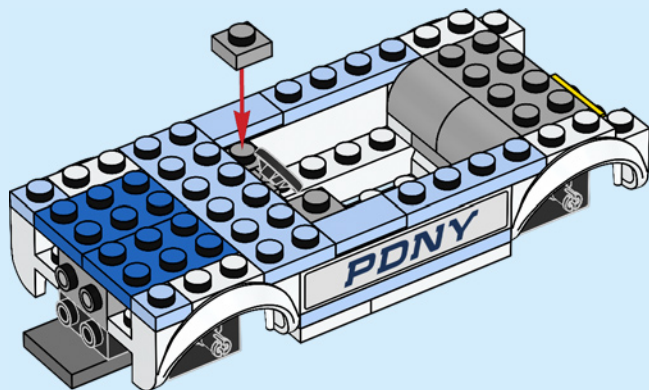

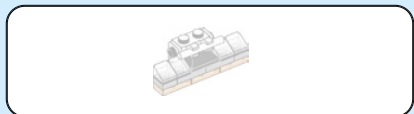

20

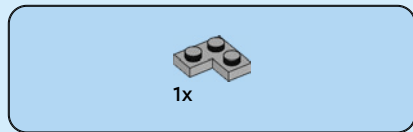
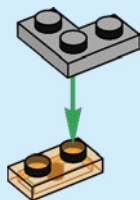

21

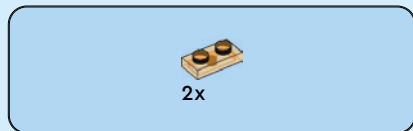
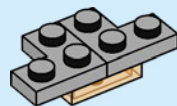

22

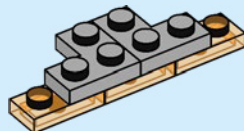



2x

23

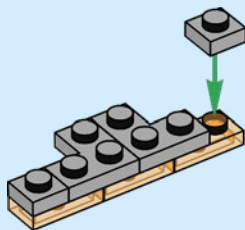



1x

24

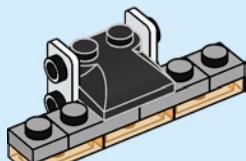

2x

25

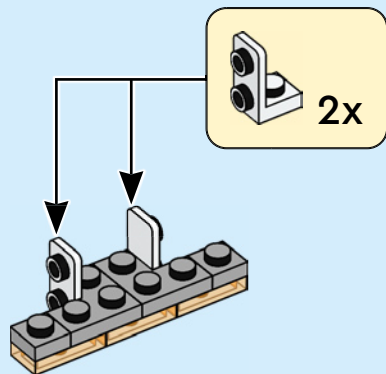



4x

26

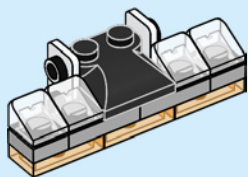



1x



1x

27

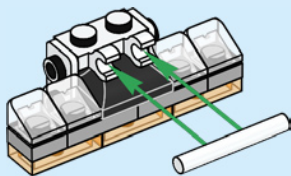

28

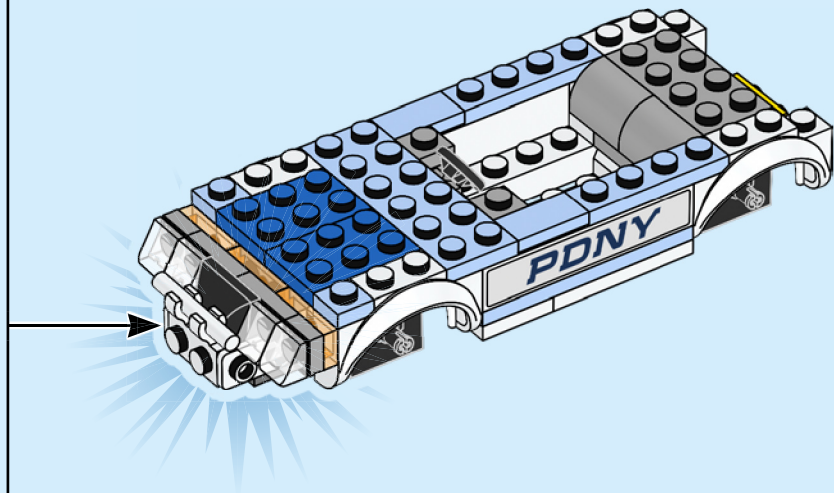



2x



2x



2x

29

1

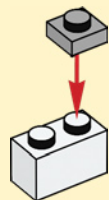

2

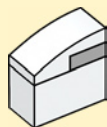

2x

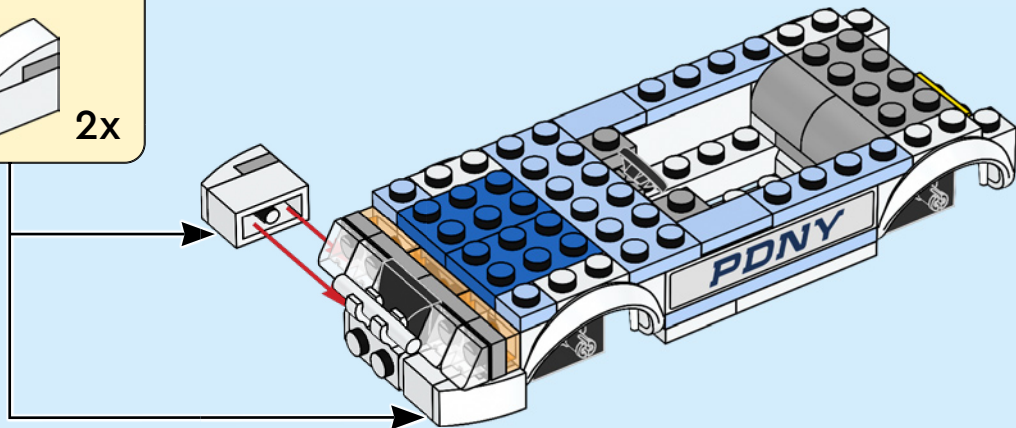



2x

30

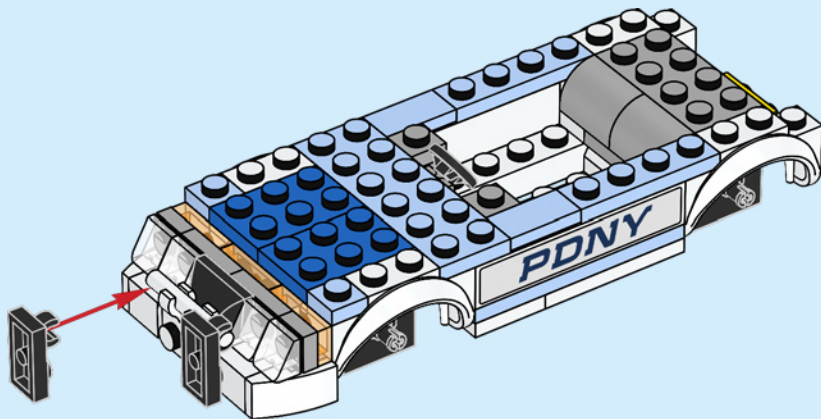



1x

31

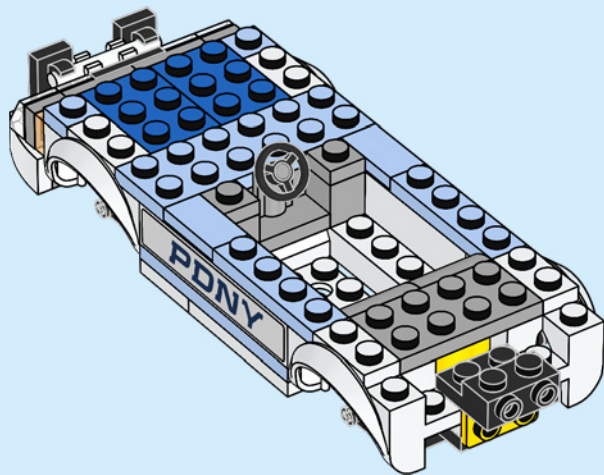
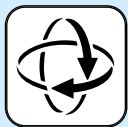



4x

32

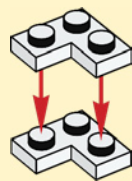
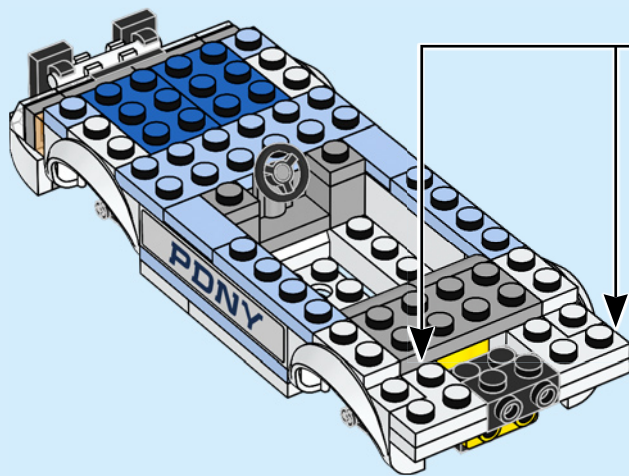

2x





2x



1x

33

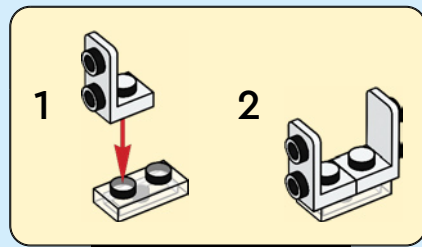
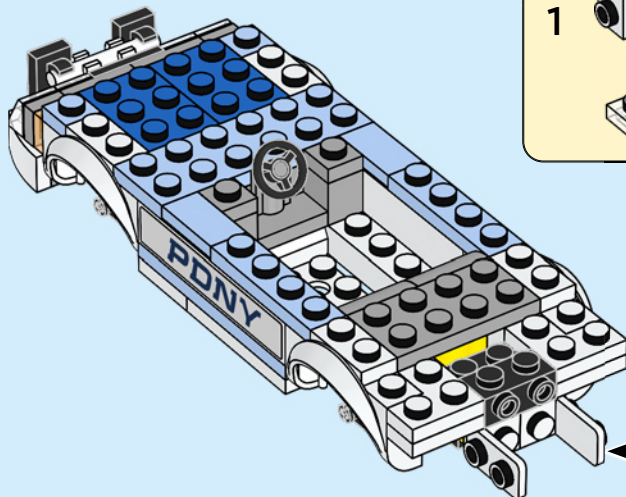

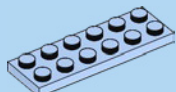

1x

34

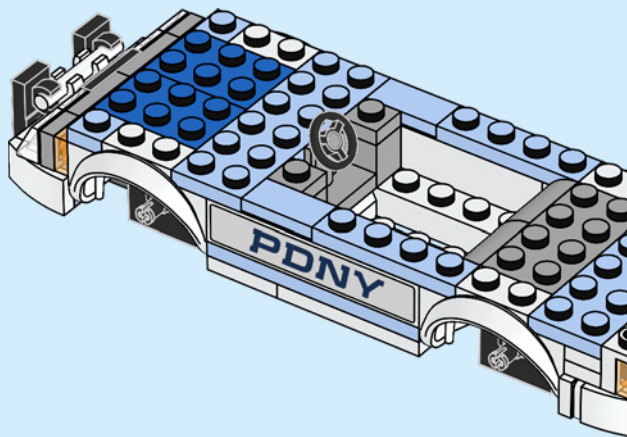



2x

35

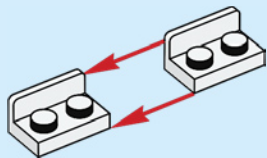

1x

36

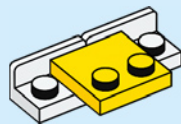



1x

37

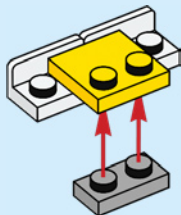

2x

38

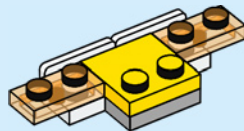



2x

39

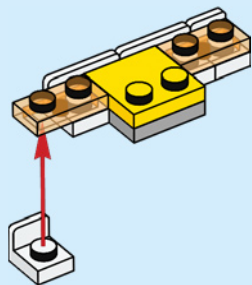

2x

40

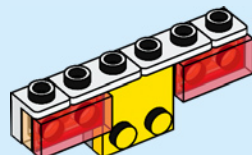

41

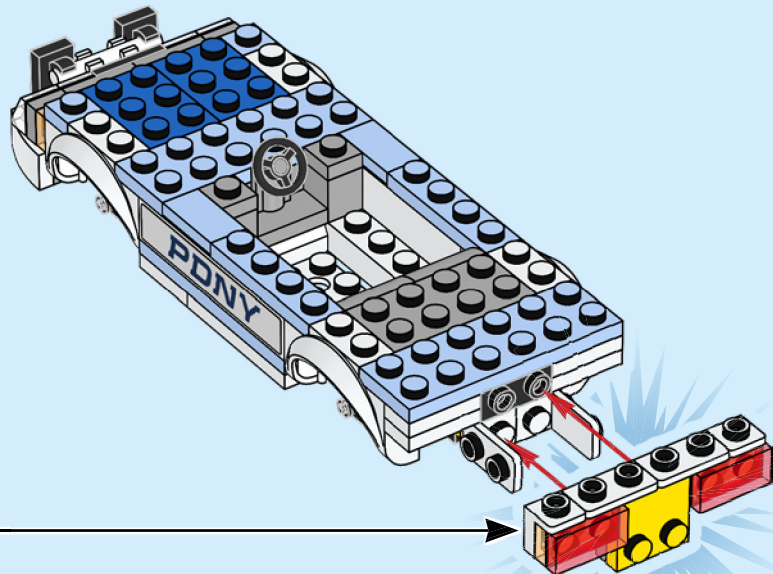



1x



1x

42

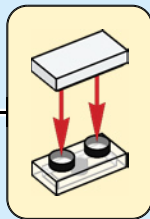
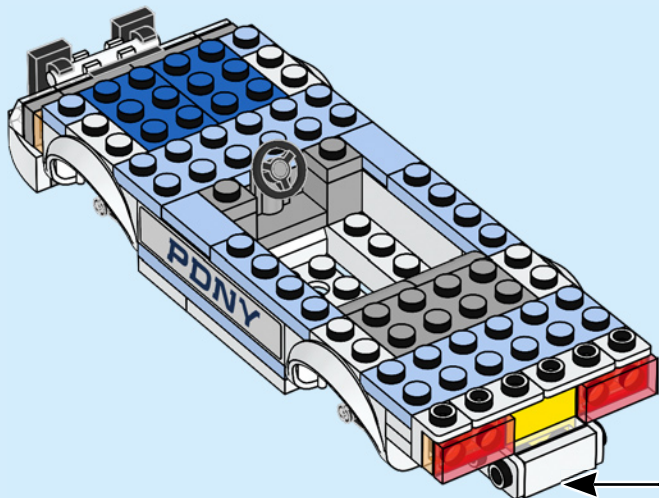



4x



2x



2x



2x

43

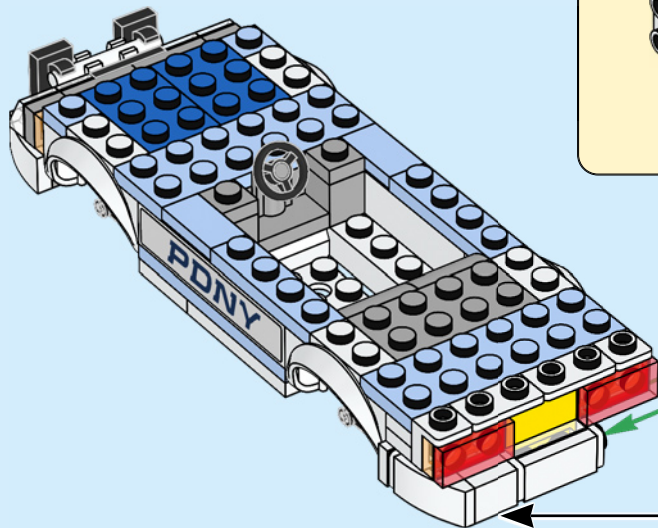

1



2

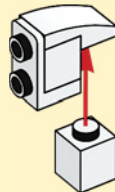

3

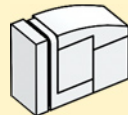

2x



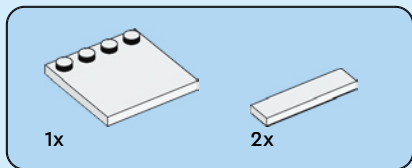

44

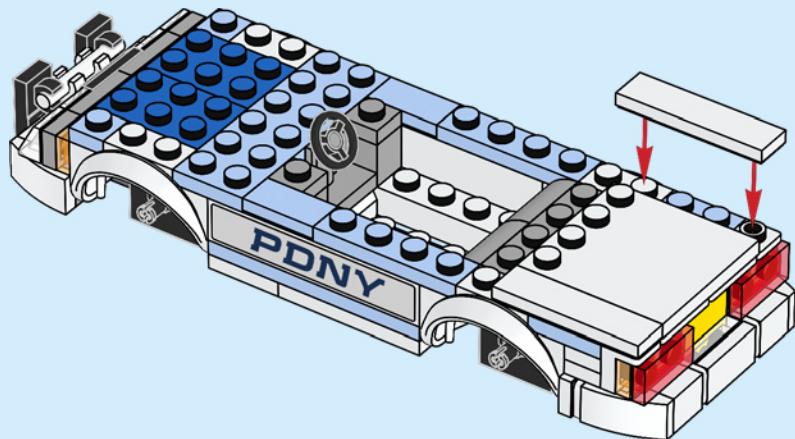

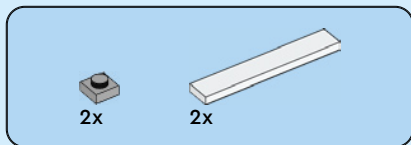

45

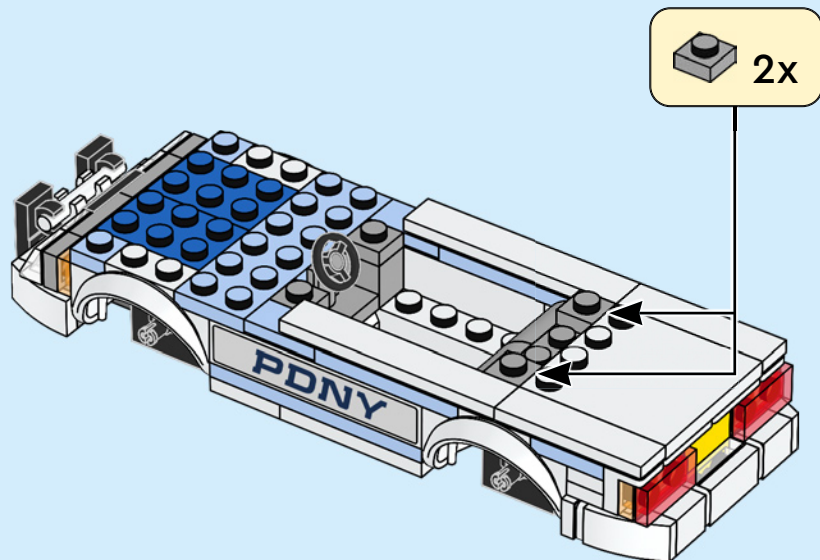



2x



2x

46

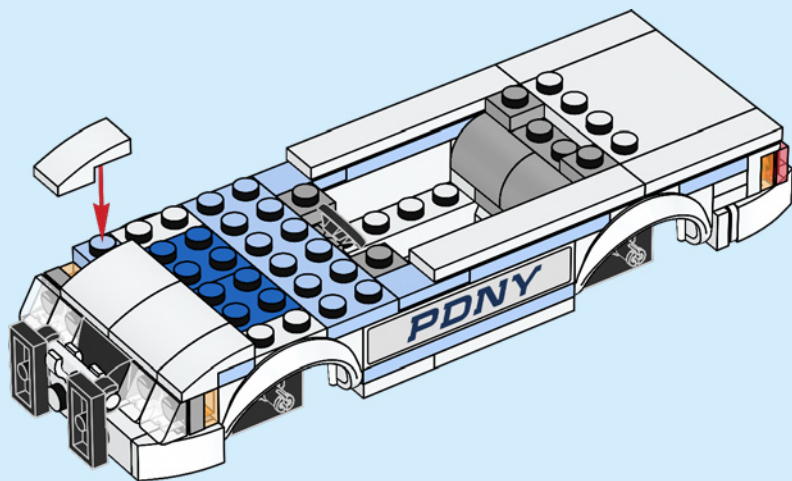

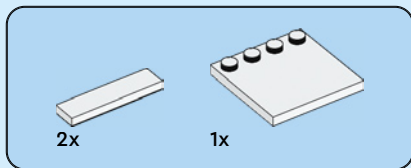

47

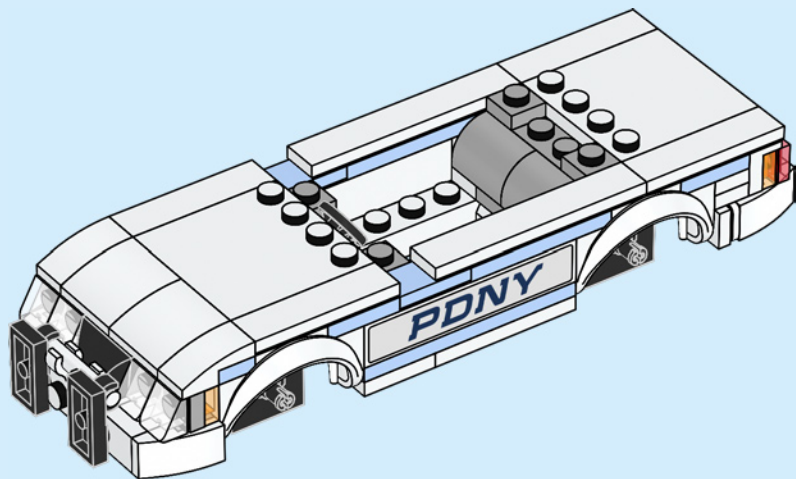



48

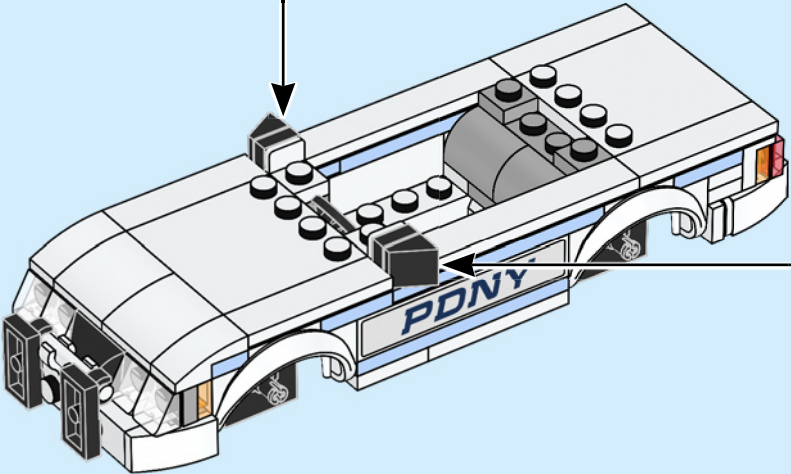
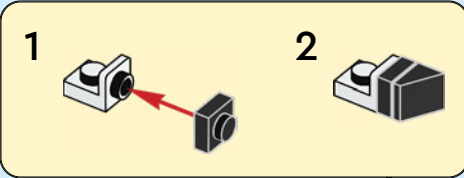
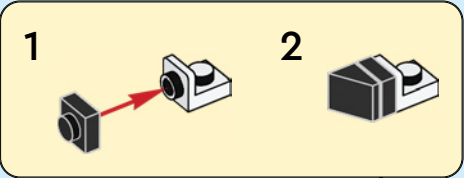

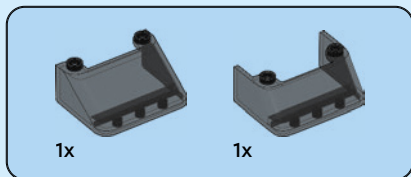

49

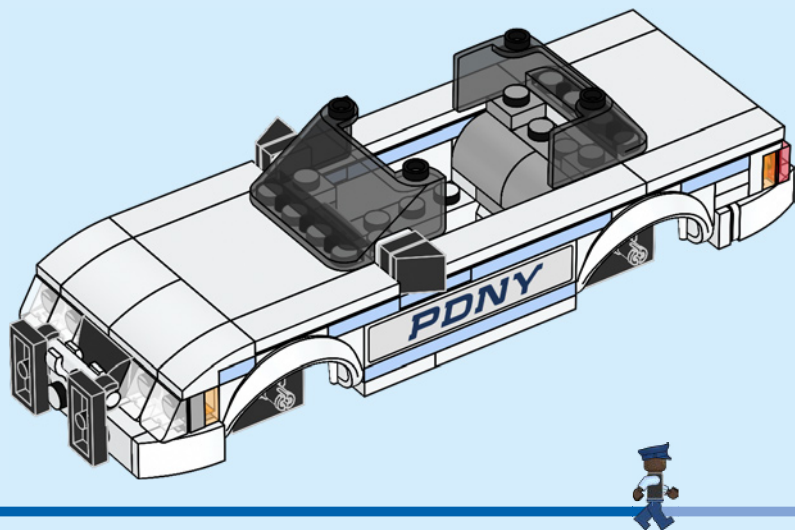



50

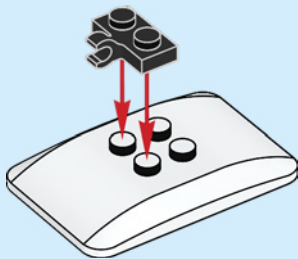

51





2x



2x

52

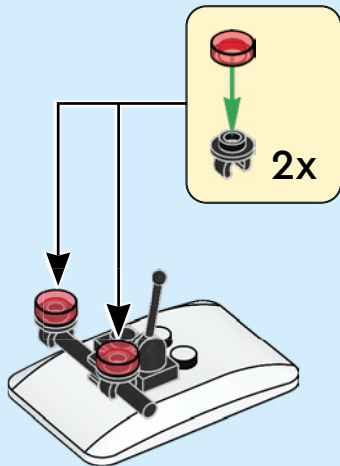

2x



2x

53

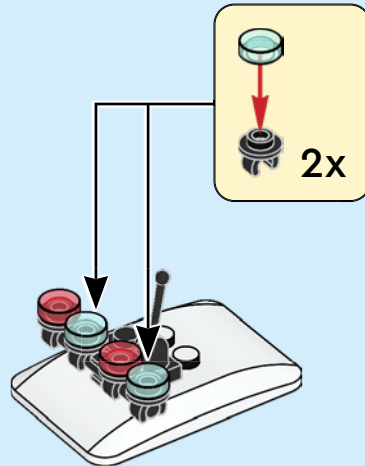

54

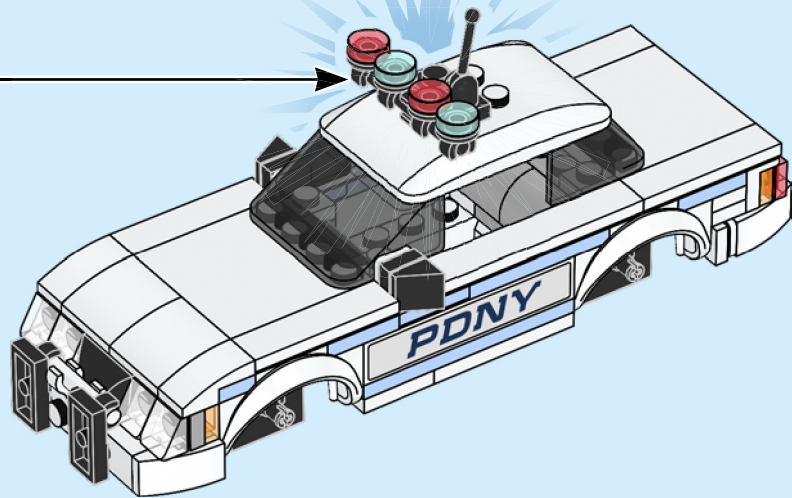



4x



4x

55

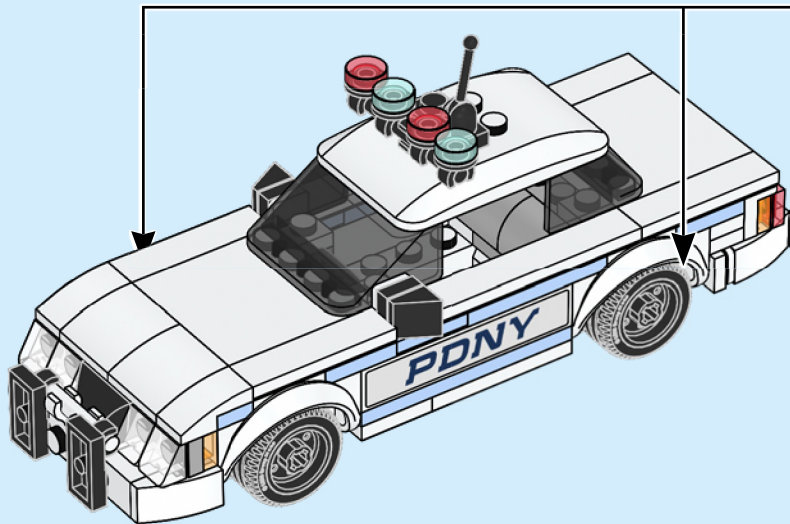

4x



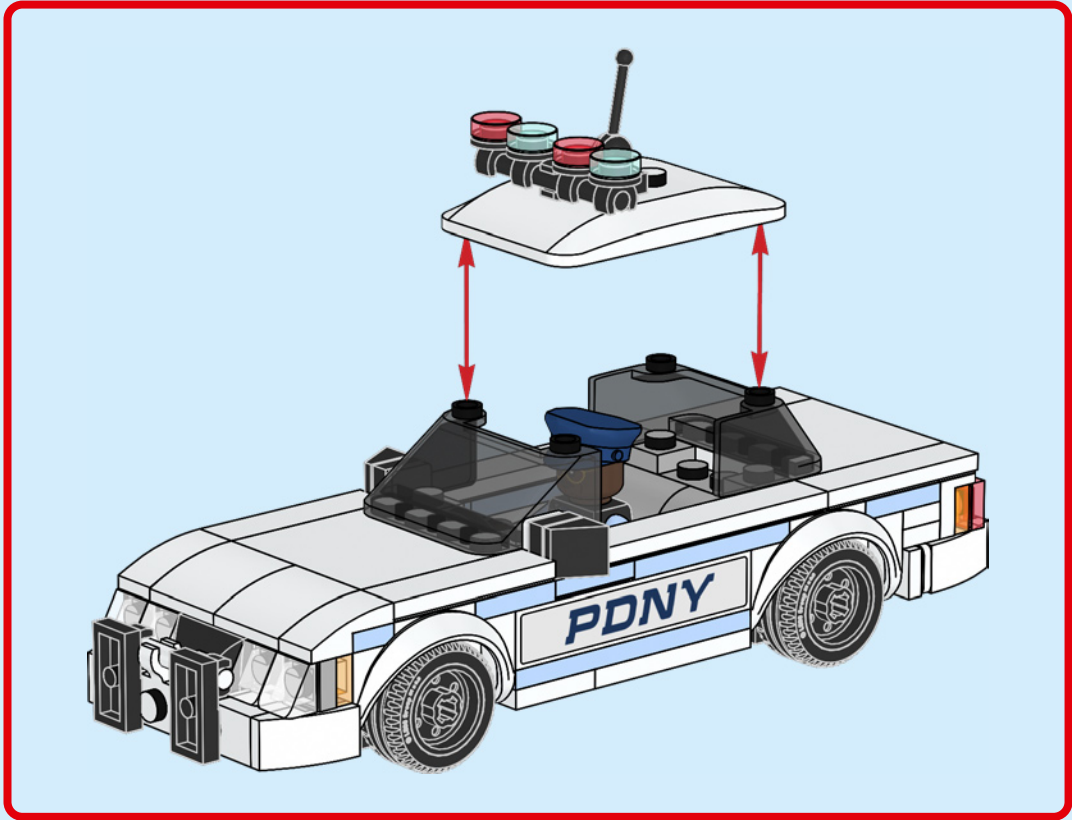

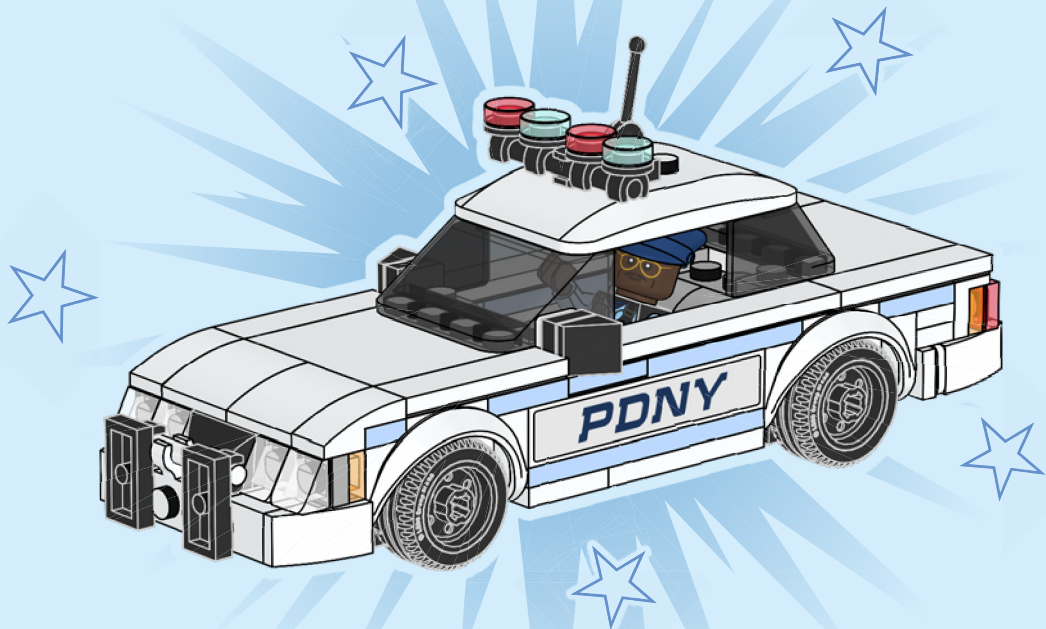



**Rebuild
the
World™**



LEGO and the LEGO logo are trademarks of the/son des marques de commerce du/
son marcas registradas de LEGO Group. ©2025 The LEGO Group. 6559650
© 2025 MARVEL © 2025 CPII