

The LEGO logo, consisting of the word "LEGO" in a white, stylized font with a black outline, set against a red square background.The MARVEL logo, consisting of the word "MARVEL" in a white, bold, sans-serif font, set against a red rectangular background.

76307



Q LEGO® Builder



Get excited about our new packaging!

We're switching from plastic to paper-based packaging. That's why you might find a mix of paper and plastic in our boxes!

Nos nouveaux emballages vous emballeront !

Nous passons des emballages en plastique aux emballages à base de papier. C'est pourquoi vous pourriez trouver un mélange de papier et de plastique dans nos boîtes !

¡Te presentamos nuestros nuevos empaques!

Estamos sustituyendo las bolsas de plástico por bolsas con base de papel. ¡Por eso, puedes encontrar una mezcla de papel y de plástico en nuestras cajas!

[LEGO.com/sustainable-packaging](https://www.lego.com/sustainable-packaging)



Q LEGO® Builder

BUILDER



Apple and the Apple logo are trademarks of Apple Inc., registered in the U.S. and other countries and regions. App Store is a service mark of Apple Inc. Google Play and the Google Play logo are trademarks of Google LLC. Tencent and the Tencent logo are trademarks of Tencent Inc.

Q LEGO.com/devicecheck

EN Ask parents' permission before going online | **DE** Eltern um Erlaubnis bitten, bevor du online gehst | **FR** Demande l'autorisation d'un parent avant d'aller en ligne | **IT** Chiedi il permesso ai tuoi genitori prima di andare online | **ES** Pídeles permiso a tus papás antes de conectarte a Internet | **PT** Peça autorização aos pais antes de acederes online | **ZH** 上网前应先征得父母的同意 | **PL** Poproś rodziców o zgodę, zanim wejdiesz do Internetu | **CS** Než půjdeš na internet, požádej rodiče o svolení | **SK** Skôr než pôjdeš na internet, vypýtaj si povolenie od rodičov | **HU** Kérj szülői engedélyt, mielőtt online csatlakoznál! | **RO** Cere permisiunea părinților înainte de a te conecta online | **BG** Поискайте разрешение от родител, преди да влезете онлайн | **LV** Pirms došanās tiešsaistē palūdz atļauju vecākiem | **ET** Enne Interneti kasutamist küsi vanematelt luba | **LT** Prieš prisijungdami prie interneto, atsiklauskite tėvų



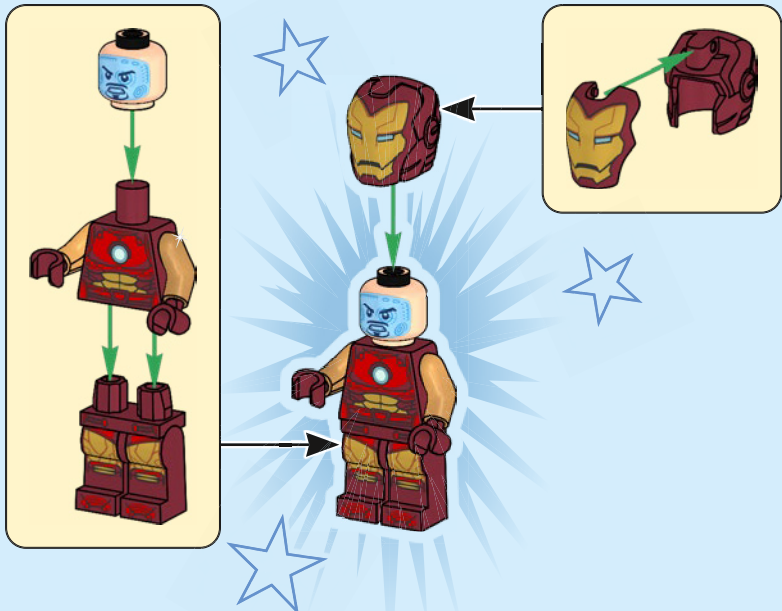

1

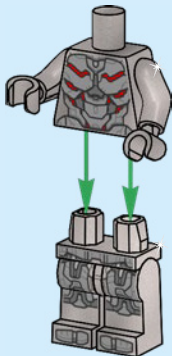

2

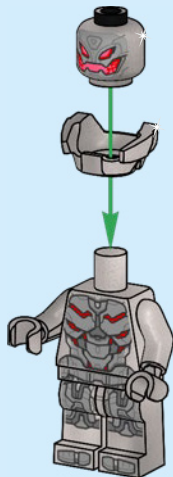

3

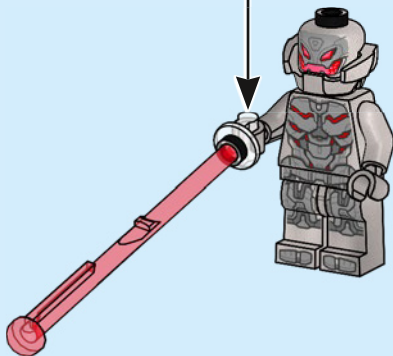
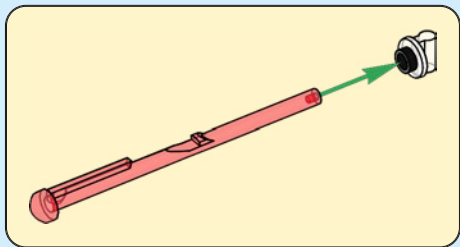

4

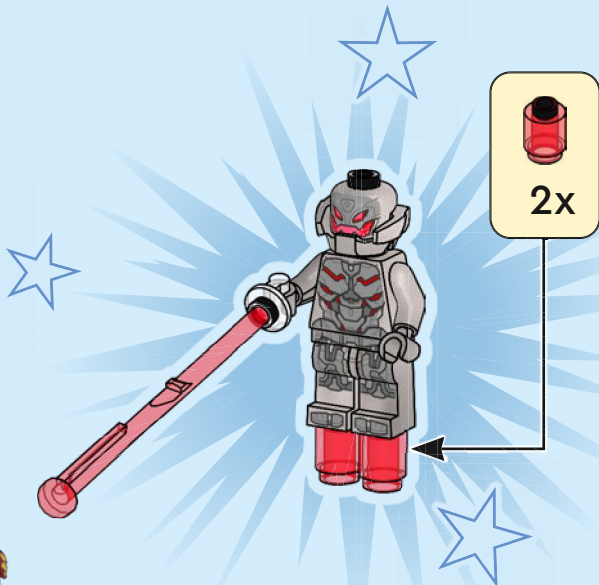

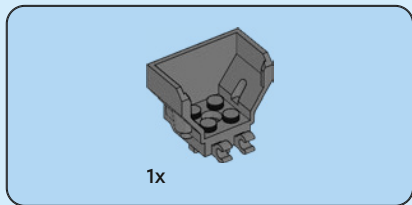

1

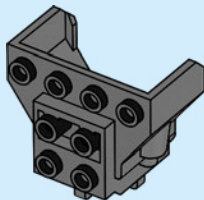



2x

2

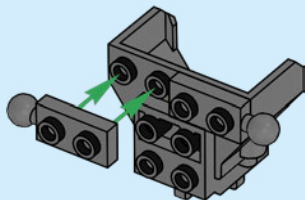



2x

3

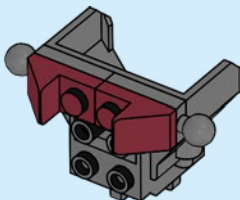

1x

4

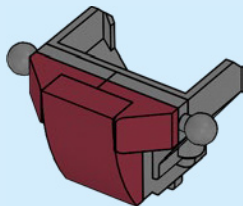



1x



1x

5

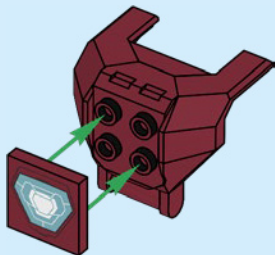

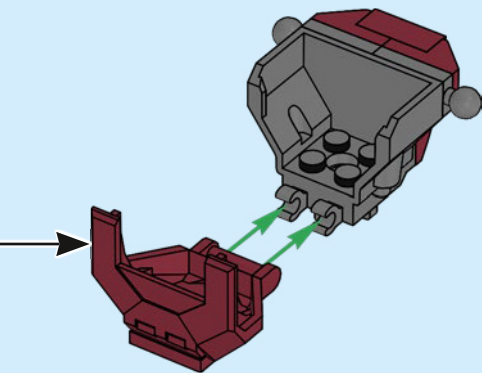

6

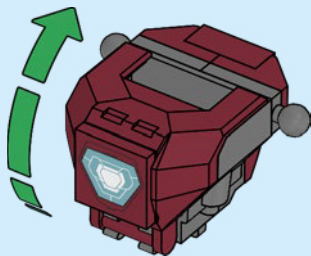



1x

7

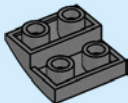

1x

8

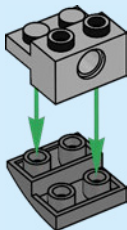



1x

9

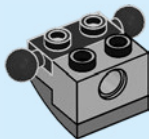

2x

10

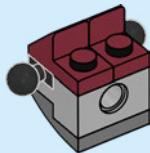



2x

11

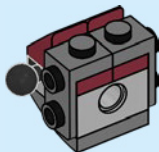

3x

12

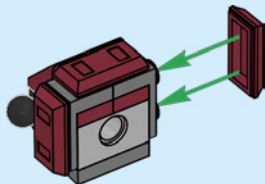



1x

13

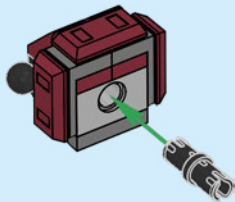

14

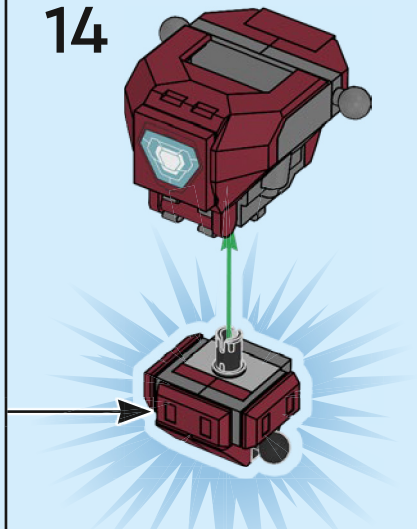



2x



1x

15

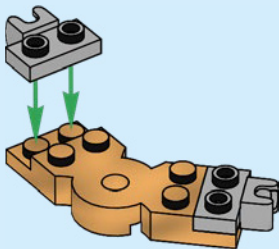

1x

16

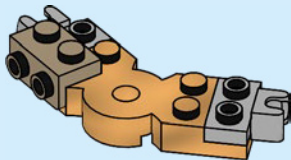



1x



1x

17

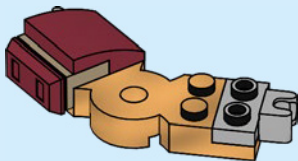

1x

18

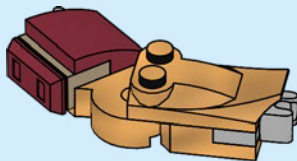



1x

19

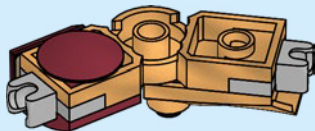

20

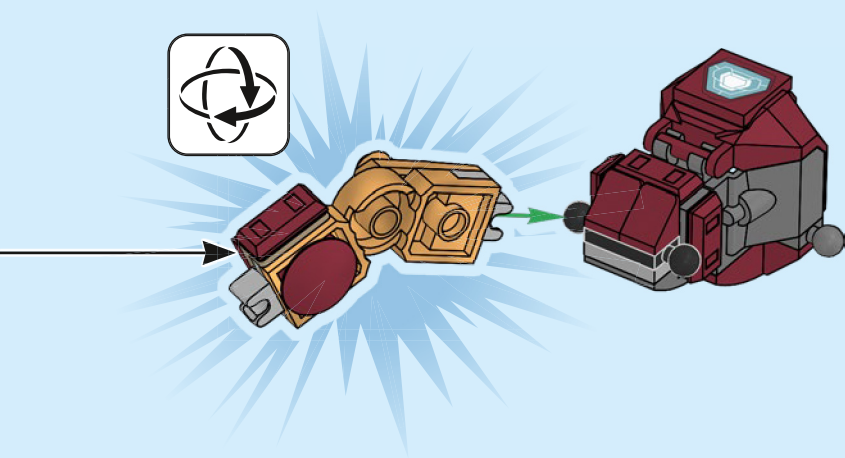



2x



1x

21

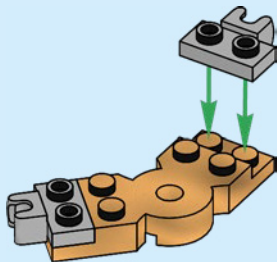

1x

22

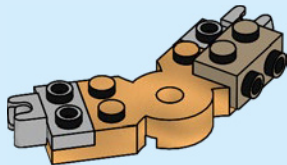



1x



1x

23

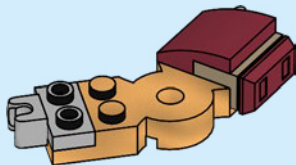

1x

24

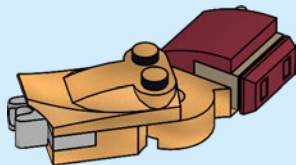



1x

25

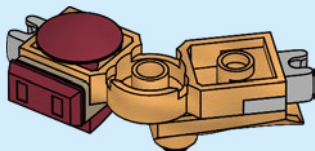

26

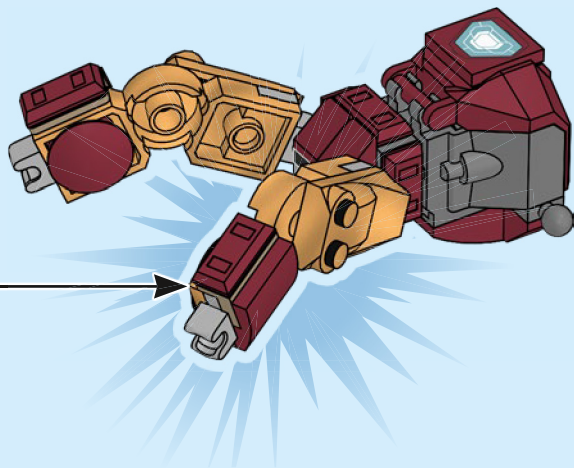



1x

27

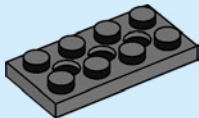

26



1x



1x

28

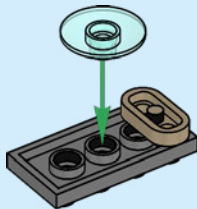



1x

29



1x

30

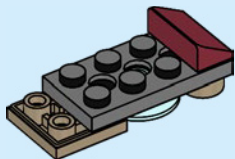



1x



1x

31

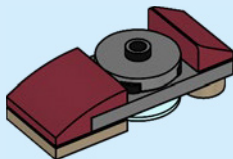

1x

32

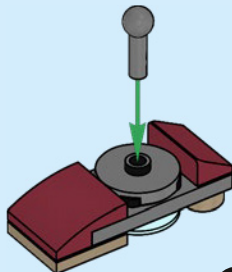

2x



33

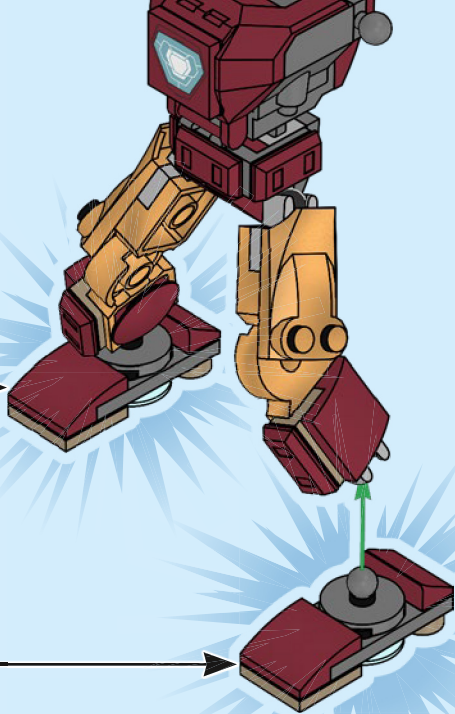



1x



1x

34

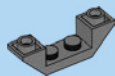
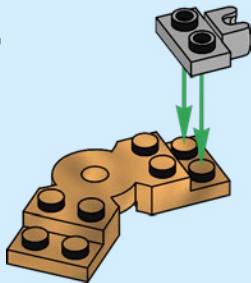

1x

35

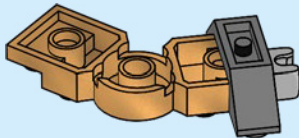



1x

36

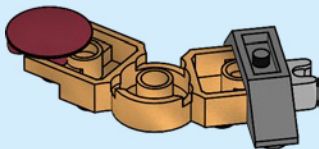

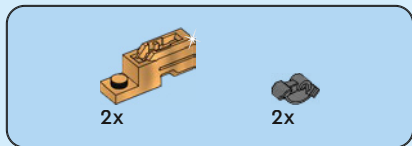

37

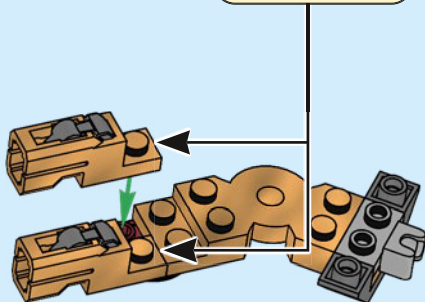
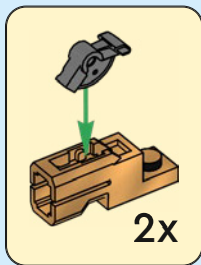



1x

38

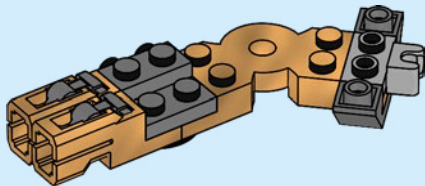



1x

39

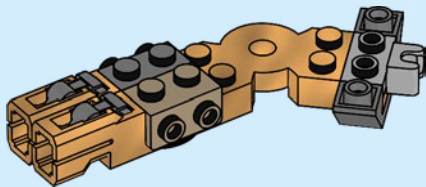



1x



2x

40

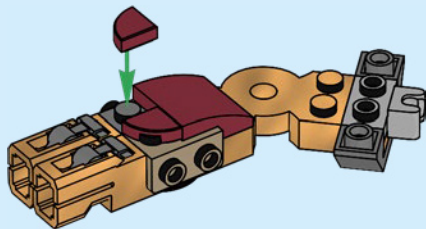



1x

41





1x

42

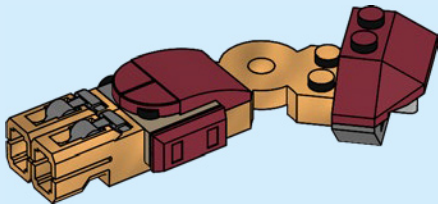



1x

43

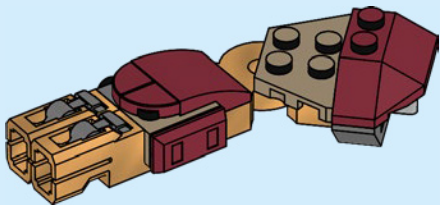



1x

44

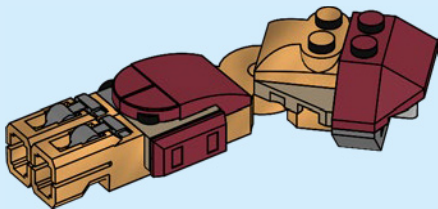



1x

45

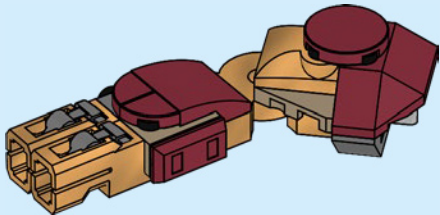

46

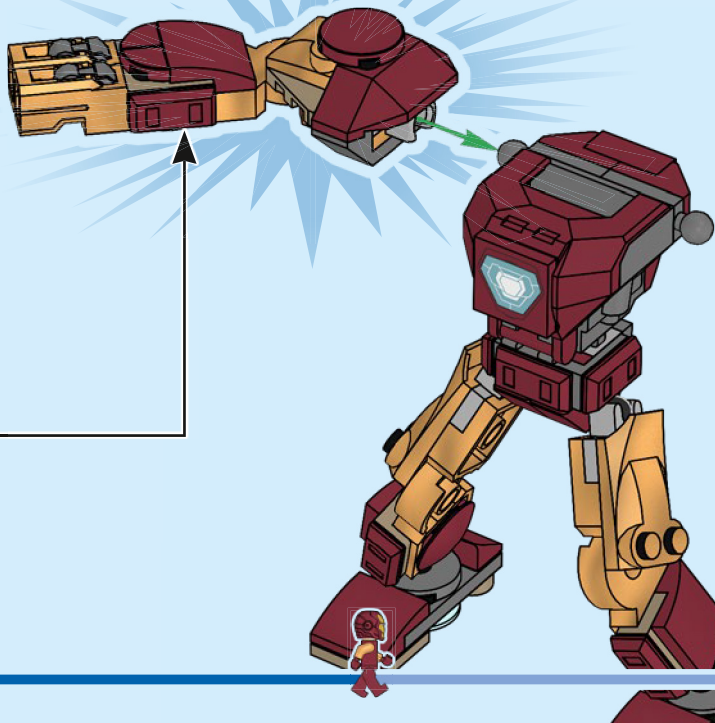

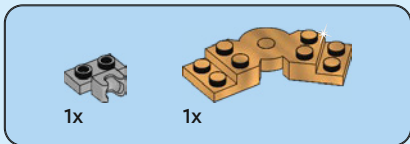

47

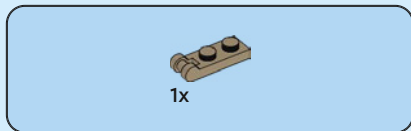
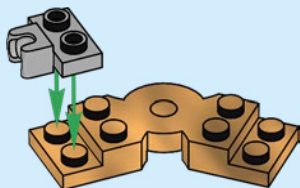

48

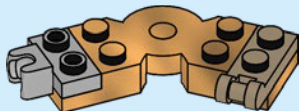

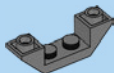

1x



1x

49

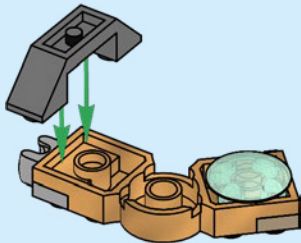

50

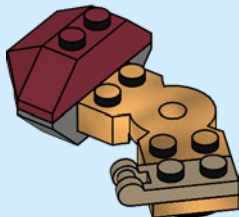
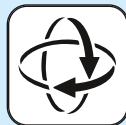



1x

51

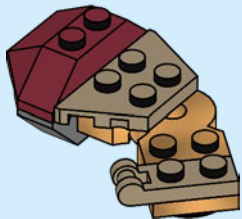

1x

52

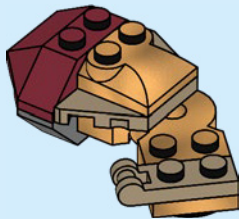



1x

53

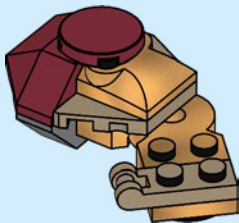

1x

54

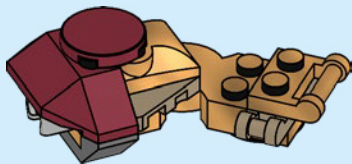



1x

55

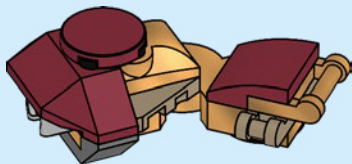

4x

56

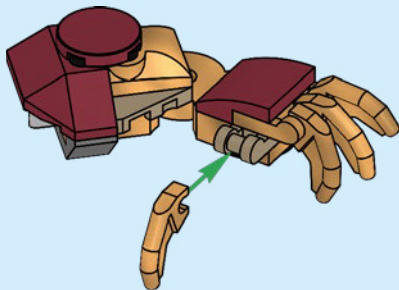

57

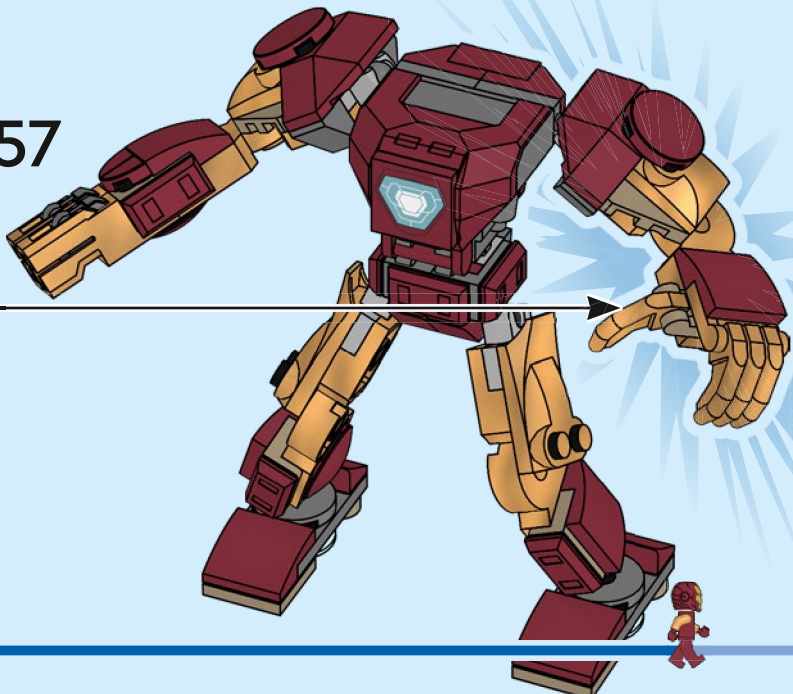

58

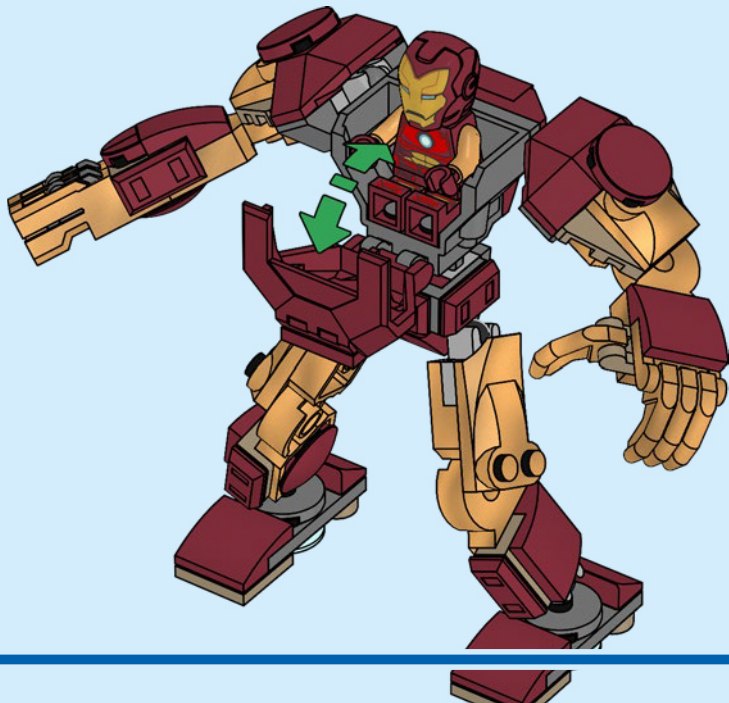

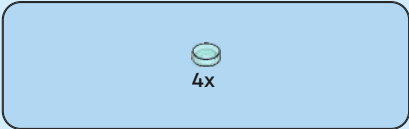

59

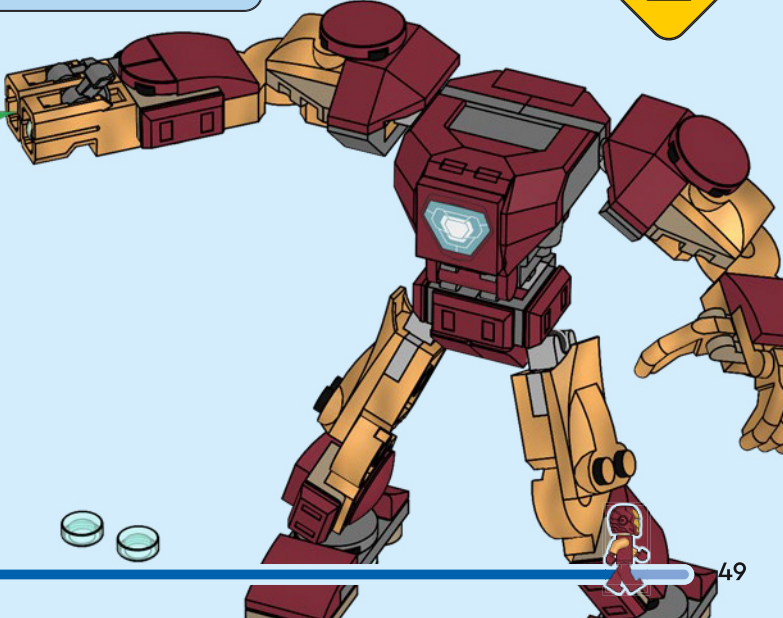

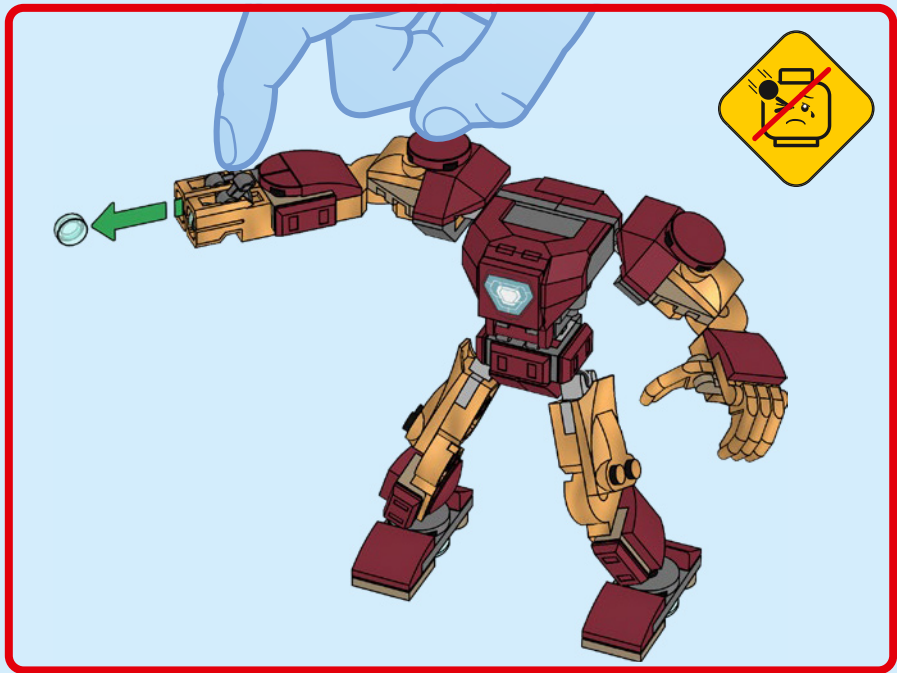

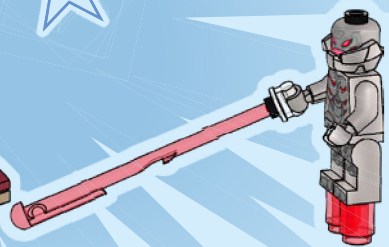
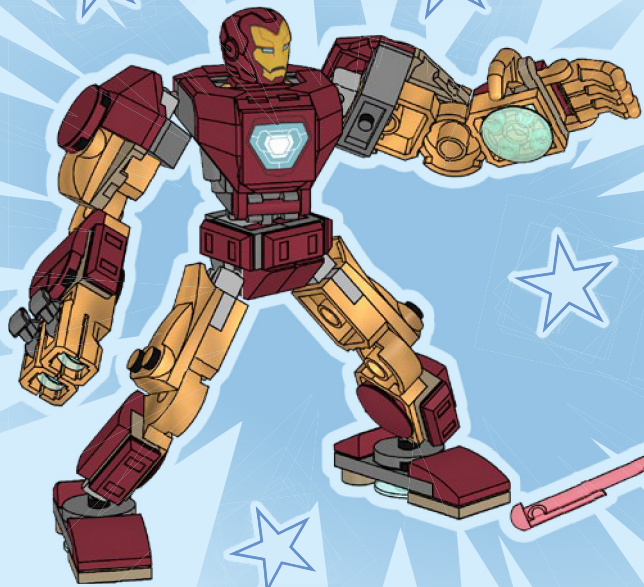

LEGO

MARVEL



76313



76314



76310



76307

MARVEL
AVENGERS



1x
6279875



2x
6245307



2x
6311890



1x
6448822



1x
6264031



1x
6416838



2x
6231386



1x
6526663



6x
6448315



2x
6525969



1x
6510217



3x
6328477



1x
6398321



4x
6251611



1x
6440776



2x
6514235



2x
6406008



2x
6083977



6x
6107758



6x
6043656



1x
6287550



1x
6135607



3x
6192839



1x
6526664



1x
6326478



4x
6514192



2x
6003379



2x
6264149



1x
6453200



2x
6435043

2x
6364352

2x
6123814

1x
6469463

1x
6221340

4x
6525970

2x
6360675

1x
6344820

2x
6185675

4x
6426622

1x
6526665

2x
6115080

2x
4227398

1x
4585493

1x
6526617



1x
6384443

2x
4286597

2x
6345949

1x
6531888

 [LEGO.com/service](https://www.LEGO.com/service)

2x
6357918

1x
6350385



Rebuild
the
World 

YOU COULD
WIN



Scan this QR code or go to
LEGO.COM/PRODUCTFEEDBACK and give us
your short feedback about this LEGO® set
for a chance to win a cool LEGO prize.

Terms and Conditions apply*

EN: YOU COULD WIN. Terms and Conditions apply* **DE: Du könntest GEWINNEN.** Es gelten die Teilnahmebedingungen* **FR: Tu pourrais GAGNER.** Des conditions s'appliquent* **IT: Potresti VINCERE tu.** Termini e condizioni sono applicabili* **ES: Puedes GANAR.** Aplican términos y condiciones* **PT: Poderá GANHAR.** Aplicam-se termos e condições* **ZH: 轻松获奖.** 条款和条件适用* **PL: Szansa na WYGRANĄ.** Obowiązują warunki korzystania* **CS: Máte šanci VYHRÁT.** Platí všeobecné smluvní podmínky* **SK: Máte šancu VYHRÁT.** Platia všeobecné zmluvné podmienky* **HU: TE IS NYERHETSZ.** Felhasználási feltételek érvényesek* **RO: Ai putea CÂȘTIGA.** Se aplică termenii și condiții* **BG: Можете да СПЕЧЕЛИТЕ.** Има определени правила и условия* **LV: Tu vari LAIMĒT.** Ir spēkā noteikumi un nosacījumi.* **ET: Sul on võimalus VÕITA.** Kehtivad tingimused* **LT: Jūs galite LAIMĖTI.** Taikomos sąlygos*

*[LEGO.com/productfeedback-terms](https://www.lego.com/productfeedback-terms)

LEGO and the LEGO logo are trademarks of the/son des marques de commerce du/
son marcas registradas de LEGO Group. ©2025 The LEGO Group.

© 2025 MARVEL

6559642