



CITY

60445



2

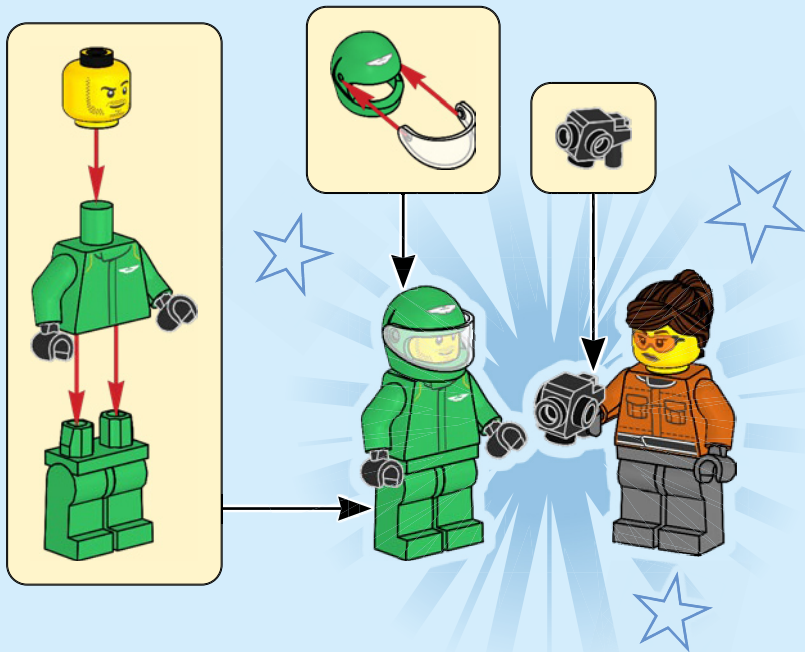

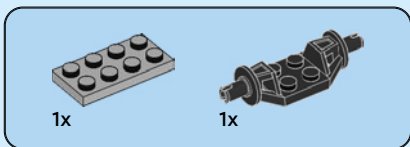
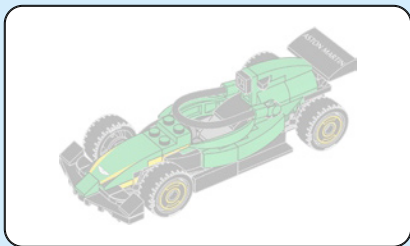

1

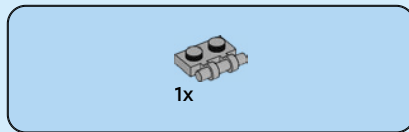
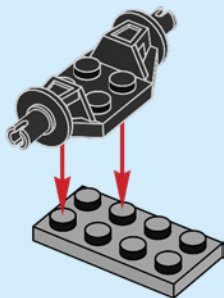

2

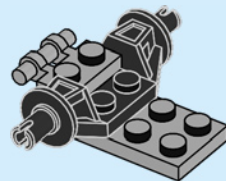



1x



1x

3

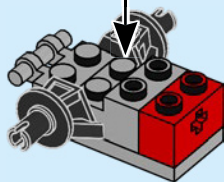
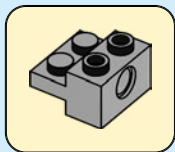

2x

4

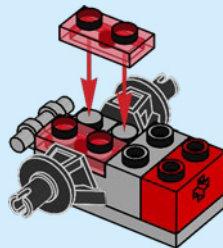

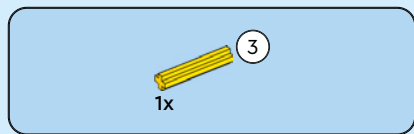

5

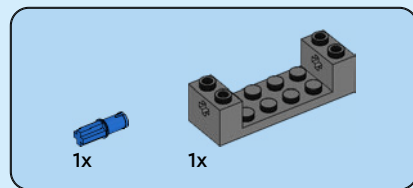
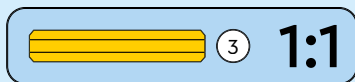
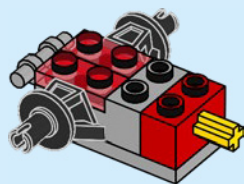

6

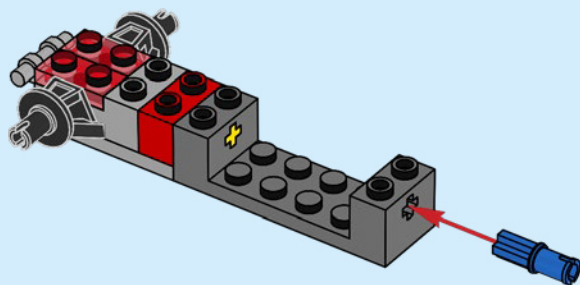



2x

7

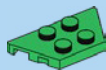
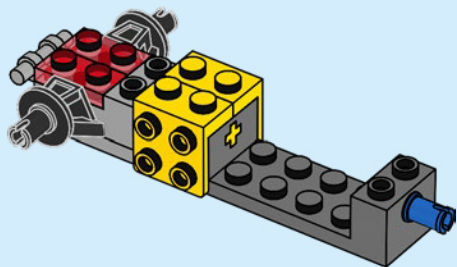

1x



2x

8

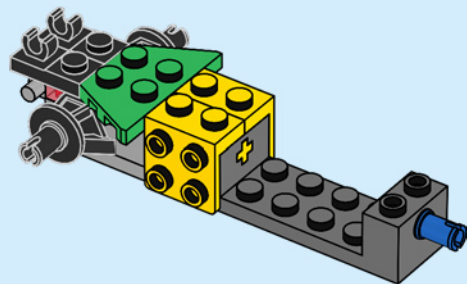



1x

9

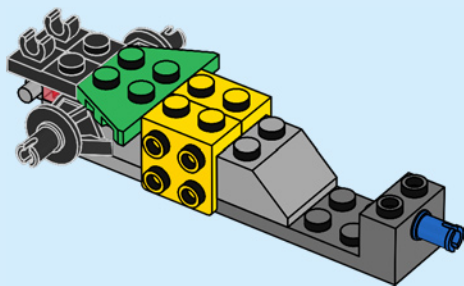

1x



2x

10

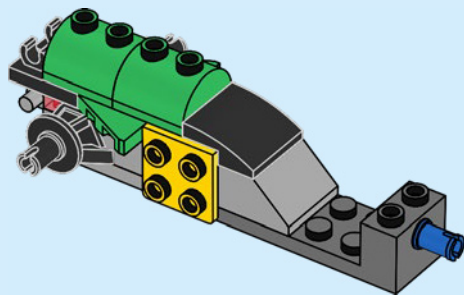



1x



1x

11

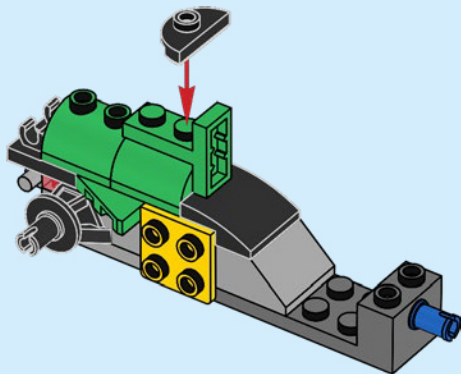



1x

12

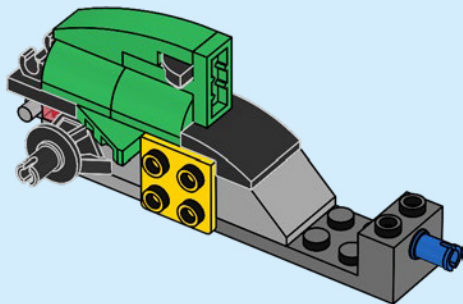

1x

13

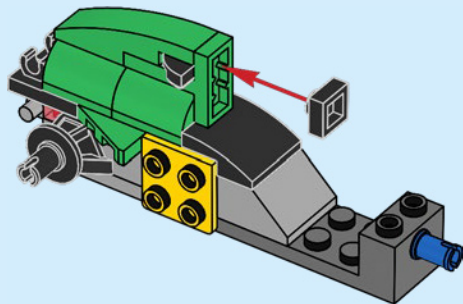

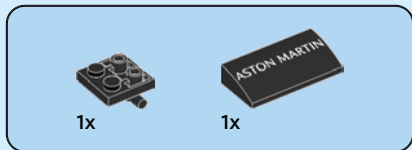

14

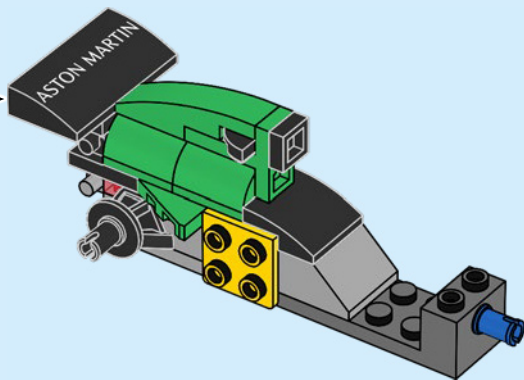
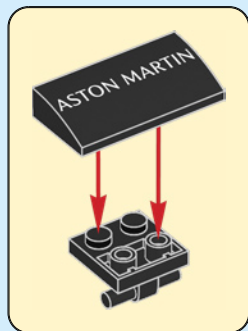

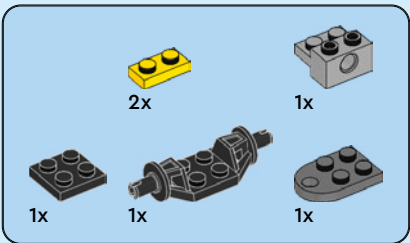

15

1

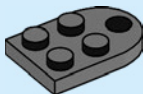

2

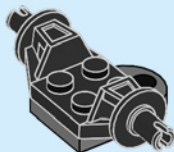

3



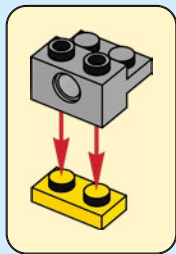

4



5

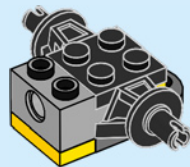

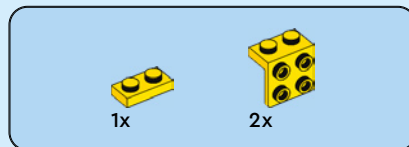

16

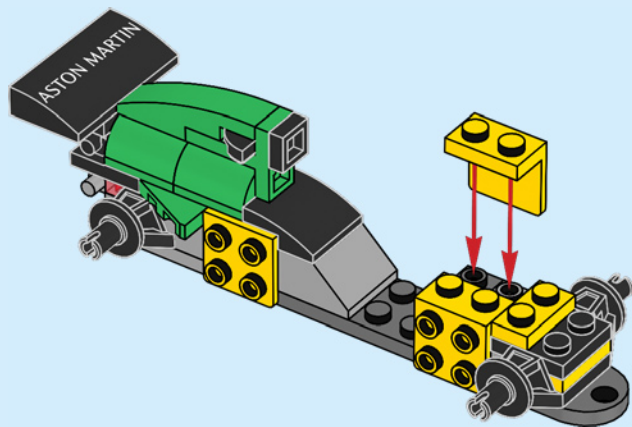
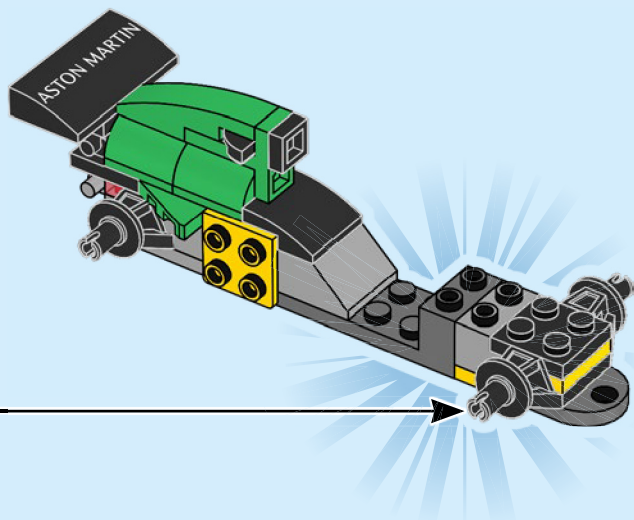

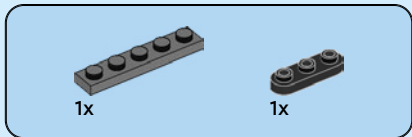
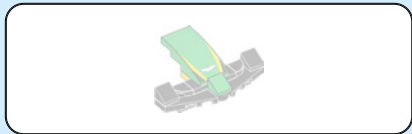

17

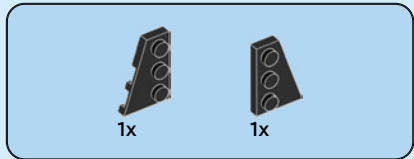
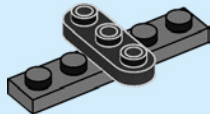

18

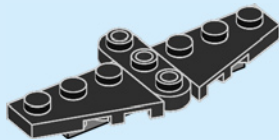

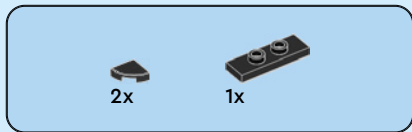

19

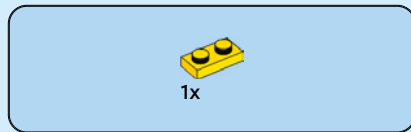
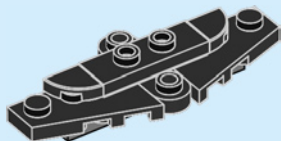

20

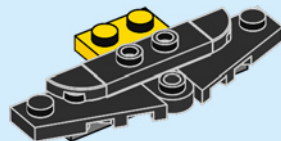



2x



1x

21

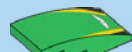
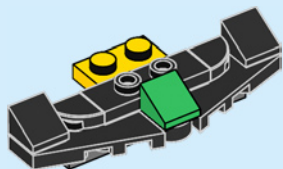

1x

22

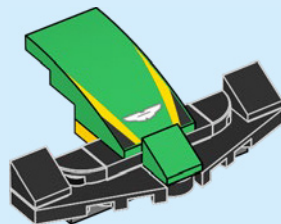

23

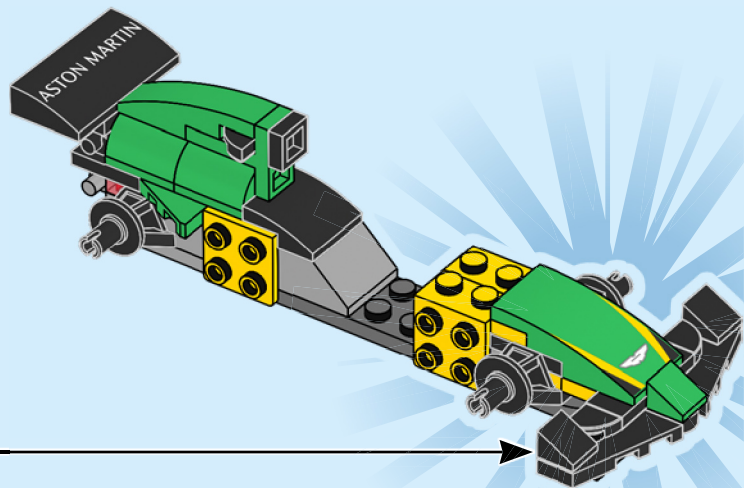



1x



1x

24

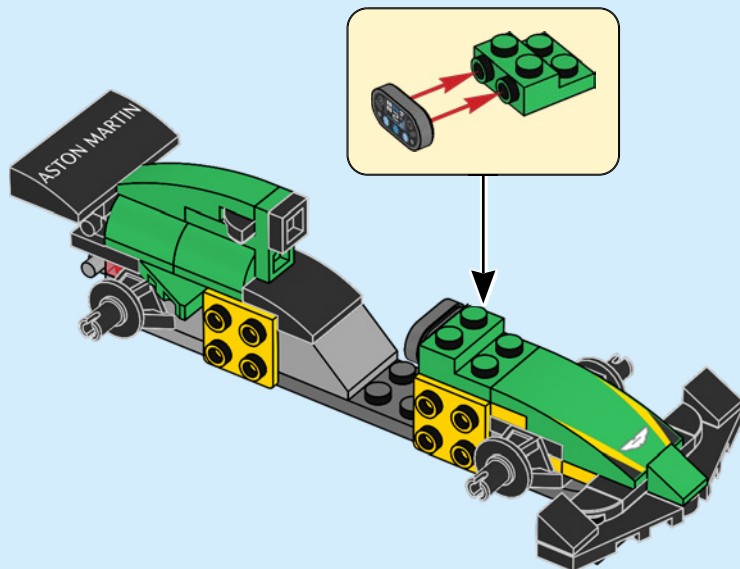

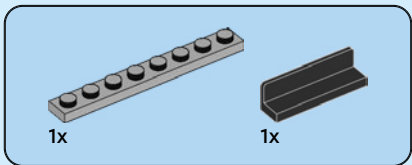

25

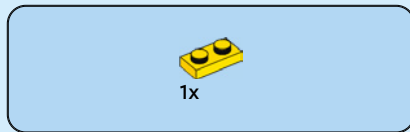
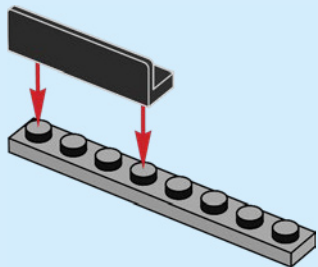

26

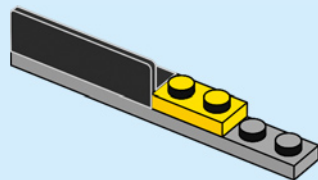



1x



1x

27

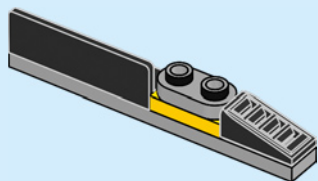

1x

28

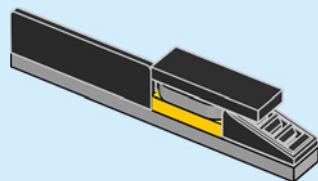

29

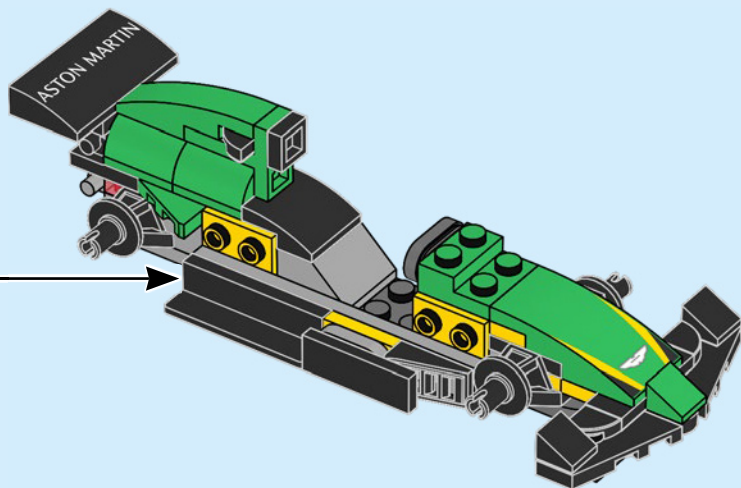

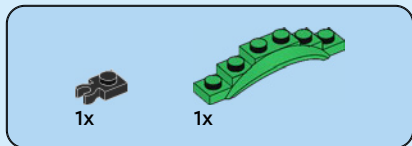

30

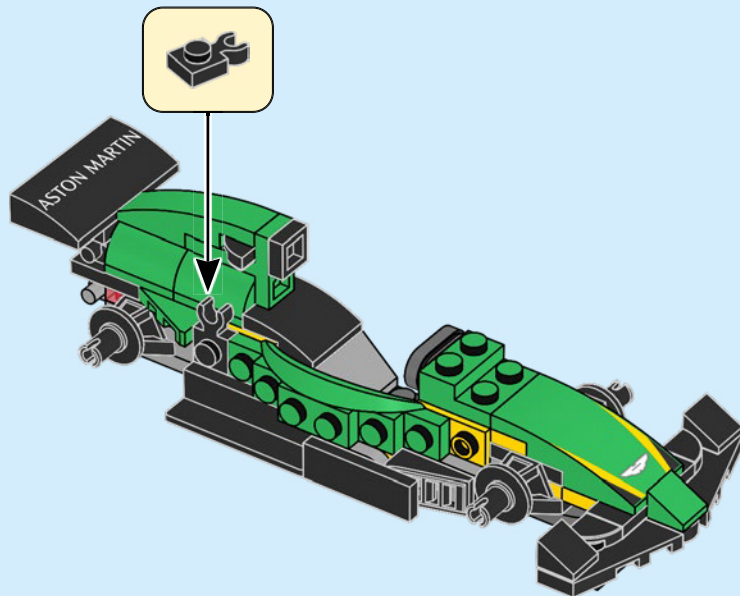

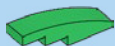

1x

31

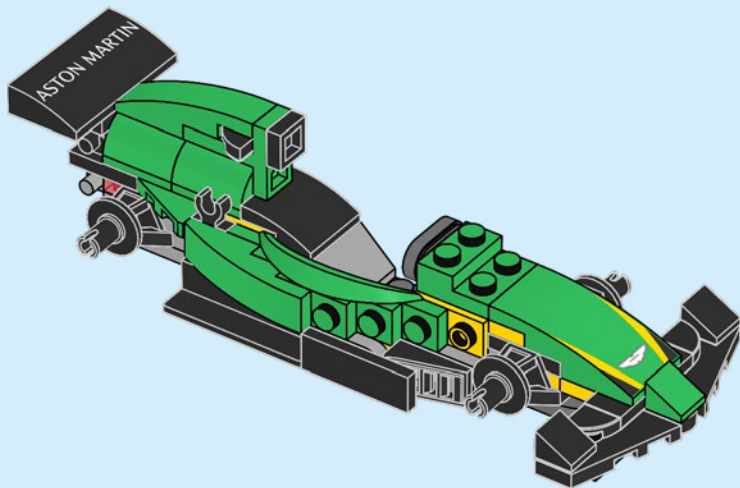



1x



1x

32

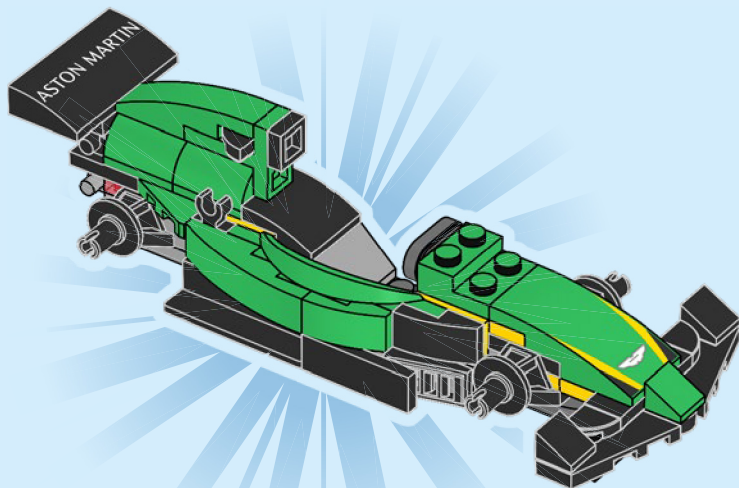

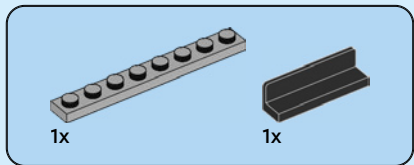
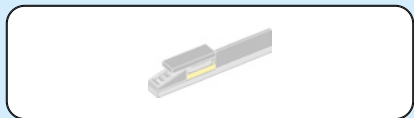

33

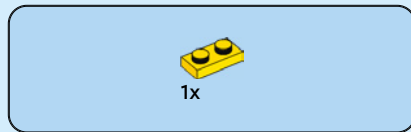
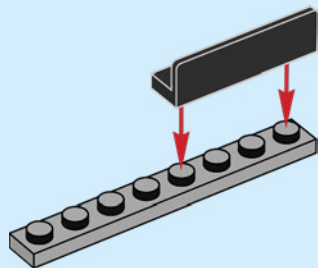

34

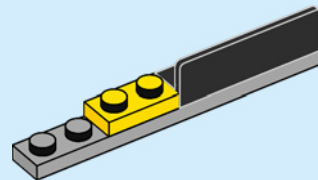



1x



1x

35

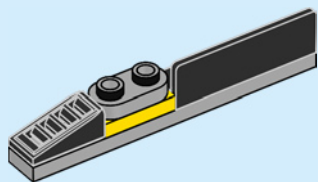

1x

36

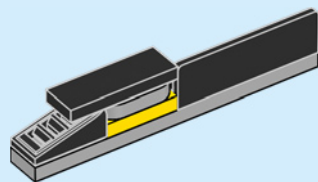

37

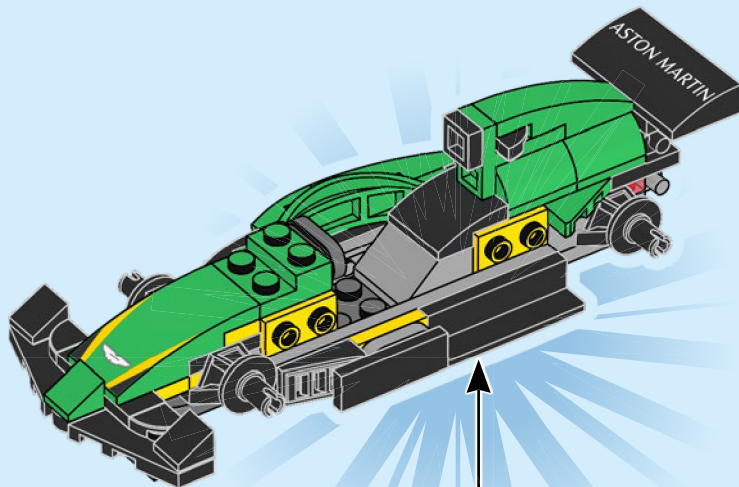

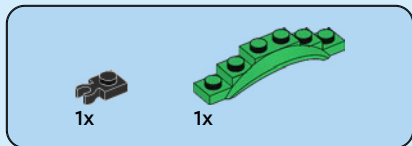

38

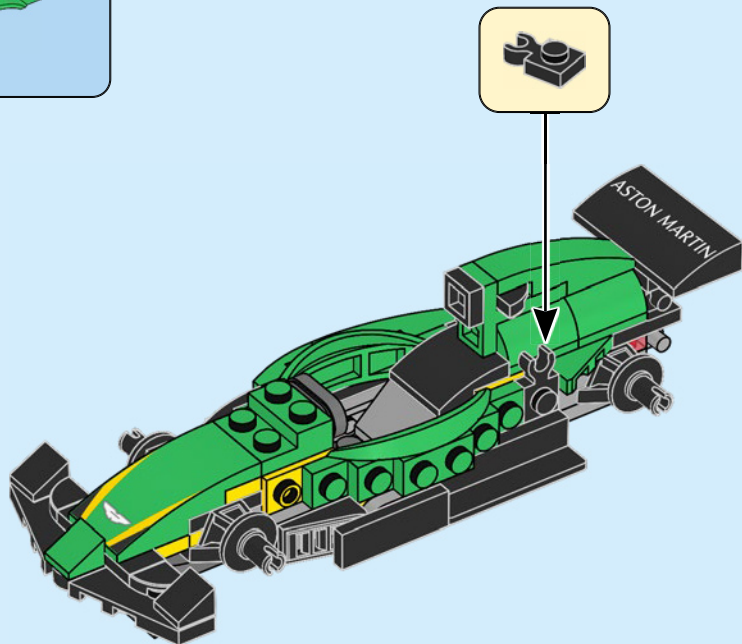

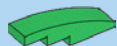

1x

39

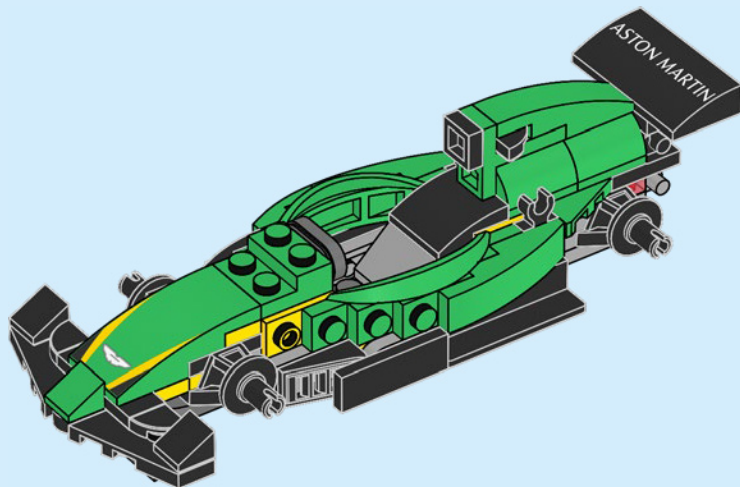



1x



1x

40

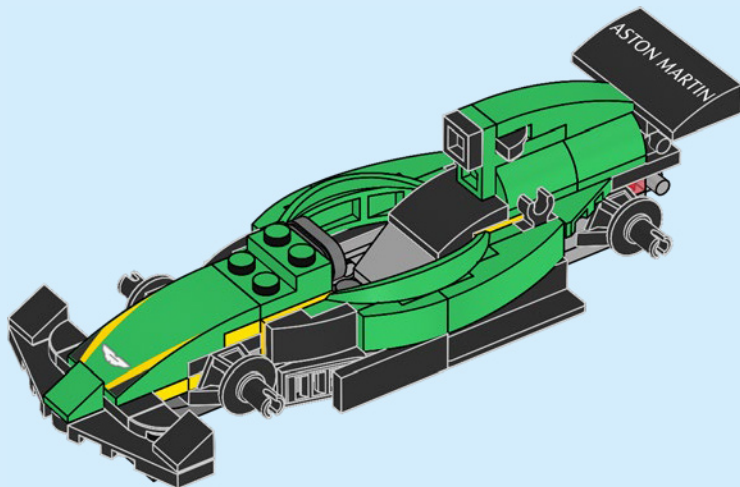

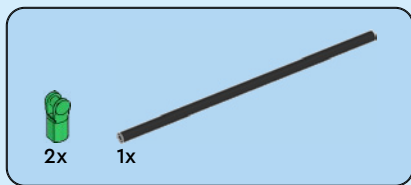

41

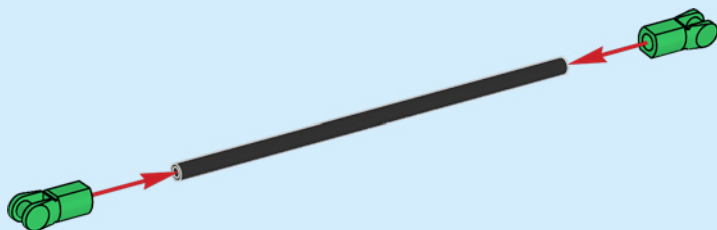

42

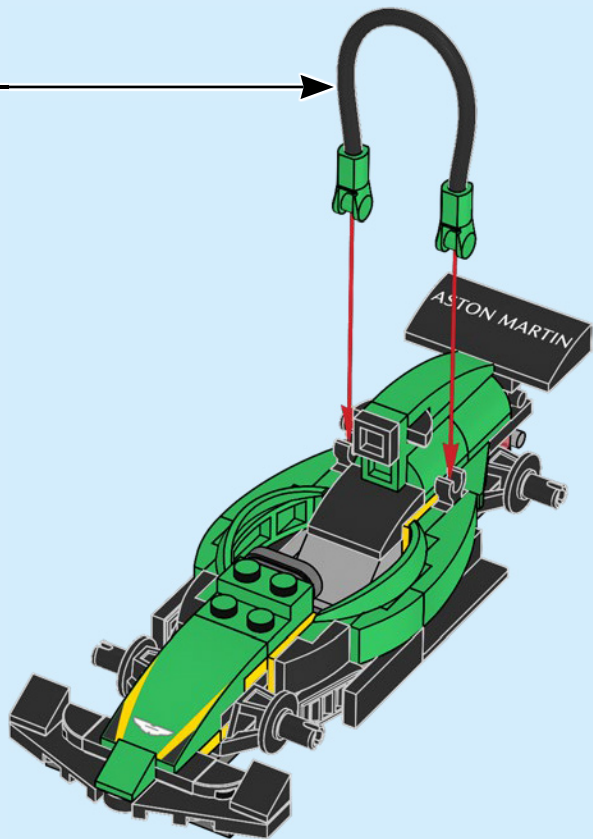

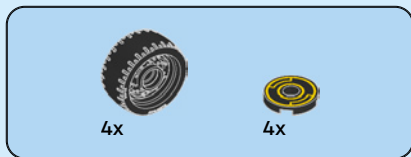

43

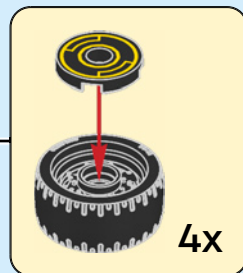
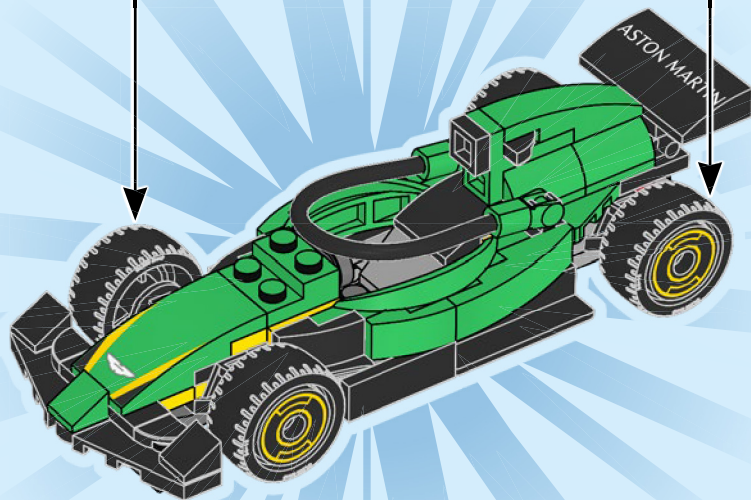

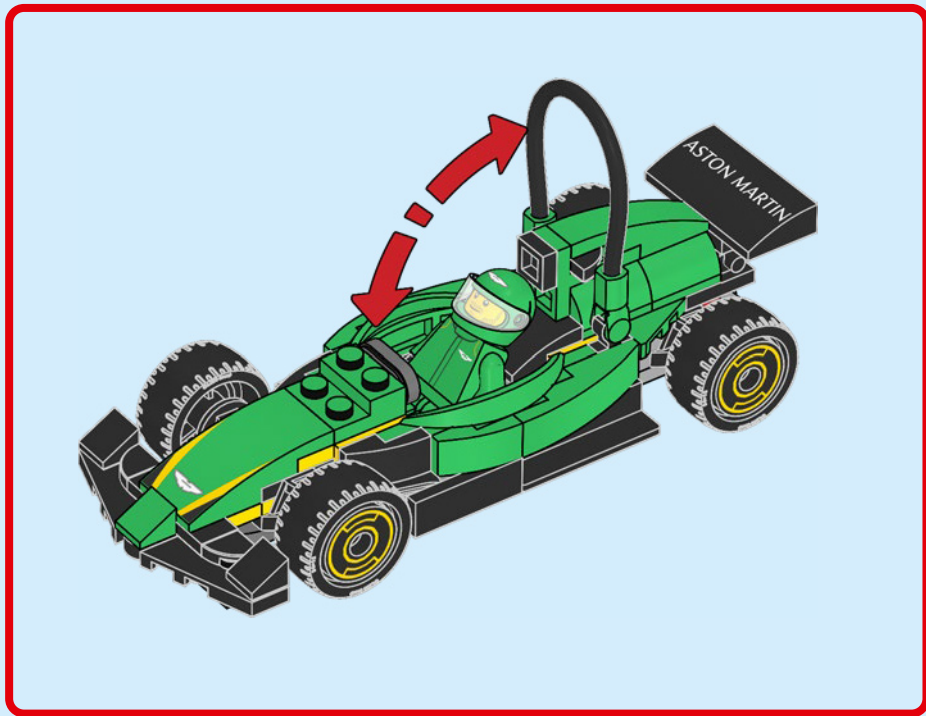

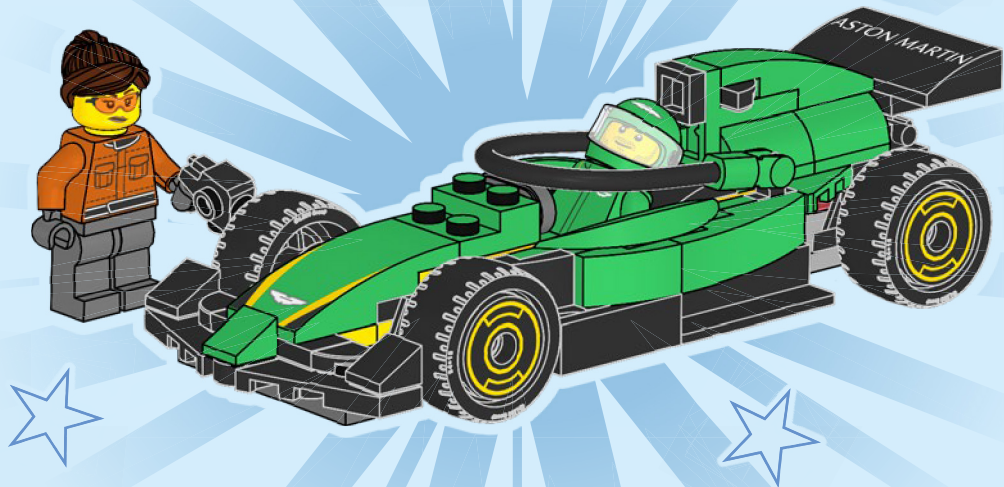



LEGO and the LEGO logo are trademarks of the/son des marques de commerce du/son marcas registradas de LEGO Group.
©2025 The LEGO Group. 6557724

The F1 logo, FORMULA 1, F1, GRAND PRIX and related marks are trademarks of Formula One Licensing BV, a Formula 1 company.
All other trade marks, logos and copyrights, including those of the teams featured, are the property of their respective owners. All rights reserved.

OFFICIAL LICENSEE OF FORMULA 1®