

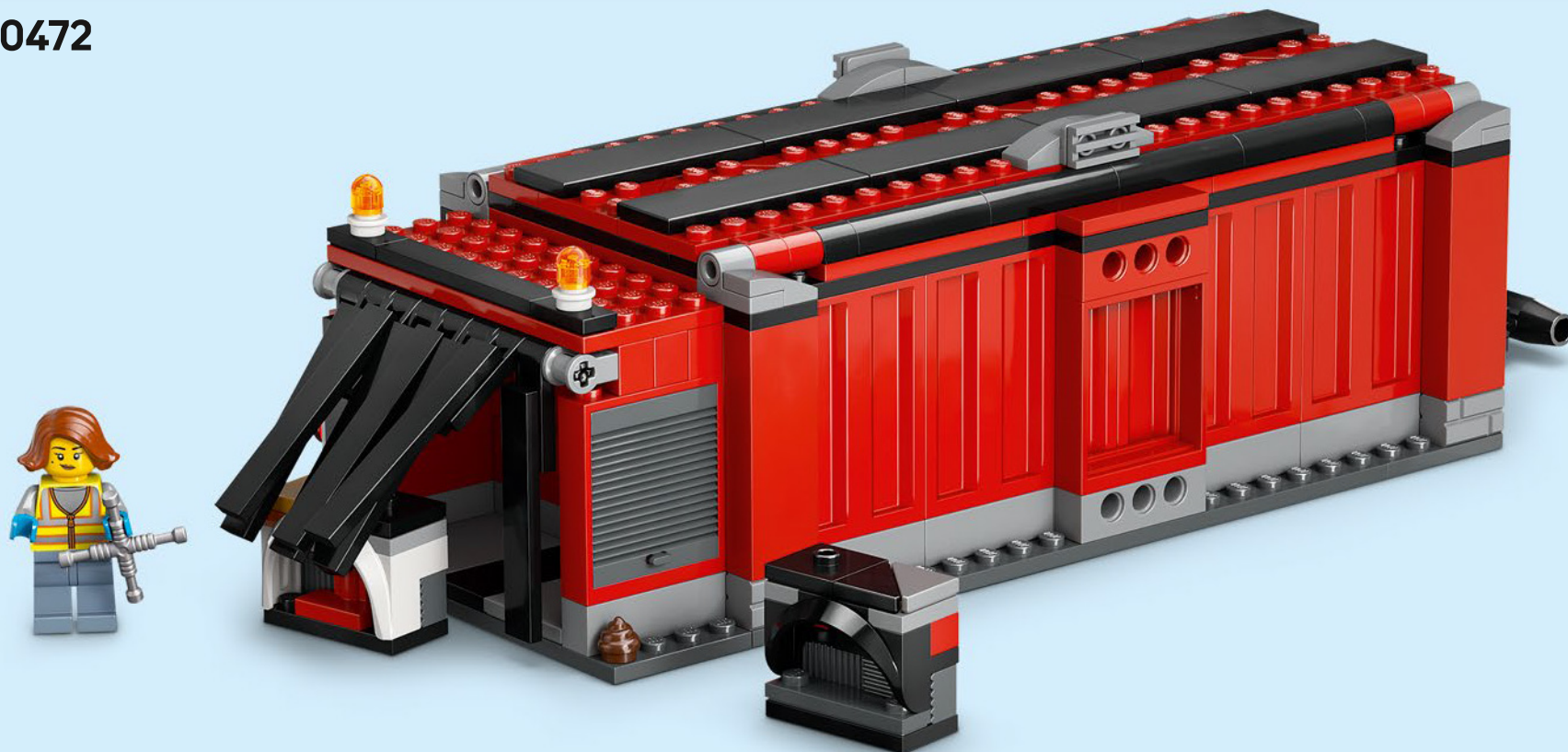

CITY

60472



6 7 8

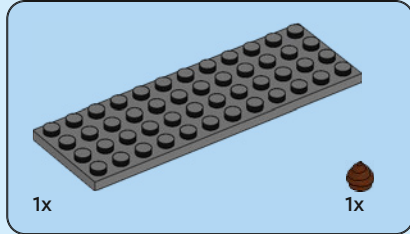
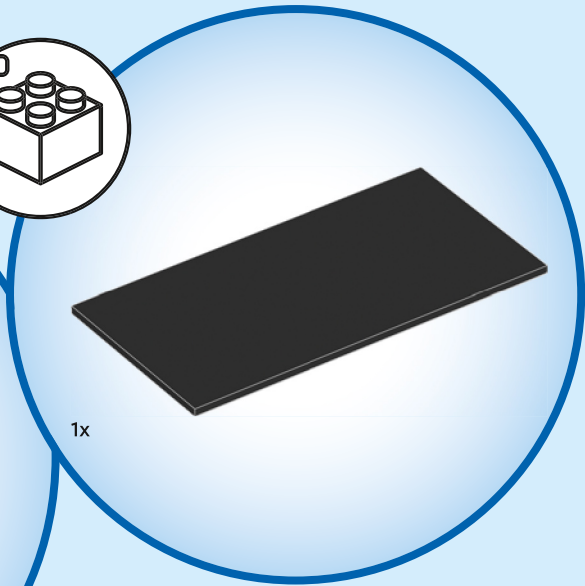
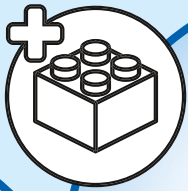

1

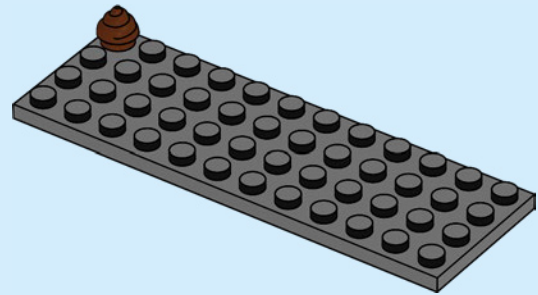



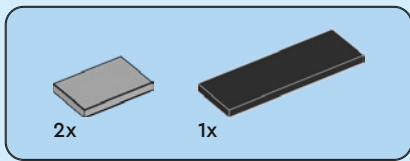

2

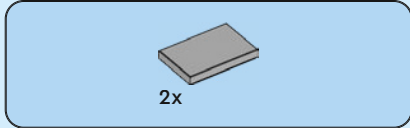
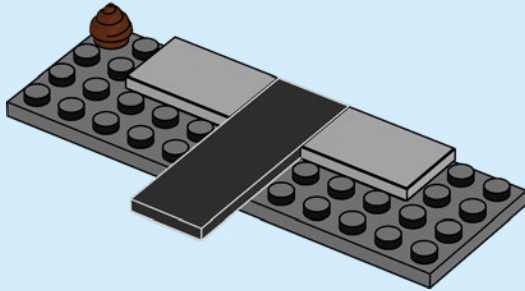

3

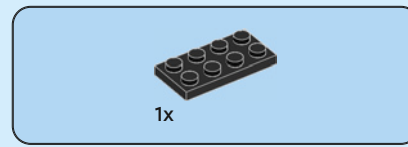
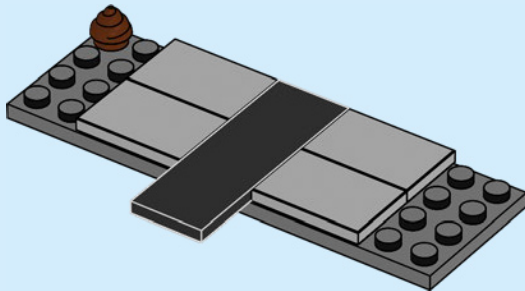

4

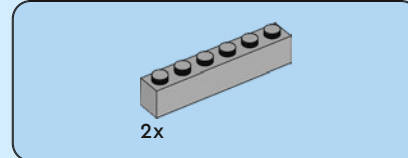
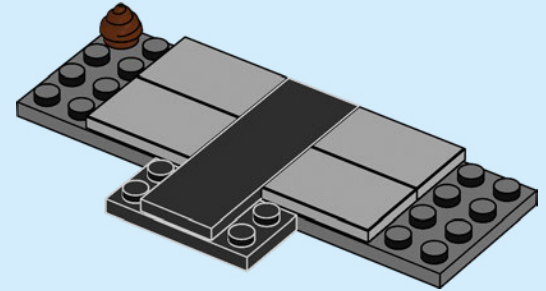

5

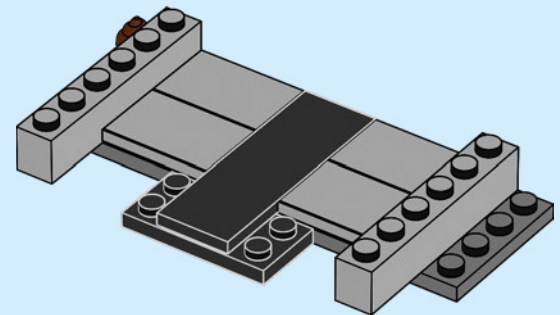

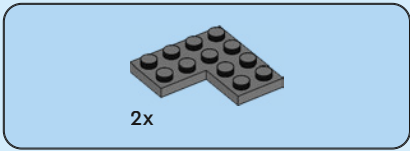

6

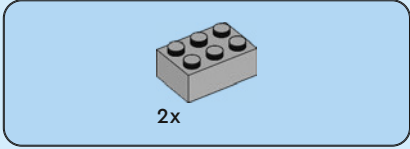
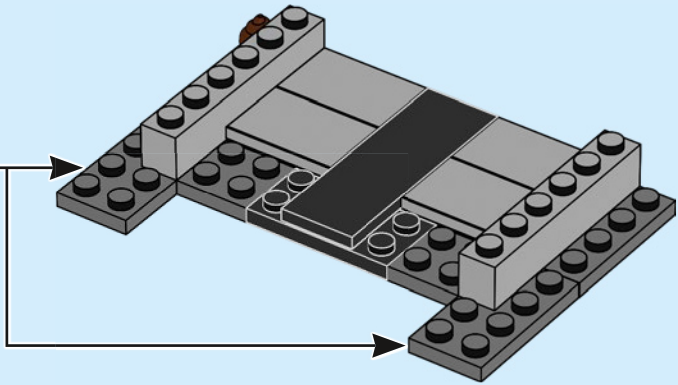
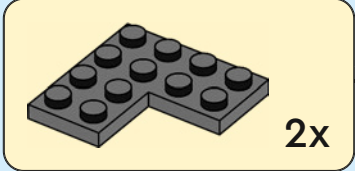

7

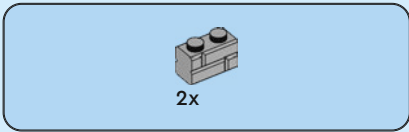
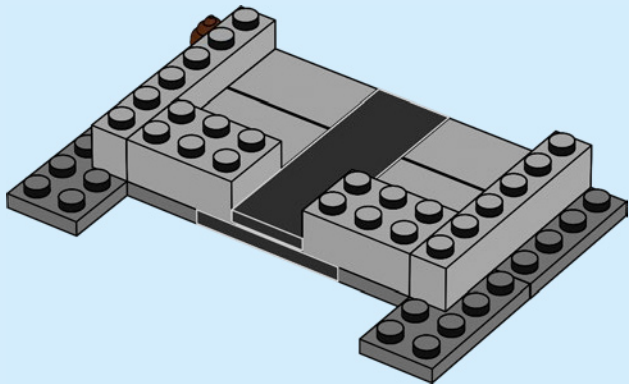

8

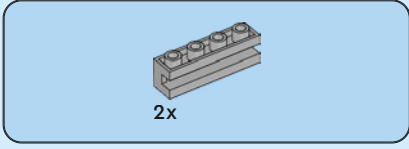
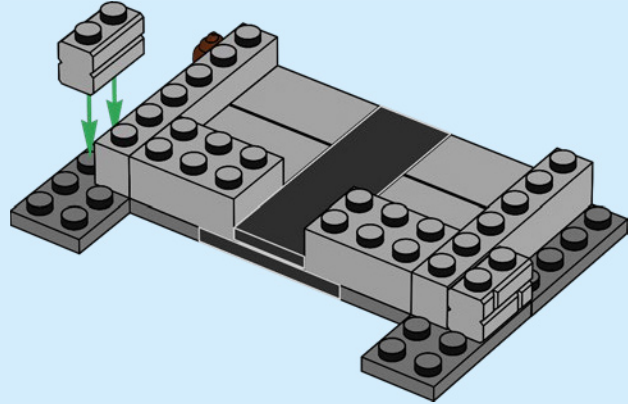

9

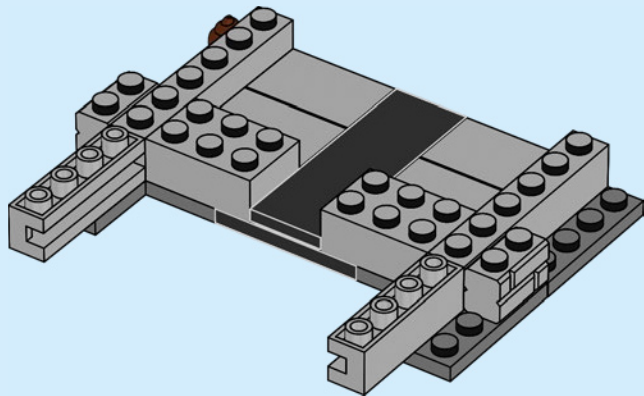

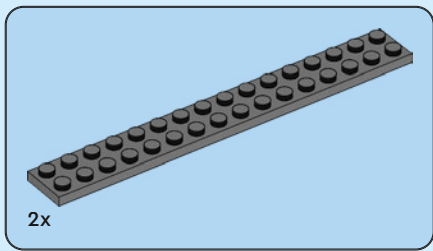

10

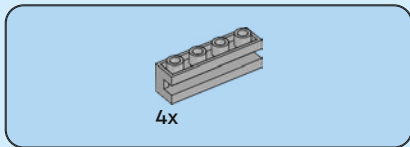
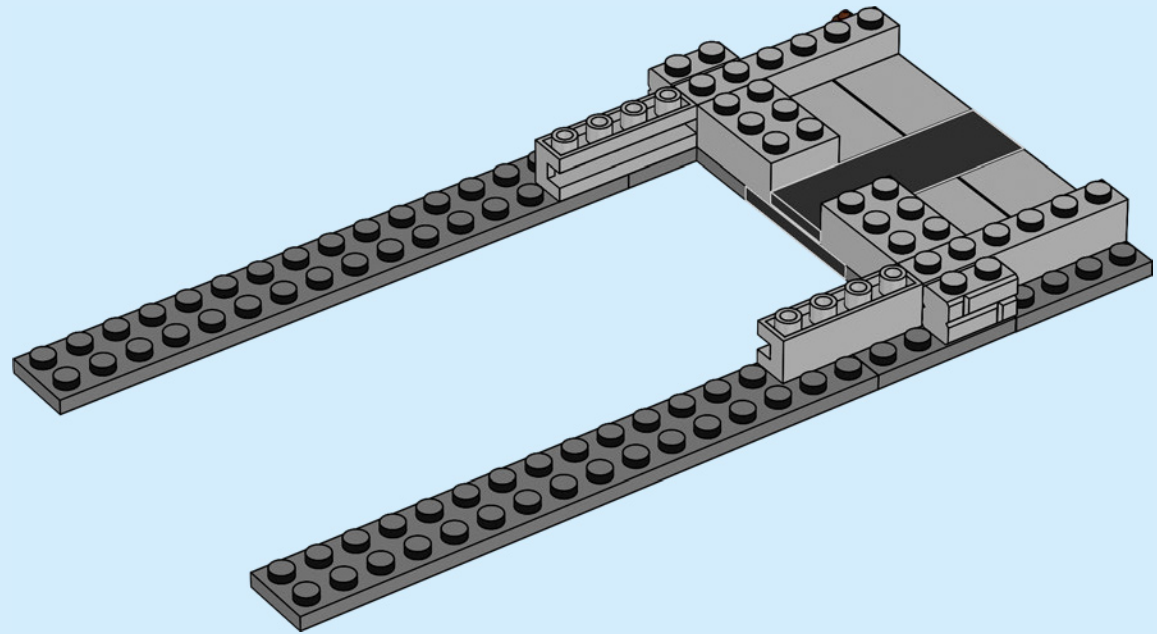

11

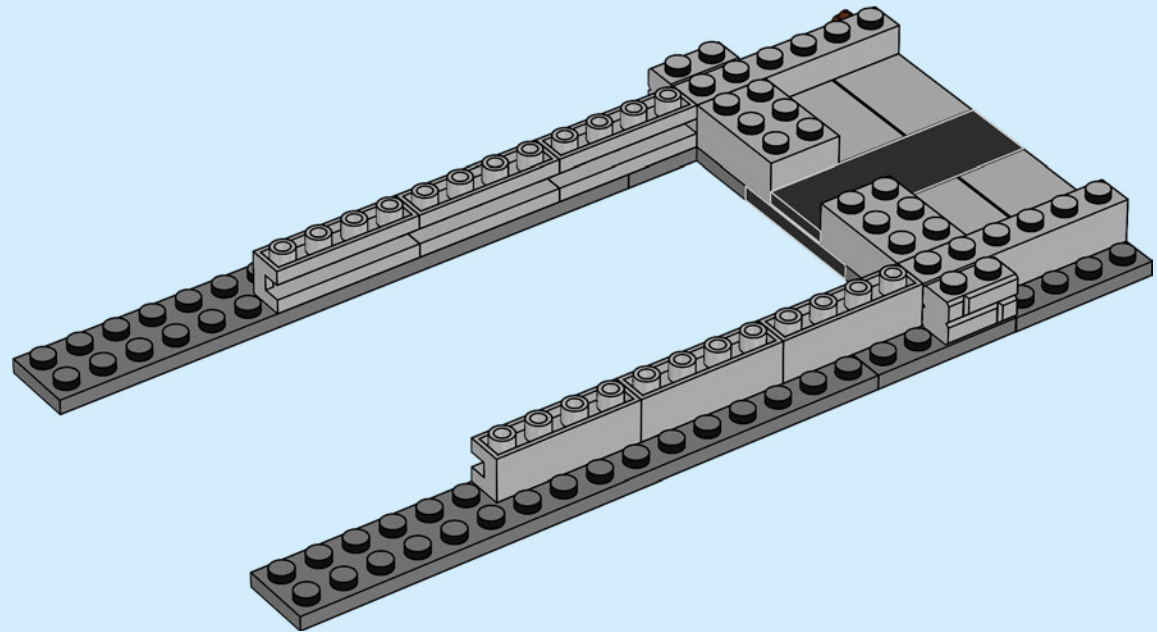



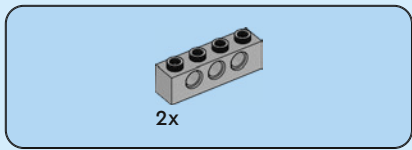

12

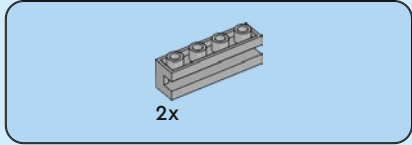
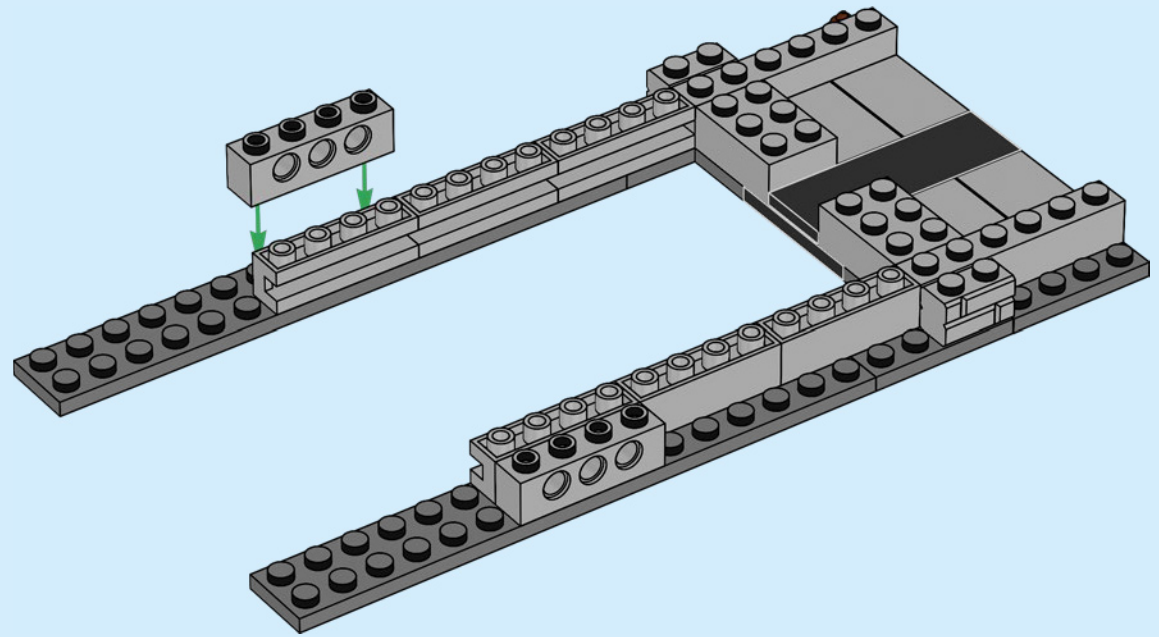

13

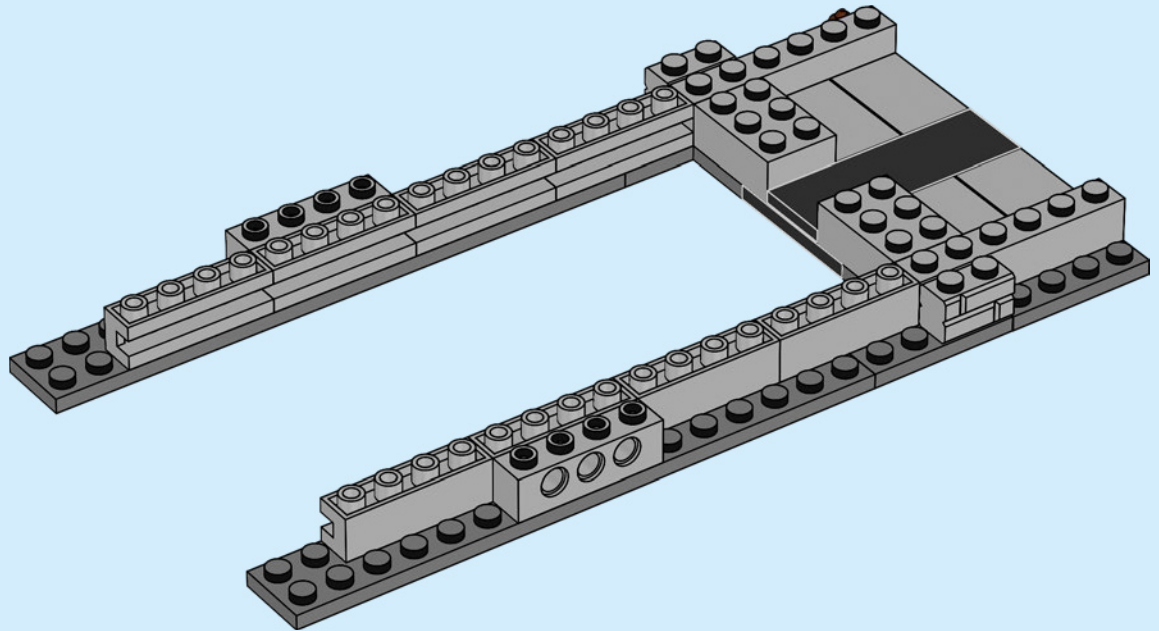

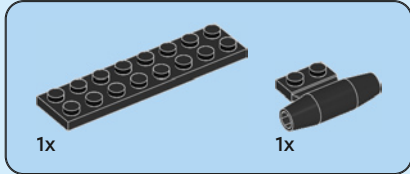
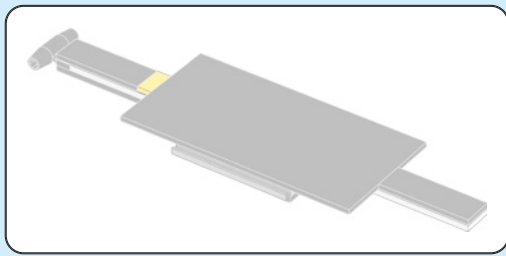

14

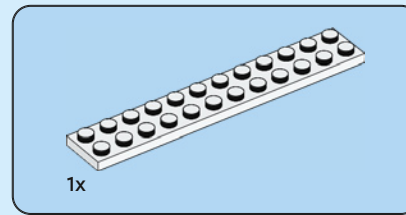
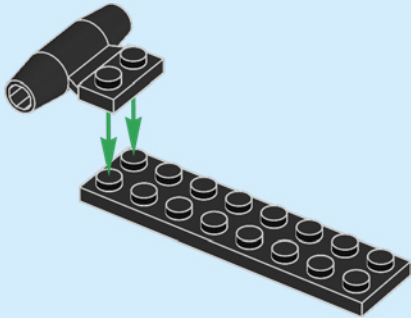

15

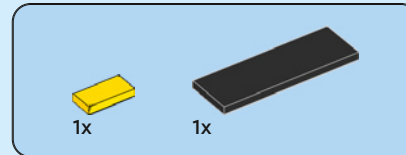
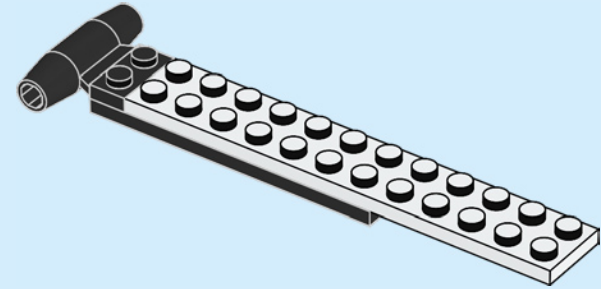

16

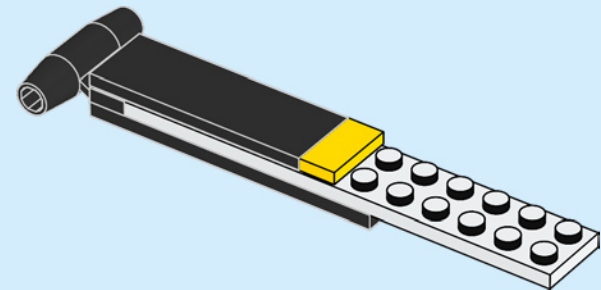

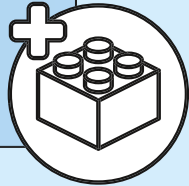
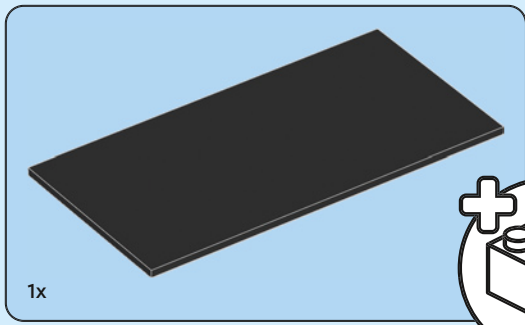

17

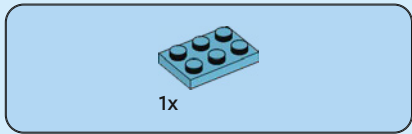
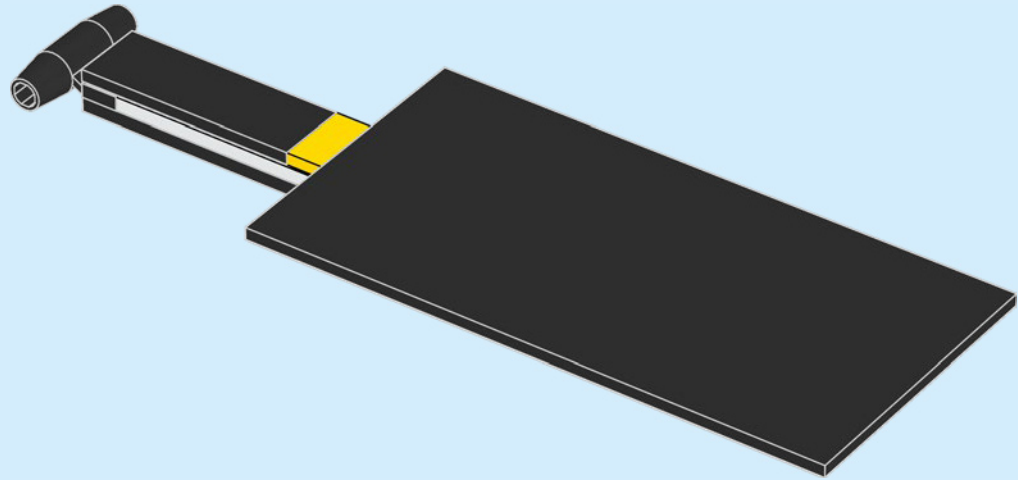

18

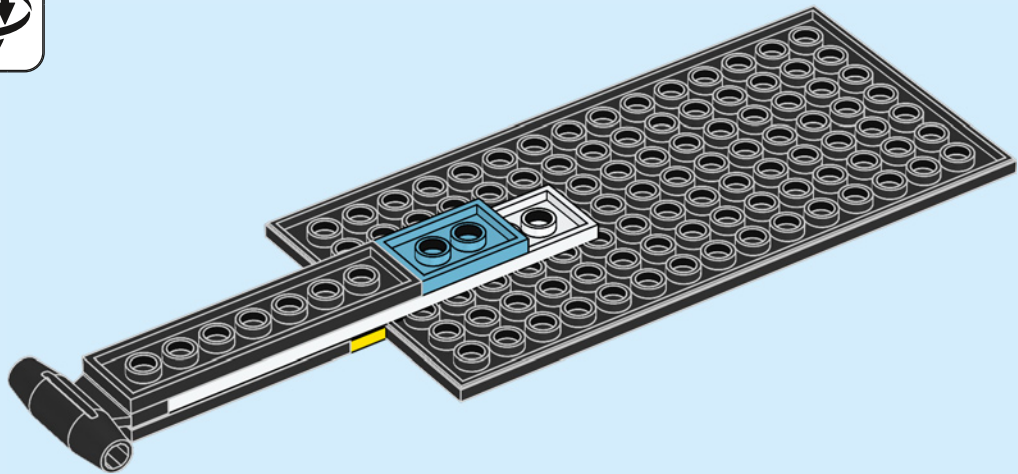





2x

19

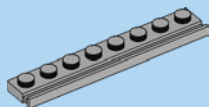
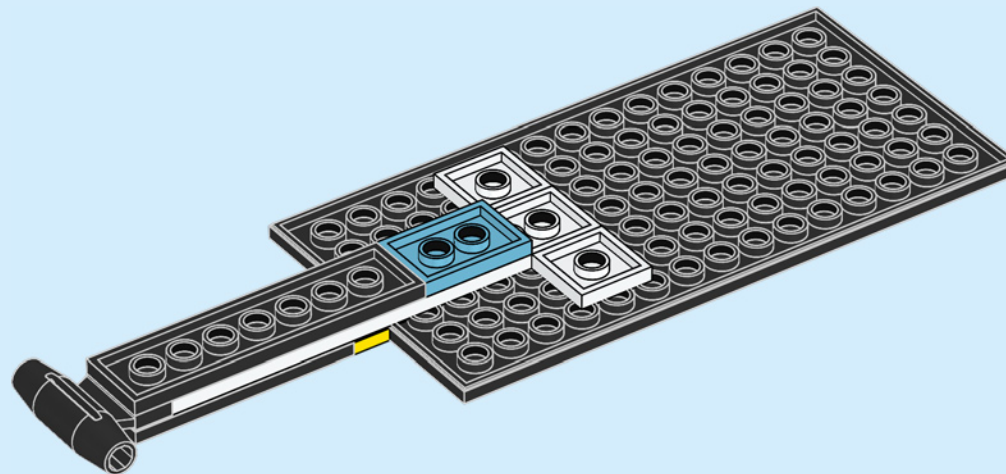

2x

20

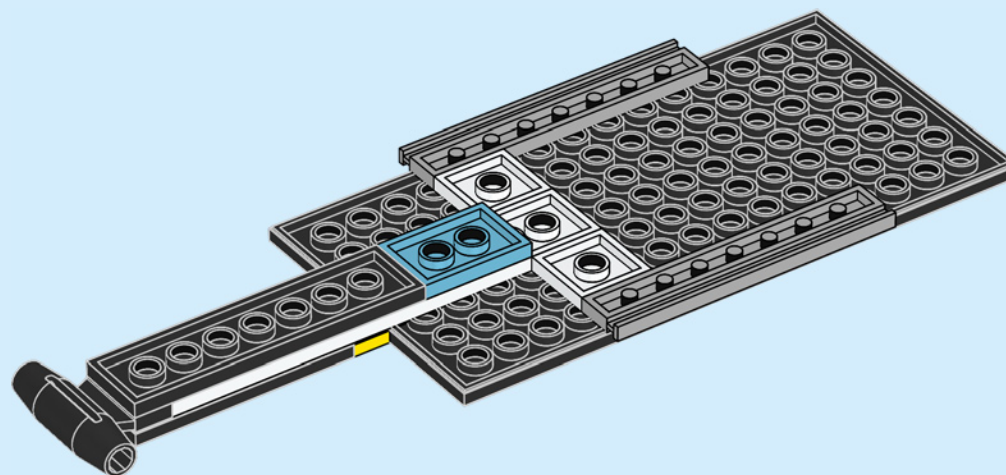

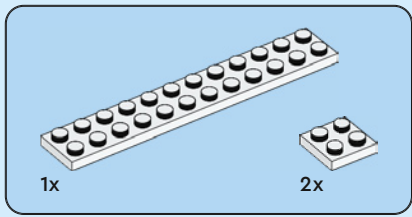

21

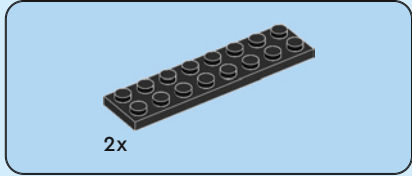
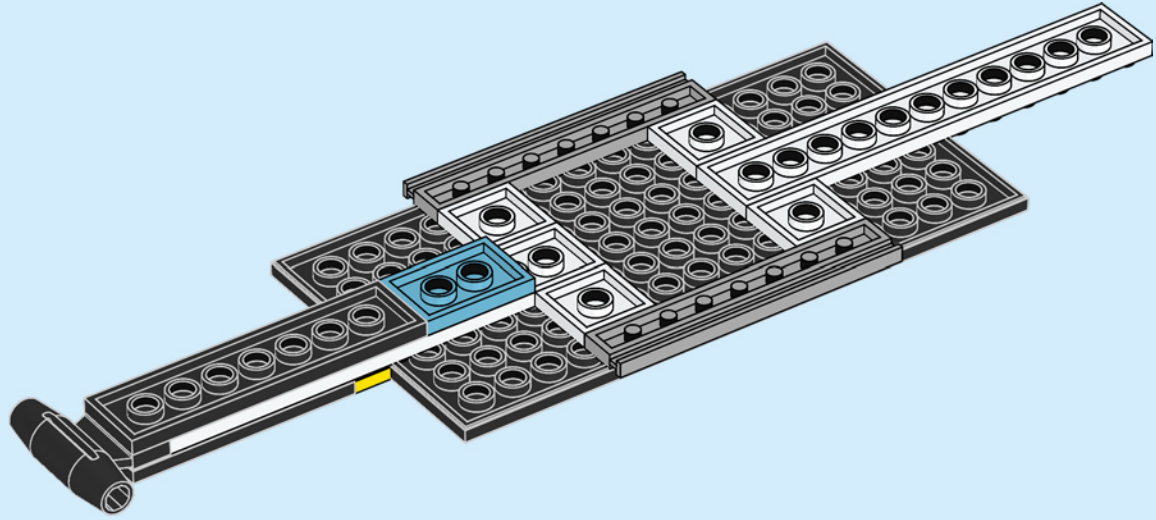

22

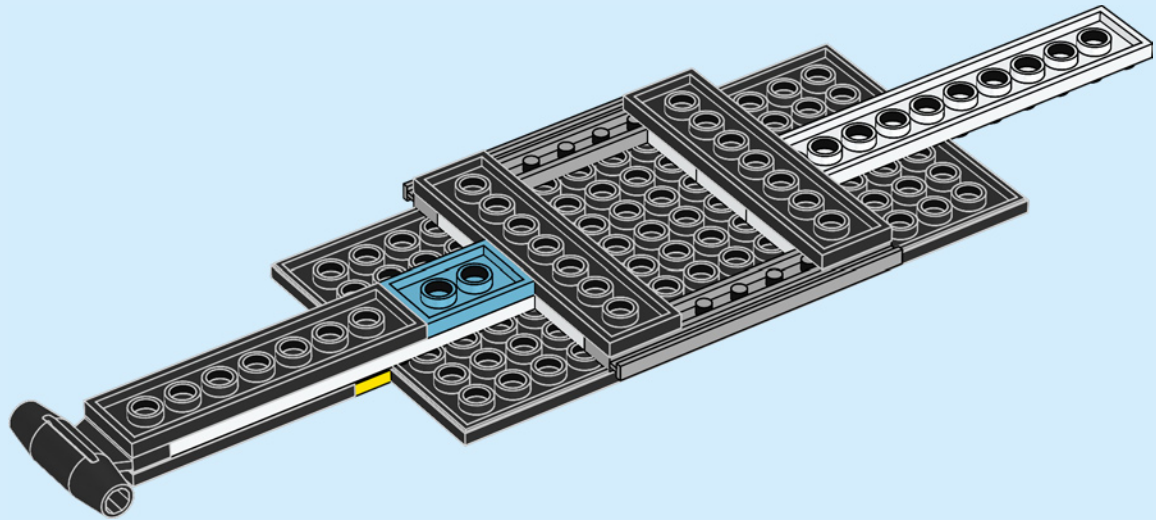



23

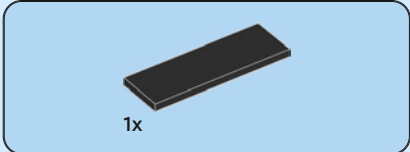
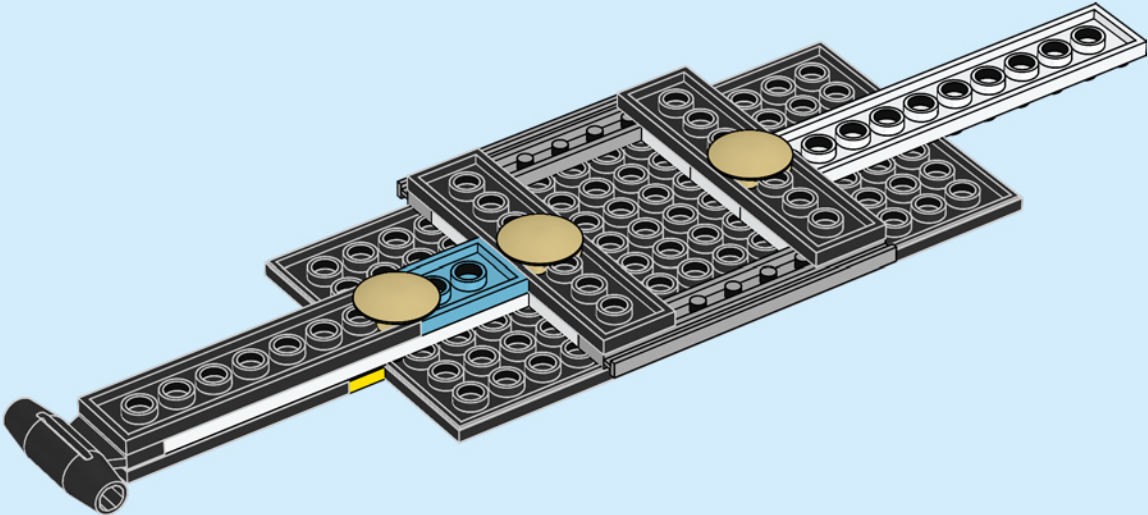

24

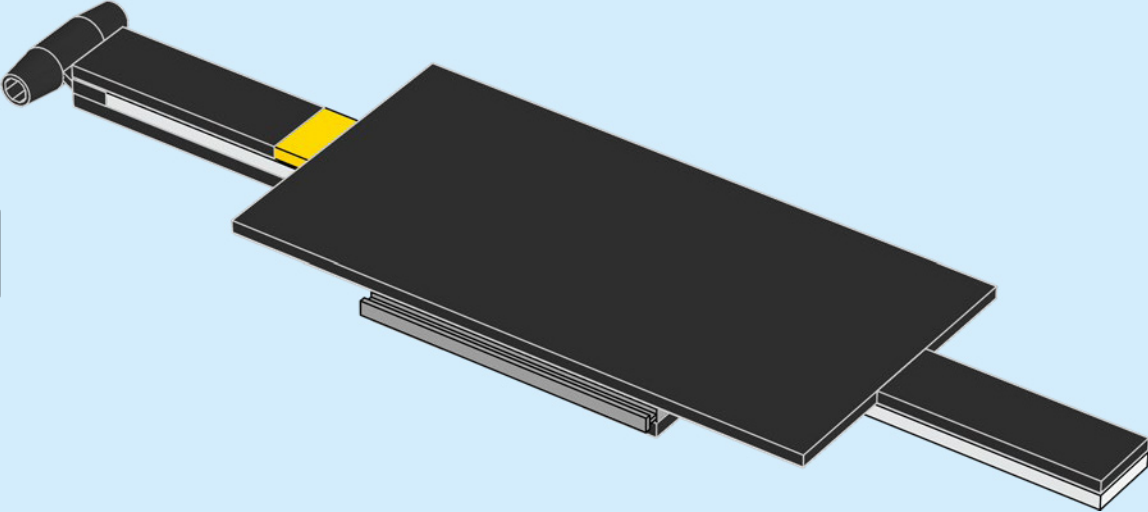



25

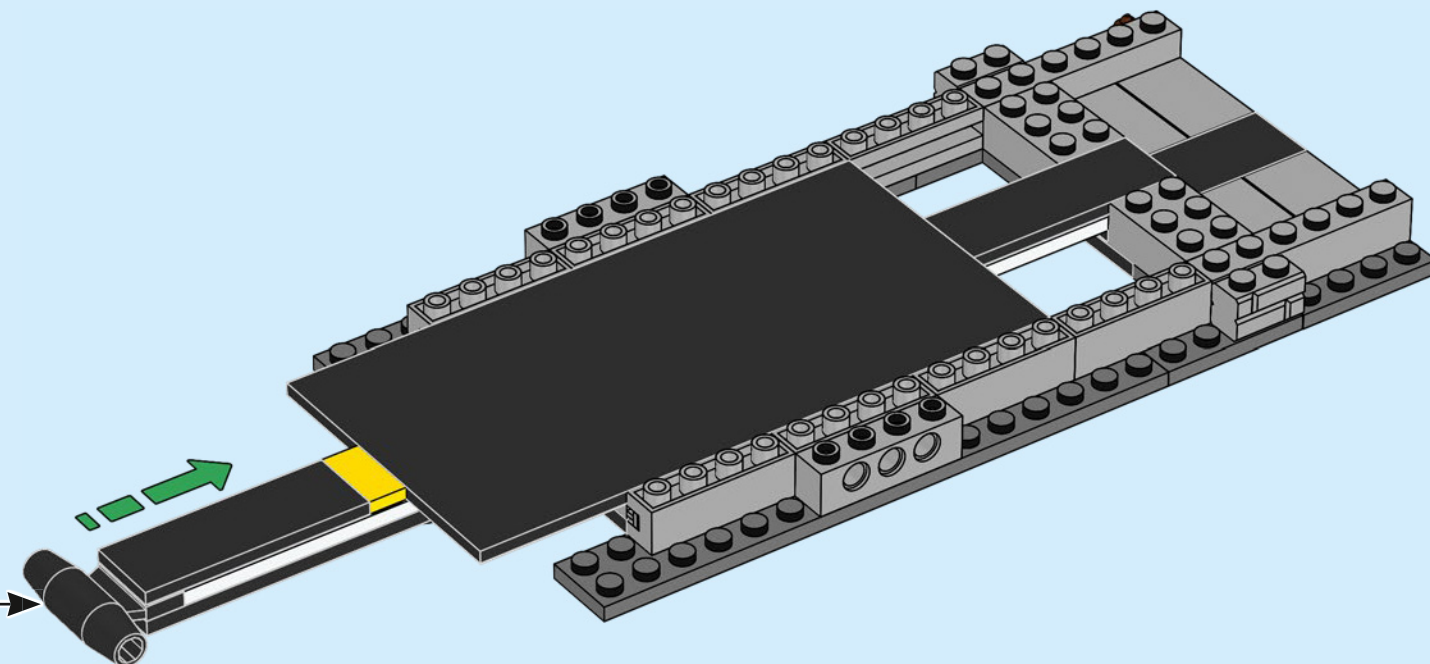

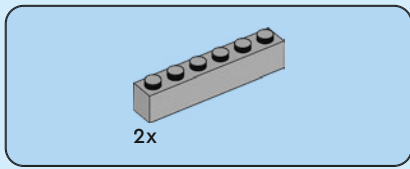

26

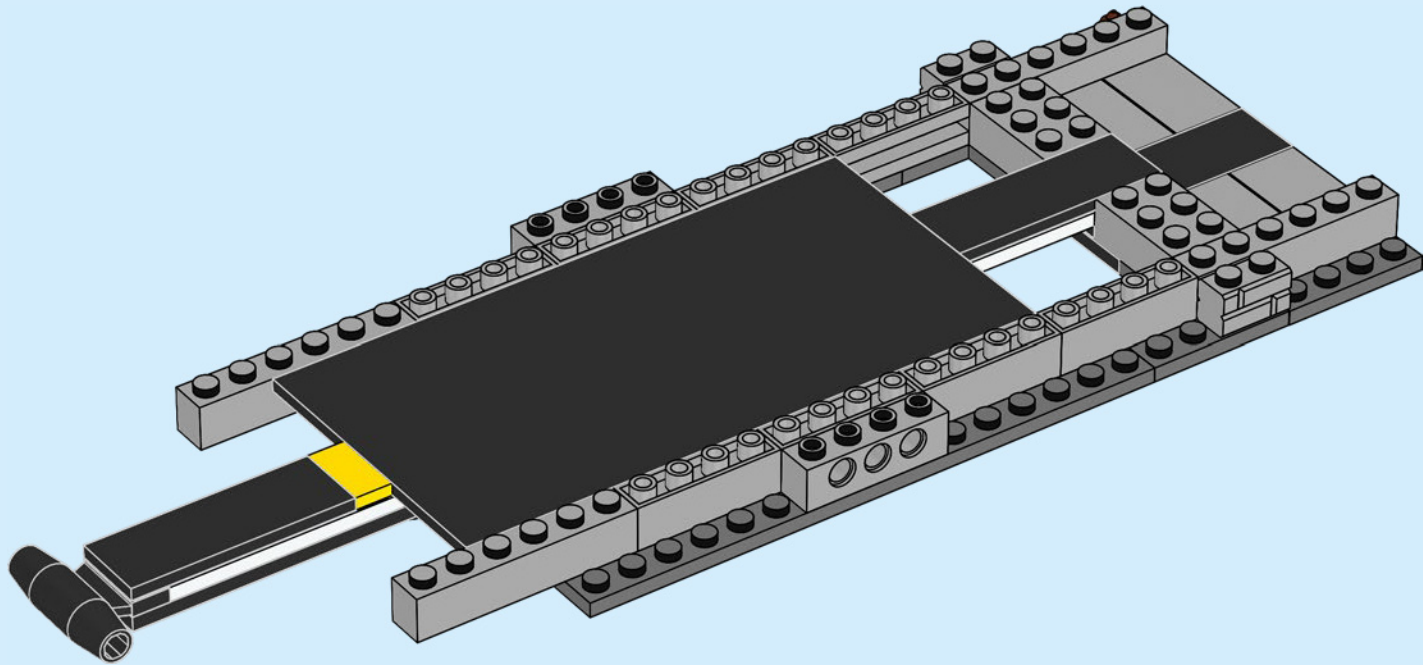

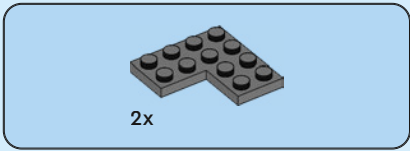

27

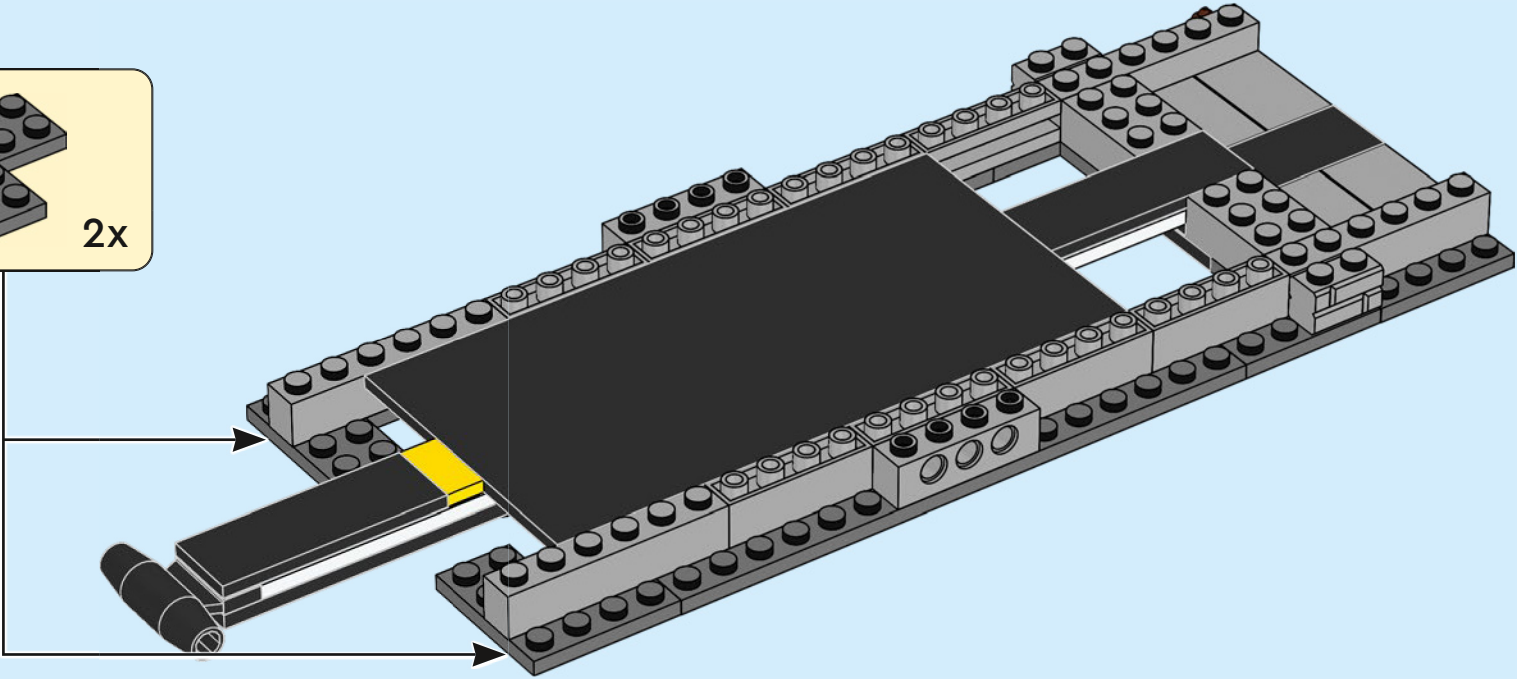
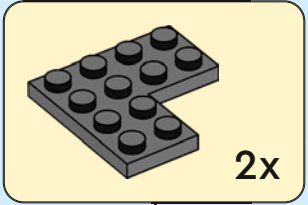





2x

28

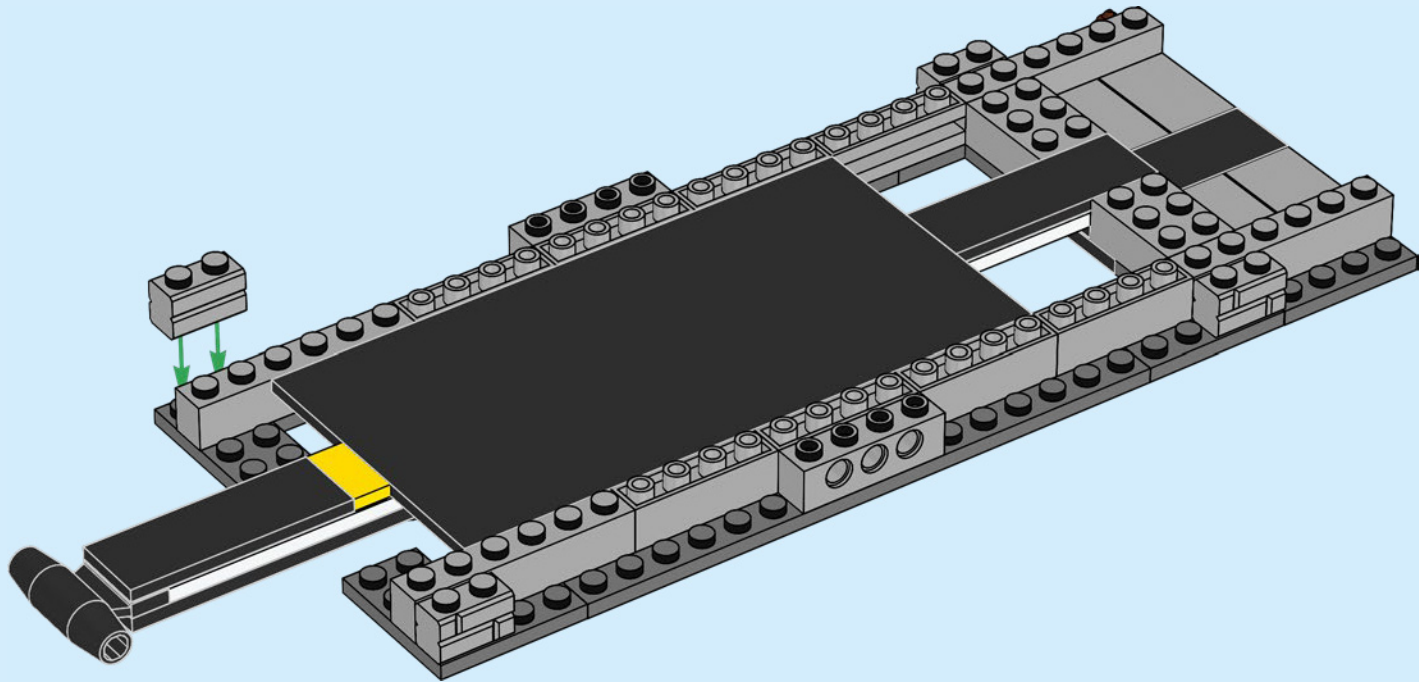

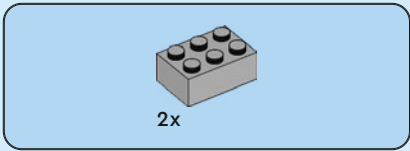

29

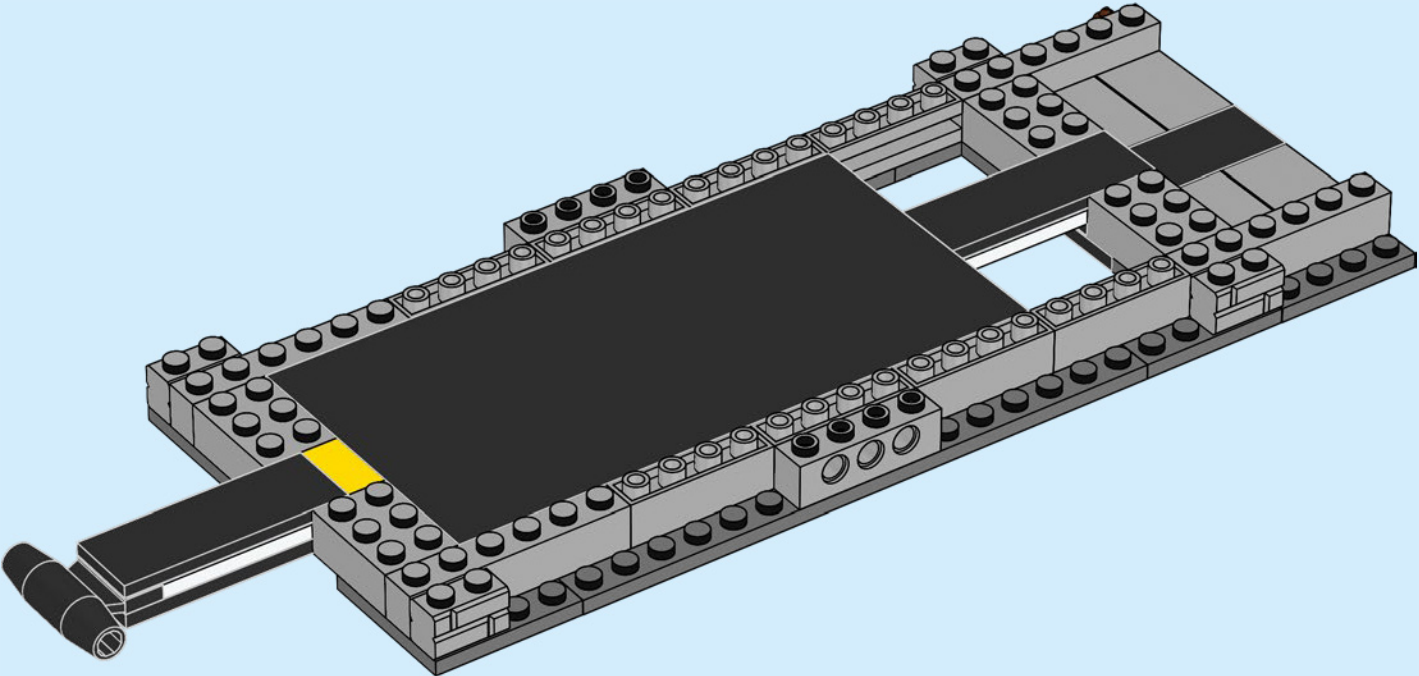

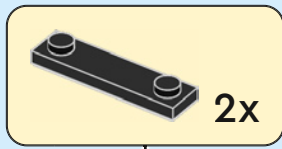
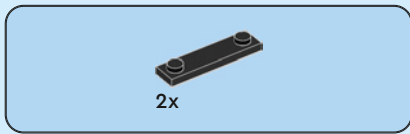

30

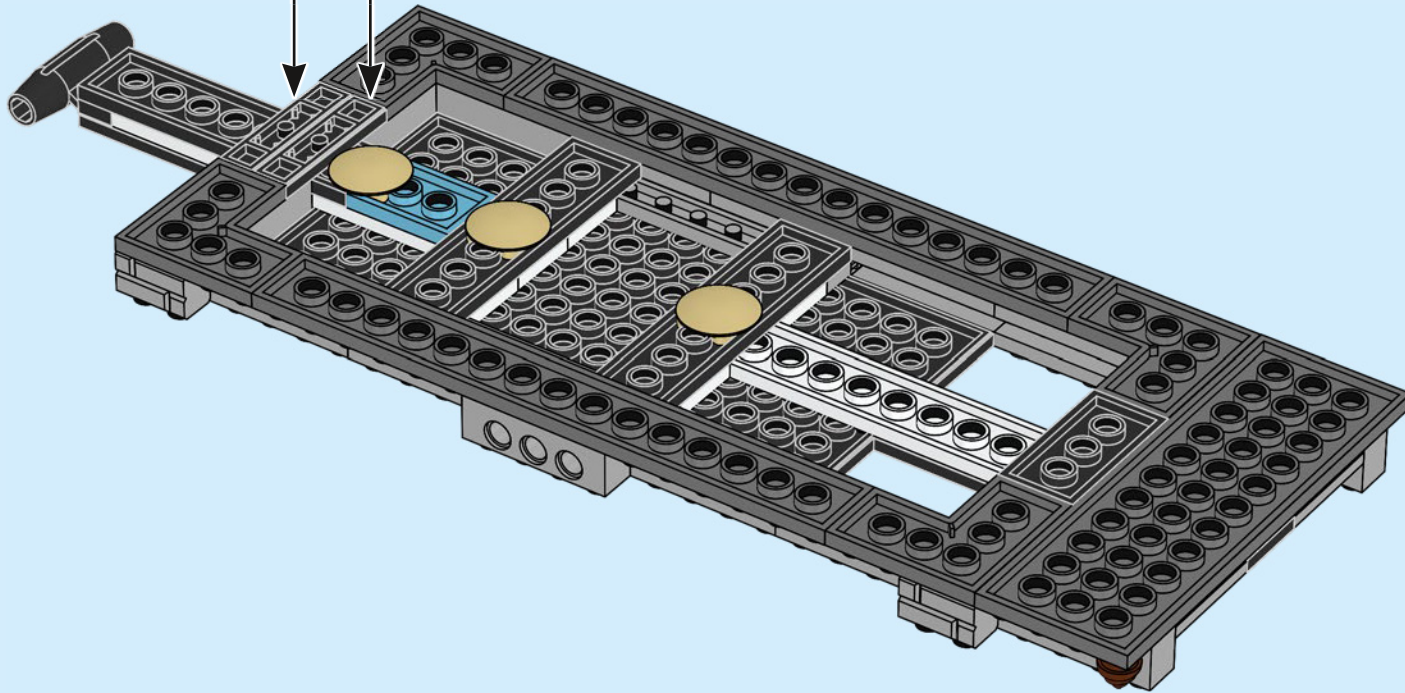

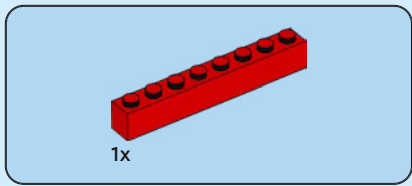

31

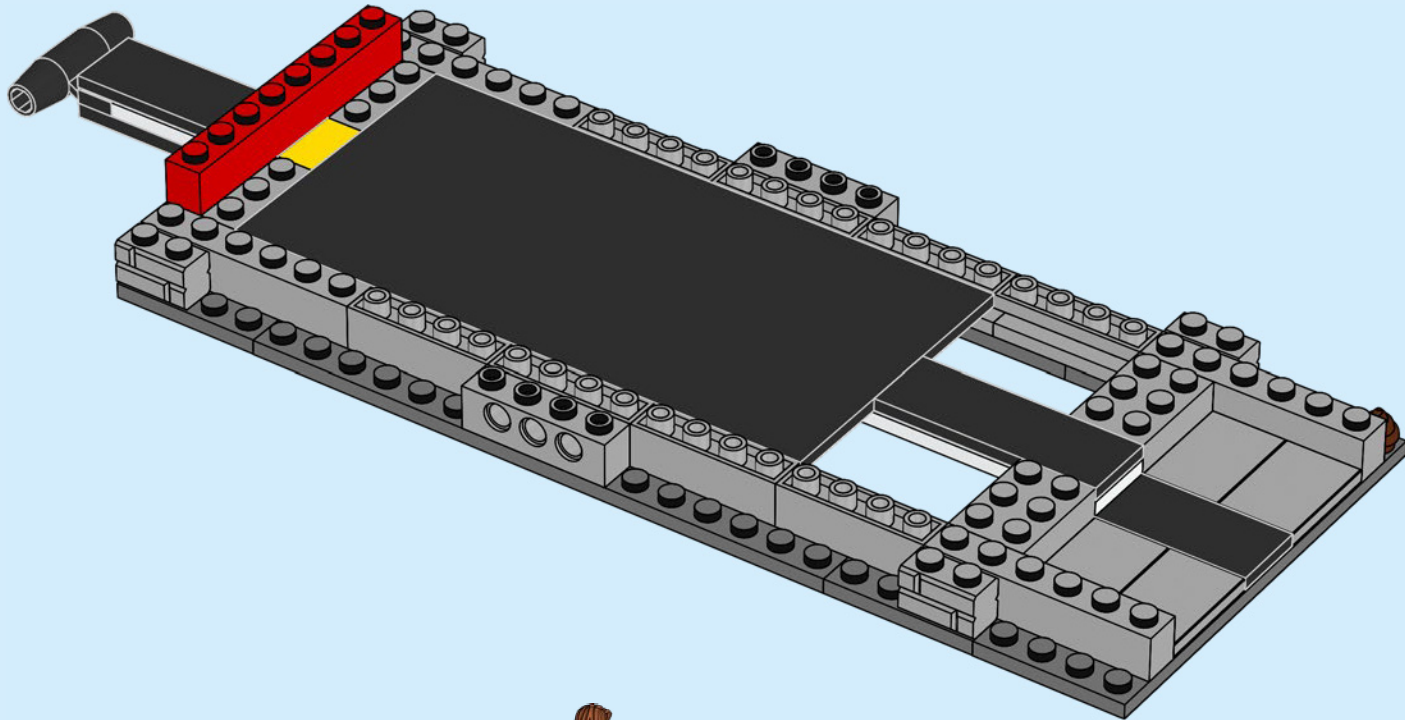

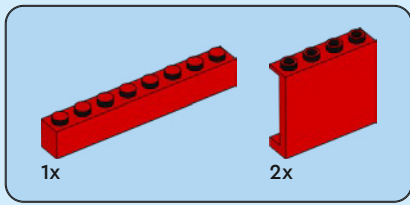

32

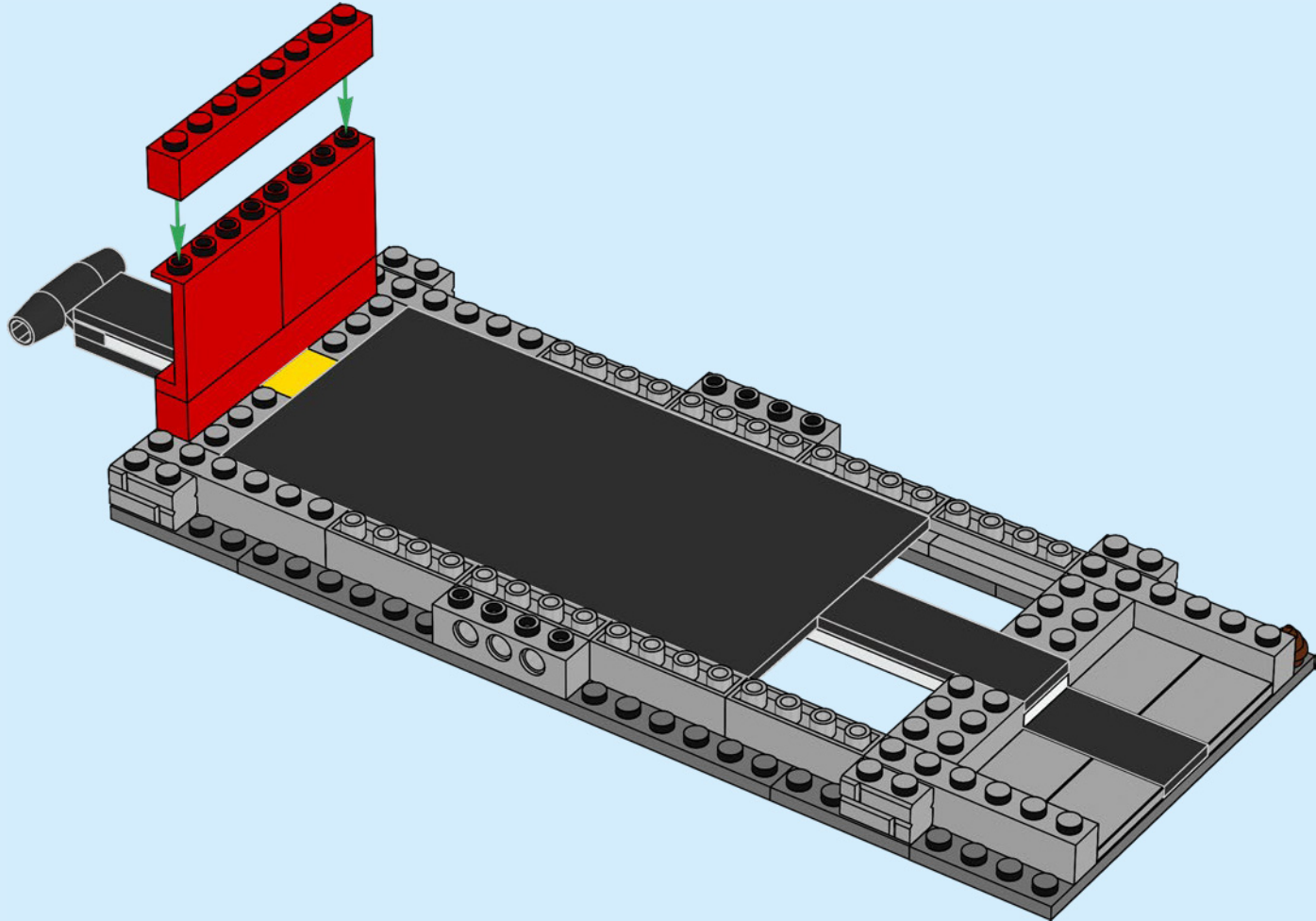



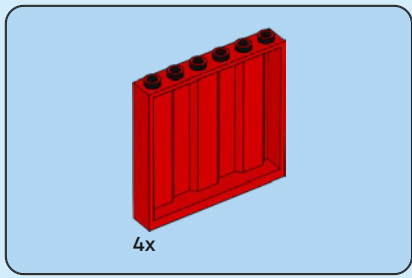

33

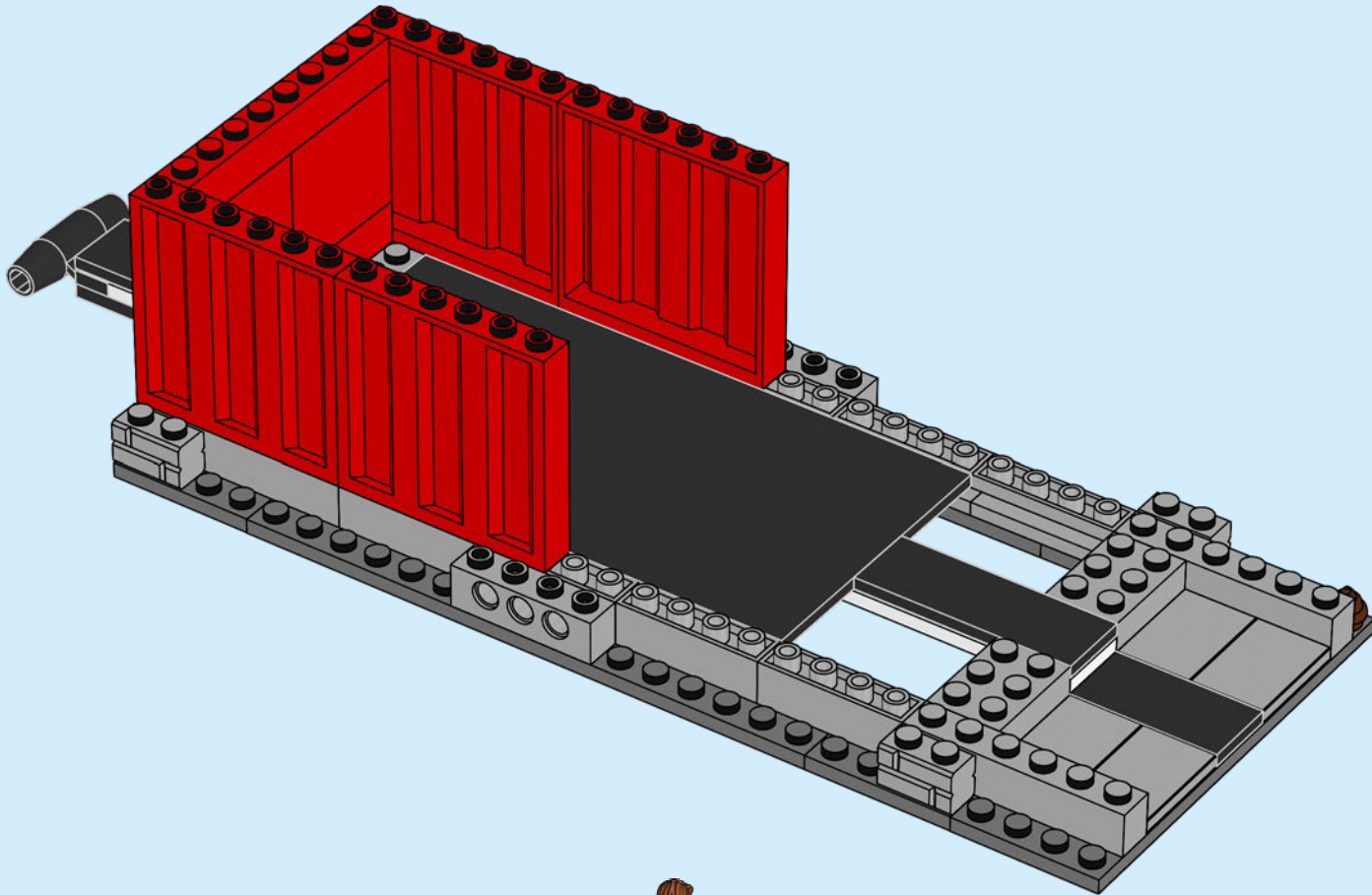

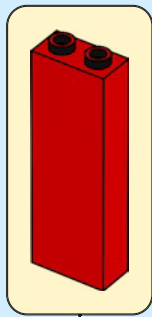
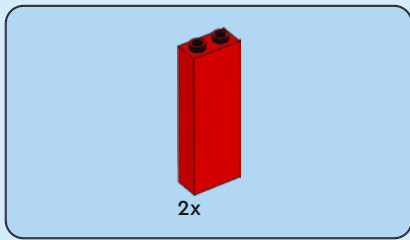

34

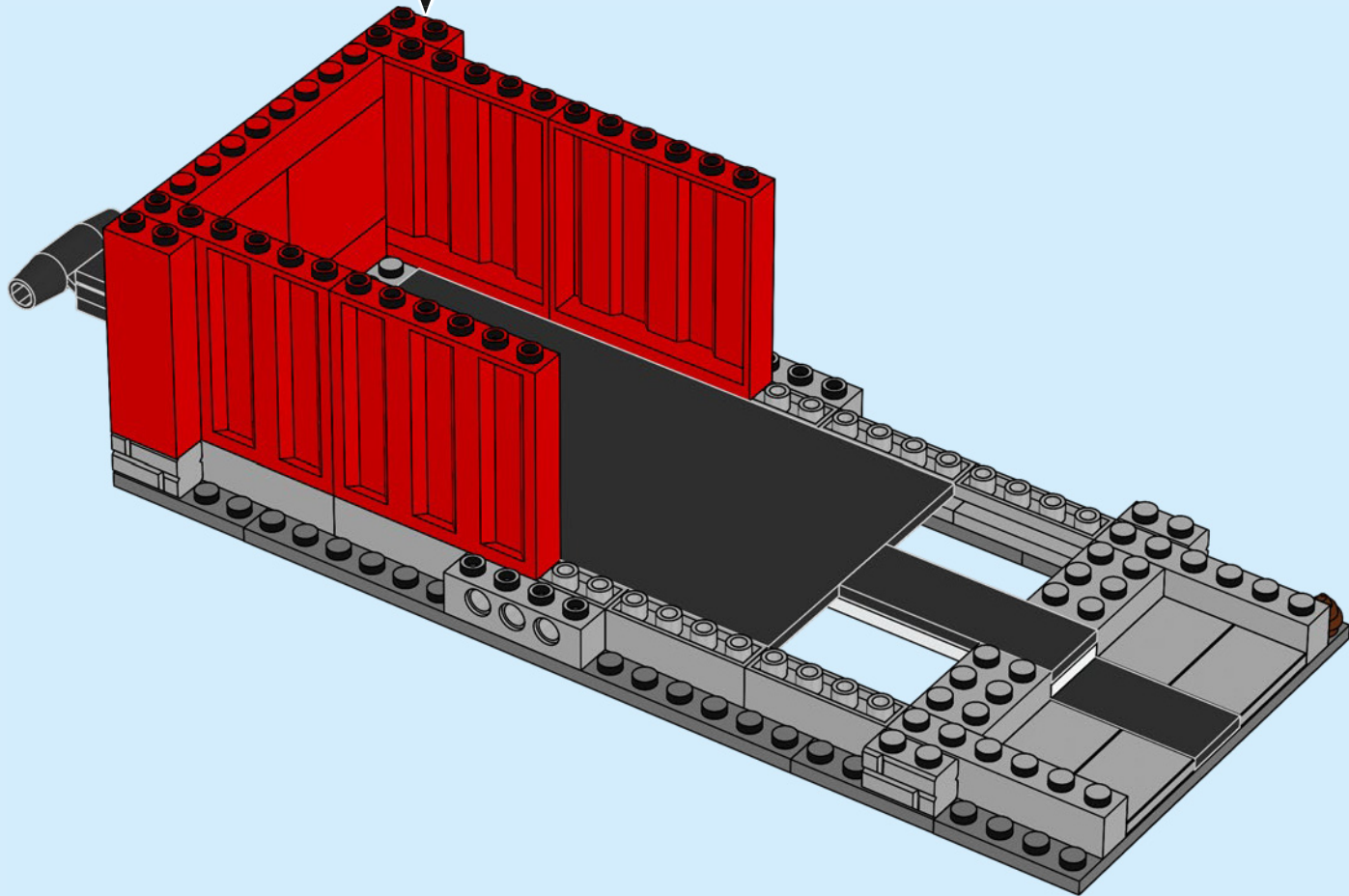

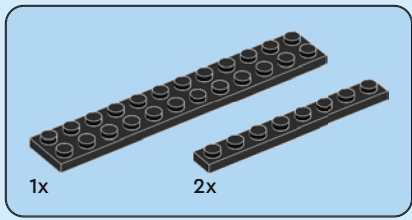

35

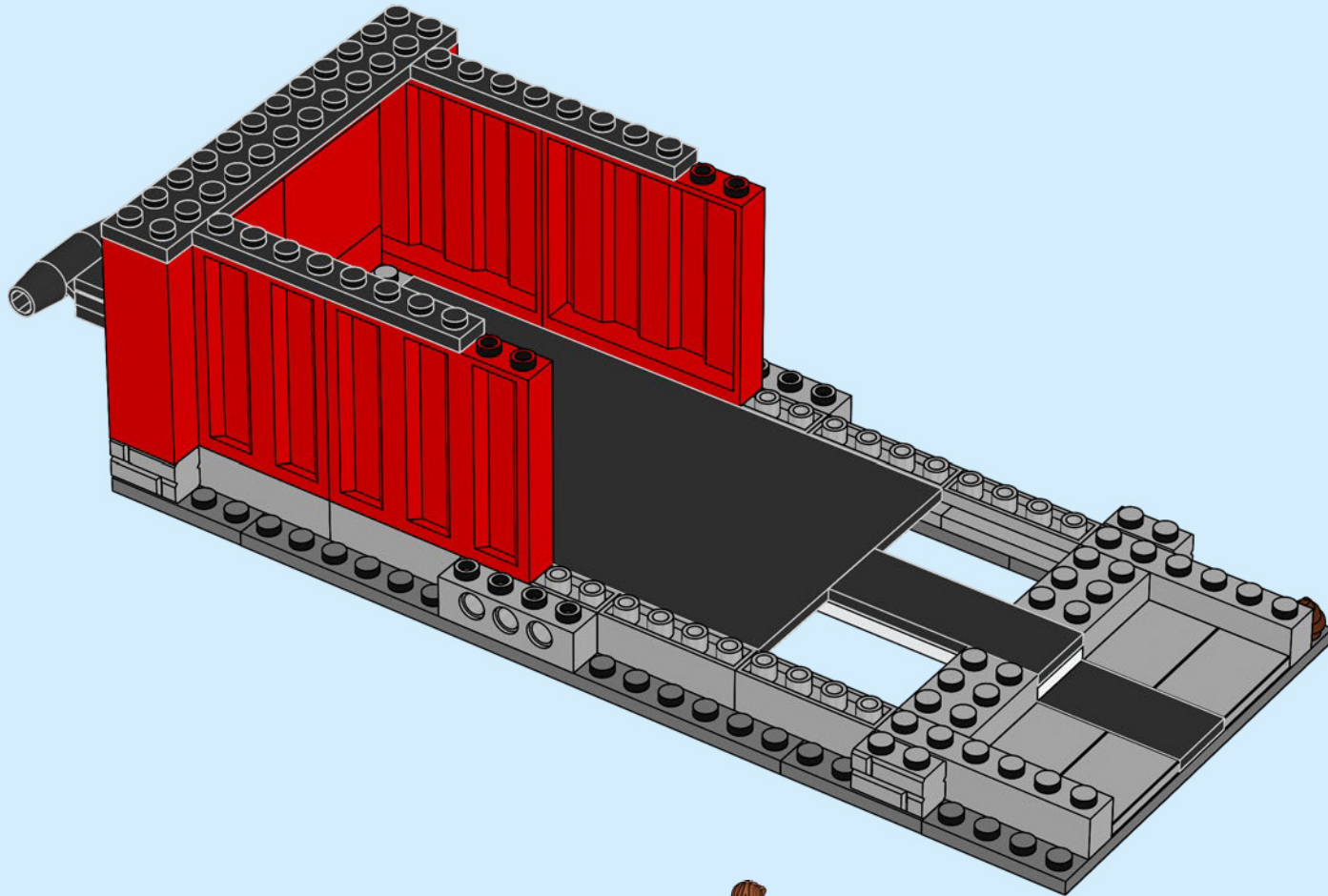

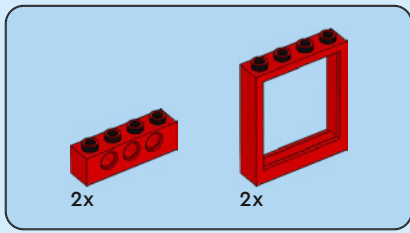

36

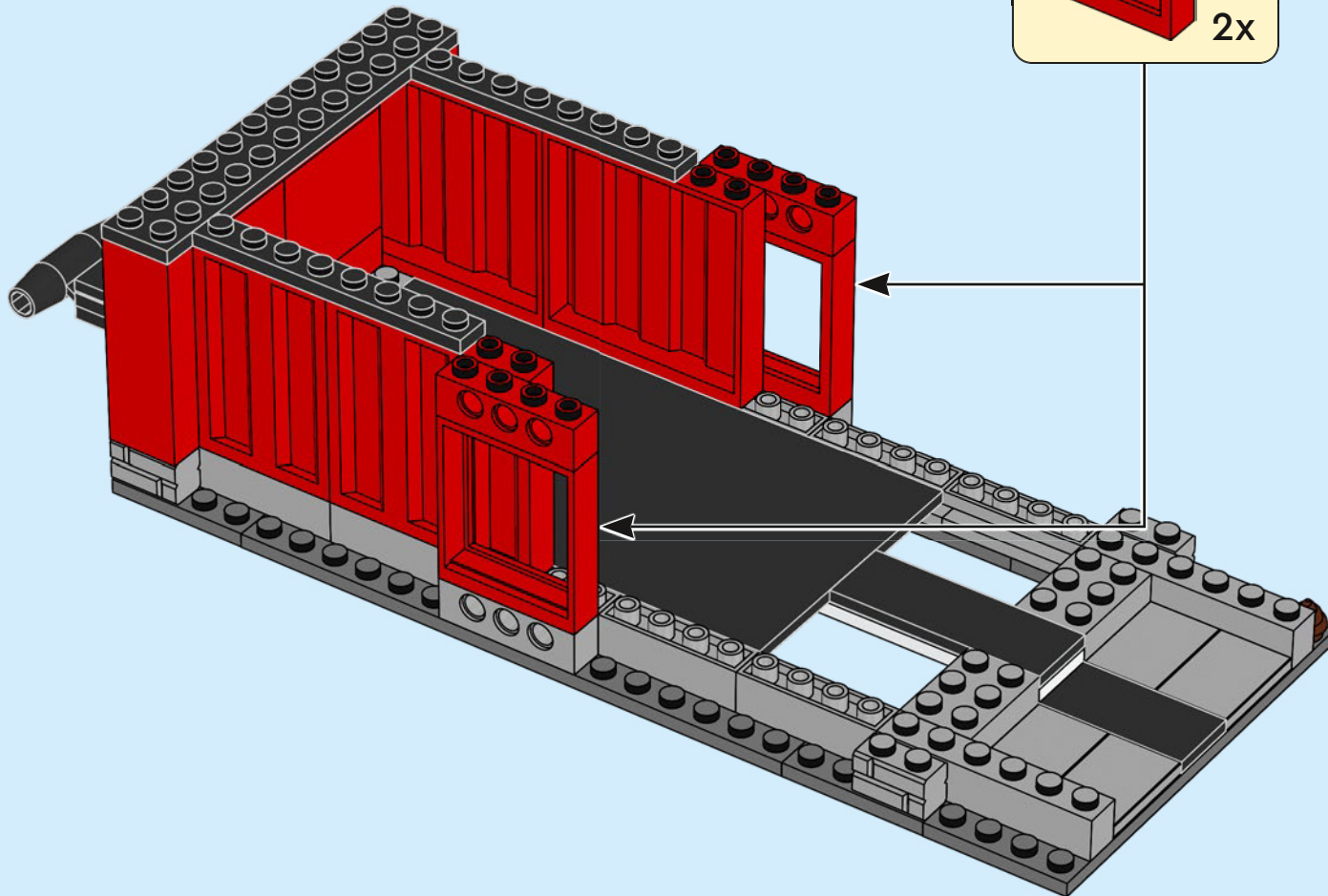
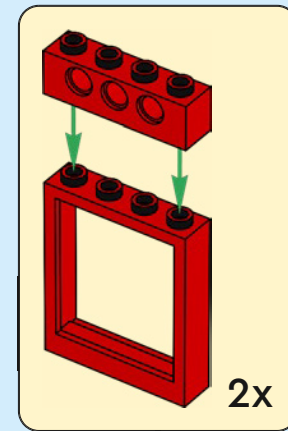



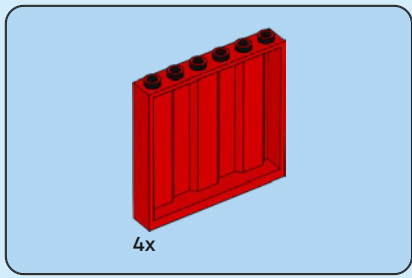

37

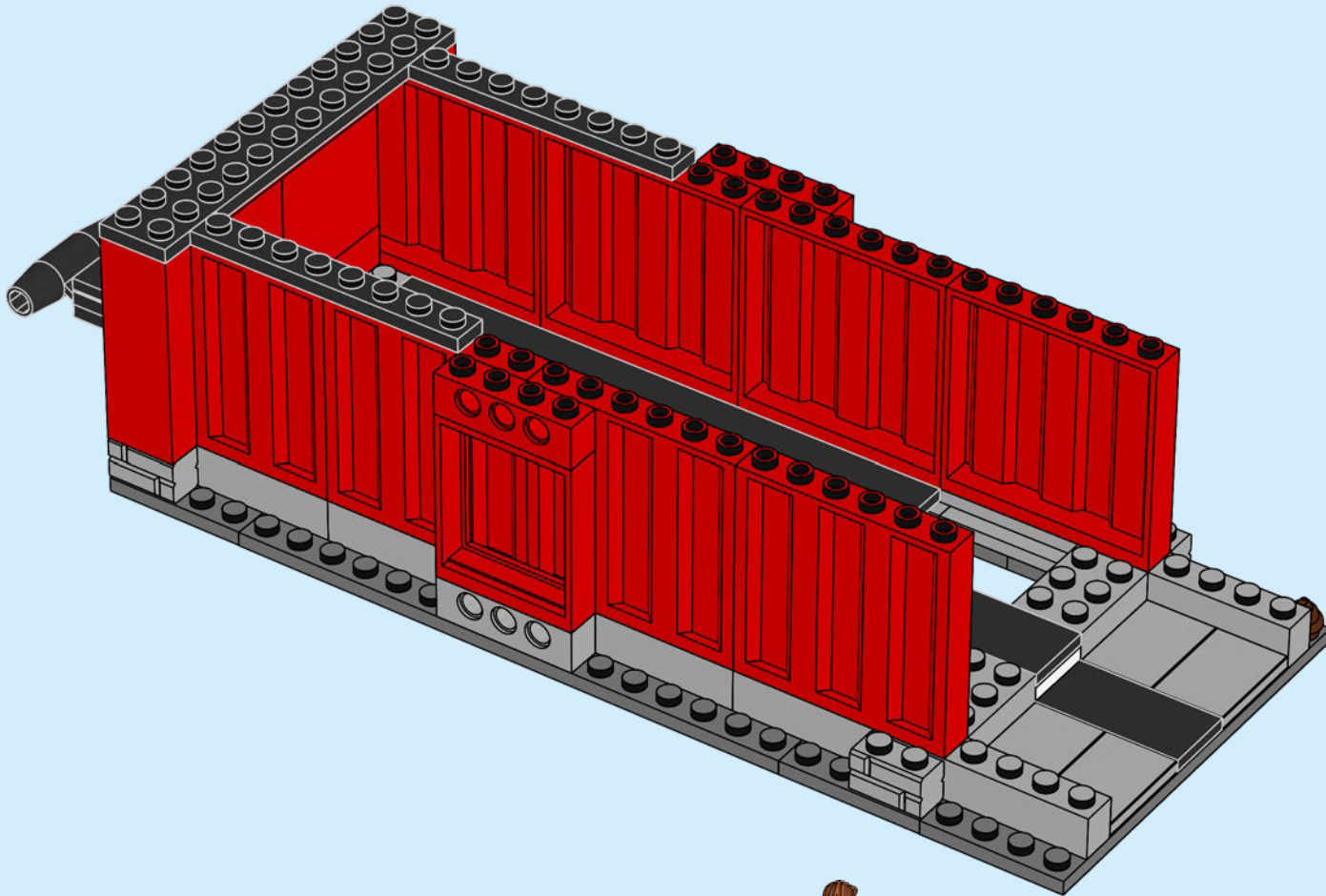



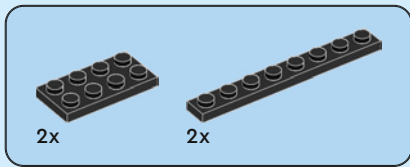

38

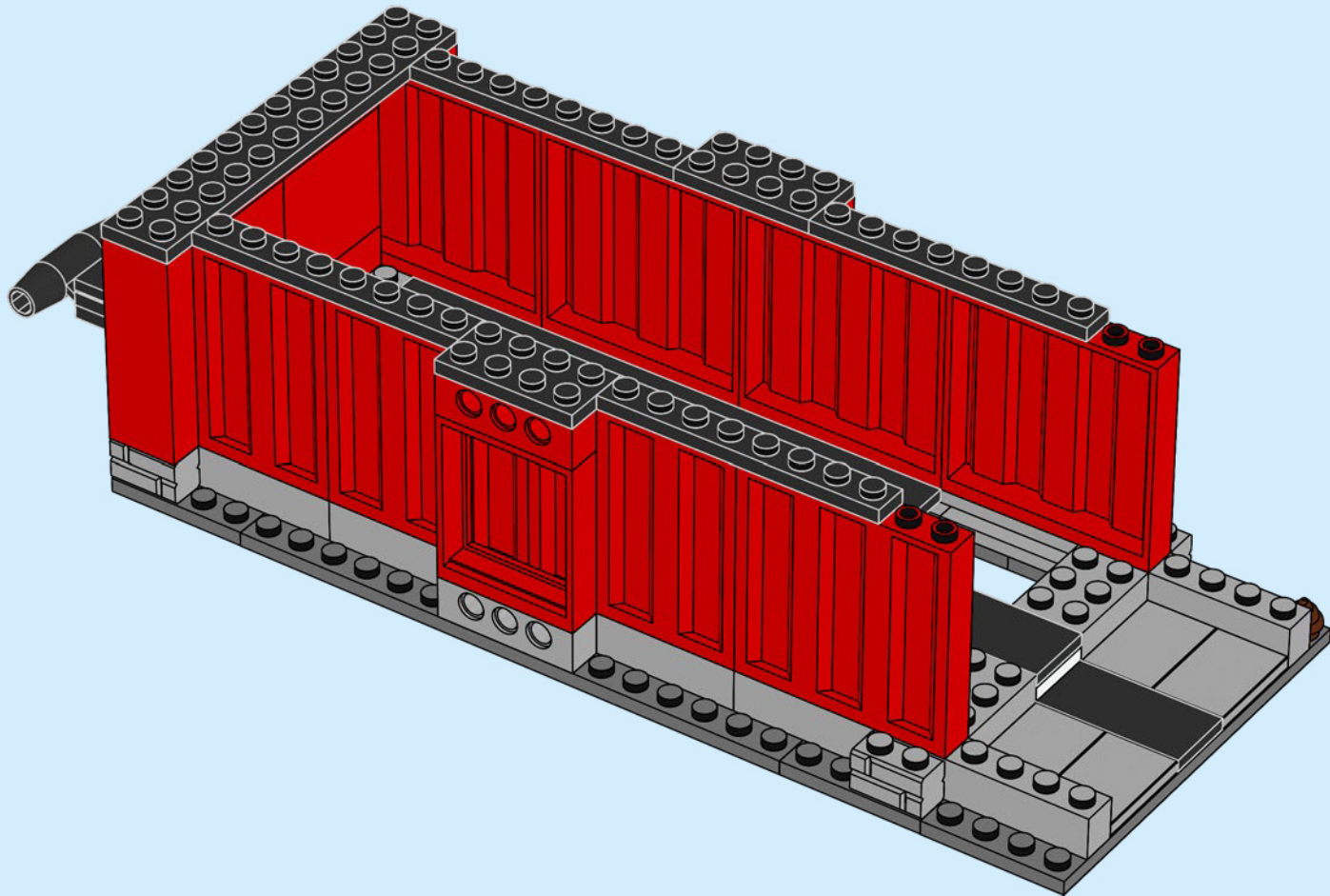

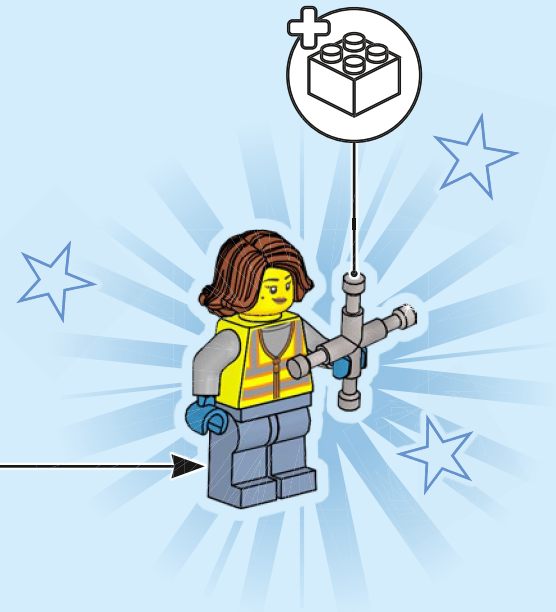
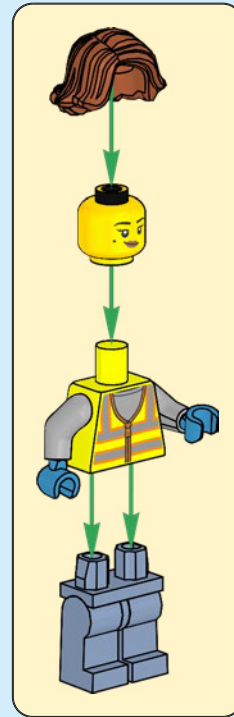

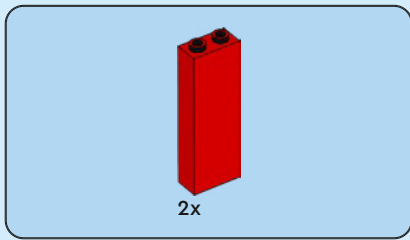

39

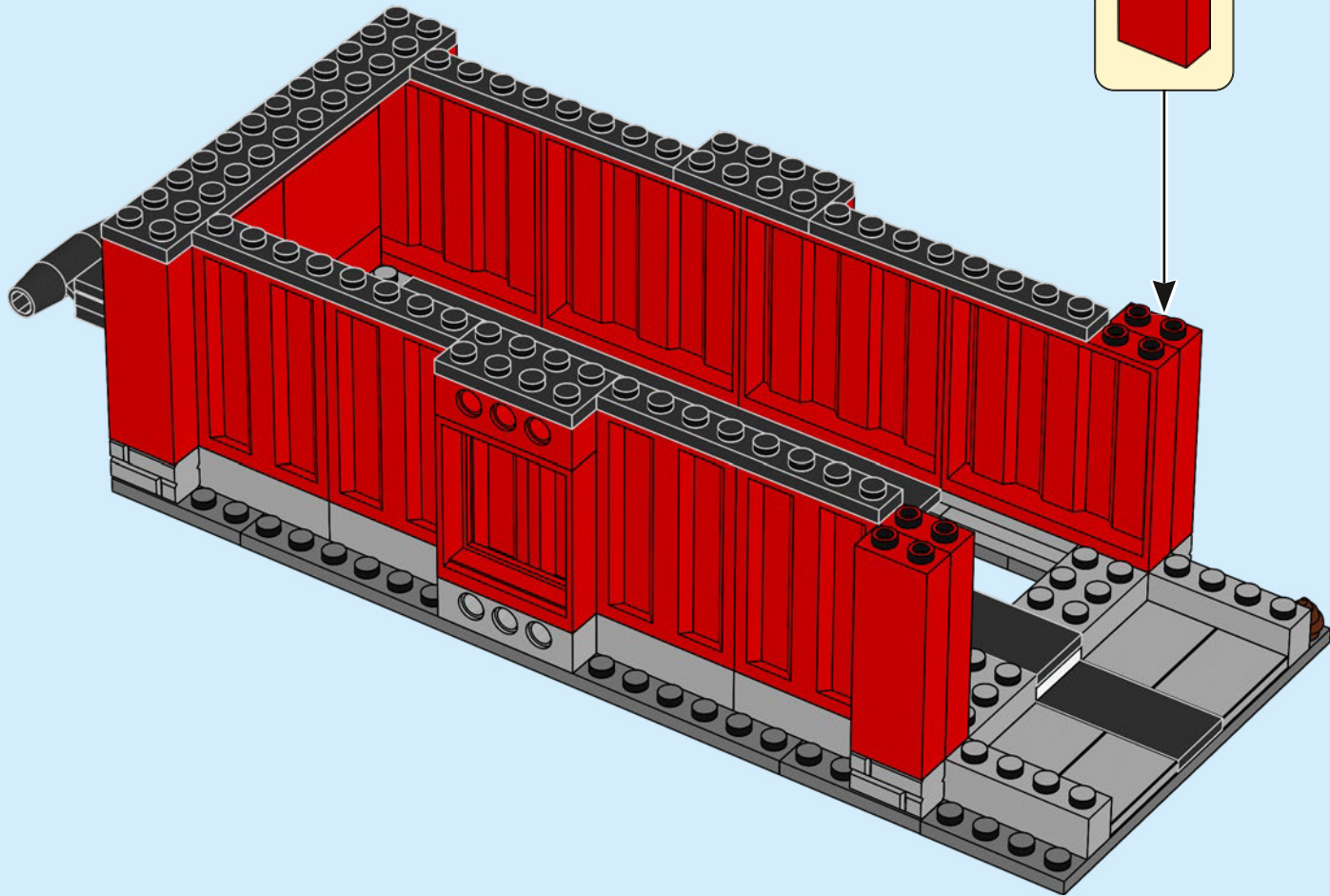
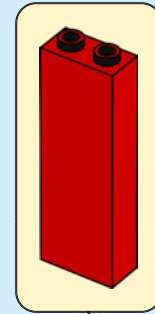

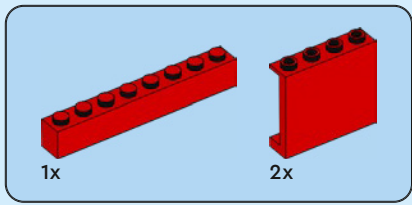

40

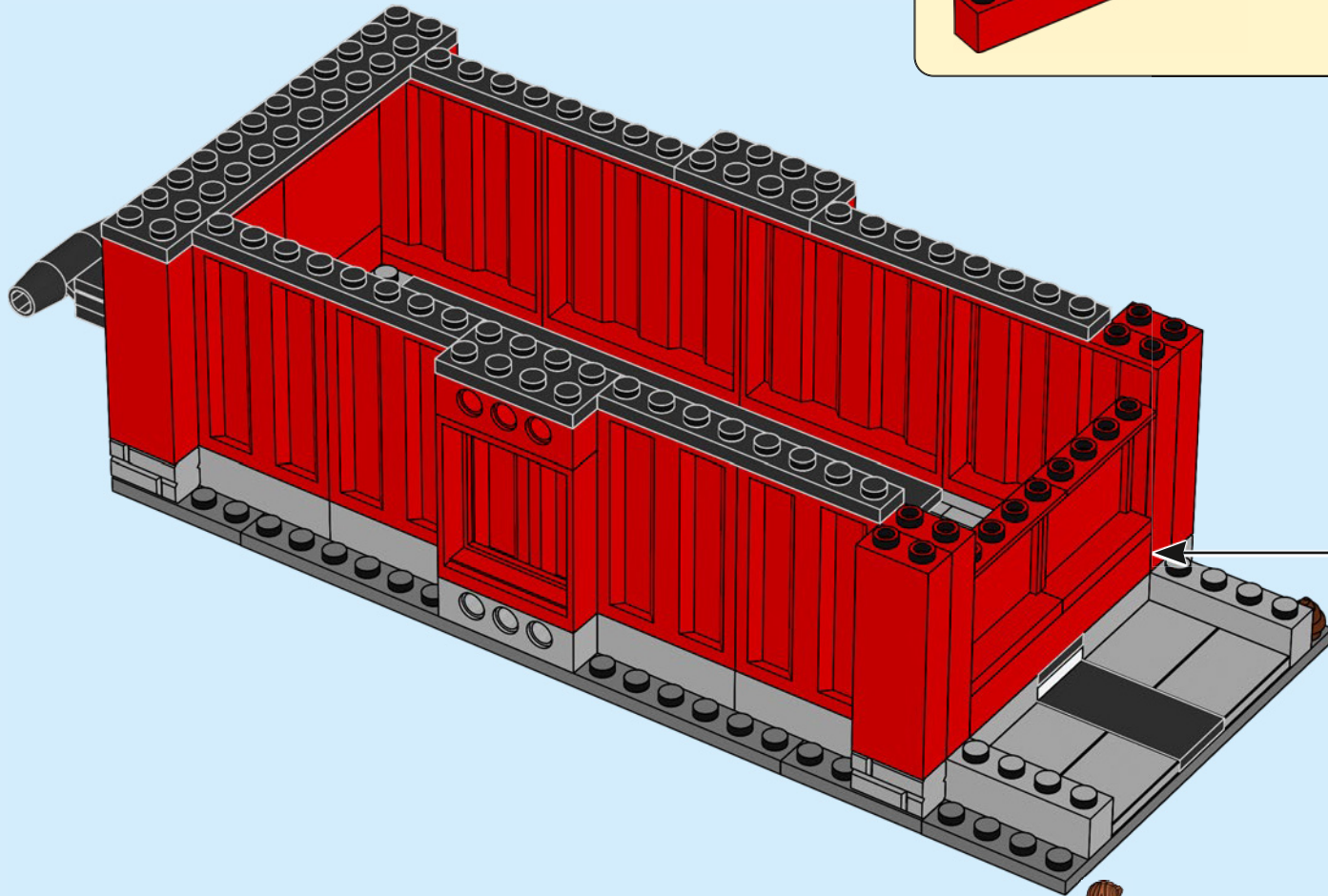
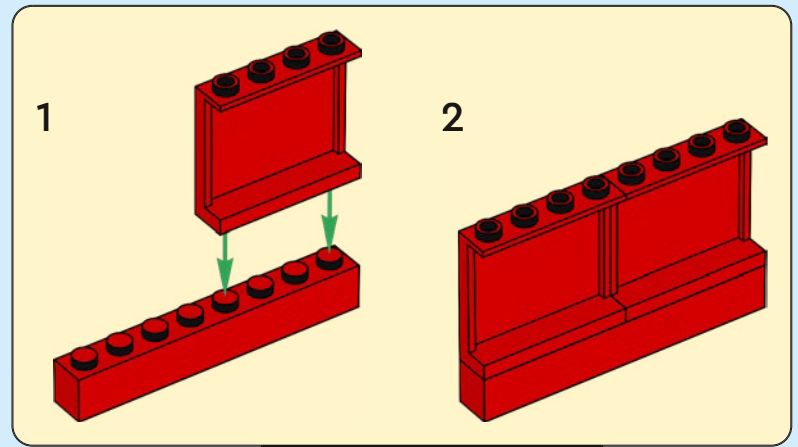



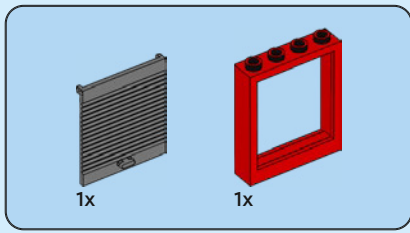

41

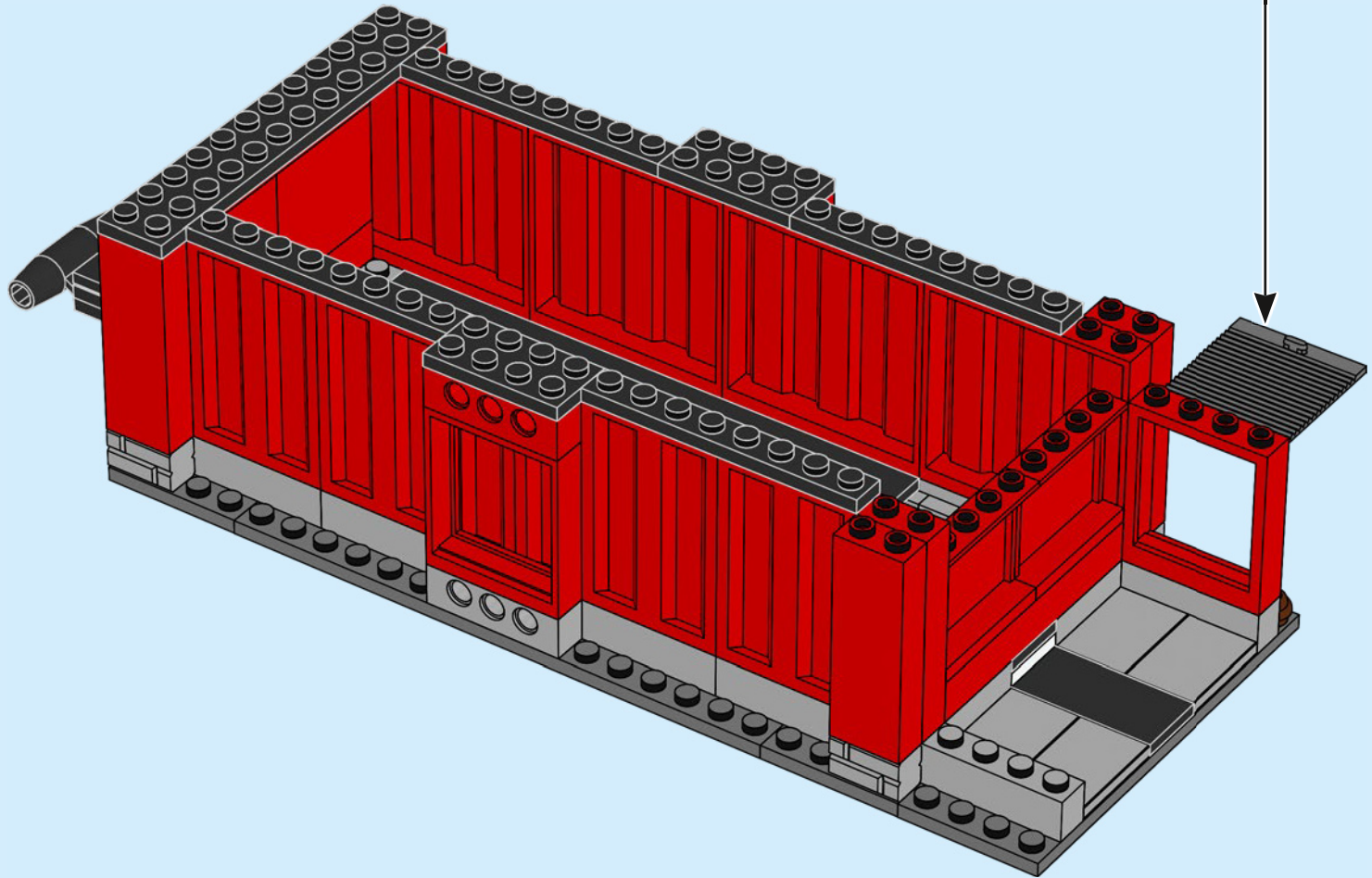
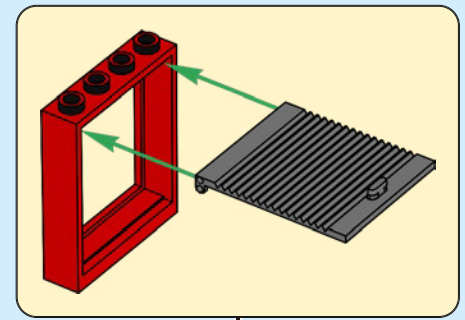



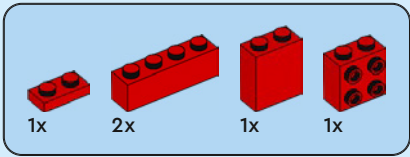

42

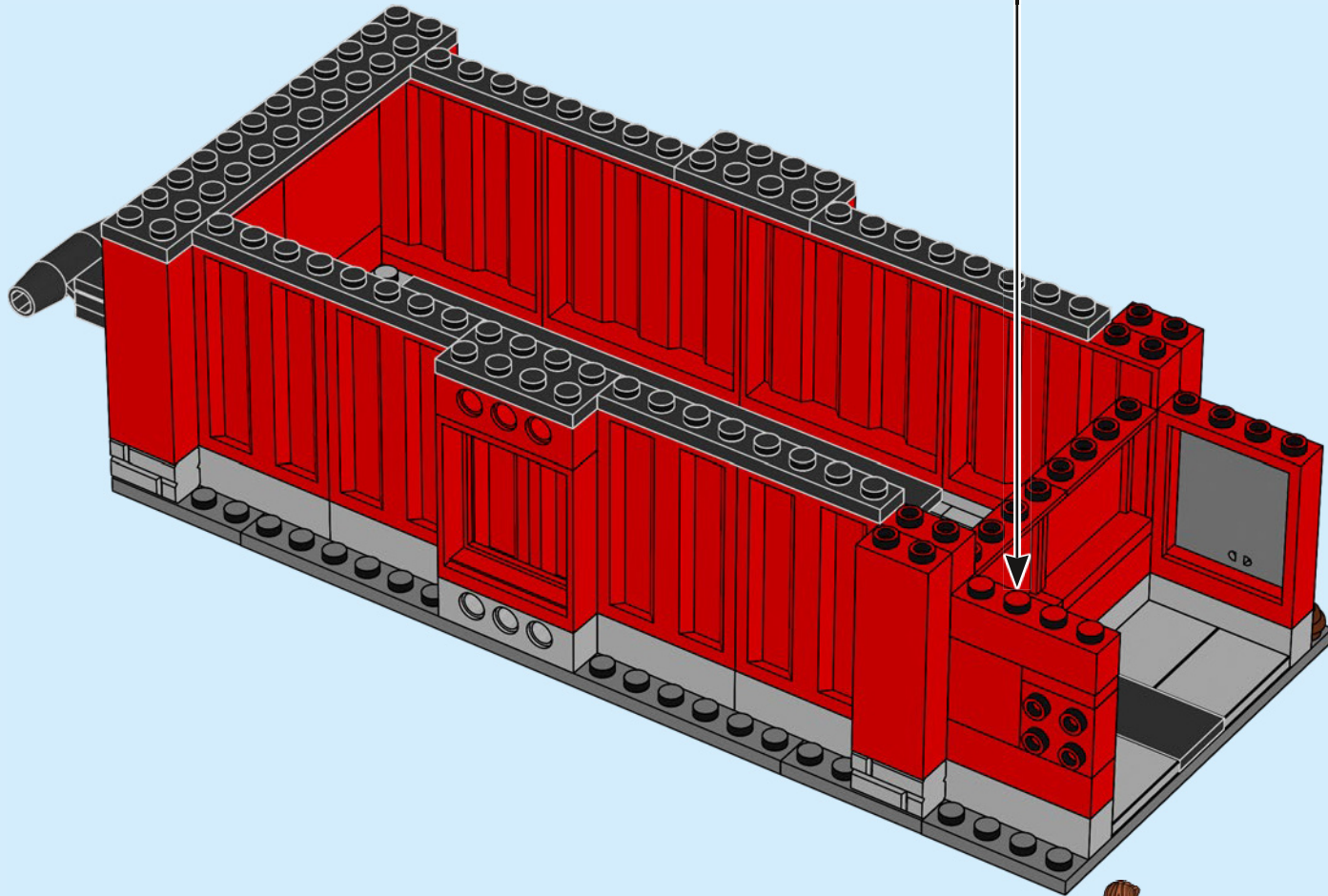
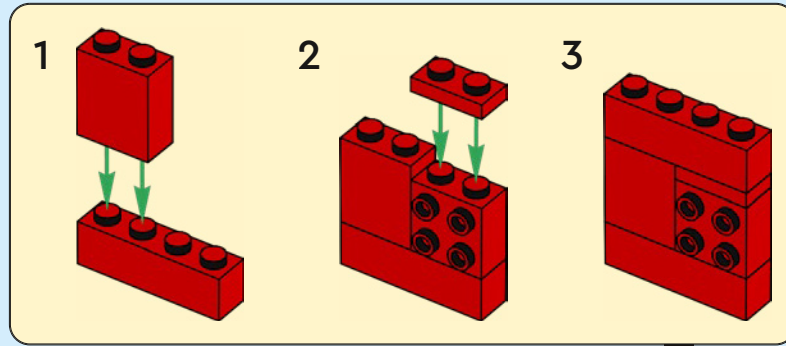

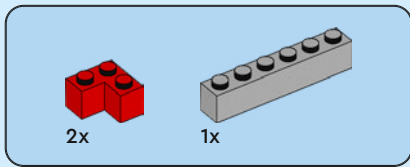

43

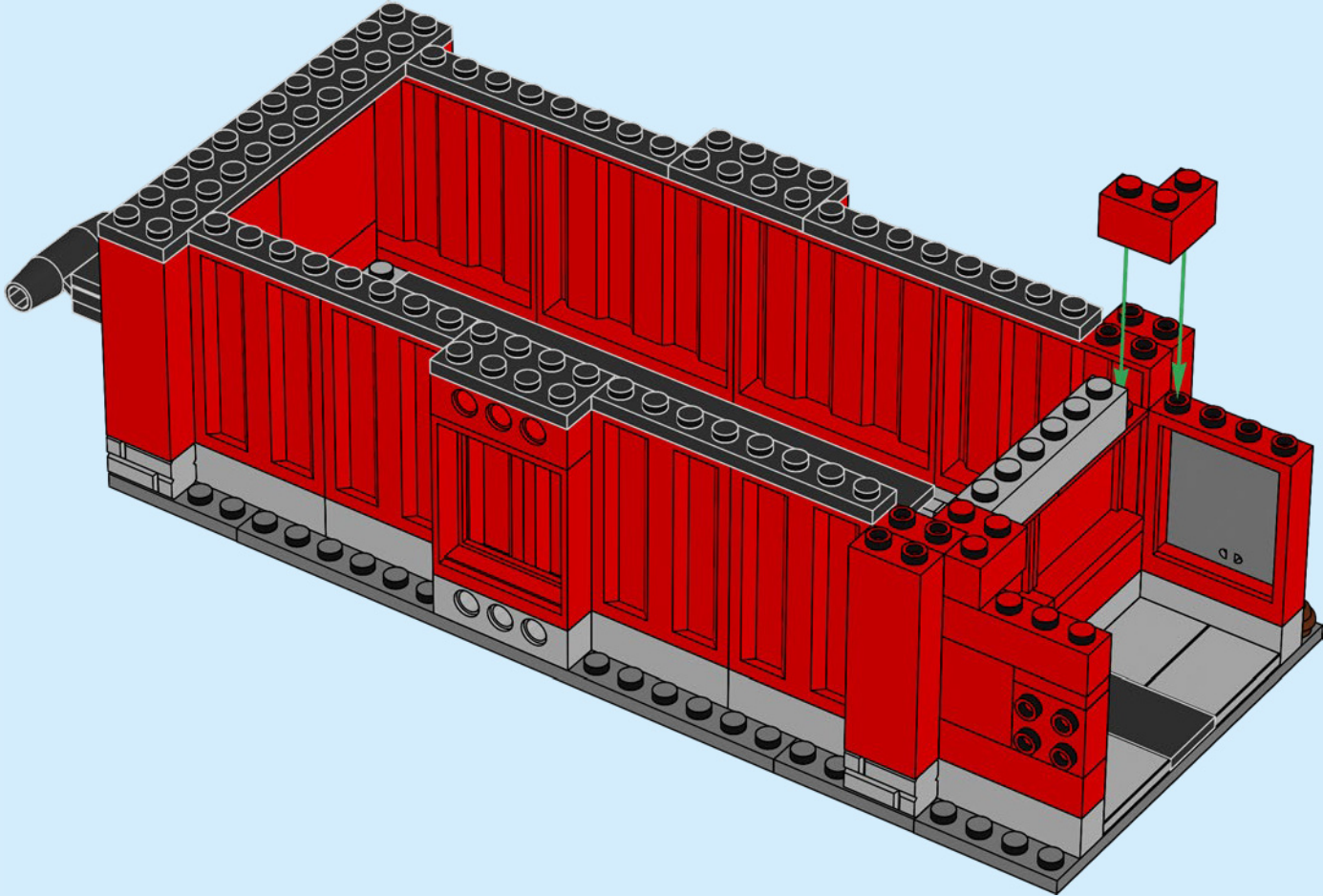



4x

44

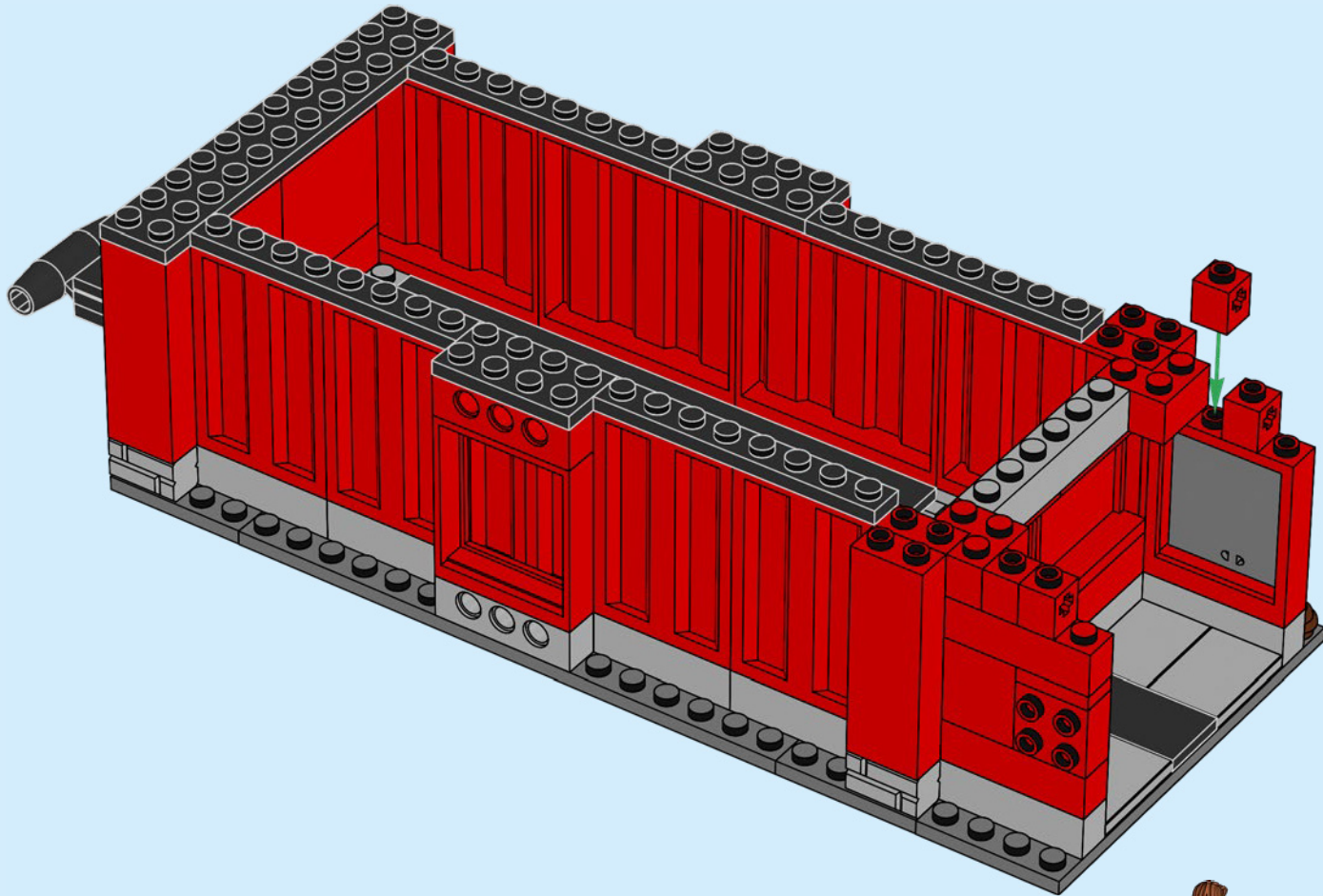



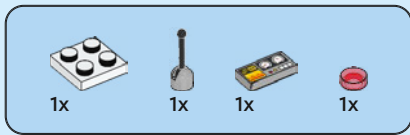

45

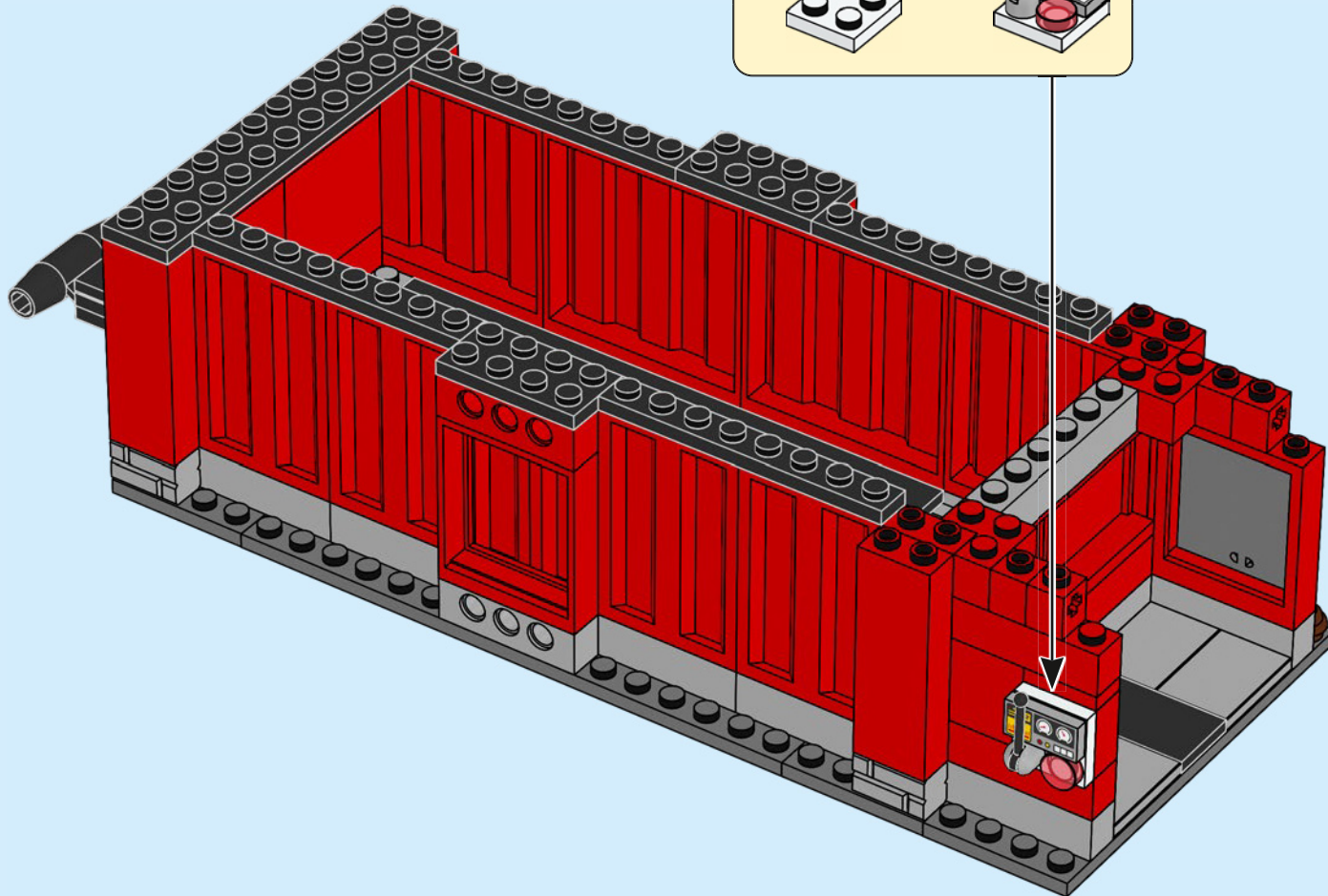
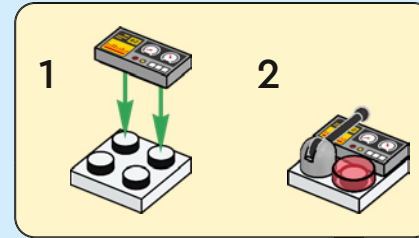

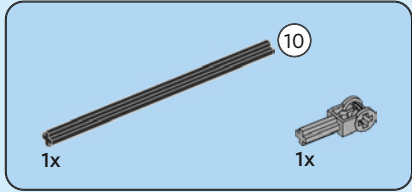
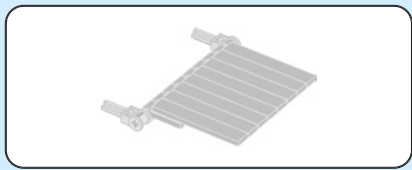

46

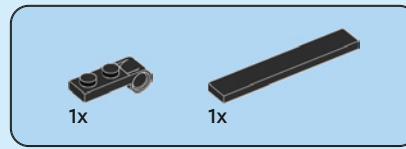
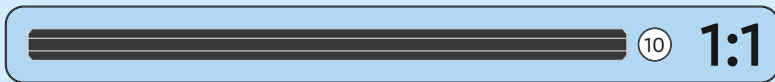
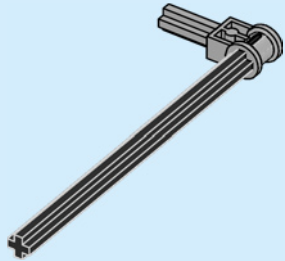

47

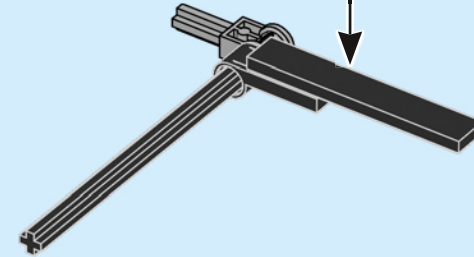
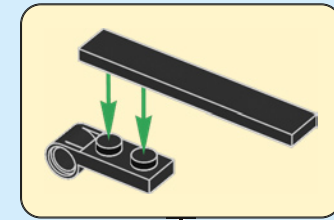



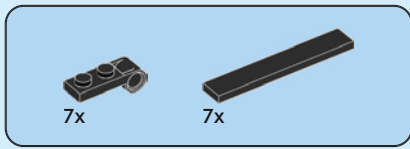

48

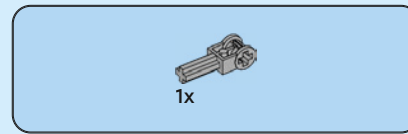
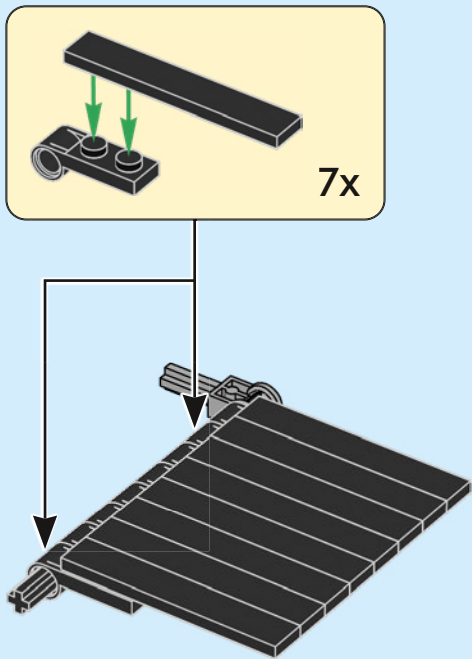

49

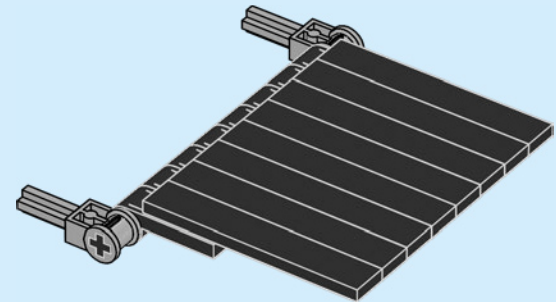

50

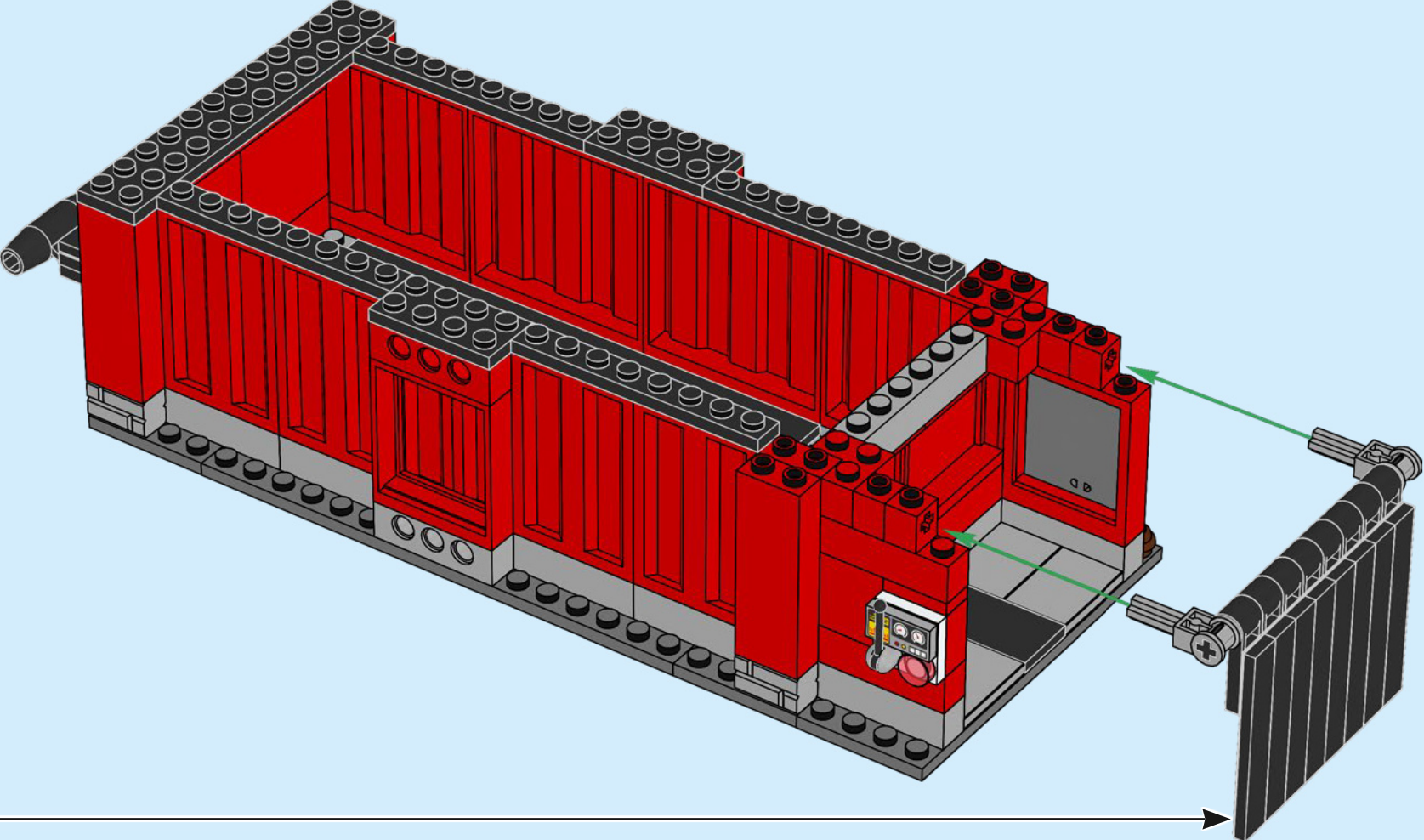

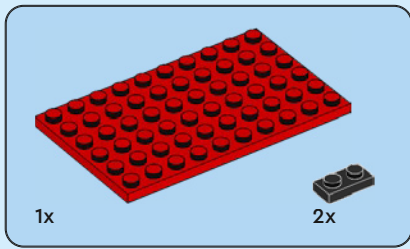

51

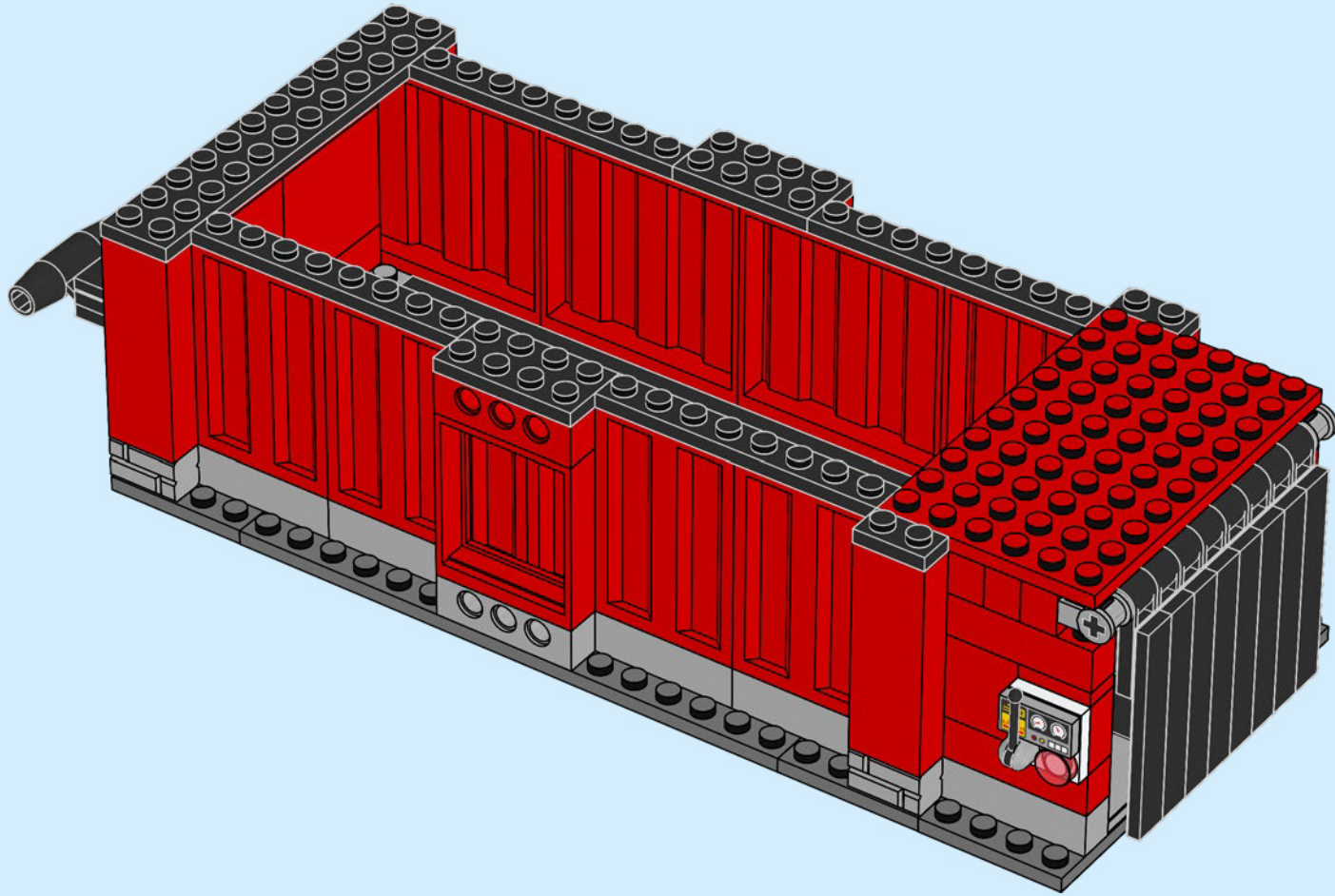

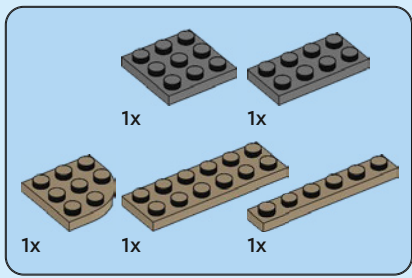

52

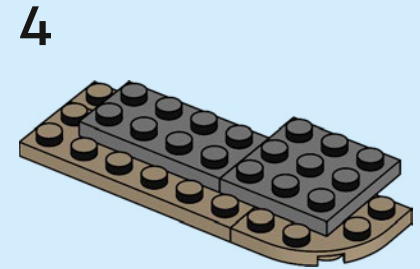
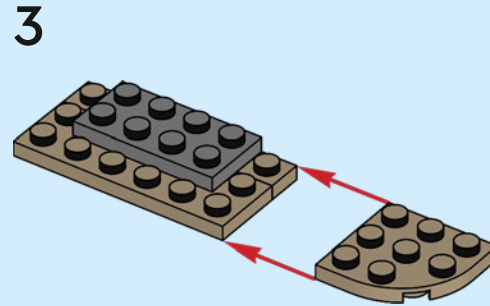
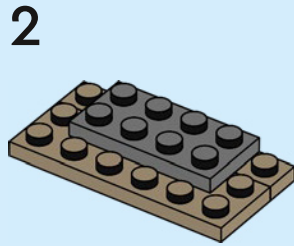
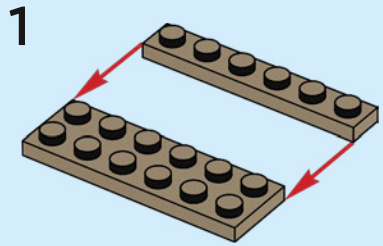



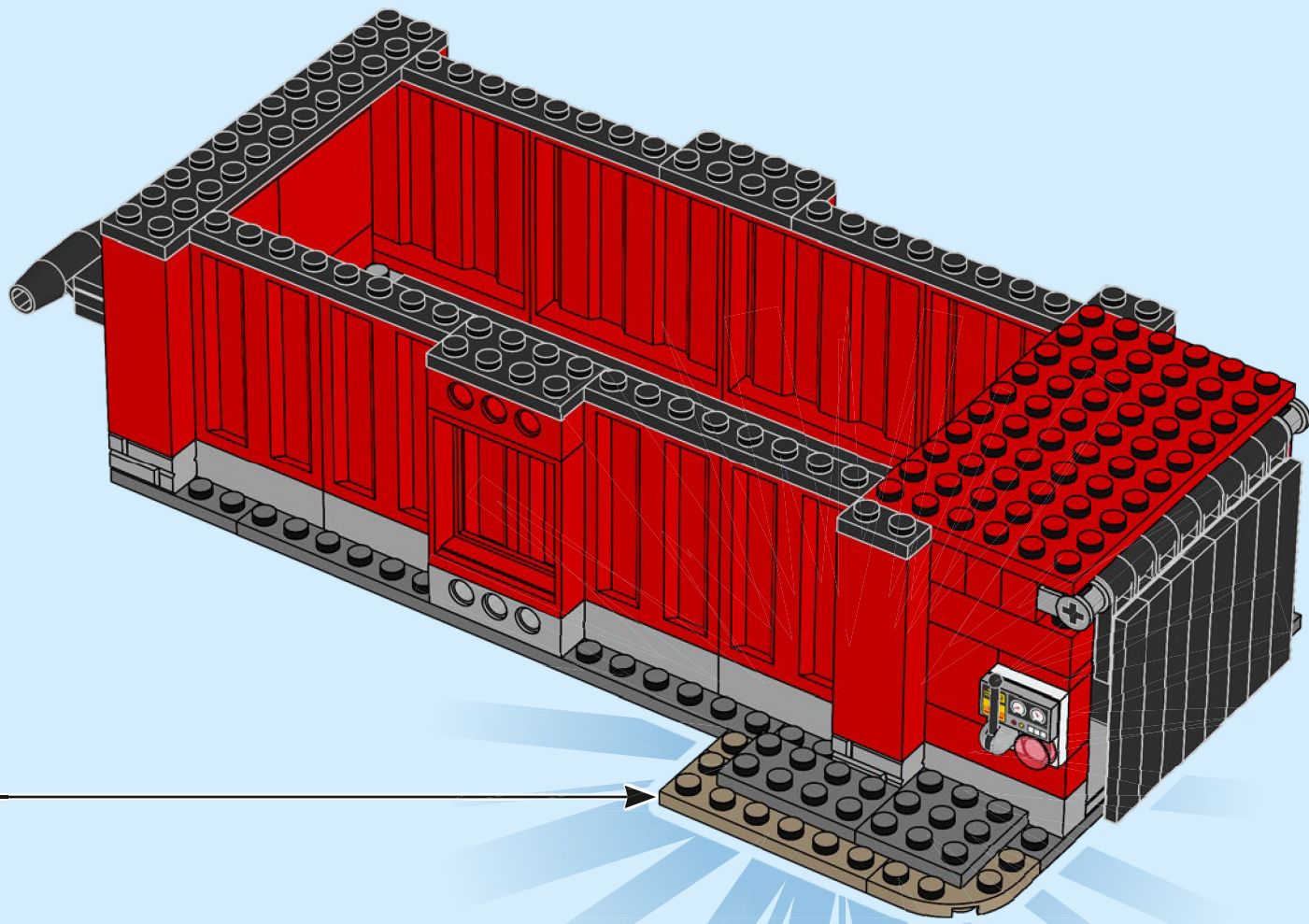

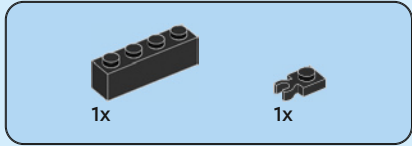
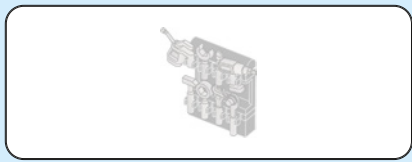

53

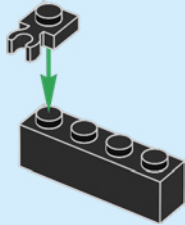

54

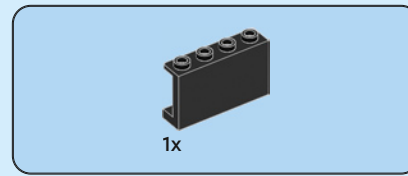
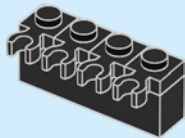

55

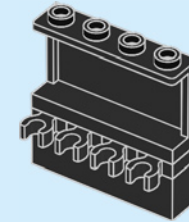

56

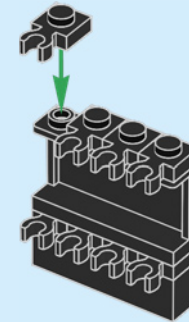

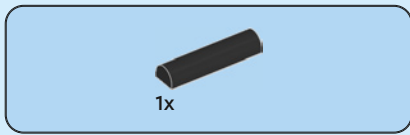

57

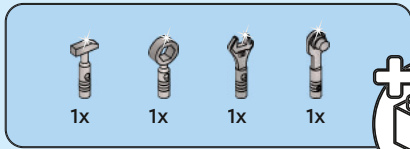
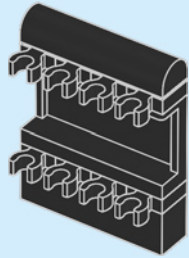

58

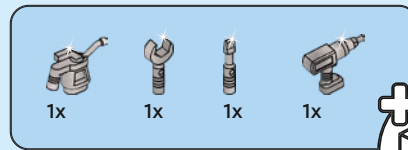
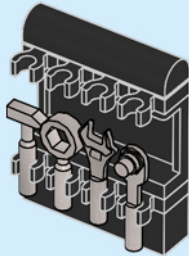

59

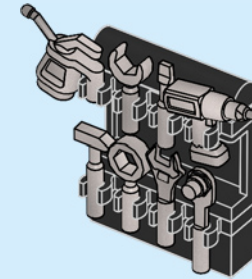
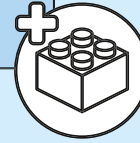

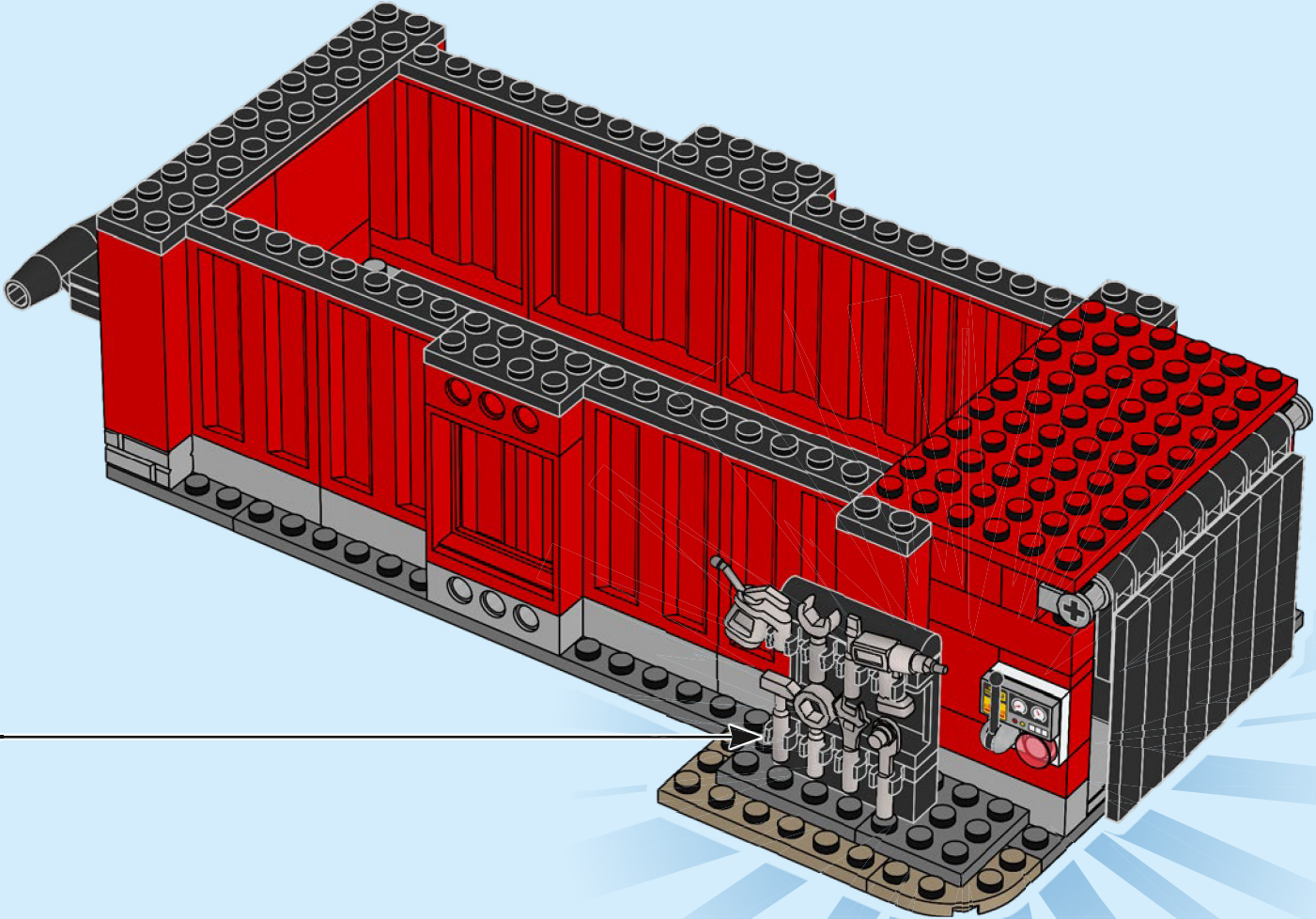





1x

61

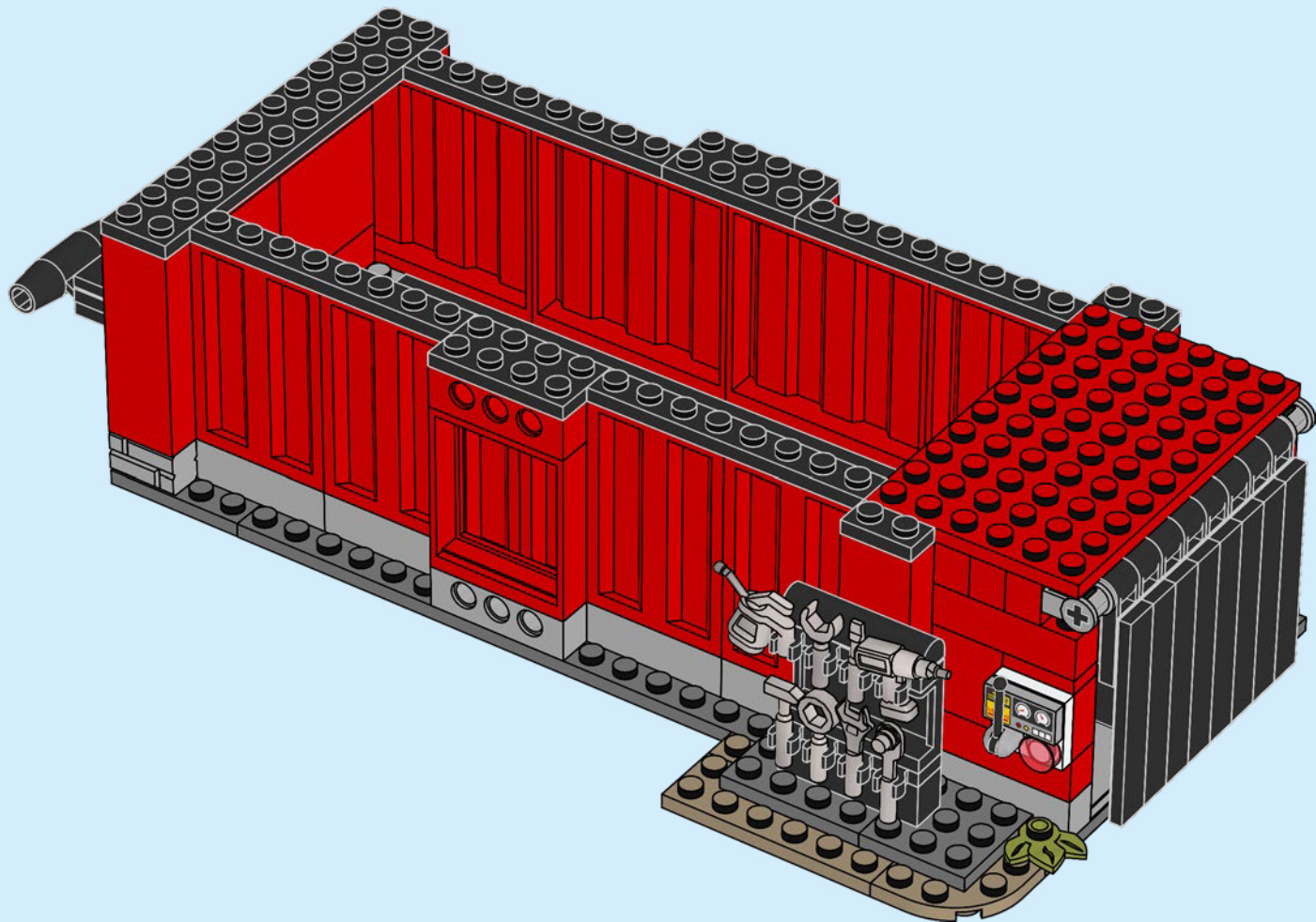



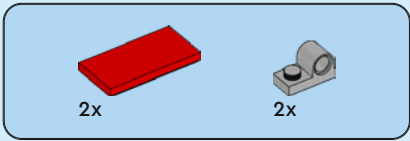

62

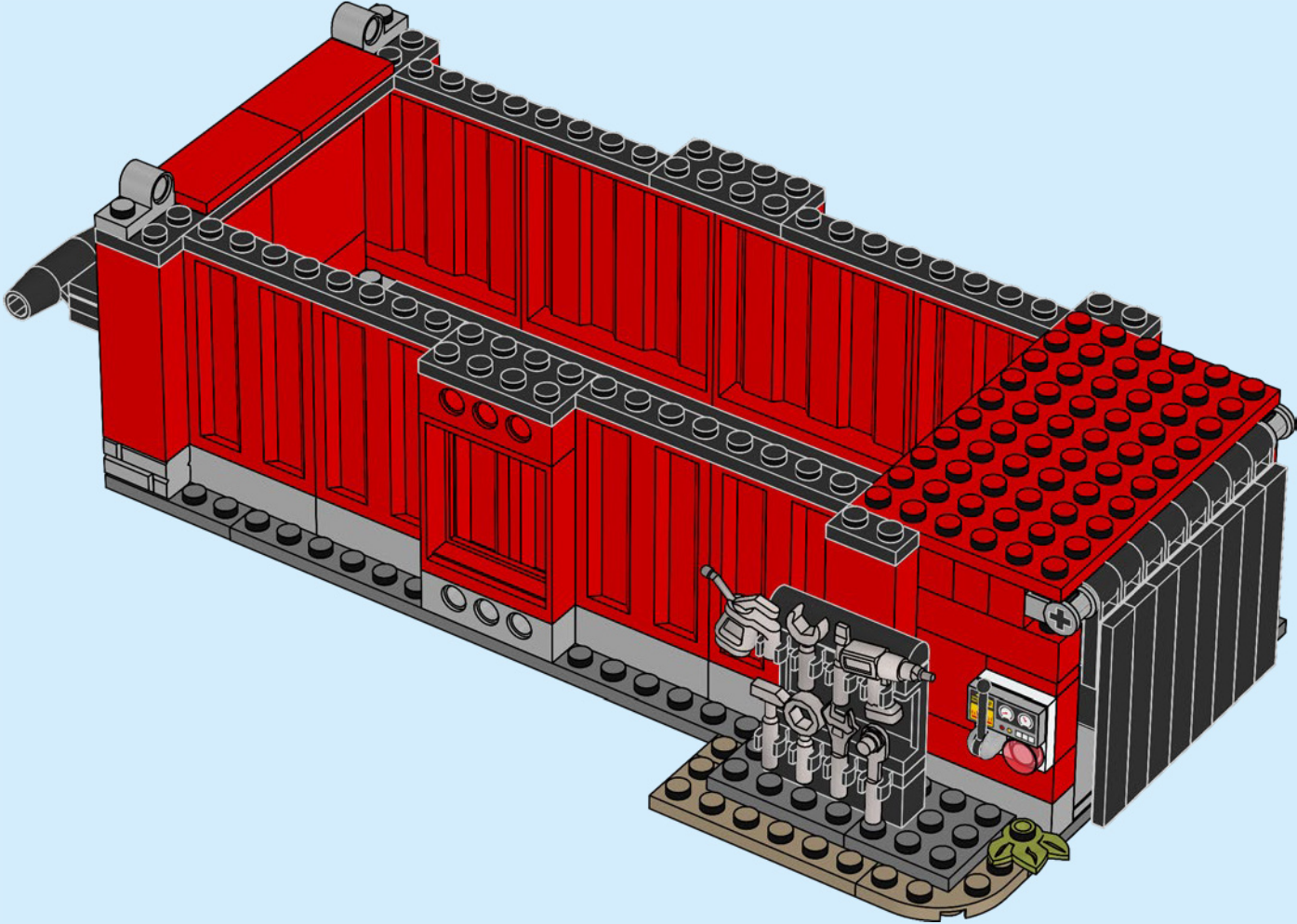

2x

63

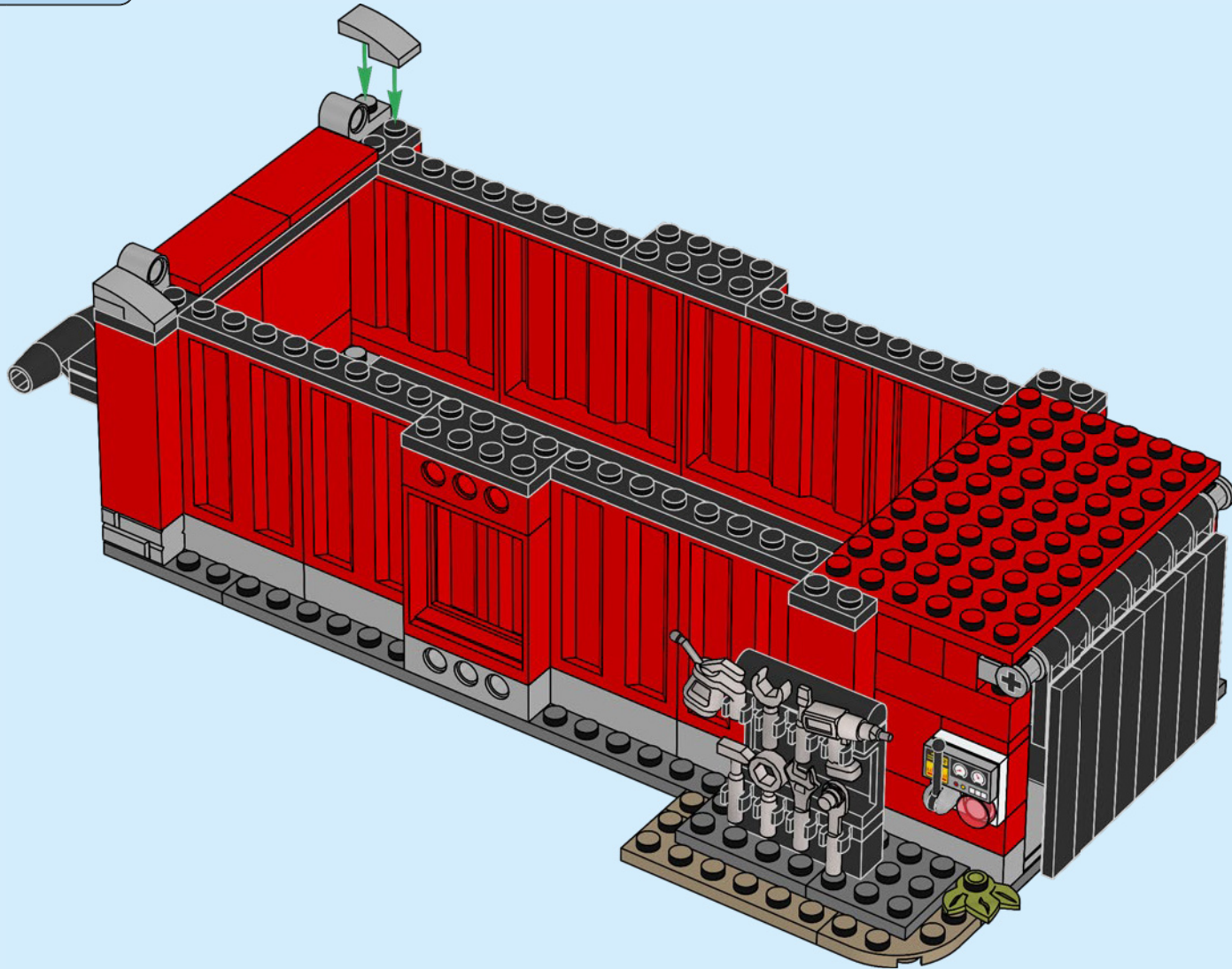



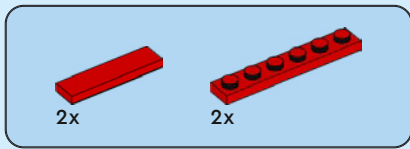

64

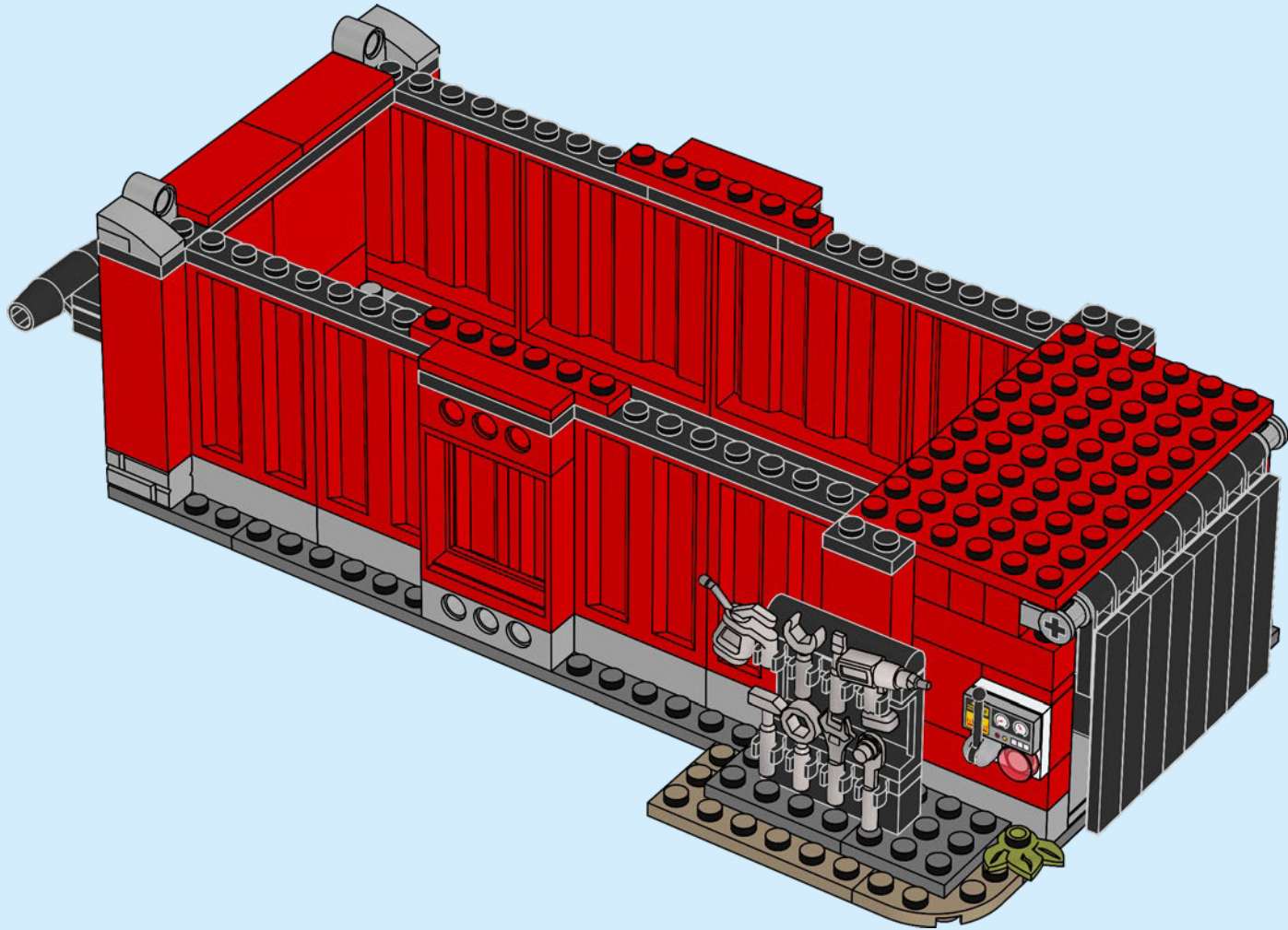

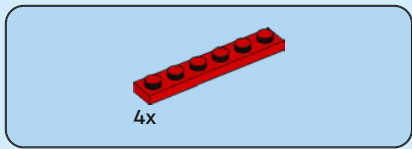

65

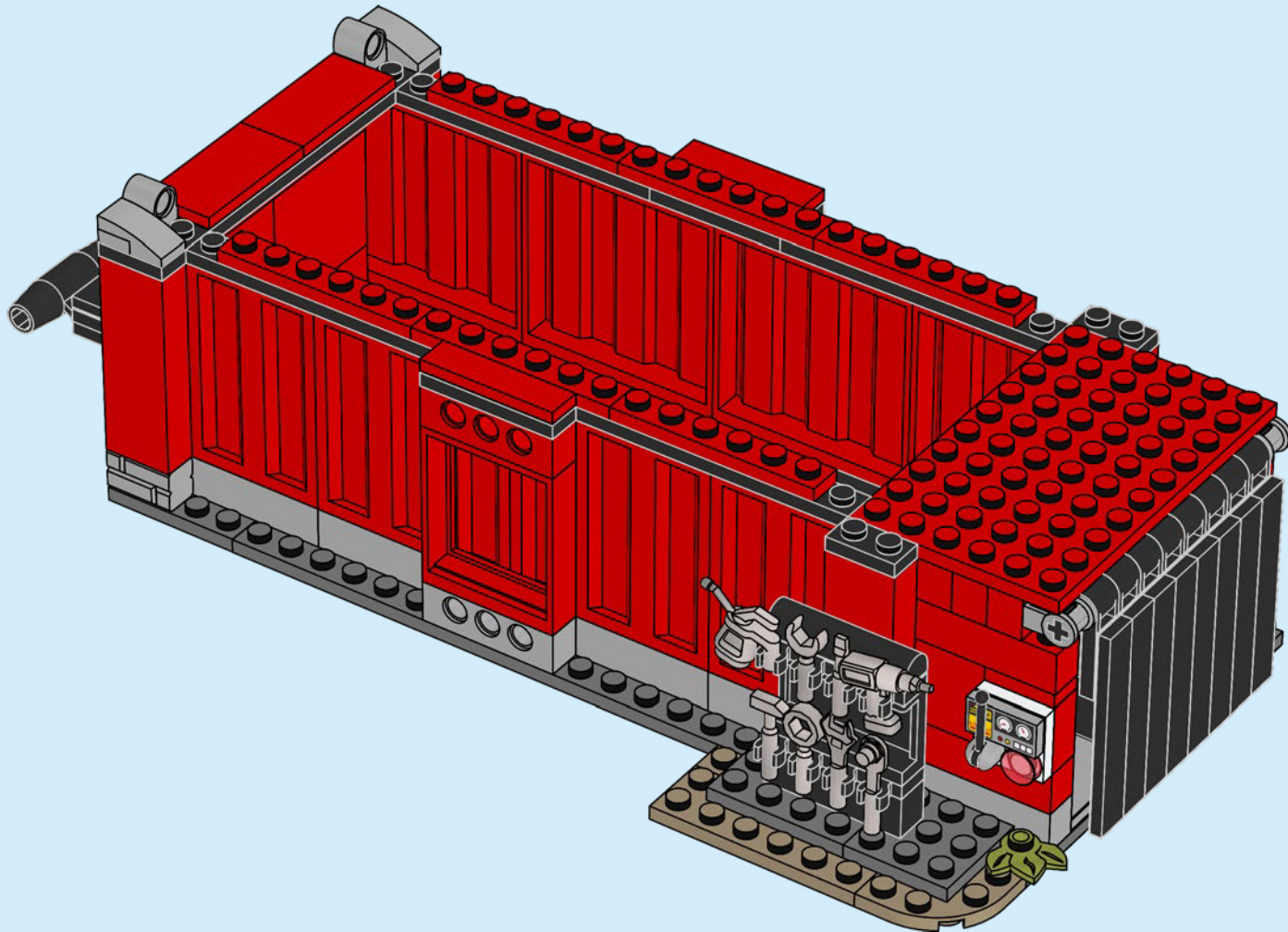

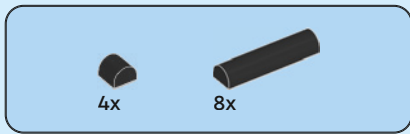

66

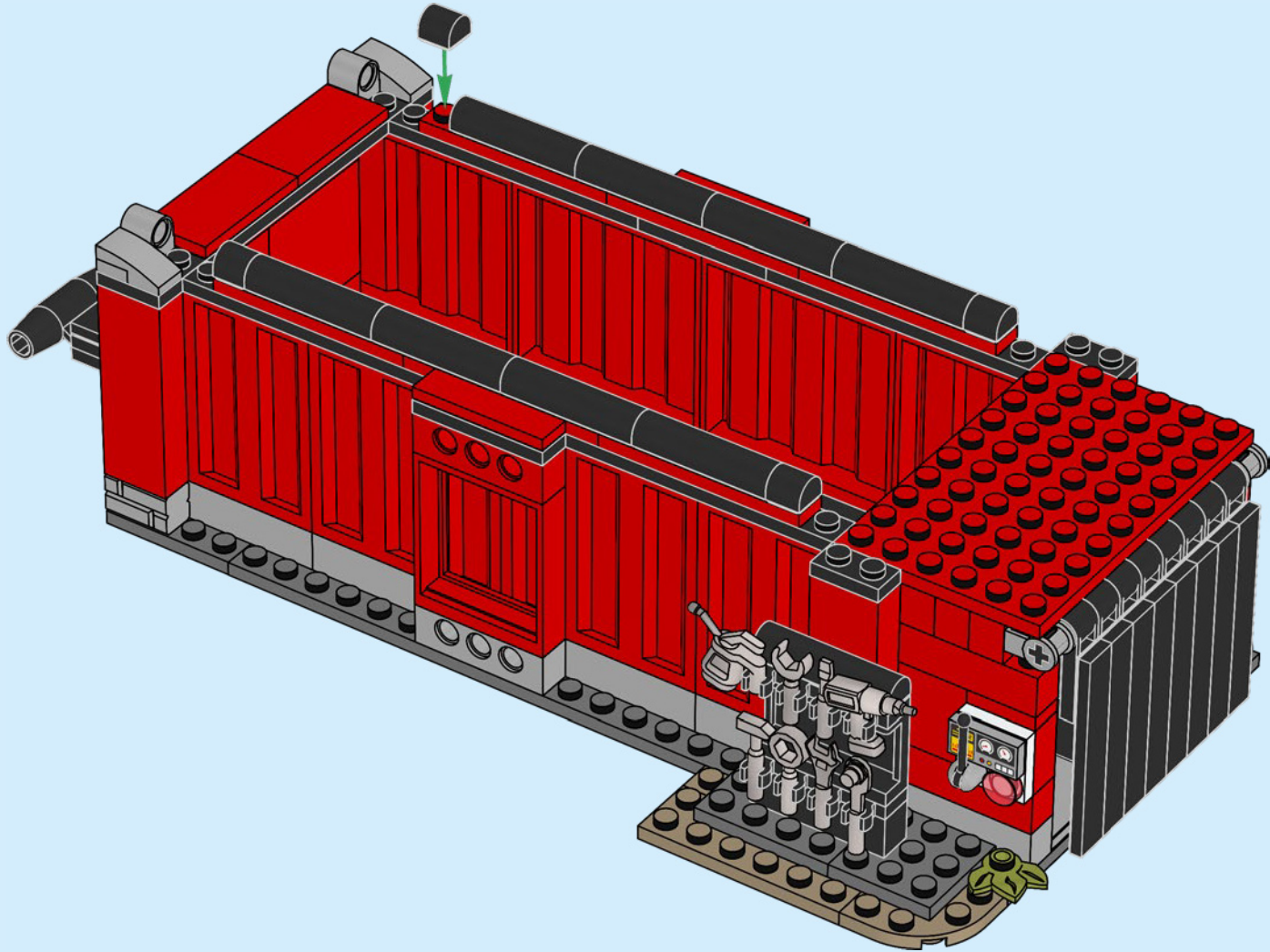



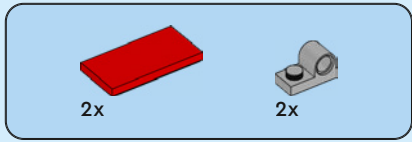

67

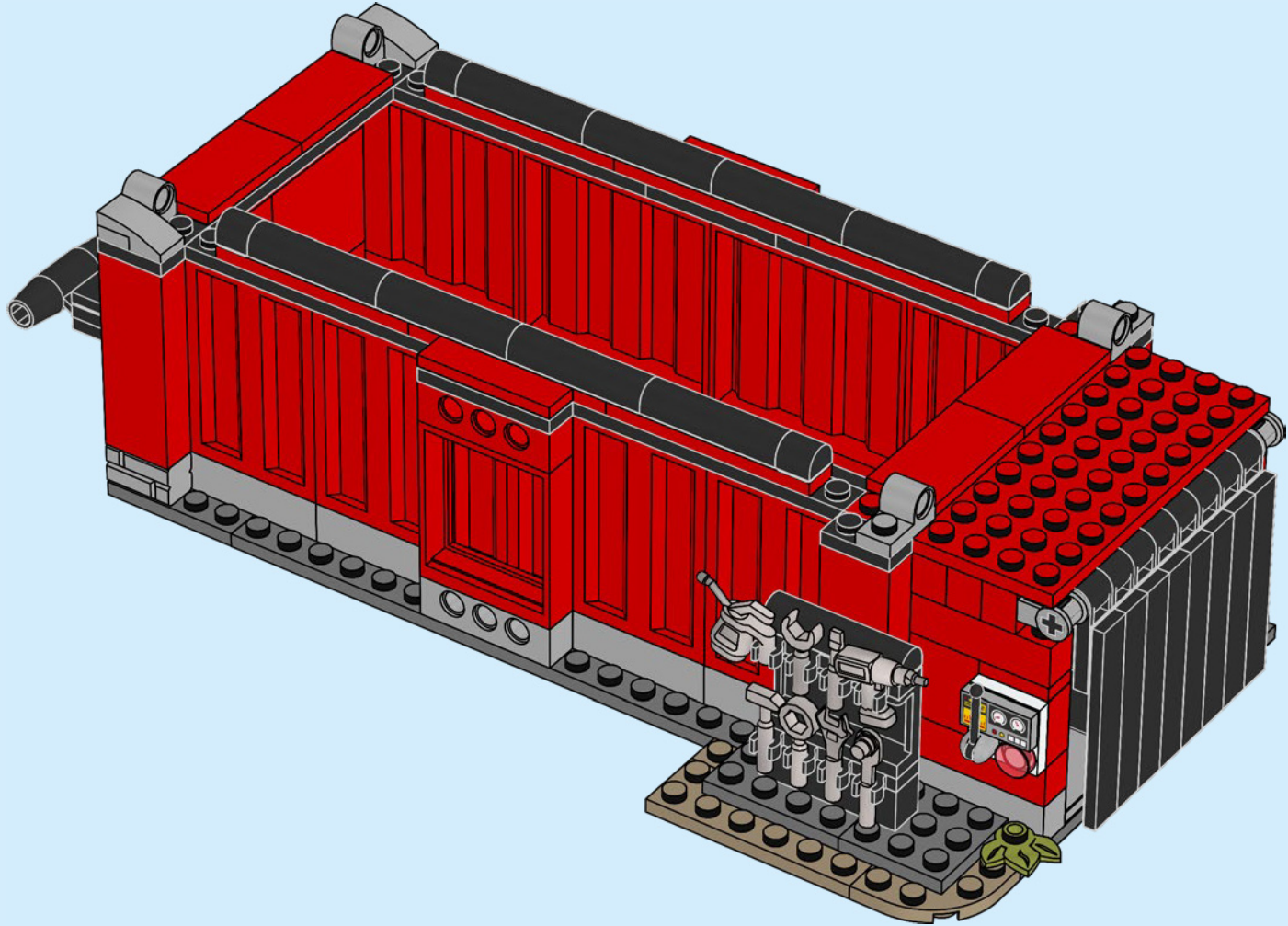



2x

68

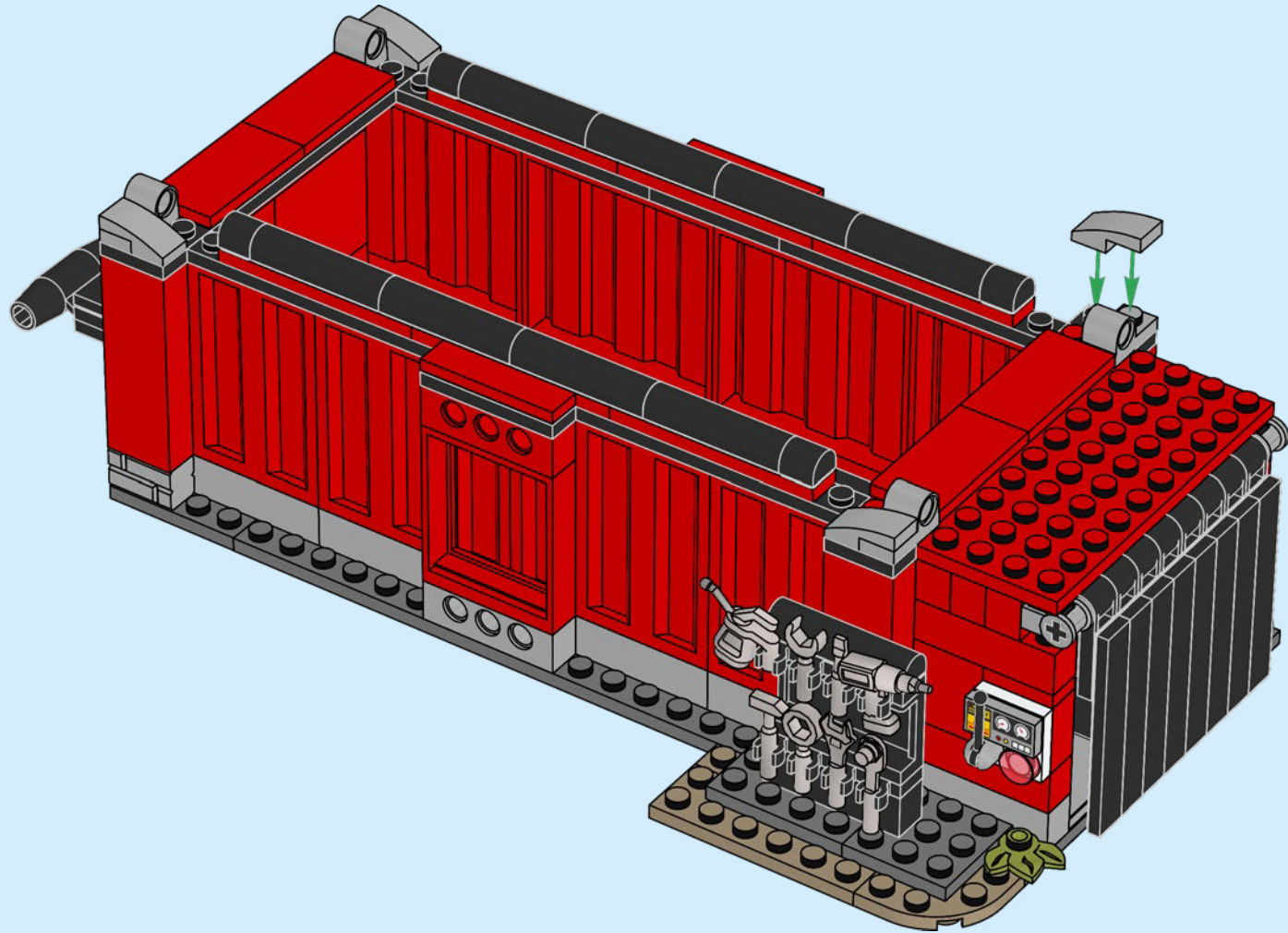



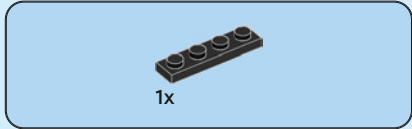
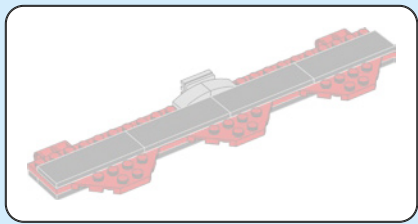

69

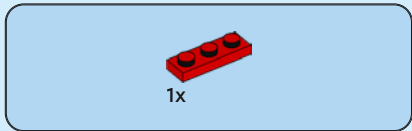
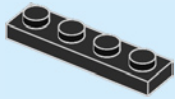

70

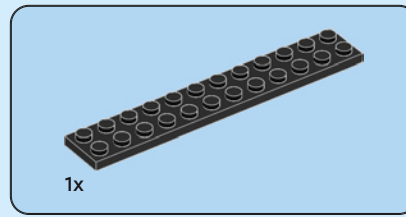
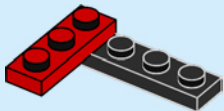

71

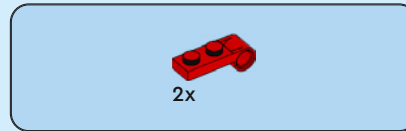
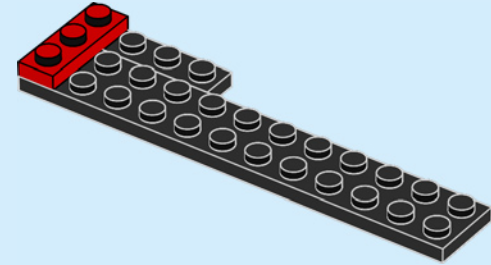

72

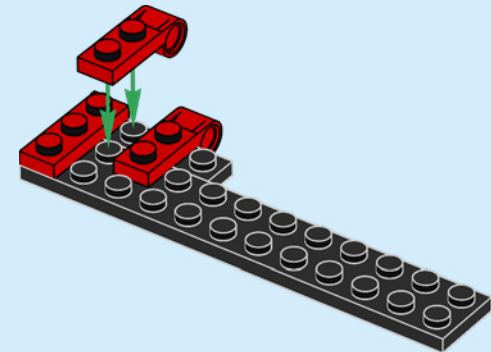

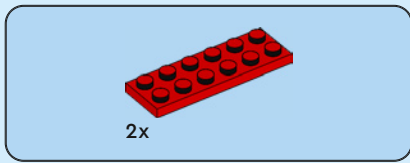

73

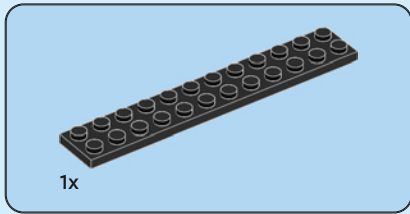
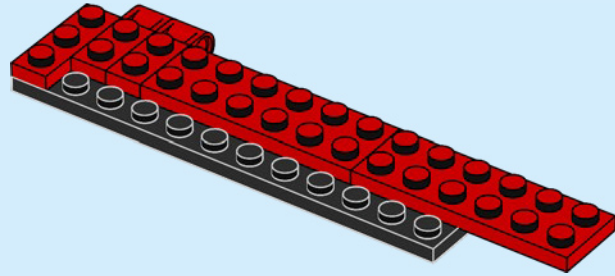

74

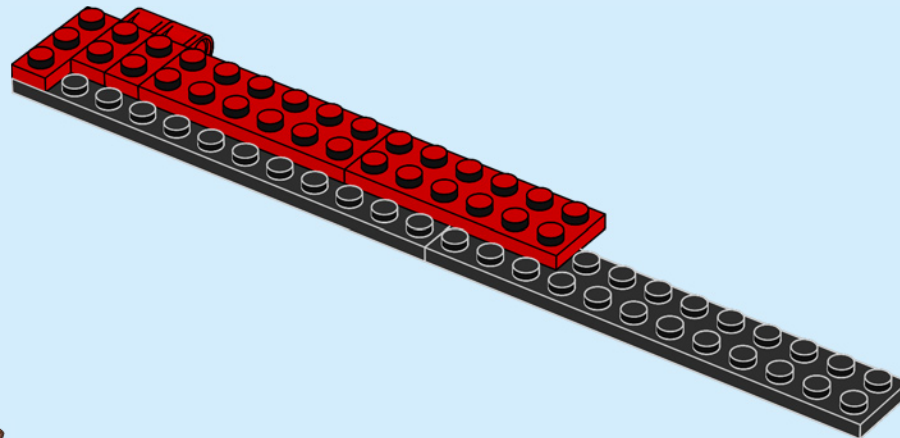

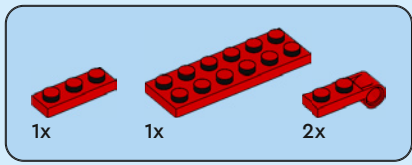

75

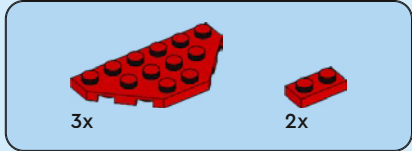
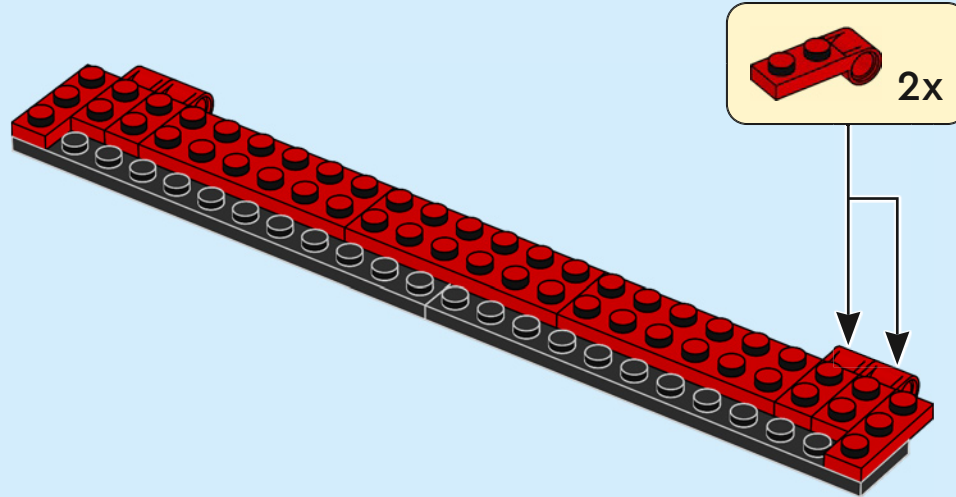

76

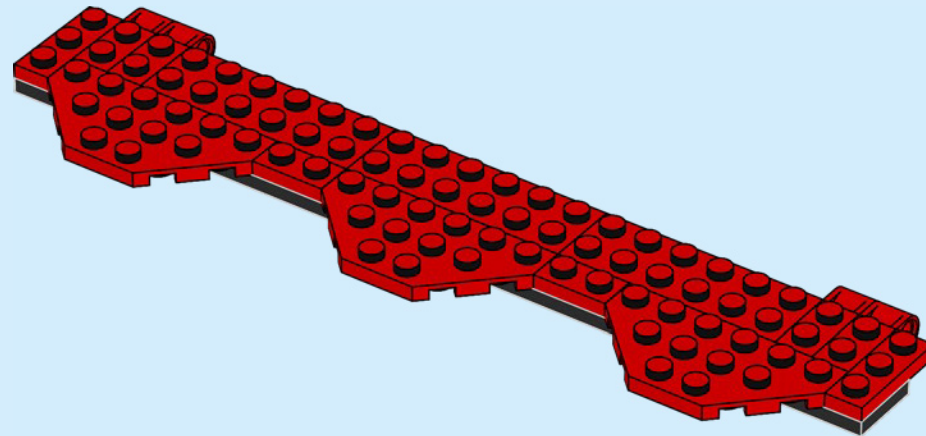

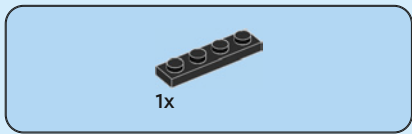

77

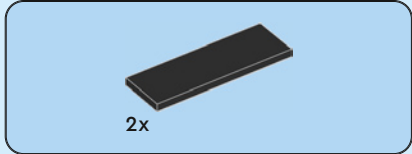
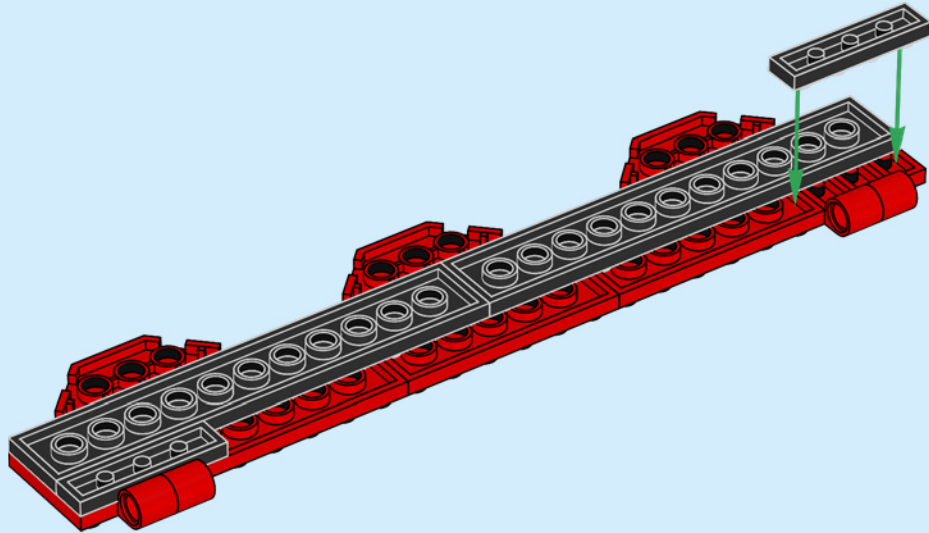

78

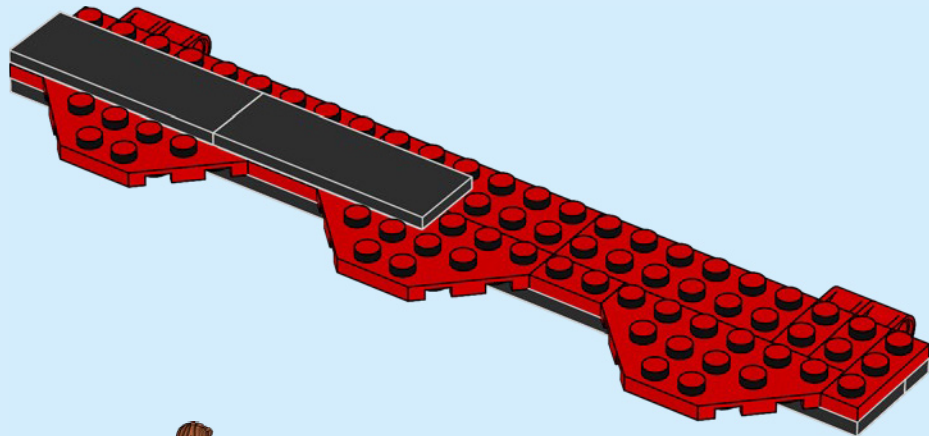

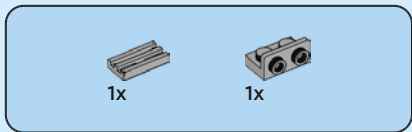

79

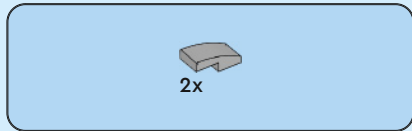
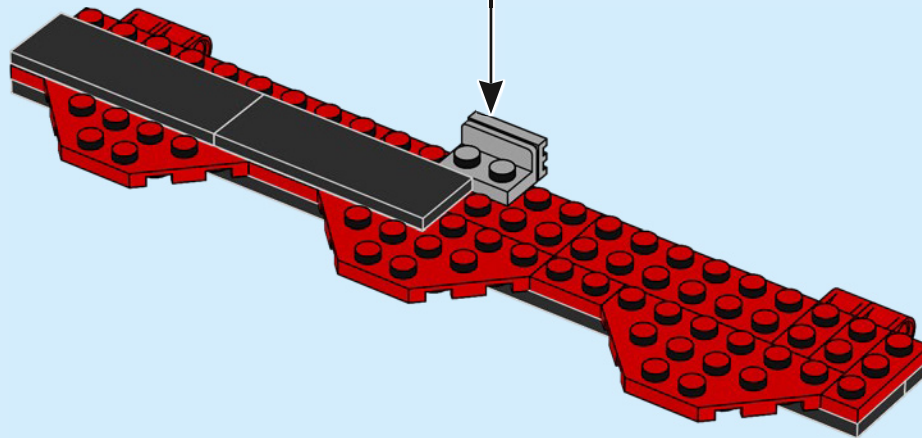
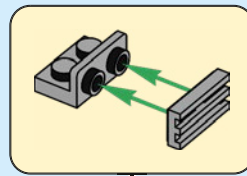

80

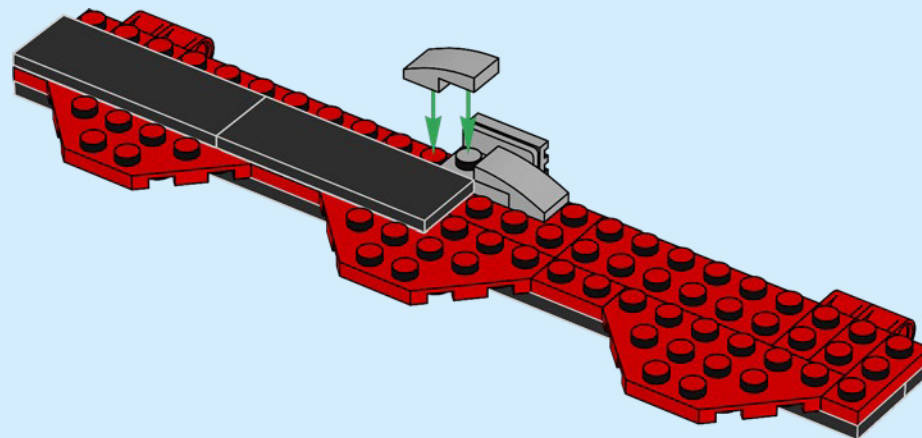



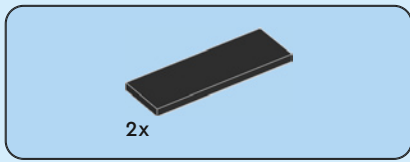

81

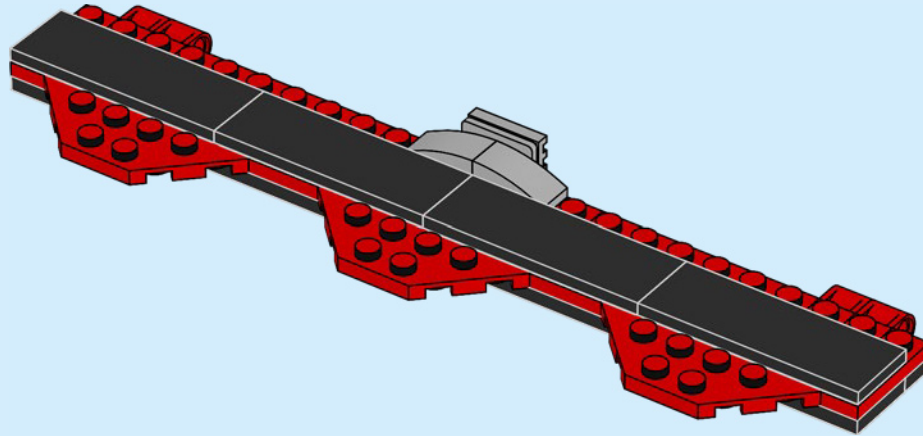

82

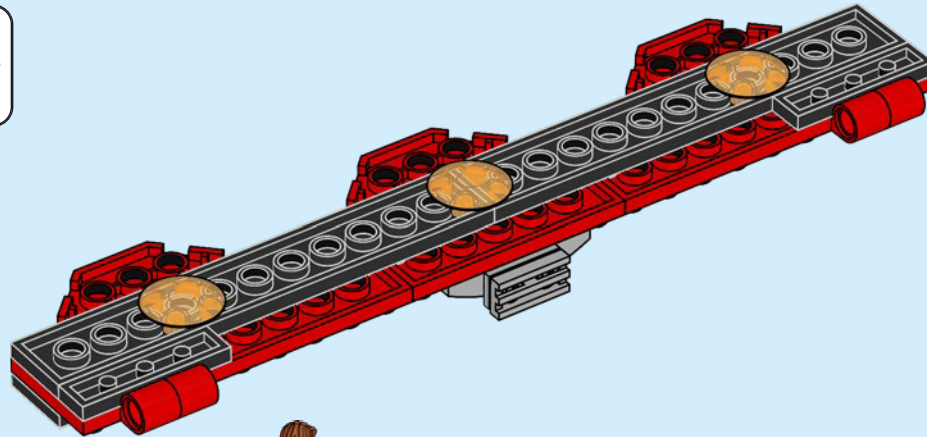

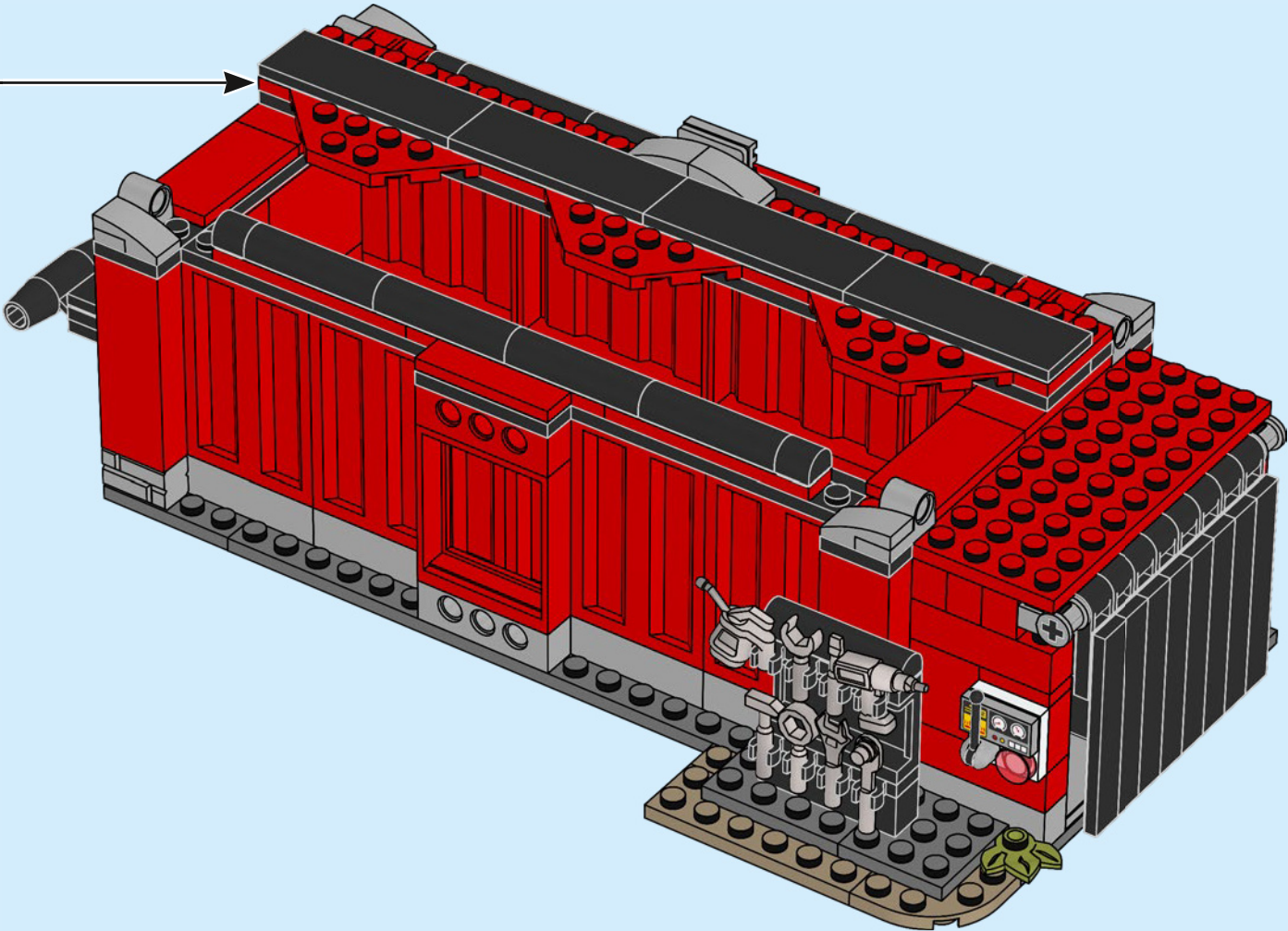

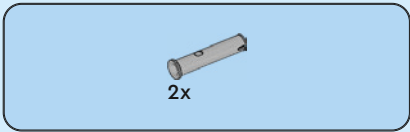

84

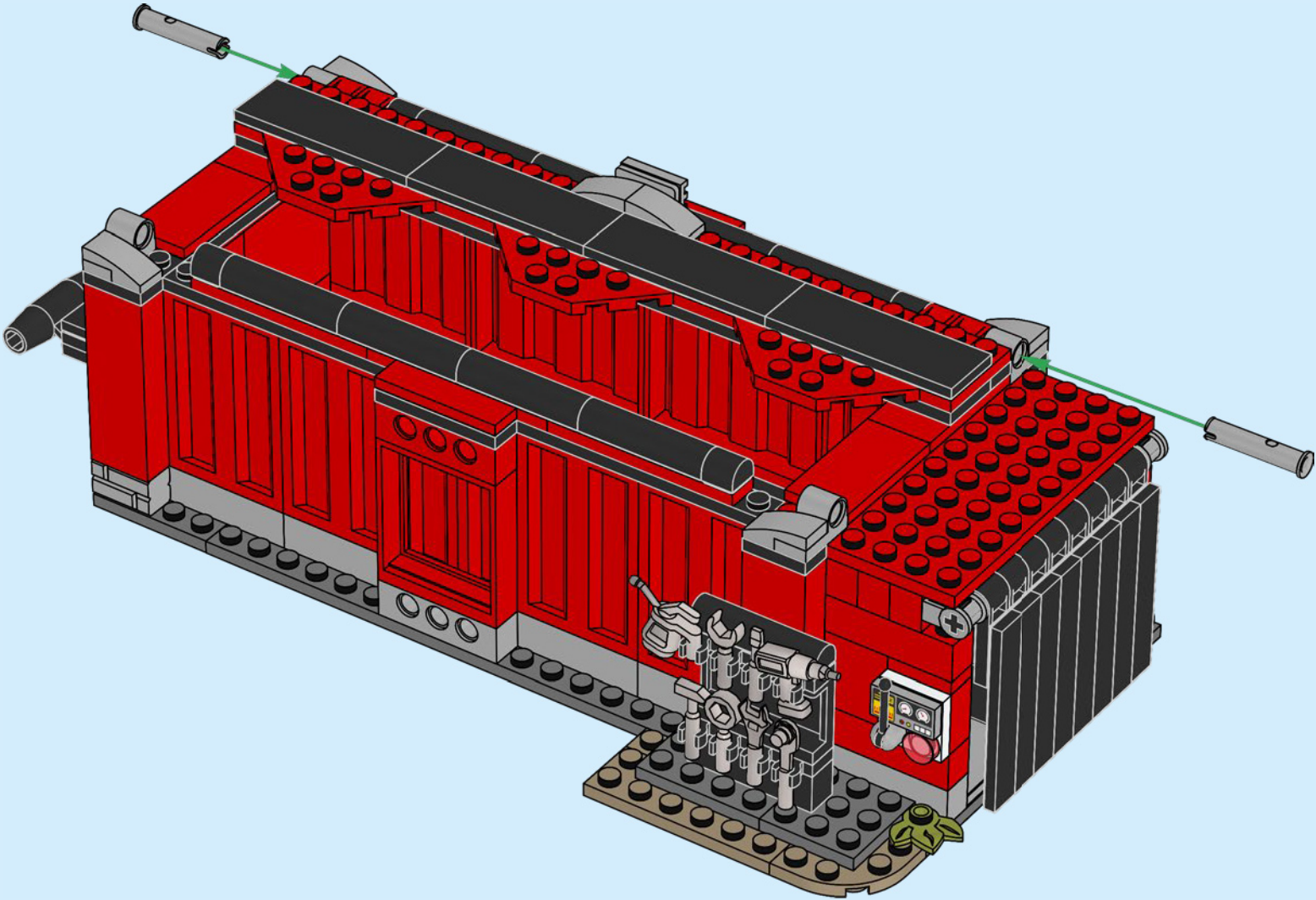

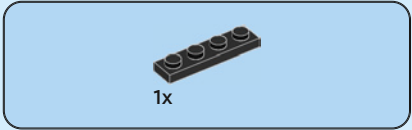
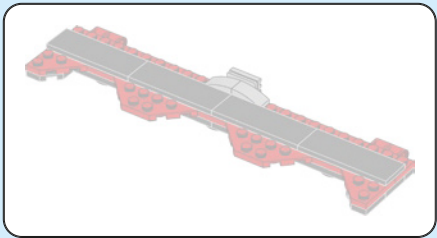

85

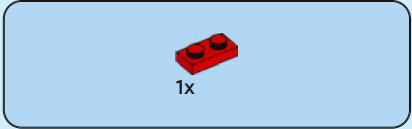
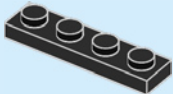

86

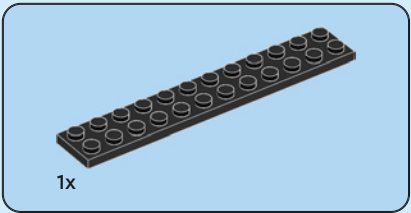
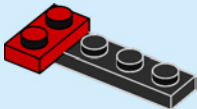

87

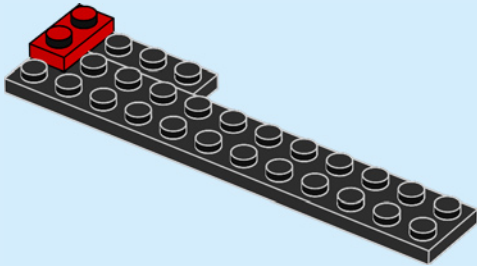

88

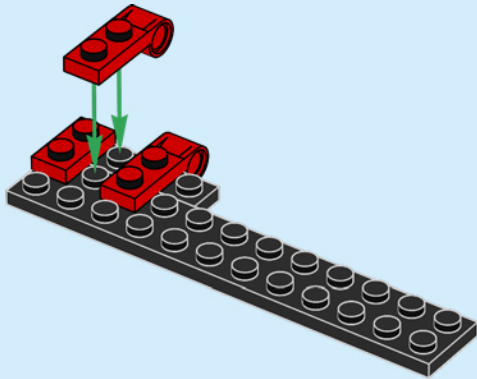



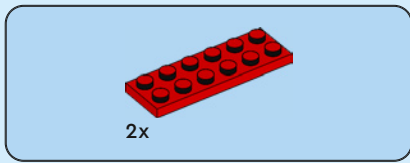

89

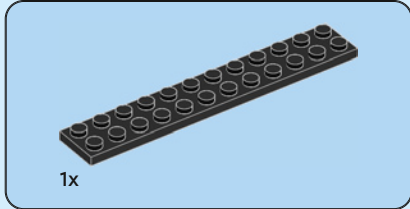
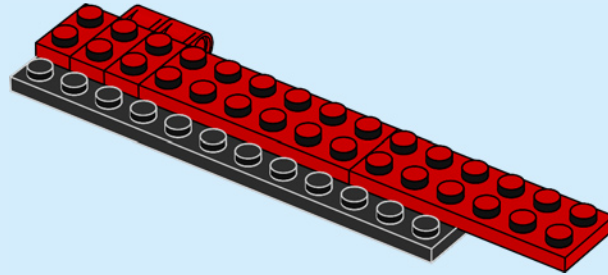

90

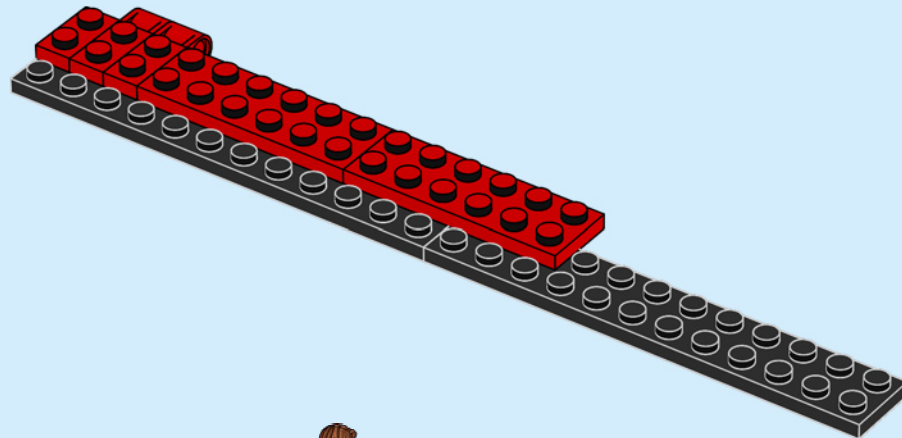

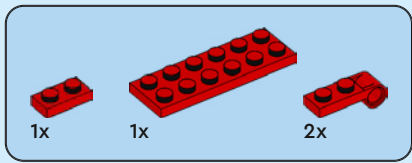

91

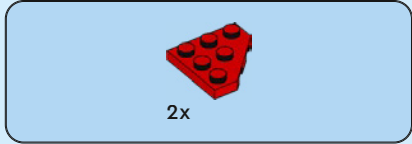
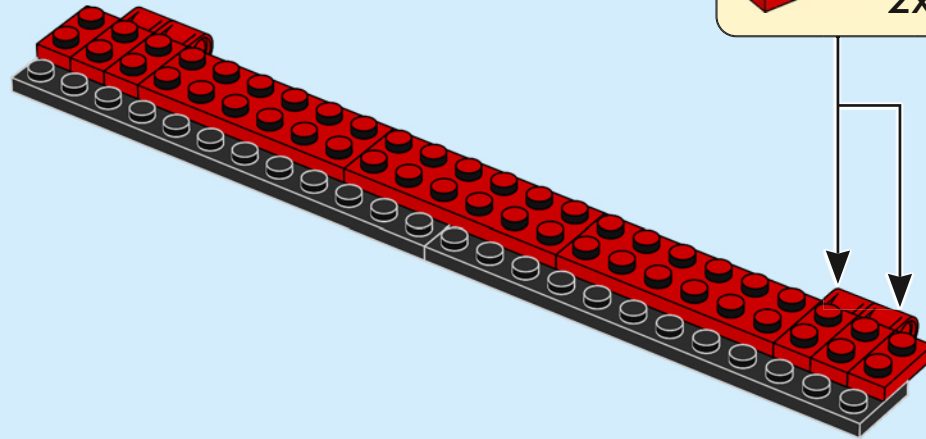

92

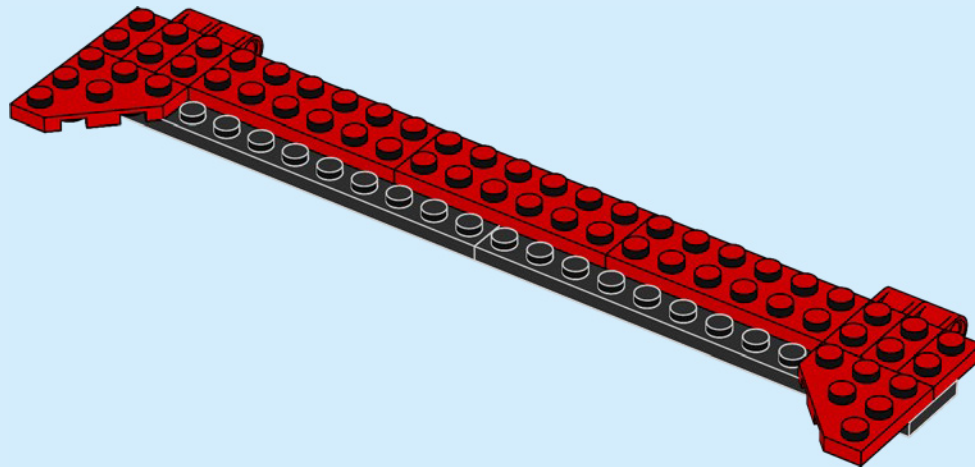



93

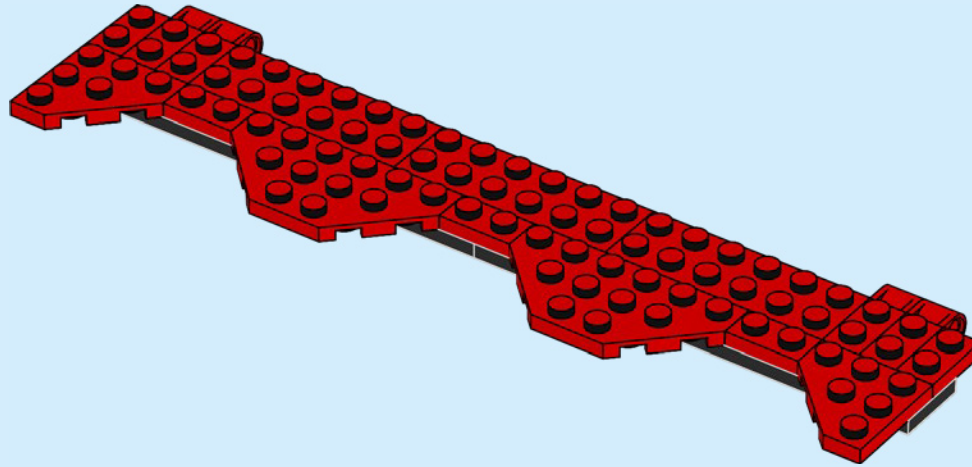

94

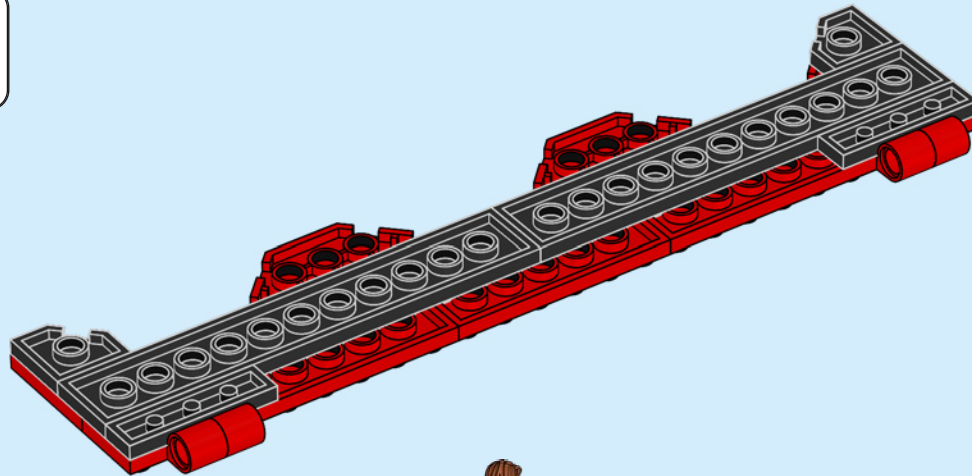

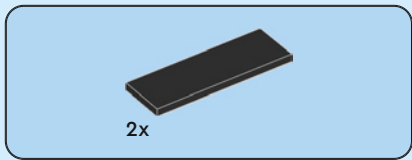

95

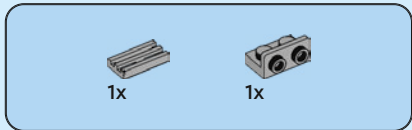
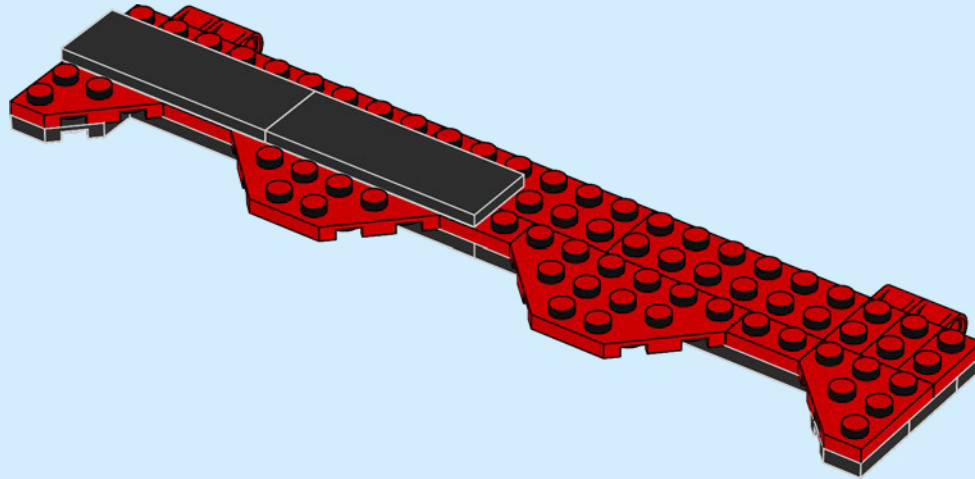

96

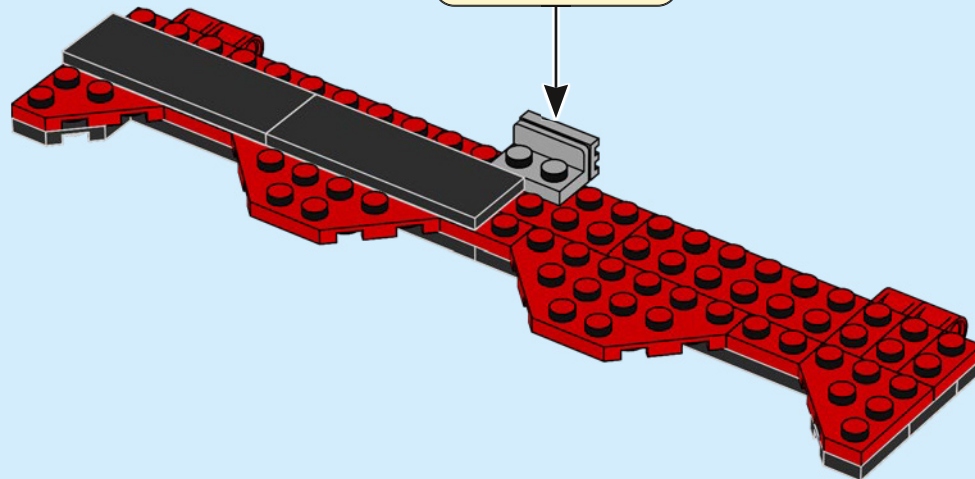
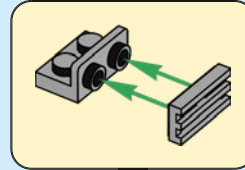





2x

97

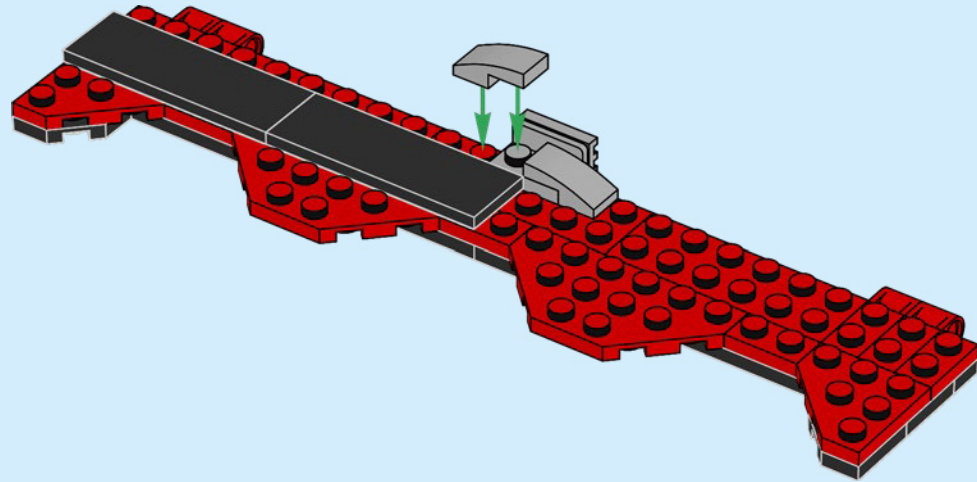

2x

98

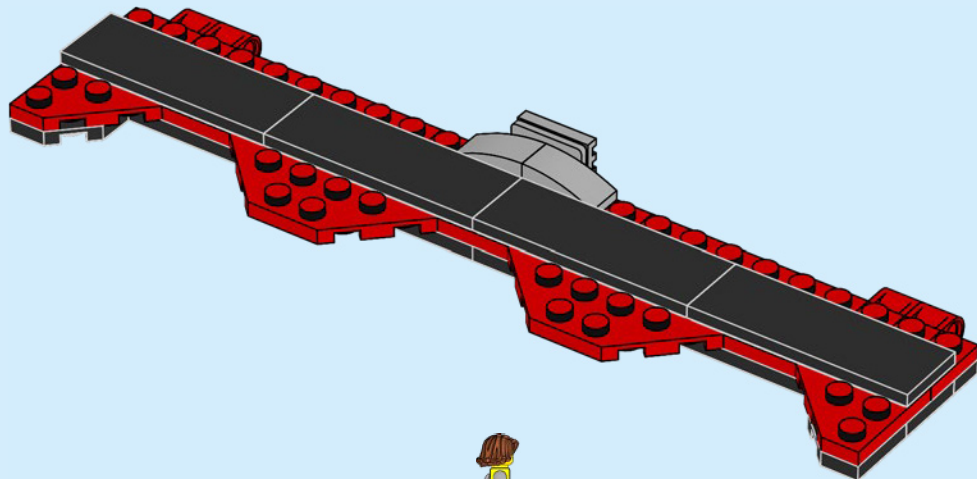



3x

99

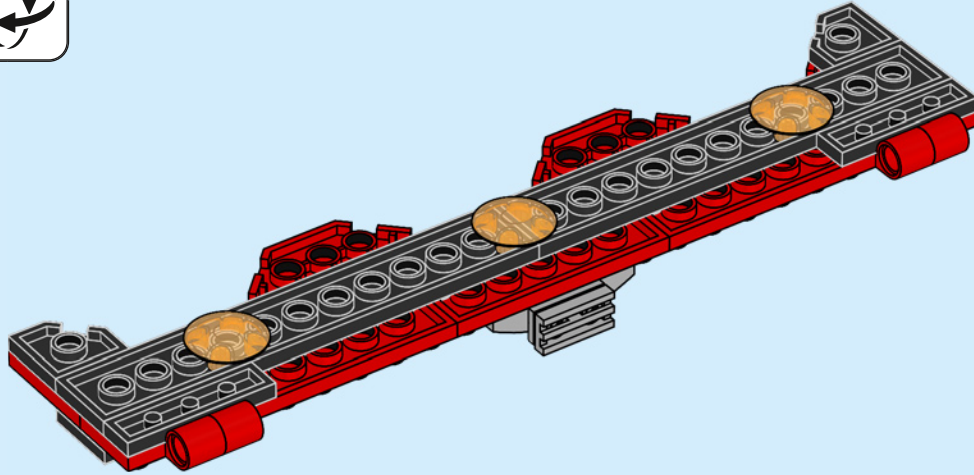

100

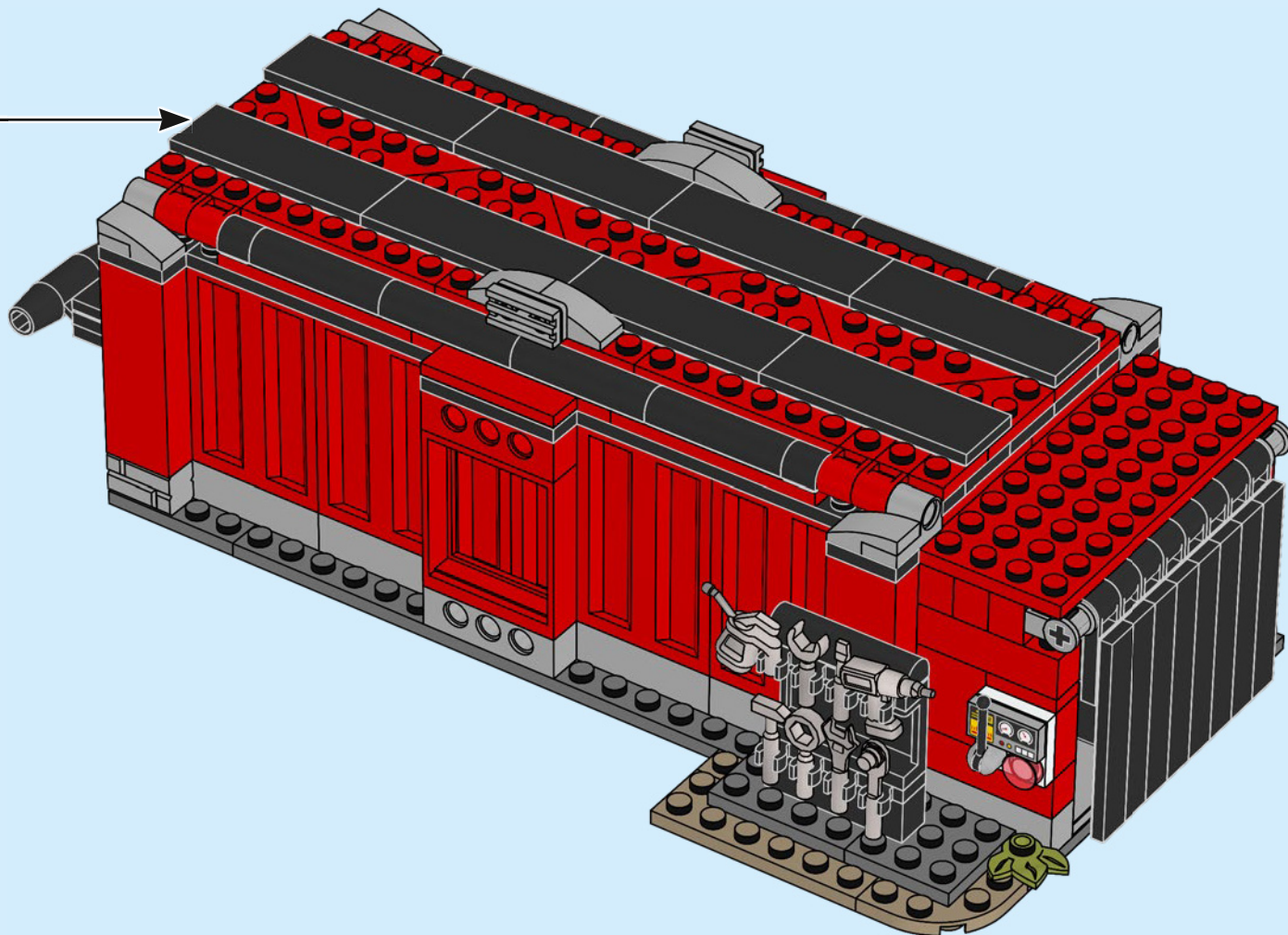

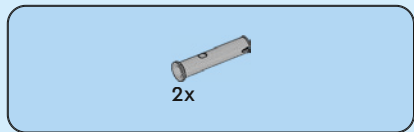

101

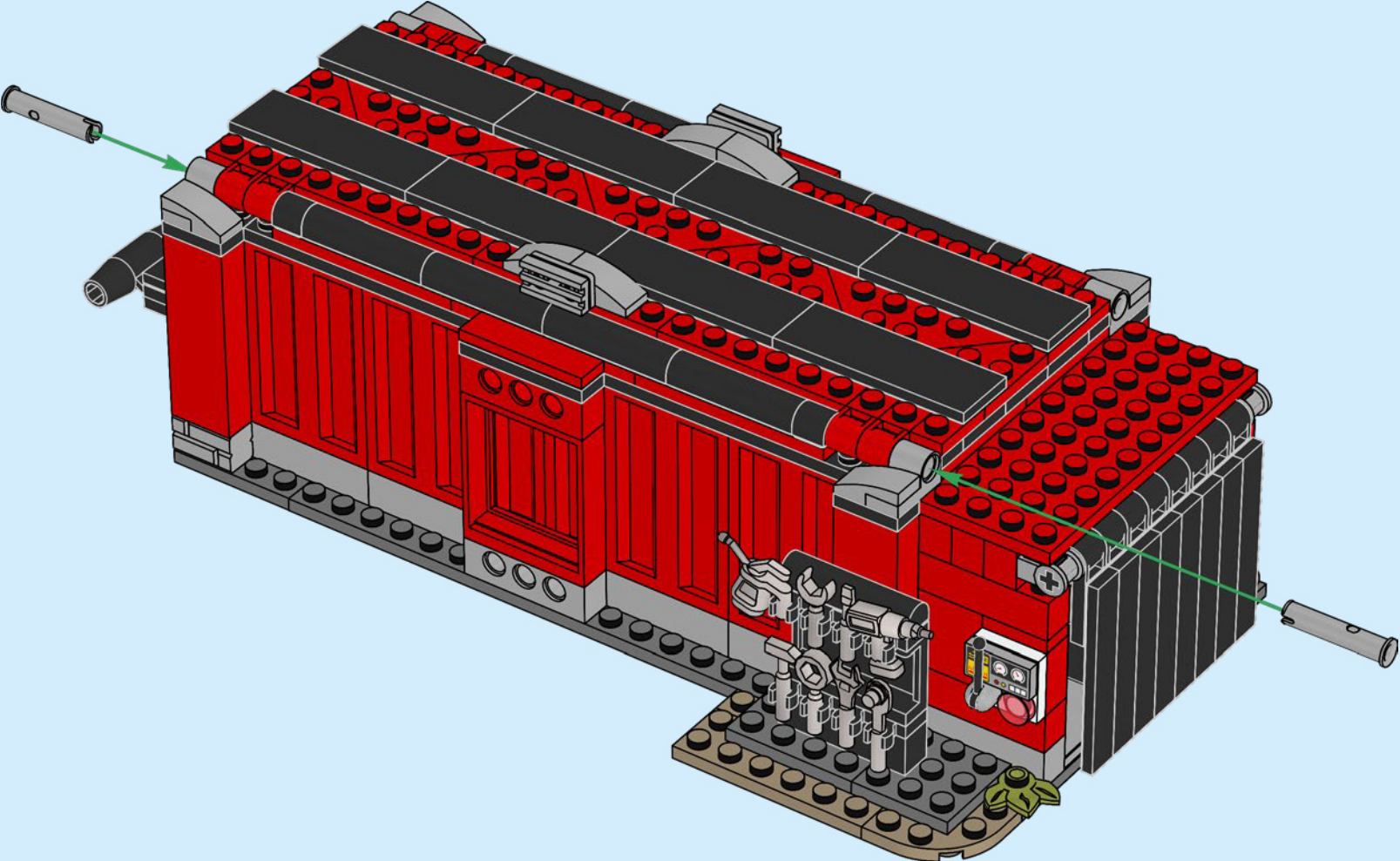



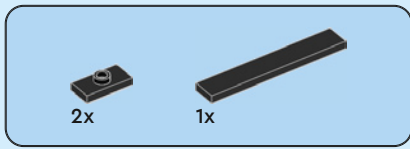

102

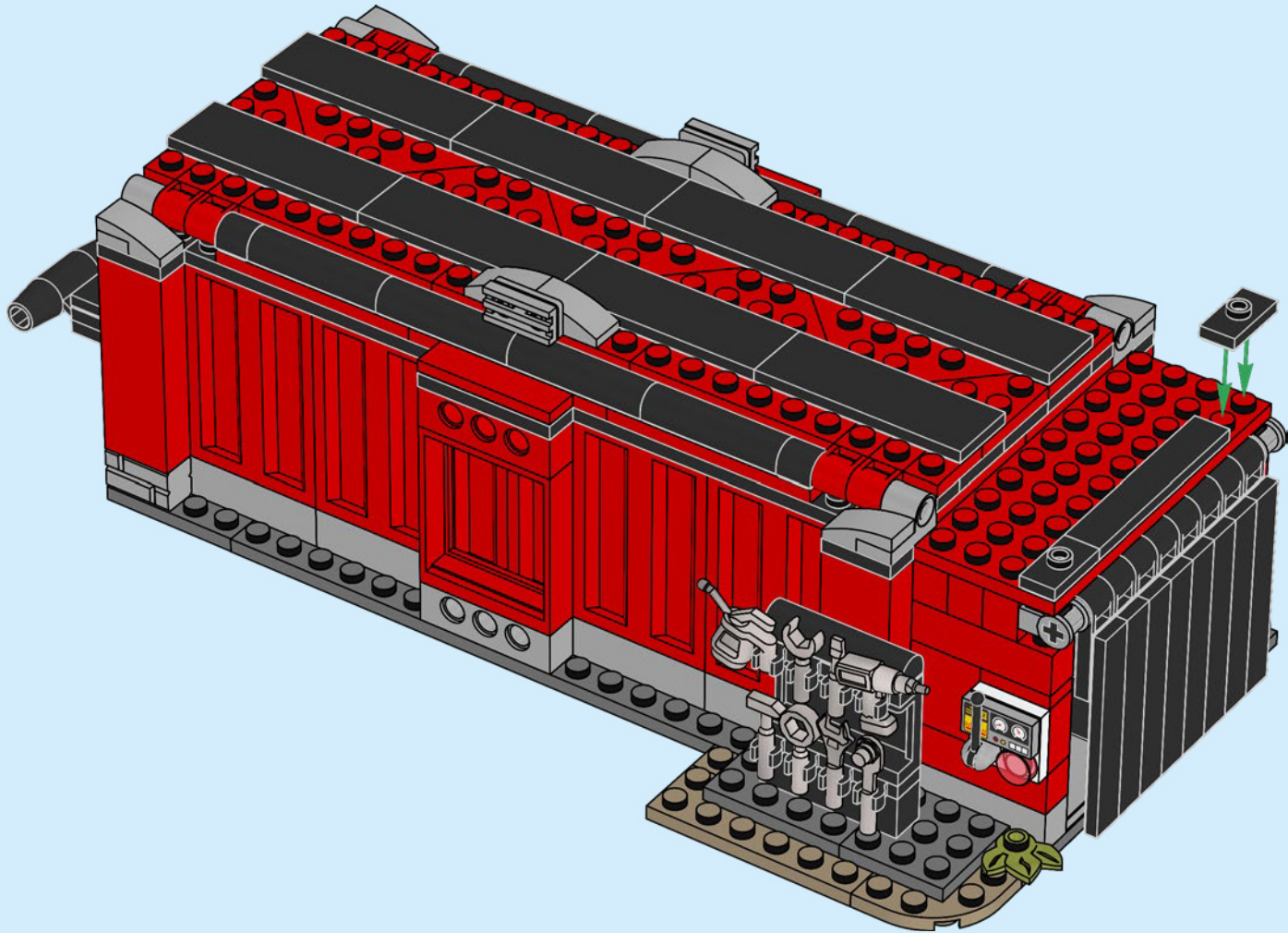



2x

103

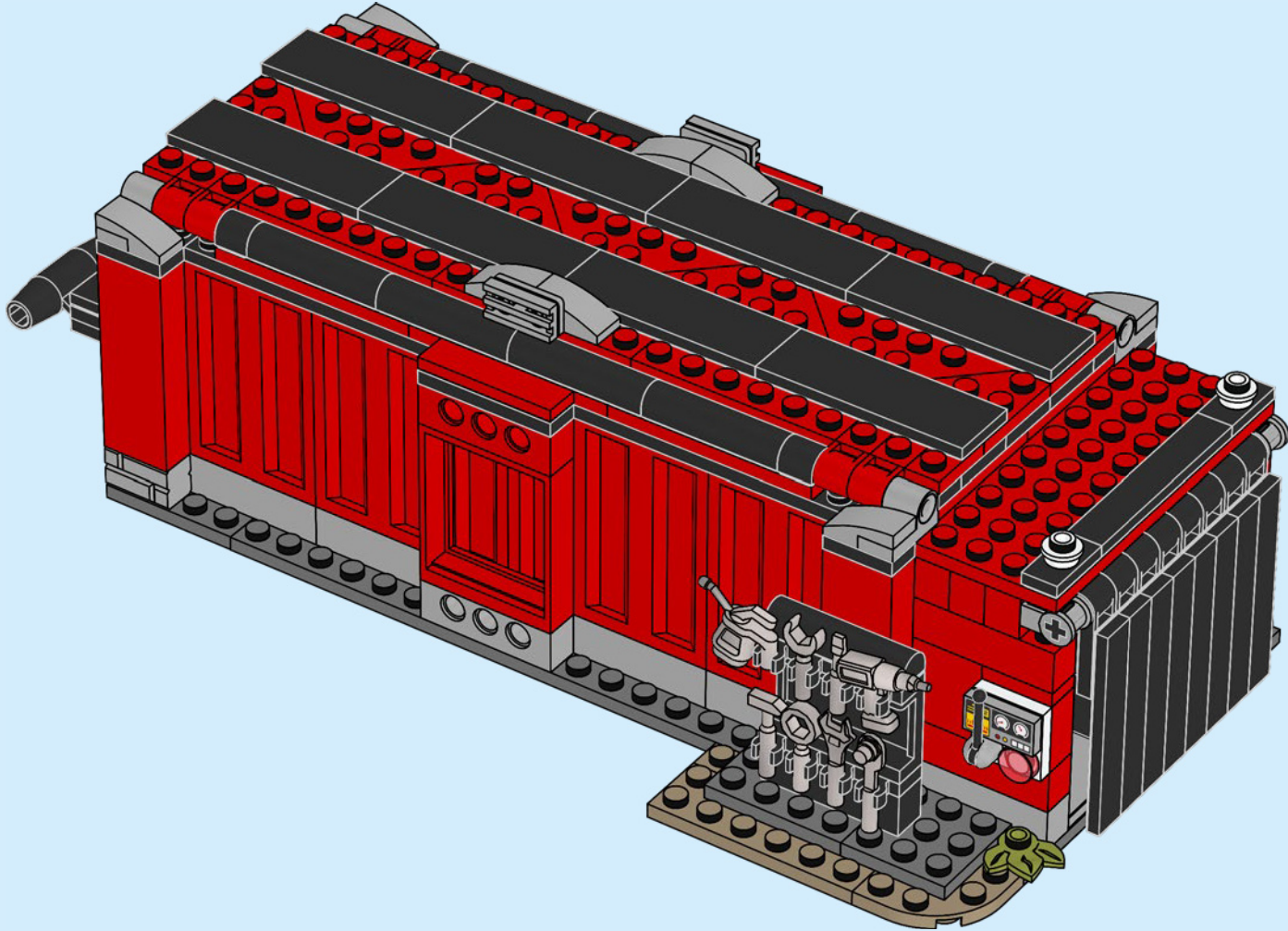



2x

104

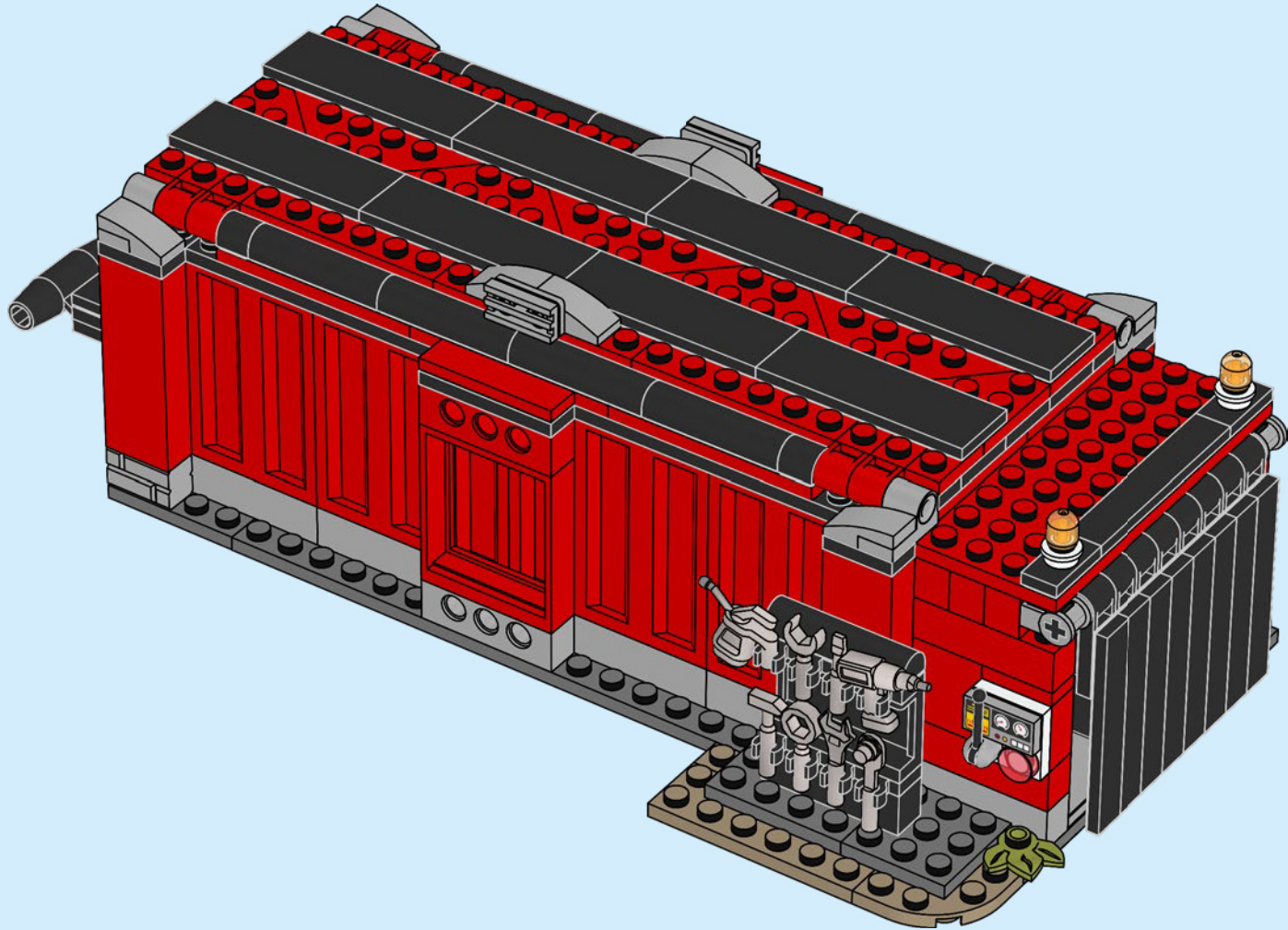



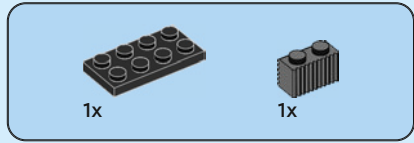
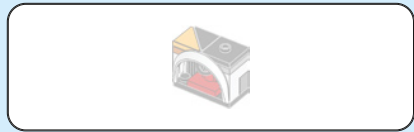

105

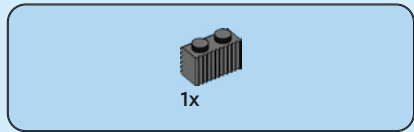
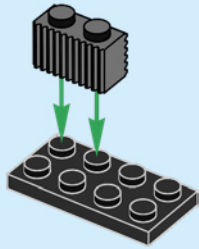

106

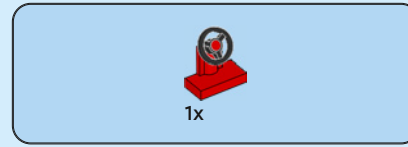
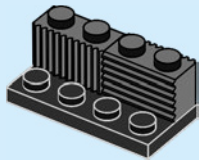

107

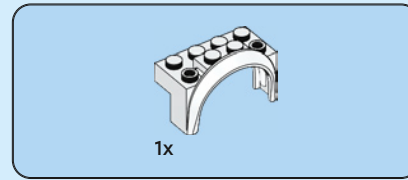
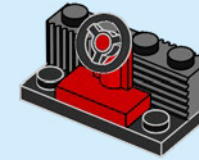

108

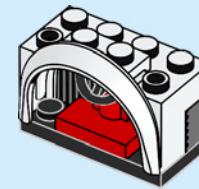



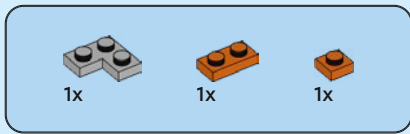

109

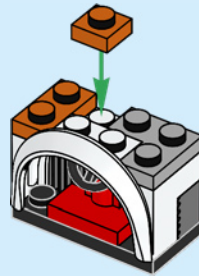

110

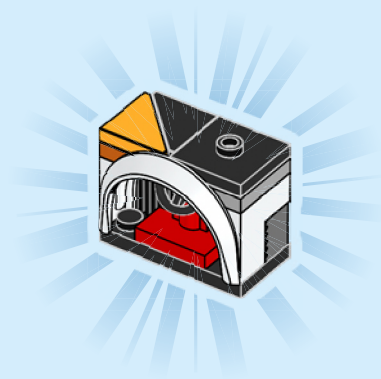

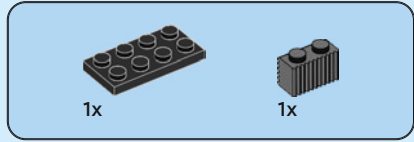

111

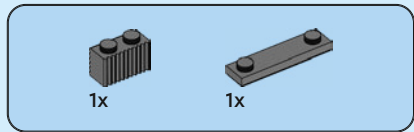
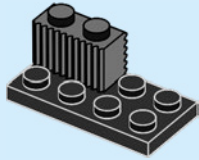

112

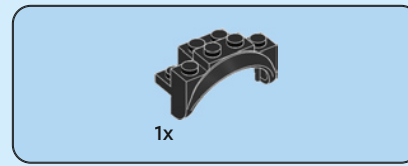
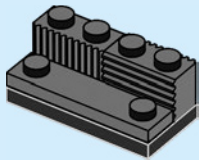

113

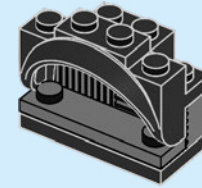

114

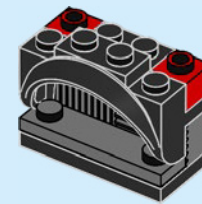



2x

115

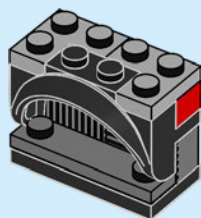

1x



1x



1x

116

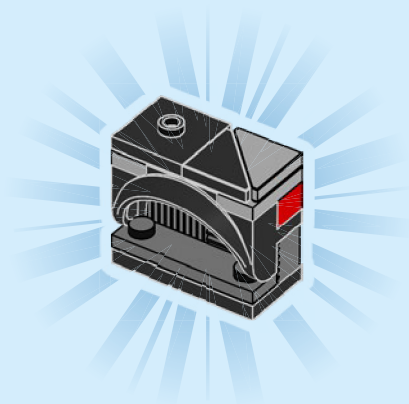

1

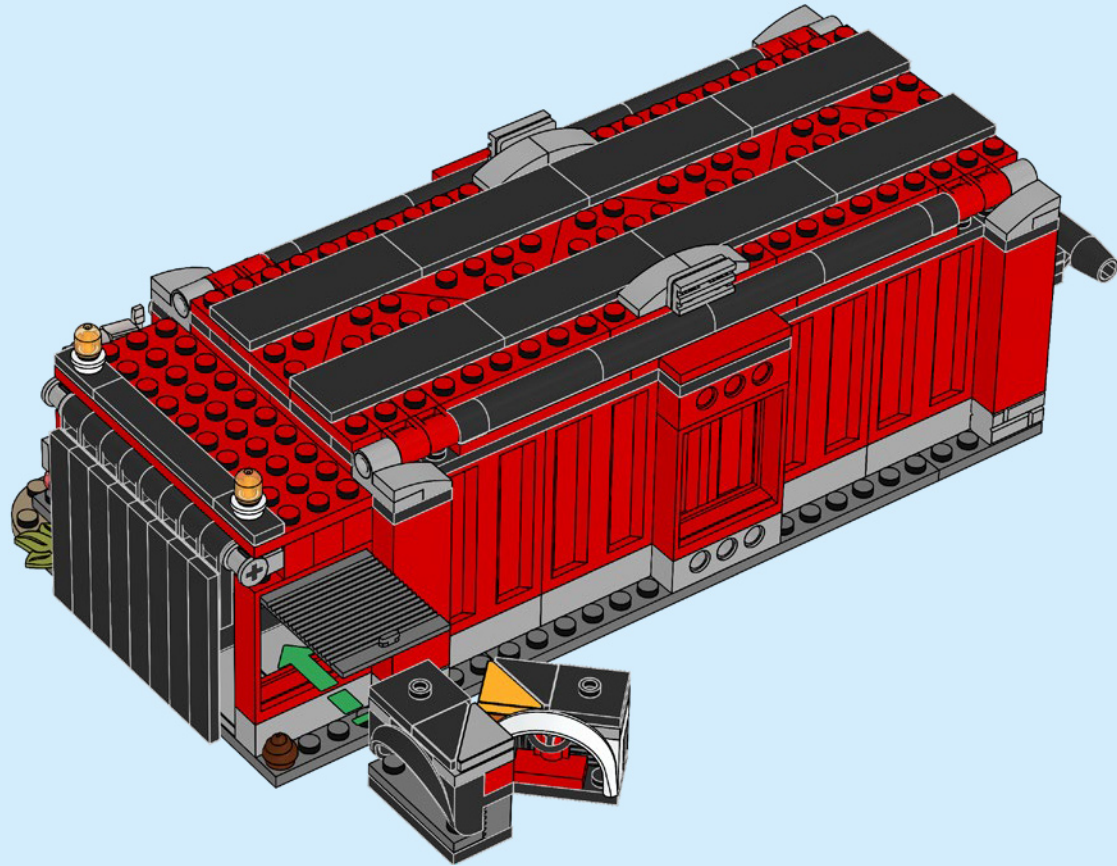



2

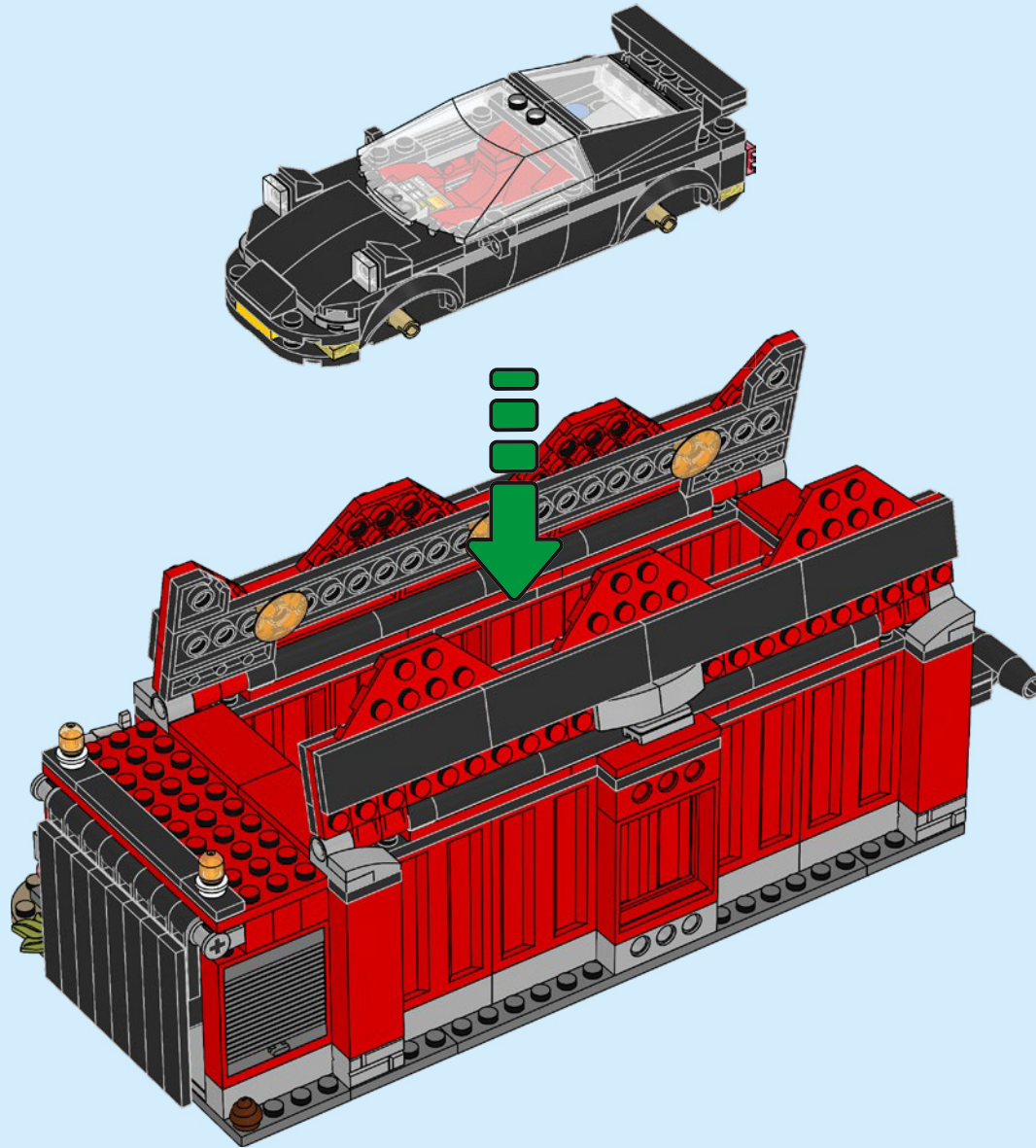

3

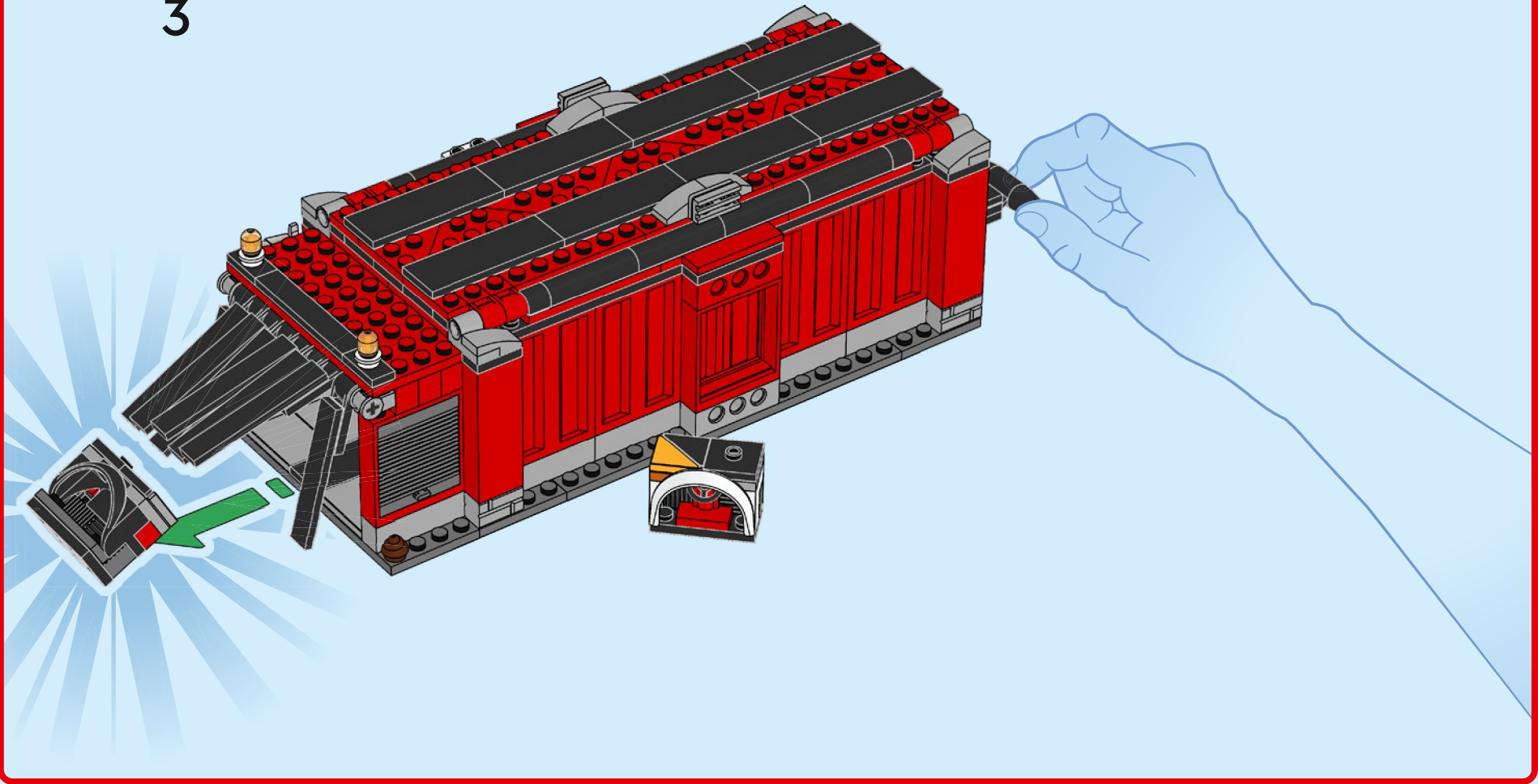









# CITY

60451



60447



60452



60453



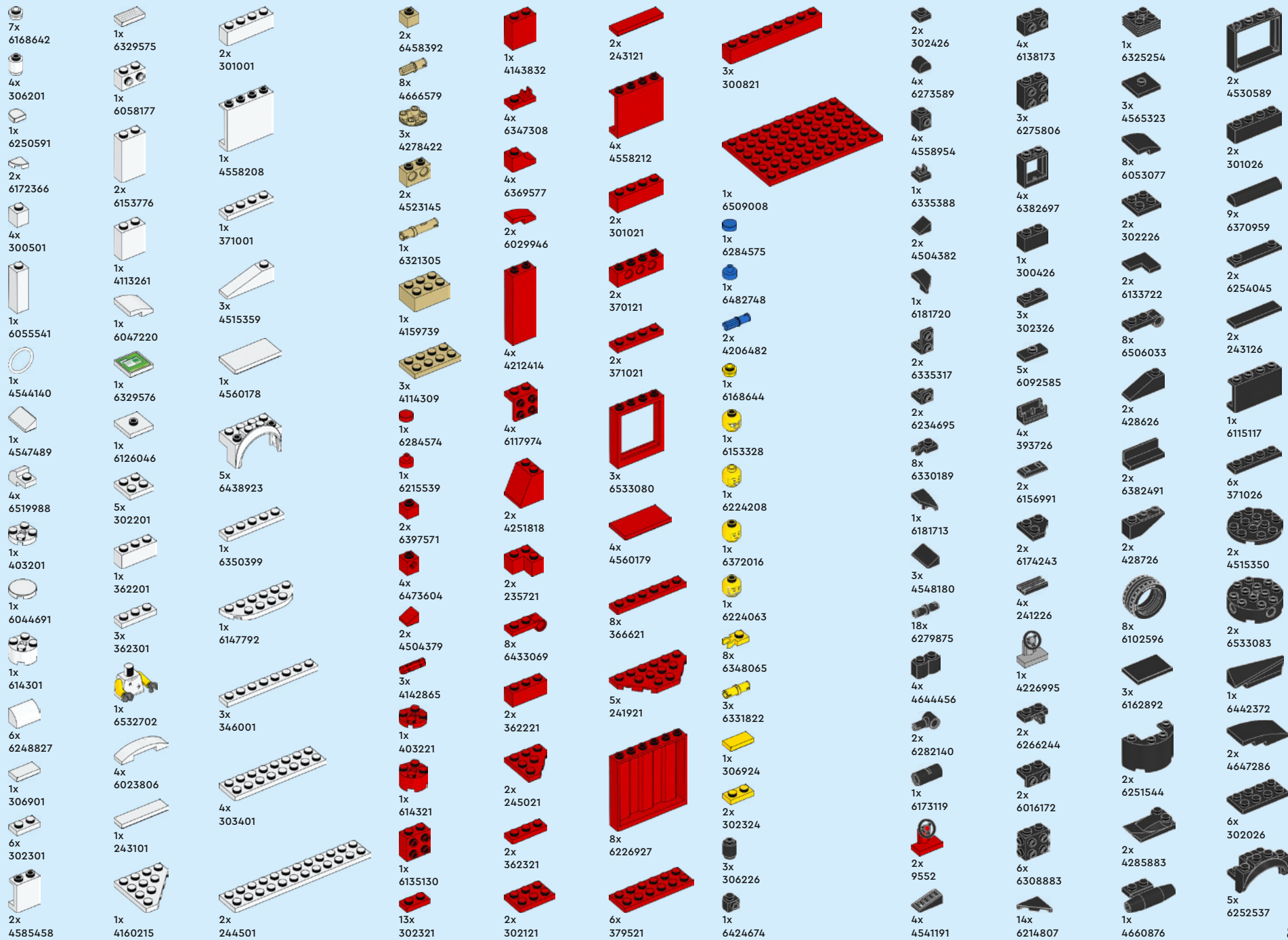



- 1x 6442373
- 2x 379526
- 1x 6177156
- 1x 4191191
- 5x 6105963
- 6x 366626
- 12x 663626
- 1x 6064228
- 2x 6058118
- 1x 4517986
- 1x 4243819
- 11x 6318582
- 4x 346026
- 4x 416226
- 2x 4100378
- 3x 303426
- 3x 4645732
- 2x 373726
- 2x 447726
- 5x 244526
- 2x 4107558

- 2x 6515869
- 1x 6443861
- 1x 6484420
- 1x 403228
- 1x 6254484
- 1x 6006514
- 4x 6314383
- 4x 6441768
- 2x 4570877
- 2x 4614158
- 1x 6115306

- 6x 6274738
- 2x 6254254
- 4x 6254552
- 2x 6514262
- 1x 6239418
- 1x 6247362
- 2x 6253734
- 1x 6245269
- 1x 6507933
- 1x 6515540
- 2x 6258607
- 1x 6514189
- 2x 6250158

- 1x 6238677
- 3x 6274739
- 1x 4518029
- 1x 4524929
- 4x 4177932
- 1x 6532670
- 1x 6240515
- 1x 6521210
- 3x 4267425
- 1x 6532700
- 1x 6489458
- 1x 6459334

- 2x 6368432
- 1x 6328307
- 1x 6035540
- 1x 6015424
- 1x 4550329
- 1x 6056241
- 1x 6303004
- 6x 6507868
- 6x 6171727
- 2x 4622062
- 13x 6479470
- 1x 6003033
- 2x 6365966
- 2x 6097509
- 2x 6490803

- 1x 6438899
- 1x 6374056
- 1x 4211206
- 1x 4211186
- 4x 6436421
- 1x 4221775
- 2x 6258831
- 1x 6176433
- 2x 6296894
- 1x 6310181
- 3x 4211440
- 4x 6000066
- 2x 6329585
- 4x 6225230

- 8x 6028813
- 2x 4211350
- 2x 6004990
- 2x 4211568
- 1x 6217876
- 1x 6446028
- 2x 6271815
- 3x 4211353
- 1x 4211397
- 8x 6163990
- 2x 4211387
- 1x 6170708
- 1x 4211376
- 1x 4259422
- 2x 4211881



1x  
6185676



4x  
6338962



2x  
4211536



2x  
6195471



2x  
4558169



1x  
4211428



4x  
4211429



1x  
6347992



4x  
4211386



4x  
6171894



4x  
4211445



5x  
4211441



1x  
6314891



8x  
4211613



1x  
6173095



1x  
4211356



2x  
4211385



2x  
6332151



6x  
4211393



1x  
4211438



1x  
4211640



1x  
4211795



2x  
4211425



2x  
4211498



2x  
4211374



1x  
4542577



4x  
6514002



4x  
6221607



4x  
4210636



4x  
4211063



2x  
4210763



1x  
6092572



2x  
6176400



1x  
6214341



2x  
4211055



2x  
6469463



2x  
6343852



2x  
6369944



1x  
6267165



1x  
6302647



1x  
6257592



1x  
4211001



1x  
4210728



1x  
6039176



1x  
4211065



4x  
4210651



4x  
4539429



1x  
4243831



4x  
6321746



1x  
4211061

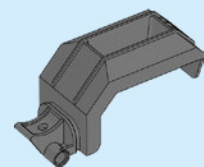

2x  
6513203



4x  
4211067

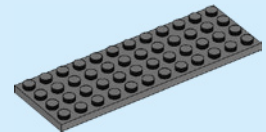

2x  
4210706

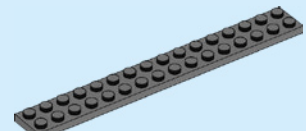

2x  
4210796

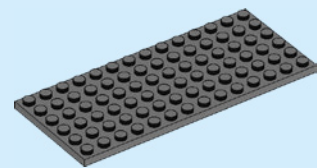

1x  
4210720



4x  
6510211



1x  
6287856



1x  
6353962



1x  
6419079



1x  
4619513



1x  
6233166



1x  
6430210



2x  
6442979



4x  
6442368



1x  
6508356



1x  
6167576



9x  
6469087



1x  
6469087



2x  
6469087



2x  
6469087



2x  
6469087



3x  
6398008



1x  
6390087



1x  
6469084



2x  
6483784



5x  
6466720



4x  
6533081



2x  
6469087



2x  
6469087



2x  
6469087



2x  
6469087



2x  
6469087

 [LEGO.com/service](https://www.LEGO.com/service)



YOU COULD **WIN** 

Scan this QR code or go to **LEGO.COM/PRODUCTFEEDBACK** and give us your short feedback about this LEGO® set for a chance to win a cool LEGO prize.

Terms and Conditions apply\*



**EN: YOU COULD WIN.** Terms and Conditions apply\* **DE: Du könntest GEWINNEN.** Es gelten die Teilnahmebedingungen\* **FR: Tu pourrais GAGNER.** Des conditions s'appliquent\* **IT: Potresti VINCERE tu.** Termini e condizioni sono applicabili\* **ES: Puedes GANAR.** Aplican términos y condiciones\* **PT: Poderá GANHAR.** Aplicam-se termos e condições\* **ZH: 轻松获奖. 条款和条件适用\*** **PL: Szansa na WYGRANĄ.** Obowiązują warunki korzystania\* **CS: Máte šanci VYHRÁT.** Platí všeobecné smluvní podmínky\* **SK: Máte šancu VYHRAŤ.** Platia všeobecné zmluvné podmienky\* **HU: TE IS NYERHETSZ.** Felhasználási feltételek érvényesek\* **RO: Ai putea CÂȘTIGA.** Se aplică termenii și condițiile\* **BG: Можете да СПЕЧЕЛИТЕ.** Има определени правила и условия\* **LV: Tu vari LAIMĒT.** Ir spēkā noteikumi un nosacījumi.\* **ET: Sul on võimalus VÕITA.** Kehtivad tingimused\* **LT: Jūs galite LAIMĖTI.** Taikomos sąlygos\*

\*[LEGO.com/productfeedback-terms](https://www.lego.com/productfeedback-terms)