



CITY

60447



Q LEGO® Builder



Get excited about our new packaging!

We're switching from plastic to paper-based packaging. That's why you might find a mix of paper and plastic in our boxes!

Nos nouveaux emballages vous emballeront !

Nous passons des emballages en plastique aux emballages à base de papier. C'est pourquoi vous pourriez trouver un mélange de papier et de plastique dans nos boîtes !

¡Te presentamos nuestros nuevos empaques!

Estamos sustituyendo las bolsas de plástico por bolsas con base de papel. ¡Por eso, puedes encontrar una mezcla de papel y de plástico en nuestras cajas!

[LEGO.com/sustainable-packaging](https://www.lego.com/sustainable-packaging)



Q LEGO® Builder

BUILDER



Apple and the Apple logo are trademarks of Apple Inc., registered in the U.S. and other countries and regions. App Store is a service mark of Apple Inc. Google Play and the Google Play logo are trademarks of Google LLC. Tencent and the Tencent logo are trademarks of Tencent Inc.

Q LEGO.com/devicecheck

EN Ask parents' permission before going online | **DE** Eltern um Erlaubnis bitten, bevor du online gehst | **FR** Demande l'autorisation d'un parent avant d'aller en ligne | **IT** Chiedi il permesso ai tuoi genitori prima di andare online | **ES** Pídeles permiso a tus papás antes de conectarte a Internet | **PT** Peça autorização aos pais antes de acederes online | **ZH** 上网前应先征得父母的同意 | **PL** Poproś rodziców o zgodę, zanim wejdiesz do Internetu | **CS** Než půjdeš na internet, požádej rodiče o svolení | **SK** Skôr než pôjdeš na internet, vypýtaj si povolenie od rodičov | **HU** Kérj szülői engedélyt, mielőtt online csatlakoznál! | **RO** Cere permisiunea părinților înainte de a te conecta online | **BG** Поискайте разрешение от родител, преди да влезете онлайн | **LV** Pirms došanās tiešsaistē palūdz atļauju vecākiem | **ET** Enne Interneti kasutamist küsi vanematelt luba | **LT** Prieš prisijungdami prie interneto, atsiklauskite tėvų





CONSTRUISEZ À VOTRE FAÇON
CONSTRÚYELO A TU MANERA

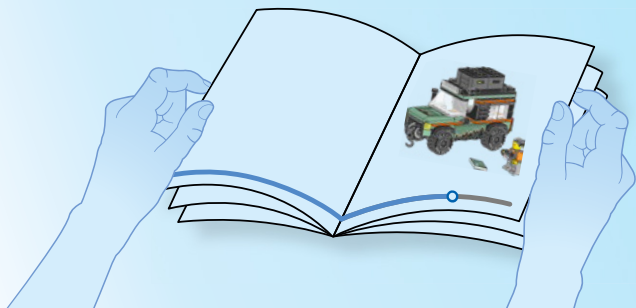

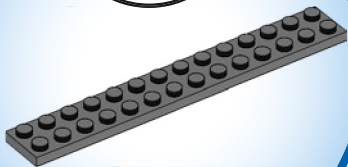
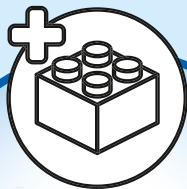

2x



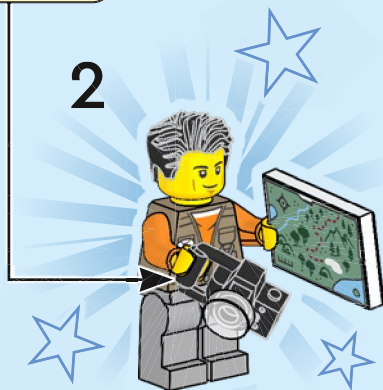
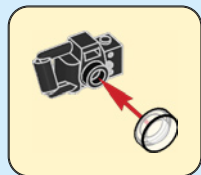
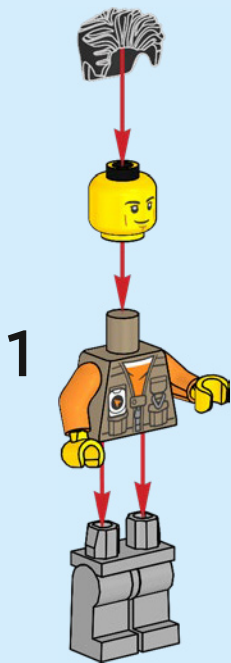

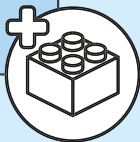
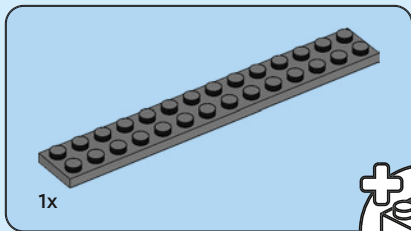

1

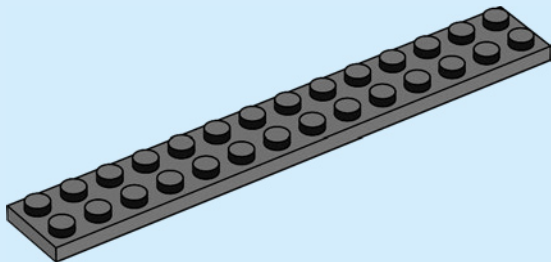

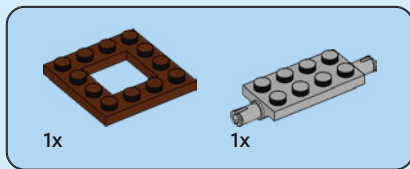

2

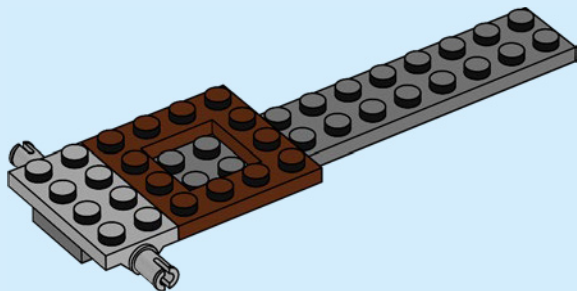

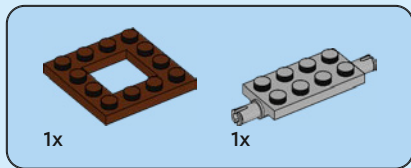

3

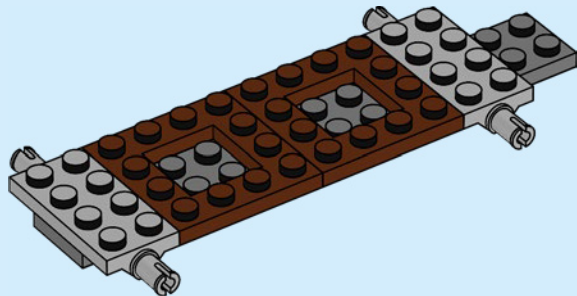

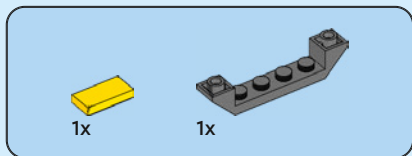

4

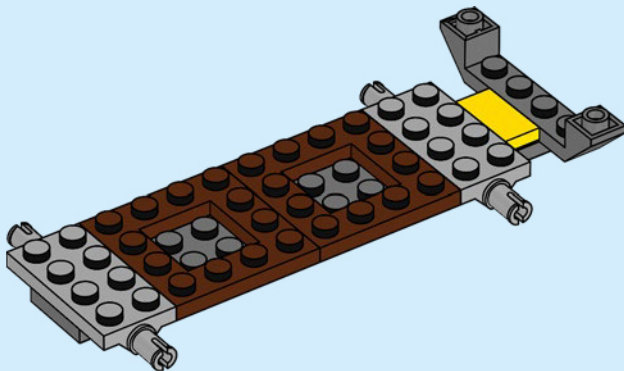

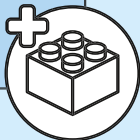
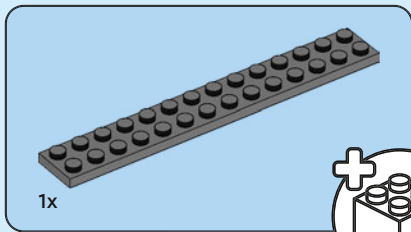

5

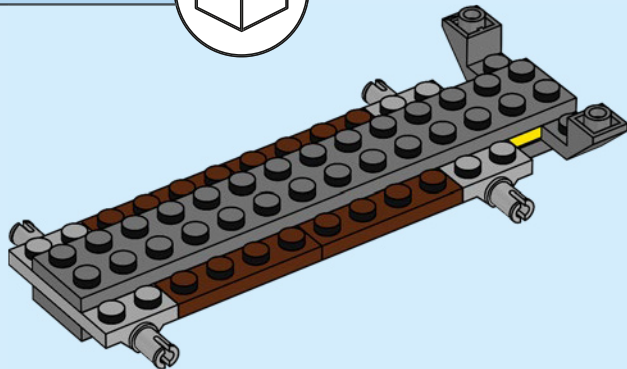



2x

6

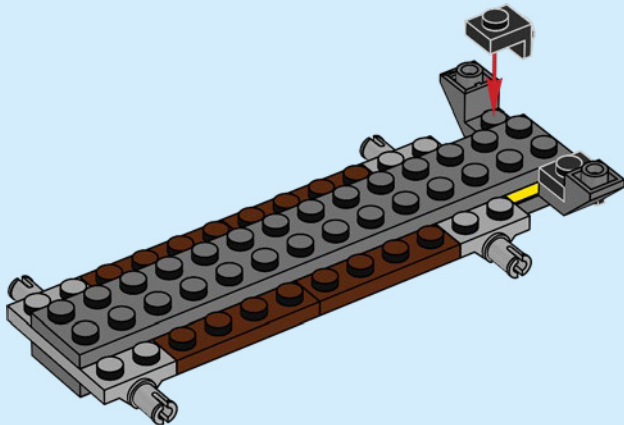



2x

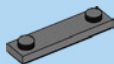

1x

7

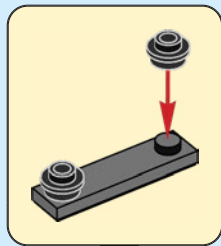
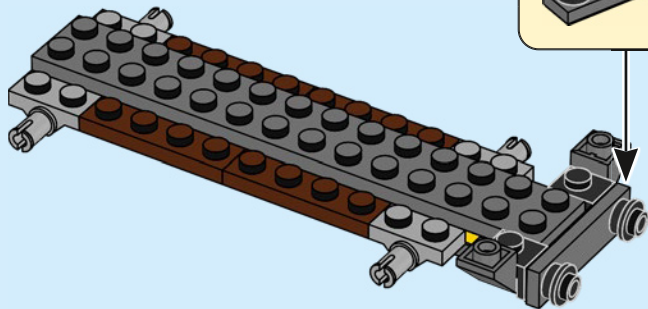



2x

8

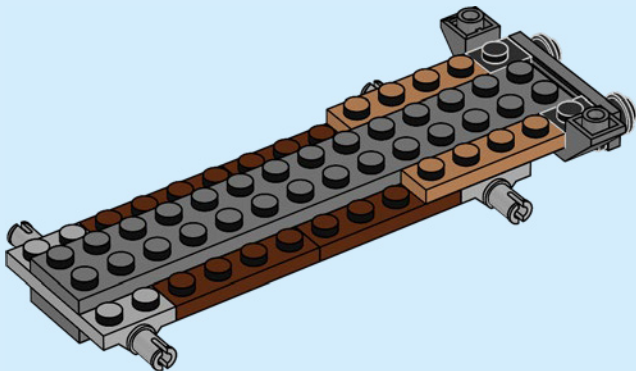

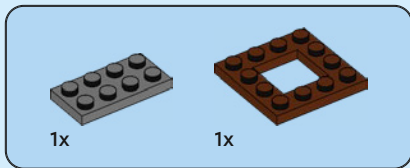

9

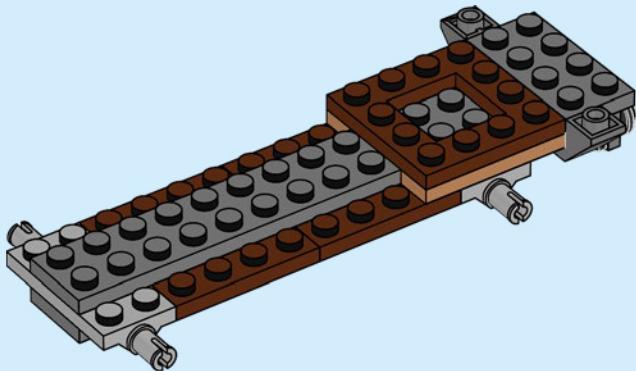



6x

10

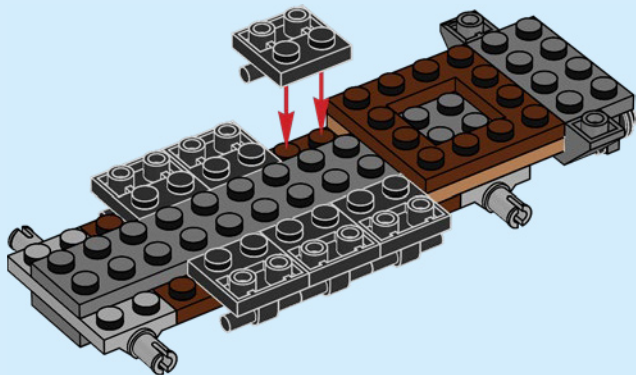



2x

11

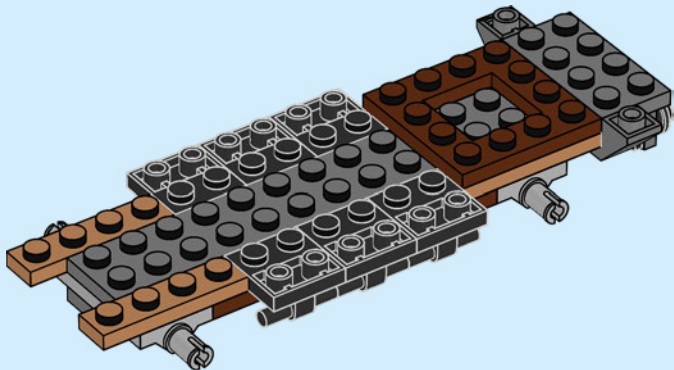

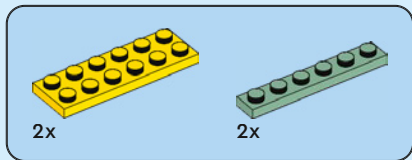

12

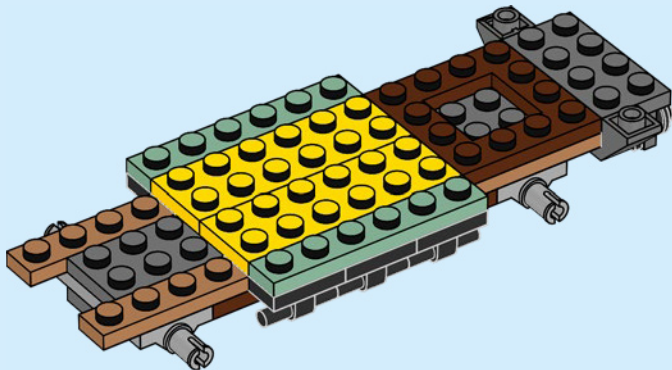



2x

13

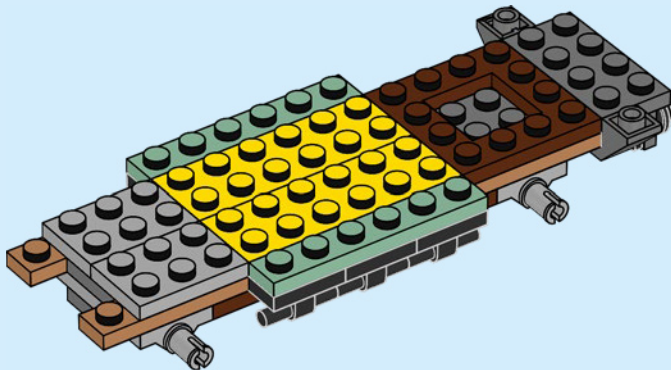



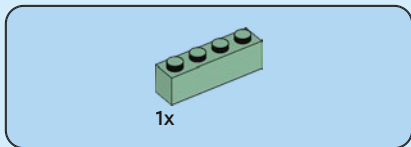

14

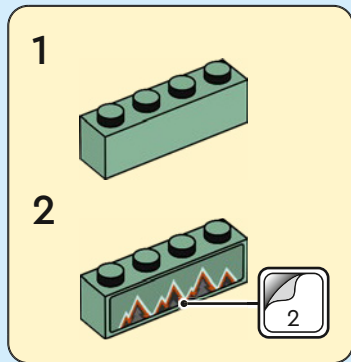

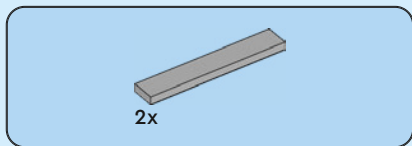

15

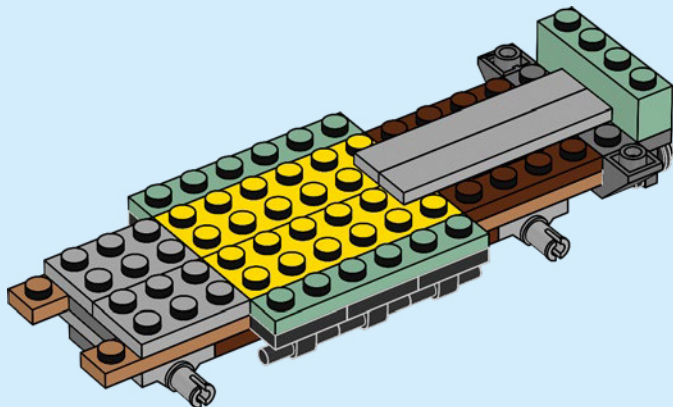



2x



2x

17

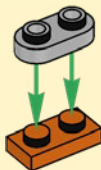

2x

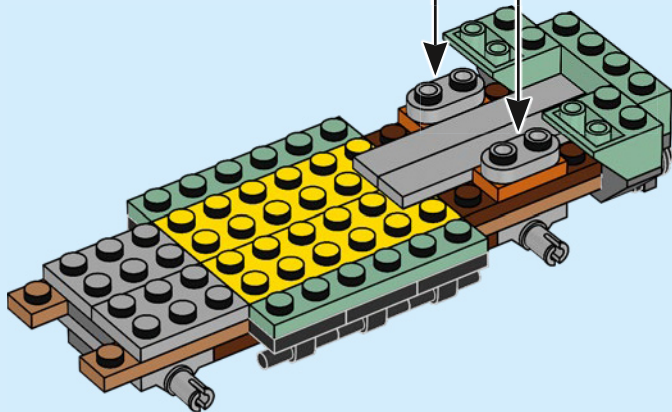



2x

18

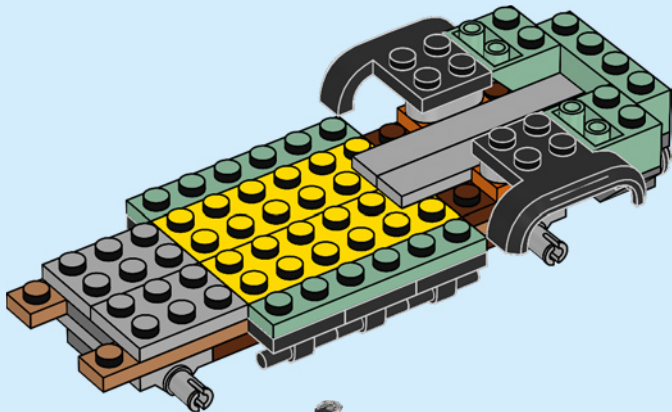



2x

19

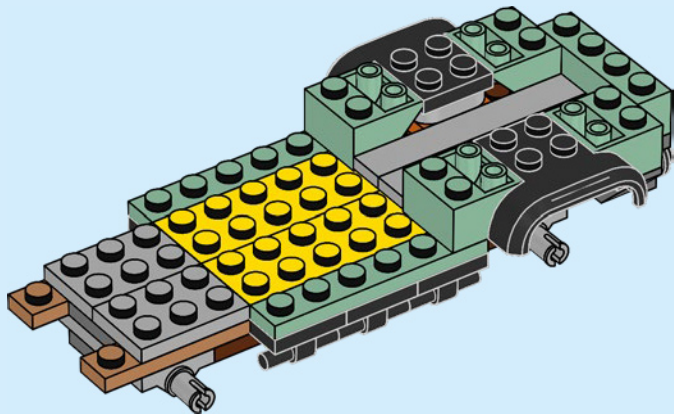



2x



2x

20

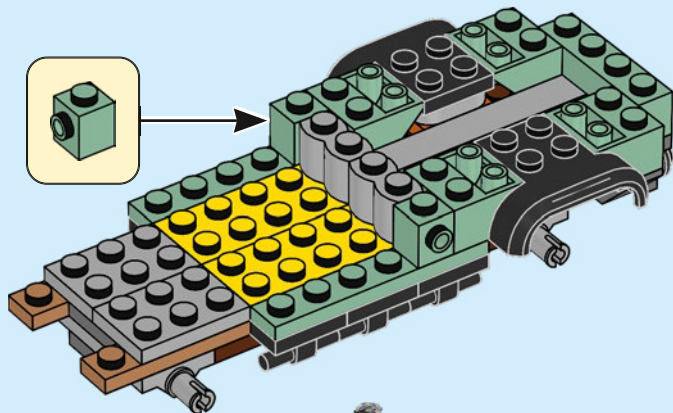

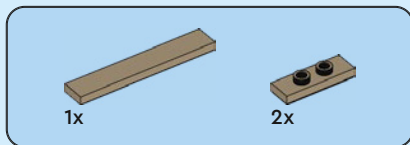

21

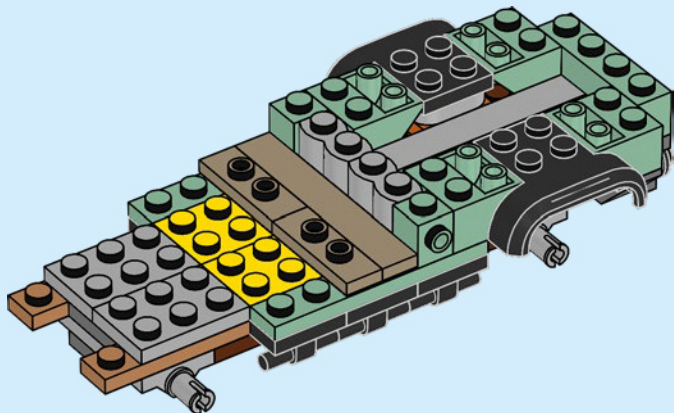



1x



1x

22

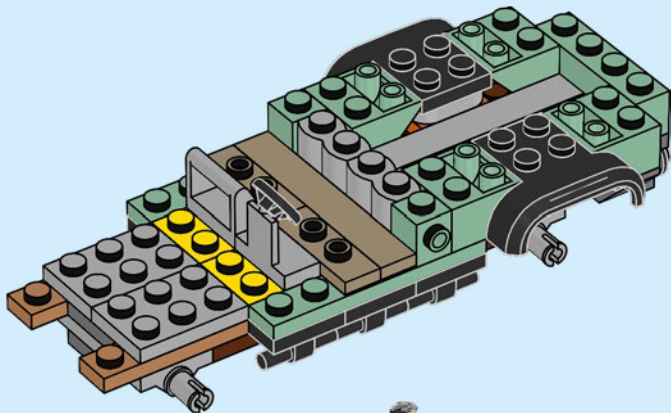



1x



2x

23

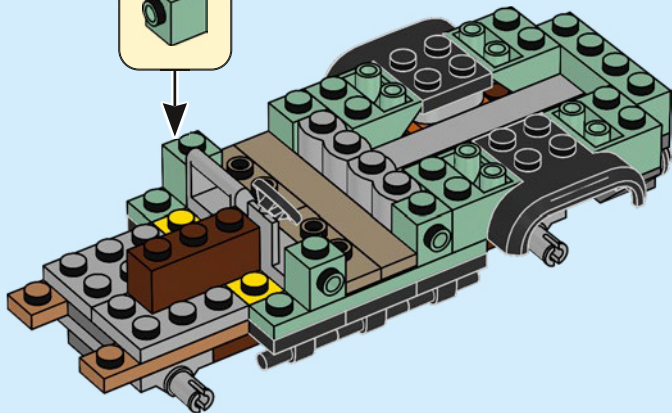



2x

24

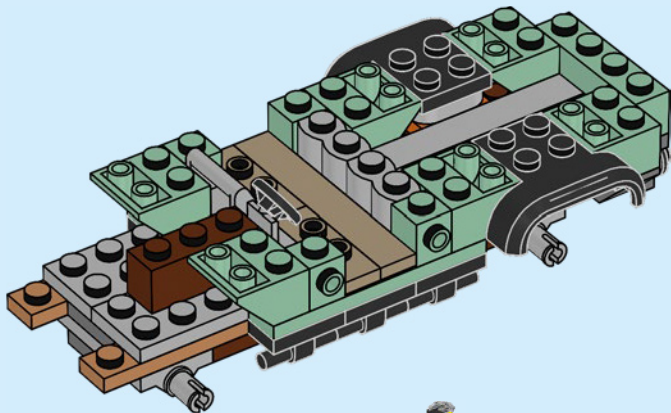



1x

25

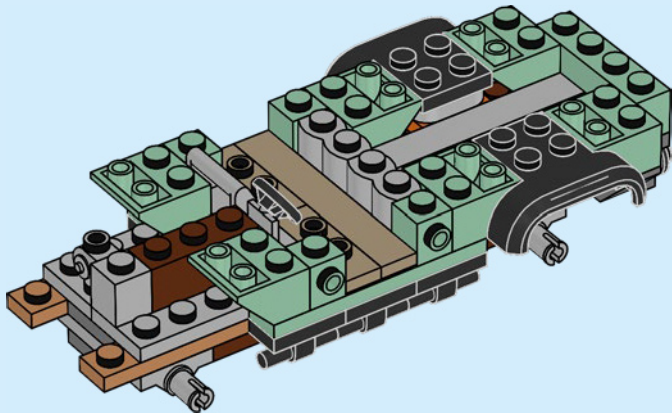

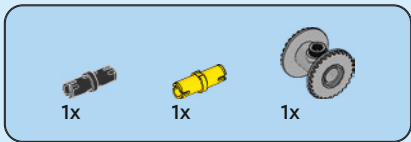

26

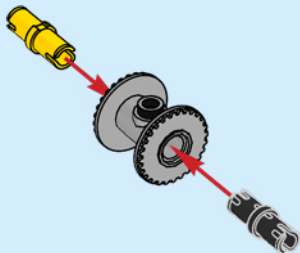

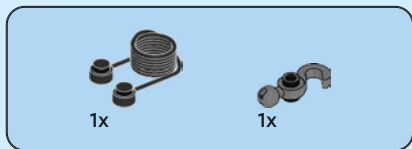

27

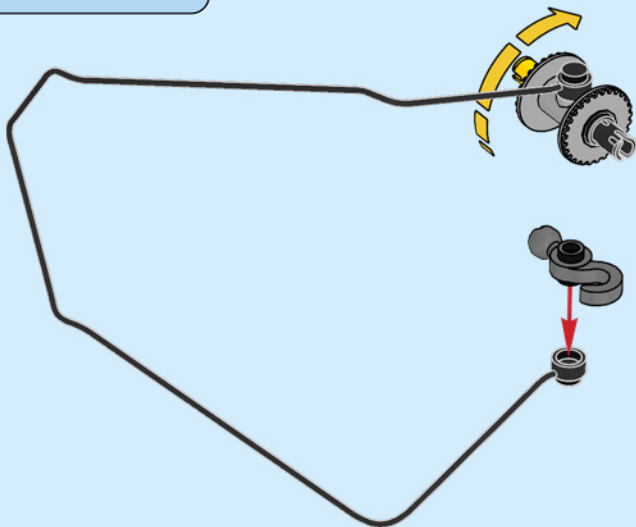



2x

28

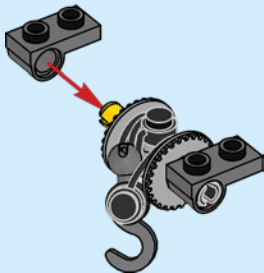

29

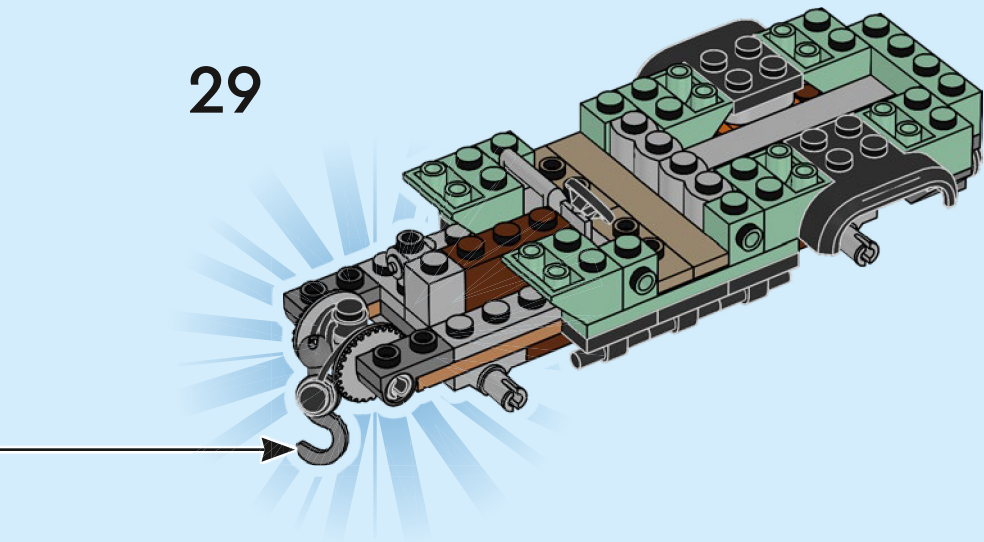

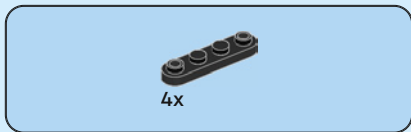

30

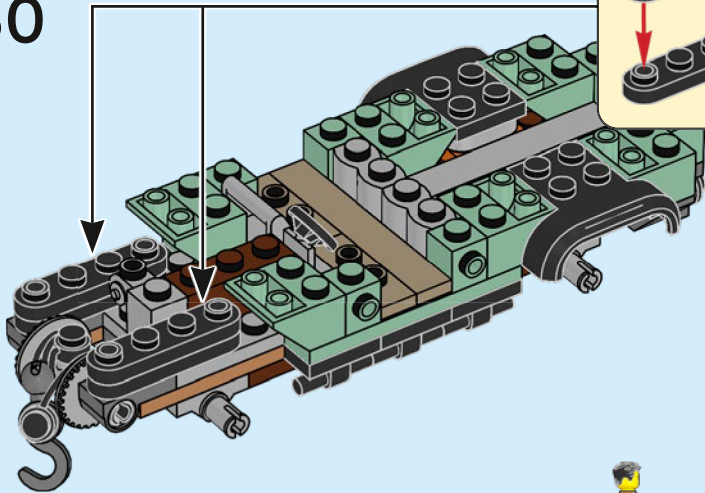
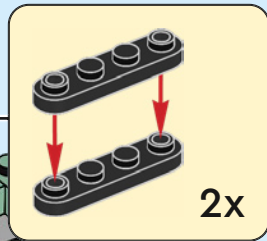

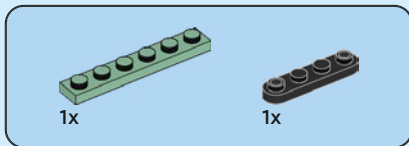

31

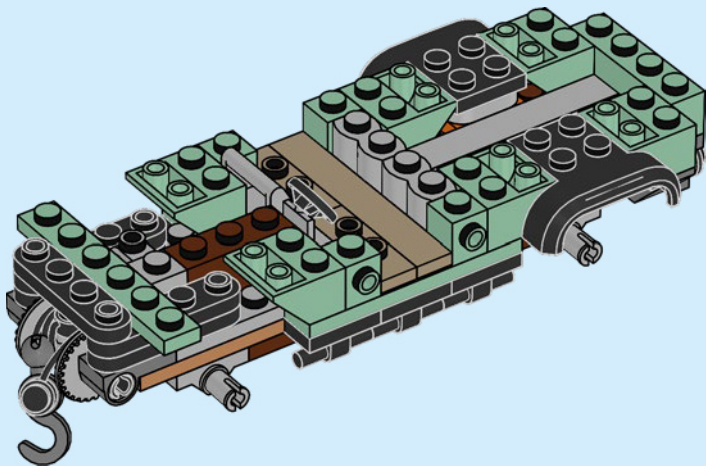

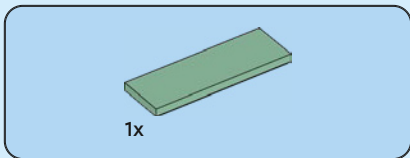

32

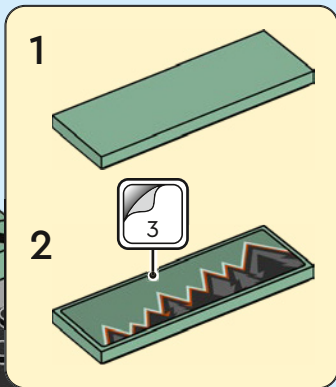
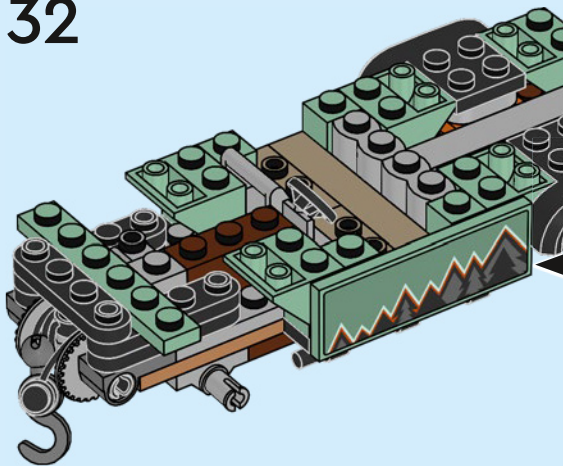

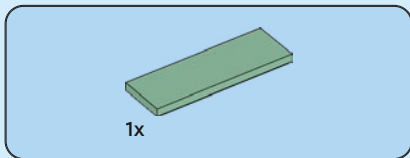

33

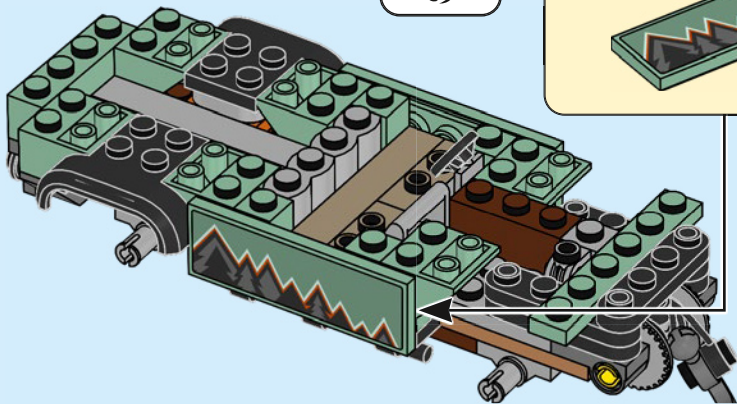
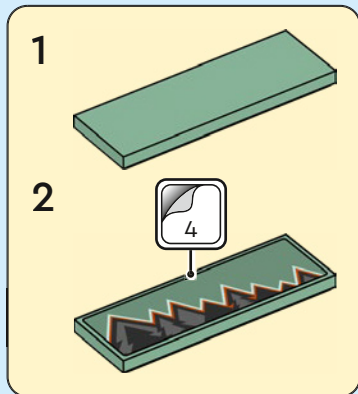



2x

34

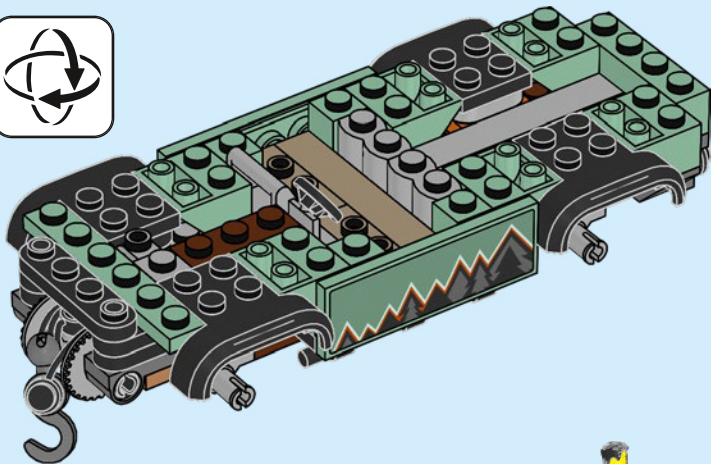



2x

35

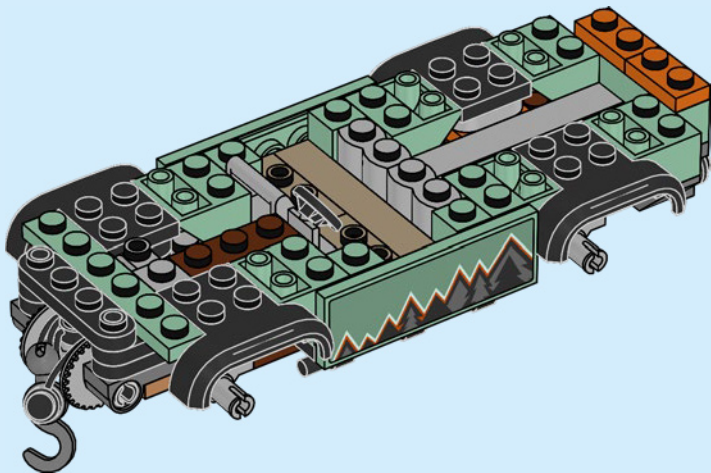

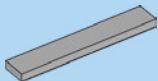

2x

36

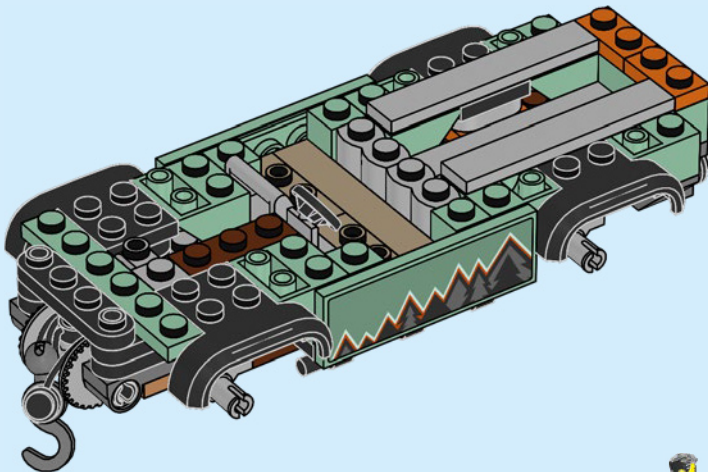

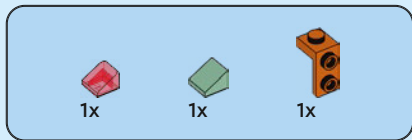

37

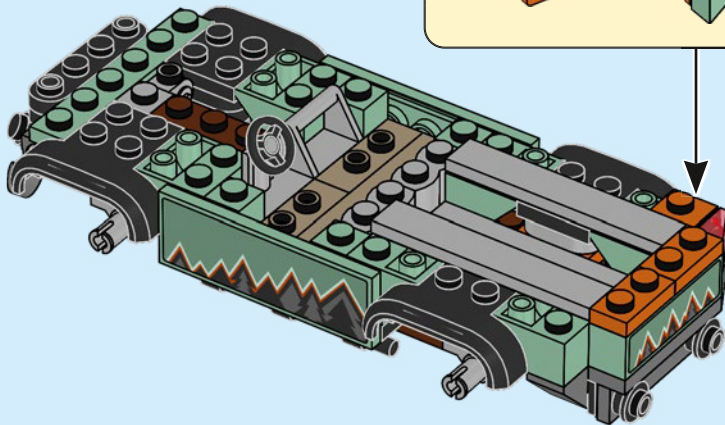
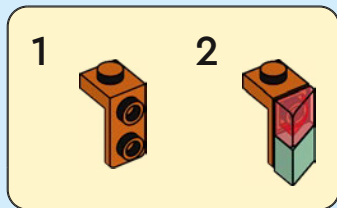



1x



1x



1x

38

1



2

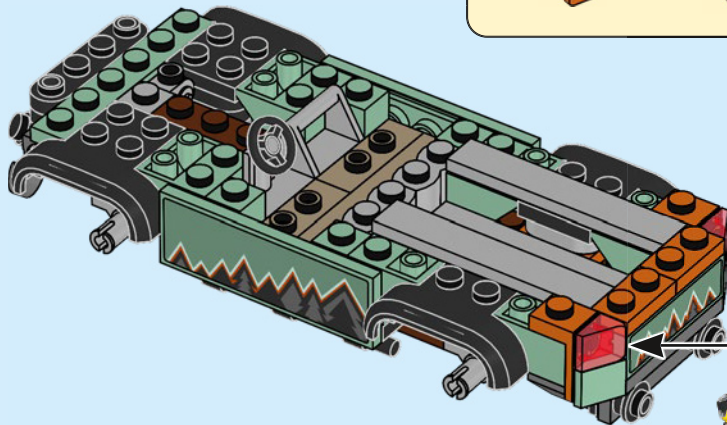

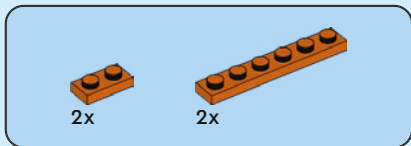

39

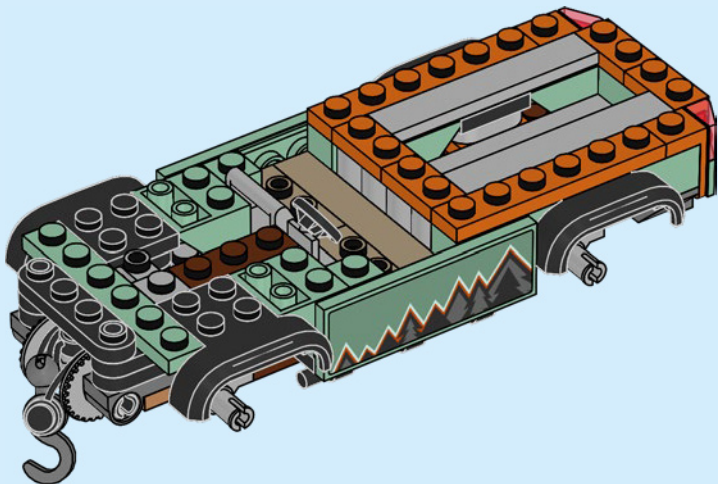

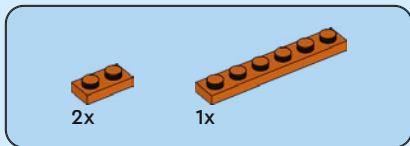

40

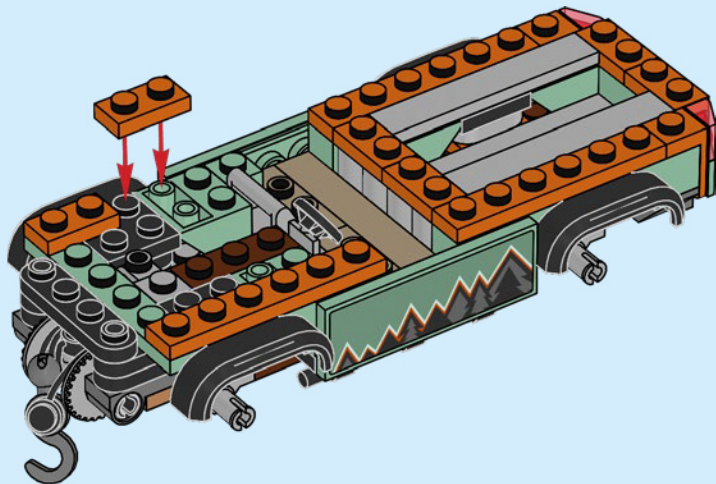



1x



2x

41

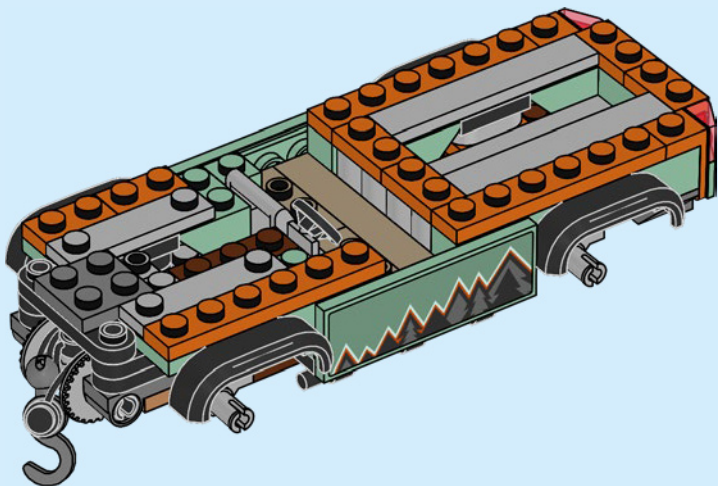



1x



3x

42

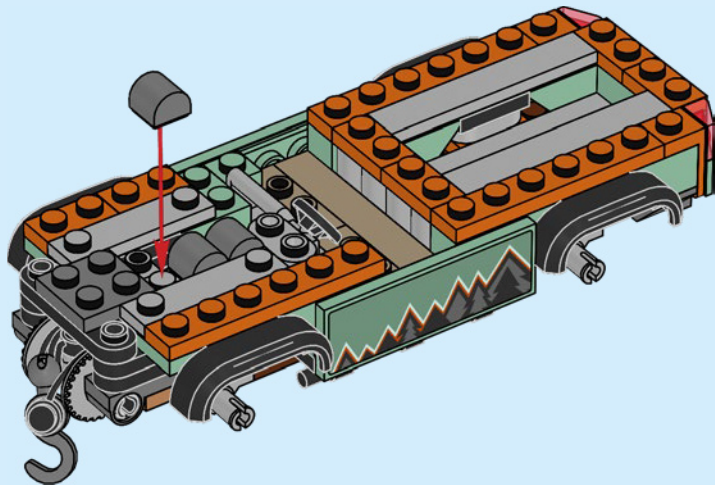

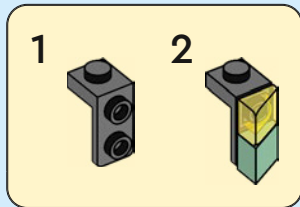

43

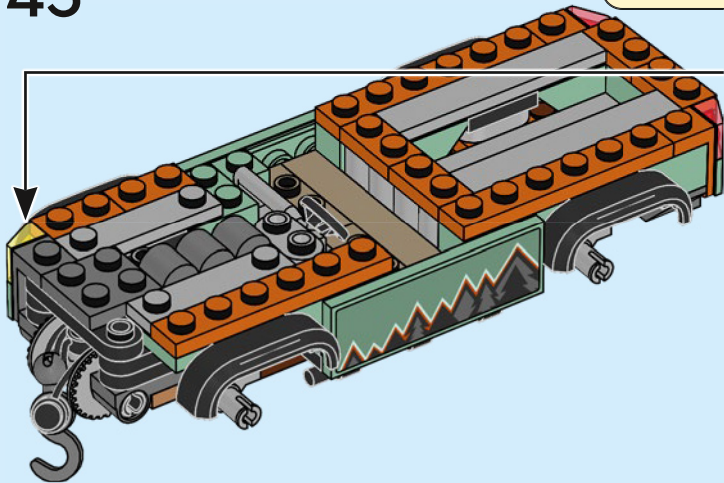



1x



1x



1x

1



2



44

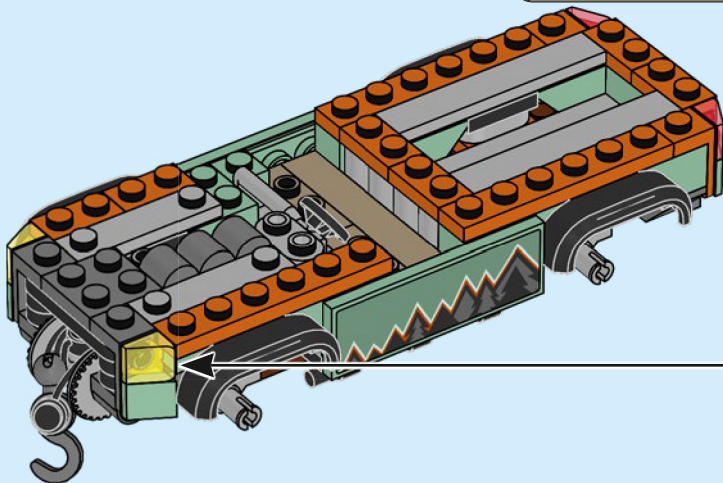



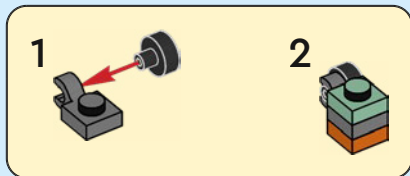
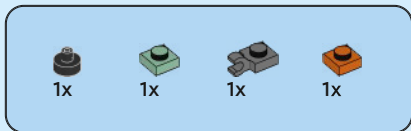

45

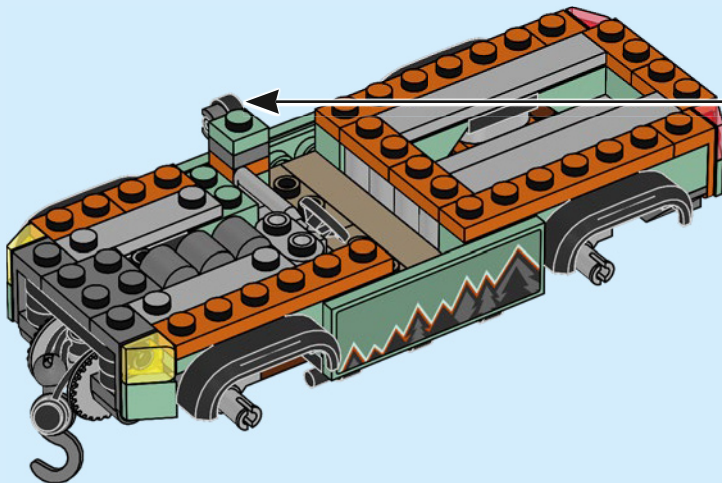

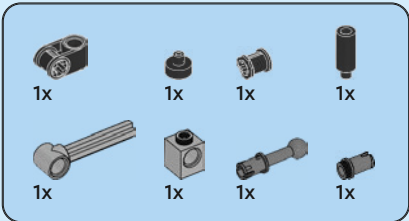
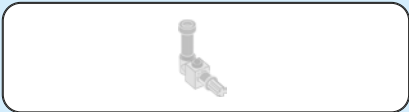

46

1

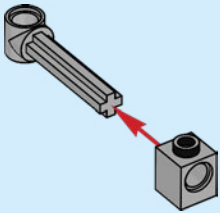

2

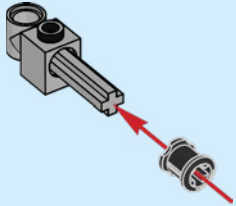

3

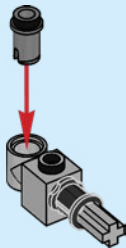

4



5

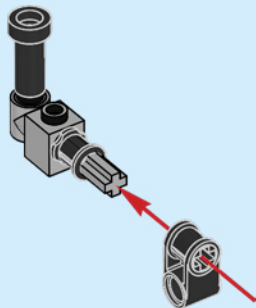

6

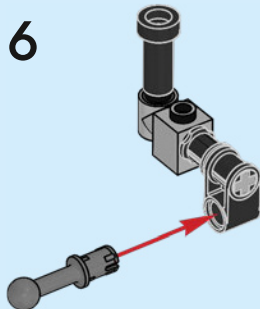

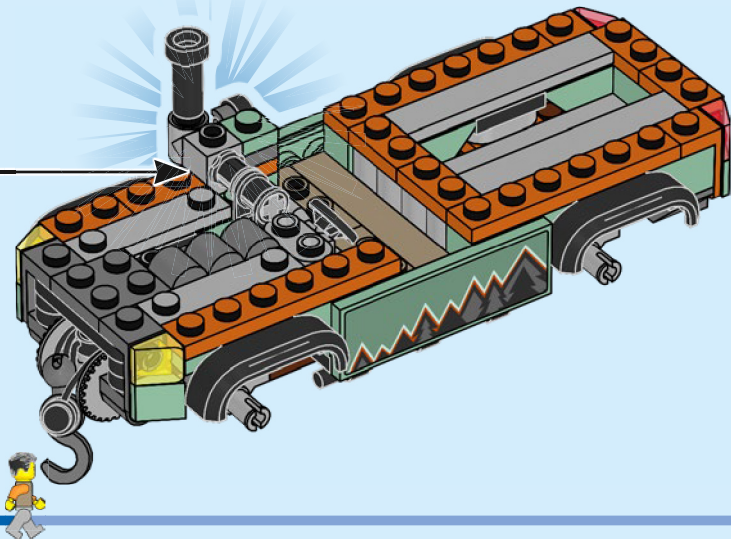



1x



1x



1x

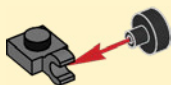

47

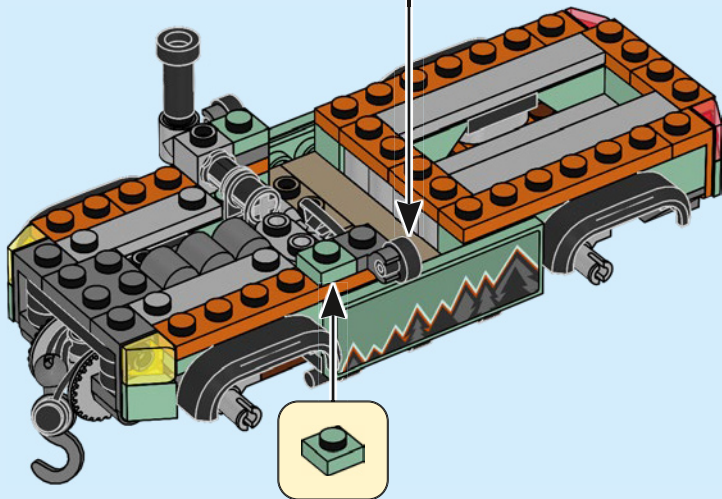



1x



1x

48

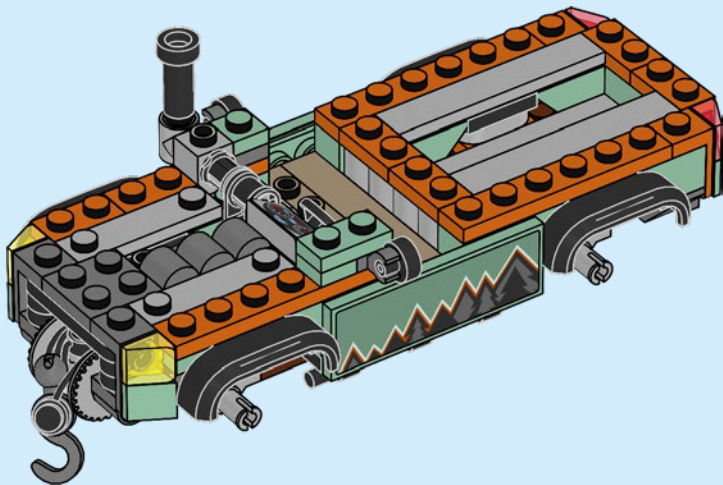

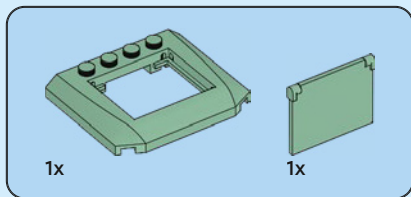

49

1

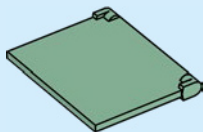

2

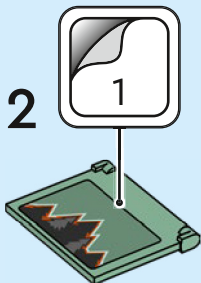

3

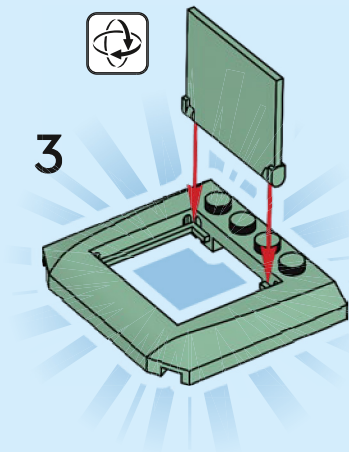

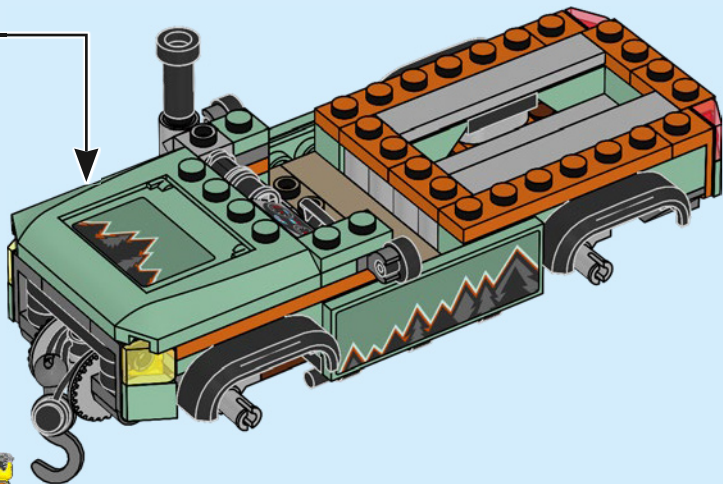



1x

50

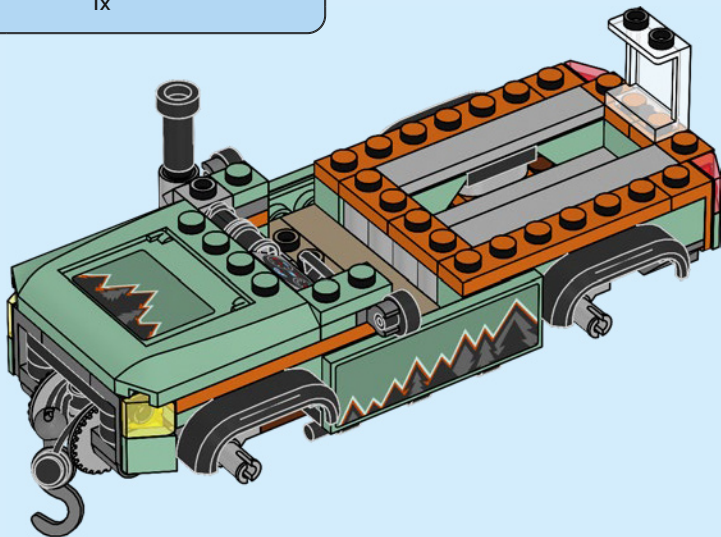



4x

51

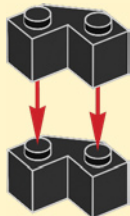
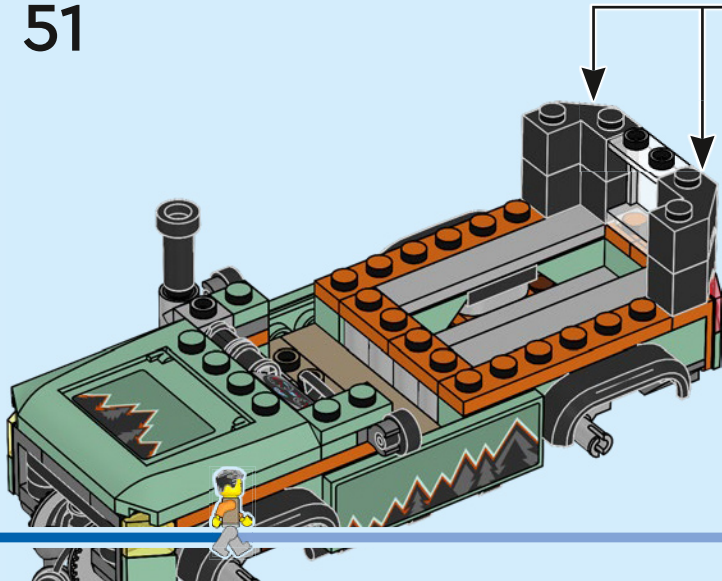

2x



4x

52

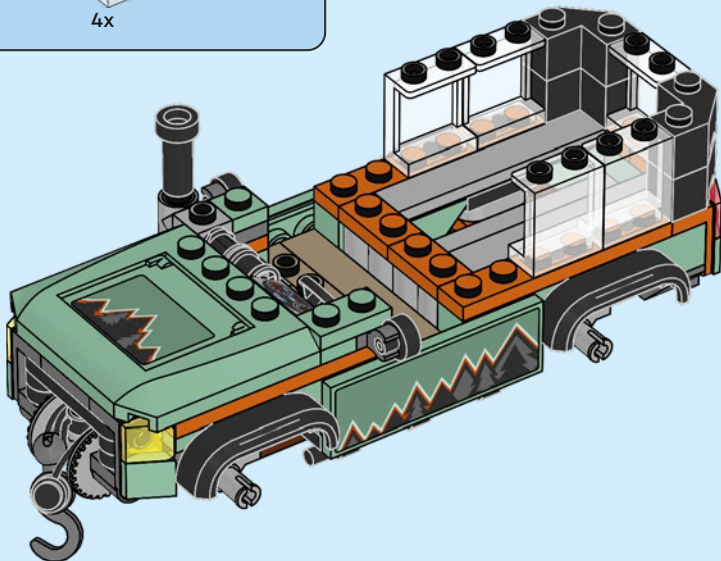



4x

53

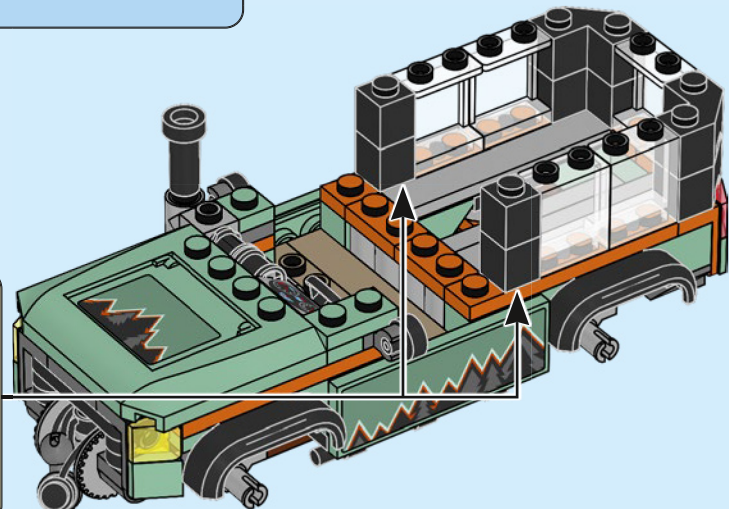

2x





2x

54

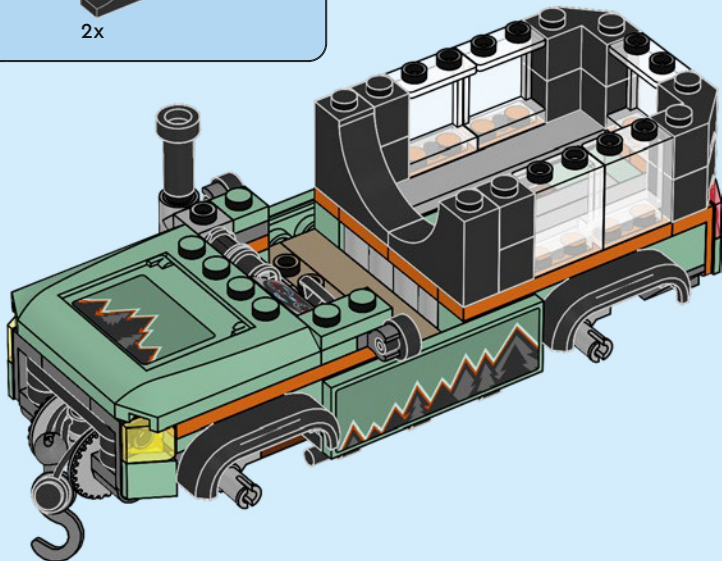

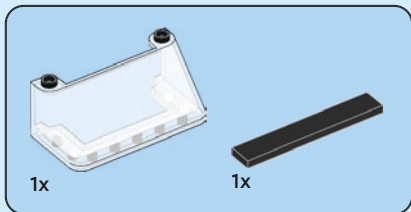

55

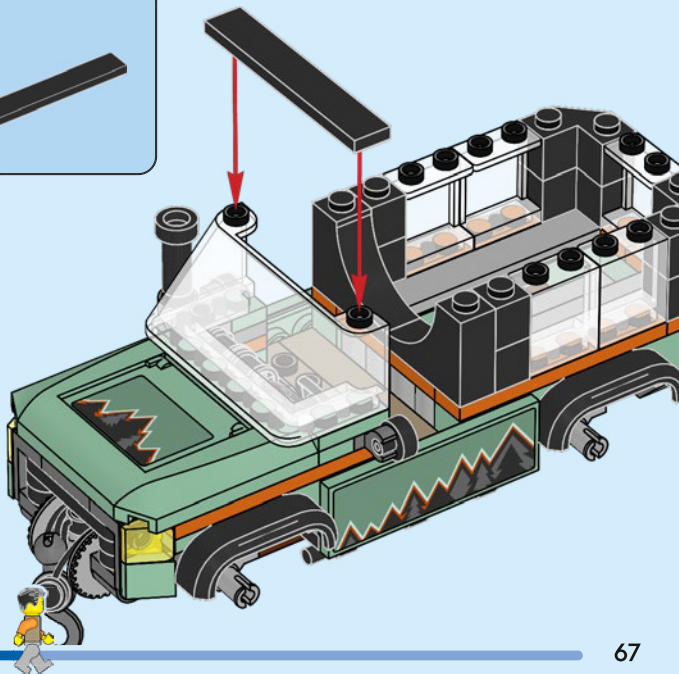

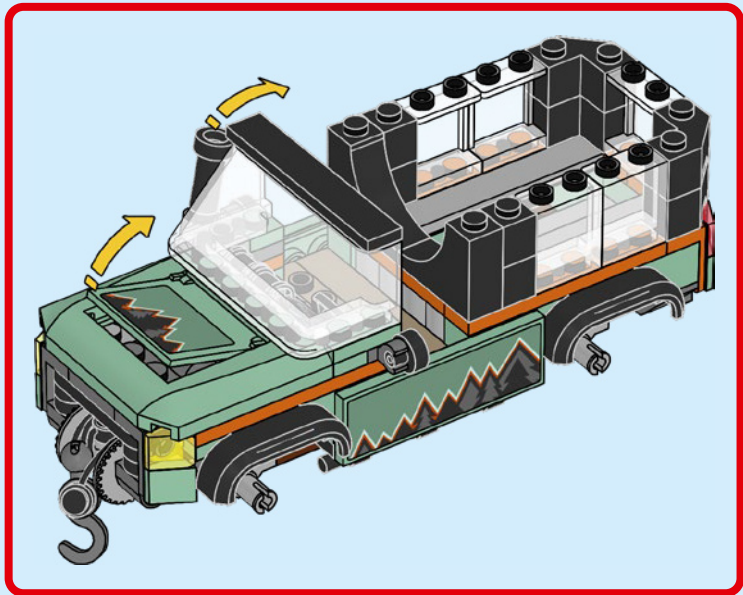



1x



2x

56

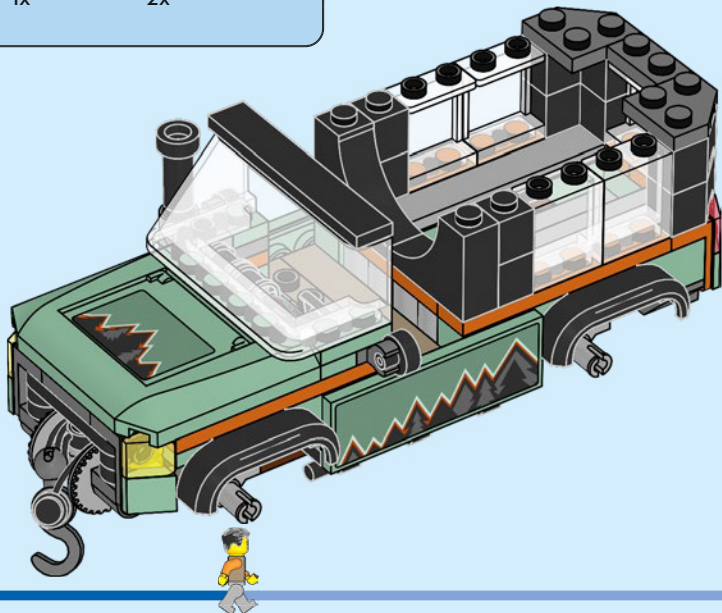

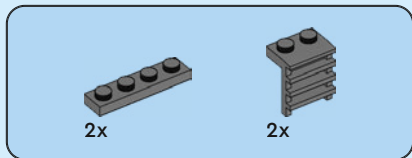

57

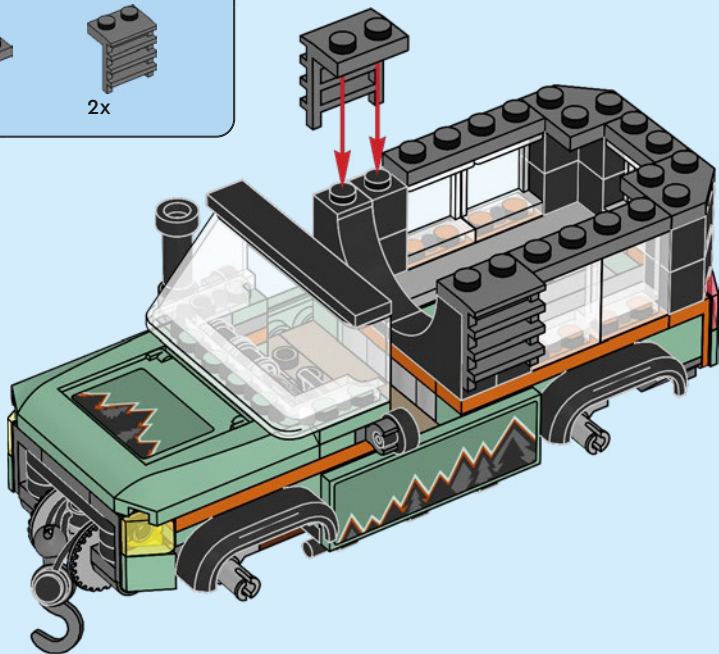



2x



2x



2x

58

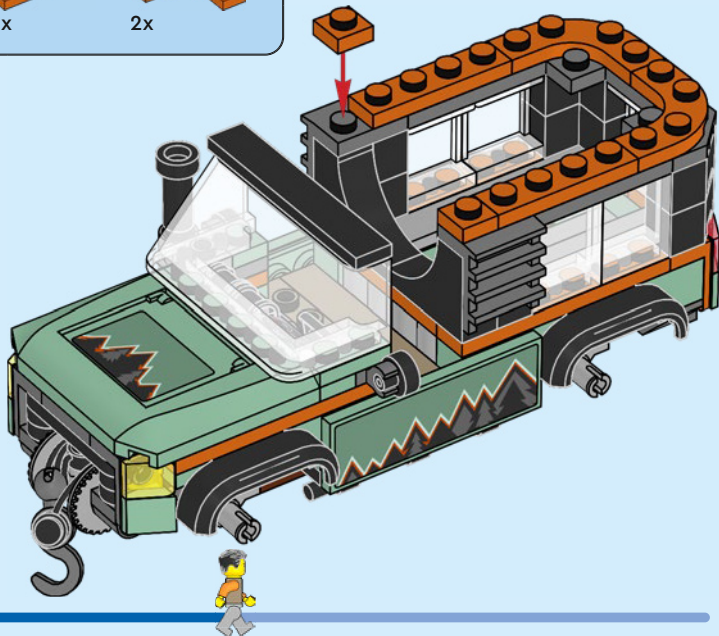



2x



2x

59

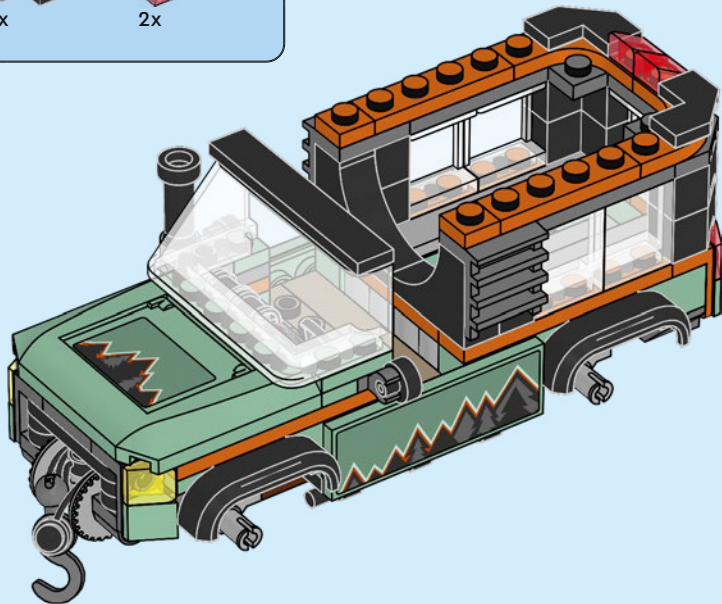

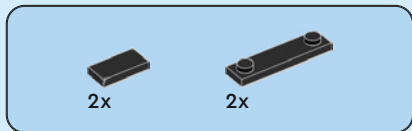

60

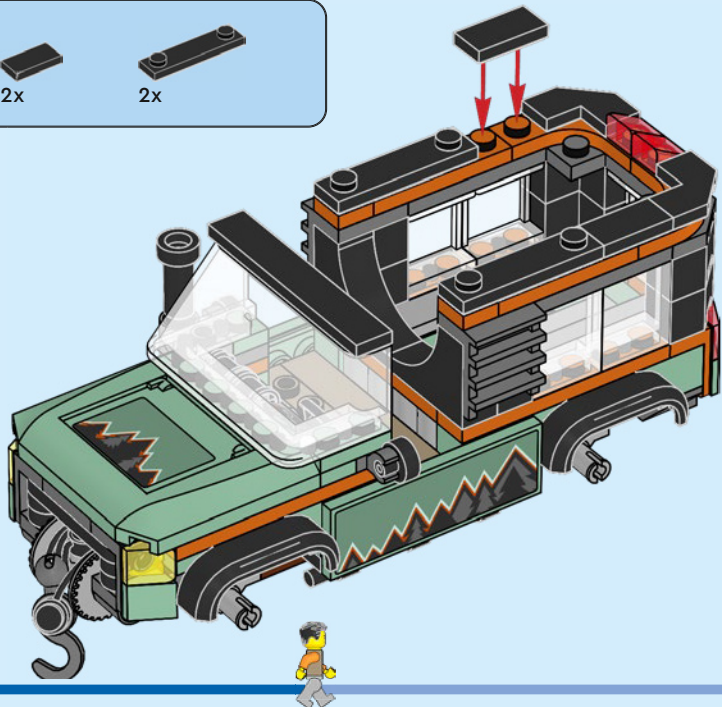



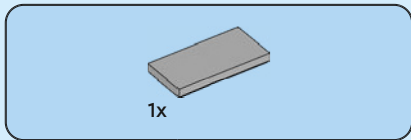

61

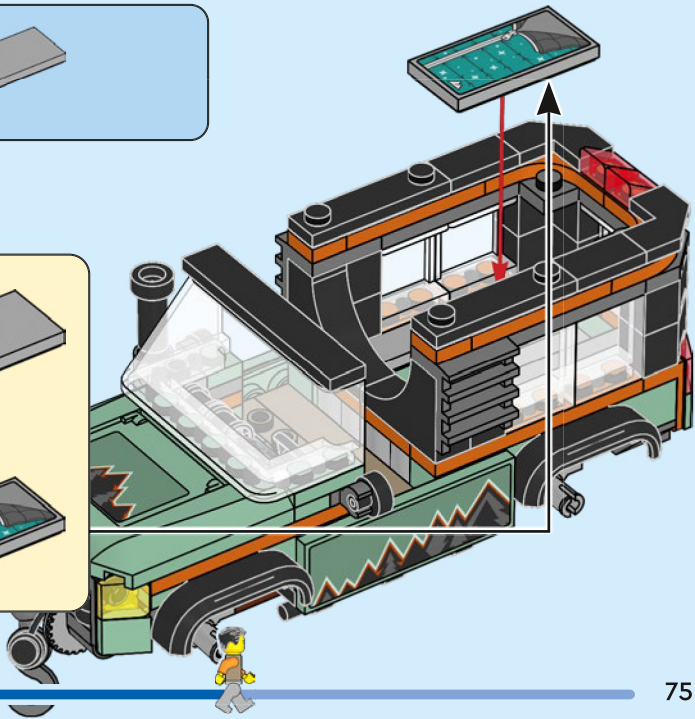
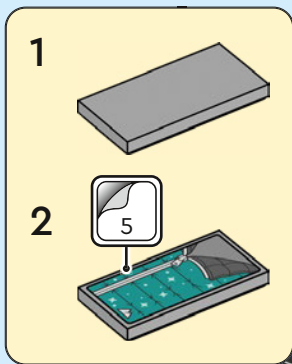

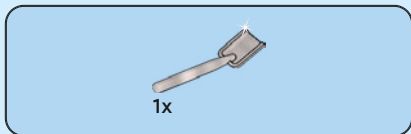

62

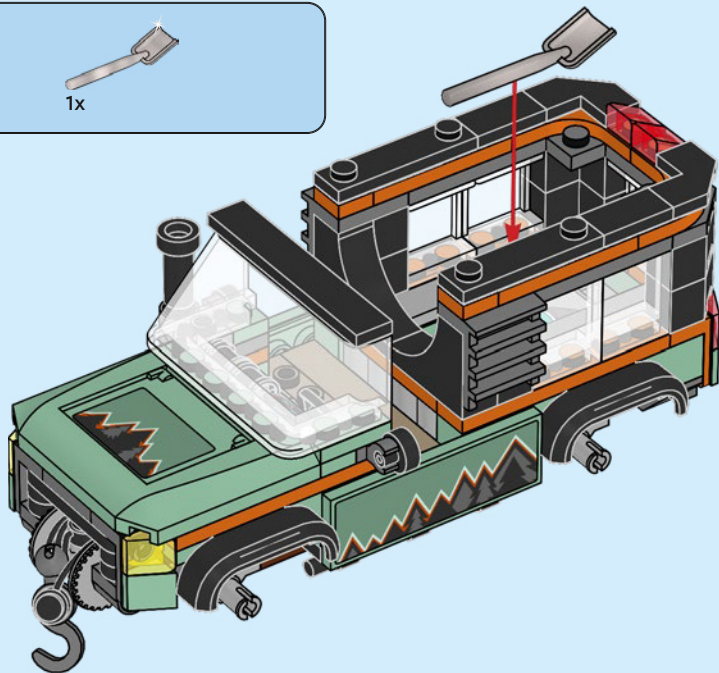

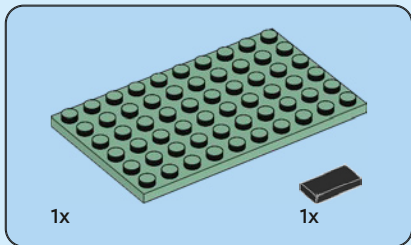
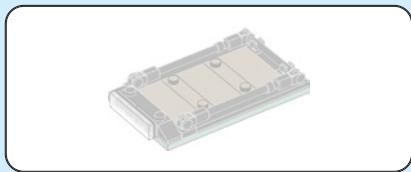

63

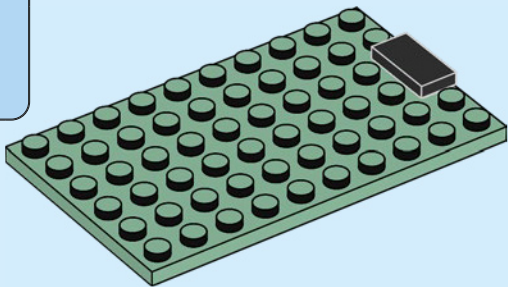



2x

64

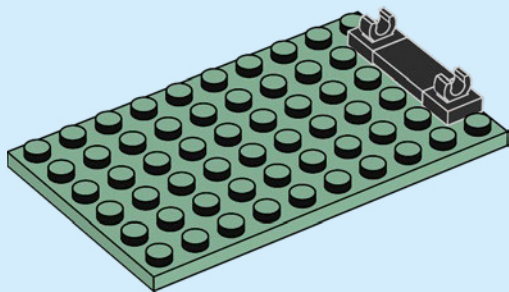

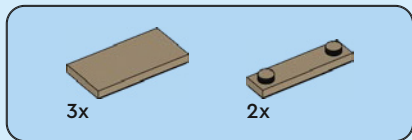

65

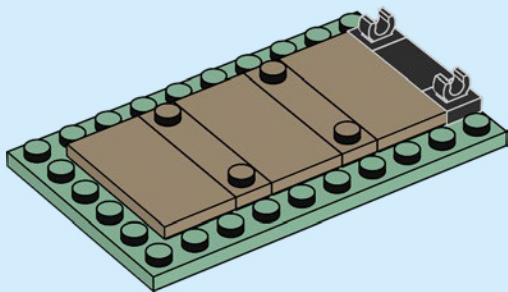



2x

66

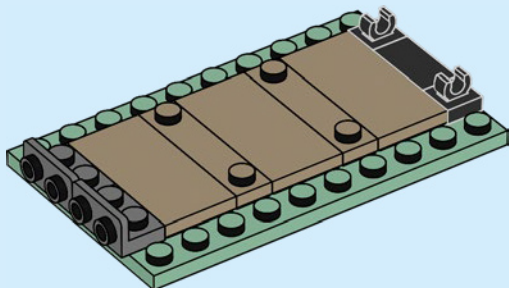

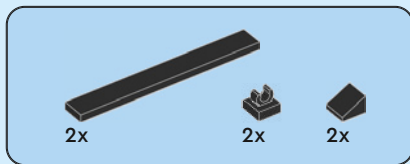

67

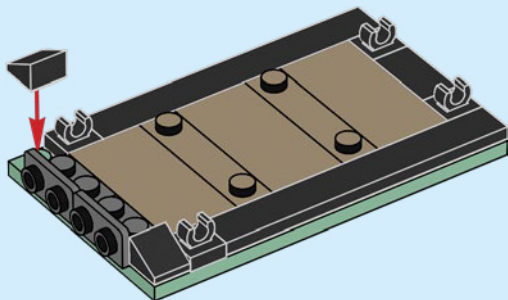



1x

68

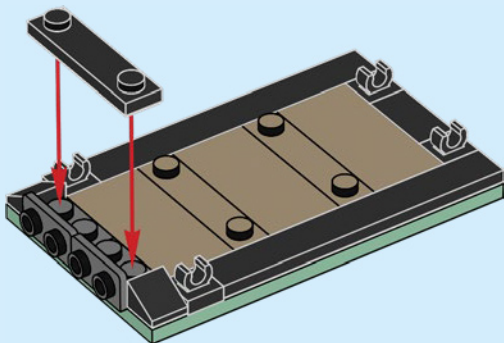



1x

69

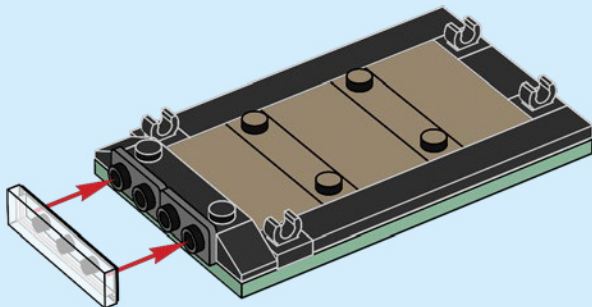

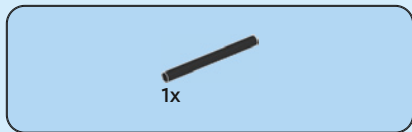

70

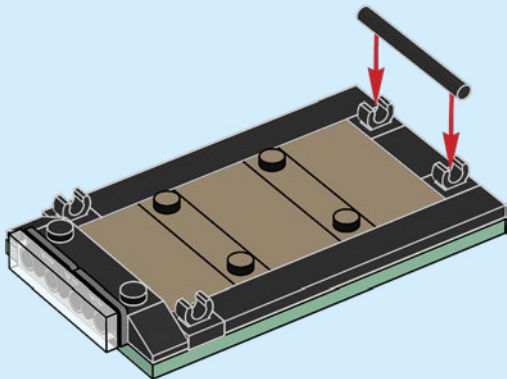



71

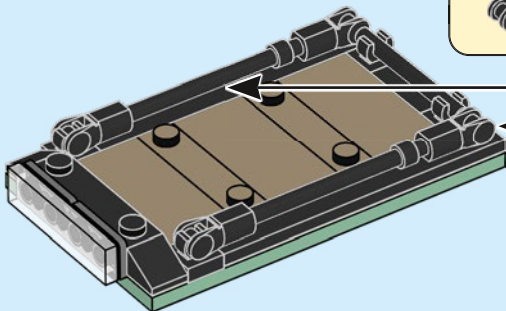
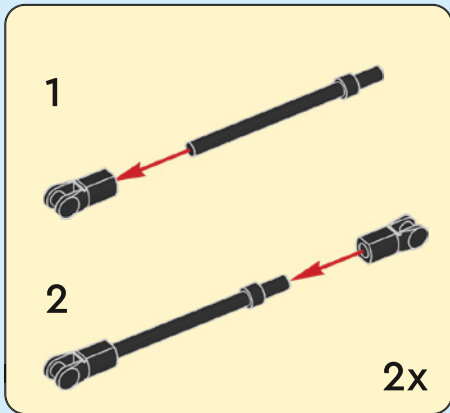

72

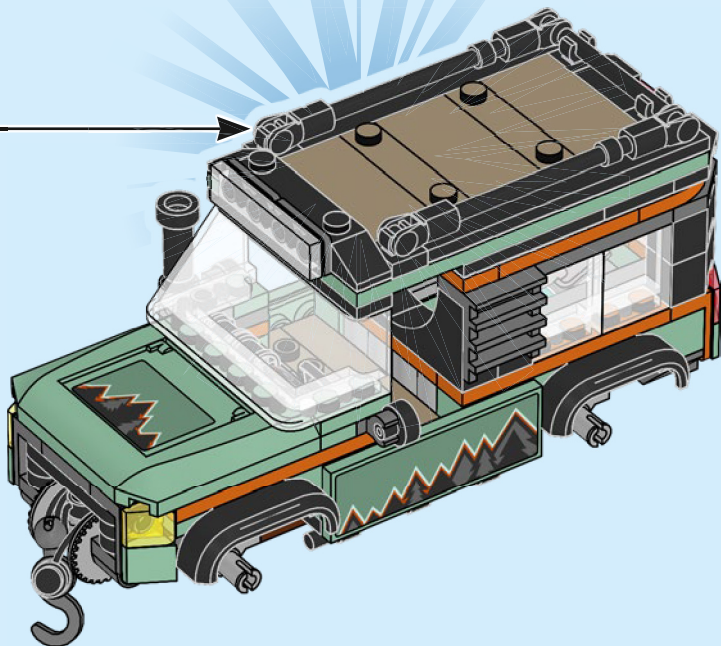



1x



1x



1x



1x



1x

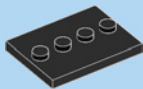

1x

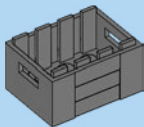

1x

1

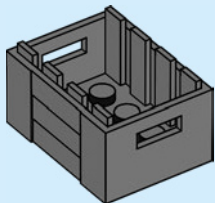

73



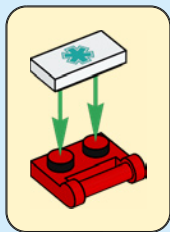

2

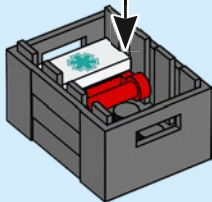

3

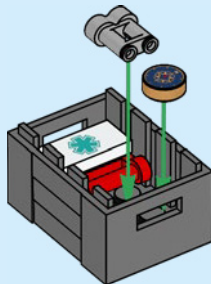

4



5

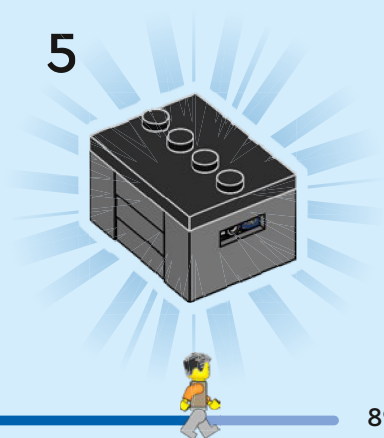

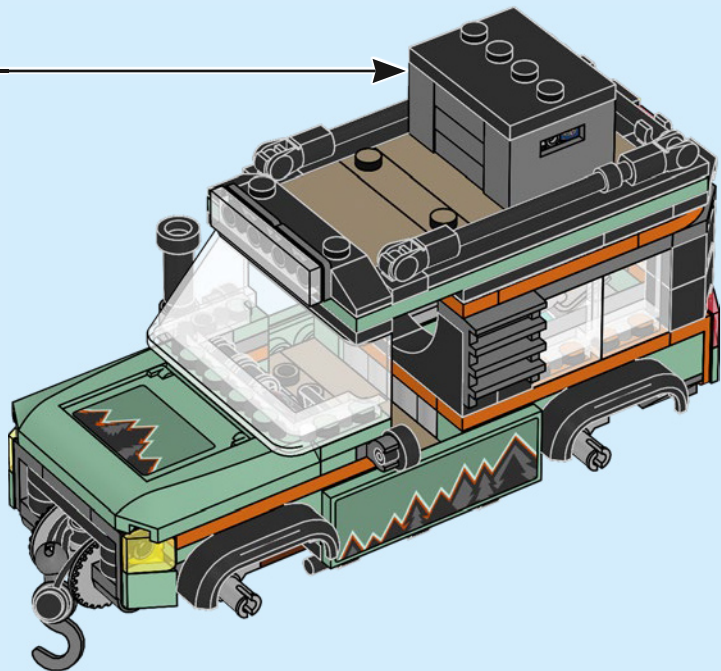

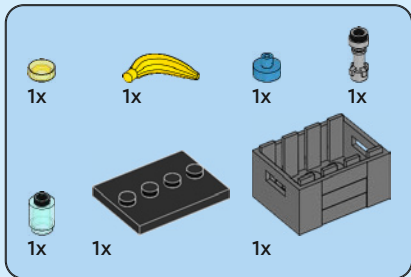

74

1

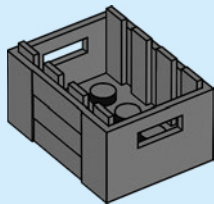

2

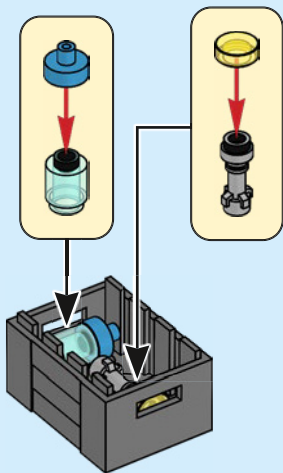

3

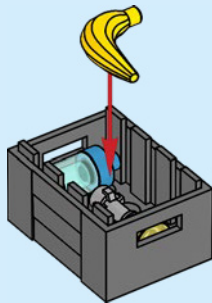

4

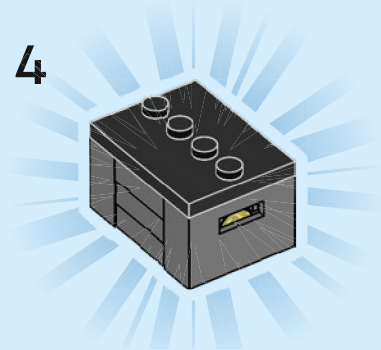

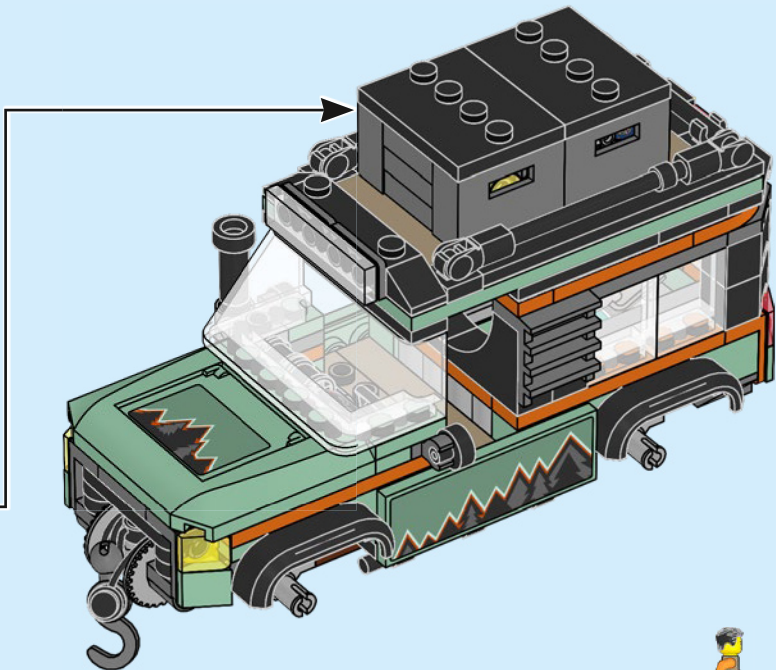

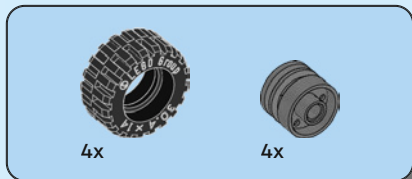

75

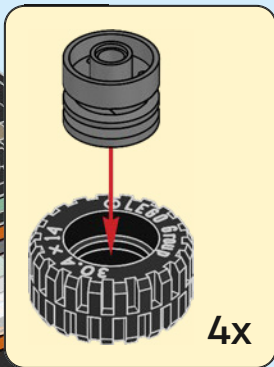
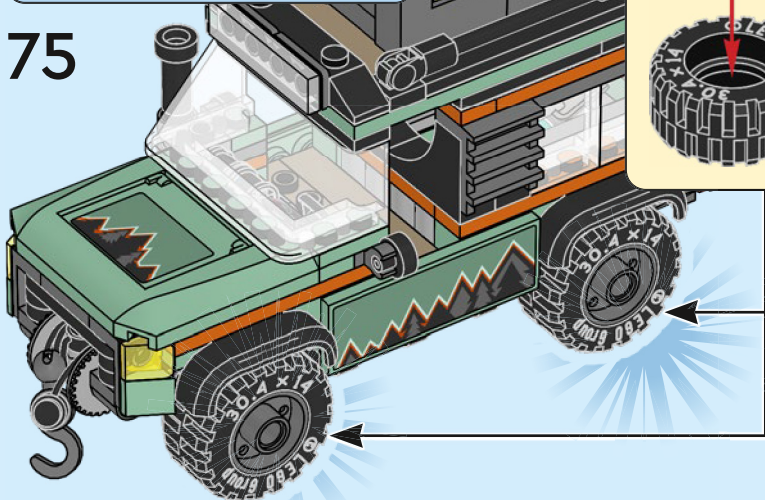

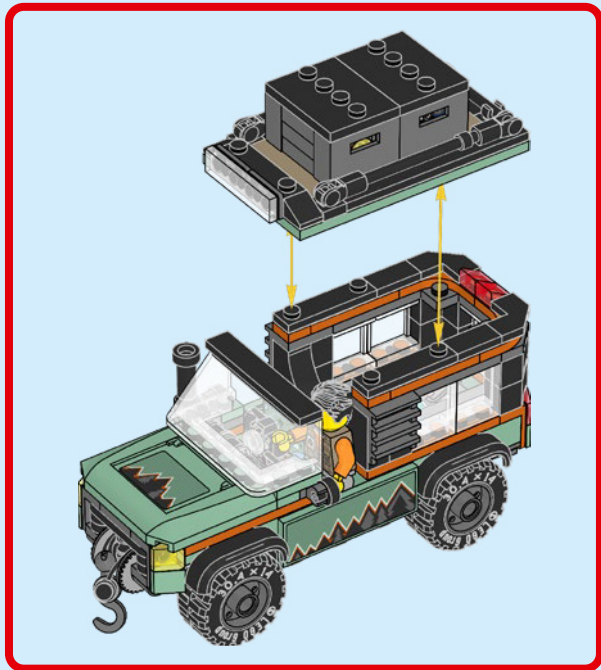

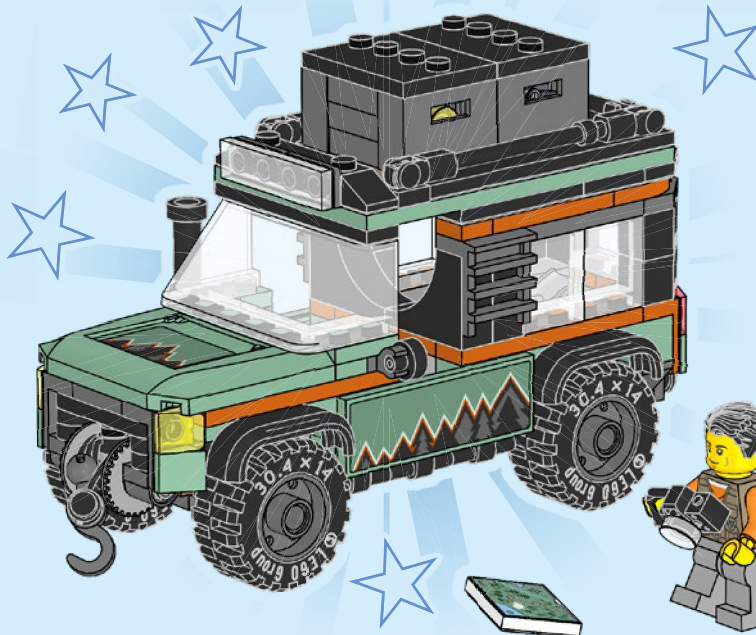



1x
6434779



1x
6520699



1x
4226876



1x
6283875



1x
6331822



1x
306924



1x
4114584

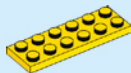

2x
379524



1x
6290456



4x
6321194



2x
6168646



1x
6332148



4x
300526



2x
4504382



4x
6335388



2x
6299338



1x
6134617



1x
6261371



1x
6279875



1x
6476480



3x
306926



1x
4226995



6x
6488003



2x
6166859



3x
6186675



4x
4584274



2x
6154860



1x
6096957



5x
6428167



1x
6116604



3x
6254045



4x
4619323



4x
6170597



2x
6076678



2x
6170421



1x
663626



2x
416226



2x
6099189



1x
4655080



4x
4652205

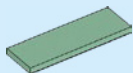

2x
6529252

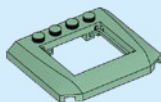

1x
6528238

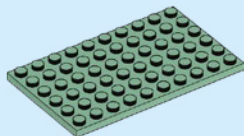

1x
6528242

98



4x
6009656



6x
6529192



1x
6528243



1x
4521947

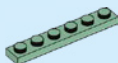

3x
6099187



1x
6223733



2x
6245272



2x
6449594



1x
6531809



2x
6257599



3x
6164288

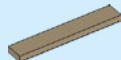

1x
4507047



4x
6245252



1x
6514238



1x
6514193



1x
6514191



5x
6253231



1x
6510182

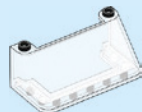

1x
6503221



1x
4211535



1x
6343889



2x
4211396



3x
6248890



2x
6257593



1x
4560183

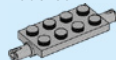

2x
6408542



4x
4211549



1x
4539481



2x
4550325



1x
4550170



1x
6329152



1x
4211357



1x
6211917



1x
4227657



1x
6484902



1x
4211220



3x
6070442



2x
6164073



1x
4211063



1x
4211065



2x
6000970

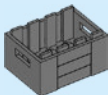

2x
6528237



1x
4294180



3x
6333129



2x
6435043



2x
6360111



2x
6396058



1x
6395635



2x
6000606



2x
6285244



1x
6365695



1x
6347464



1x
4211094



4x
6490807



1x
6257592



2x
4211001



1x
6287847



4x
6167700



1x
6167576



1x
6210601



3x
6469084



2x
6529189



8x
6466720



2x
6469089



2x
6529190



3x
6469087



[LEGO.com/service](https://www.LEGO.com/service)

YOU COULD

WIN



Scan this QR code or go to
LEGO.COM/PRODUCTFEEDBACK and give us
your short feedback about this LEGO® set
for a chance to win a cool LEGO prize.

Terms and Conditions apply*

EN: YOU COULD WIN. Terms and Conditions apply* **DE: Du könntest GEWINNEN.** Es gelten die Teilnahmebedingungen* **FR: Tu pourrais GAGNER.** Des conditions s'appliquent* **IT: Potresti VINCERE tu.** Termini e condizioni sono applicabili* **ES: Puedes GANAR.** Aplican términos y condiciones* **PT: Poderá GANHAR.** Aplicam-se termos e condições* **ZH: 轻松获奖.** 条款和条件适用* **PL: Szansa na WYGRANĄ.** Obowiązują warunki korzystania* **CS: Máte šanci VYHRÁT.** Platí všeobecné smluvní podmínky* **SK: Máte šancu VYHRÁT.** Platia všeobecné zmluvné podmienky* **HU: TE IS NYERHETSZ.** Felhasználási feltételek érvényesek* **RO: Ai putea CÂȘTIGA.** Se aplică termenii și condiții* **BG: Можете да СПЕЧЕЛИТЕ.** Има определени правила и условия* **LV: Tu vari LAIMĒT.** Ir spēkā noteikumi un nosacījumi.* **ET: Sul on võimalus VÕITA.** Kehtivad tingimused* **LT: Jūs galite LAIMĖTI.** Taikomos sąlygos*

*[LEGO.com/productfeedback-terms](https://www.lego.com/productfeedback-terms)

LEGO and the LEGO logo are trademarks of the/sonnt des marques de commerce du/
son marcas registradas de LEGO Group. ©2025 The LEGO Group.

6557570