

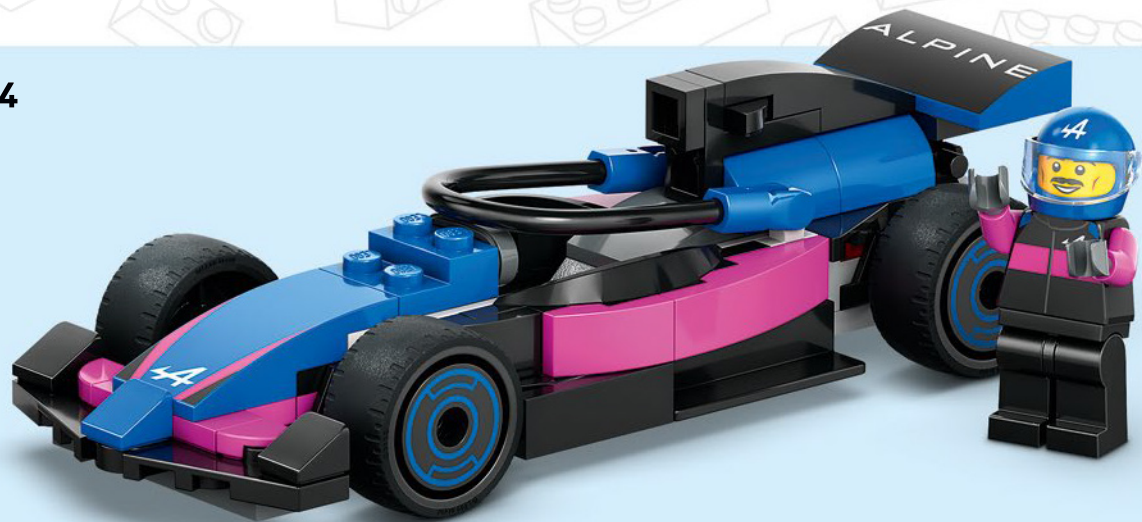

CITY

60444



2

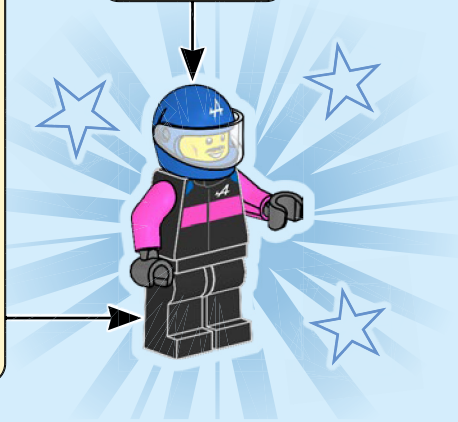
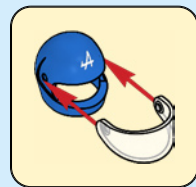
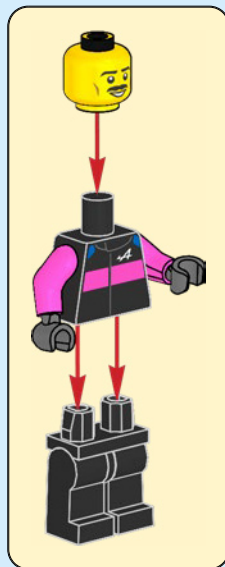



1x

1

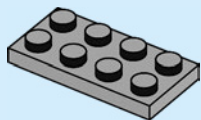

1x

2

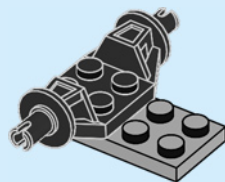



1x



1x

3

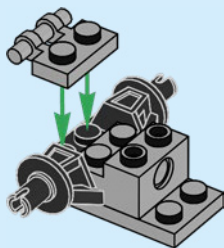

2x

4

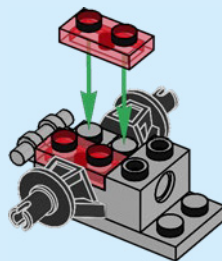

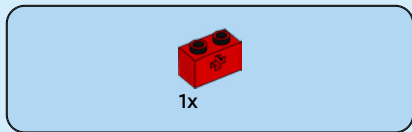

5

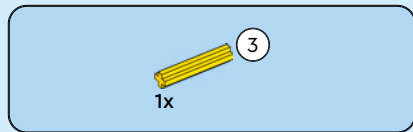
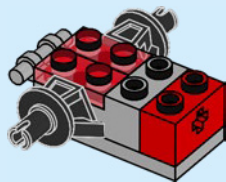

6

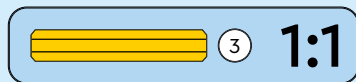
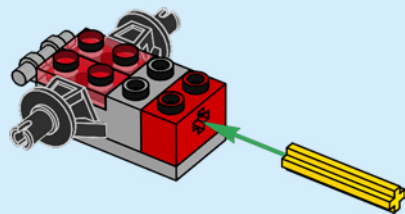

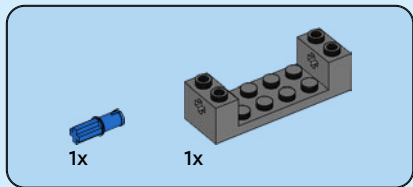

7

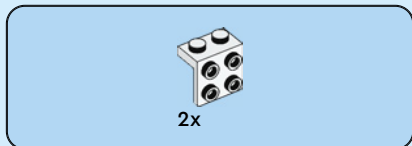
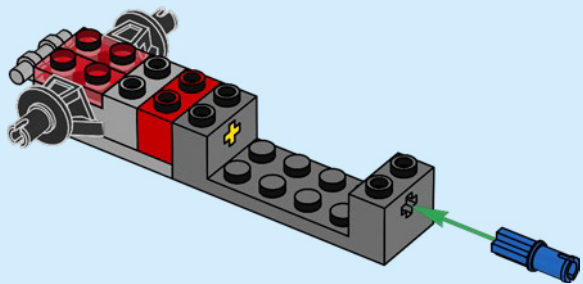

8

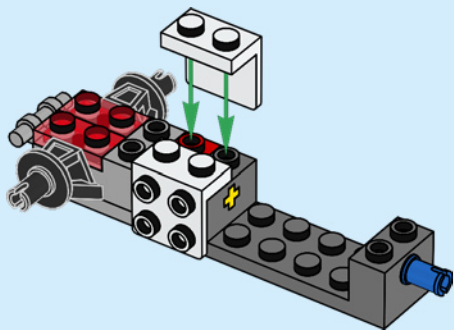

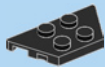

1x

9

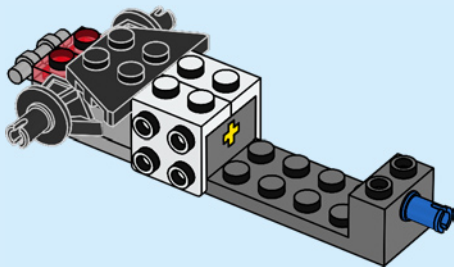

2x

10

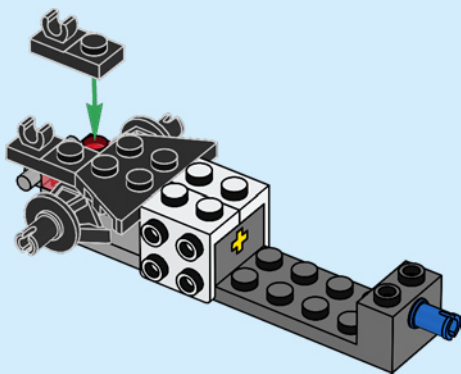



1x

11

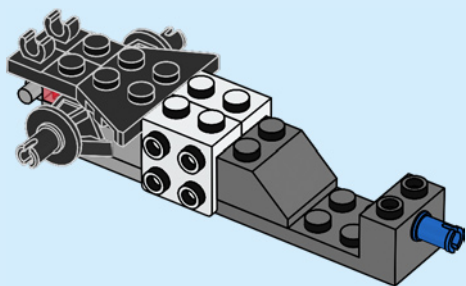

1x

12

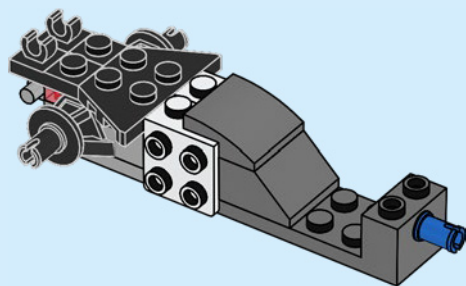



2x

13

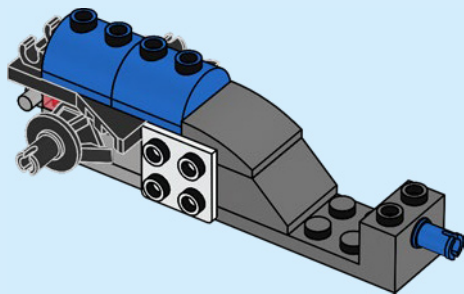

1x



1x

14

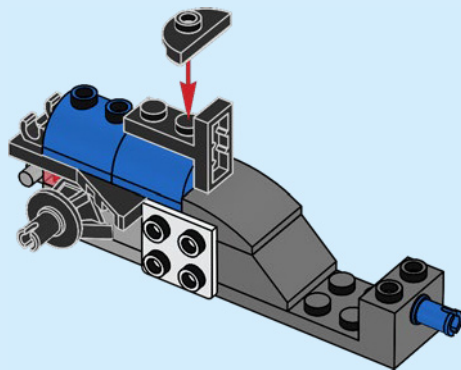



1x

15

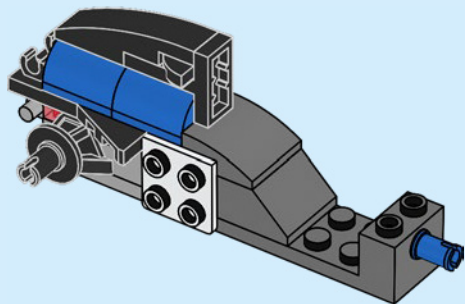

1x

16

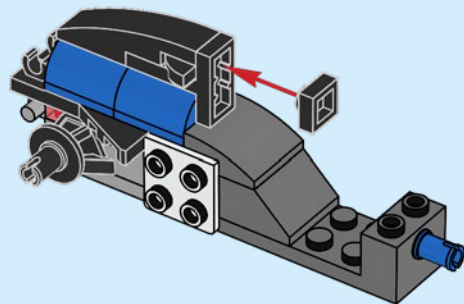

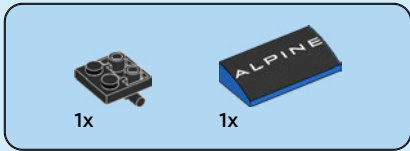

17

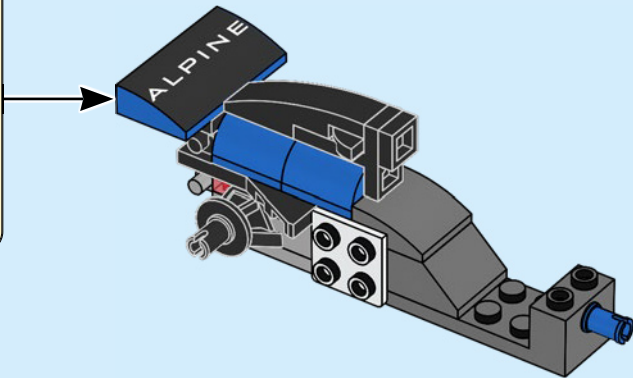
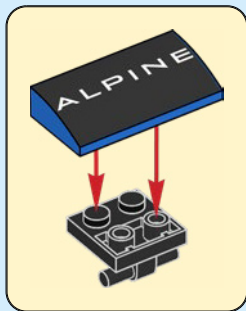

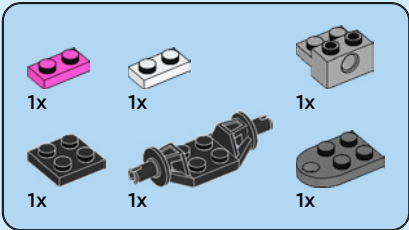

18

1

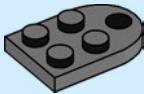

2

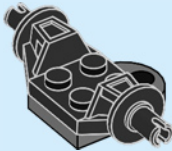

3

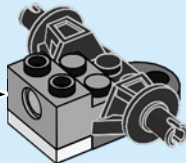
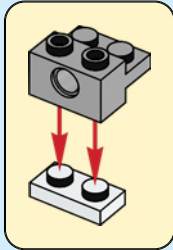

4

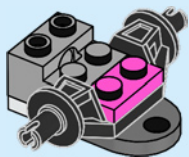

5

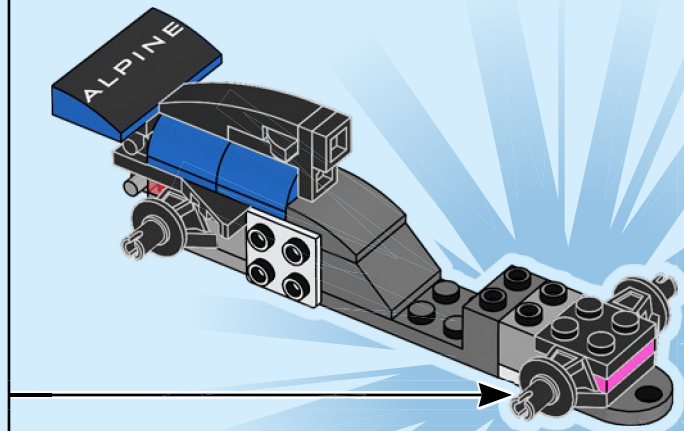
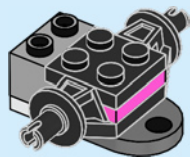



2x

19

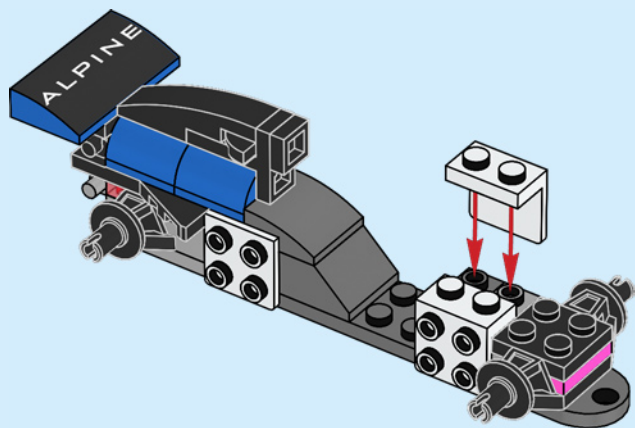

1x

20

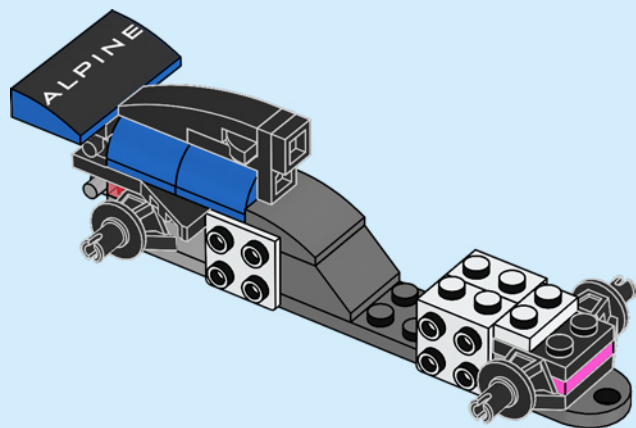

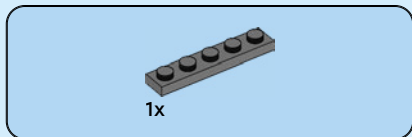
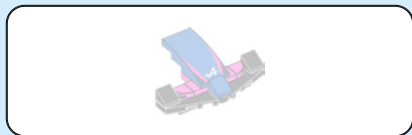

21

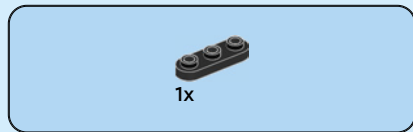
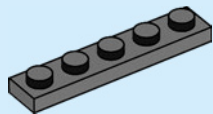

22

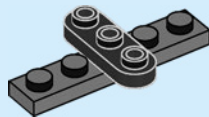

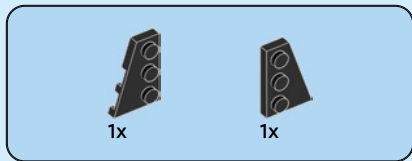

23

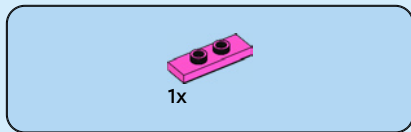
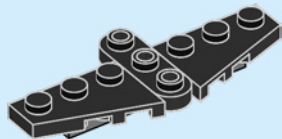

24

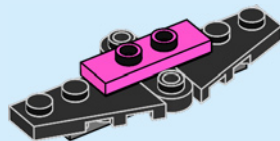



1x



2x

25

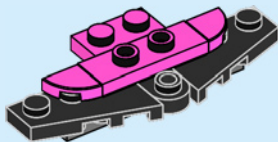

1x



2x

26

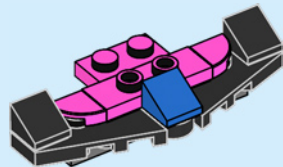



1x

27

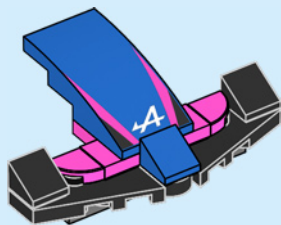

28

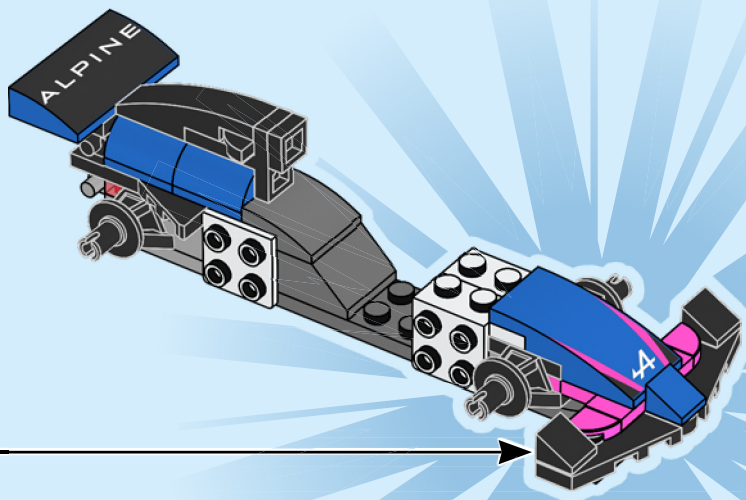



1x



1x

29

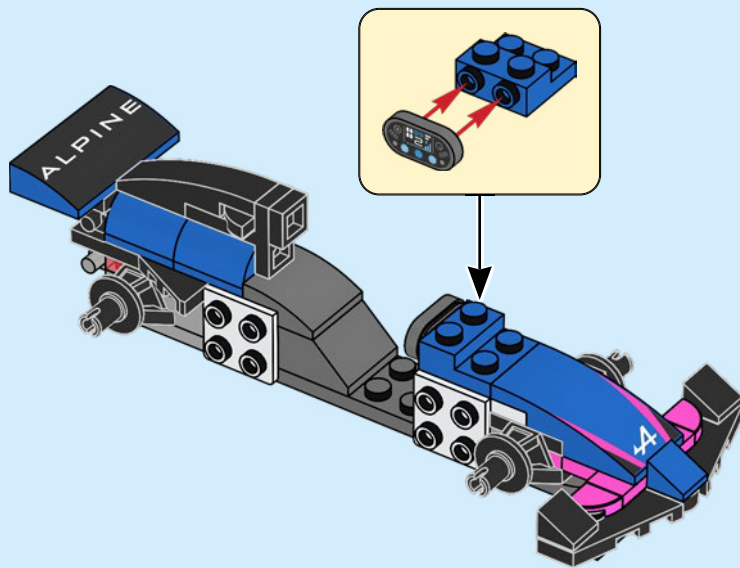

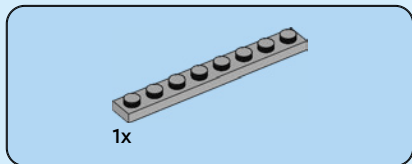

30

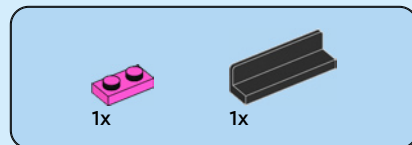
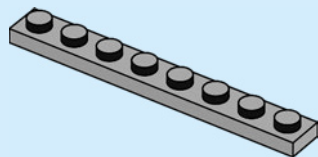

31

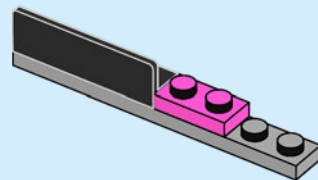



1x



1x

32

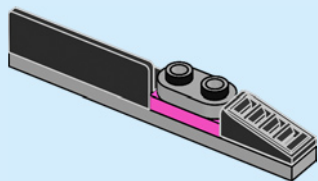

1x

33

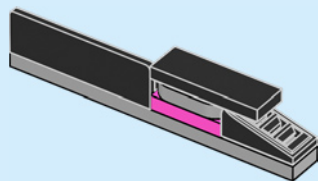

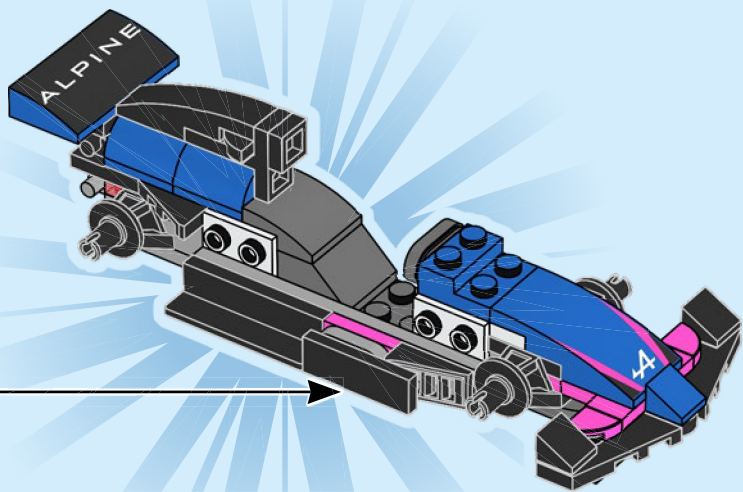



1x

34

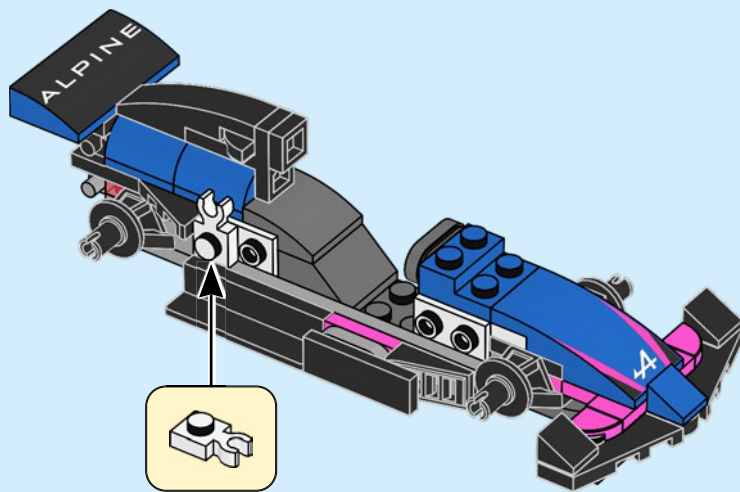



1x

35

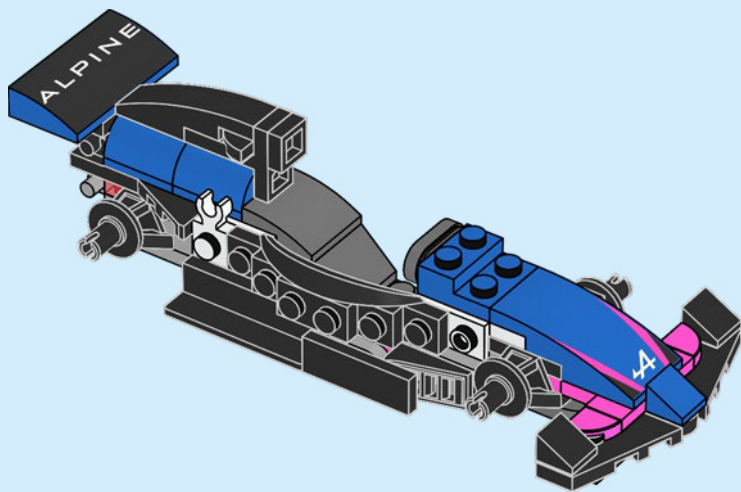



1x

36

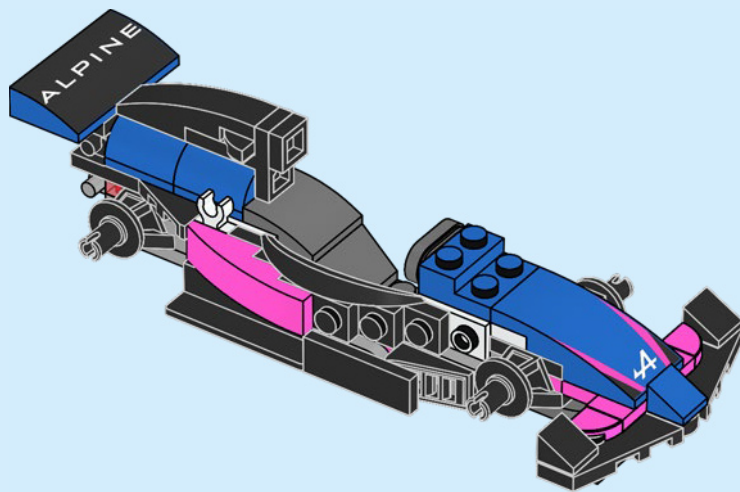



1x



1x

37

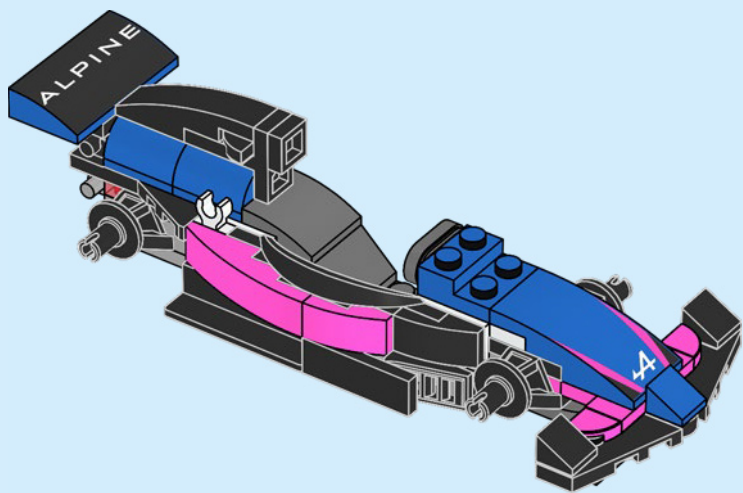

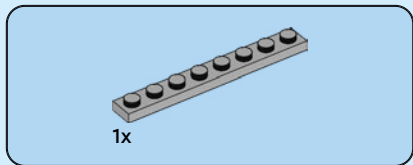

38

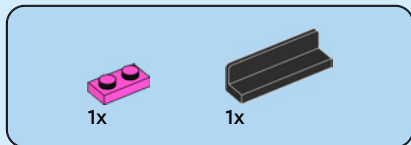
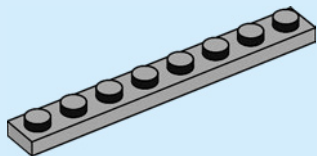

39

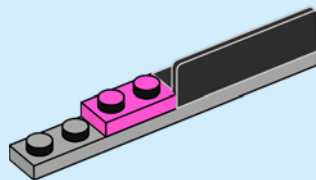



1x



1x

40

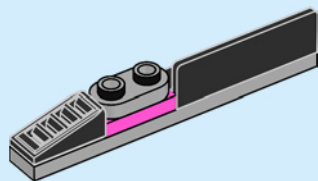

1x

41

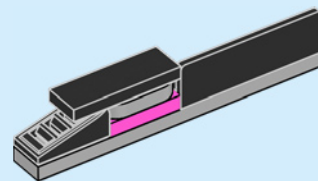

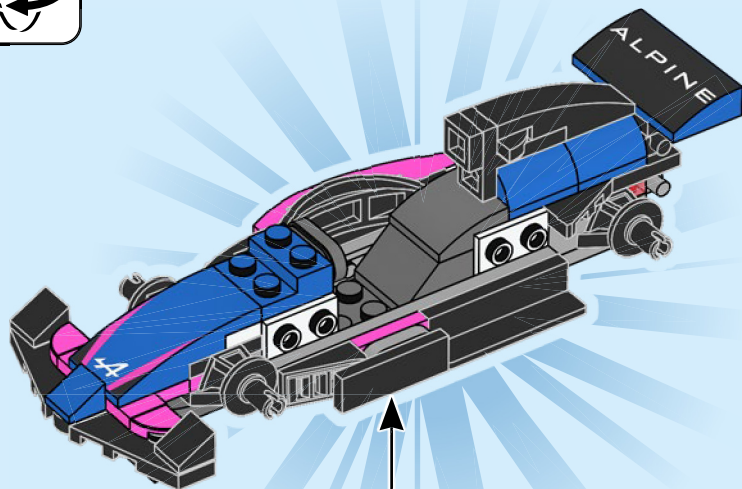
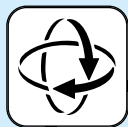



1x

42

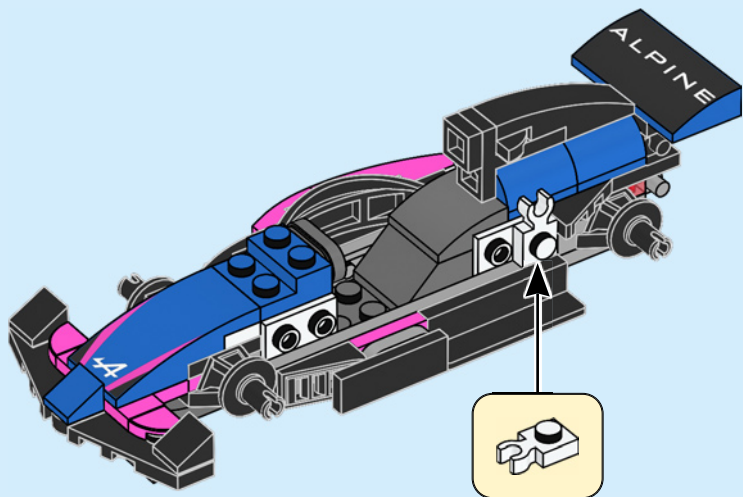



1x

43

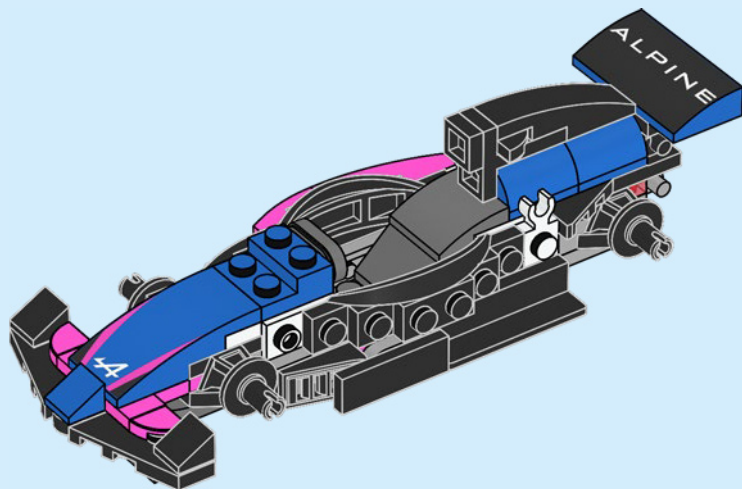



1x

44

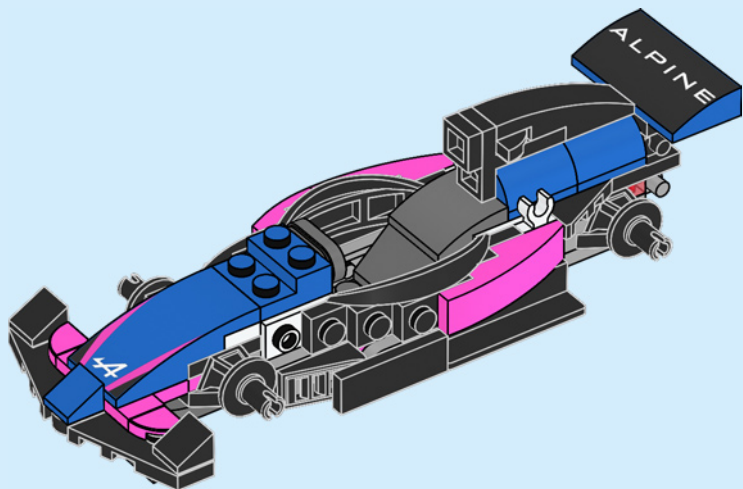



1x



1x

45

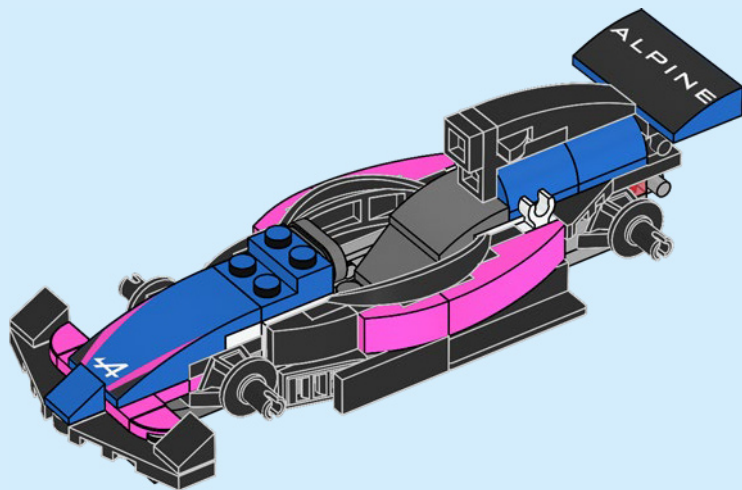

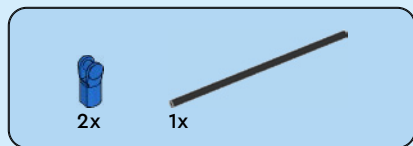

46

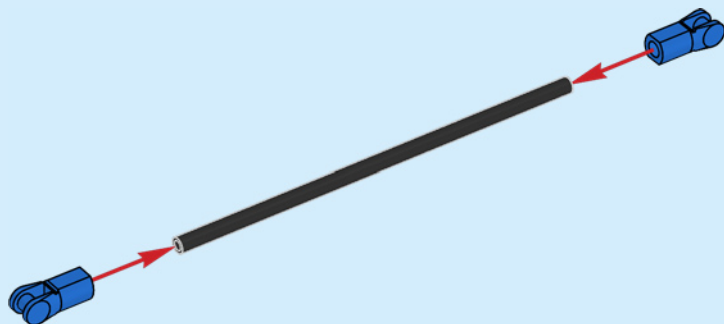

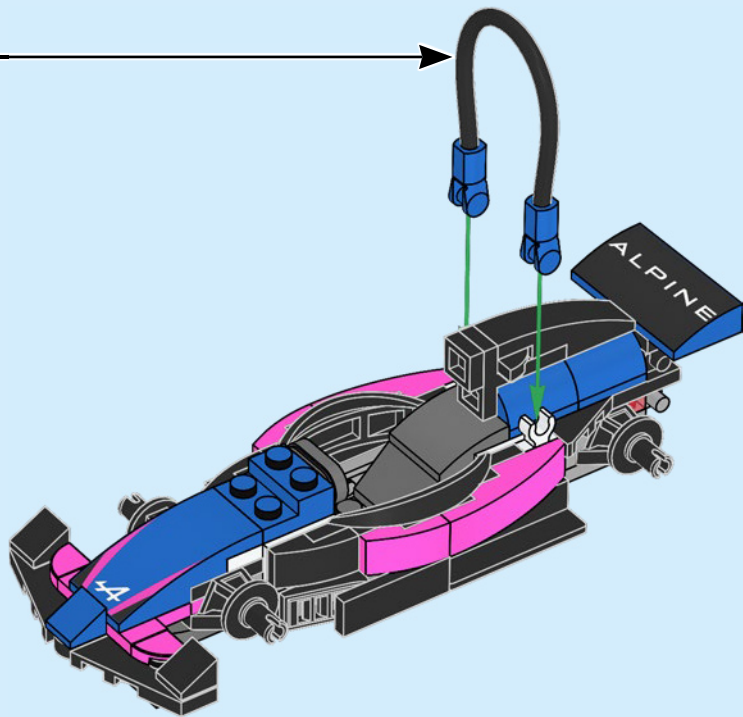

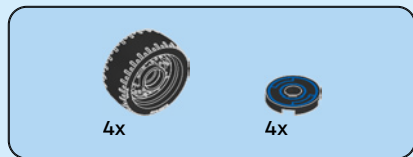

47

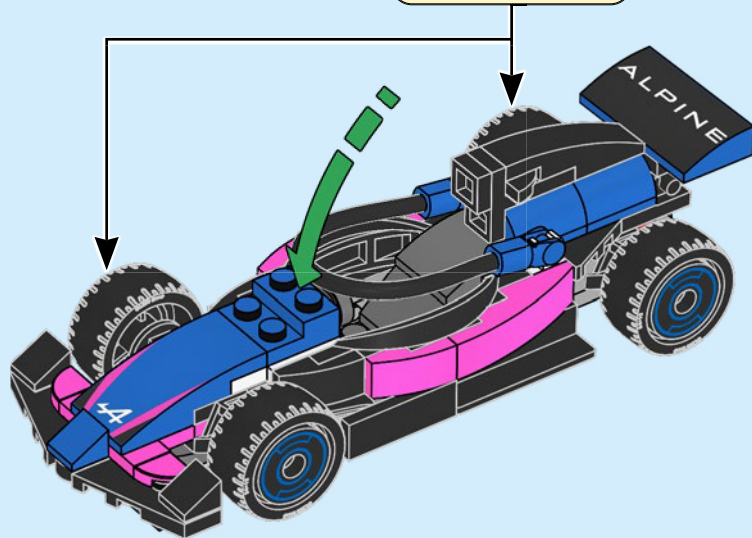
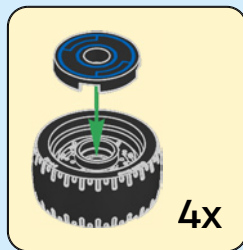

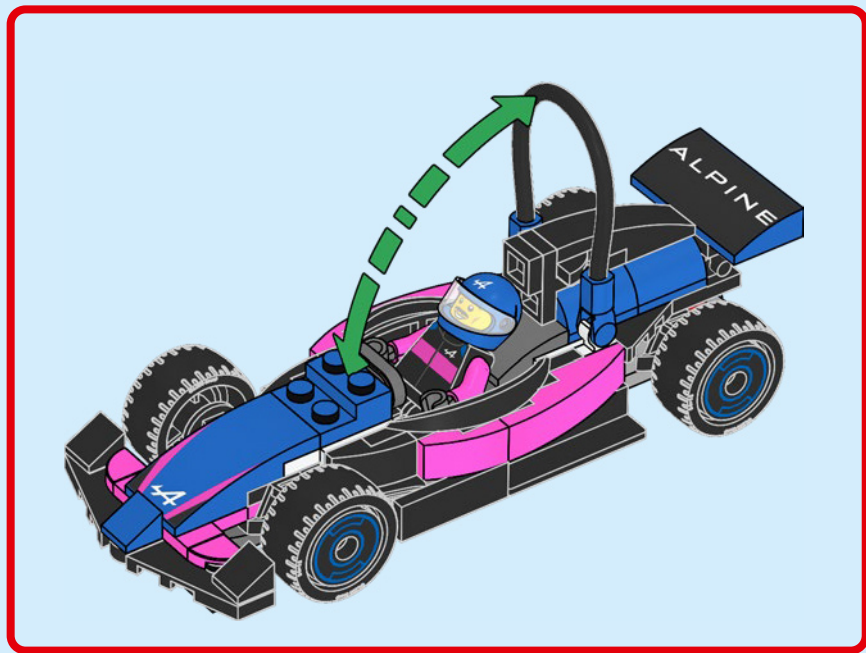

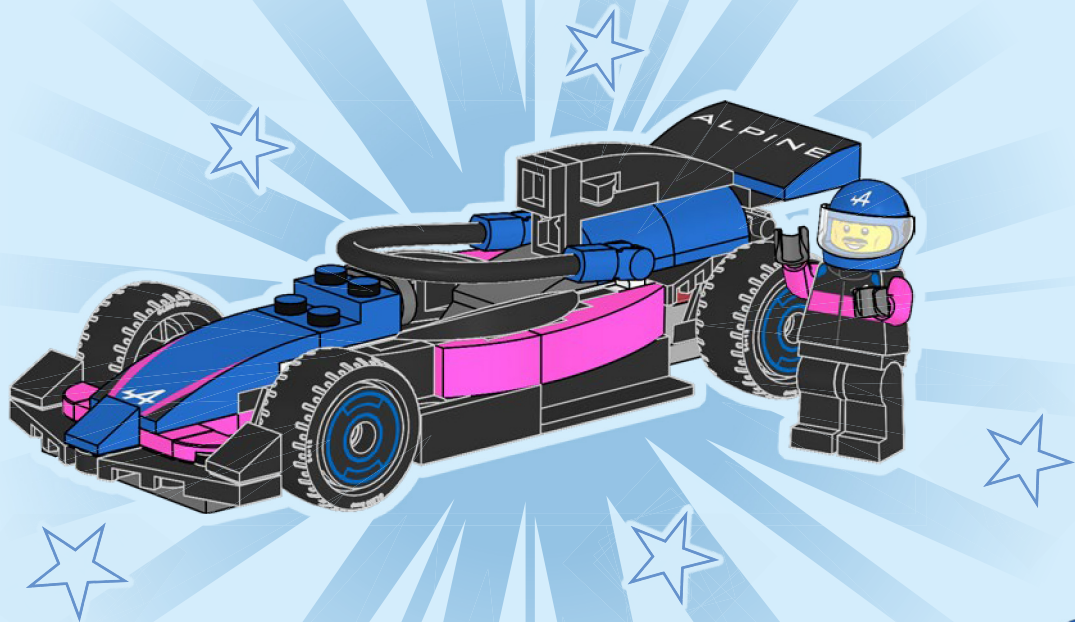

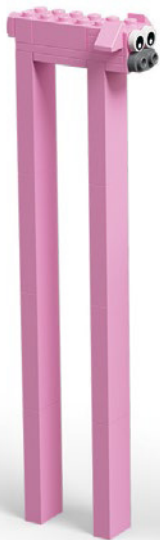

LEGO and the LEGO logo are trademarks of the/son des marques de commerce du/son marcas registradas de LEGO Group. ©2025 The LEGO Group. 6557565

The F1 logo, FORMULA 1, F1, GRAND PRIX and related marks are trademarks of Formula One Licensing BV, a Formula 1 company. All other trade marks, logos and copyrights, including those of the teams featured, are the property of their respective owners. All rights reserved.

OFFICIAL LICENSEE OF FORMULA 1®

**Rebuild
the
World™**

