

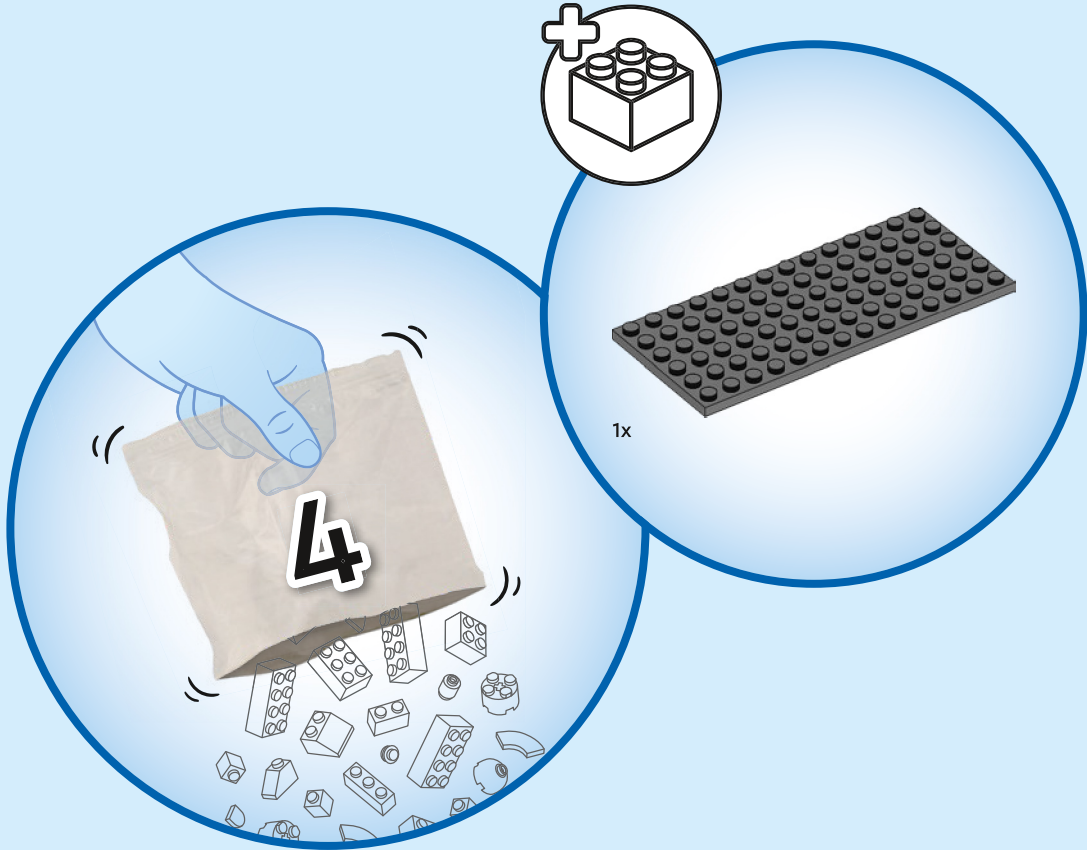

CITY

60472





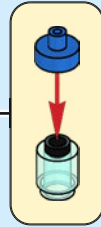
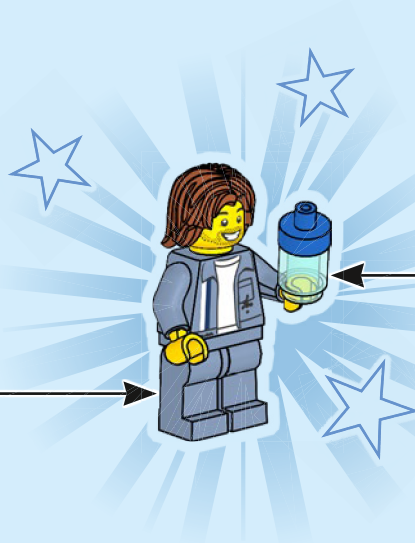
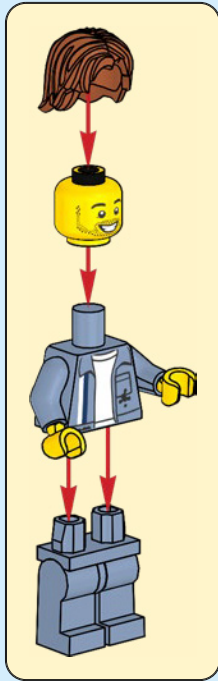

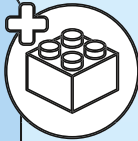
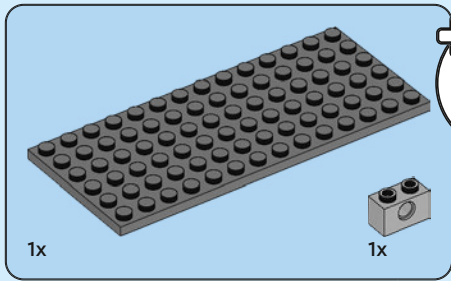

1

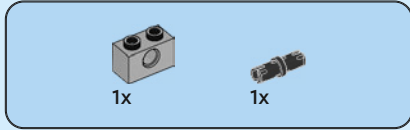
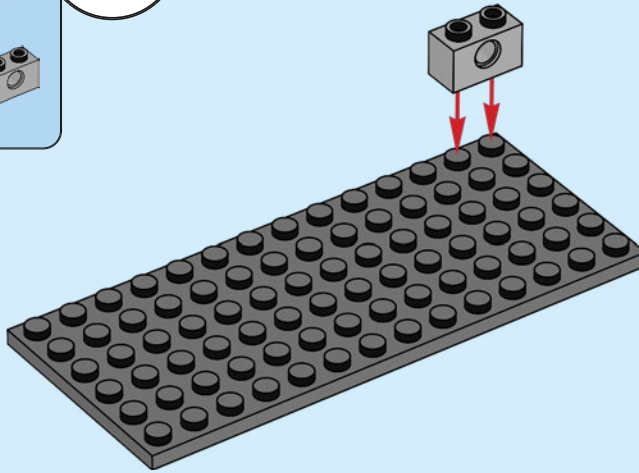

2

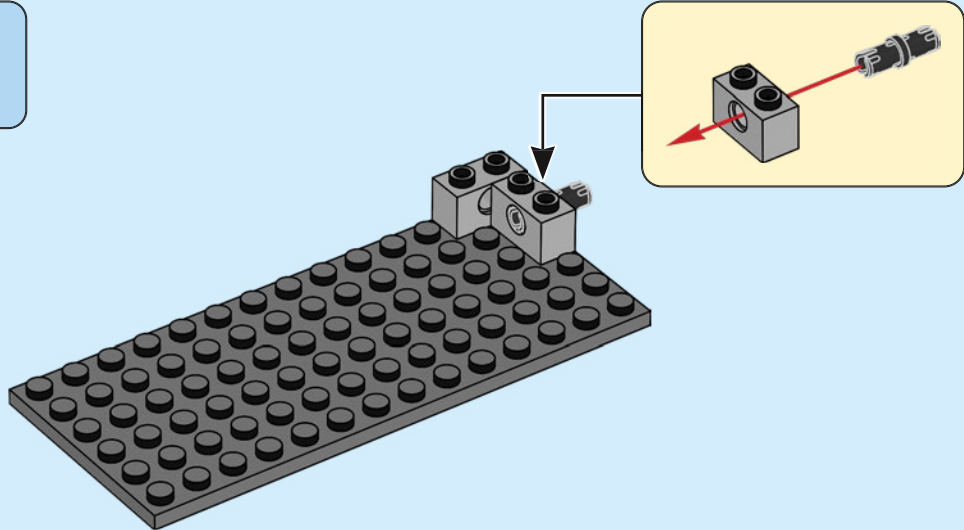



1x

3

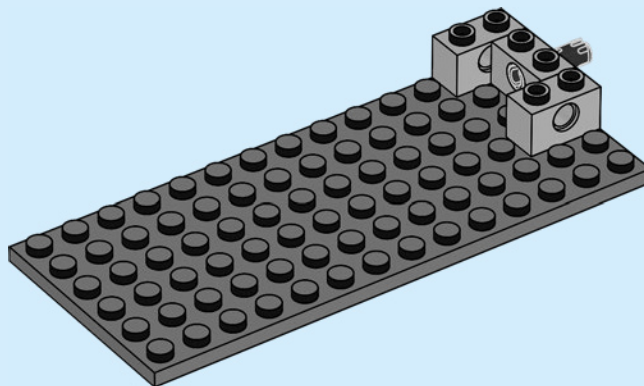

1x

4

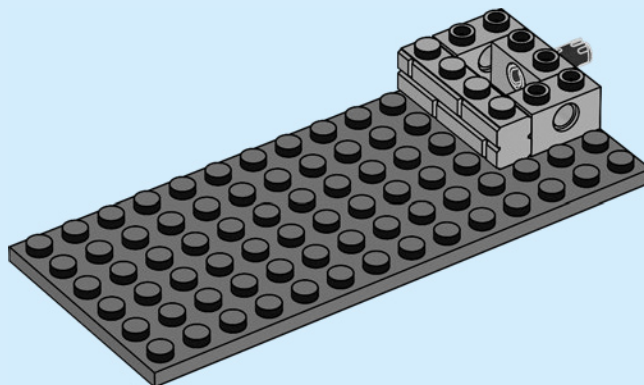



1x



1x

5

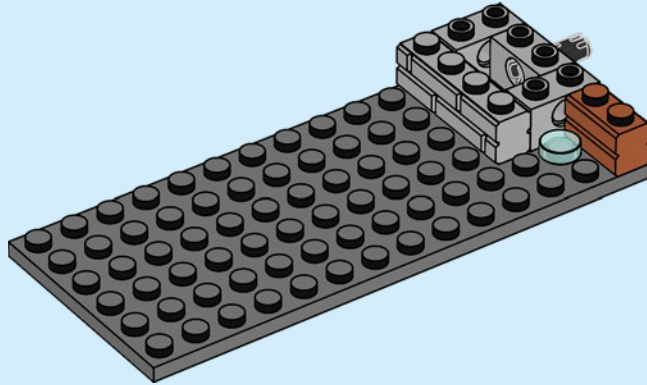

1x

6

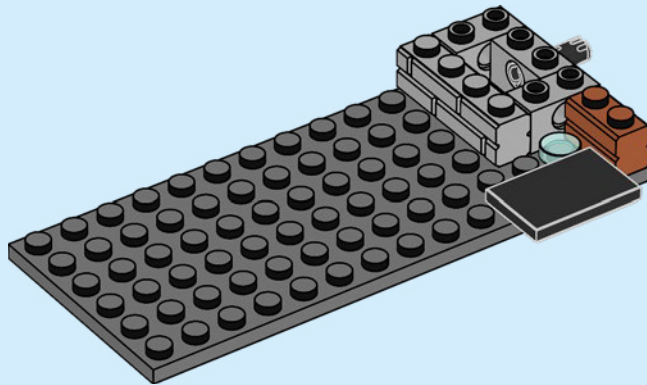

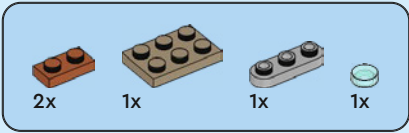

7

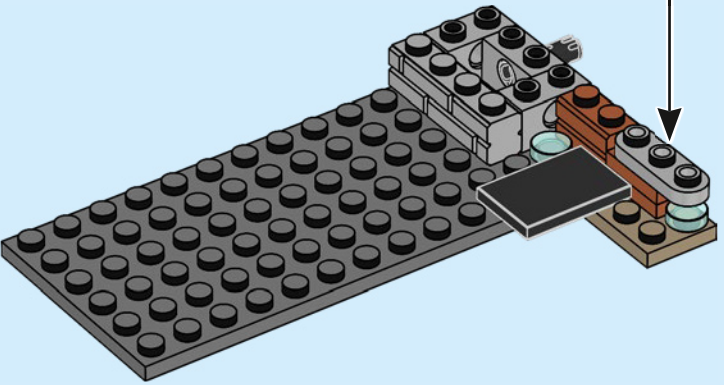
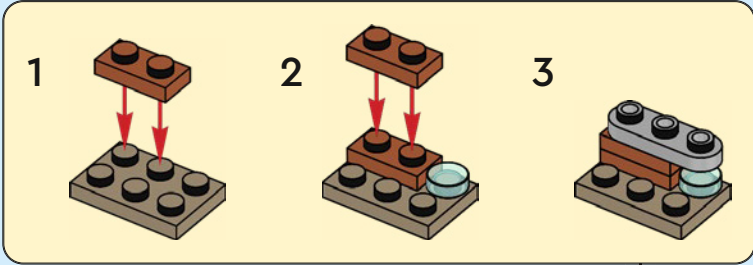

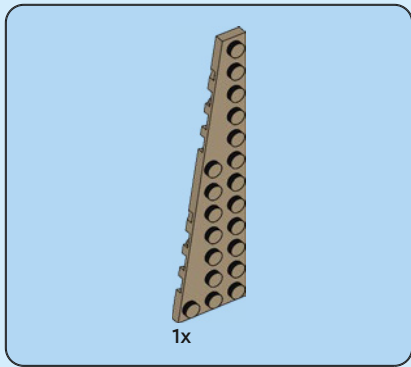

8

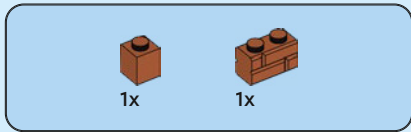
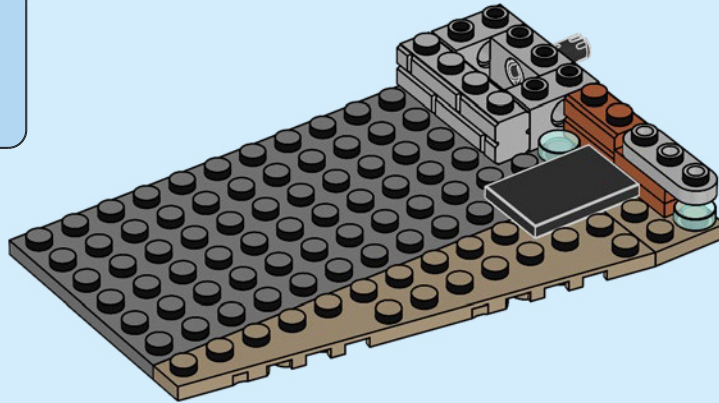

9

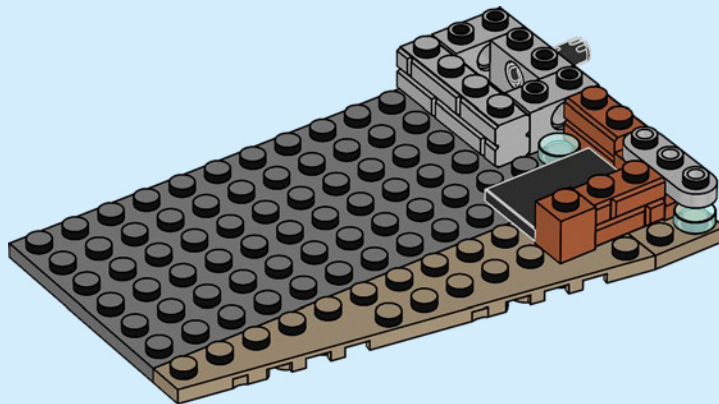



1x

10

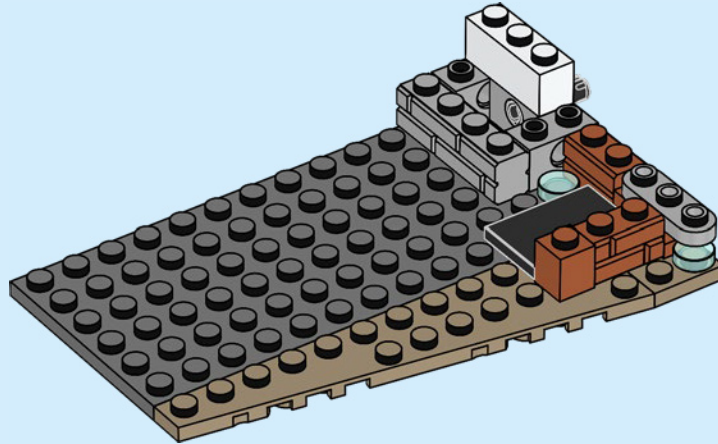

1x

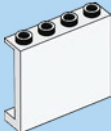

1x



1x

11

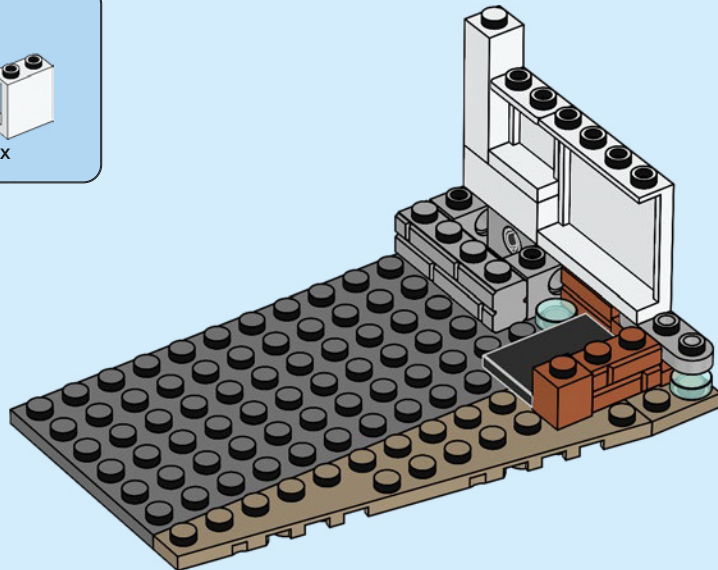

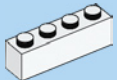

1x

12

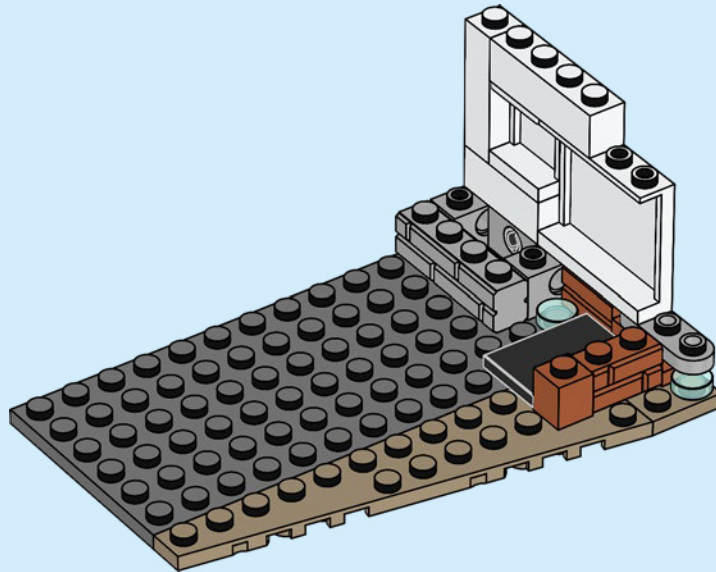

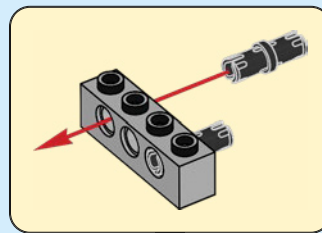
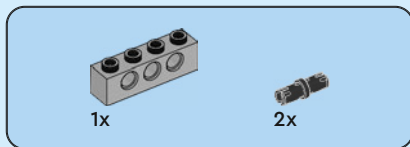

13

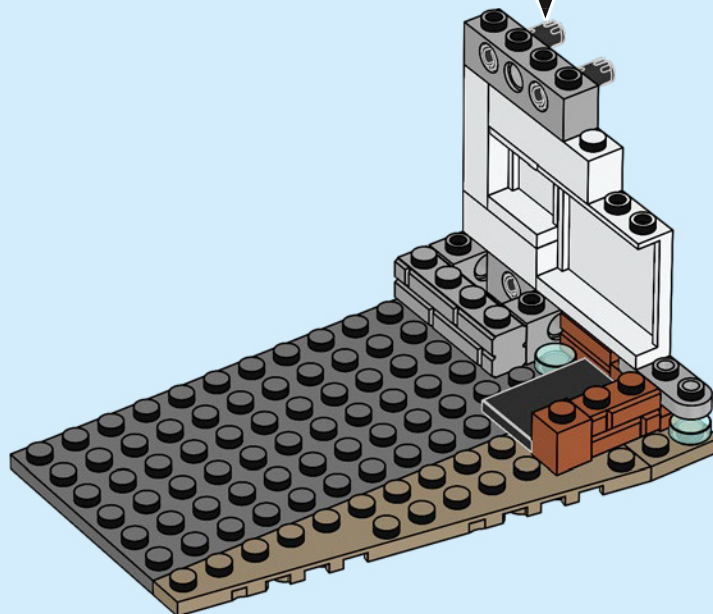

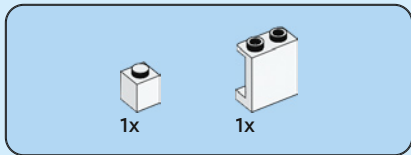

14

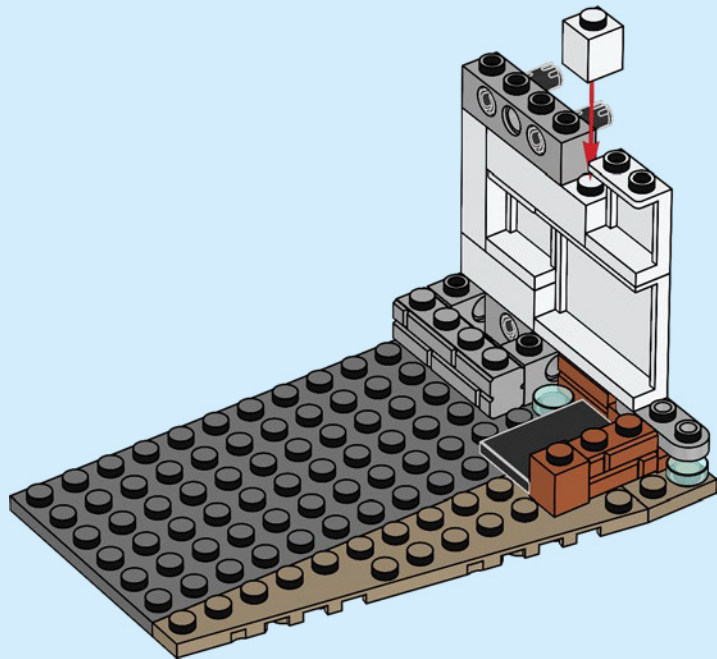



1x

16



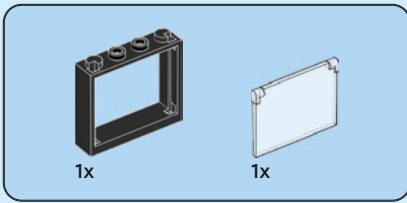

17

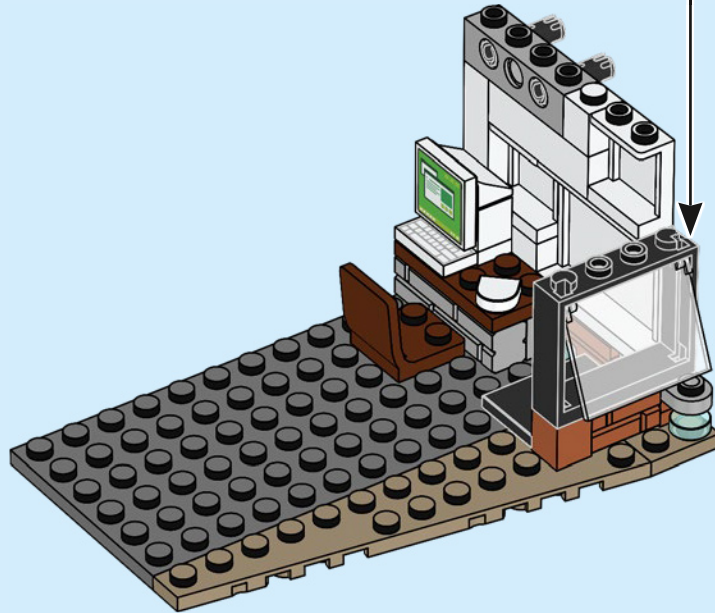
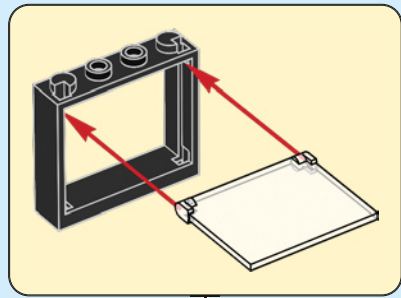

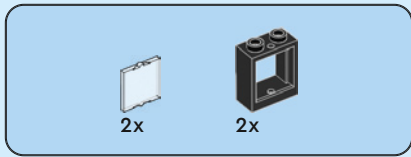

18

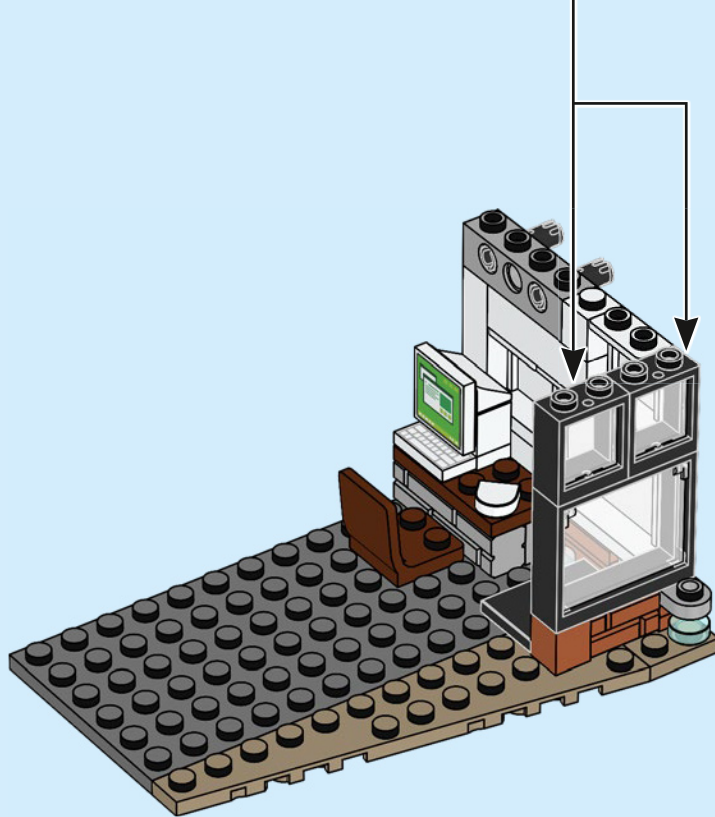
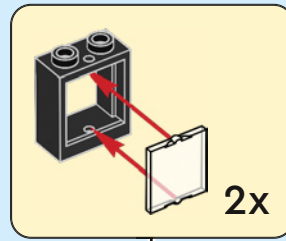

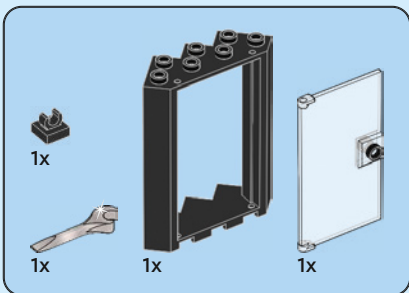

19

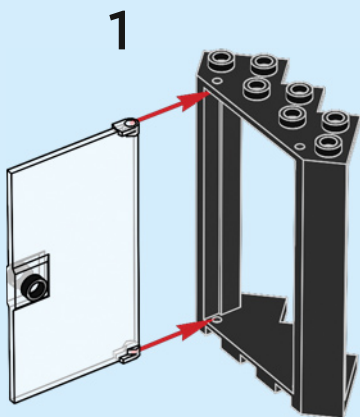

2

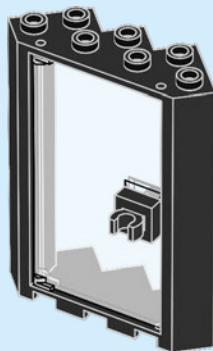

3

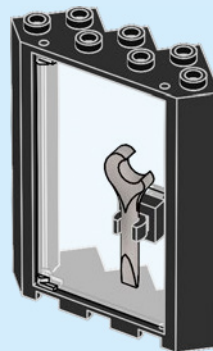

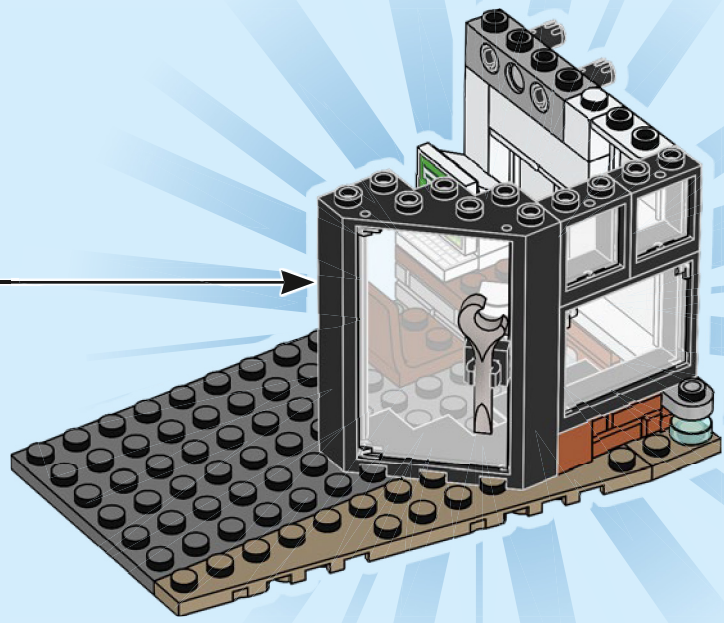



2x

20

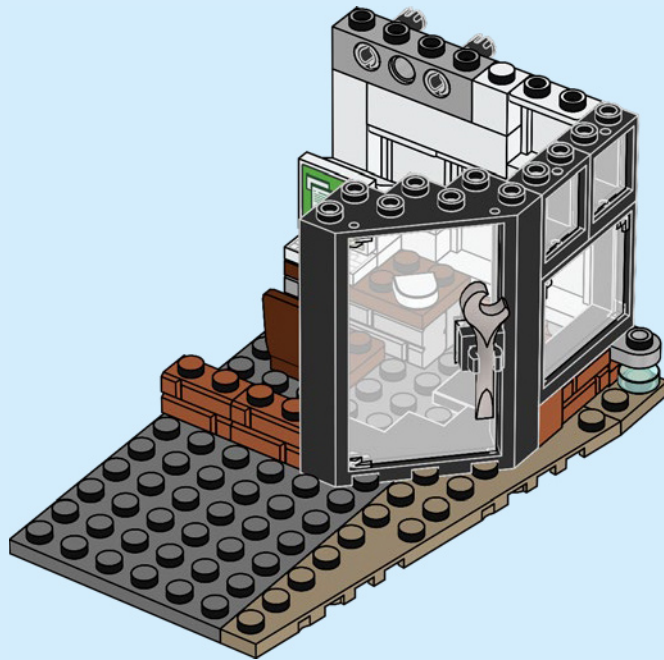

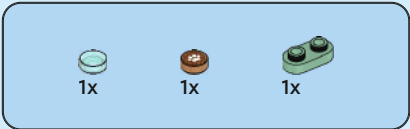

21

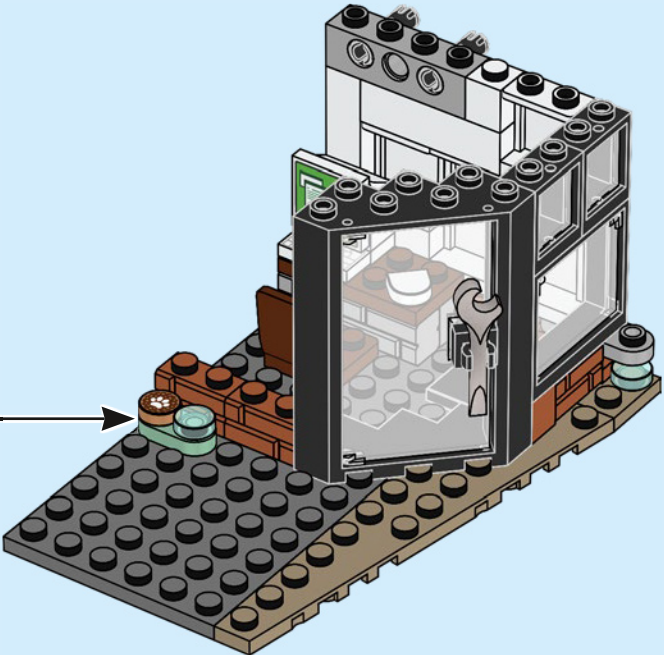
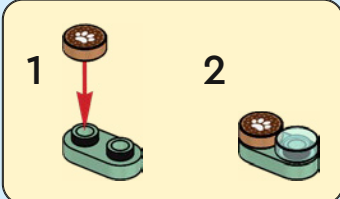

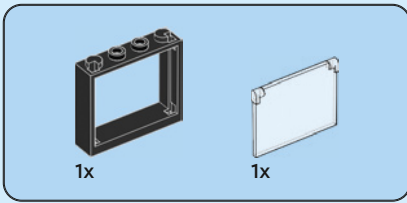

22

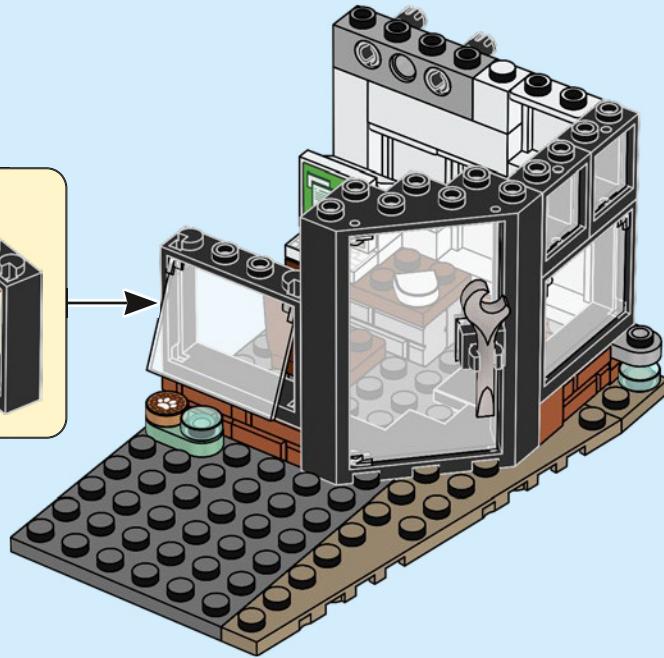
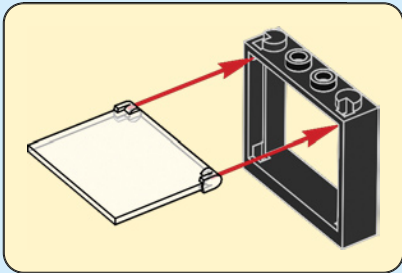

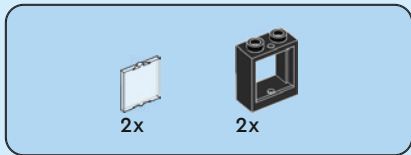

23

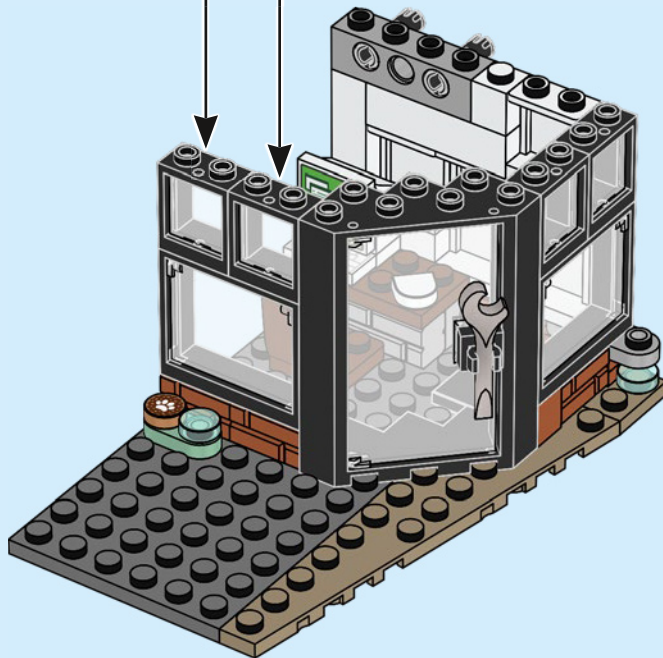
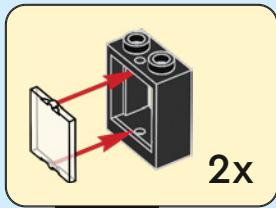

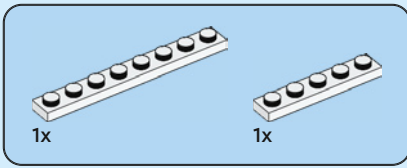

24

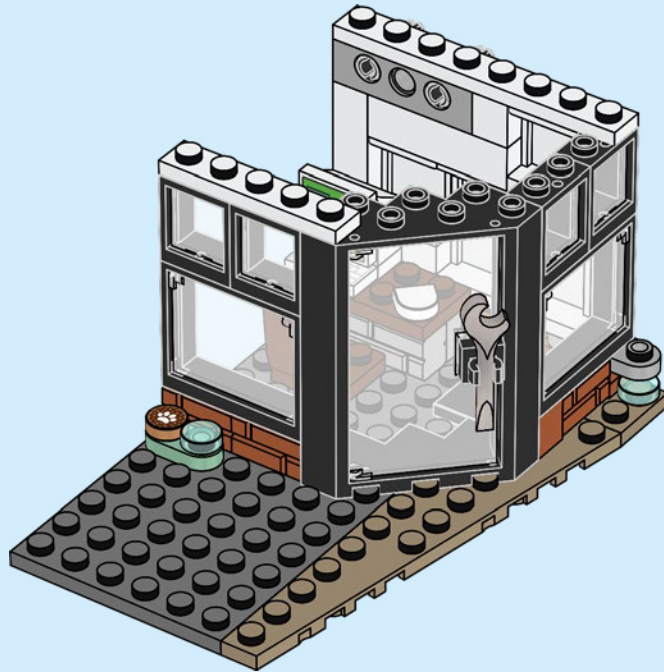

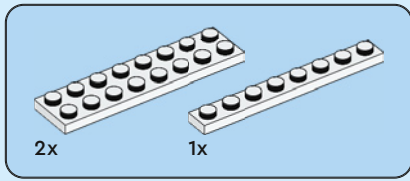

25

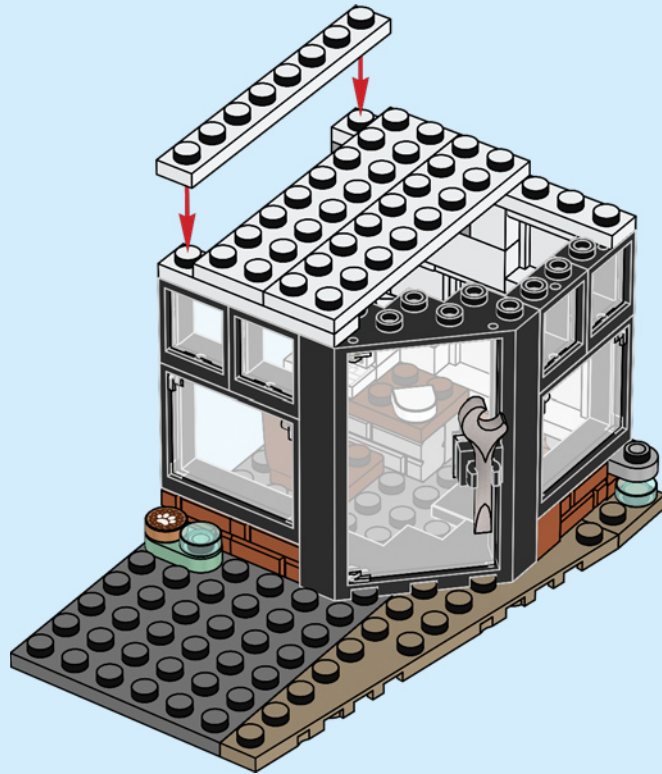



1x

26

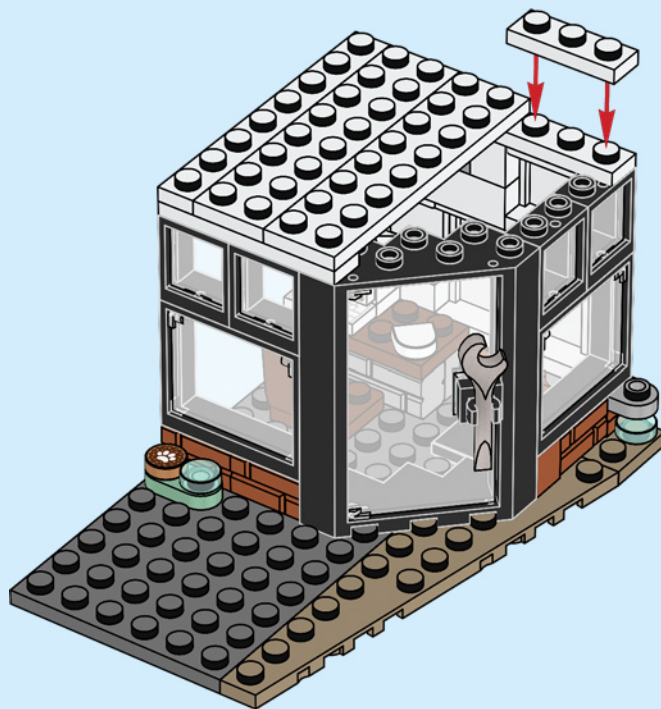

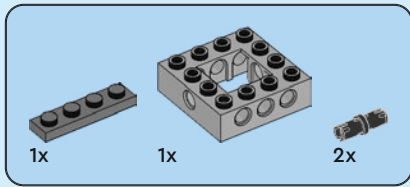

27

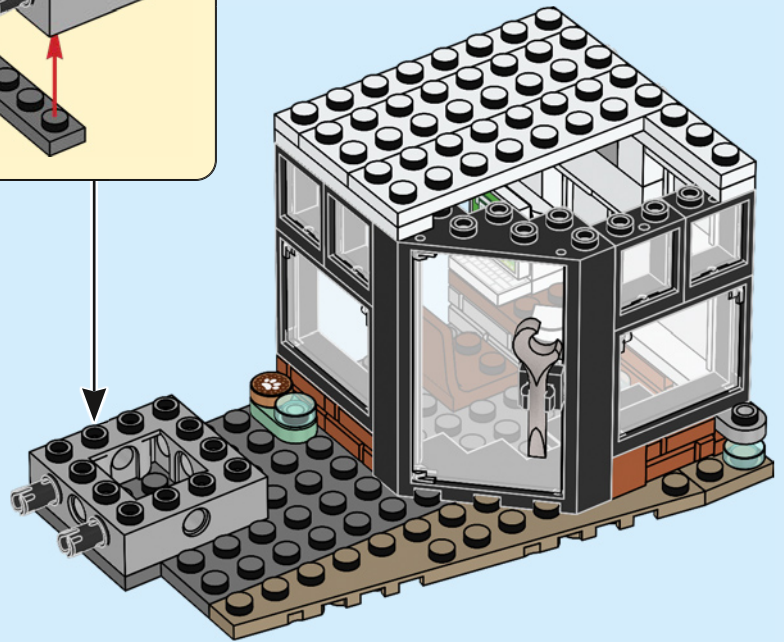
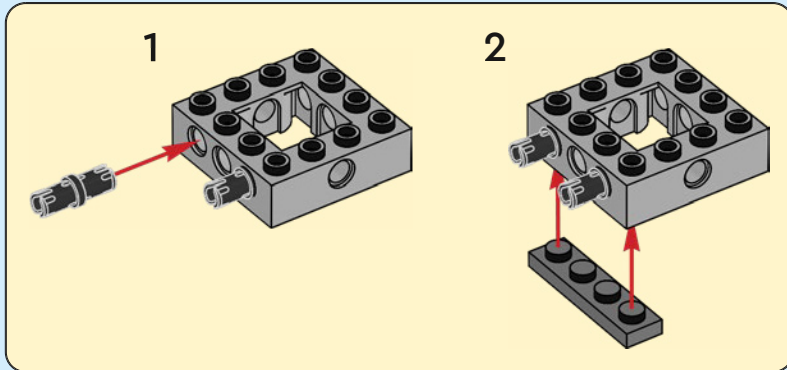

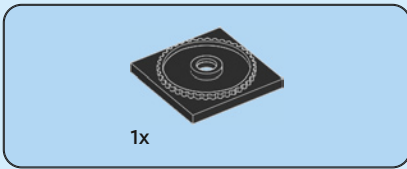

28

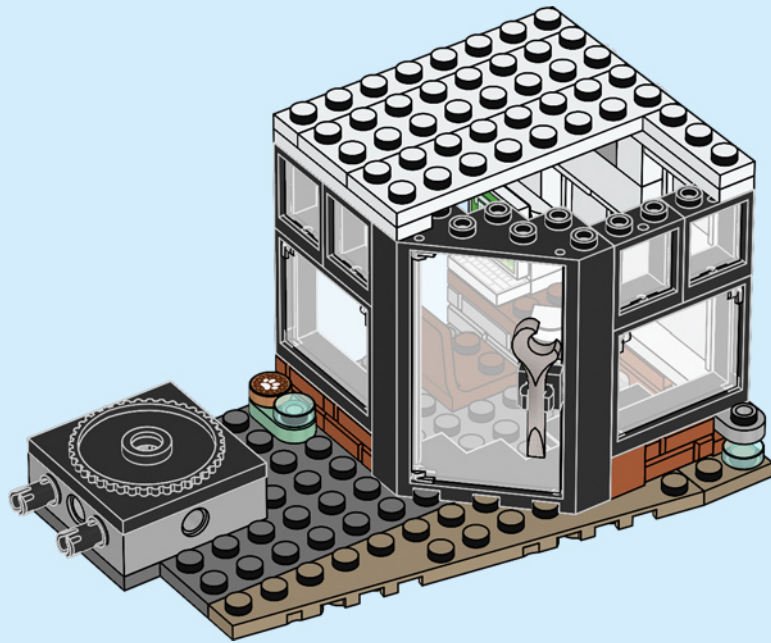

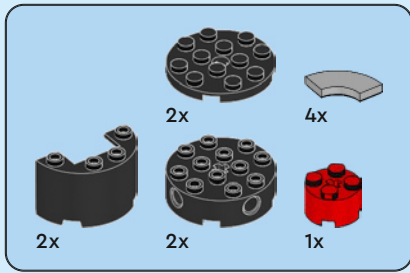

29

1

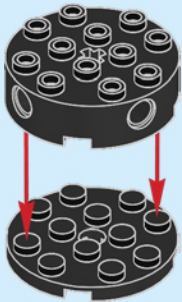

2

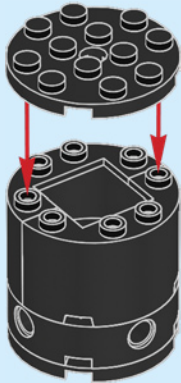

3

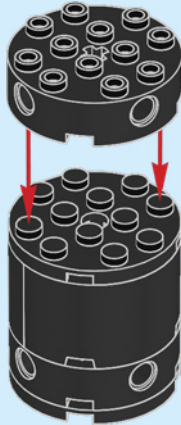

4

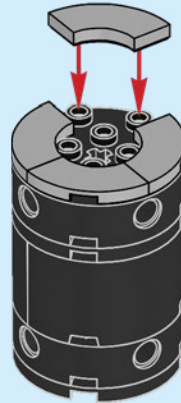

5

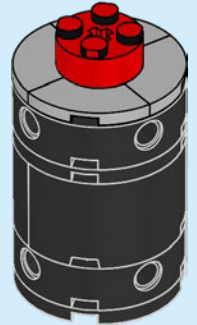

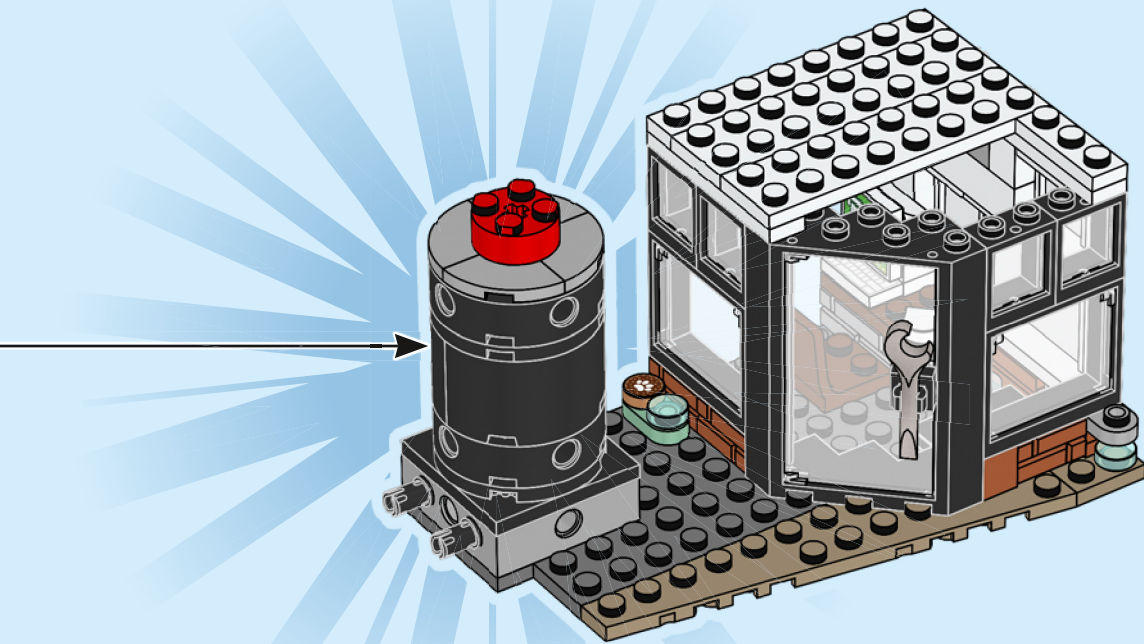

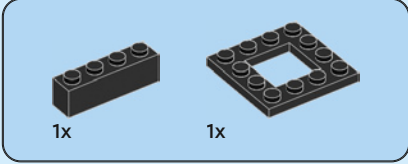
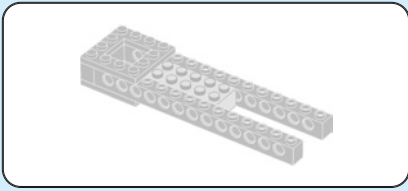

30

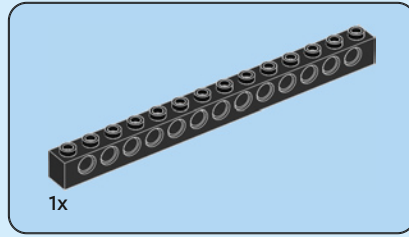
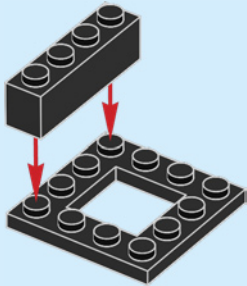

31

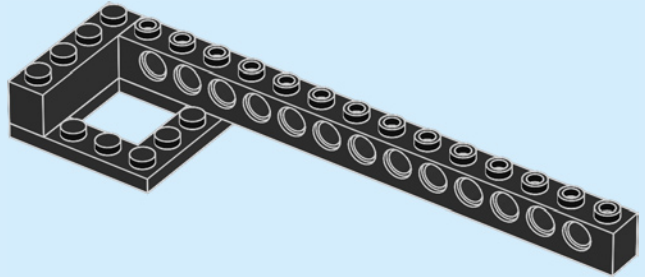

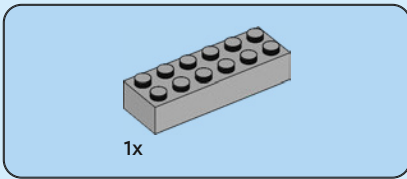

32

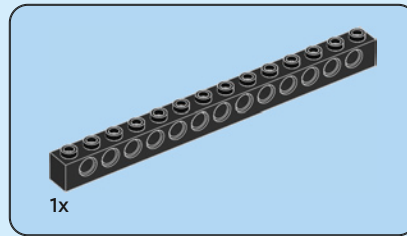
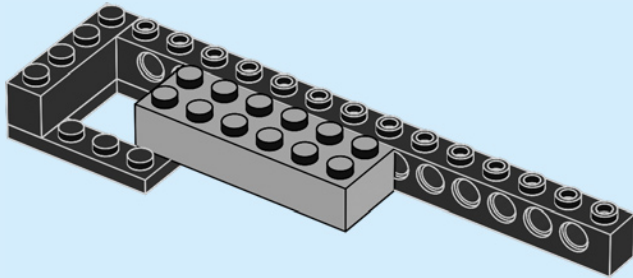

33

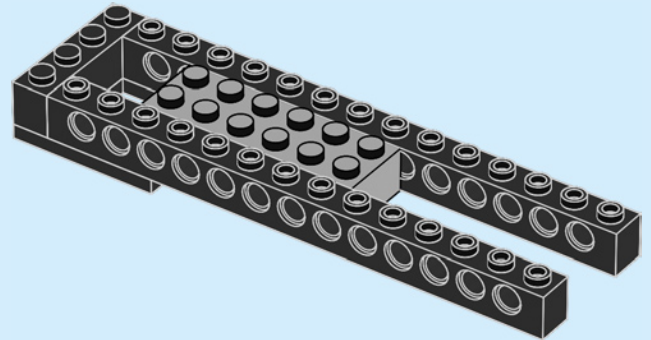

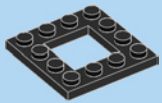

1x

34

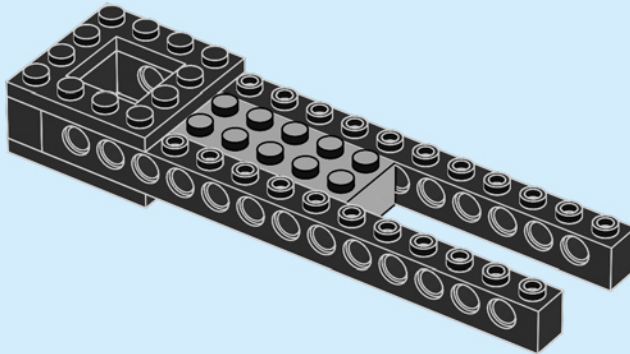

35

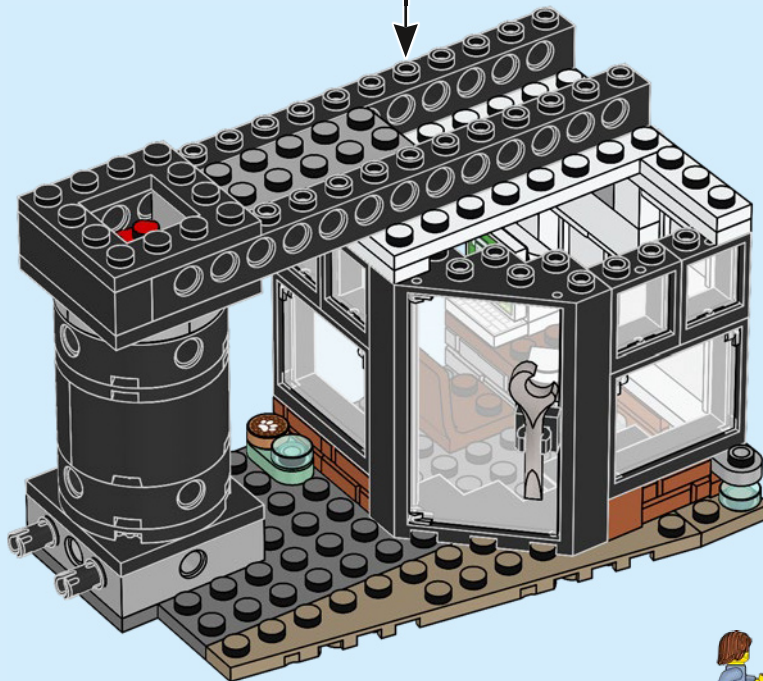



1x

36

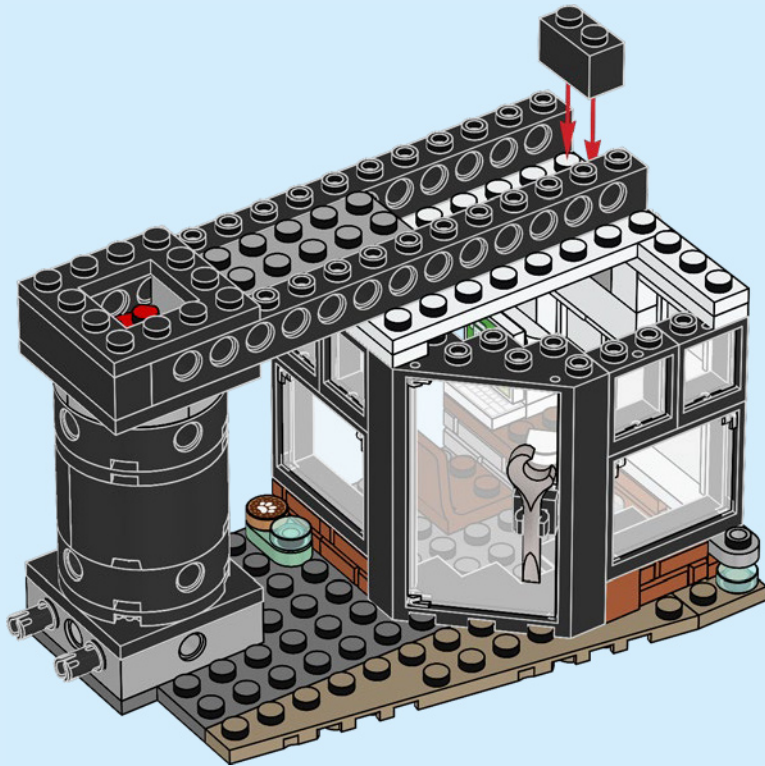

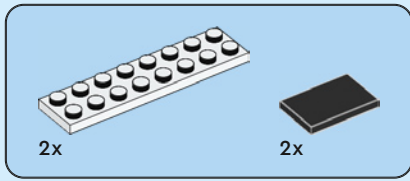

37

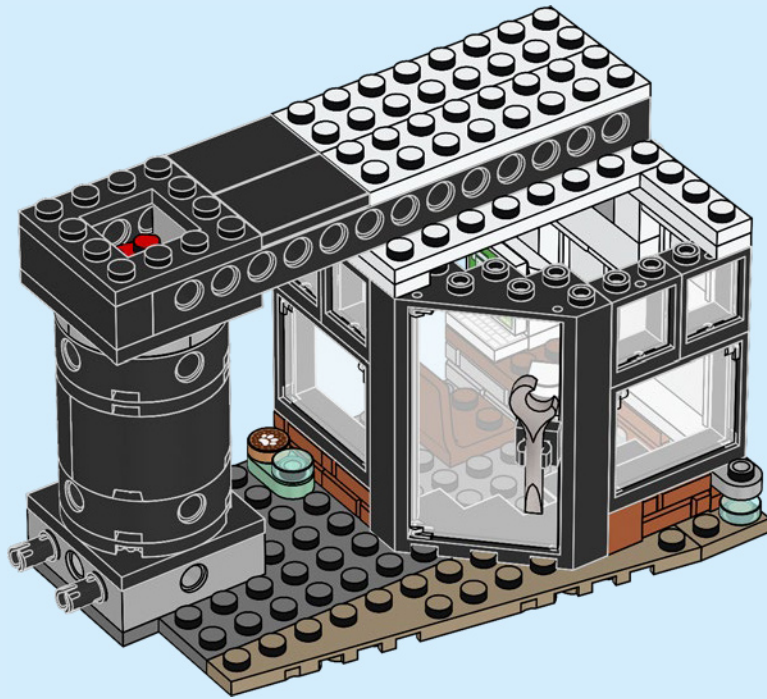



4x

38

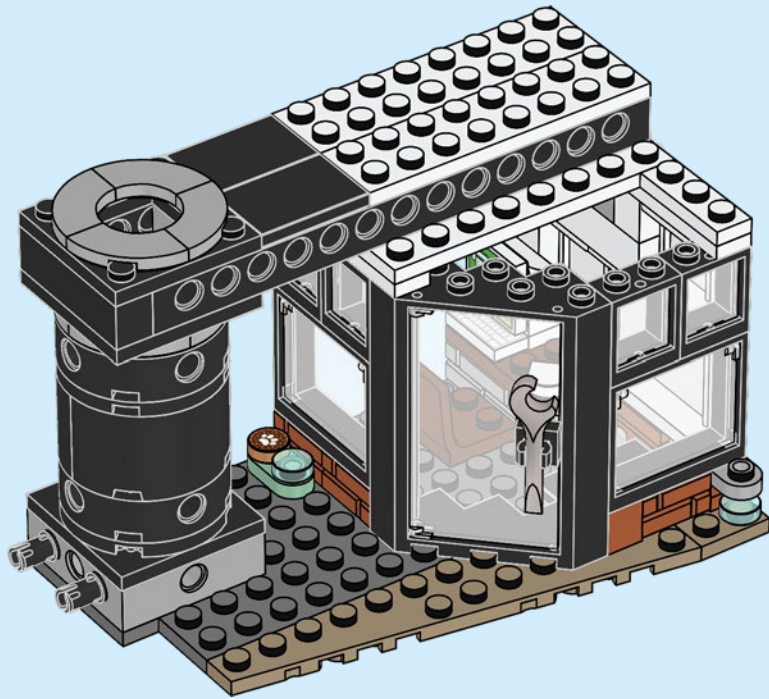

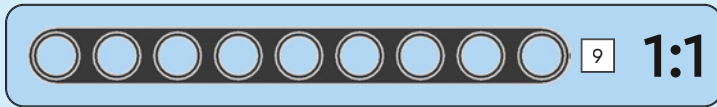
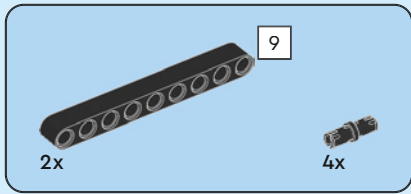

39

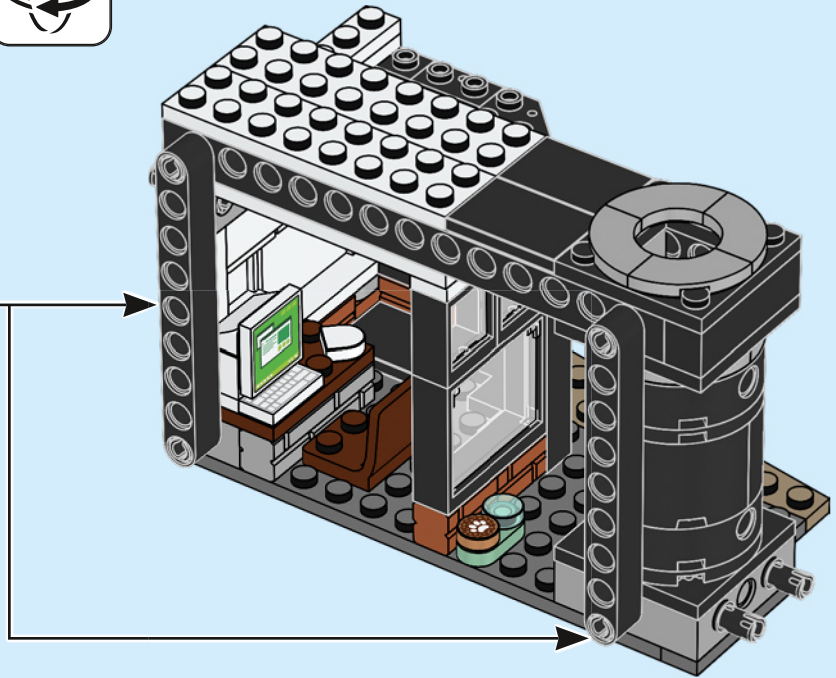
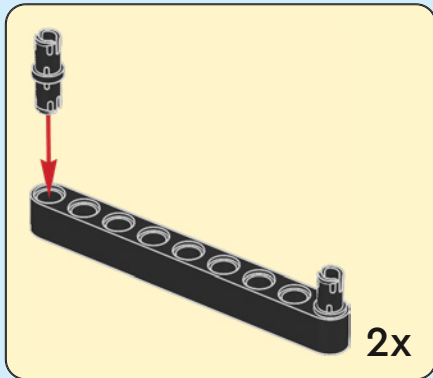

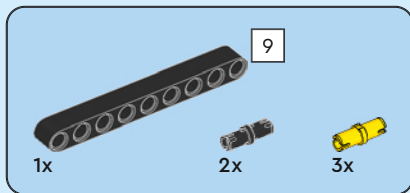

40

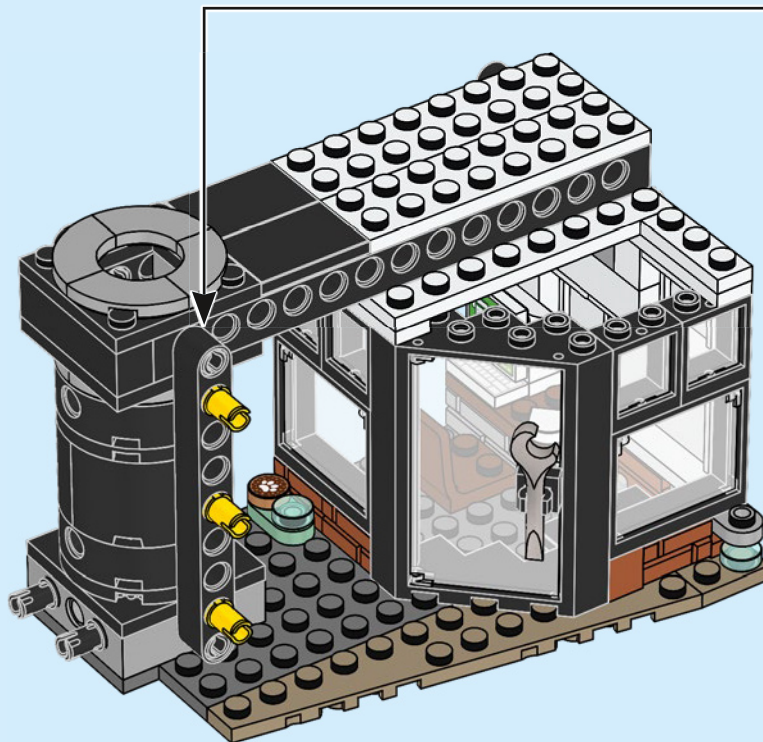
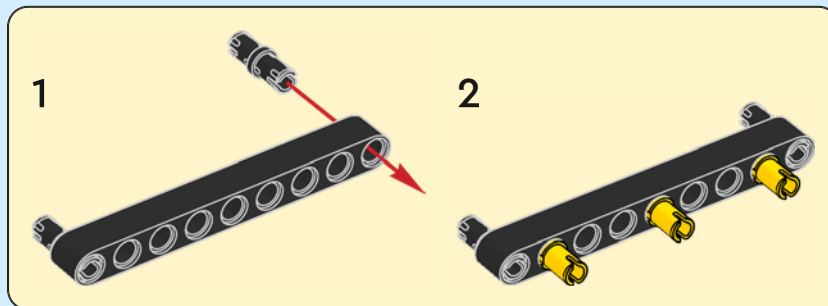

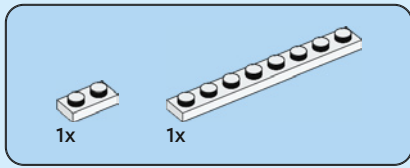

41

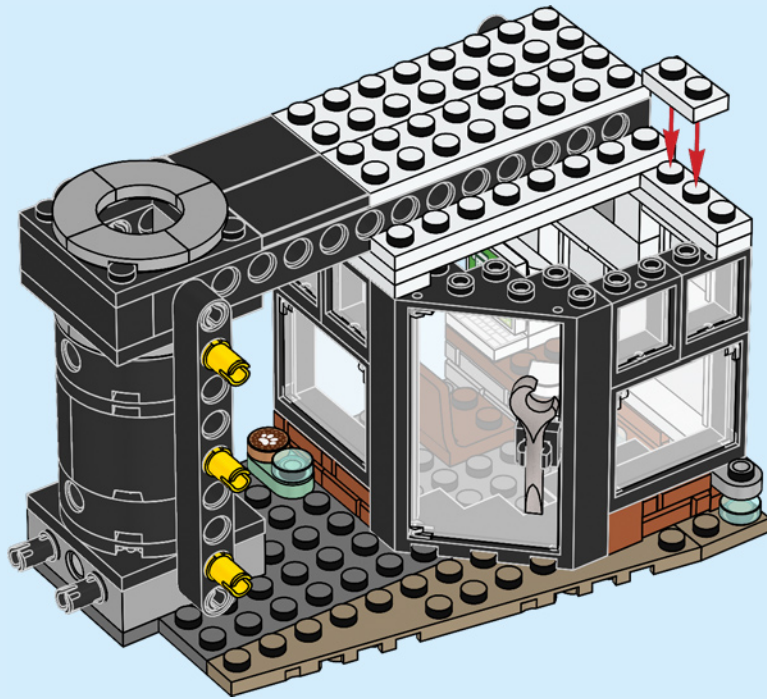



1x



4x

42

1



2

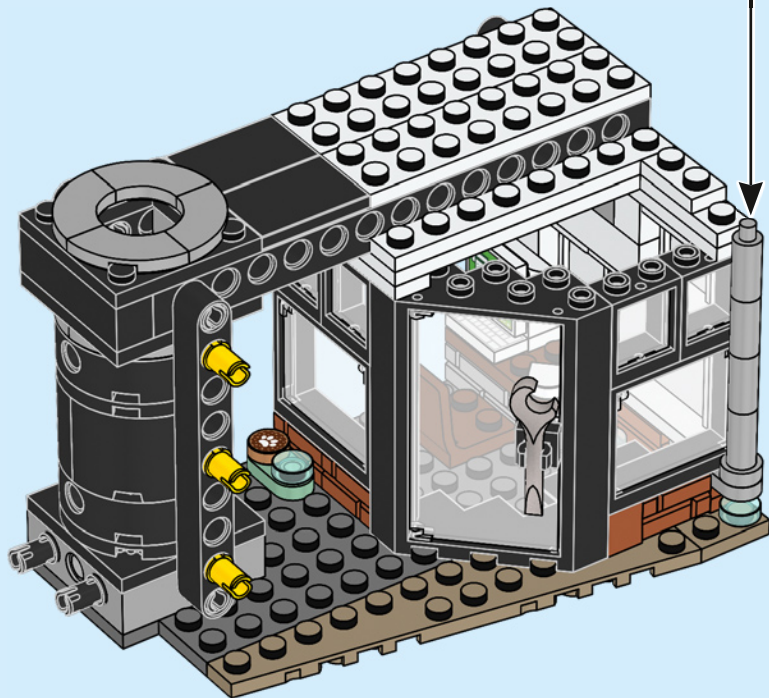

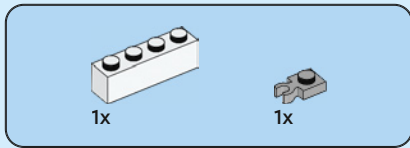

43

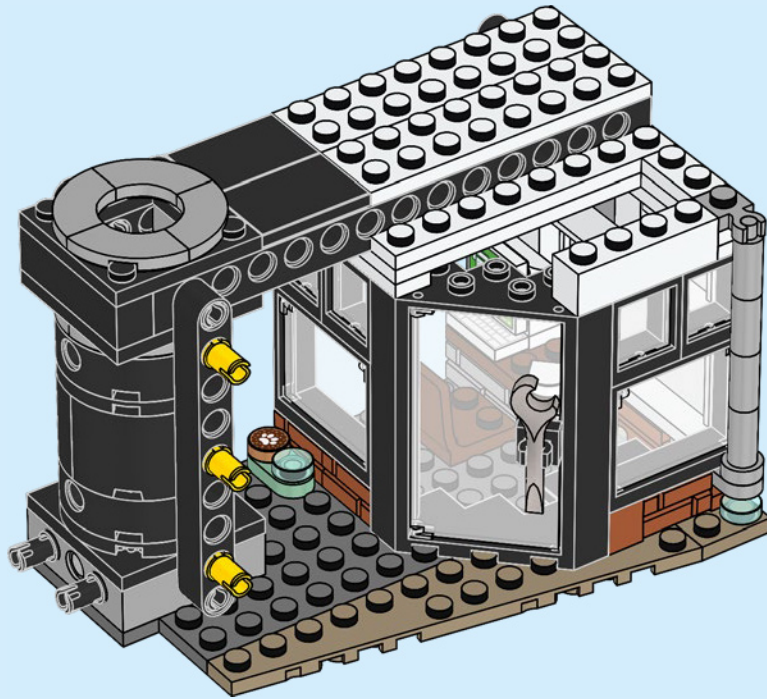



1x

44

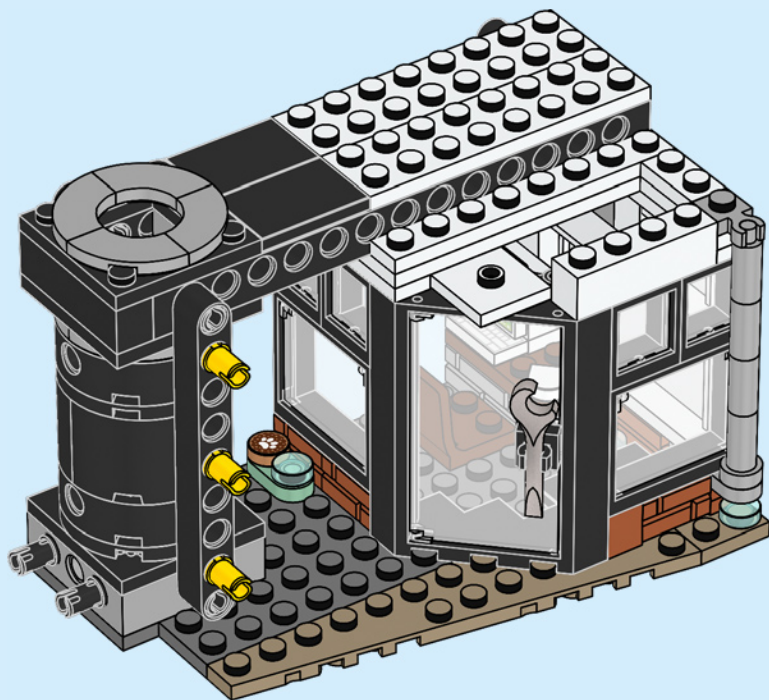



1x



1x

45

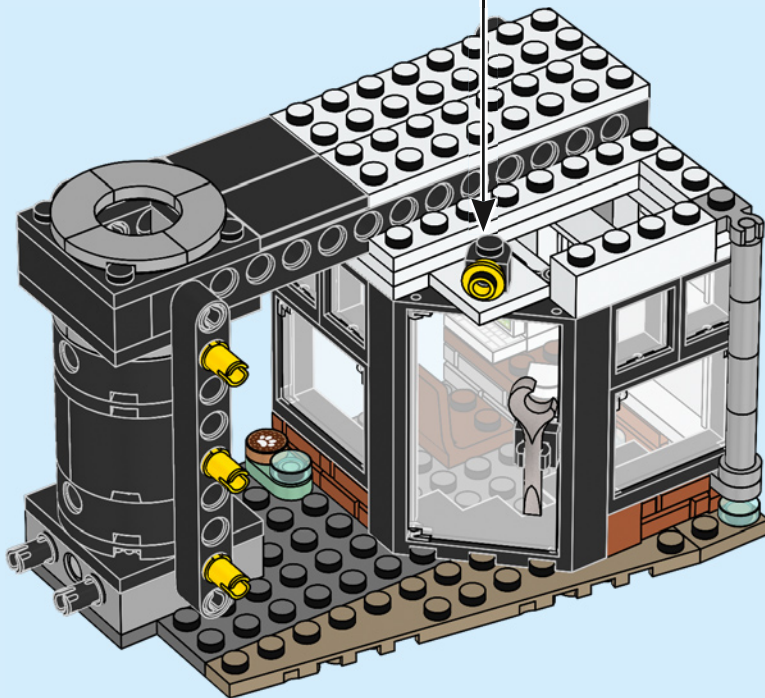
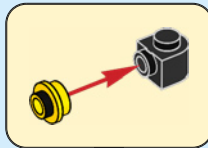

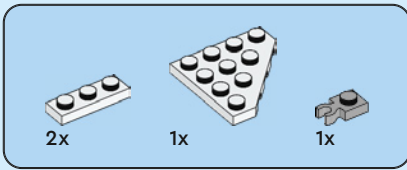

46

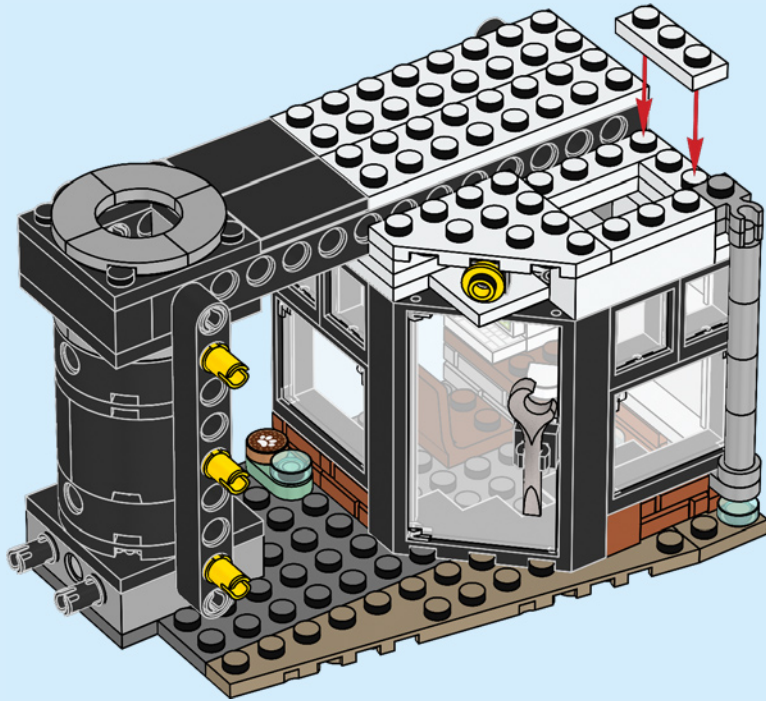



4x

47

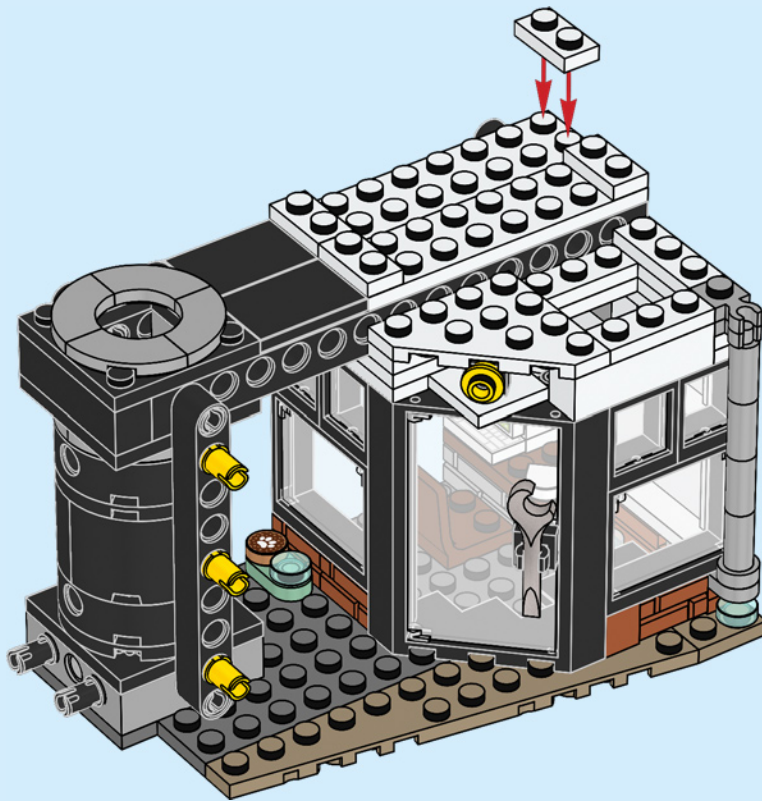

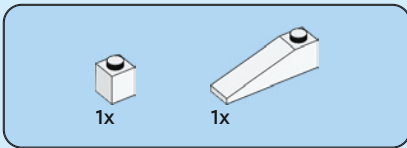

48

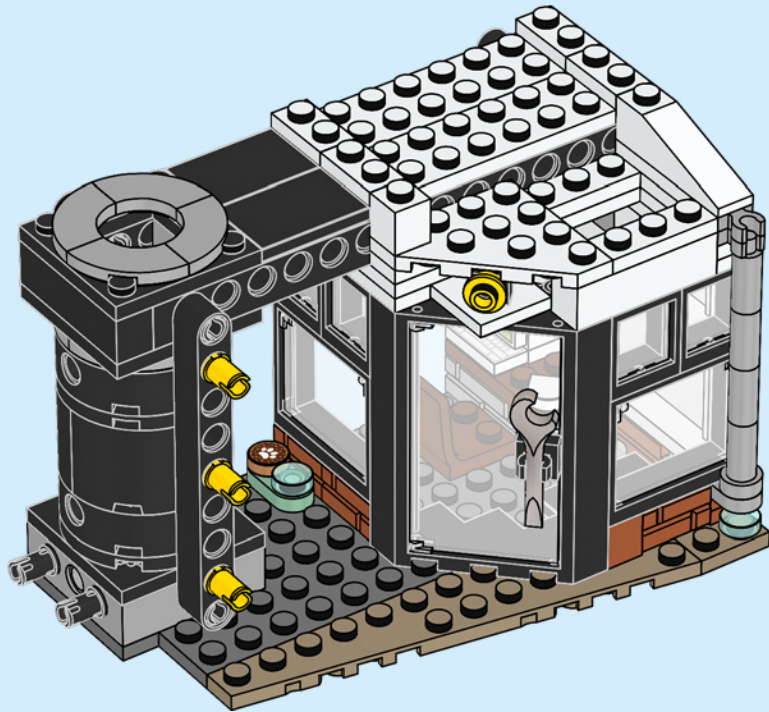



49

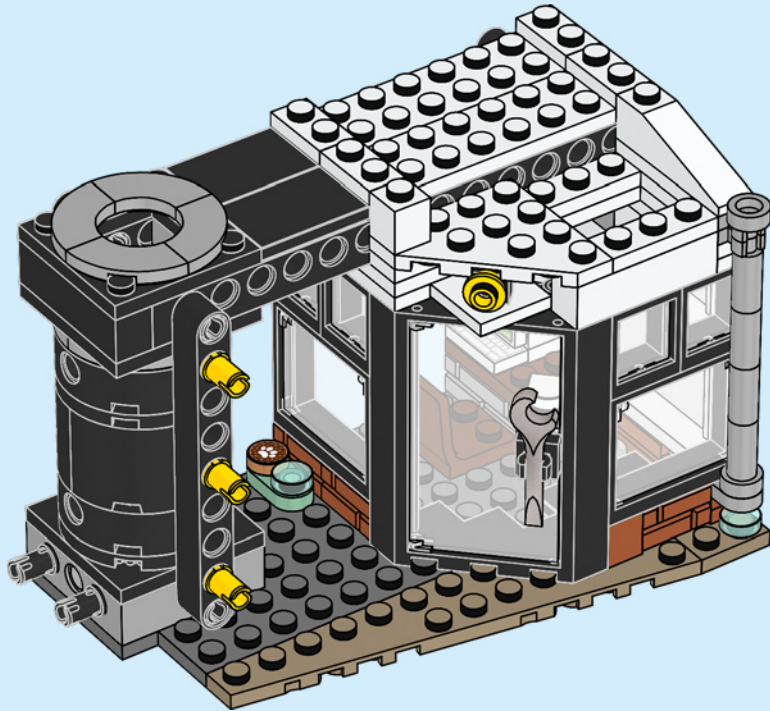

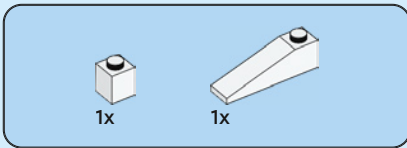

50

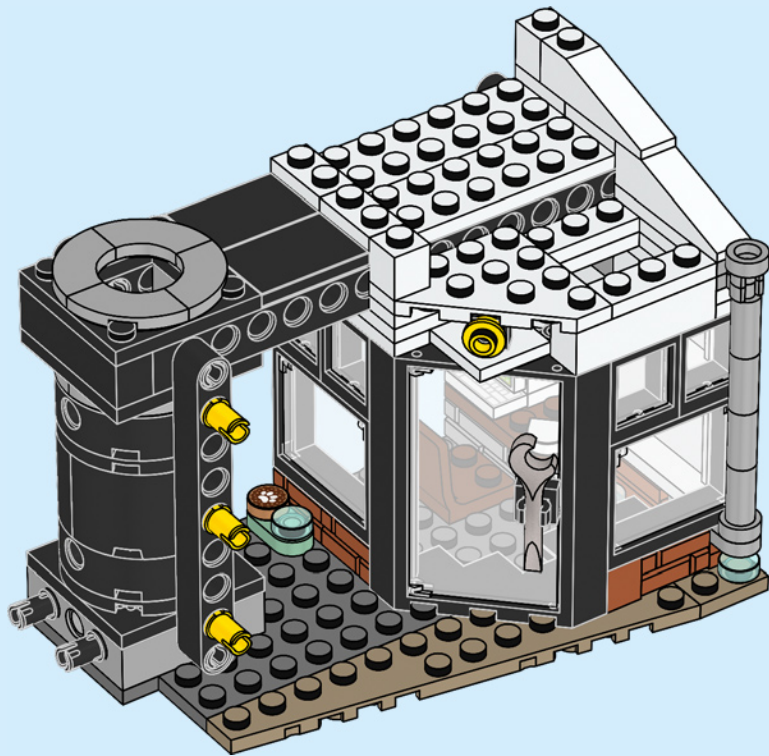



4x

51

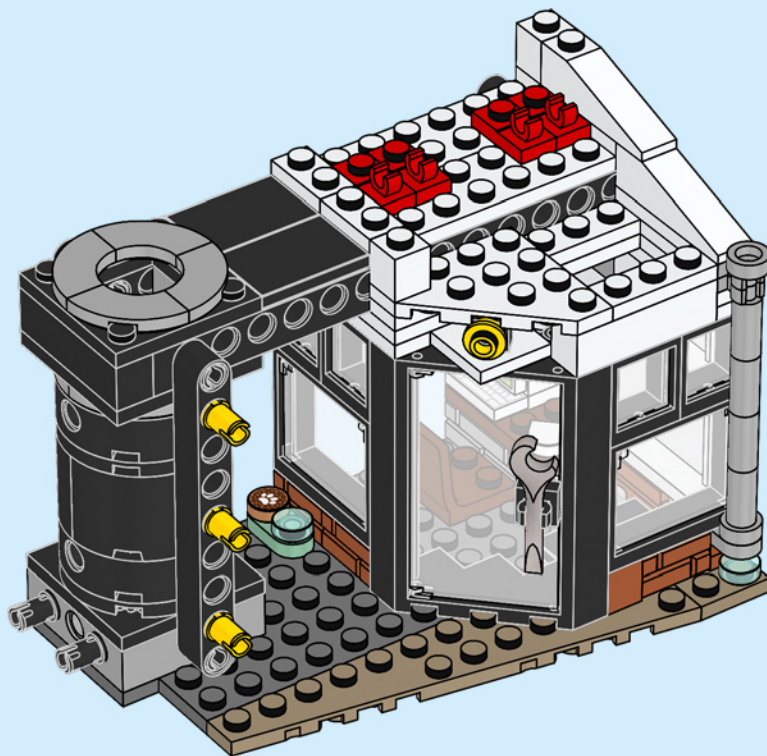



2x

52

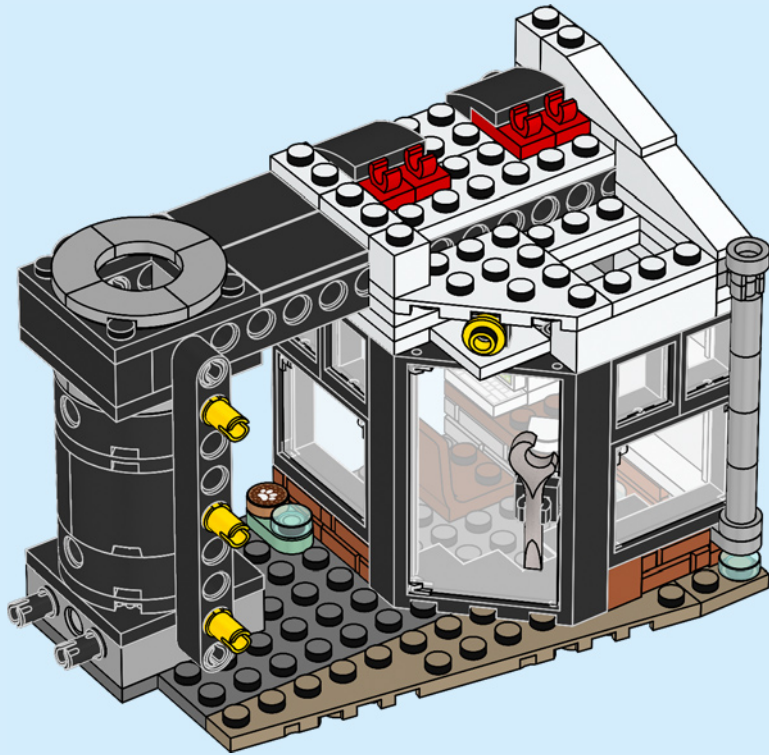



1x

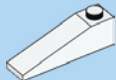

1x

53

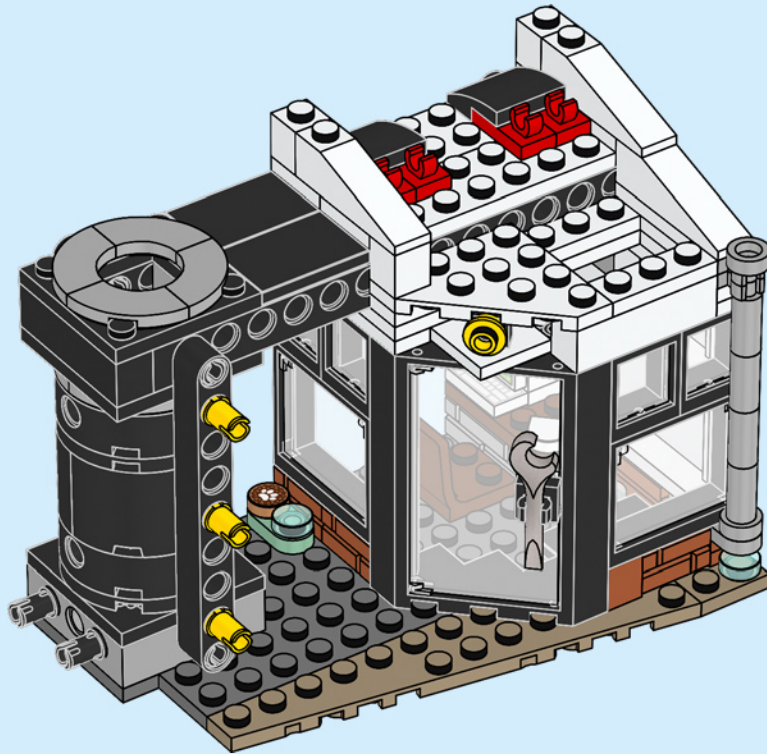





1x



1x



1x

54

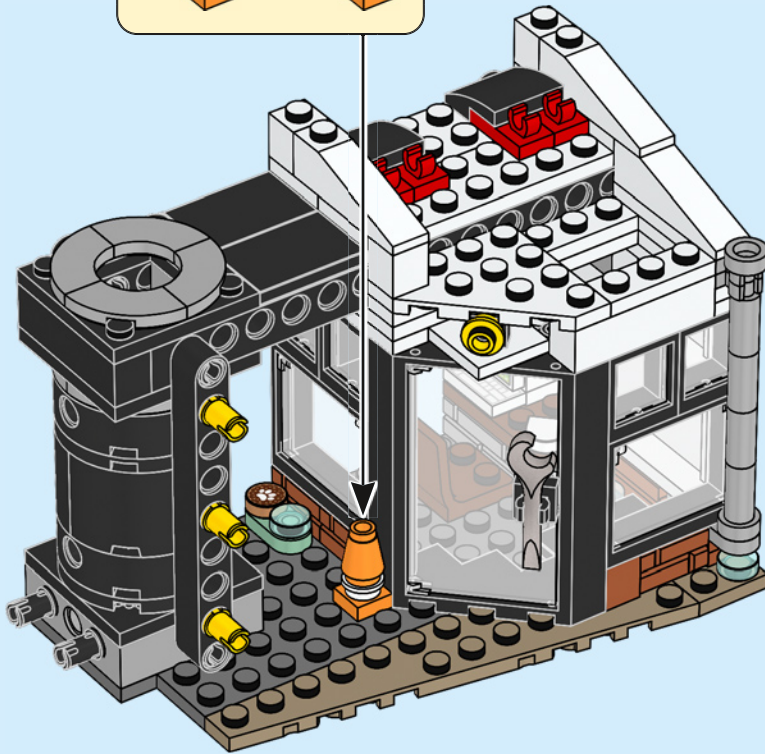
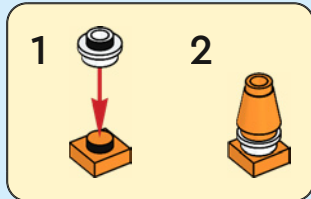

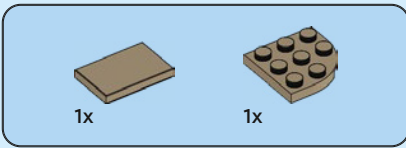

55

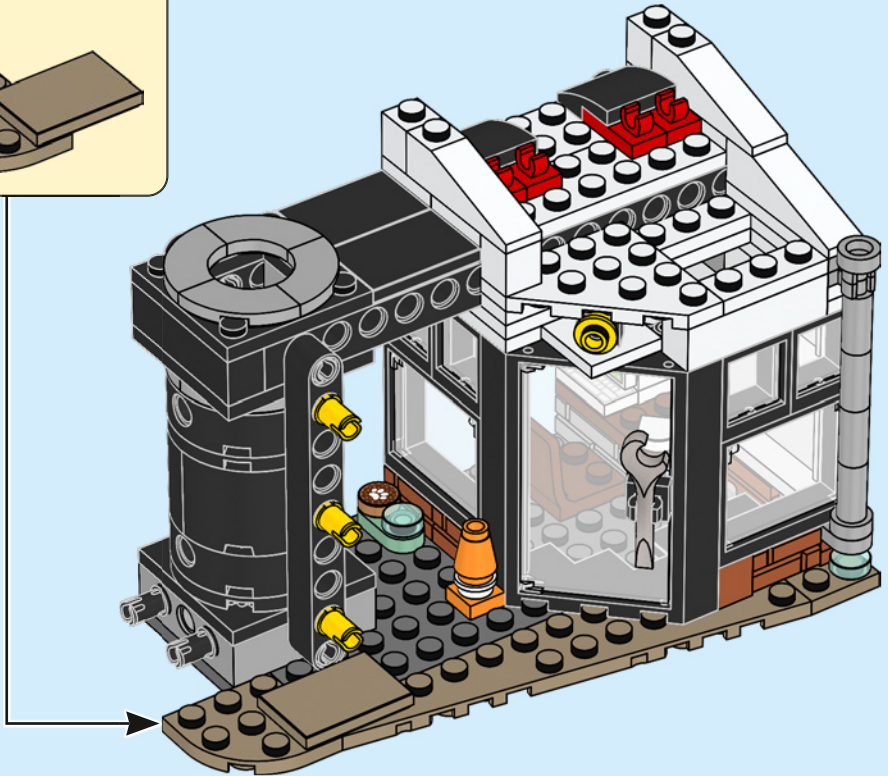
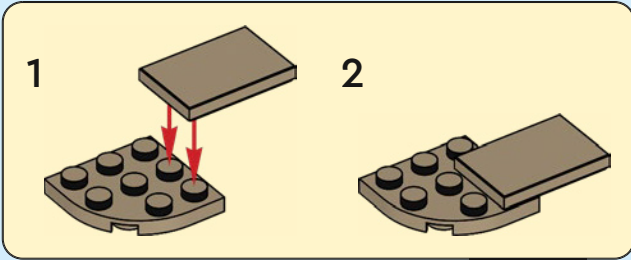



56

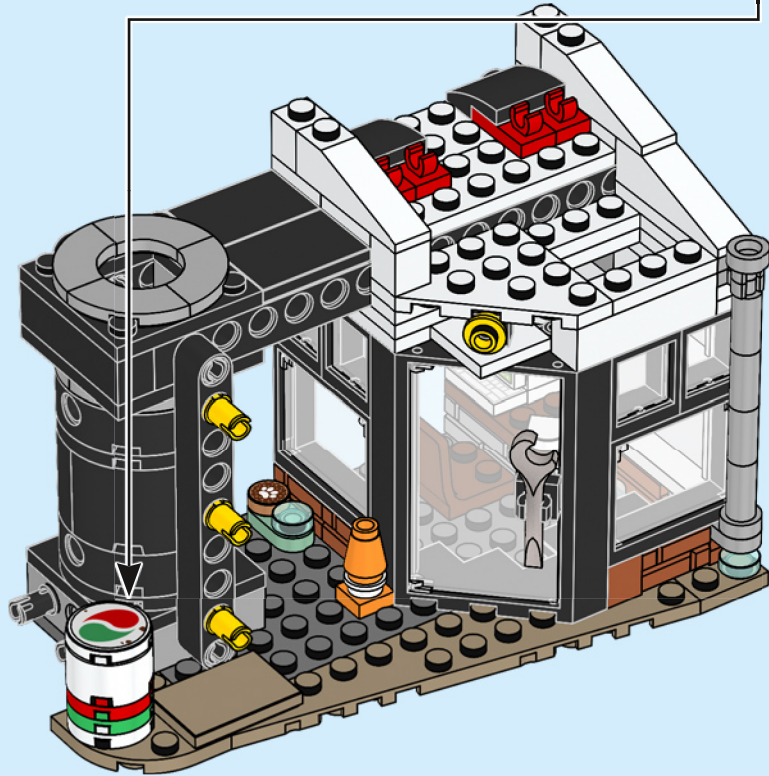
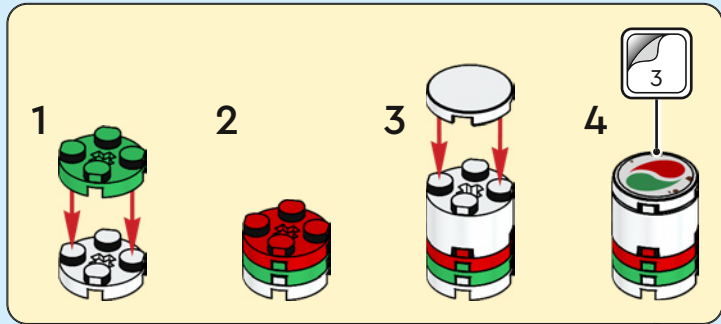



1x

57

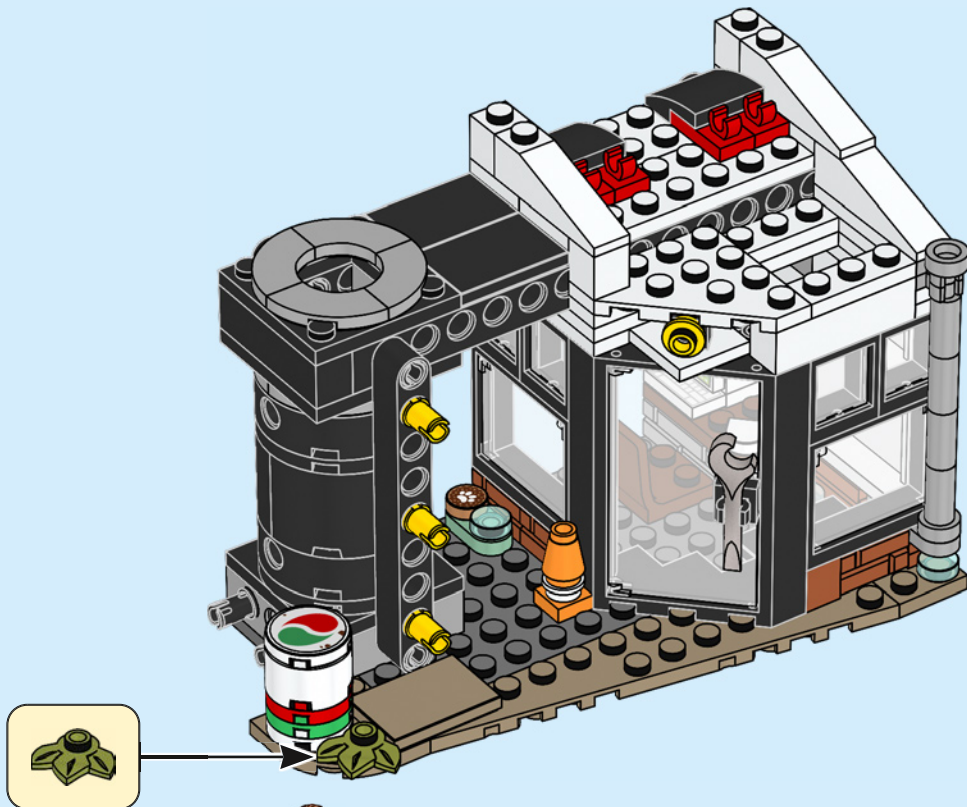

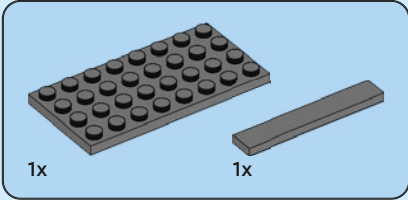
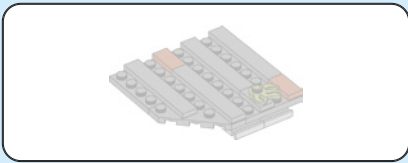

58

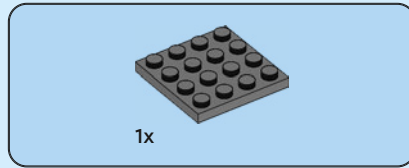
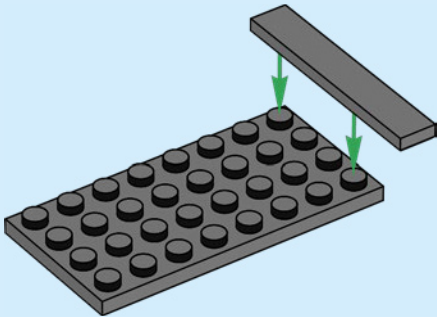

59

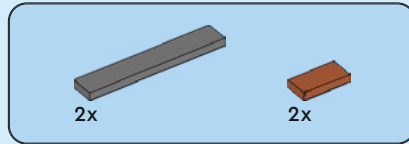
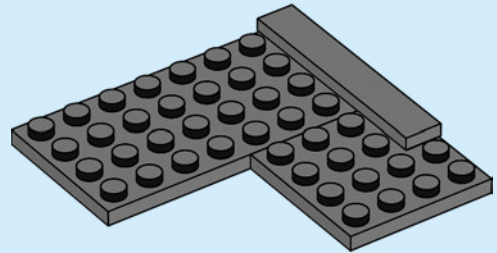

60

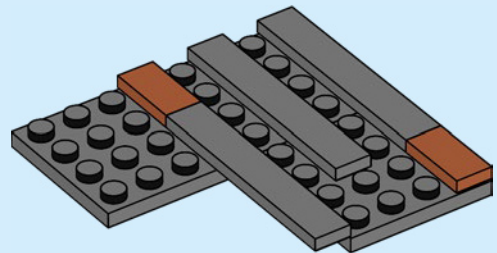



2x

65

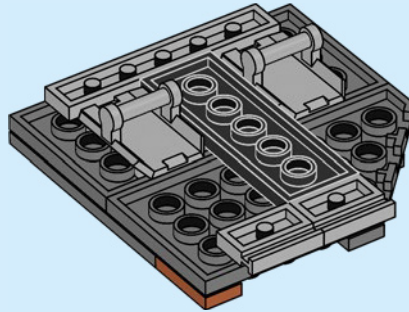

1x



1x

66

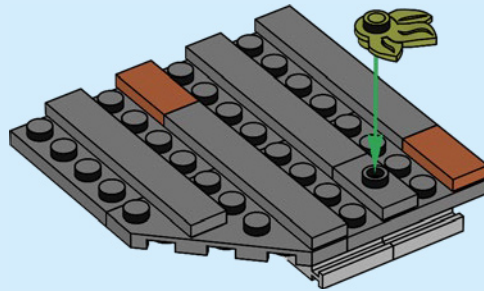

67

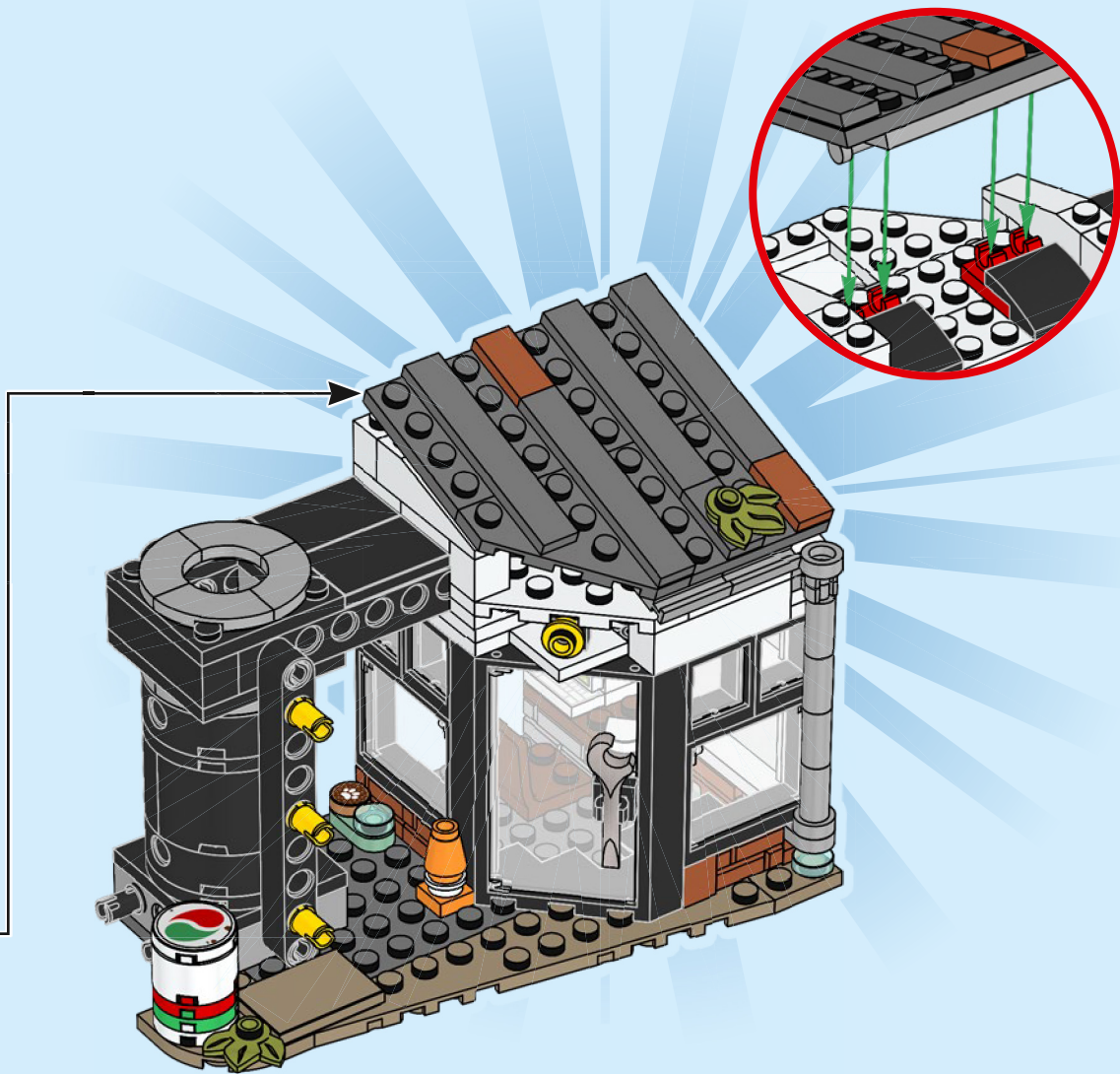

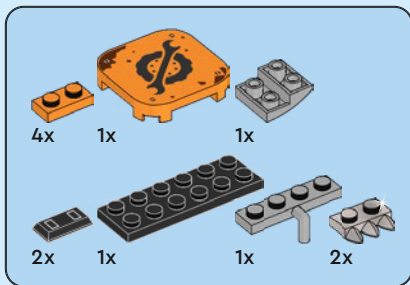

68

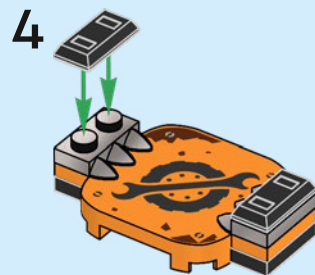
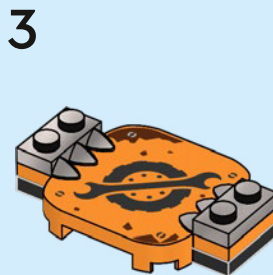
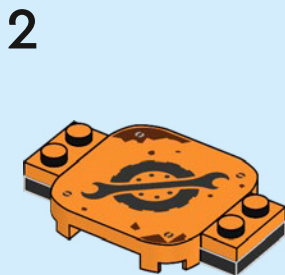
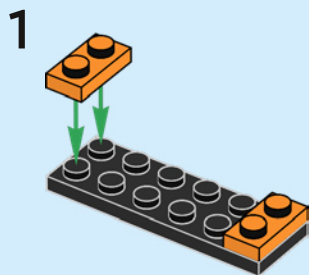



5

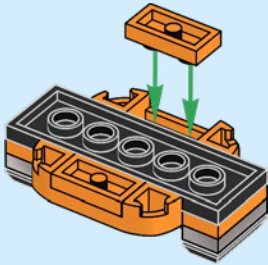

6

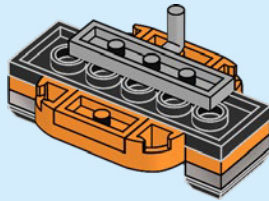

7

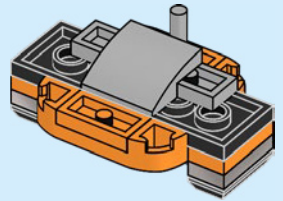

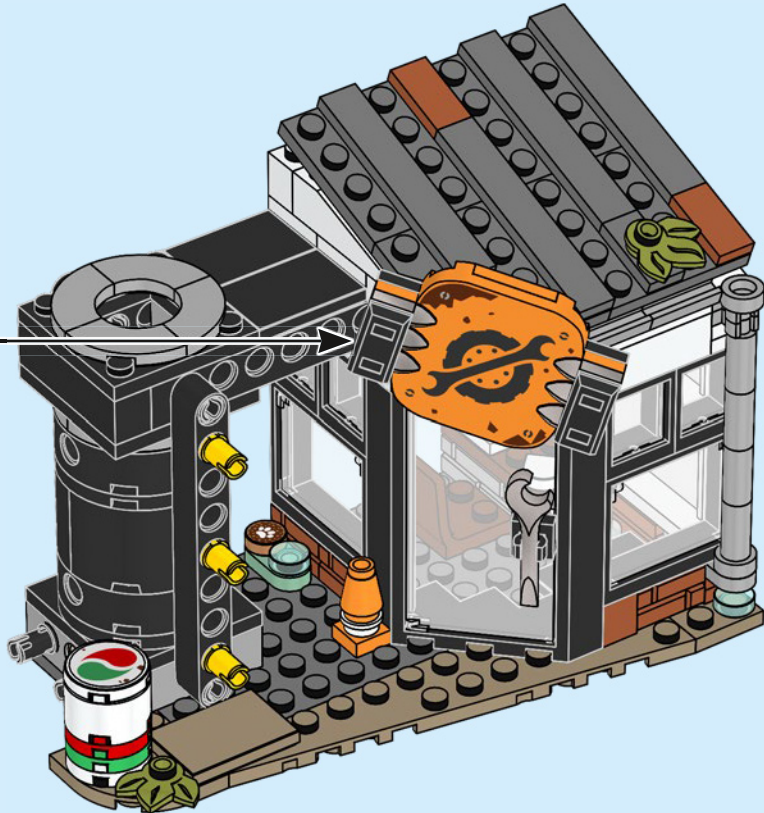

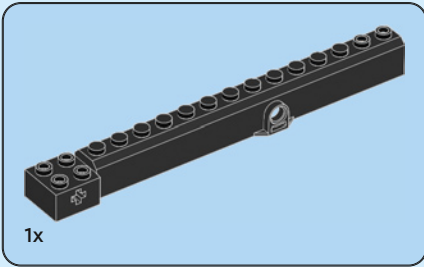
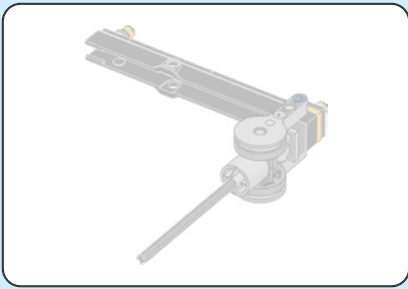

69

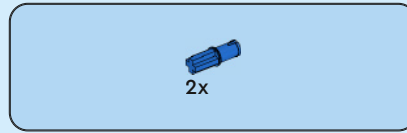
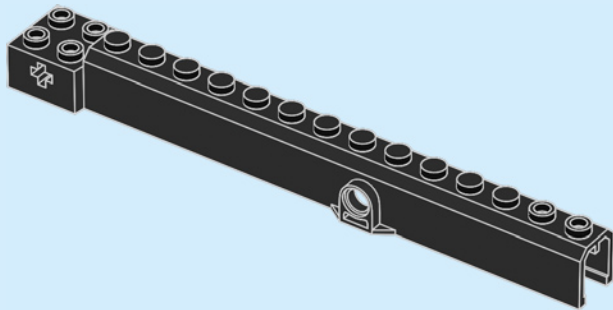

70

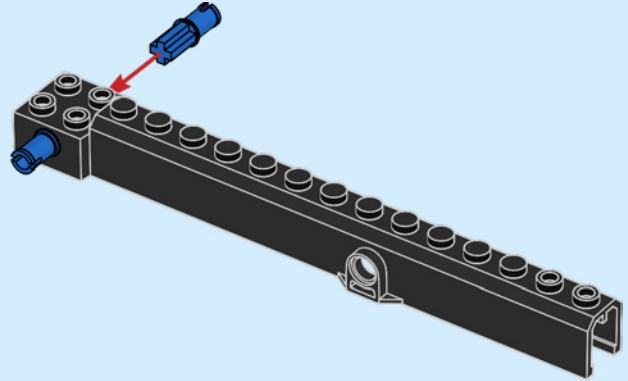

71

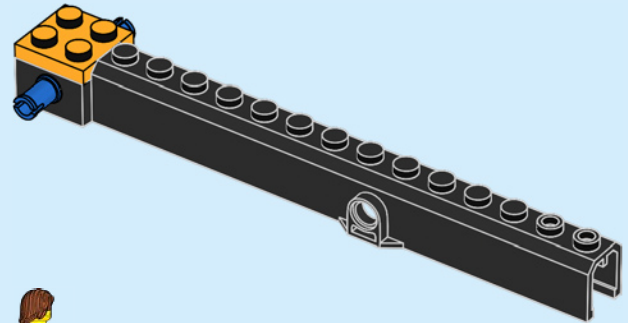

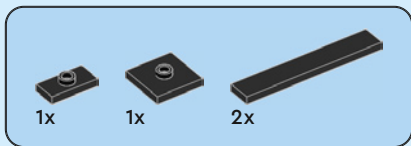

72

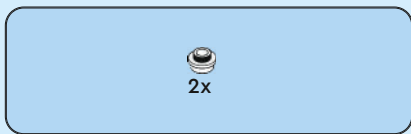
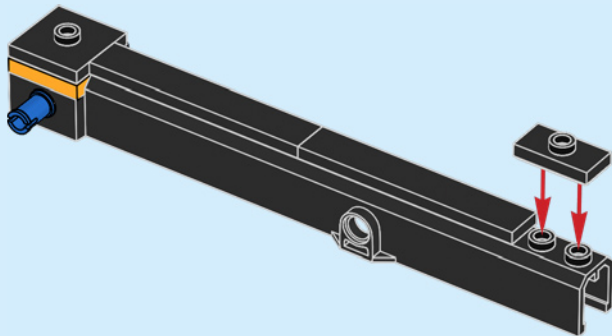

73

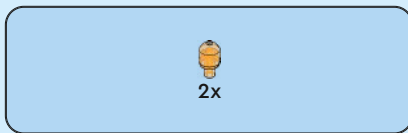
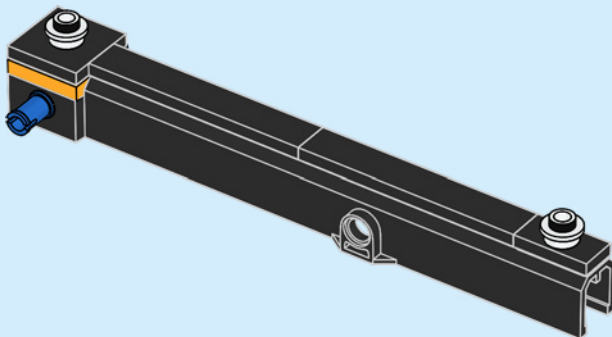

74

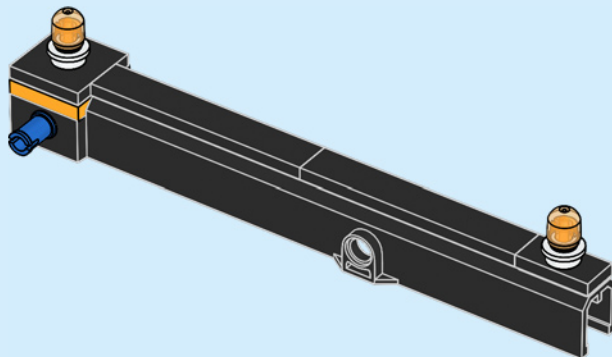

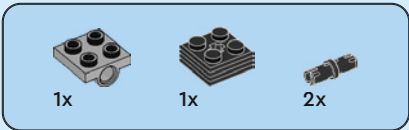

75

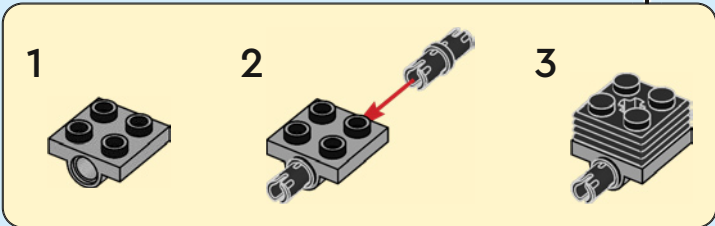
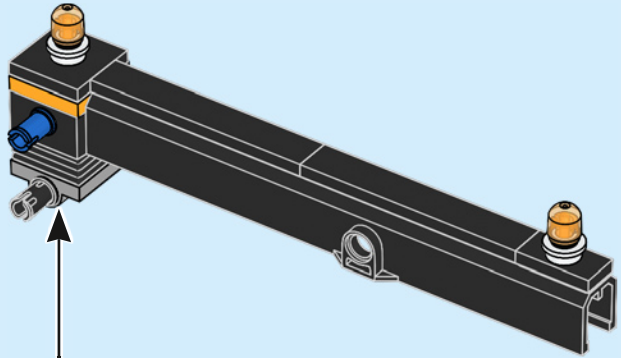

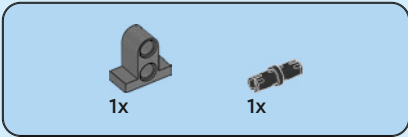

76

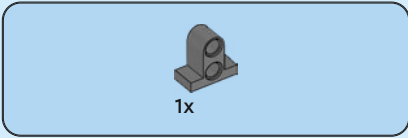
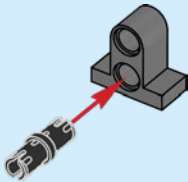

77

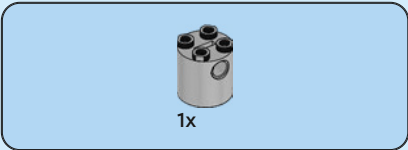
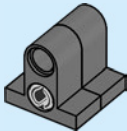

78

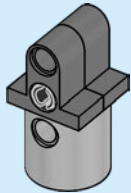

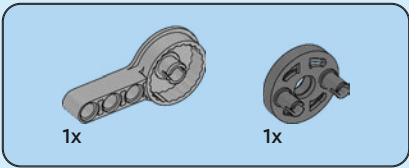

79

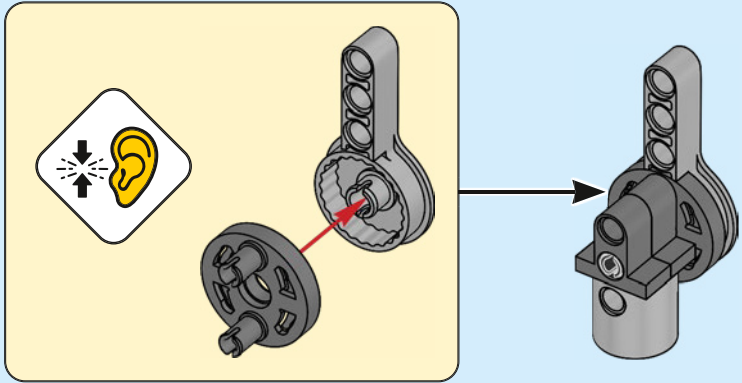

80

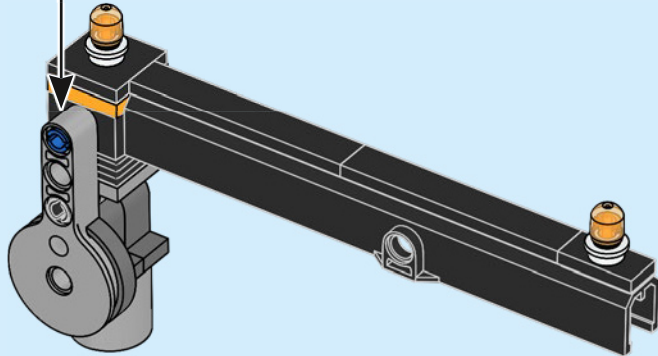

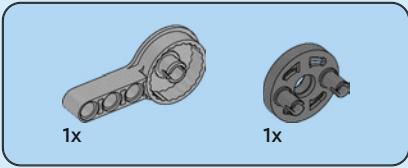

81

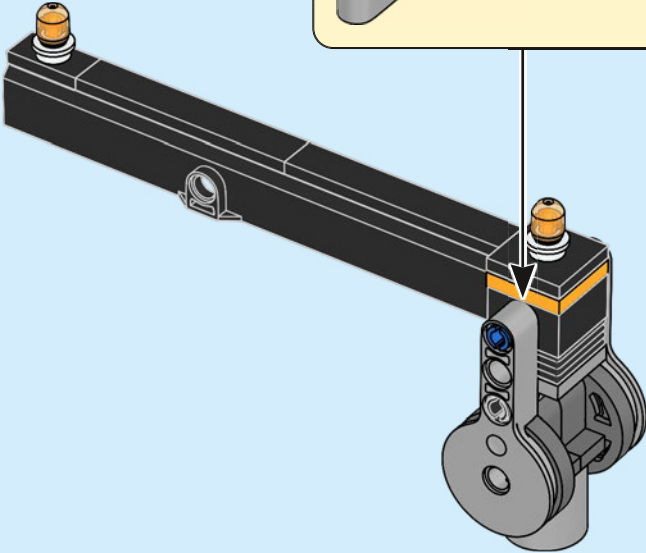
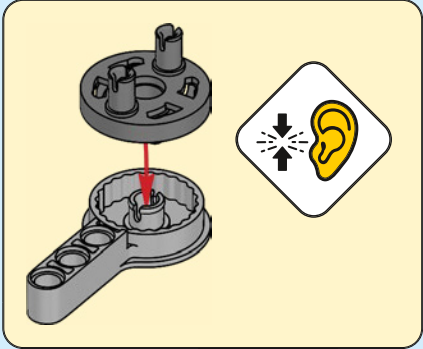

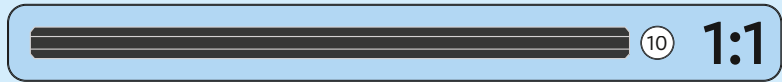
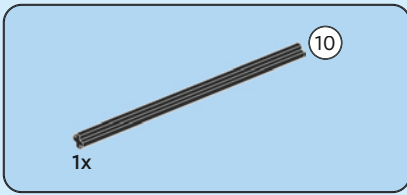

82

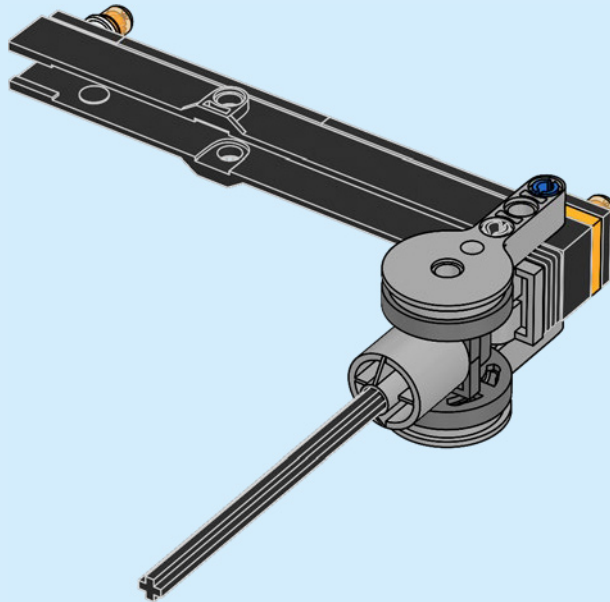

83

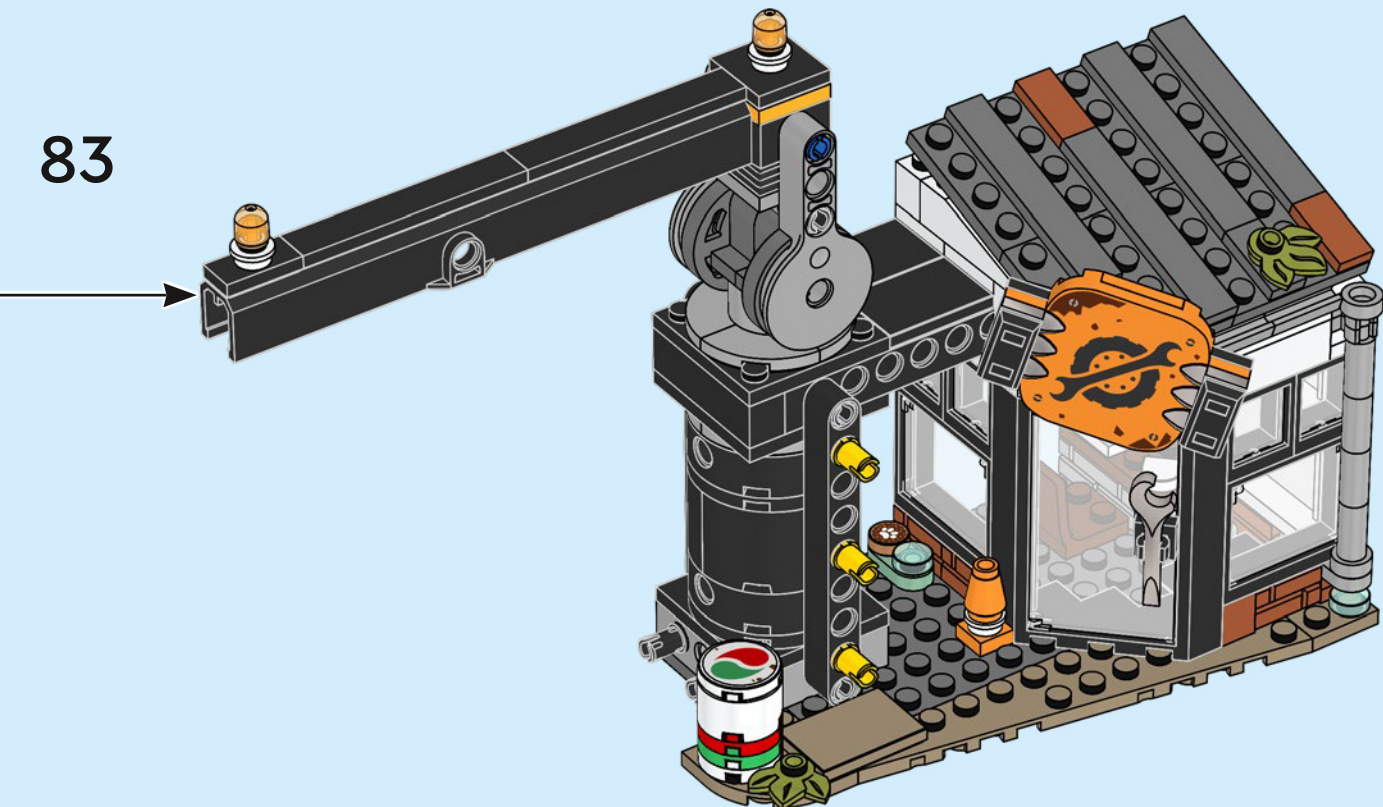

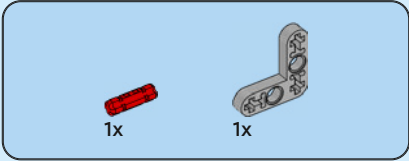
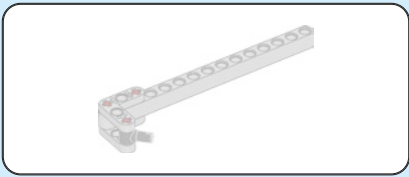

84

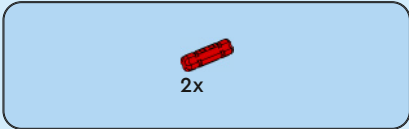
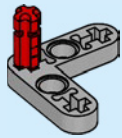

85

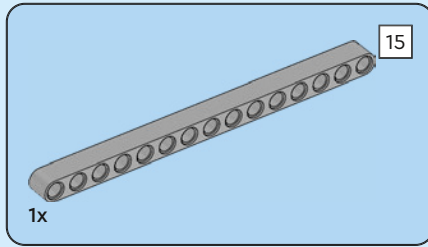
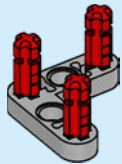

86

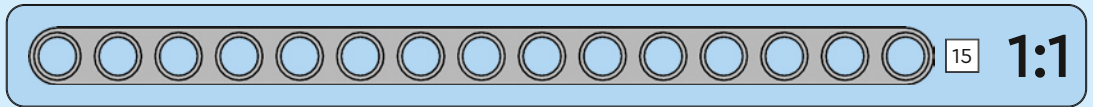
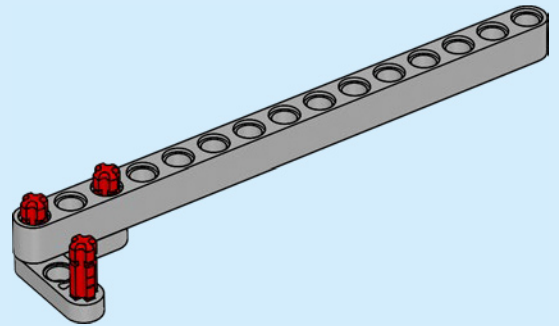



1x

87

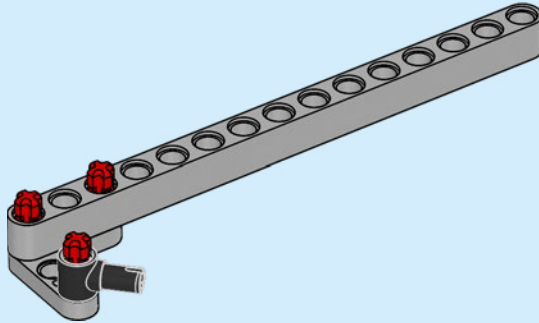

1x

88

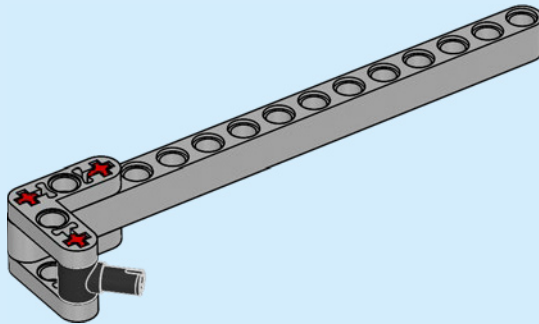

89

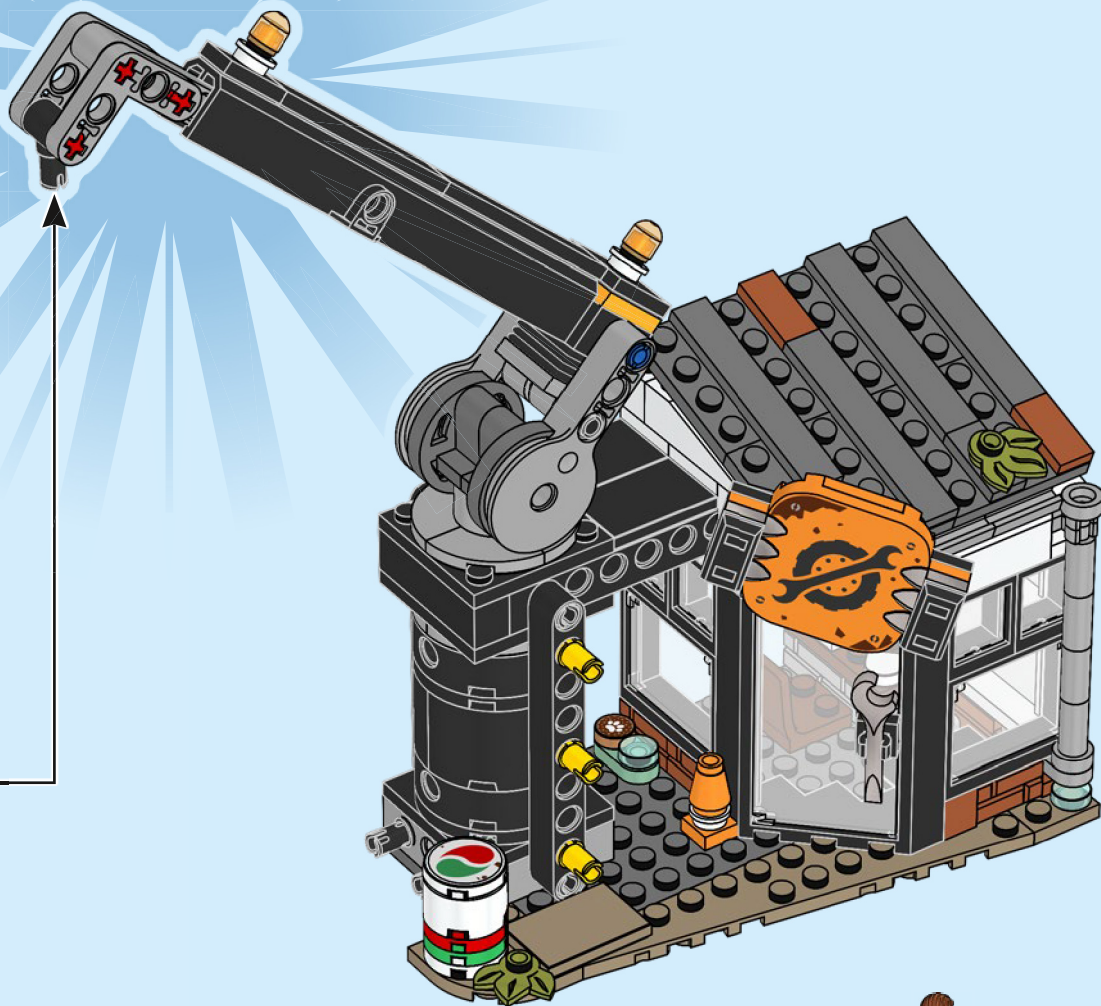

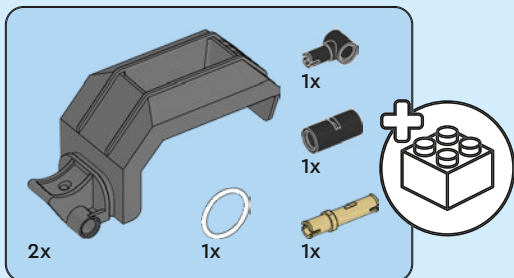
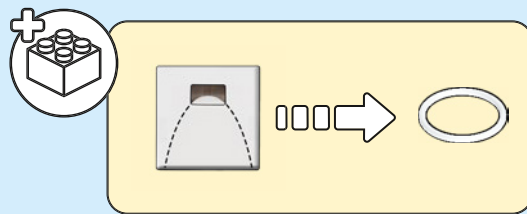
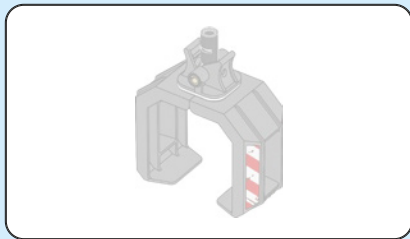

90

1

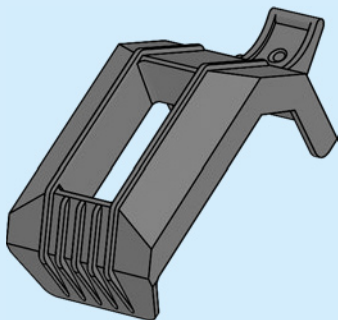

2

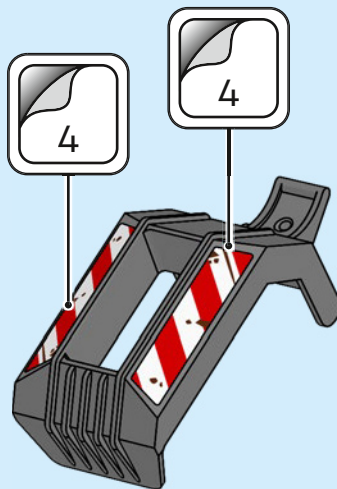



3

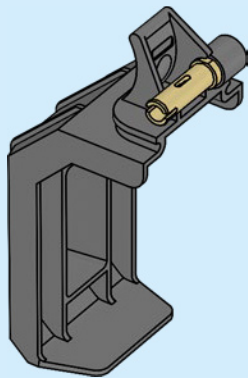

4

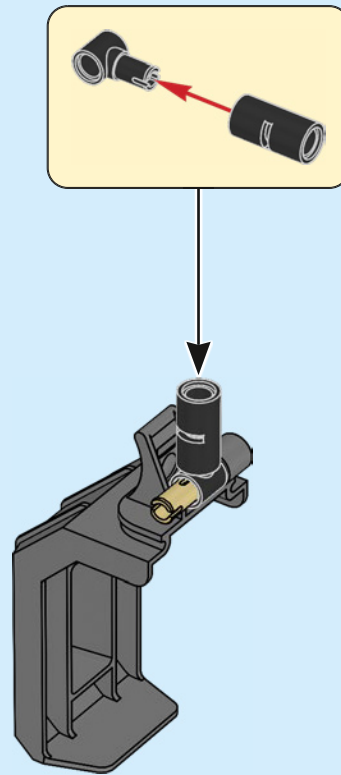

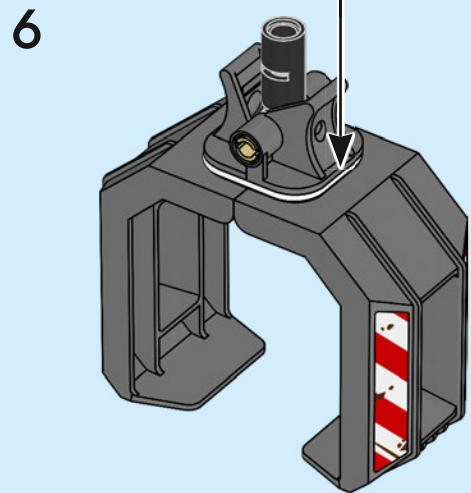
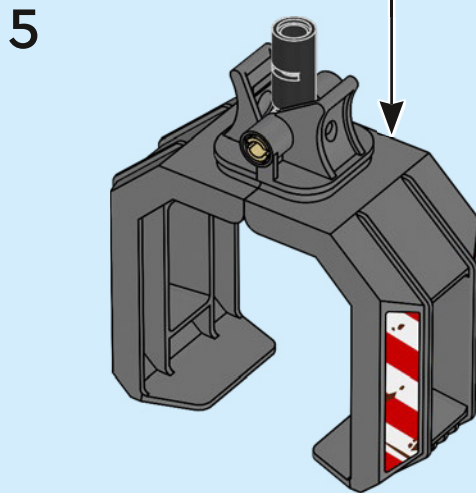
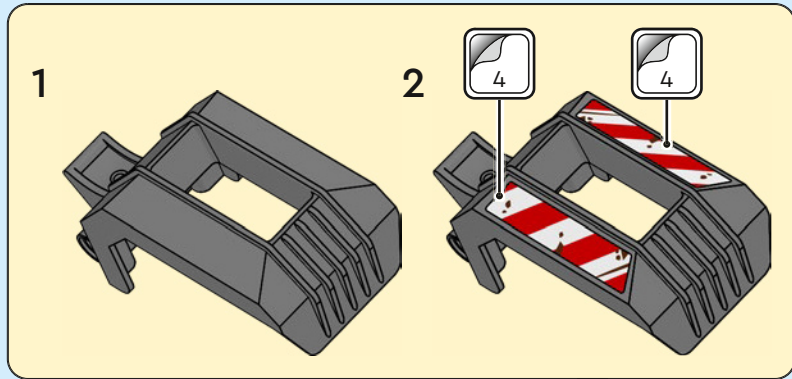

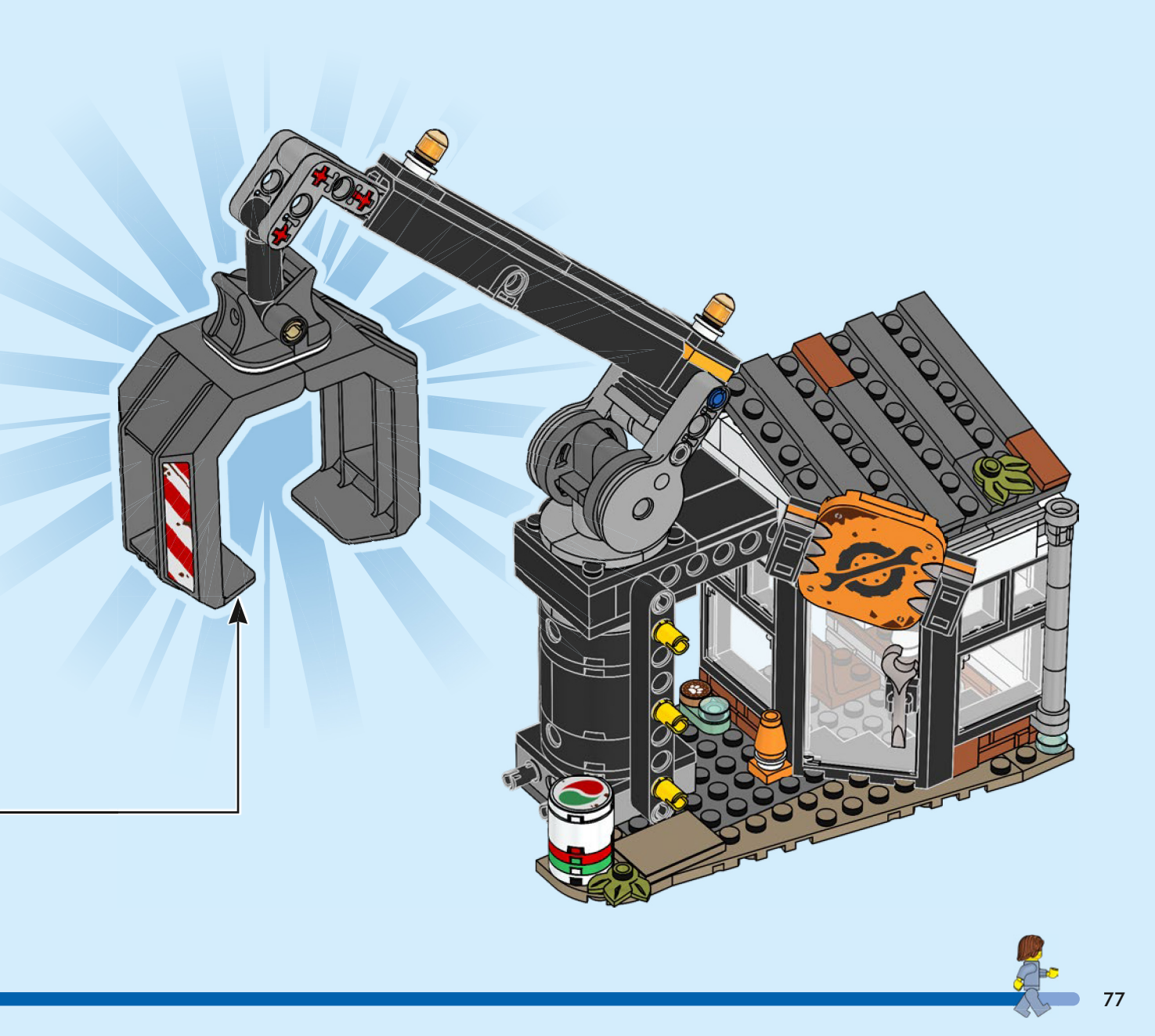



1x

91

