



CITY

60460



Q LEGO® Builder





LEGO.com/sustainable-packaging



FR
DONNEZ
OU
RECYCLEZ

 OU  OU 

ASSOCIATION MAGASIN DÉCHÈTERIE

Adresses sur quefairedemesdechets.fr



Q LEGO® Builder

BUILDER



Apple and the Apple logo are trademarks of Apple Inc., registered in the U.S. and other countries and regions. App Store is a service mark of Apple Inc. Google Play and the Google Play logo are trademarks of Google LLC. Tencent and the Tencent logo are trademarks of Tencent Inc.

Q LEGO.com/devicecheck

EN Ask parents' permission before going online | **DE** Eltern um Erlaubnis bitten, bevor du online gehst | **FR** Demande l'autorisation d'un parent avant d'aller en ligne | **IT** Chiedi il permesso ai tuoi genitori prima di andare online | **ES** Pídeles permiso a tus papás antes de conectarte a Internet | **PT** Peça autorização aos pais antes de acederes online | **ZH** 上网前应先征得父母的同意 | **PL** Poproś rodziców o zgodę, zanim wejdiesz do Internetu | **CS** Než půjdeš na internet, požádej rodiče o svolení | **SK** Skôr než pôjdeš na internet, vypýtaj si povolenie od rodičov | **HU** Kérj szülői engedélyt, mielőtt online csatlakoznál! | **RO** Cere permisiunea părinților înainte de a te conecta online | **BG** Поискайте разрешение от родител, преди да влезете онлайн | **LV** Pirms došanās tiešsaistē palūdz atļauju vecākiem | **ET** Enne Interneti kasutamist küsi vanematelt luba | **LT** Prieš prisijungdami prie interneto, atsiklauskite tėvų





EN Build It Your Way | **DE** Bau, wie du willst | **FR** Construisez à votre façon | **IT** Costruiscilo come vuoi tu | **ES** Constrúyelo a tu manera | **PT** Constrói à Tua Maneira | **ZH** 自由拼搭 | **PL** Zbuduj po swojemu | **CS** Postavte to po svém | **SK** Postavte to po svojom | **HU** Építs kedved szerint! | **RO** Construięște așa cum dorești | **BG** Постройте го по своя начин | **LV** Būvē tieši tā, kā vēlies | **ET** Ehita enda moodi | **LT** Sukonstruokite savaip

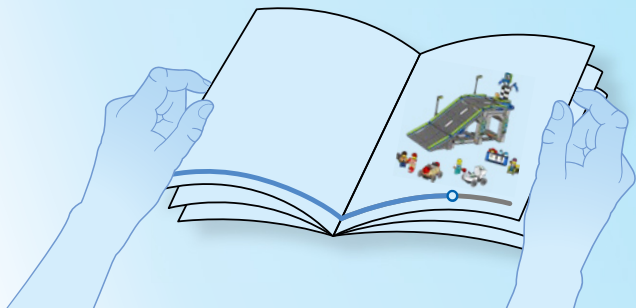

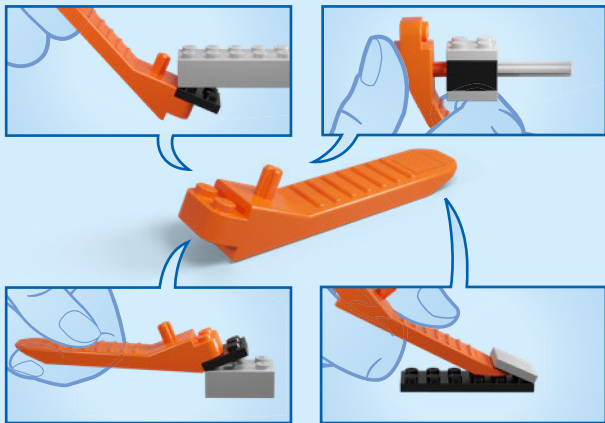

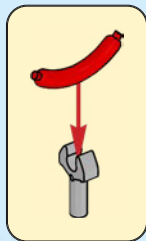

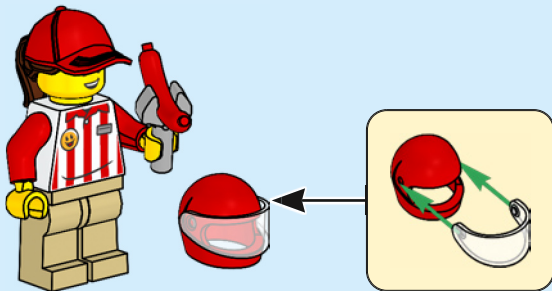
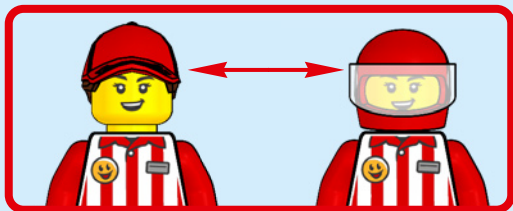

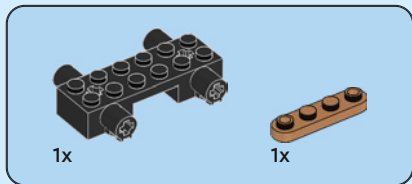

1

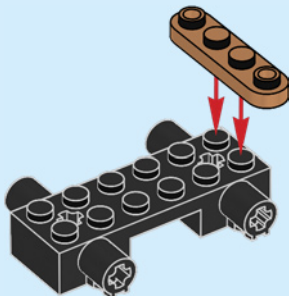

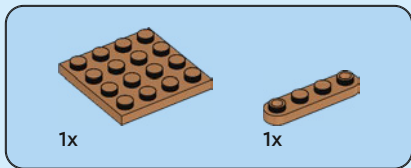

2

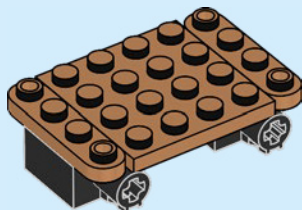



2x

3

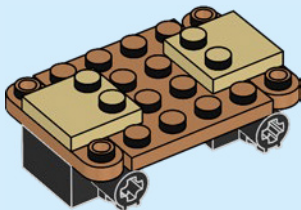



2x

4

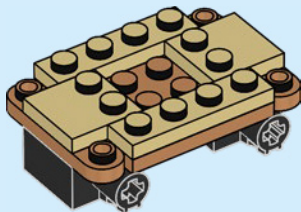



4x

5

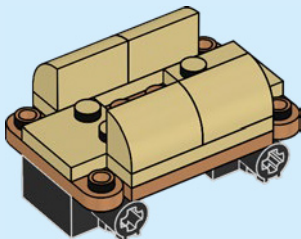

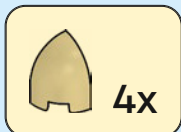
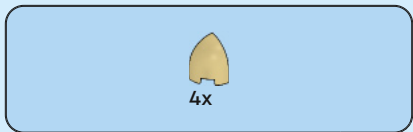

6

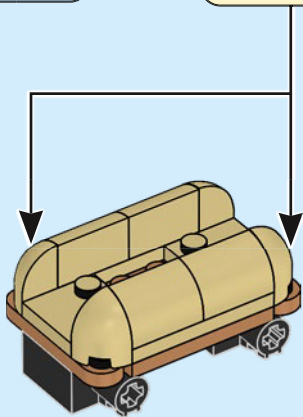

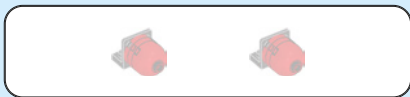

7

1

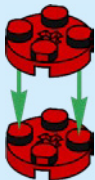

2



3

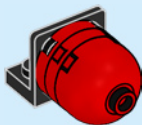

2x

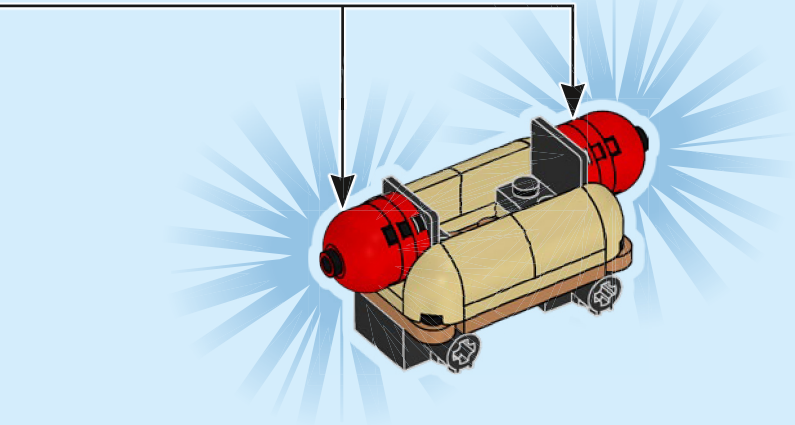



1x



1x

8

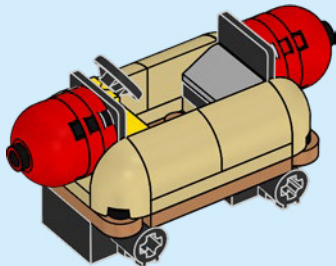



4x

9



4x

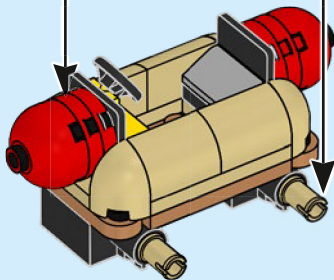

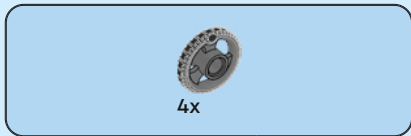

10

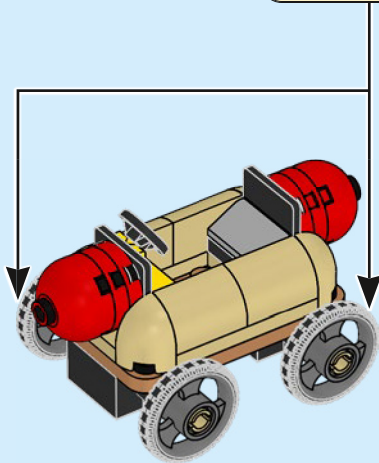



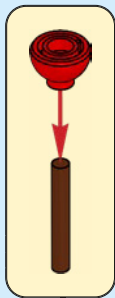
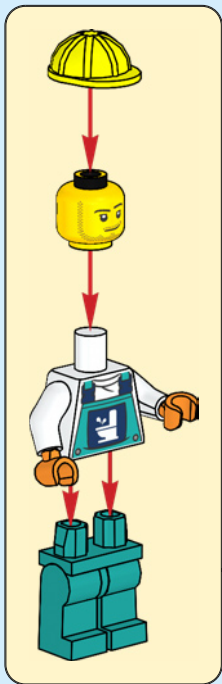

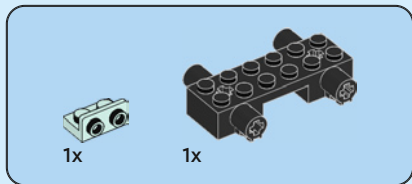

1

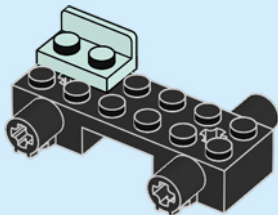



3x

2

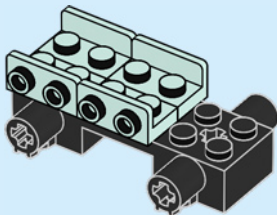



2x

3

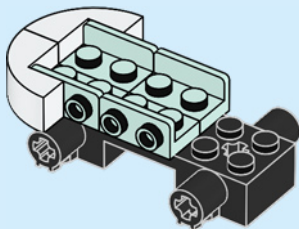



2x



2x

4

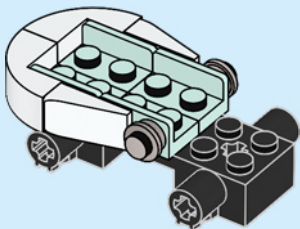



1x

5

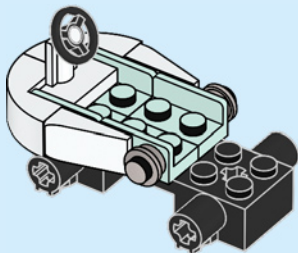



1x

6

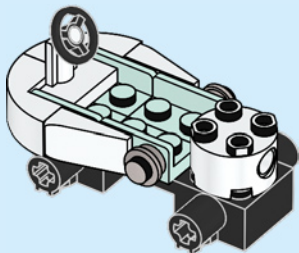



1x



1x

7

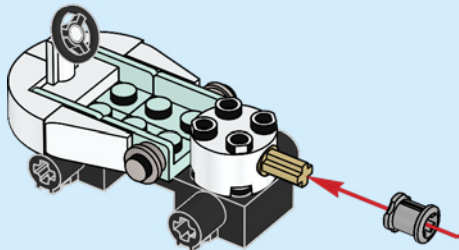



2x

8

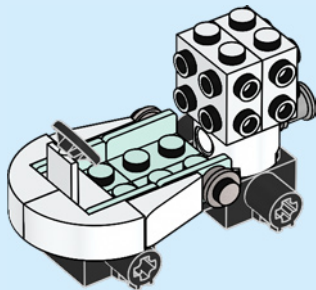



1x



1x

9

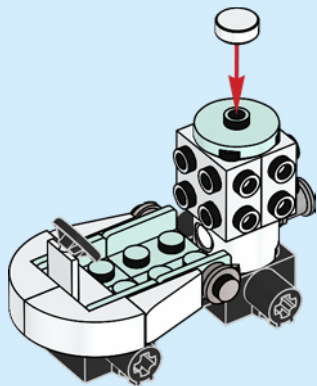



2x



2x

10



2x

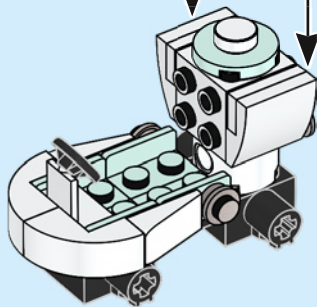



1x

11

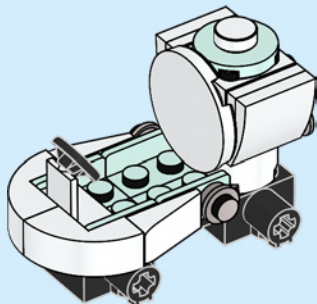



4x

12



4x

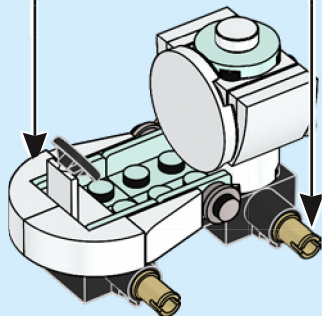

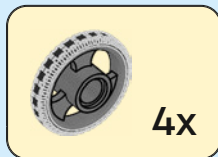
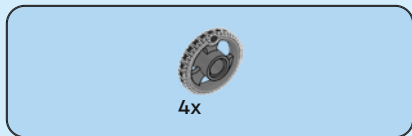

13

