



# NINJAGO

## DRAGONS RISING

71841



**WARNING: CHOKING HAZARD.**  
Toy contains small parts and a small ball.  
Not for children under 3 years.



LEGO® Builder



### **Get excited about our new packaging!**

We're switching from plastic to paper-based packaging. That's why you might find a mix of paper and plastic in our boxes!

### **Nos nouveaux emballages vous emballeront !**

Nous passons des emballages en plastique aux emballages à base de papier. C'est pourquoi vous pourriez trouver un mélange de papier et de plastique dans nos boîtes !

### **¡Te presentamos nuestros nuevos empaques!**

Estamos sustituyendo las bolsas de plástico por bolsas con base de papel. ¡Por eso, puedes encontrar una mezcla de papel y de plástico en nuestras cajas!

**[LEGO.com/sustainable-packaging](https://www.lego.com/sustainable-packaging)**



# BUILDER



Apple and the Apple logo are trademarks of Apple Inc., registered in the U.S. and other countries and regions. App Store is a service mark of Apple Inc. Google Play and the Google Play logo are trademarks of Google LLC. Tencent and the Tencent logo are trademarks of Tencent Inc.



**EN** Ask parents' permission before going online | **DE** Eltern um Erlaubnis bitten, bevor du online gehst | **FR** Demande l'autorisation d'un parent avant d'aller en ligne | **IT** Chiedi il permesso ai tuoi genitori prima di andare online | **ES** Pídeles permiso a tus papás antes de conectarte a Internet | **PT** Pede autorização aos pais antes de acederes online | **ZH** 上网前应先征得父母的同意 | **PL** Poproś rodziców o zgodę, zanim wejdiesz do Internetu | **CS** Než půjdeš na internet, požádej rodiče o svolení | **SK** Skôr než pôjdeš na internet, vypýtaj si povolenie od rodičov | **HU** Kérj szülői engedélyt, mielőtt online csatlakoznál! | **RO** Cere permisiunea părinților înainte de a te conecta online | **BG** Поискайте разрешение от родител, преди да влезете онлайн | **LV** Pirms došanās tiešsaistē palūdz atļauju vecākiem | **ET** Enne Interneti kasutamist küsi vanematelt luba | **LT** Prieš prisijungdami prie interneto, atsiklauskite tėvų



**BUILD IT  
YOUR  
WAY**



CONSTRUISEZ À VOTRE FAÇON  
CONSTRÚYELO A TU MANERA





**AVERTISSEMENT : RISQUE D'ÉTOUFFEMENT.**

Le jouet contient des petites pièces ainsi qu'une petite boule.  
Il ne convient pas aux enfants de moins de 3 ans.



**ADVERTENCIA: PELIGRO DE ASFIXIA.**

Juguete que contiene partes pequeñas y una pelota  
pequeña. No recomendado para niños menores de 3 años.



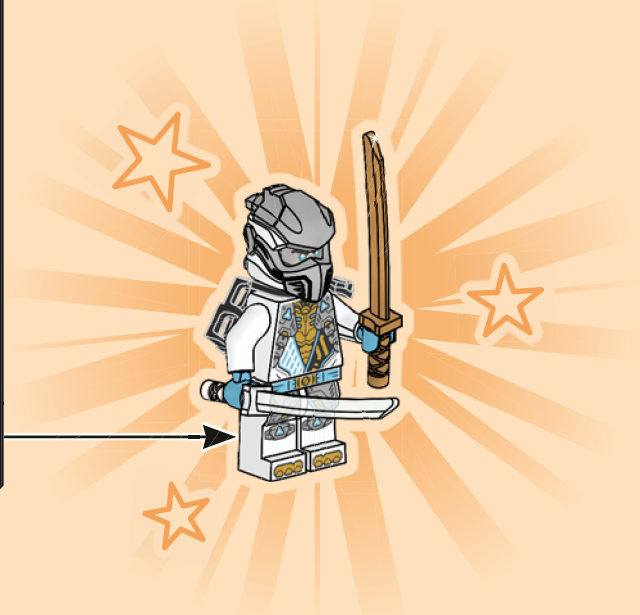
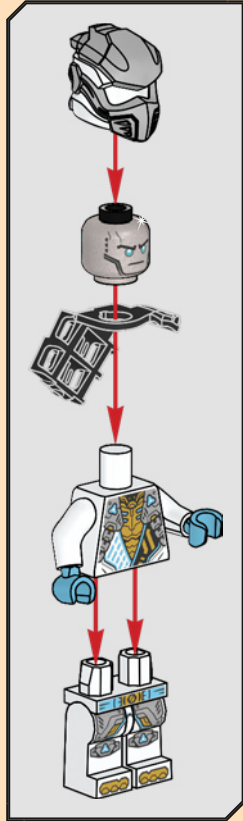

1

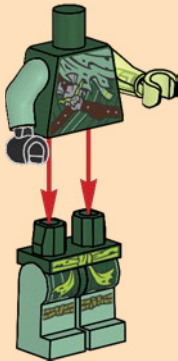

2

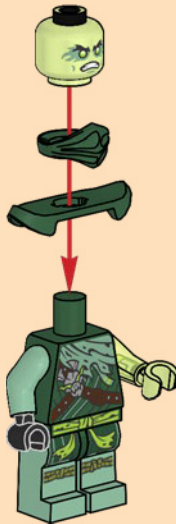

3





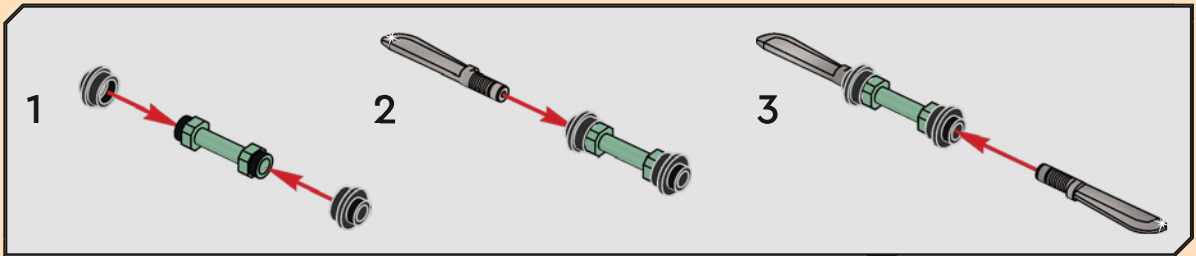

4

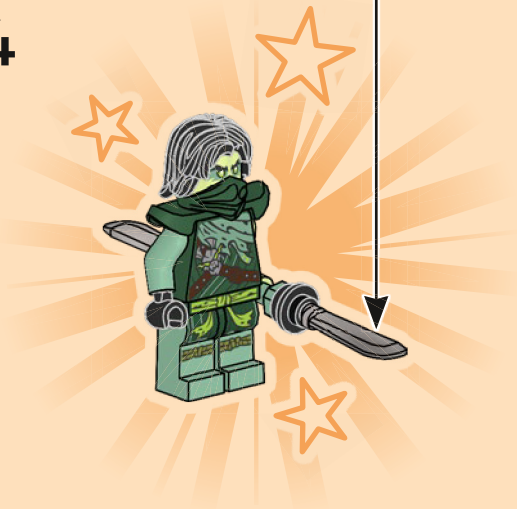

1

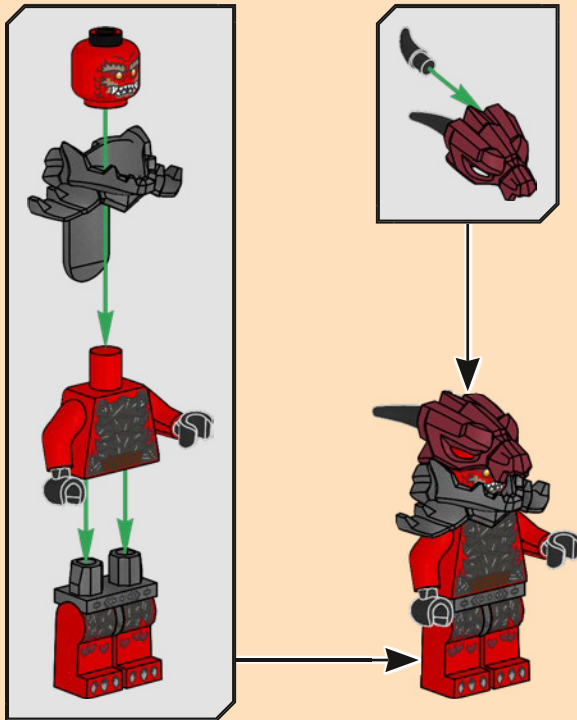

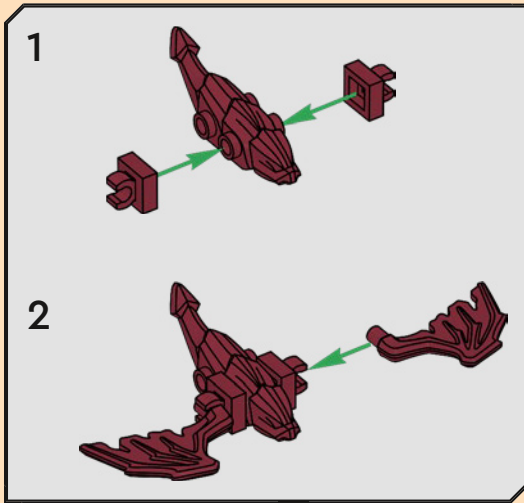

2

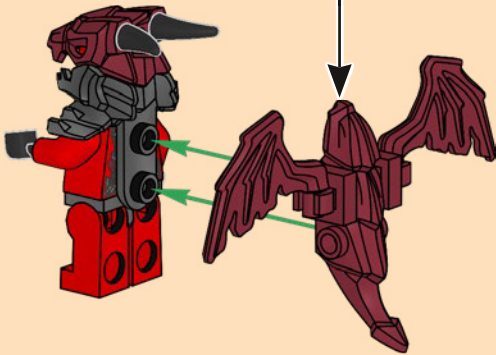

3



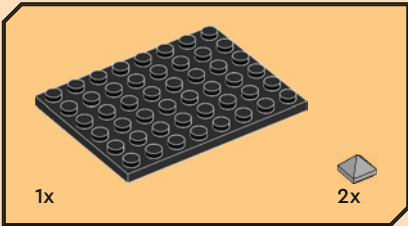
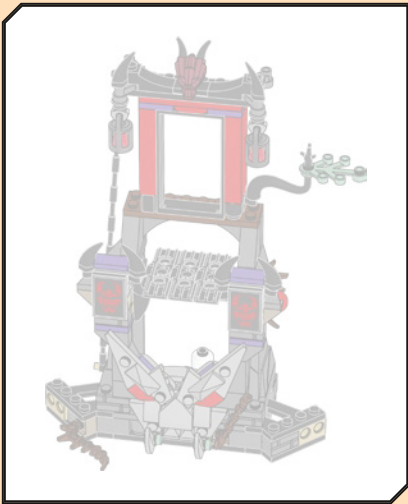

1x

2x

1

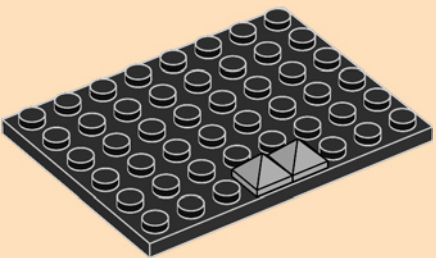

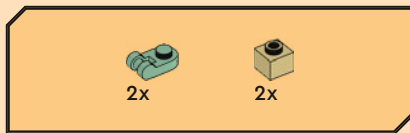

2

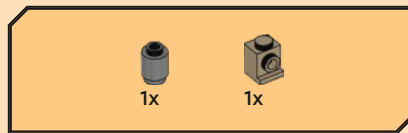
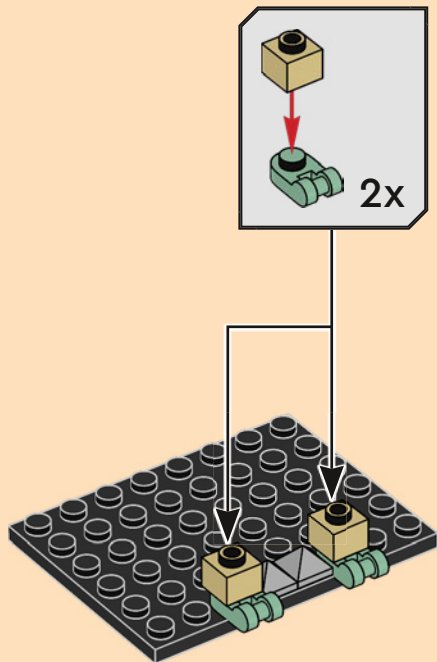

3

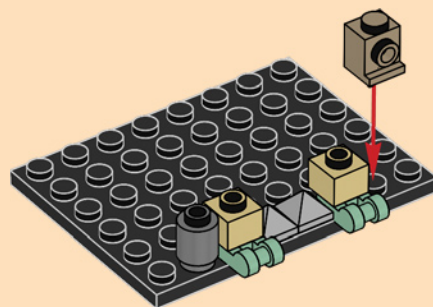

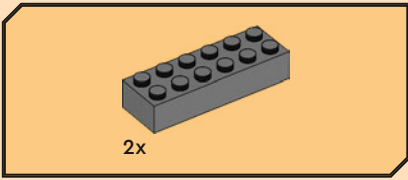

4

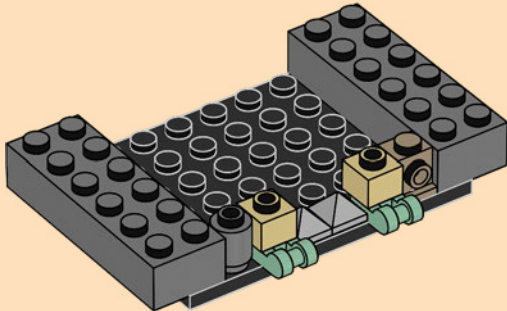

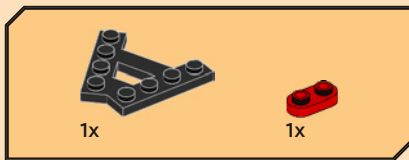

5

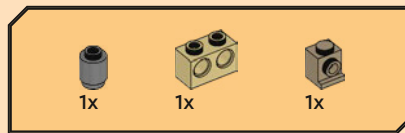
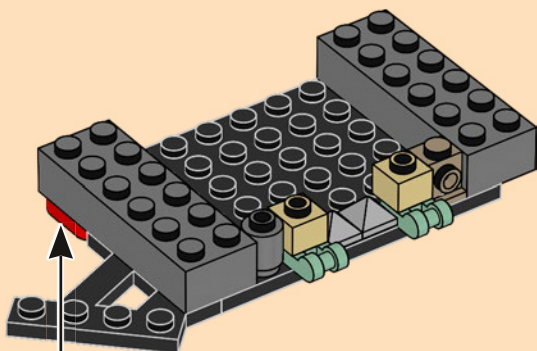

6

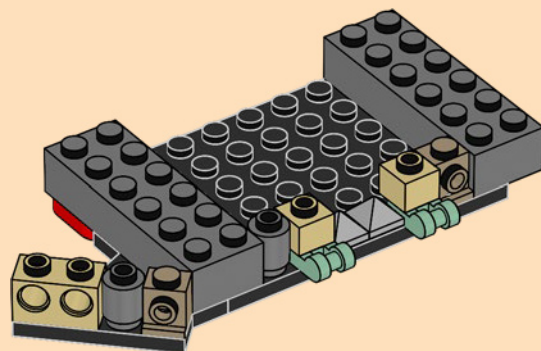

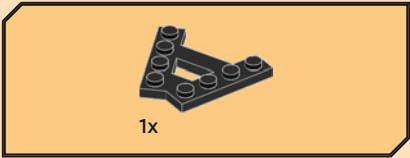

7

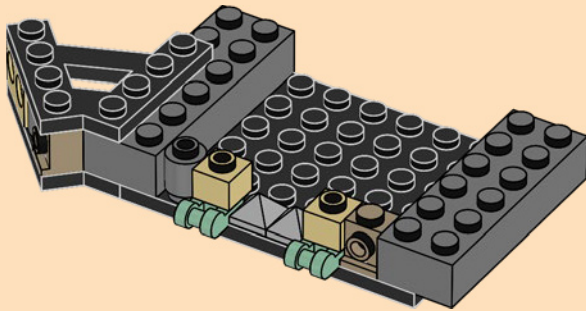



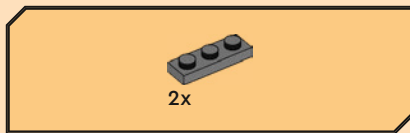

8

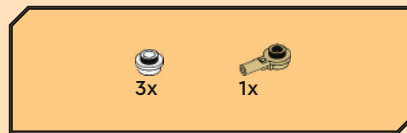
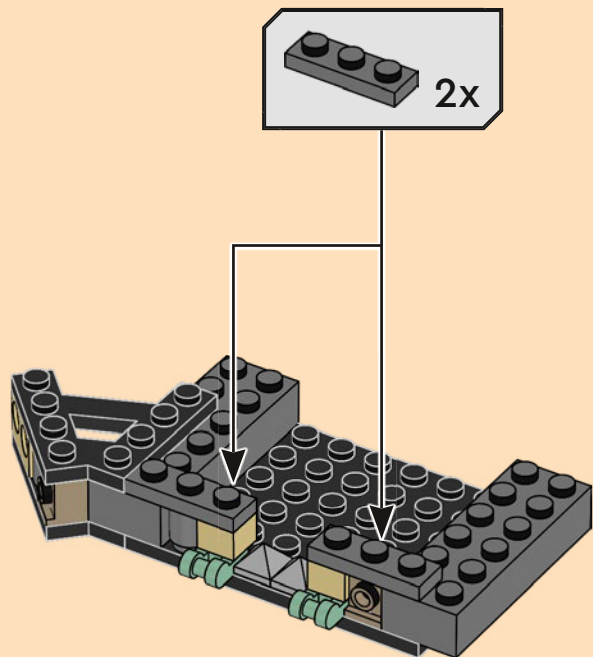

9

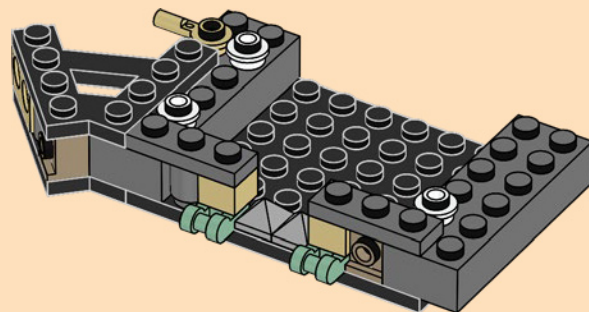

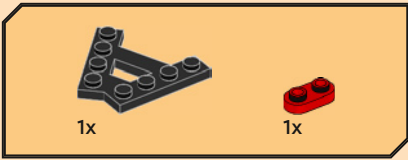

10

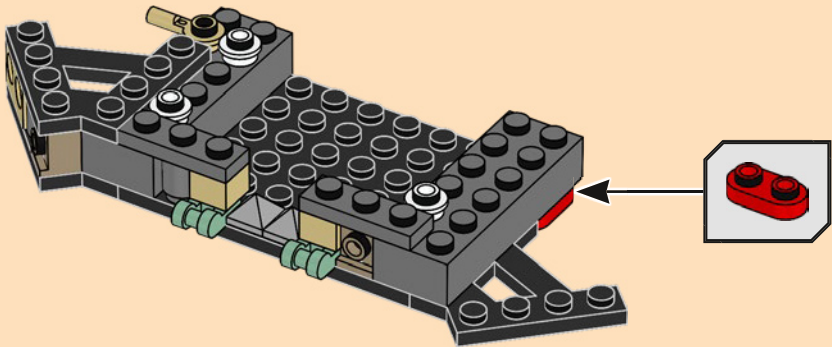

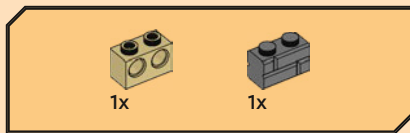

11

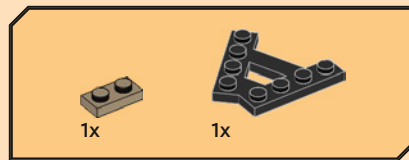
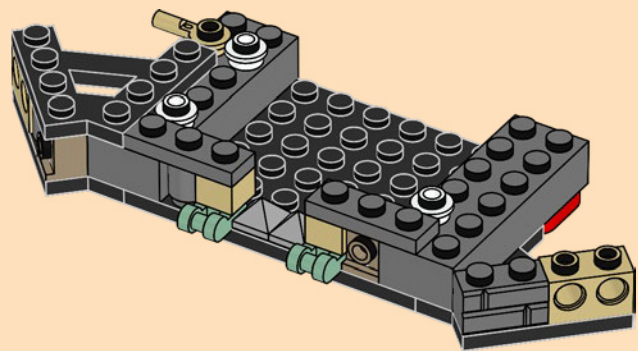

12

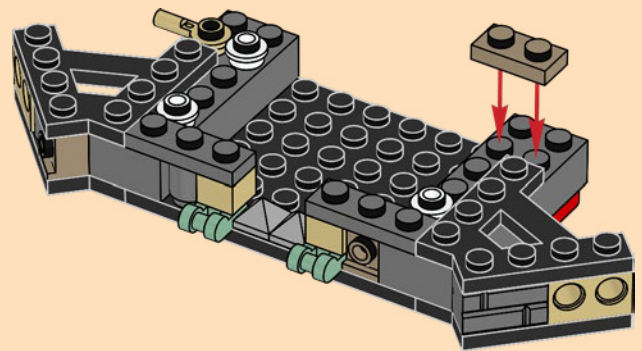

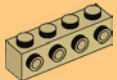

1x

13

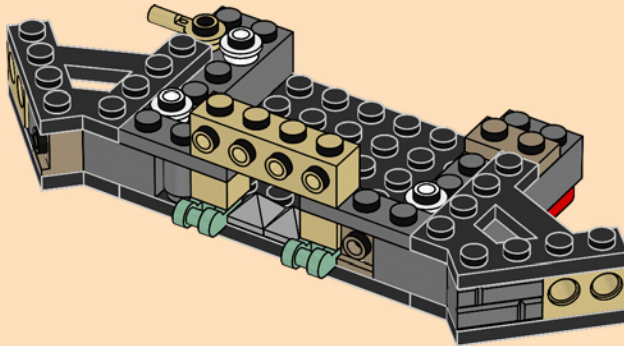

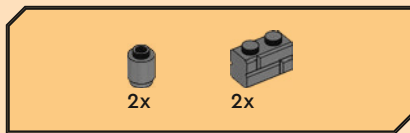

14

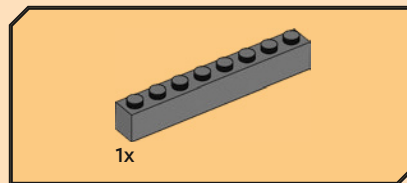
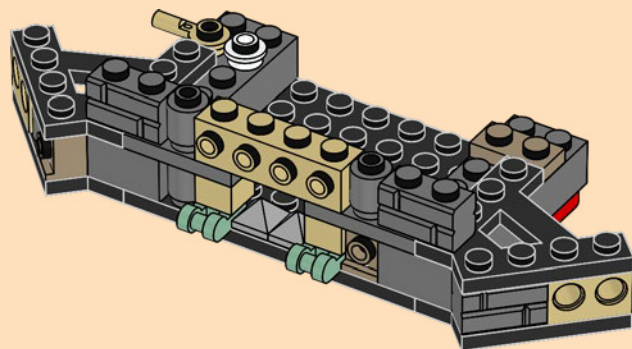

15

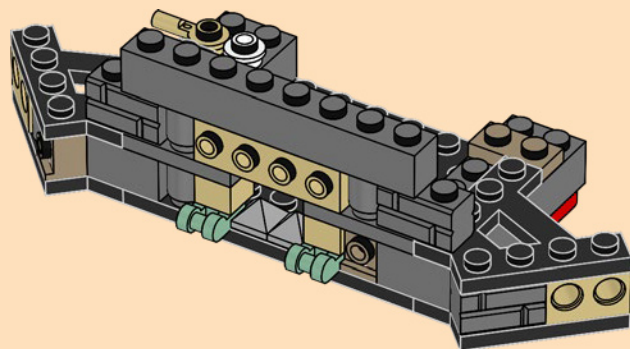

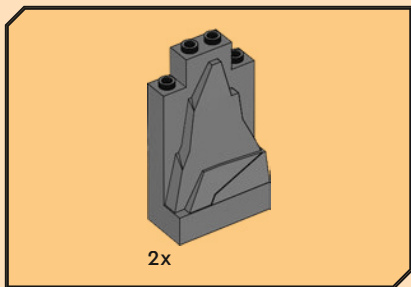

16

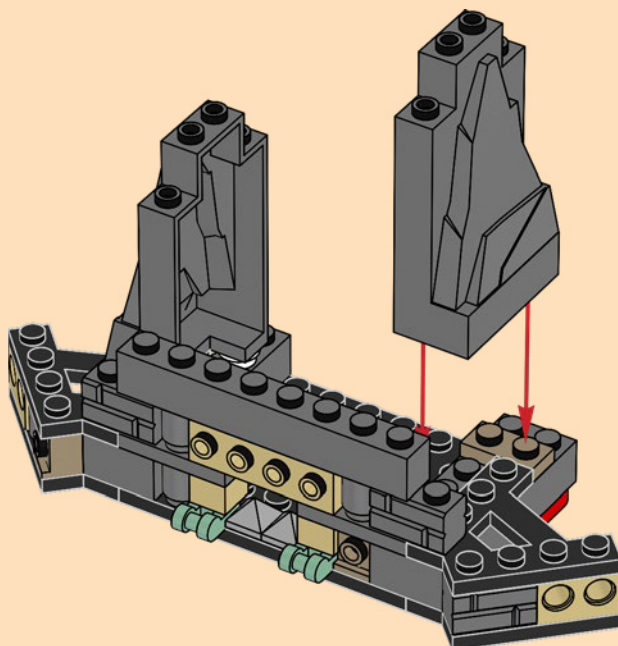



17

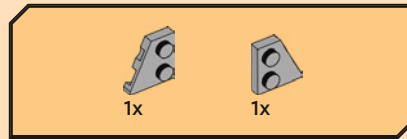
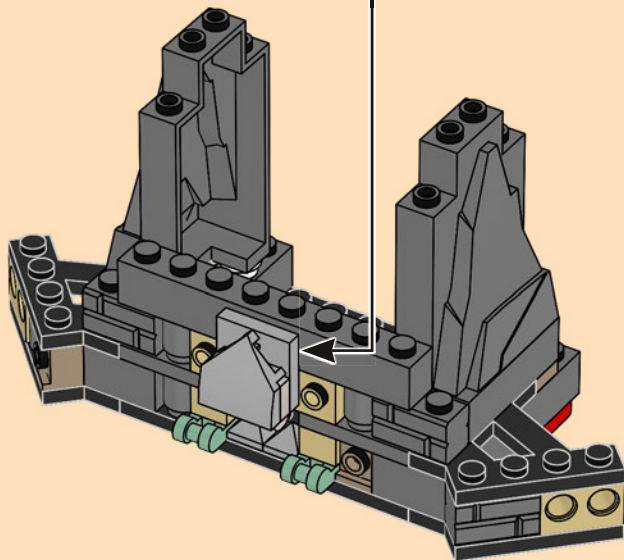
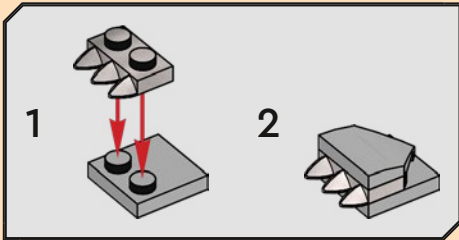

18

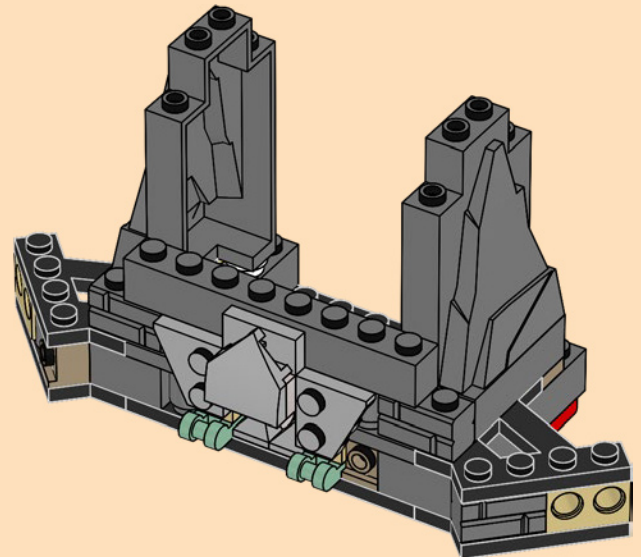



2x

19

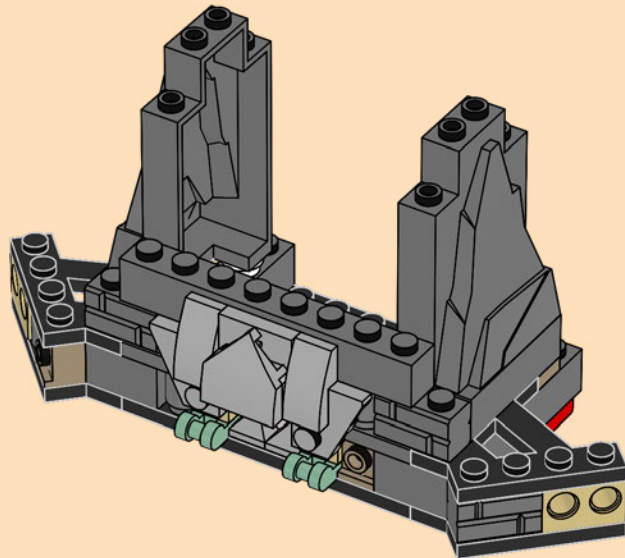





20

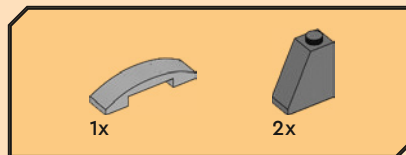
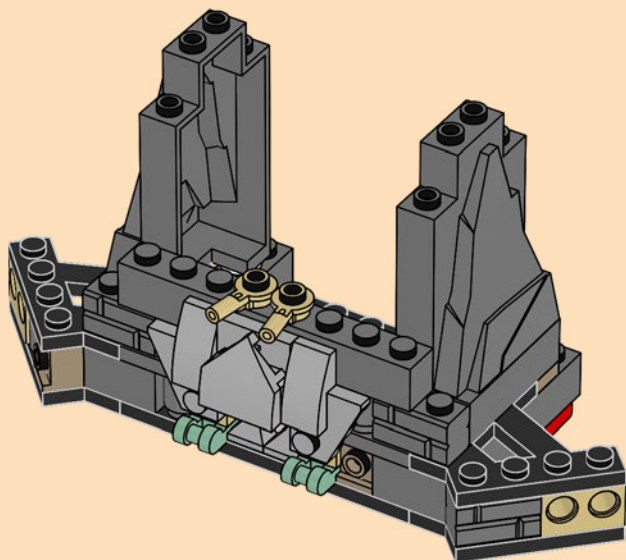

21

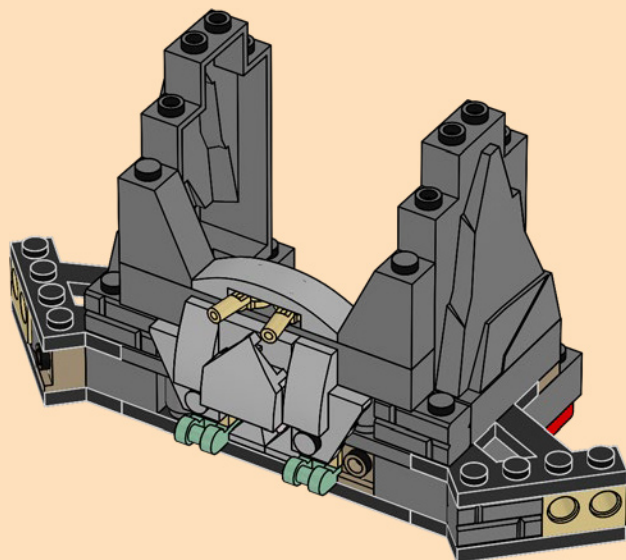



2x

22

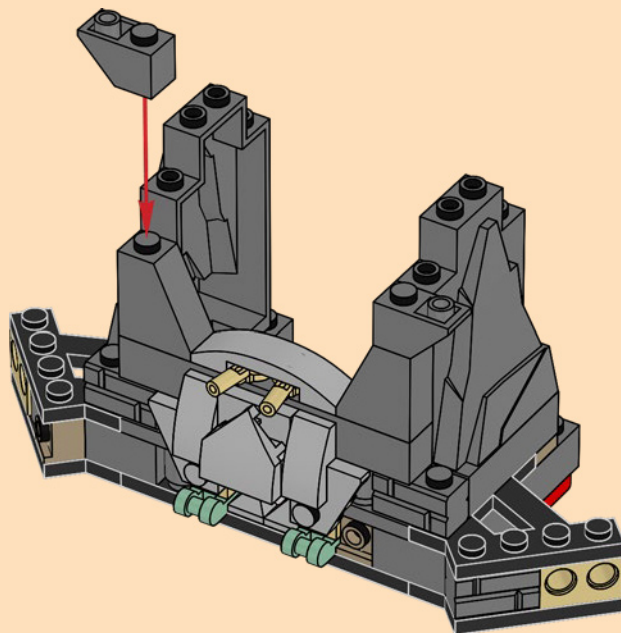



2x

23

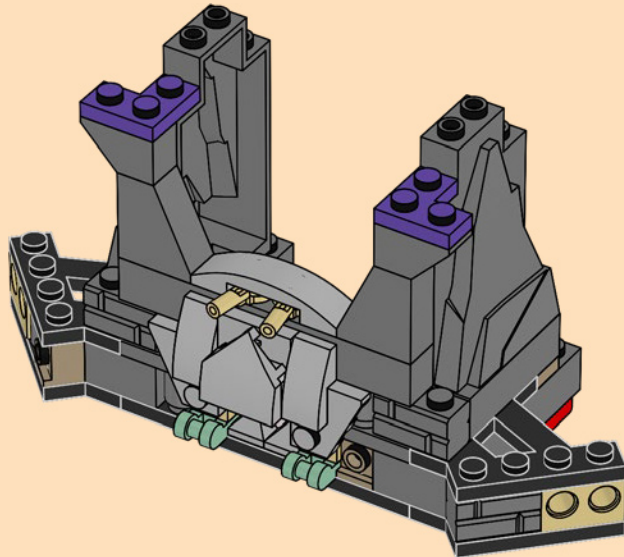

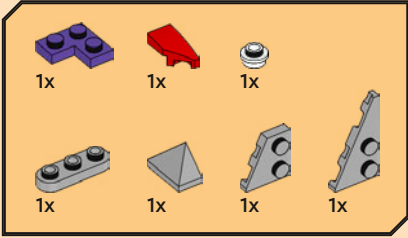
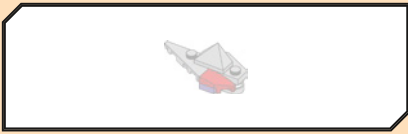

24

1

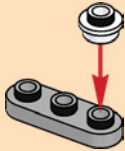

2



3

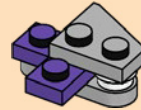

4

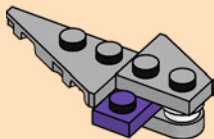

5

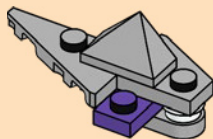

6

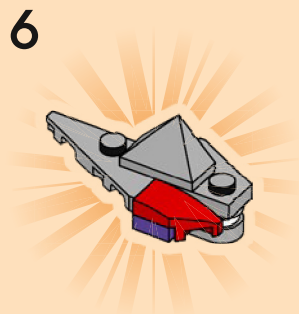

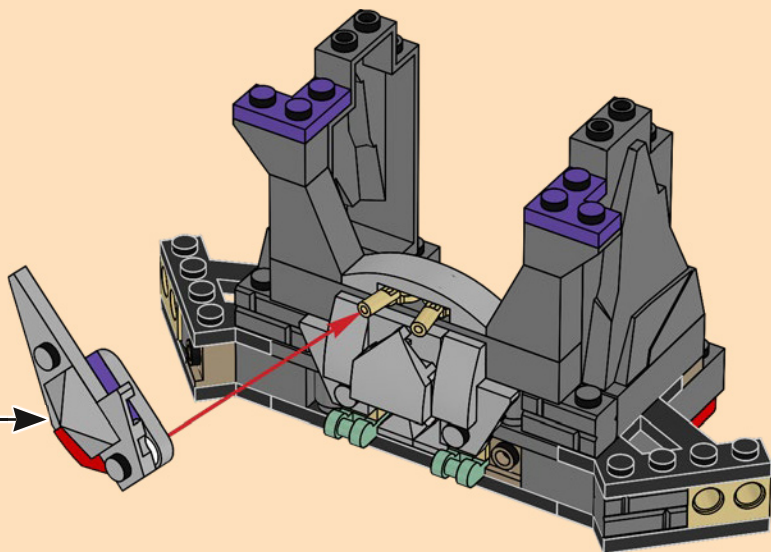

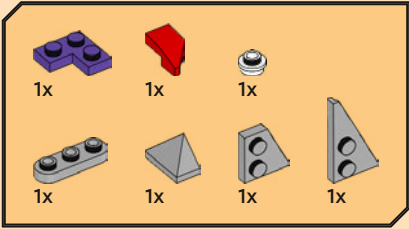
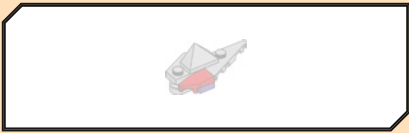

25

1

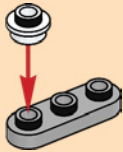

2



3



4

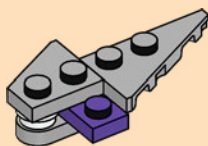

5

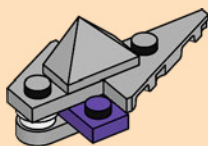

6

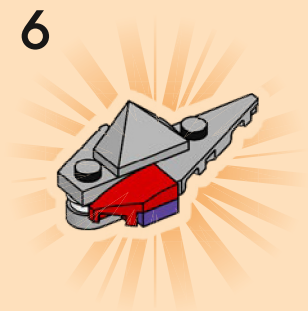



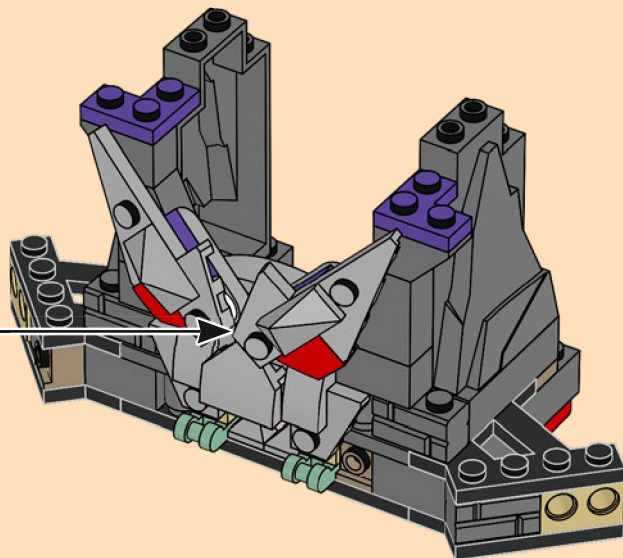



2x

26

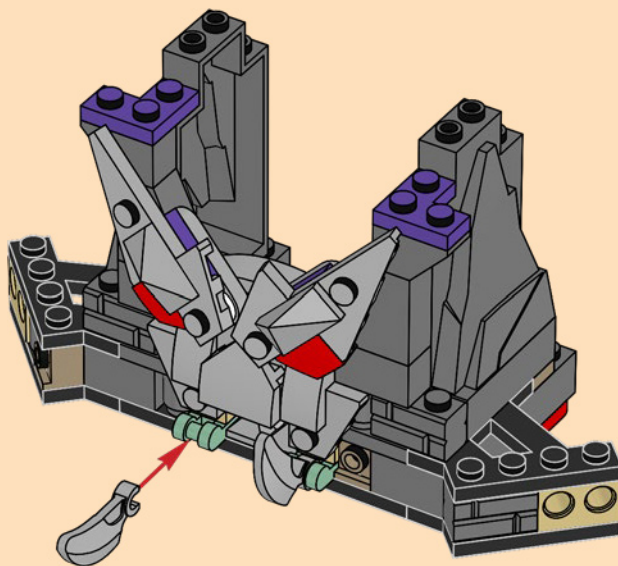



27

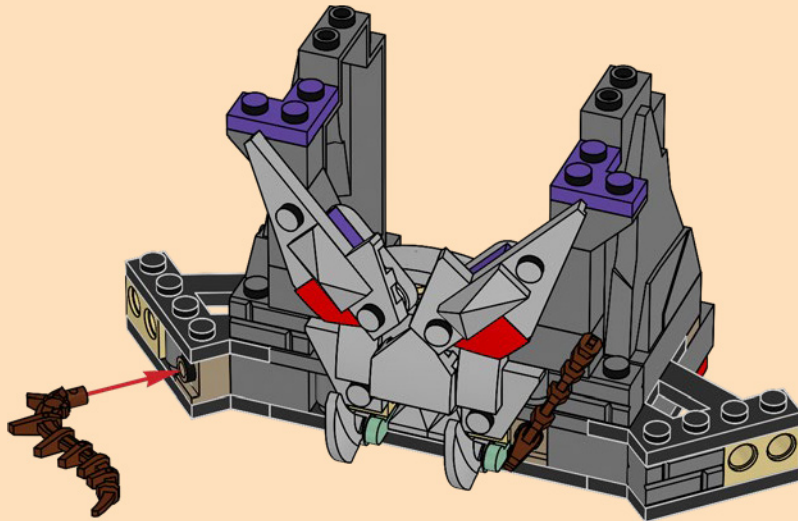



2x

28

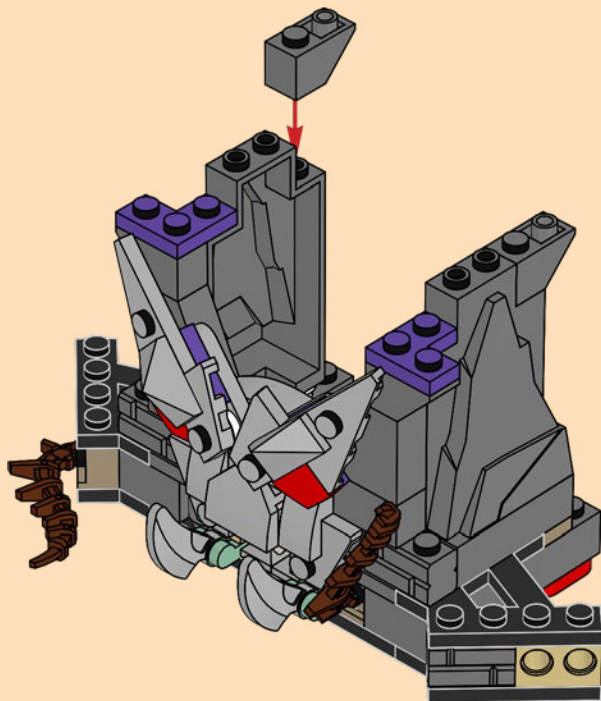



2x

29

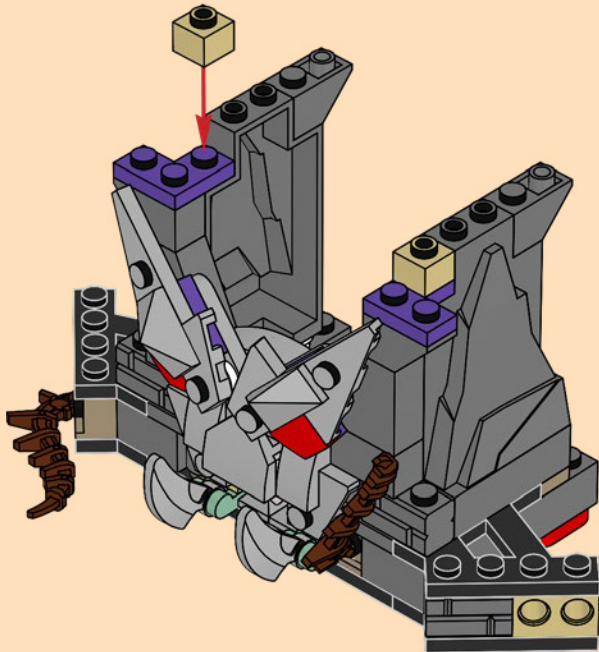

2x

30

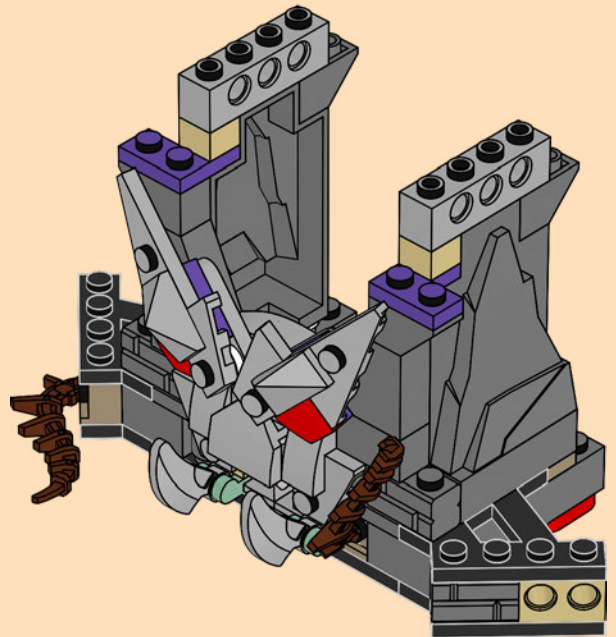

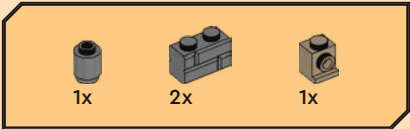

31

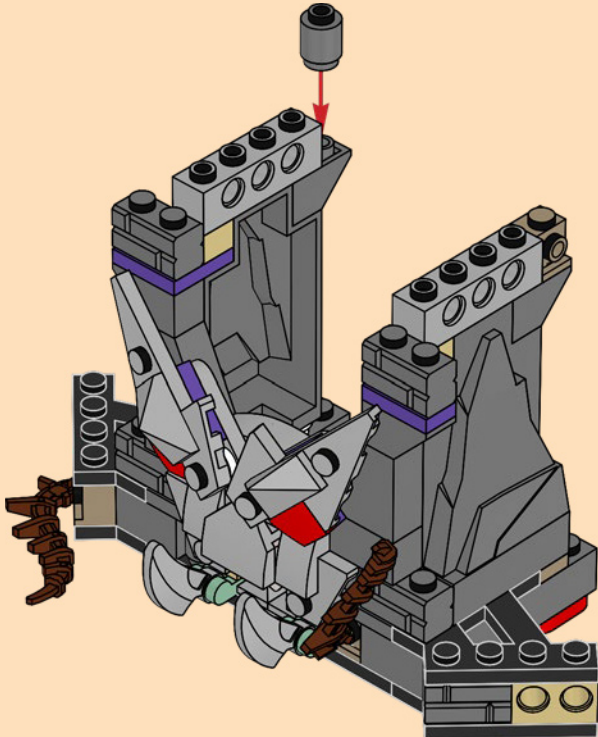



2x

32

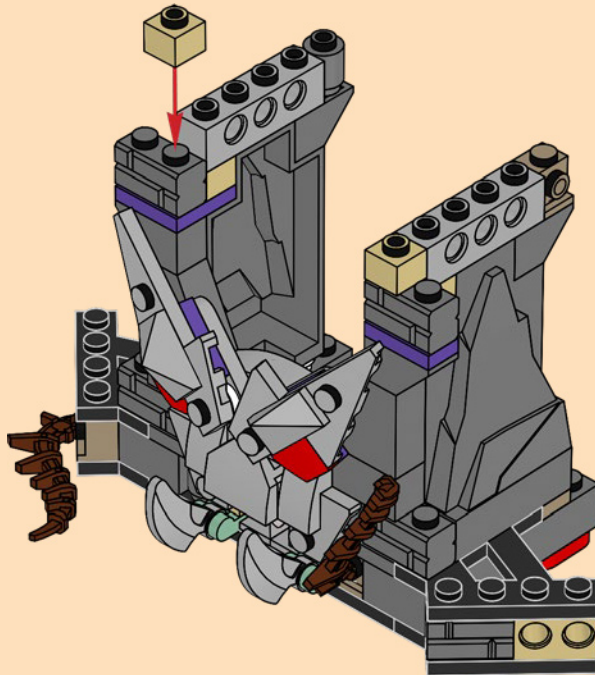

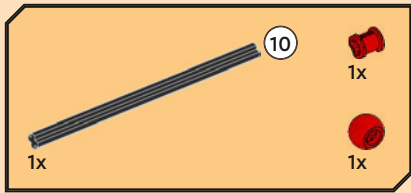

33

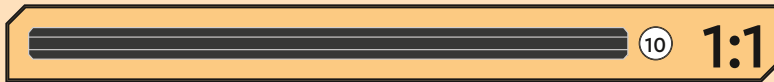
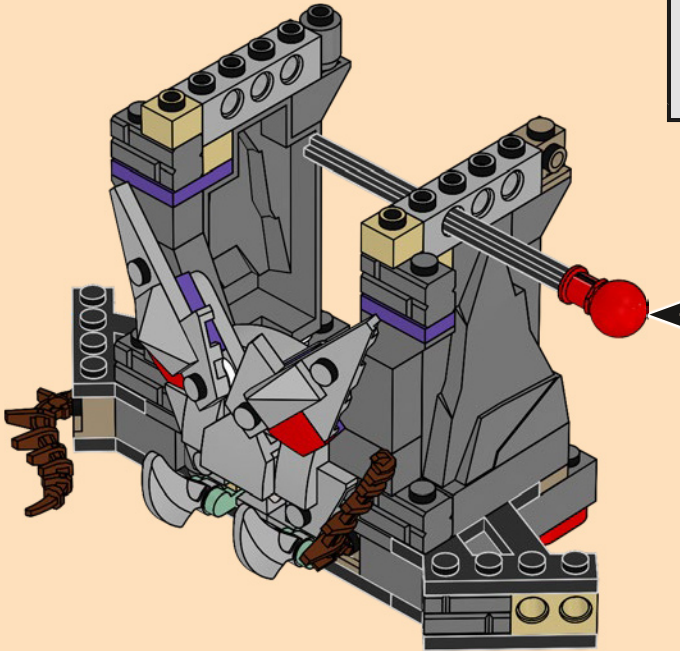
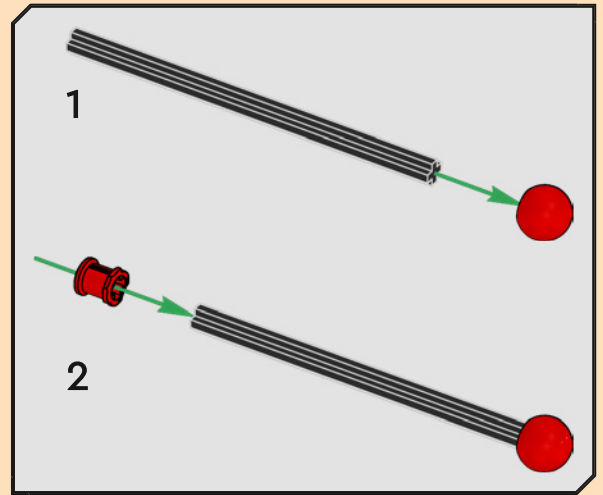





1x

34

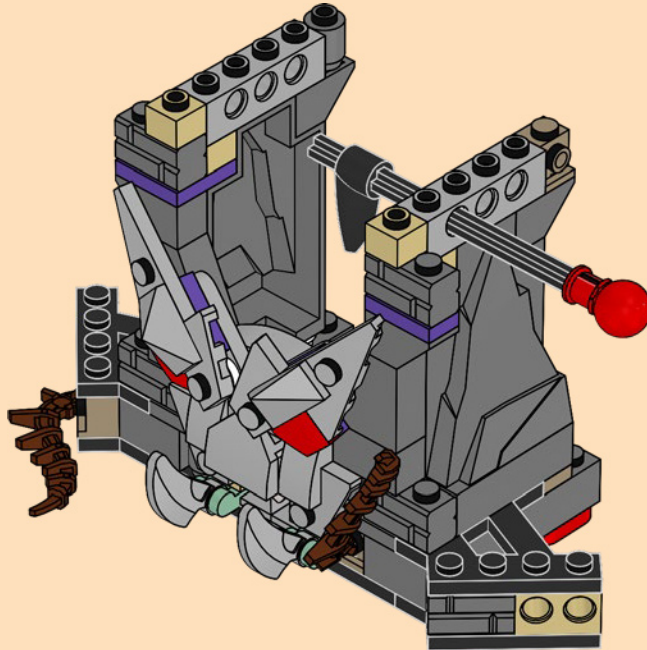

35

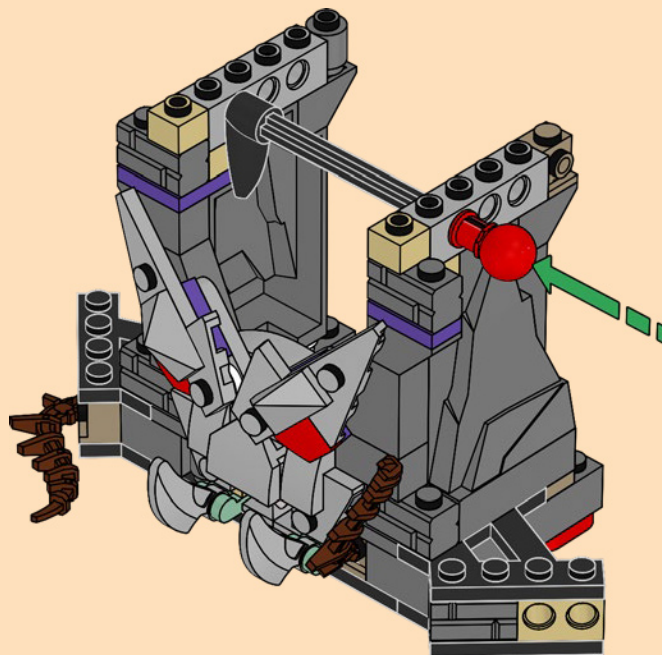

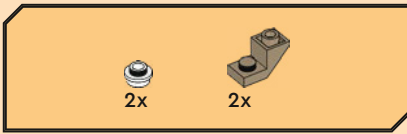

36

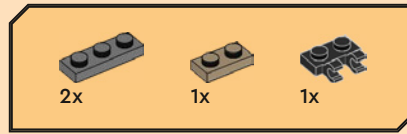
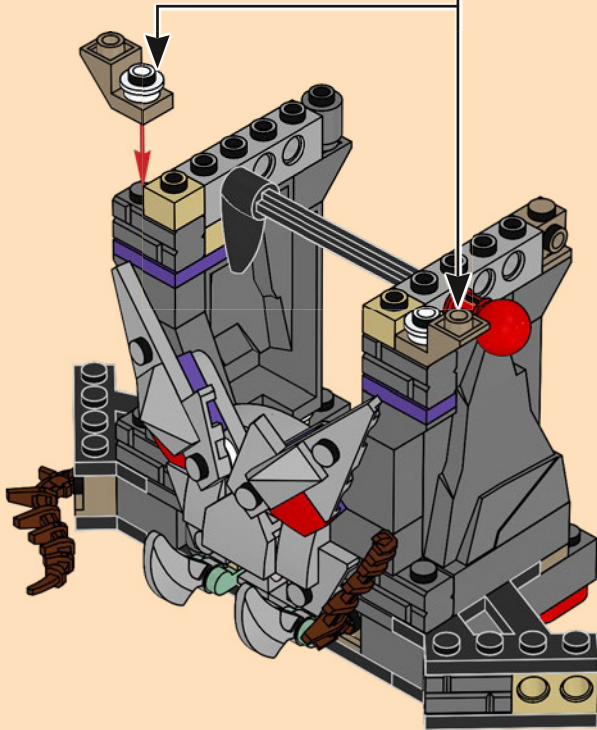
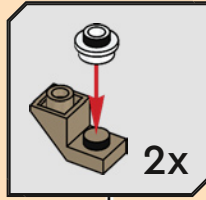

37

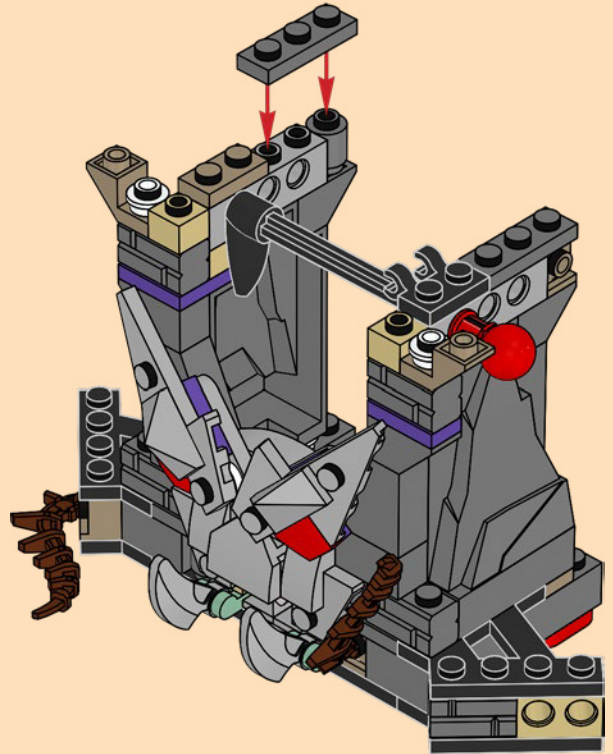



2x

38

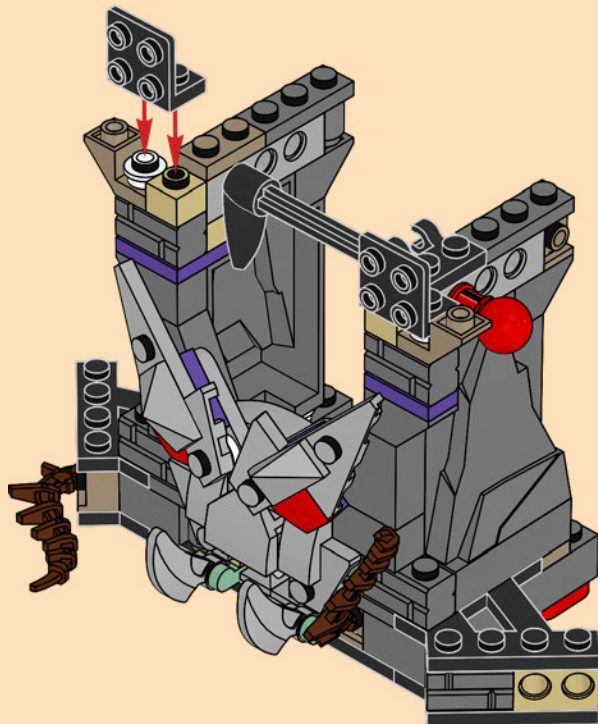

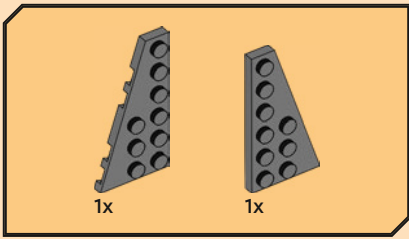

39

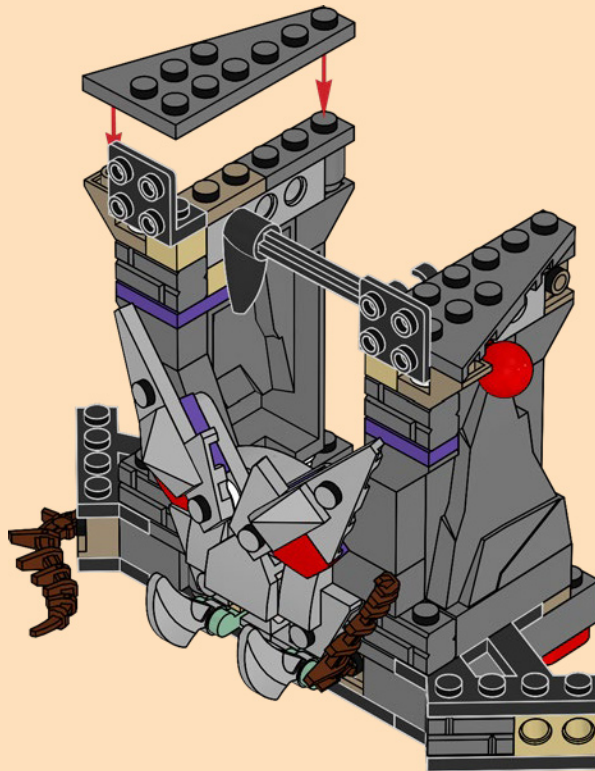

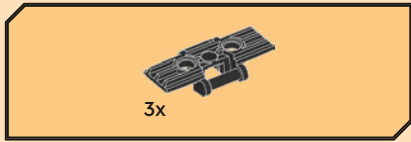

40

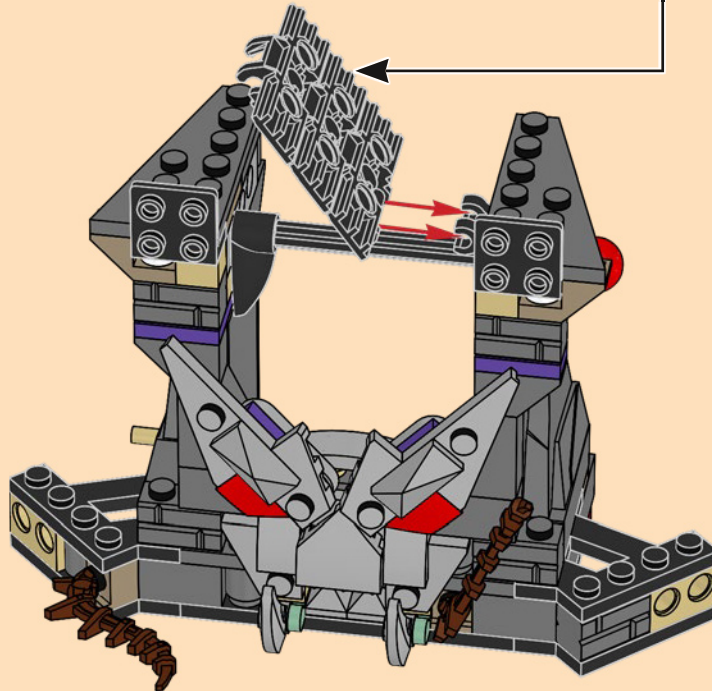
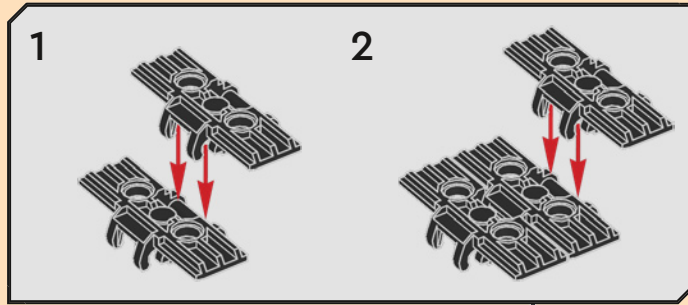

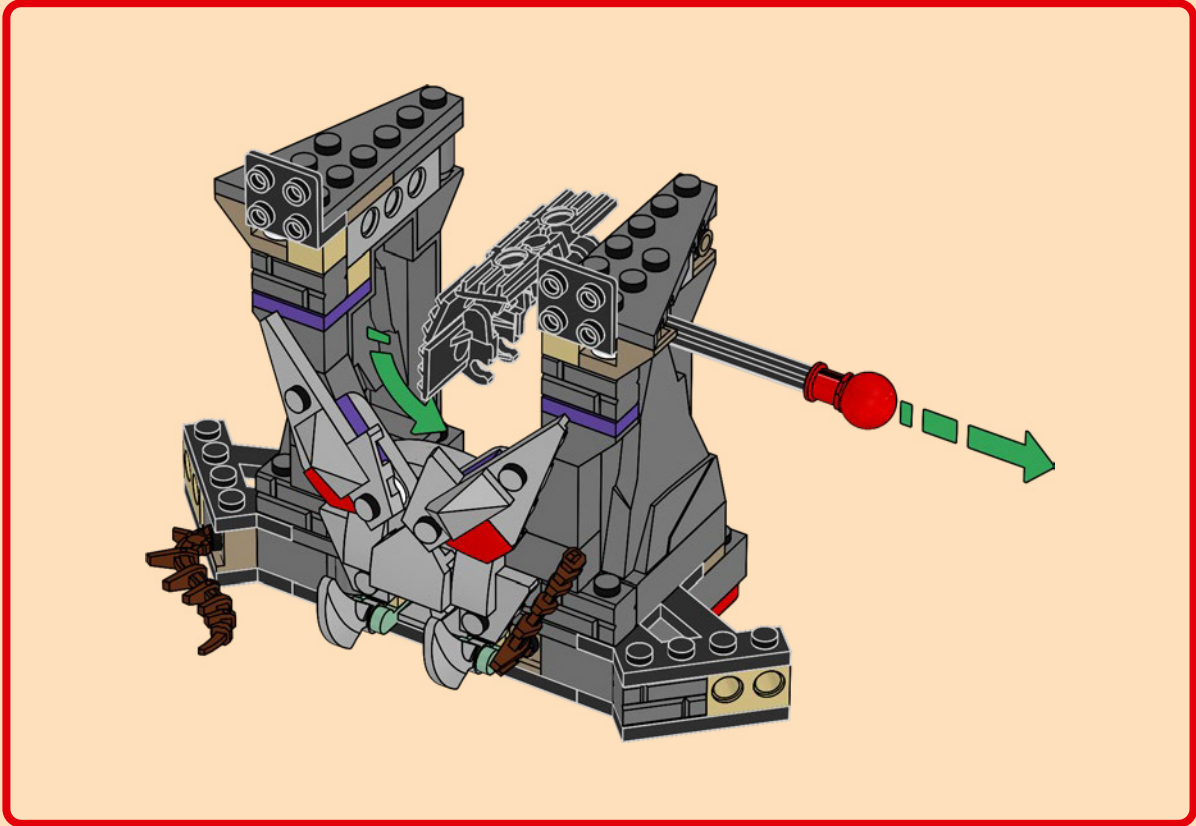

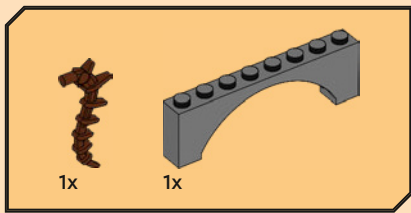

41

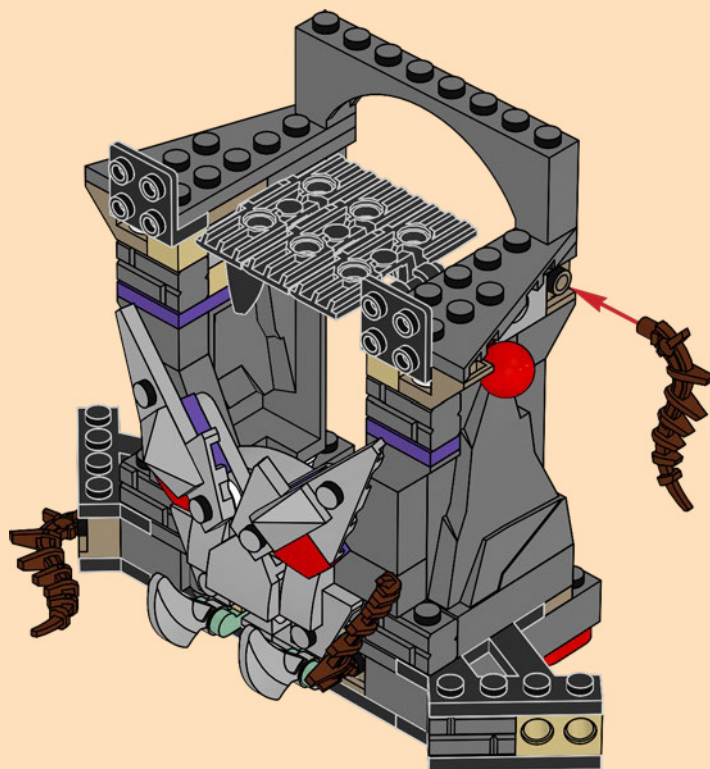



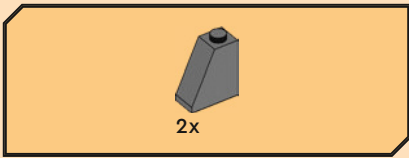

42

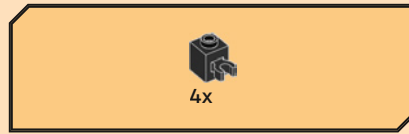
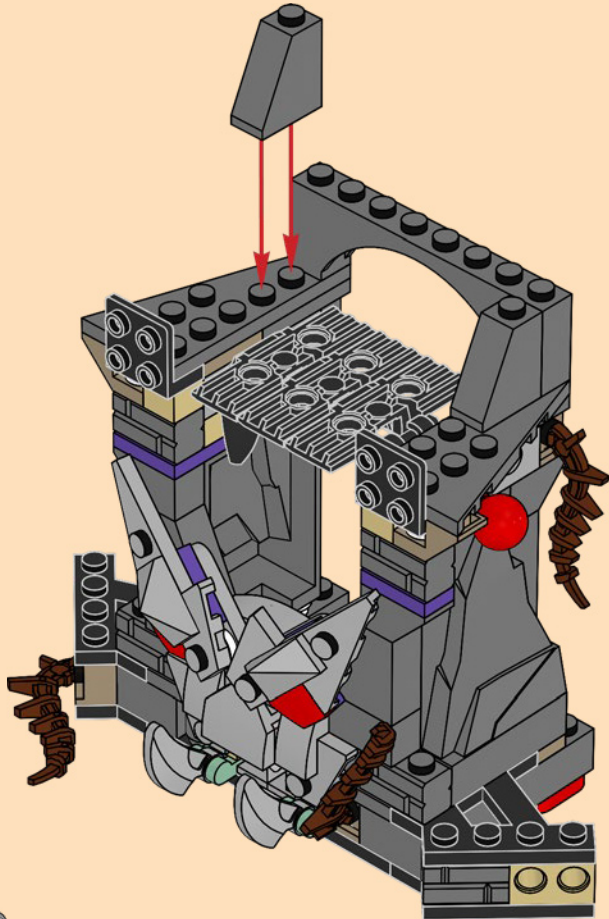

43

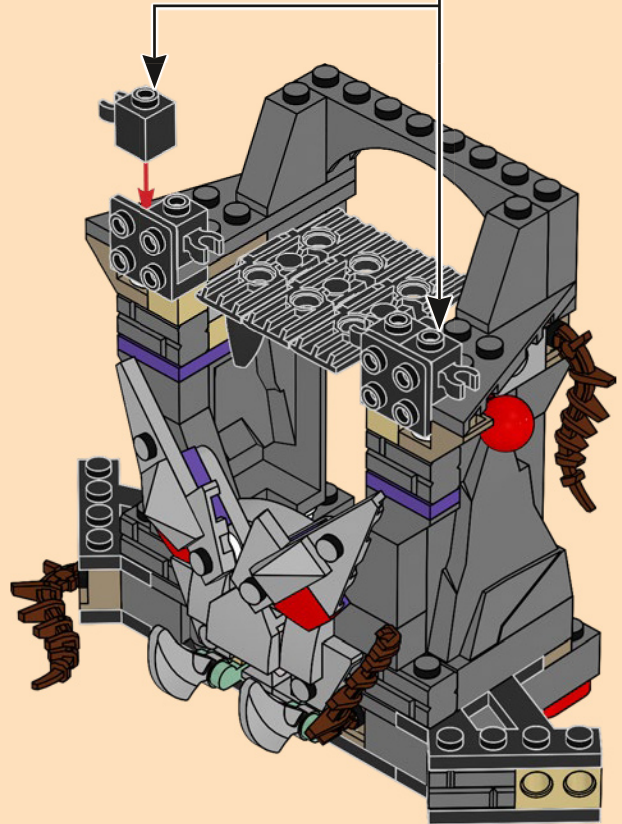



2x

44

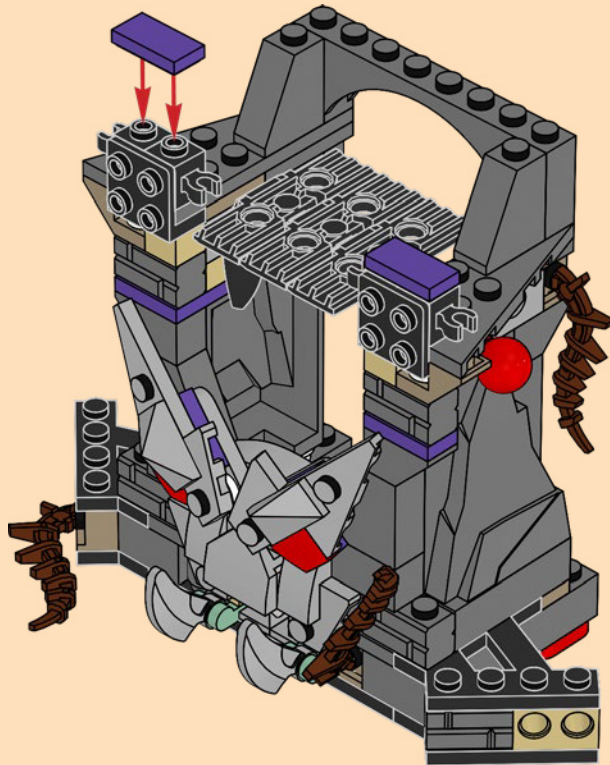



45

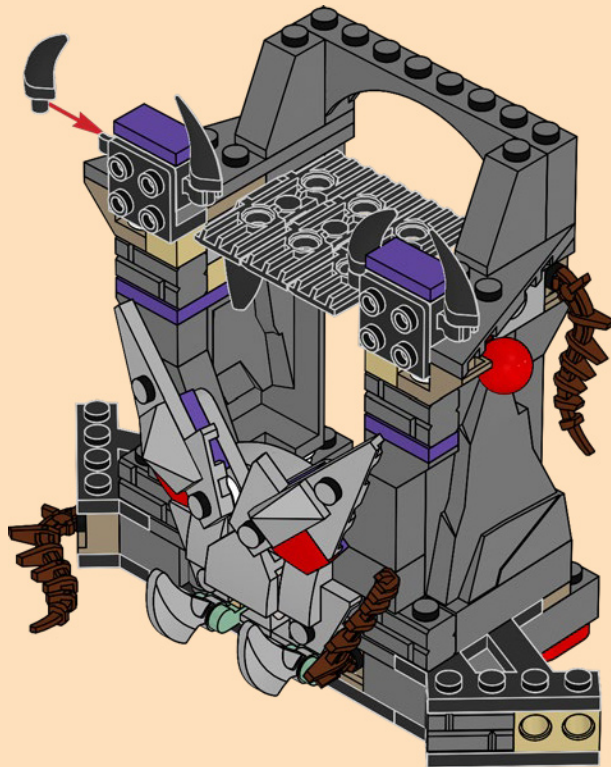

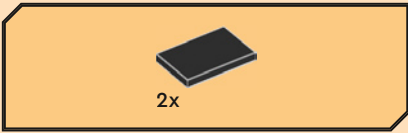

46

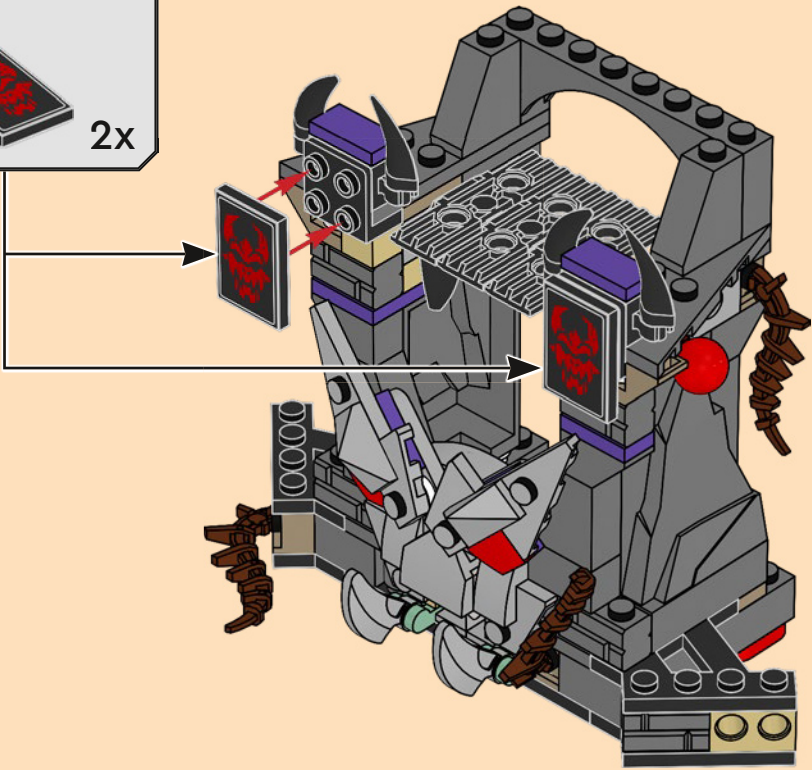
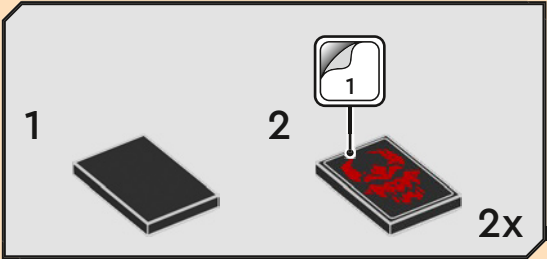

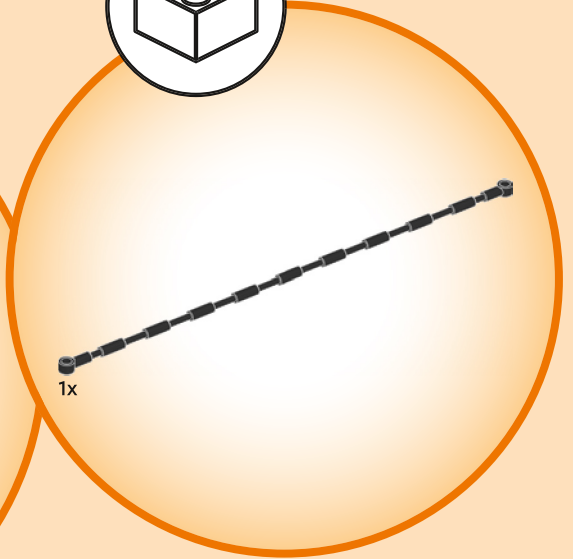
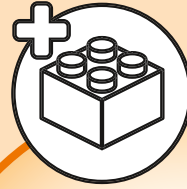

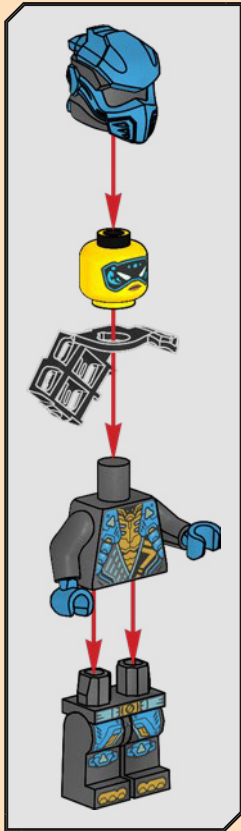

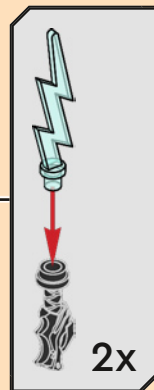
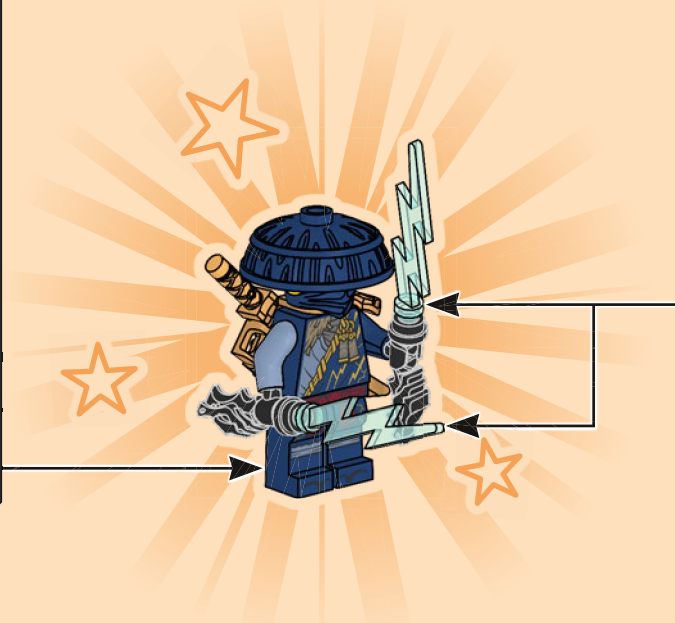
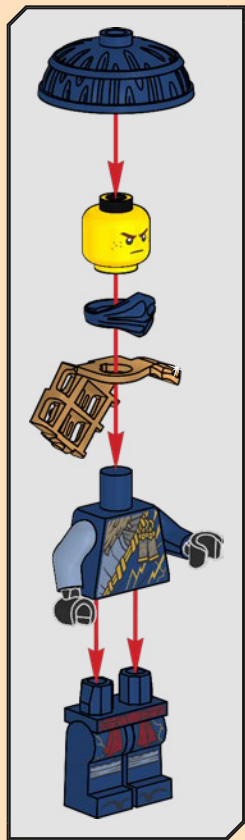

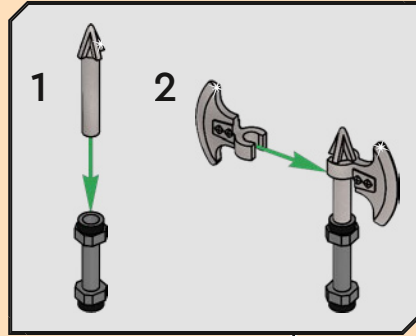
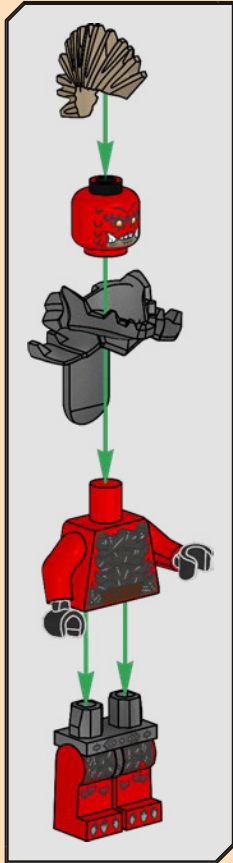



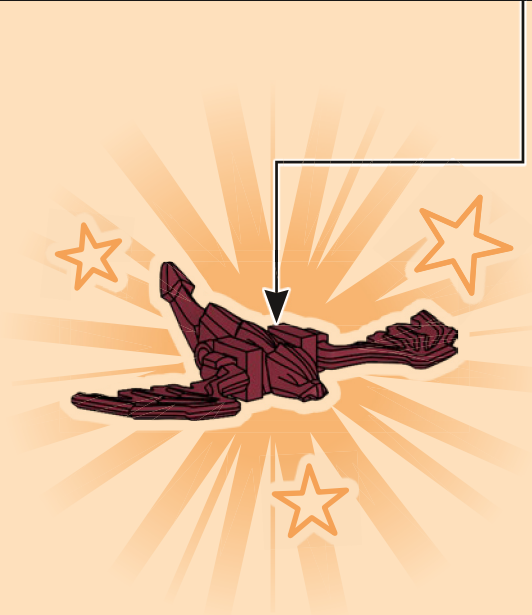
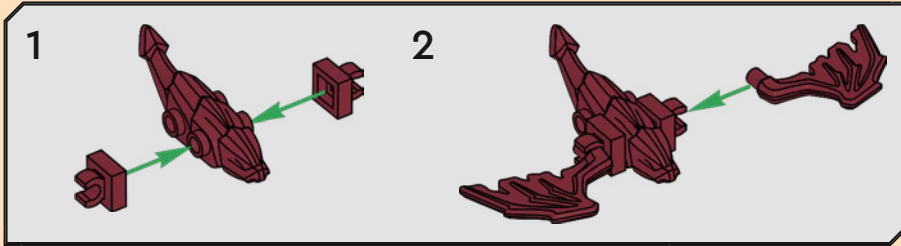

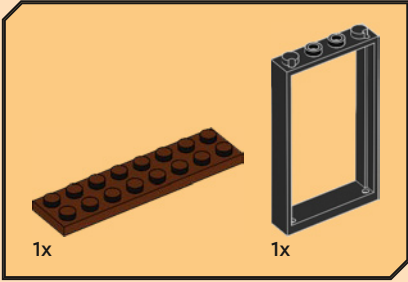
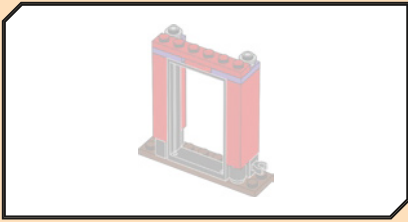

47

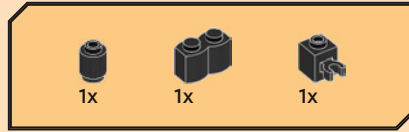
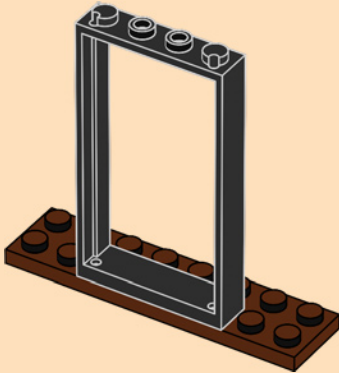

48

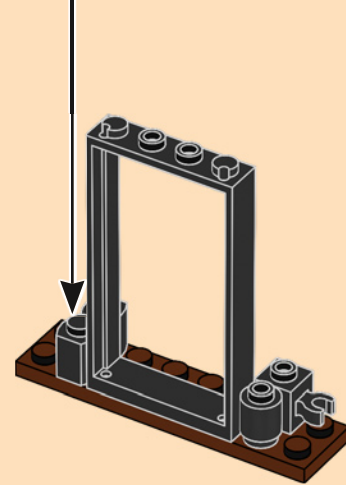
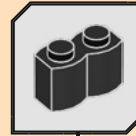

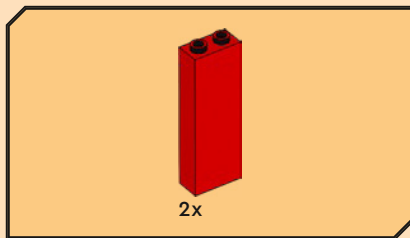

49

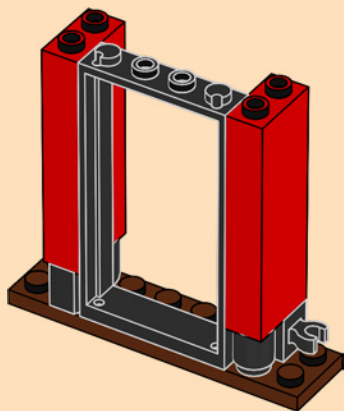

50

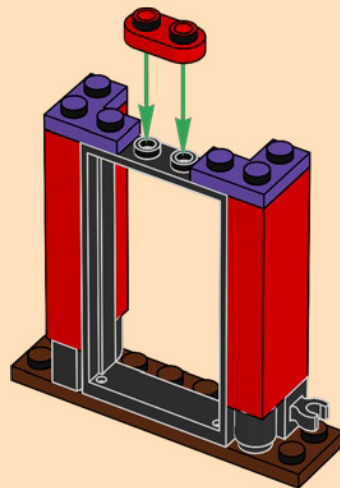

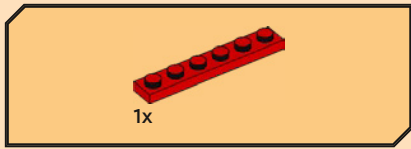

51

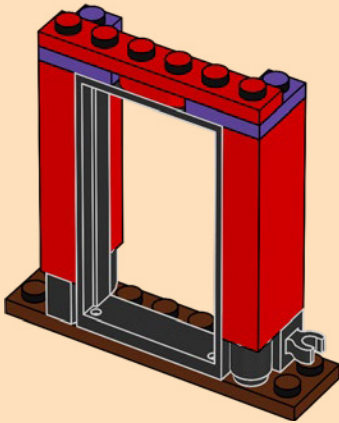

52

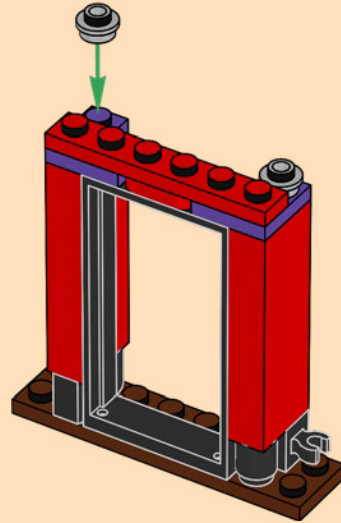

53

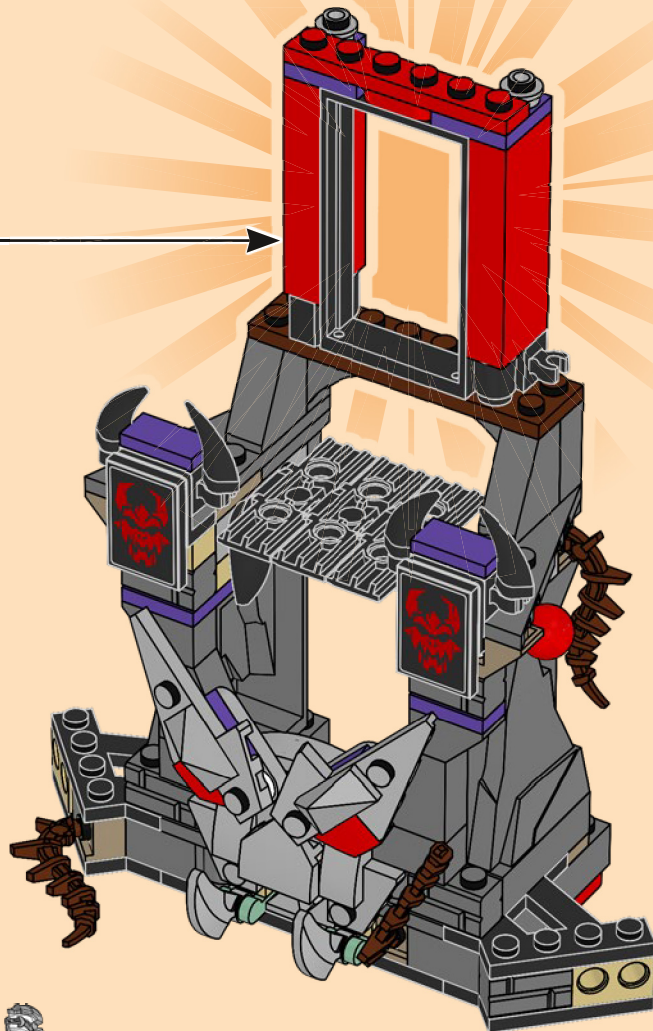

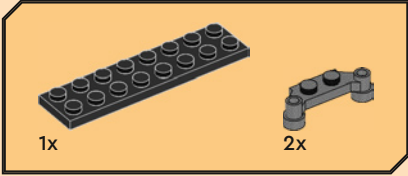
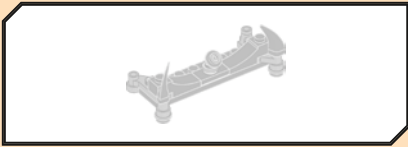

54

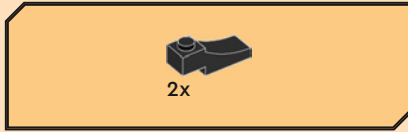
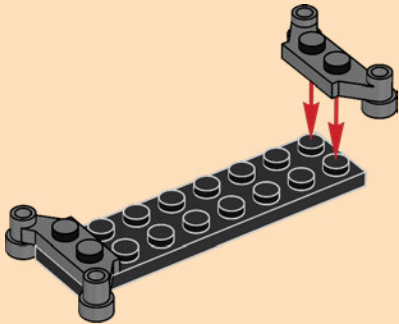

55

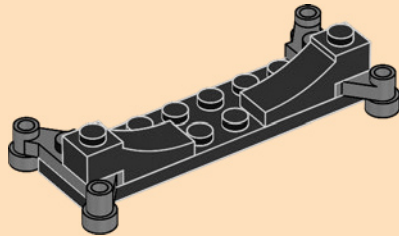

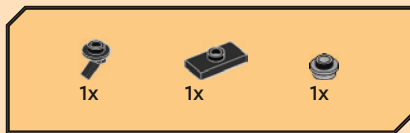

56

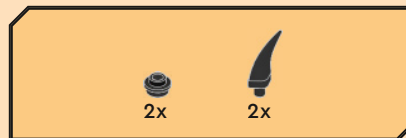
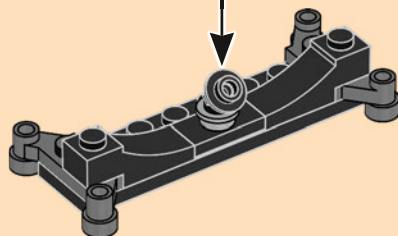
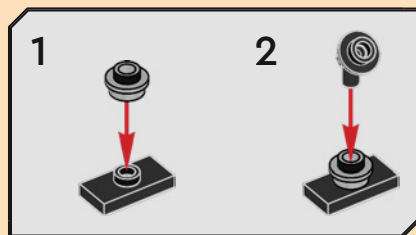

57

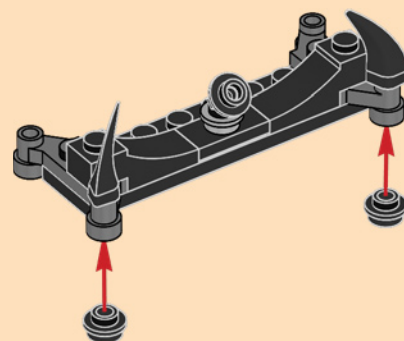

58

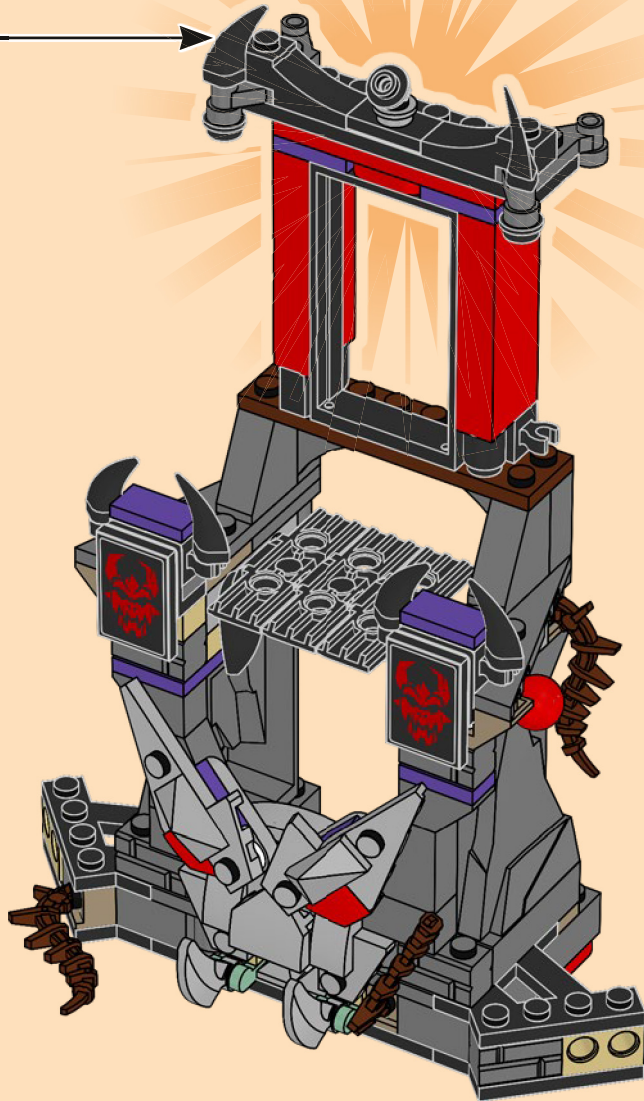



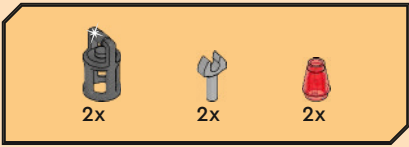

59

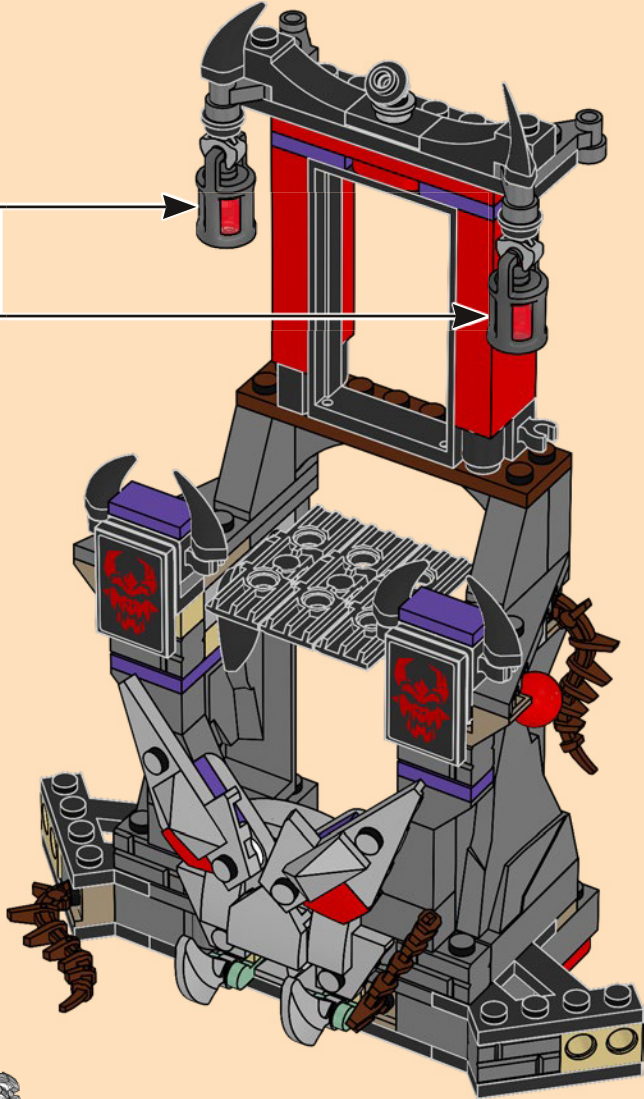
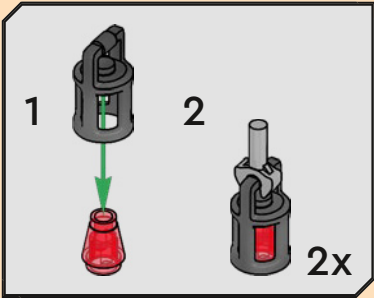

2x



60

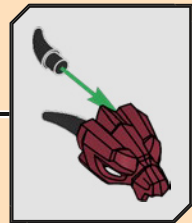
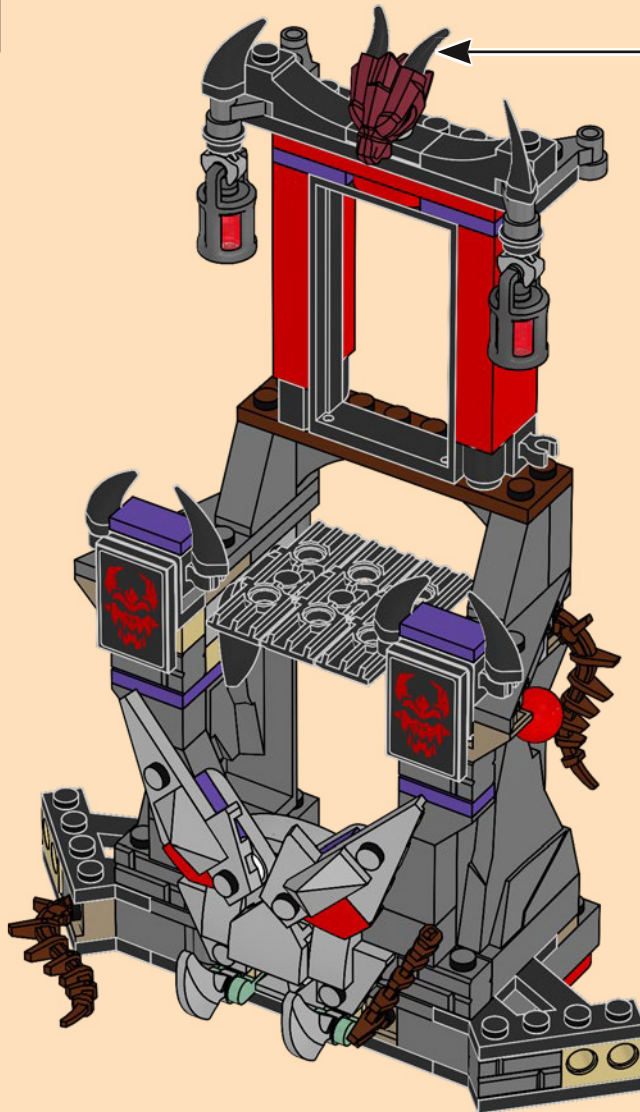

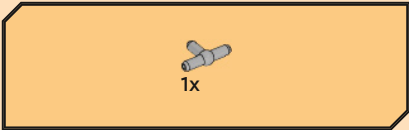

61

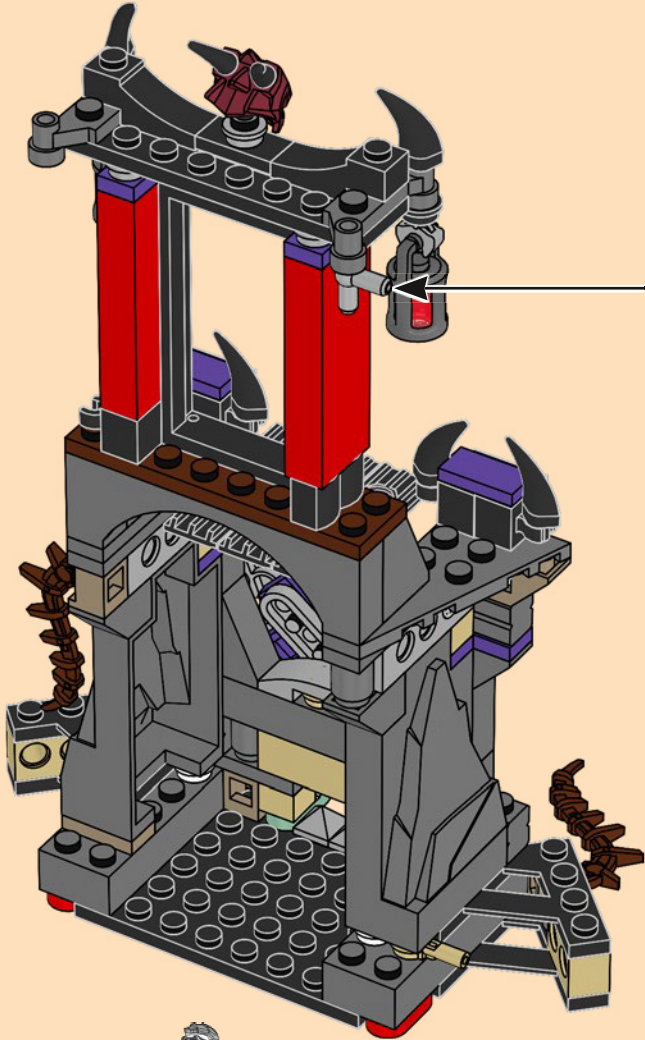

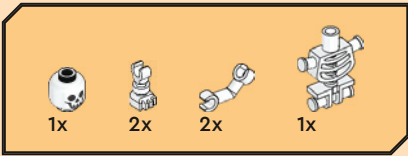

62

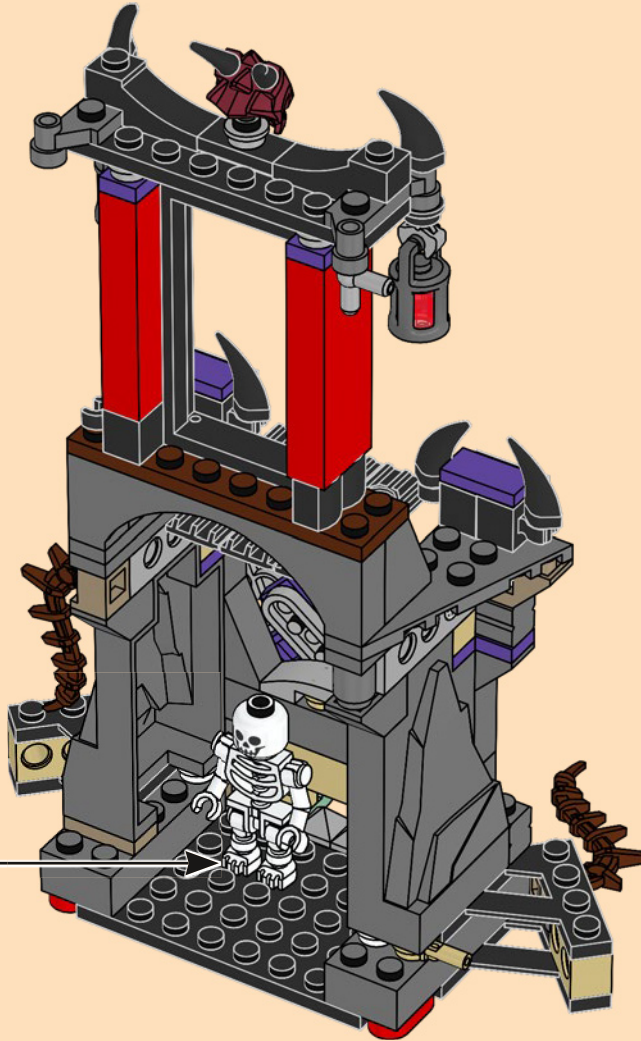
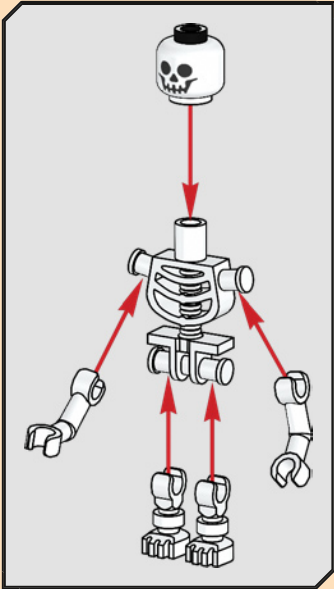

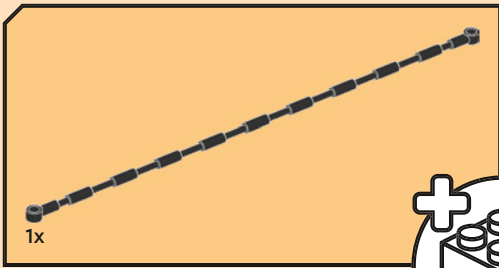

63

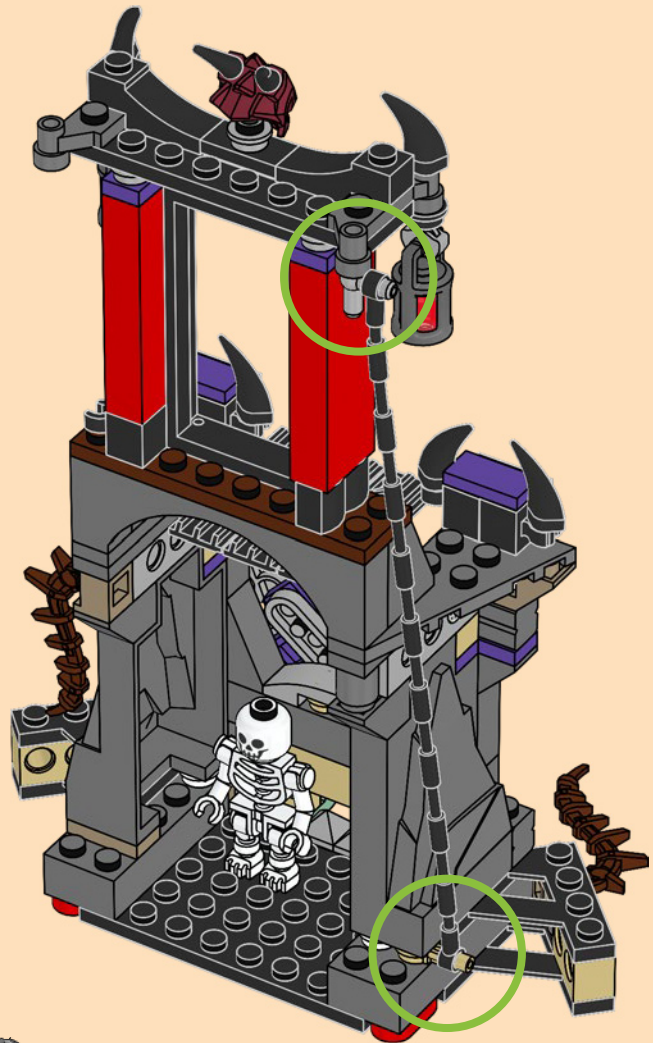
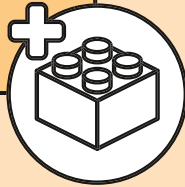

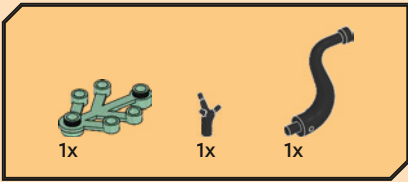

64

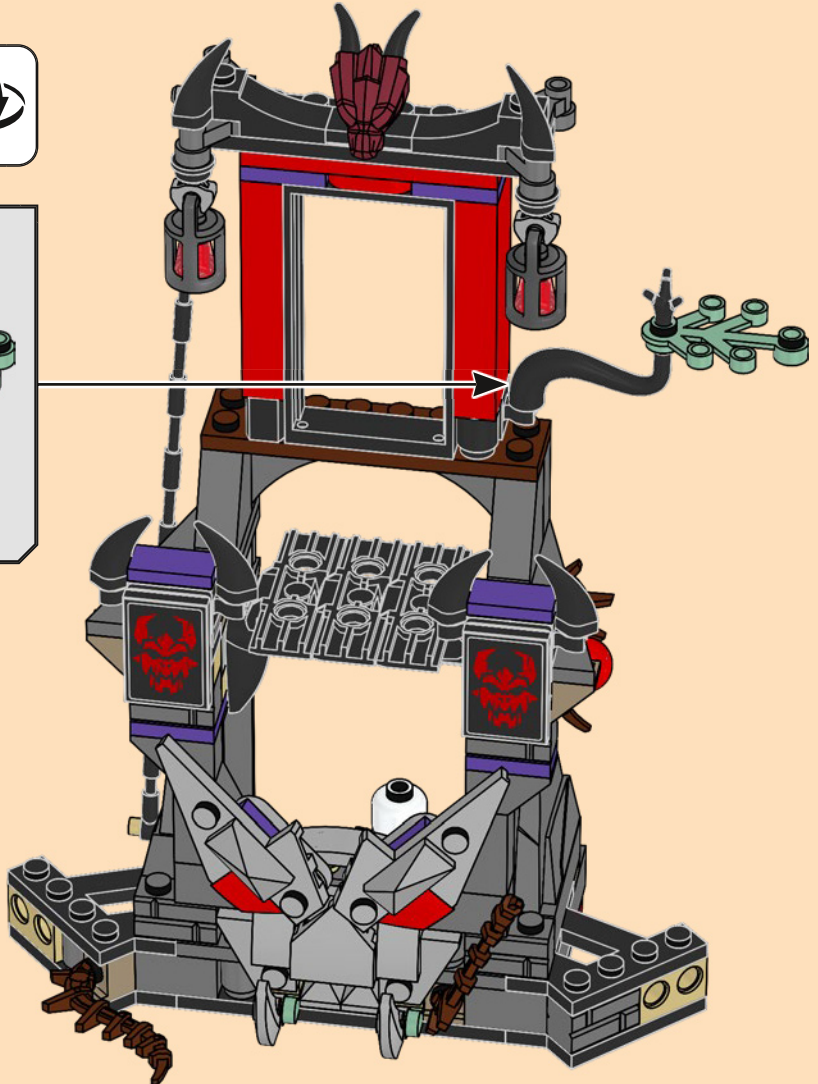
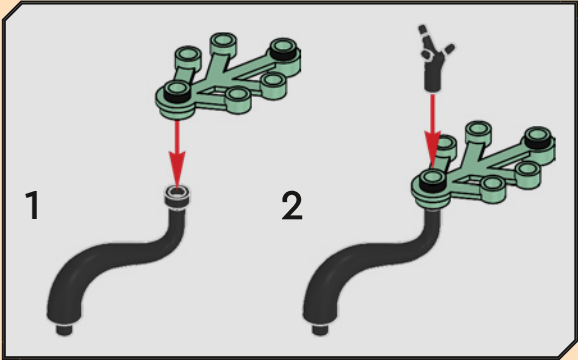

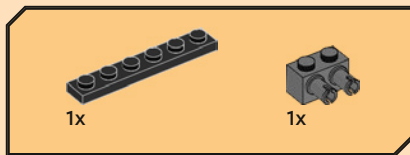

65

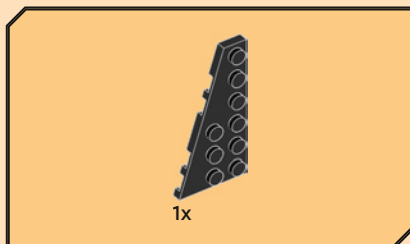
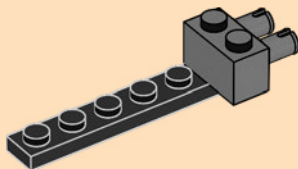

66

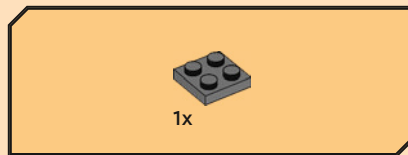
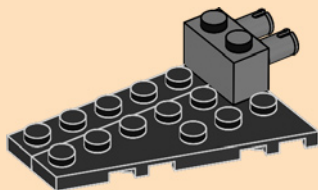

67

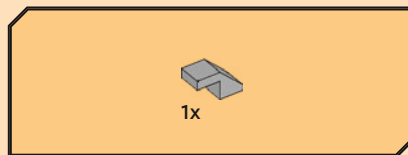
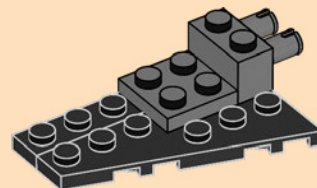

68

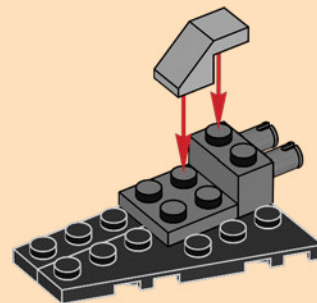

69

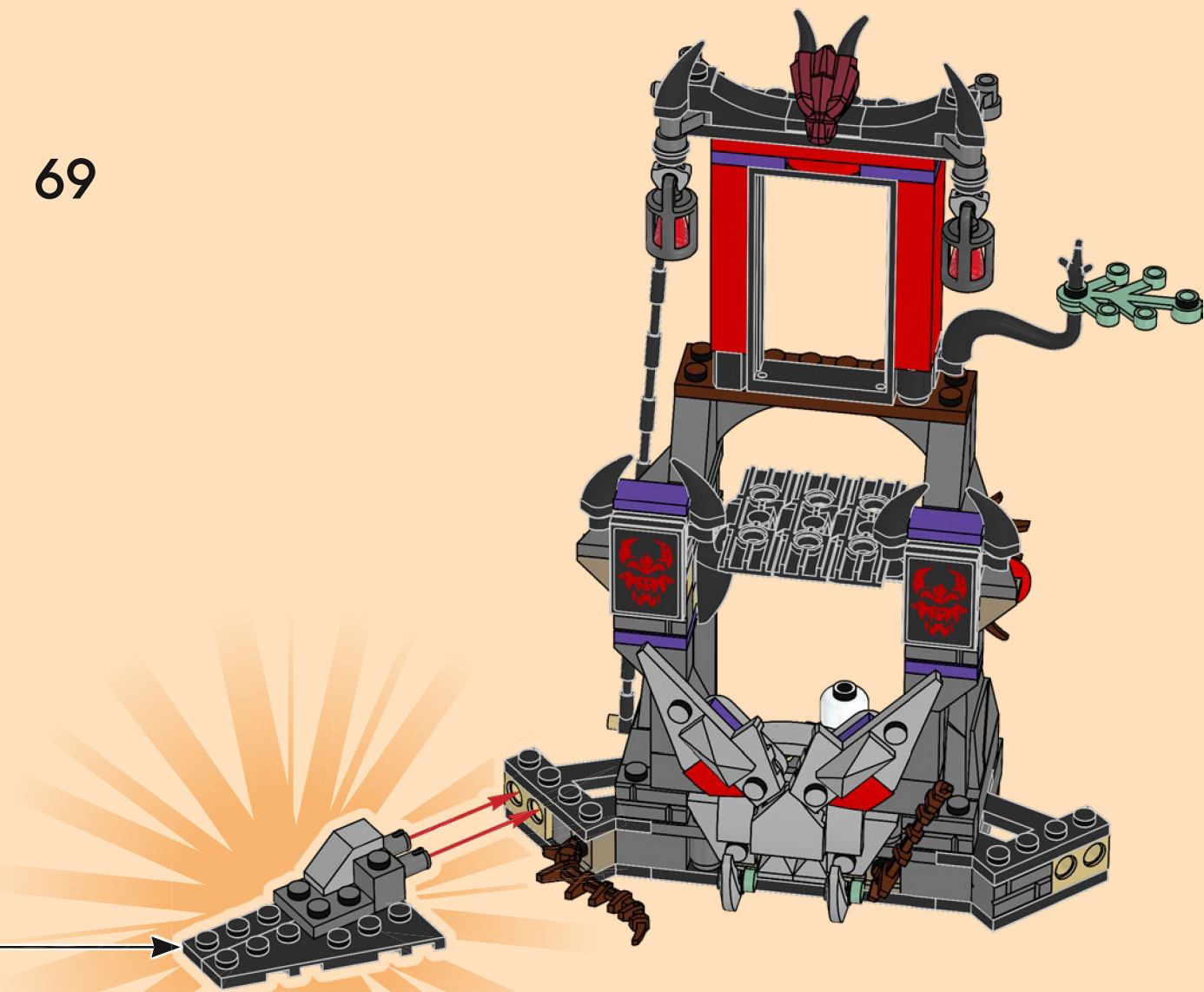



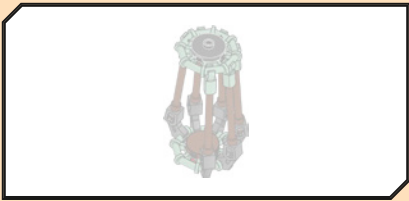

70

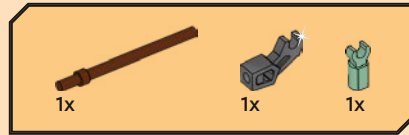
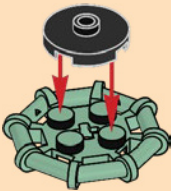

71

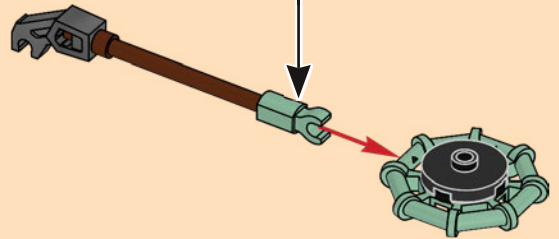
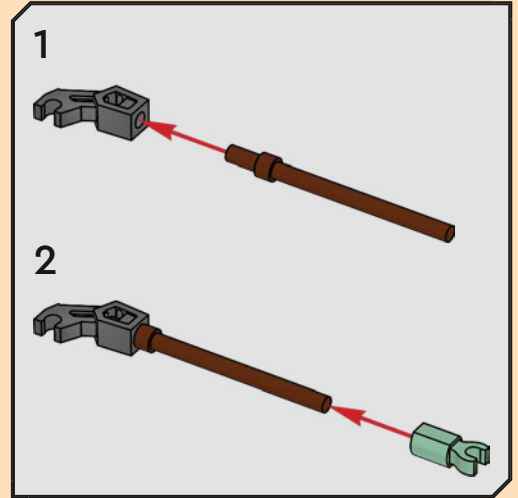

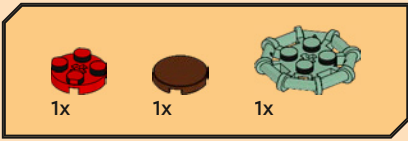

72

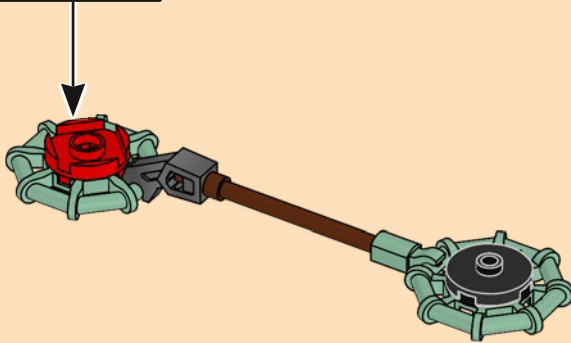
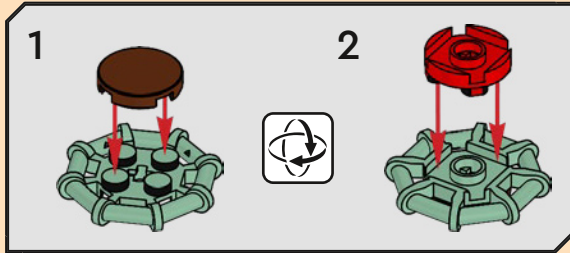



73

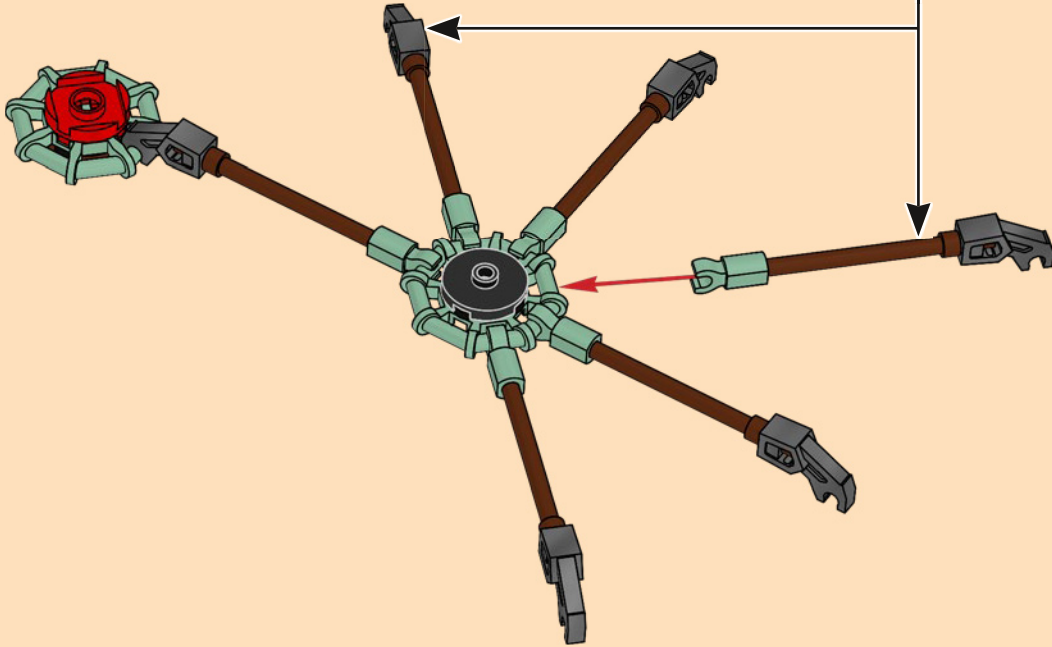
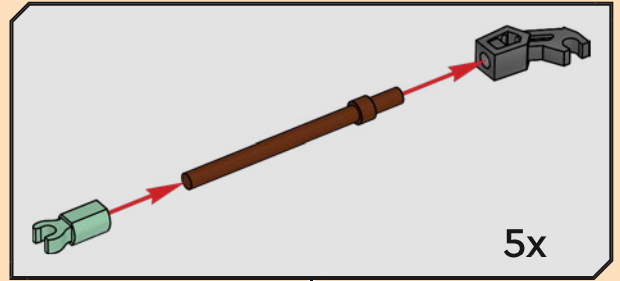

74

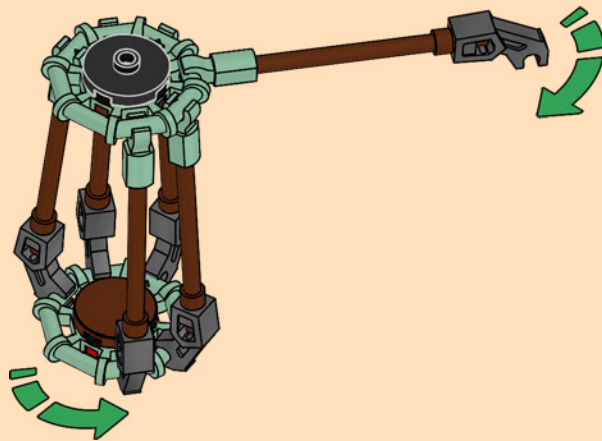

75

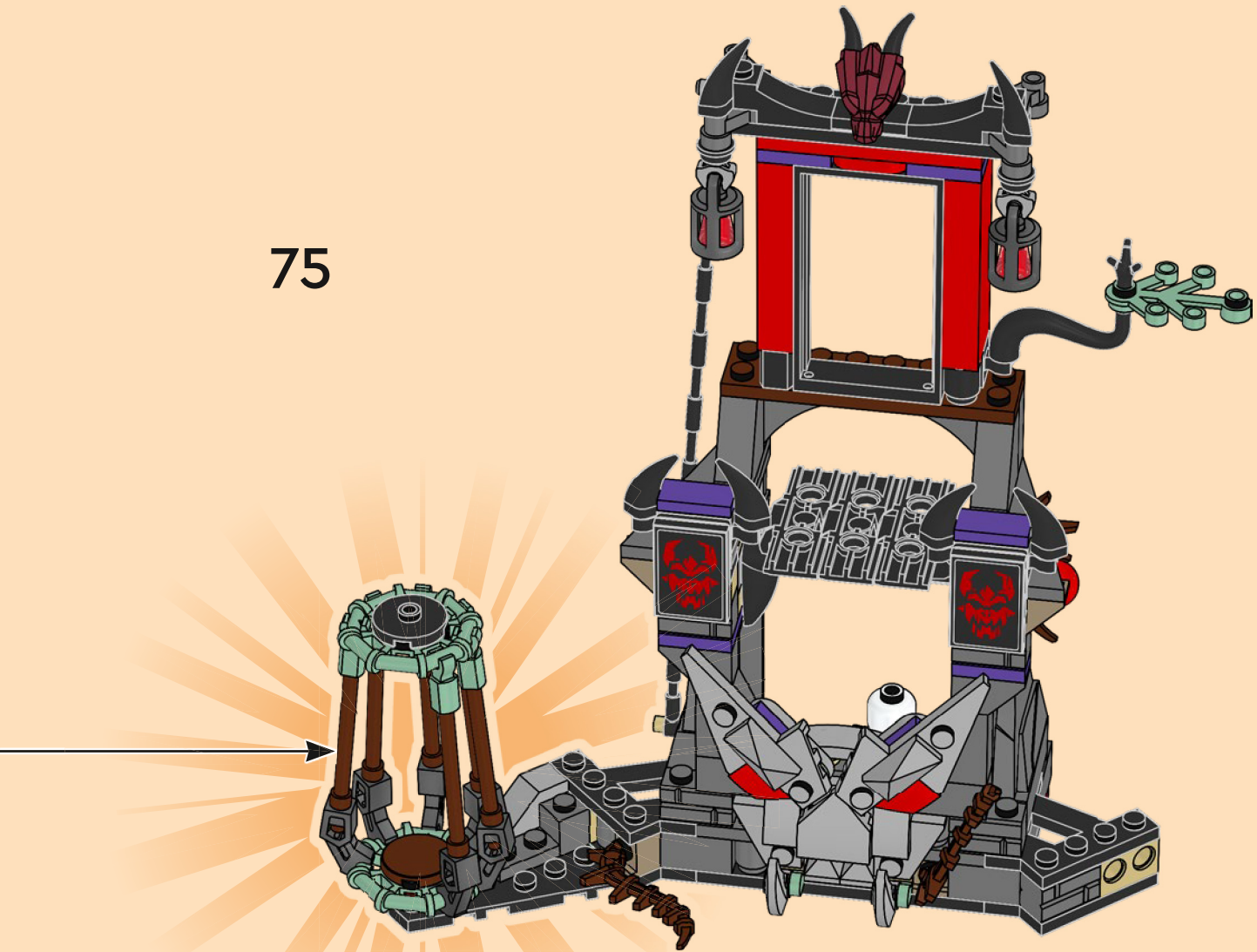



76

1



2



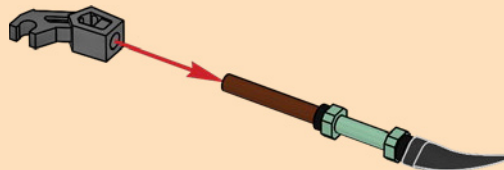

3

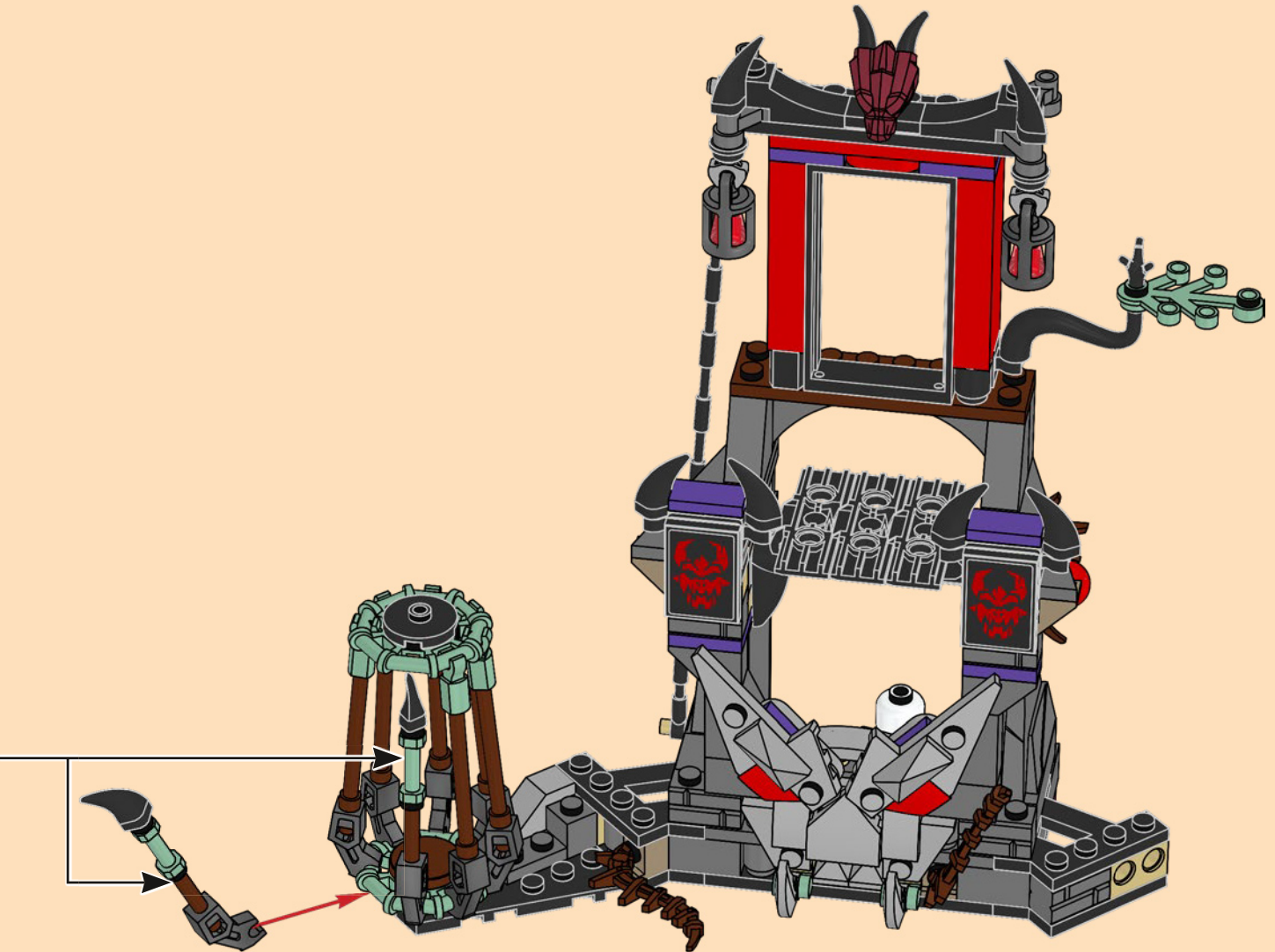

2x



1x  1x 

77

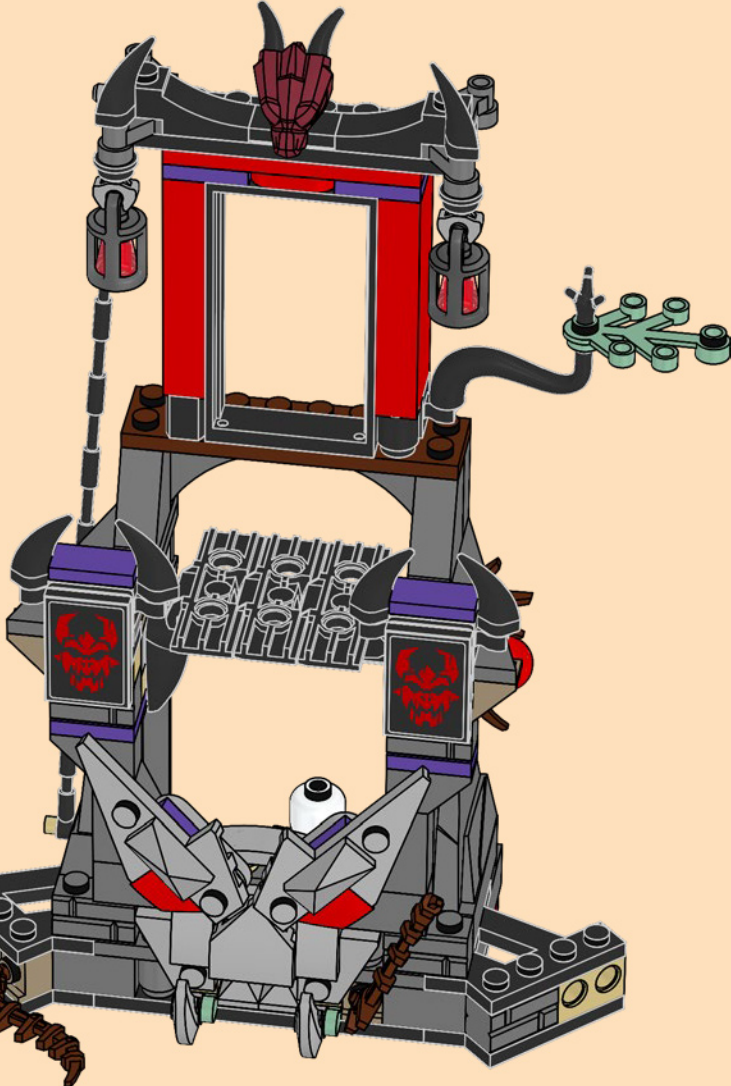
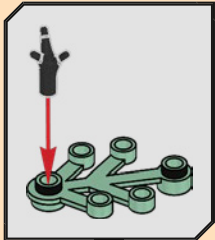



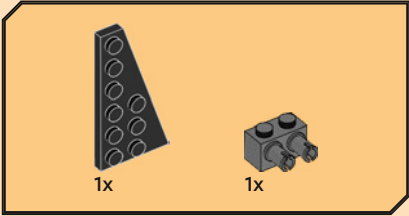
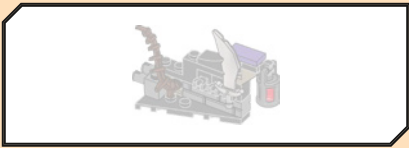

78

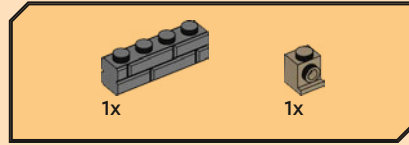
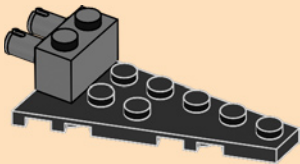

79

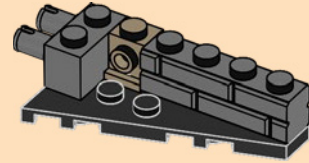

80

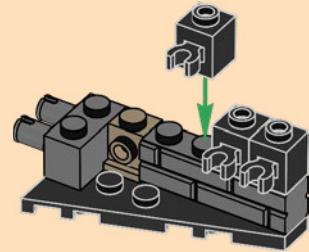

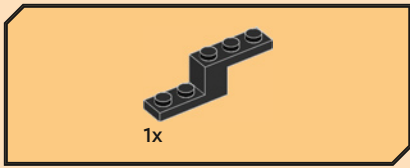

81

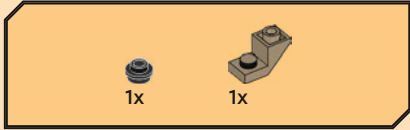
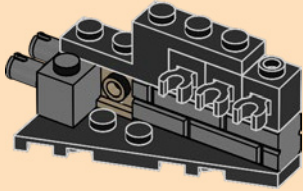

82

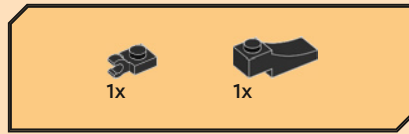
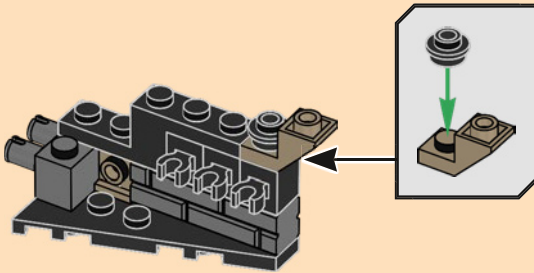

83

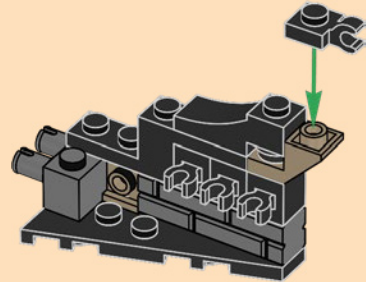



84

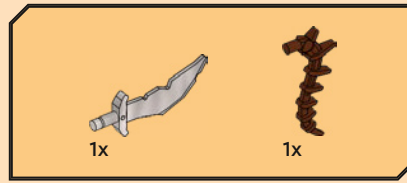
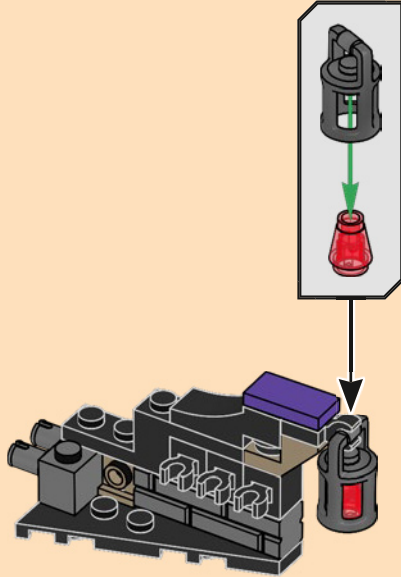

85

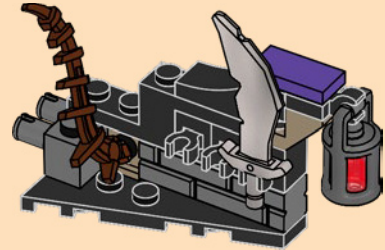

86

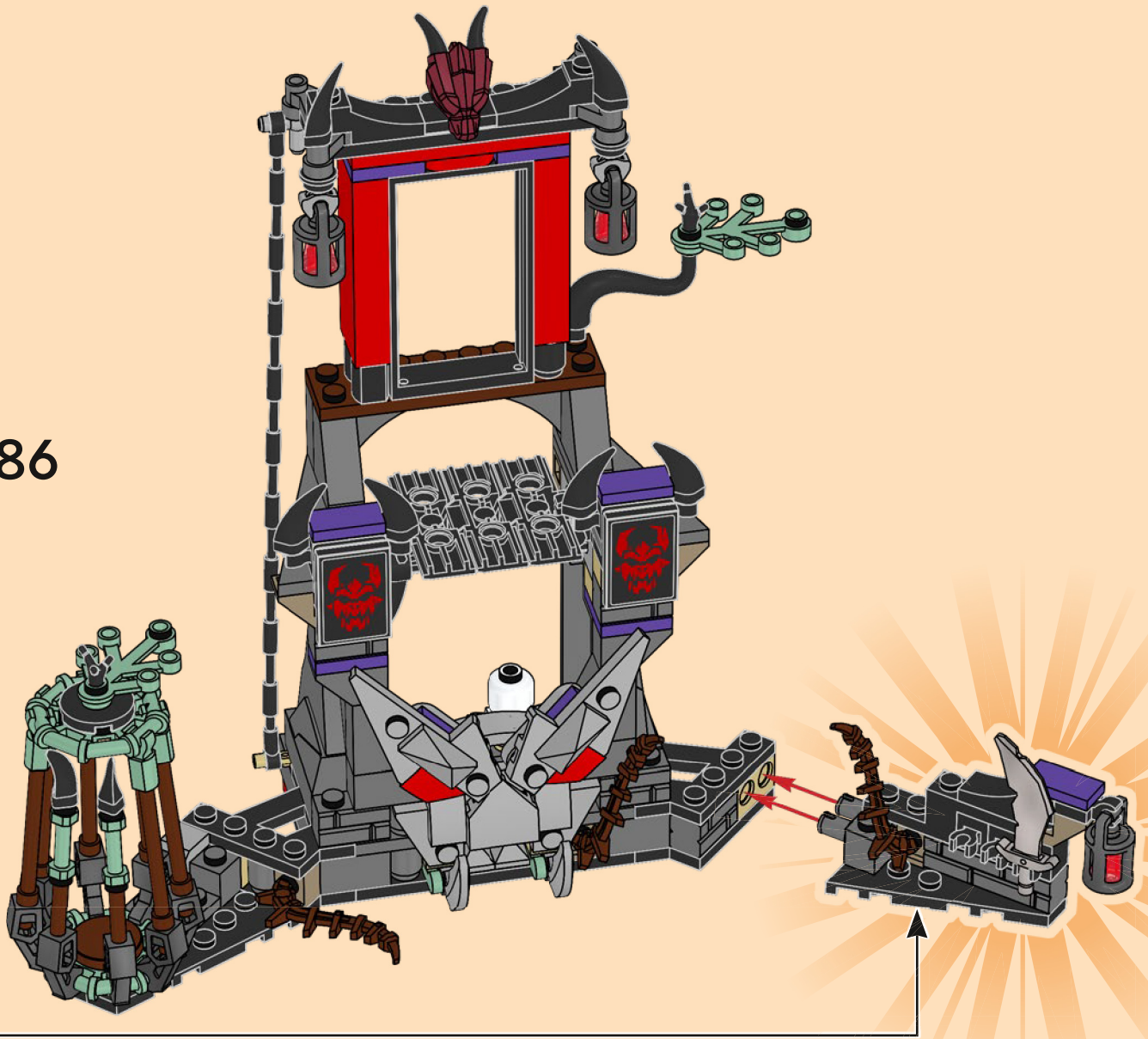

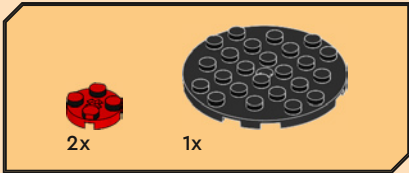

1

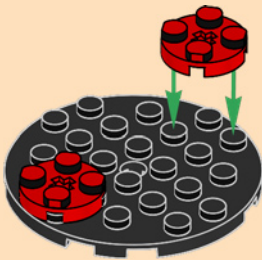

2

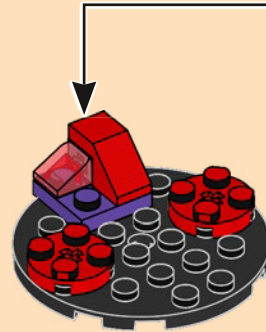
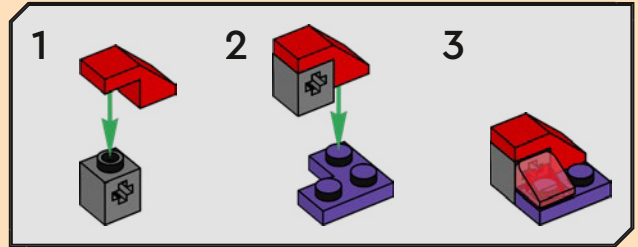



3



4

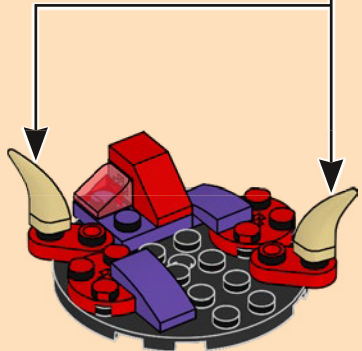
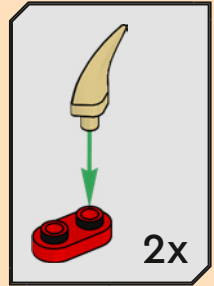

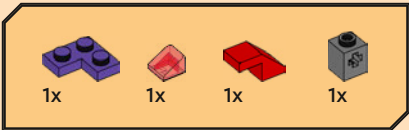

5

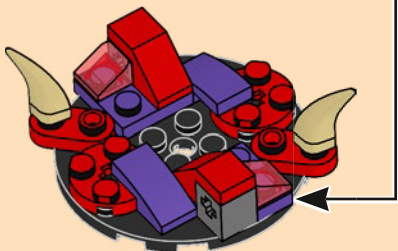
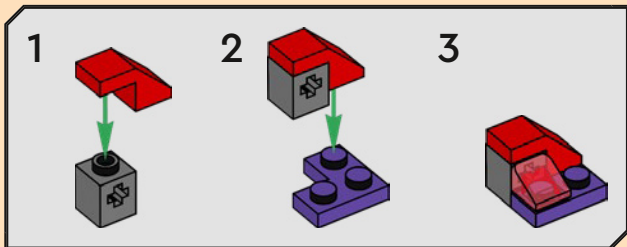

6

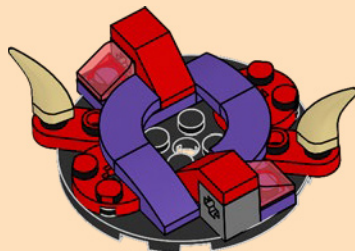

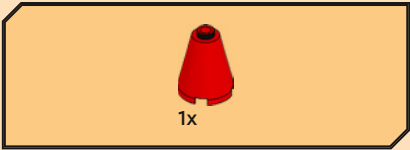

7

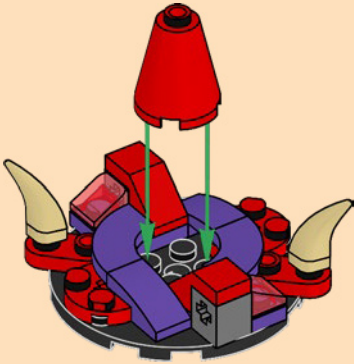

8

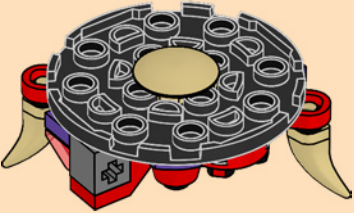





9



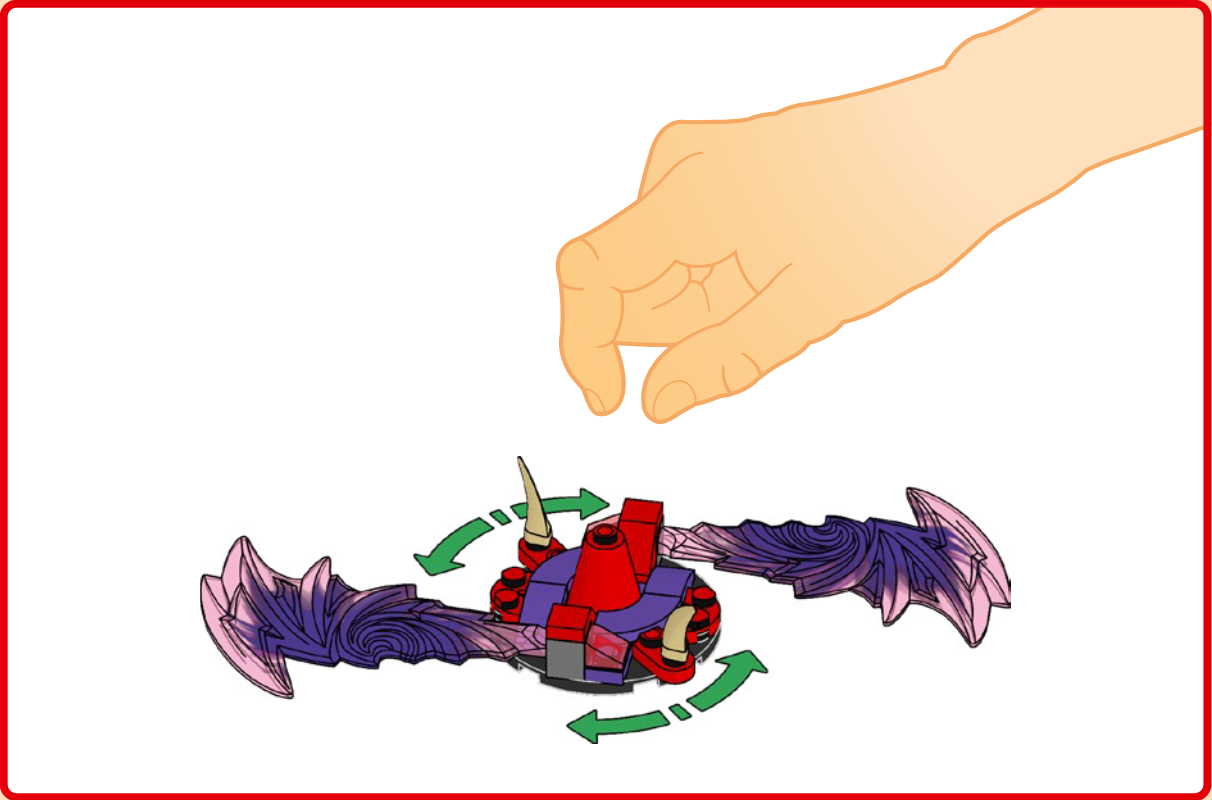







71823



71824



71826



71830



71834



71833



71841

 2x 6240495	 1x 4290714	 4x 6270103	 1x 6310268	 1x 6337273	 3x 6514021	 2x 6314377
 7x 6168642	 1x 6271820	 2x 6315915	 1x 6382249	 1x 6434431	 2x 6245252	 6x 6458392
 1x 4651445	 1x 6518763	 2x 6302576	 1x 6288220	 1x 6519410	 1x 6434431	 3x 6286492
 1x 6531801	 1x 6518760	 1x 306226	 1x 4283046	 4x 6054852	 1x 6519410	 1x 4278422
 2x 6252200	 1x 6177505	 5x 6168646	 1x 4283046	 1x 366626	 5x 6210269	 2x 4523145
 1x 6518755	 1x 6177507	 1x 6510193	 1x 4283047	 1x 6187587	 1x 6518755	 1x 4201062
 1x 6359891	 3x 403221	 8x 6270091	 2x 6489303	 1x 303426	 4x 6273590	 1x 4201062
 1x 6530707	 1x 6056297	 8x 6336977	 3x 6328095	 1x 373726	 2x 4528604	 1x 6521182
 4x 6360079	 2x 6275178	 1x 4568933	 2x 6162892	 1x 303626	 3x 6452010	 4x 6270052
 2x 6528576	 1x 4212414	 1x 6308000	 1x 6484901	 1x 303626	 1x 6474842	 1x 6075213
 4x 6524971	 2x 6524915	 1x 6195325	 3x 6325504	 1x 6309203	 3x 6519412	 2x 6428805
 2x 6524972	 1x 366621	 1x 6092585	 1x 6440995	 1x 6309203	 1x 6531804	 6x 6170468

3x  
6168647

2x  
6439041

2x  
6258381

1x  
4211508

2x  
6163478

1x  
6306729

2x  
6163477

1x  
6306728

2x  
6075075

1x  
6213378

1x  
6305049

2x  
6028813

2x  
6446028

2x  
6359723

1x  
6212077

1x  
4622803

2x  
4211441

1x  
6296951

5x  
4211090

2x  
6362259

4x  
6013658

4x  
4211096

5x  
6000311

2x  
6276873

1x  
4290149

1x  
4290150

1x  
4211094

4x  
4211133

2x  
6302647

1x  
6055310

2x  
4513326

2x  
4210875

1x  
4211099

1x  
6313652

2x  
6483955

1x  
6162578

1x  
6434440

2x  
6363145

1x  
6442979

2x  
4611882

3x  
4613192

2x  
6057390

8x  
6167461

2x  
6199899

2x  
6551012

3x  
6234116

1x  
6528524

2x  
6518765

1x  
6518777

8x  
6276869

1x  
6529483

2x  
6524925

1x  
6487238

4x  
6116596

1x  
6519413

1x  
6519415

1x  
6489675

1x  
6532066

3x  
6474604

6x  
6341975

2x  
6278550

2x  
6328339

2x  
6223219



 [LEGO.com/service](https://www.LEGO.com/service)

YOU COULD **WIN**



Scan this QR code or go to **LEGO.COM/PRODUCTFEEDBACK** and give us your short feedback about this LEGO® set for a chance to win a cool LEGO prize.

Terms and Conditions apply\*

**EN: YOU COULD WIN.** Terms and Conditions apply\* **DE: Du könntest GEWINNEN.** Es gelten die Teilnahmebedingungen\* **FR: Tu pourrais GAGNER.** Des conditions s'appliquent\* **IT: Potresti VINCERE tu.** Termini e condizioni sono applicabili\* **ES: Puedes GANAR.** Aplican términos y condiciones\* **PT: Poderá GANHAR.** Aplicam-se termos e condições\* **ZH: 轻松获奖. 条款和条件适用\*** **PL: Szansa na WYGRANĄ.** Obowiązują warunki korzystania\* **CS: Máte šanci VYHRÁT.** Platí všeobecné smluvní podmínky\* **SK: Máte šancu VYHRAŤ.** Platia všeobecné zmluvné podmienky\* **HU: TE IS NYERHETSZ.** Felhasználási feltételek érvényesek\* **RO: Ai putea CÂȘTIGA.** Se aplică termeni și condiții\* **BG: Можете да СПЕЧЕЛИТЕ.** Има определени правила и условия\* **LV: Tu vari LAIMĒT.** Ir spēkā noteikumi un nosacījumi.\* **ET: Sul on võimalus VÕITA.** Kehtivad tingimused\* **LT: Jūs galite LAIMĖTI.** Taikomos sąlygos\*

\*[LEGO.com/productfeedback-terms](https://www.lego.com/productfeedback-terms)

LEGO, the LEGO logo, NINJAGO and the NINJAGO logo are trademarks of the/son des marques de commerce du/son marcas registradas de LEGO Group.  
©2025 The LEGO Group.