



NINJAGO

DRAGONS RISING

71827



Q LEGO® Builder



Get excited about our new packaging!

We're switching from plastic to paper-based packaging. That's why you might find a mix of paper and plastic in our boxes!

Nos nouveaux emballages vous emballeront !

Nous passons des emballages en plastique aux emballages à base de papier. C'est pourquoi vous pourriez trouver un mélange de papier et de plastique dans nos boîtes !

¡Te presentamos nuestros nuevos empaques!

Estamos sustituyendo las bolsas de plástico por bolsas con base de papel. ¡Por eso, puedes encontrar una mezcla de papel y de plástico en nuestras cajas!

[LEGO.com/sustainable-packaging](https://www.lego.com/sustainable-packaging)



Q LEGO® Builder

BUILDER



Apple and the Apple logo are trademarks of Apple Inc., registered in the U.S. and other countries and regions. App Store is a service mark of Apple Inc. Google Play and the Google Play logo are trademarks of Google LLC. Tencent and the Tencent logo are trademarks of Tencent Inc.

Q [LEGO.com/devicecheck](https://www.lego.com/devicecheck)

EN Ask parents' permission before going online | **DE** Eltern um Erlaubnis bitten, bevor du online gehst | **FR** Demande l'autorisation d'un parent avant d'aller en ligne | **IT** Chiedi il permesso ai tuoi genitori prima di andare online | **ES** Pídeles permiso a tus papás antes de conectarte a Internet | **PT** Peça autorização aos pais antes de acederes online | **ZH** 上网前应先征得父母的同意 | **PL** Poproś rodziców o zgodę, zanim wejdiesz do Internetu | **CS** Než půjdeš na internet, požádej rodiče o svolení | **SK** Skôr než pôjdeš na internet, vypýtaj si povolenie od rodičov | **HU** Kérj szülői engedélyt, mielőtt online csatlakoznál! | **RO** Cere permisiunea părinților înainte de a te conecta online | **BG** Поискайте разрешение от родител, преди да влезете онлайн | **LV** Pirms došanās tiešsaistē palūdz atļauju vecākiem | **ET** Enne Interneti kasutamist küsi vanematelt luba | **LT** Prieš prisijungdami prie interneto, atsiklauskite tėvų





CONSTRUISEZ À VOTRE FAÇON
CONSTRÚYELO A TU MANERA



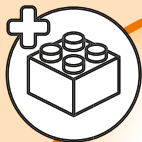

1x

1

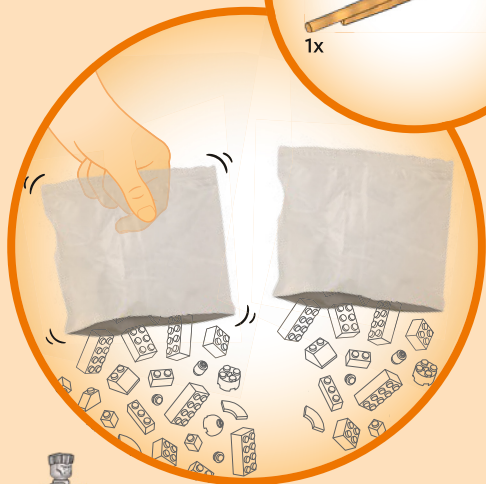
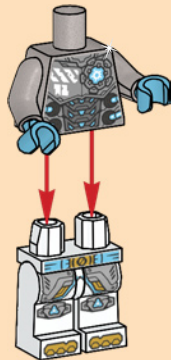

6



2

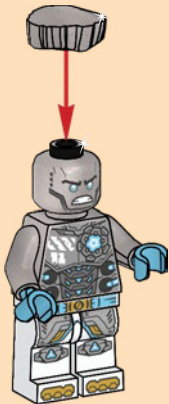

3

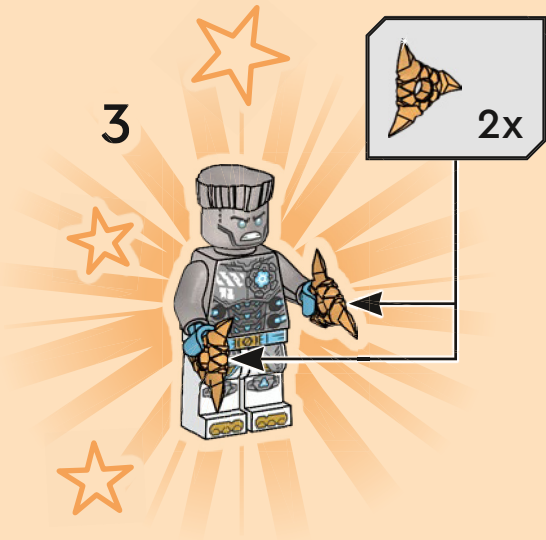

1

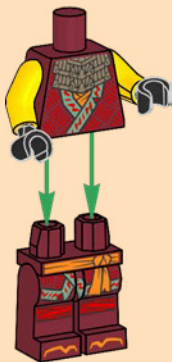

2



3



1

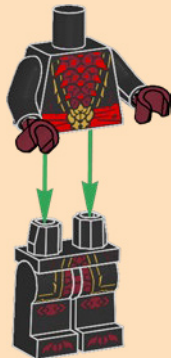

2

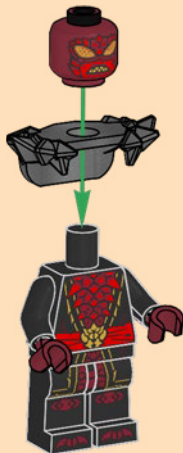

3



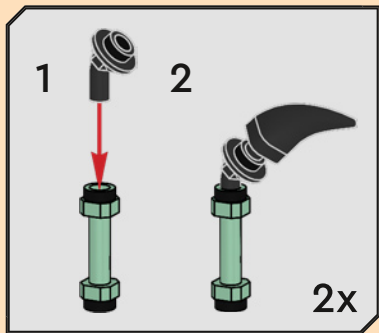

4

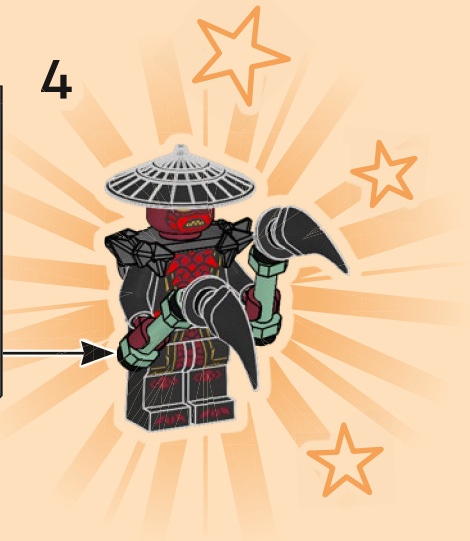

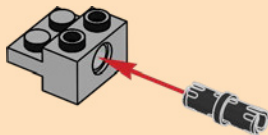
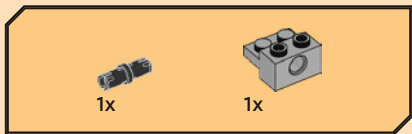

1





2

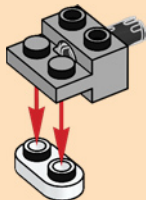

3

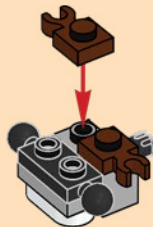



1x



1x

4



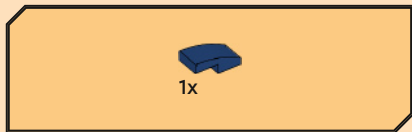

5

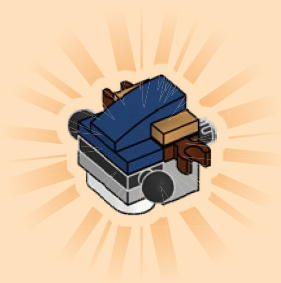

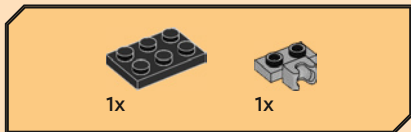
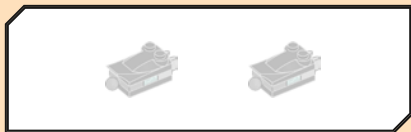

6

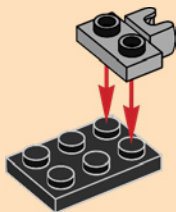



1x



1x

7



1x

8

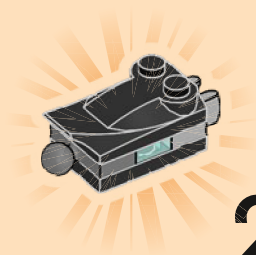

2x

9

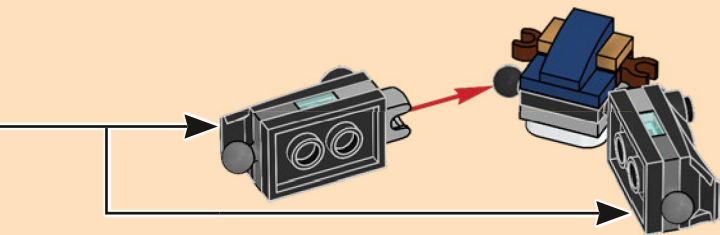



10

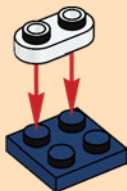

11





1x

12

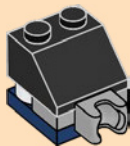



1x

13

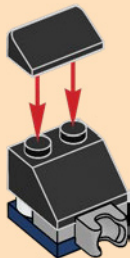

1x

14

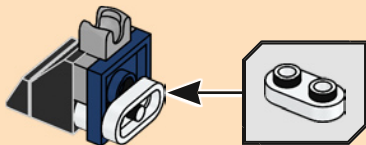

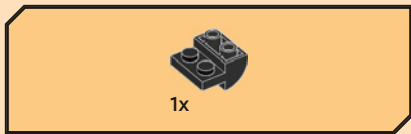

15

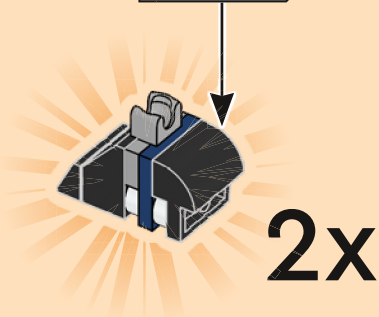
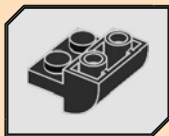

16

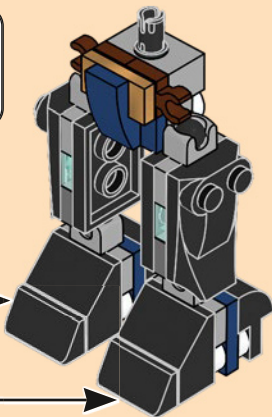

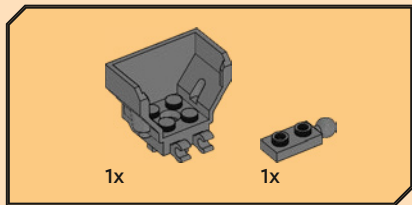
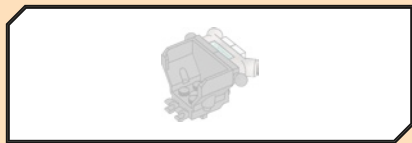

17

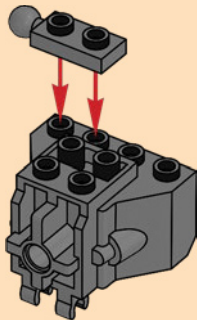



1x

18

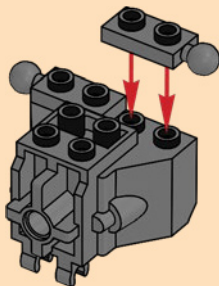

1x

19

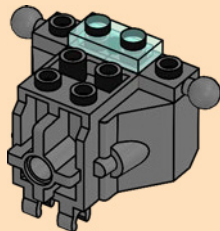

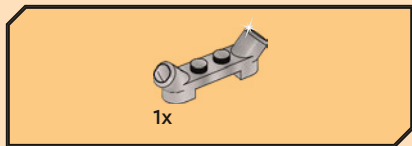

20

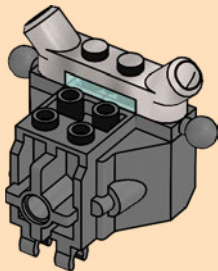



2x

21

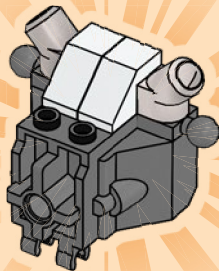

22

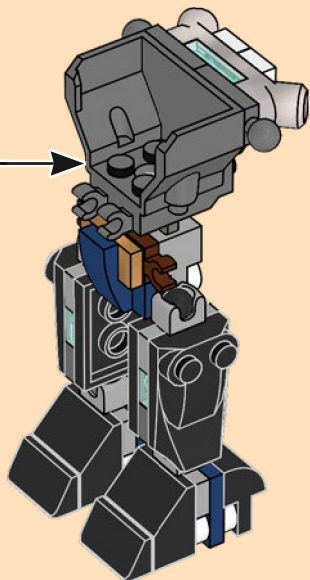

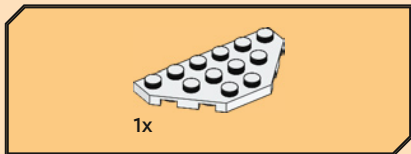
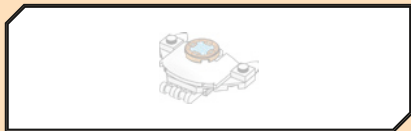

23



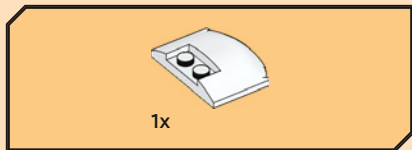

24





1x

25

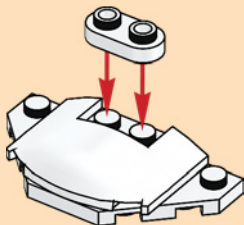

1x

26





2x

27

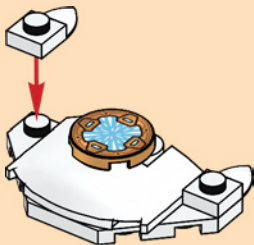



2x

28

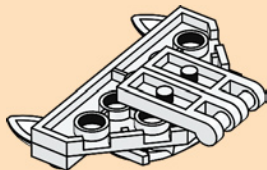

1x

29

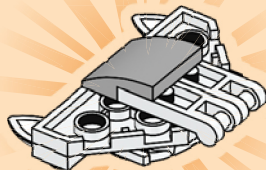

30

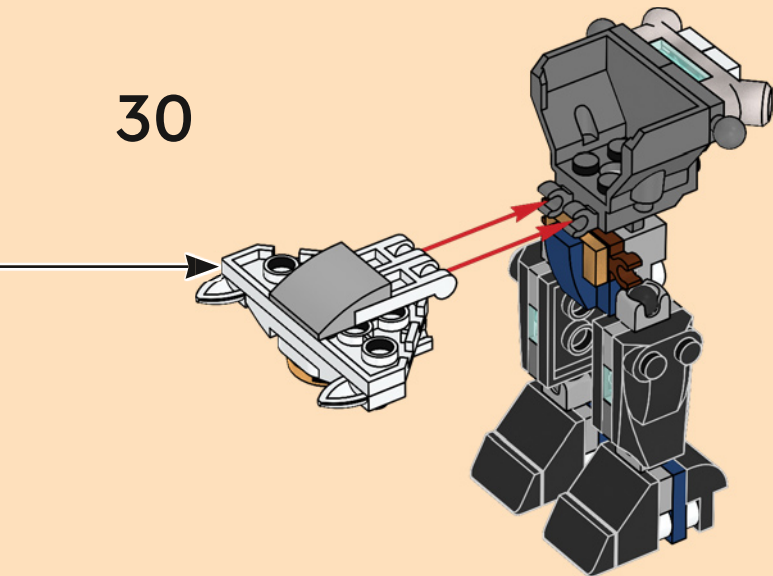

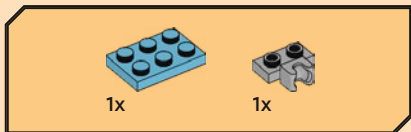

31

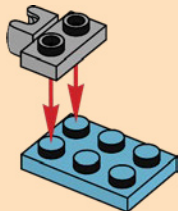

32

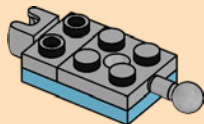



1x

33

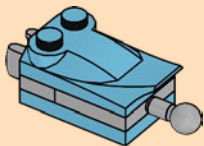

1x

34

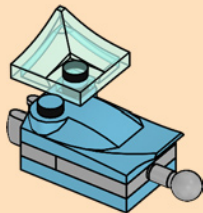



1x

35

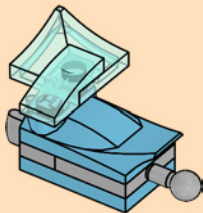

1x



1x

36

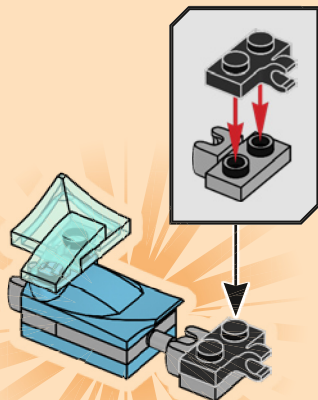

37

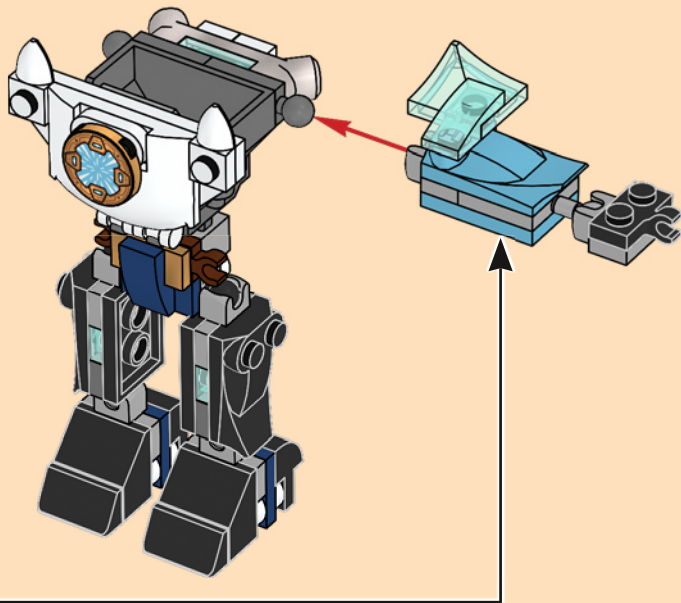

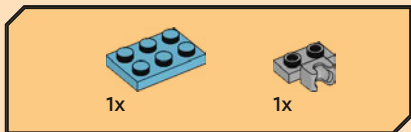

38

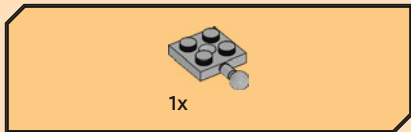
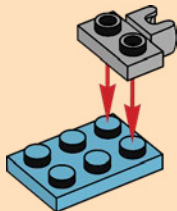

39

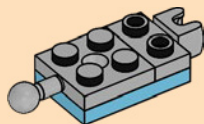

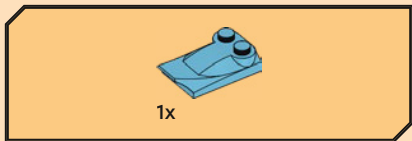

40

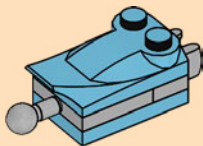

41

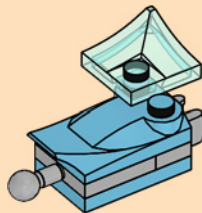



1x

42

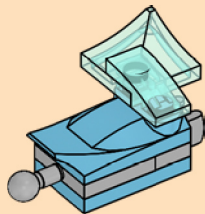

1x



1x

43

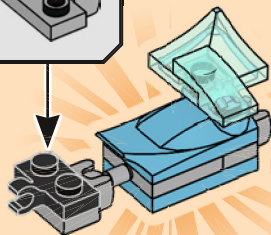
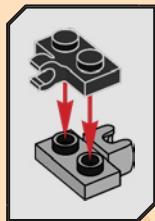

44

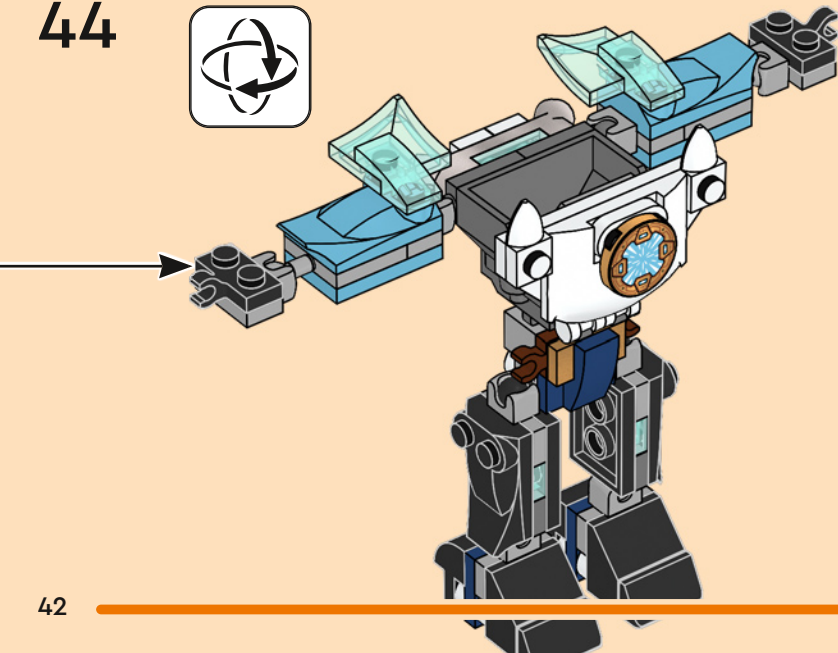

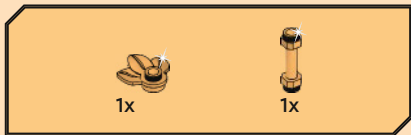
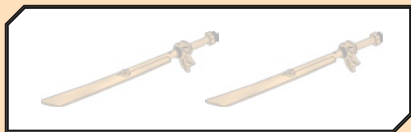

45

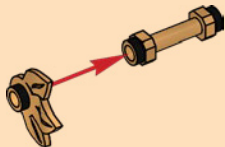

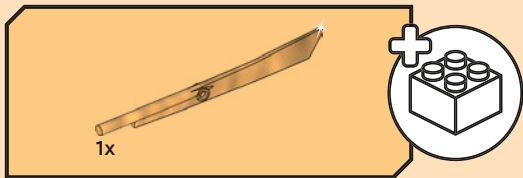

46

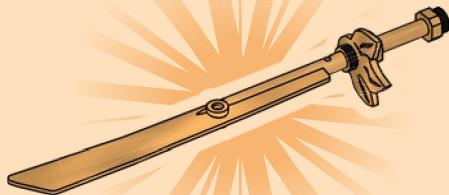

2x

47

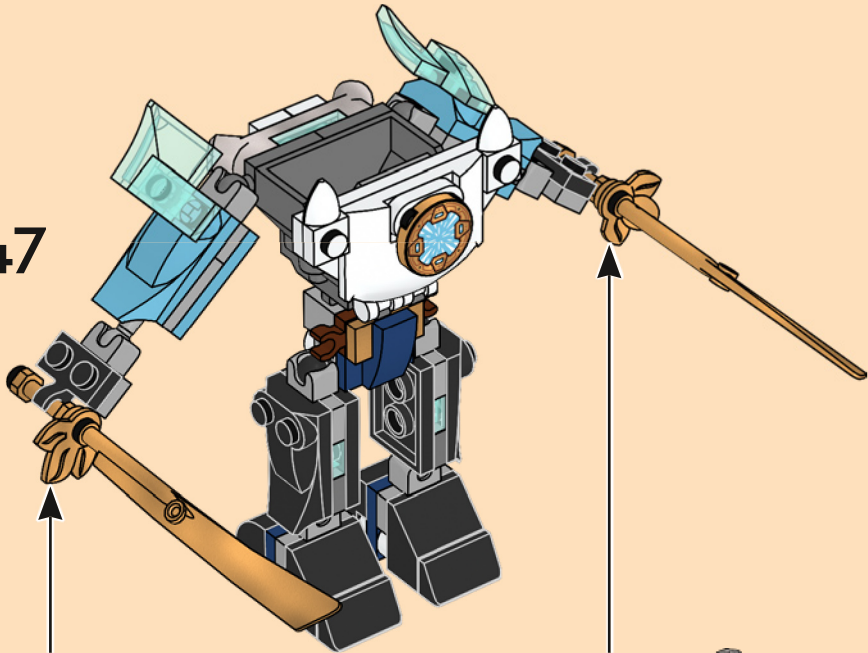

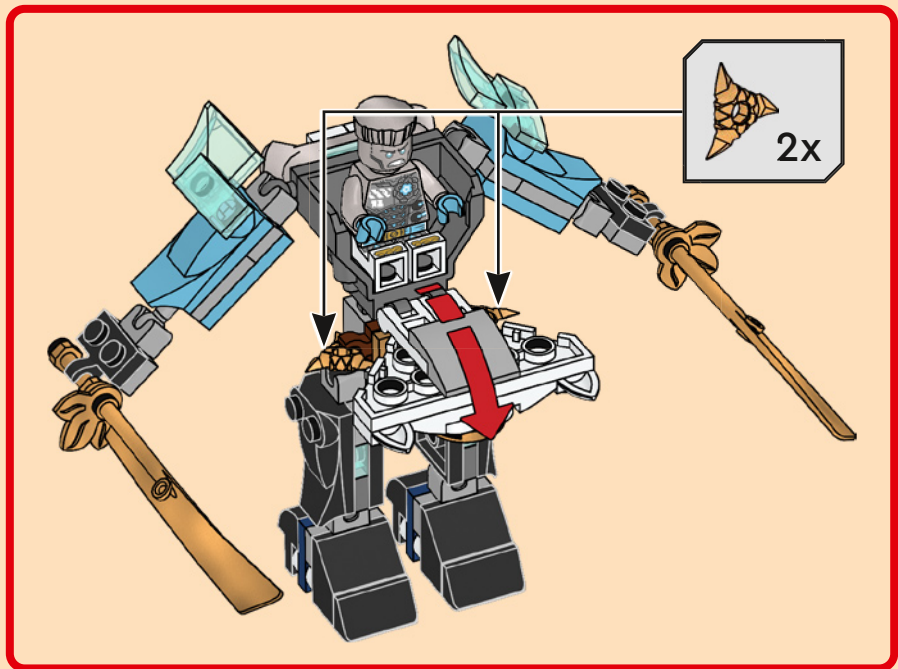

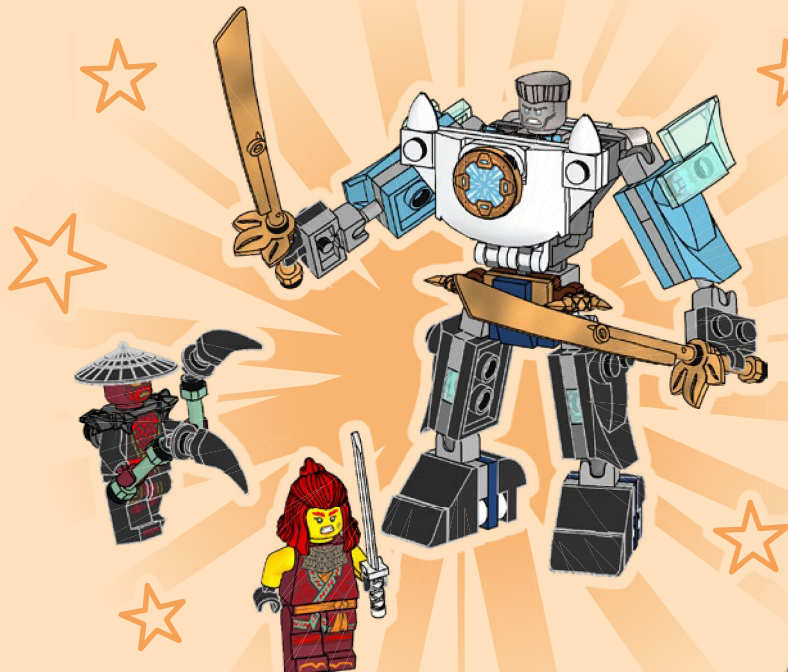





71823



71824



71826



71830



71834



71833



71841



2x
4224792



6x
6210272



1x
6518755



2x
6166894



2x
4515364



1x
6018101



1x
241901

50



1x
6478060



2x
6510193



2x
6270091



2x
4548180



1x
6279875



1x
6518758



2x
6313116



1x
6416838



2x
303926



2x
6458098



1x
6524932



1x
6525595



2x
302126



2x
4285883



1x
6474604



1x
6215718



1x
6320779



1x
6525722



1x
4632100



1x
6092588



1x
6094143



2x
6037890



1x
6521182



2x
6378168



2x
6219088



1x
6518759



1x
6092594



1x
6114925



2x
6270131



2x
4619513



2x
6439464



1x
6434461



1x
6518756



1x
6473850



1x
6482044



8x
6043656



1x
6326478



1x
6185676



2x
6448319



2x
6039479



2x
6123814



1x
6397284



1x
6384443



2x
6337003



3x
6514007



2x
6508249



2x
6527412

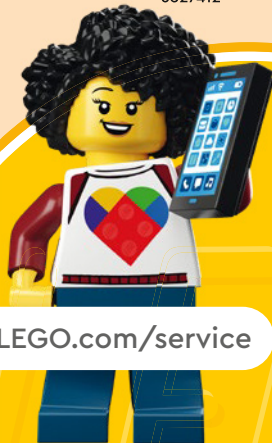

[LEGO.com/service](https://www.lego.com/service)

YOU COULD

WIN



Scan this QR code or go to
LEGO.COM/PRODUCTFEEDBACK and give us
your short feedback about this LEGO® set
for a chance to win a cool LEGO prize.

Terms and Conditions apply*

EN: YOU COULD WIN. Terms and Conditions apply* **DE: Du könntest GEWINNEN.** Es gelten die Teilnahmebedingungen* **FR: Tu pourrais GAGNER.** Des conditions s'appliquent* **IT: Potresti VINCERE tu.** Termini e condizioni sono applicabili* **ES: Puedes GANAR.** Aplican términos y condiciones* **PT: Poderá GANHAR.** Aplicam-se termos e condições* **ZH: 轻松获奖.** 条款和条件适用* **PL: Szansa na WYGRANĄ.** Obowiązują warunki korzystania* **CS: Máte šanci VYHRÁT.** Platí všeobecné smluvní podmínky* **SK: Máte šancu VYHRÁT.** Platia všeobecné zmluvné podmienky* **HU: TE IS NYERHETSZ.** Felhasználási feltételek érvényesek* **RO: Ai putea CÂȘTIGA.** Se aplică termenii și condiții* **BG: Можете да СПЕЧЕЛИТЕ.** Има определени правила и условия* **LV: Tu vari LAIMĒT.** Ir spēkā noteikumi un nosacījumi.* **ET: Sul on võimalus VÕITA.** Kehtivad tingimused* **LT: Jūs galite LAIMĖTI.** Taikomos sąlygos*

*[LEGO.com/productfeedback-terms](https://www.lego.com/productfeedback-terms)

LEGO, the LEGO logo, NINJAGO and the NINJAGO logo are trademarks of the/son des marques de commerce du/son marcas registradas de LEGO Group. ©2025 The LEGO Group.

6556894