



# CREATOR™



31169



3in1	3 in 1	3合1	3 az 1-ben	3 ühes
3-in-1	3en1	3 w 1	3 in 1	„Trys viename“
3-en-1	3em1	3 v 1	„3 в 1“	







LEGO® Builder



[LEGO.com/sustainable-packaging](https://LEGO.com/sustainable-packaging)



 <sup>FR</sup> **DONNEZ**  
OU  
**RECYCLEZ**

 OU  OU 

ASSOCIATION    MAGASIN    DÉCHÈTERIE

Adresses sur [quefairedemesdechets.fr](https://quefairedemesdechets.fr)



Q LEGO® Builder

# BUILDER



Apple and the Apple logo are trademarks of Apple Inc., registered in the U.S. and other countries and regions. App Store is a service mark of Apple Inc. Google Play and the Google Play logo are trademarks of Google LLC. Tencent and the Tencent logo are trademarks of Tencent Inc.

Q [LEGO.com/devicecheck](https://www.lego.com/devicecheck)

EN Ask parents' permission before going online | DE Eltern um Erlaubnis bitten, bevor du online gehst | FR Demande l'autorisation d'un parent avant d'aller en ligne | IT Chiedi il permesso ai tuoi genitori prima di andare online | ES Pídeles permiso a tus papás antes de conectarte a Internet | PT Pede autorização aos pais antes de acederes online | ZH 上网前应先征得父母的同意 | PL Poproś rodziców o zgodę, zanim wejdiesz do Internetu | CS Než půjdeš na internet, požádej rodiče o svolení | SK Skôr než pôjdeš na internet, vypýtaj si povolenie od rodičov | HU Kérj szülői engedélyt, mielőtt online csatlakoznál! | RO Cere permisiunea părinților înainte de a te conecta online | BG Поискайте разрешение от родител, преди да влезете онлайн | LV Pirms došanās tiešsaistē palūdz atļauju vecākiem | ET Enne Interneti kasutamist küsi vanematelt luba | LT Prieš prisijungdami prie interneto, atsiklauskite tėvų

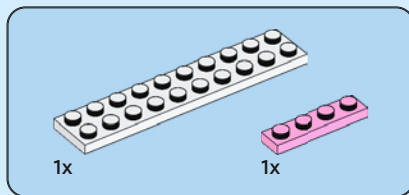

1

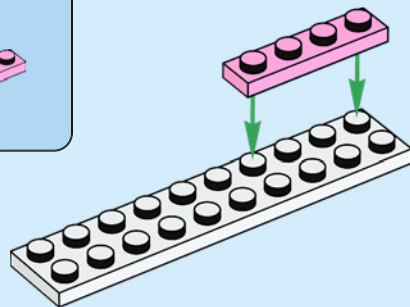

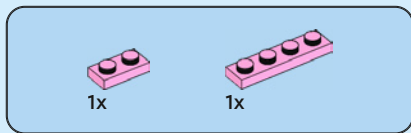

2

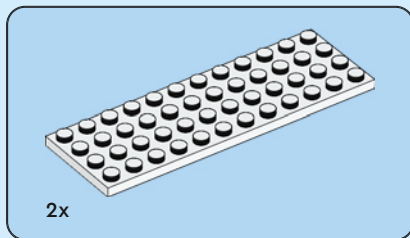
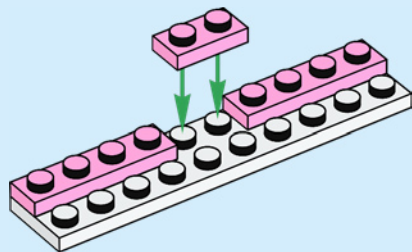

3

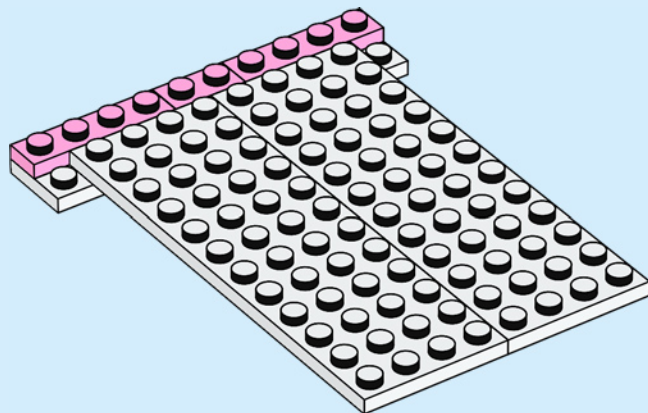

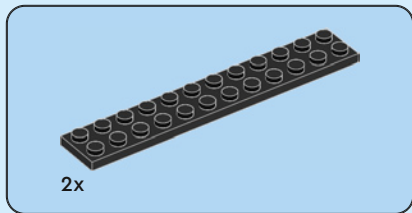

4

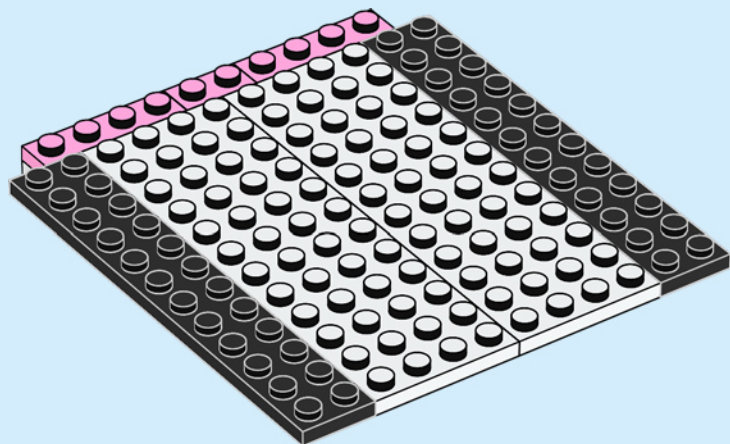



3x

5

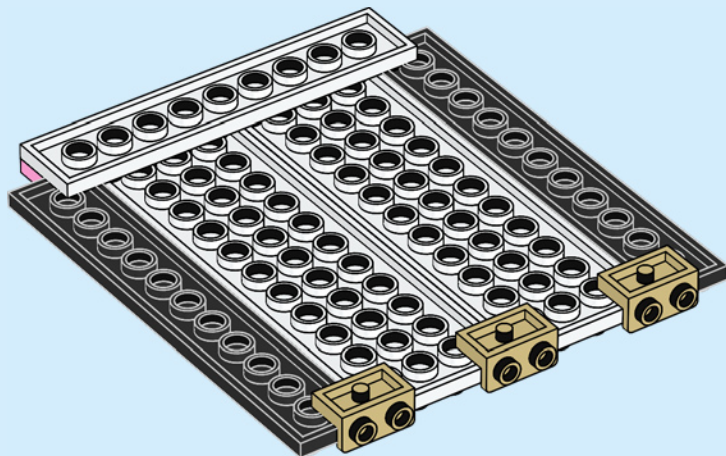



6x

6

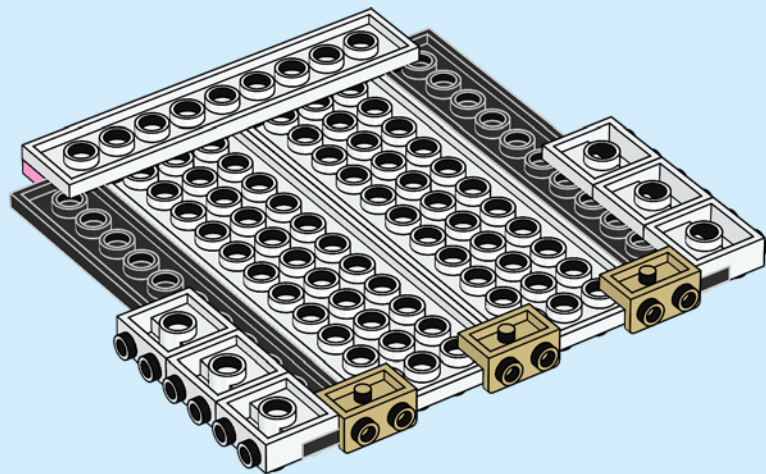



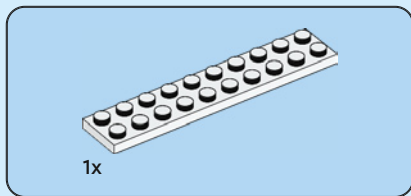

7

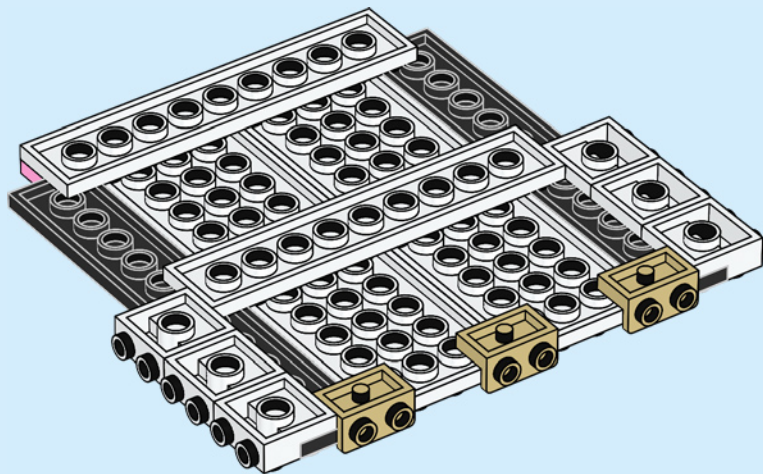



6x

8

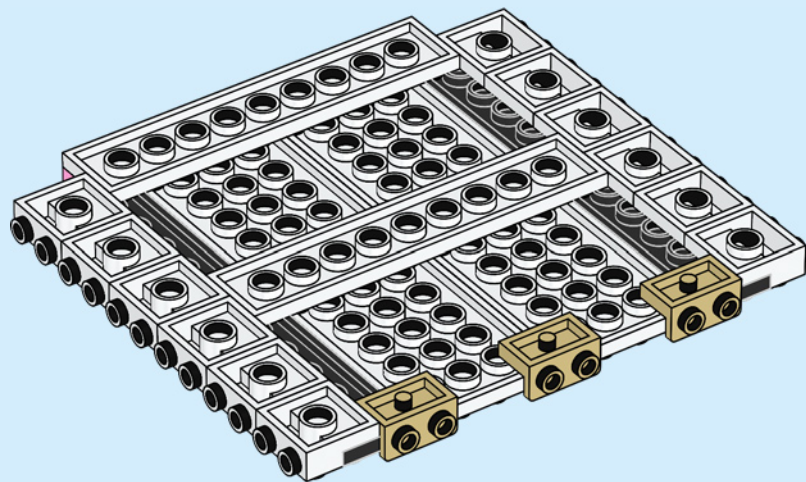

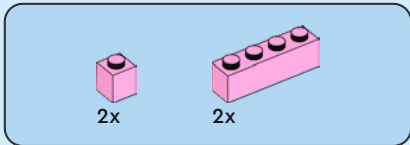

9

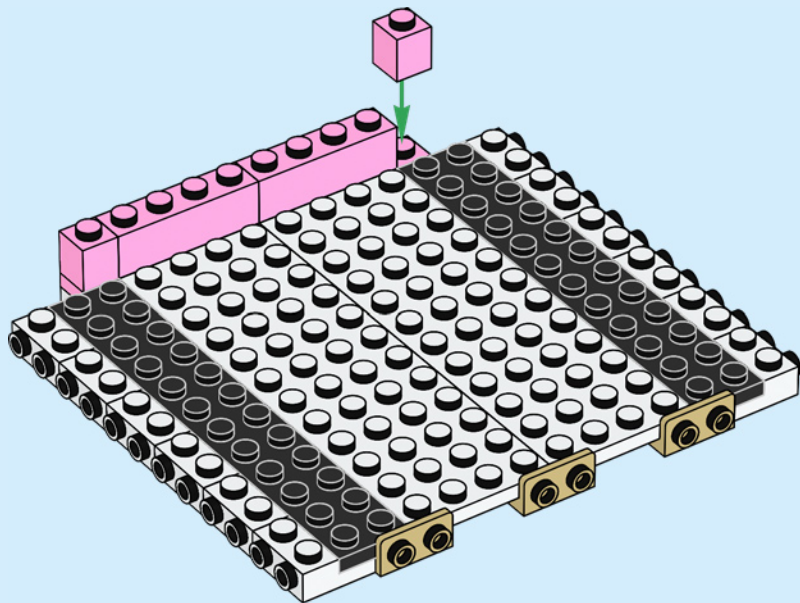

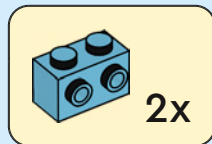
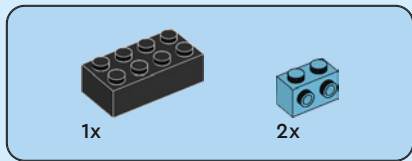

10

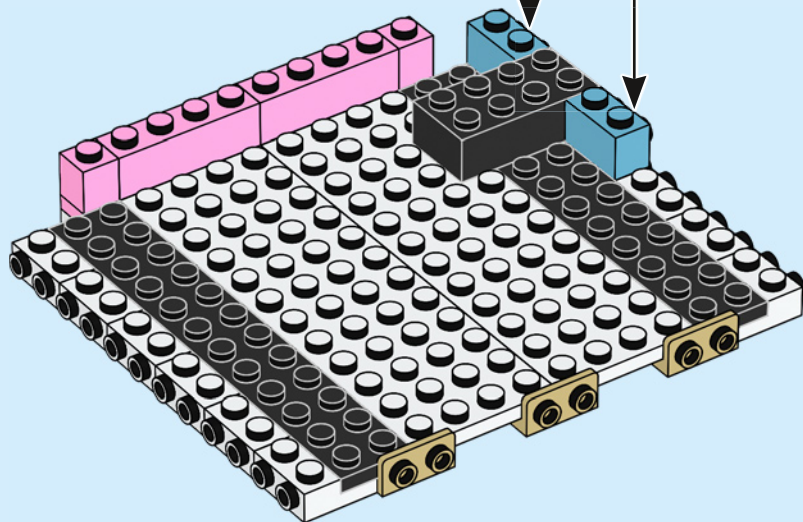

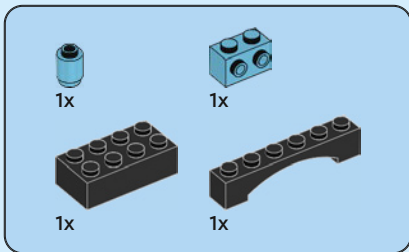

11

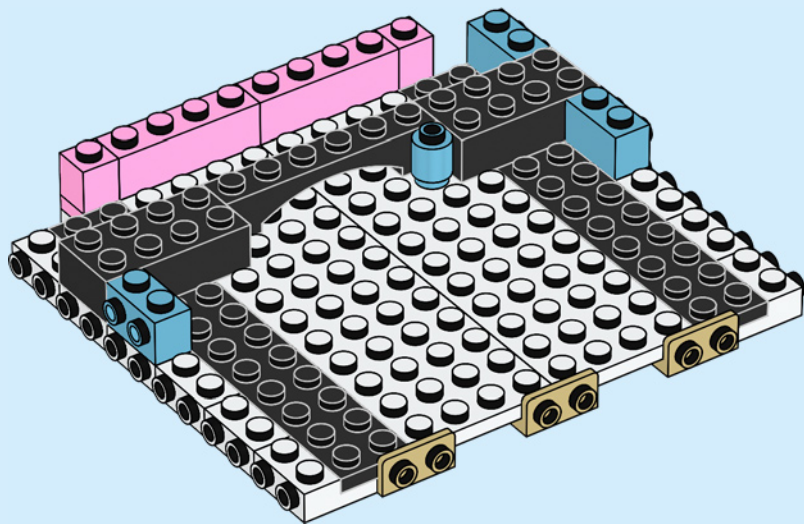

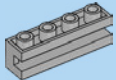

1x

12

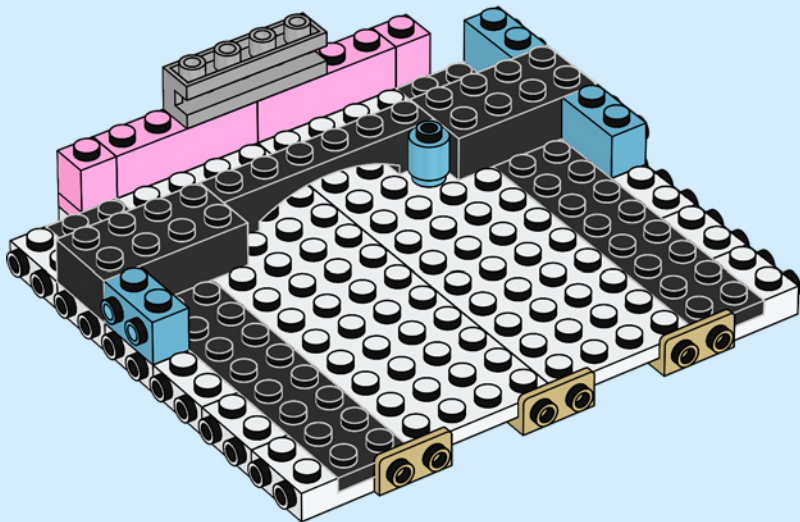

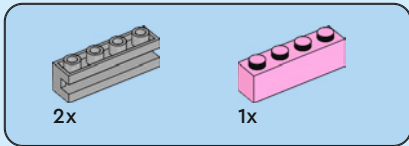

13

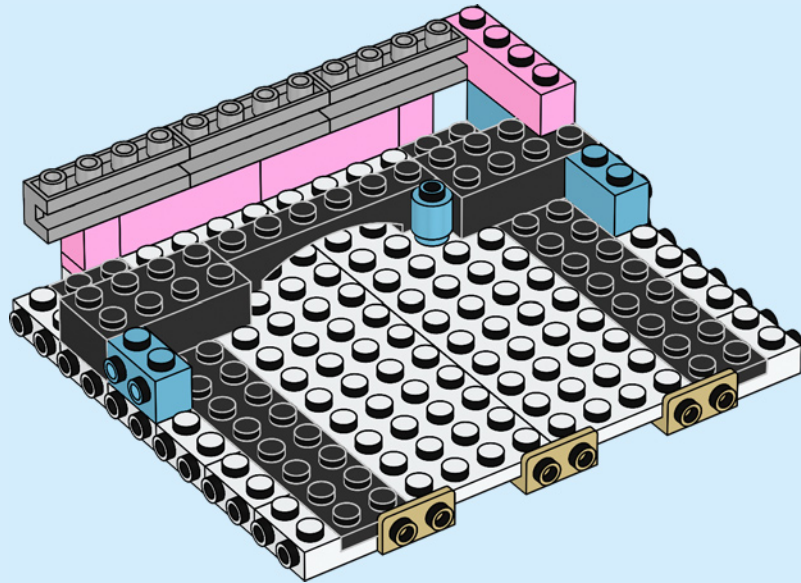

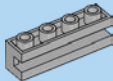

3x

14

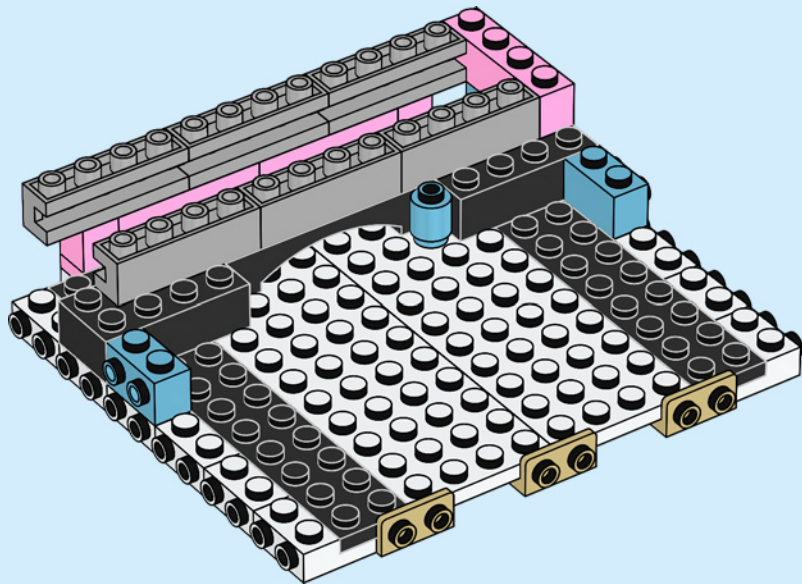



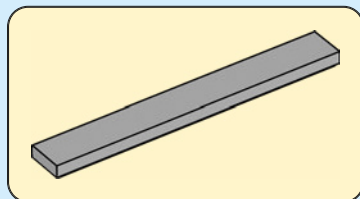
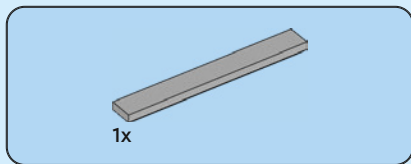

15

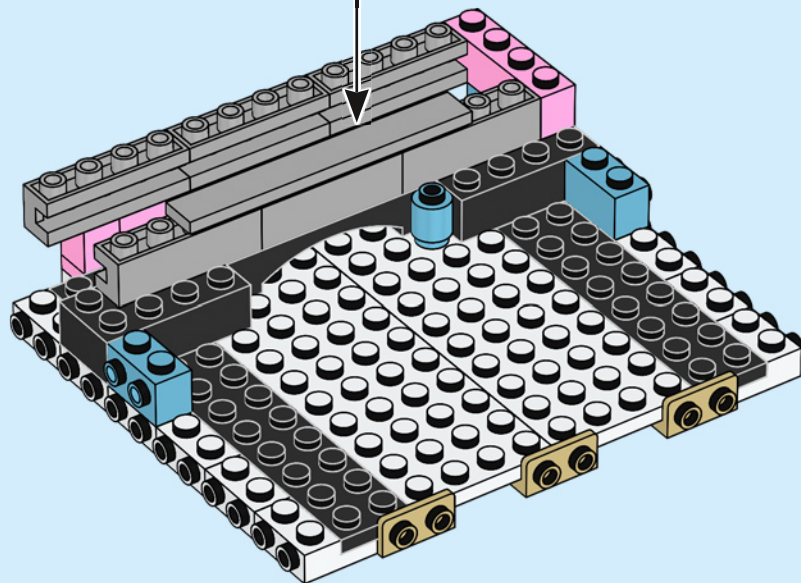

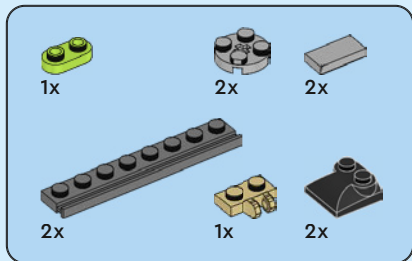

16

1

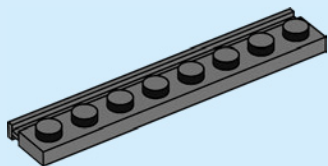

2

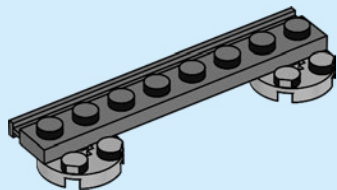

3

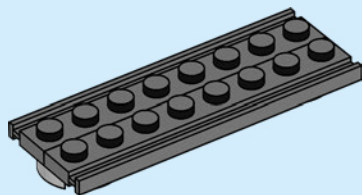

4

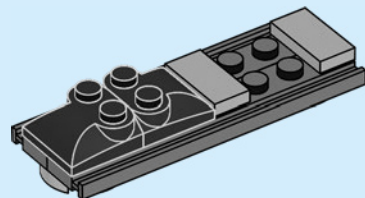

5

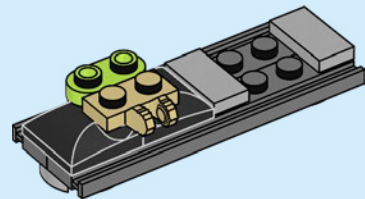

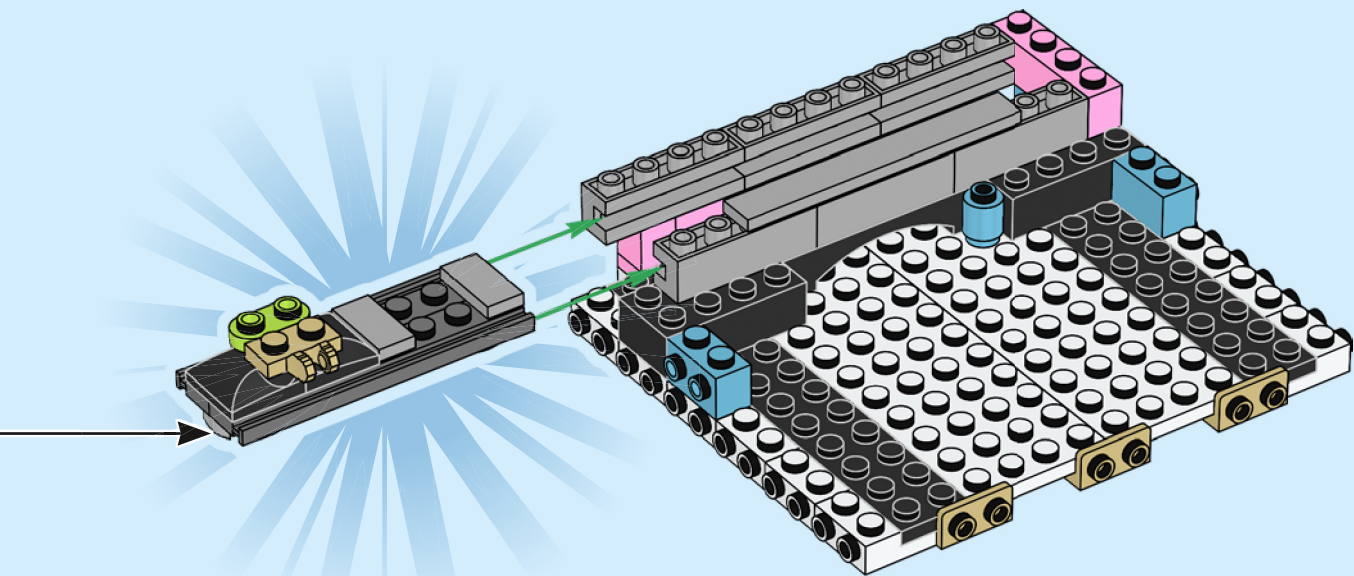

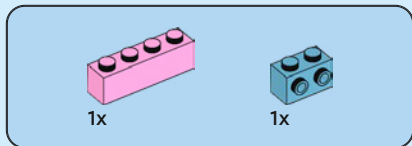

17

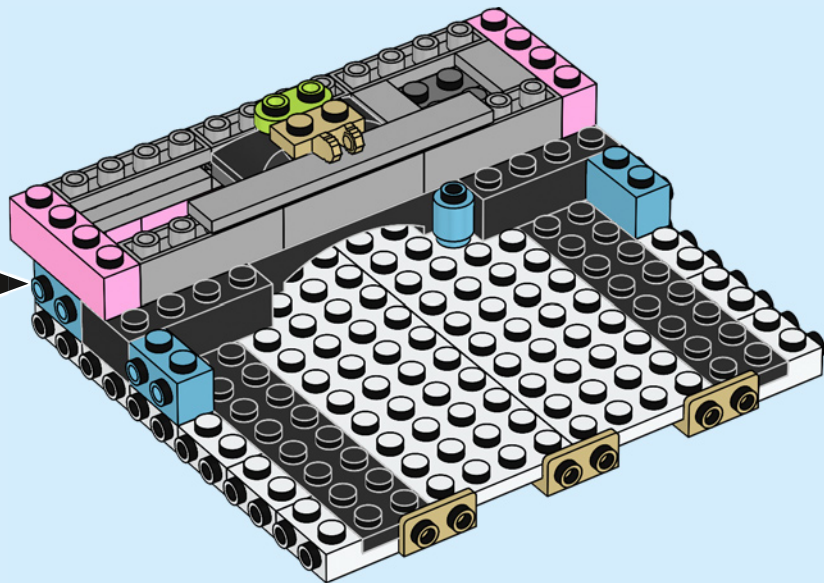
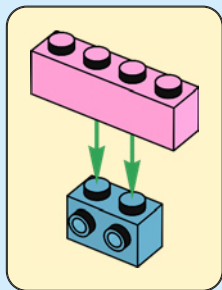

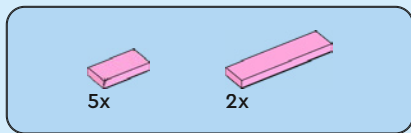

18

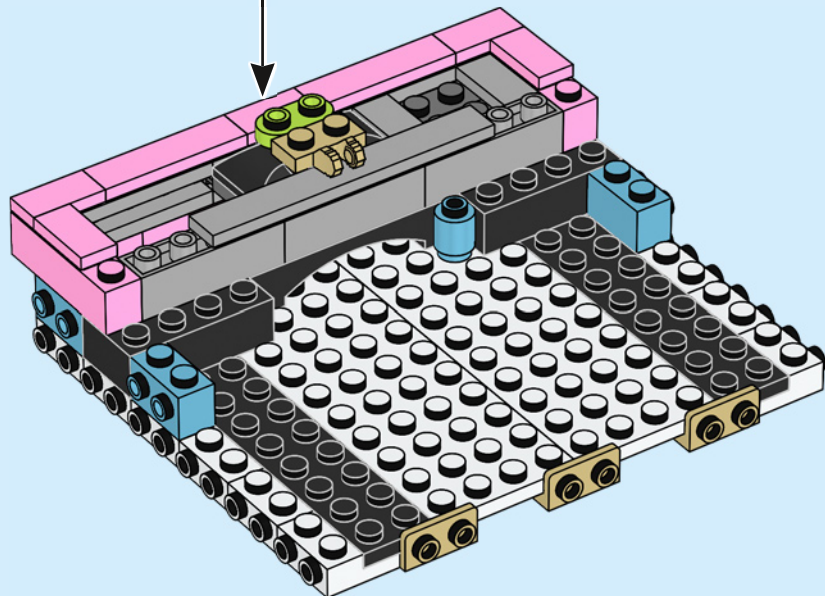

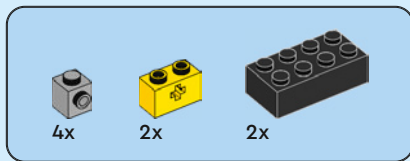

19

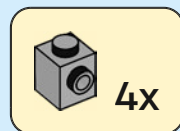
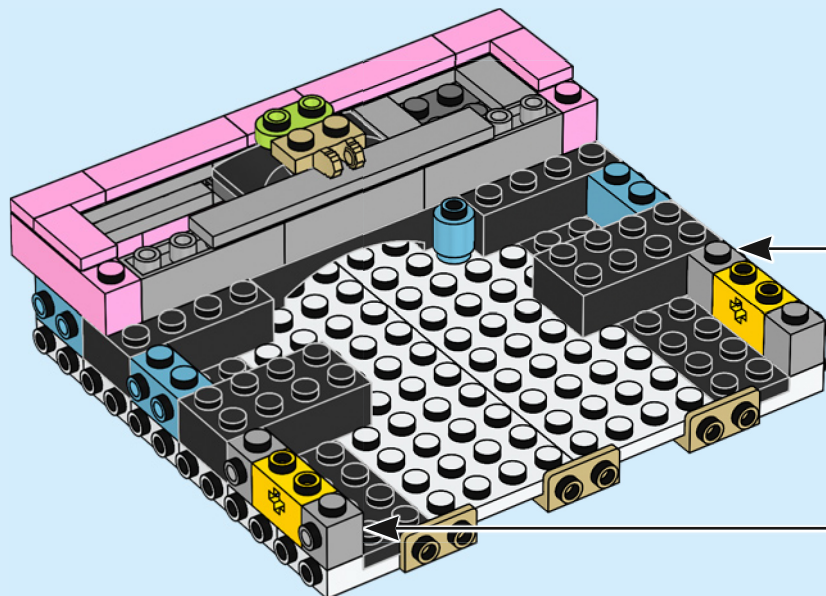

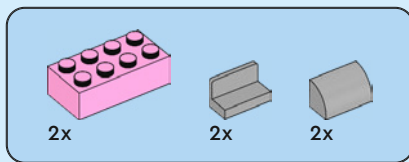

20

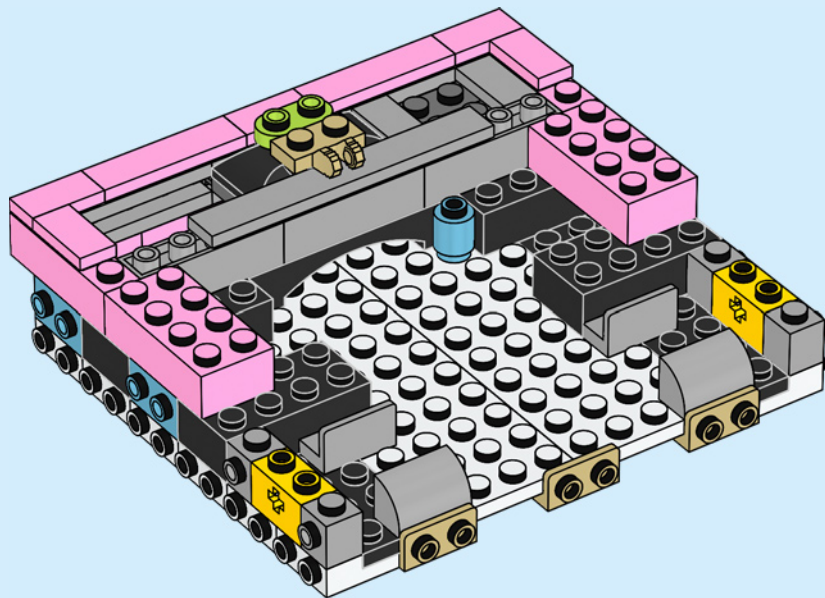



2x

21

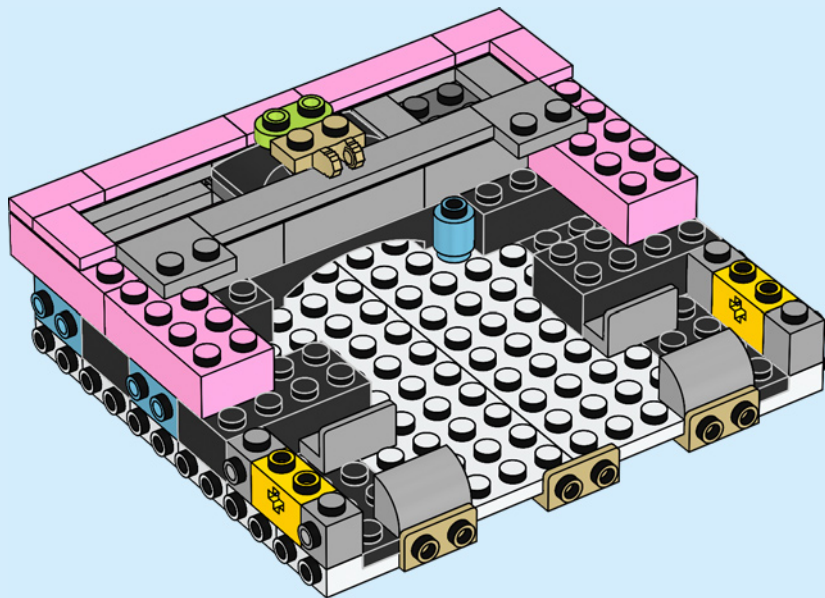





2x



1x

# 22

1

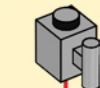

2

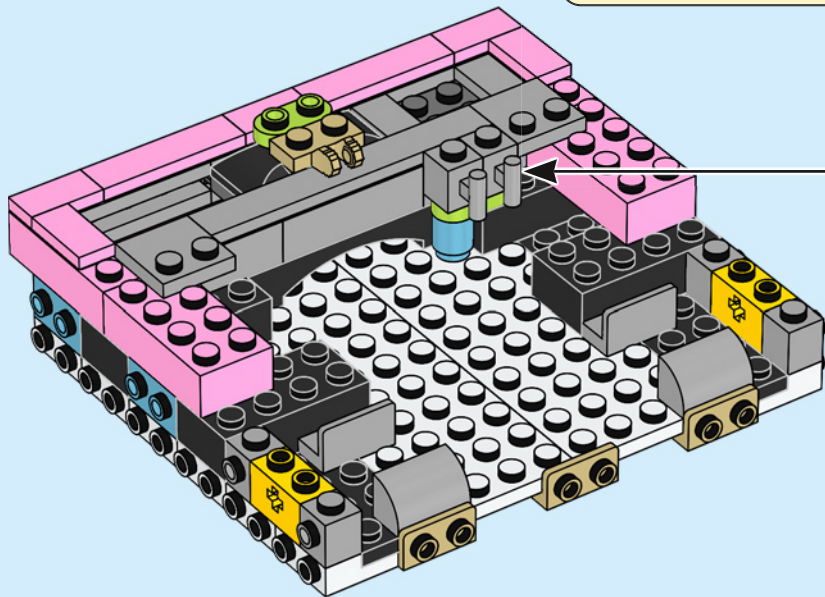



2x



2x



2x

# 23

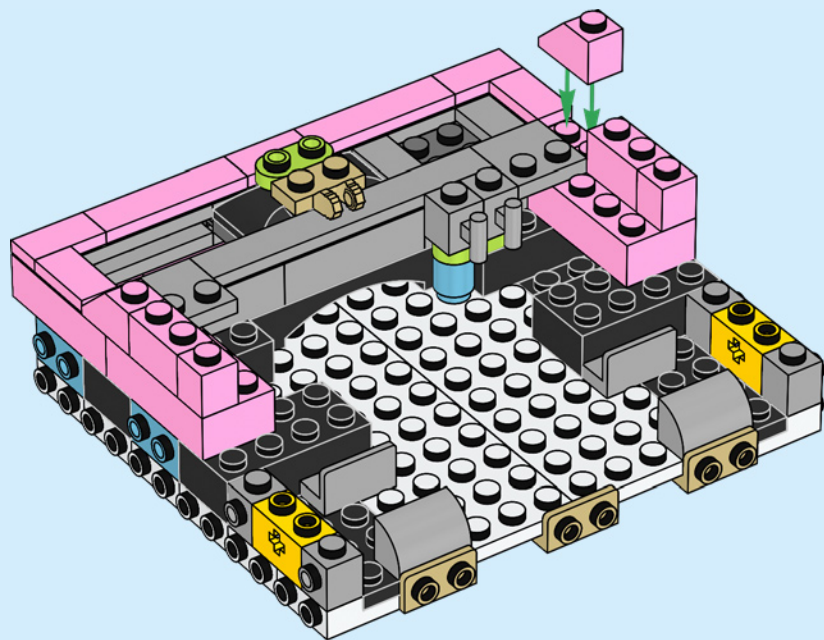

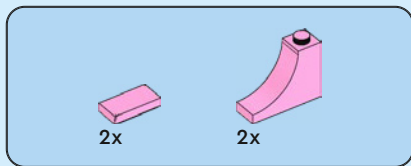

24

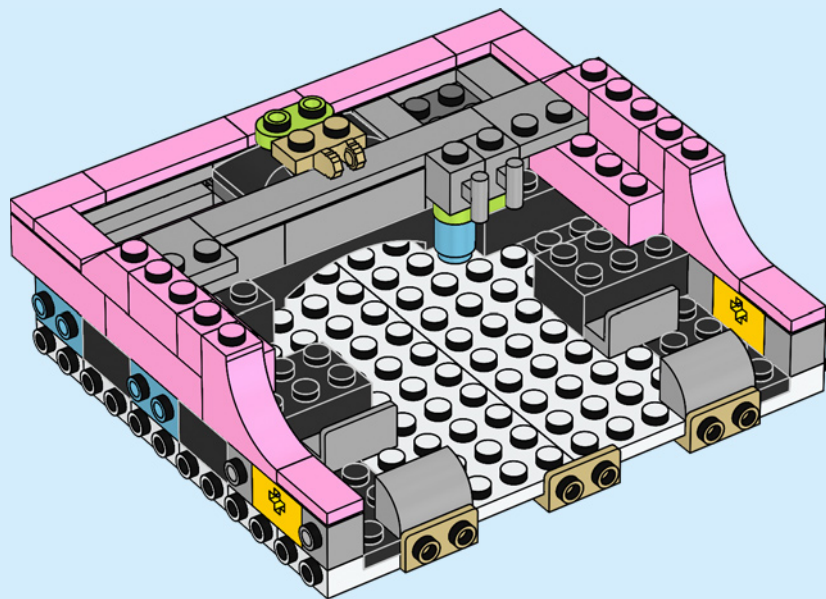

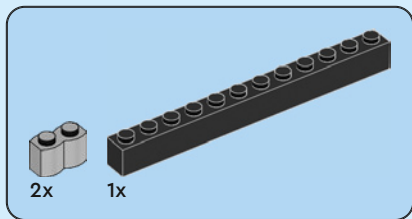

25

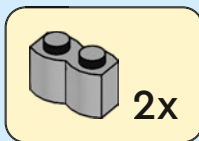
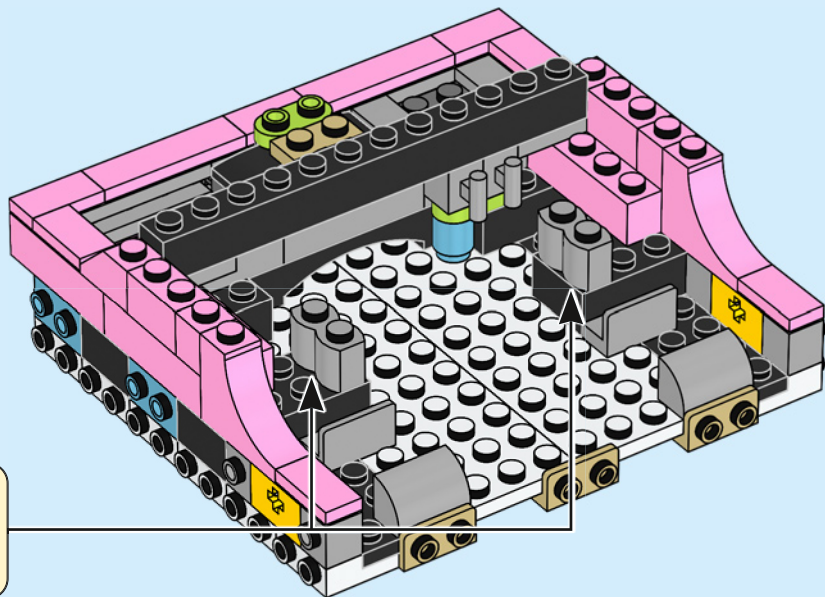



2x

26

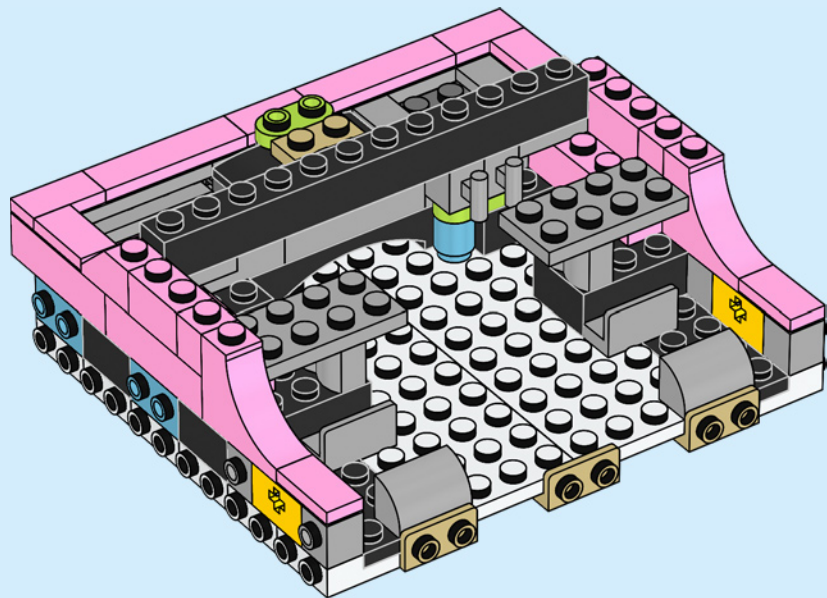



2x



2x

27

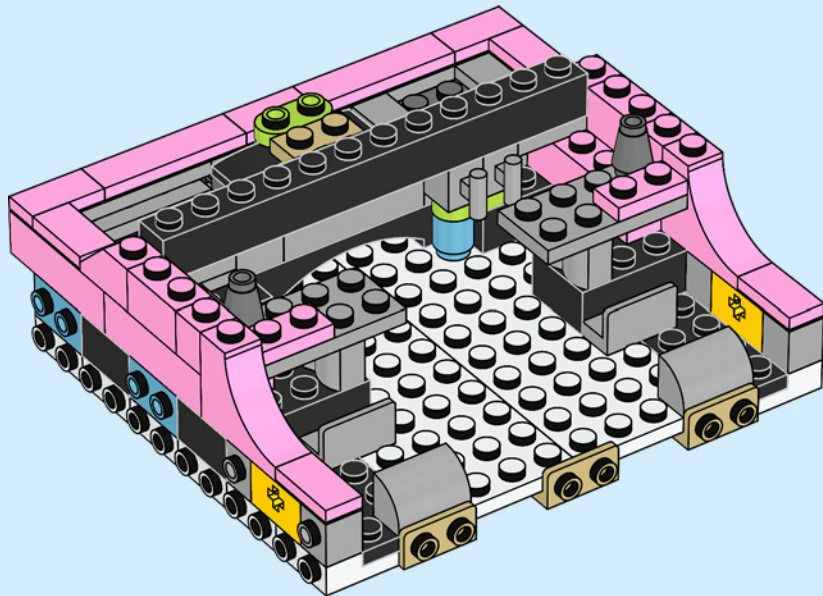

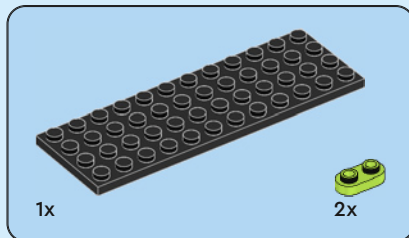
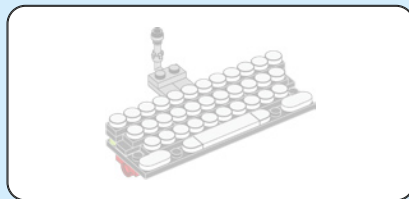

28

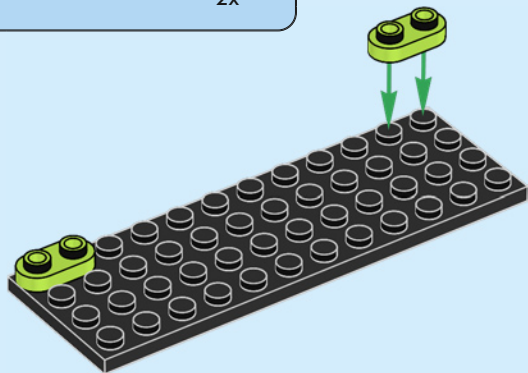



6x

29

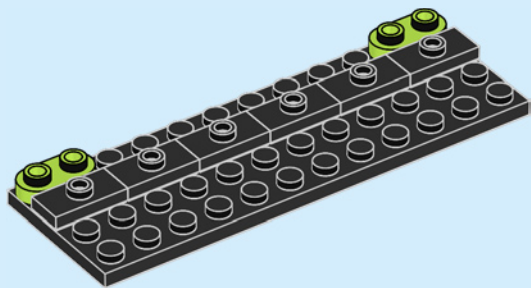

2x

30

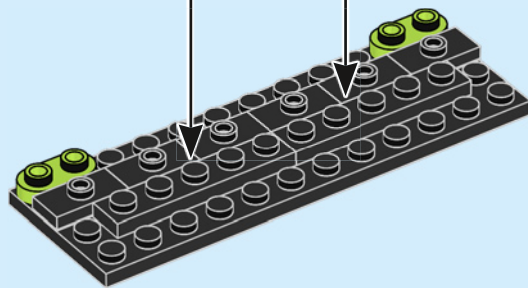
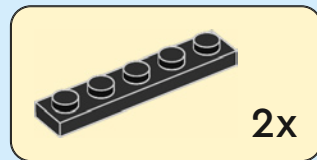



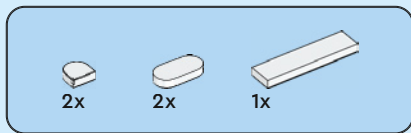

31

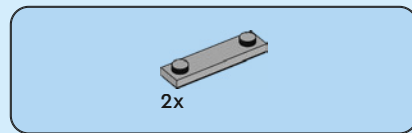
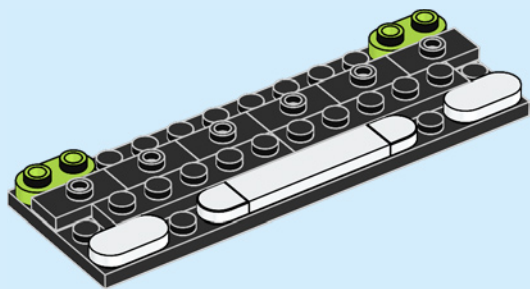

32

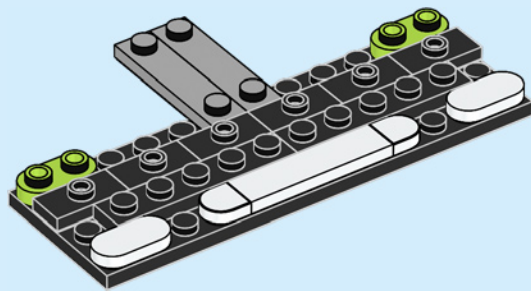



1x



1x

# 33

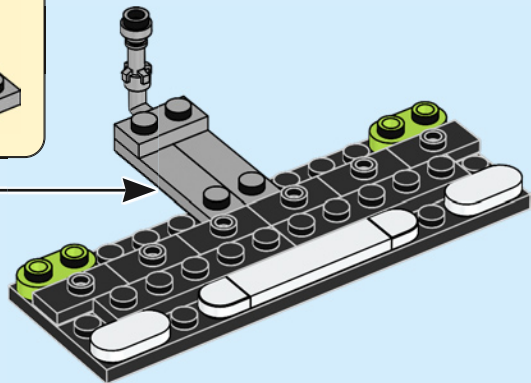
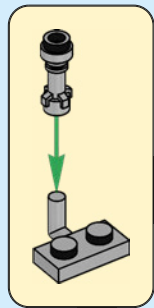

2x



1x

# 34

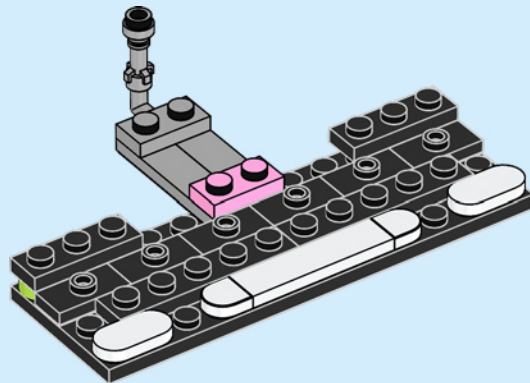

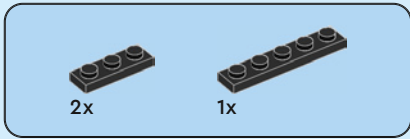

35

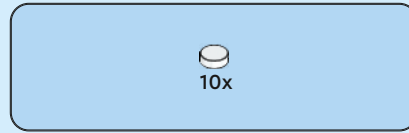
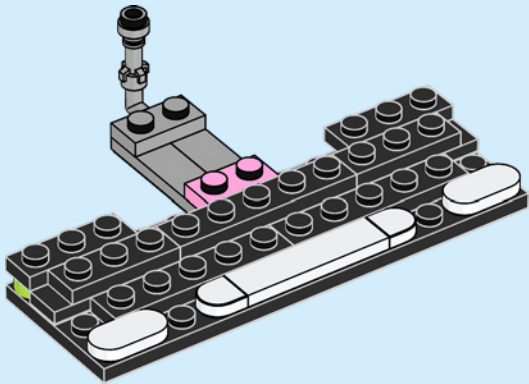

36

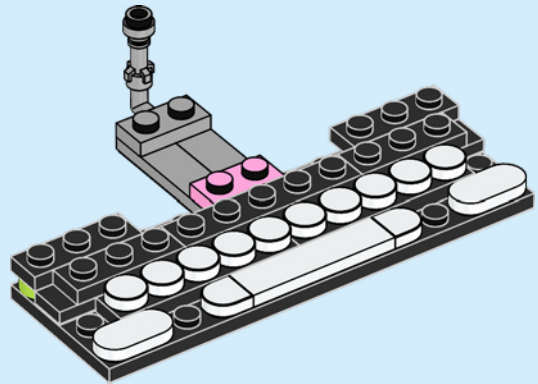

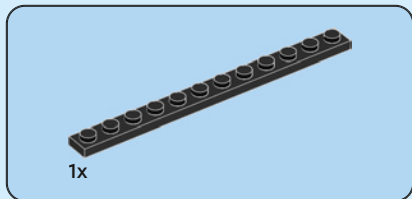

37

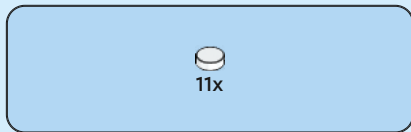
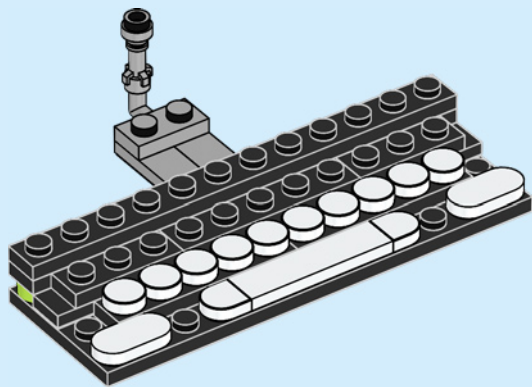

38

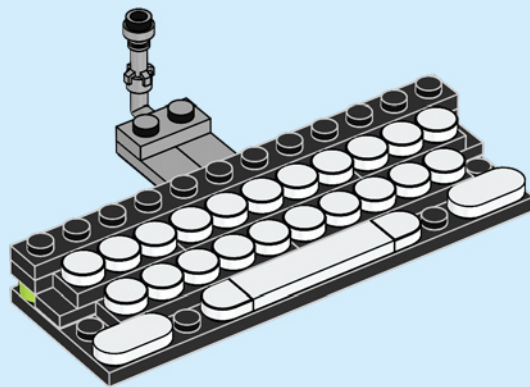

12x

39

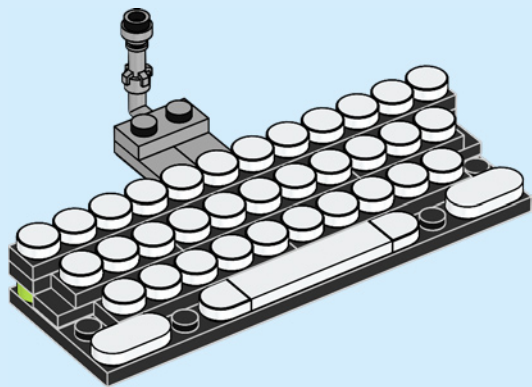

2x

40

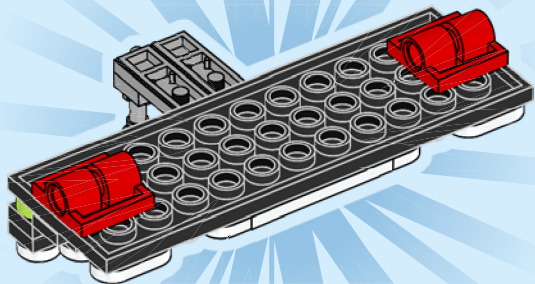

41

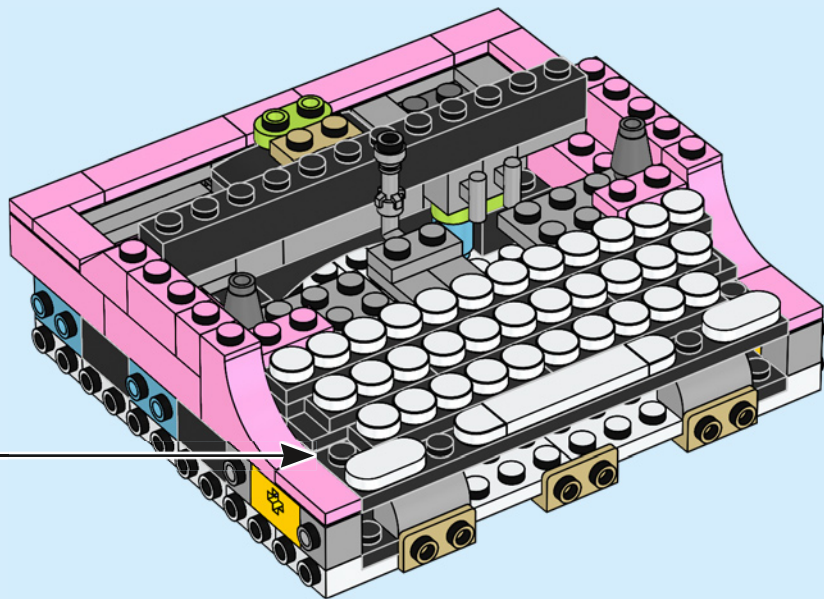



2x

42

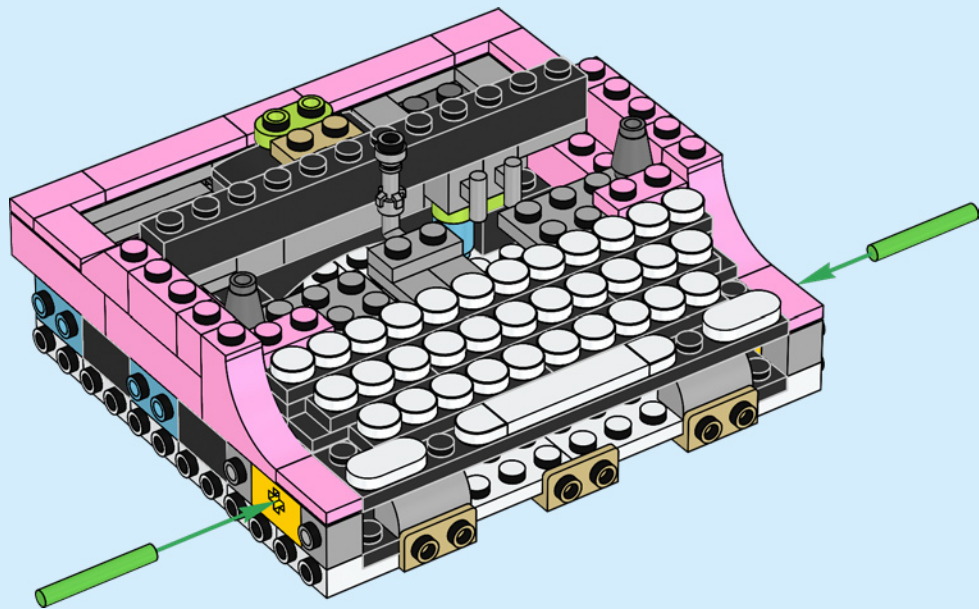

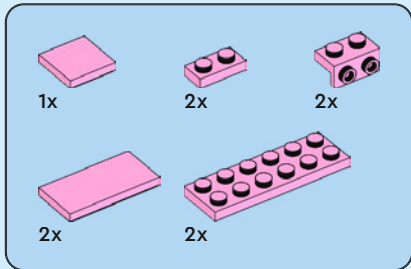
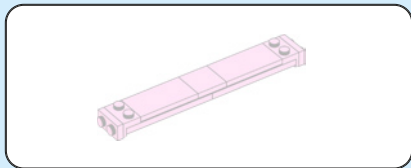

43

1

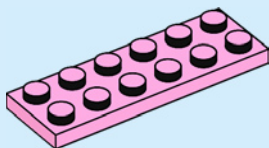

2

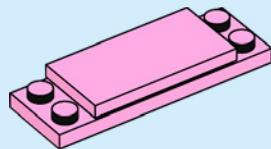

3

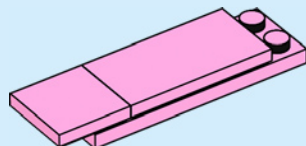



4

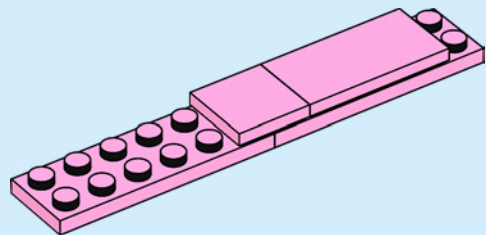

5

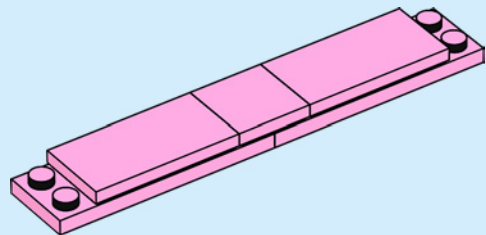

6

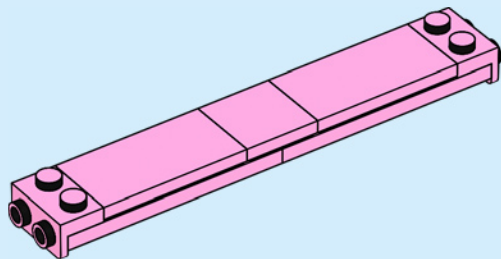

7

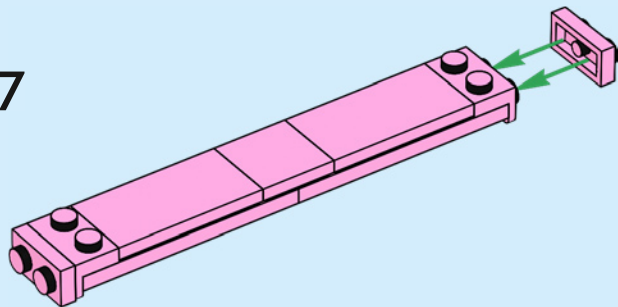

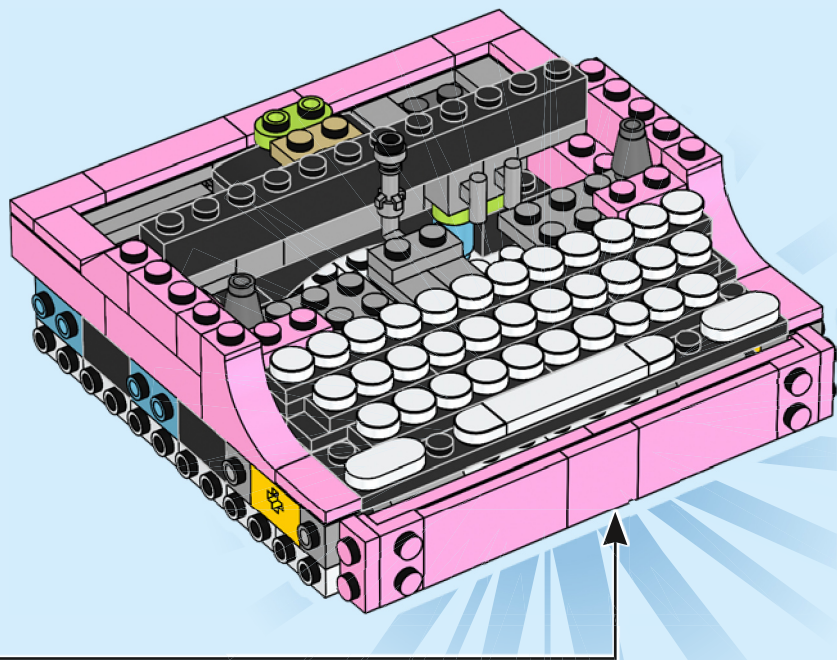

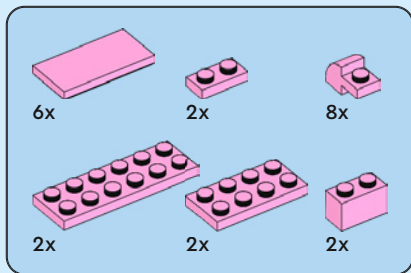
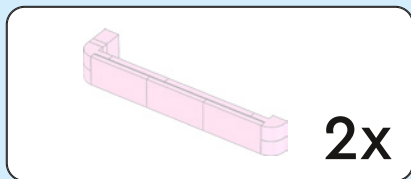

44

1

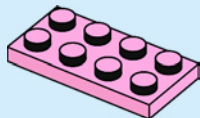

2

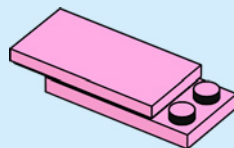

3

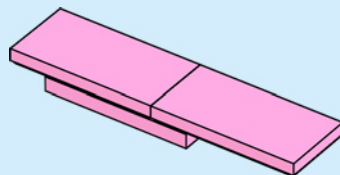

4

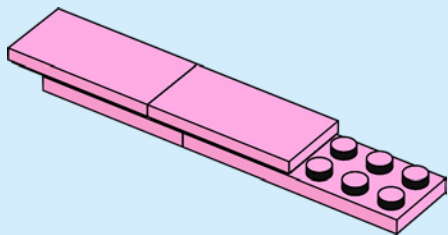

5

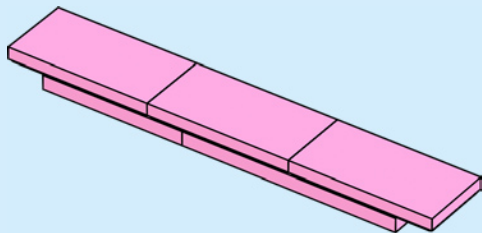

6

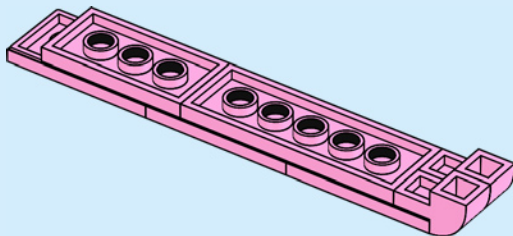

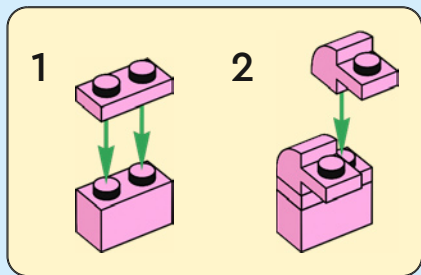

7

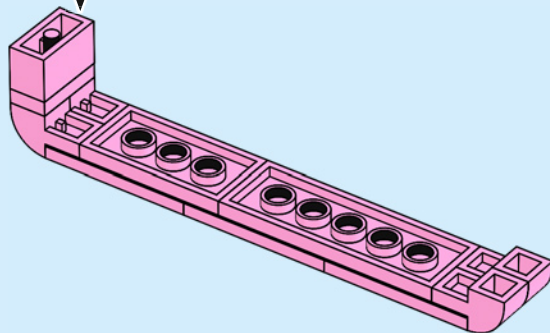

2x

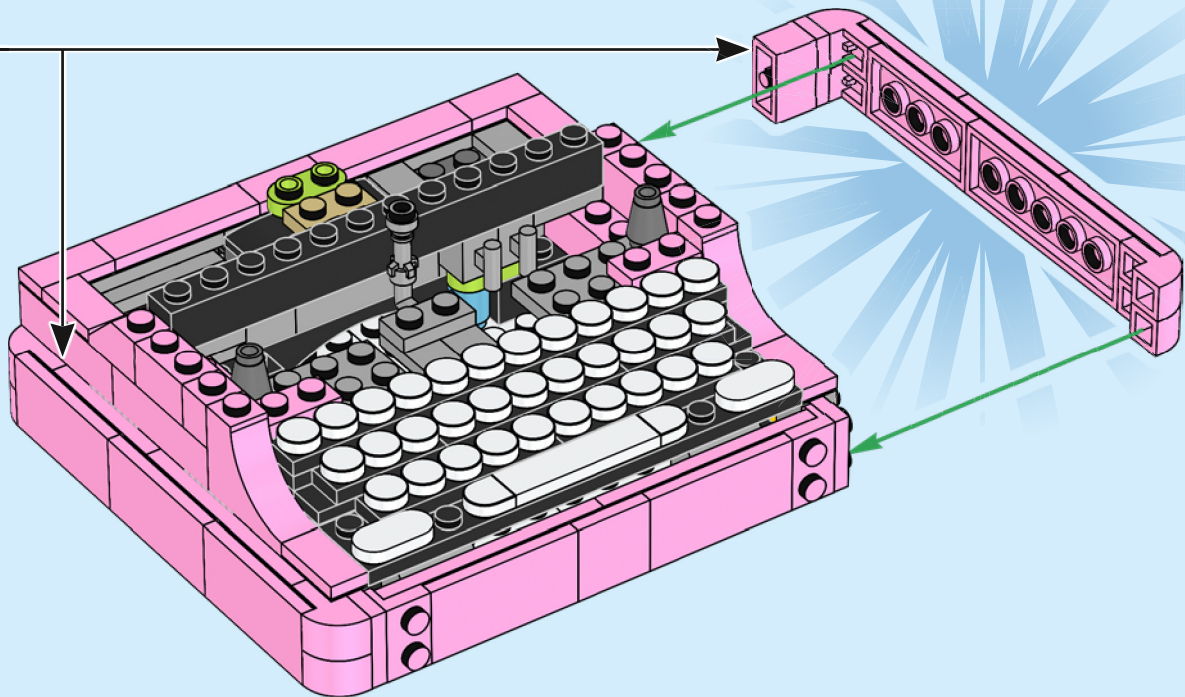

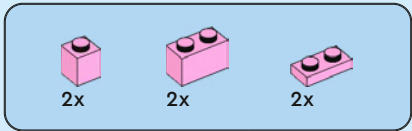

45

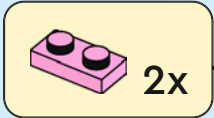
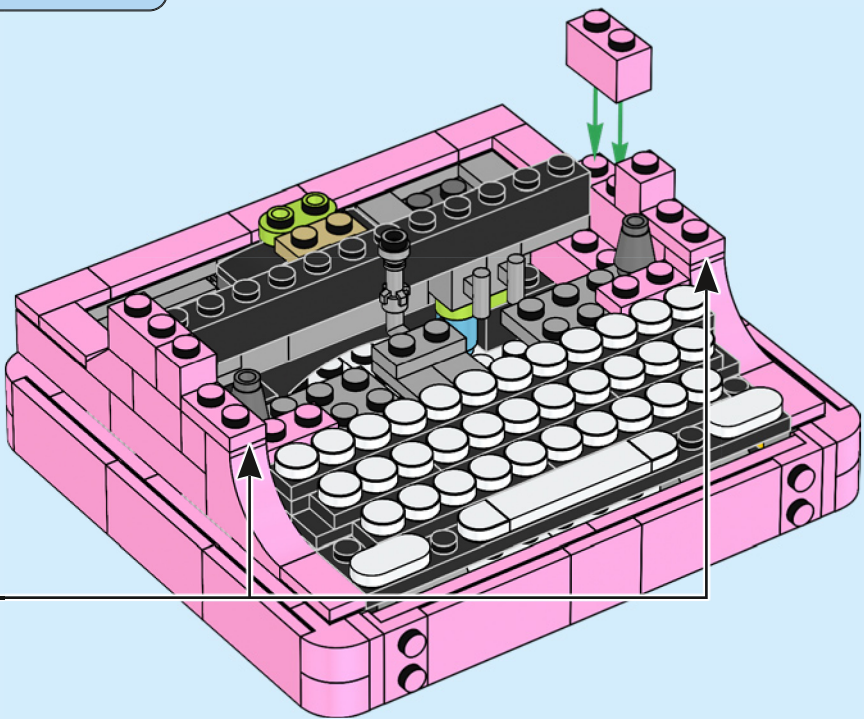



2x

46

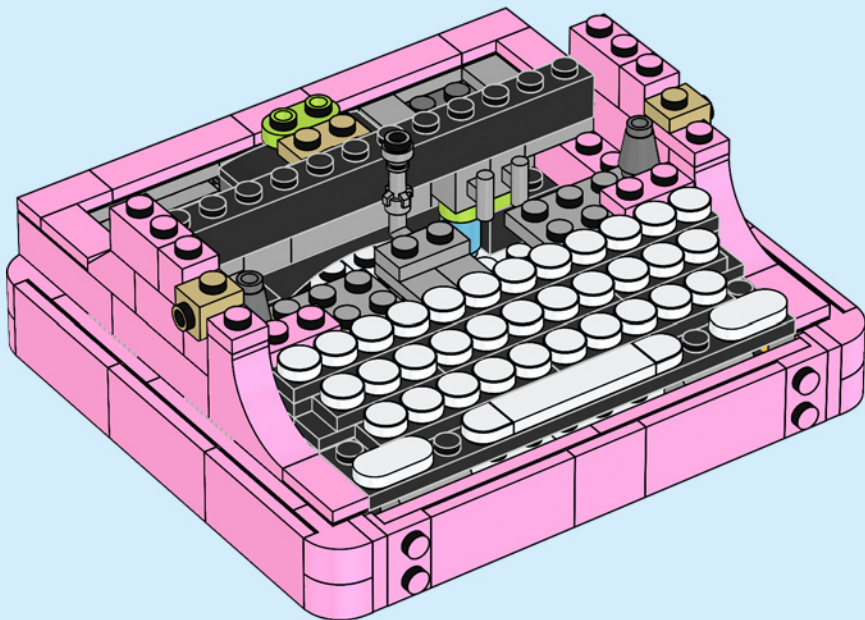





2x

47

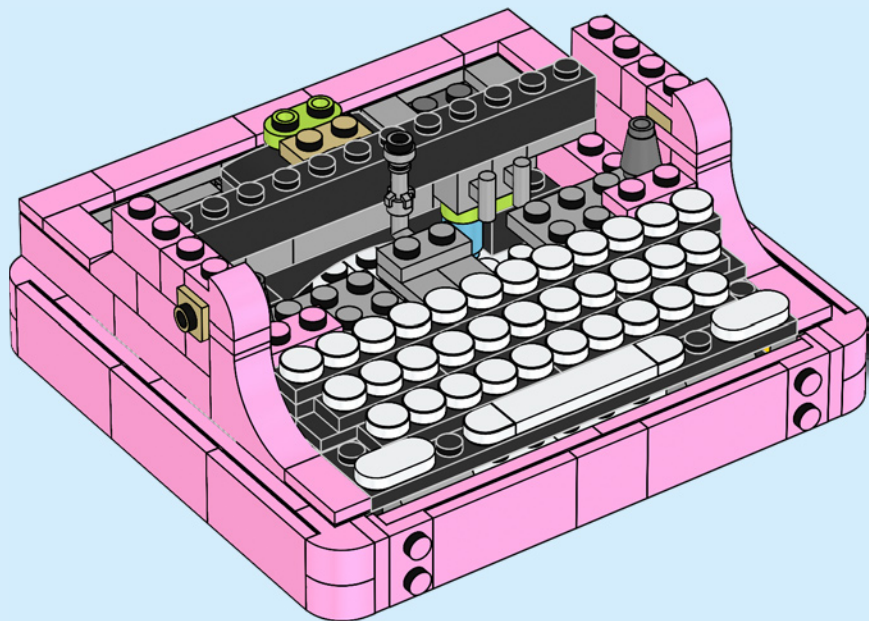

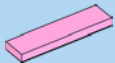

2x

48

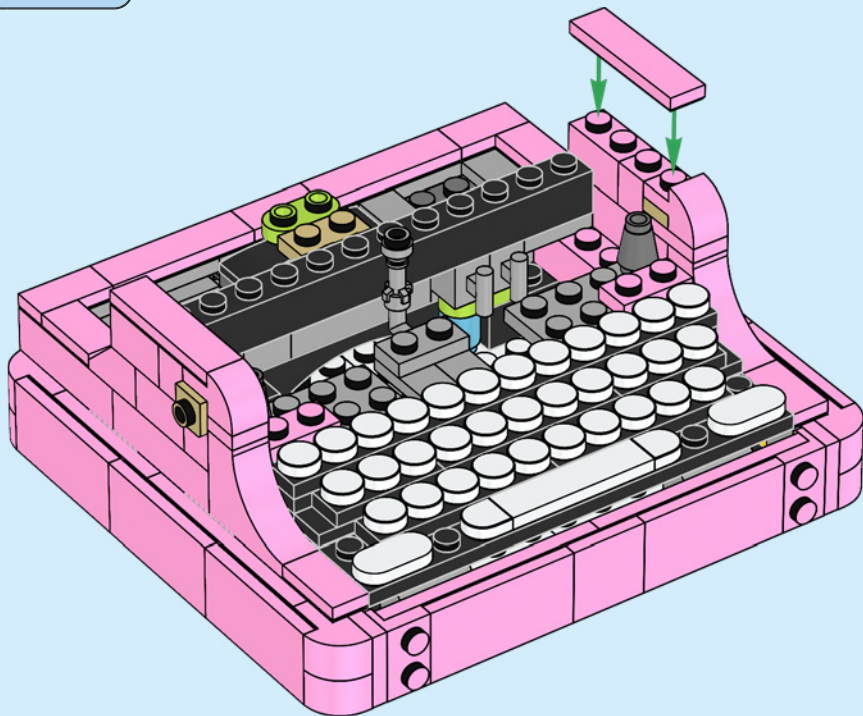



2x

49

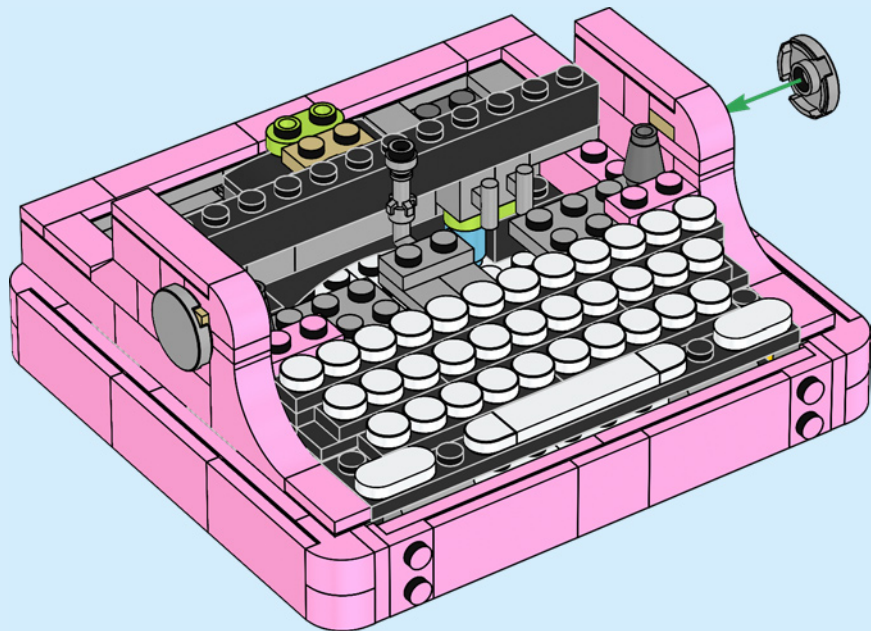

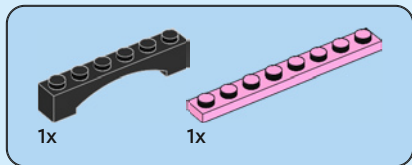

50

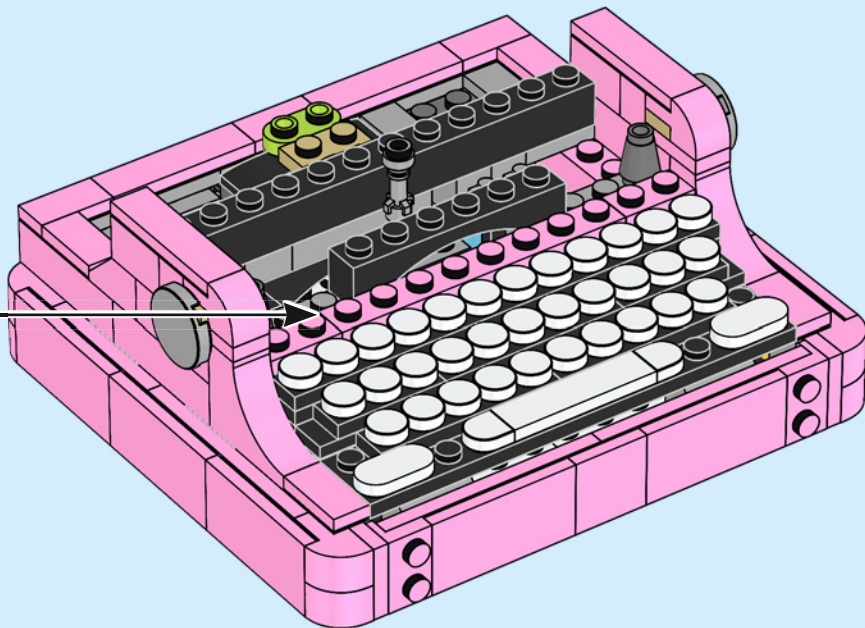
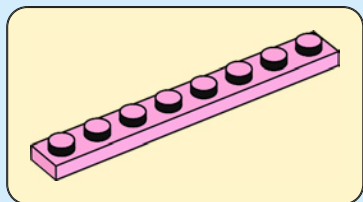



6x

51

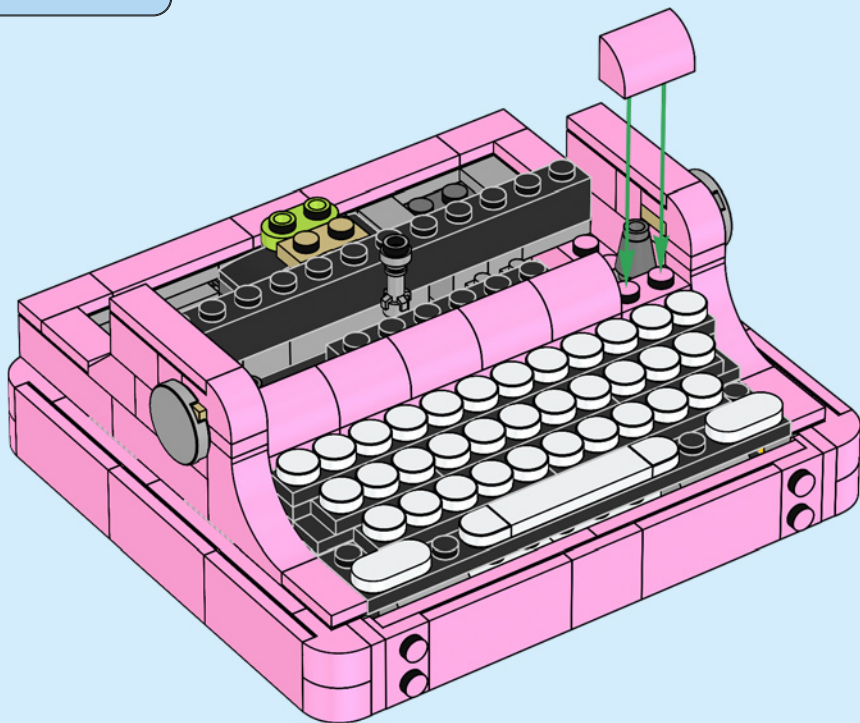

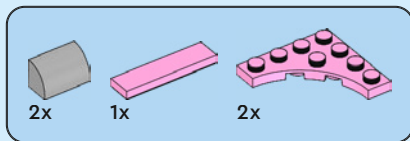

52

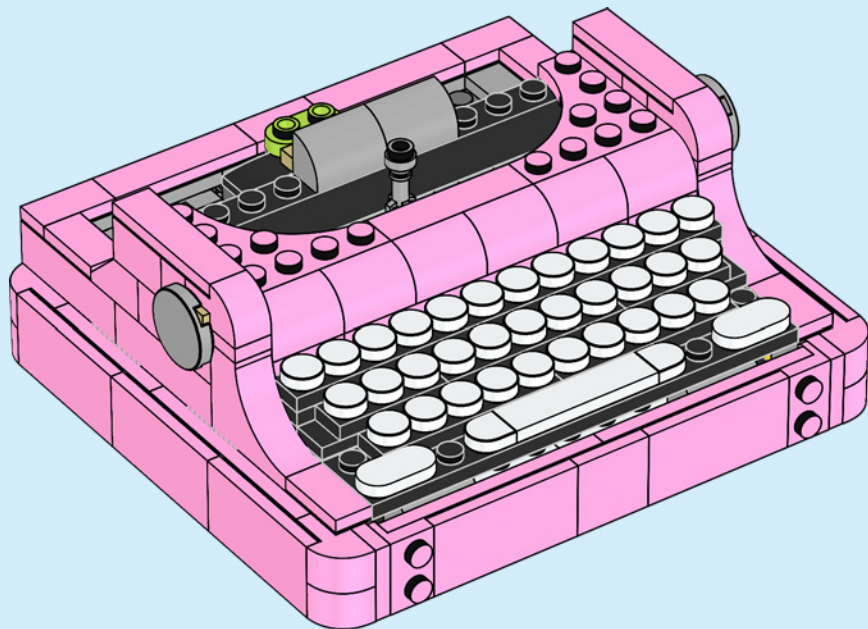



4x



4x

53

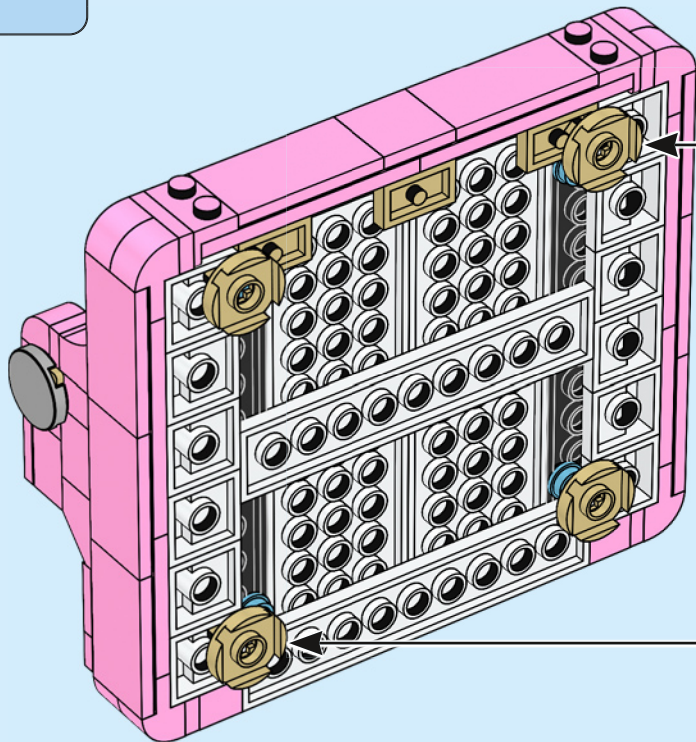

4x

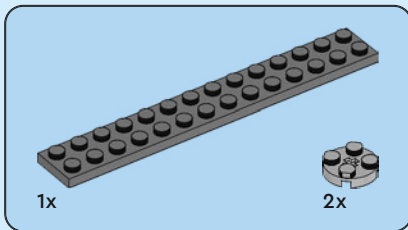
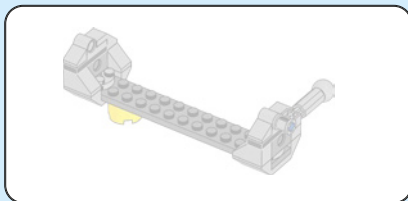

54

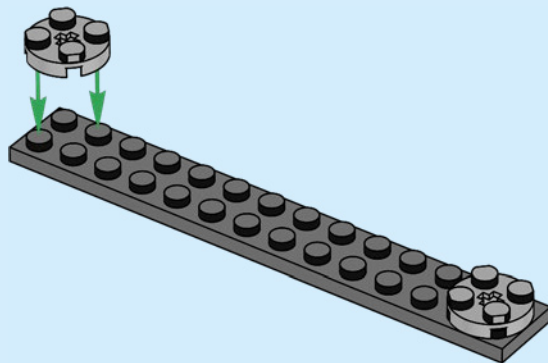



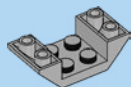

2x

55

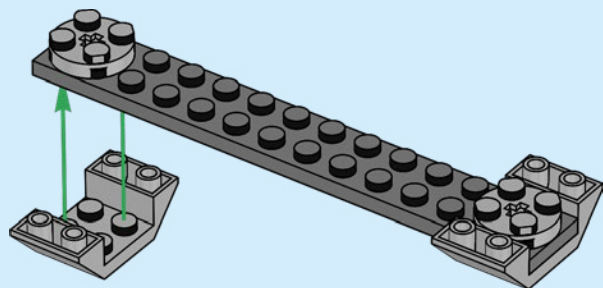

2x



4x

56

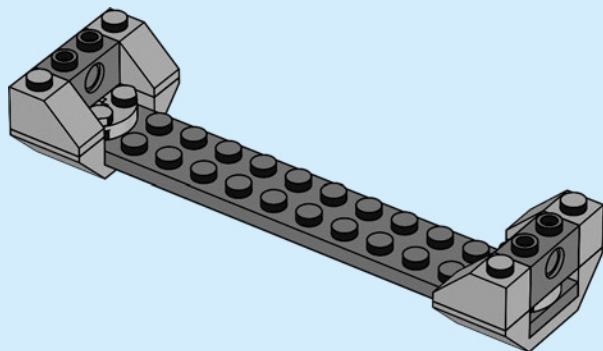

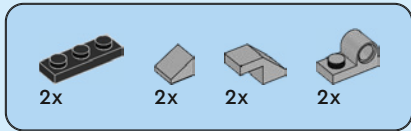

57

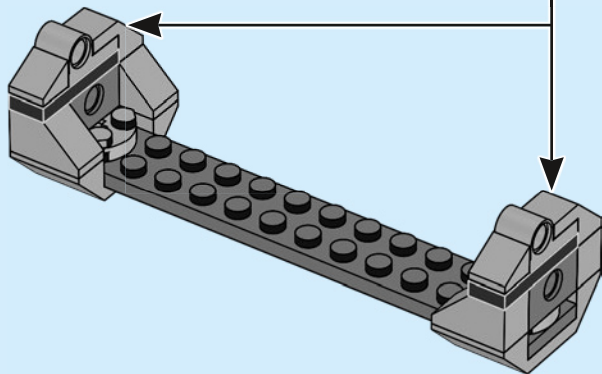
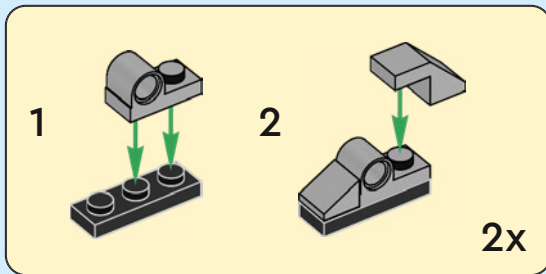

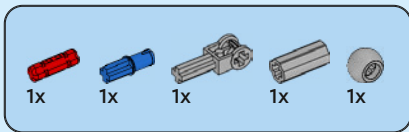

58

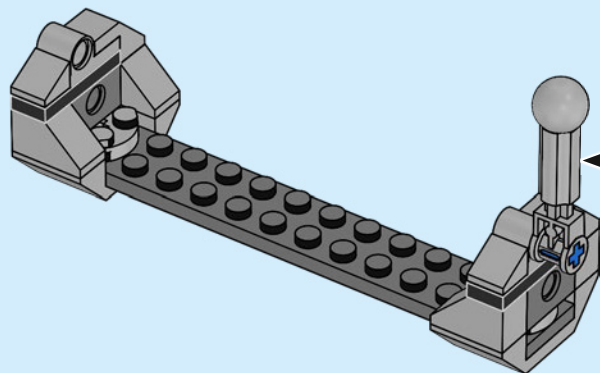
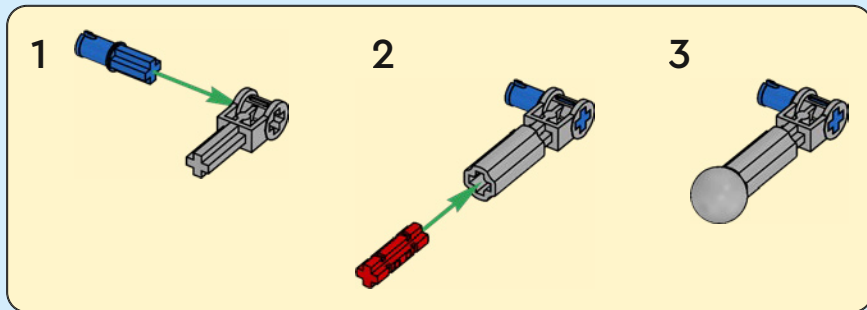



1x

59

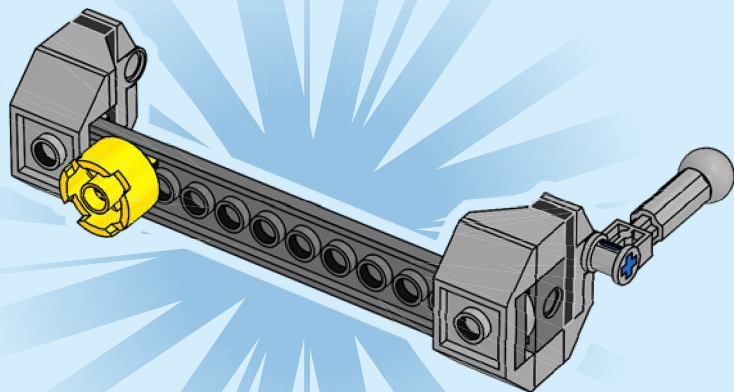

60

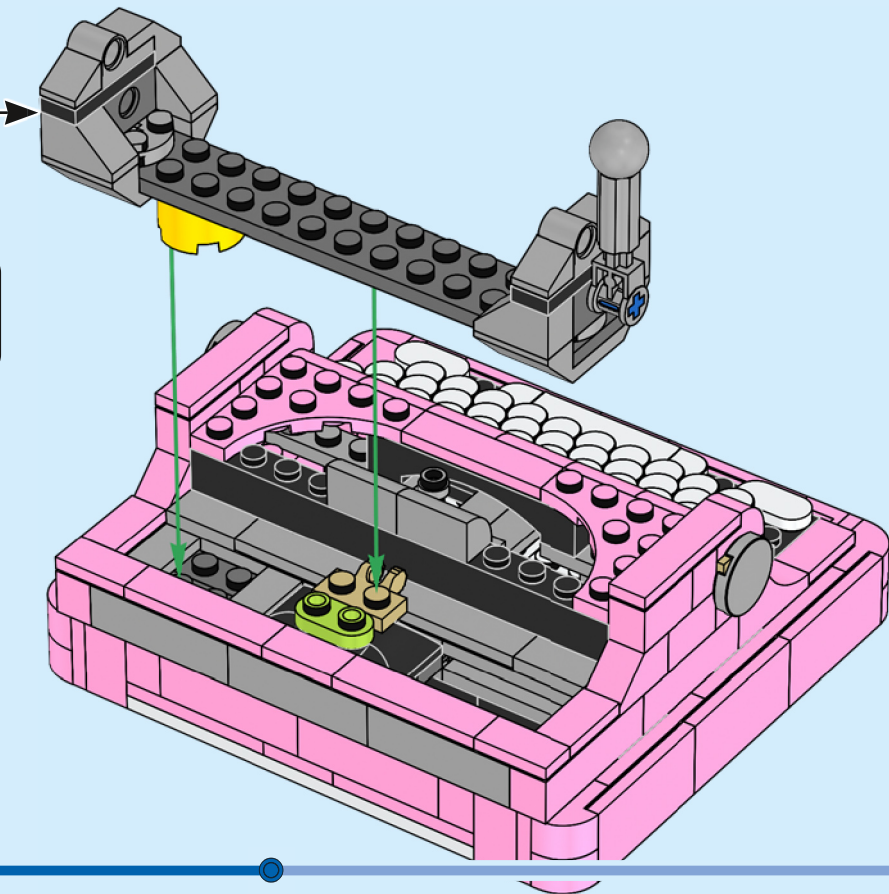

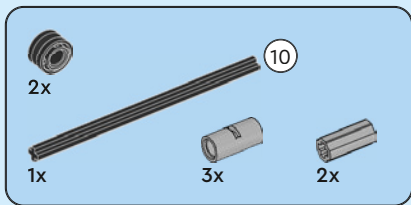
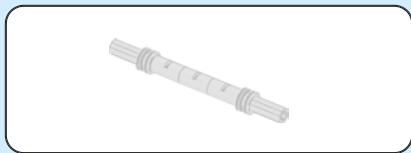

61

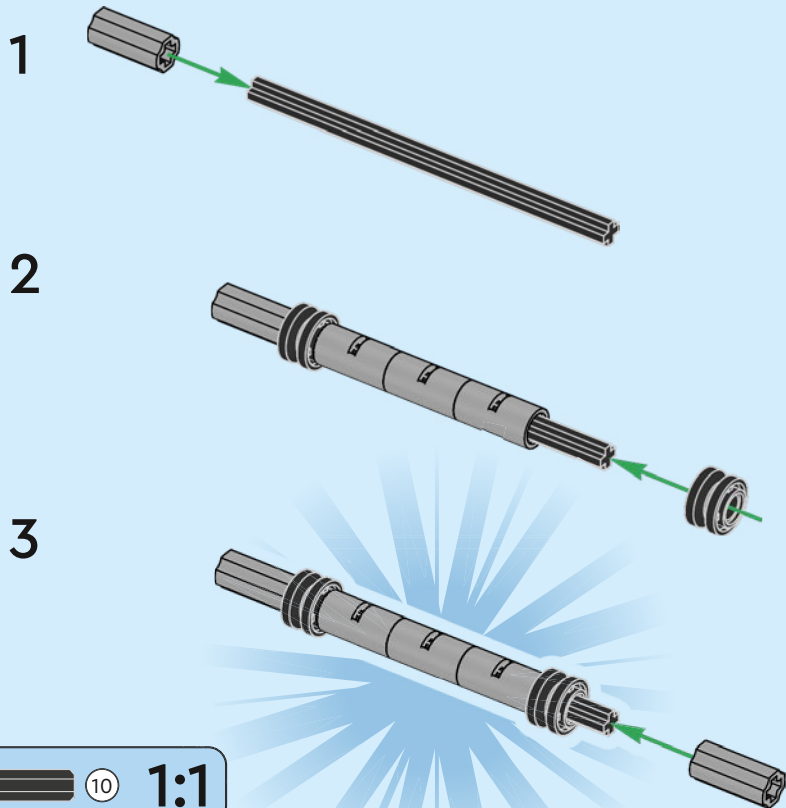
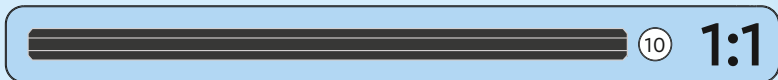

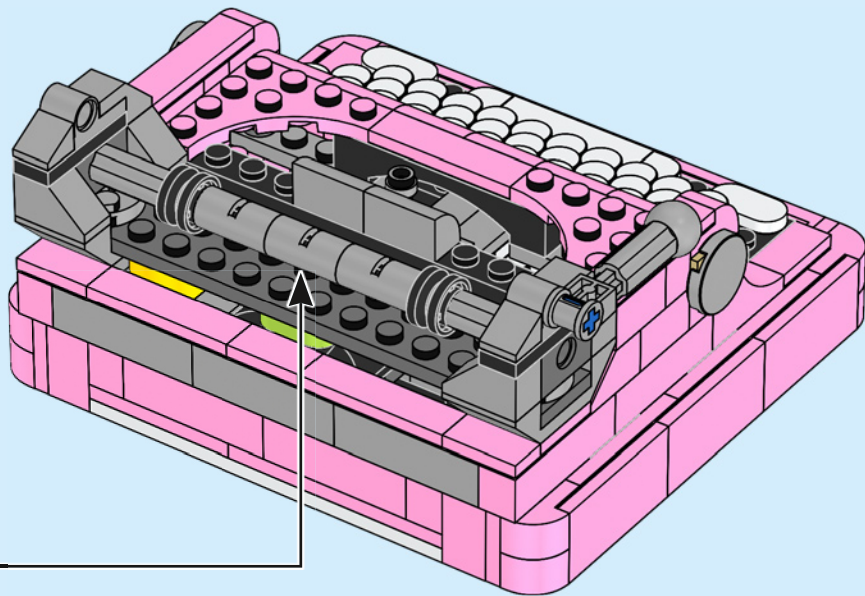

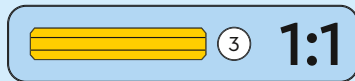
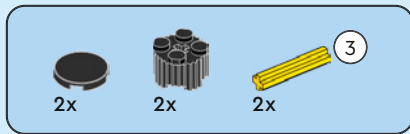

62

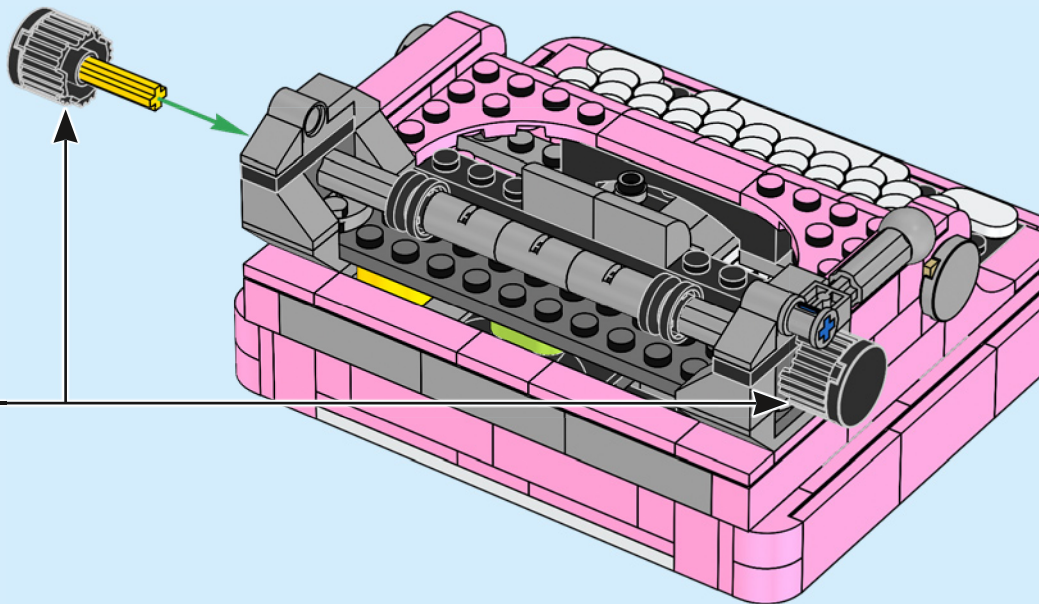
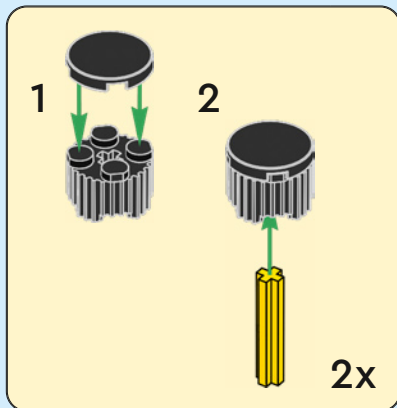



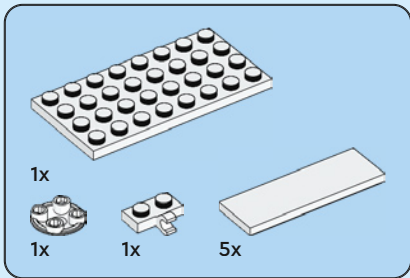
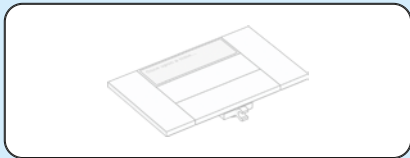

63

1

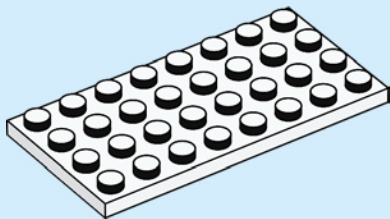

2

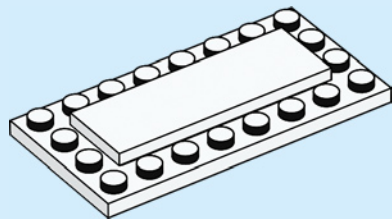

3

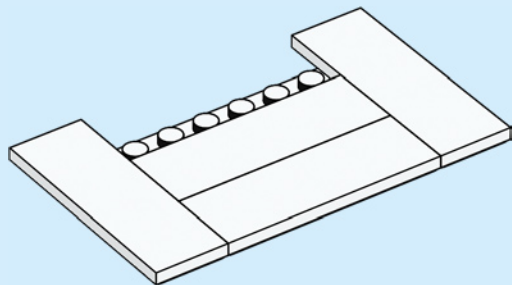

4

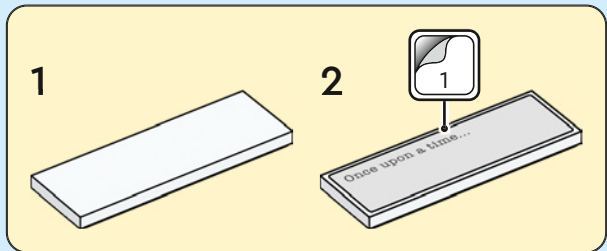
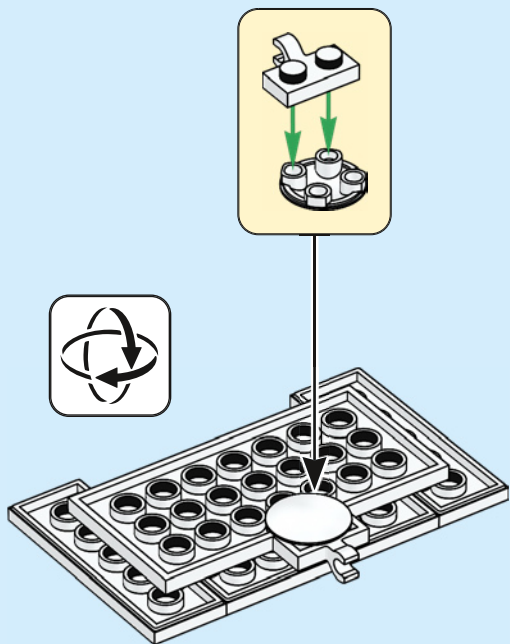

5

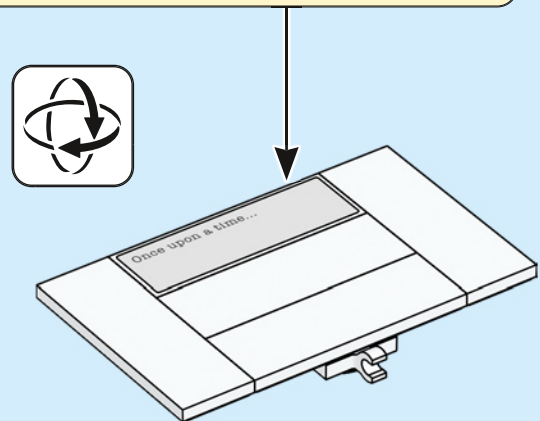

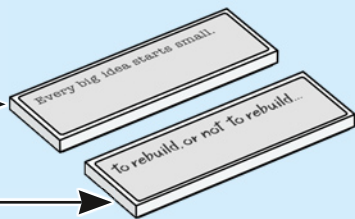
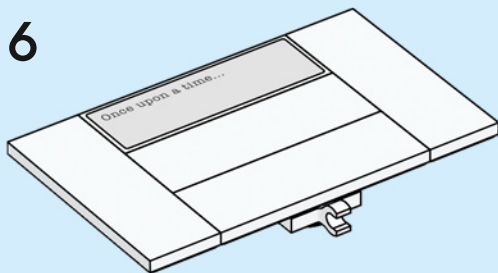
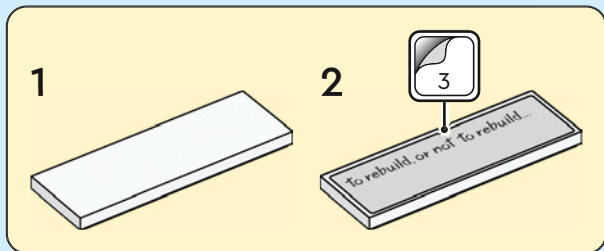
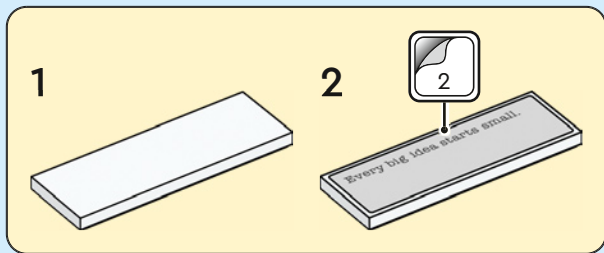

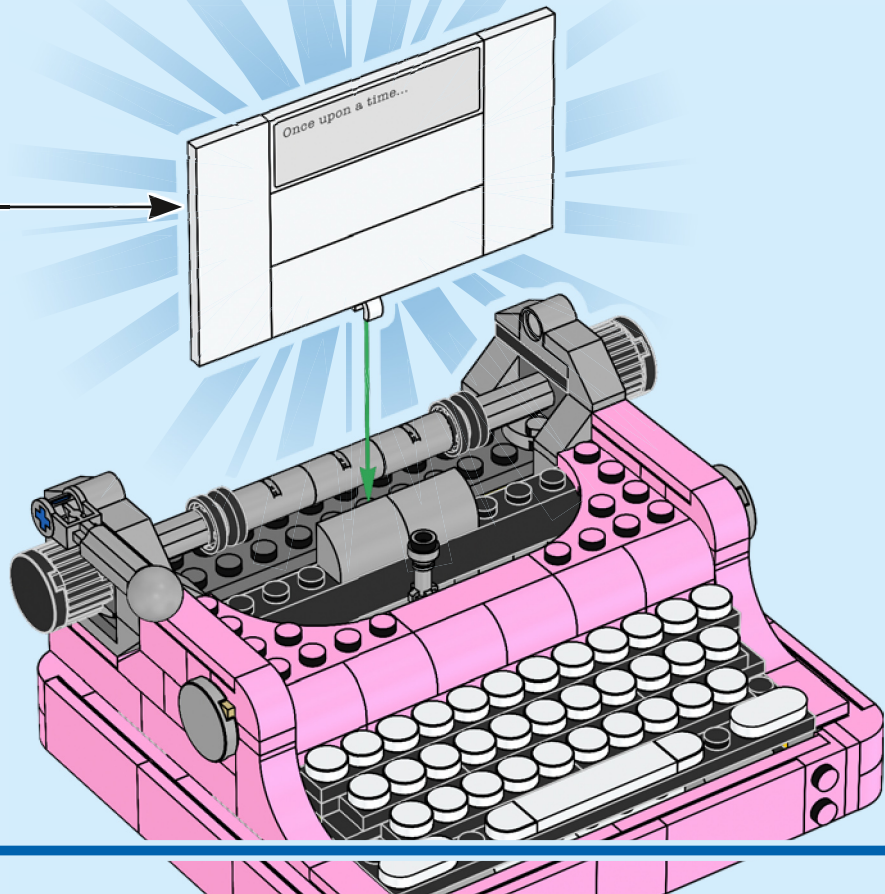

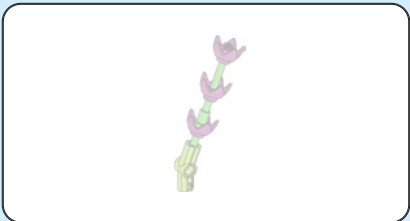

64

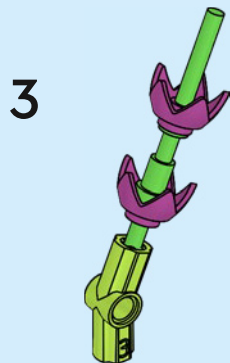
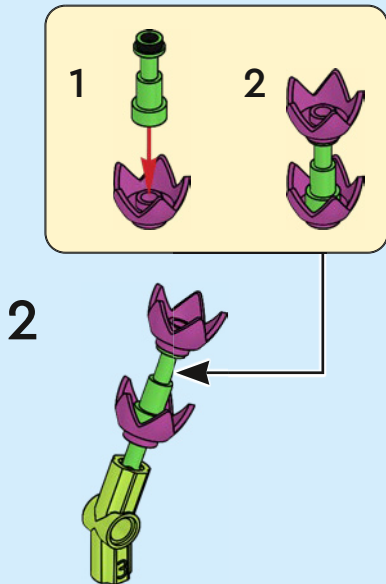
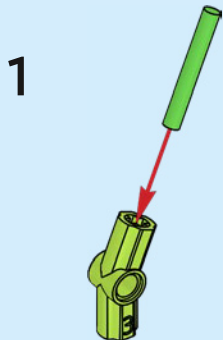

4



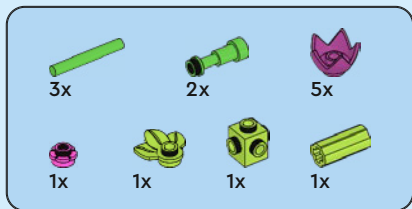
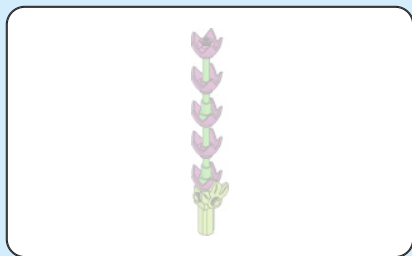

65

1



2



3



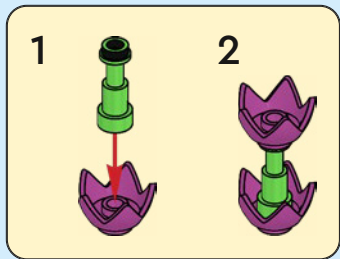

4



5

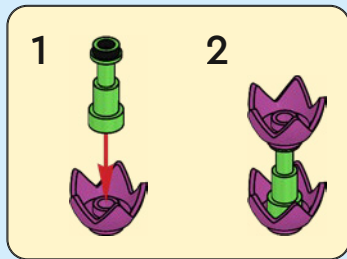

6

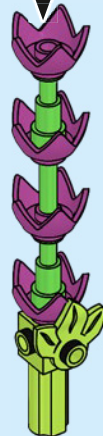



7



8

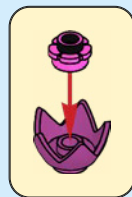



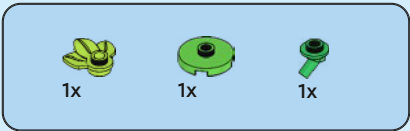

66

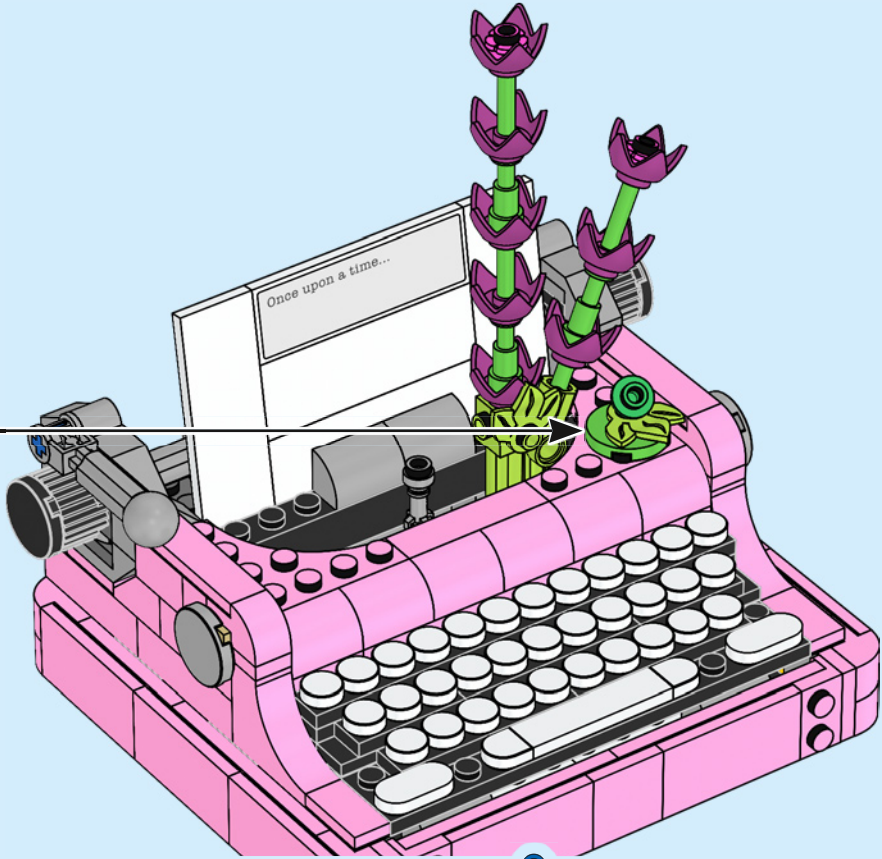
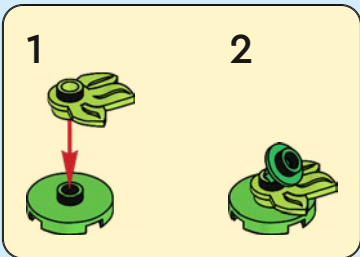

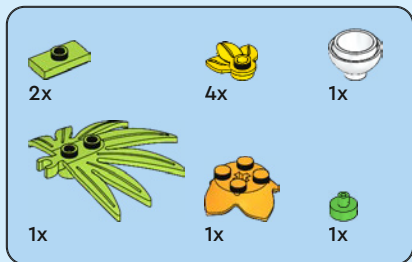

67

1



2

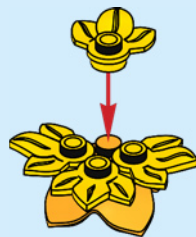

3



4



5



6

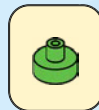

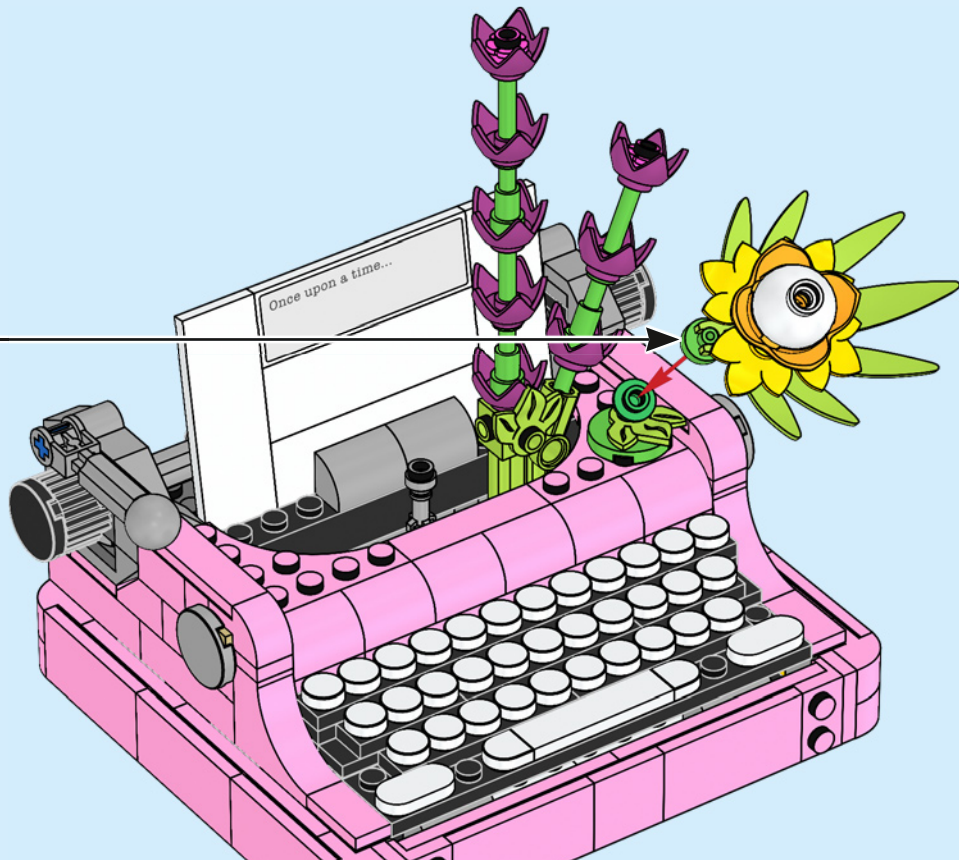

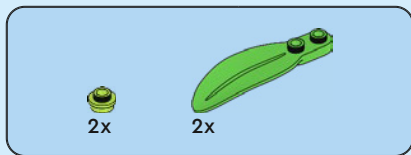

68

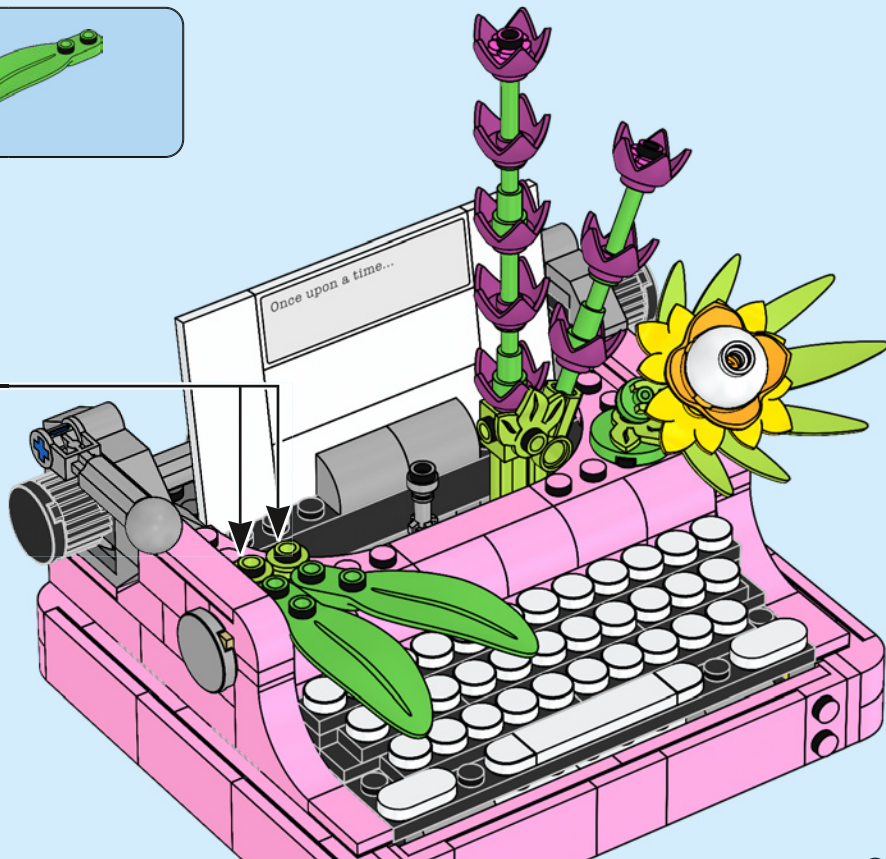
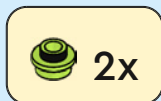

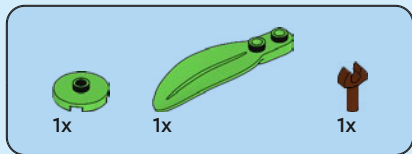

69

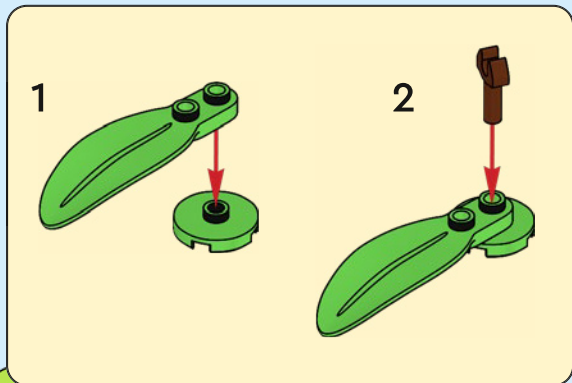



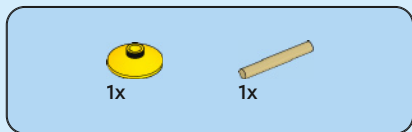
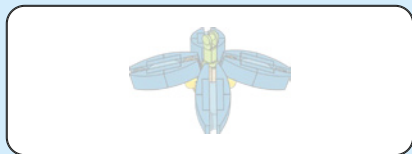

70

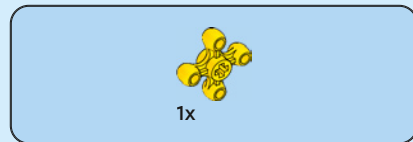
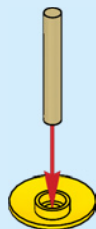

71

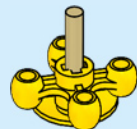

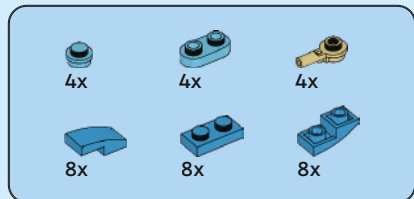

72

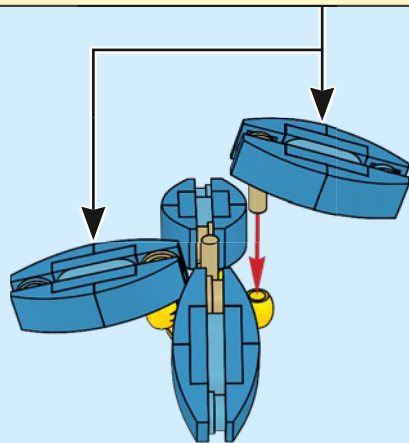
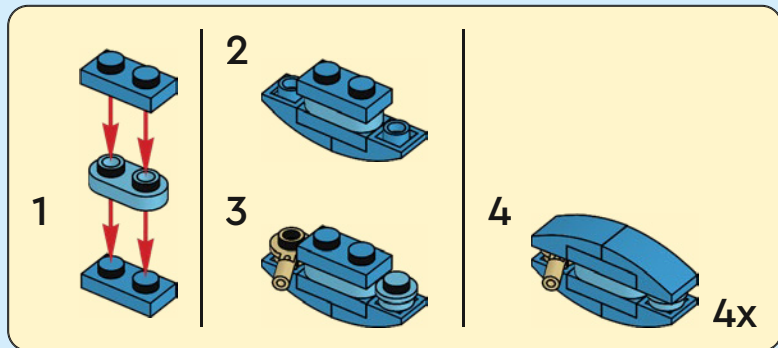



1x

73

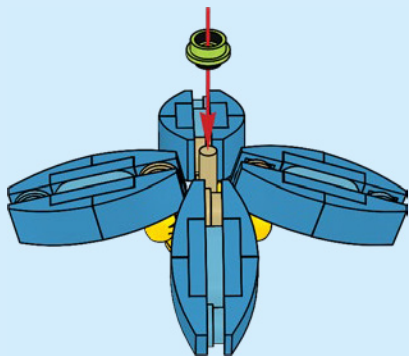

1x

74

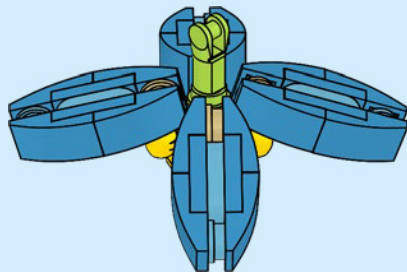

75

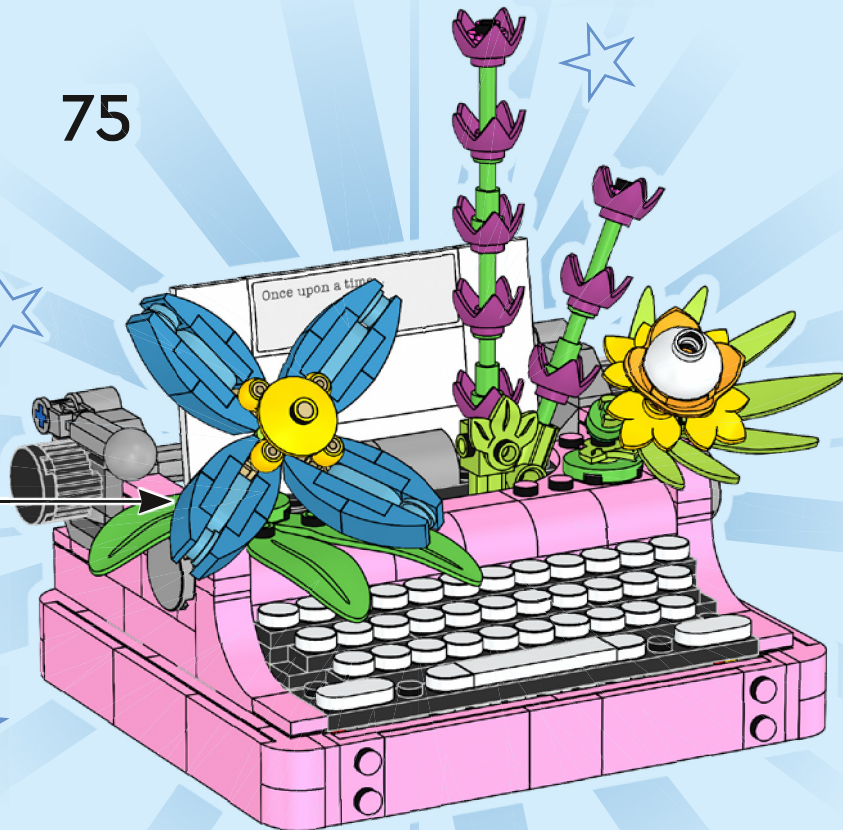



# CREATOR™

# 3 IN 1

31162



31163



31164



33x  
6284572

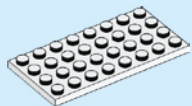

1x  
303501

2x  
6250591

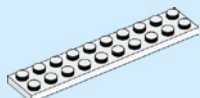

2x  
383201

2x  
6507793

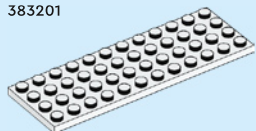

2x  
4168072

1x  
6050914

1x  
6374192

1x  
4278271

4x  
6286492

1x  
6313115

4x  
4140562

12x  
6469441

1x  
6338180

1x  
243101

3x  
6313611



7x  
6332042

86

1x  
6443062

1x  
4142865

2x  
281721

1x  
4206482

4x  
6286830

1x  
614324

1x  
4169960

2x  
6206240

1x  
6284189

2x  
6130007

2x  
6291068

2x  
6024730

2x  
6070695

6x  
6092585

2x  
6394979

6x  
362326

4x  
300126

3x  
6350415

2x  
4620763

1x  
373726

1x  
4514845

1x  
611226

2x  
244526

1x  
302926

1x  
6510190

1x  
6400649

2x  
6380676

3x  
6365617

7x  
6161772

3x  
6510105

1x  
6448749

3x  
6190251

1x  
6174006

4x  
6264062

2x  
6286831

1x  
6302735

2x  
6092592

1x  
6366186

1x  
6313098

1x  
6525787

1x  
6439053

1x  
4539481

1x  
6070731

4x  
4558953

10

2x  
4521921

2x  
6170569

2x  
6052200

4x  
4211475

2x  
4550325

3x  
4512360

2x  
6213378

3x  
6173127

1x  
6261353

4x  
6227184

2x  
6146223

4x  
4211614

2x  
6225230

2x  
4211414

2x  
6212077

1x  
4211536

2x  
6257593

6x  
4211613

2x  
4211395

2x  
4211517

1x  
4211481

2x  
6209679

8x  
6510519

2x  
4529240

2x  
4211111

2x  
4210967

1x  
6000970

10x  
6526031

10x  
4654128

6x  
4517993

7x  
4580010

6x  
6314374

2x  
4517995

2x  
6353189

1x  
4615728

2x  
6526011

6x  
4286050

2x  
6002148

4x  
4518890

5x  
4621552

2x  
6204535

8x  
6106713

2x  
4520632

2x  
6526012

4x  
4625633

1x  
6143789

8x  
6475998

8x  
6137300

8x  
4653988

1x  
4620909

8x  
6102986

4x  
6396673

4x  
6348142

 [LEGO.com/service](https://www.LEGO.com/service)



YOU COULD **WIN**



Scan this QR code or go to **LEGO.COM/PRODUCTFEEDBACK** and give us your short feedback about this LEGO® set for a chance to win a cool LEGO prize.

Terms and Conditions apply\*

**EN: YOU COULD WIN.** Terms and Conditions apply\* **DE: Du könntest GEWINNEN.** Es gelten die Teilnahmebedingungen\* **FR: Tu pourrais GAGNER.** Des conditions s'appliquent\* **IT: Potresti VINCERE tu.** Termini e condizioni sono applicabili\* **ES: Puedes GANAR.** Aplican términos y condiciones\* **PT: Poderá GANHAR.** Aplicam-se termos e condições\* **ZH: 轻松获奖. 条款和条件适用\*** **PL: Szansa na WYGRANĄ.** Obowiązują warunki korzystania\* **CS: Máte šanci VYHRÁT.** Platí všeobecné smluvní podmínky\* **SK: Máte šancu VYHRAŤ.** Platia všeobecné zmluvné podmienky\* **HU: TE IS NYERHETSZ.** Felhasználási feltételek érvényesek\* **RO: Ai putea CÂȘTIGA.** Se aplică termenii și condiții\* **BG: Можете да СПЕЧЕЛИТЕ.** Има определени правила и условия\* **LV: Tu vari LAIMĒT.** Ir spēkā noteikumi un nosacījumi.\* **ET: Sul on võimalus VÕITA.** Kehtivad tingimused\* **LT: Jūs galite LAIMĖTI.** Taikomos sąlygos\*

\*LEGO.com/productfeedback-terms