



CREATOR™

3 in 1

31159



3in1	3 in 1	3 合 1	3 az 1-ben	3 ühes
3-in-1	3en1	3 w 1	3 in 1	„Trys viename“
3-en-1	3em1	3 v 1	„3 B 1“	



Q LEGO® Builder



LEGO.com/sustainable-packaging



FR
DONNEZ
OU
RECYCLEZ

 OU  OU 

ASSOCIATION MAGASIN DÉCHÈTERIE

Adresses sur quefairedemesdechets.fr



Q LEGO® Builder

BUILDER



Apple and the Apple logo are trademarks of Apple Inc., registered in the U.S. and other countries and regions. App Store is a service mark of Apple Inc. Google Play and the Google Play logo are trademarks of Google LLC. Tencent and the Tencent logo are trademarks of Tencent Inc.

Q LEGO.com/devicecheck

EN Ask parents' permission before going online | **DE** Eltern um Erlaubnis bitten, bevor du online gehst | **FR** Demande l'autorisation d'un parent avant d'aller en ligne | **IT** Chiedi il permesso ai tuoi genitori prima di andare online | **ES** Pídeles permiso a tus papás antes de conectarte a Internet | **PT** Peça autorização aos pais antes de acederes online | **ZH** 上网前应先征得父母的同意 | **PL** Poproś rodziców o zgodę, zanim wejdiesz do Internetu | **CS** Než půjdeš na internet, požádej rodiče o svolení | **SK** Skôr než pôjdeš na internet, vypýtaj si povolenie od rodičov | **HU** Kérj szülői engedélyt, mielőtt online csatlakoznál! | **RO** Cere permisiunea părinților înainte de a te conecta online | **BG** Поискайте разрешение от родител, преди да влезете онлайн | **LV** Pirms došanās tiešsaistē palūdz atļauju vecākiem | **ET** Enne Interneti kasutamist küsi vanematelt luba | **LT** Prieš prisijungdami prie interneto, atsiklauskite tėvų







1x

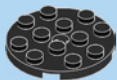

1x

1



4x

2



4x





4x

3



4x

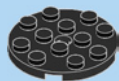
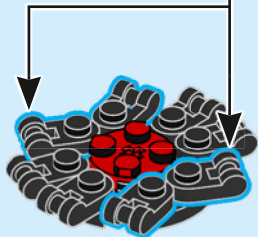

1x

4

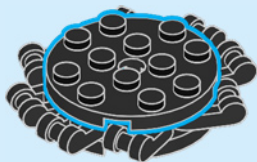

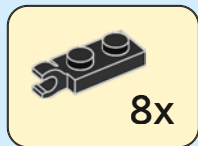
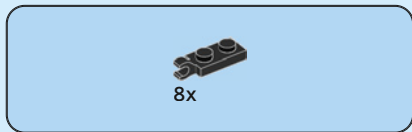

5

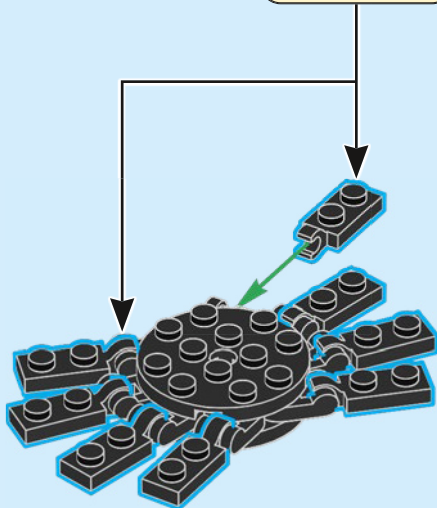



2x

6

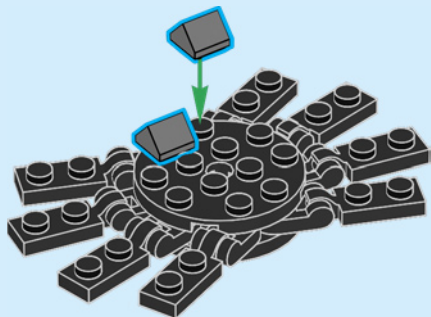

2x

7

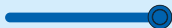
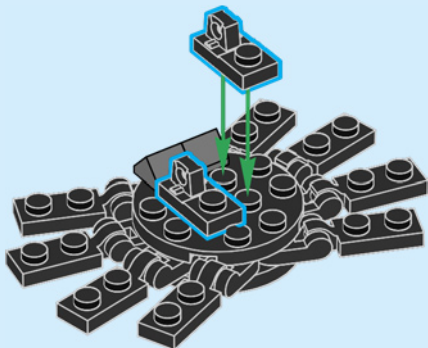



2x



2x



2x

8

1

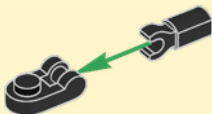

2

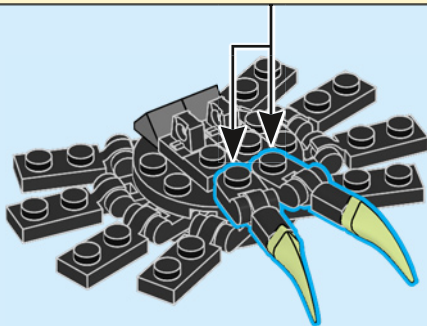
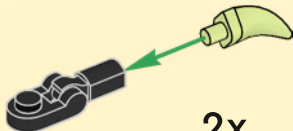



1x

9

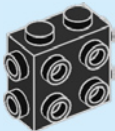

2x

10

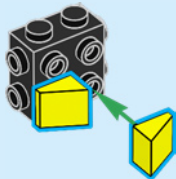

10





2x

11

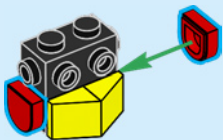

6x

12

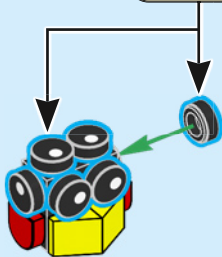



1x

13

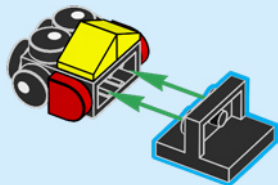

1x

14

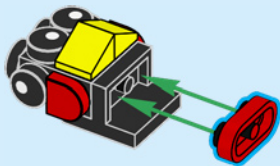

15

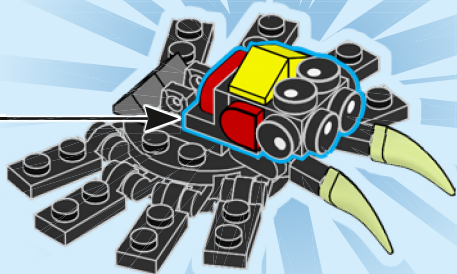



8x



1x



1x



1x

16

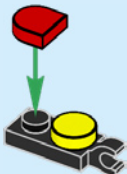

1x

17

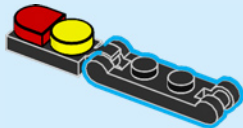



1x



1x

18

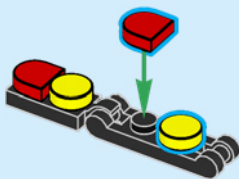

1x

19

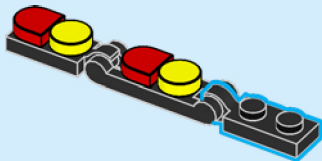

8x

20

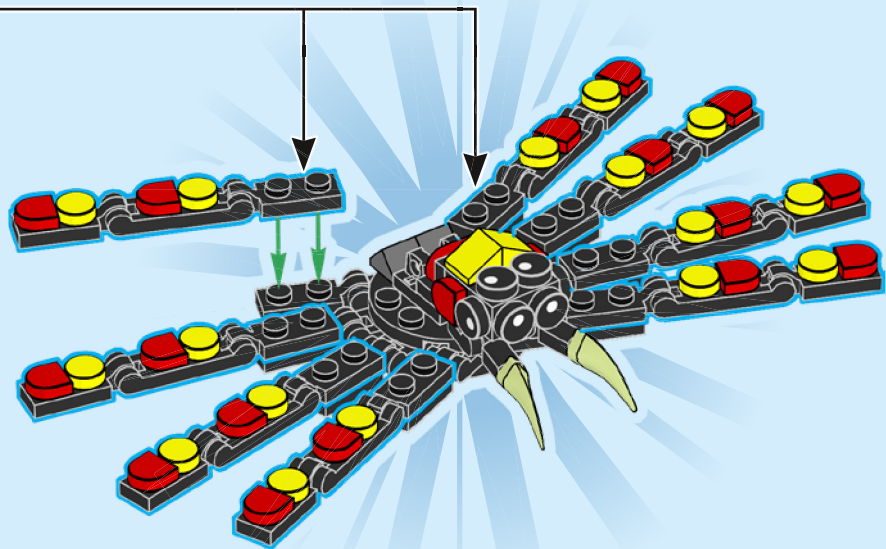

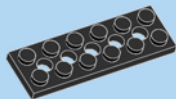

1x



1x

21

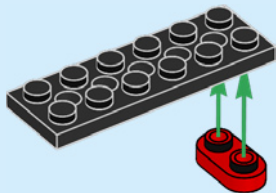

2x

22

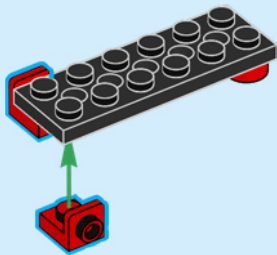



1x

23

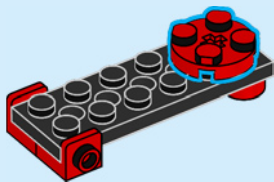

2x

24

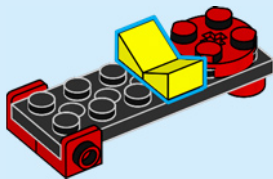



2x

25

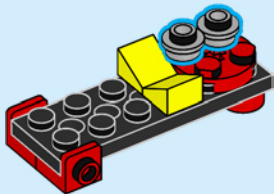

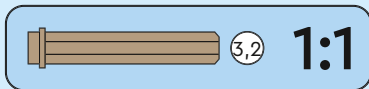
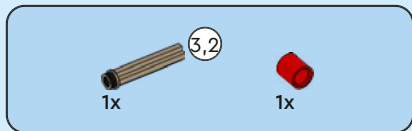

26

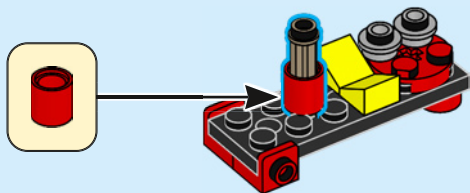



1x

27

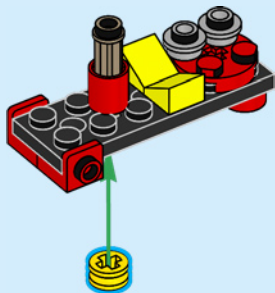
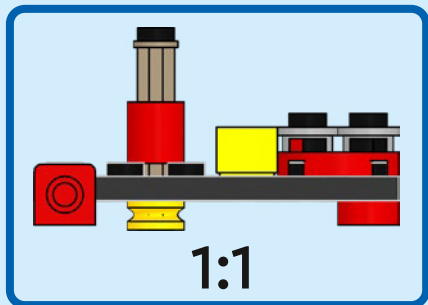

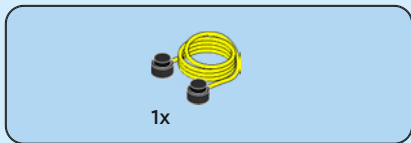

28

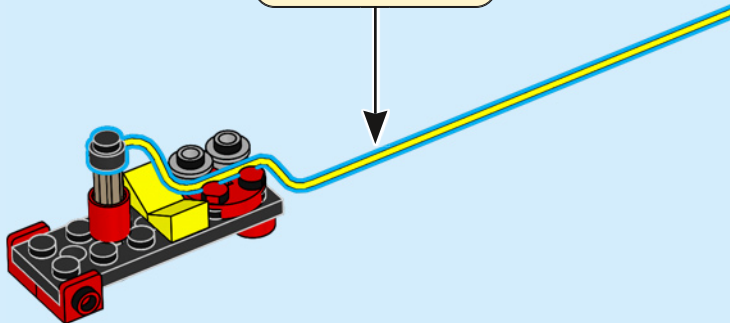
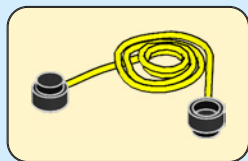



2x

29

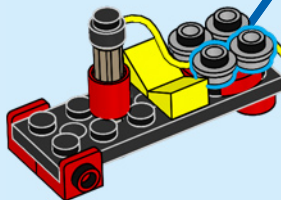
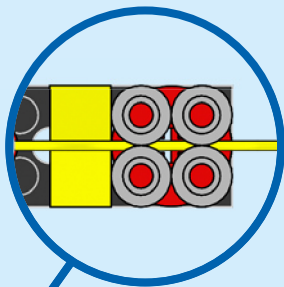



2x

30

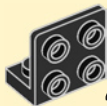

2x

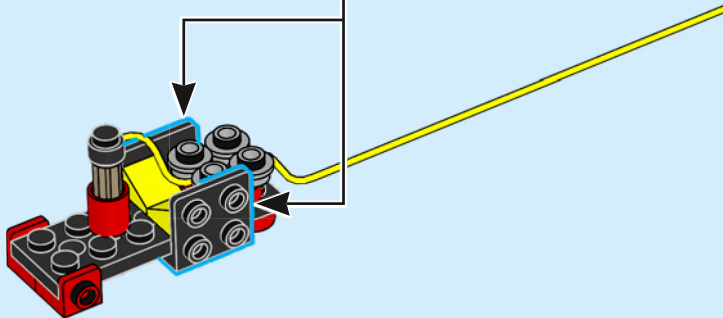



1x

31

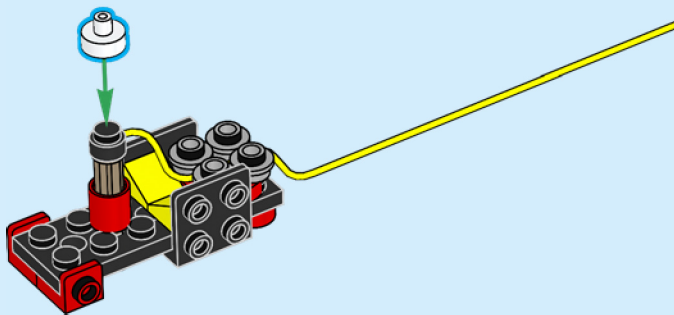



1x



1x

32

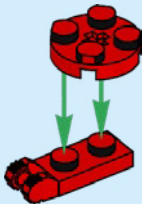

1x

33

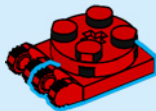



2x

34

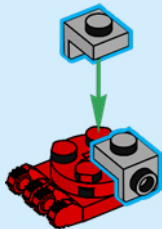

1x

35

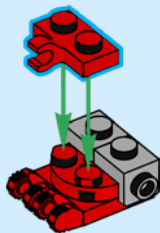

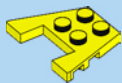

1x

36

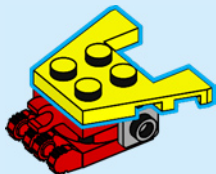

1x

37

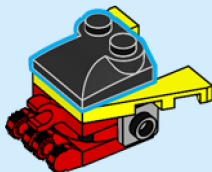

38

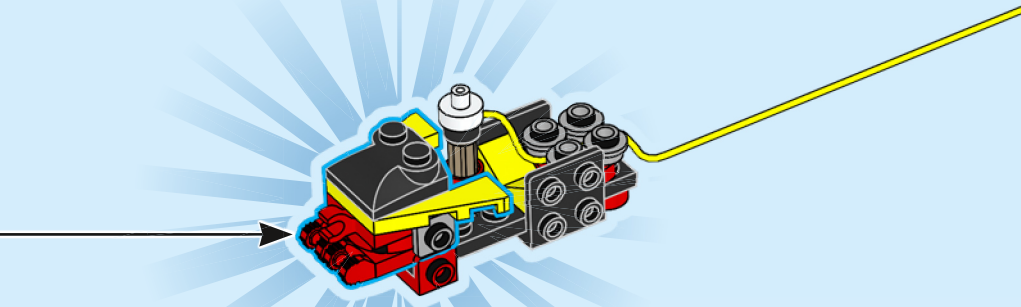

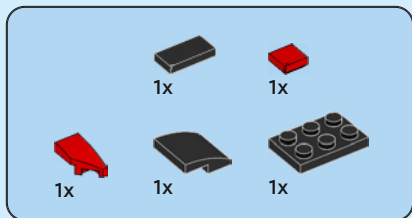

39

1

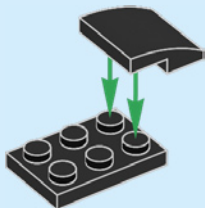

2

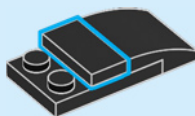

3

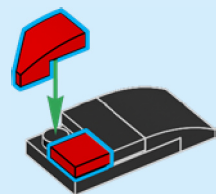

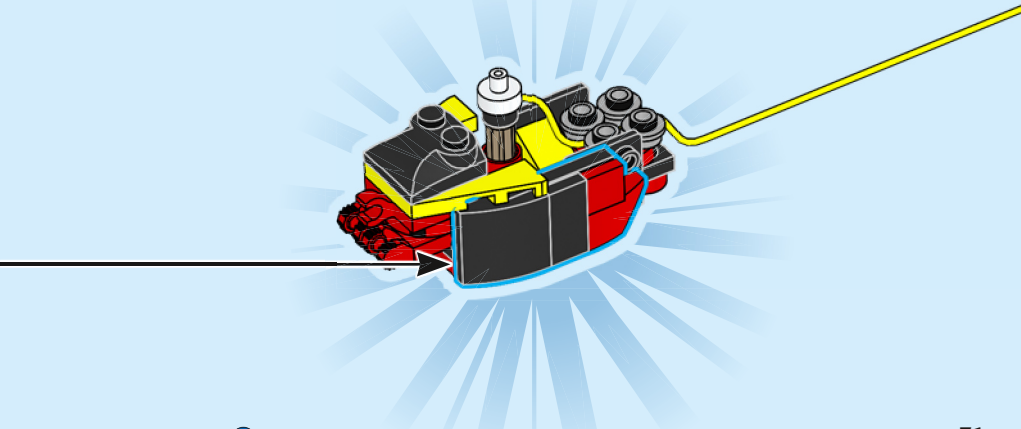

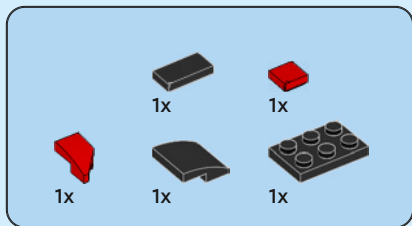

40

1

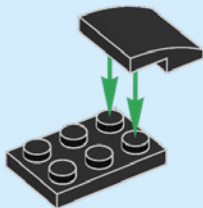

2

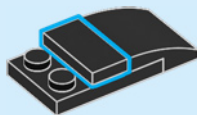

3

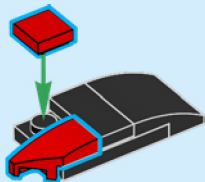

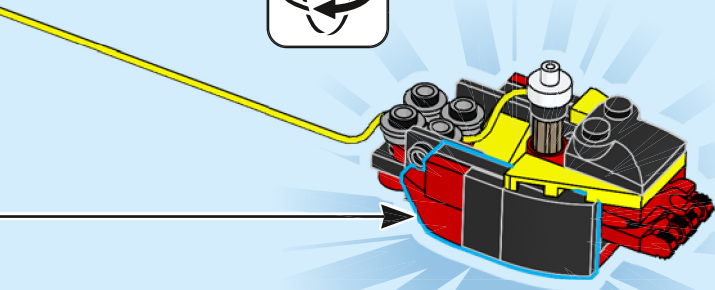



1x

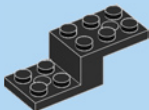

1x

41

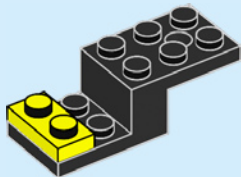



2x

42

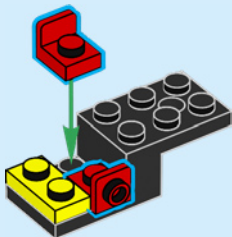

1x

43

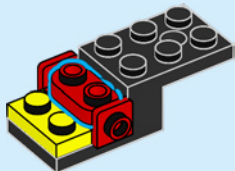



1x

44

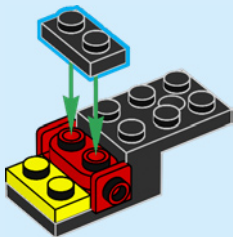



2x

45

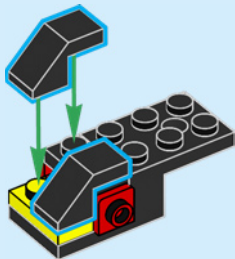



2x



2x

46

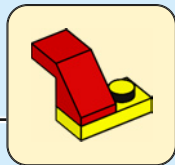
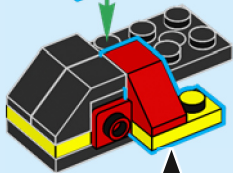
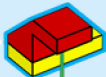
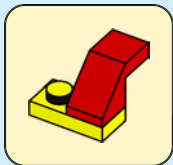

47

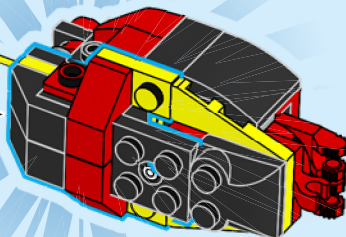



2x

48

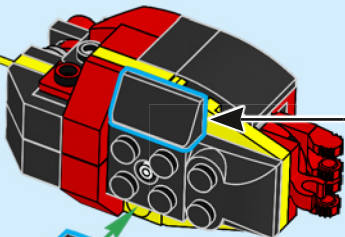

2x



1x

49

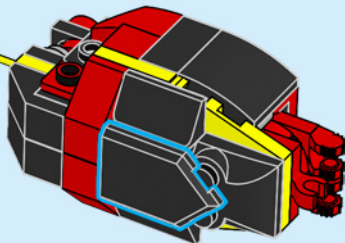



2x

50

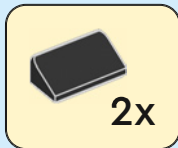

2x

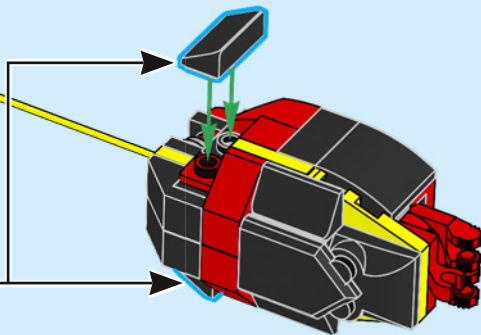

51

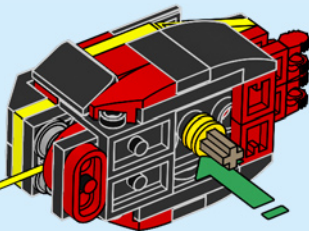



1x

52

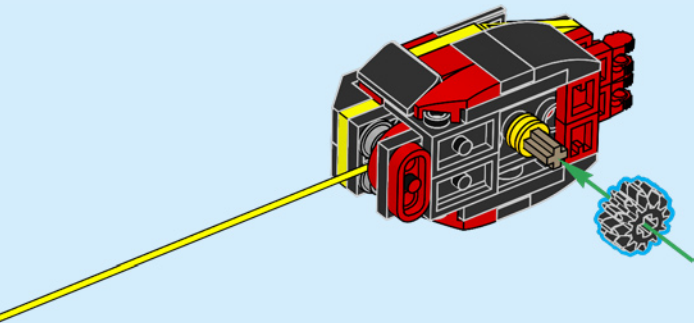

53

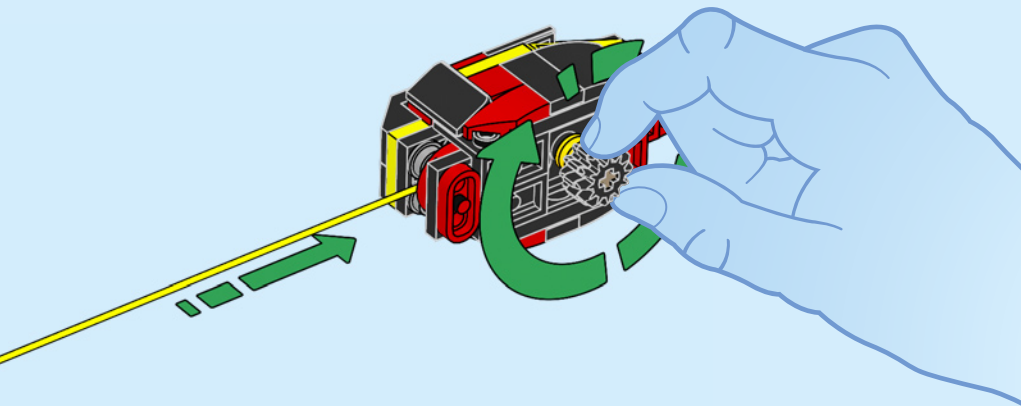

54

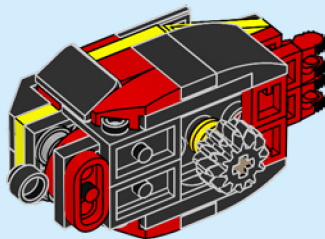

55

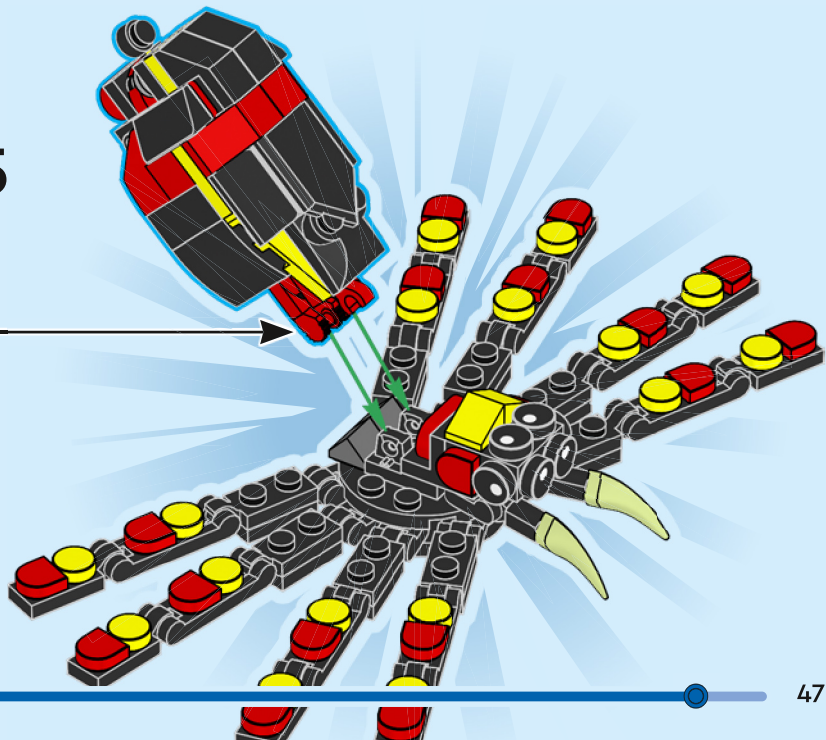



1x

56

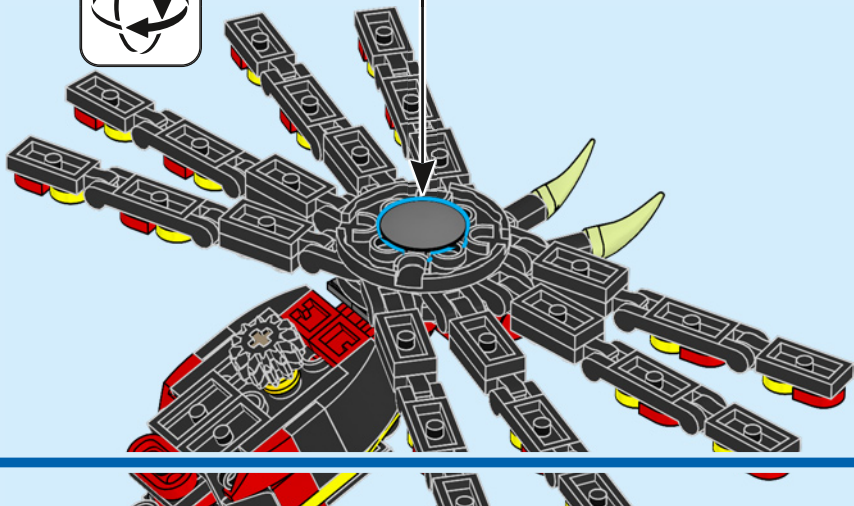

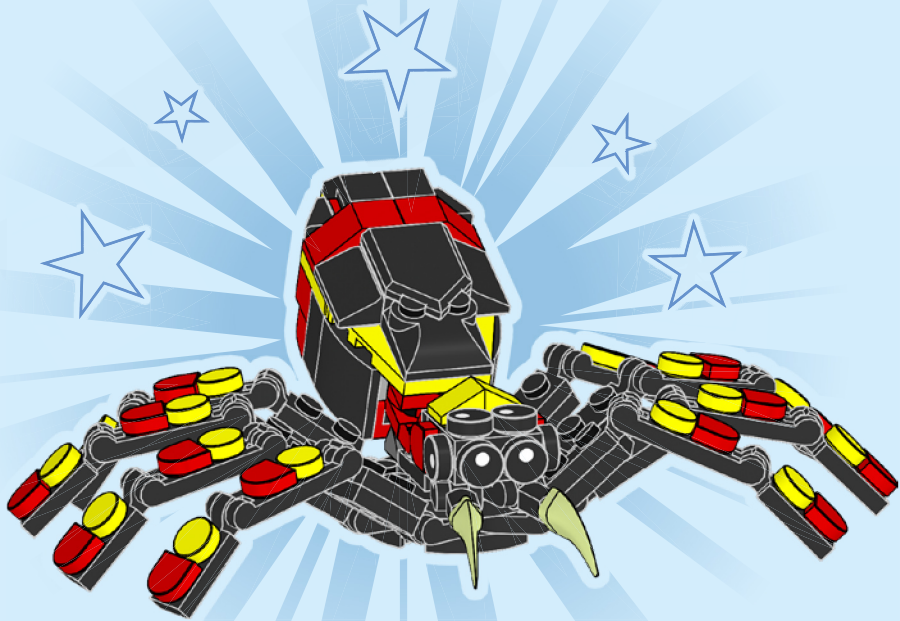



CREATOR™

3 IN 1

31162



31163



31164





1x
6186681



18x
6258973



1x
6093950



2x
307021



1x
6177505



4x
6249907



3x
6210269



1x
6177507



3x
403221



2x
6275178



1x
6313120



2x
6267049



1x
6271167



2x
6315887



6x
6284072



1x
4177431



10x
6157554



4x
4548180



2x
6267487



2x
6338799



2x
306926



1x
302326



2x
6000650



1x
6308883



1x
6250020



24x
6336989



2x
6053077



1x
6394979



1x
6245251



1x
6448794



8x
6099483



2x
302126



2x
4515350



1x
6533639



1x
3200126



2x
6267417



4x
6168647



2x
6248078



2x
6262021



1x
4278274



1x
6031821



16x
6376825



4x
6427900



3x
6382324



1x
6381735

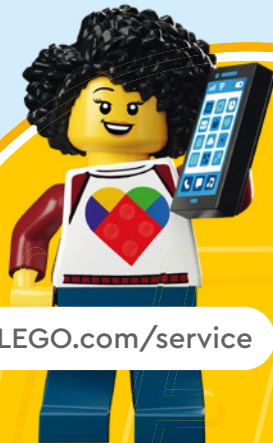

LEGO.com/service

YOU COULD
WIN



Scan this QR code or go to
LEGO.COM/PRODUCTFEEDBACK and give us
your short feedback about this LEGO® set
for a chance to win a cool LEGO prize.

Terms and Conditions apply*

EN: YOU COULD WIN. Terms and Conditions apply* **DE: Du könntest GEWINNEN.** Es gelten die Teilnahmebedingungen* **FR: Tu pourrais GAGNER.** Des conditions s'appliquent* **IT: Potresti VINCERE tu.** Termini e condizioni sono applicabili* **ES: Puedes GANAR.** Aplican términos y condiciones* **PT: Poderá GANHAR.** Aplicam-se termos e condições* **ZH: 轻松获奖.** 条款和条件适用* **PL: Szansa na WYGRANĄ.** Obowiązują warunki korzystania* **CS: Máte šanci VYHRÁT.** Platí všeobecné smluvní podmínky* **SK: Máte šancu VYHRÁT.** Platia všeobecné zmluvné podmienky* **HU: TE IS NYERHETSZ.** Felhasználási feltételek érvényesek* **RO: Ai putea CÂȘTIGA.** Se aplică termenii și condiții* **BG: Можете да СПЕЧЕЛИТЕ.** Има определени правила и условия* **LV: Tu vari LAIMĒT.** Ir spēkā noteikumi un nosacījumi.* **ET: Sul on võimalus VÕITA.** Kehtivad tingimused* **LT: Jūs galite LAIMĖTI.** Taikomos sąlygos*

*[LEGO.com/productfeedback-terms](https://www.lego.com/productfeedback-terms)