

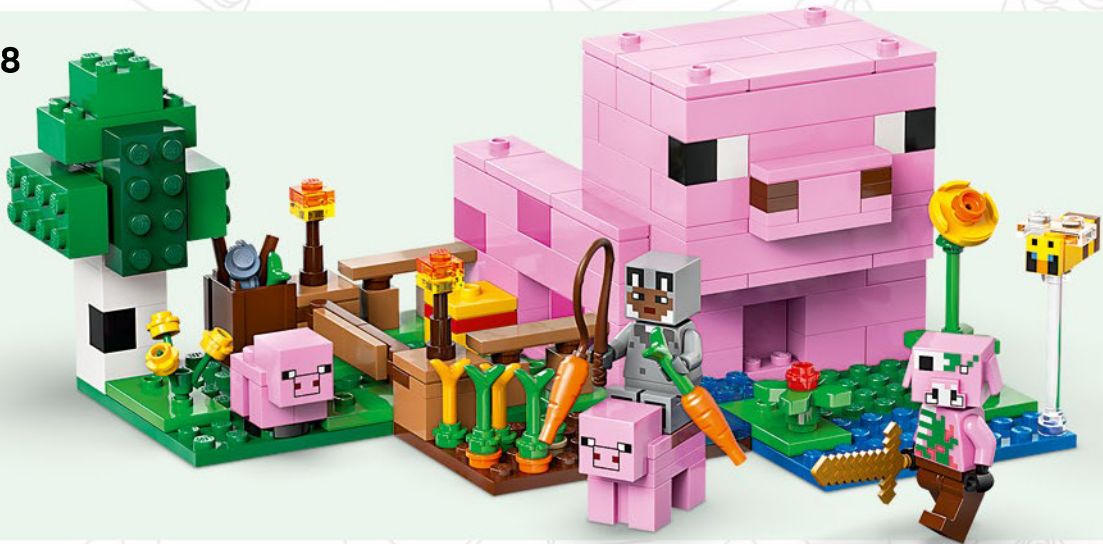

MINECRAFT

21268



Q LEGO® Builder



Get excited about our new packaging!

We're switching from plastic to paper-based packaging. That's why you might find a mix of paper and plastic in our boxes!

Nos nouveaux emballages vous emballeront !

Nous passons des emballages en plastique aux emballages à base de papier. C'est pourquoi vous pourriez trouver un mélange de papier et de plastique dans nos boîtes !

¡Te presentamos nuestros nuevos empaques!

Estamos sustituyendo las bolsas de plástico por bolsas con base de papel. ¡Por eso, puedes encontrar una mezcla de papel y de plástico en nuestras cajas!

[LEGO.com/sustainable-packaging](https://www.lego.com/sustainable-packaging)

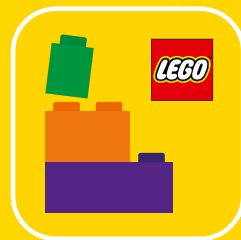

Q LEGO® Builder

BUILDER



Apple and the Apple logo are trademarks of Apple Inc., registered in the U.S. and other countries and regions. App Store is a service mark of Apple Inc. Google Play and the Google Play logo are trademarks of Google LLC. Tencent and the Tencent logo are trademarks of Tencent Inc.

Q [LEGO.com/devicecheck](https://www.lego.com/devicecheck)

EN Ask parents' permission before going online | DE Eltern um Erlaubnis bitten, bevor du online gehst | FR Demande l'autorisation d'un parent avant d'aller en ligne | IT Chiedi il permesso ai tuoi genitori prima di andare online | ES Pídeles permiso a tus papás antes de conectarte a Internet | PT Pede autorização aos pais antes de acederes online | ZH 上网前应先征得父母的同意 | PL Poproś rodziców o zgodę, zanim wejdiesz do Internetu | CS Než půjdeš na internet, požádej rodiče o svolení | SK Skôr než pôjdeš na internet, vypýtaj si povolenie od rodičov | HU Kérj szülői engedélyt, mielőtt online csatlakoznál! | RO Cere permisiunea părinților înainte de a te conecta online | BG Поискайте разрешение от родител, преди да влезете онлайн | LV Pirms došanās tiešsaistē palūdz atļauju vecākiem | ET Enne Interneti kasutamist küsi vanematelt luba | LT Prieš prisijungdami prie interneto, atsiklauskite tėvų

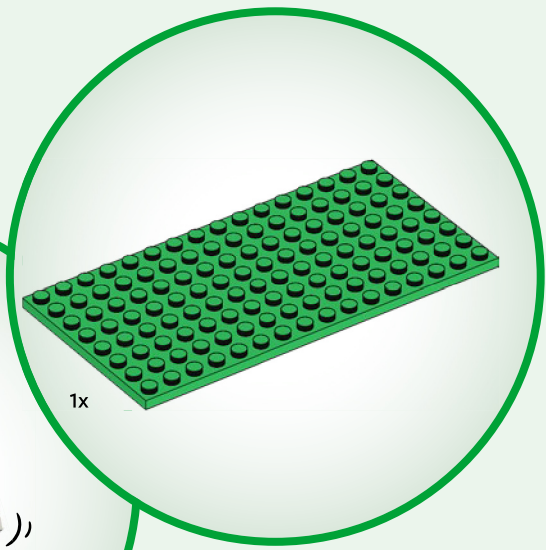
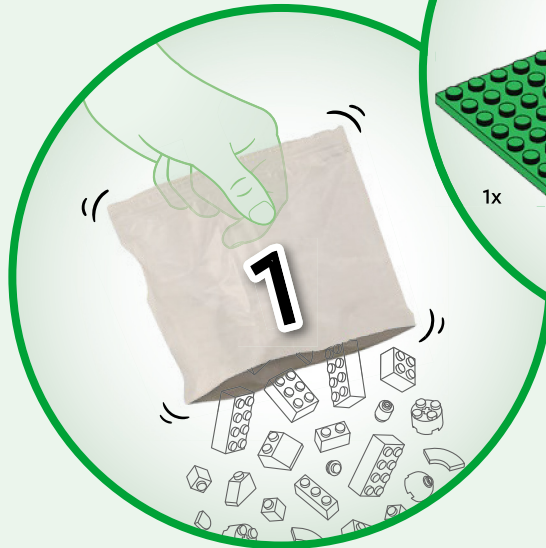

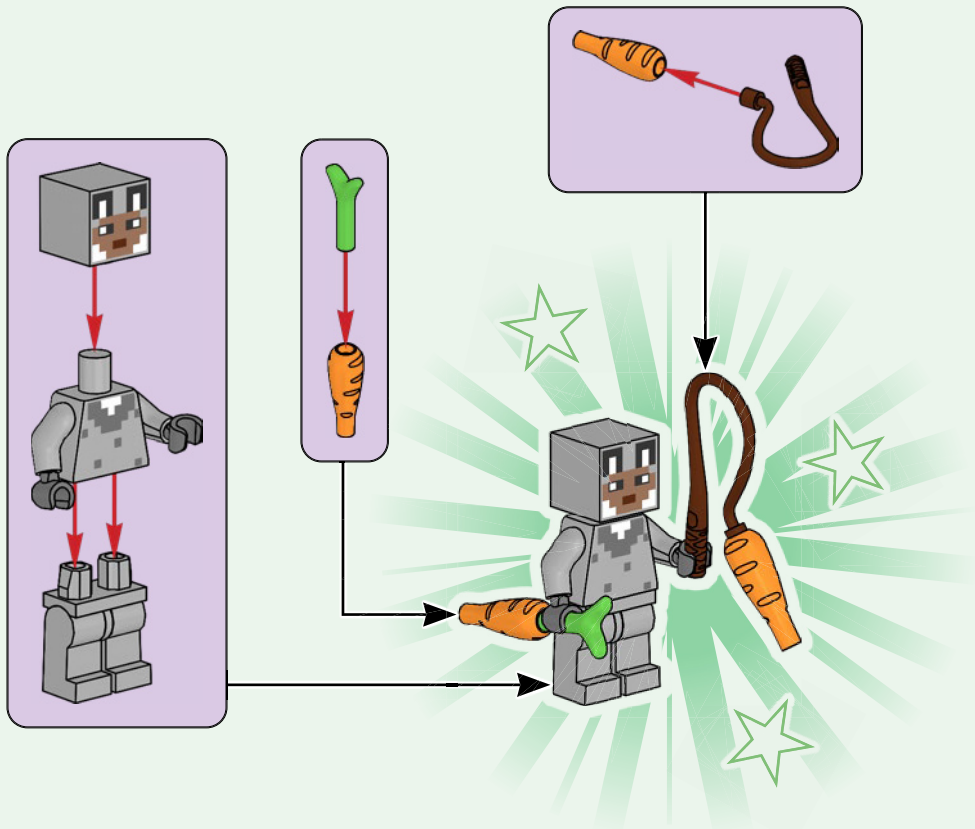

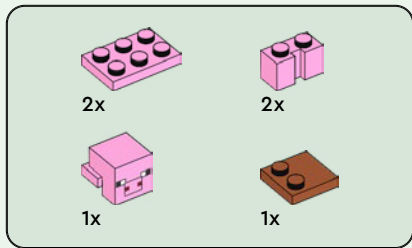

1



1

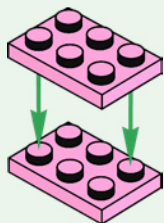

2

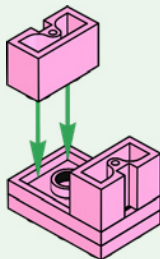

3

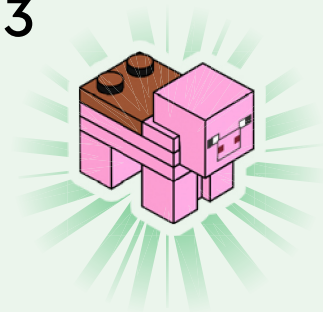

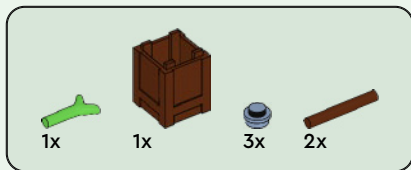

1

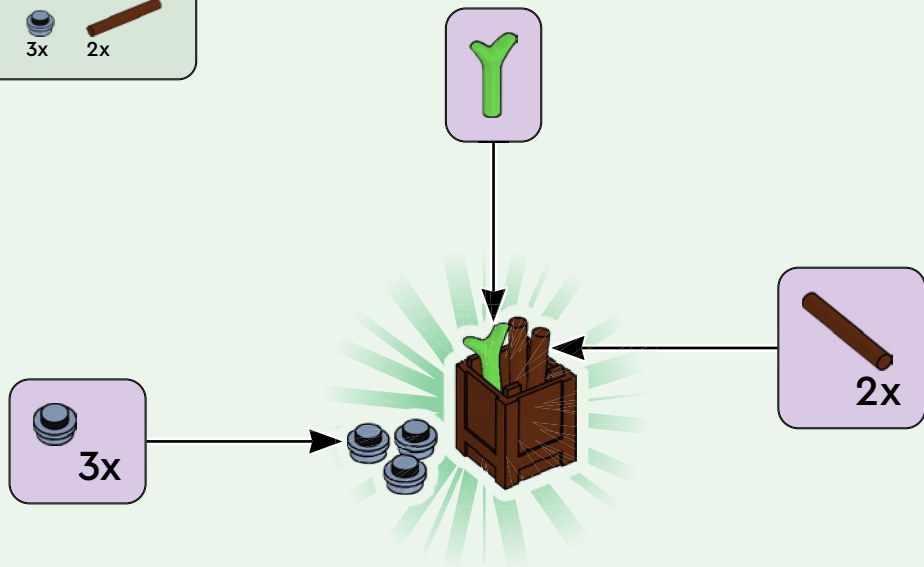

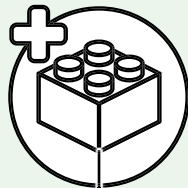
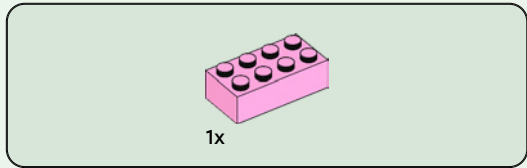

1

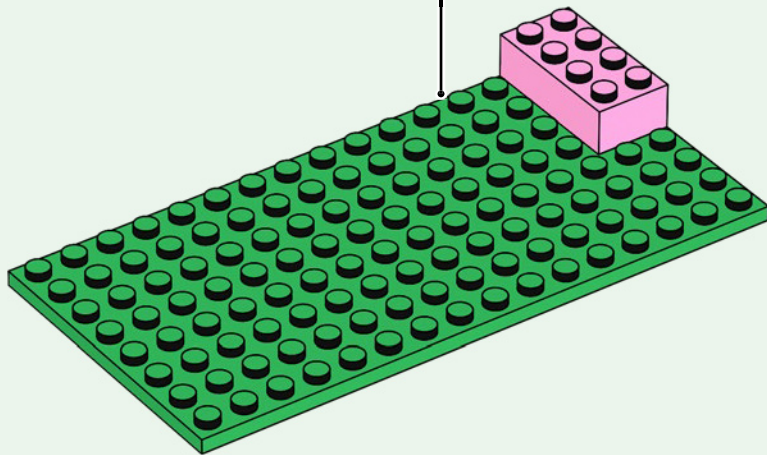



1x

2

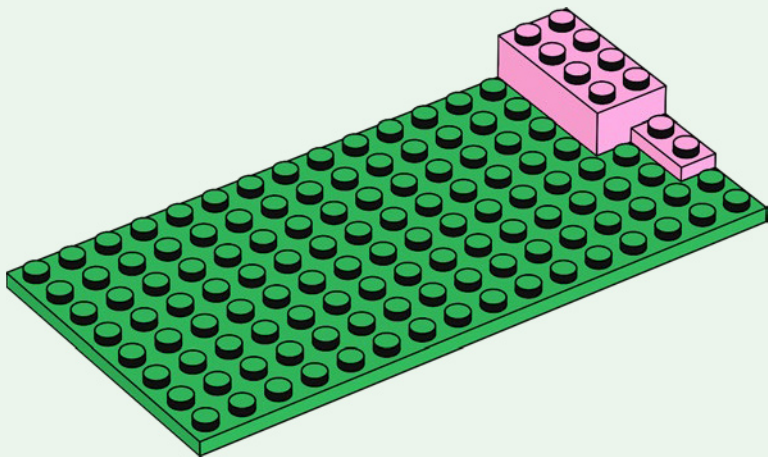



1x

3

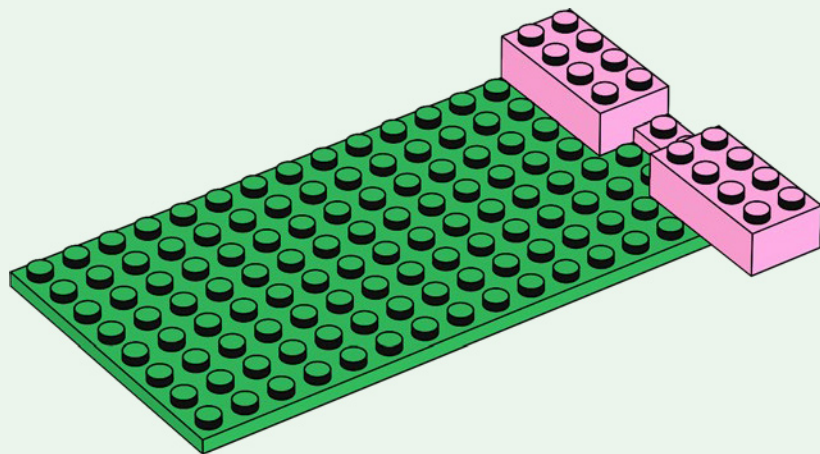

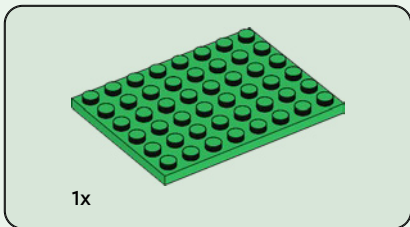

4

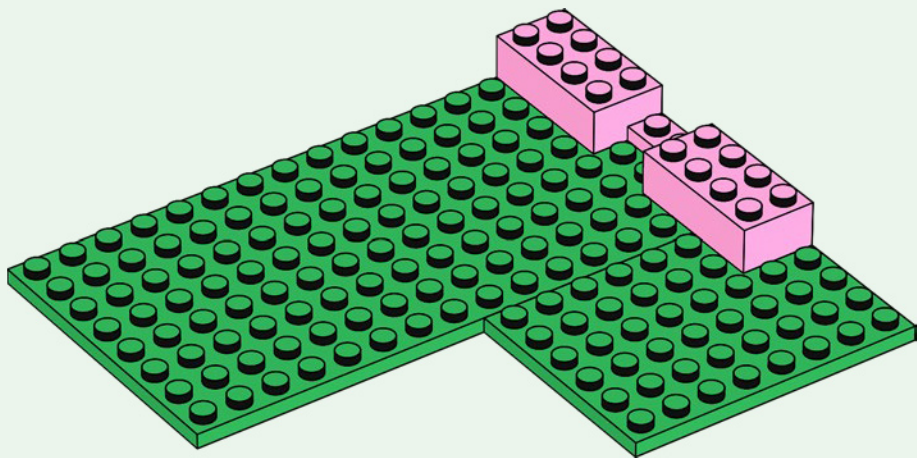



2x



1x

5

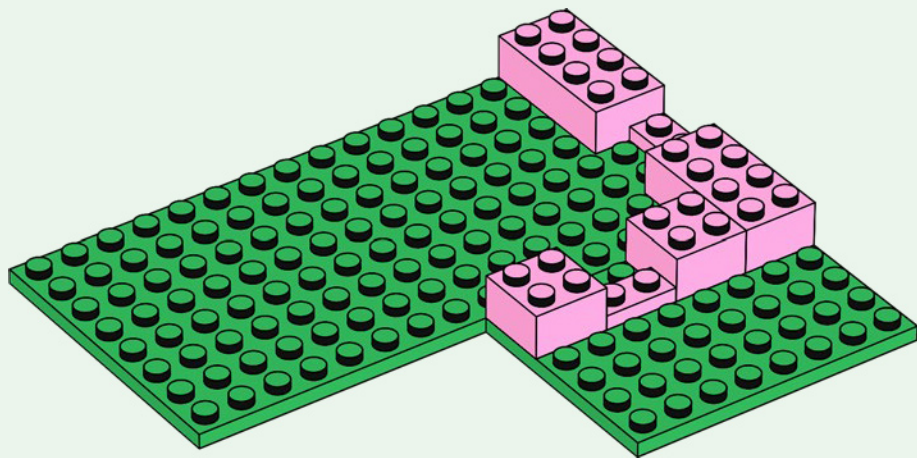

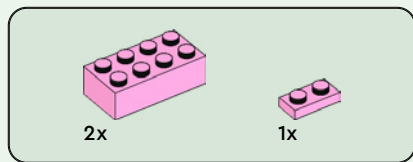

6

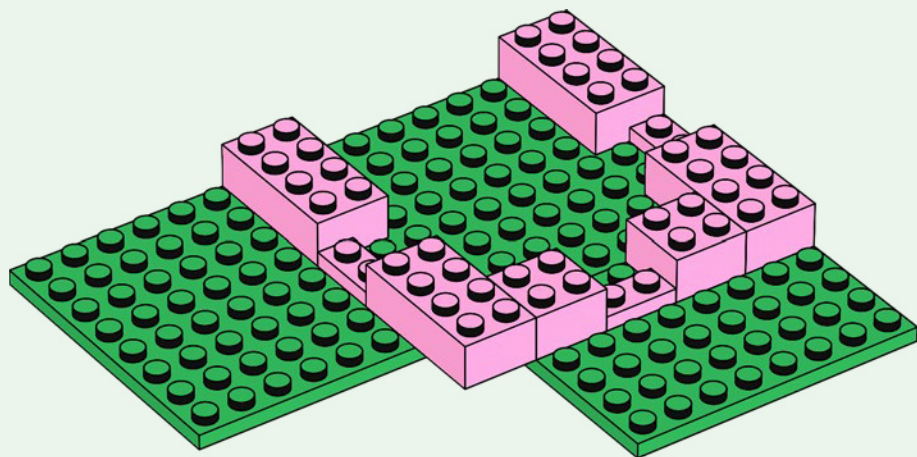



7

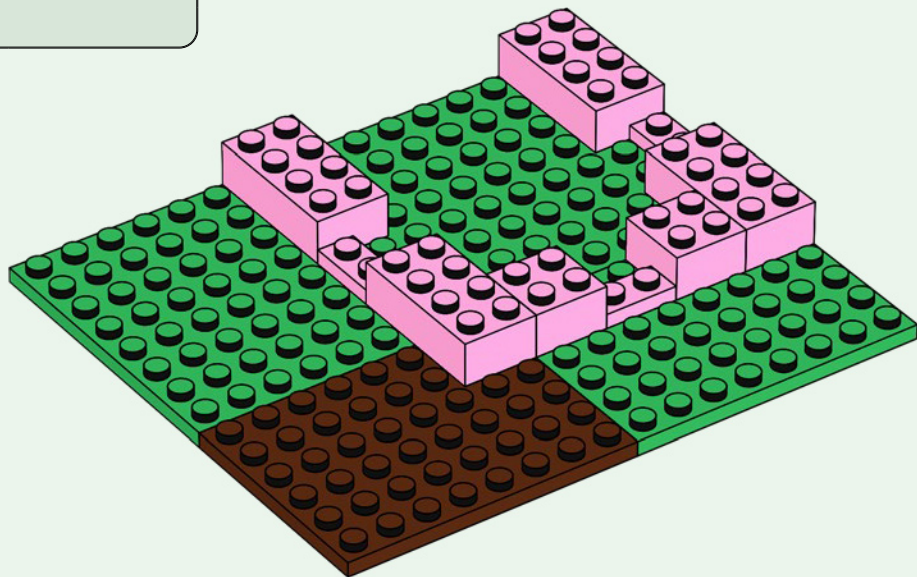

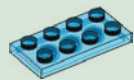

1x



1x

8

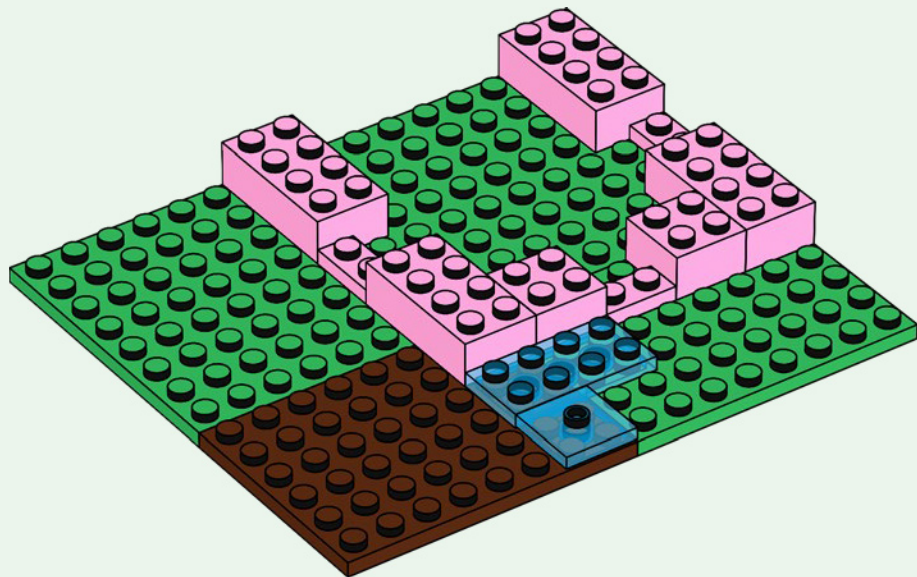

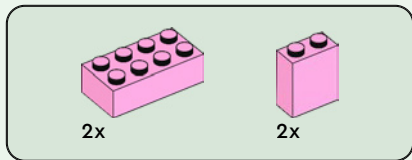

9

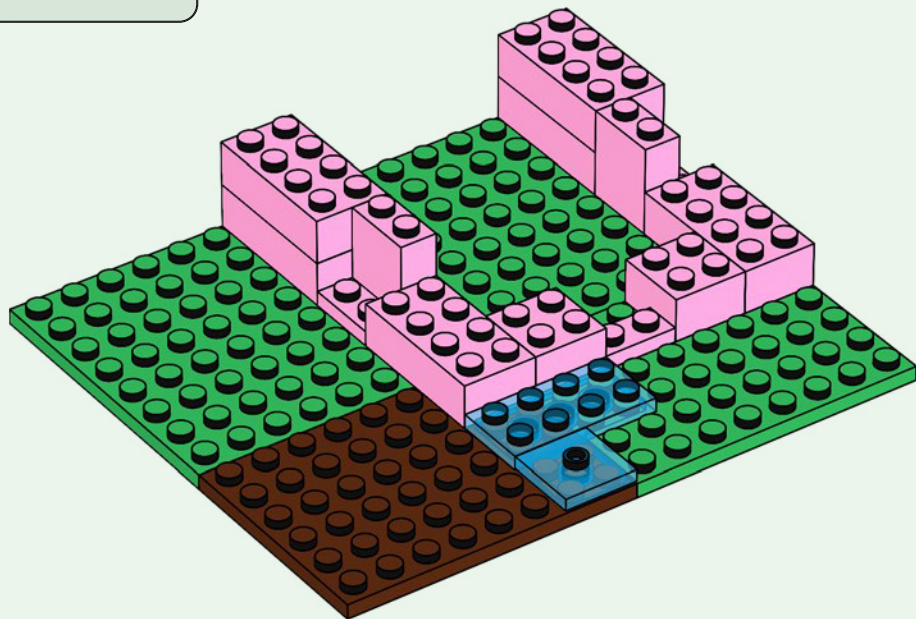



2x

10

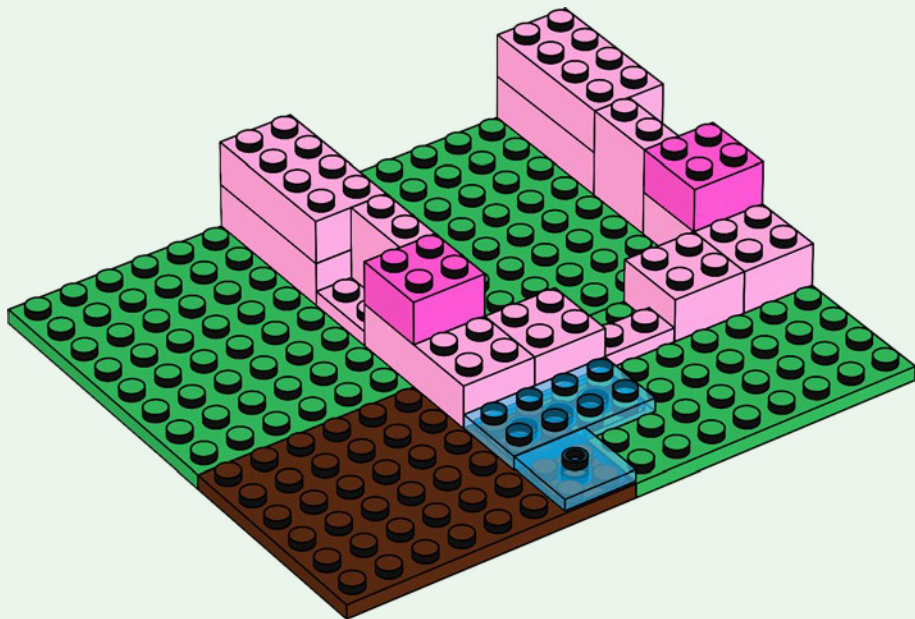

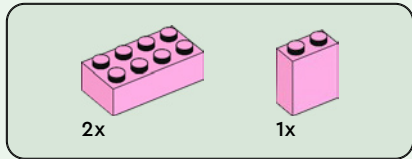

11

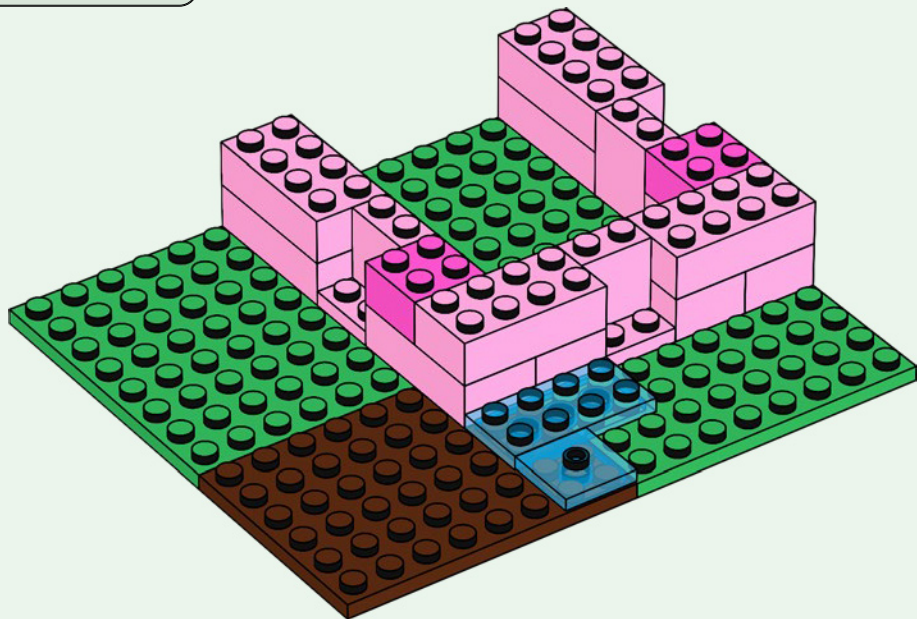



2x

12

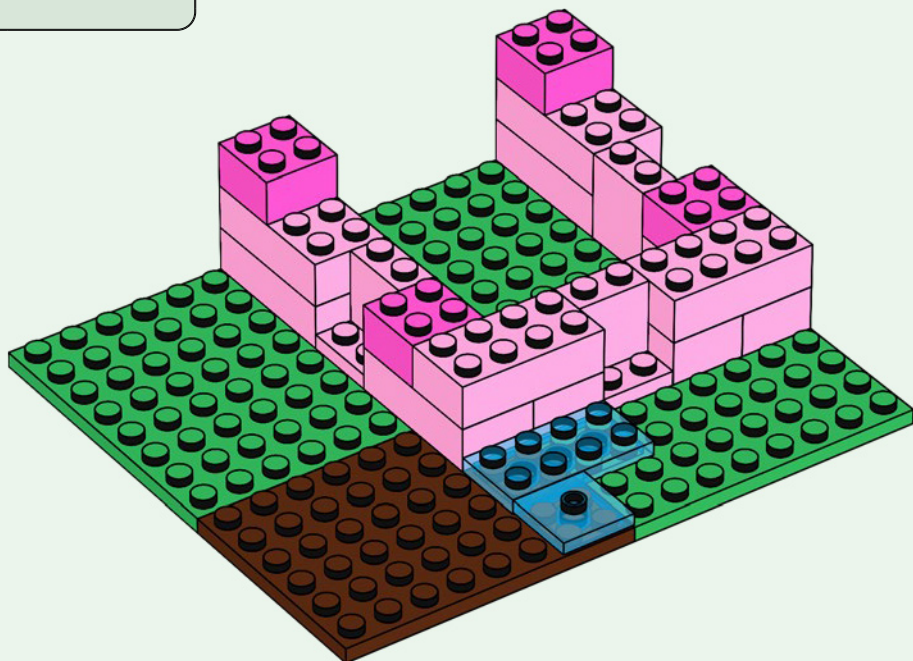

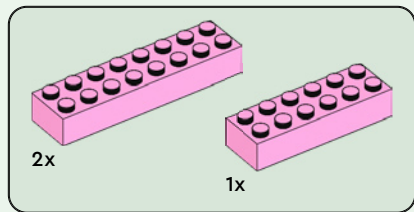

13

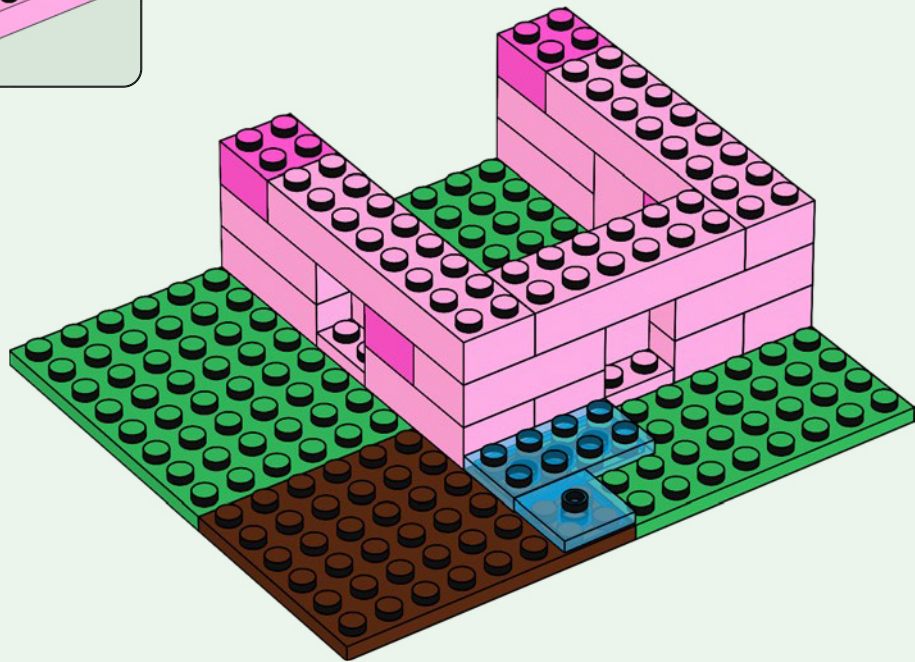

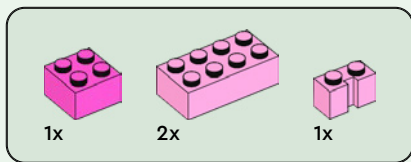

14

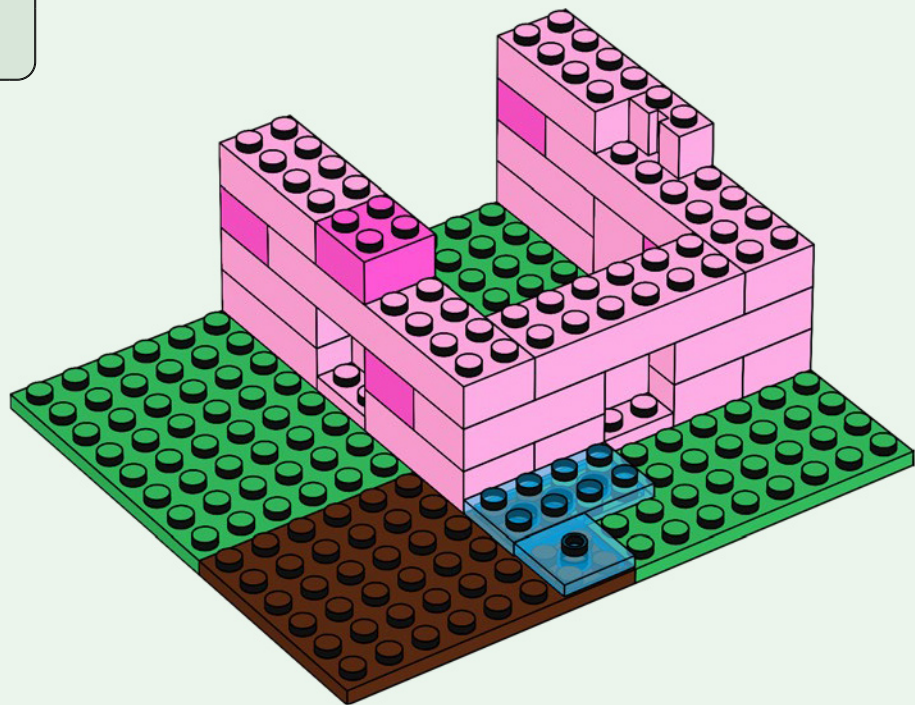

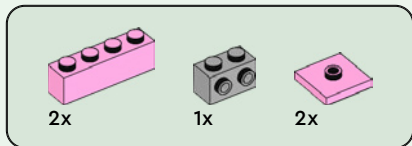

15

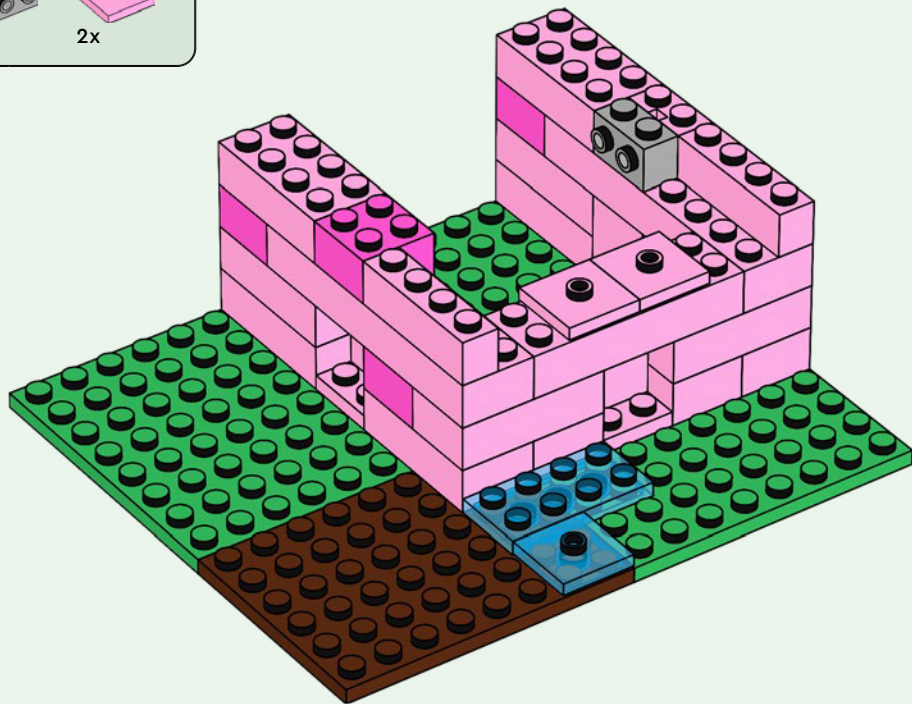

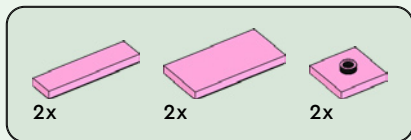

16

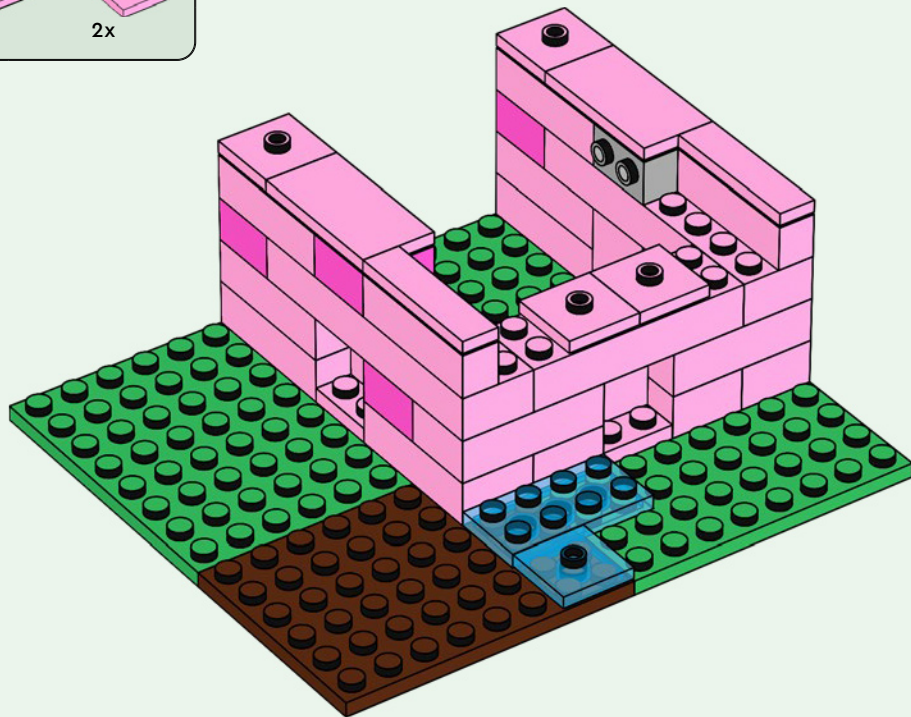

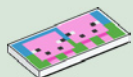

1x

17

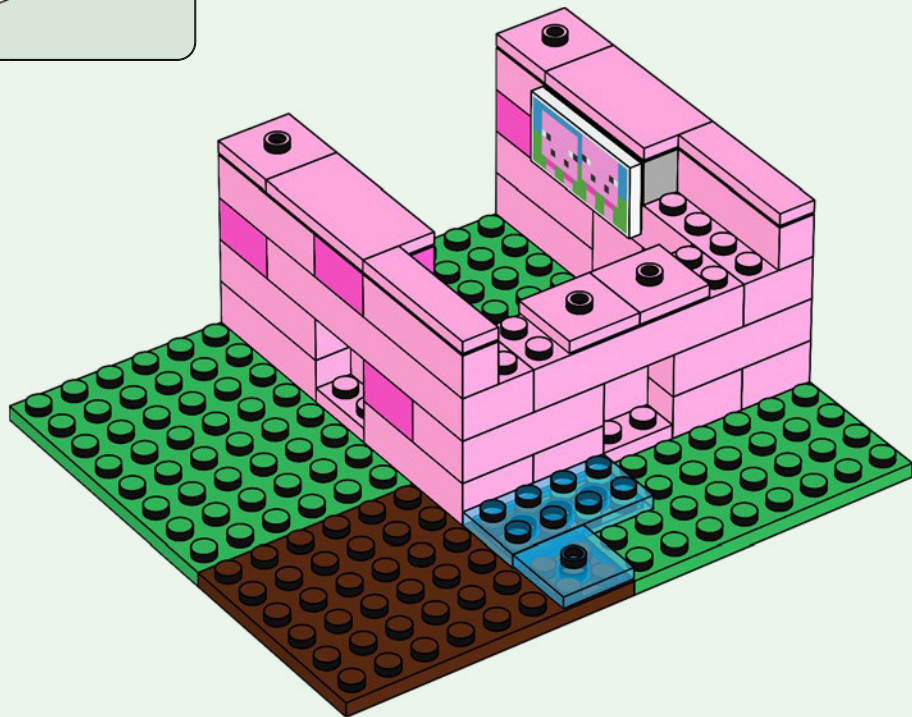



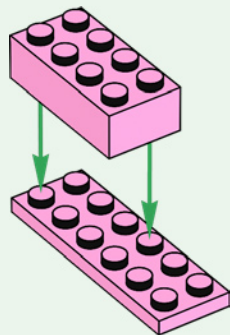
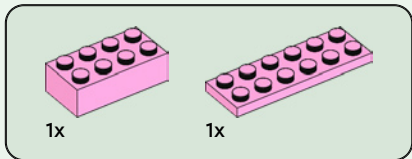
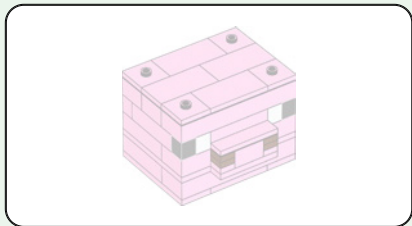

18



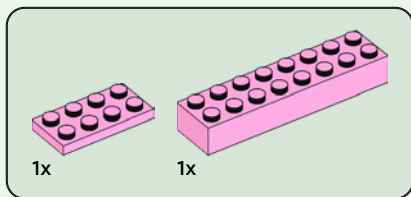

19

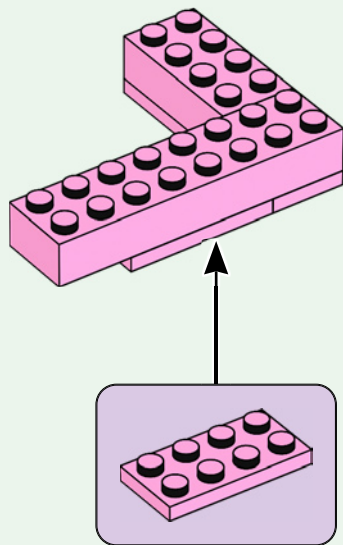

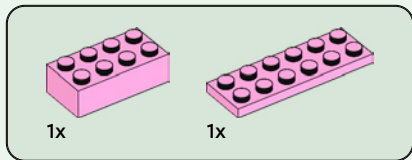

20

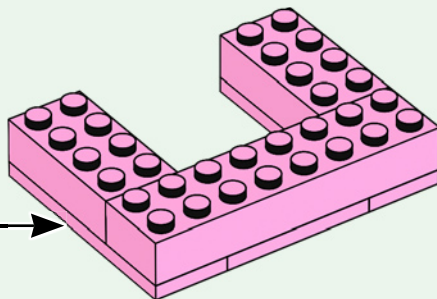
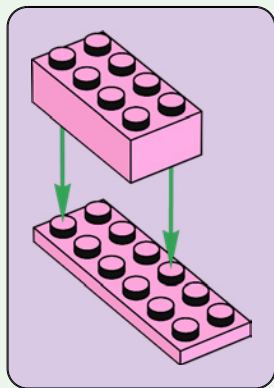

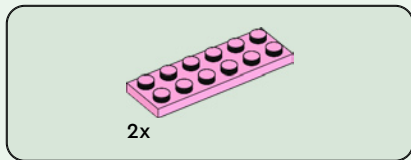

21

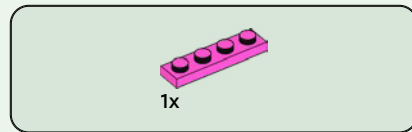
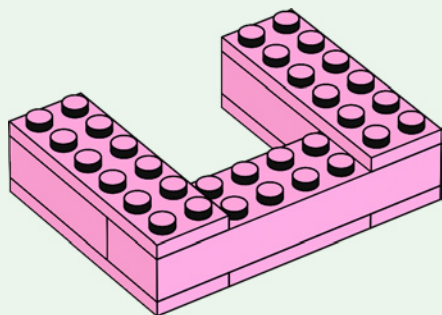

22

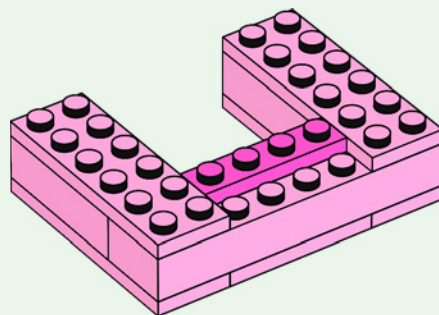

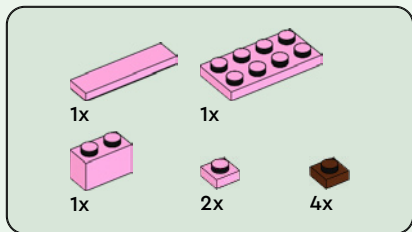

23

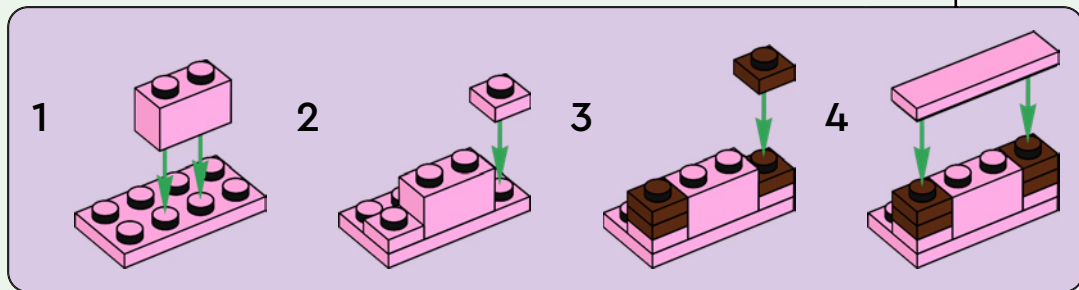
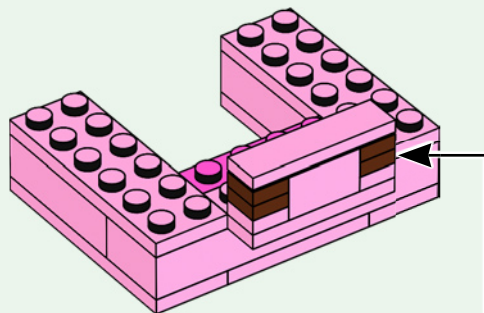

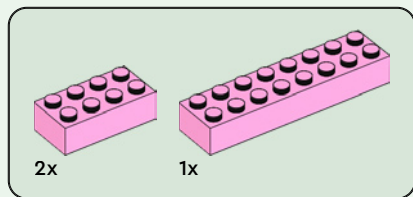

24

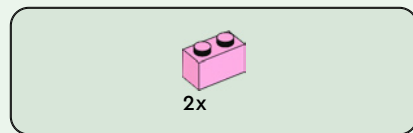
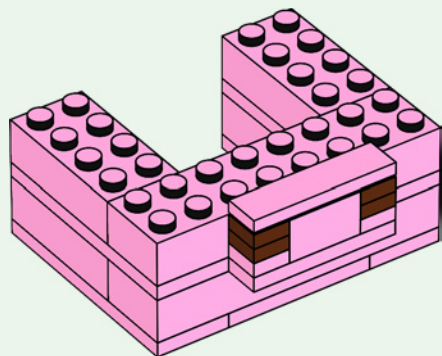

25

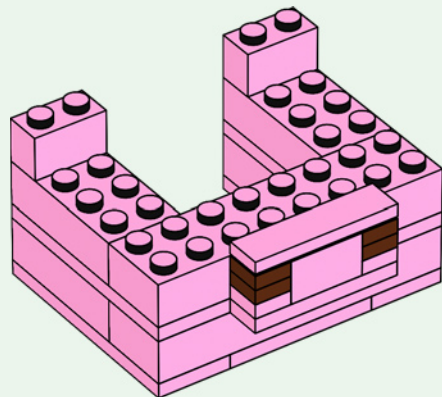



3x

26

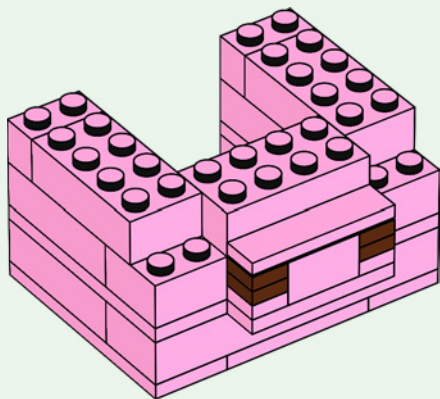



2x



2x

27

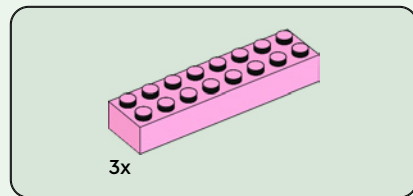
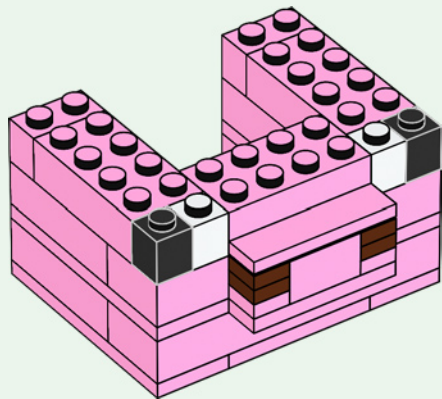

3x

28

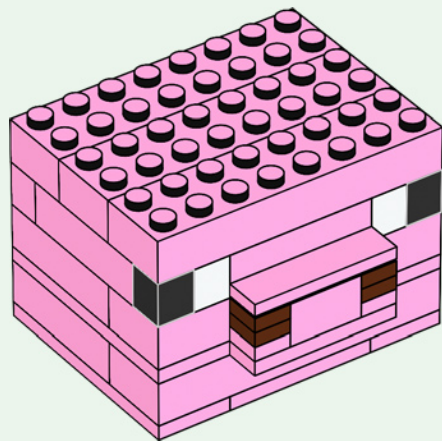

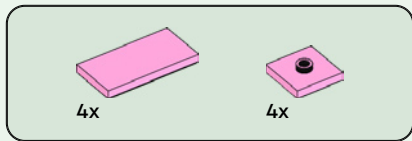

29

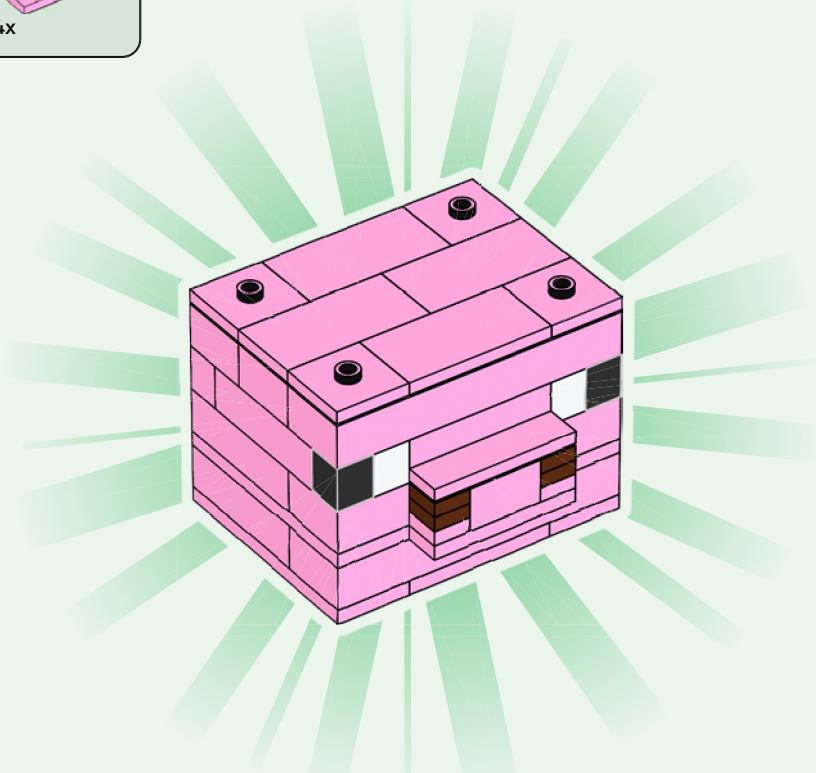

30

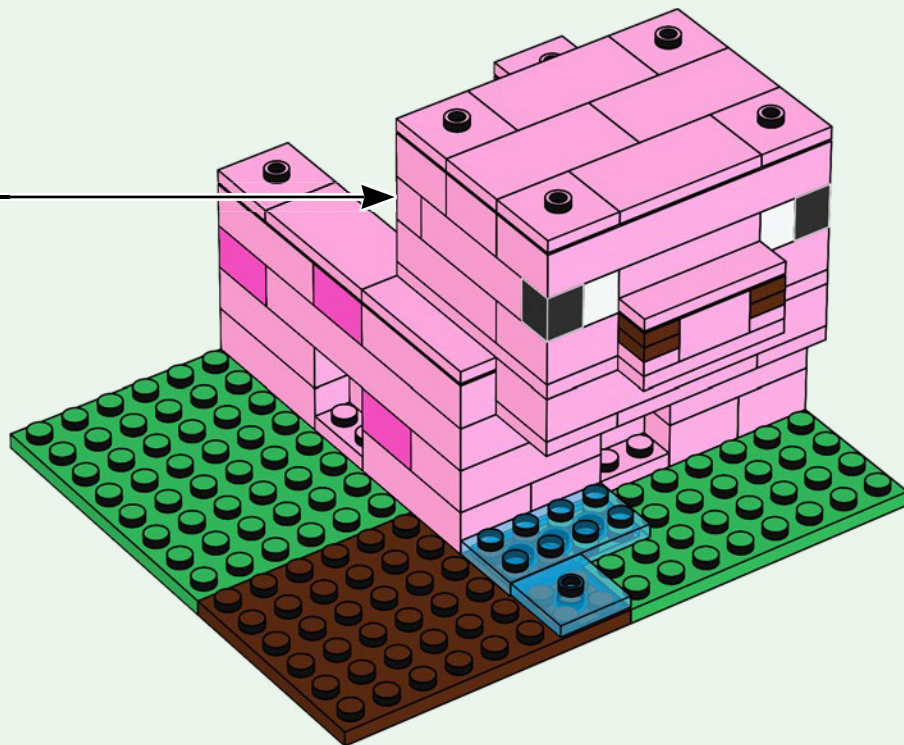

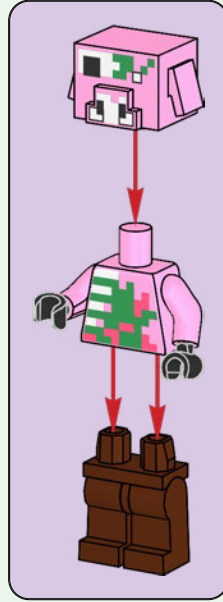

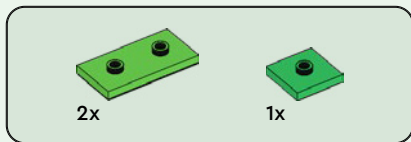

31

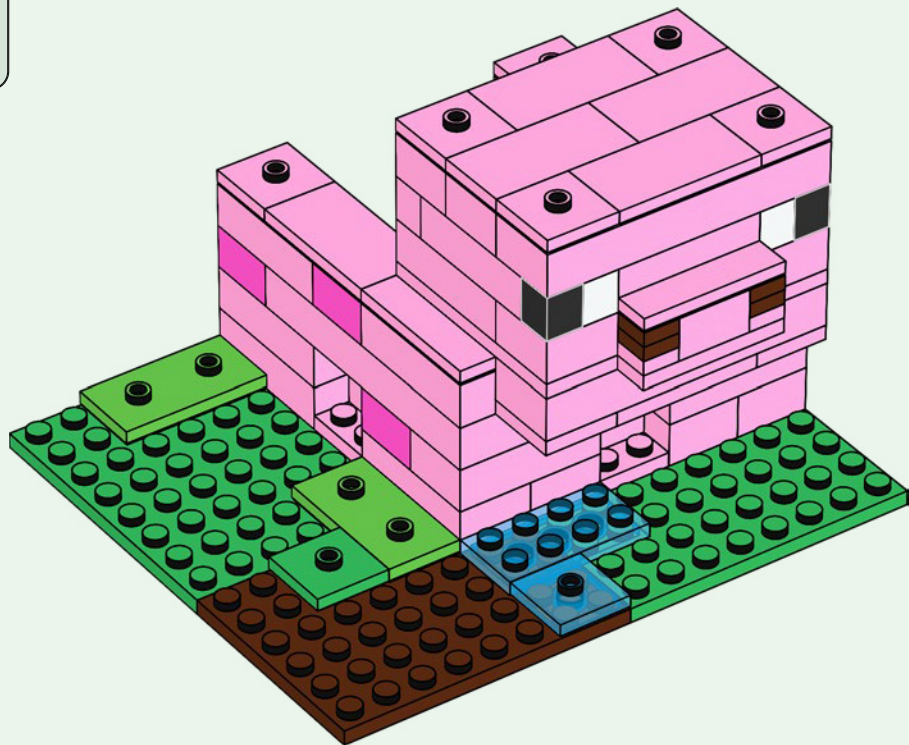



2x

32

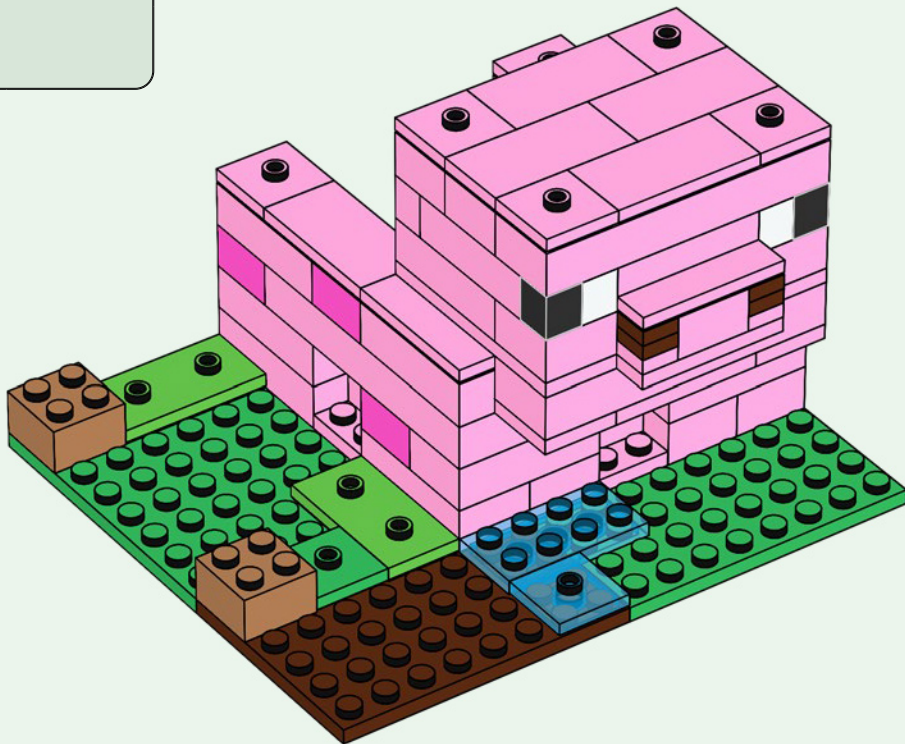

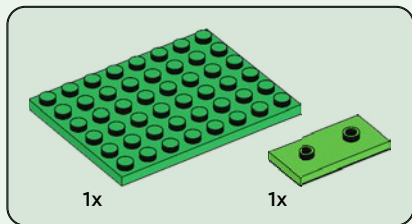

33

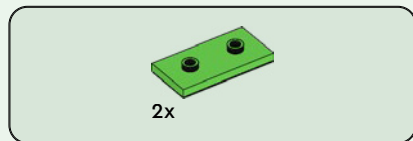
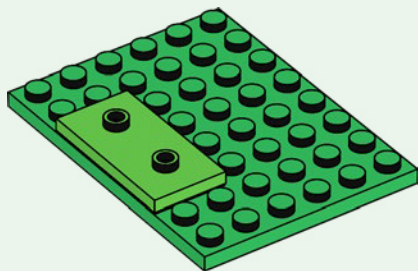

34

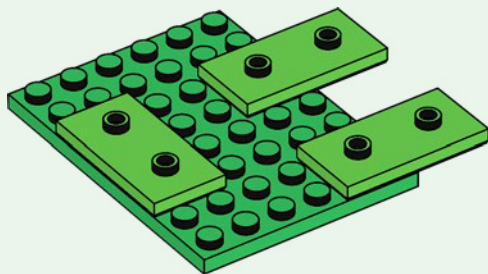

35

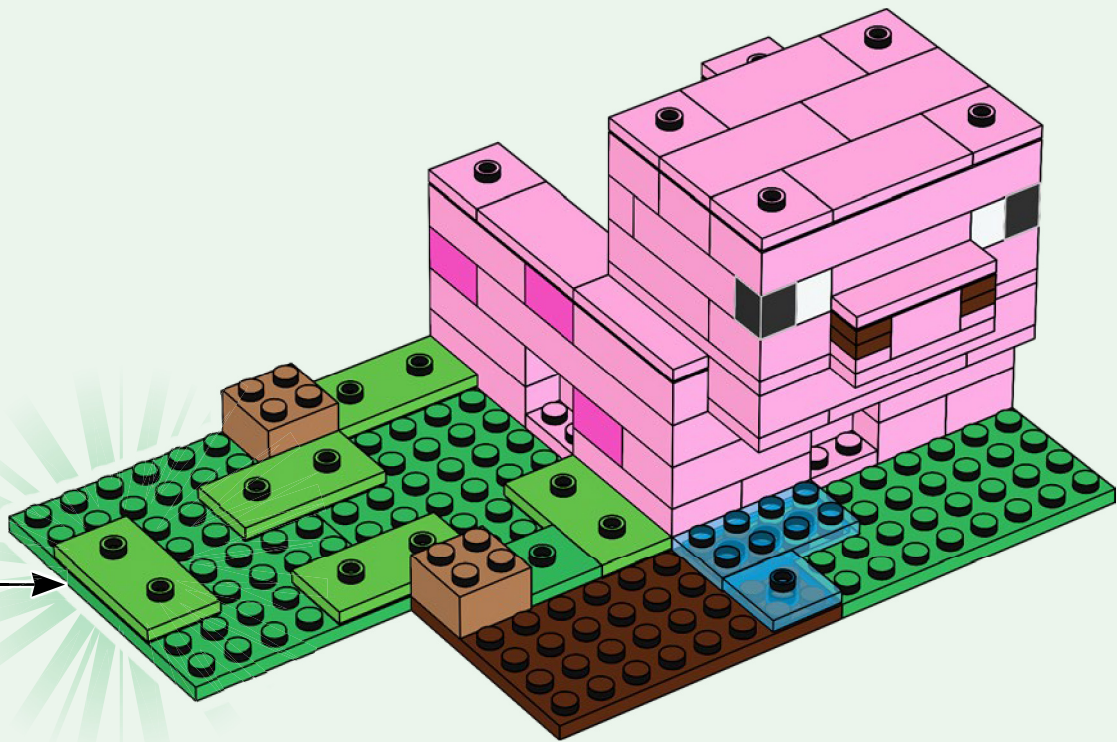



4x



4x

36

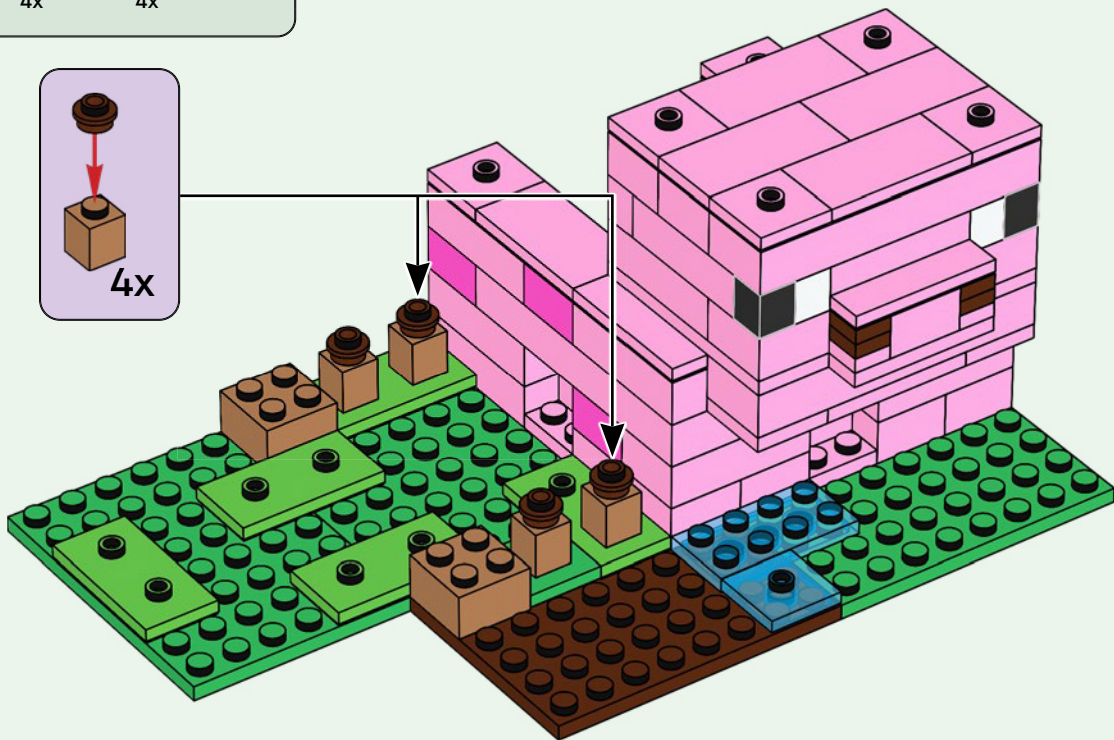
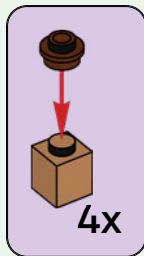



2x

37

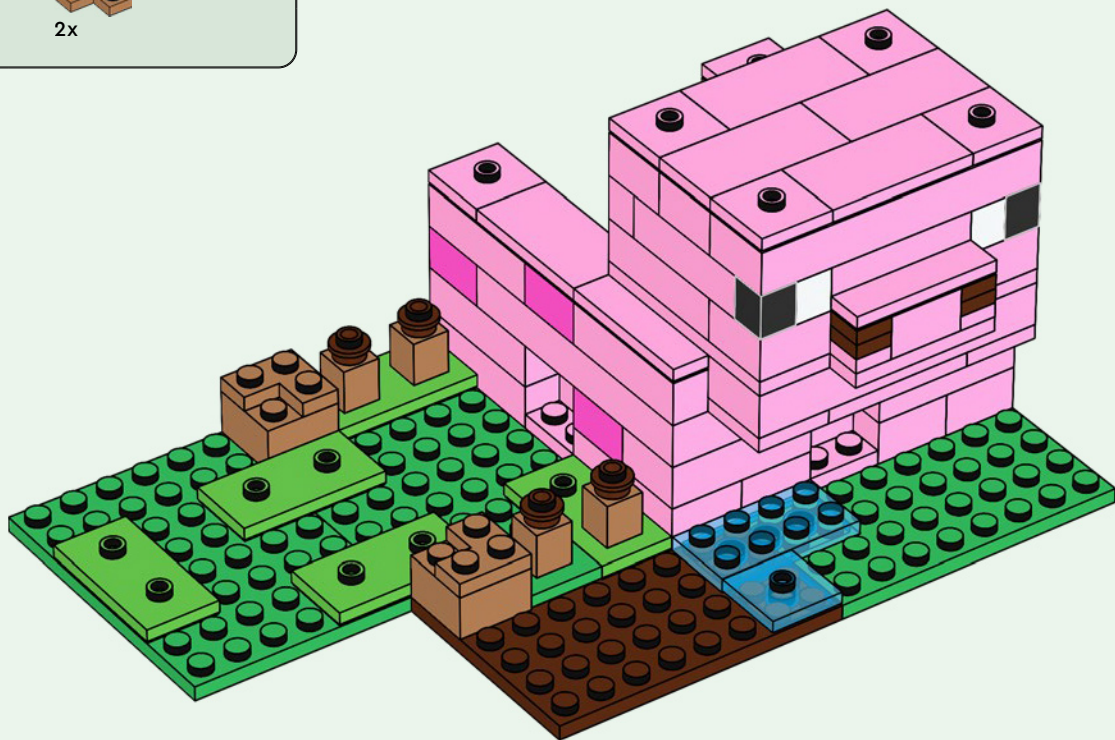



2x

38

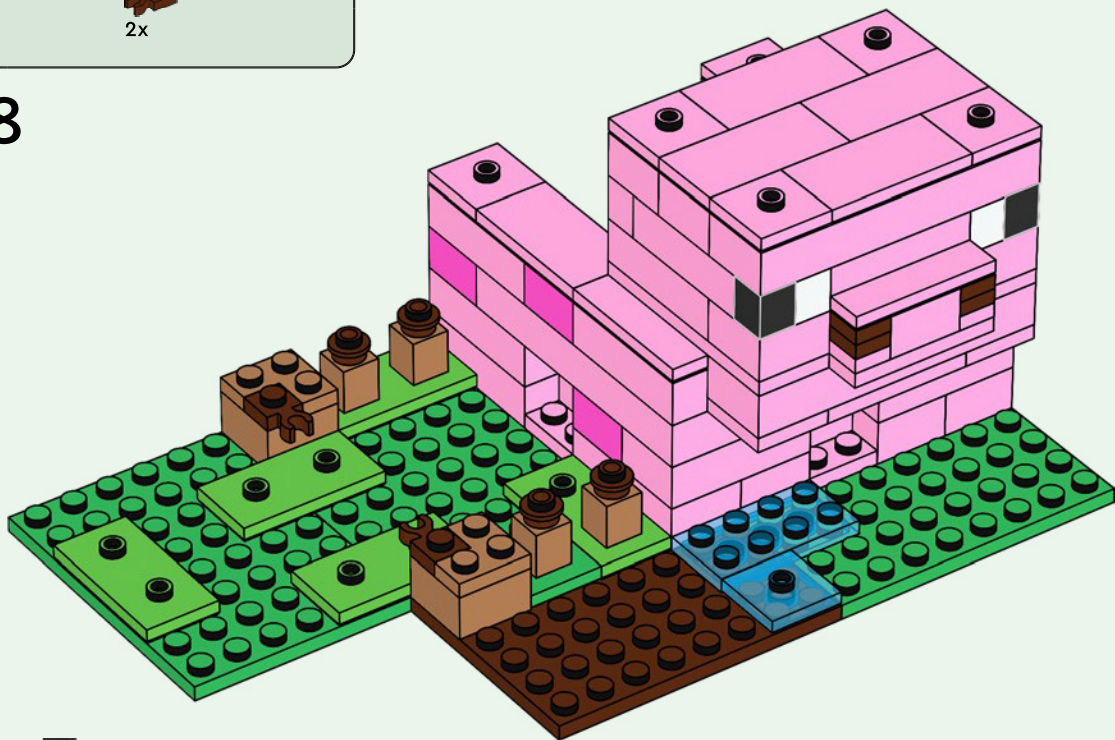

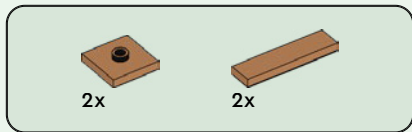

39

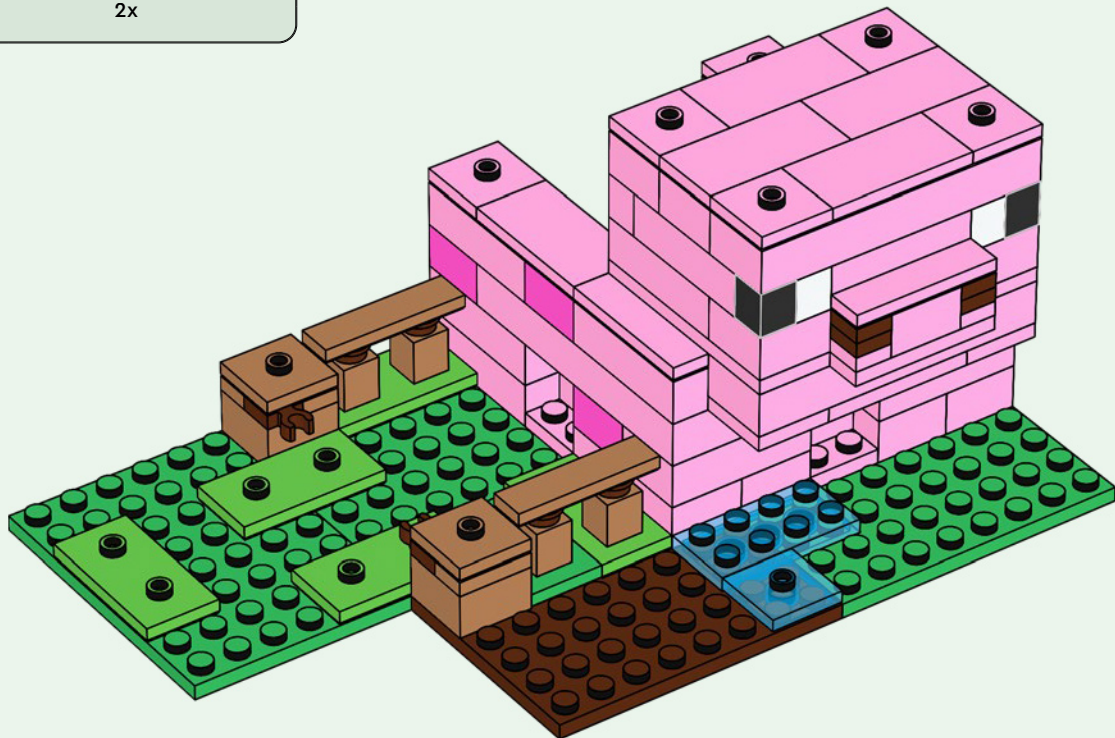

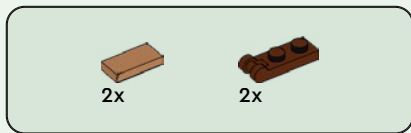

40

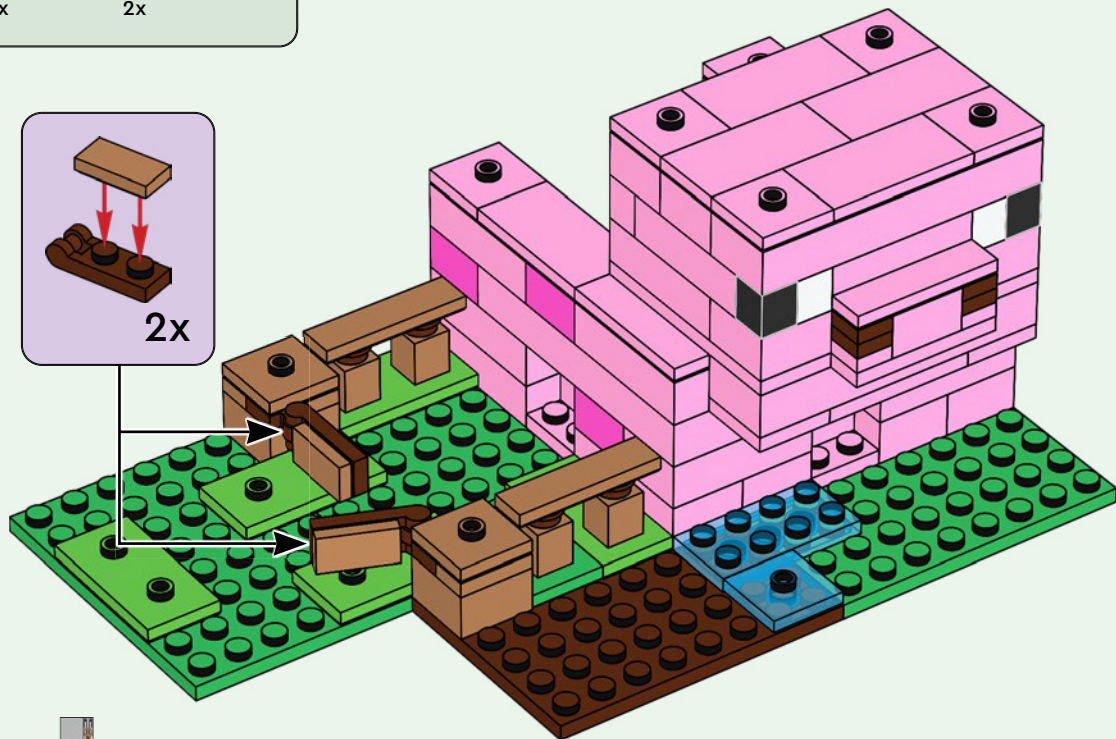
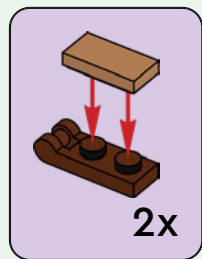



2x



2x



2x



2x

41





2x

42





6x

43

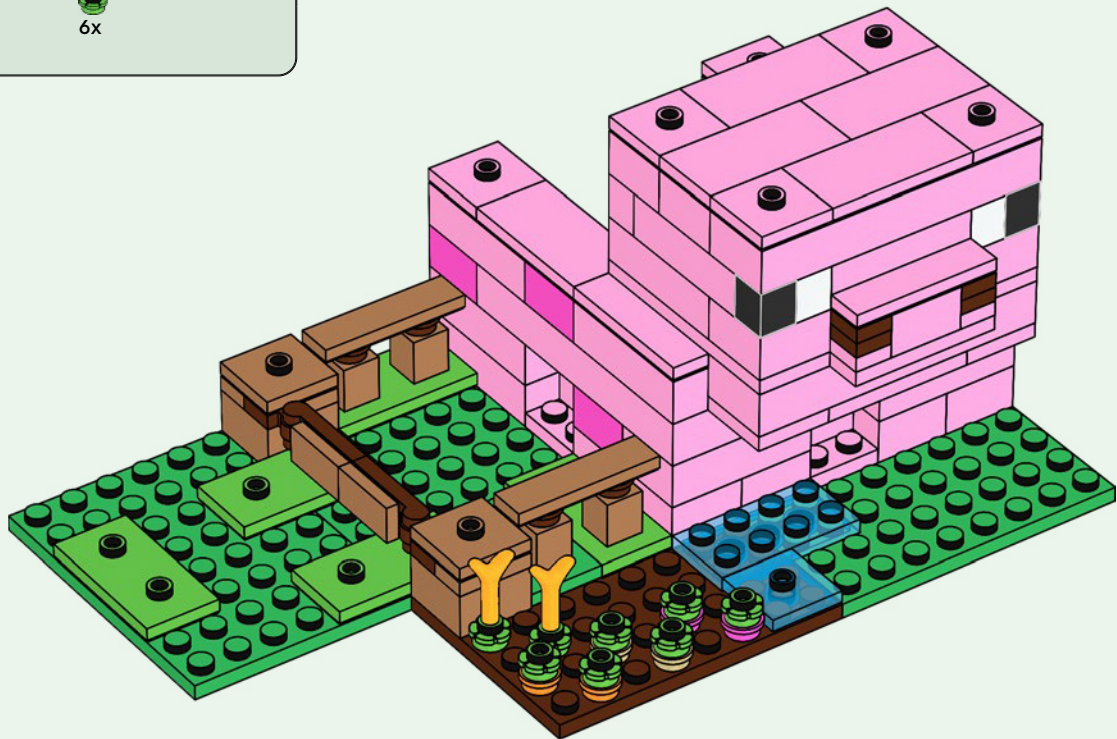



2x

44



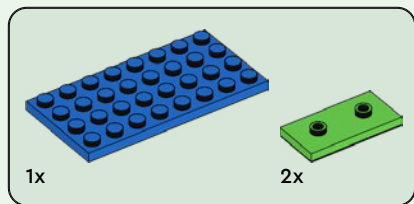

45

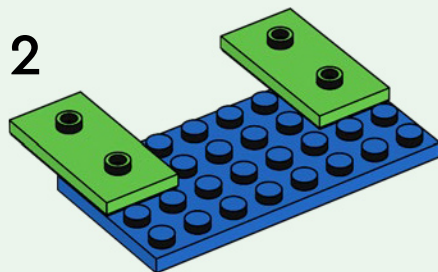
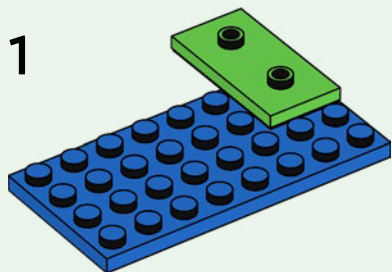

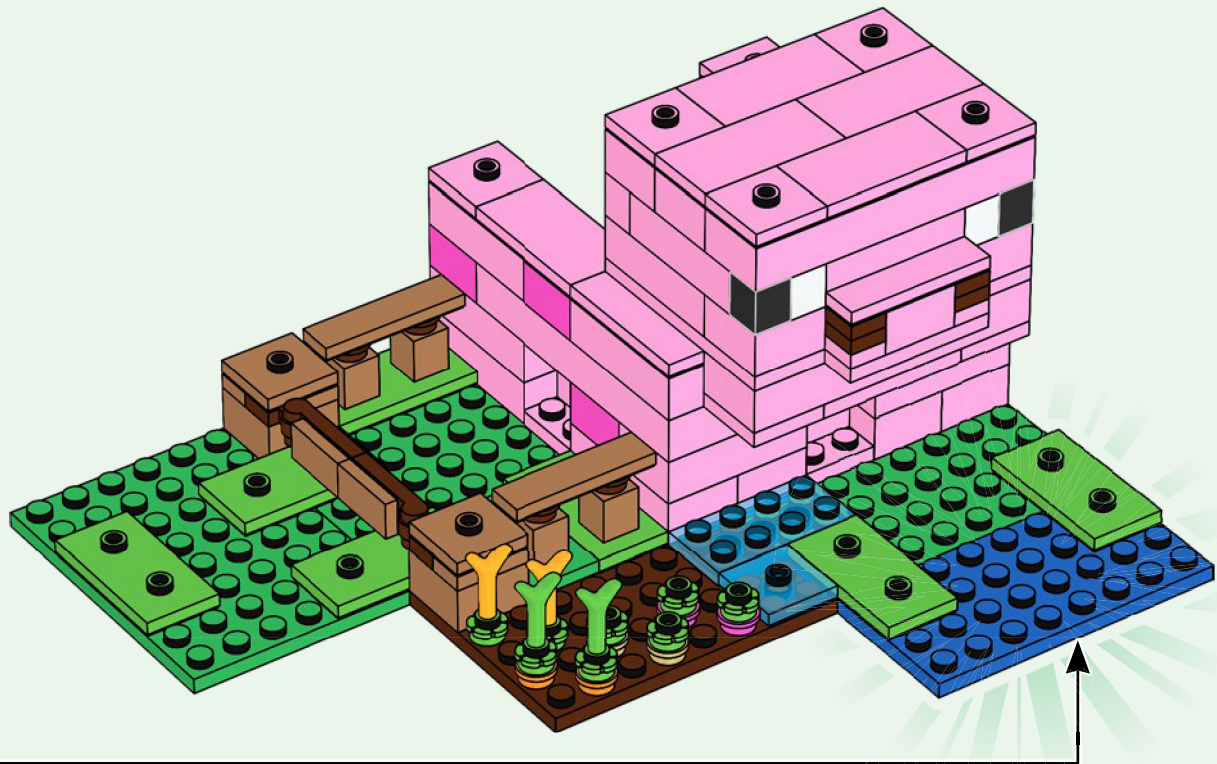



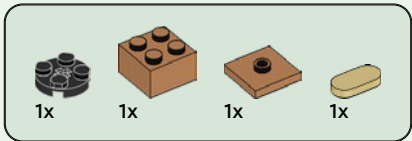

46

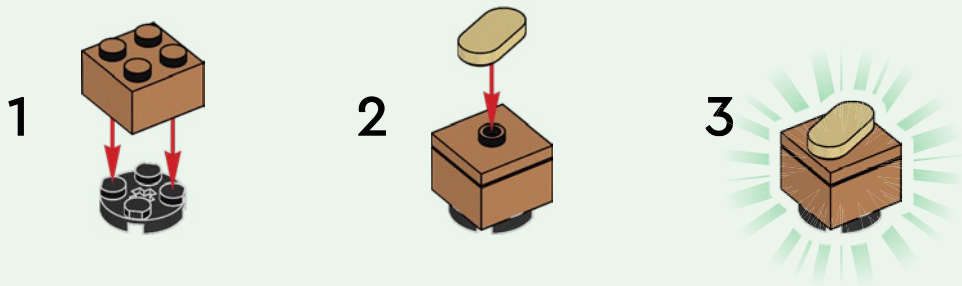



1x



1x



2x

47

1

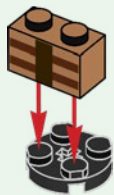

2

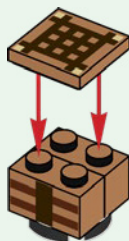

3





2x



1x



1x



2x



1x

48

1

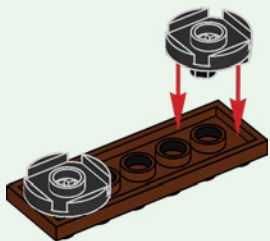

2

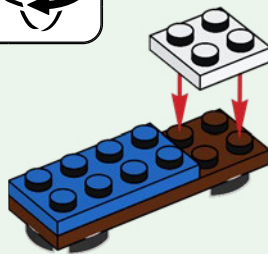

3

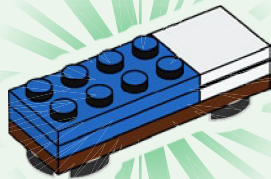

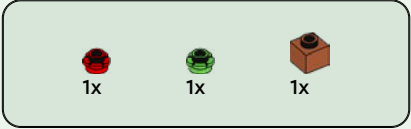

49

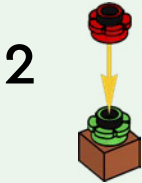
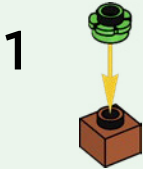

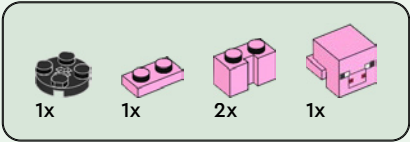

50

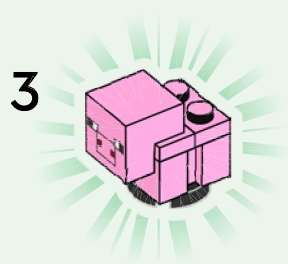
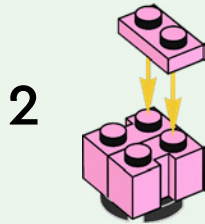
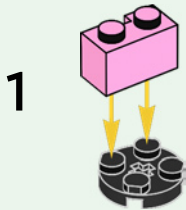



1x



1x



2x



1x



1x



1x



2x



1x

51

1



2

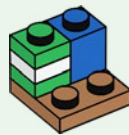

3



4



5

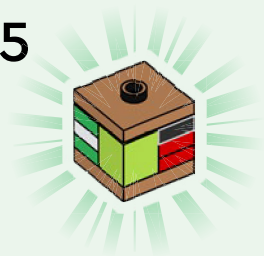



52

1



2



2x



1x



1x

53

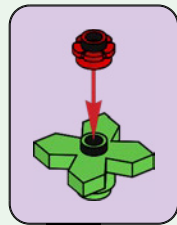
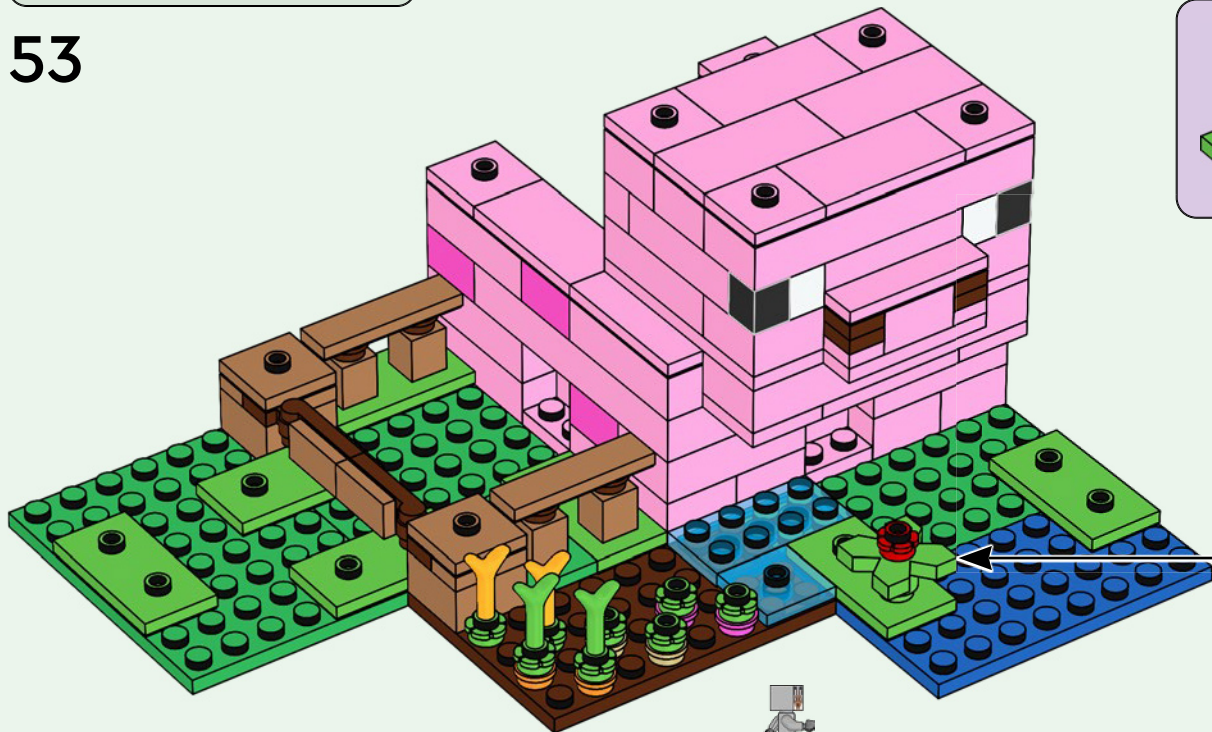

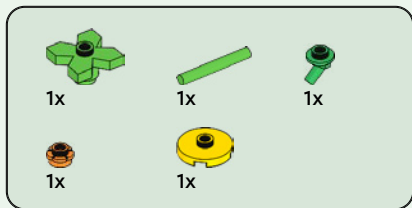

54

1

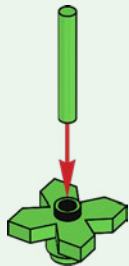

2

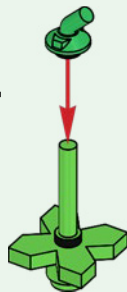

3

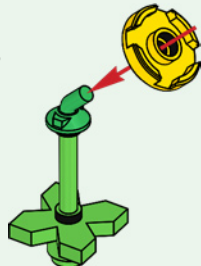

4

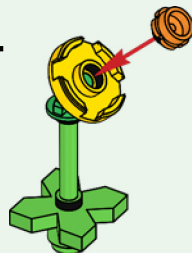

55

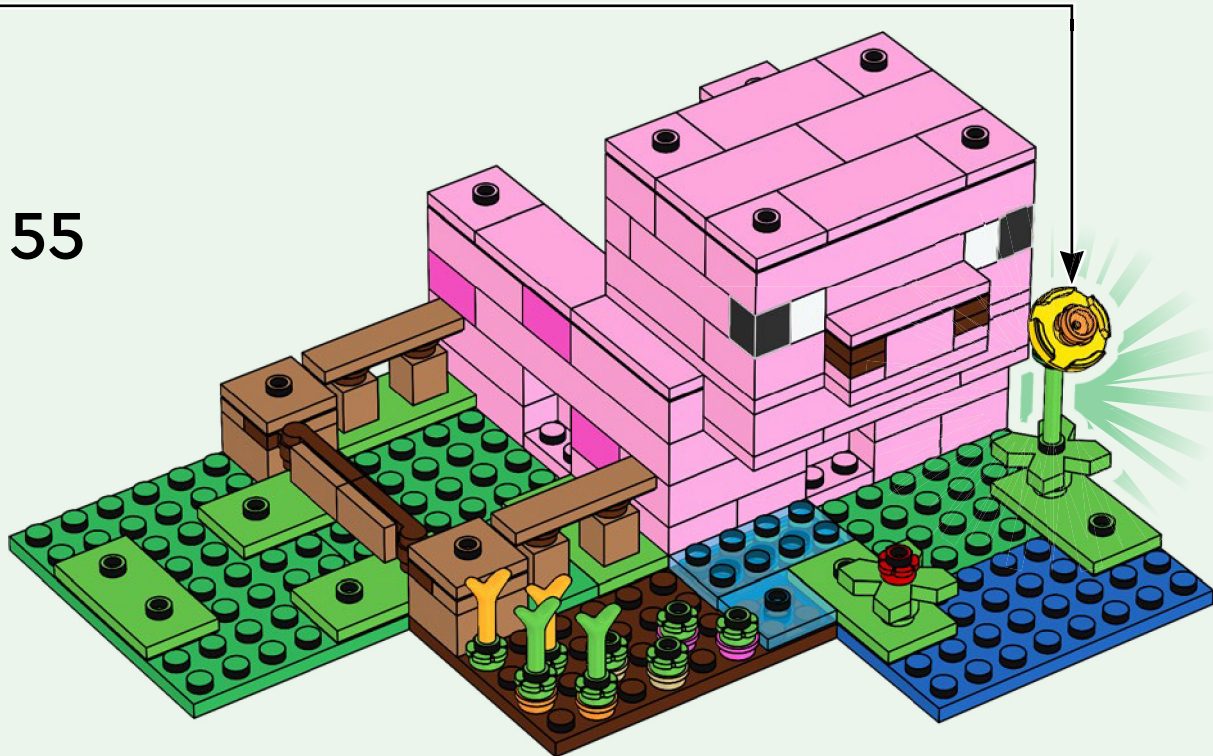

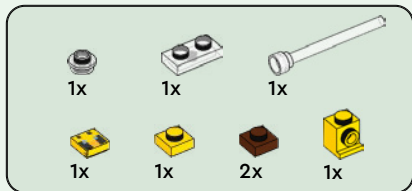

56

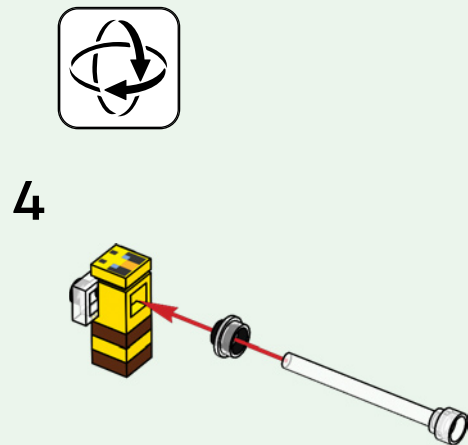
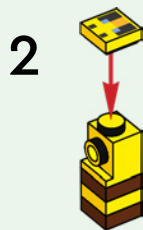
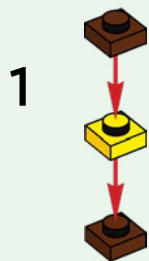

57

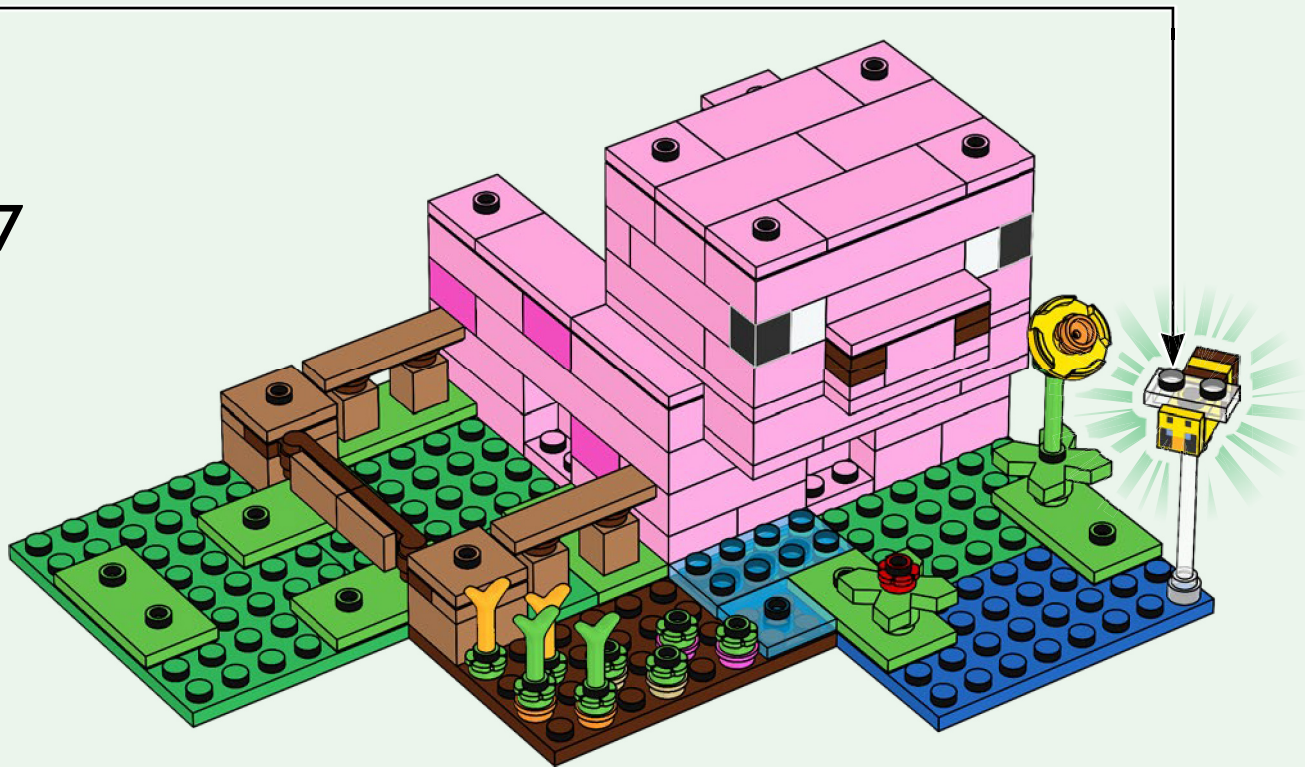



1x



3x

58

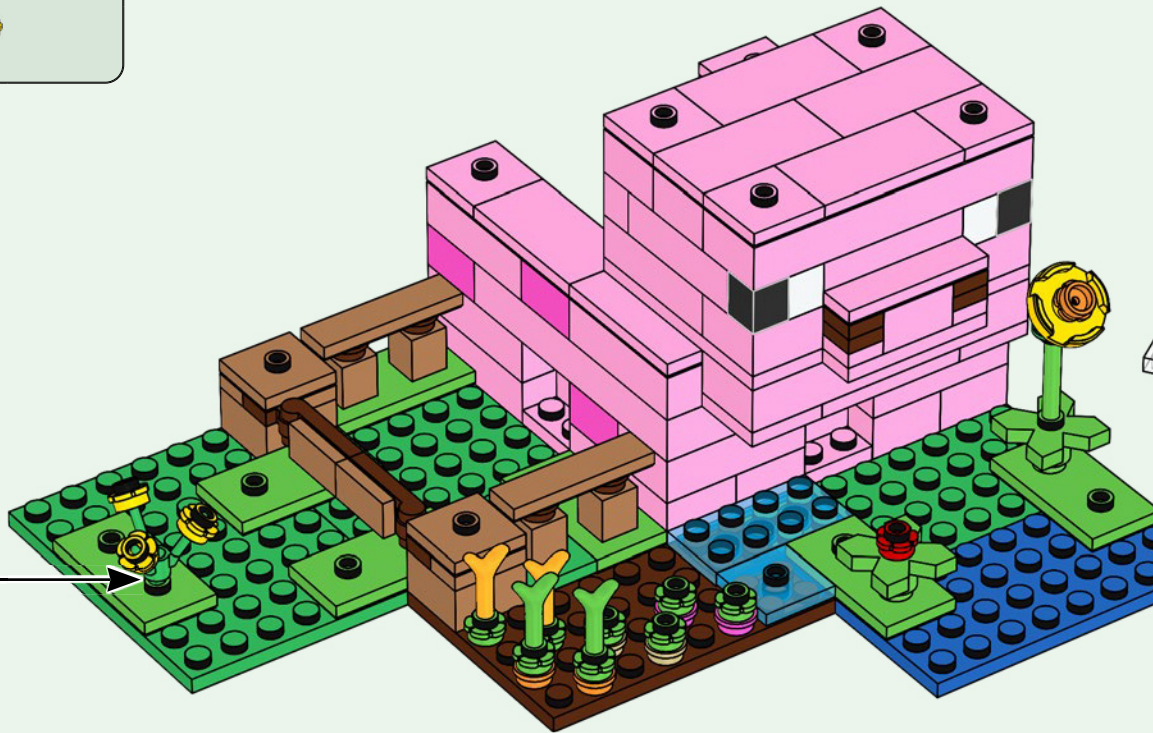
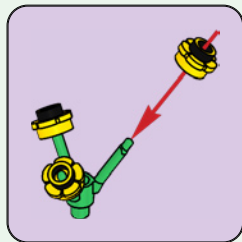

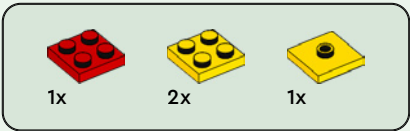

59

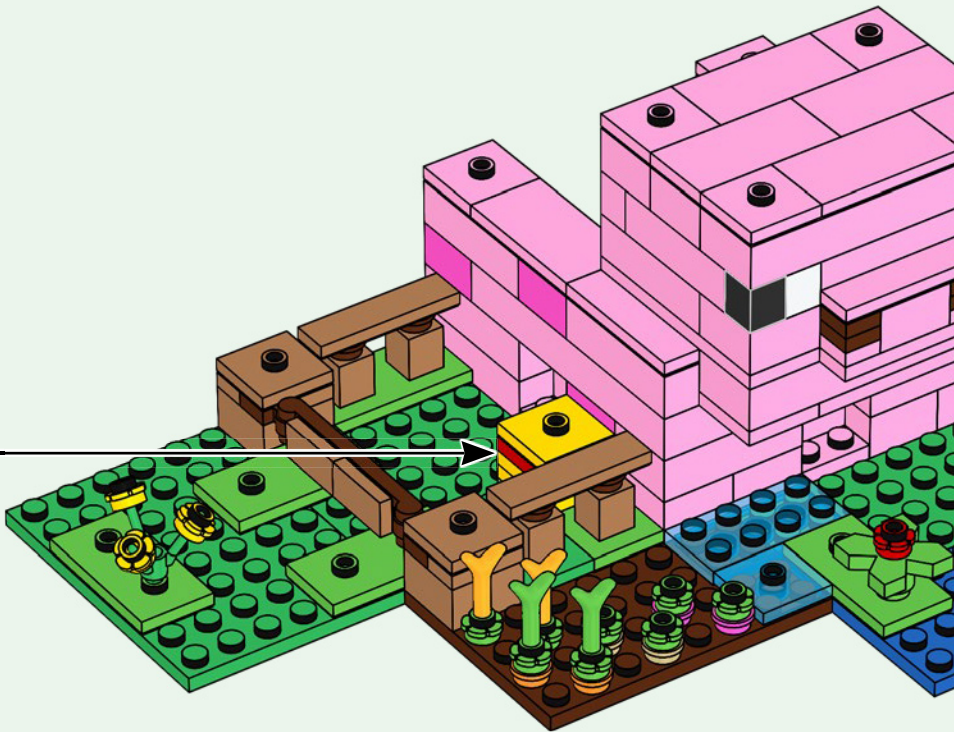
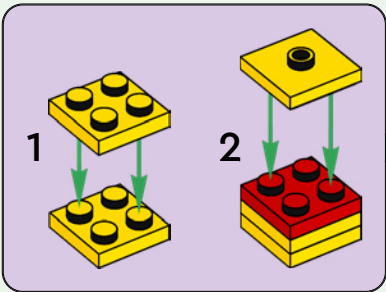

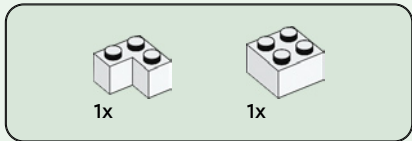
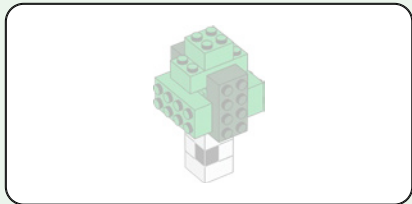

60

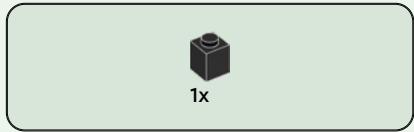
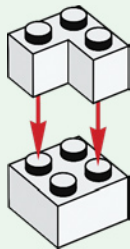

61

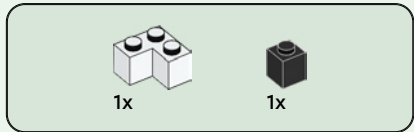
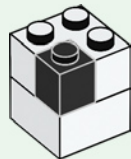

62

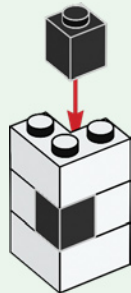



2x

63

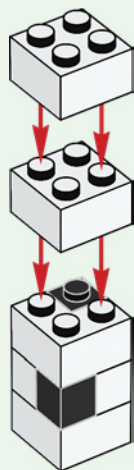

2x

64

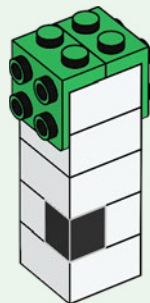



2x

65

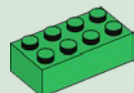
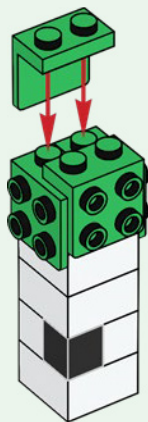

2x

66

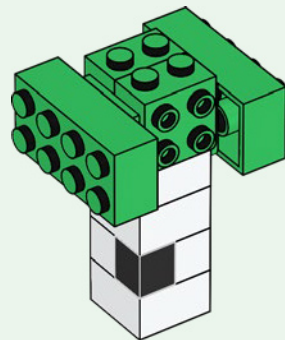

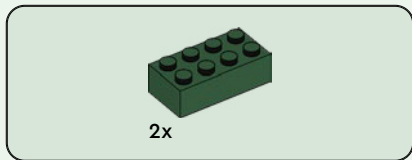

67

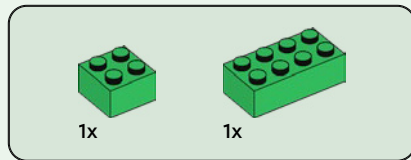
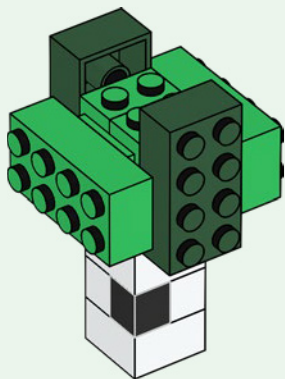

68

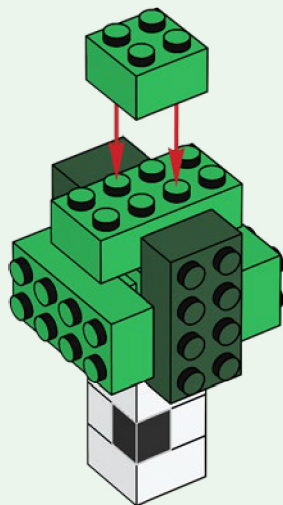

69





70

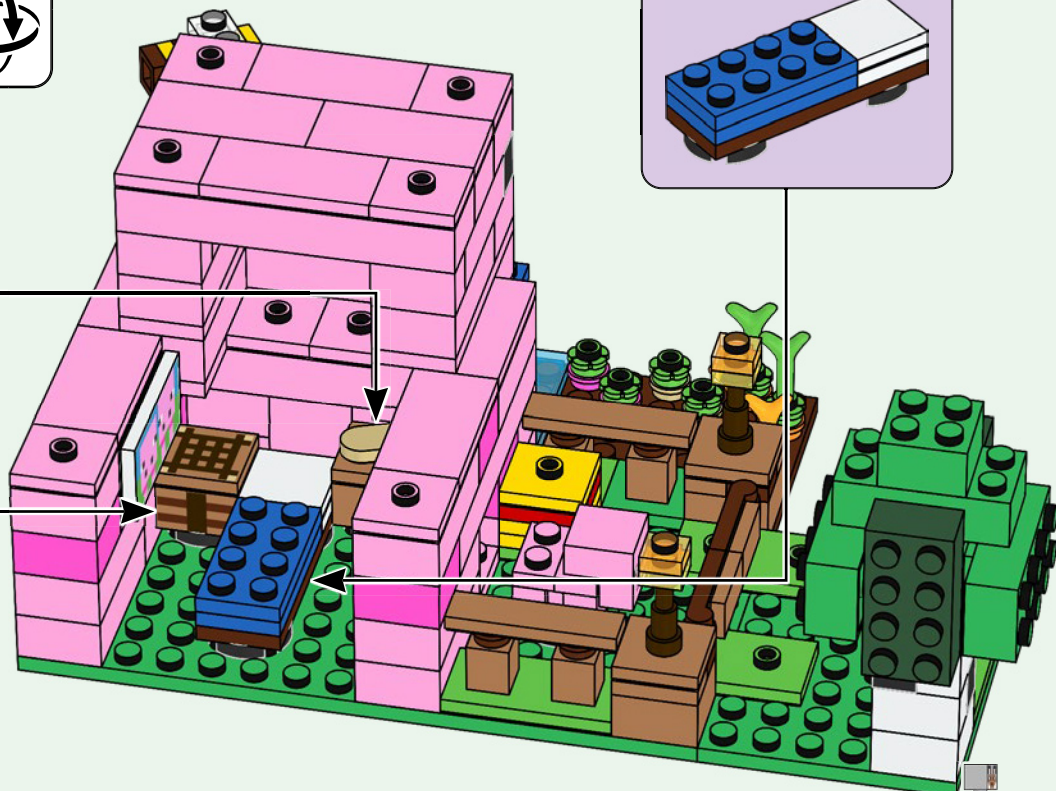
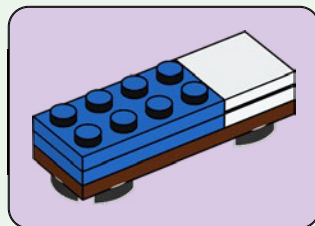
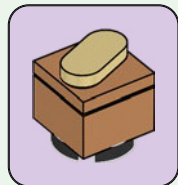

71

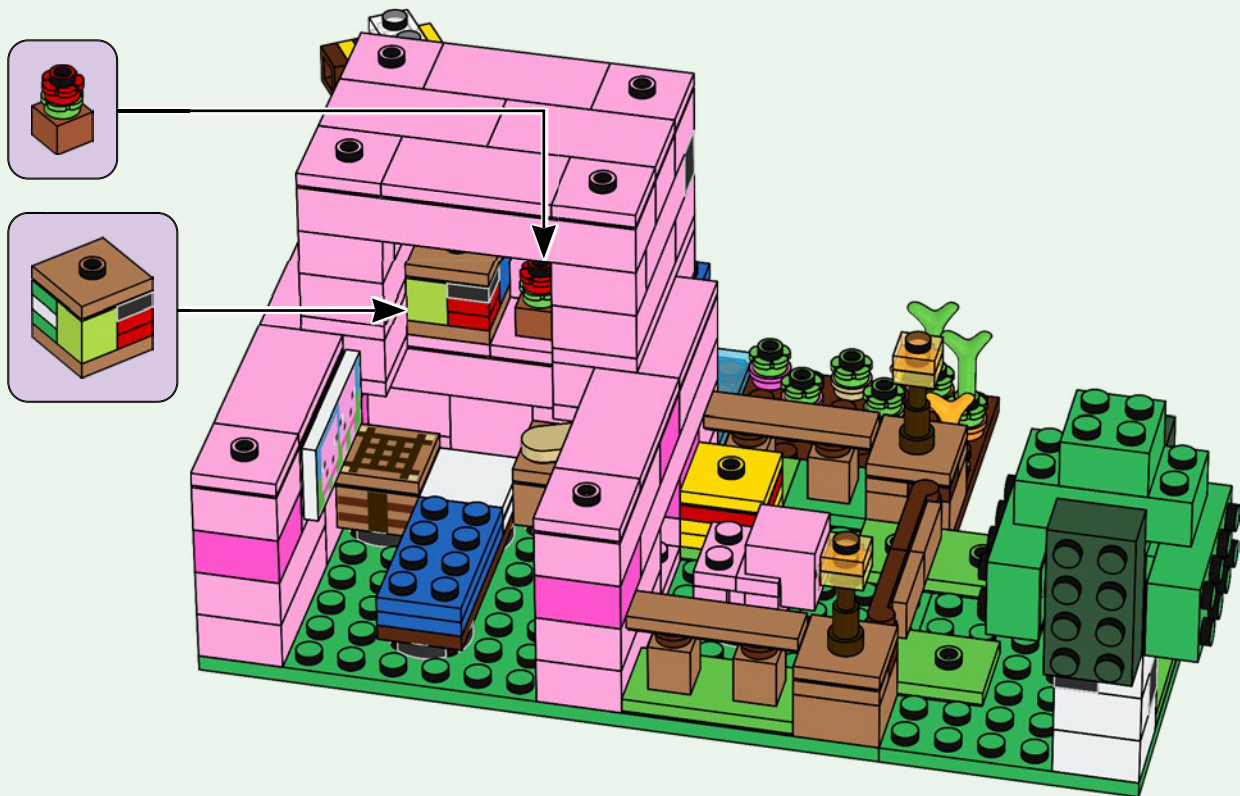

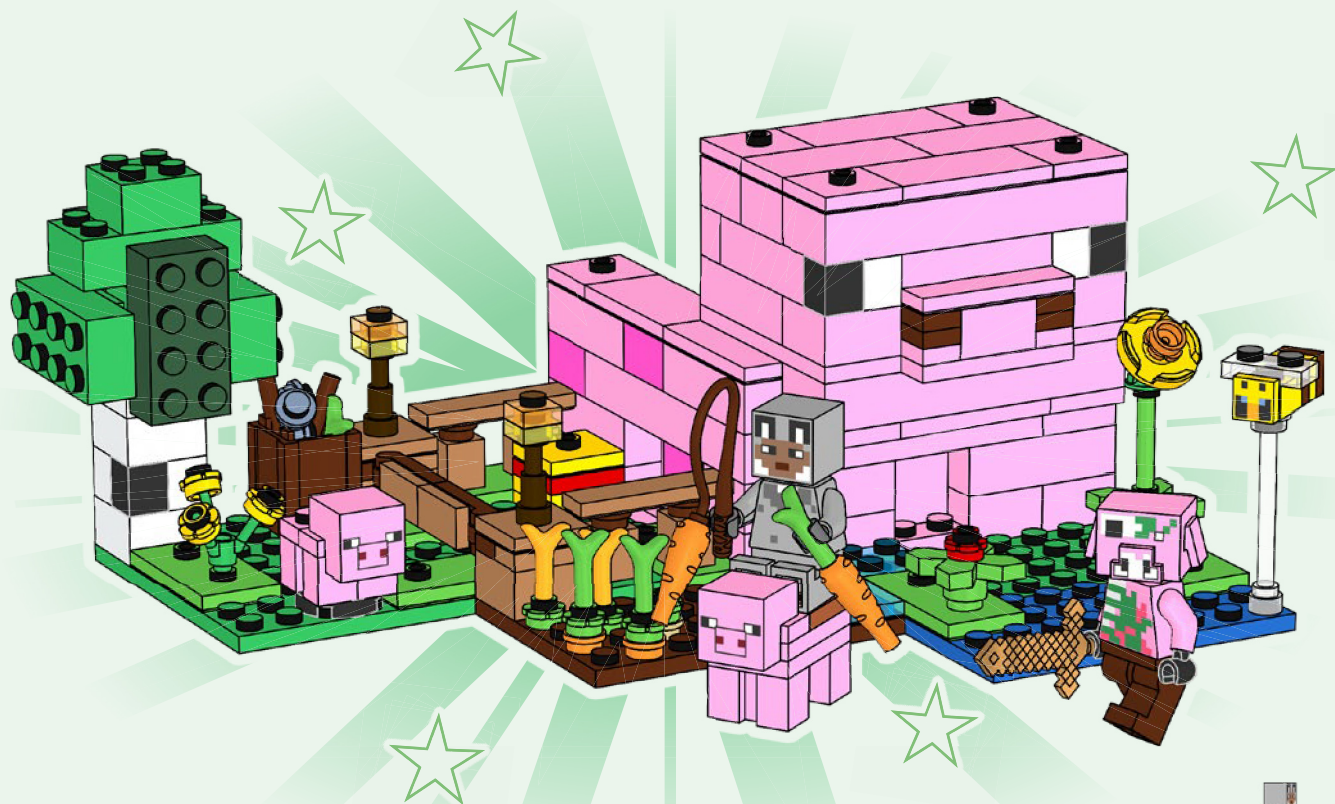



MINECRAFT



21269



21268



21267





1x
6528873



1x
4227657



1x
6015344



1x
6529160



2x
300501



1x
302401



1x
306801



1x
302201



3x
300301



2x
235701



1x
6528878



2x
4161734



1x
6507789



2x
4538950



1x
6093621



1x
300523



2x
302023



1x
303523



4x
300526



1x
302426



5x
403226



3x
6299813



1x
407024



1x
6335369



1x
302424



1x
6299764



2x
302224



1x
6126050



2x
6206148



2x
302421



1x
302221



1x
6382577



1x
6394948



1x
6510164



1x
6514001



1x
6166111



1x
6499253



1x
6513941



2x
6513966



2x
4157103



1x
6214234



2x
6424015



1x
4220634



3x
6315783



2x
4260493



2x
6513961



2x
6096682



1x
6359864



4x
6215659



6x
4221744



2x
6337003



1x
4221886



2x
6428805



1x
4520638



2x
6102975



1x
4211247



1x
4223729

2x
6230582



5x
4517992



1x
6161222



2x
6031883



4x
4654128



3x
4517993



5x
6291009



2x
4550359



2x
6529878



1x
6528875



1x
6530017



8x
6251842



2x
6102999



2x
4518890



6x
6106713



3x
6528999

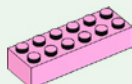

1x
6228963

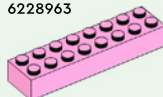

7x
6529000



4x
4625633



17x
4520632



2x
6204535



3x
4621552



3x
6058085



2x
6177535



4x
6102994



1x
6056383



2x
6102998



4x
6057986



2x
6097024



2x
6021997



1x
6097003



4x
6117971



2x
302428



1x
300328



1x
6269971



1x
6510190



1x
6389692



9x
6206150



4x
4119479



1x
6161772



2x
4143562



7x
6293826

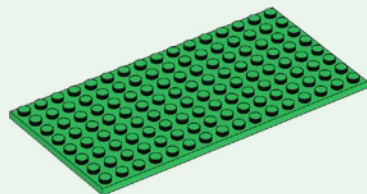

1x
4610602



2x
4507311



3x
4106356



 [LEGO.com/service](https://www.LEGO.com/service)

YOU COULD
WIN

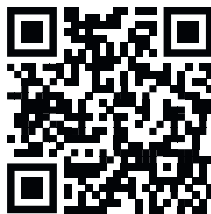

Scan this QR code or go to
LEGO.COM/PRODUCTFEEDBACK and give
us your short feedback about this LEGO® set
for a chance to win a cool LEGO prize.

Terms and Conditions apply*

EN: YOU COULD WIN. Terms and Conditions apply* **DE: Du könntest GEWINNEN.** Es gelten die Teilnahmebedingungen* **FR: Tu pourrais GAGNER.** Des conditions s'appliquent* **IT: Potresti VINCERE tu.** Termini e condizioni sono applicabili* **ES: Puedes GANAR.** Aplican términos y condiciones* **PT: Poderá GANHAR.** Aplicam-se termos e condições* **ZH: 轻松获奖. 条款和条件适用*** **PL: Szansa na WYGRANĄ.** Obowiązują warunki korzystania* **CS: Máte šanci VYHRÁT.** Platí všeobecné smluvní podmínky* **SK: Máte šancu VYHRAŤ.** Platia všeobecné zmluvné podmienky* **HU: TE IS NYERHETSZ.** Felhasználási feltételek érvényesek* **RO: Ai putea CÂȘTIGA.** Se aplică termenii și condiții* **BG: Можете да СПЕЧЕЛИТЕ.** Има определени правила и условия* **LV: Tu vari LAIMĒT.** Ir spēkā noteikumi un nosacījumi.* **ET: Sul on võimalus VÕITA.** Kehtivad tingimused* **LT: Jūs galite LAIMĖTI.** Taikomos sąlygos*

*[LEGO.com/productfeedback-terms](https://www.lego.com/productfeedback-terms)

LEGO and the LEGO logo are trademarks of the/sont des marques de commerce du/son marcas registradas de LEGO Group. ©2025 The LEGO Group.

© 2025 Mojang AB. All Rights Reserved. Minecraft, the Minecraft logo, the Mojang Studios logo and the Creeper logo are trademarks of the Microsoft group of companies.

6556014