



# SONIC™

THE HEDGEHOG

77001



LEGO® Builder



### **Get excited about our new packaging!**

We're switching from plastic to paper-based packaging. That's why you might find a mix of paper and plastic in our boxes!

### **Nos nouveaux emballages vous emballeront !**

Nous passons des emballages en plastique aux emballages à base de papier. C'est pourquoi vous pourriez trouver un mélange de papier et de plastique dans nos boîtes !

### **¡Te presentamos nuestros nuevos empaques!**

Estamos sustituyendo las bolsas de plástico por bolsas con base de papel. ¡Por eso, puedes encontrar una mezcla de papel y de plástico en nuestras cajas!

**[LEGO.com/sustainable-packaging](https://www.lego.com/sustainable-packaging)**

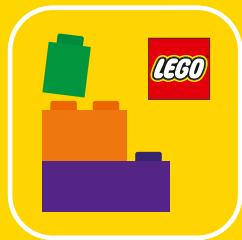

Q LEGO® Builder

# BUILDER



Apple and the Apple logo are trademarks of Apple Inc., registered in the U.S. and other countries and regions. App Store is a service mark of Apple Inc. Google Play and the Google Play logo are trademarks of Google LLC. Tencent and the Tencent logo are trademarks of Tencent Inc.

Q [LEGO.com/devicecheck](https://www.lego.com/devicecheck)

EN Ask parents' permission before going online | DE Eltern um Erlaubnis bitten, bevor du online gehst | FR Demande l'autorisation d'un parent avant d'aller en ligne | IT Chiedi il permesso ai tuoi genitori prima di andare online | ES Pídeles permiso a tus papás antes de conectarte a Internet | PT Pede autorização aos pais antes de acederes online | ZH 上网前应先征得父母的同意 | PL Poproś rodziców o zgodę, zanim wejdiesz do Internetu | CS Než půjdeš na internet, požádej rodiče o svolení | SK Skôr než pôjdeš na internet, vypýtaj si povolenie od rodičov | HU Kérj szülői engedélyt, mielőtt online csatlakoznál! | RO Cere permisiunea părinților înainte de a te conecta online | BG Поискайте разрешение от родител, преди да влезете онлайн | LV Pirms došanās tiešsaistē palūdz atļauju vecākiem | ET Enne Interneti kasutamist küsi vanematelt luba | LT Prieš prisijungdami prie interneto, atsiklauskite tėvų

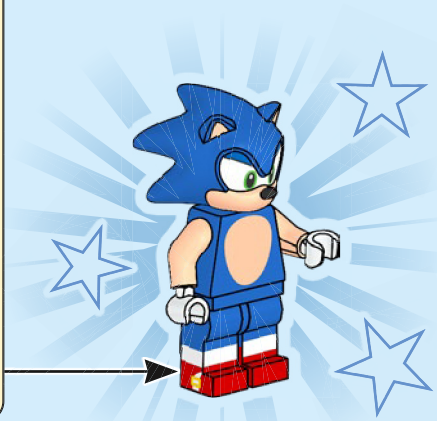
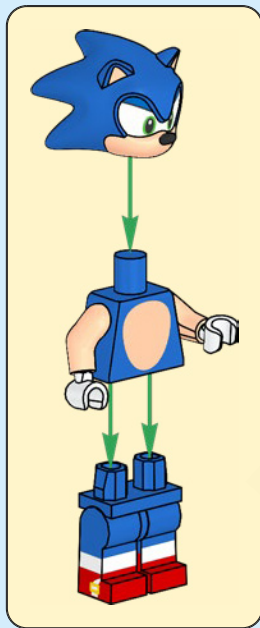
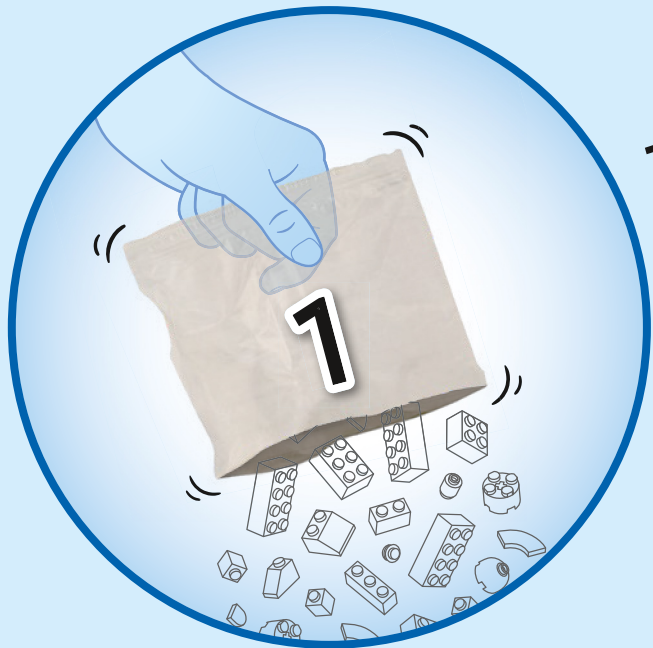



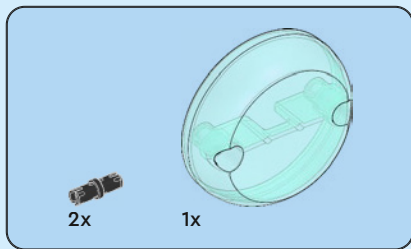

2

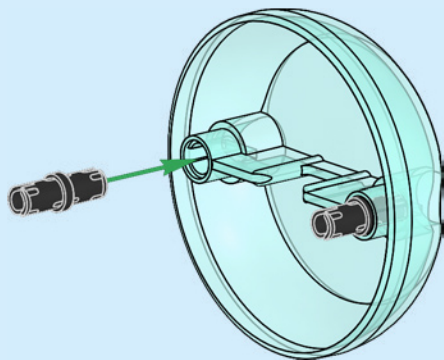

3

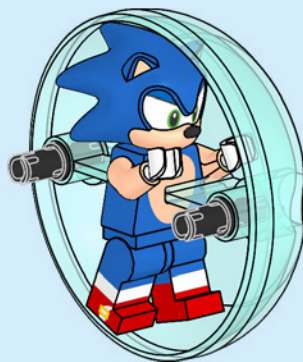

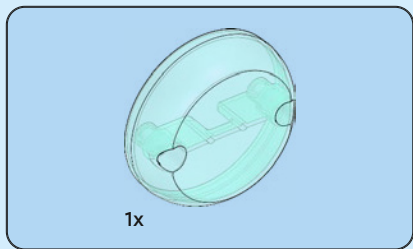

4

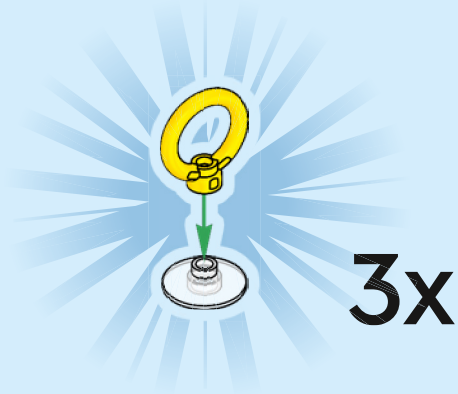
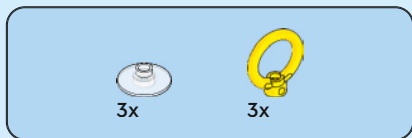
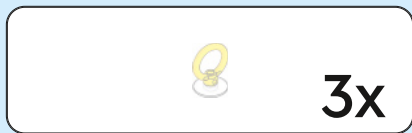
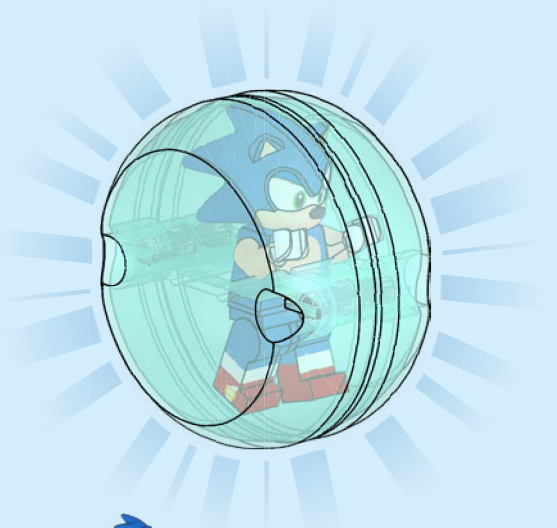

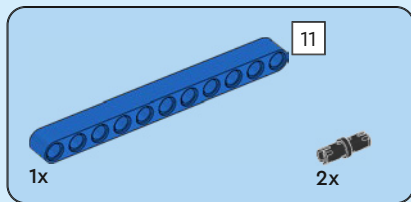
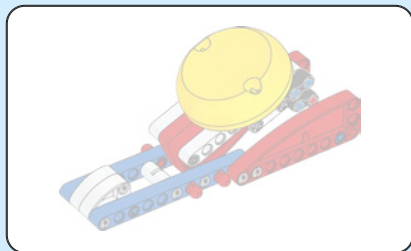

1

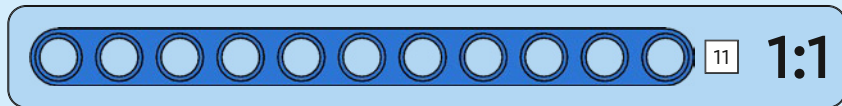
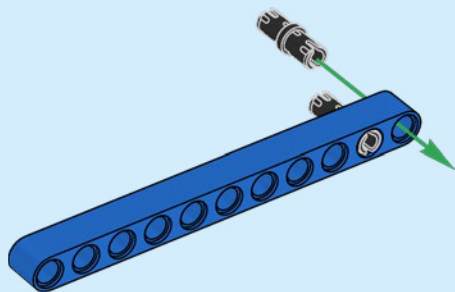

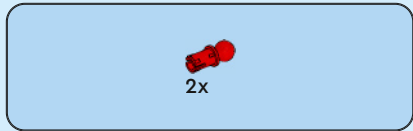

2

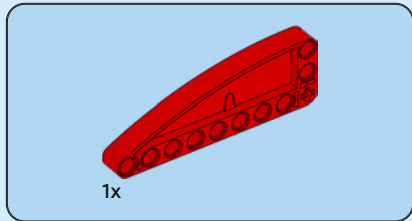
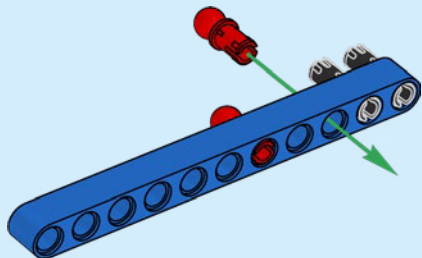

3

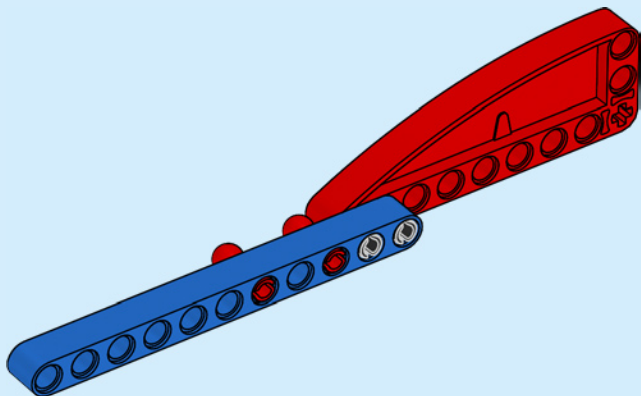

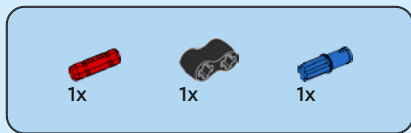

4

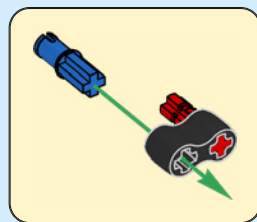
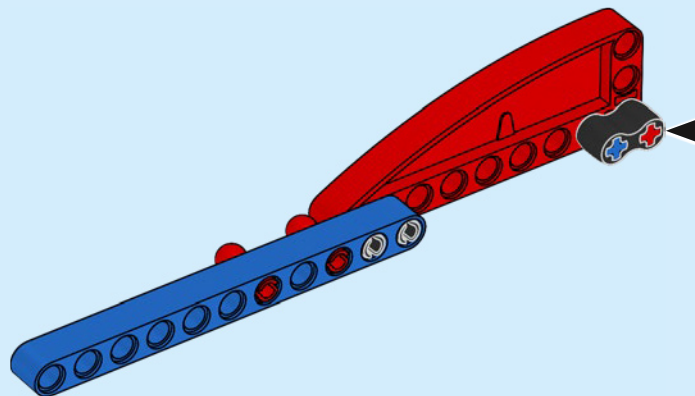



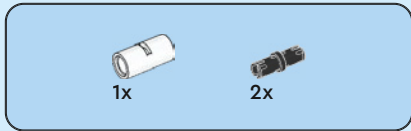

5

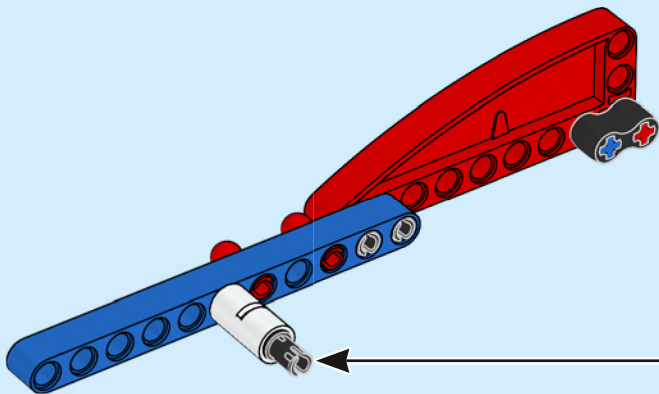
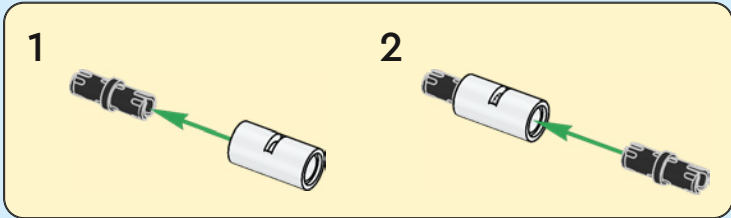



6

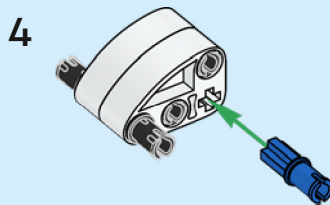
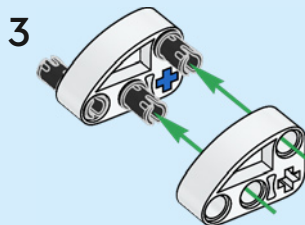
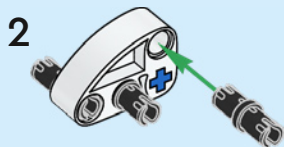
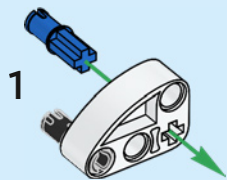

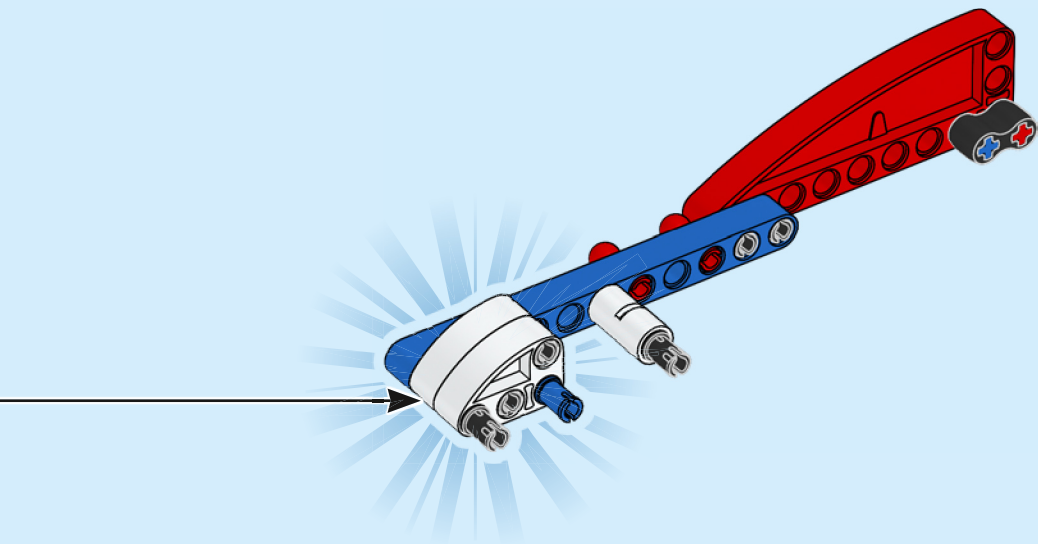

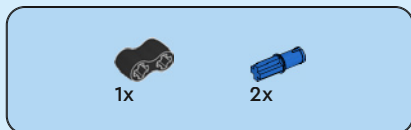
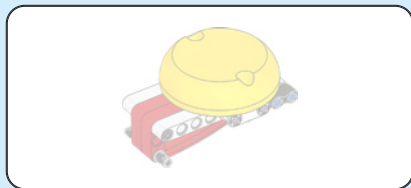

7

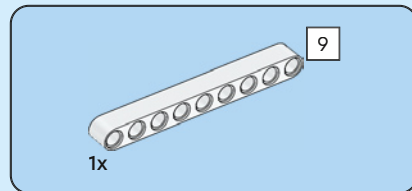
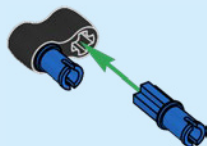

8

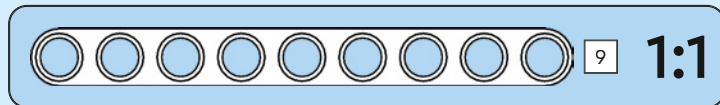
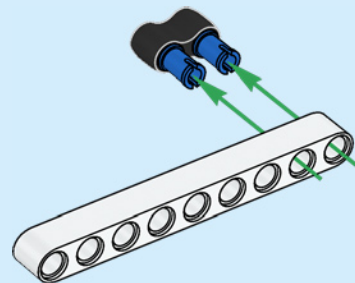

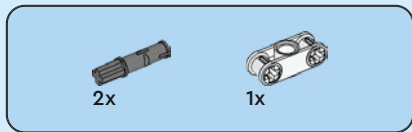

9

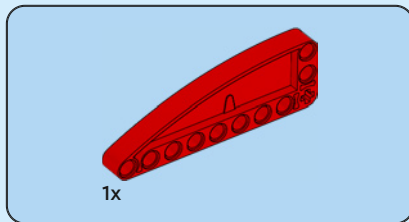
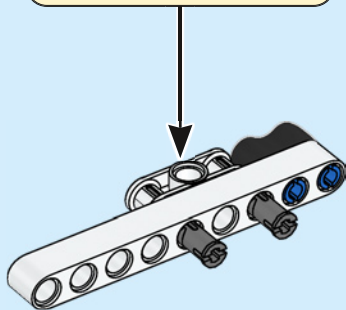
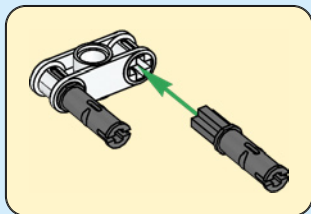

10

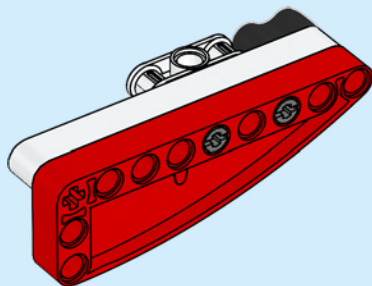



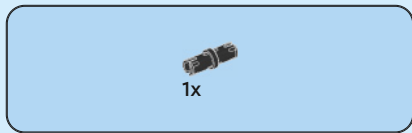

11

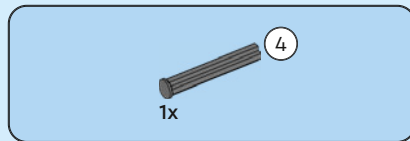
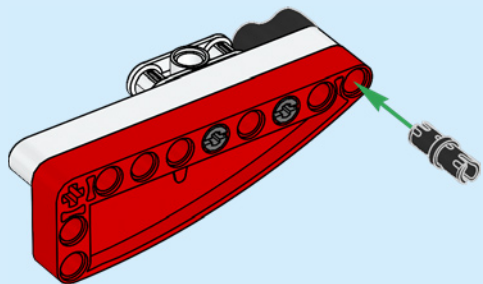

12

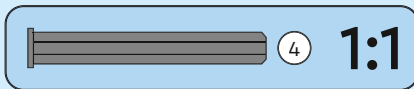
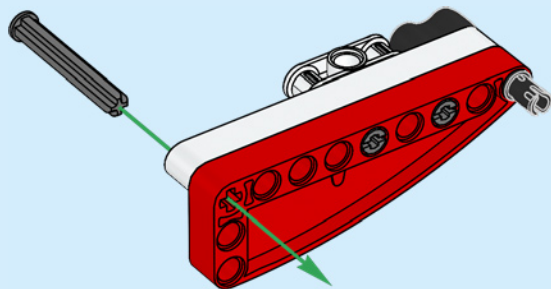

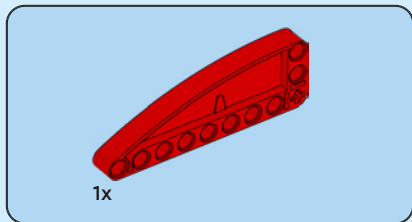

13

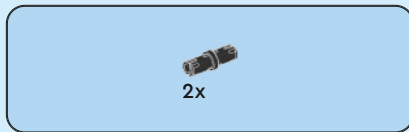
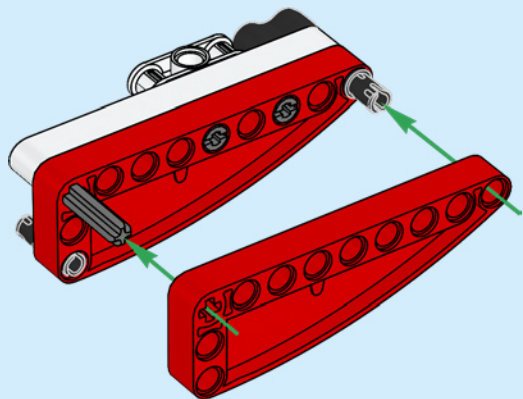

14

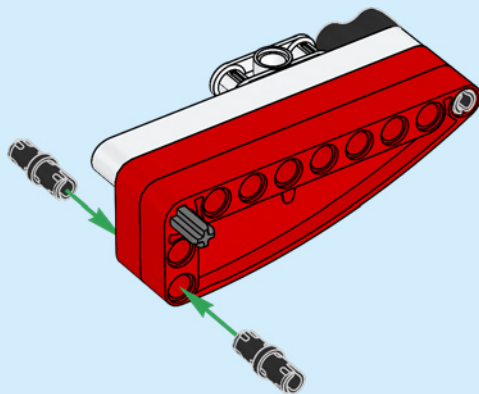

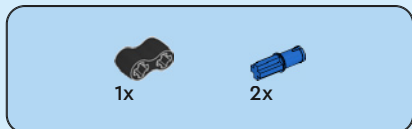
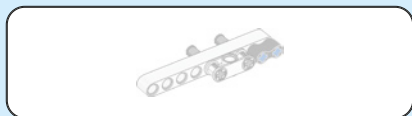

15

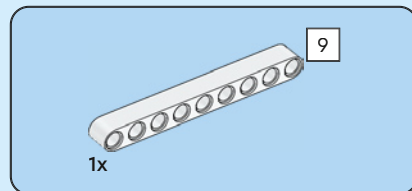
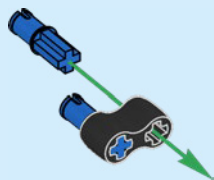

16

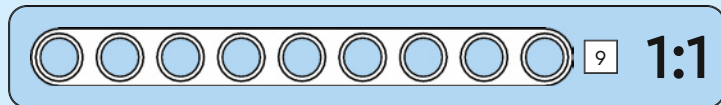
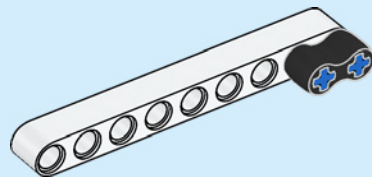

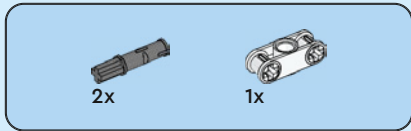

17

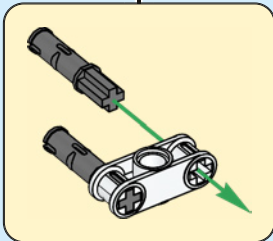
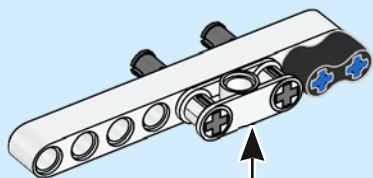

18

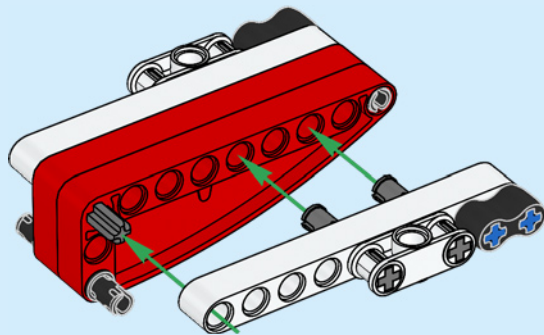



19

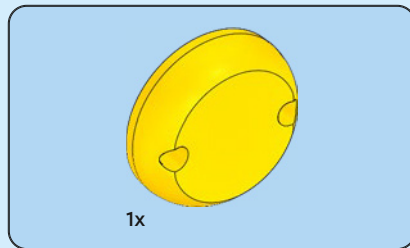
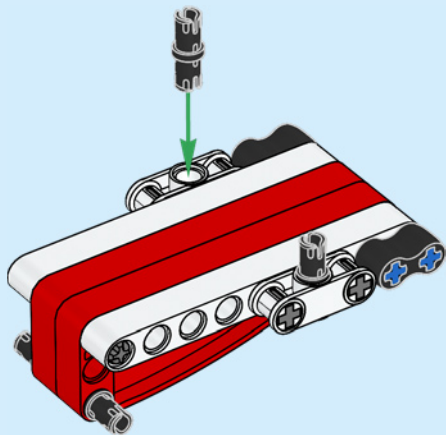

20

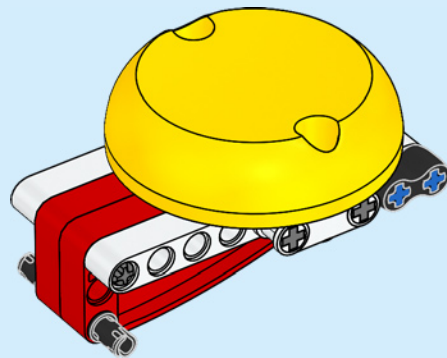



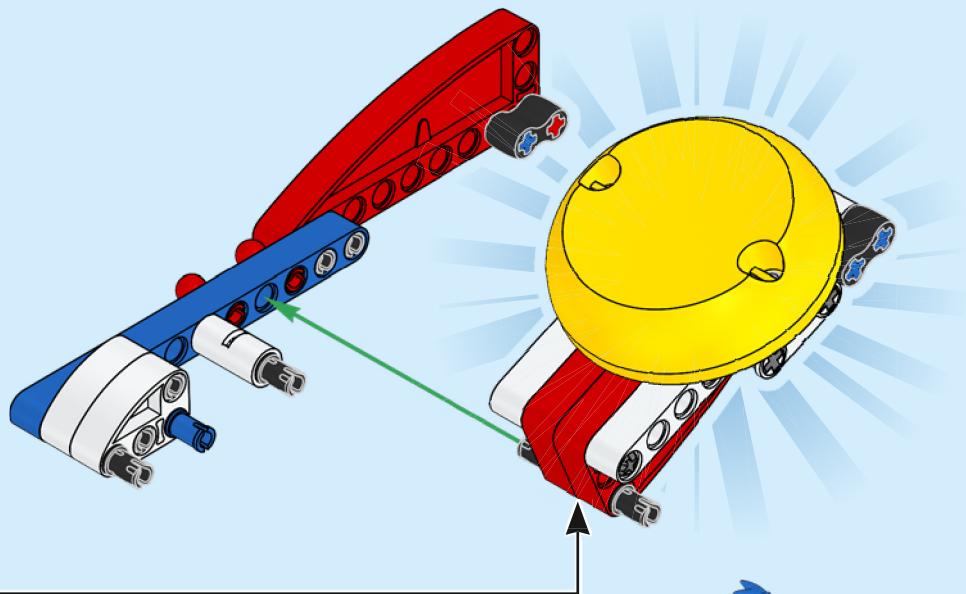

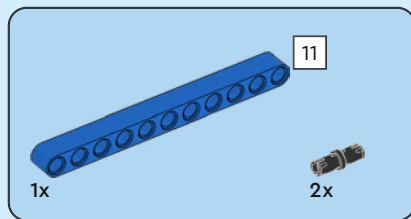

22

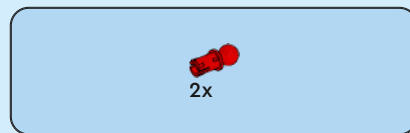
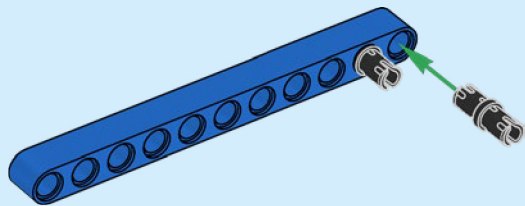

23

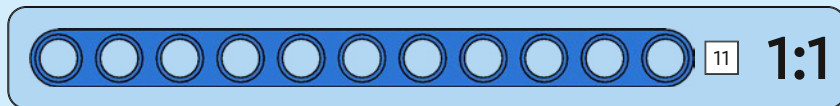
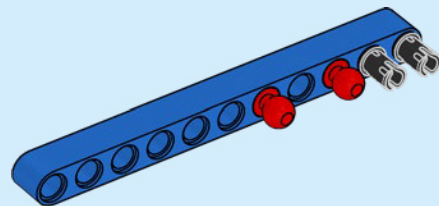

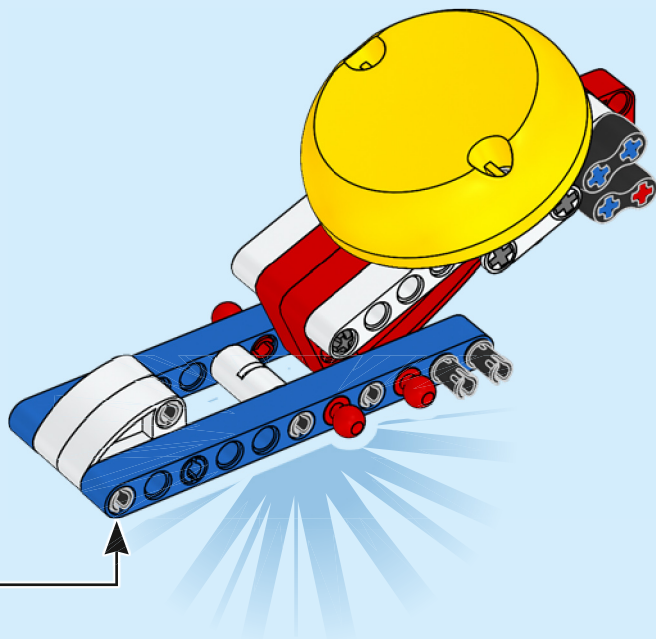

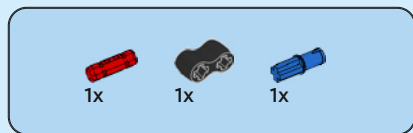

25

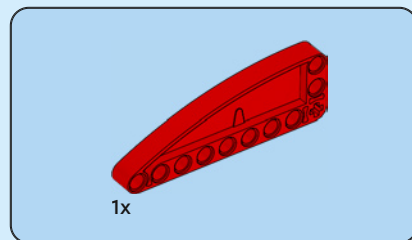
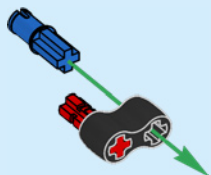

26

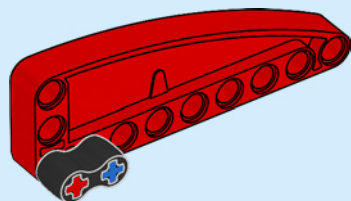

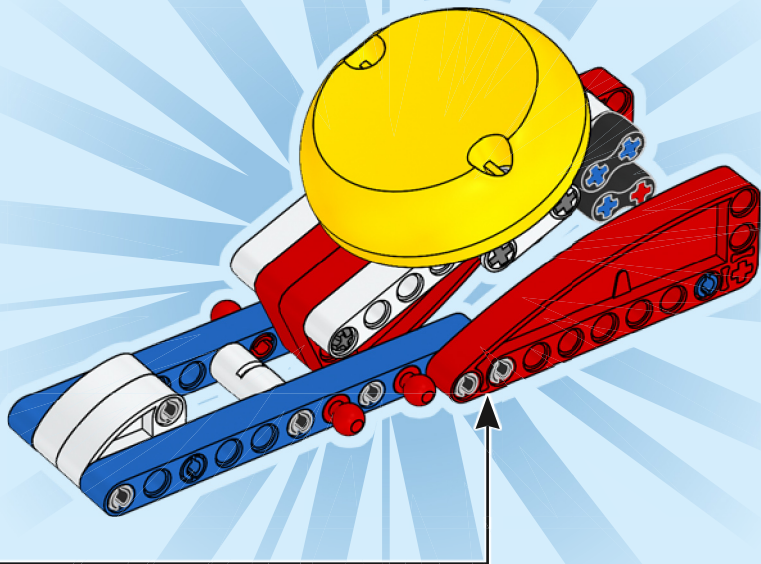





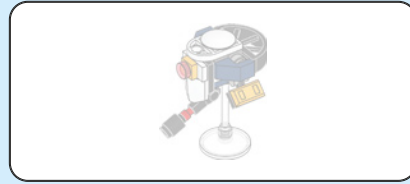

1

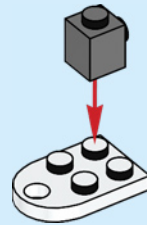



3x

2

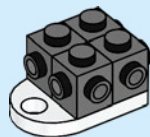

1x

3

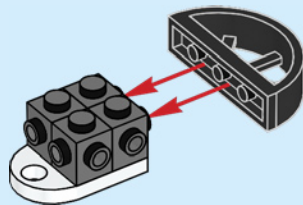

2x

4

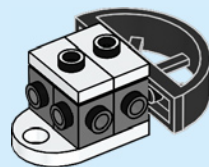

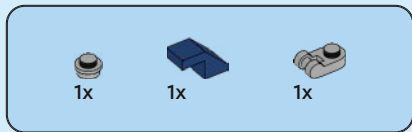

5

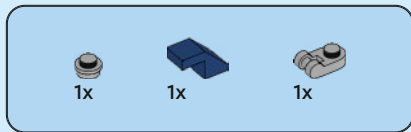
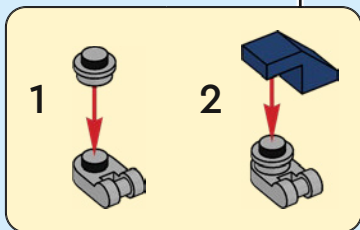
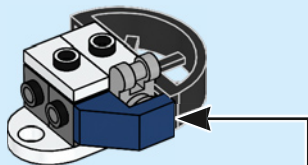

6

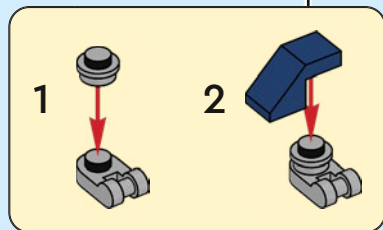
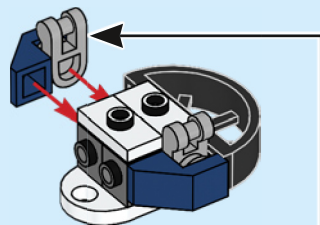



2x



1x

# 7

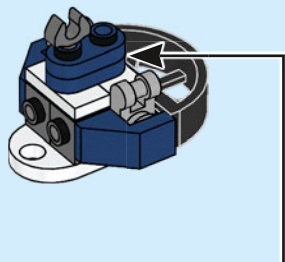

1



2

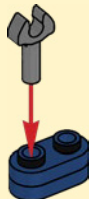

1x



1x



1x



1x



1x

# 8

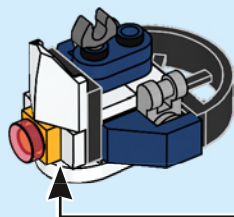

1

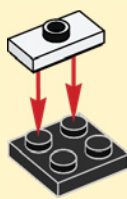

2



3

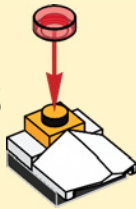



2x



2x

9

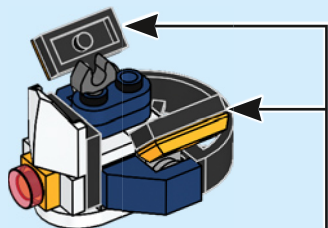

2x



1x



1x



1x

10

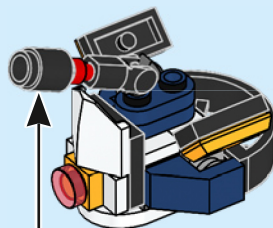

1

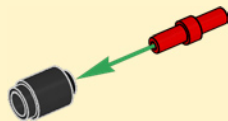

2

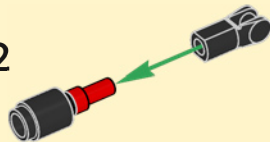

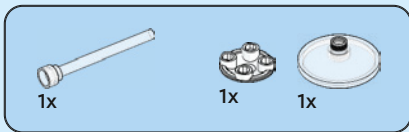

11

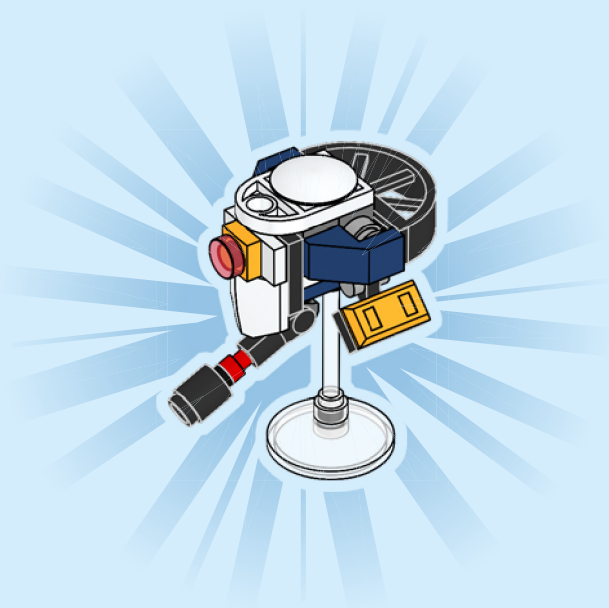
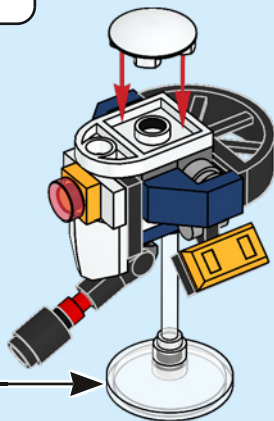
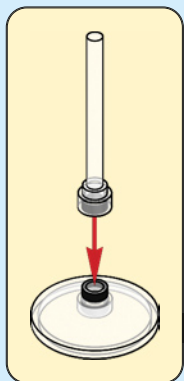

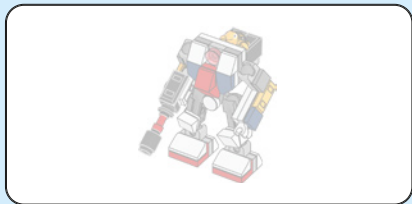

1

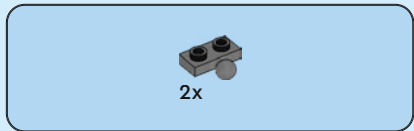
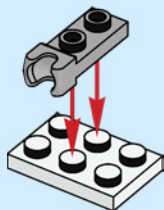

2

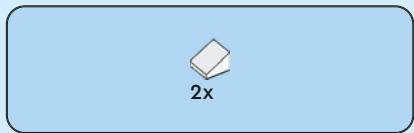
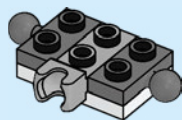

3

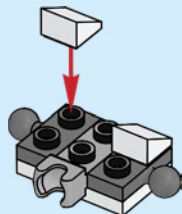





1x



1x

4

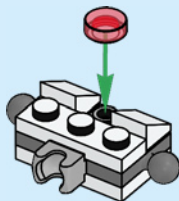

1x



1x

5

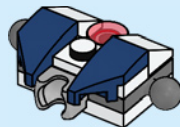

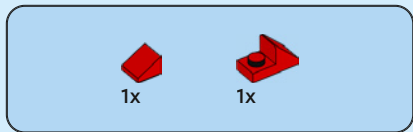

6

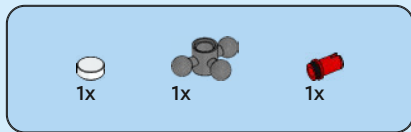
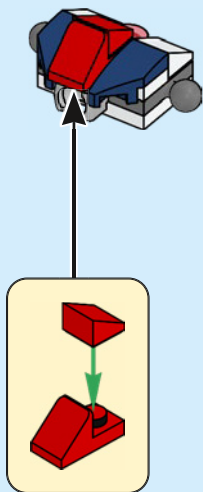

7

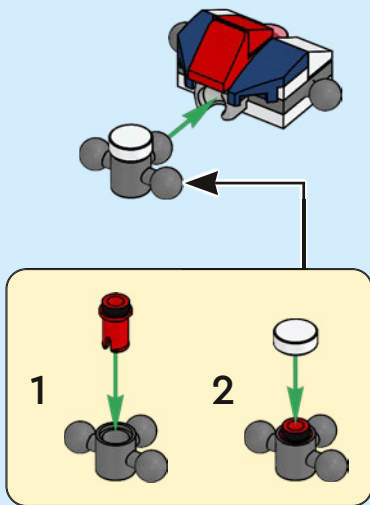

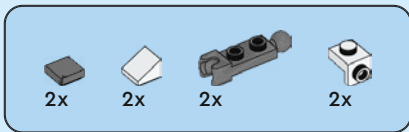

8

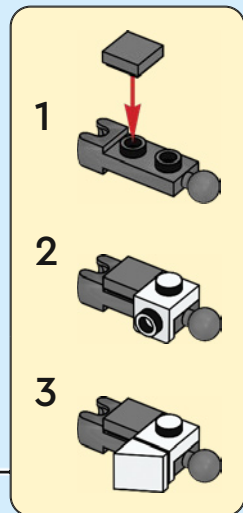
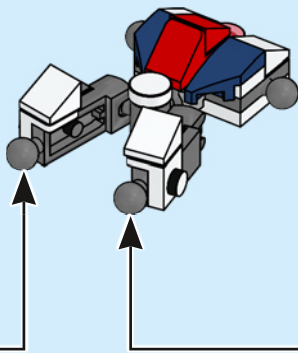
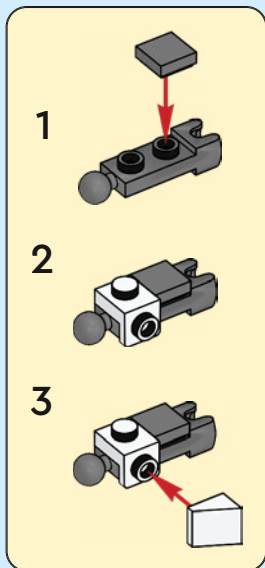



2x



4x



2x



2x

9

1

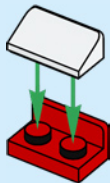

2

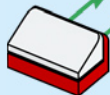

2x

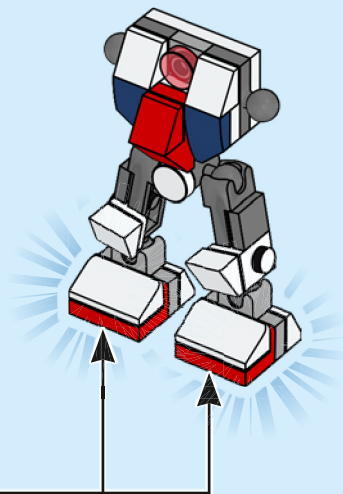
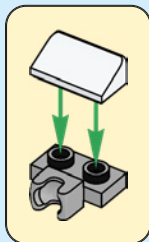

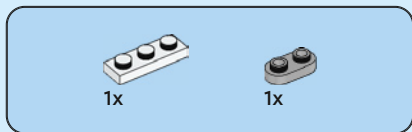
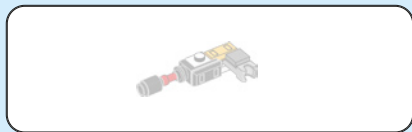

10

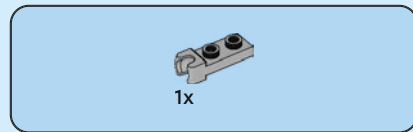
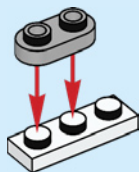

11

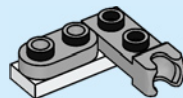



1x



1x

# 12

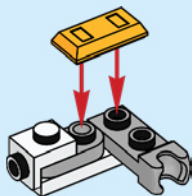

1x



1x

# 13

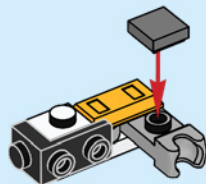



1x



1x

14

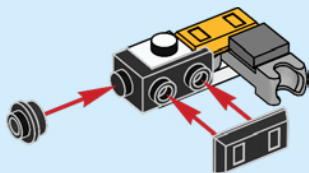

1x



1x

15

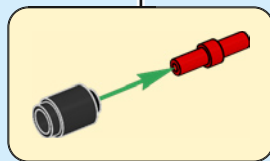
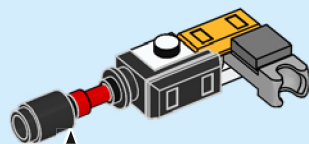

16

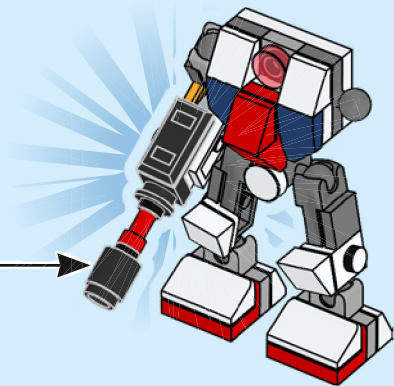



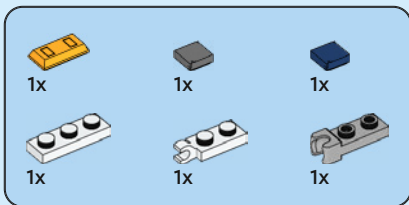

17

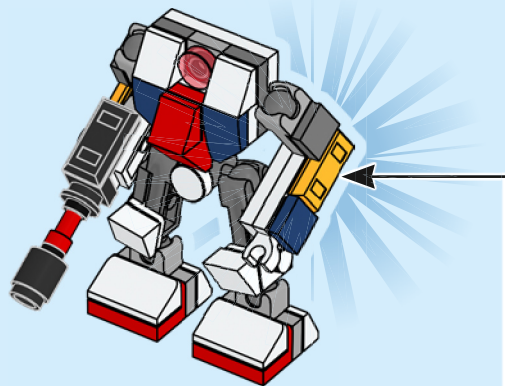

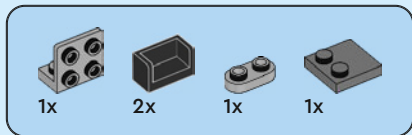

18

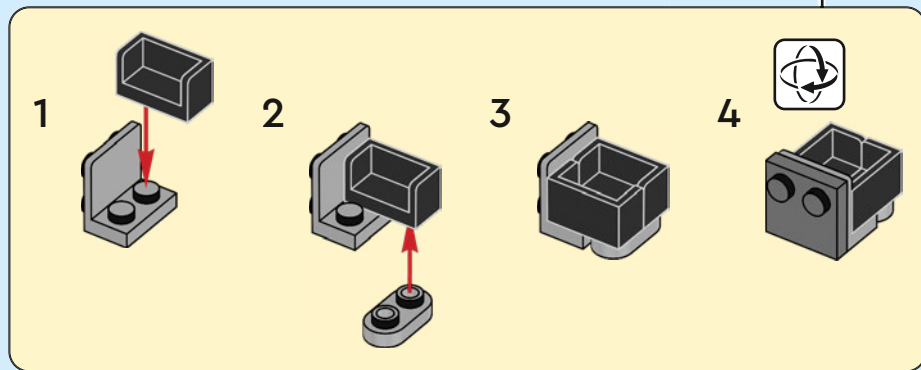
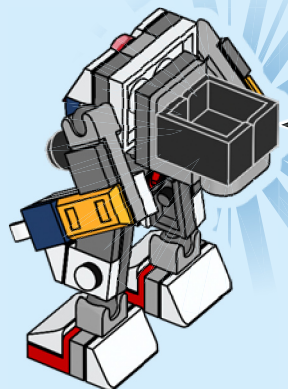



1x

19

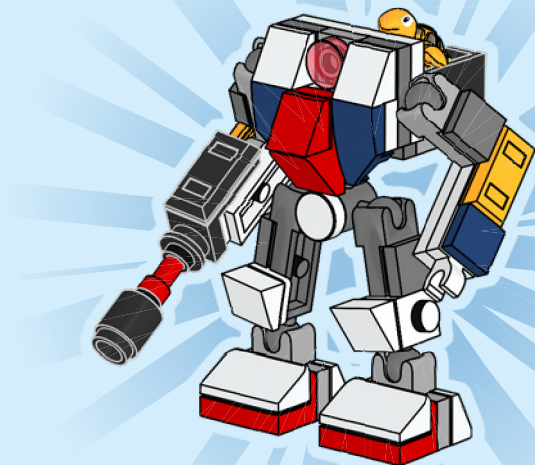
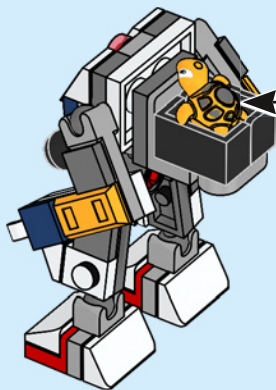

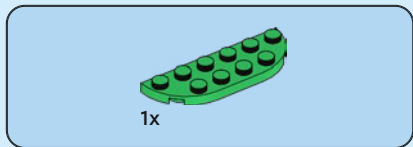

1

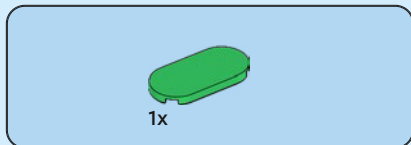
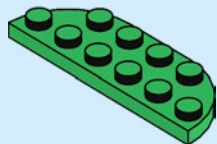

2

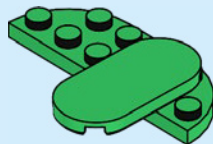

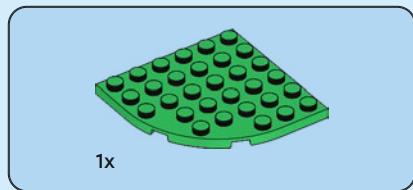

3

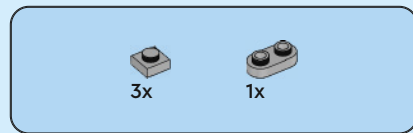
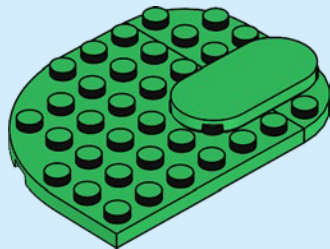

4

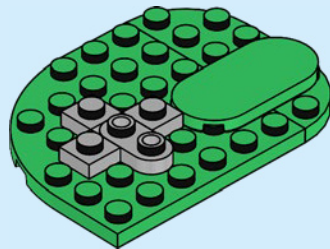



4x

5

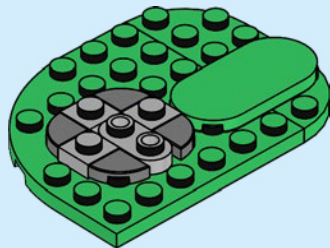

1x



1x

6

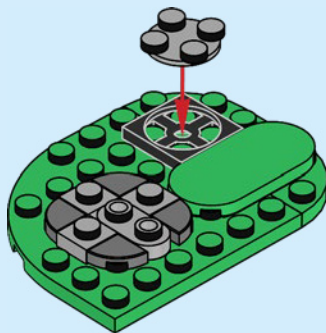



1x

7

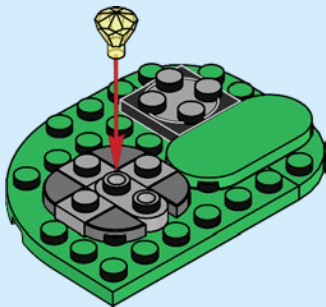

1x



1x

8

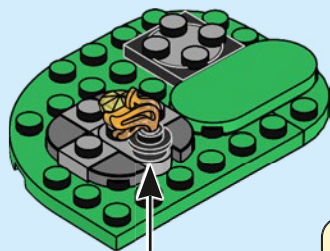



3x

9

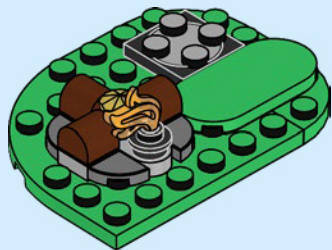

2x



2x

10

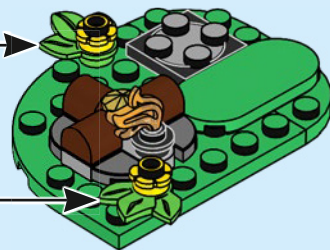
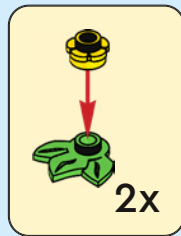



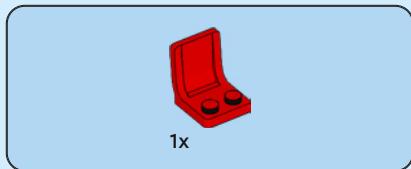

11

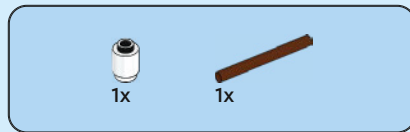

12

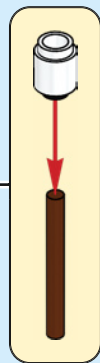







# SONIC™

THE HEDGEHOG





©SEGA. All rights reserved. SEGA is registered in the U.S. Patent and Trademark Office. SEGA and SONIC THE HEDGEHOG are either registered trademarks or trademarks of SEGA CORPORATION.

**EXPLORE MORE**  
**DÉCOUVRIR PLUS**  
**EXPLORAMÁS**



 [LEGO.com/sonic](https://LEGO.com/sonic)



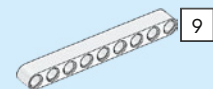

9

2x  
6001831



4x  
4504369



4x  
4547489



2x  
6276981



2x  
6345327



3x  
6051511



3x  
362301



1x  
302101



1x  
306201



3x  
6296132



1x  
6361170



1x  
6089696



1x  
6284572



1x  
4278271



1x  
6507816



1x  
6173116



2x  
6089698



1x  
6053011



1x  
407921



2x  
6399645



1x  
6378120



4x  
6360104



2x  
4142865



1x  
4504379

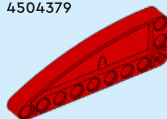

4x  
6530412

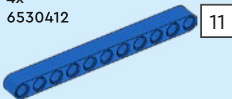

11

2x  
6390388



1x  
6501150



1x  
6452519



1x  
6529882



8x  
4206482



2x  
6299813



1x  
6530425



3x  
6508325



2x  
6168646



2x  
6248496



1x  
6177083



1x  
6321194



17x  
6279875



4x  
4198367



1x  
368026



1x  
6156991



2x  
306226



1x  
302226





1x  
6380236



2x  
6313116



1x  
6469787



1x  
6133852



2x  
6182261



1x  
6021999



1x  
6073040



1x  
6314353



1x  
6443215



4x  
6236454



2x  
6514189



1x  
6247795



3x  
6245306



1x  
6507917



1x  
6514014

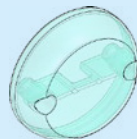

2x  
6507988



2x  
6166857



1x  
6214811



1x  
4631385



2x  
6236571



1x  
6214812



3x  
6371437



1x  
6116613



2x  
6043656



1x  
4654580



3x  
6043639



2x  
4211525



3x  
6248890



3x  
4211399



2x  
6225246



1x  
4540203



4x  
6332045



2x  
6039482



1x  
6309059



2x  
6039479



4x  
4210848



4x  
6199549



1x  
6359227



1x  
6439040



4x  
6015356



1x  
6083620

4



 [LEGO.com/service](https://www.LEGO.com/service)

YOU COULD  
**WIN**

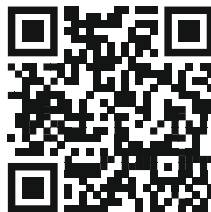

Scan this QR code or go to  
**LEGO.COM/PRODUCTFEEDBACK** and give  
us your short feedback about this LEGO® set  
for a chance to win a cool LEGO prize.

Terms and Conditions apply\*

**EN: YOU COULD WIN.** Terms and Conditions apply\* **DE: Du könntest GEWINNEN.** Es gelten die Teilnahmebedingungen\* **FR: Tu pourrais GAGNER.** Des conditions s'appliquent\* **IT: Potresti VINCERE tu.** Termini e condizioni sono applicabili\* **ES: Puedes GANAR.** Aplican términos y condiciones\* **PT: Poderá GANHAR.** Aplicam-se termos e condições\* **ZH: 轻松获奖. 条款和条件适用\*** **PL: Szansa na WYGRANĄ.** Obowiązują warunki korzystania\* **CS: Máte šanci VYHRÁT.** Platí všeobecné smluvní podmínky\* **SK: Máte šancu VYHRAŤ.** Platia všeobecné zmluvné podmienky\* **HU: TE IS NYERHETSZ.** Felhasználási feltételek érvényesek\* **RO: Ai putea CÂȘTIGA.** Se aplică termeni și condiții\* **BG: Можете да СПЕЧЕЛИТЕ.** Има определени правила и условия\* **LV: Tu vari LAIMĒT.** Ir spēkā noteikumi un nosacījumi.\* **ET: Sul on võimalus VÕITA.** Kehtivad tingimused\* **LT: Jūs galite LAIMĖTI.** Taikomos sąlygos\*

\*[LEGO.com/productfeedback-terms](https://www.lego.com/productfeedback-terms)

LEGO and the LEGO logo are trademarks of the/son des marques de commerce du/son marcas registradas de LEGO Group. ©2025 The LEGO Group.

©SEGA. All rights reserved. SEGA is registered in the U.S. Patent and Trademark Office.

SEGA and SONIC THE HEDGEHOG are either registered trademarks or trademarks of SEGA CORPORATION.

6555873