



YOU COULD WIN

Scan this QR code or go to [LEGO.COM/PRODUCTFEEDBACK](https://www.lego.com/productfeedback) and give us your short feedback about this LEGO® set for a chance to win a cool LEGO prize. Terms and Conditions apply*



EN: YOU COULD WIN. Terms and Conditions apply* **DE: Du könntest GEWINNEN.** Es gelten die Teilnahmebedingungen* **FR: Tu pourrais GAGNER.** Des conditions s'appliquent* **IT: Potresti VINCERE tu.** Termini e condizioni sono applicabili* **ES: Pudes GANAR.** Des condiciones s'apliquen* **PT: Poderás GANHAR.** Aplicam-se Termos e Condições* **ZH: 轻松获奖.** 条款和条件适用* **PL: Szansa na WYGRANA.** Obowiązują regulamin* **CS: Máte šanci VYHRÁT.** Platí všeobecné smluvní podmínky* **SK: Máte šancu VYHRÁT.** Platia všeobecné zmluvné podmienky* **HU: Te is NYERHETSZ.** Felhasználási feltételek érvényesek* **RO: Ai putea CĂȘTIGA.** Se aplică termenii și condiții* **BG: Можете да ЦЕЛЕВИТЕ!** Искa oпpeдeлeниa пpавилa и ycлoвиa* **LV: Tu vari LAIMĒT.** Ir spēka noteikumi un nosacījumi. **ET: Sul on võimatus VÕITA.** Kehtivad tingimused* **LT: Jūs galite LAIMĖTI.** Taikomos sąlygos*

*[LEGO.com/productfeedback-terms](https://www.lego.com/productfeedback-terms)



SONIC™
THE HEDGEHOG

30704



6555870

1

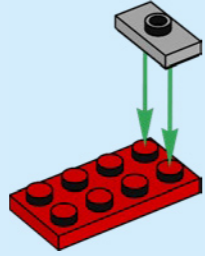

2

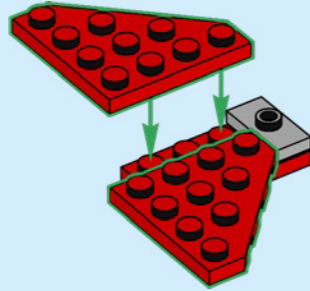

3

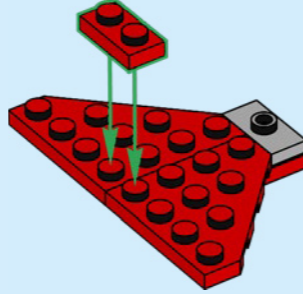

4

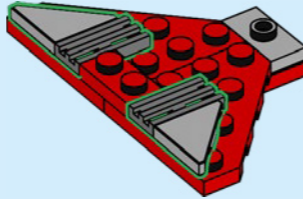

5

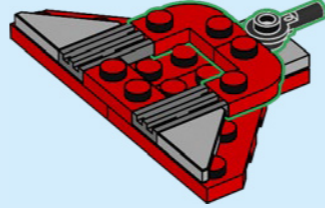

6

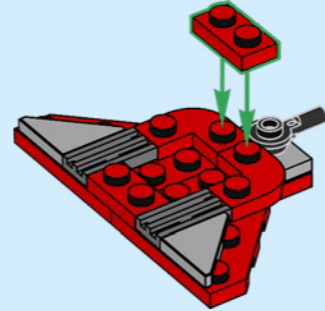

7

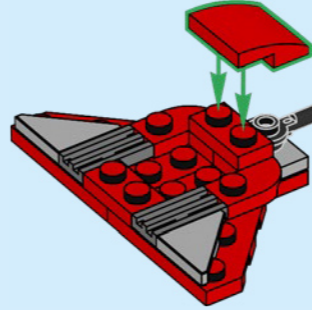

8

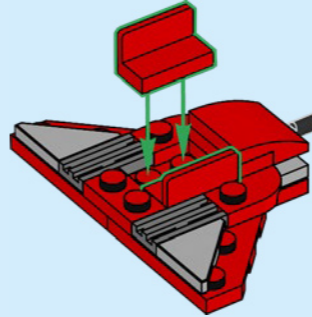

9

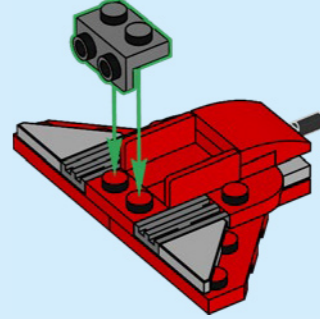

10

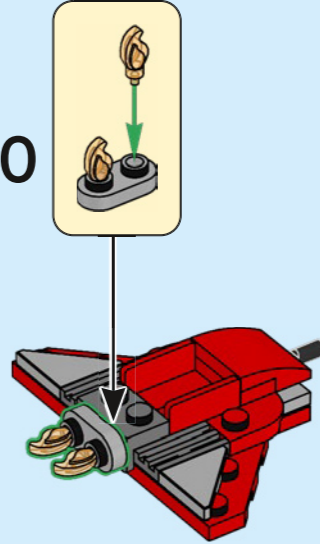

11

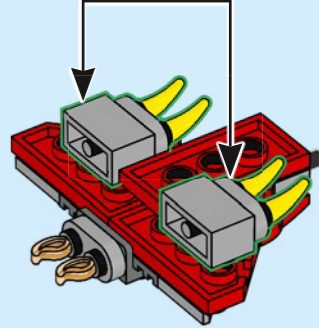
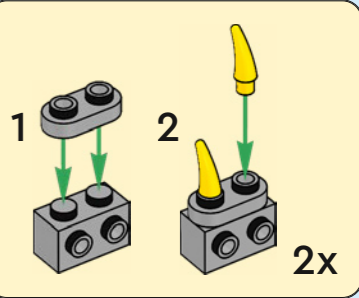

12

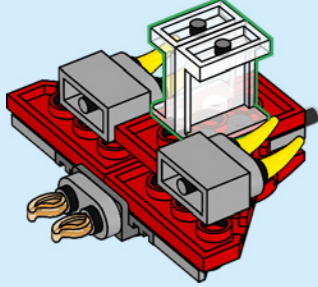

13

1

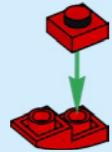

2

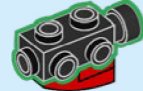

3

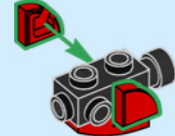

4

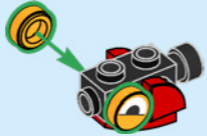

5



6

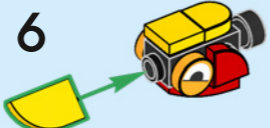

7

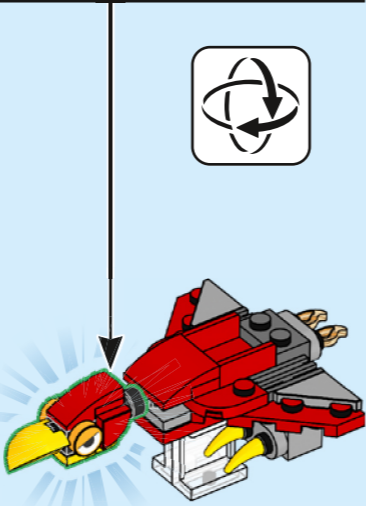
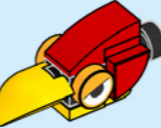

14

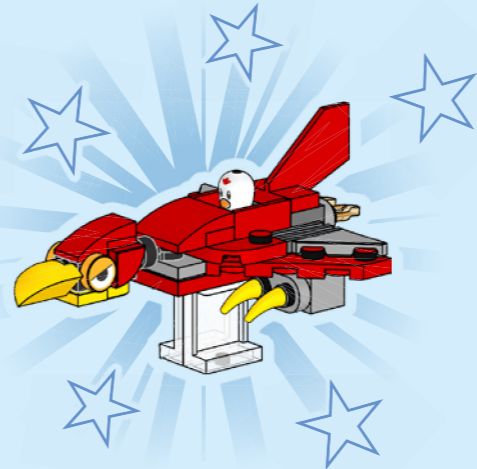
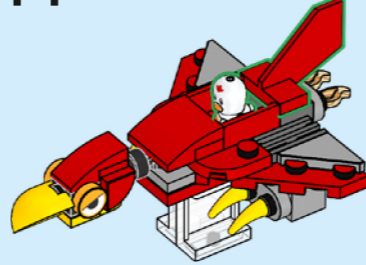

[LEGO.com/service](https://www.lego.com/service)

 [LEGO.com/sonic](https://www.lego.com/sonic)

LEGO and the LEGO logo are trademarks of the/son des marques de commerce du/son marcas registradas de LEGO Group. ©2025 The LEGO Group. 6555870

©SEGA. All rights reserved. SEGA is registered in the U.S. Patent and Trademark Office. SEGA and SONIC THE HEDGEHOG are either registered trademarks or trademarks of SEGA CORPORATION.