



SONIC™
THE HEDGEHOG

40781





LEGO.com/sustainable-packaging



FR
DONNEZ
OU
RECYCLEZ

 OU  OU 

ASSOCIATION MAGASIN DÉCHÈTERIE

Adresses sur quefairedemesdechets.fr



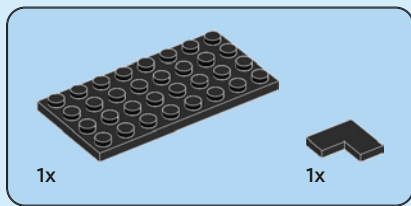
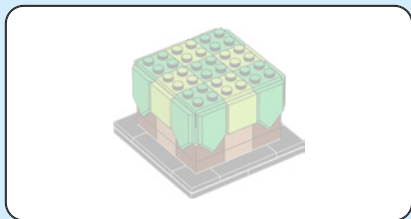

1

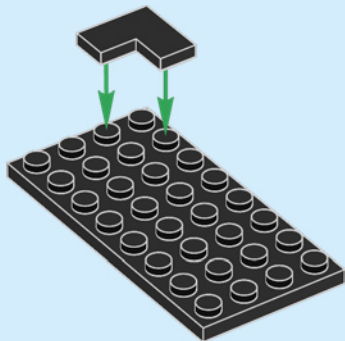



1x



1x

2

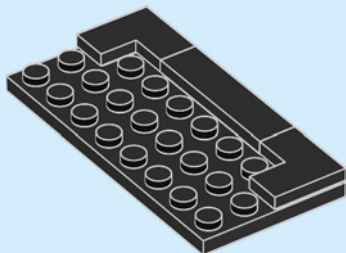

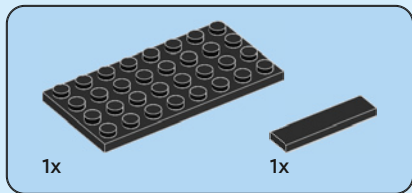

3

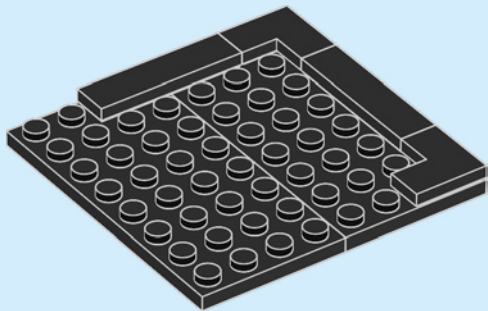

6





2x



2x

4

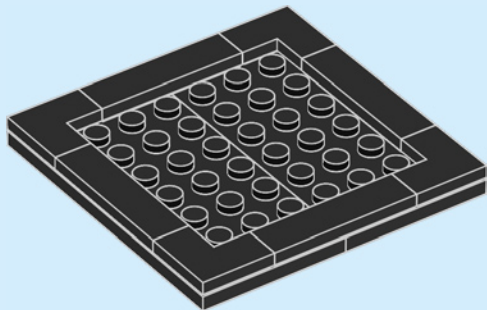



4x

5

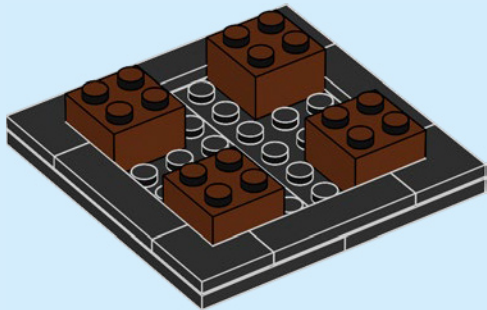



4x

6

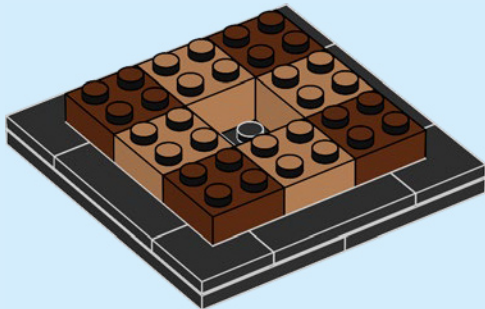



4x



4x

7

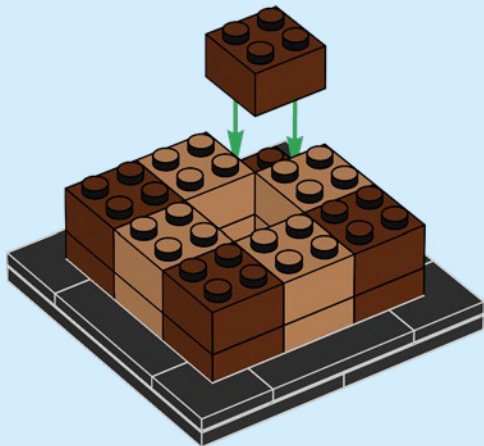

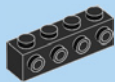

4x

8

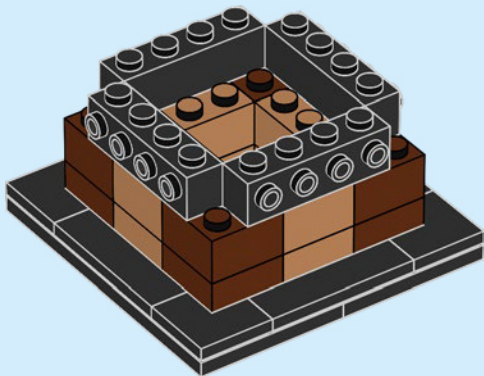



4x

9



4x

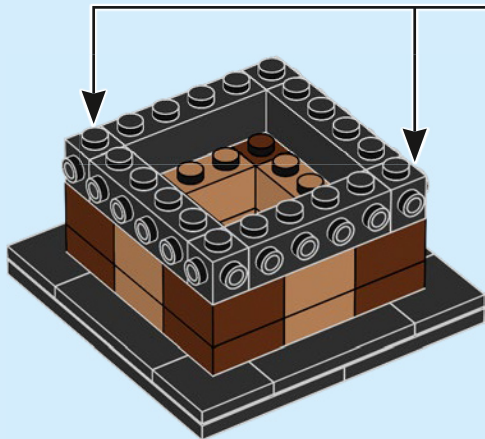



2x

10

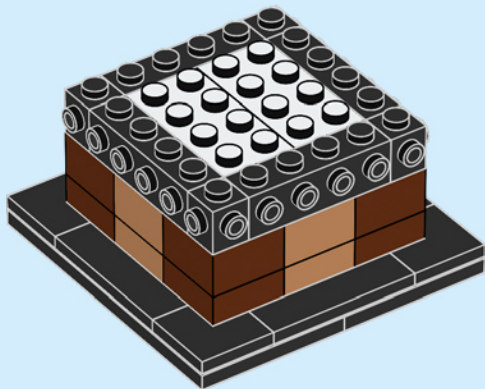



4x

11

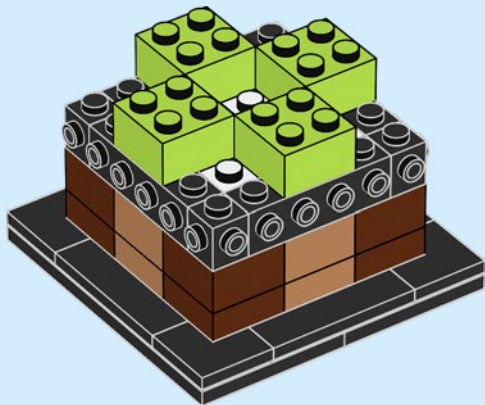

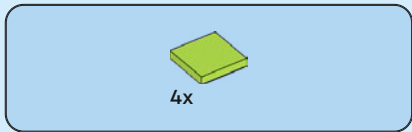

12

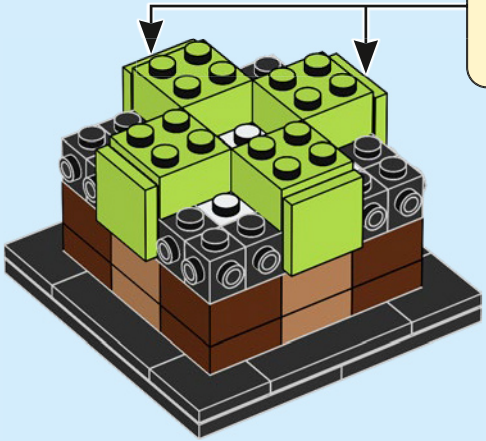
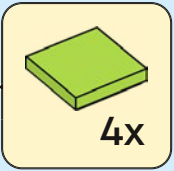



5x

13

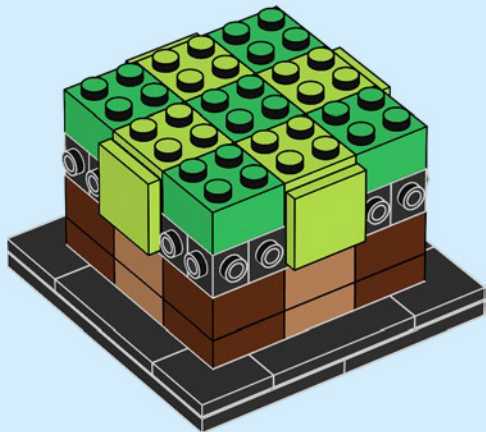

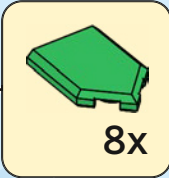

14

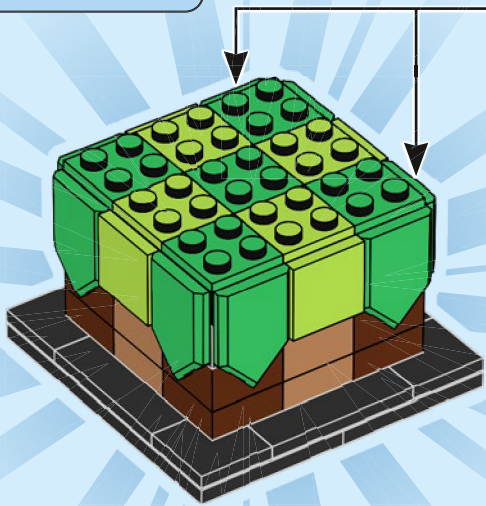



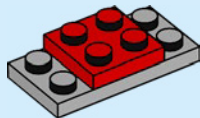
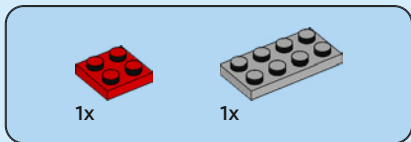
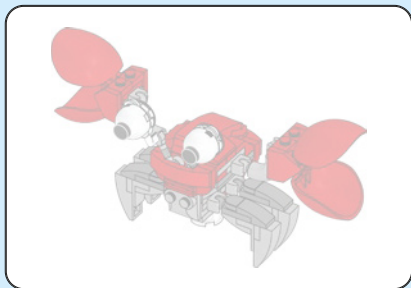

1



2x

2

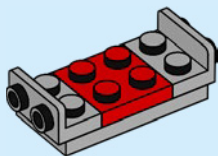



4x

3

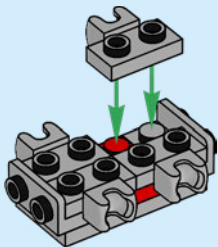

1x

4

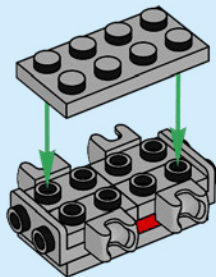

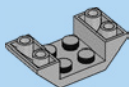

2x

5

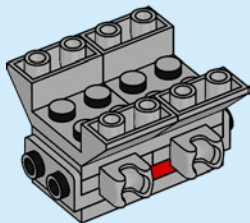

2x

6

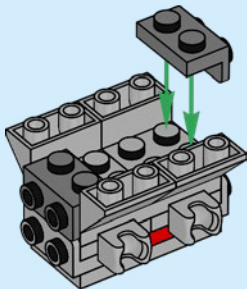



1x

7

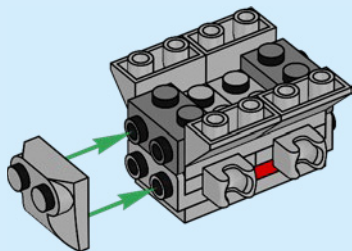

2x

8

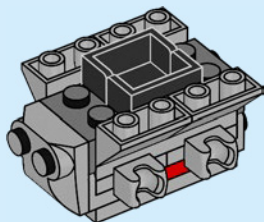



1x



1x

9

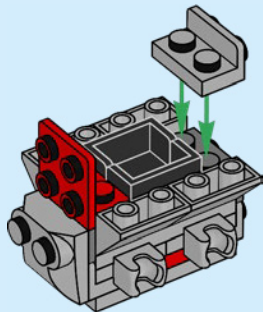

24

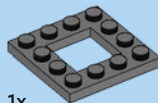

1x

10

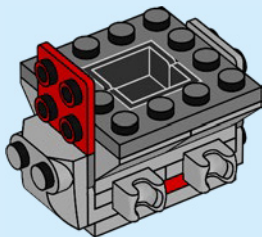



1x



2x

11

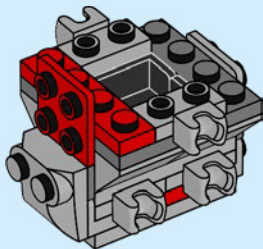

2x



1x

12

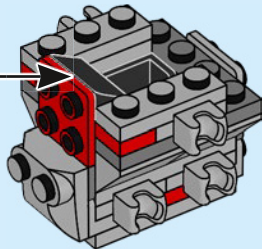



2x

13

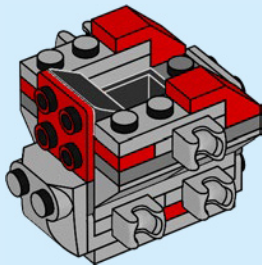

2x



2x

14

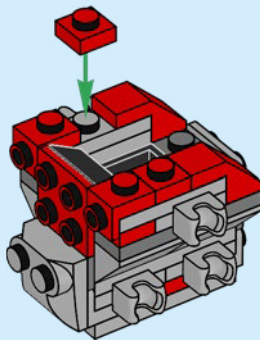



1x

15

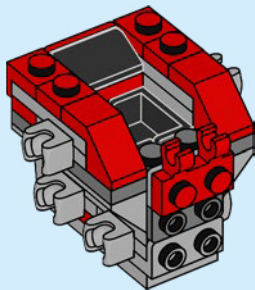

2x

16

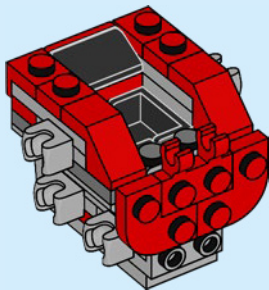



1x

17

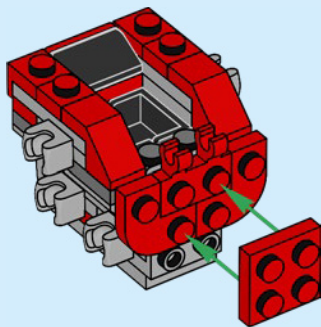

2x

18

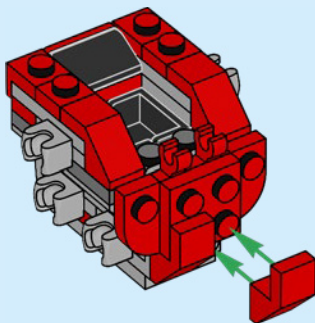



1x

19

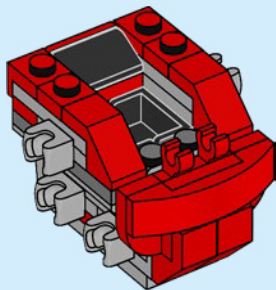

2x

20

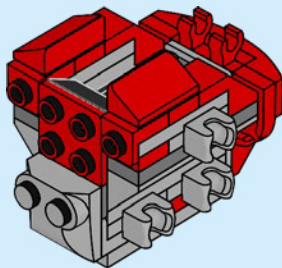



2x

21

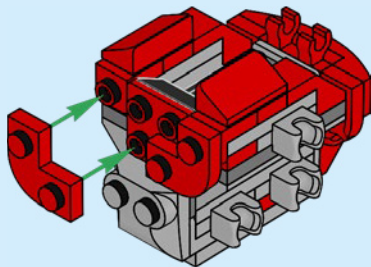

1x

22

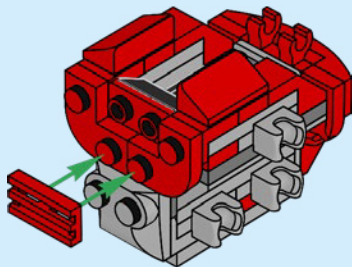



2x

23

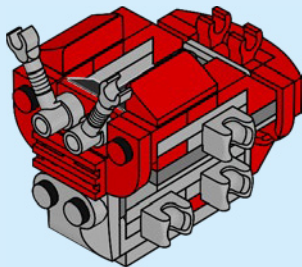

1x

24

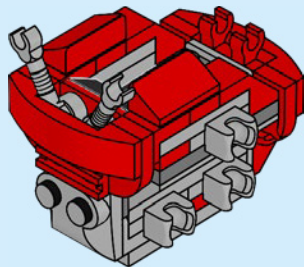





1x



1x

25

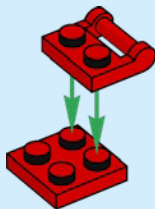

1x

26

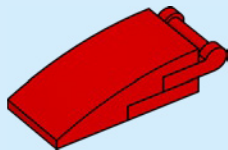



2x



1x

27

1

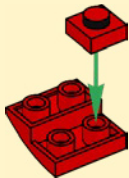

2

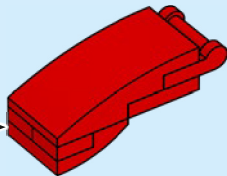
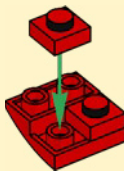

28

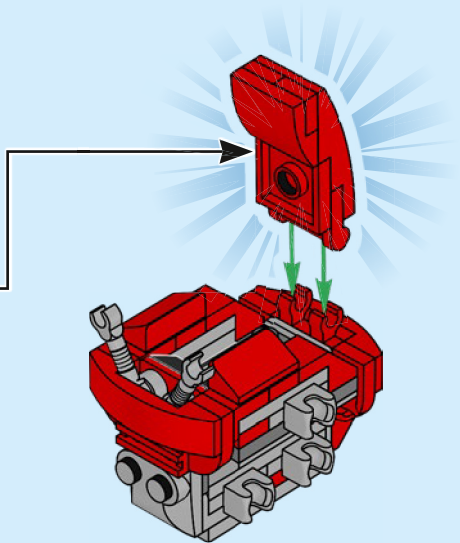



1x

29

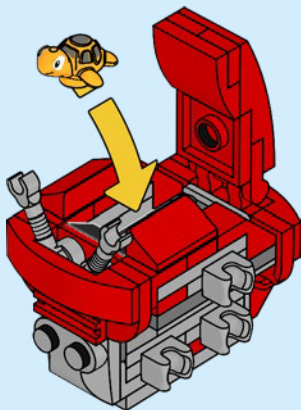

30

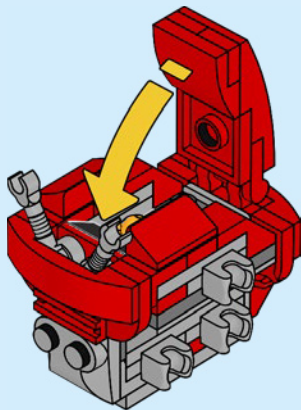

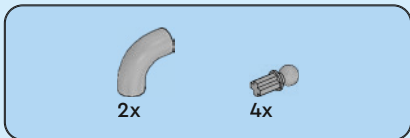

31

1

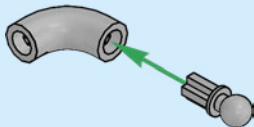

2

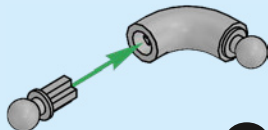

2x

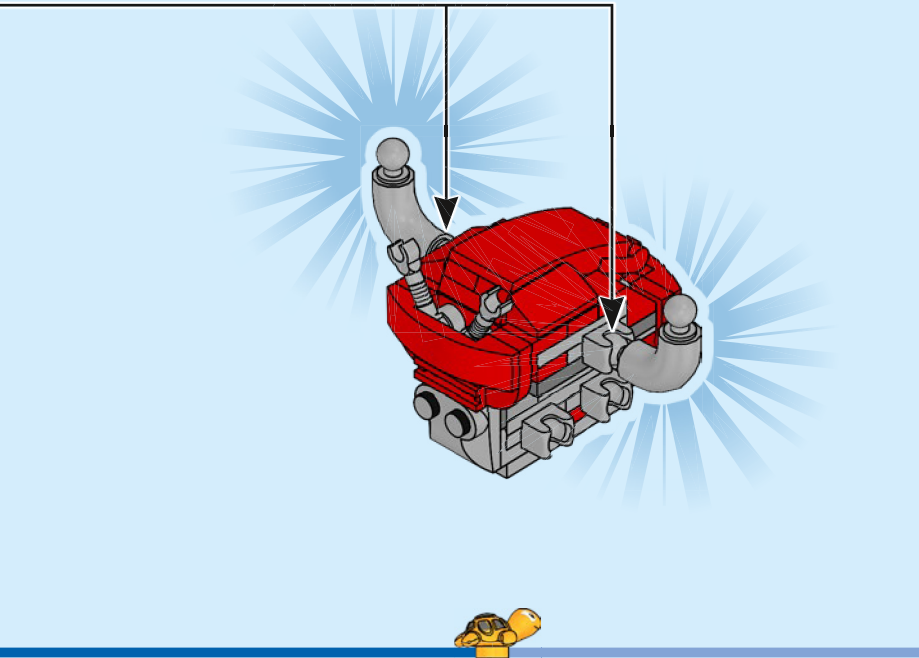



2x



1x



1x

32

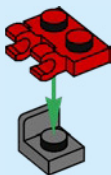

1x

33

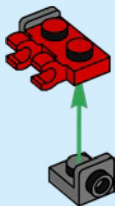



1x



1x

34

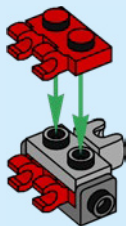

2x

35

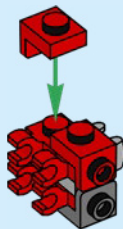



2x

36

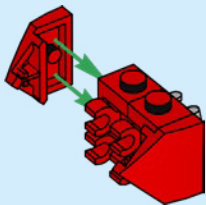

2x

37

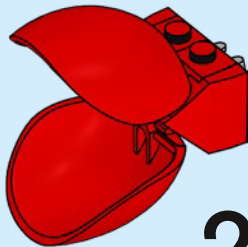

2x

38

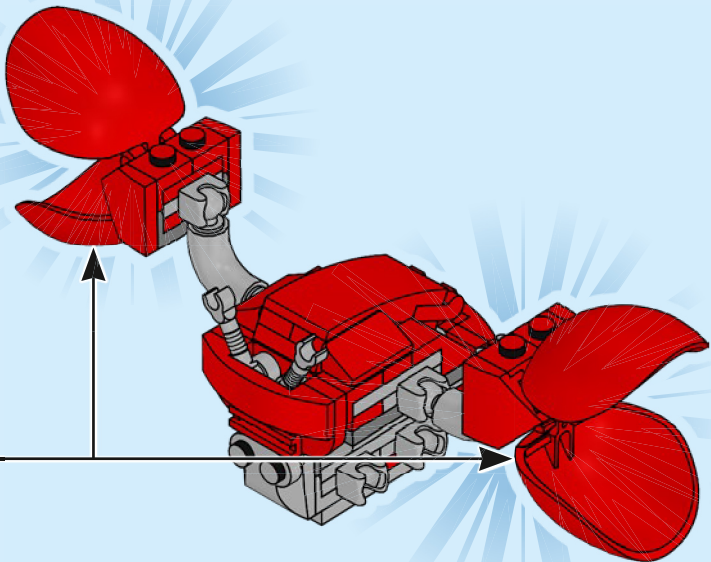



2x



2x



2x



4x



2x



2x



2x

39

1

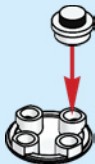

2



3

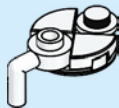

4



2x

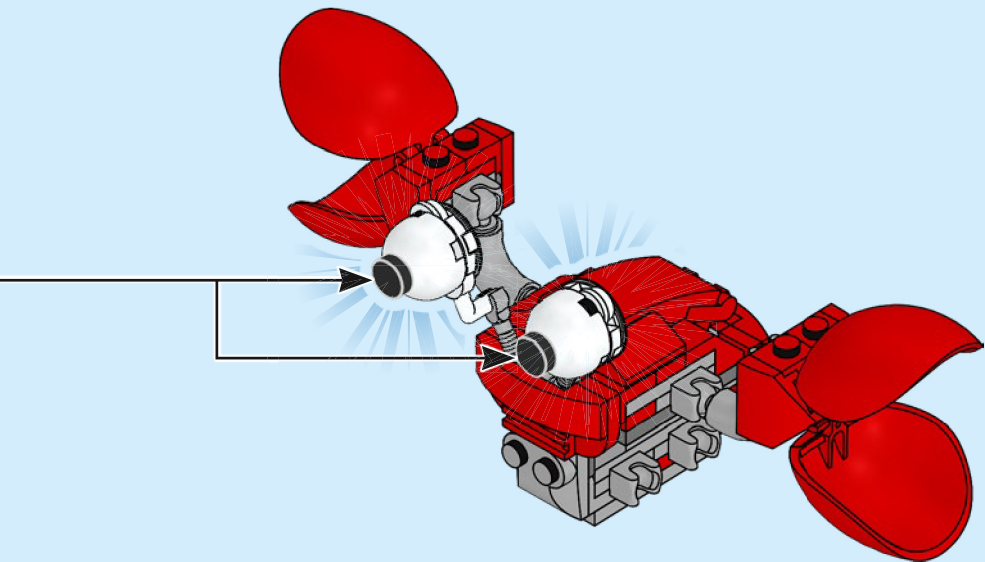



1x

40

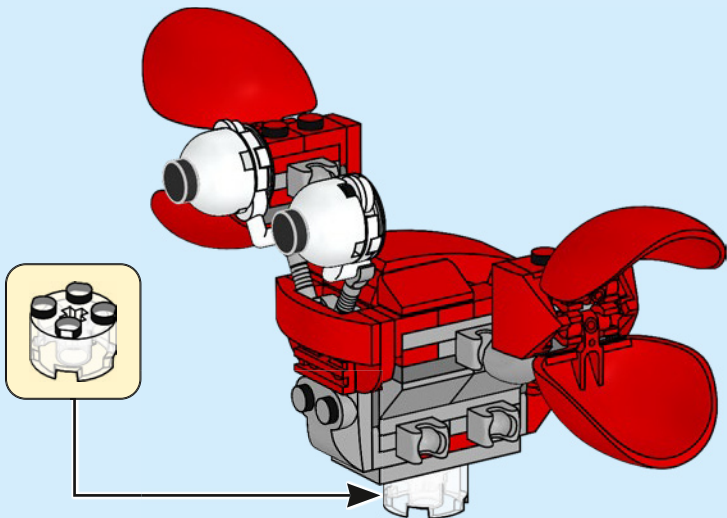



4x



1x



1x

41

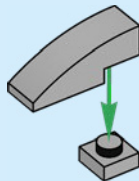



1x

42

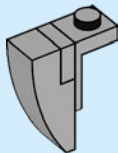

1x

43

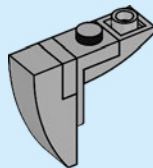



1x



1x



1x

44

1



2

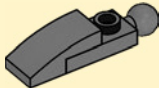

3

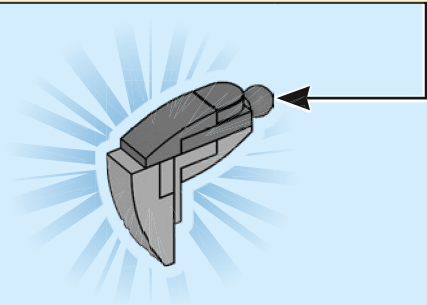
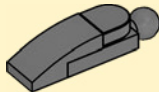

4x



45

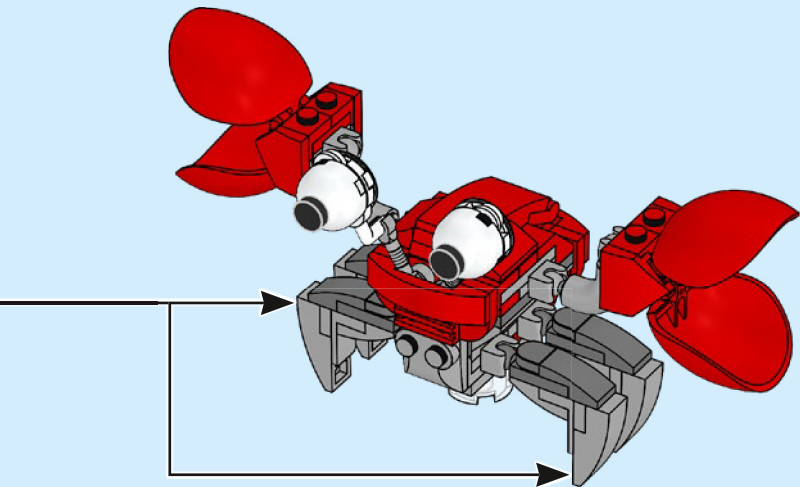

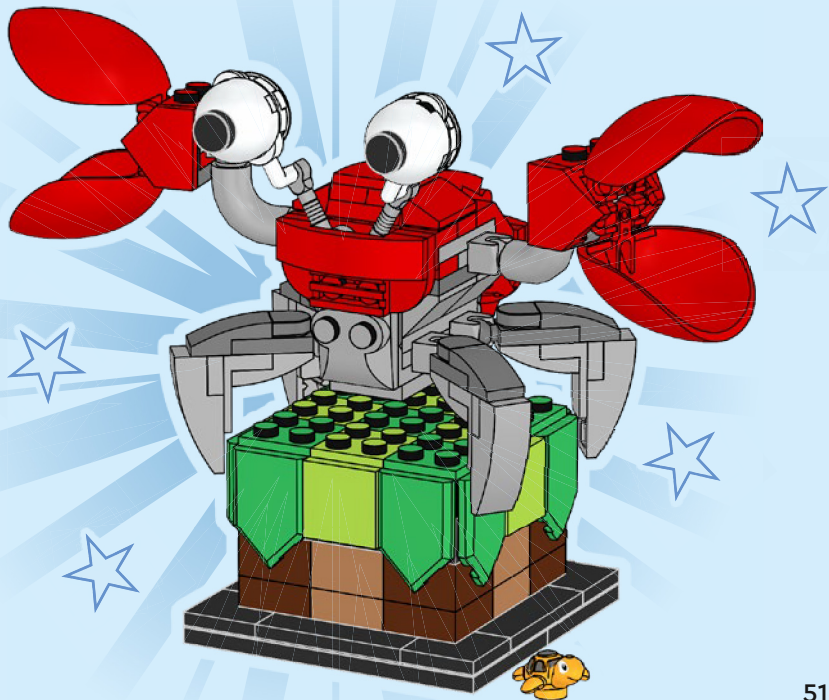



SONIC™

THE HEDGEHOG



77002



77001



77003



76997



76999



76998

©SEGA. All rights reserved. SEGA is registered in the U.S. Patent and Trademark Office. SEGA and SONIC THE HEDGEHOG are either registered trademarks or trademarks of SEGA CORPORATION.

EXPLORE MORE



LEGO.com/sonic

Explore more	Objev vice
Mehr entdecken	Objav viac
En savoir plus	Tudj meg többet!
Esplora di più	Descoperă mai multe
Explora más	Разгледайте още
Explorar mais	Izpėti vairāk
了解更多	Uuri lähemalt
Zobacz więcej	Atraskite daugiau





2x
300101



2x
6429053



2x
6508268



2x
614101



4x
6172366



2x
4278271



2x
4651524



4x
6275178

54



4x
6305047



1x
6442314



2x
4633914



1x
4613174



4x
302421



1x
241221



3x
302221



1x
371021



6x
6372478



1x
6001806



5x
6360036



1x
4226876



4x
6384910



4x
6510978



4x
6187572



4x
4162443



1x
4548180



4x
6133722



4x
243126

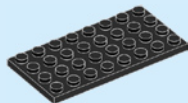

2x
303526



2x
6284070



2x
6248496



5x
300328



8x
6290600



1x
6514281



4x
4220632



4x
4518611



1x
6443215



8x
4211210



2x
4211517



4x
6144138



4x
4251163



4x
4211399



2x
4211429



2x
4211395



4x
6362975



8x
6043656



3x
6004990



2x
6151349



1x
4494475



4x
6443149



2x
4211644



4x
6029948



1x
6186825



4x
6225494



2x
6214341



4x
6123814



4x
6362252



8x
6058085

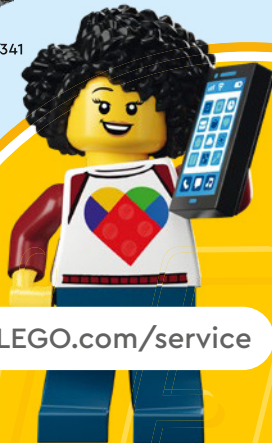

LEGO.com/service

YOU COULD
WIN



Scan this QR code or go to
LEGO.COM/PRODUCTFEEDBACK and give us
your short feedback about this LEGO® set
for a chance to win a cool LEGO prize.
Terms and Conditions apply*

EN: YOU COULD WIN. Terms and Conditions apply* **DE: Du könntest GEWINNEN.** Es gelten die Teilnahmebedingungen* **FR: Tu pourrais GAGNER.** Des conditions s'appliquent* **IT: Potresti VINCERE tu.** Termini e condizioni sono applicabili* **ES: Puedes GANAR.** Aplican términos y condiciones* **PT: Poderá GANHAR.** Aplicam-se termos e condições* **ZH: 轻松获奖. 条款和条件适用*** **PL: Szansa na WYGRANĄ.** Obowiązują warunki korzystania* **CS: Máte šanci VYHRÁT.** Platí všeobecné smluvní podmínky* **SK: Máte šancu VYHRÁT.** Platia všeobecné zmluvné podmienky* **HU: TE IS NYERHETSZ.** Felhasználási feltételek érvényesek* **RO: Ai putea CÂȘTIGA.** Se aplică termenii și condiții* **BG: Можете да СПЕЧЕЛИТЕ.** Има определени правила и условия* **LV: Tu vari LAIMĒT.** Ir spēkā noteikumi un nosacījumi.* **ET: Sul on võimalus VÕITA.** Kehtivad tingimused* **LT: Jūs galite LAIMĖTI.** Taikomos sąlygos*

*[LEGO.com/productfeedback-terms](https://www.lego.com/productfeedback-terms)

LEGO and the LEGO logo are trademarks of the LEGO Group. ©2025 The LEGO Group.

©SEGA. All rights reserved. SEGA is registered in the U.S. Patent and Trademark Office.

SEGA and SONIC THE HEDGEHOG are either registered trademarks or trademarks of SEGA CORPORATION.

6555865