

YOU COULD WIN



Scan this QR code or go to [LEGO.COM/PRODUCTFEEDBACK](https://www.lego.com/productfeedback) and give us your short feedback about this LEGO® set for a chance to win a cool LEGO prize. Terms and Conditions apply\*



**EN: YOU COULD WIN.** Terms and Conditions apply\* **DE: Du könntest GEWINNEN.** Es gelten die Teilnahmebedingungen\* **FR: Tu pourrais GAGNER.** Des conditions s'appliquent\* **IT: Potresti VINCERE tu.** Termini e condizioni sono applicabili\* **ES: Puedes GANAR.** Des condiciones s'apliquen\* **PT: Poderás GANHAR.** Aplicam-se termos e condições\* **ZH: 轻松获奖.** 条款和条件适用\* **PL: Szansa na WYGRANA.** Obowiązują regulamin i warunki\* **VYHRÁT.** Platí všeobecné smluvní podmínky\* **SK: Máte šancu VYHRÁT.** Platia všeobecné zmluvné podmienky\* **HU: TE IS NYERHETSZ.** Felhasználási feltételek érvényesek\* **RO: Ai putea CĂȘTIGA.** Se aplică termenii și condiții\* **BG: Можете да ЦЕЛЕВИТЕ.** Икма отпазененик правари на условията\* **LV: Tu vari LAIMĒT.** Ir spēka noteikumi un nosacījumi. **ET: Sui on võitmaus VÕITA.** Kehtivad tingimused\* **LT: Jūs galite LAIMĖTI.** Taikomos sąlygos\*

\*[LEGO.com/productfeedback-terms](https://www.lego.com/productfeedback-terms)



SONIC™ THE HEDGEHOG



30704

6555863

1

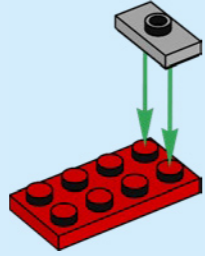

2

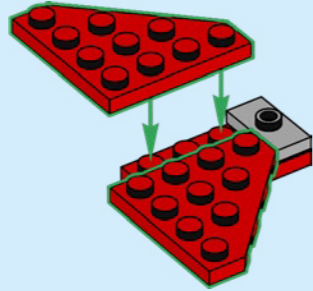

3

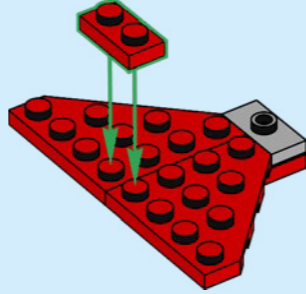

4

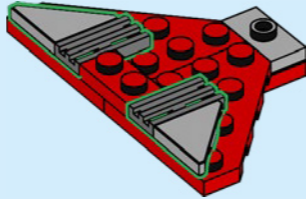

5

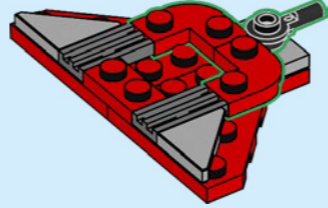

6

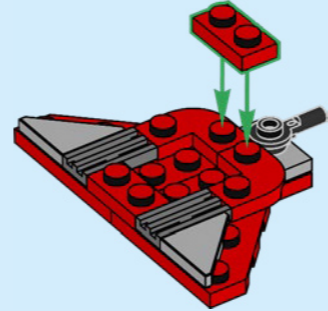

7

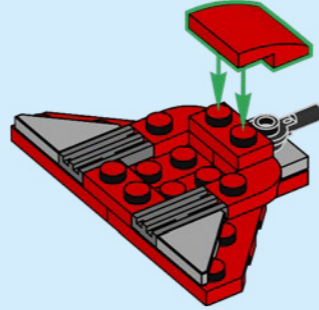

8

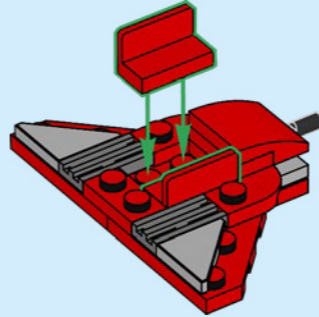

9

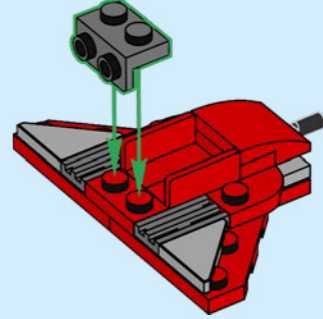

10

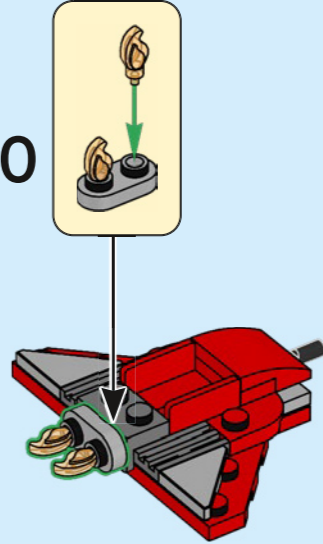

11

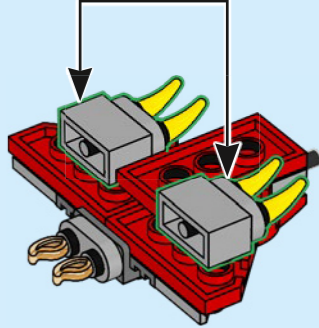
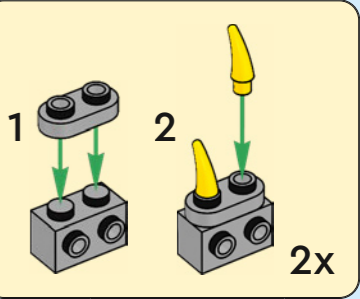

12

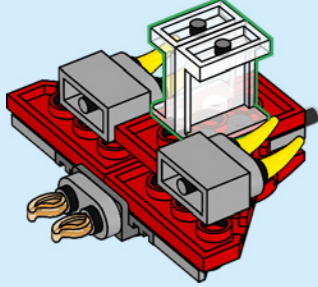

13

1

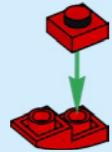

2

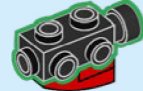

3

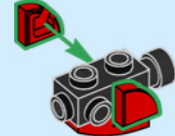

4

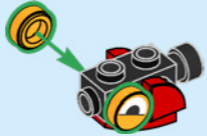

5



6

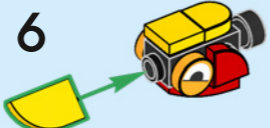

7

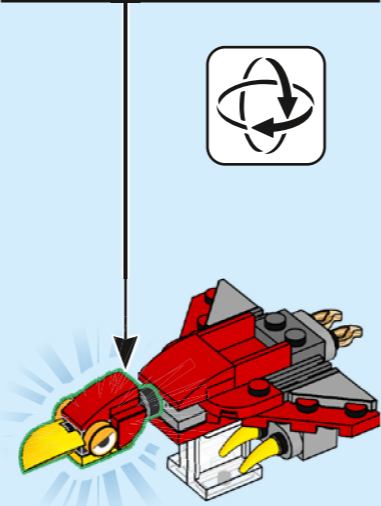
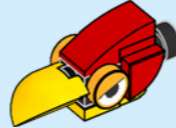

14

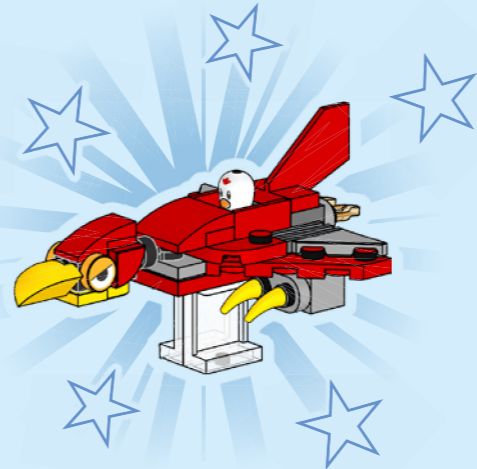
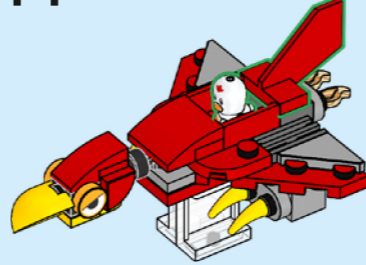

[LEGO.com/service](https://www.lego.com/service)

 [LEGO.com/sonic](https://www.lego.com/sonic)

LEGO and the LEGO logo are trademarks of the LEGO Group. ©2025 The LEGO Group. 6555863  
©SEGA. All rights reserved. SEGA is registered in the U.S. Patent and Trademark Office.  
SEGA and SONIC THE HEDGEHOG are either registered trademarks or trademarks of SEGA CORPORATION.