

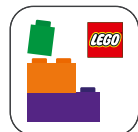

10342



Booklet available in English
Livret disponible en français
Folleto disponible en español



LEGO® Builder

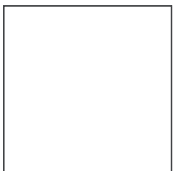



WE'RE MAKING OUR PACKAGING MORE SUSTAINABLE

We're transitioning from single-use plastic to paper-based packaging. As we progress, you may find a mix of paper and plastic in our boxes.

NOUS RENDONS NOS EMBALLAGES PLUS DURABLES

Nous passons des emballages en plastique à usage unique aux emballages à base de papier. Durant la transition, vous pourriez trouver un mélange de papier et de plastique dans nos boîtes.

QUEREMOS HACER MÁS SUSTENTABLES NUESTROS MATERIALES DE EMBALAJE

Estamos cambiando las bolsas de plástico desechables por bolsas con base de papel. Conforme avanzamos en este propósito, puedes encontrar una mezcla de papel y de plástico en nuestras cajas.

[LEGO.com/sustainable-packaging](https://www.lego.com/sustainable-packaging)



BUiLDER

Download on the
App Store

GET IT ON
Google Play

 **腾讯应用宝**
安卓应用商店

Apple and the Apple logo are trademarks of Apple Inc., registered in the U.S. and other countries and regions. App Store is a service mark of Apple Inc. Google Play and the Google Play logo are trademarks of Google LLC. Tencent and the Tencent logo are trademarks of Tencent Inc.

 LEGO.com/devicecheck



 **LEGO® Builder**

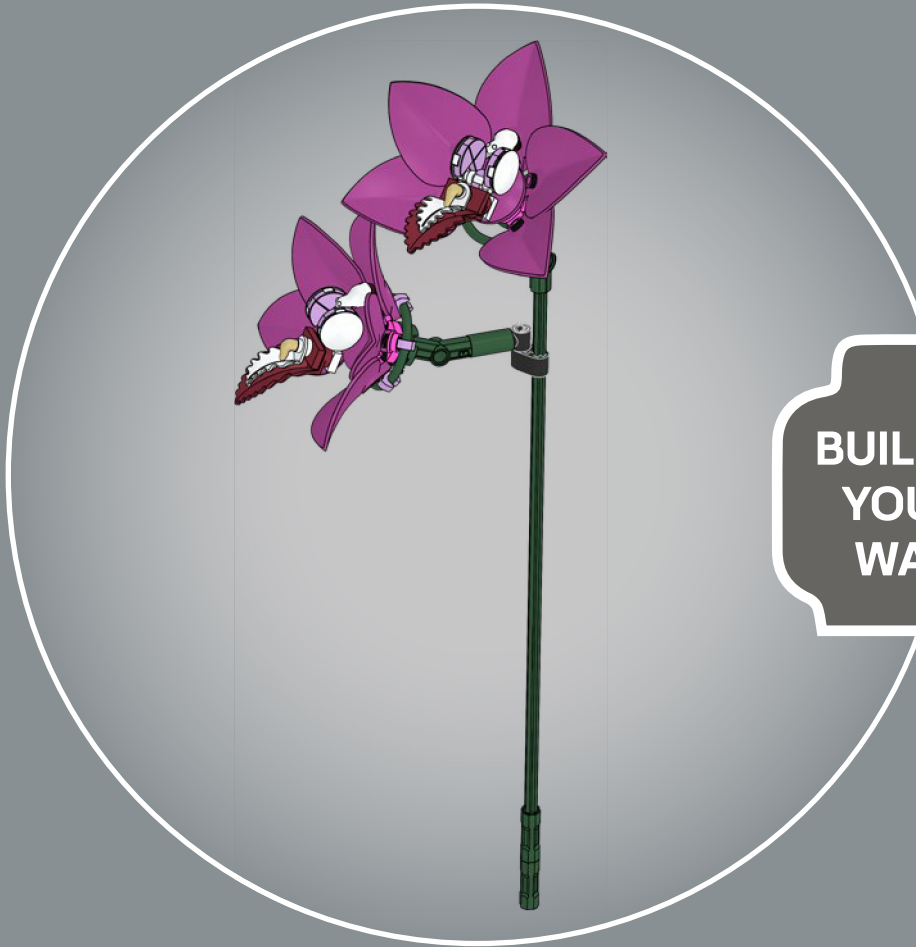

**BUILD IT
YOUR
WAY**



CONSTRUISEZ À VOTRE FAÇON
CONSTRÚYELO A TU MANERA

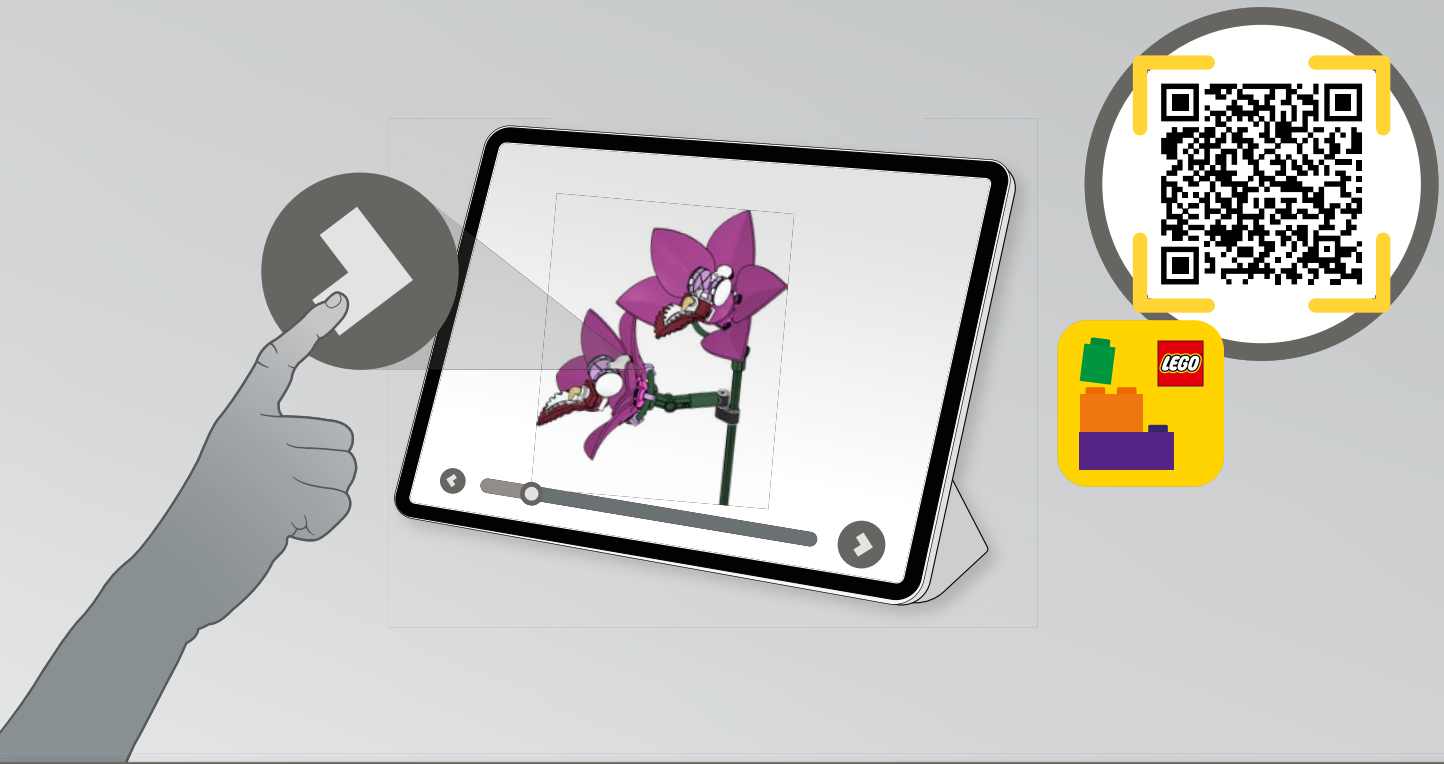



Elegant by nature

When we design a LEGO® floral arrangement, nature offers us a cornucopia of colors, plant species and scents for inspiration. Styling pastel and vibrantly colored blossoms with elegant evergreens, we experimented with new techniques (and creative uses of LEGO elements) to bring this lavish bouquet to life. Every detail is meticulously recreated as an authentic and artistic tribute to nature's own diverse treasures.

The LEGO® Botanicals Design Team

L'élégance au naturel

Lorsque nous concevons une composition florale LEGO®, nous puisons notre inspiration dans la nature, riche en couleurs, en espèces végétales et en fragrances. Grâce à de nouvelles techniques (et à l'utilisation créative d'éléments LEGO), la combinaison des fleurs aux couleurs pastel et vibrantes avec d'élégantes plantes à feuilles persistantes donne vie à ce somptueux bouquet. Chaque détail est méticuleusement recréé pour rendre un hommage authentique et artistique aux divers trésors de la nature.

L'équipe de conception de LEGO® Botanique

Elegante por naturaleza

Cuando diseñamos un arreglo floral LEGO®, la naturaleza nos ofrece una enorme abundancia de colores, especies de plantas y olores como fuente de inspiración. Mientras combinamos flores en colores vibrantes y tonos pastel con elegantes hojas de un intenso verde, experimentamos con nuevas técnicas (y usos creativos de los elementos LEGO) para dar vida a este opulento ramo. Cada detalle se ha recreado meticulosamente para rendir un homenaje tan auténtico como artístico a los diversos tesoros de la naturaleza.

El equipo de diseño de LEGO® Botanical

(Centaurea cyanus)

CORNFLOWER CENTAURÉE BLEUET PINCEL

From rebellious weeds to beloved bouquet flowers, this beauty thrives in Europe and North America and is wildly popular among bees and butterflies.

De mauvaise herbe rebelle à fleur de bouquet adorée, cette beauté prospère en Europe et en Amérique du Nord est très appréciée des abeilles et des papillons.

De maleza rebelde a apreciada flor para ramos, esta belleza increíblemente popular entre las abejas y las mariposas crece con fuerza en Europa y Norteamérica.



(Eucalyptus pulverulenta)
EUCALYPTUS 'BABY BLUE'
EUCALYPTUS « BABY BLUE »
EUCALIPTO AZUL

Also known as an Australian silver-leaved mountain gum, this member of the eucalyptus species often complements flowers in bouquets around the world.

Également connu sous le nom de gommier argenté d'Australie, ce membre de l'espèce eucalyptus complète souvent les fleurs des bouquets dans le monde entier.

Conocido también como goma de montaña con hojas plateadas de Australia, este miembro de la especie de los eucaliptos es un clásico en los ramos de flores de todo el mundo.



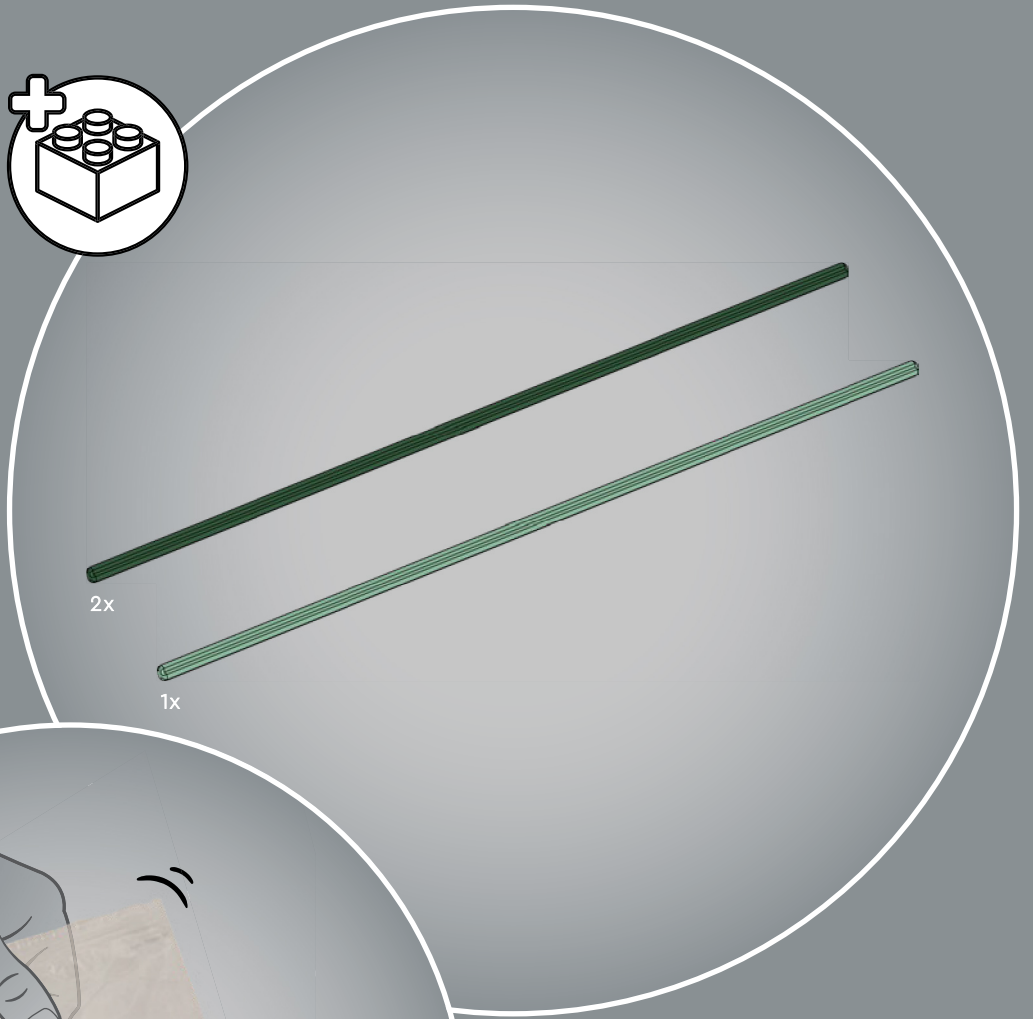
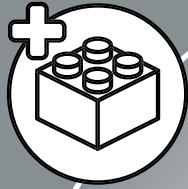



1

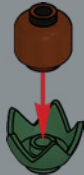

2



3

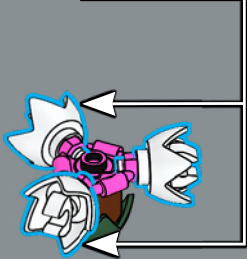
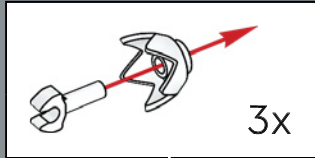

4

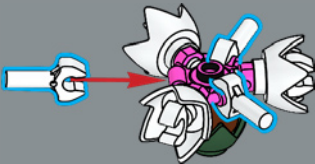

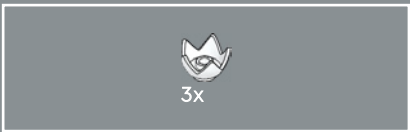

5

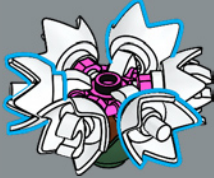

These little LEGO® bricks used for the cornflower petals are actually minifigure crowns.

Ces petites briques LEGO® utilisées pour les pétales sont en fait des couronnes de figurines.

Estos pequeños bricks LEGO® usados para los pétalos del pincel son, en realidad, coronas para minifiguras.



6

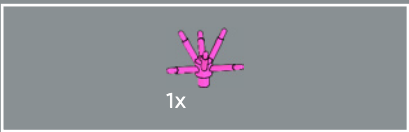
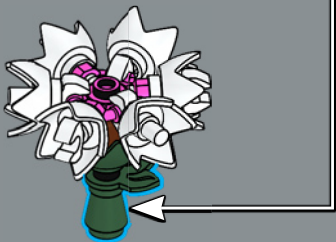
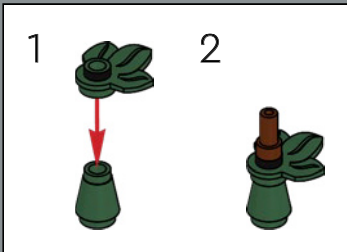

7



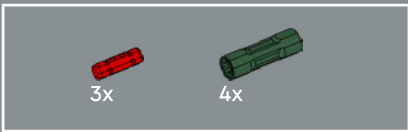

8

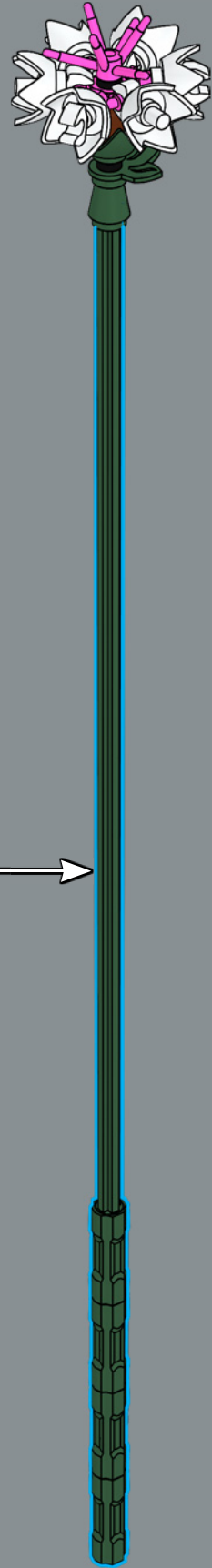
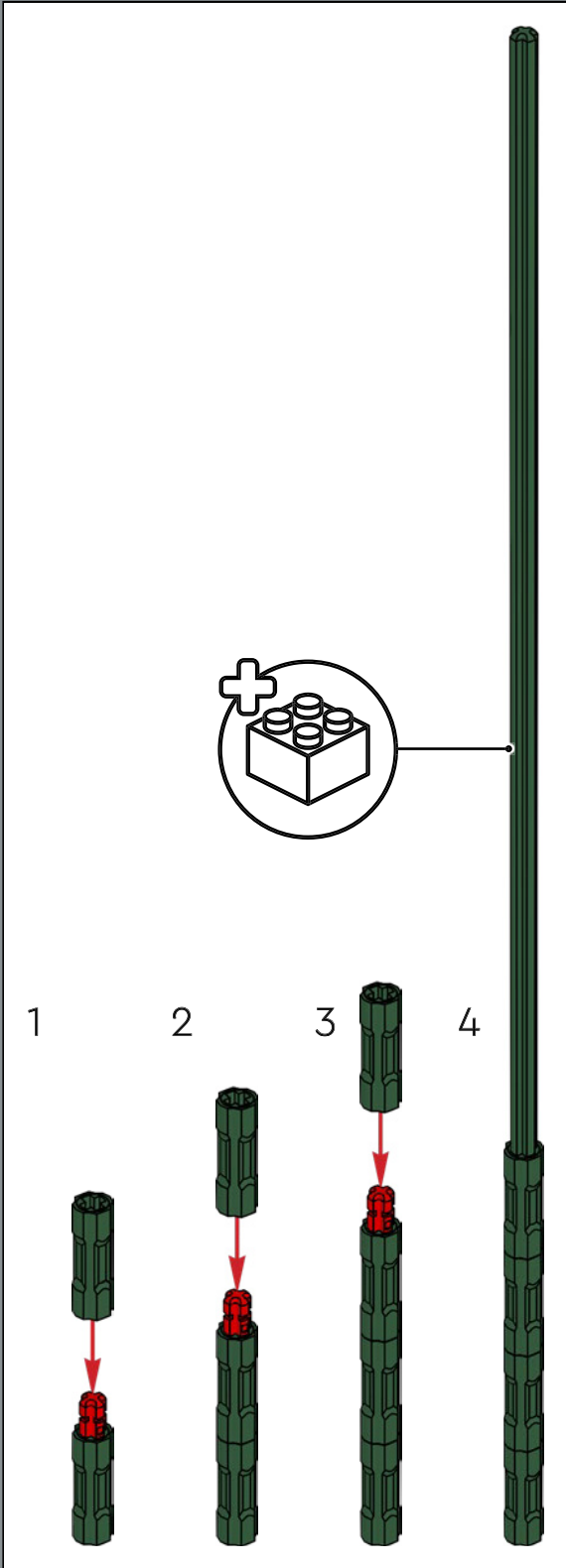

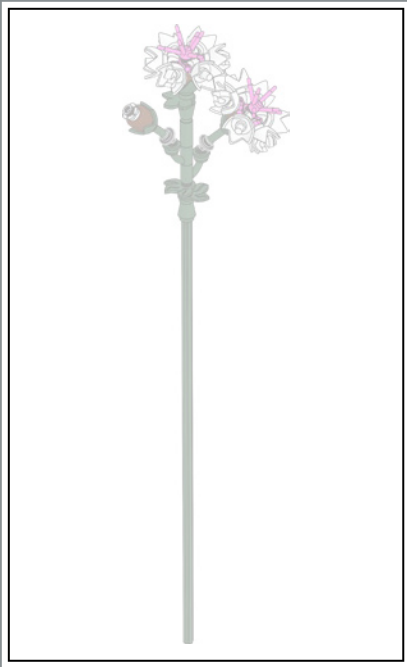

1

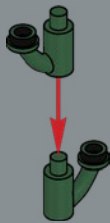

2

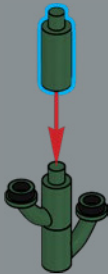

3

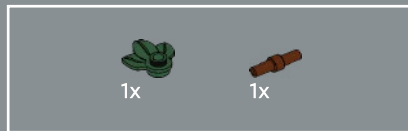
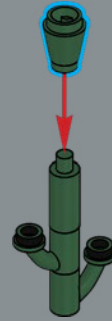

4





5



6

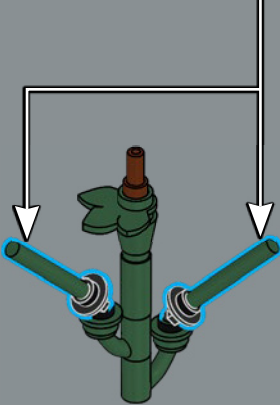
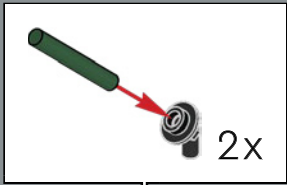

7

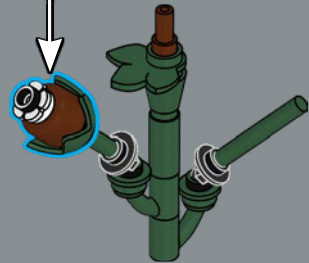
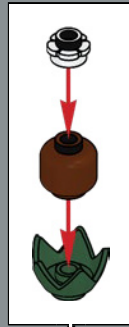



8

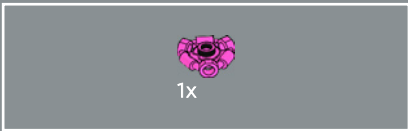
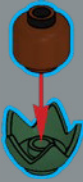

9



10

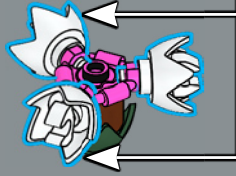
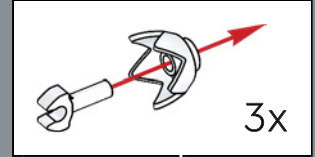

11

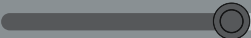
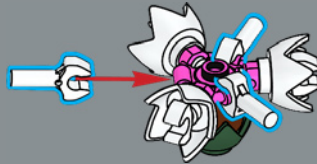

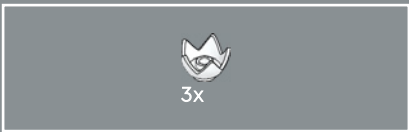

12

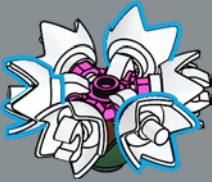

13



2x

14

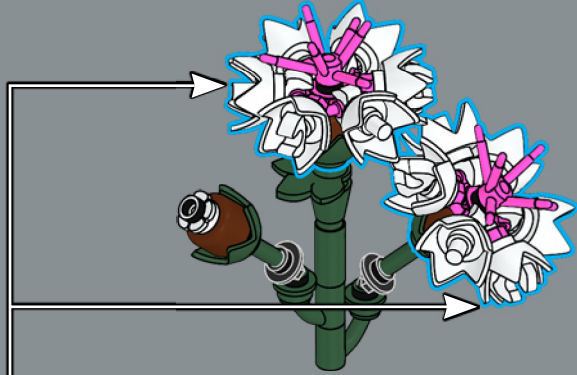

15

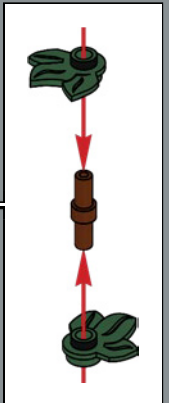
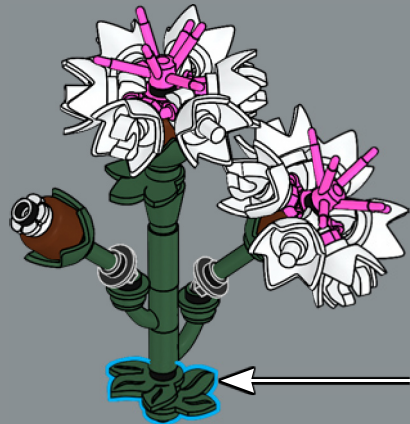



16

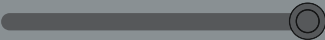
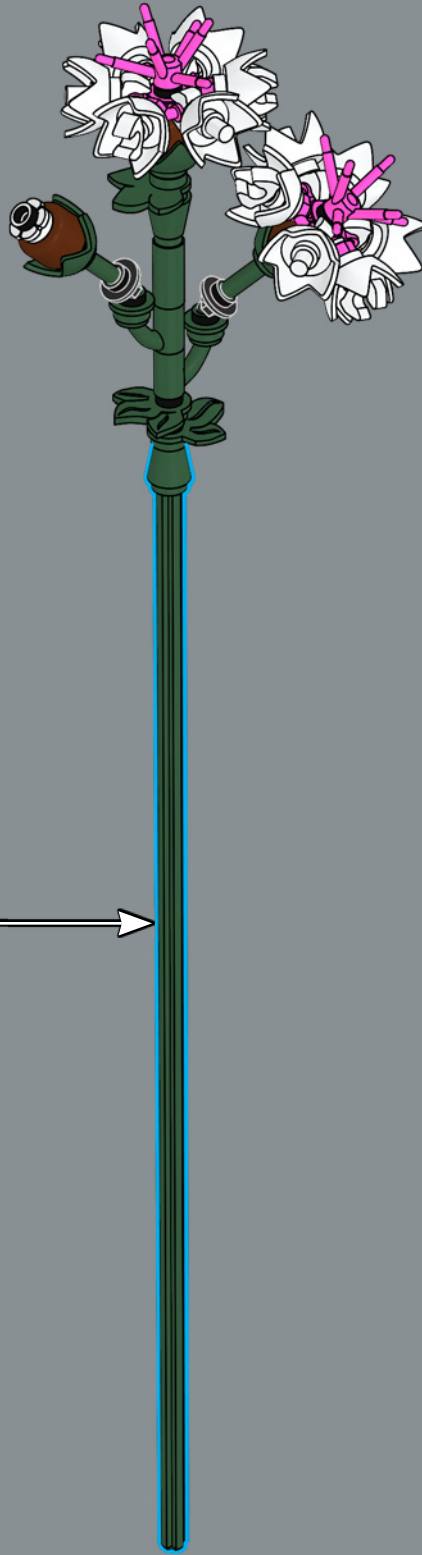
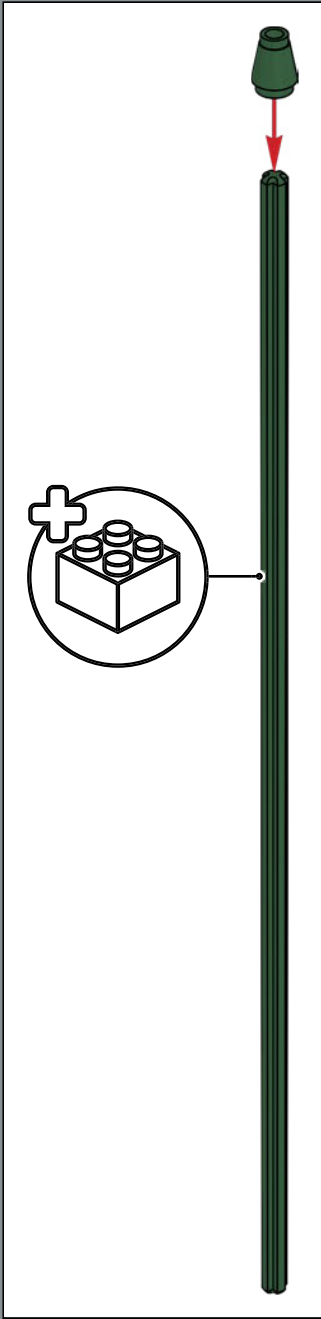

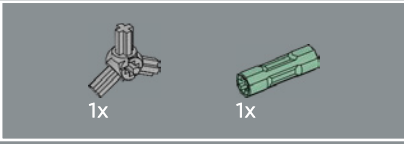

1

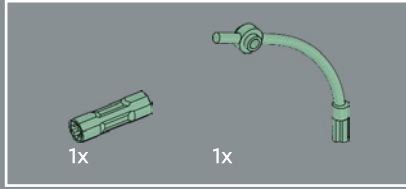
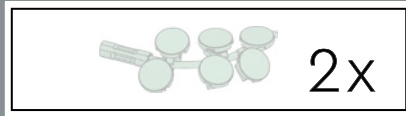
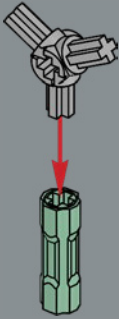

2

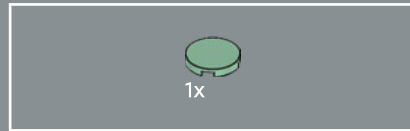
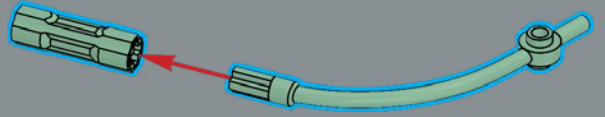

3

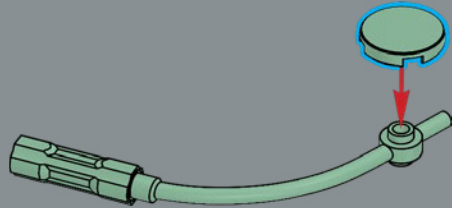



4

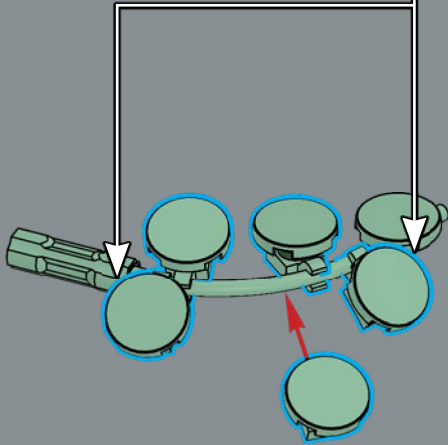
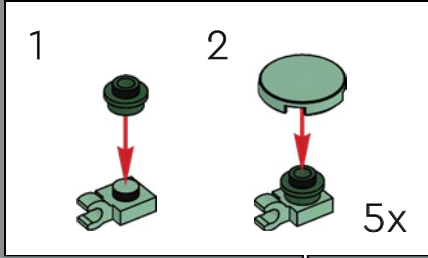

5

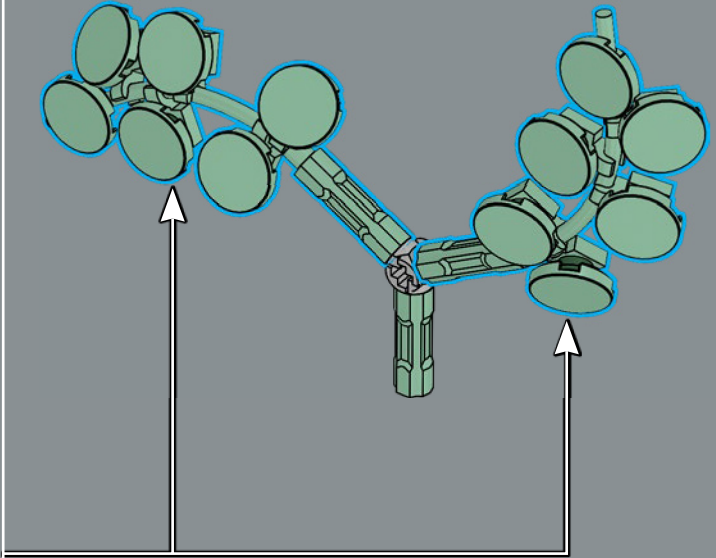



(Sambucus nigra)

ELDER
SUREAU NOIR
SAÚCO



Deciduous elder shrub species vary globally but most produce delicate white flowers and dark purple berries. Both are popular flavors in food and drinks.

Les espèces d'arbustes de sureau à feuilles caduques varient dans le monde entier, mais la plupart produisent de délicates fleurs blanches et des baies pourpre foncé. Les fleurs comme les baies sont des arômes populaires dans les aliments et les boissons.

Las especies de arbustos caducifolios de saúco varían en todo el mundo, pero la mayoría produce delicadas flores blancas y bayas de color púrpura oscuro. Ambas son sabores muy populares en platillos y bebidas.



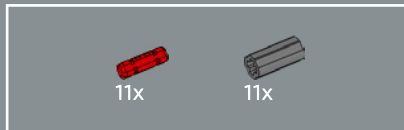

1

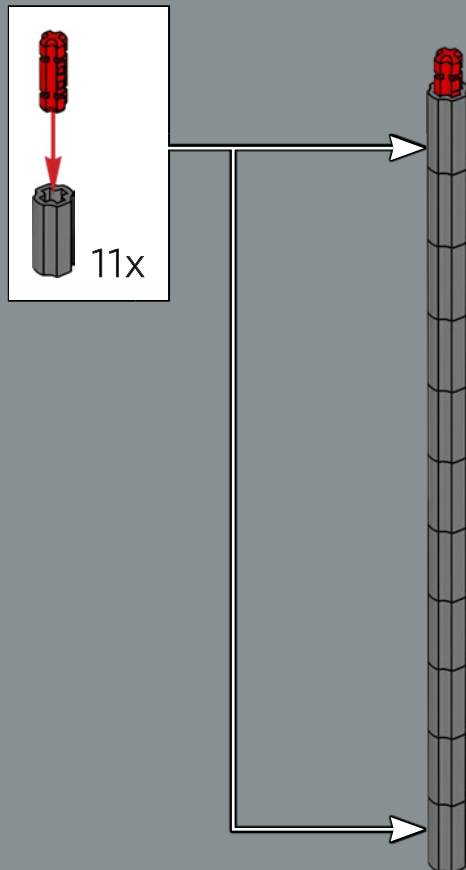

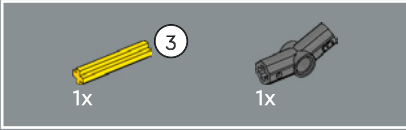
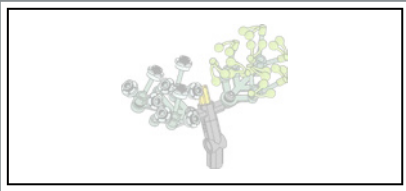

2

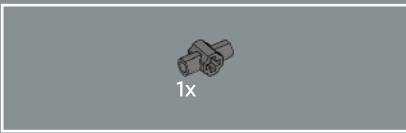
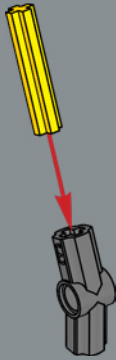

3

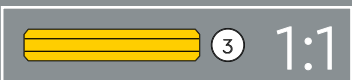
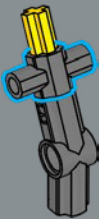

4

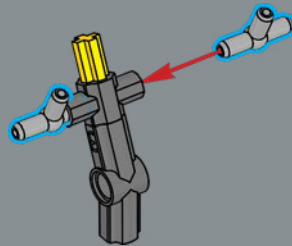

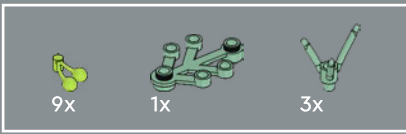

5

1



2

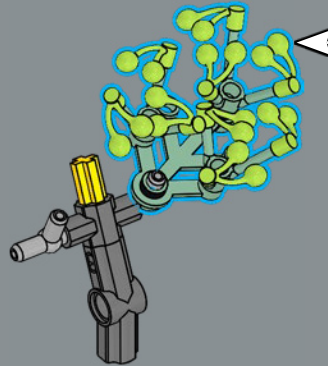
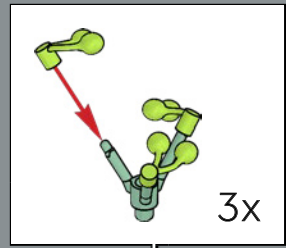
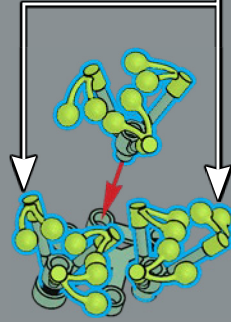

The unopened elder buds here are built using classic LEGO® minifigure cherries.

Les bourgeons non ouverts sont construits avec les classiques cerises pour figurines LEGO®.

Estos capullos sin abrir de saúco se construyen con las clásicas cerezas para minifiguras LEGO®.

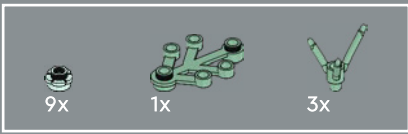

6

1



2

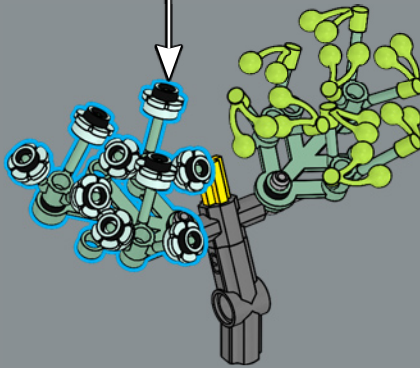
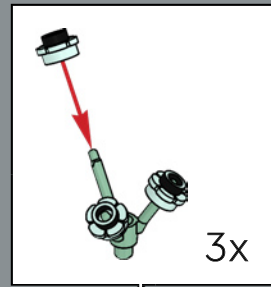
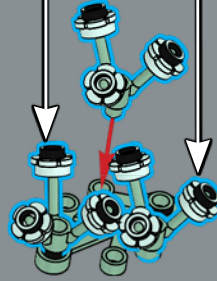

7

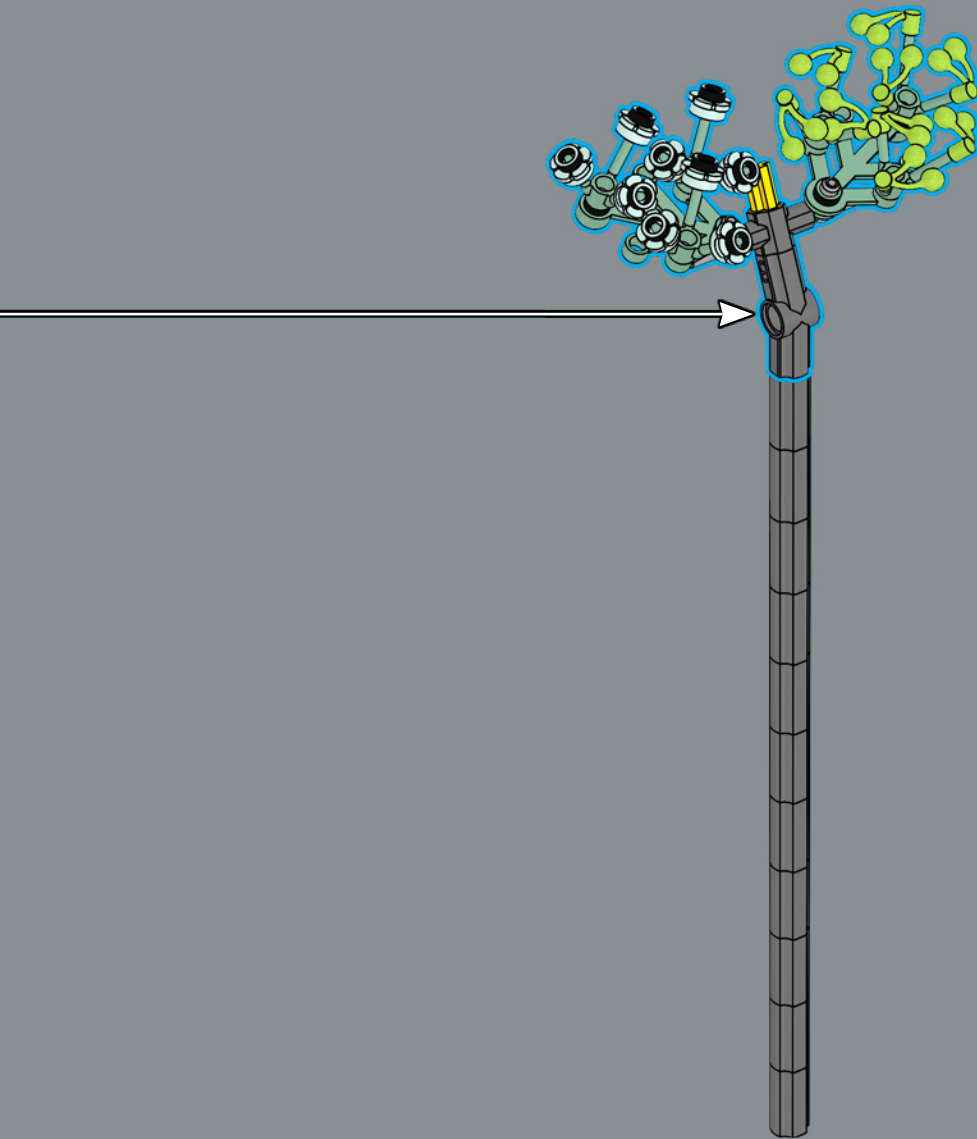

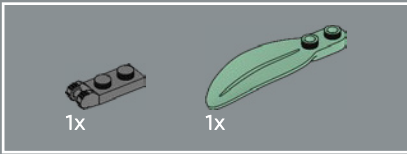
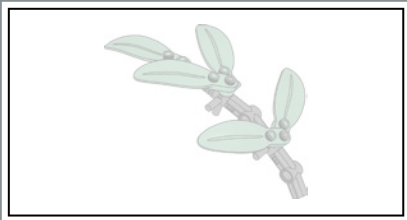

8

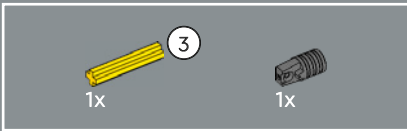
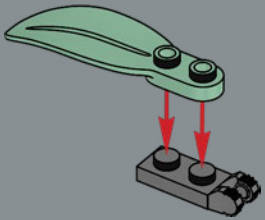

9

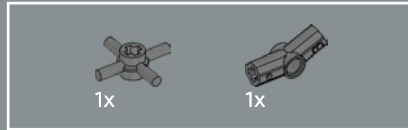
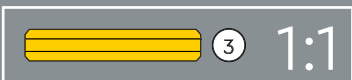
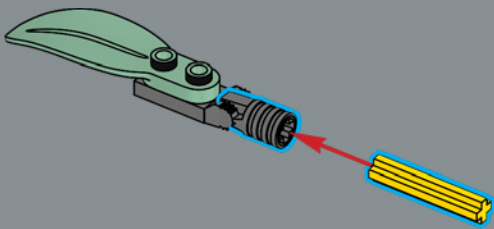

10

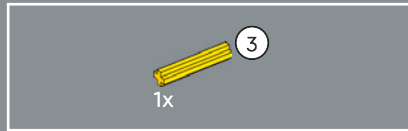
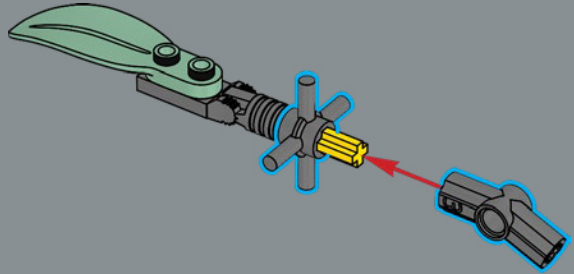

11

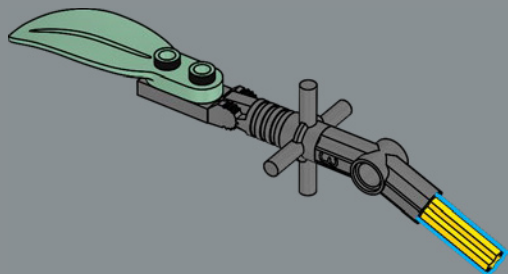

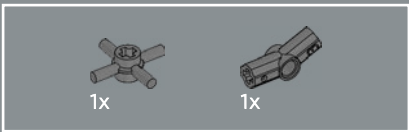

12

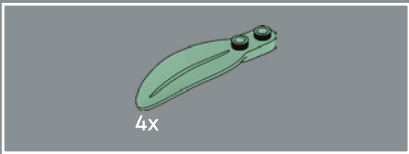
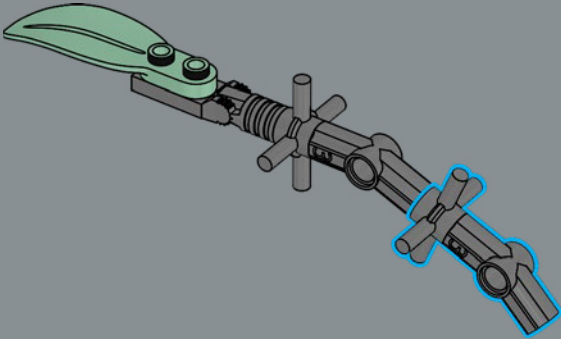

13

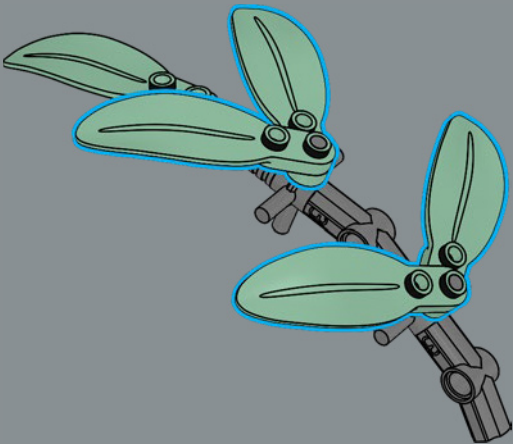

14

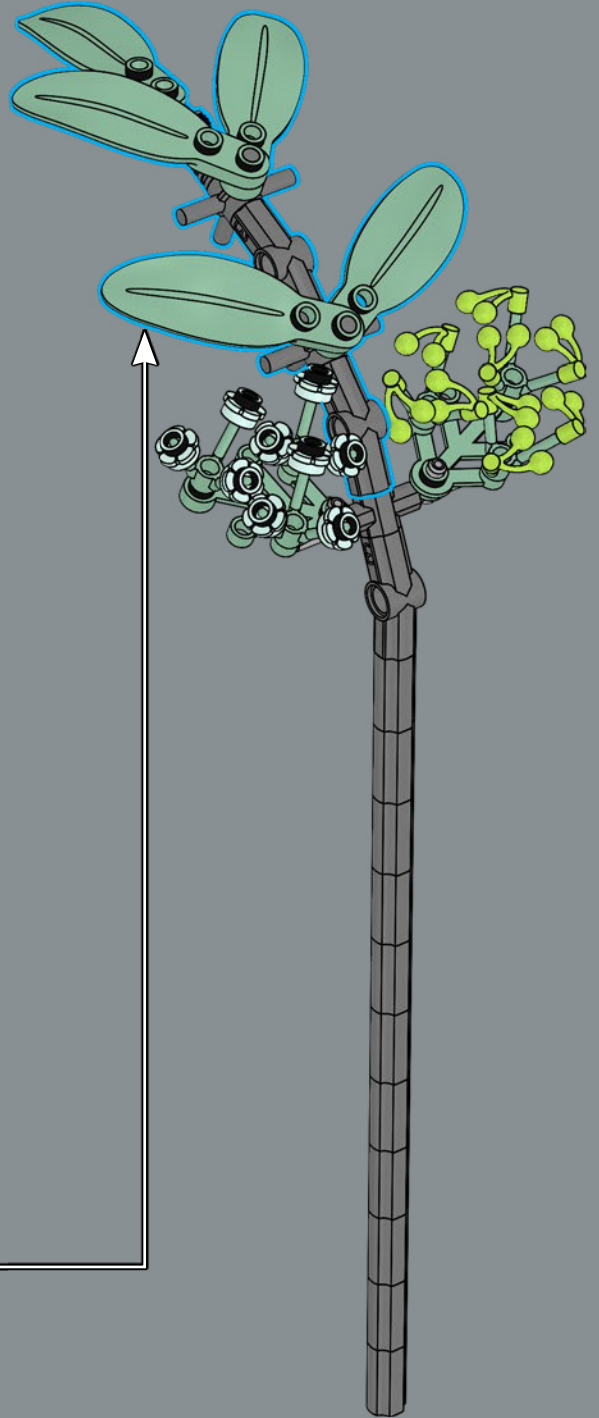

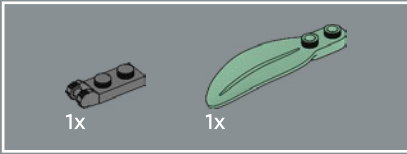
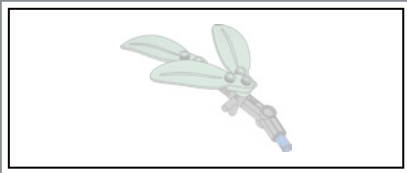

15

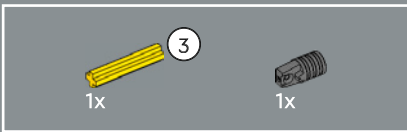
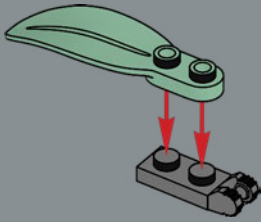

16

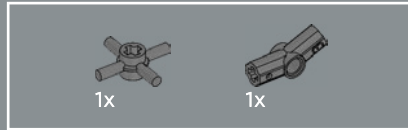
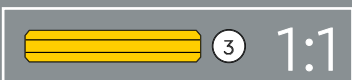
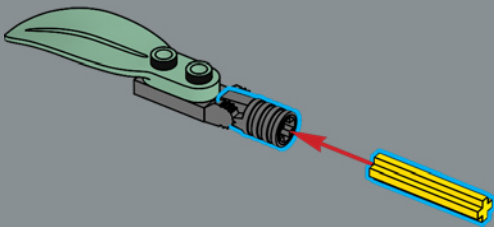

17

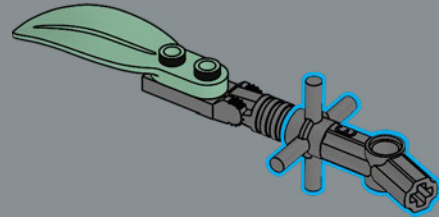

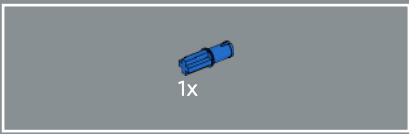

18

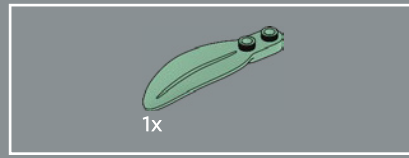
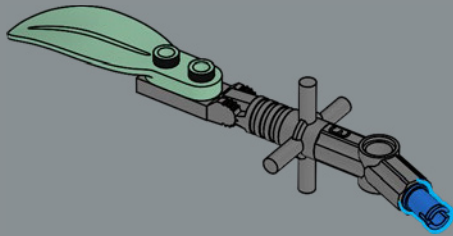

19

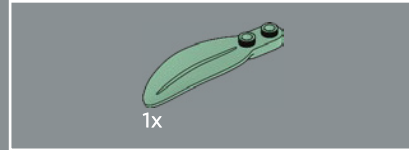
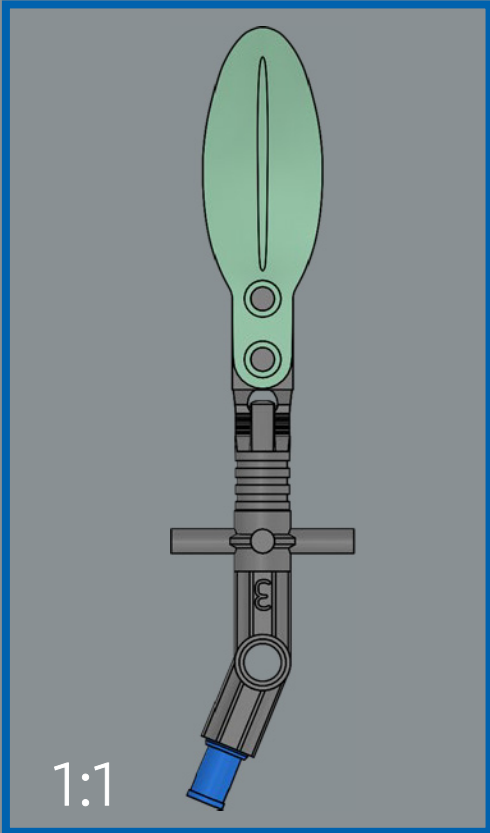
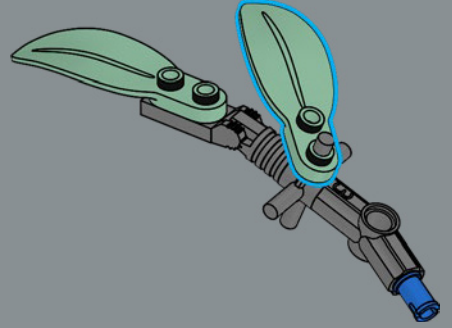

20

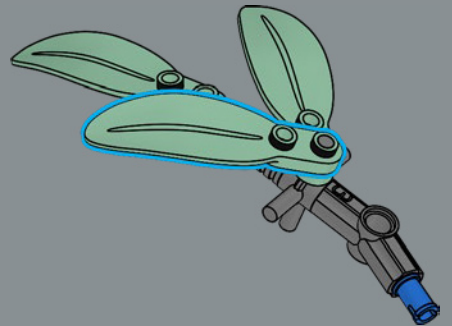

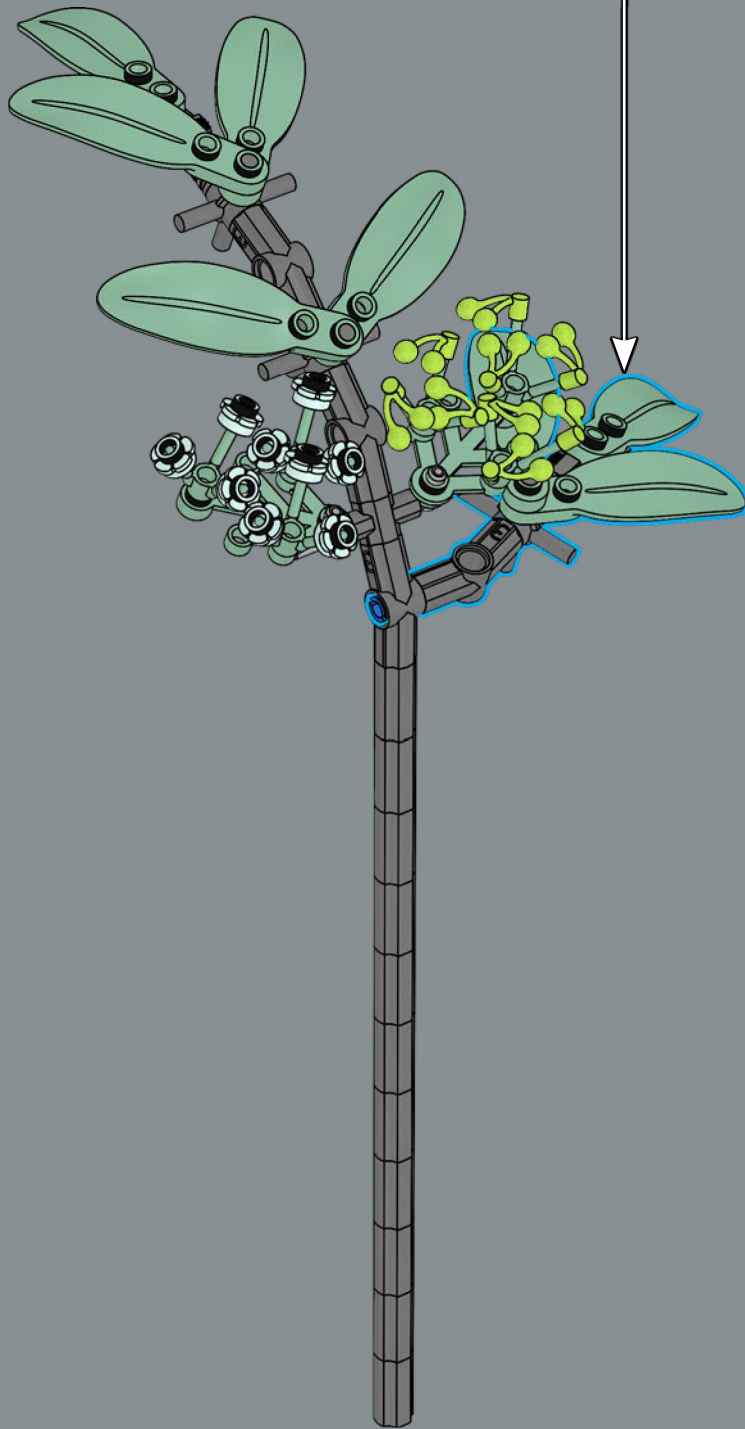

2x





(Rosa)

ROSE
ROSE
ROSA

Gifted as symbols of love and tokens of beauty for centuries, roses in every color add grace to any bouquet – in real life, and in LEGO® form.

Offerte comme symbole d'amour et gage de beauté depuis des siècles, la rose sous toutes ses couleurs ajoute de la grâce à n'importe quel bouquet – dans la vie réelle et sous forme LEGO®.

Las rosas, regaladas como símbolo de amor y belleza durante siglos, aportan gracia y elegancia a cualquier ramo (ya sean naturales o en formato LEGO®).



Commonly found in Europe and North America, blue daisies symbolize commitment and trust, making them a perfect gift for a loved one.

Couramment trouvée en Europe et en Amérique du Nord, la pâquerette bleue symbolise l'engagement et la confiance, ce qui en fait un cadeau parfait pour un être cher.

Comunes en Europa y Norteamérica, las margaritas azules, símbolo del compromiso y la confianza, son el regalo perfecto para un ser querido.

(Felicia amelloides)
BLUE DAISY
PÂQUERETTE BLEUE
MARGARITA AZUL

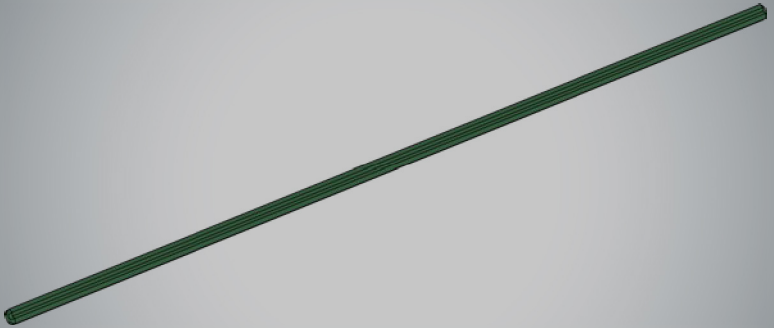
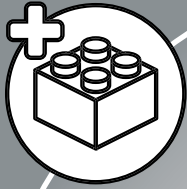

2x



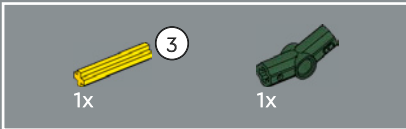
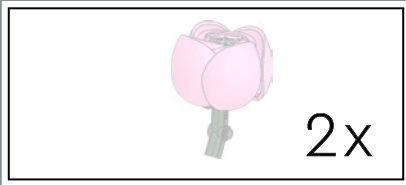
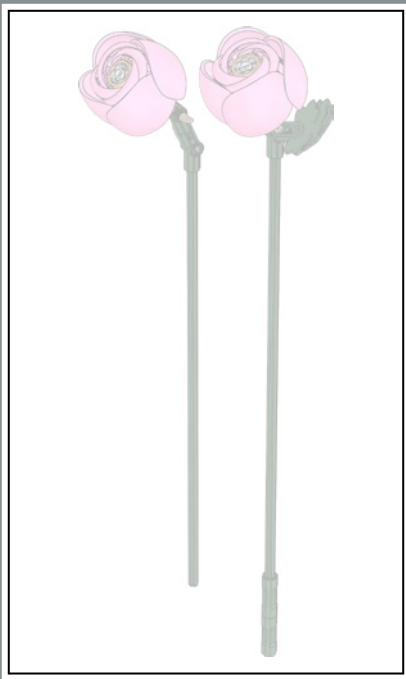

1

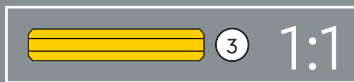
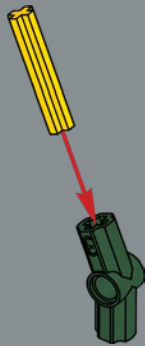

2

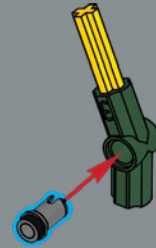

3



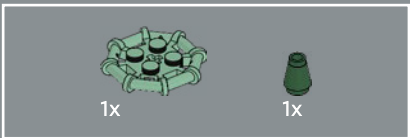

4

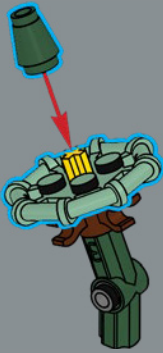

5



6

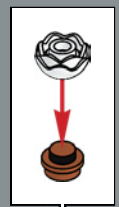

Our LEGO® minifigures like flowers too. This little flower, originally designed as a small peony, now forms the centre of a rose.
 Nos figurines LEGO® aiment aussi les fleurs. Cette petite fleur, conçue à l'origine comme une petite pivoine, forme le centre d'une rose.
 A nuestras minifiguras LEGO® también les gustan las flores. Esta florecilla fue originalmente una peonía y ahora forma el centro de una rosa.

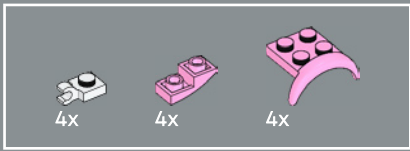

7

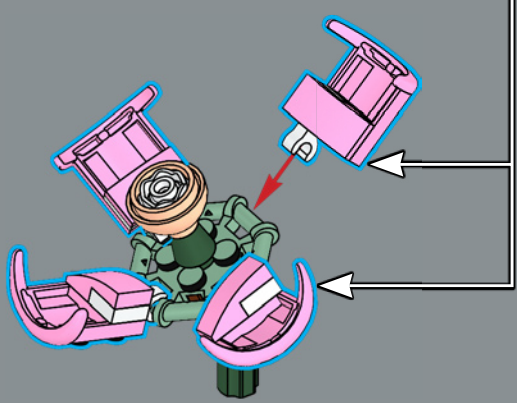
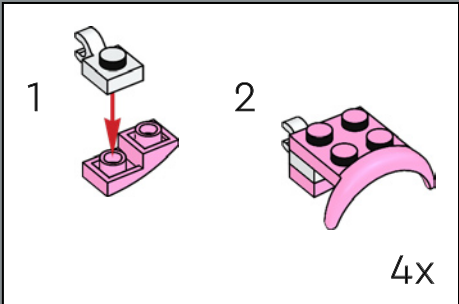

8

The central spiral of petals in this rose is built from LEGO® car wheel arches.

La spirale de pétales au centre de cette rose est construite avec des passages de roues de voitures LEGO®.

La espiral de pétalos del centro de esta rosa está creada a partir de salpicaderas de autos LEGO®.

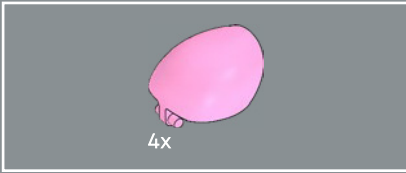
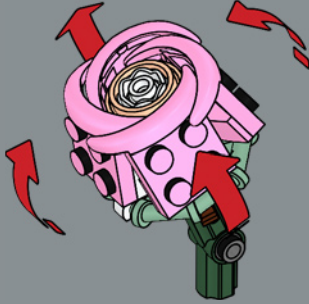

9

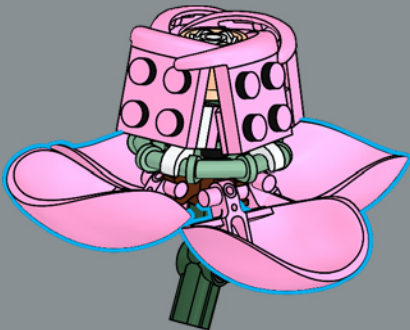

10

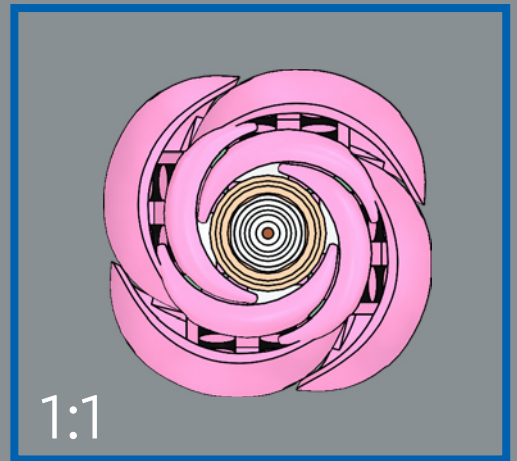

2x

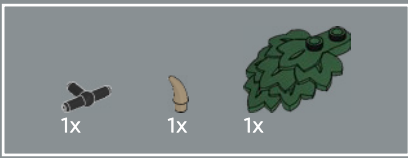

11

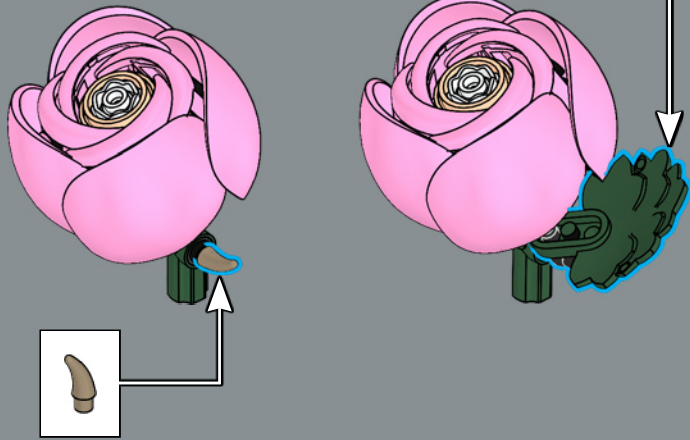
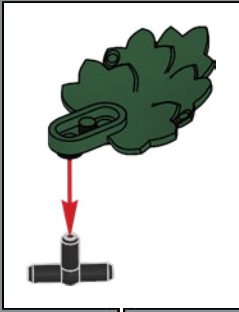

12

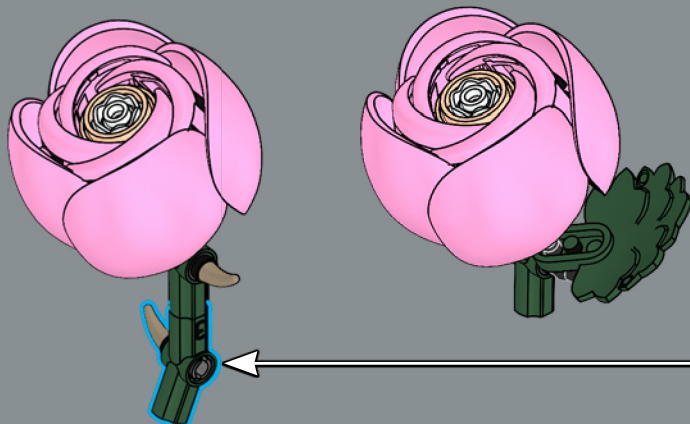
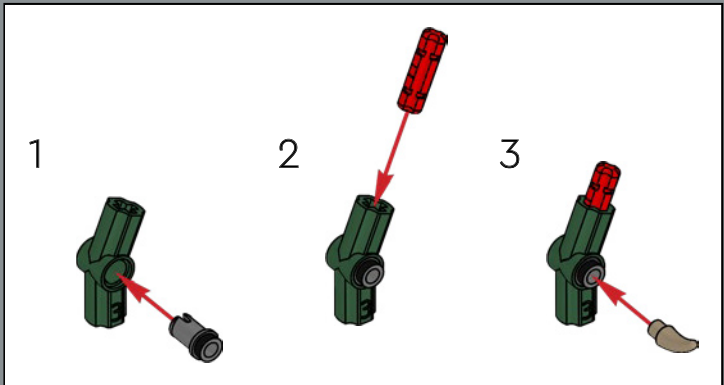

13

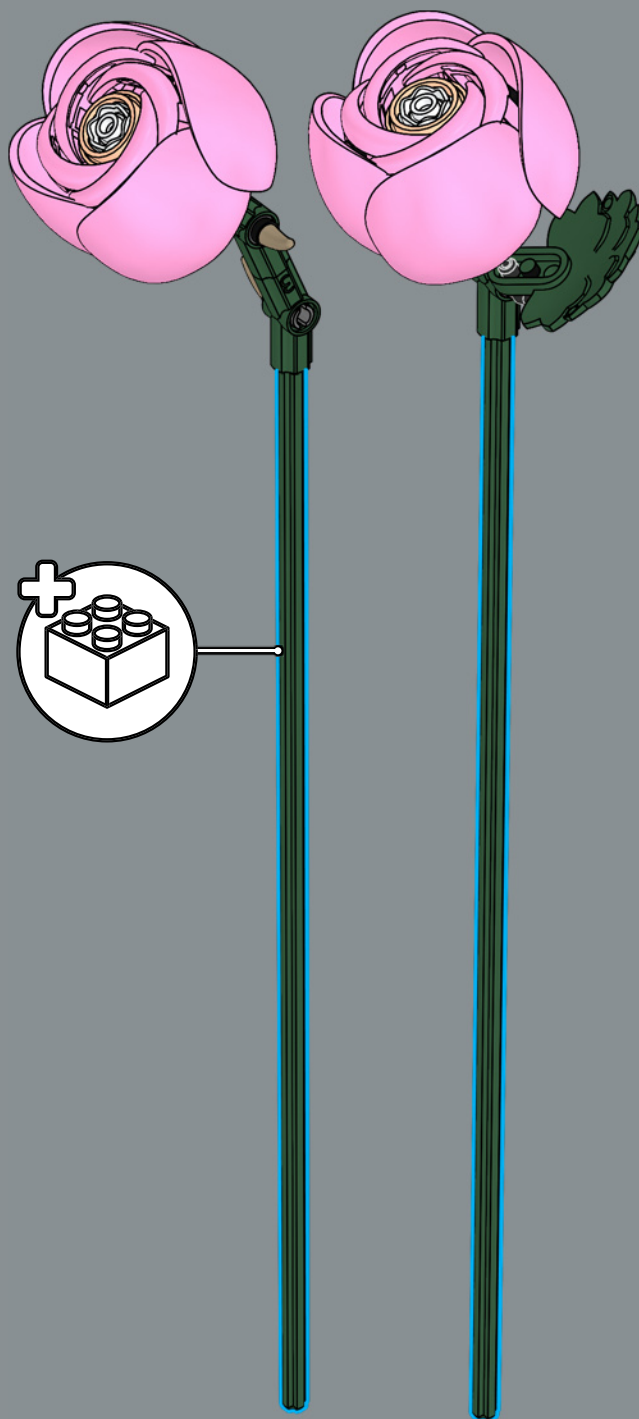

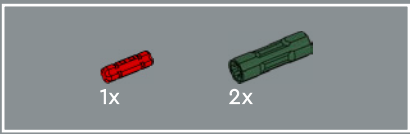

14

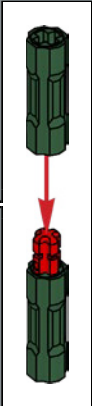

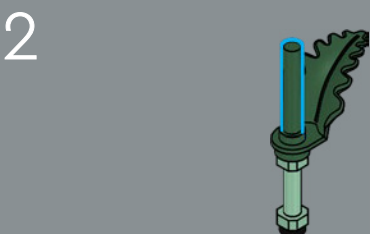
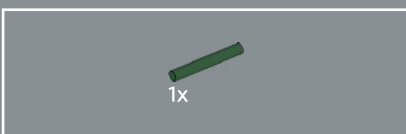
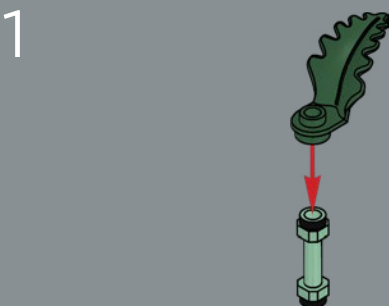
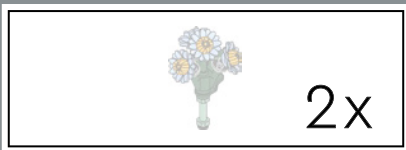
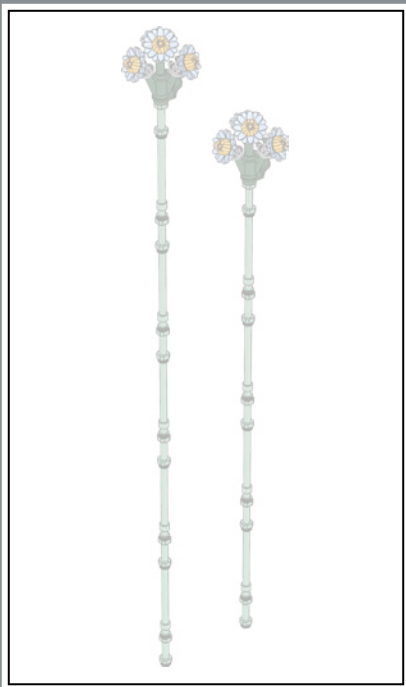

3

This little tripod element was meant to help LEGO® minifigures steady their cameras. Now it holds a little bunch of blue daisies.

Ce petit élément de trépied était destiné à aider les figurines LEGO® à stabiliser leur appareil photo. Maintenant, il tient un petit bouquet de pâquerettes bleues.

Este pequeño elemento que representa un trípode servía para ayudar a las minifiguras LEGO® a mantener firmes sus cámaras. Ahora sostiene un ramillete de margaritas azules.

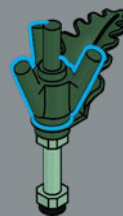

4

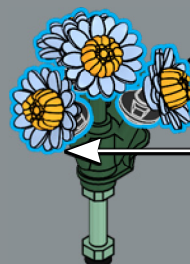
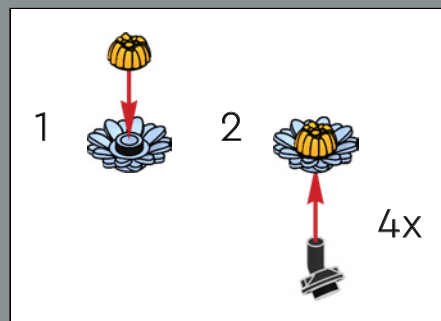

2x

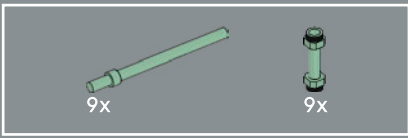

5

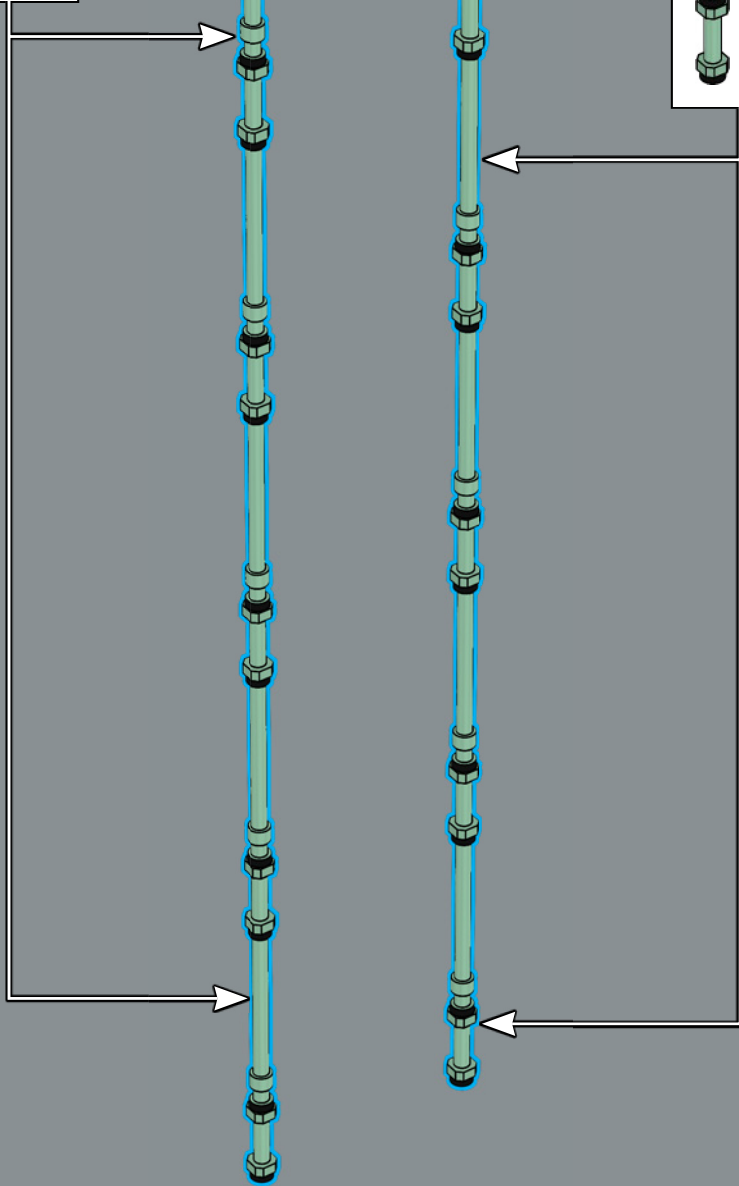
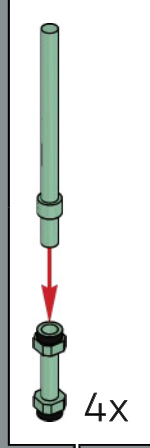
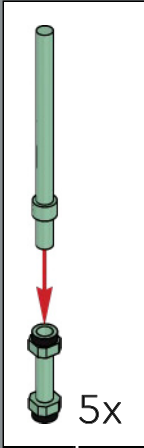



(*Campanula medium*)

CANTERBURY BELLS CAMPANULE CARILLON CAMPANILLA DE CANTERBURY

A southern European biennial, the *Campanula's* cup- or bell-shaped blossoms can usually be seen in blue, white or pink hues all through the summer.

Biennale du sud de l'Europe, la campanule présente des fleurs en forme de coupe ou de cloche, généralement dans les tons bleus, blancs ou roses, tout au long de l'été.

Los farolillos de la *Campanula*, una especie bienal de la flora del sur de Europa típica del verano, tienen forma de campana en tonos azules, blancos o rosas.



(*Ranunculus*)

PERSIAN BUTTERCUP RENONCULE RANÚNCULO

Native to Europe, North America and Asia, the Persian buttercup with its intricate layers of pastel-colored petals is always popular bouquet material.

Originnaire d'Europe, d'Amérique du Nord et d'Asie, la renoncule, avec ses couches complexes de pétales aux couleurs pastel, est toujours très appréciée dans les bouquets.

Los ranúnculos, autóctonos de Europa, Norteamérica y Asia, con intrincadas capas de pétalos en colores pastel, siempre son una opción popular para los ramos de flores.



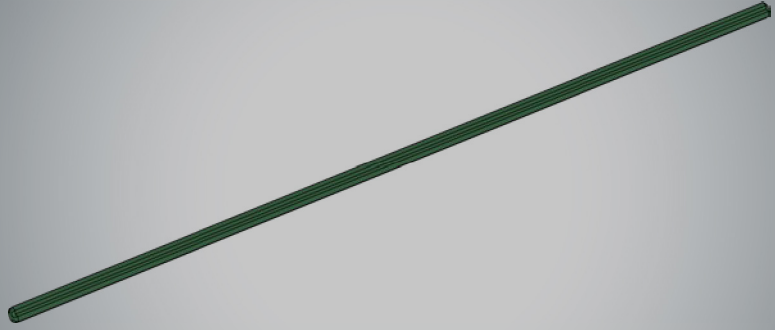
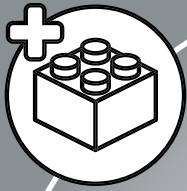

1x



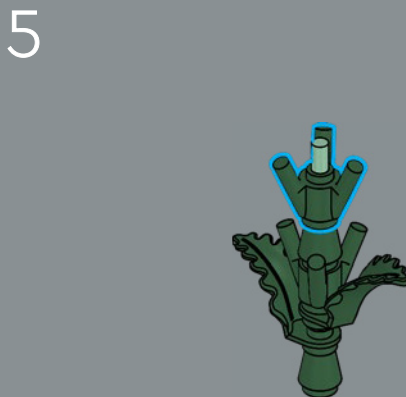
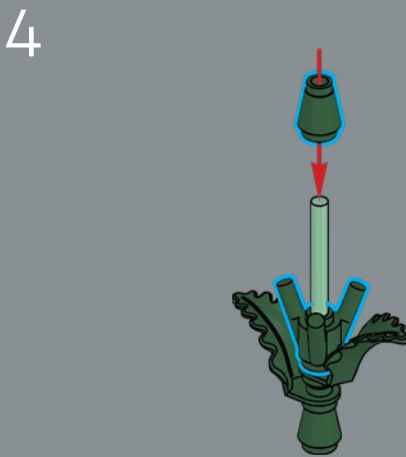
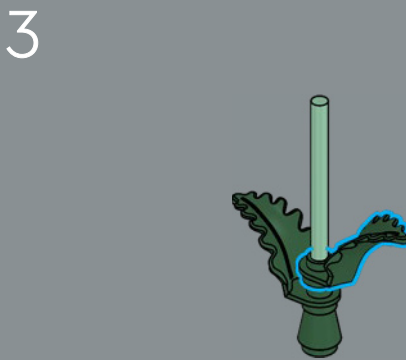
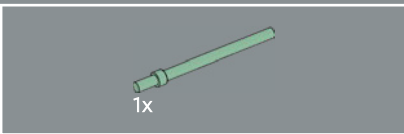
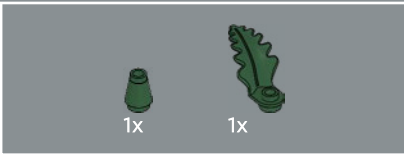
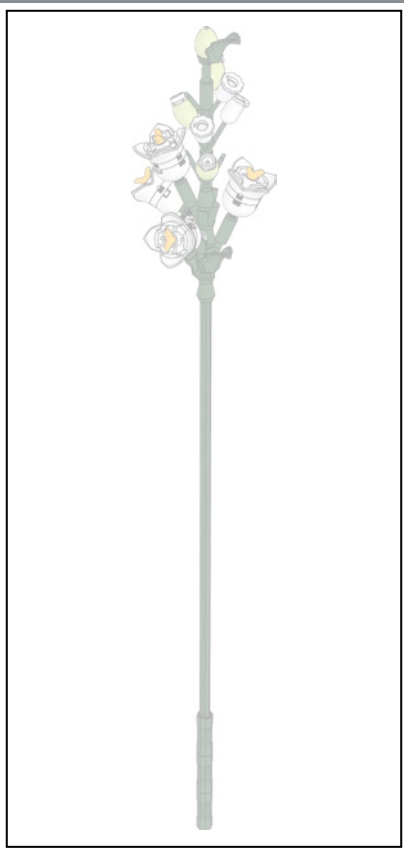

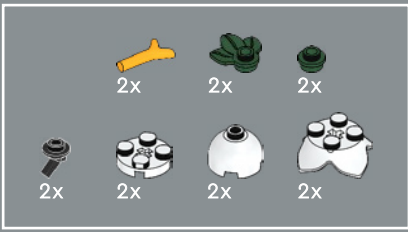

6

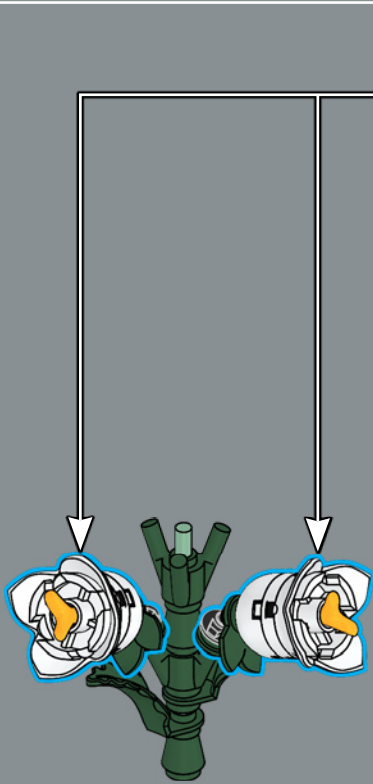
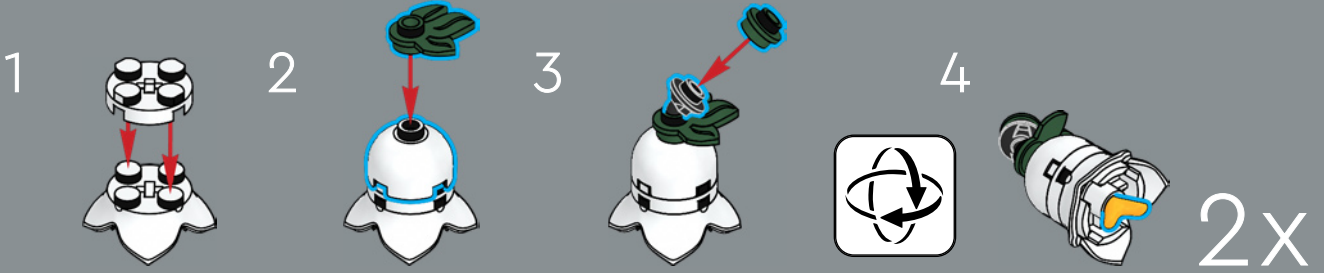



7

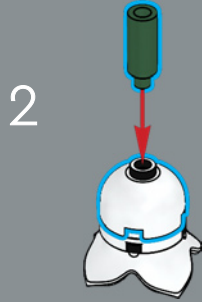
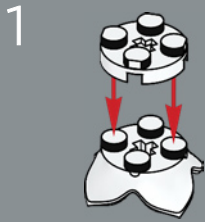

2x

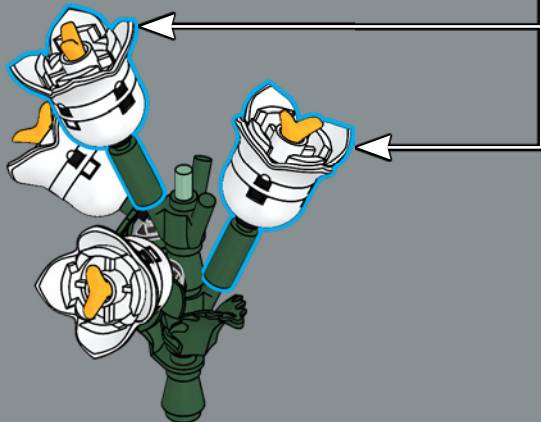

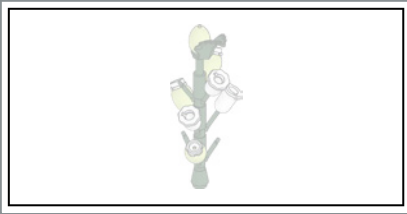

8

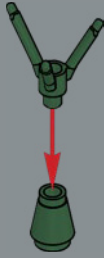

9

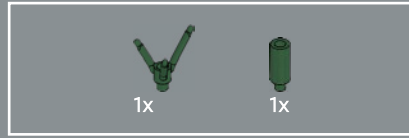
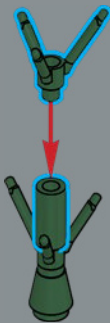

10

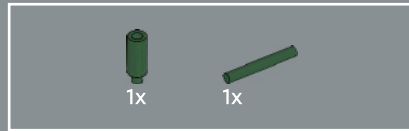
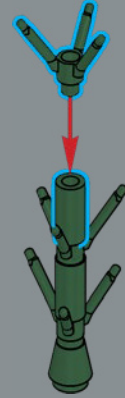

11

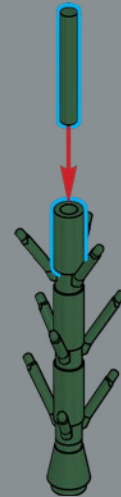



12

One of our characters from the LEGO® DREAMzzz™ line is used here to represent a small *Campanula* blossom.

L'un de nos personnages de la gamme LEGO® DREAMzzz™ est utilisé ici pour représenter une petite fleur de campanule (*Campanula*).

Uno de los personajes de nuestro tema LEGO® DREAMzzz™ se usó aquí para representar una florecilla de *Campanula*.

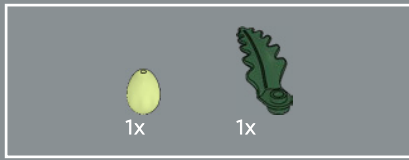
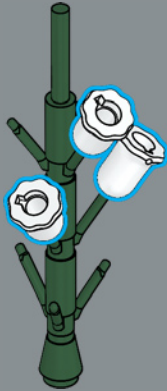

14

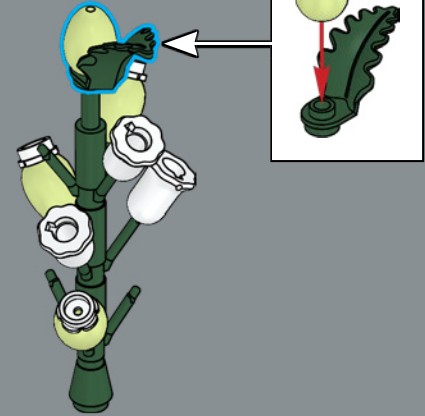

13

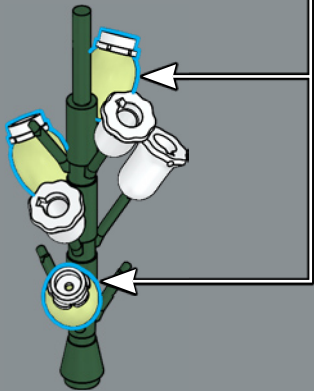
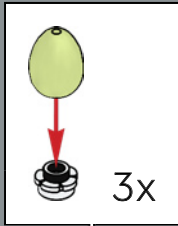

15

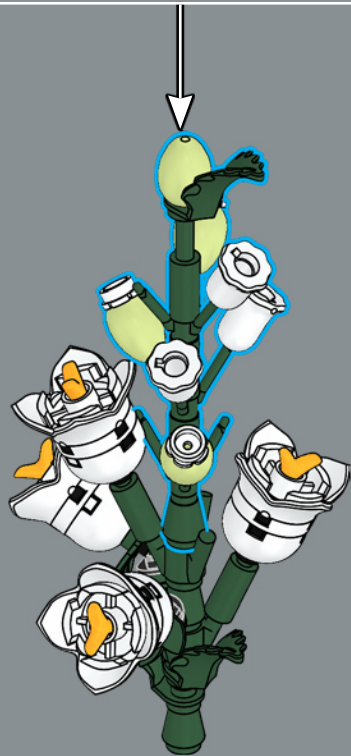

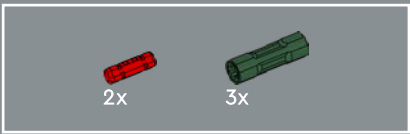

16

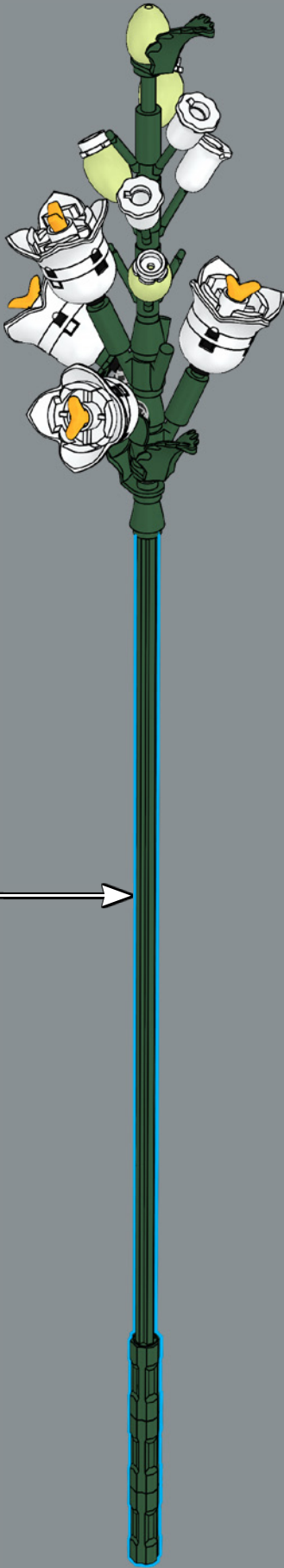
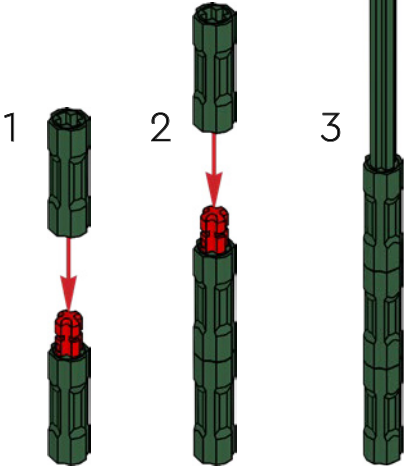
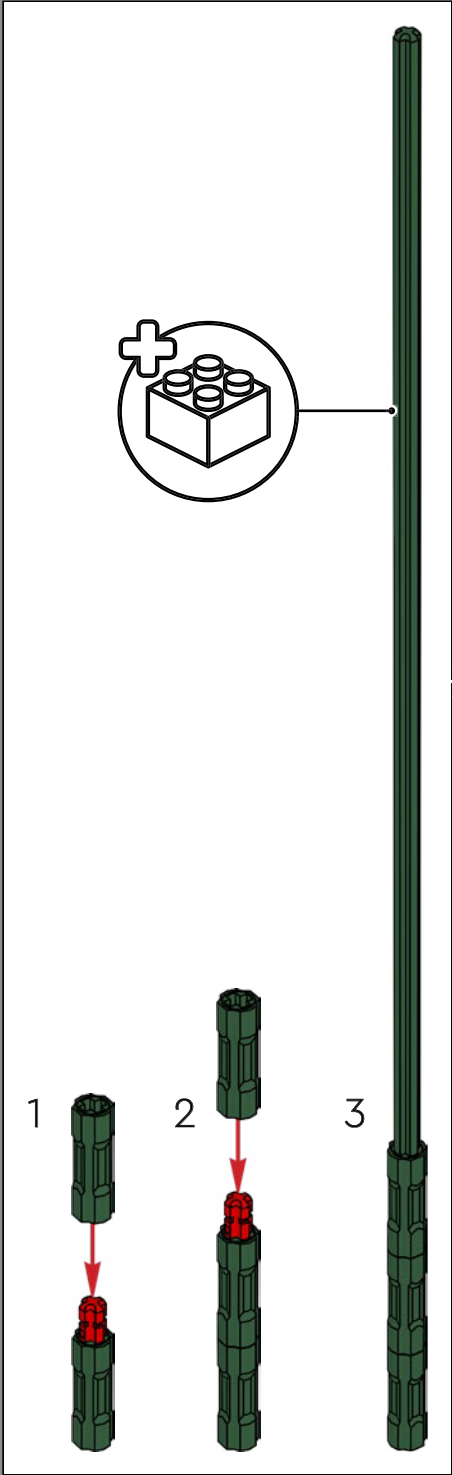

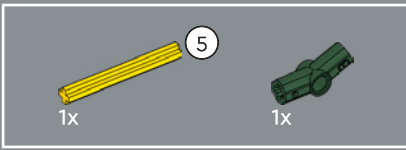

1

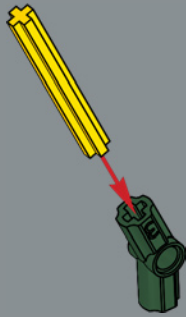

2

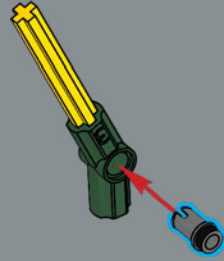

3

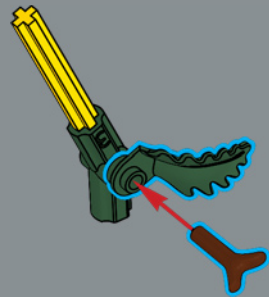

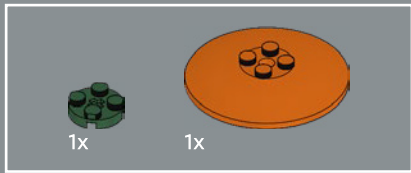

4

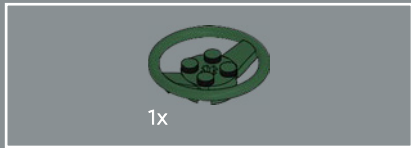
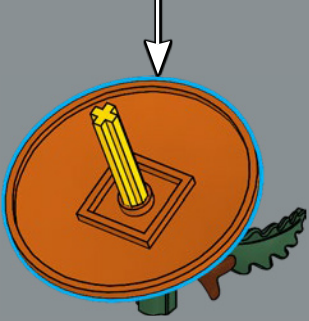
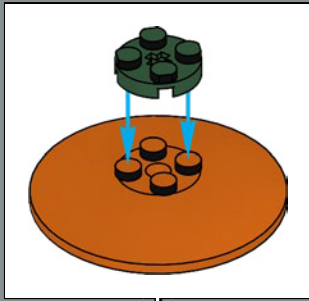

5

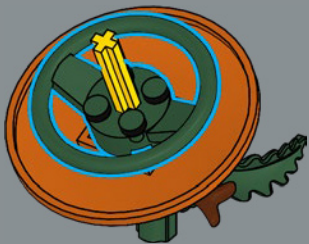

6

This steering wheel, designed for large-scale LEGO® cars, now constructs the centre of our LEGO flowers. The minifigure axe head was introduced in 2005 for the LEGO Vikings line.

Ce volant, conçu pour les voitures LEGO® de grande taille, constitue désormais le centre de nos fleurs LEGO. La tête de hache pour figurine a été introduite en 2005 pour la gamme LEGO Vikings.

Este volante, diseñado para autos LEGO® a gran escala, ahora conforma el centro de nuestras flores LEGO. La cabeza de hacha para minifiguras se introdujo en 2005 para la gama LEGO Vikings.

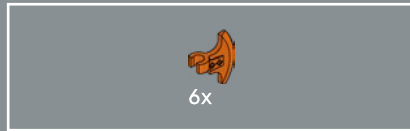
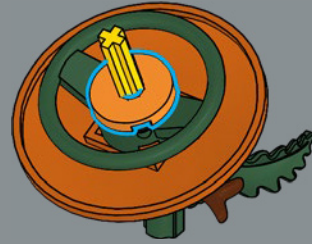

7

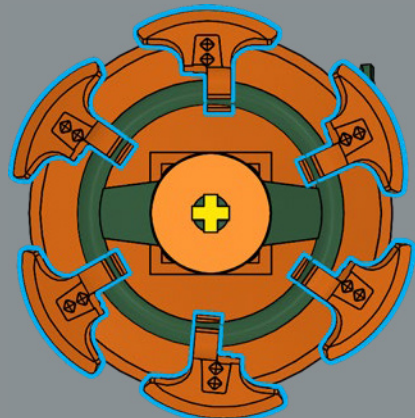



8

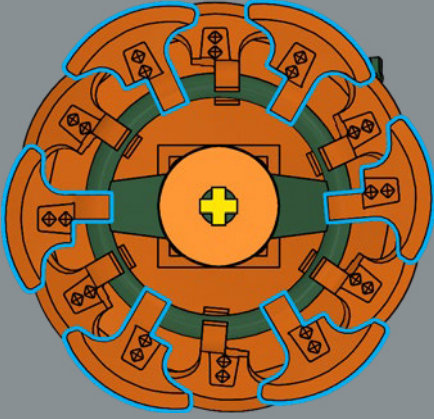

9

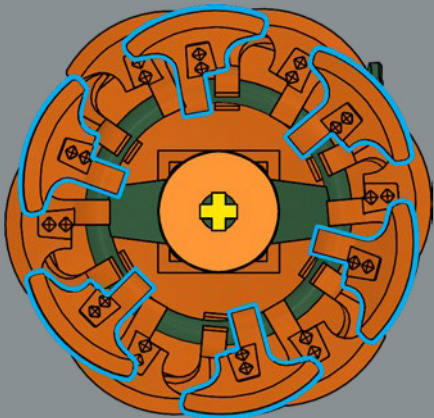

10

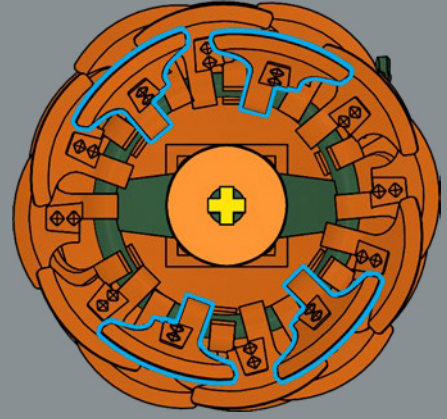

11

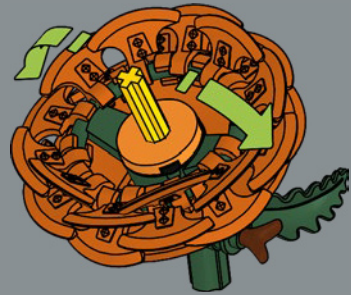

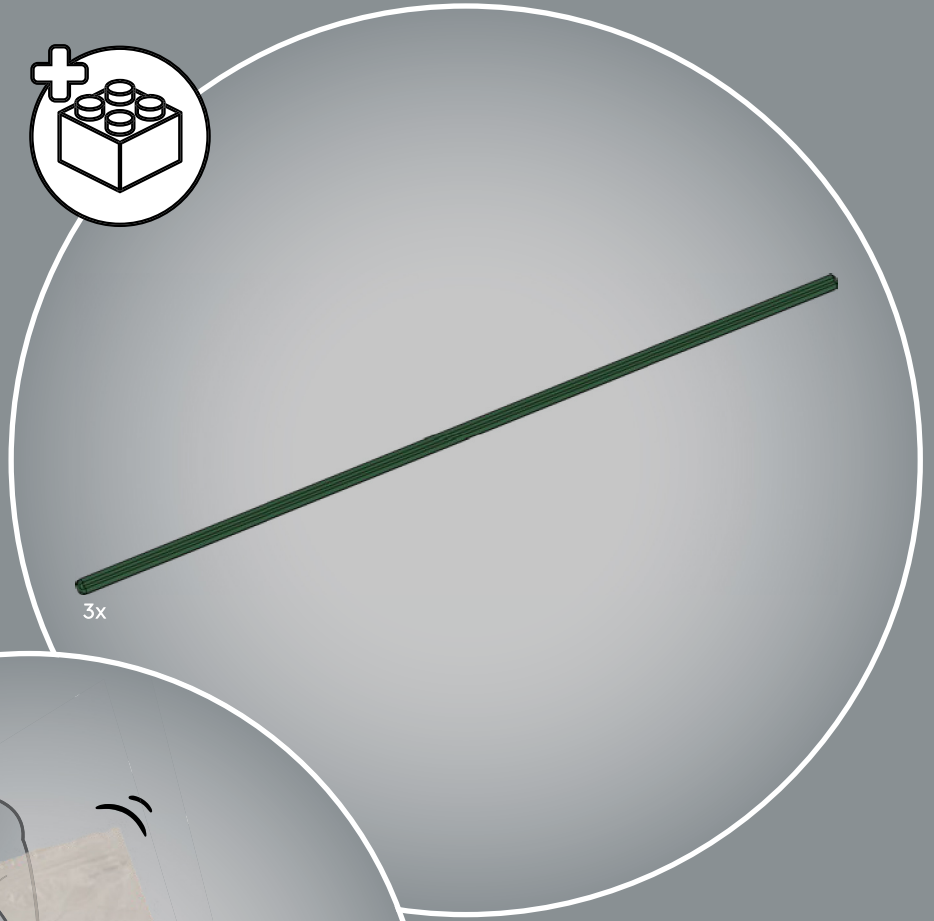
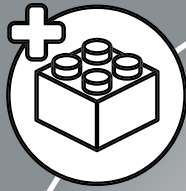

3x



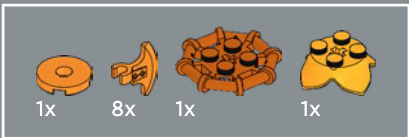

12

1

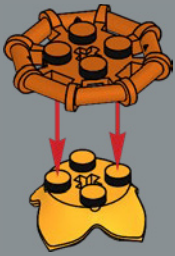

2

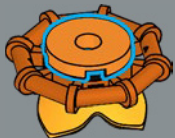

3

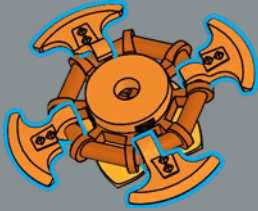

4

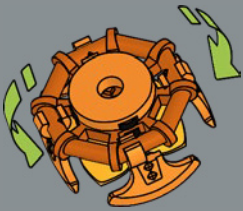

5

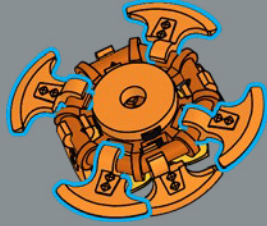

6

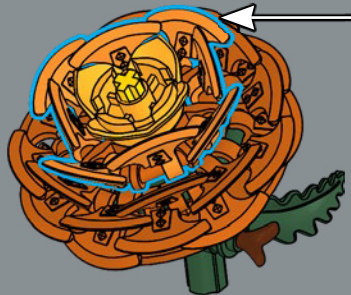
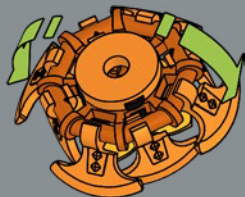

2x

This is, perhaps, the most axes ever used in a LEGO® flower.
 C'est peut-être le plus grand nombre de haches jamais utilisées dans une fleur LEGO®.
 Es, quizá, la flor LEGO® que más hachas tiene de todas las que hemos creado.

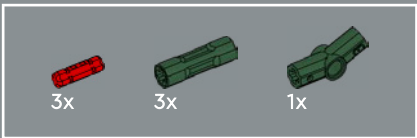

13

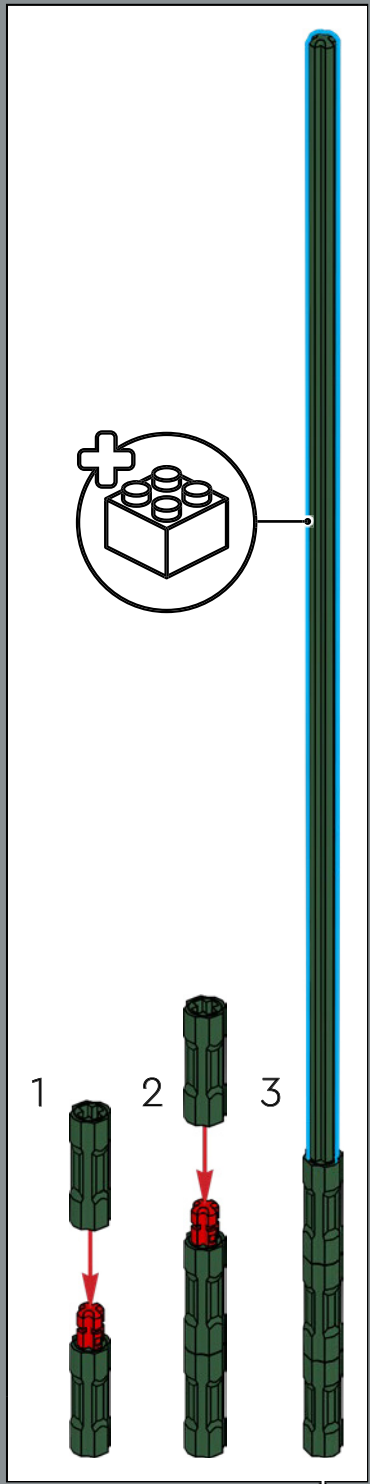
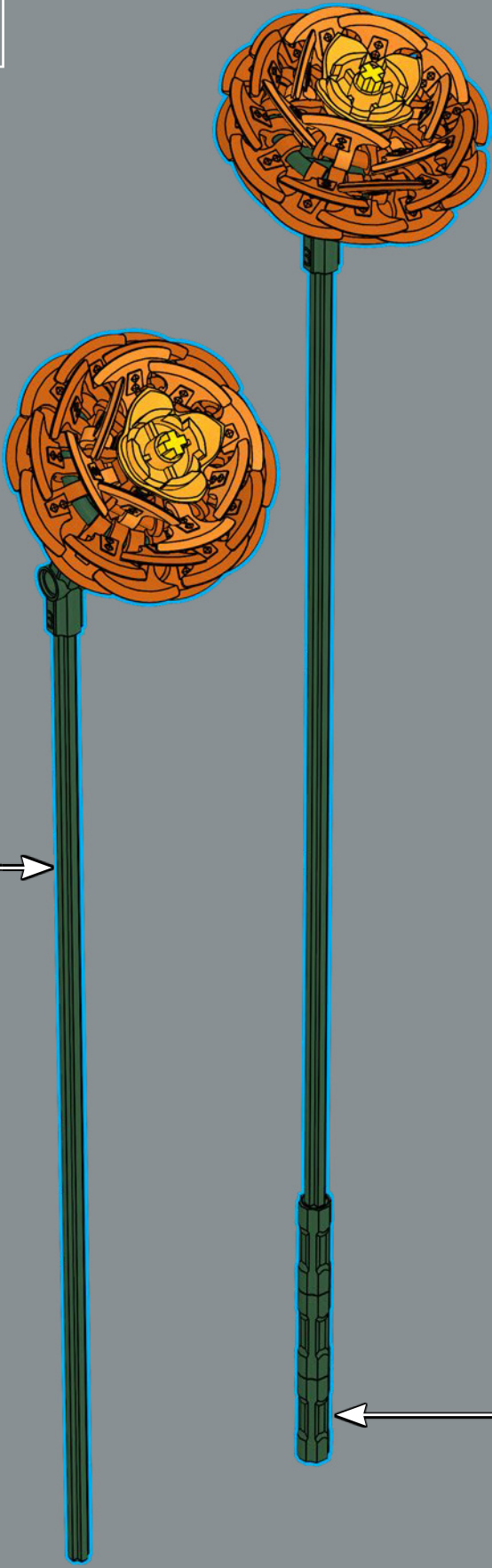
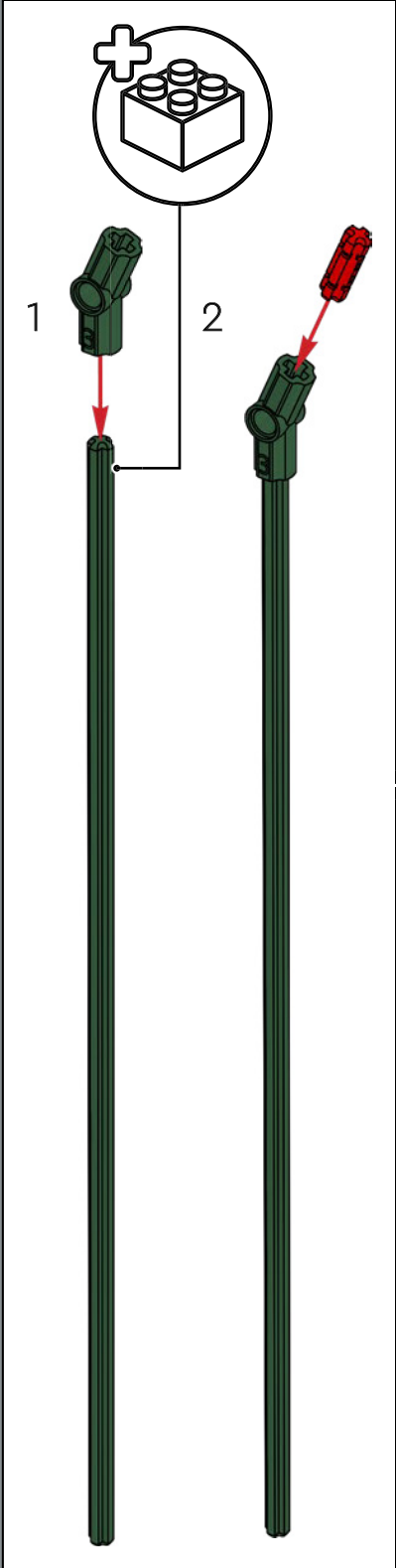



(Dahlia nymphaea)

WATERLILY DAHLIA
DAHLIA NÉNUPHAR
DALIA NENÚFAR

Symbols of elegance and grace, the decorative waterlily dahlia blossoms unfold like a luxurious firework display.

Symbole d'élégance et de grâce, la fleur du dahlia nénuphar décoratif se déploie comme un superbe feu d'artifice.

Símbolos de elegancia y finura, las decorativas flores de la dalia nenúfar se abren en un despliegue semejante a fastuosos fuegos artificiales.

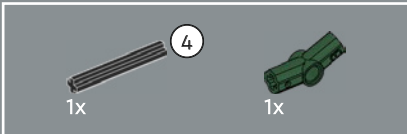
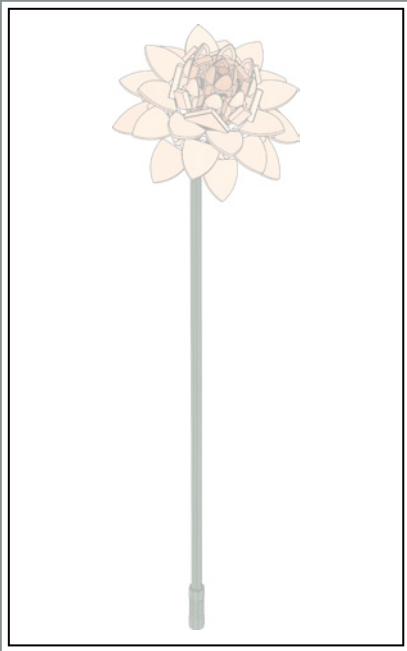

1

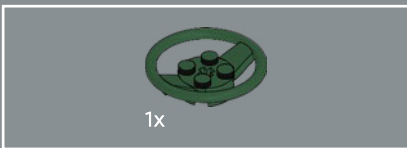
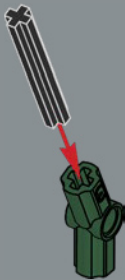

2

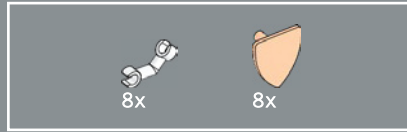
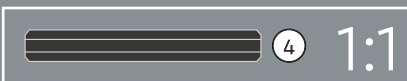
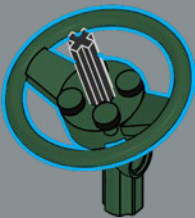

3

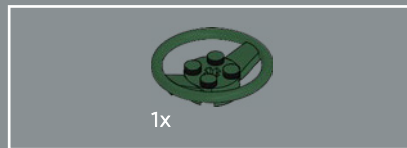
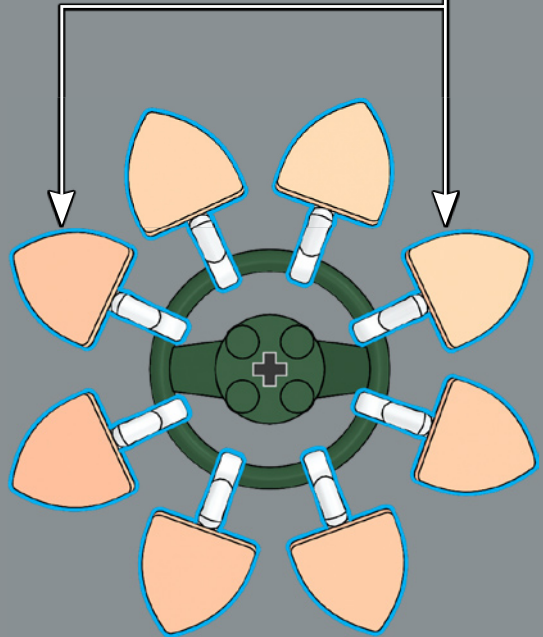
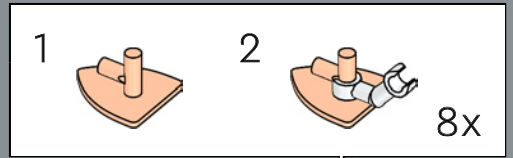

4

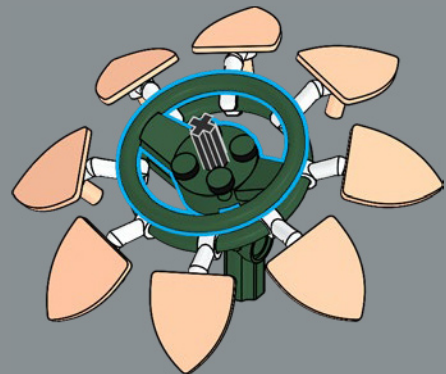

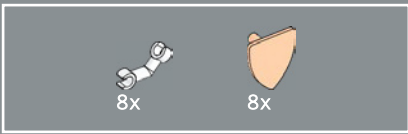

5

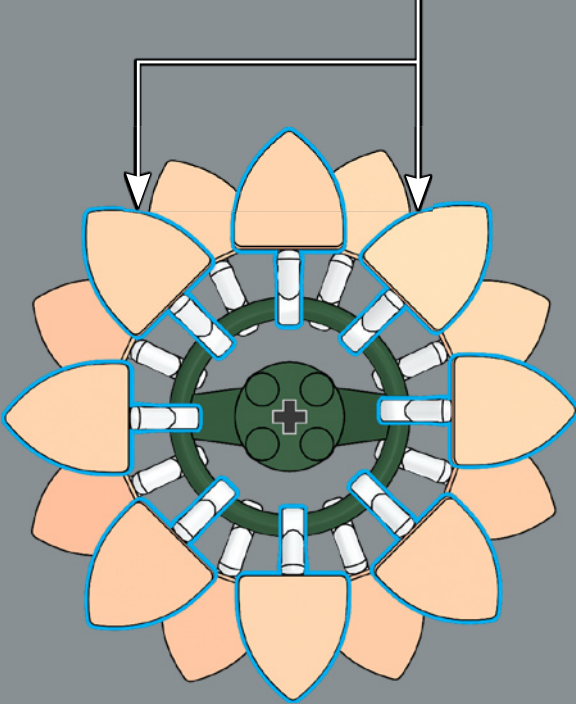
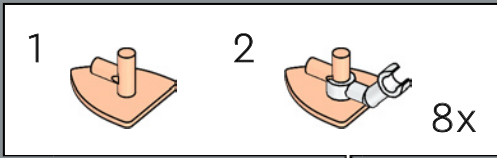

Congratulations! You are now better equipped than our LEGO® knights were when these shields were introduced back in 1978!

Félicitations ! Vous avez maintenant un meilleur équipement que nos chevaliers LEGO® lorsque ces boucliers ont été introduits en 1978 !

¡Felicidades! Ahora puedes cubrirte y resguardarte mejor que nuestros caballeros LEGO® antes de que se introdujeran estos escudos en 1978...

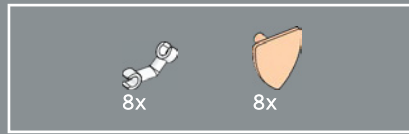

6

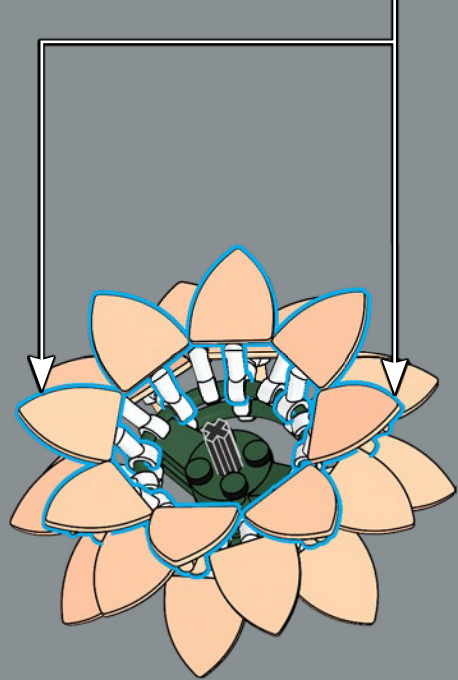
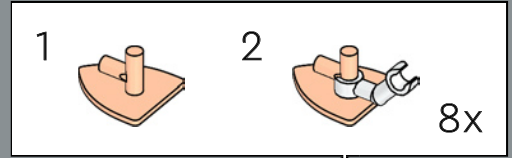

7

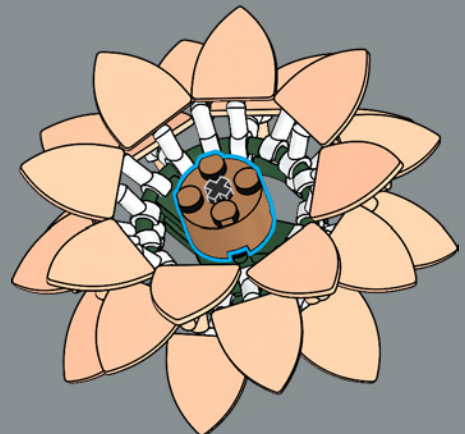

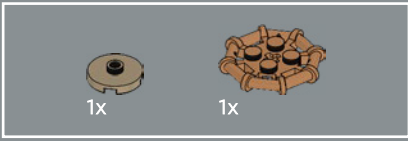

8

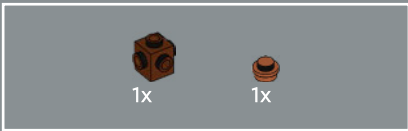
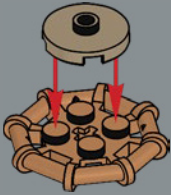

9

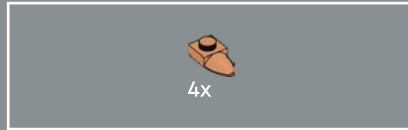
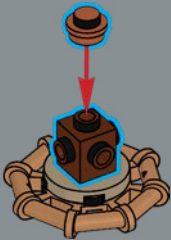

10

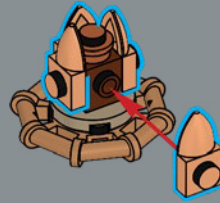

11

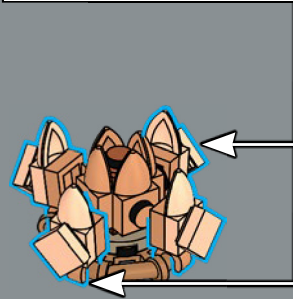
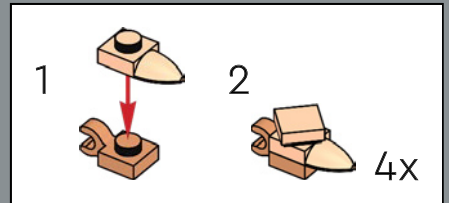



12

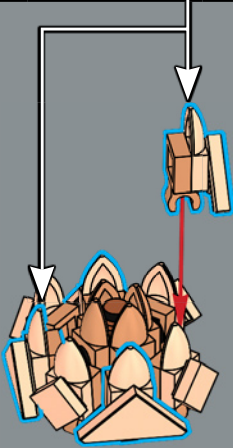
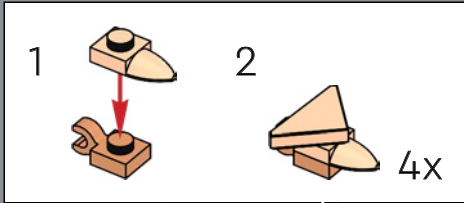

13

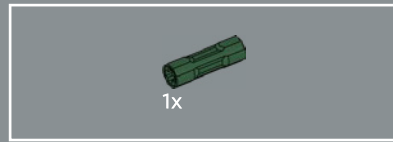
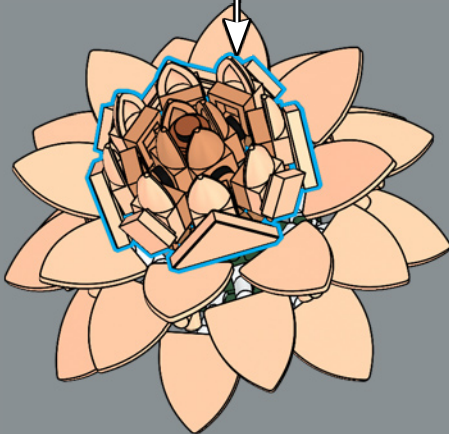

14

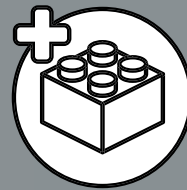
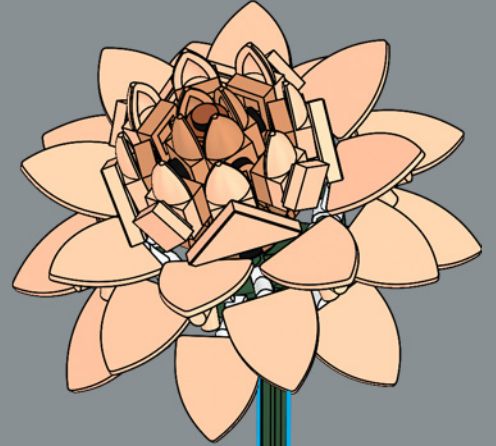



(Cymbidium)

BOAT ORCHID L'ORCHIDÉE BATEAU ORQUÍDEA BARCO

Cymbidium orchids are documented in records from Confucius' time, around 500 BCE, making them the oldest known cultivated orchid species.

L'orchidée *Cymbidium* est décrite dans des documents datant de l'époque de Confucius, vers 500 avant notre ère, ce qui en fait l'espèce d'orchidée cultivée la plus ancienne connue.

Las orquídeas *Cymbidium* aparecen documentadas en registros de la época de Confucio, alrededor del año 500 a. C., lo que las convierte en la especie de orquídea cultivada más antigua que conocemos.

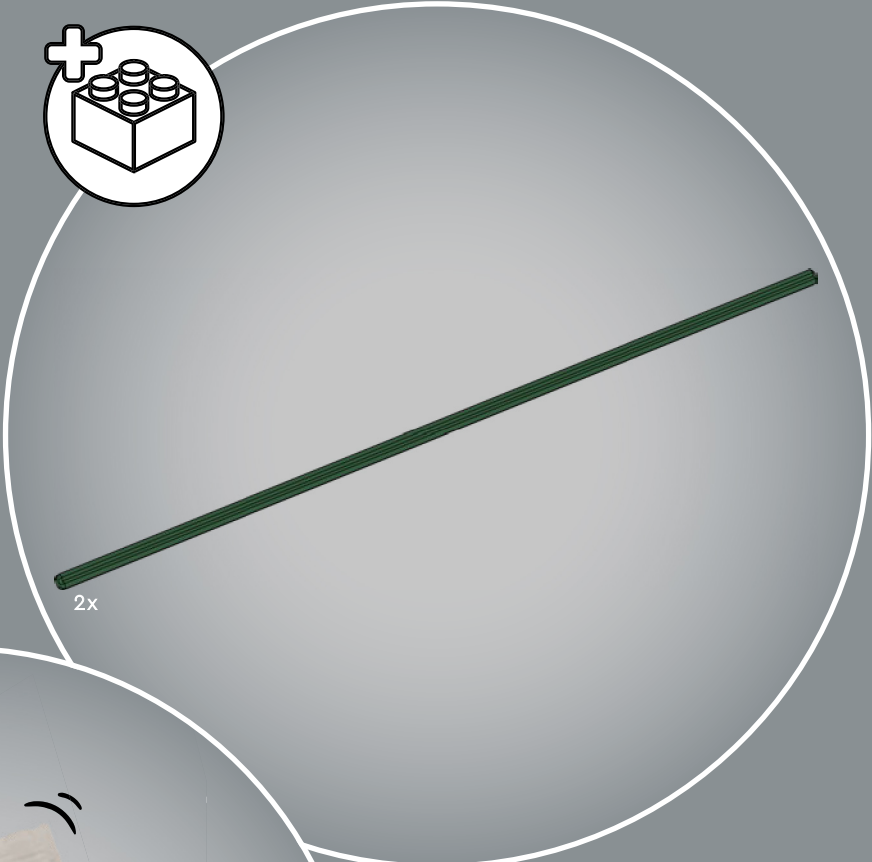
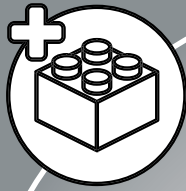

2x



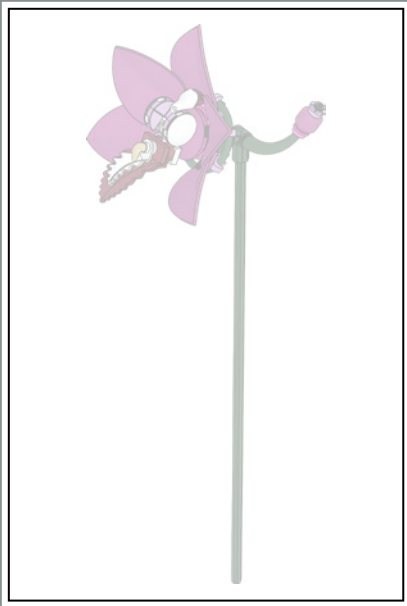

1

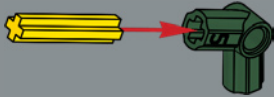

2

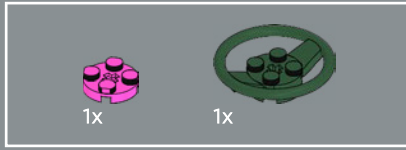
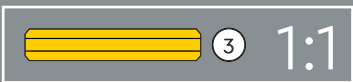
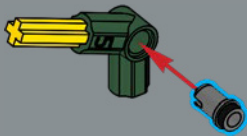

3

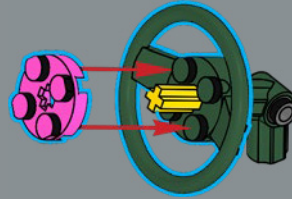

4

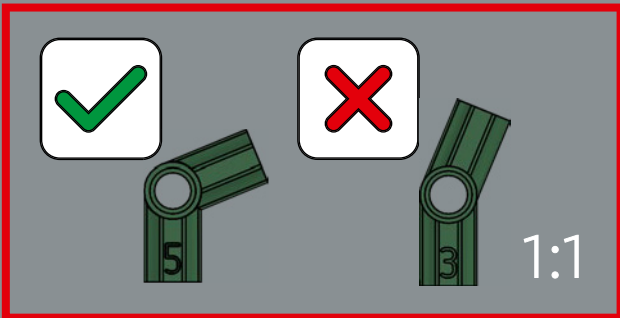
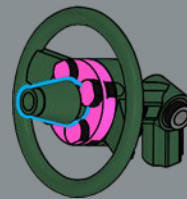

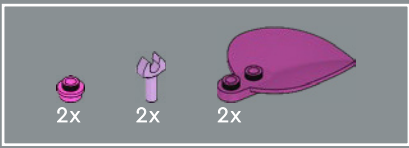

5

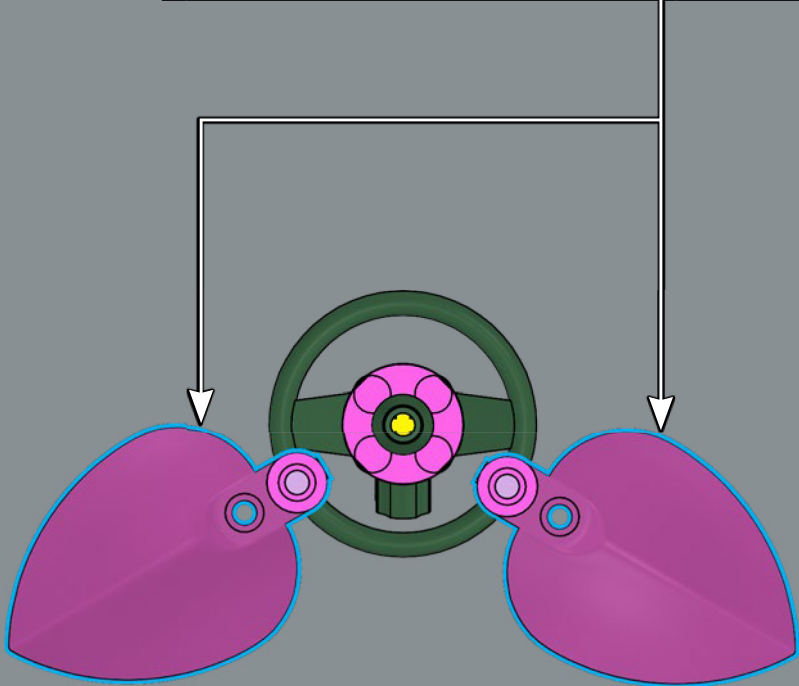
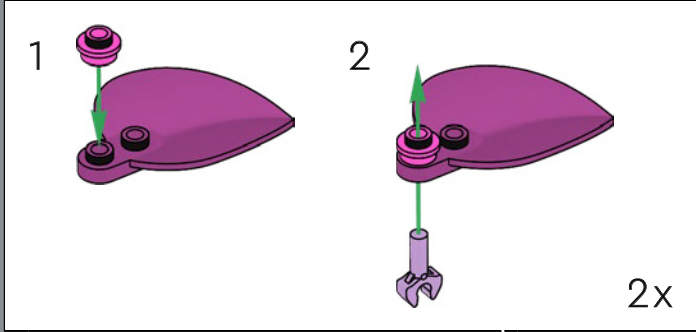



6

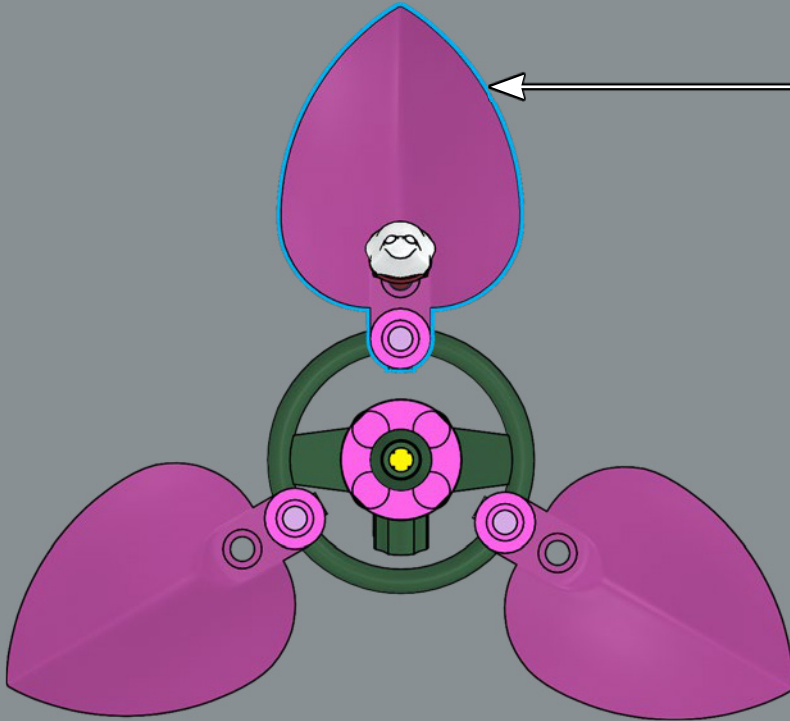
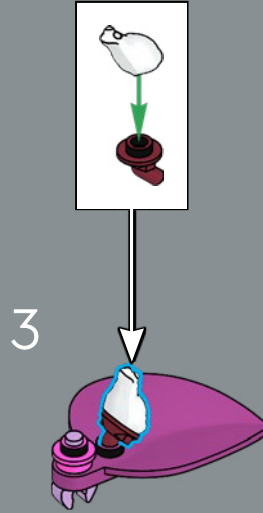
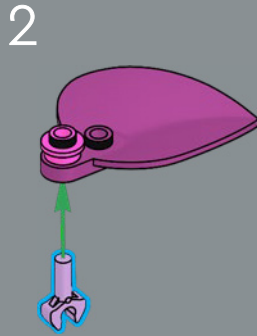
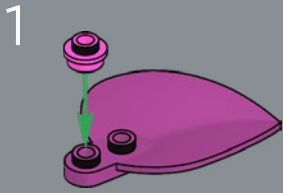

Even a LEGO® frog can be used to mimic parts of a flower!

Même une grenouille LEGO® peut être utilisée pour imiter les parties d'une fleur !

Para recrear partes de una flor puede usarse... ¡hasta una rana LEGO®!

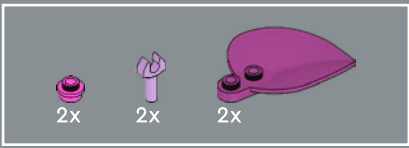

7

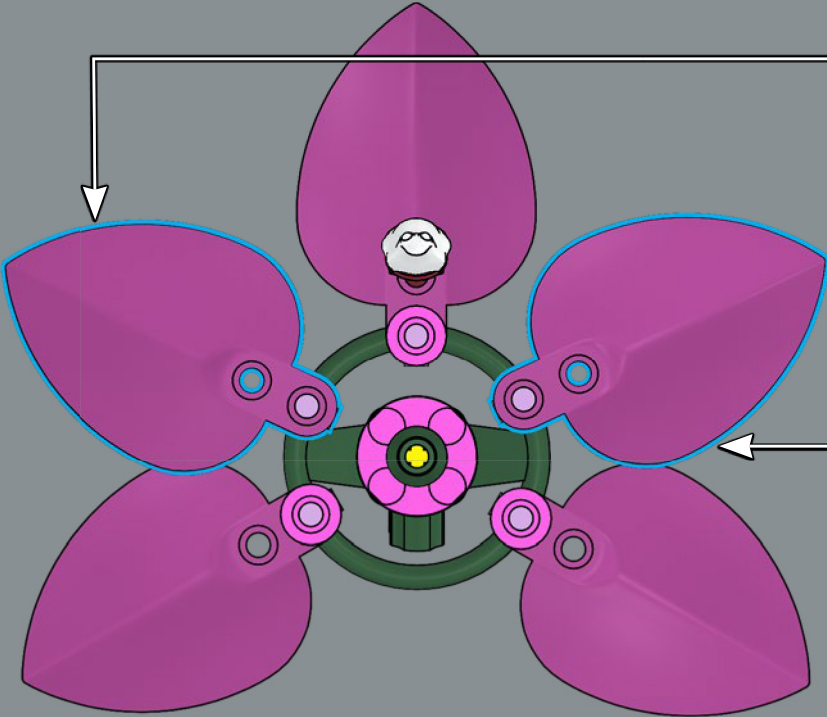
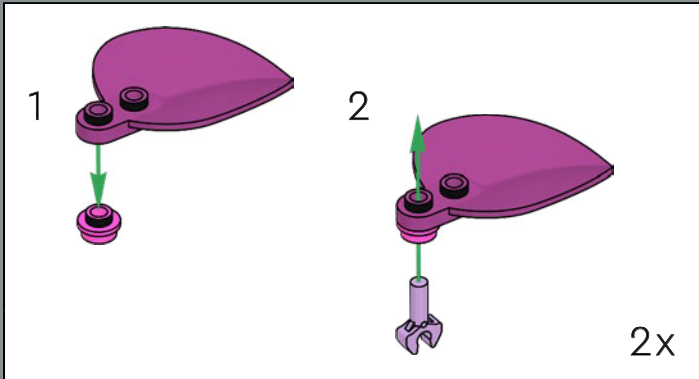

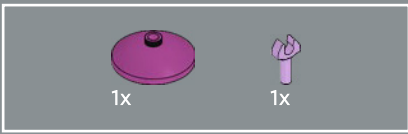

8

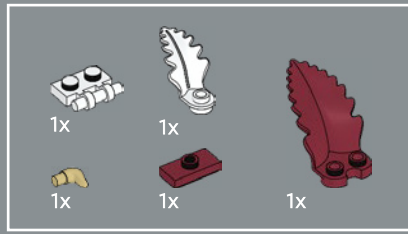
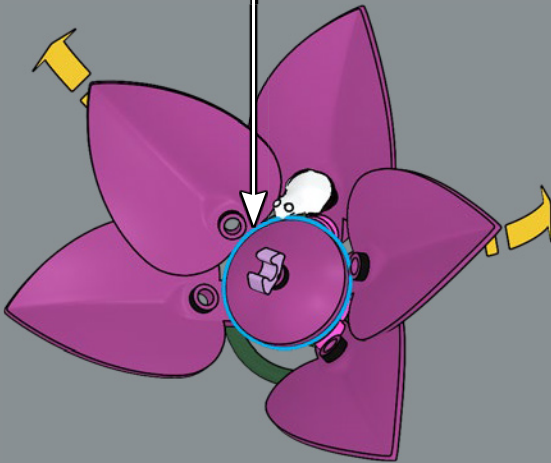
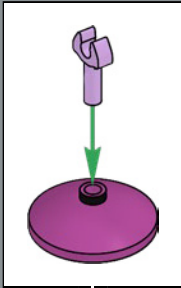

9

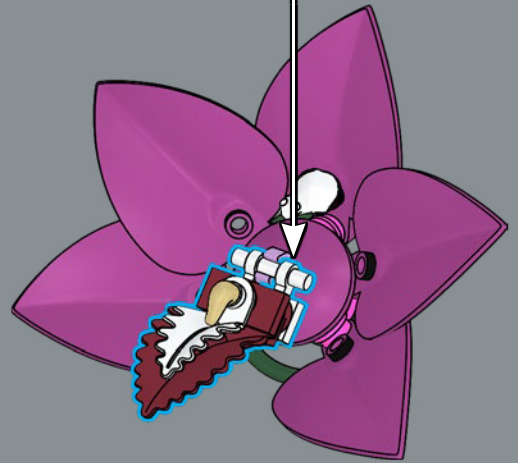
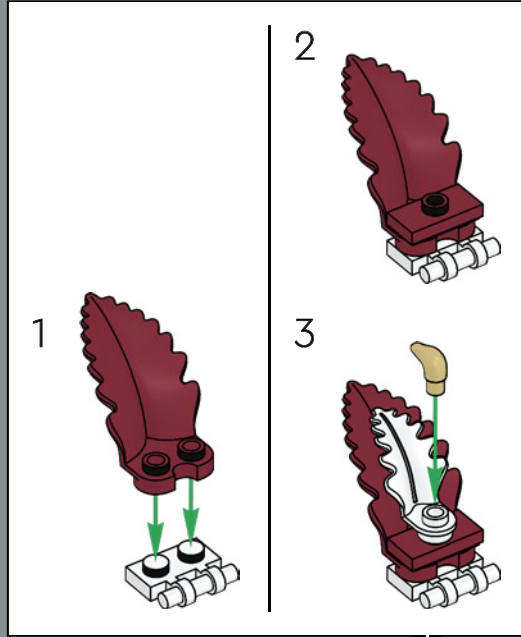



10

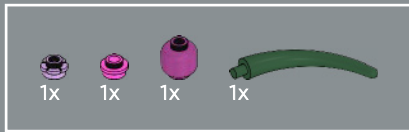
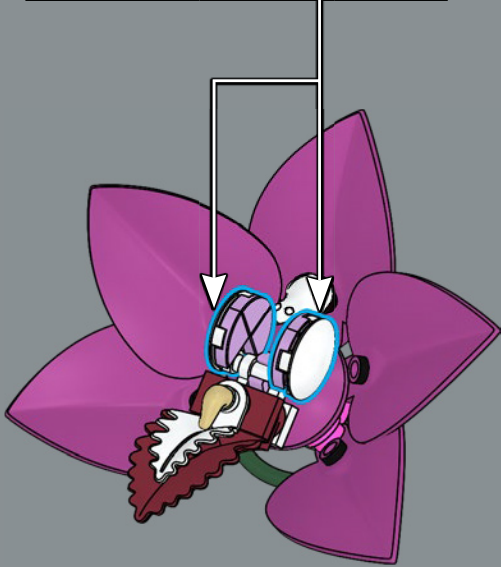
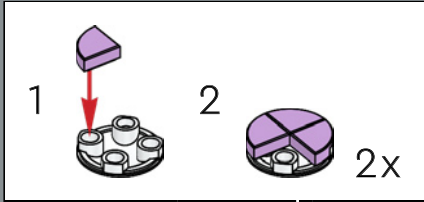

11

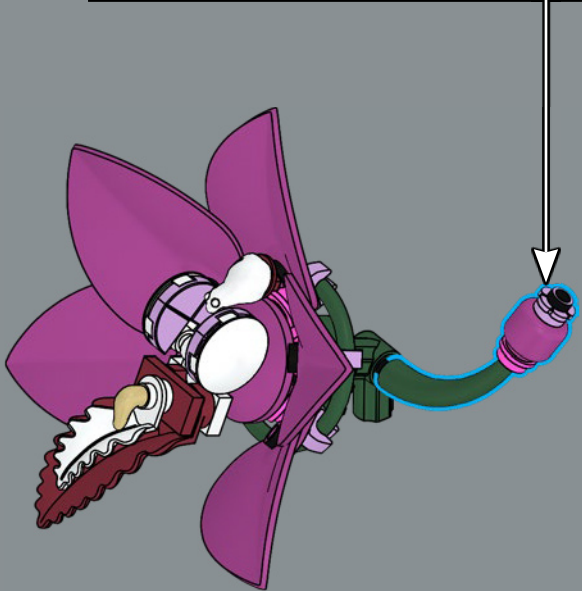
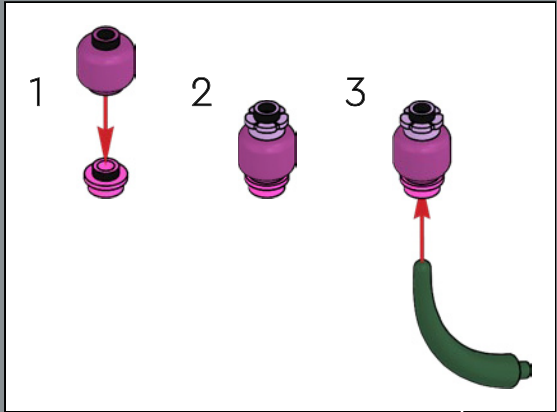

12

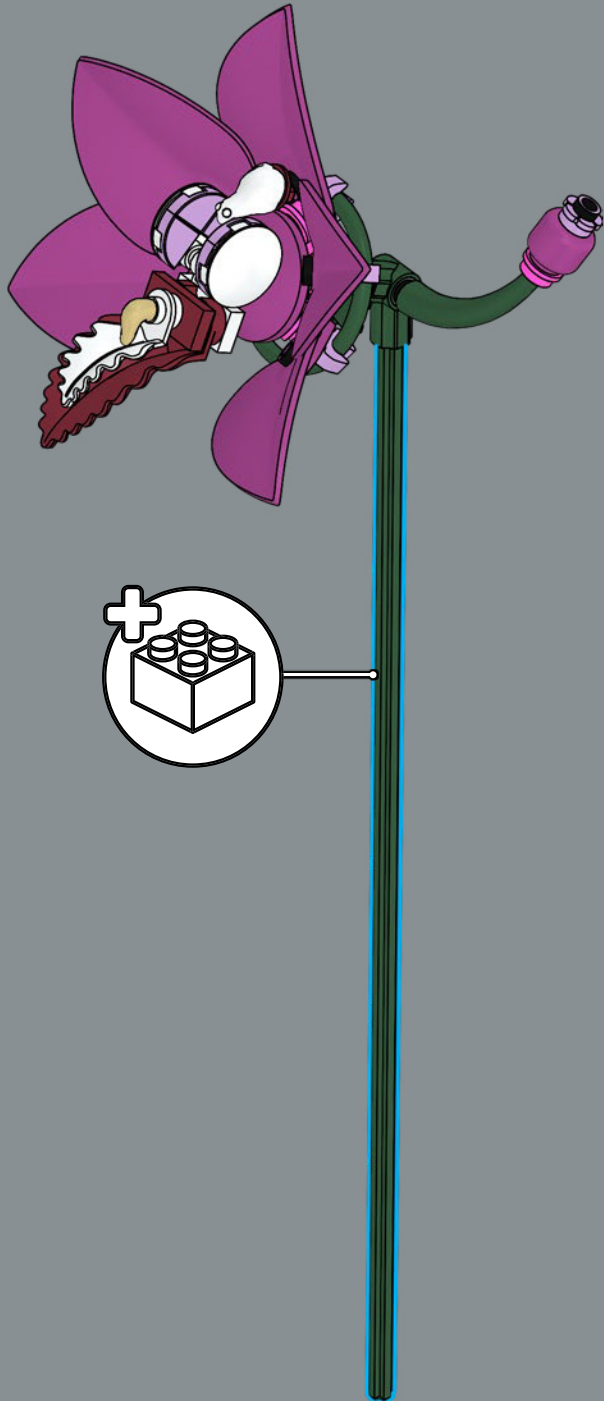

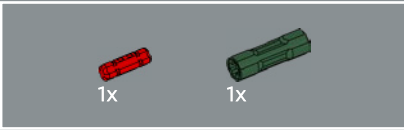
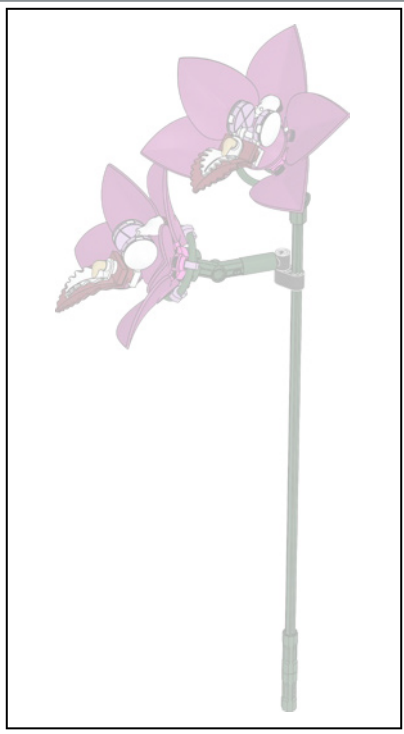

13



14



15



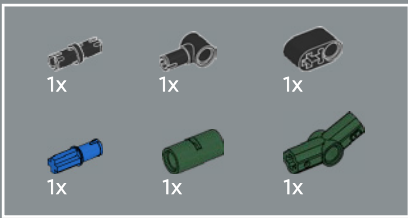

16

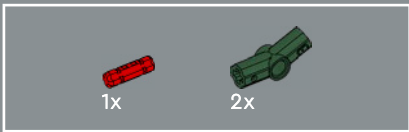
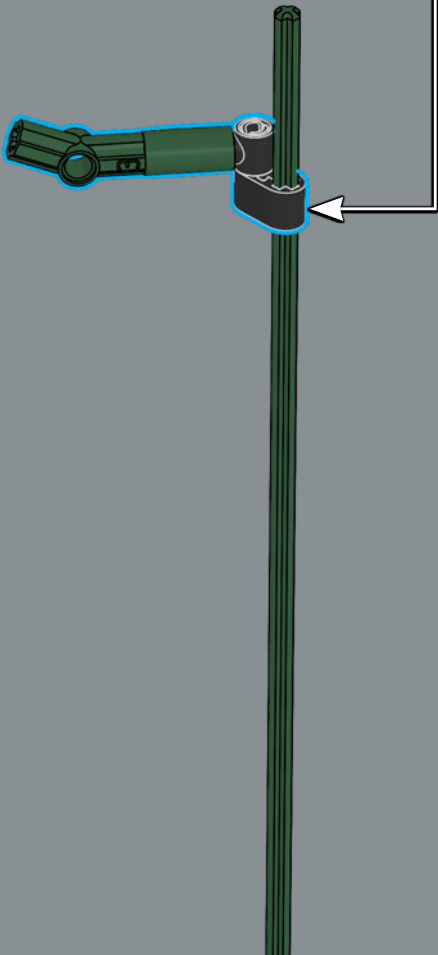
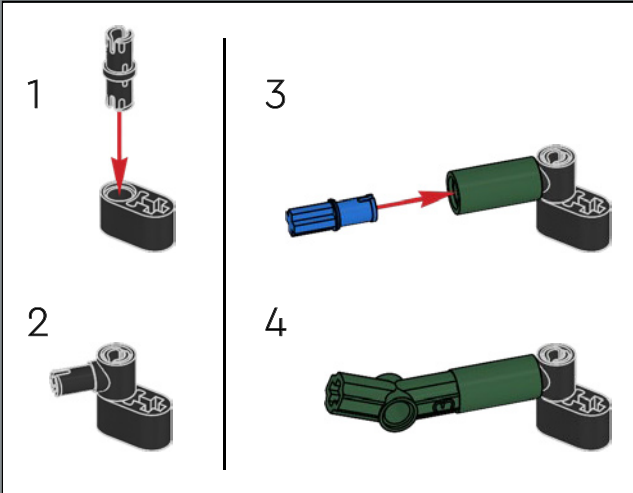

17

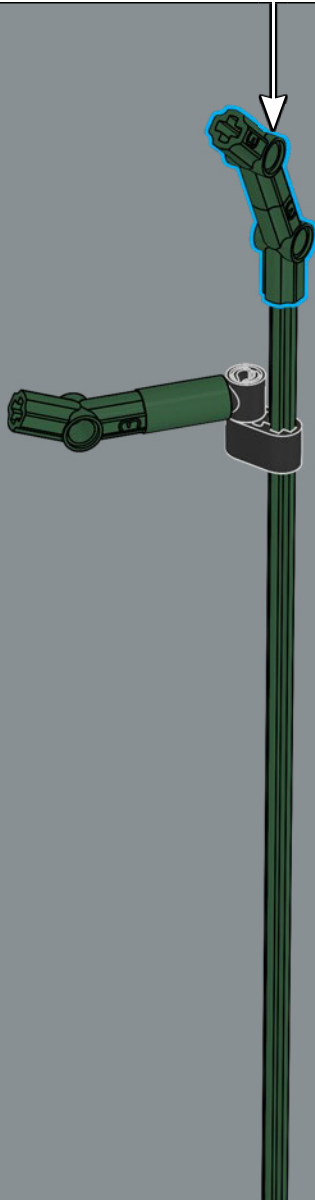
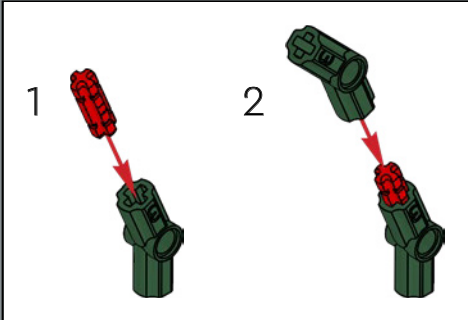

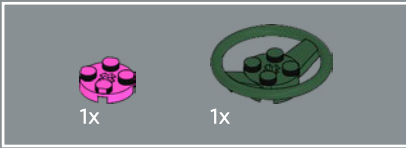
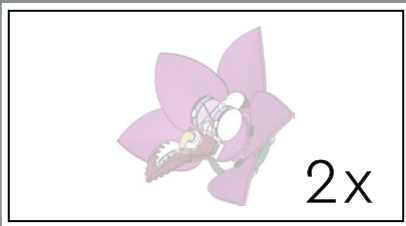

18

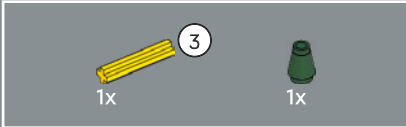
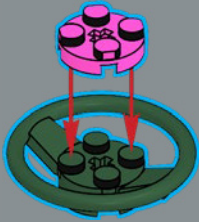

19

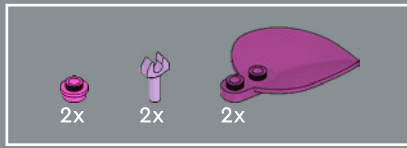
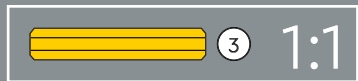
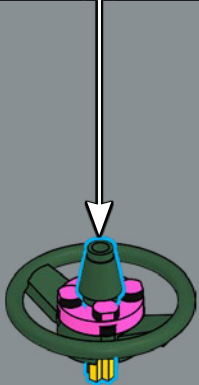
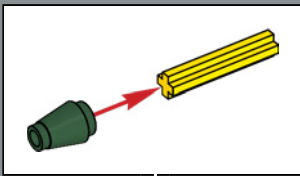

20

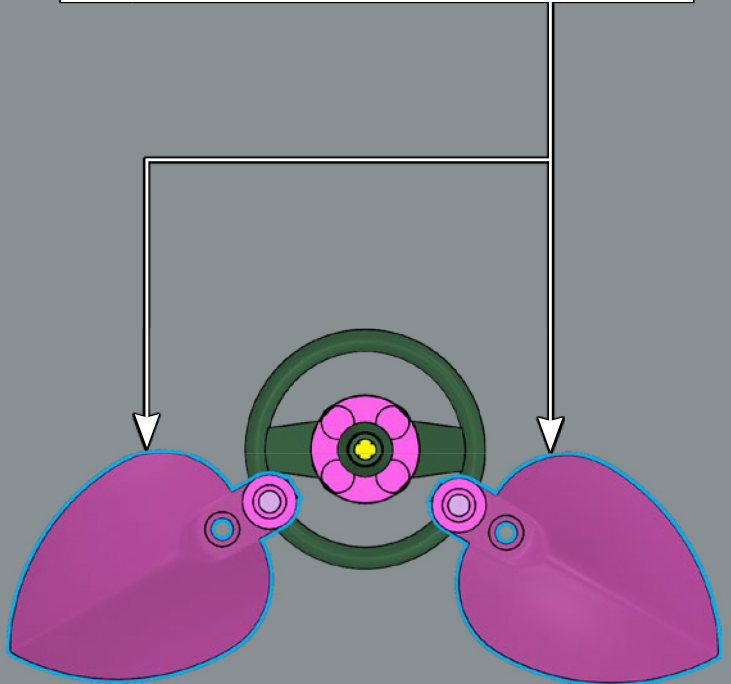
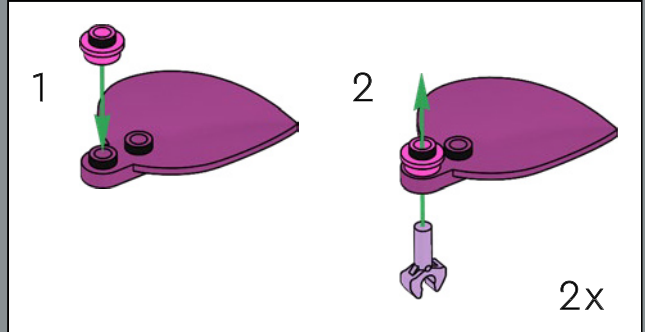



21

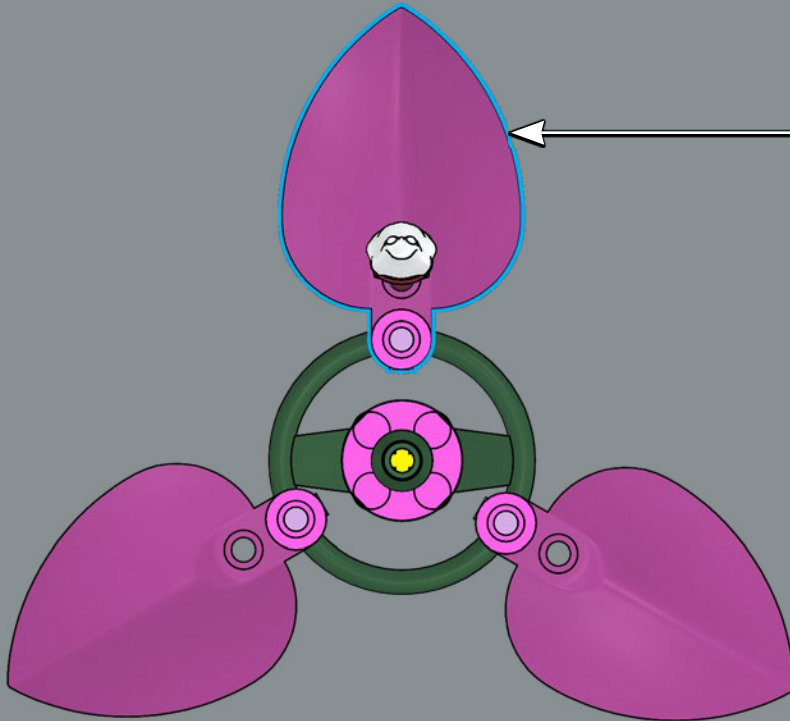
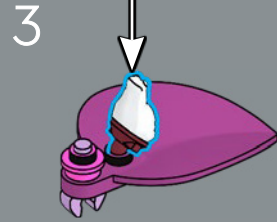
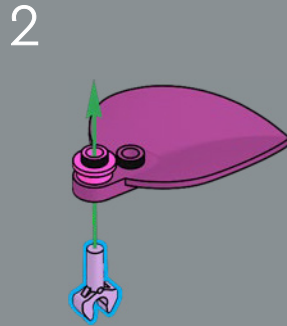
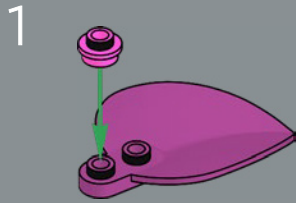

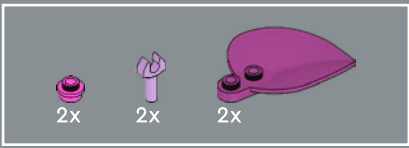

22

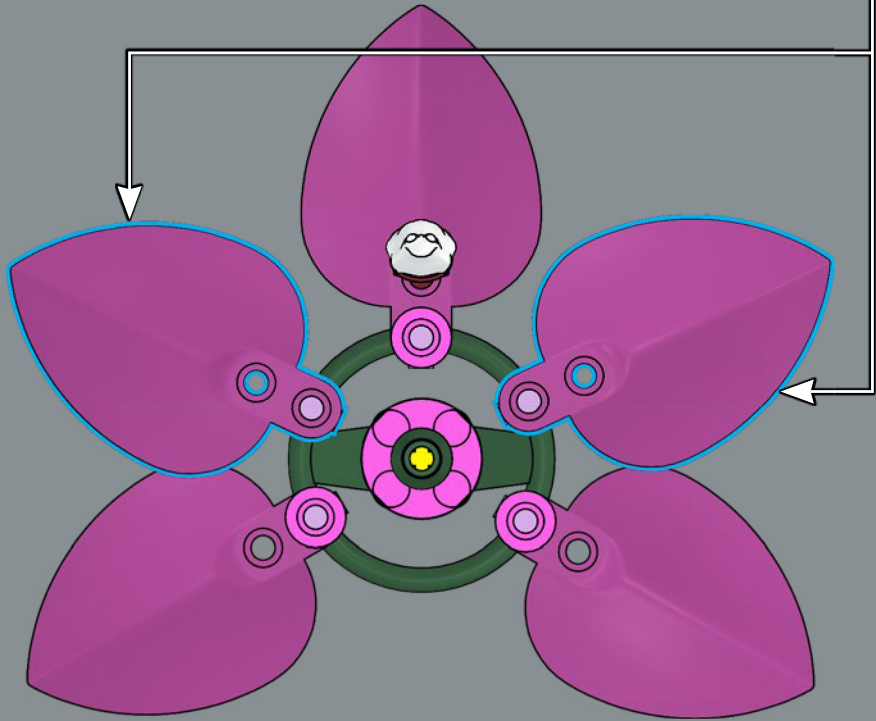
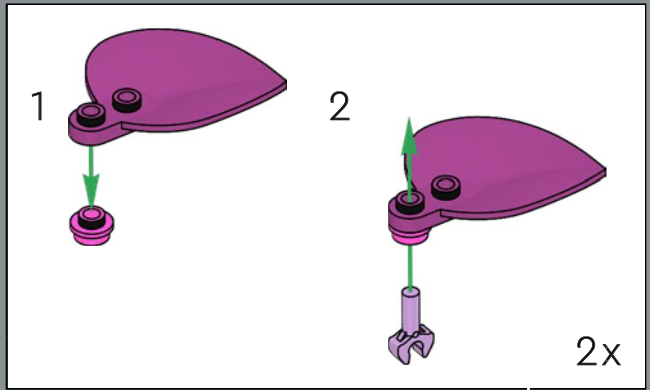

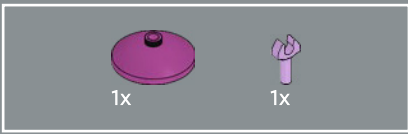

23

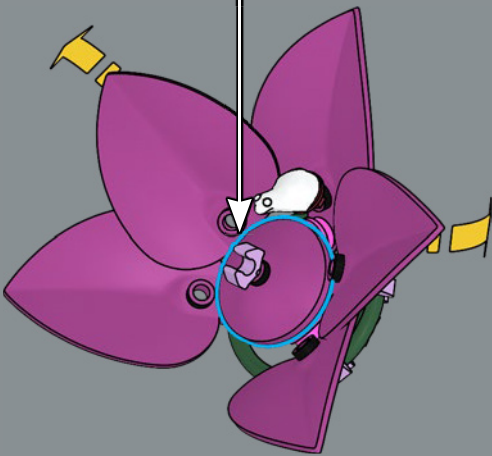
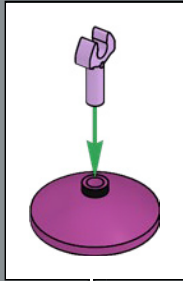

24

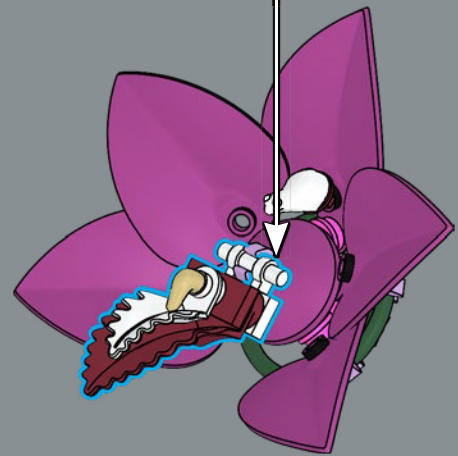
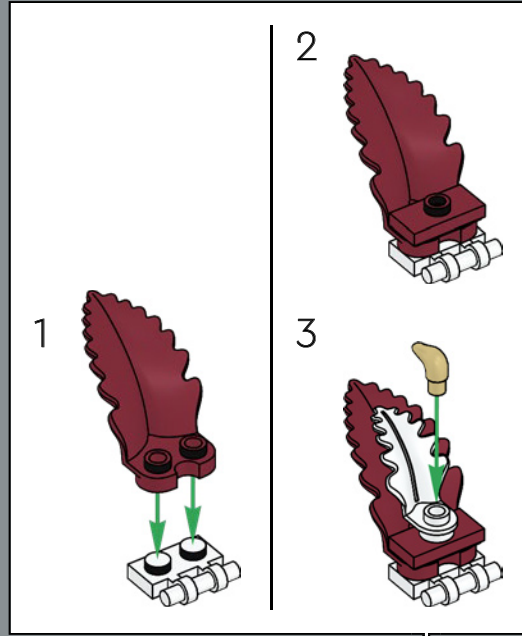

A plant built from plants? The labellum of this orchid is built using two LEGO® fern leaves.

Une plante construite avec des plantes ? Le labelle de cette orchidée est construit avec deux feuilles de fougère LEGO®.

¿Una planta hecha con plantas? El labelo de esta orquídea se construyó usando dos hojas de helecho LEGO®.



25

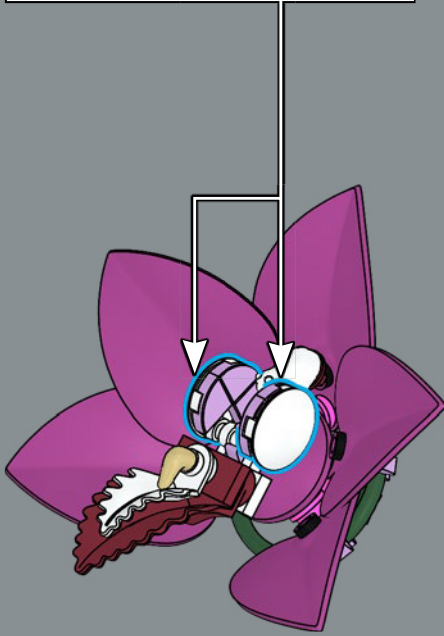
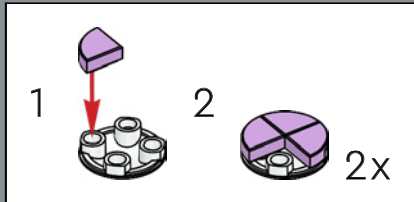

2x

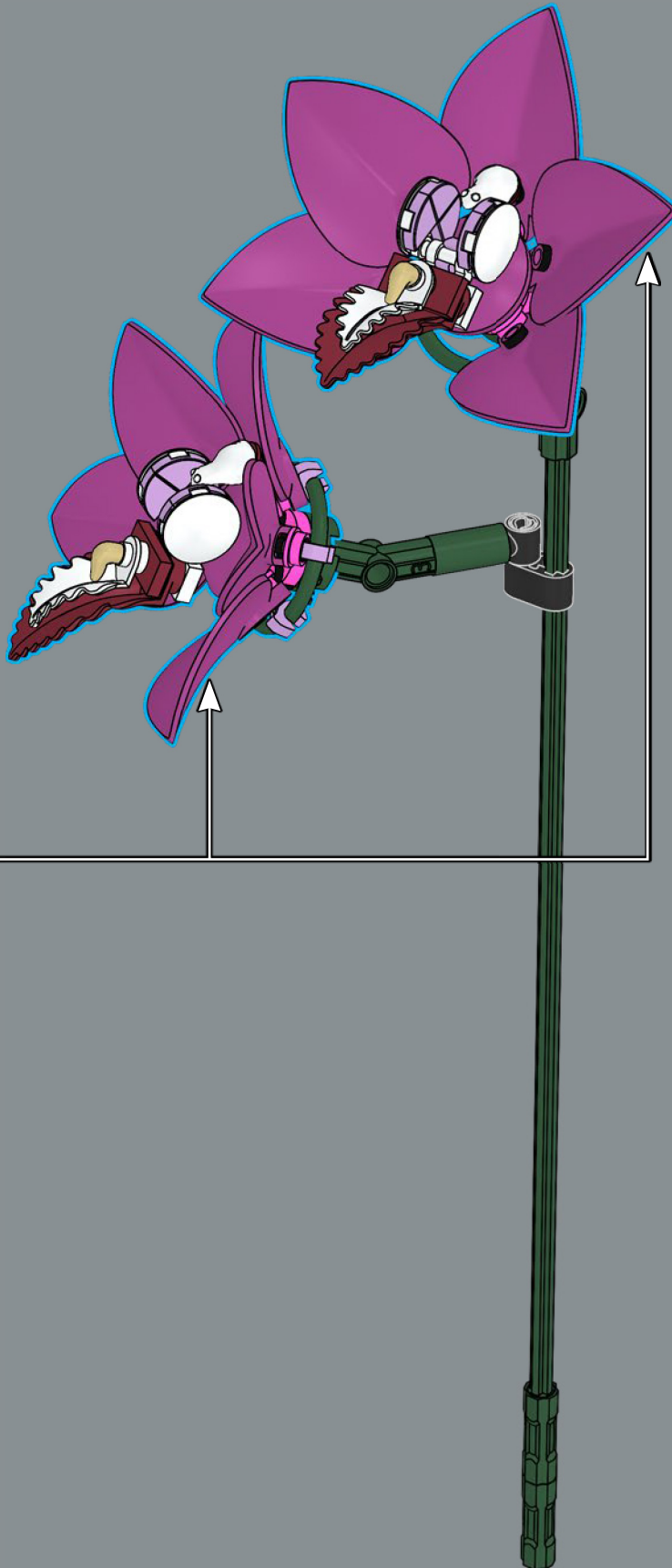

Expand your bouquet

Ready to discover new species of LEGO® flowers? Find more flowers and plants in our Botanicals series and be inspired to mix your own bouquets and floral arrangements.

Étoffe^z votre bouquet

Envie de découvrir de nouvelles espèces de fleurs LEGO® ? Trouvez d'autres fleurs et plantes dans notre série Botanique et laissez-vous inspirer pour composer vos propres bouquets et arrangements floraux.

Crea ramos más grandes

¿Quieres descubrir nuevas especies de flores LEGO®? Encuentra más flores y plantas en nuestra serie Botanical y llénate de inspiración para crear tus propios ramos y arreglos florales.



Discover more blooming creative tips with your LEGO® Insiders account on

Découvrez d'autres astuces créatives fleuries avec votre compte LEGO® Insiders sur

Descubre más consejos creativos florales con tu cuenta LEGO® Insiders en



[LEGO.com/Botanicals-exclusive](https://www.lego.com/Botanicals-exclusive)

- 4x 6206149
- 1x 6279875
- 3x 6498565
- 3x 6510194
- 44x 6525752
- 22x 4516546
- 4x 6398468
- 18x 6439046
- 1x 6282140
- 1x 6349342
- 3x 6092597
- 6x 6316692
- 18x 6240465
- 3x 6298930
- 1x 6265091
- 1x 6515241
- 3x 6510511
- 4x 6267047
- 4x 4211508
- 2x 6525773
- 1x 370526
- 5x 6525789
- 2x 6483785
- 8x 6366184
- 3x 6525849
- 1x 6315782
- 4x 6454729
- 6x 6395635
- 1x 4502595
- 18x 6259700
- 10x 6344177
- 1x 6133765
- 4x 6395635
- 1x 4502595
- 8x 6347293
- 16x 6525753
- 15x 6330196
- 4x 6265702
- 18x 6087084
- 8x 6347293
- 24x 6252200
- 4x 6147052
- 1x 6507841
- 2x 6310174
- 8x 6525786
- 16x 6230582
- 6x 4278271
- 1x 6493246
- 7x 6329283
- 3x 6326495
- 36x 4142865
- 4x 403201
- 3x 6217587
- 1x 6512537
- 3x 6525769
- 3x 4206482
- 4x 6429053
- 15x 6519960
- 2x 6529632
- 16x 6525770
- 3x 6525790
- 13x 6130007
- 3x 6439714
- 2x 6270111
- 10x 6474602
- 4x 6480369
- 8x 6296041
- 2x 6130008
- 3x 4140583
- 3x 6400754
- 4x 6328339
- 1x 6454167
- 8x 6517912
- 8x 6517912
- 4x 6468789
- 1x 6132767
- 4x 6328339
- 1x 6454167
- 8x 6517912
- 8x 6456642
- 3x 6368620
- 6x 6400754
- 11x 6474604
- 1x 6454167
- 8x 6517912
- 4x 6456642
- 4x 6525785
- 14x 6230571
- 10x 6360112
- 1x 6214235
- 4x 6096682
- 8x 6525785
- 11x 6411591
- 7x 6447541
- 12x 6468072
- 1x 6439052
- 18x 6439052
- 2x 6525787
- 8x 6251854
- 8x 6525784
- 11x 6411591
- 7x 6447541
- 12x 6468072
- 1x 6439052
- 18x 6439052
- 2x 6525787
- 8x 6251854
- 12x 6526753
- 6x 6348251
- 2x 6223219
- 2x 6525748
- 1x 6329299
- 10x 6523407

4

3

5





YOU COULD WIN



YOU COULD WIN

Your feedback will help shape the future development of this product series.

Visit:

DU KÖNNTEST GEWINNEN

Dein Feedback trägt zur Weiterentwicklung dieser Produktreihe bei.

Geh auf:

VOUS POURRIEZ GAGNER

Vos commentaires nous aideront à concevoir les futurs produits de cette gamme.

Visitez :

POTRESTI VINCERE TU

La tua opinione ci aiuterà a migliorare la creazione futura di questa linea di prodotti.

Visita:

PUEDES GANAR

Tu opinión contribuirá al futuro de esta serie de productos.

Visita:

轻松获奖

您的反馈将有助于我们在今后改进本产品系列。

请访问:

LEGO.com/productfeedback

You also have the chance to win a LEGO® set.

Terms and conditions apply.*

Außerdem hast du die Chance, ein LEGO® Set zu gewinnen.

Es gelten die Teilnahmebedingungen.*

Vous pourriez également gagner un ensemble LEGO®.

Des conditions s'appliquent.*

Hai anche la possibilità di vincere un set LEGO®.

Termini e condizioni sono applicabili.*

También tienes la oportunidad de ganar un set LEGO®.

Aplican términos y condiciones.*

您还有机会赢取乐高®套装。

条款和条件适用。*

*LEGO.com/productfeedback-terms

