

---

# TITANIC

BOOK 3

LIVRE 3

LIBRO 3

---

## THE UNSINKABLE OCEAN LINER

Though the RMS *Titanic* boasted many advanced safety features, outdated maritime safety regulations dictated that the liner only needed to have 20 lifeboats onboard: enough for just one third of her crew and passengers. When she collided with an iceberg at high speed just before midnight on April 14<sup>th</sup>, 1912, and quickly began to sink, the lack of lifeboats ensured only 710 people survived while more than 1,500 perished. As a direct result of the tragedy, new wide-ranging international safety standards were introduced, many of which are still in force today.

---

## LE PAQUEBOT INSUBMERSIBLE

Le RMS *Titanic* est doté de nombreux dispositifs de sécurité avancés, mais la réglementation désuète en matière de sécurité maritime n'exige que 20 canots de sauvetage à bord, soit juste assez pour accueillir un tiers de l'équipage et des passagers. Peu avant minuit le 14 avril 1912, le navire heurte un iceberg à haute vitesse et sombre. Le nombre limité de canots ne permet de sauver que 710 personnes, alors que plus de 1 500 autres périssent. Suite à cette tragédie, de nouvelles normes de sécurité internationales, dont plusieurs sont encore en vigueur aujourd'hui, sont instaurées.



↑ *Lifeboats in their davits on the Titanic.*

↑ *Canots de sauvetage dans leurs bossoirs sur le Titanic.*

↑ *Botes salvavidas en pescantes del Titanic.*

---

## EL TRANSATLÁNTICO INSUMERGIBLE

Aunque el RMS *Titanic* estaba equipado con numerosos y extraordinarios avances en materia de seguridad, según los obsoletos reglamentos de seguridad marítima de entonces, el transatlántico no necesitaba más que 20 botes salvavidas a bordo: suficientes para tan solo un tercio de la tripulación y los pasajeros. Minutos antes de la medianoche del 14 de abril de 1912, el buque colisionó con un iceberg a gran velocidad y empezó a hundirse rápidamente. Debido a la falta de botes, perecieron más de 1500 personas y solo 710 lograron sobrevivir. Como consecuencia directa de esta tragedia, se aprobaron nuevos estándares internacionales de seguridad de amplio alcance, muchos de los cuales siguen vigentes hoy en día.

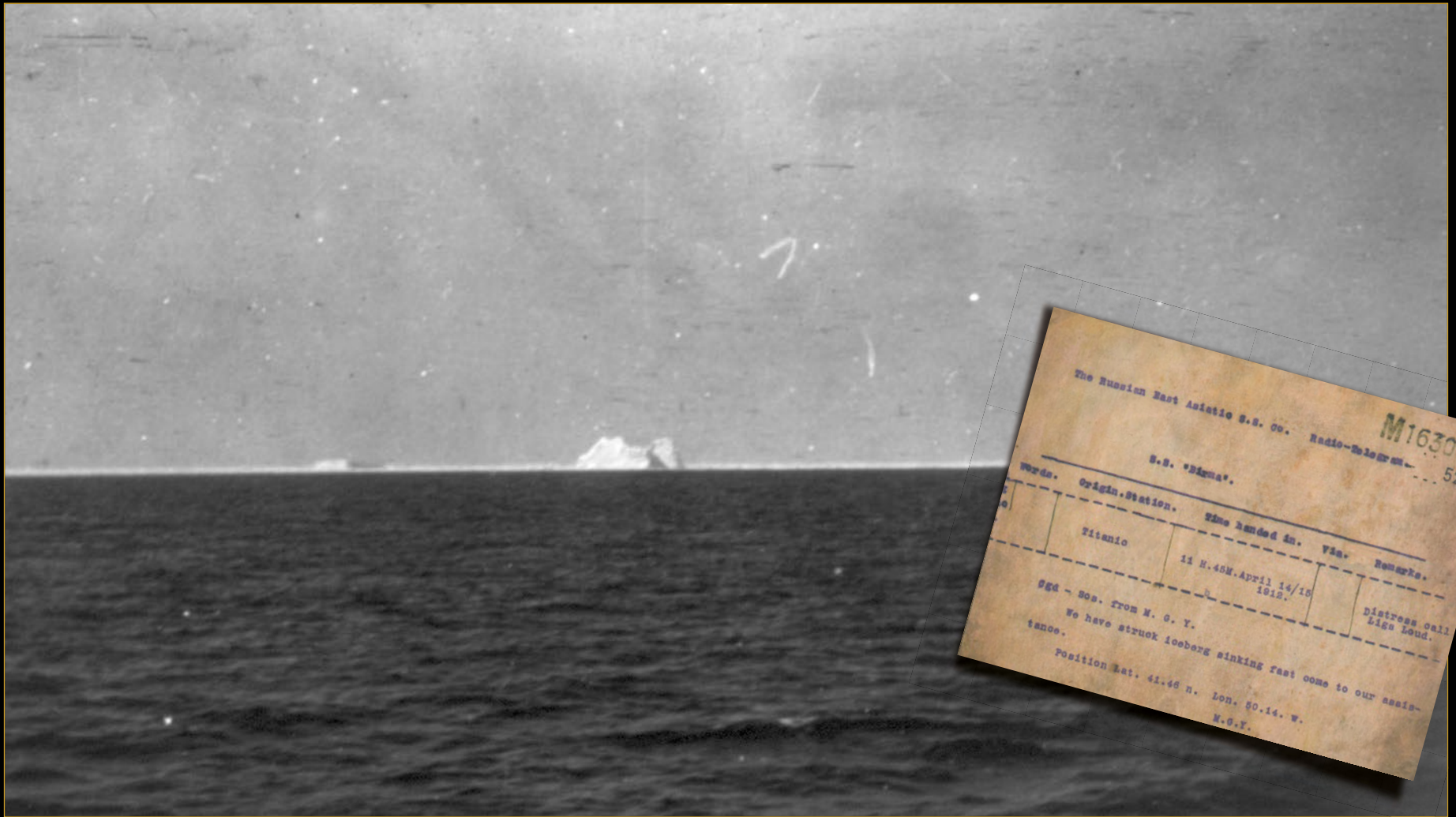

↑ The presumed location of the disaster taken from the SS Carpathia which picked up survivors from the Titanic.

↑ Photo de l'emplacement présumé de la catastrophe prise depuis le SS Carpathia, qui a recueilli des survivants du Titanic.

↑ Fotografía de la supuesta localización del desastre, tomada desde el SS Carpathia, que rescató a sobrevivientes del naufragio del Titanic.

↗ A telegram transmitted from RMS Titanic to the SS Birma requesting assistance.

↗ Un télégramme transmis du RMS Titanic au SS Birma, demandant de l'aide.

↗ Telegrama de solicitud de ayuda transmitido por el RMS Titanic al SS Birma.

## IMPRESSIVE SCALE

At its launch, the *Titanic* was the largest man-made vessel ever constructed. She was over 882.9 ft. (269 meters) long and measured 175 ft. (53.3 meters) from the bottom of the hull to the top of her smokestacks. Likewise, the LEGO® version of the RMS *Titanic* is the longest LEGO model created so far and one of the most intricate.

## IMPRESIONANTE ESCALA

En su botadura, el *Titanic* era la nave más grande jamás construida por el hombre. Tenía 269 m de eslora y medía 53,3 m desde la parte inferior del casco hasta la parte superior de sus chimeneas. De la misma manera, la versión LEGO® del RMS *Titanic* es el modelo LEGO de mayor longitud que hemos creado hasta ahora y uno de los más elaborados.

## UNE AMPLEUR TITANESQUE

À son lancement, le *Titanic* est le plus grand navire jamais construit. Il mesure plus de 269 m (882,9 pi) de long et 53,3 m (175 pi) du fond de la coque jusqu'à la pointe de ses cheminées. De même, la version LEGO® du RMS *Titanic* est le modèle LEGO le plus long jamais créé, et l'un des plus complexes.

*The LEGO version of the Titanic is built at 1:200 scale, the same scale as the LEGO Architecture Statue of Liberty set.*

*La version LEGO du Titanic est construite à l'échelle 1:200, la même échelle utilisée pour l'ensemble LEGO Architecture La statue de la Liberté.*

*La versión LEGO del Titanic está diseñada a escala 1:200, la misma utilizada para el set LEGO Architecture Estatua de la Libertad.*

*The Titanic was 11 times as long as the blue whale, the largest animal ever known to have lived on Earth.*

*Le Titanic est 11 fois plus long que la baleine bleue, le plus grand animal ayant jamais vécu sur Terre.*

*El Titanic era 11 veces más largo que la ballena azul, el animal conocido más grande que haya poblado la Tierra.*

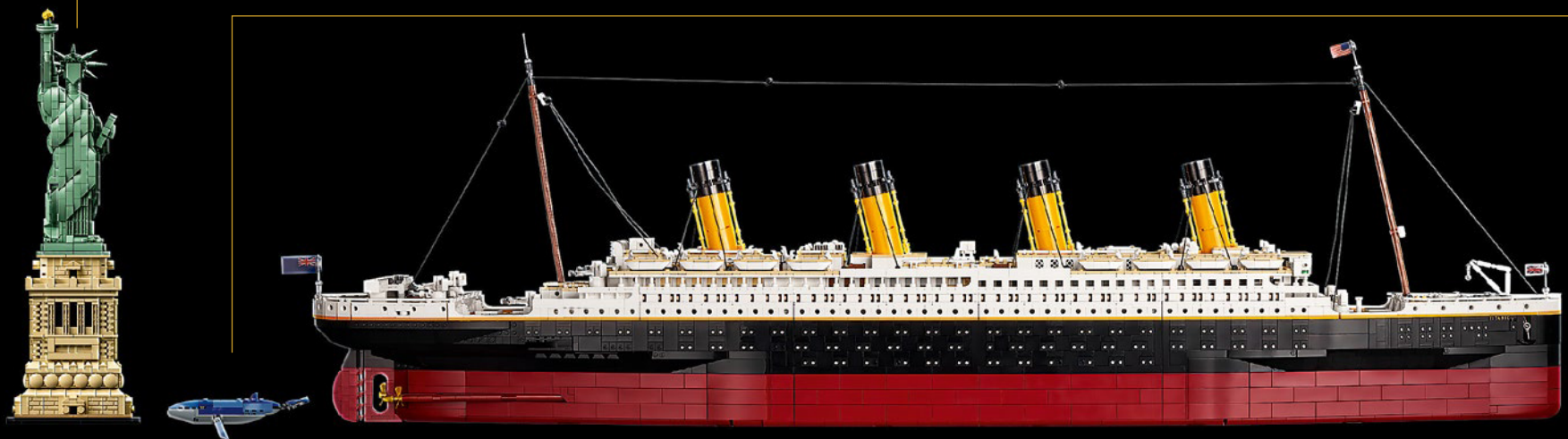



[LEGO.com/brickseparator](https://www.lego.com/brickseparator)

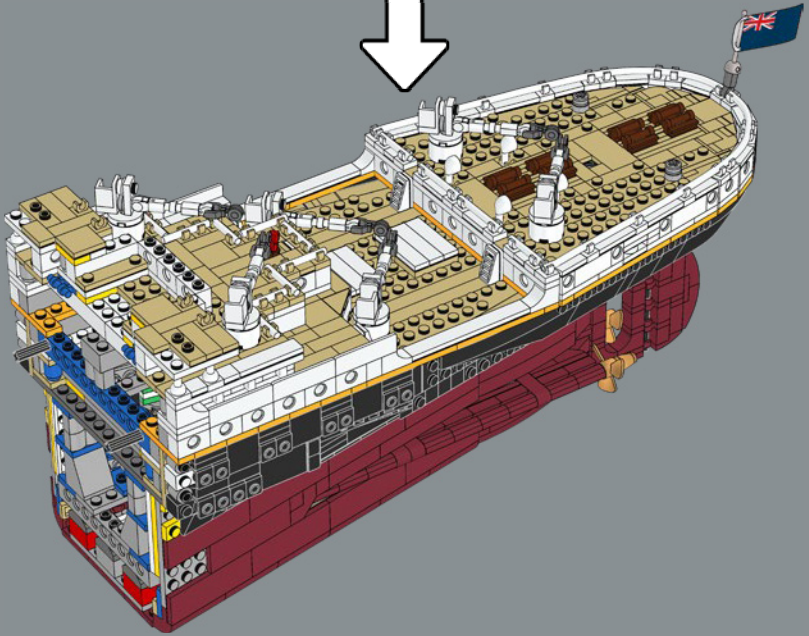
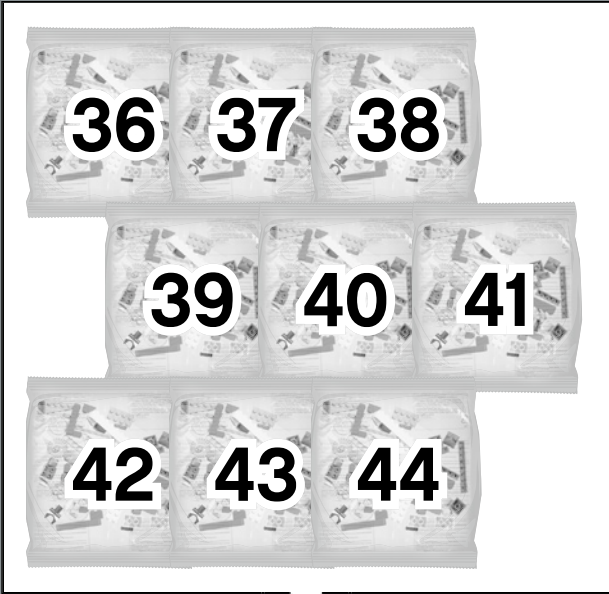
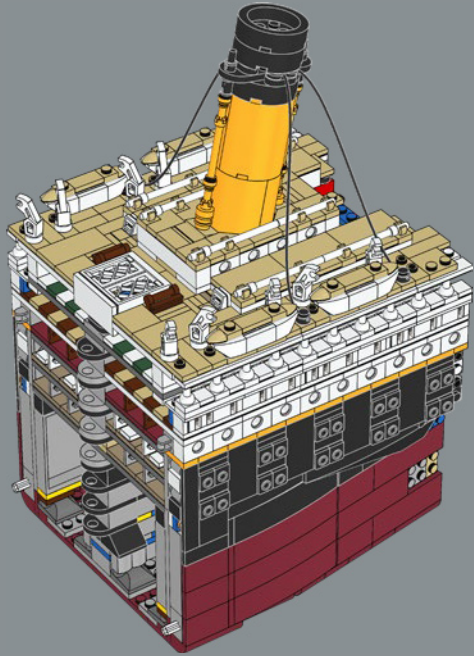
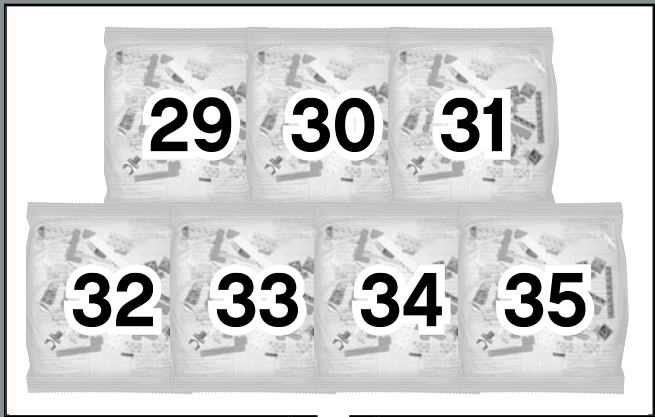

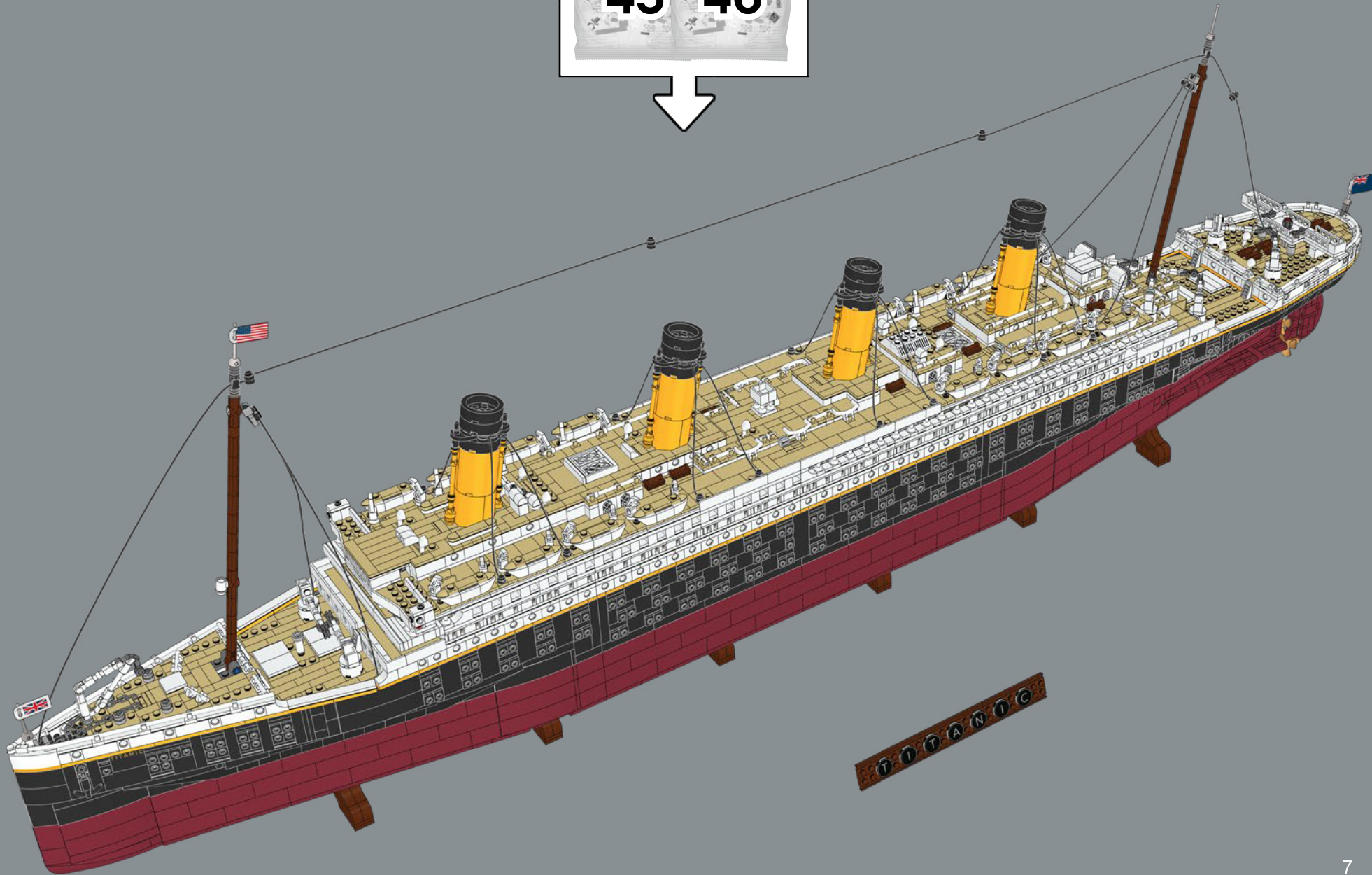
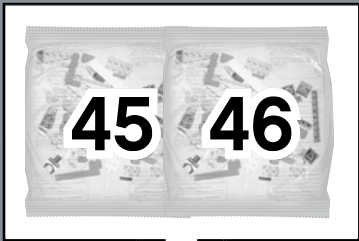

TITANIC

## SECTION 5:

# FUNNEL & ENGINE ROOM

In this section the model narrows as it tapers towards the propellers and rudder at the stern of the ship. You will also build the model's final funnel. On the real *Titanic*, this funnel was not connected to any boilers but was included in the design of the ship to make it feel more beautiful and complete.

## SECTION 5 :

# CHEMINÉE ET SALLE DES MACHINES

Dans cette section, le modèle s'effile vers la poupe du navire, où se trouvent les hélices et le gouvernail. Vous construirez également la dernière cheminée du modèle. Sur le vrai *Titanic*, cette cheminée n'est reliée à aucune chaudière, et fait tout simplement partie de la conception du navire pour lui donner une apparence plus élégante.

## SECCIÓN 5:

# CHIMENEA Y SALA DE MÁQUINAS

En esta sección, el modelo se estrecha conforme sus líneas se van afilando hacia las hélices y el timón en la popa del barco. También construirás la última chimenea. En el *Titanic* real, esta chimenea no estaba conectada a ninguna caldera; se incluyó en el diseño de la nave para realzar su belleza y sensación de equilibrio.

↓ At the top of this section, you will add the ship's reading room and some of its 2nd class cabins.

↓ Tout en haut de cette section, vous ajouterez la salle de lecture et certaines des cabines de la 2<sup>e</sup> classe.

↓ En la parte superior de esta sección, incorporarás la sala de lectura y algunos camarotes de segunda clase.

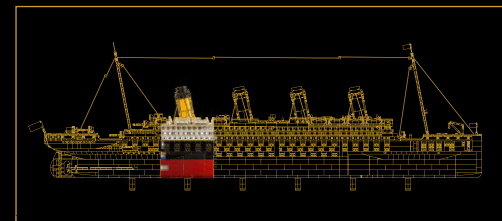



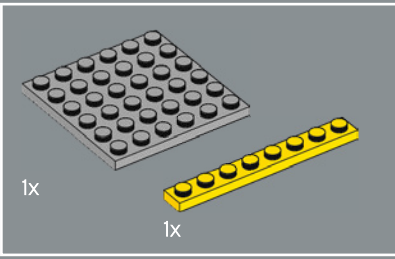
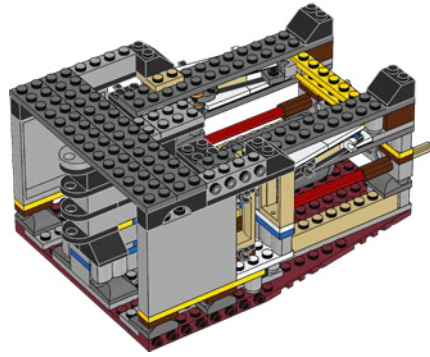
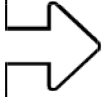

2

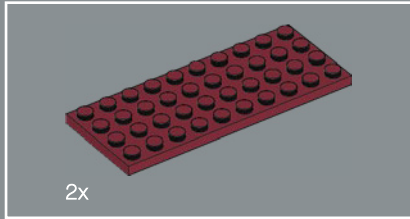

1

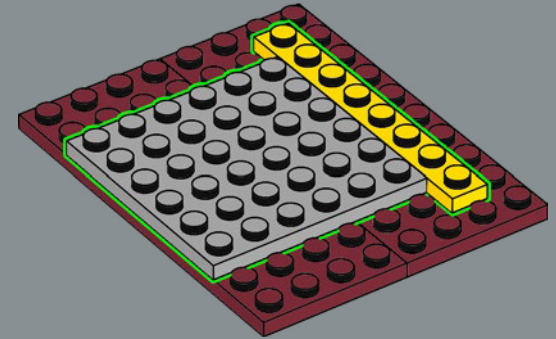
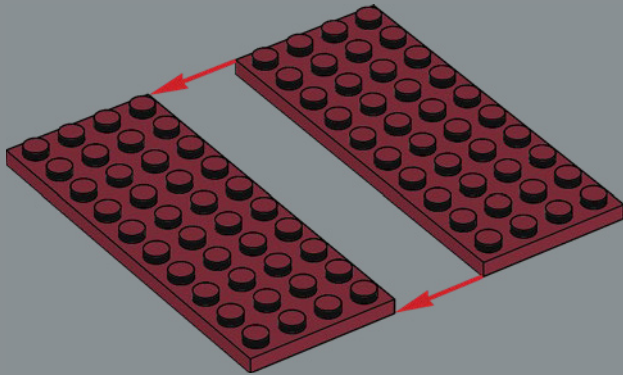

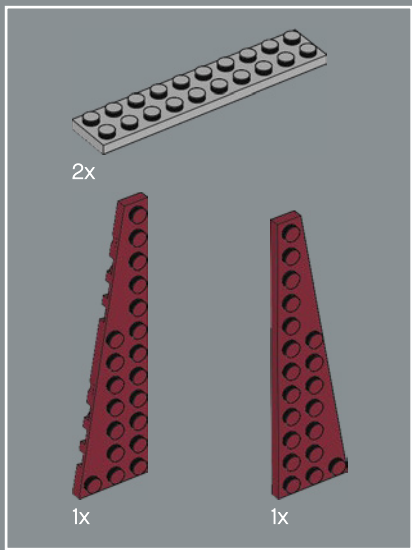

3

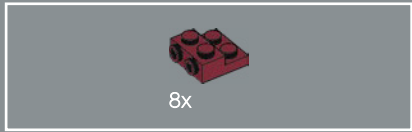
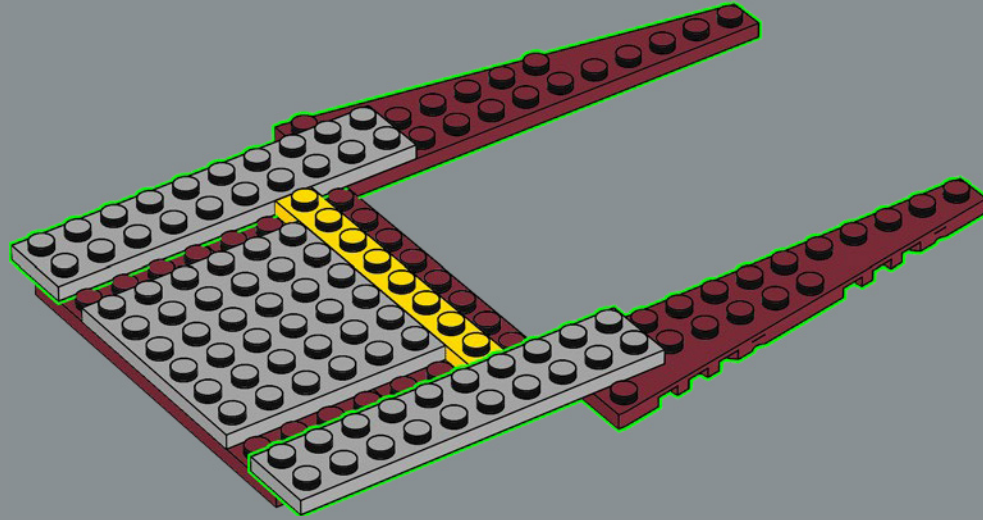

4

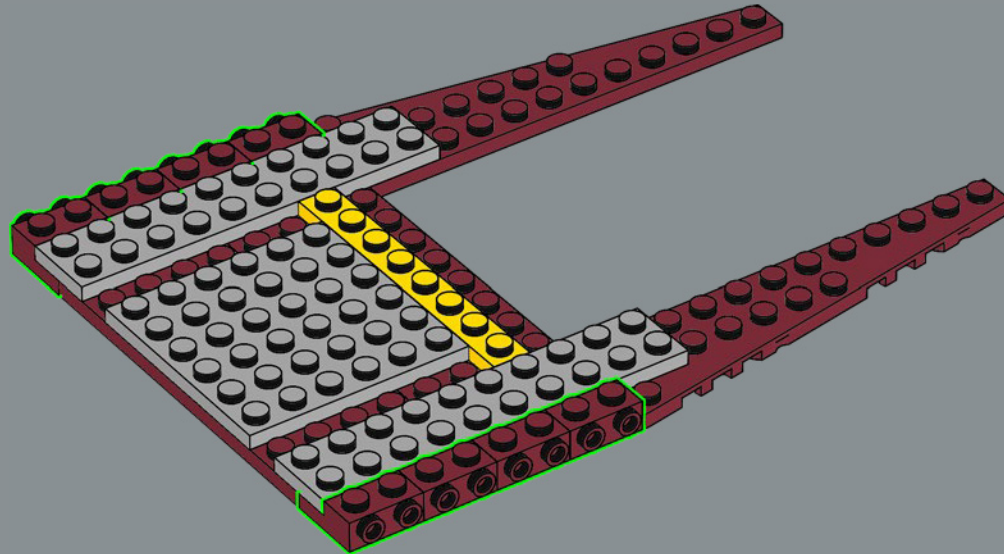

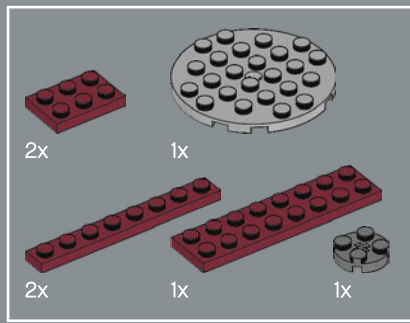

5

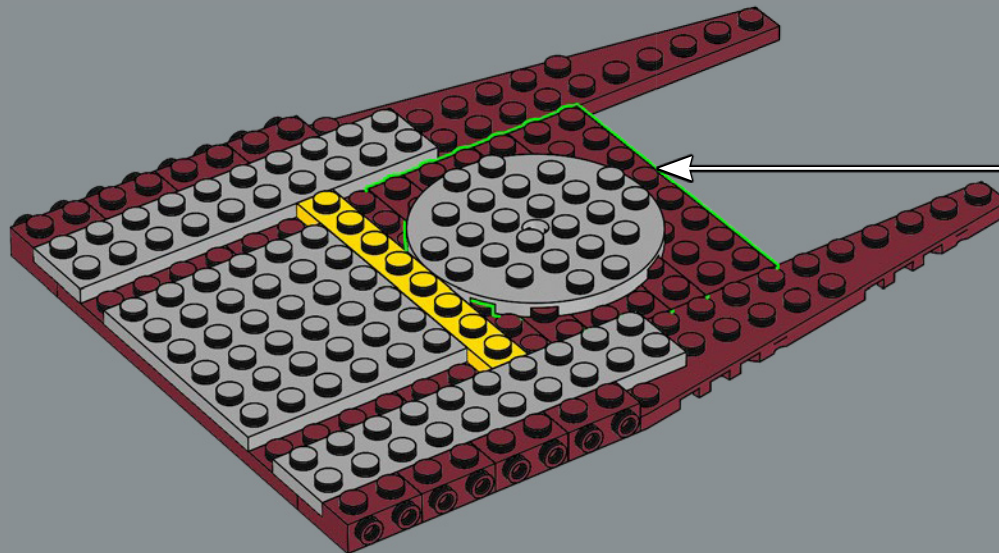
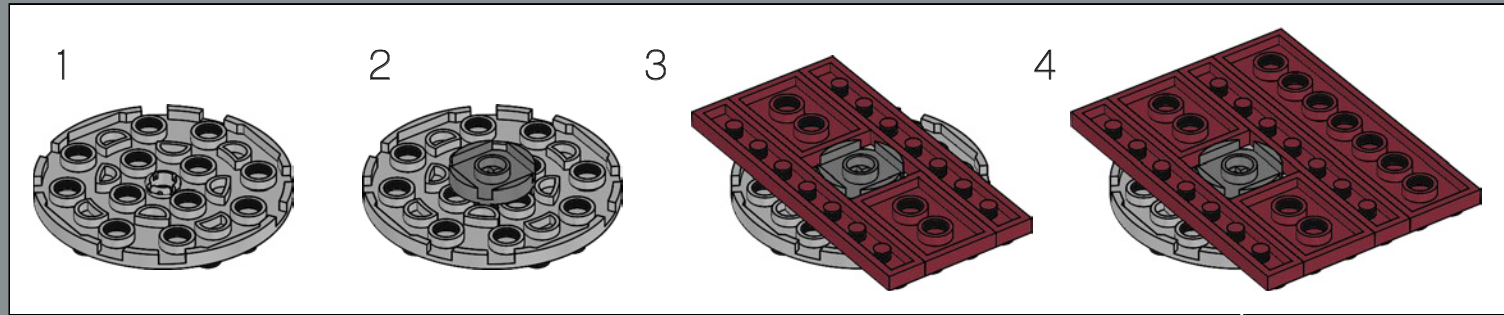

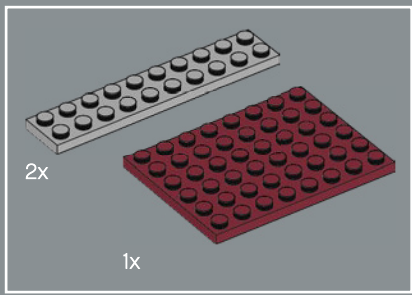

6

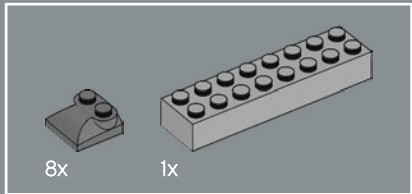
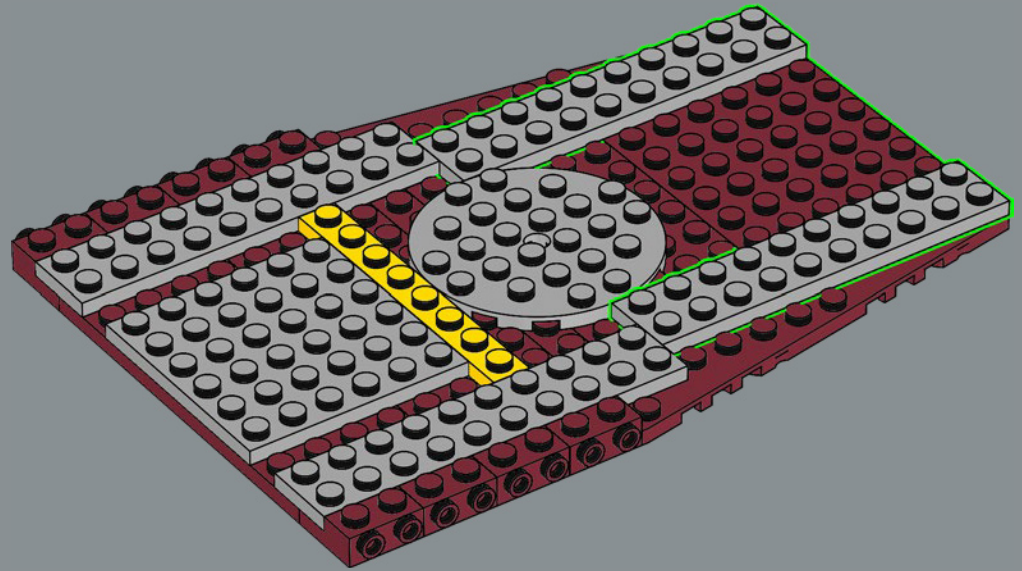

7

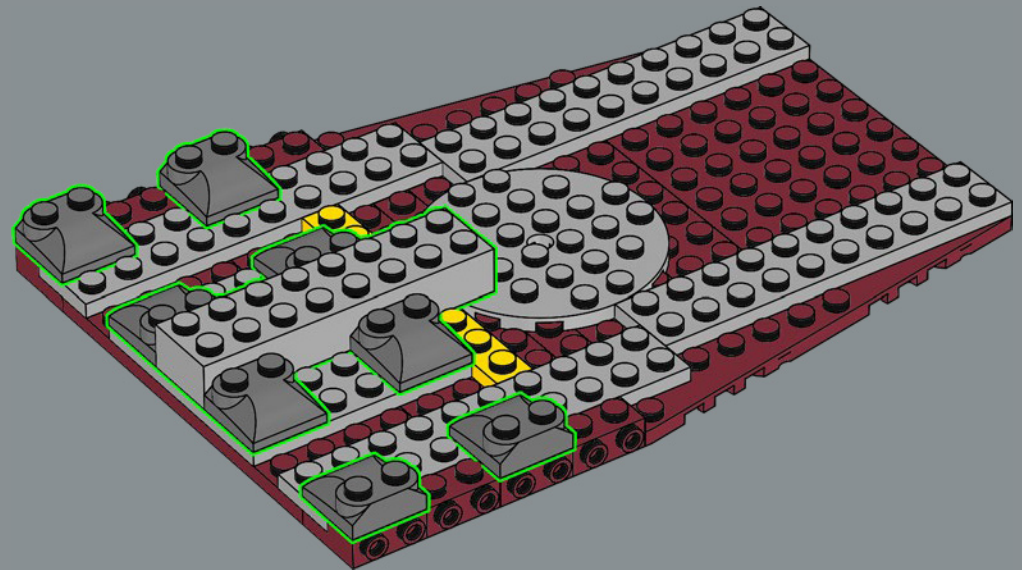



8

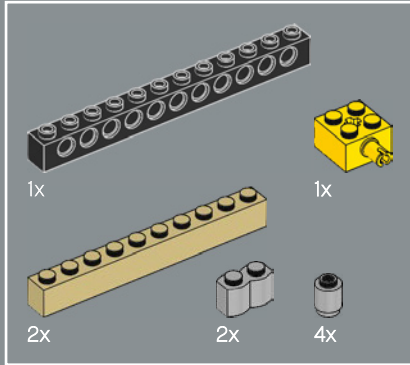
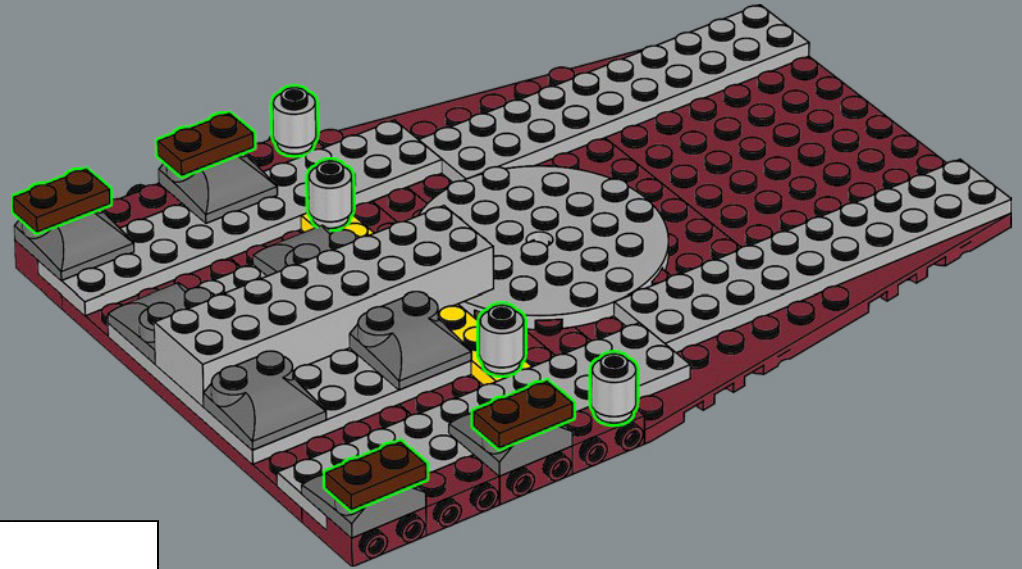

9

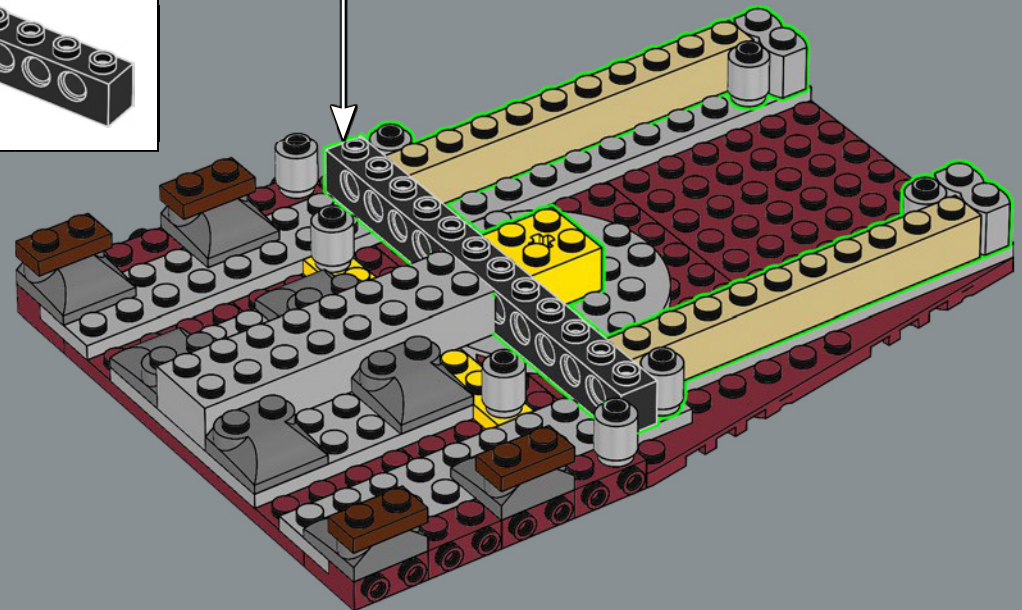
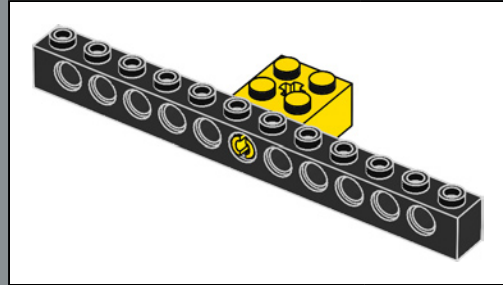

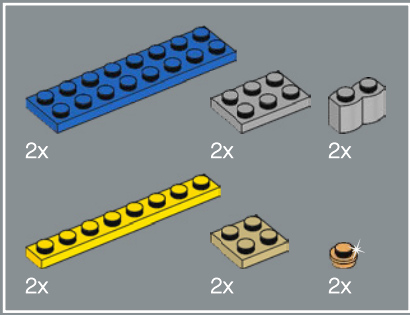

10

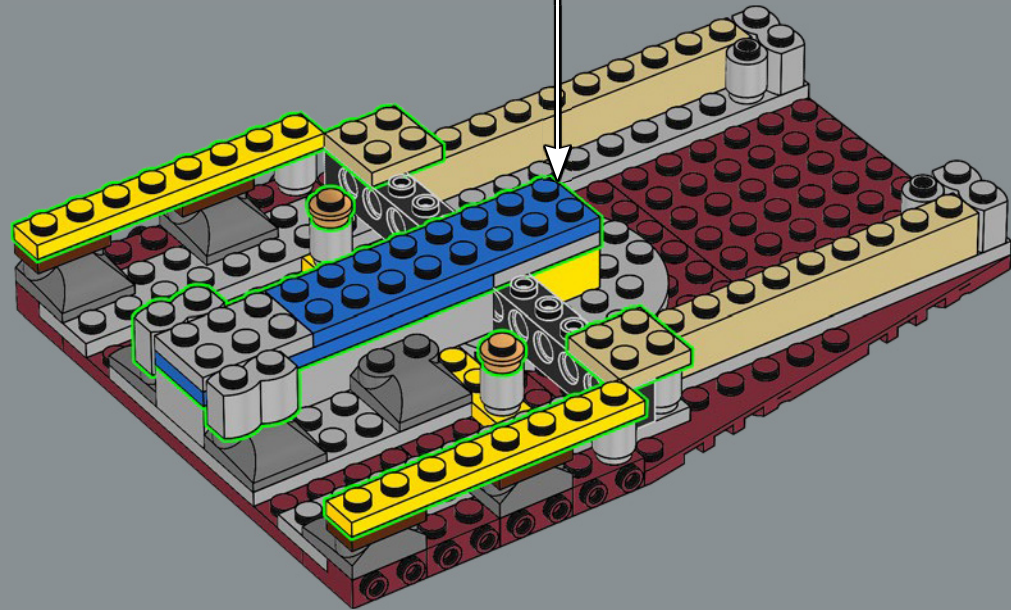
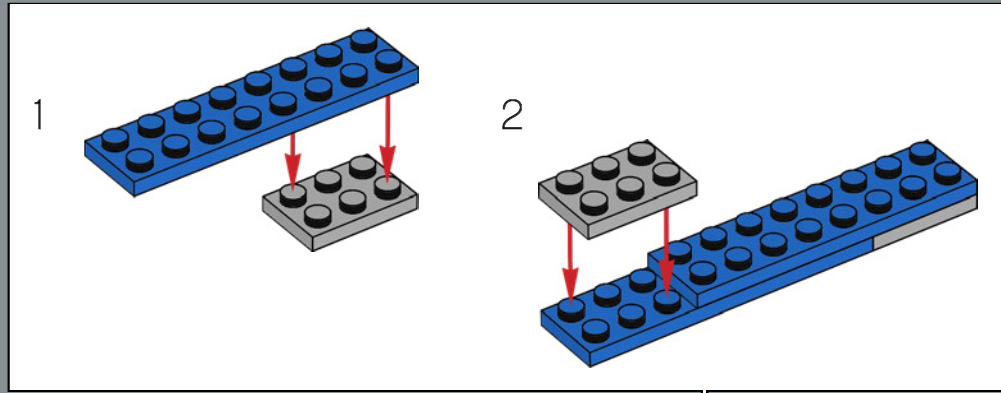

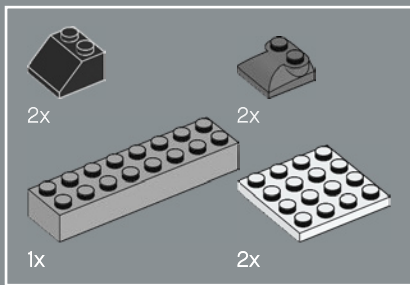

11

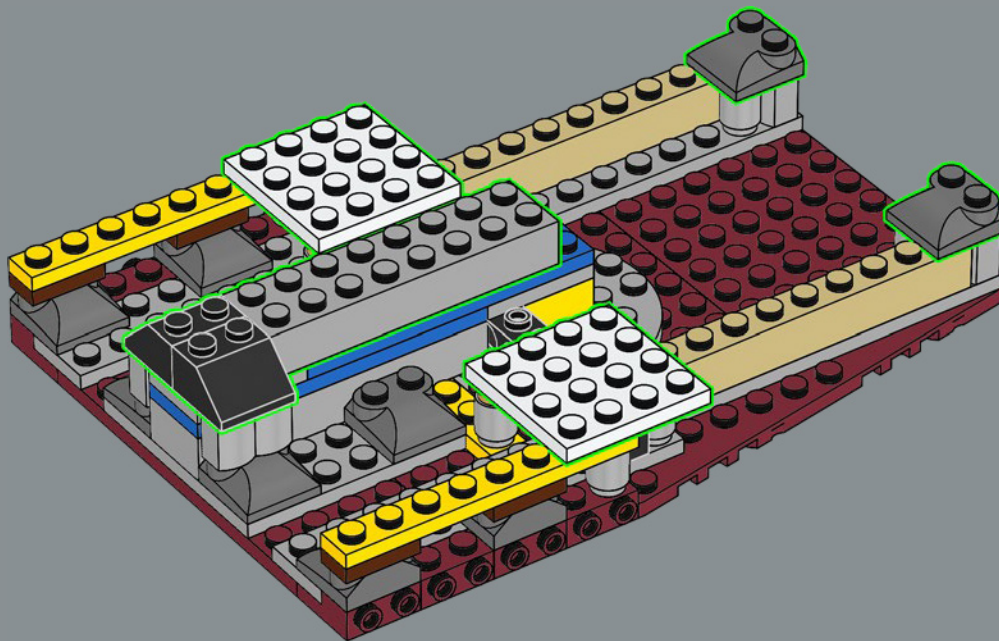

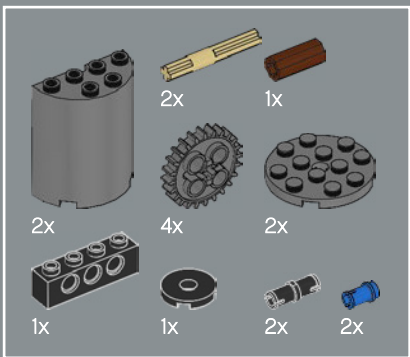

12

1

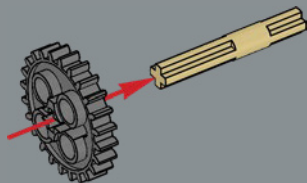

2

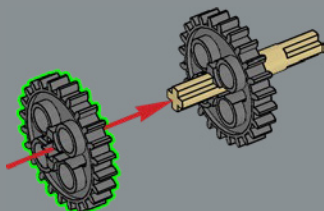

3

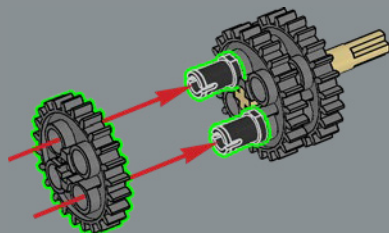

4

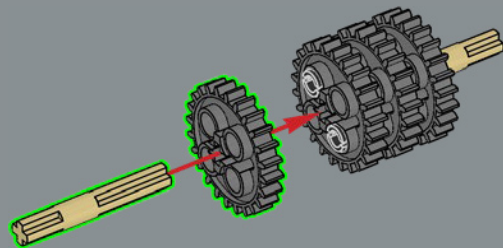

5

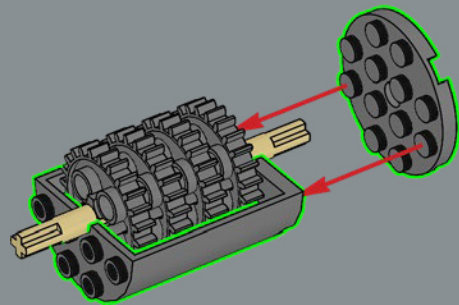

6

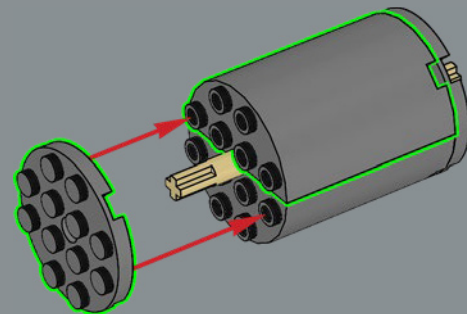

7

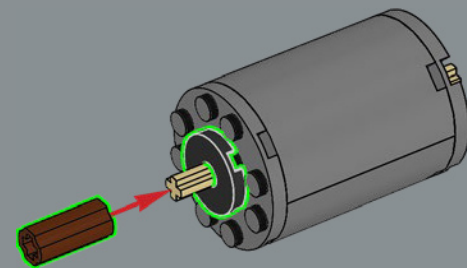

8

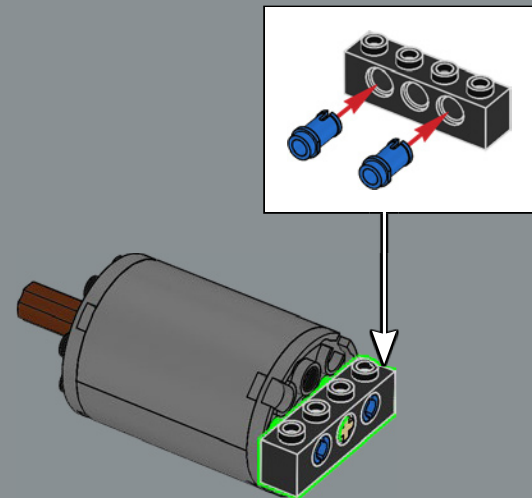



---

The *Titanic's* electrical plant was capable of producing more power than an average city power station of the time.

Les dynamos du *Titanic* peuvent produire plus d'énergie qu'une centrale électrique moyenne de l'époque.

El sistema de suministro eléctrico del *Titanic* era capaz de producir más potencia que una central eléctrica de una ciudad de tamaño medio de la época.

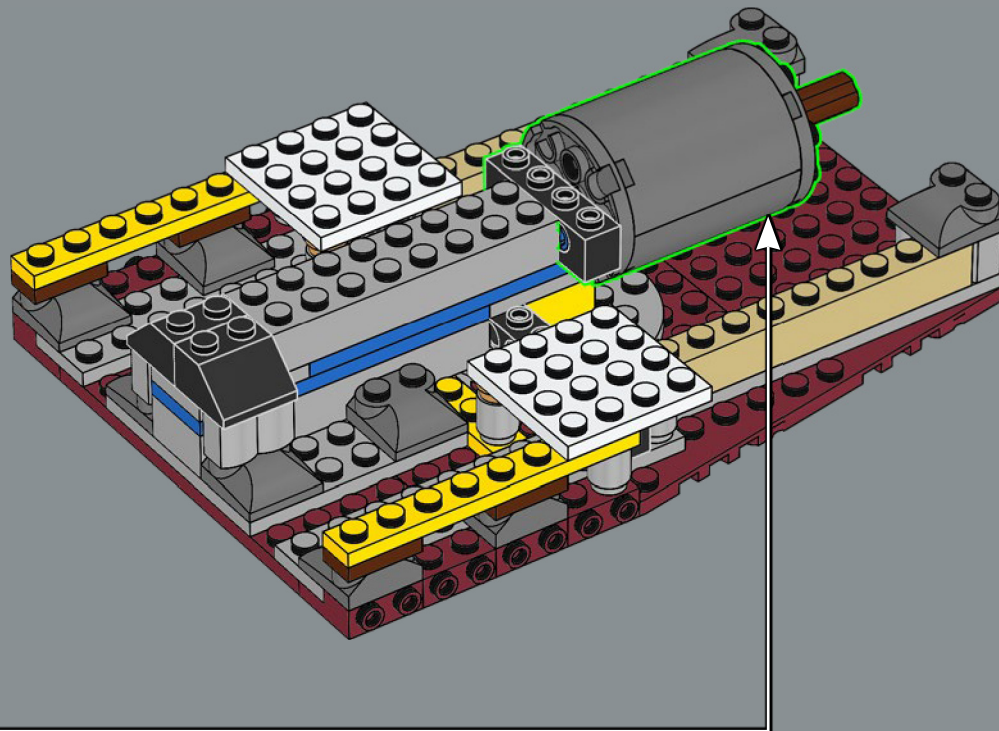

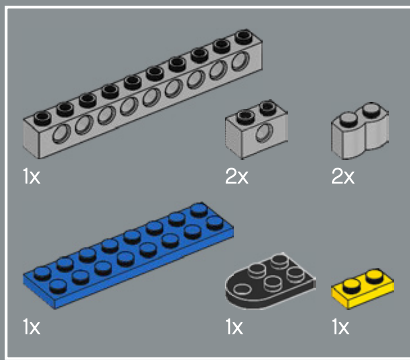

13

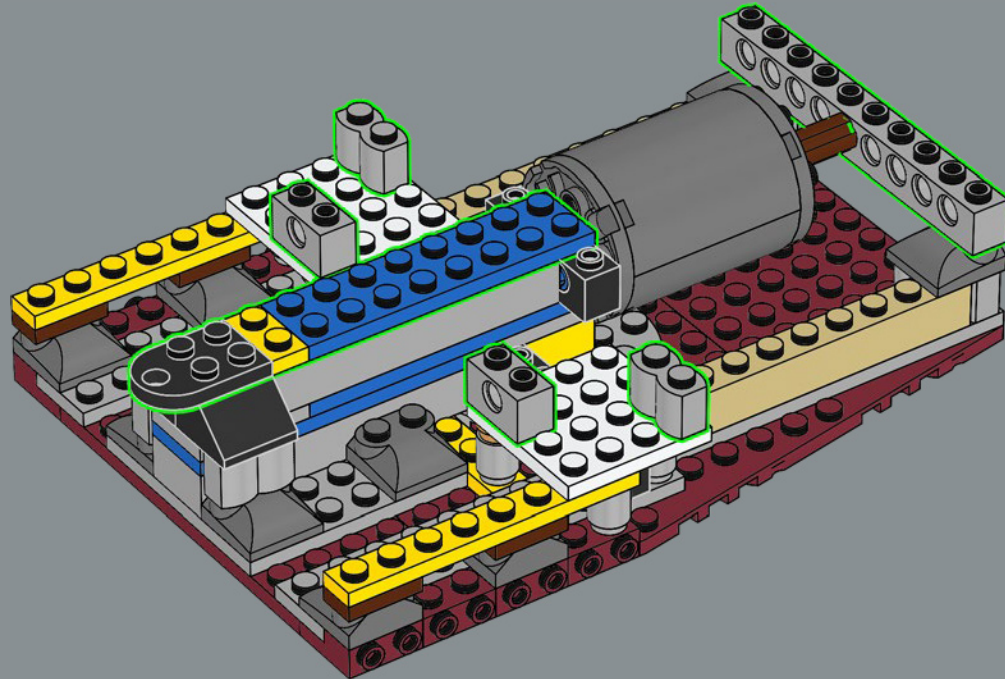

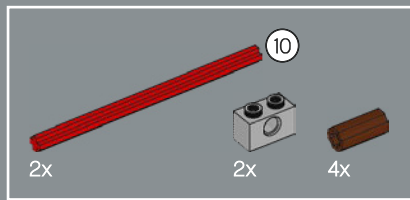

14

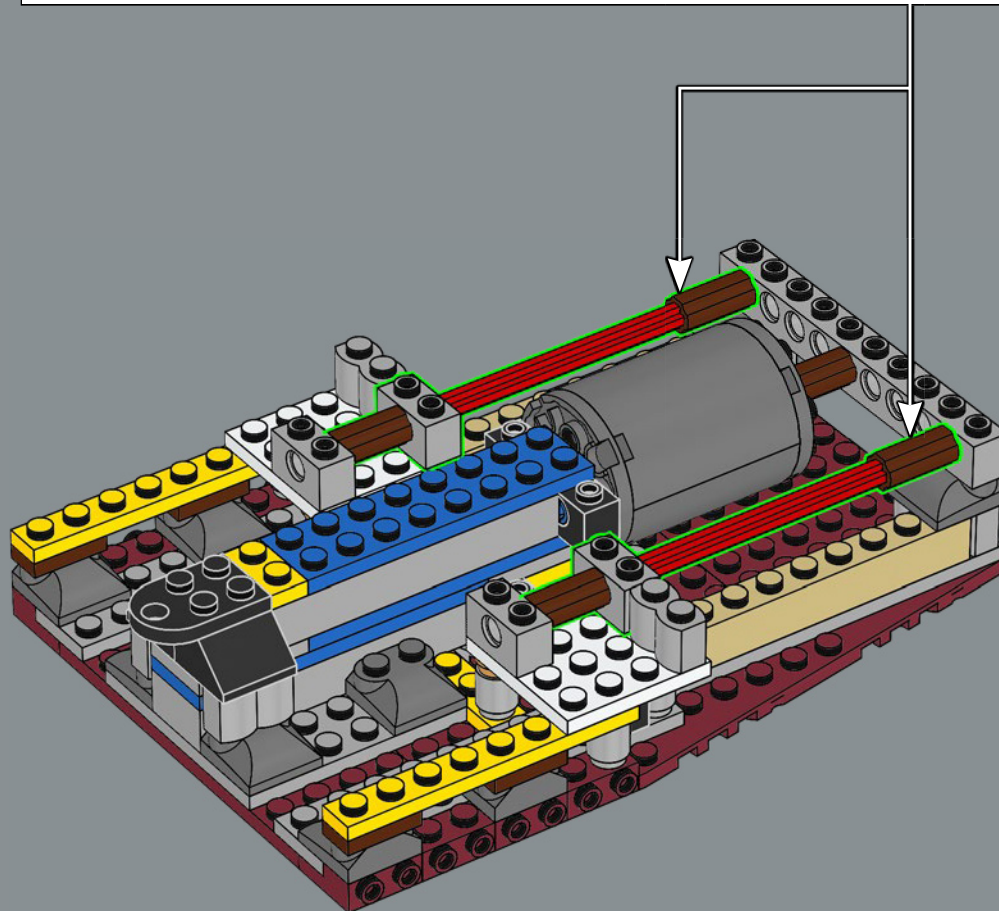
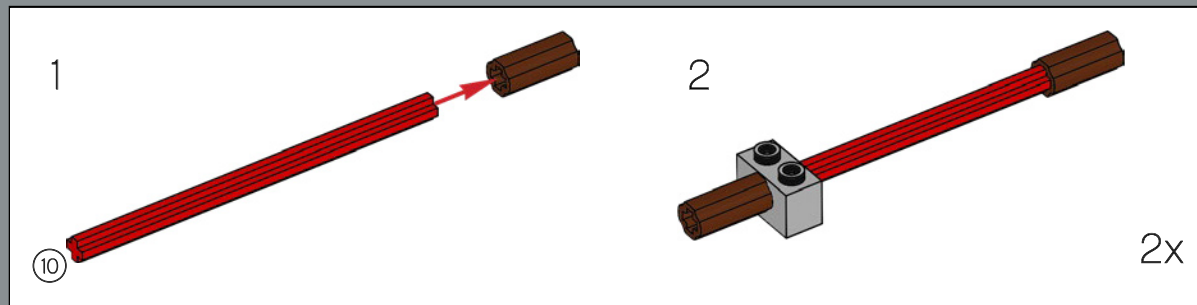

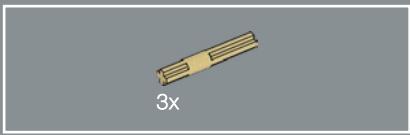

15

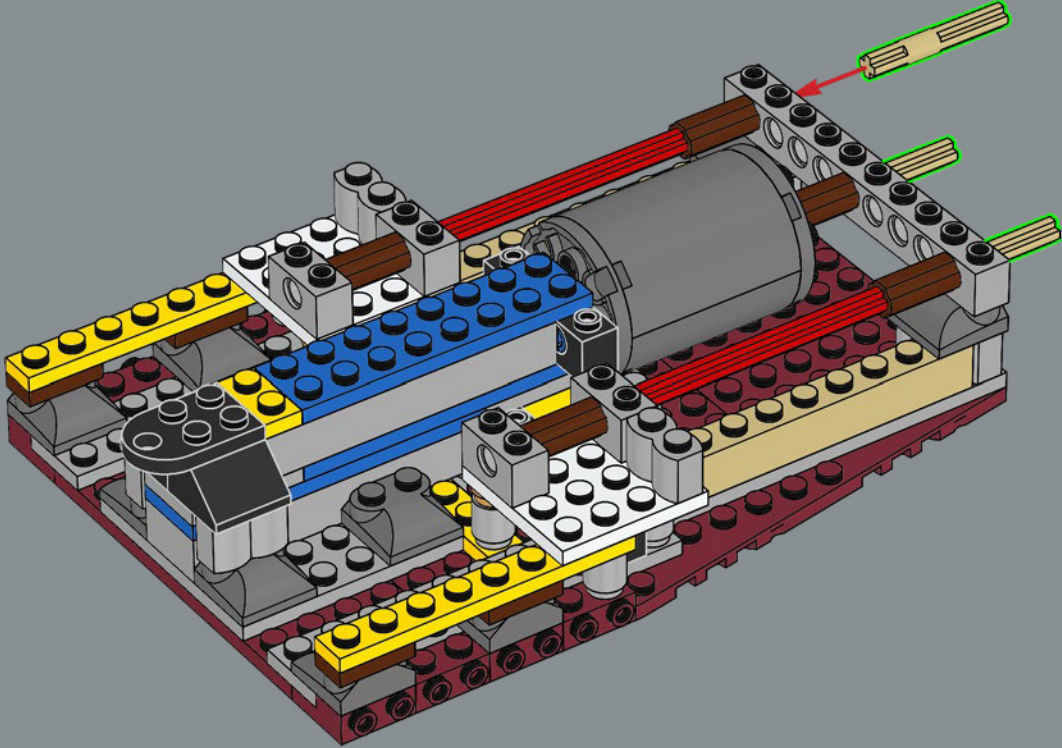

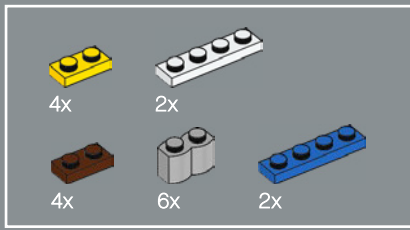

16

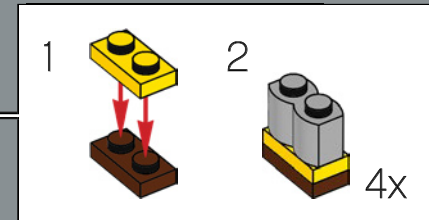
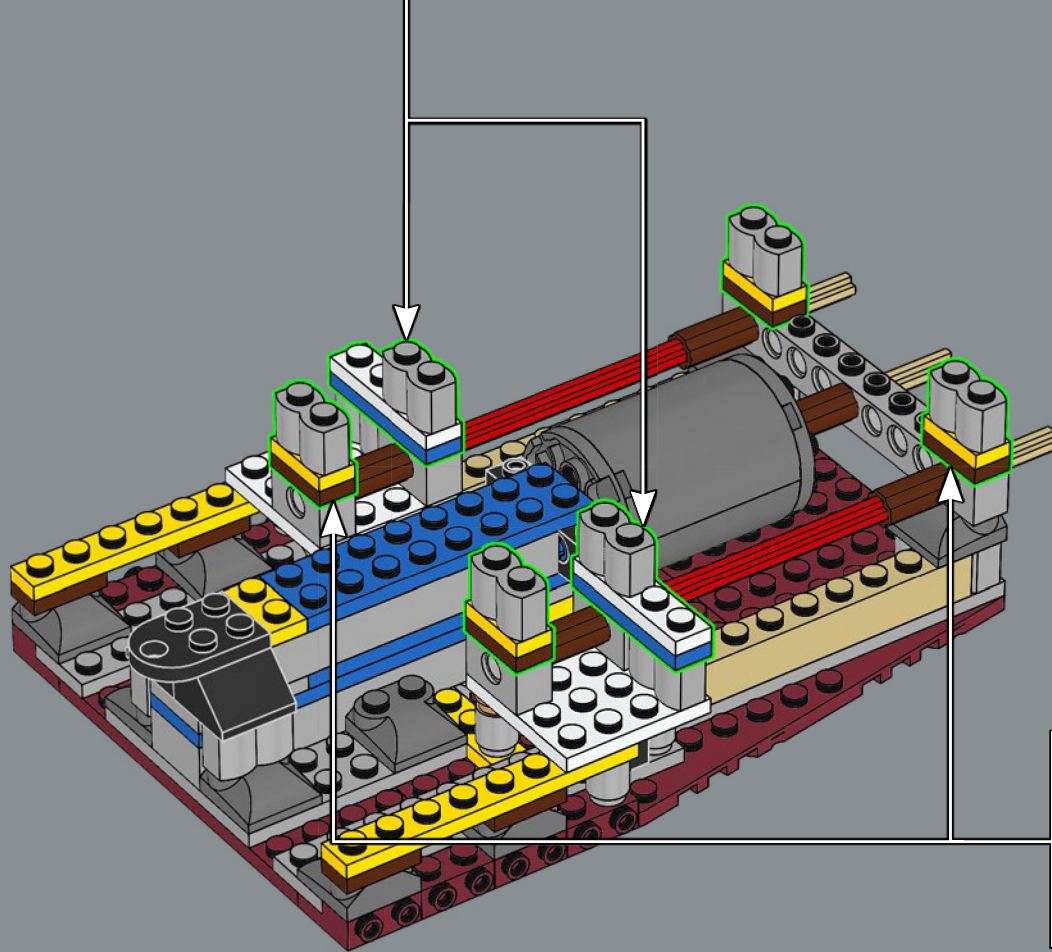
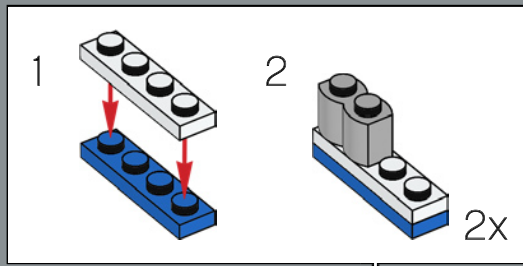

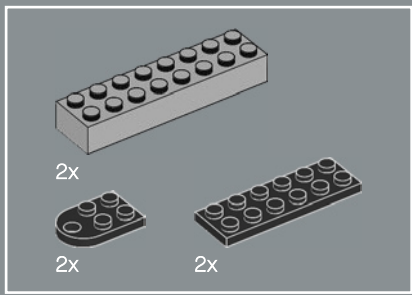

17

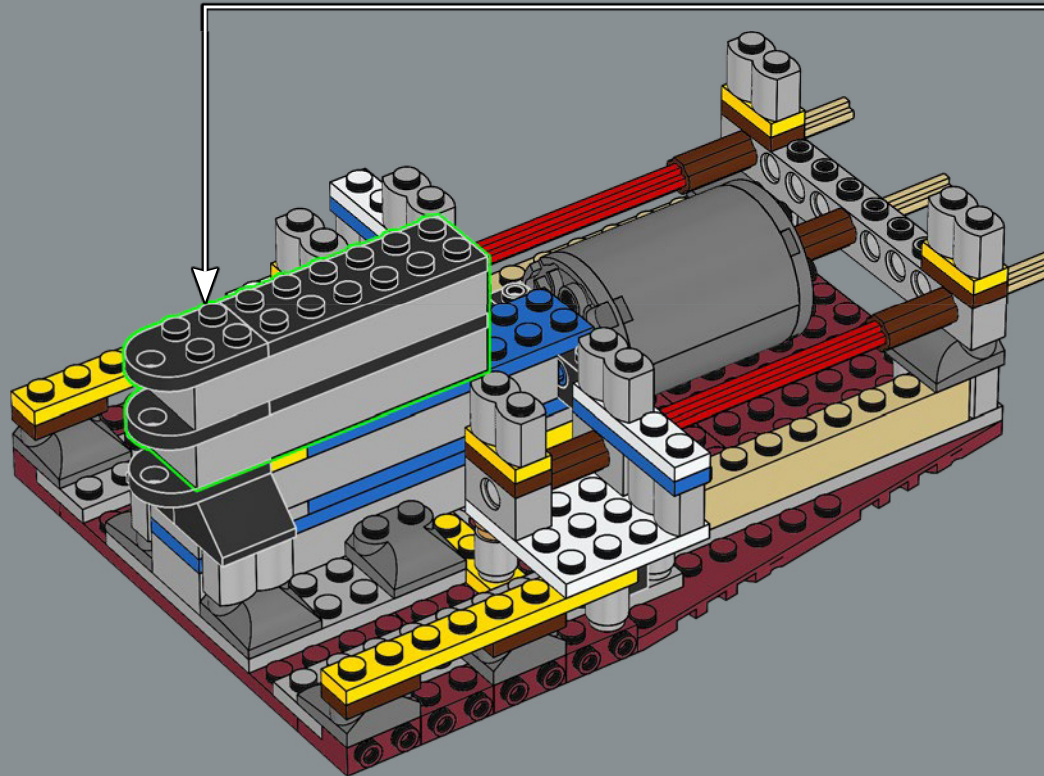
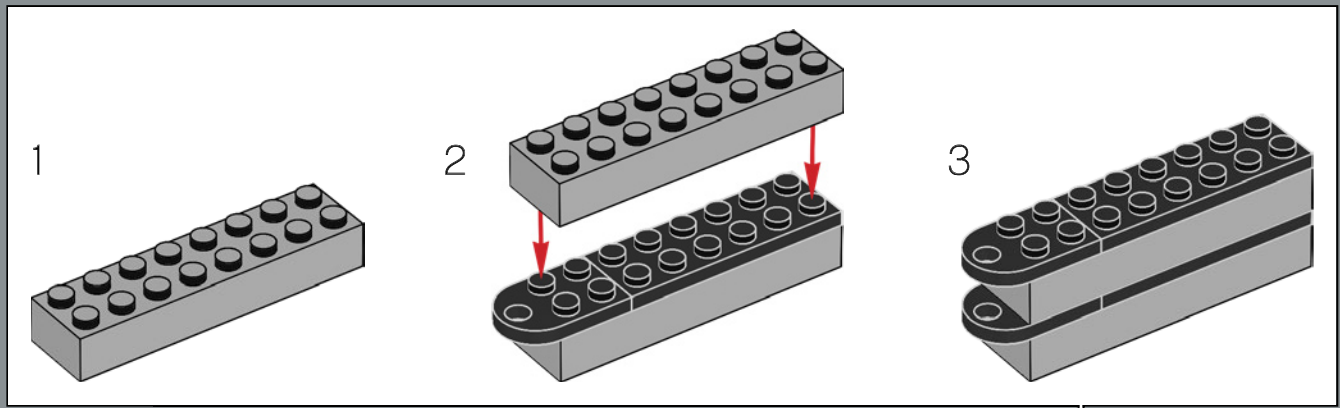

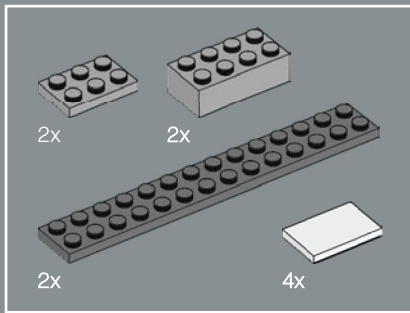

18

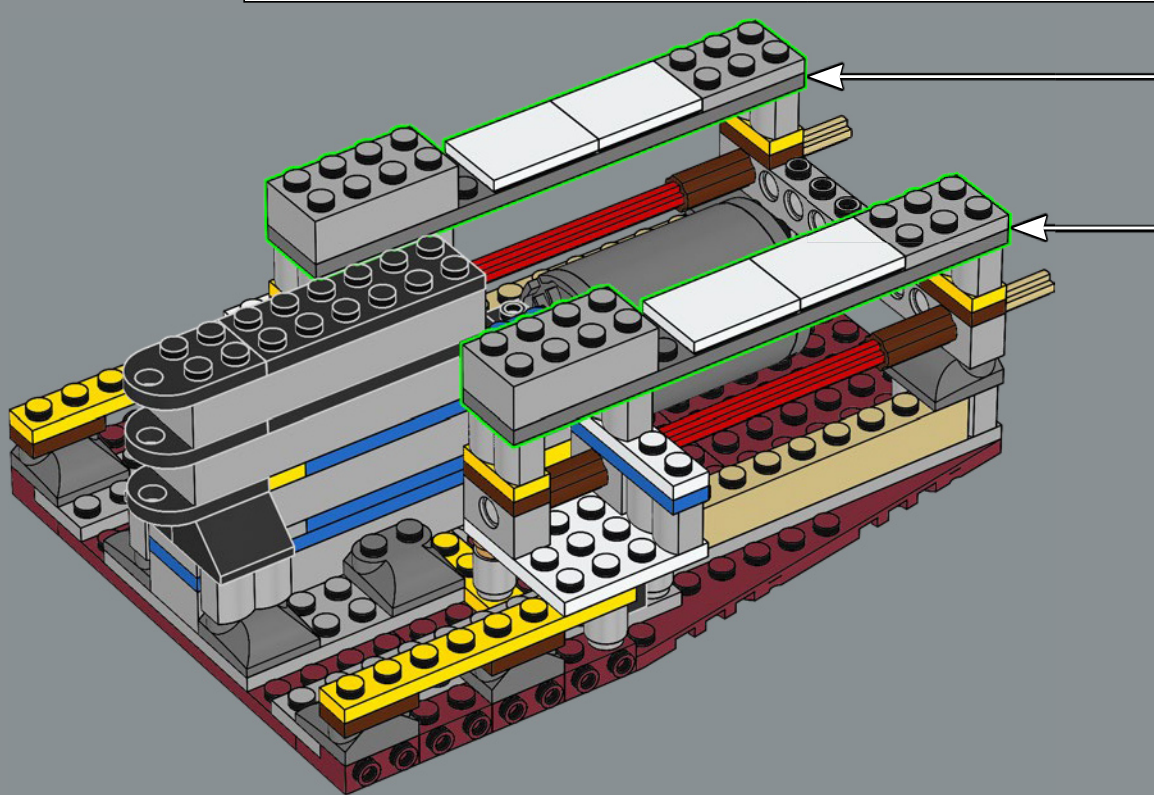
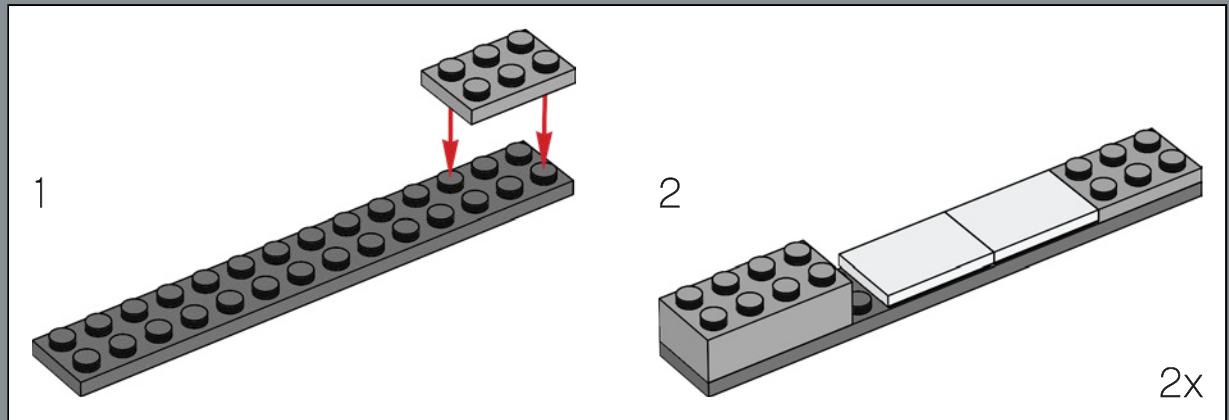

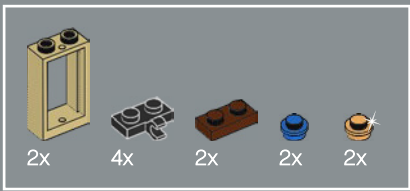

19

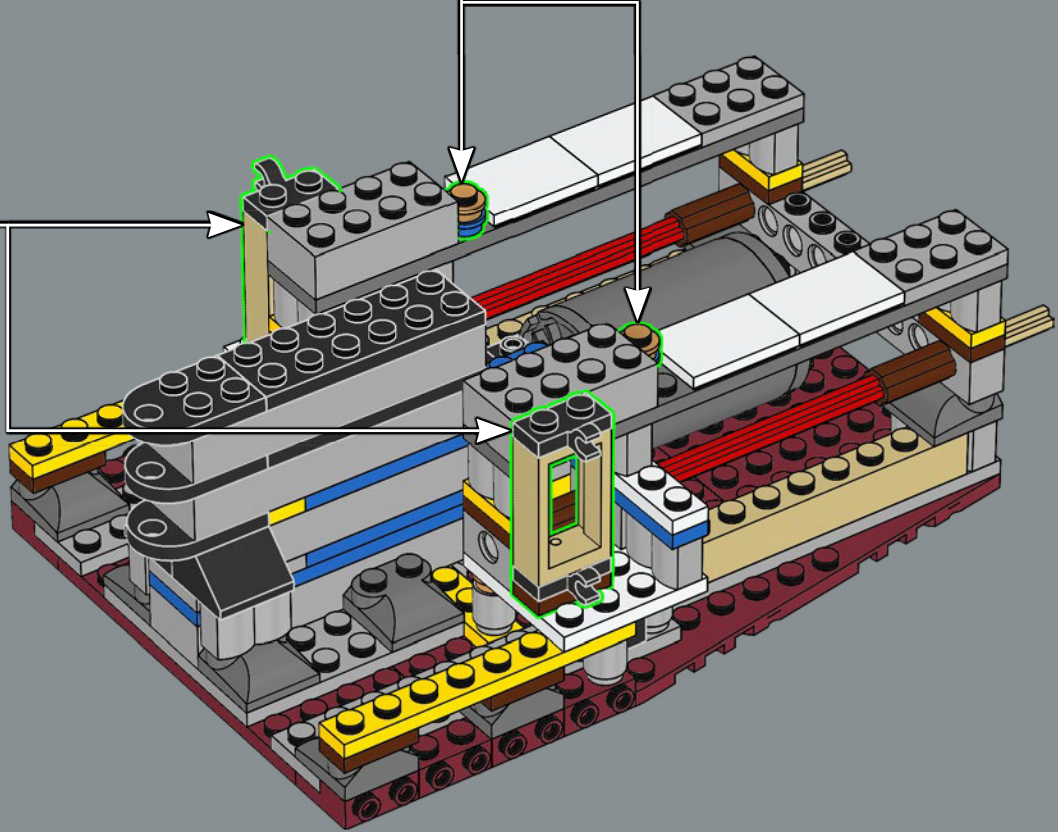
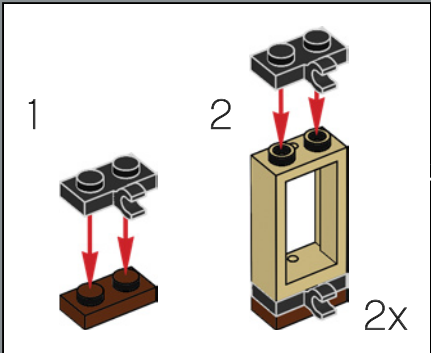
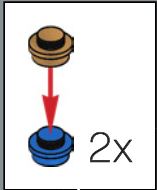



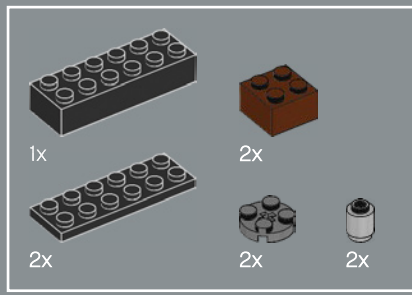

20

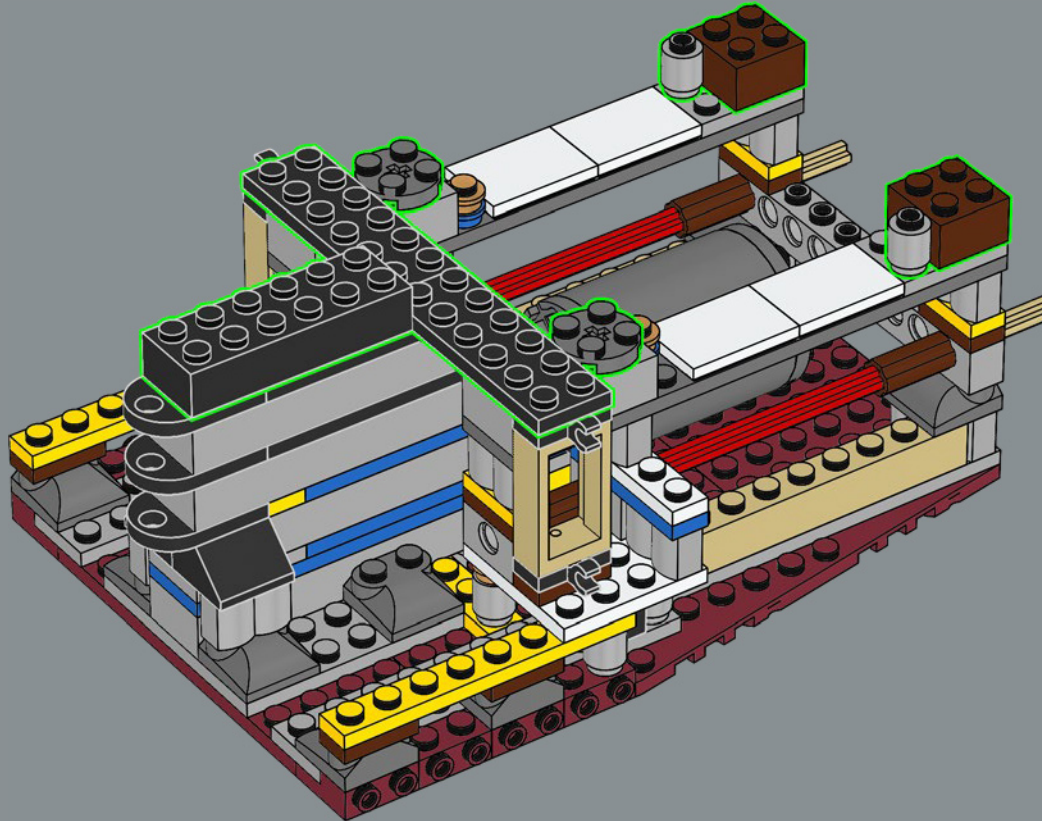



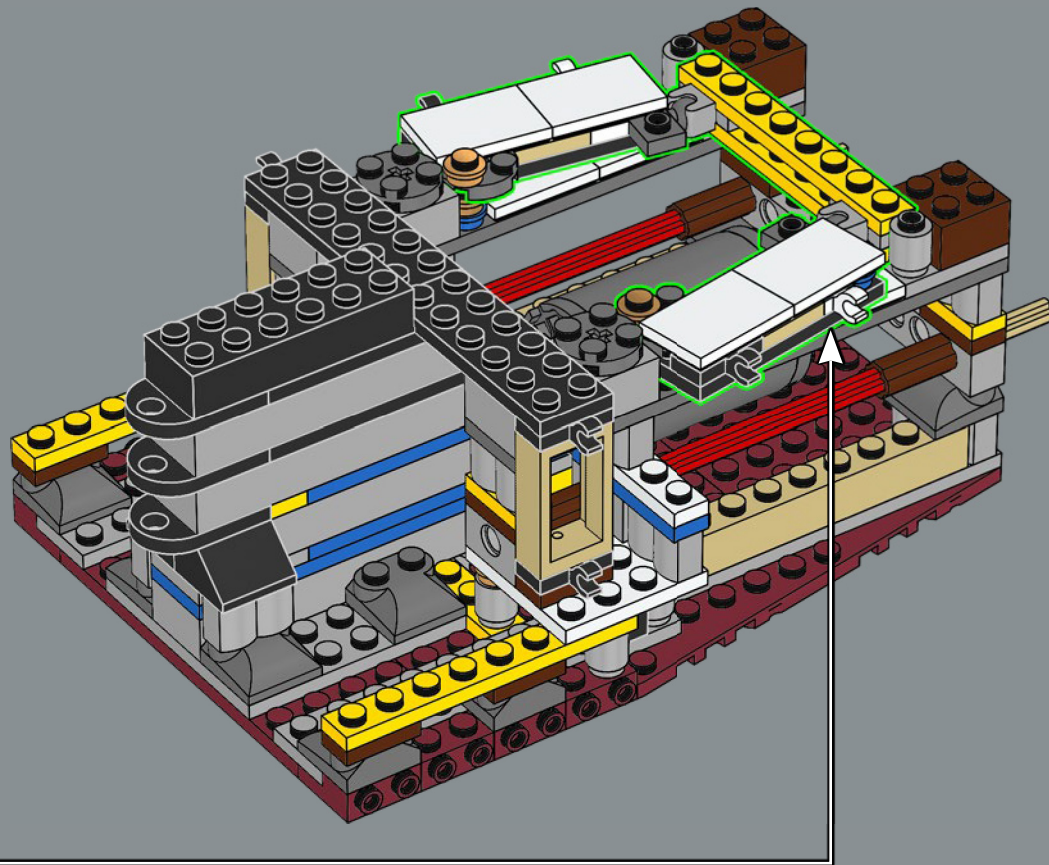

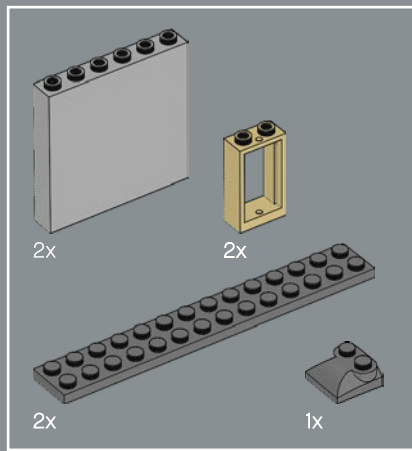

22

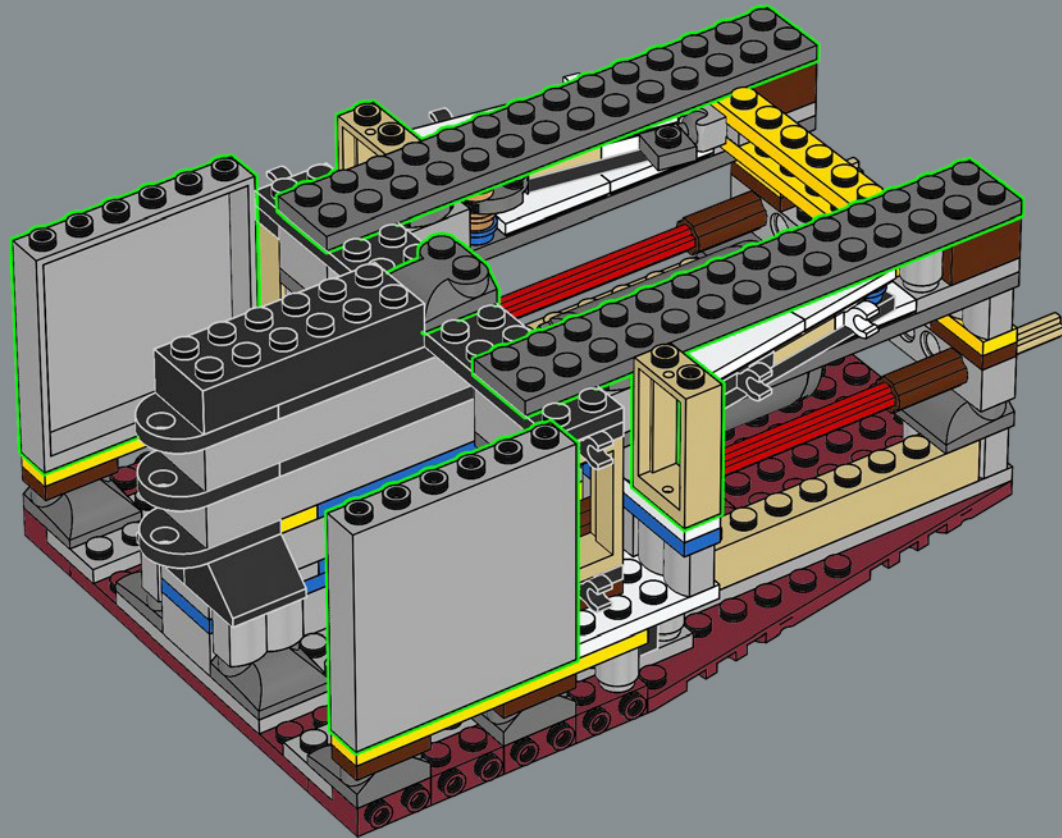

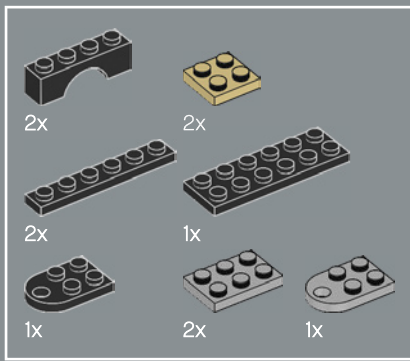

23

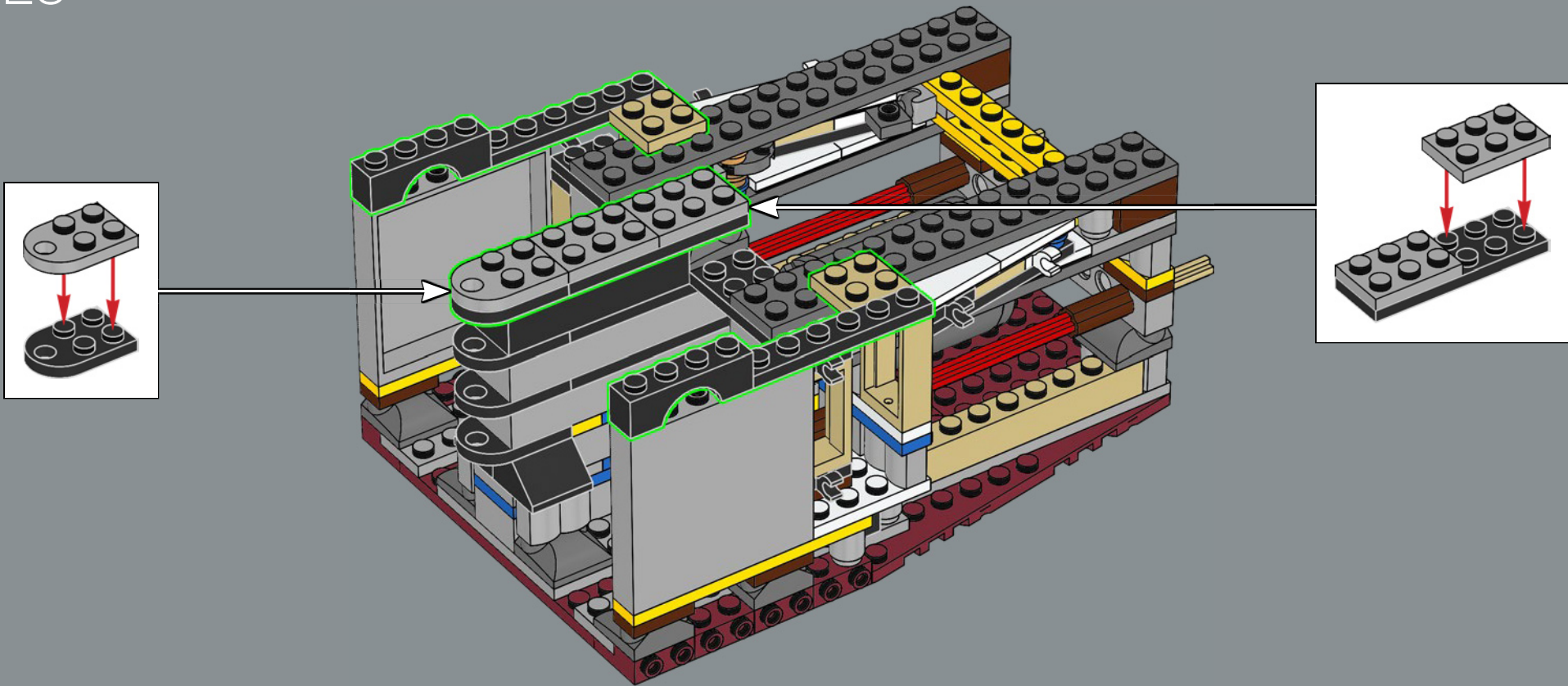

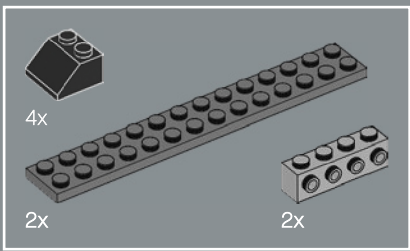

24

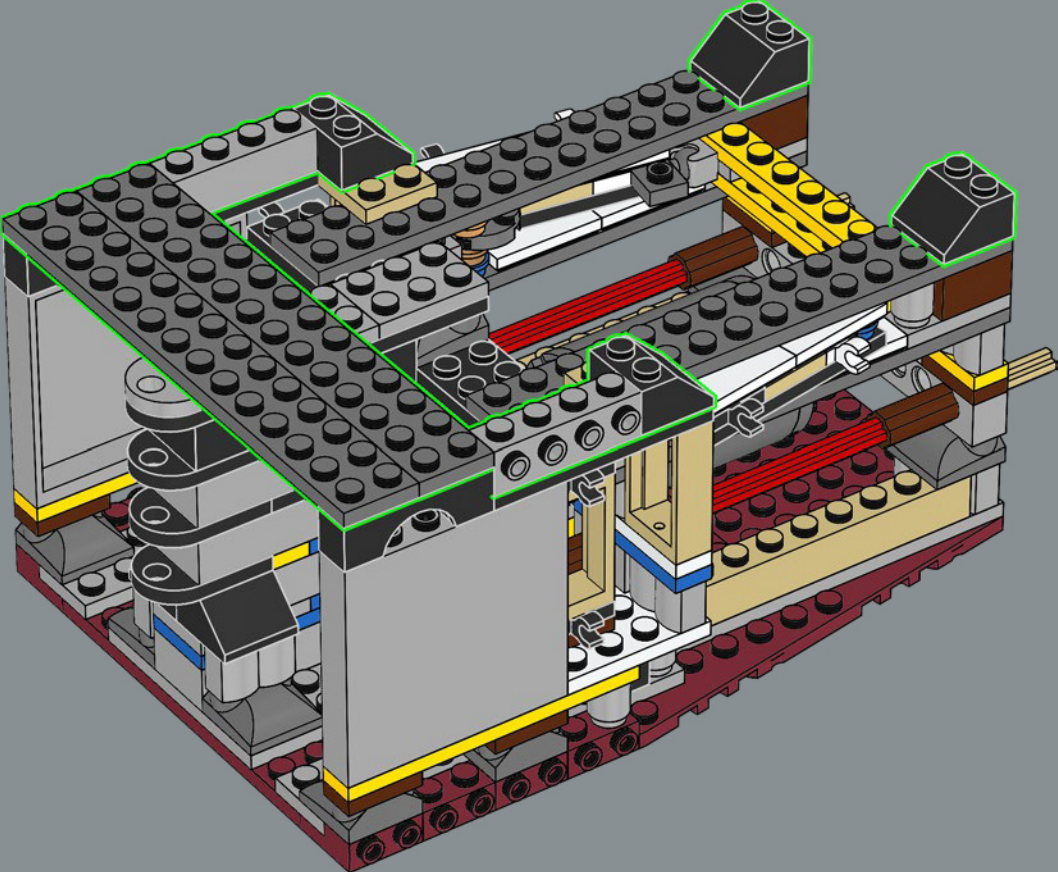

30

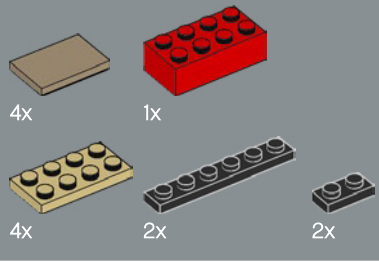
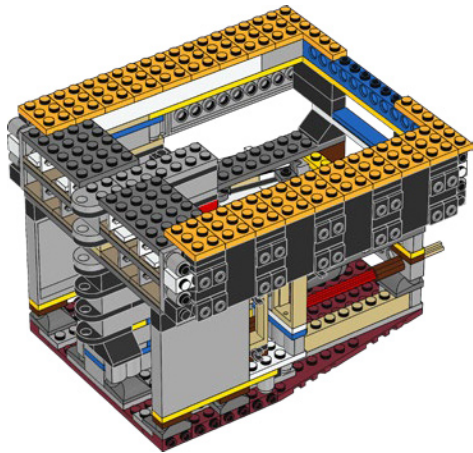
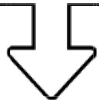

25

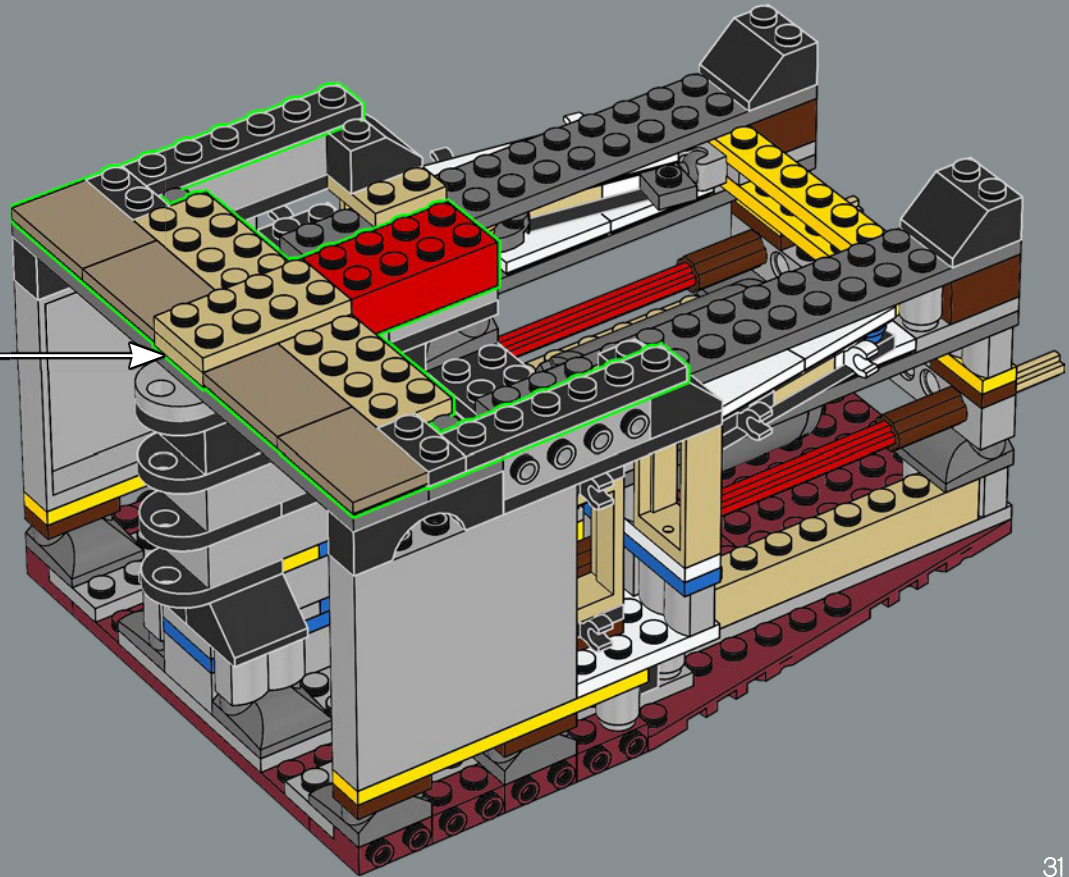
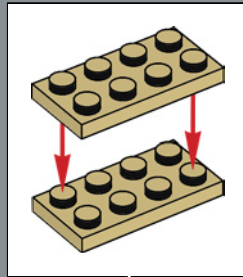

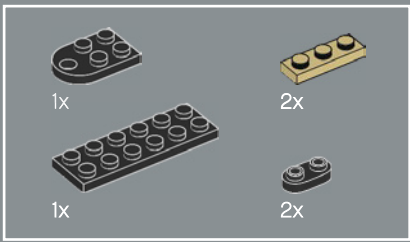

26

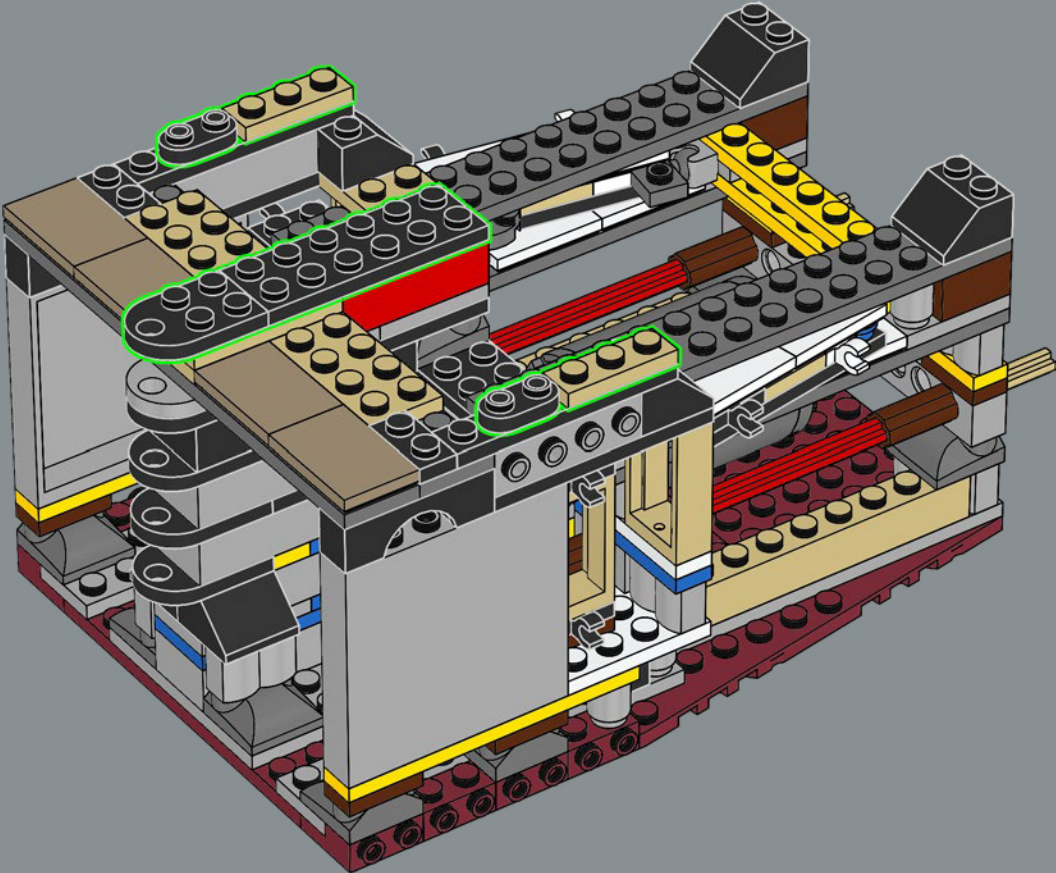



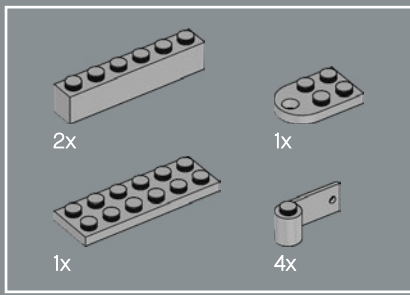

27

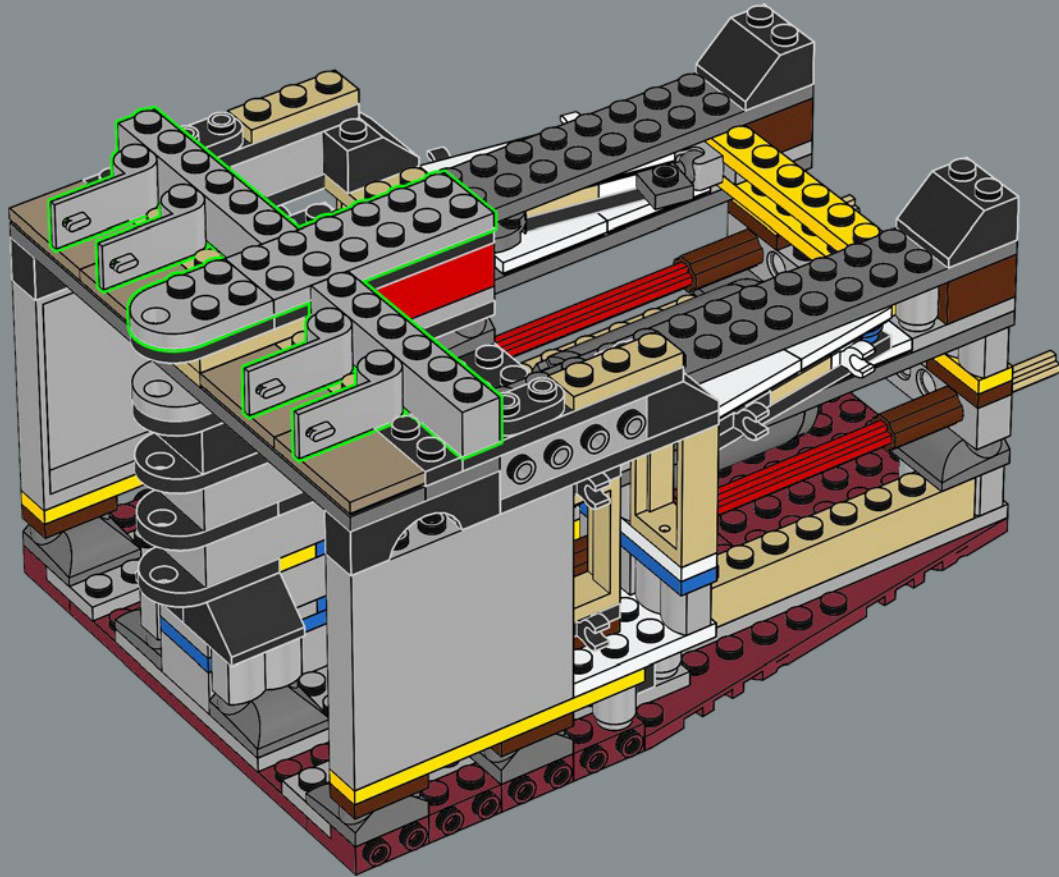

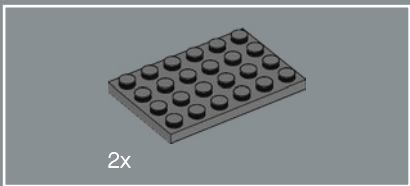

28

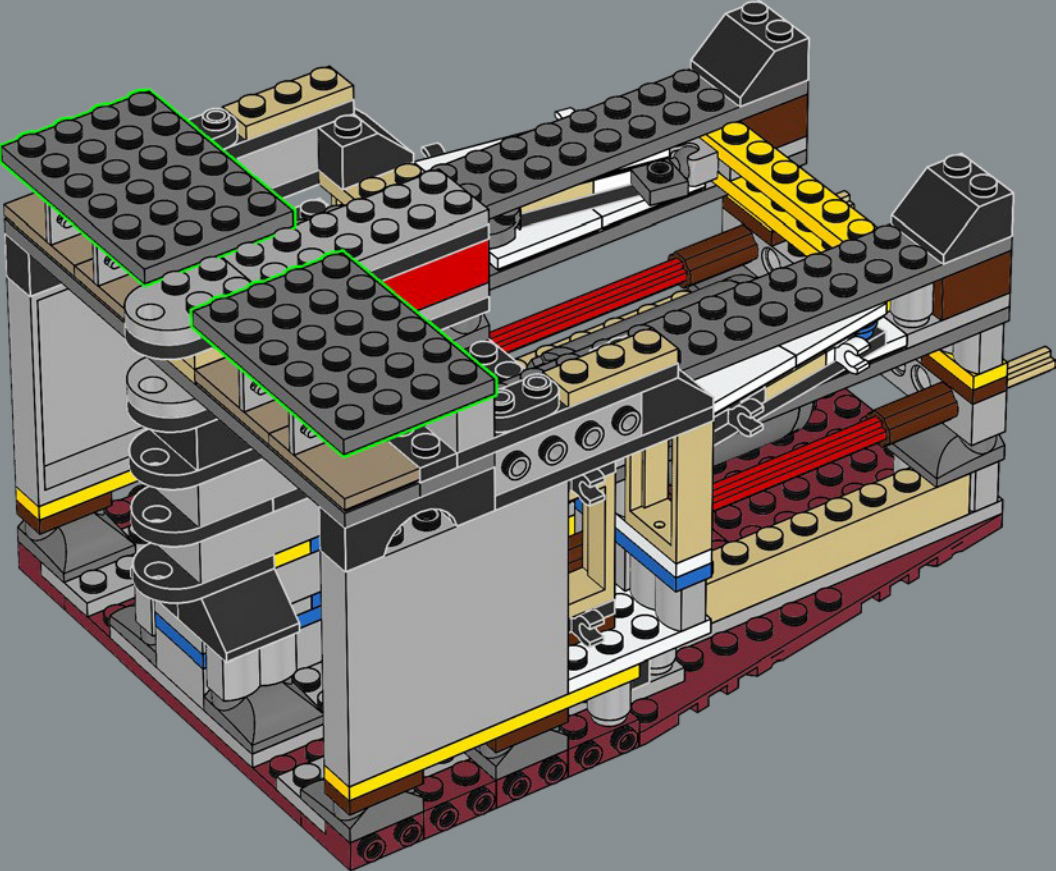

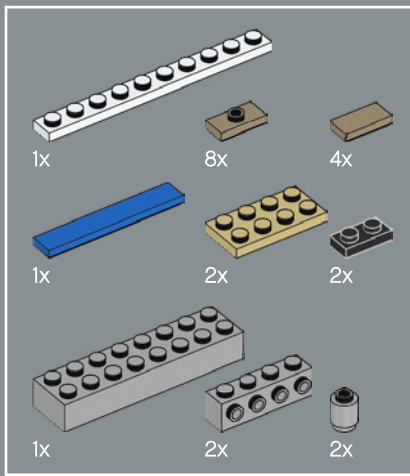

29

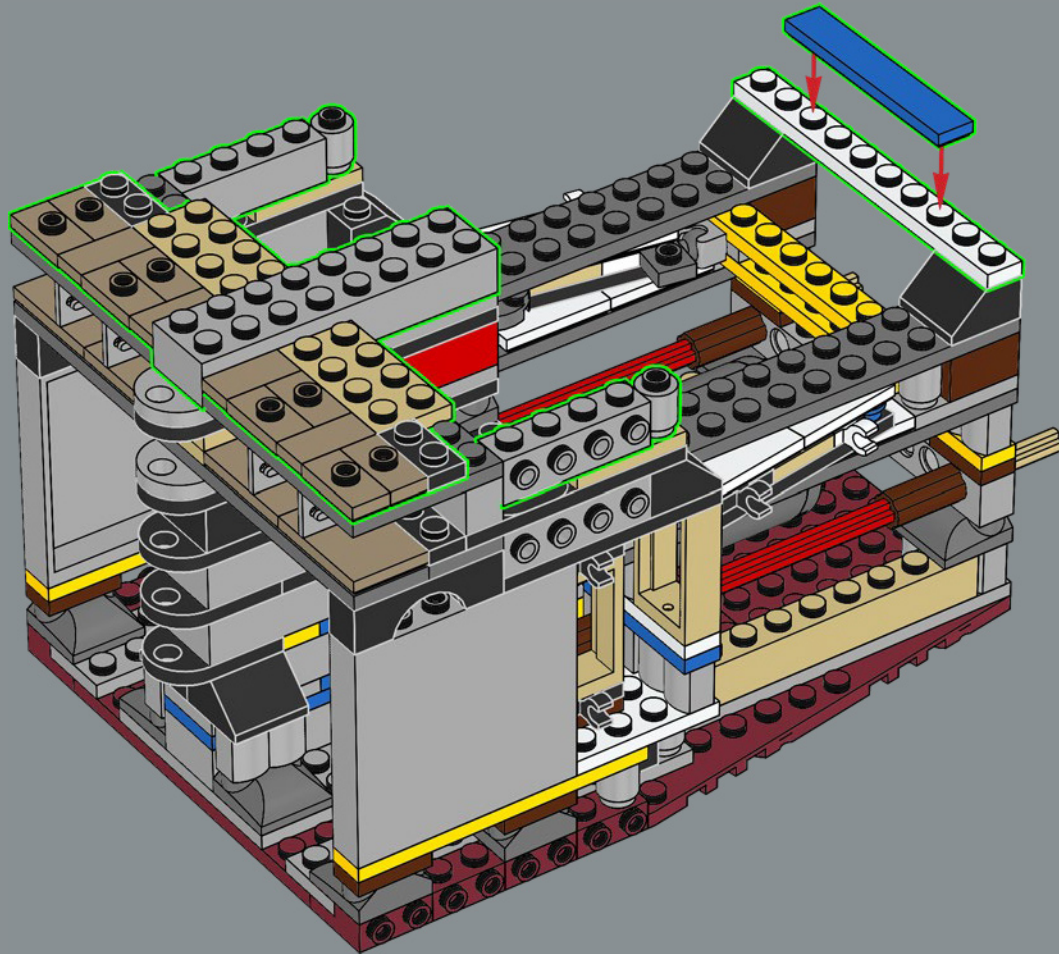

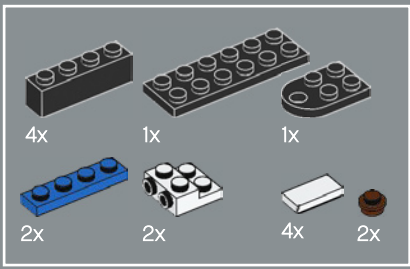

30

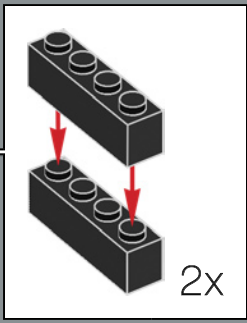
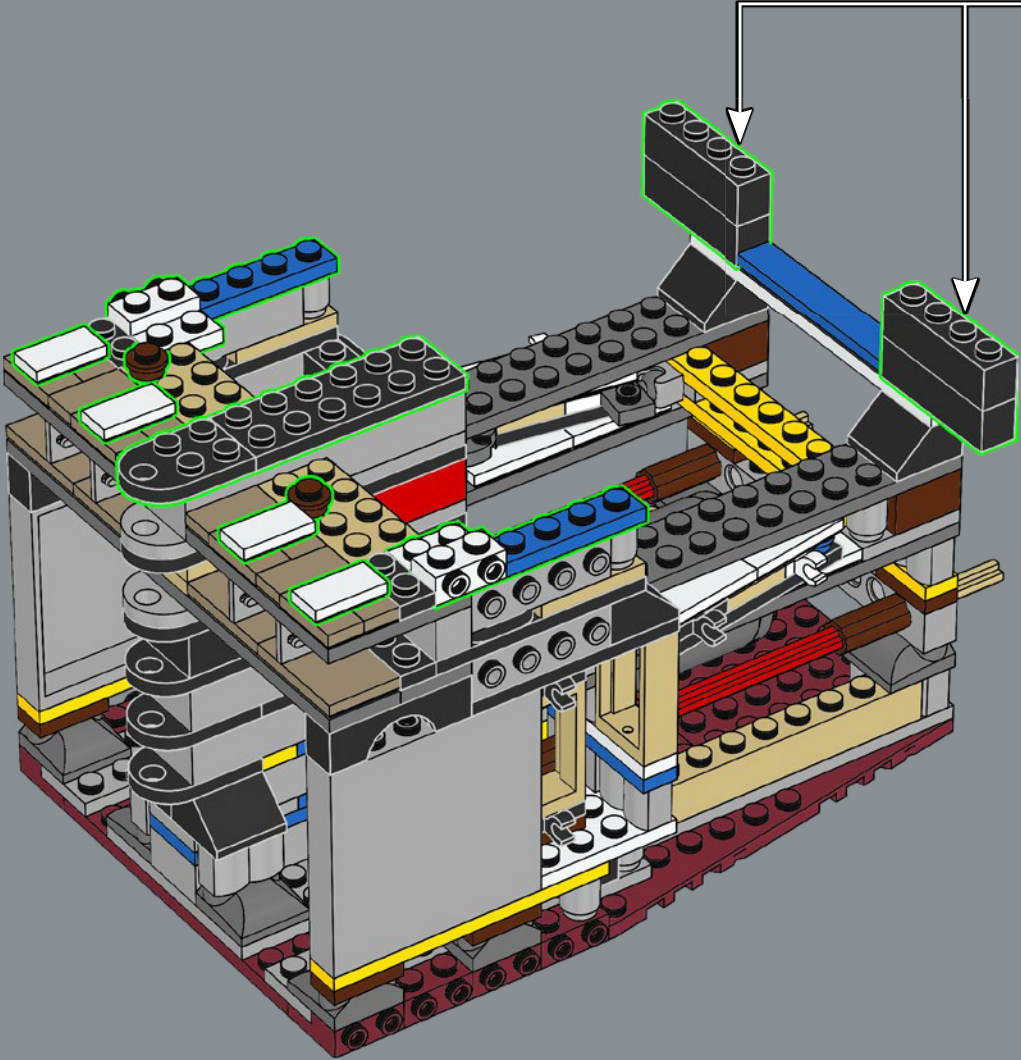

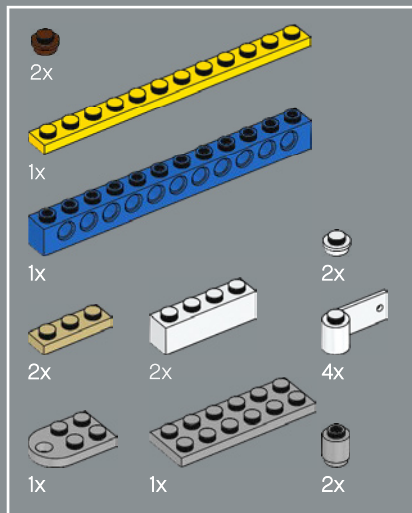

31

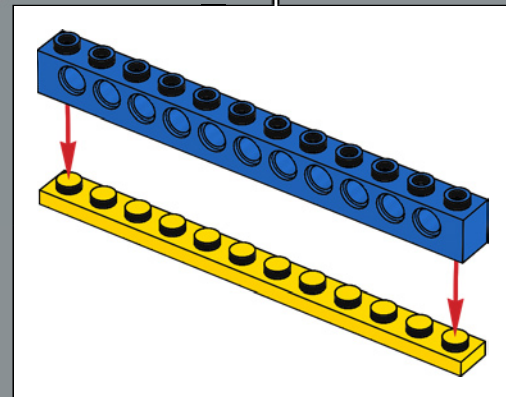
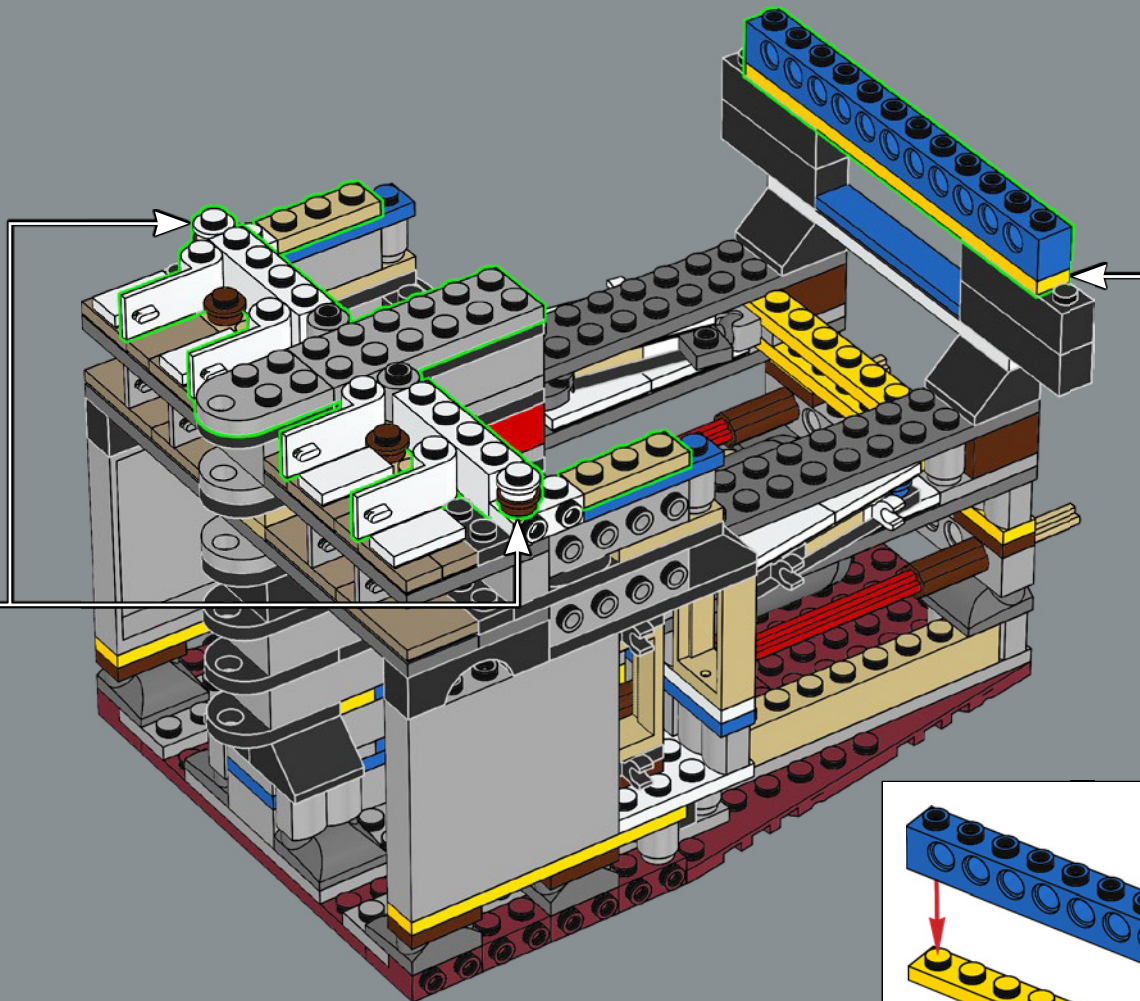
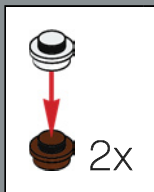

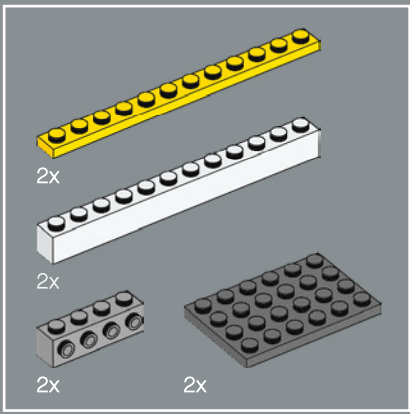

32

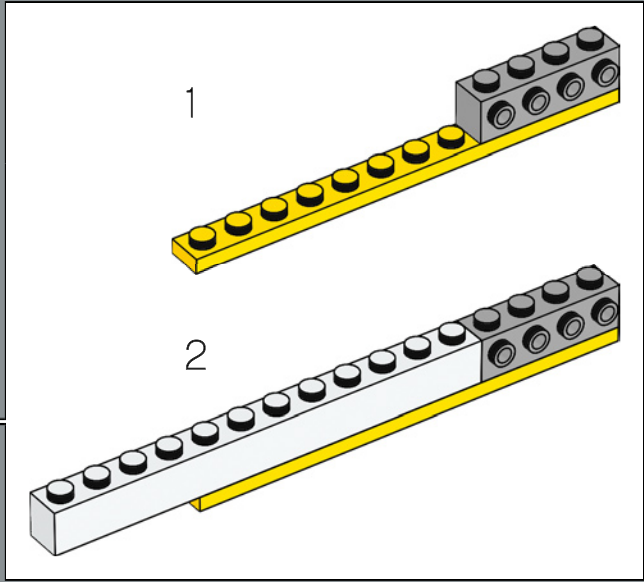
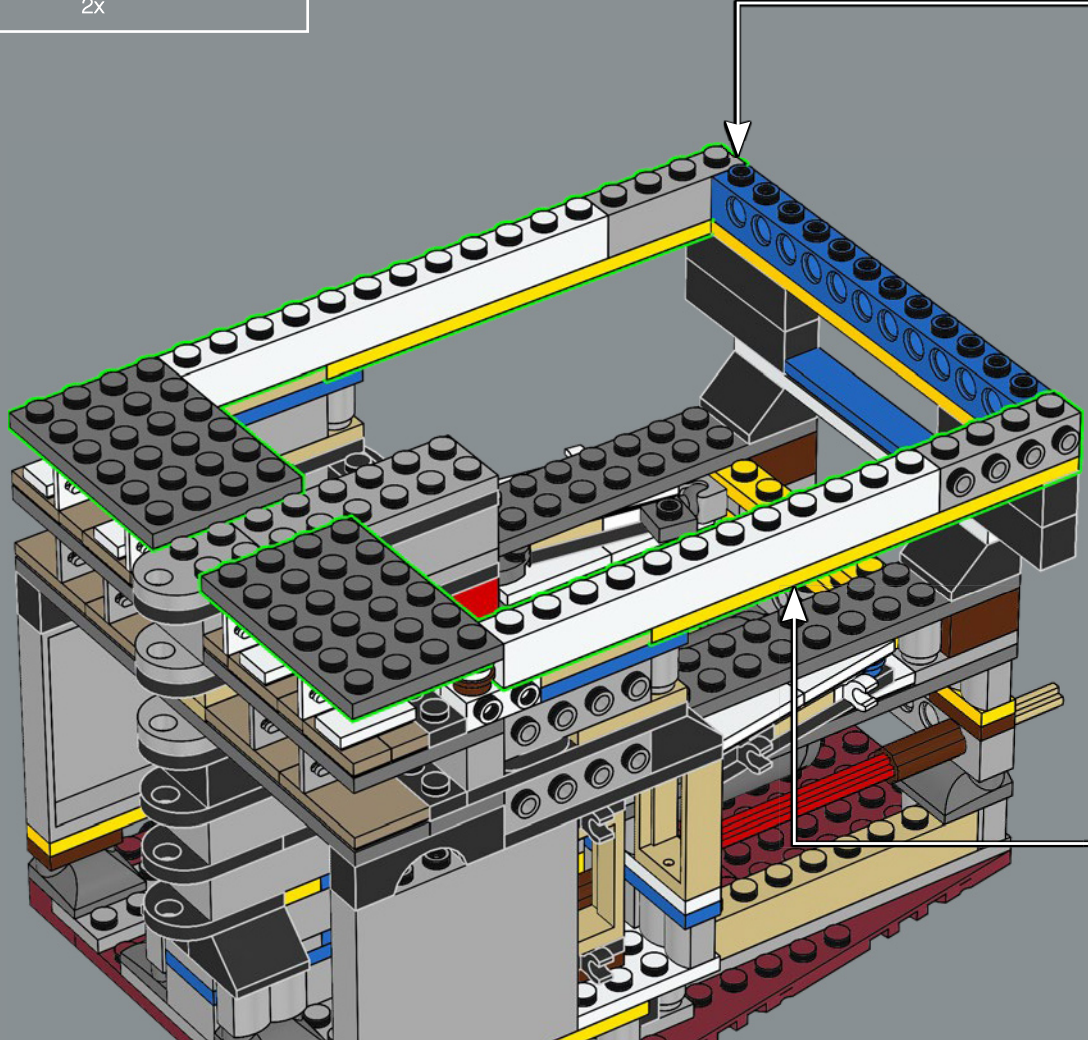
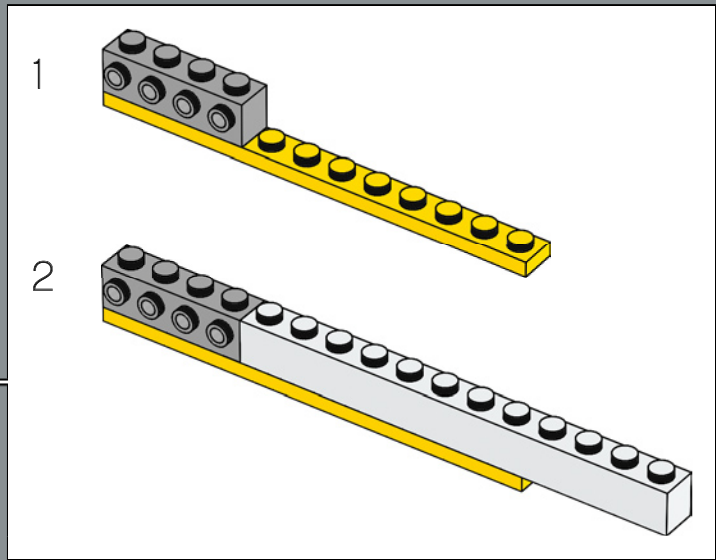

38

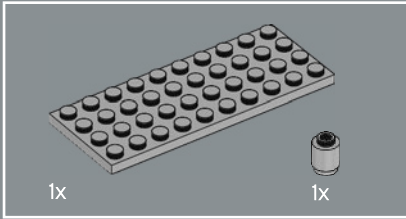
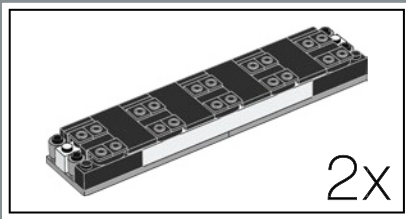

33

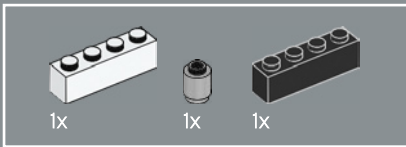
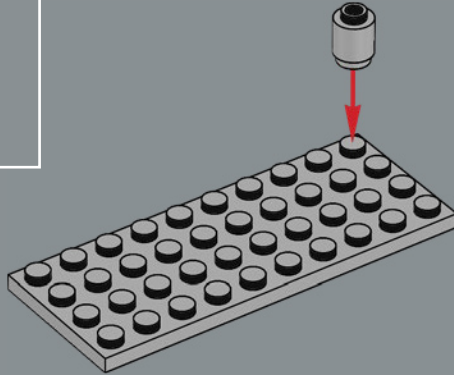

34

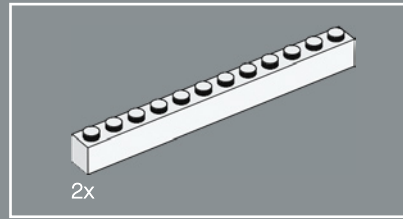
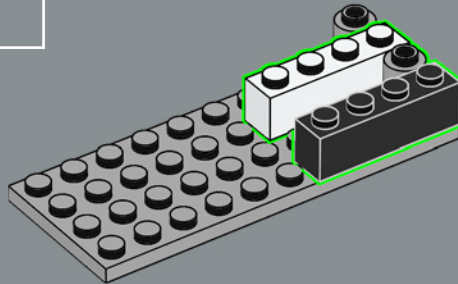

35

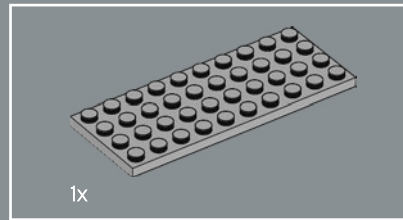
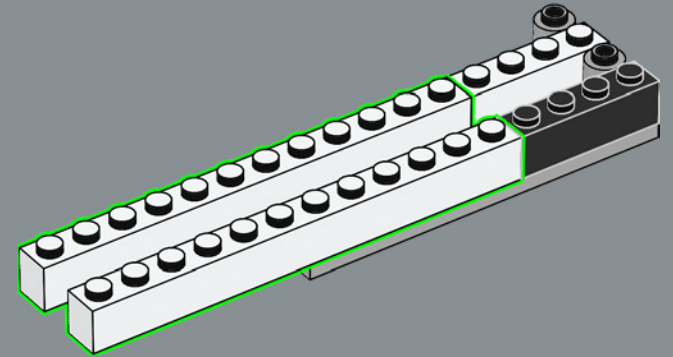

36

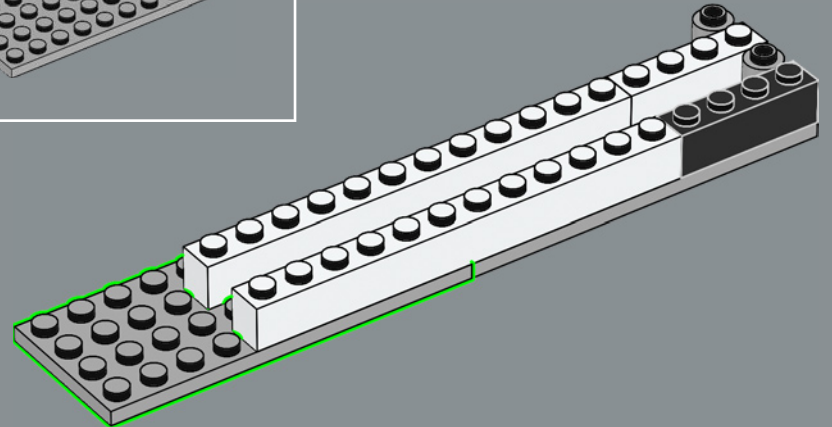

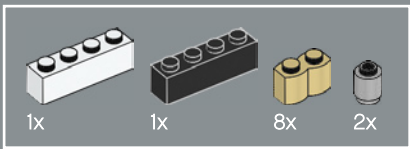

37

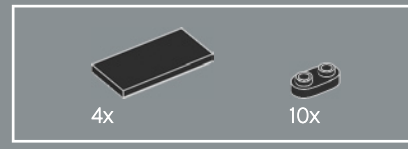
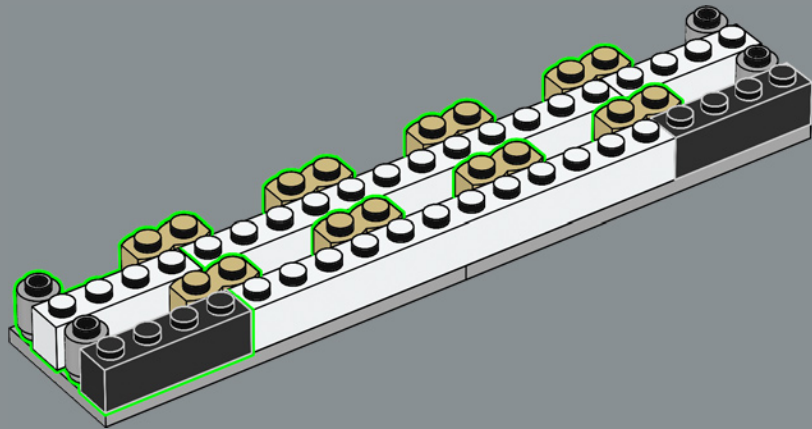

38

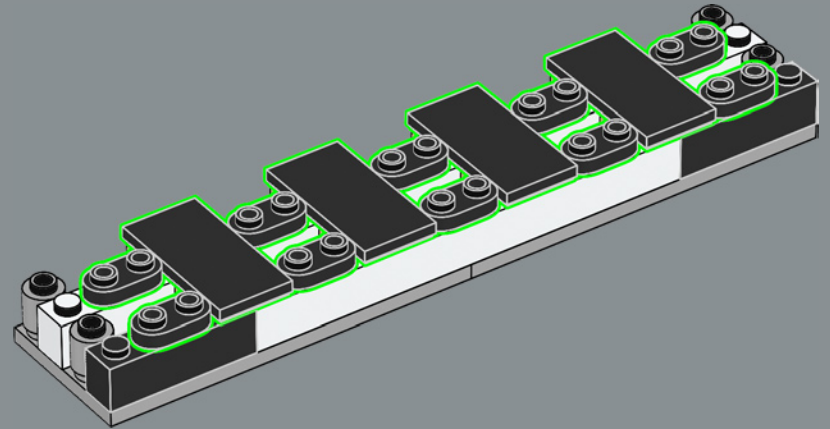





39

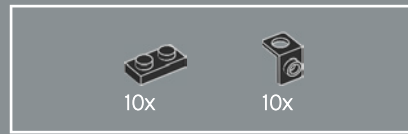
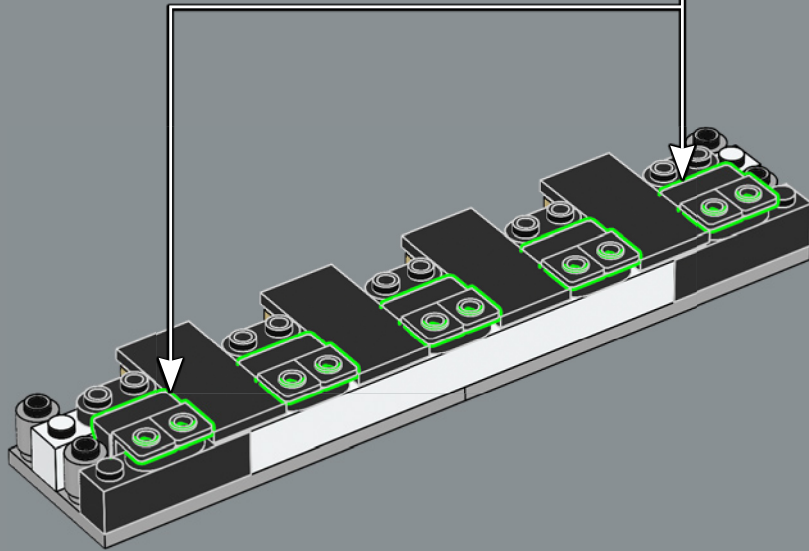
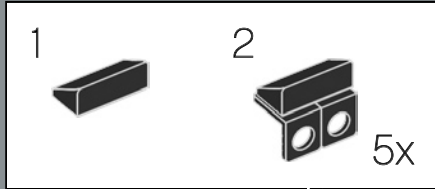

40

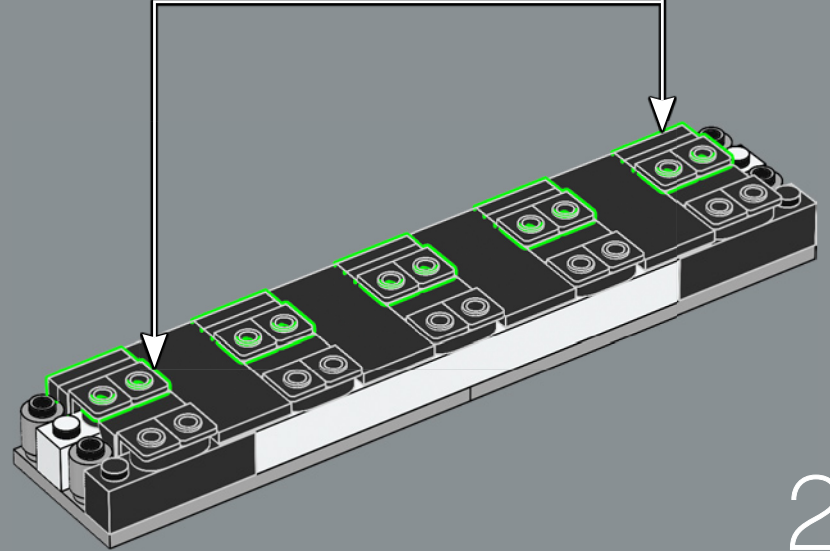
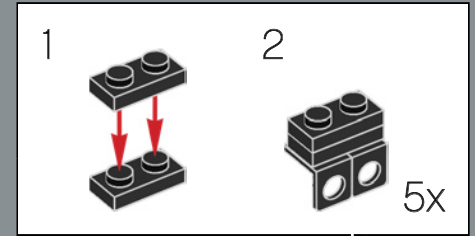

2x

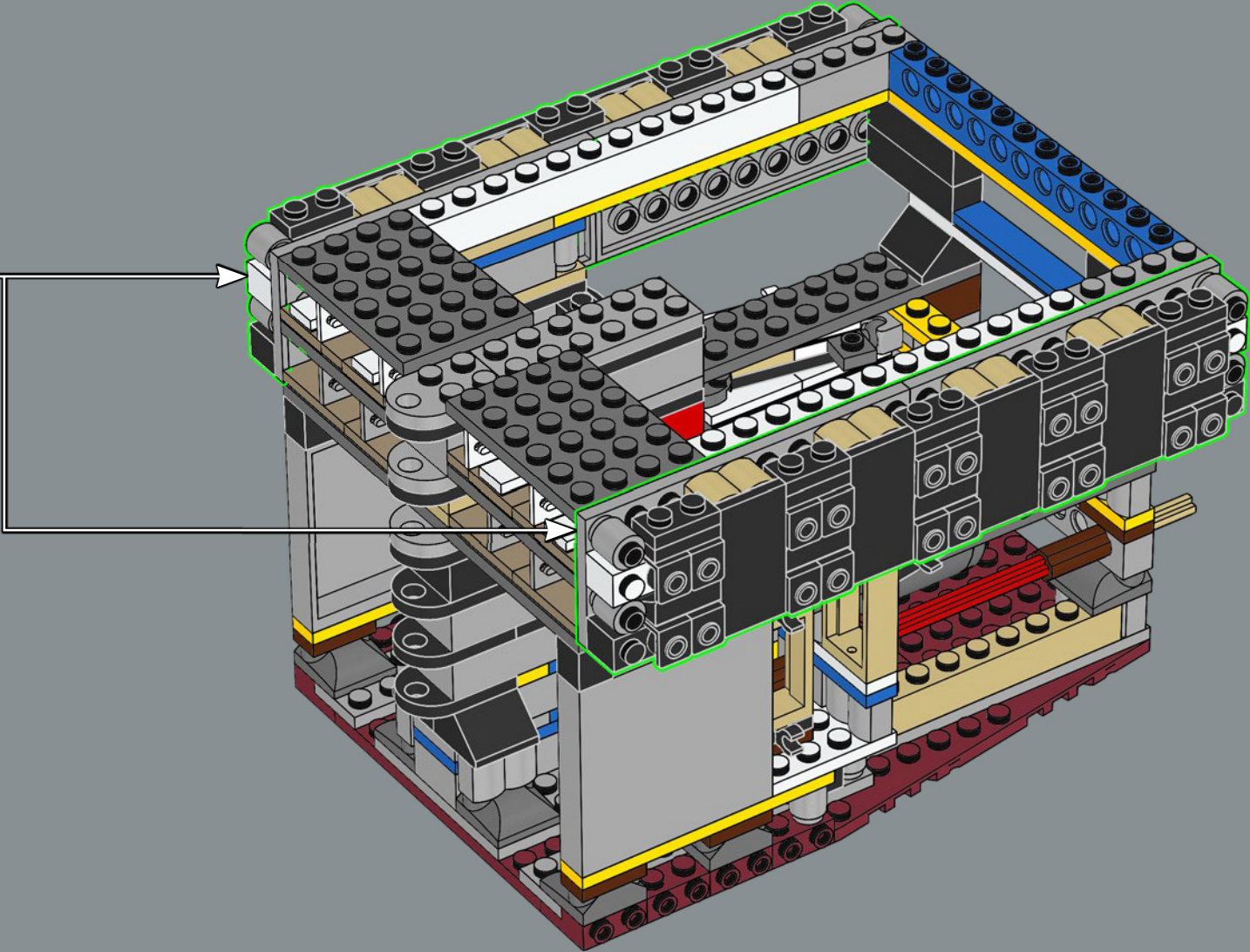

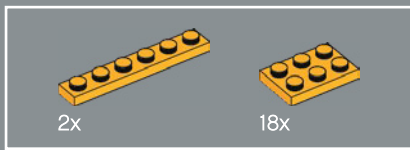

42

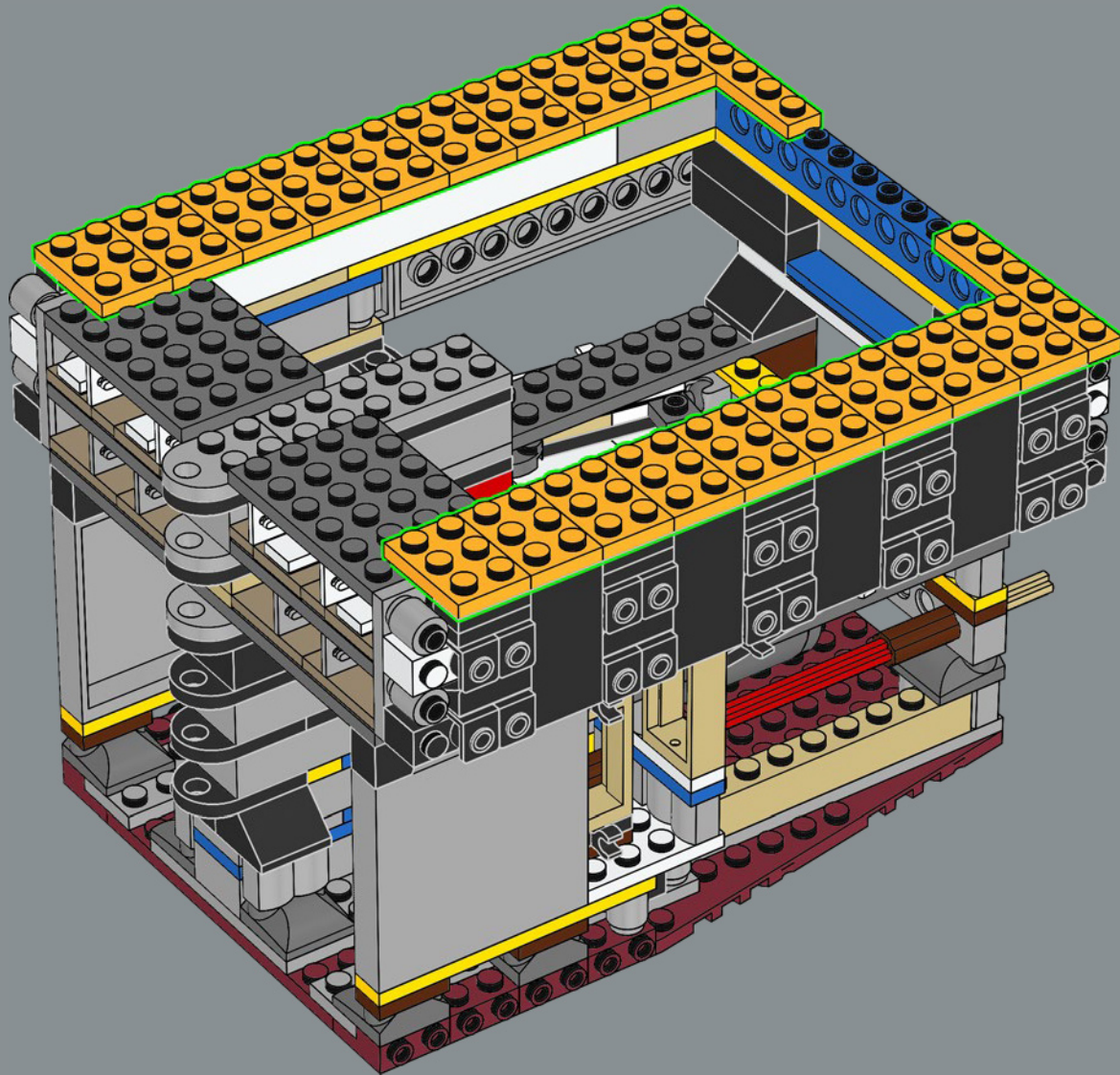

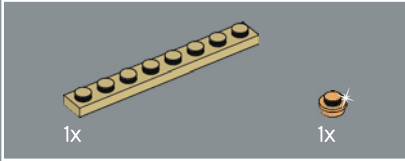
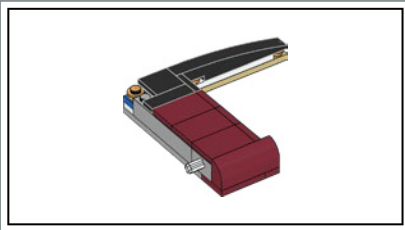
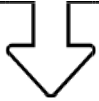

43

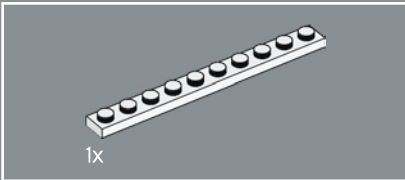
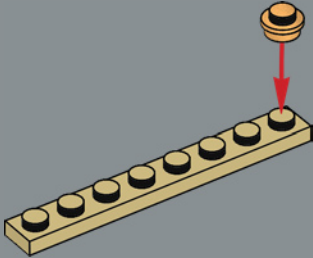

44

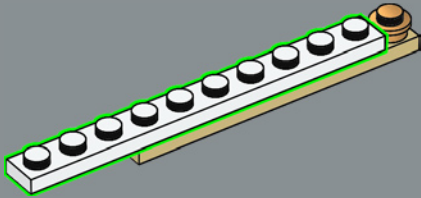

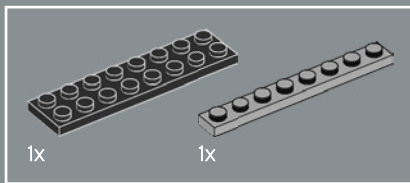

45

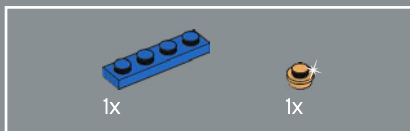
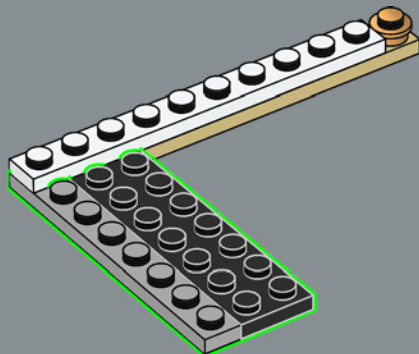

46

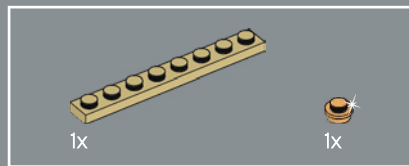
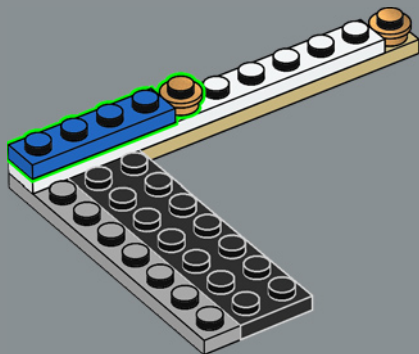

47

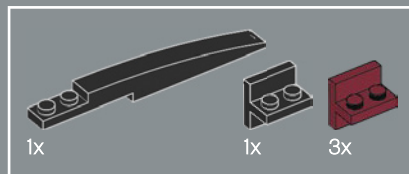
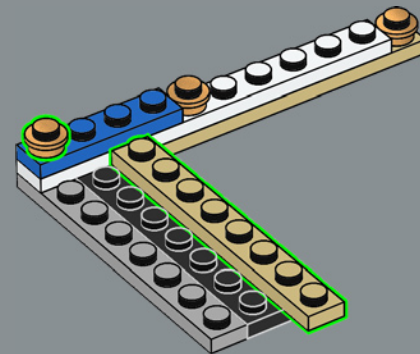

48

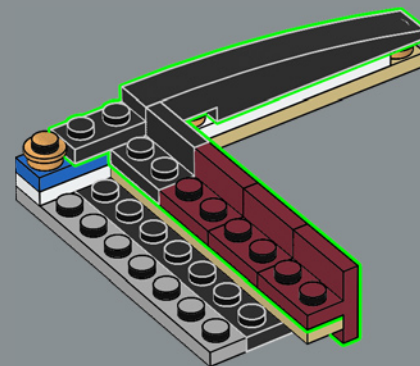

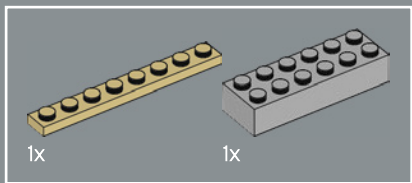

49

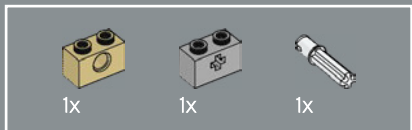
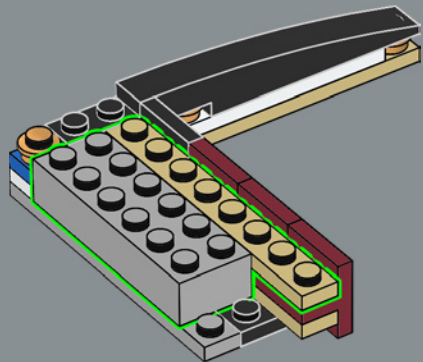

50

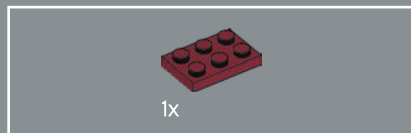
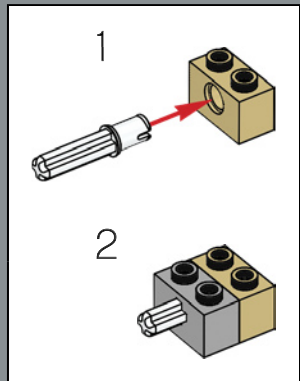
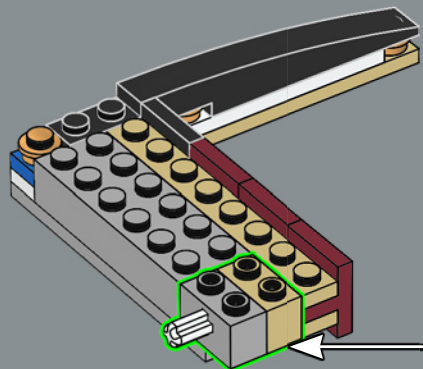

51

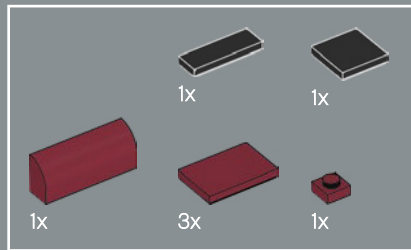
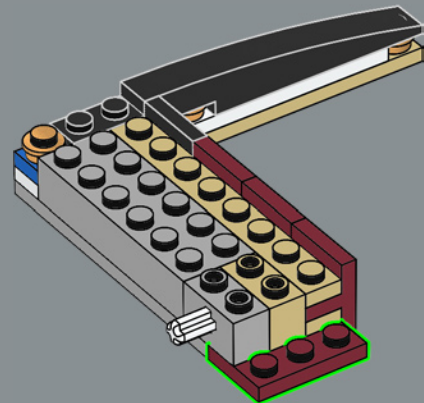

52

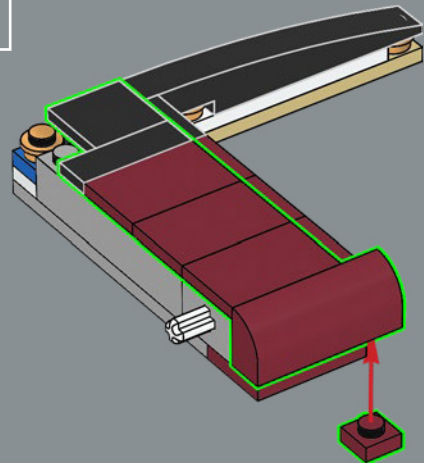

53

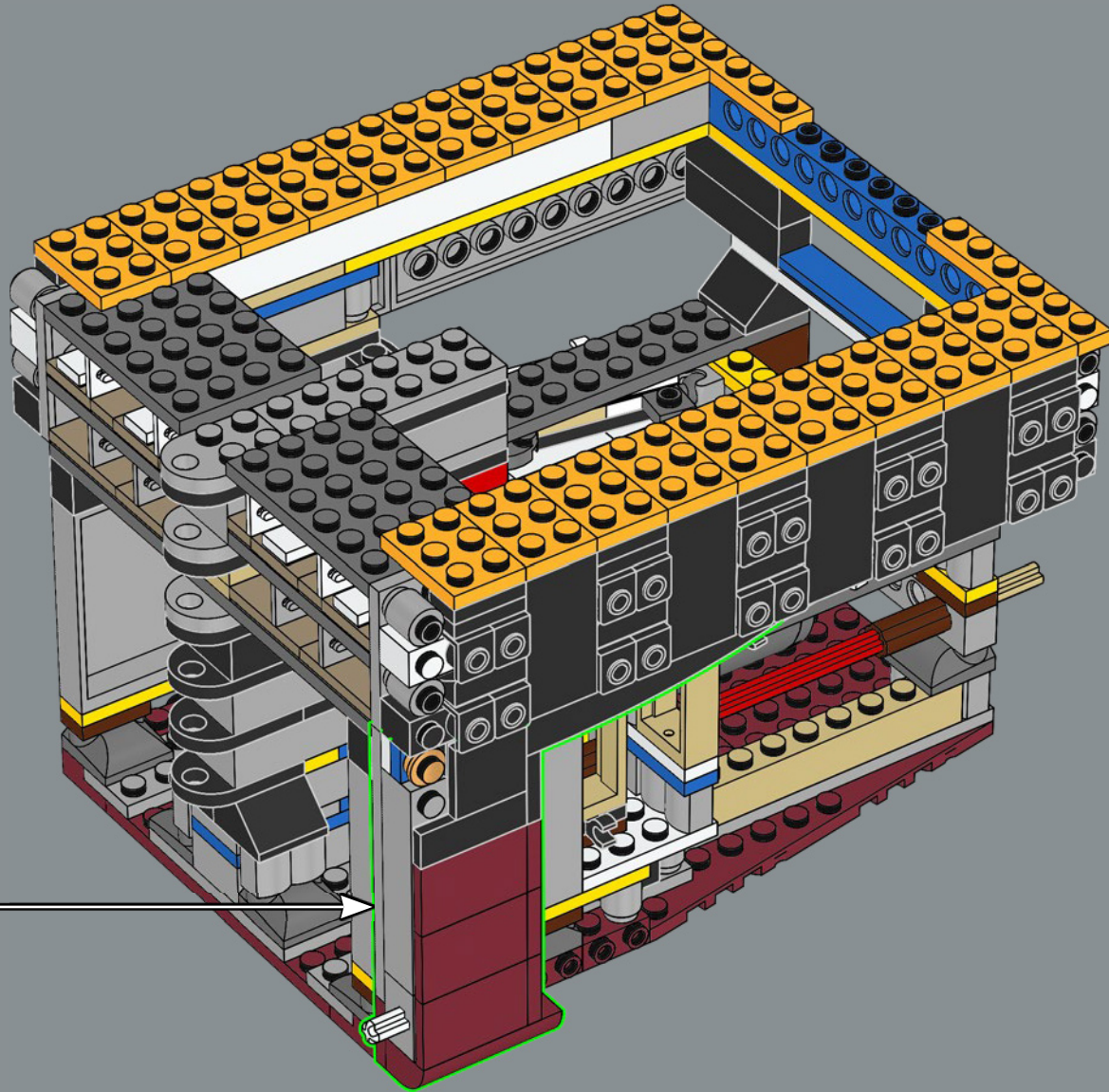

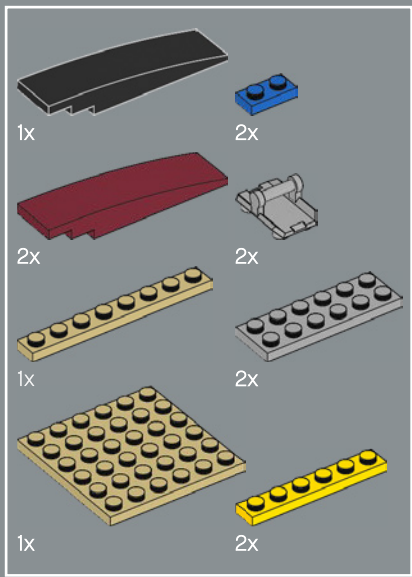

54

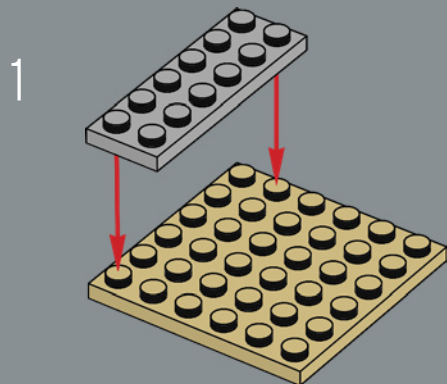

2

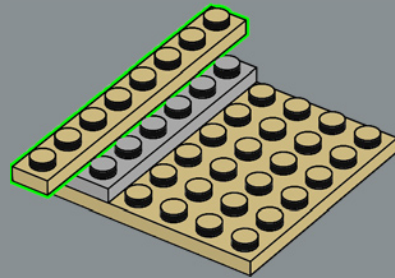

3

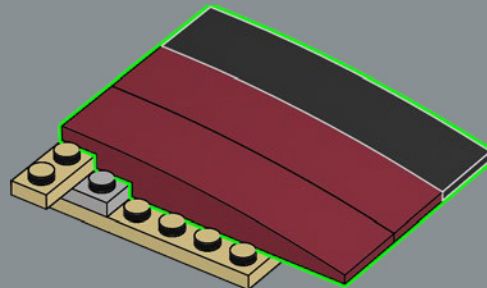

4

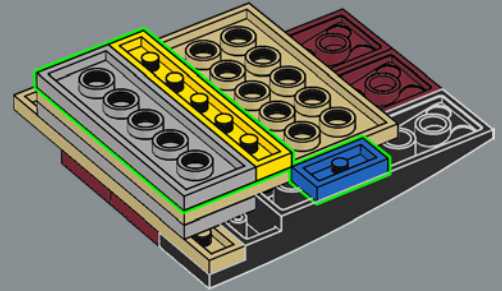

5

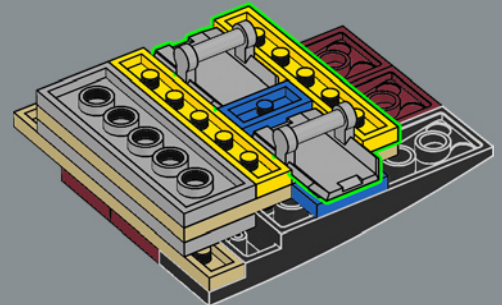



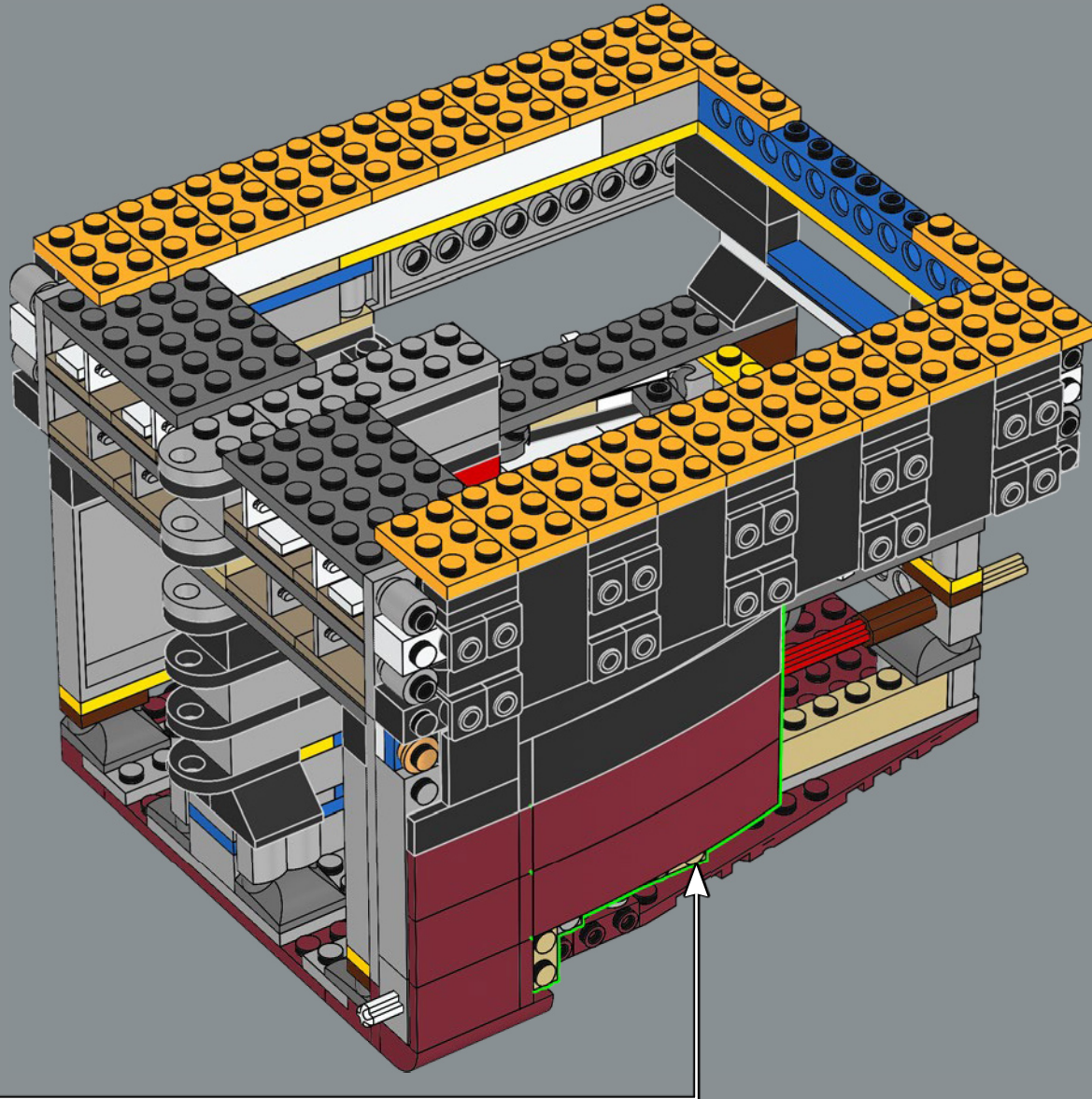

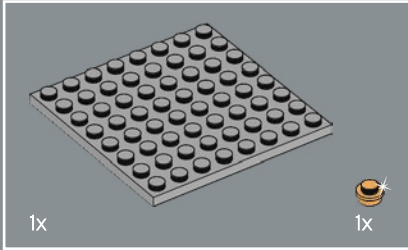
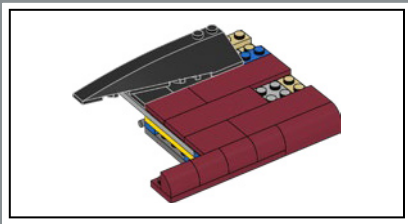

55

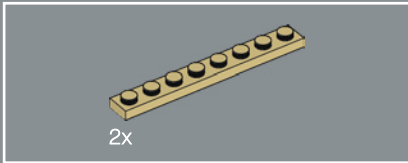
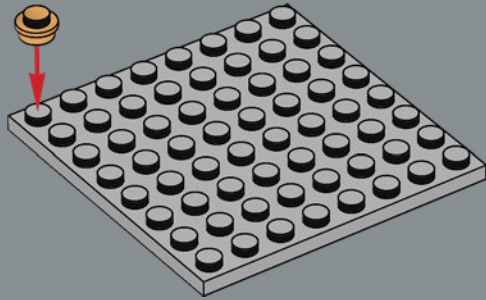

56

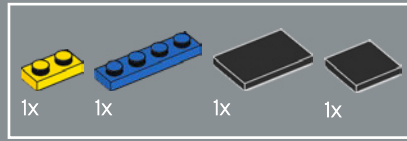
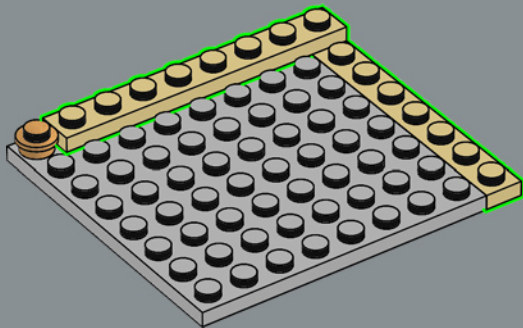

57

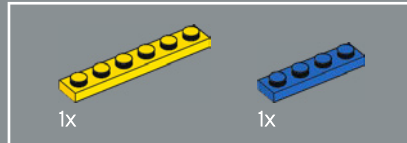
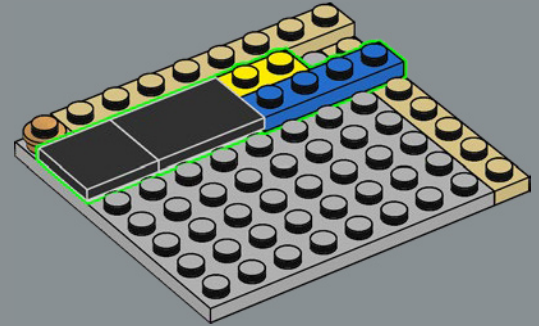

58

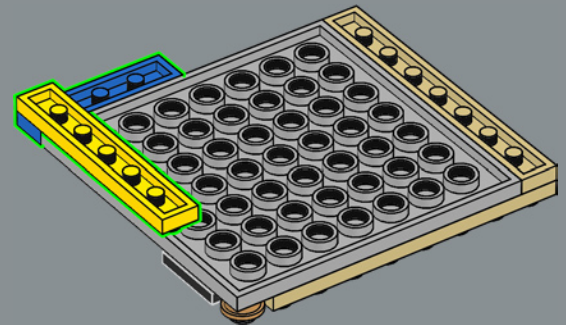

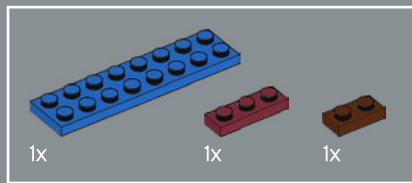

59

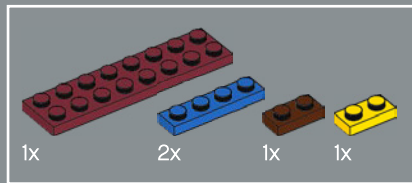
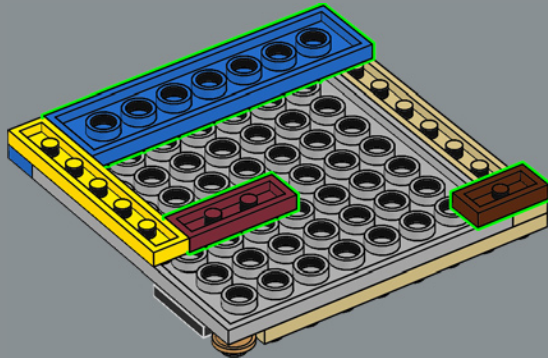

60

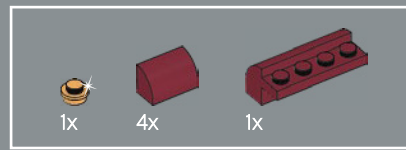
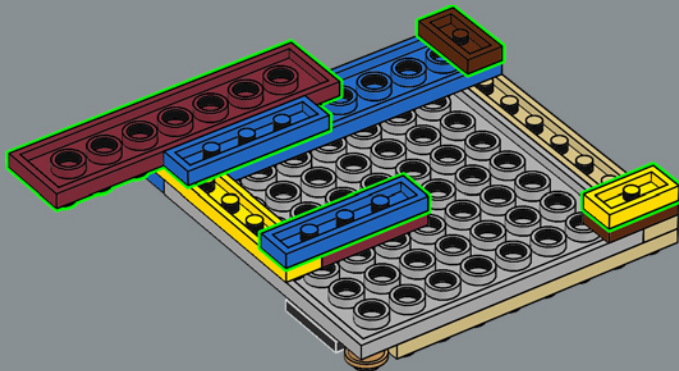

61

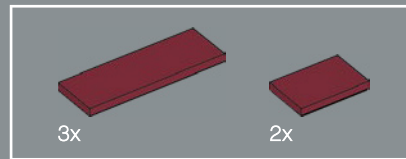
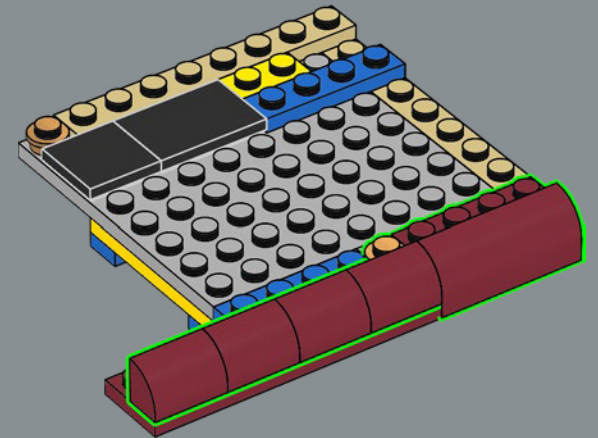

62

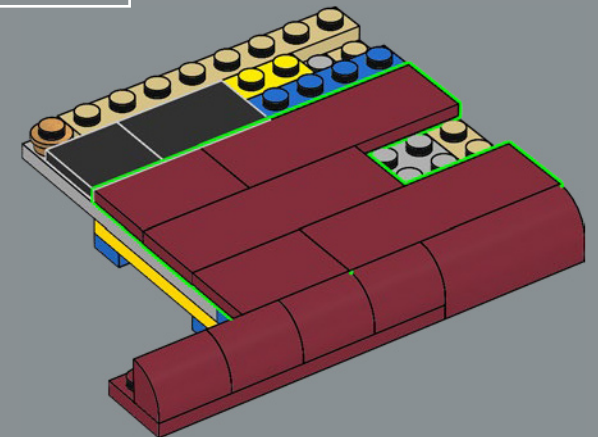

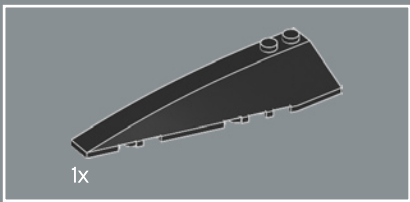

63

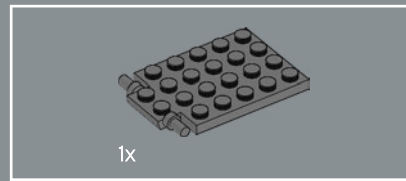
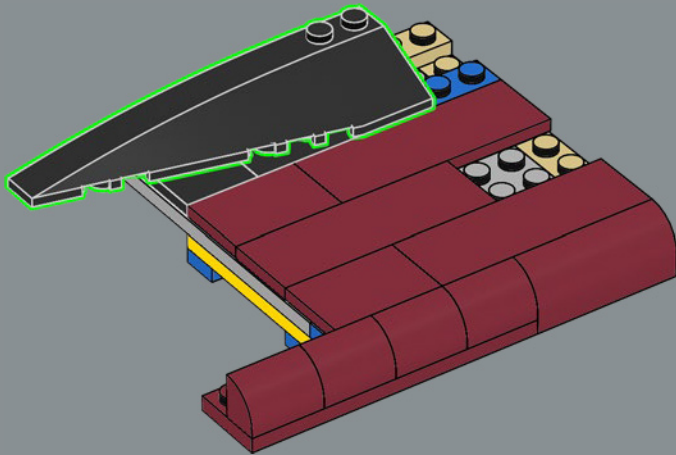

64

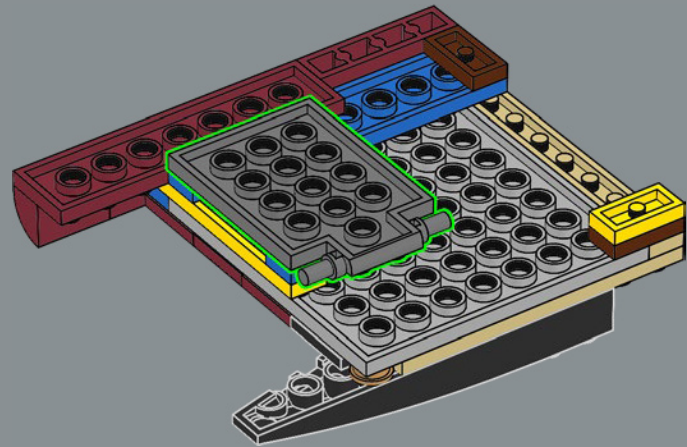

65

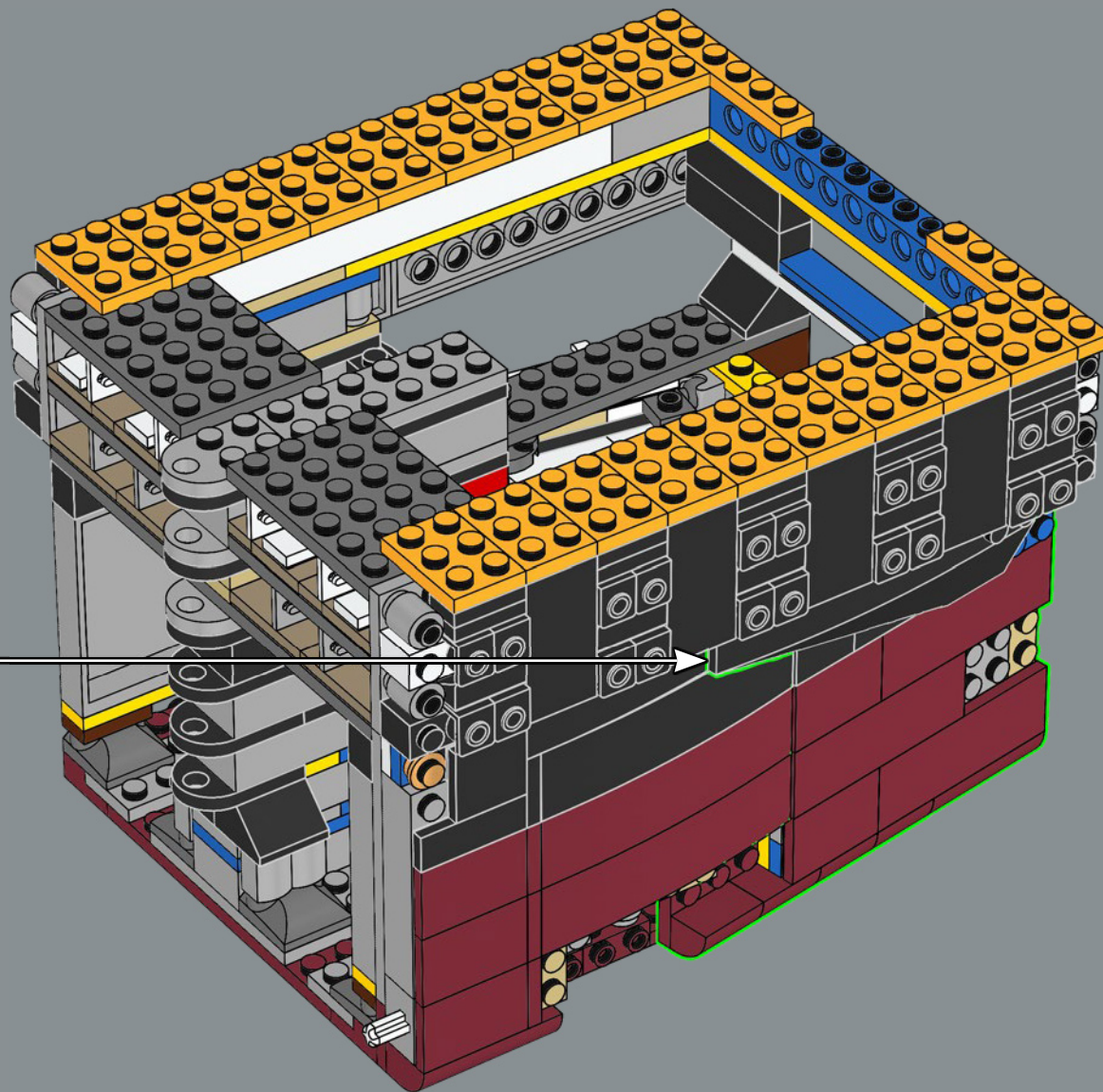

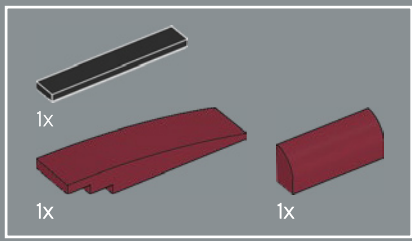

66

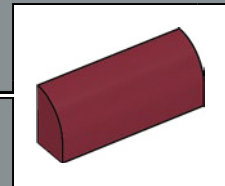
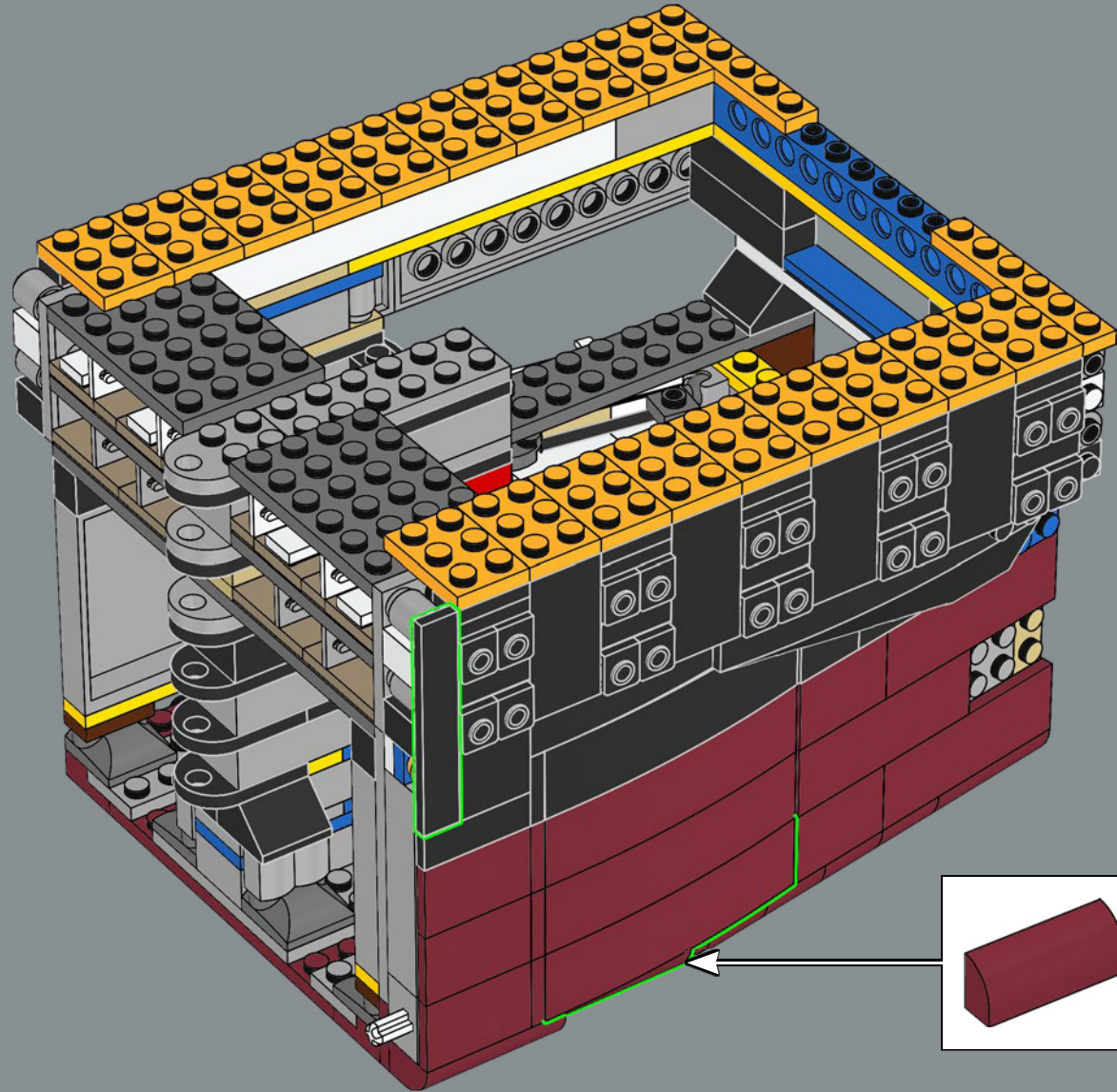

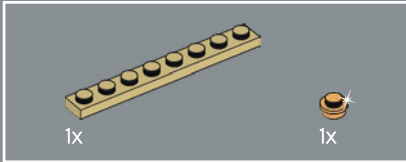
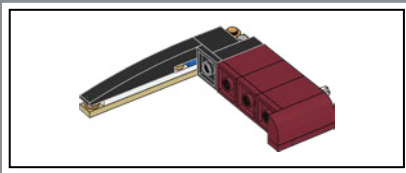

67

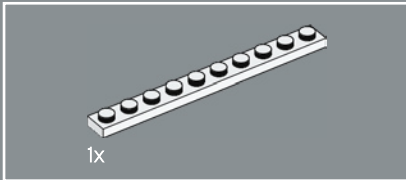
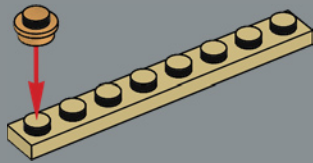

68

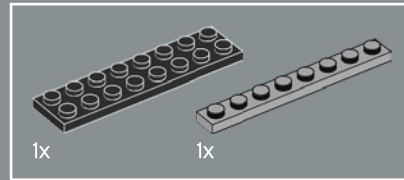
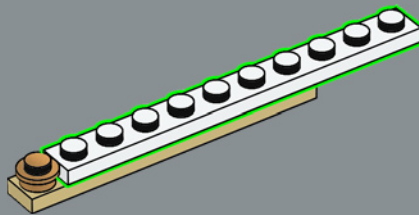

69

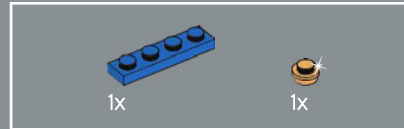
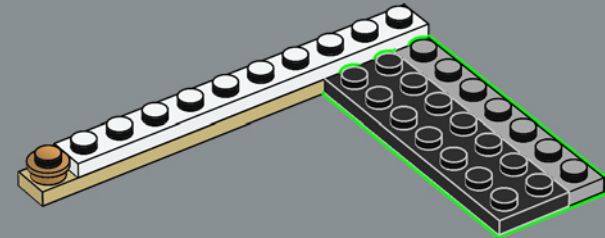

70

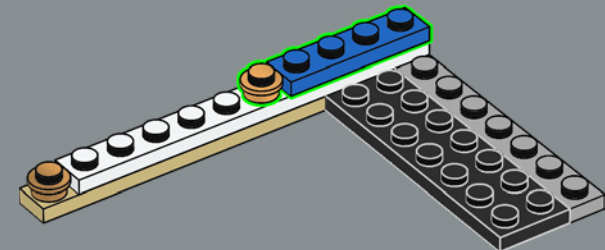

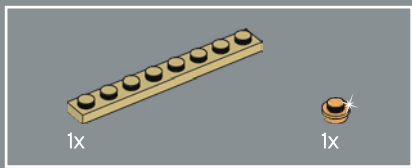

71

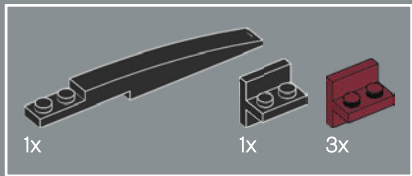
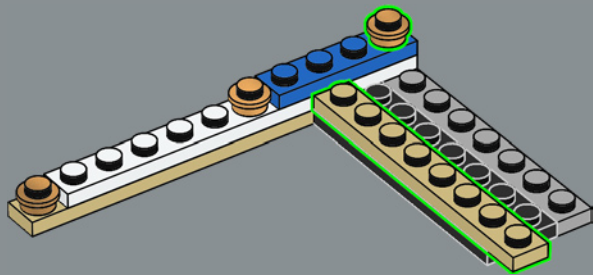

72

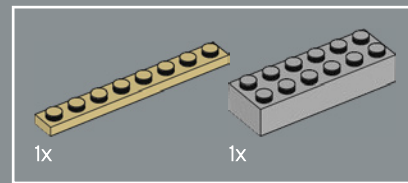
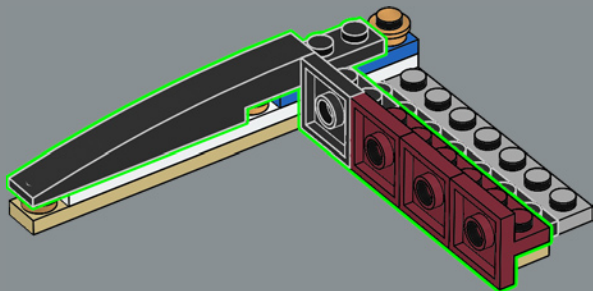

73

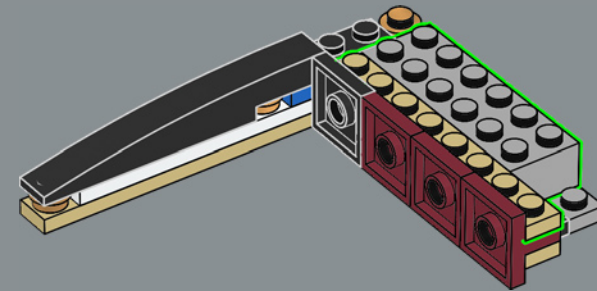



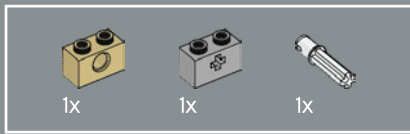

74

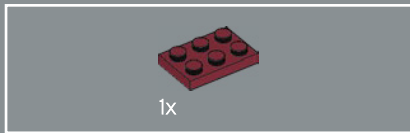
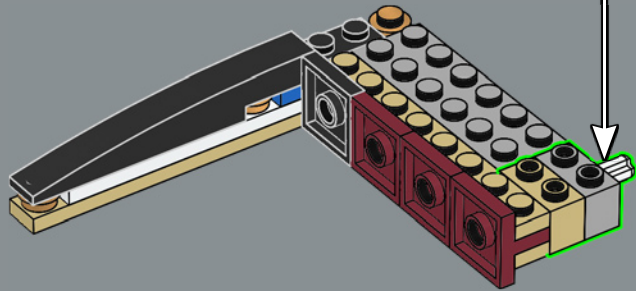
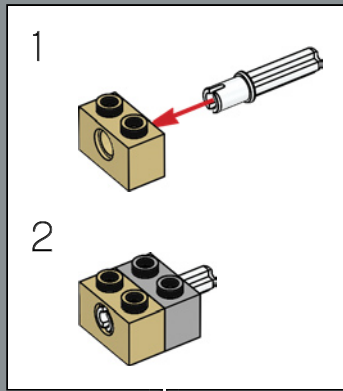

75

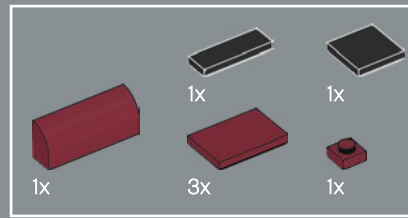
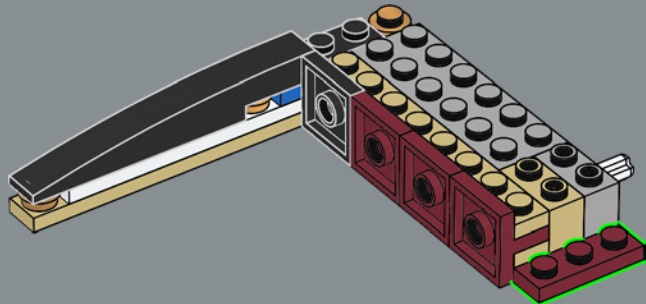

76

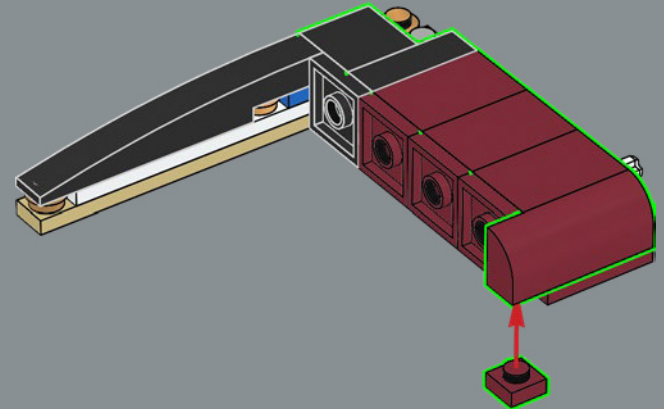

77

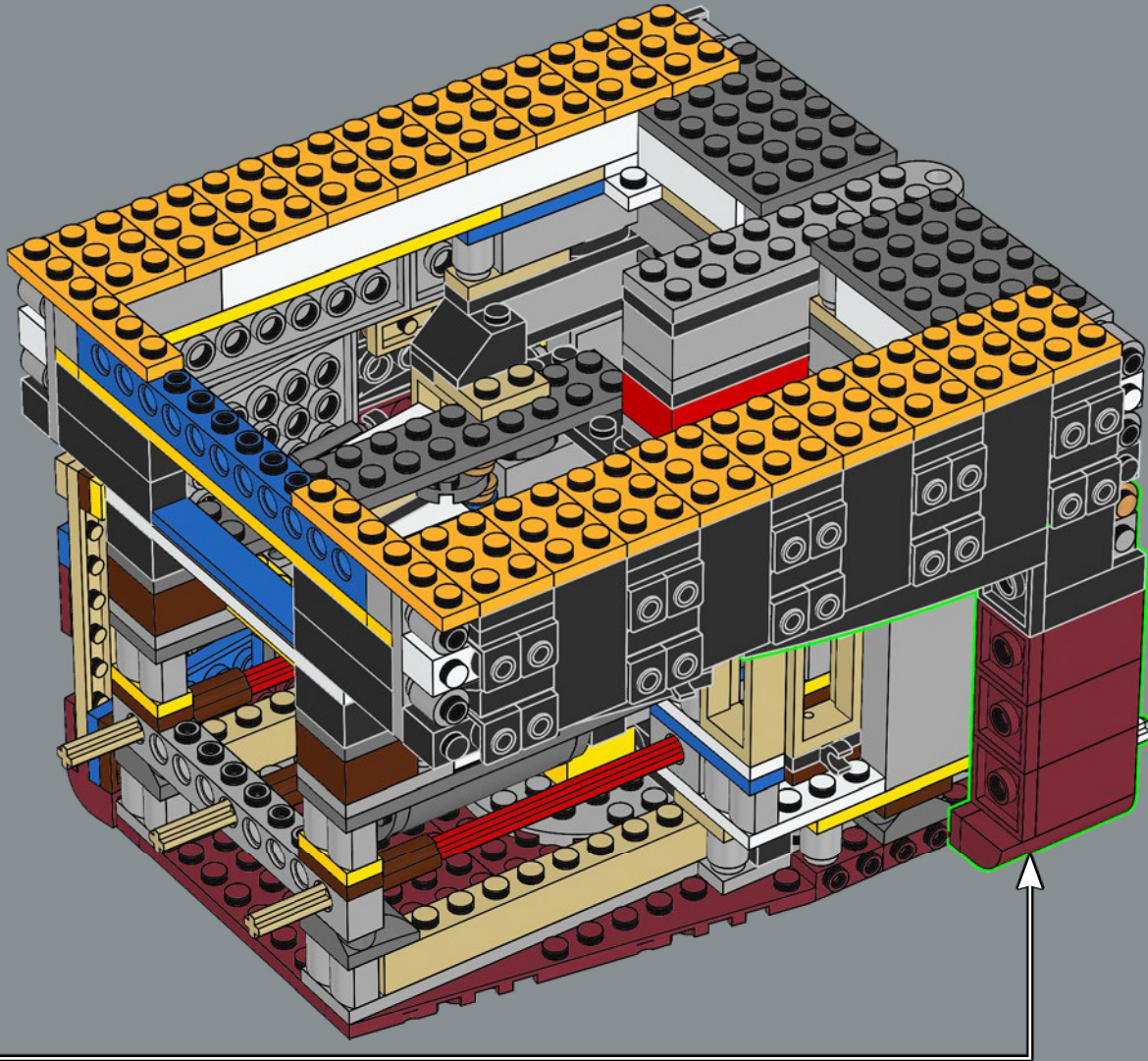

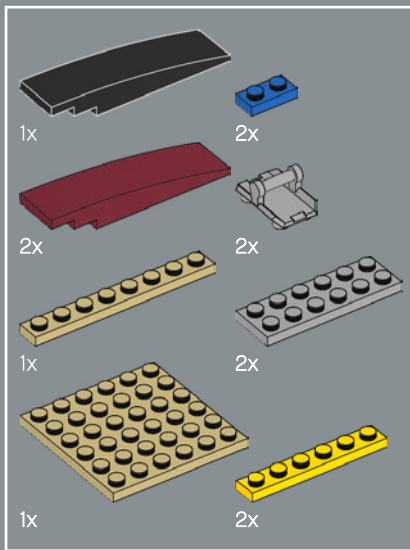

78

1

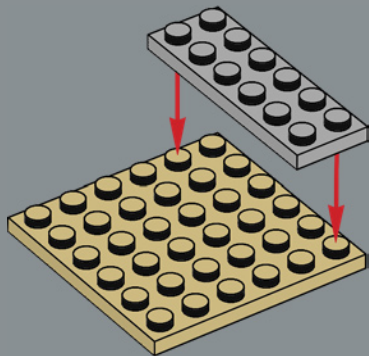

2

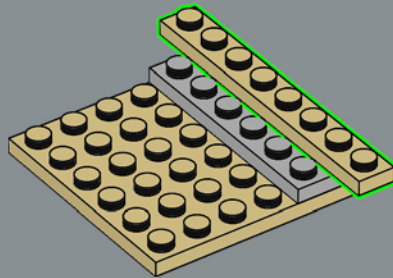

3

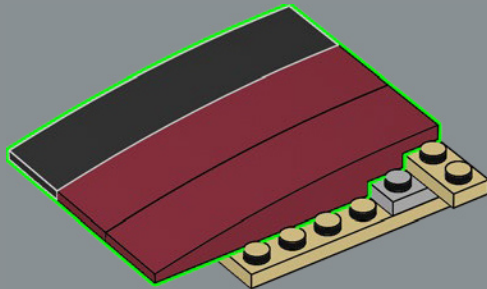

4

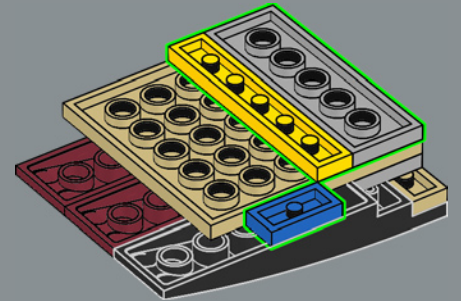

5

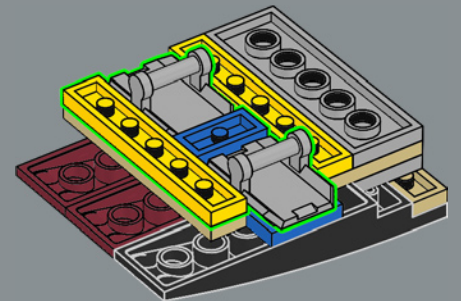

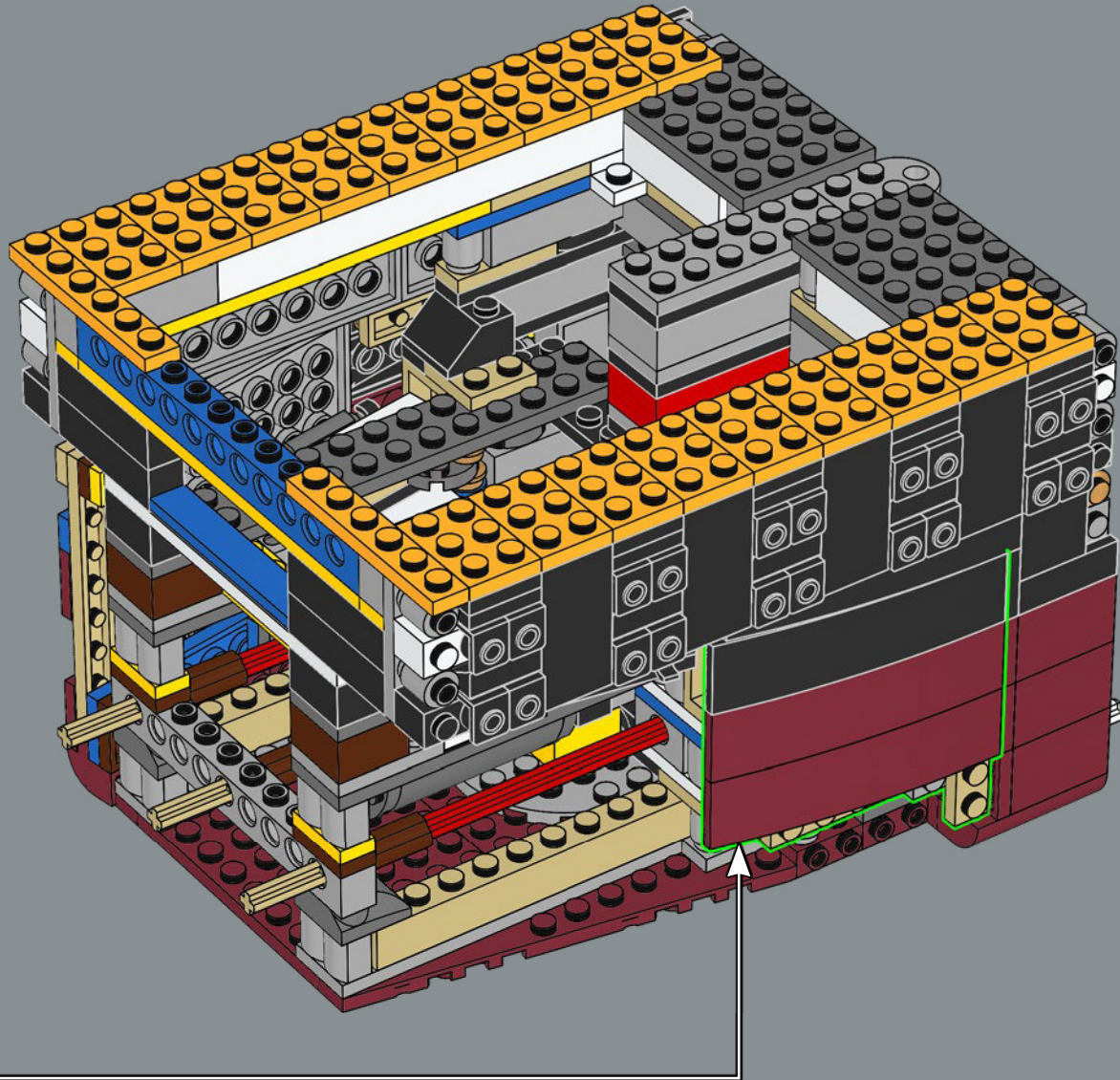

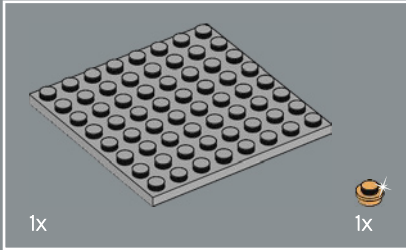
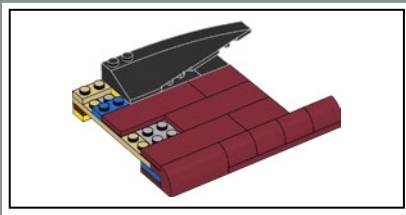

79

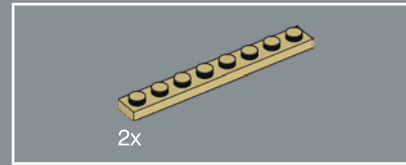
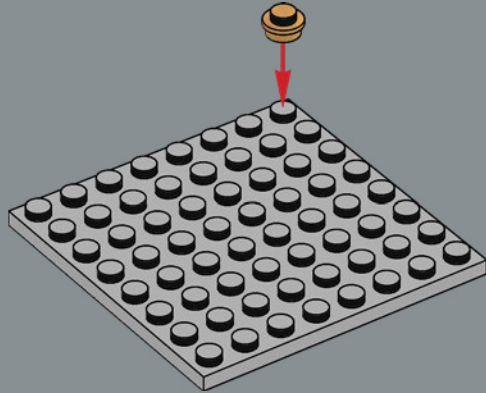

80

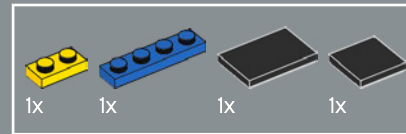
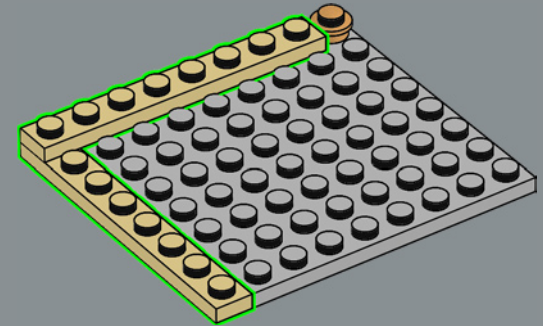

81

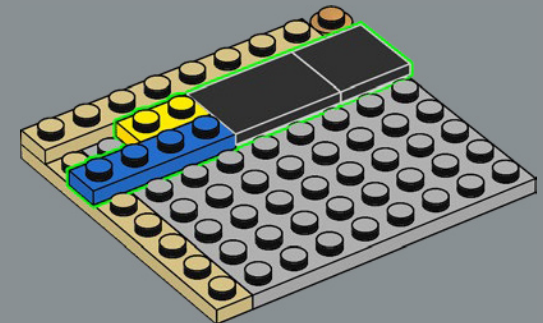

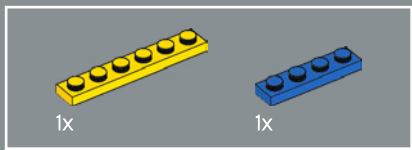

82

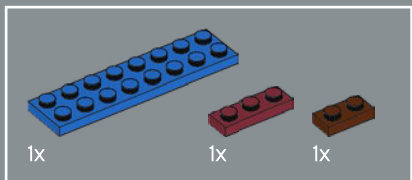
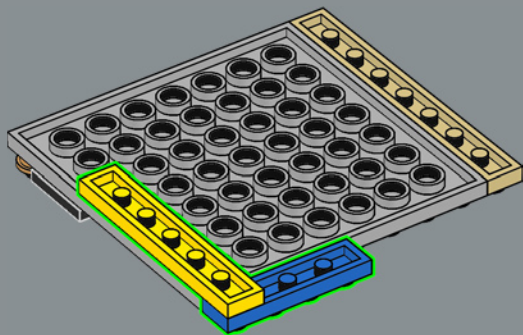

83

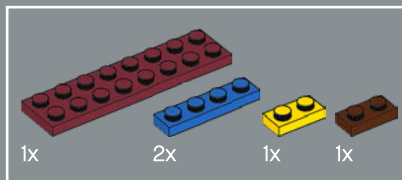
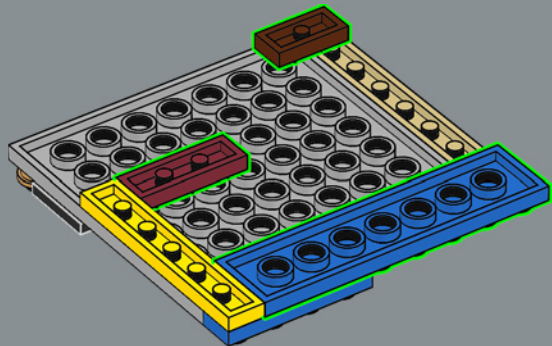

84

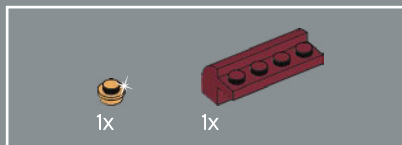
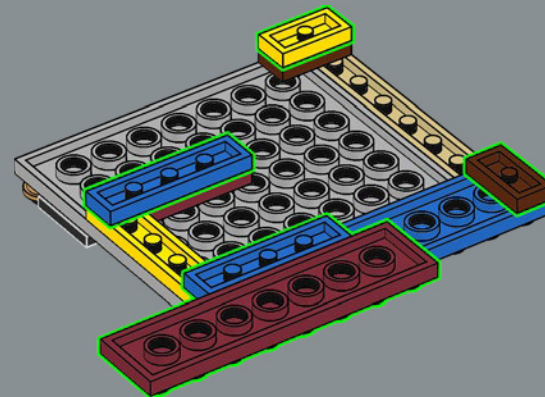

85

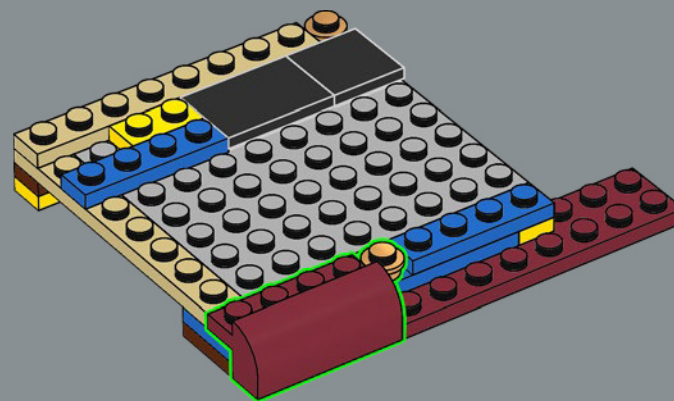

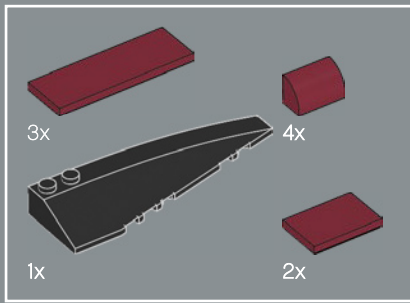

86

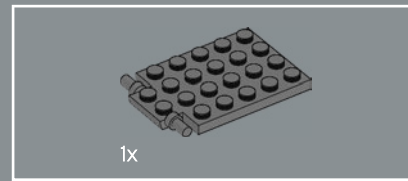
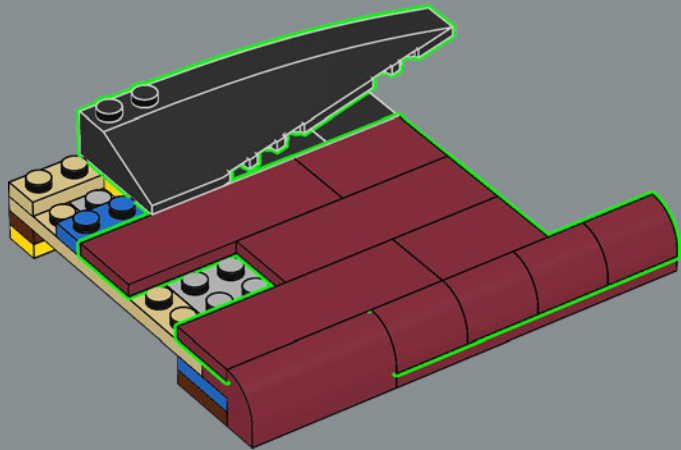

87

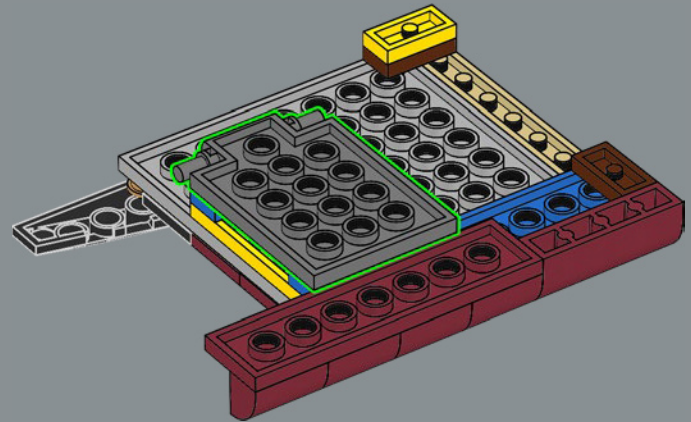

The *Titanic* was 400 miles (640 km) from land when she struck the iceberg.

Le *Titanic* se trouve à 640 km (400 mi) de la terre ferme lorsqu'il heurte l'iceberg.

El *Titanic* se encontraba a 640 km de la costa cuando colisionó con el iceberg.

88

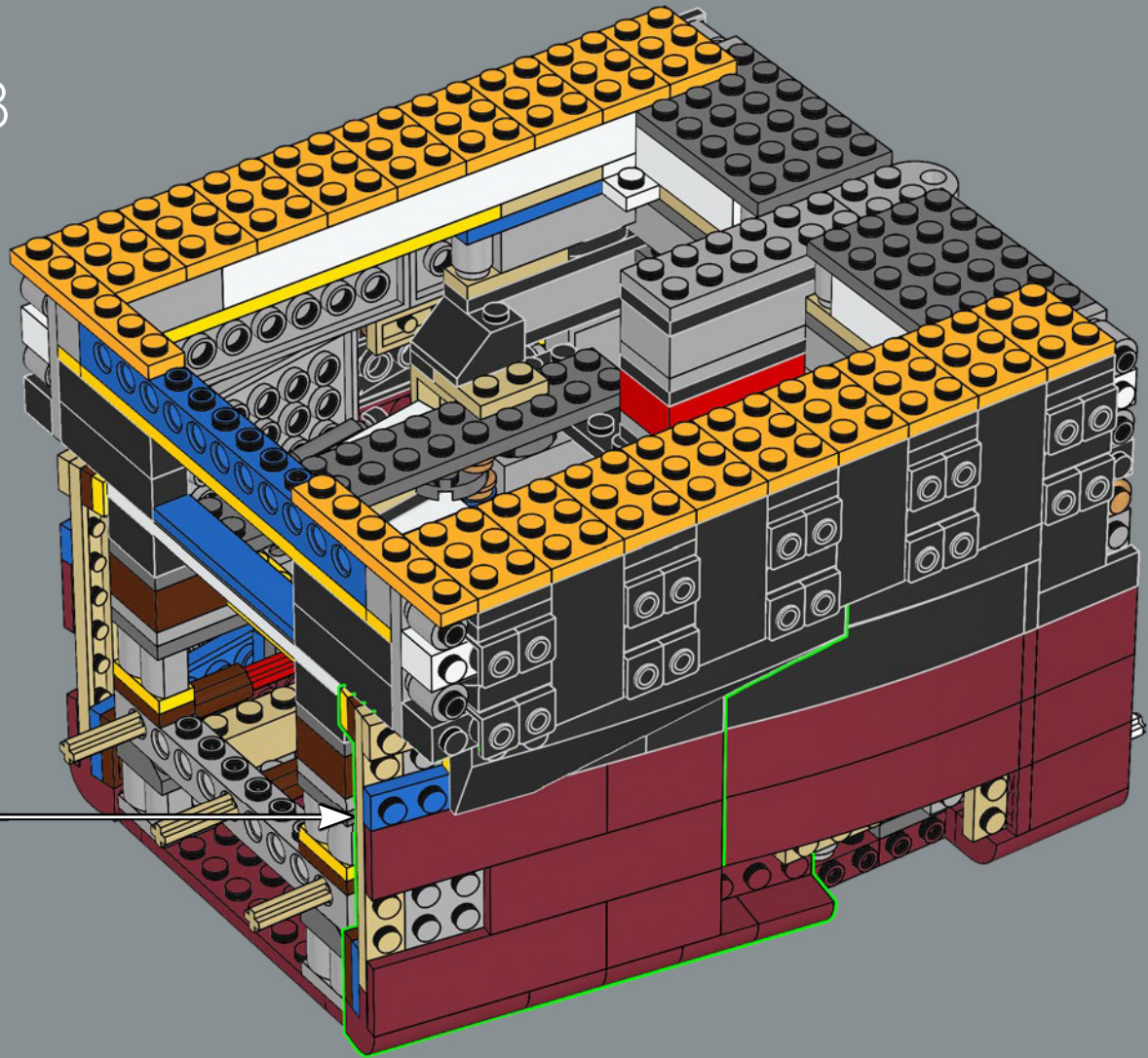



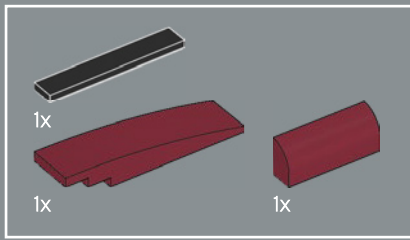

89

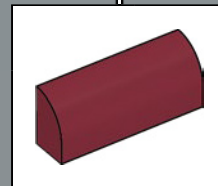
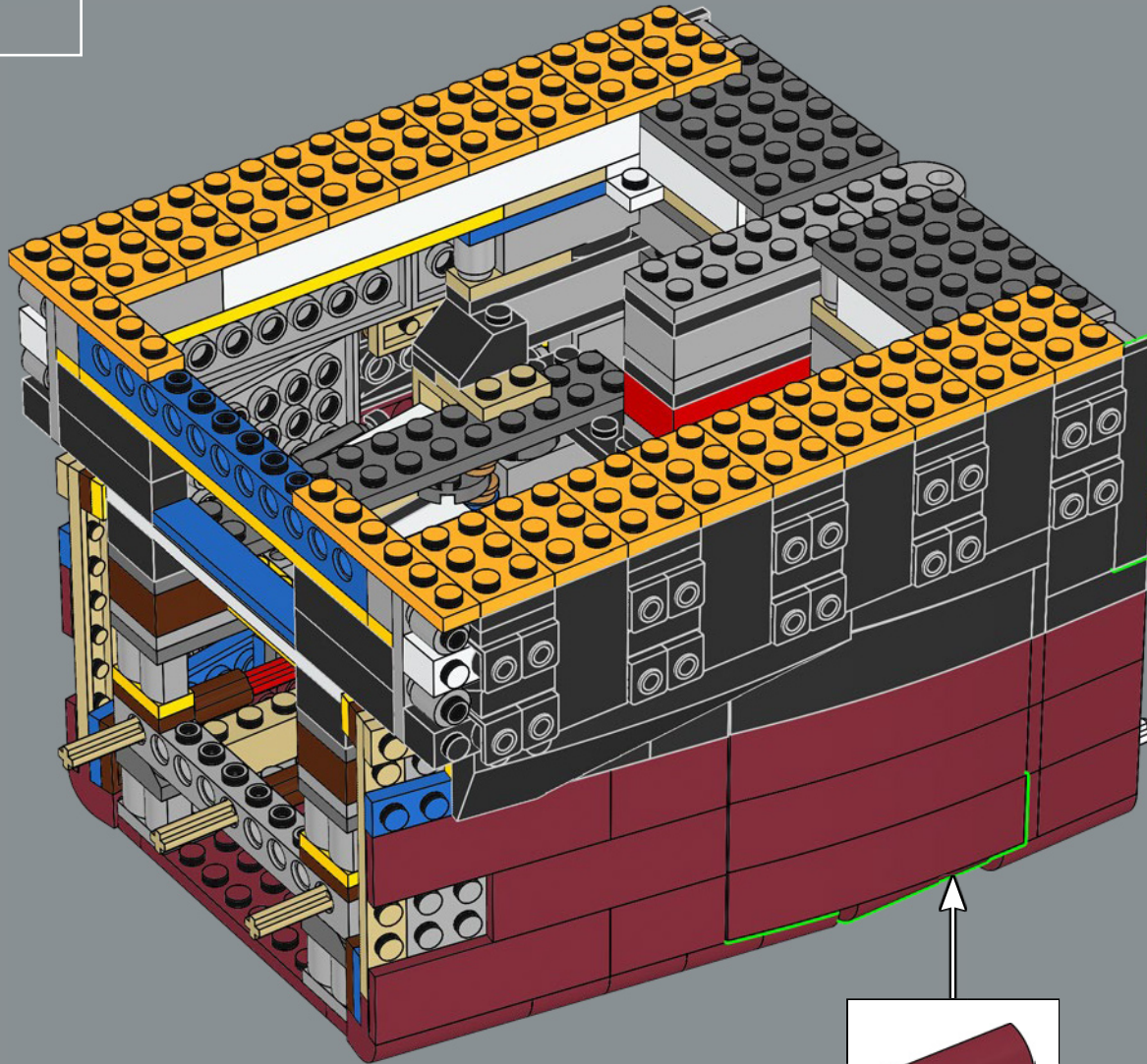

32

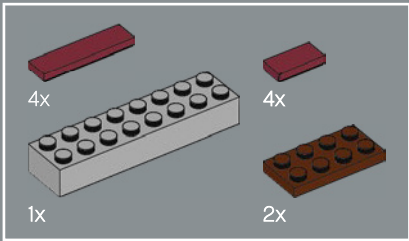

90

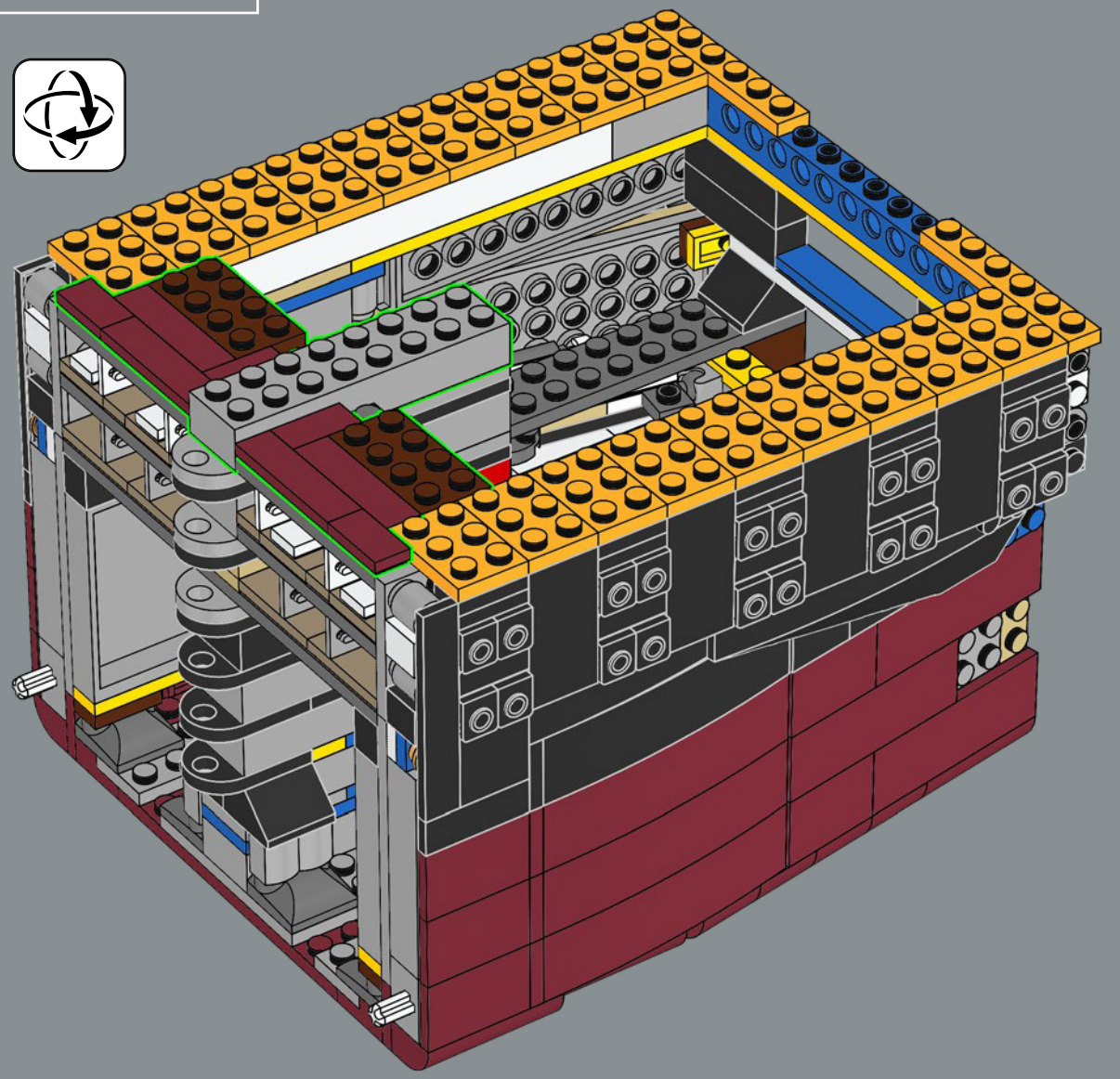
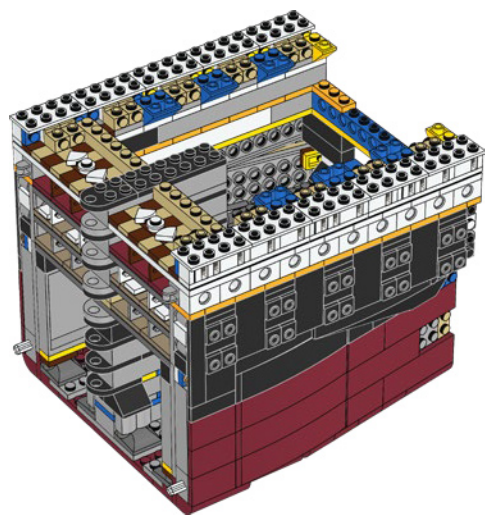

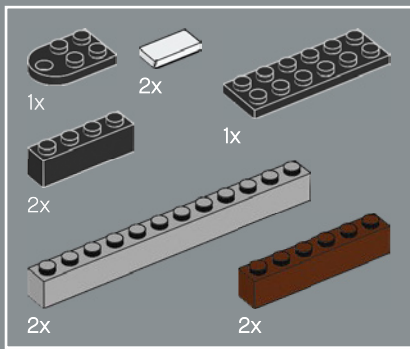

91

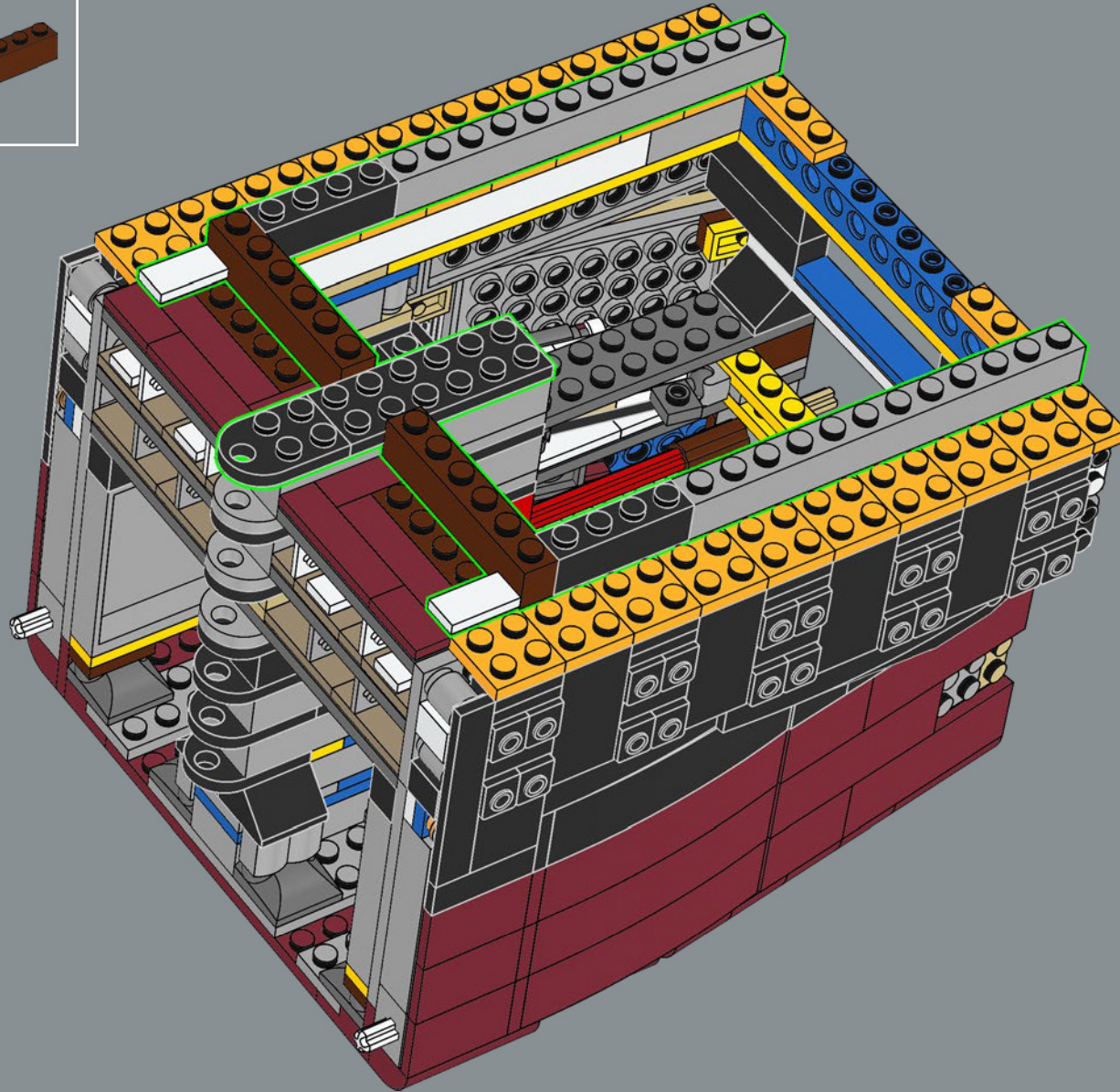

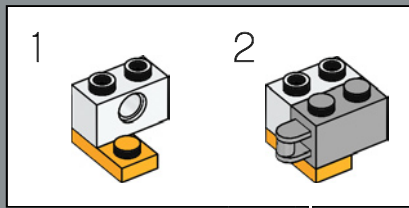
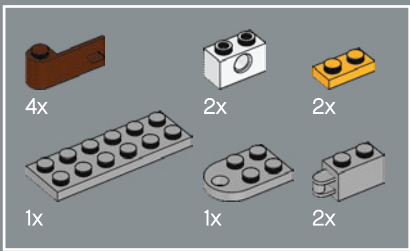

92

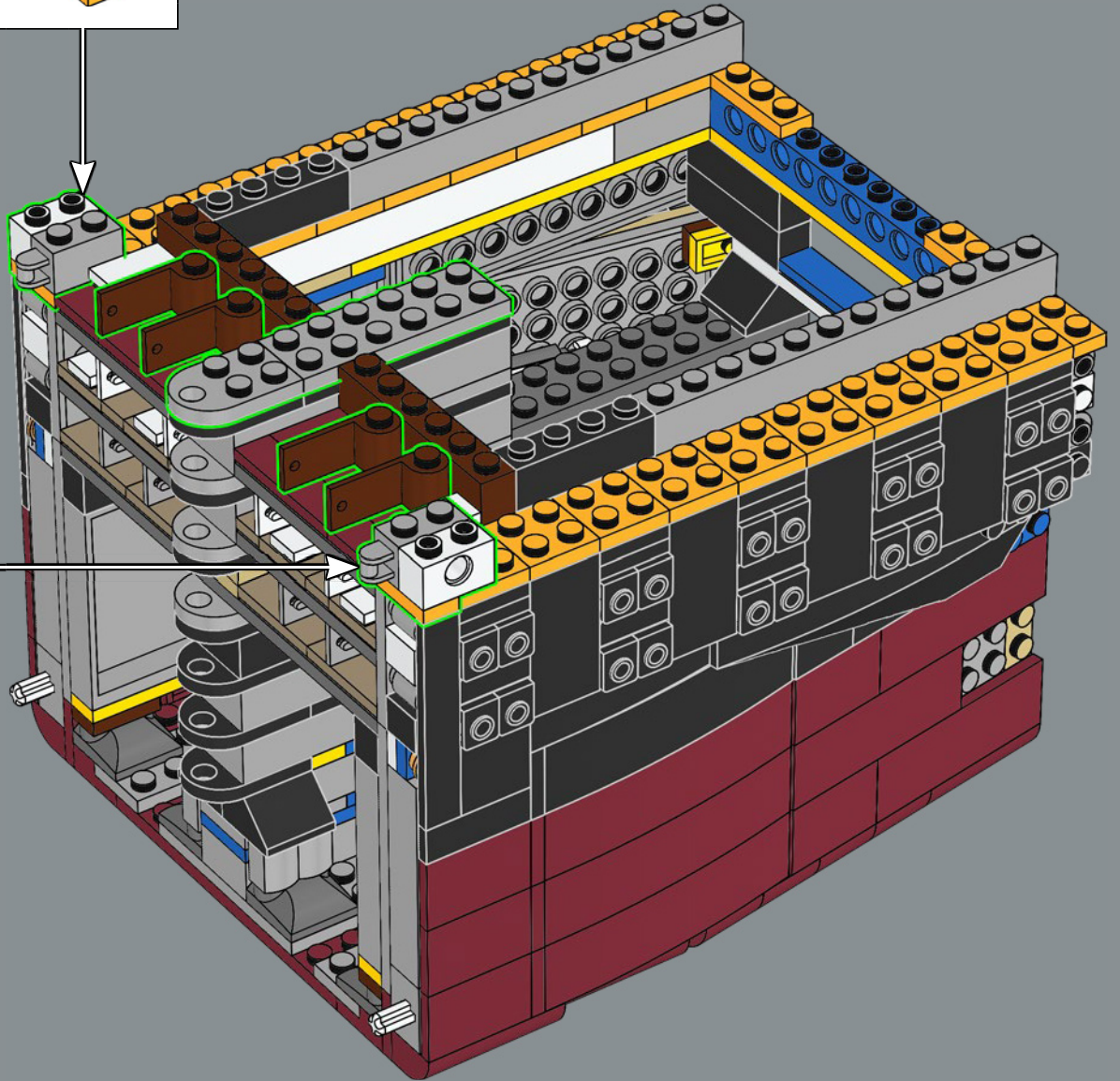
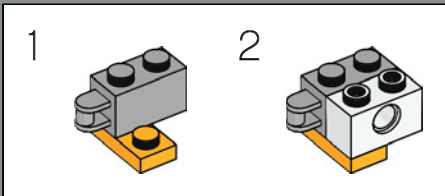



18x

93

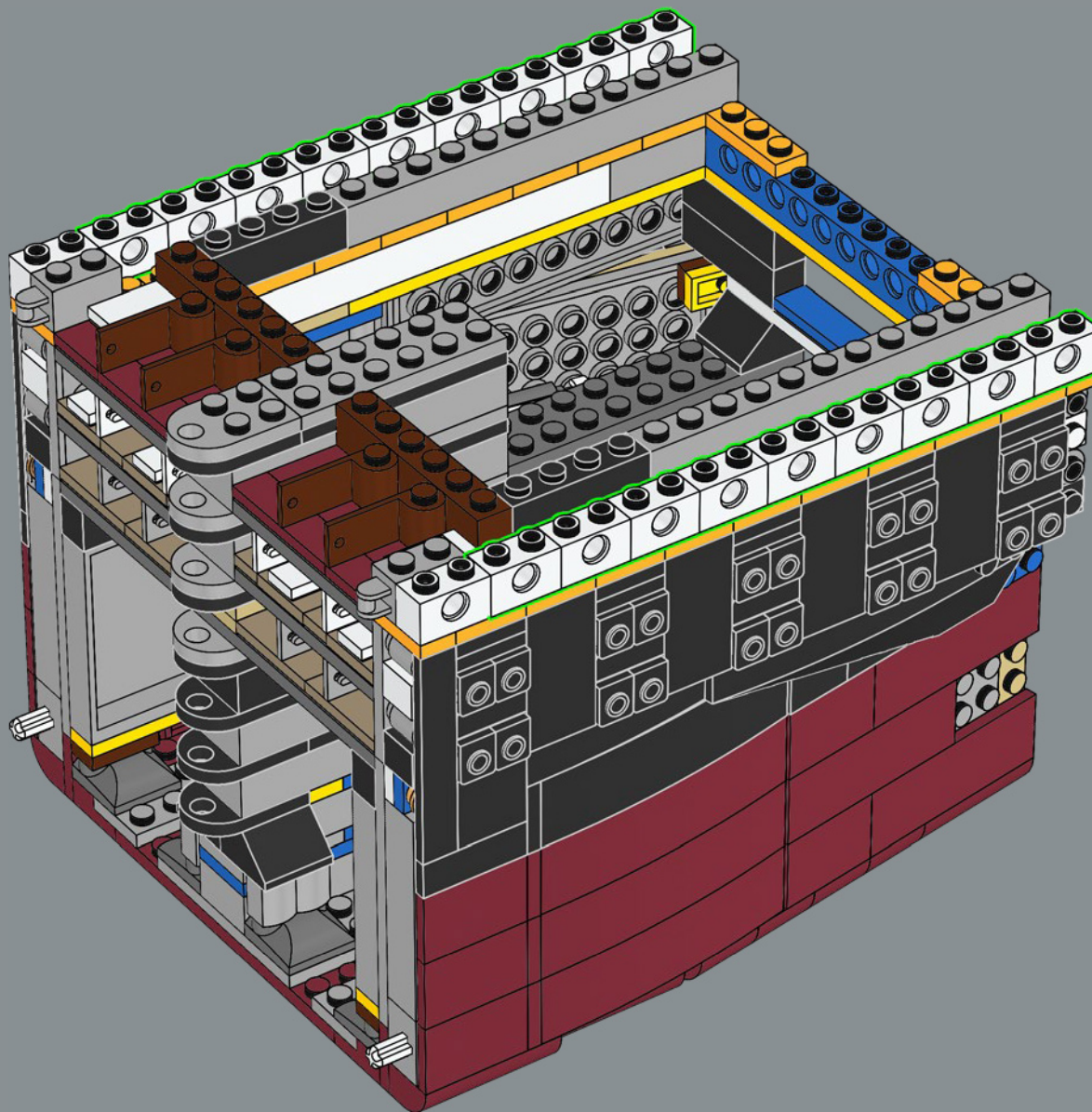

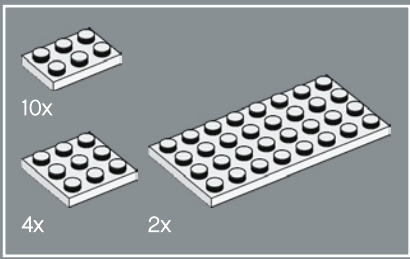

94

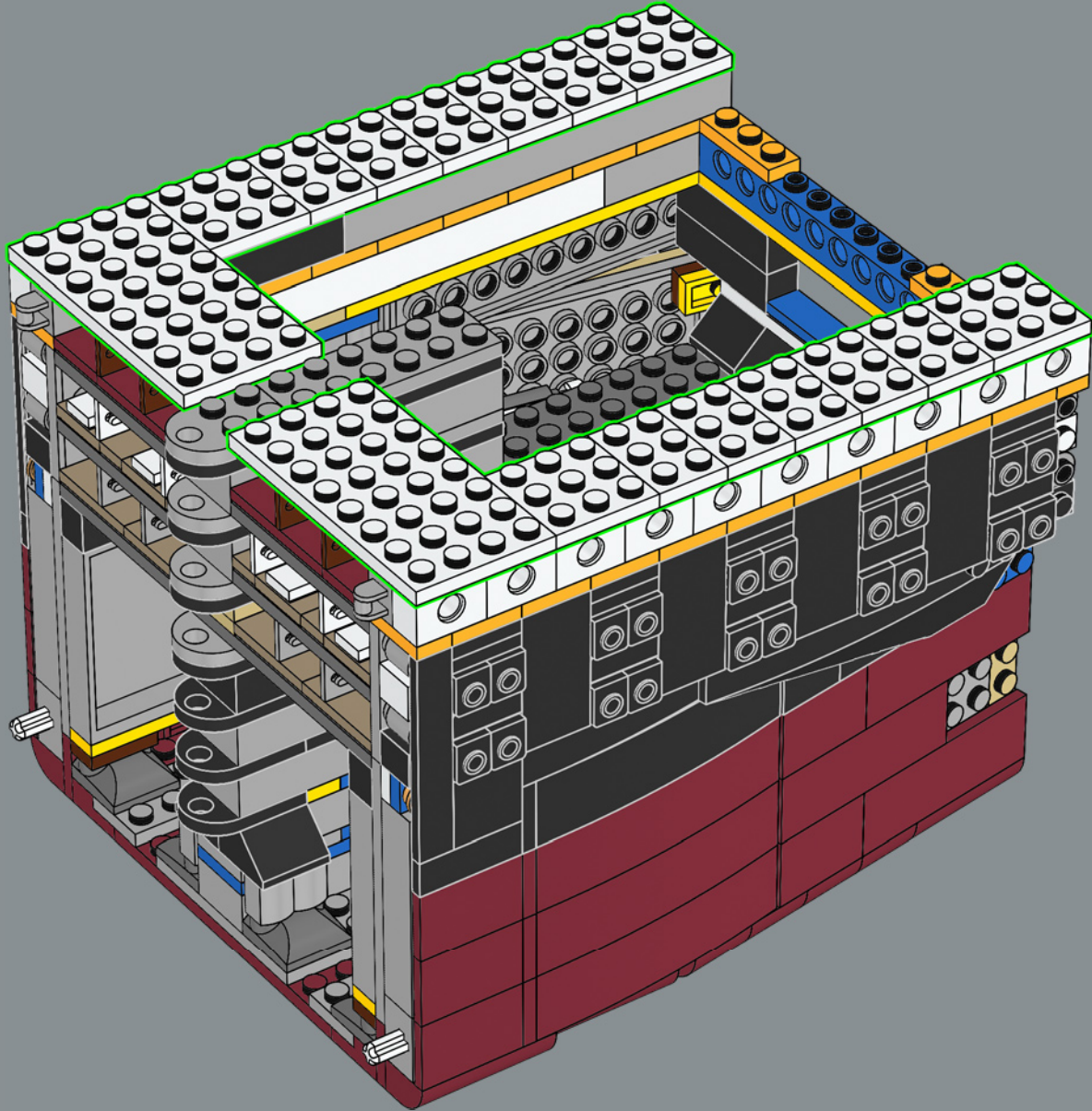

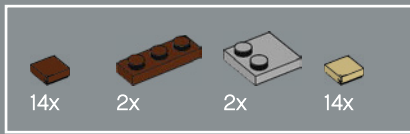

95

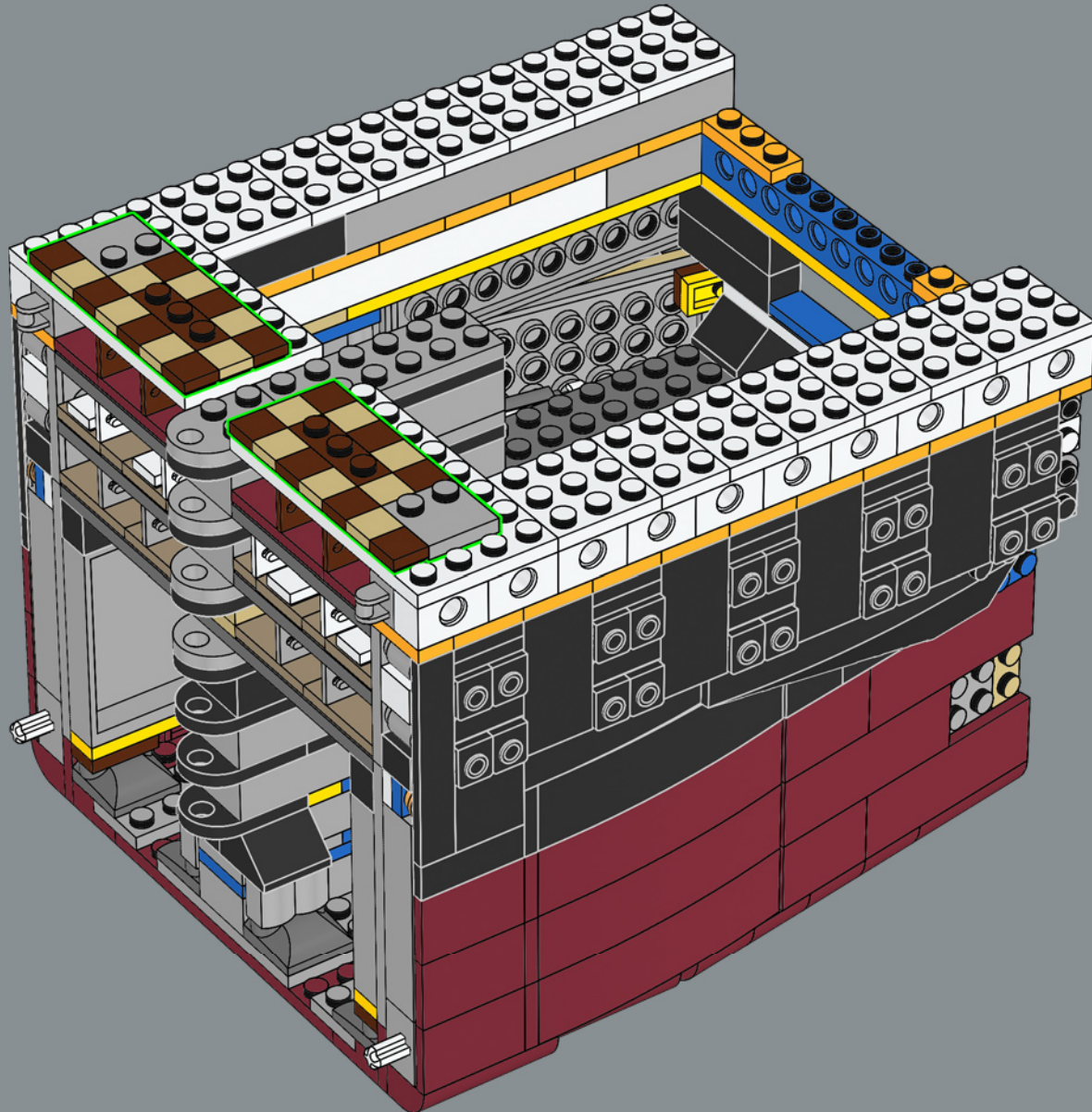

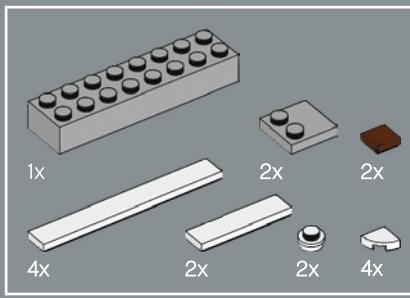

96

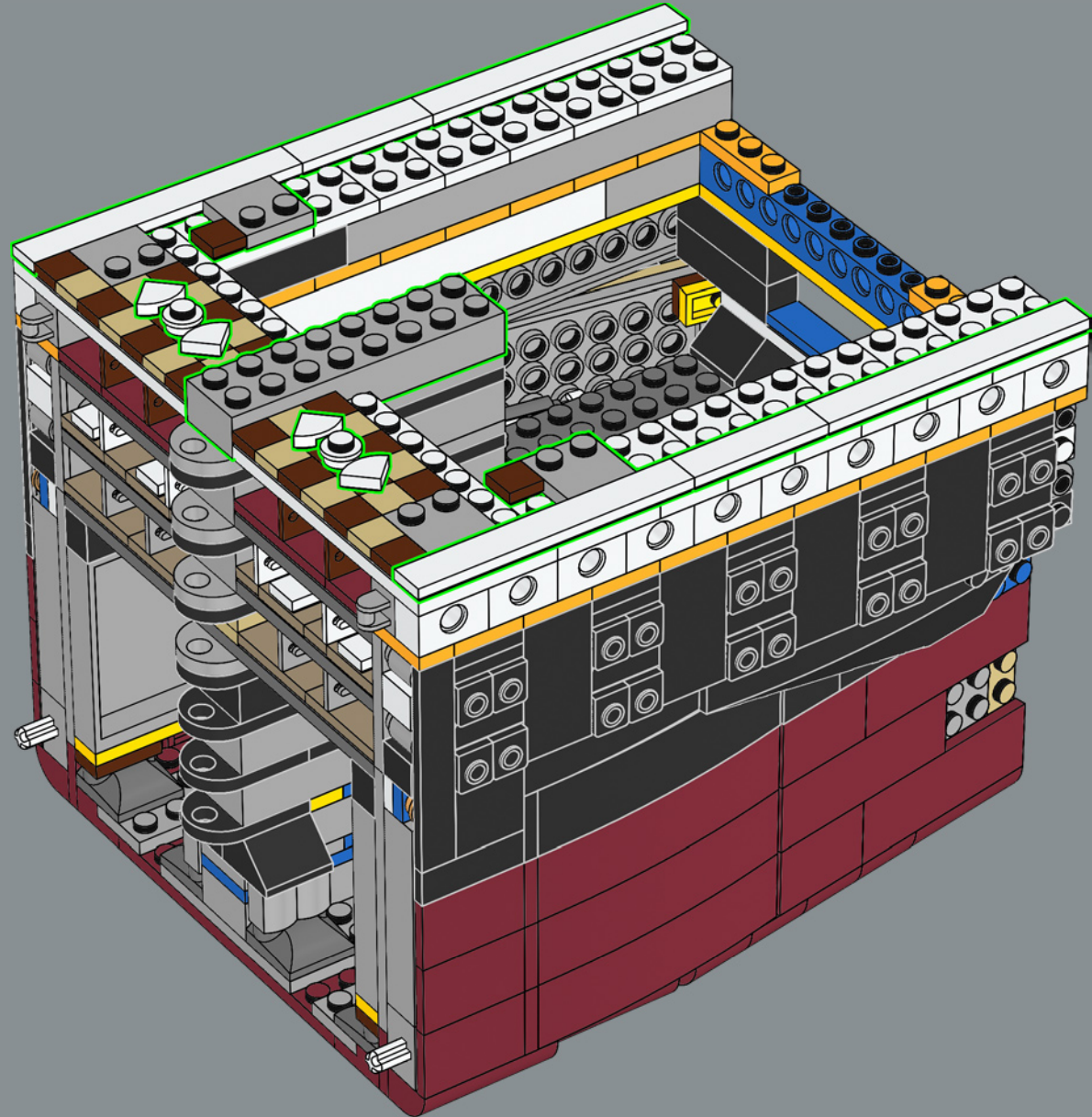



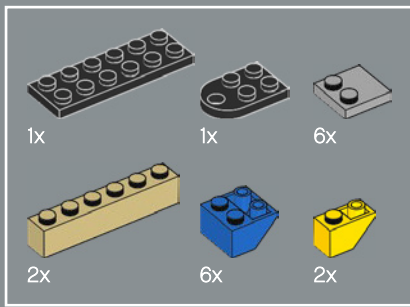

97

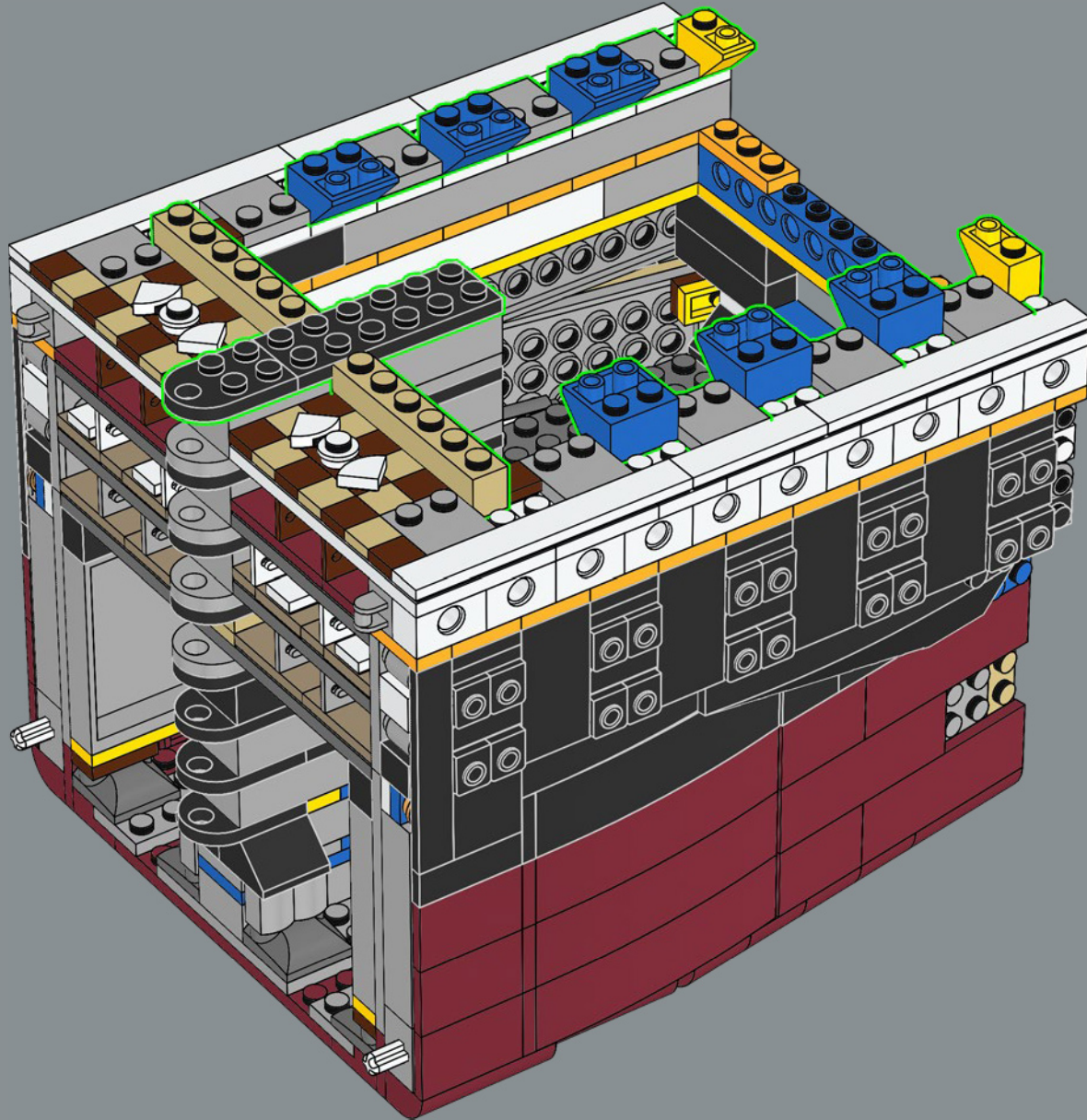

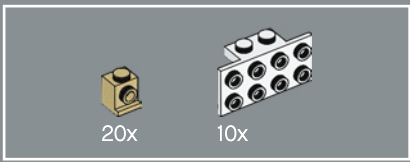

98

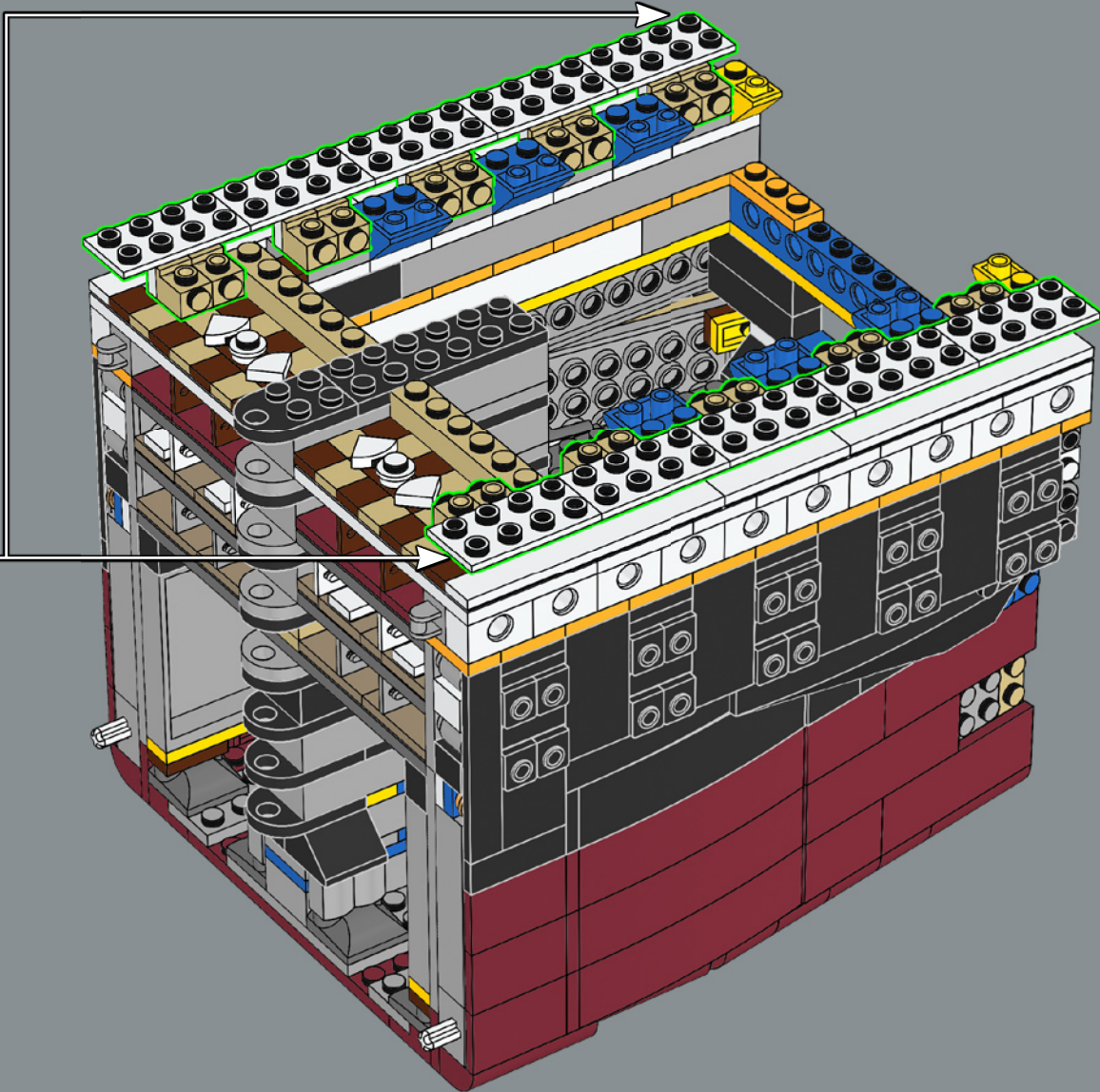
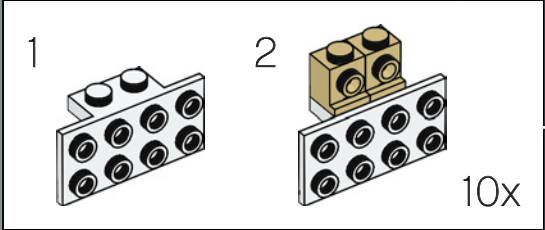

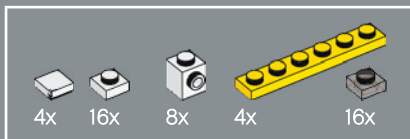

99

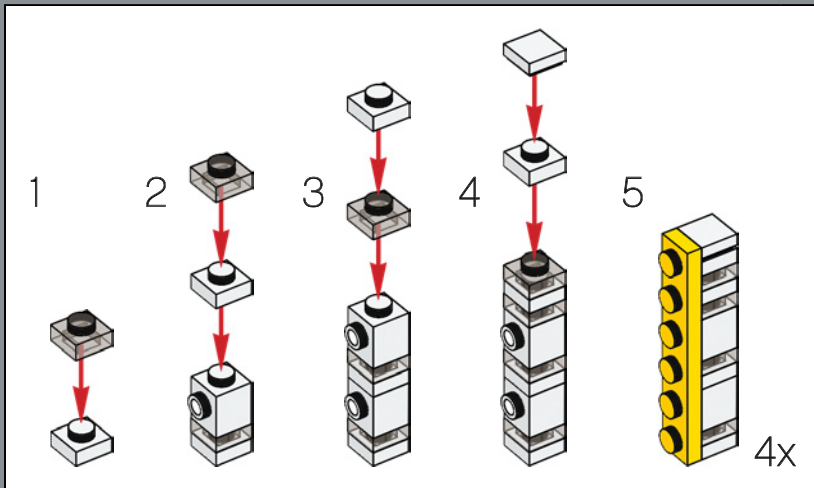
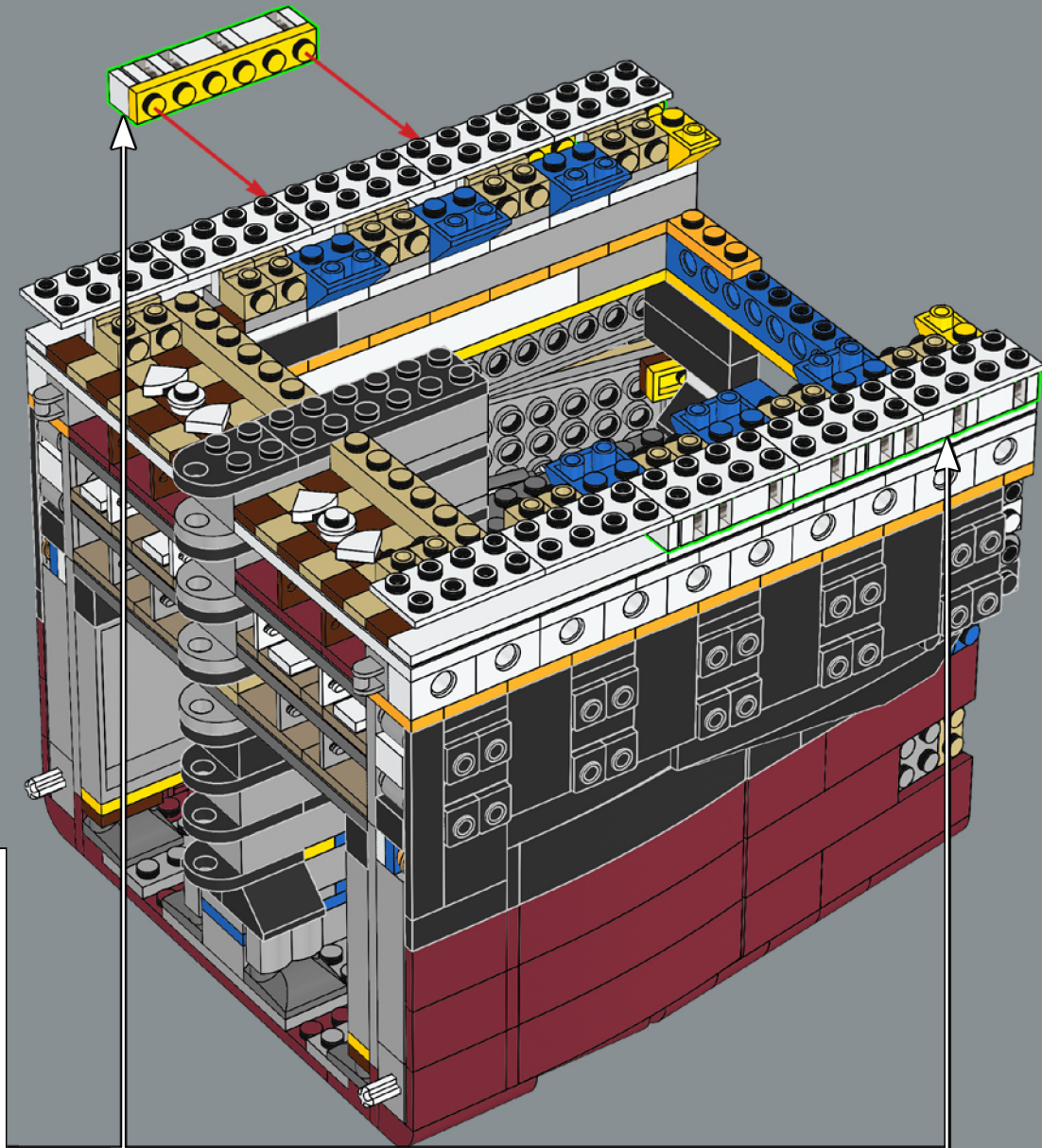

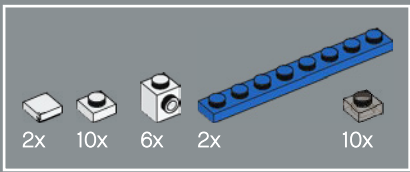

100

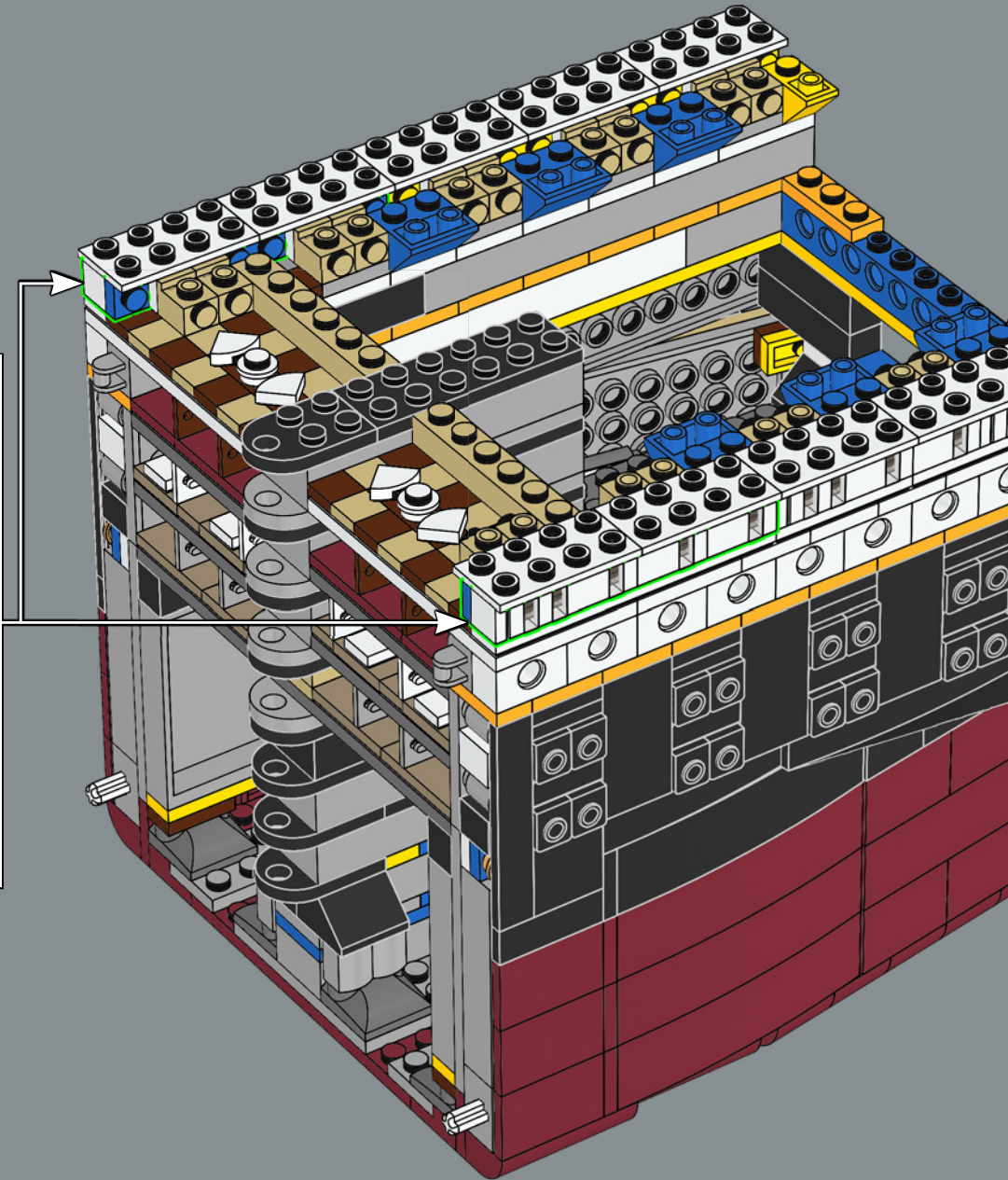
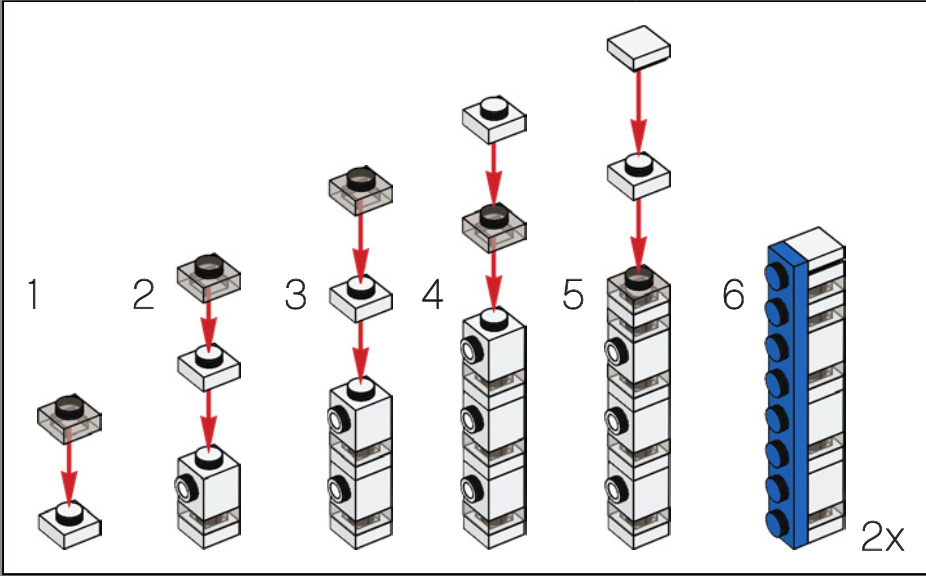

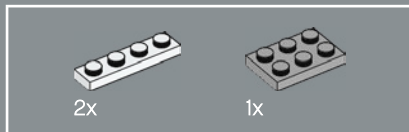
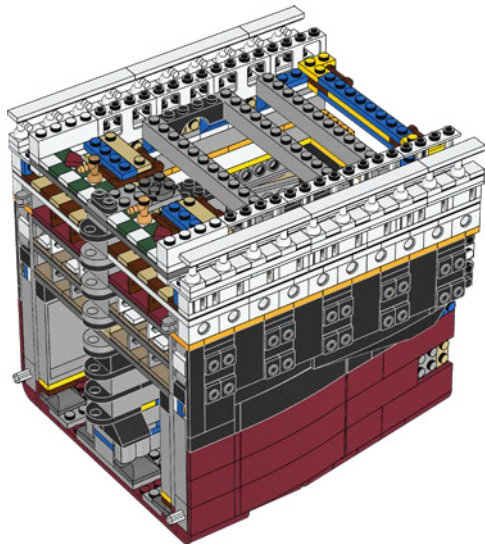
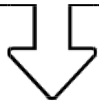

101

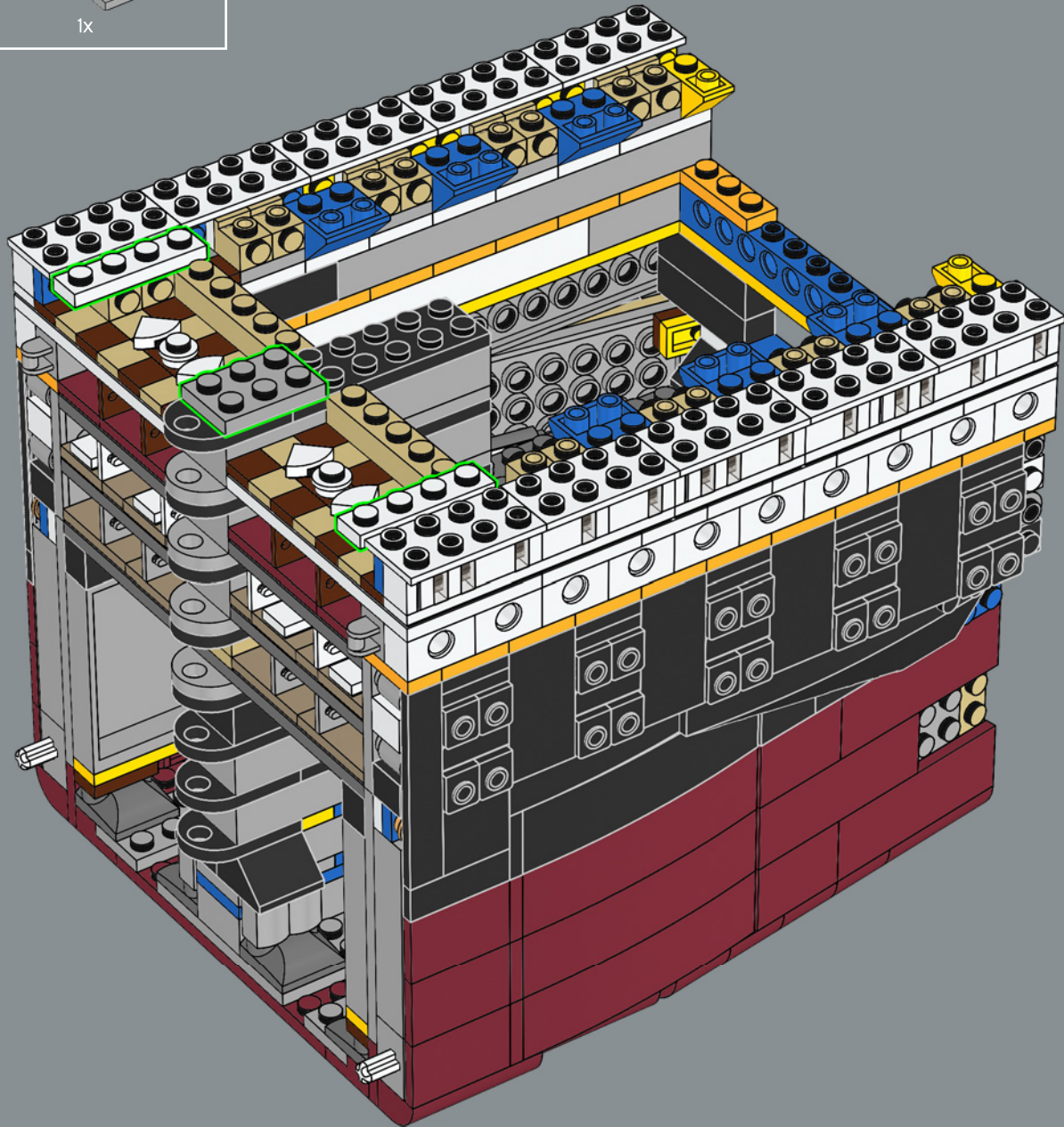

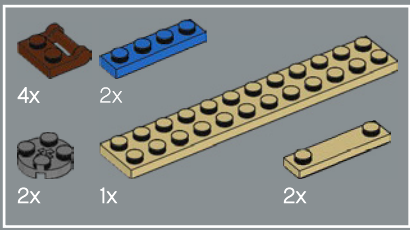

102

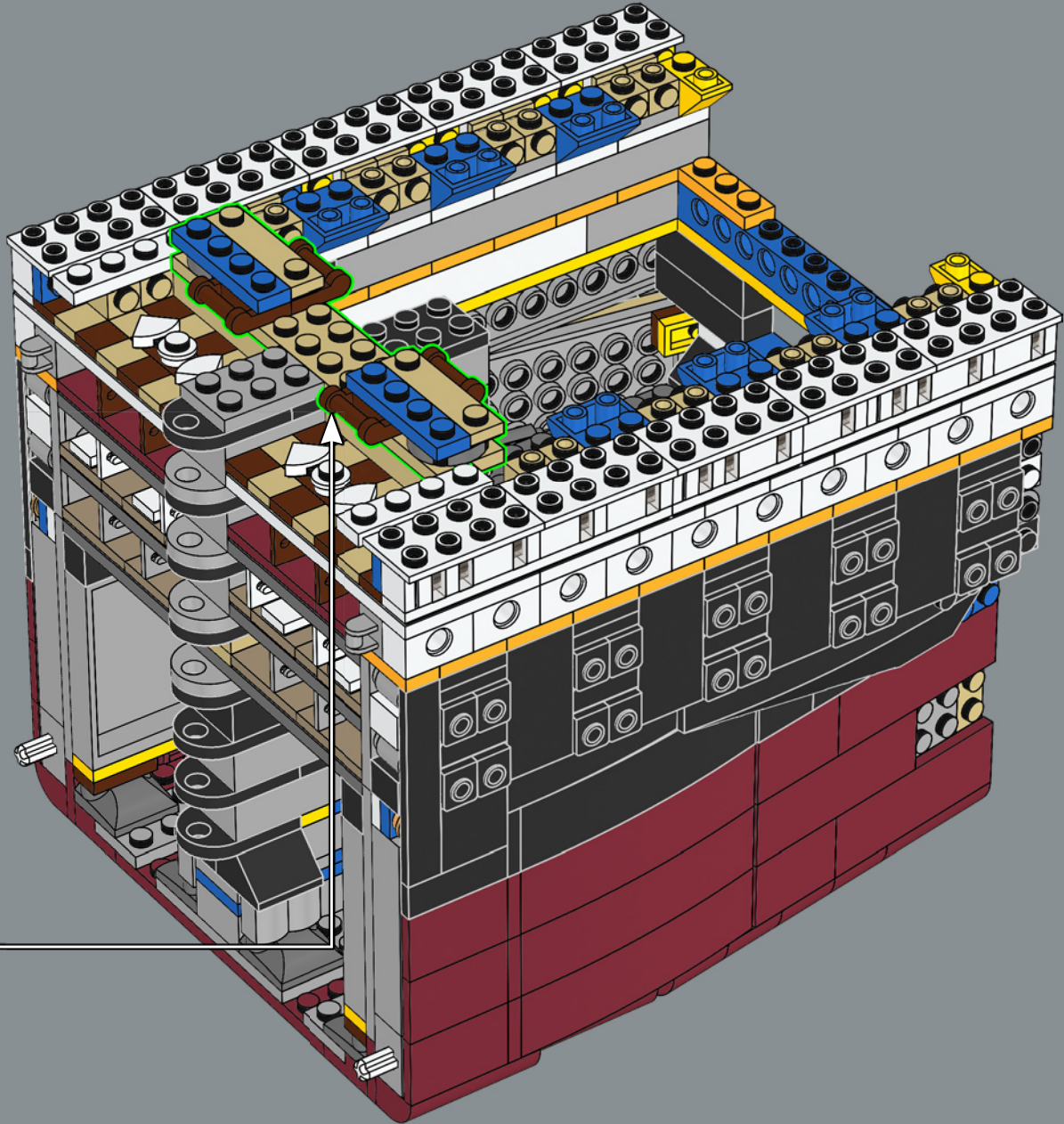
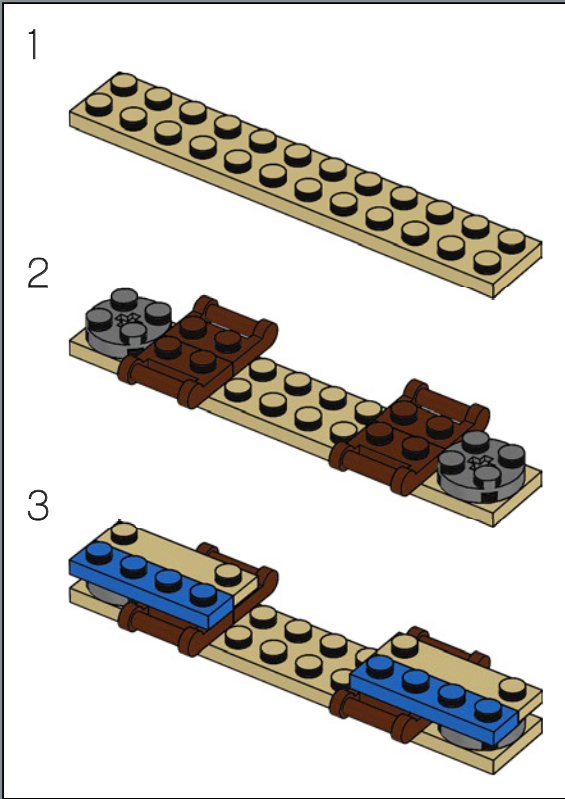

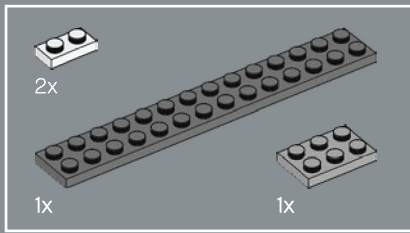

103

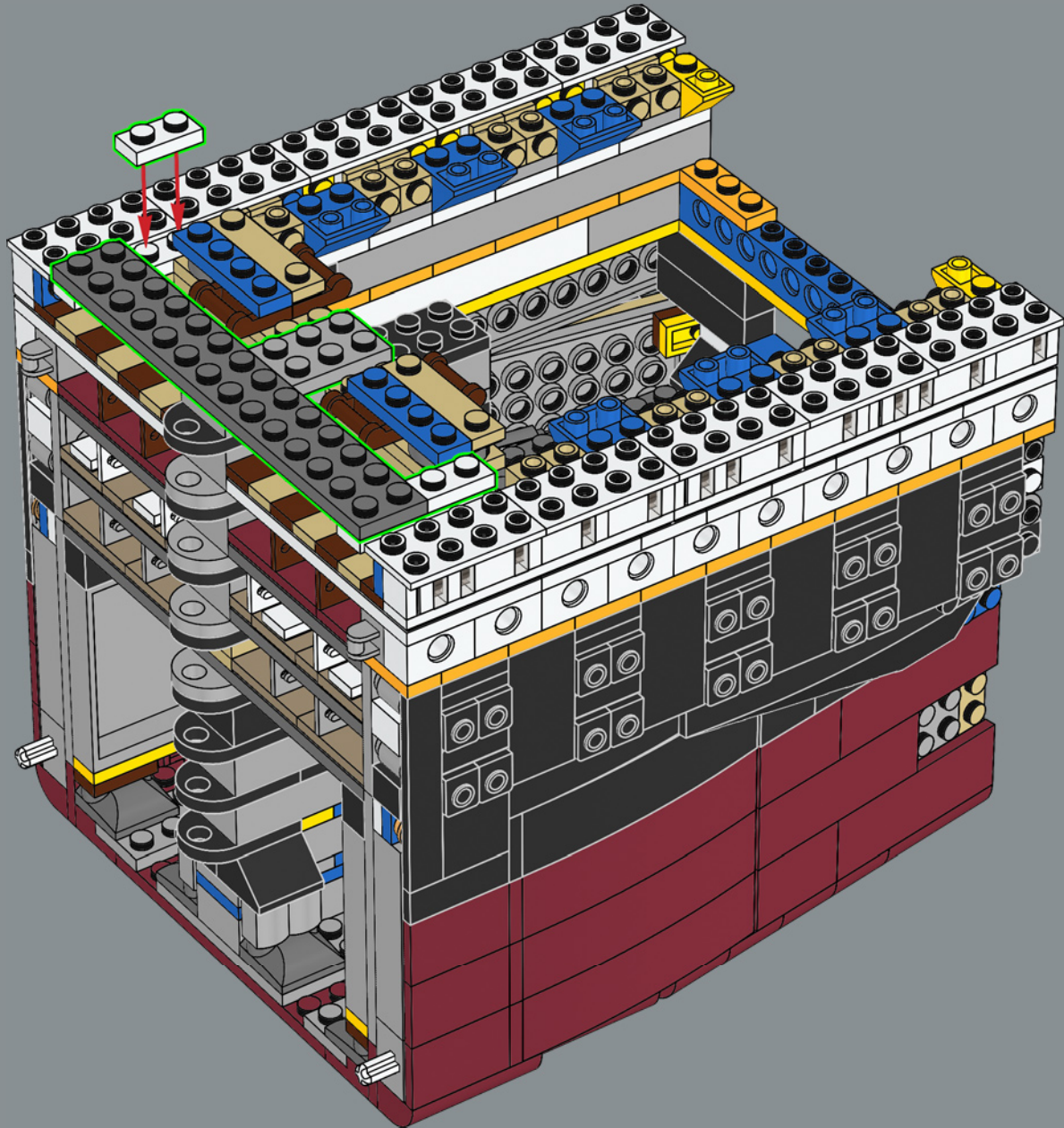

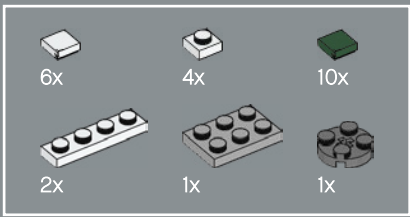

104

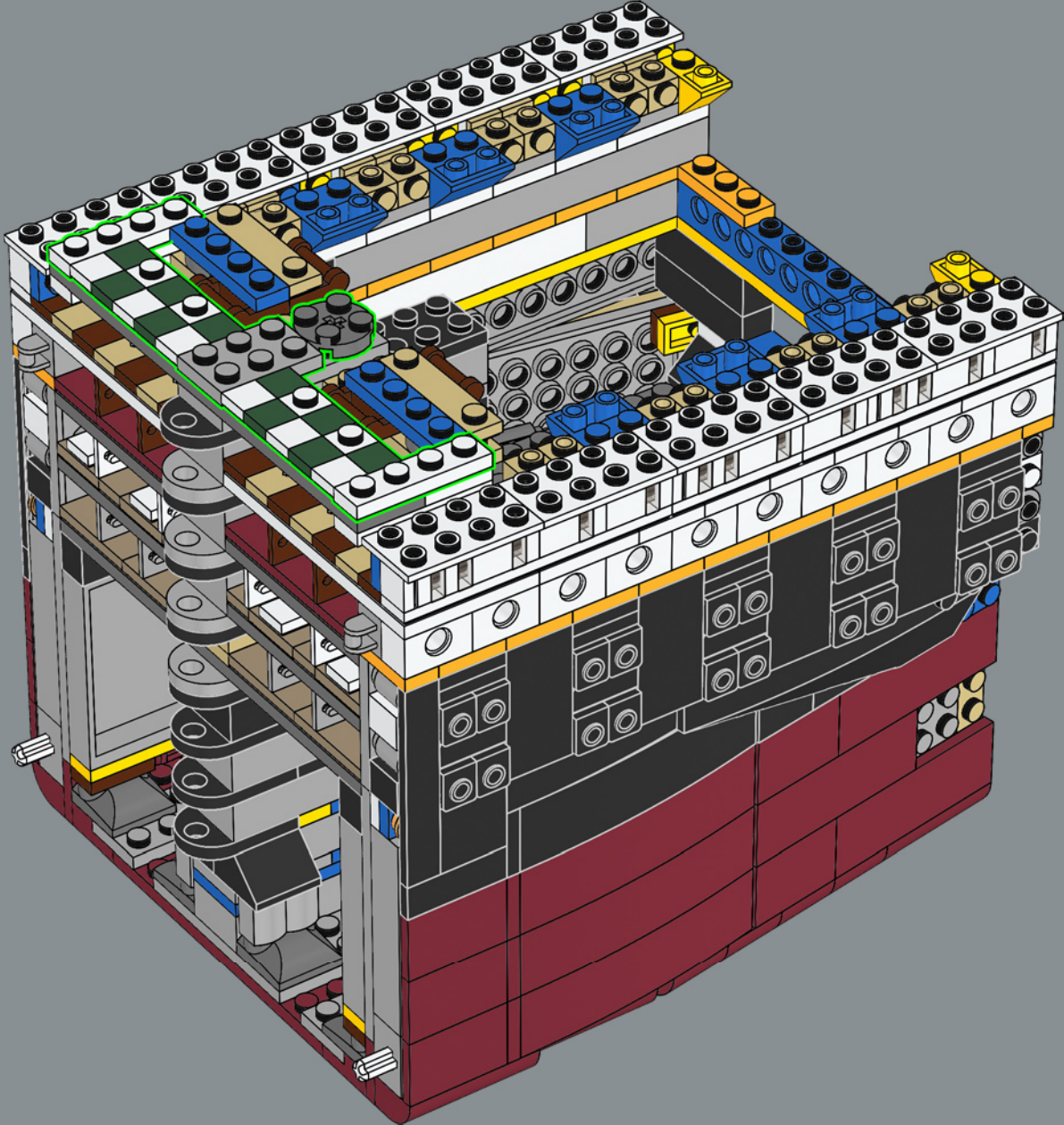



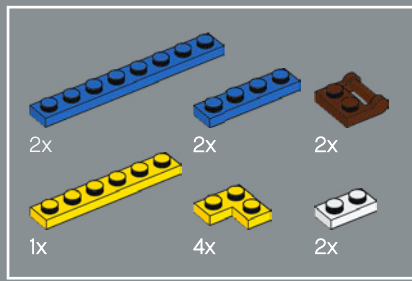

105

1

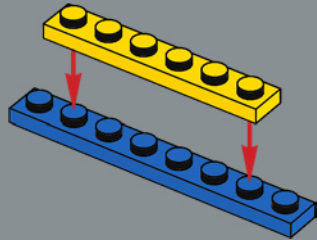

2

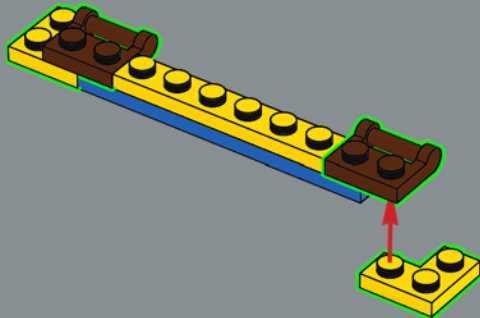

3

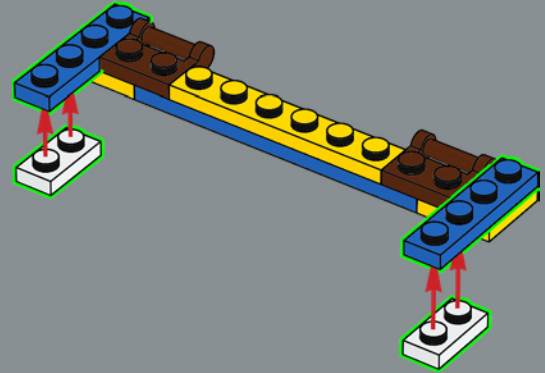

4

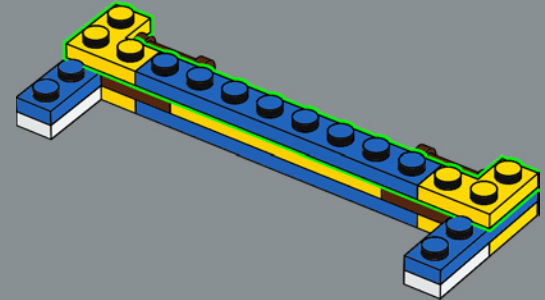

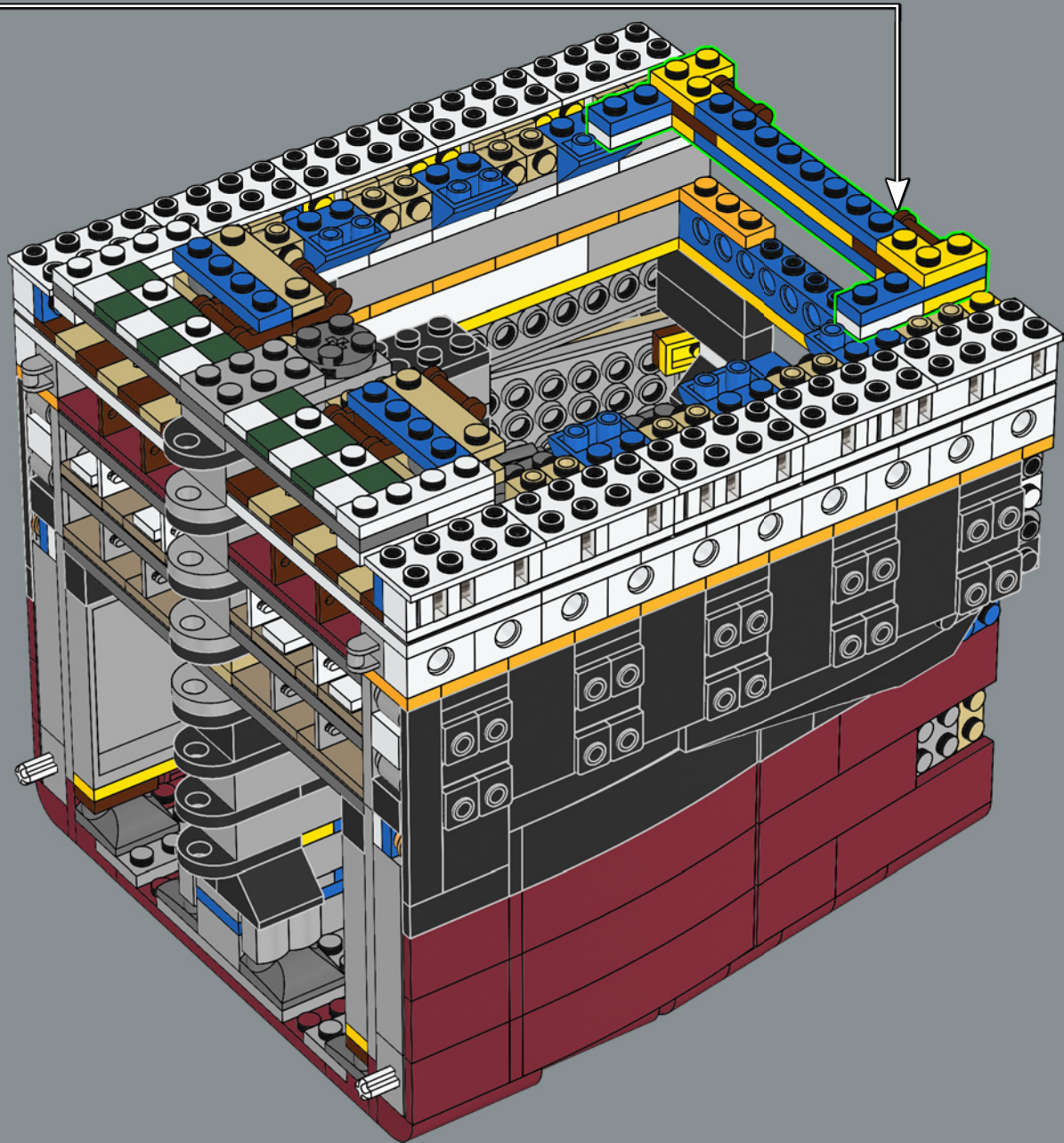

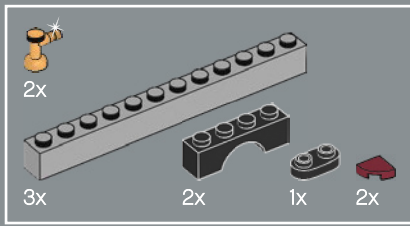

106

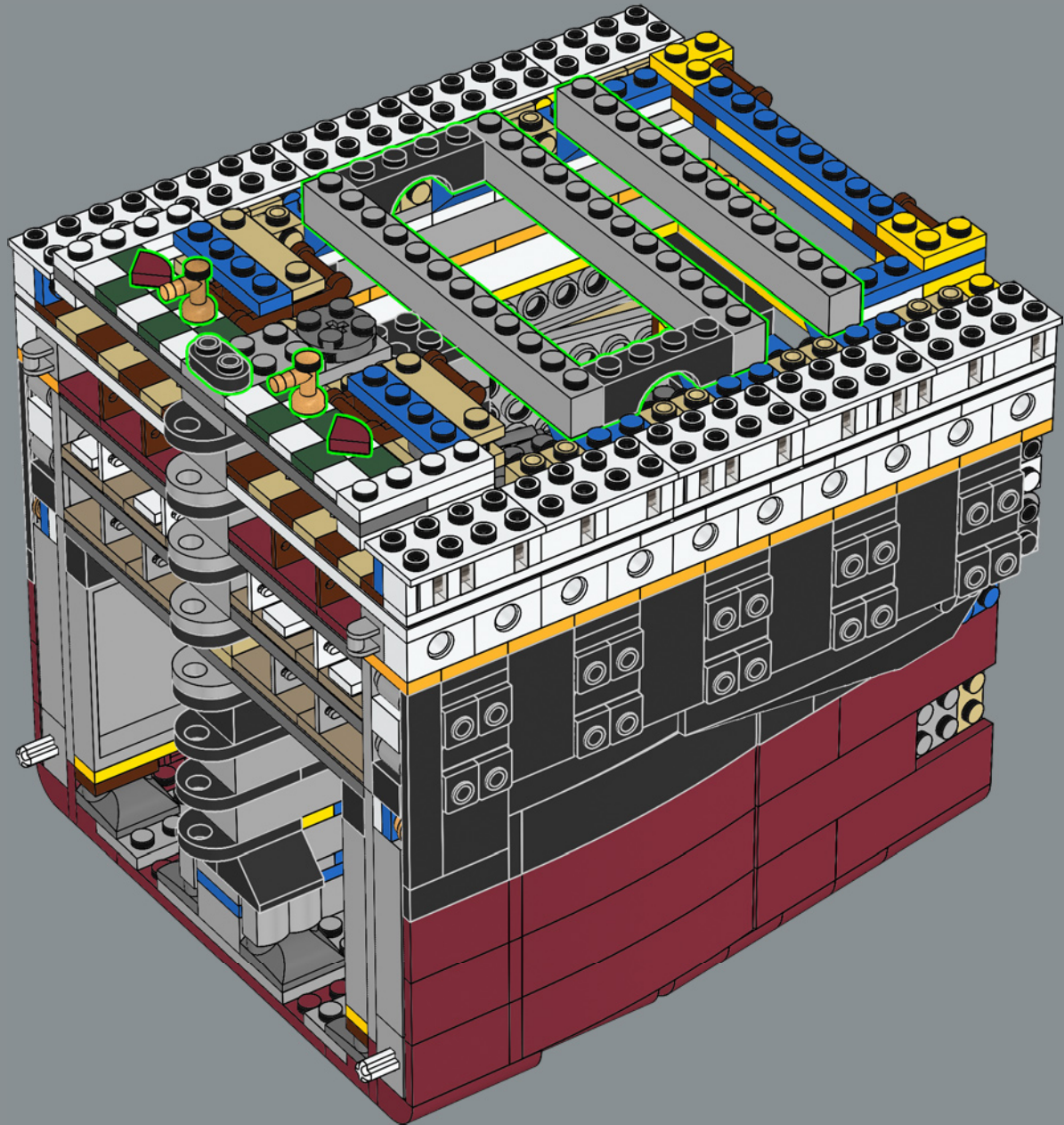

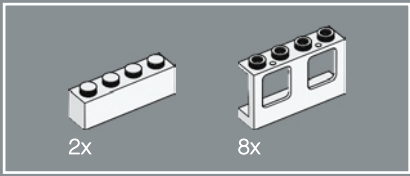

107

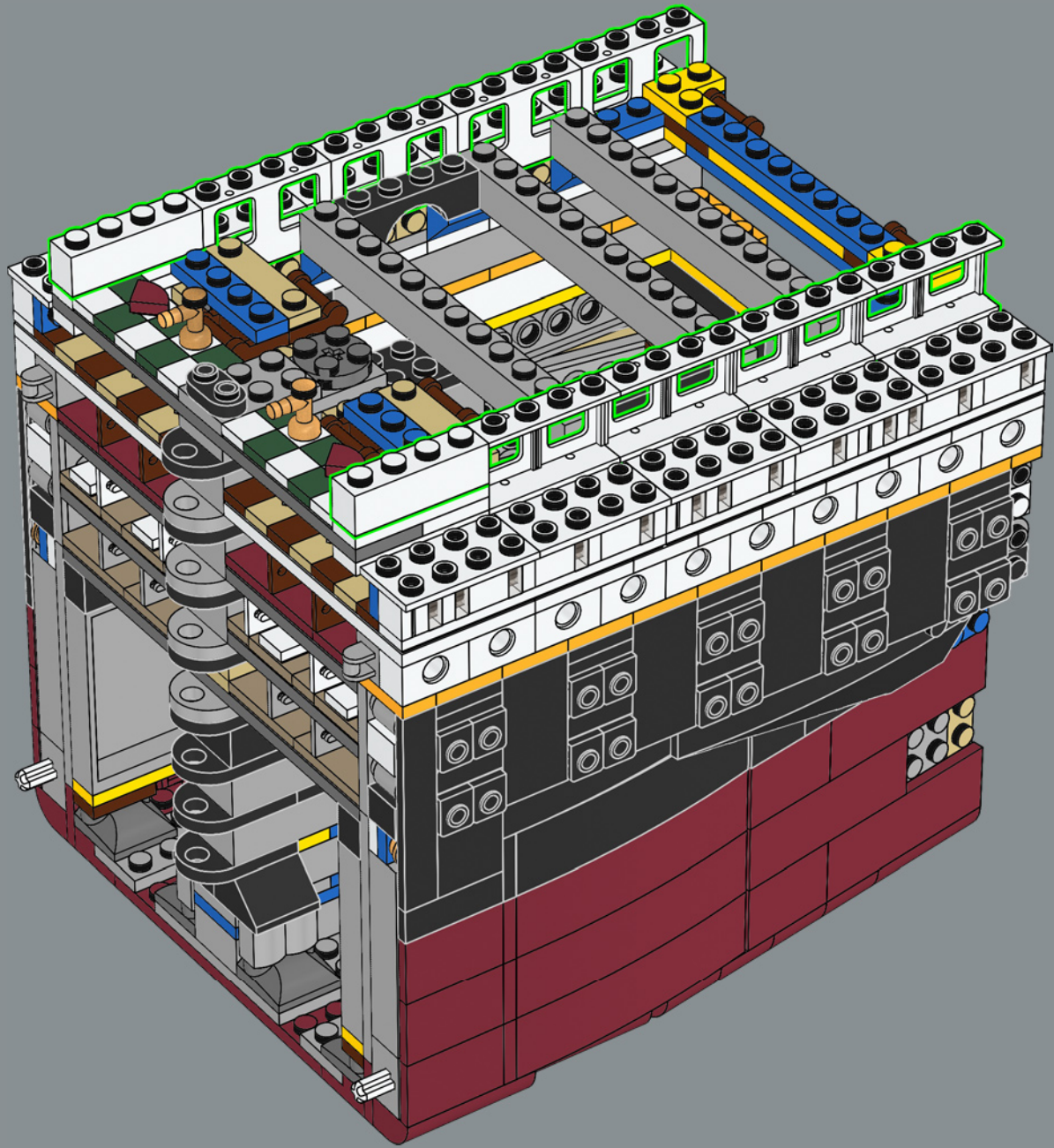

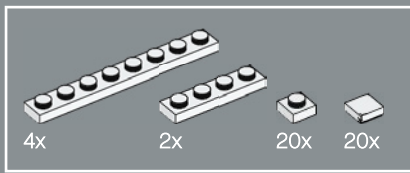

108

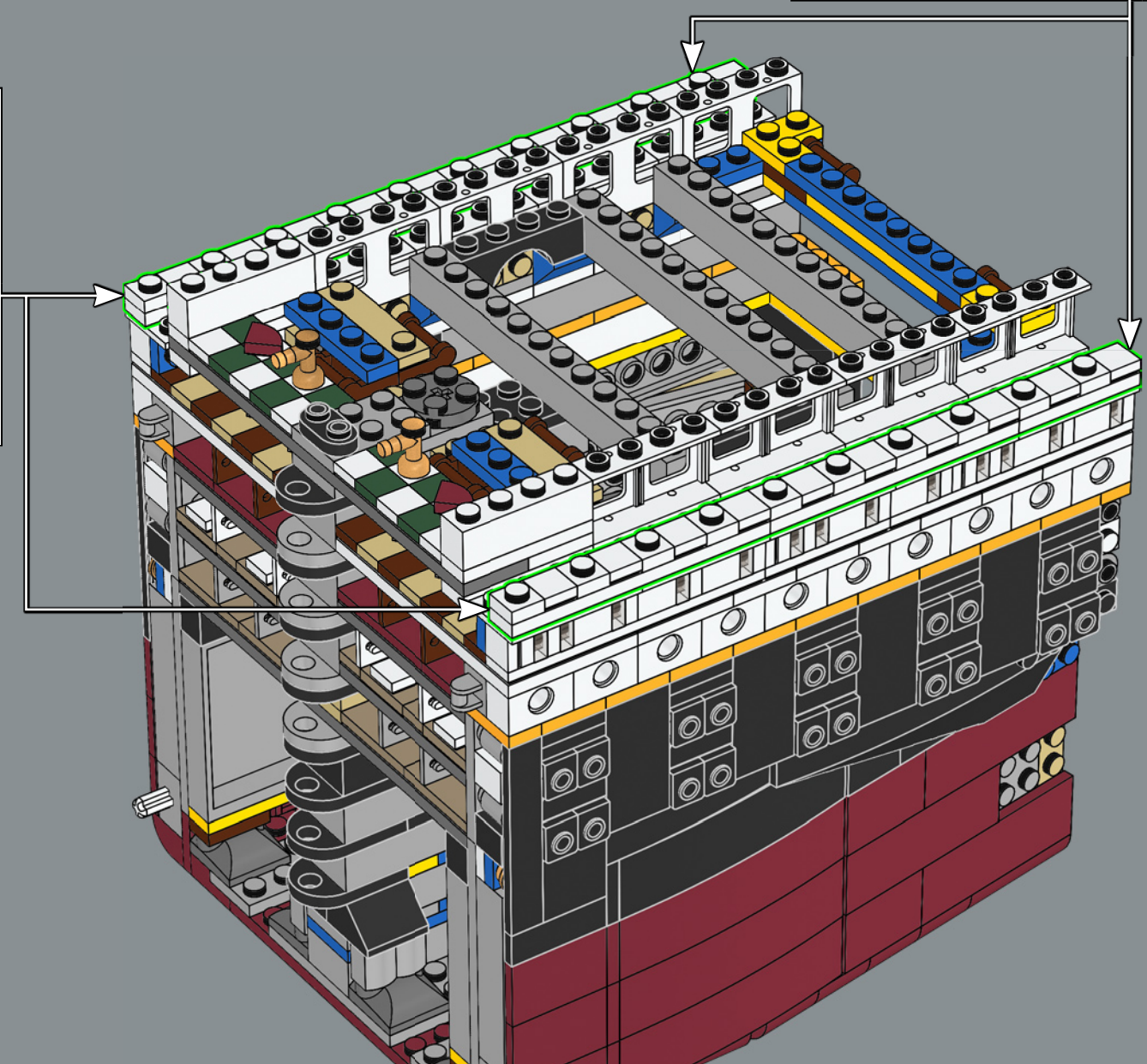
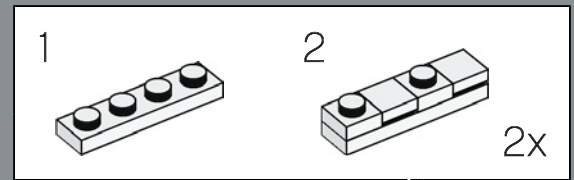
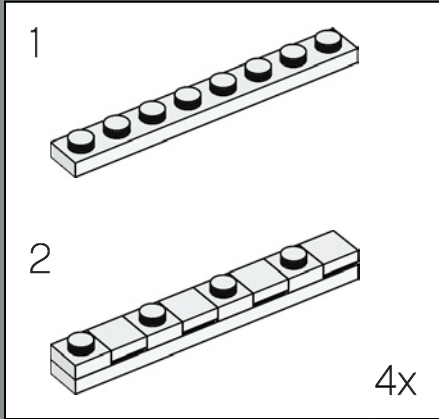



20x

109

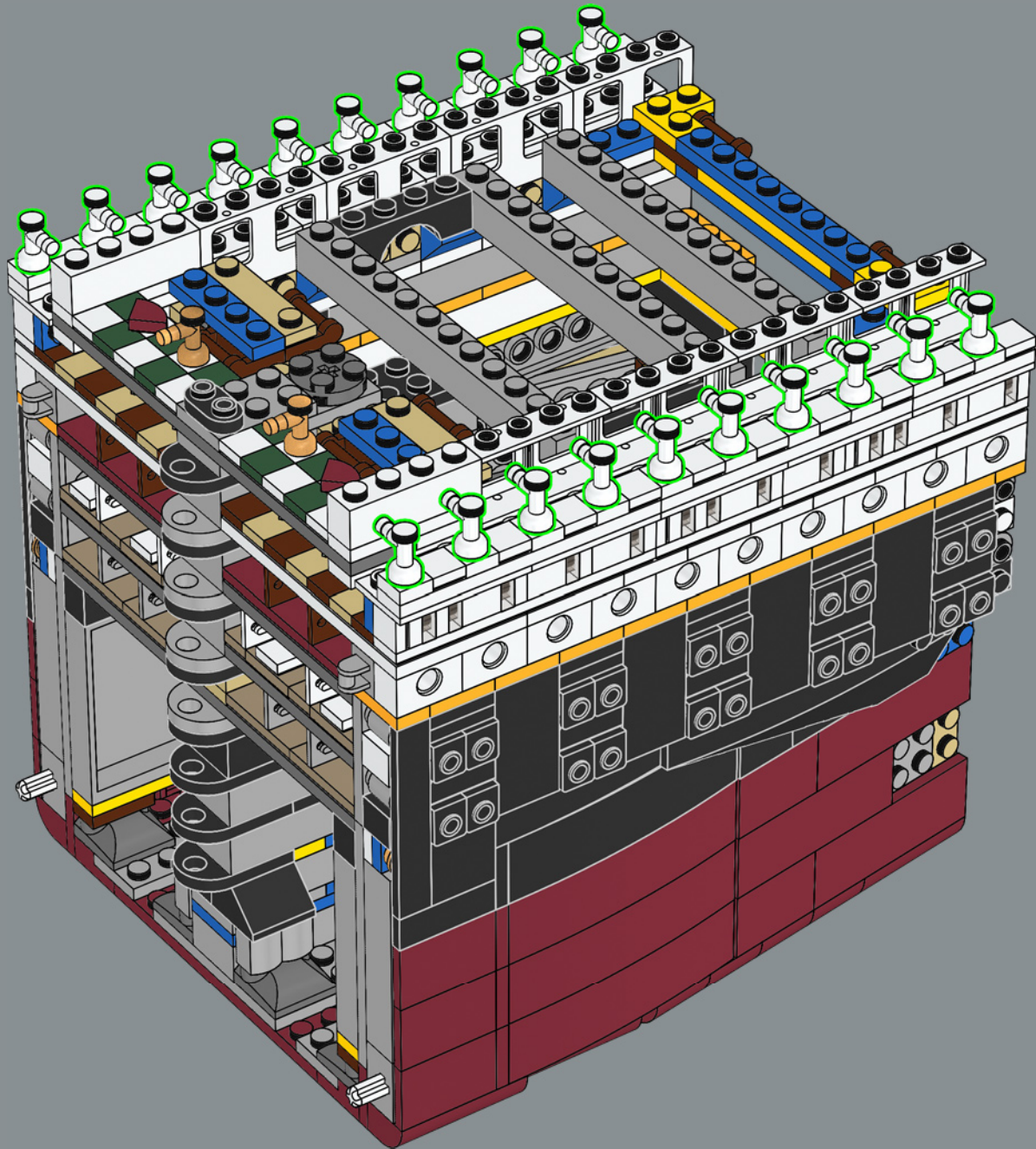

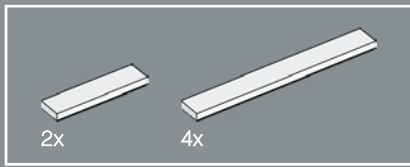

110

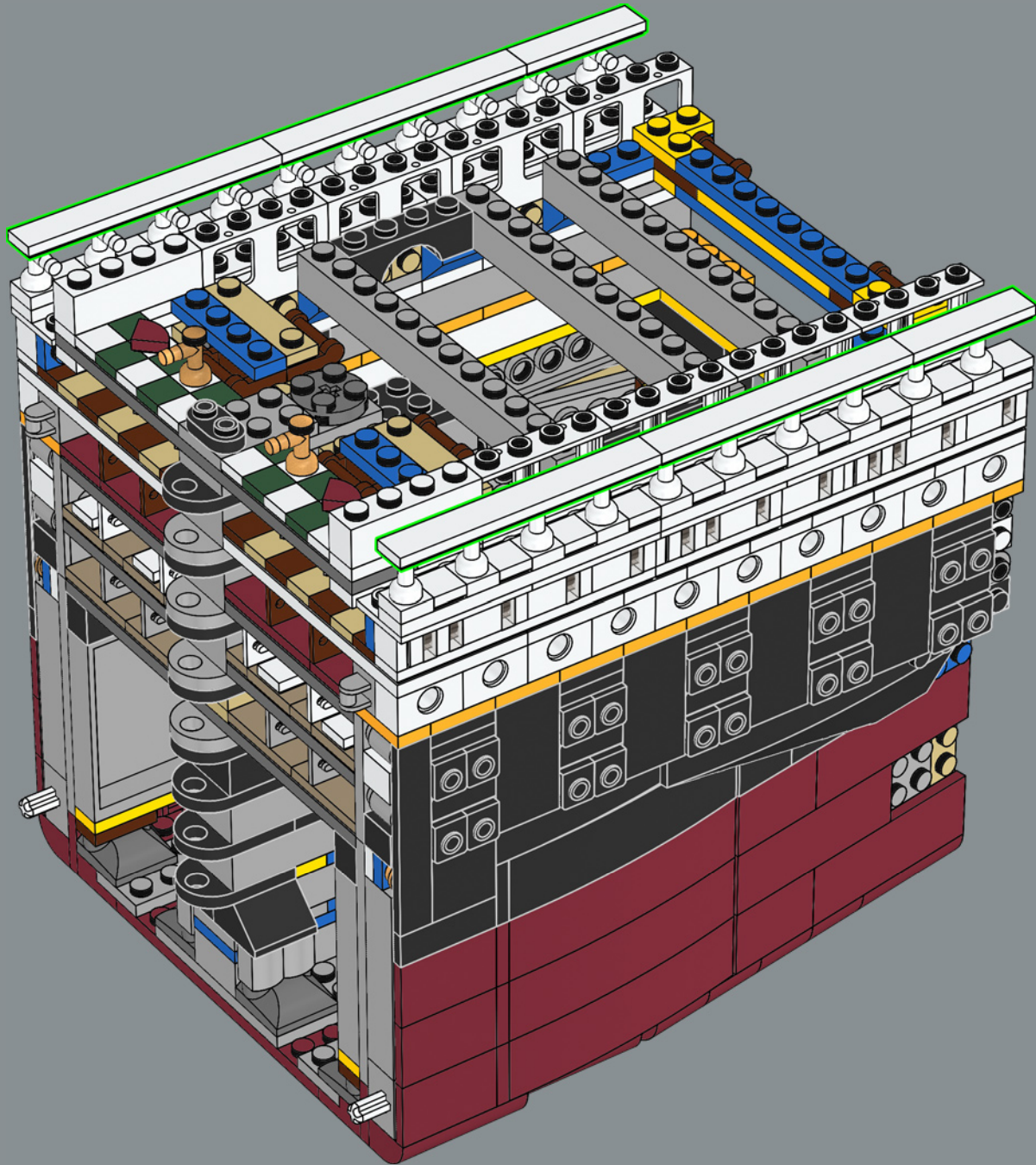

34

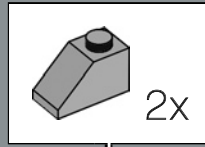
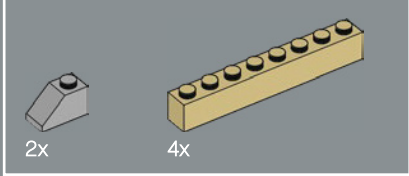

111

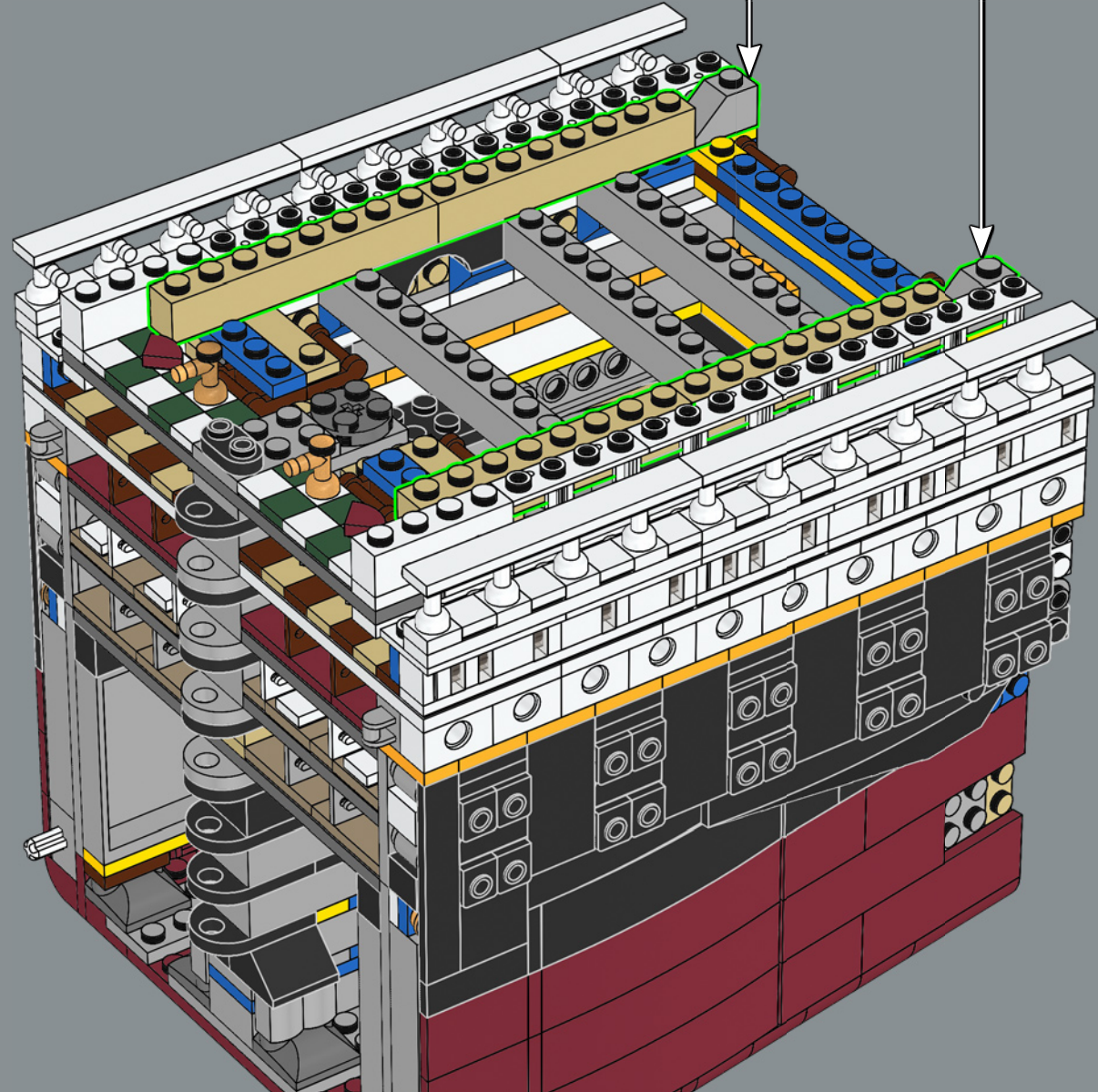



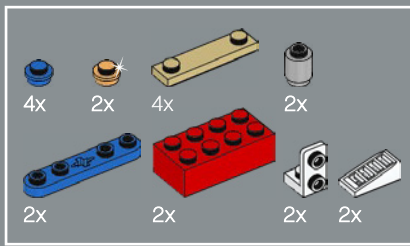

112

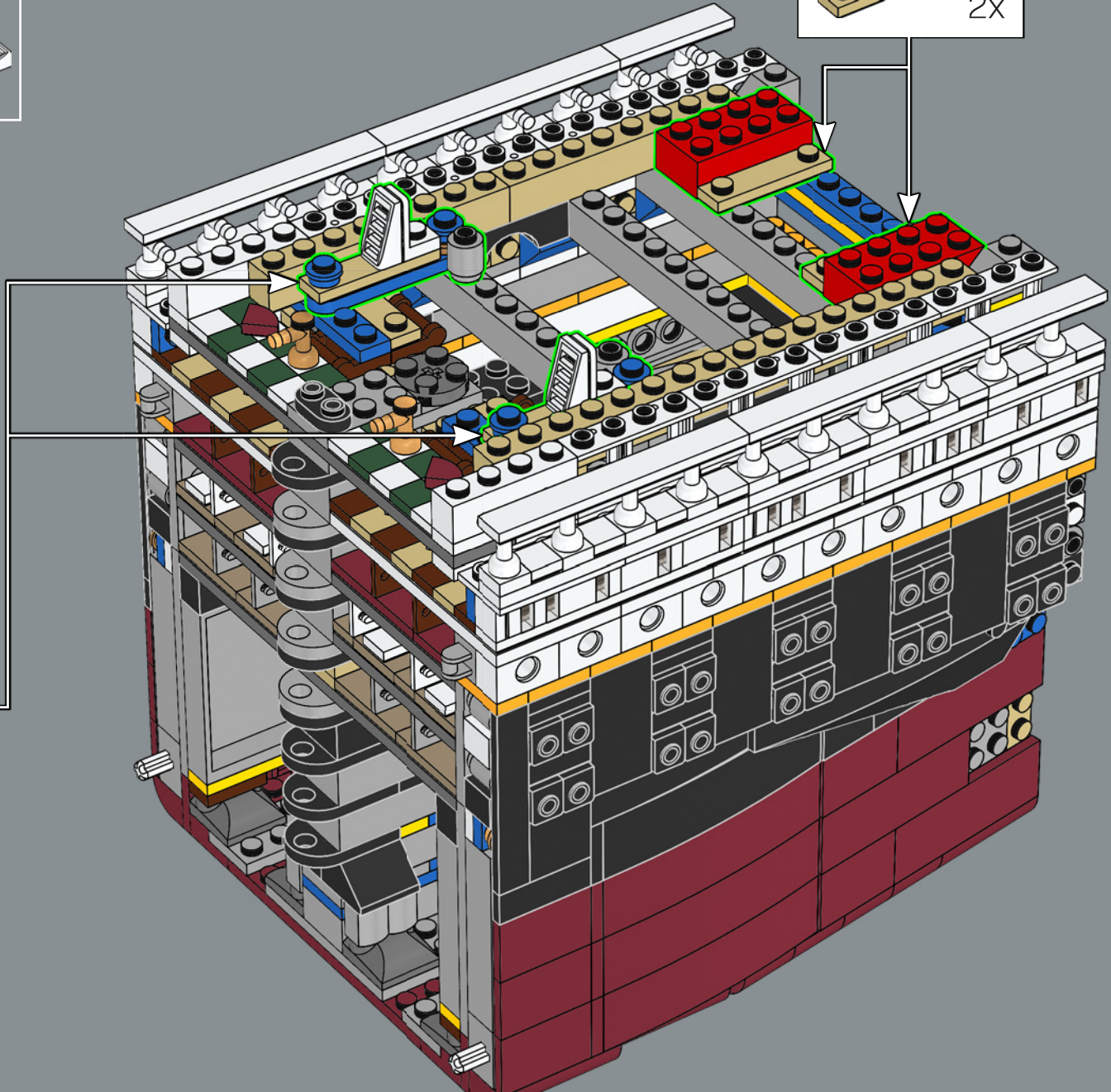
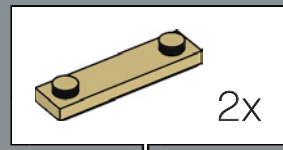
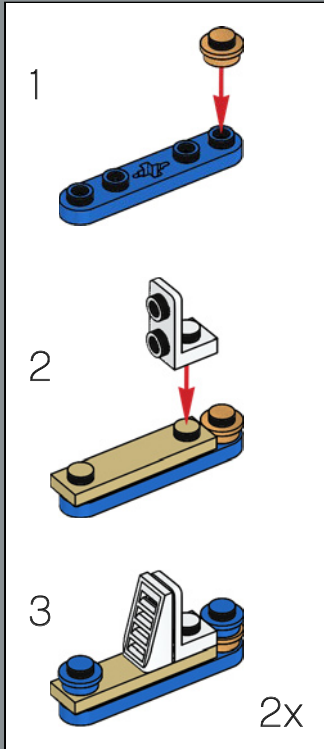

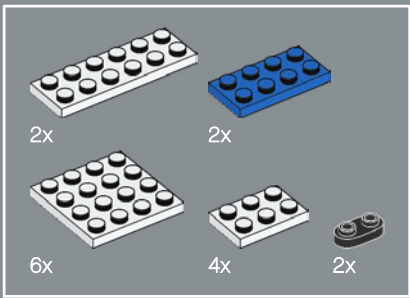

113

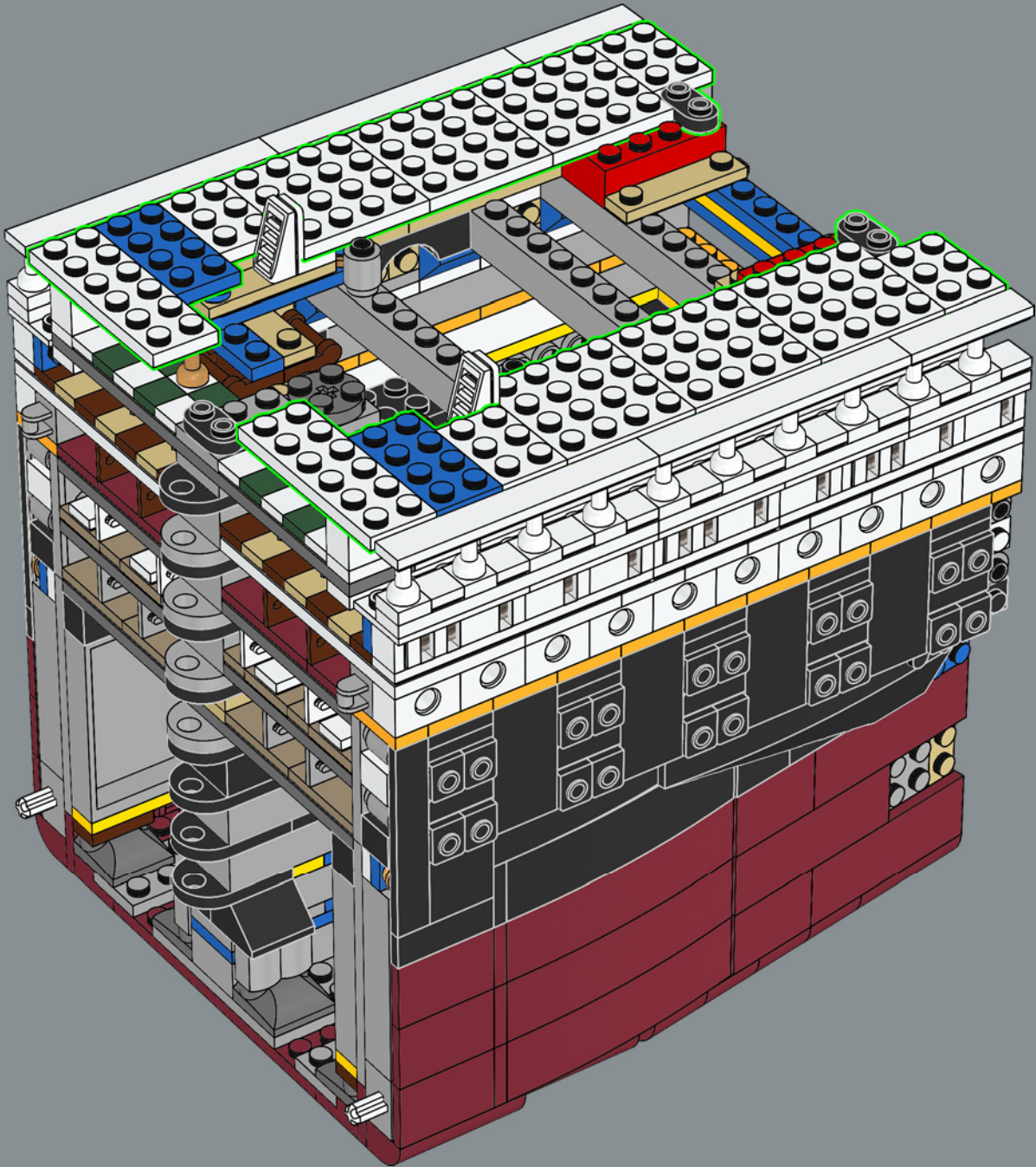

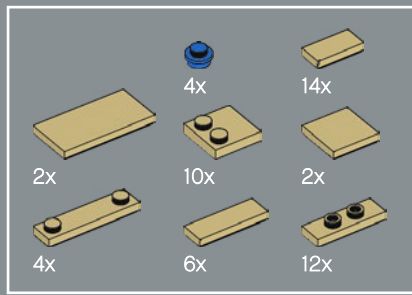

114

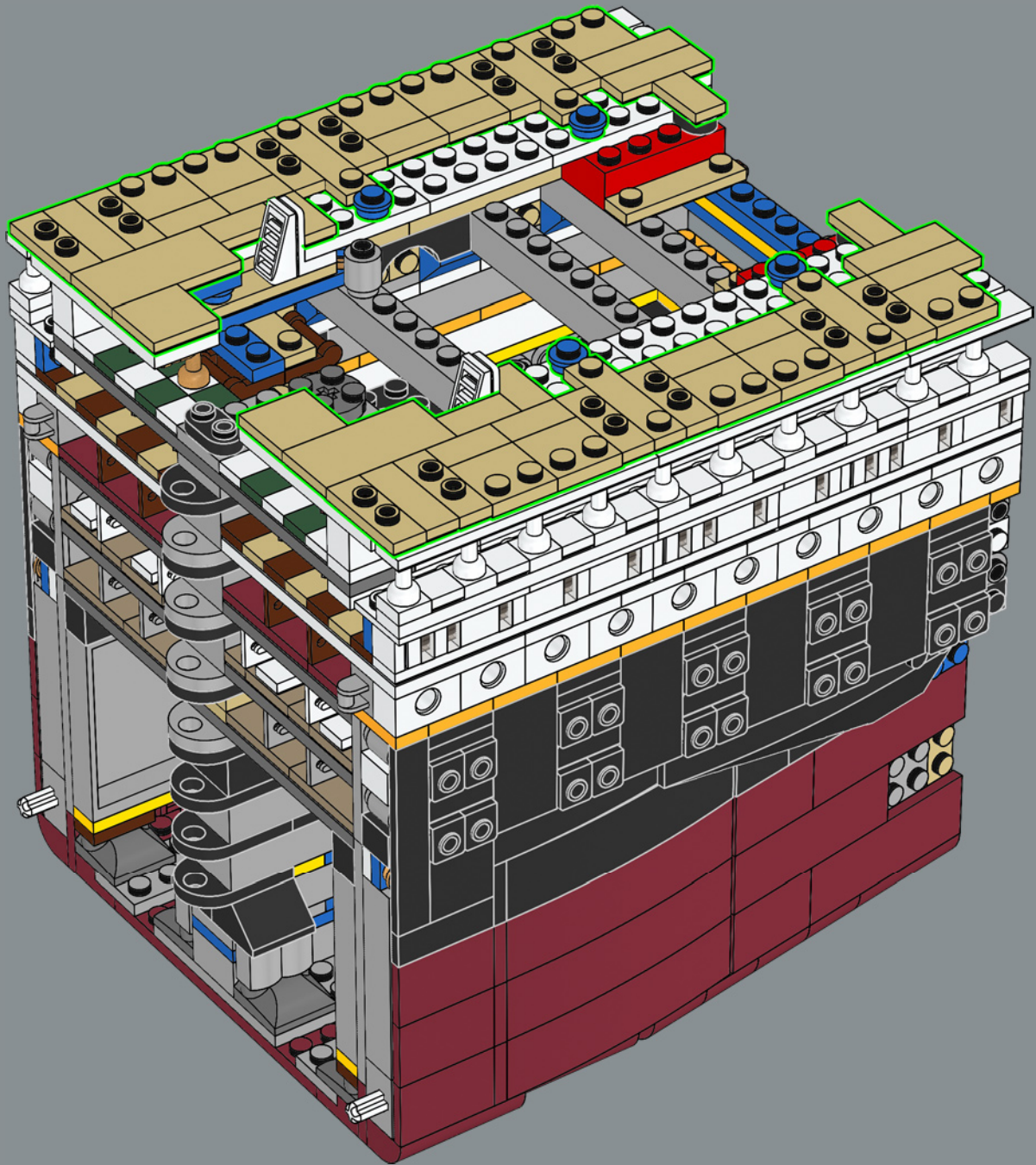

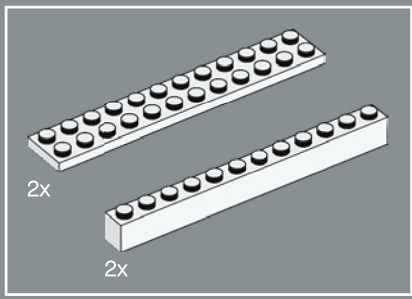

115

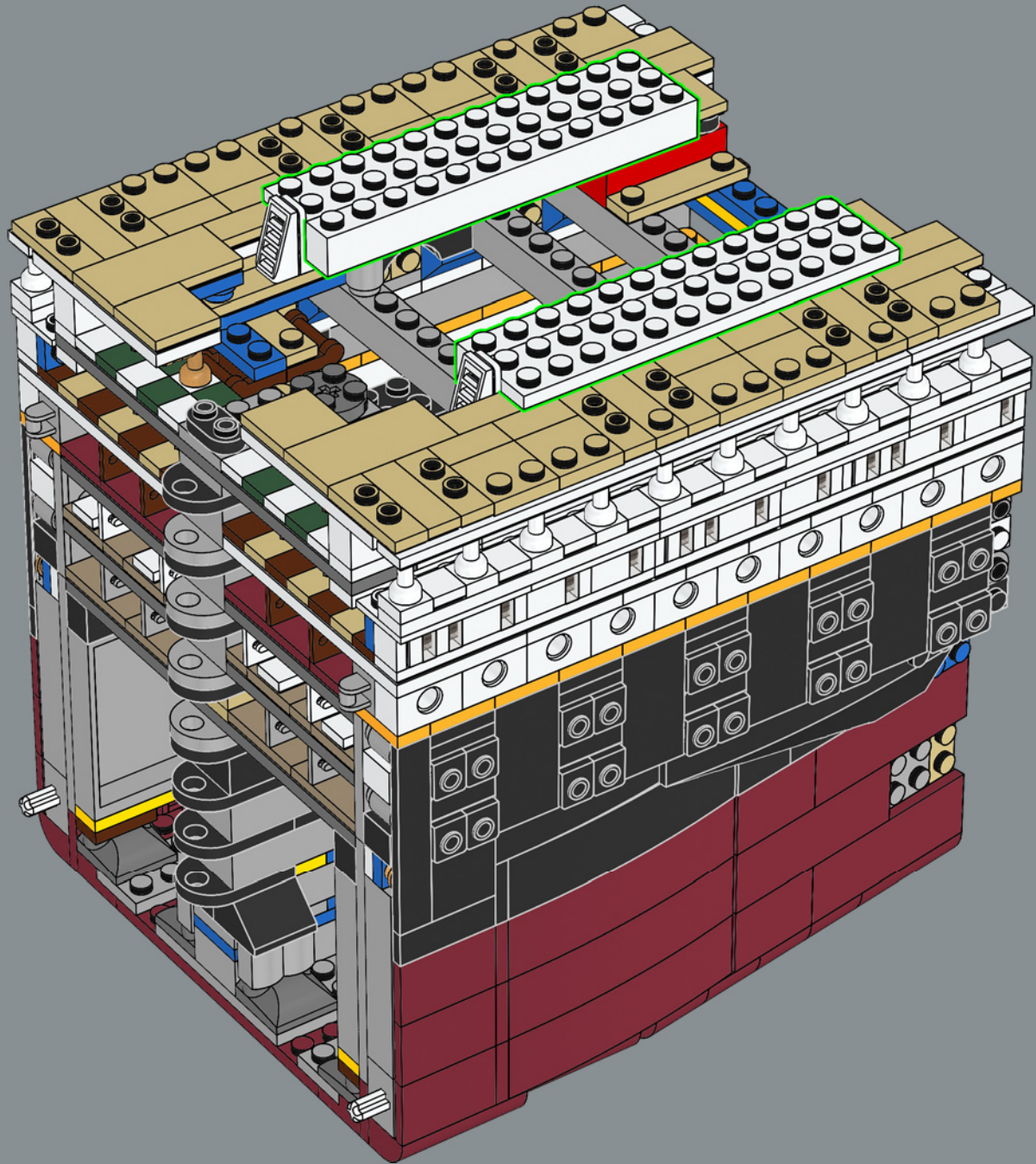

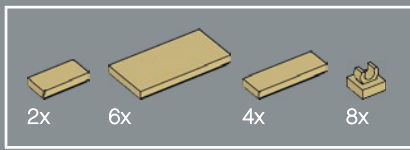

116

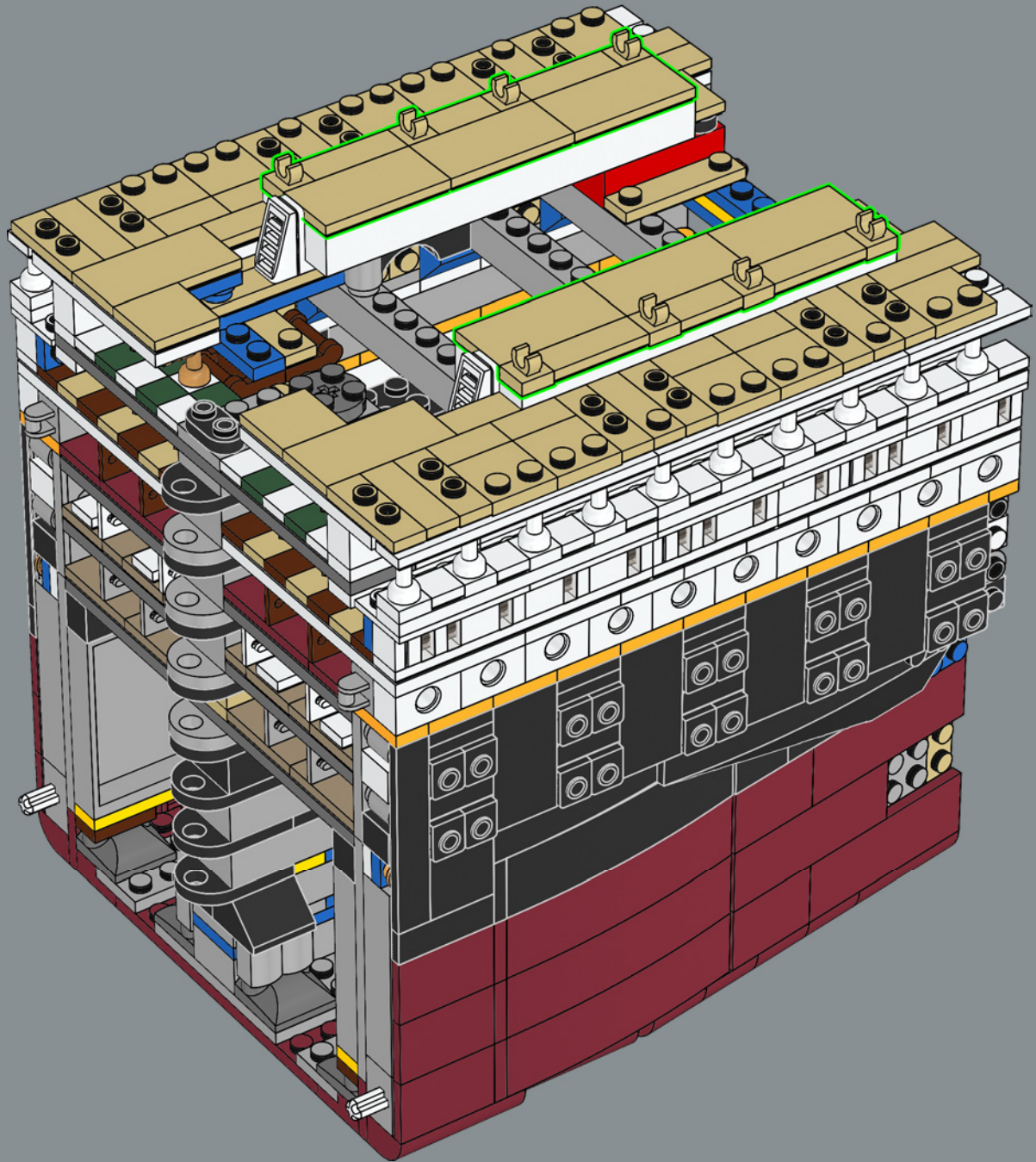

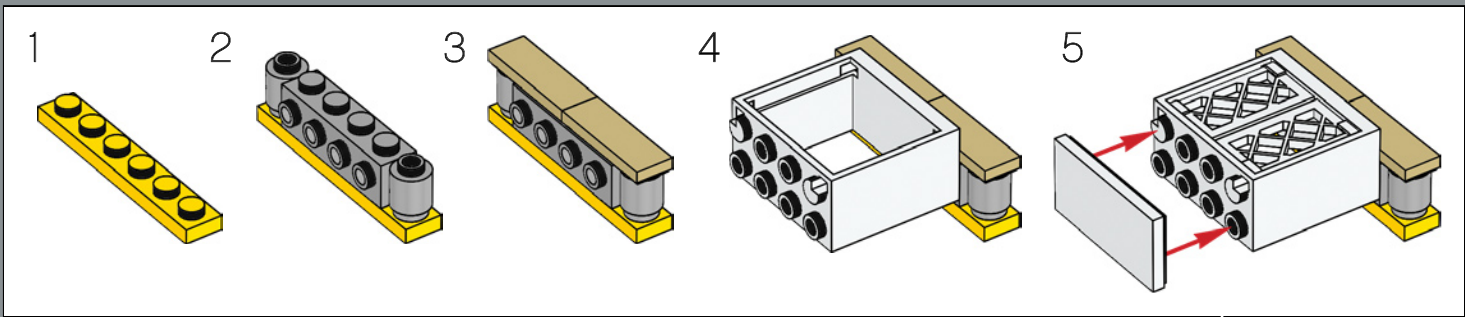
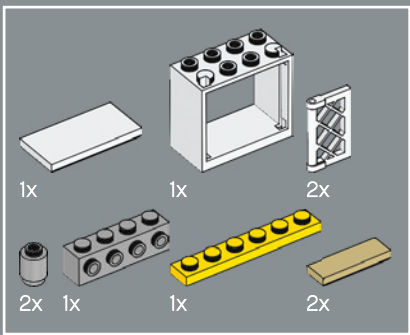

117

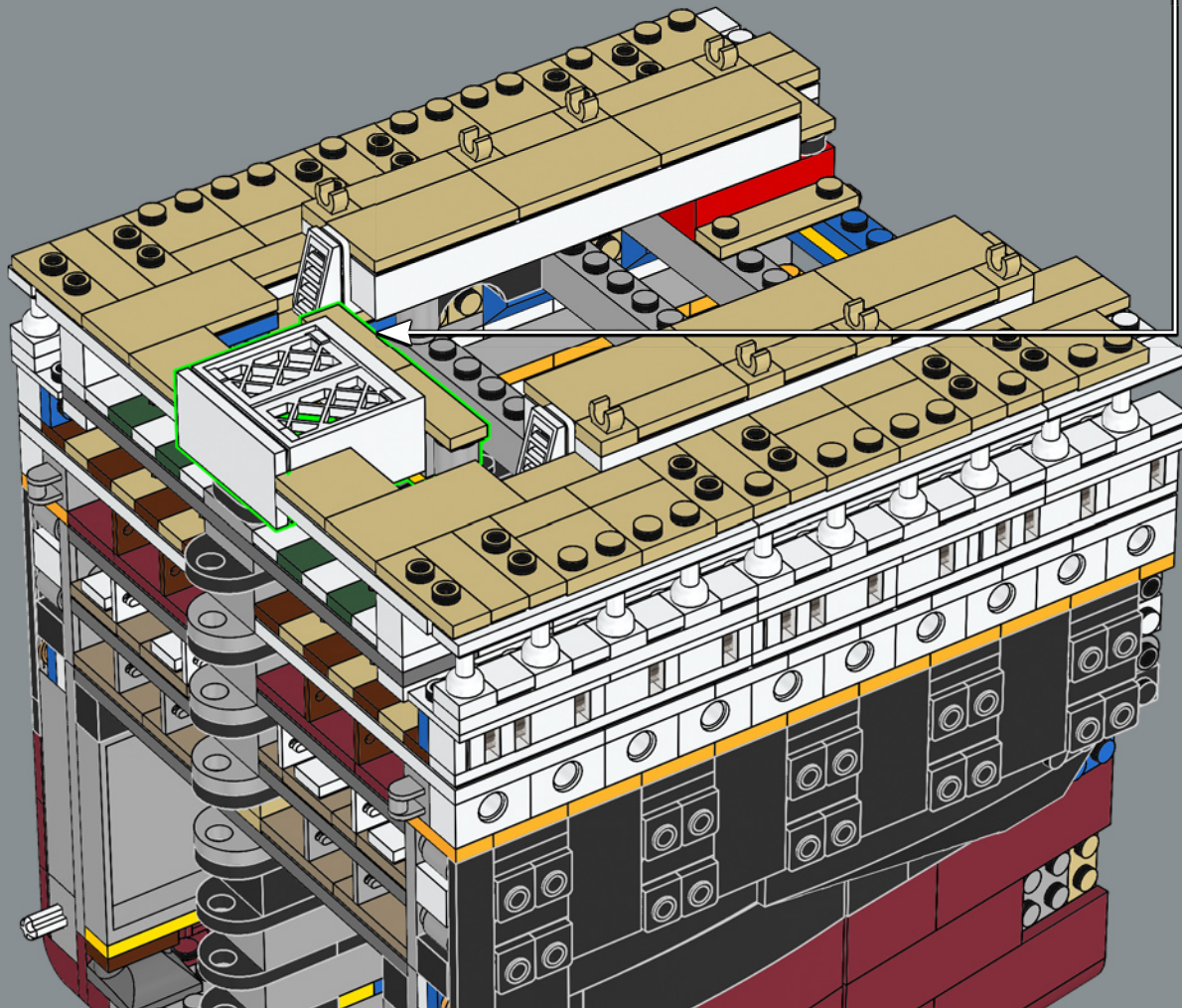

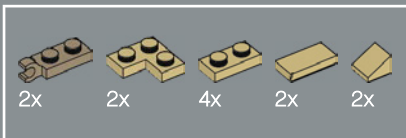

118

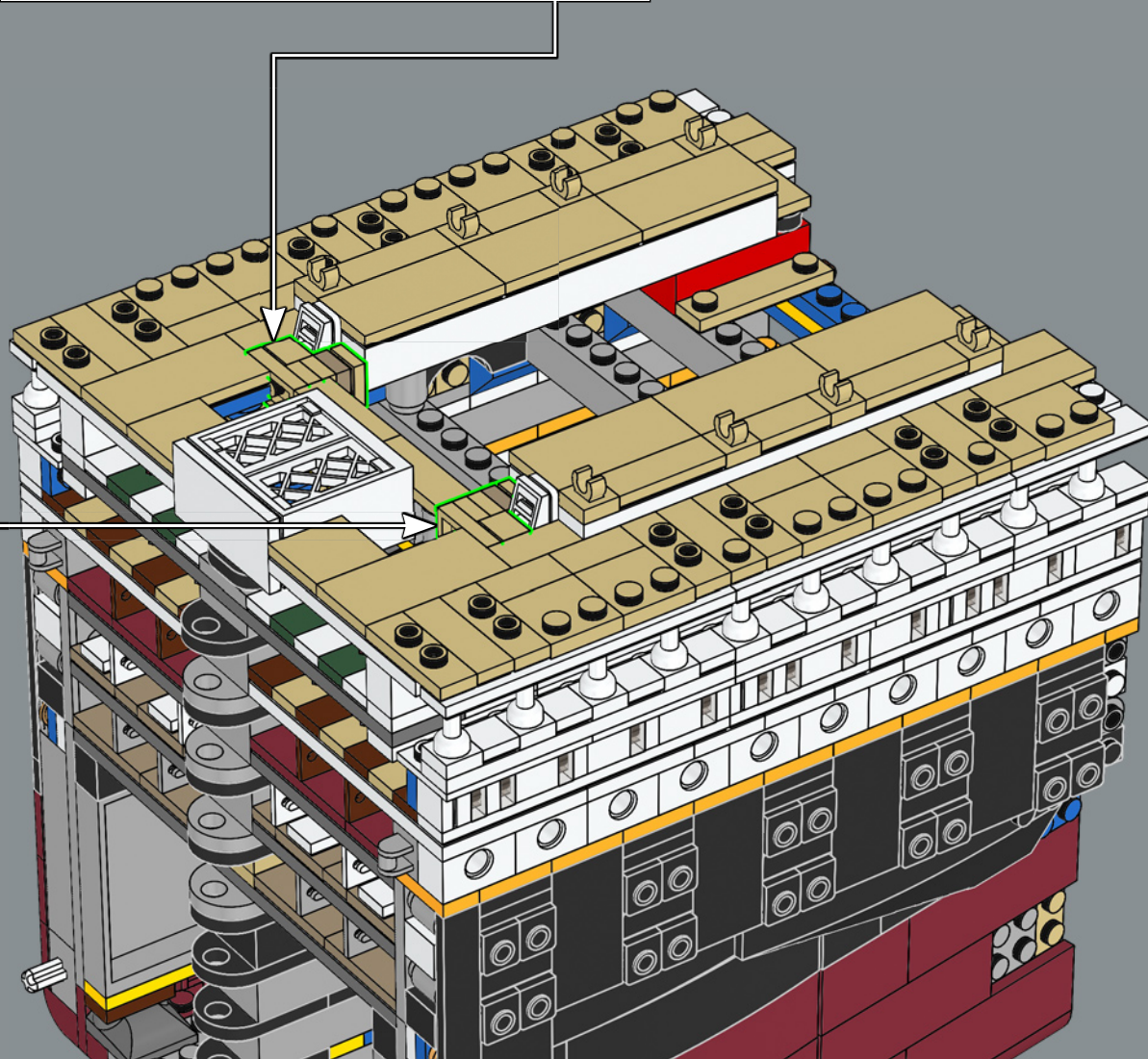
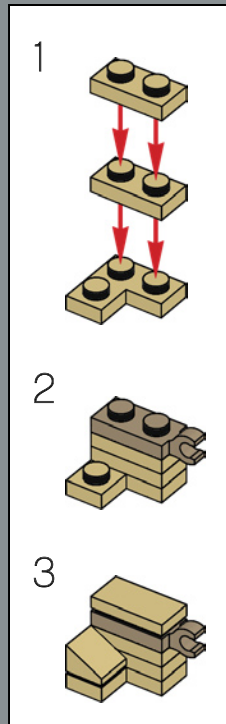
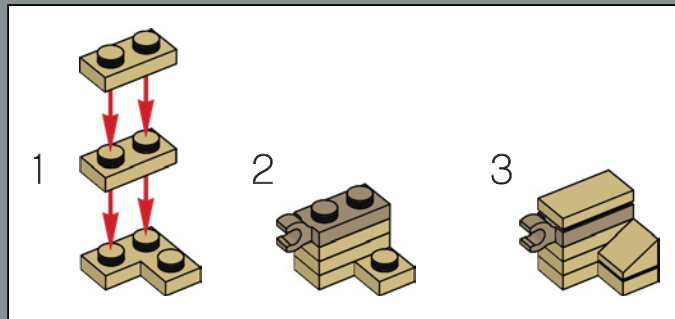

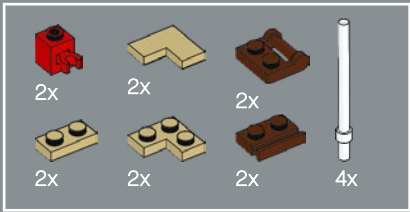

119

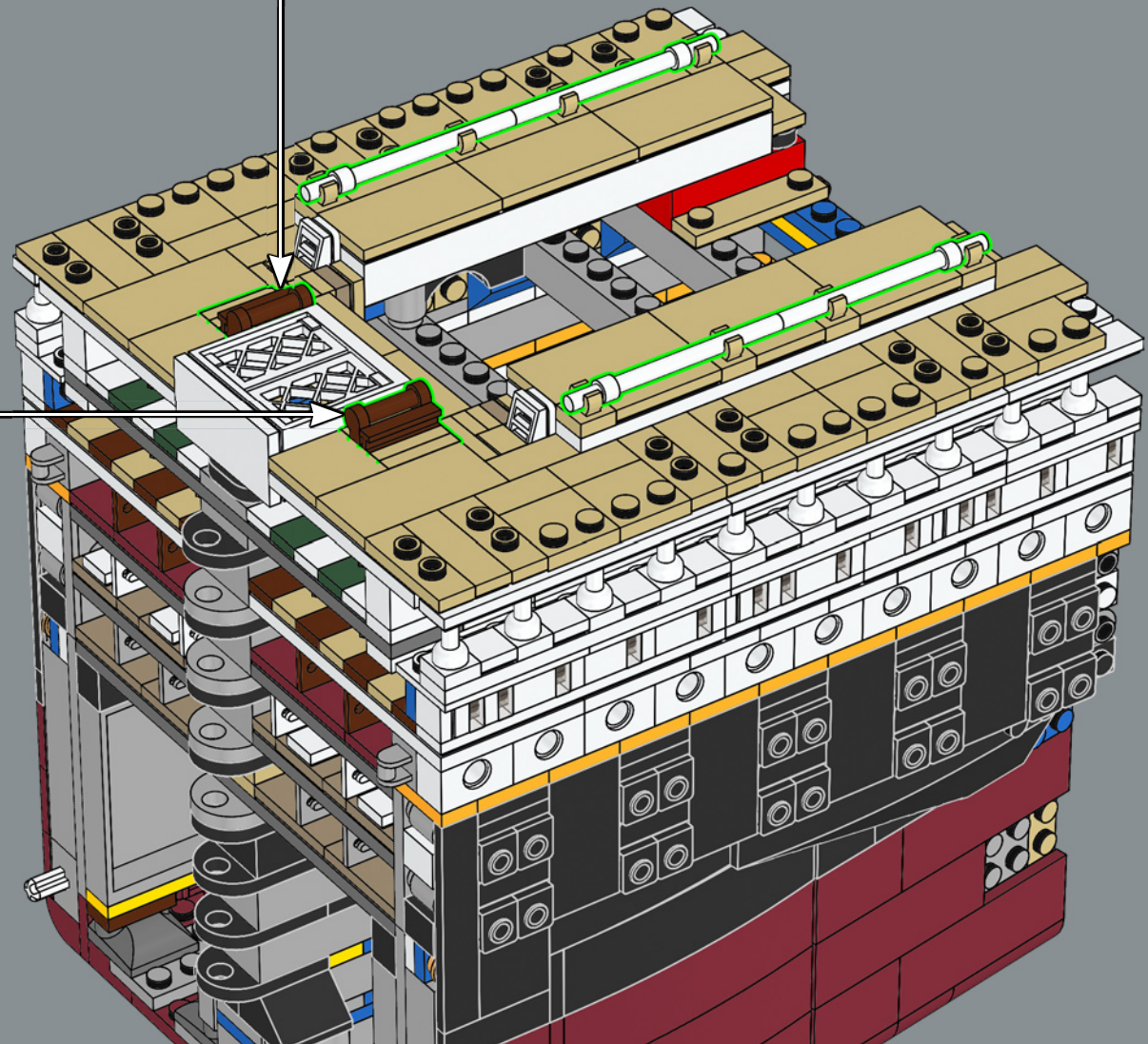
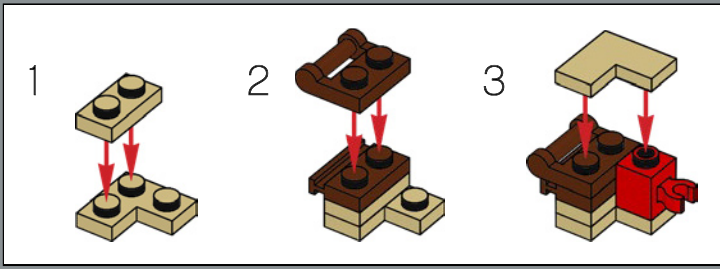
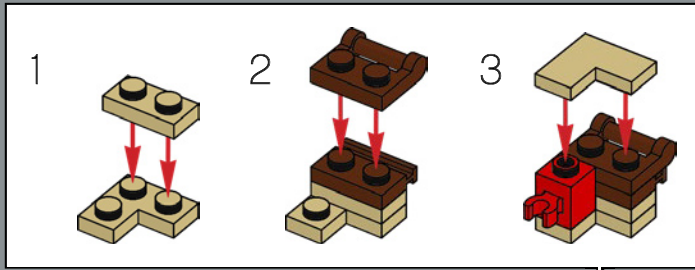



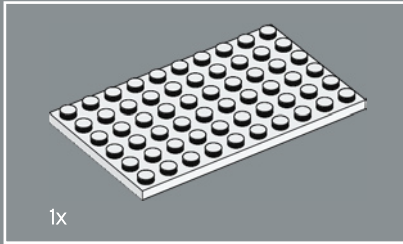
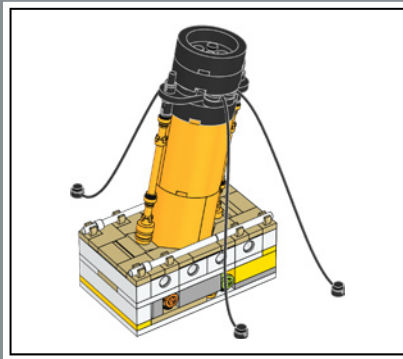
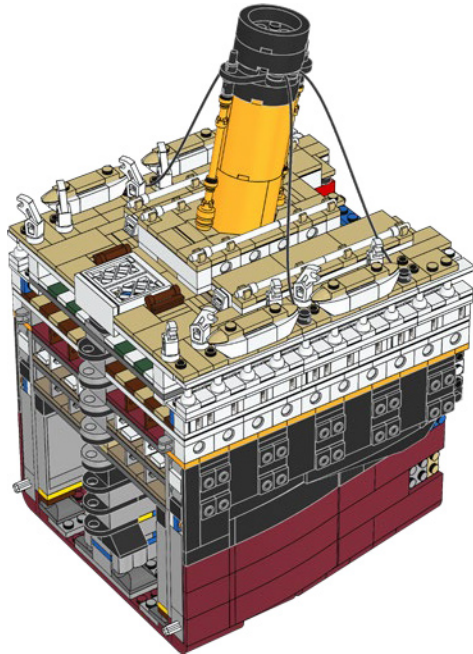

120

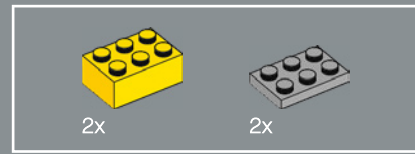
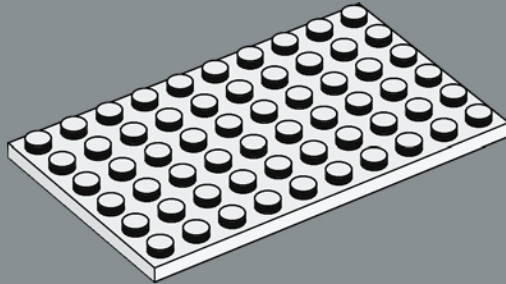

121

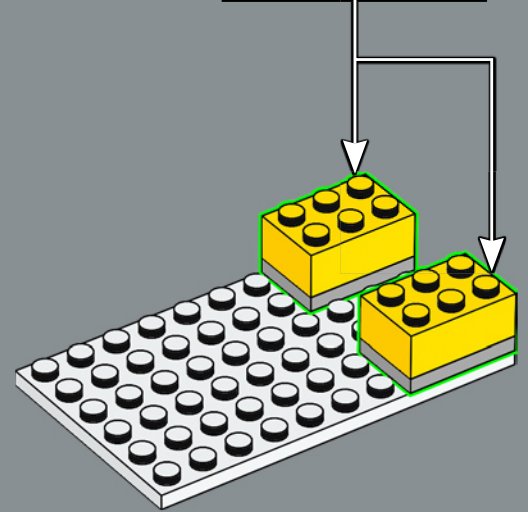
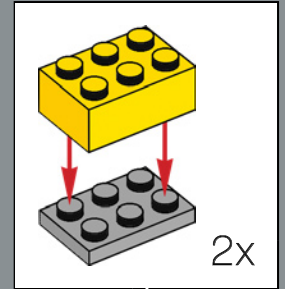

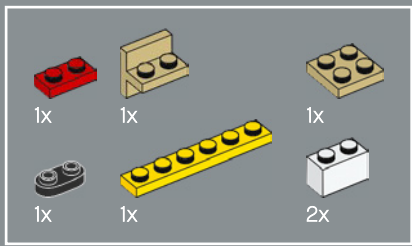

122

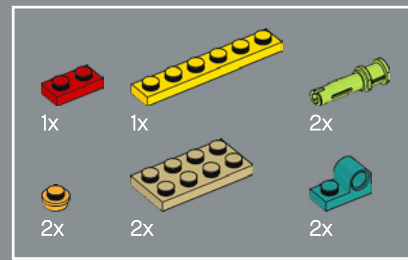
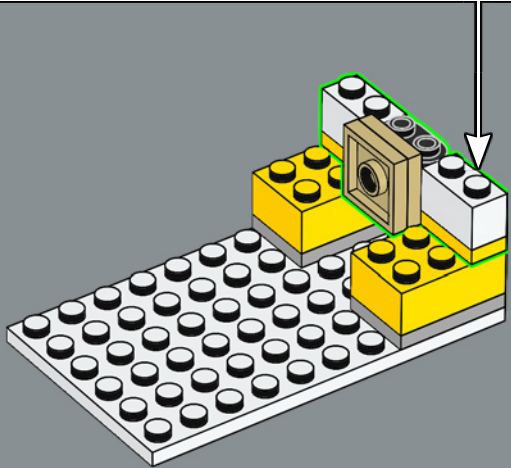
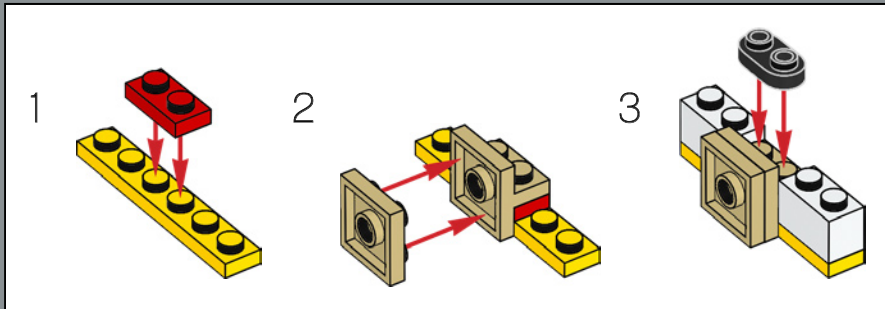

123

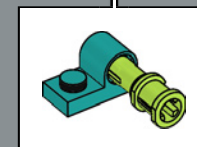
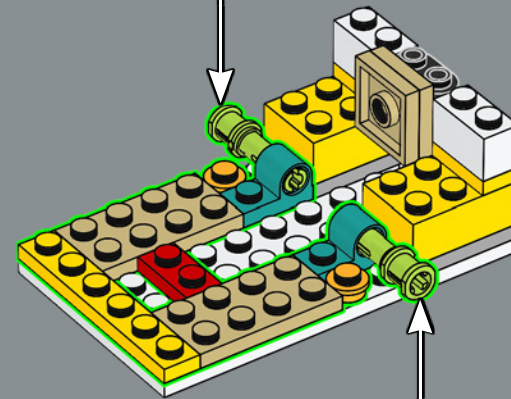
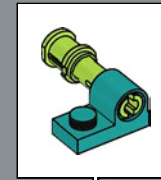

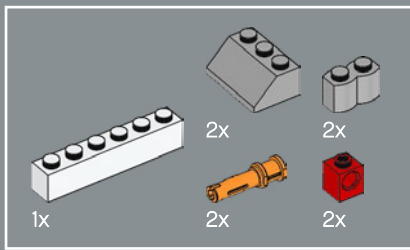

124

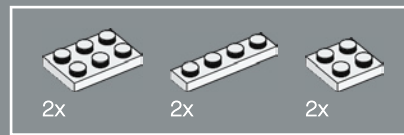
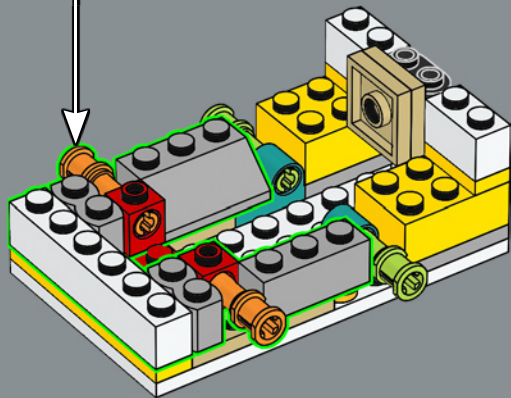
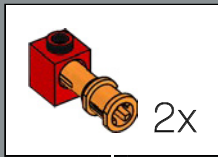

125

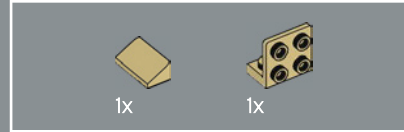
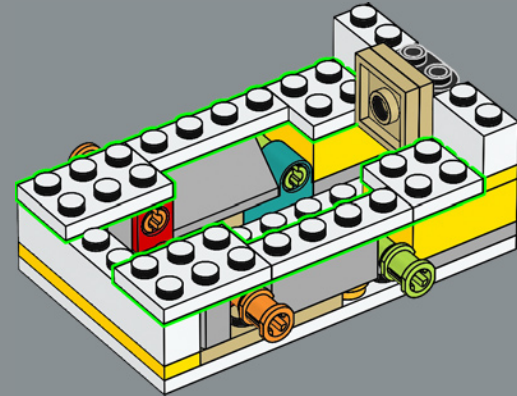

126

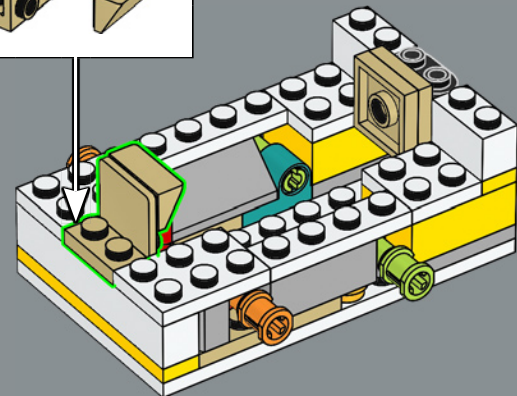
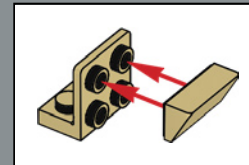

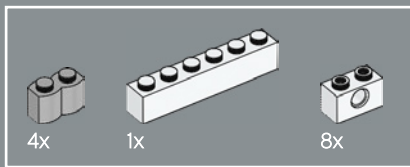

127

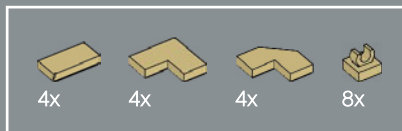
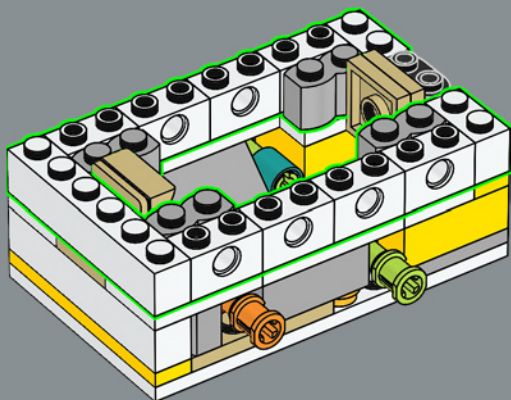

128

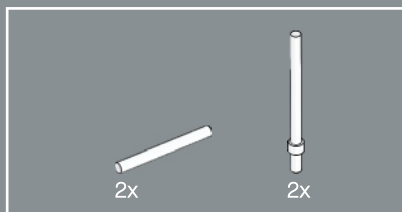
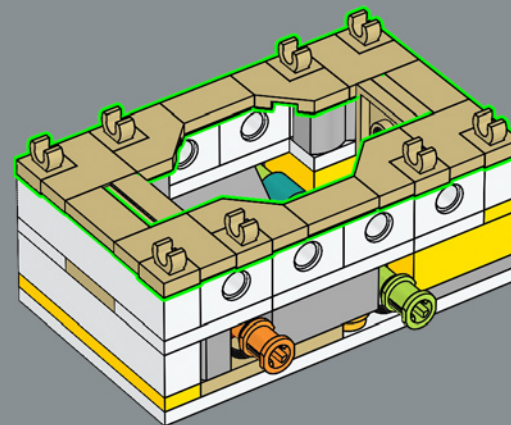

129

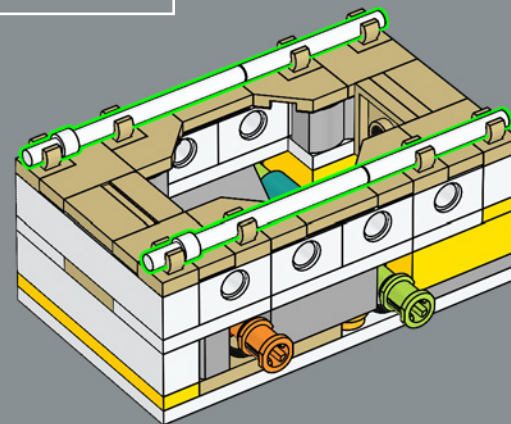

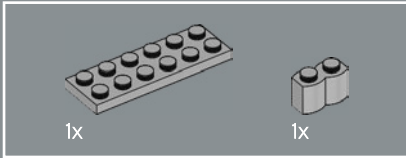
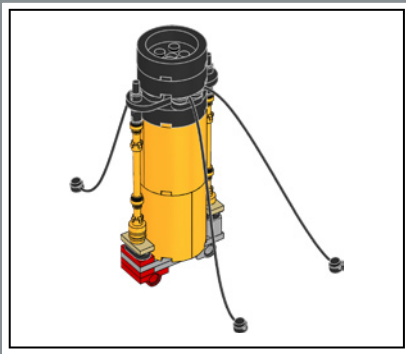

130

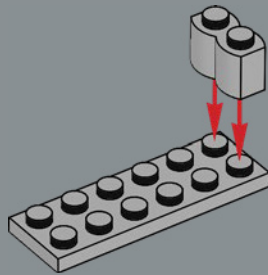

131

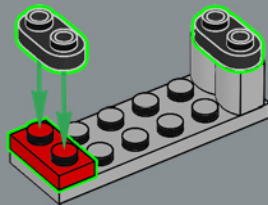

132

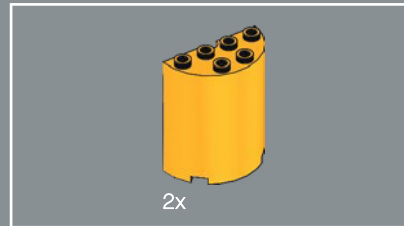
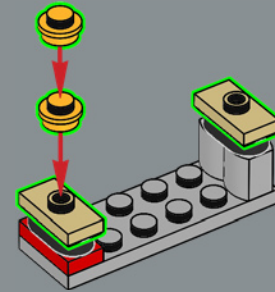

133

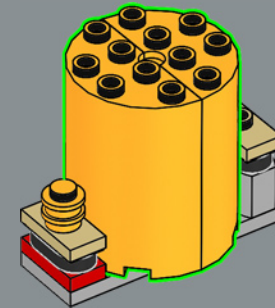

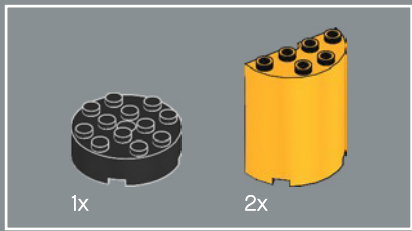

134

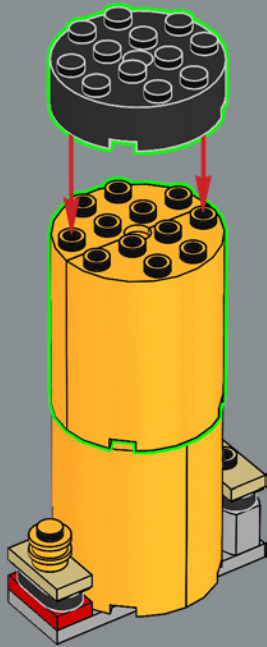

135

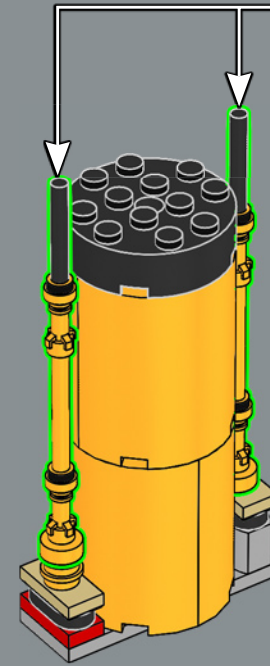
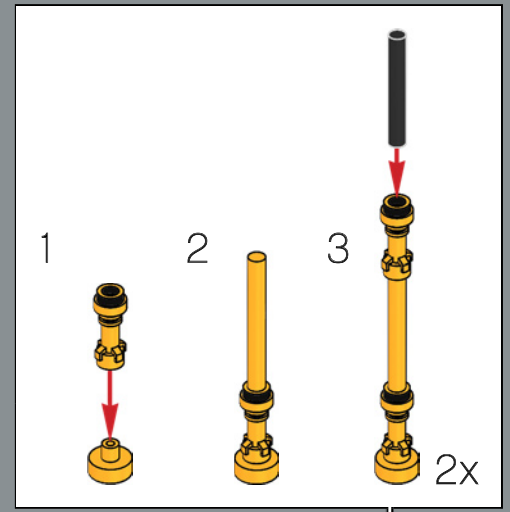

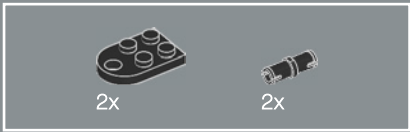

136

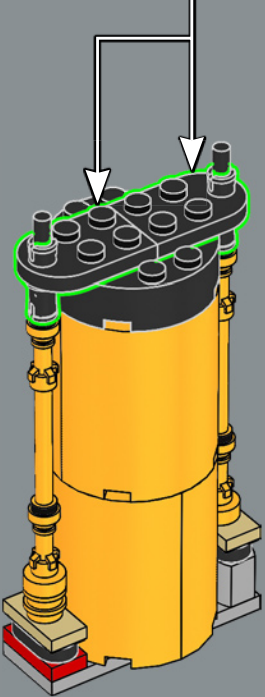
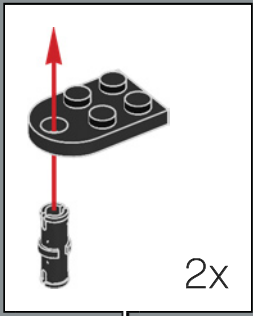

137

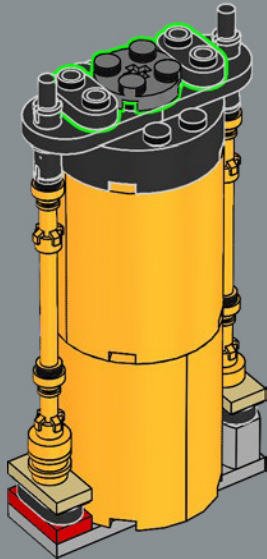

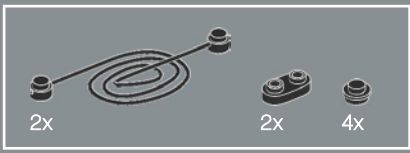

138

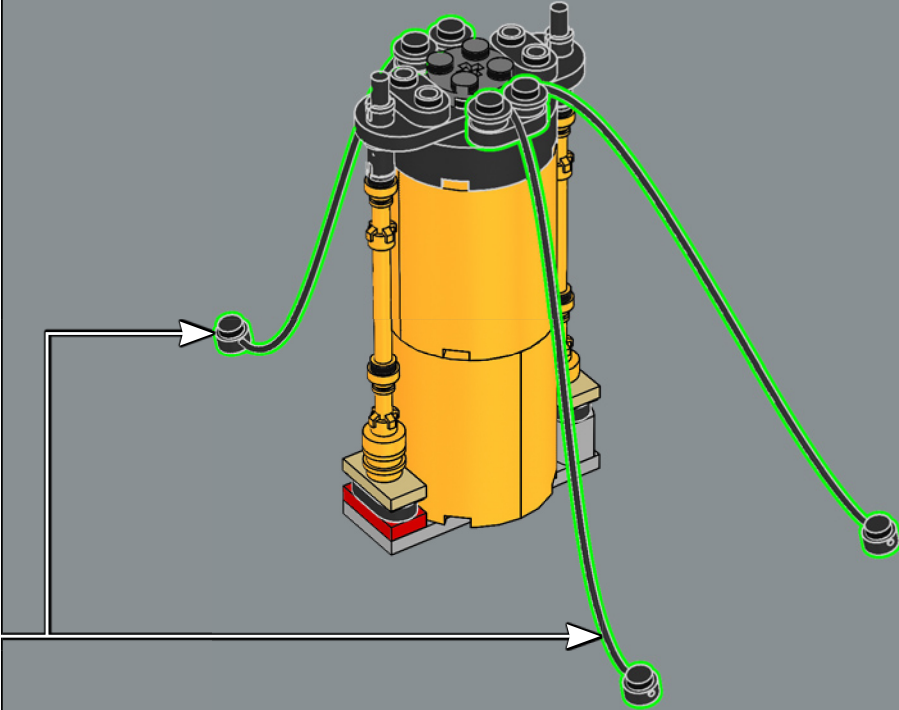
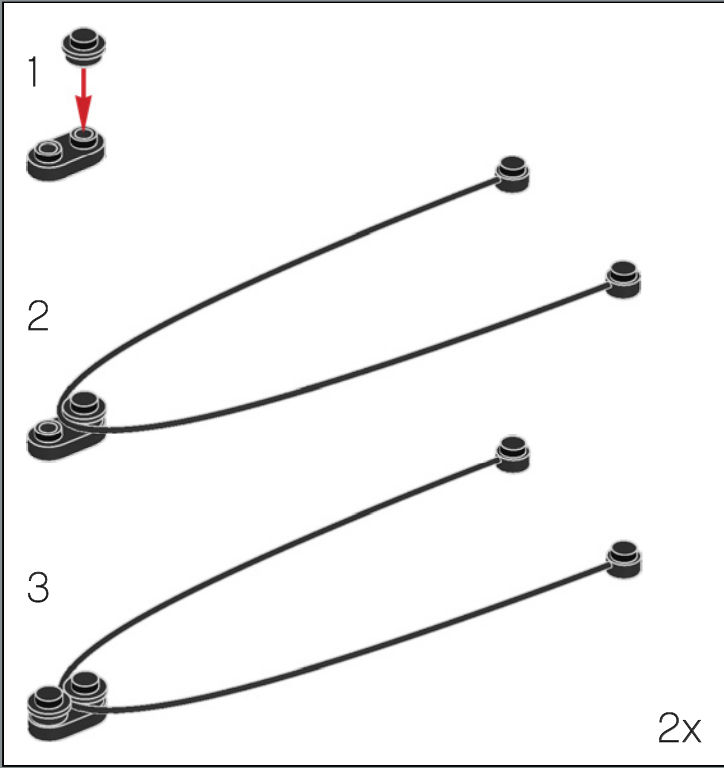



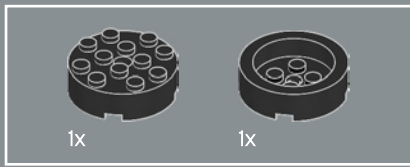

139

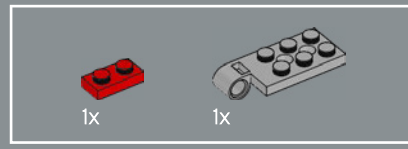
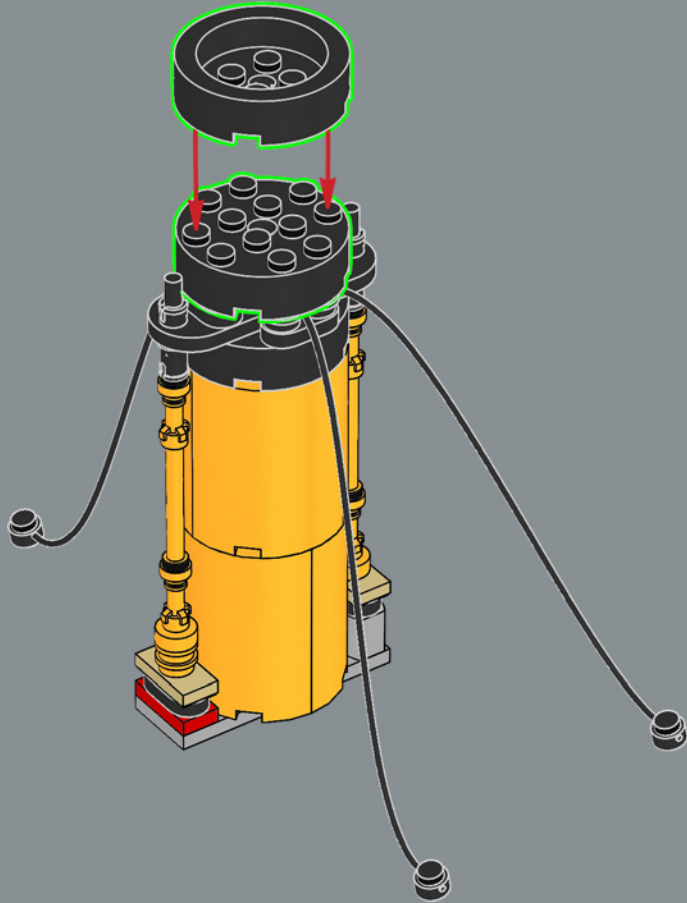

140

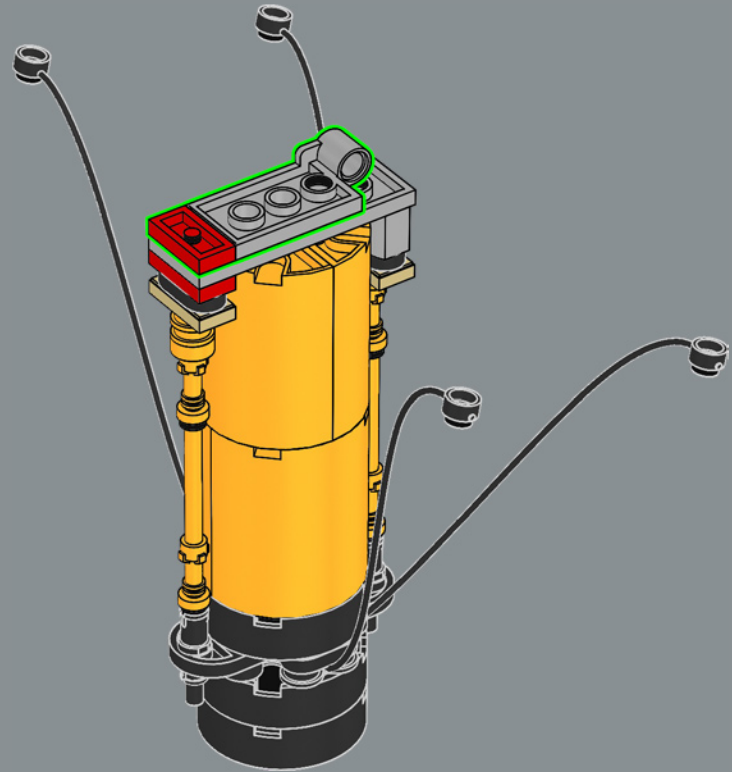

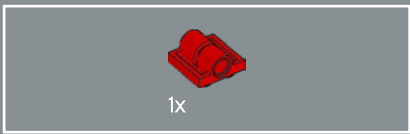

141

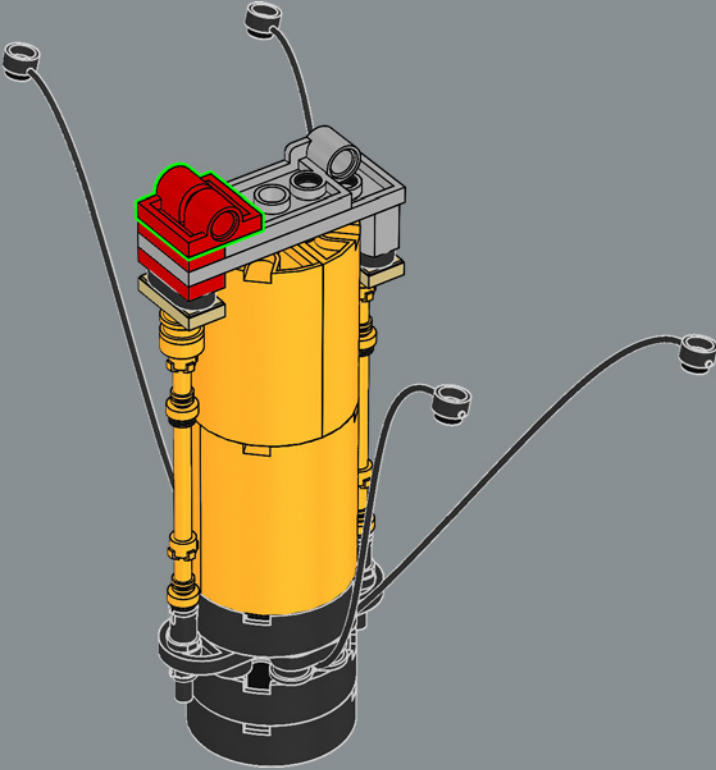

142

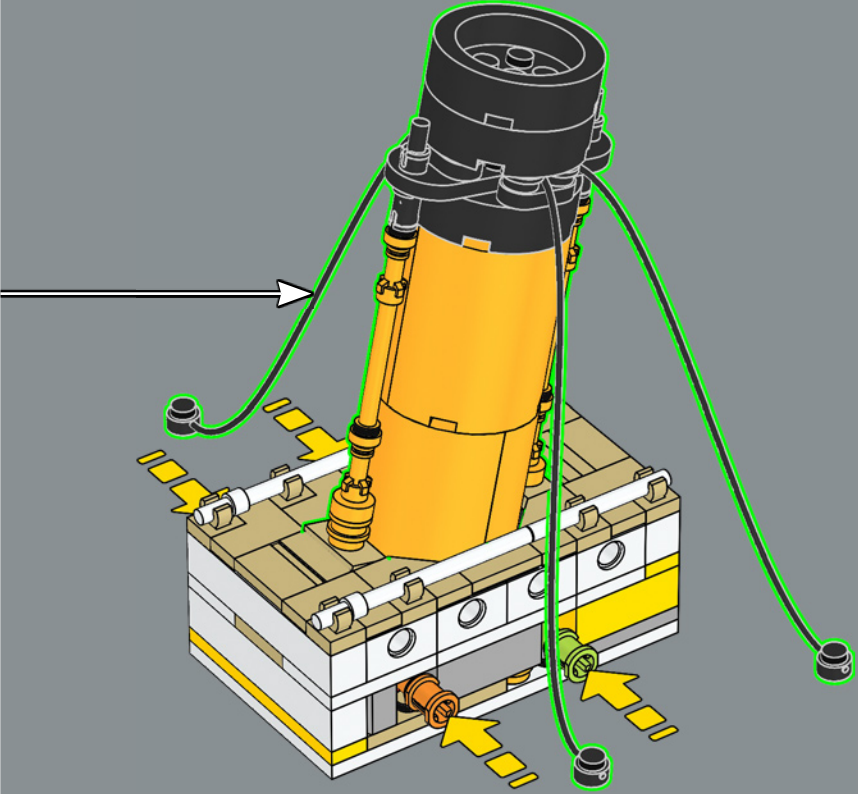

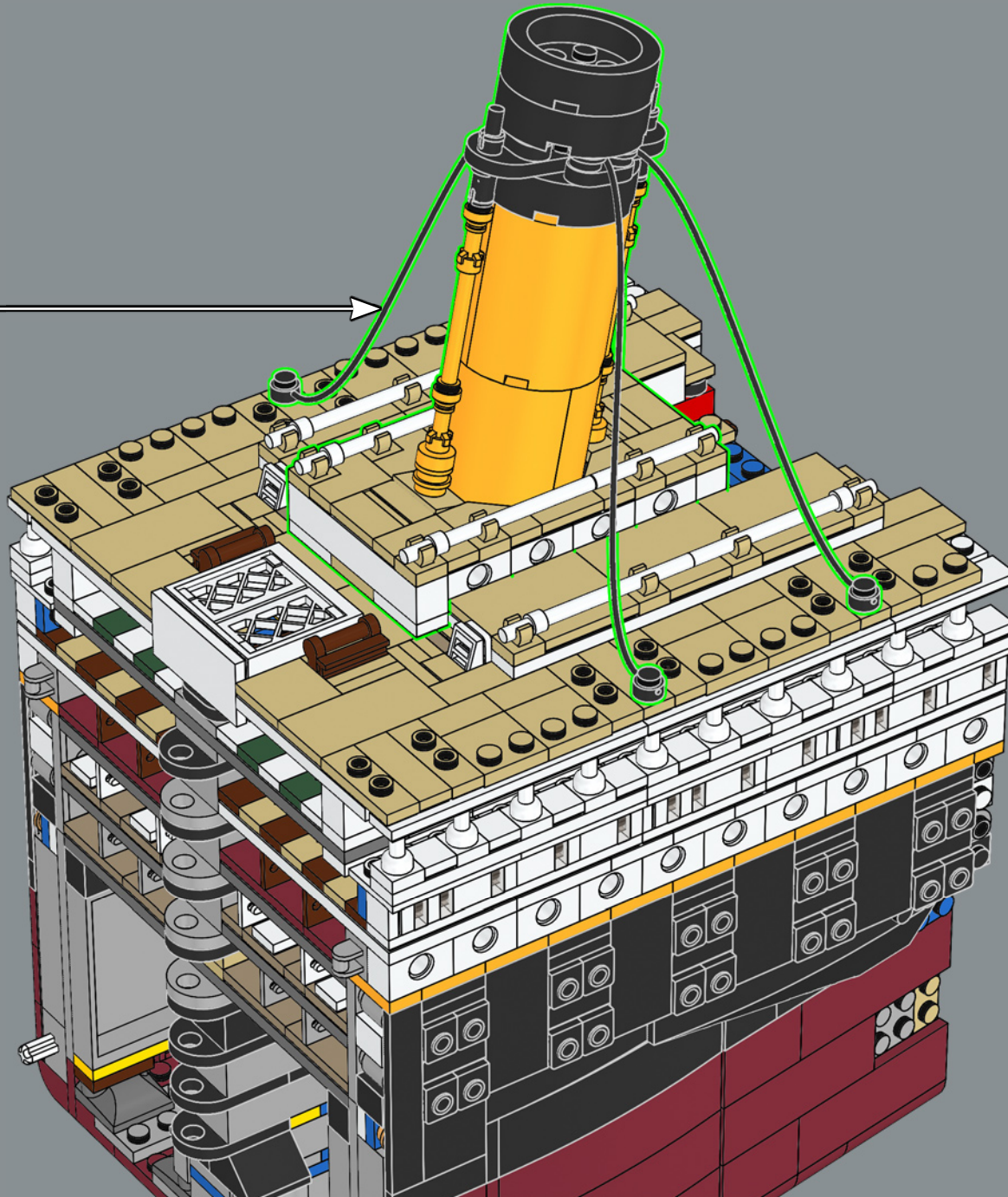

The *Titanic* had four funnels, though only three were functional—the last one was a dummy, installed for aesthetic purposes.

Le *Titanic* a quatre cheminées, mais seules trois sont opérationnelles — la dernière est factice, et n'a été posée qu'à des fins esthétiques.

El *Titanic* contaba con cuatro chimeneas, aunque solo tres funcionaban como tales: la cuarta era ornamental, instalada con fines estéticos.

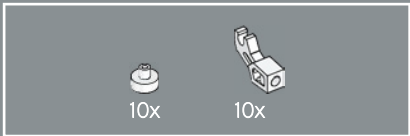

144

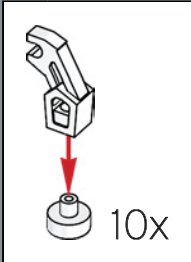
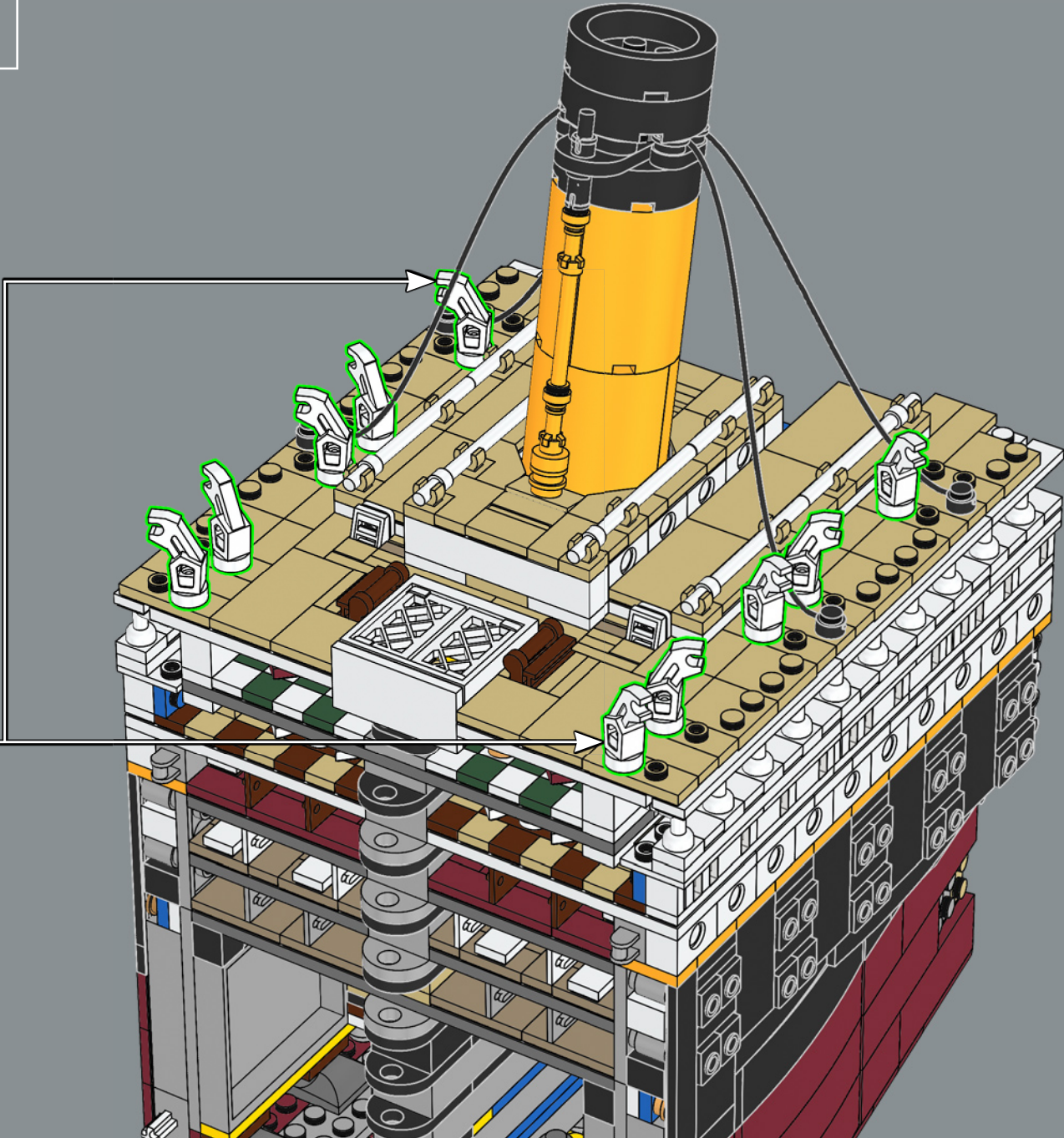

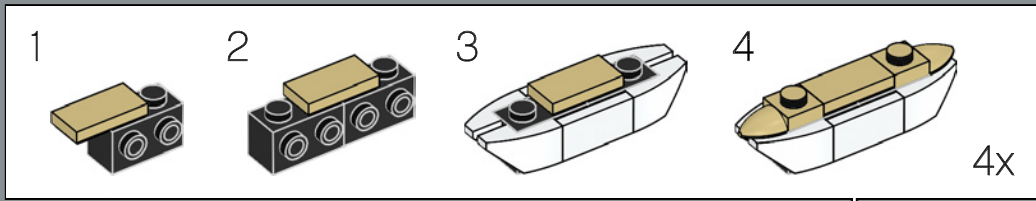
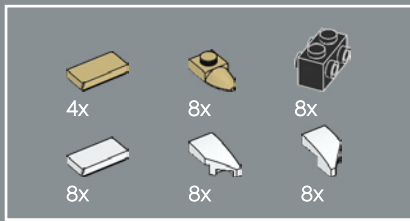

145

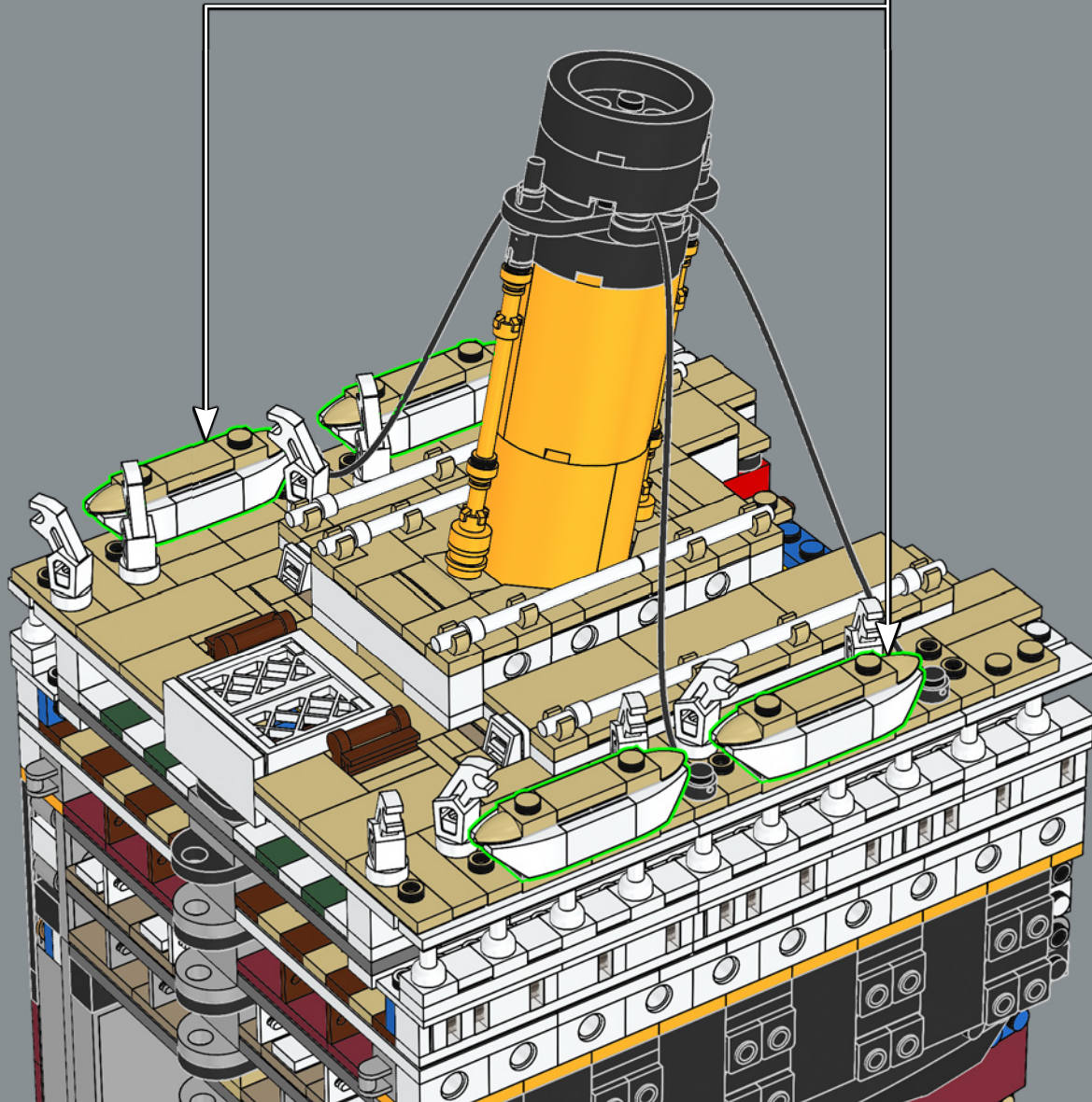

## SECTION 6:

# STERN & WELL DECK

This final section is the most complicated section of the hull and includes the rudder and three main driveshafts that connect the propellers to the engines. You will build the two main piston engines that are linked directly to the port and starboard screws. Turning the screws moves the engine crankshafts and pistons inside the model.

## SECTION 6 :

# POUPE ET COFFRE

Cette dernière section représente la partie la plus complexe de la coque et comprend le gouvernail et les trois principaux arbres de transmission qui relient les hélices aux machines et à la turbine. Vous construirez les deux principales machines à pistons qui sont reliées directement aux vis à bâbord et à tribord. En tournant les vis, vous pouvez faire bouger les vilebrequins et les pistons à l'intérieur du modèle.

## SECCIÓN 6:

# POPA Y CUBIERTA DE POZO

Esta sección final es la más complicada del casco e incluye el timón y tres árboles de transmisión principales que conectan las hélices a los motores. Vas a construir los dos motores de pistones principales vinculados directamente a las hélices de babor y estribor. Al girar las hélices, se mueven los cigüeñales y los pistones del motor en el interior del modelo.

↓ The exterior details of this section include the stern bridge and benches for the 3rd class passengers.

↓ Les détails extérieurs de cette section comprennent la poupe et les bancs pour les passagers de la 3<sup>e</sup> classe.

↓ Los detalles exteriores de esta sección incluyen el puente de popa y bancos para los pasajeros de tercera clase.

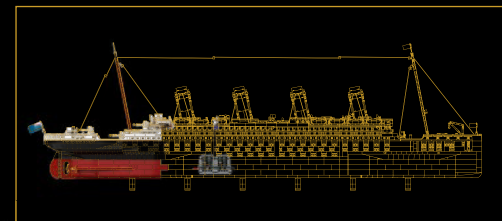

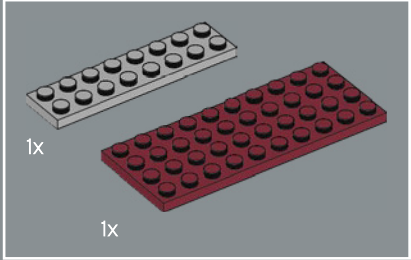
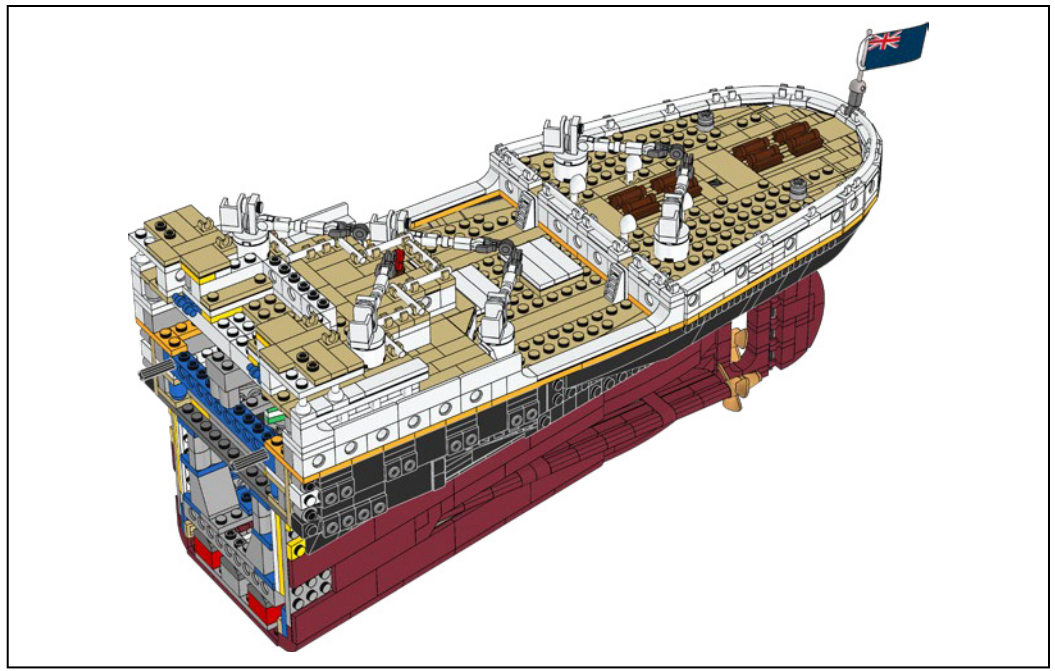
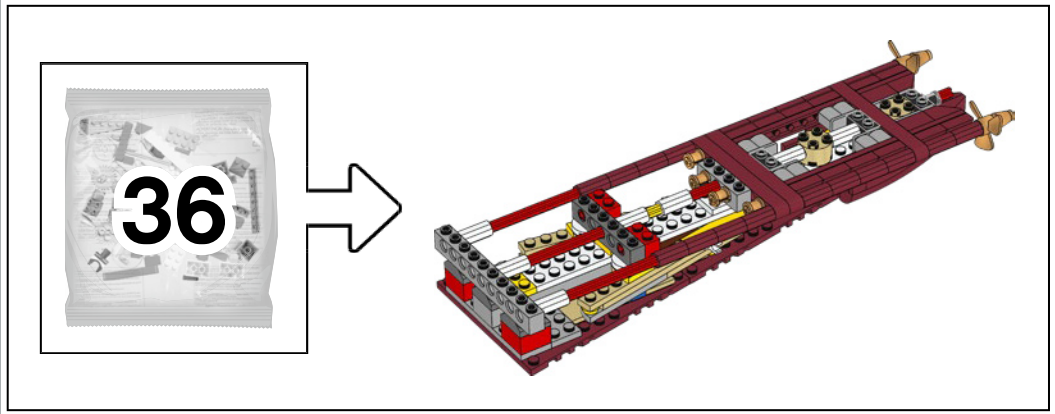

146

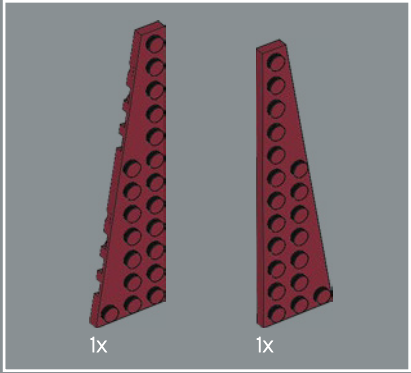
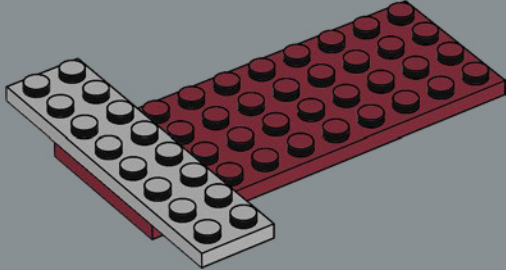

147

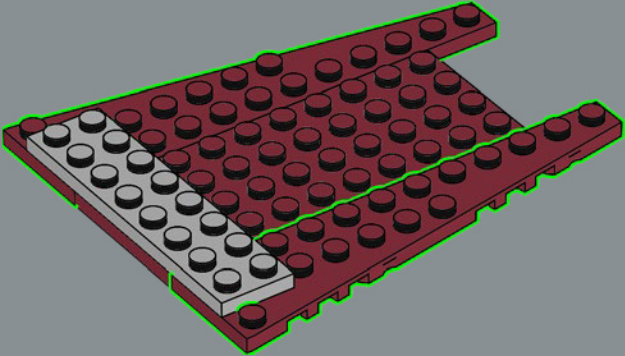

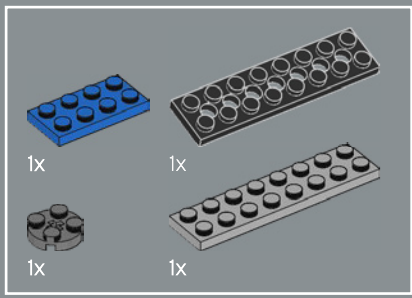

148

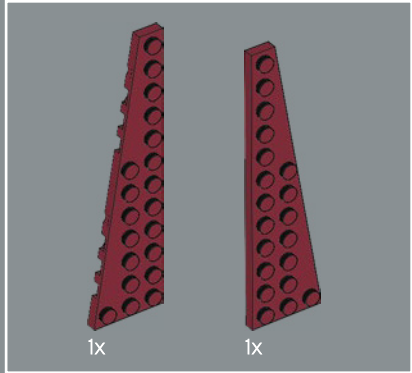
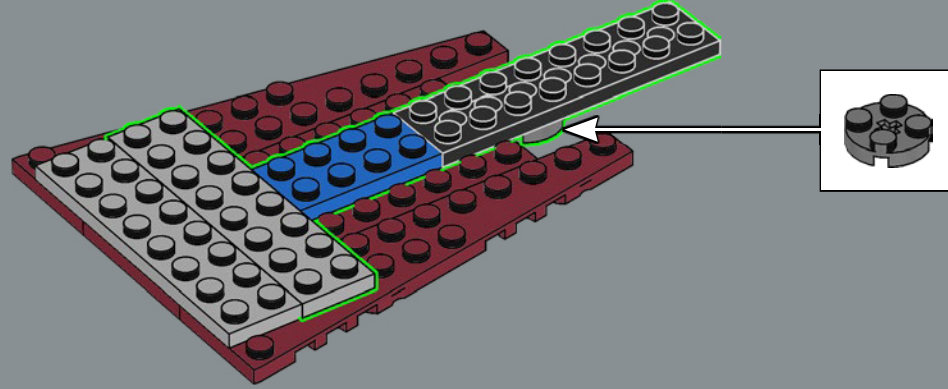

149

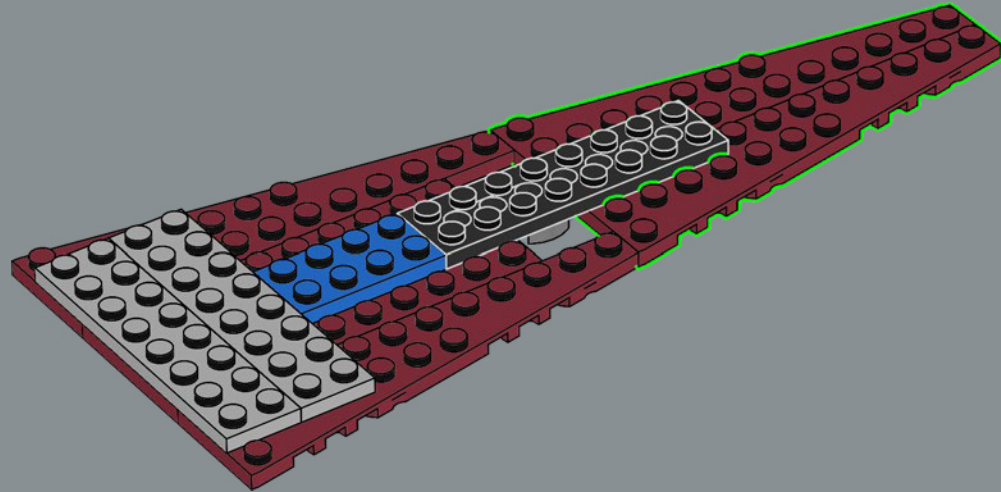



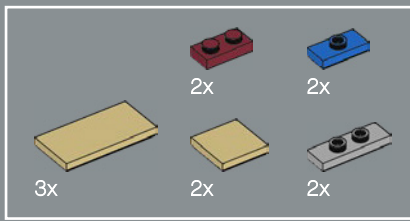

150

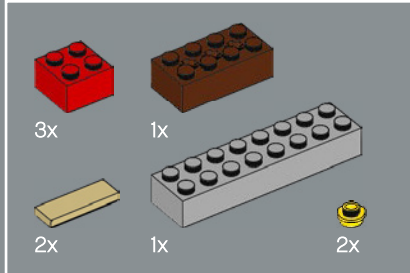
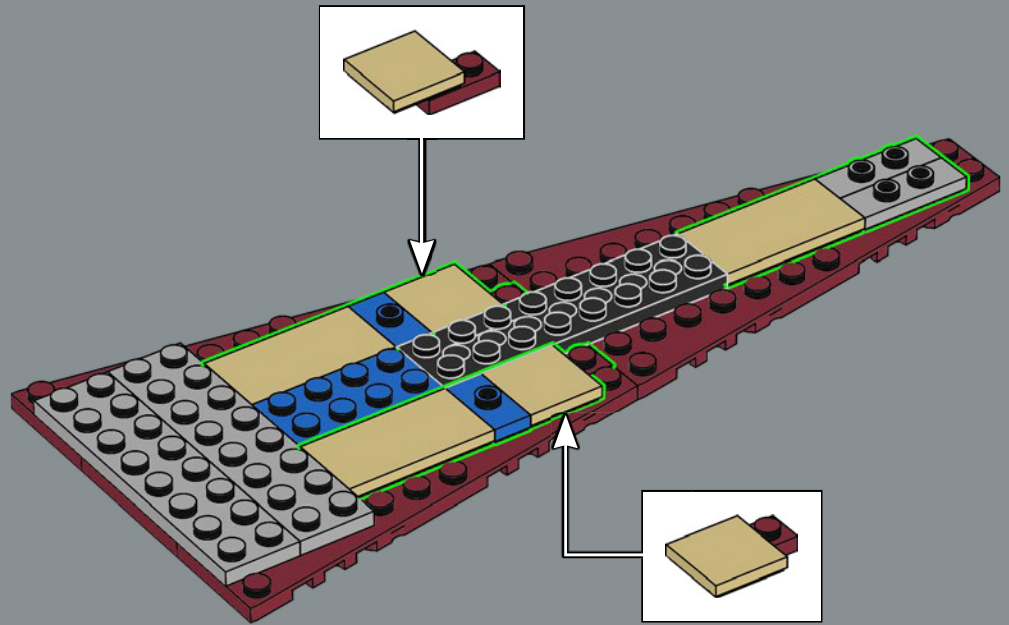

151

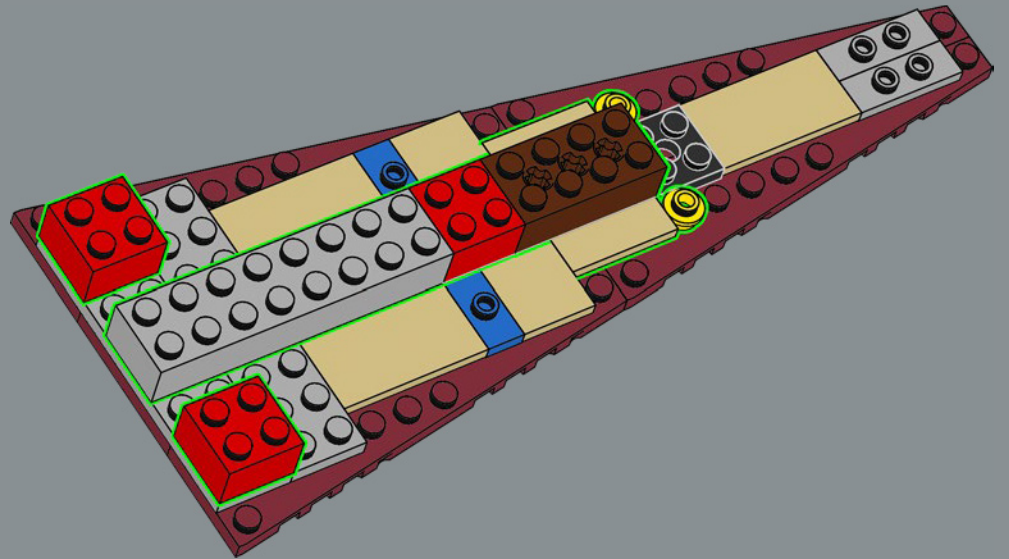

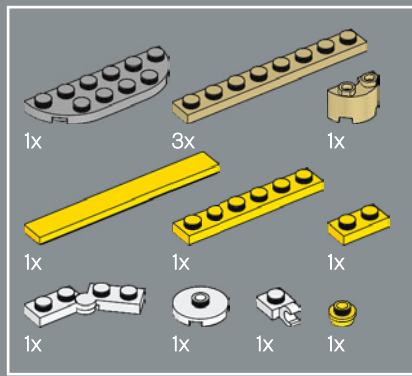

152

1

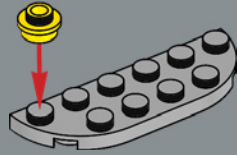

2

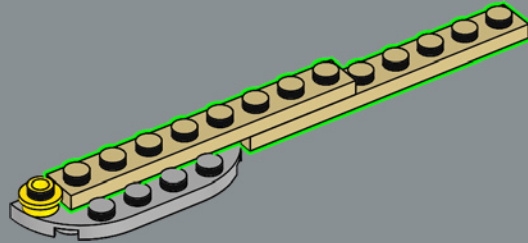

3

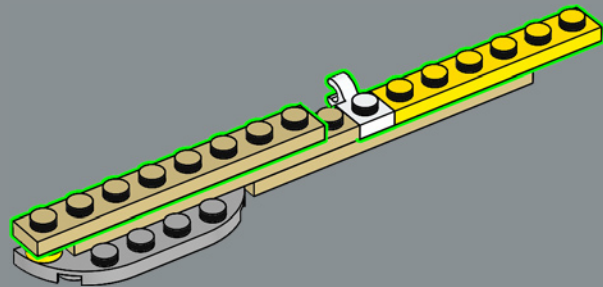

4

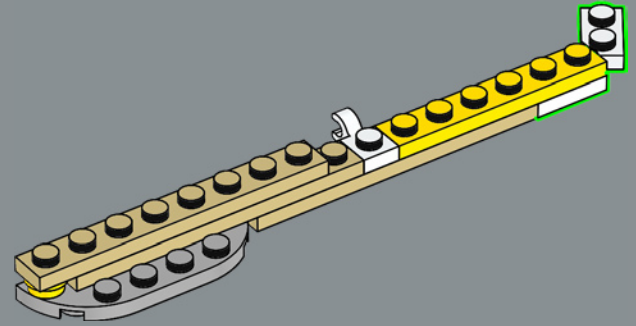

5

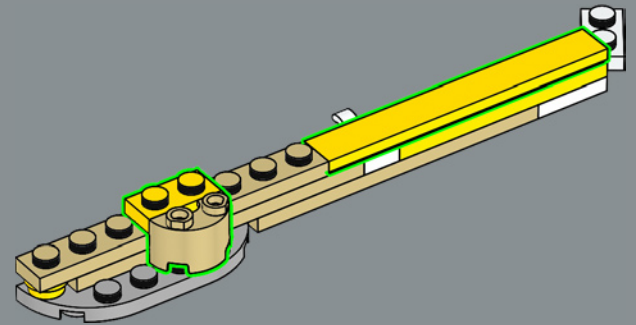

6

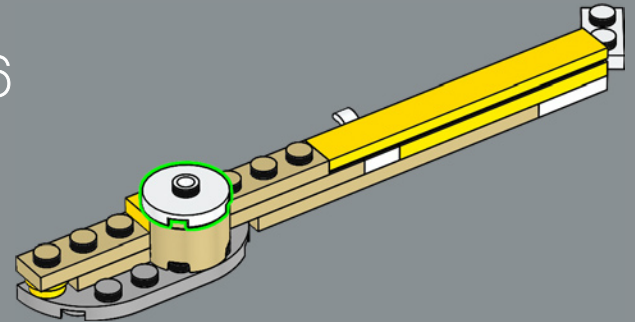

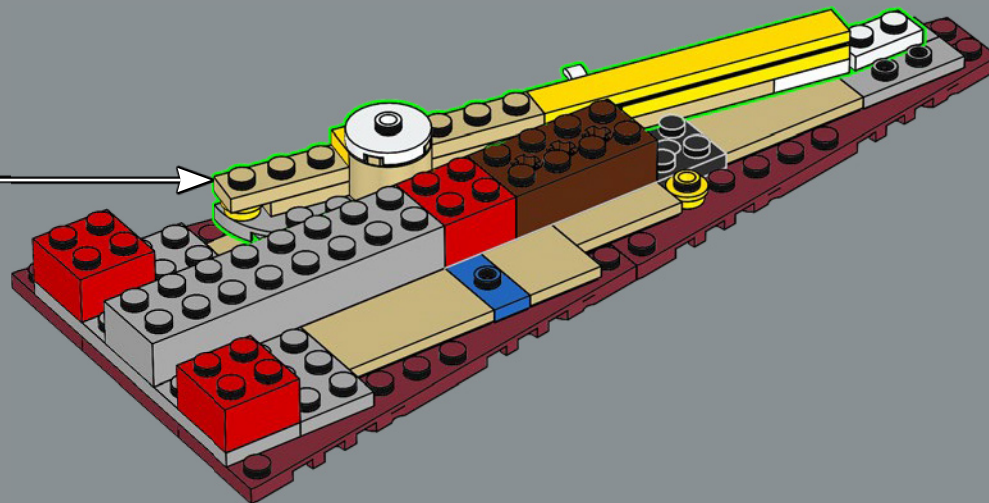

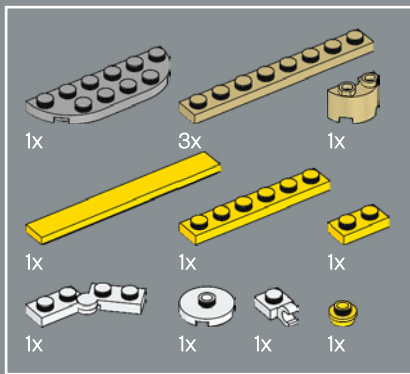

153

1

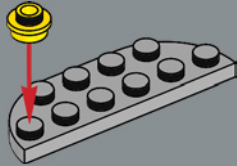

2

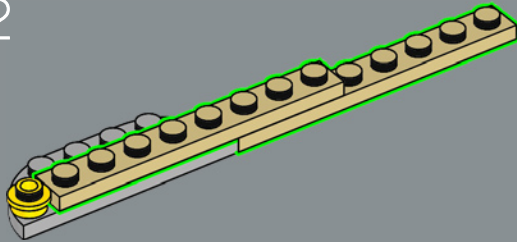

3

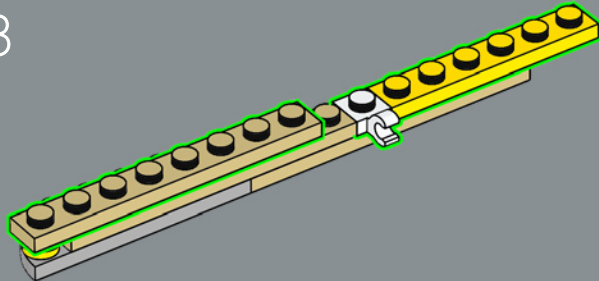

4

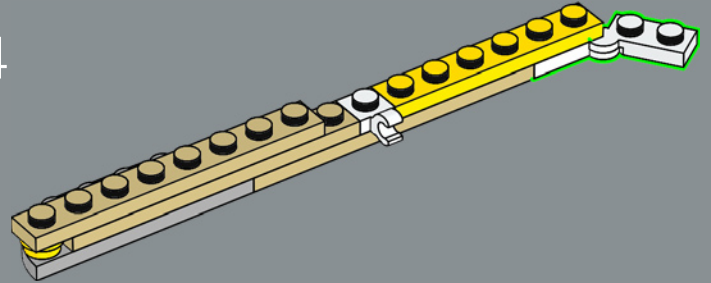

5

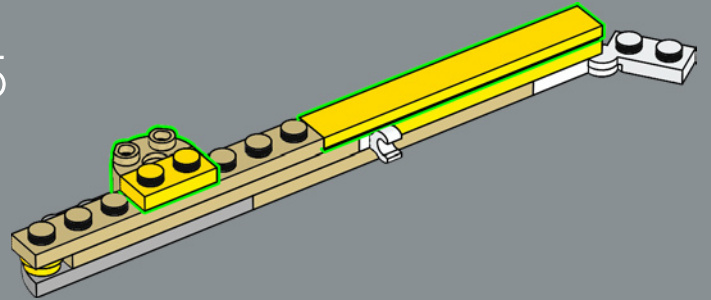

6

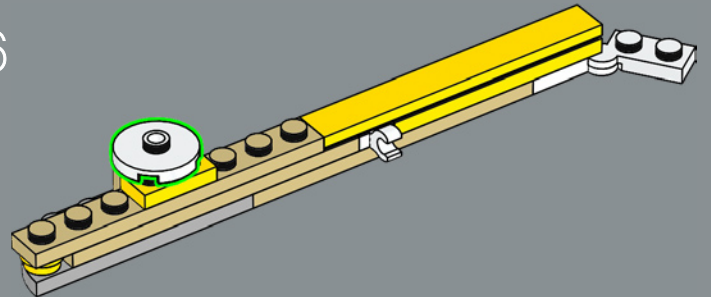

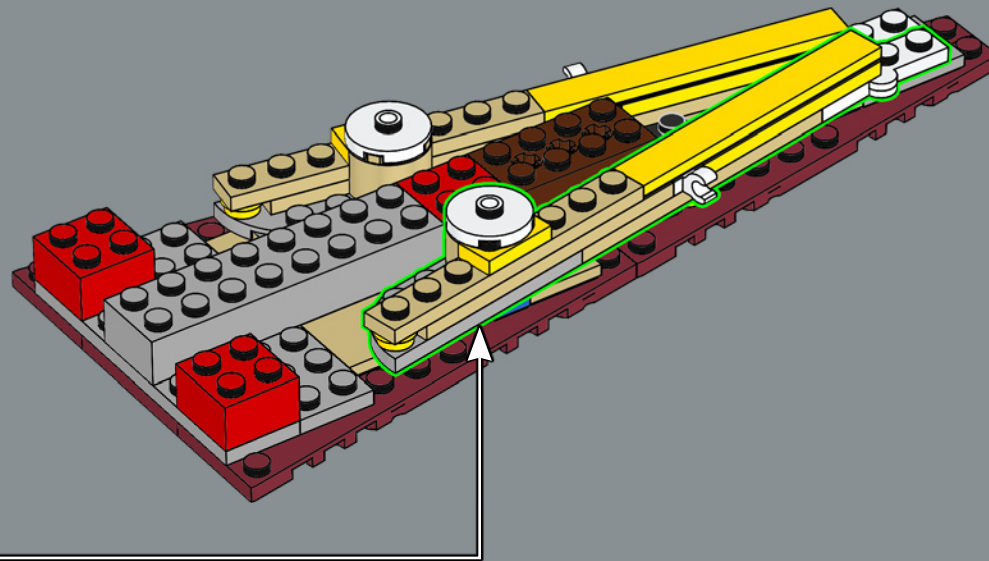

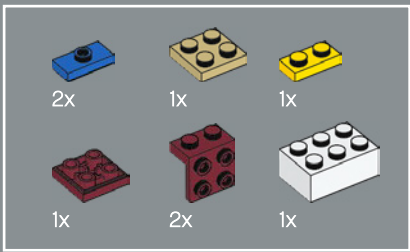

154

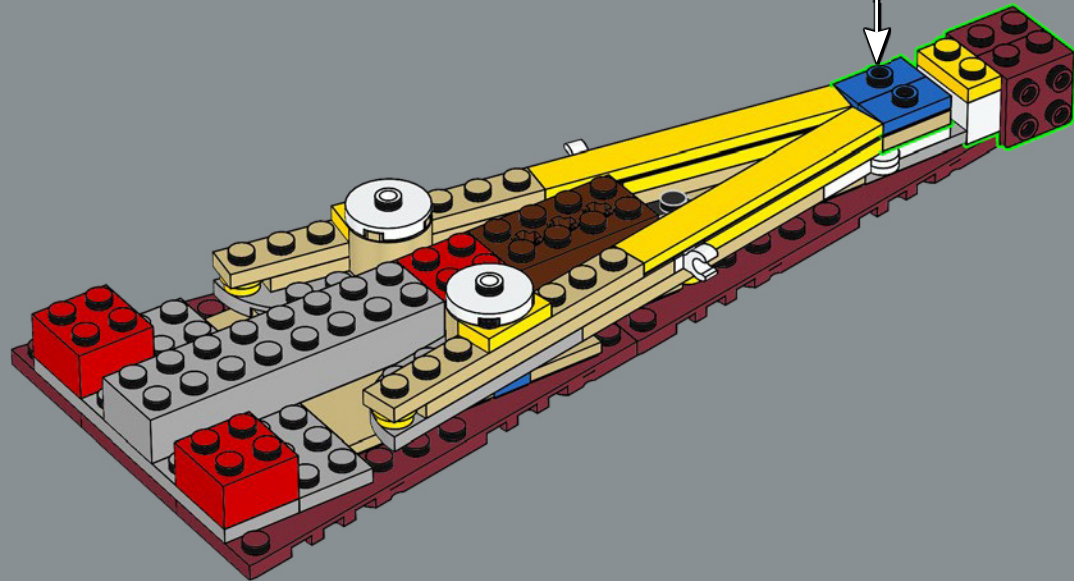
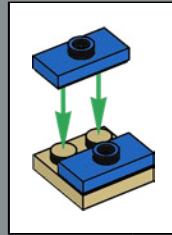
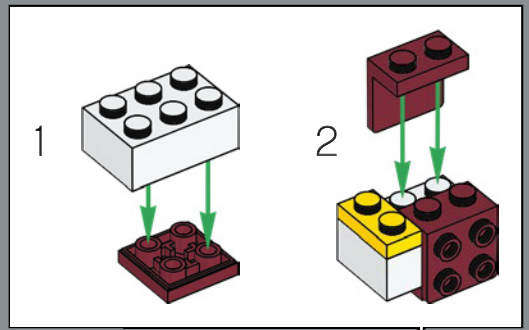

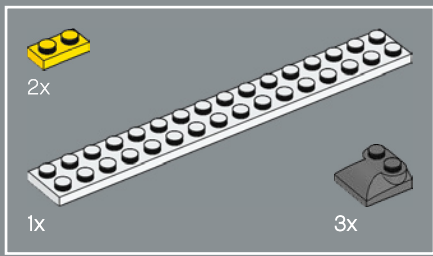

155

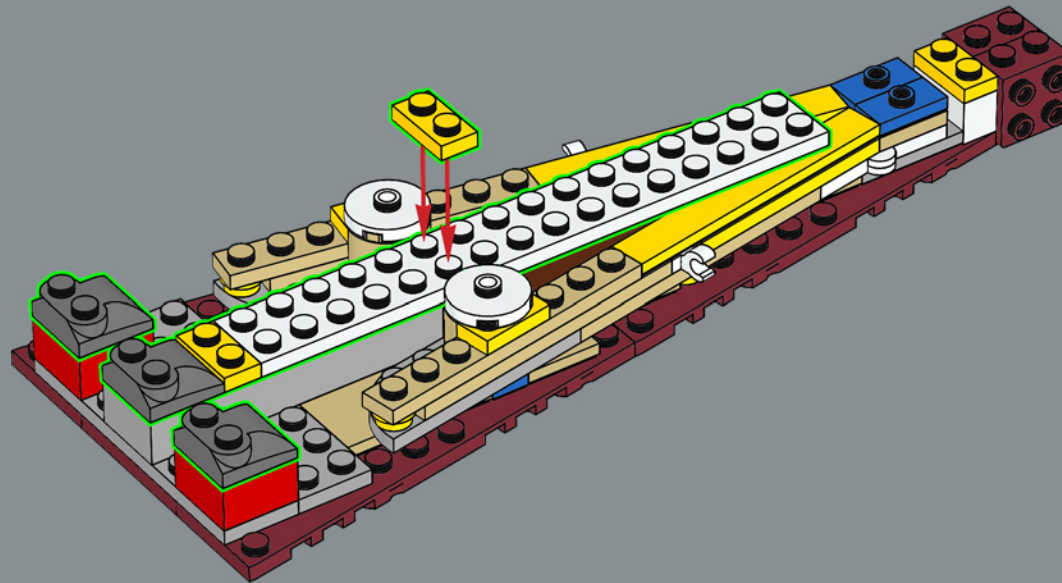

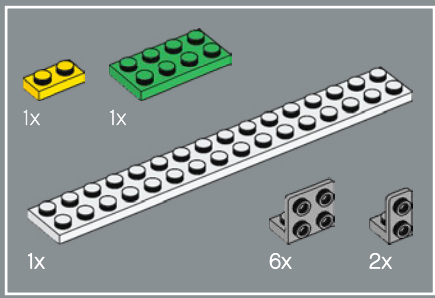

156

1

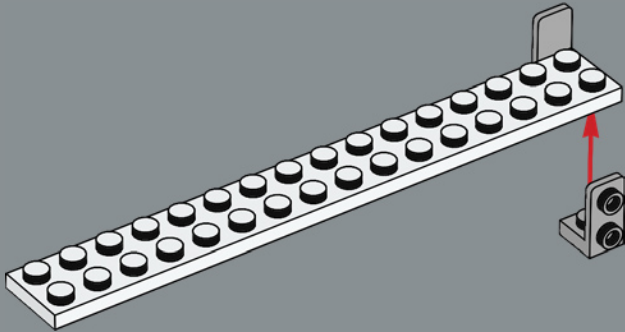

2

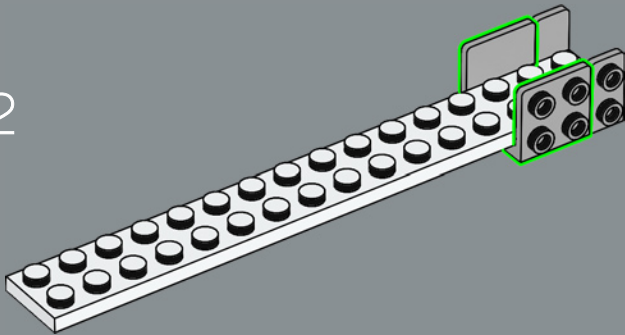

3

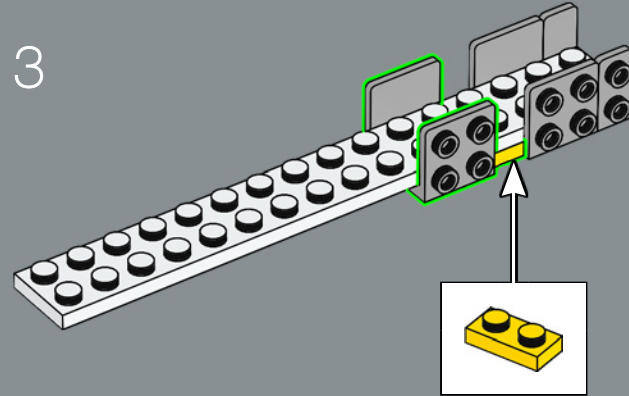

4

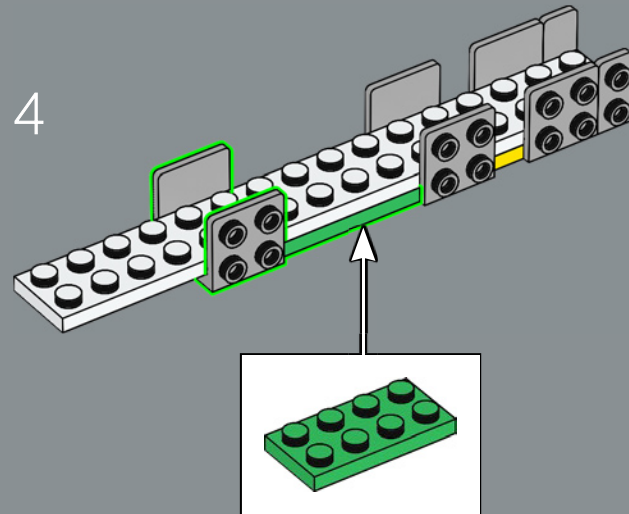



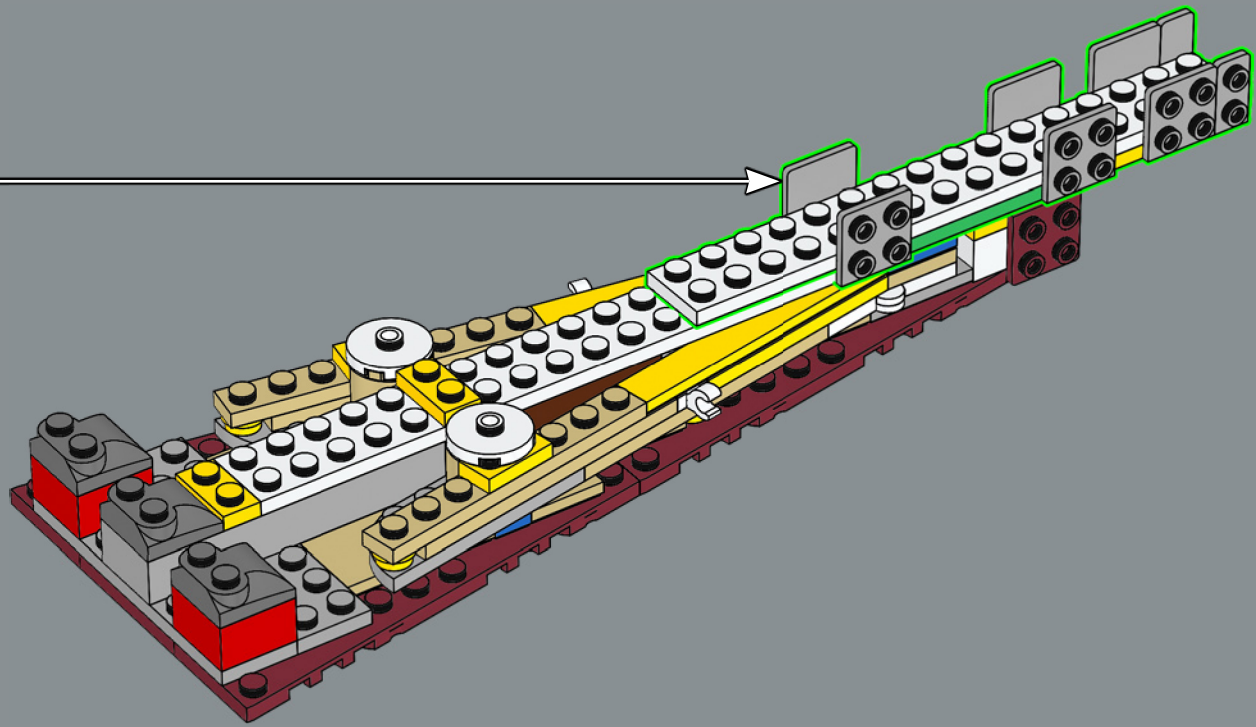

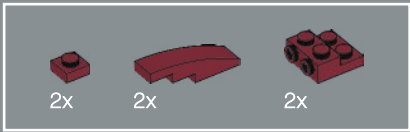

157

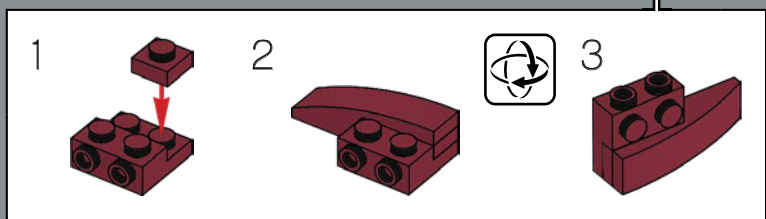
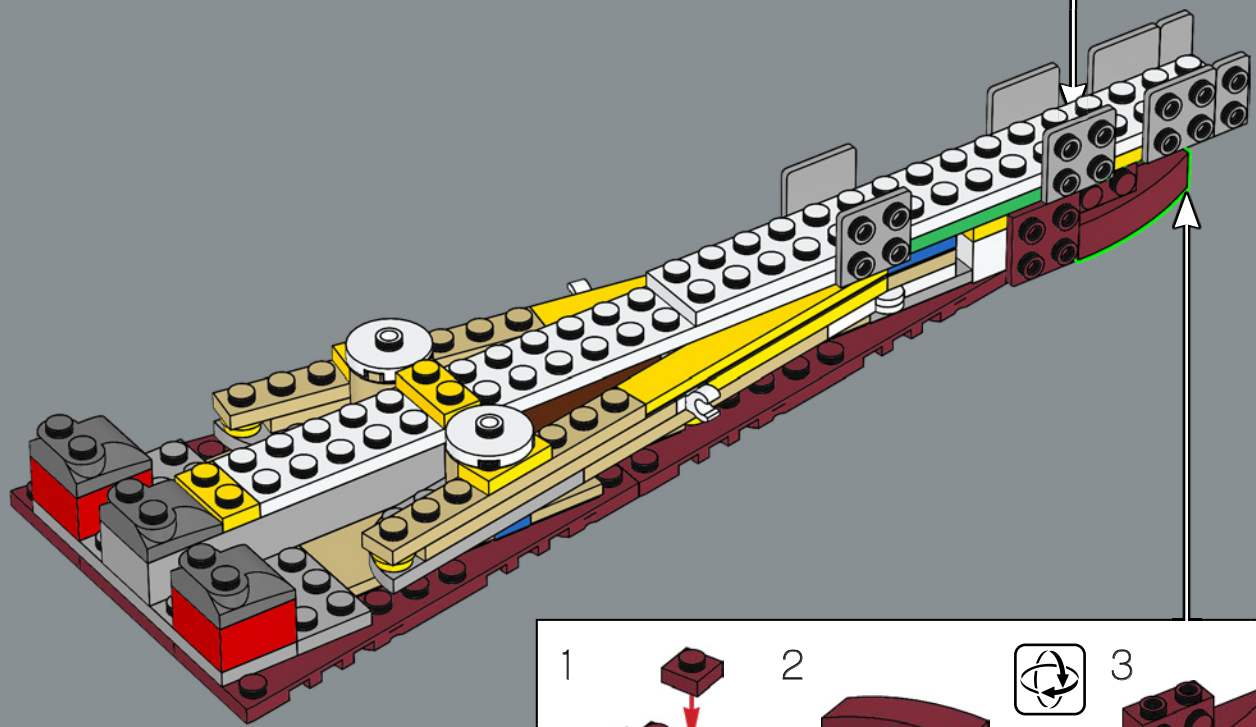
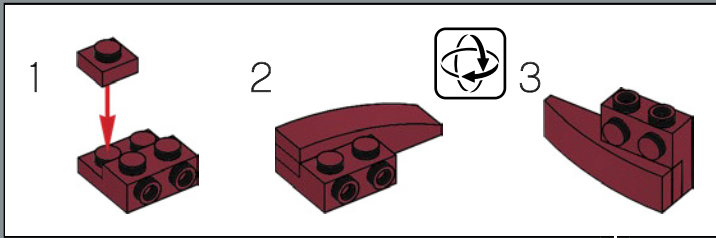

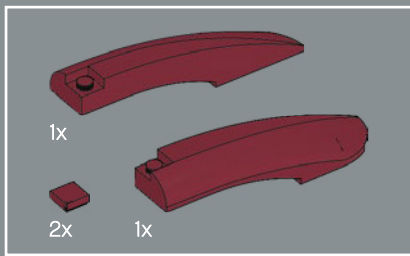

158

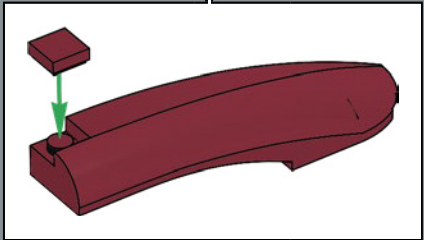
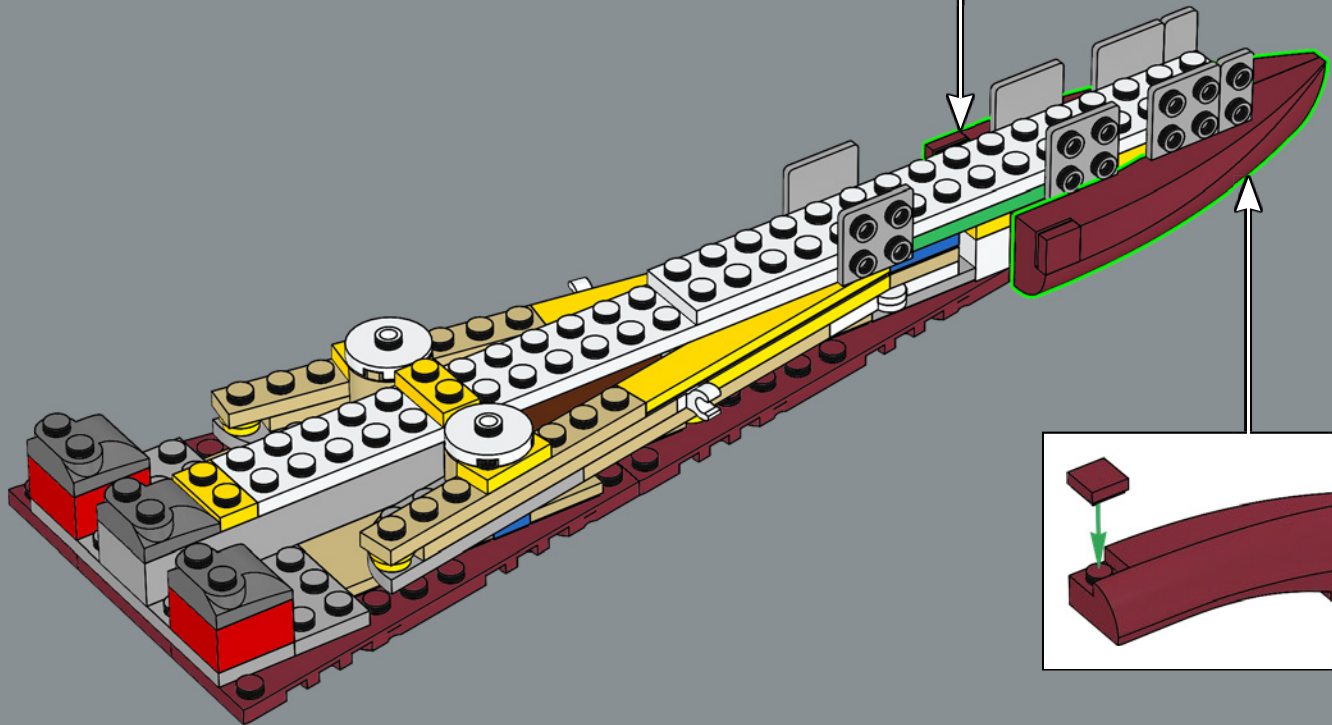
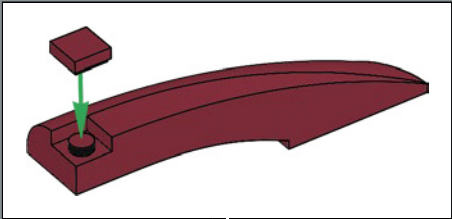

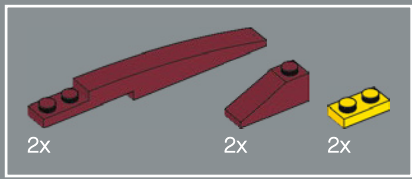

159

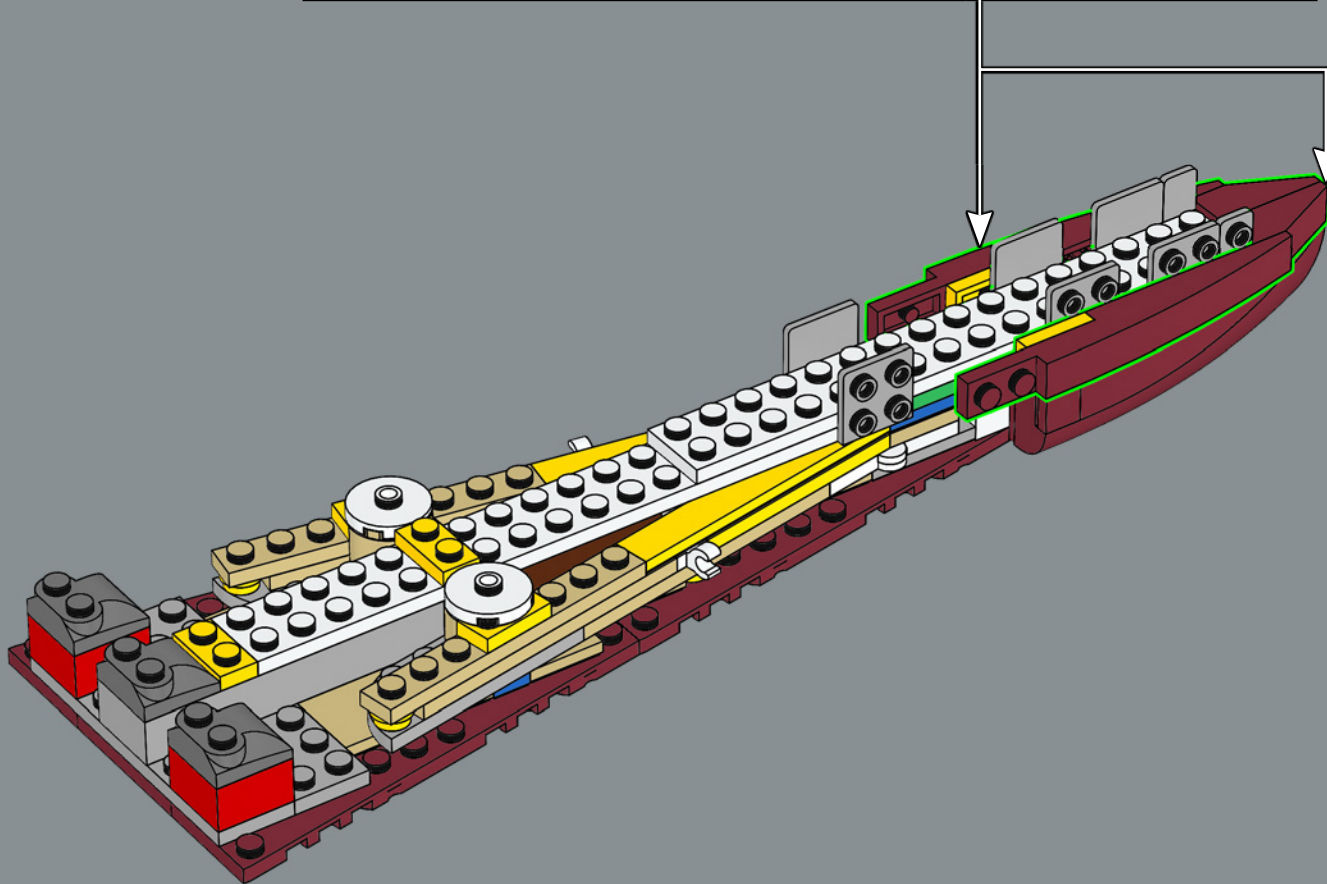
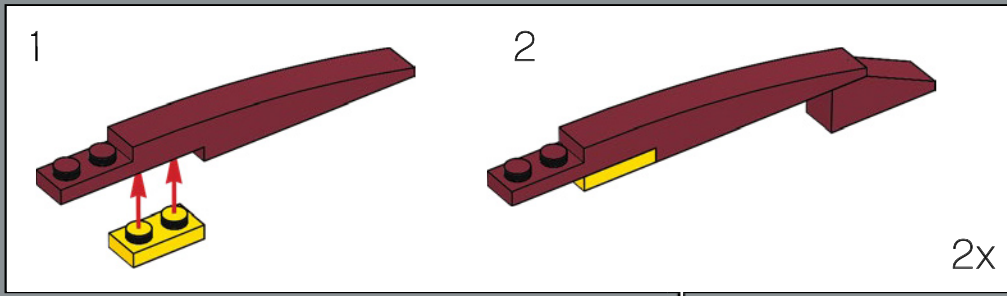

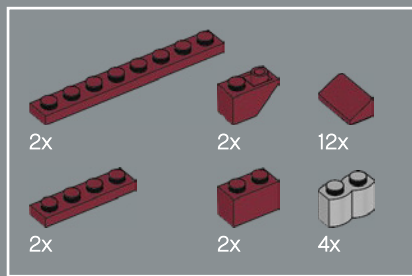

160

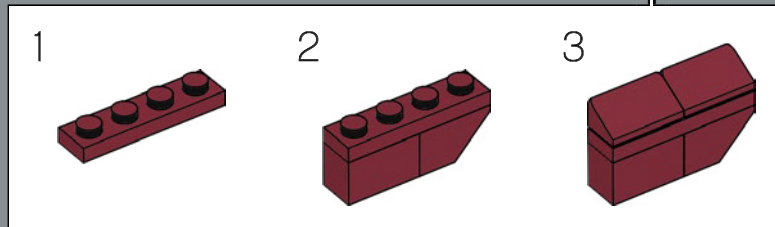
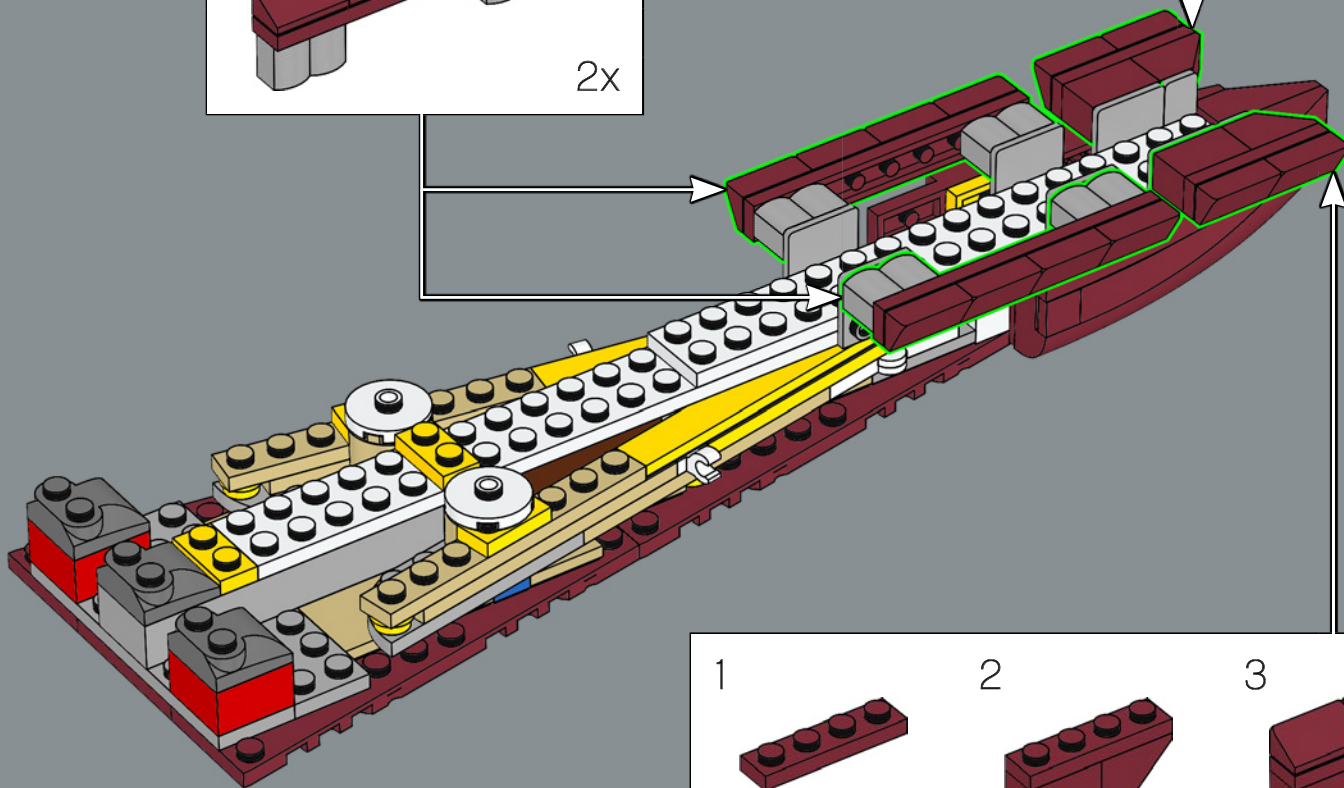
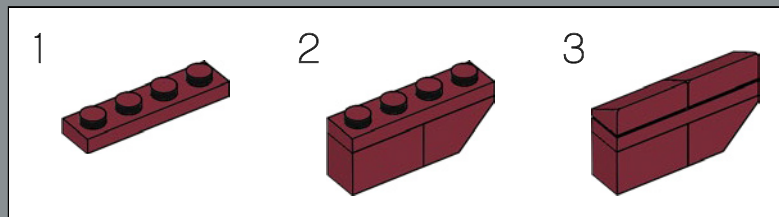
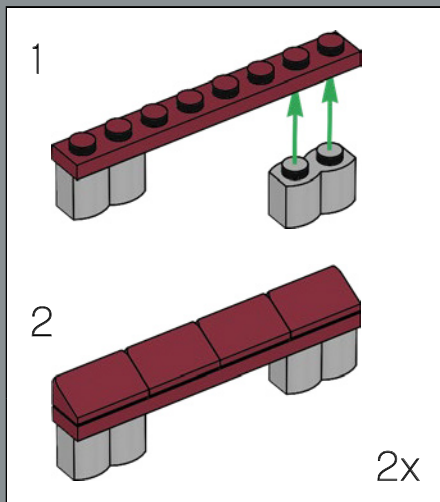

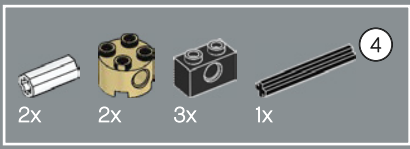

161

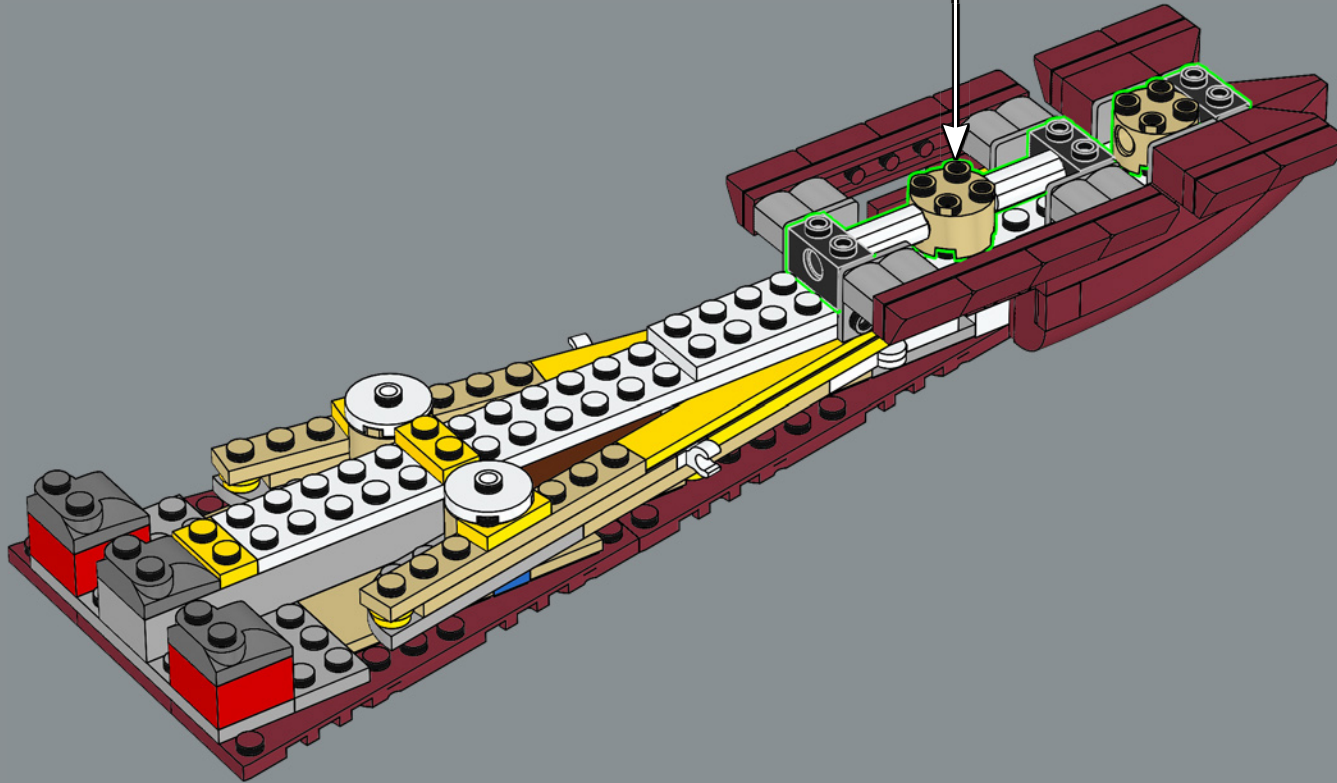
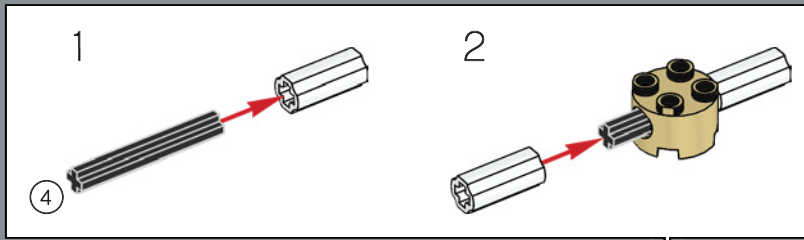

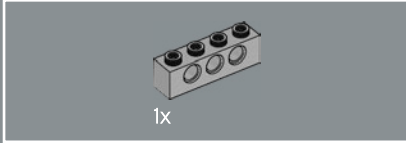
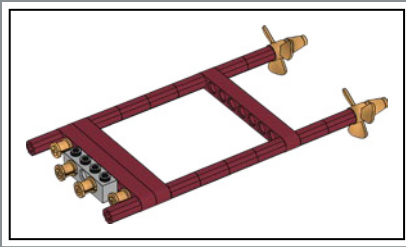

162

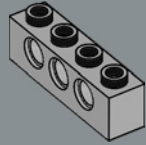

163

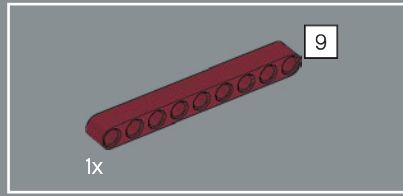
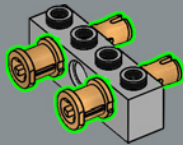

164

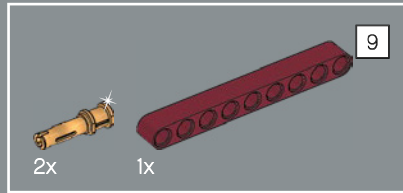
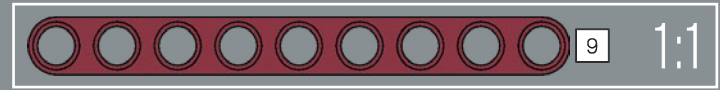

165

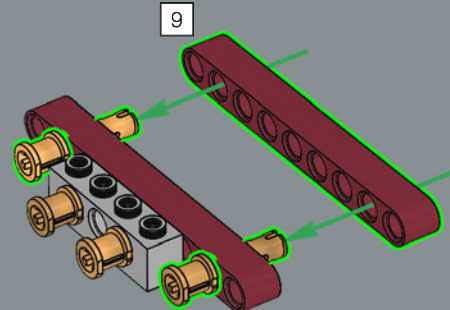
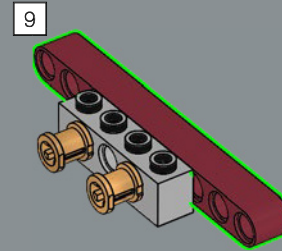

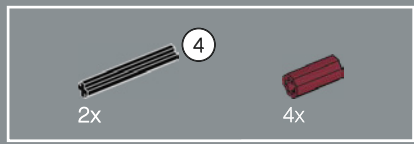

166

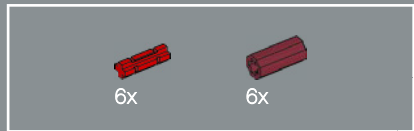
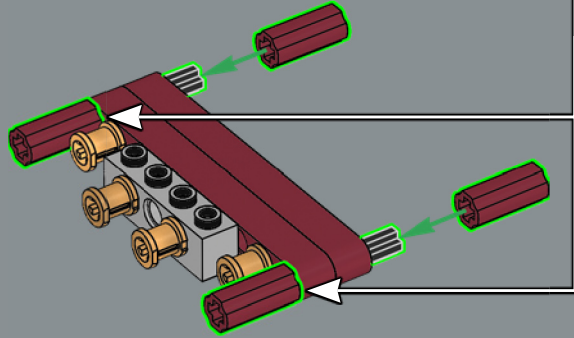
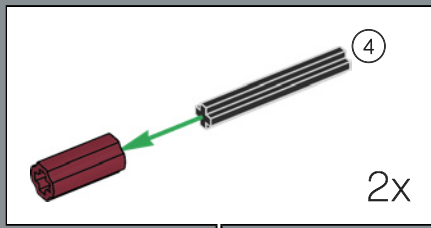

167

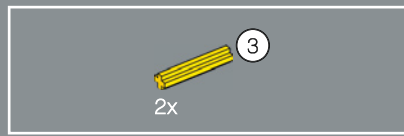
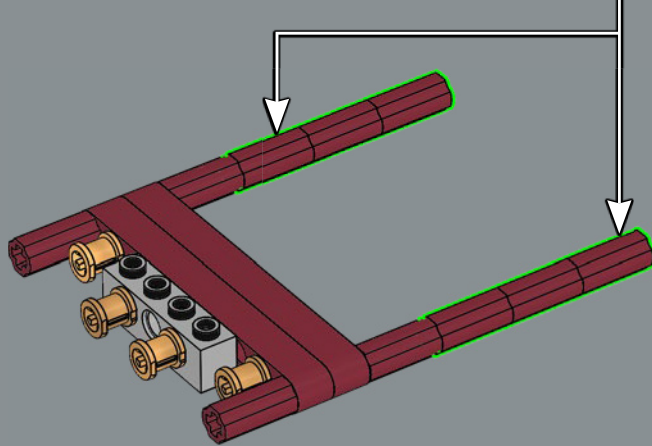
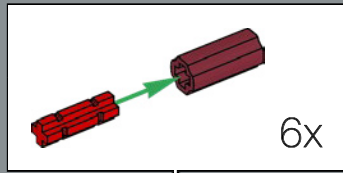

168

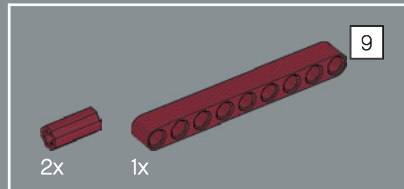
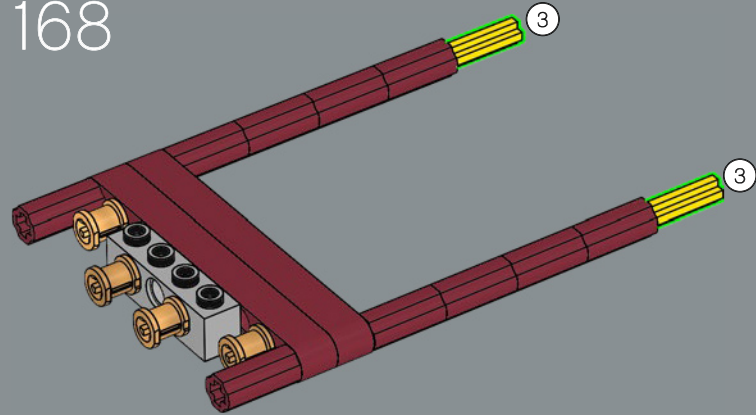

169

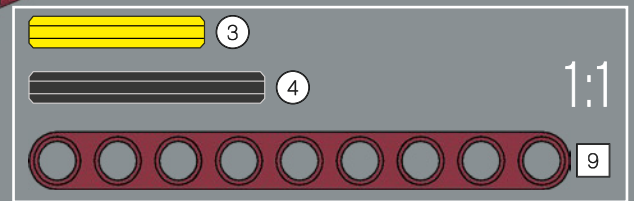
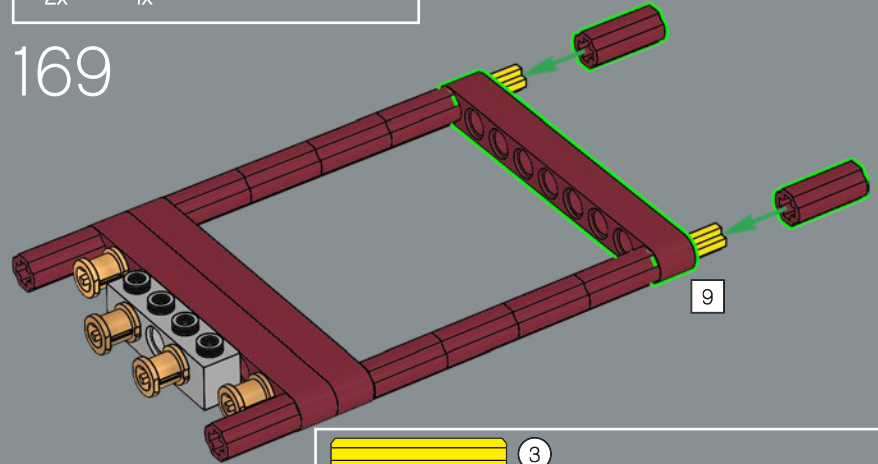



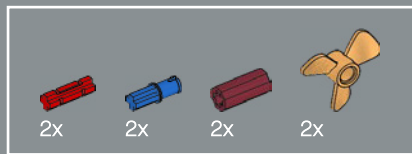

170

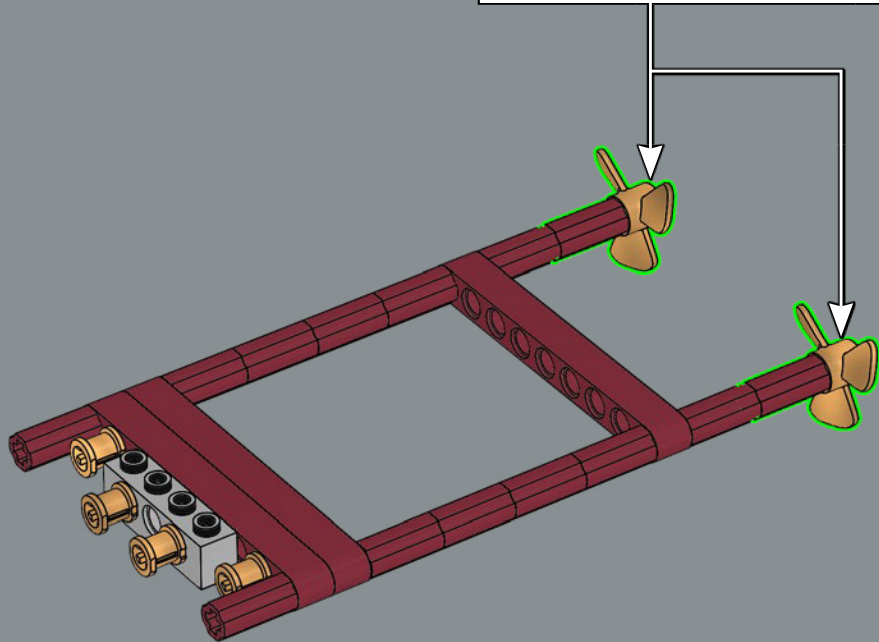
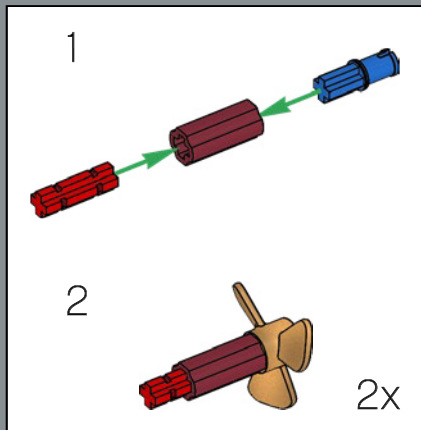

171

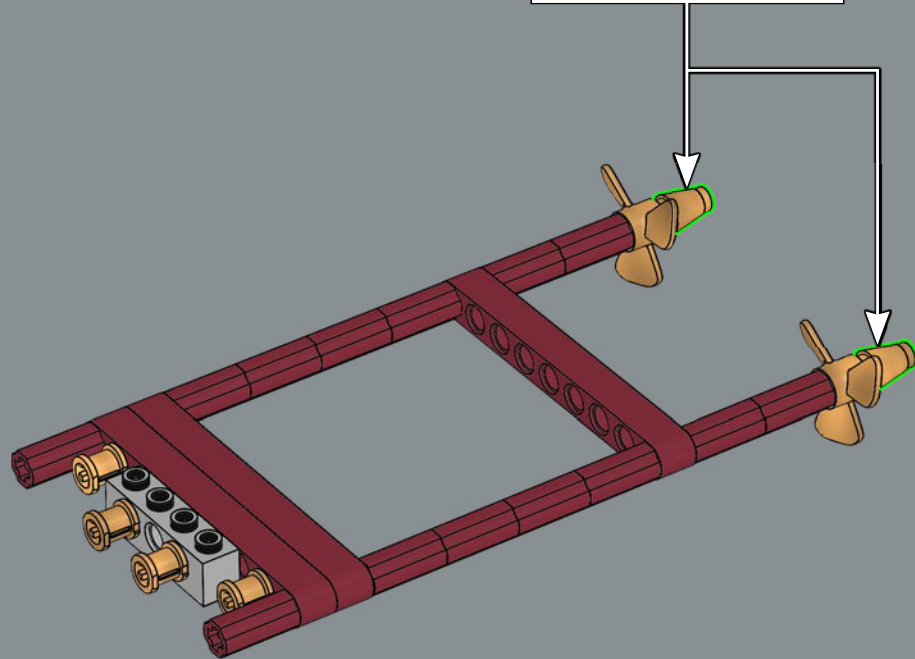
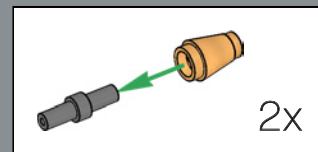

172

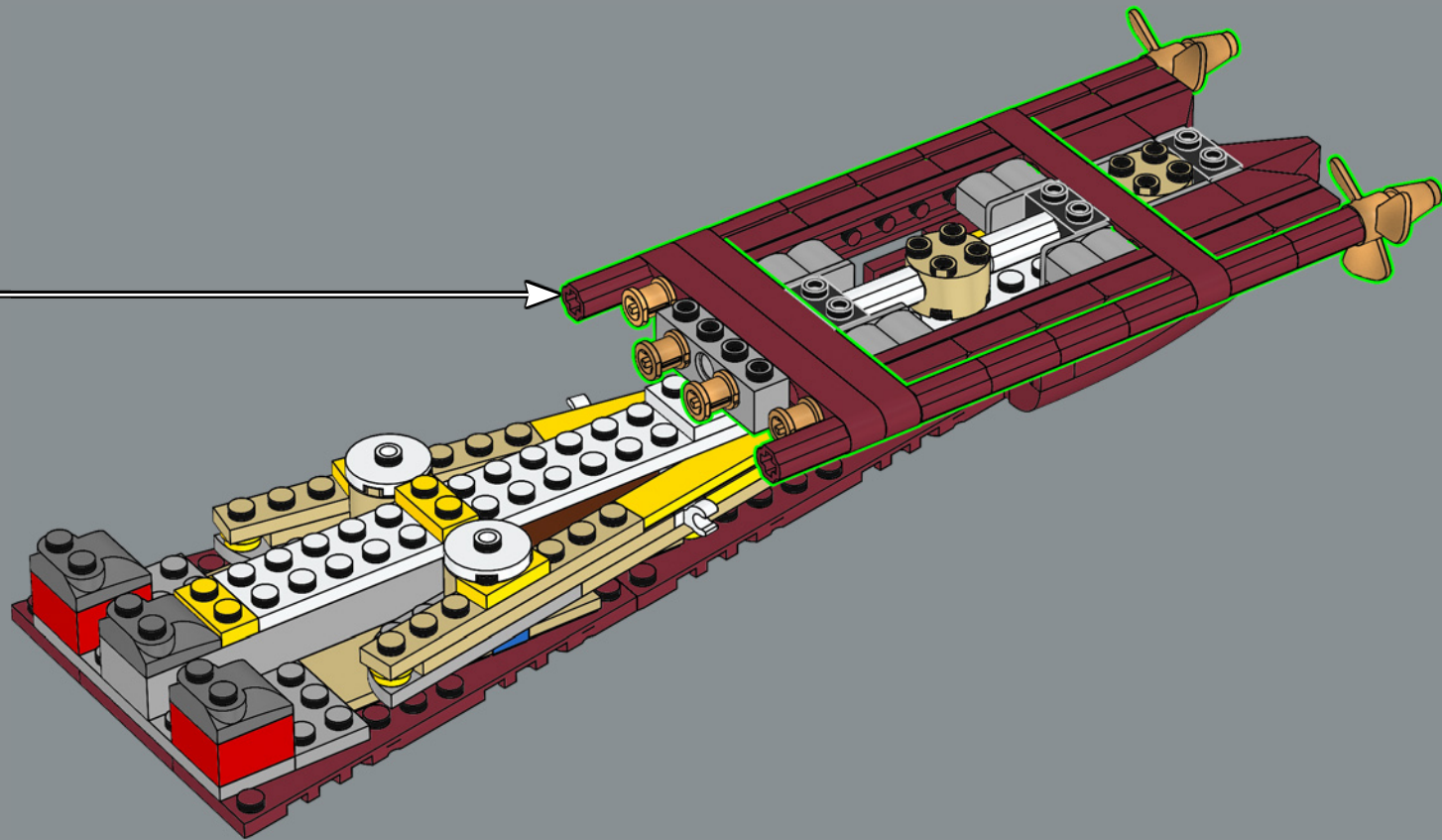

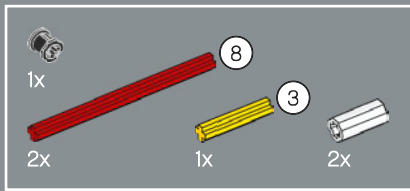

173

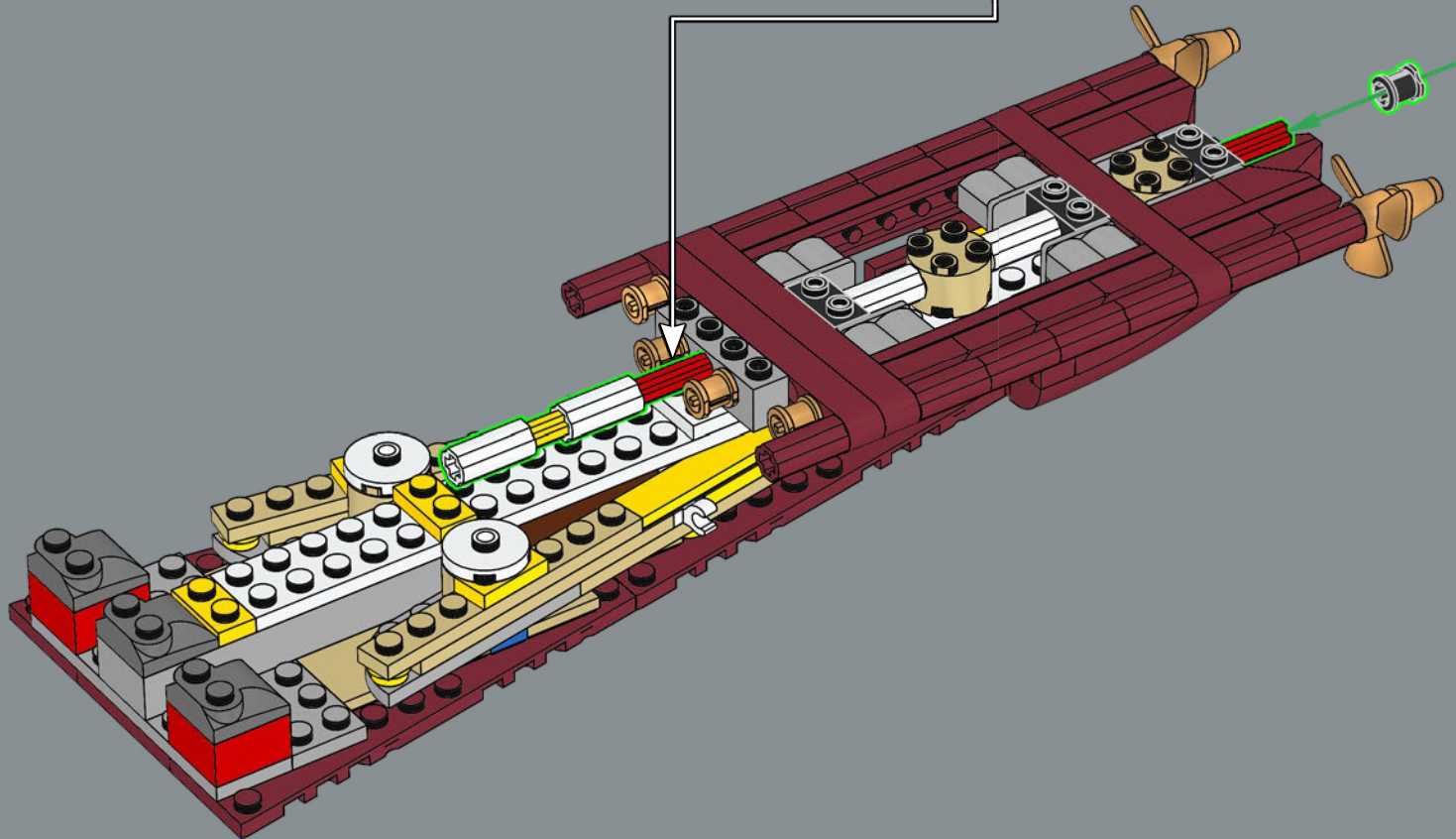
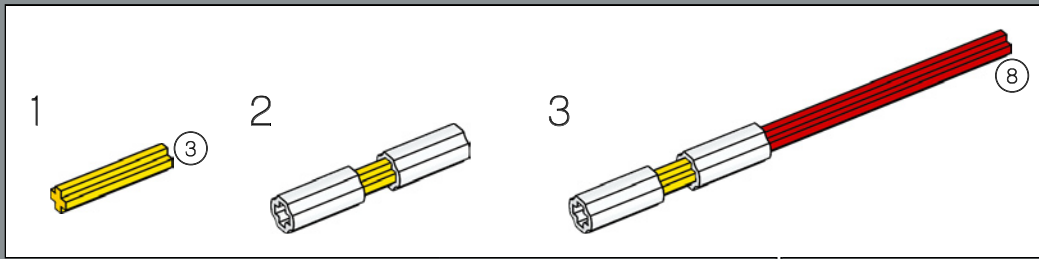

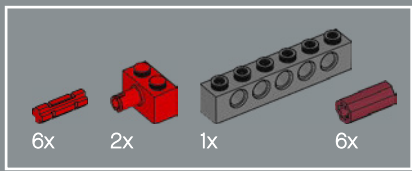

174

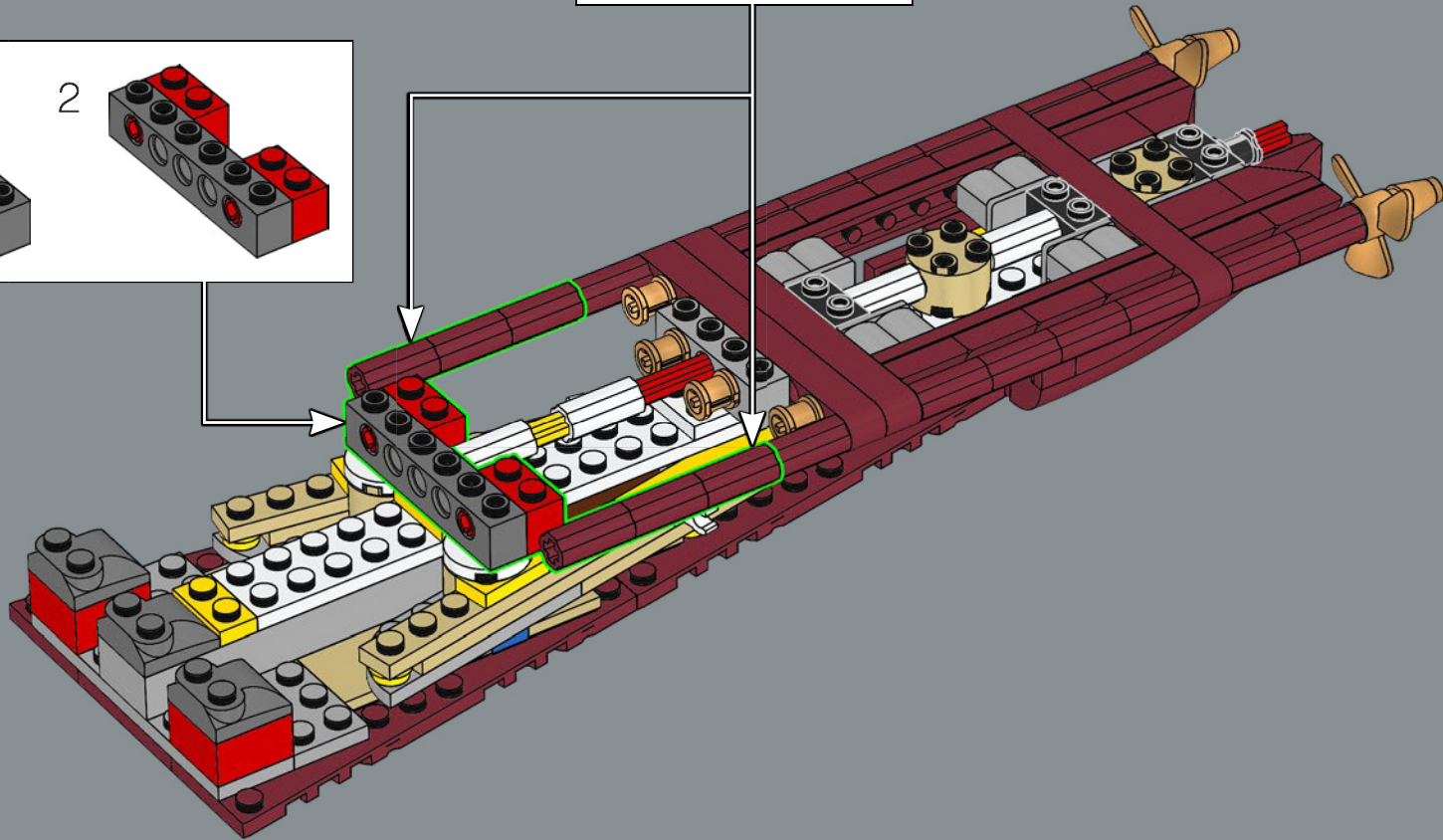
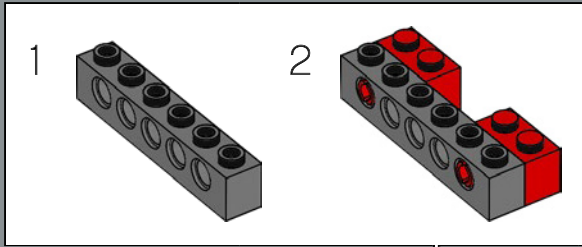
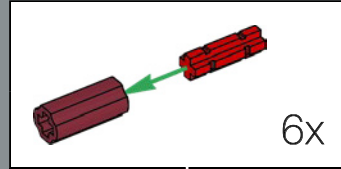

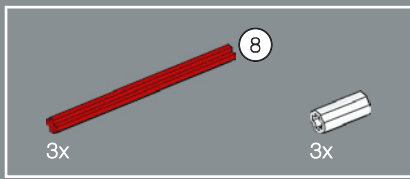

175

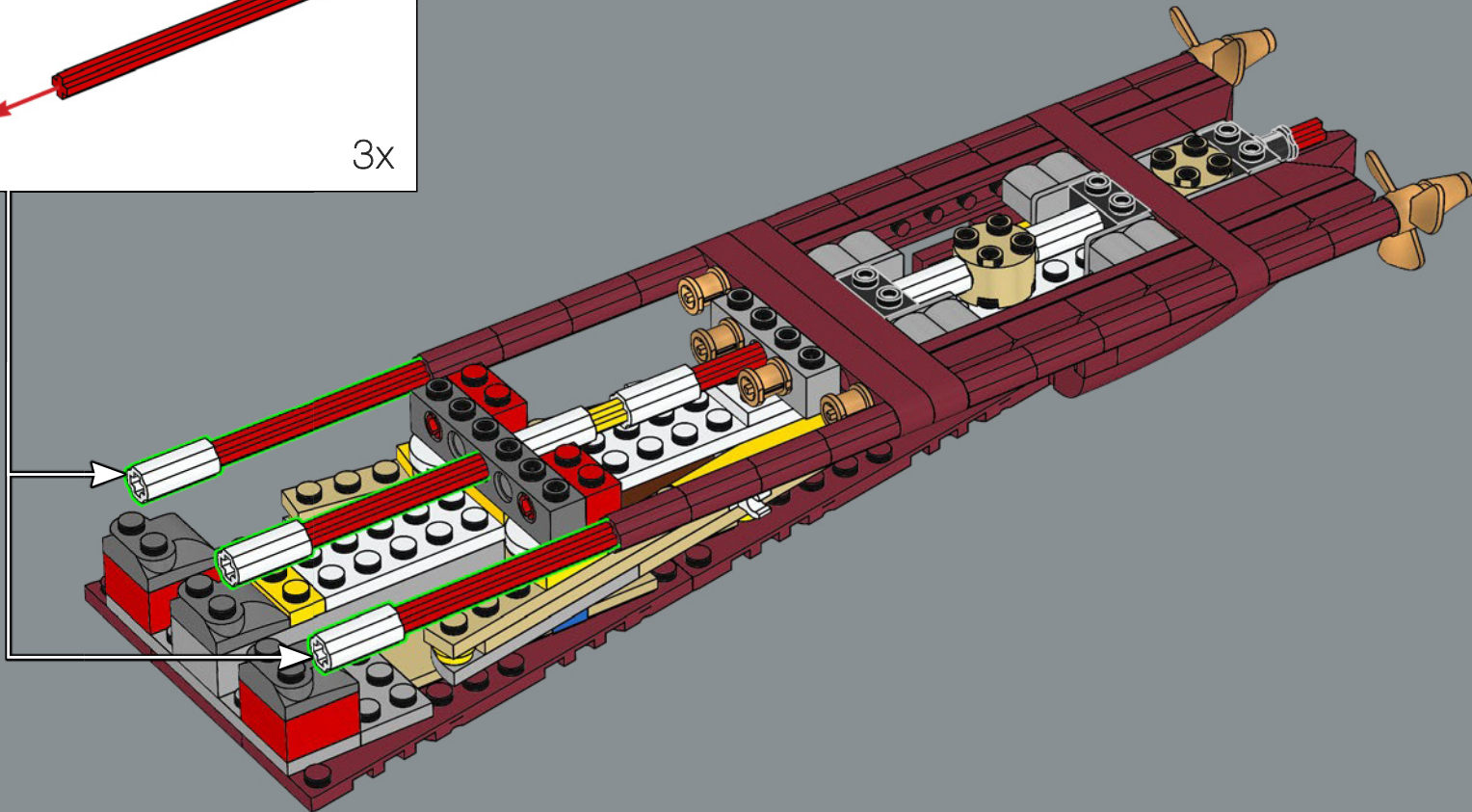
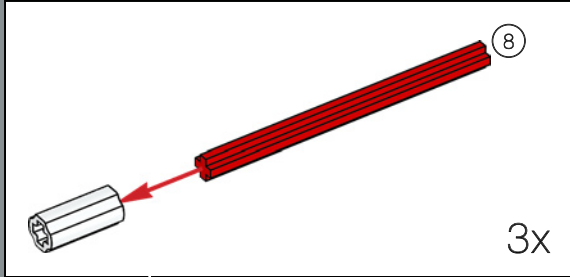

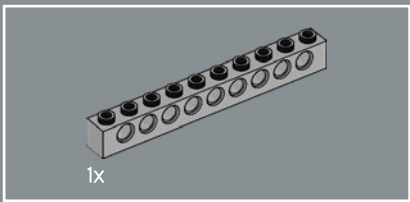

176

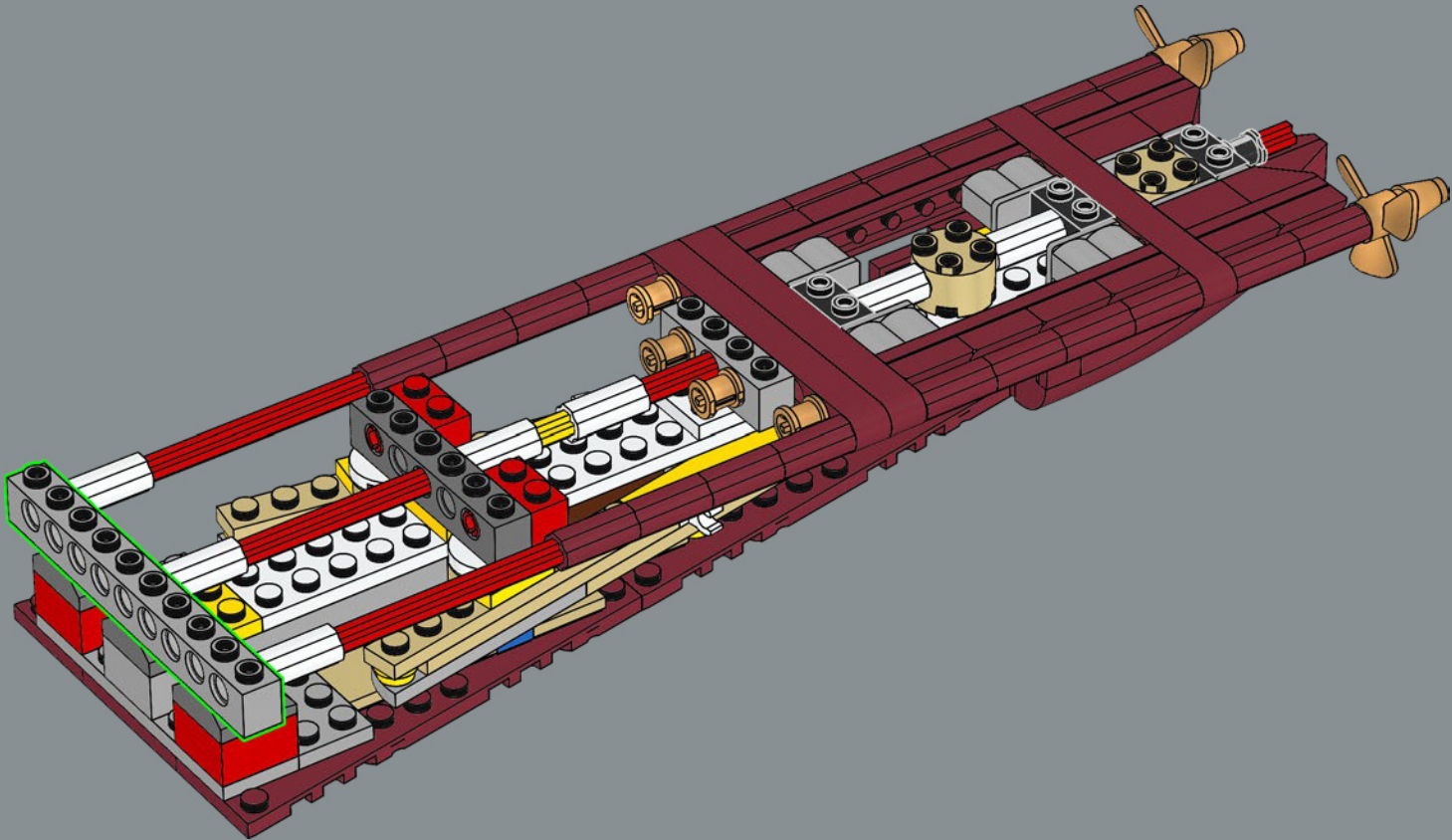

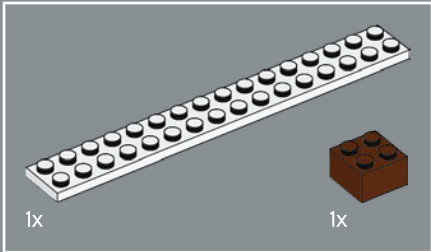
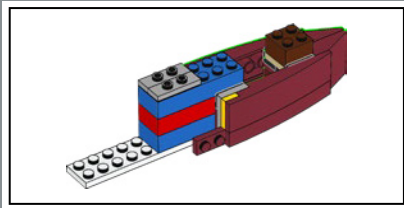
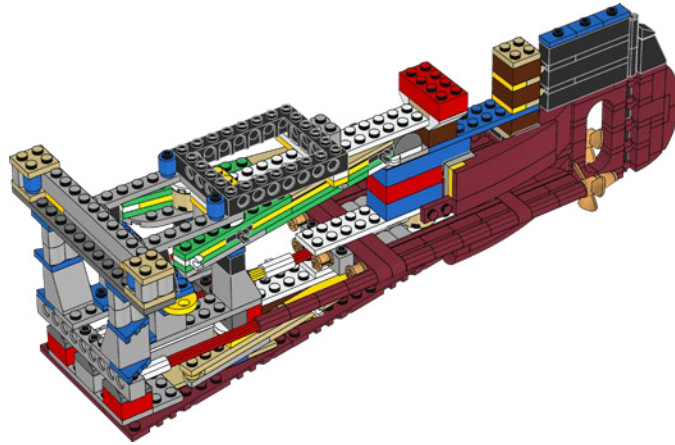
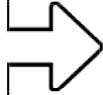

177

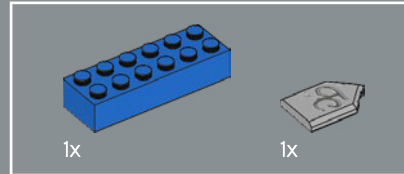
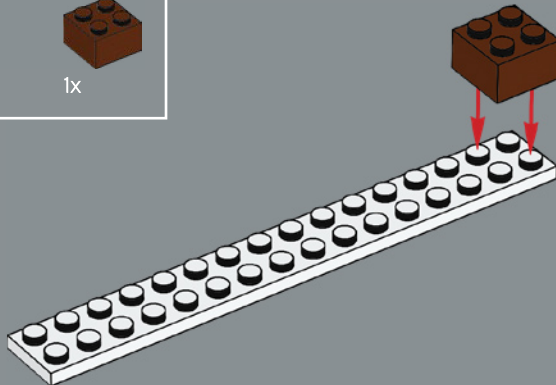

178

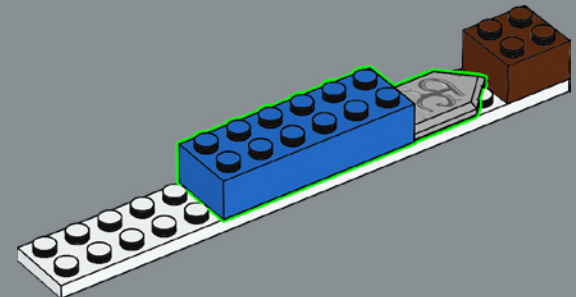



4x

179

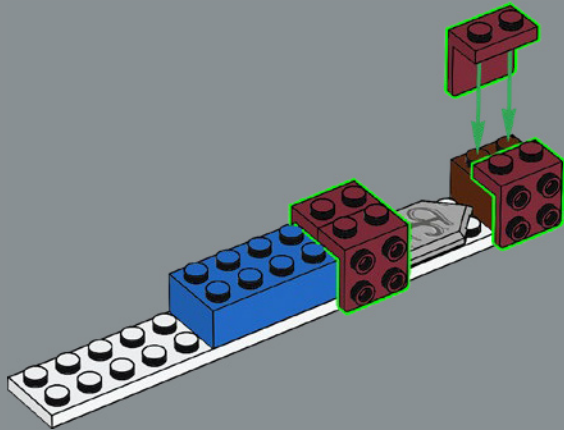

4x

180

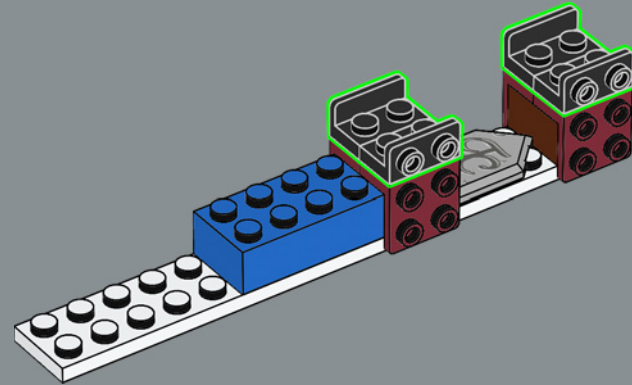



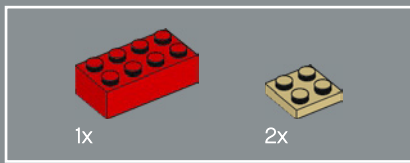

181

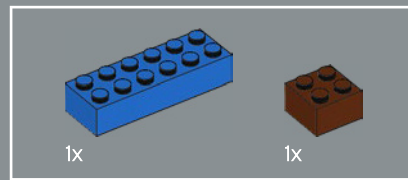
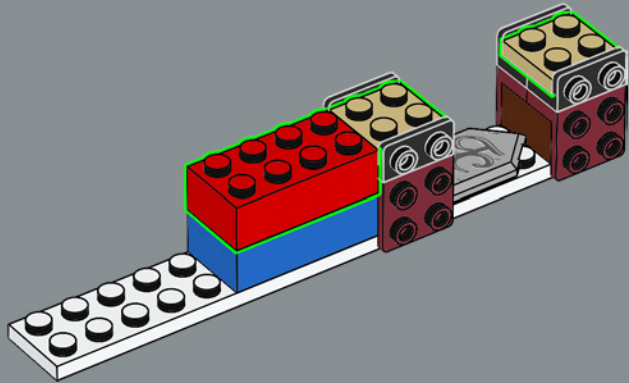

182

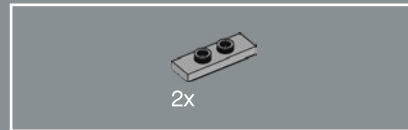
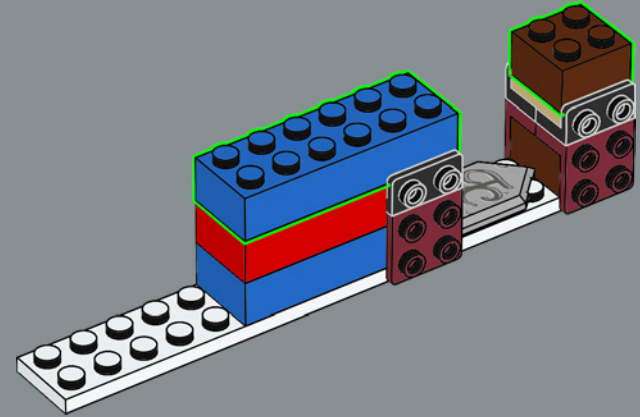

183

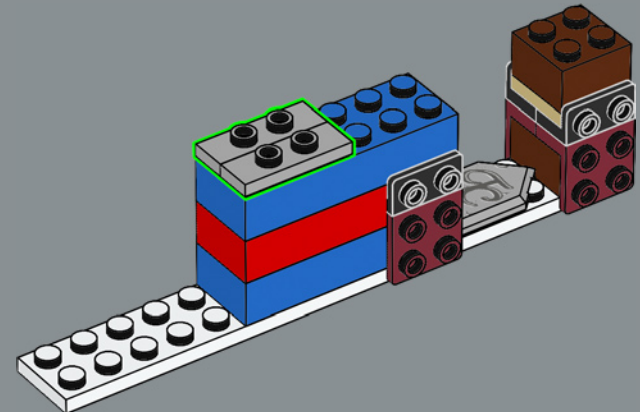

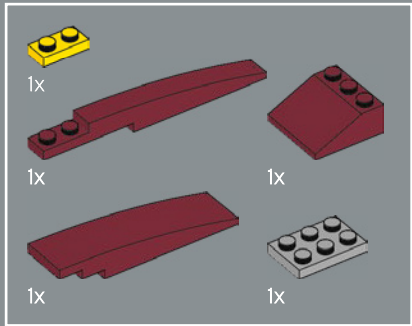

184

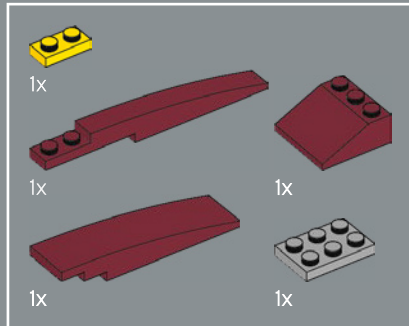
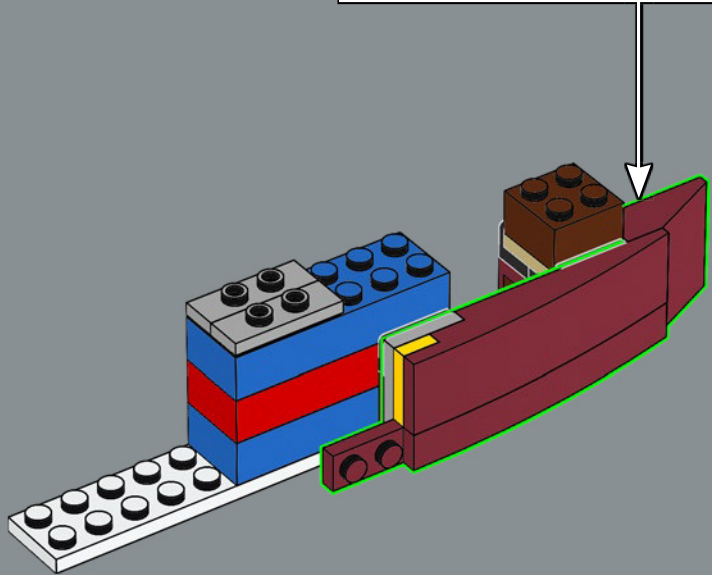
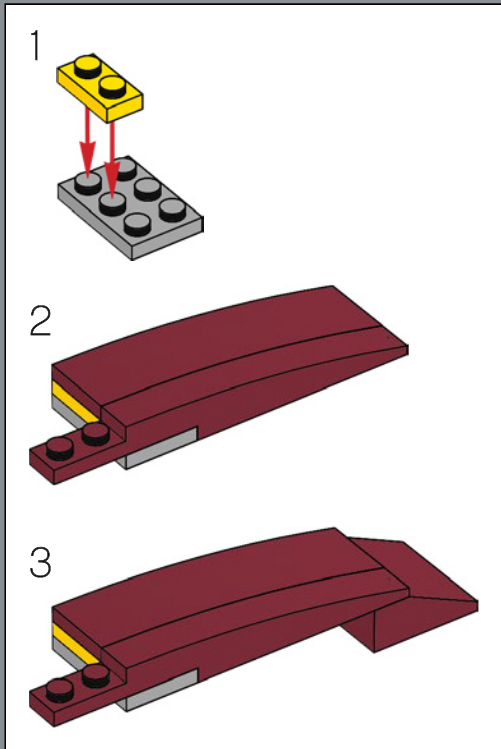

185

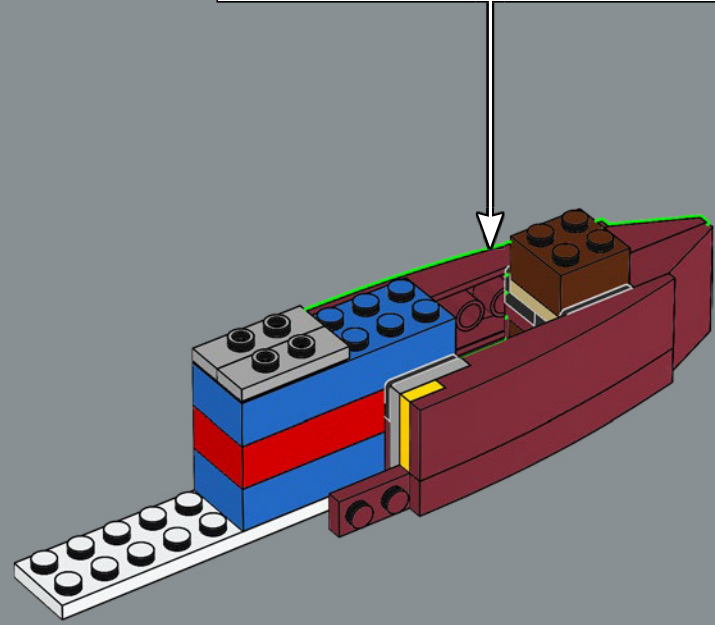
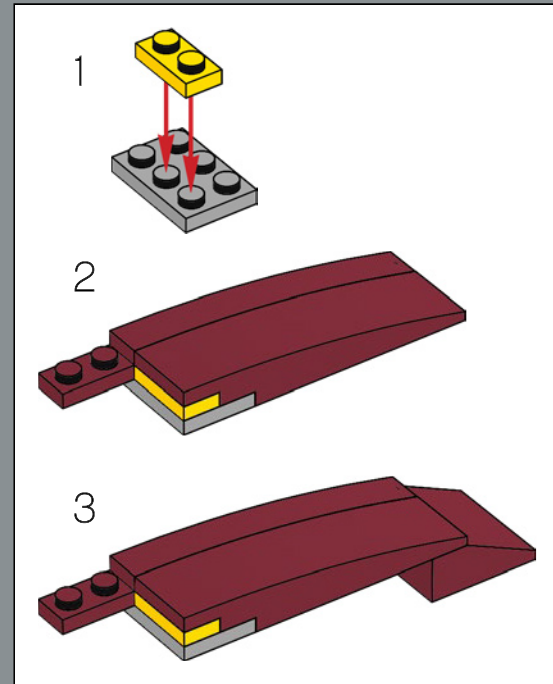

186

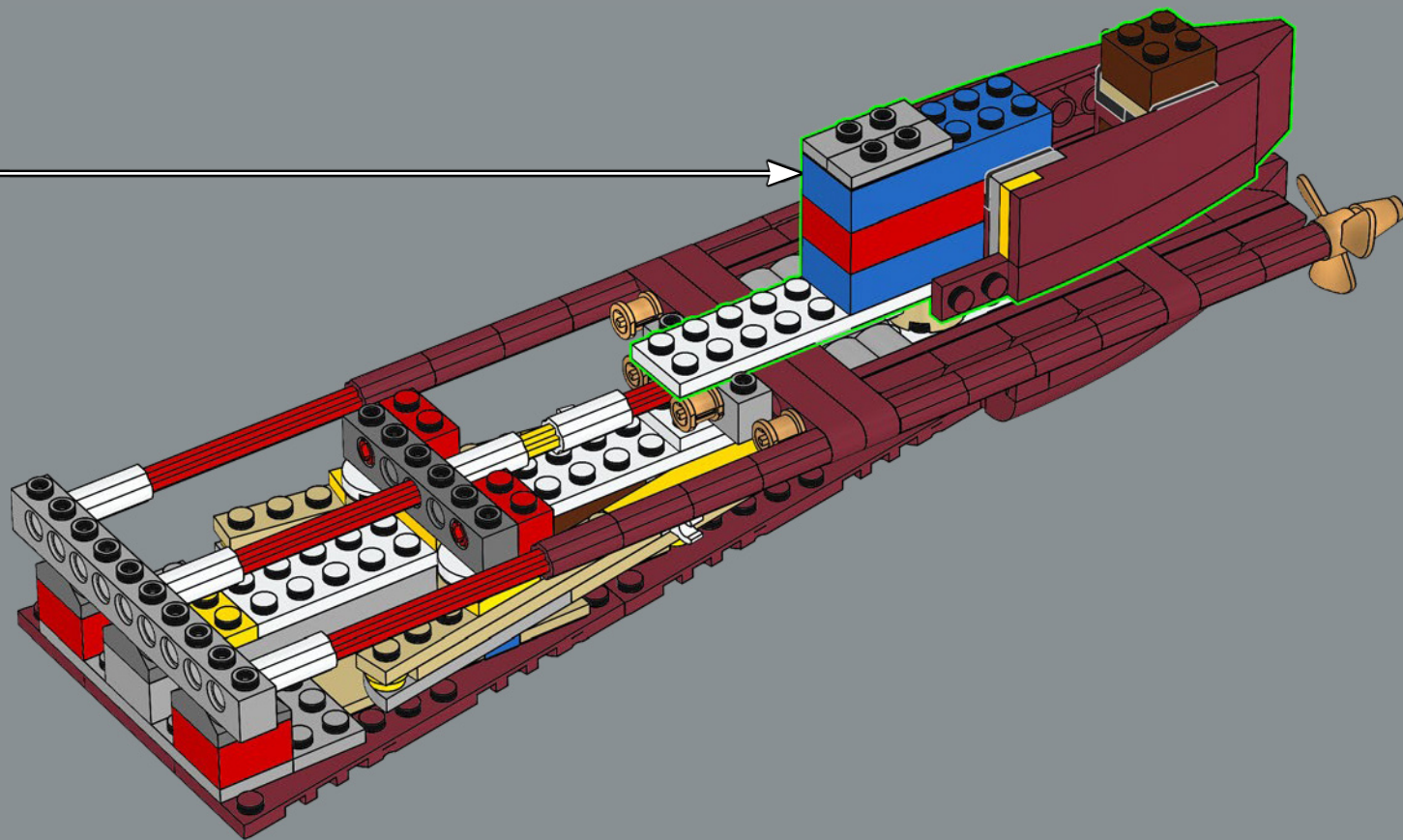

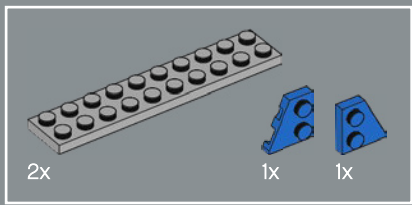

187

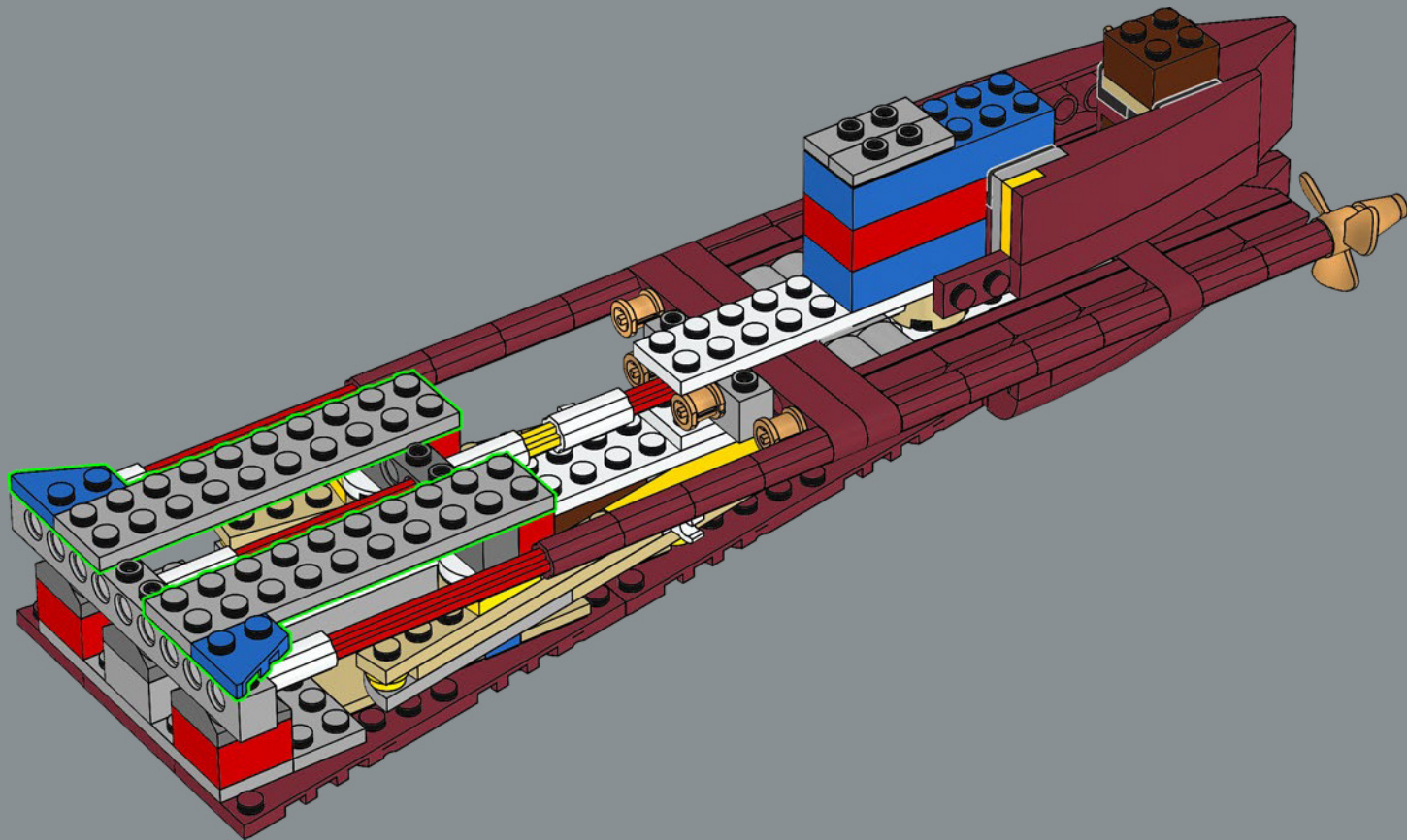

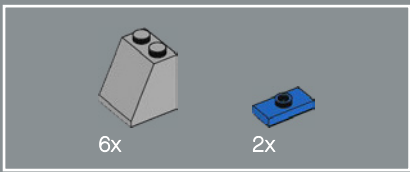

188

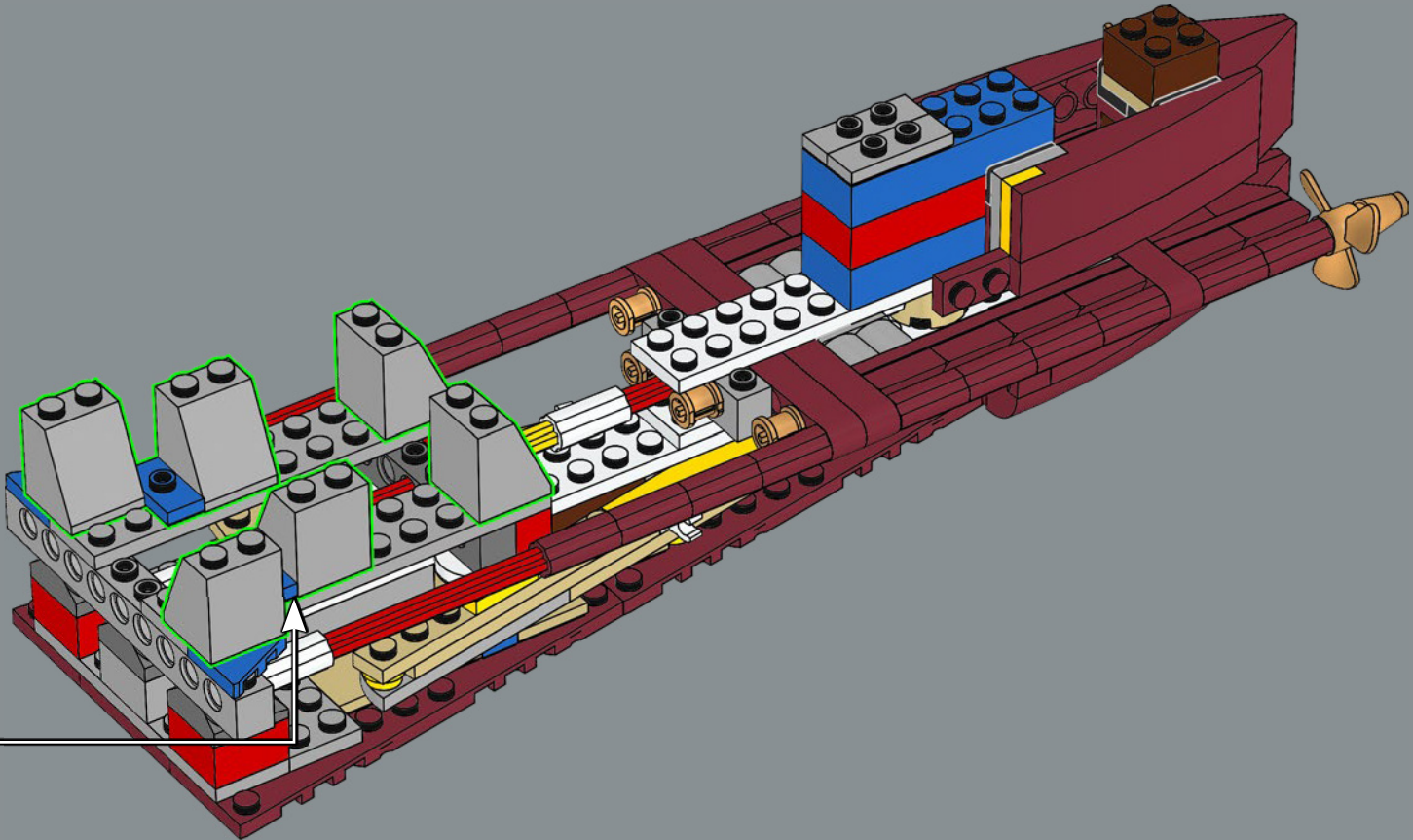

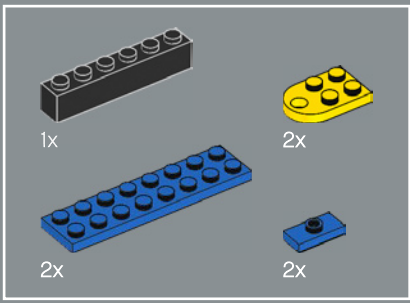

189

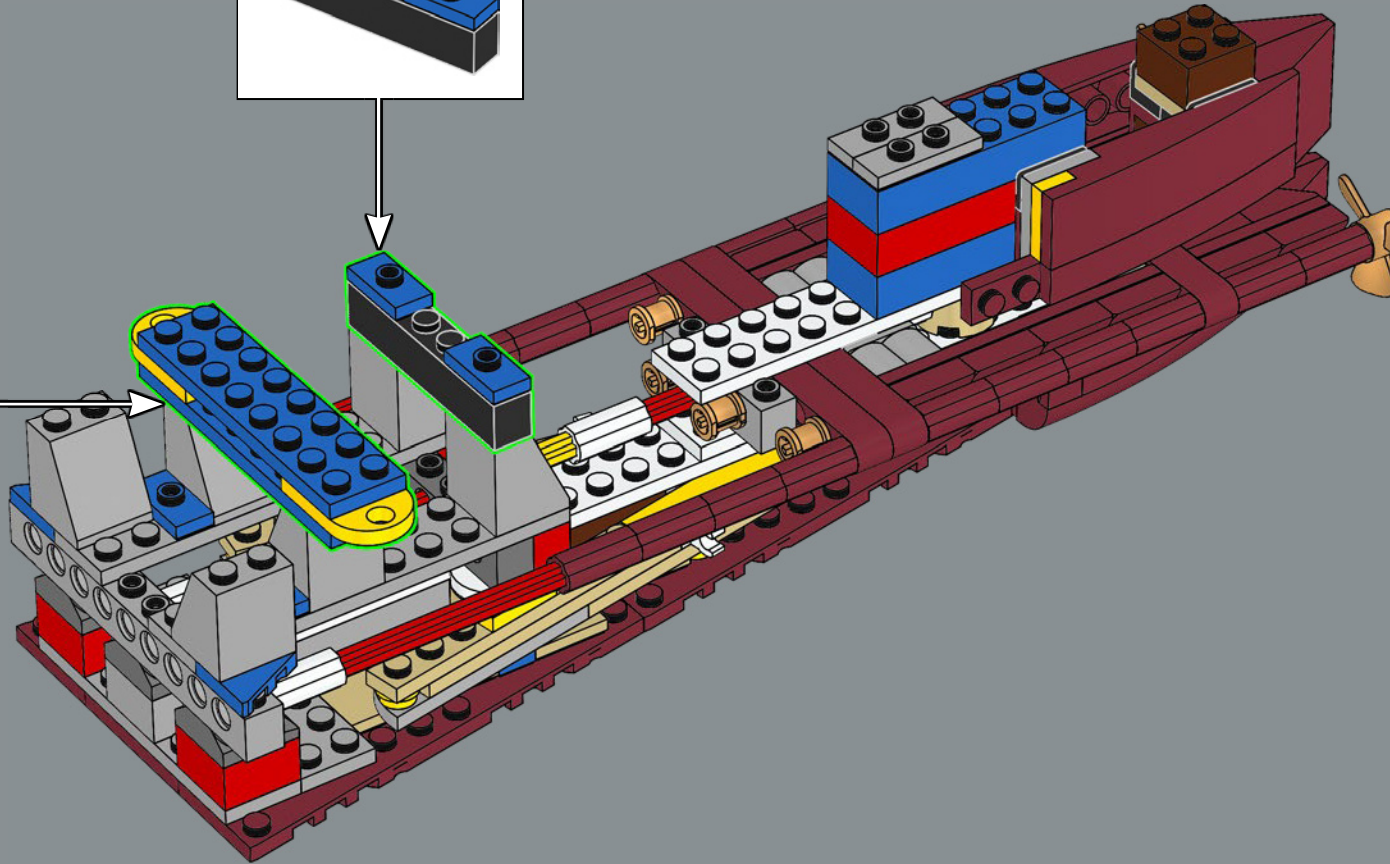
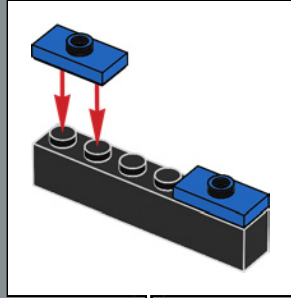
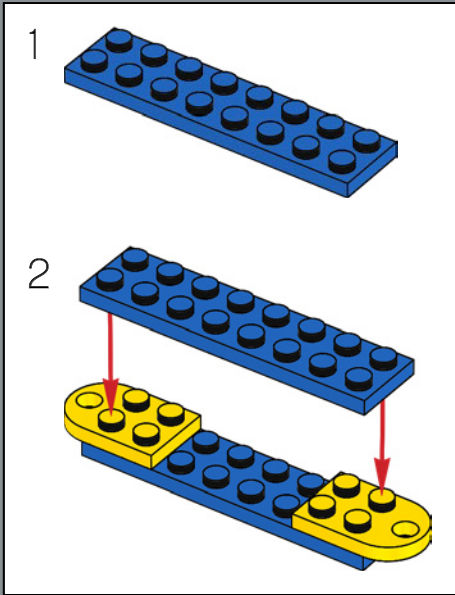



190

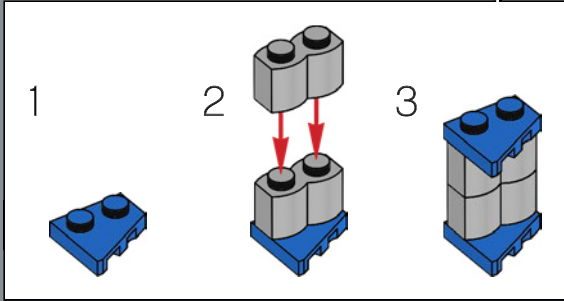
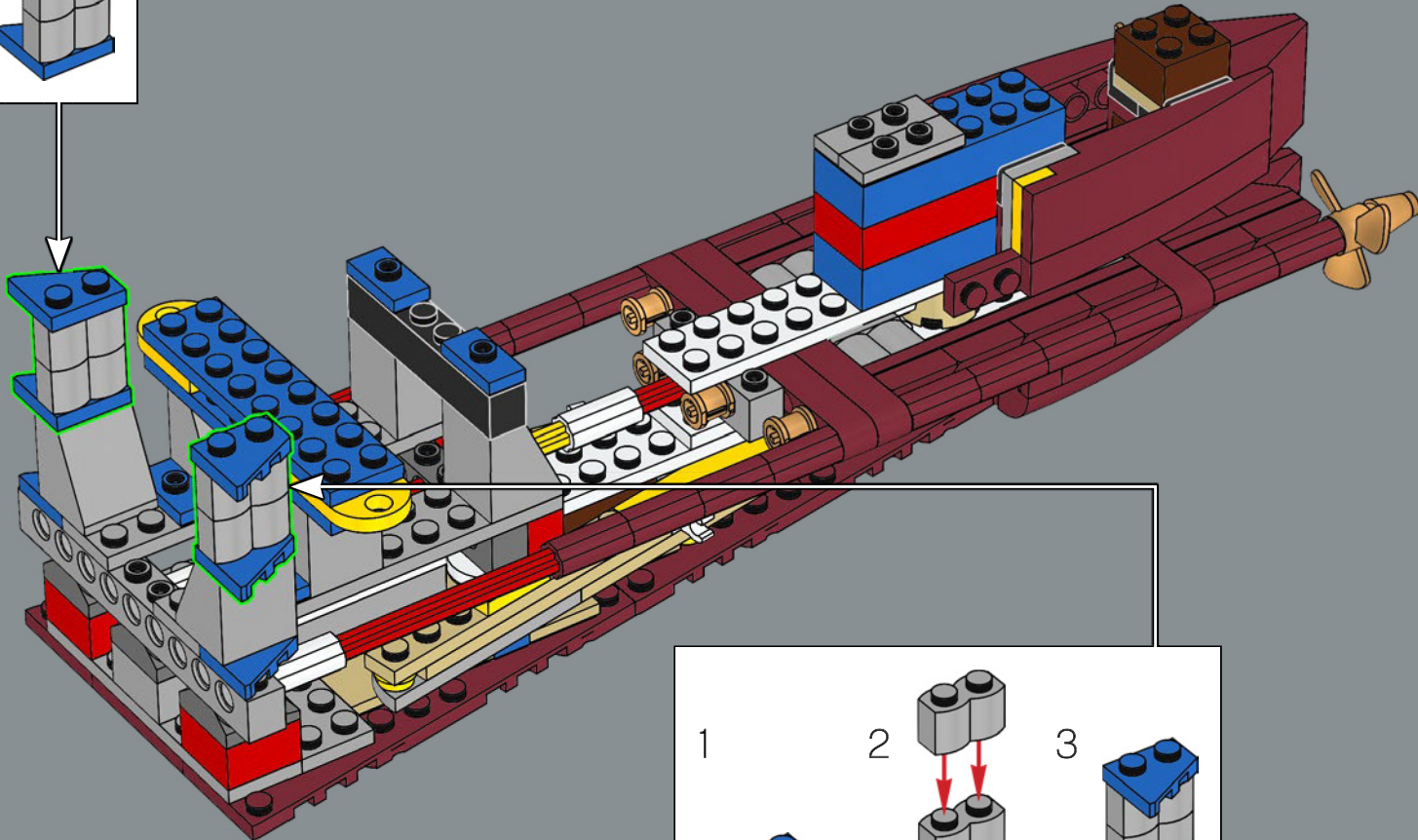
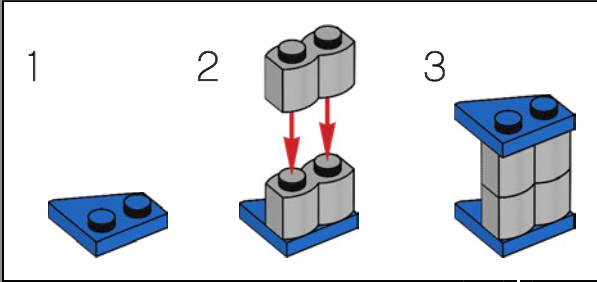

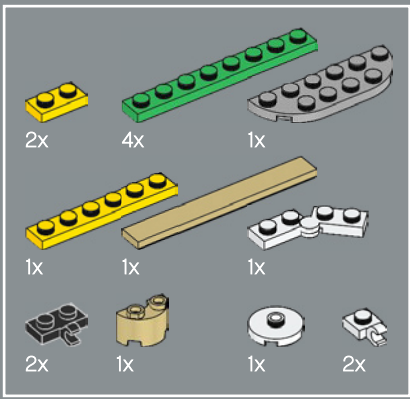

191

1



2

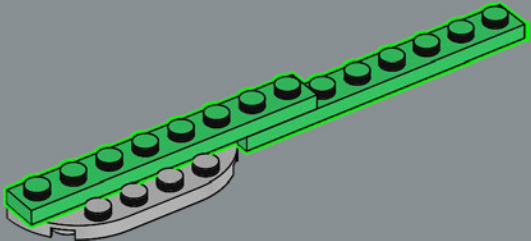

3

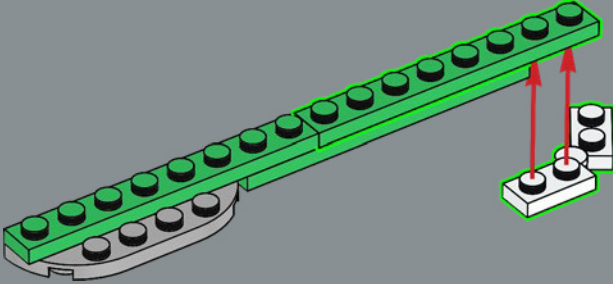

4

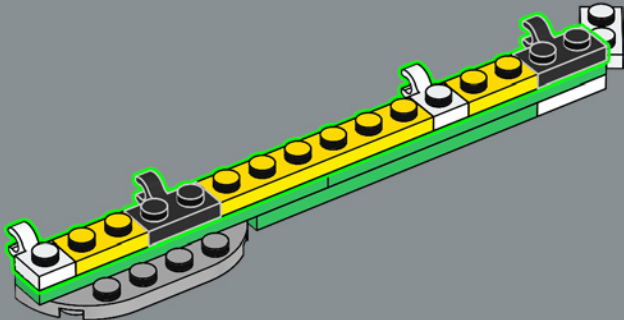

5

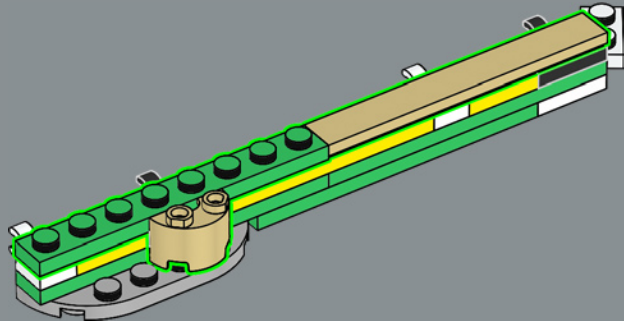

6

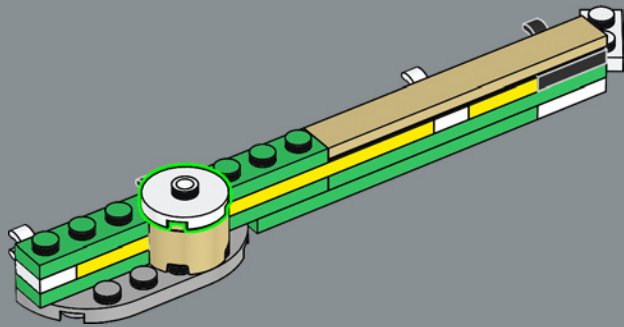



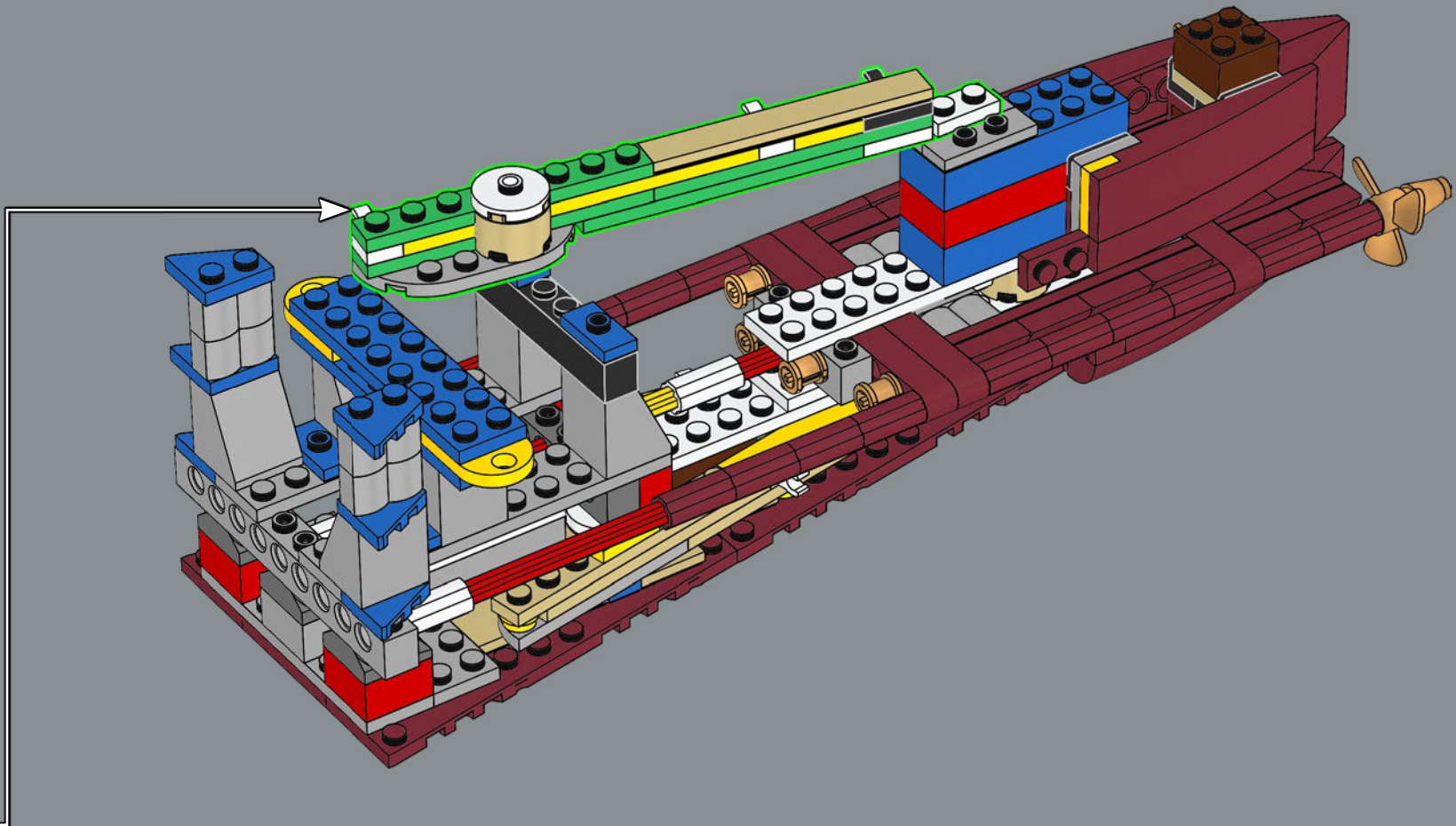

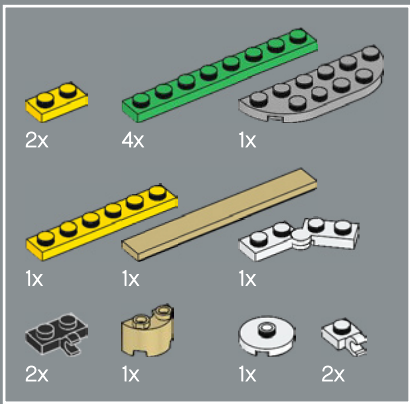

192

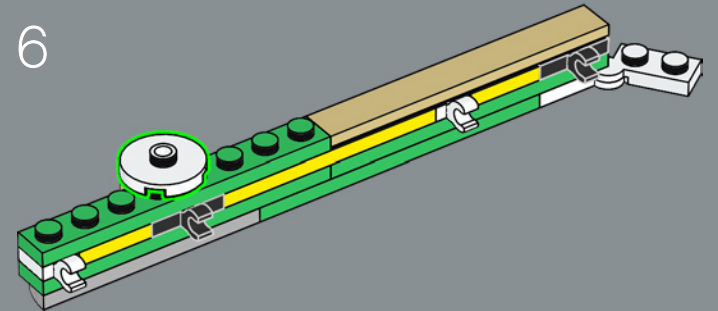
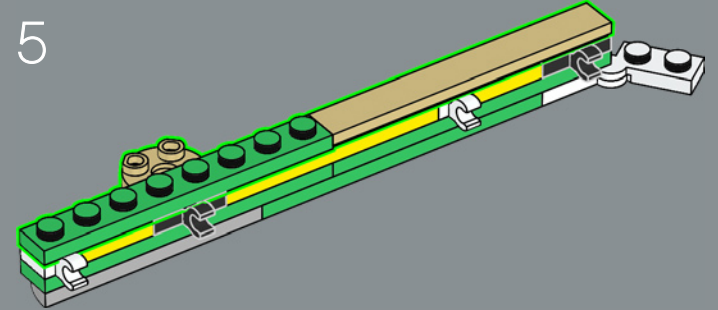
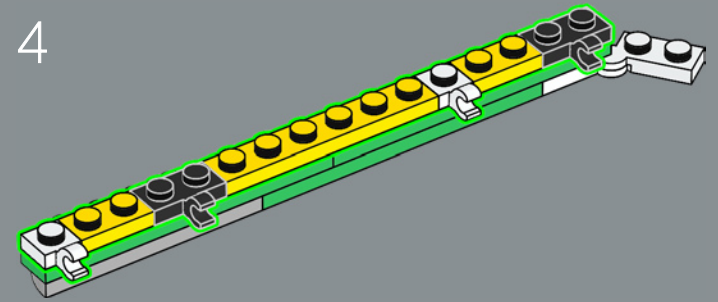
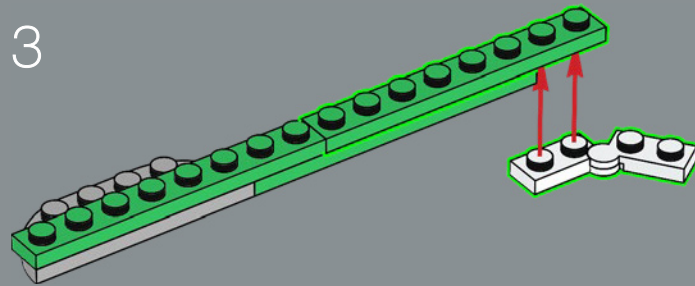
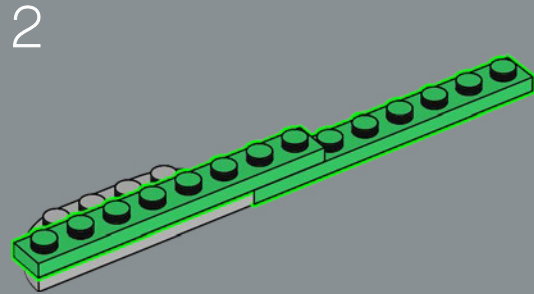
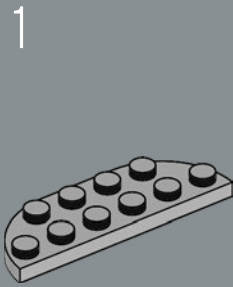

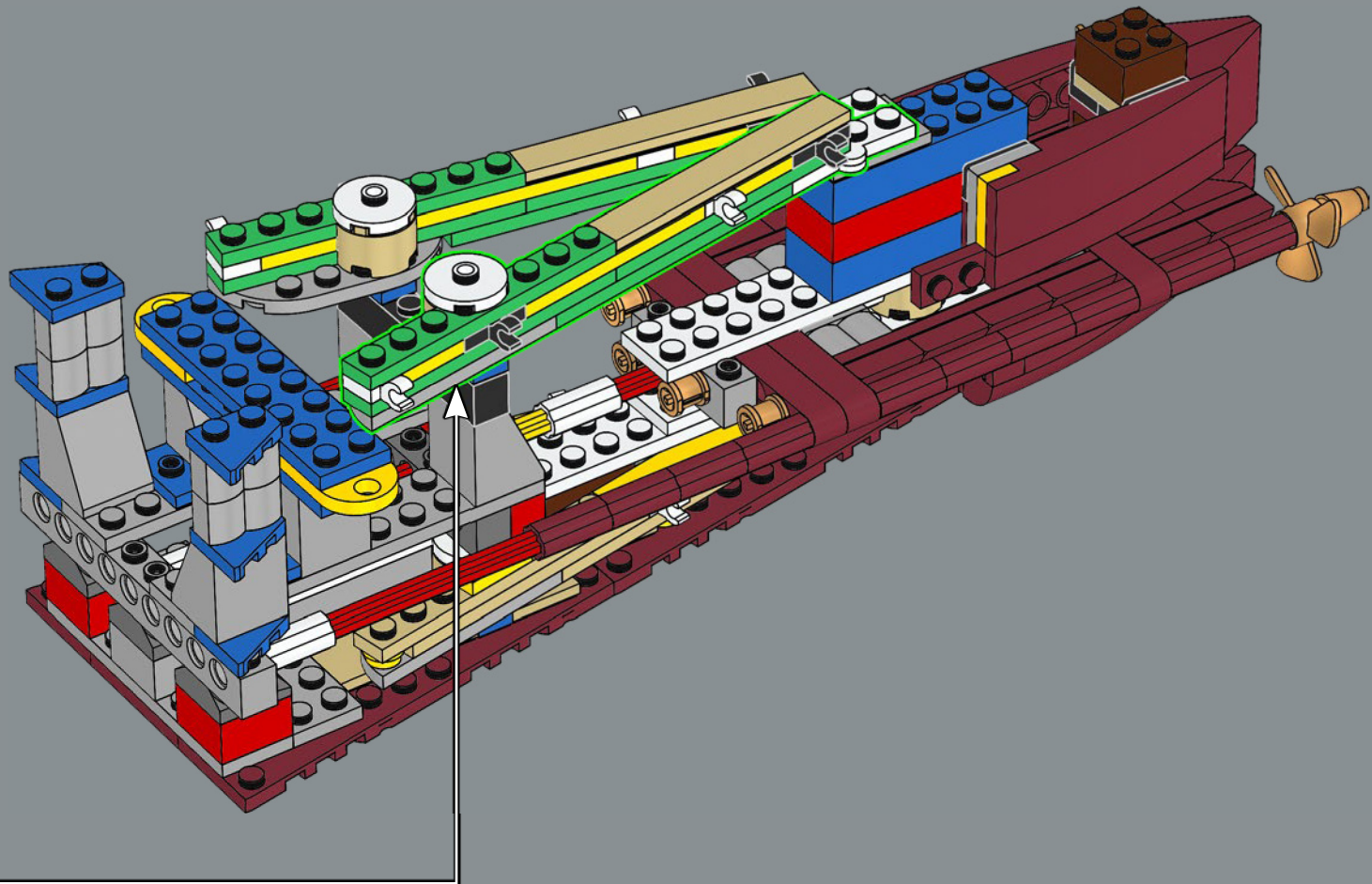

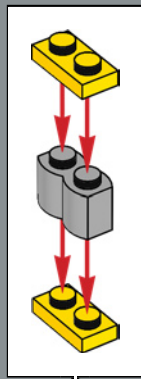
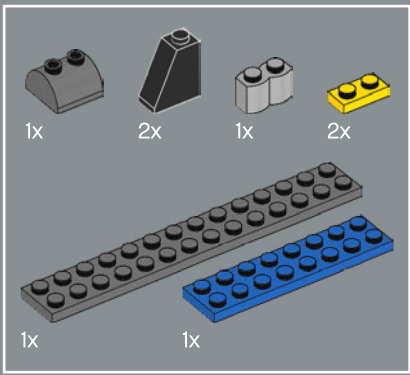

193

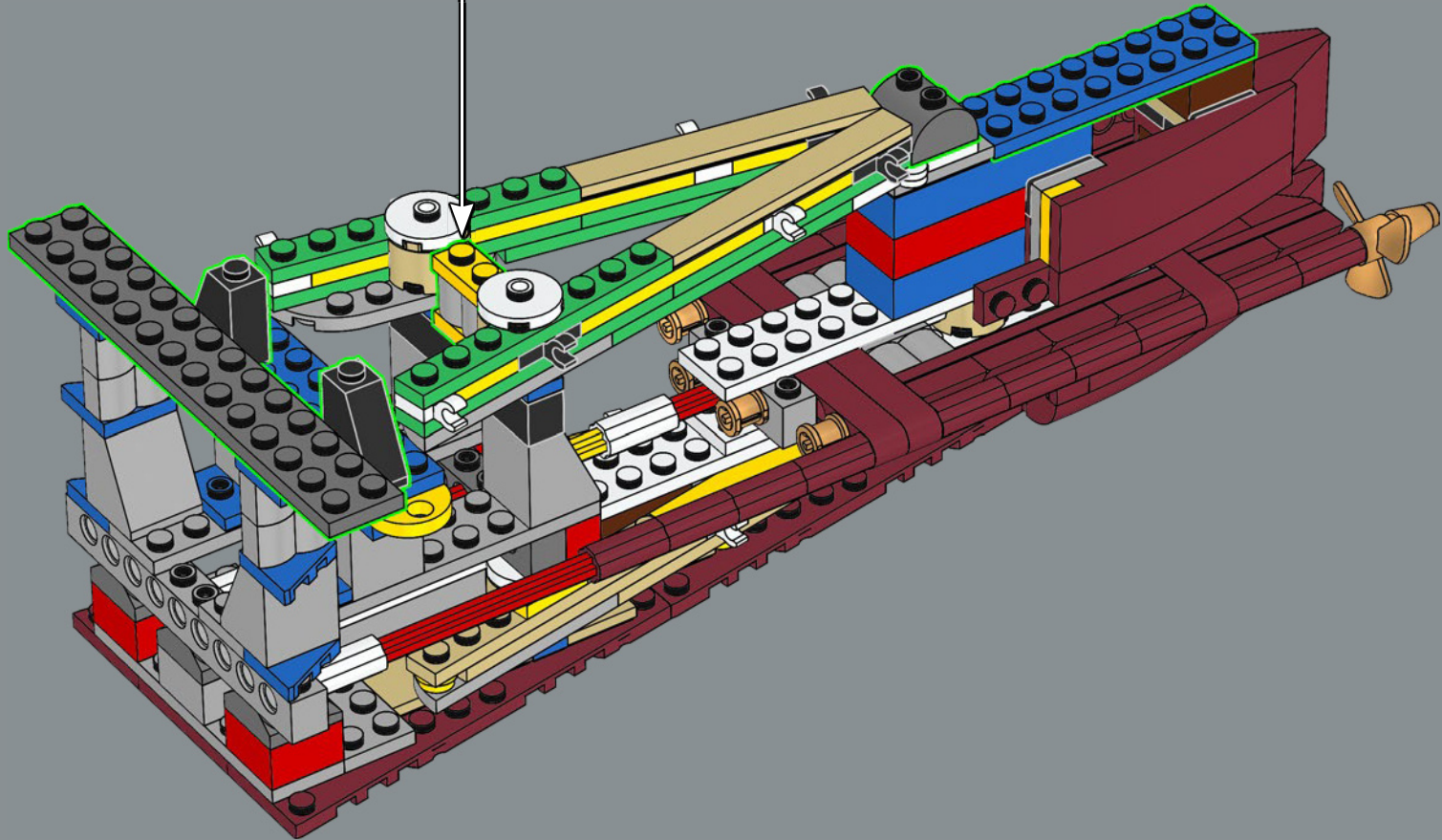

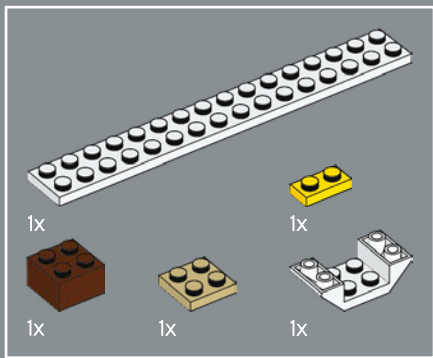

194

1

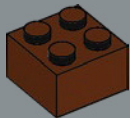

2

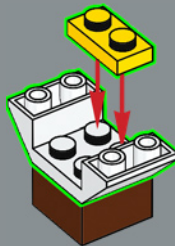

3

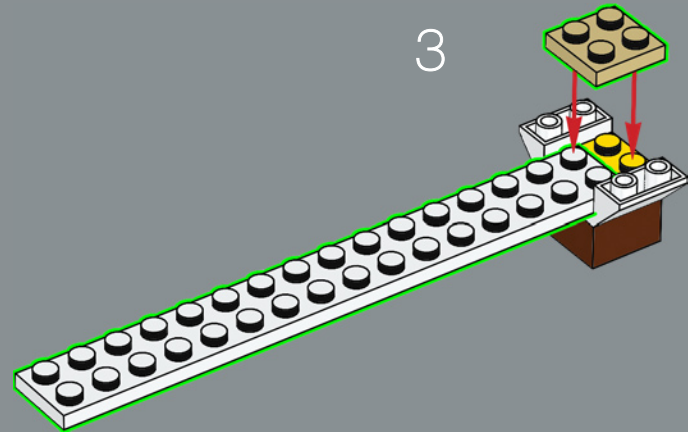

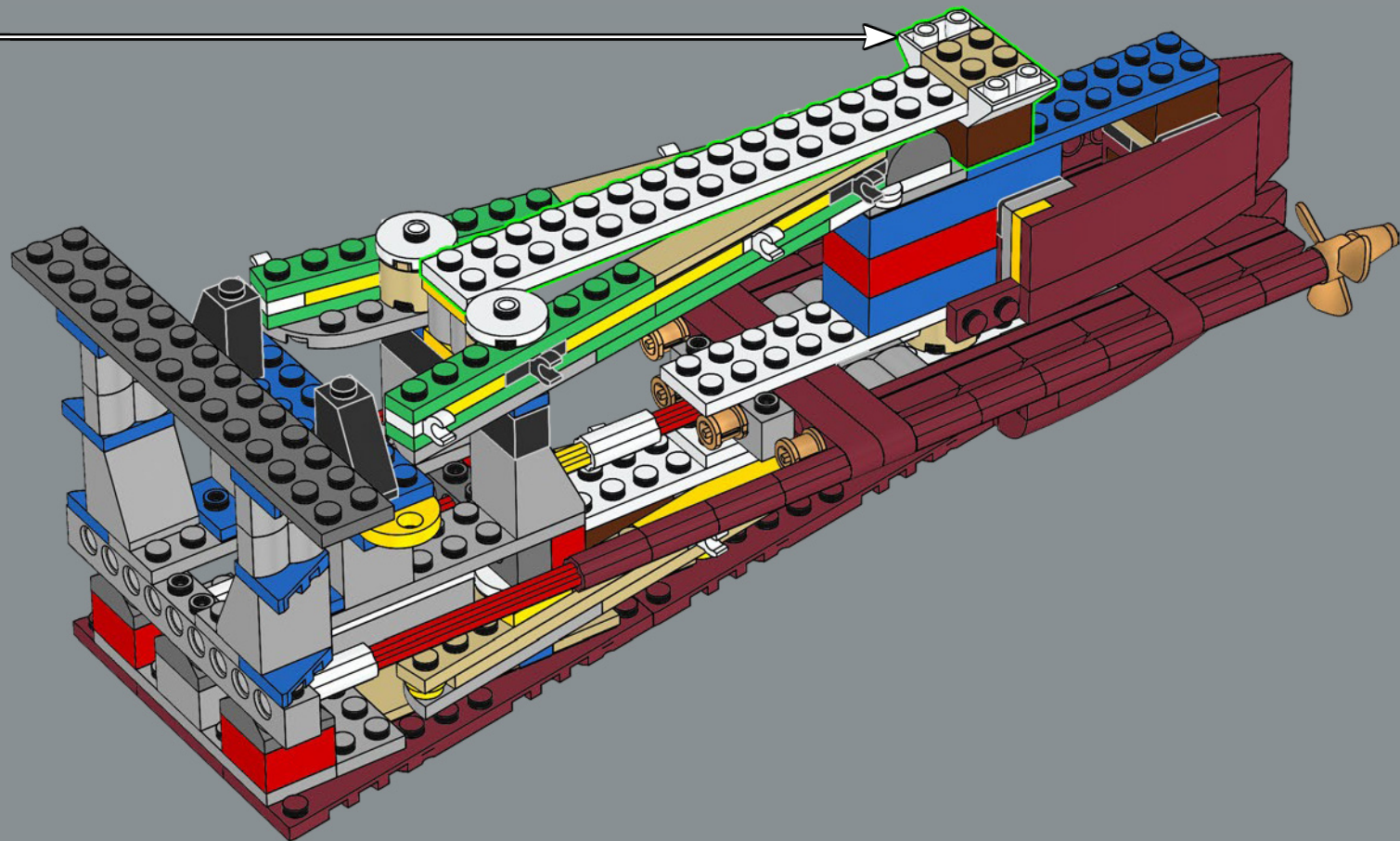

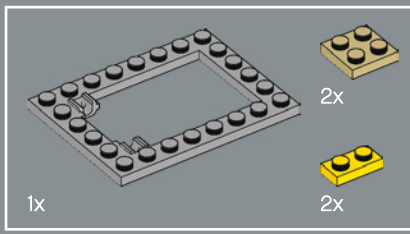

195

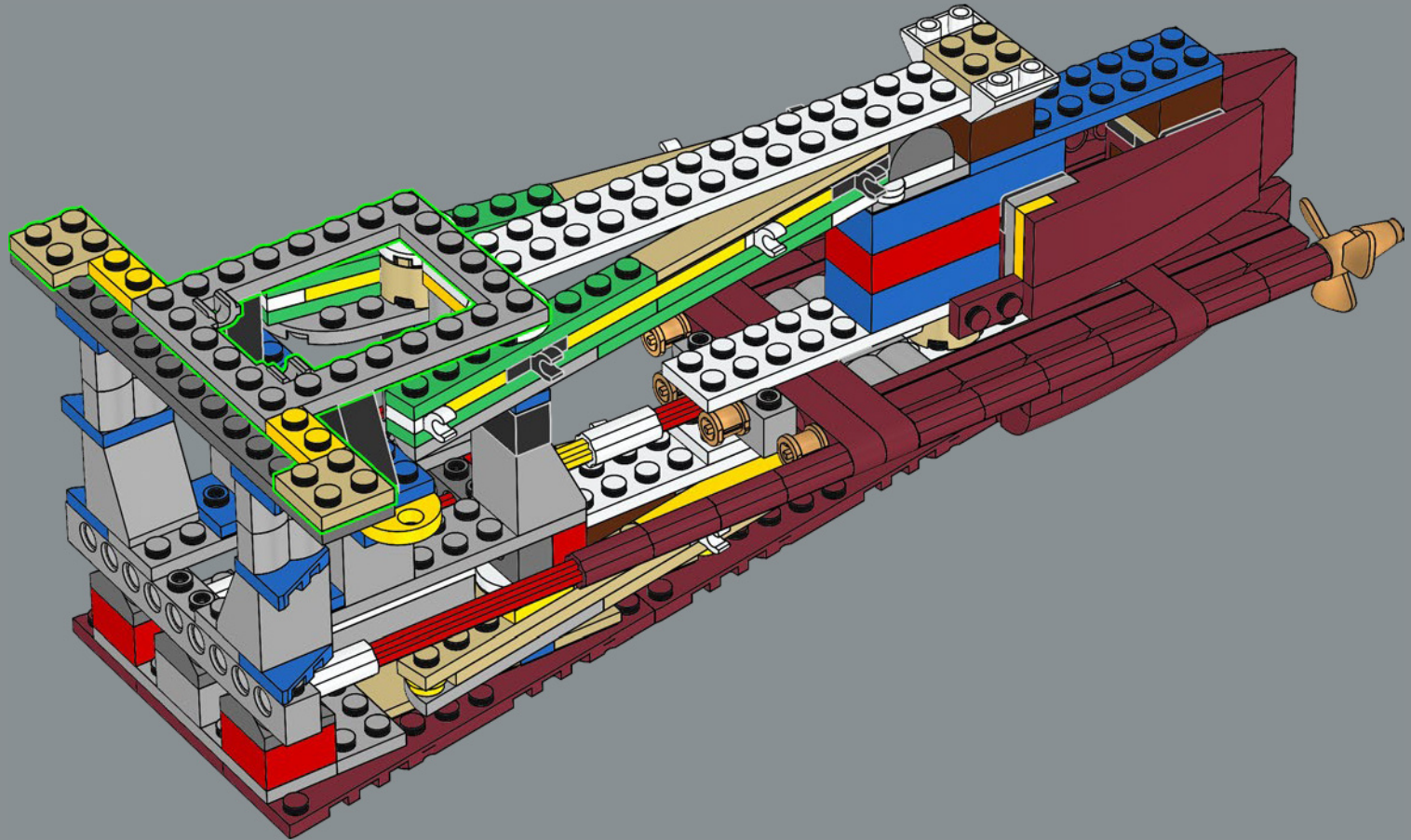

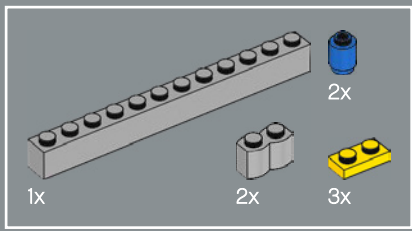

196

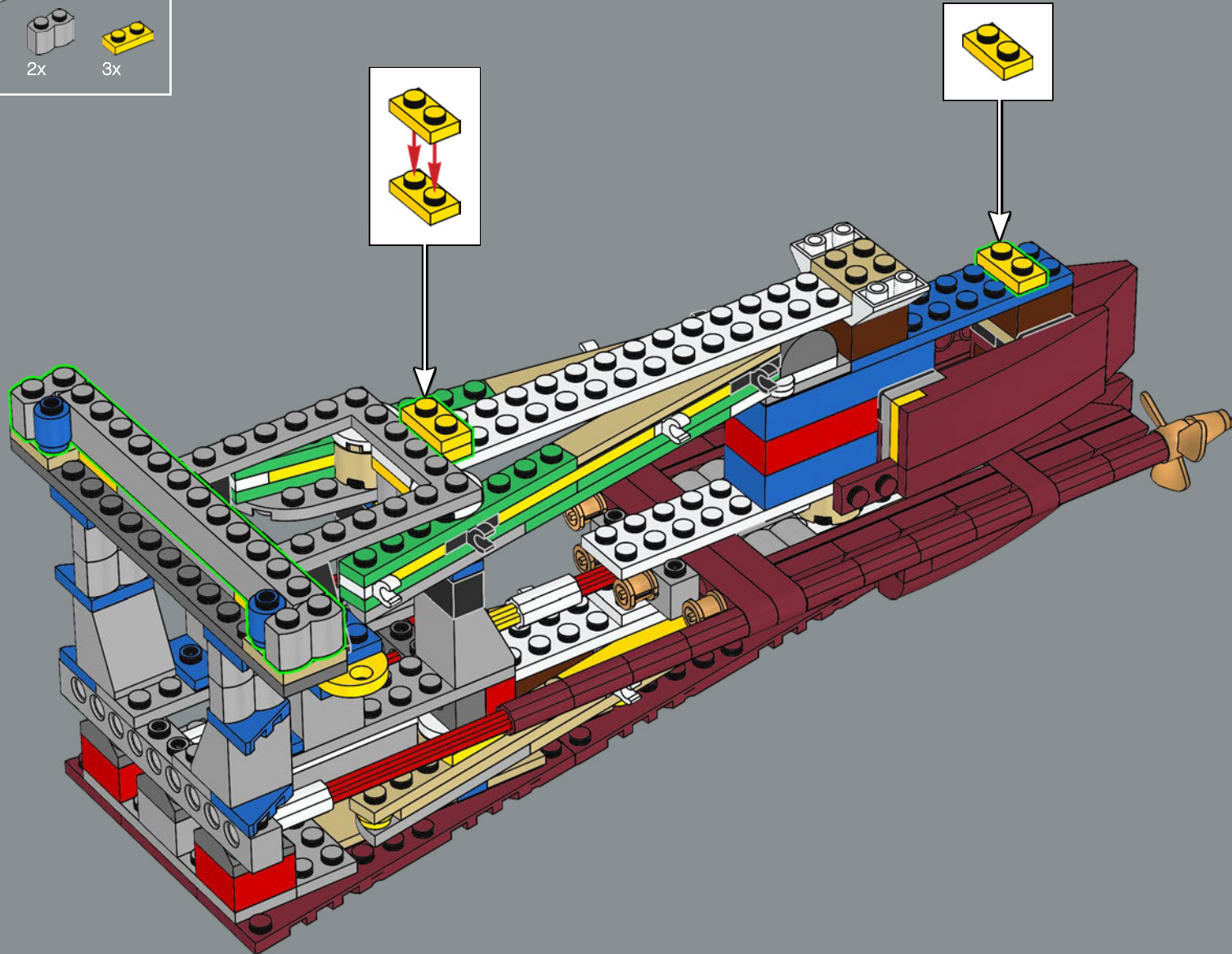



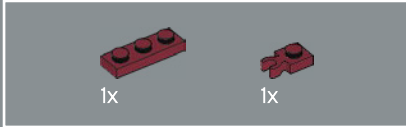
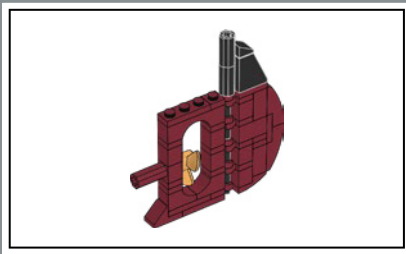

197

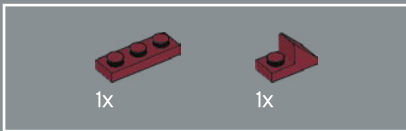
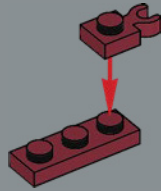

198

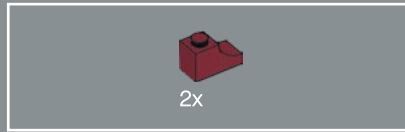
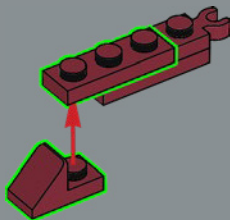

199

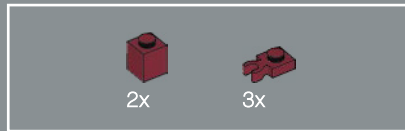
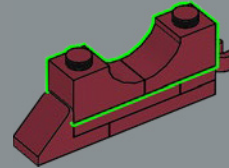

200

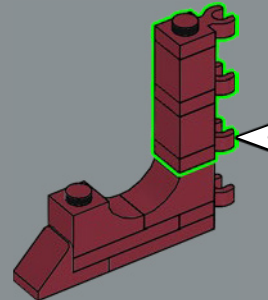
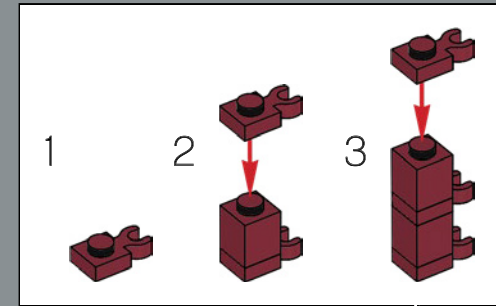

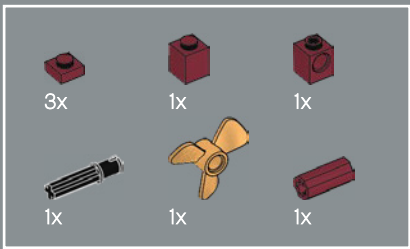

201

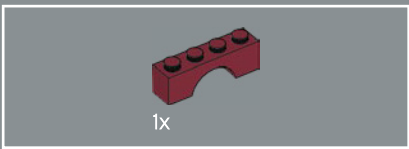
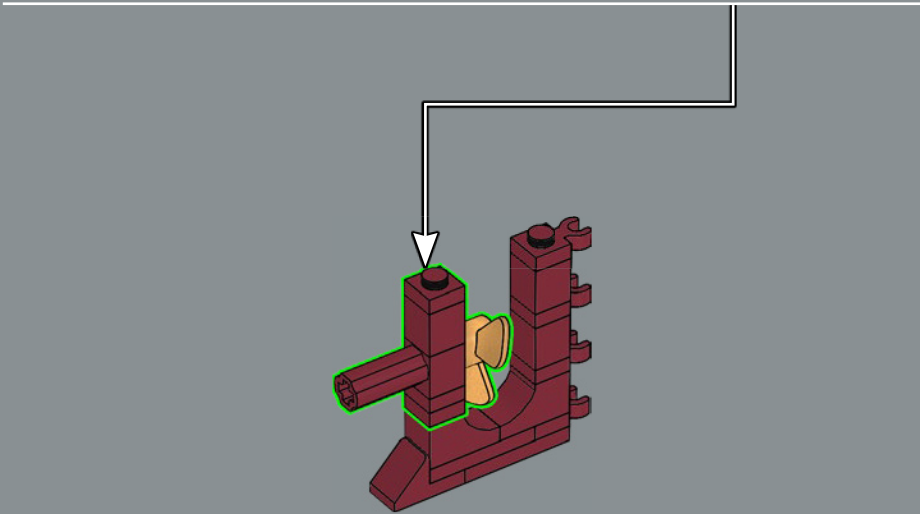
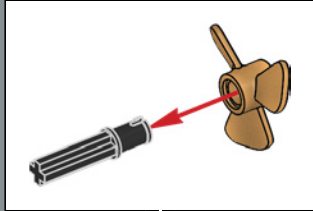
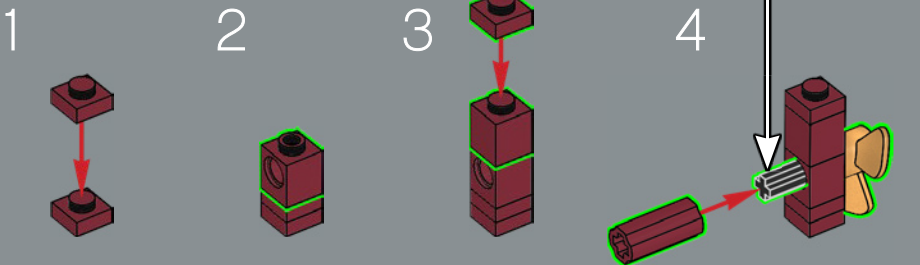

202

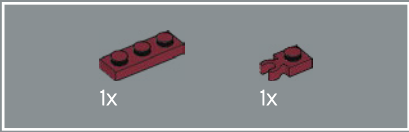
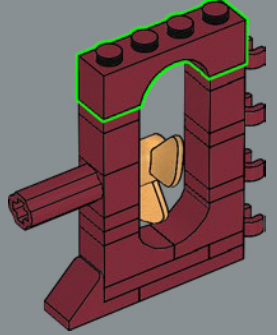

203

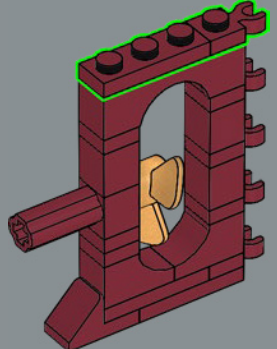

204

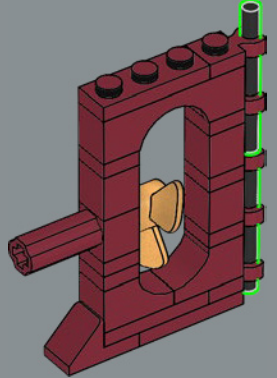

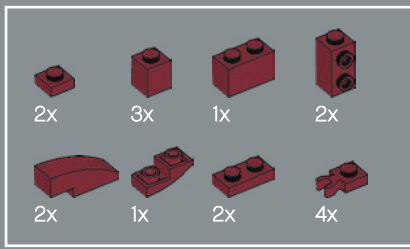

205

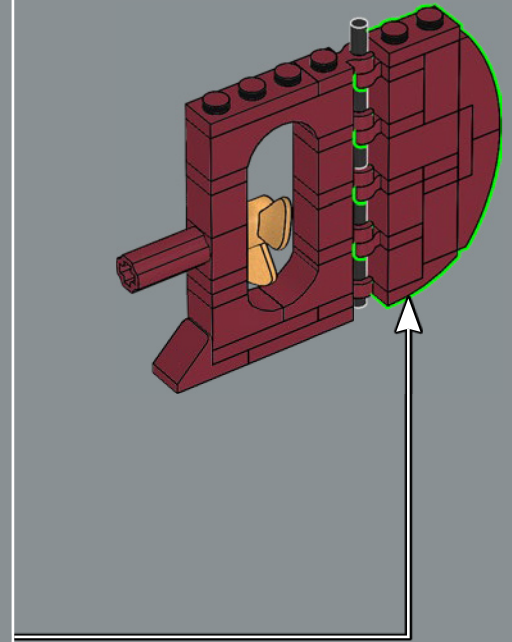
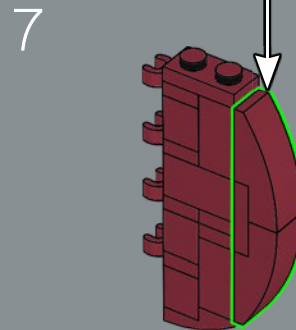
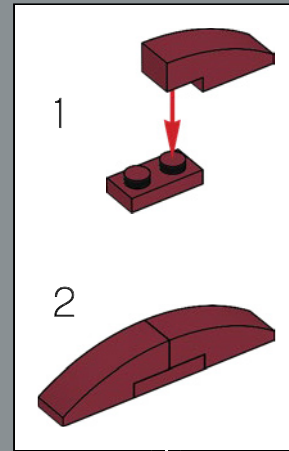
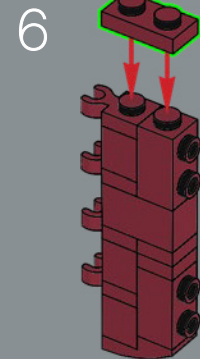
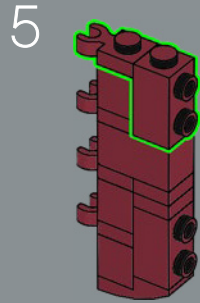
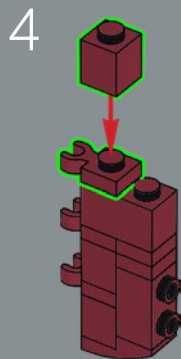
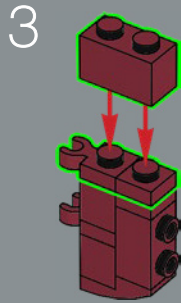
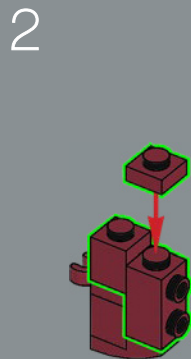
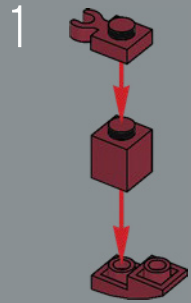

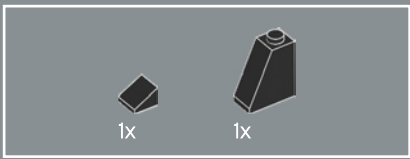

206

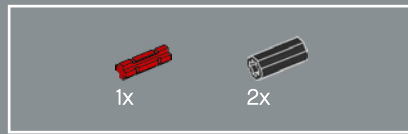
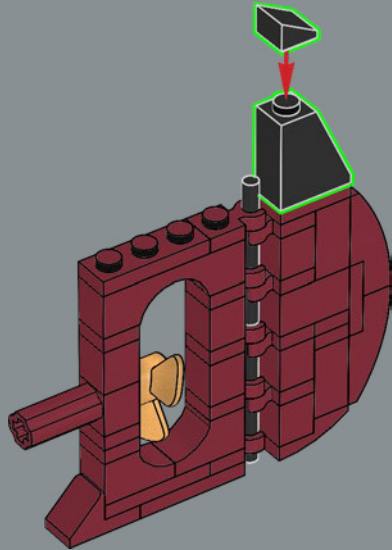

207

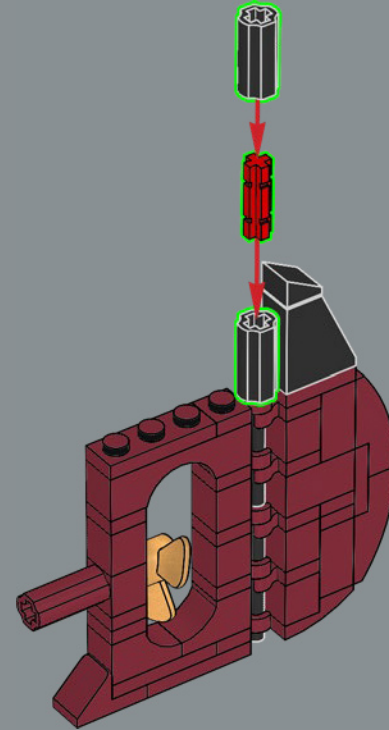

The ship's rudder was so large at 78.8 ft. (24 meters) high, 15.3 ft. (4.65 meters) long and weighing over 110.2 tons (100 metric tonnes), it required steering engines to move it.

Vu ses dimensions imposantes, soit 24 m (78,8 pi) de haut et 4,65 m (15,3 pi) de large, ainsi que son poids de plus de 100 tonnes métriques (110,2 tonnes courtes), le gouvernail doit être dirigé à l'aide de moteurs de direction.

El timón del barco era tan grande (24 m de altura, 4,65 m de longitud y 100 t de peso) que se requerían motores auxiliares para moverlo.

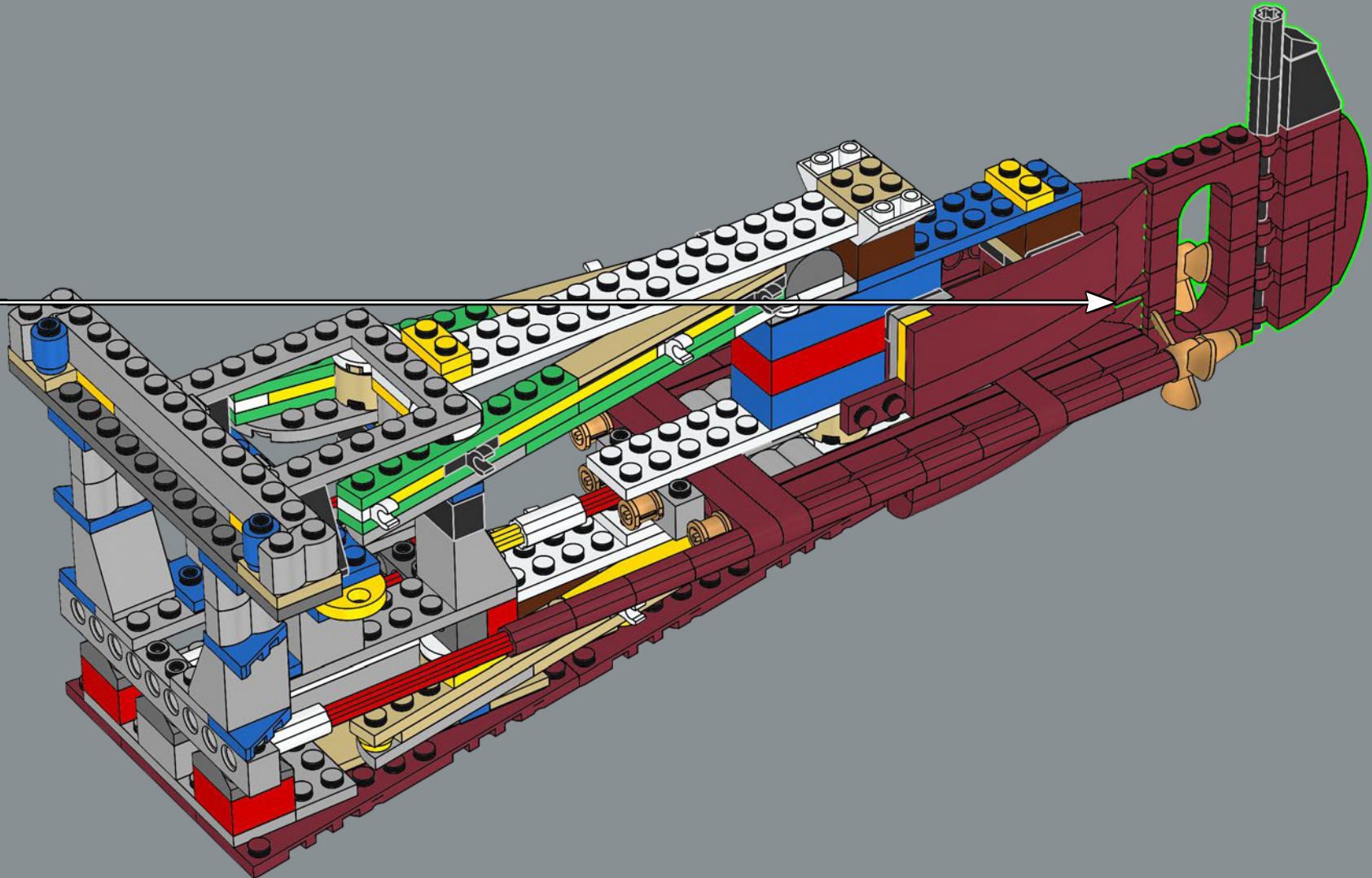

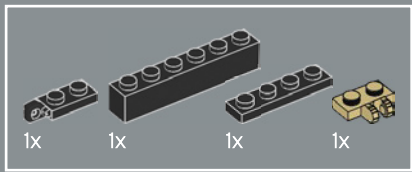

209

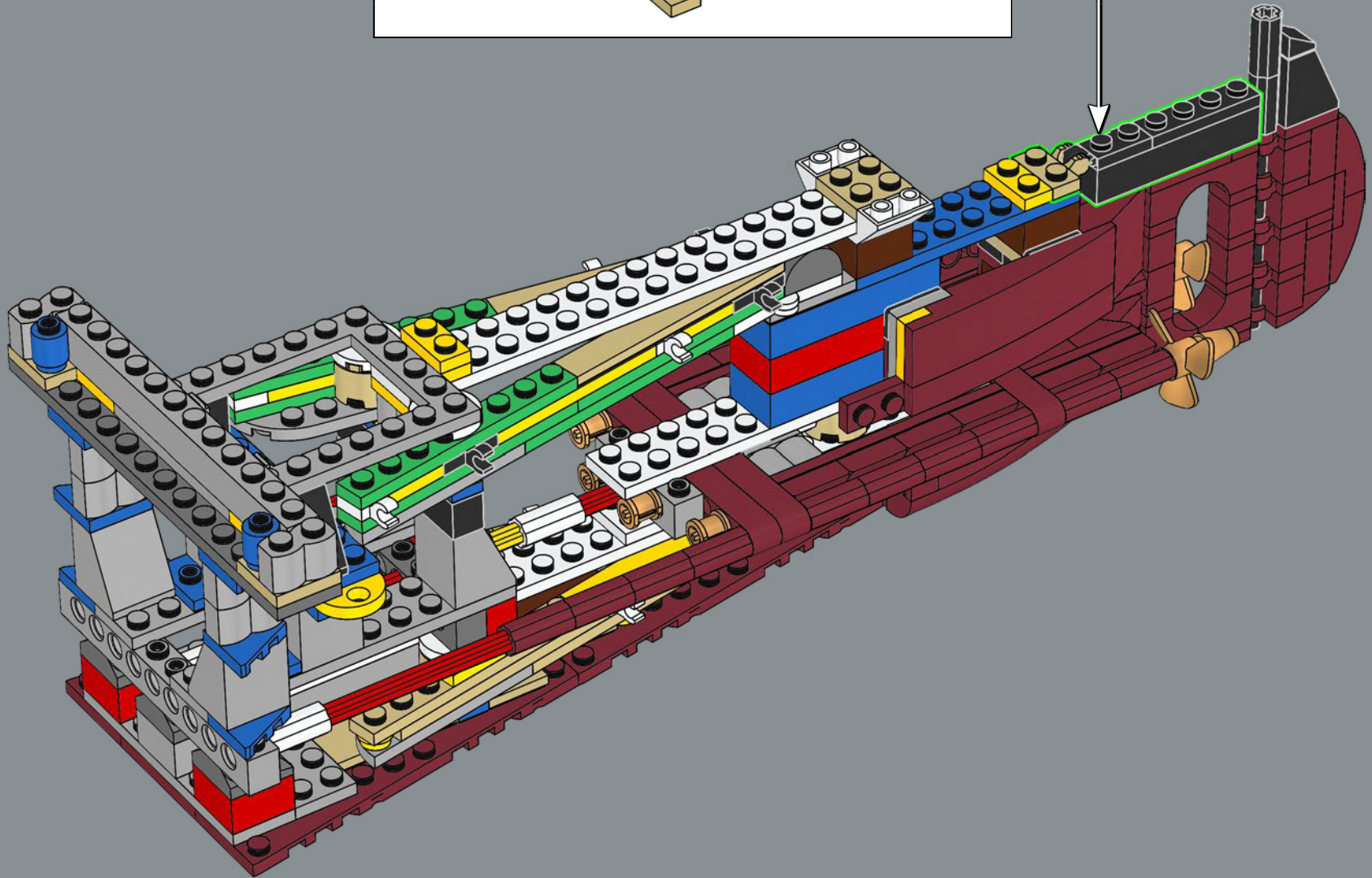
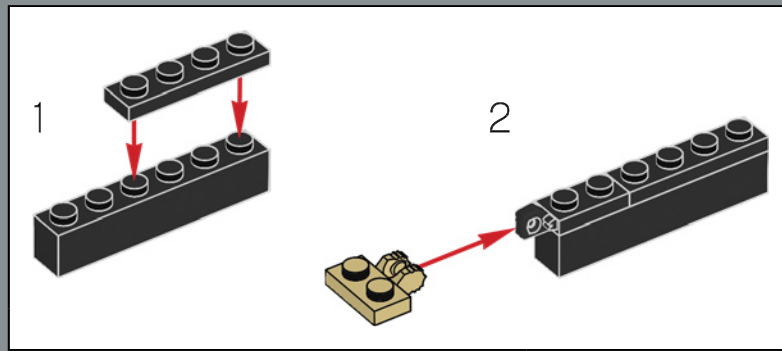

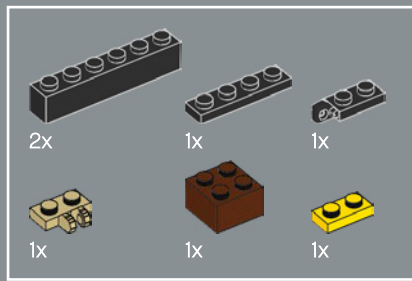

210

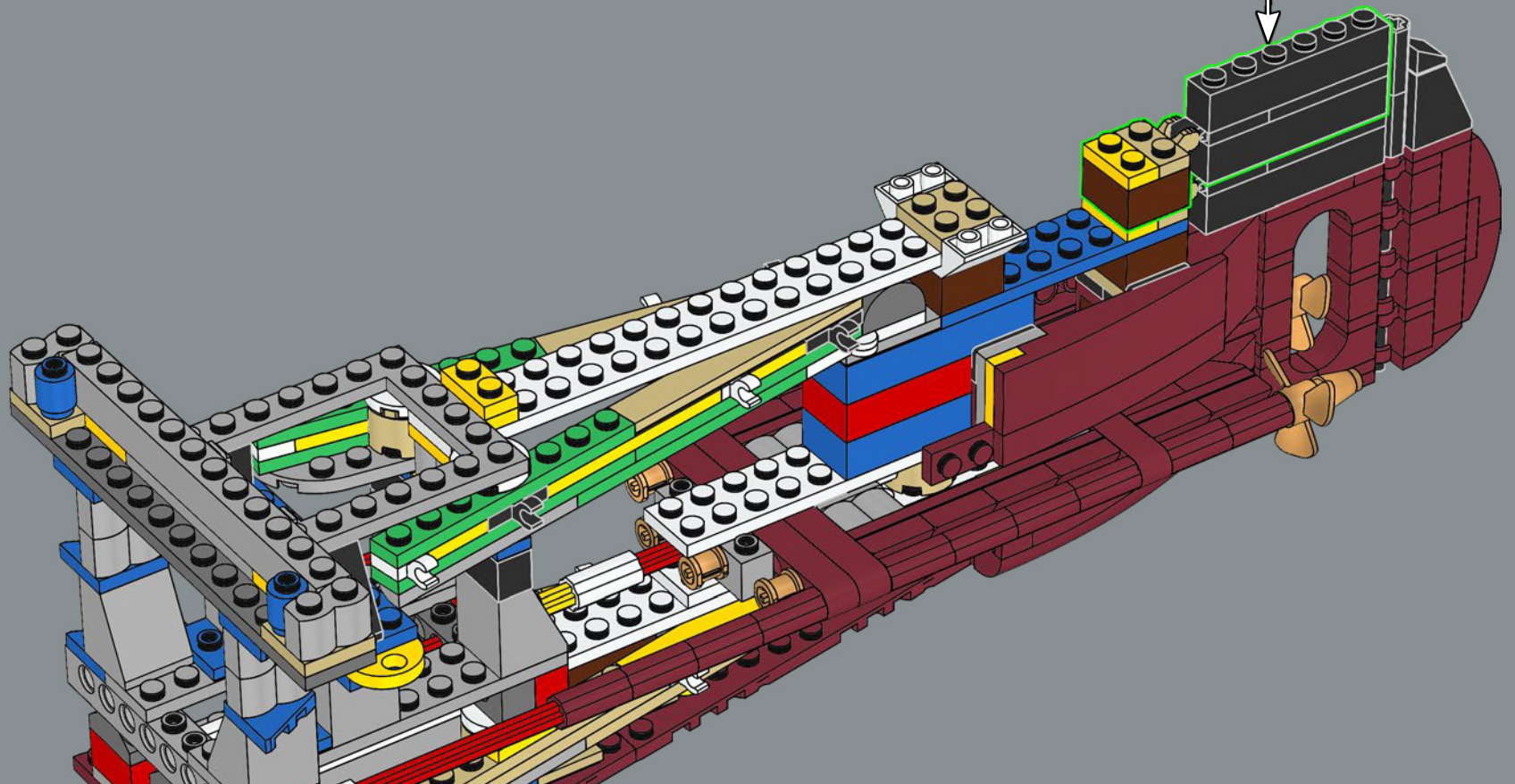
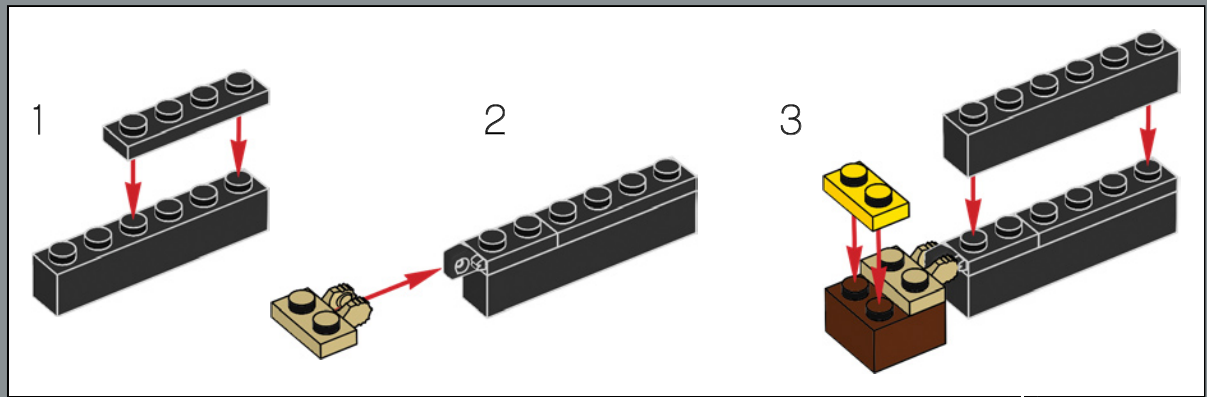

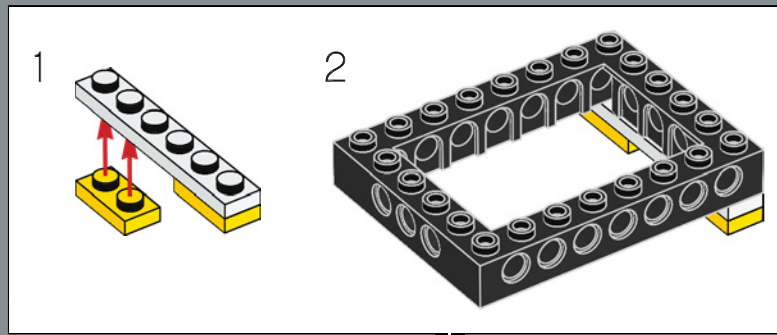
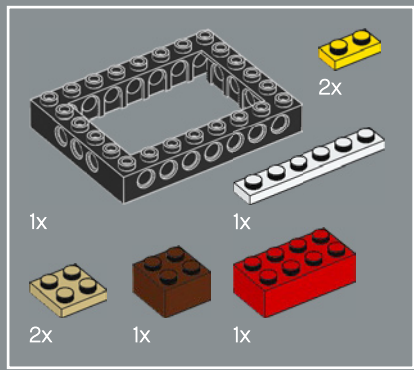

211

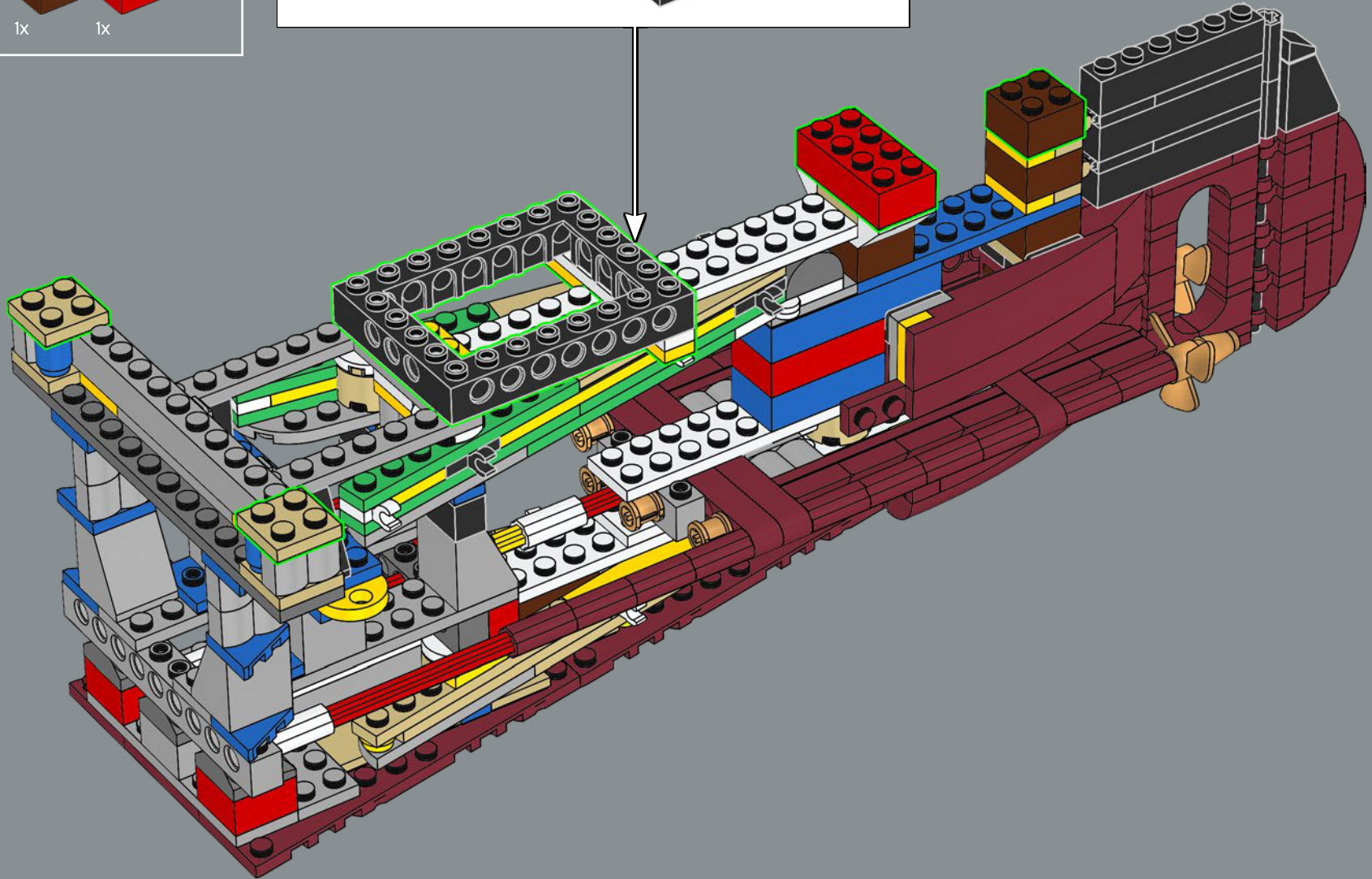



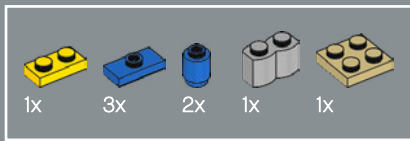

212

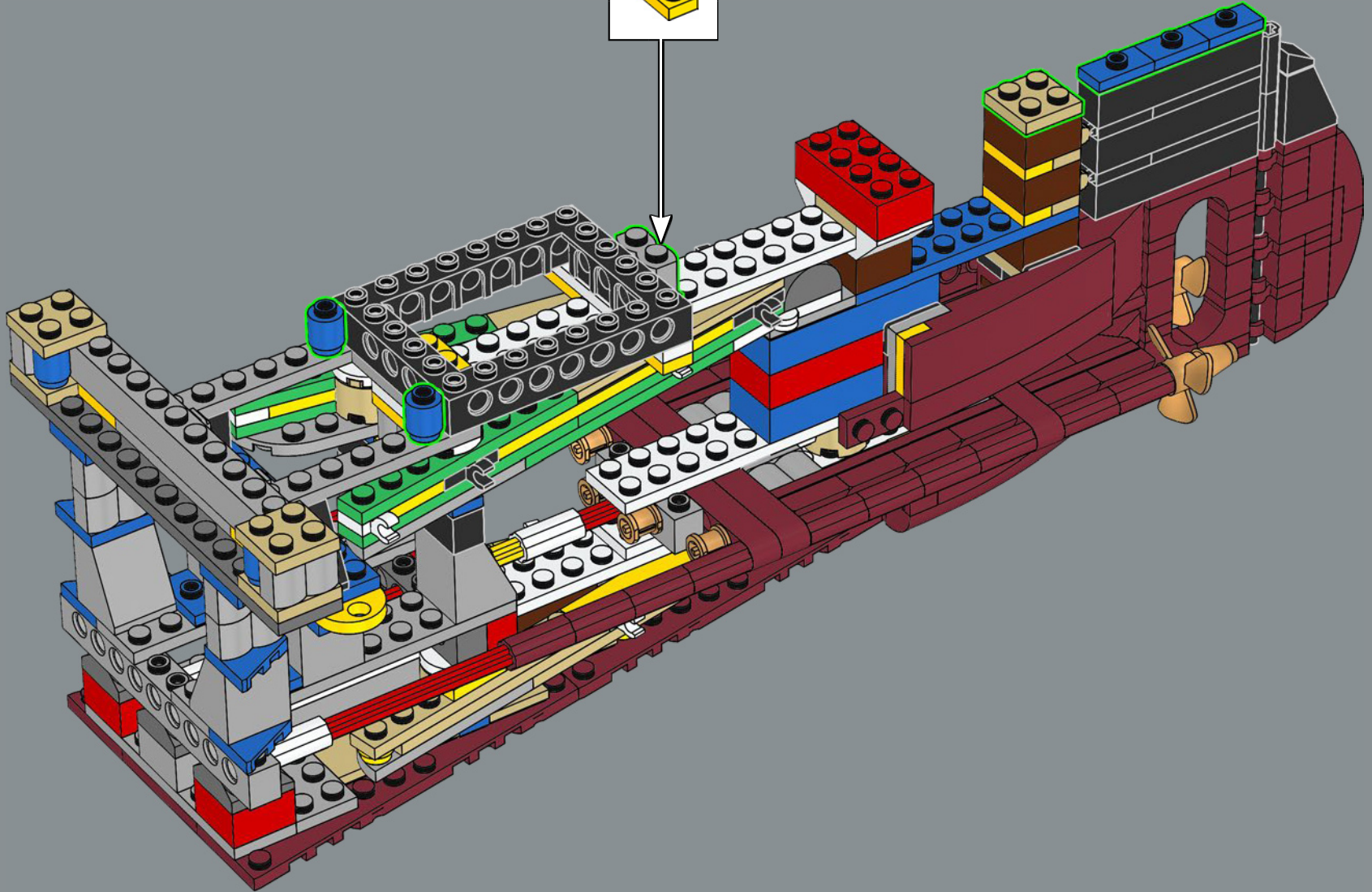
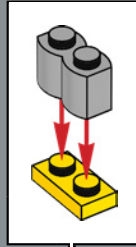

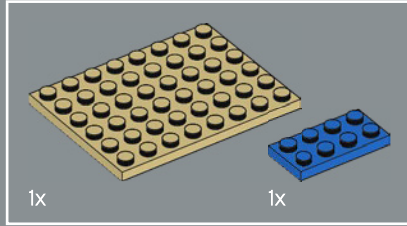
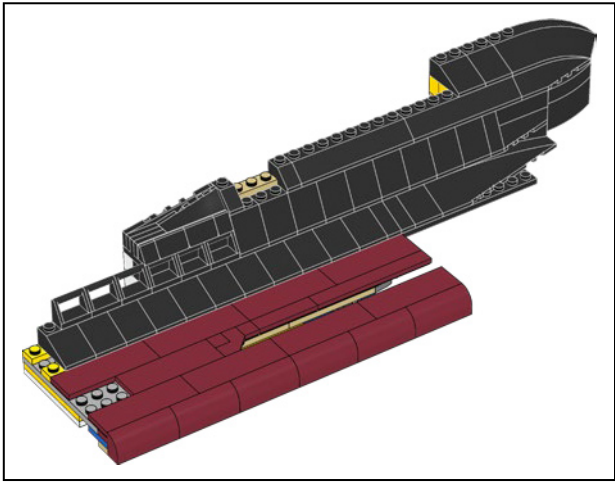
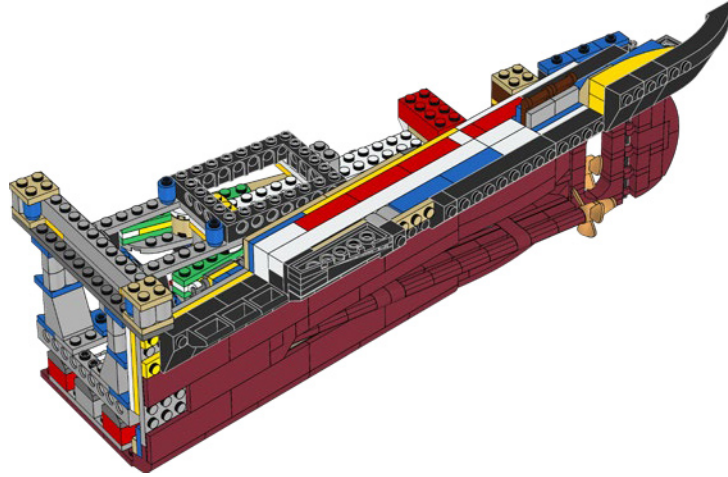
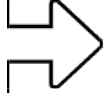

213

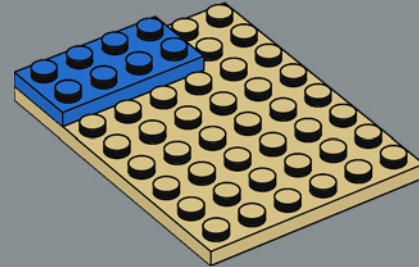

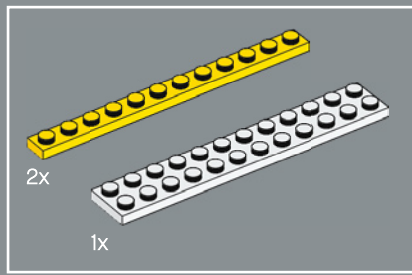

214

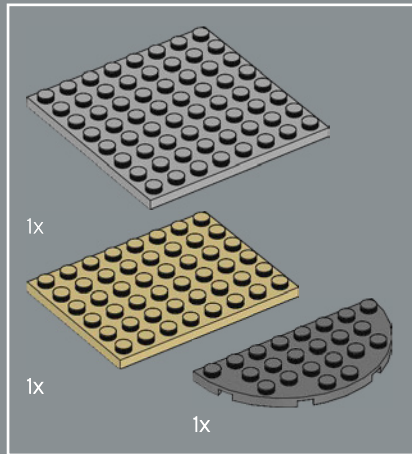
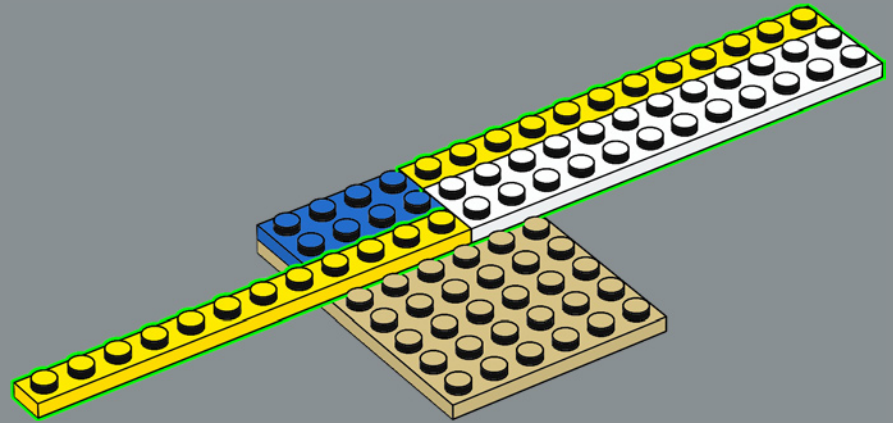

215

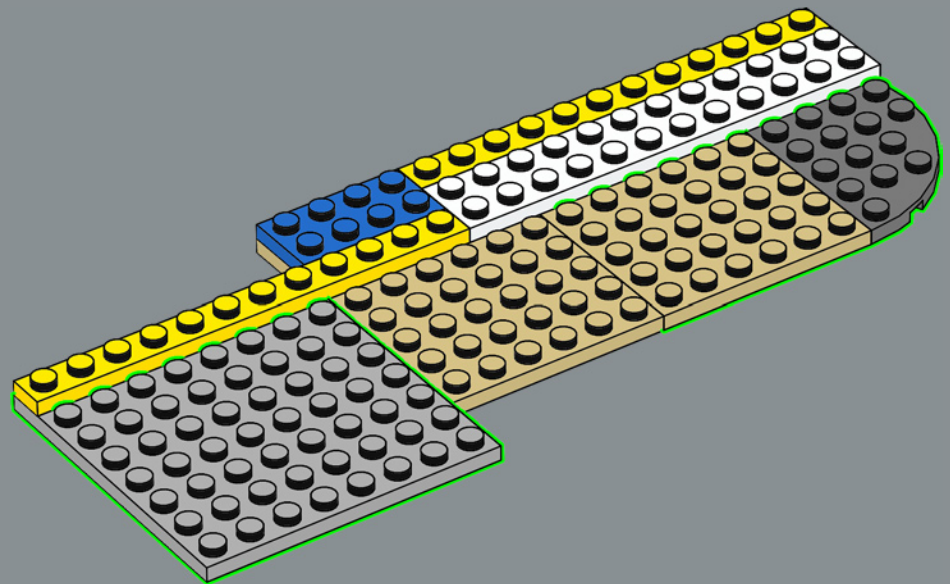

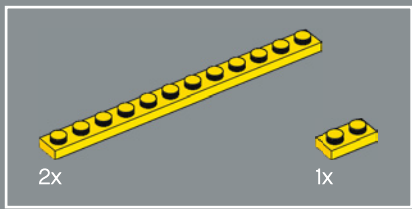

216

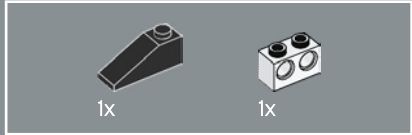
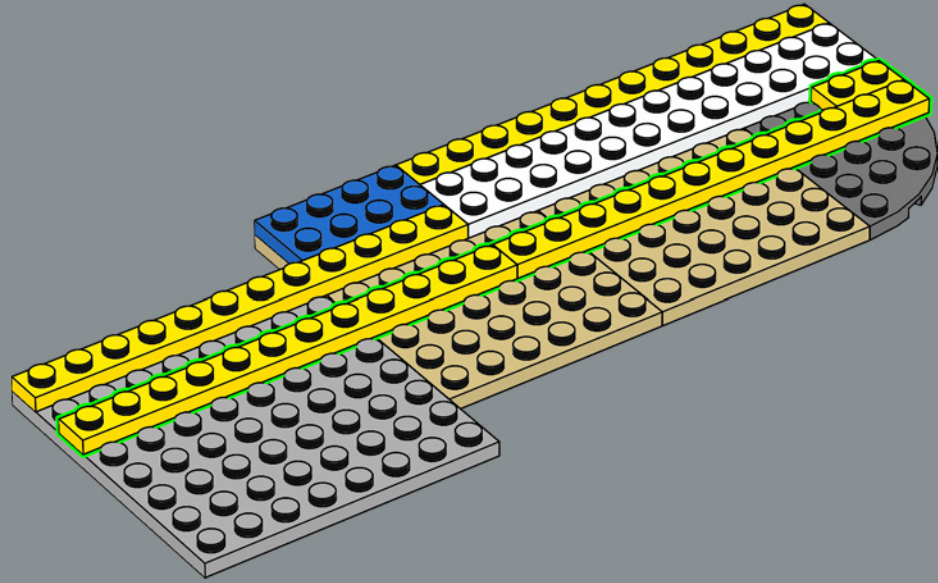

217

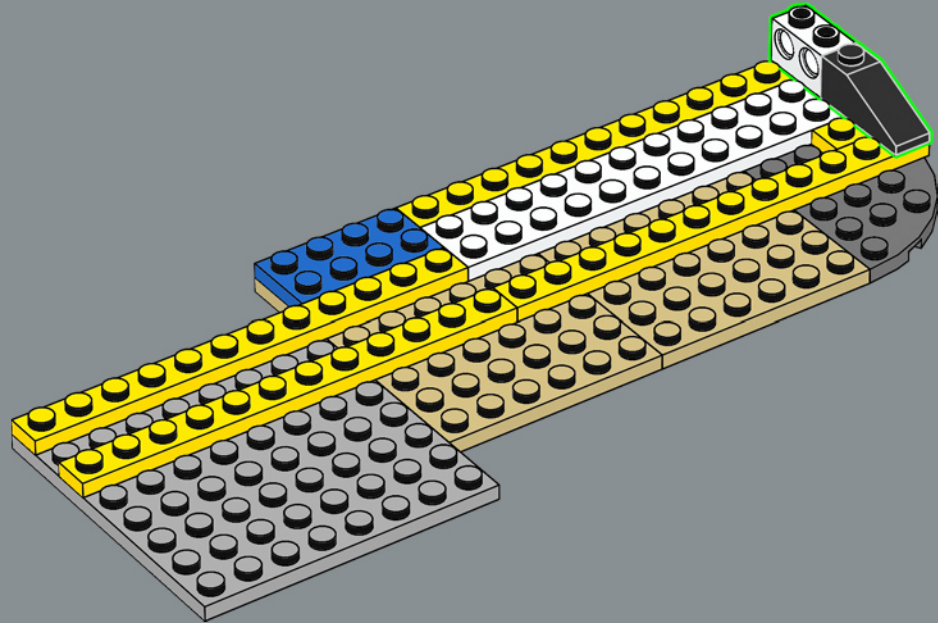

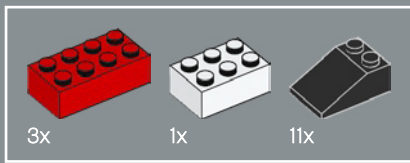

218

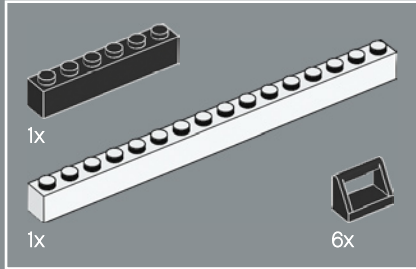
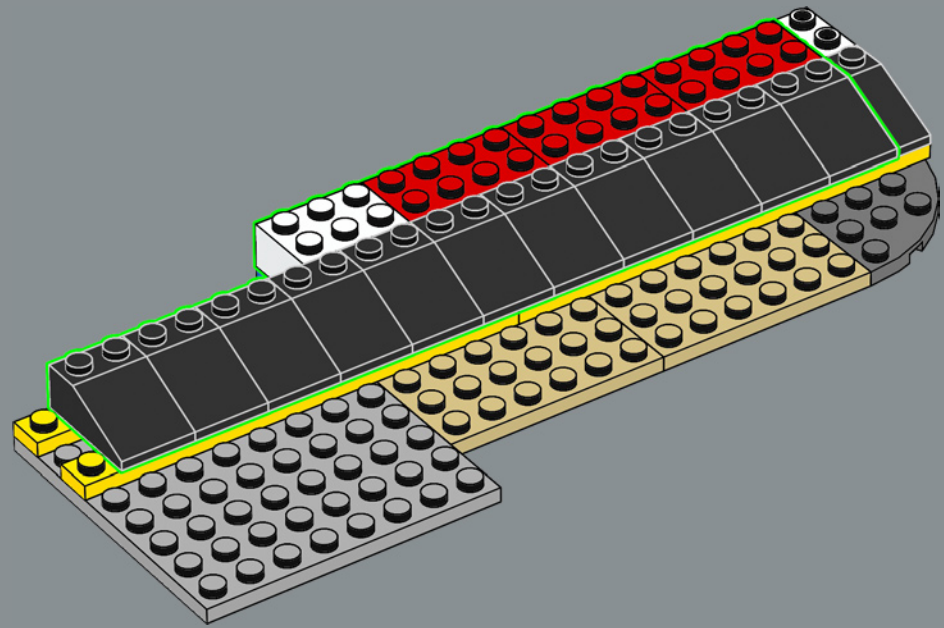

219

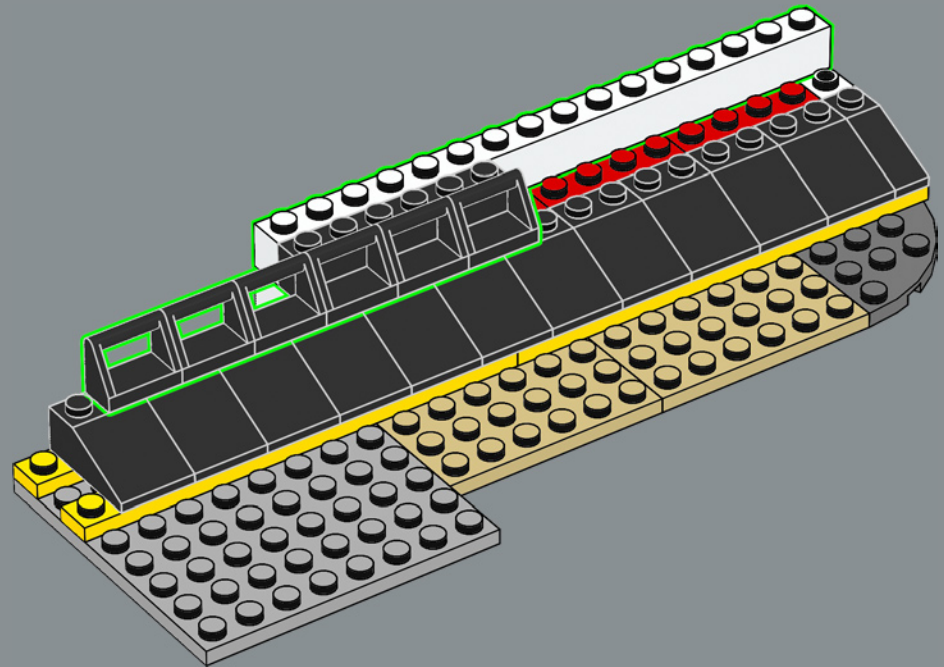

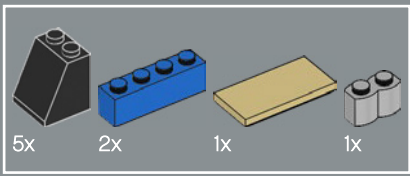

220

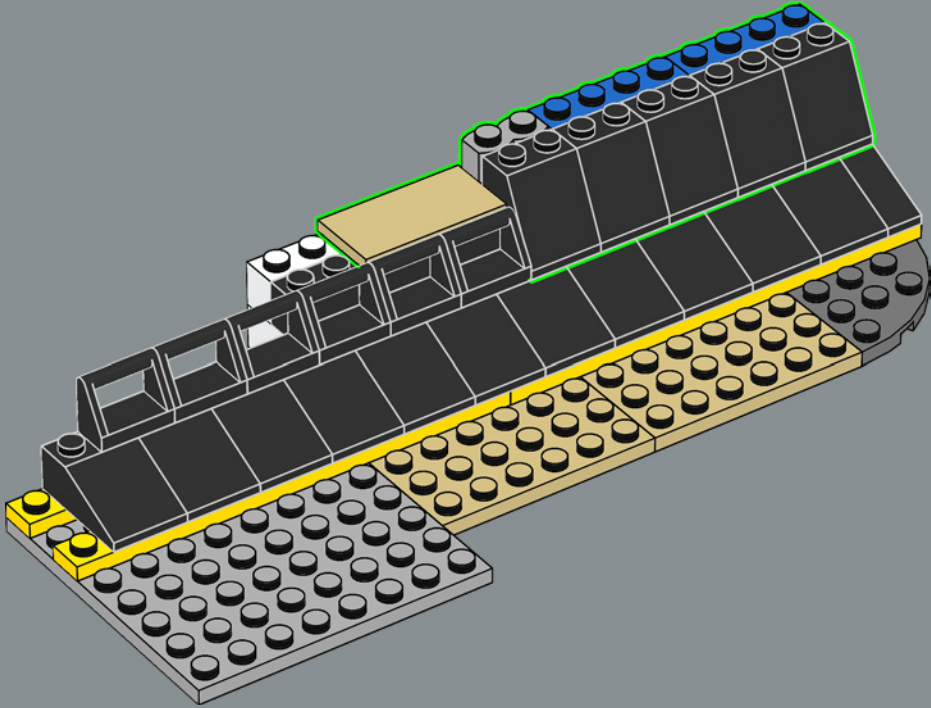

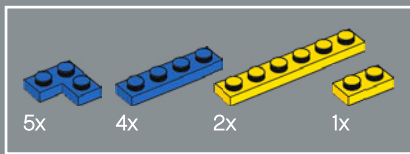

221

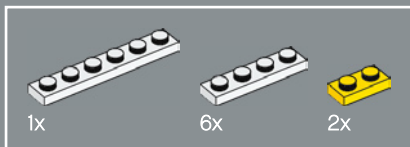
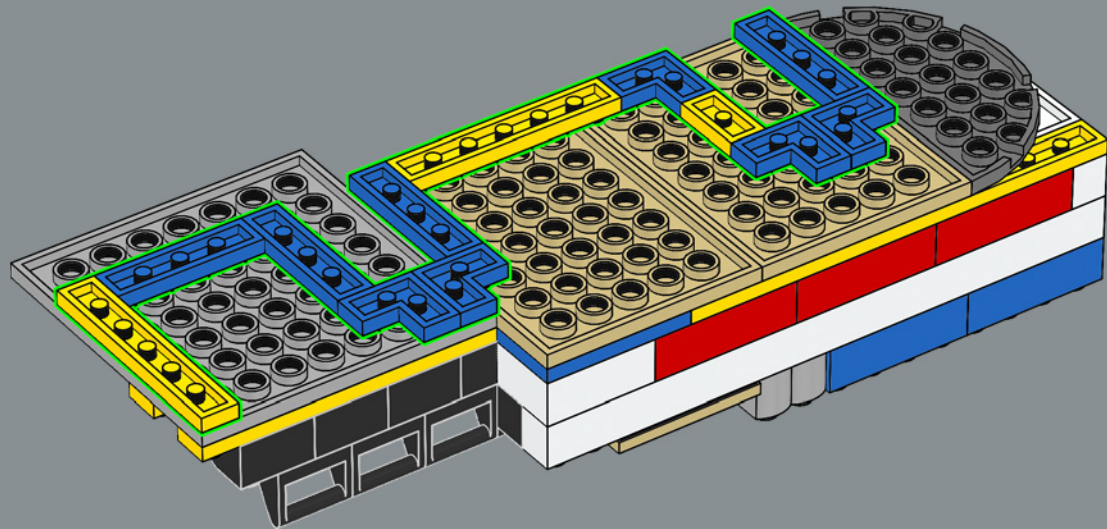

222

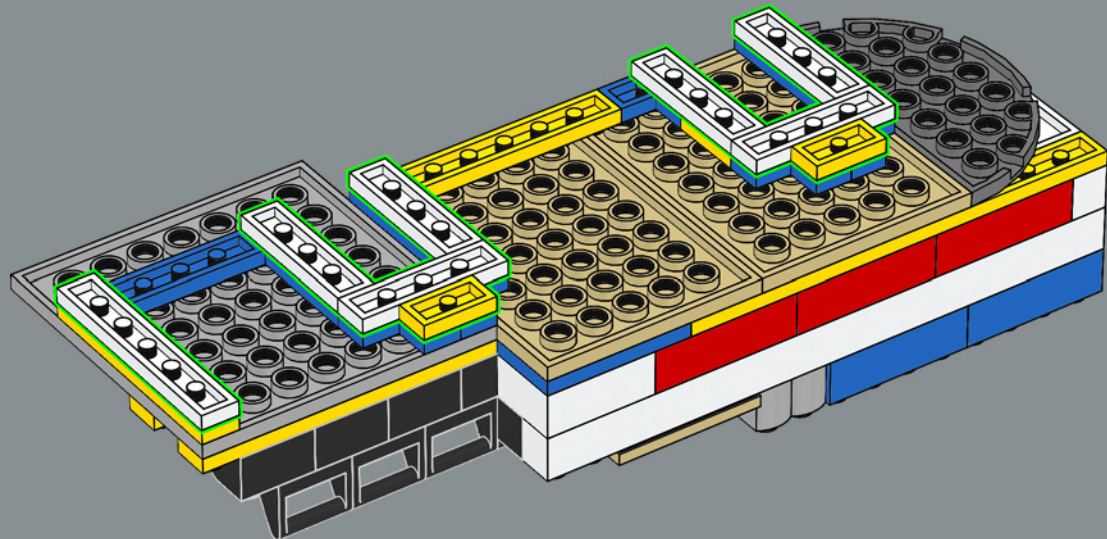

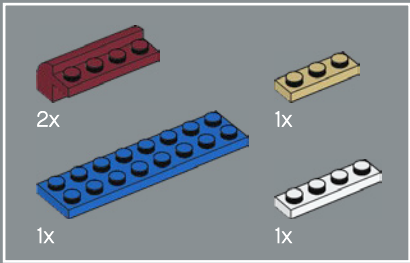

223

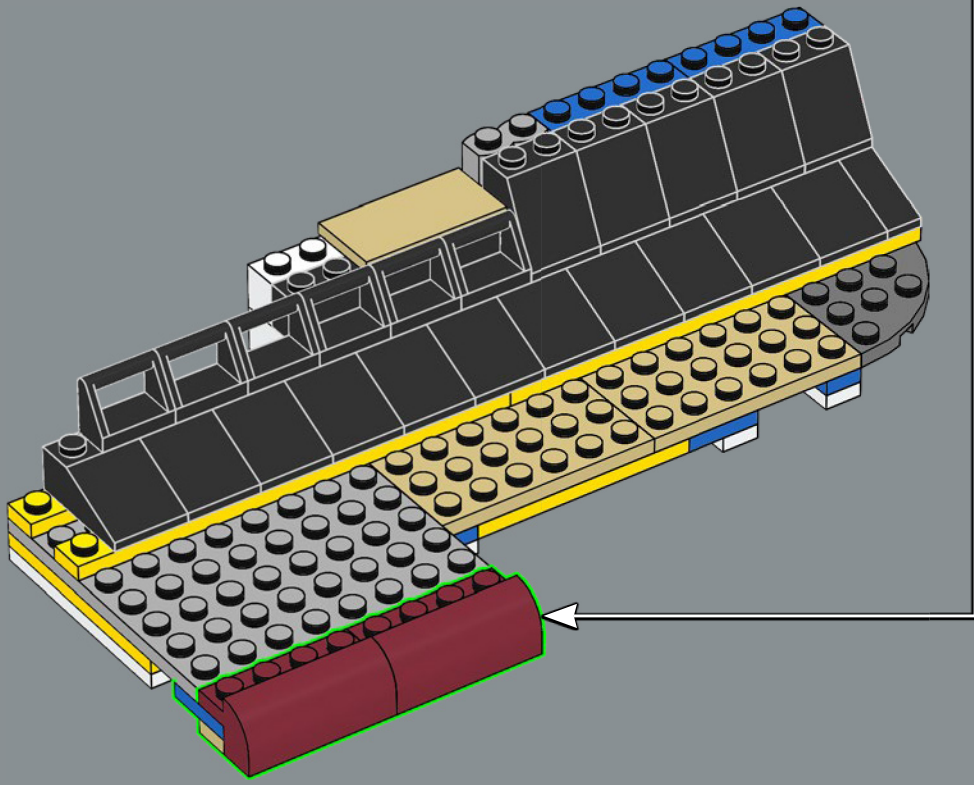
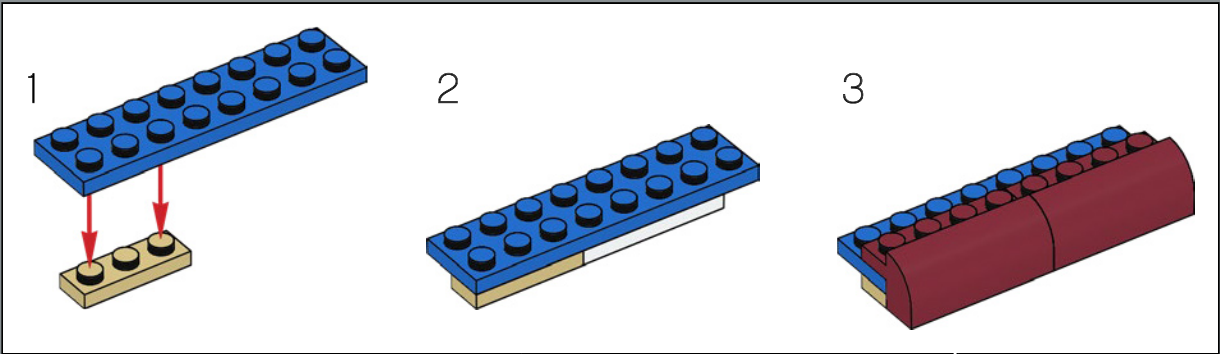





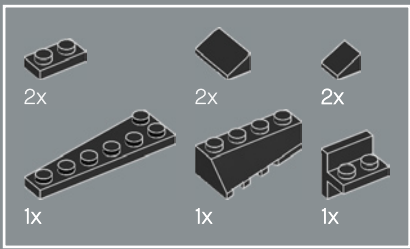

225

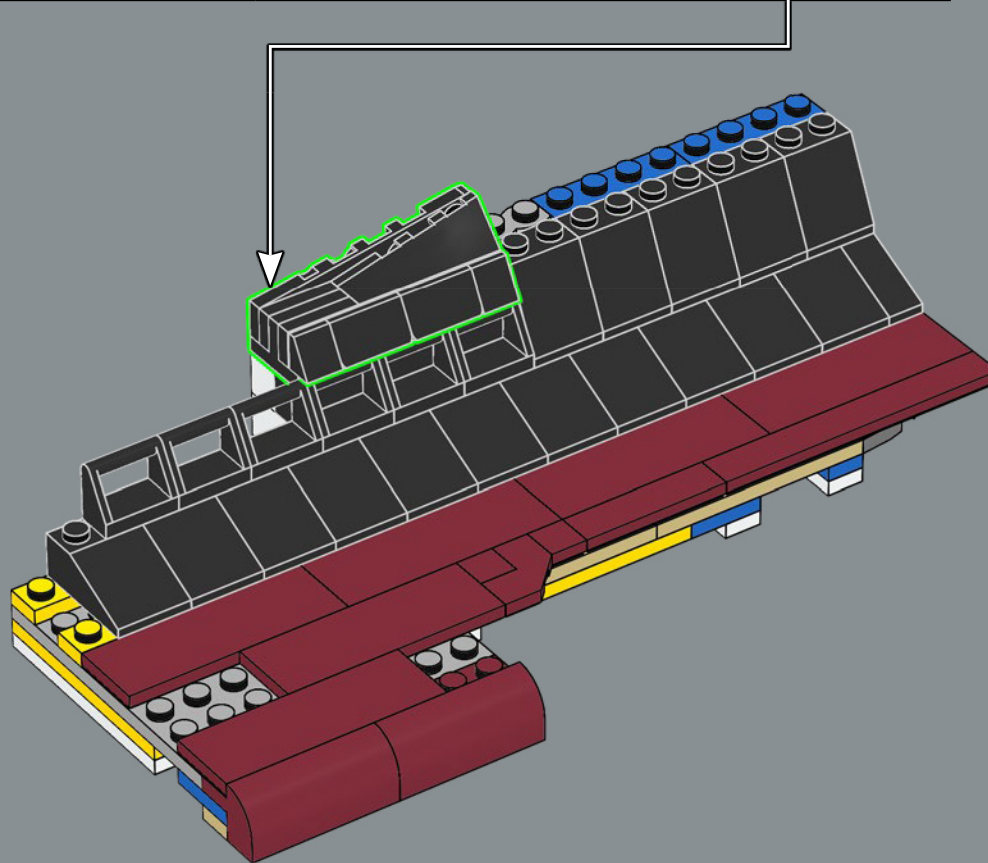
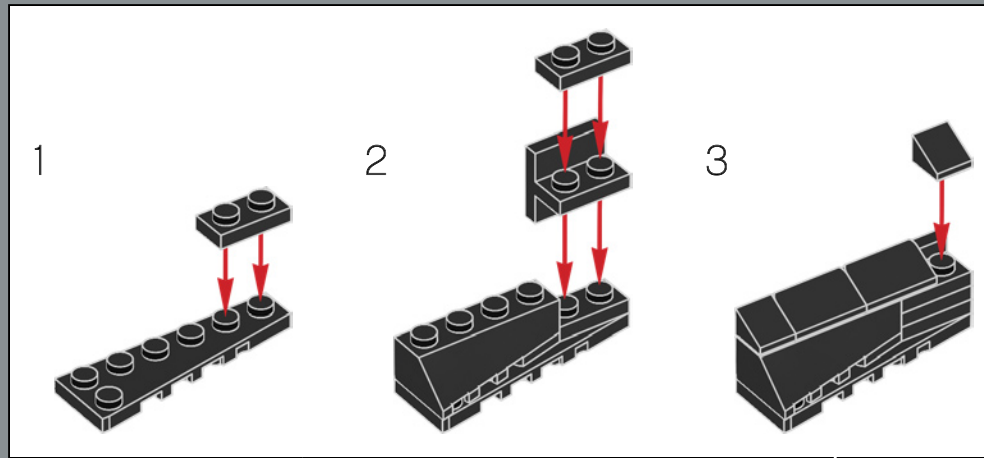

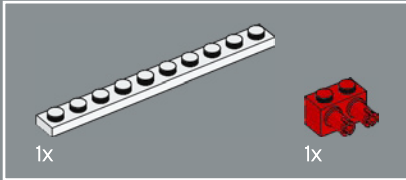
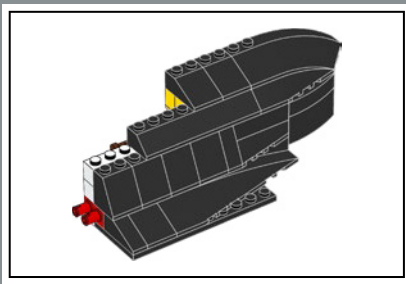

226

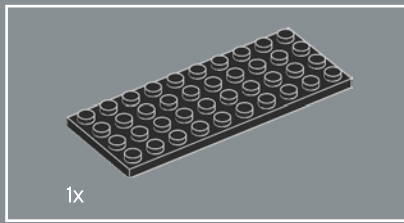
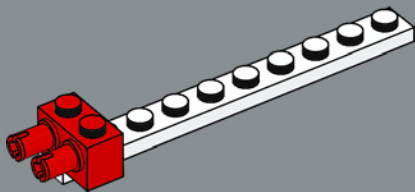

227

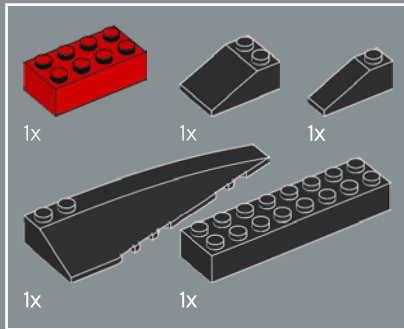
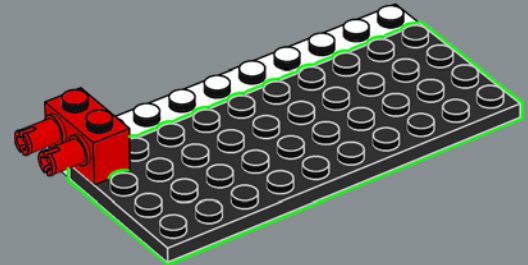

228

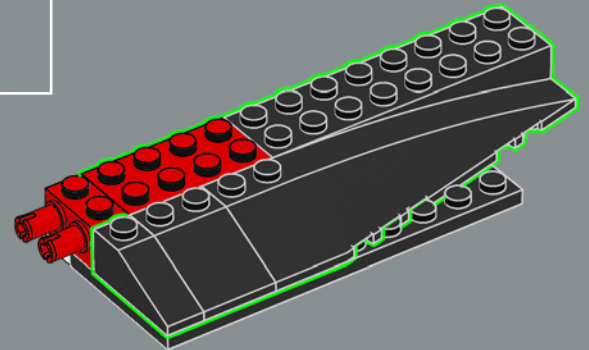

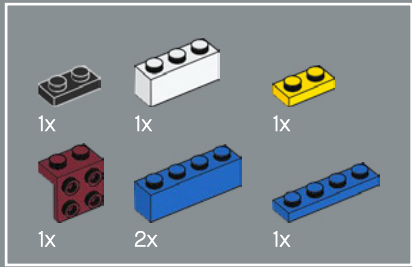

229

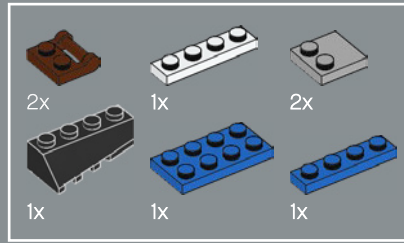
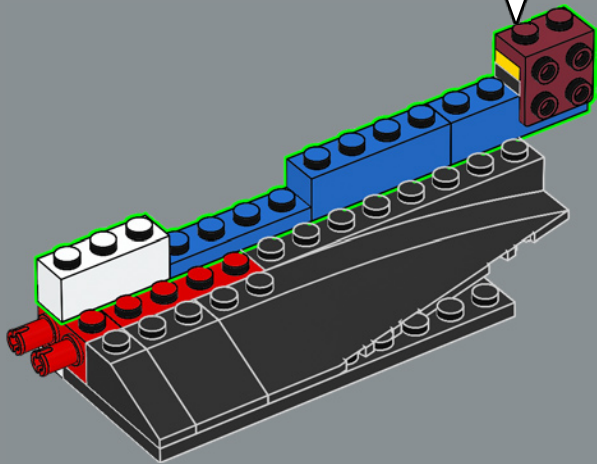
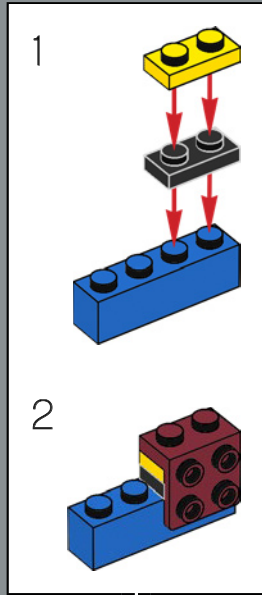

230

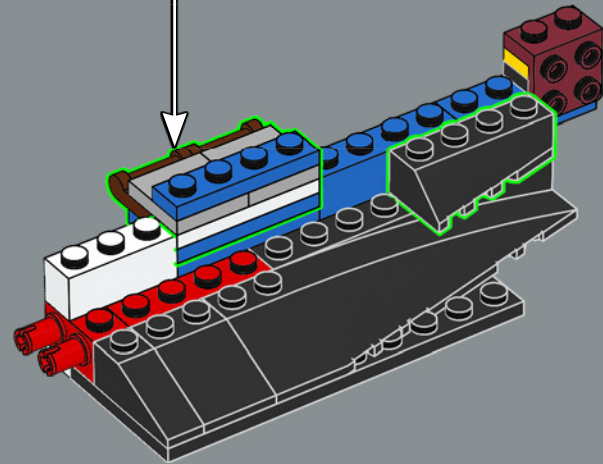
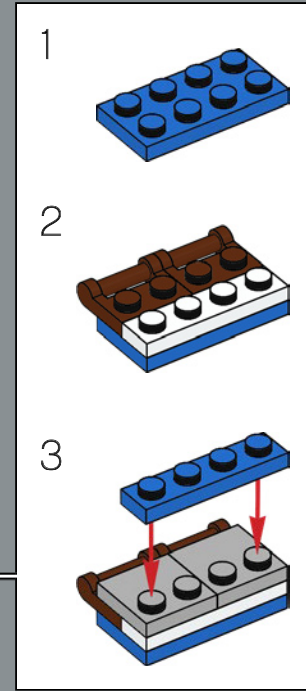

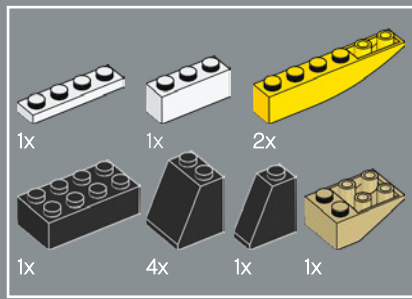

231

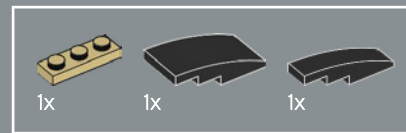
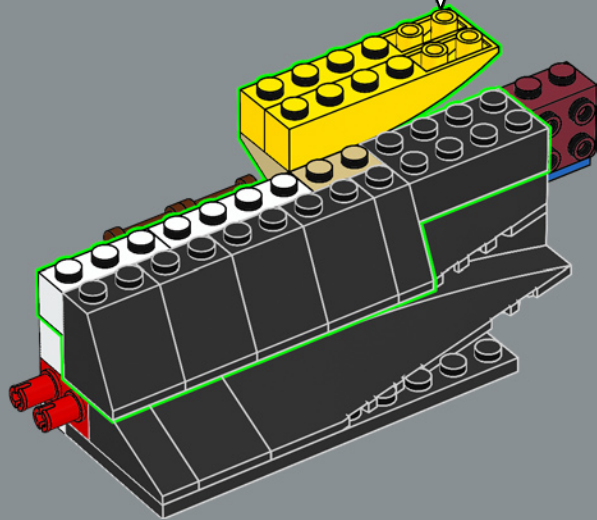
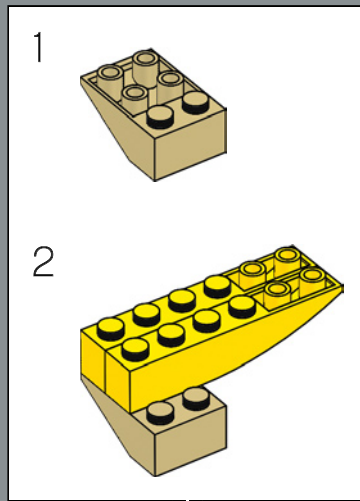

232

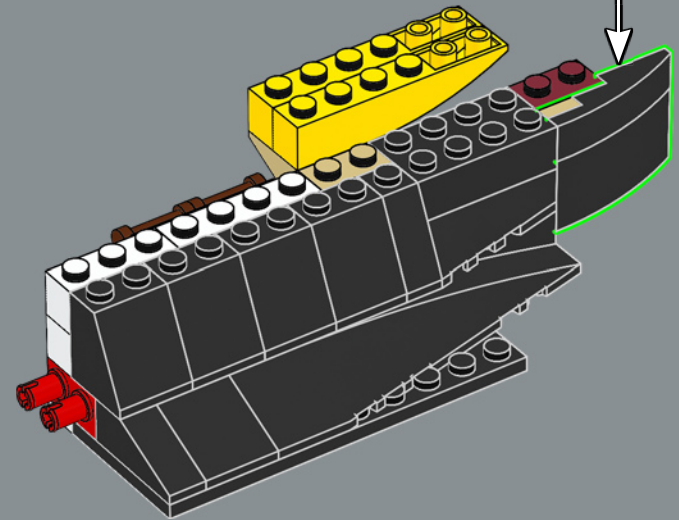
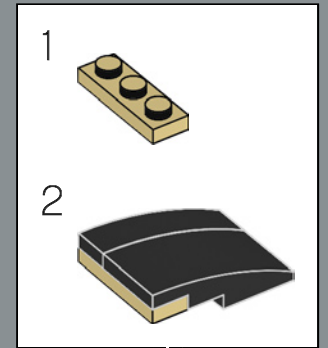

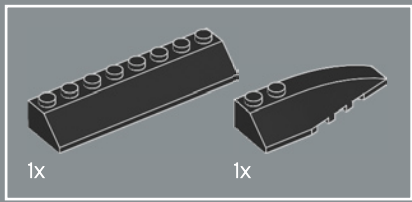

233

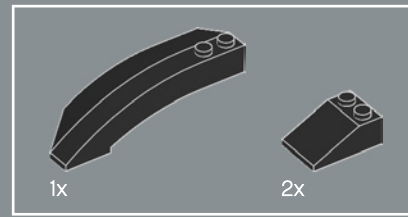
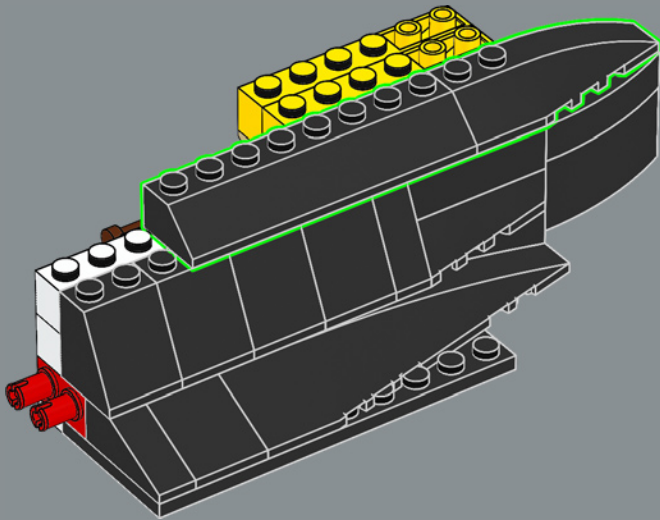

234

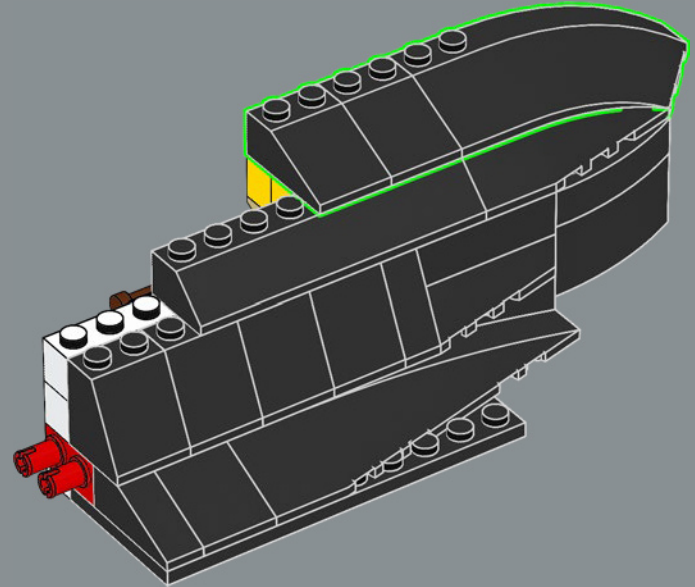

235

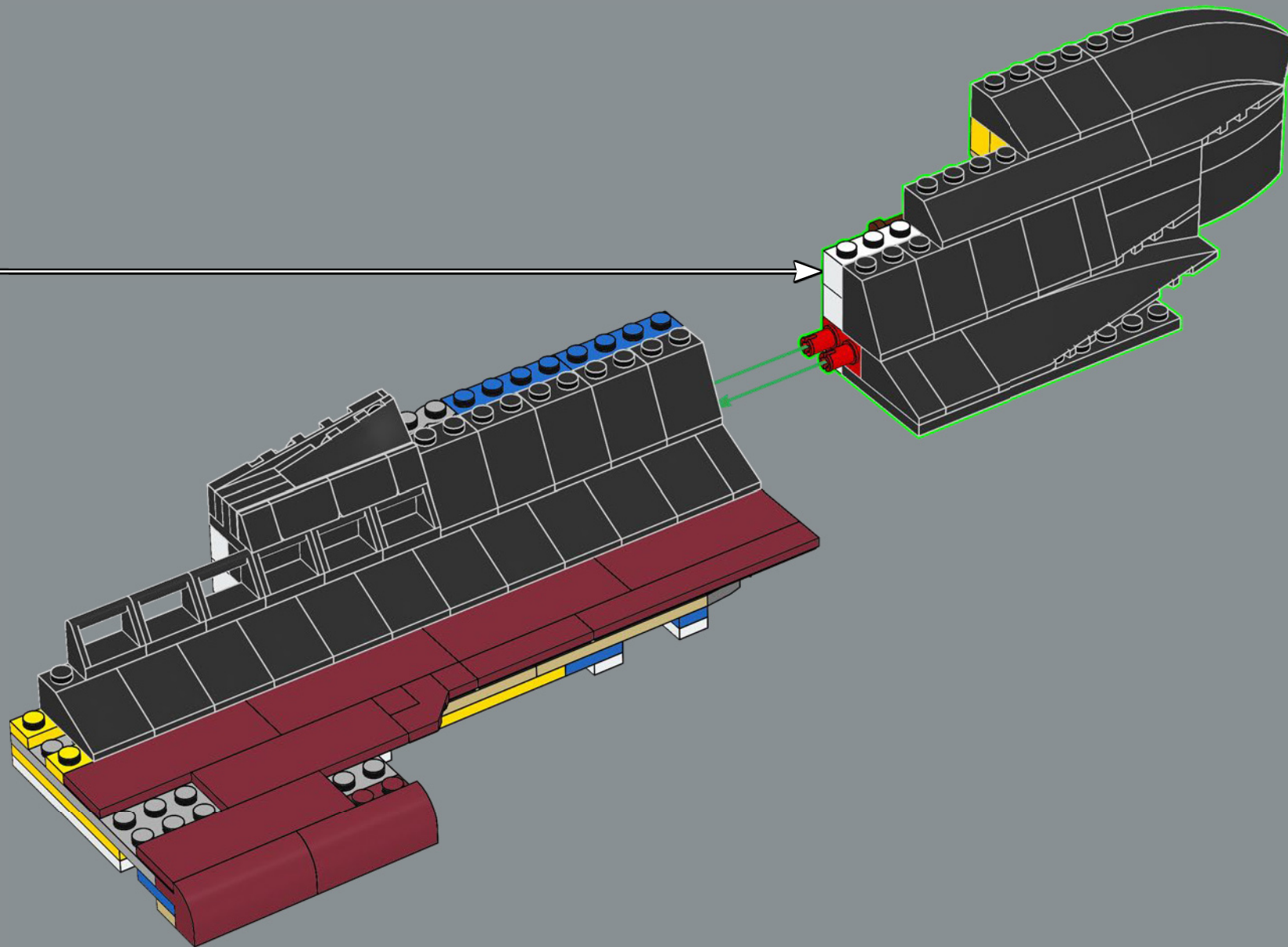





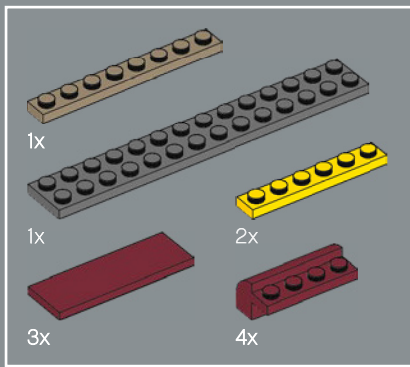

237

1

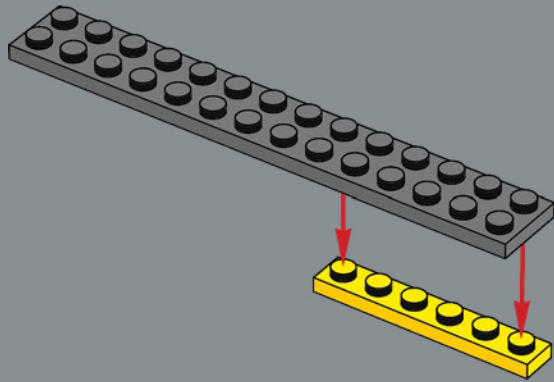

2

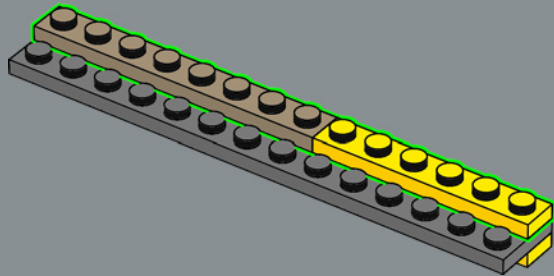

3

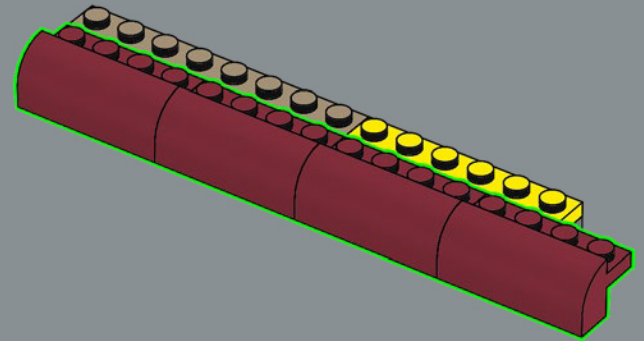

4

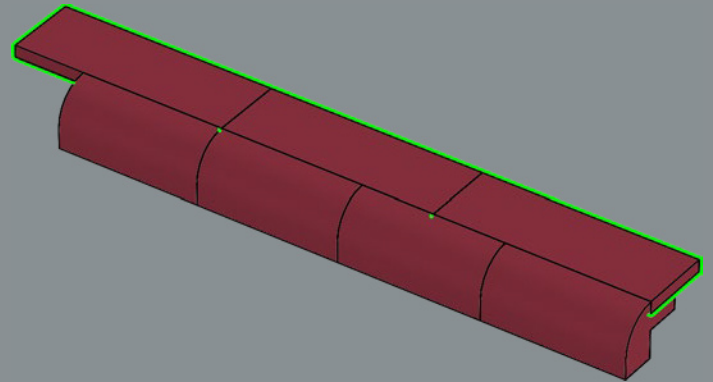

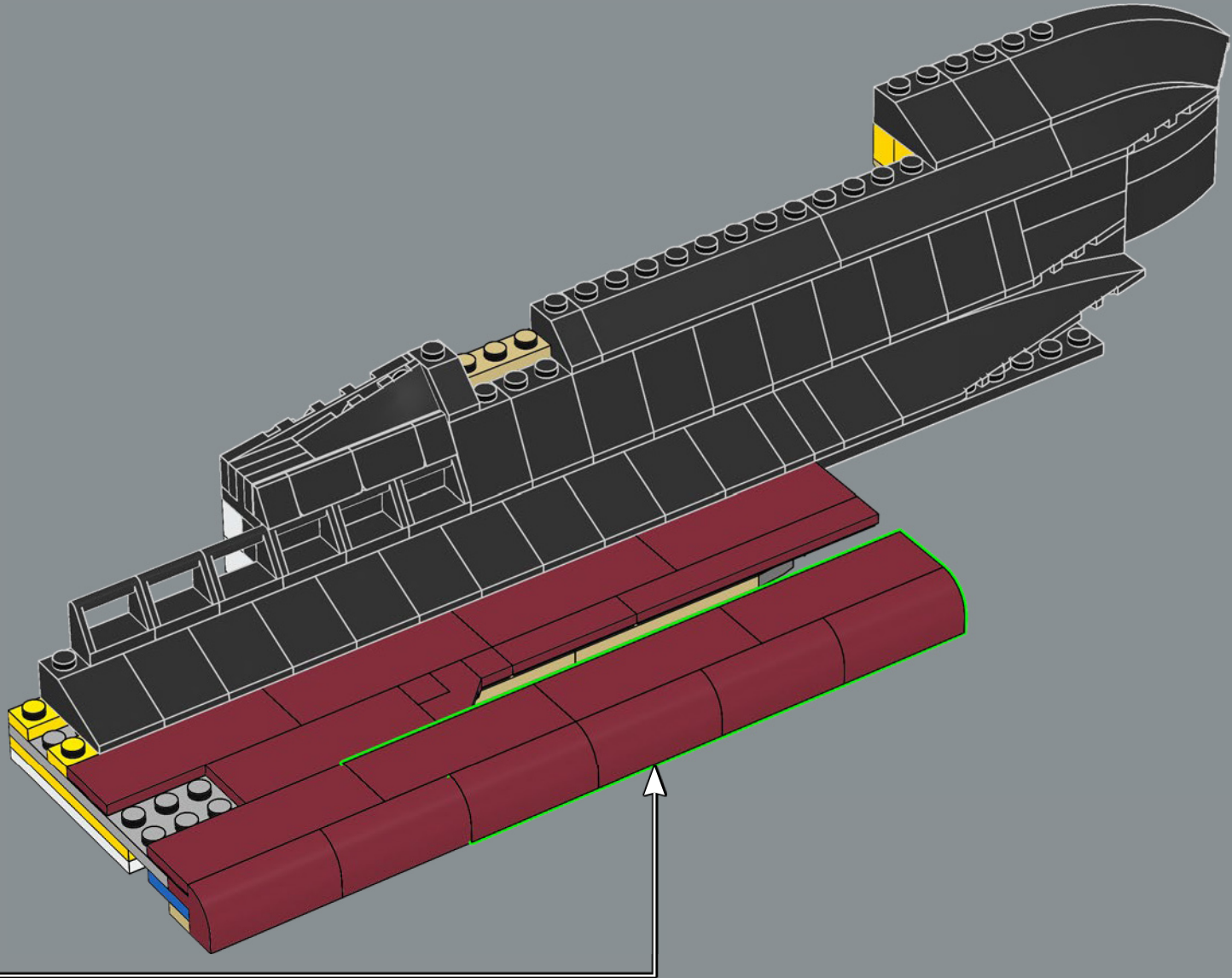

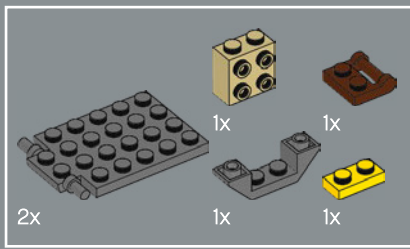

238

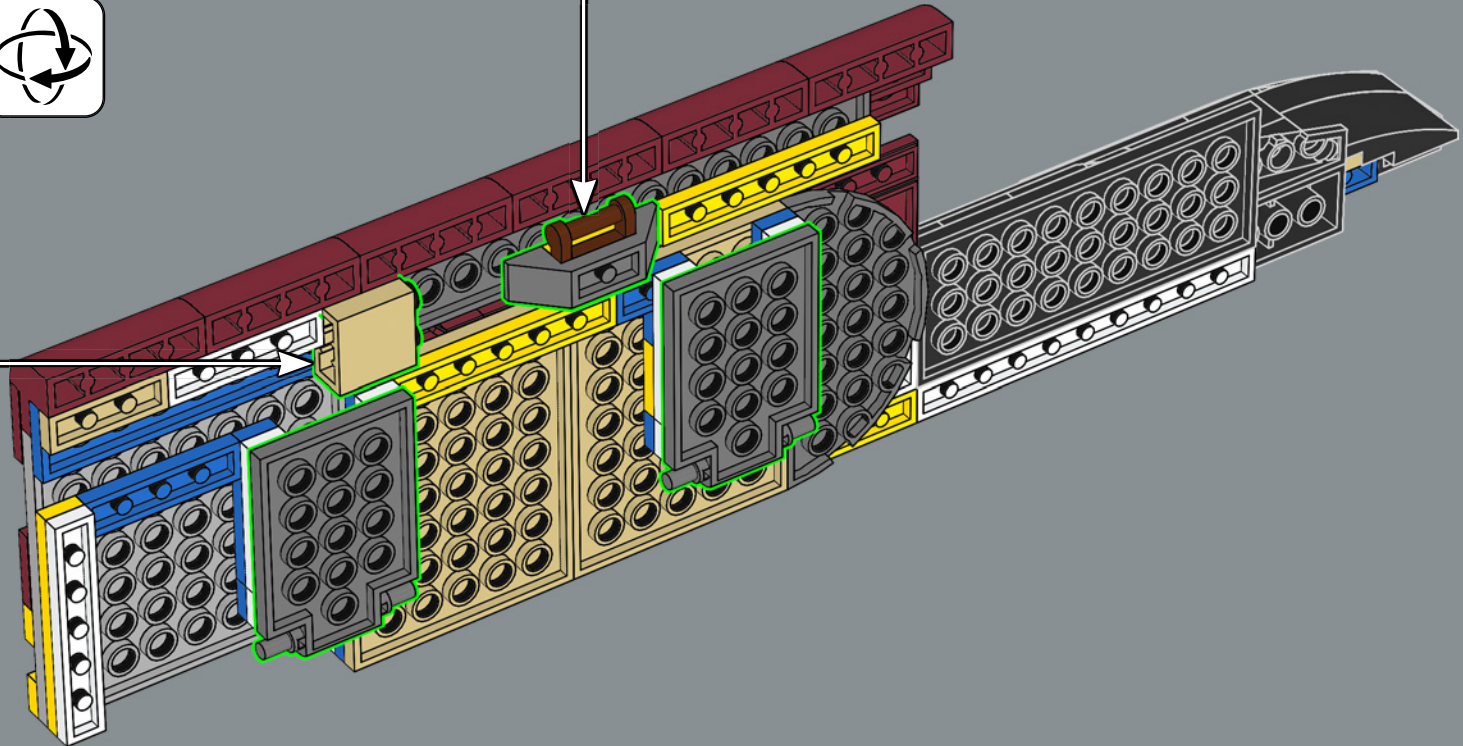
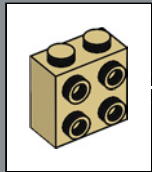
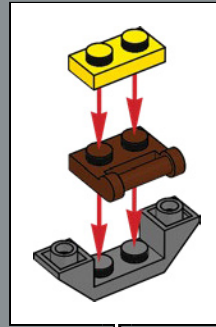

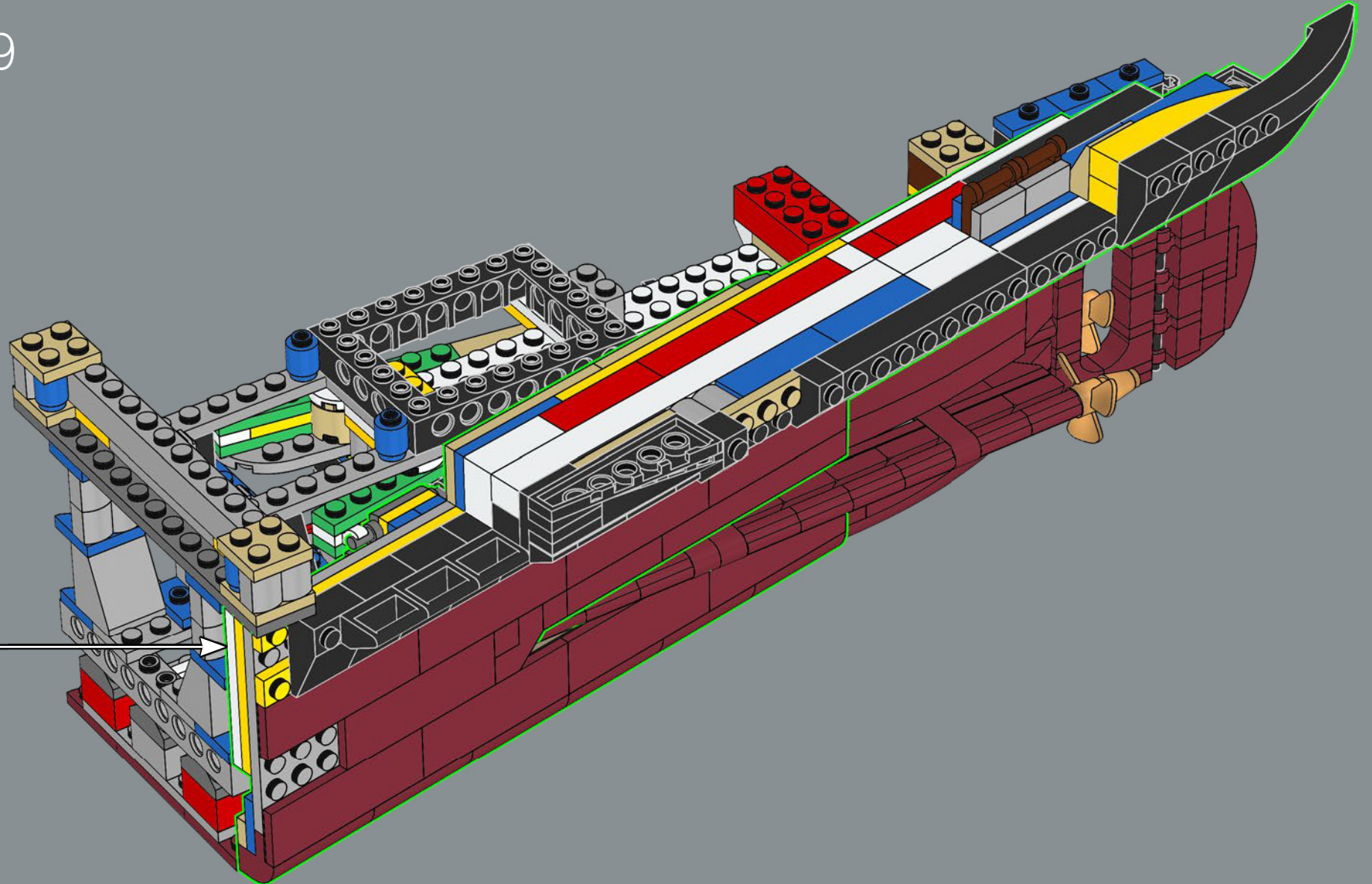

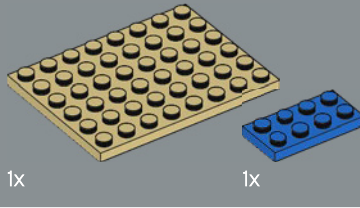
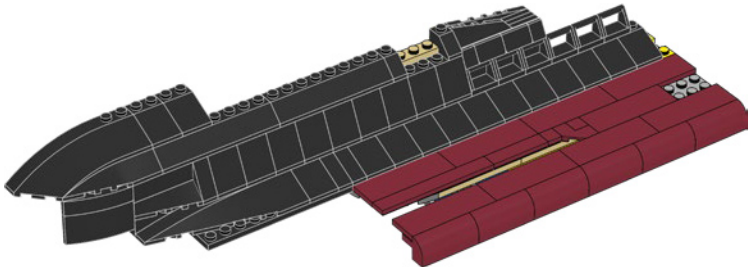
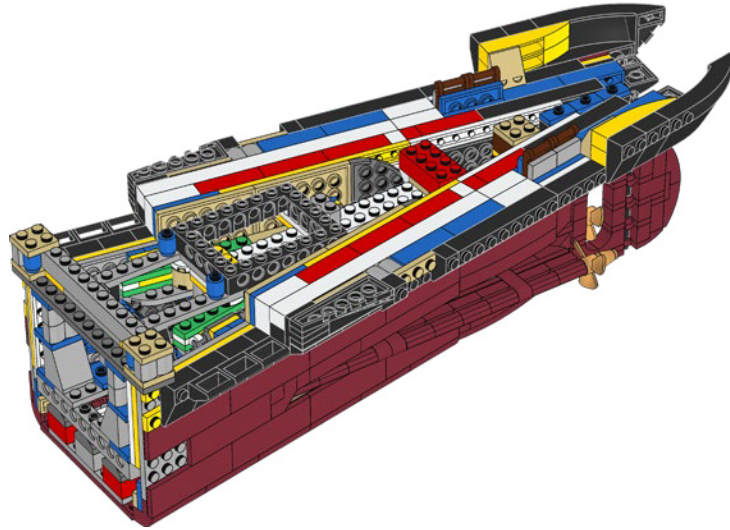
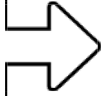

240

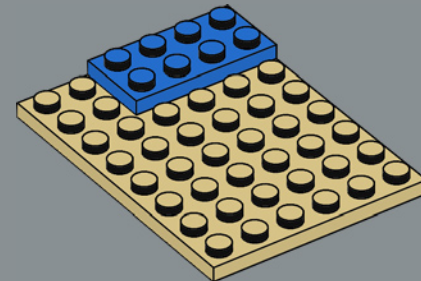

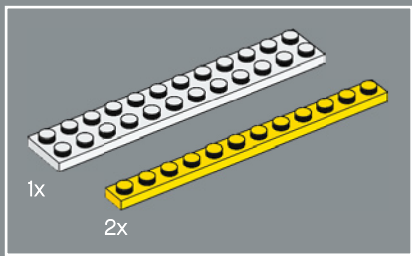

241

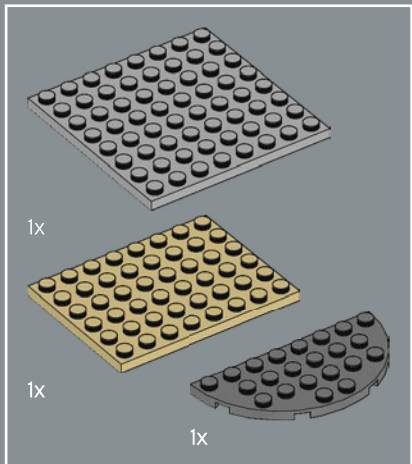
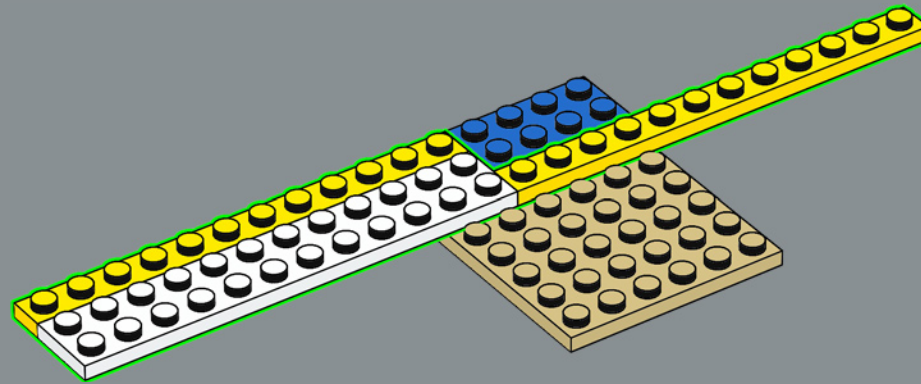

242

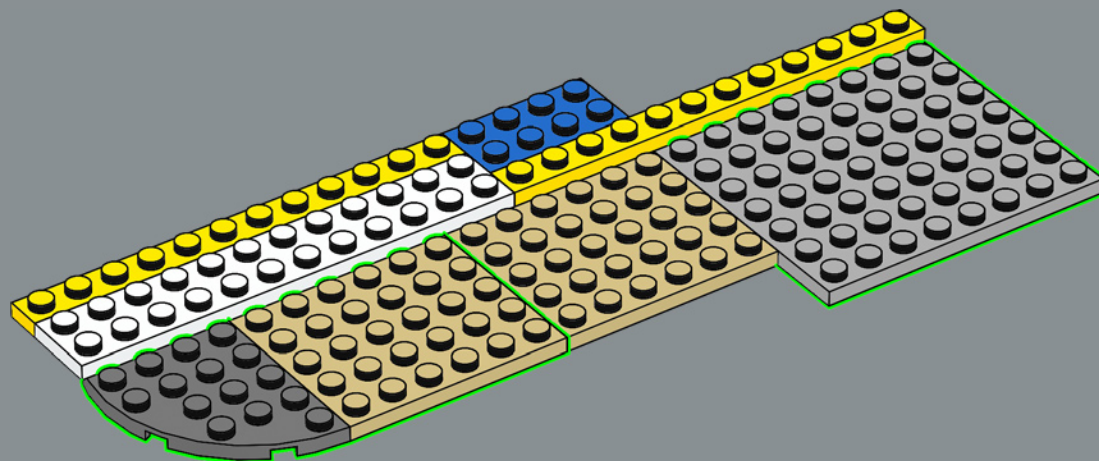

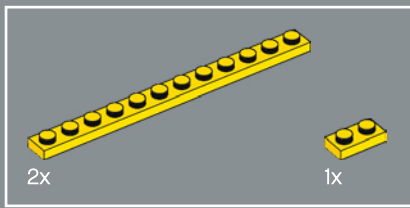

243

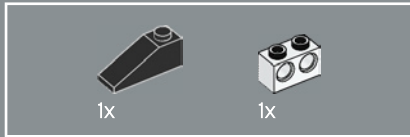
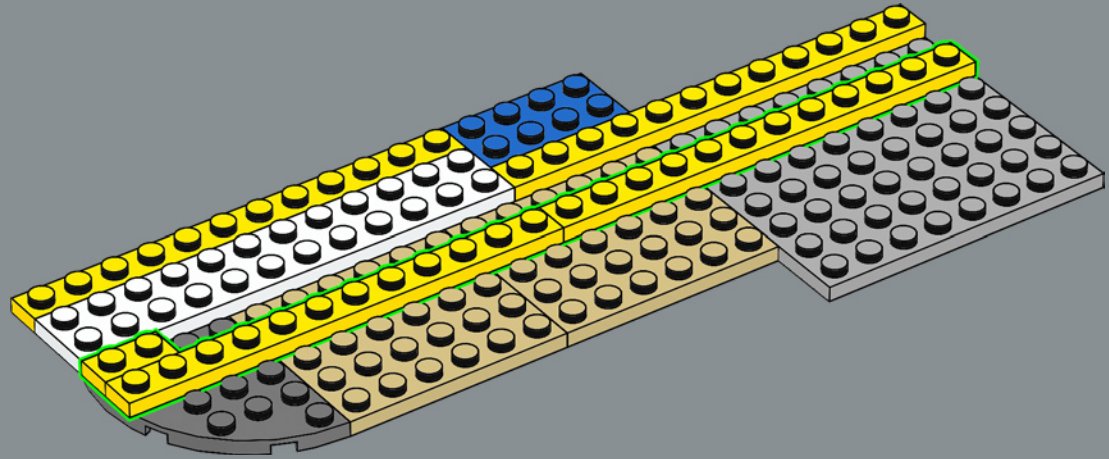

244

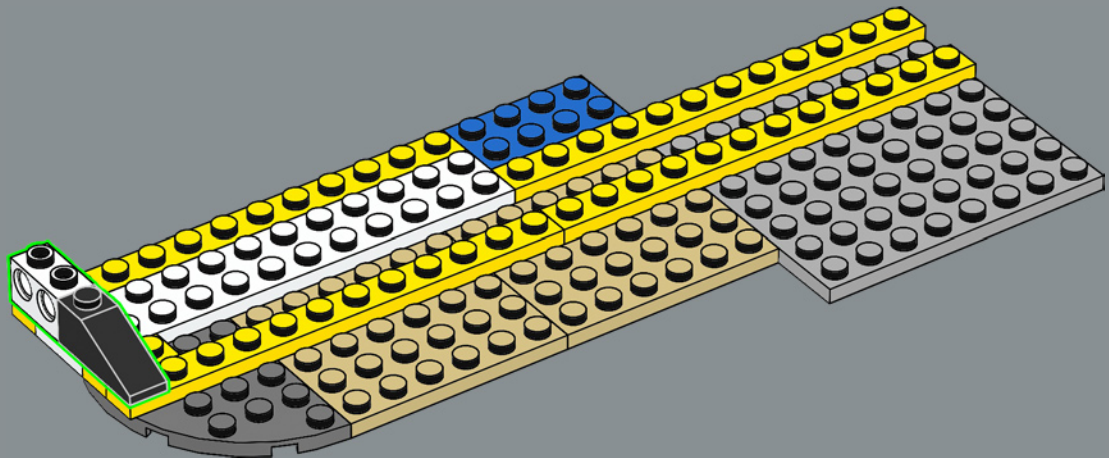

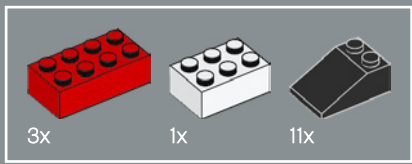

245

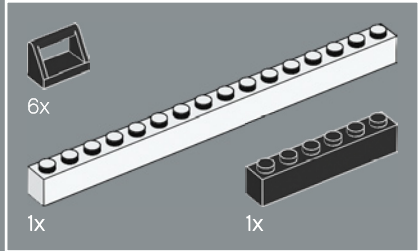
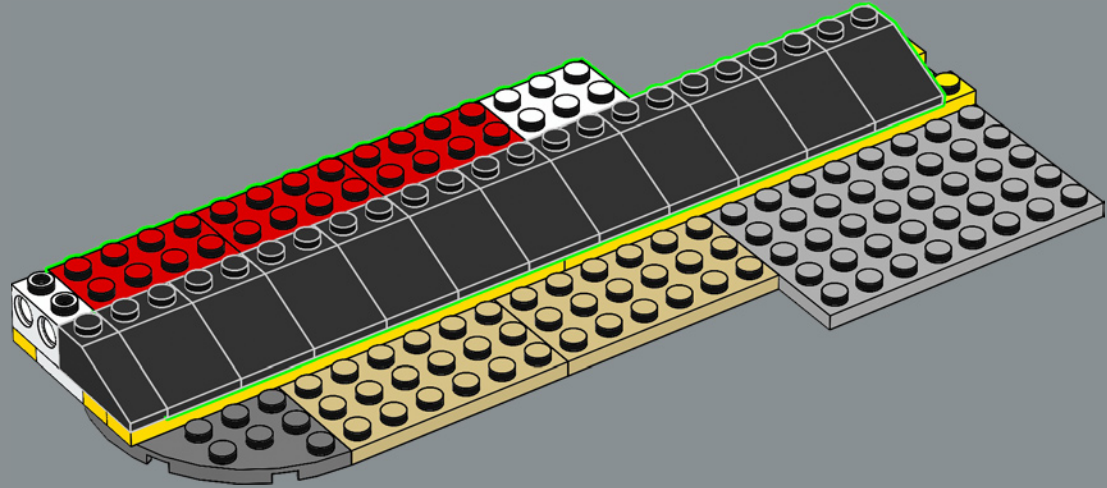

246

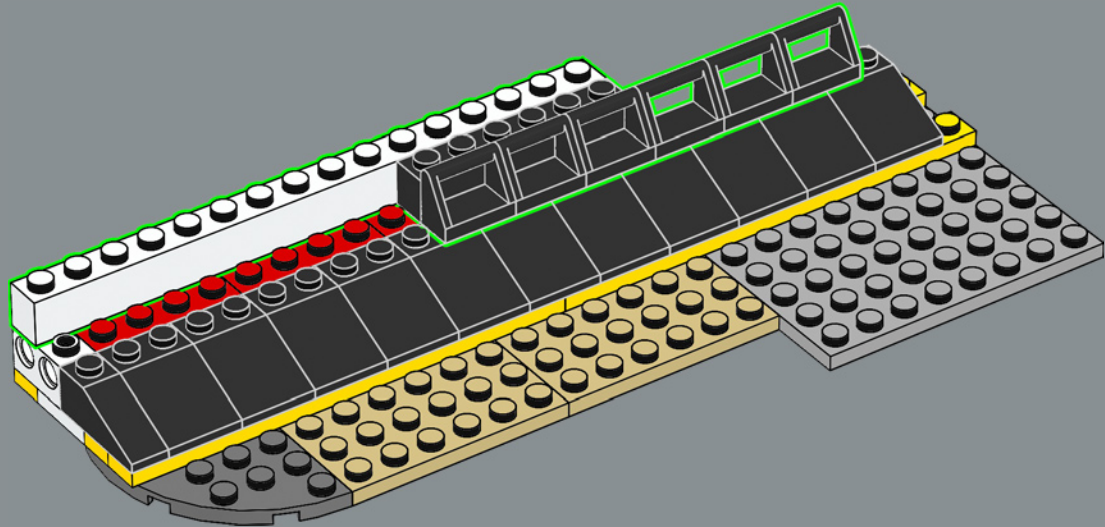



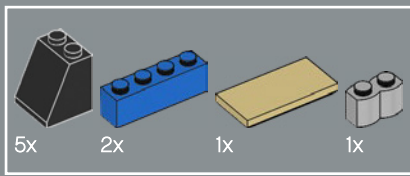

247

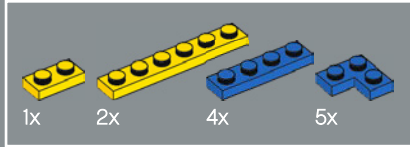
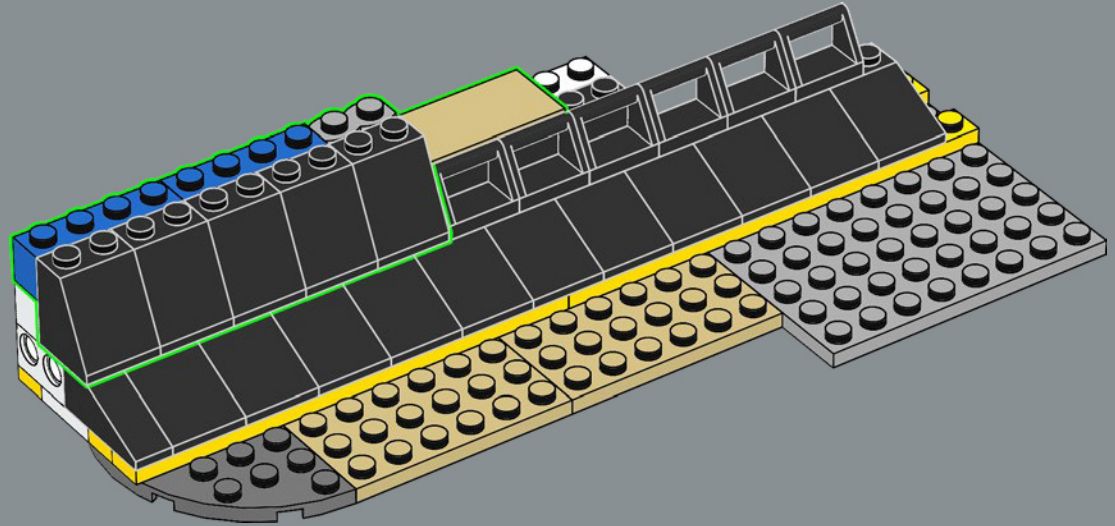

248

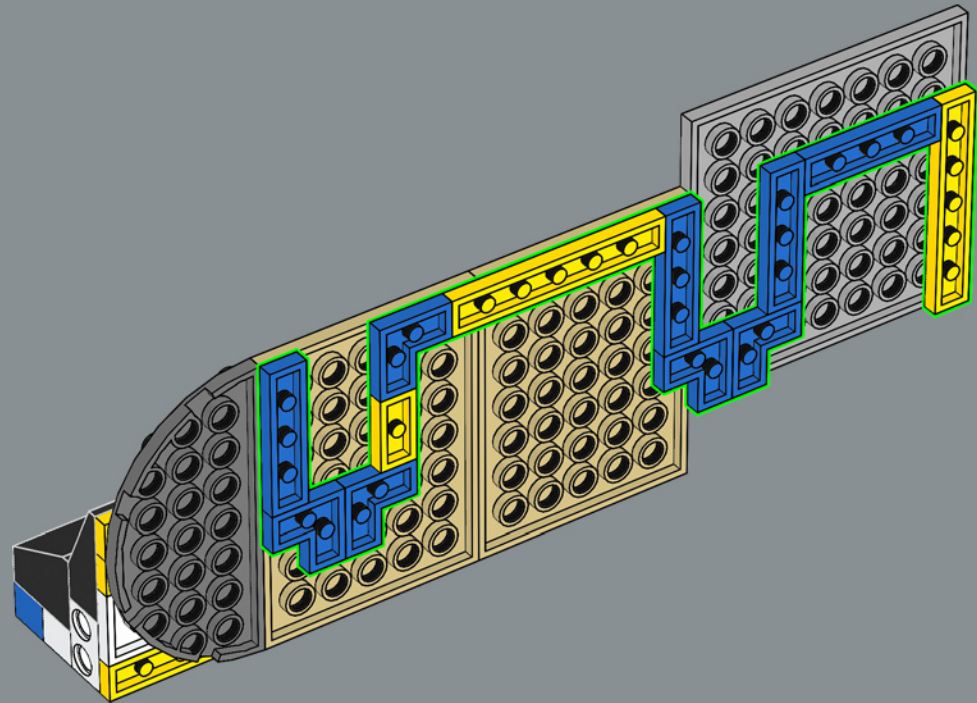

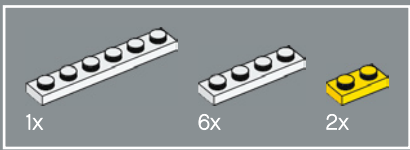

249

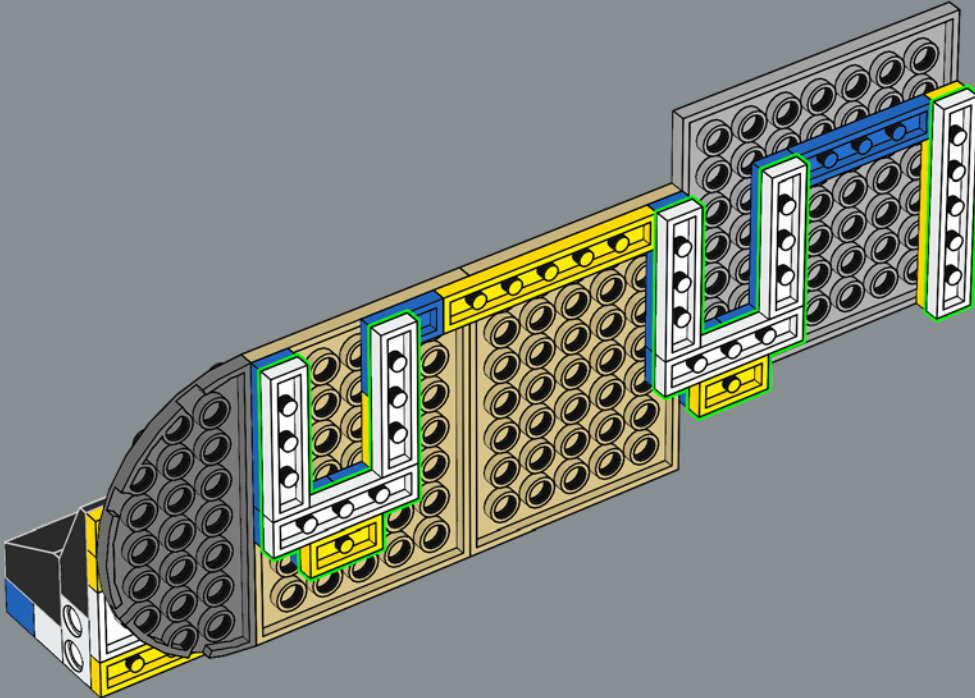

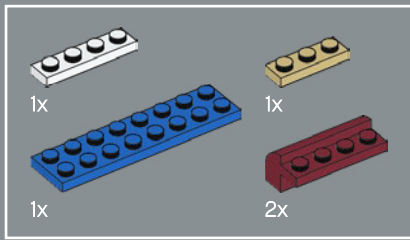

250

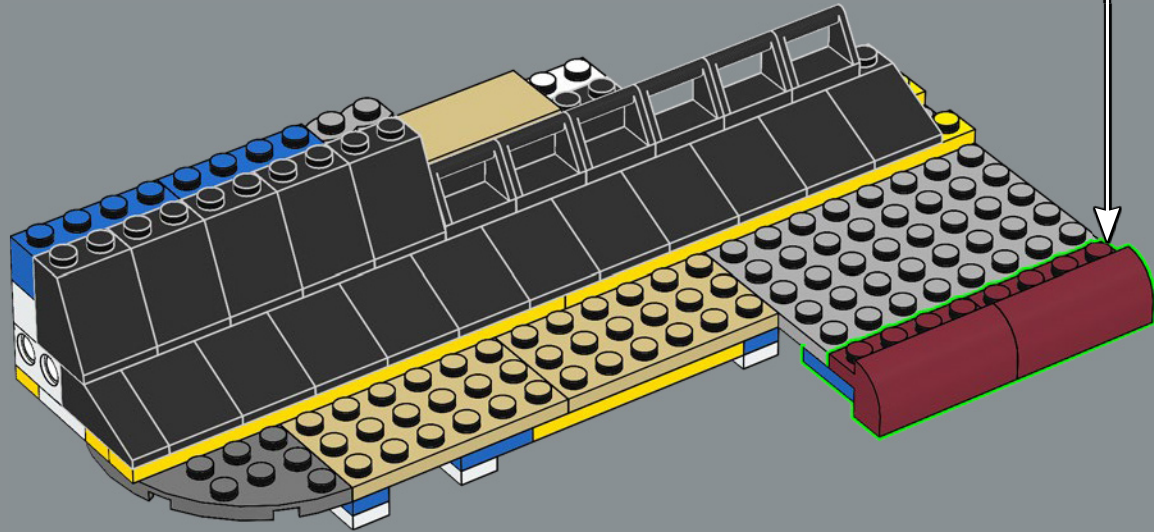
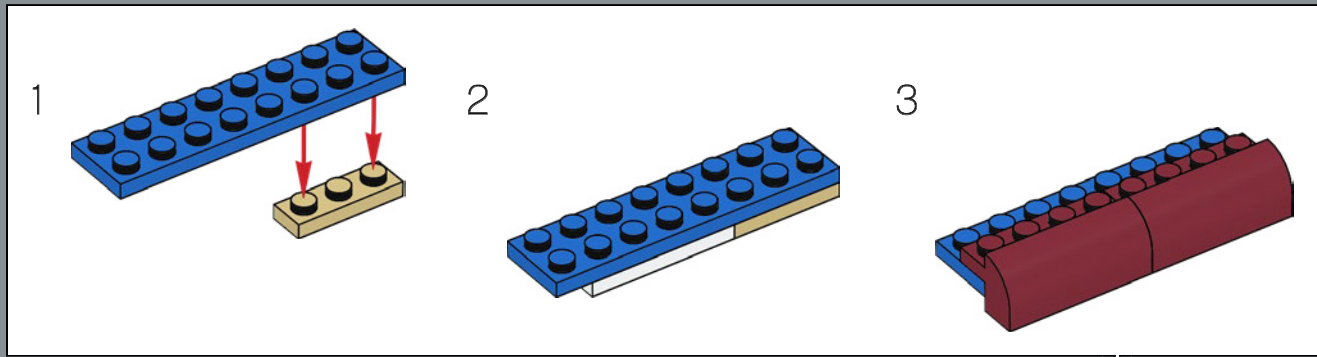

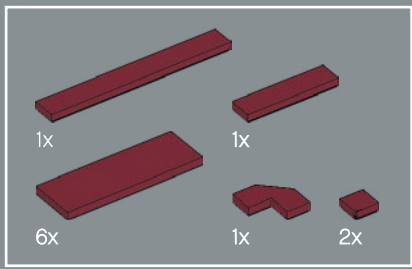

251

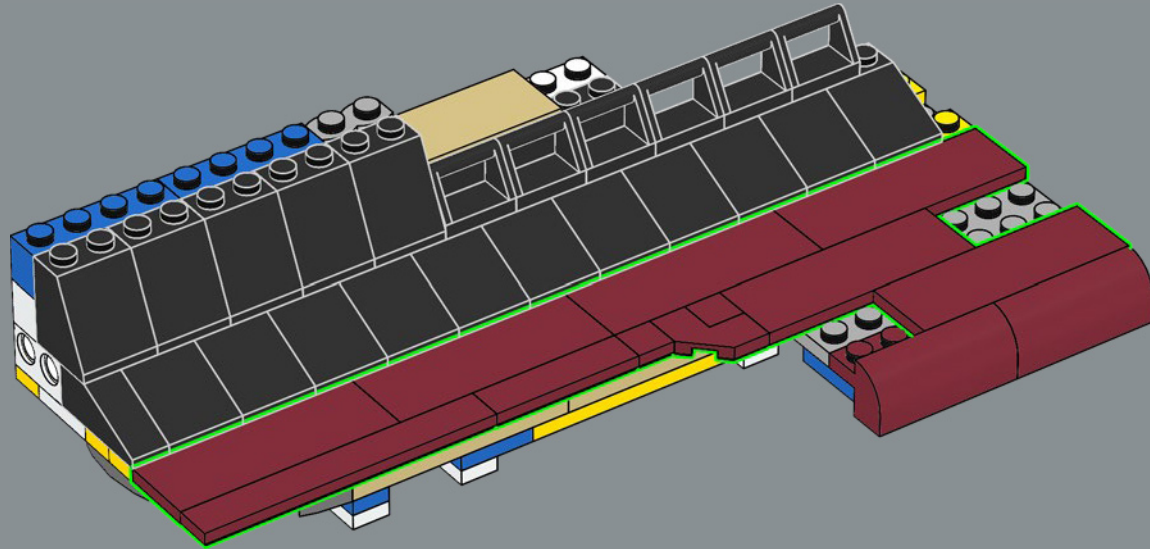

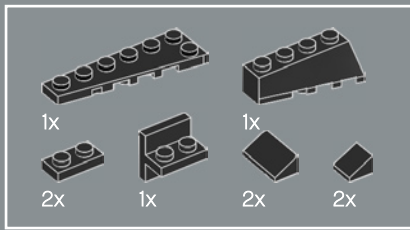

252

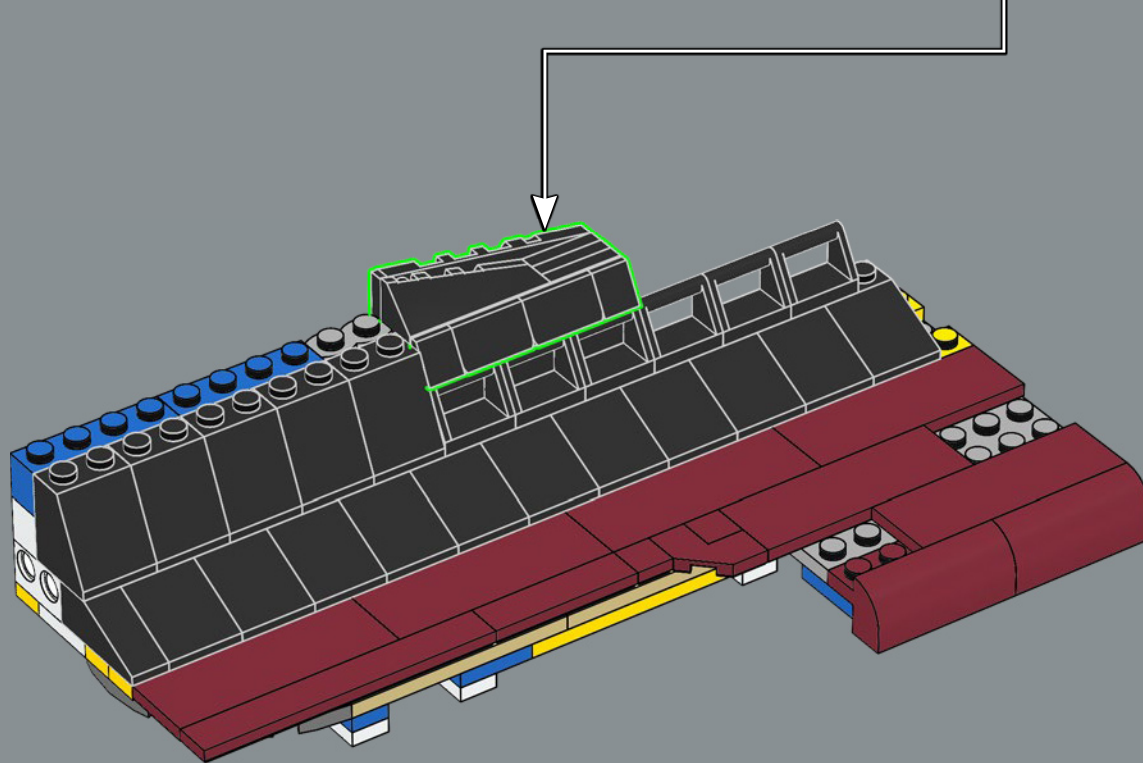
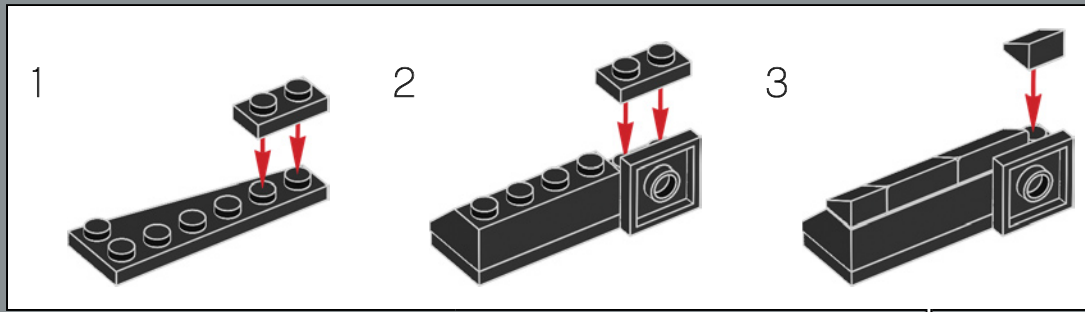

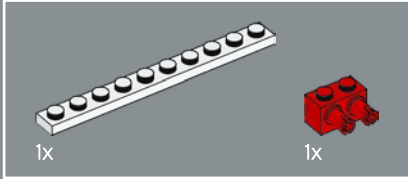
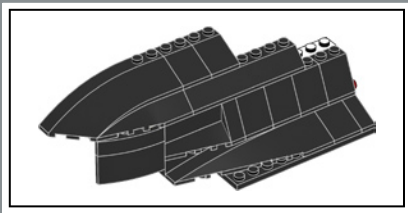

253

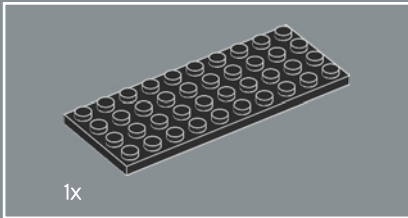
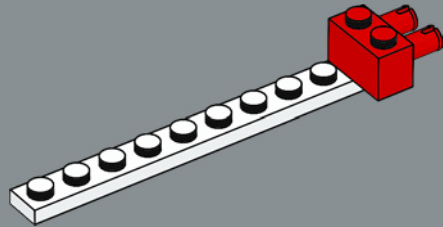

254

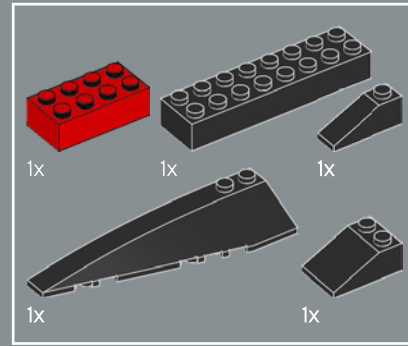
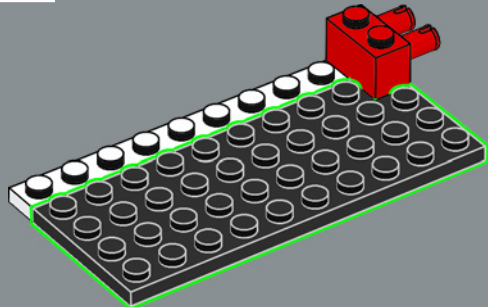

255

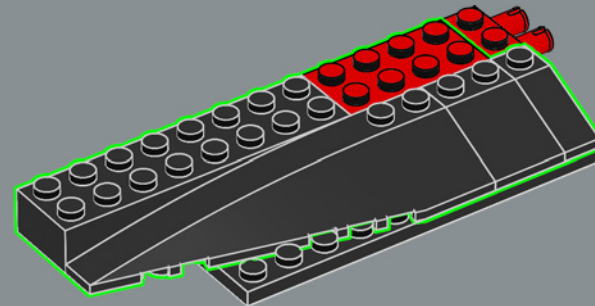

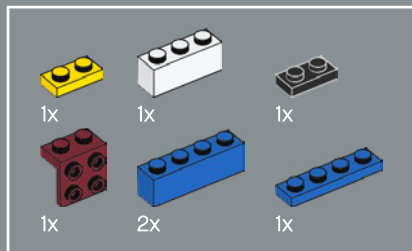

256

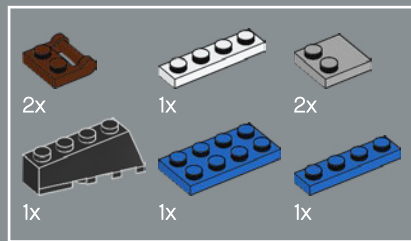
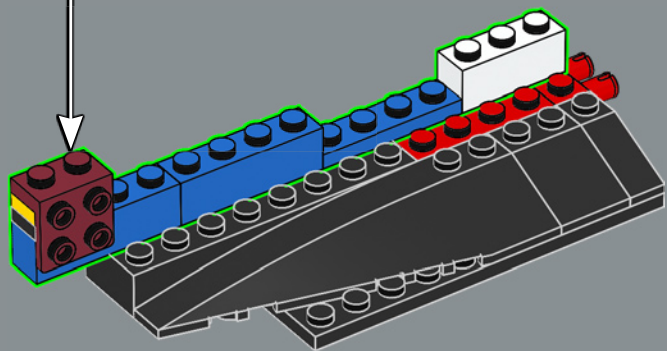
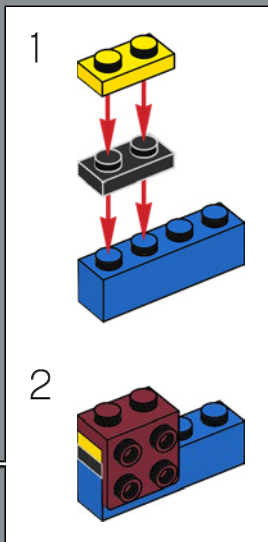

257

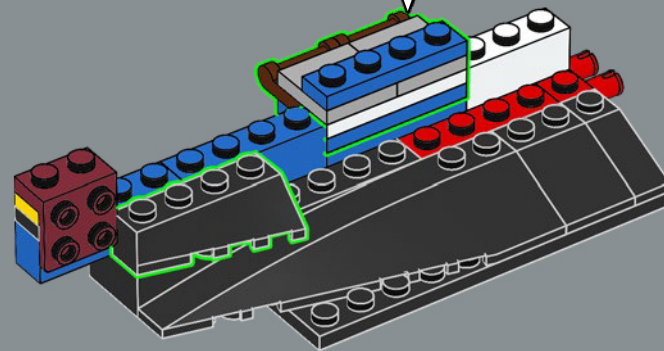
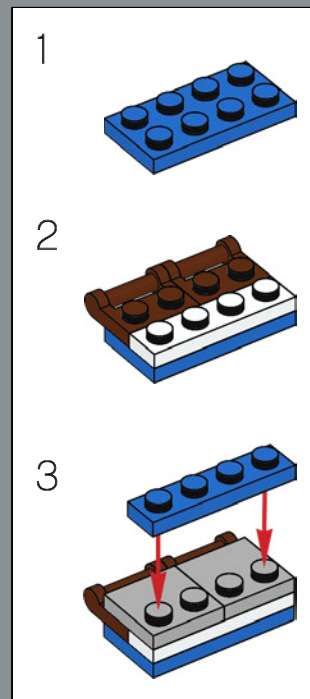

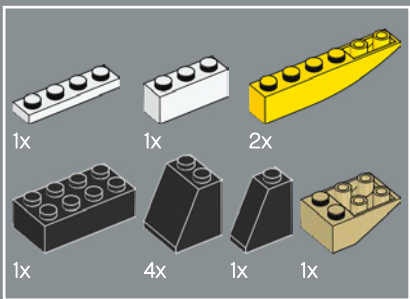

258

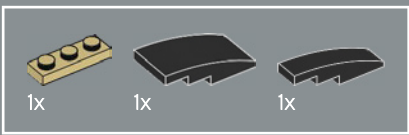
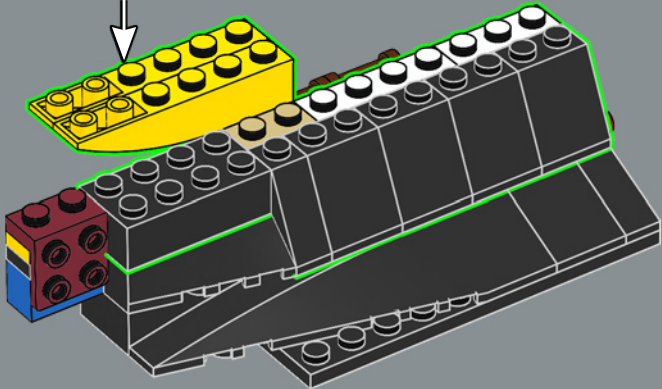
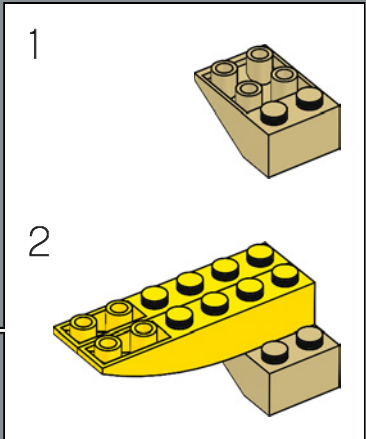

259

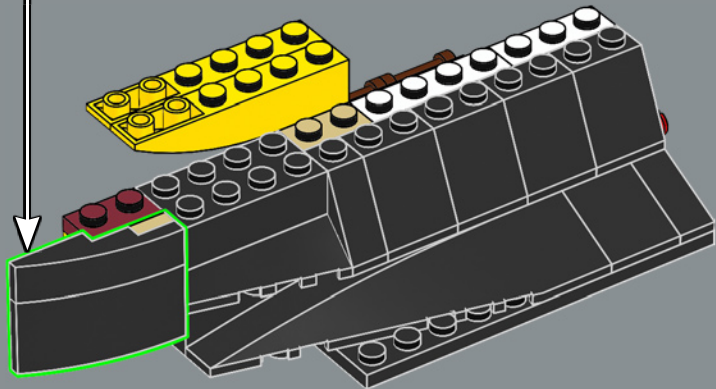
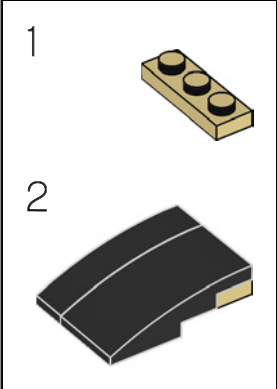



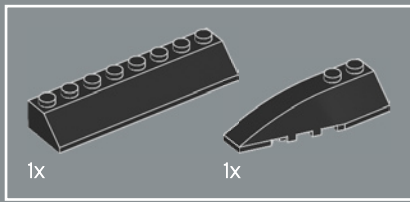

260

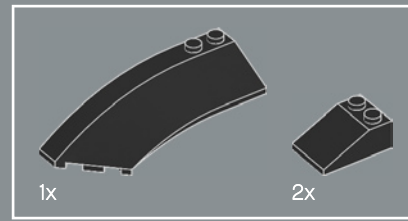
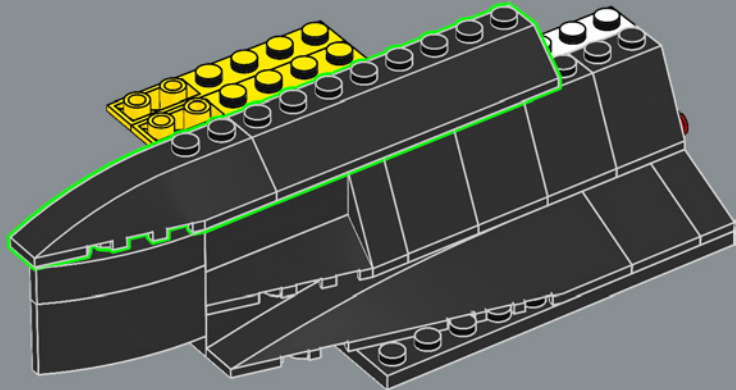

261

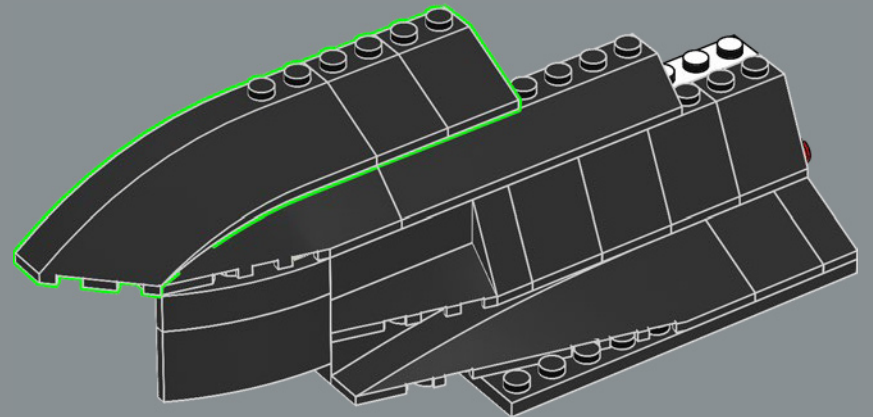

262

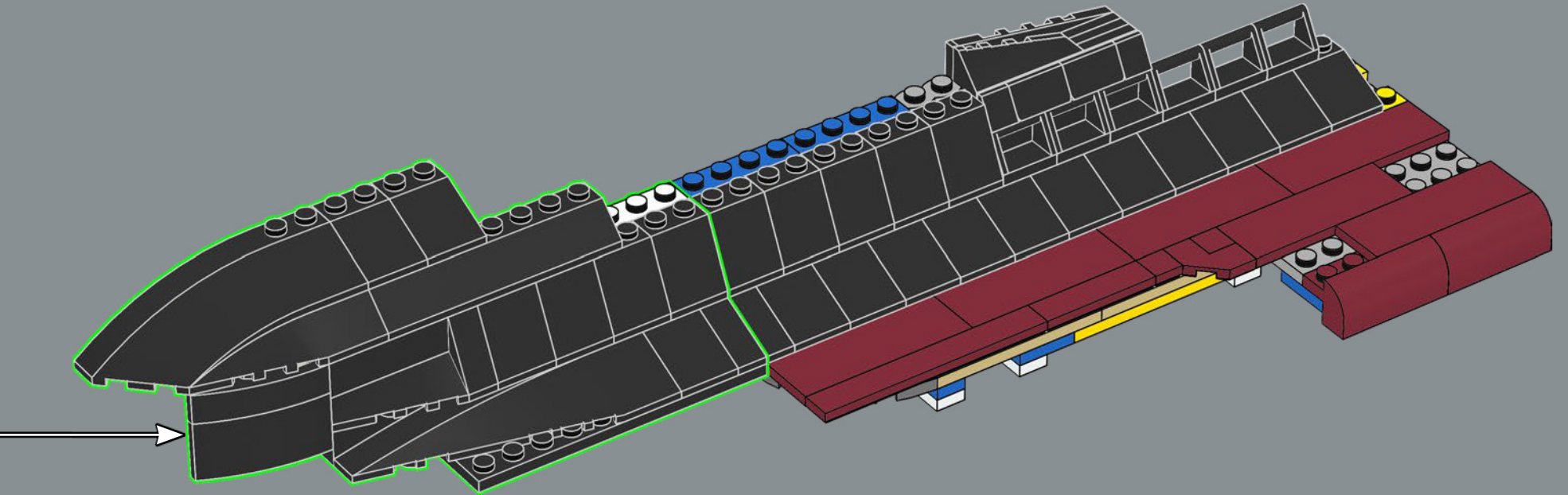

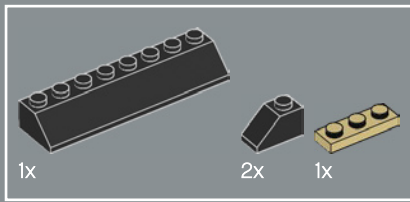

263

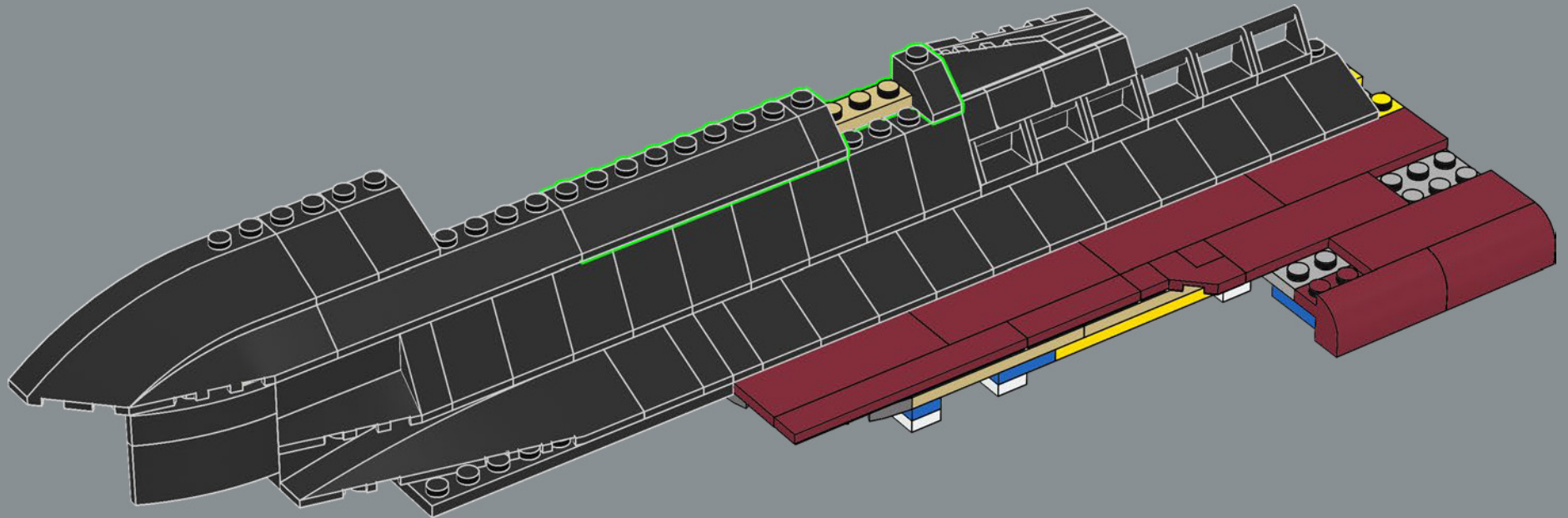

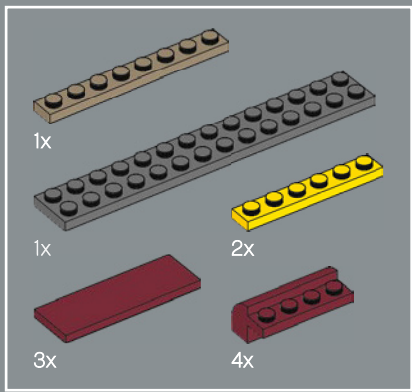

264

1

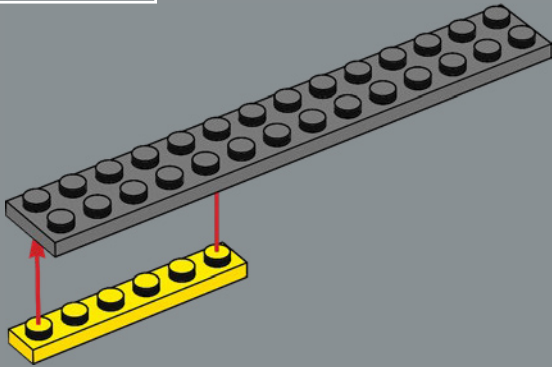

2

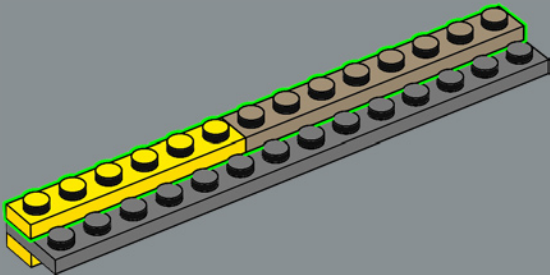

3

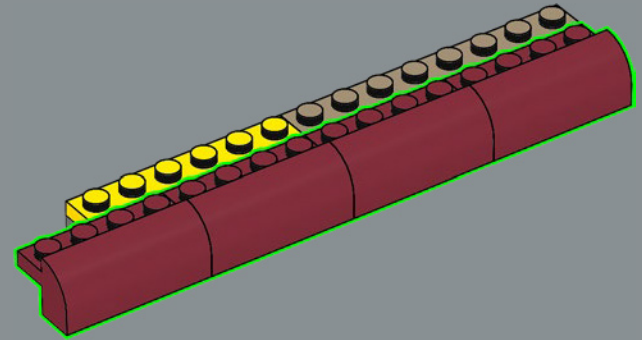

4

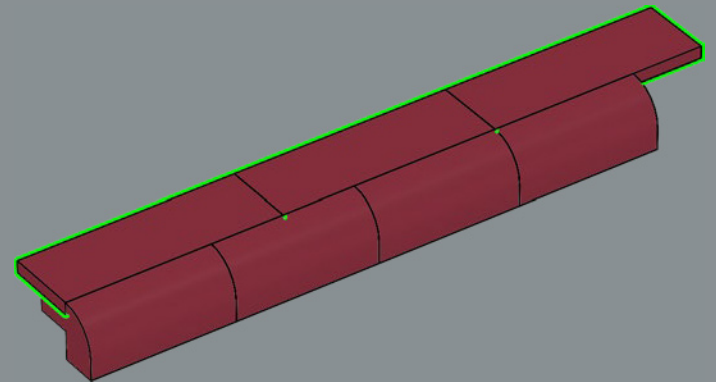

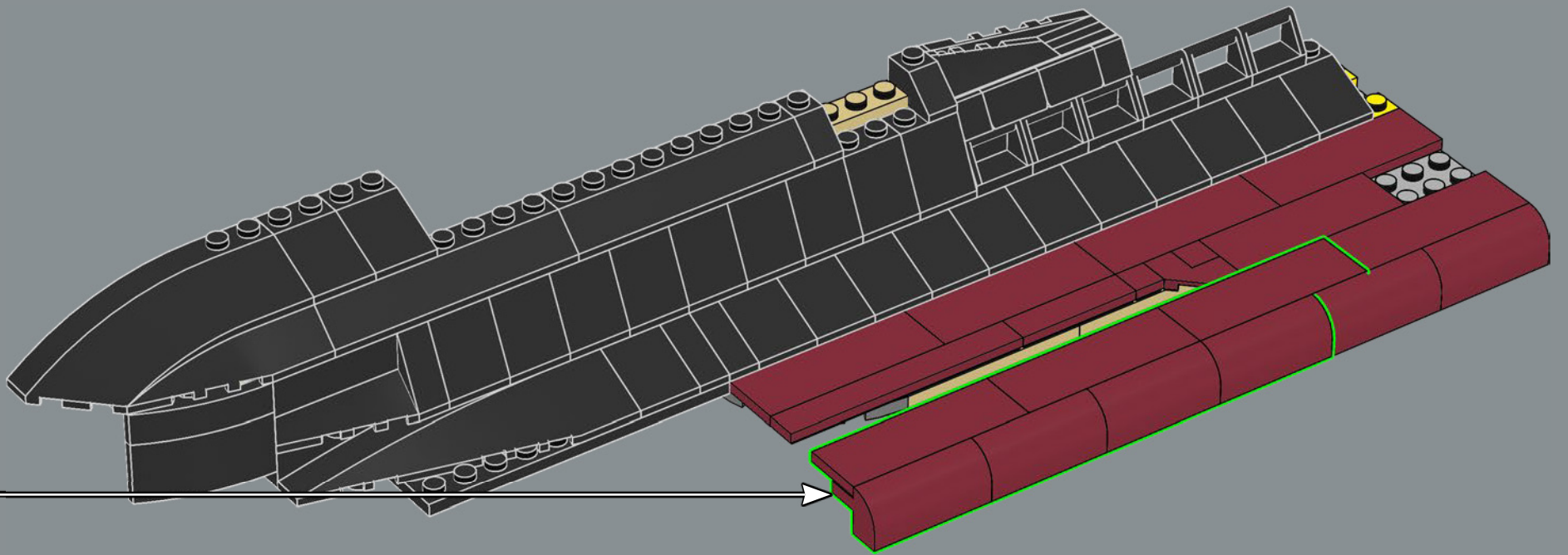

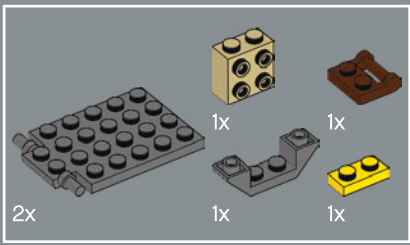

265

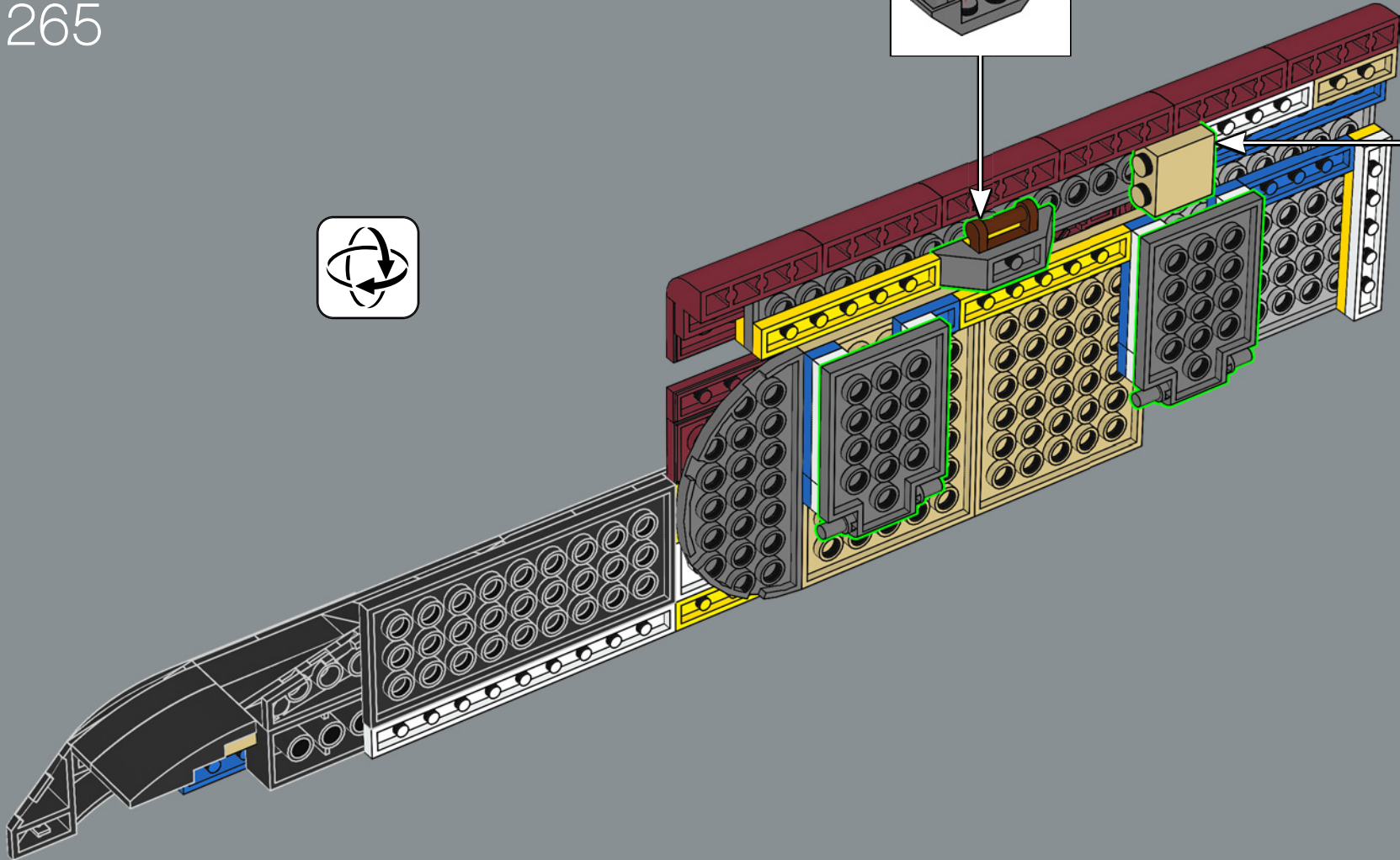
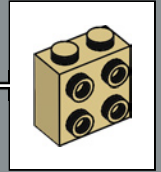
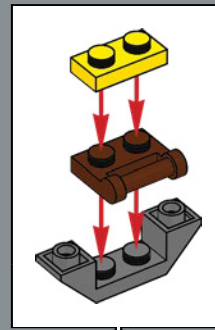

266

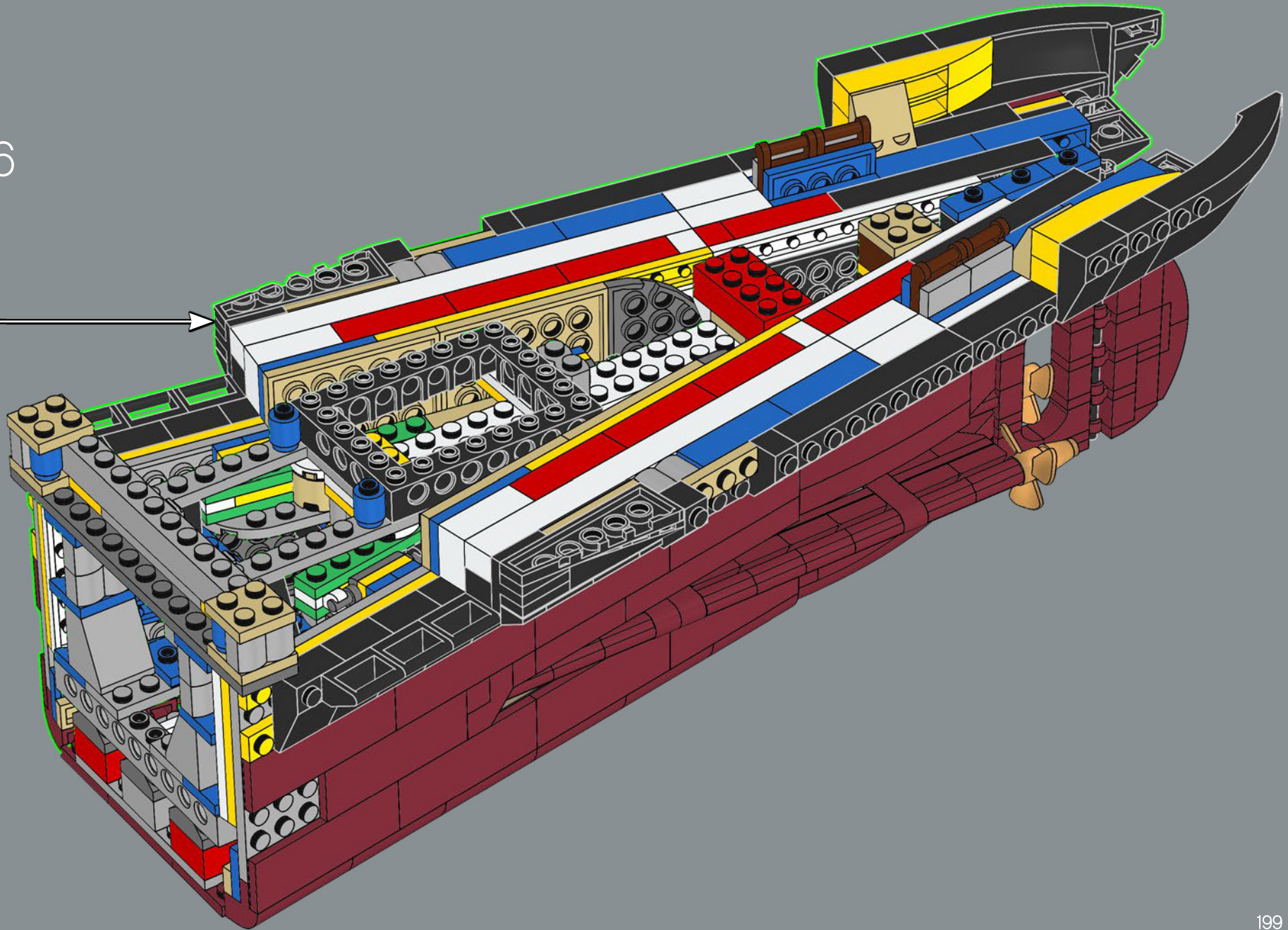

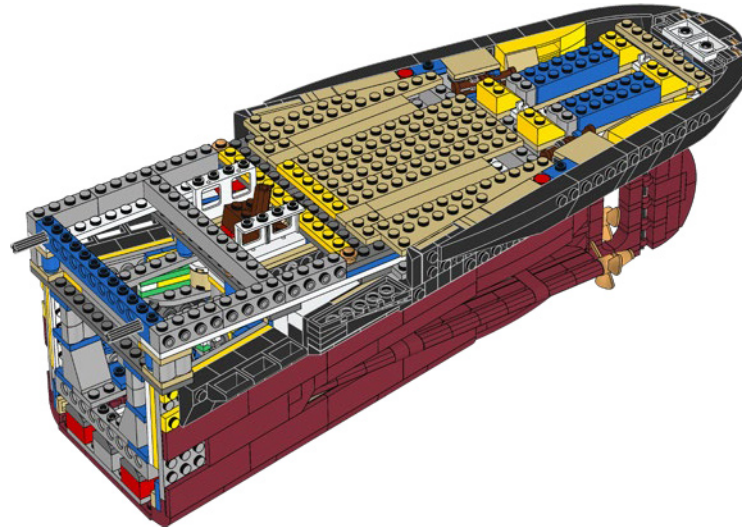
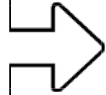



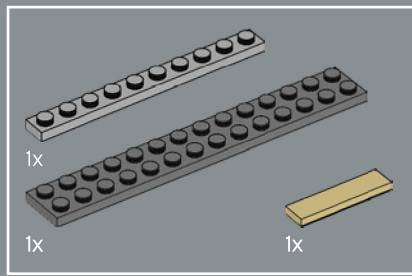

267

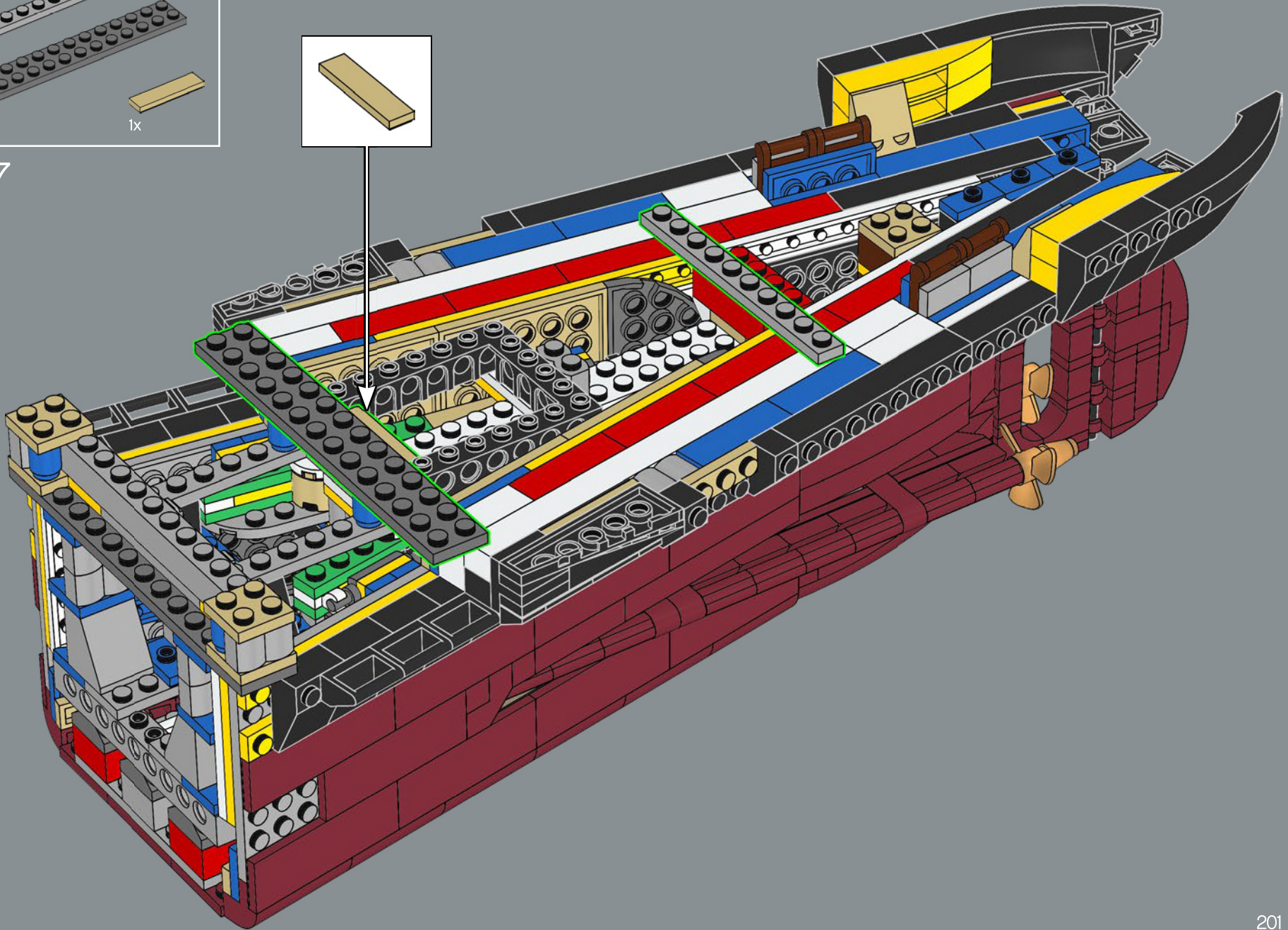
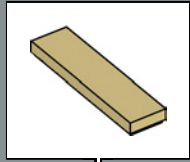

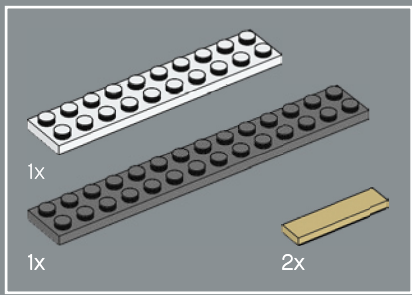

268

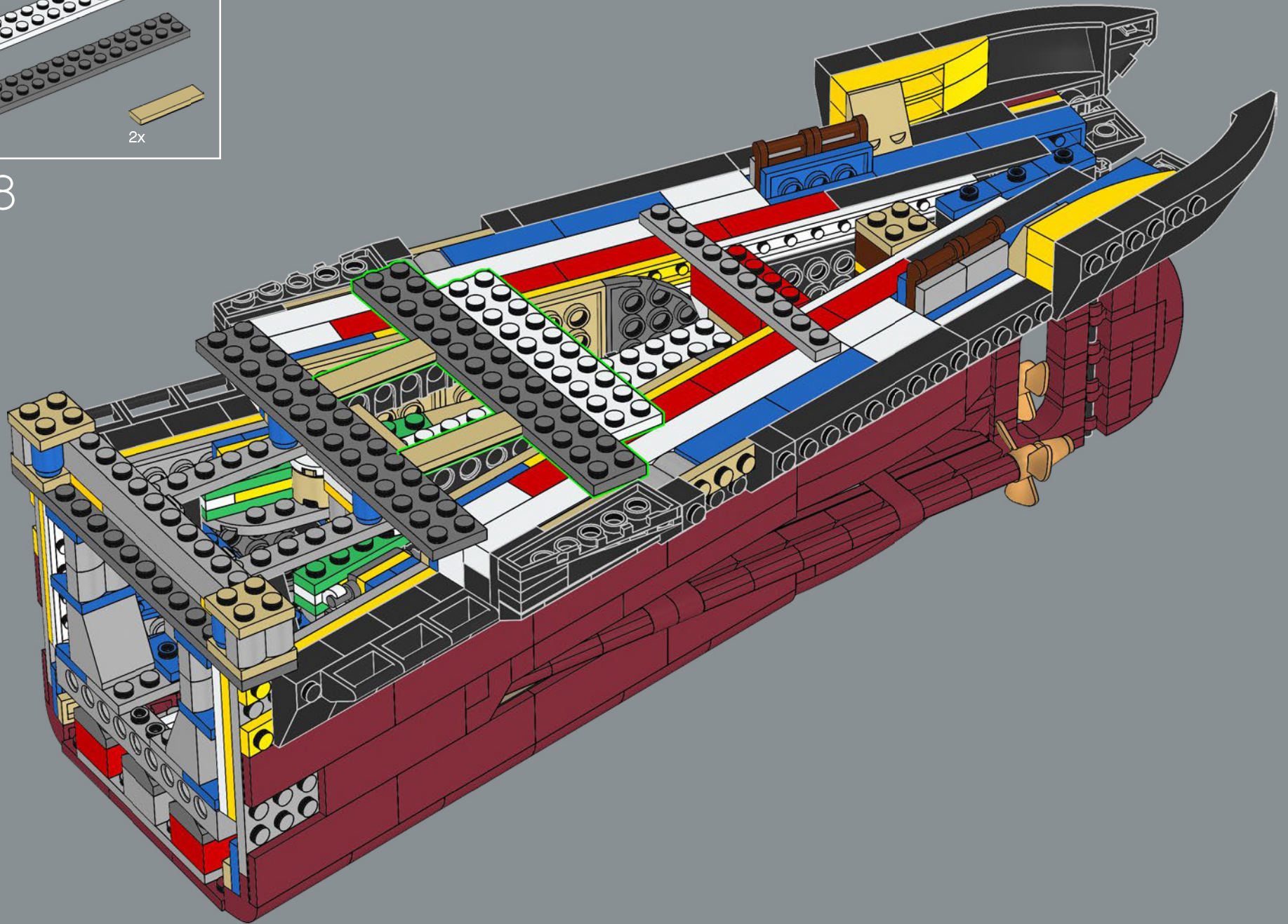

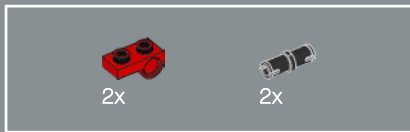

269

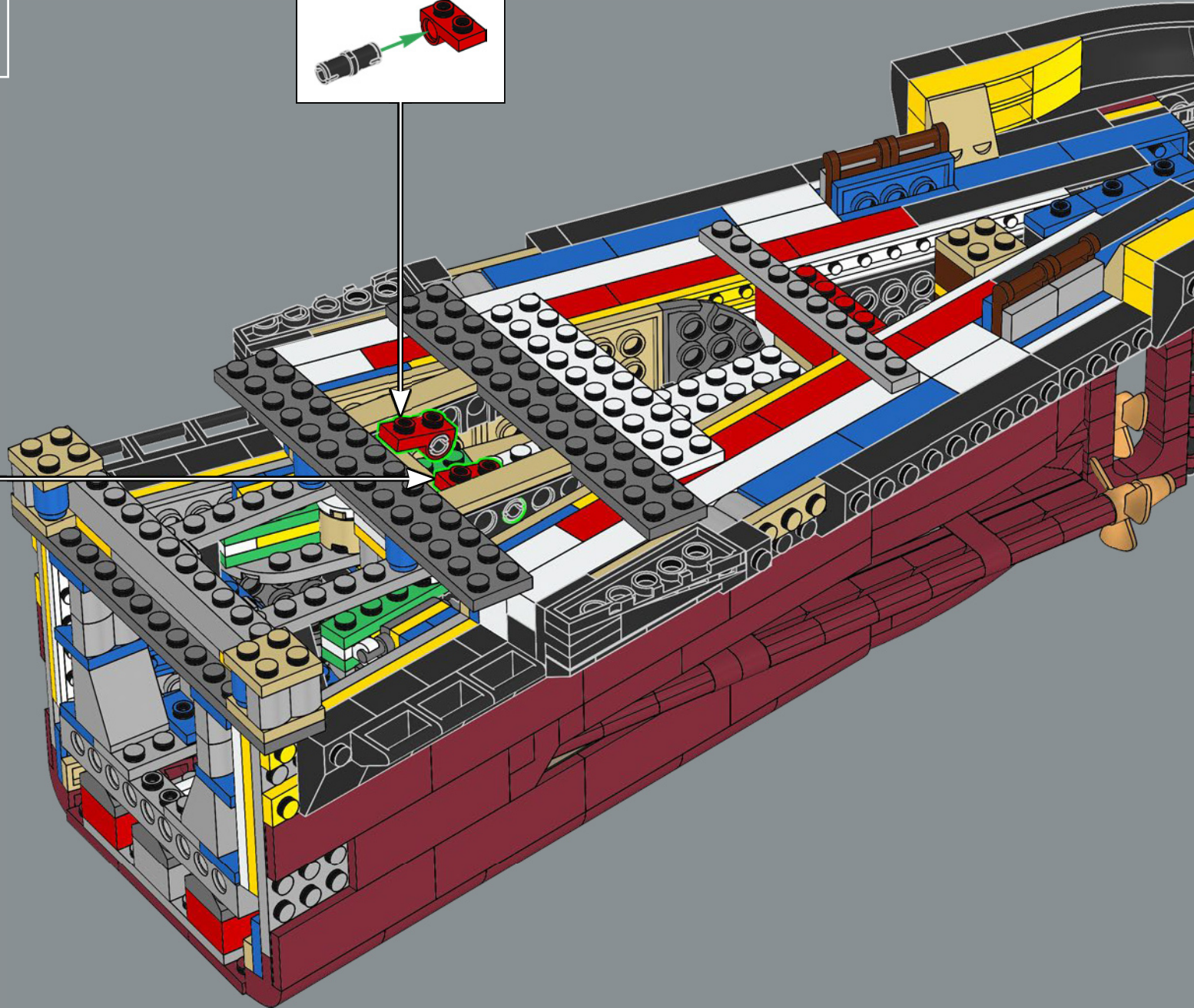
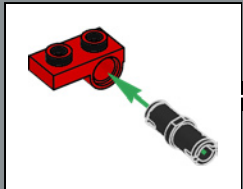
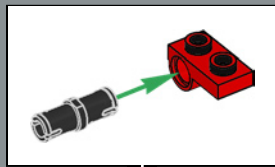

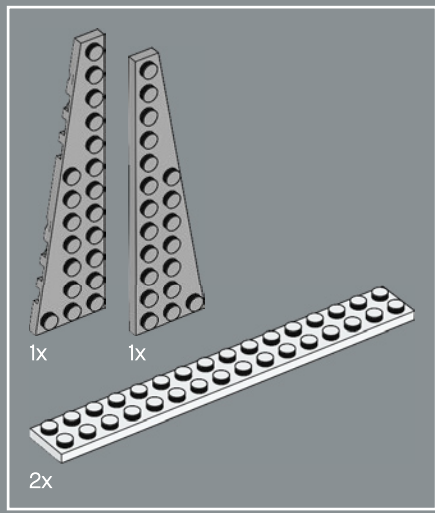

270

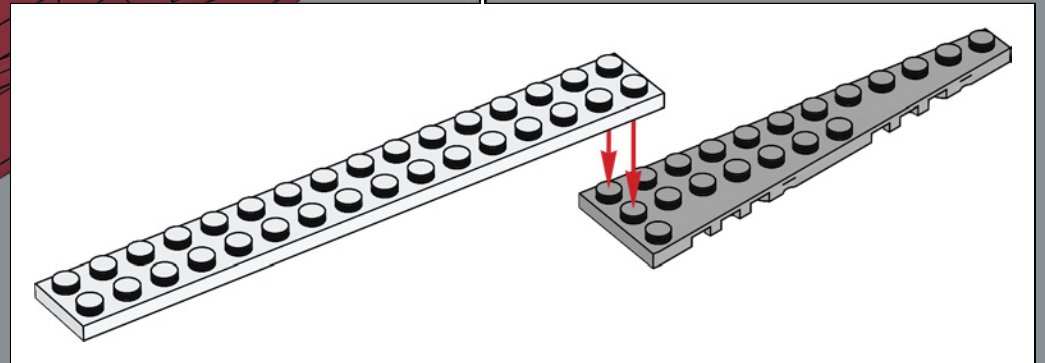
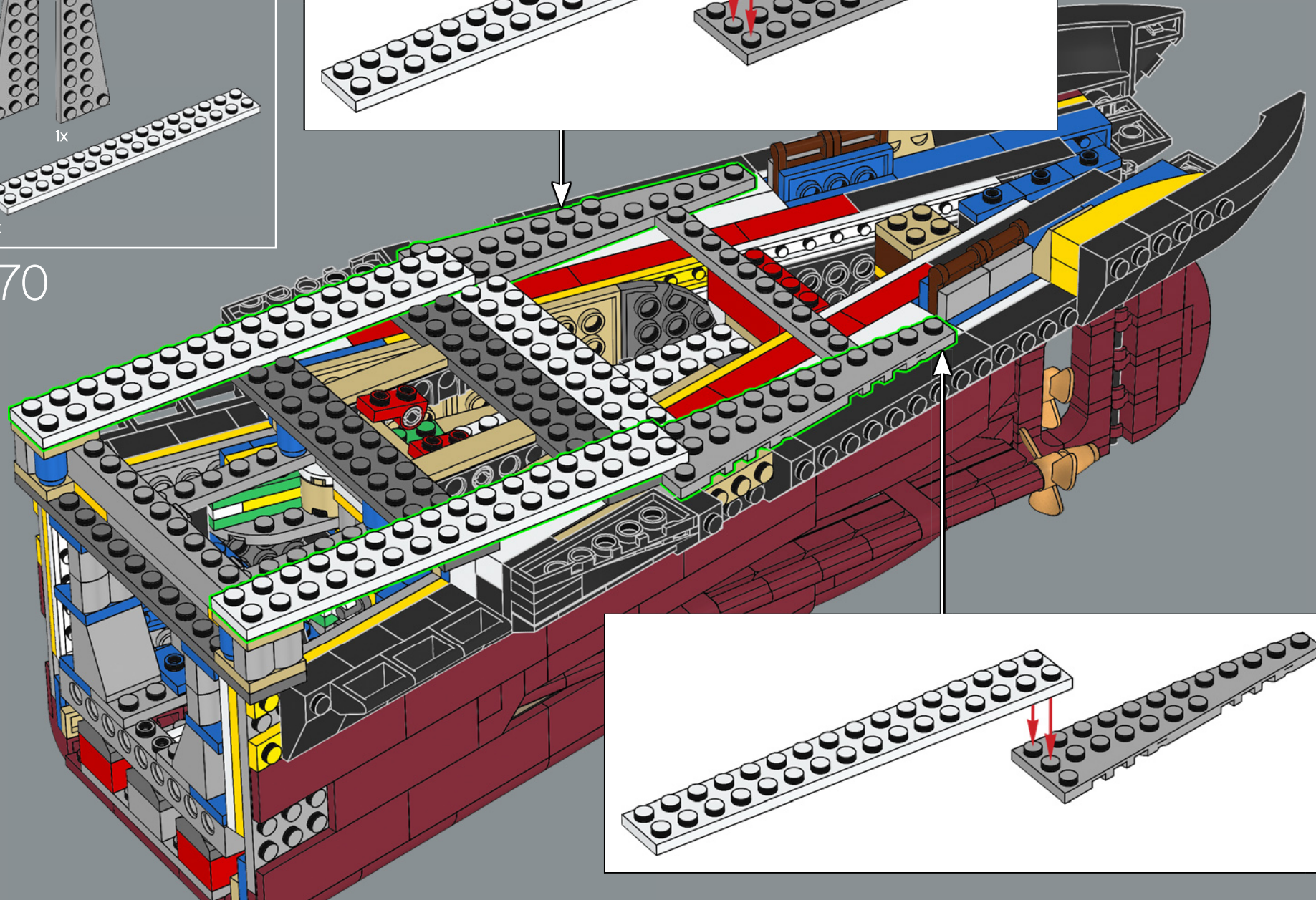
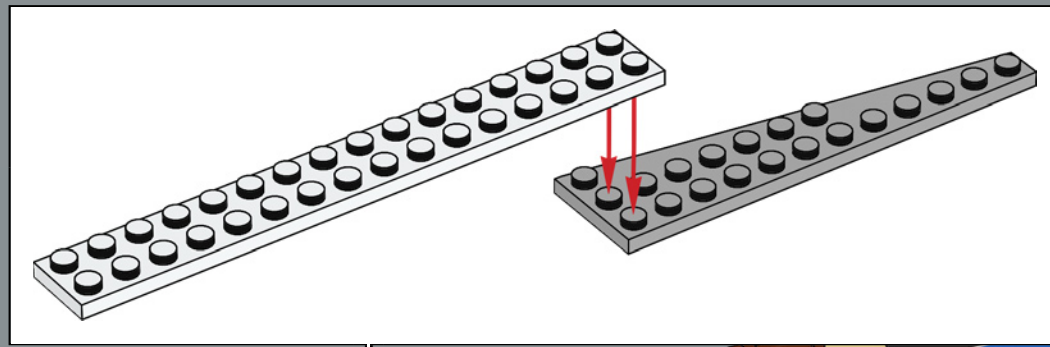

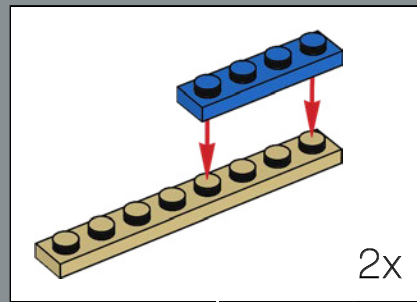
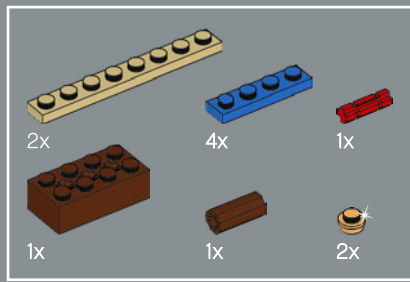

271

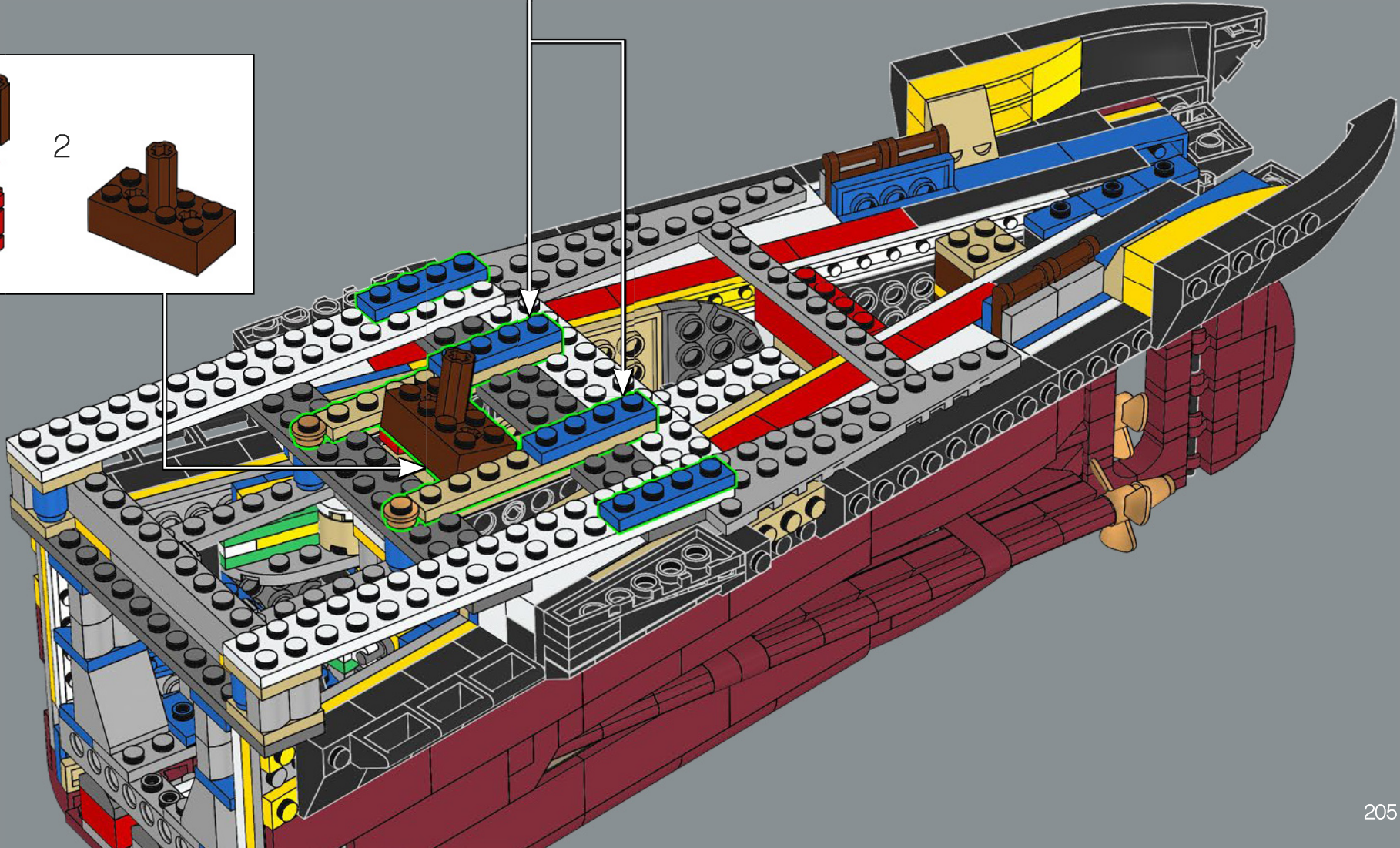
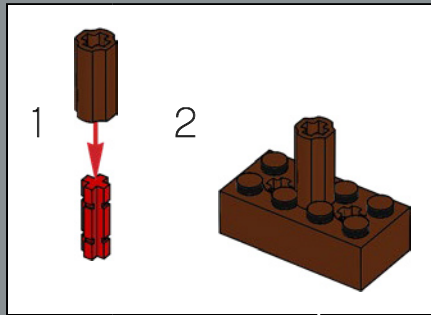

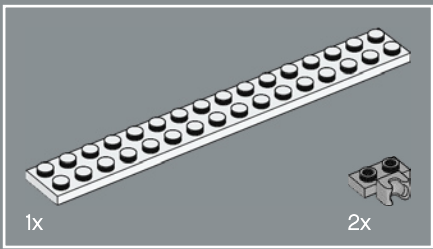

272

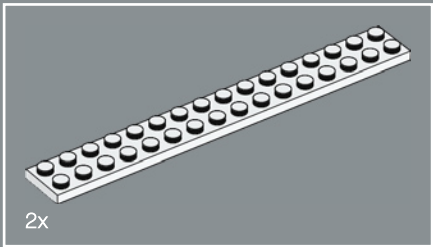
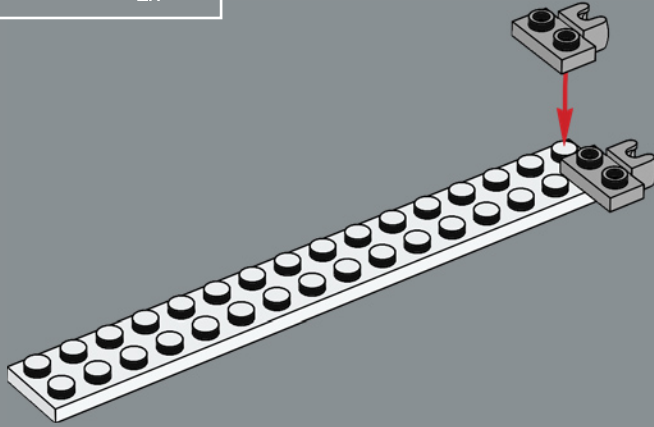

273

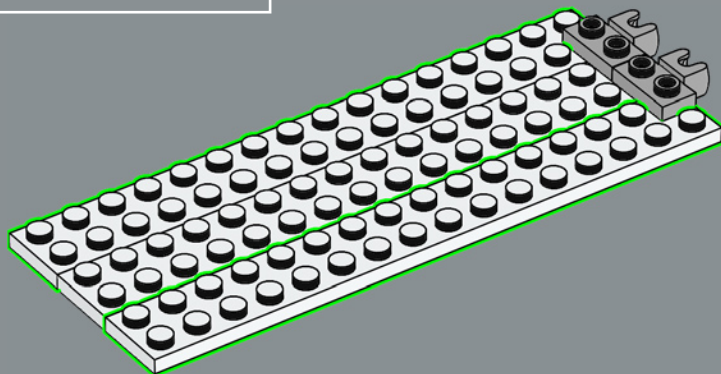

274

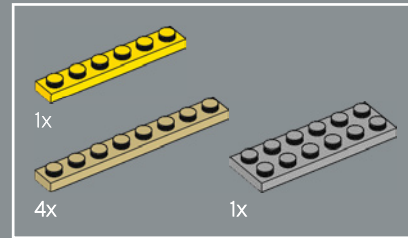
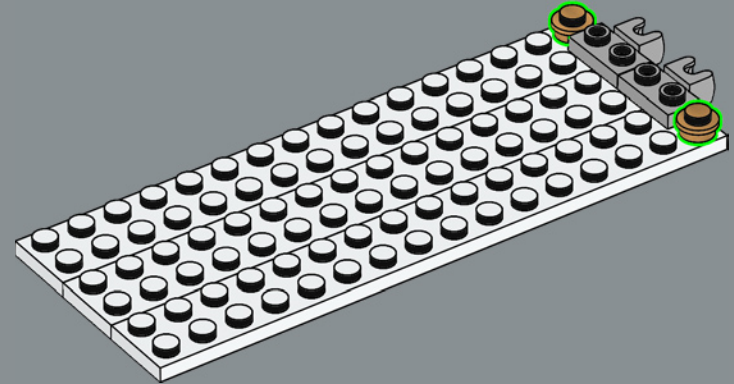

275

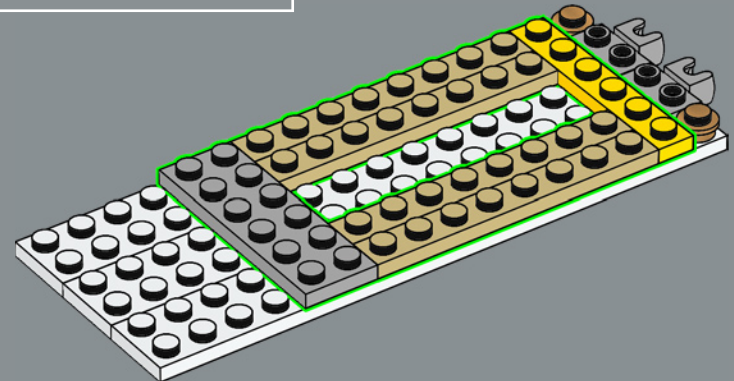

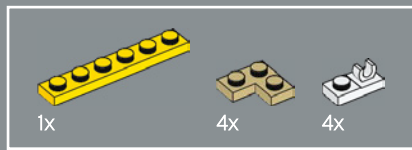

276

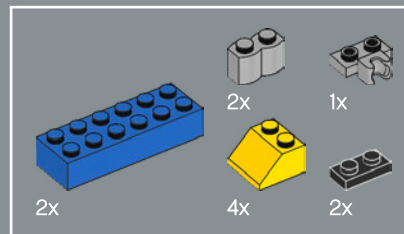
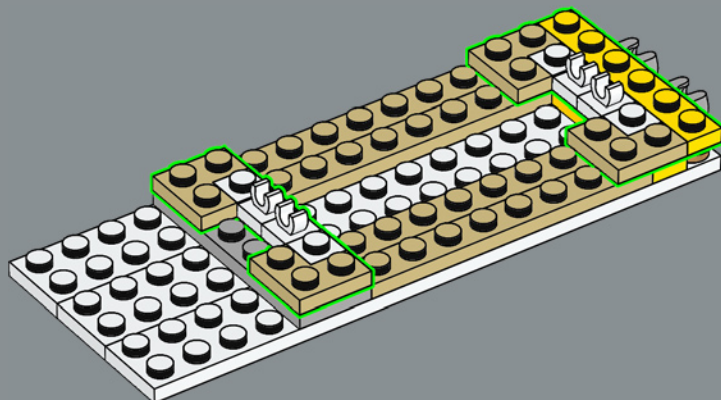

277

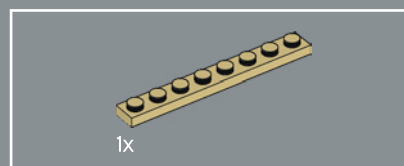
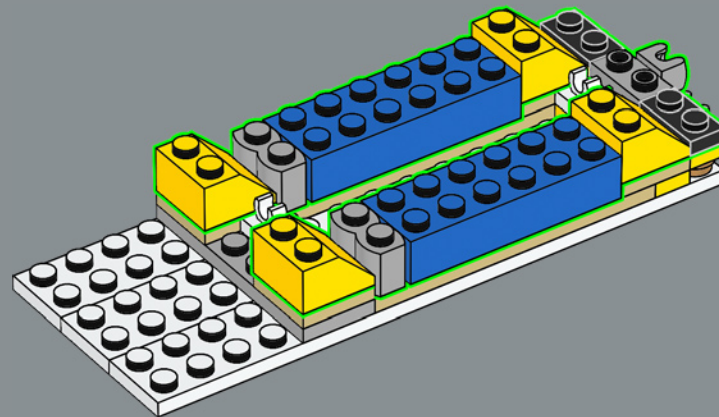

278

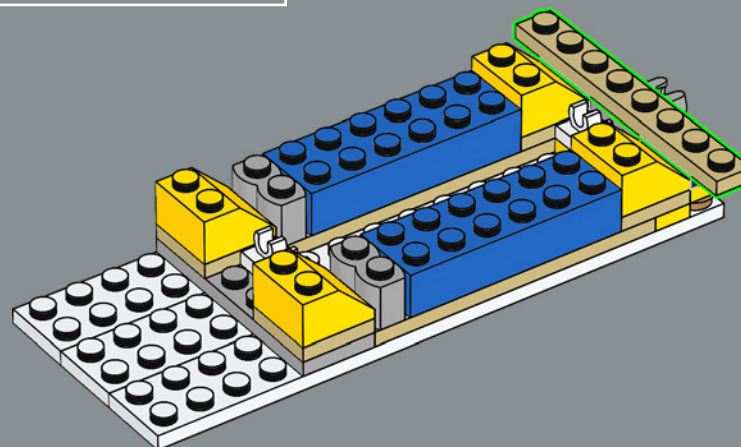

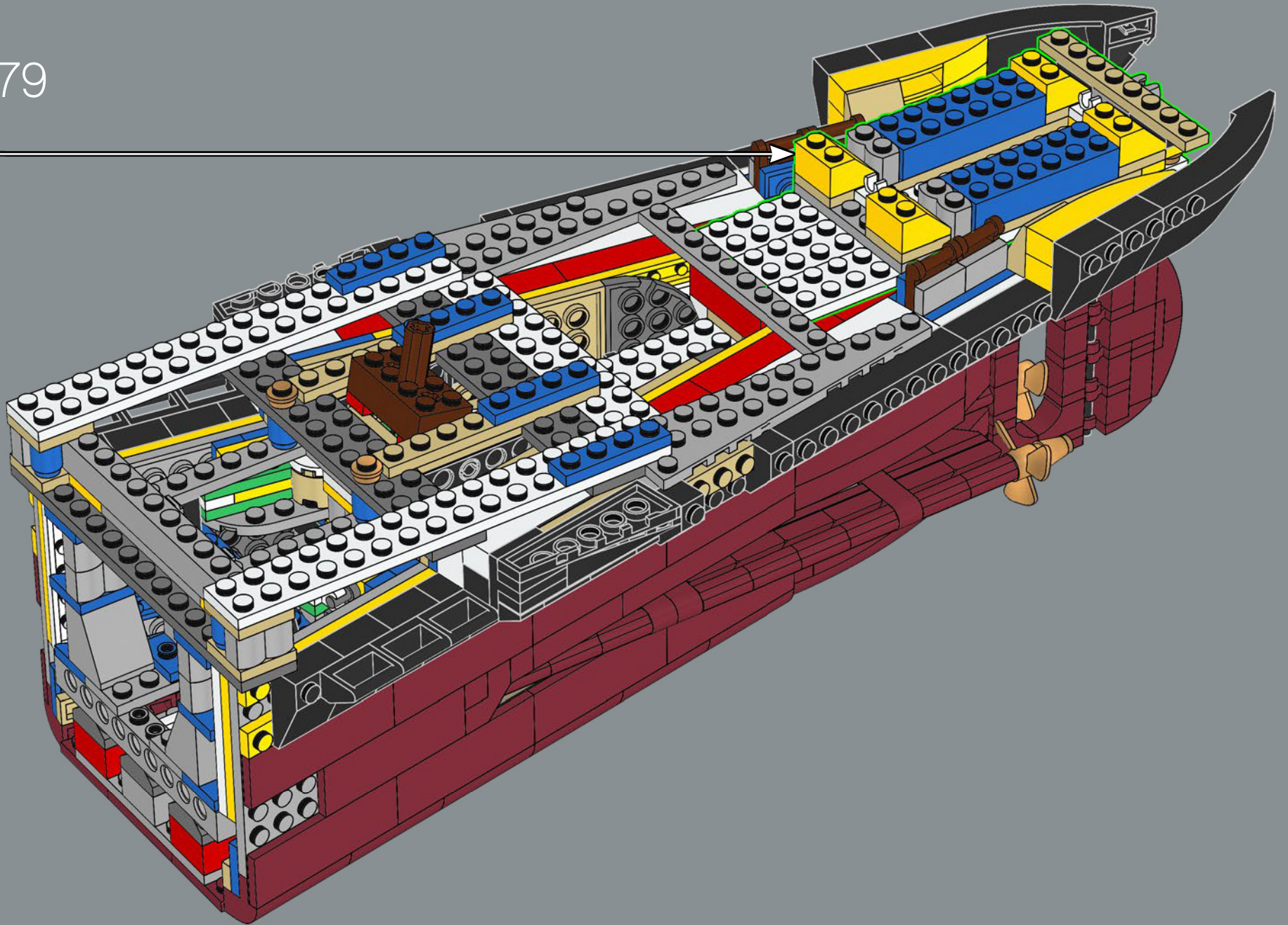





280

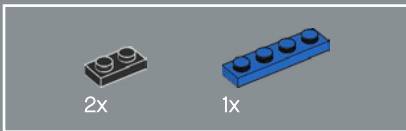
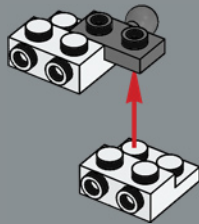

281

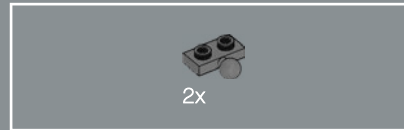
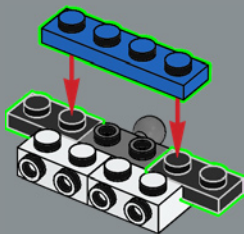

282

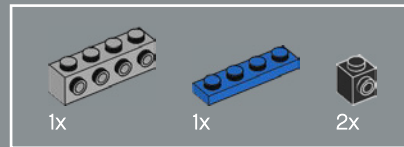
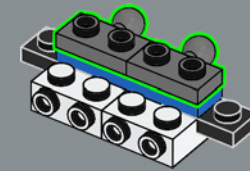

283

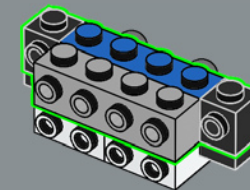

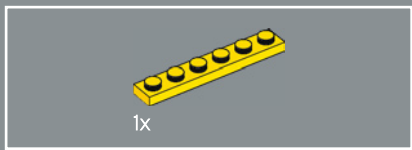

284

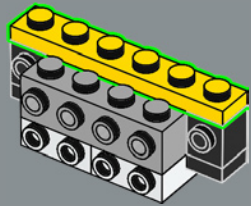

285

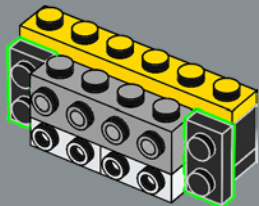

286

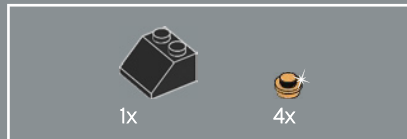
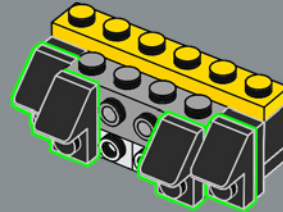

287

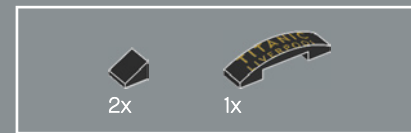
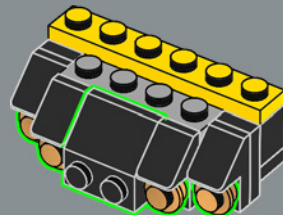

288

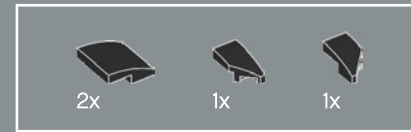
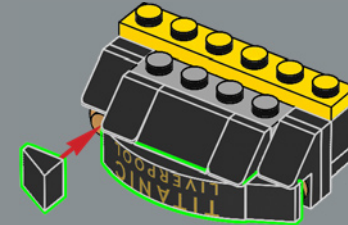

289

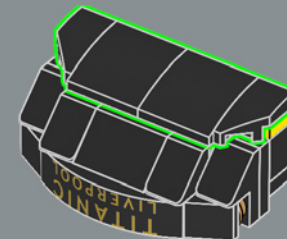

The *Titanic* lacked a searchlight and had no Public Address system.

Le *Titanic* n'a pas de projecteur ni de système de sonorisation.

El *Titanic* carecía de reflector y no disponía de sistema de megafonía.

290

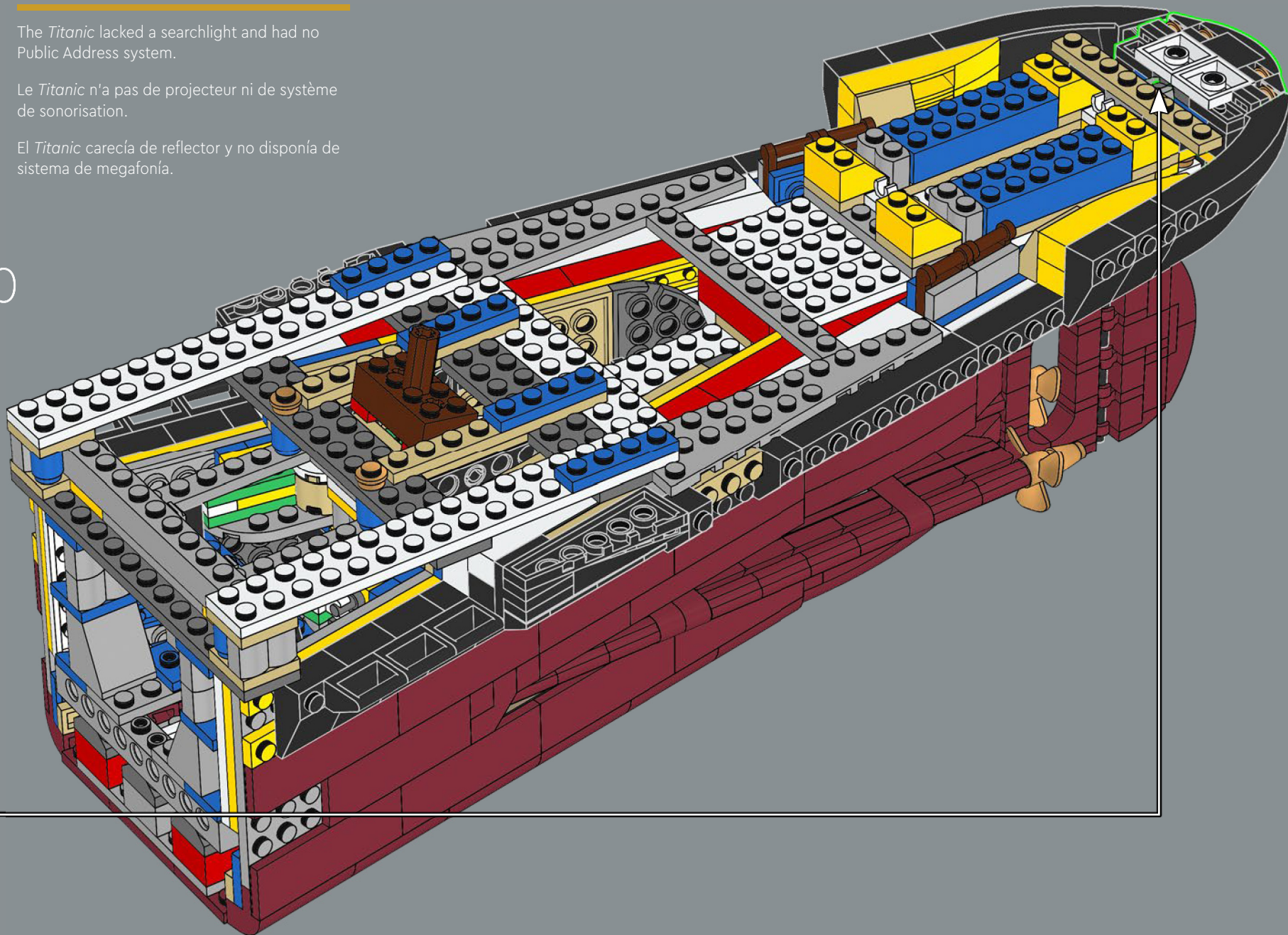

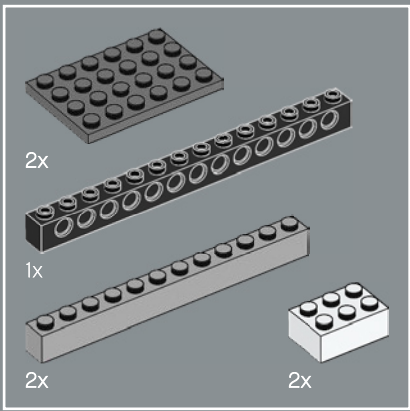

291

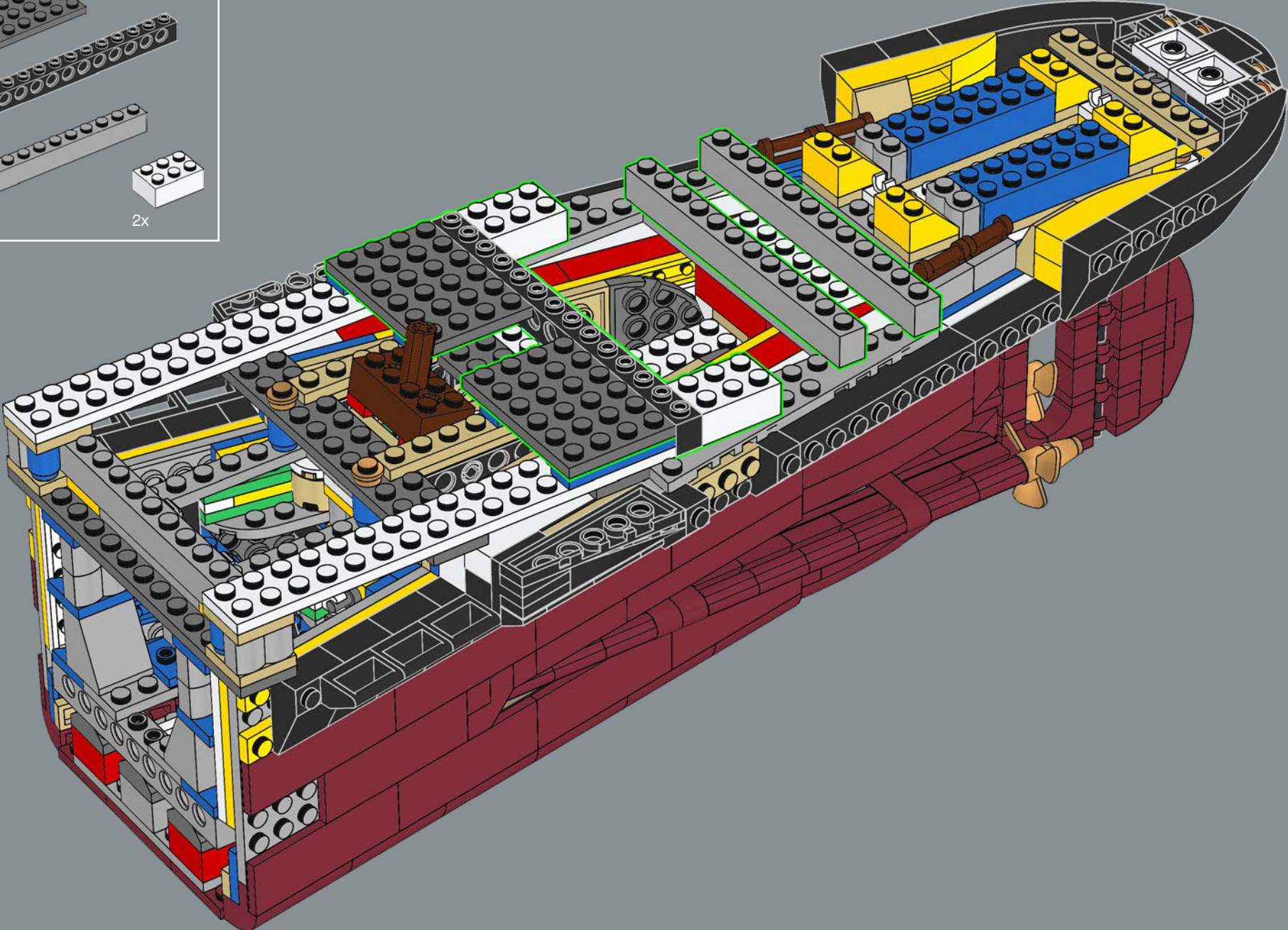

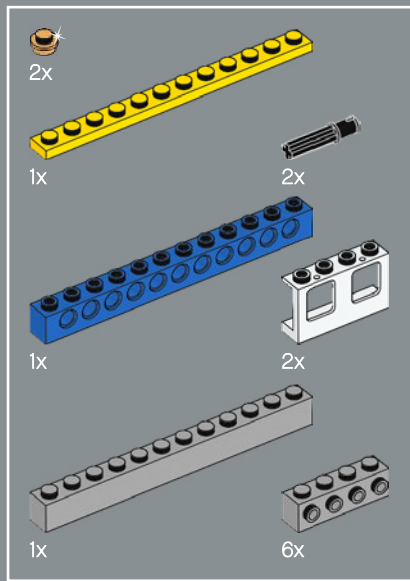

292

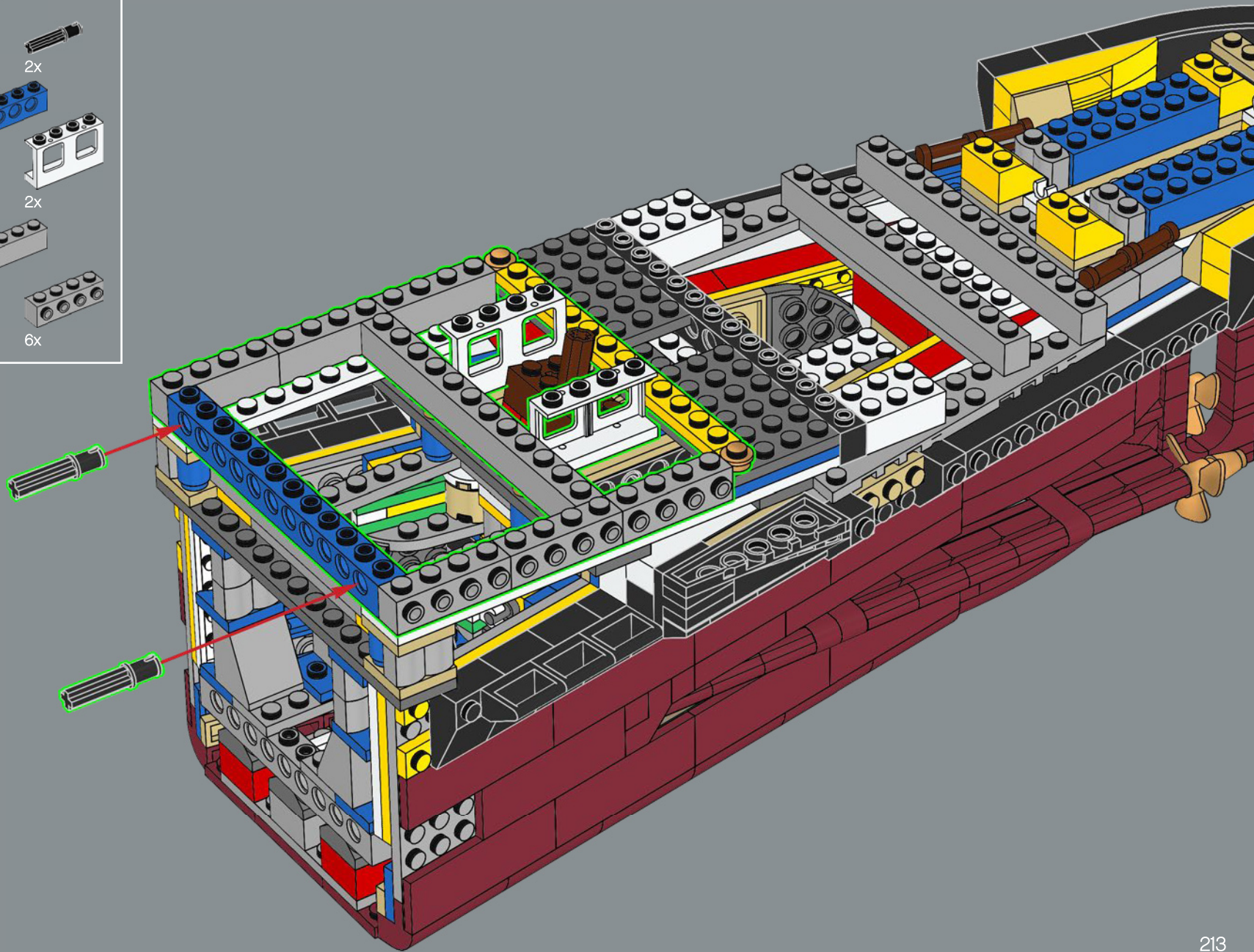

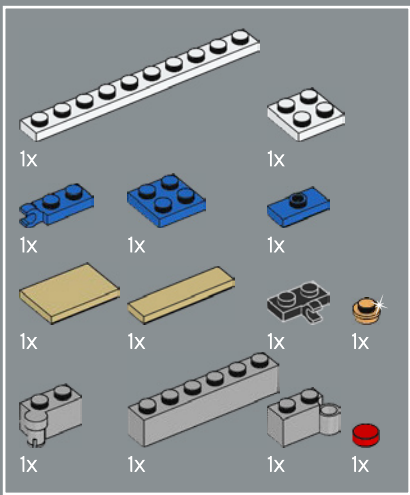

293

1

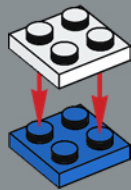

2

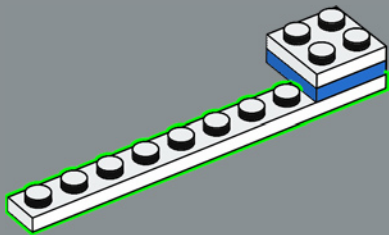

3

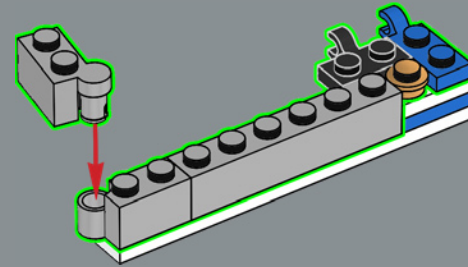

4

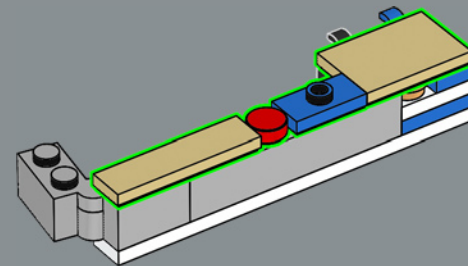

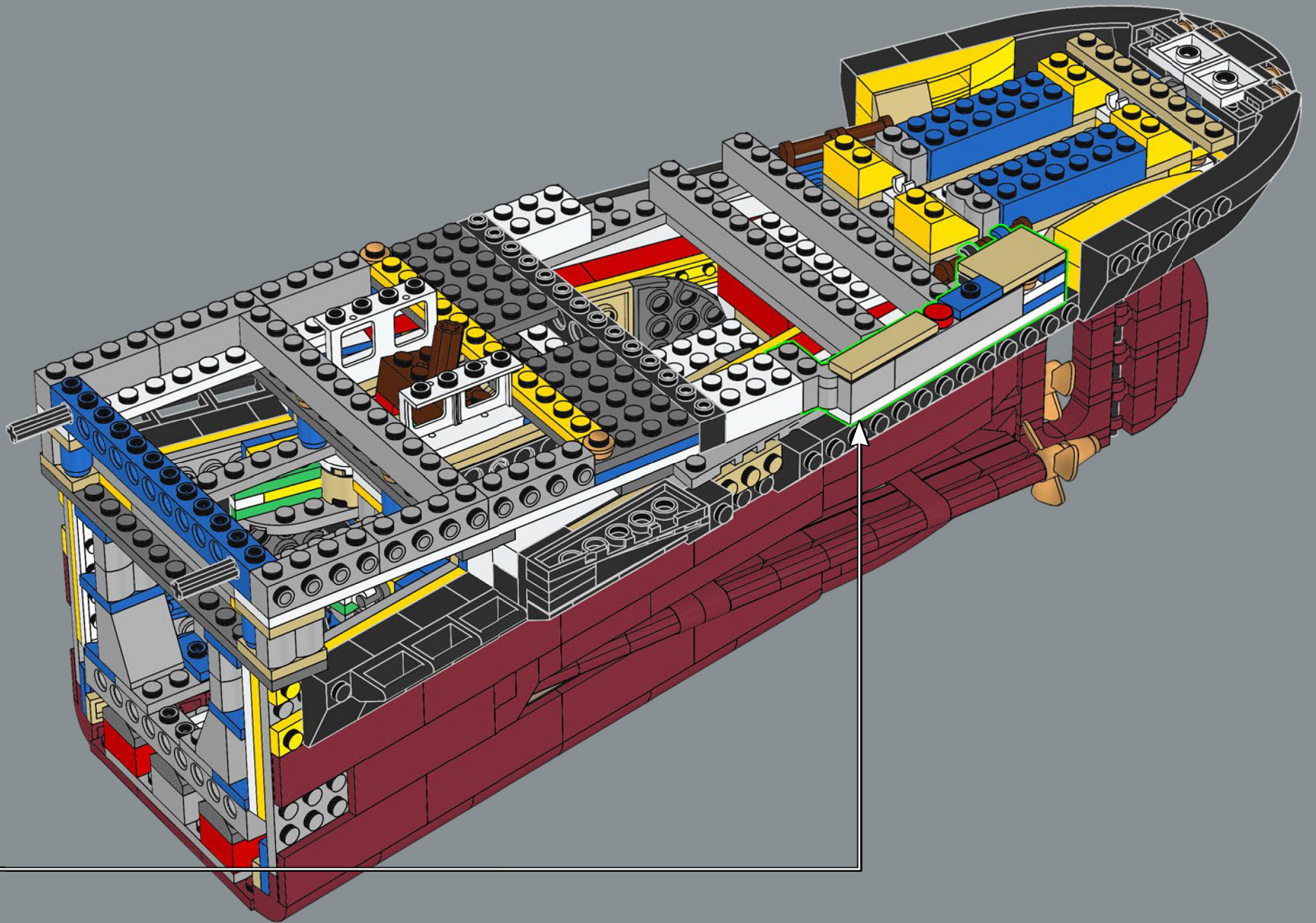

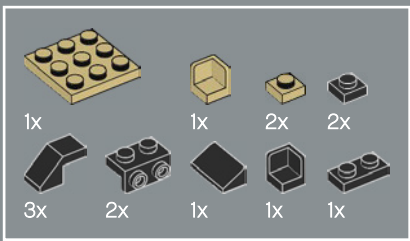

294

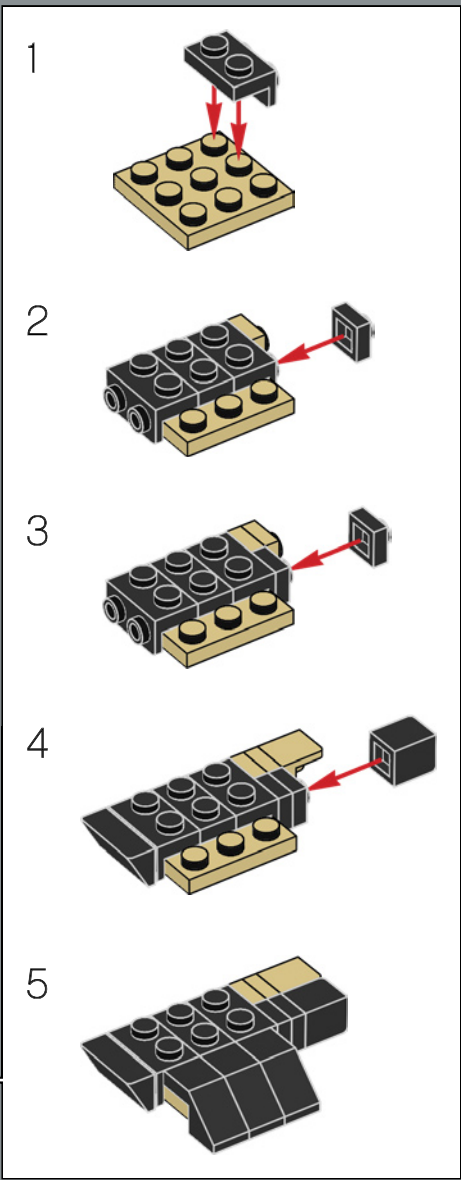
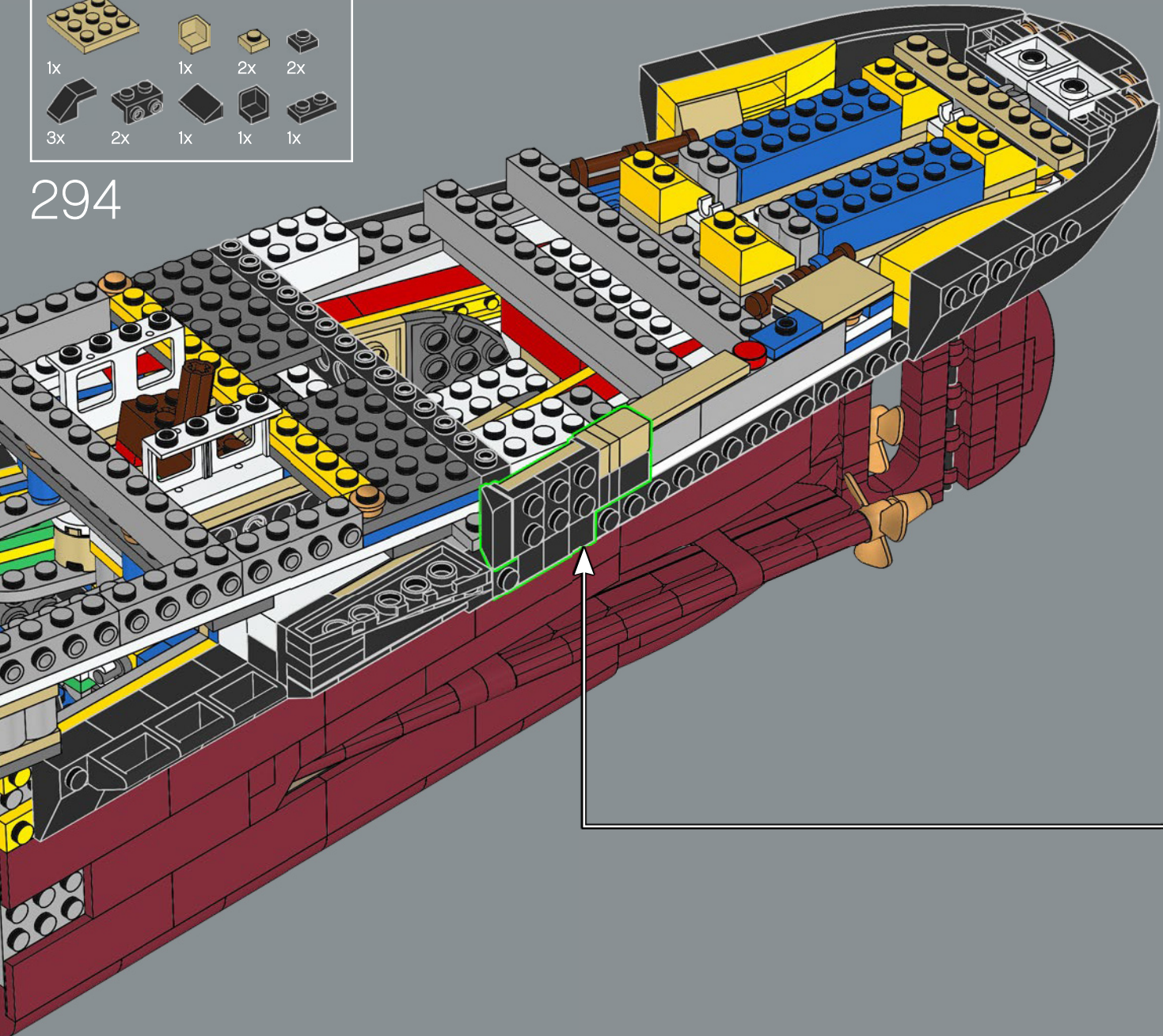



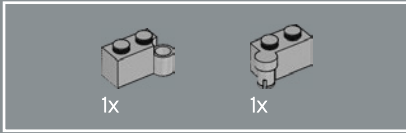
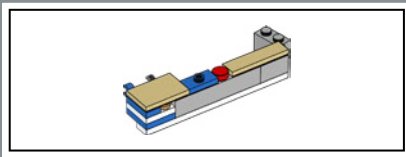

295

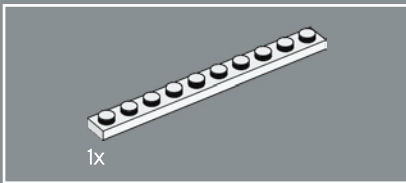
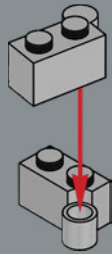

296

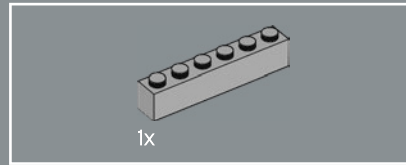
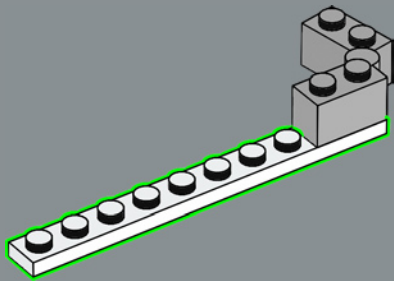

297

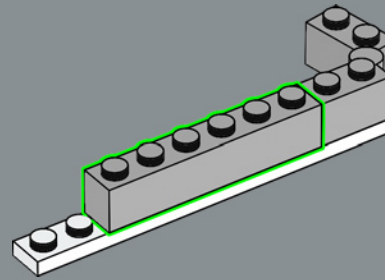

298

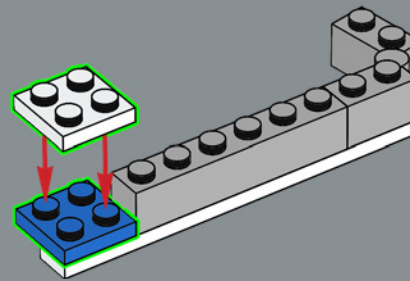

299

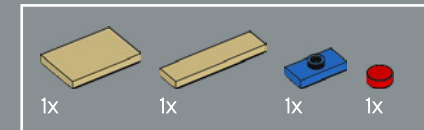
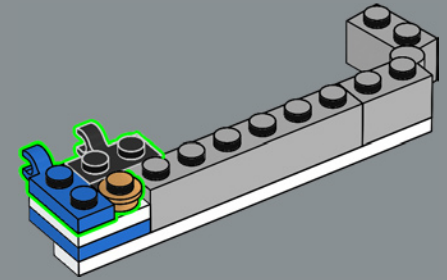

300

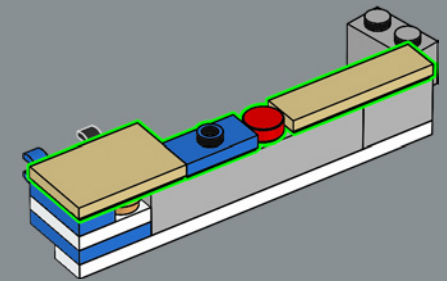

301

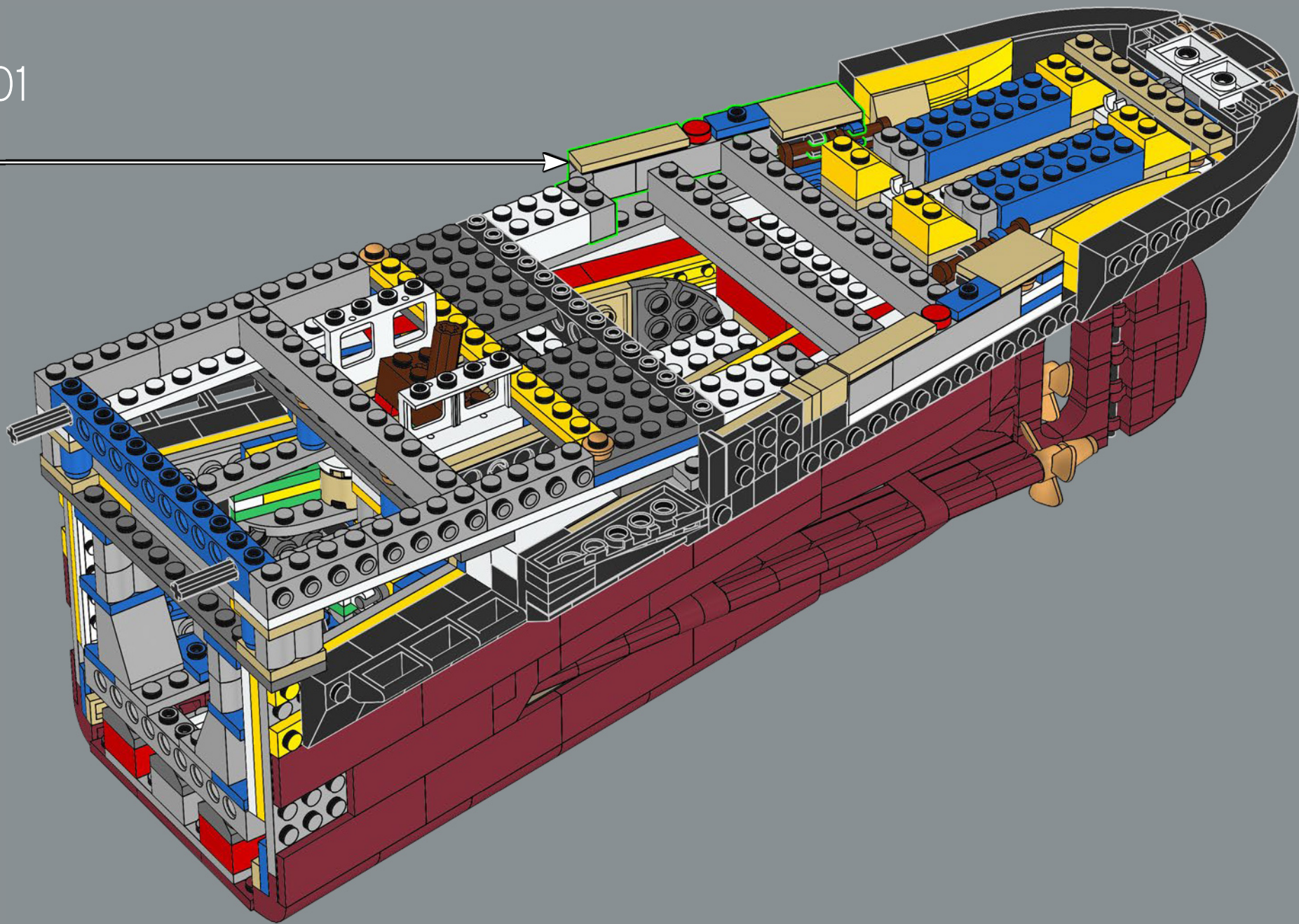

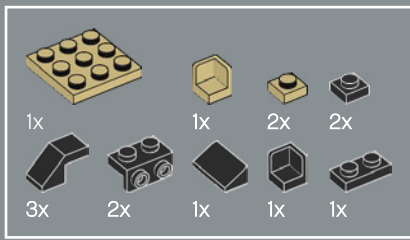

302

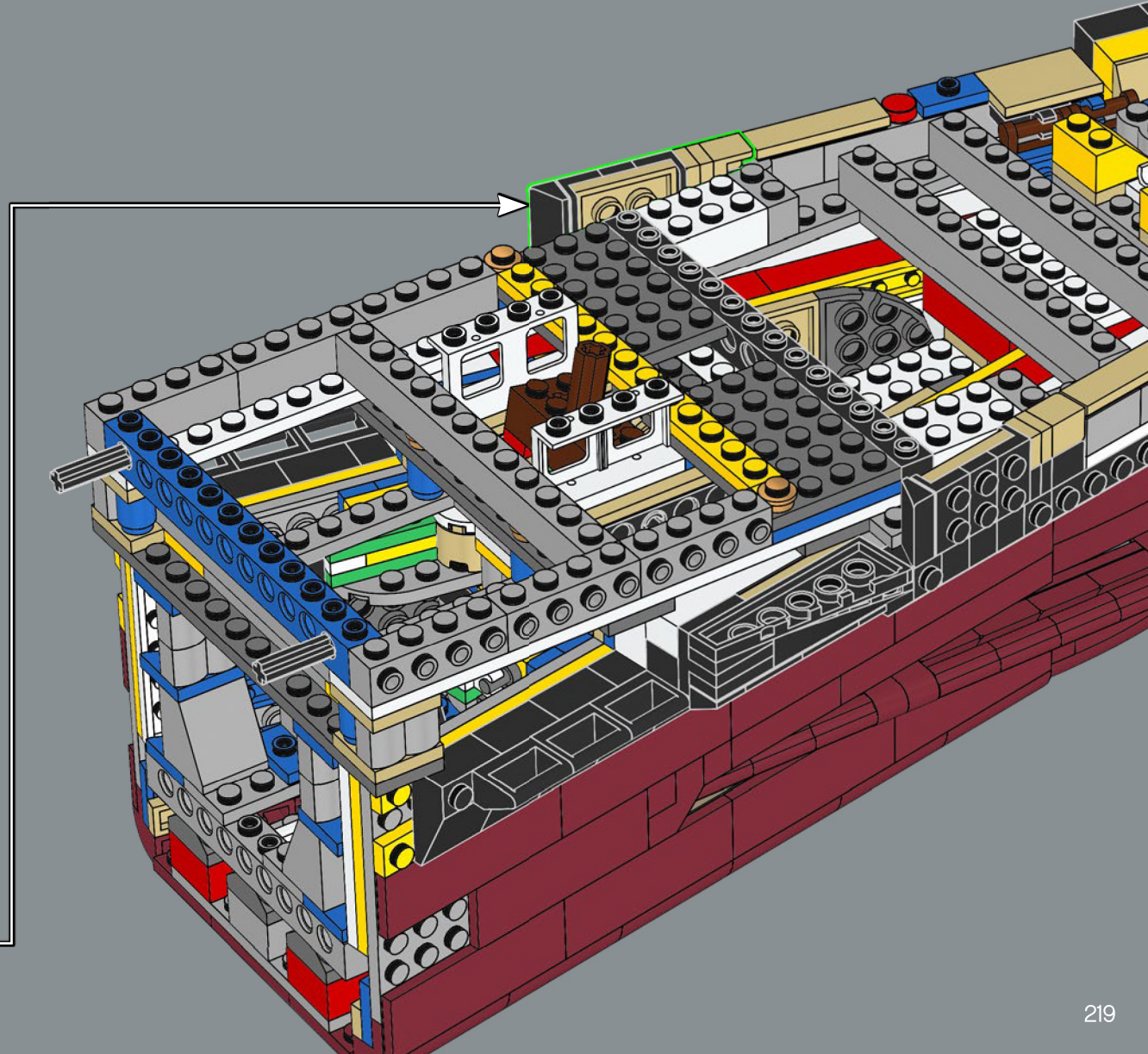
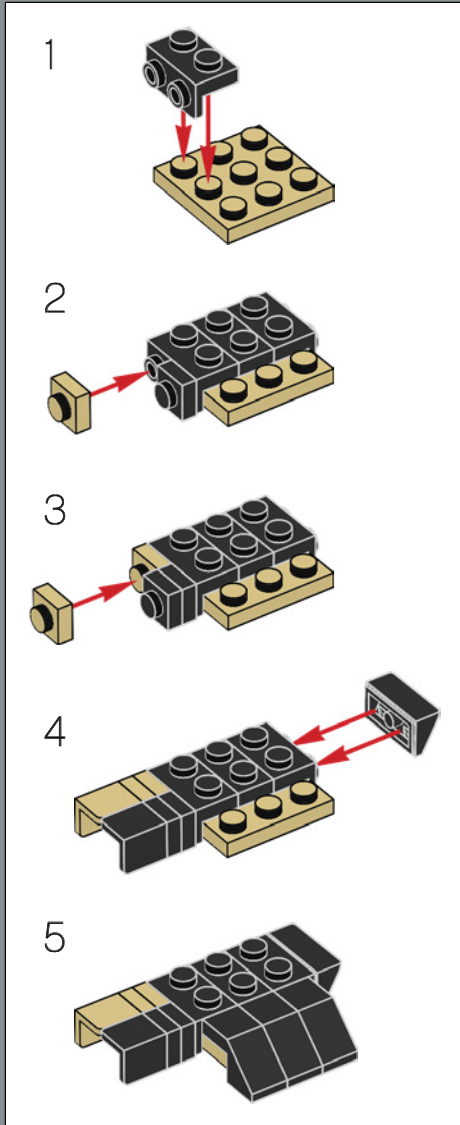

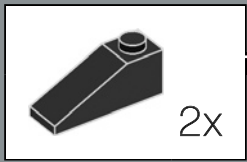
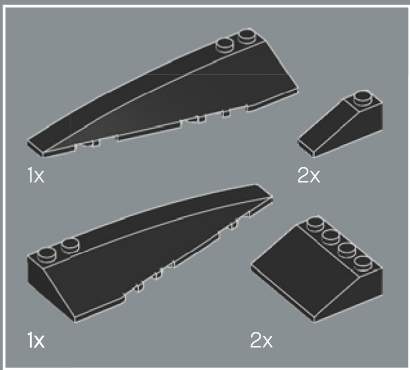

303

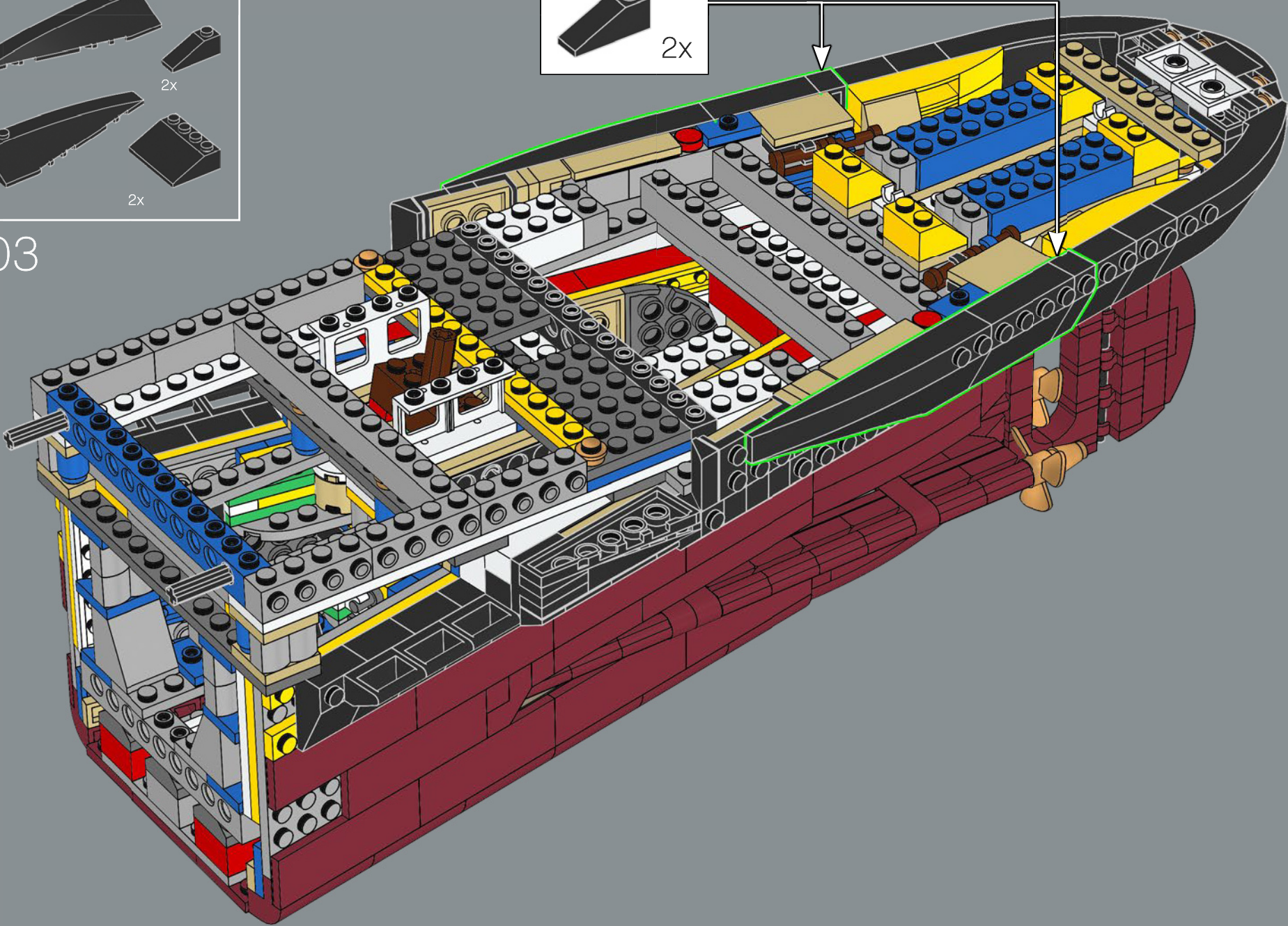

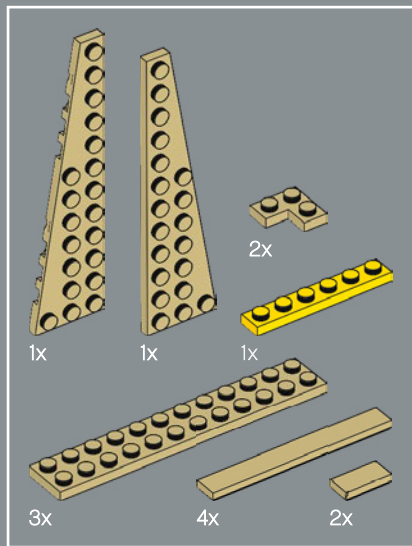

304

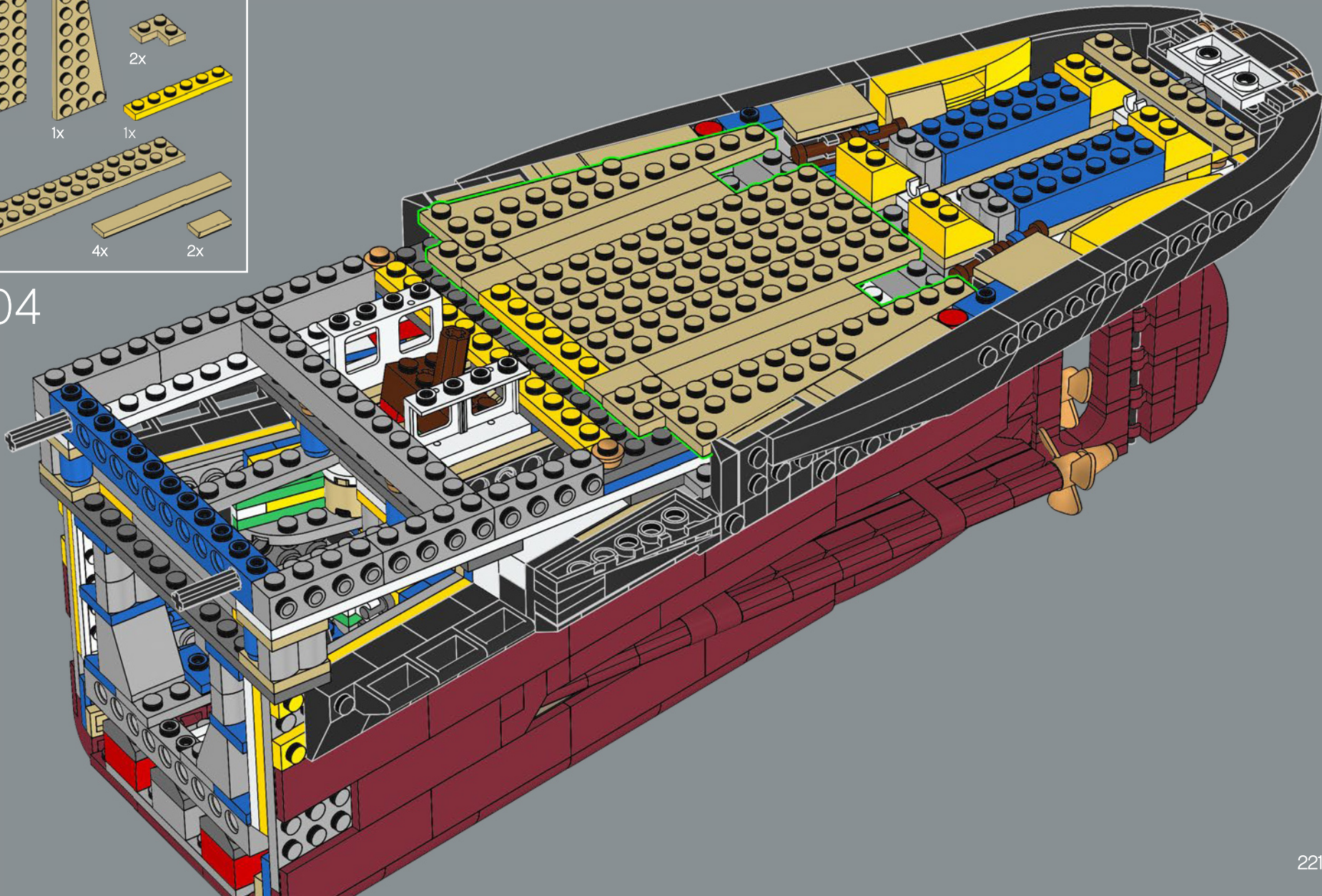

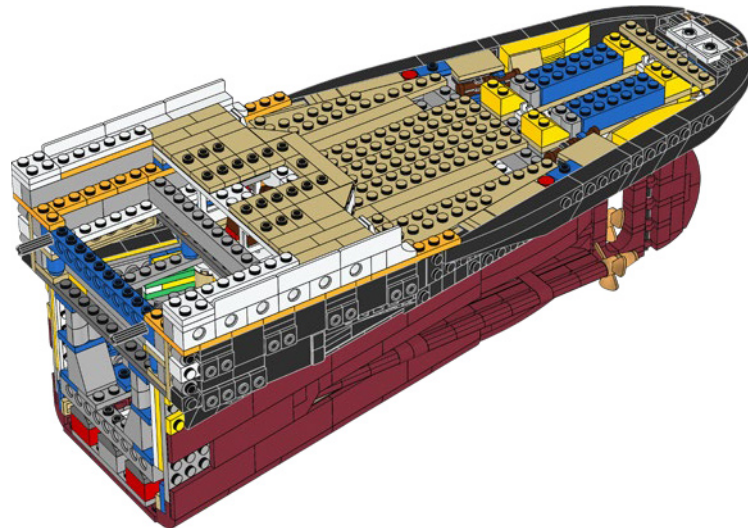

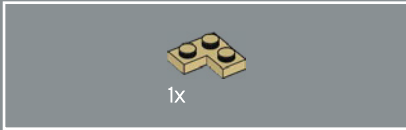
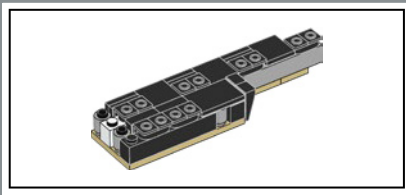

305

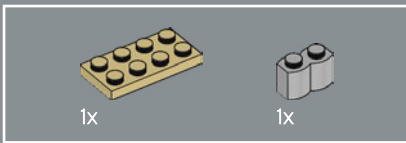
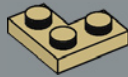

306

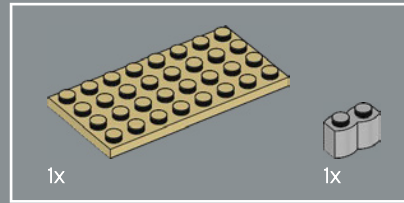
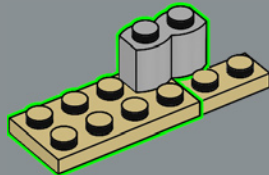

307

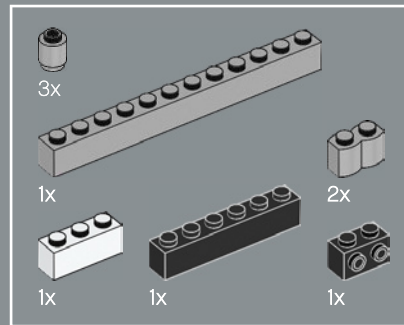
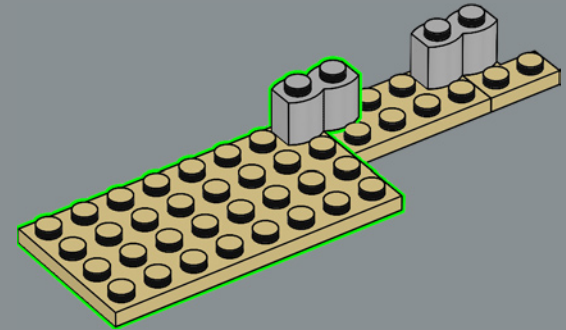

308

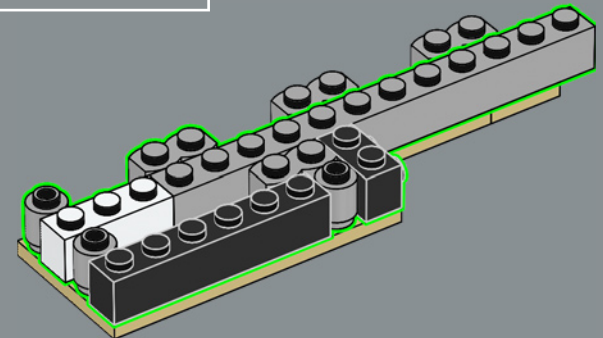

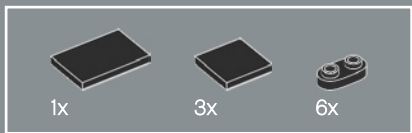

309

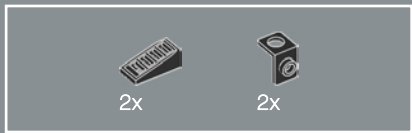
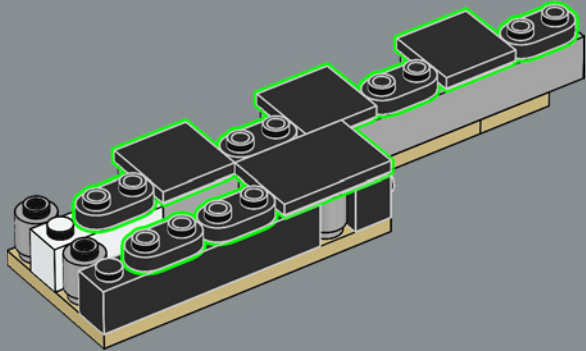

310

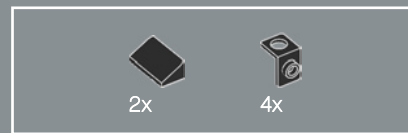
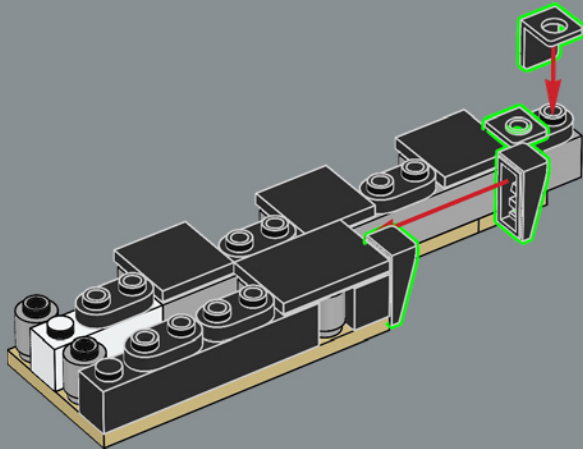

311

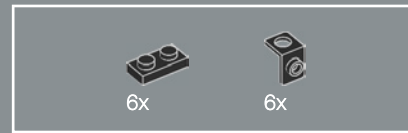
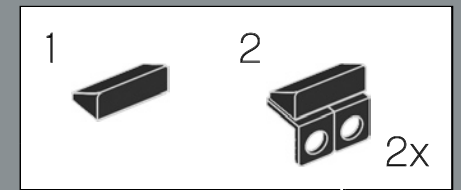
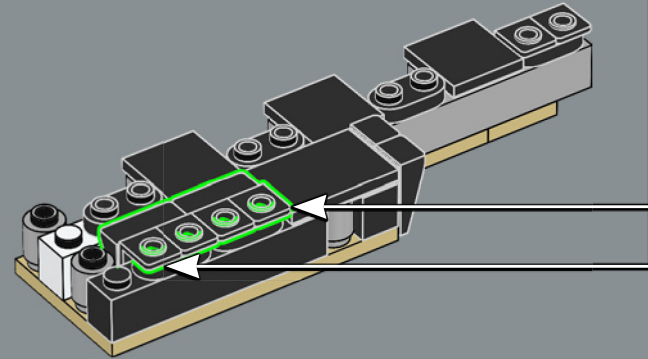

312

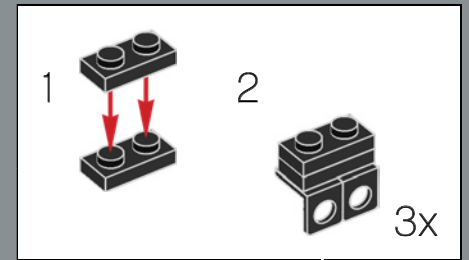
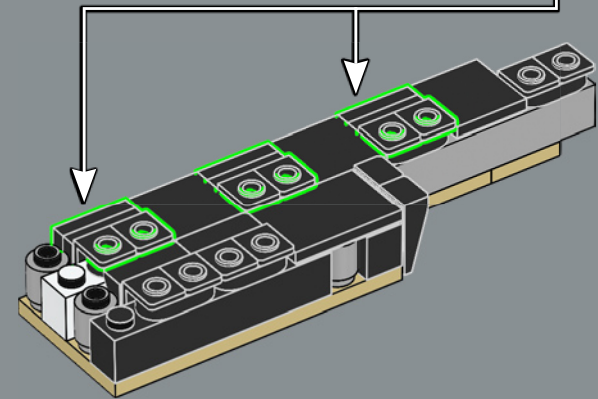



313

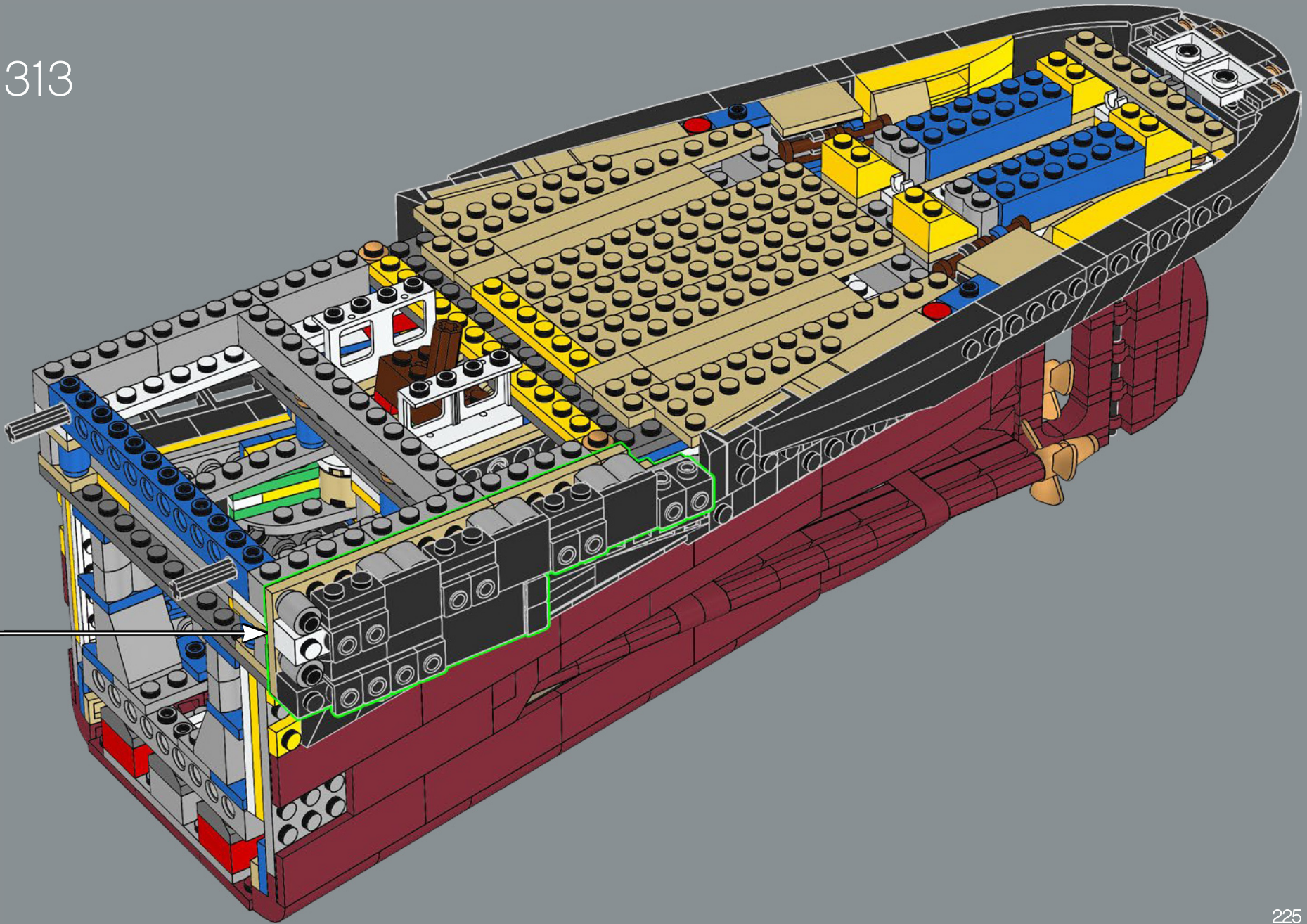

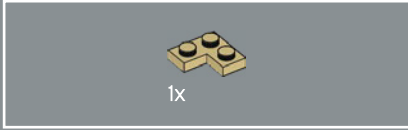
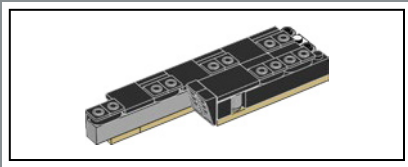

314

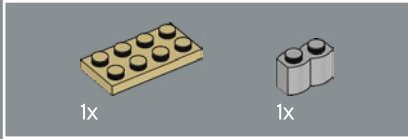

315

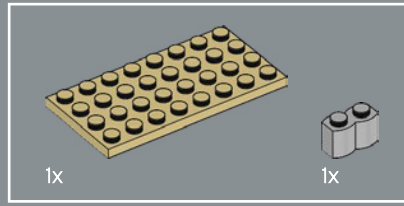
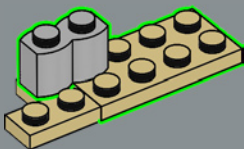

316

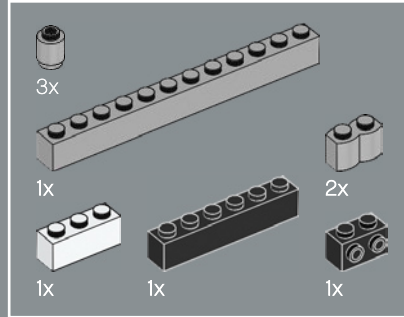
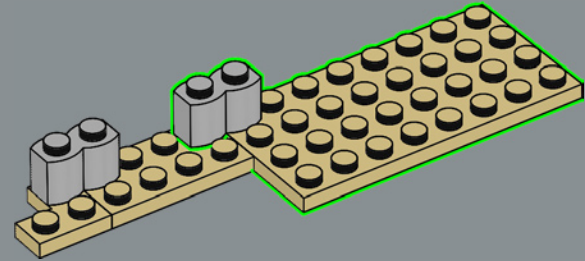

317

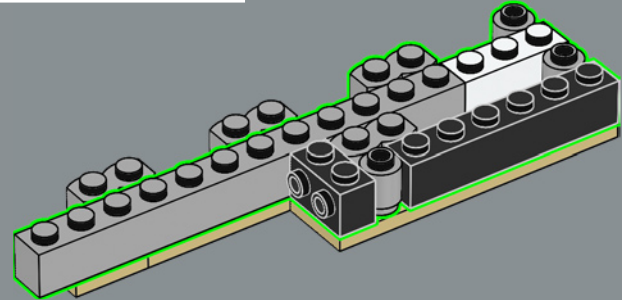

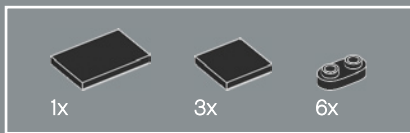

318

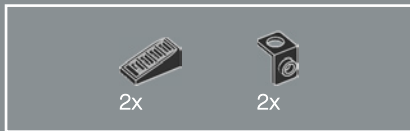
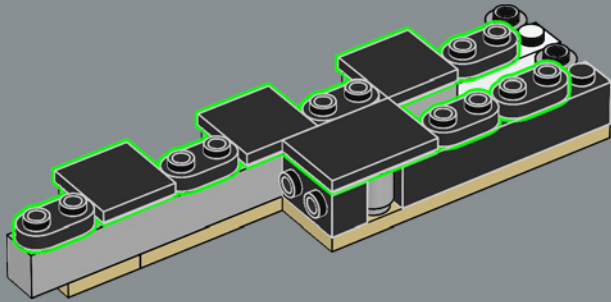

319

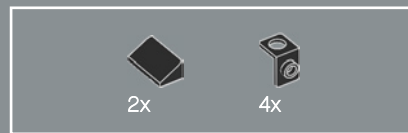
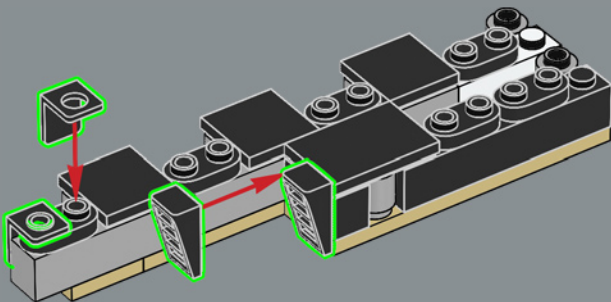

320

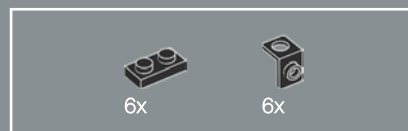
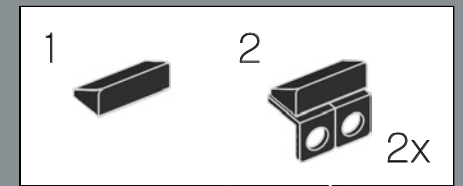
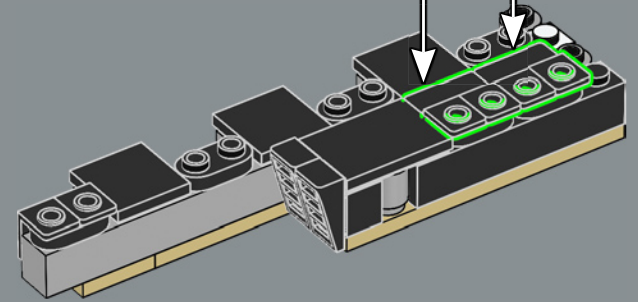

321

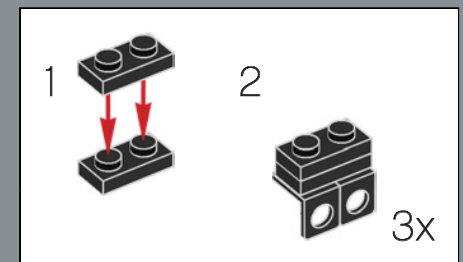
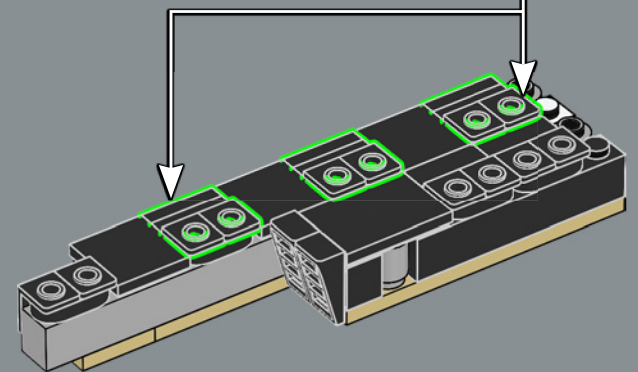

322

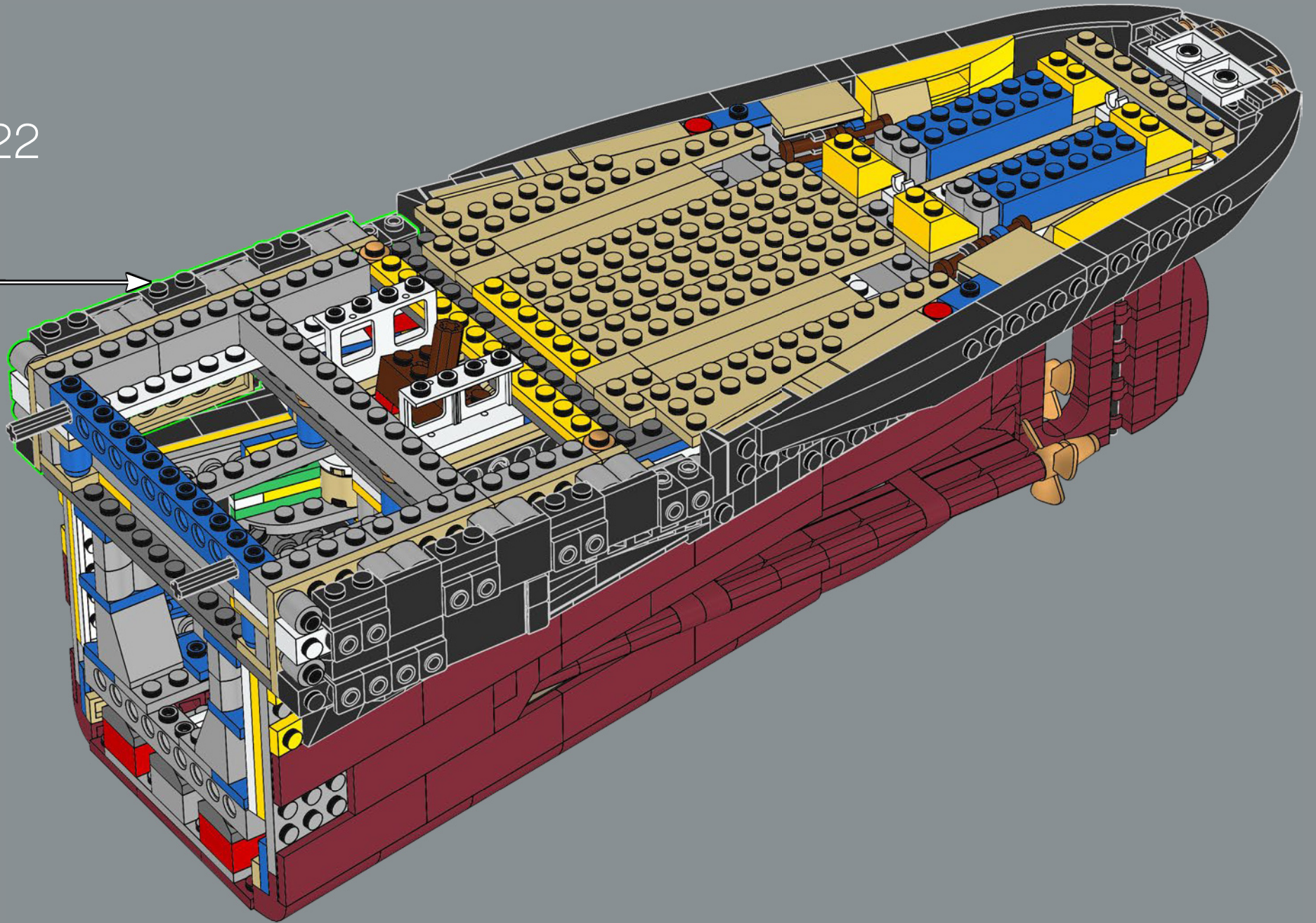

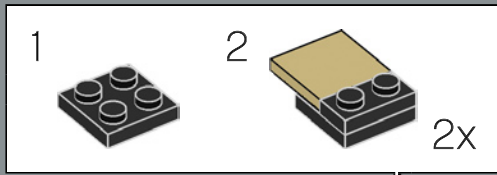
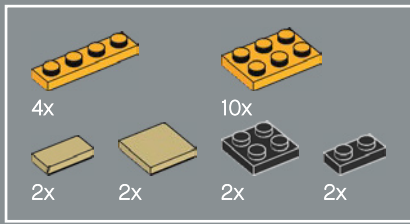

323

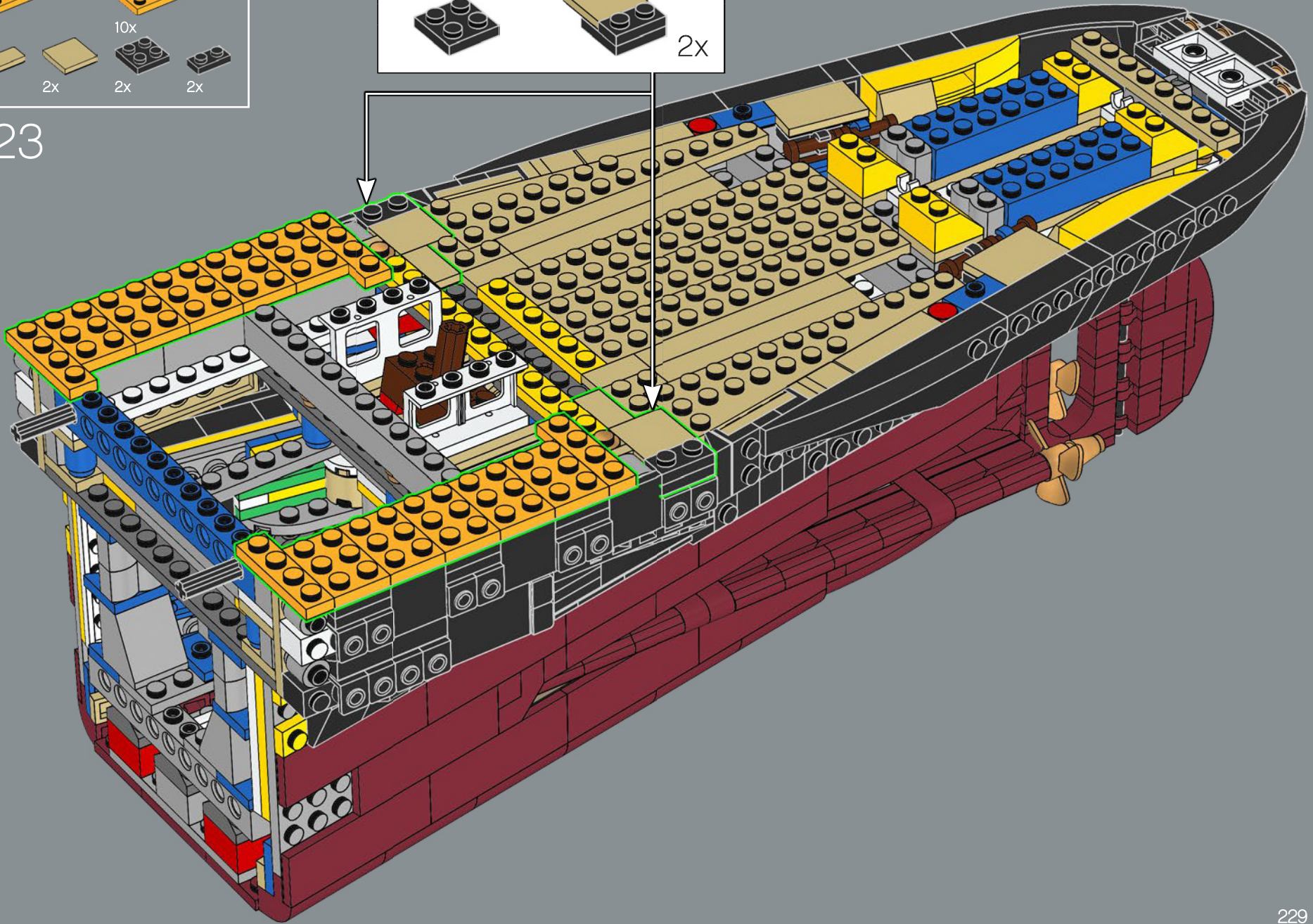

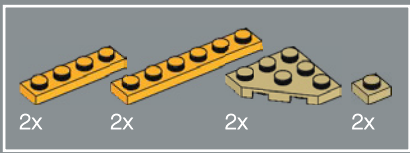

324

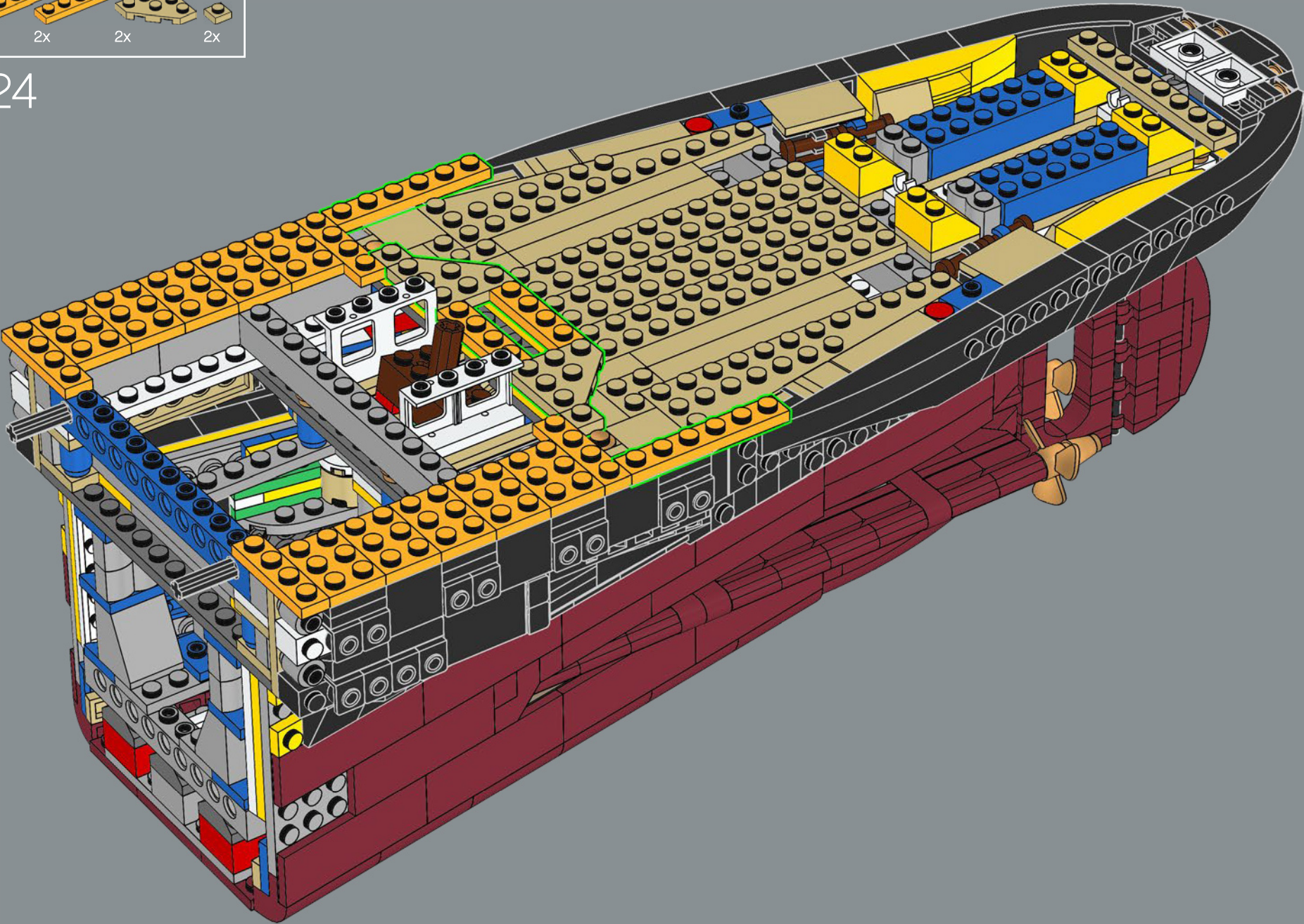

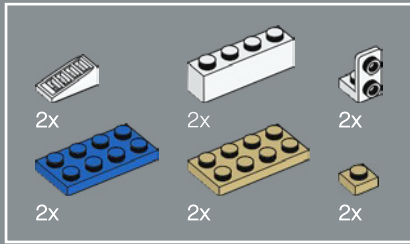

325

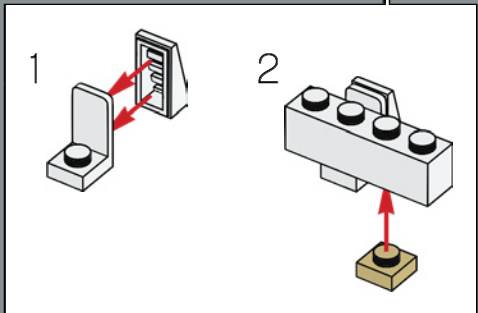
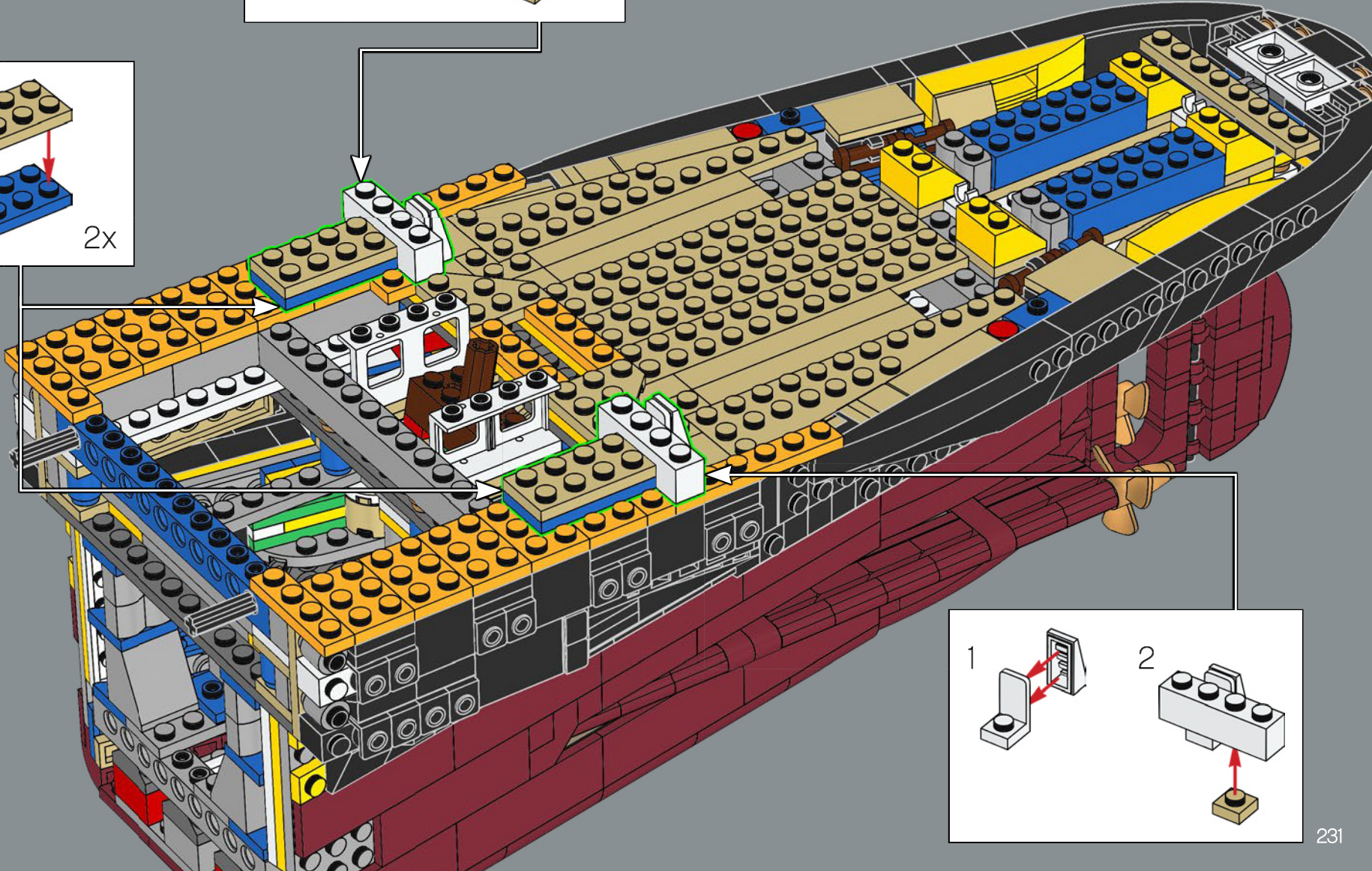
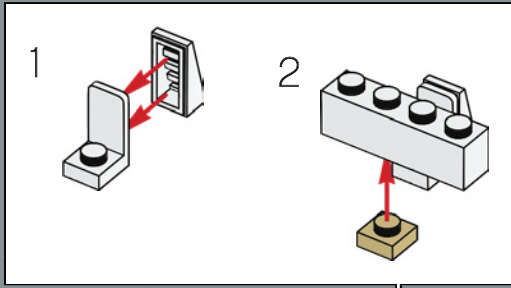
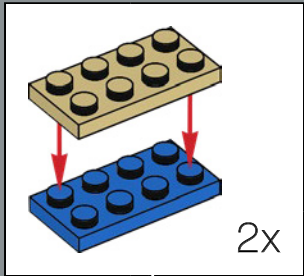

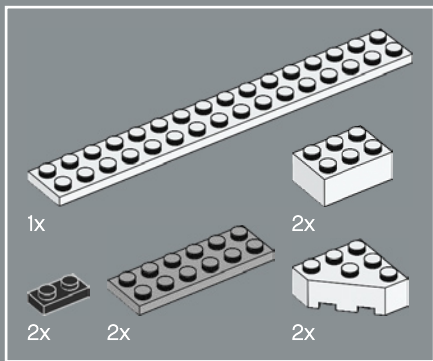

326

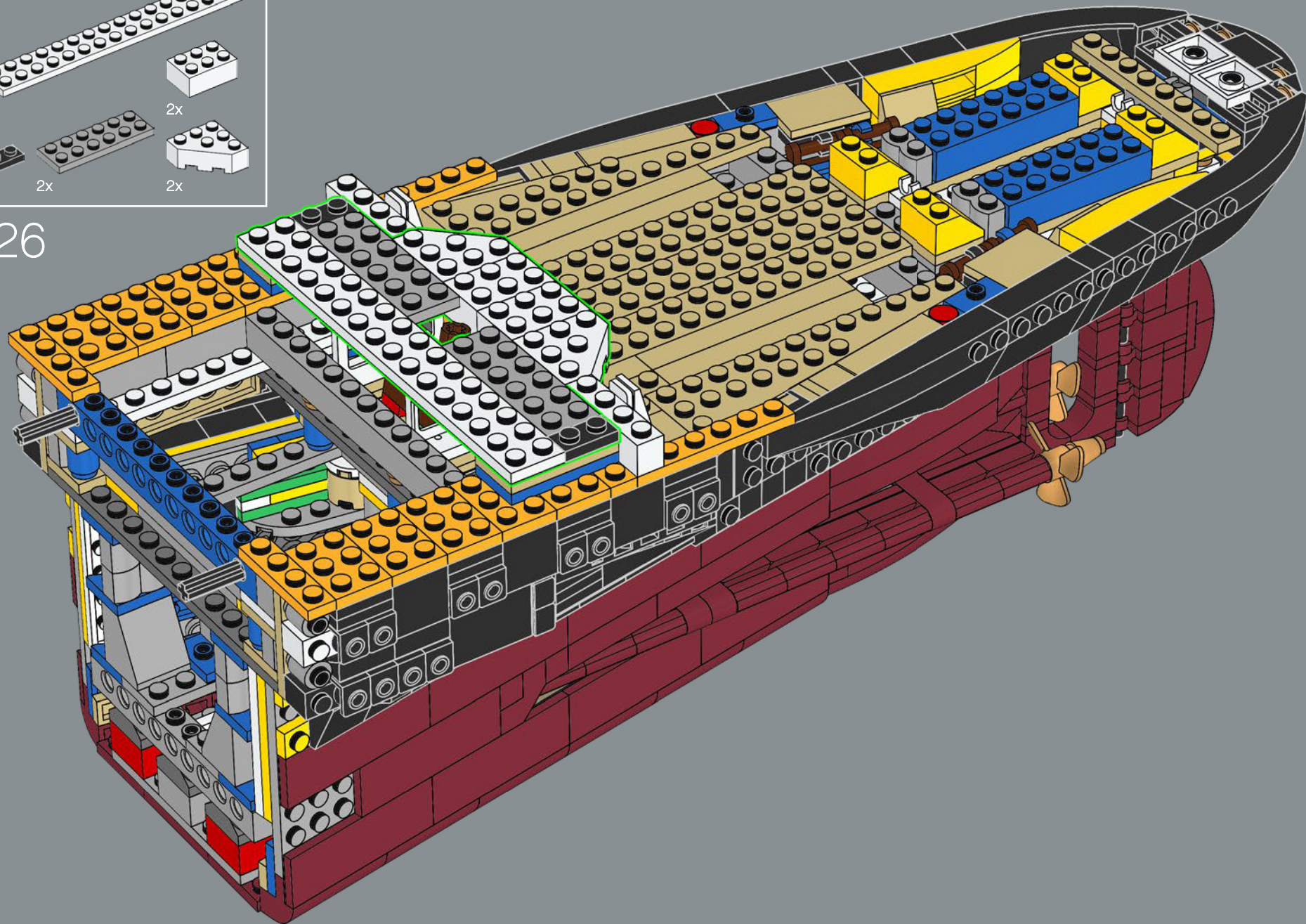



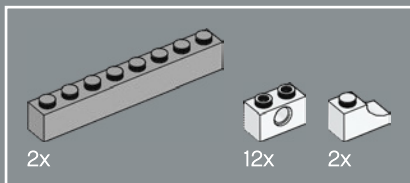

327

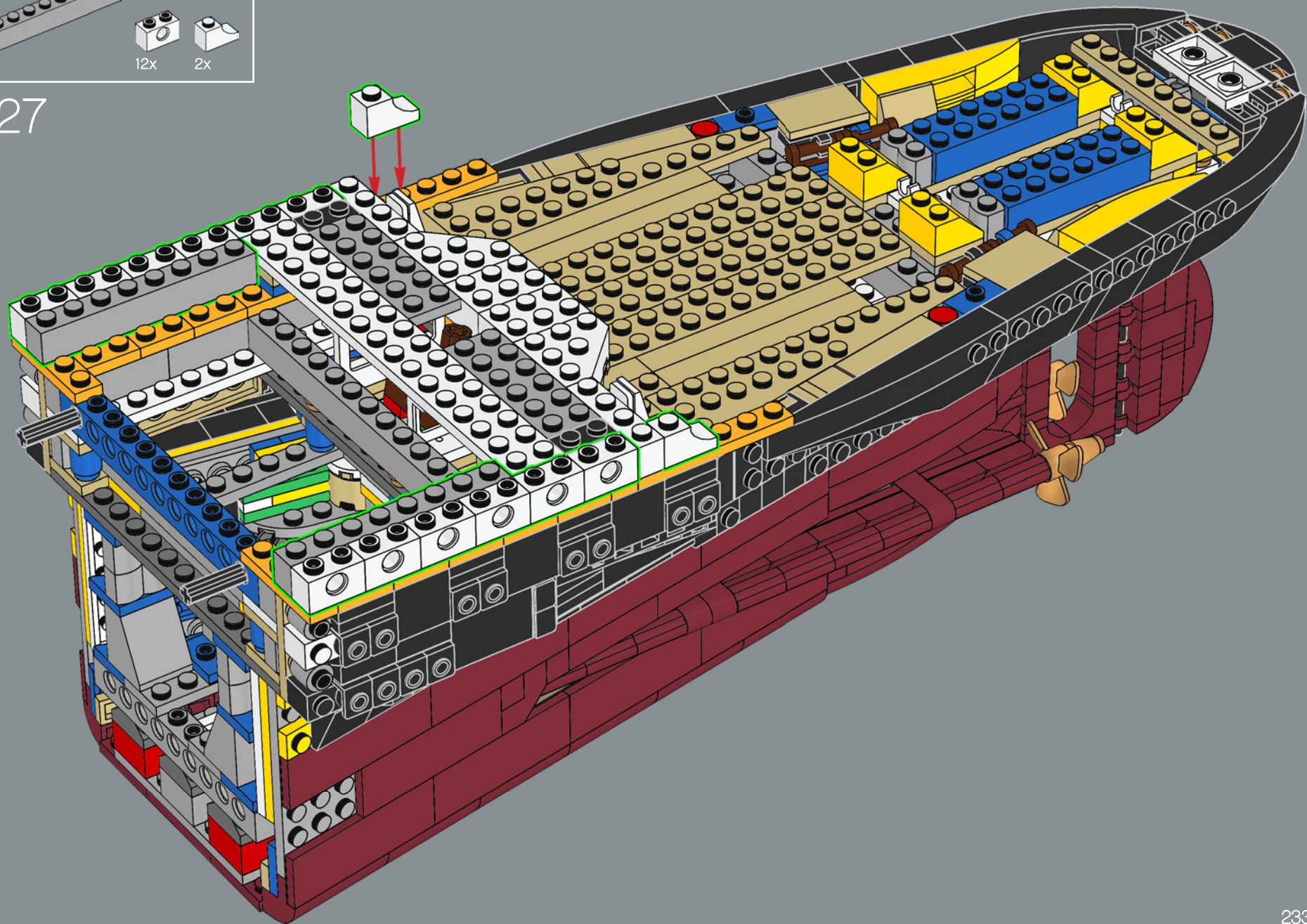

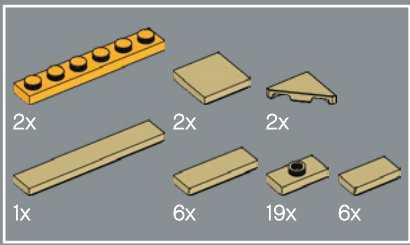

328

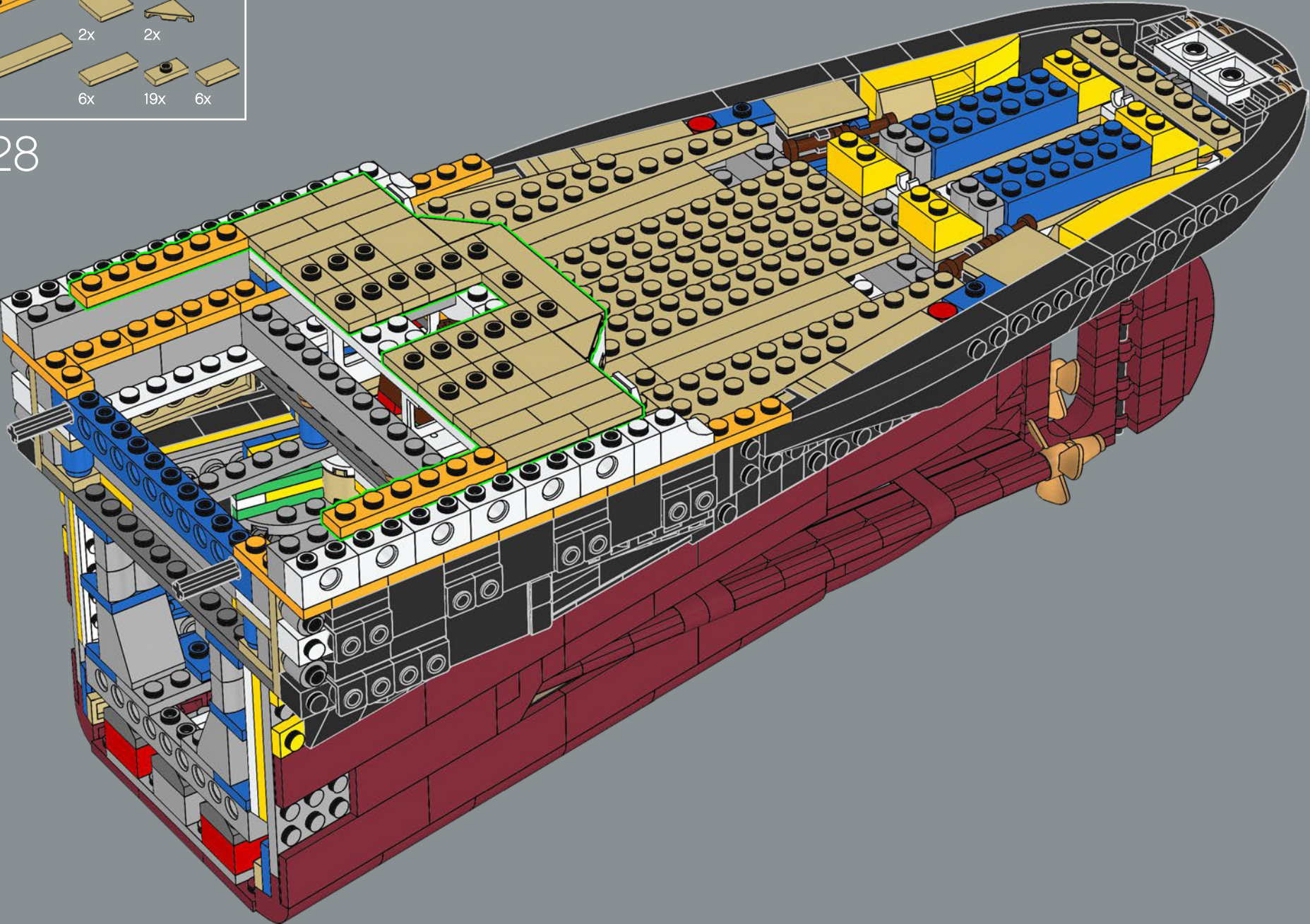

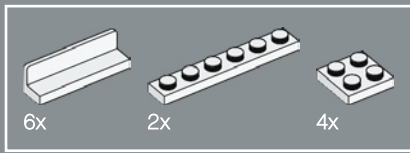

329

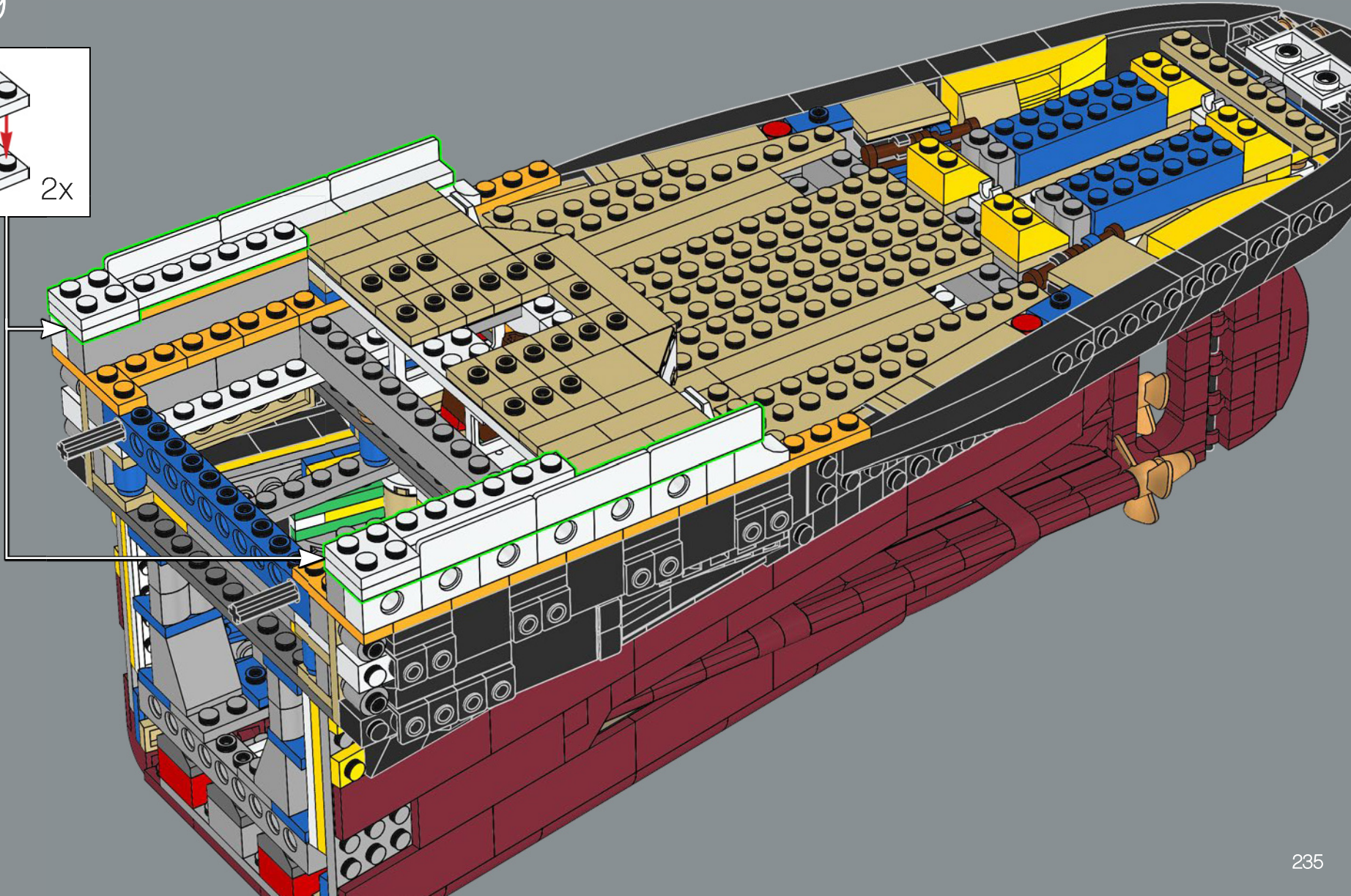
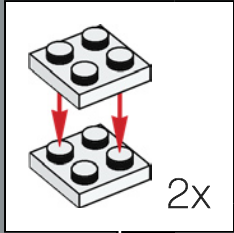

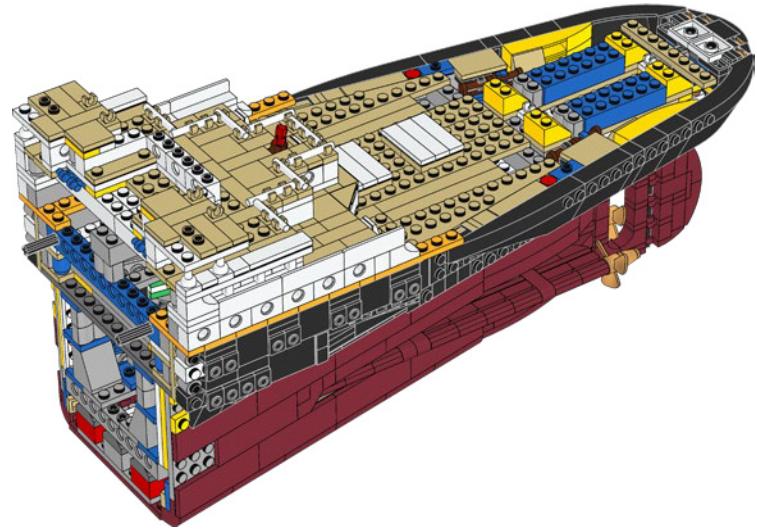
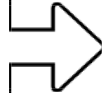

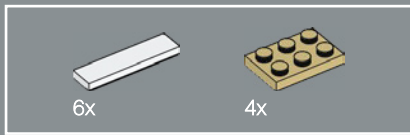

330

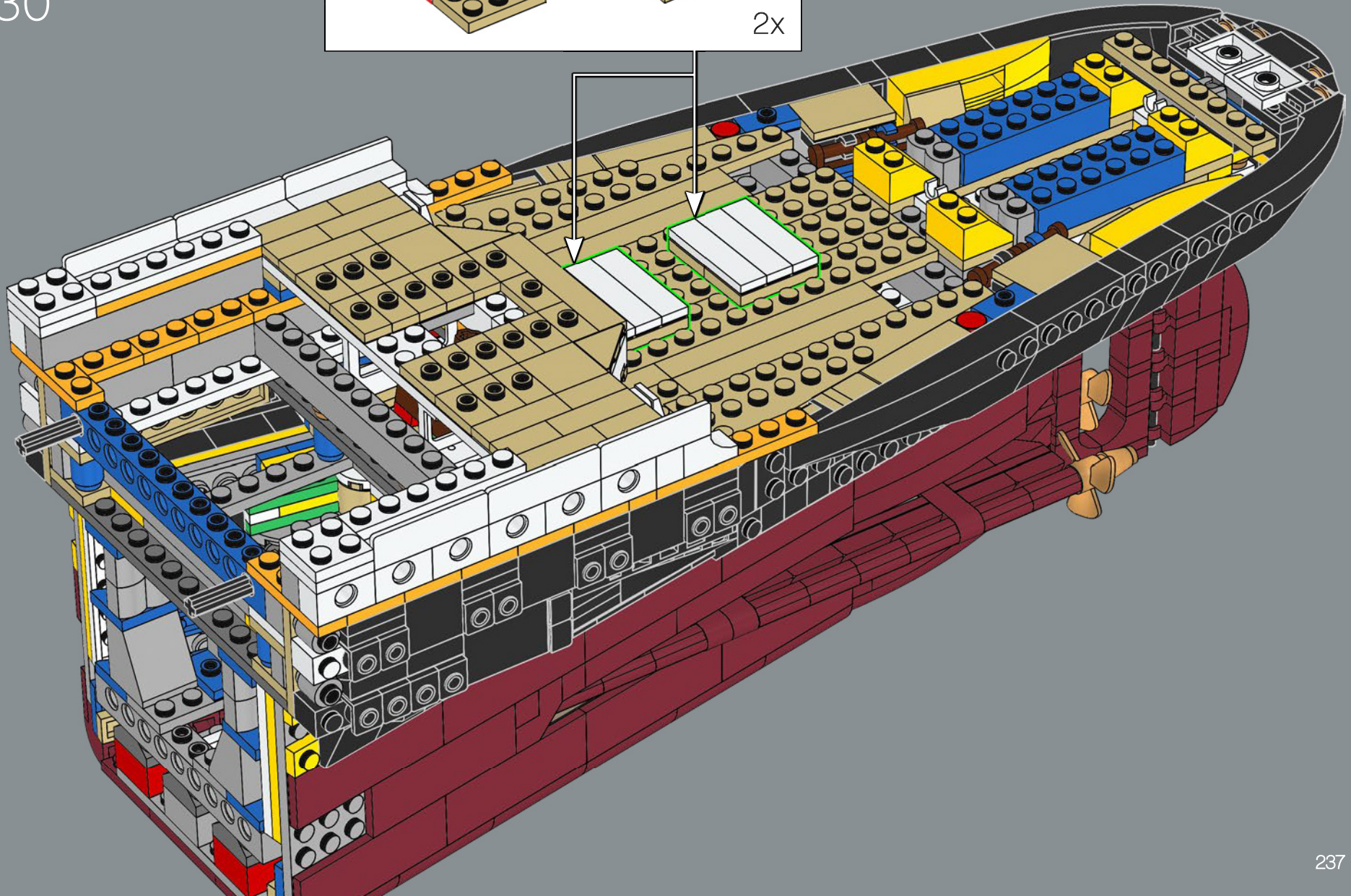
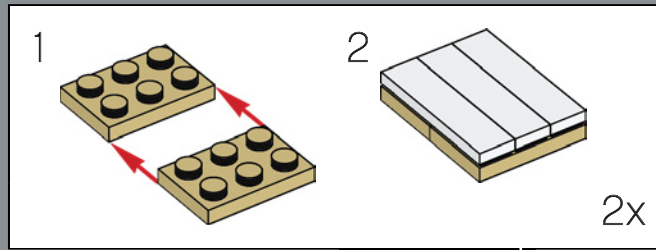

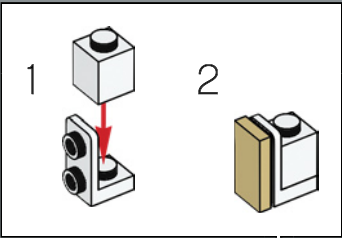
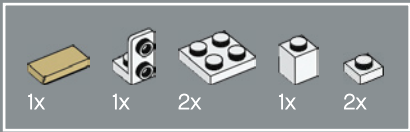

331

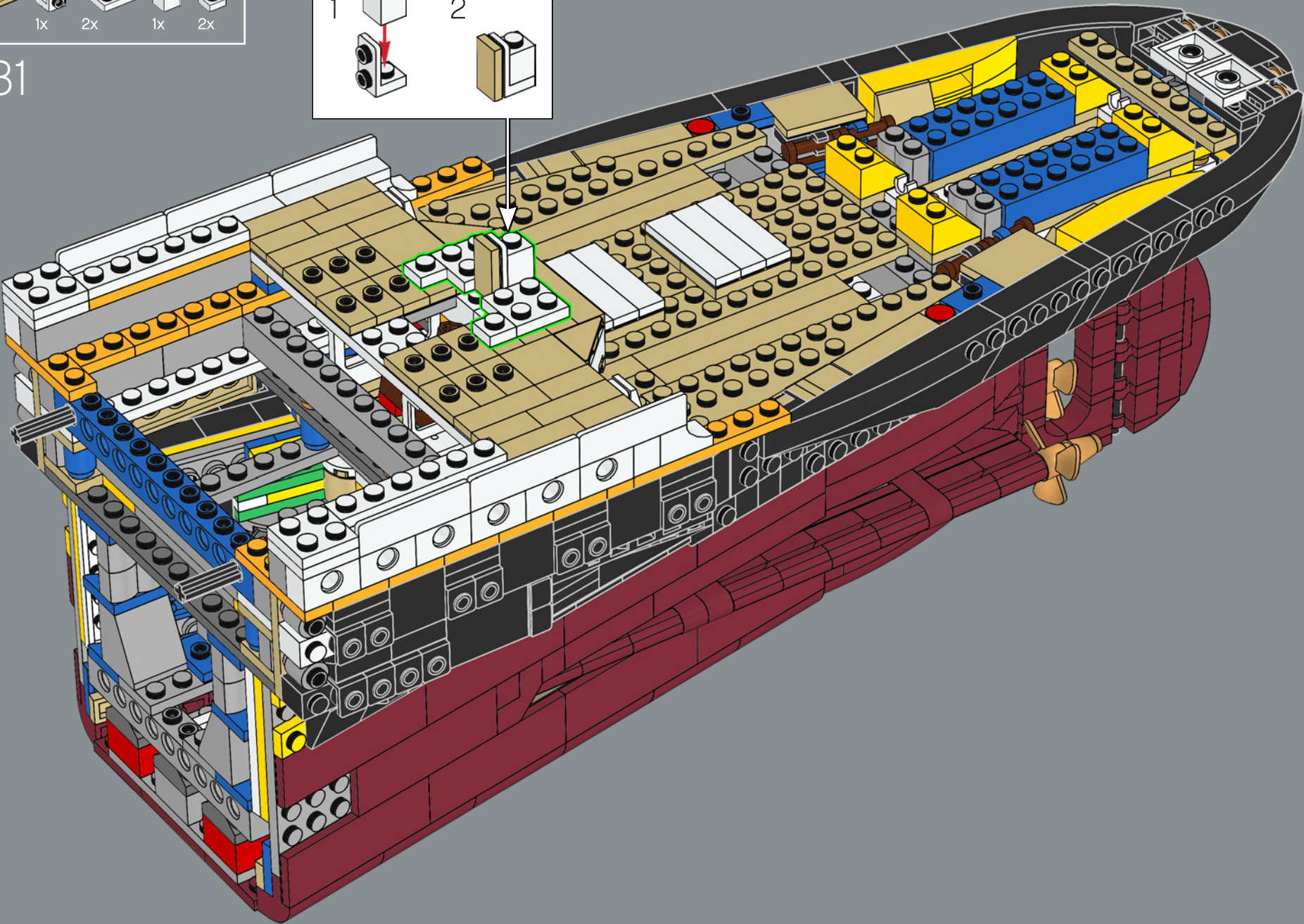

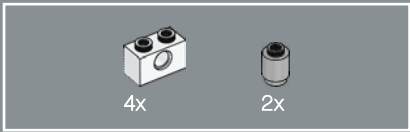

332

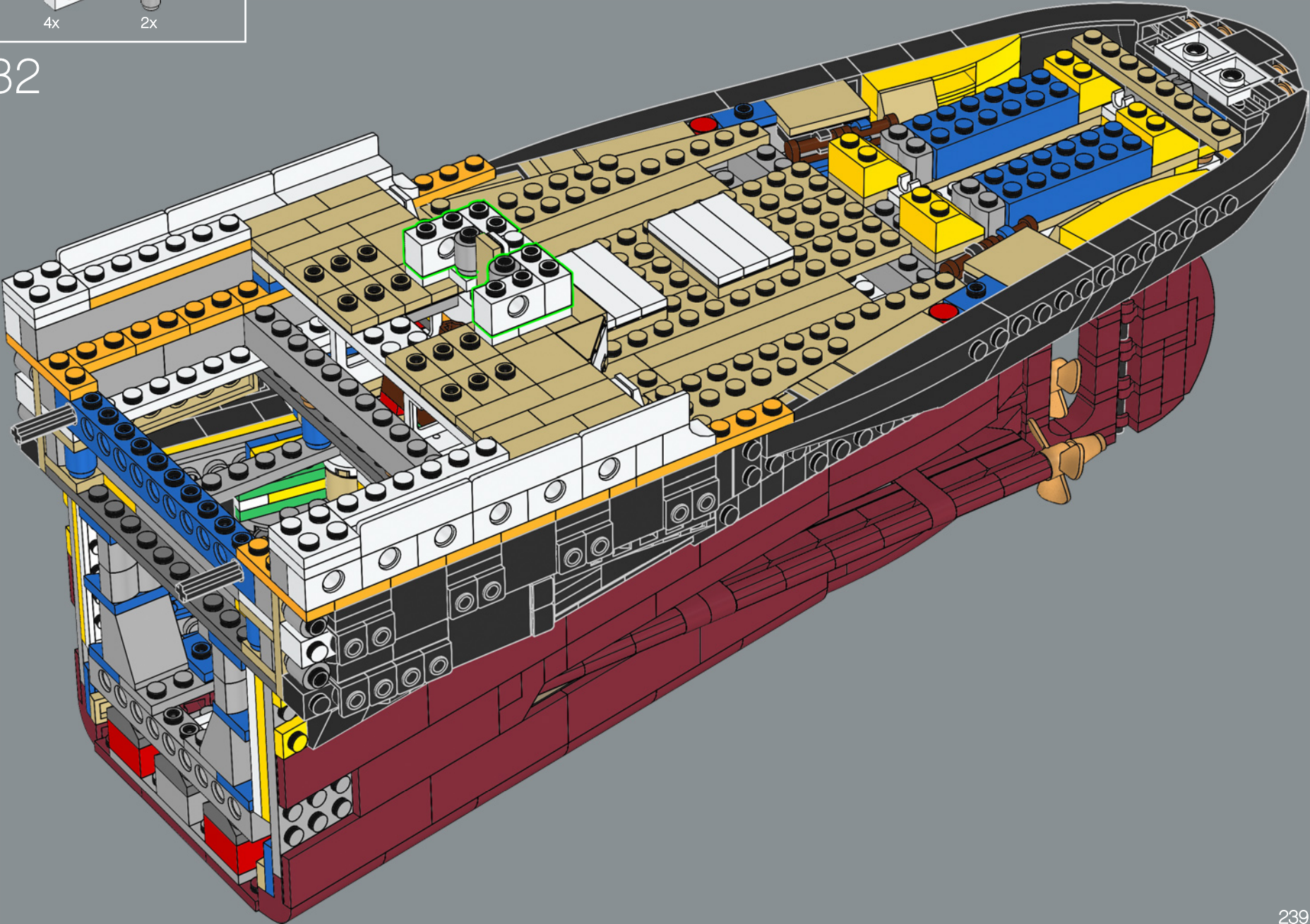

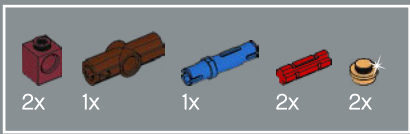

333

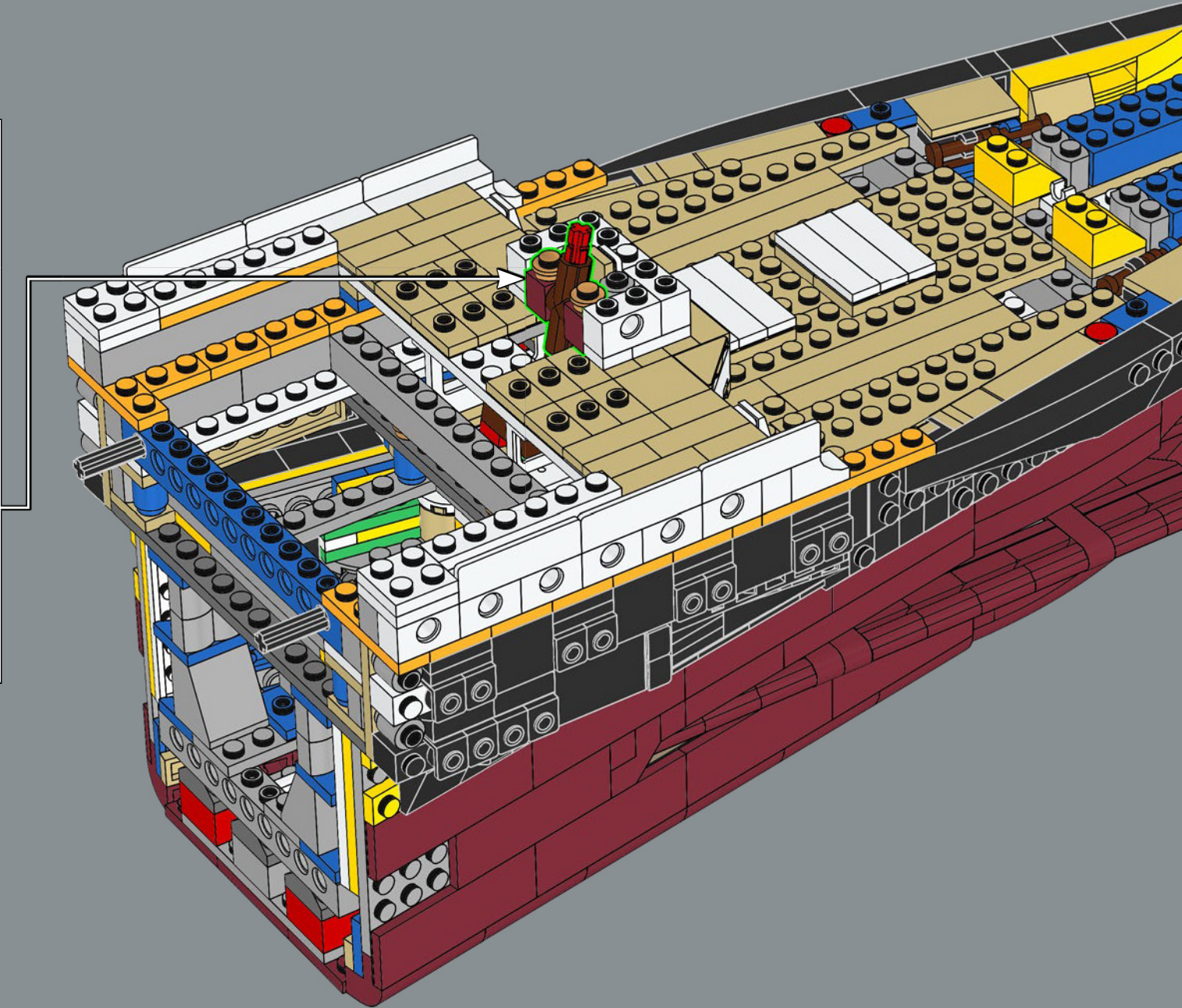
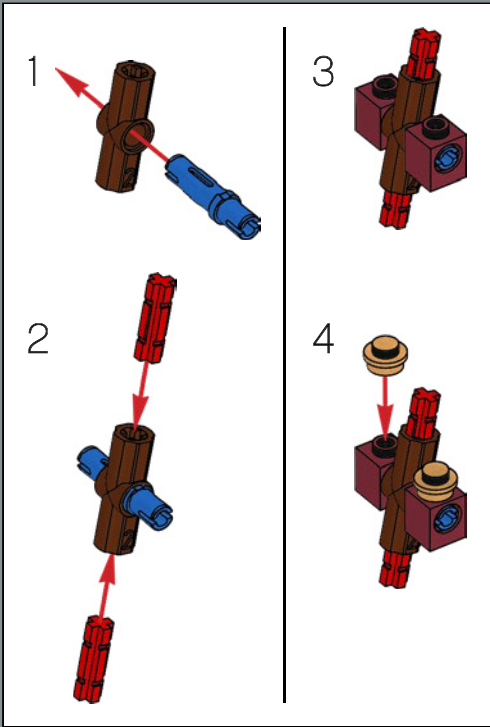



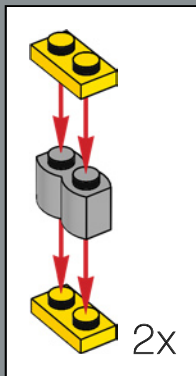
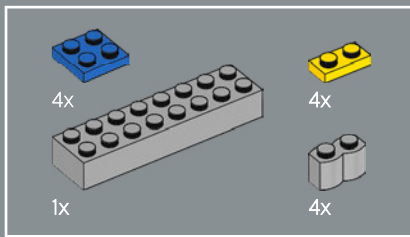

334

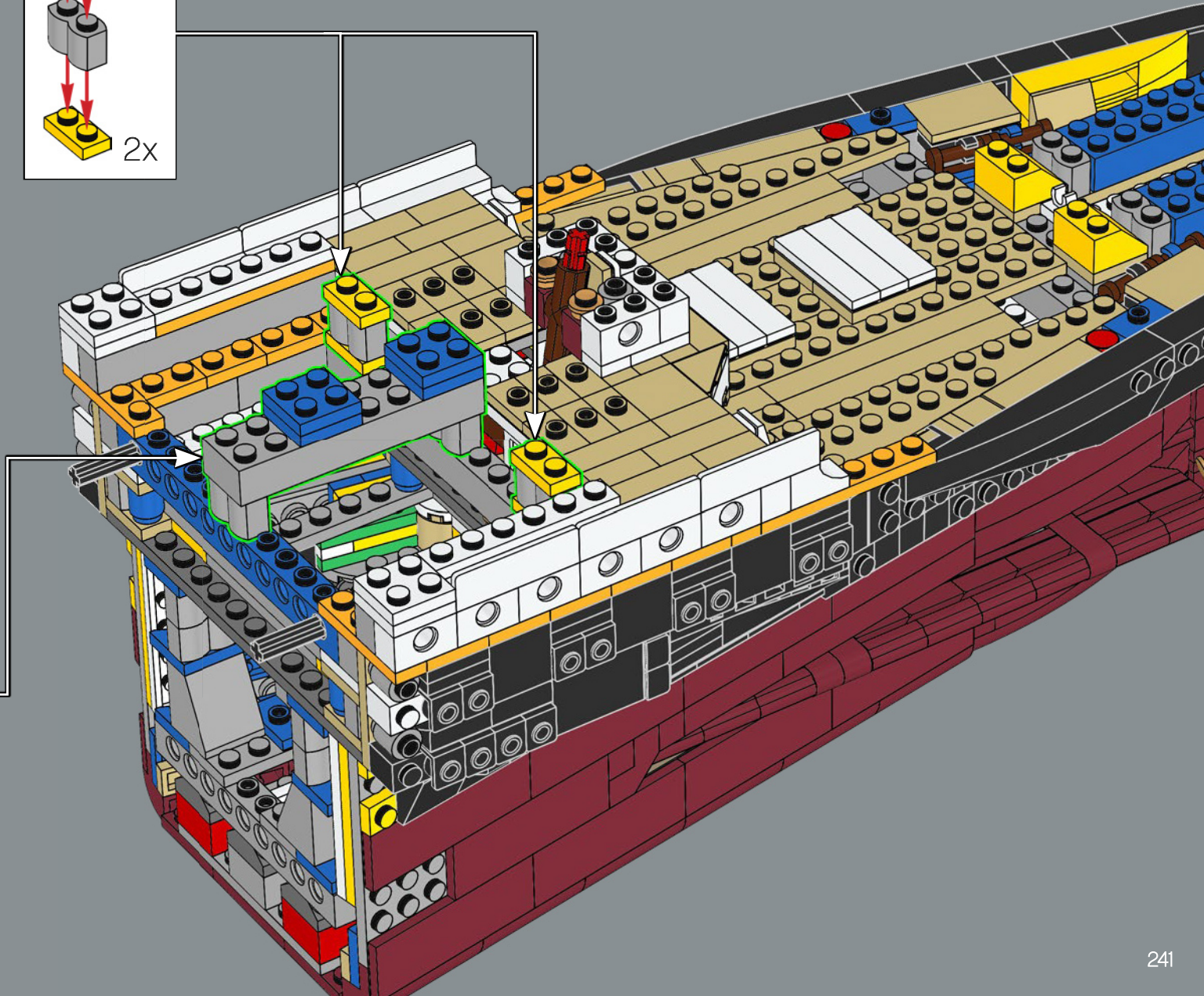
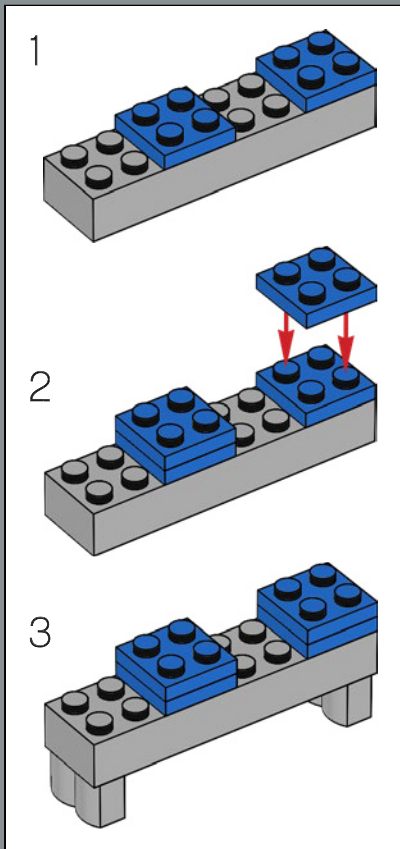

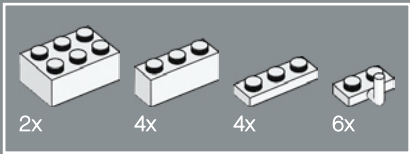

335

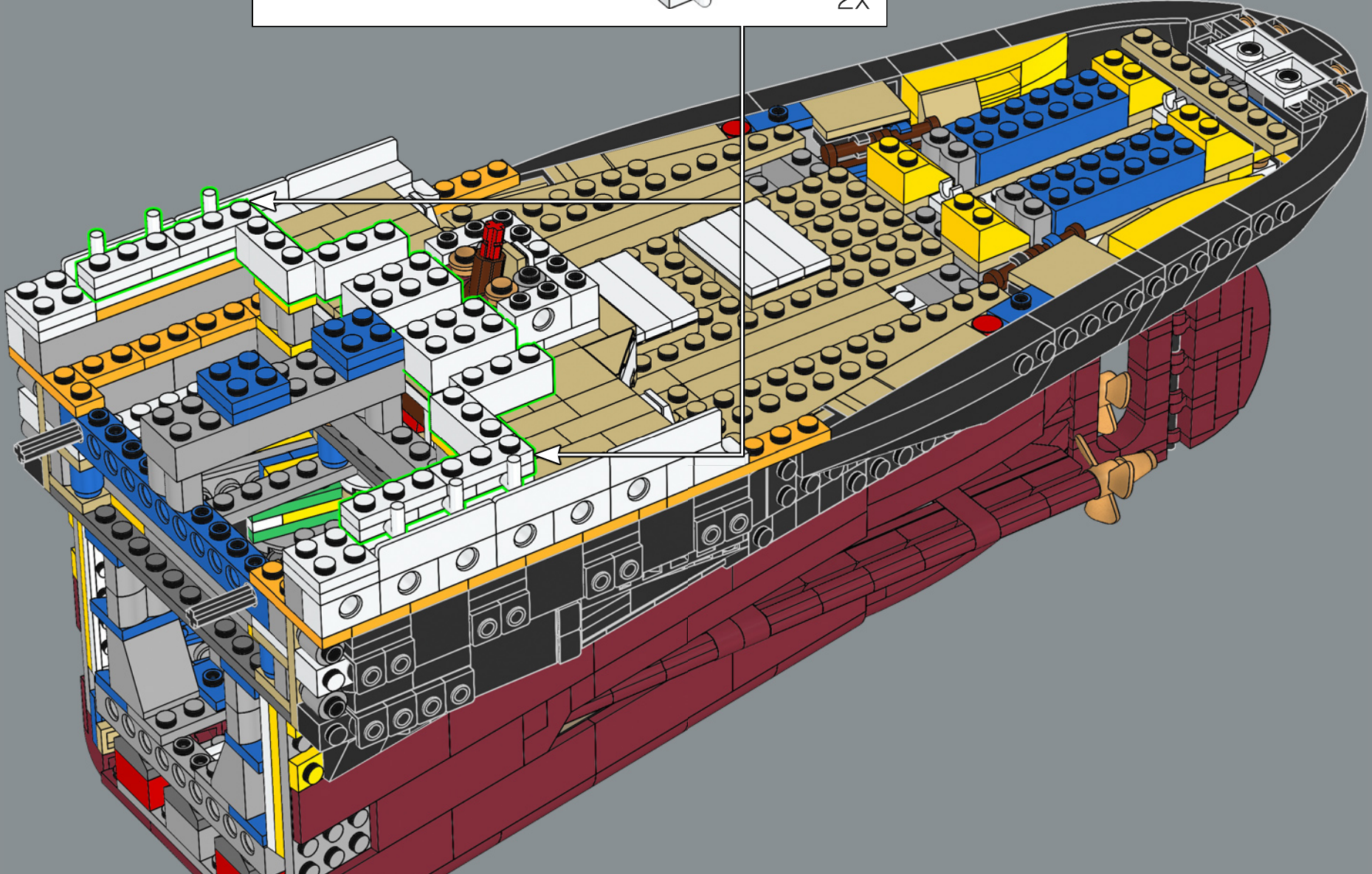
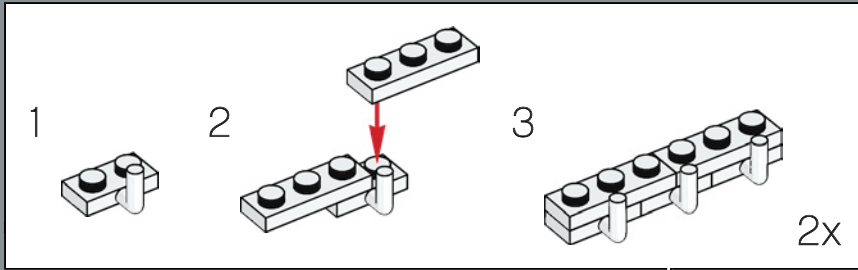

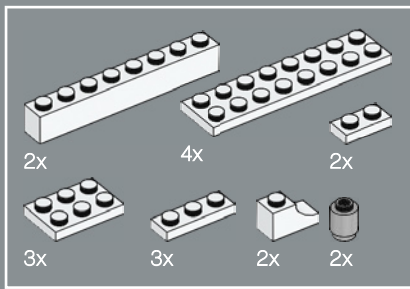

336

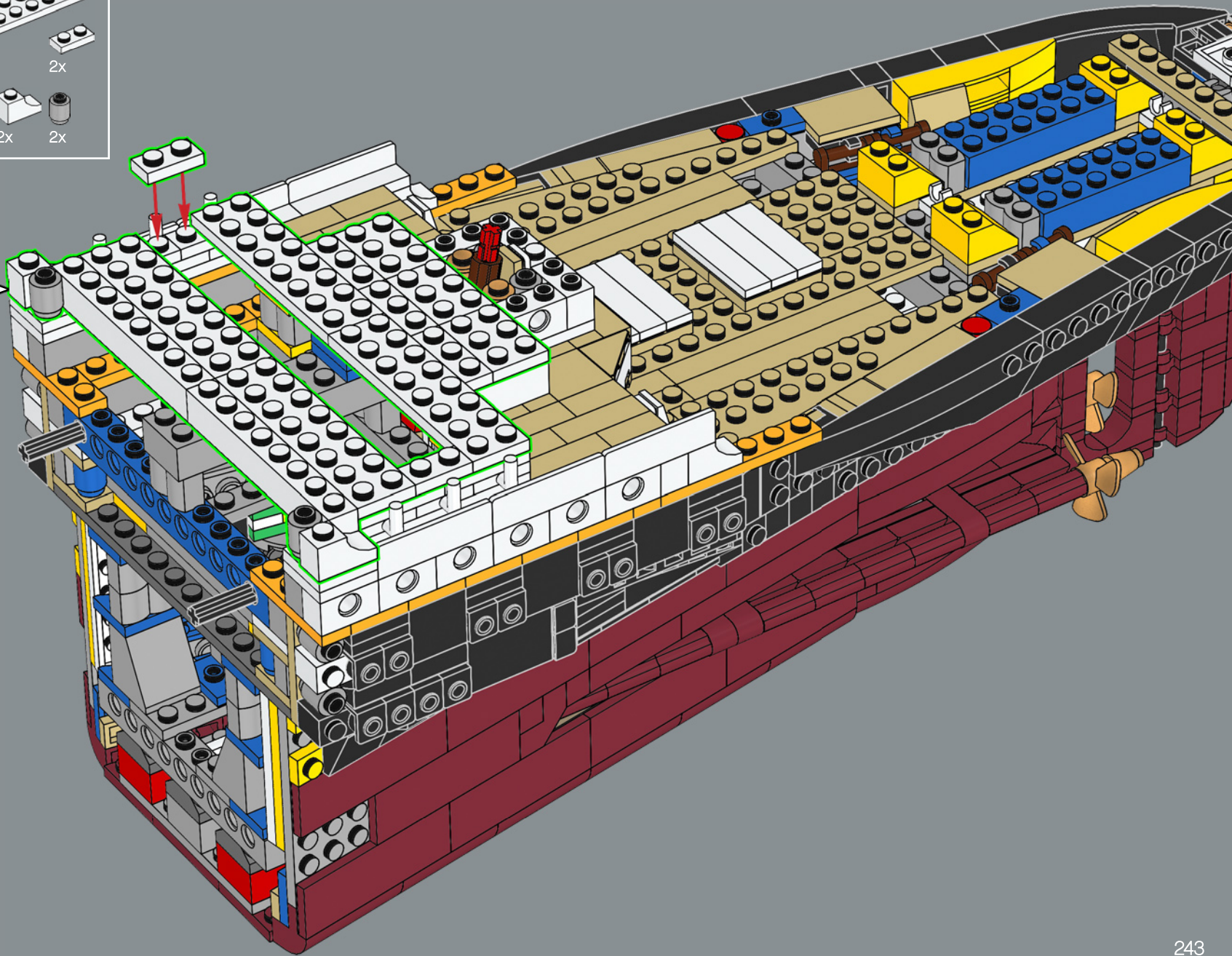
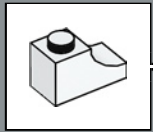

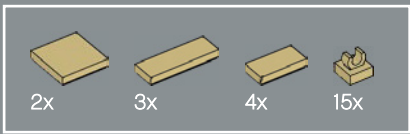

337

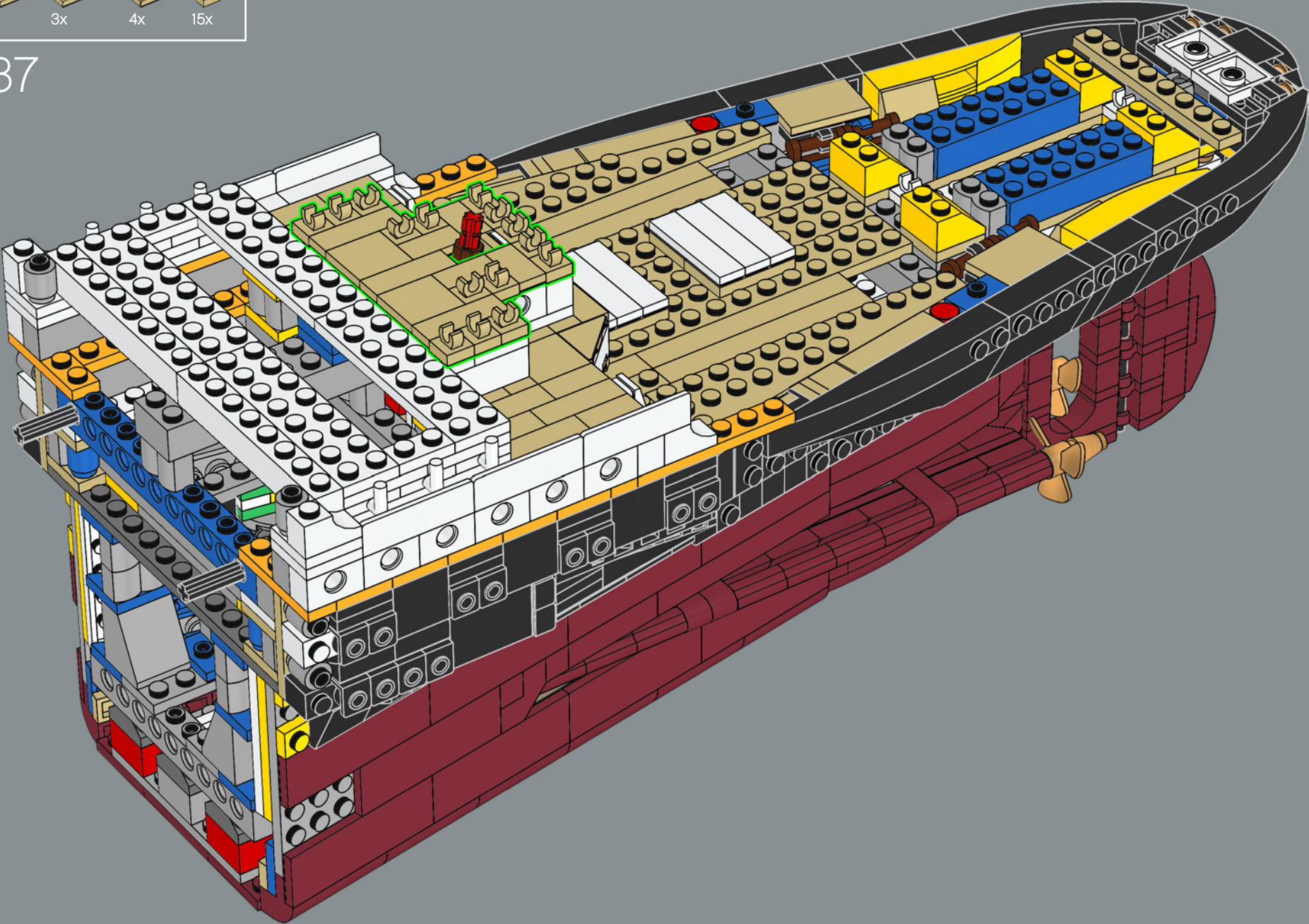

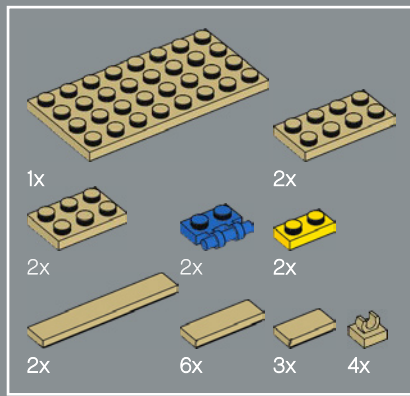

338

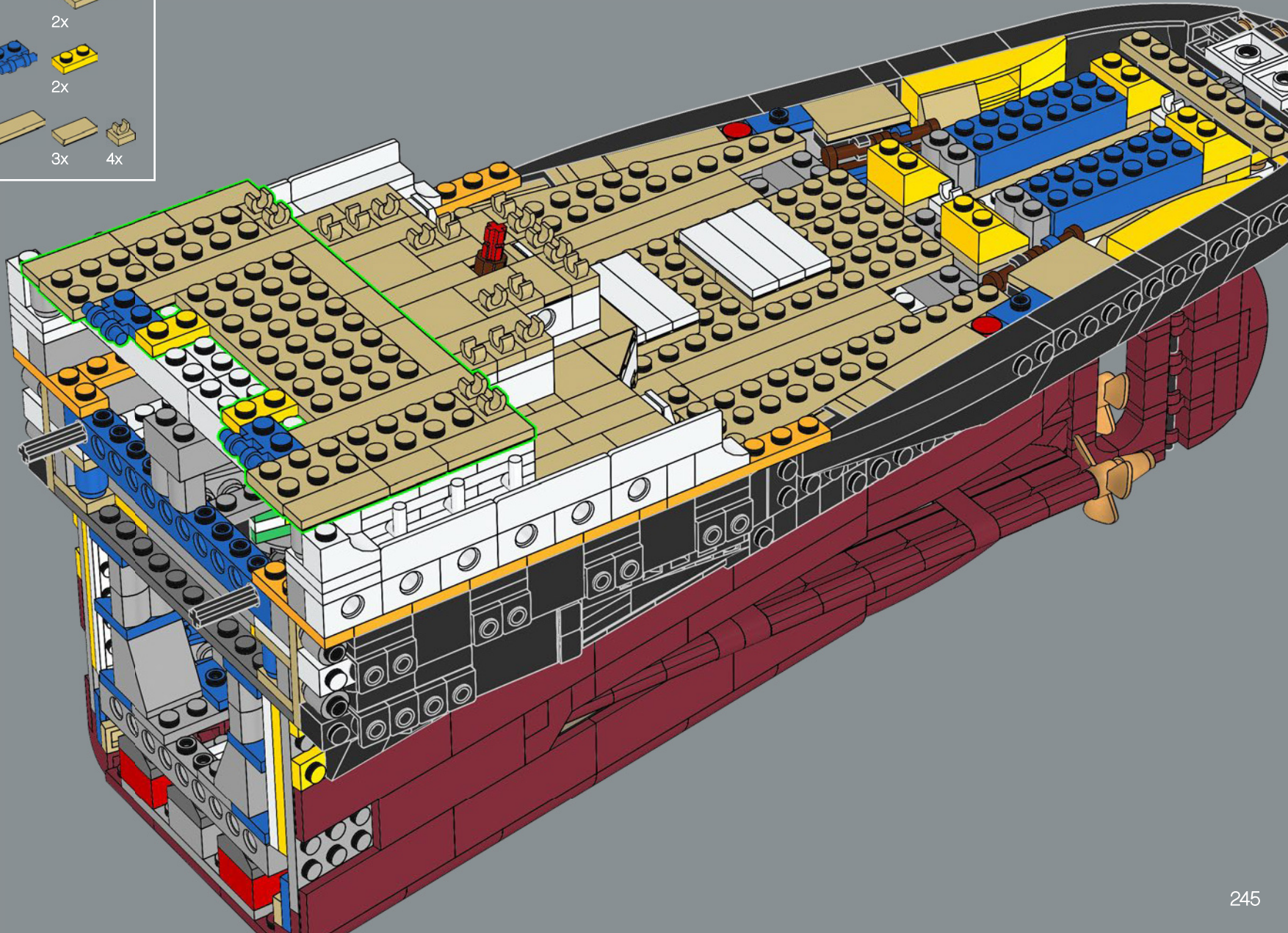

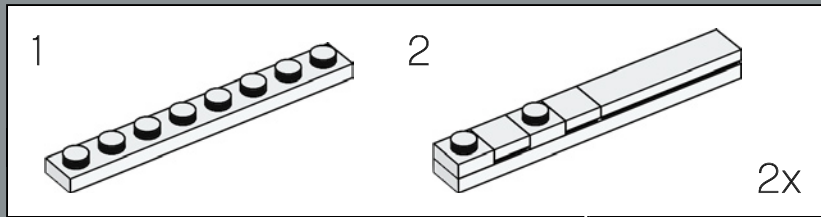
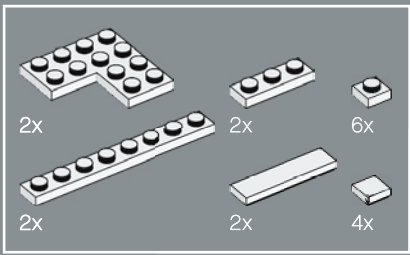

339

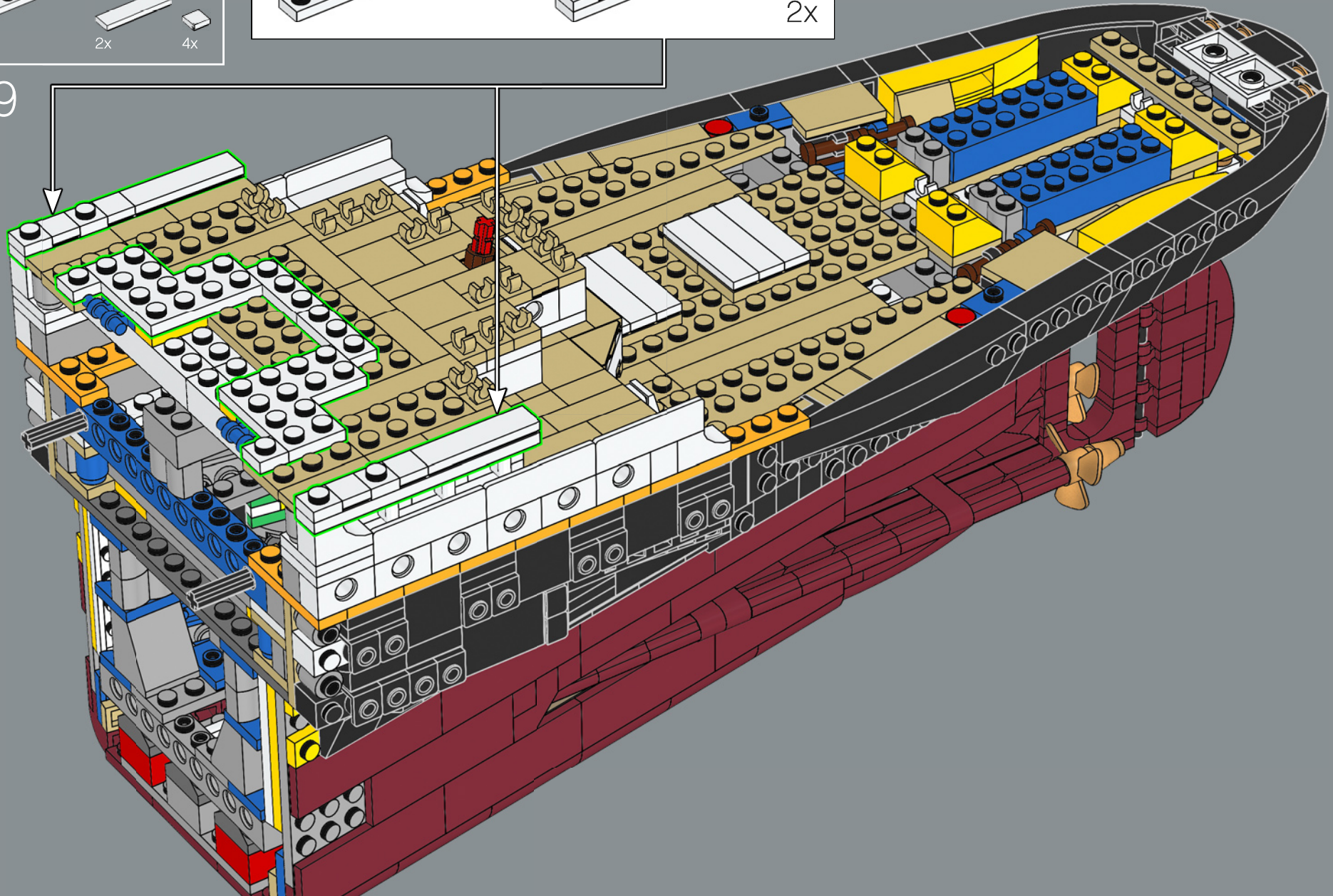

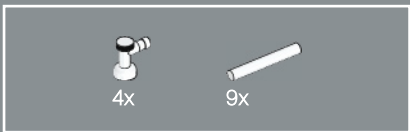

340

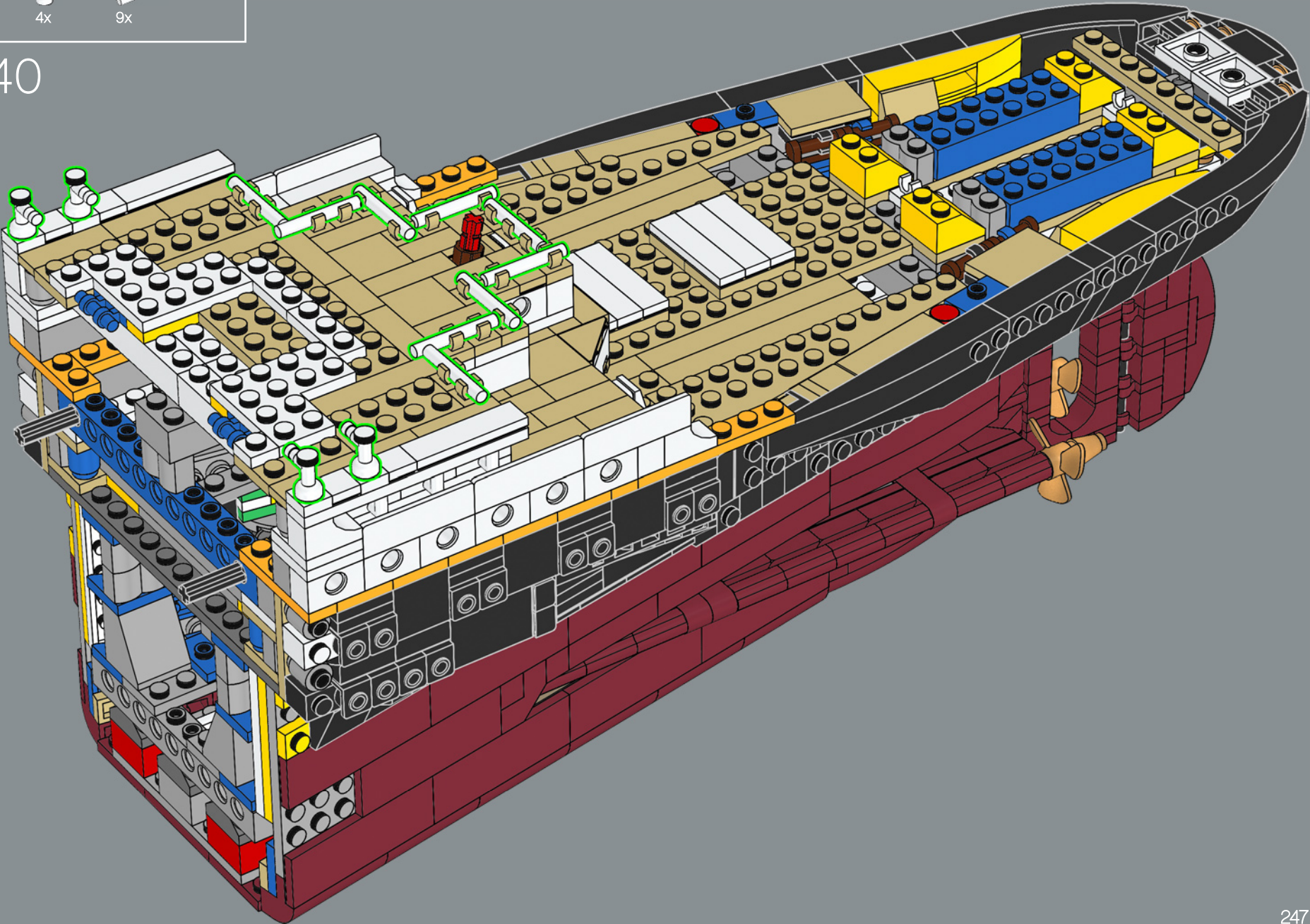

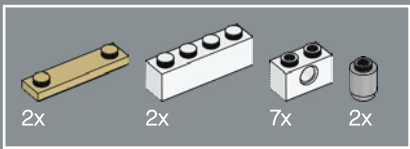

341

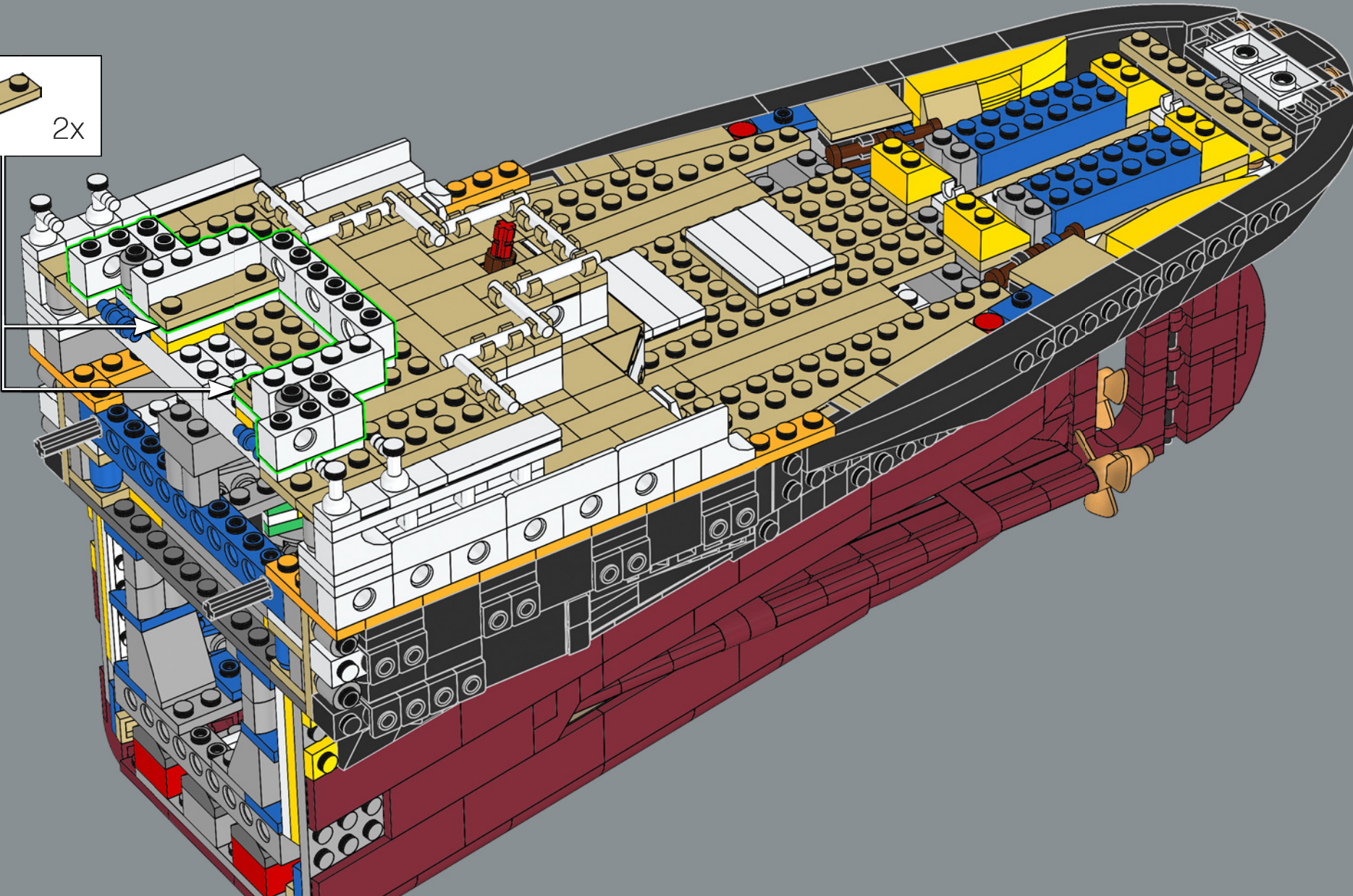
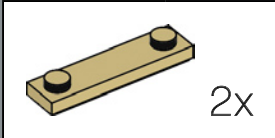



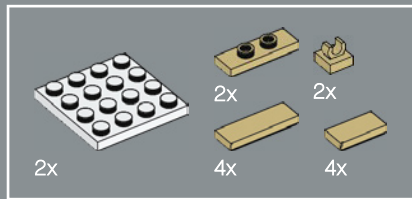

342

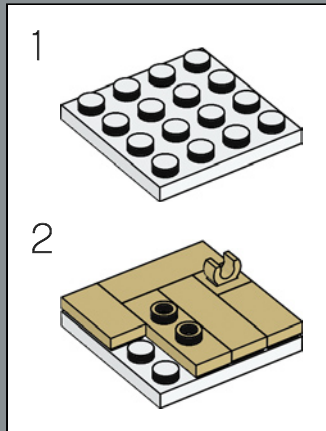
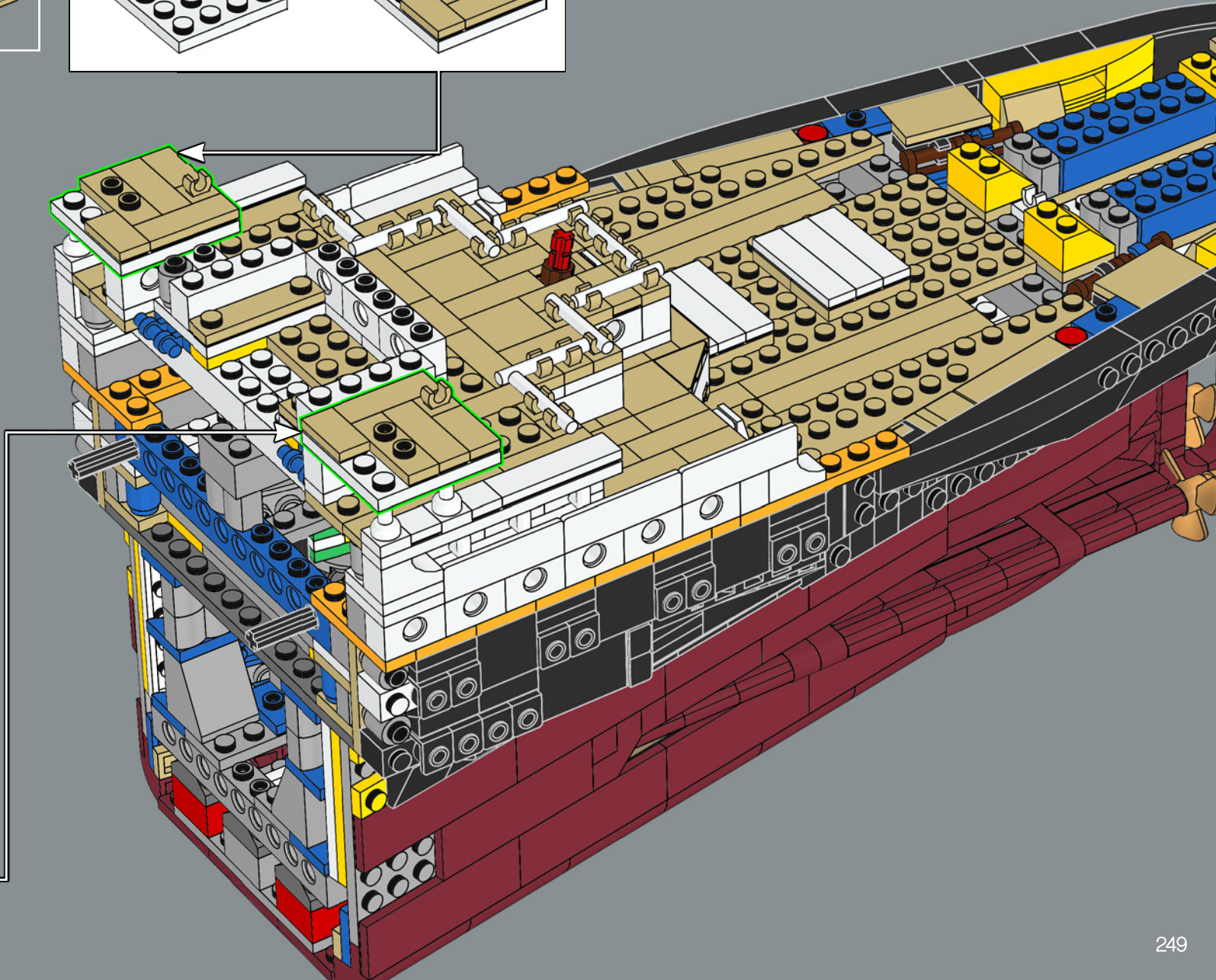
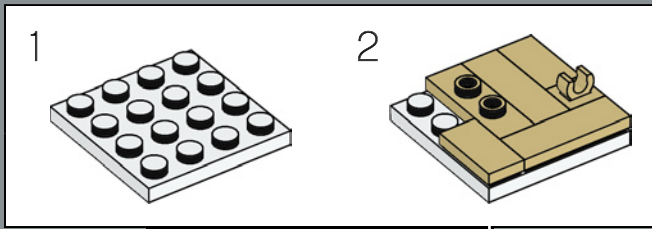

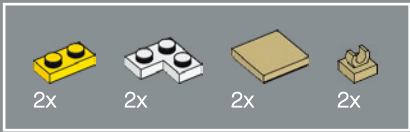

343

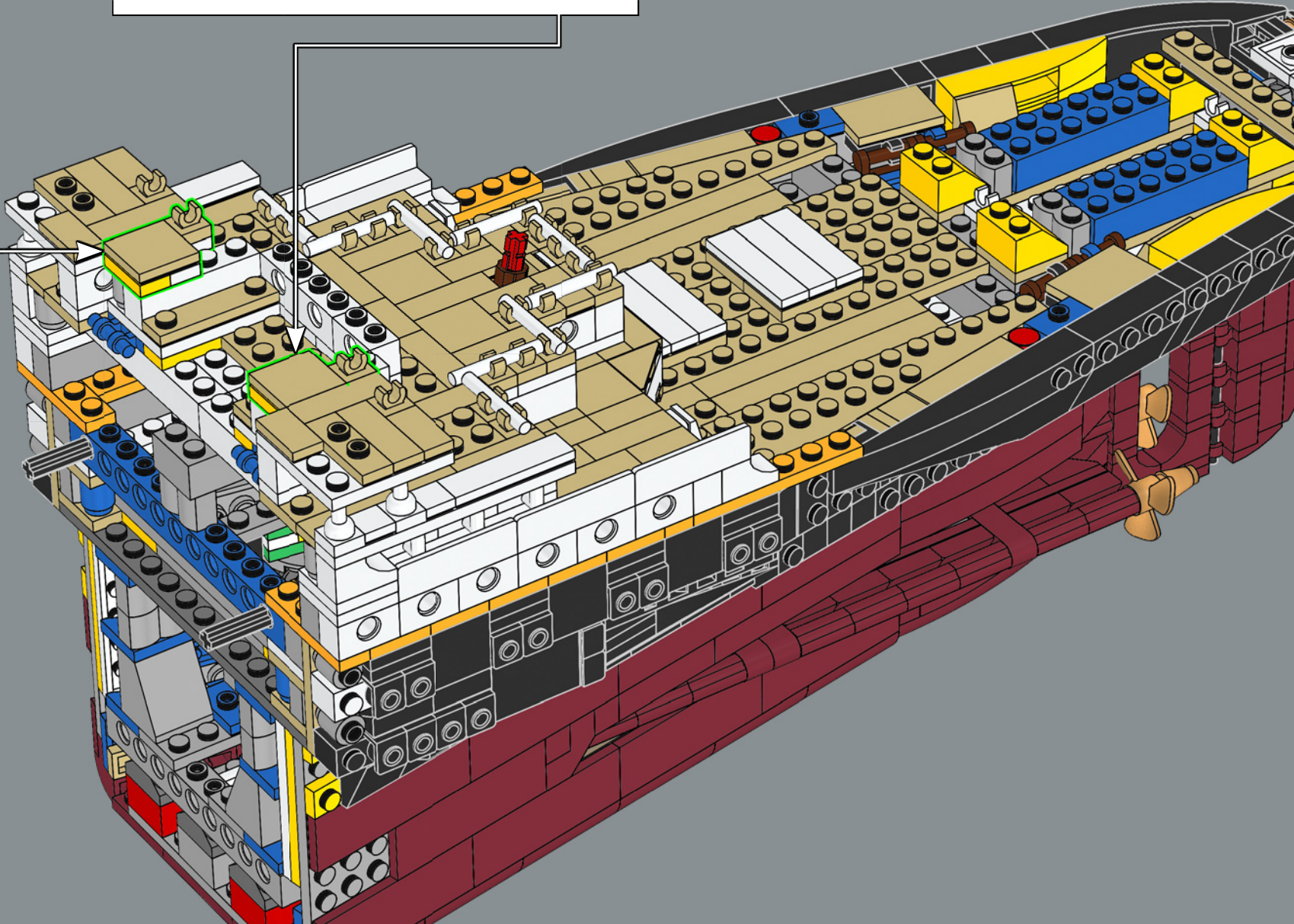
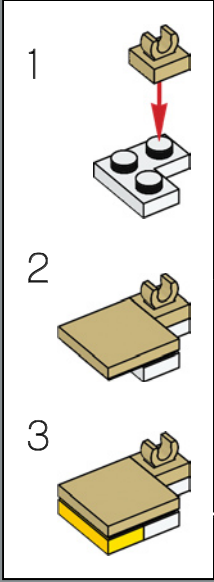
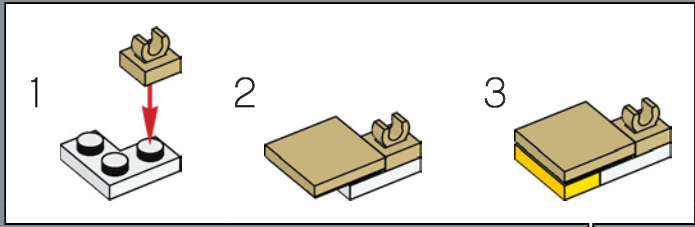

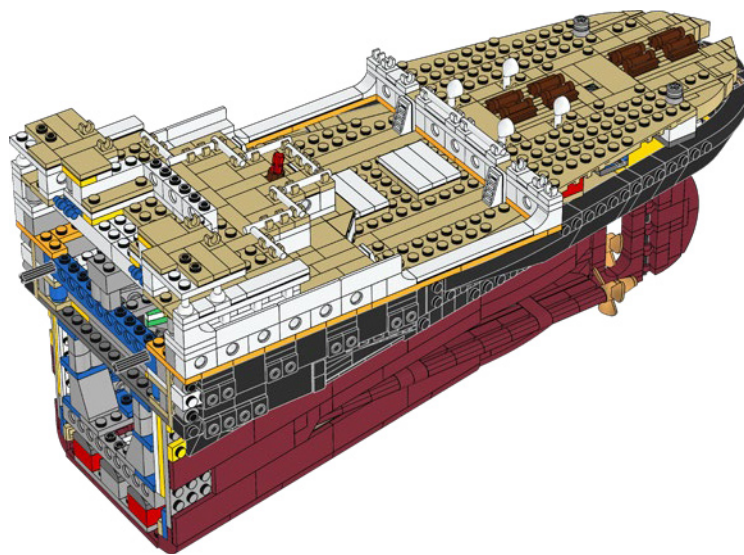

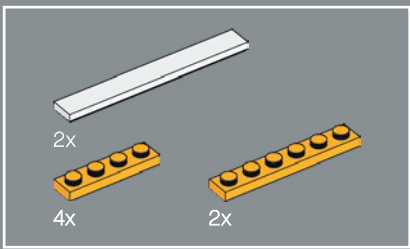

344

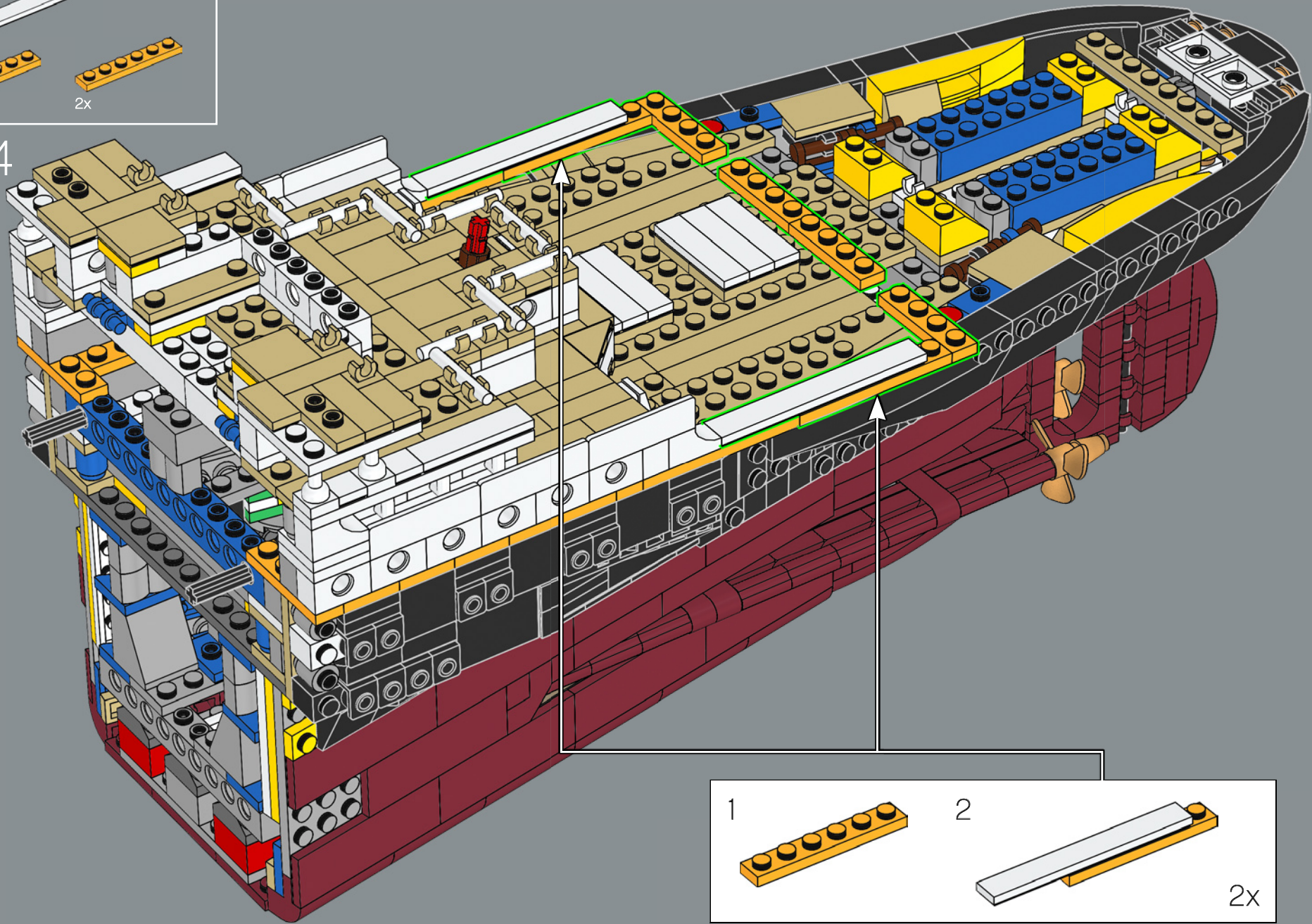

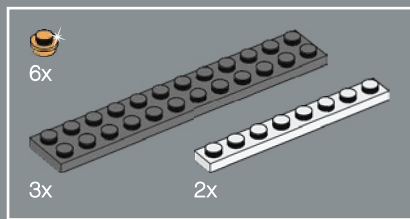

345

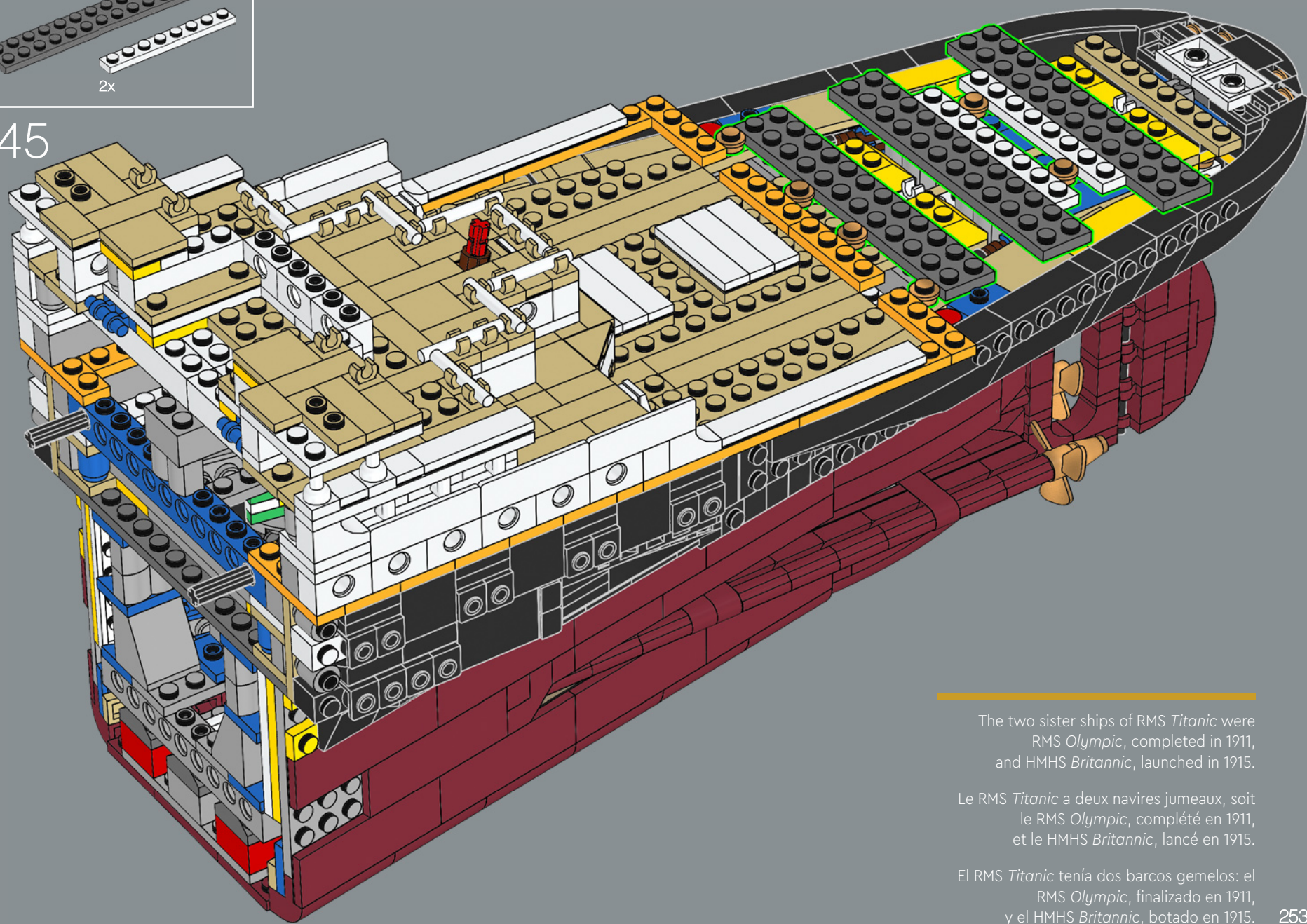

The two sister ships of RMS *Titanic* were RMS *Olympic*, completed in 1911, and HMHS *Britannic*, launched in 1915.

Le RMS *Titanic* a deux navires jumeaux, soit le RMS *Olympic*, complété en 1911, et le HMHS *Britannic*, lancé en 1915.

El RMS *Titanic* tenía dos barcos gemelos: el RMS *Olympic*, finalizado en 1911, y el HMHS *Britannic*, botado en 1915.

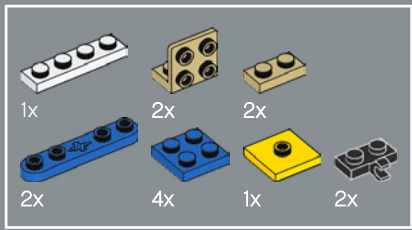

346

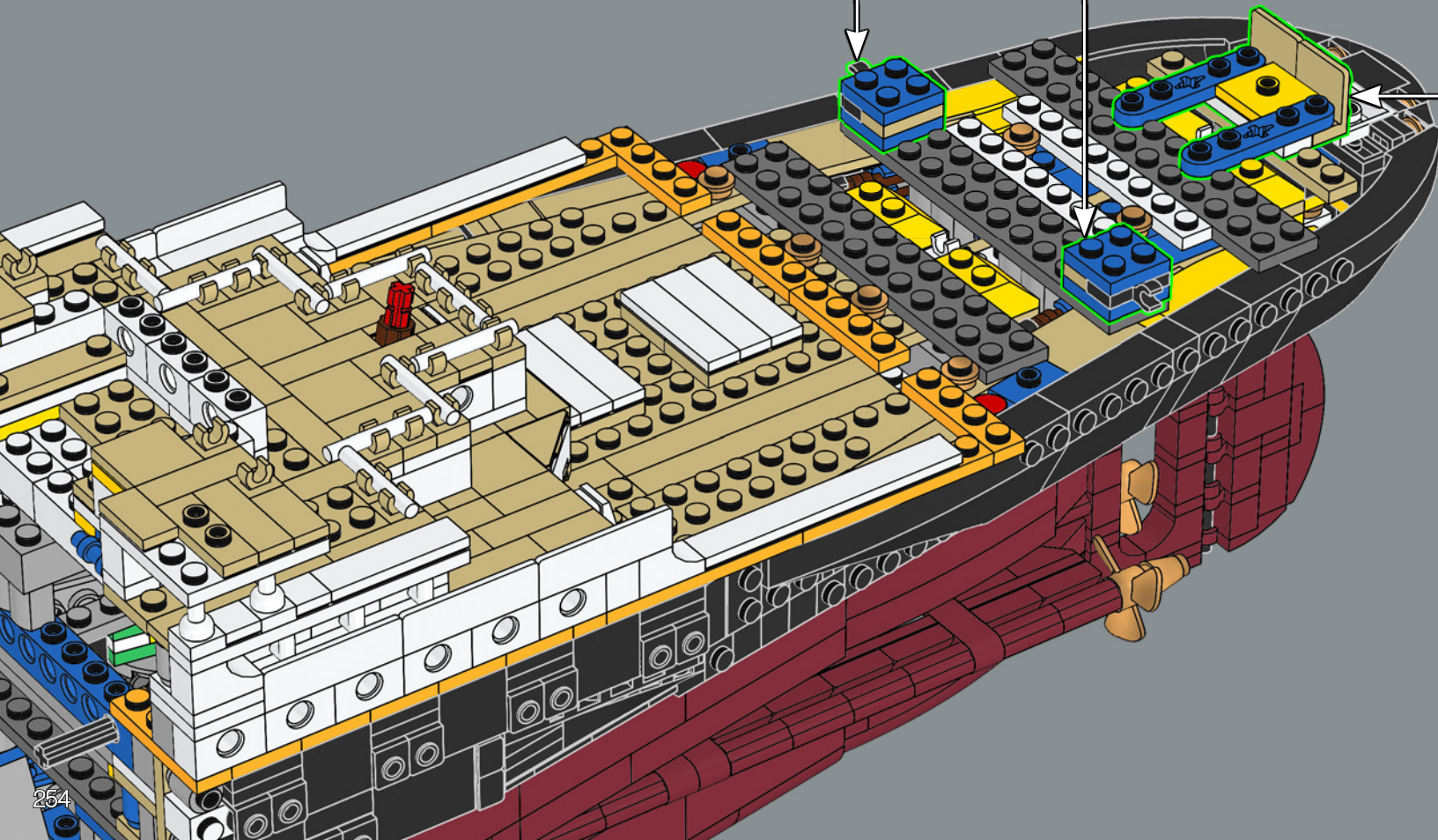
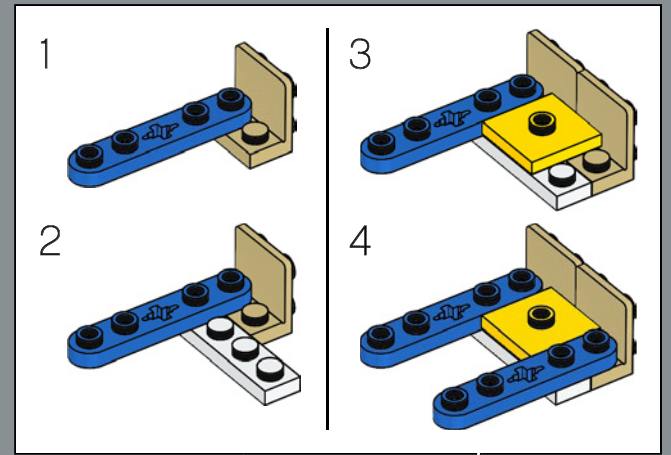
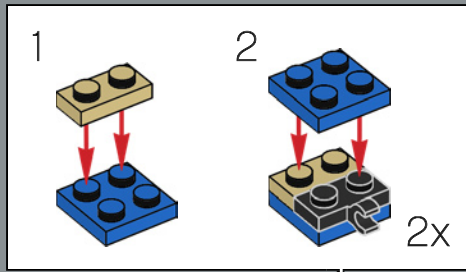

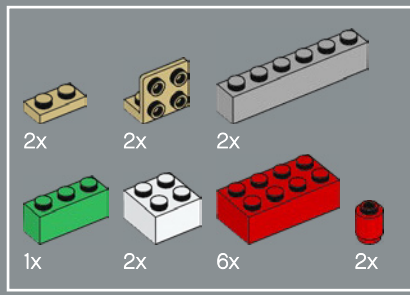

347

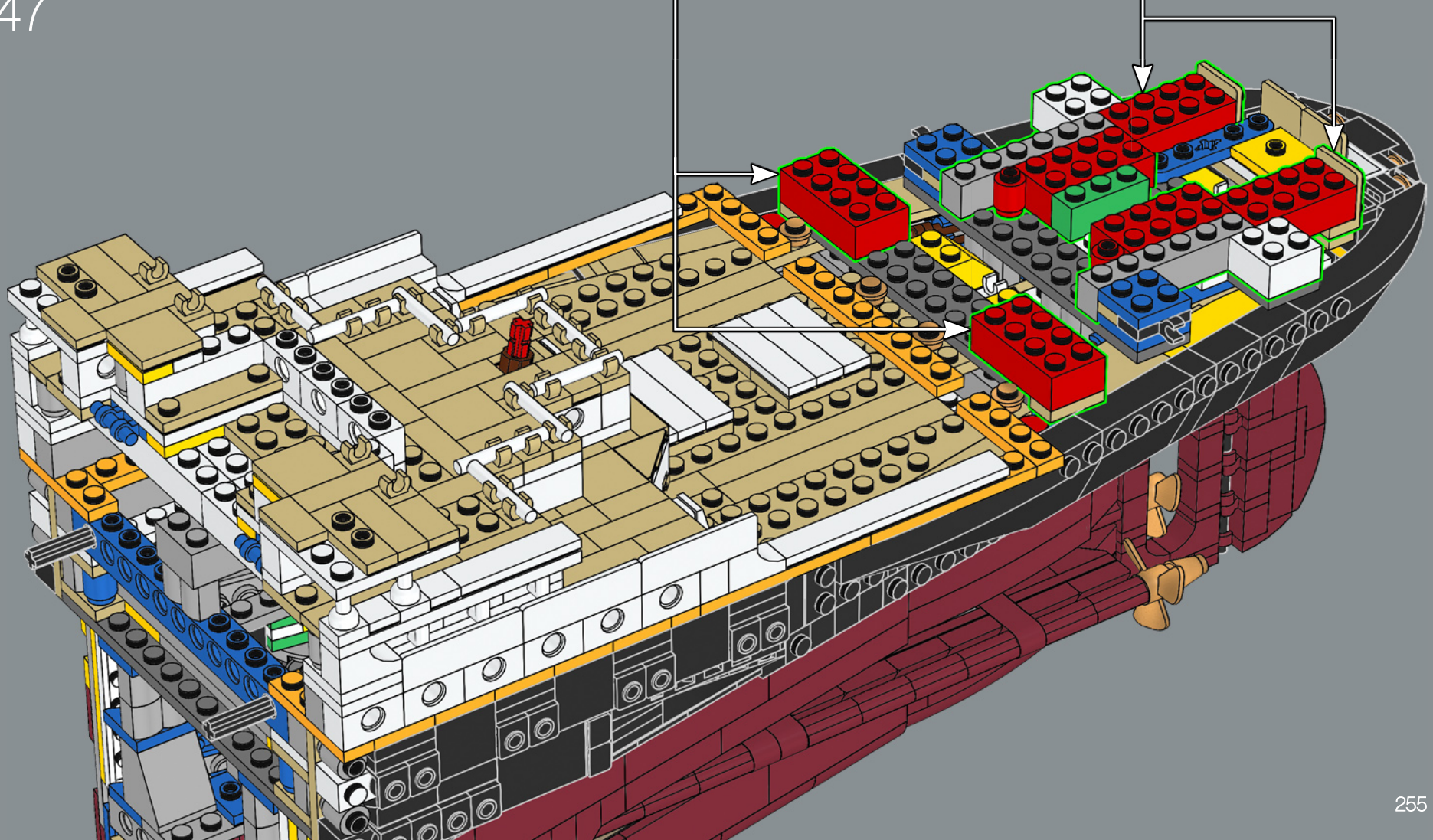
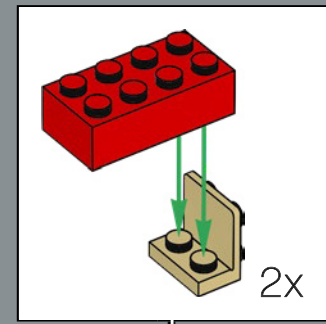
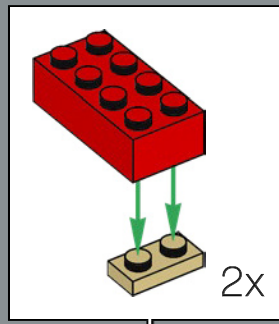

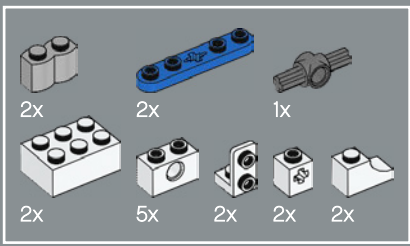

348

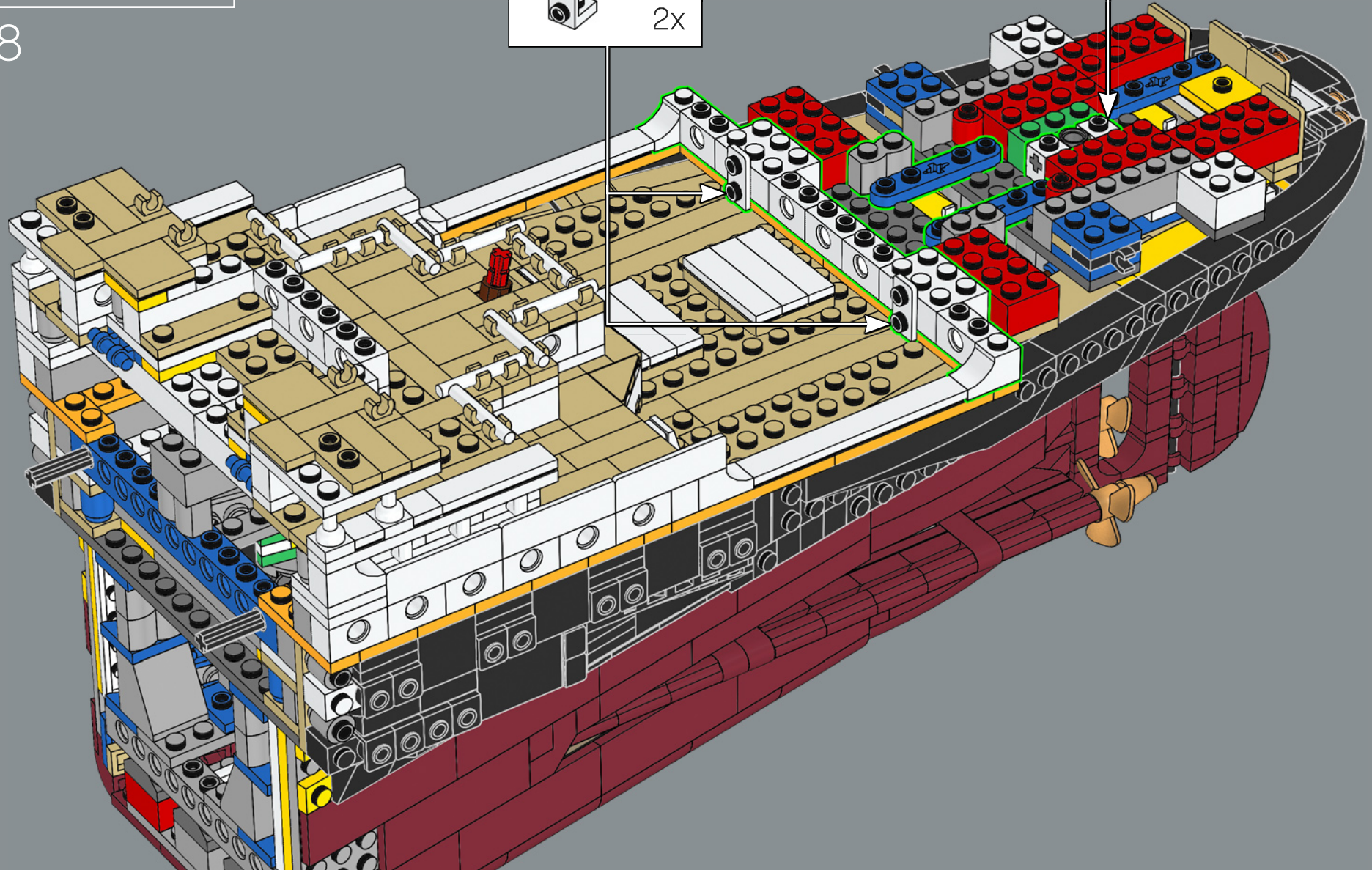
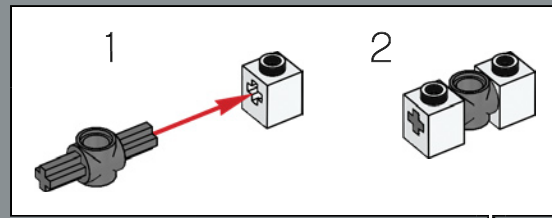
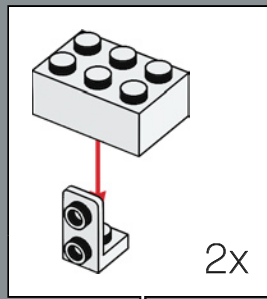



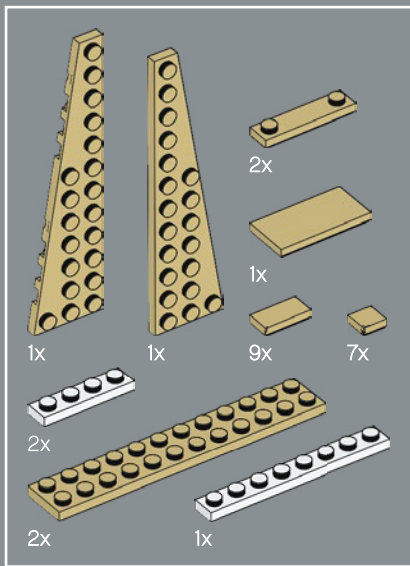

349

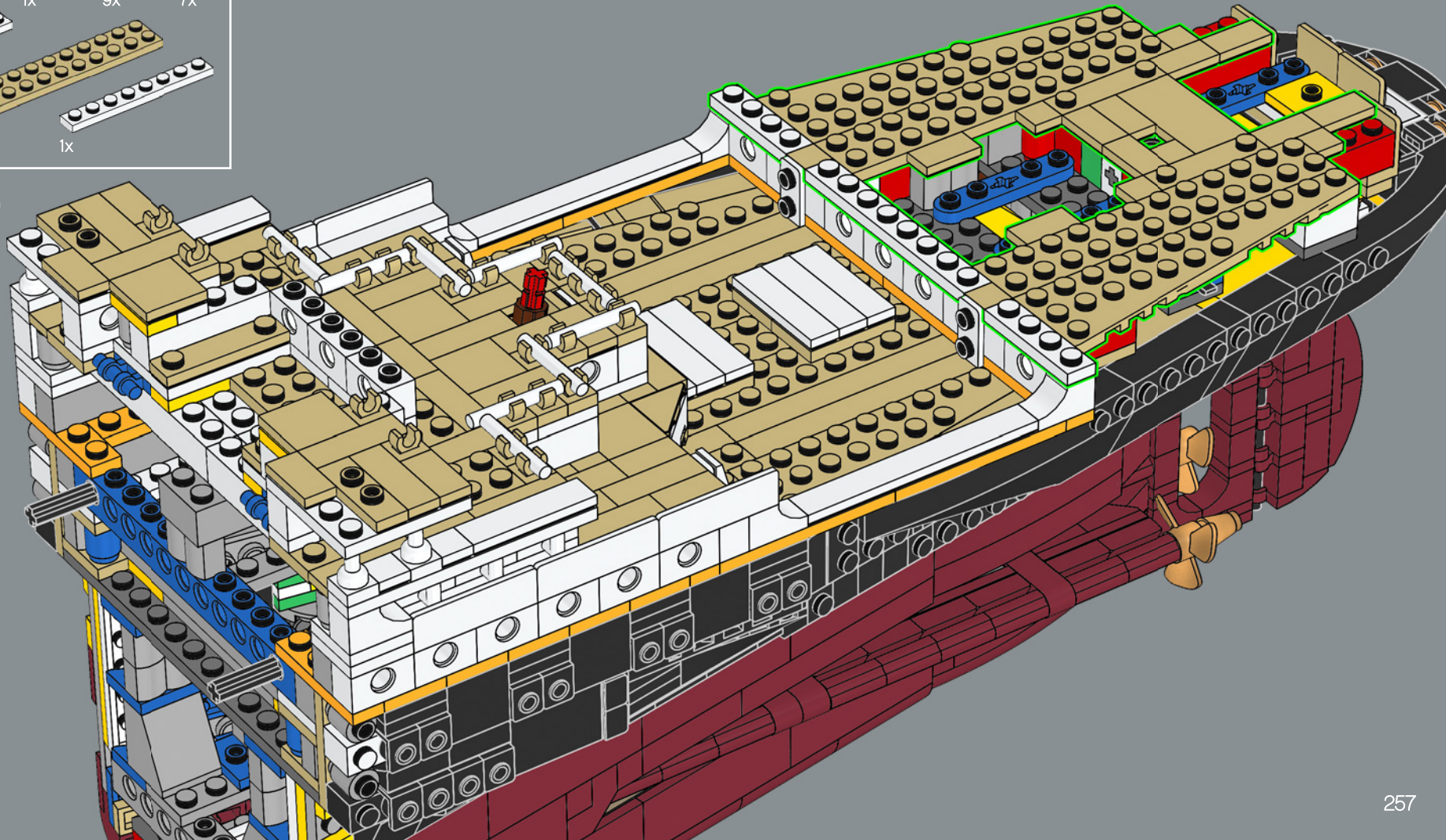

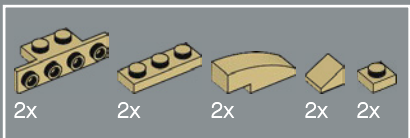

350

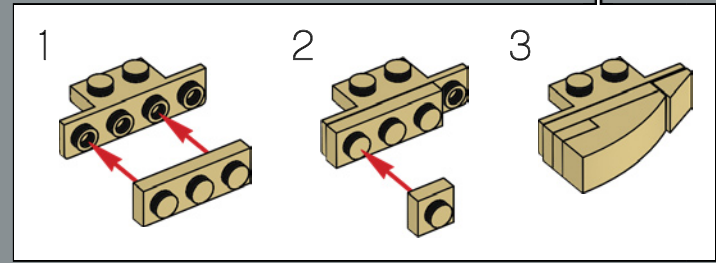
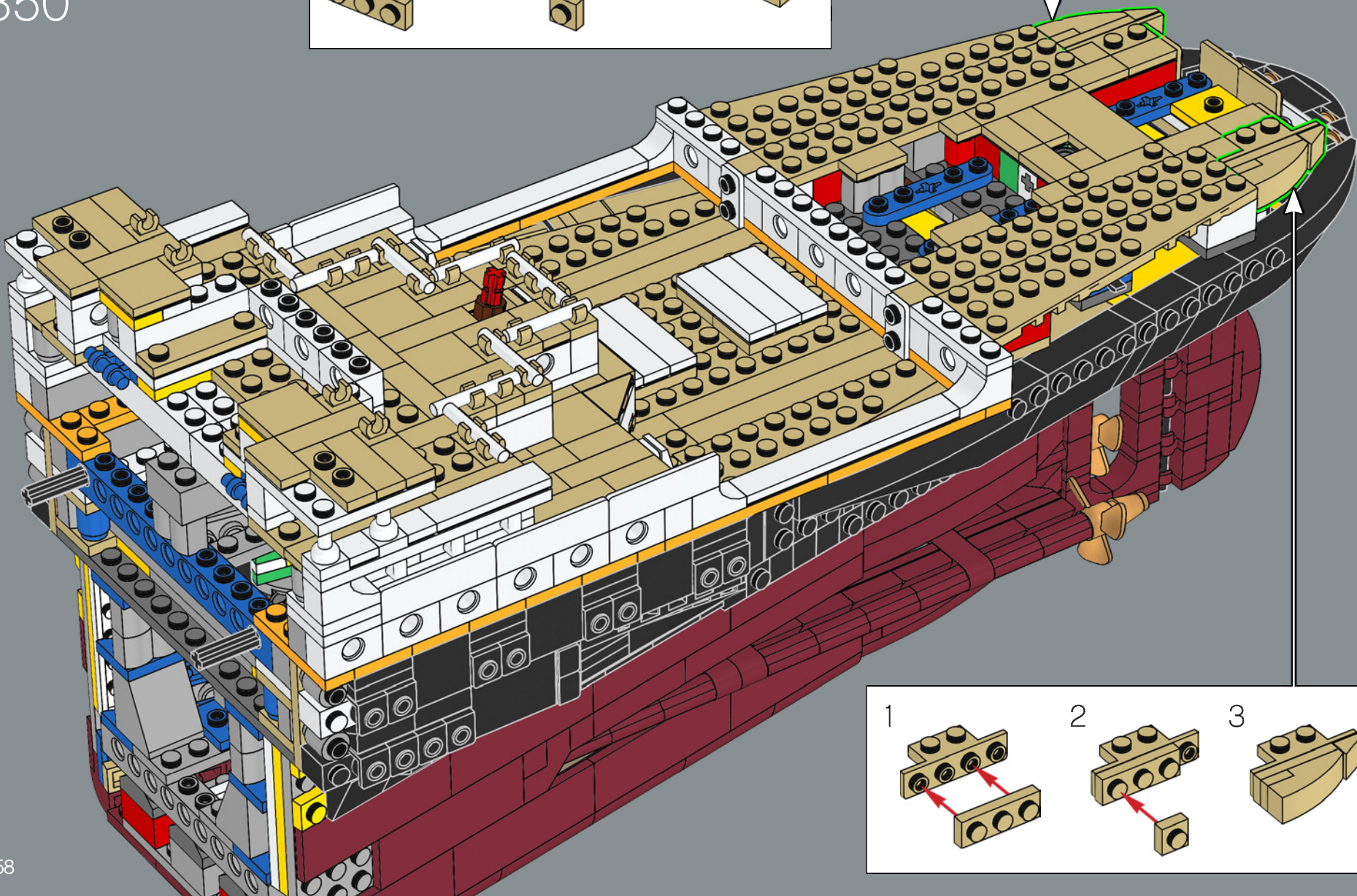
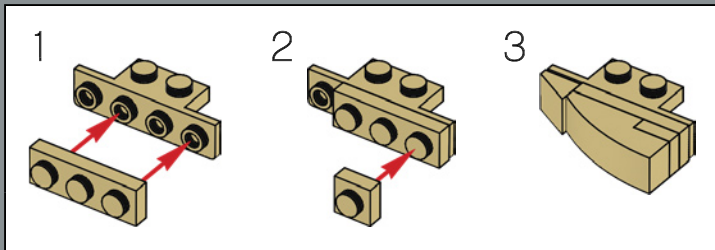

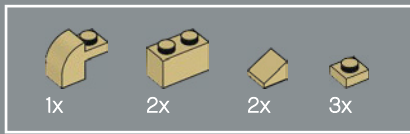

351

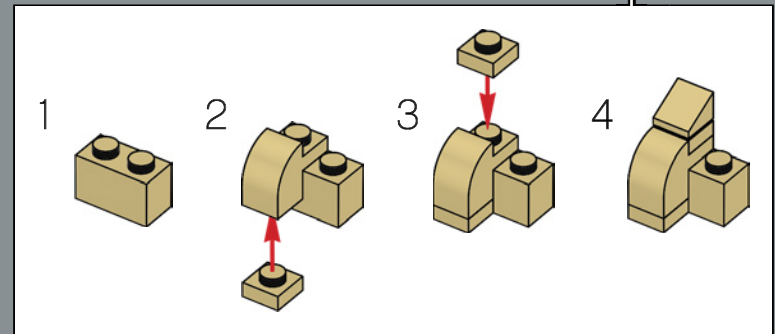
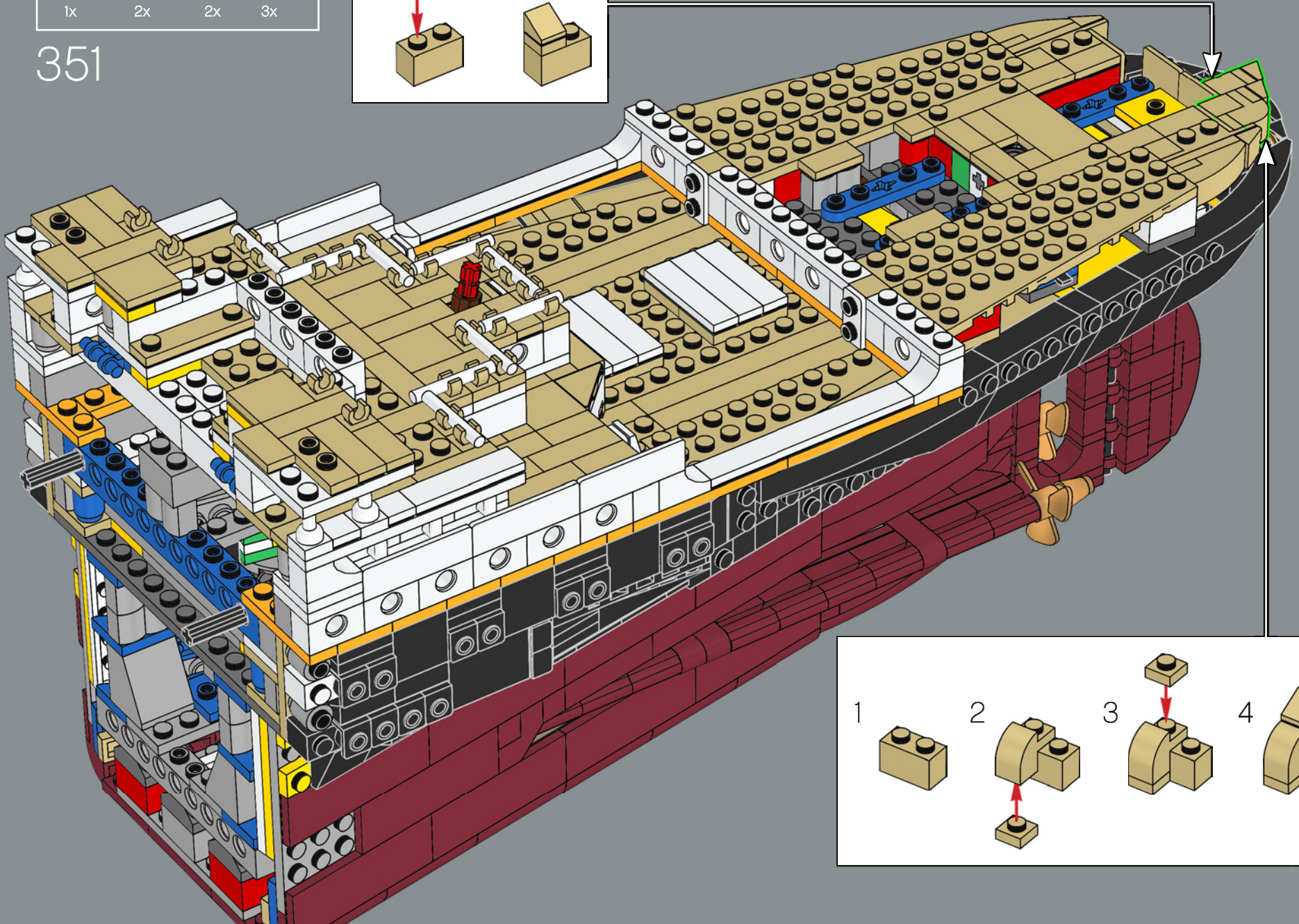
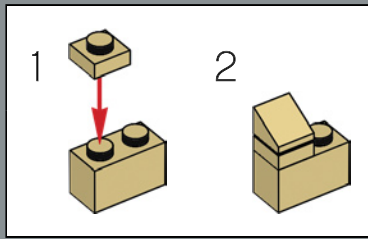

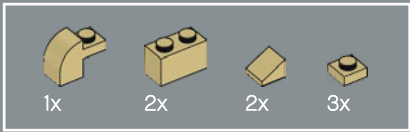

352

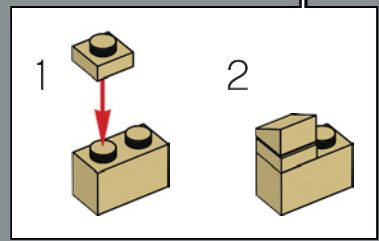
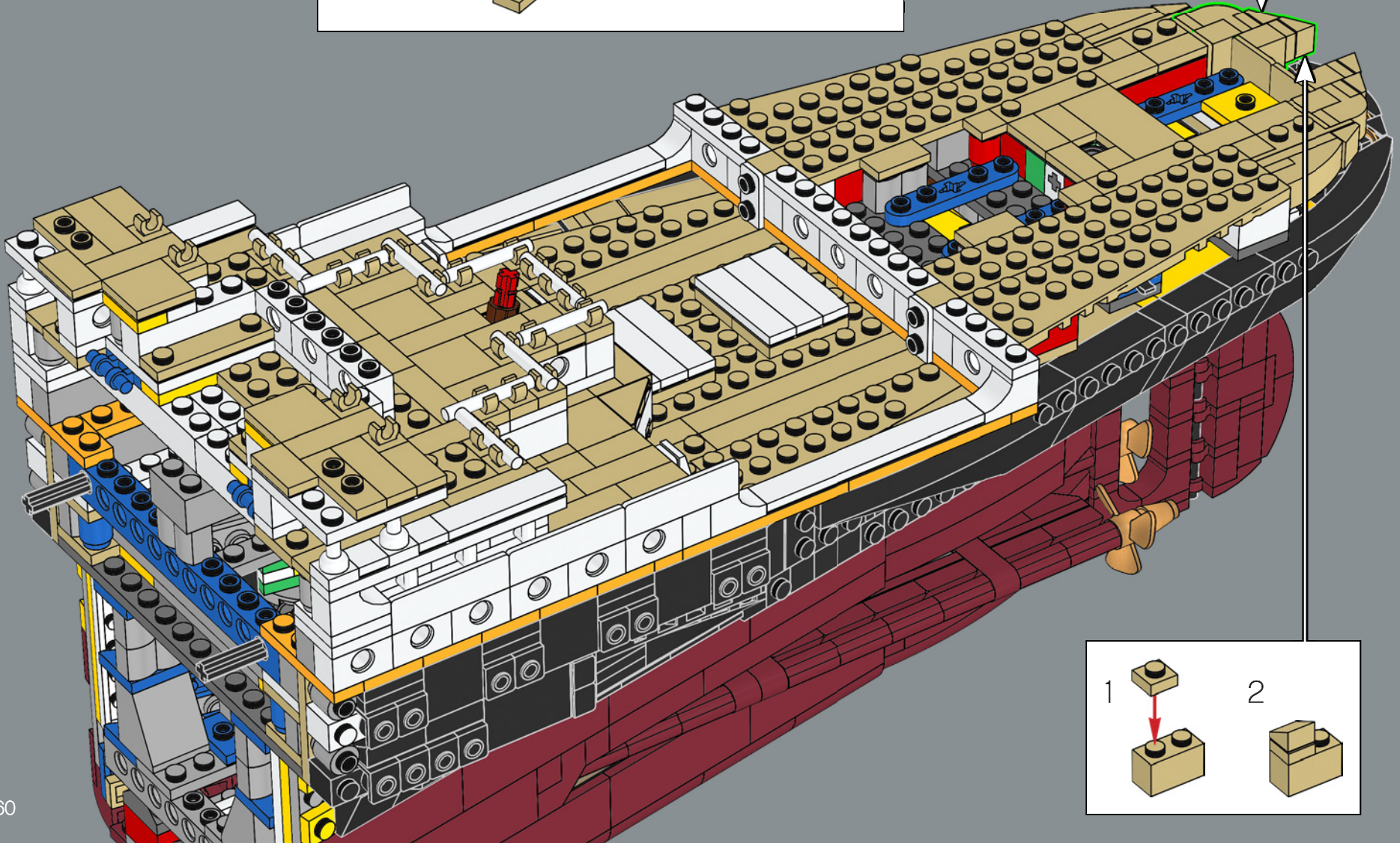
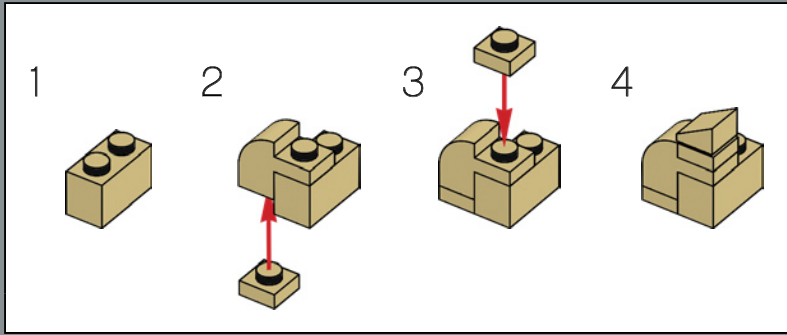

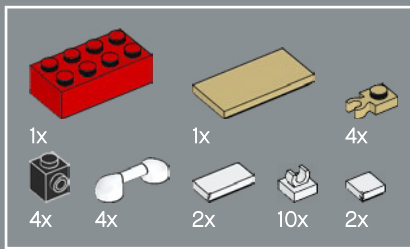

353

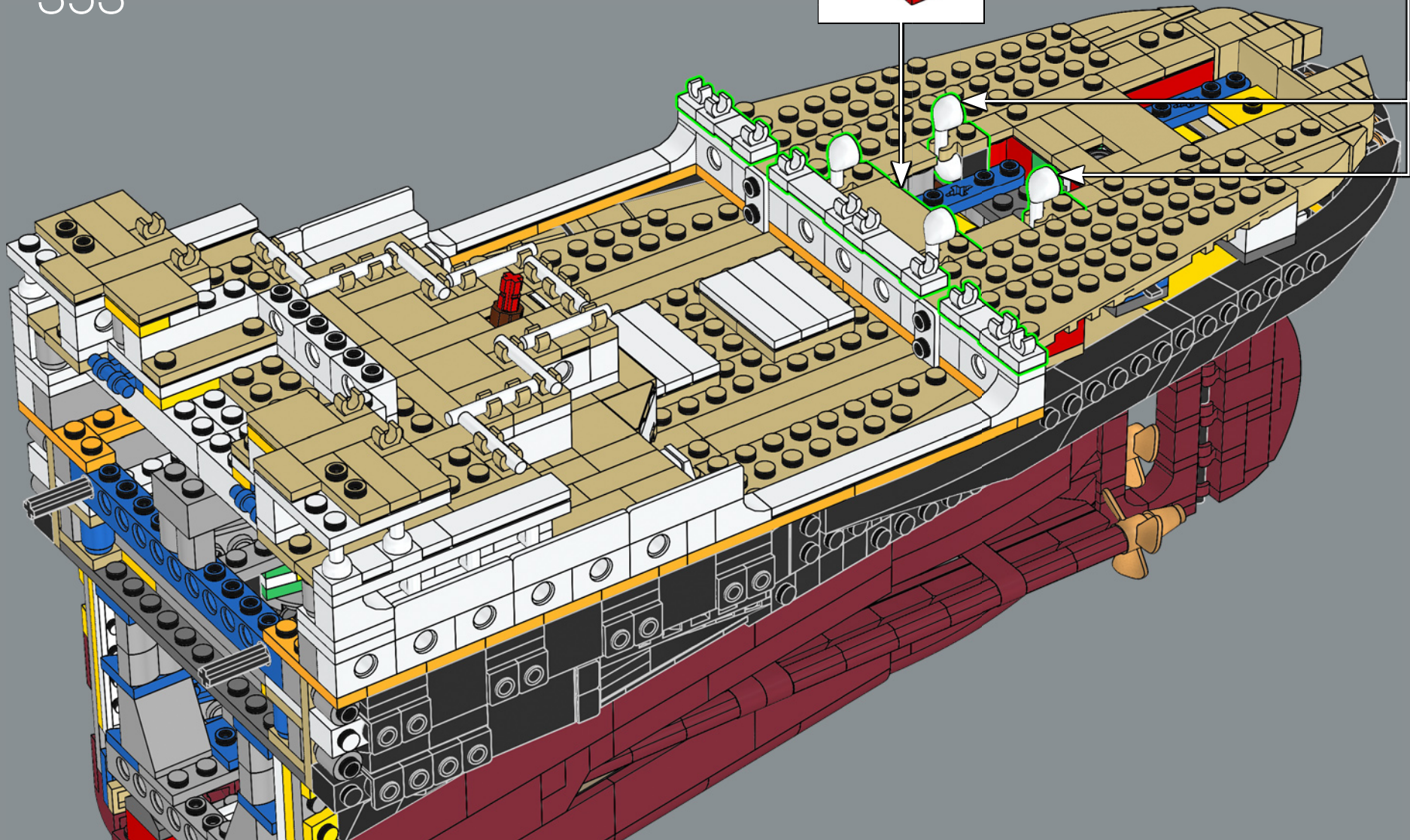
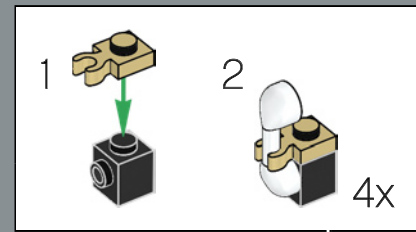
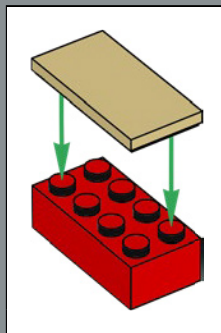



354

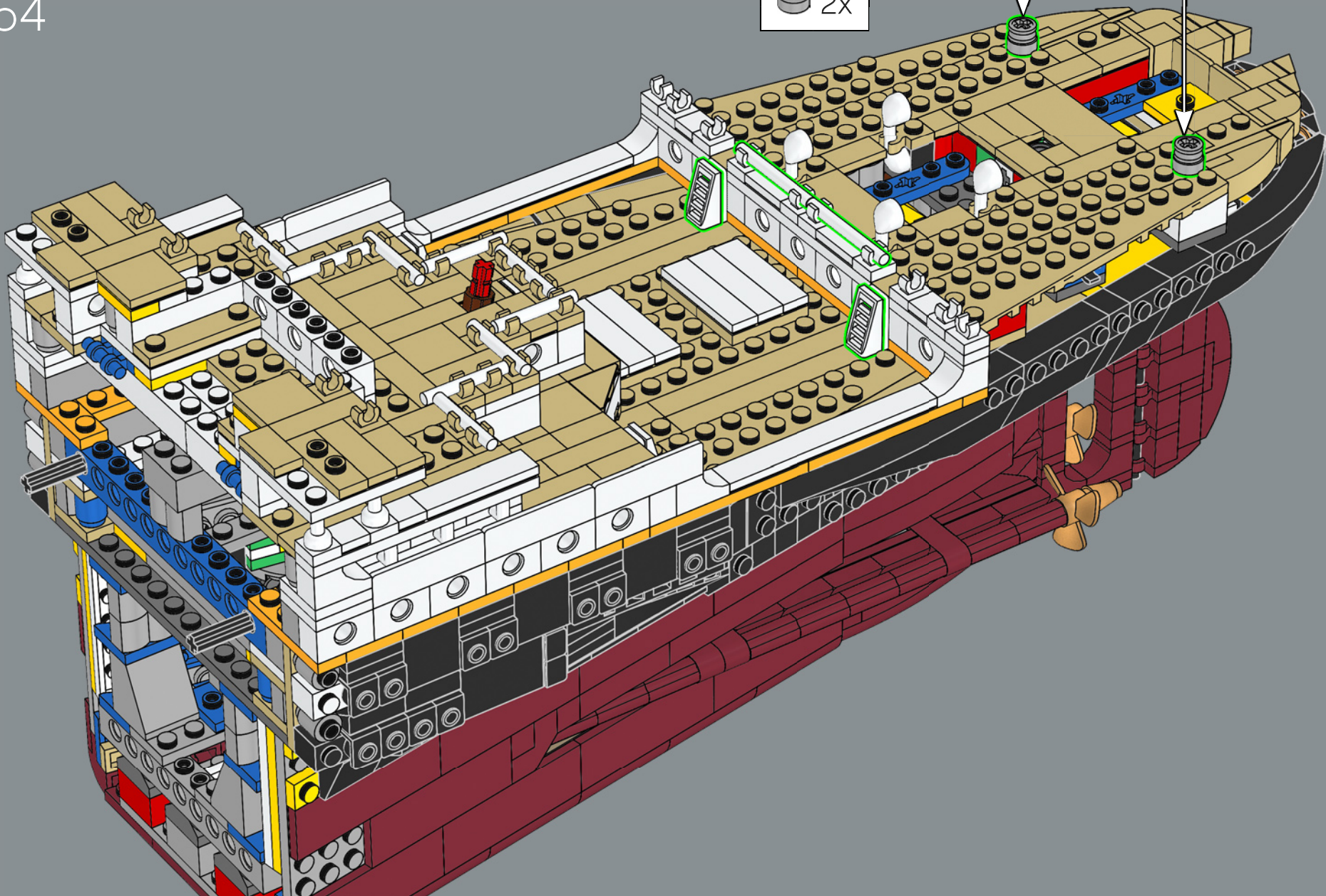
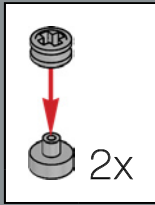



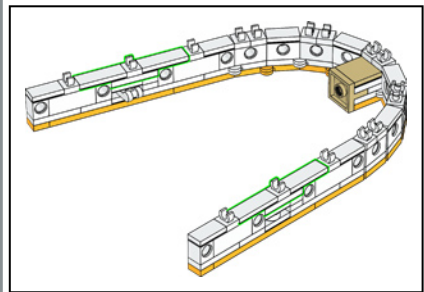
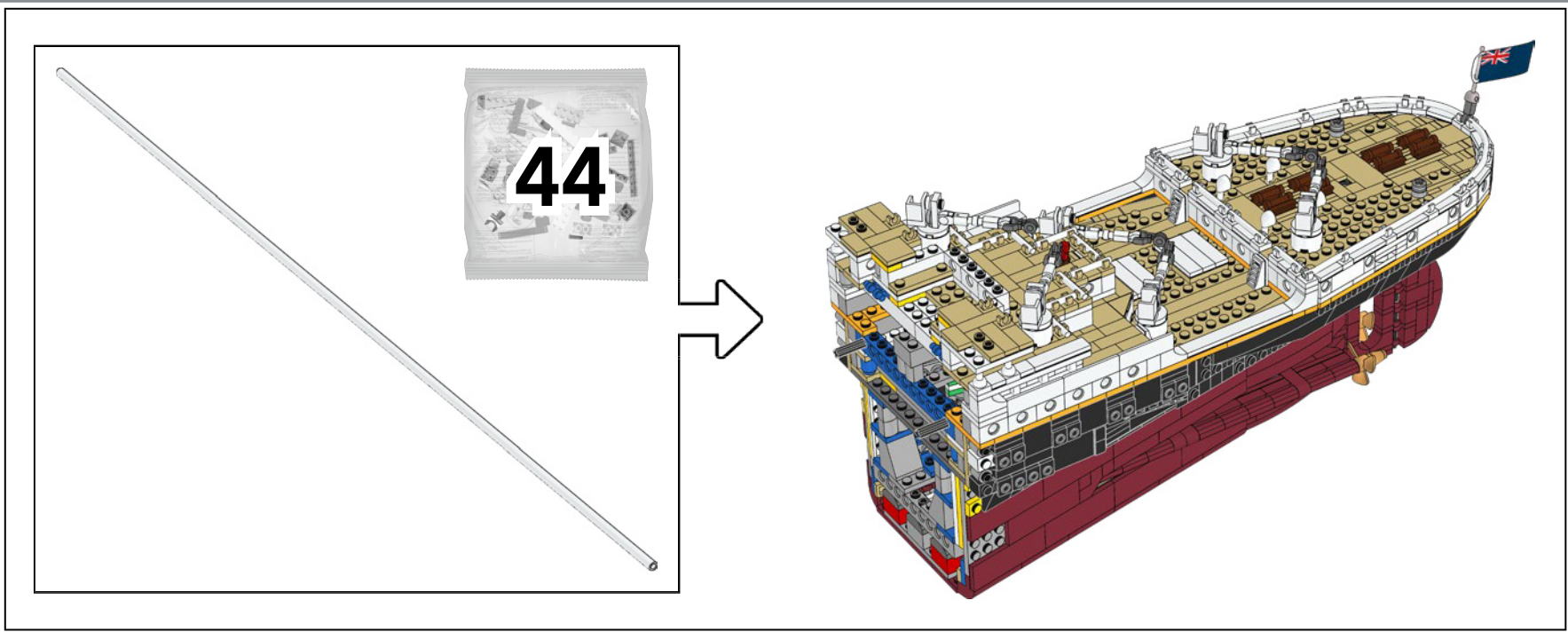

356

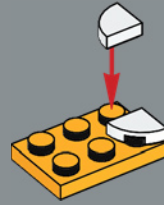

357

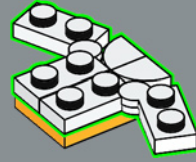



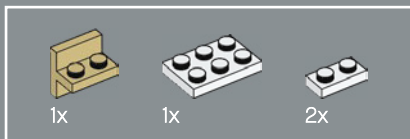

358

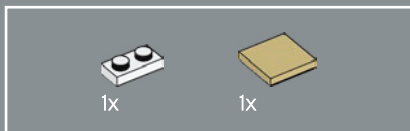
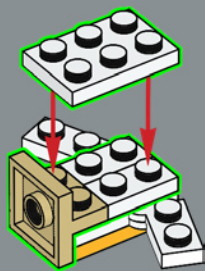

359

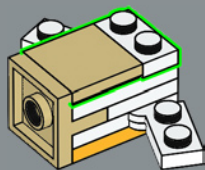

360

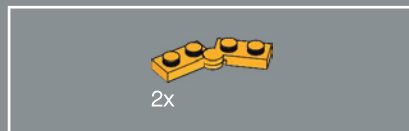
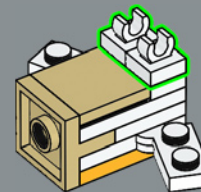

361

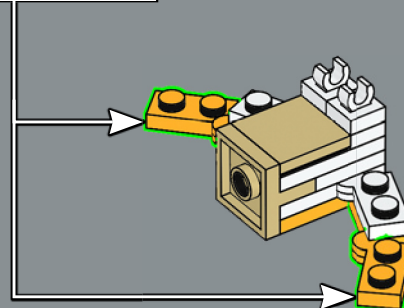
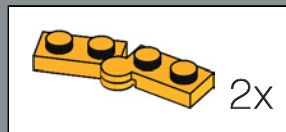



362

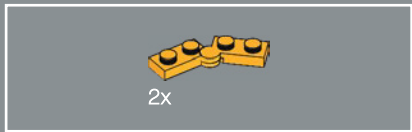
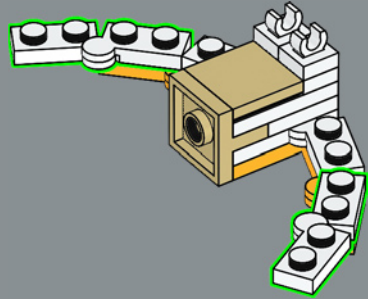

363

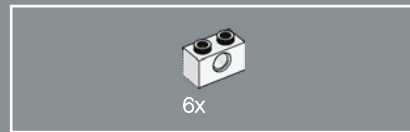
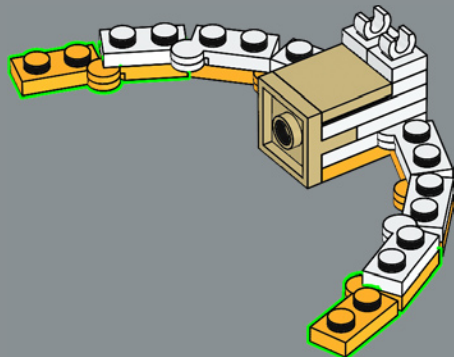

364

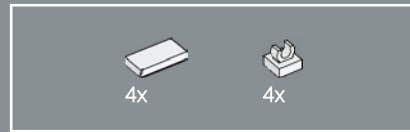
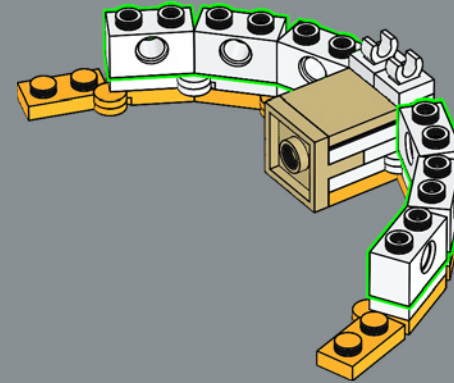

365

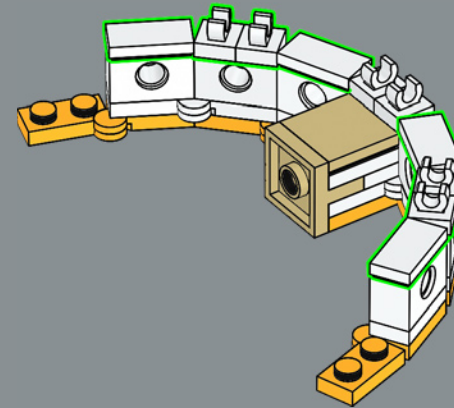



366

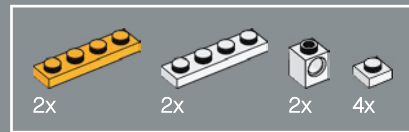
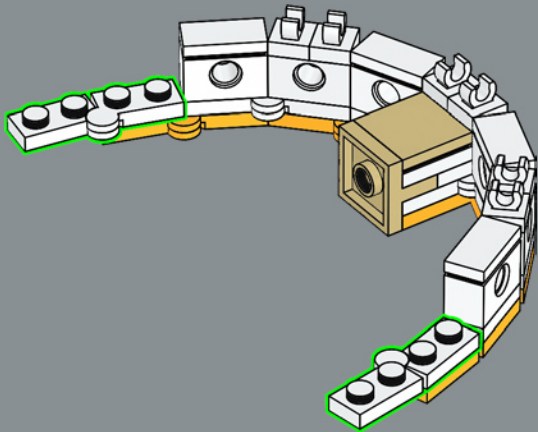

367

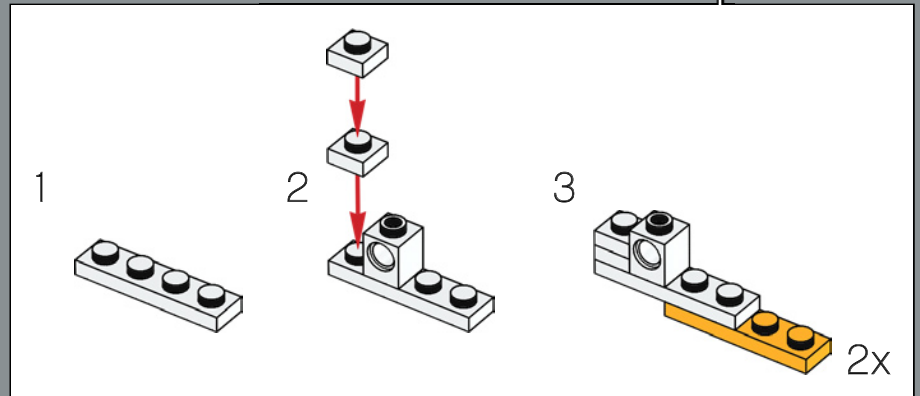
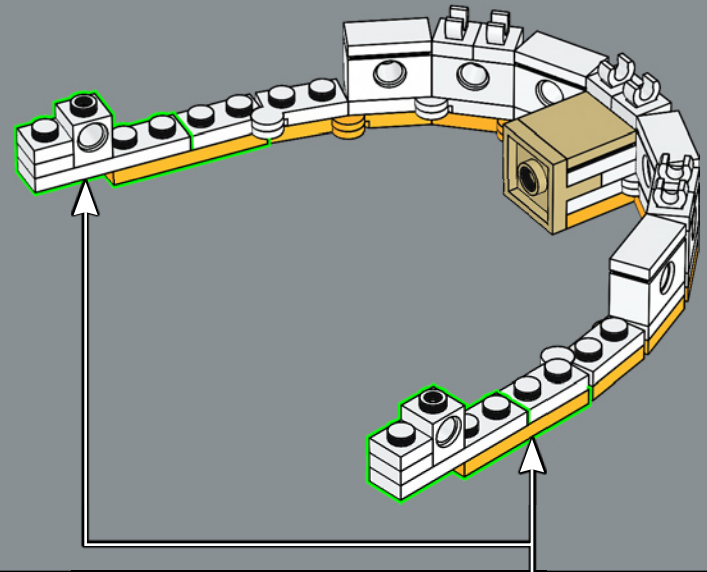

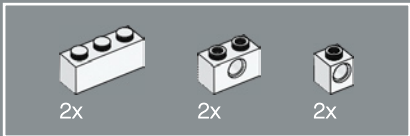

368

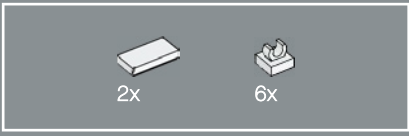
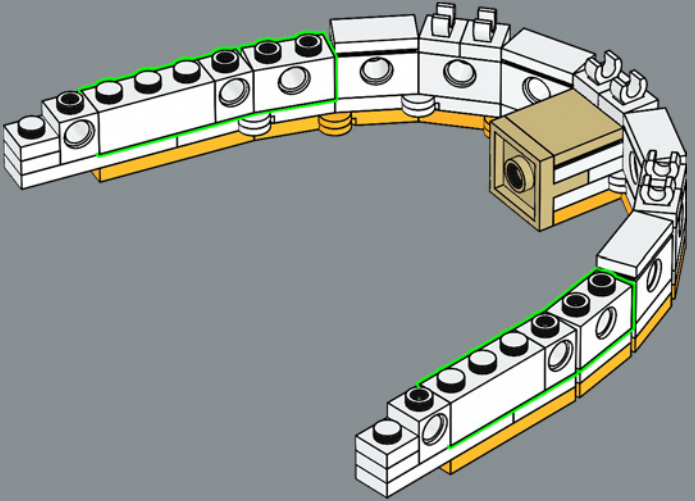

369

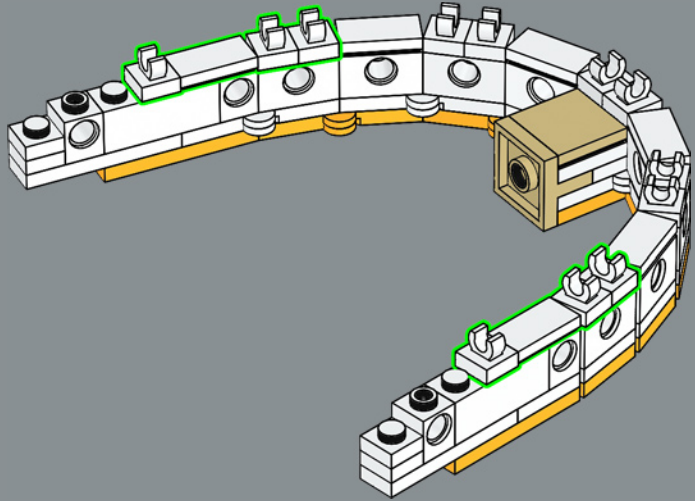

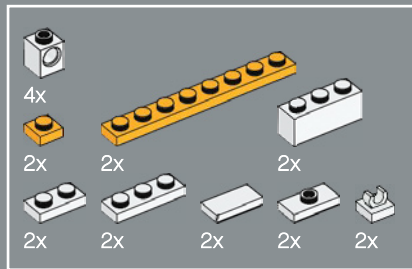

370

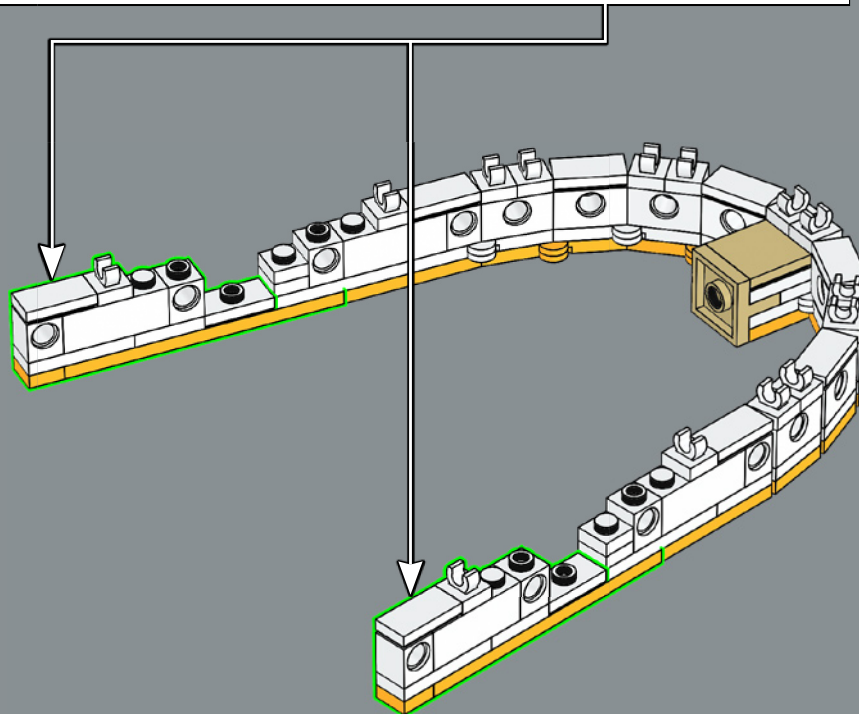
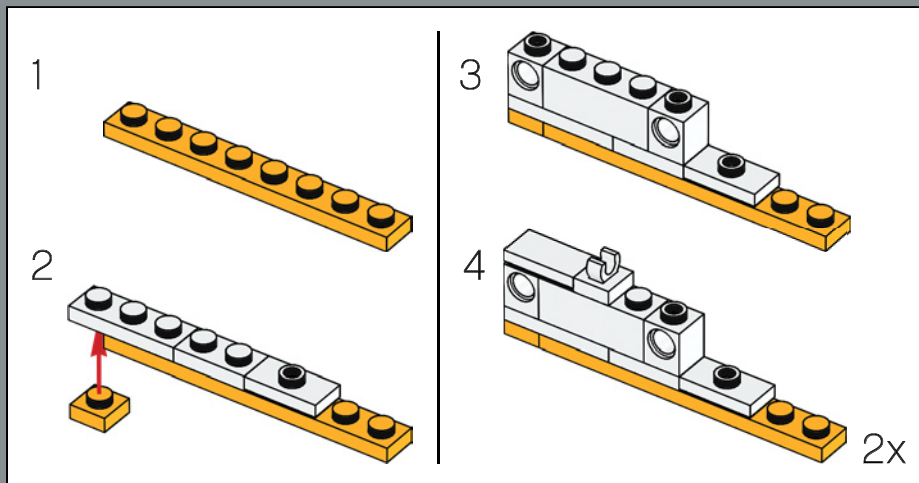



2x

371

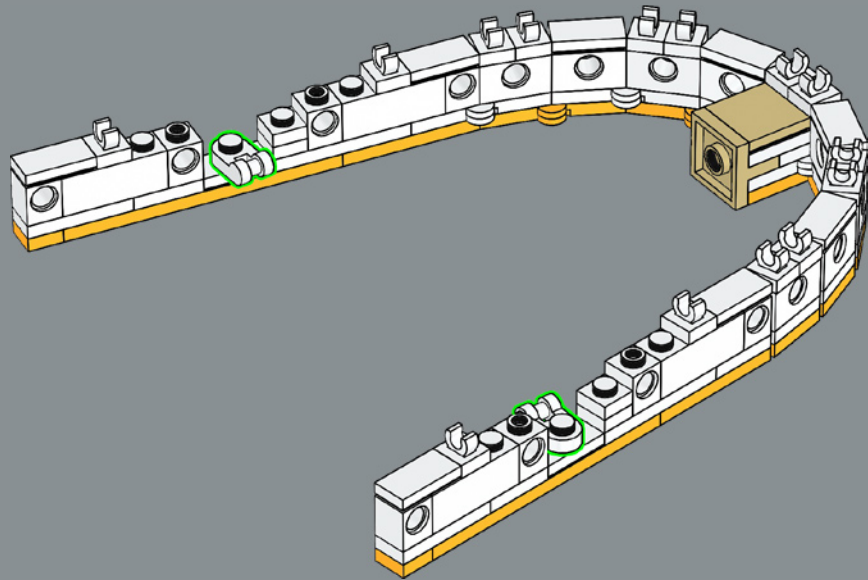

2x

372

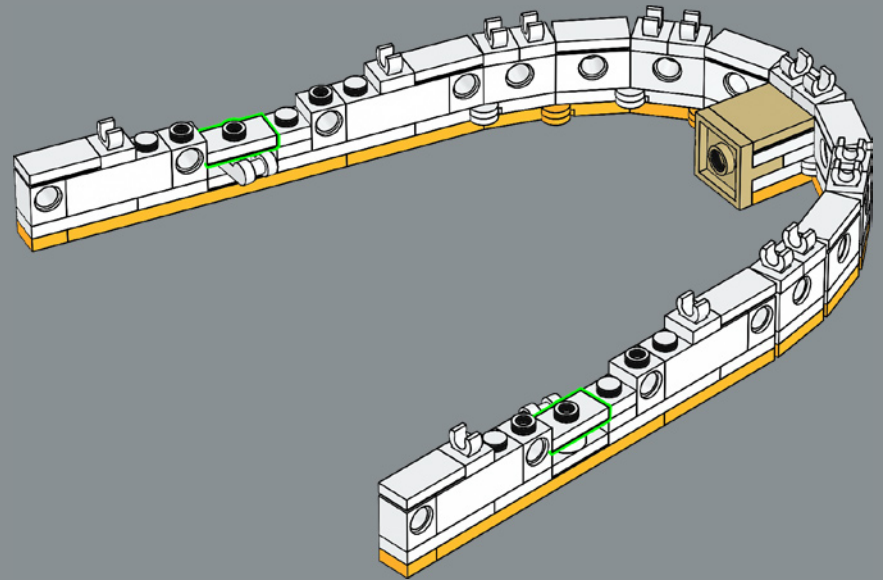

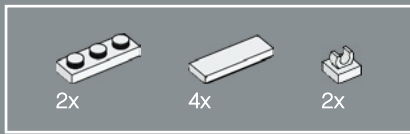

373

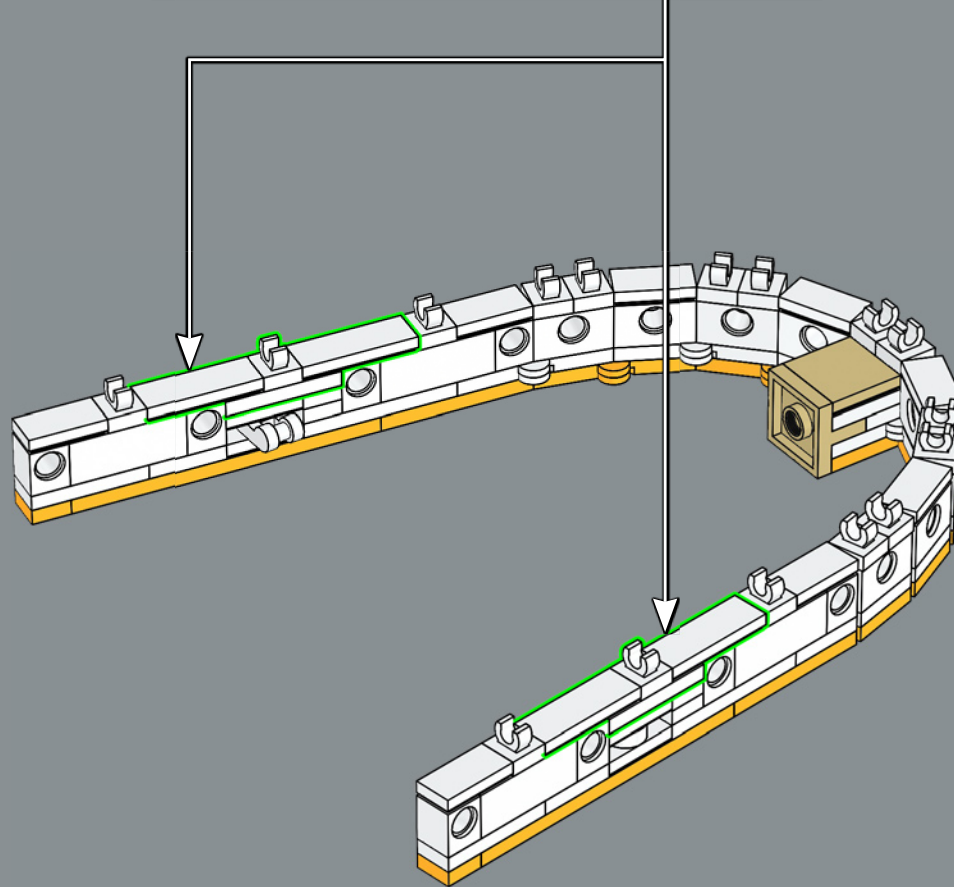
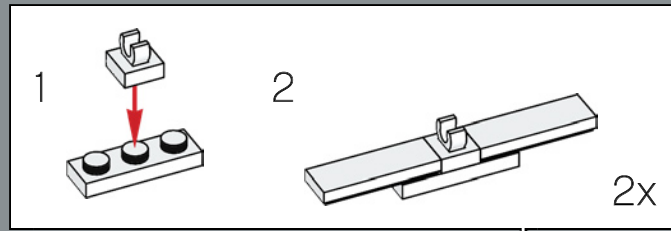

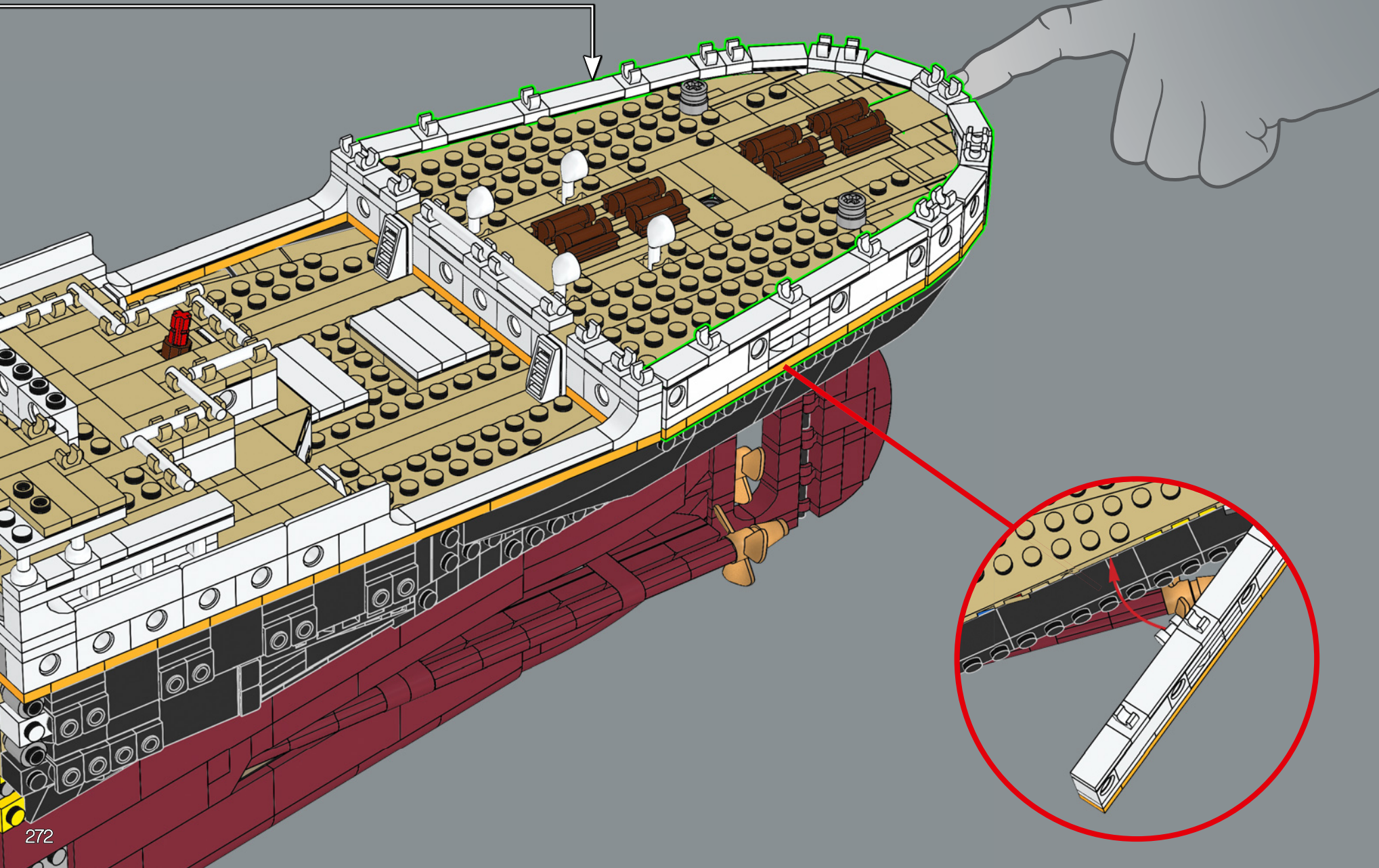



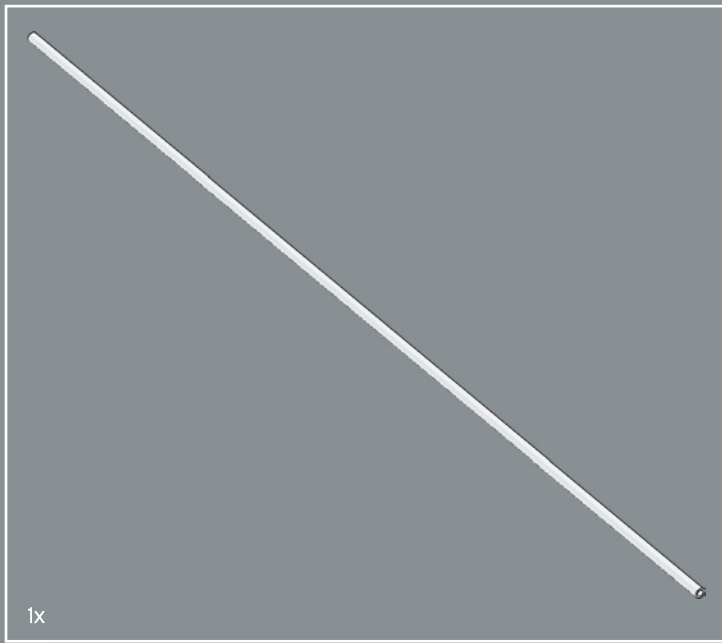

1x

375

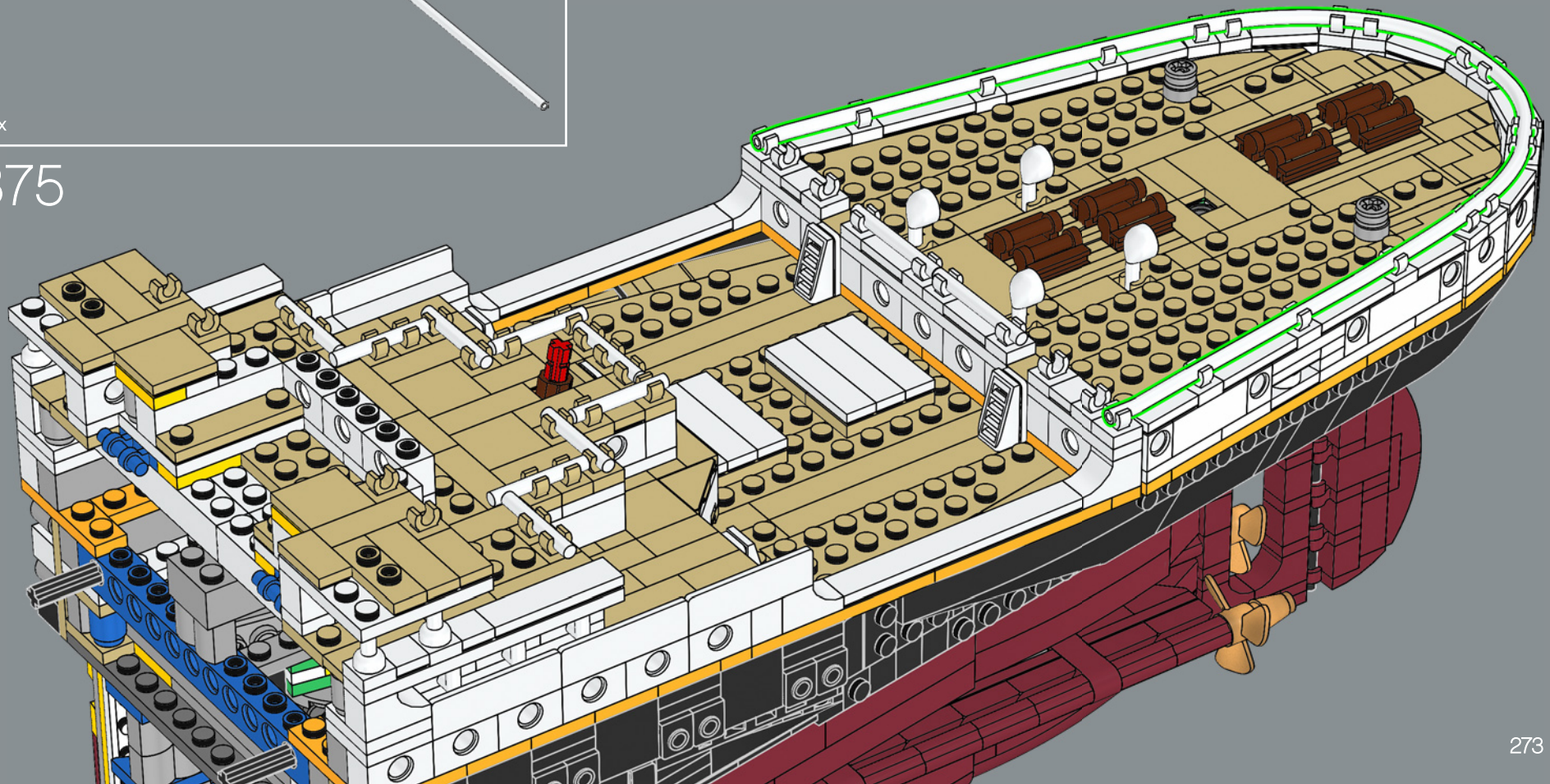



376

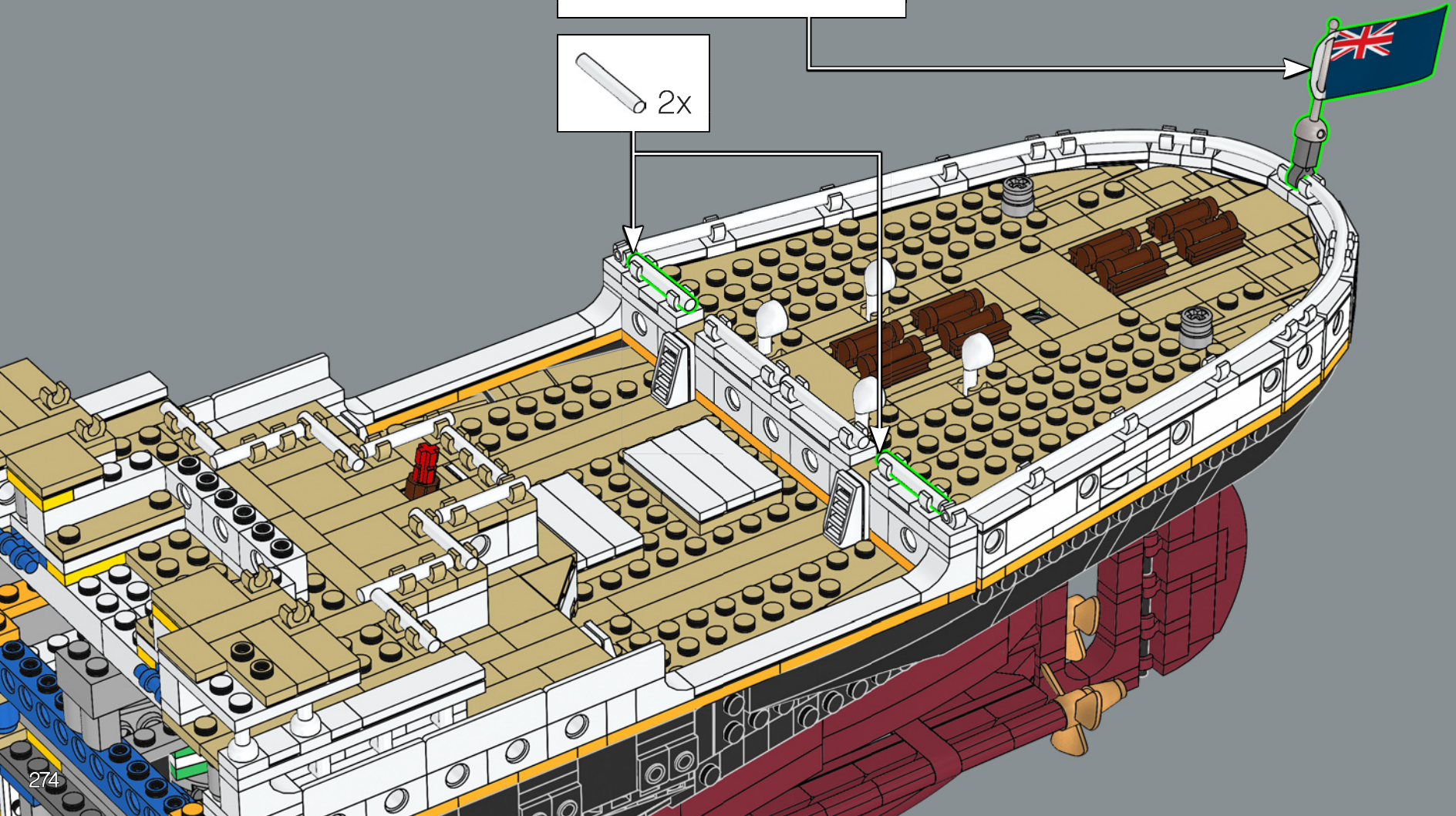
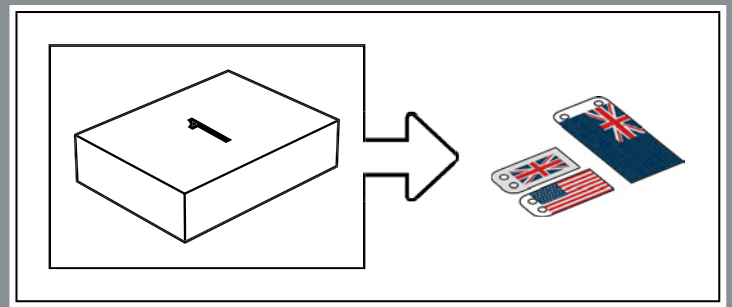
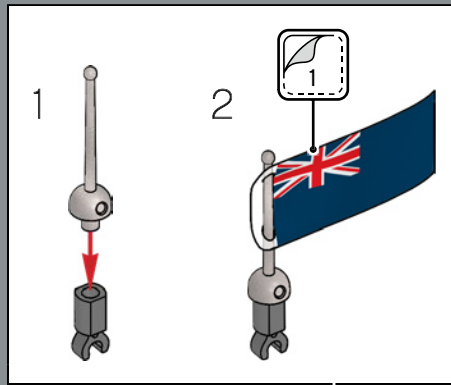

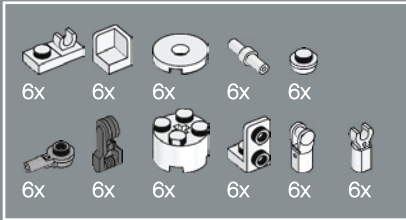
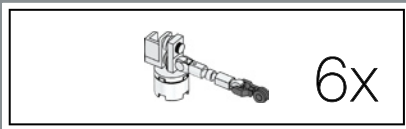

377

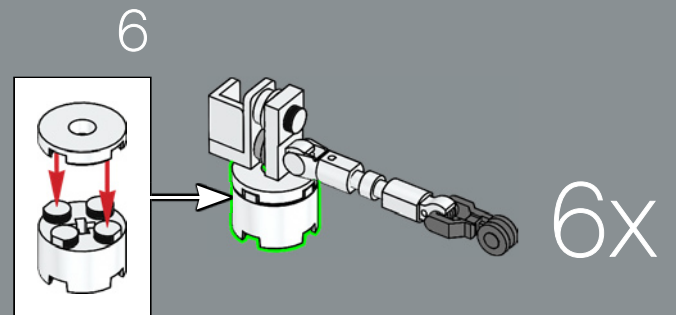
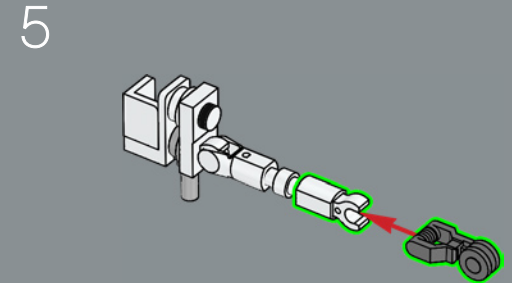
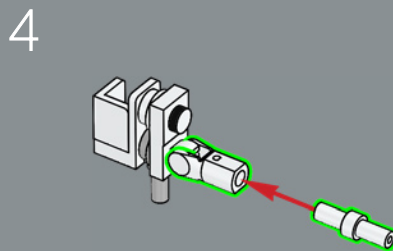
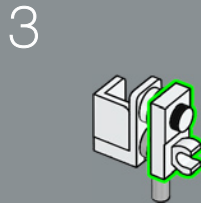
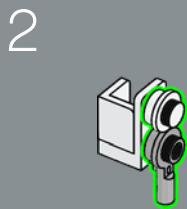
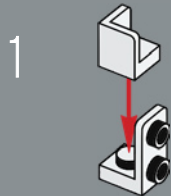

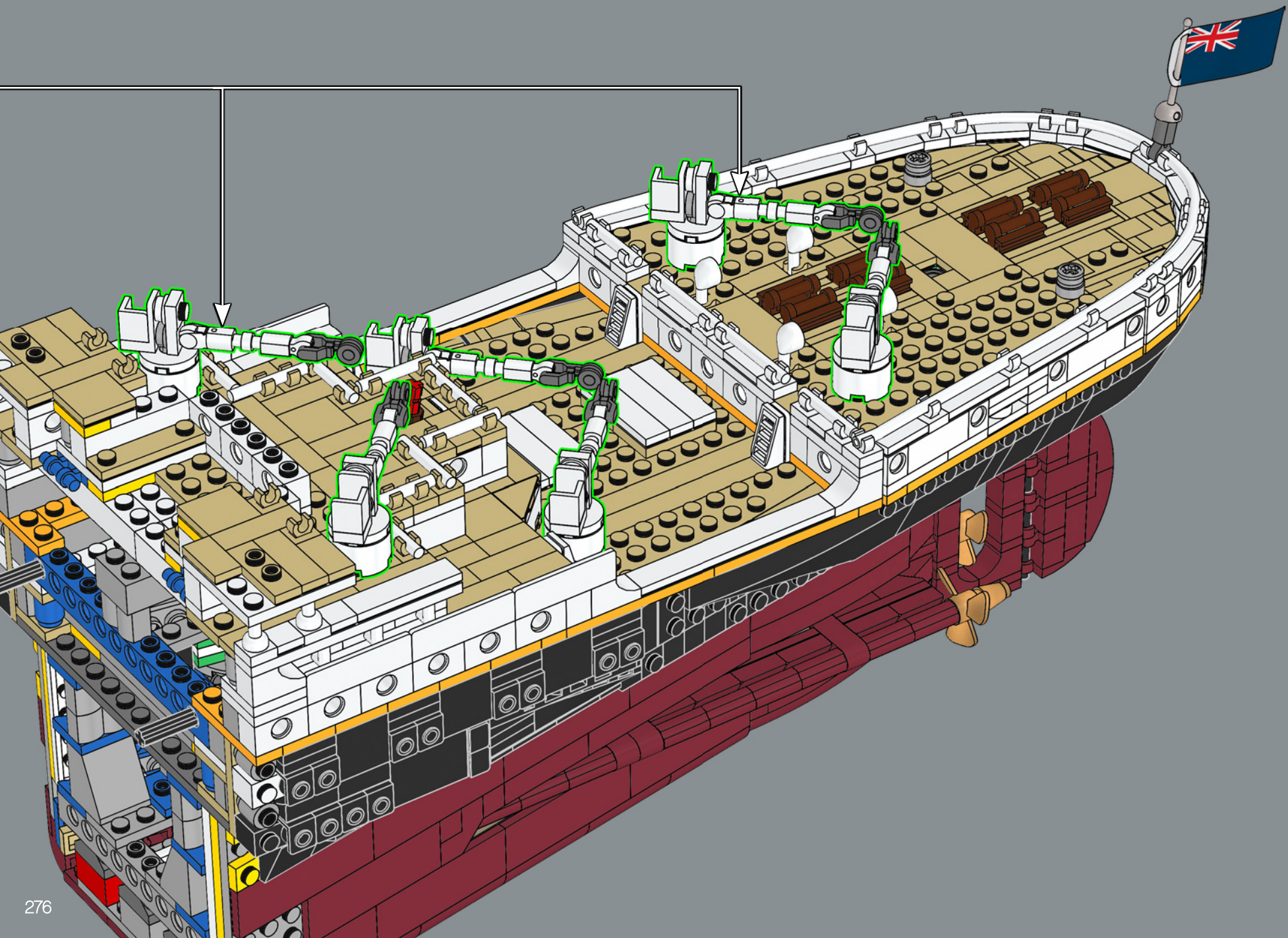

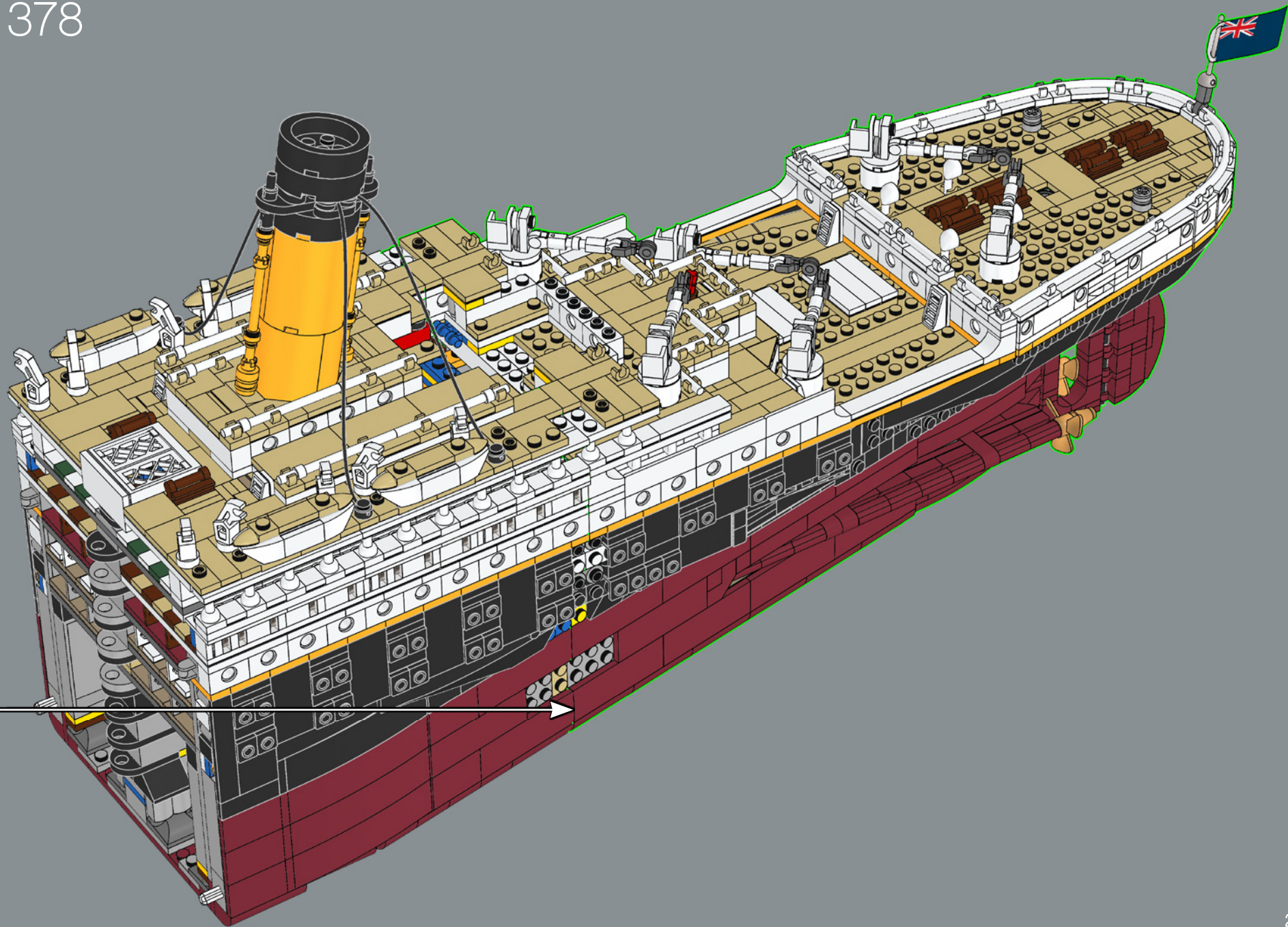

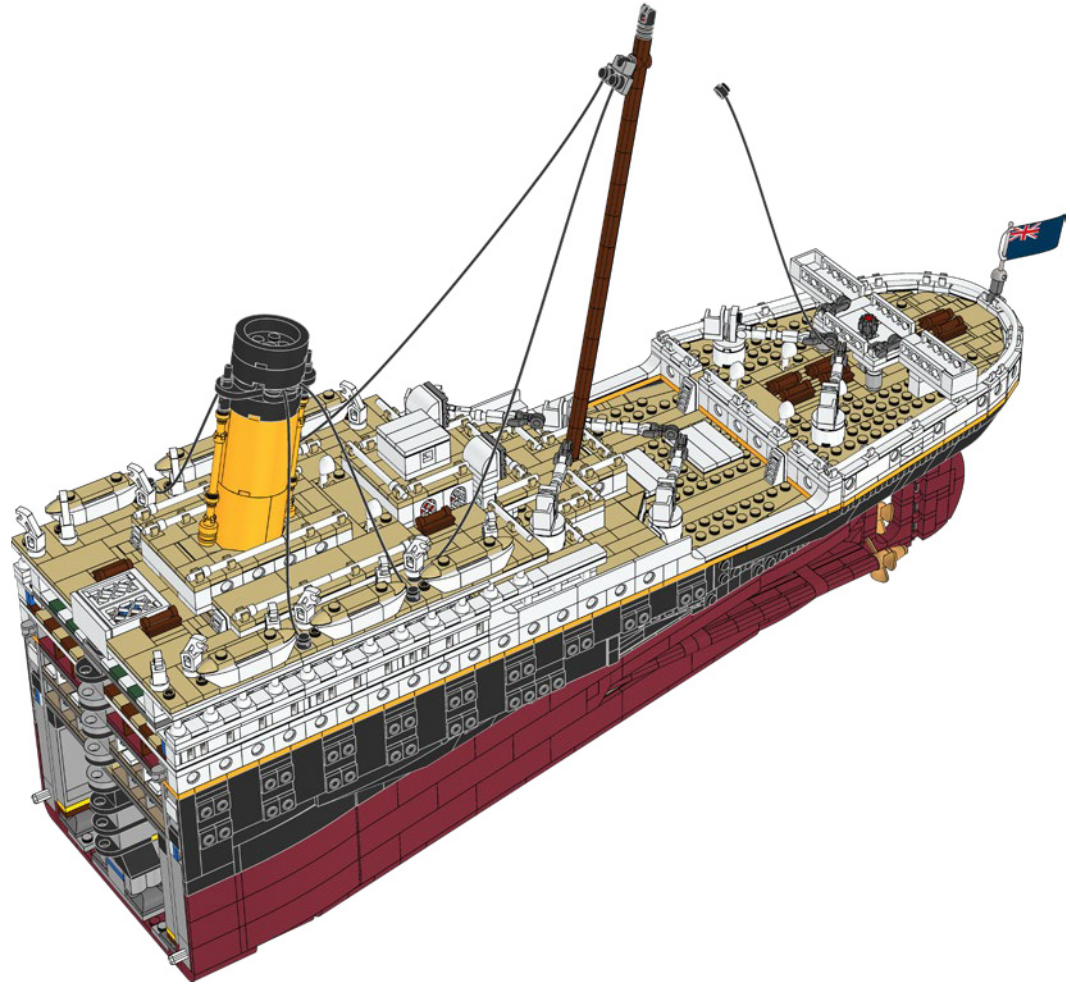
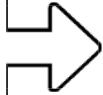

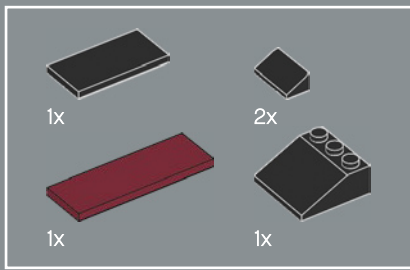

379

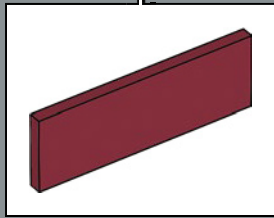
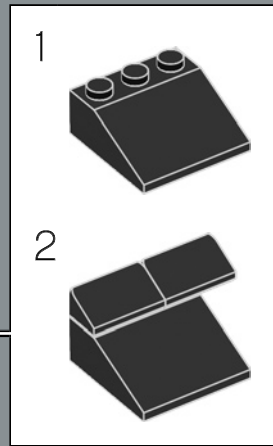
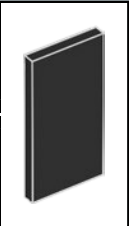
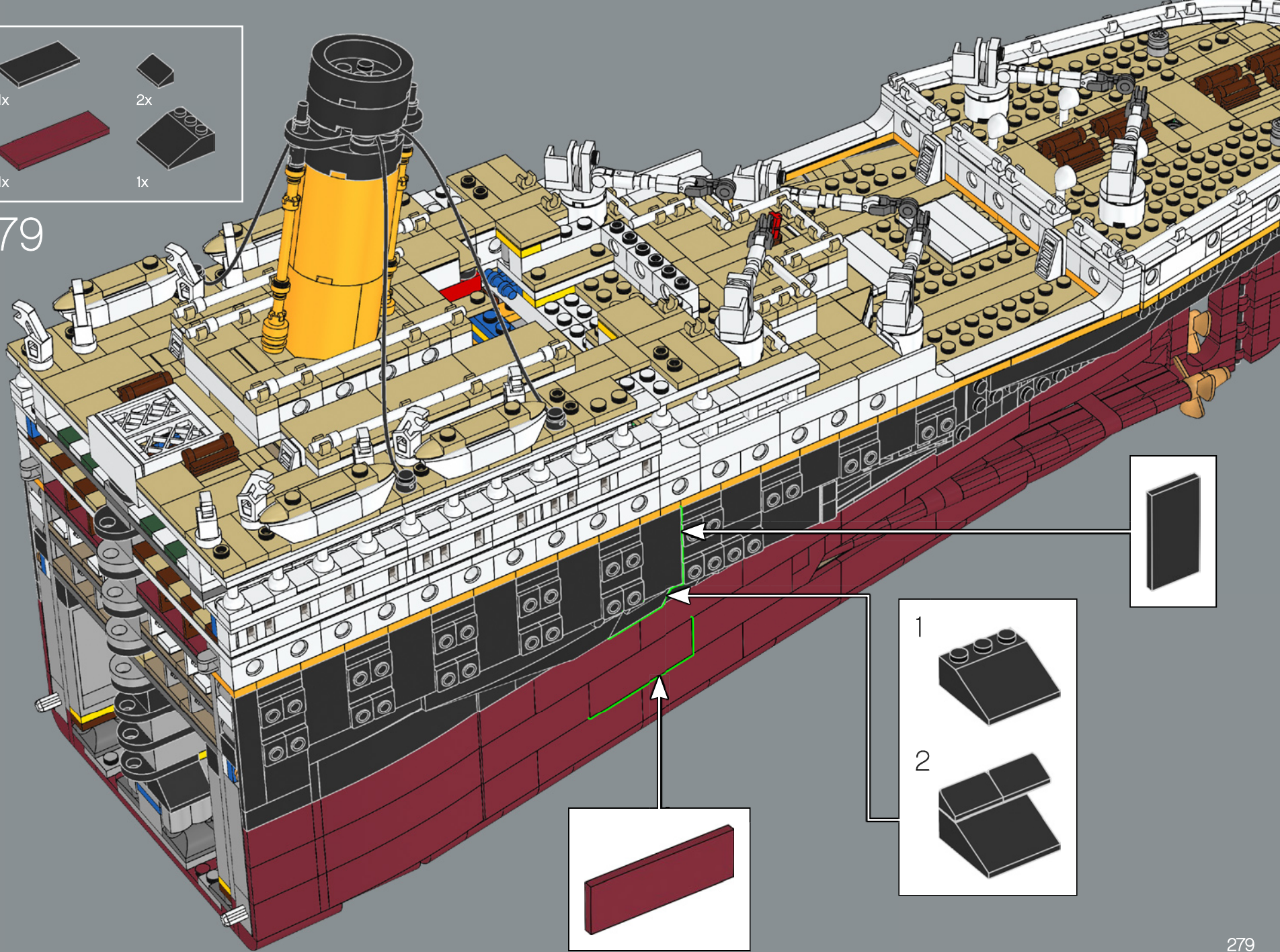

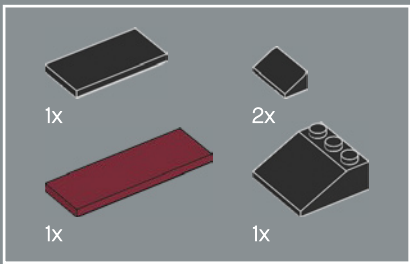

380

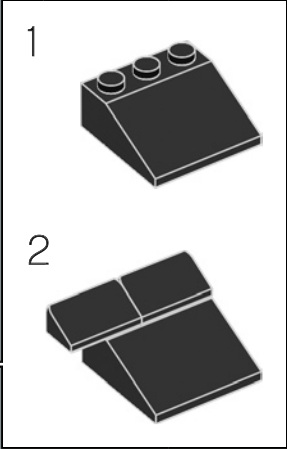
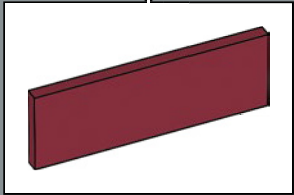
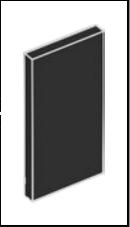
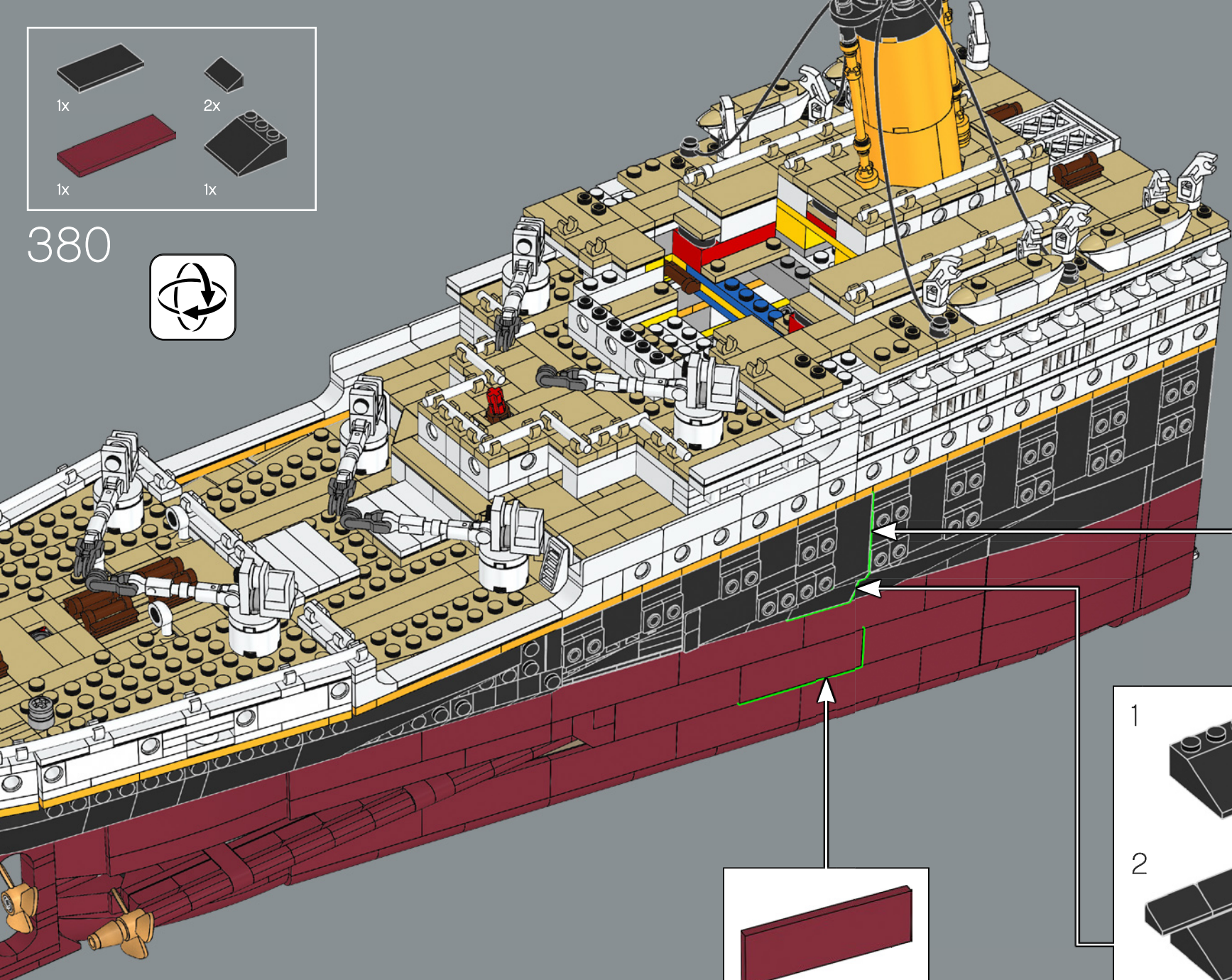



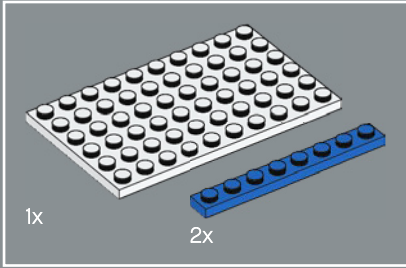
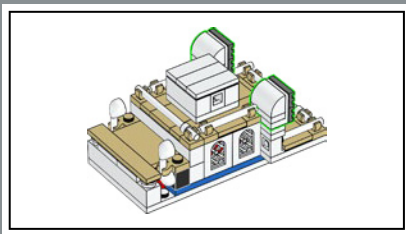

381

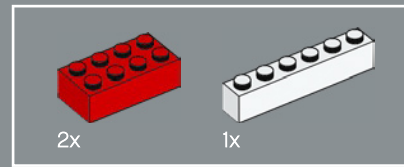
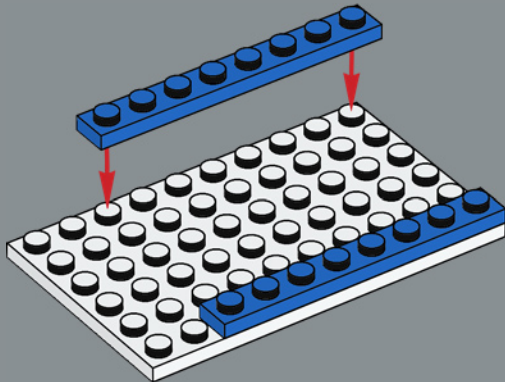

382

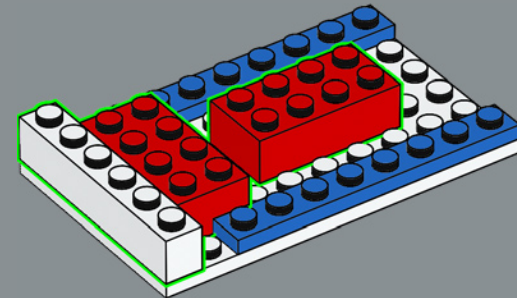

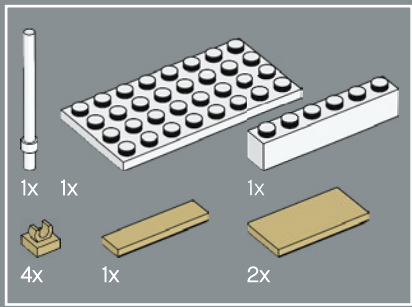

383

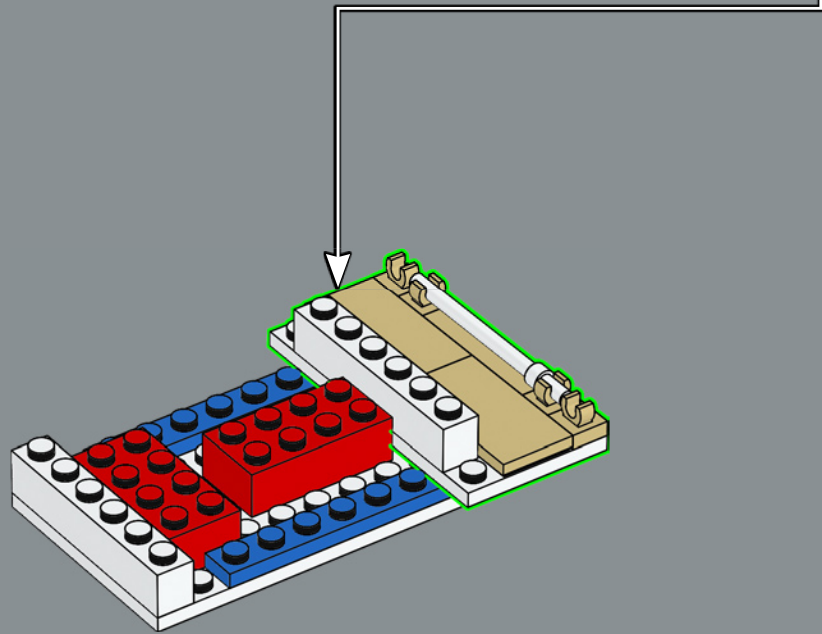
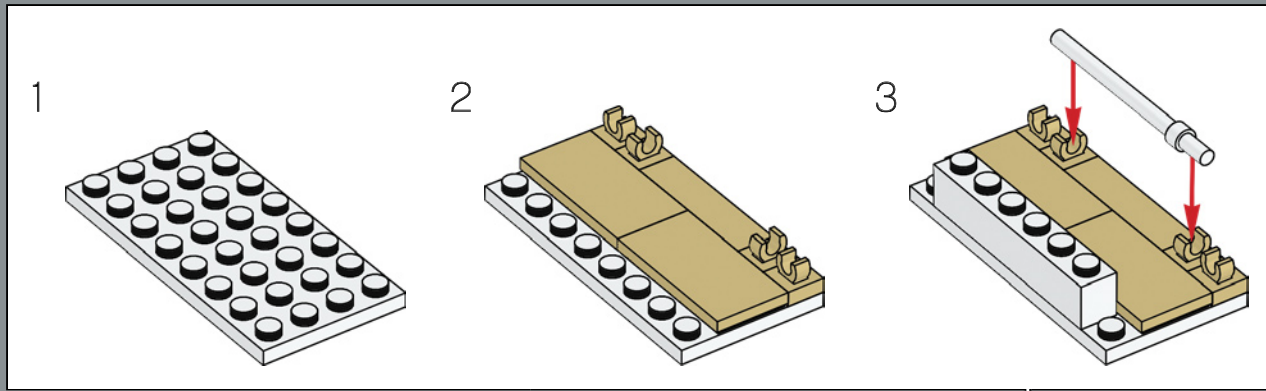

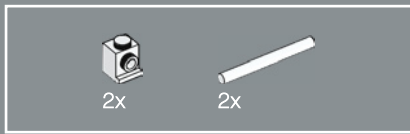

384

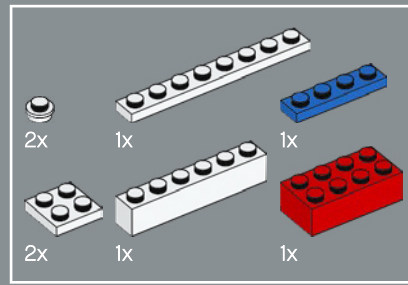
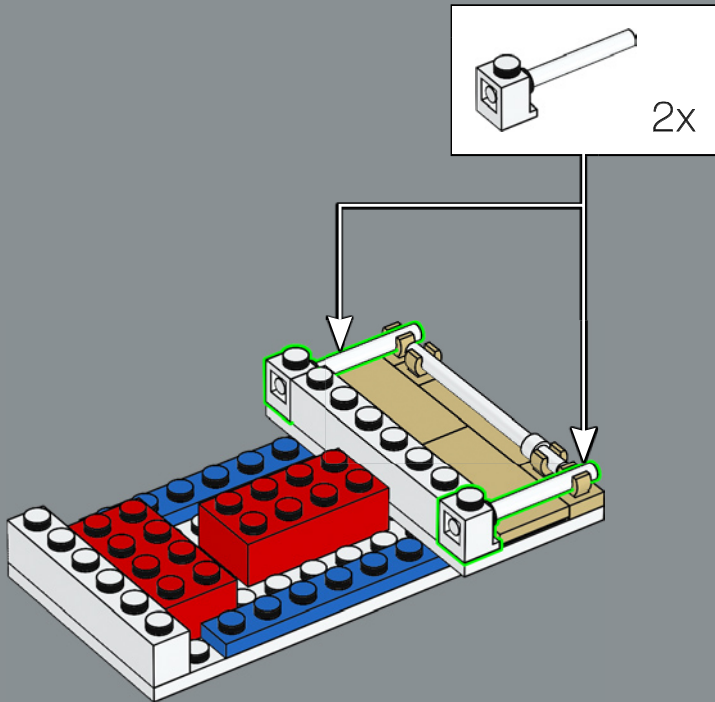

385

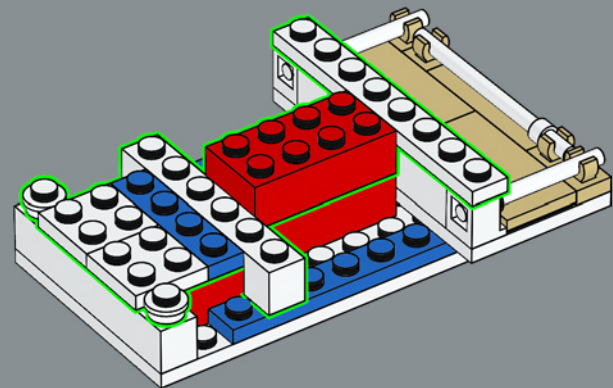

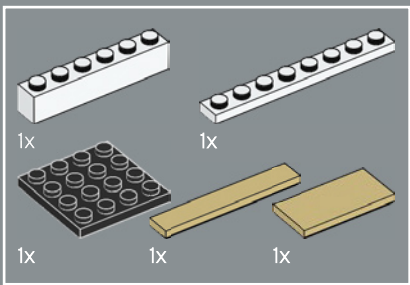

386

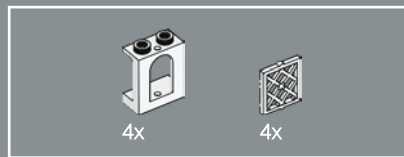
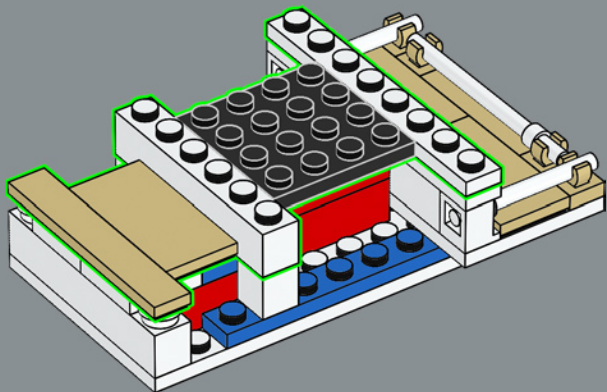

387

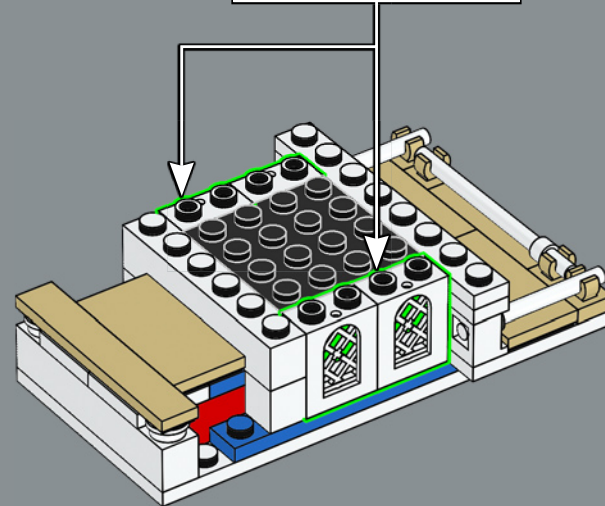
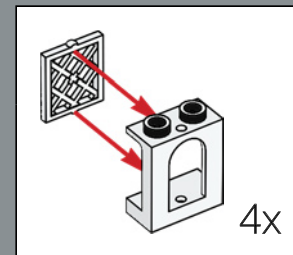

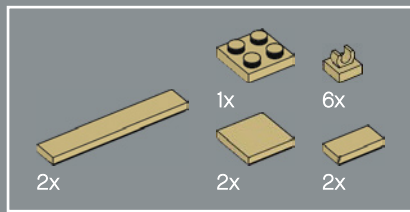

388

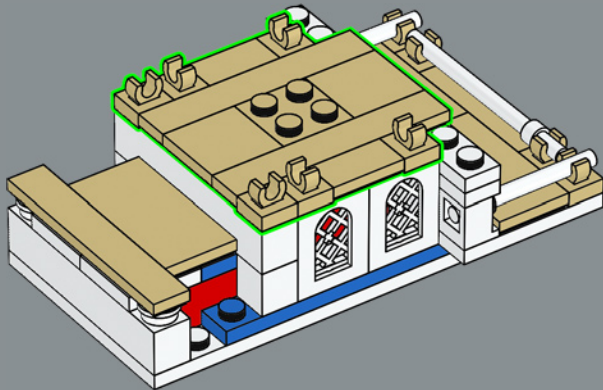

389

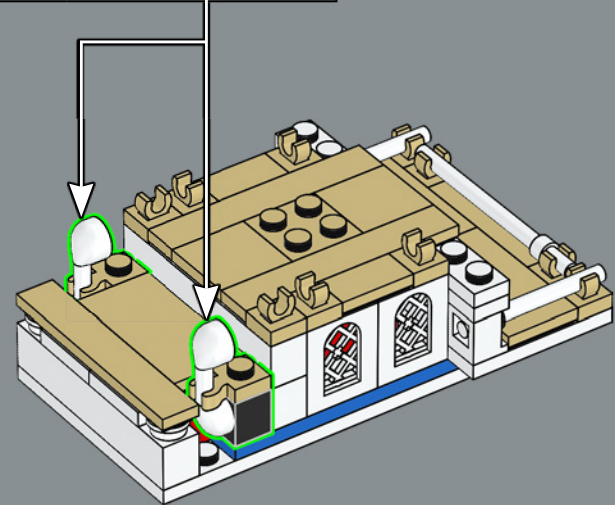
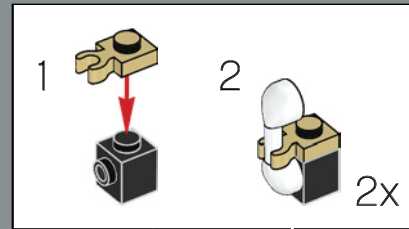

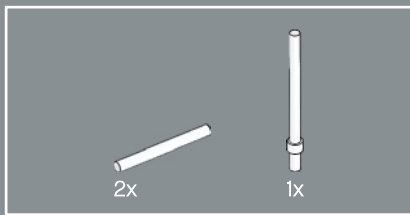

390

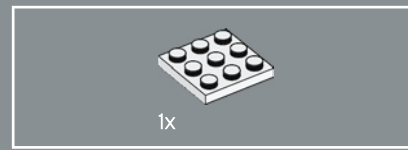
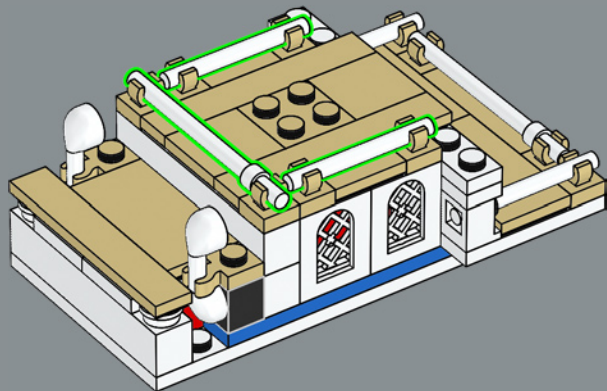

391

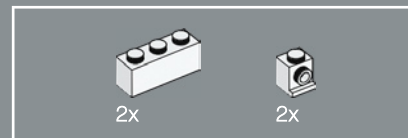
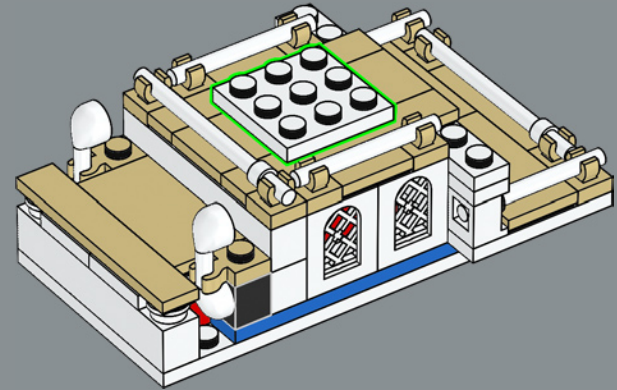

392

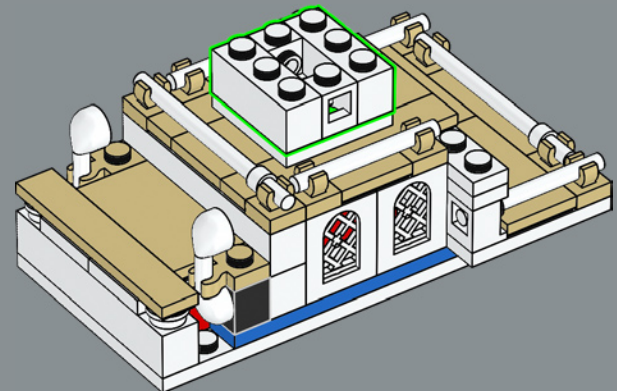

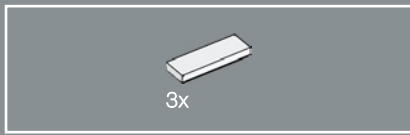

393

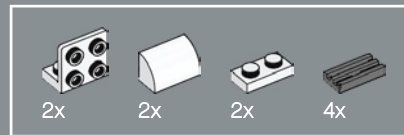
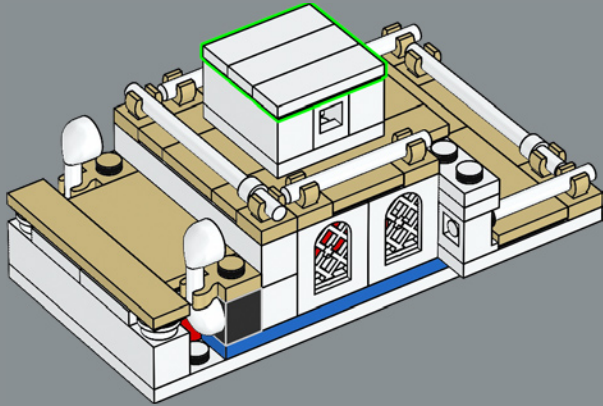

394

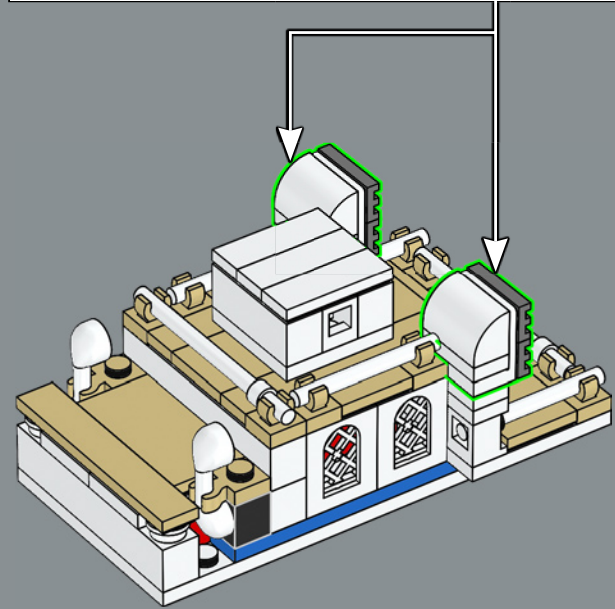
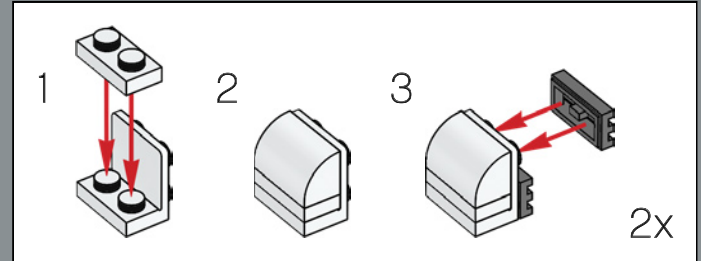

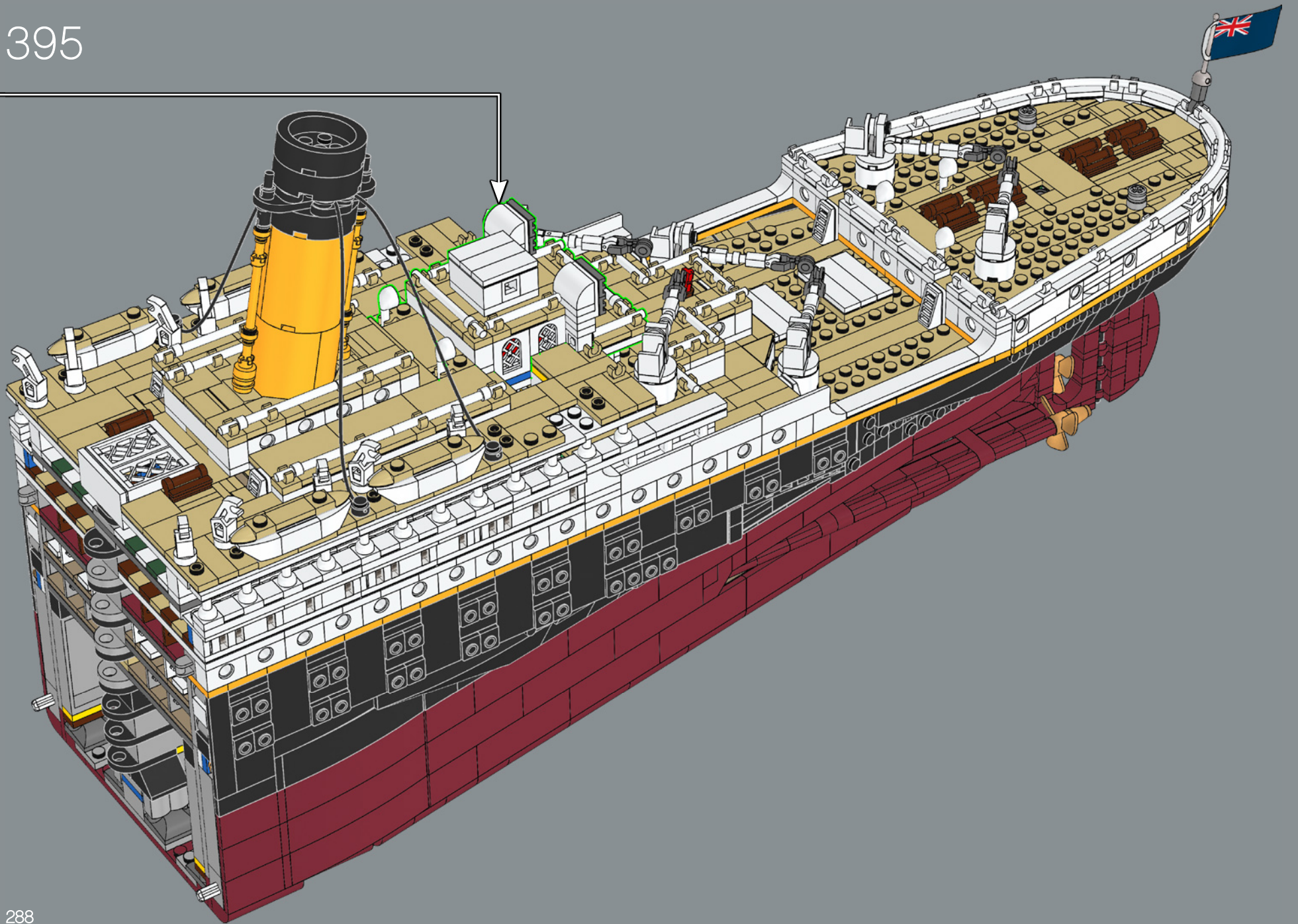



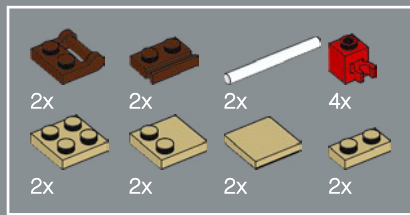

396

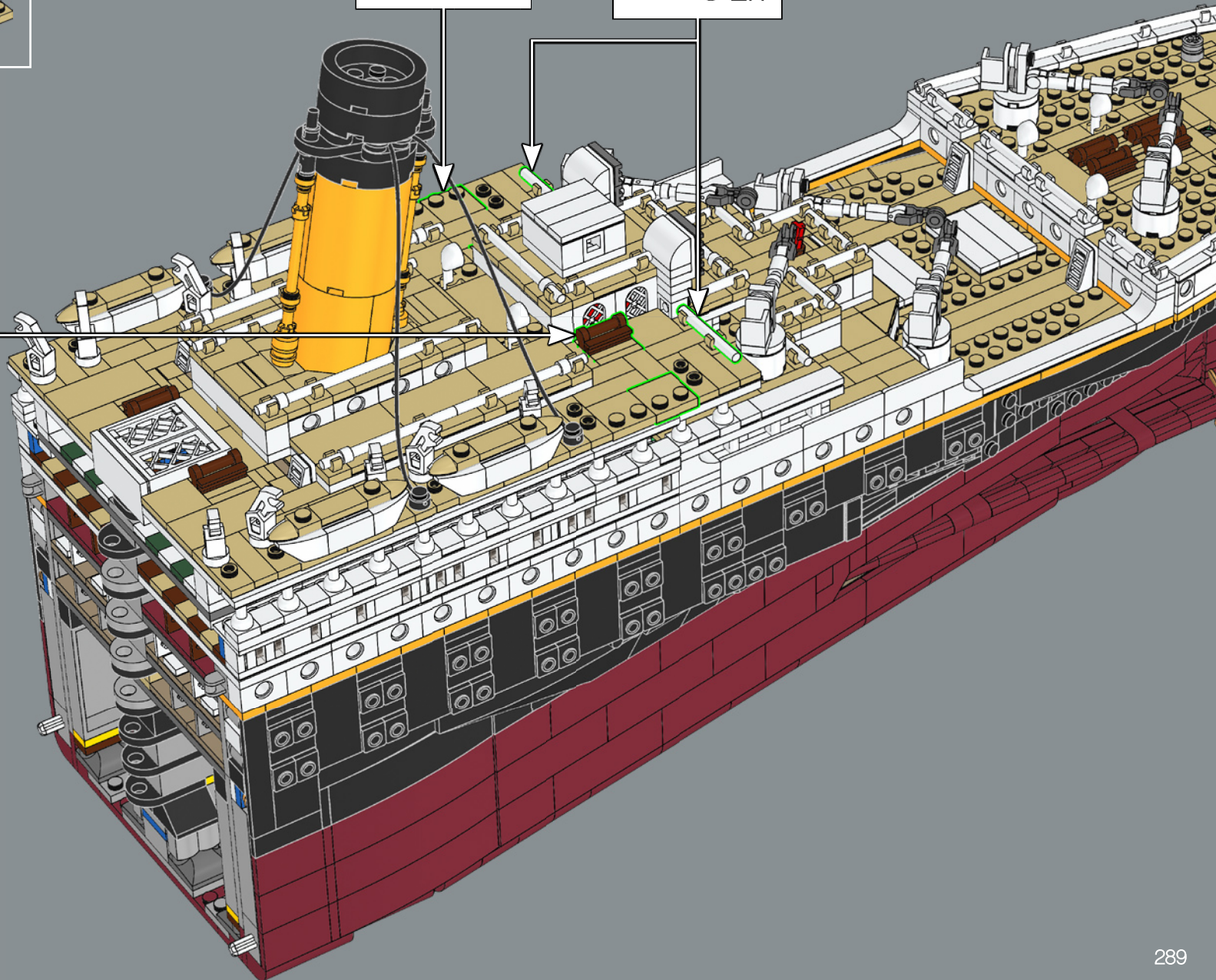
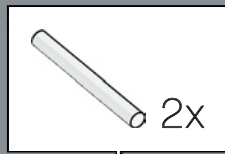
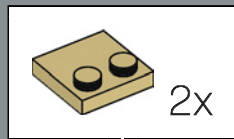
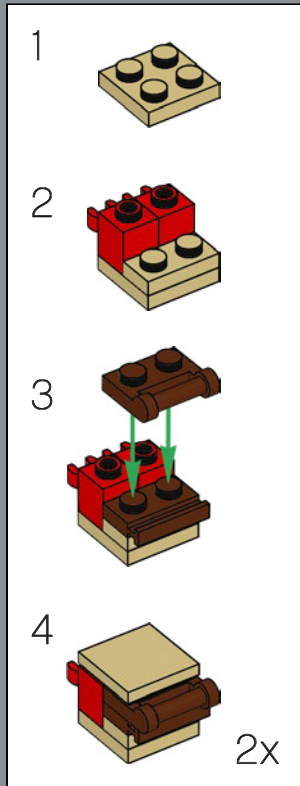

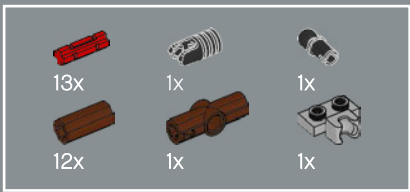

397

1

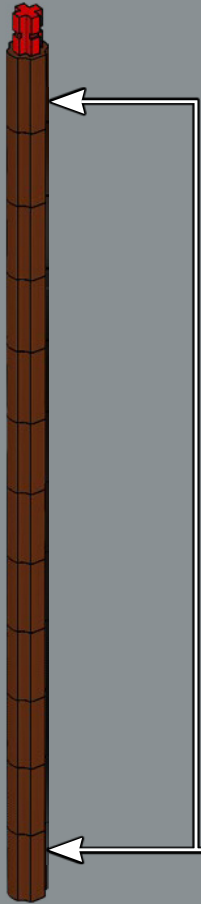

2



3

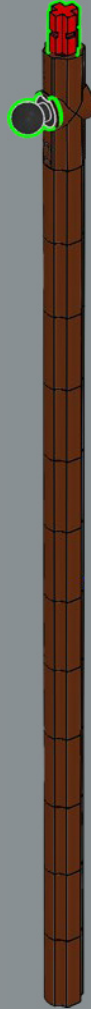

4

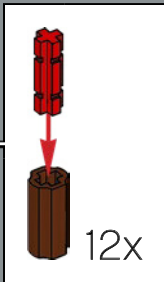
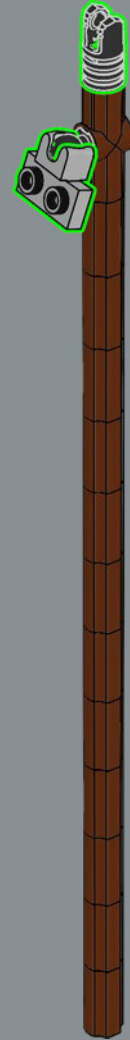

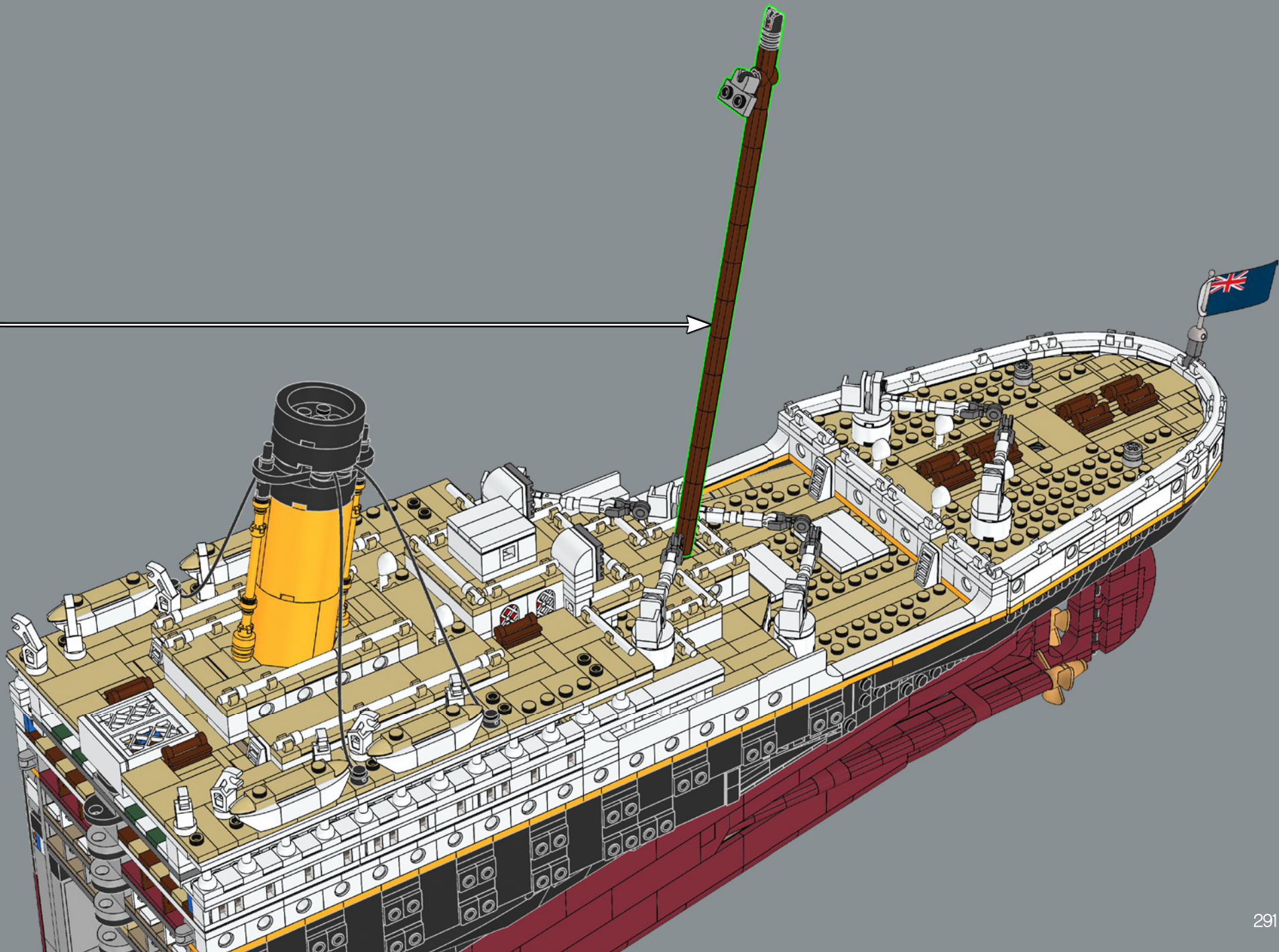

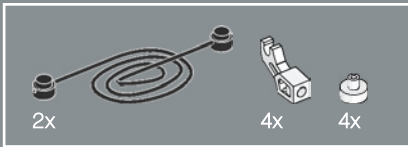
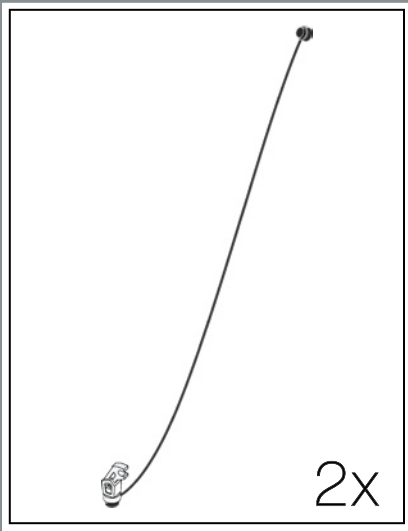

398

1

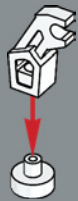

2

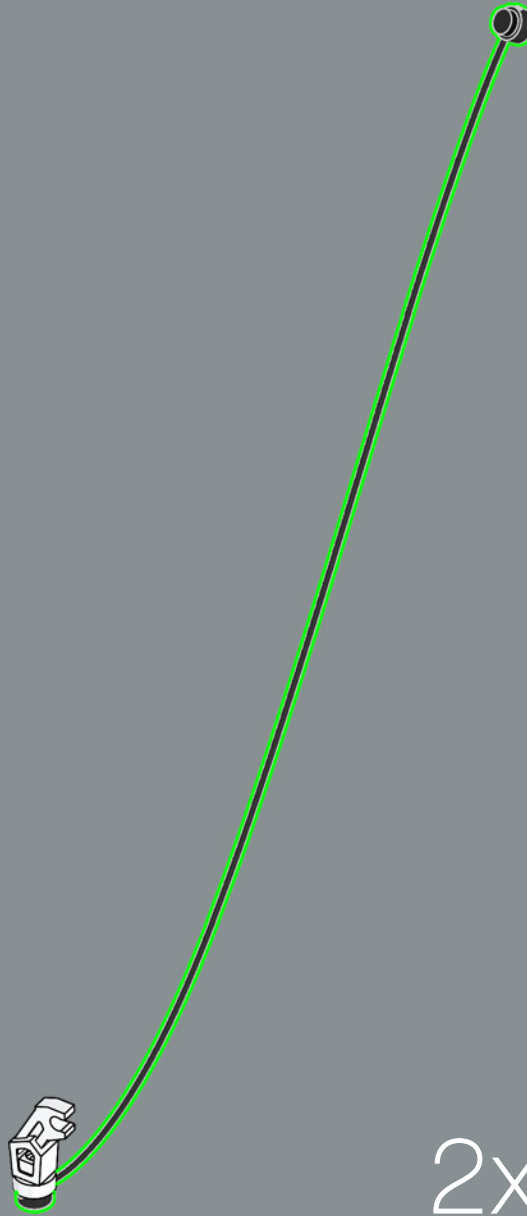

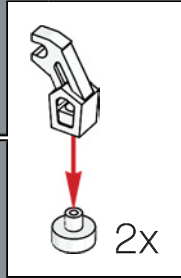
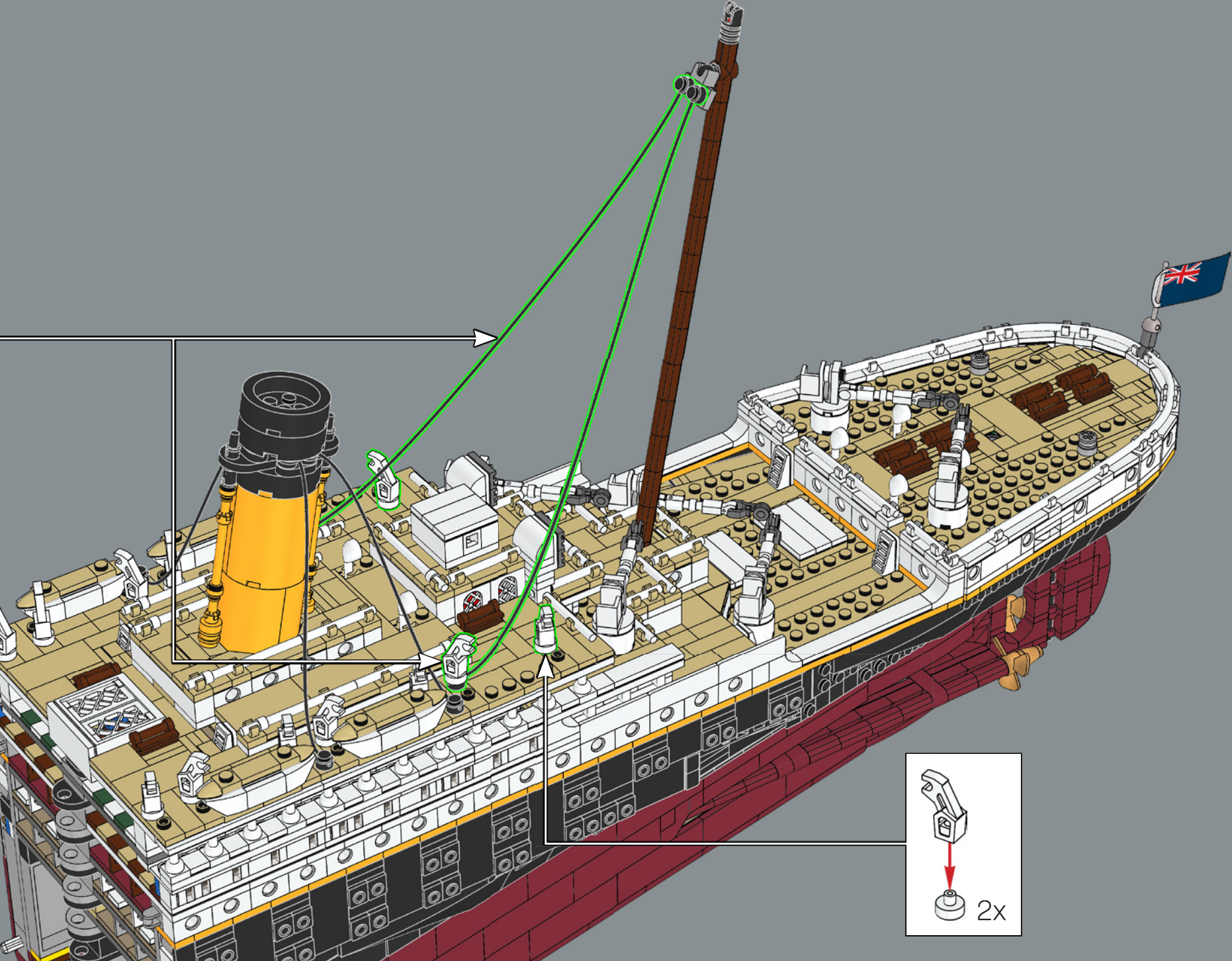

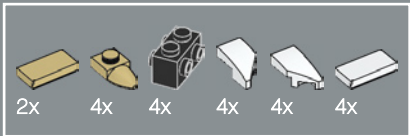

399

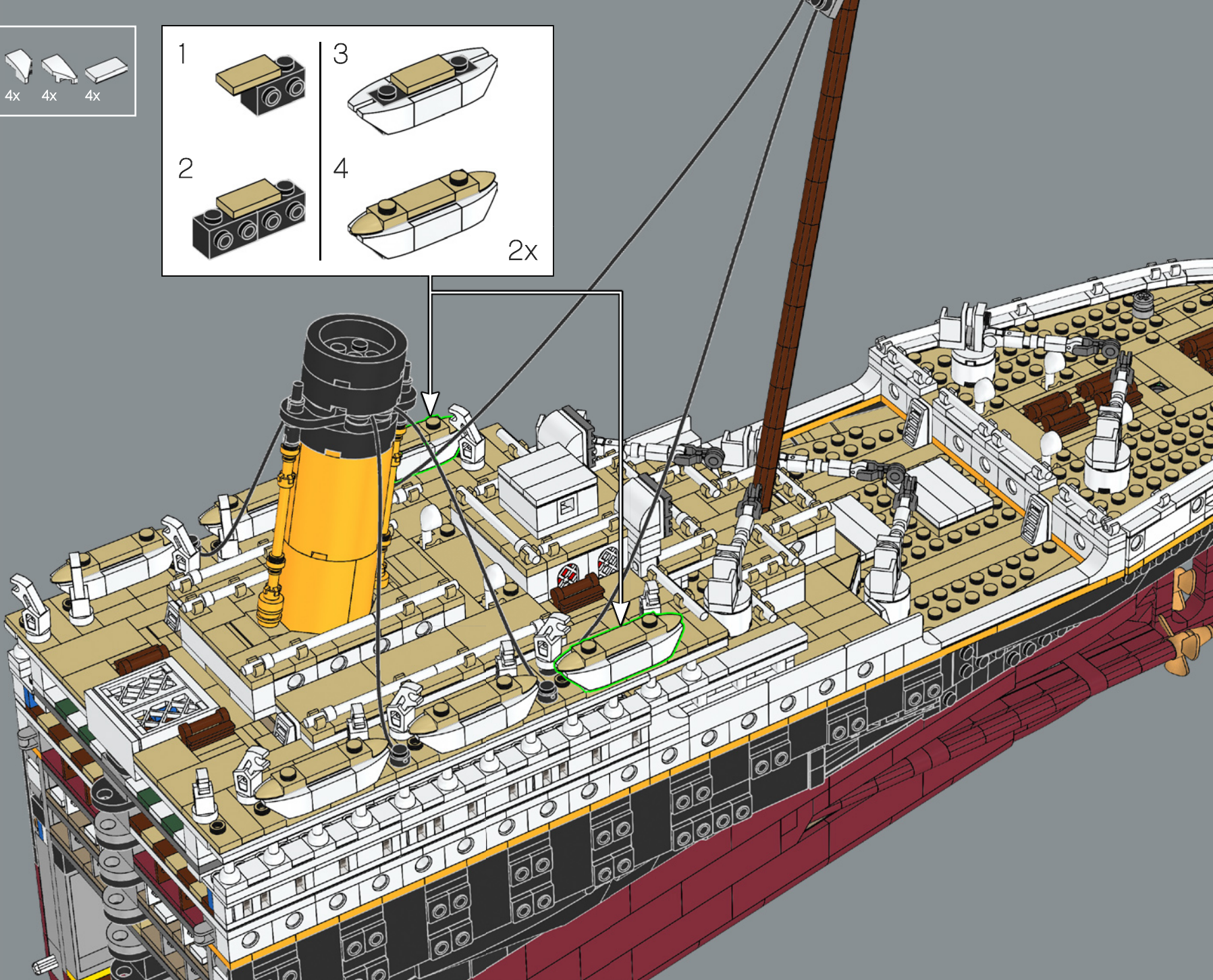
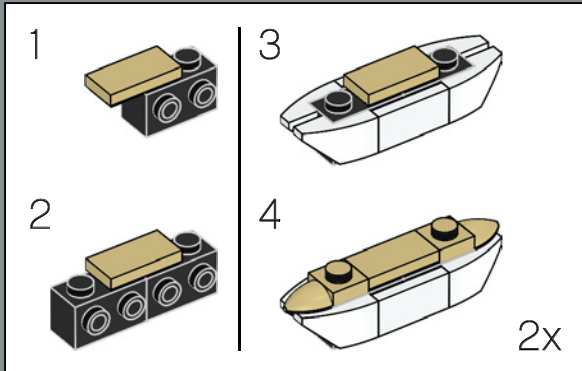

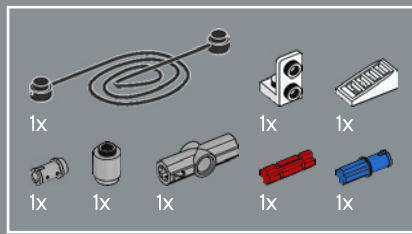

400

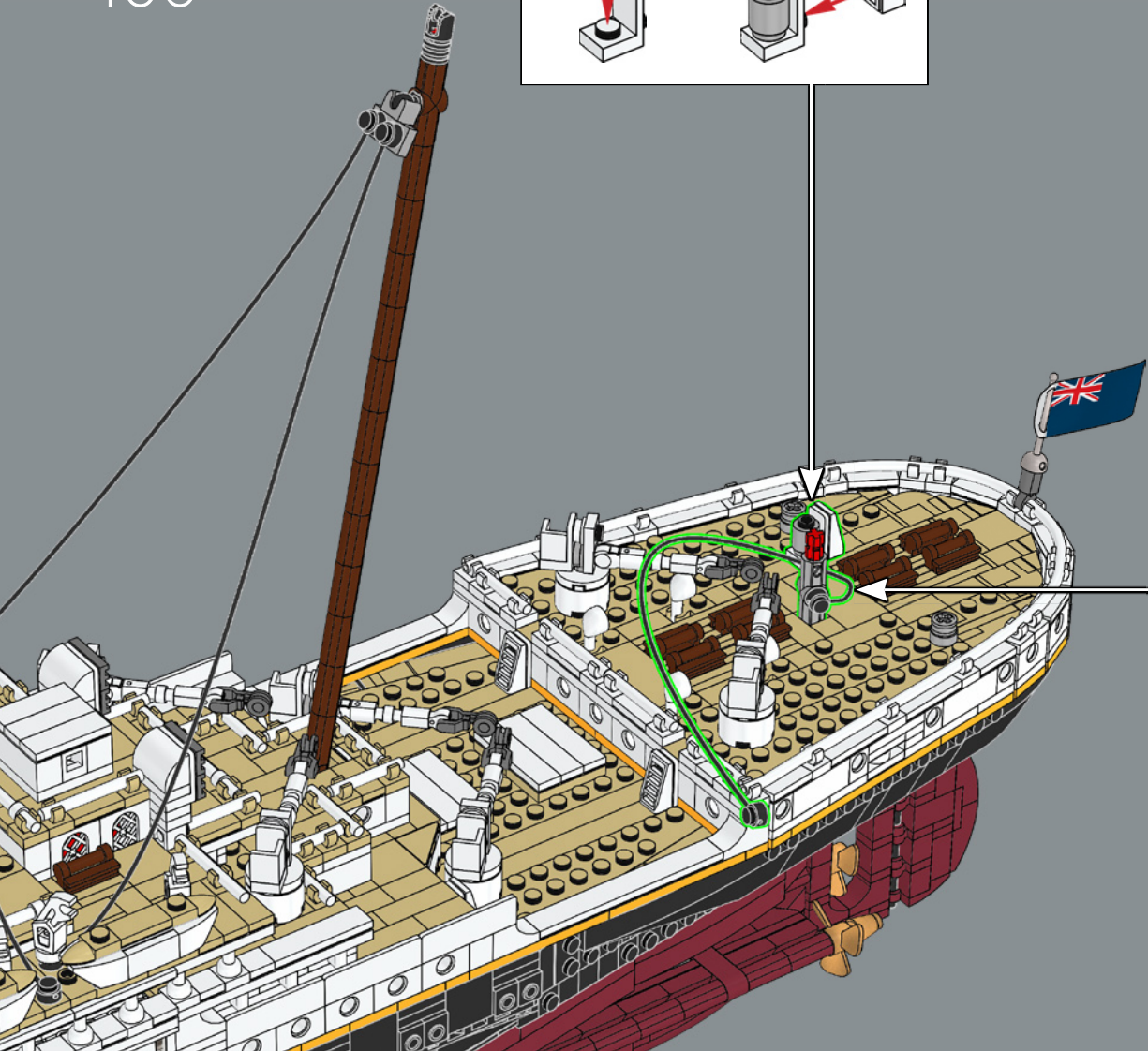
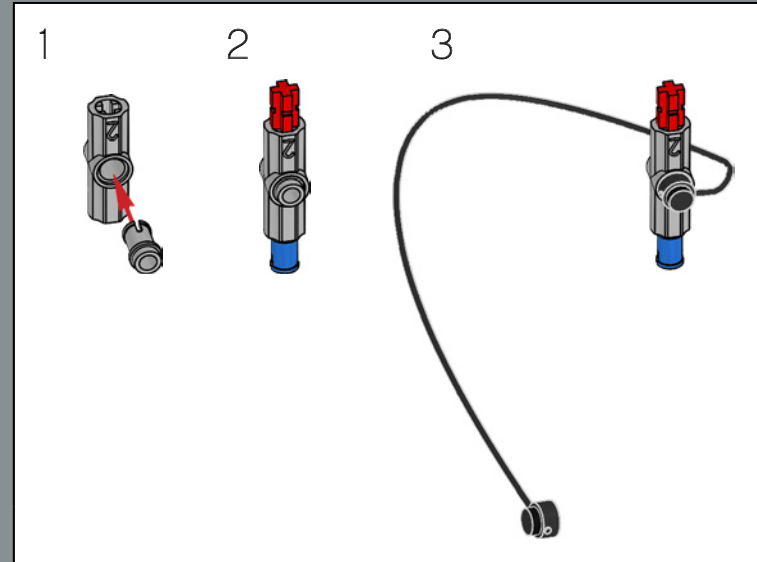
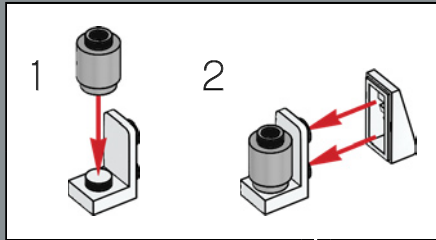

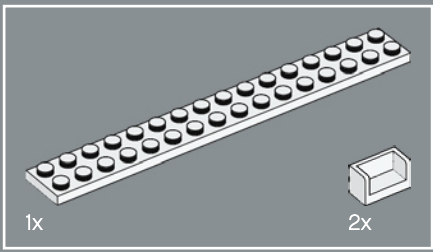

401

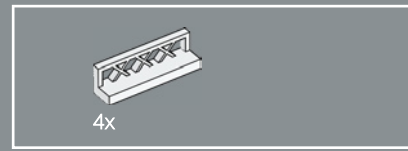
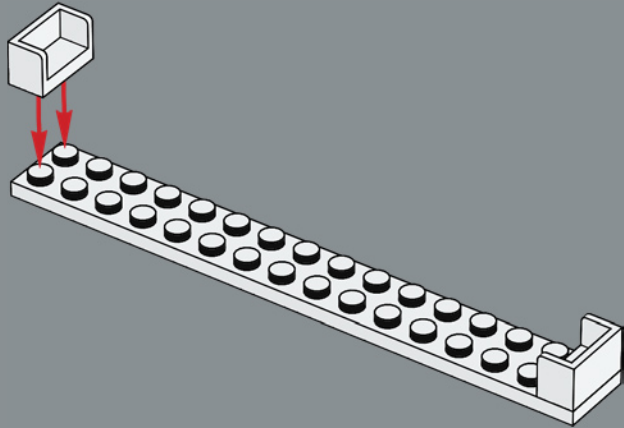

402

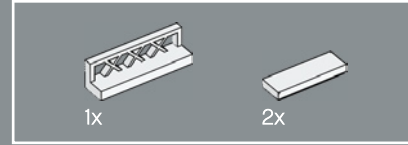
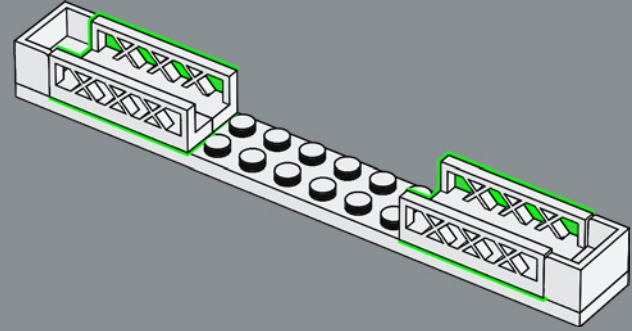

403

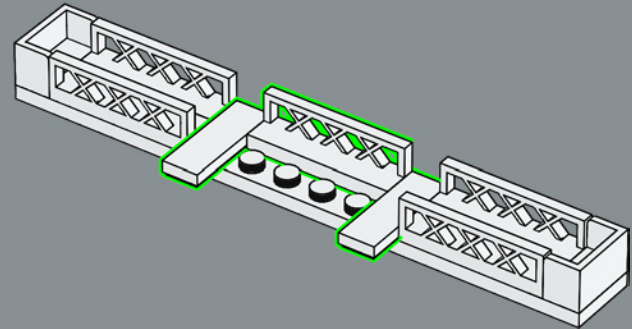





404

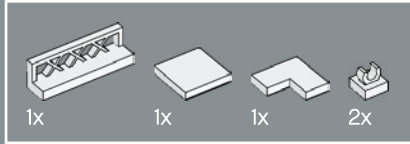
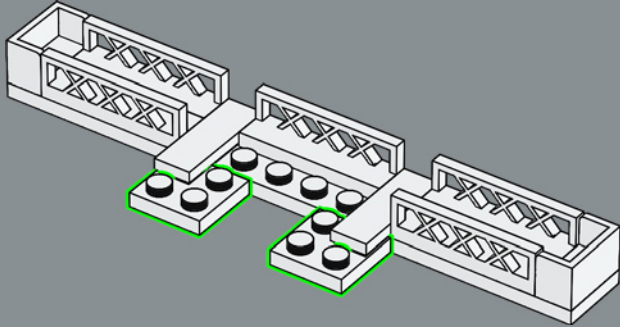

405

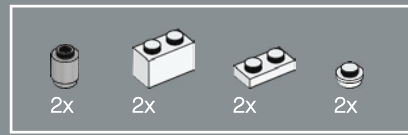
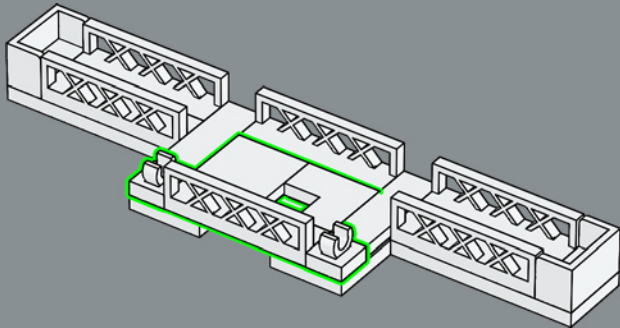

406

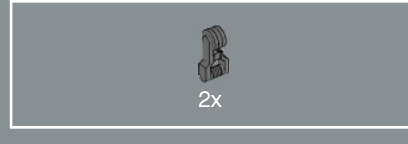
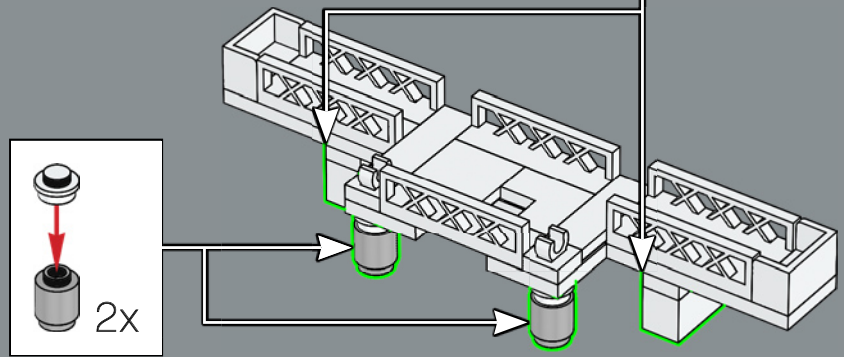
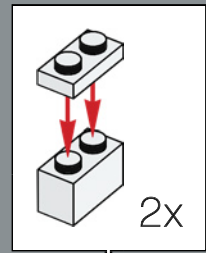
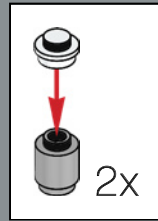

407

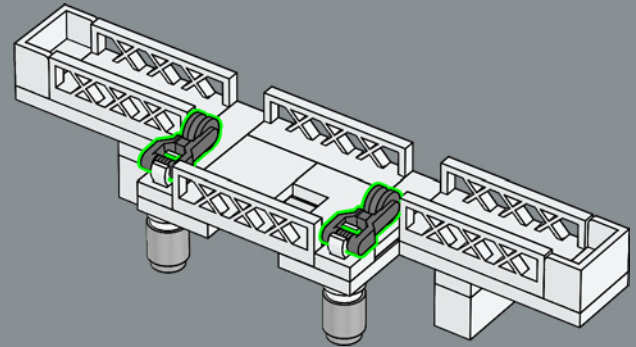



1x

408

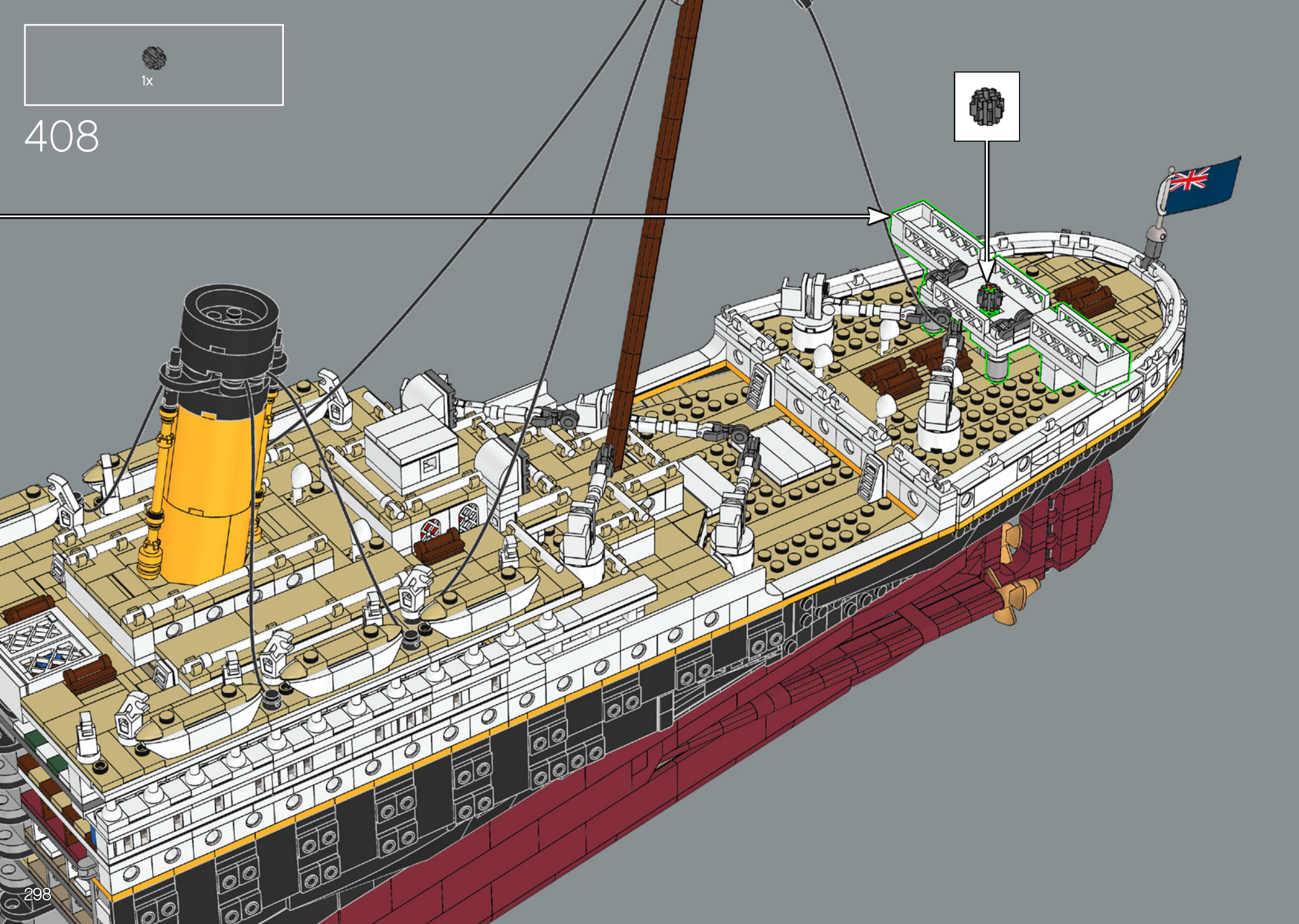

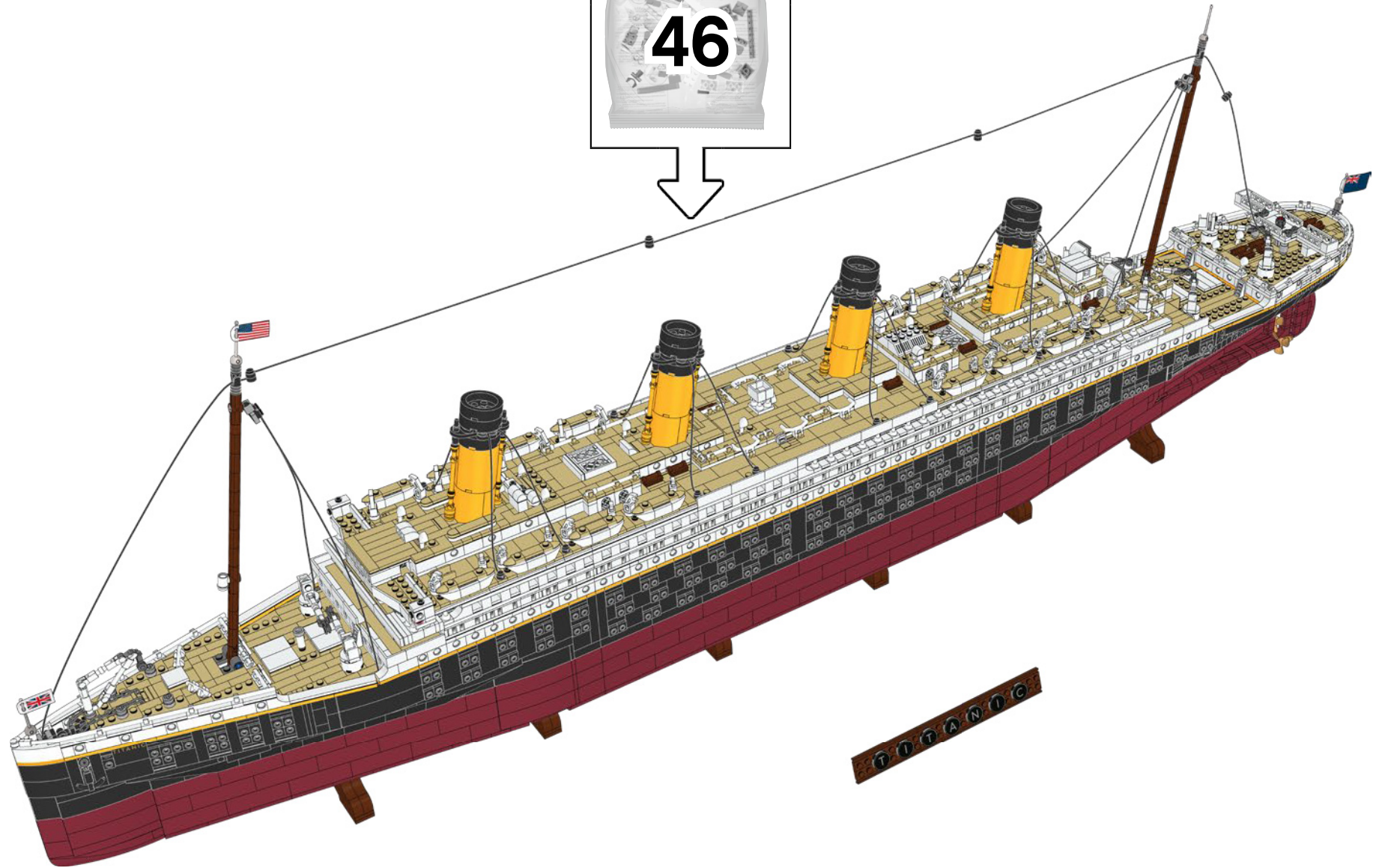

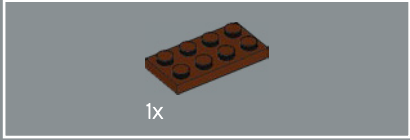
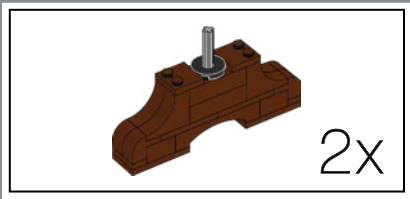

409

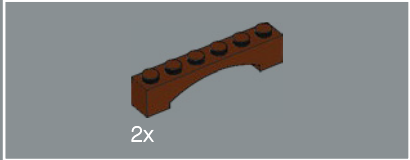
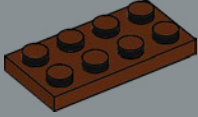

410

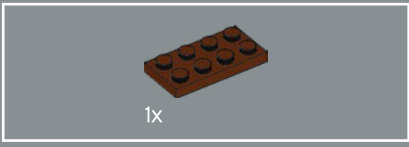
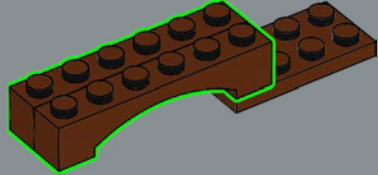

411

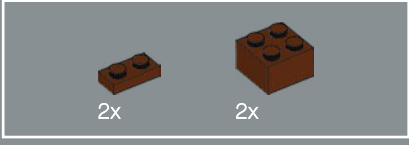
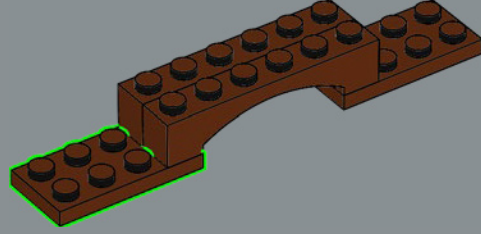

412

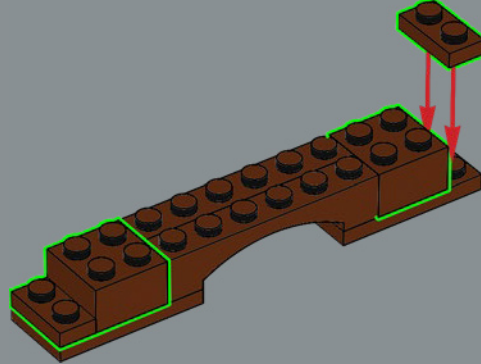

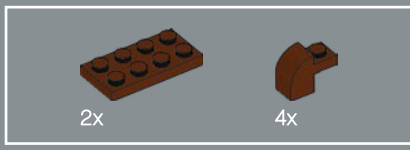

413

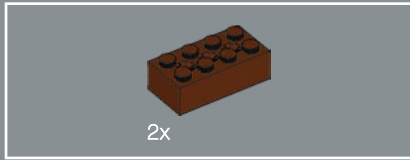
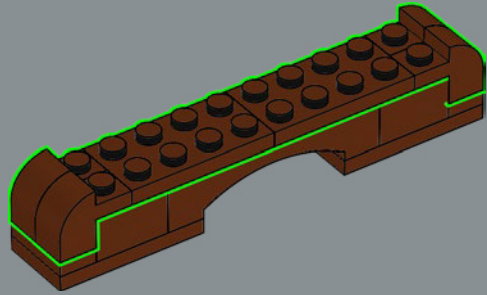

414

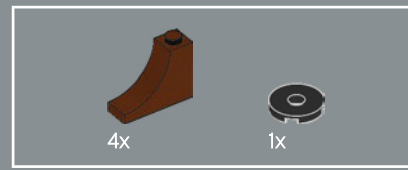
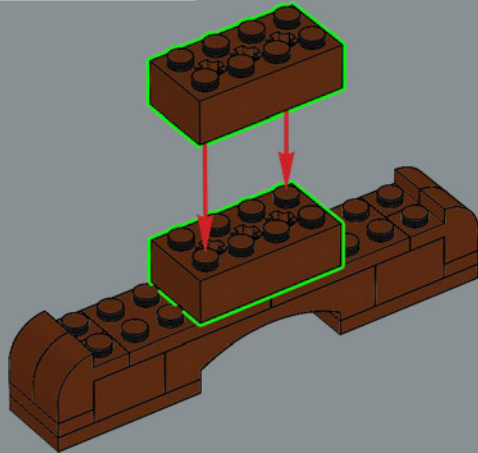

415

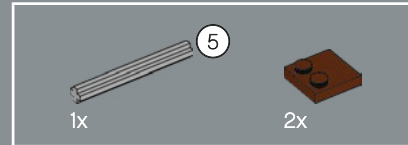
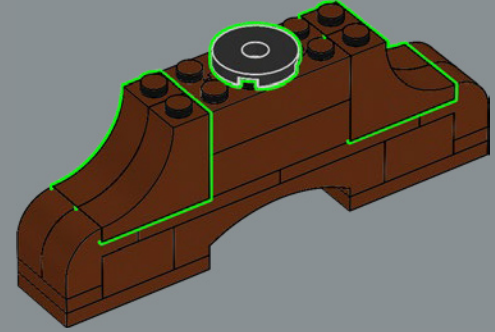

416

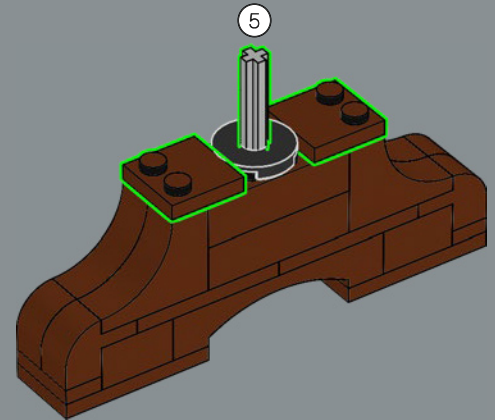

2x



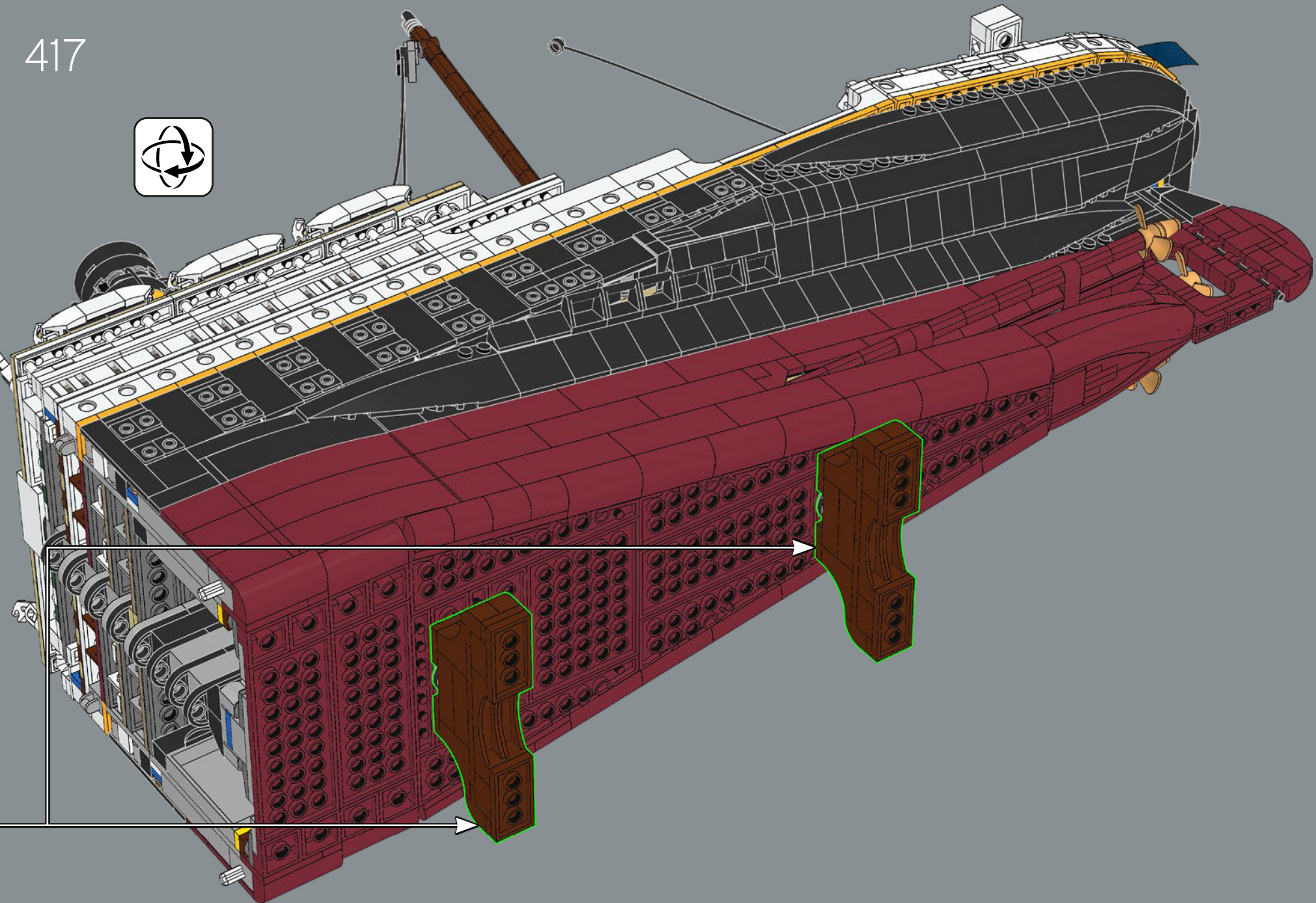

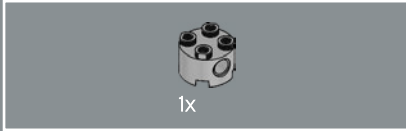
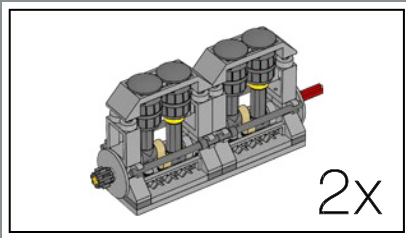

418

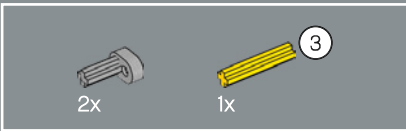
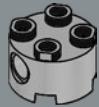

419

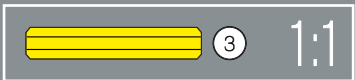
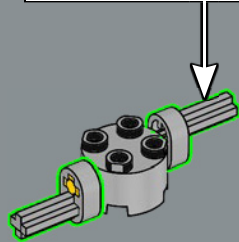
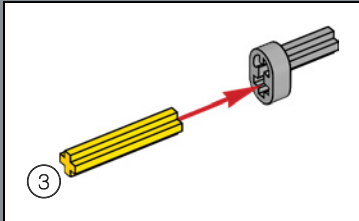

420

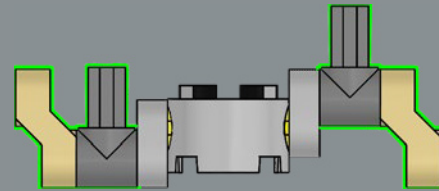

1:1

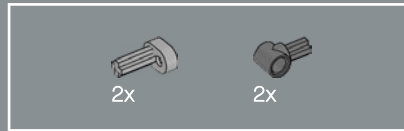

421

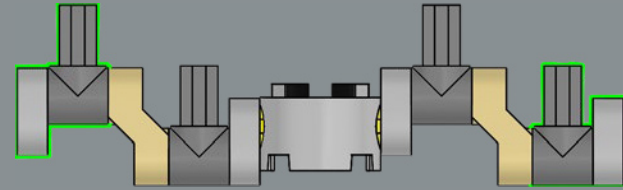

1:1

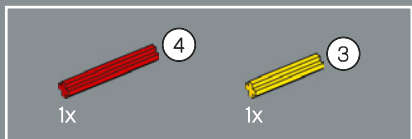

422

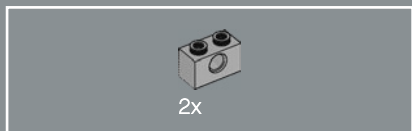
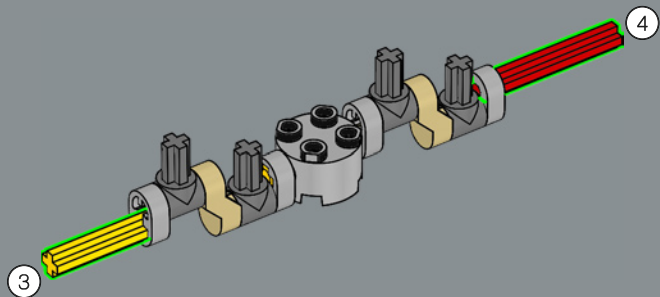

423

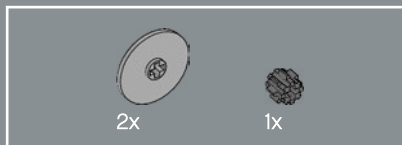
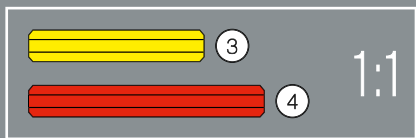
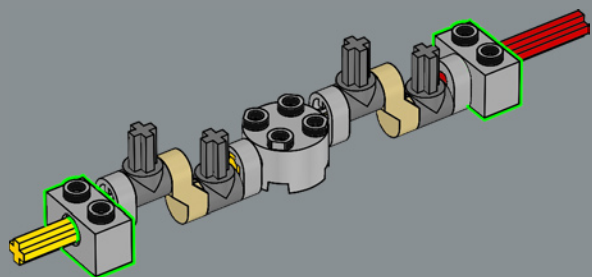

424

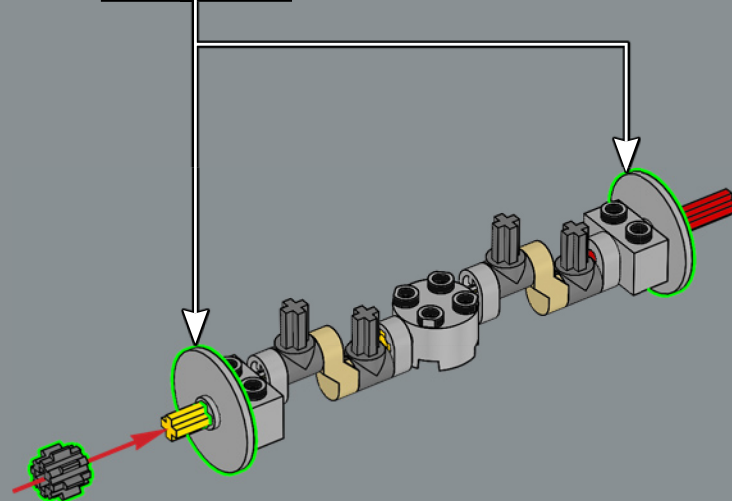
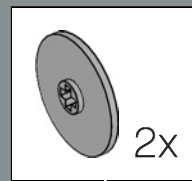



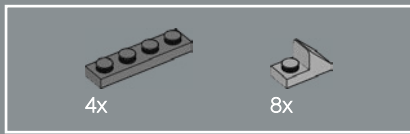

425

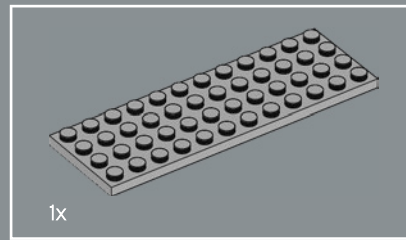
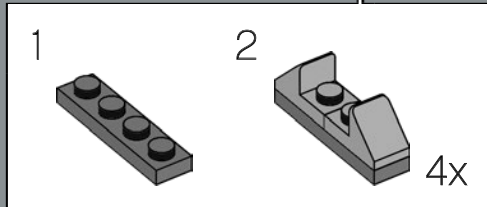
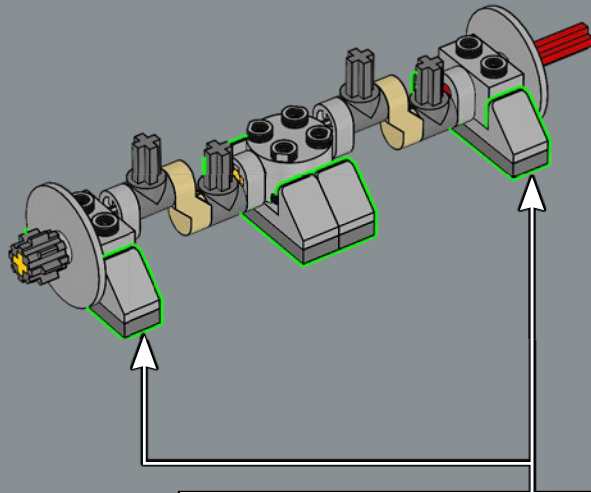

426

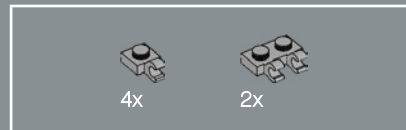
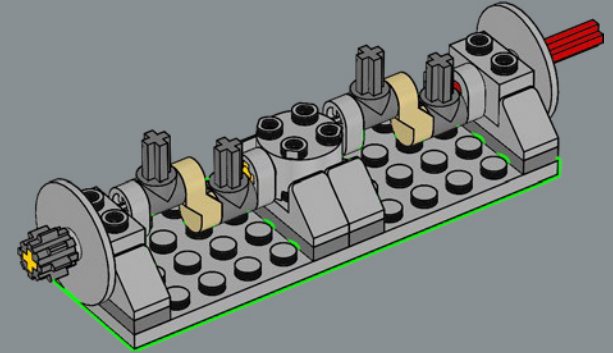

427

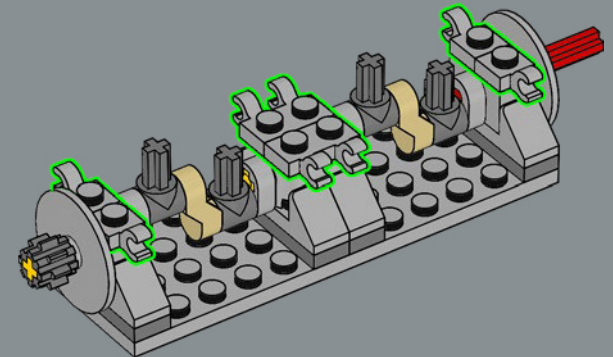



428

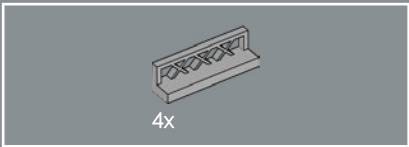
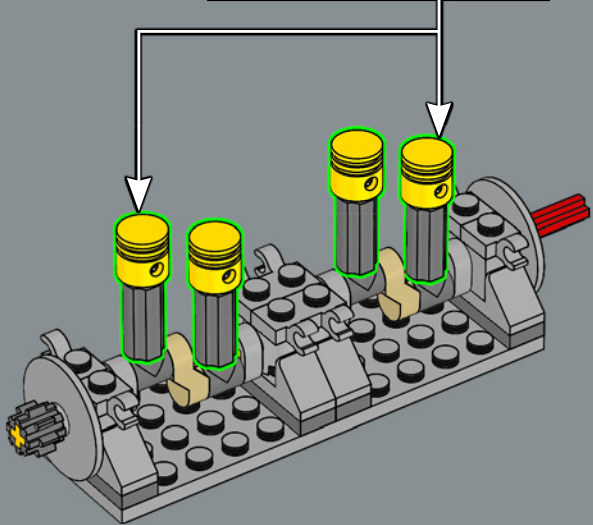
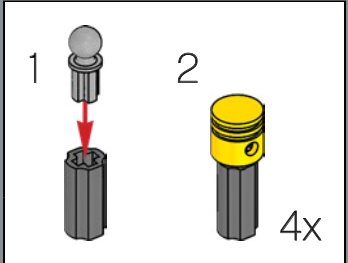

429

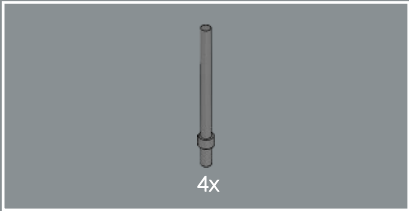
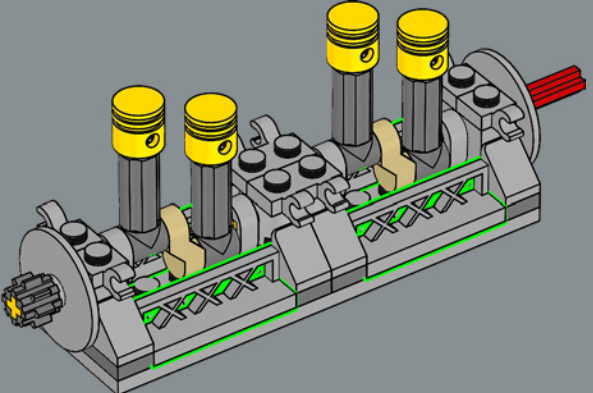

430

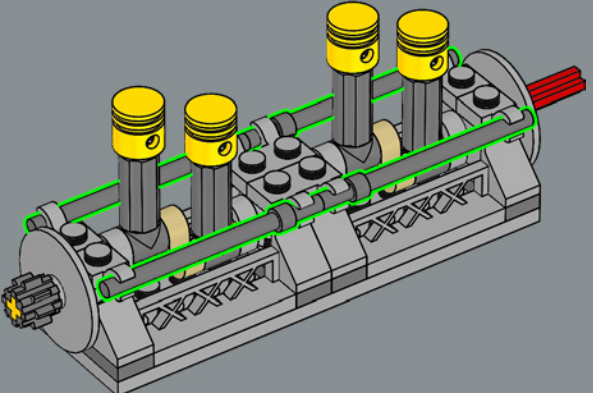

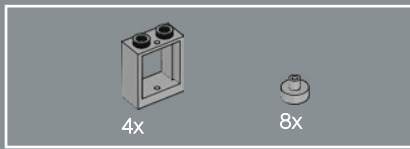

431

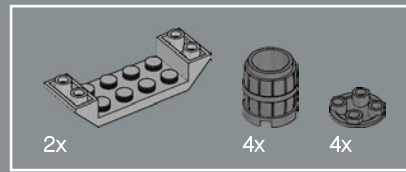
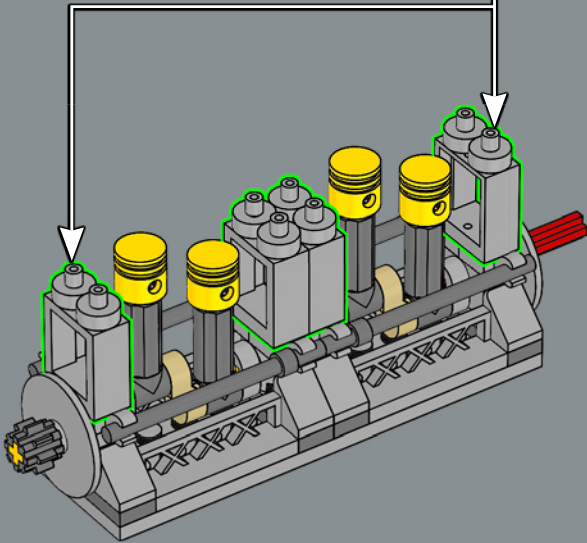
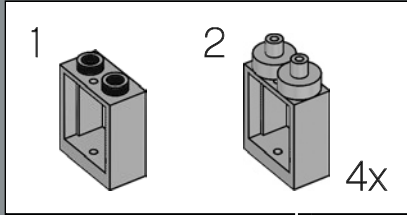

432

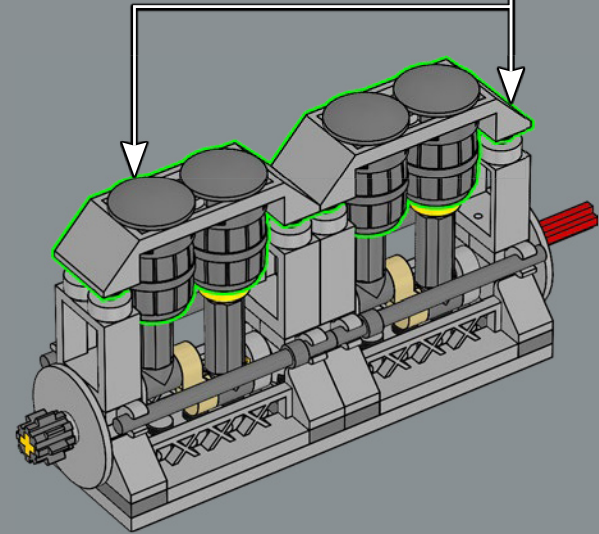
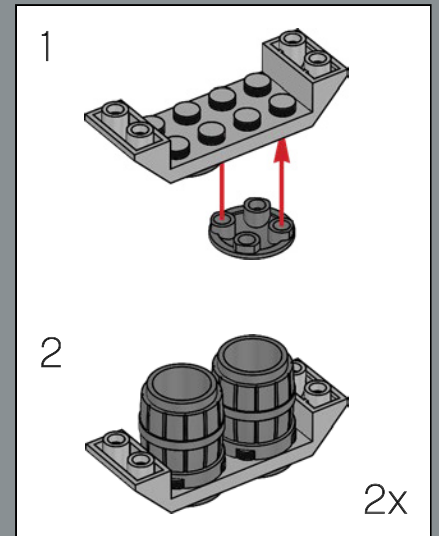

2x

433

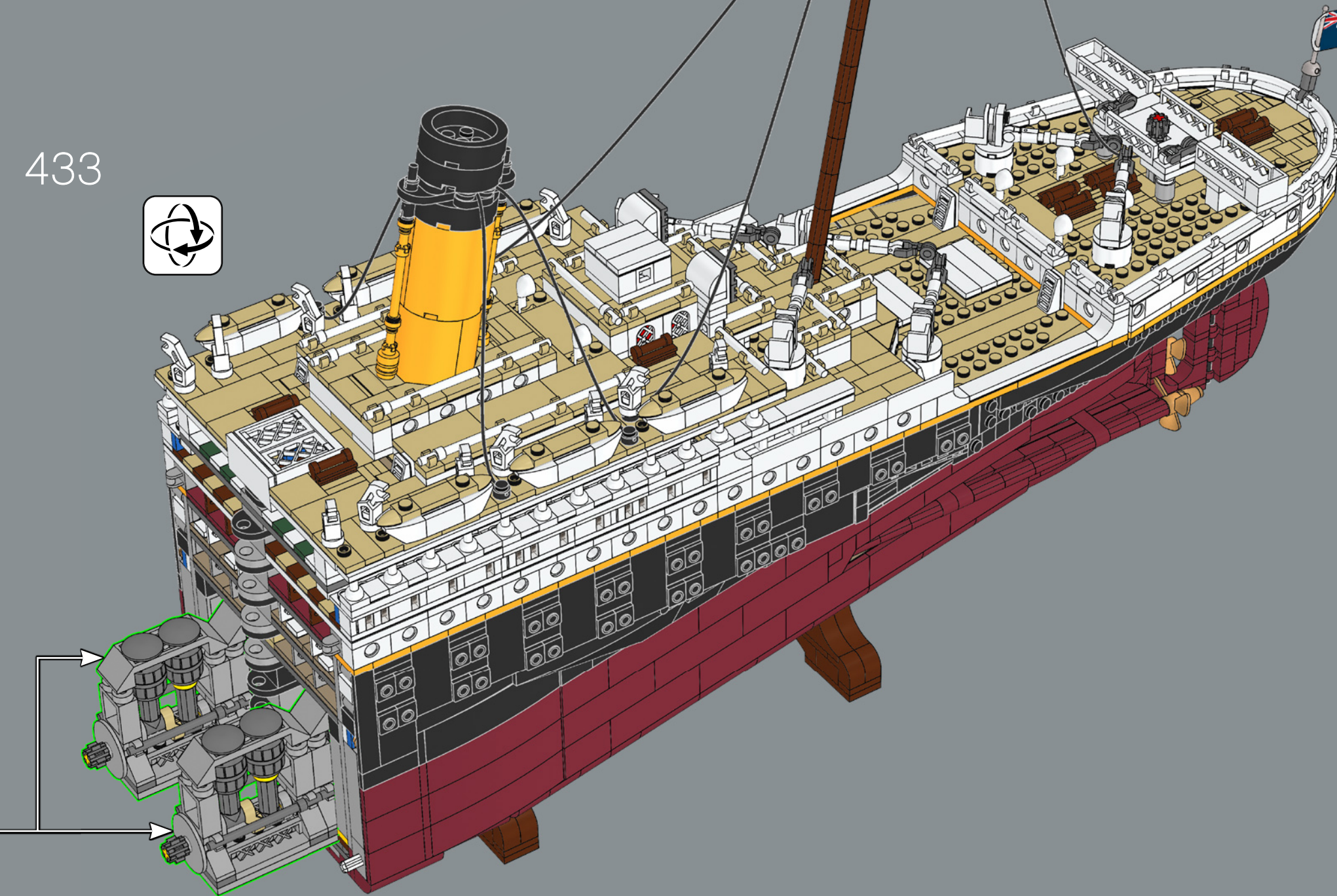

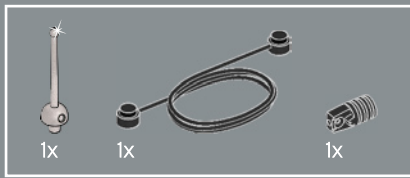

434

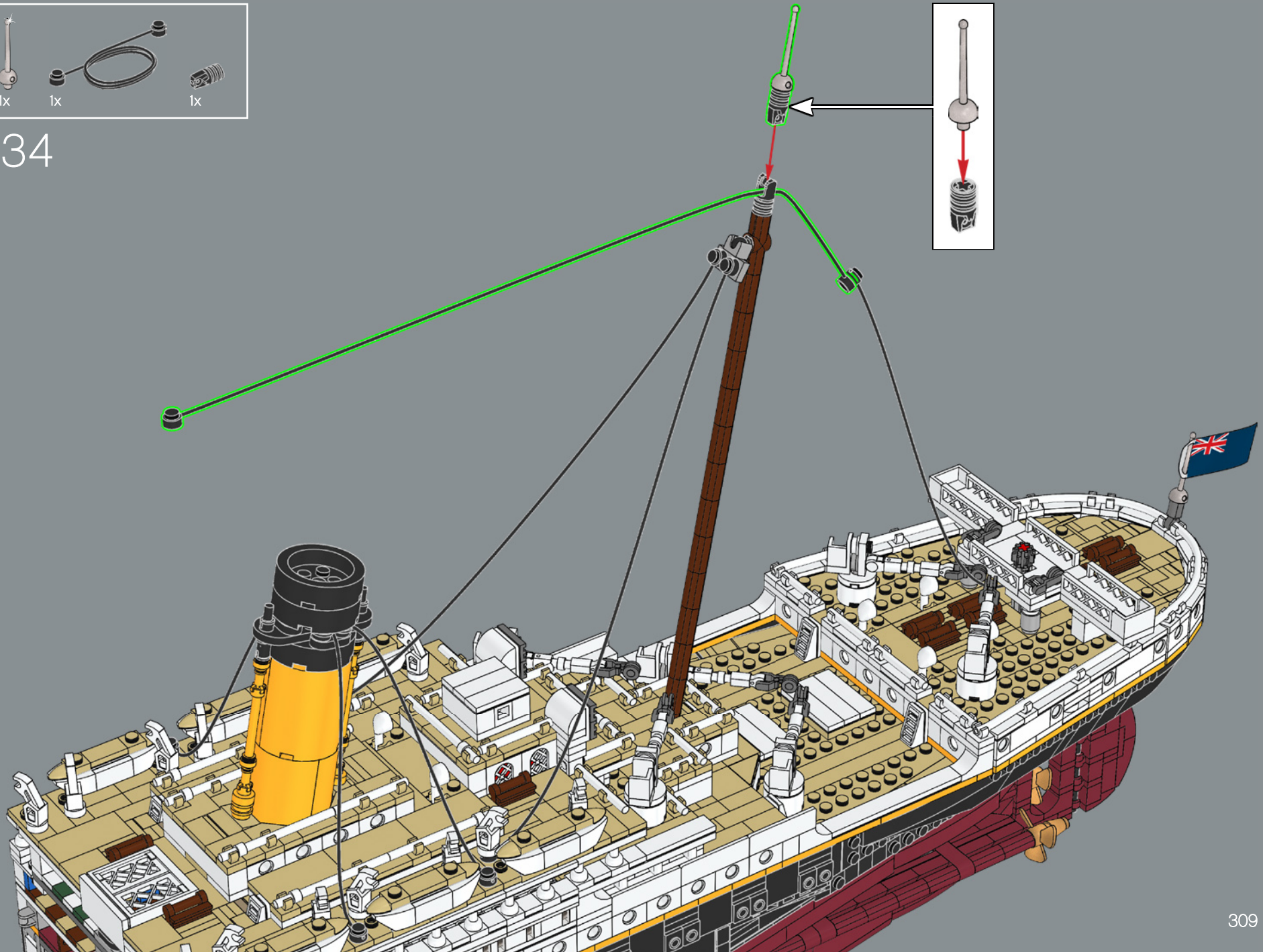

435

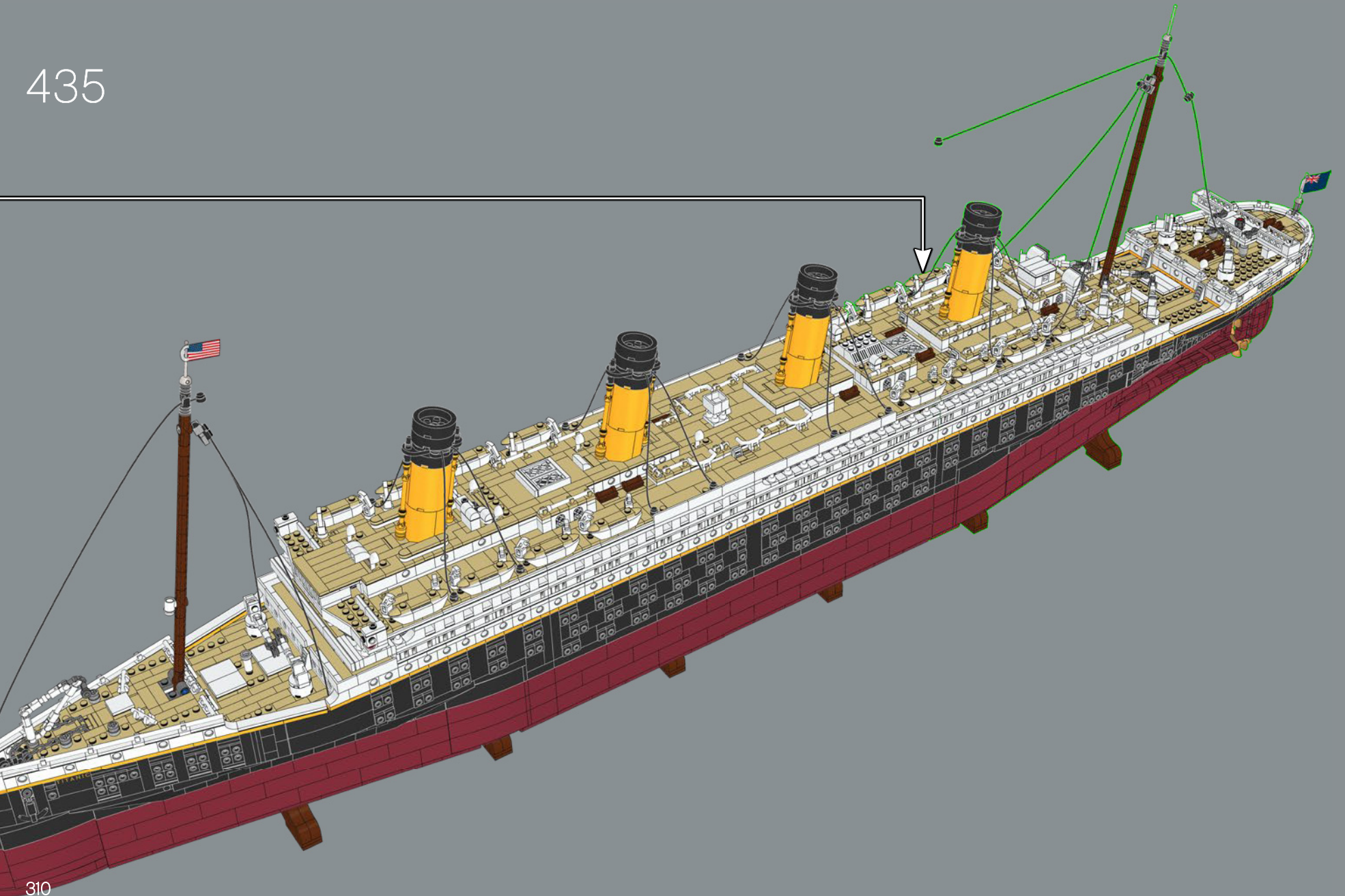

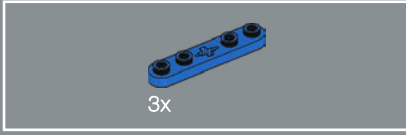
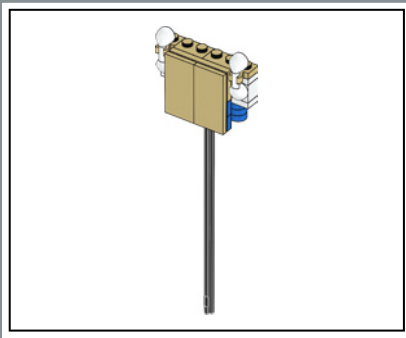

436

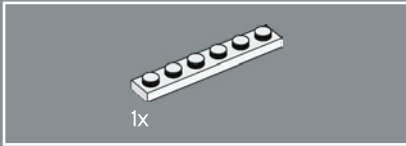
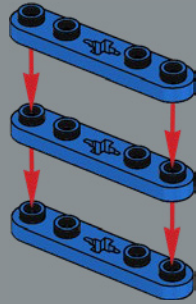

437

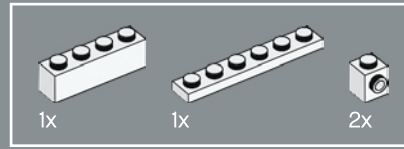
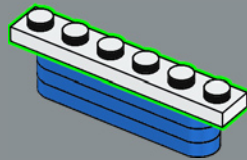

438

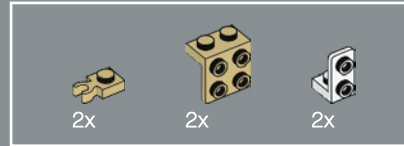
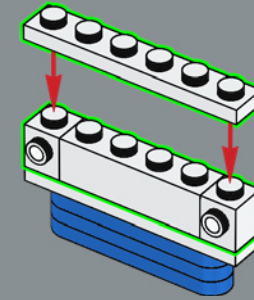

439

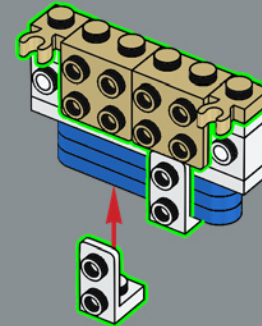

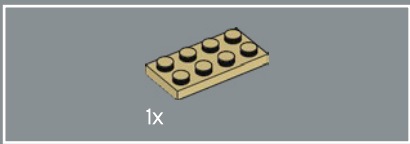

440

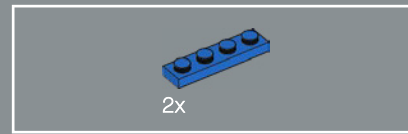
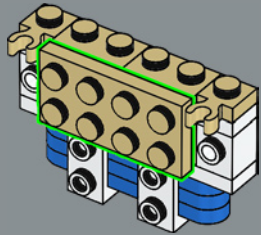

441

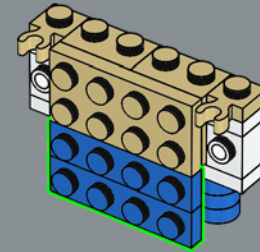



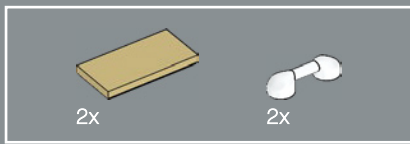

442

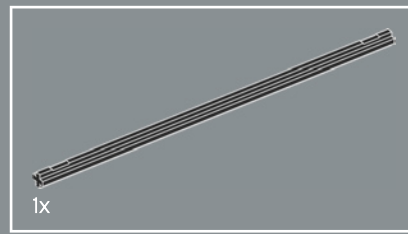
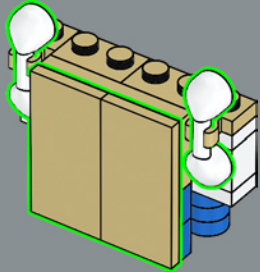

443

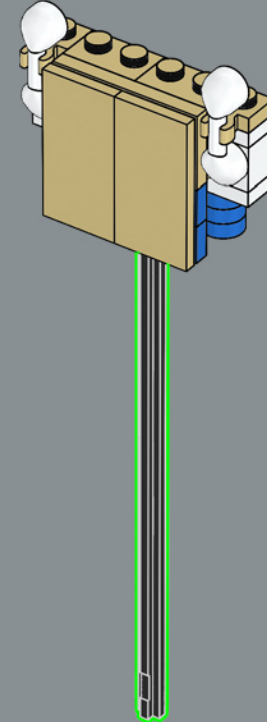

The *Titanic* was launched on the 31<sup>st</sup> of May 1911 – 110 years ago in 2021.

L'année 2021 marque le 110<sup>e</sup> anniversaire du lancement du *Titanic*, le 31 mai 1911.

El *Titanic* se botó el 31 de mayo de 1911: en 2021 se cumplirán 110 años.

444

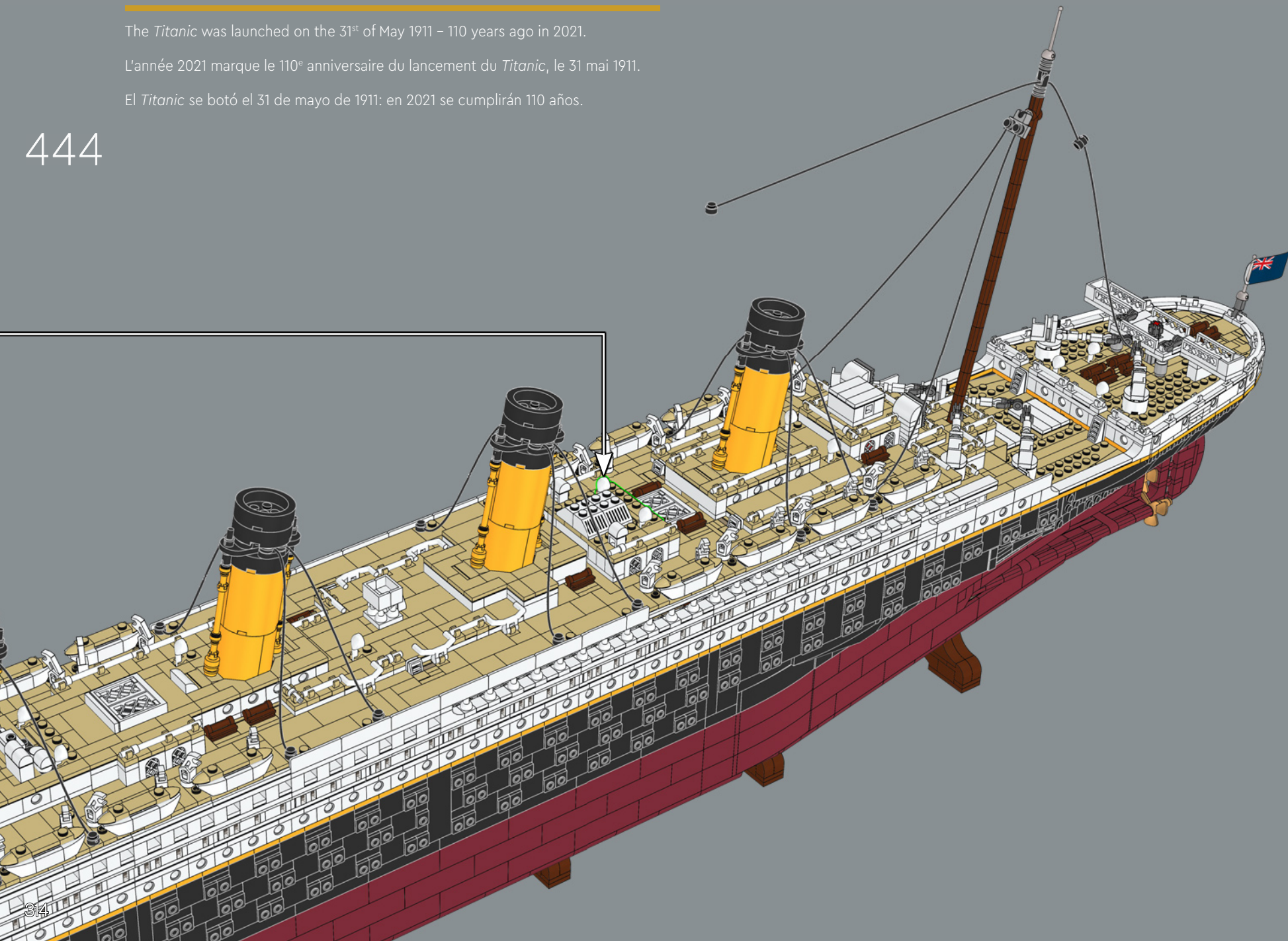

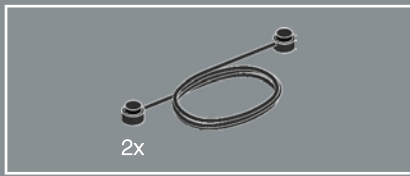

445

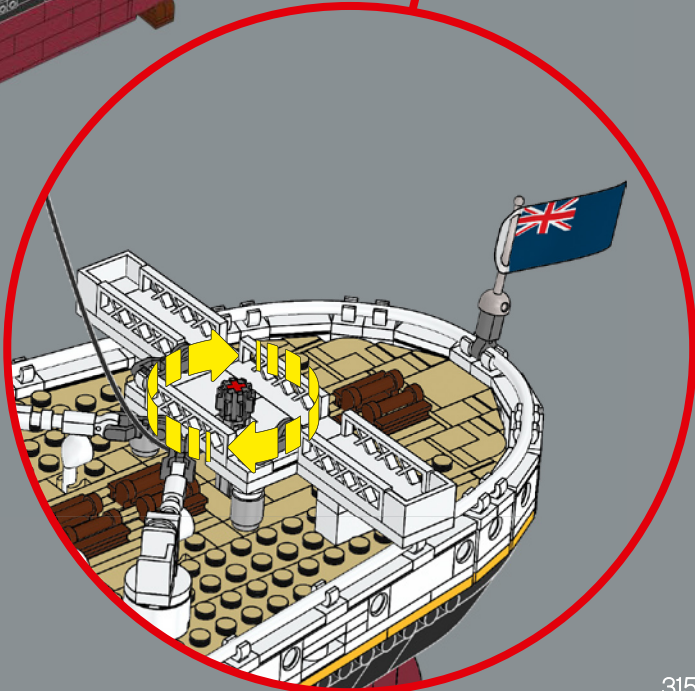
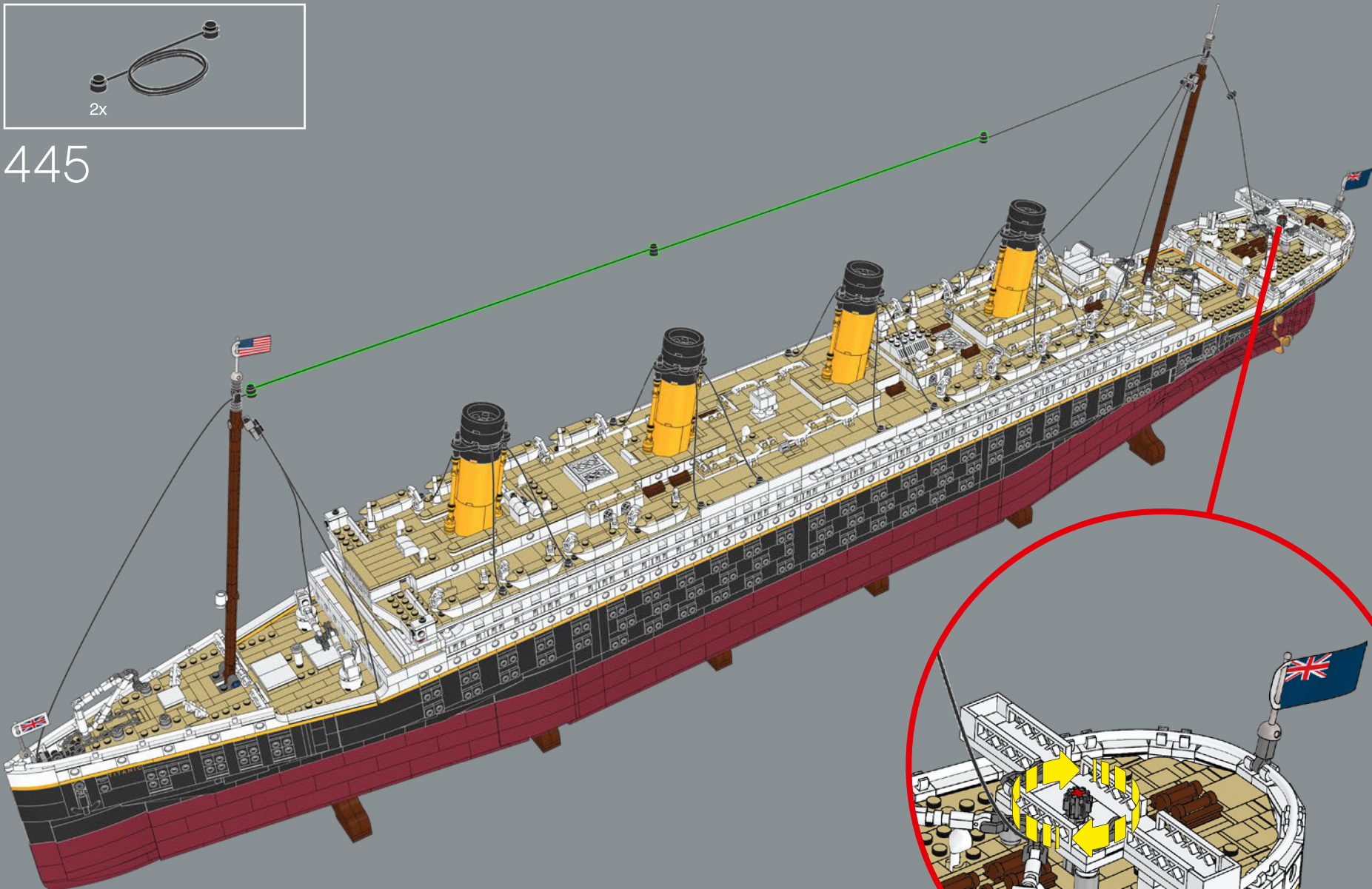

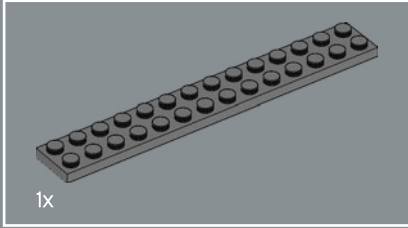
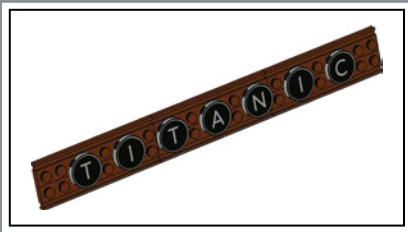

446

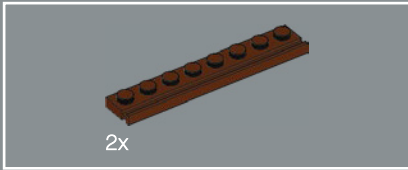
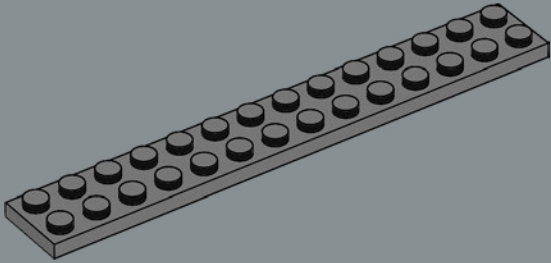

447

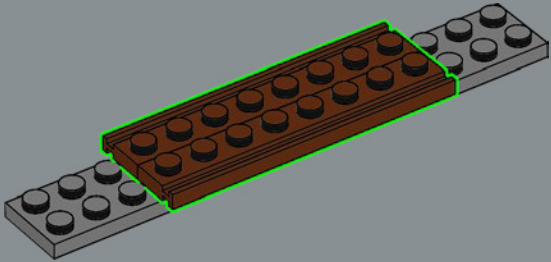

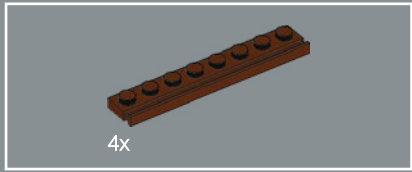

448

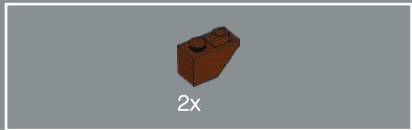
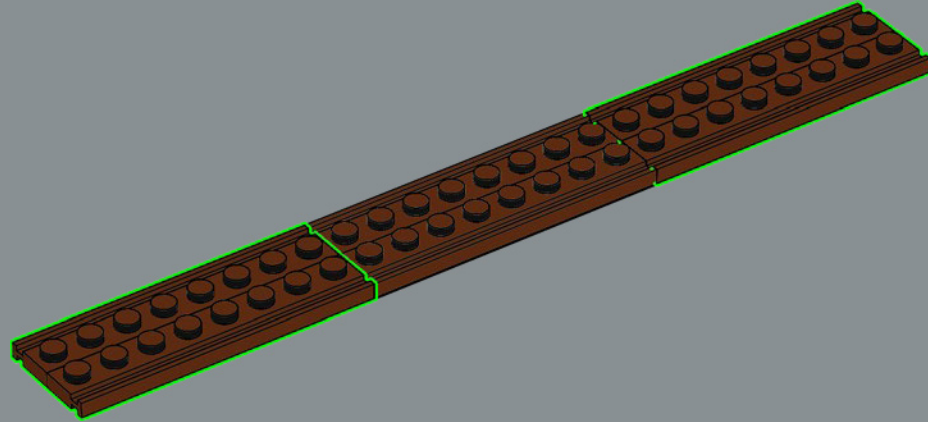

449

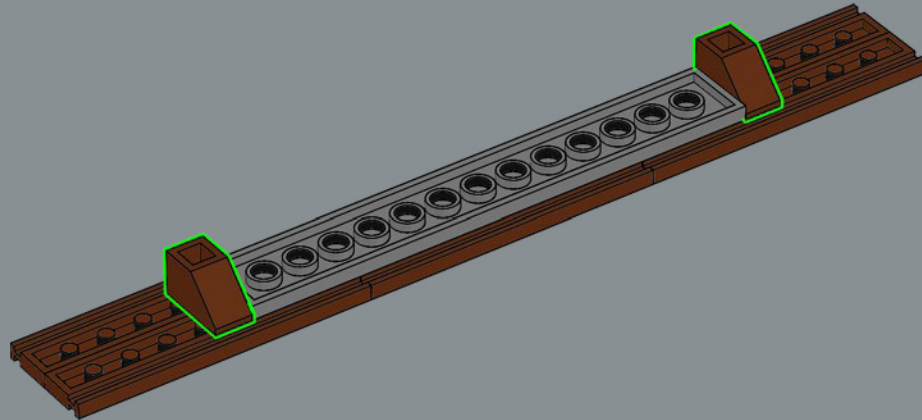



450

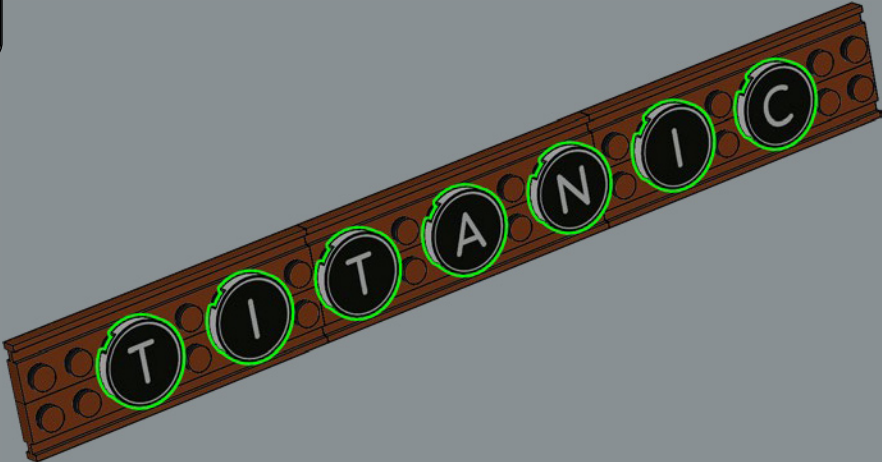

The name *Titanic* derives from the Titans of Greek mythology.

Le nom *Titanic* vient des Titans de la mythologie grecque.

El nombre, *Titanic*, proviene de los titanes de la mitología griega.

