

TITANIC

BOOK 2

LIVRE 2

LIBRO 2

THE WORLD'S MOST LUXURIOUS PASSENGER LINER

Designed to be the epitome of style, comfort and luxury, the *Titanic* aimed to convey the impression of being a floating hotel rather than a ship. It offered its 833 first-class passengers a vast range of facilities including an onboard gymnasium, squash court, swimming pool, libraries and exquisite restaurants and cabins. The ship's most distinctive feature was the *Grand Staircase*, built in solid oak, that descended in a sweeping curve down through seven decks of the liner.



↑ The Aft First-Class staircase leading to the à la carte restaurant.

↑ L'escalier de première classe arrière, menant au restaurant à la carte.

↑ Escalinata de primera clase en la zona de popa que conducía al restaurante à la carte.

LE PAQUEBOT LE PLUS LUXUEUX AU MONDE

Conçu pour être l'incarnation de l'élégance, du confort et du luxe, le *Titanic* donne l'impression d'être un hôtel flottant plutôt qu'un navire. Il offre à ses 833 passagers de première classe une vaste gamme d'installations, dont un gymnase, un terrain de squash, une piscine, des bibliothèques, des restaurants raffinés et de magnifiques cabines. L'élément le plus caractéristique du navire est le Grand Escalier, construit en chêne massif, qui traverse majestueusement les sept ponts du paquebot.

EL BUQUE DE PASAJEROS MÁS LUJOSO DEL MUNDO

Diseñado como máximo exponente del estilo, el confort y el lujo, el *Titanic* aspiraba a transmitir la impresión de ser un hotel flotante, no solo un barco. Ofrecía a sus 833 pasajeros de primera clase una amplia gama de instalaciones a bordo, como un gimnasio, una cancha de *squash*, una alberca, bibliotecas, exquisitos restaurantes y suntuosos camarotes. Nada había en todo el transatlántico que destacara por encima de la Gran Escalera, construida en roble macizo, que descendía por sus siete cubiertas describiendo una magnífica curva.

→ 2nd-Class dinner menu dated April 14, 1912, the date that Titanic struck the iceberg that caused her to sink.

→ Menu du souper de 2^e classe daté du 14 avril 1912, date à laquelle le Titanic heurte l'iceberg qui le fait couler.

→ Menú de la cena servida al pasaje de segunda clase el 14 de abril de 1912, fecha en que el Titanic chocó con el iceberg que causó su hundimiento.

↓ The First-Class gymnasium.

↓ Le gymnase de la première classe.

↓ Gimnasio de primera clase.

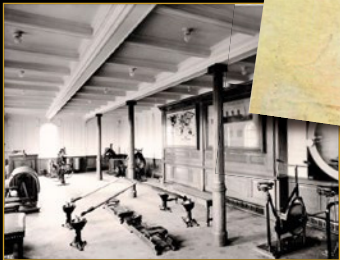

↑ The elegant splendor of First-Class parlor suite B57.

↑ L'élégante et splendide cabine de première classe B57.

↑ Suite B-57 de primera clase en todo su elegante esplendor.

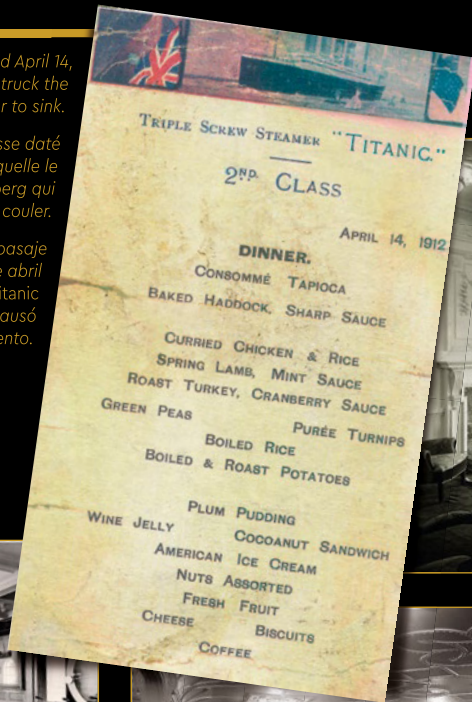

↓ Reading room on the upper promenade.

↓ Salle de lecture sur la promenade supérieure.

↓ Sala de lectura en la cubierta de paseo superior.

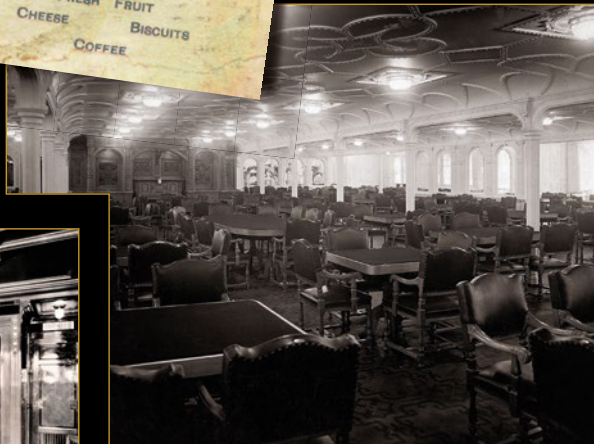

↑ Main dining room.

↑ Salle à manger principale.

↑ Comedor principal.

↓ The First-Class Lounge.

↓ Le salon de la première classe.

↓ Sala de primera clase.



↑ Café Parisien, an extension to the First-Class restaurant.

↑ Le Café Parisien, un prolongement du restaurant de la première classe.

↑ Café Parisien, creado como ampliación del restaurante de primera clase.

BUILDING THE TITANIC

What started out as a concept model during a free-build session for LEGO® designers quickly developed into one of the largest LEGO sets ever created. The impressive size was, however, never the goal in itself; instead, it grew in scale as the design team came up with a host of intricate details they felt had to be included in the model. For veteran LEGO Designer Mike Psiaki, this included creating replica steam engines with moving pistons using LEGO Technic™ elements. Once the initial design was in place, the team sat for an entire week building different versions of the model, deciding what needed to be strengthened or simplified.



↑ Some of the LEGO® team on this model (from left to right): Senior Model Coach, Torben Kilde Skov, Design Master, Mike Psiaki, Senior Building Instruction Specialist, Martin Højten Holm Buk

↑ Quelques membres de l'équipe LEGO® affectée à ce modèle (de gauche à droite) : Torben Kilde Skov, responsable principal de modèles; Mike Psiaki, maître de la conception; Martin Højten Holm Buk, spécialiste principal des instructions de construction

↑ Algunos integrantes del equipo de LEGO® a cargo de este modelo (de izquierda a derecha): Torben Kilde Skov (orientador de modelos sénior), Mike Psiaki (maestro de diseño) y Martin Højten Holm Buk (experto en instrucciones de construcción sénior)

CONSTRUCTION DU TITANIC

Ce qui n'était au départ qu'un modèle conceptuel réalisé lors d'une séance de construction libre pour les concepteurs LEGO® est rapidement devenu l'un des plus grands ensembles LEGO jamais créés. La taille impressionnante n'a cependant jamais été le but premier; au contraire, elle s'est accrue au fur et à mesure que l'équipe de conception ajoutait une foule de détails complexes qui, selon elle, devaient être inclus dans le modèle. Selon le concepteur LEGO chevronné Mike Psiaki, il fallait recréer des machines à vapeur à pistons mobiles en utilisant des éléments LEGO Technic™. Une fois le concept initial établi, l'équipe a passé une semaine entière à construire différentes versions du modèle et à délibérer sur les éléments à améliorer ou à simplifier.

CONSTRUCCIÓN DEL TITANIC

Lo que comenzó como un prototipo durante una sesión de construcción libre para diseñadores de LEGO® se convirtió rápidamente en uno de los sets LEGO más grandes jamás creados. Sin embargo, las impresionantes dimensiones de este modelo nunca fueron un objetivo por sí mismo. Su escala fue creciendo a medida que al equipo de diseño se le ocurrían nuevos elaborados detalles que les parecían imprescindibles. Por ejemplo, para el veterano diseñador de LEGO Mike Psiaki, había que crear réplicas de los motores de vapor con pistones móviles usando elementos LEGO Technic™. Una vez definido el diseño inicial, el equipo dedicó una semana entera a construir diferentes versiones del modelo mientras decidían qué necesitaba reforzarse o simplificarse.



[LEGO.com/brickseparator](https://www.lego.com/brickseparator)

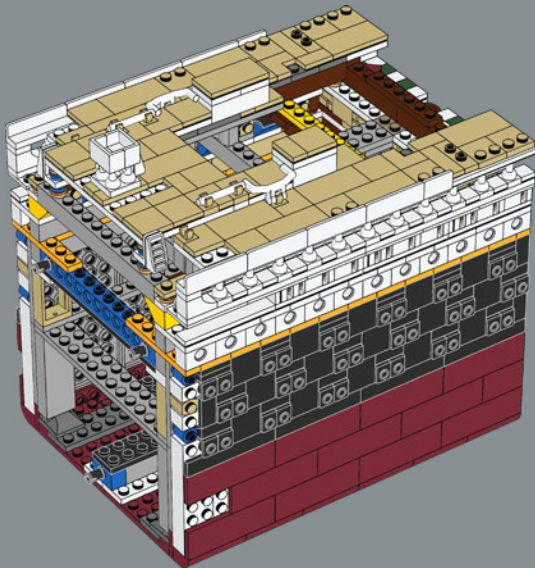
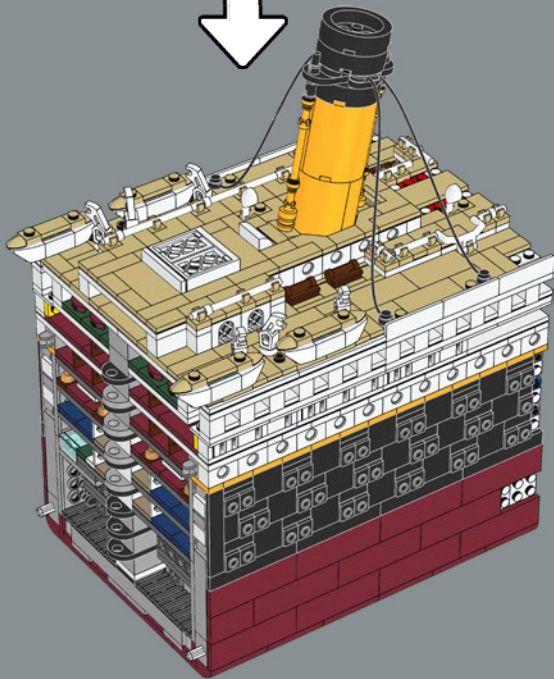

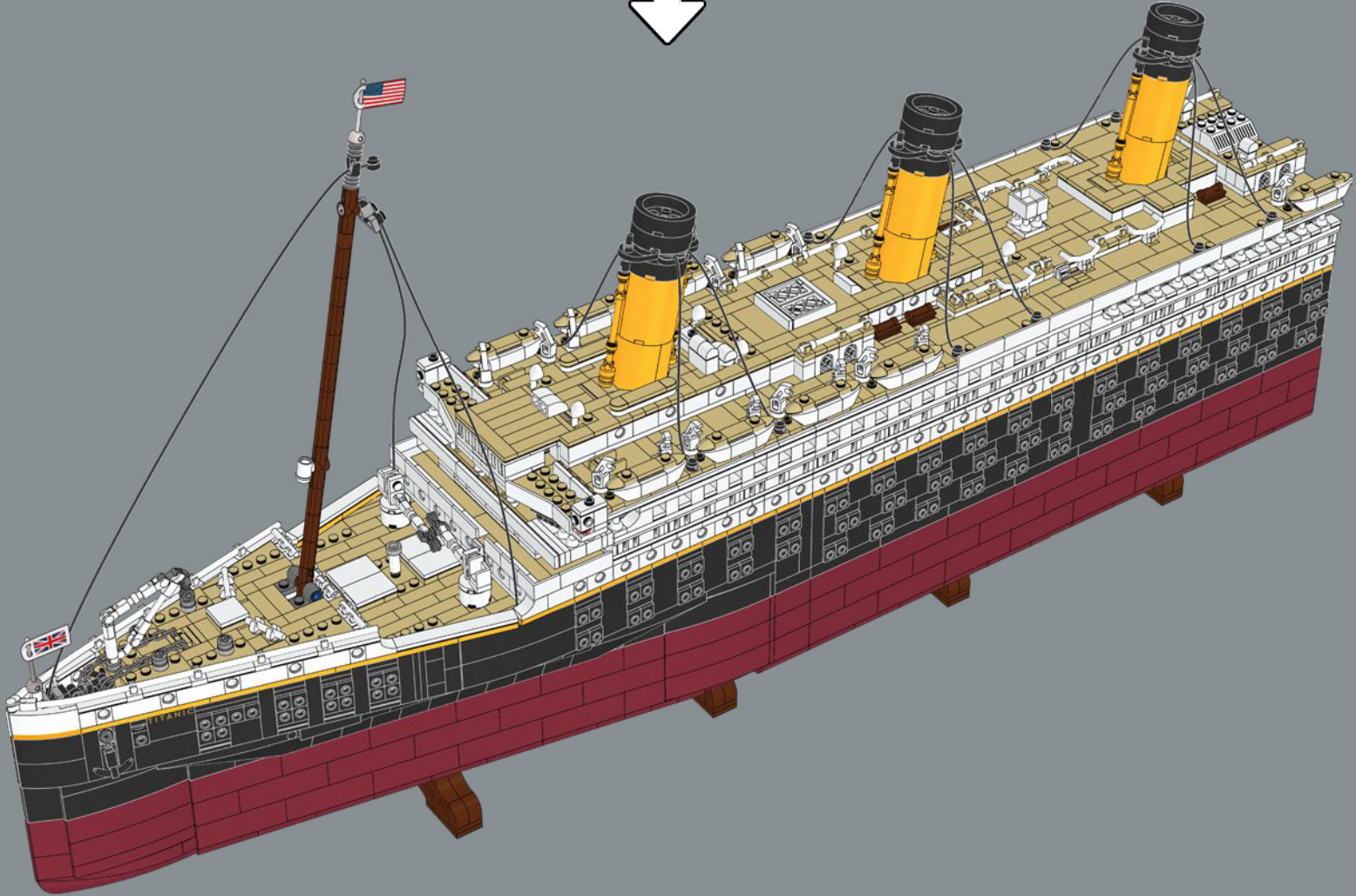
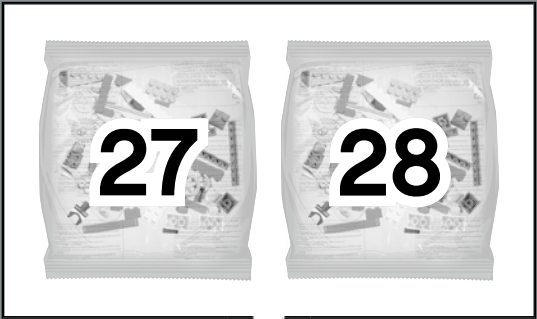

SECTION 3:

FUNNEL & MAIN CABINS

Here you will build another cross section of the ship, including some of its coal bunkers in the lowest decks, plus numerous cabins of various classes. The superstructure of this section contains the beginnings of the ship's promenade decks as well as the skylight for the grand staircase and second funnel.

SECTION 3 :

CHEMINÉE ET CABINES PRINCIPALES

Ici, vous construirez une autre section transversale du navire, comprenant quelques-unes des soutes à charbon dans les ponts inférieurs et de nombreuses cabines de différentes classes. La superstructure de cette section inclut le début des promenades du navire ainsi que le puits de lumière du Grand Escalier et la deuxième cheminée.

SECCIÓN 3:

CHIMENEA Y CAMAROTES PRINCIPALES

En esta fase inicias una nueva sección transversal del barco, en la que construirás varias carboneras de las cubiertas inferiores y numerosos camarotes de diferentes clases. La superestructura de esta sección contiene los comienzos de las cubiertas de paseo del buque, la claraboya que brindaba luz natural a la Gran Escalera y la segunda chimenea.

↓ The second half of the locking mechanism that holds the 3 main sections of the ship together is built here.

↓ La deuxième moitié du mécanisme de verrouillage qui tient les 3 sections principales du navire ensemble est construite ici.

↓ La segunda mitad del mecanismo de fijación que mantiene unidas las 3 secciones principales del barco se construye en esta fase.

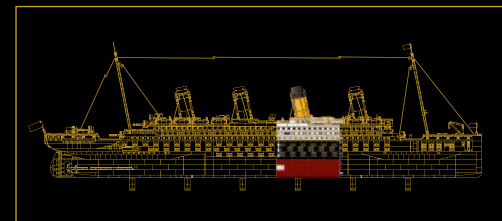

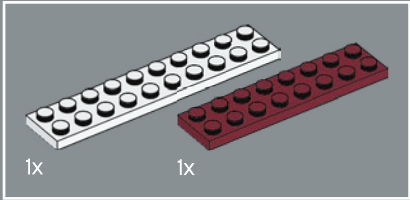
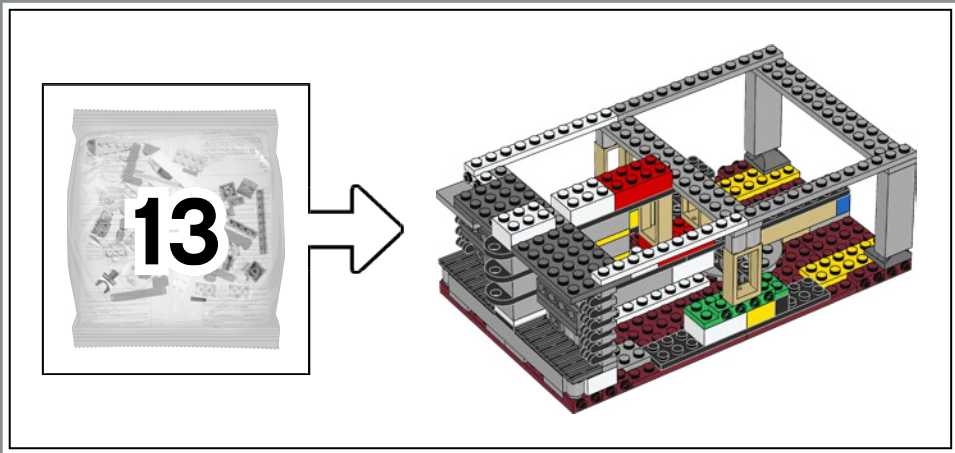

1

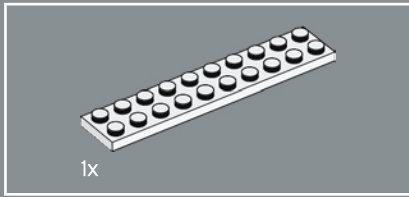
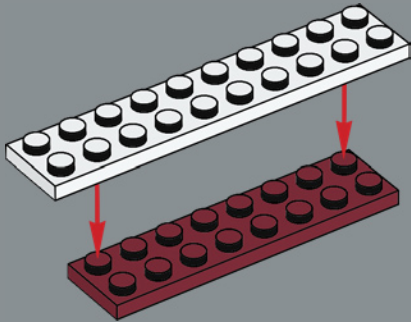

2

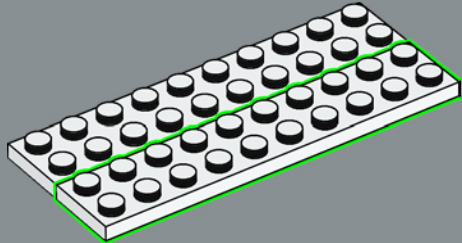

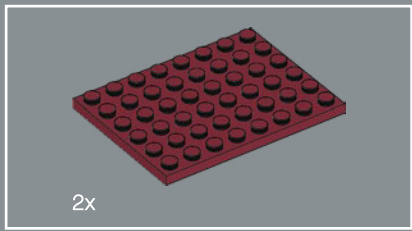

3

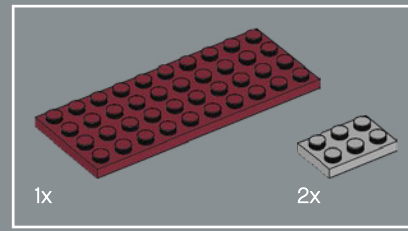
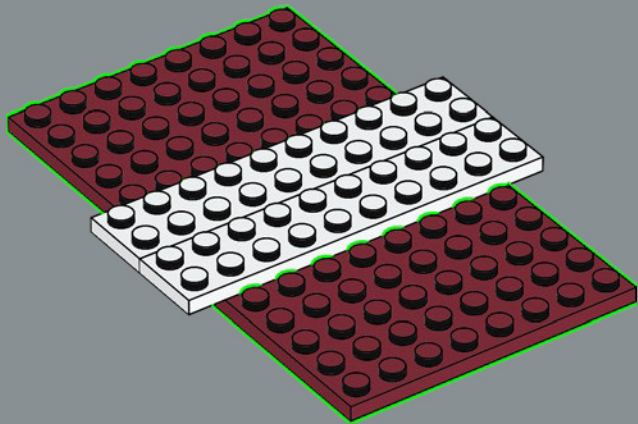

4

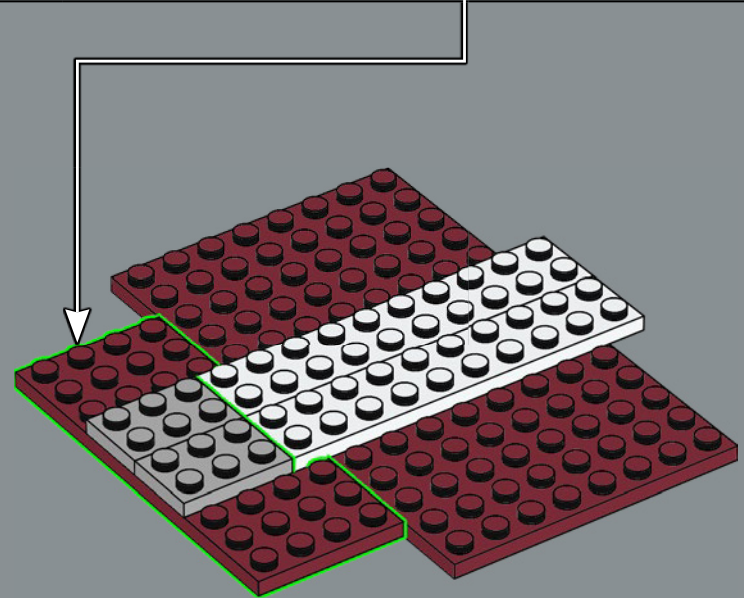
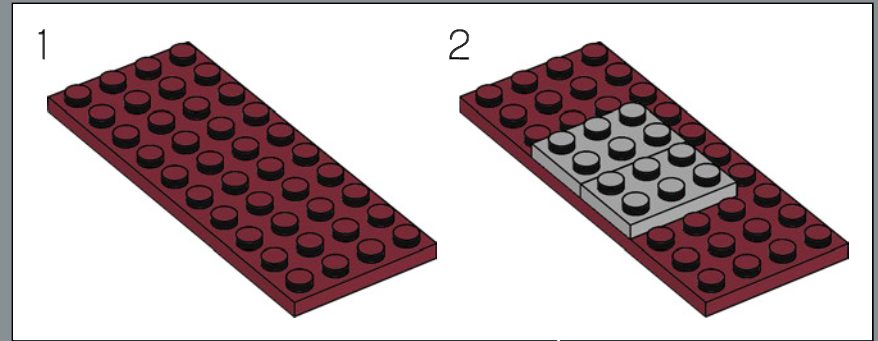

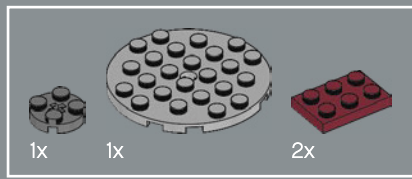

5

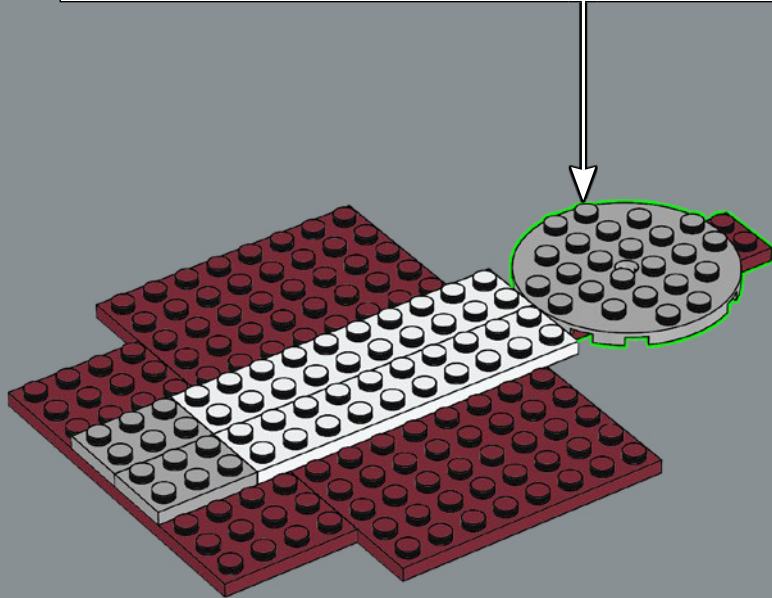
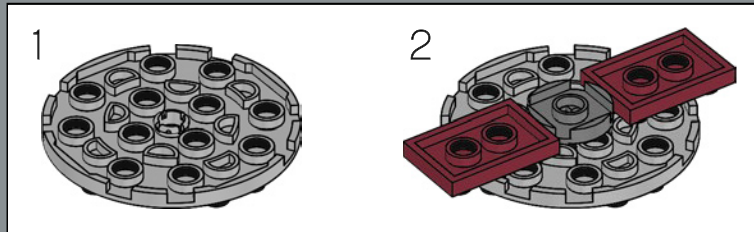

6

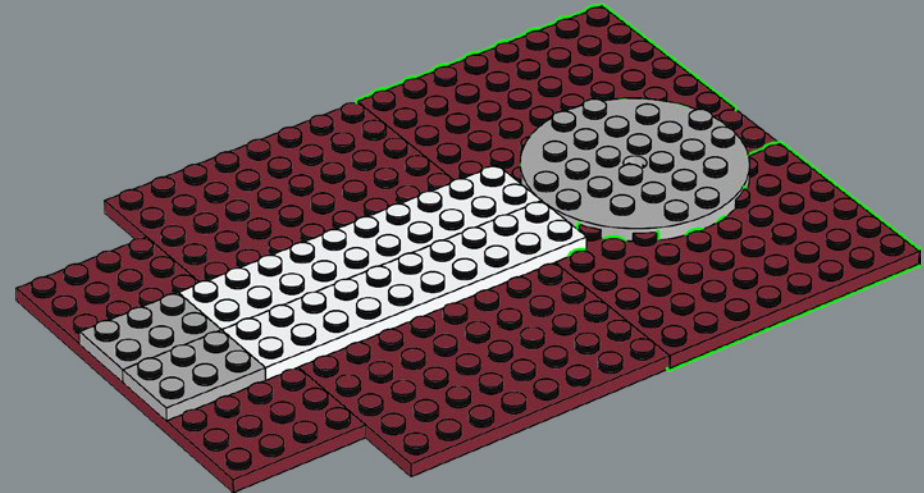

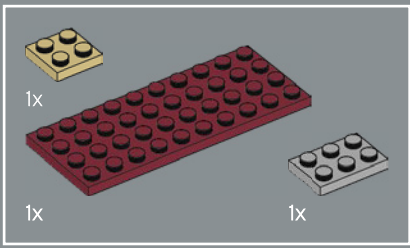

7

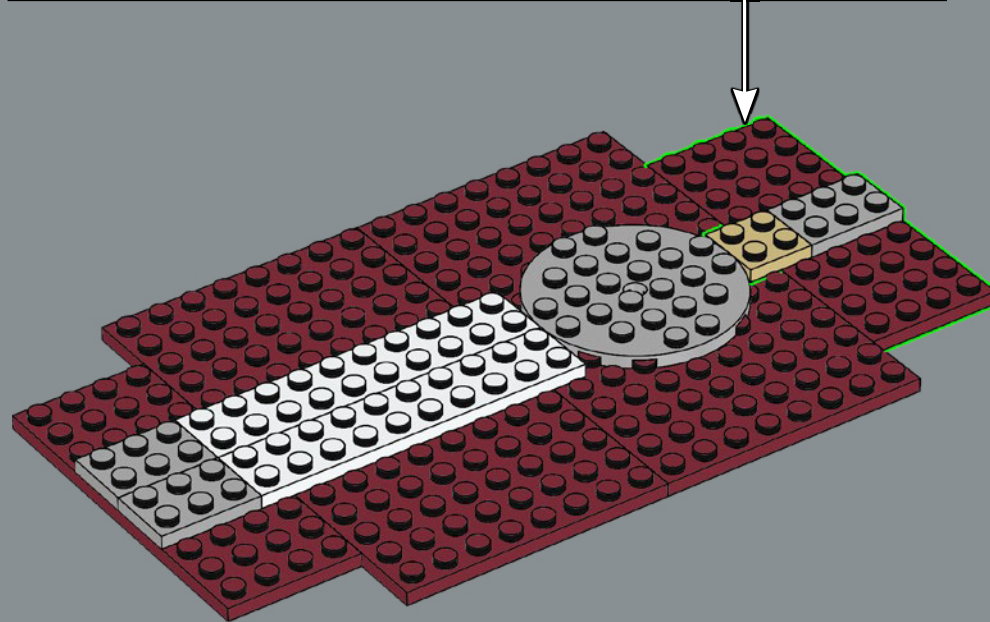
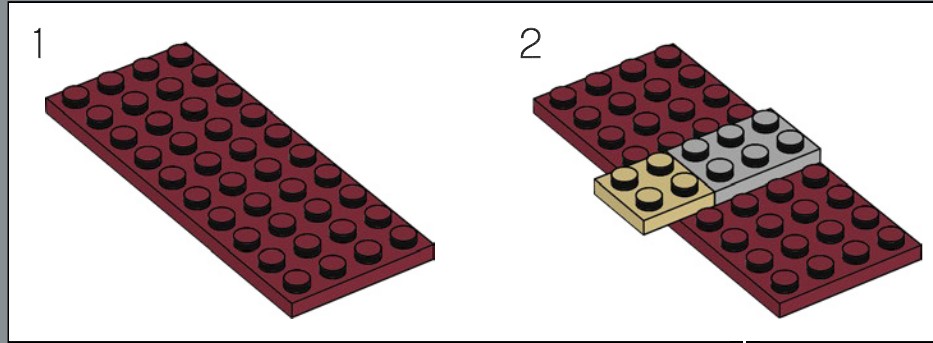

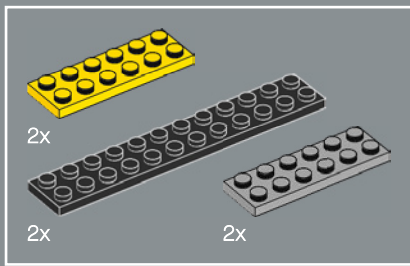

8

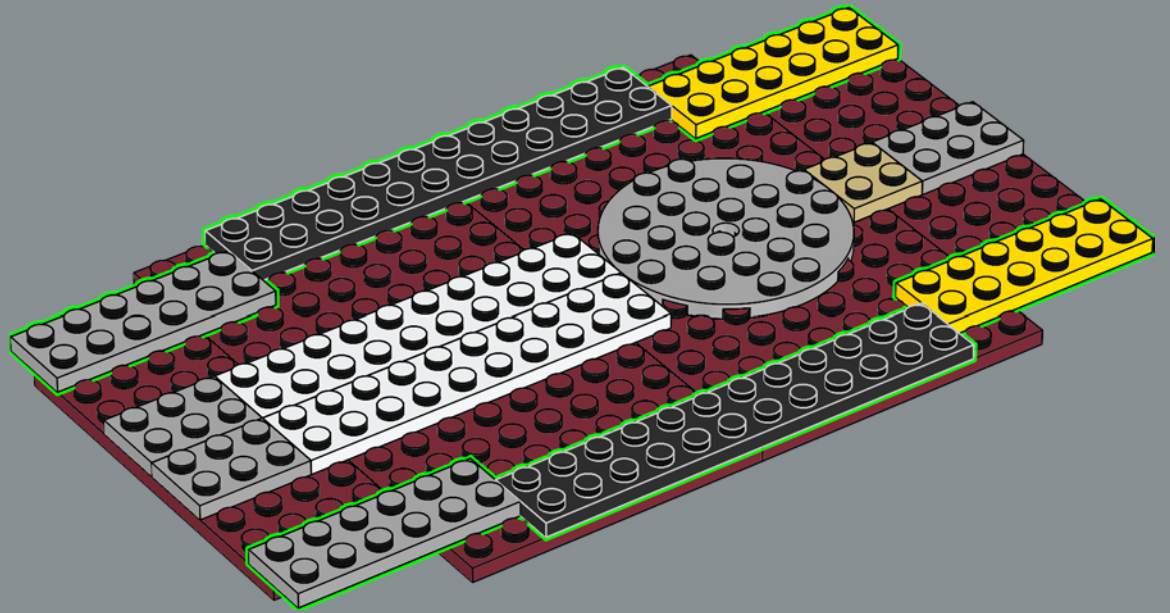

9

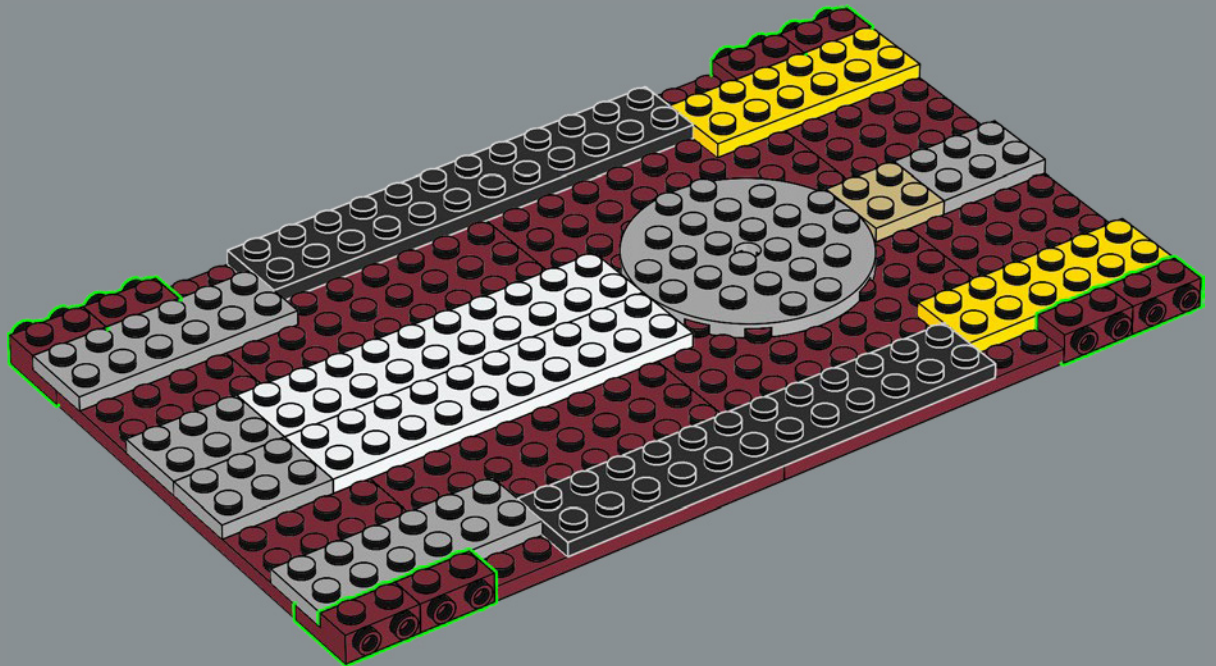

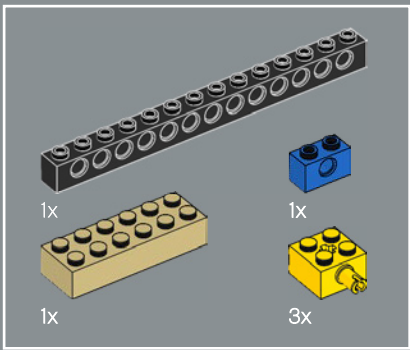

10

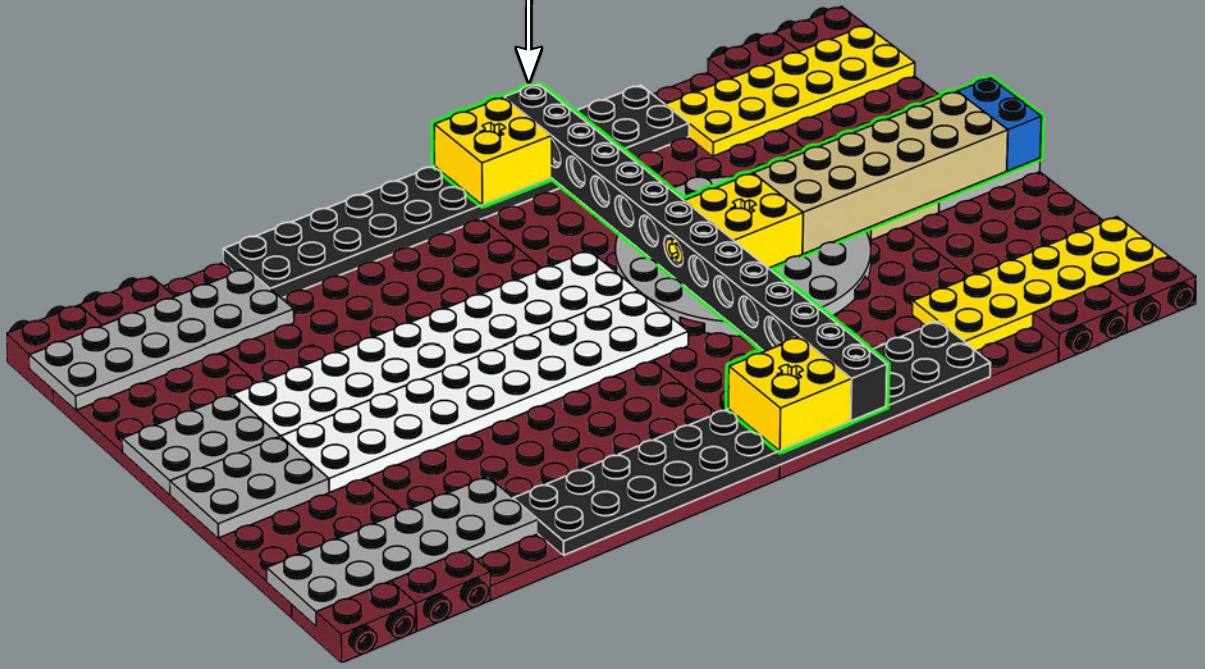
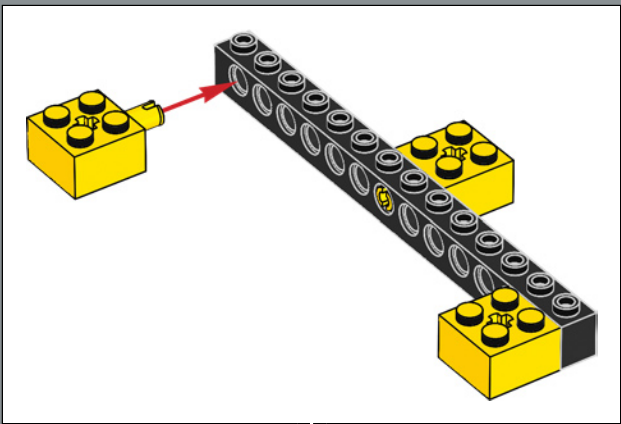

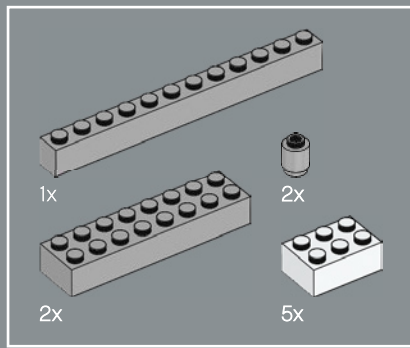

11

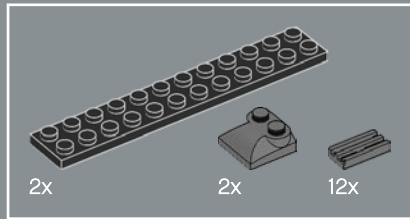
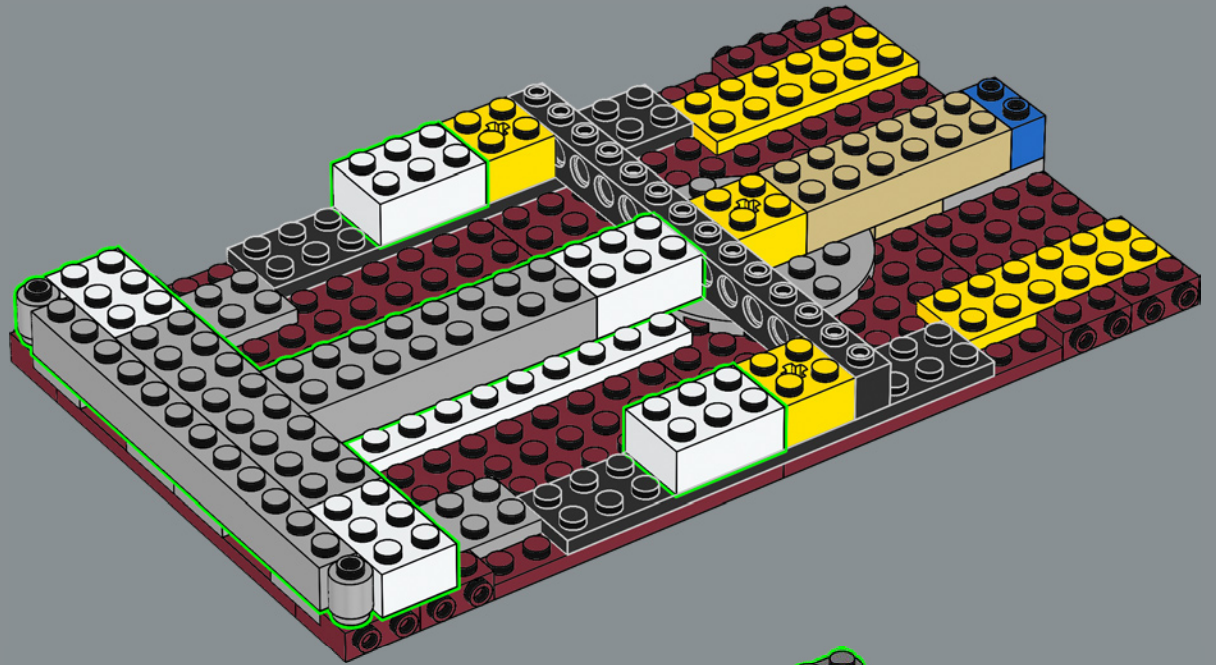

12



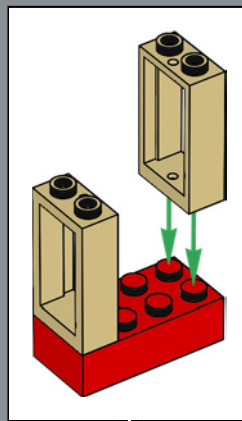
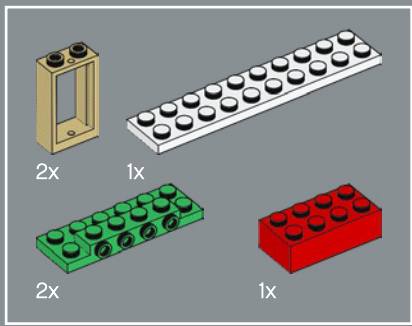

13

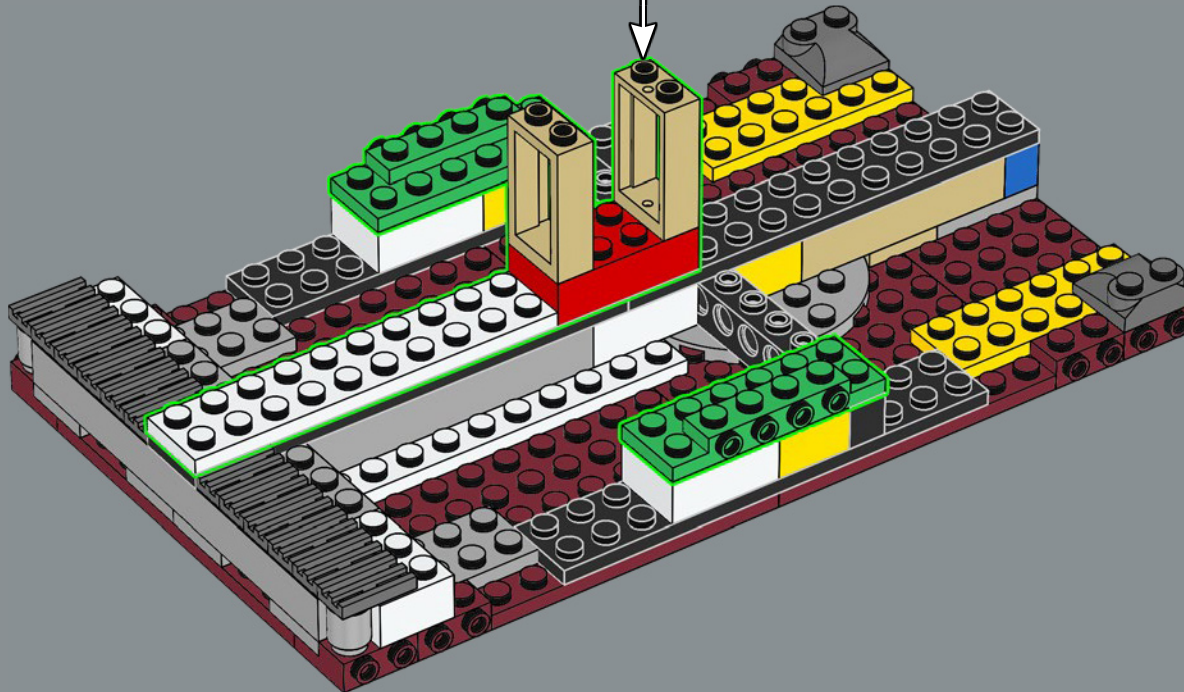

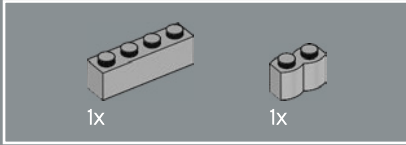
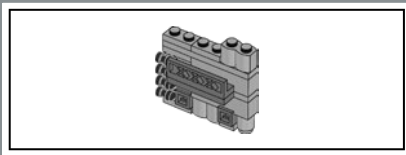

14

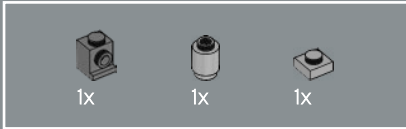
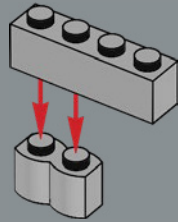

15

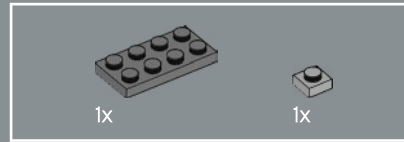
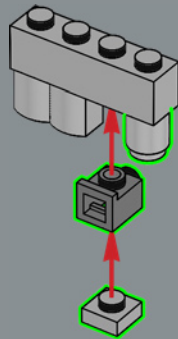

16

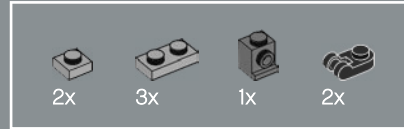
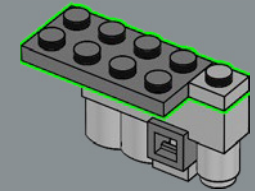

17

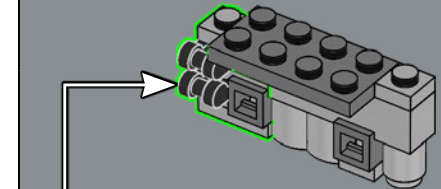
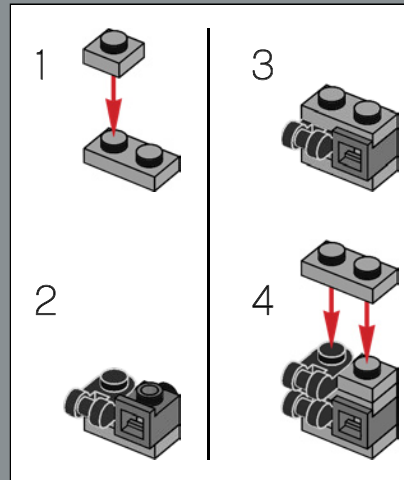

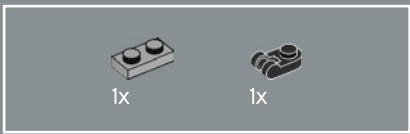

18

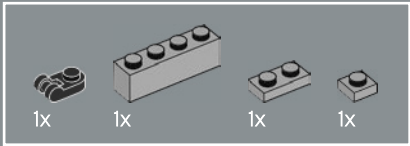
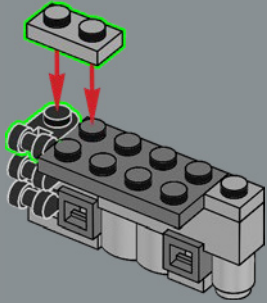

19

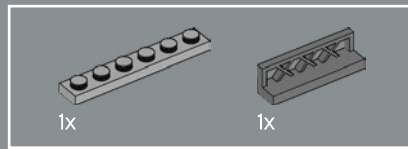
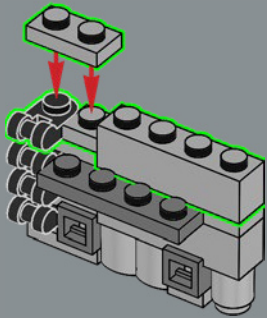

20

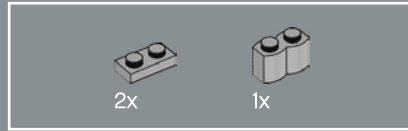
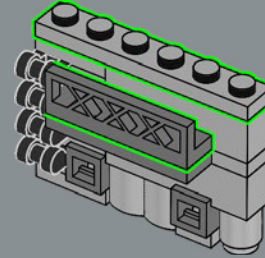

21

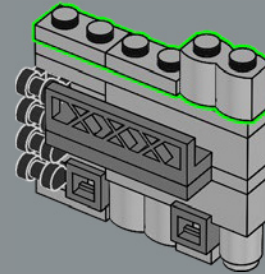

22

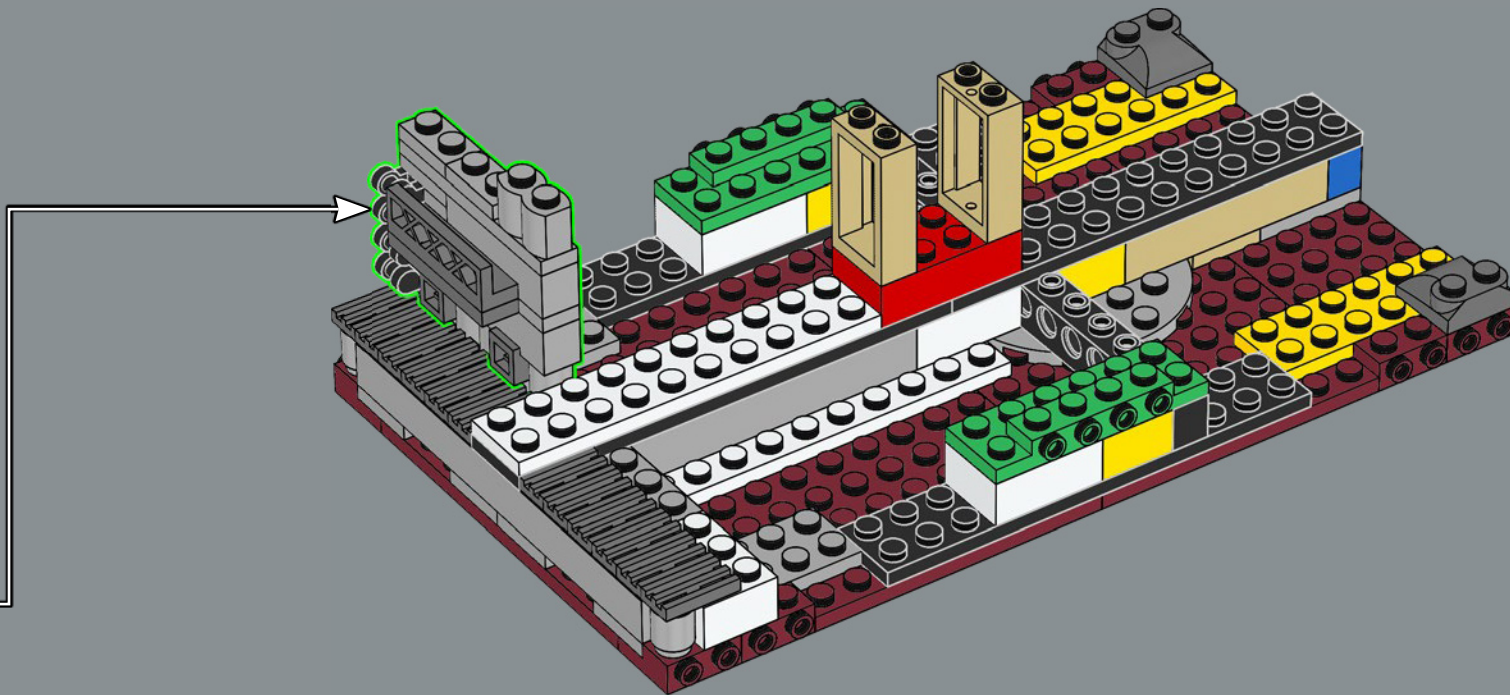

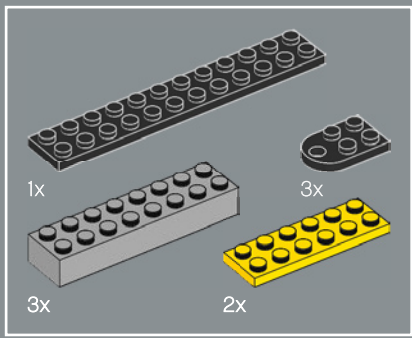

23

1

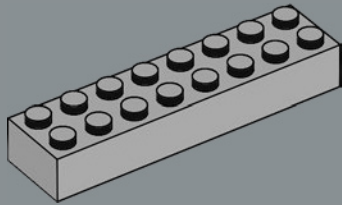

2

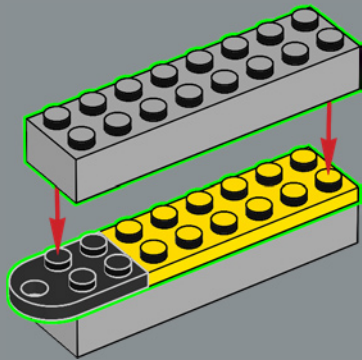

3

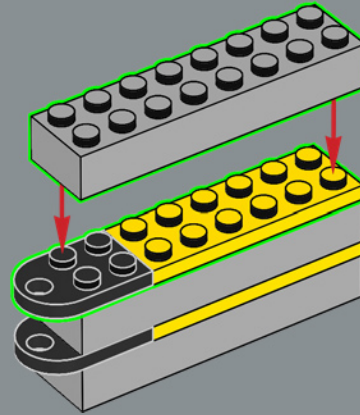

4

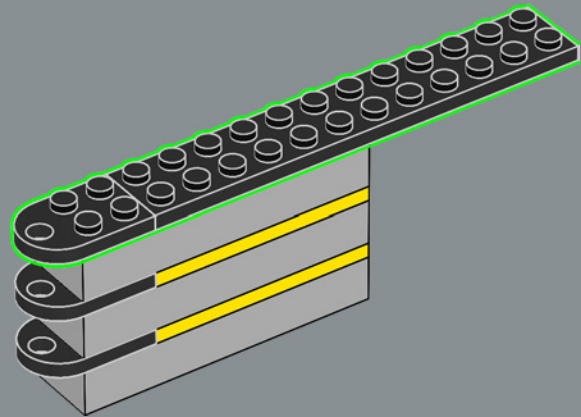

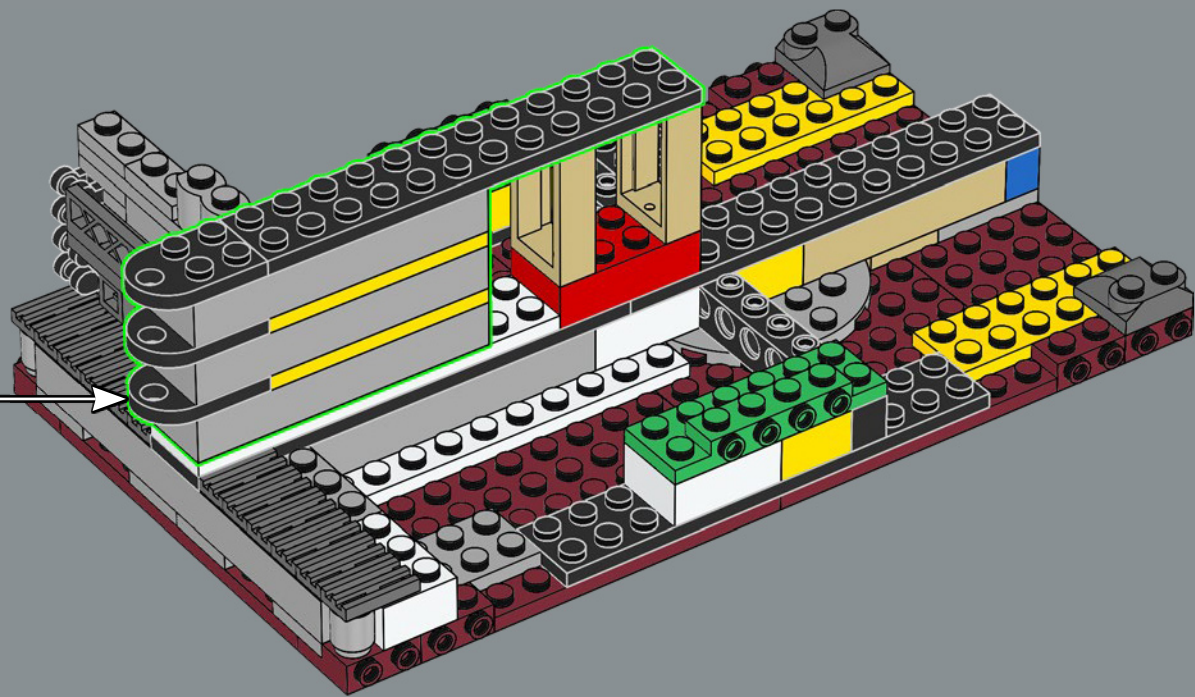

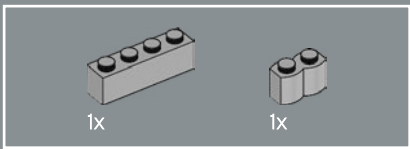

24

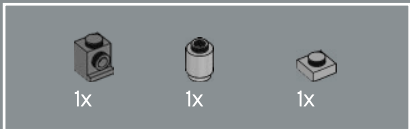
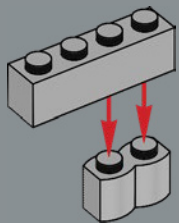

25

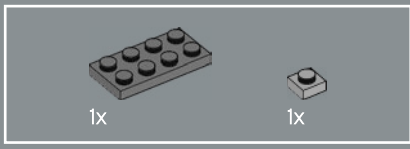
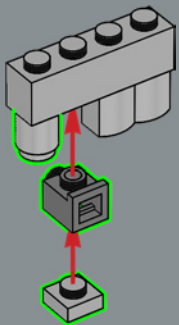

26

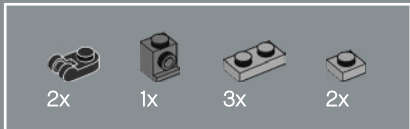
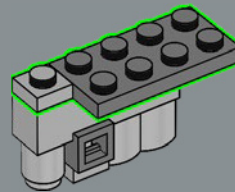

27

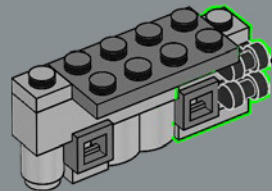
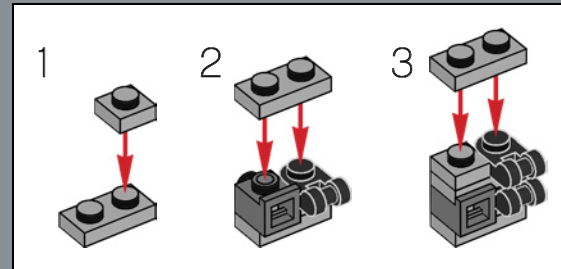

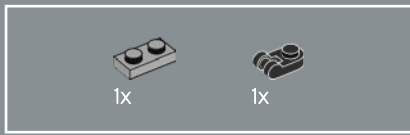

28

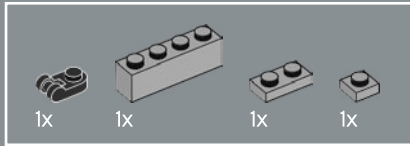
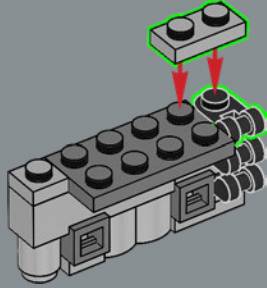

29

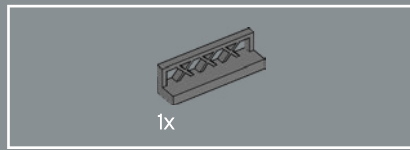
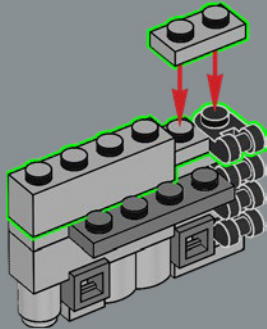

30

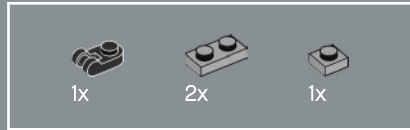
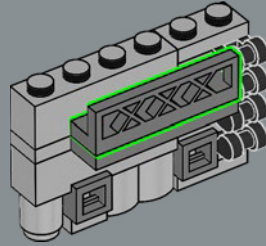

31

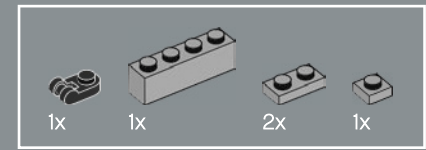
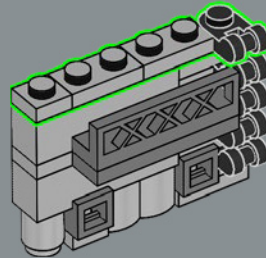

32

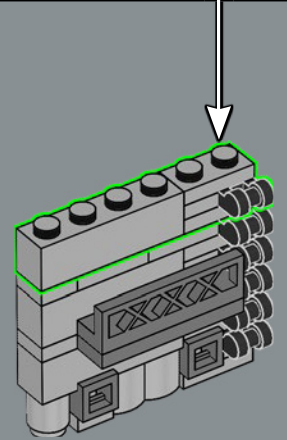
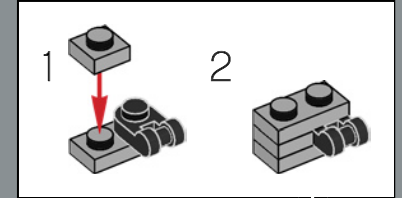

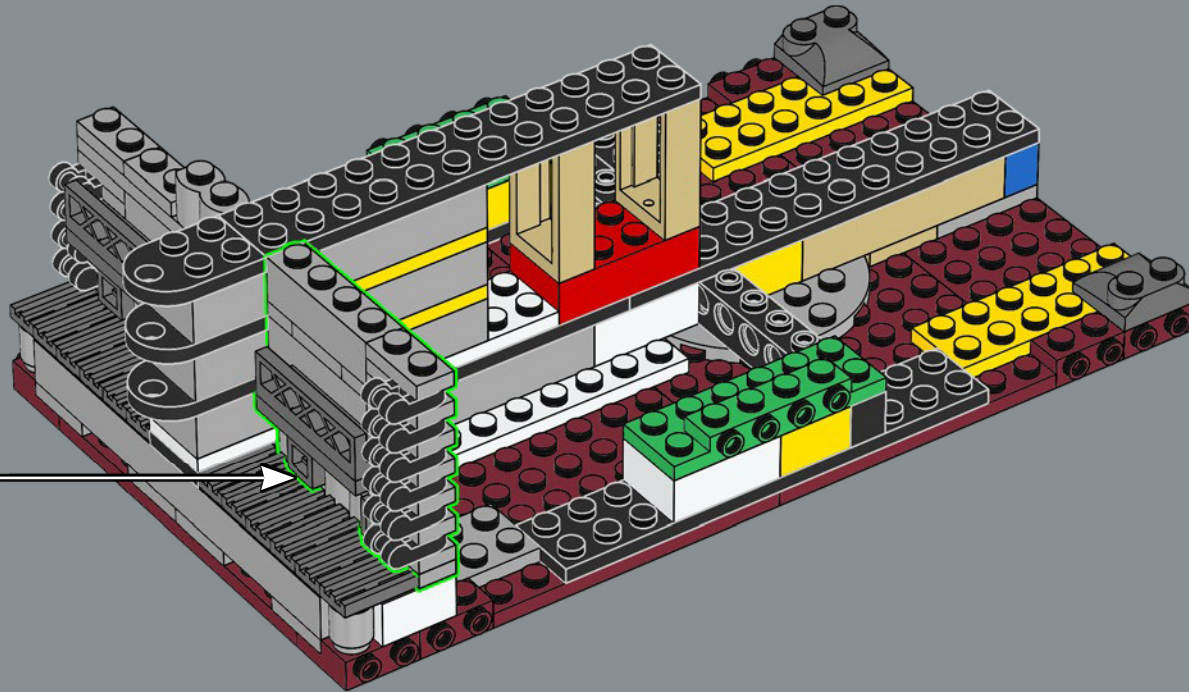

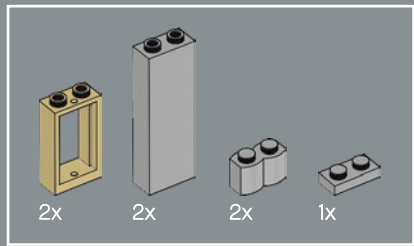

34

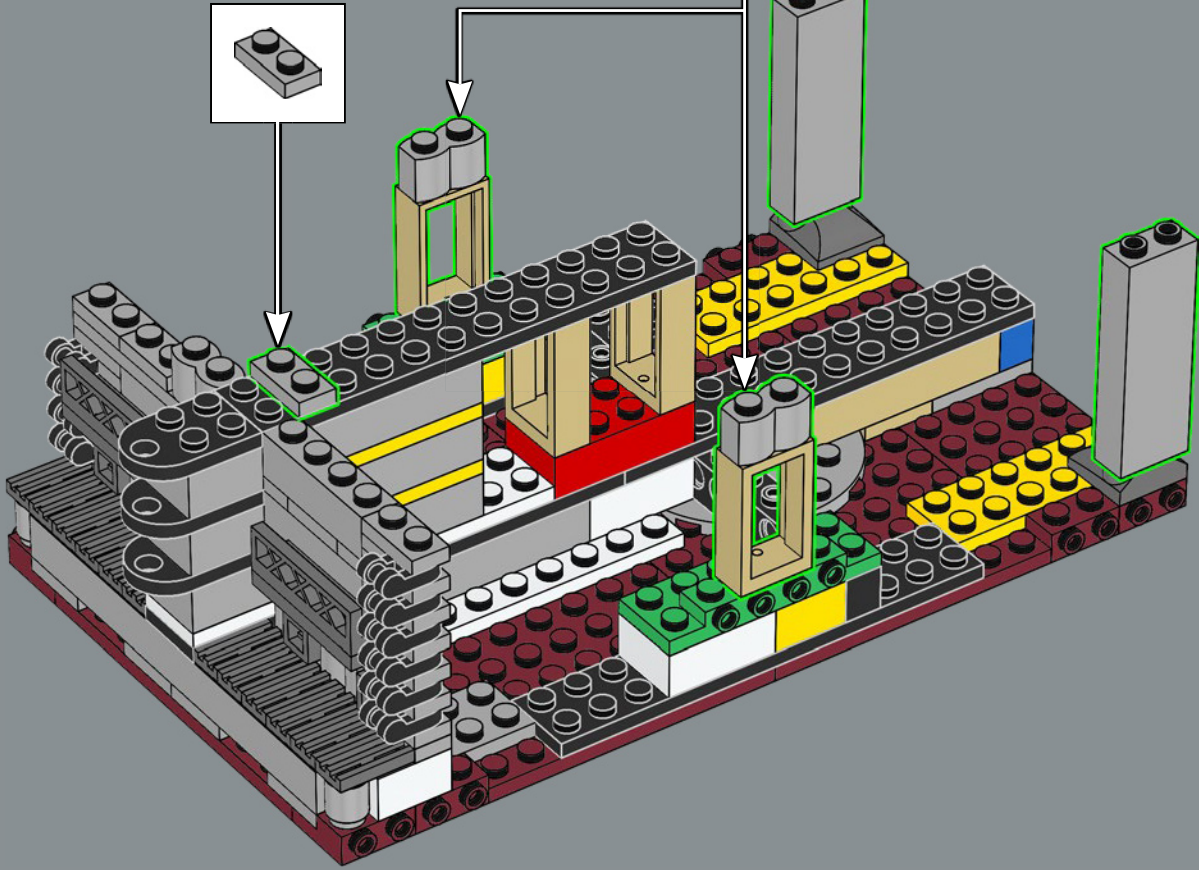
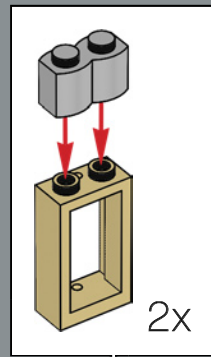

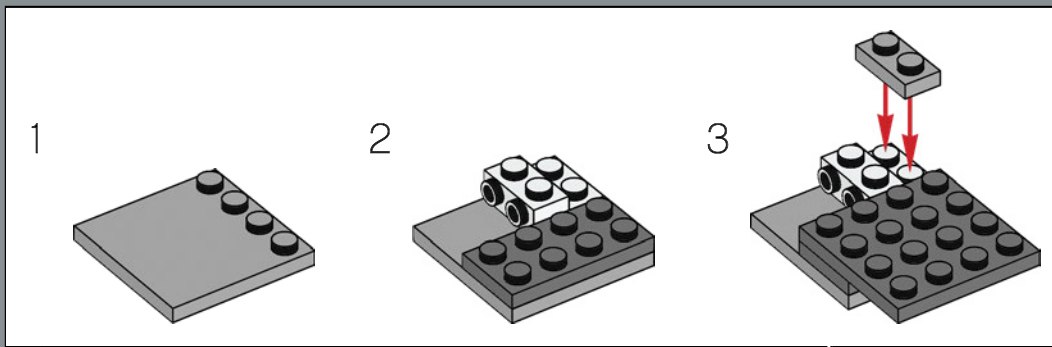
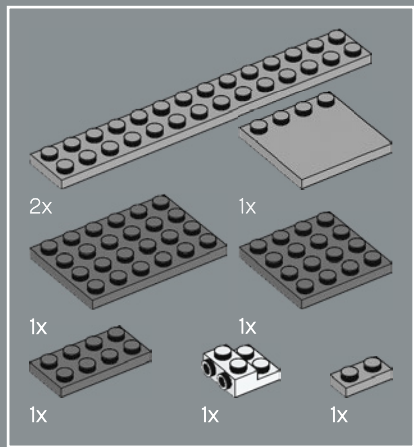

35

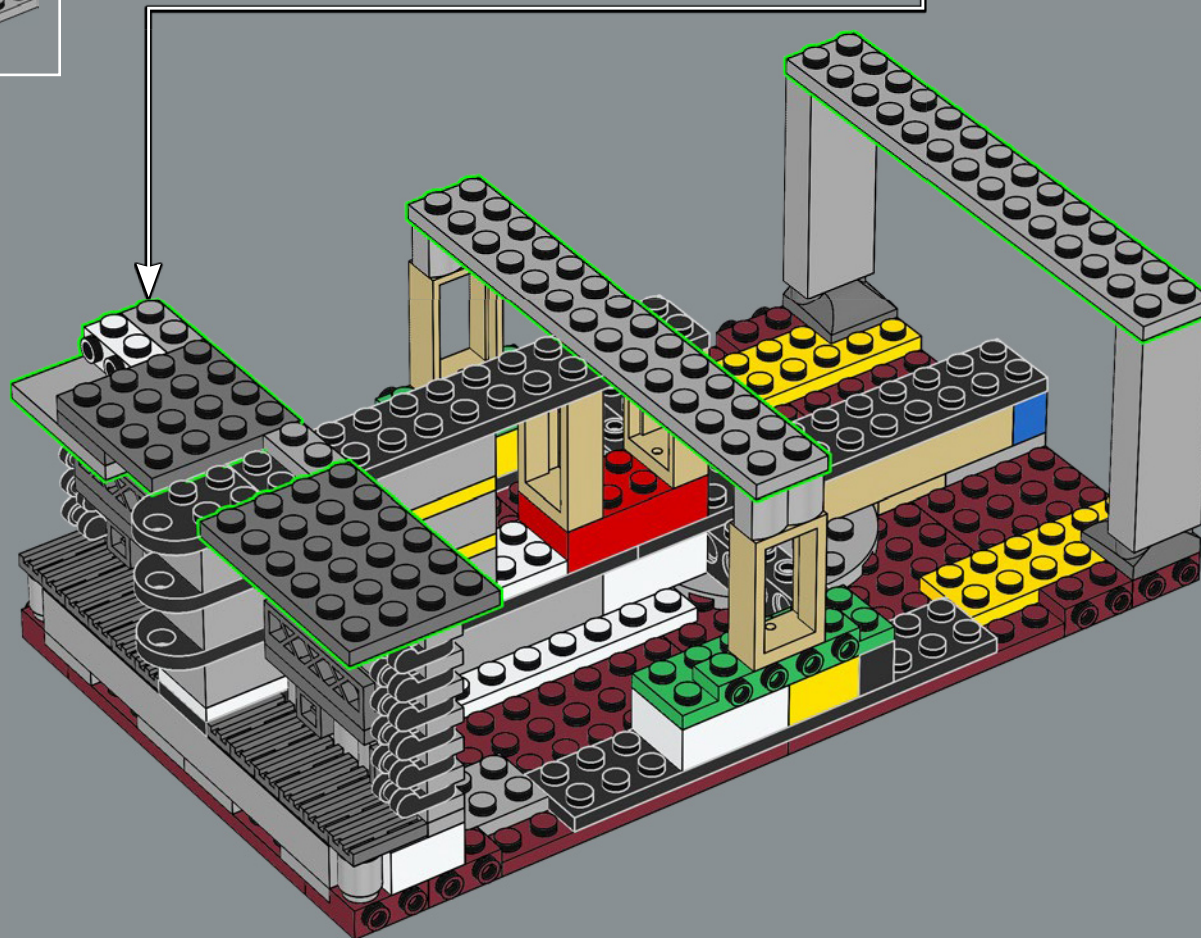

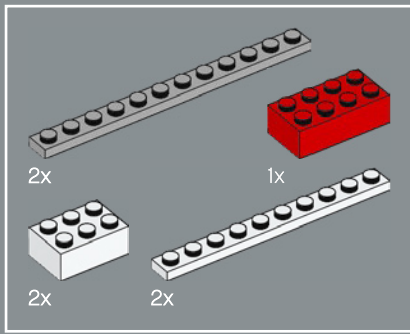

36

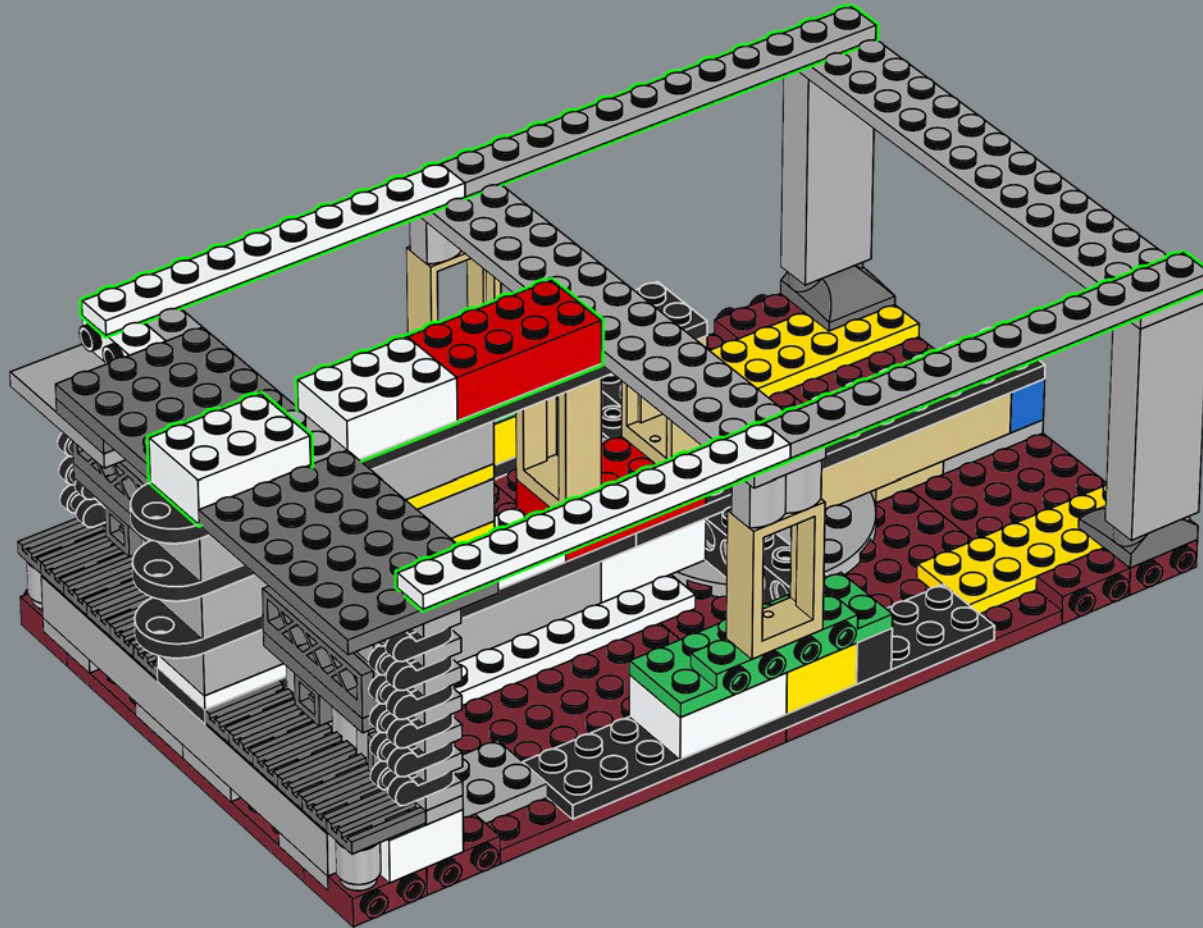

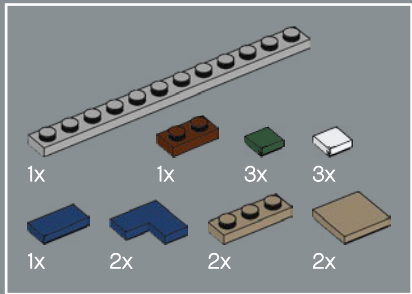
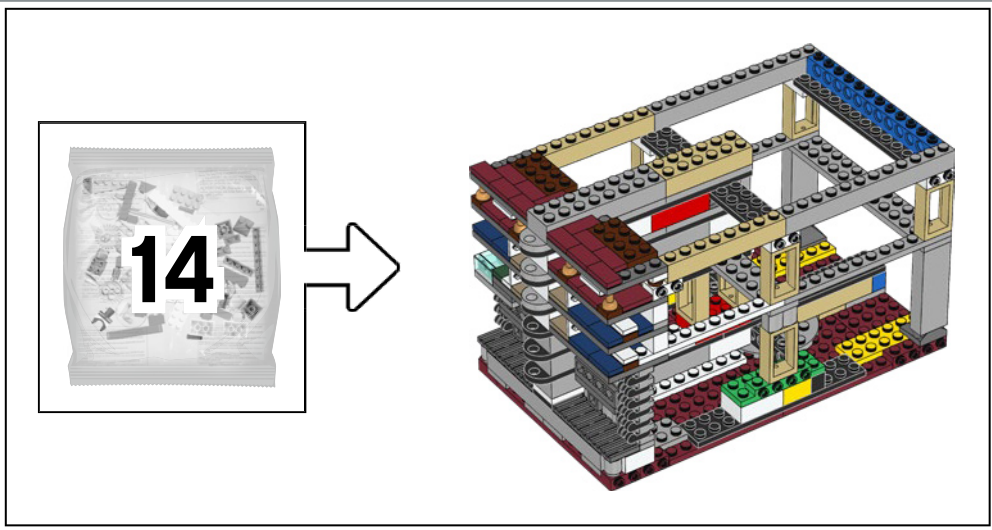

37

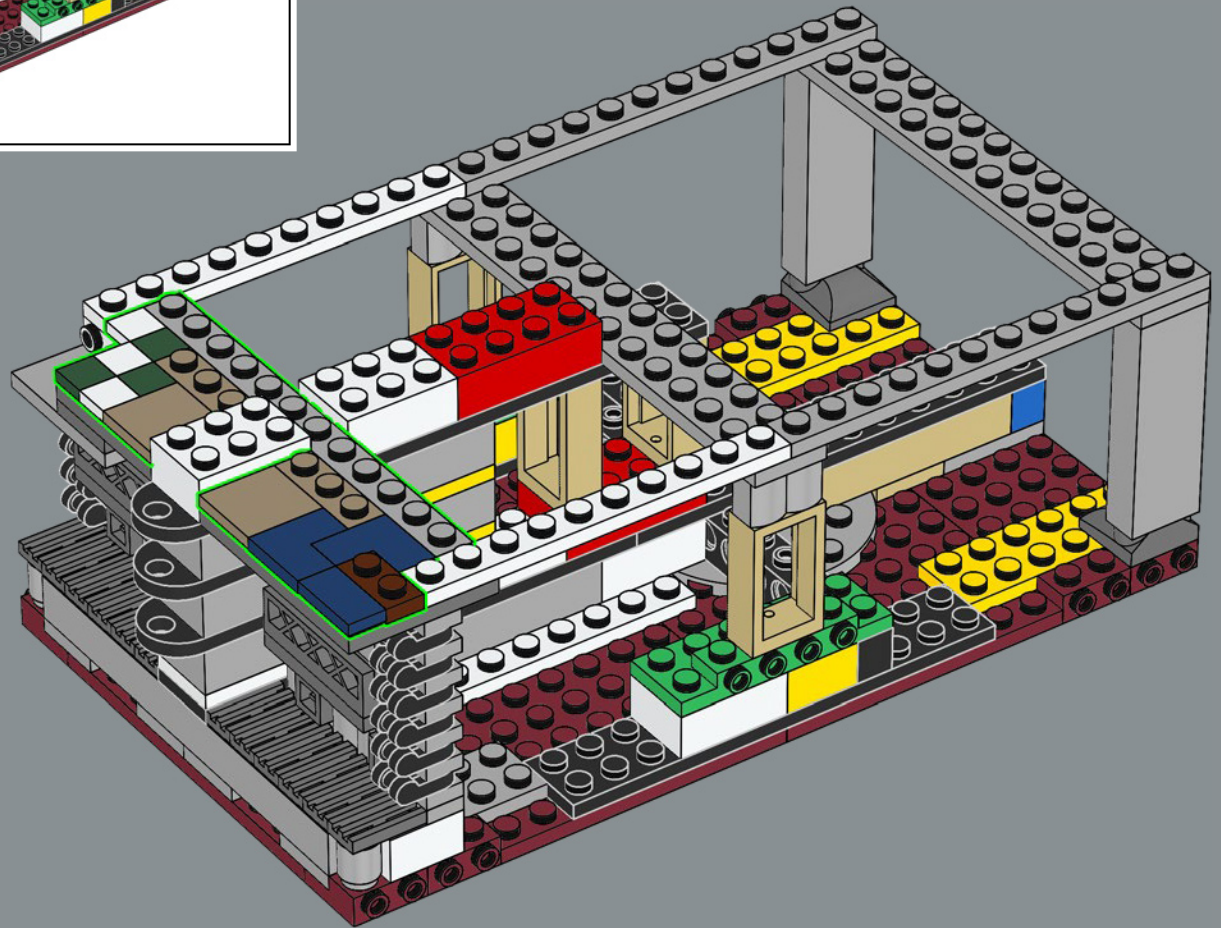

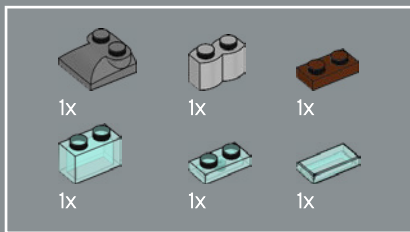

38

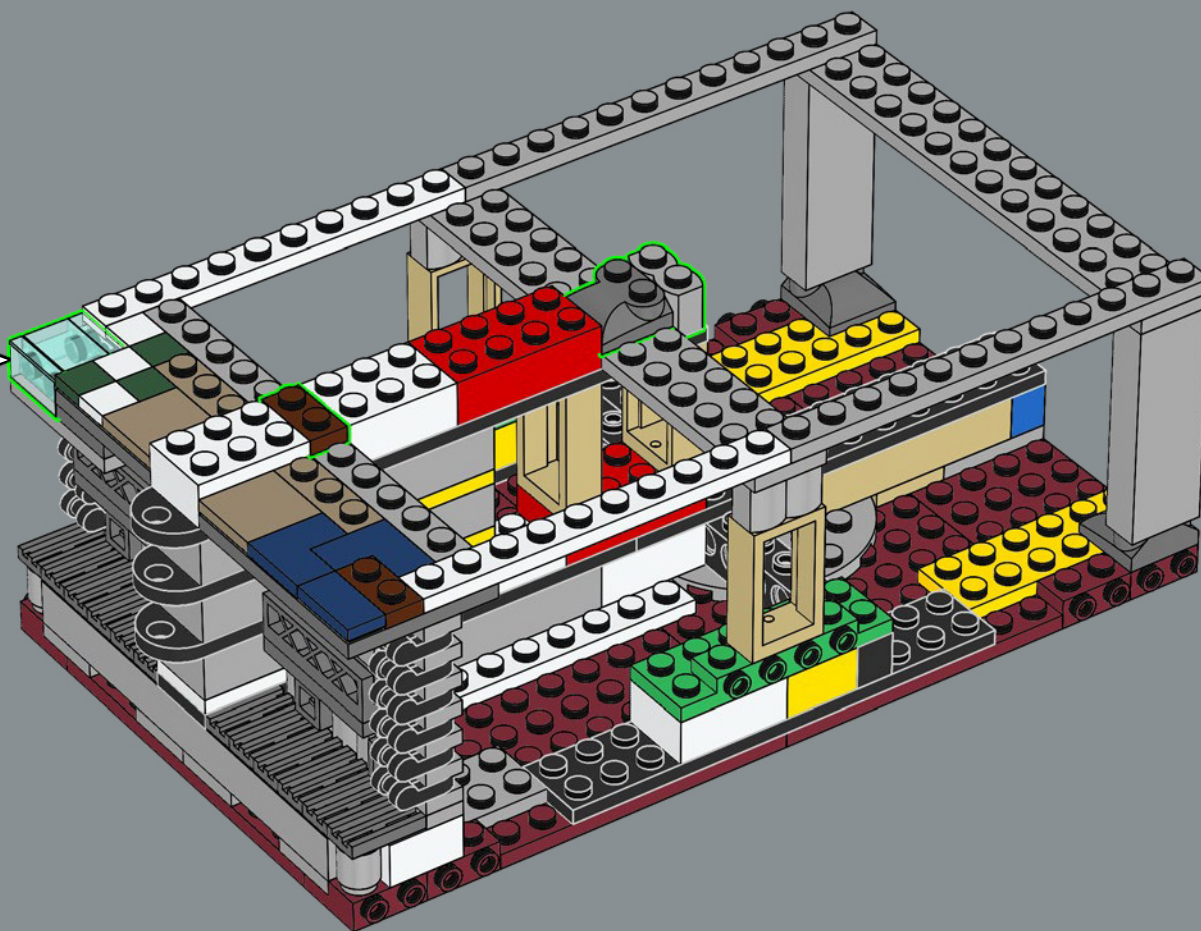
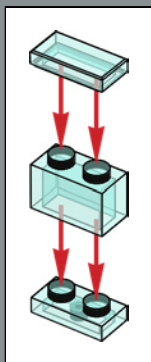

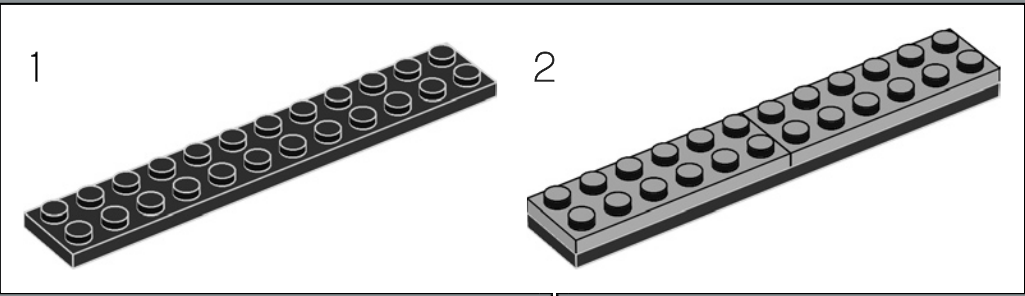
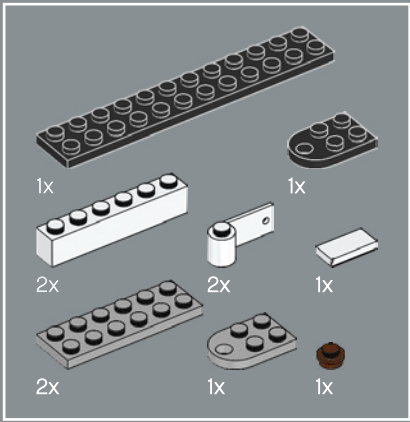

39

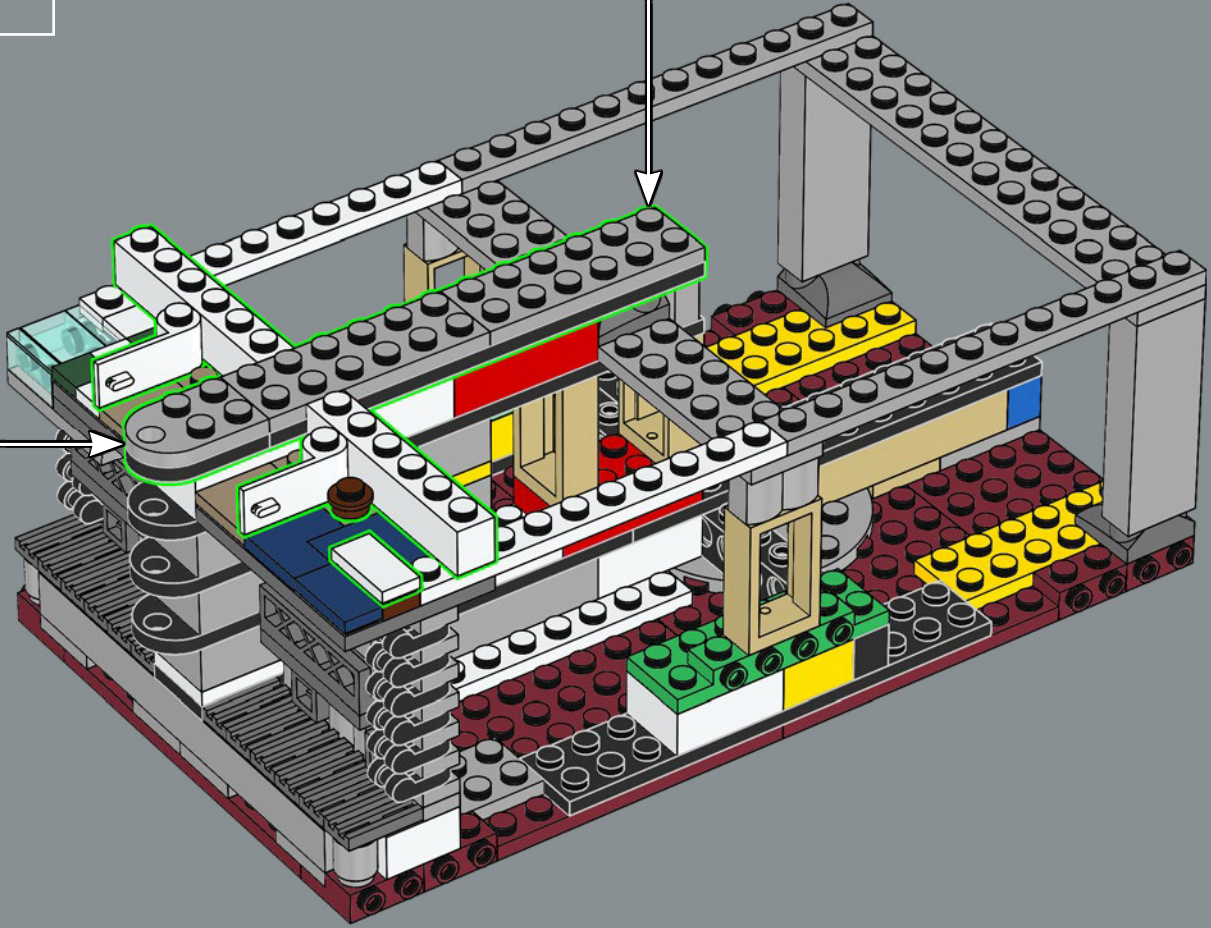
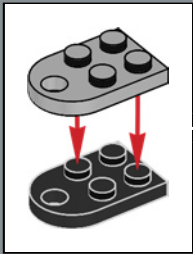

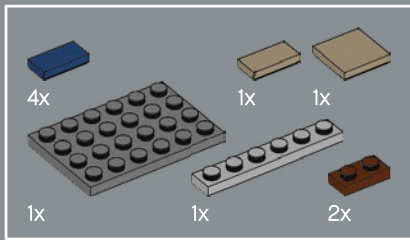

40

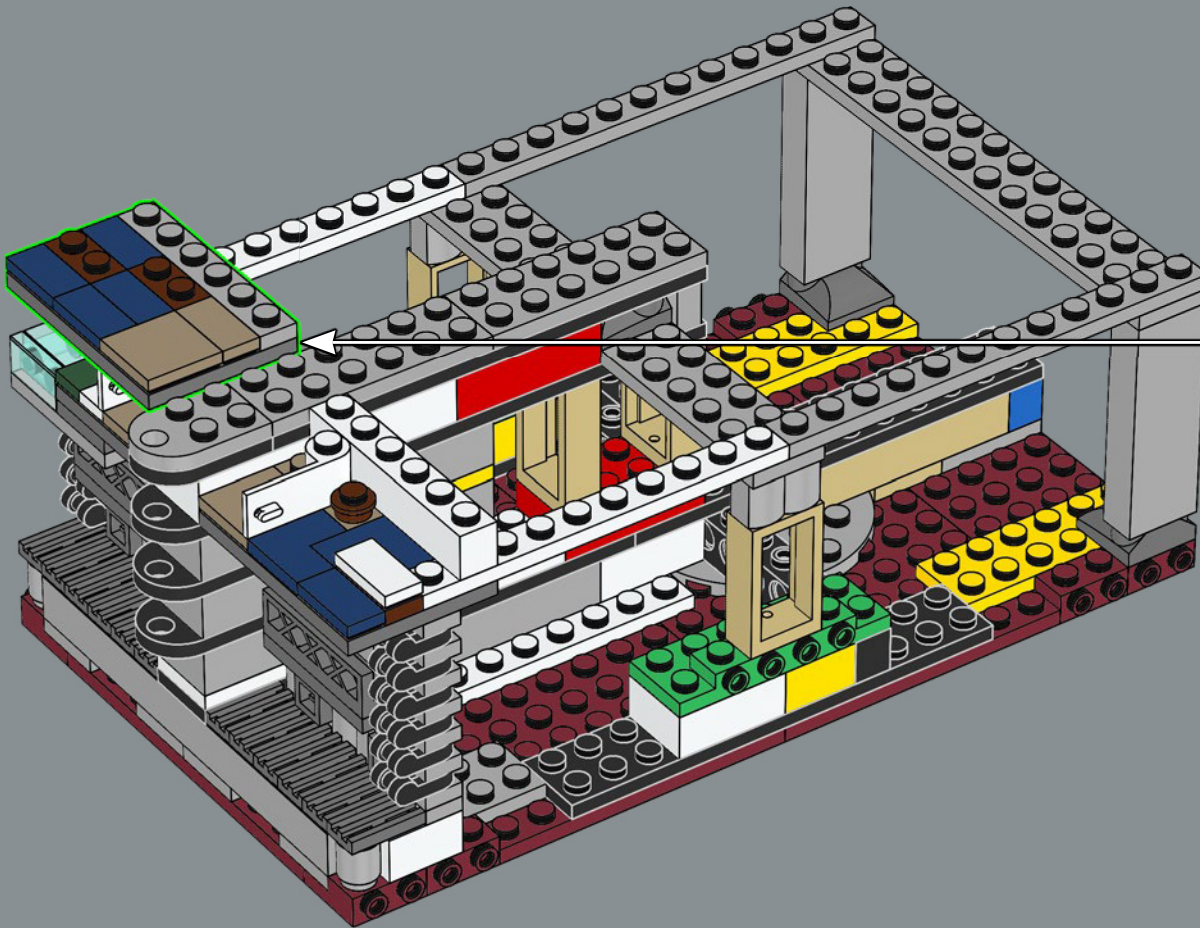
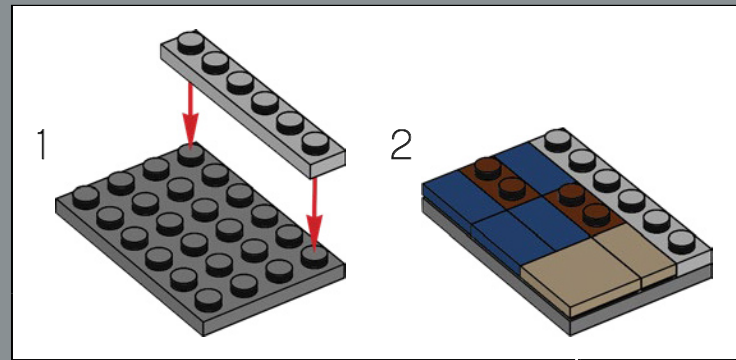

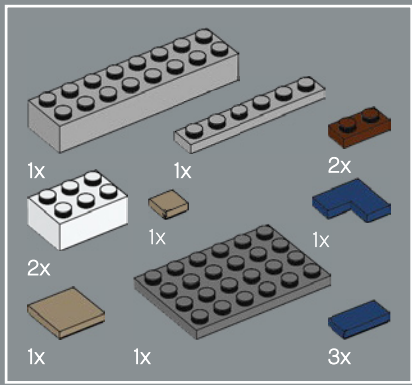

41

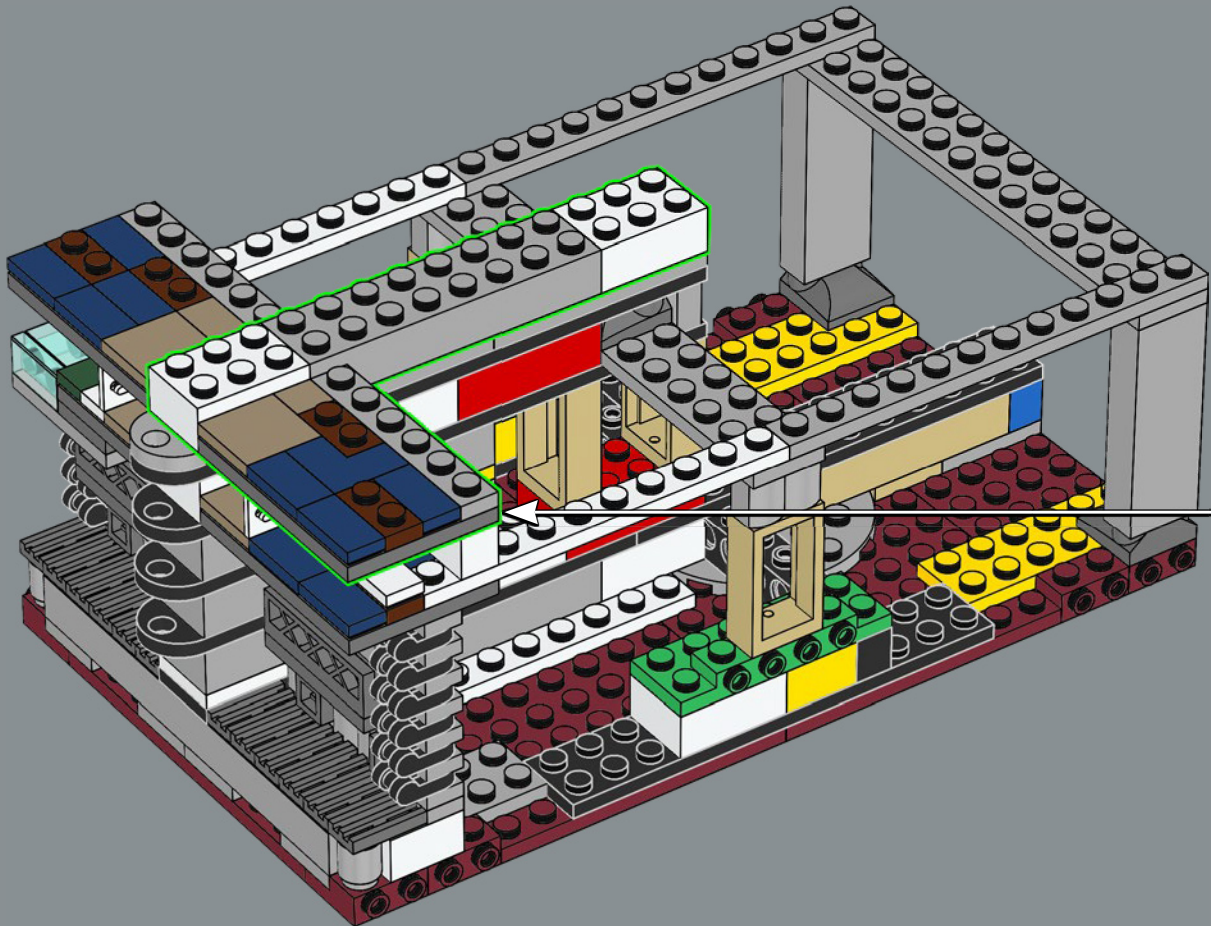
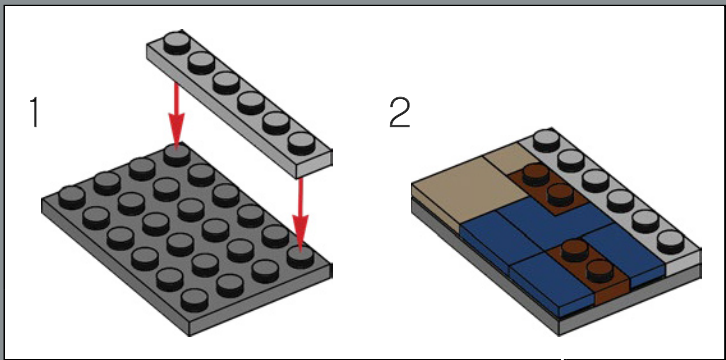

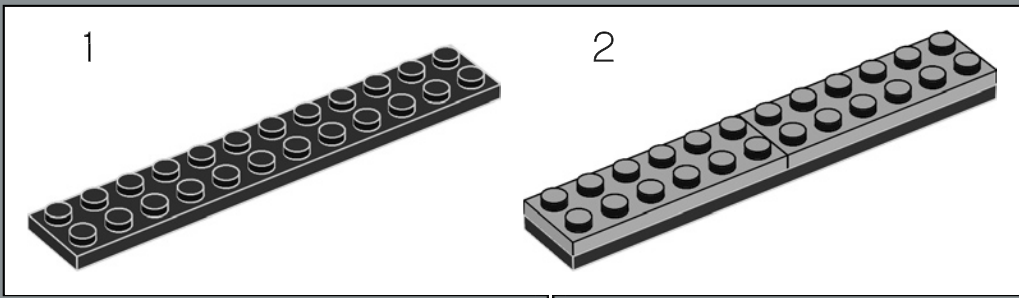
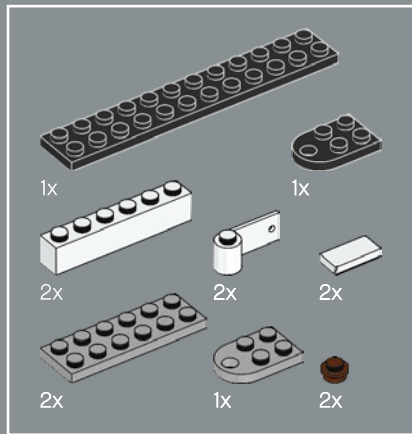

42

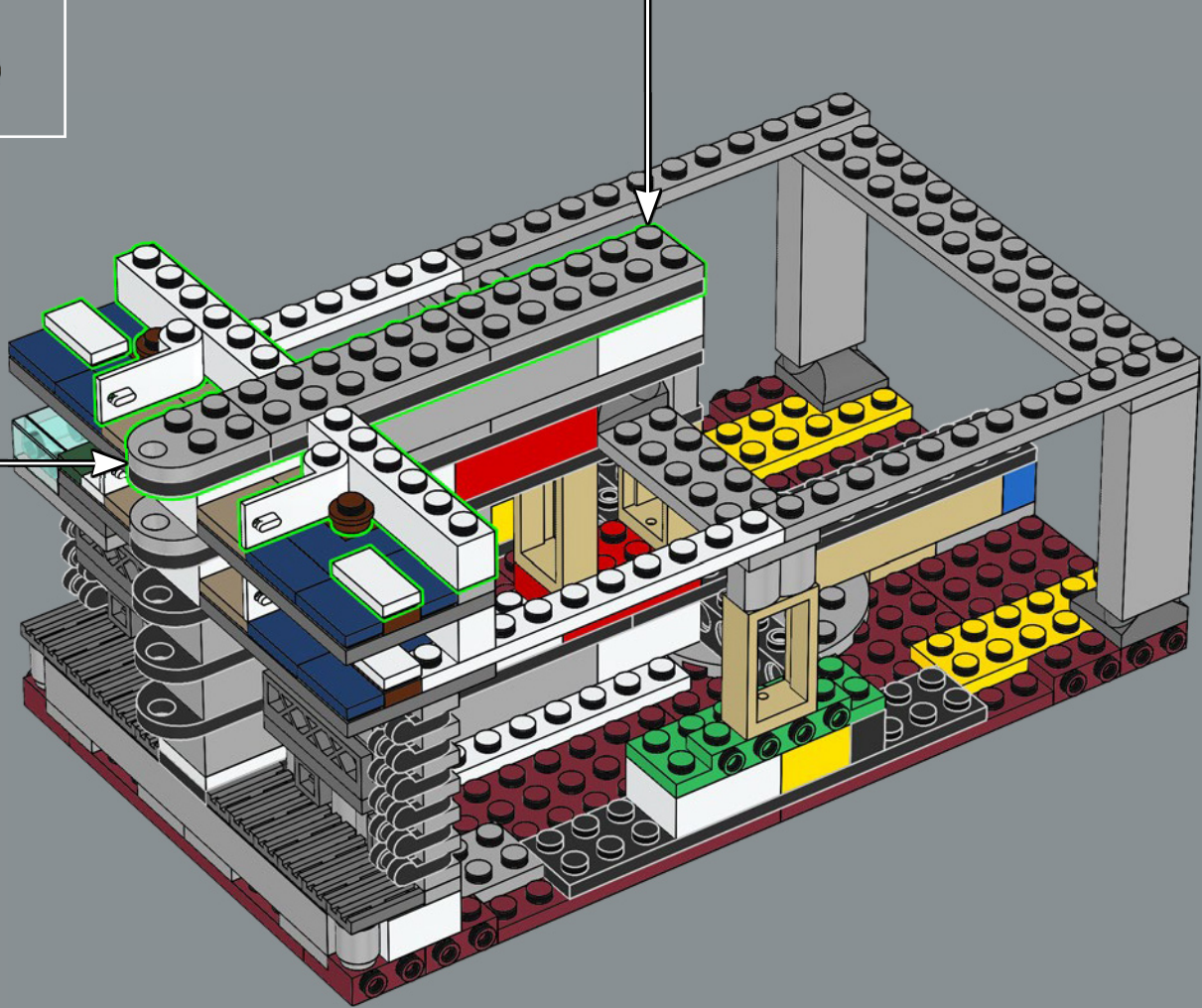
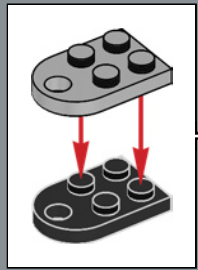

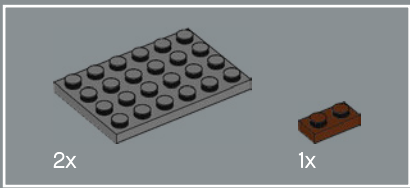

43

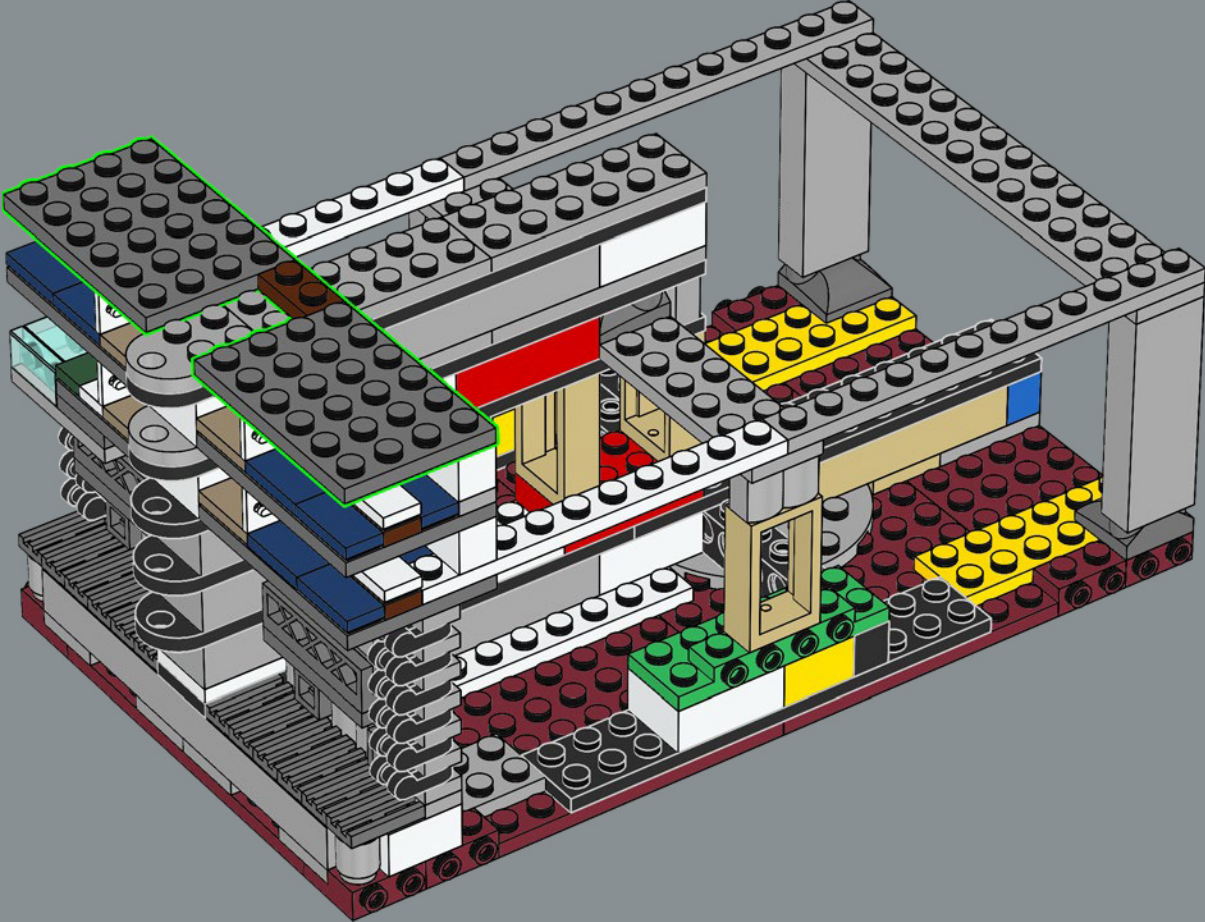

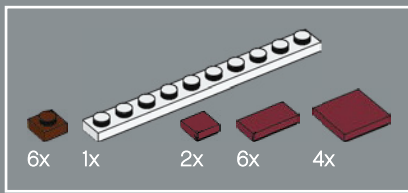

44

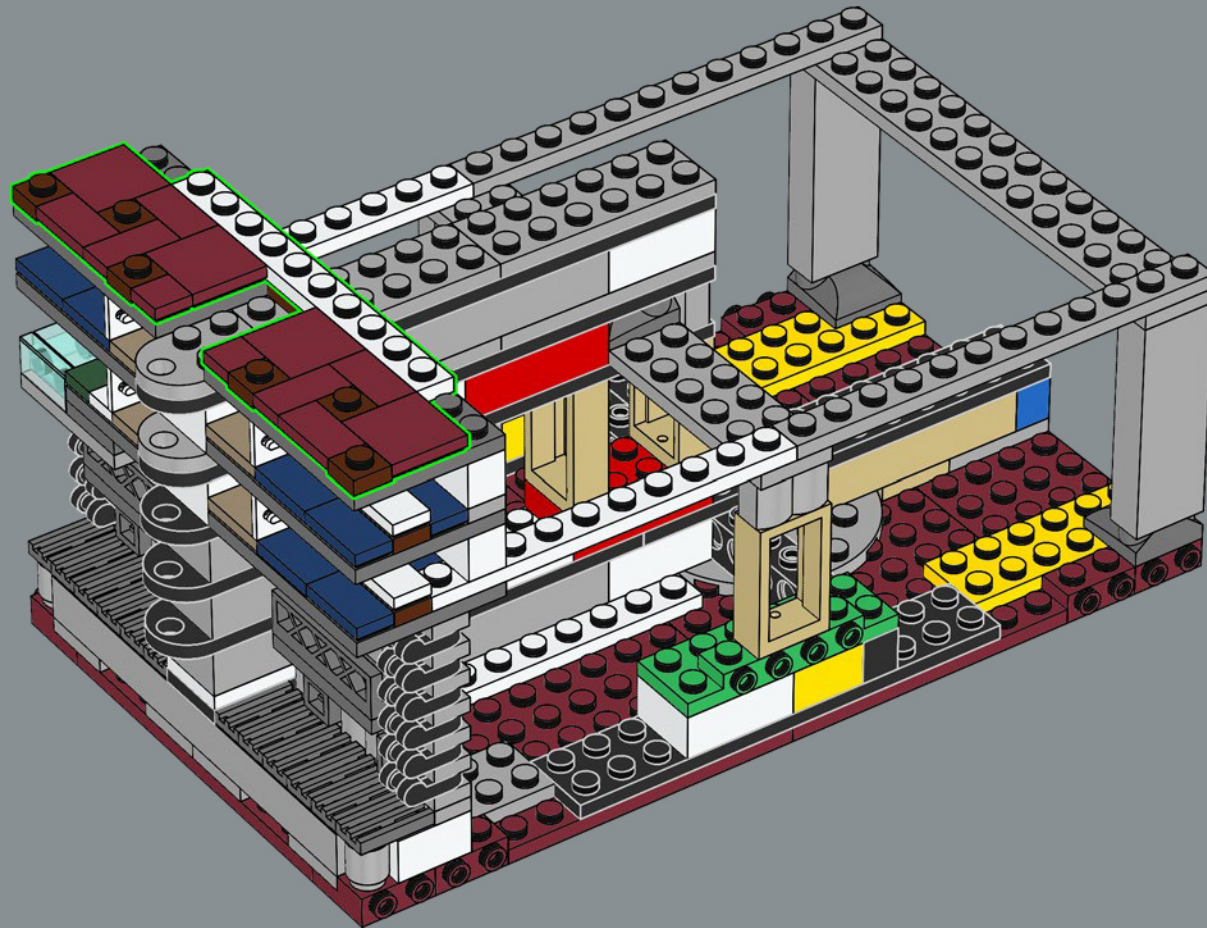

The ship was equipped with her own waterworks, capable of heating and pumping water to all parts of the vessel.

Le paquebot dispose d'un système hydraulique, capable de chauffer et de pomper l'eau dans toutes les parties du navire.

El transatlántico estaba equipado con su propia instalación de abastecimiento de agua, capaz de calentarla y de bombearla a todas las zonas de la nave.

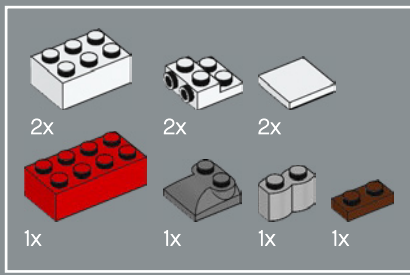

45

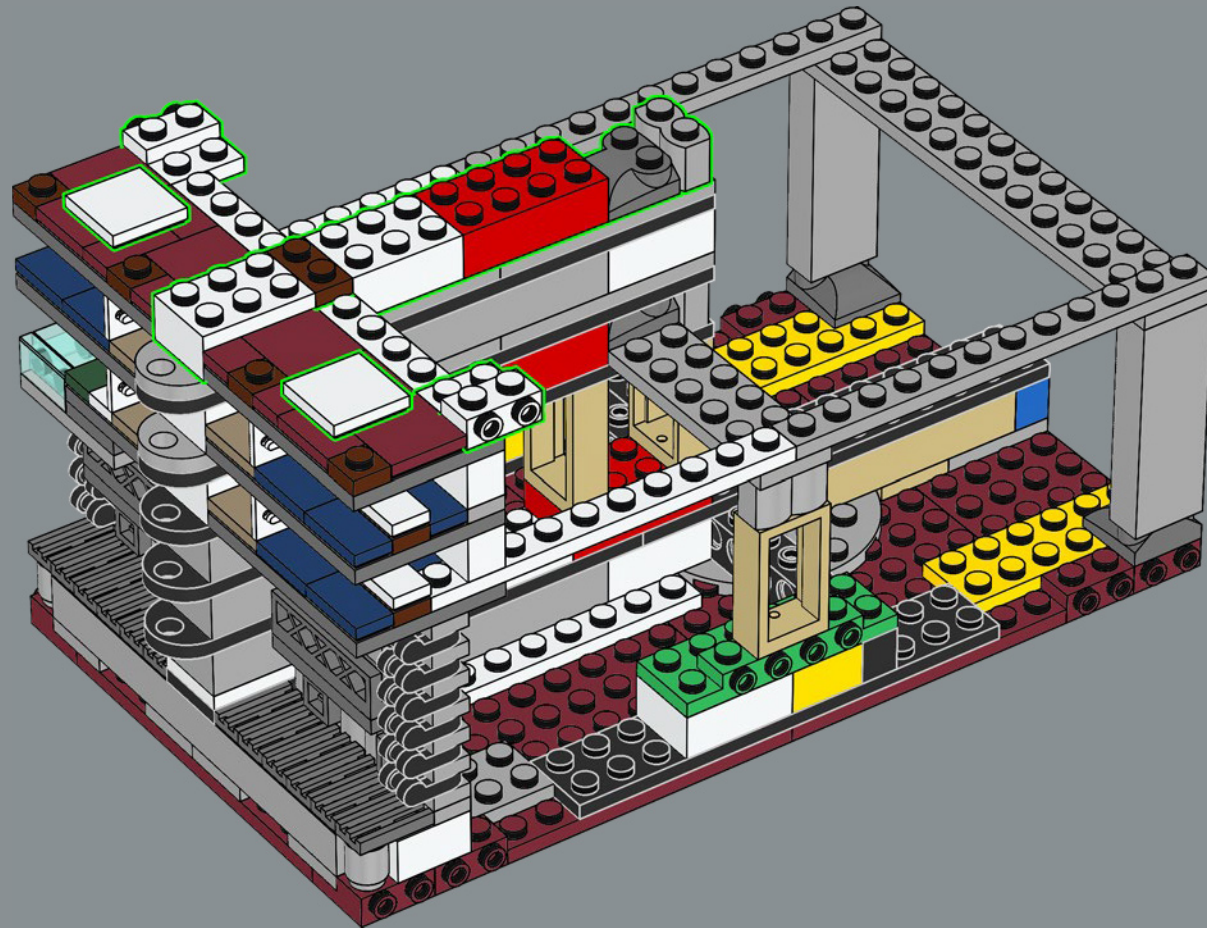

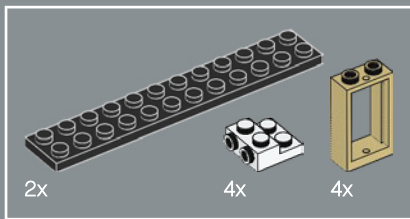

46

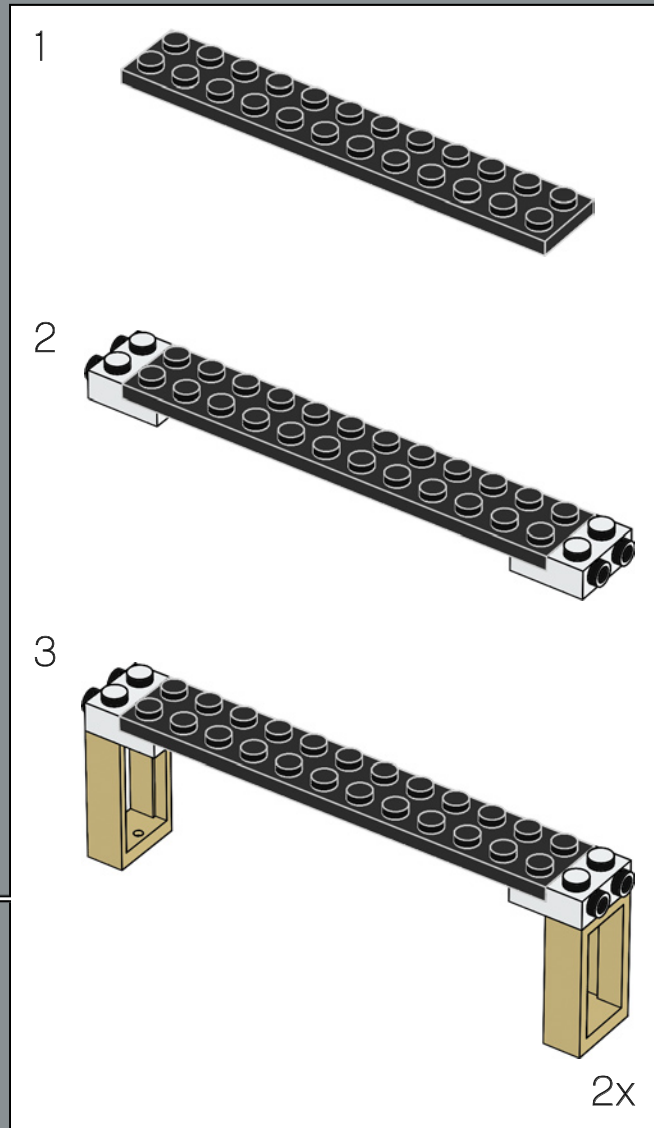
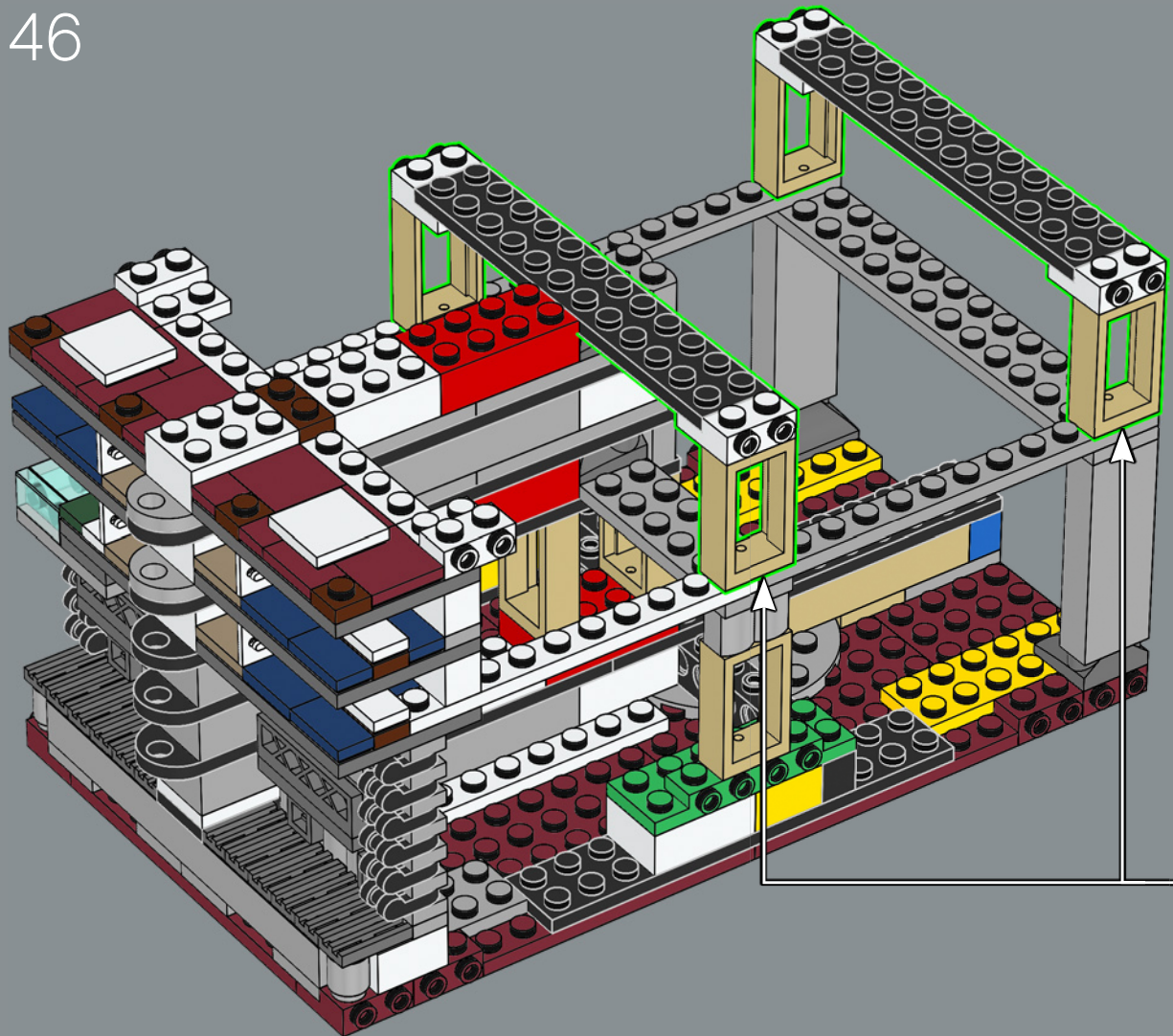

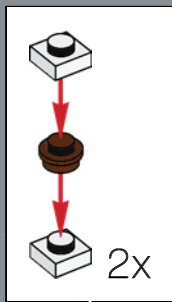
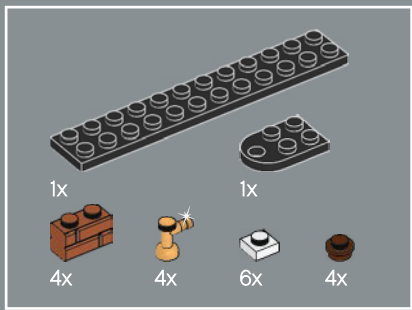

47

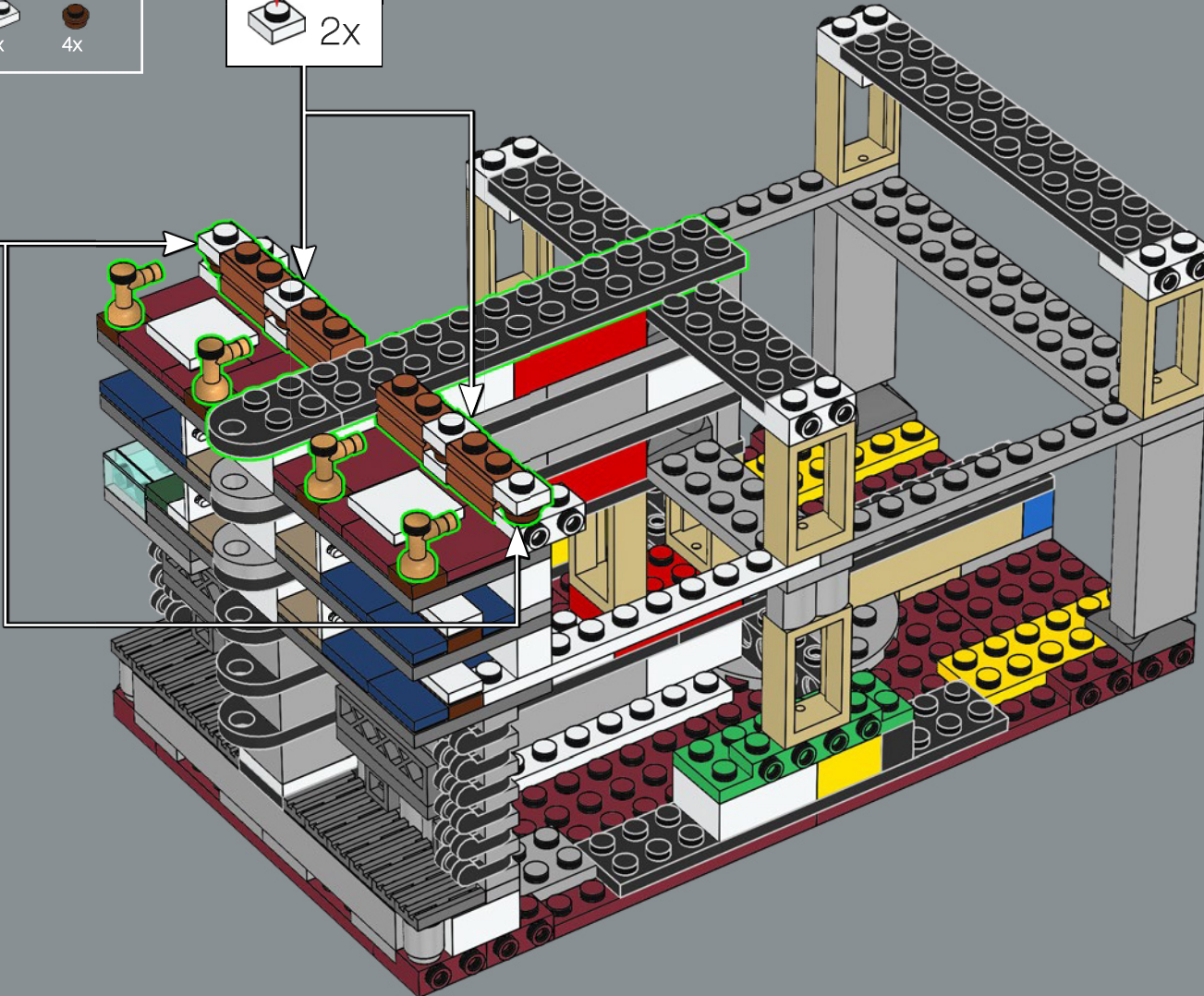
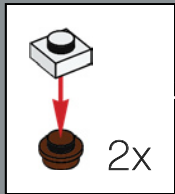

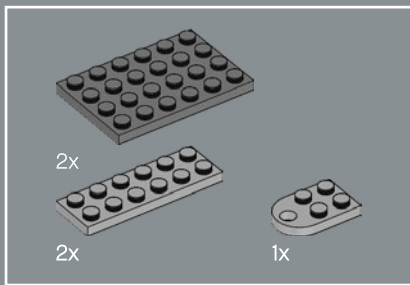

48

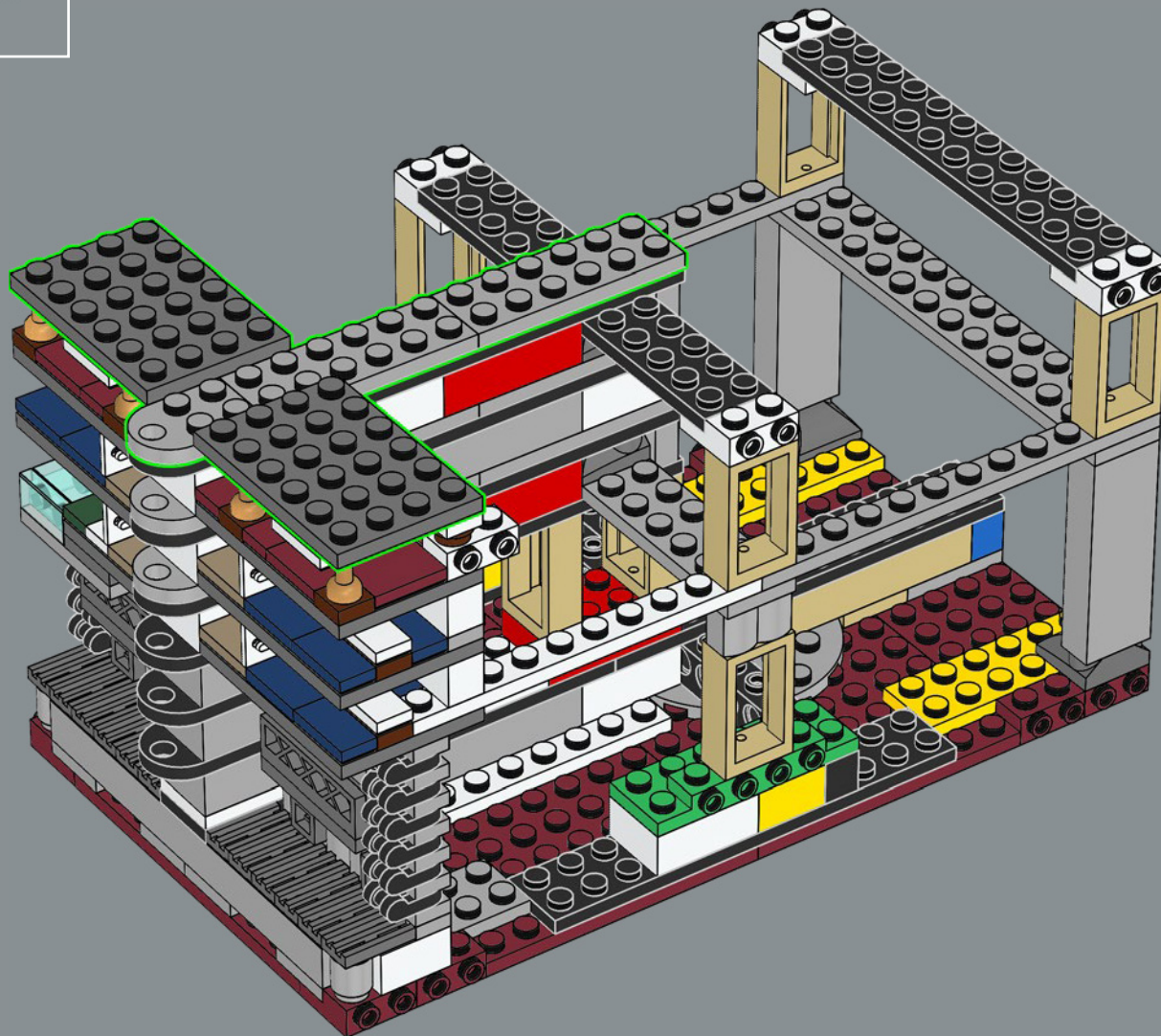



49

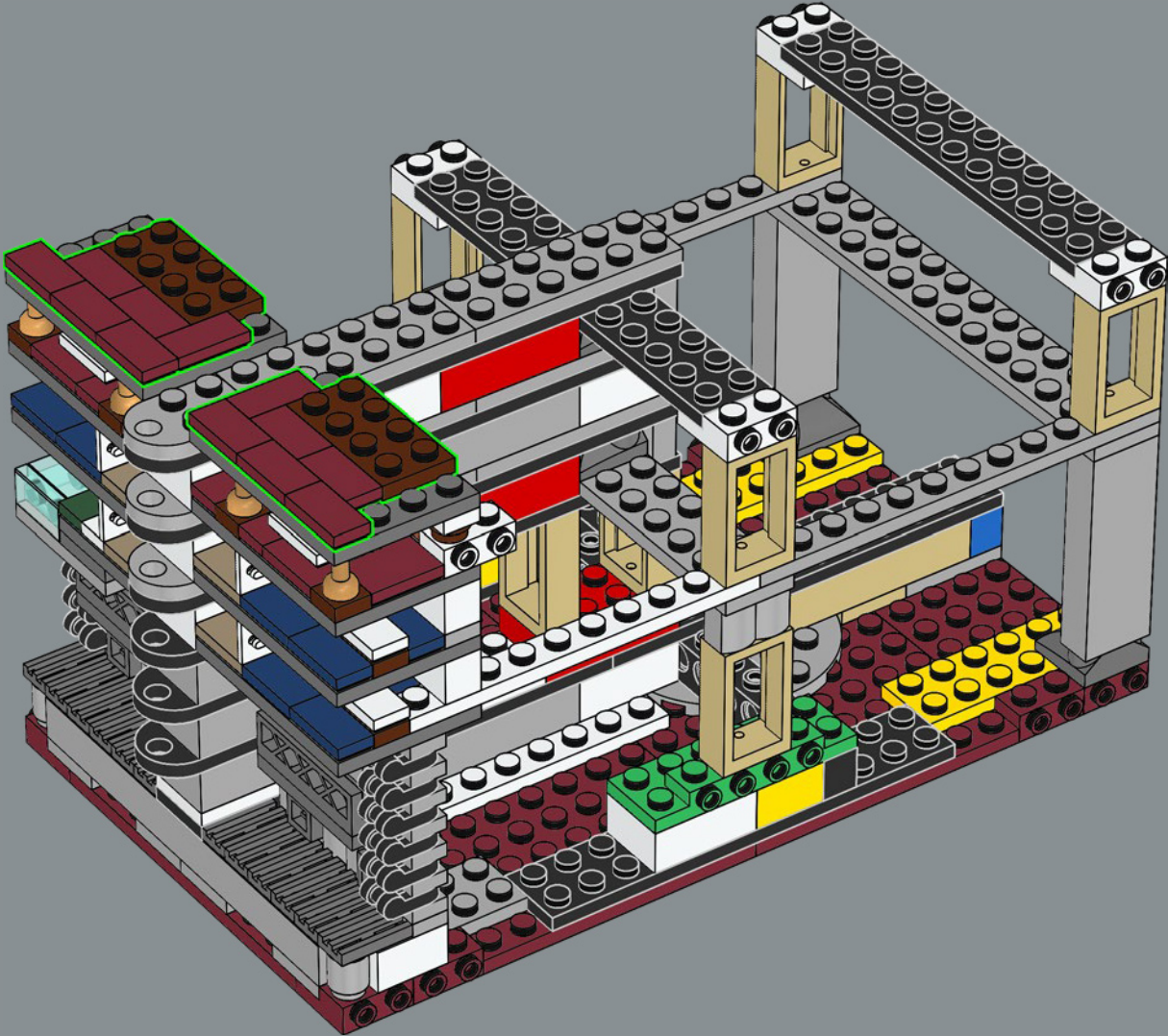

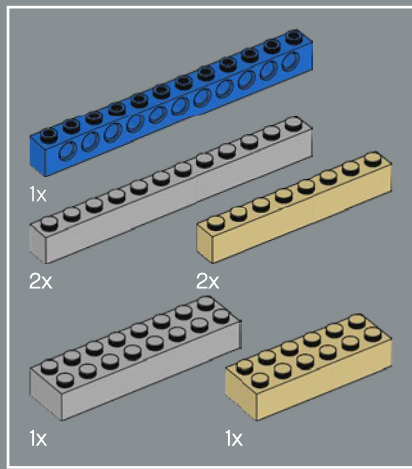

50

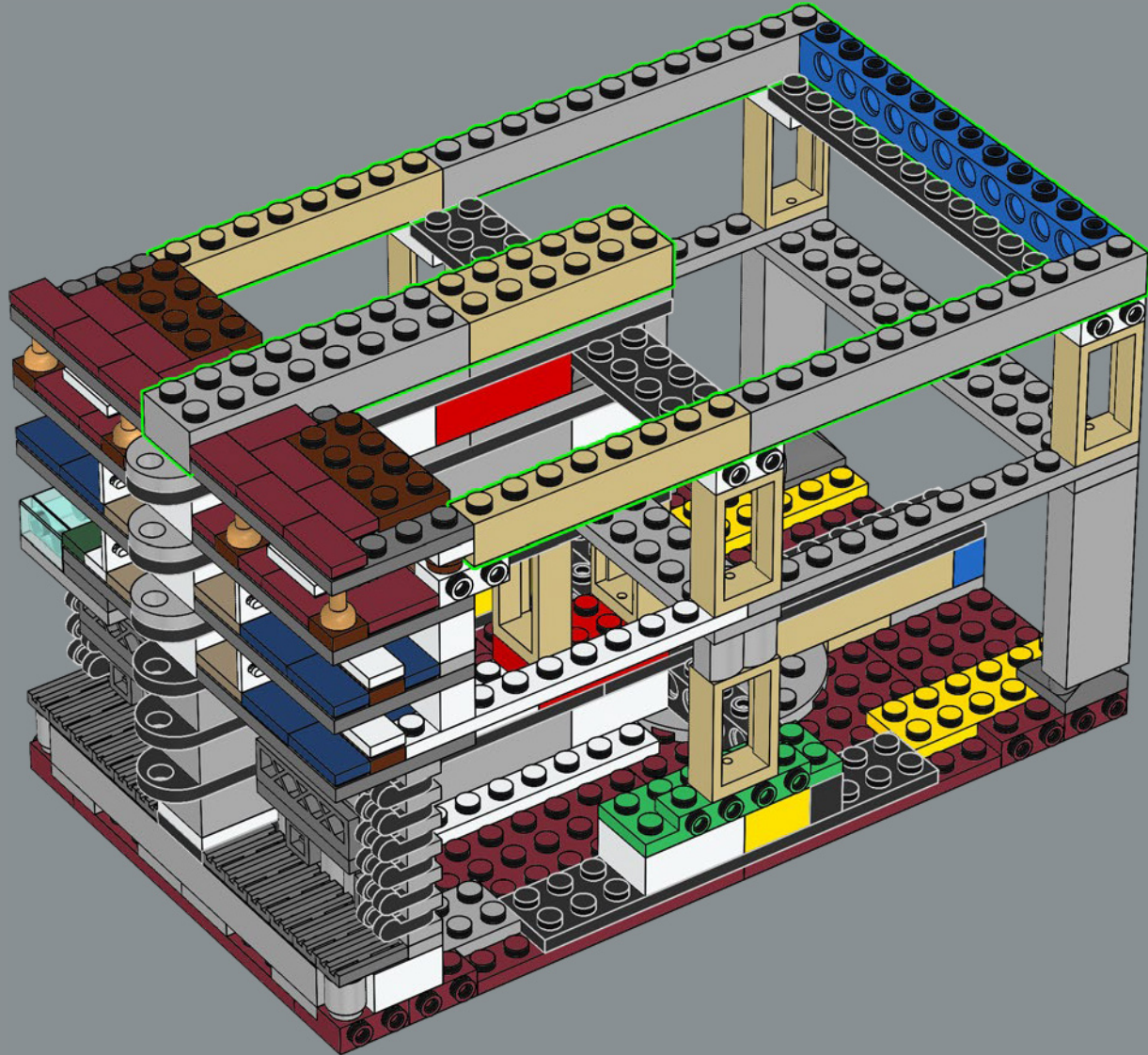

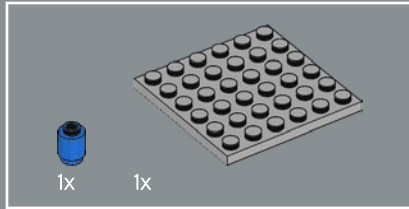
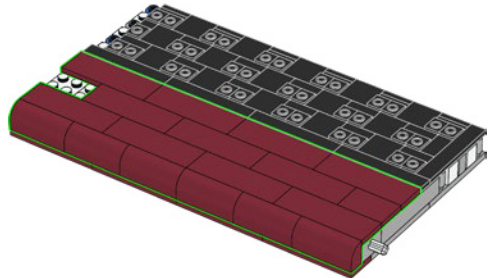
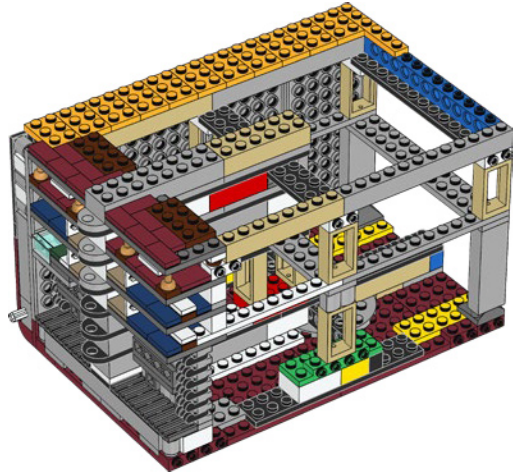
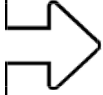

51

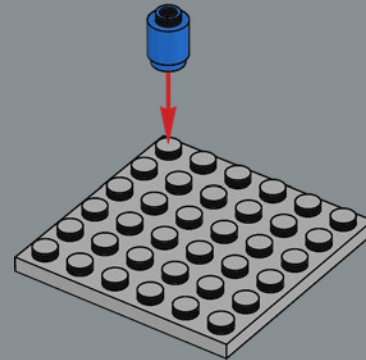

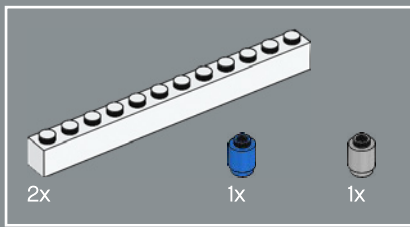

52

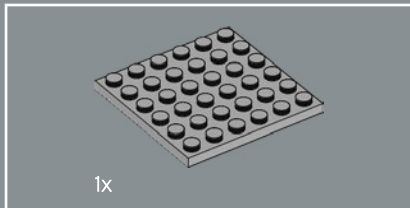
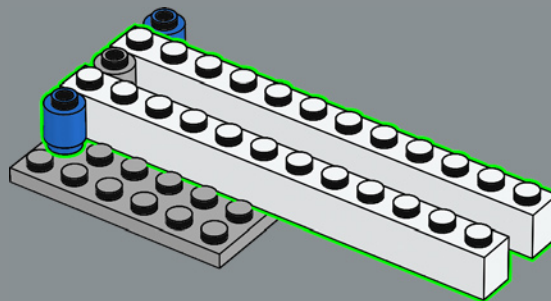

53

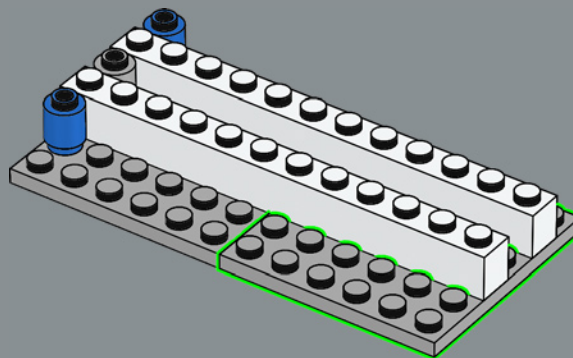

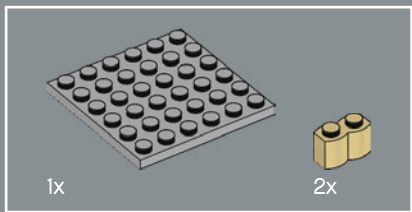

54

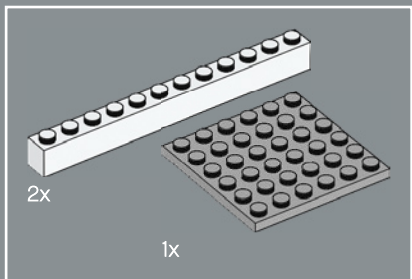
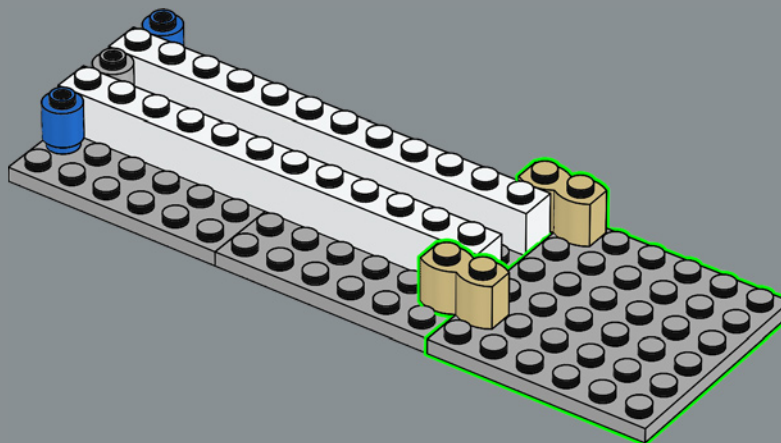

55

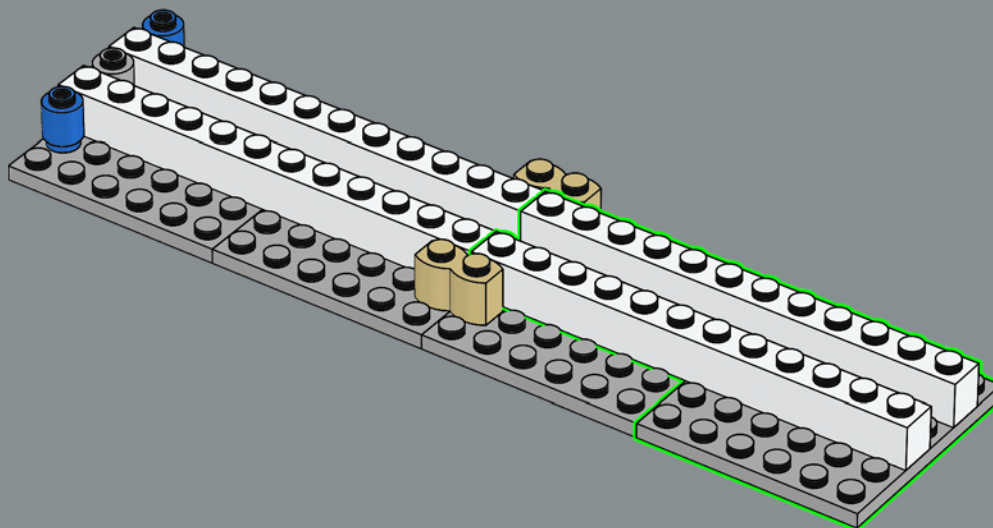



56

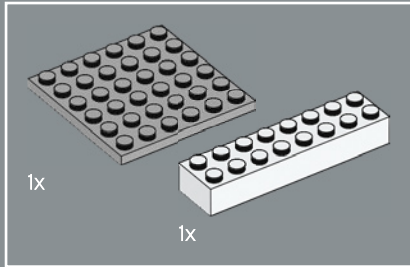
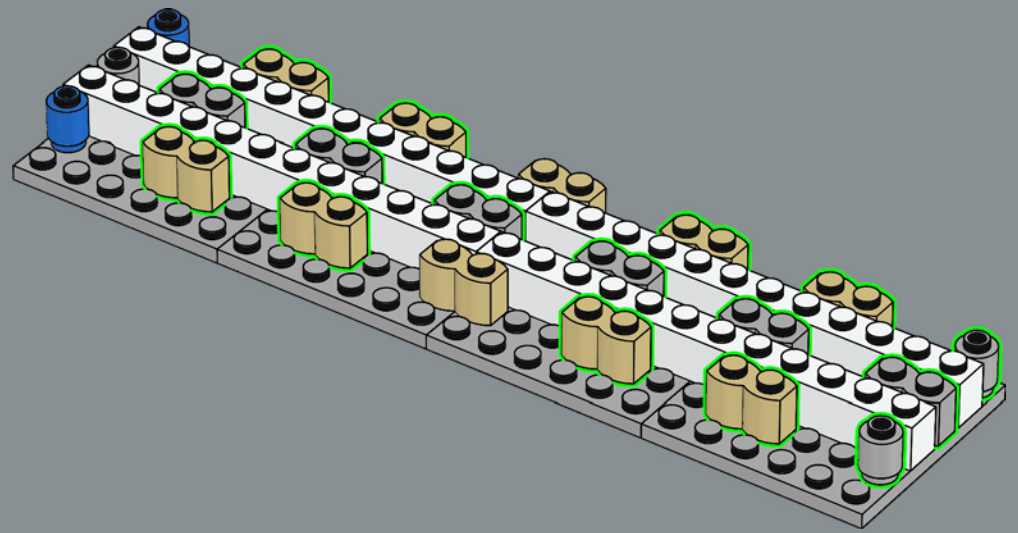

57

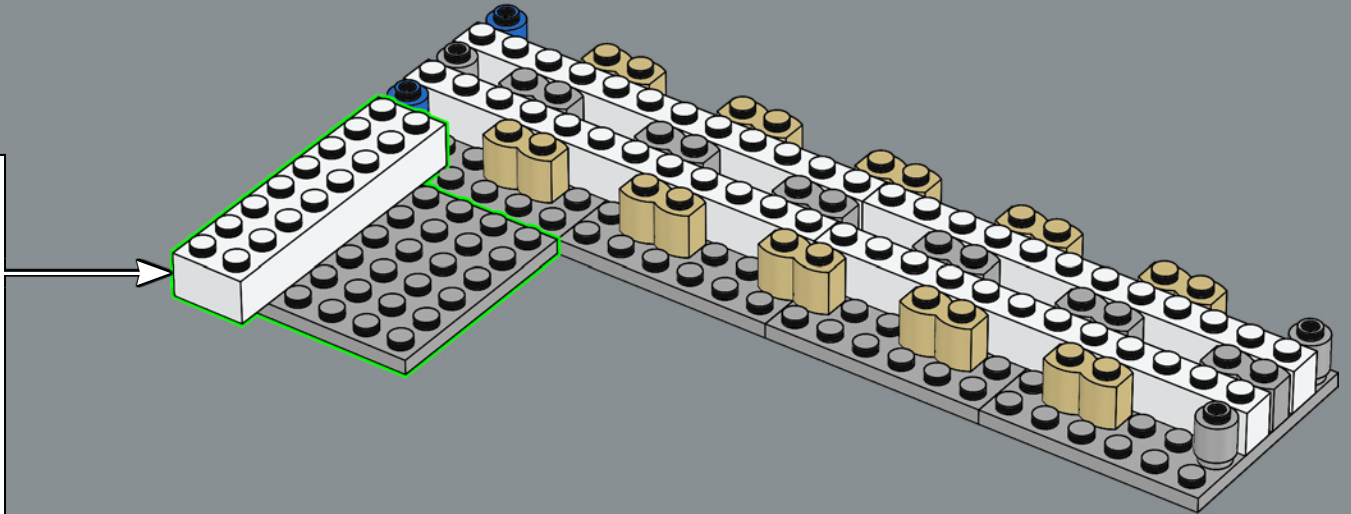
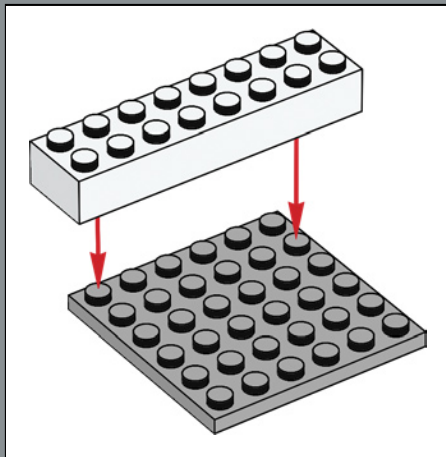

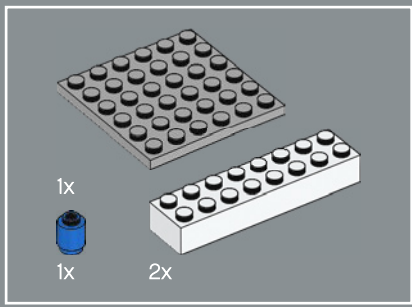

58

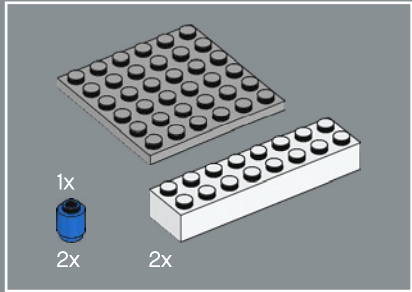
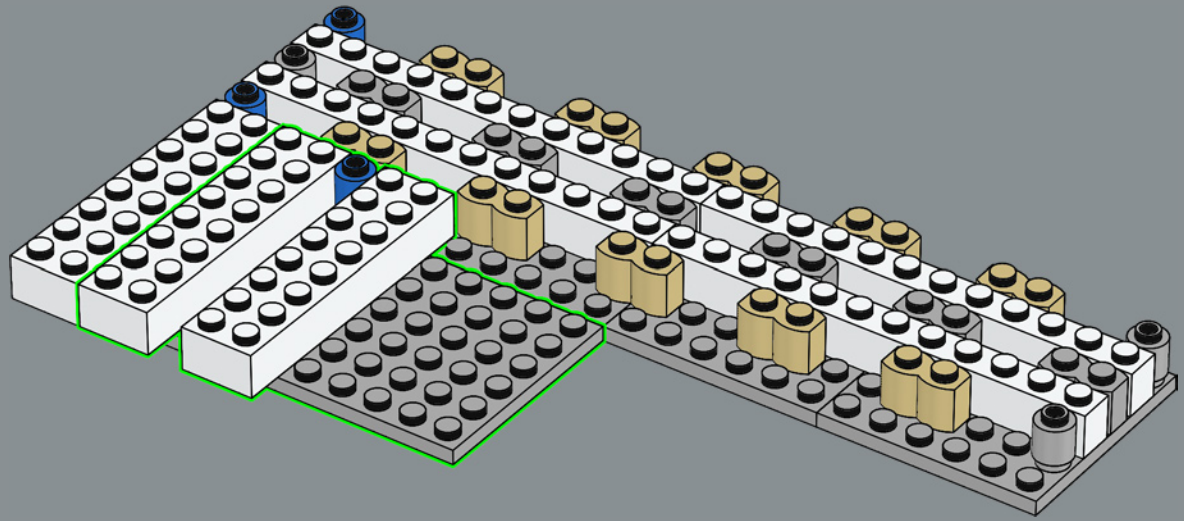

59

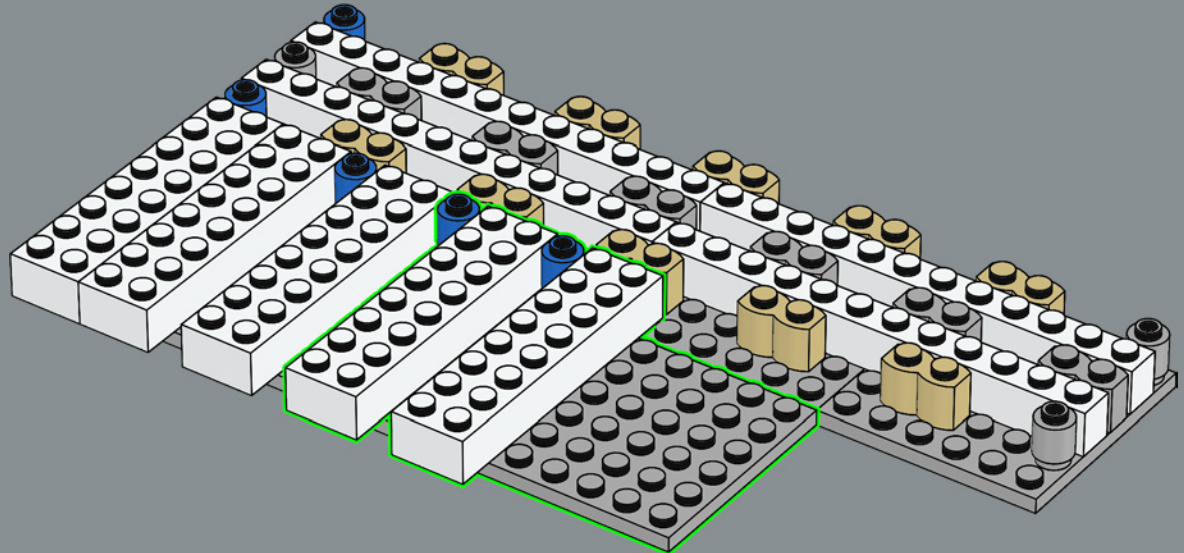

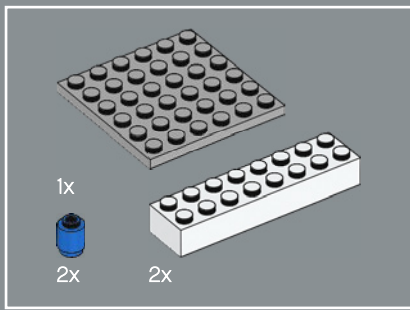

60

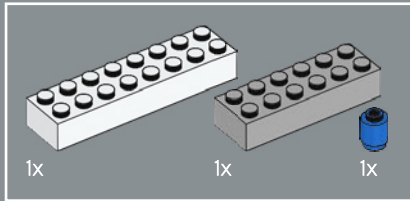
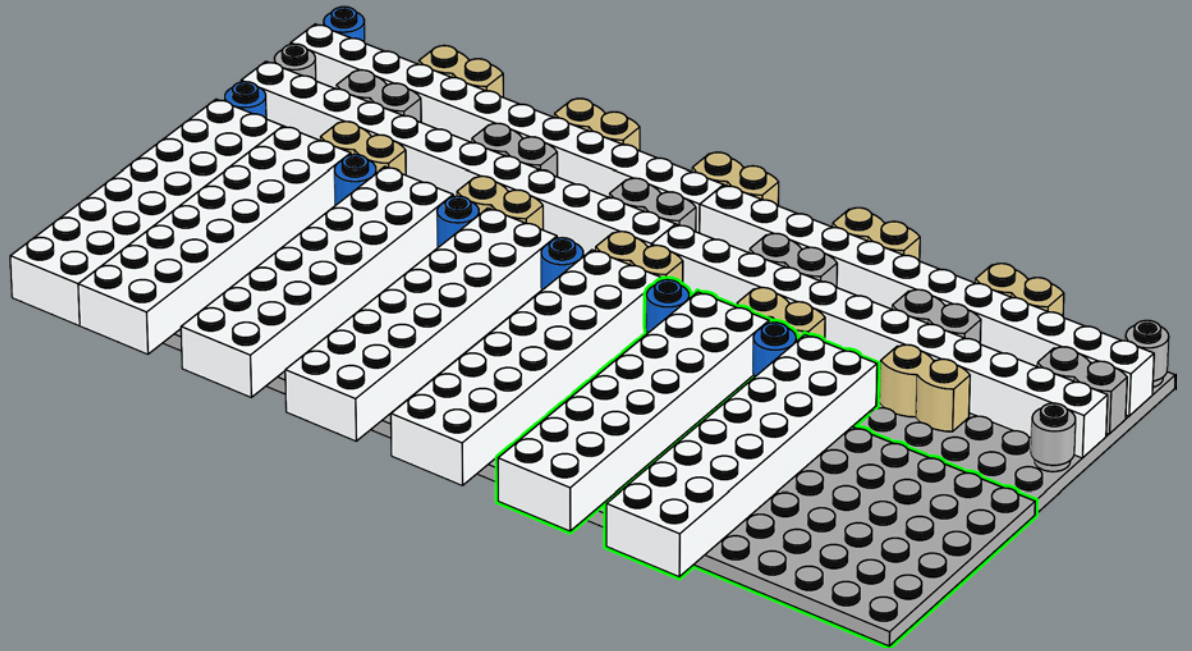

61

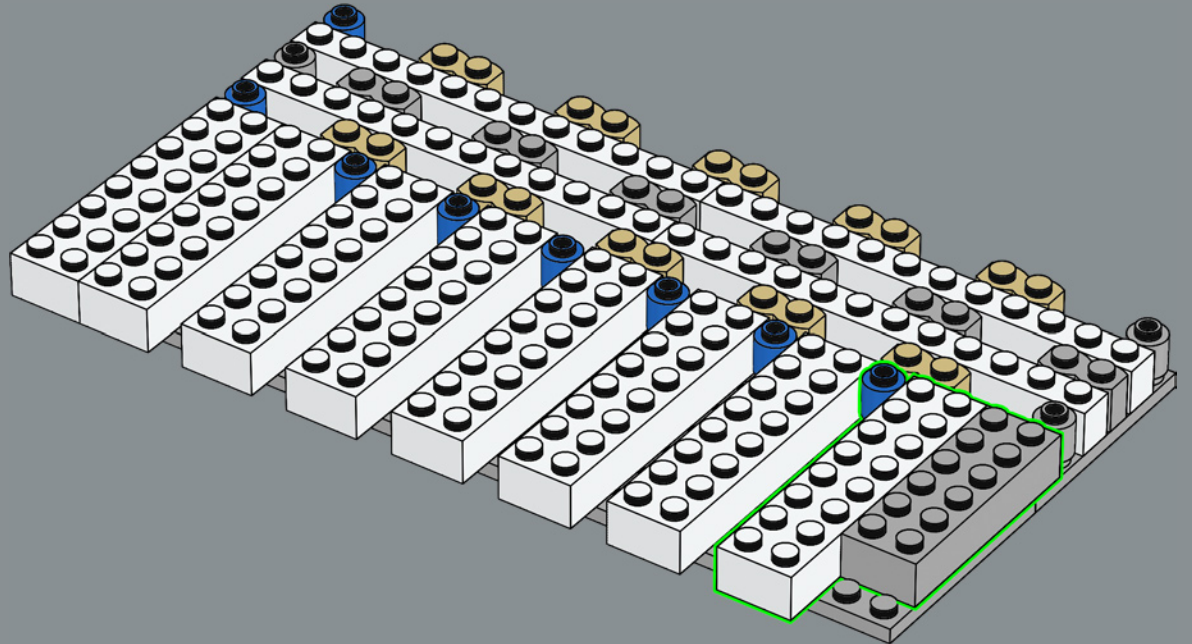

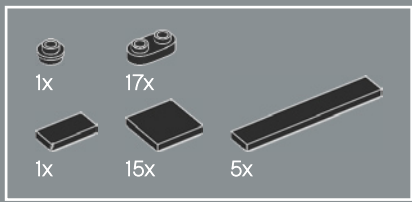

62

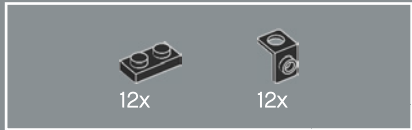
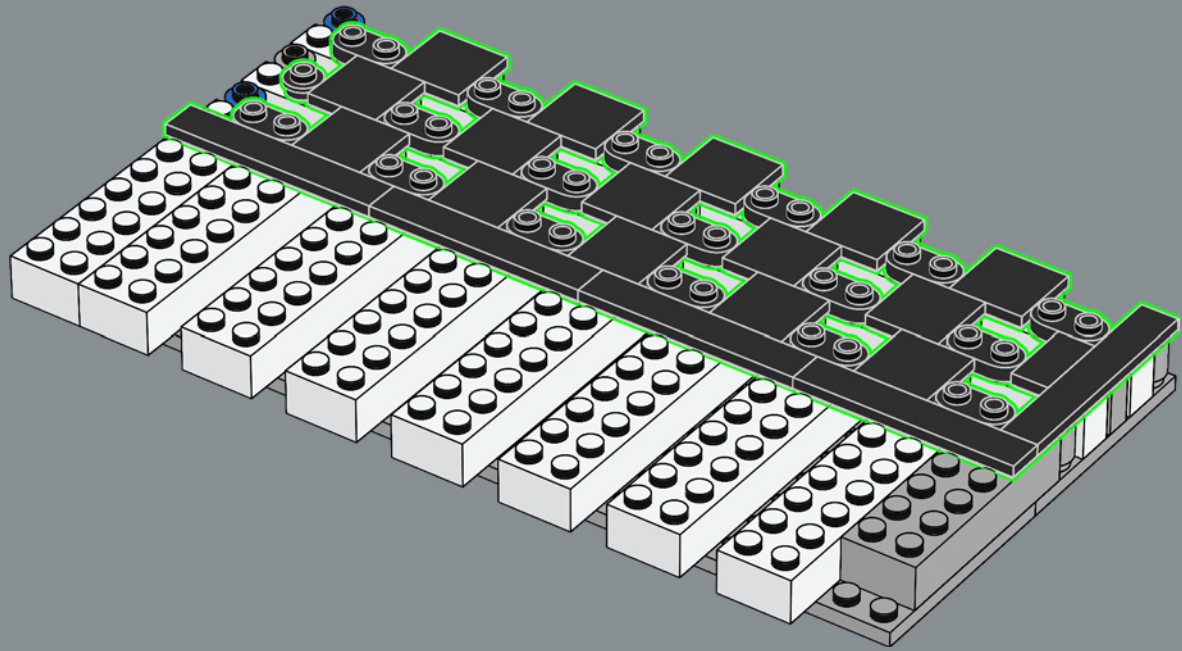

63

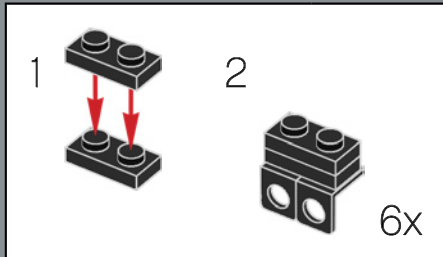
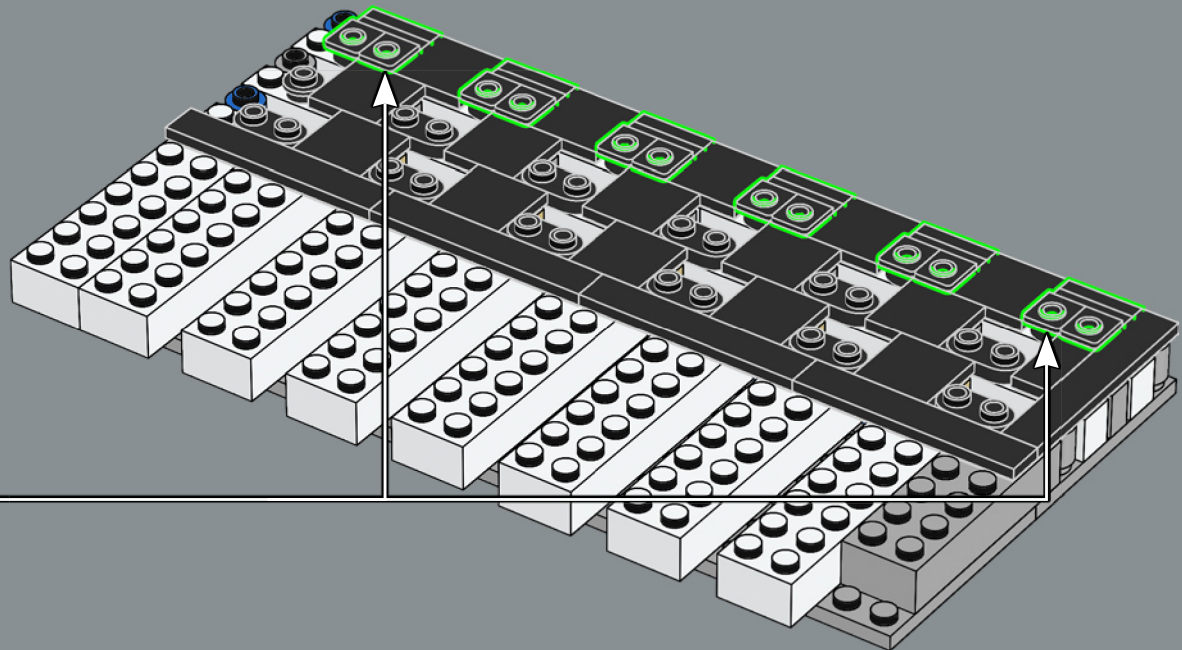

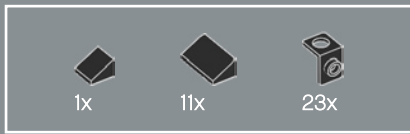

64

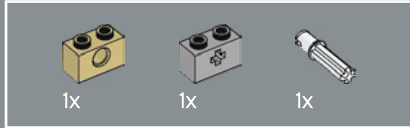
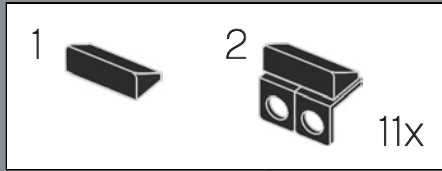
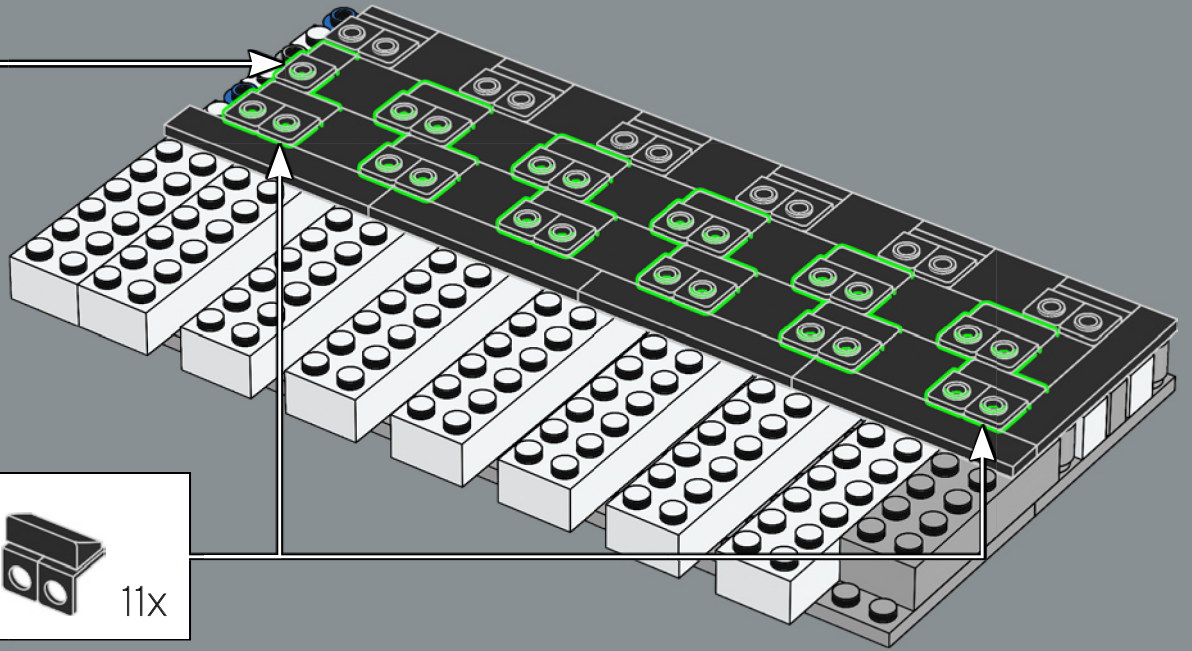
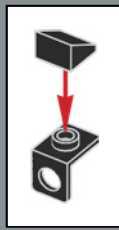

65

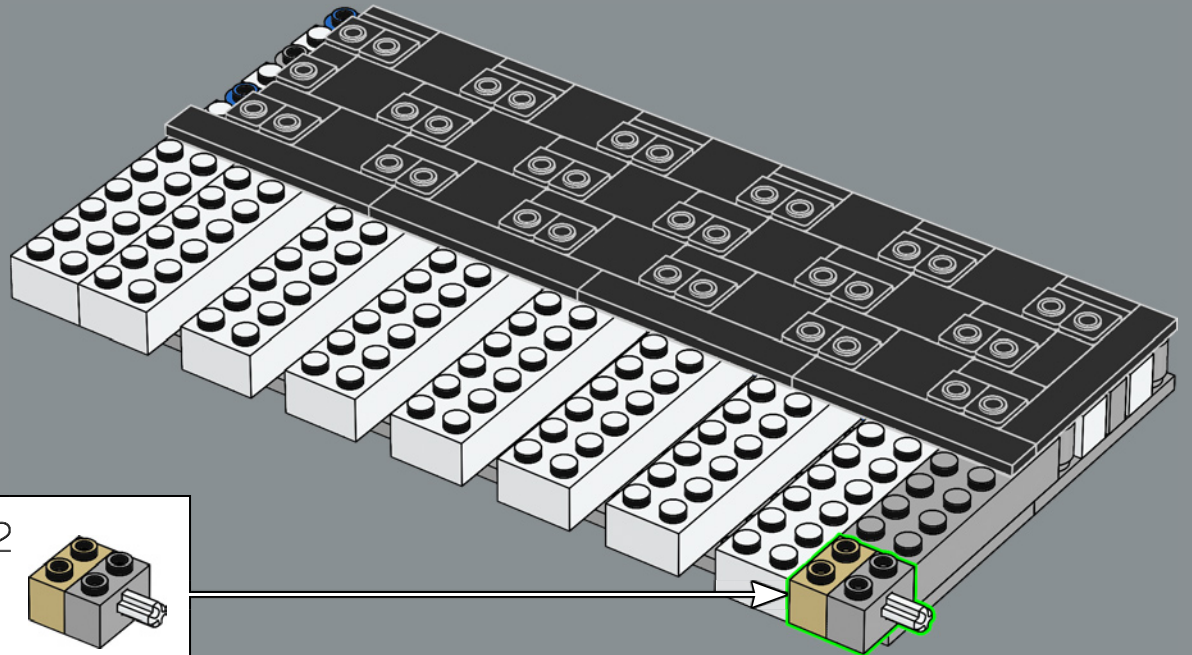
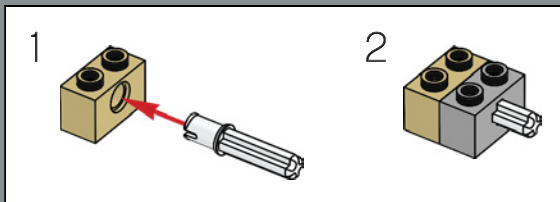

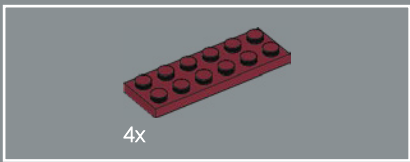

66

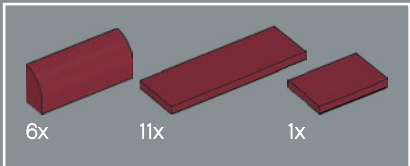
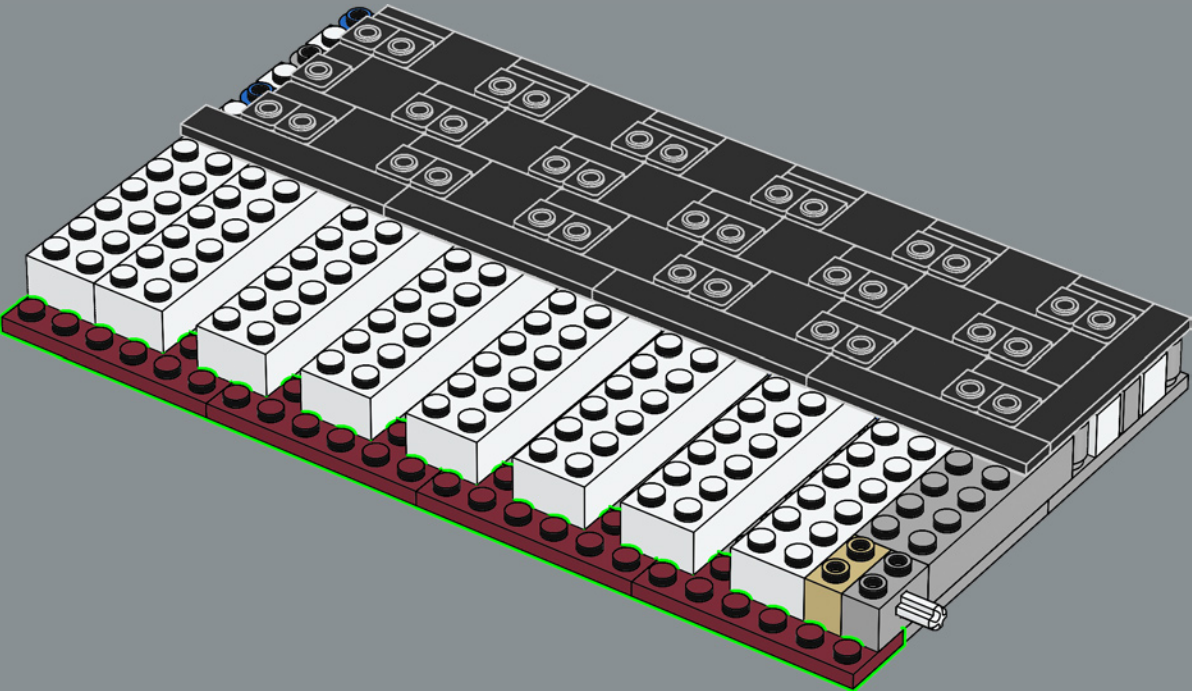

67

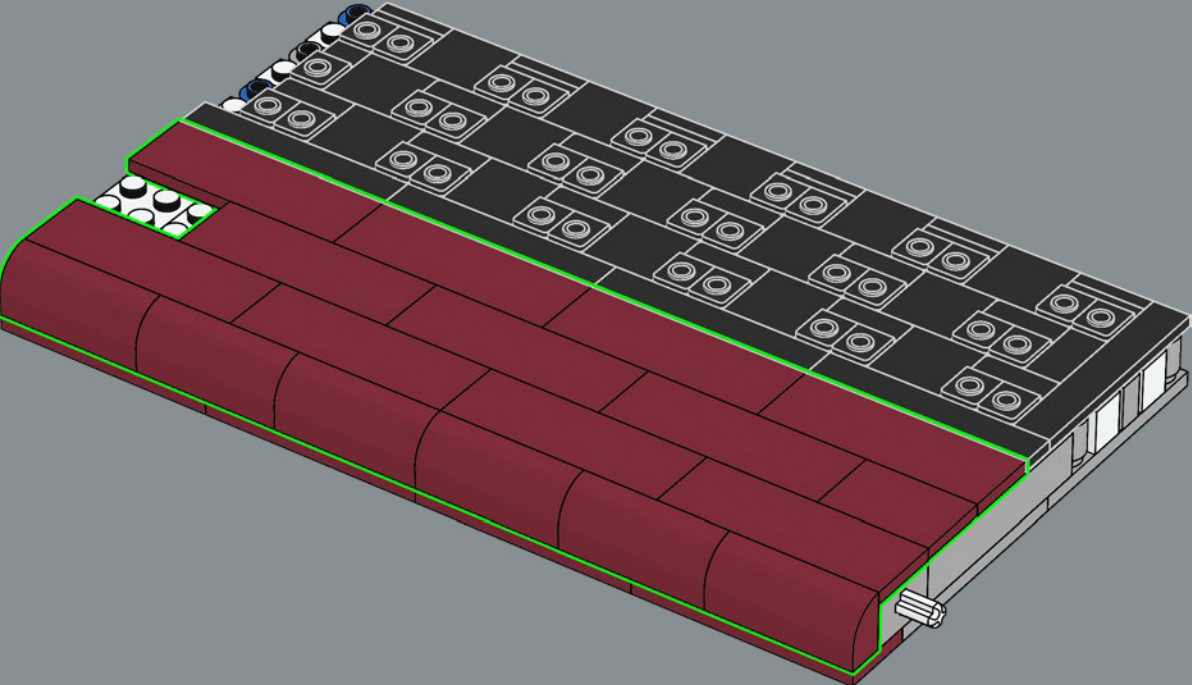

68

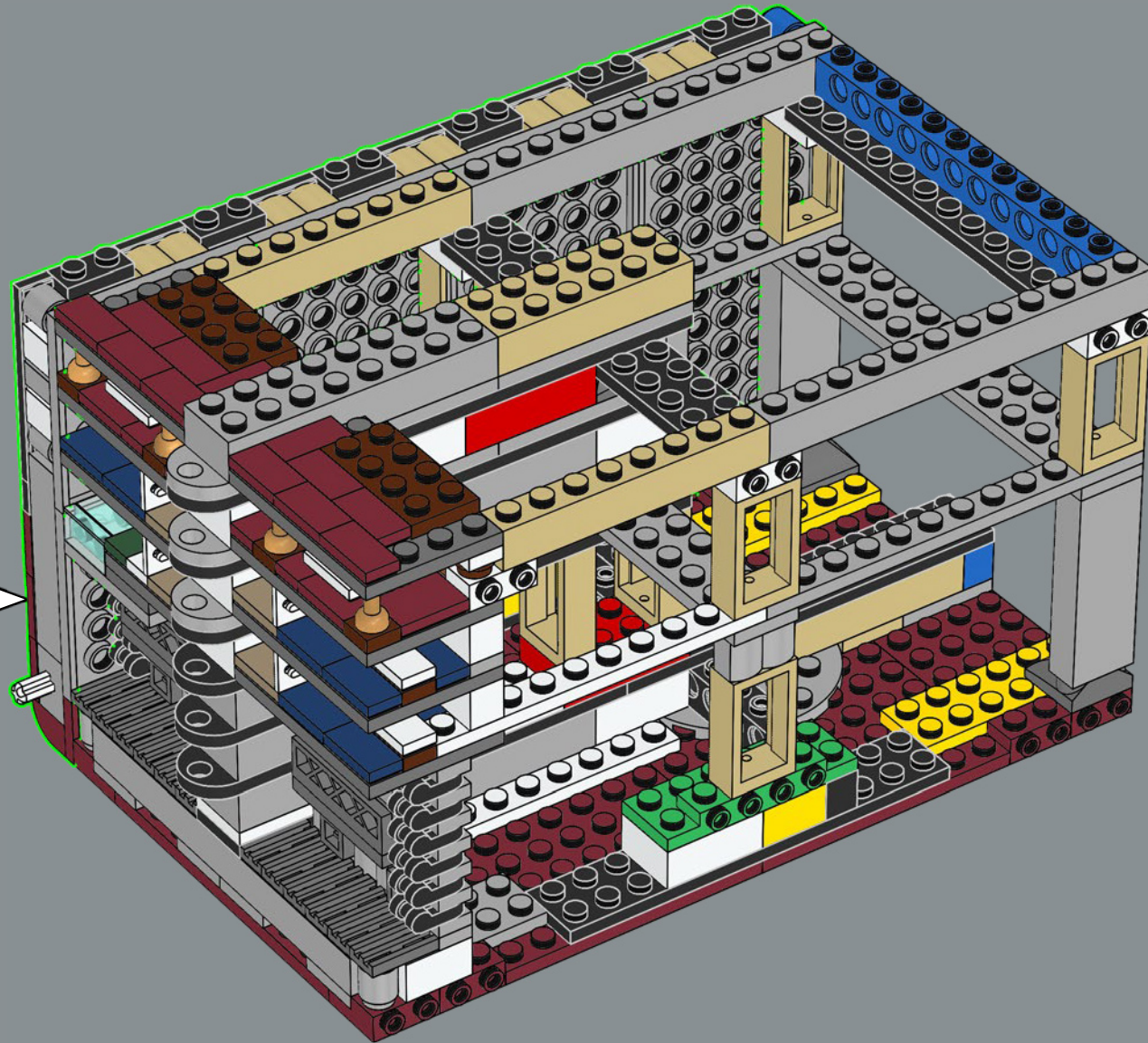

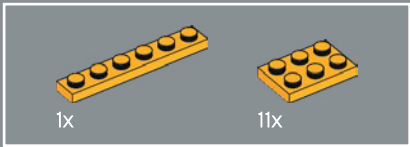

69

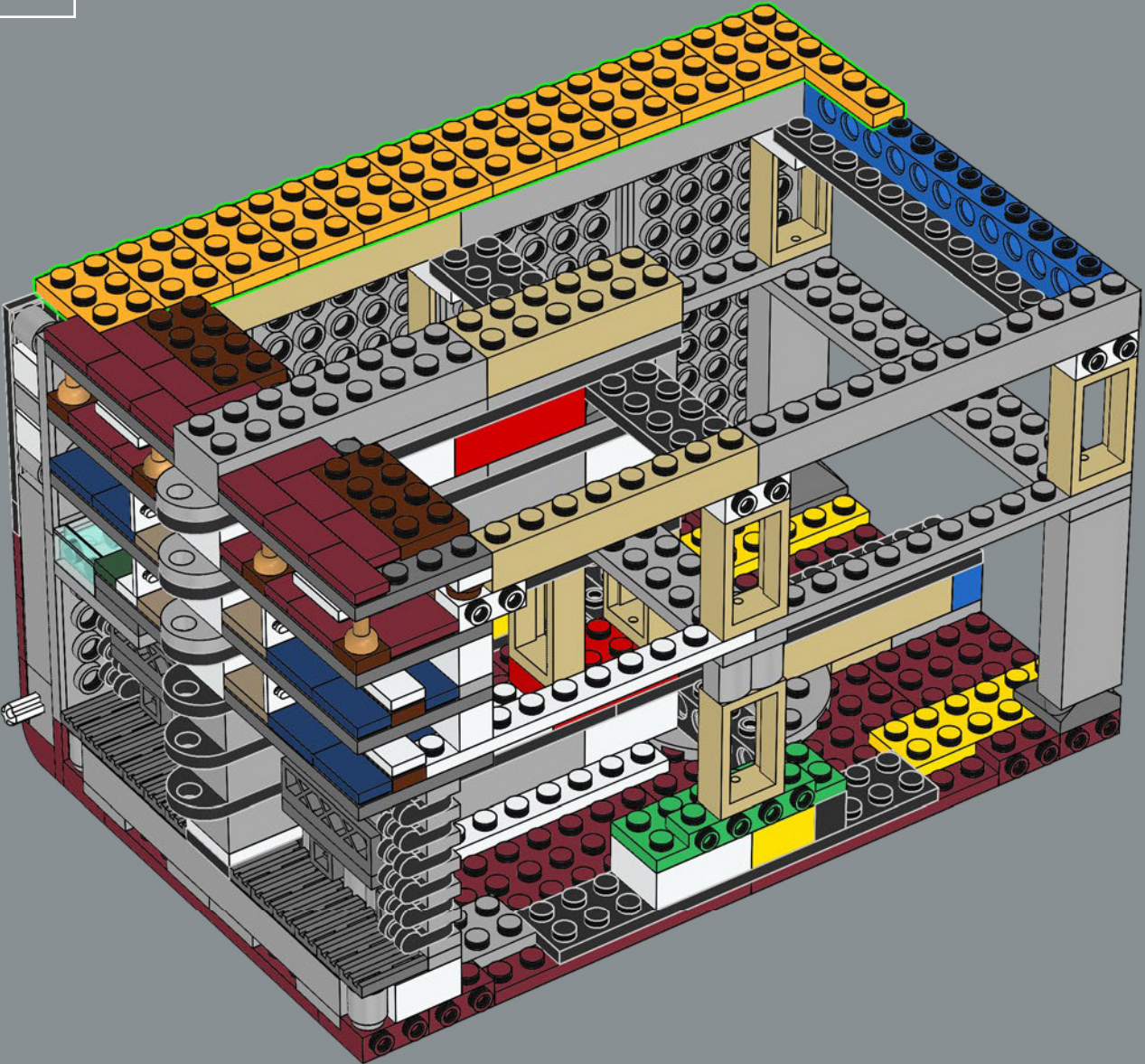

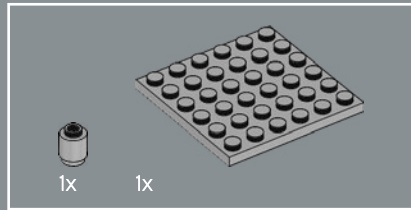
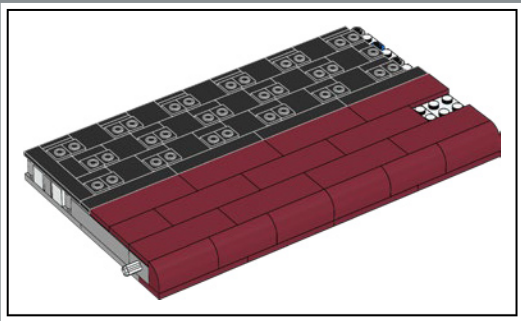
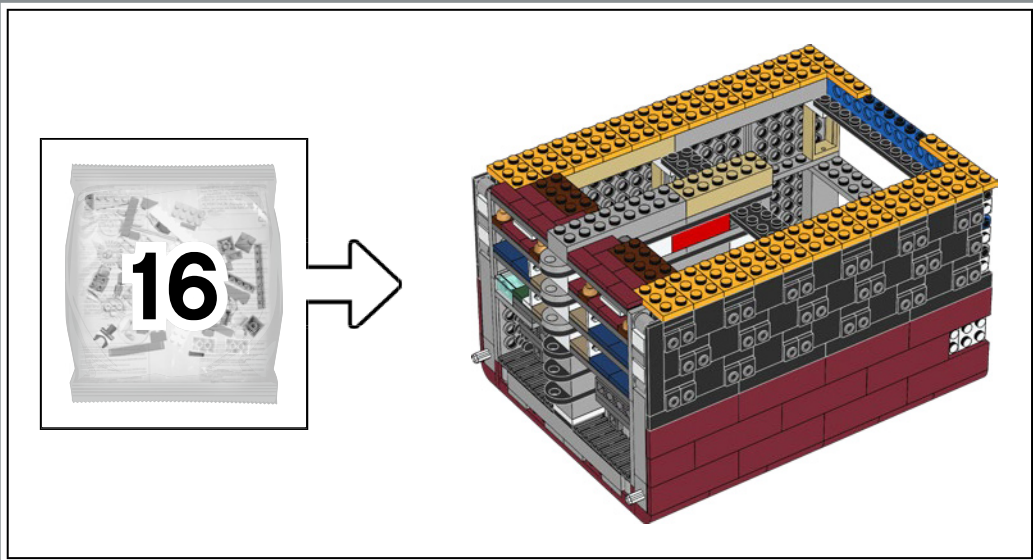

70

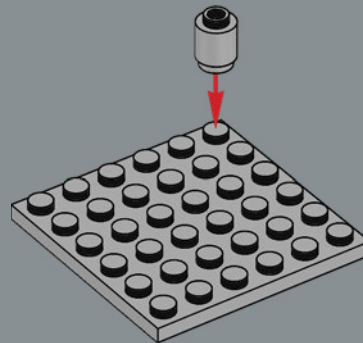

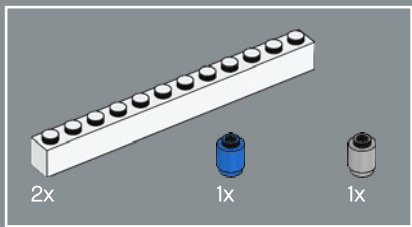

71

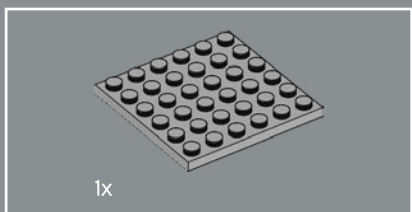
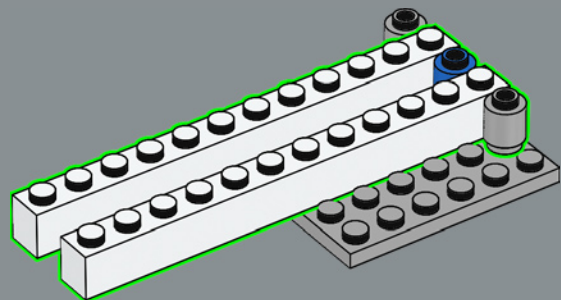

72

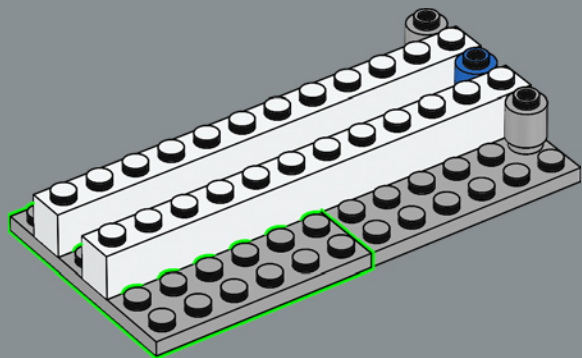

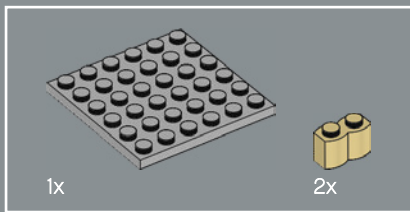

73

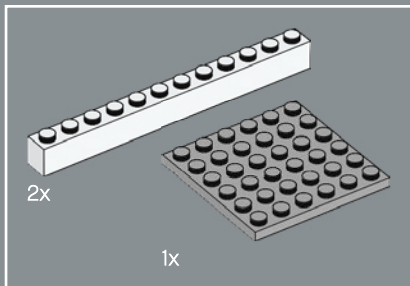
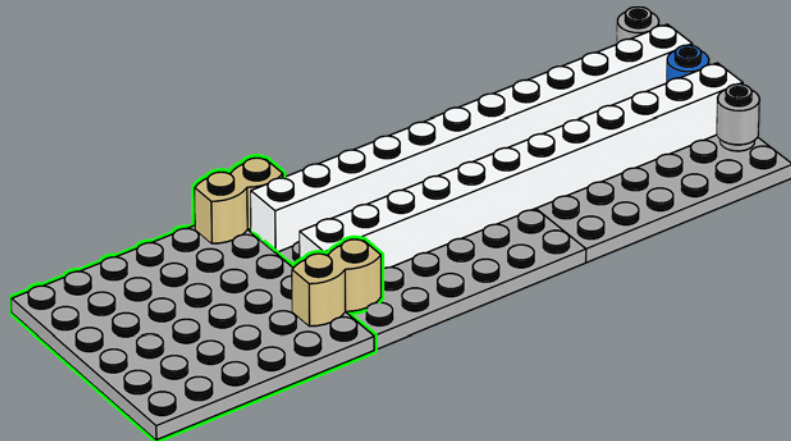

74

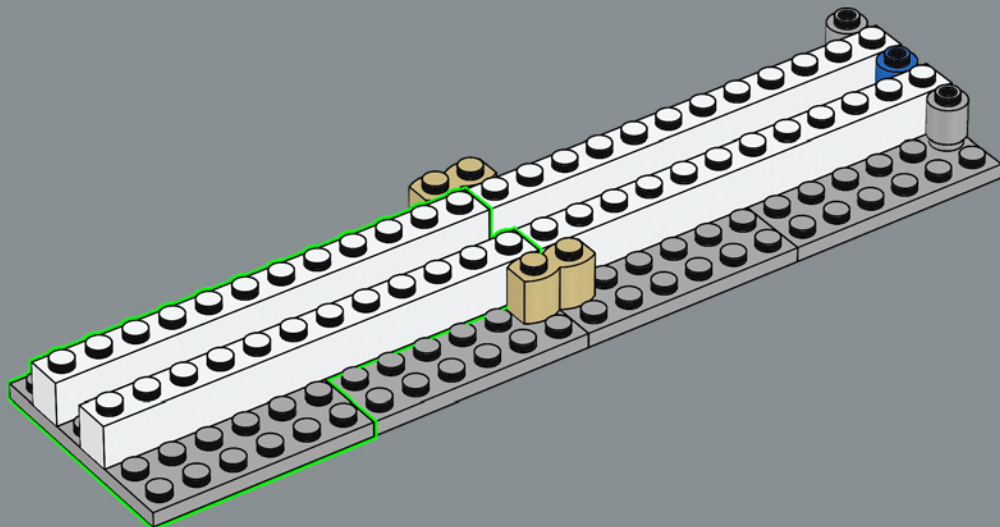

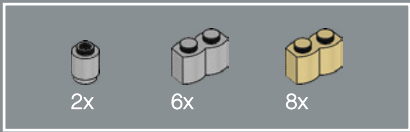

75

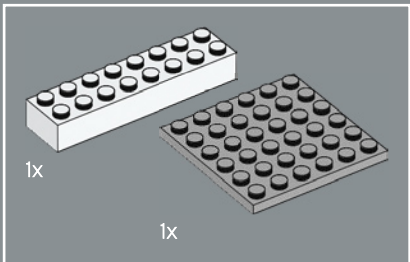
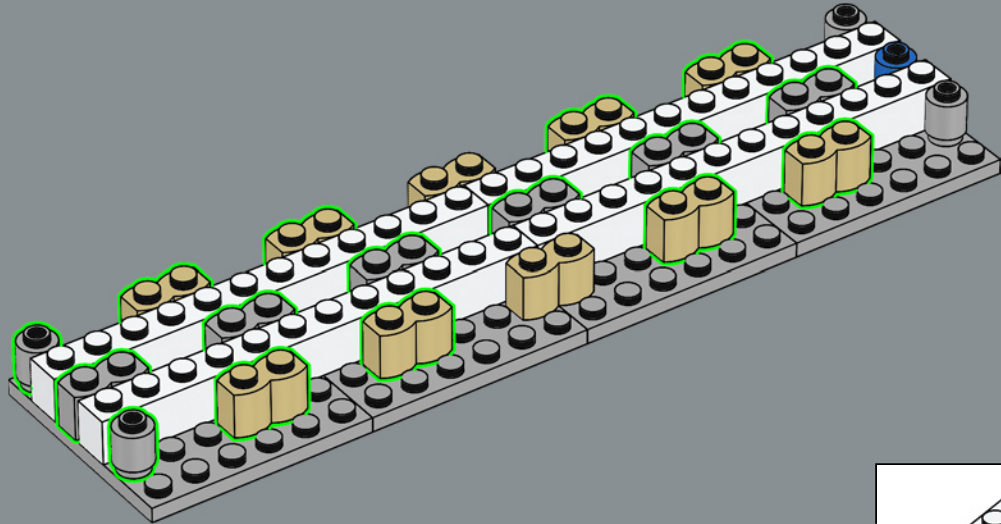

76

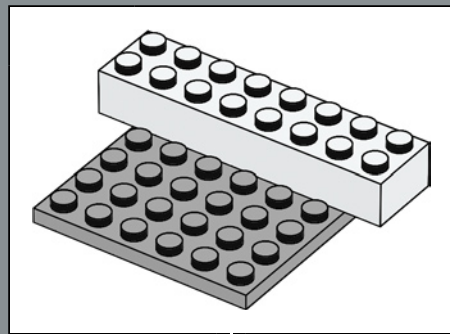
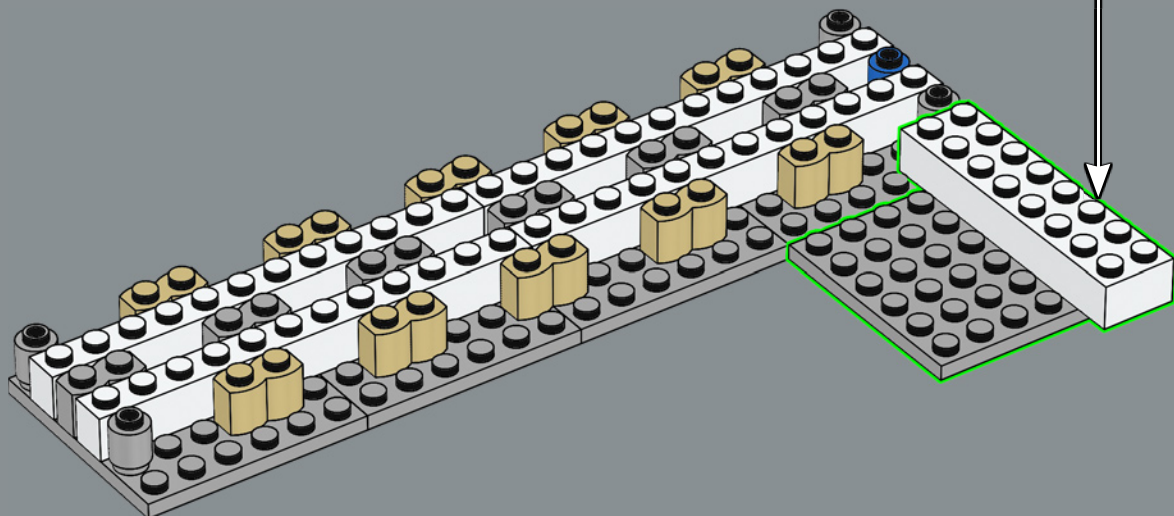

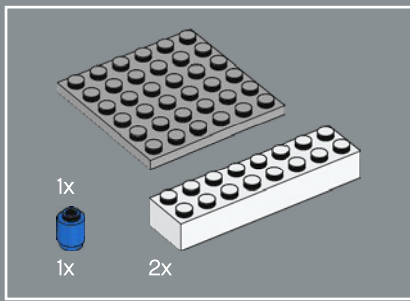

77

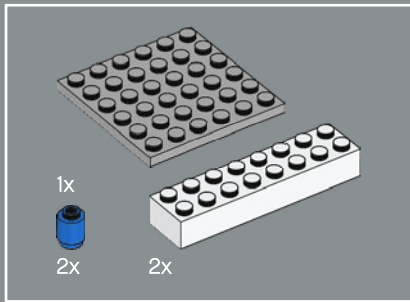
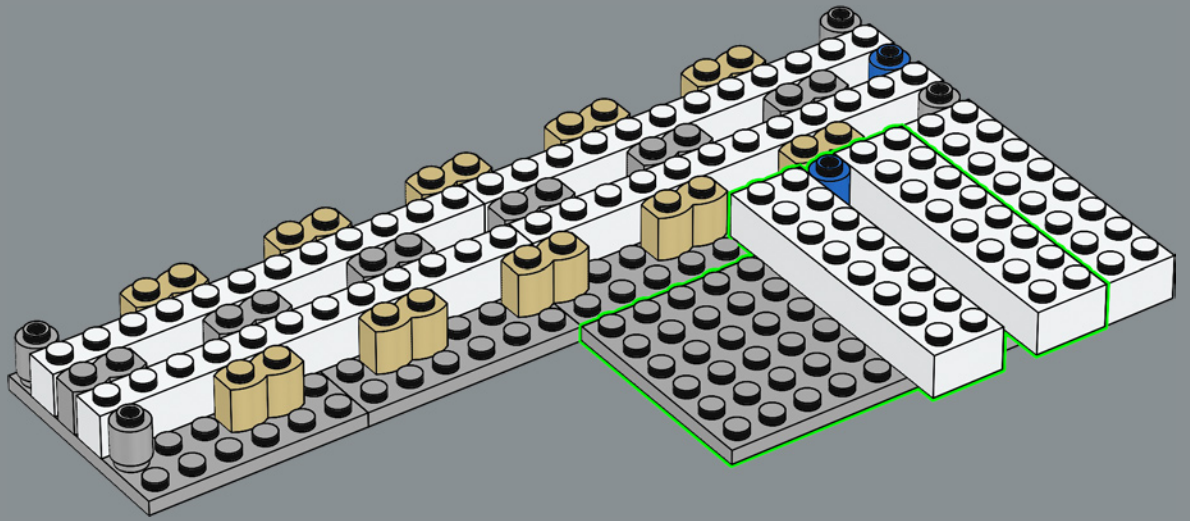

78

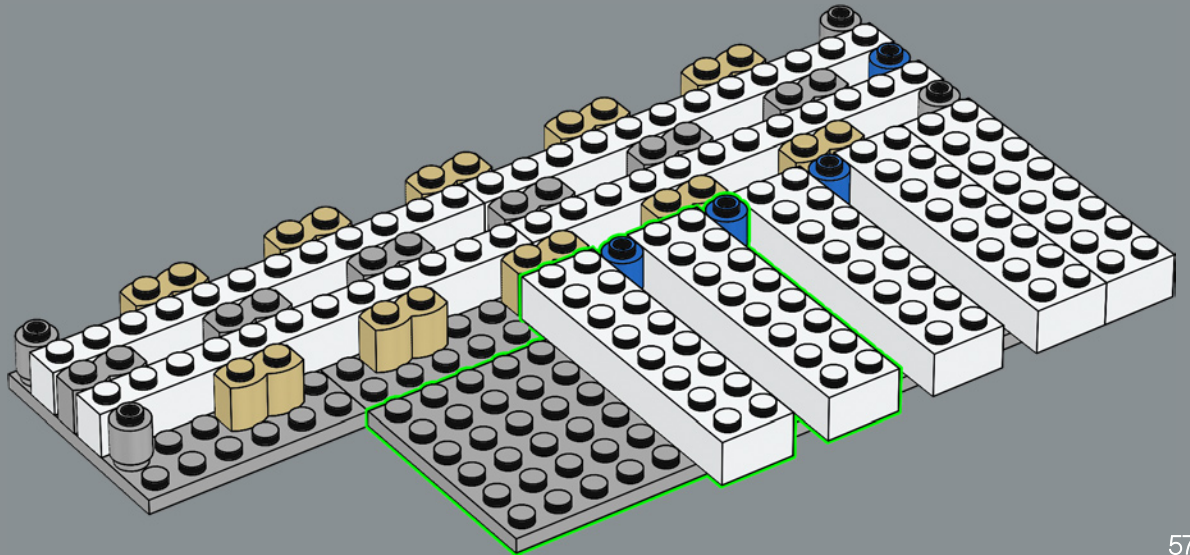

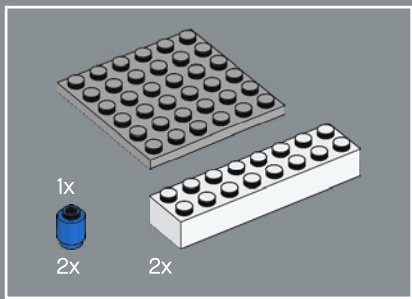

79

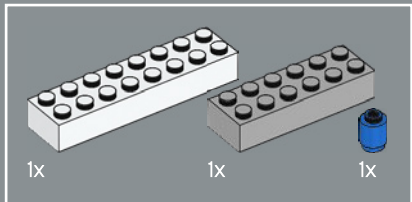
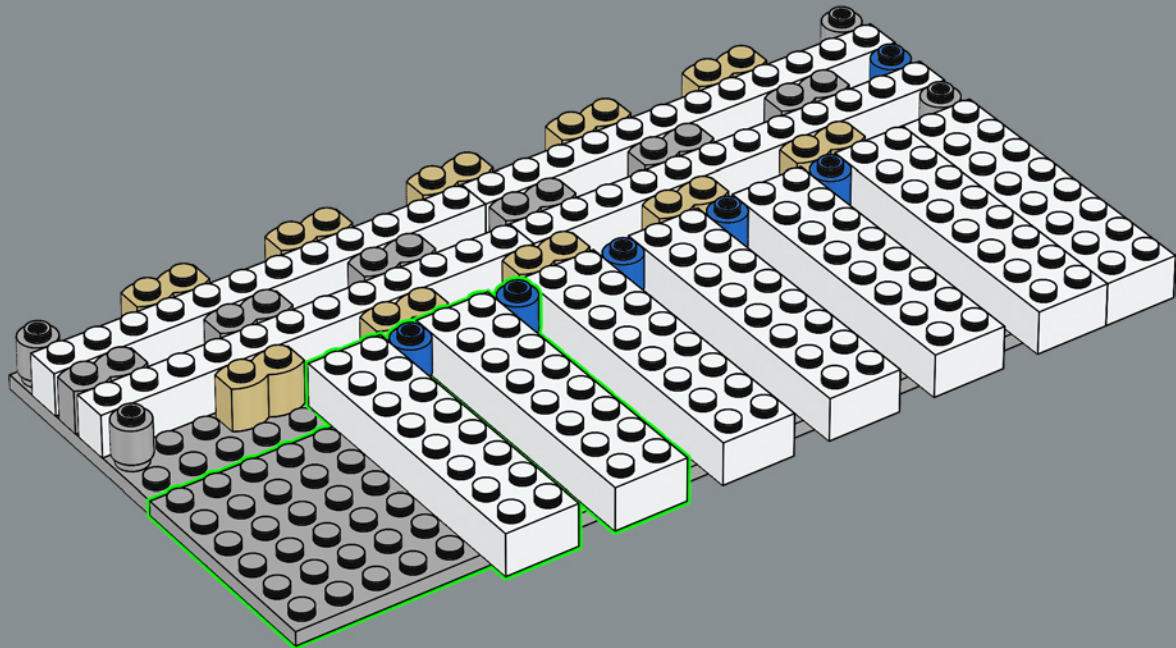

80

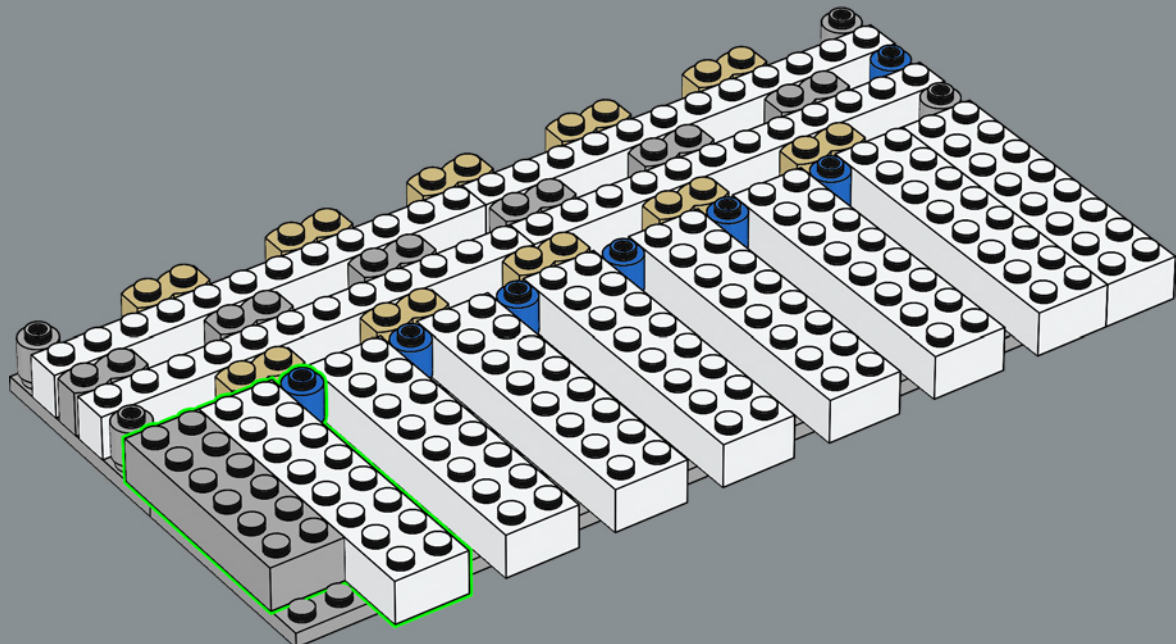

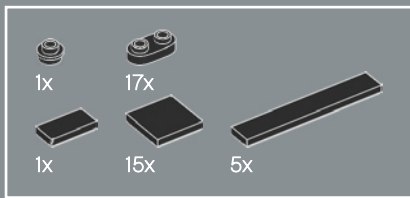

81

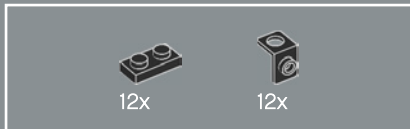
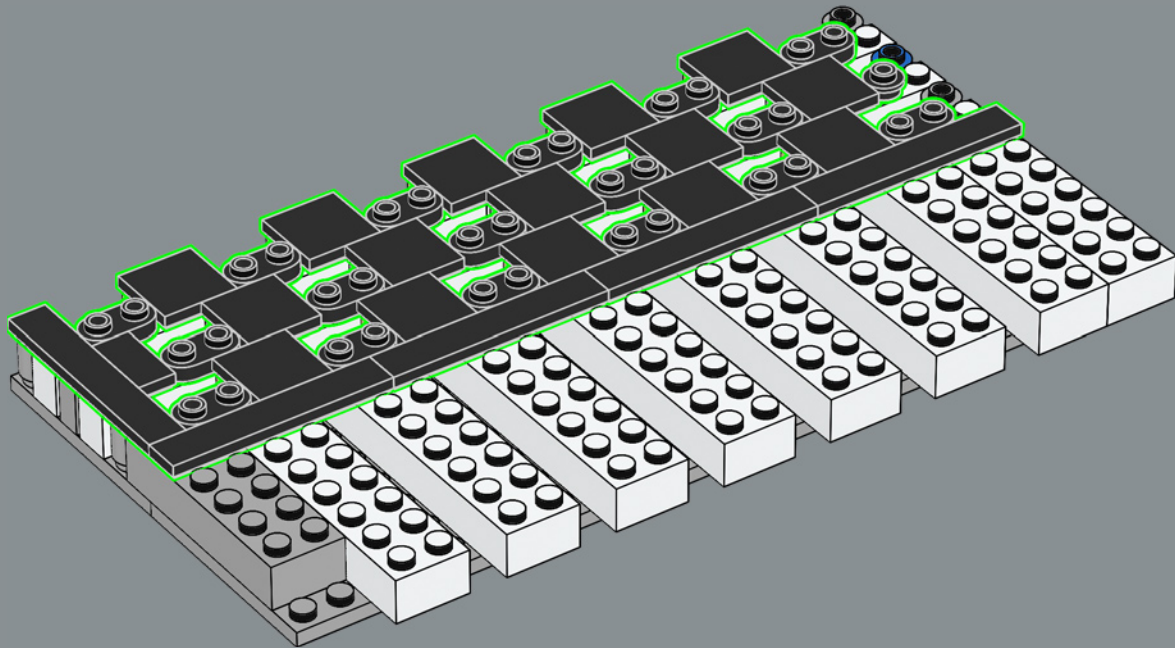

82

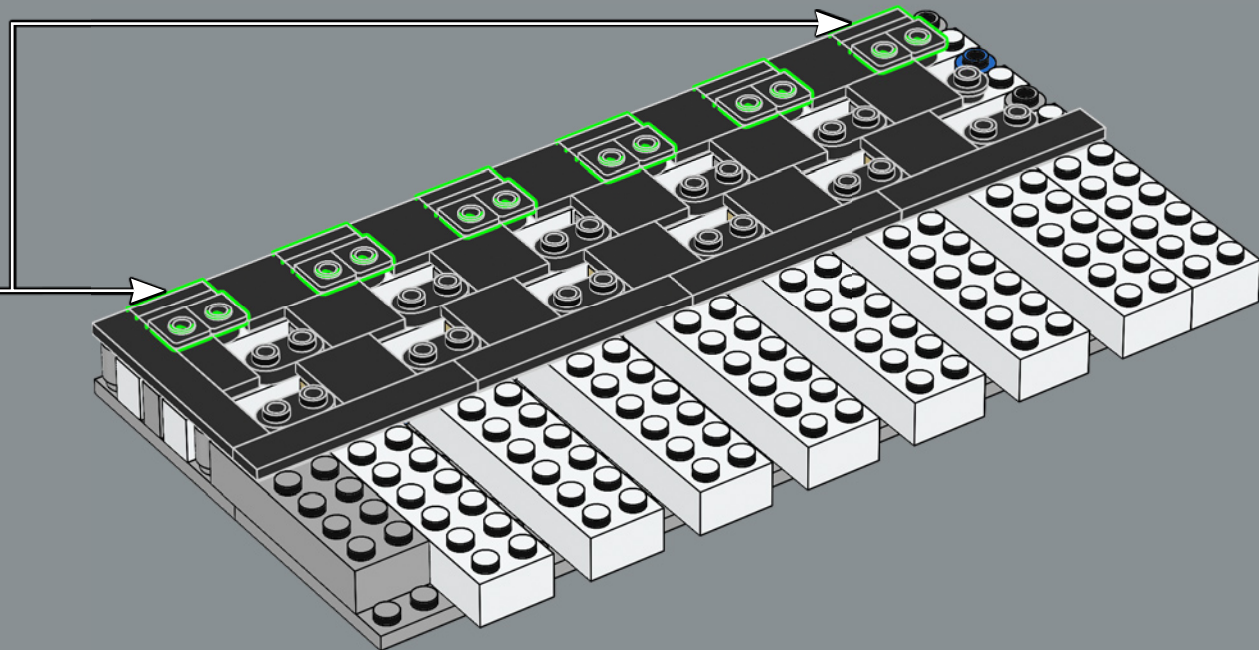
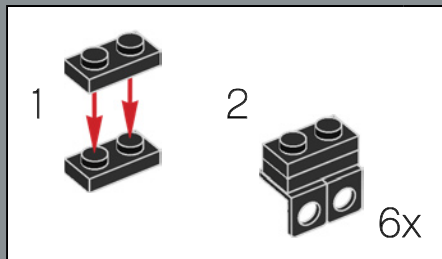



83

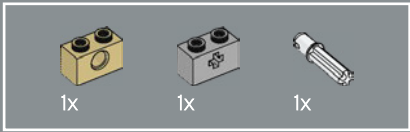
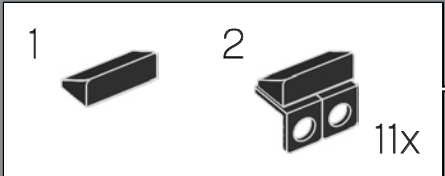
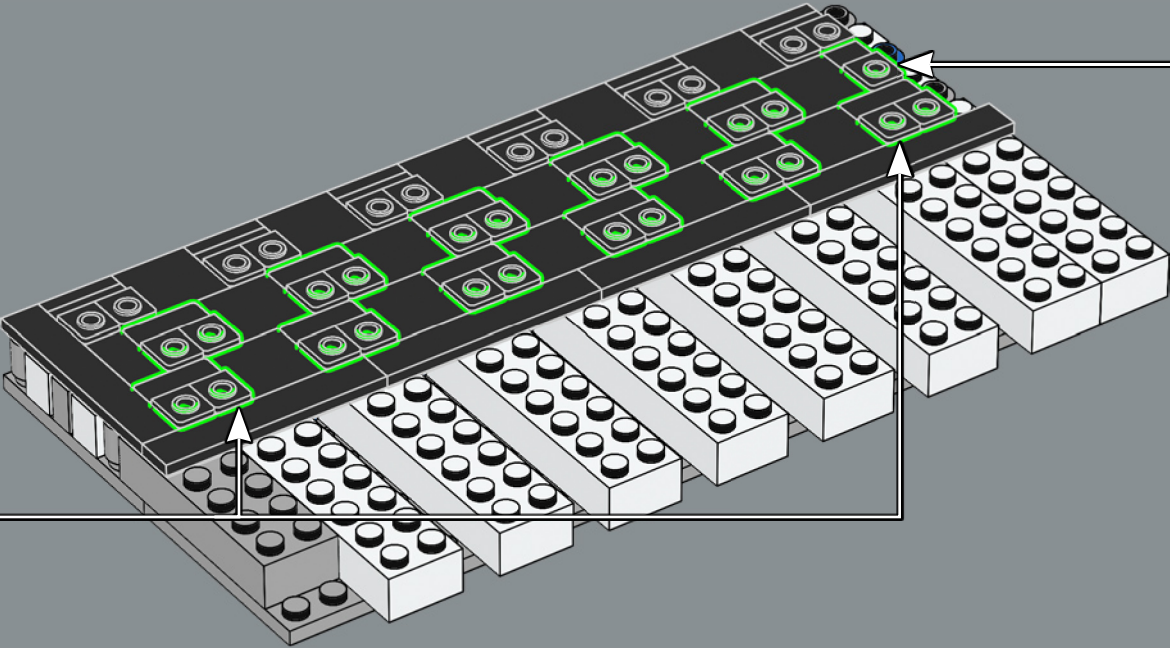
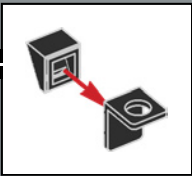

84

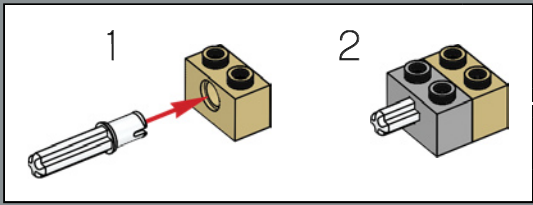
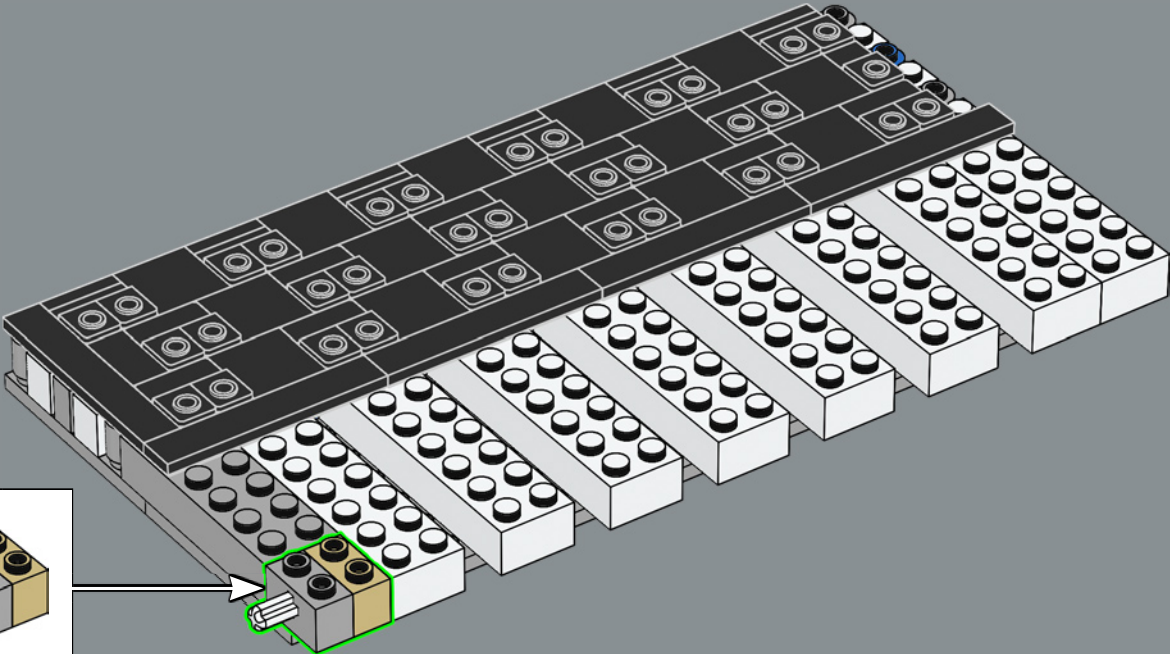

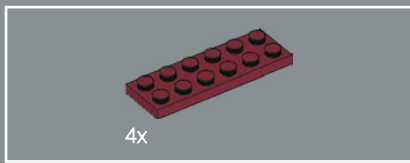

85

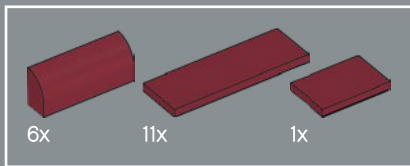
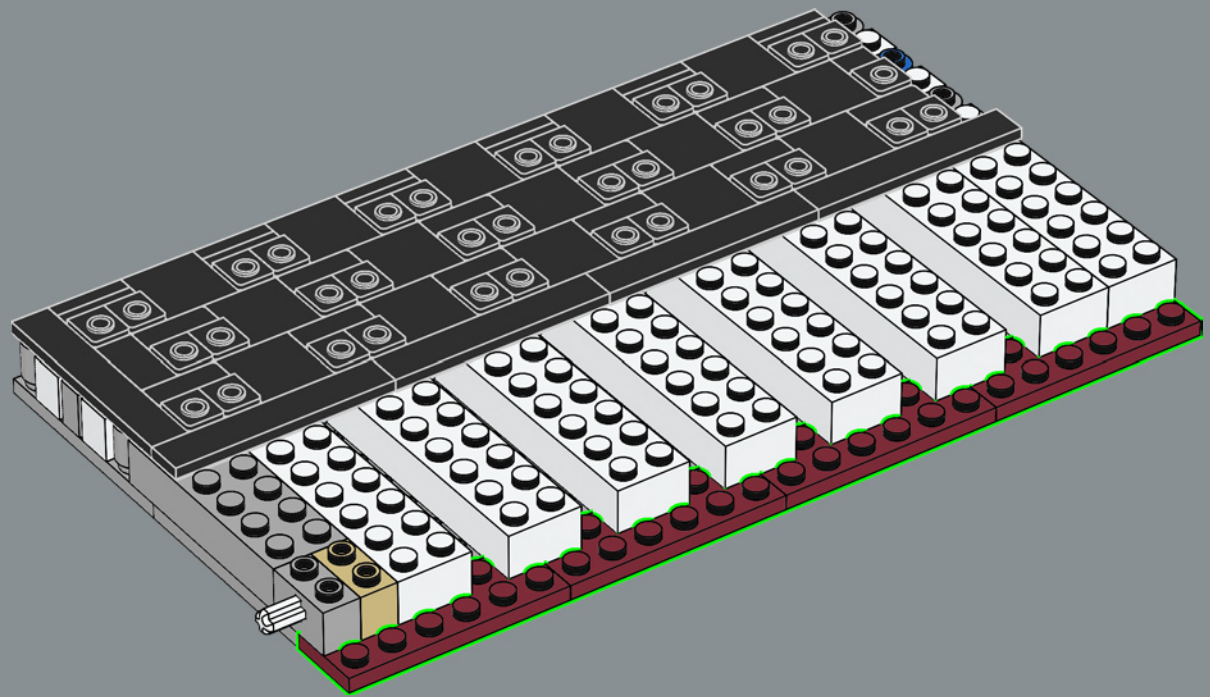

86

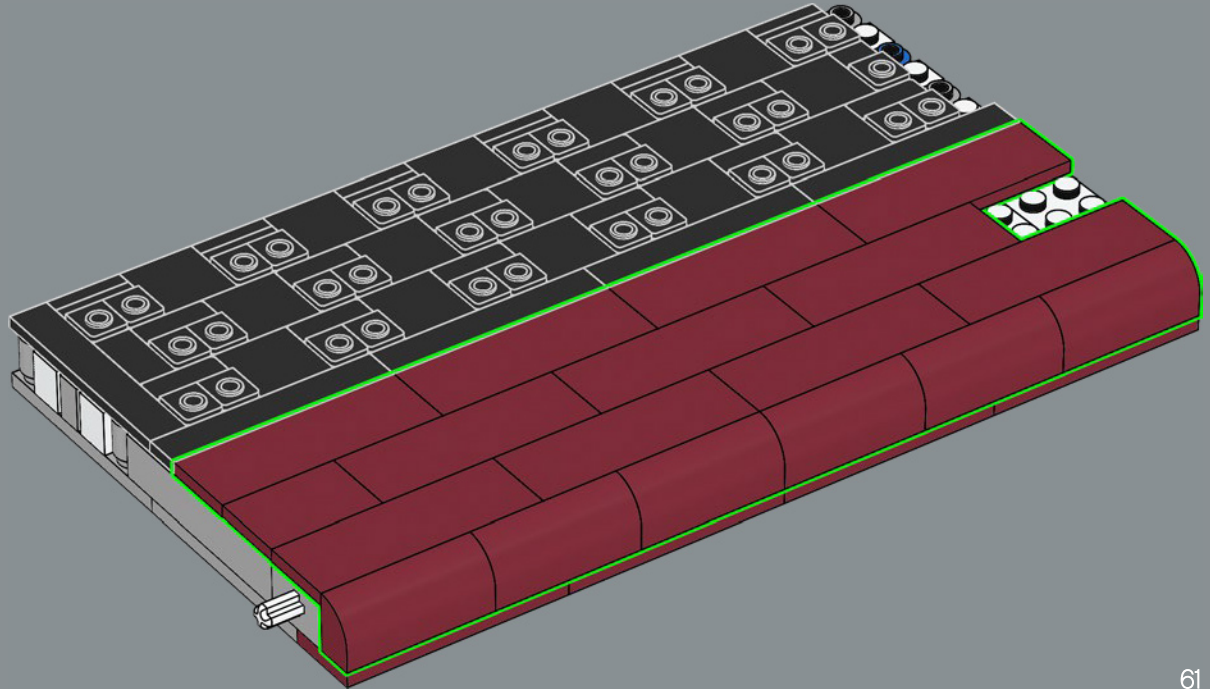

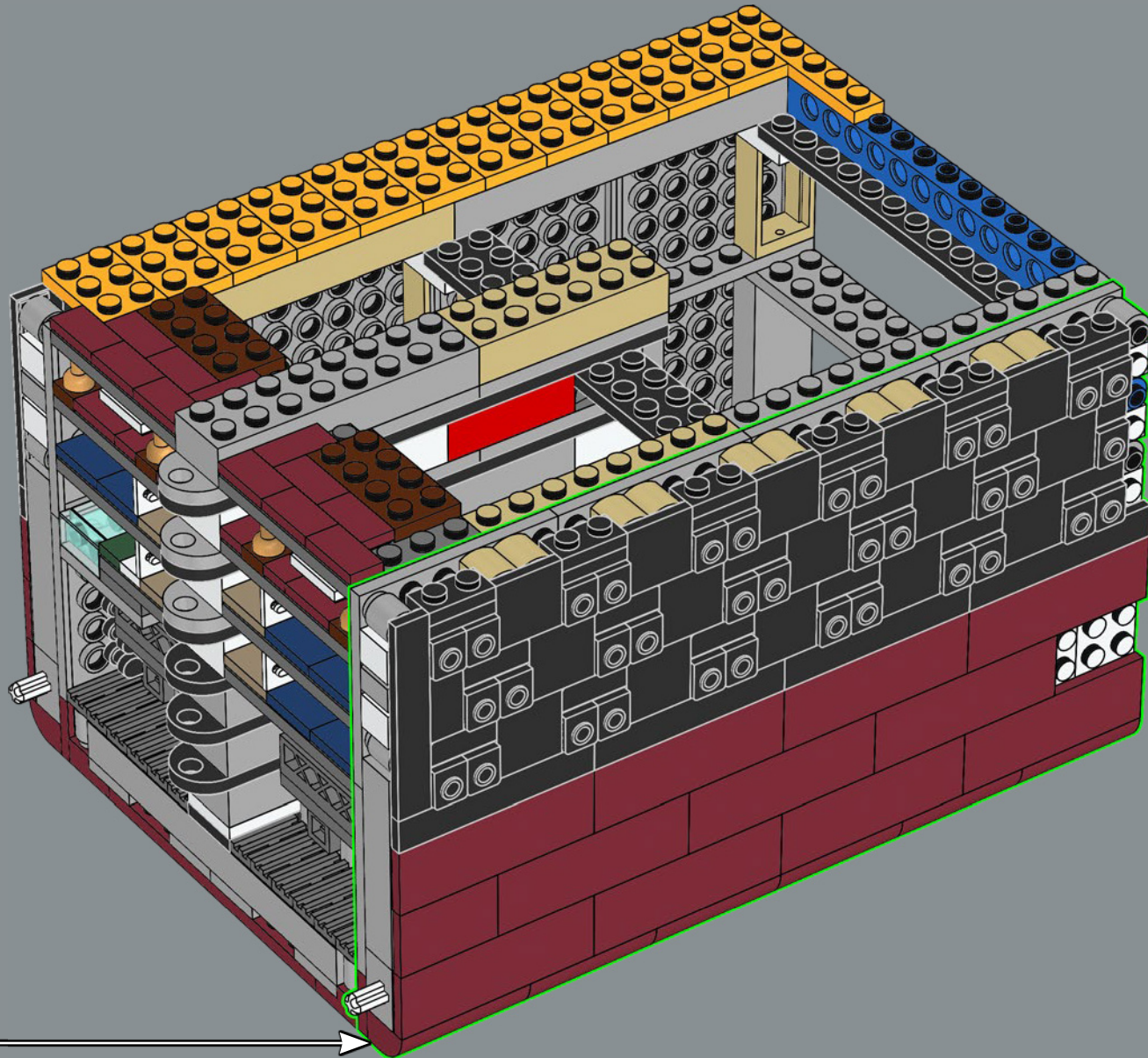

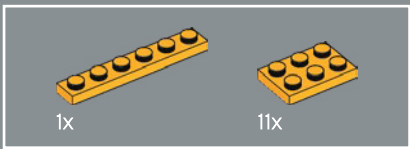

88

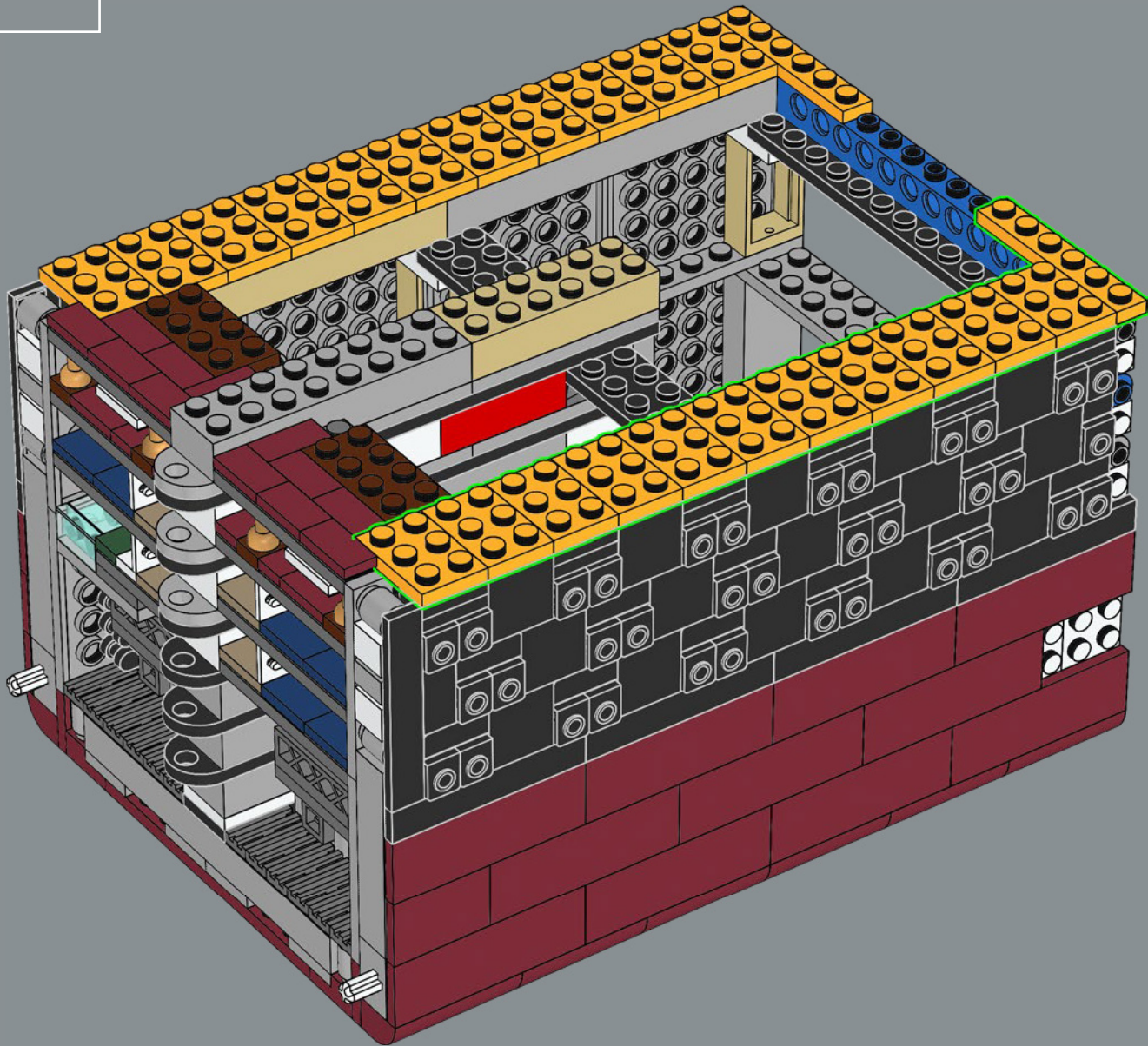

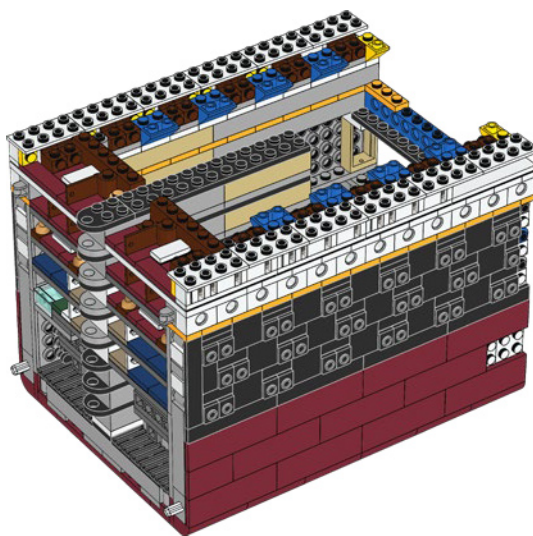
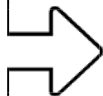

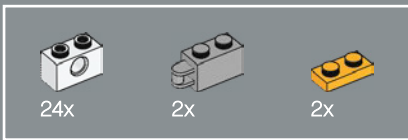

89

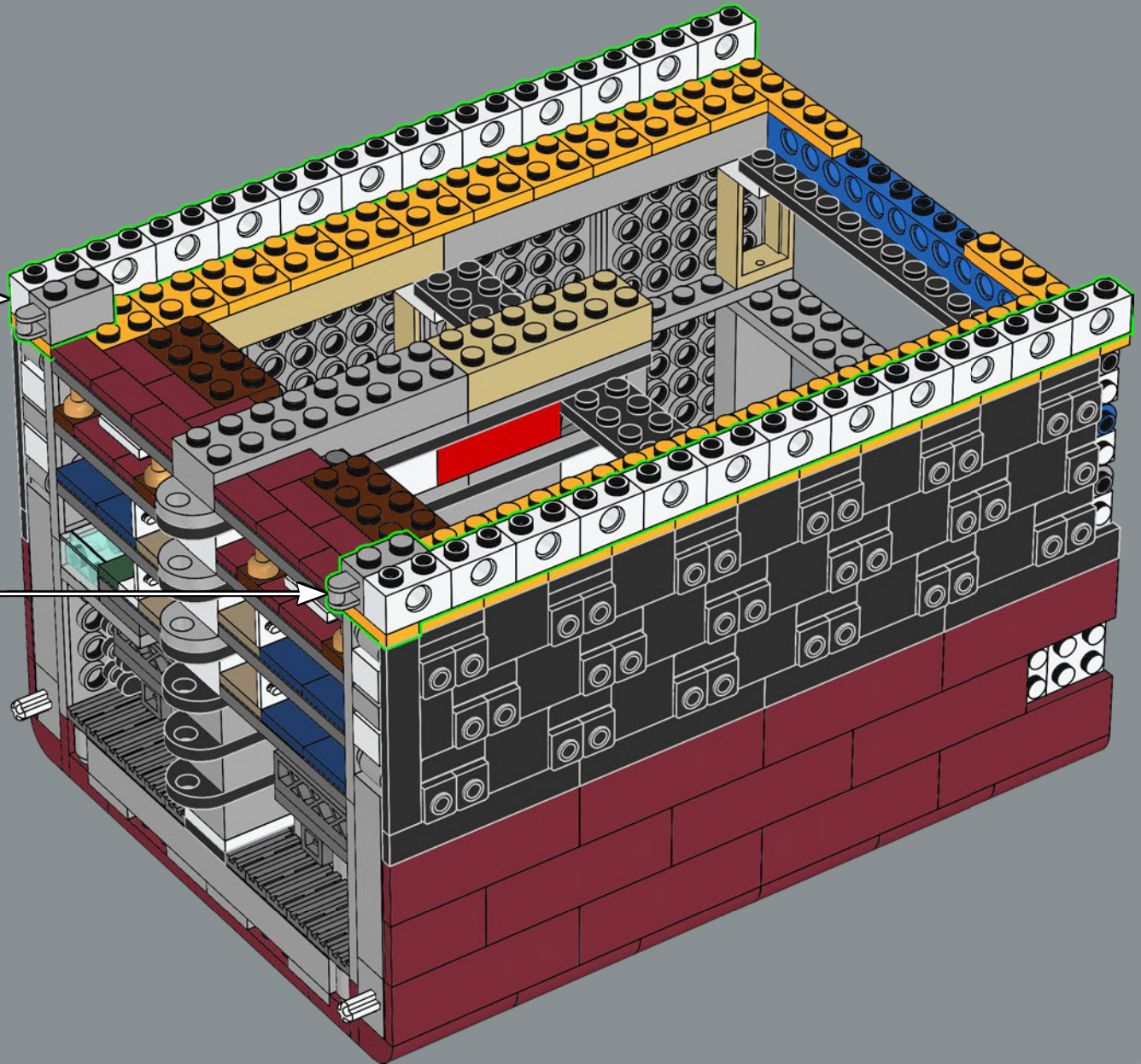
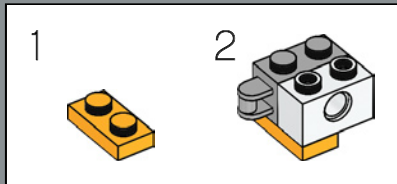
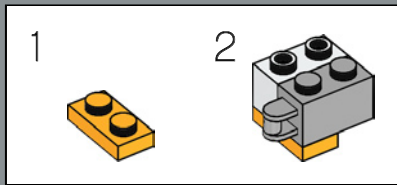

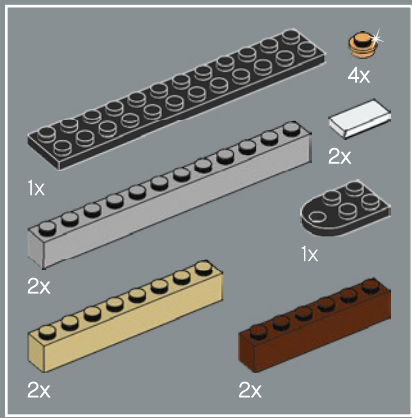

90

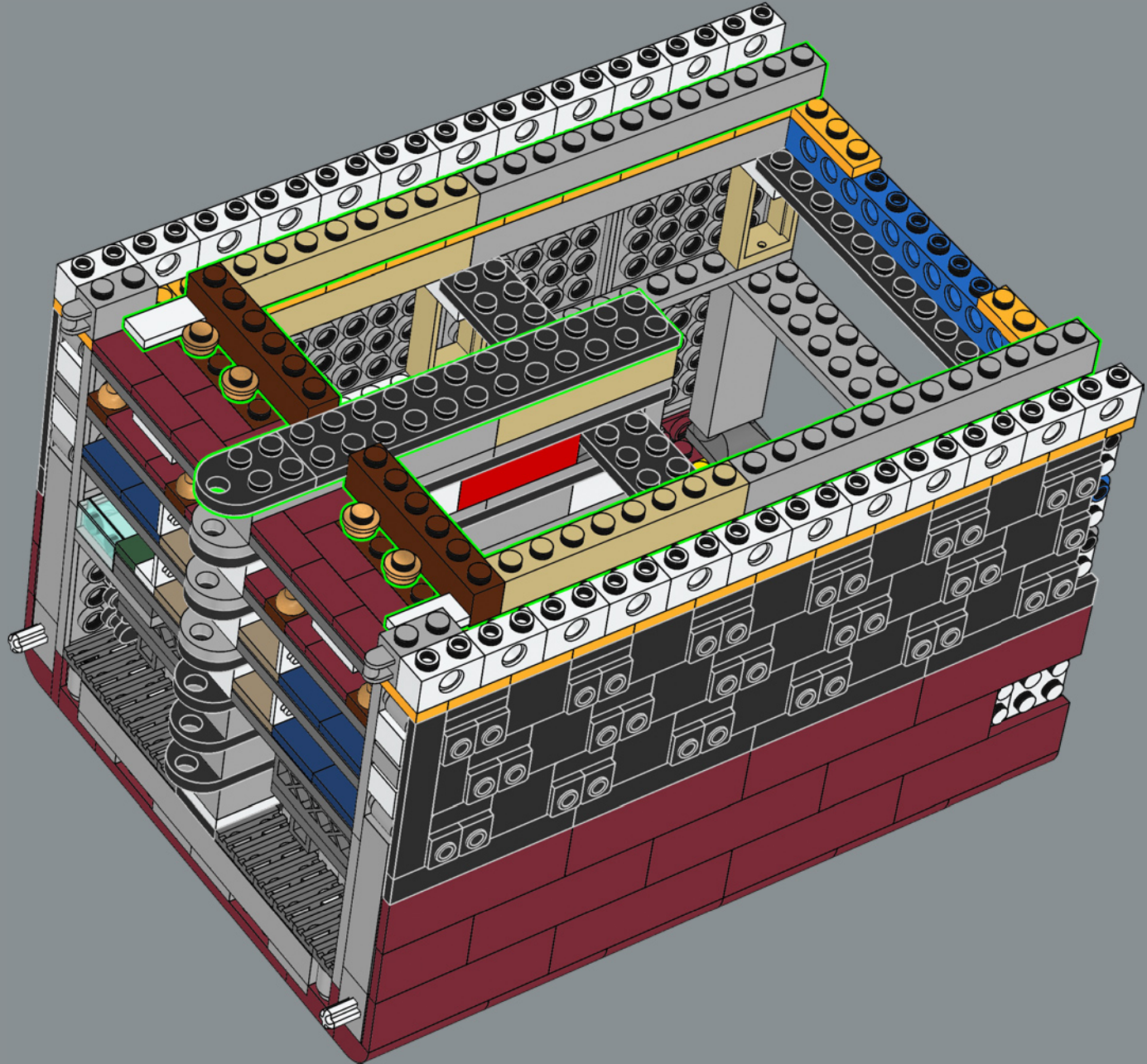

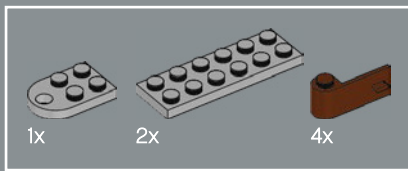

91

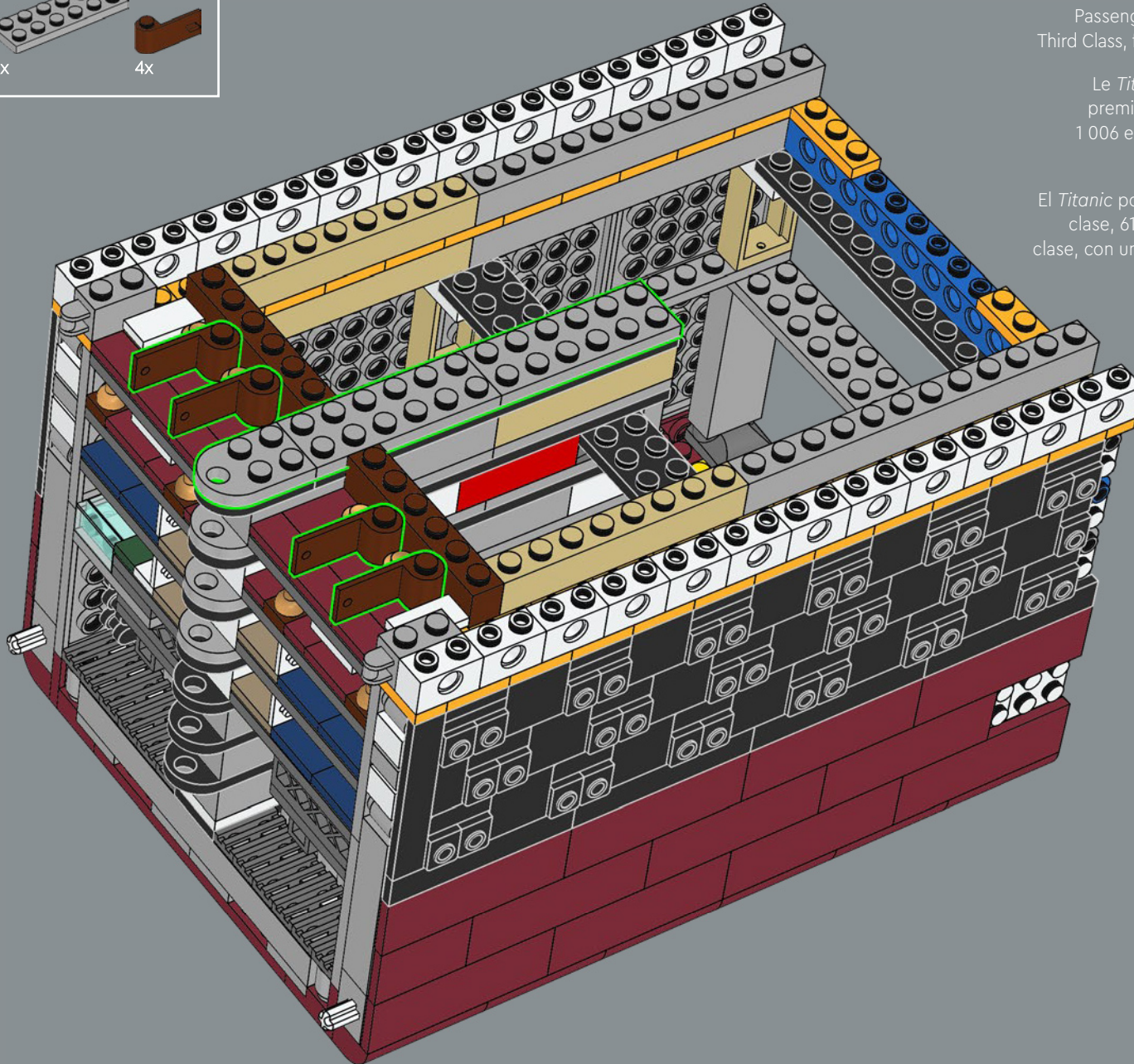

The *Titanic* could accommodate 833 First-Class Passengers, 614 in Second Class and 1,006 in Third Class, for a total passenger capacity of 2,453.

Le *Titanic* peut accueillir 833 passagers en première classe, 614 en deuxième classe et 1 006 en troisième classe, pour une capacité totale de 2 453 passagers.

El *Titanic* podía alojar a 833 pasajeros en primera clase, 614 en segunda clase y 1006 en tercera clase, con una capacidad total de 2453 pasajeros.

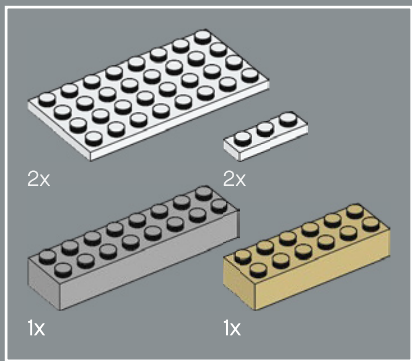

92

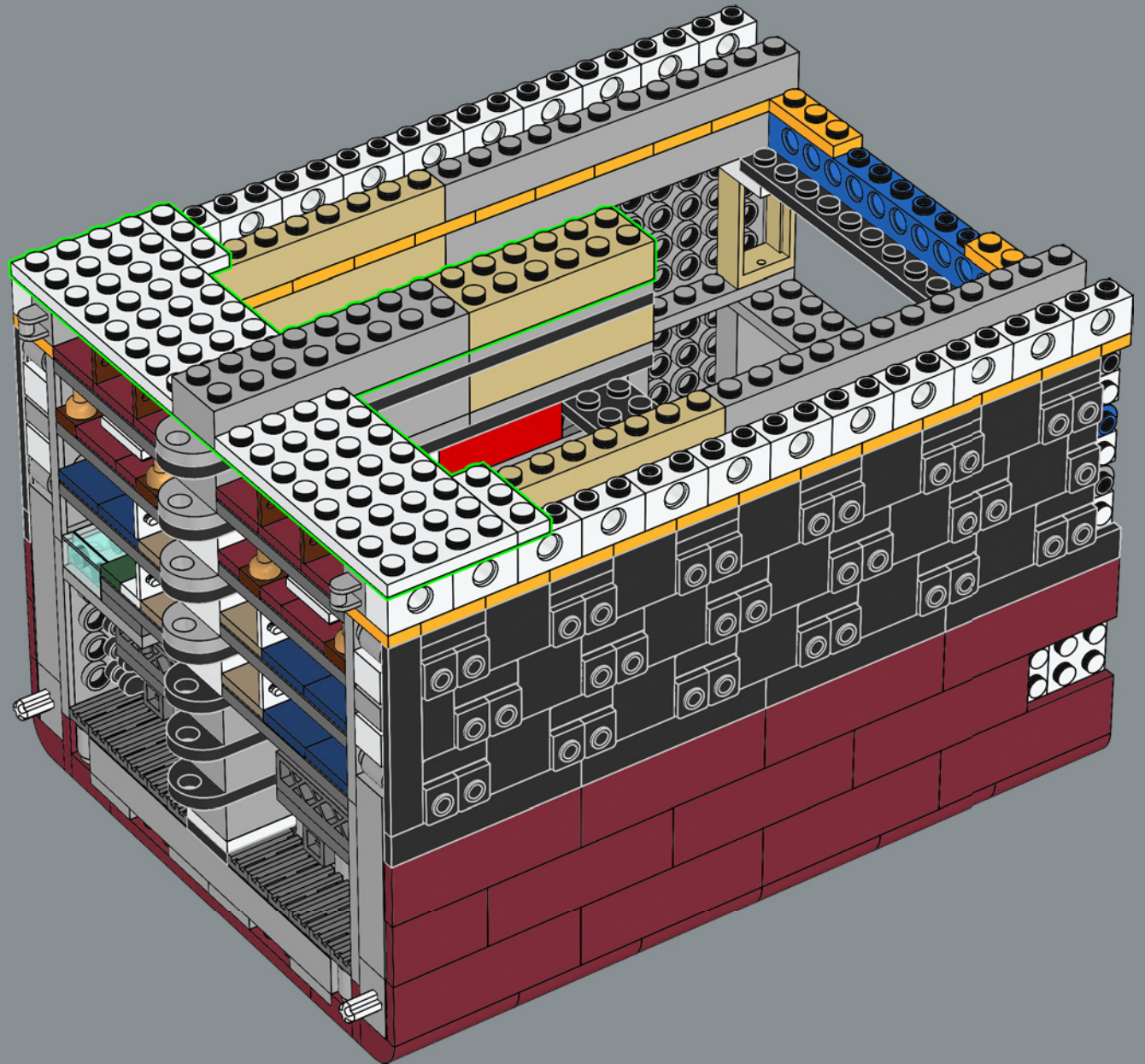

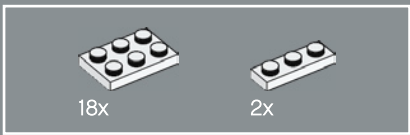

93

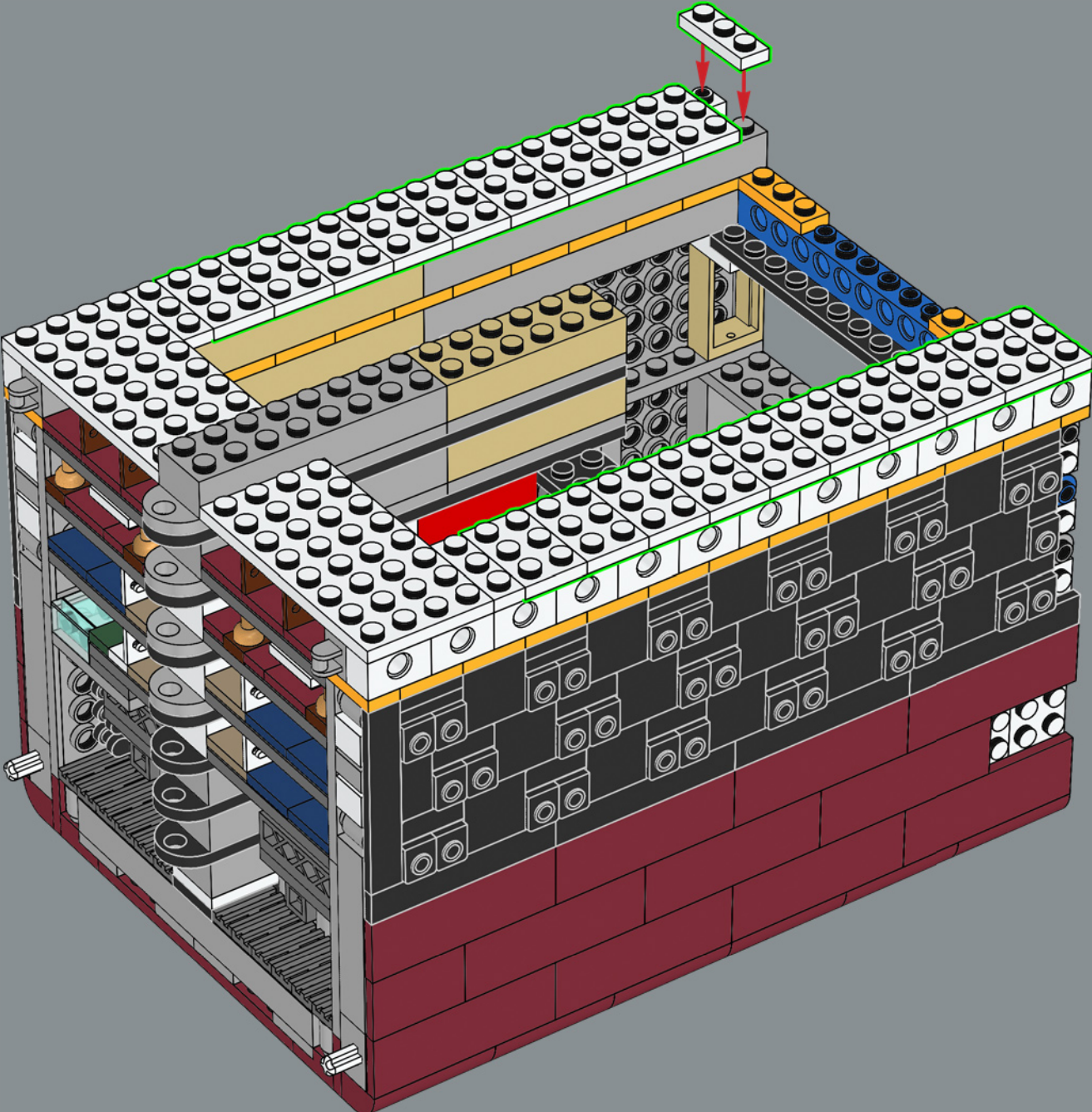

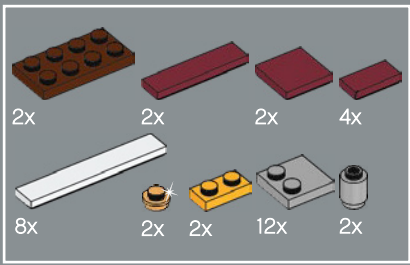

94

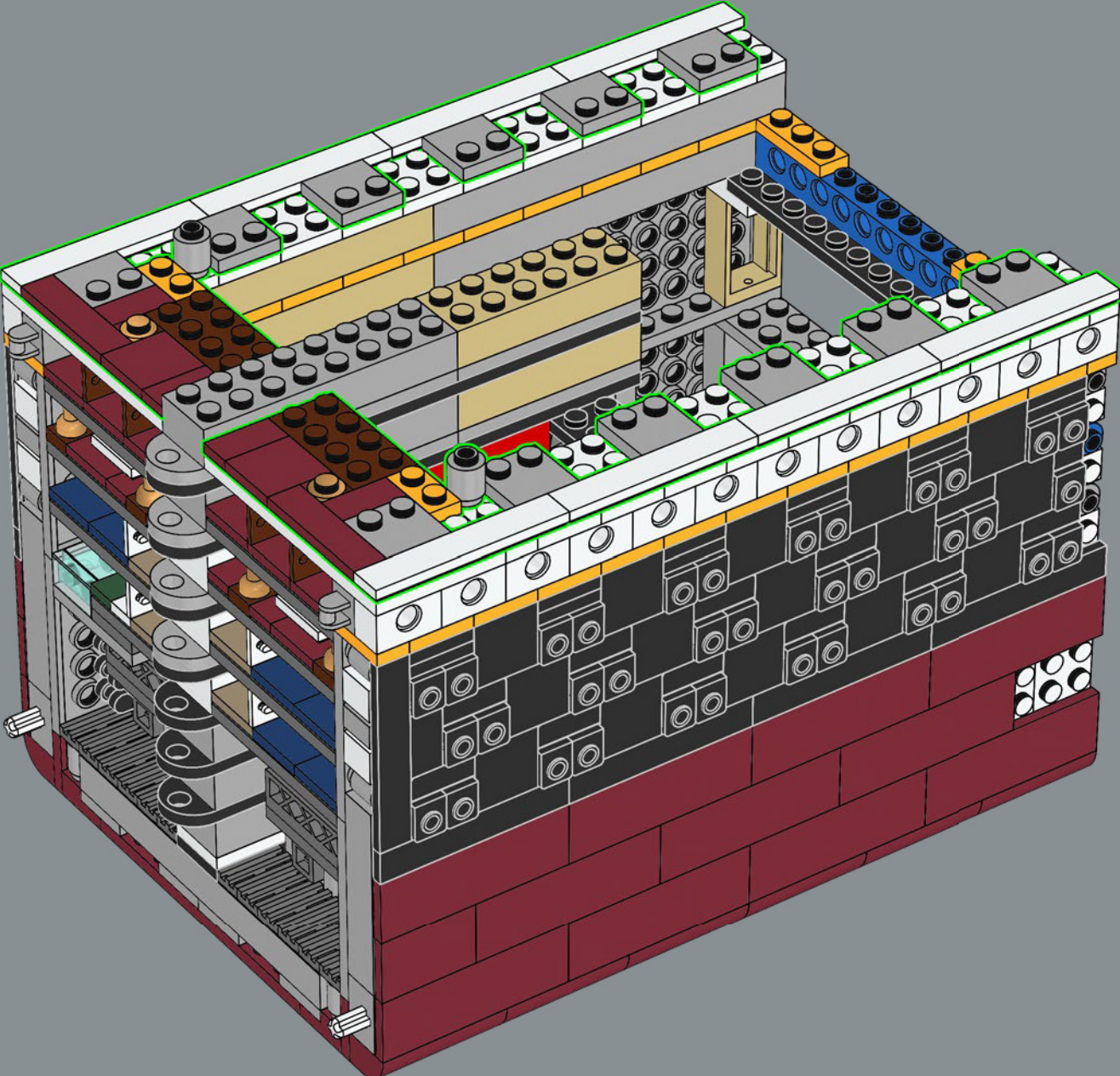

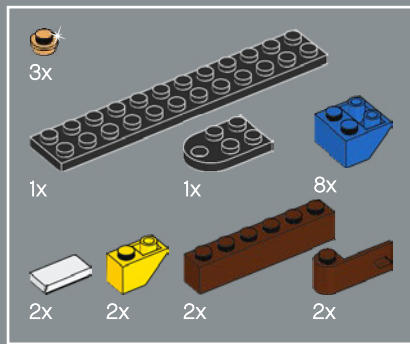

95

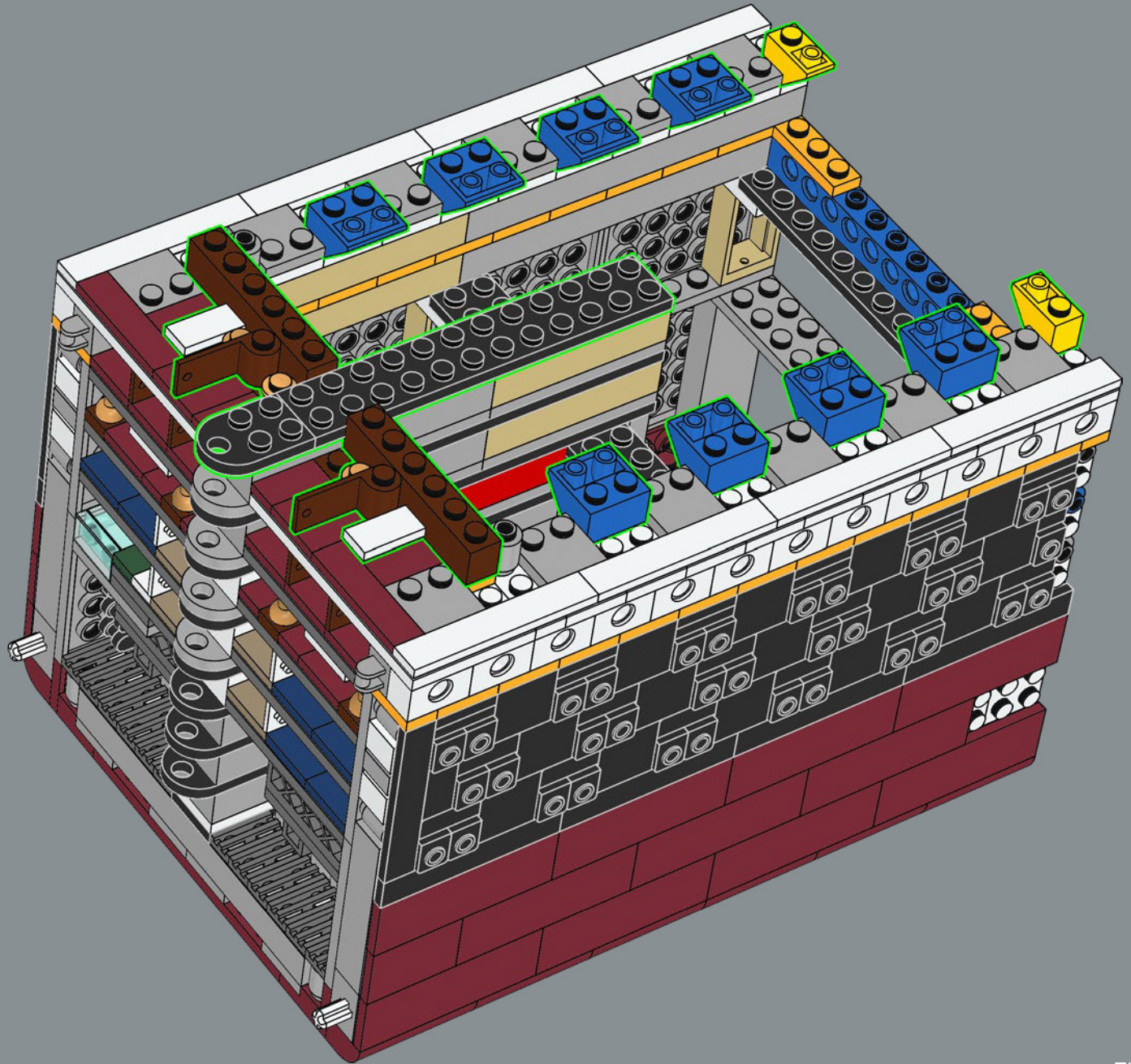

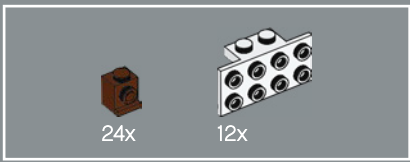

96

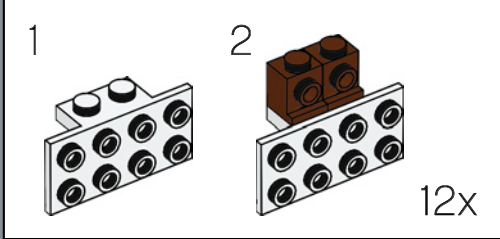
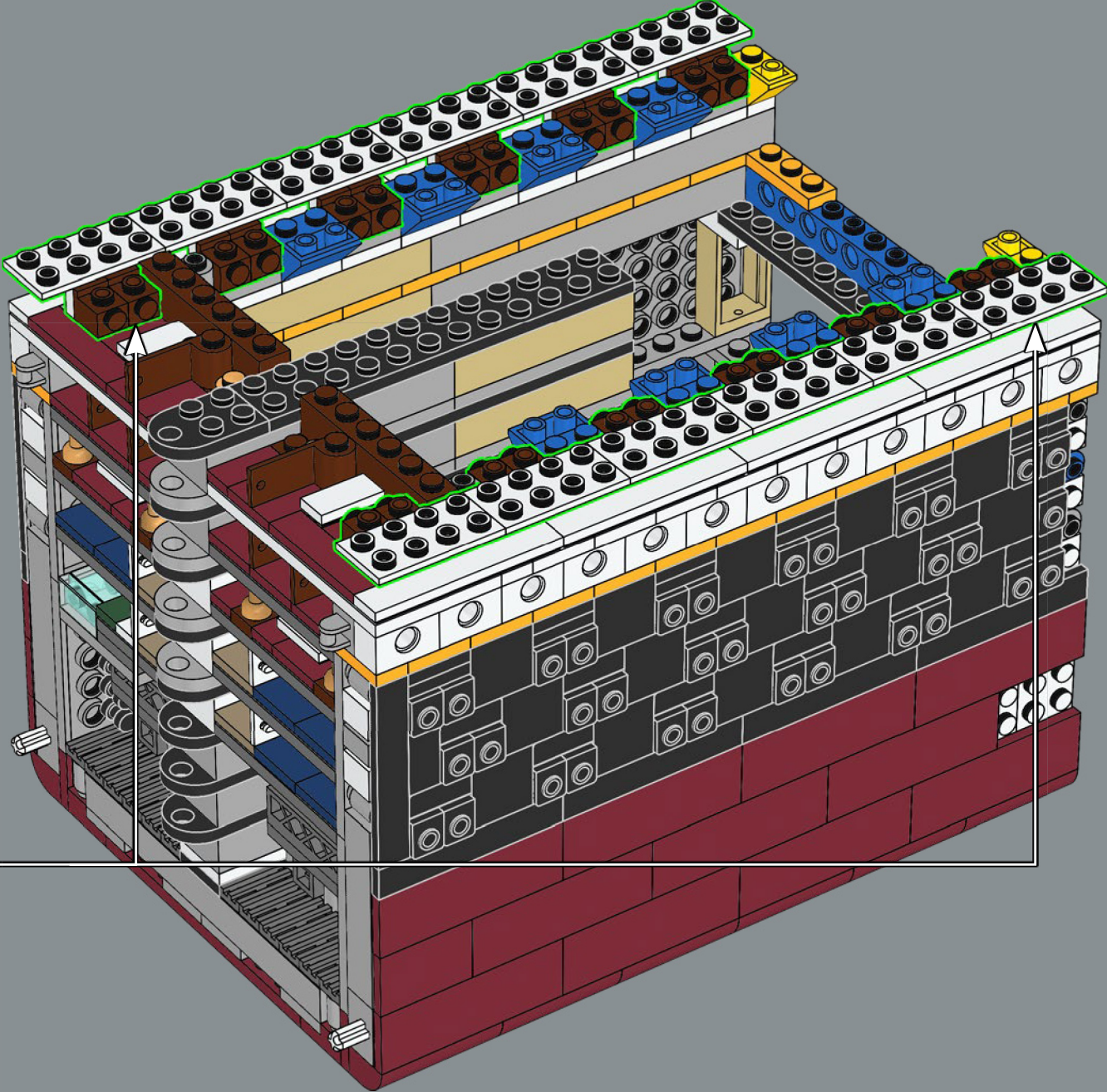

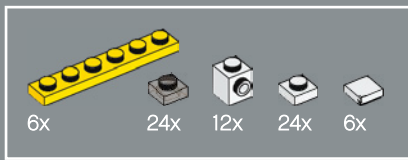

97

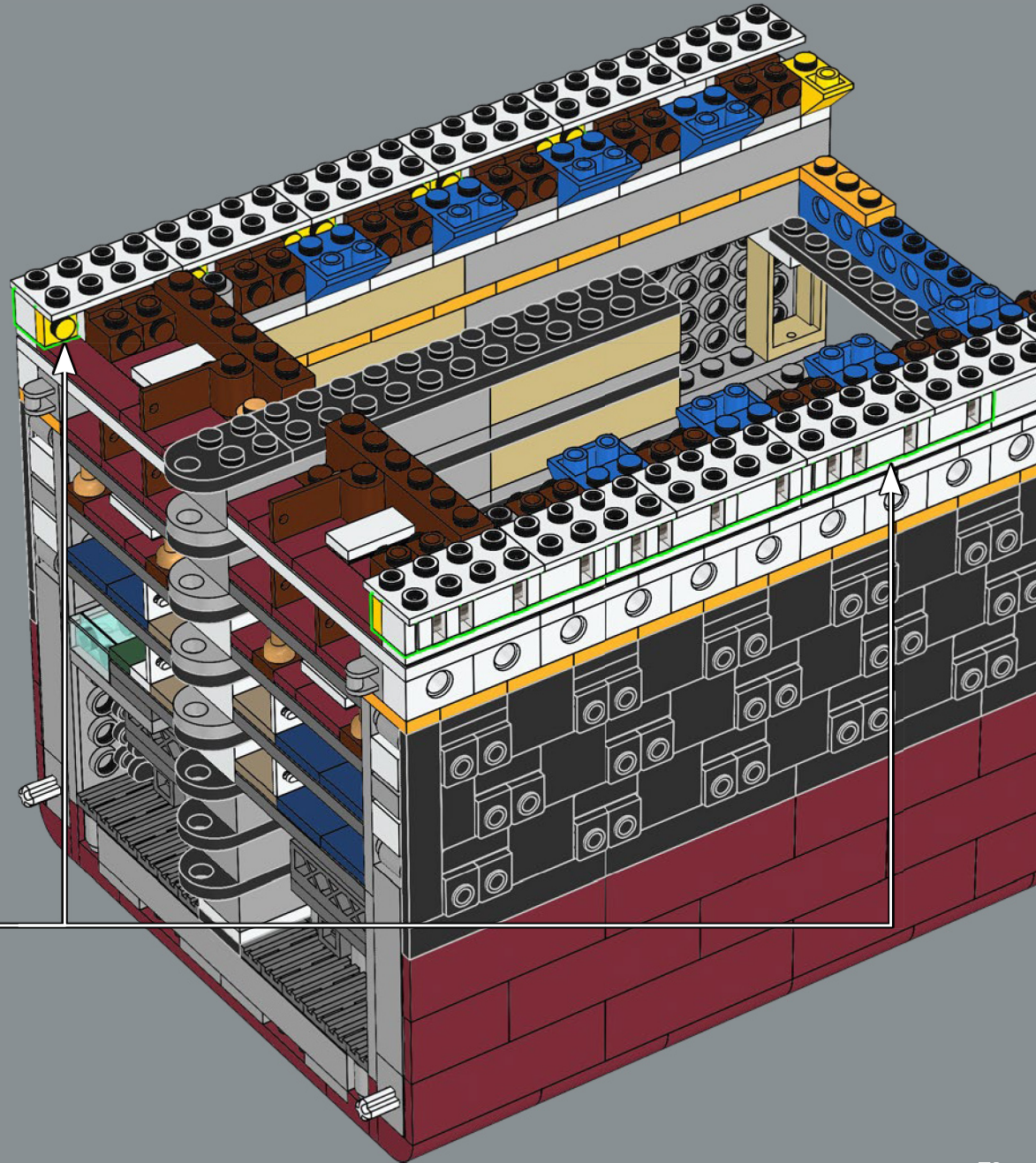
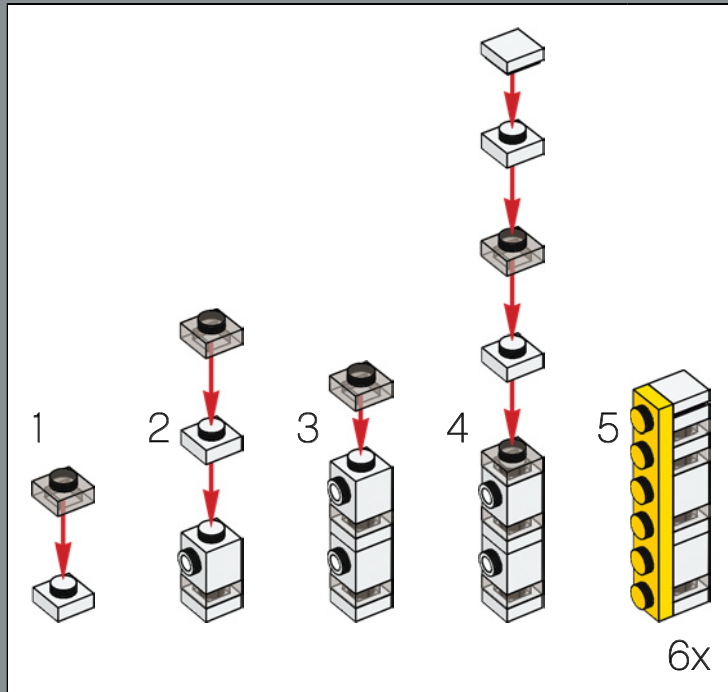

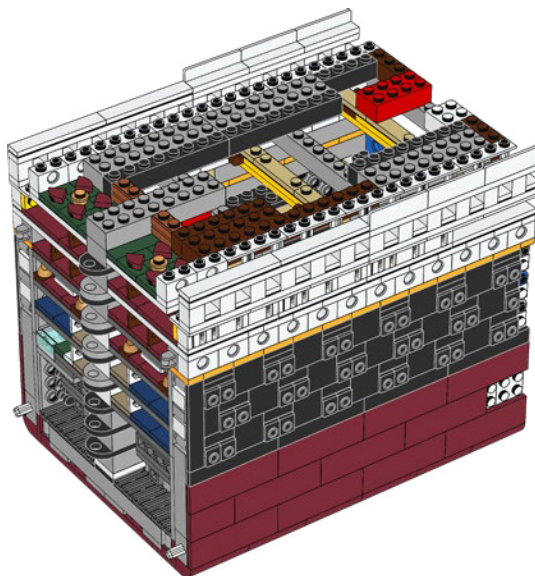
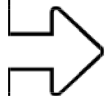

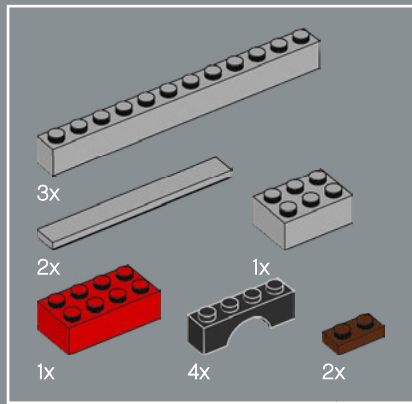

98

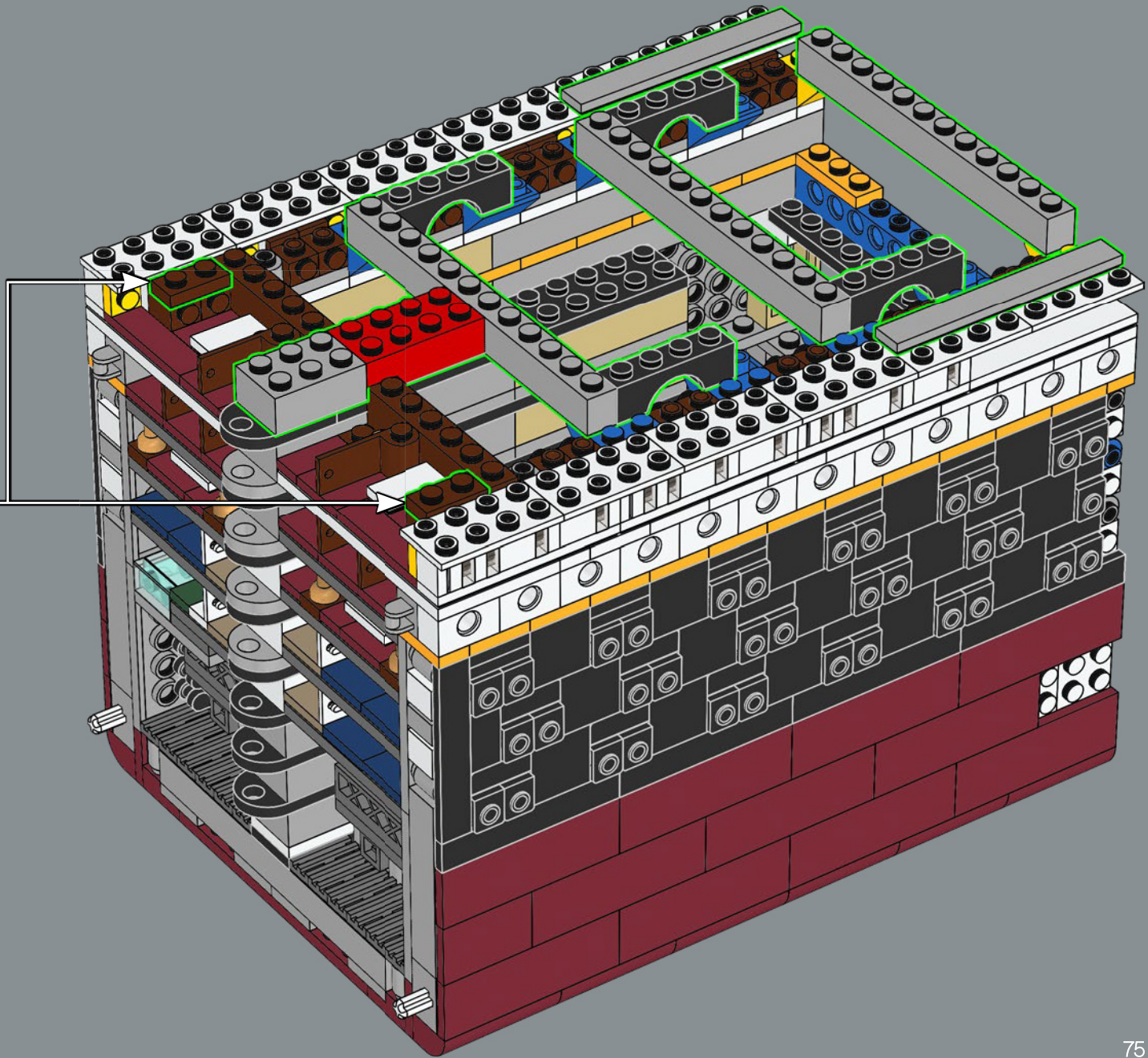
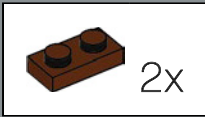

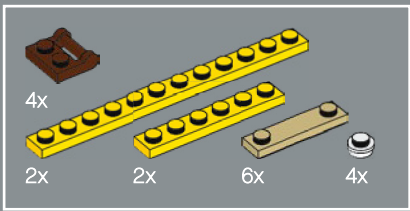

99

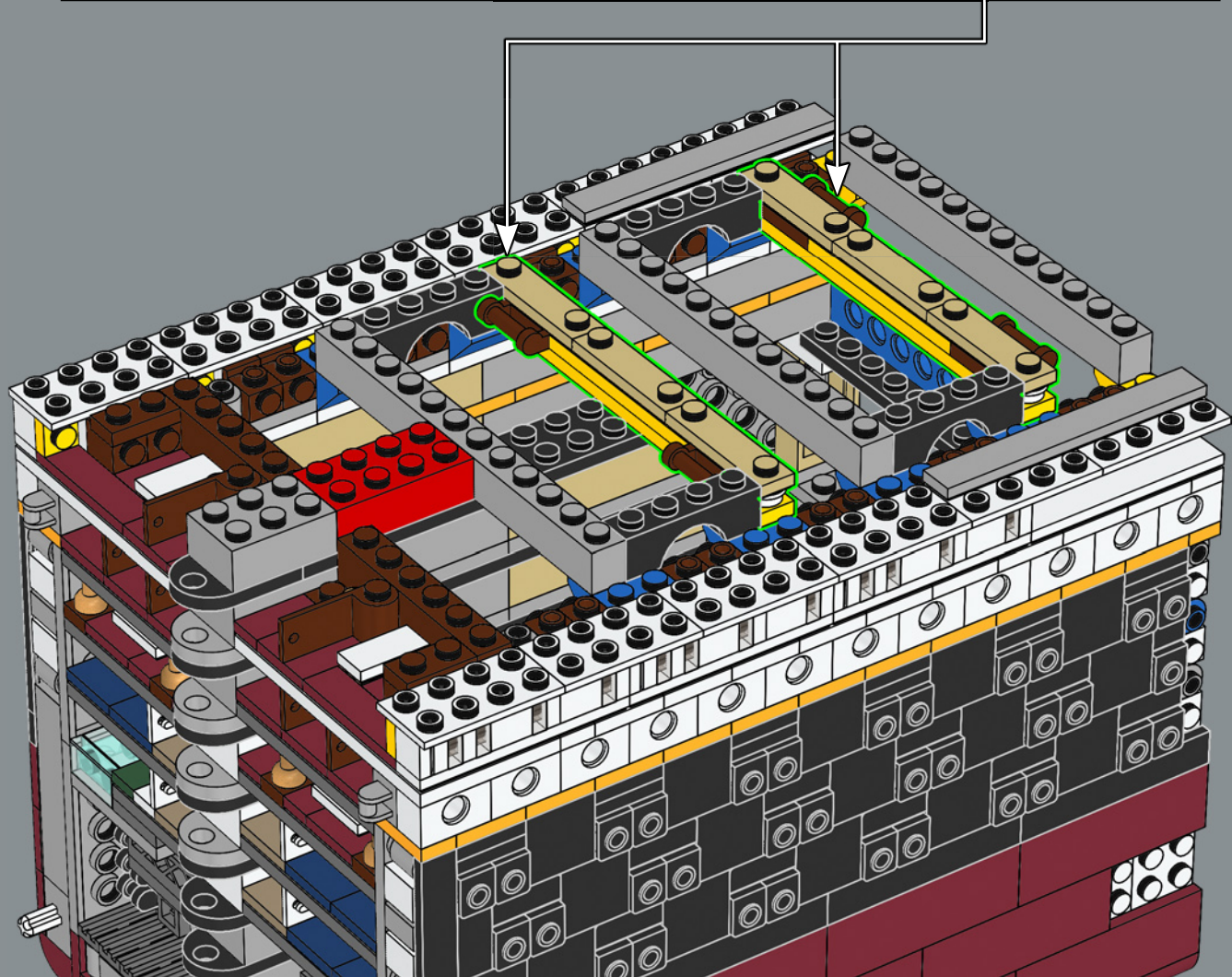
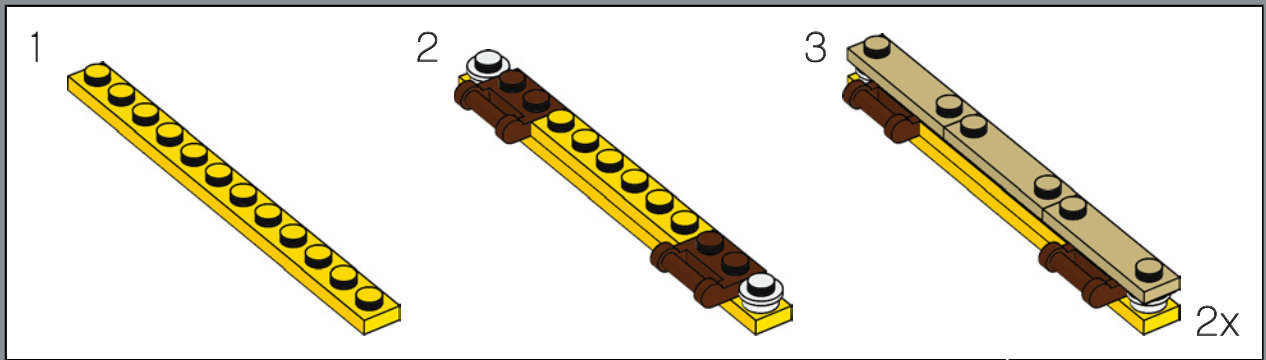

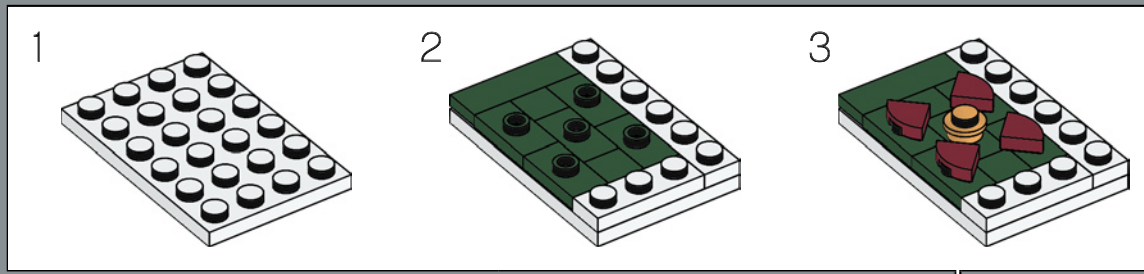
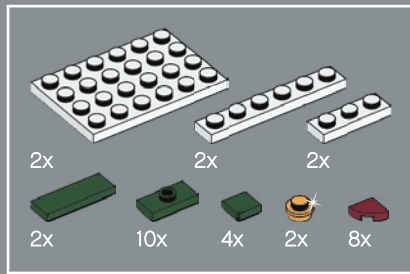

100

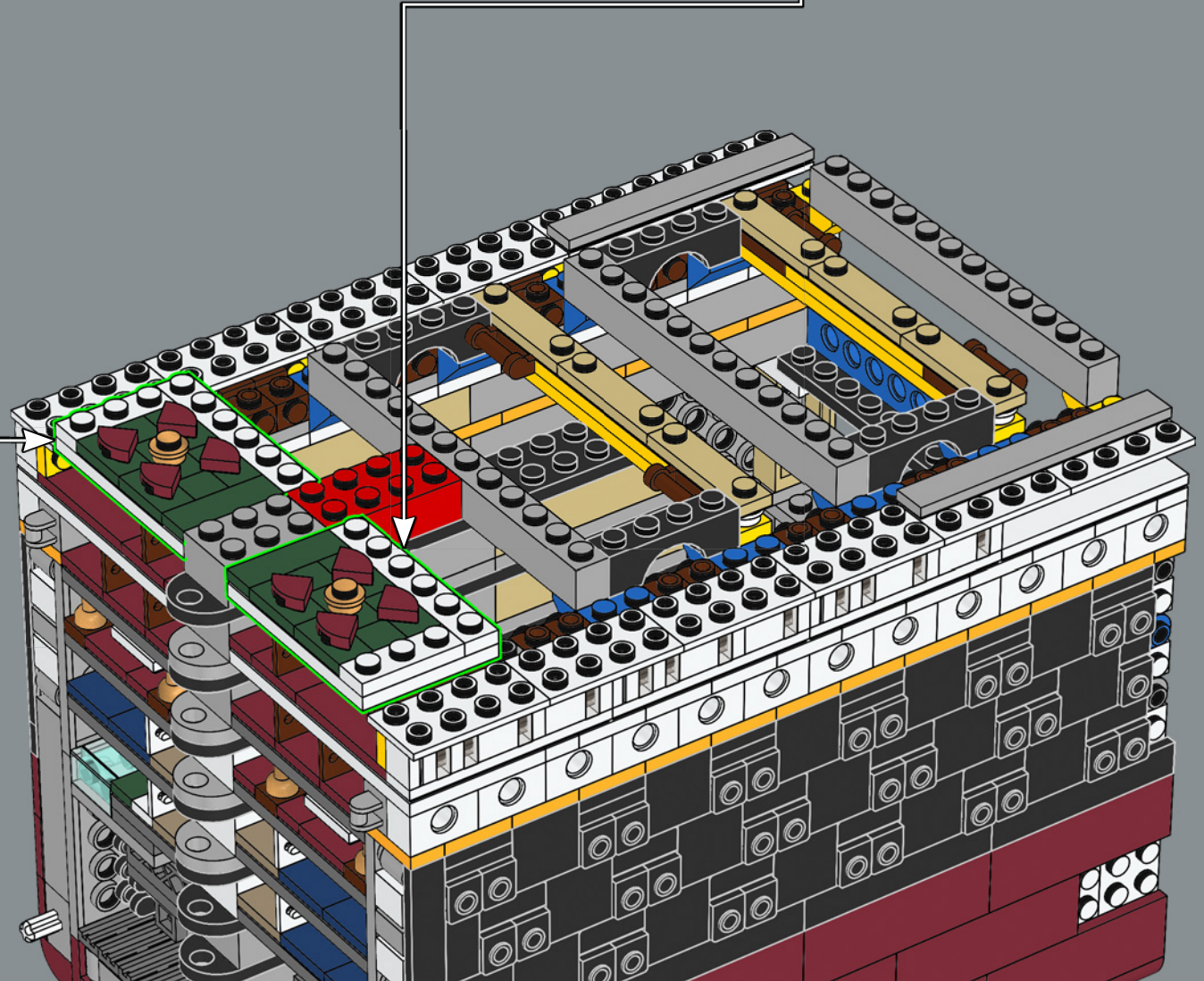
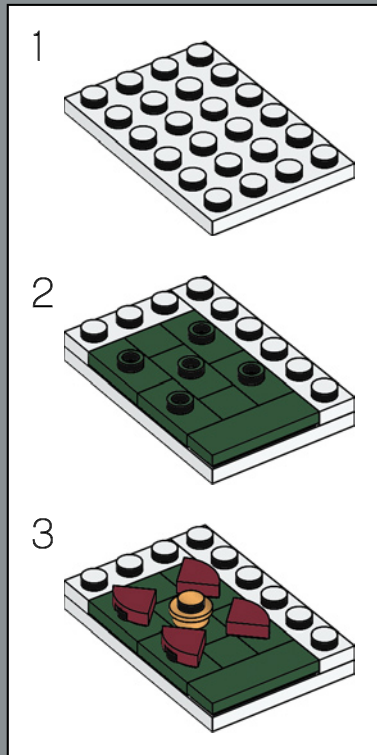

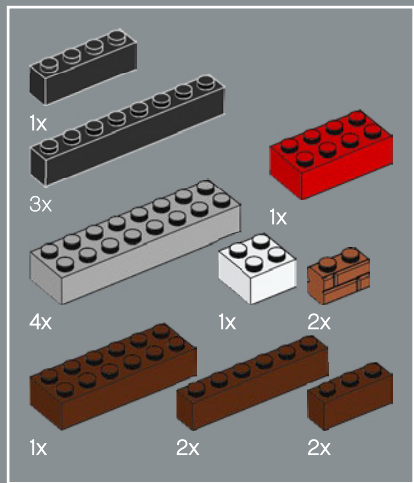

101

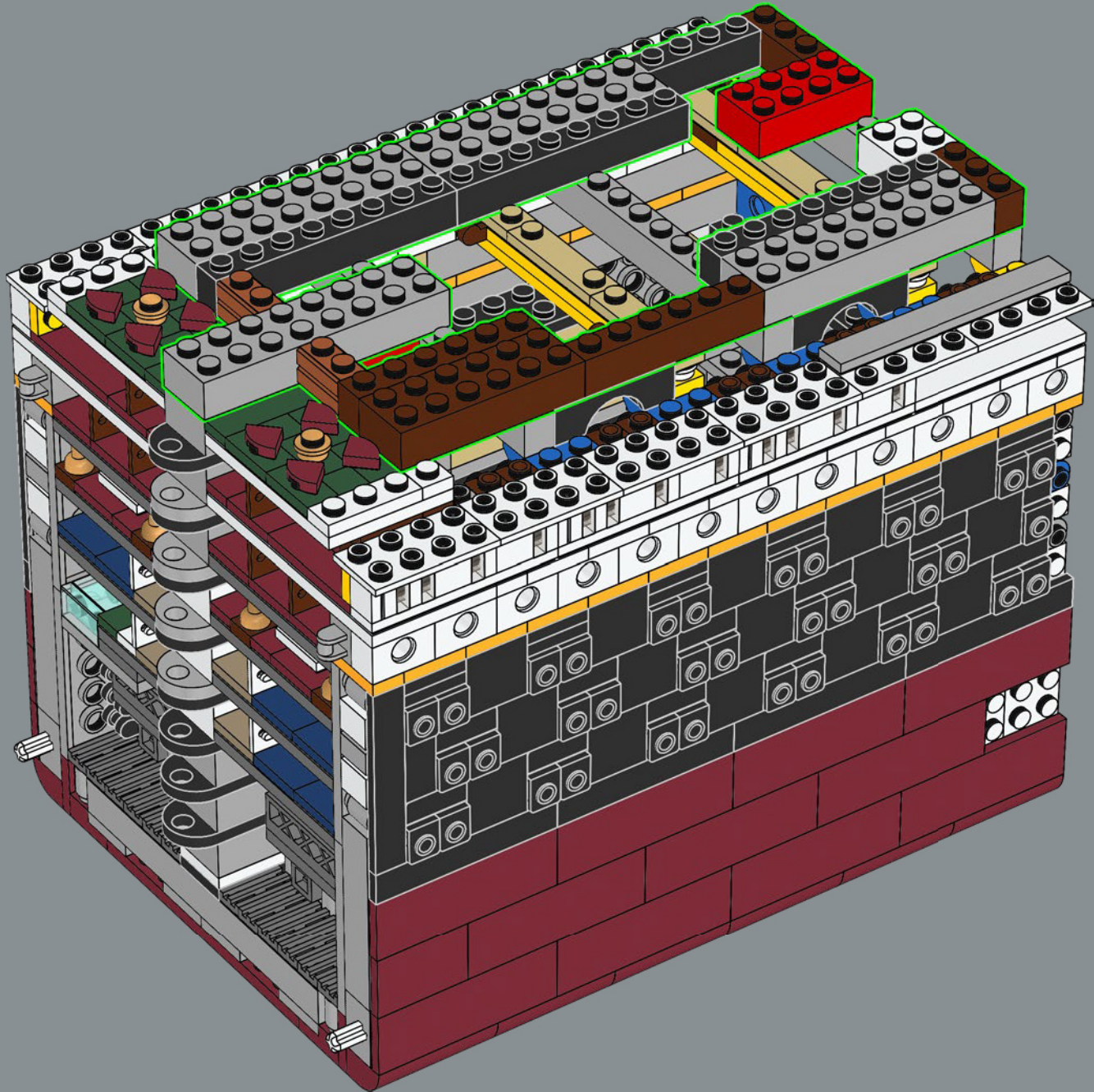

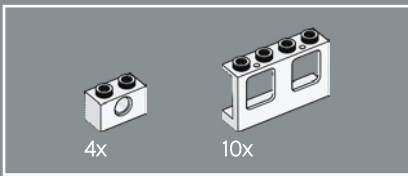

102

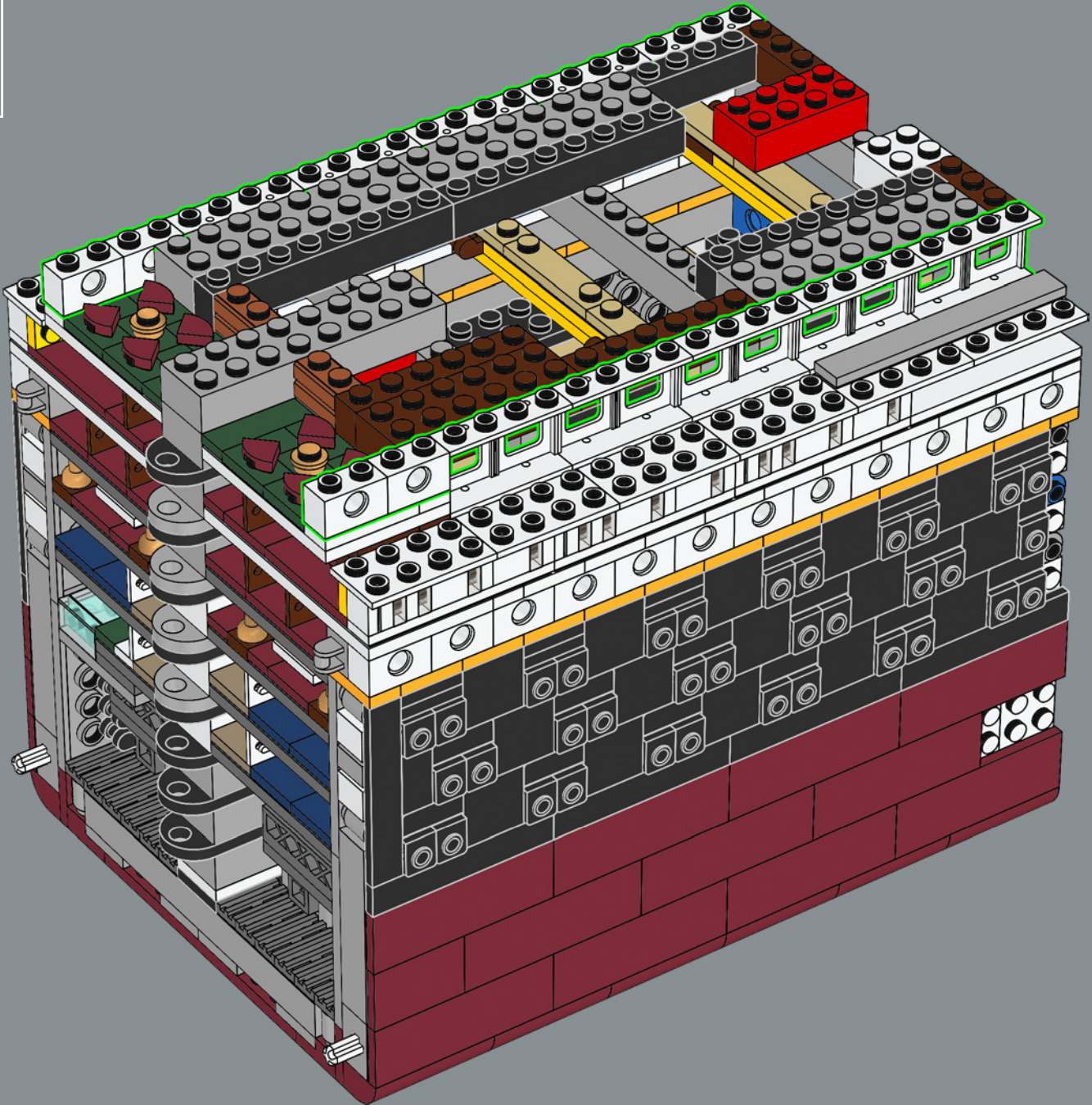

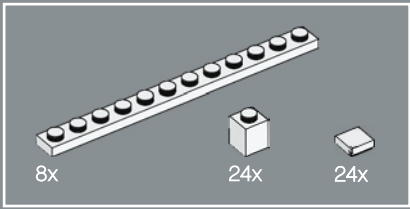

103

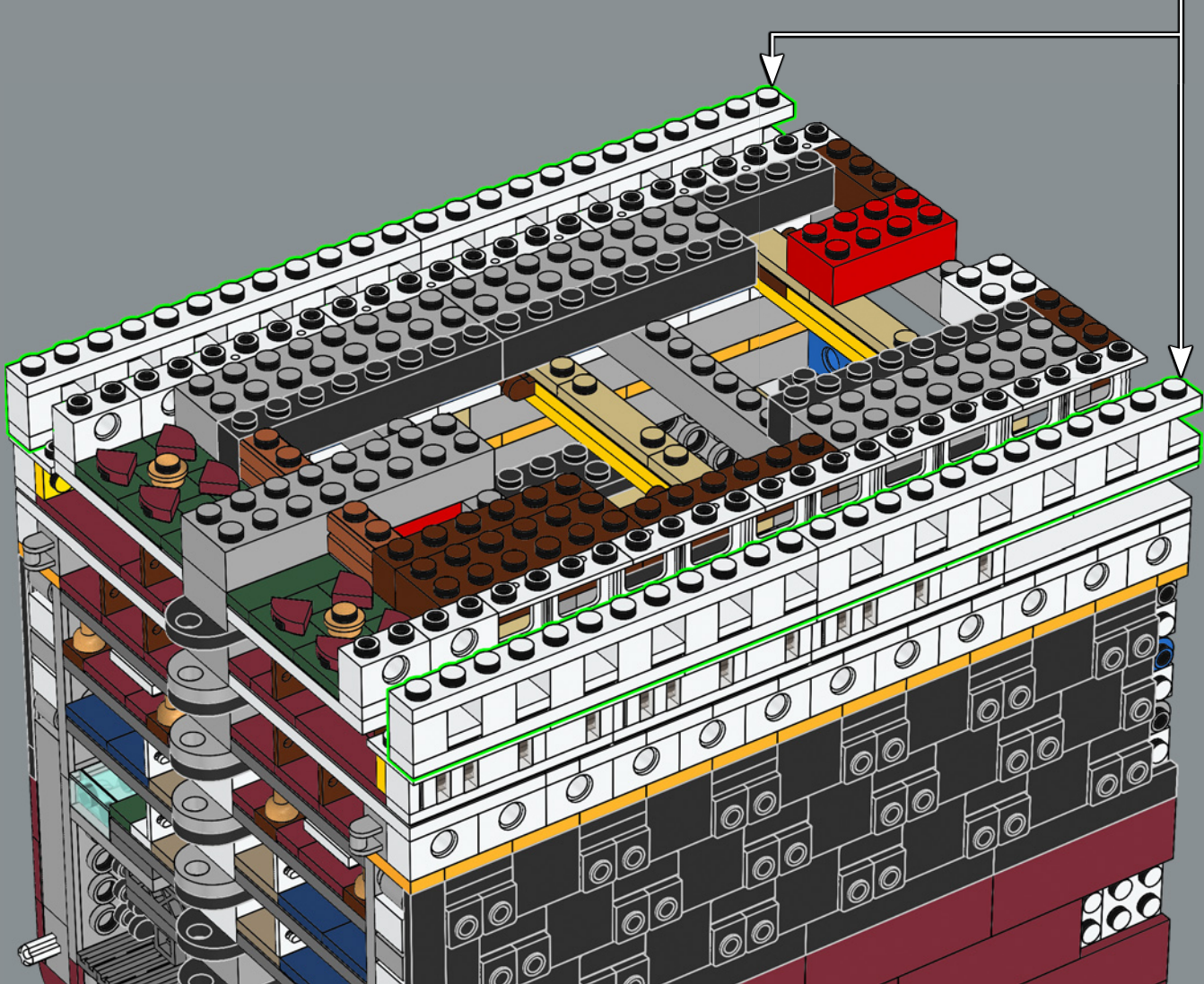
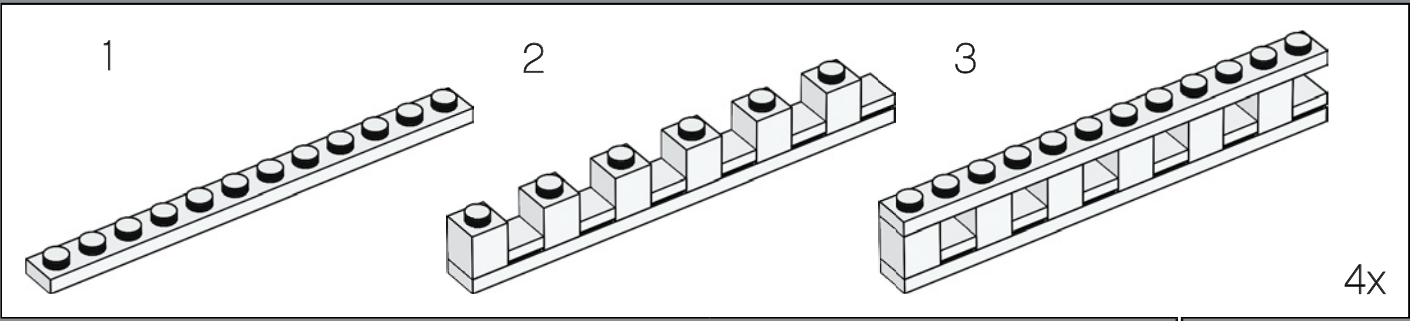

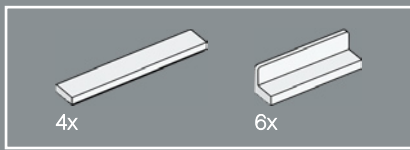

104

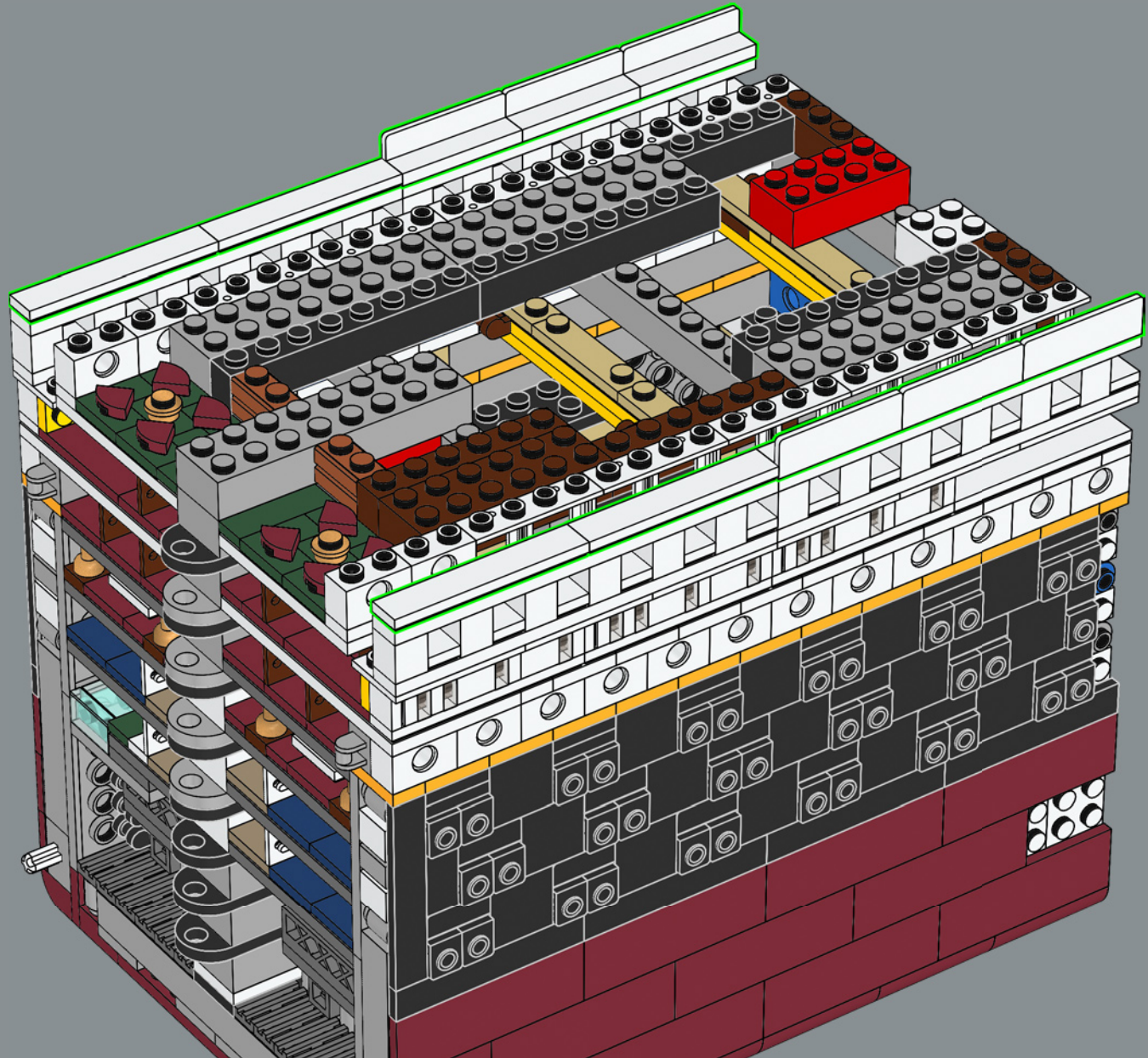

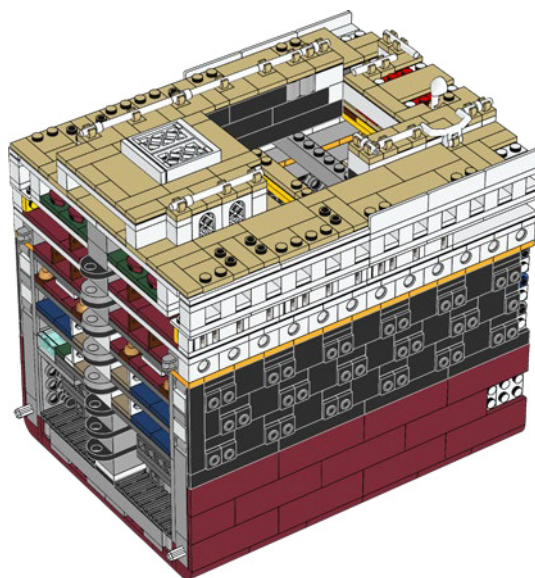
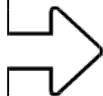

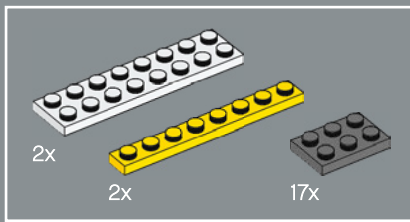

105

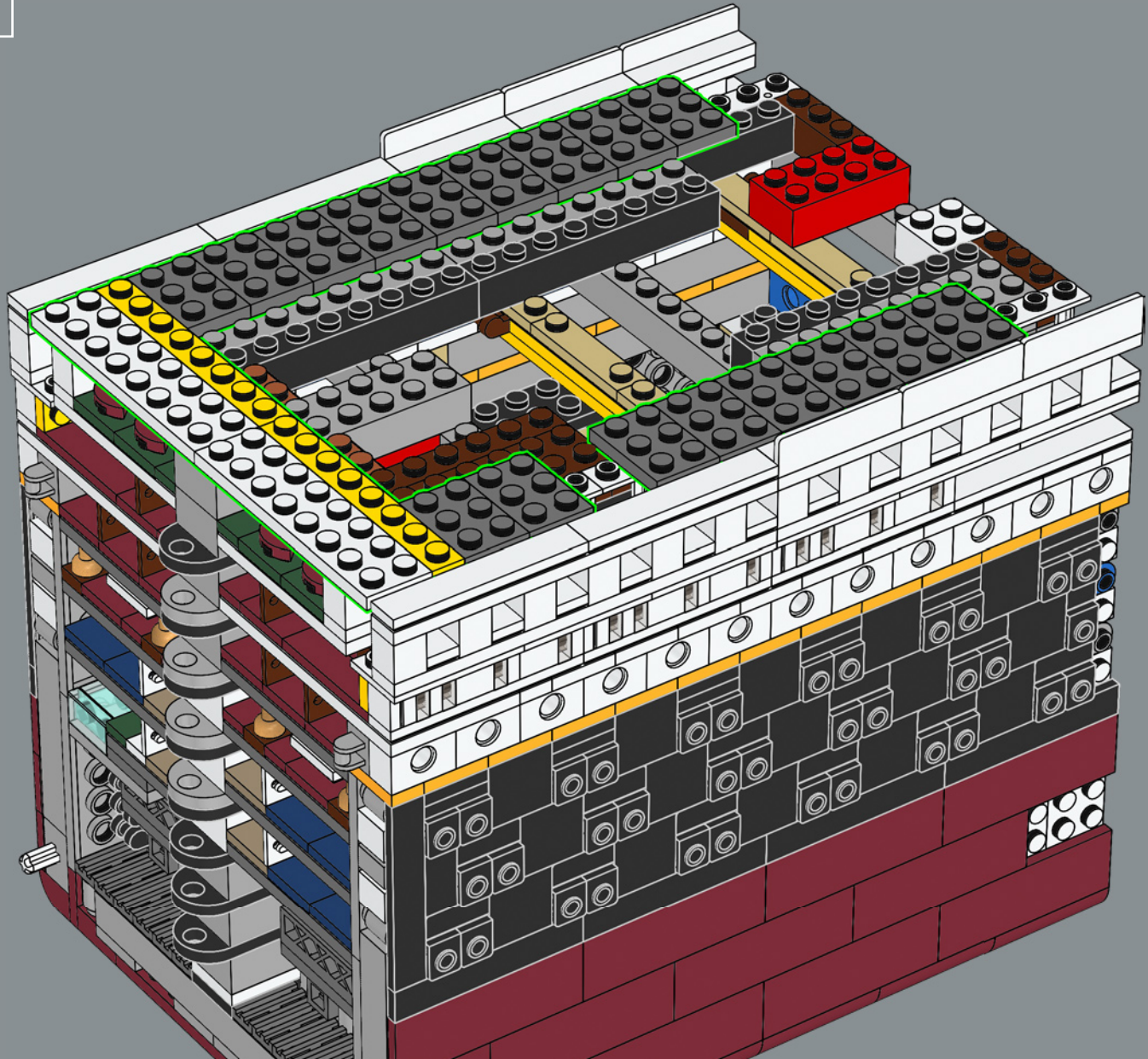

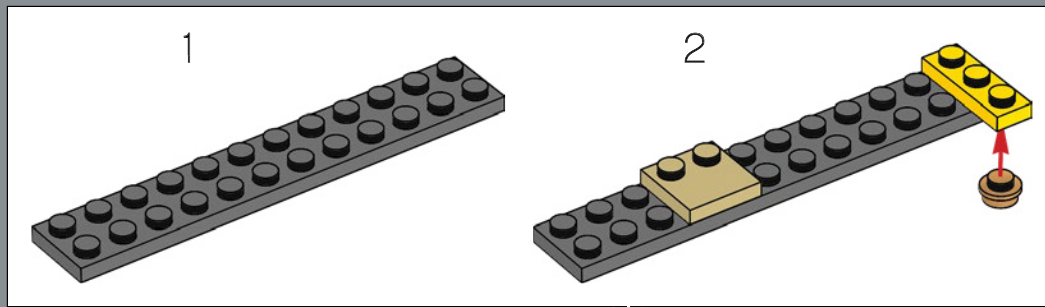
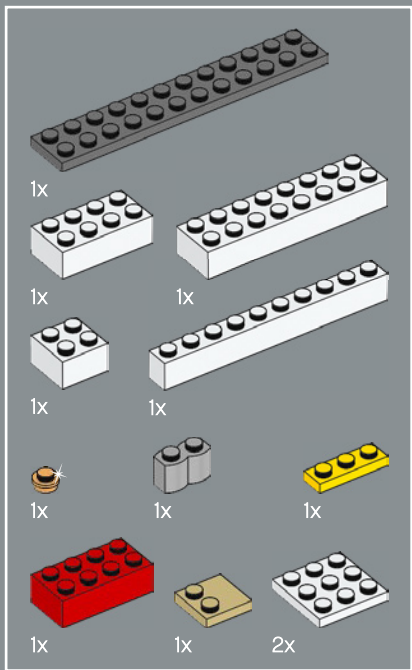

106

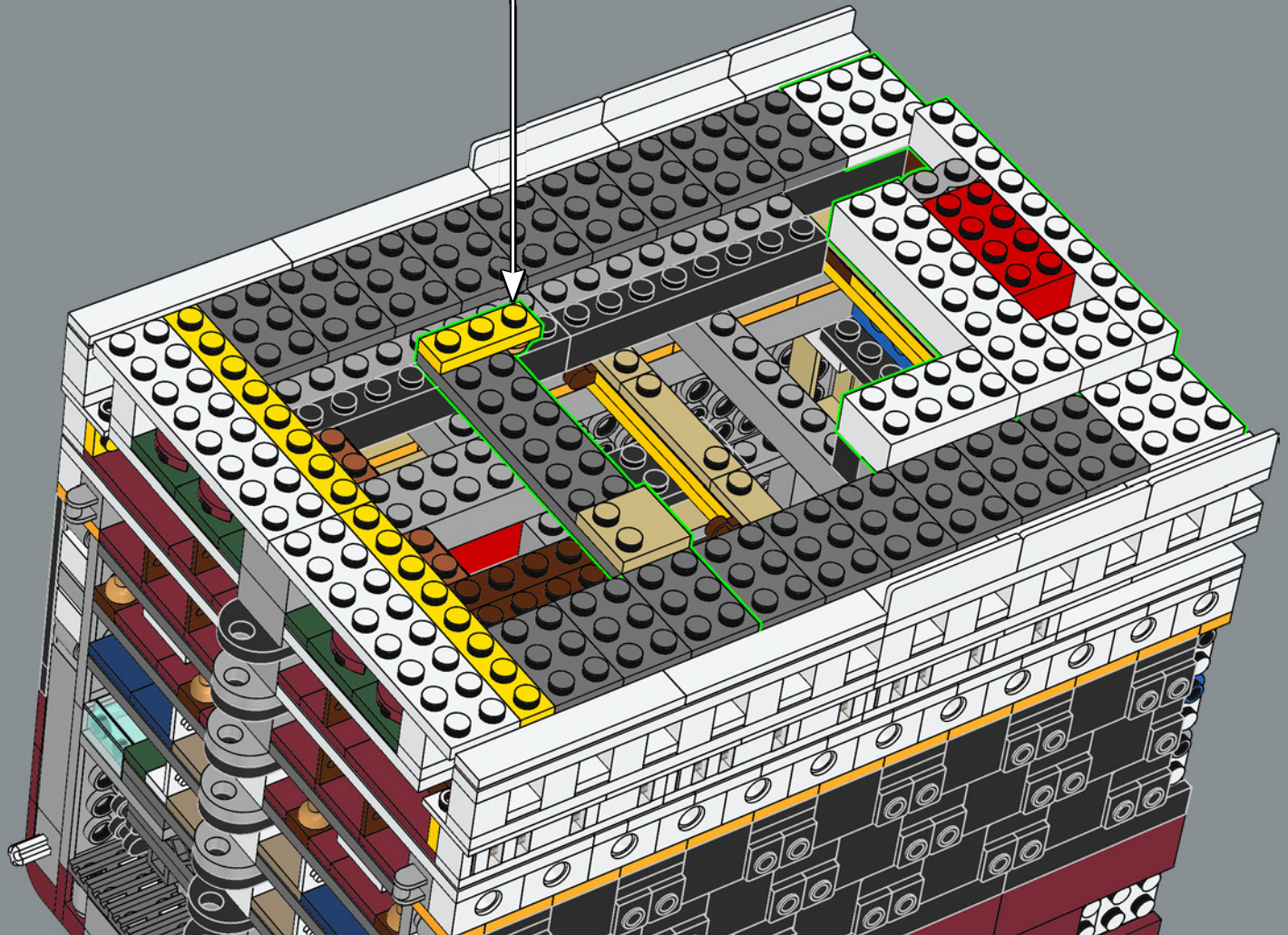

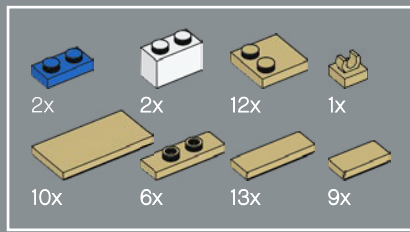

107

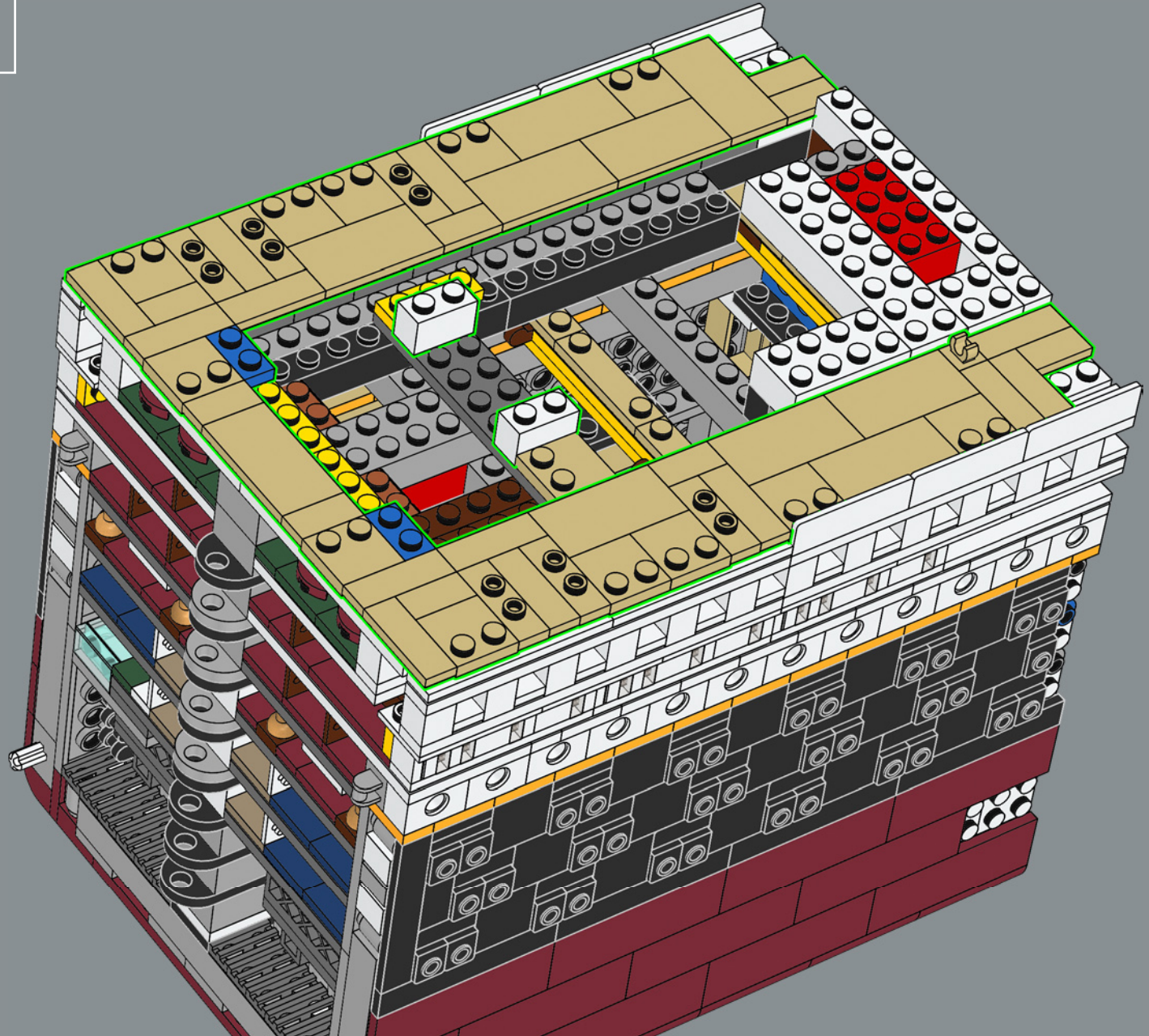

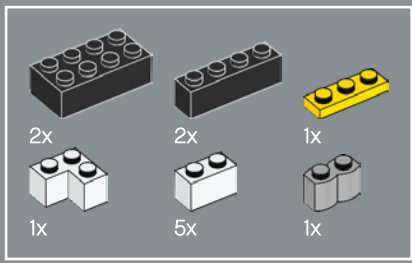

108

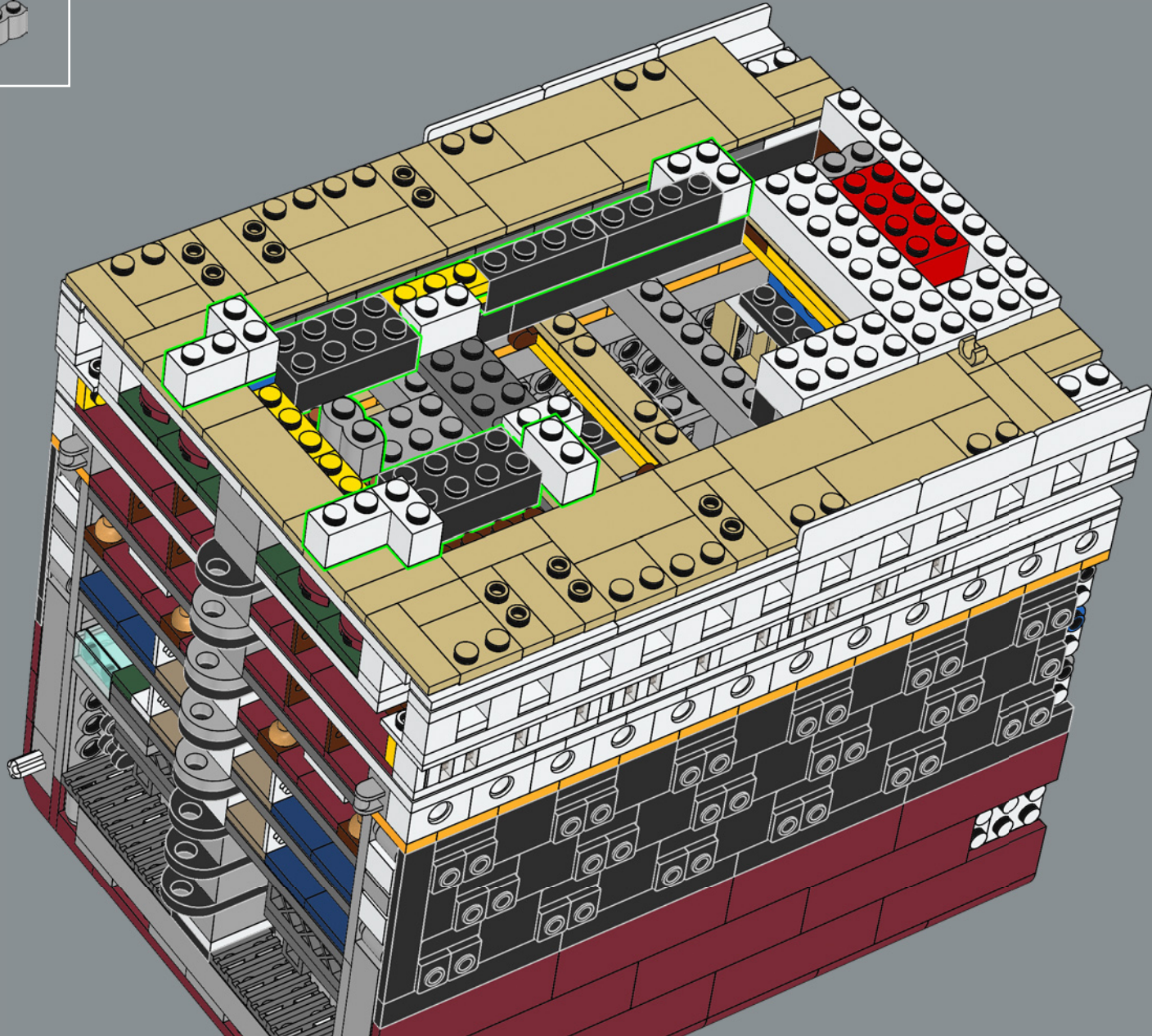

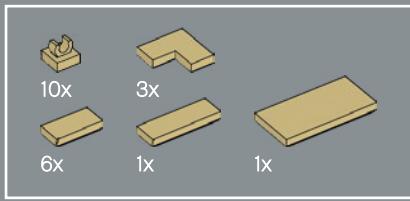

109

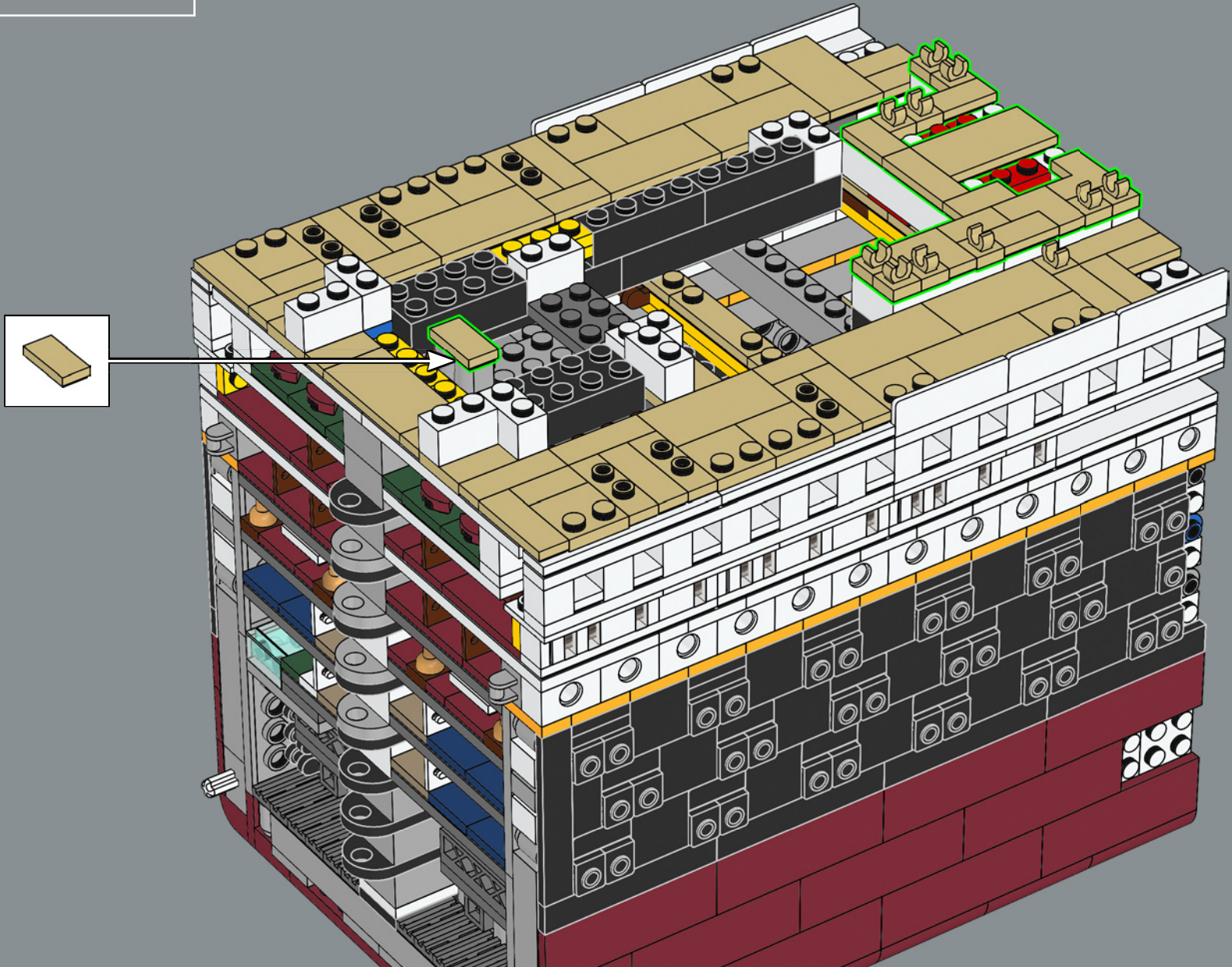

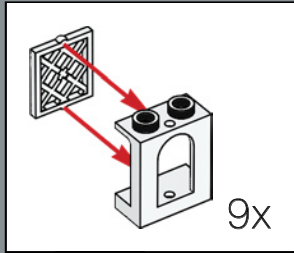
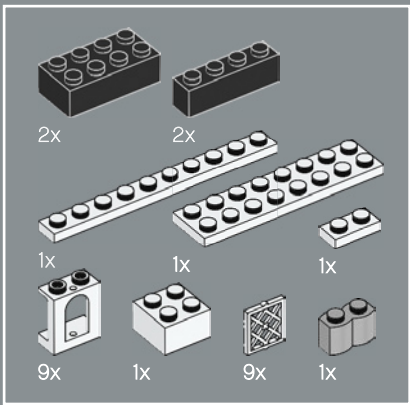

110

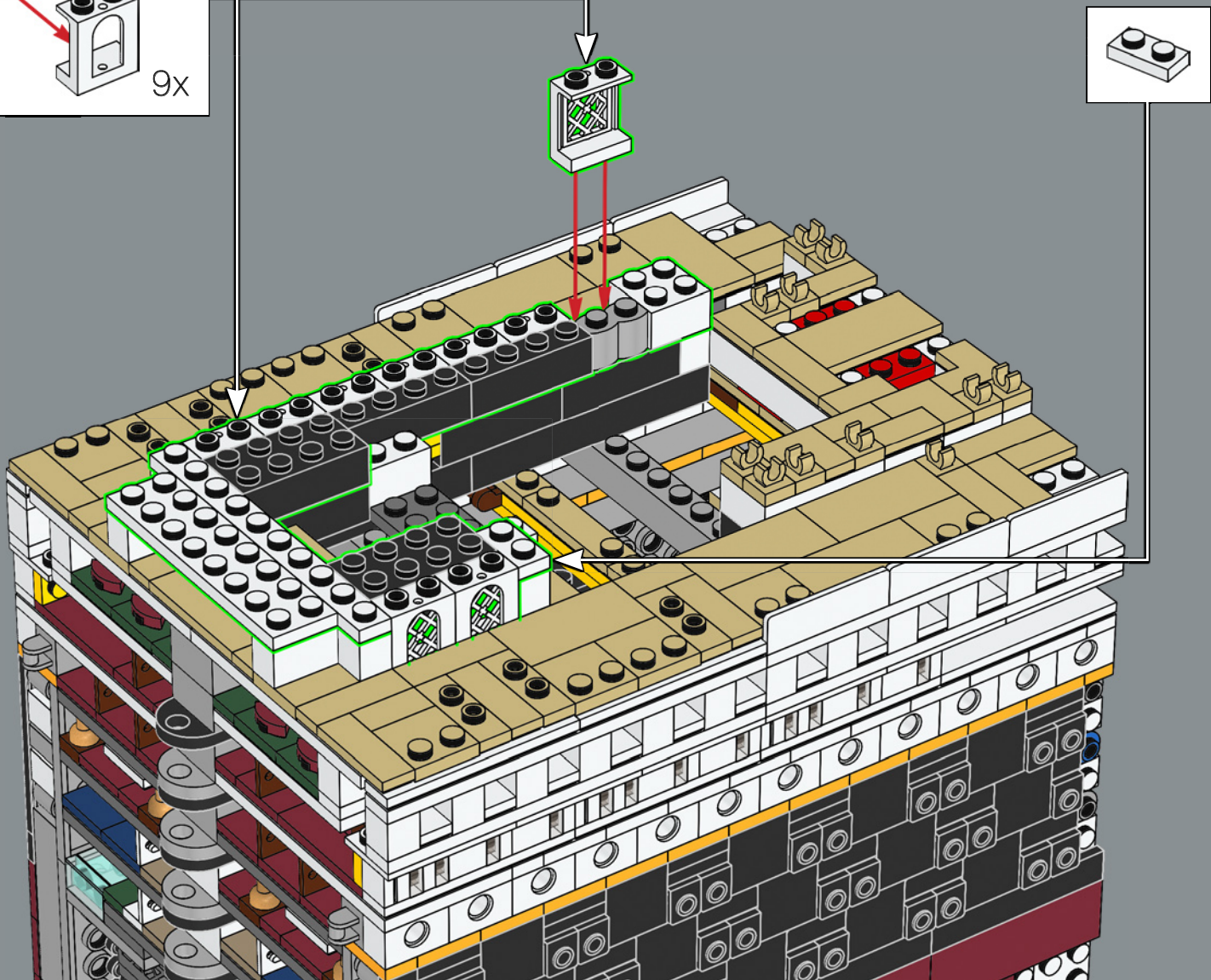

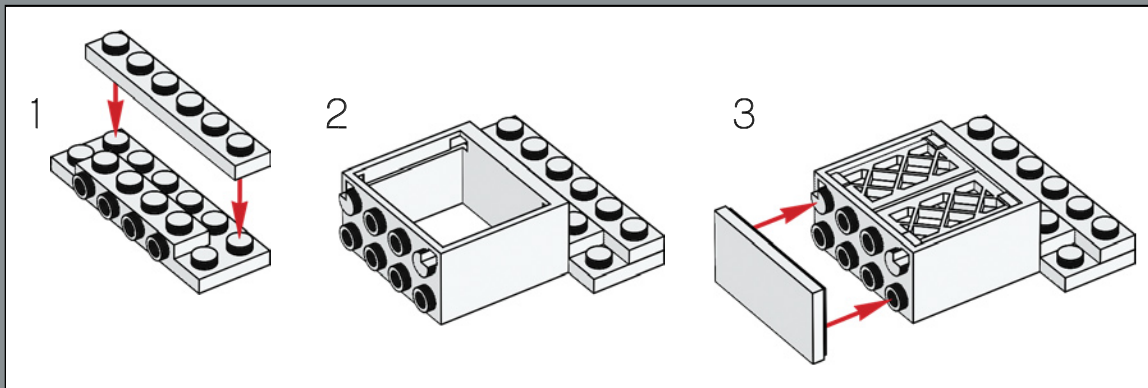
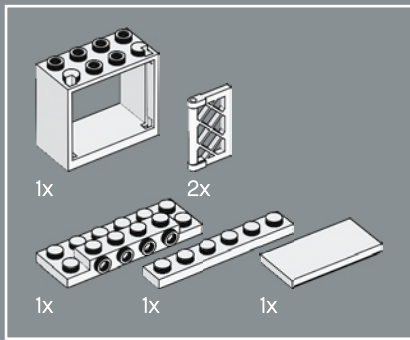

111

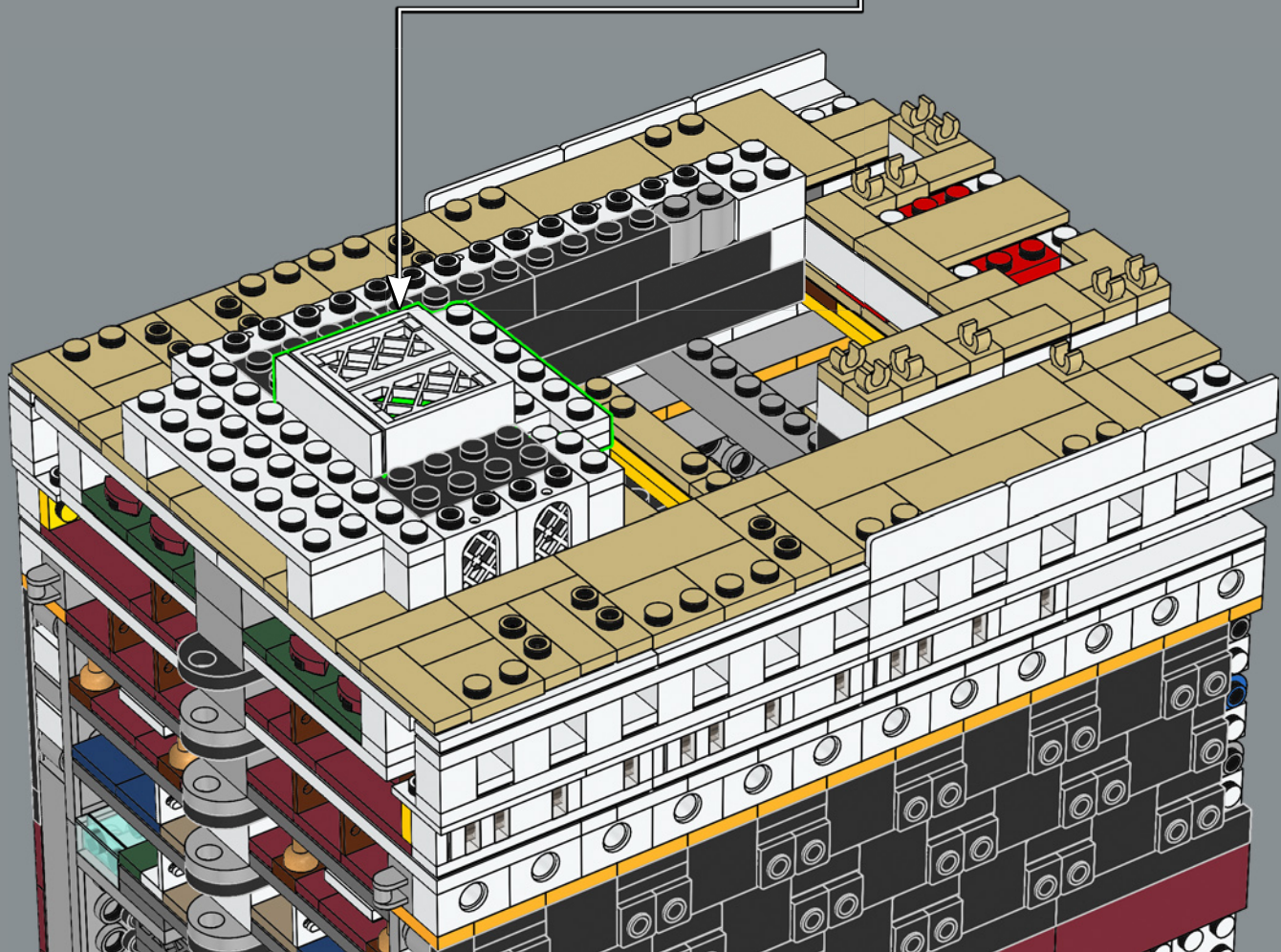

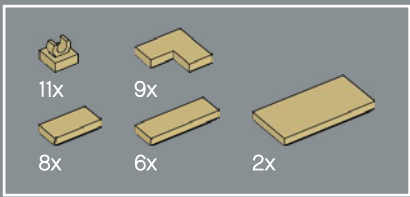

112

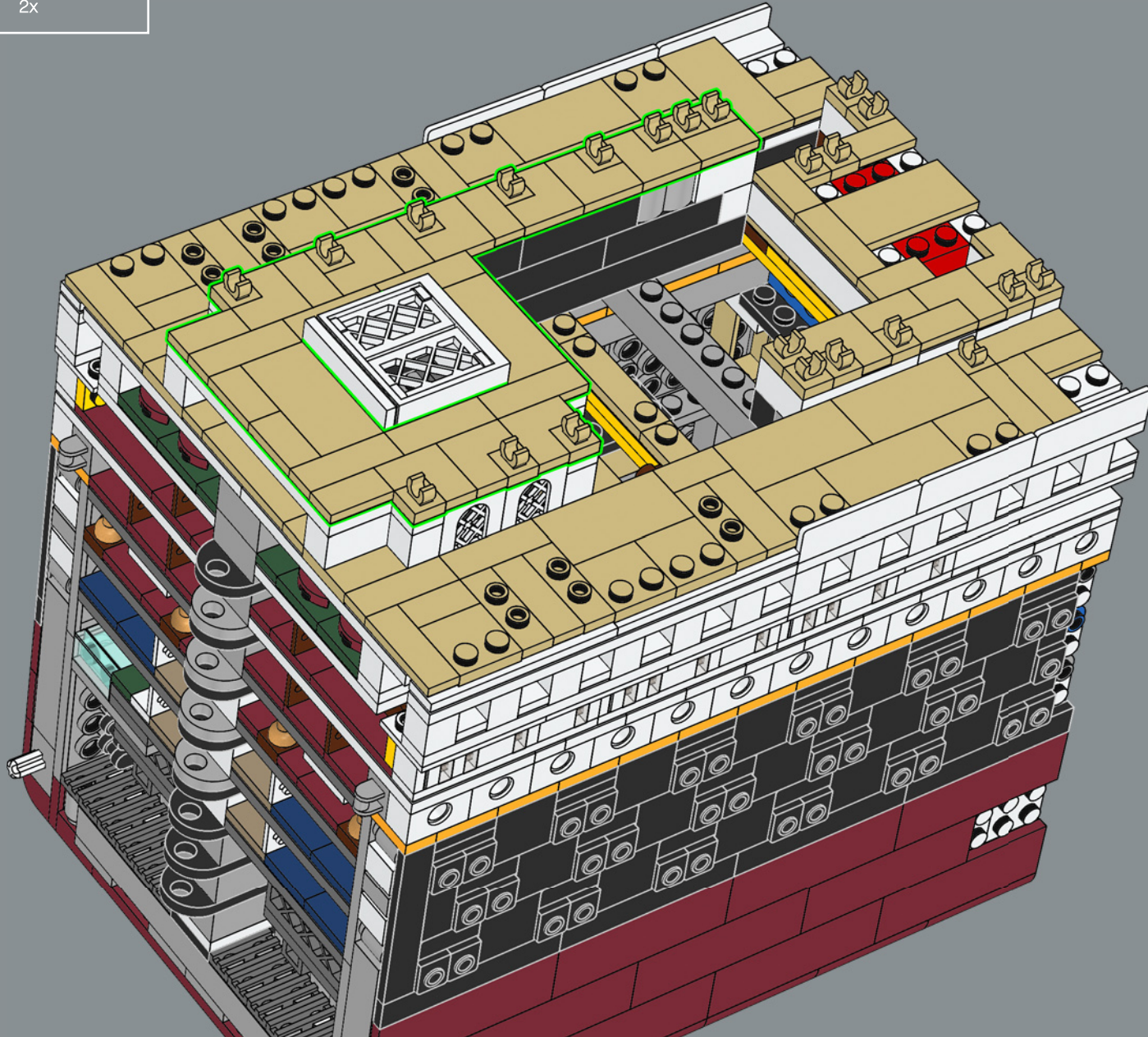

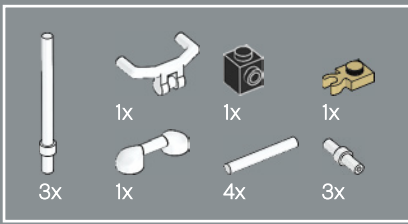

113

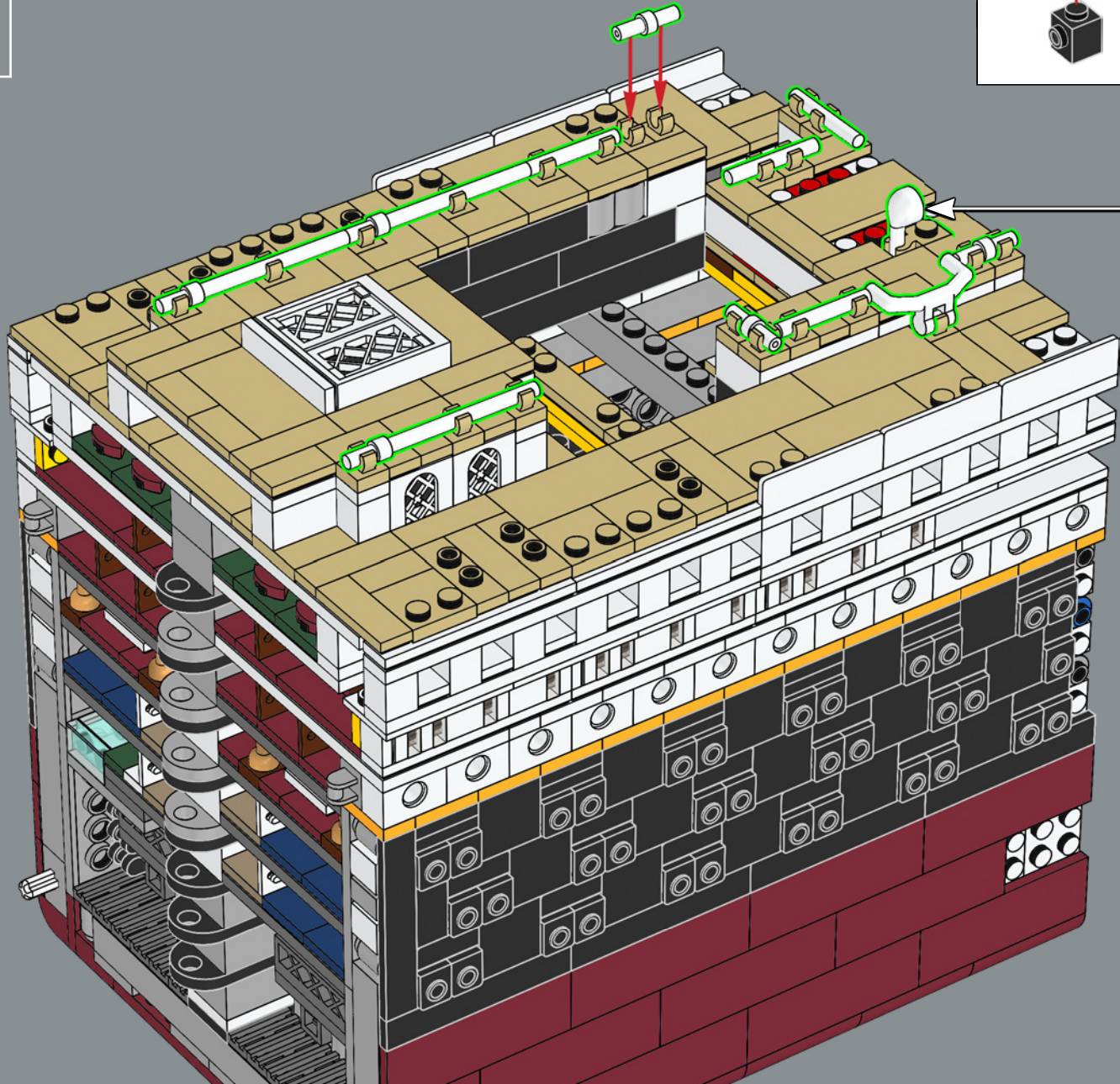
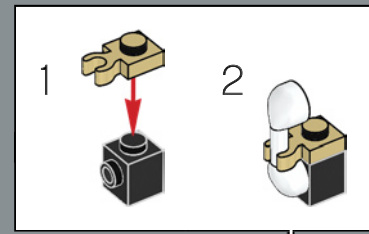

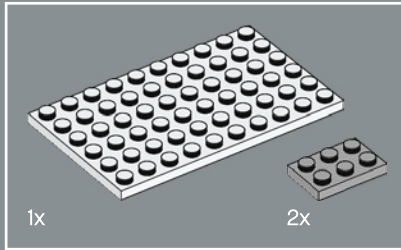
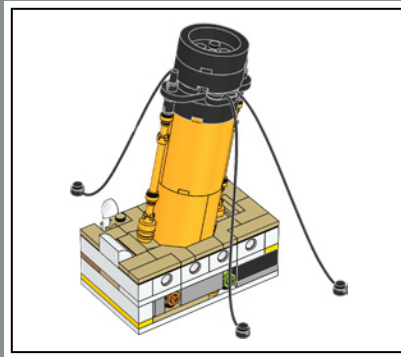
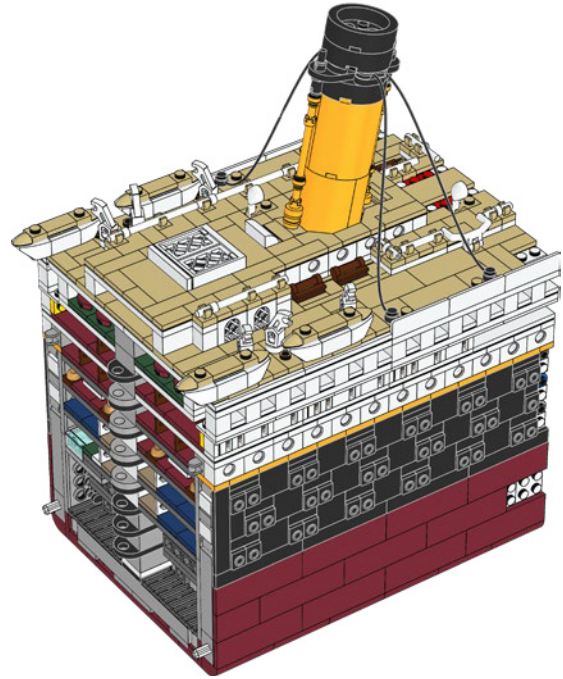
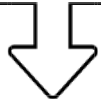

114

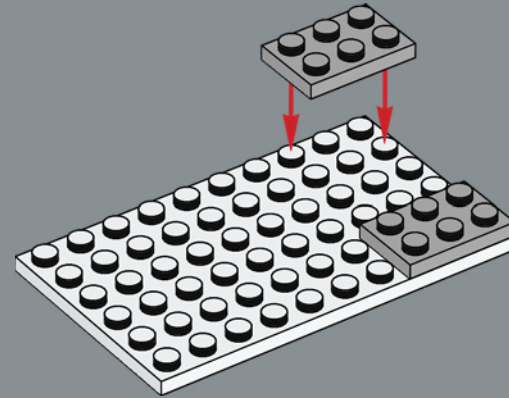

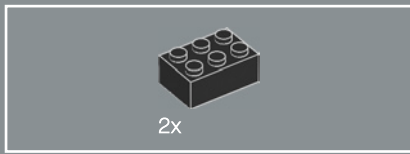

115

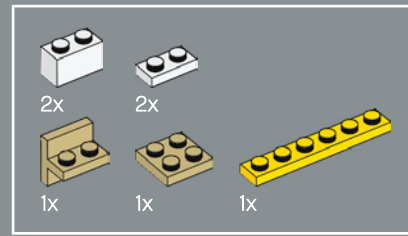
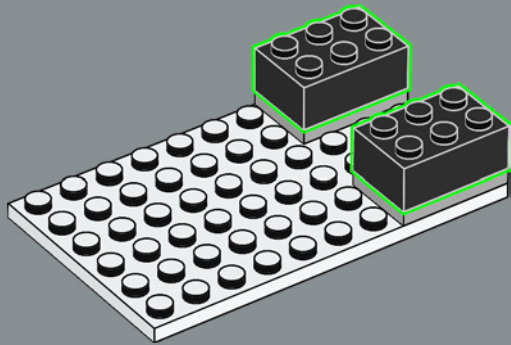

116

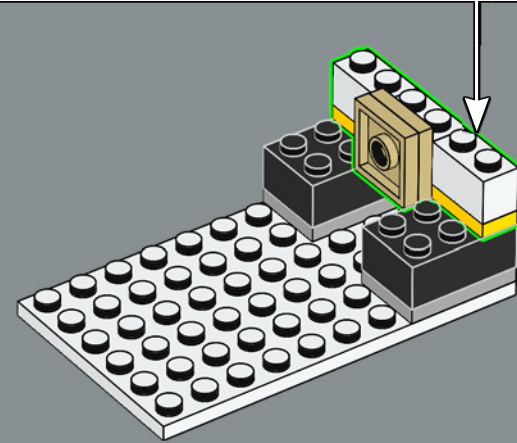
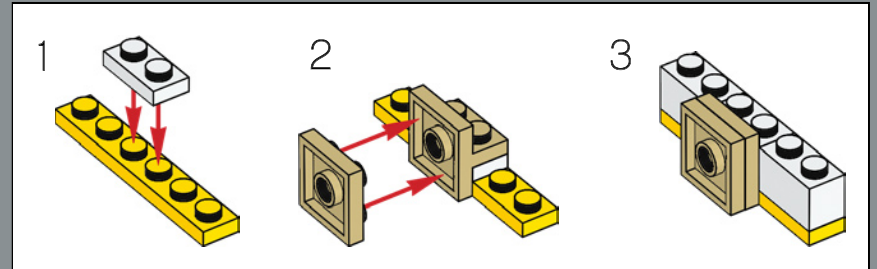

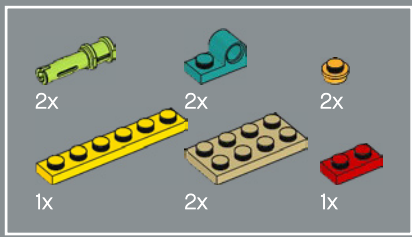

117

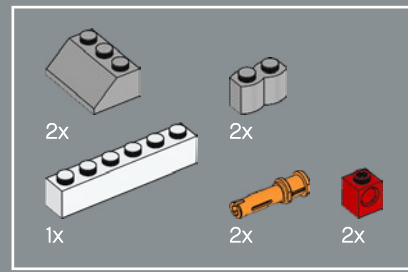
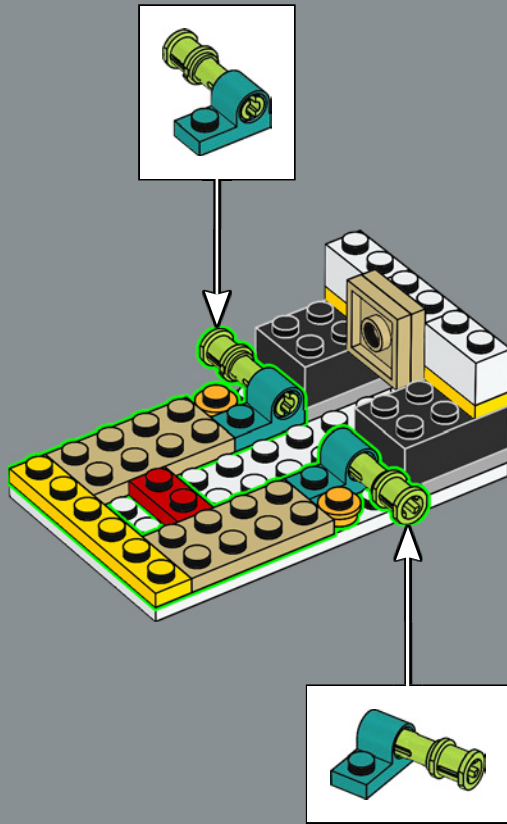

118

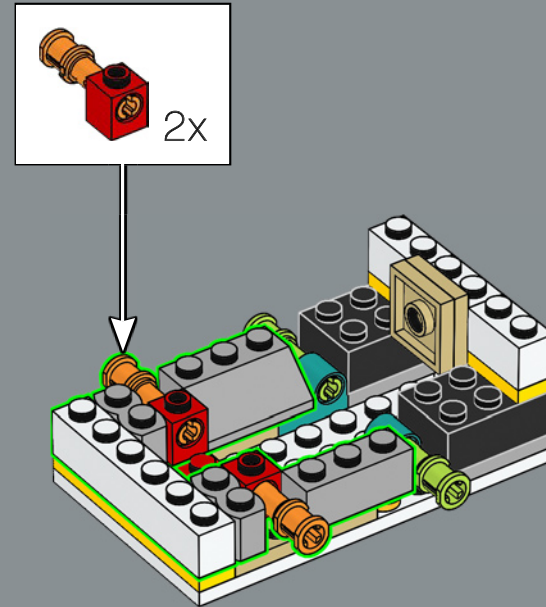

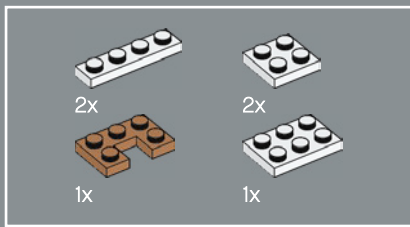

119

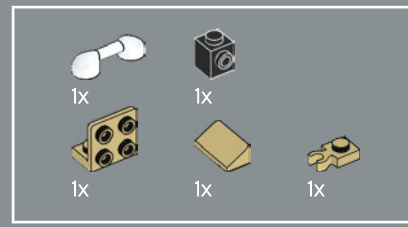
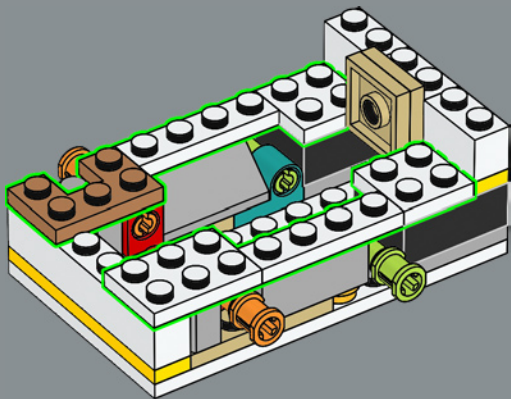

120

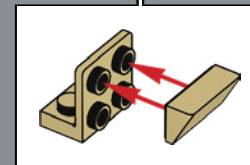
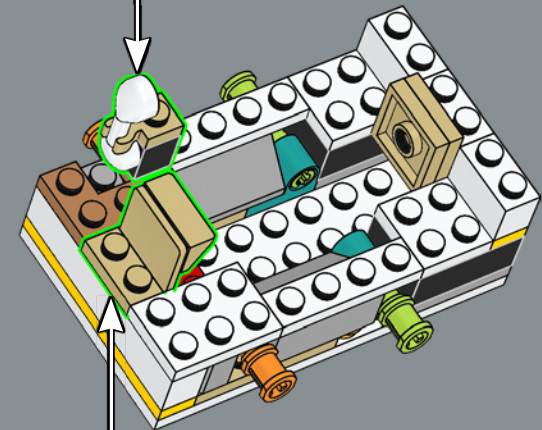
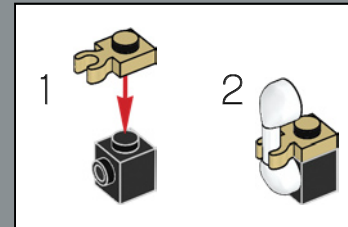

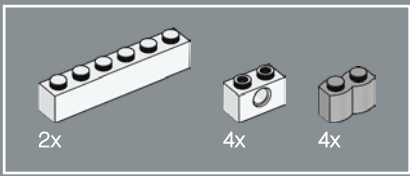

121

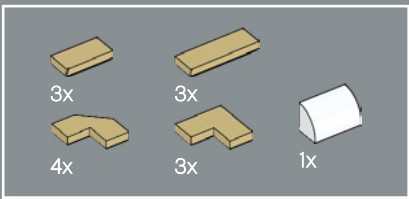
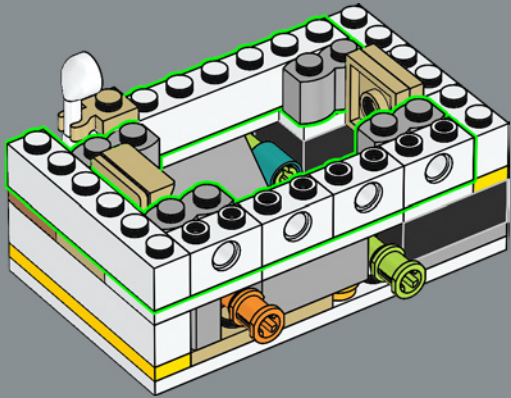

122

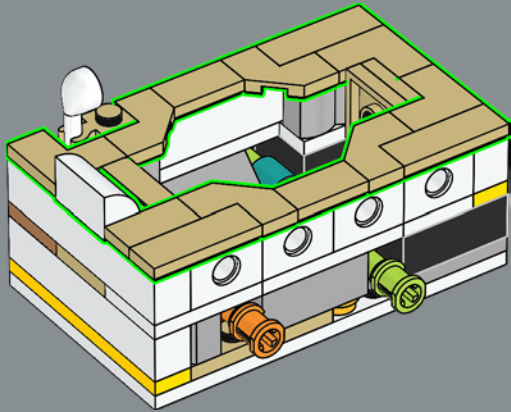

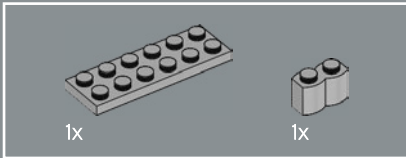
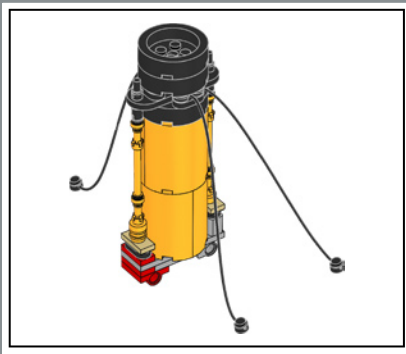

123

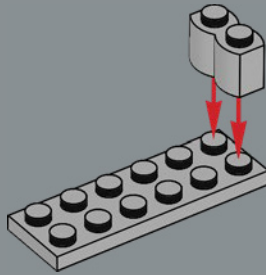

124

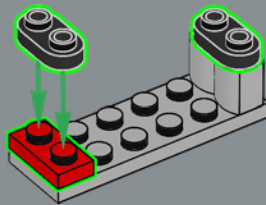

125

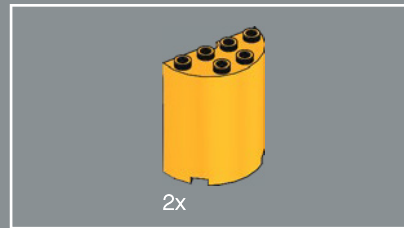
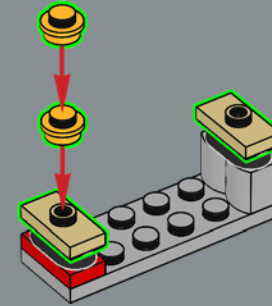

126

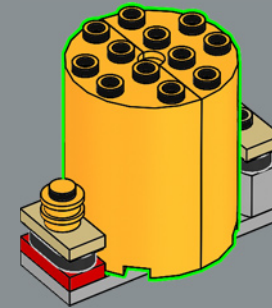

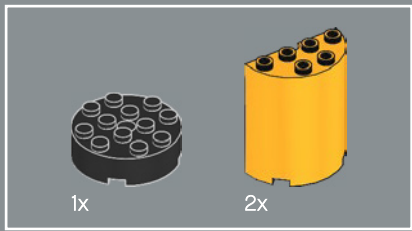

127

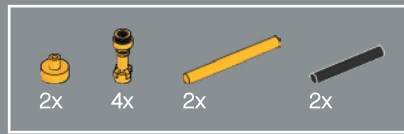
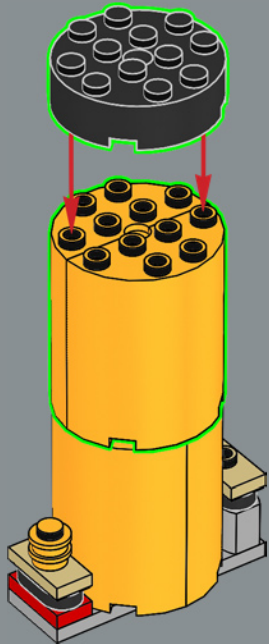

128

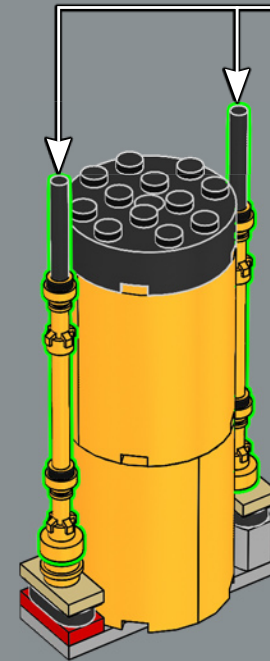
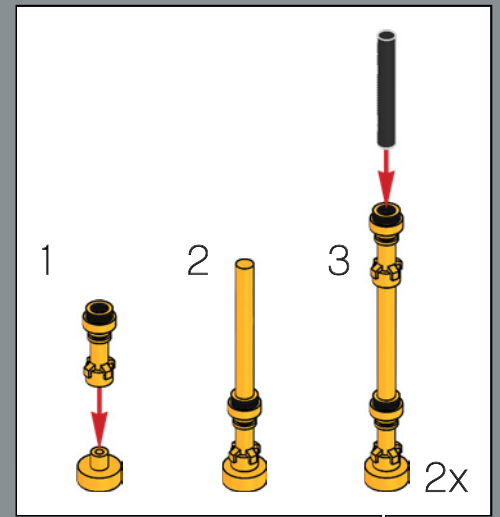

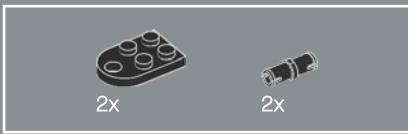

129

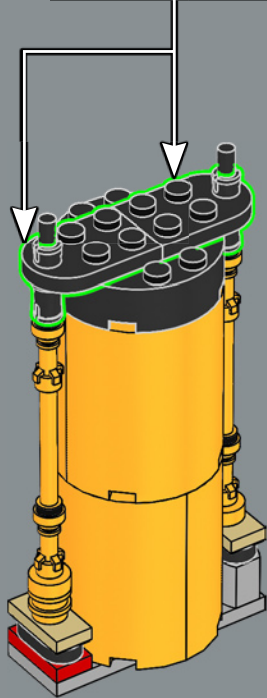
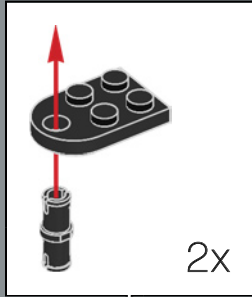

130

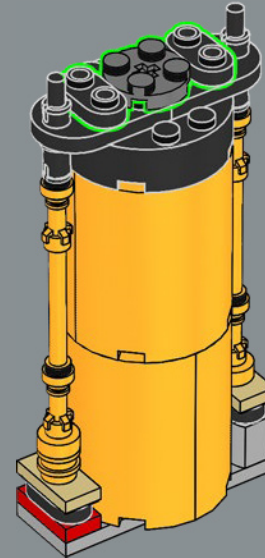

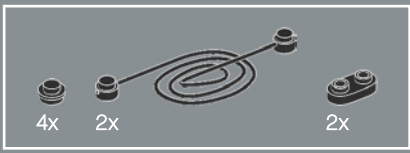

131

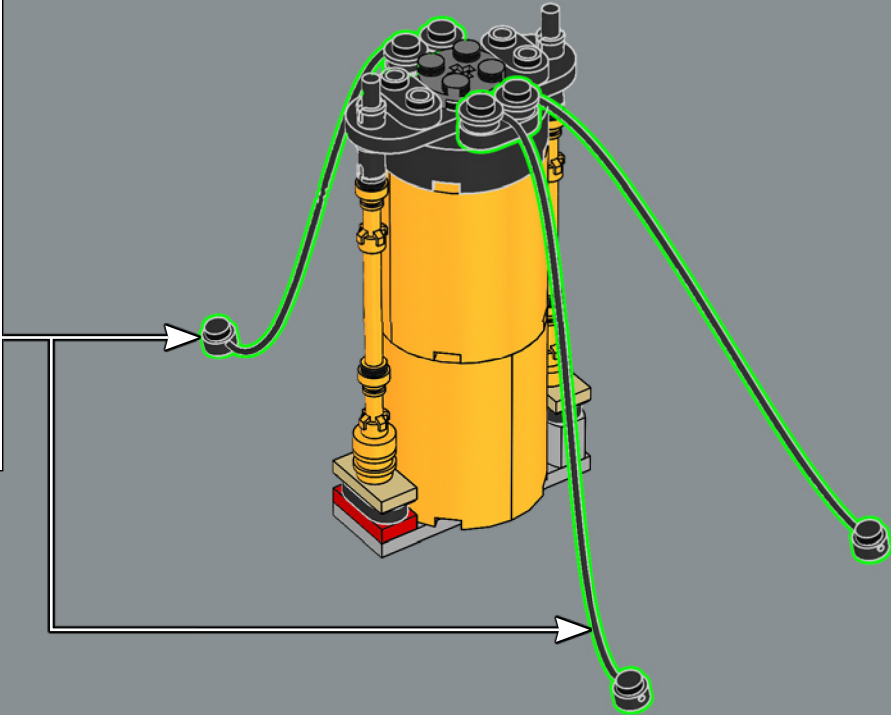
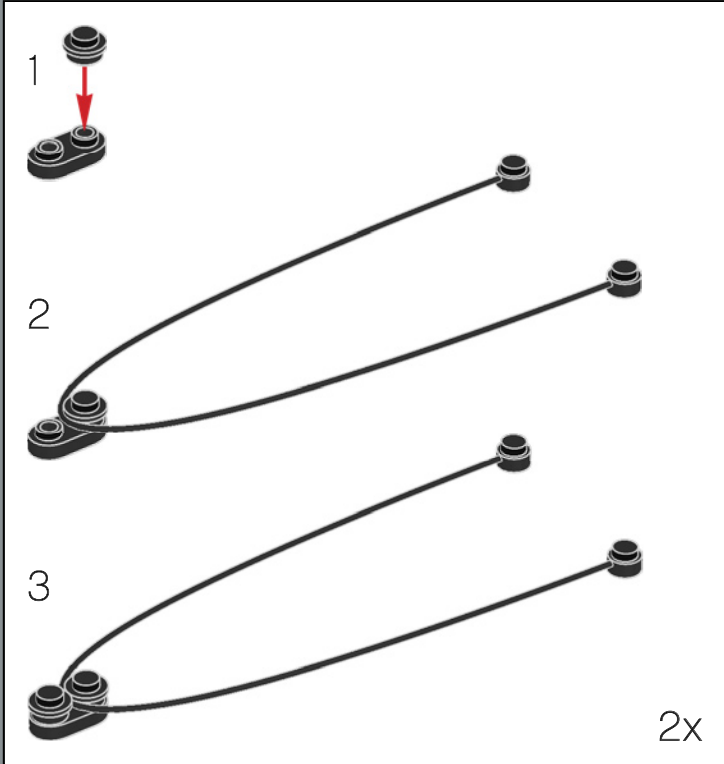

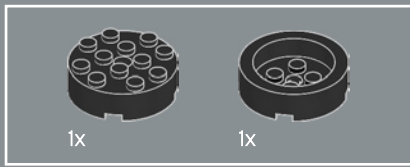

132

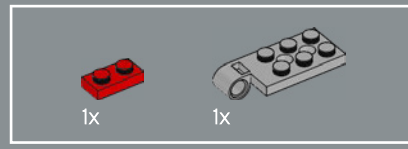
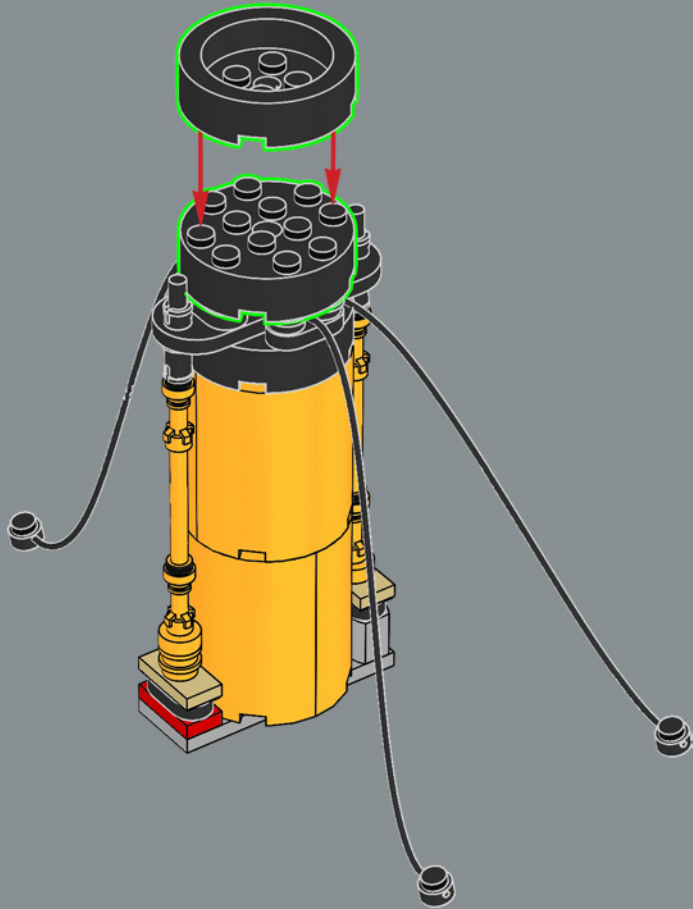

133

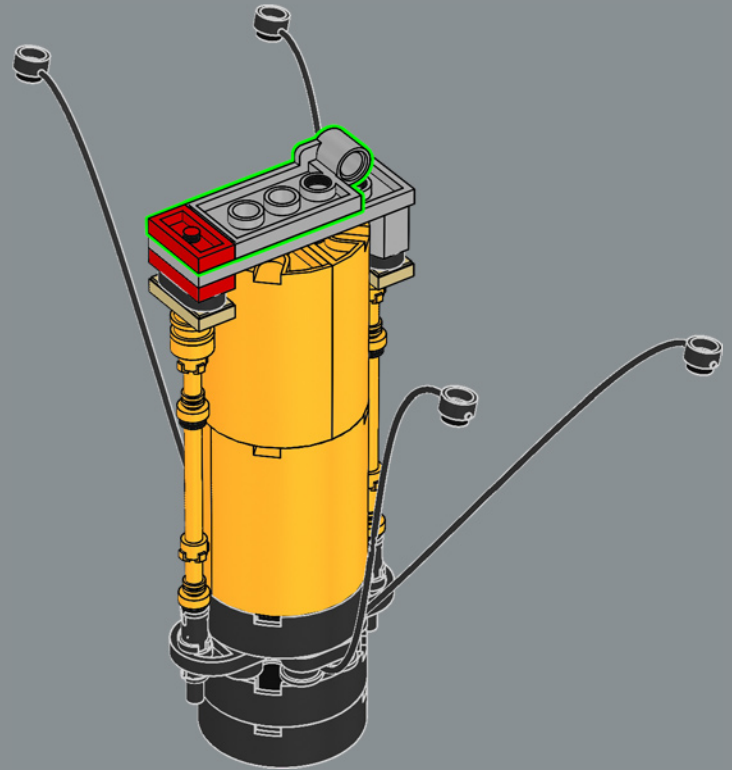

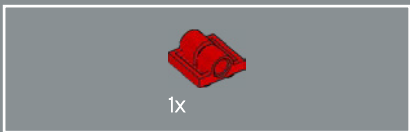

134

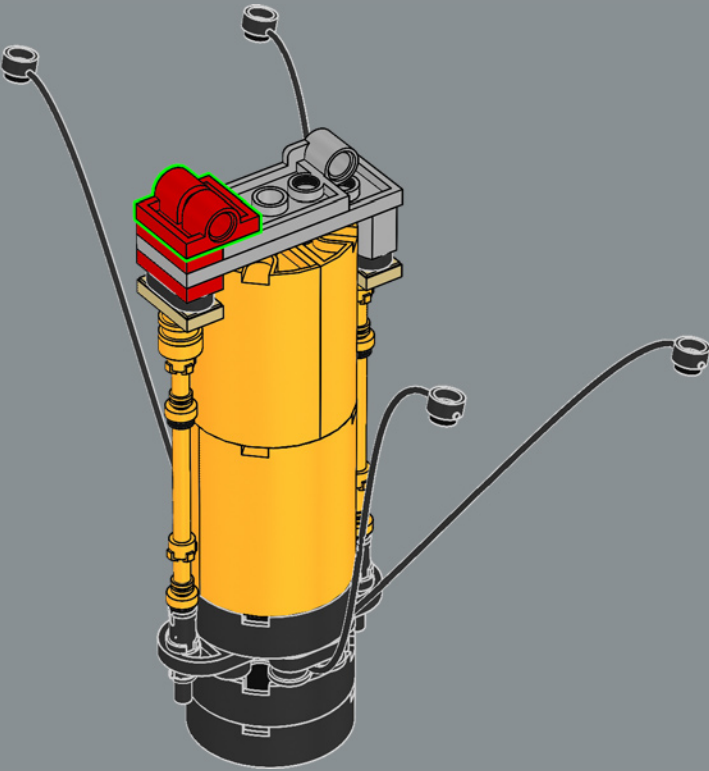

135

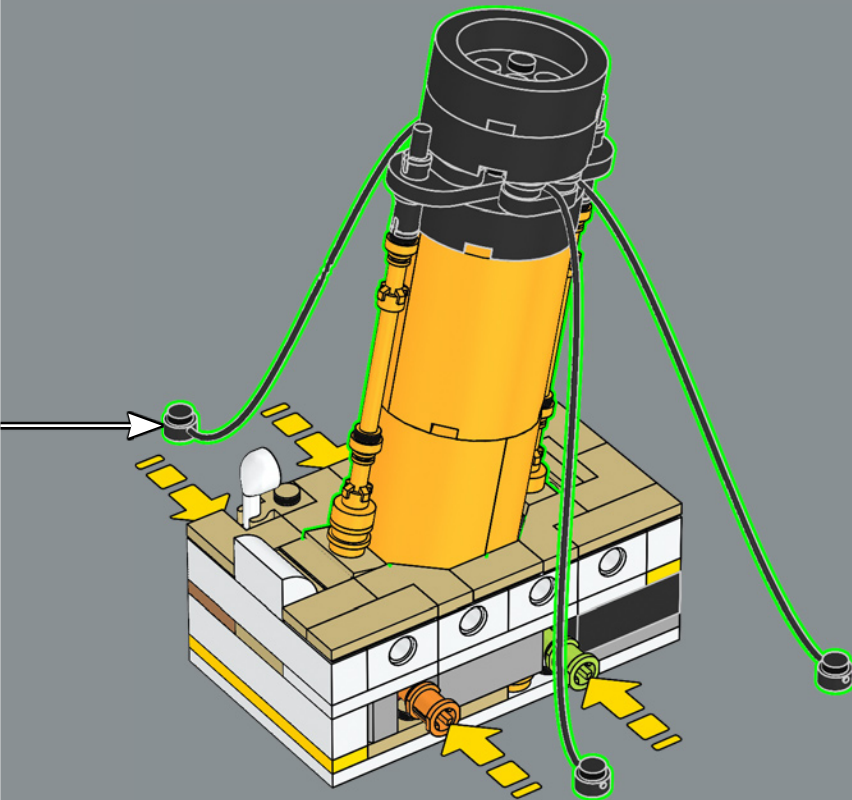

136

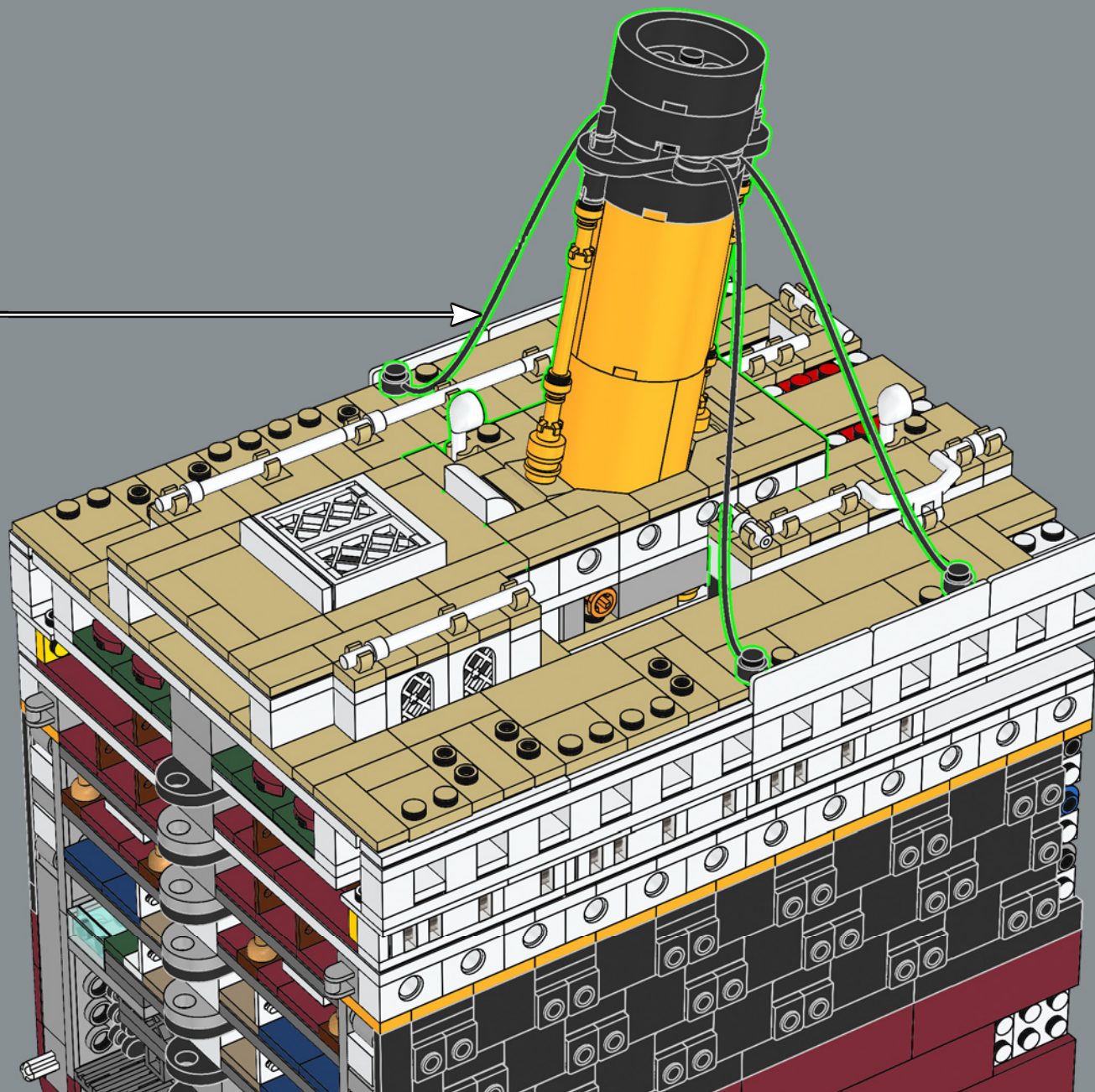

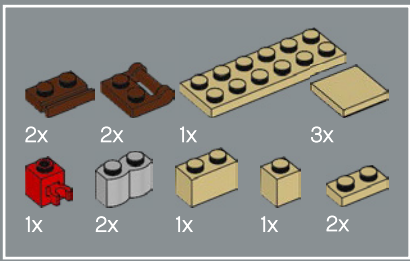

137

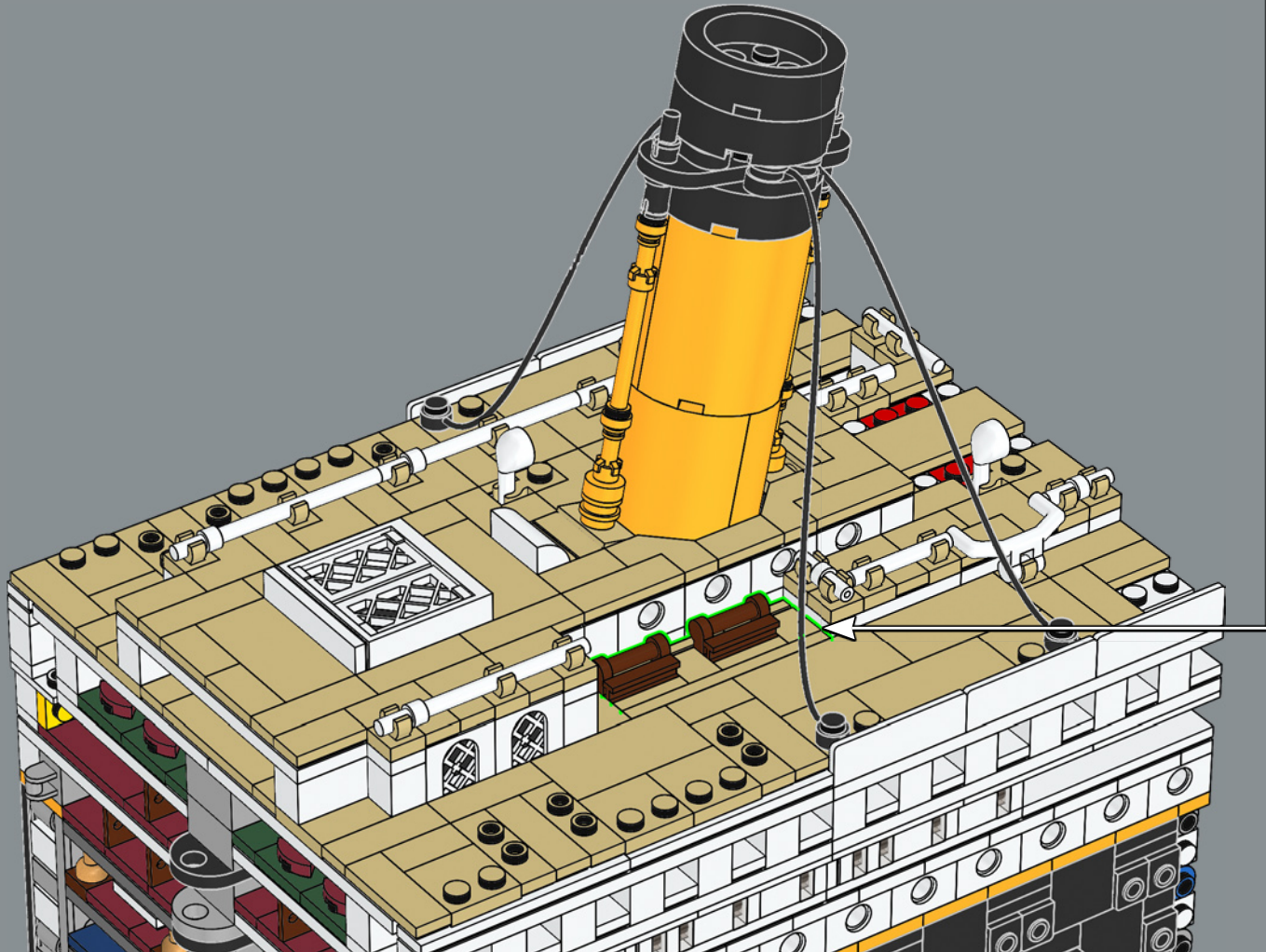
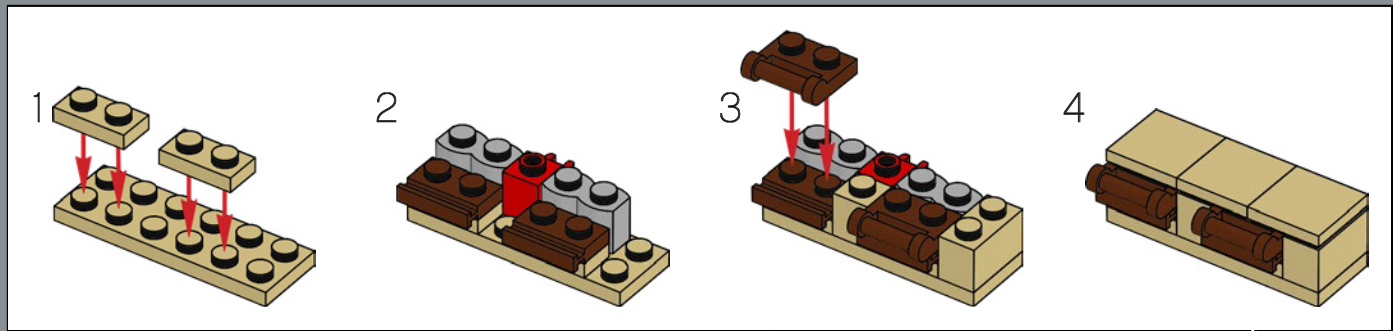

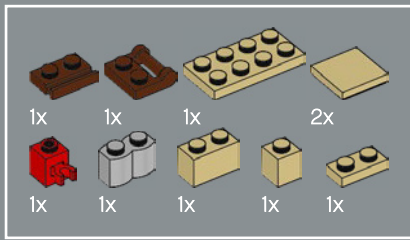

138

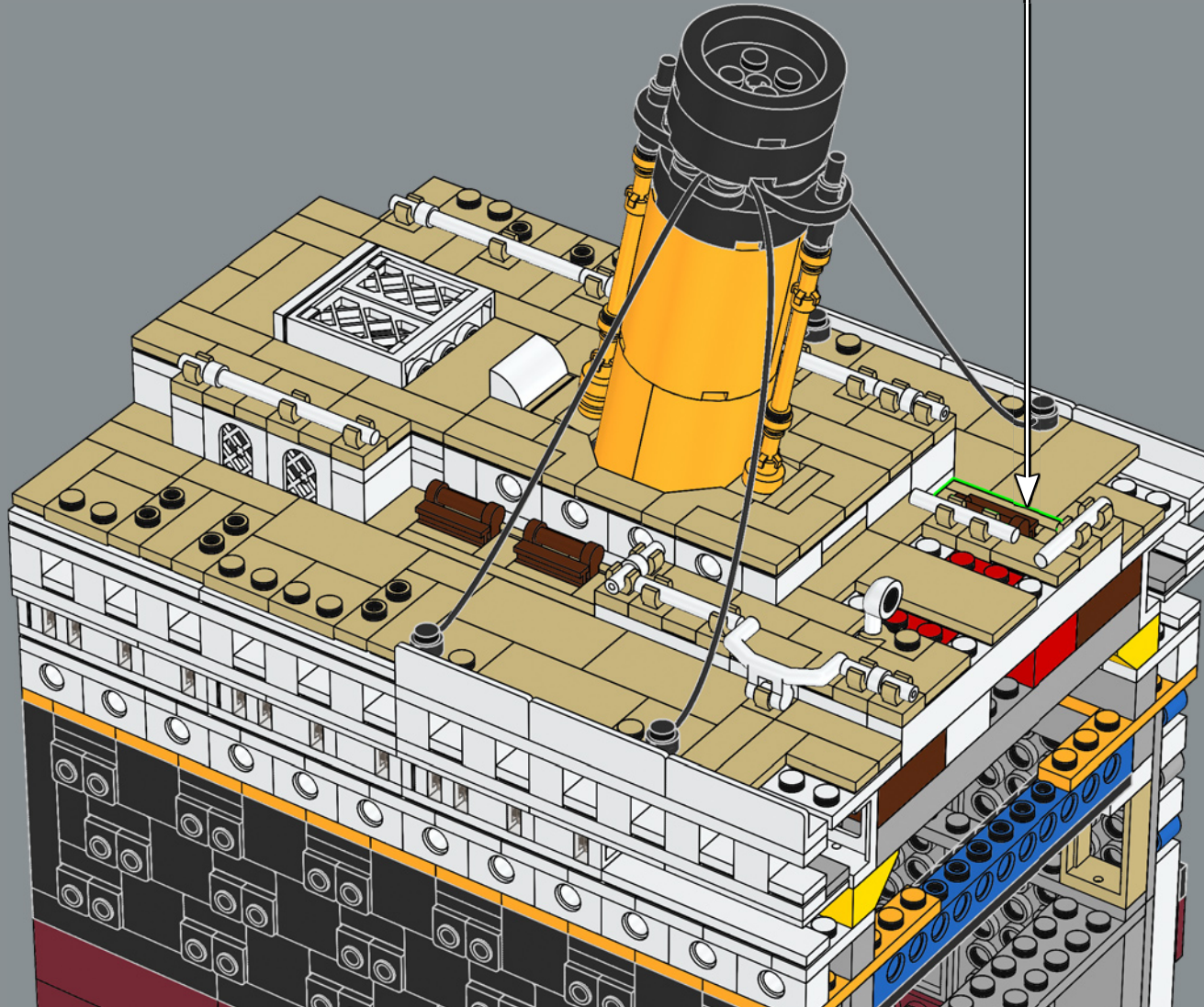
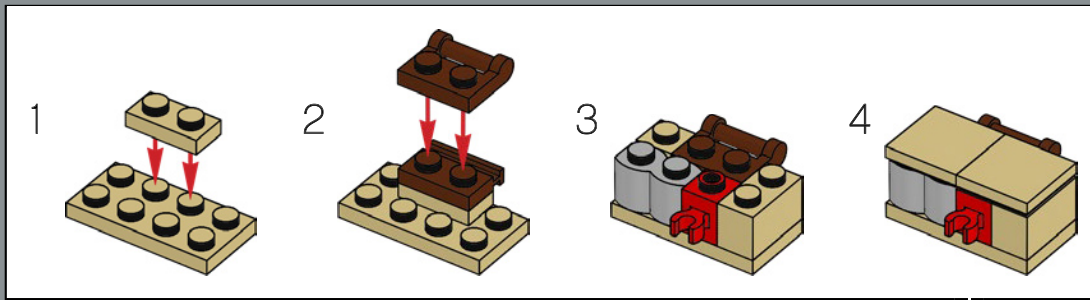

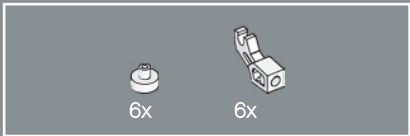

139

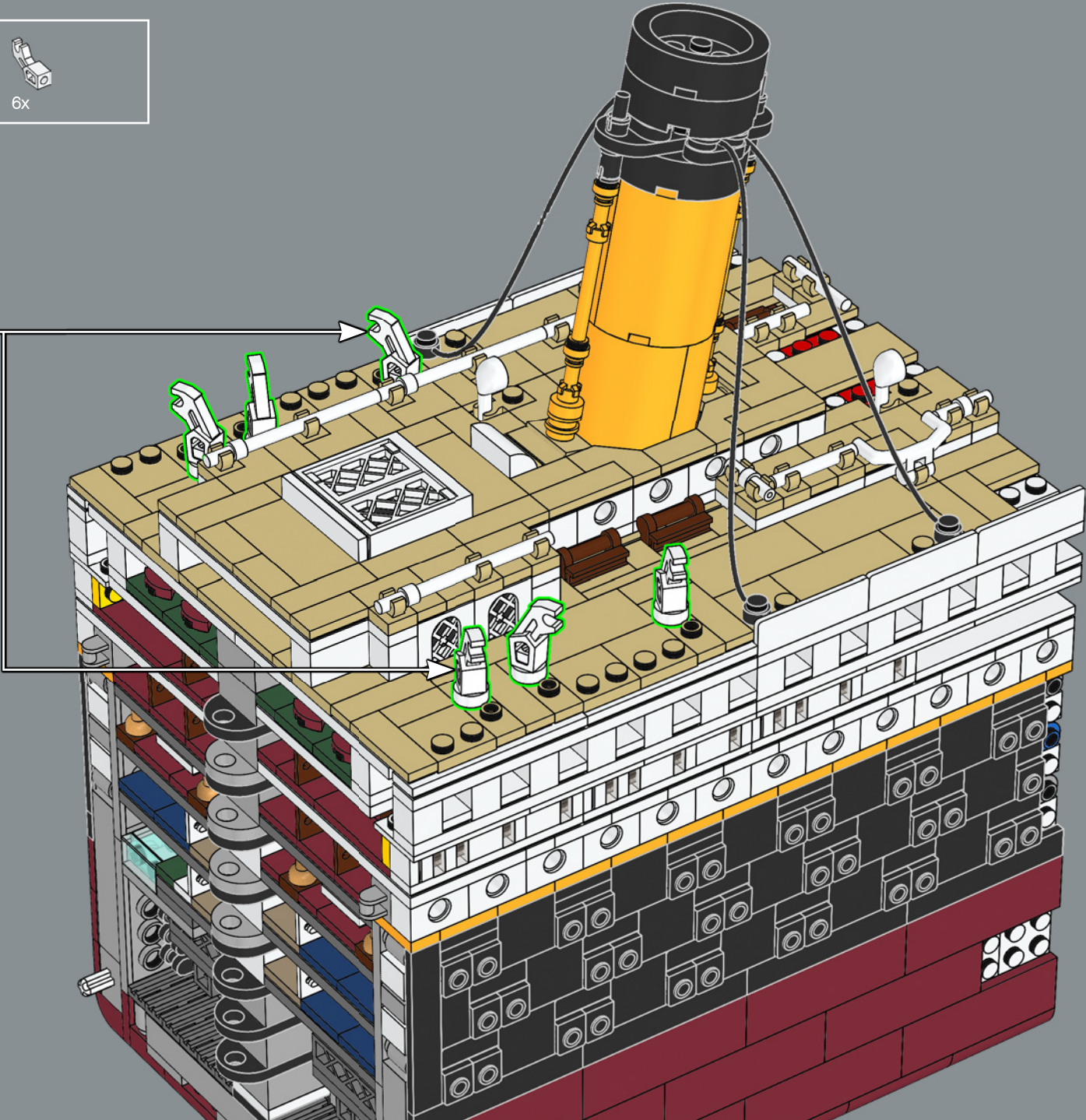
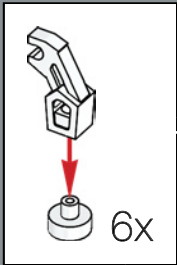

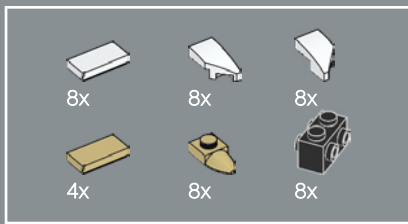

140

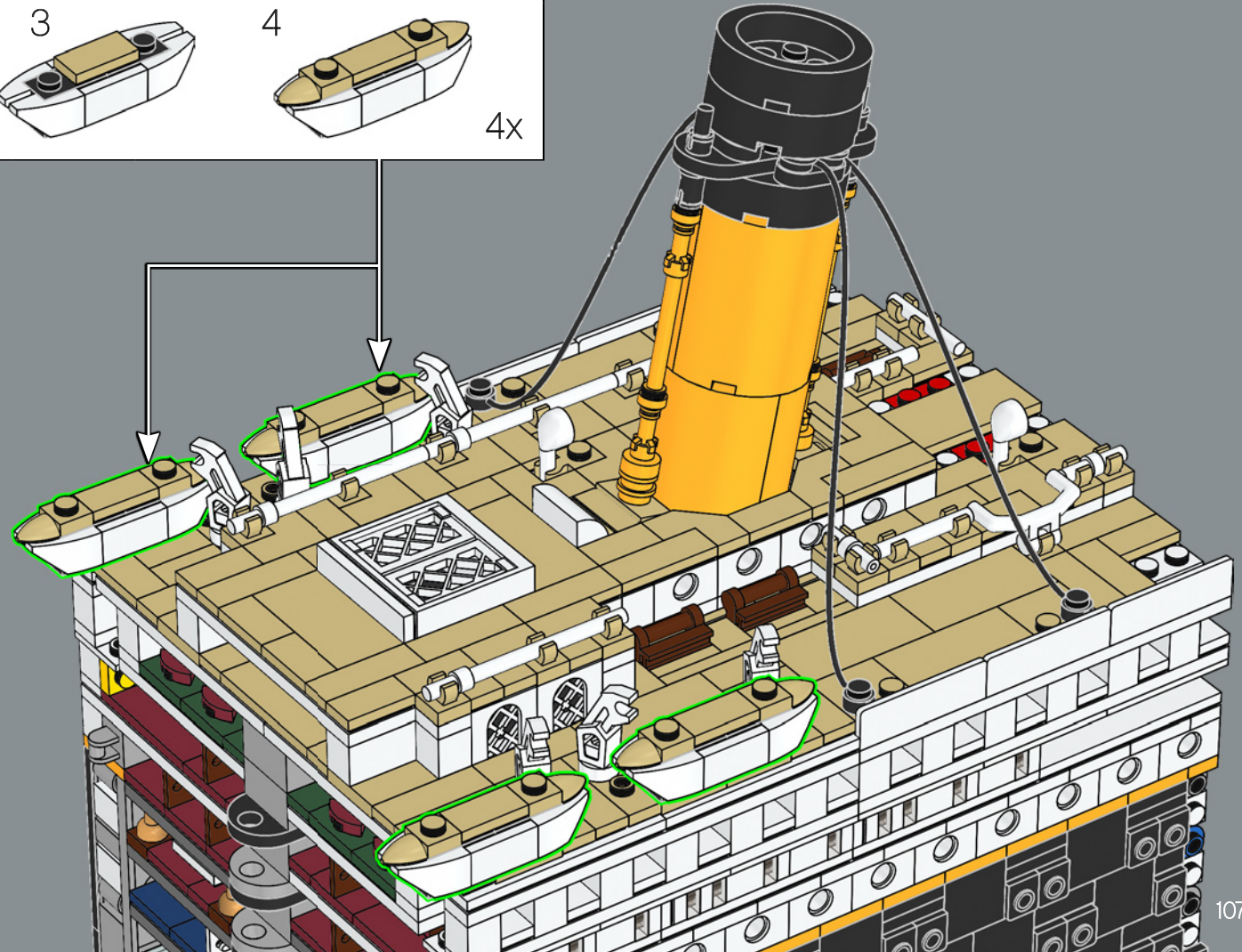
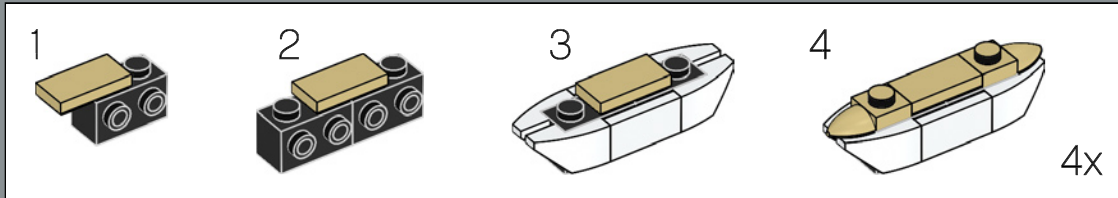

Of the 20 lifeboats onboard, 14 were standard wooden lifeboats with a capacity of 65 people each and four "collapsible" boats holding 47 people in each.

Des 20 canots de sauvetage à bord, 14 sont des canots en bois standard d'une capacité de 65 personnes, et quatre sont des canots « pliables » pouvant accueillir 47 personnes.

De los 20 botes salvavidas a bordo, 14 eran embarcaciones de madera convencionales, con capacidad para 65 personas cada una, y cuatro eran plegables, con capacidad para 47 personas.

SECTION 4:

FUNNEL & COMPASS

This section includes a portion of the *Titanic's* massive engine rooms and the elevated structure in the center that housed the main compass. It was elevated to ensure the least amount of interference from the massive amount of iron in the ship's hull. There is also a small sub-assembly that represents a bench used by passengers enjoying the upper decks of the ship.

SECTION 4 :

CHEMINÉE ET BOUSSOLE

Cette section comprend une partie des énormes salles des machines du *Titanic* ainsi que la structure surélevée au centre où se trouve la boussole principale. La boussole est élevée pour réduire l'interférence causée par l'importante quantité de fer dans la coque du paquebot. Il y a aussi un petit sous-ensemble représentant un banc utilisé par des passagers qui profitent des ponts supérieurs du navire.

SECCIÓN 4:

CHIMENEA Y BRÚJULA

Esta sección incluye una porción de las enormes salas de máquinas del *Titanic* y la estructura elevada central donde se encontraba la brújula principal. Se instaló en altura a fin de garantizar su buen funcionamiento con el mínimo de interferencias de la cantidad descomunal de hierro del casco del buque. Contiene también un pequeño modelo secundario que representa un banco usado por los pasajeros que disfrutaban de acceso a las cubiertas superiores del barco.

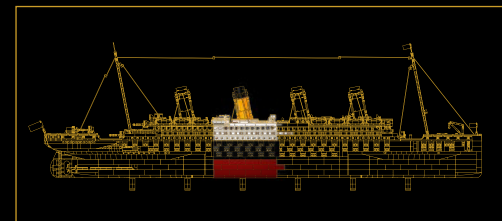

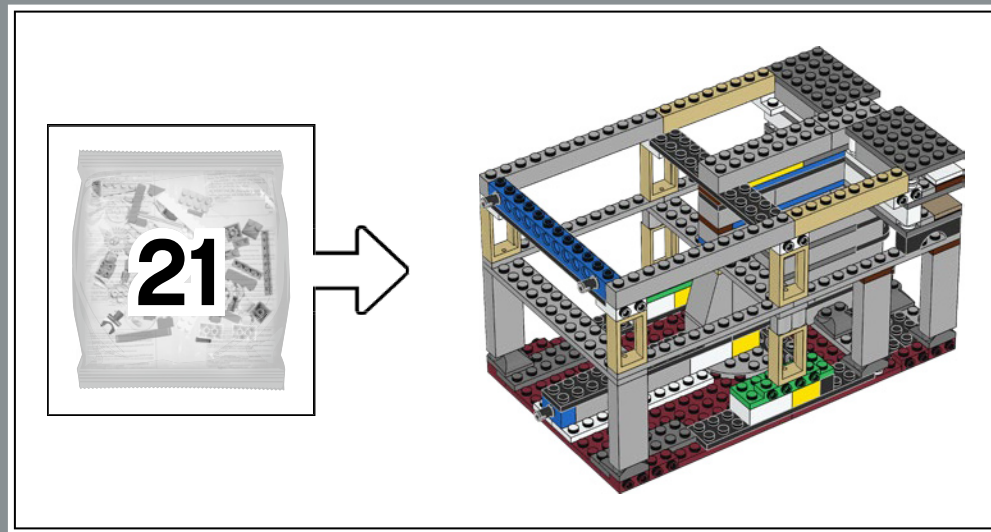

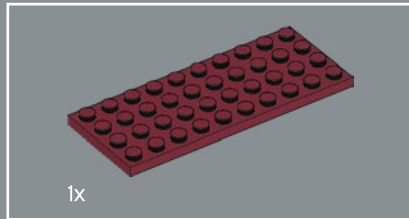
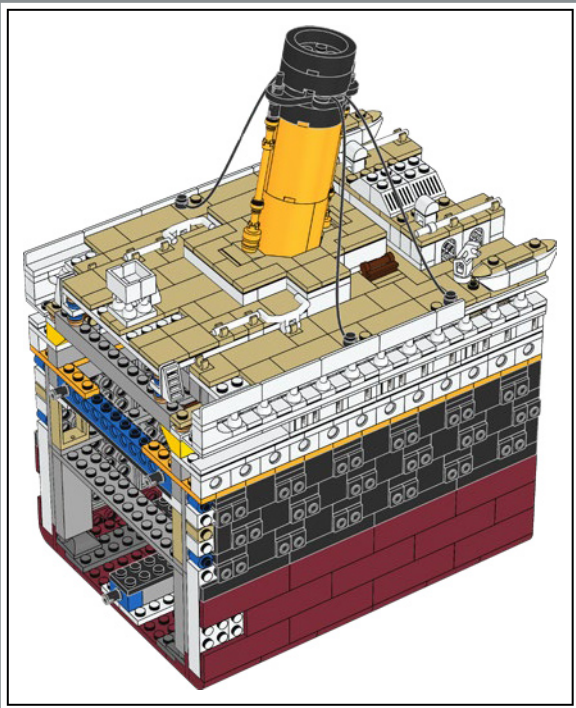

141

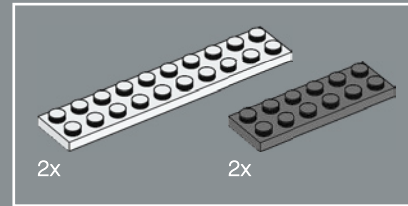
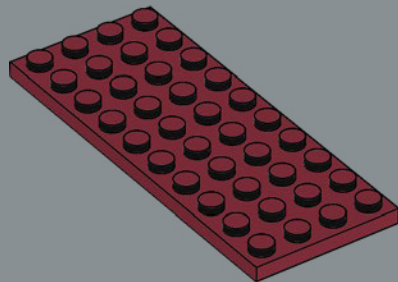

142

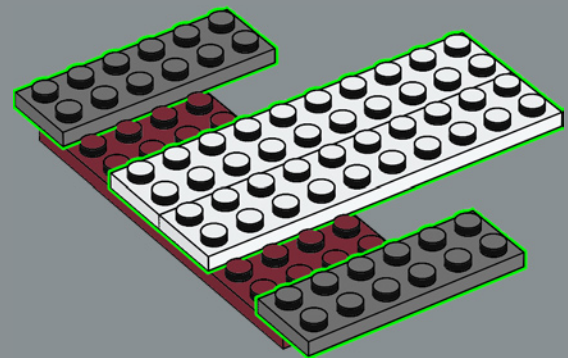

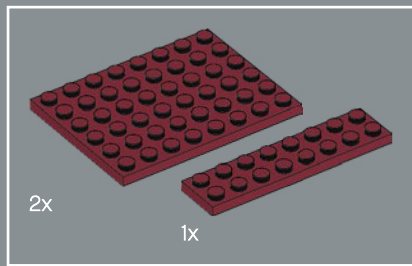

143

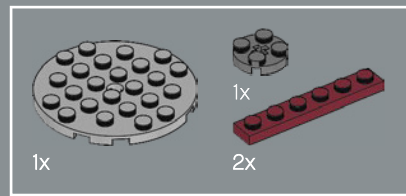
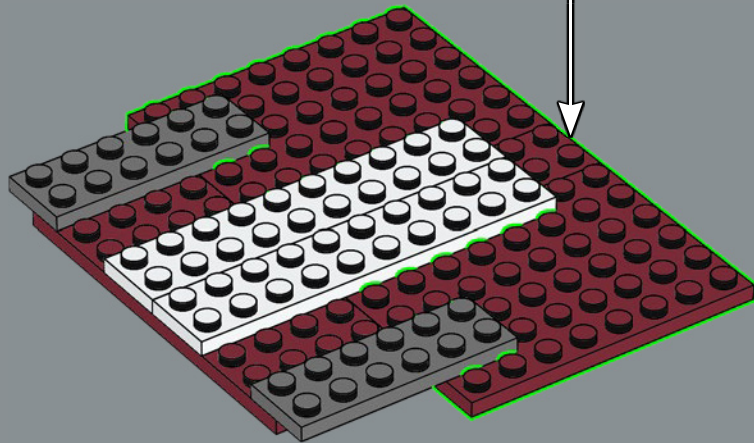
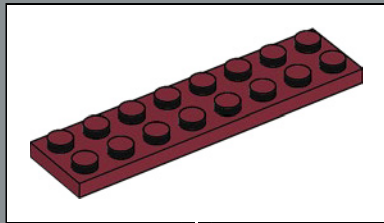

144

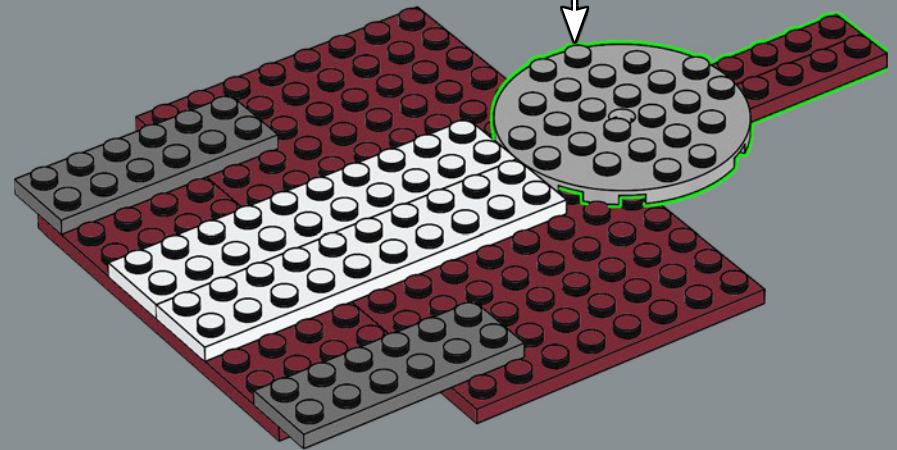
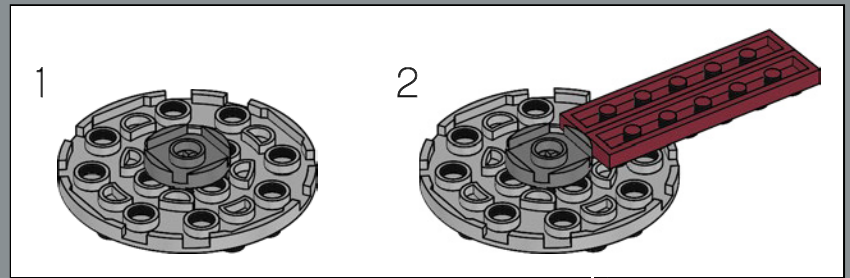

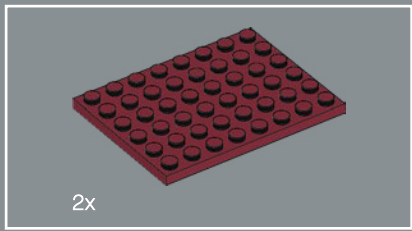

145

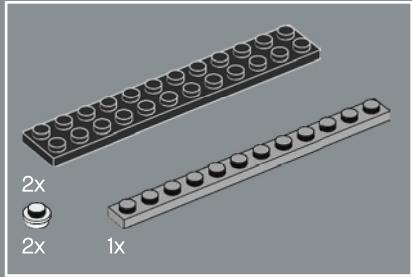
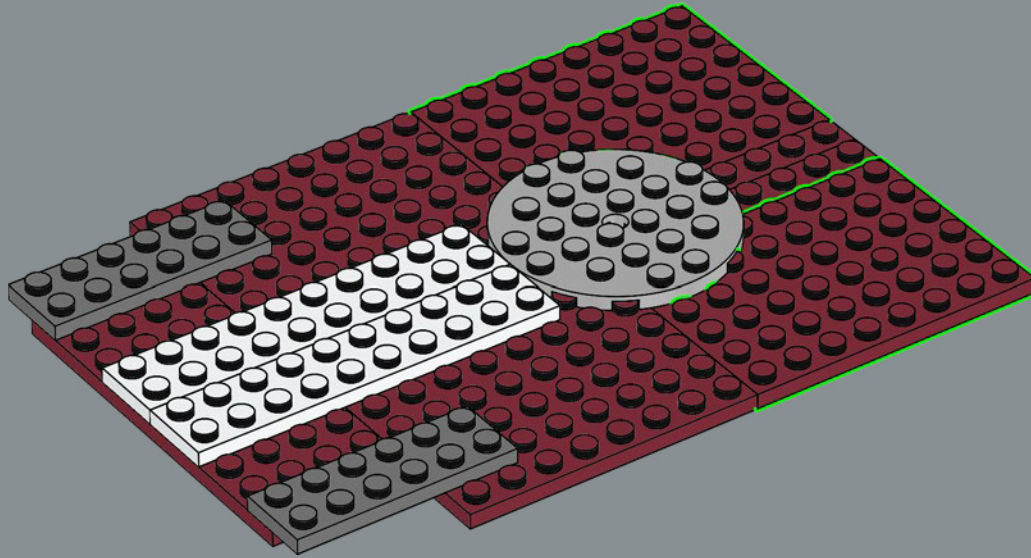

146

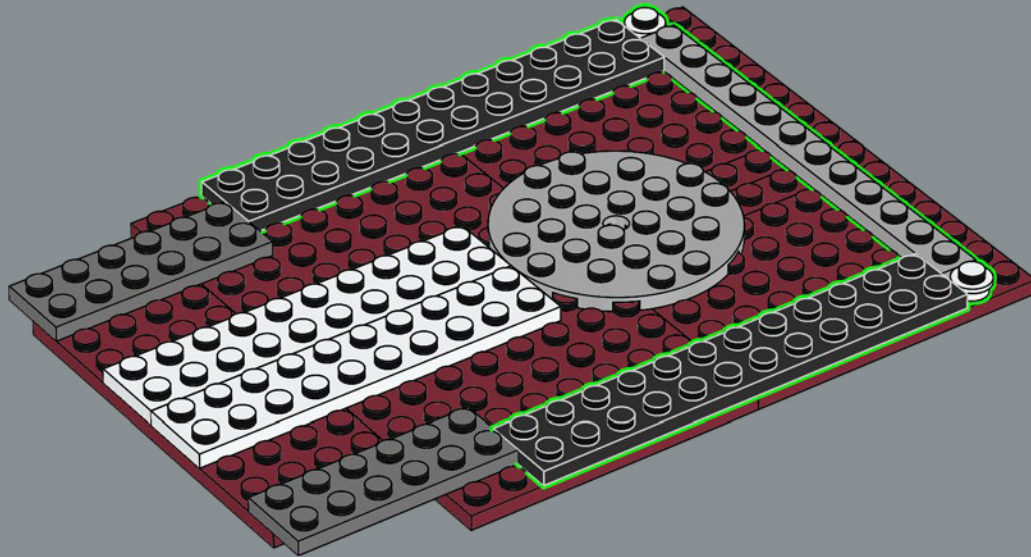

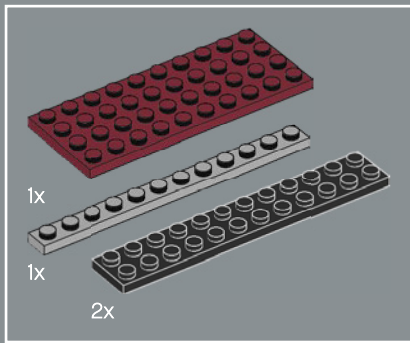

147

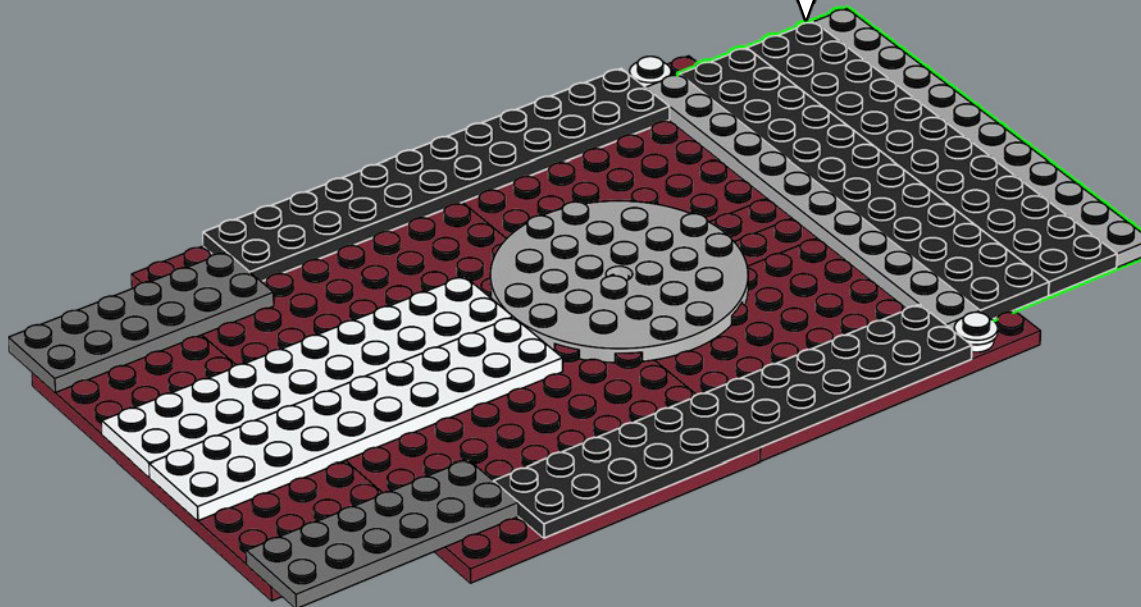
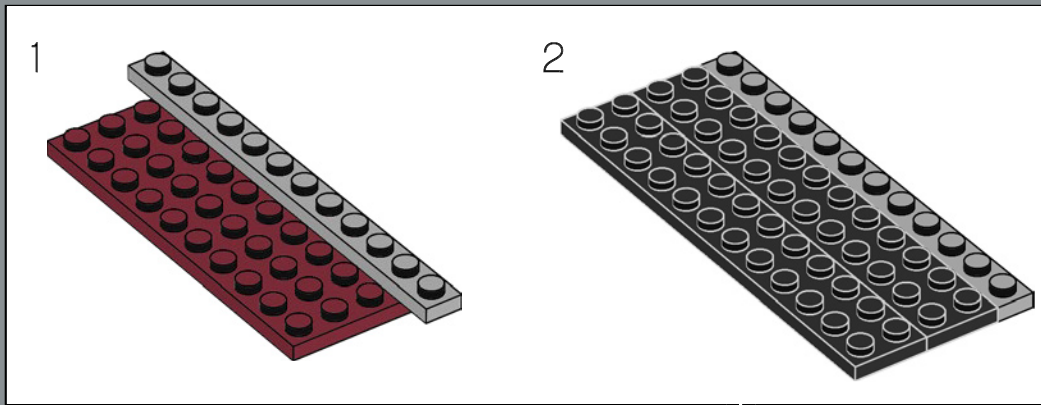



148

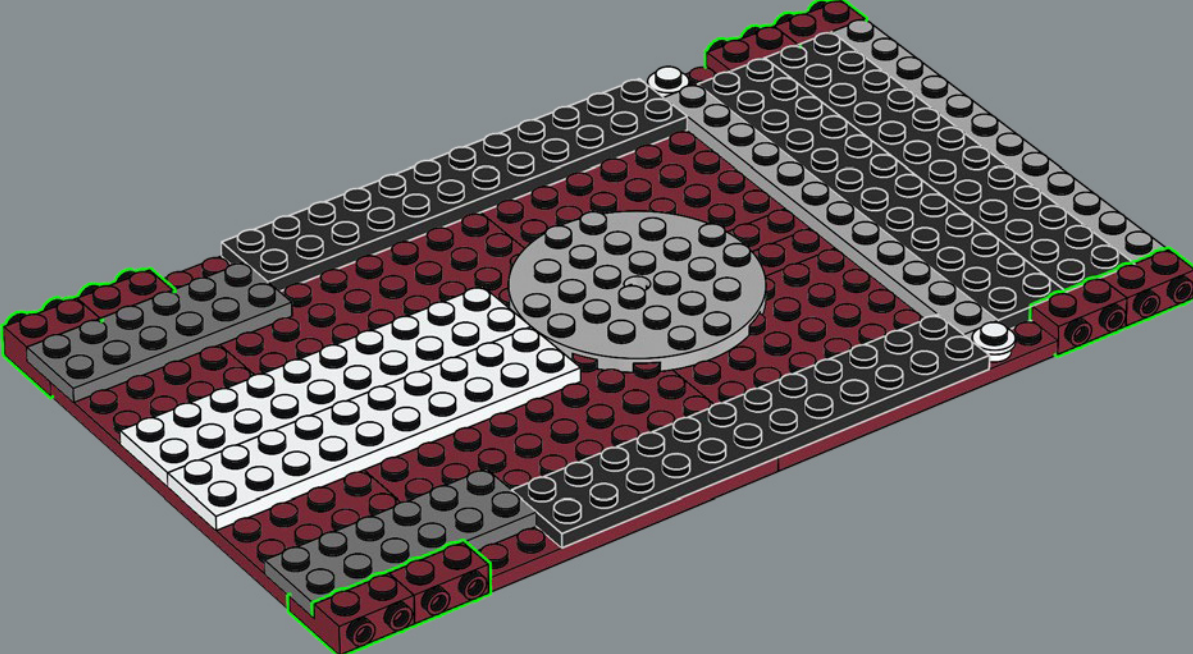

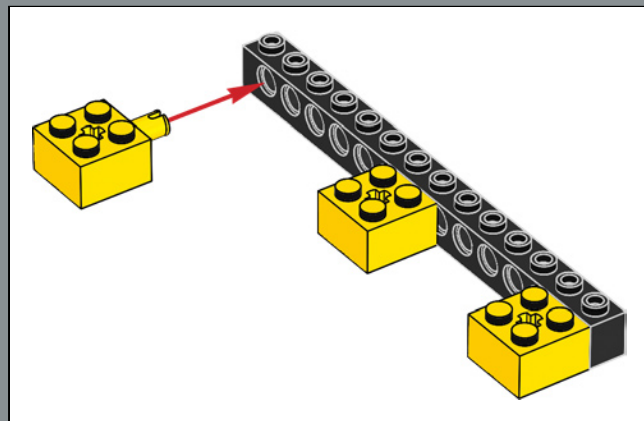
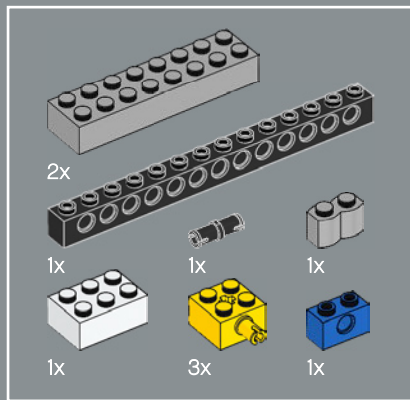

149

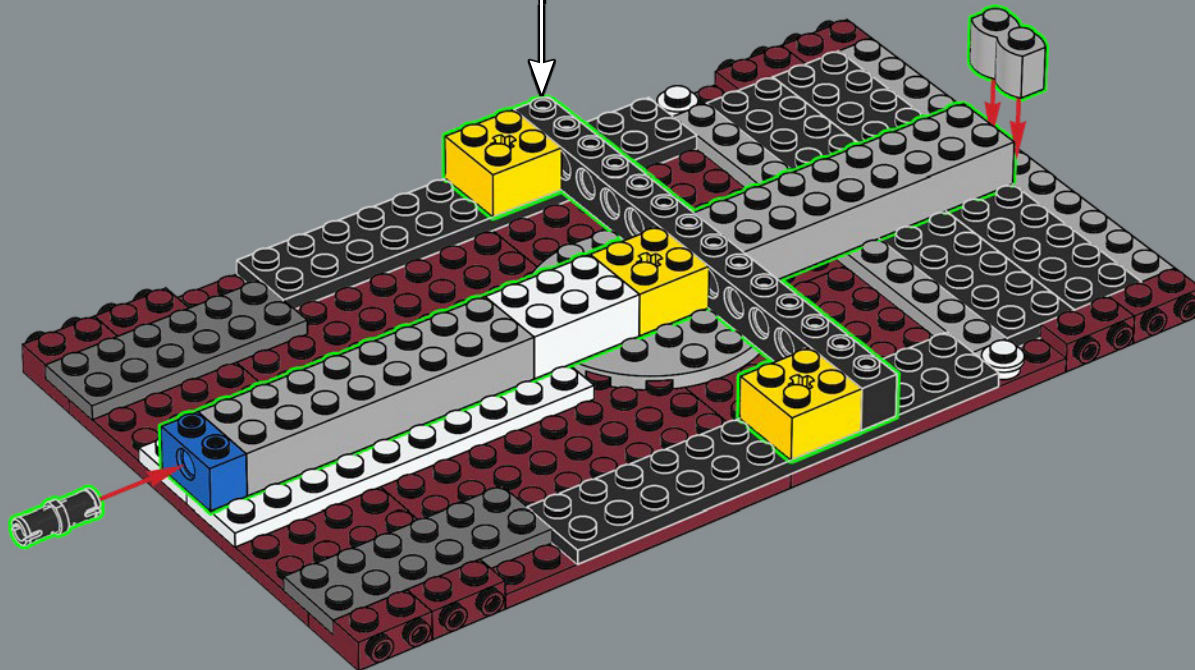

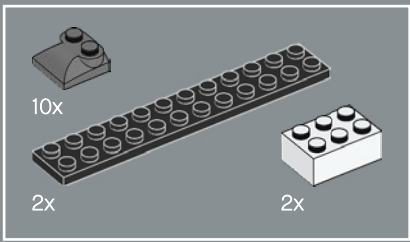

150

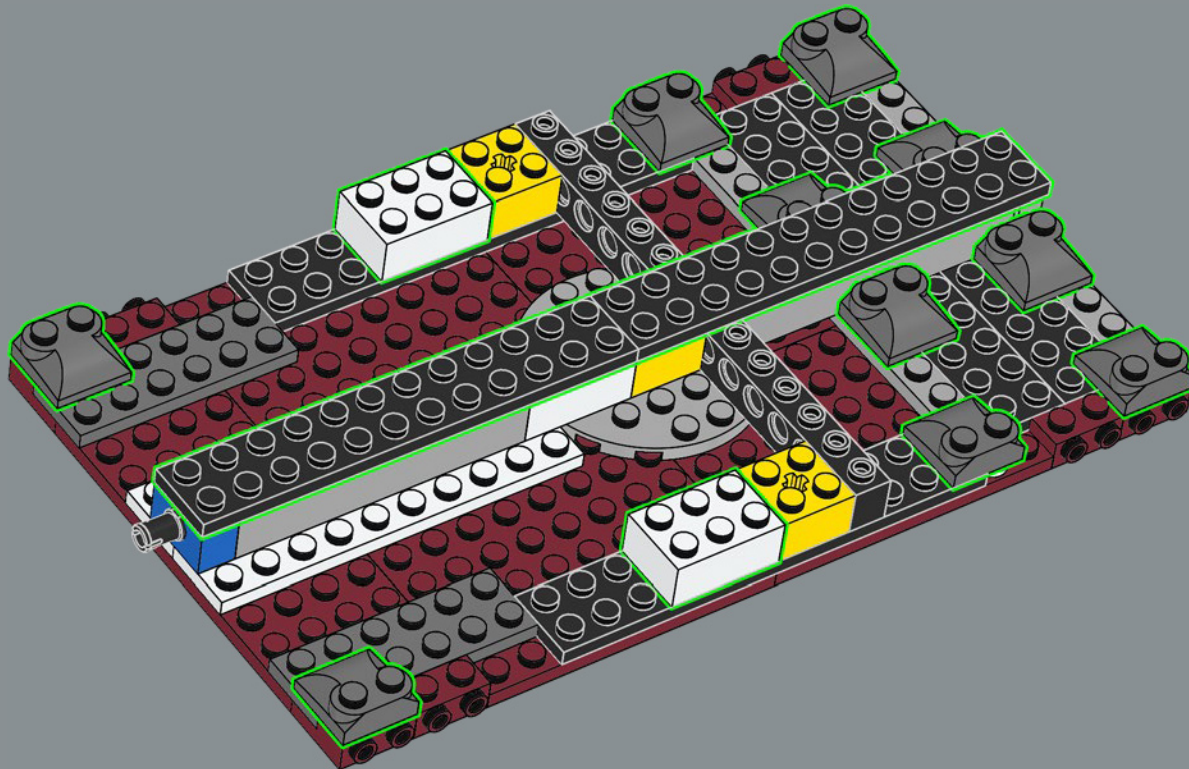

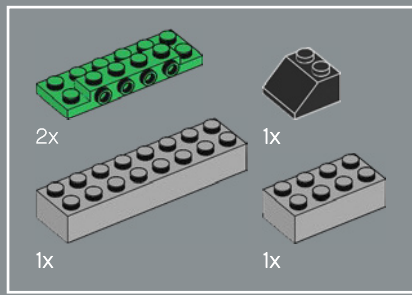

151

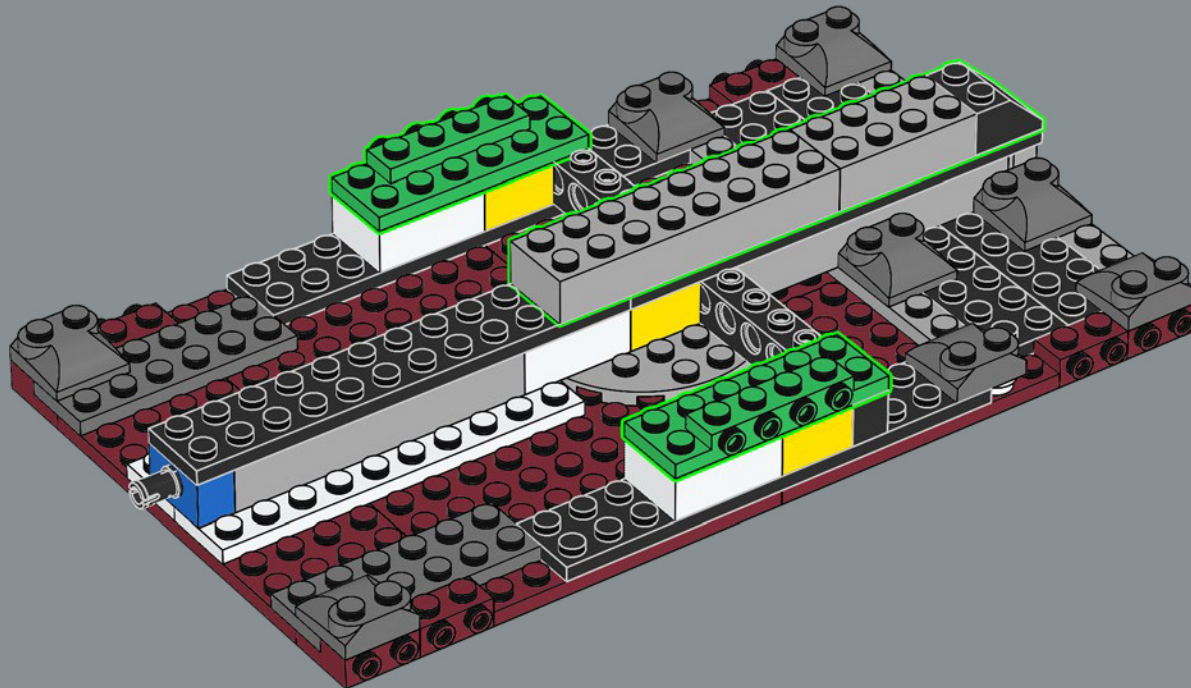

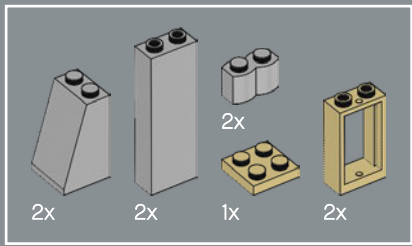

152

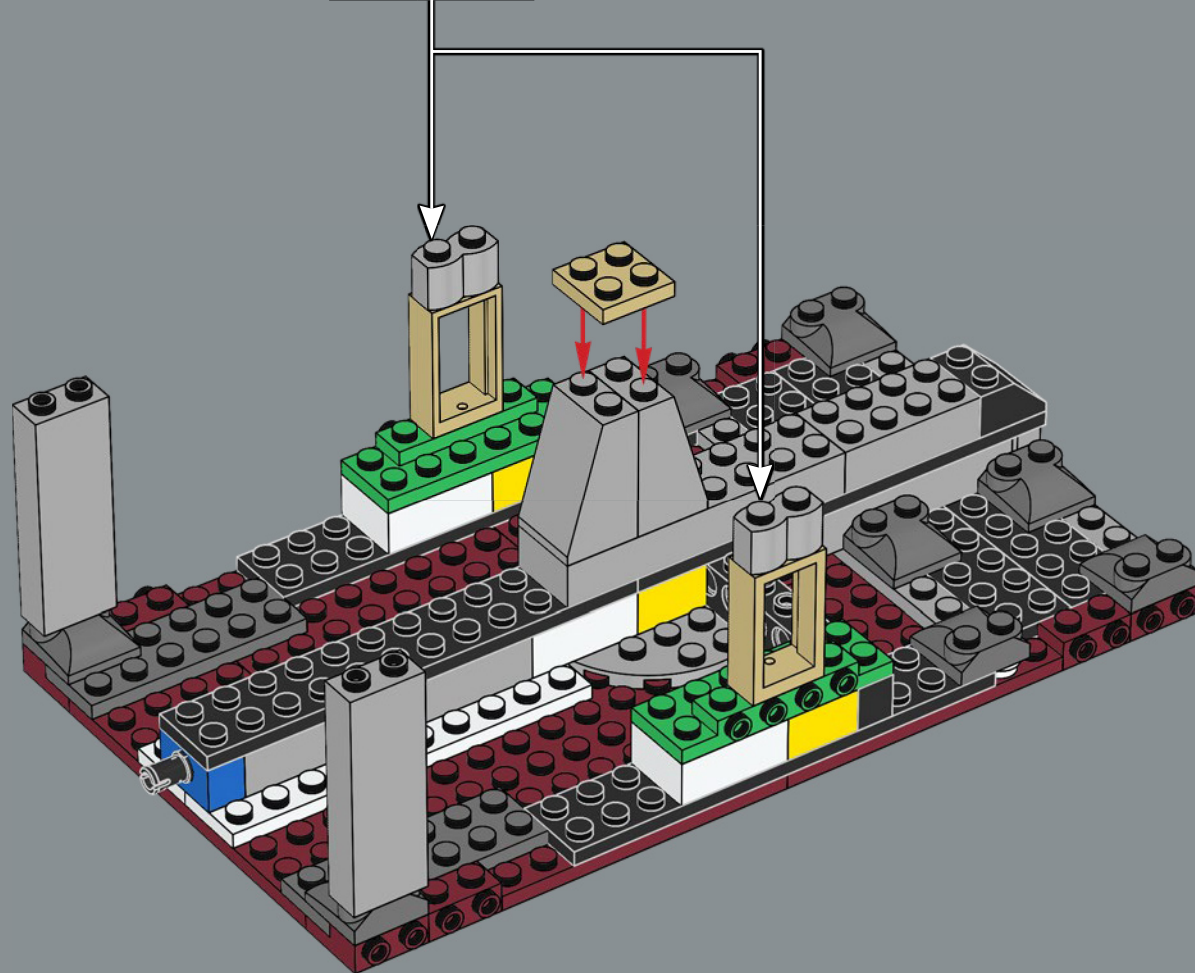
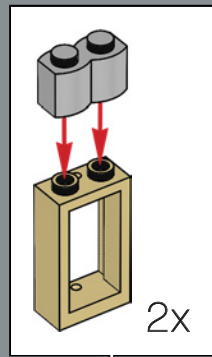

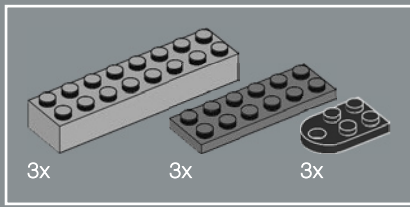

153

1

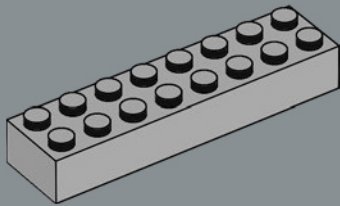

2

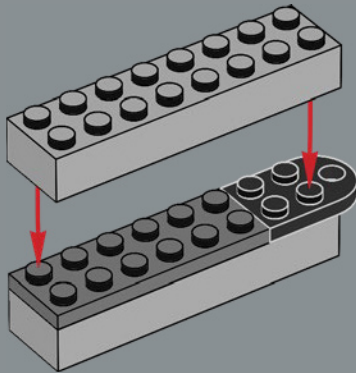

3

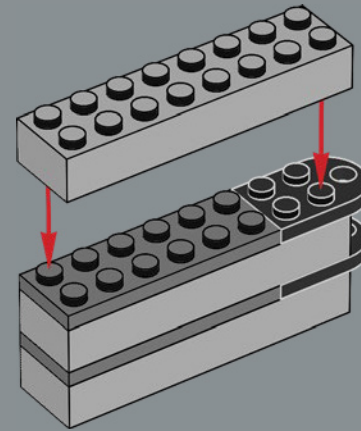

4

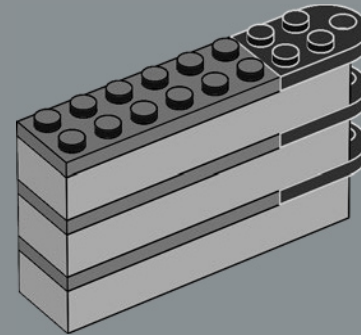

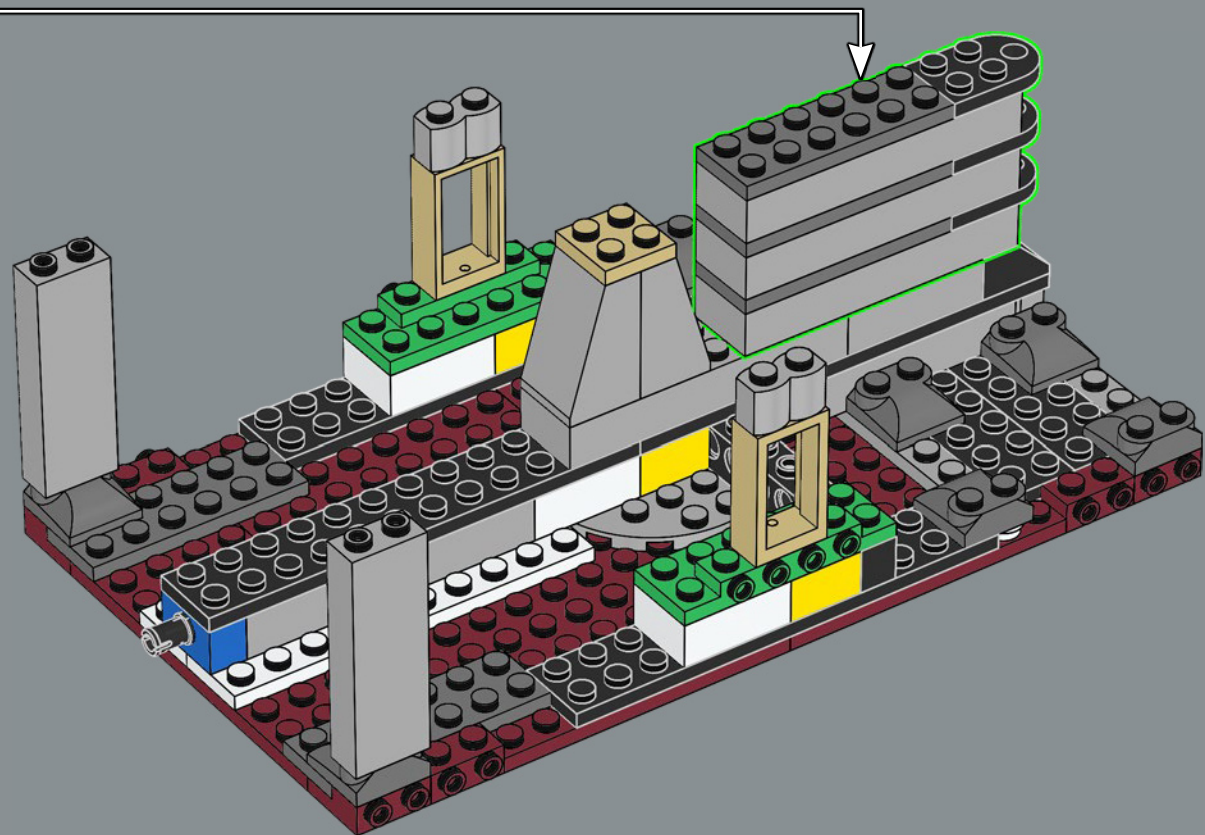

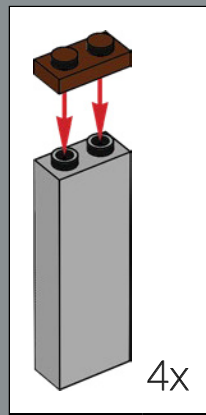
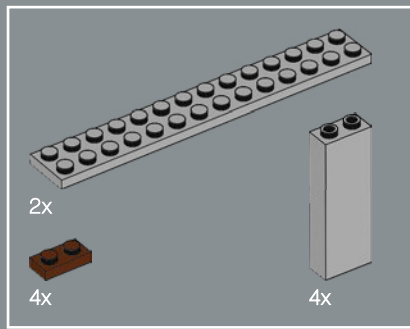

154

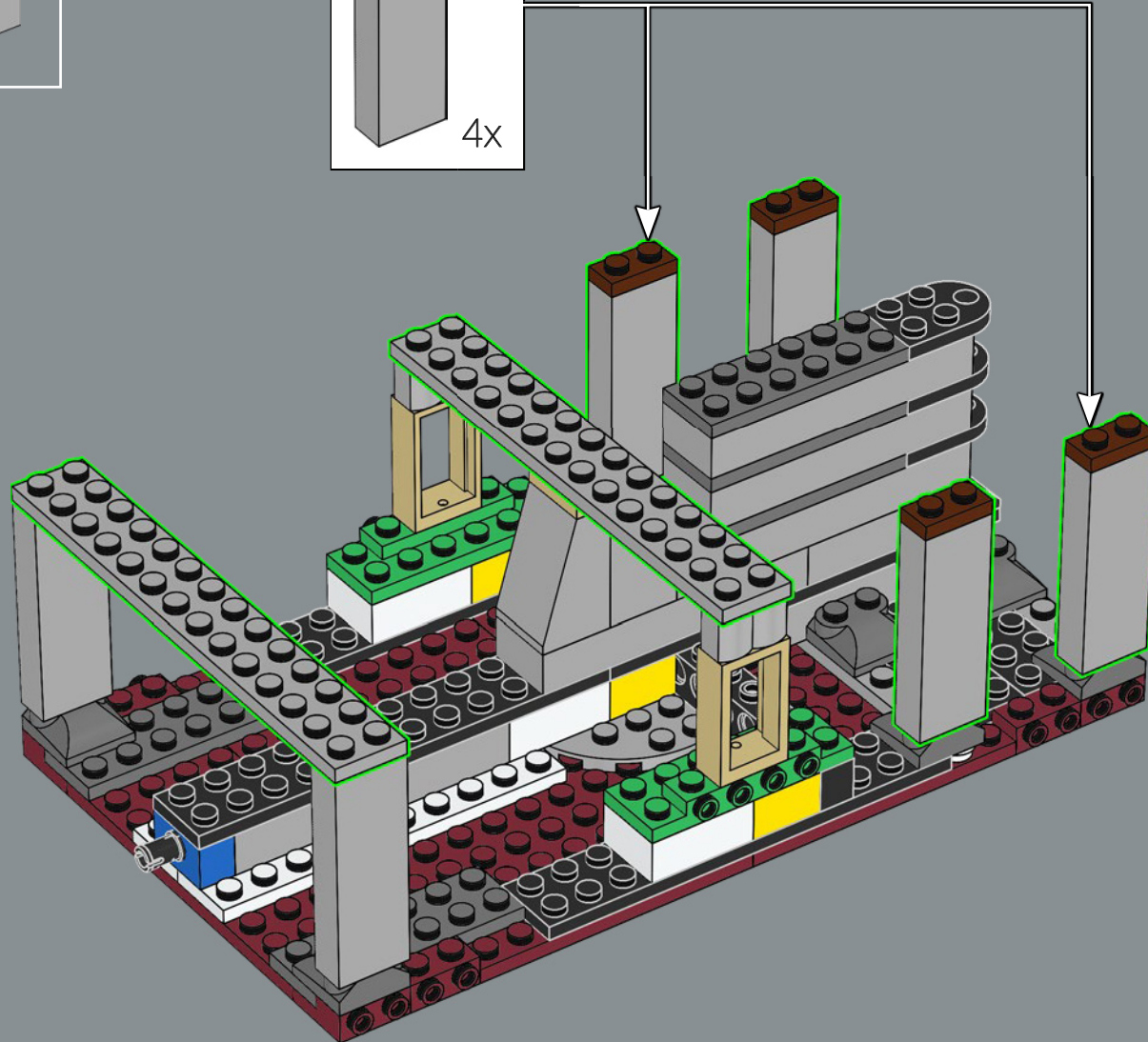

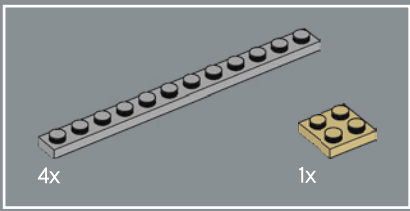

155

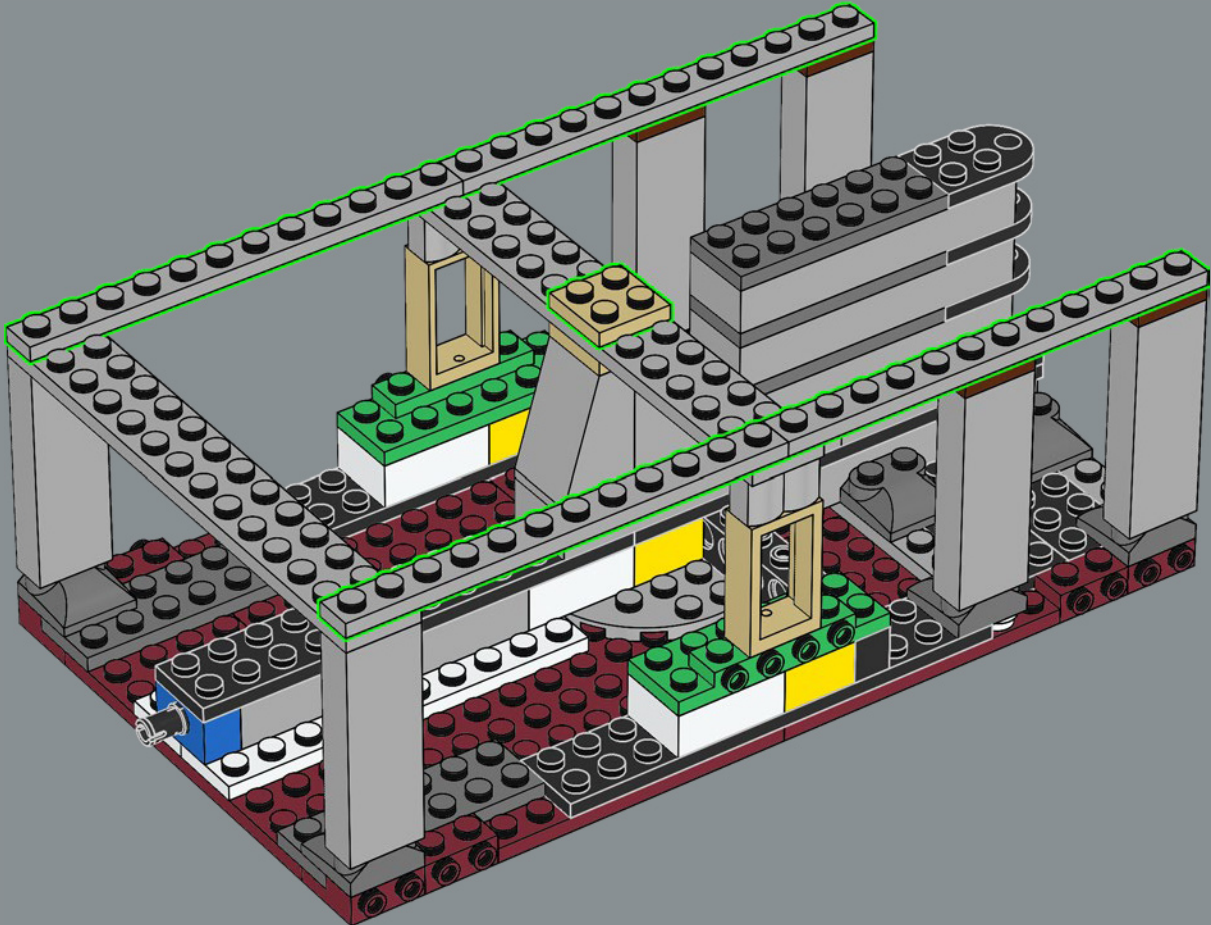

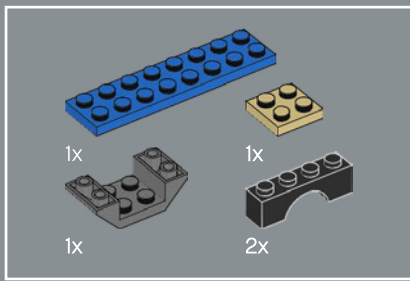

156

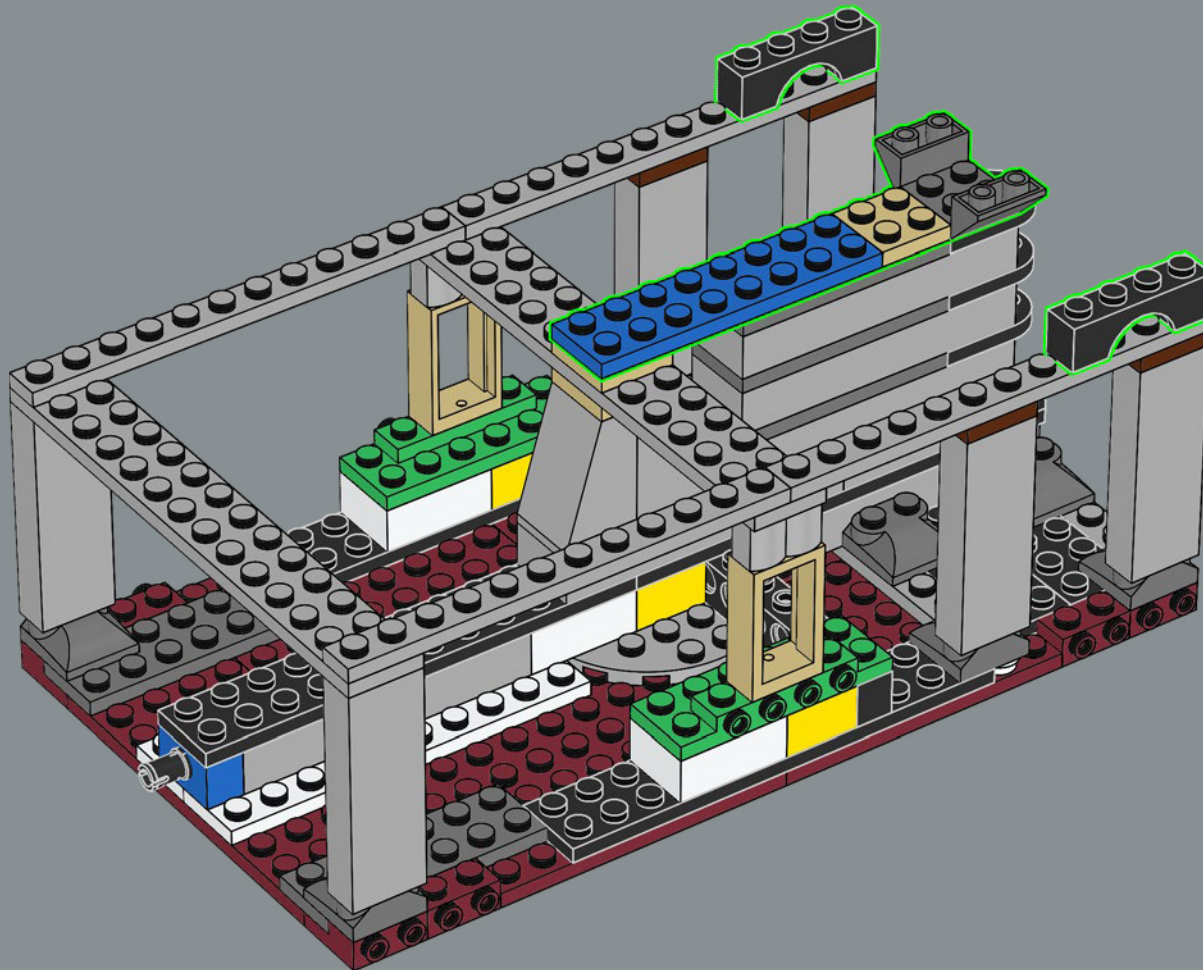

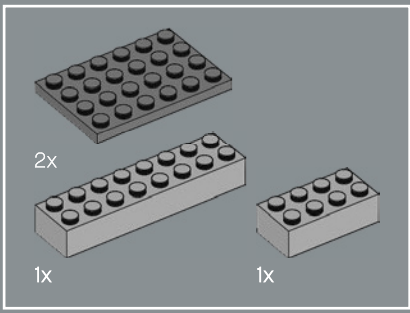

157

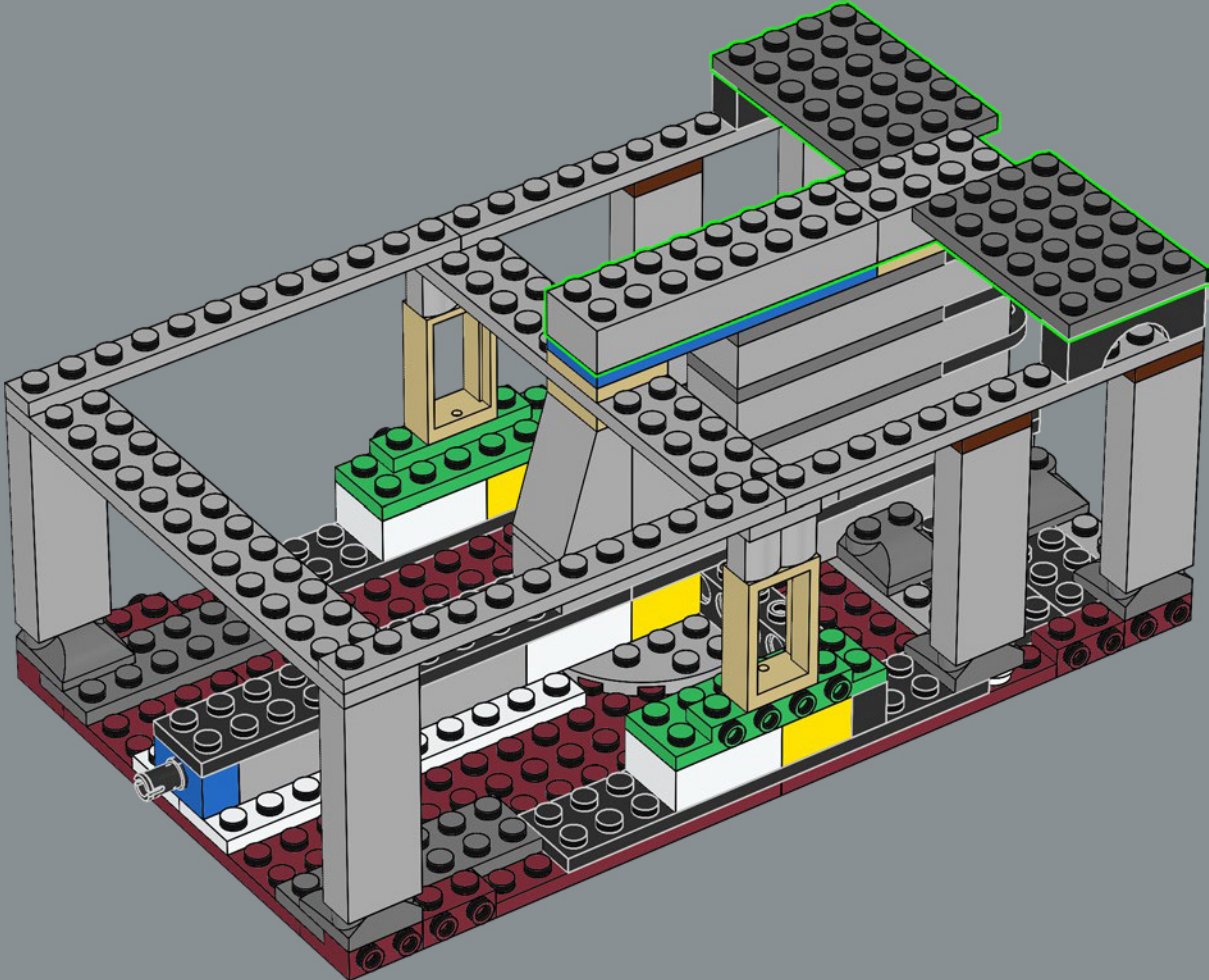

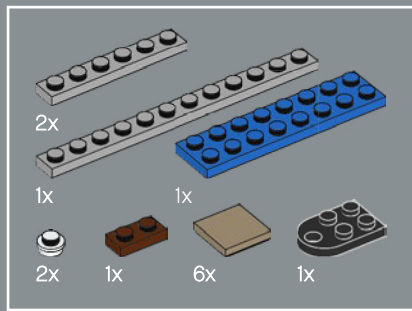

158

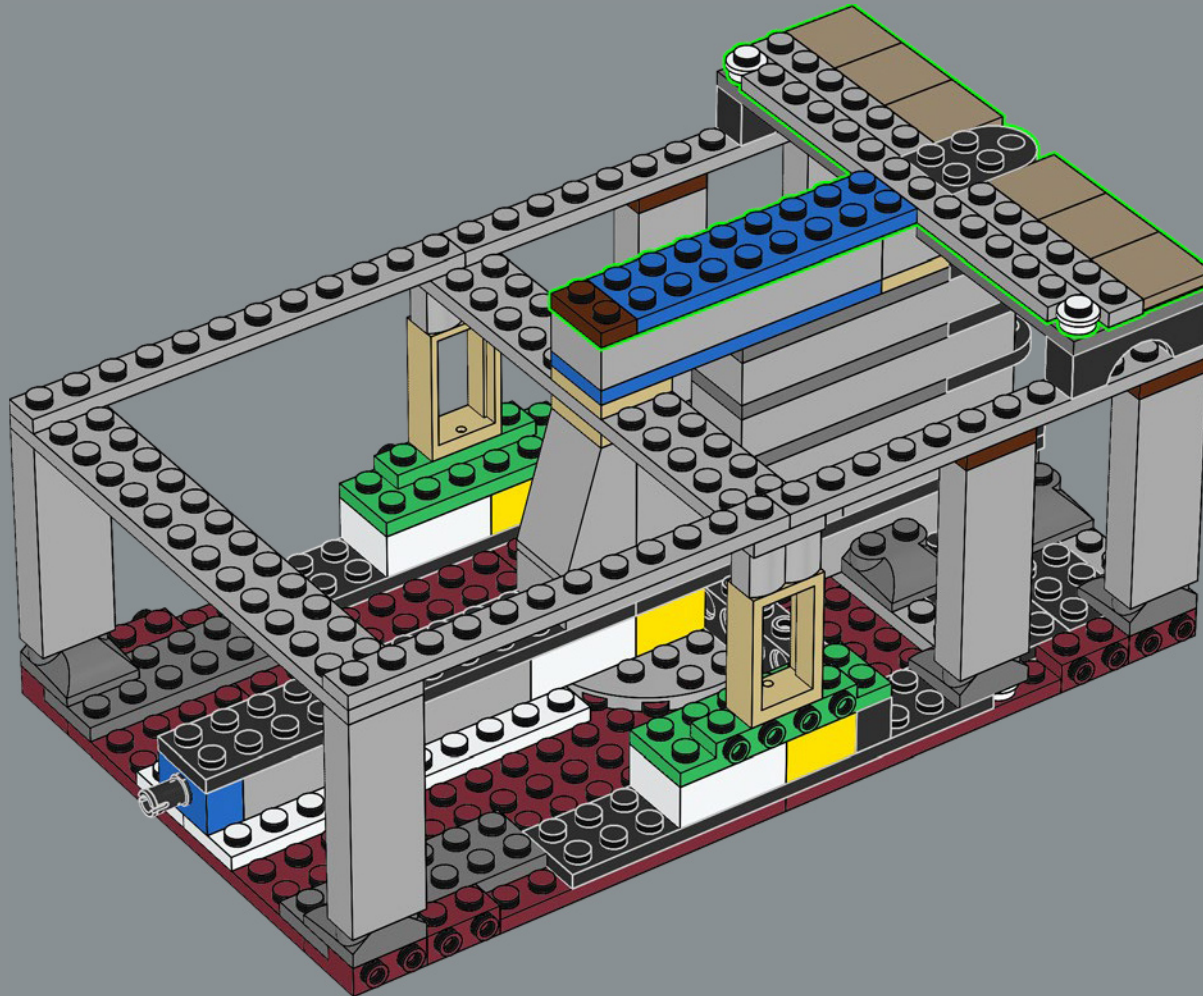

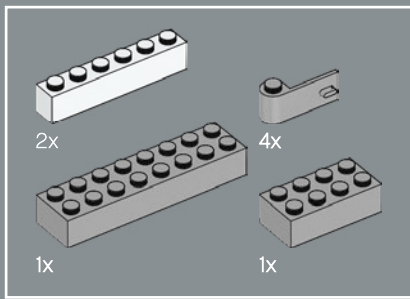

159

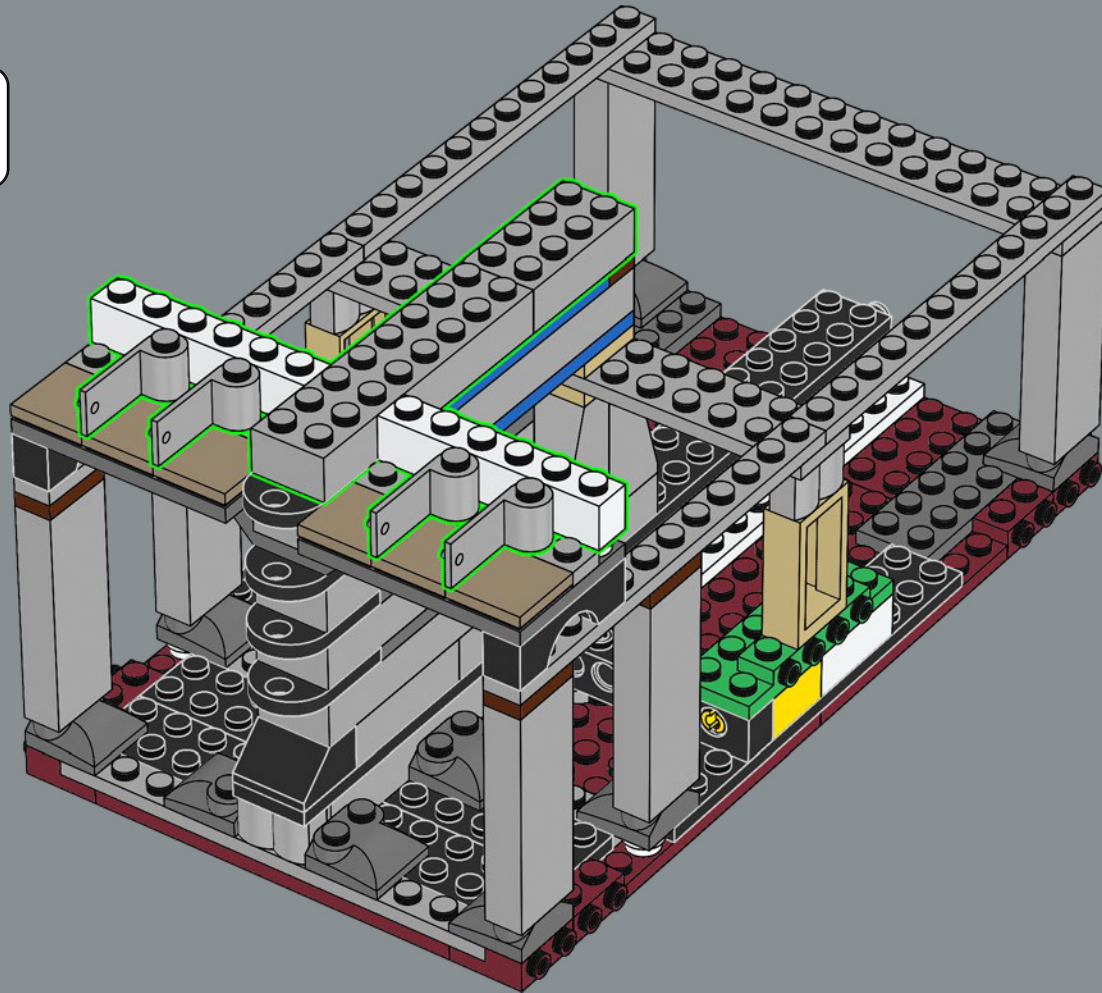

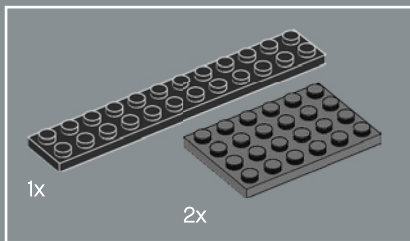

160

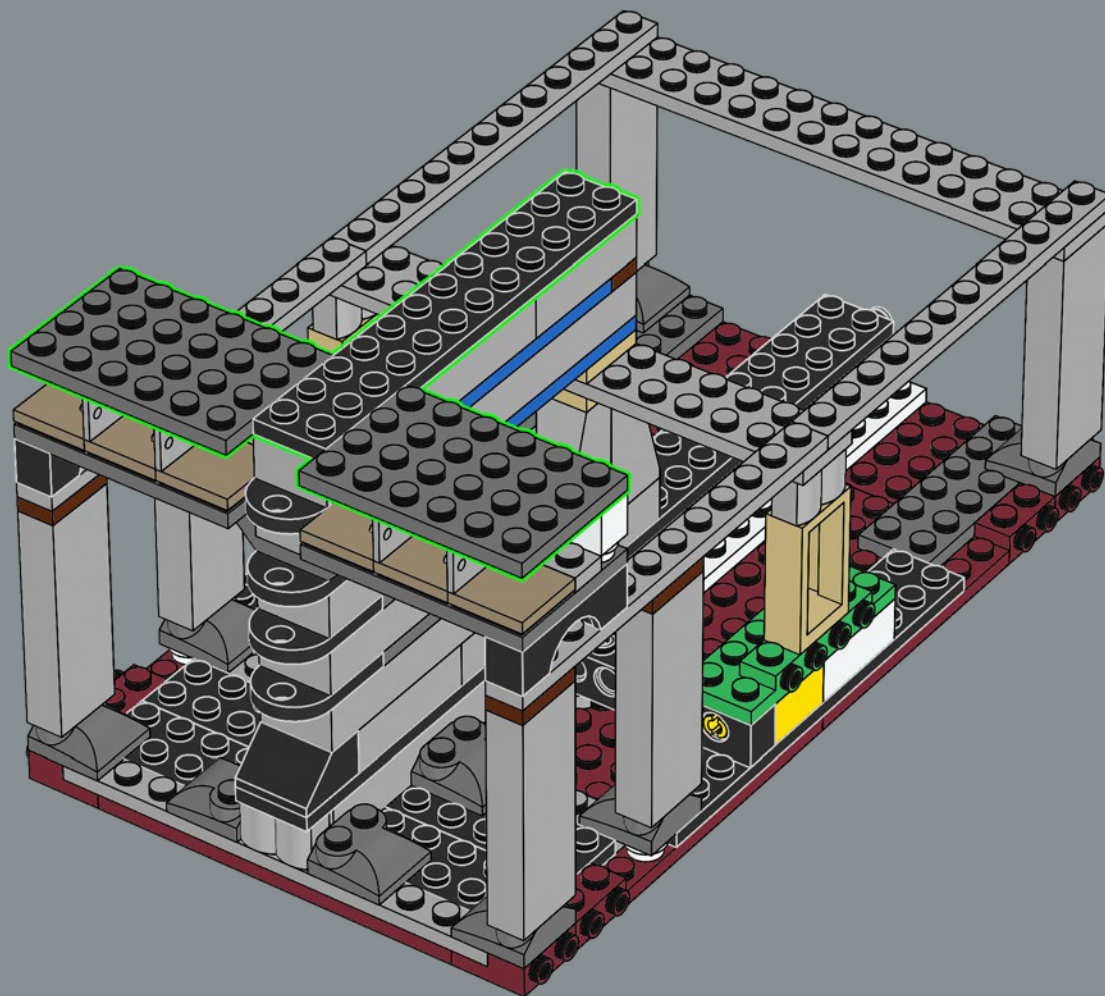

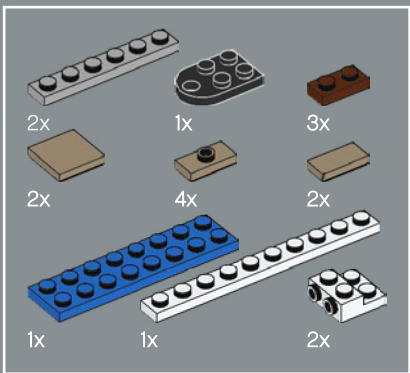

161

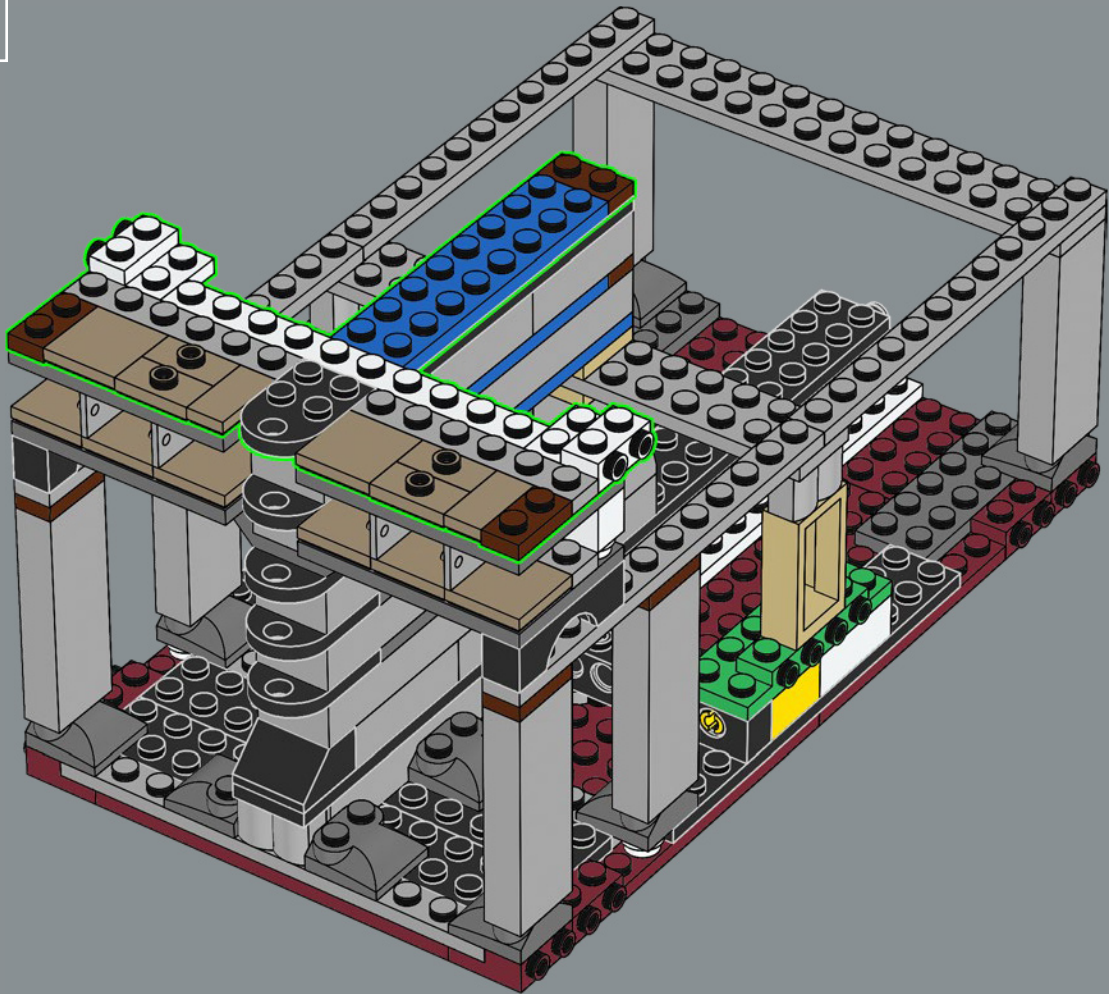

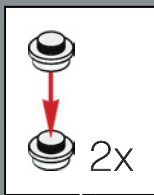
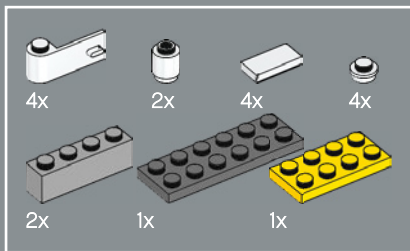

162

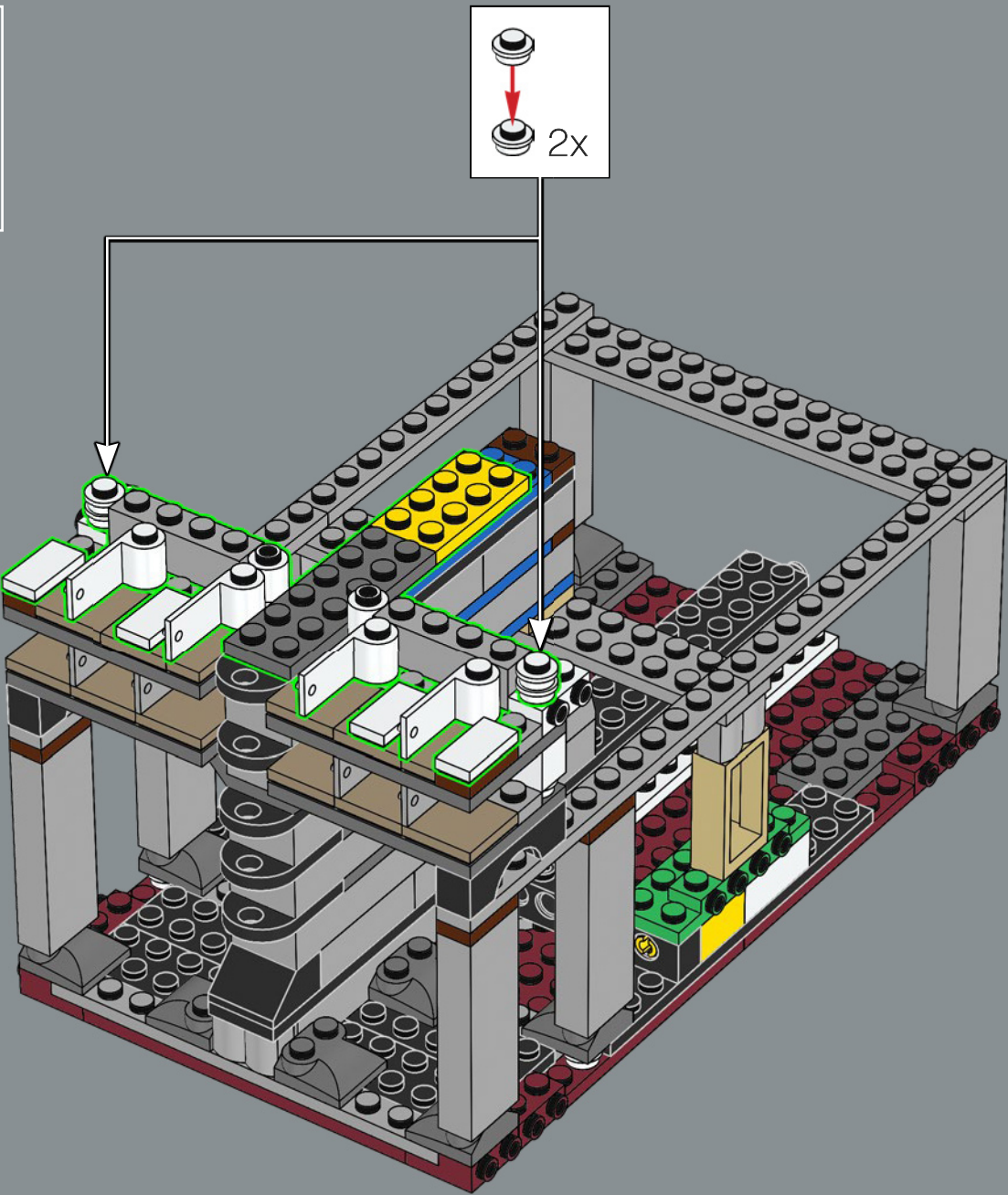

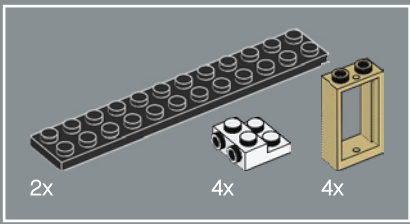

163

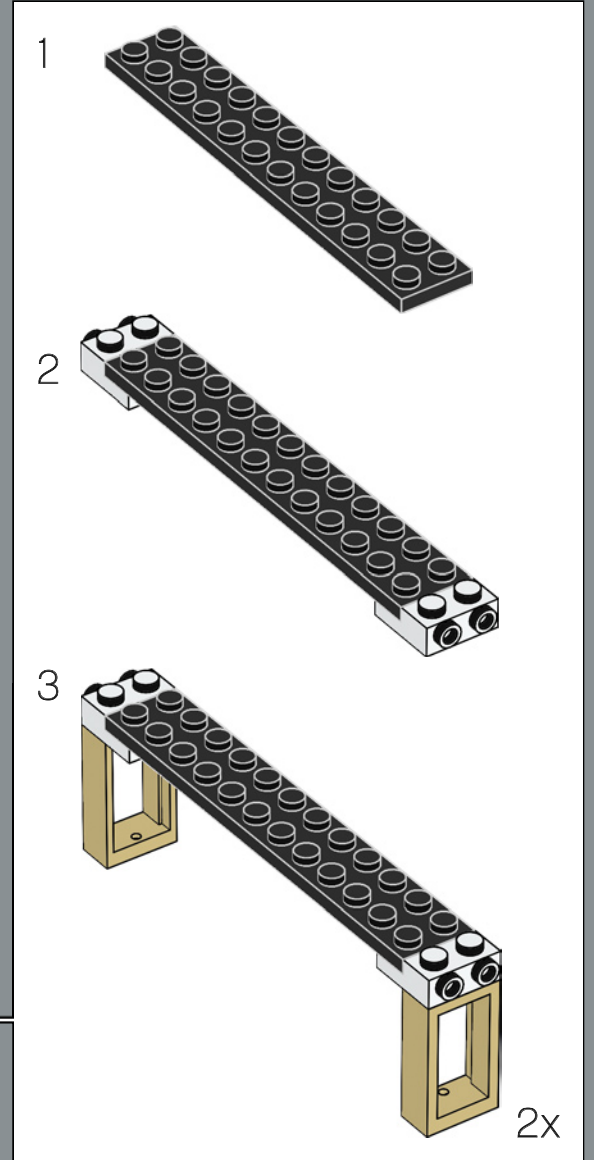
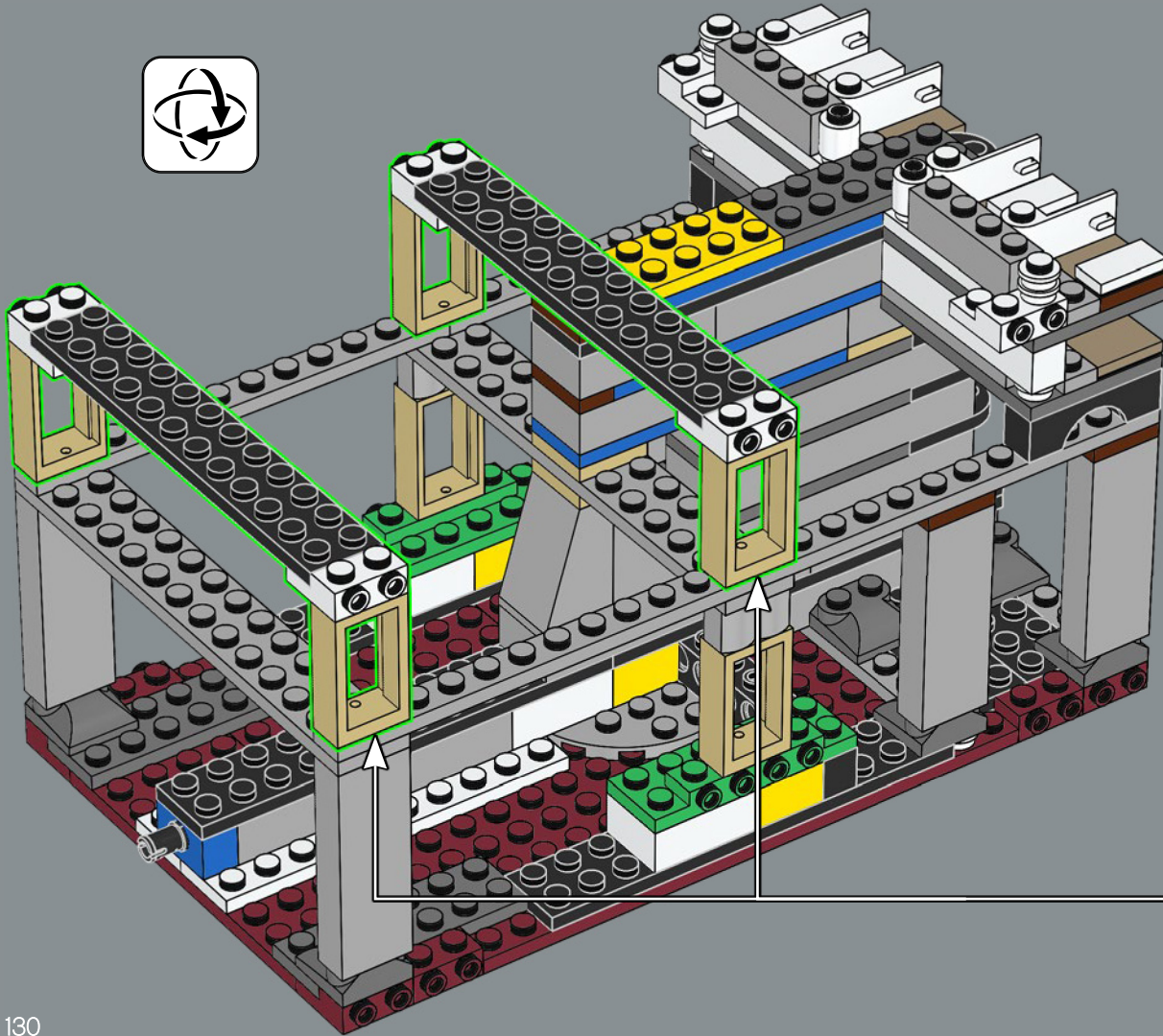

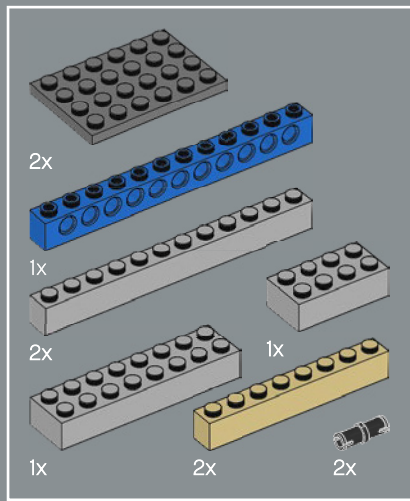

164

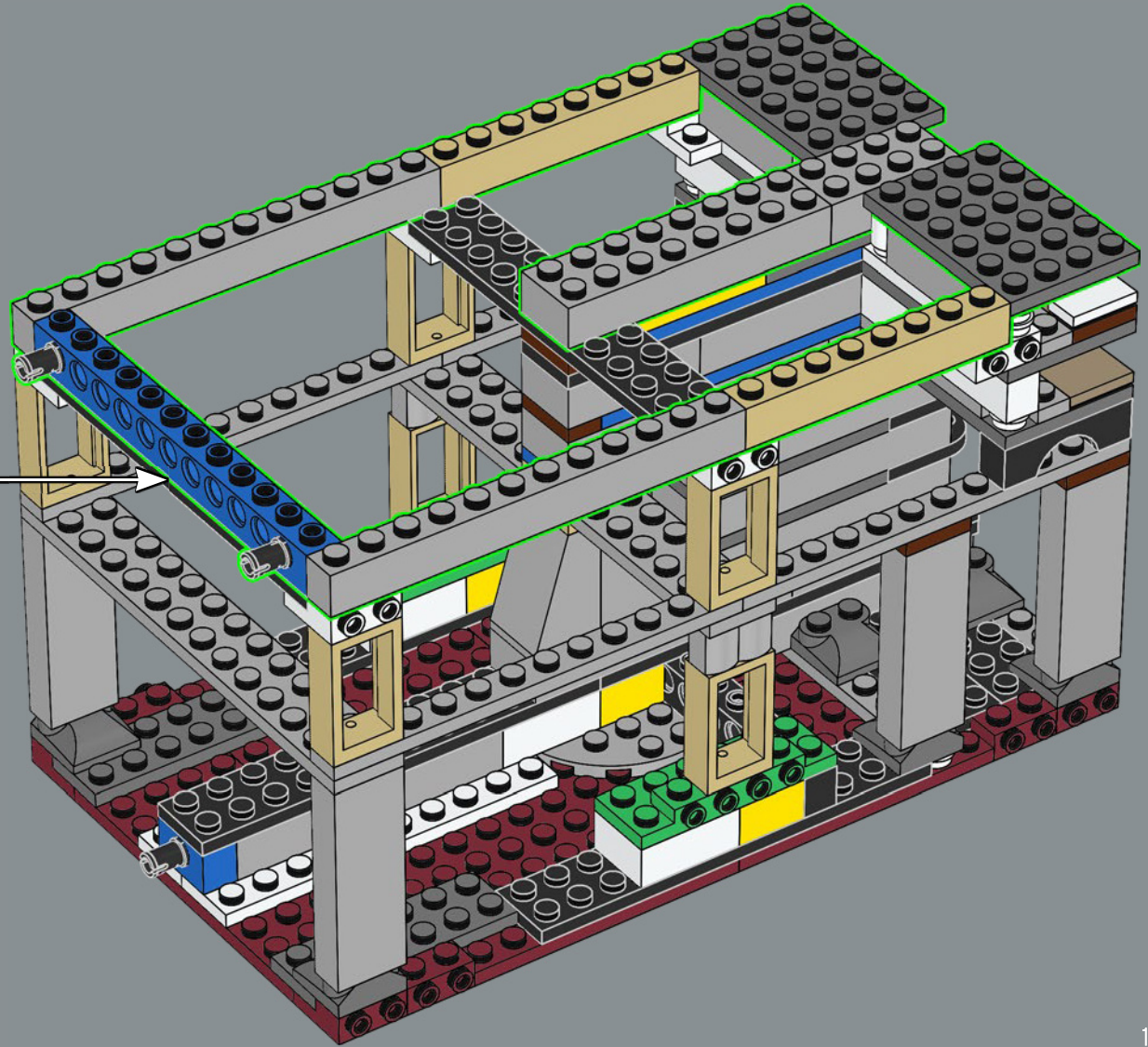
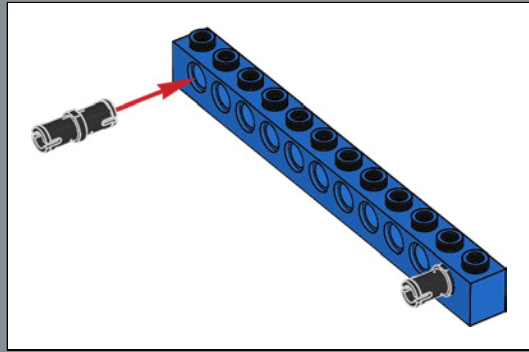

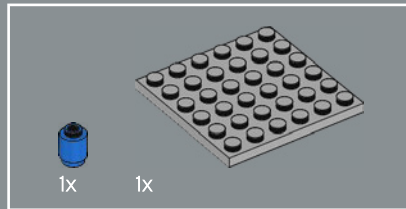
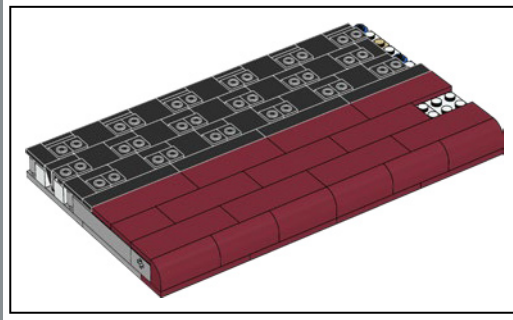
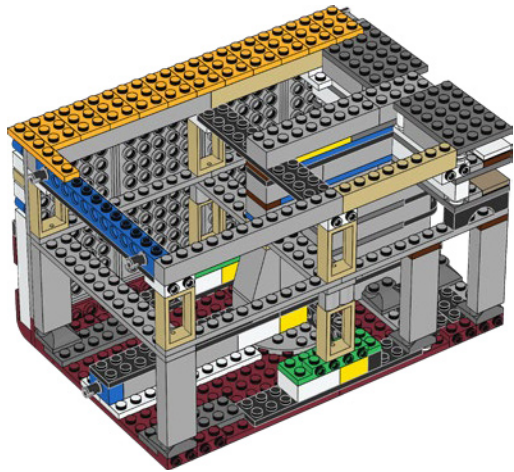
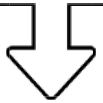

165

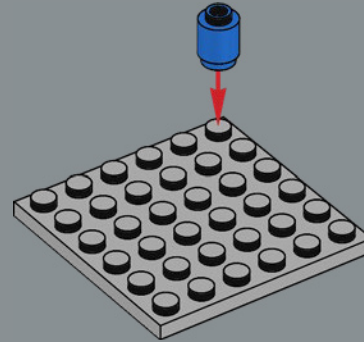

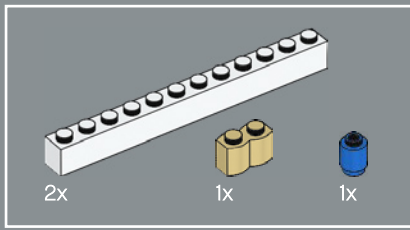

166

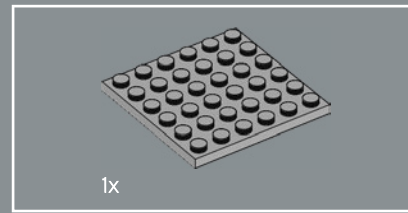
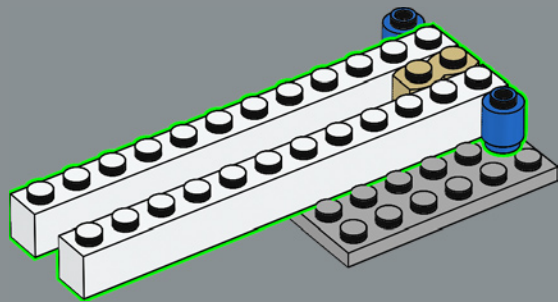

167

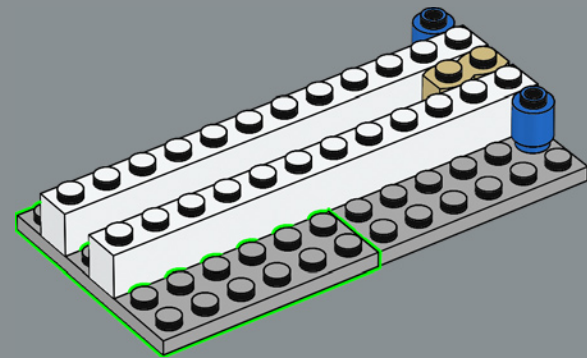

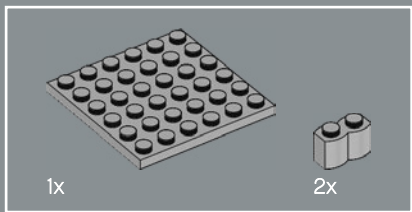

168

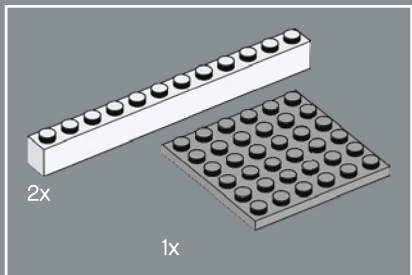
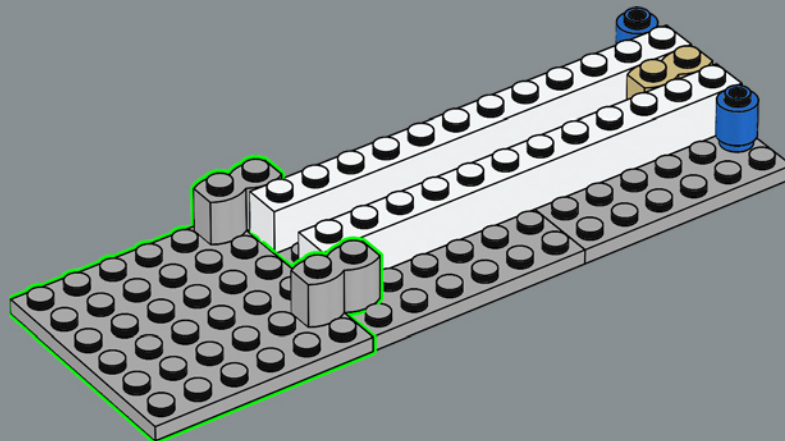

169

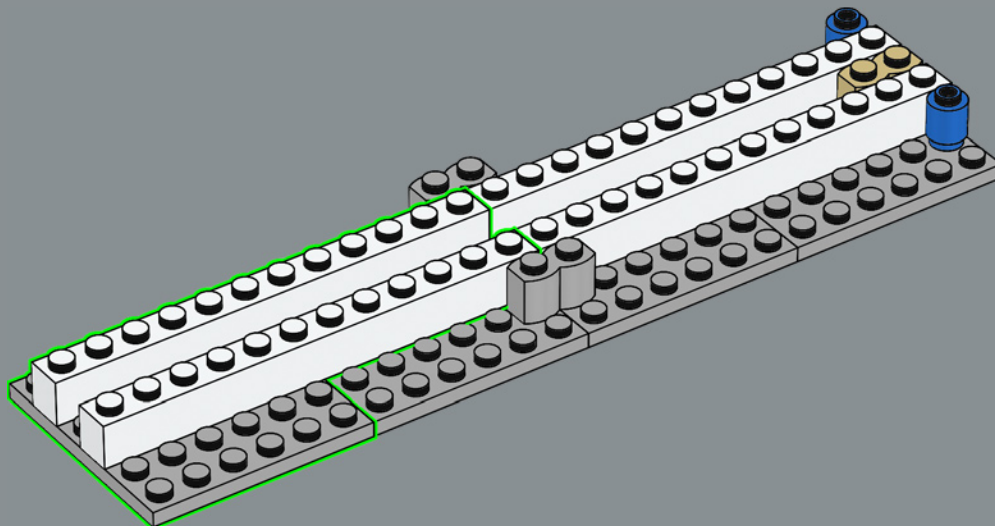

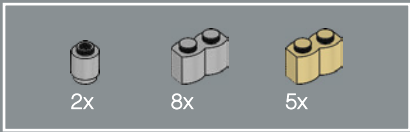

170

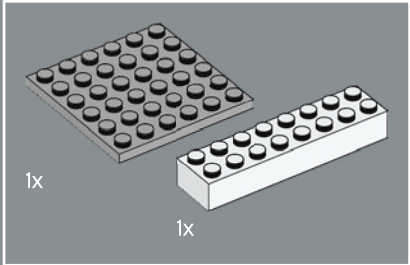
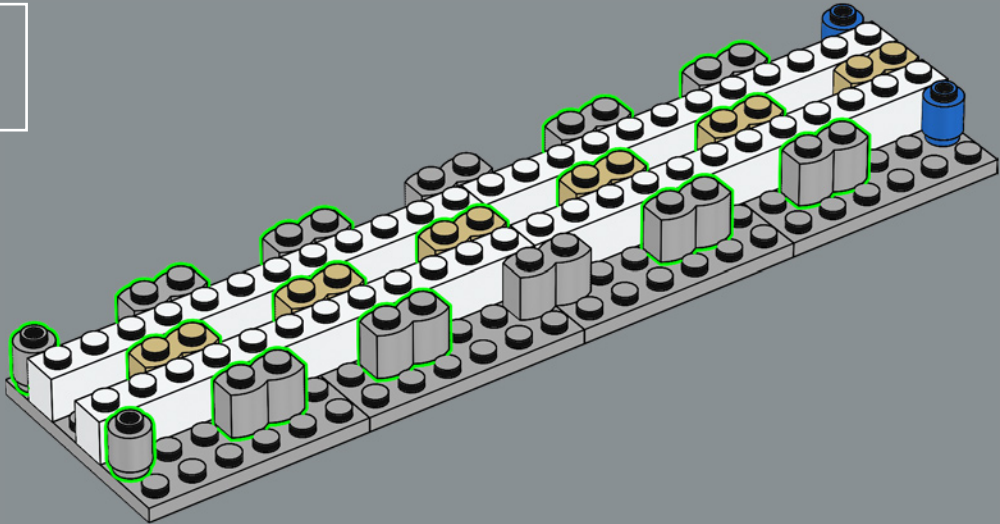

171

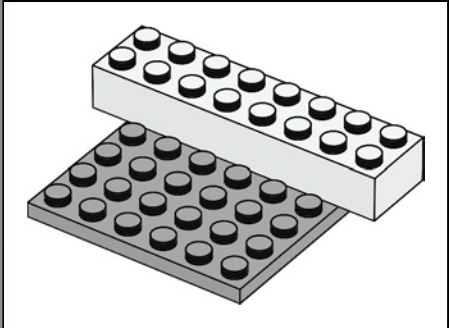
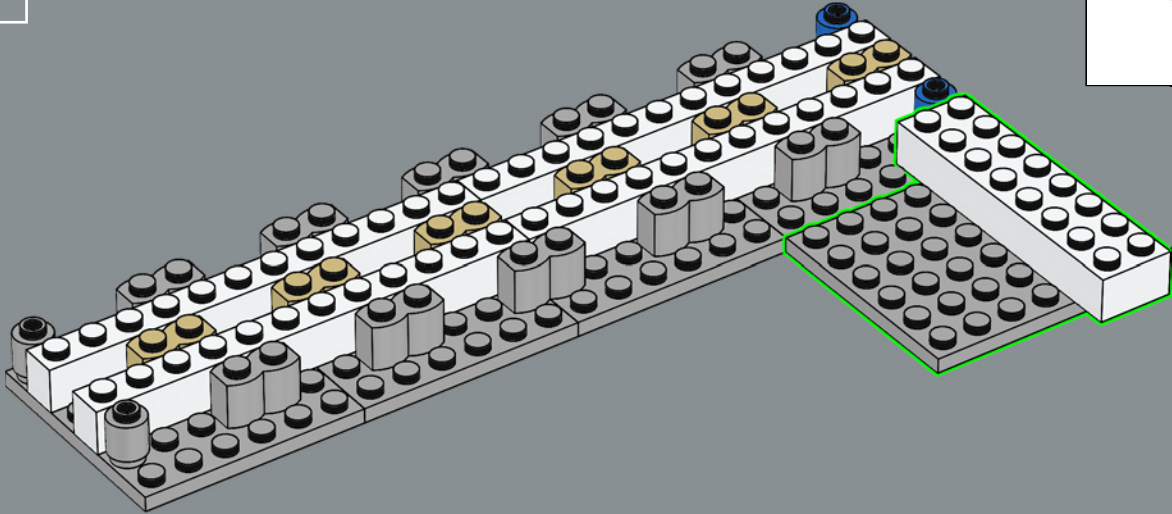

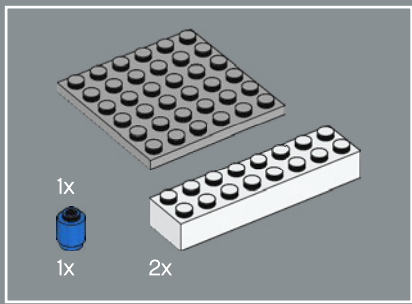

172

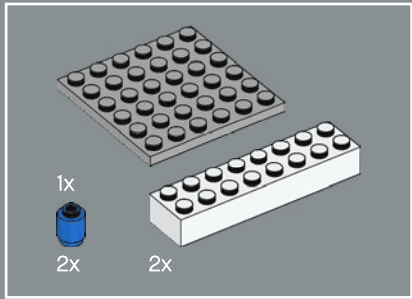
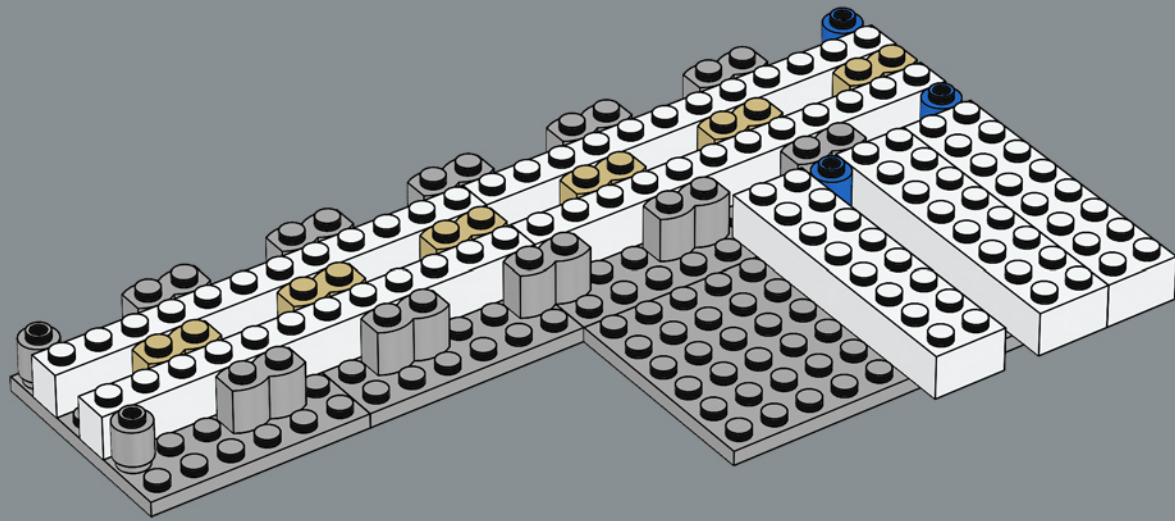

173

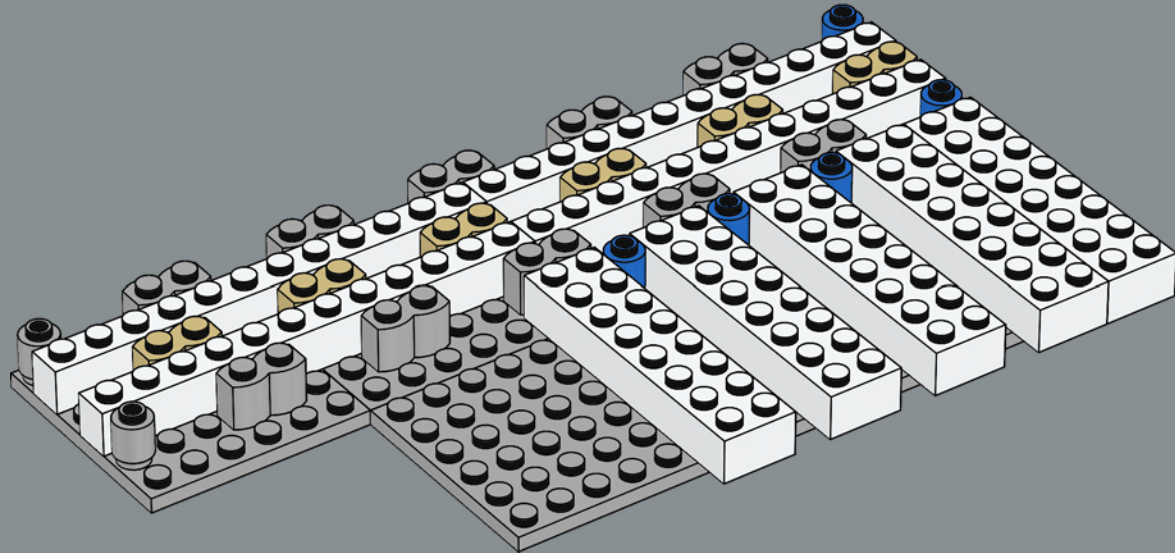

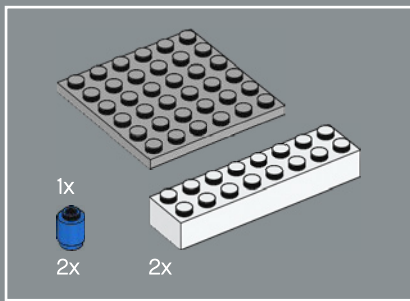

174

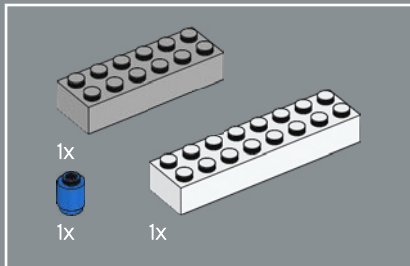
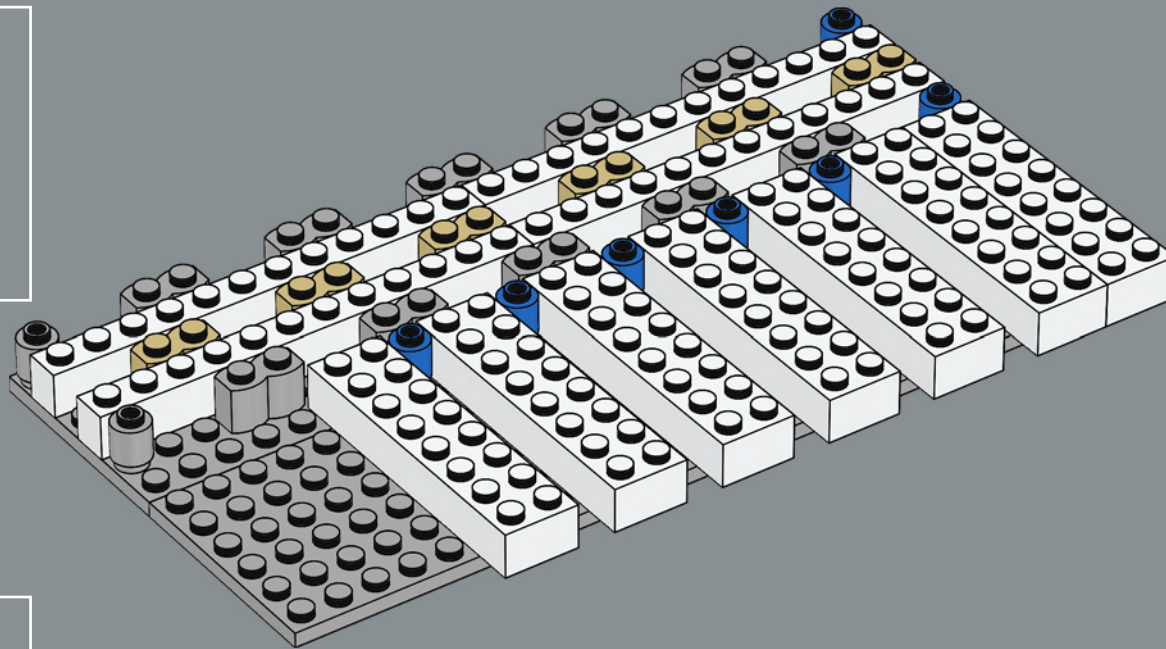

175



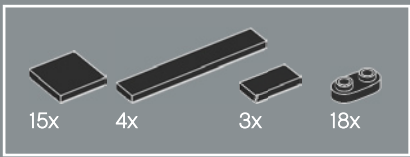

176

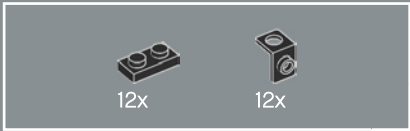
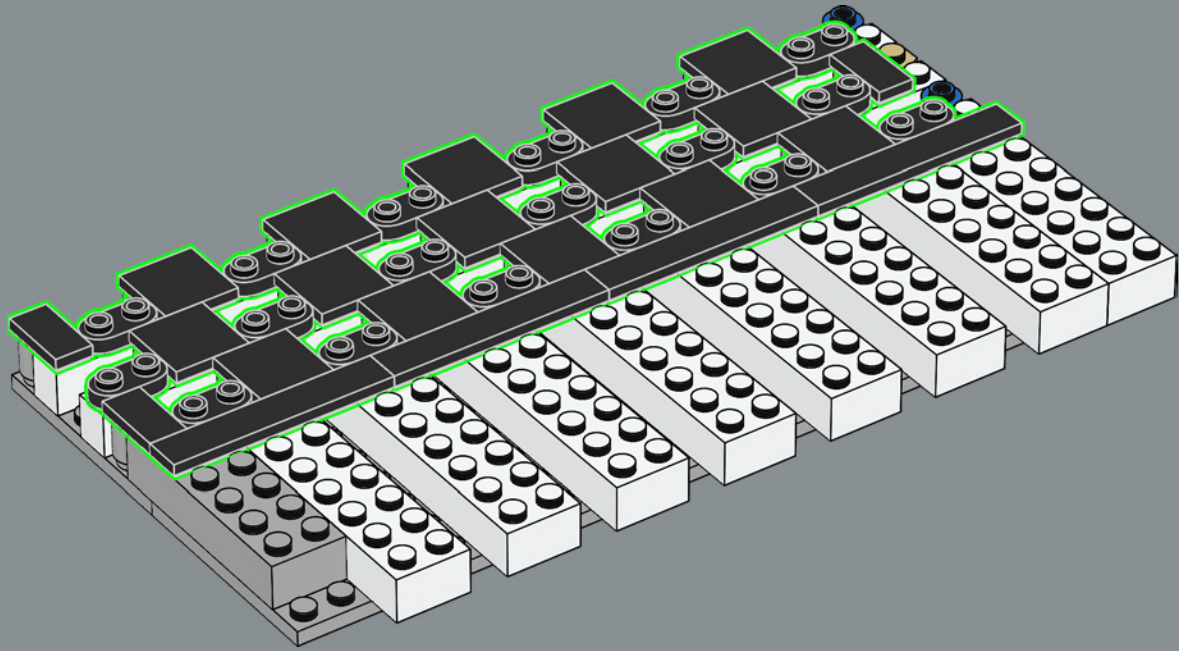

177

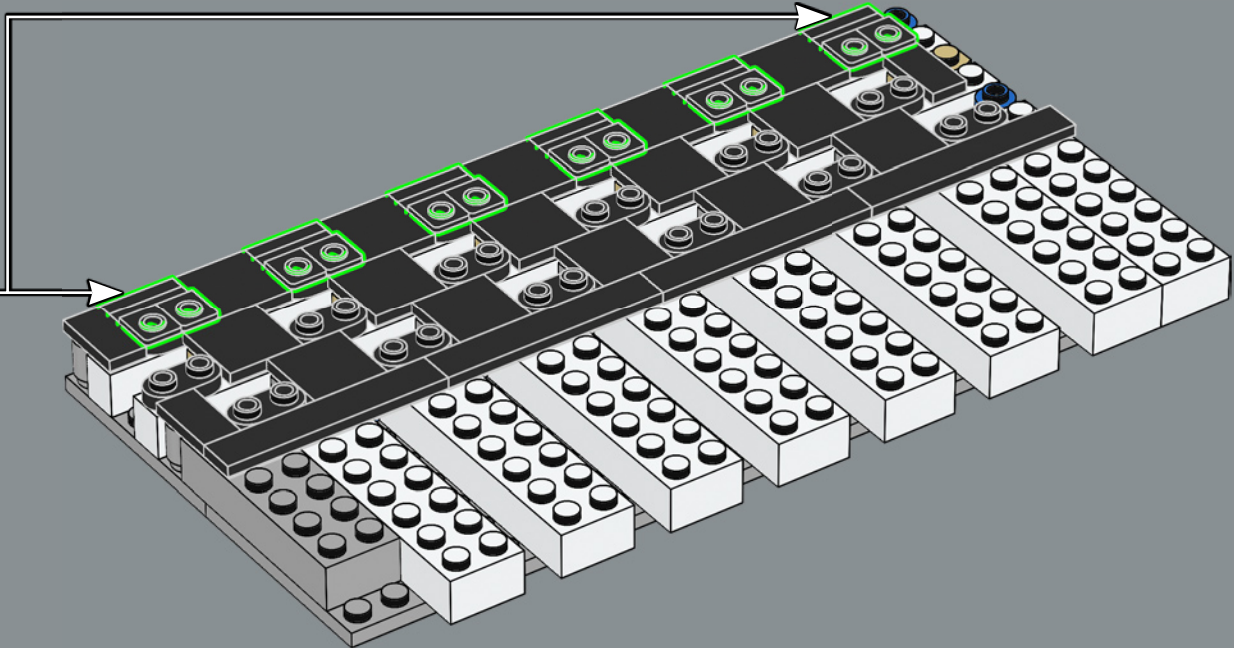
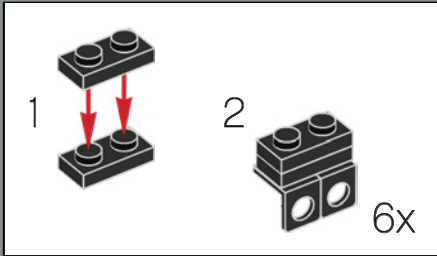



178

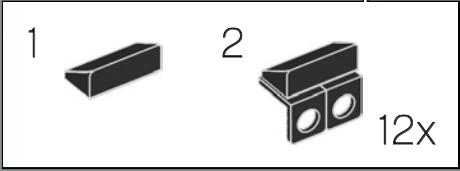
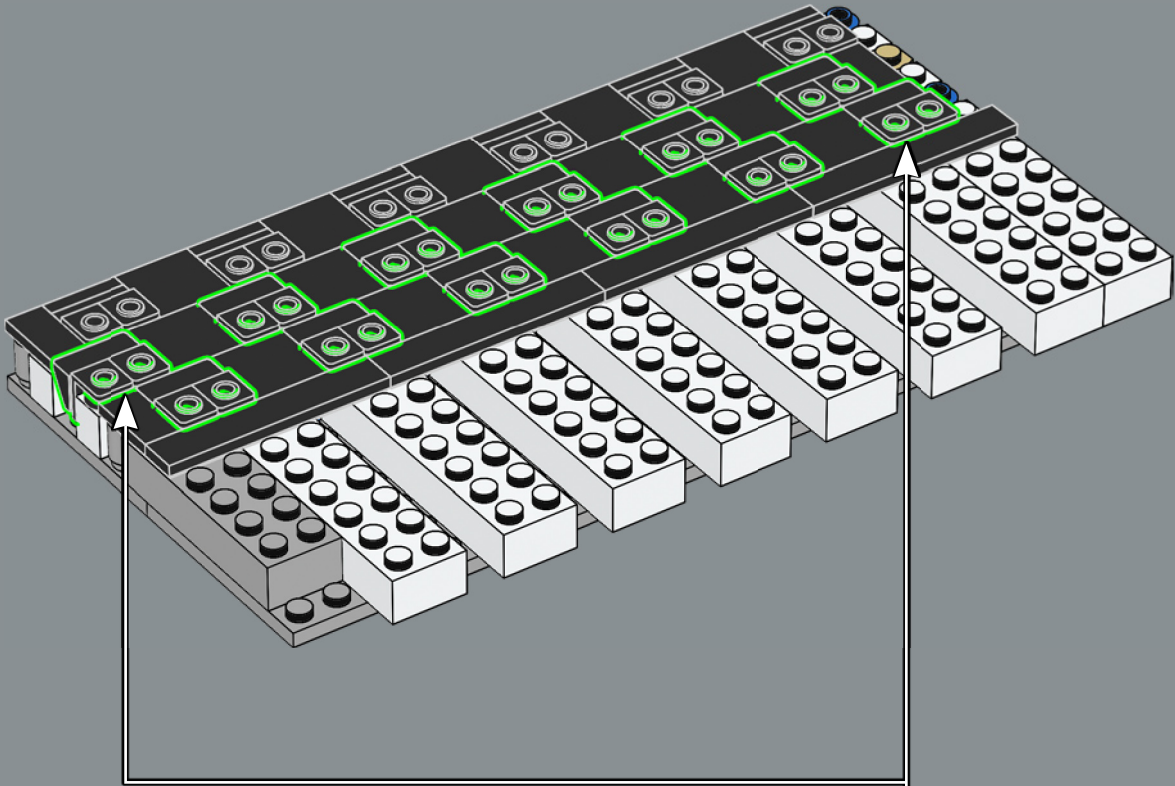

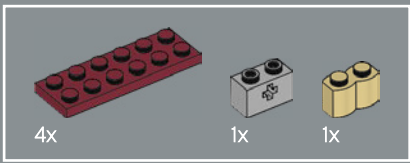

179

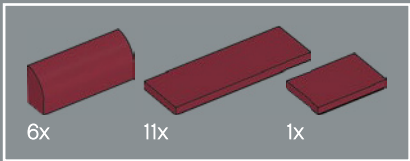
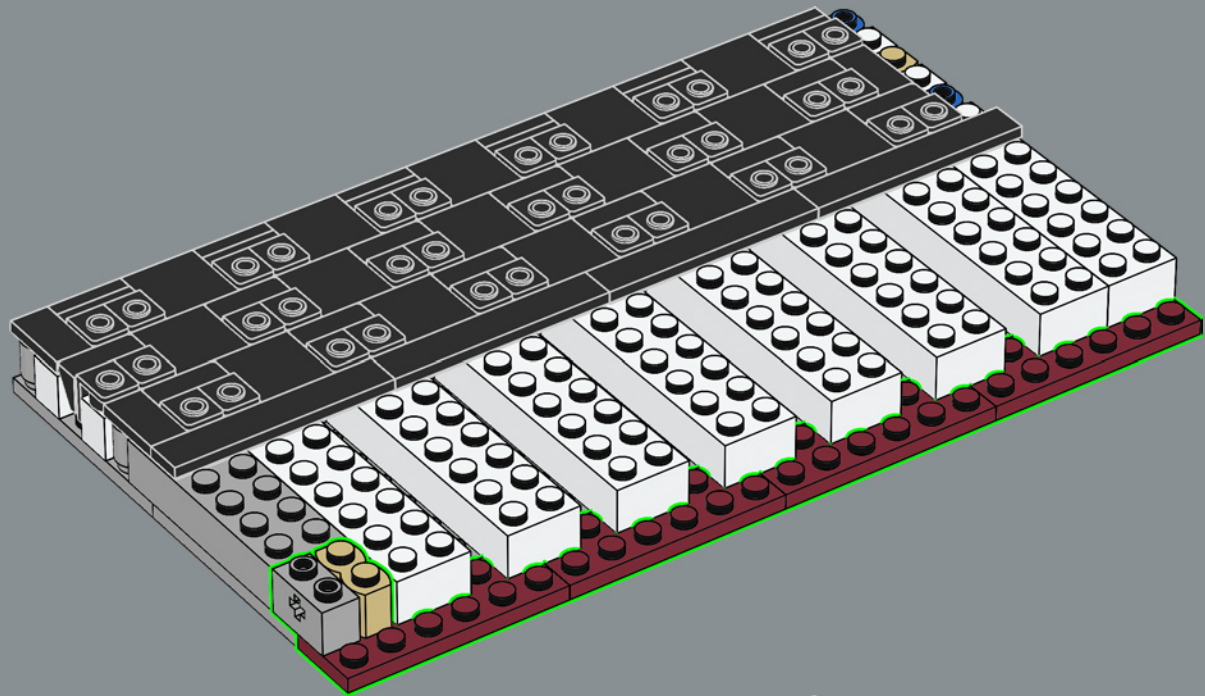

180

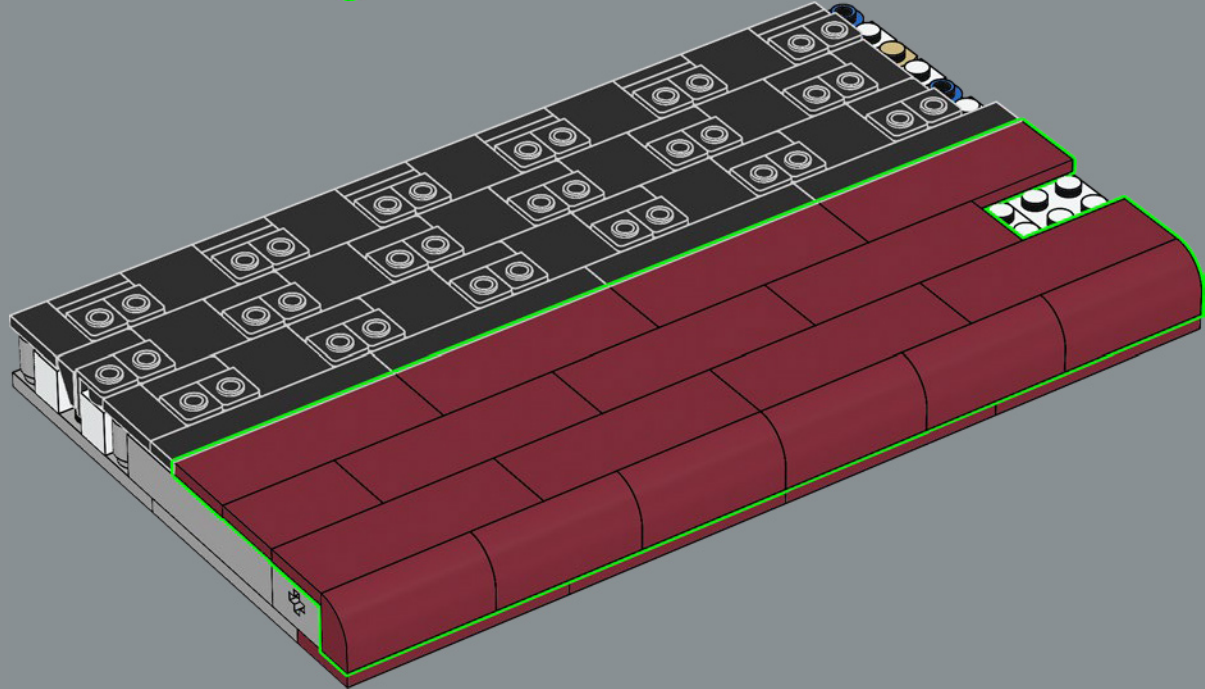

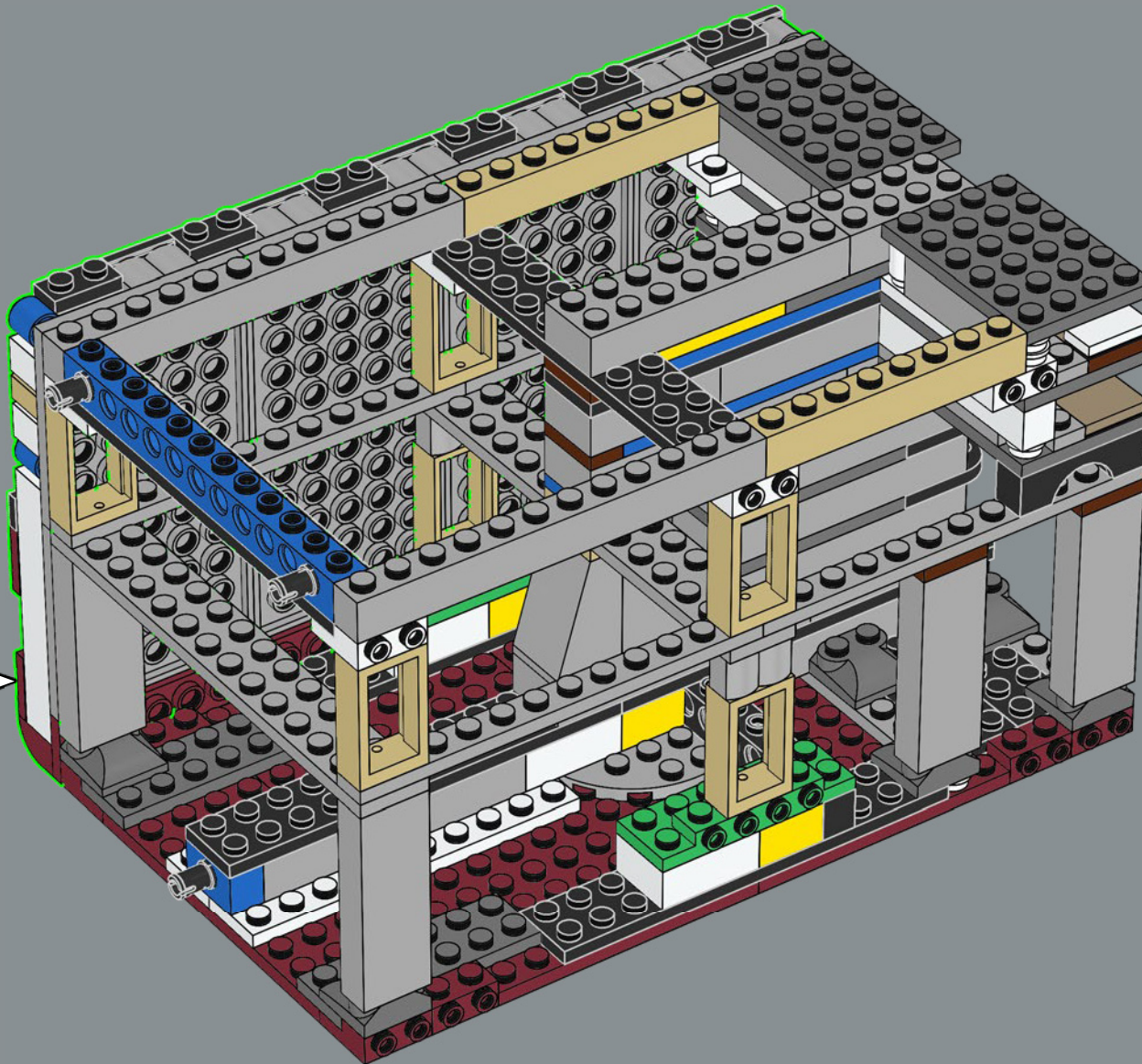

The ship's hull was held together with over three million iron and steel rivets weighing over 1,322.7 tons (1,200 metric tonnes).

La coque du navire est maintenue par plus de trois millions de rivets en fer et en acier pesant plus de 1 200 tonnes métriques (1 322,7 tonnes courtes).

El casco del barco estaba formado por planchas unidas con más de tres millones de remaches de hierro y acero que pesaban 1200 t aproximadamente.

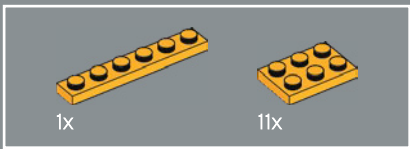

182

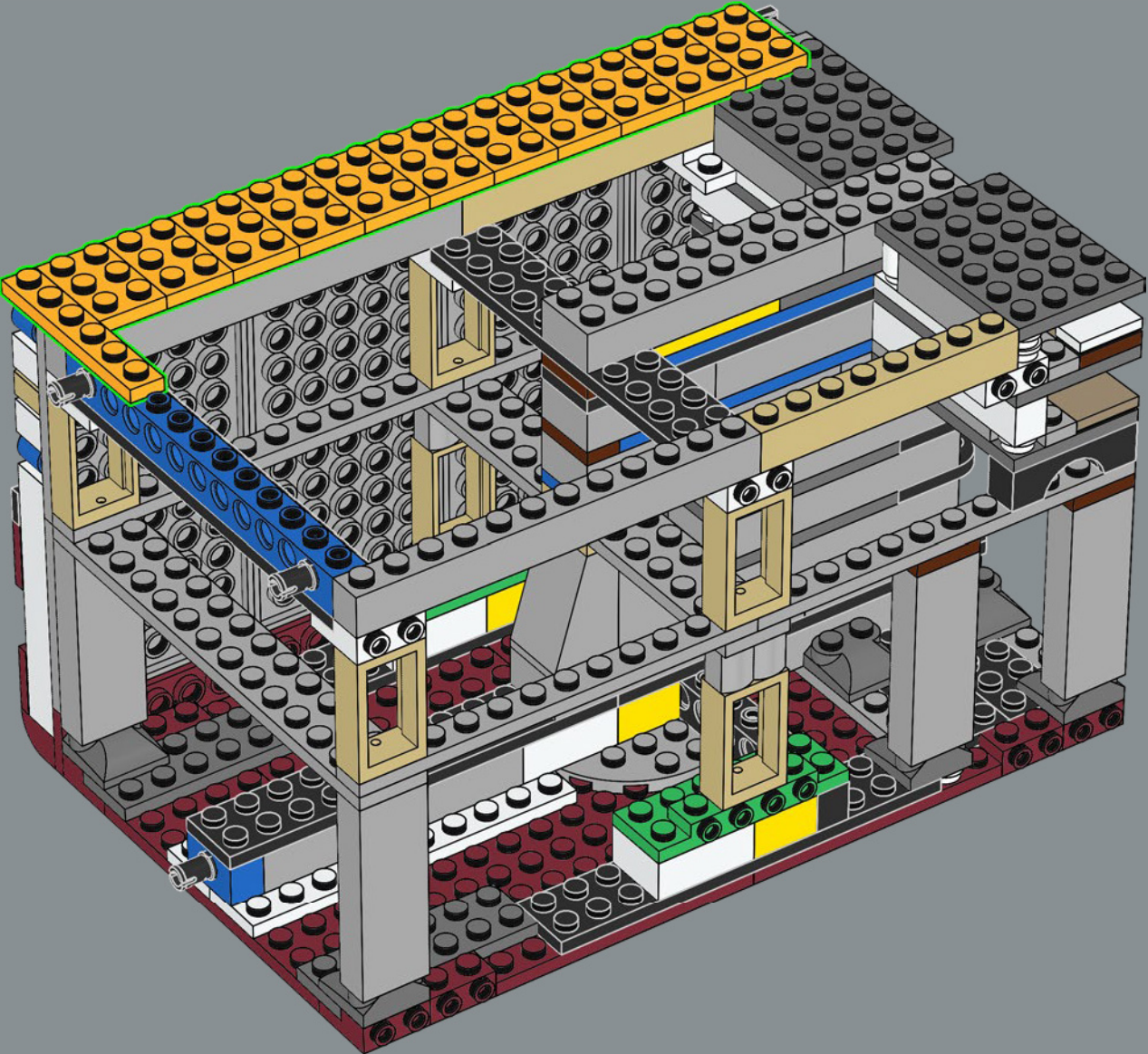

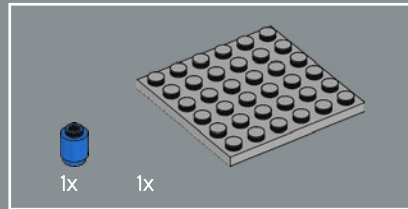
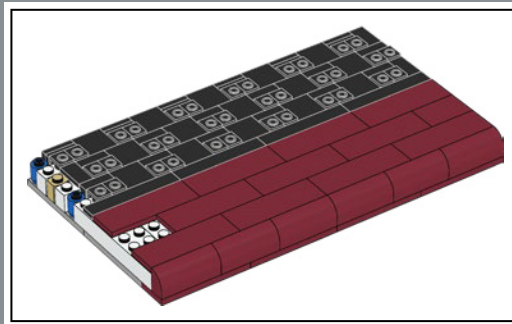
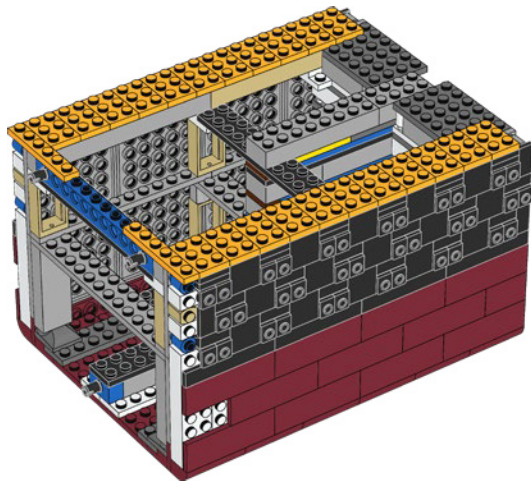
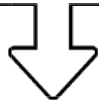

183

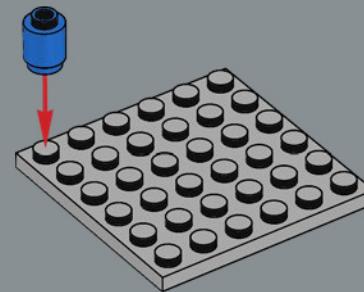

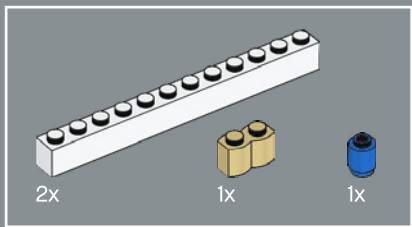

184

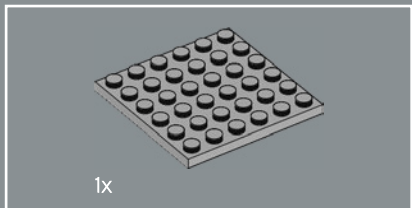
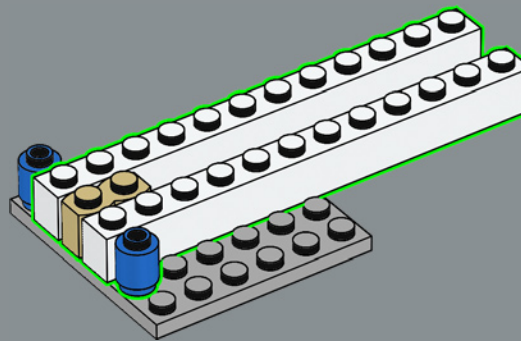

185

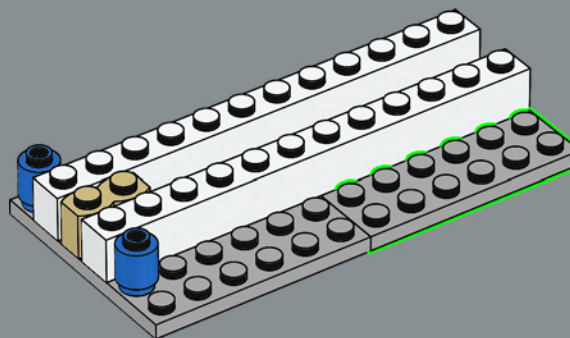

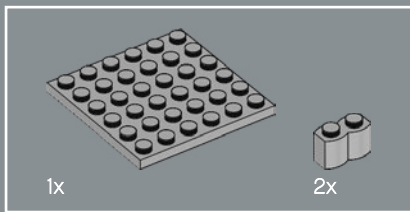

186

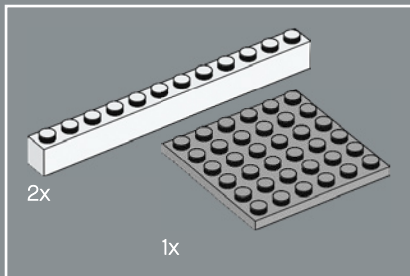
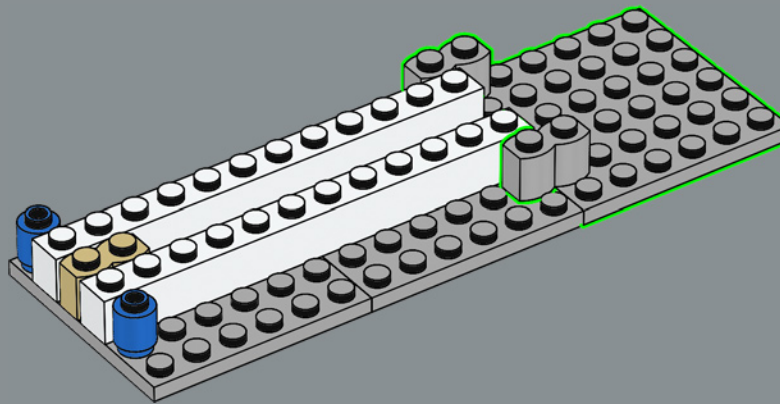

187

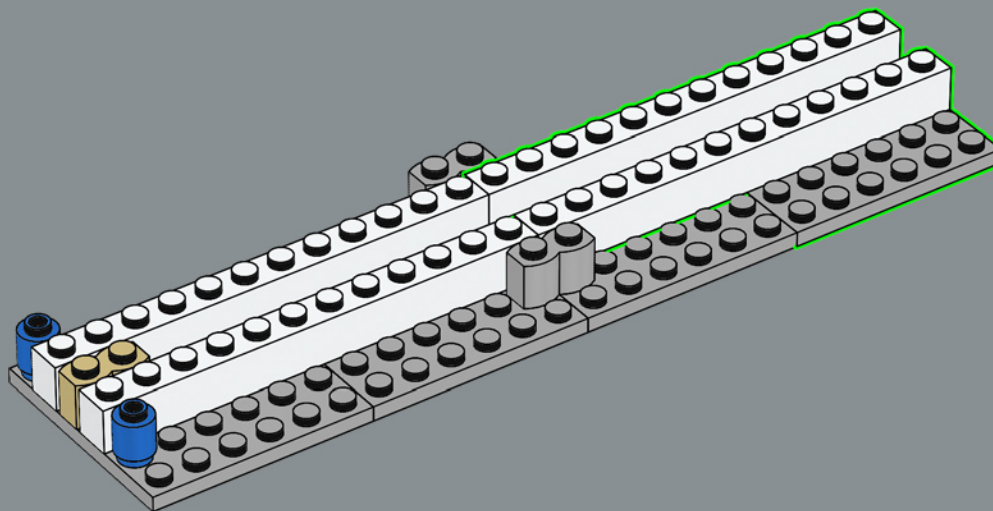



188

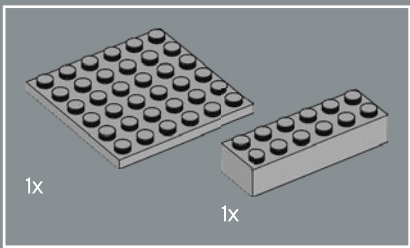
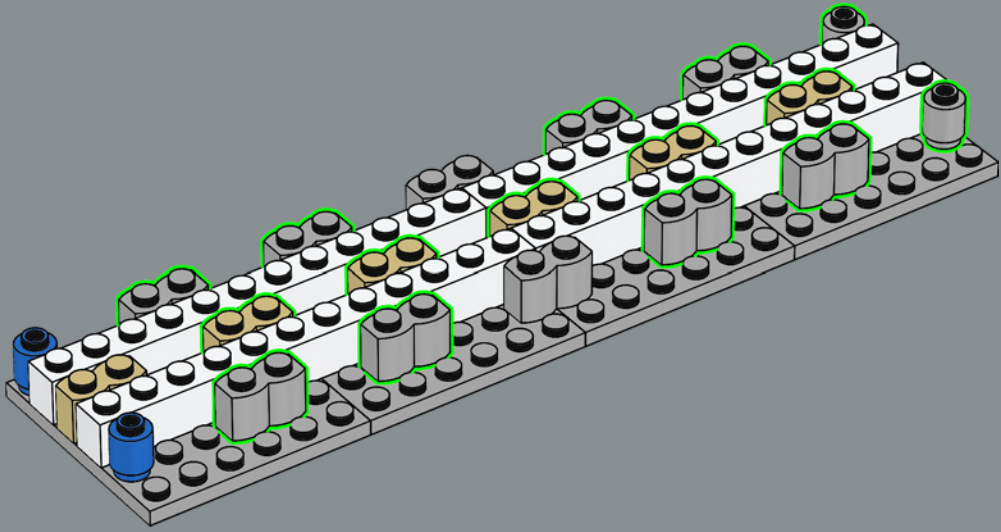

189

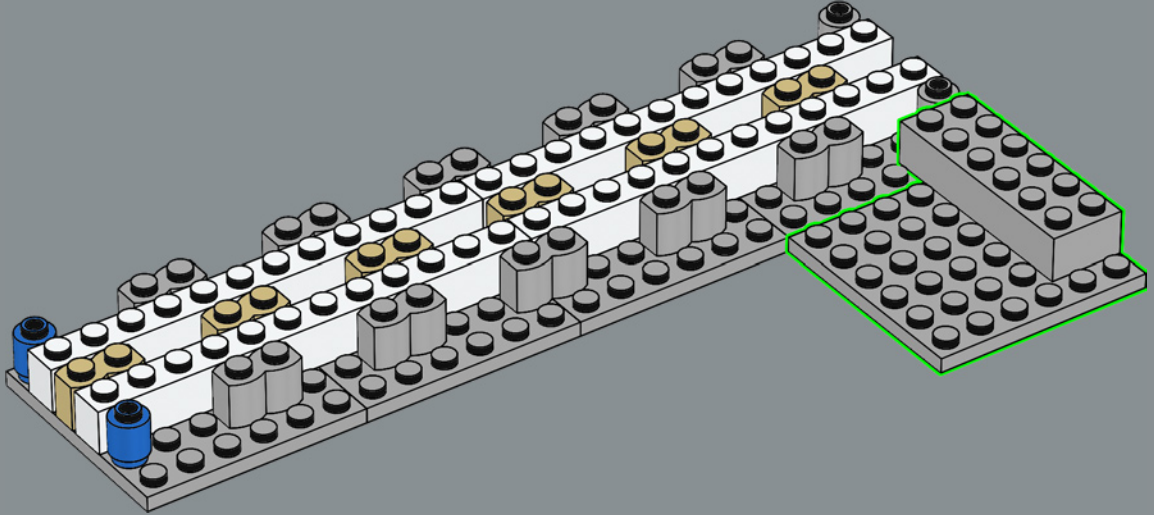

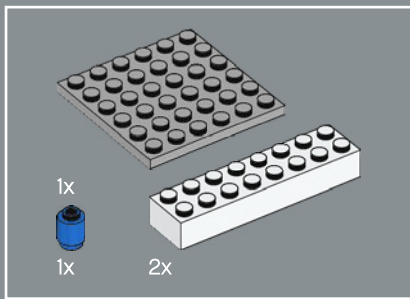

190

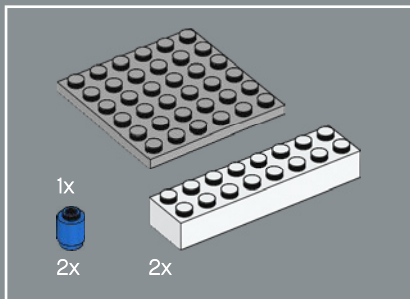
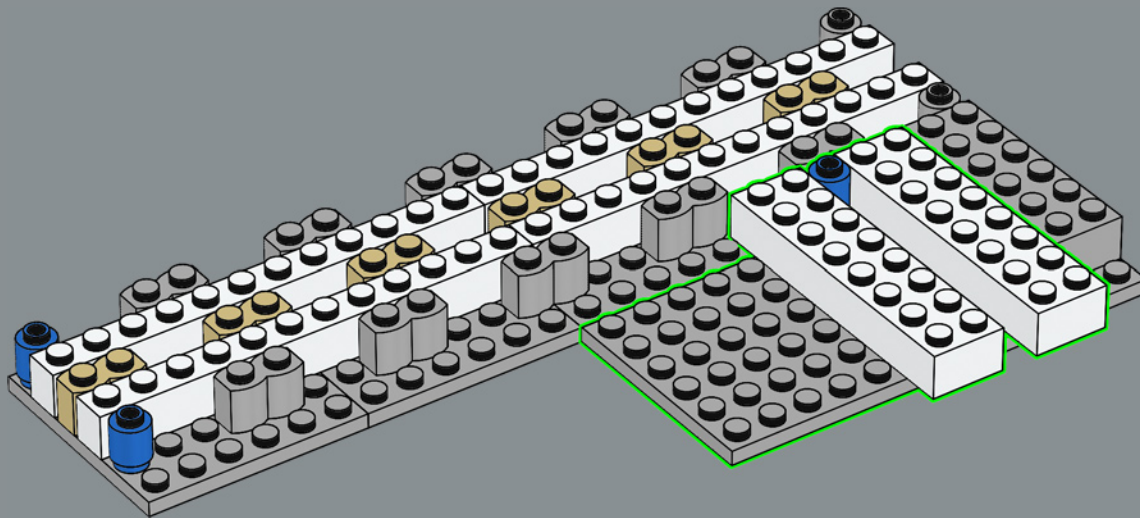

191

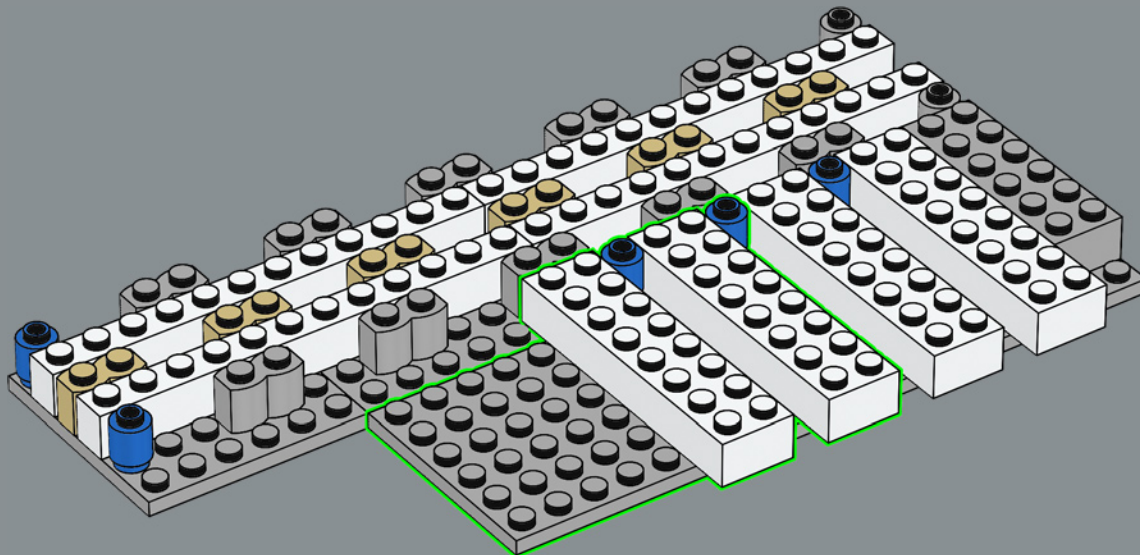

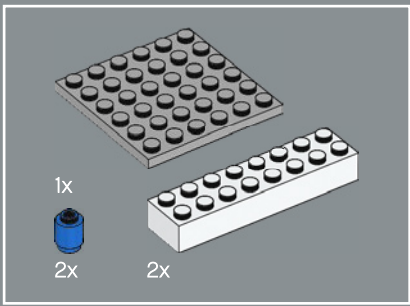

192

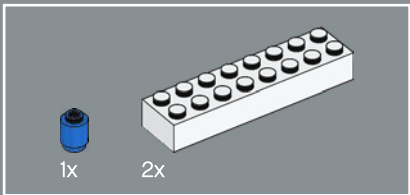
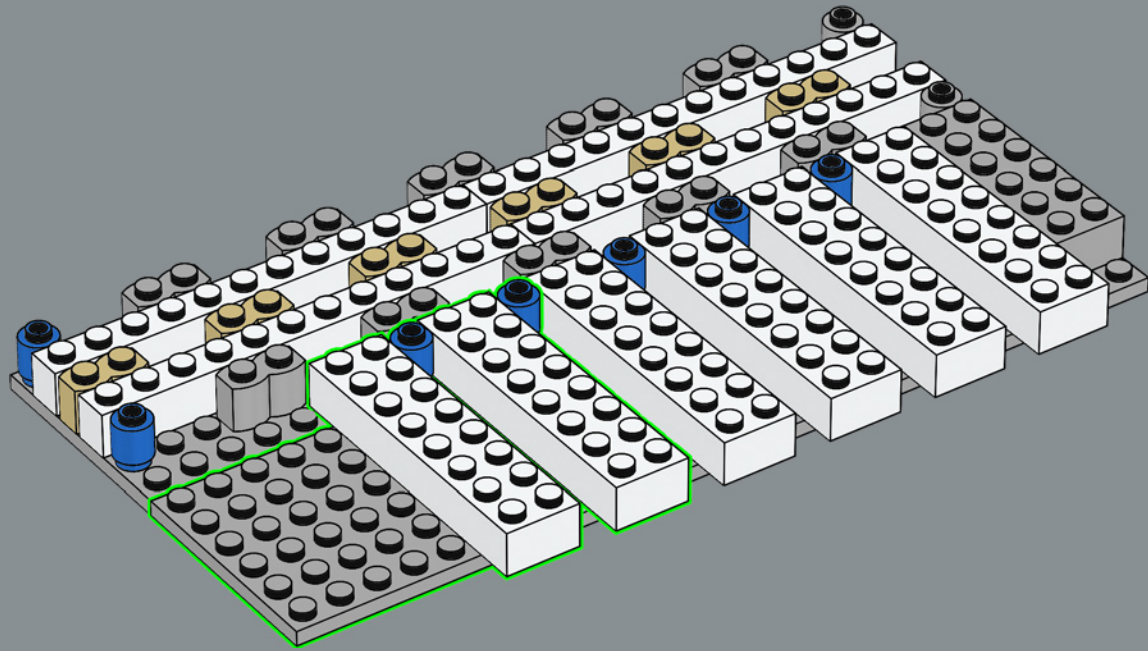

193

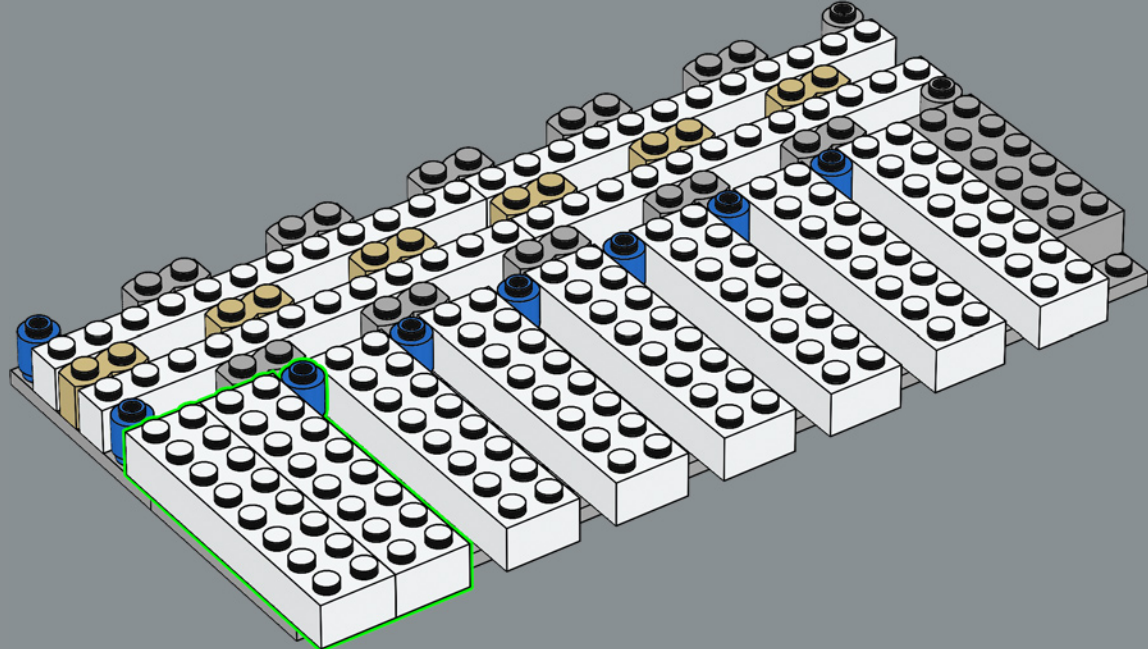

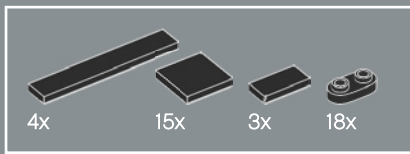

194

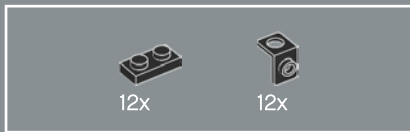
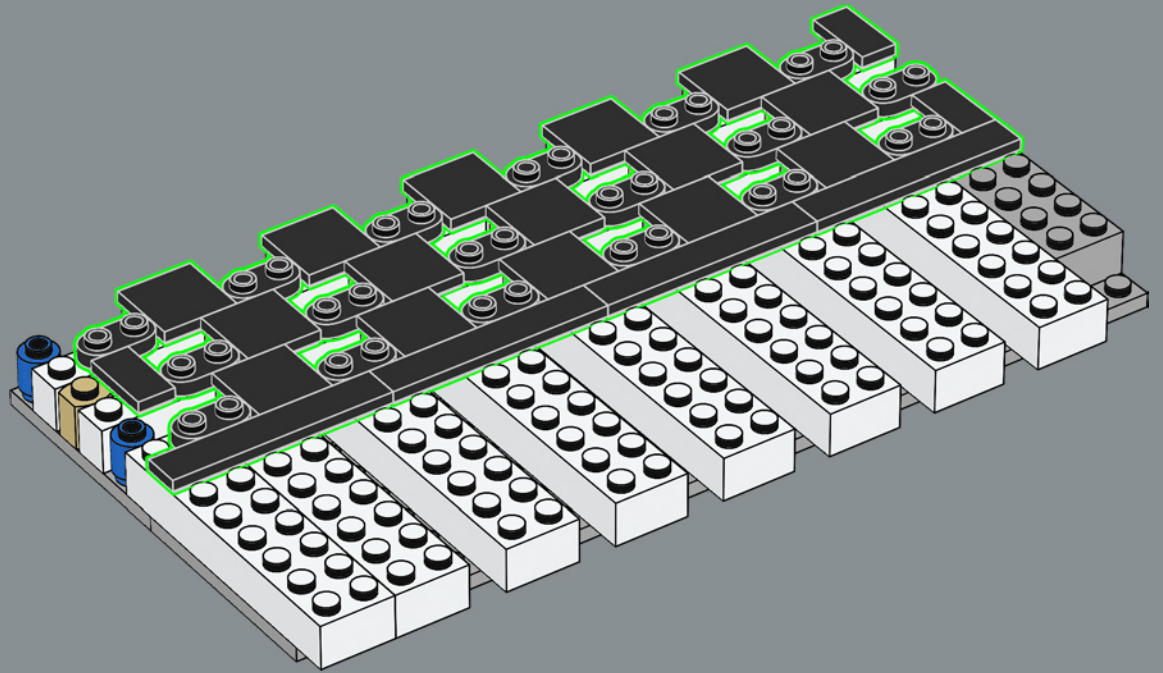

195

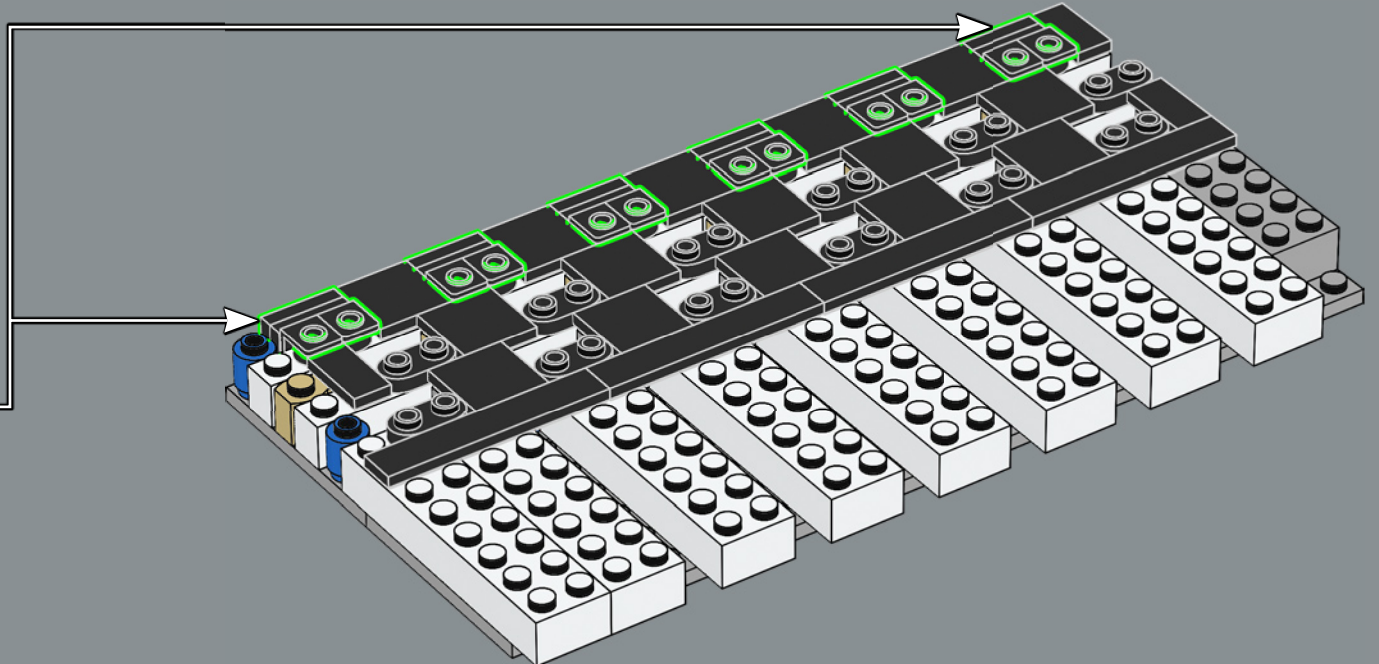
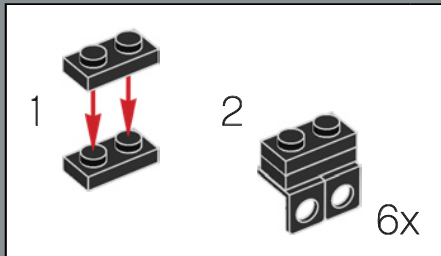

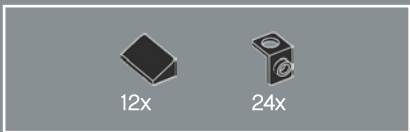

196

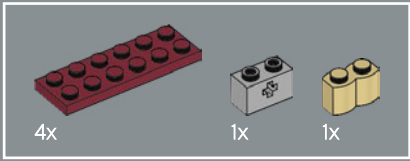
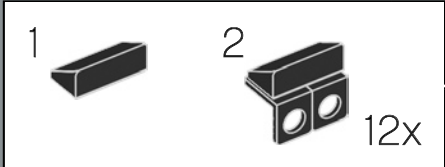
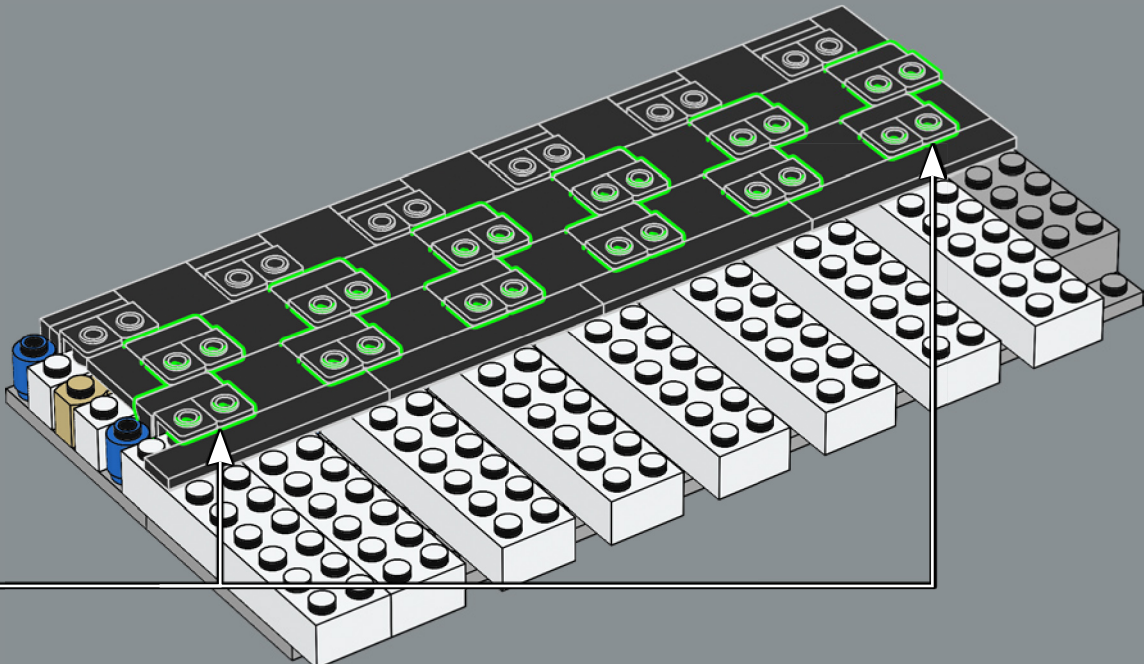

197

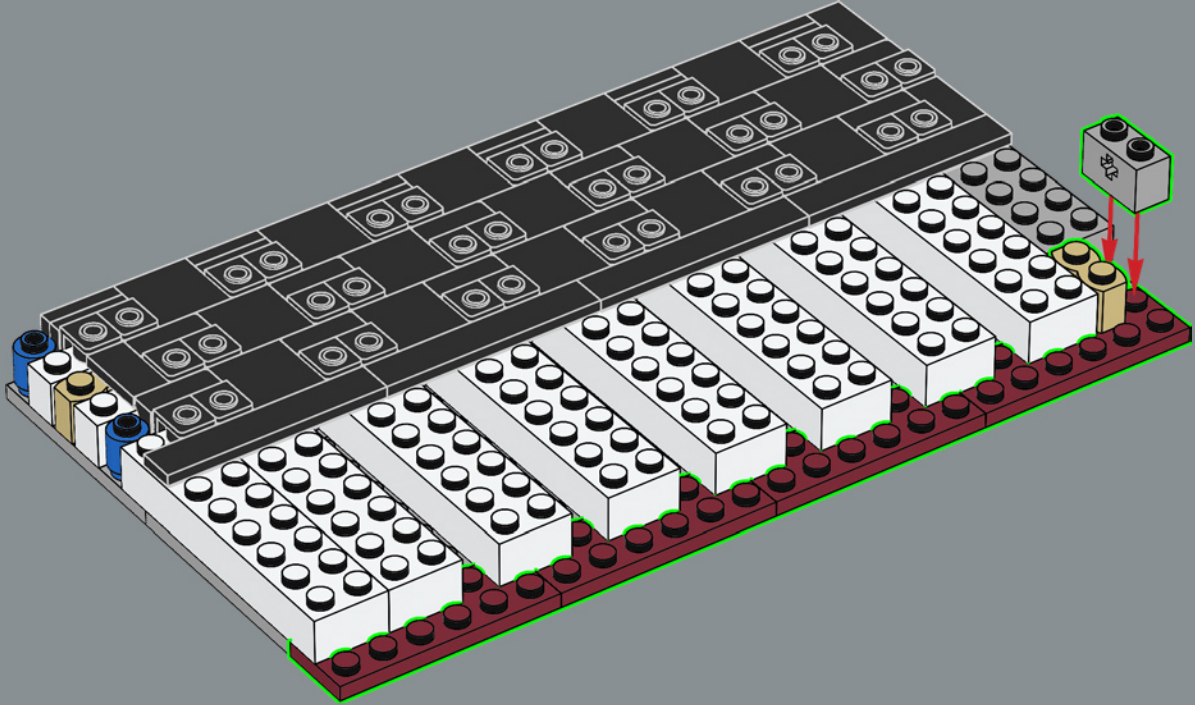

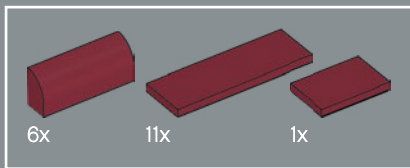

198

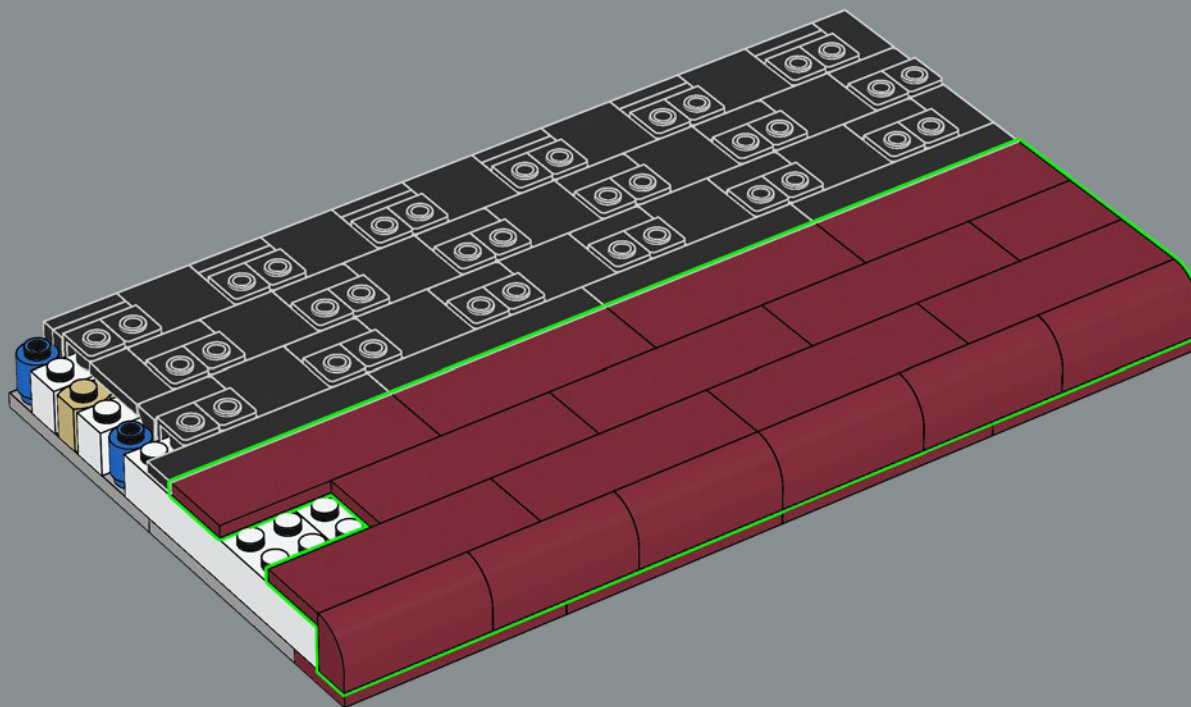

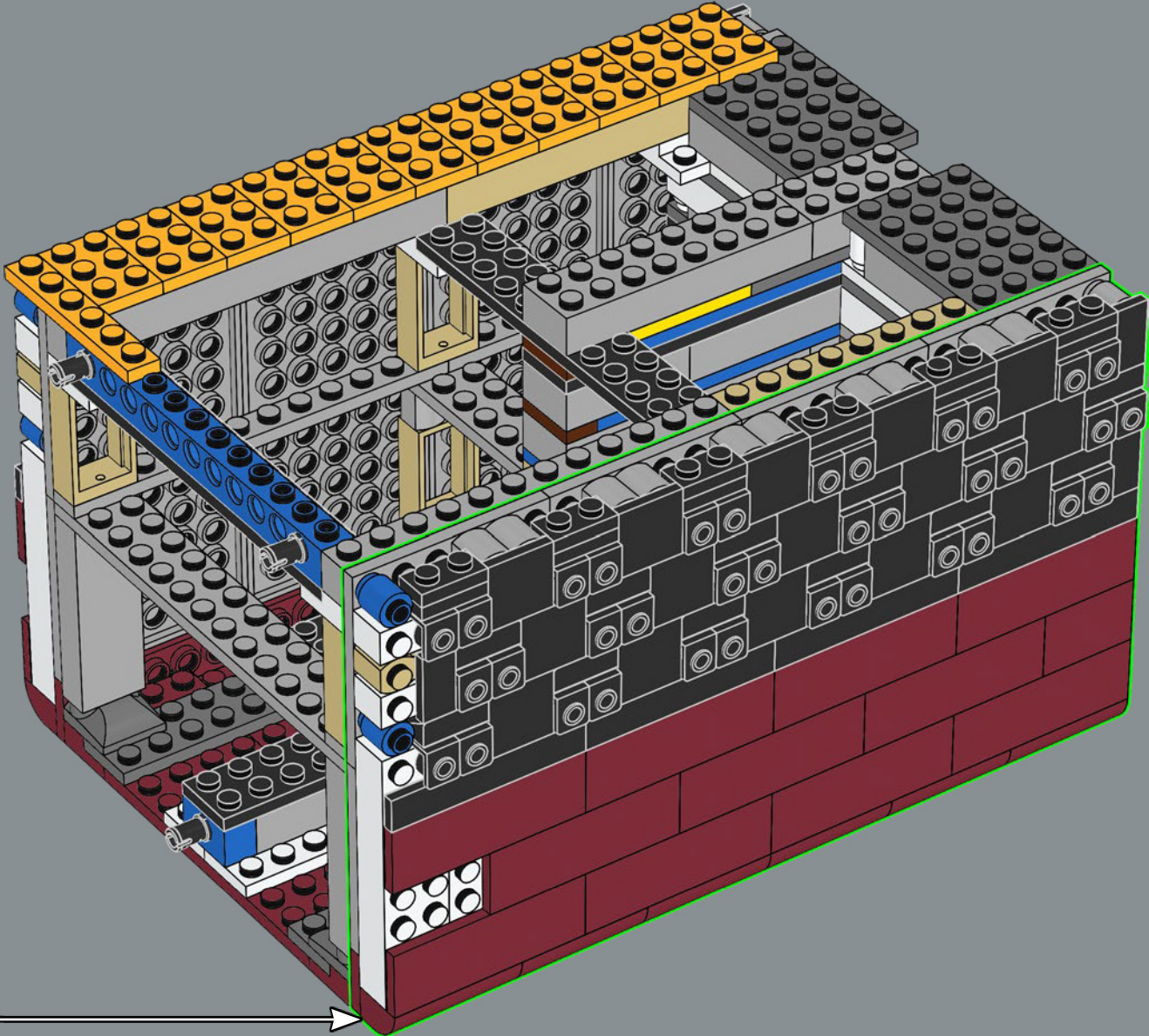

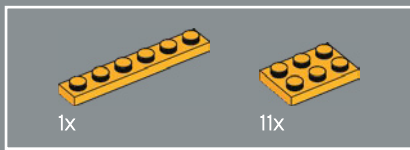

200

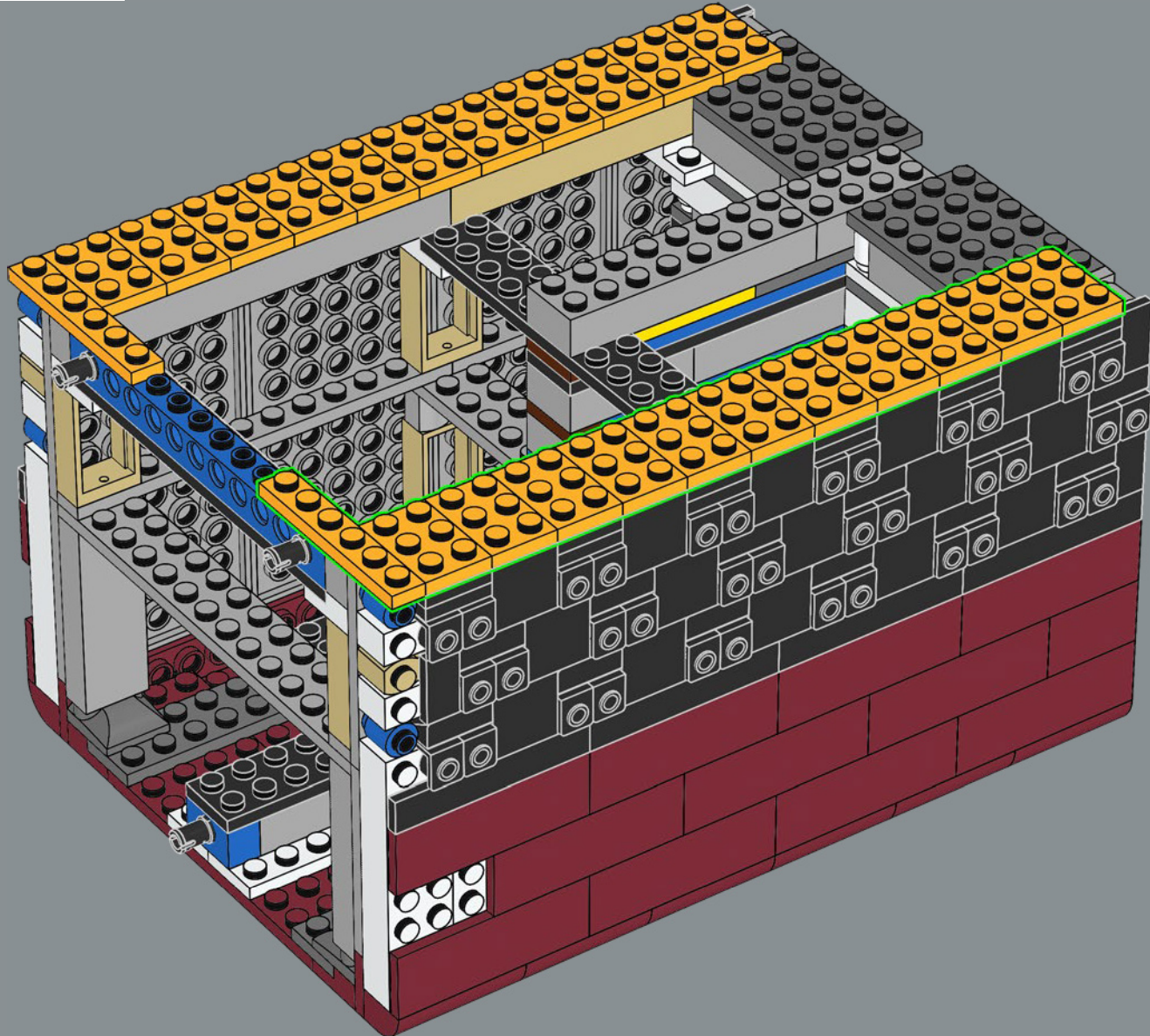

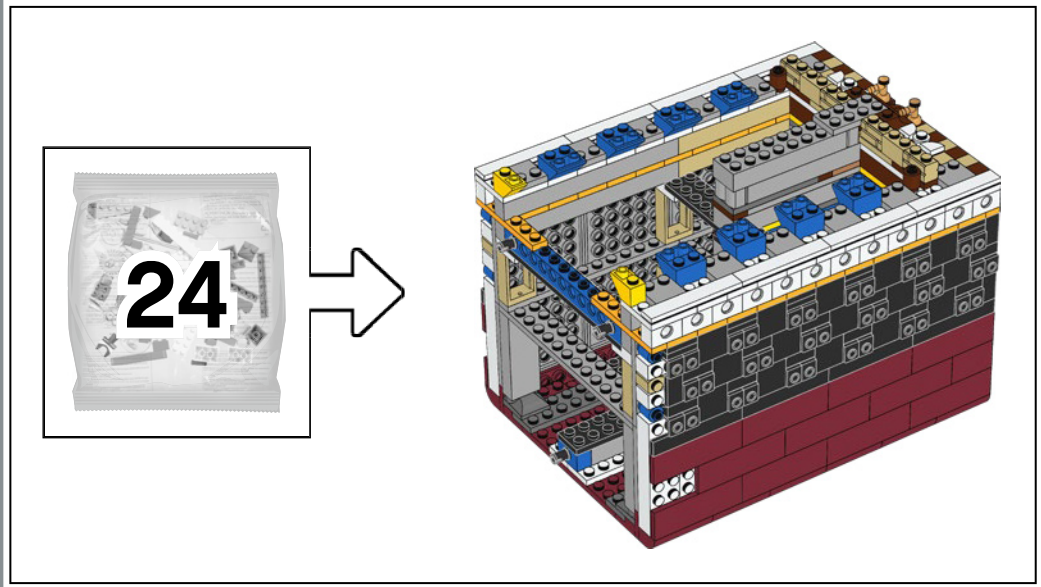

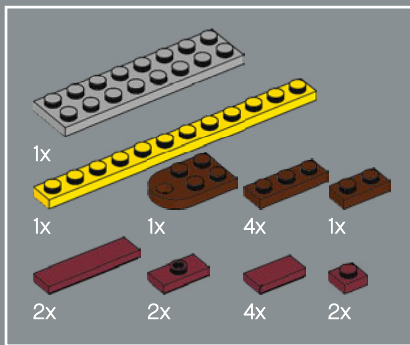

201

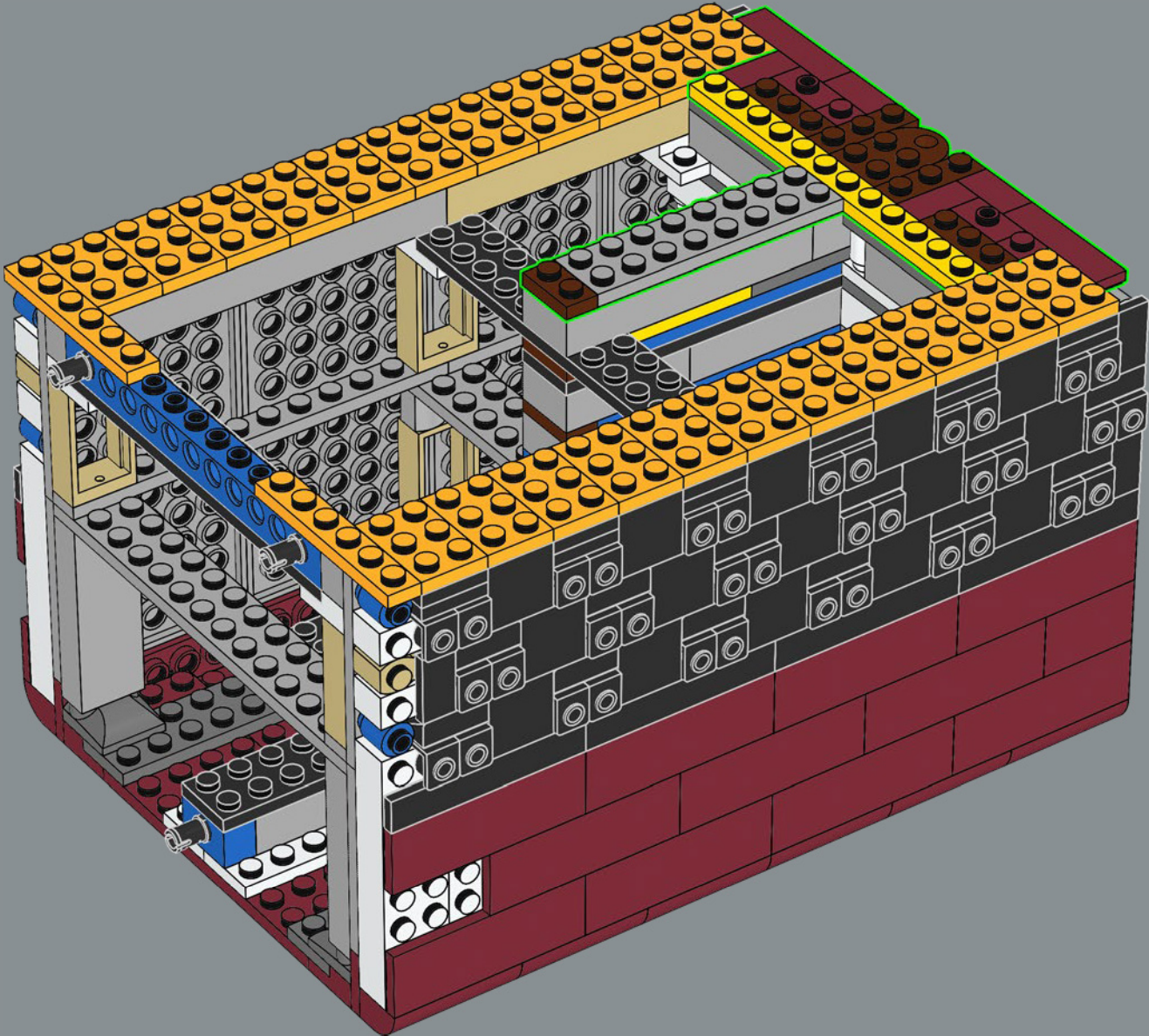

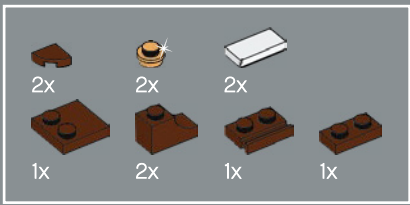

202

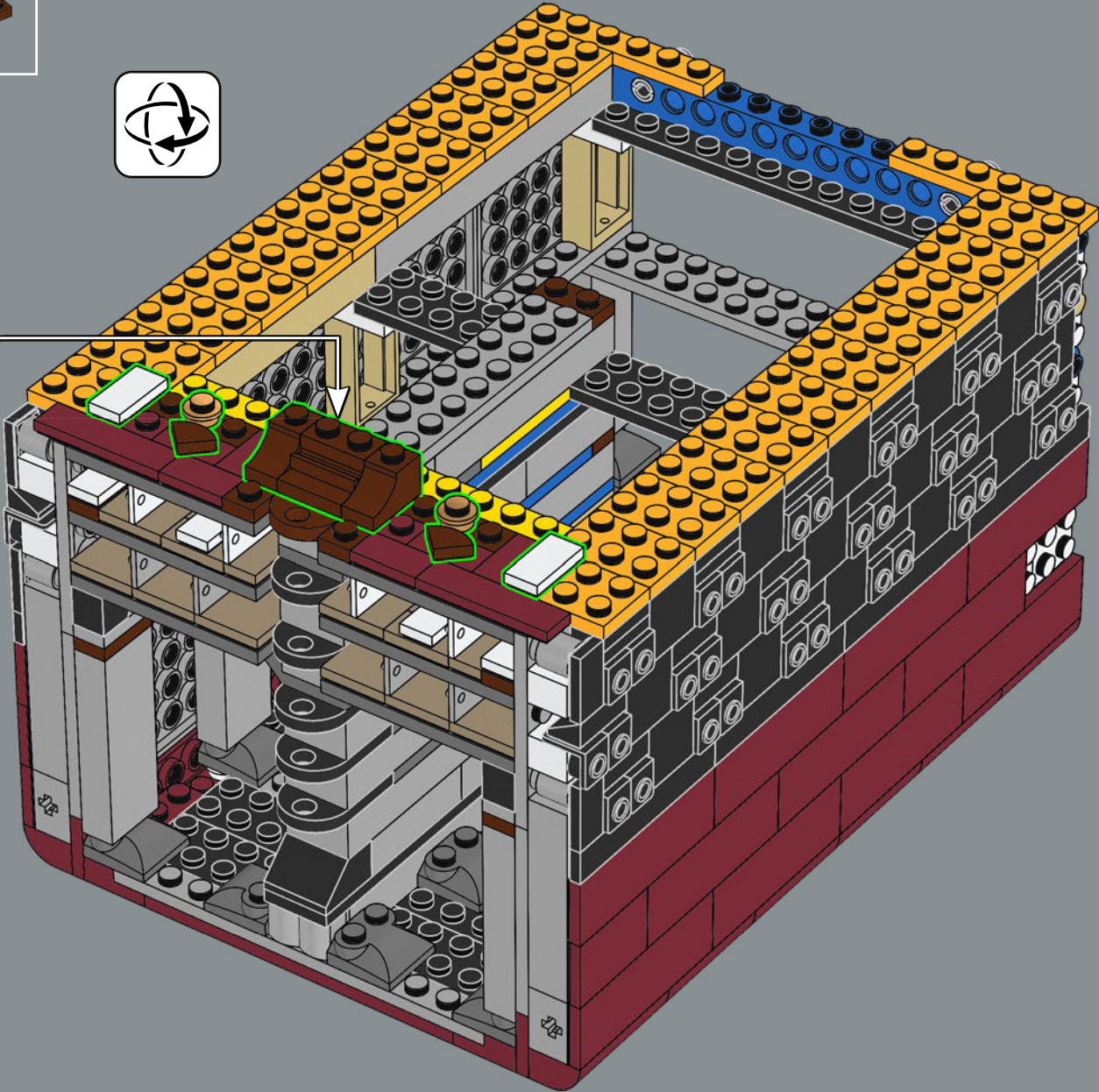
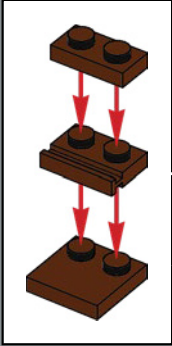

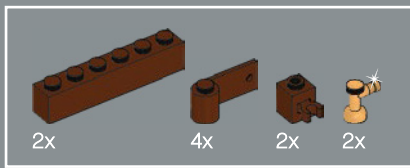

203

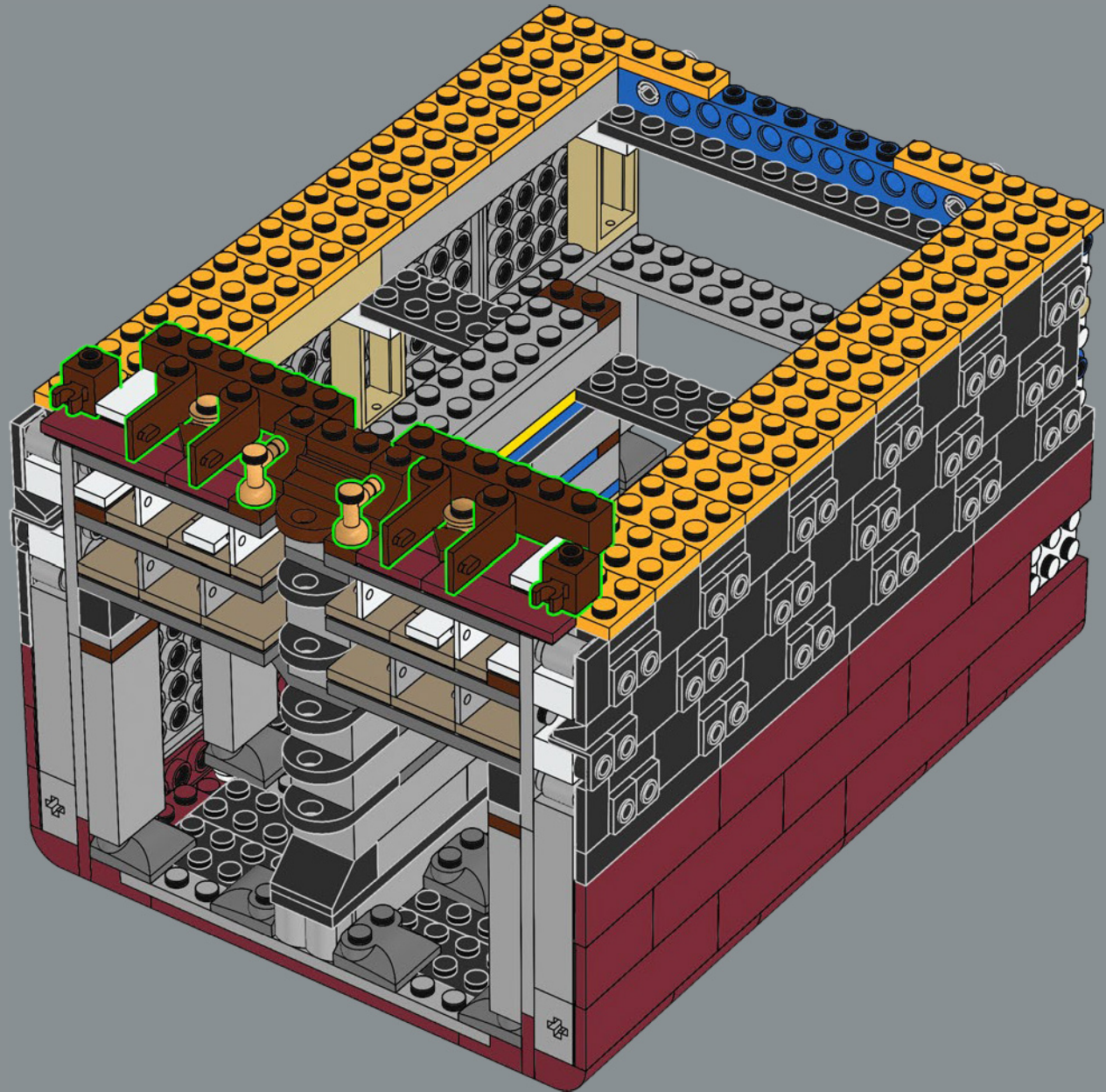

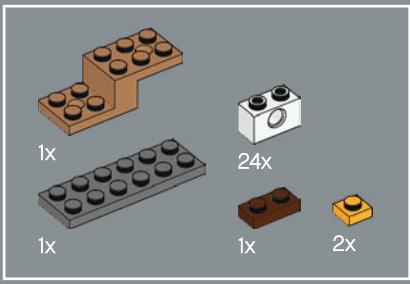

204

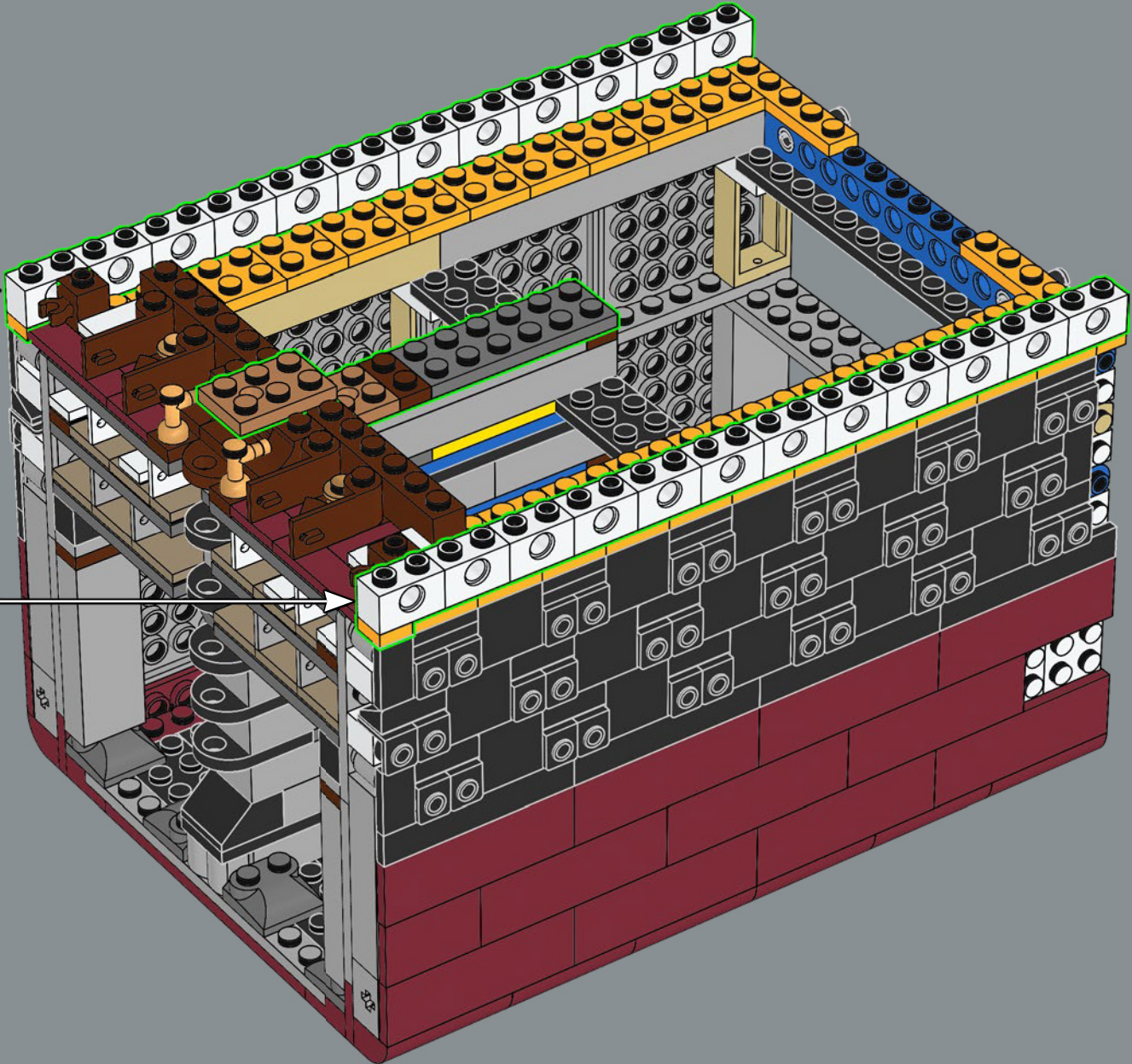
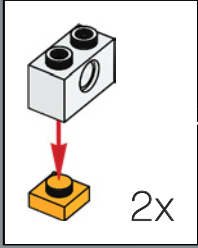

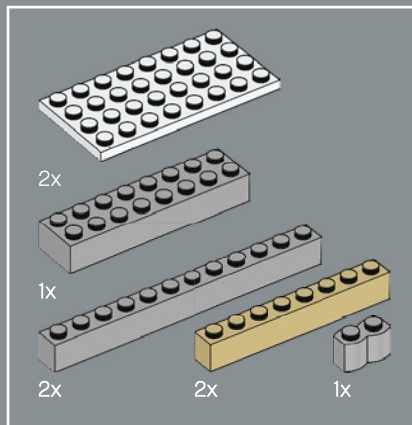

205

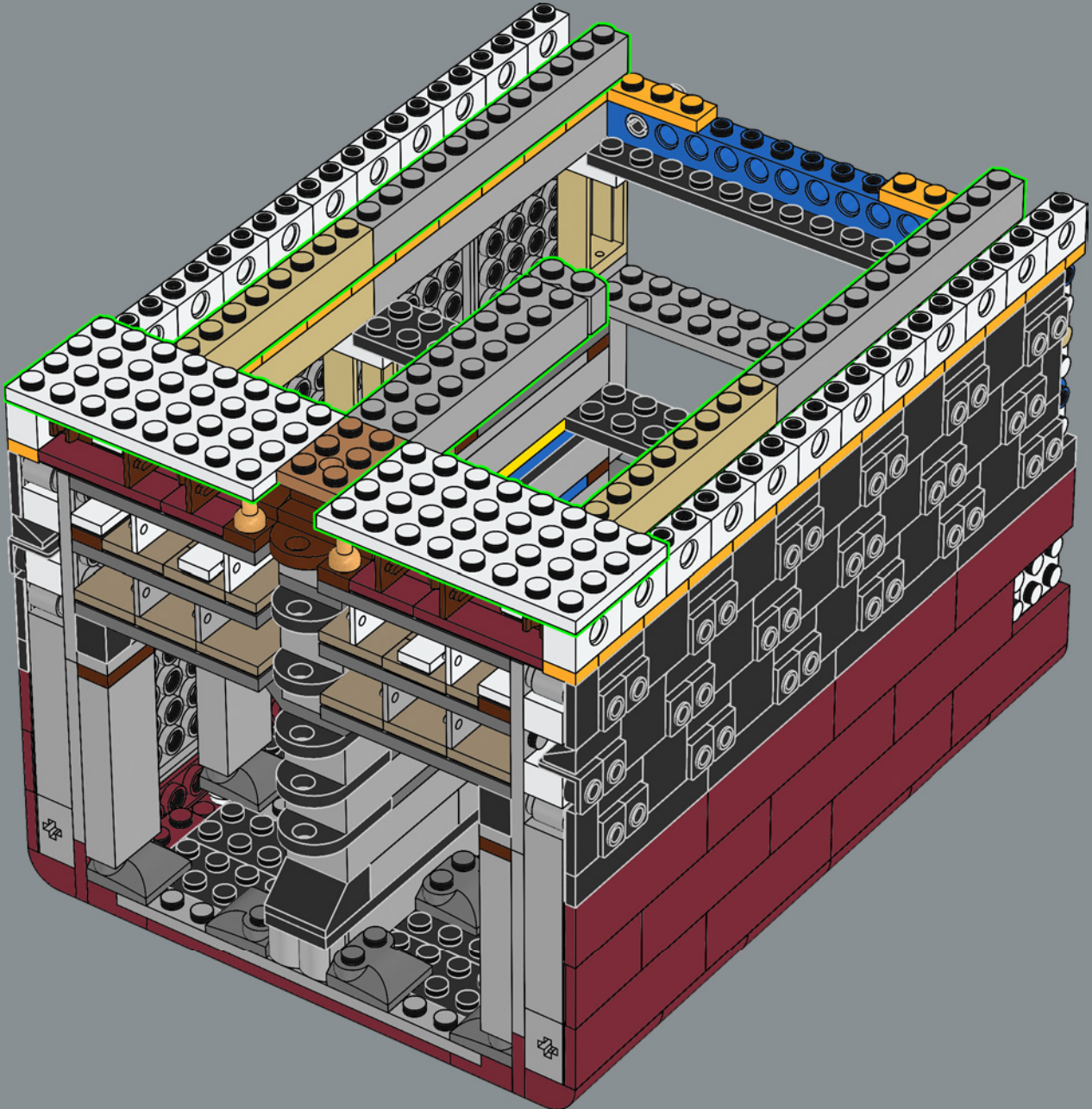

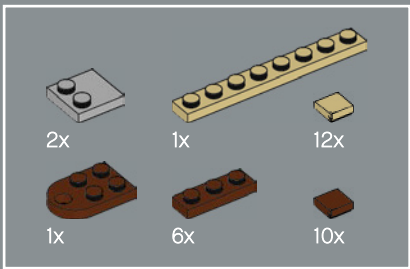

206

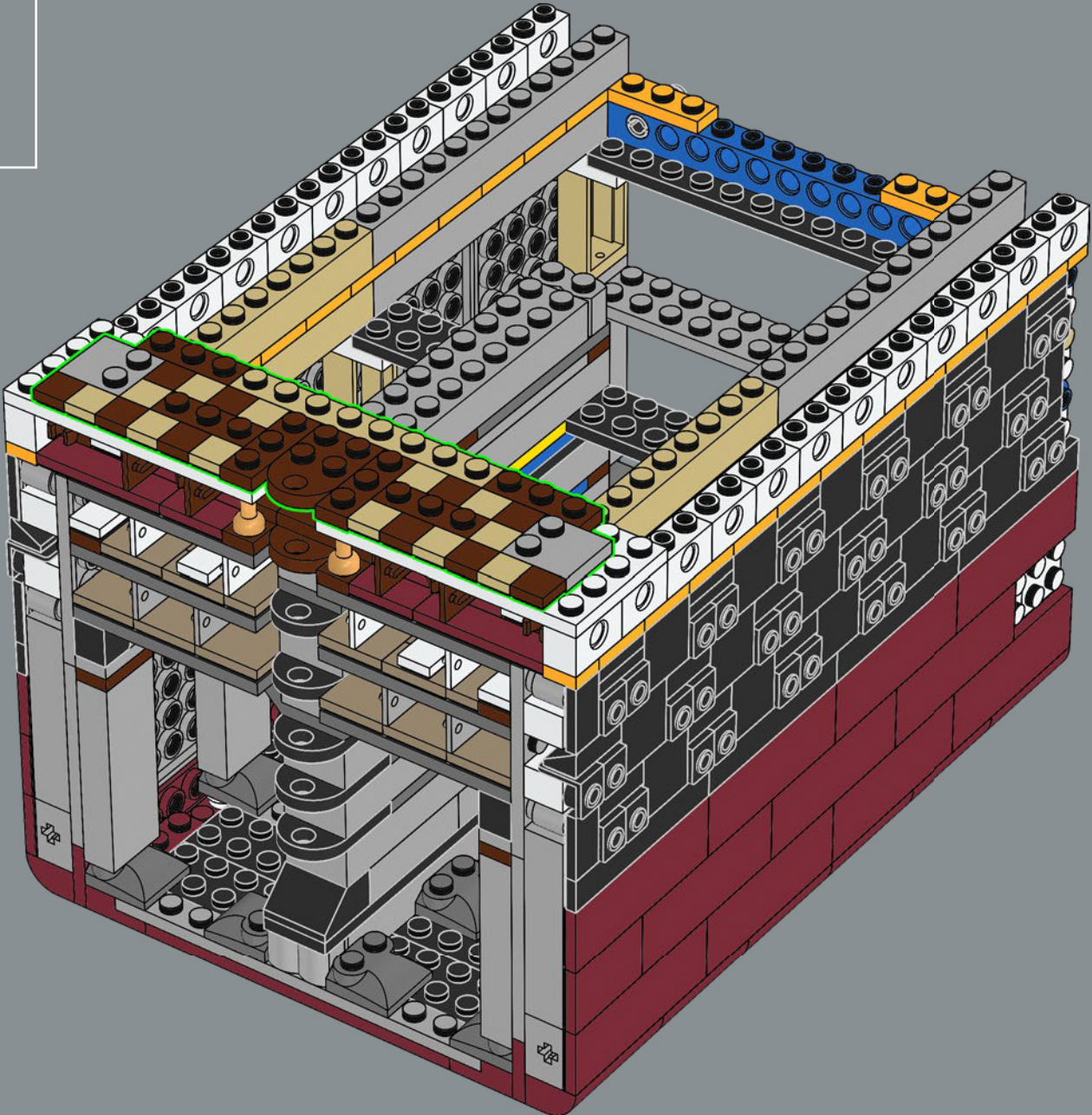

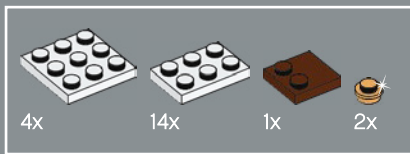

207

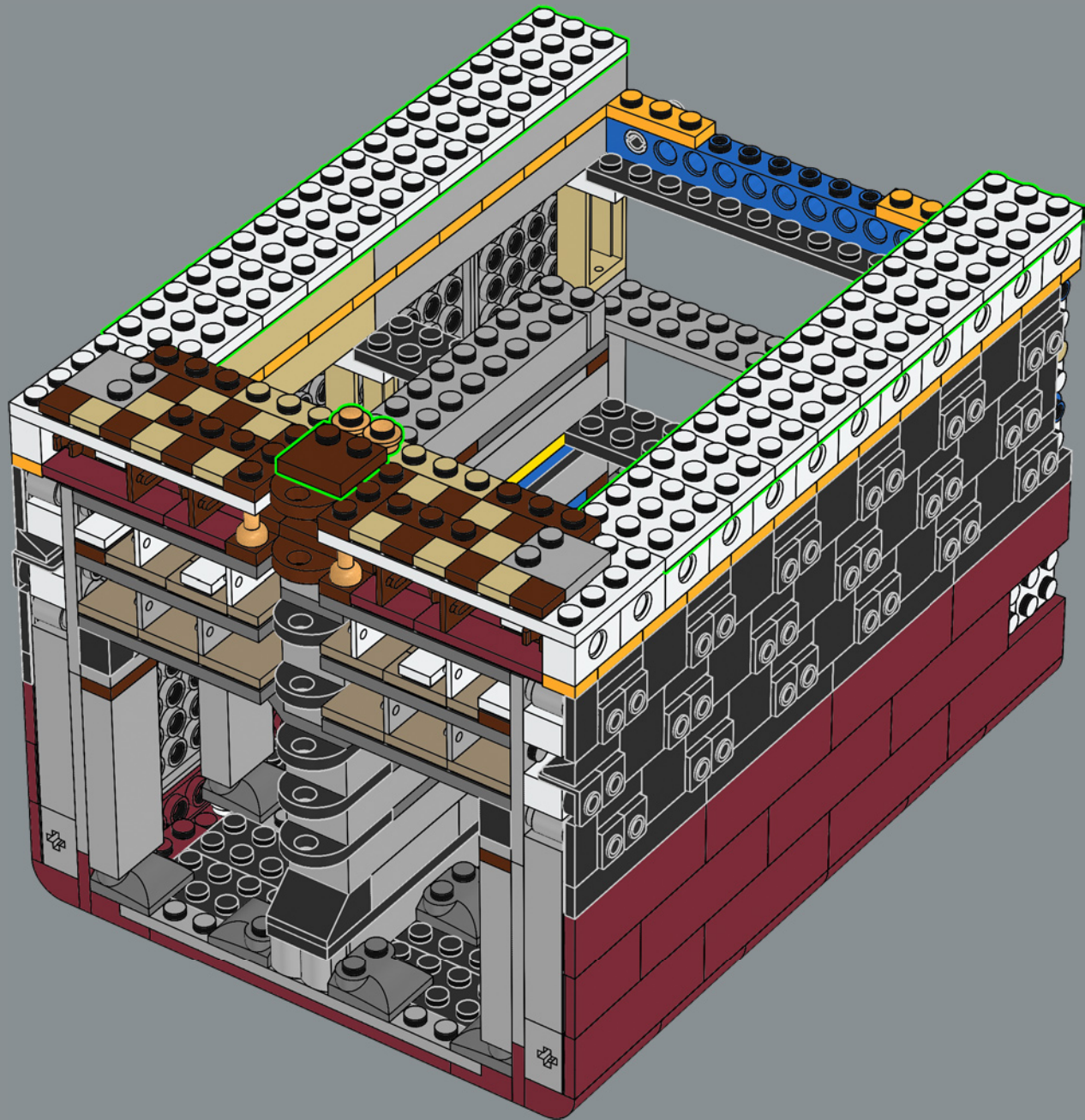

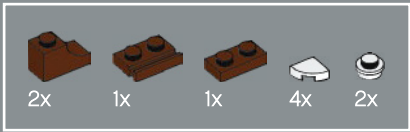

208

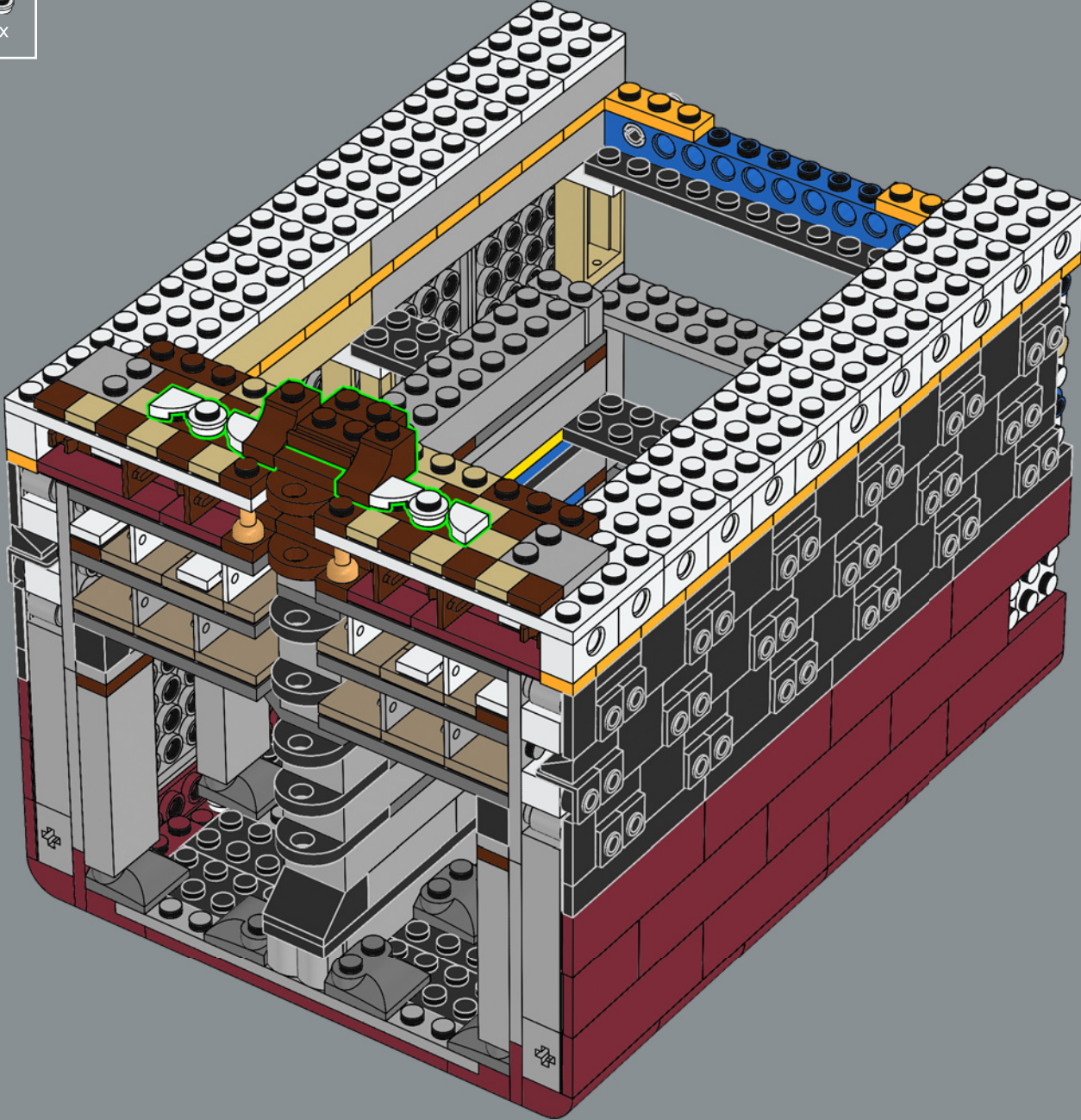

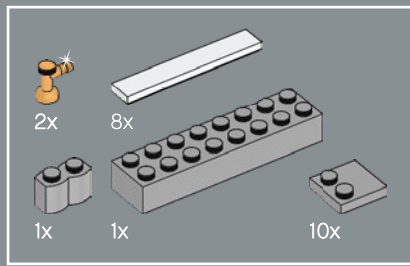

209

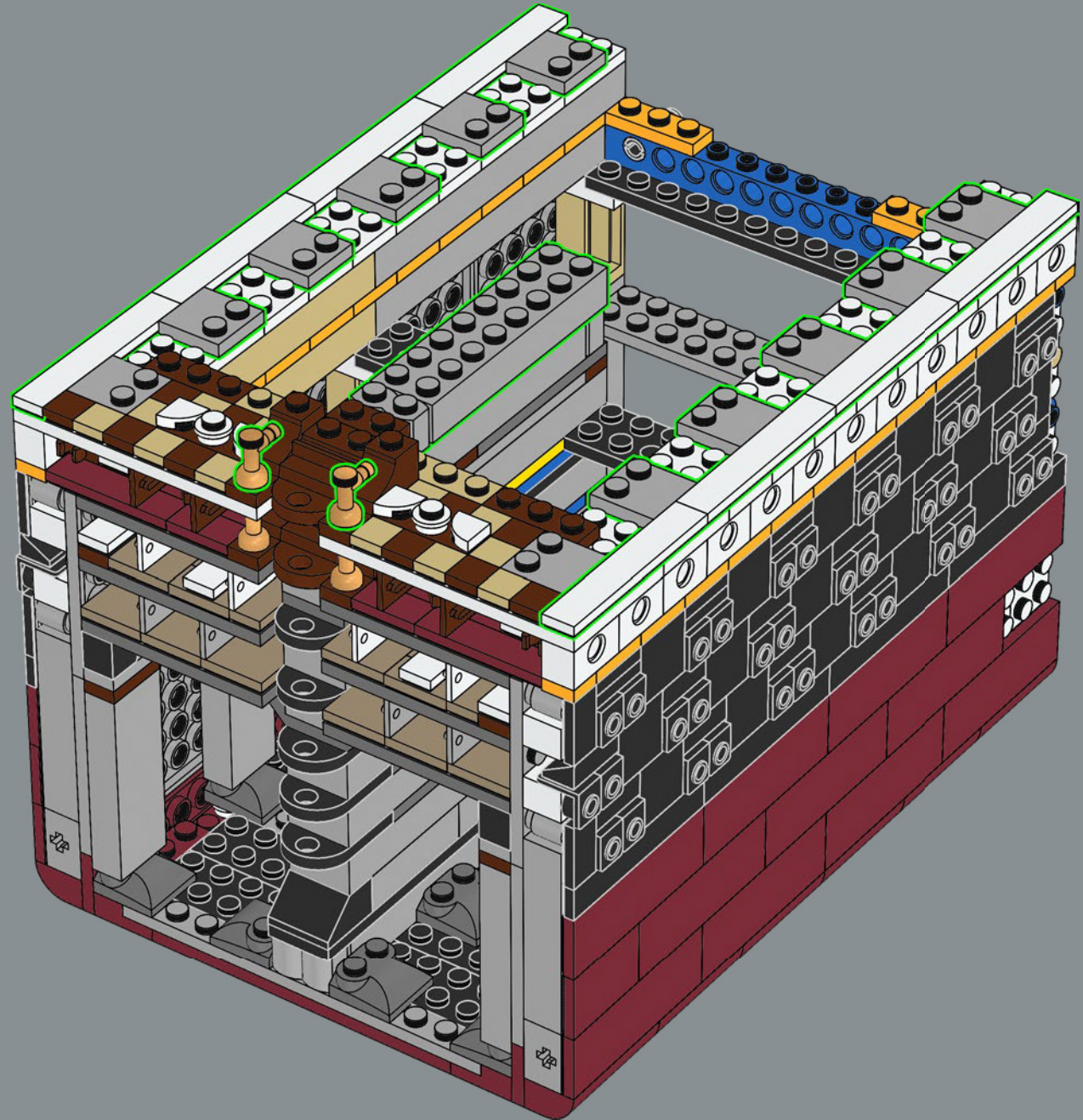

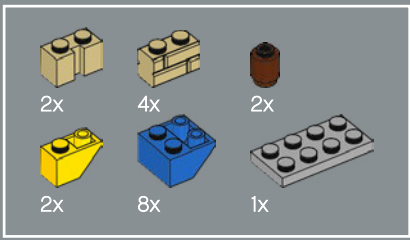

210

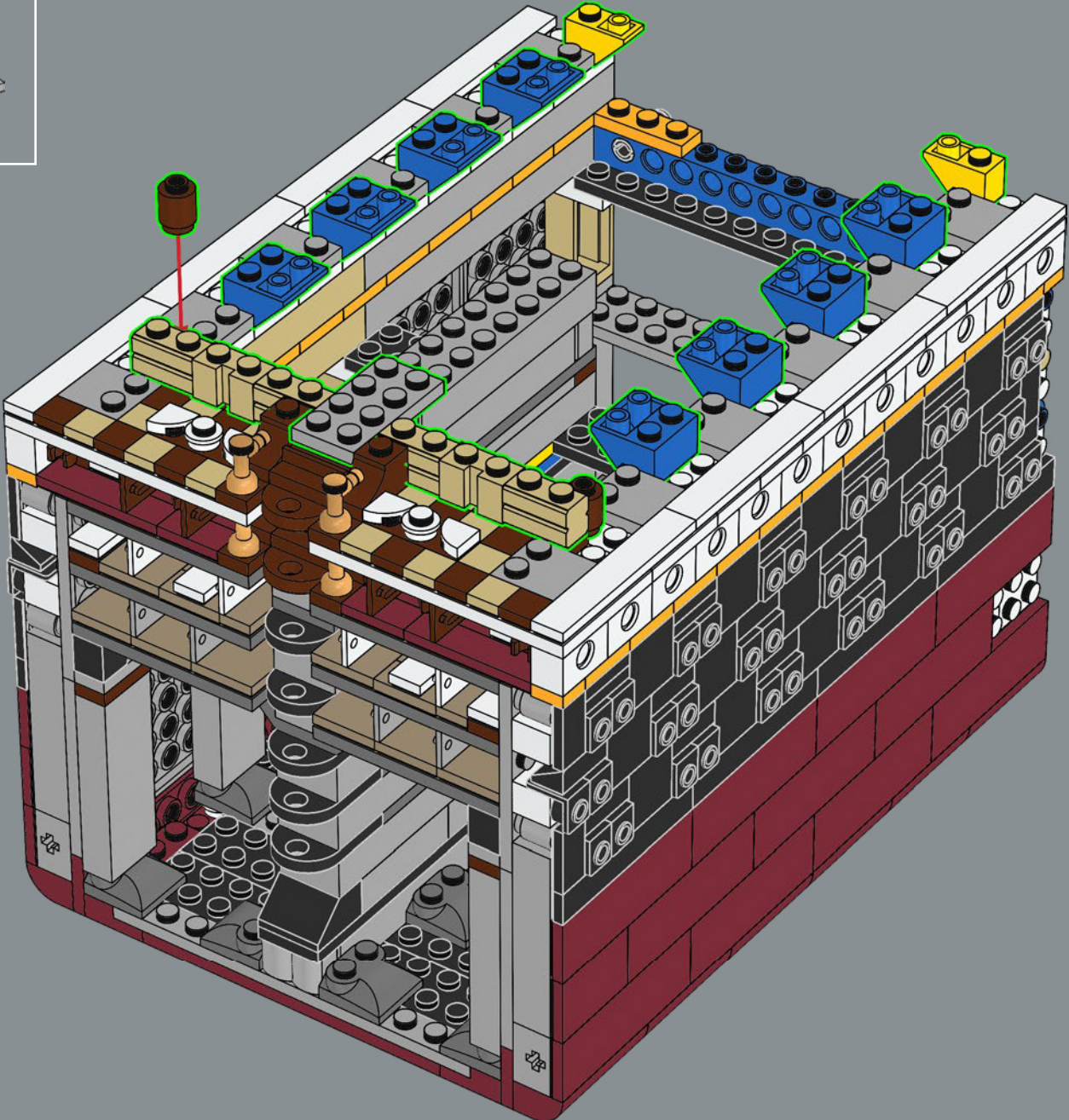

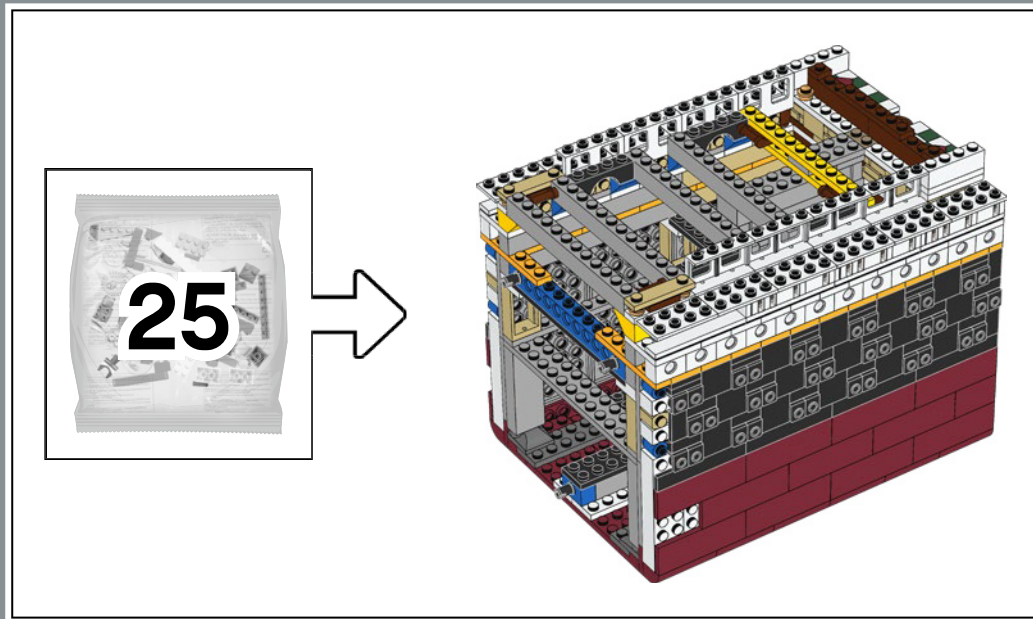



211

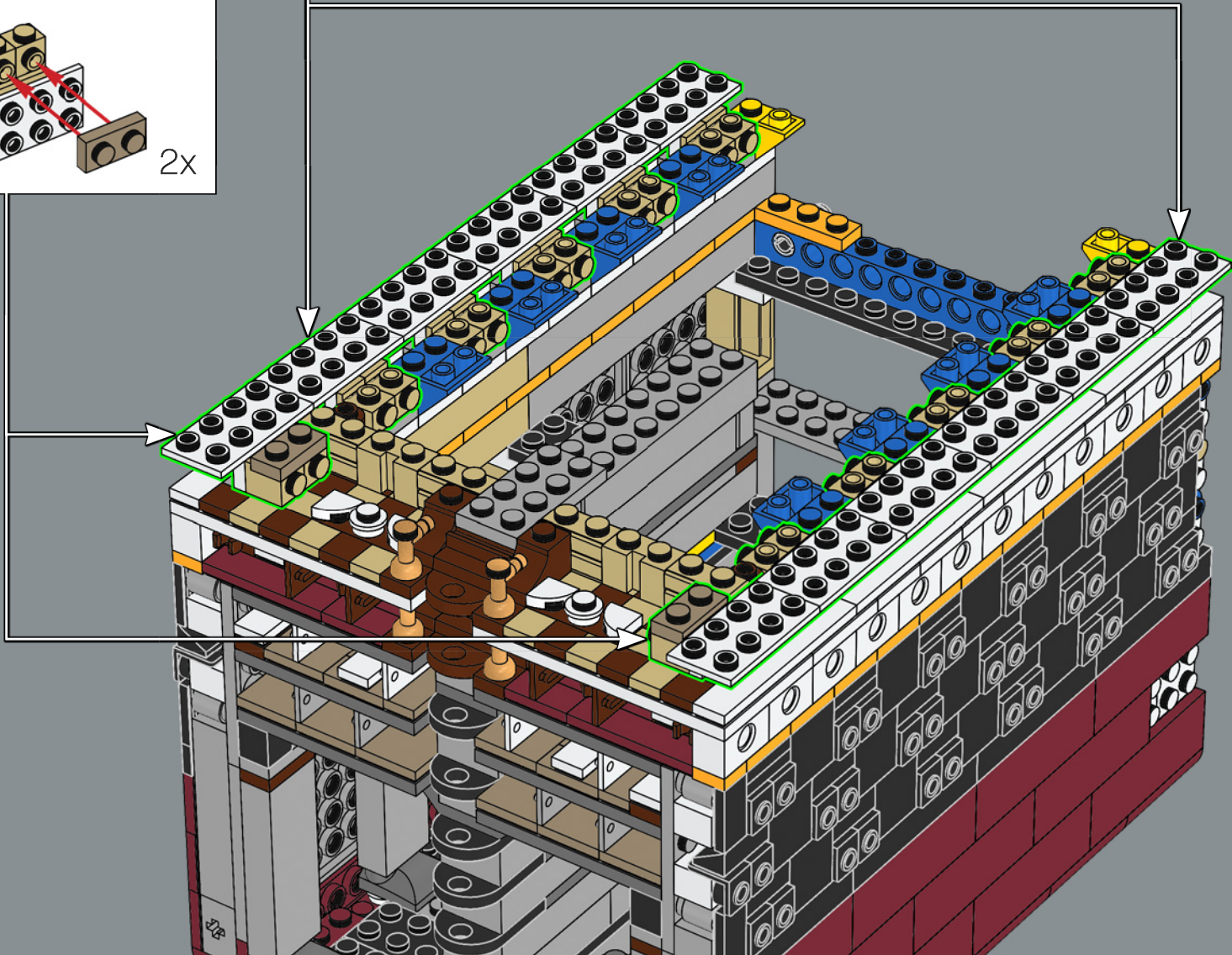
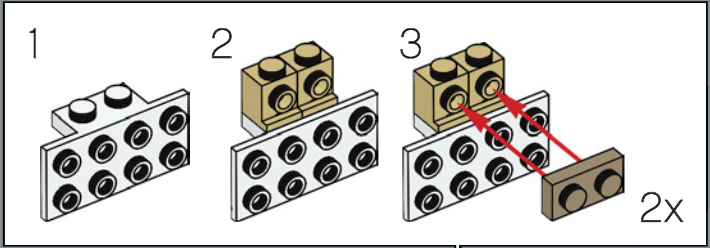
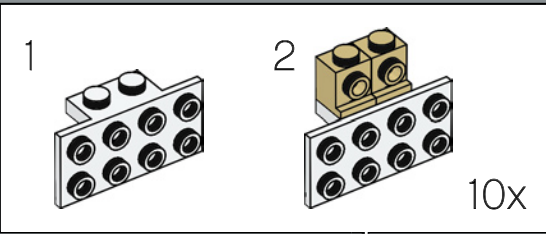

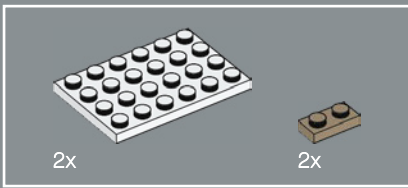

212

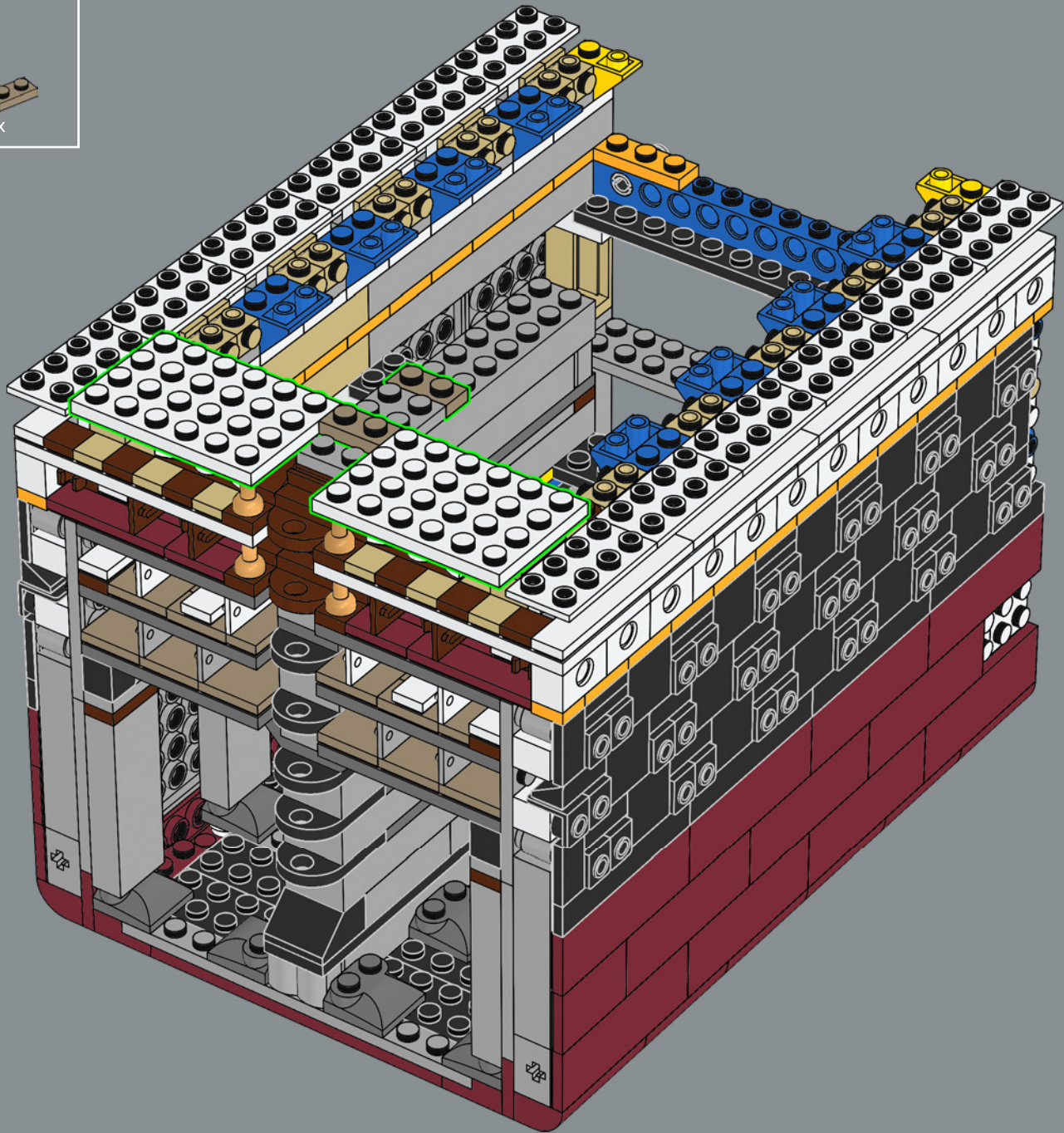

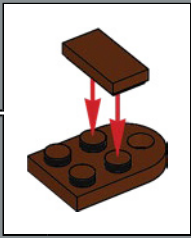
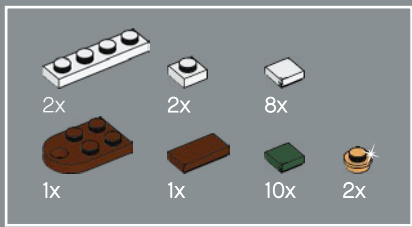

213

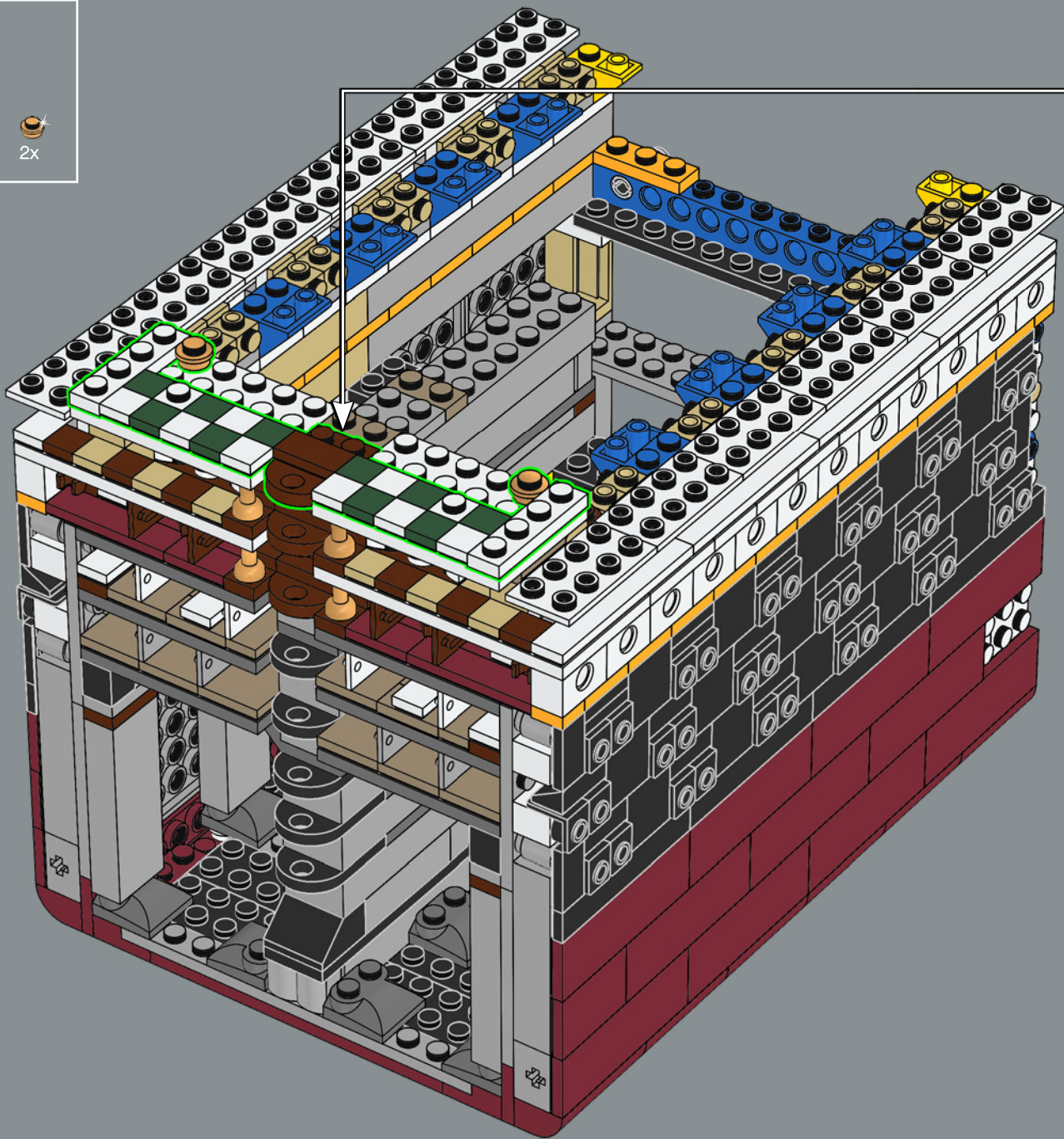

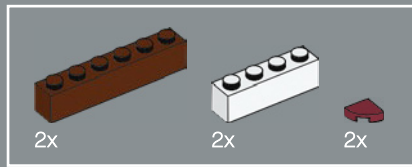

214

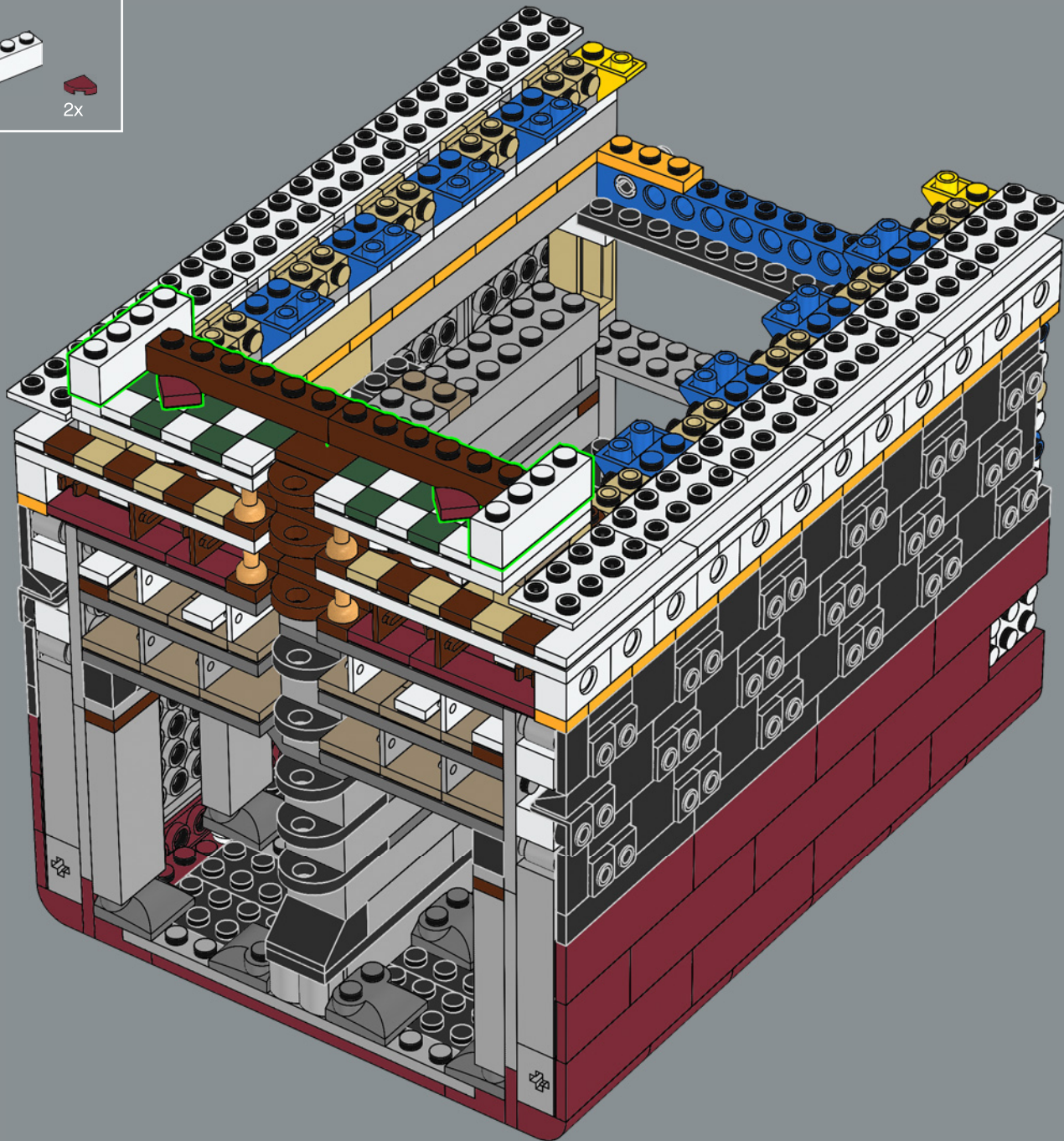

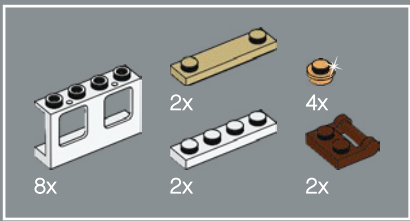

215

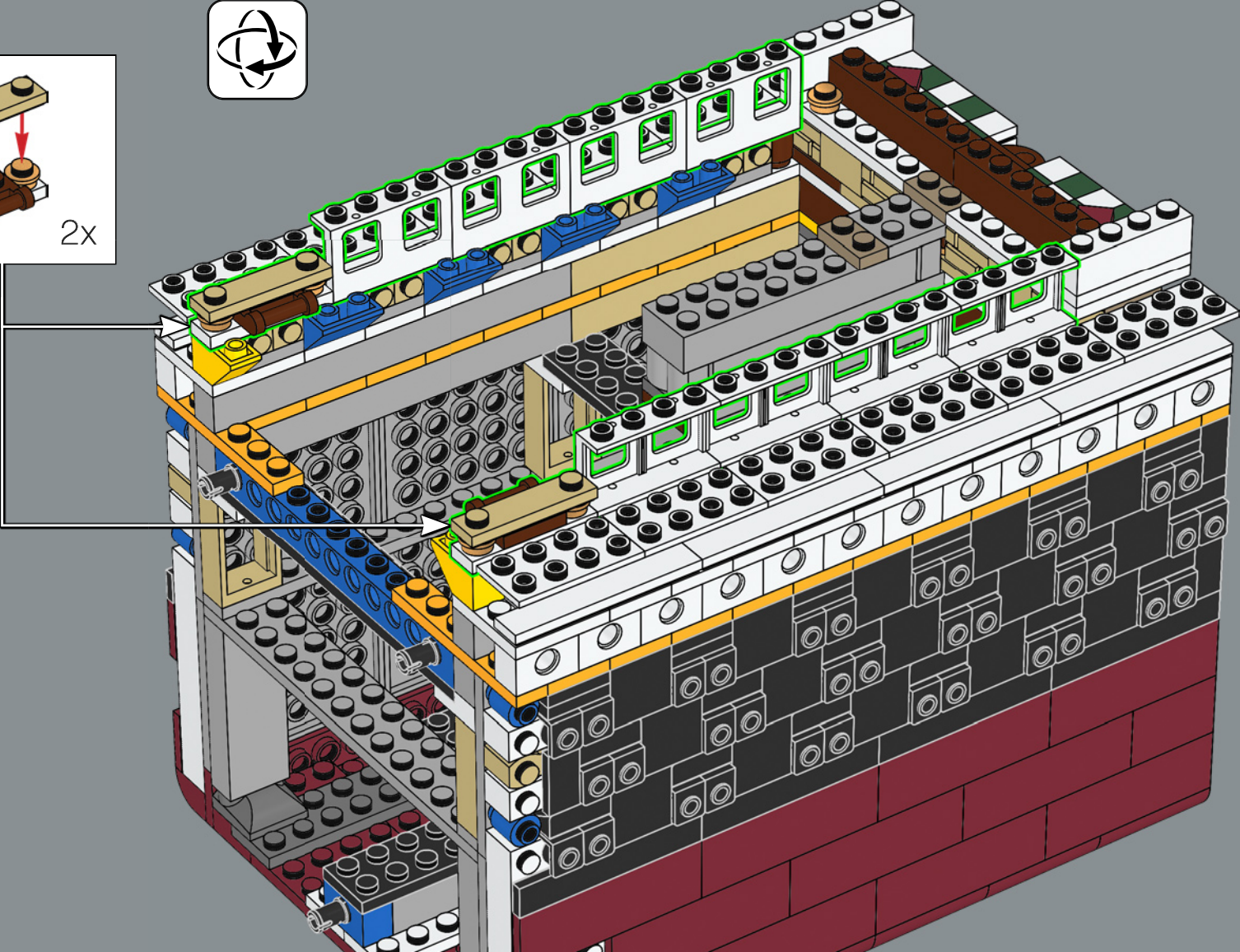
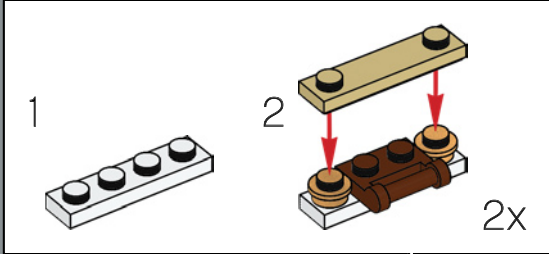

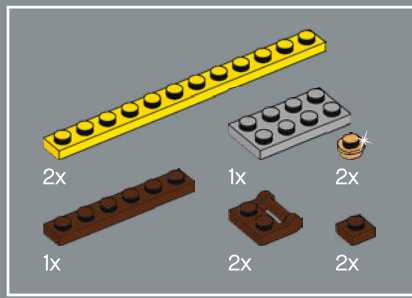

216

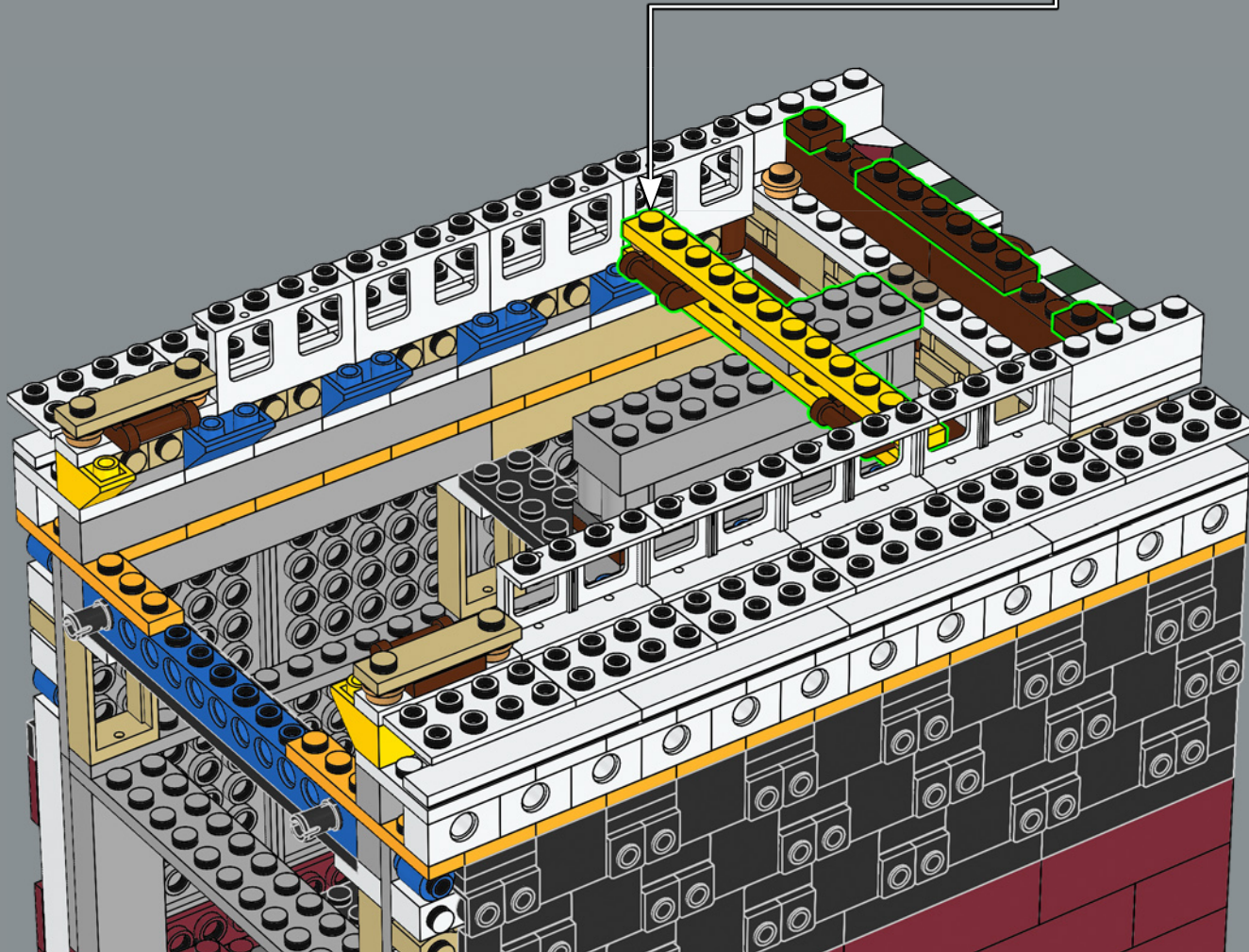
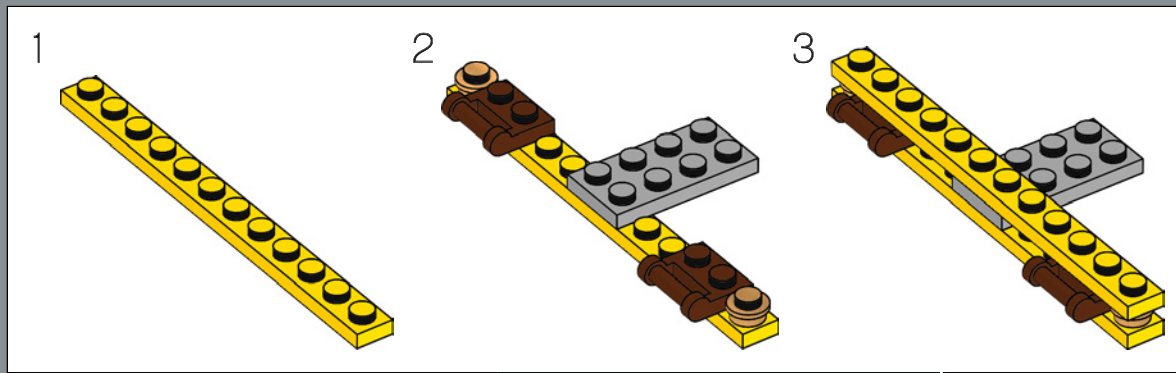

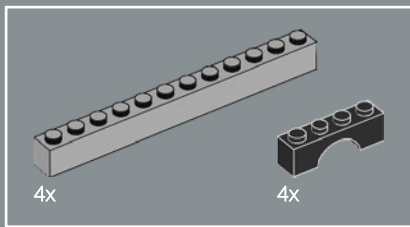

217

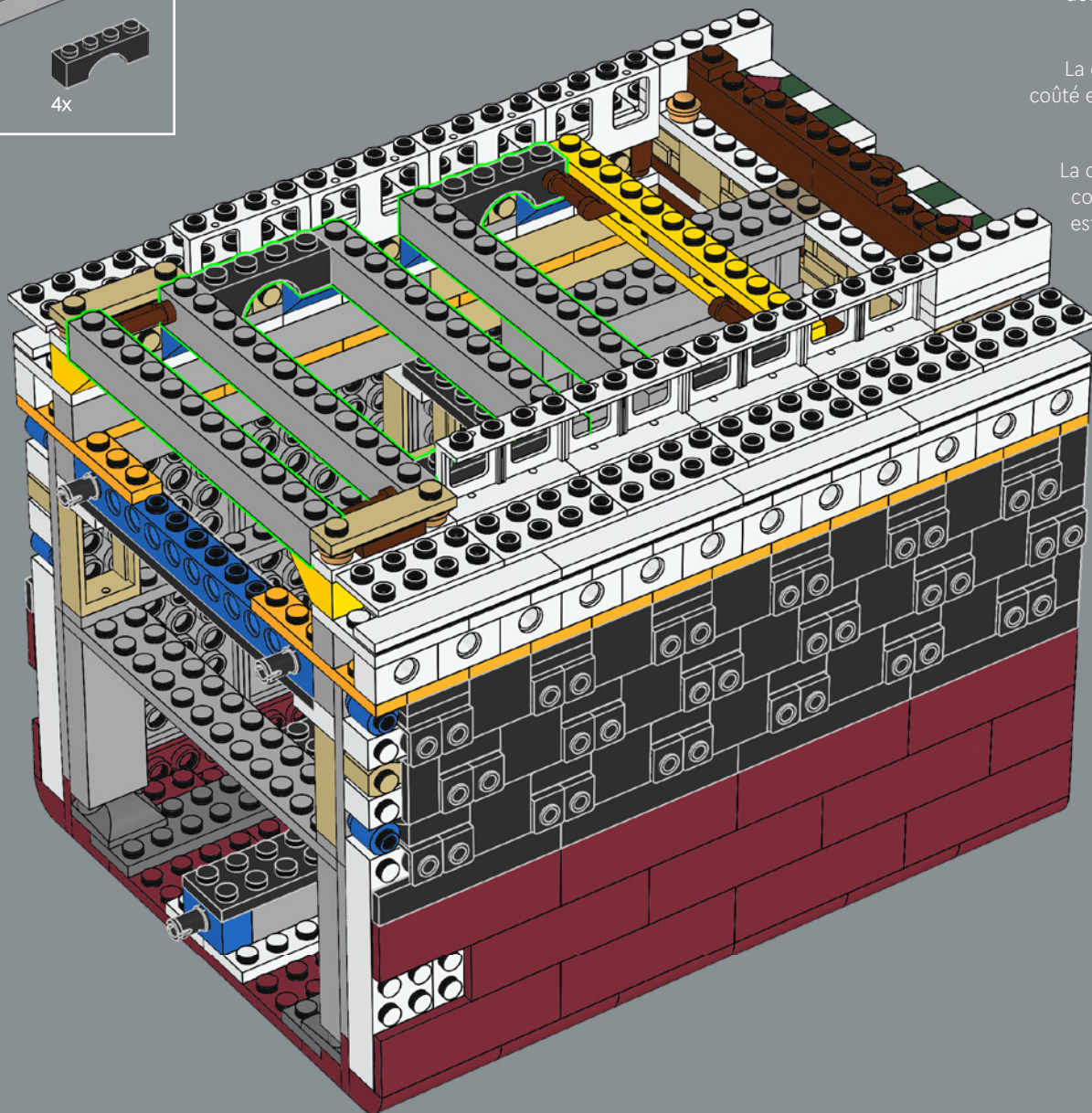

The *Titanic* and *Olympic* ships cost approx. 4.1 million dollars (£3 million) to build - 416.7 million dollars (almost £300 million) in today's money.

La construction des navires *Titanic* et *Olympic* a coûté environ 4,1 millions de dollars, ce qui équivaut aujourd'hui à 416,7 millions de dollars.

La construcción de los buques *Titanic* y *Olympic* costó aproximadamente 4,1 millones de dólares estadounidenses (casi 416,7 millones de dólares estadounidenses de hoy).

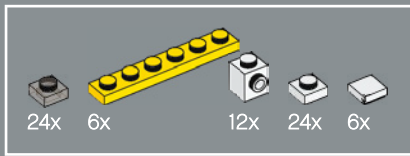

218

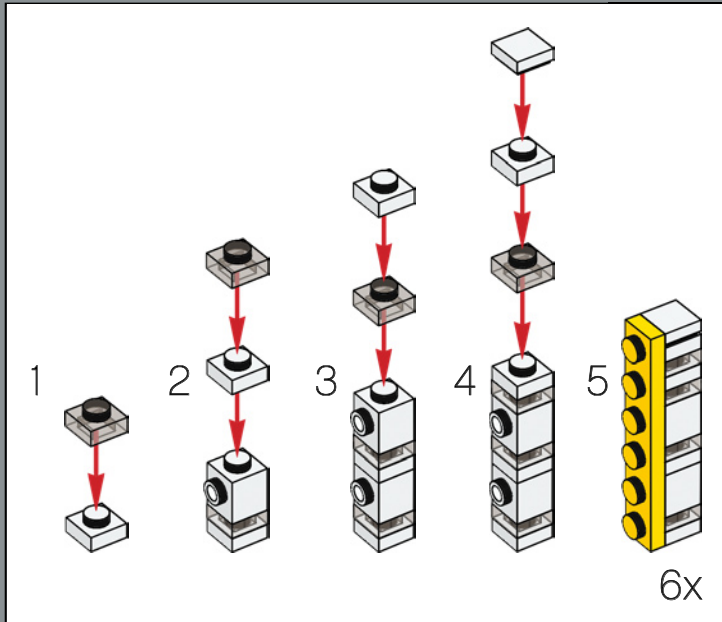
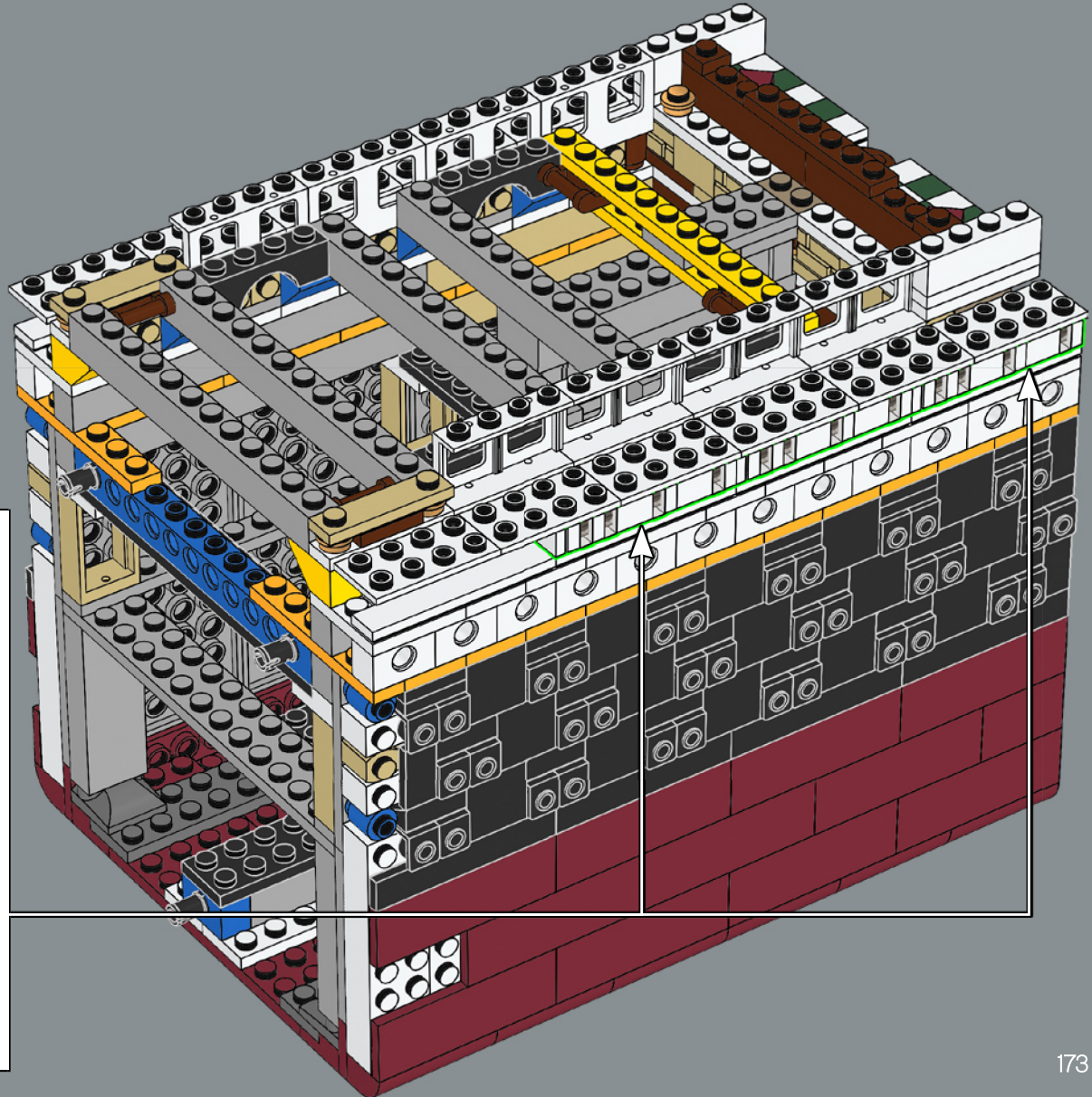

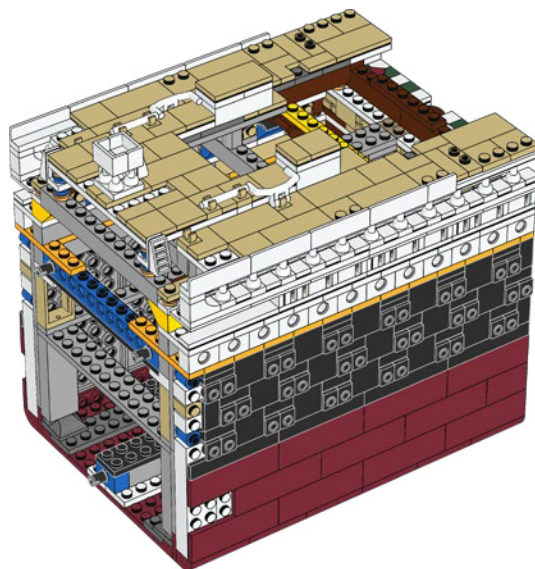
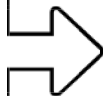

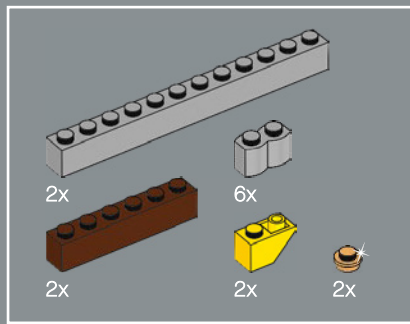

219

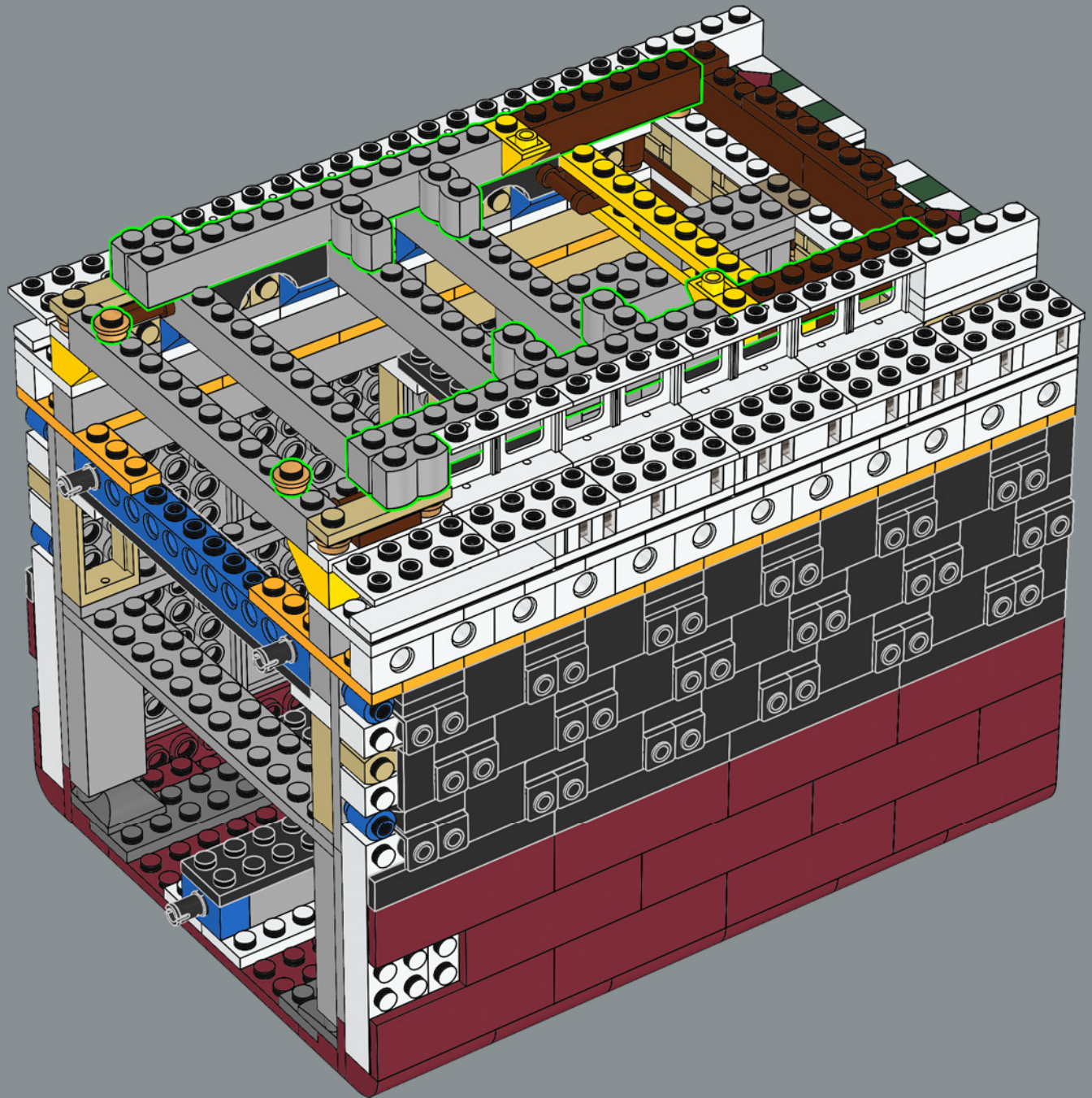

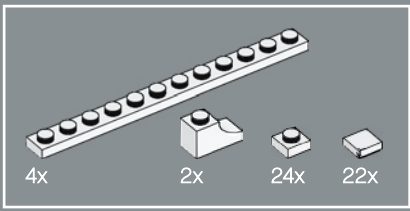

220

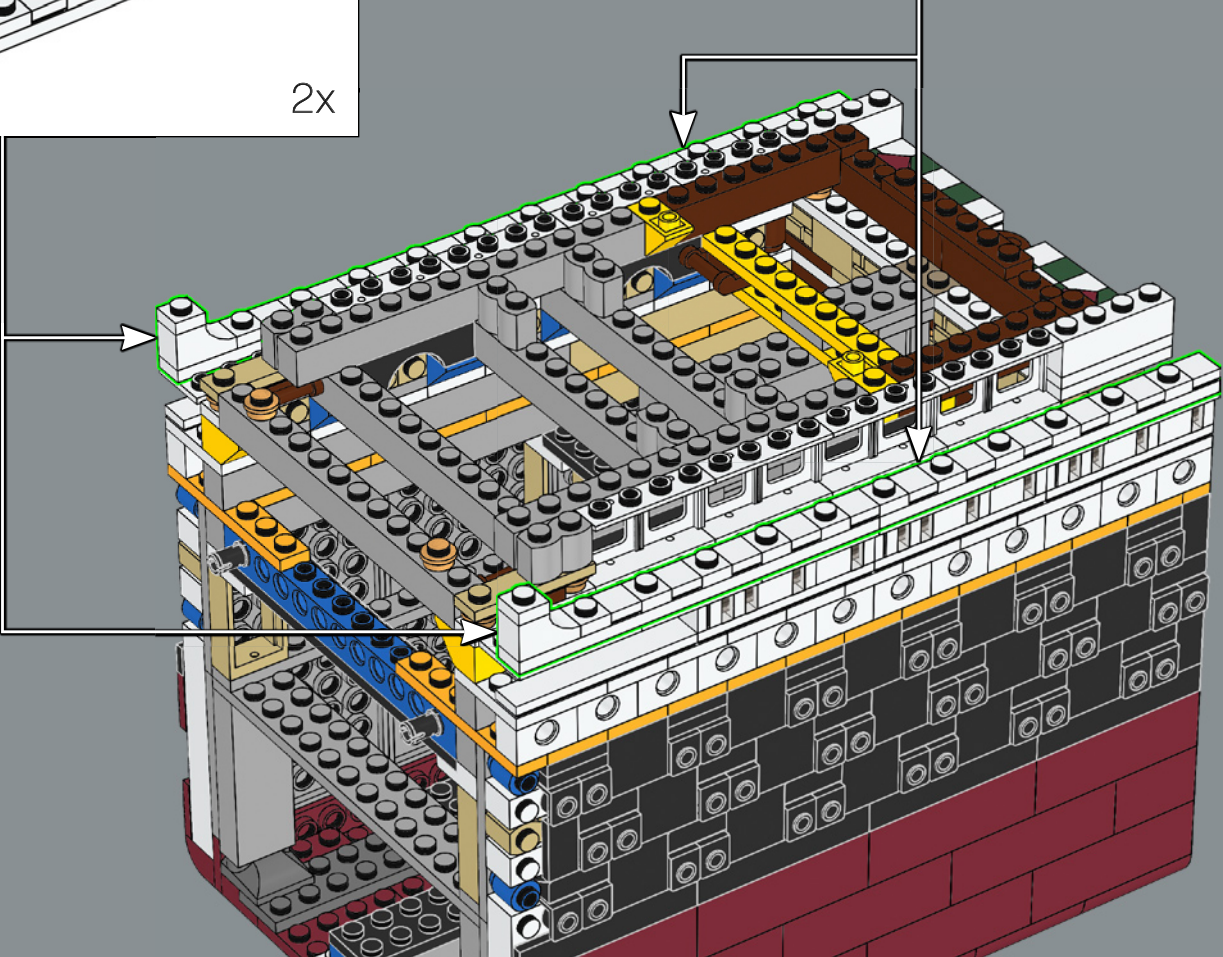
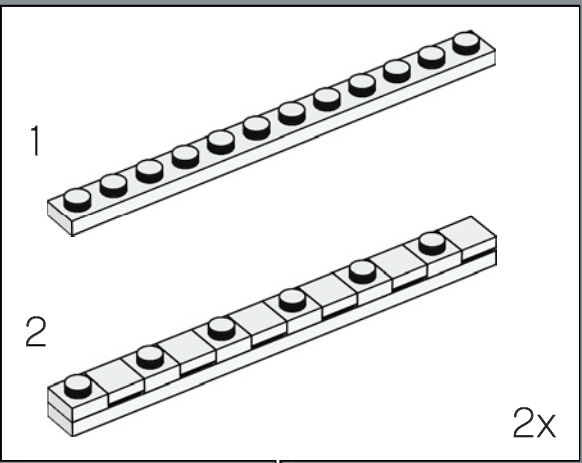
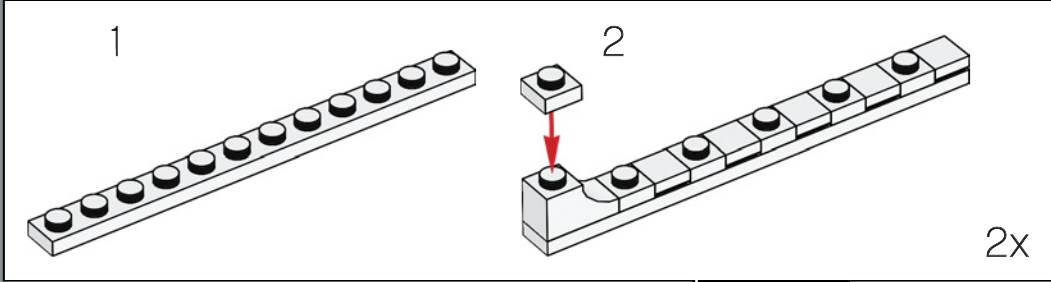

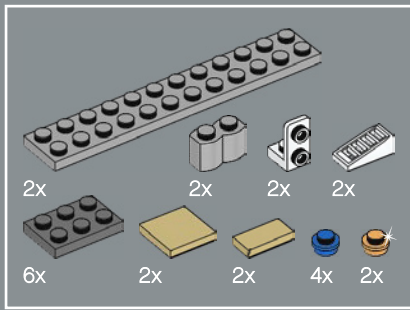

221

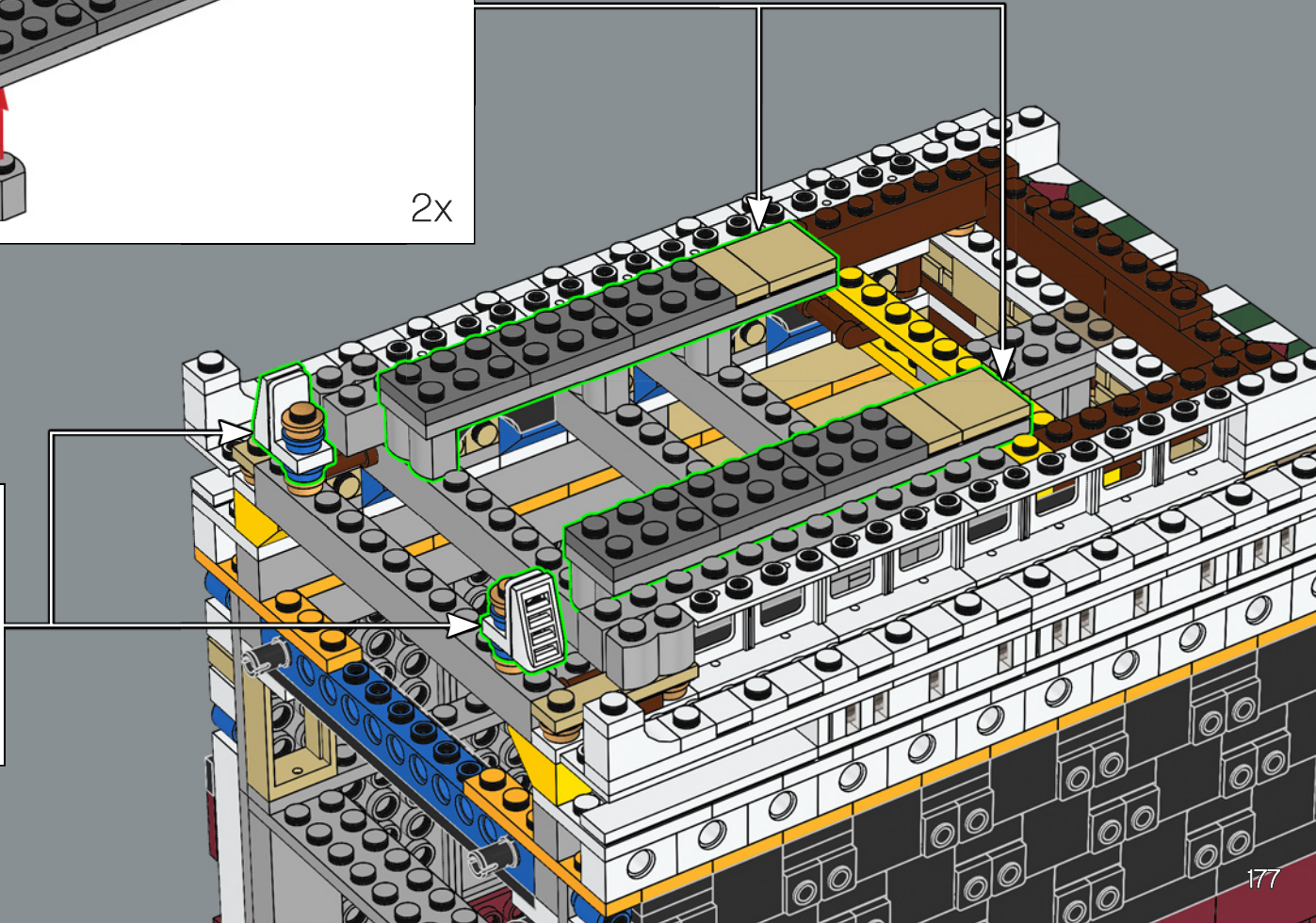
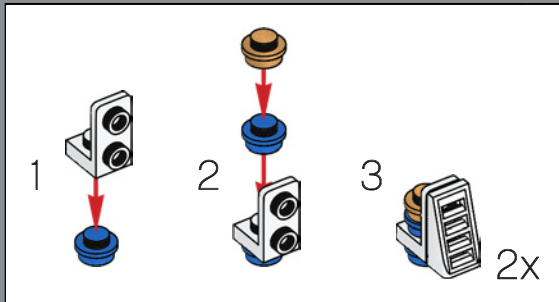
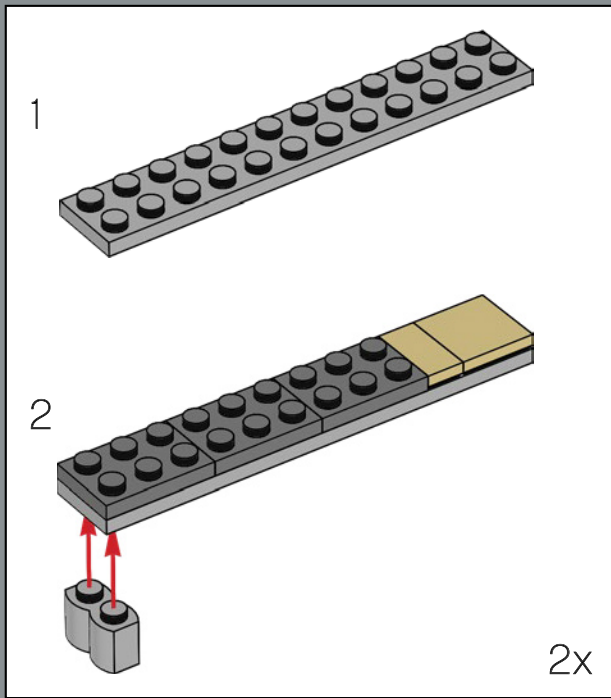

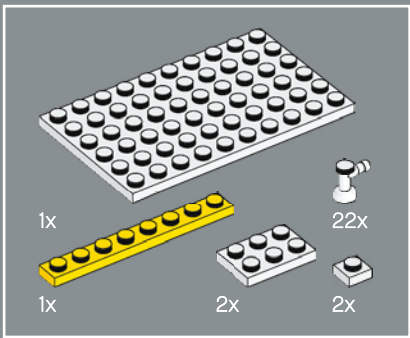

222

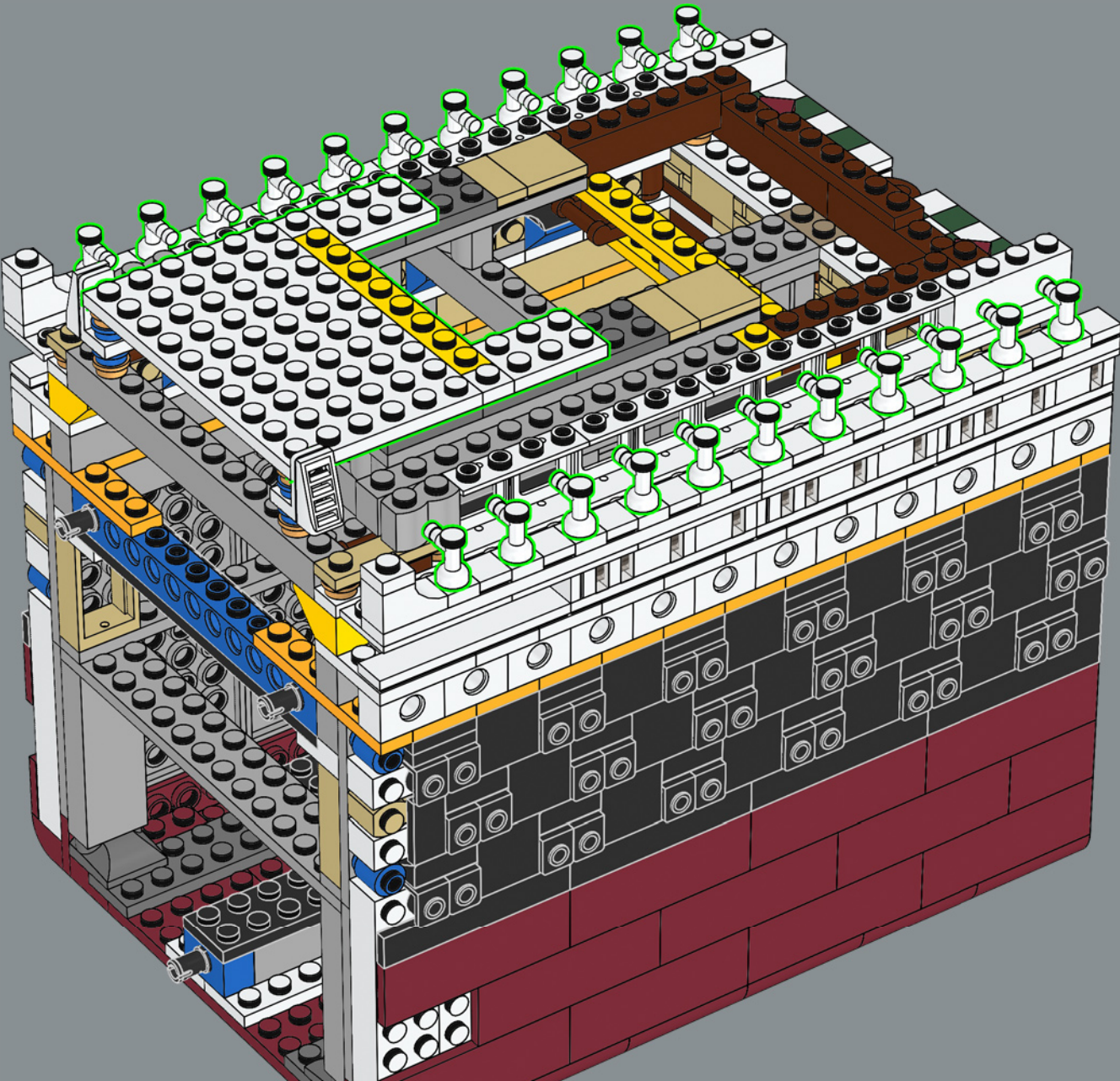

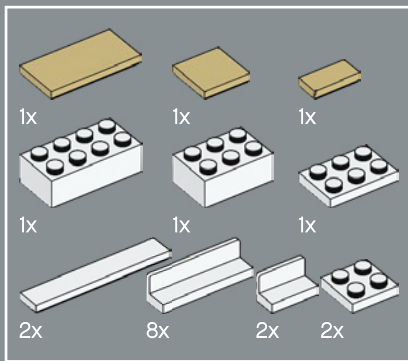

223

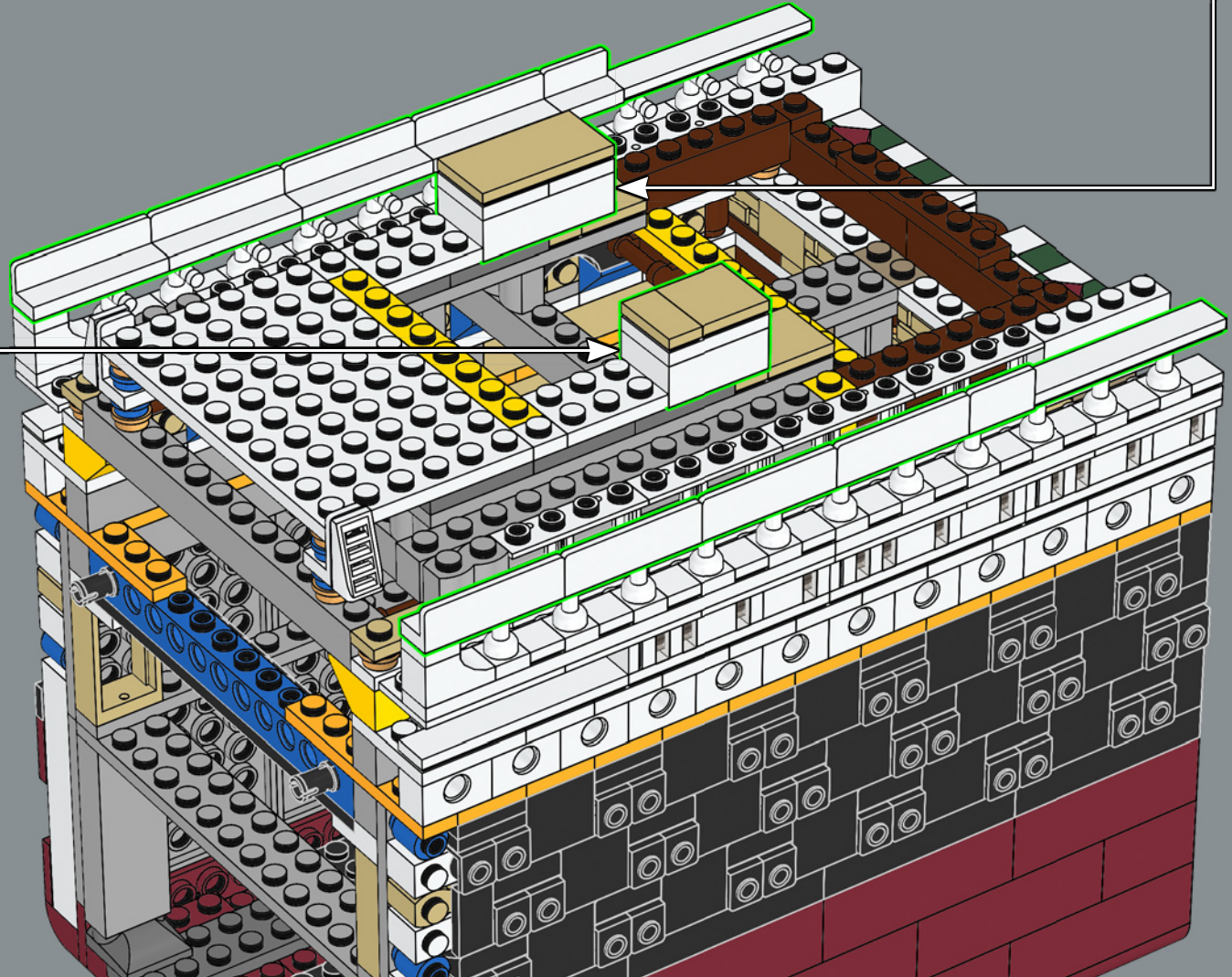
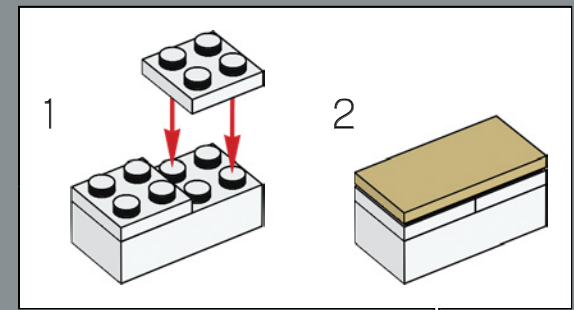
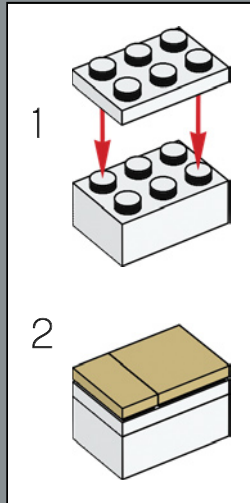

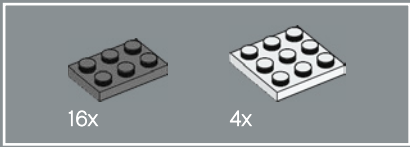

224

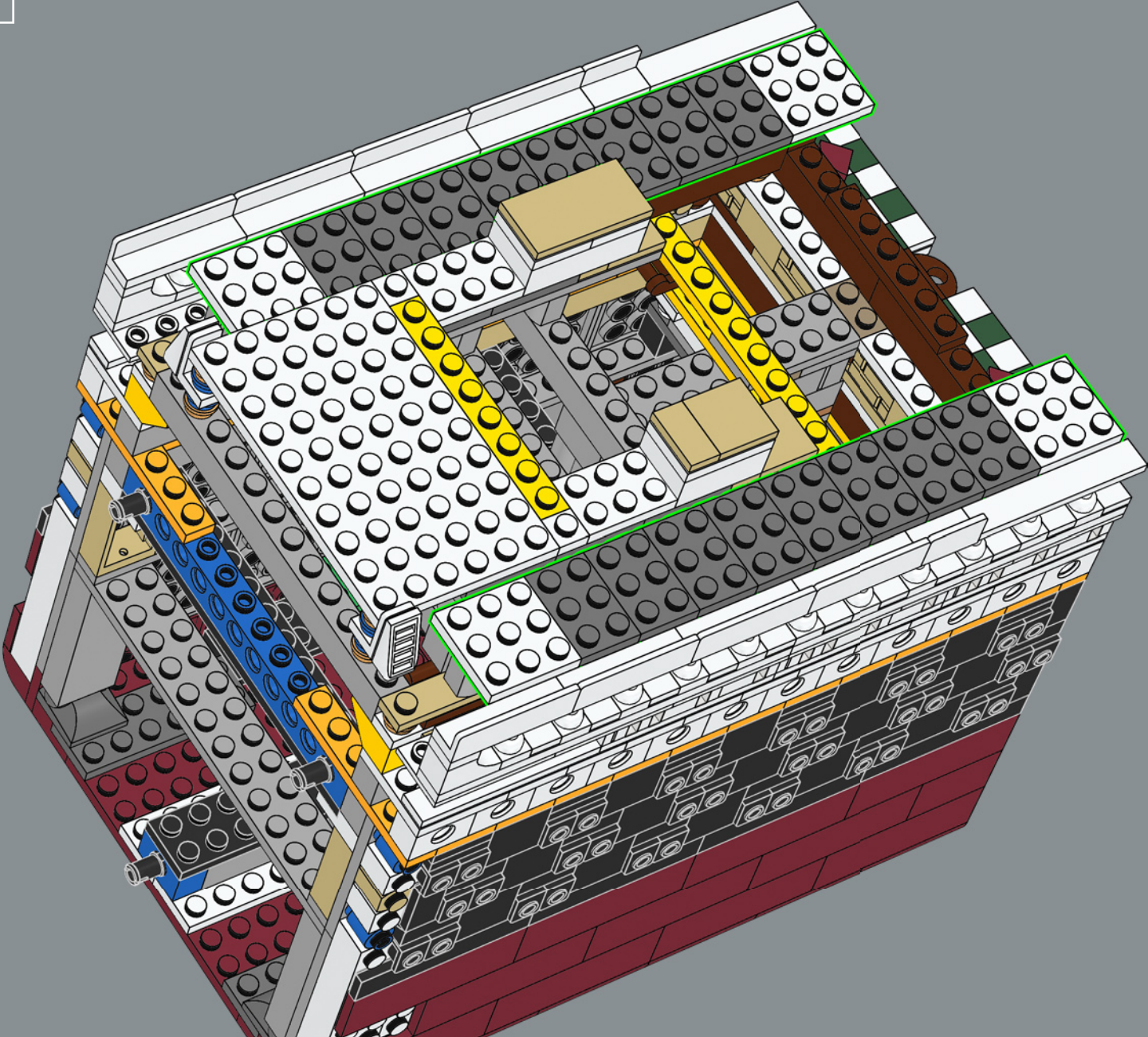

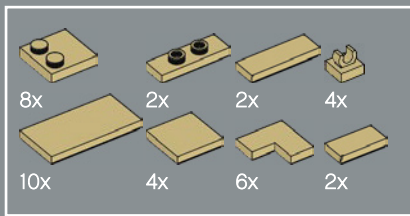

225

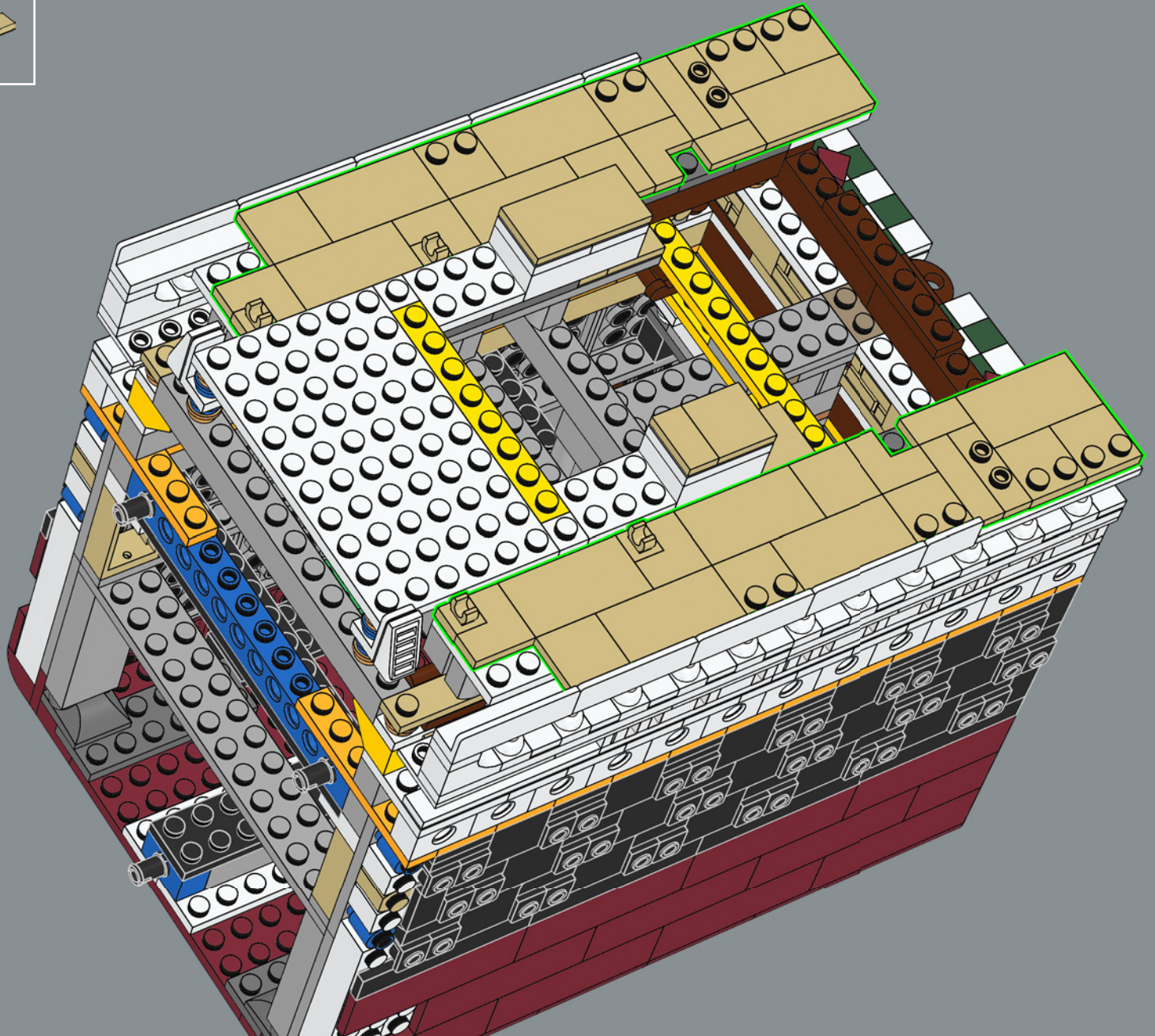

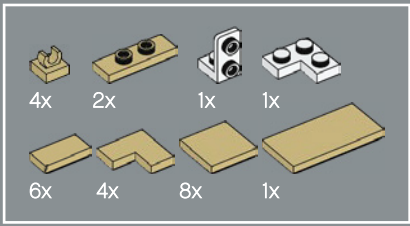

226

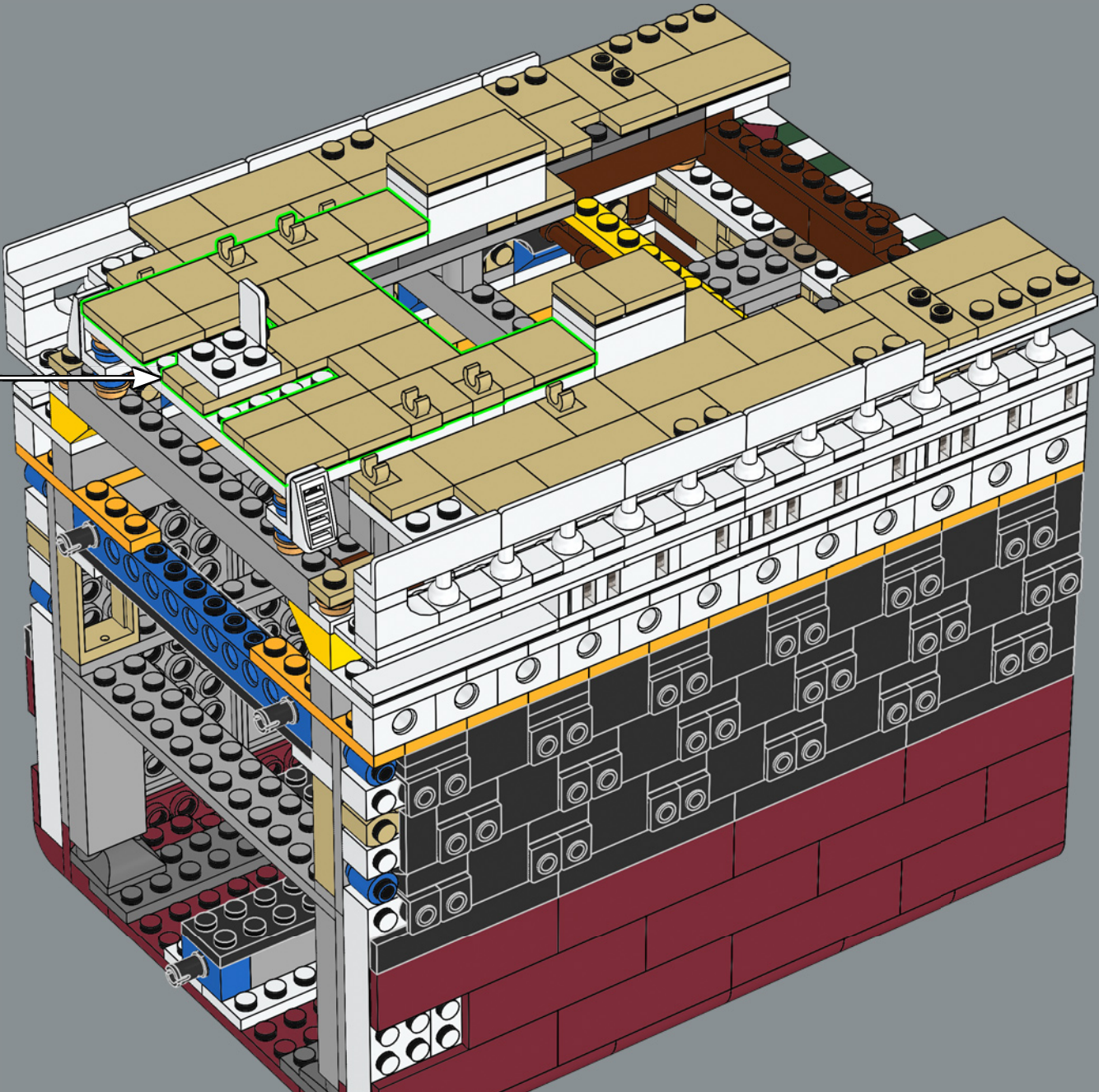
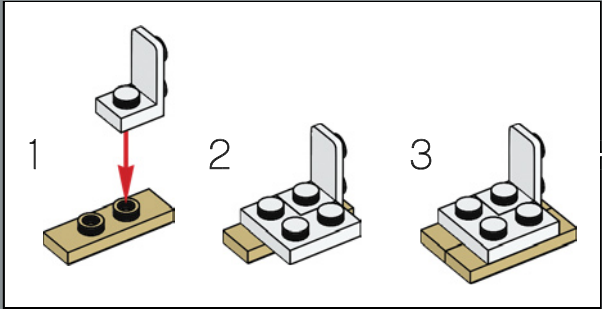



227

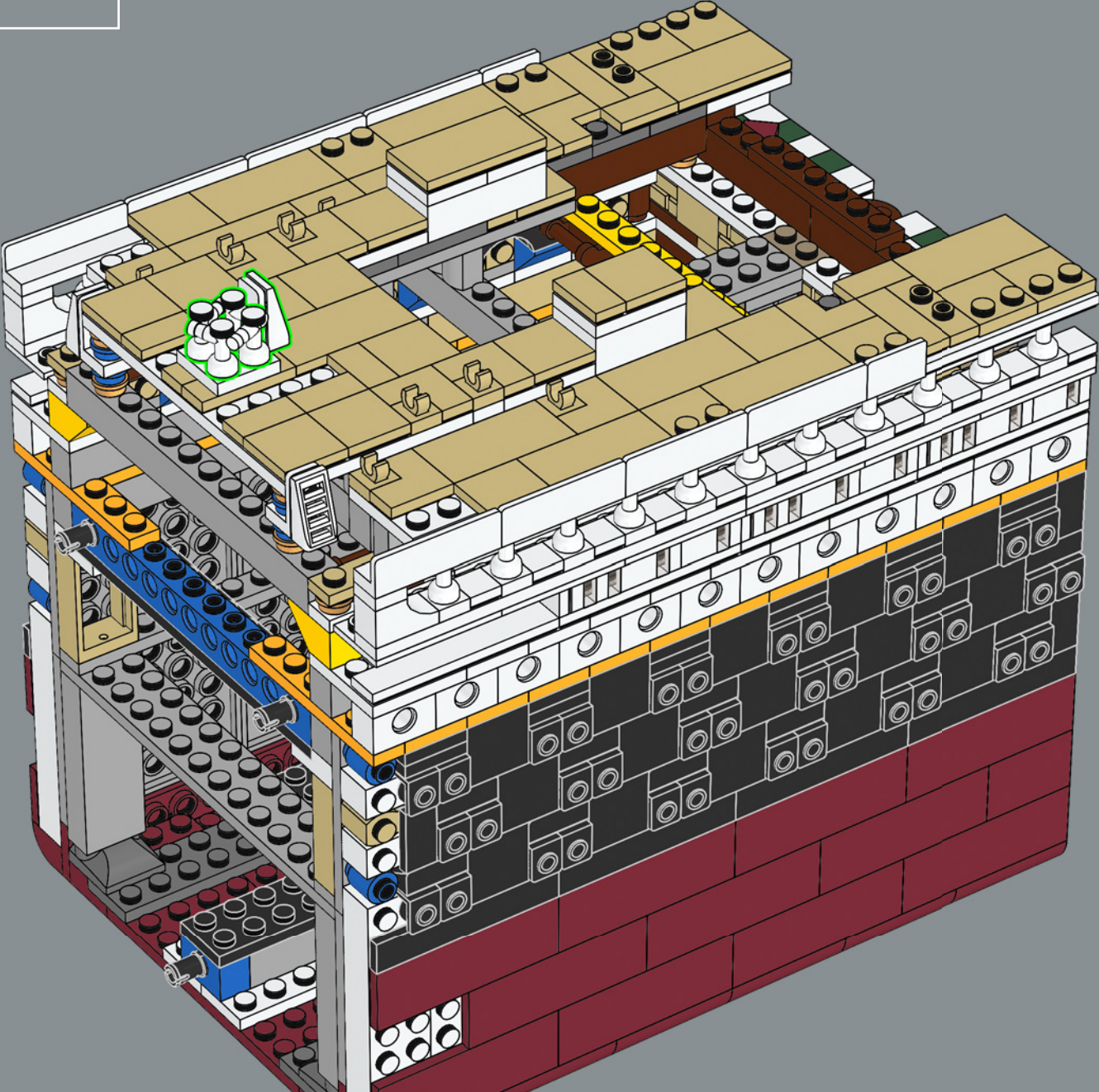

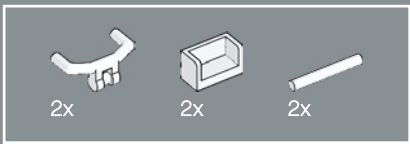

228

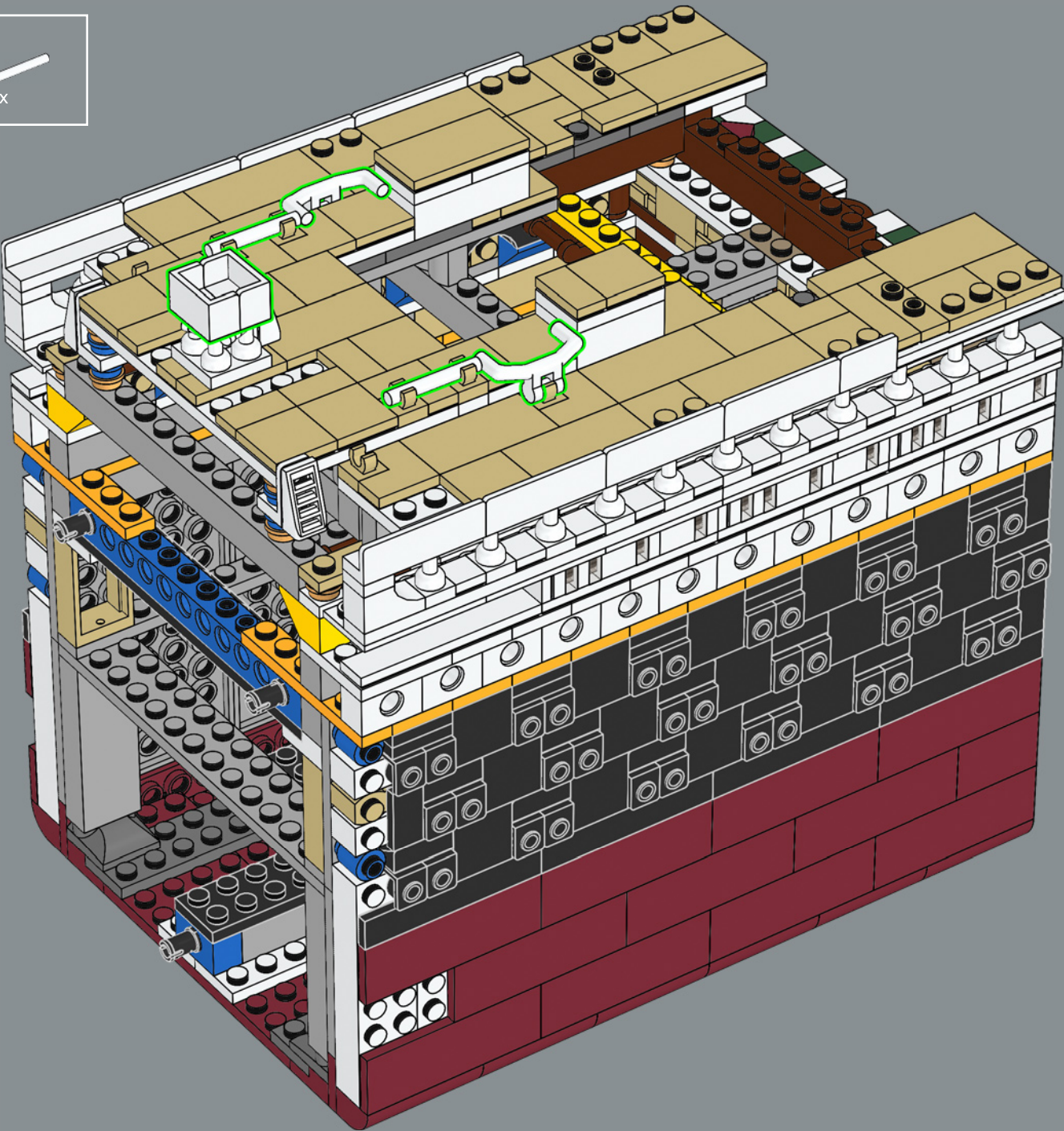

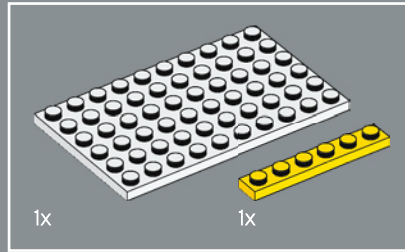
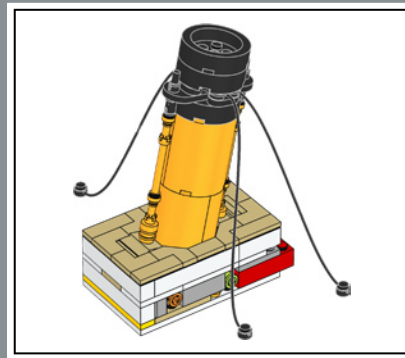
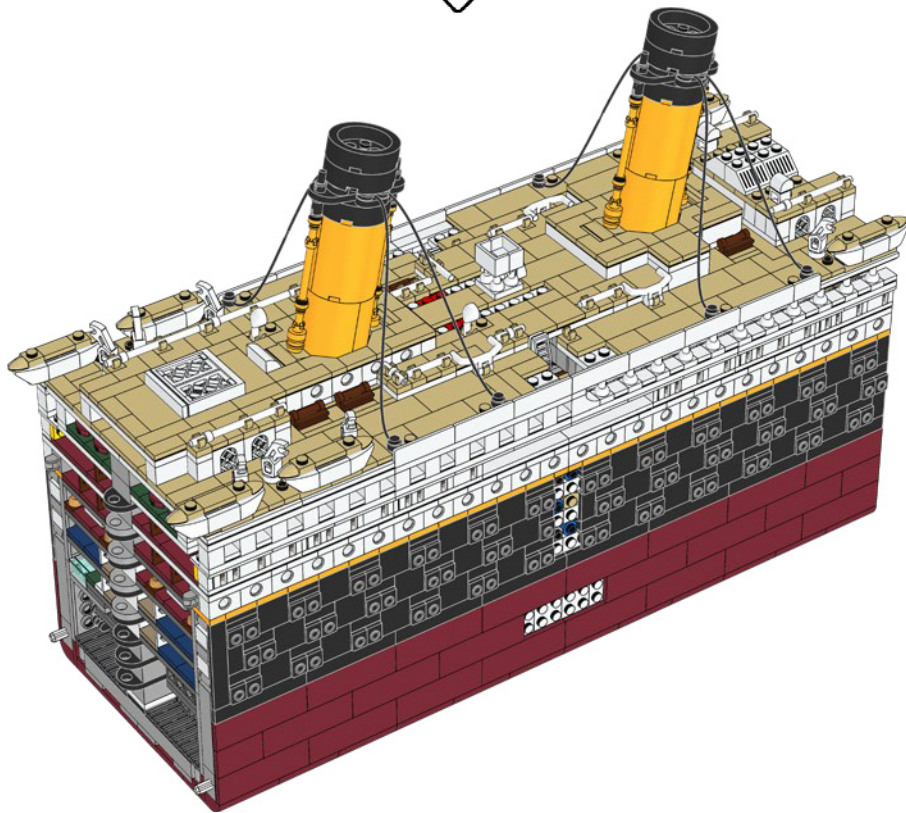
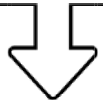

229

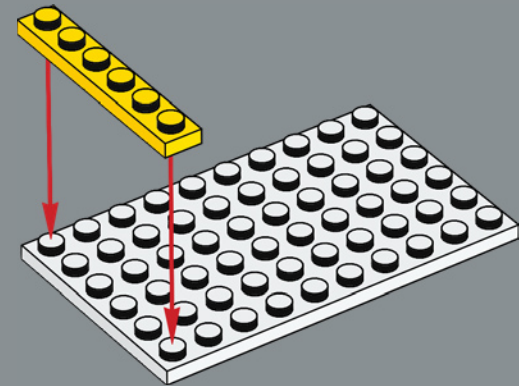

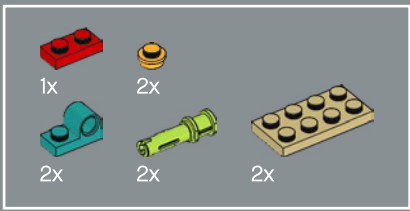

230

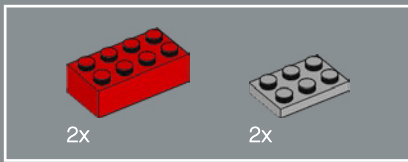
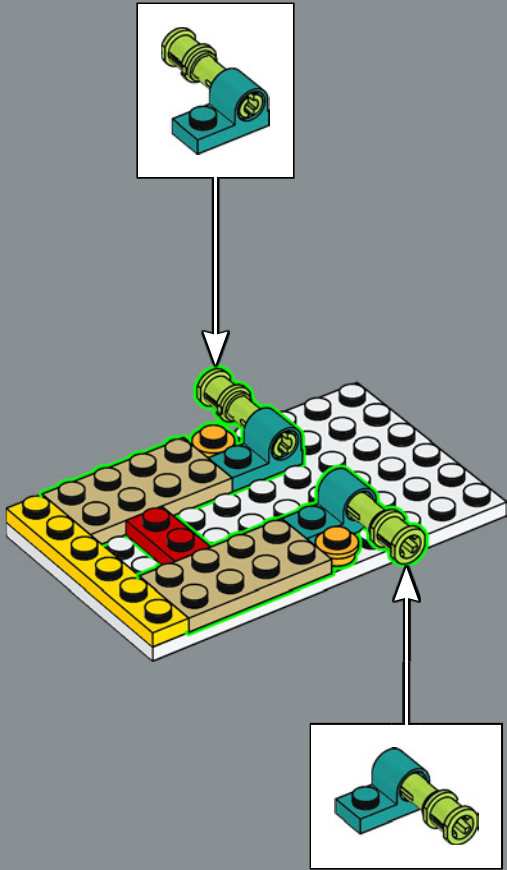

231

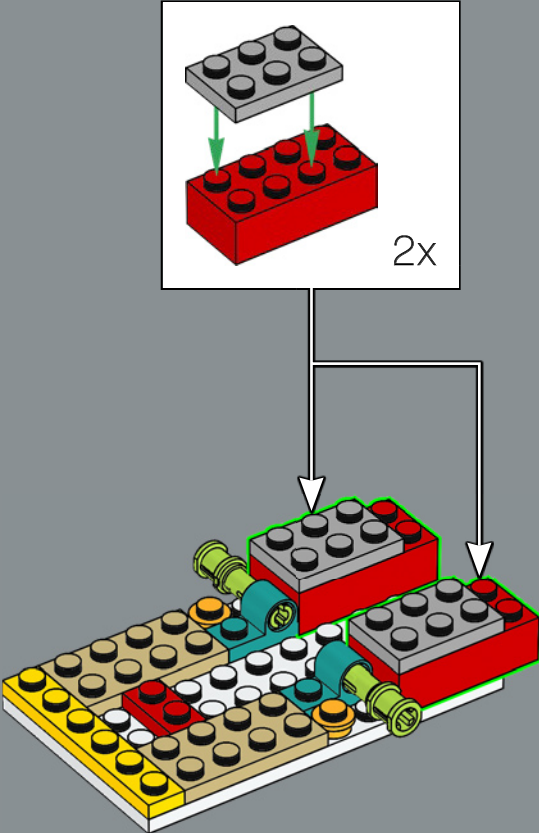

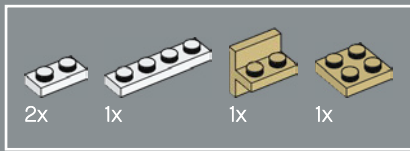

232

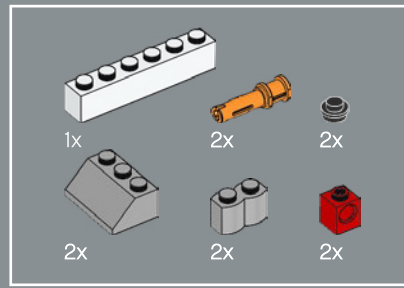
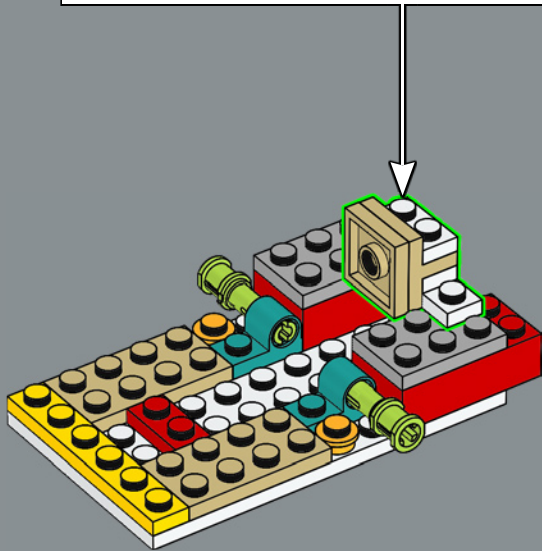
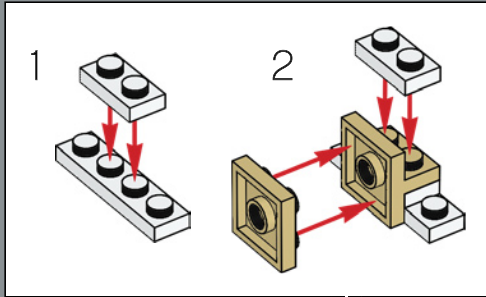

233

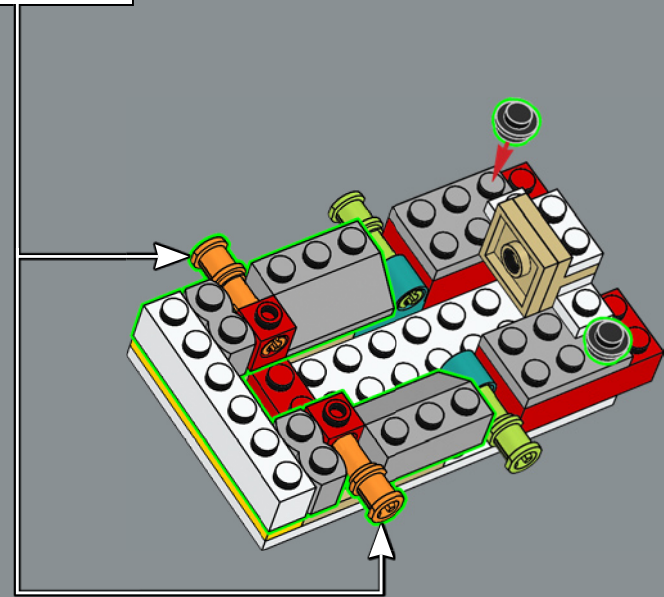
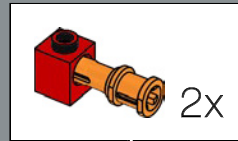

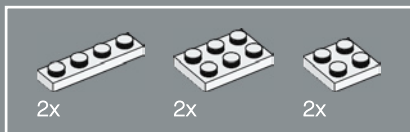

234

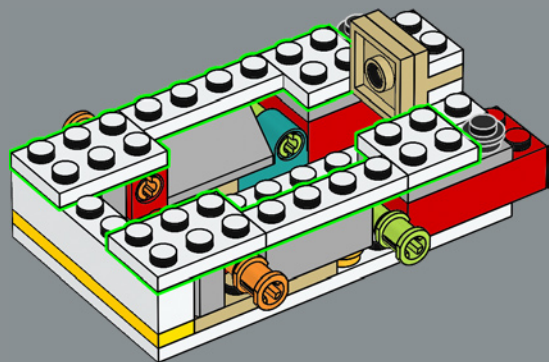

235

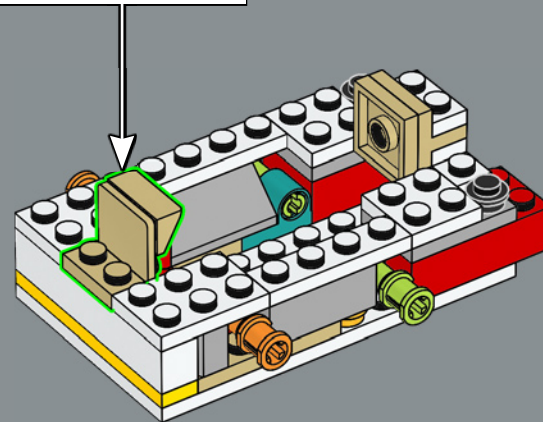
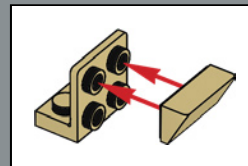

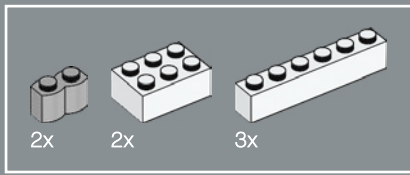

236

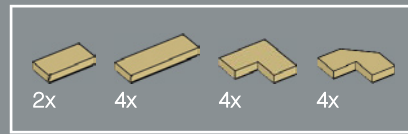
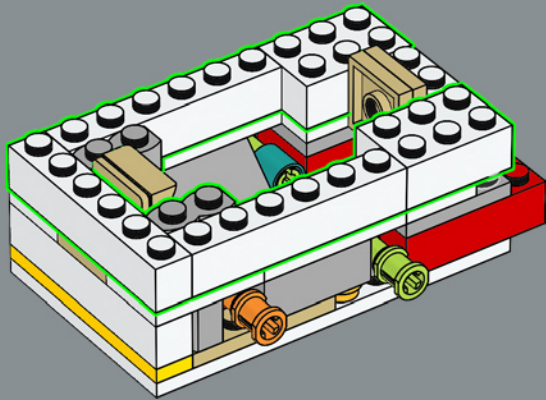

237

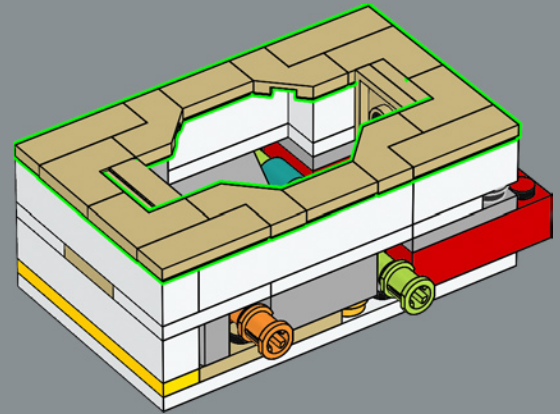

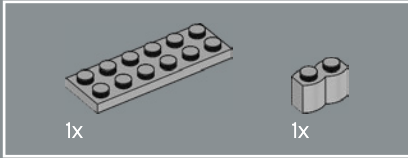
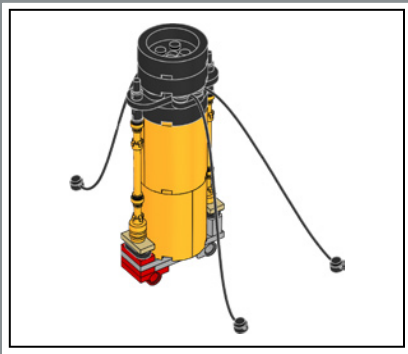

238

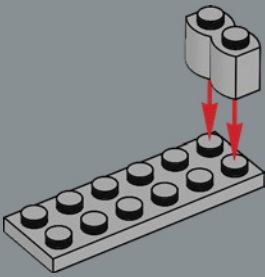

239

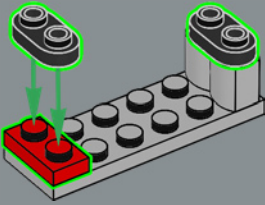

240

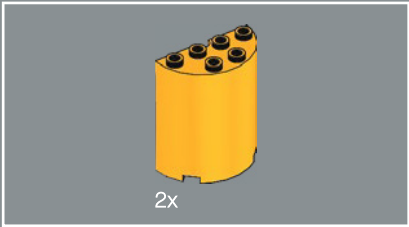
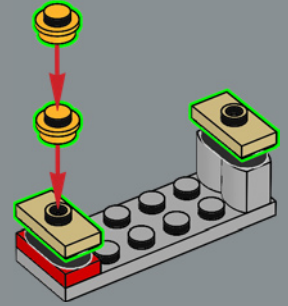

241

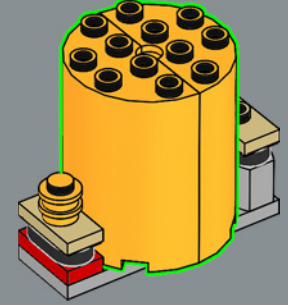

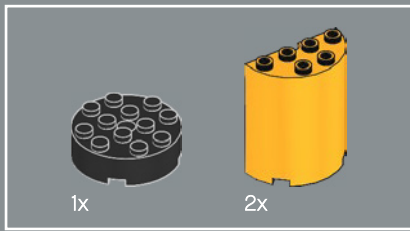

242

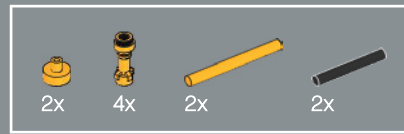
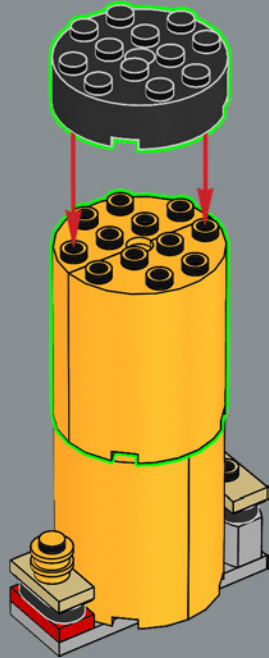

243

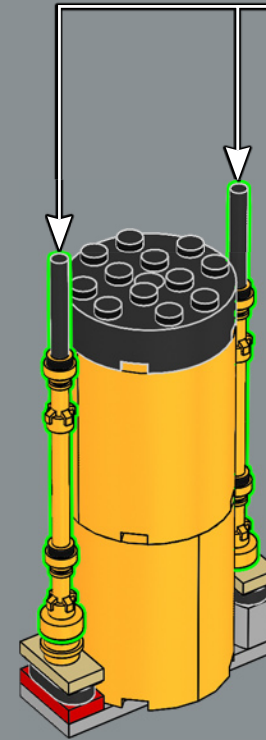
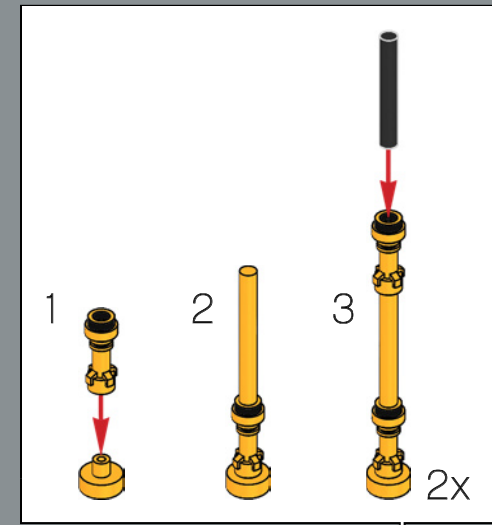

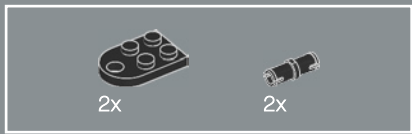

244

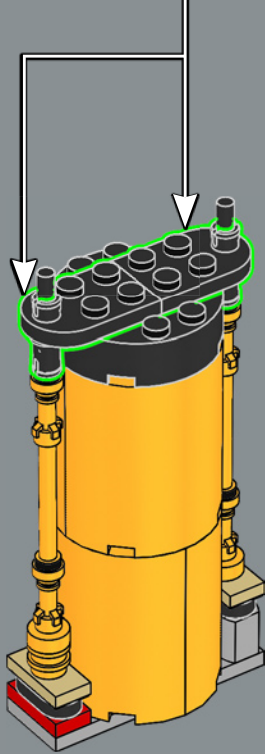
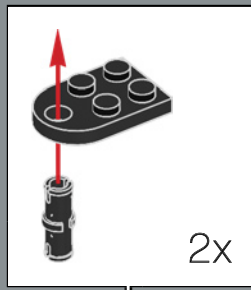

245

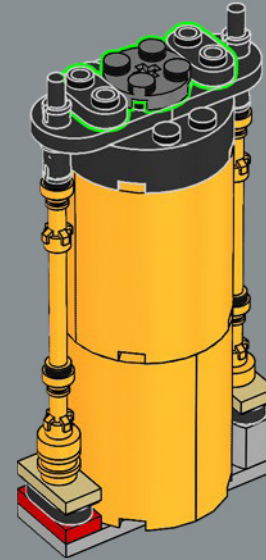



246

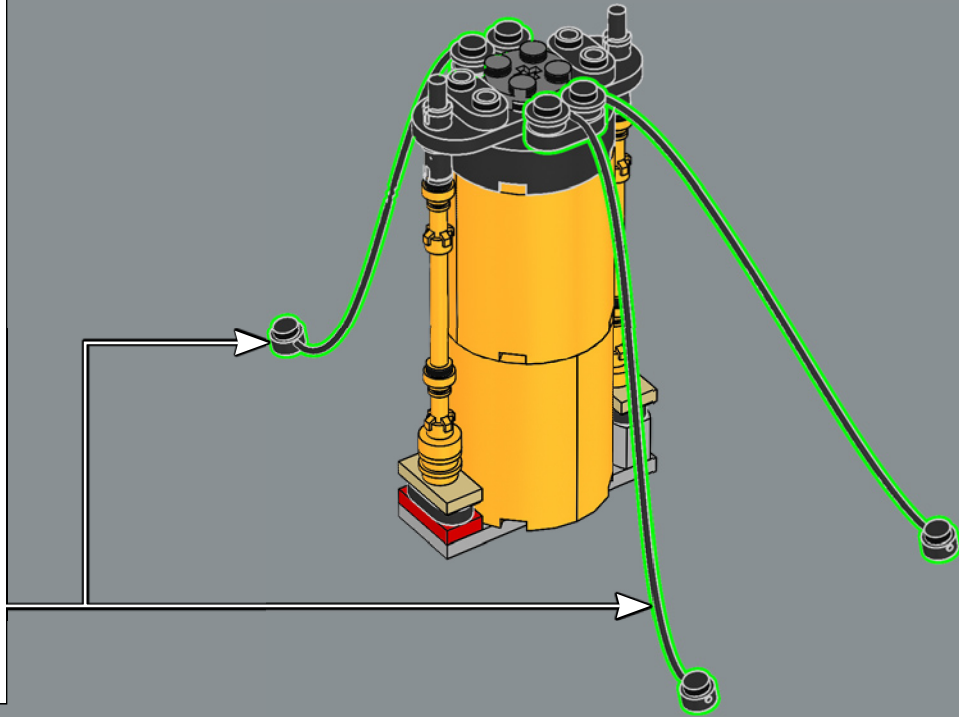
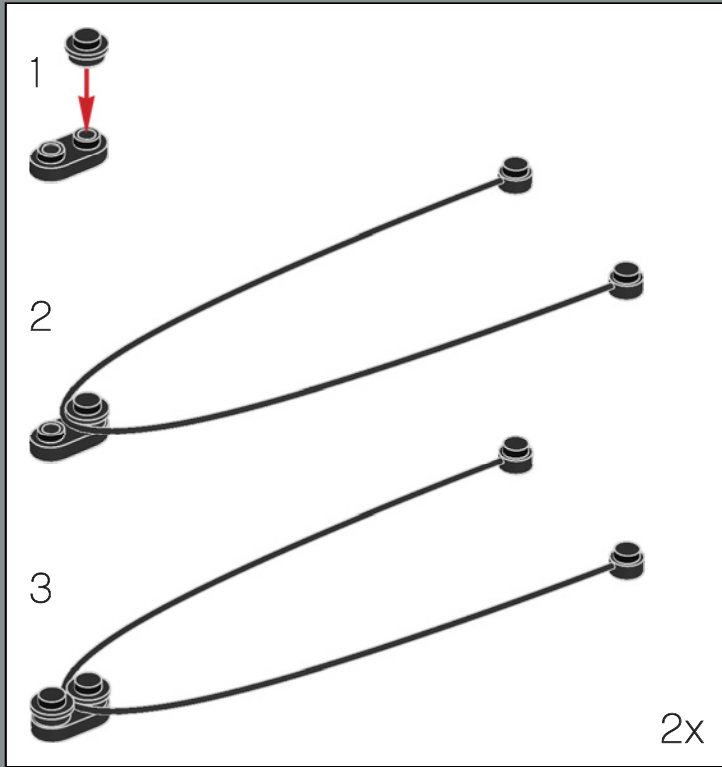

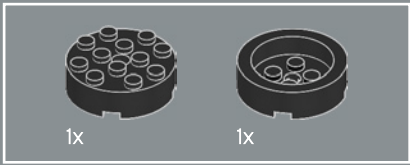

247

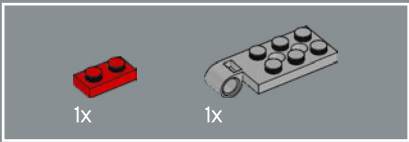
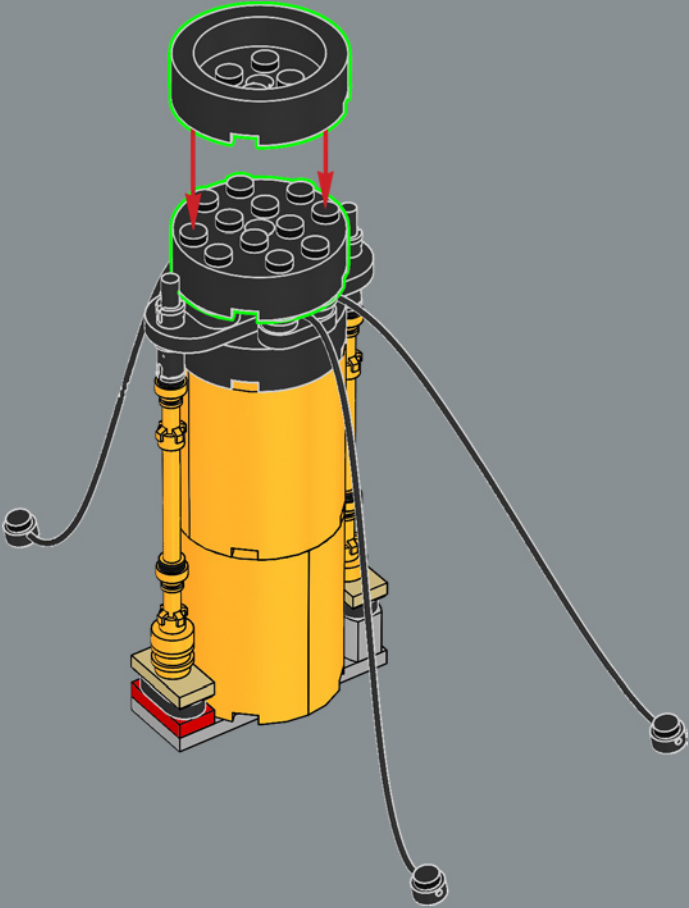

248

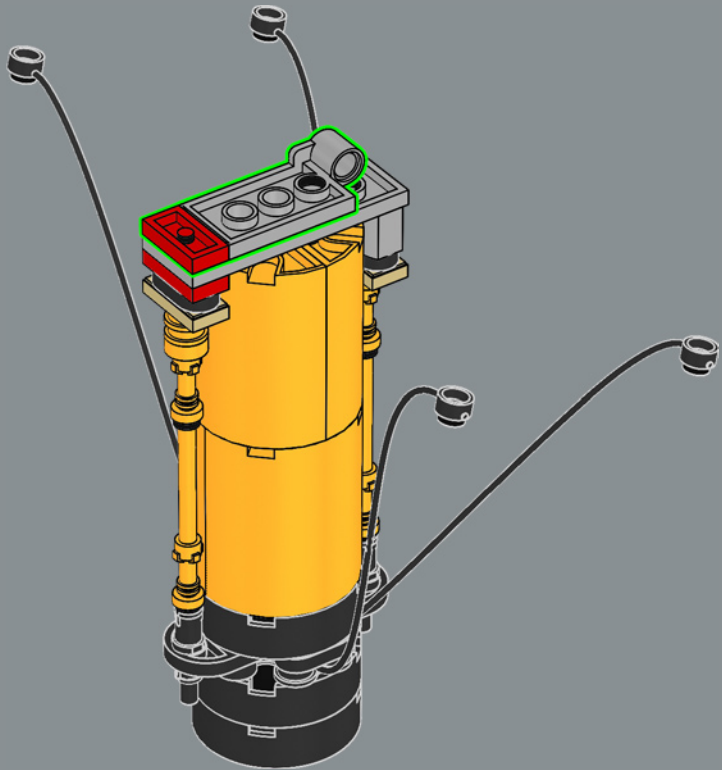

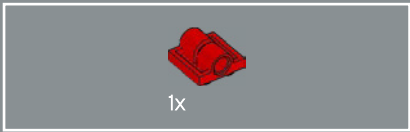

249

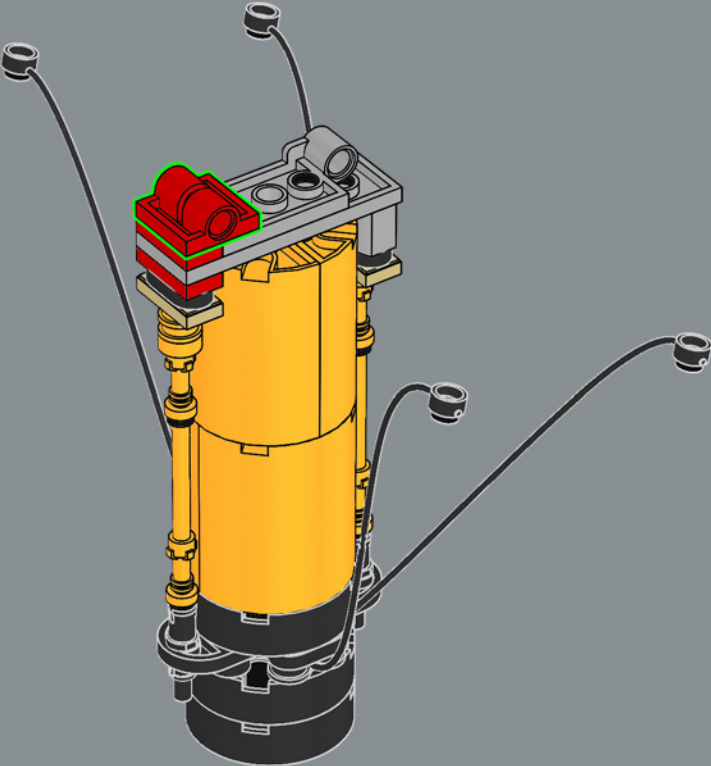

250

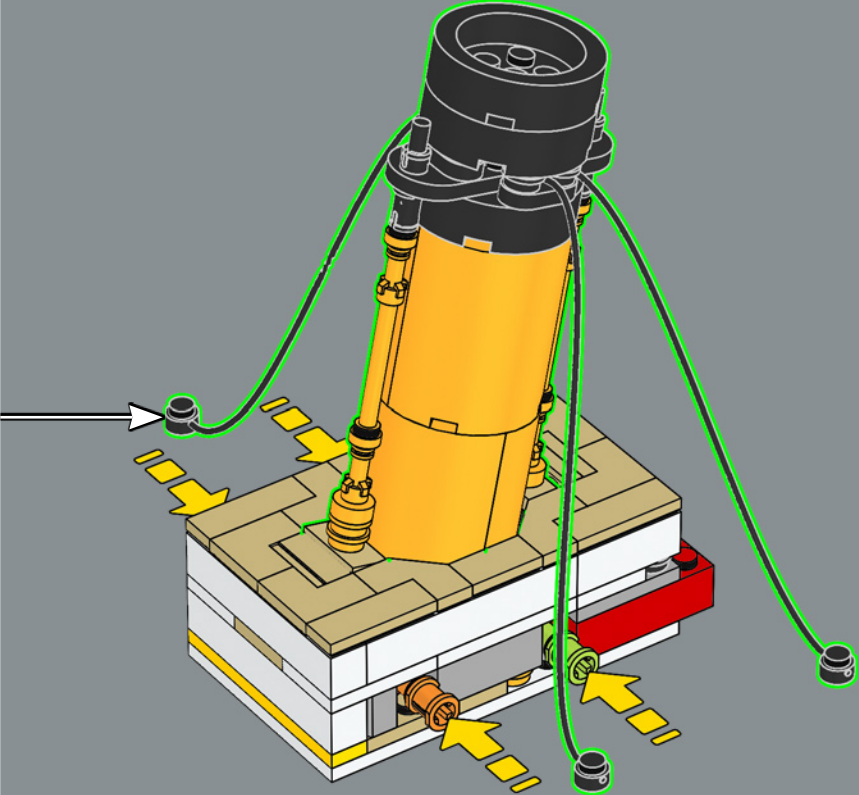

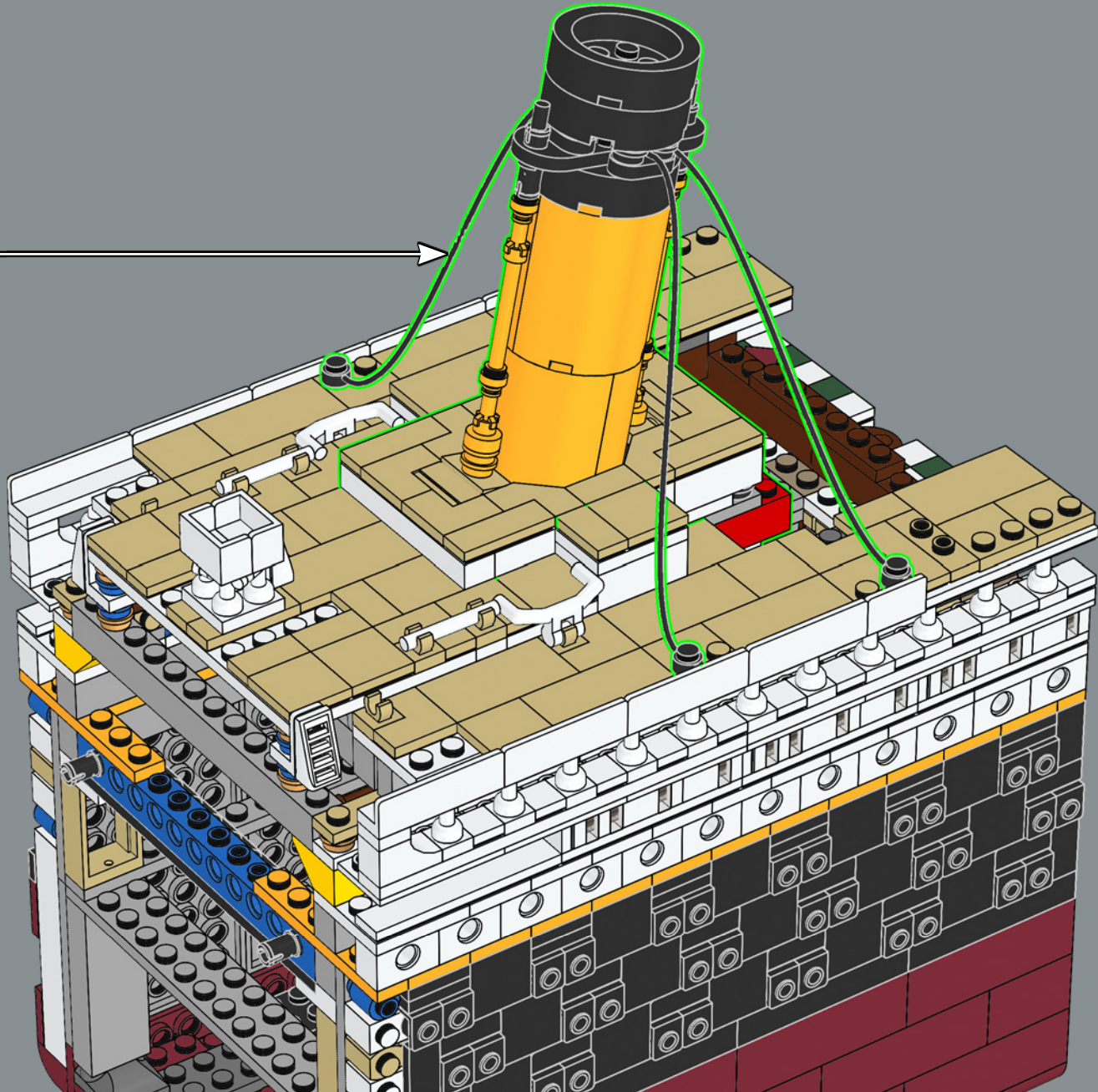

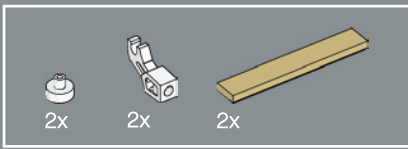

252

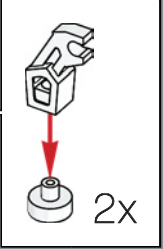
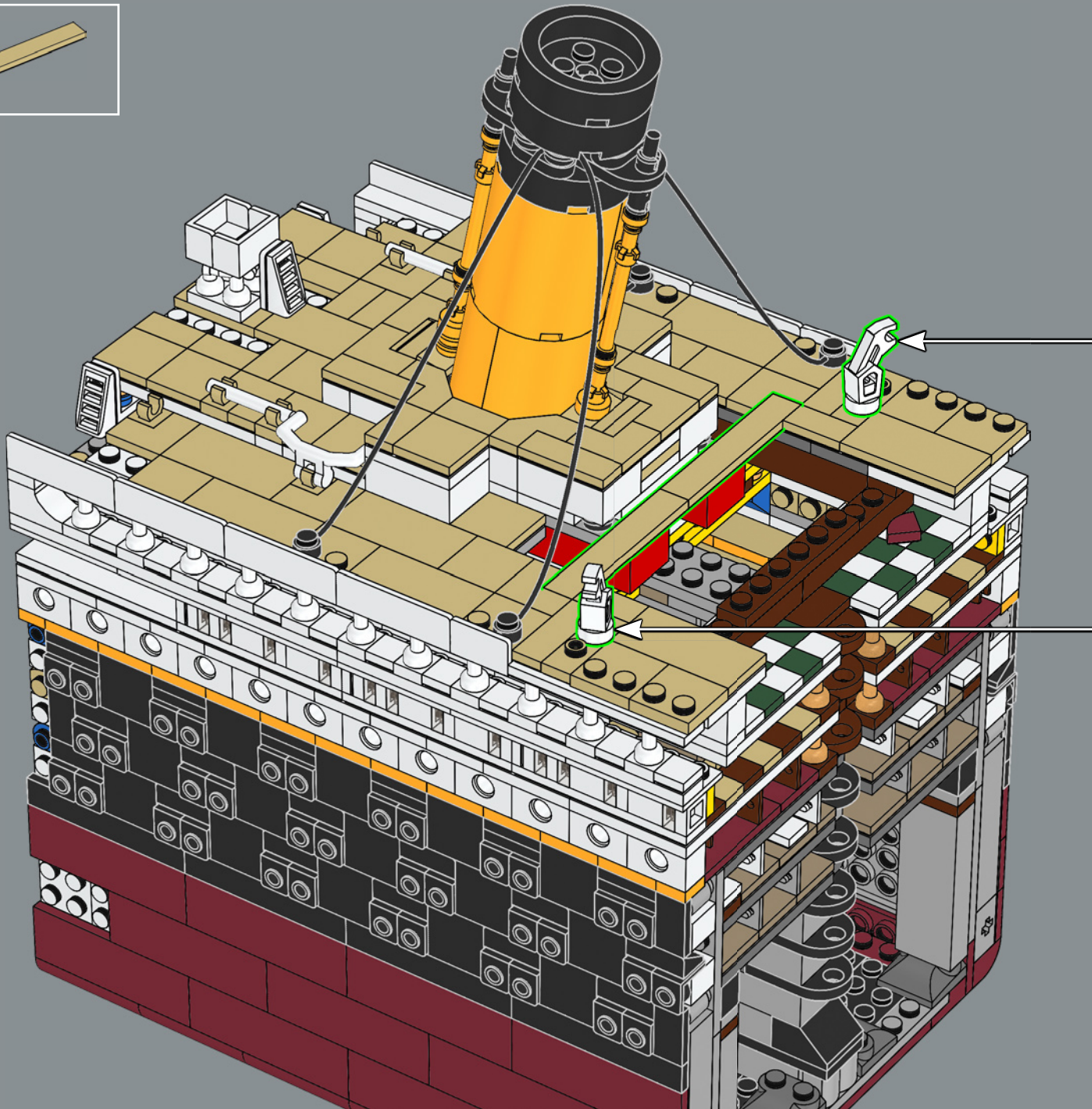

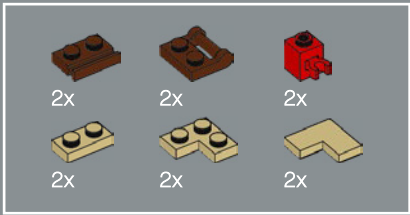

253

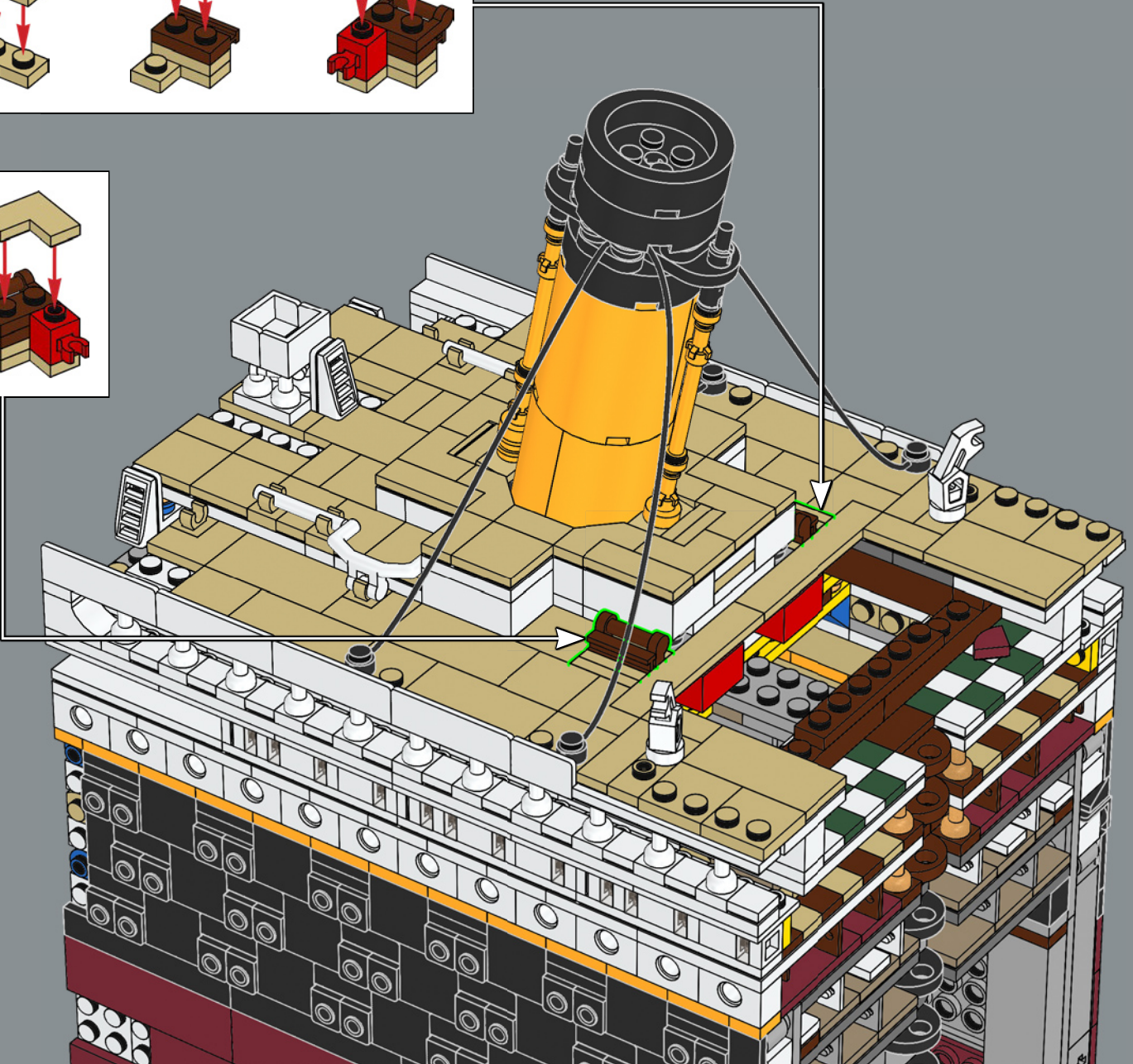
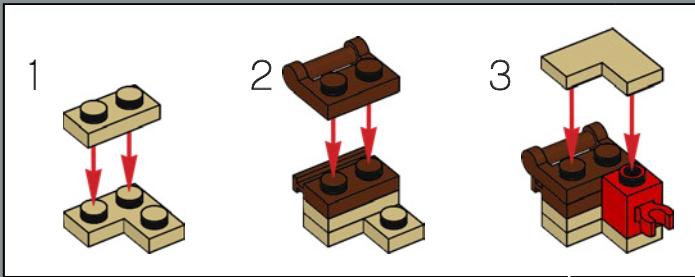
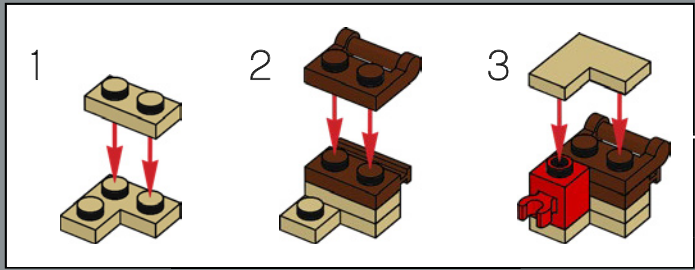

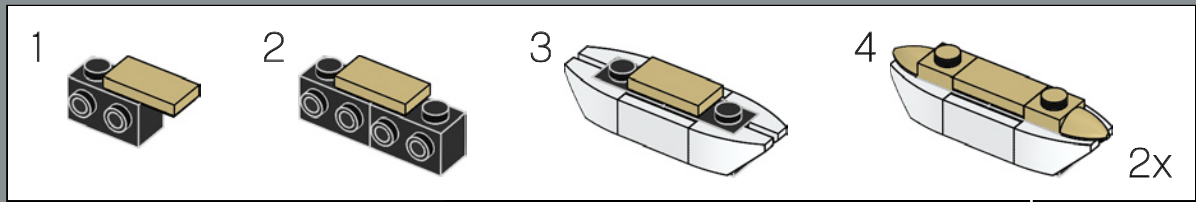
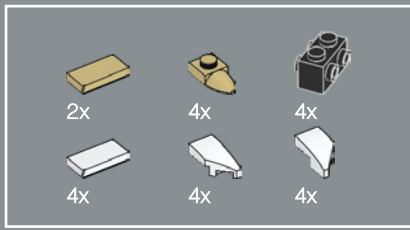

254

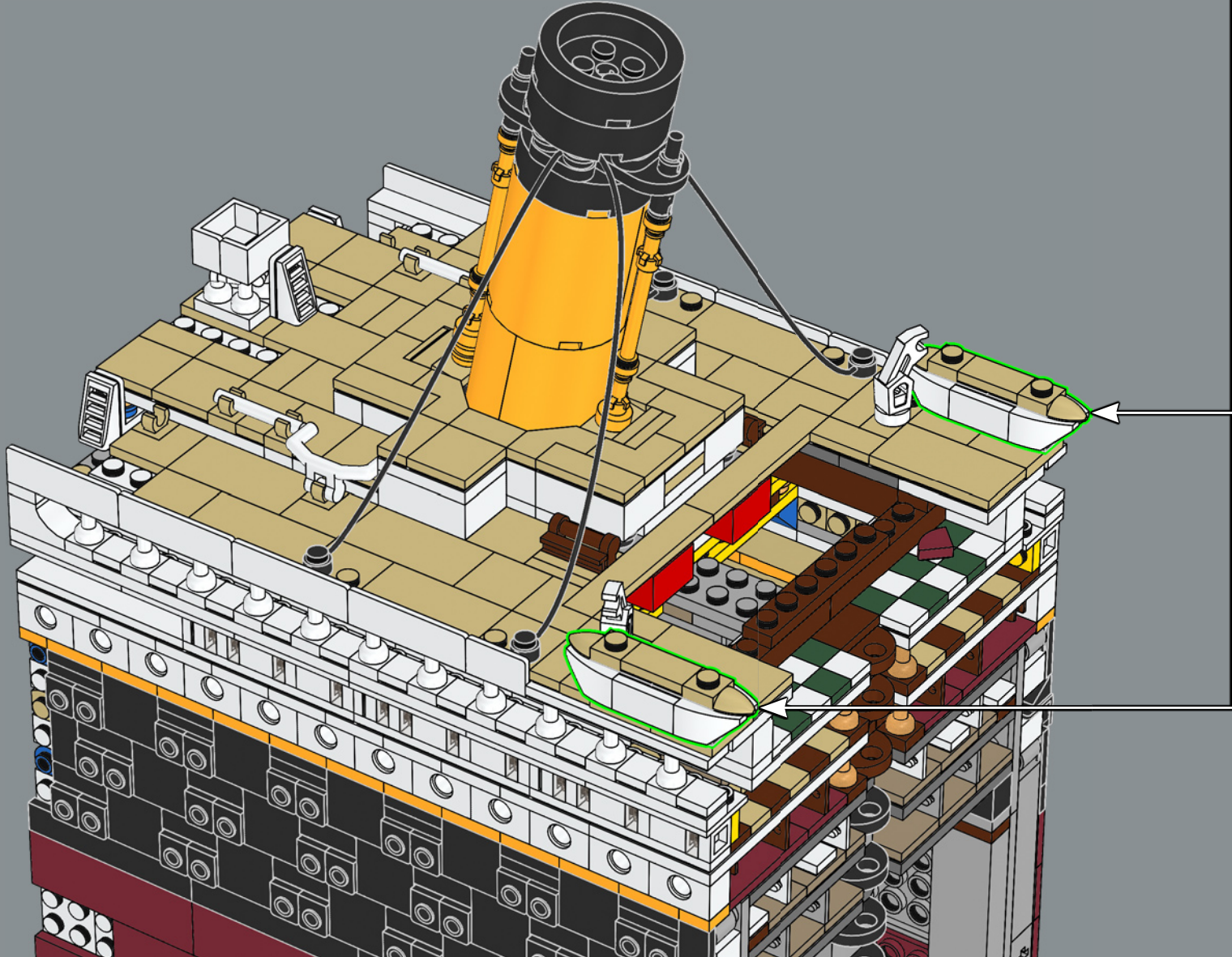

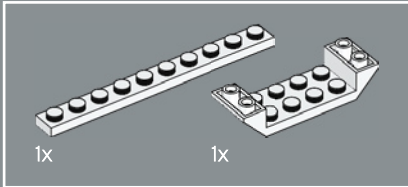
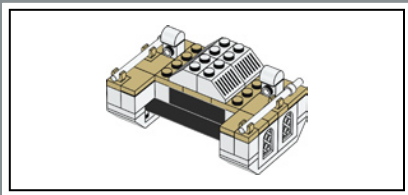

255

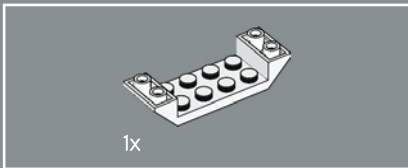
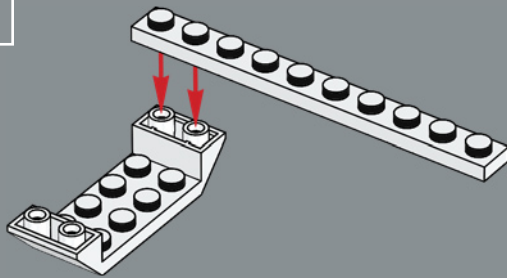

256

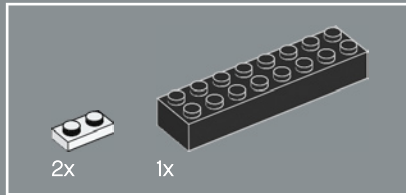
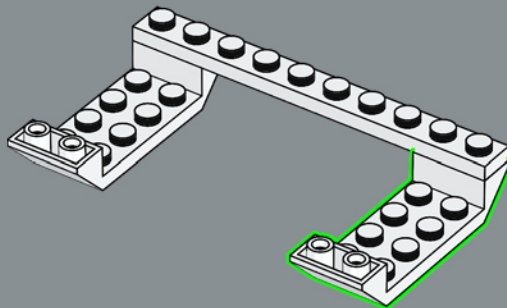

257

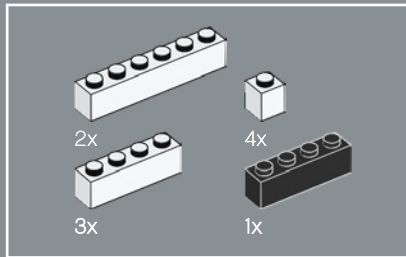
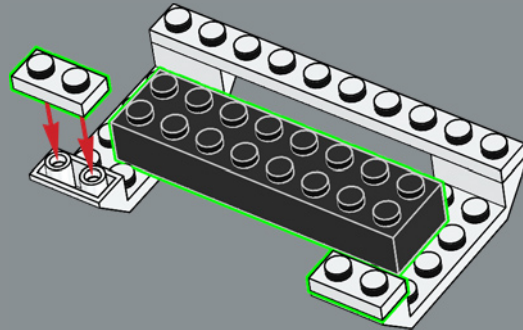

258

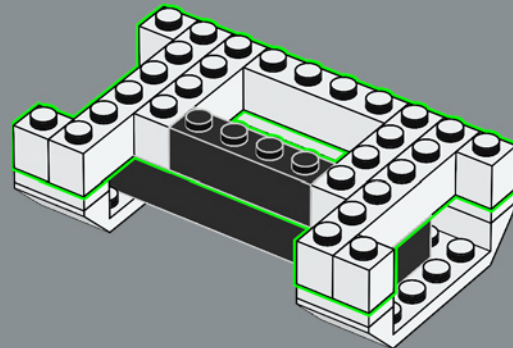

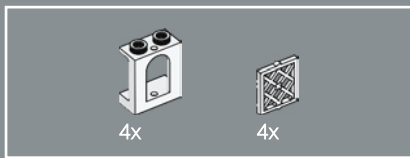

259

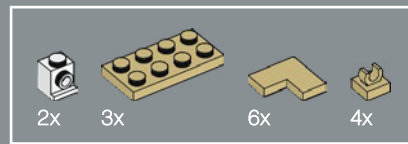
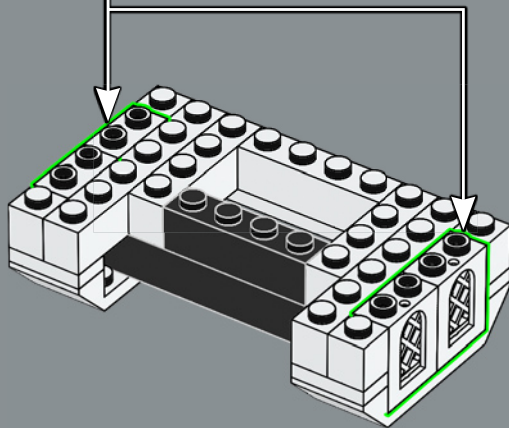
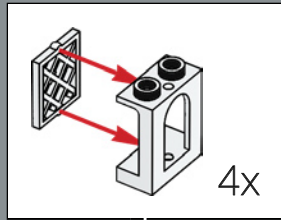

260

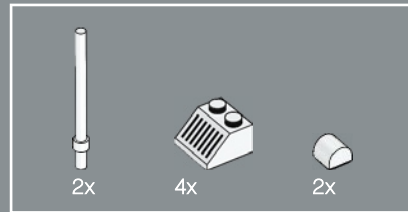
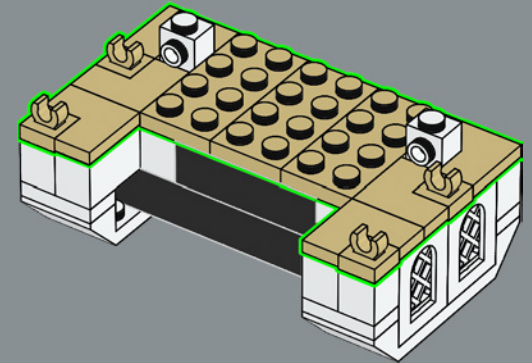

261

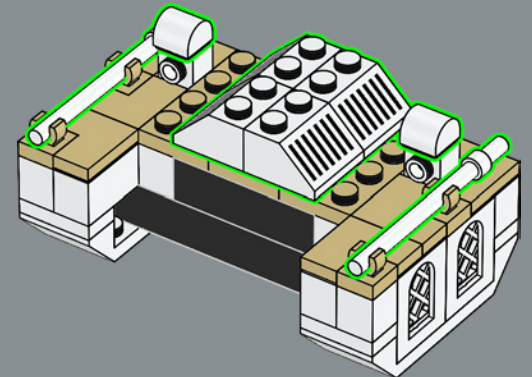

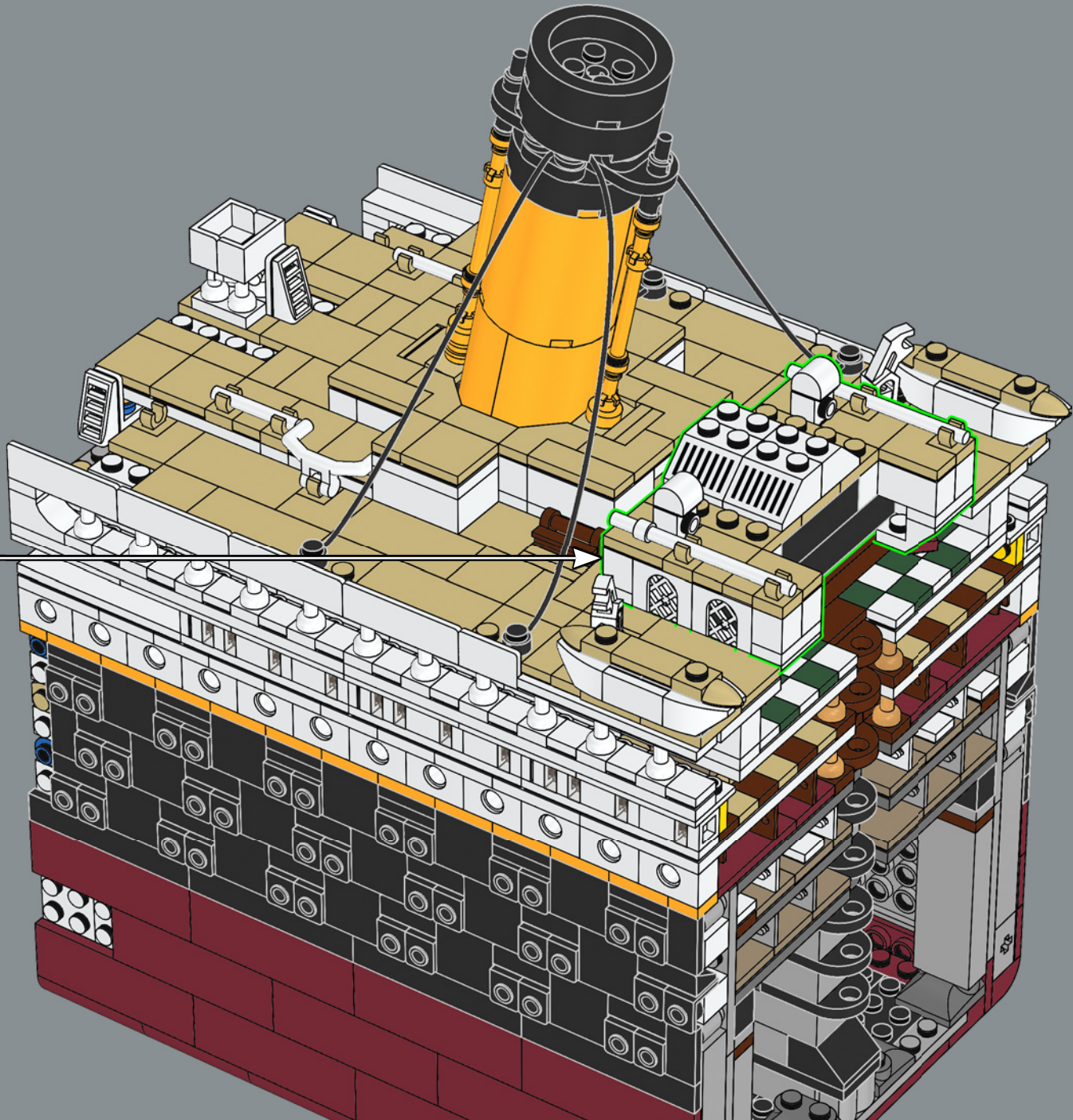

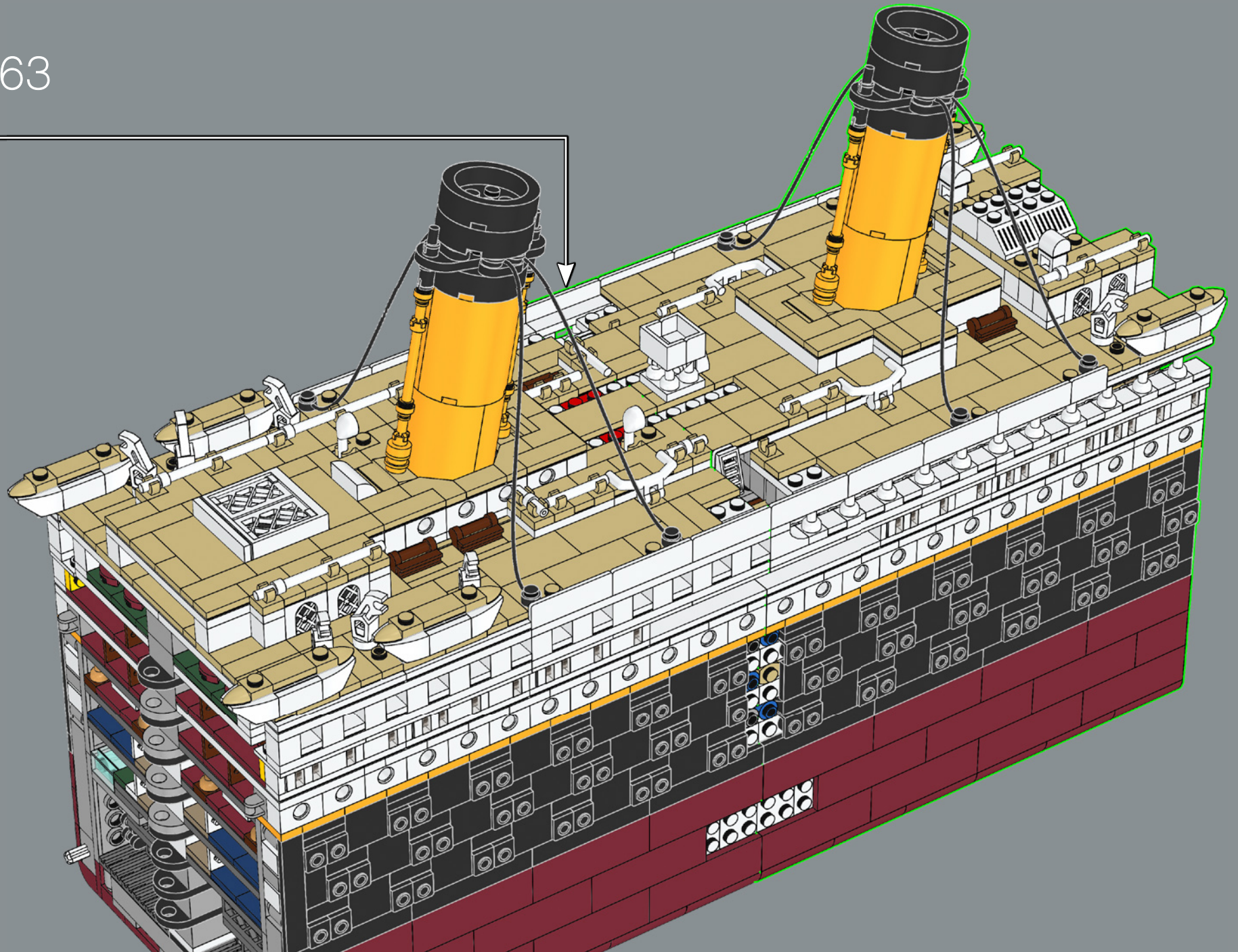

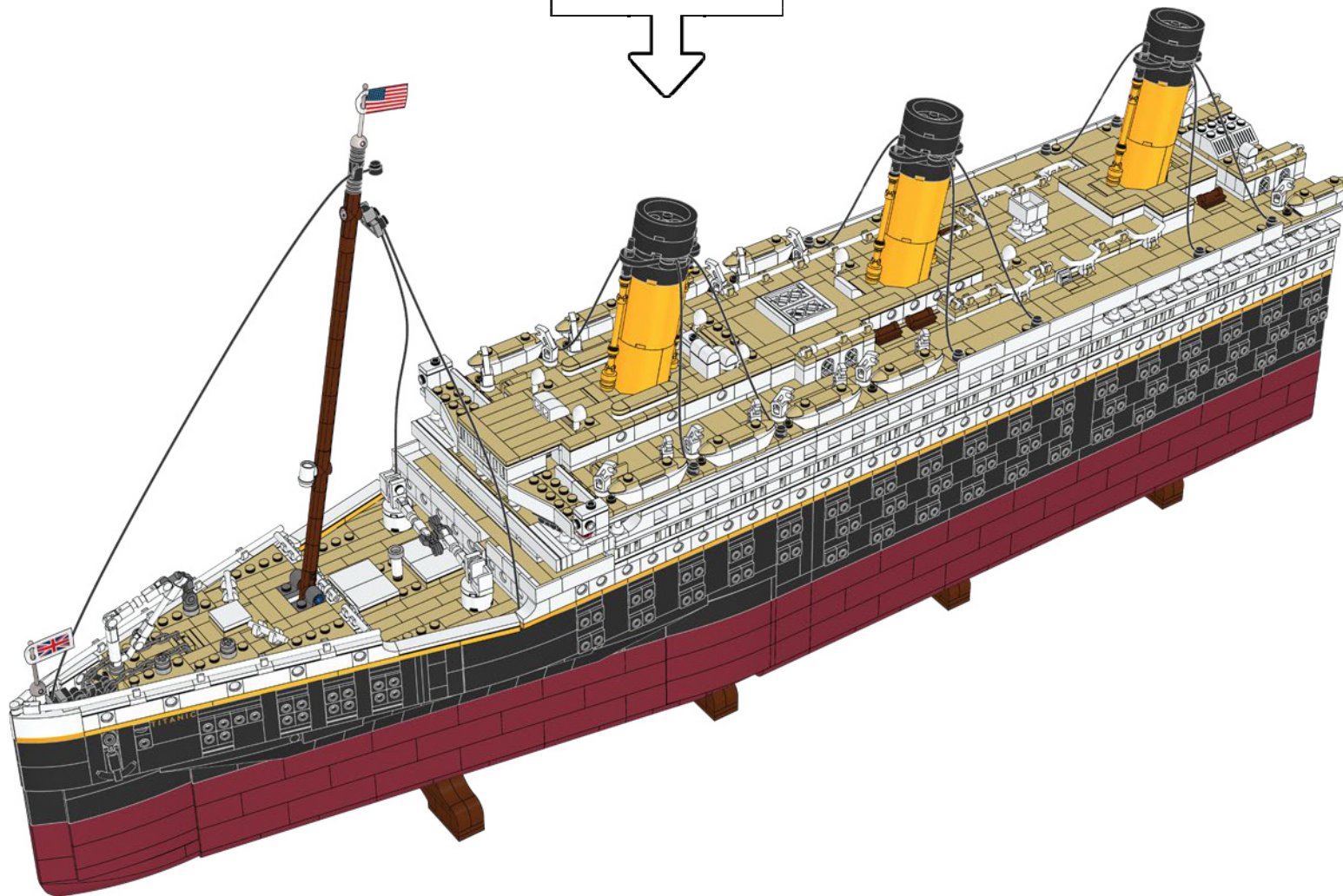

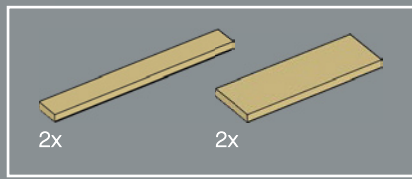

264

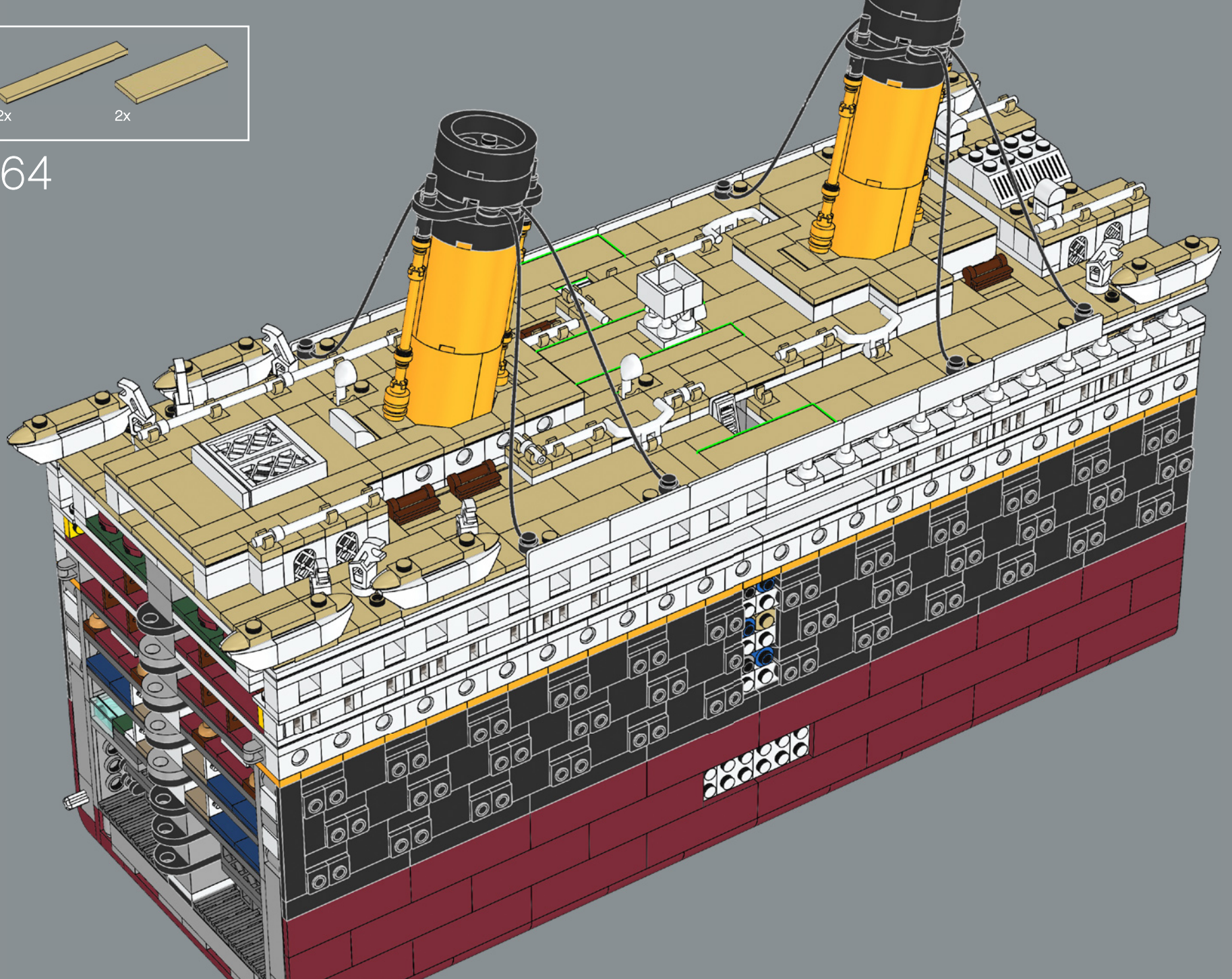

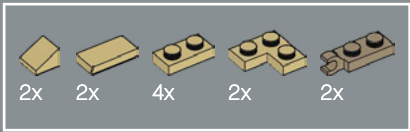

265

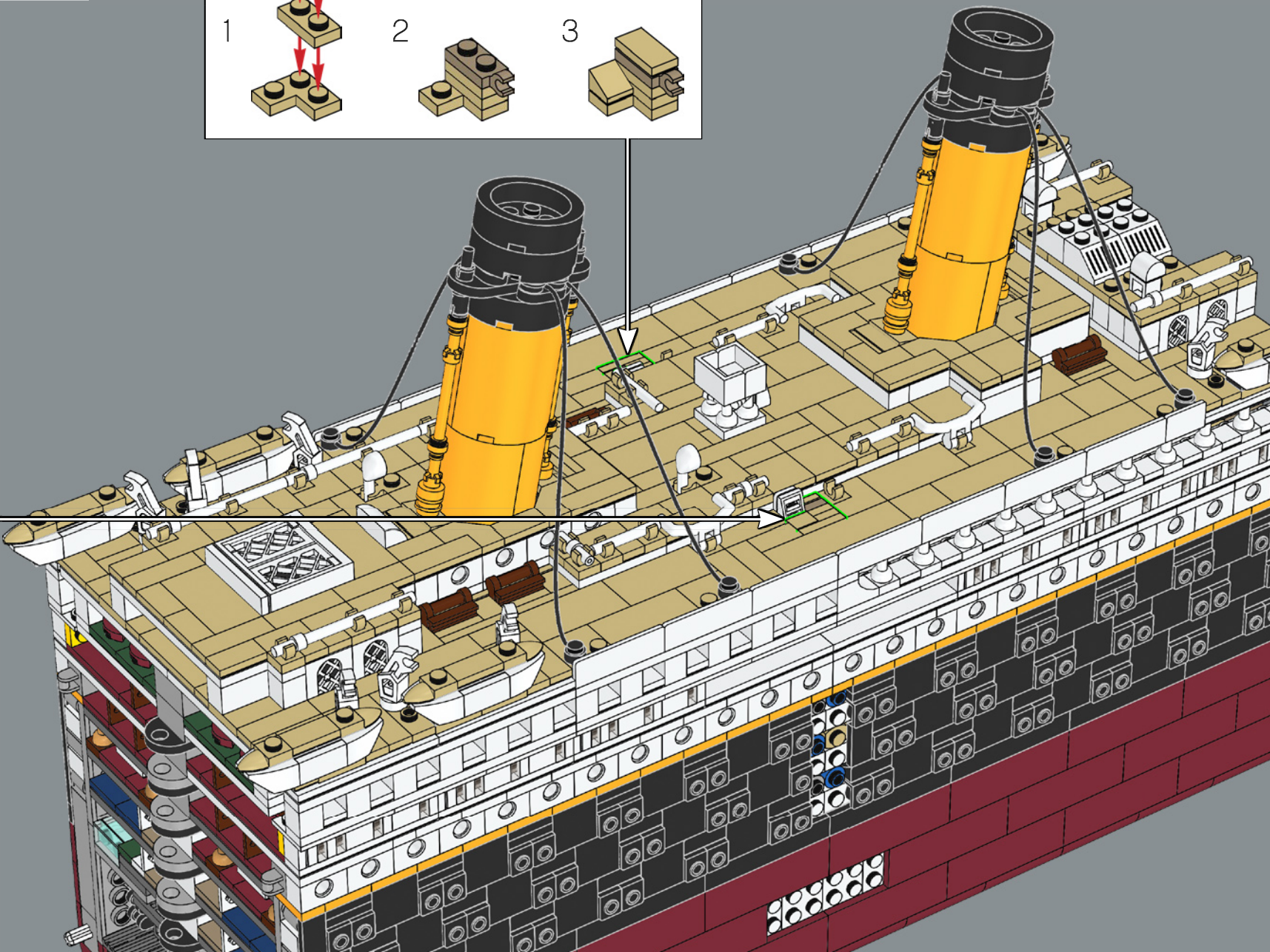
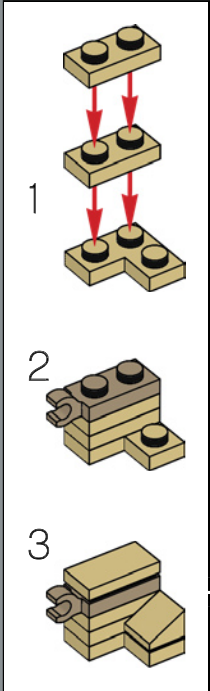
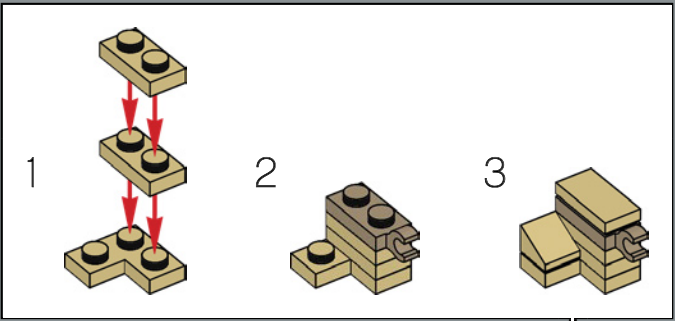

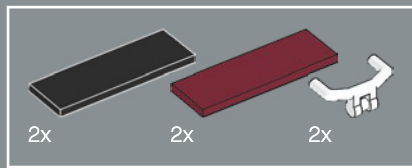

266

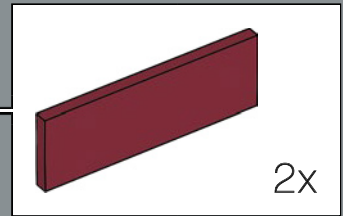
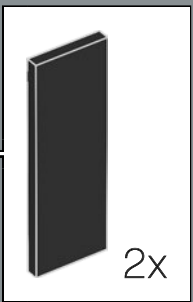
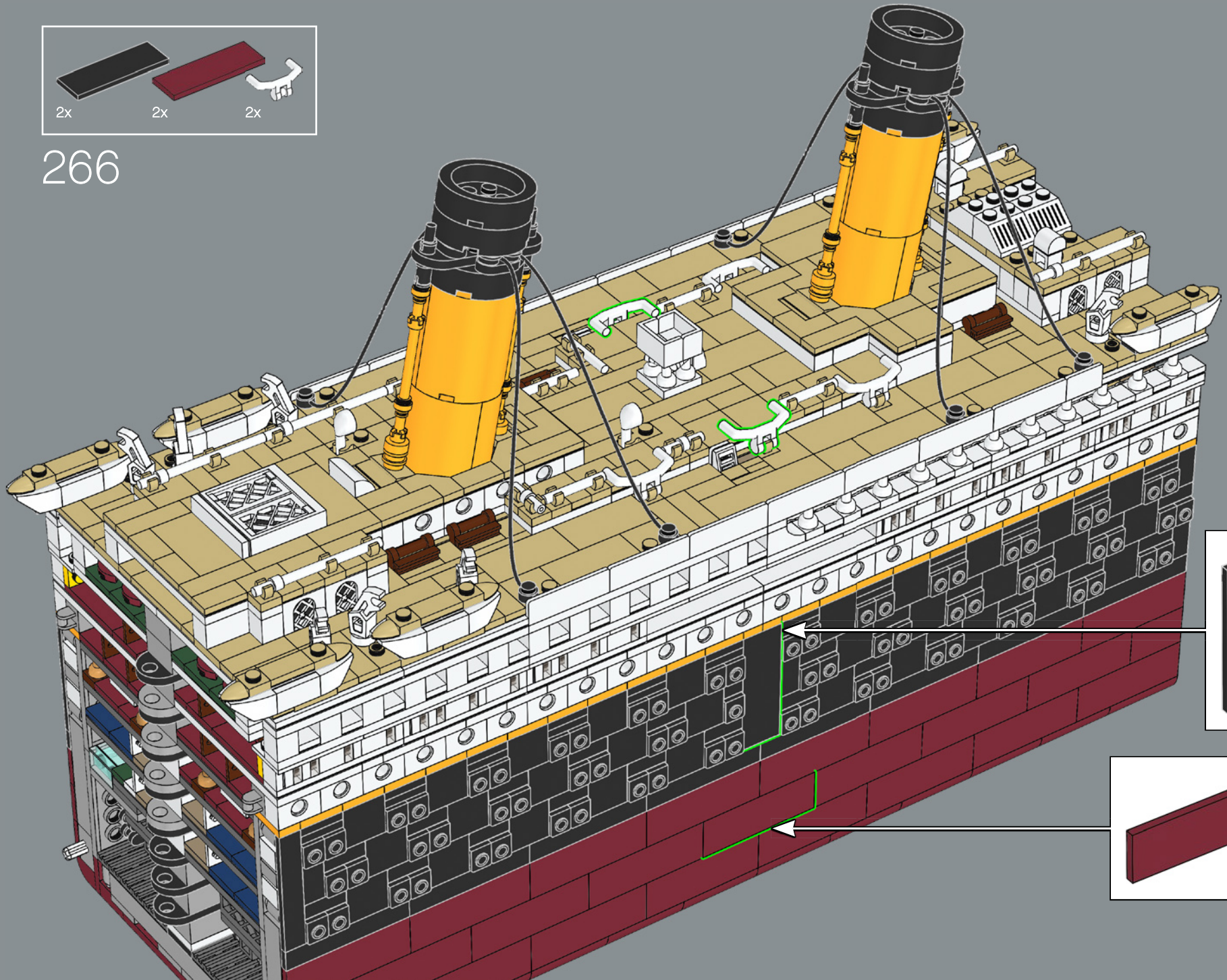

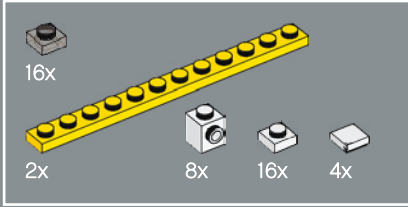
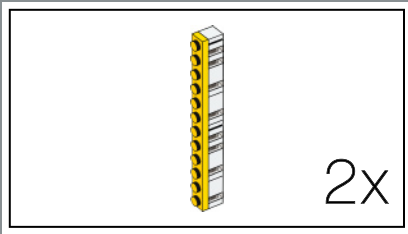

267

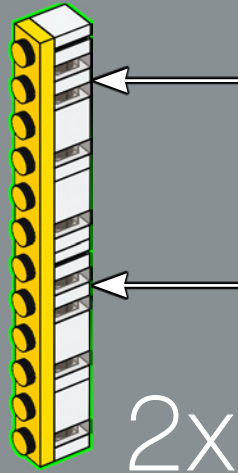
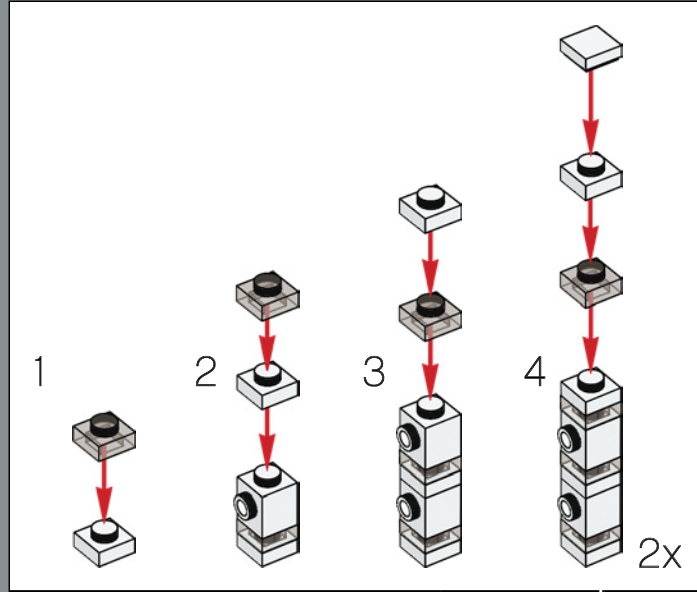

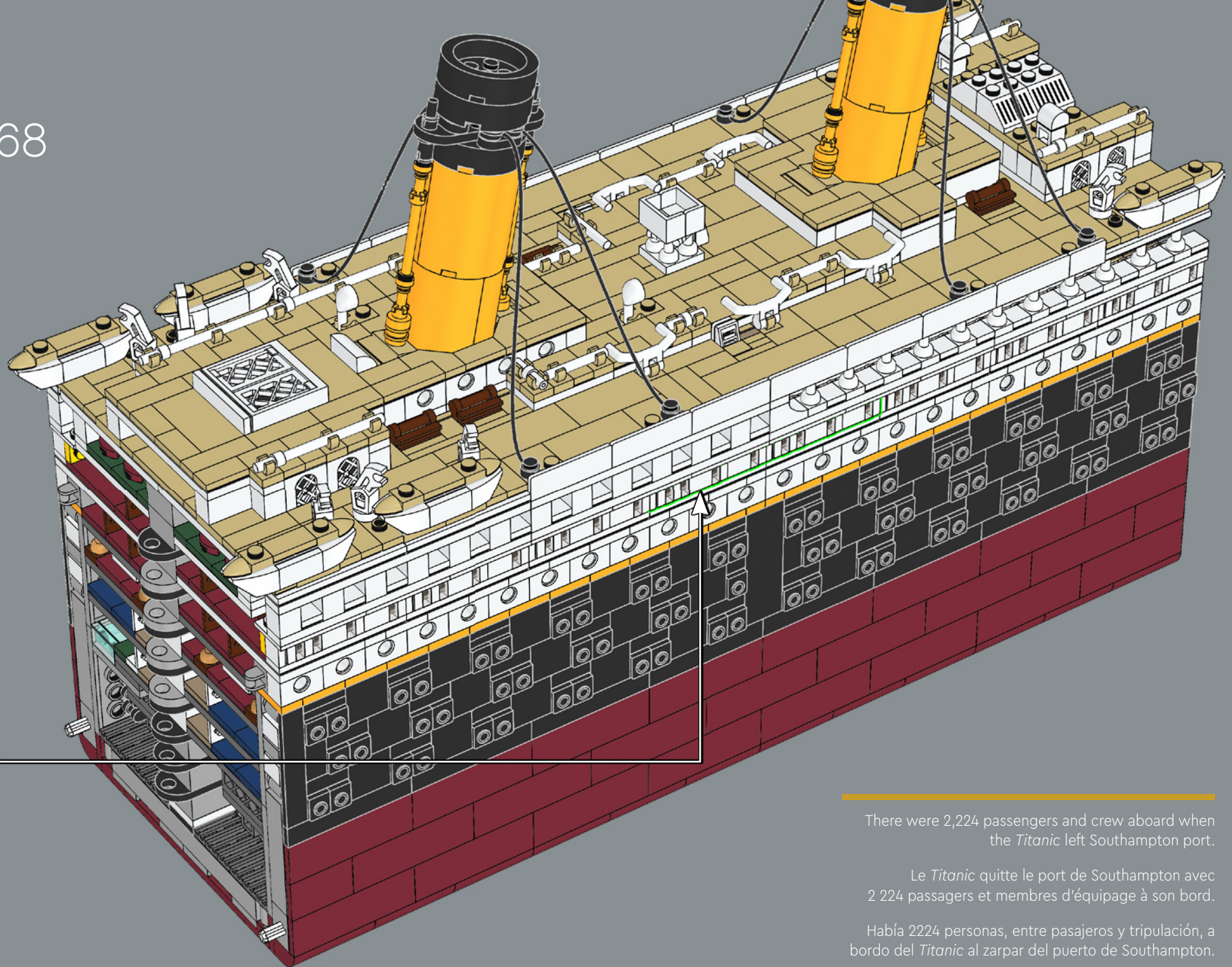

There were 2,224 passengers and crew aboard when the *Titanic* left Southampton port.

Le *Titanic* quitte le port de Southampton avec 2 224 passagers et membres d'équipage à son bord.

Había 2224 personas, entre pasajeros y tripulación, a bordo del *Titanic* al zarpar del puerto de Southampton.

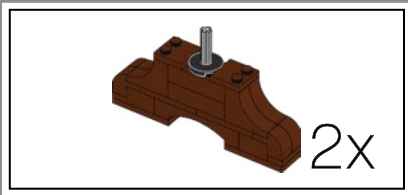

269

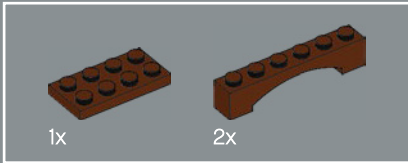
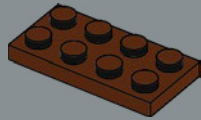

270

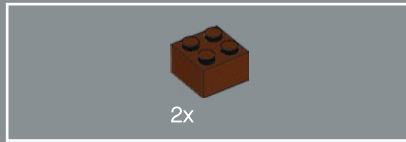
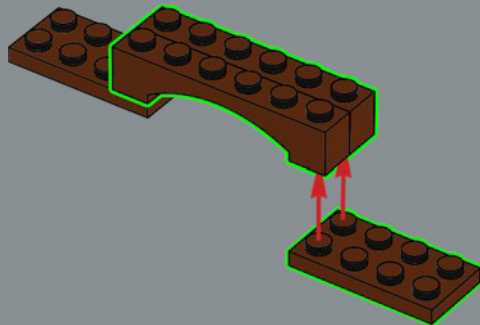

271

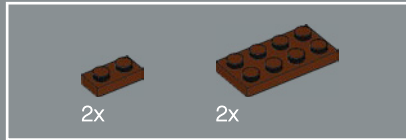
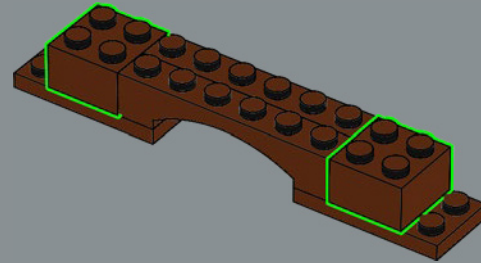

272

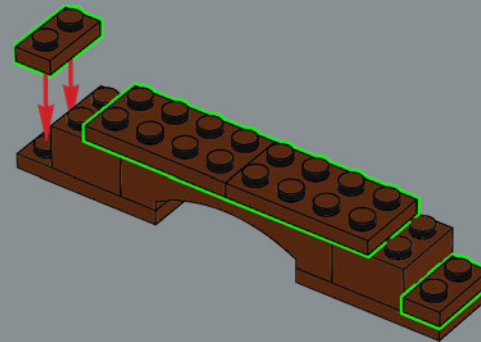



273

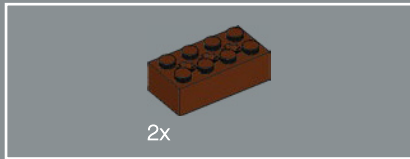
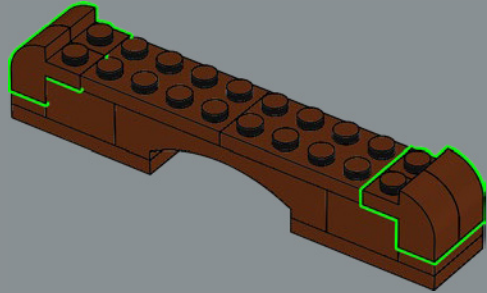

274

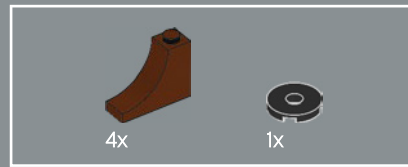
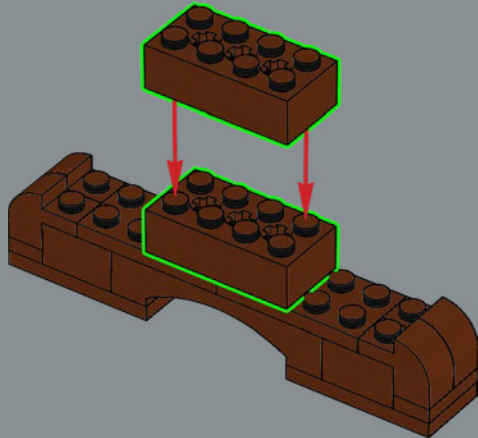

275

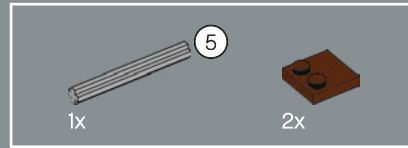
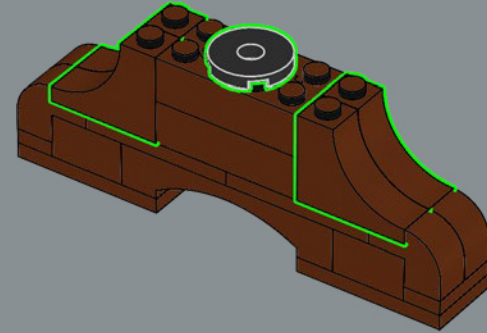

276

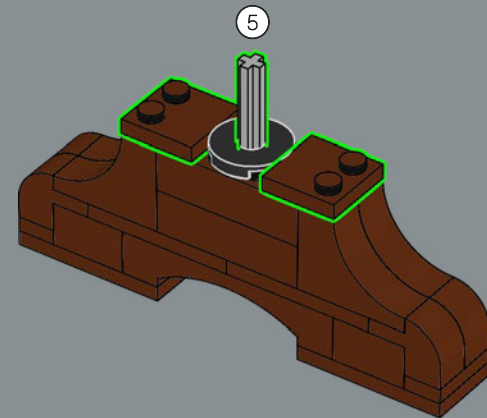

2x



277

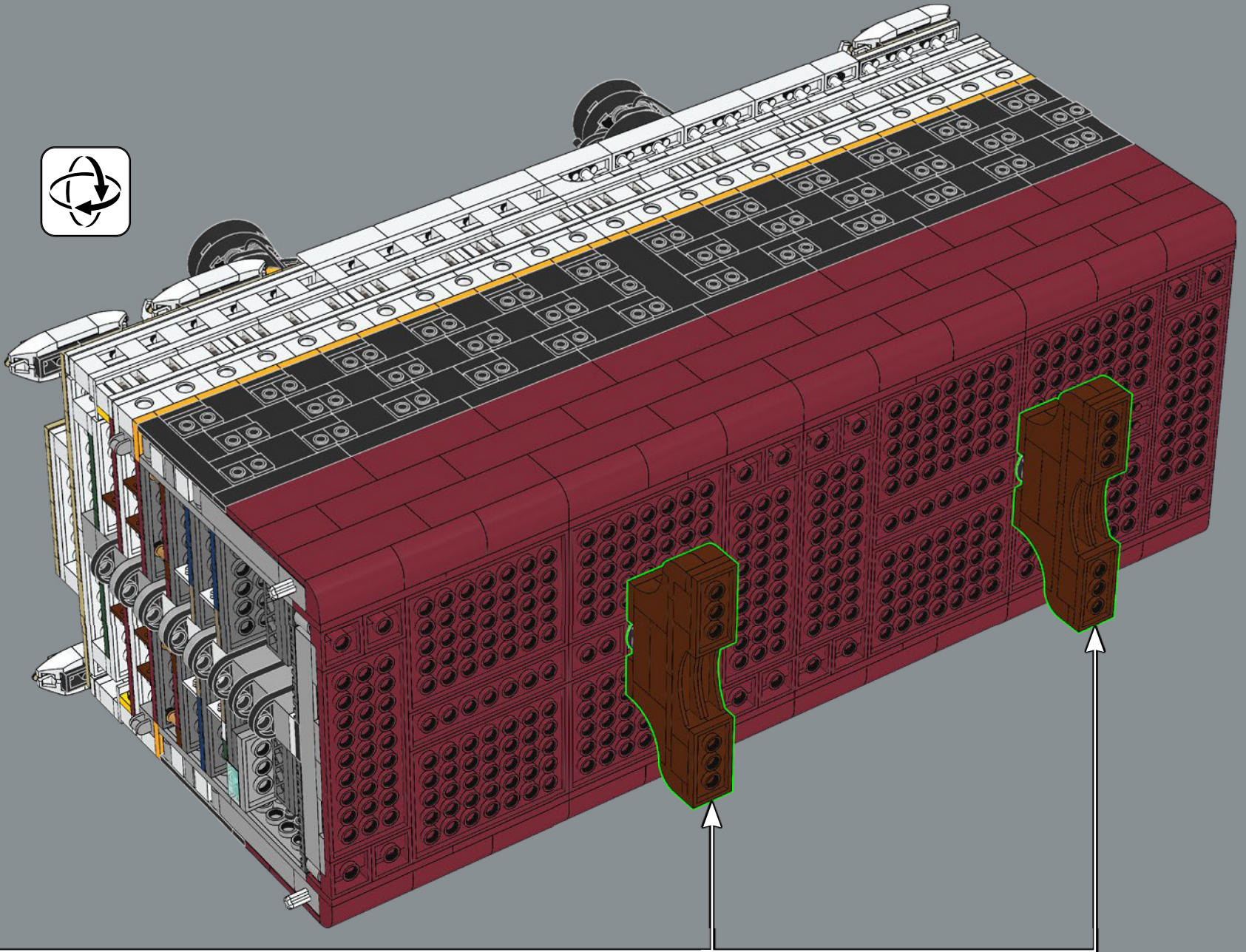

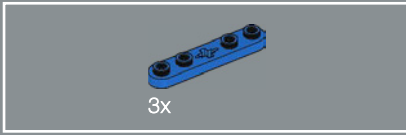
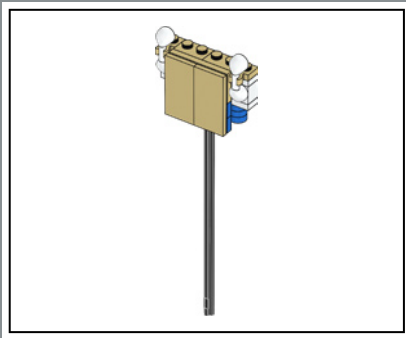

278

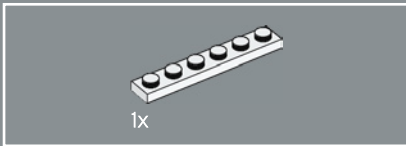
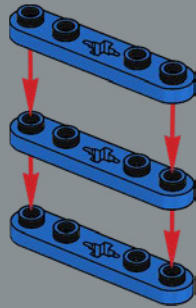

279

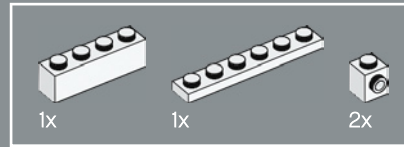
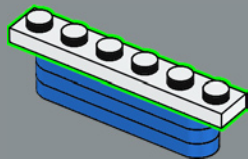

280

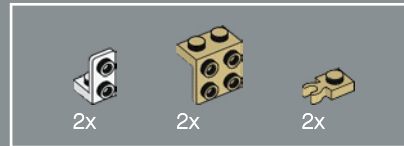
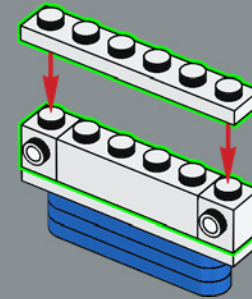

281

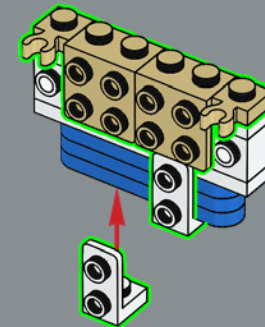

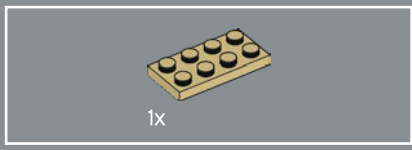

282

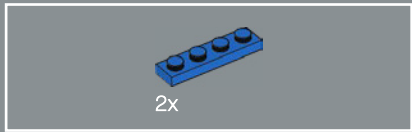
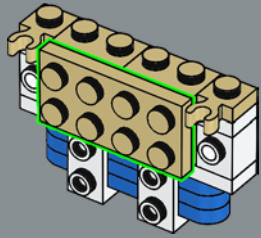

283

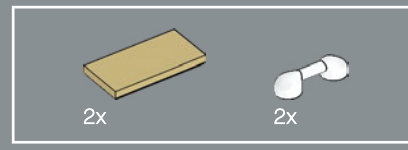
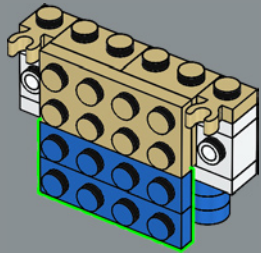

284

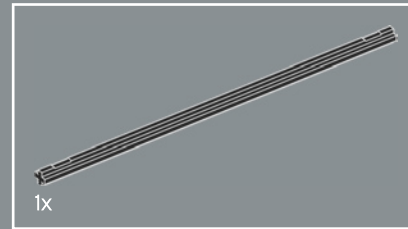
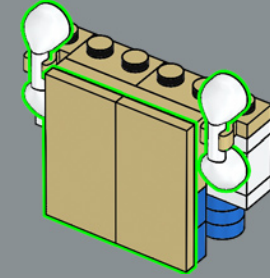

285

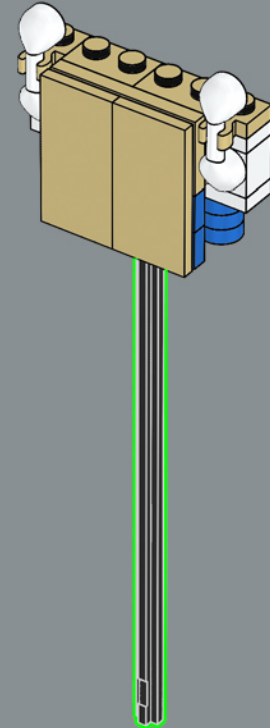

286

