

# TITANIC

BOOK 2

---

# THE WORLD'S MOST LUXURIOUS PASSENGER LINER

Designed to be the epitome of style, comfort and luxury, the *Titanic* aimed to convey the impression of being a floating hotel rather than a ship. It offered its 833 first-class passengers a vast range of facilities including an onboard gymnasium, squash court, swimming pool, libraries and exquisite restaurants and cabins. The ship's most distinctive feature was the *Grand Staircase*, built in solid oak, that descended in a sweeping curve down through seven decks of the liner.



↑ The Aft First-Class staircase leading to the a la carte restaurant.

→ 2nd-Class dinner menu dated 14 April 1912, the date that Titanic struck the iceberg that caused her to sink.

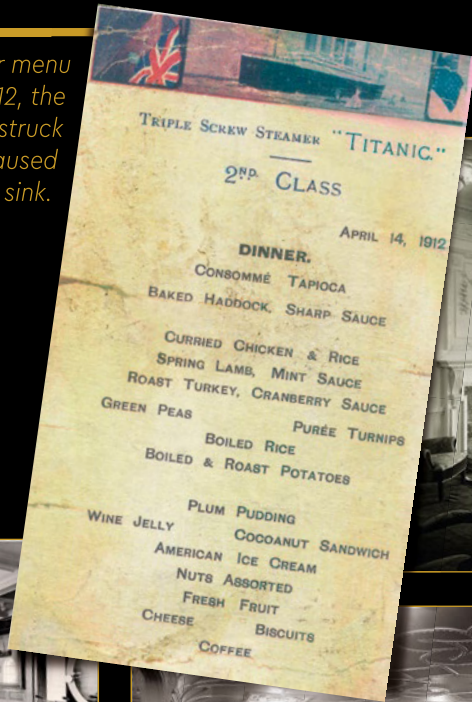

↓ Reading room on the upper promenade.



↓ The First-Class Lounge.



↓ The First-Class gymnasium.

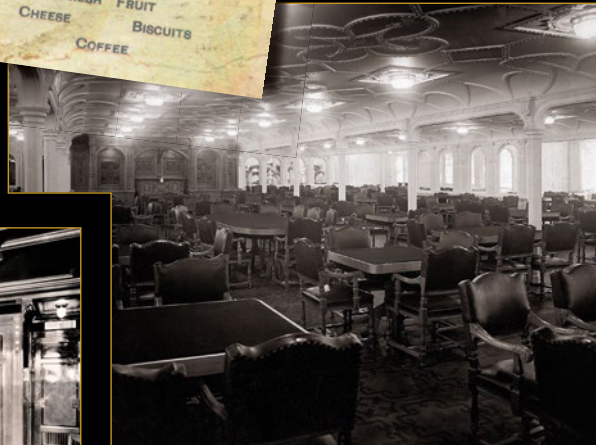

↑ Main dining room.



↑ Café Parisien, an extension to the First-Class restaurant.



↑ The elegant splendour of First-Class parlour suite B57.

---

# BUILDING THE TITANIC

What started out as a concept model during a free-build session for LEGO® designers quickly developed into one of the largest LEGO sets ever created. The impressive size was, however, never the goal in itself; instead, it grew in scale as the design team came up with a host of intricate details they felt had to be included in the model. For veteran LEGO Designer Mike Psiaki, this included creating replica steam engines with moving pistons using LEGO Technic elements. Once the initial design was in place, the team sat for an entire week building different versions of the model, deciding what needed to be strengthened or simplified.



↑ Some of the LEGO® team on this model (from left to right): Senior Model Coach, Torben Kidde Skov, Design Master, Mike Psiaki, Senior Building Instruction Specialist, Martin Højen Holm Buk



[LEGO.com/brickseparator](https://www.lego.com/brickseparator)

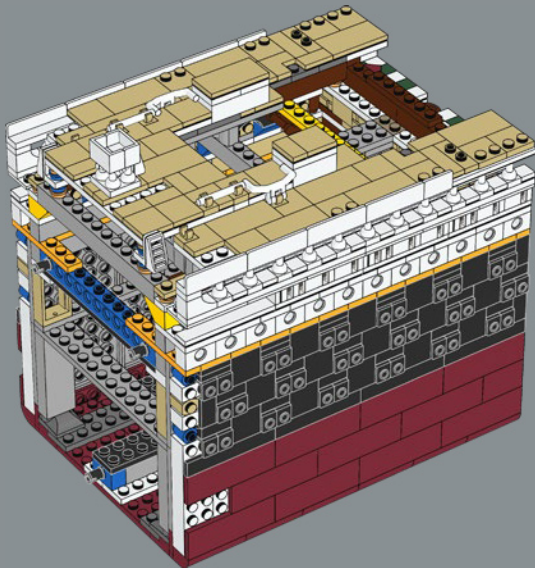
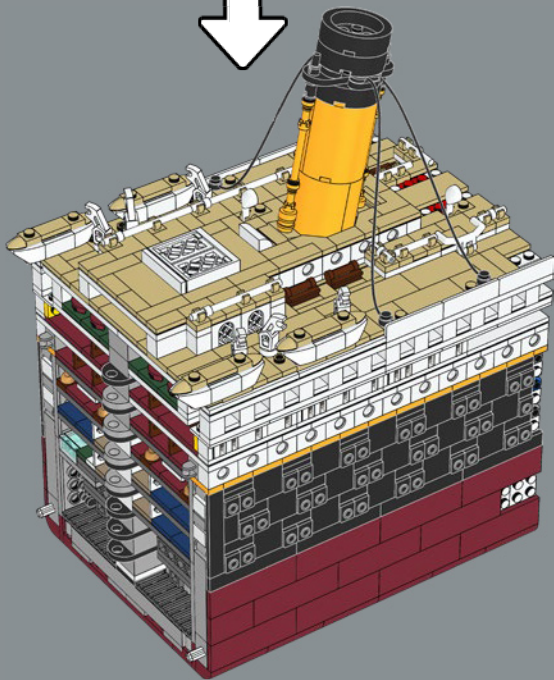

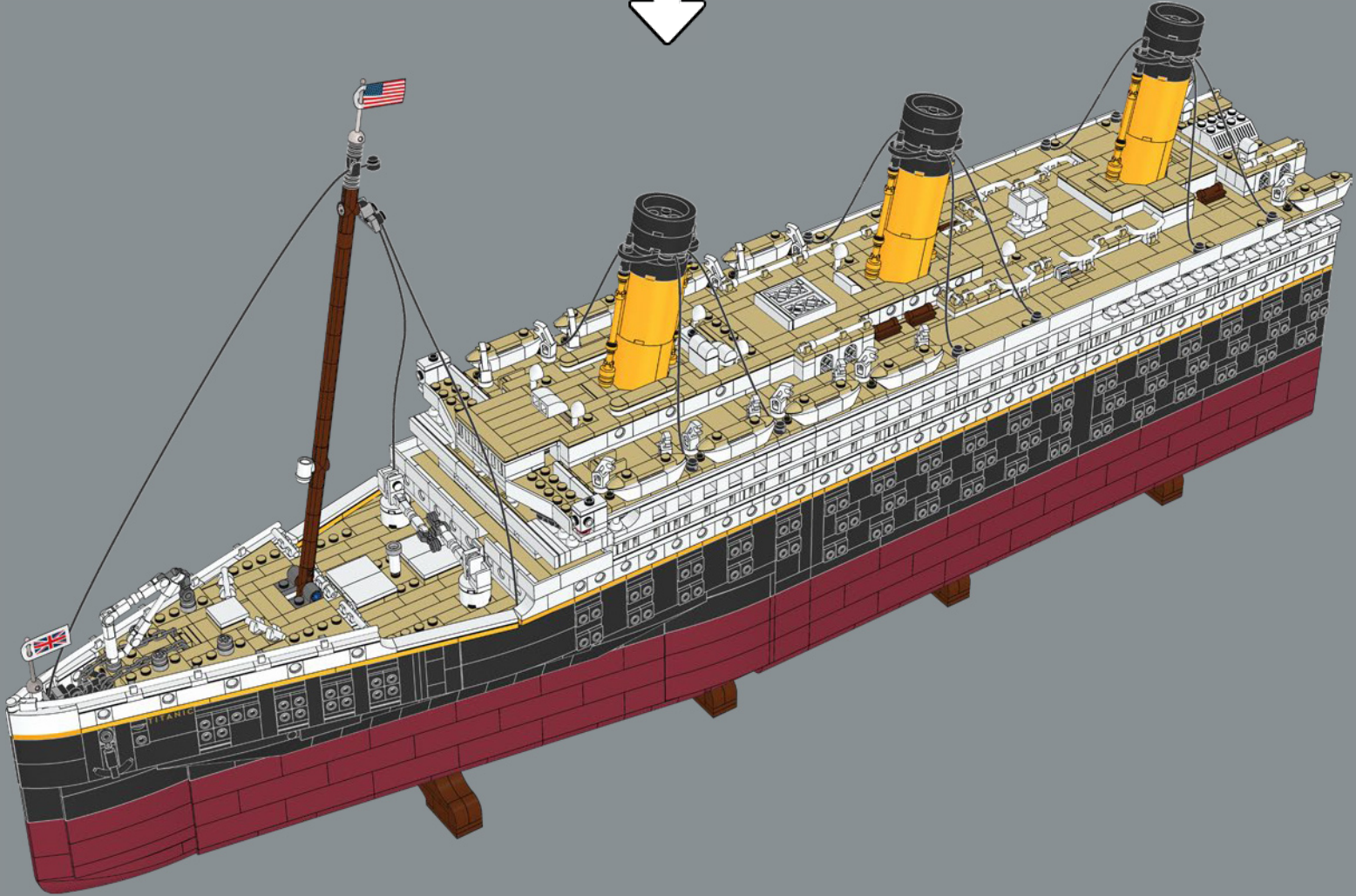
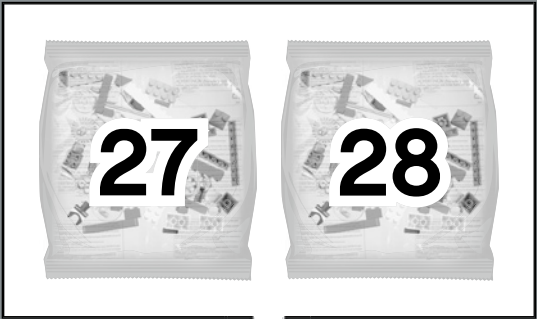

↓ The second half of the locking mechanism that holds the 3 main sections of the ship together is built here.

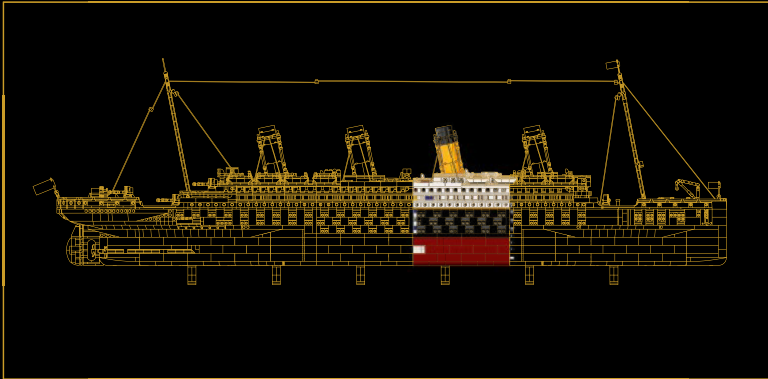

### SECTION 3:

# FUNNEL & MAIN CABINS

Here you will build another cross section of the ship, including some of its coal bunkers in the lowest decks, plus numerous cabins of various classes. The superstructure of this section contains the beginnings of the ship's promenade decks as well as the skylight for the grand staircase and second funnel.

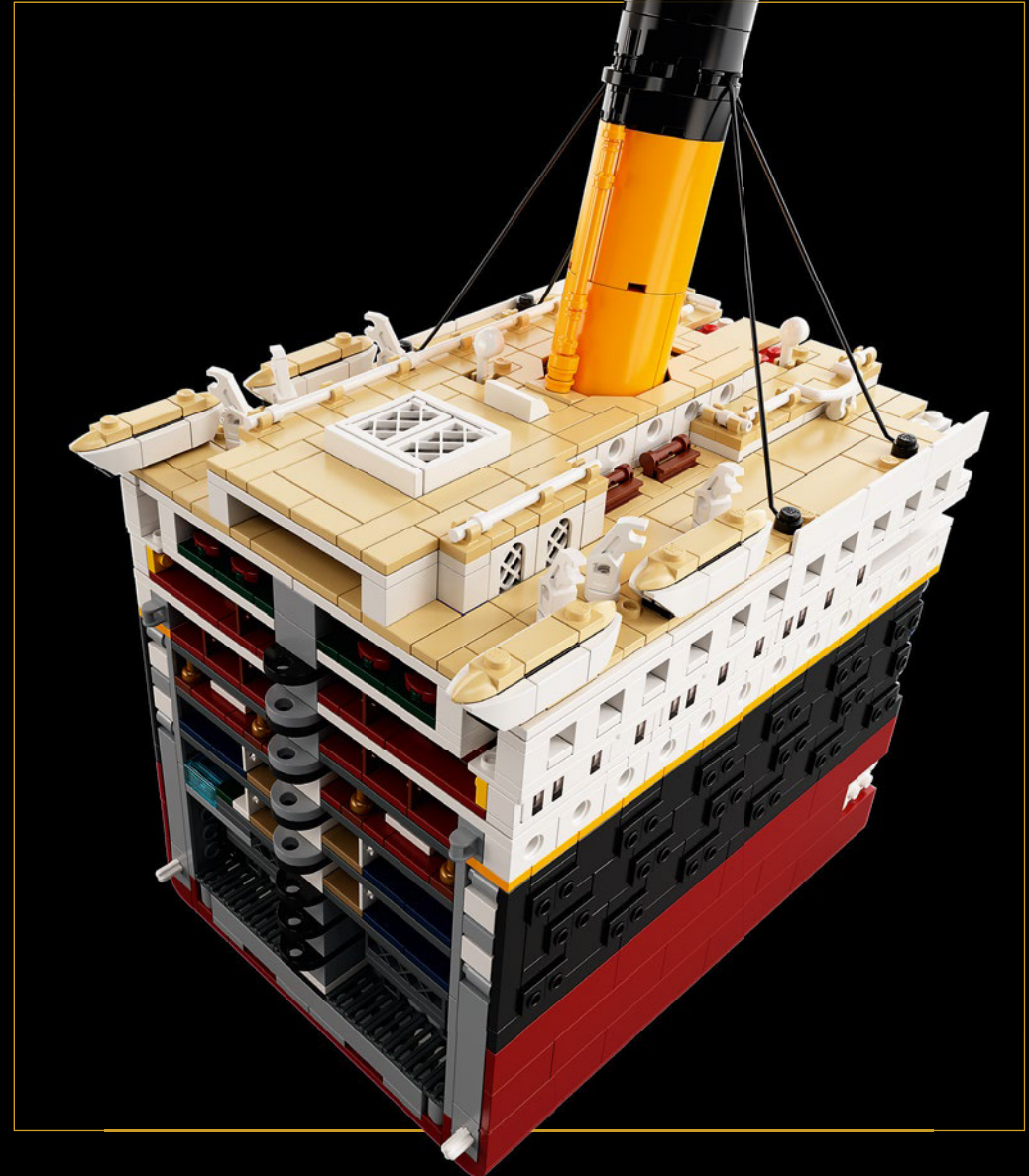



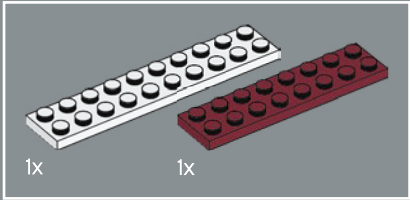
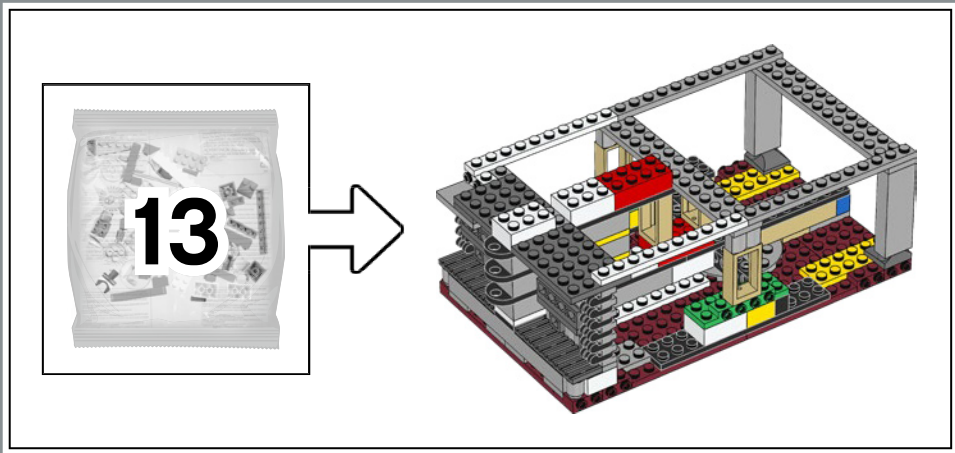

1

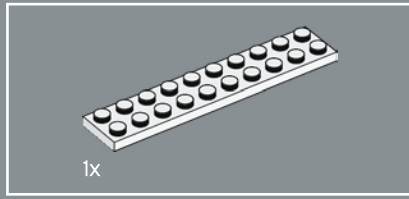
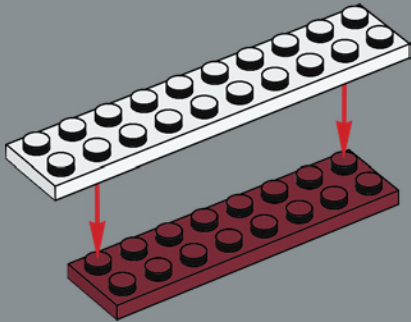

2

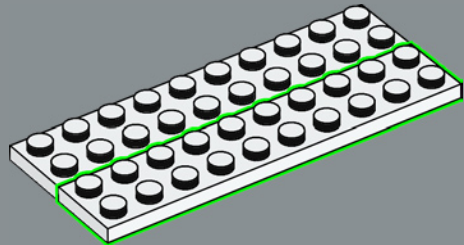

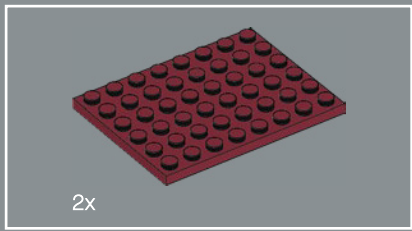

3

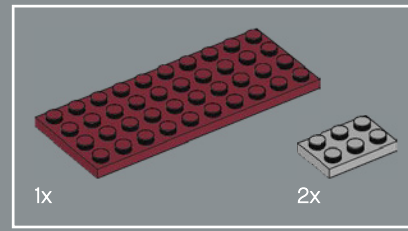
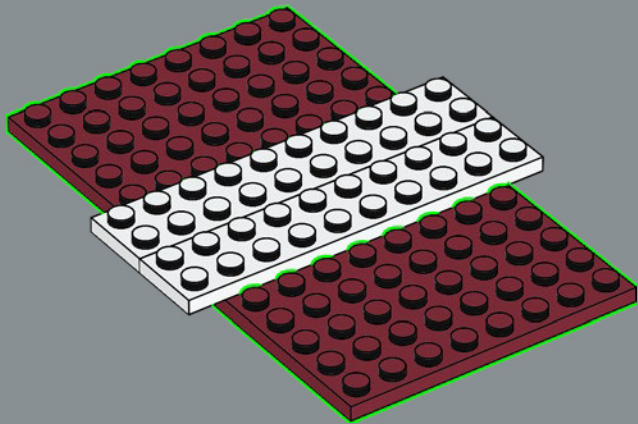

4

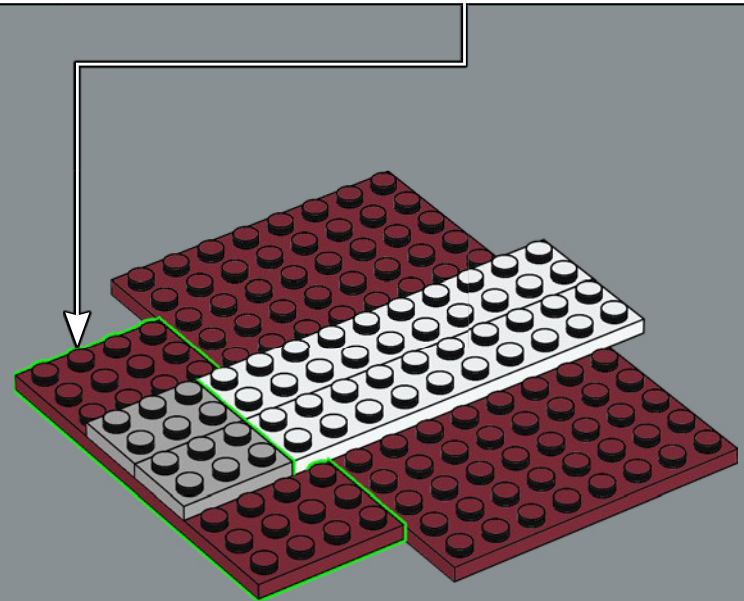
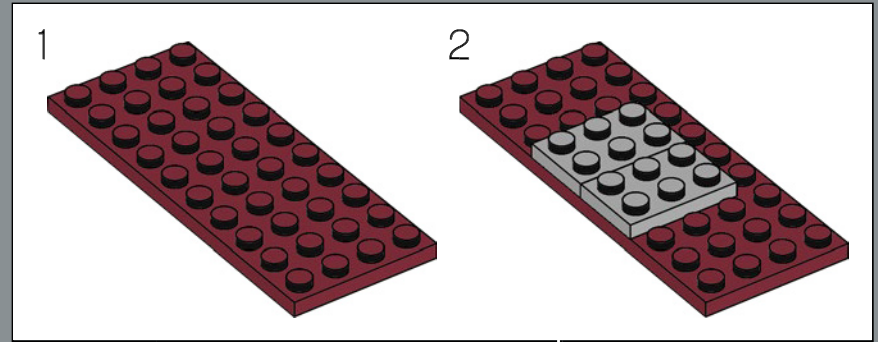

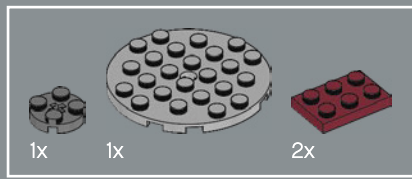

5

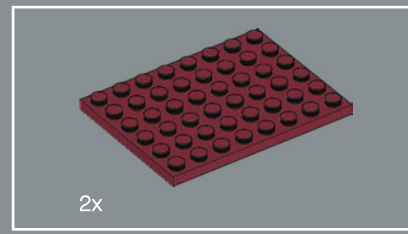
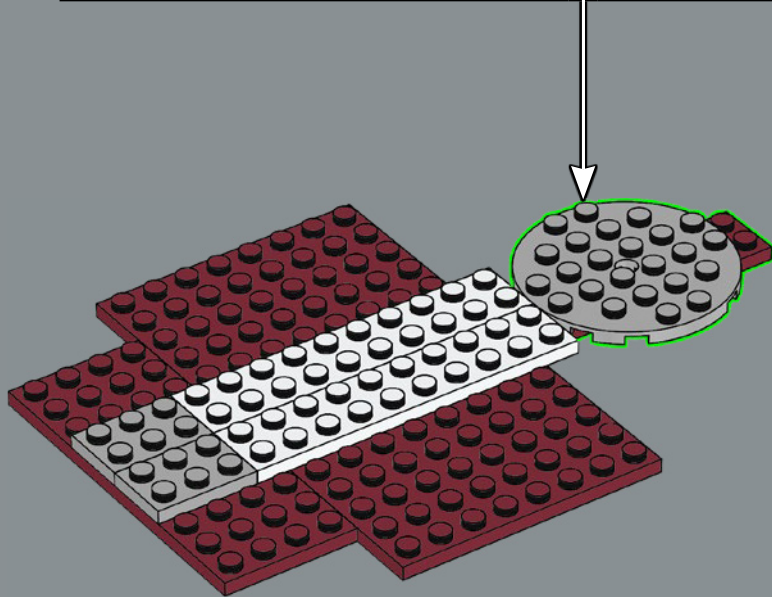
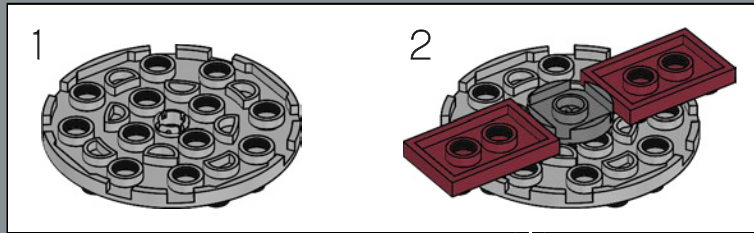

6

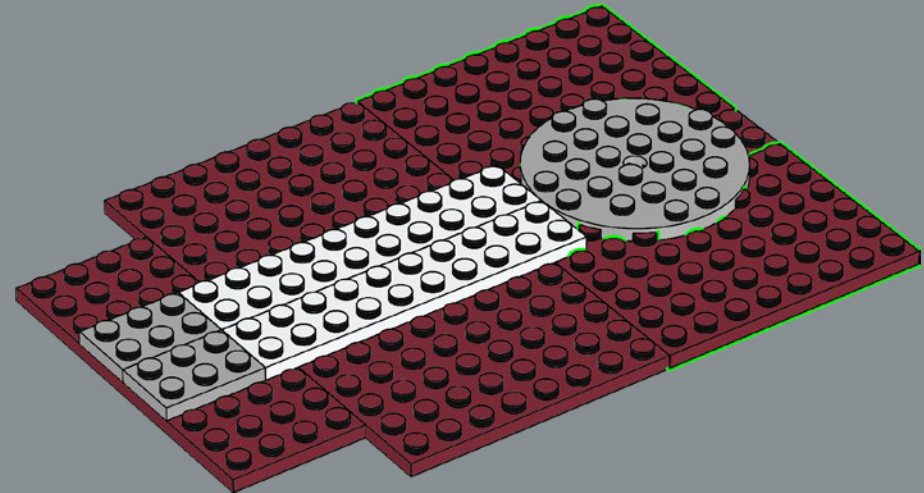

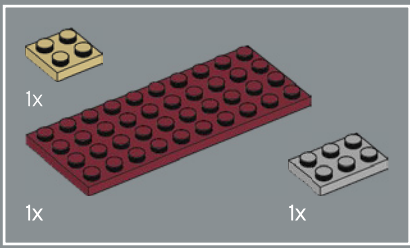

7

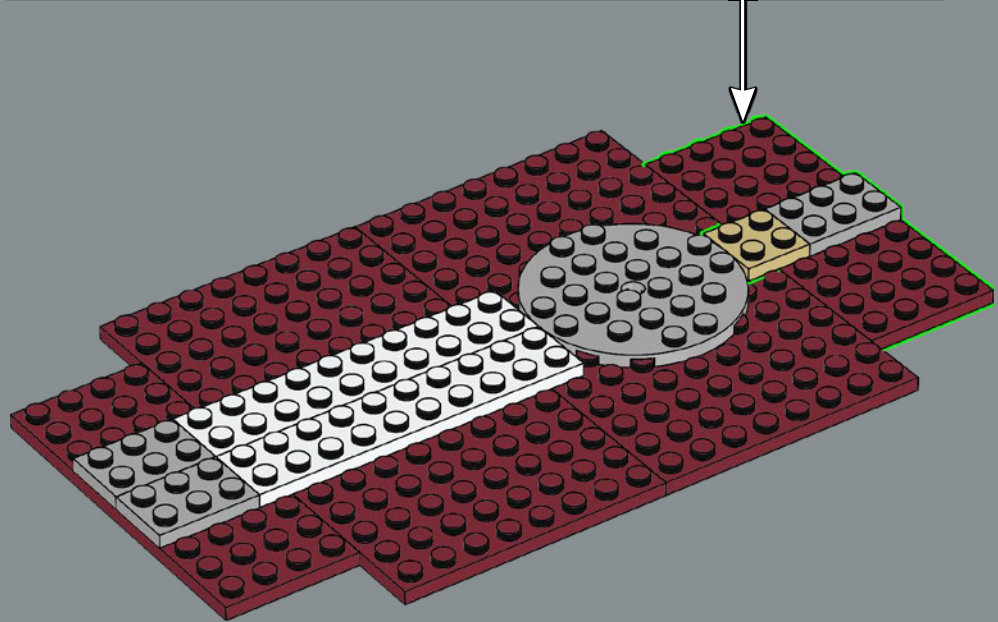
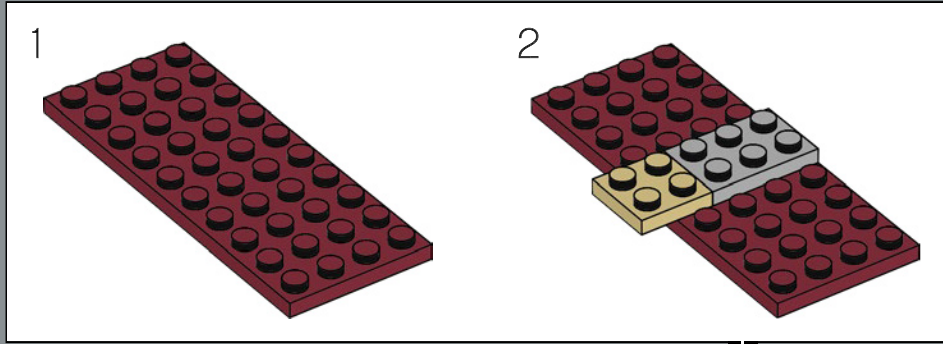

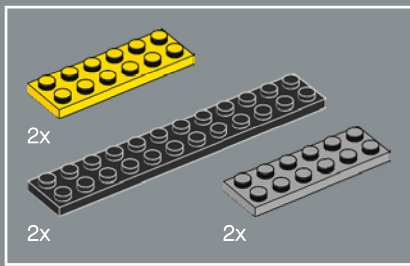

8

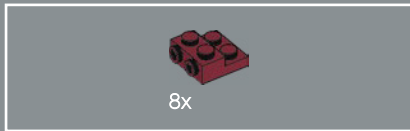
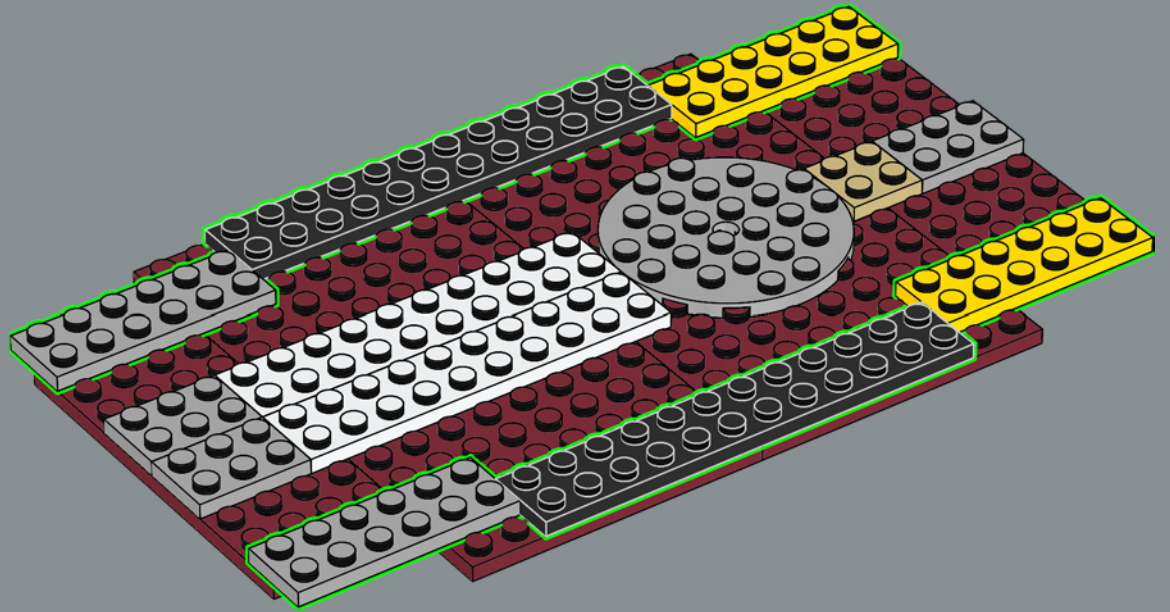

9

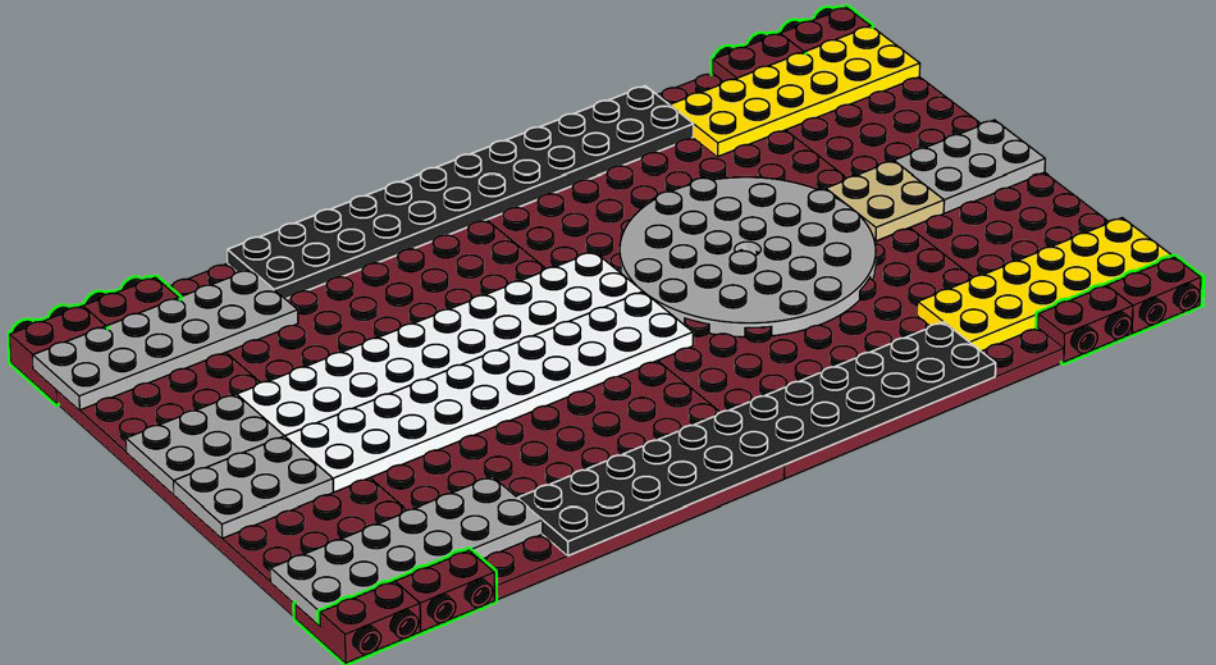

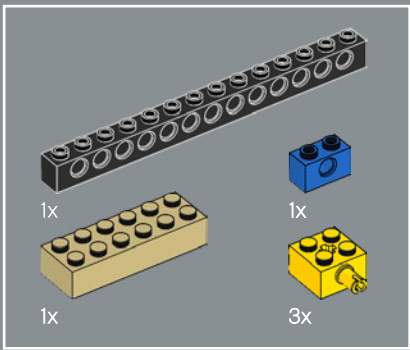

10

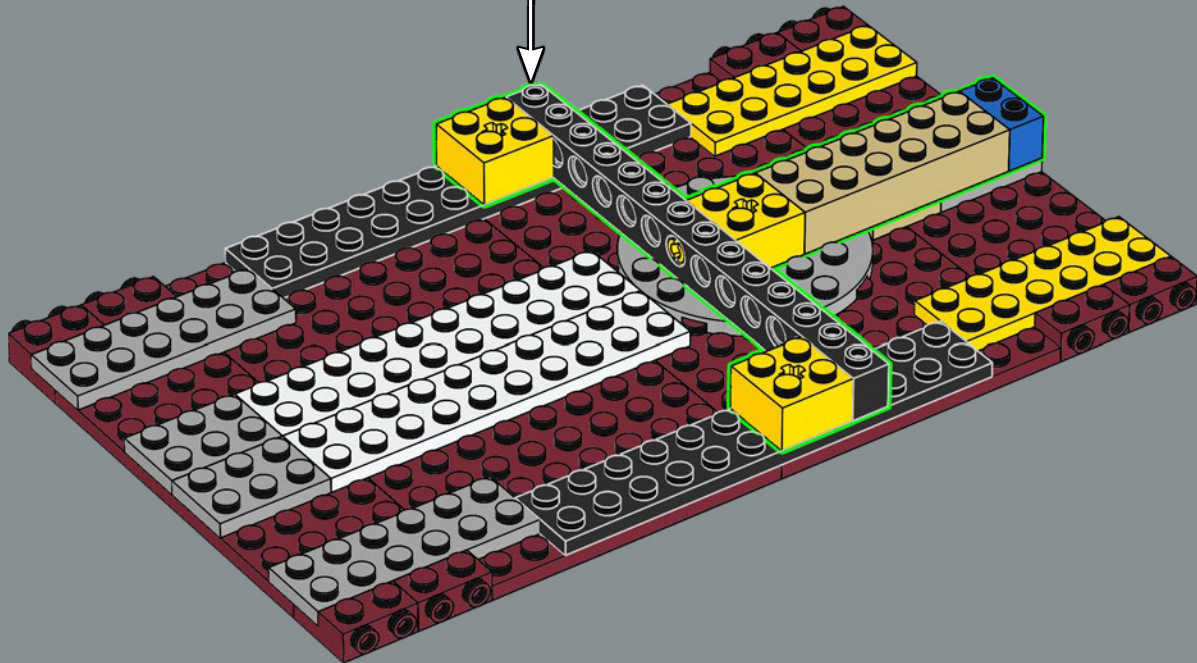
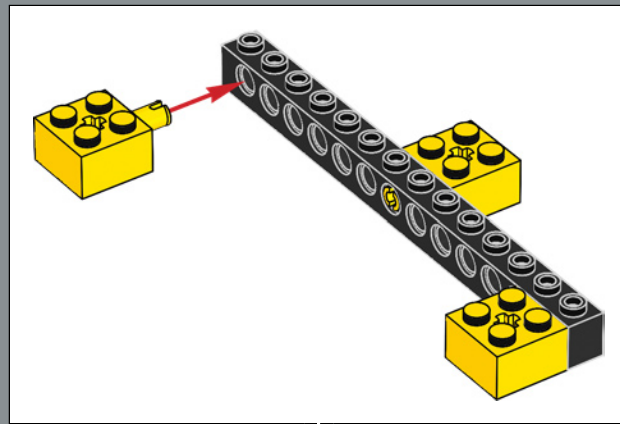

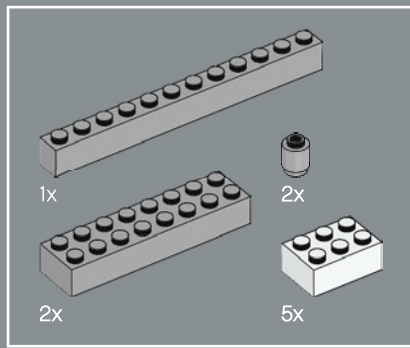

11

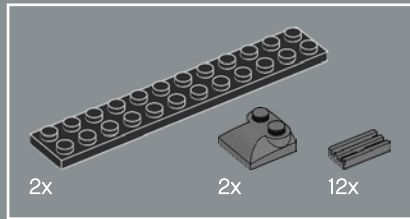
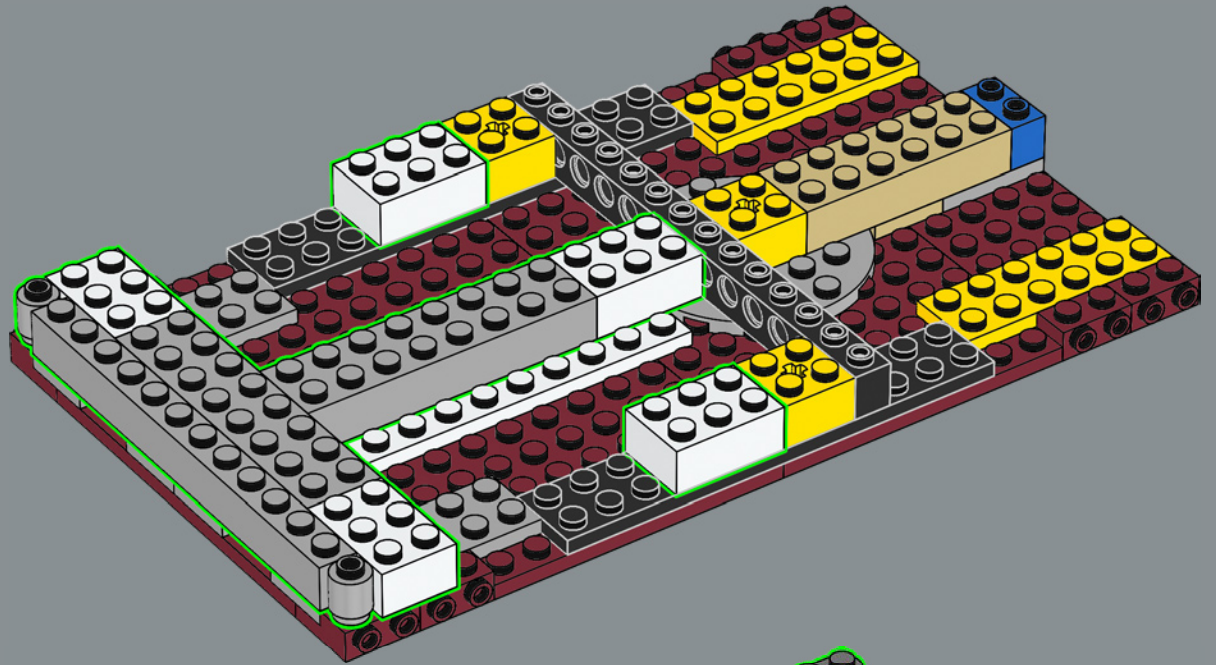

12



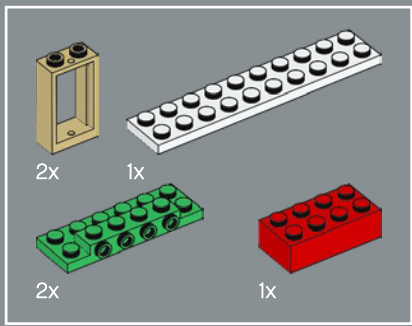

13

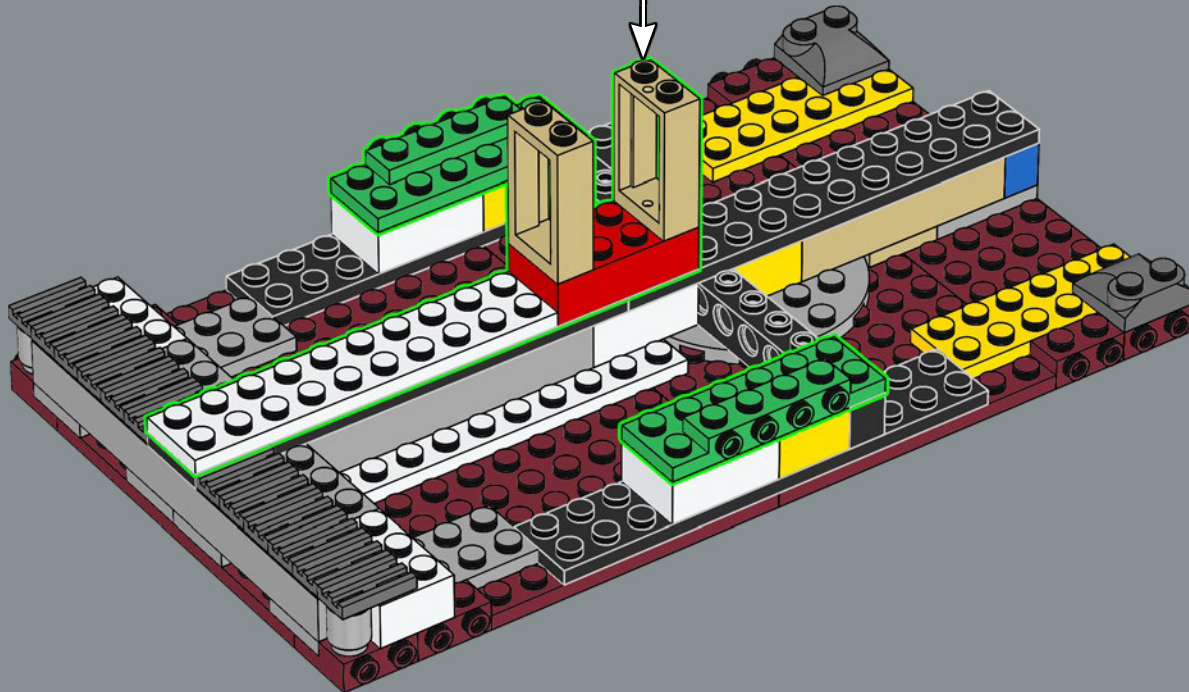
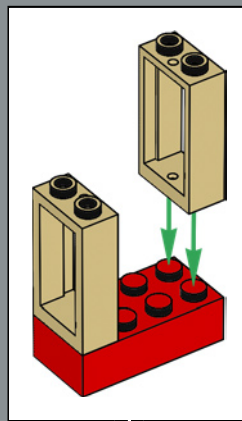



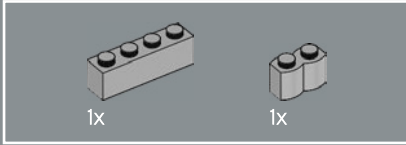
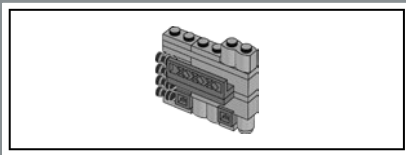

14

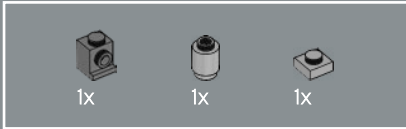
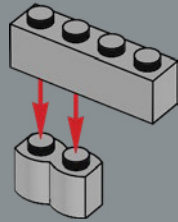

15

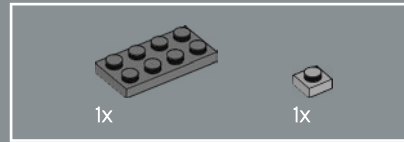
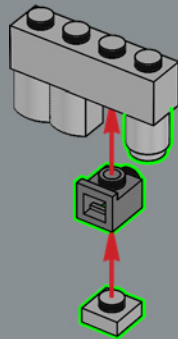

16

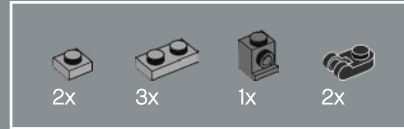
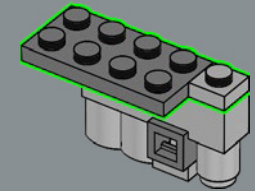

17

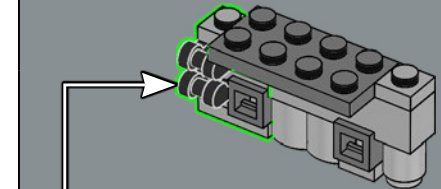
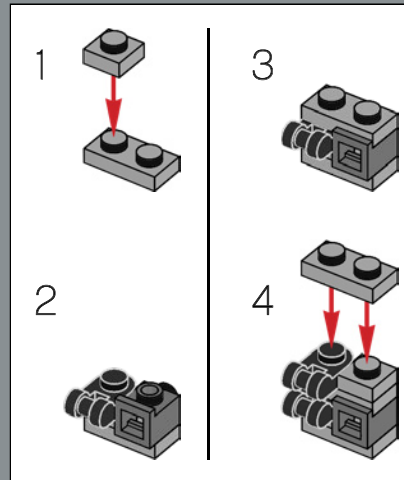

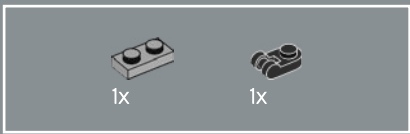

18

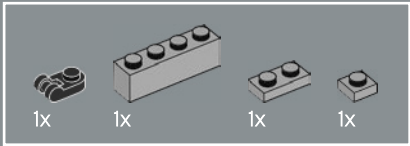
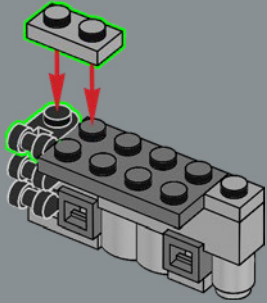

19

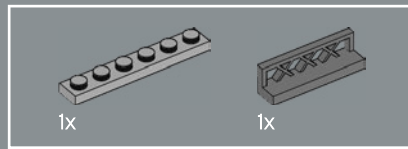
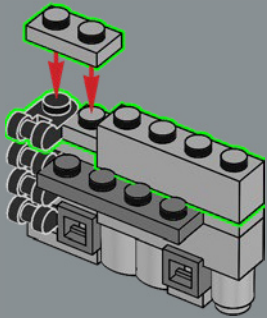

20

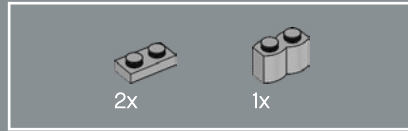
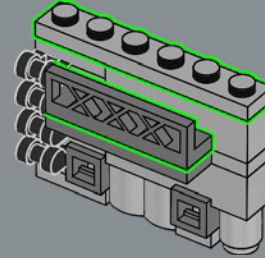

21

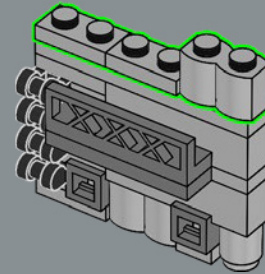

22

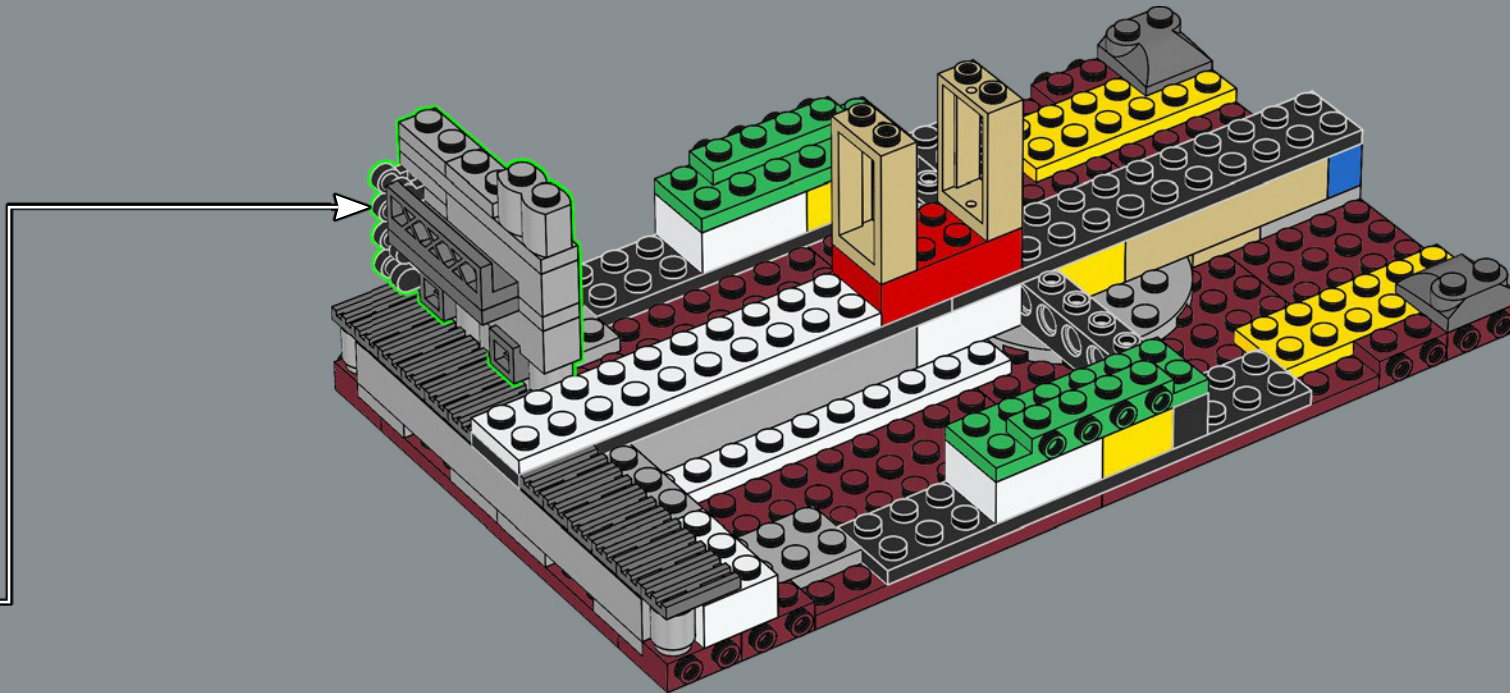

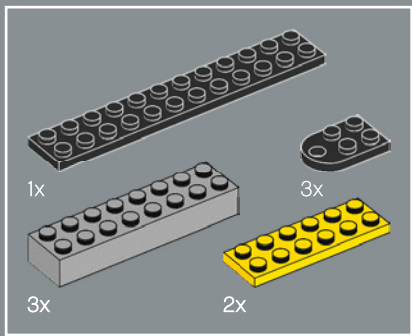

23

1

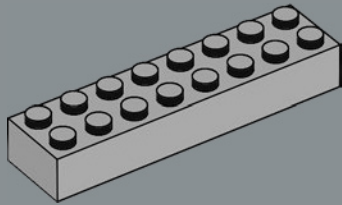

2

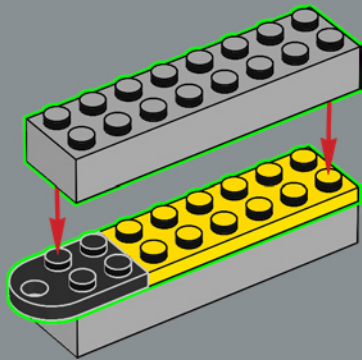

3

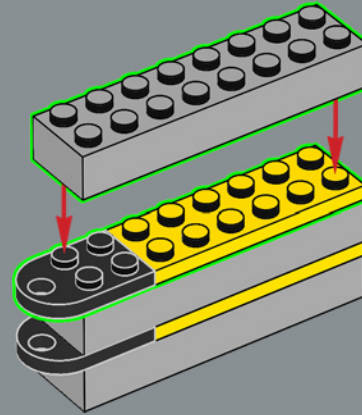

4

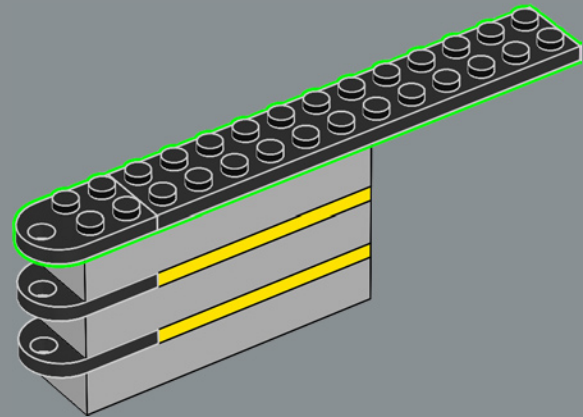

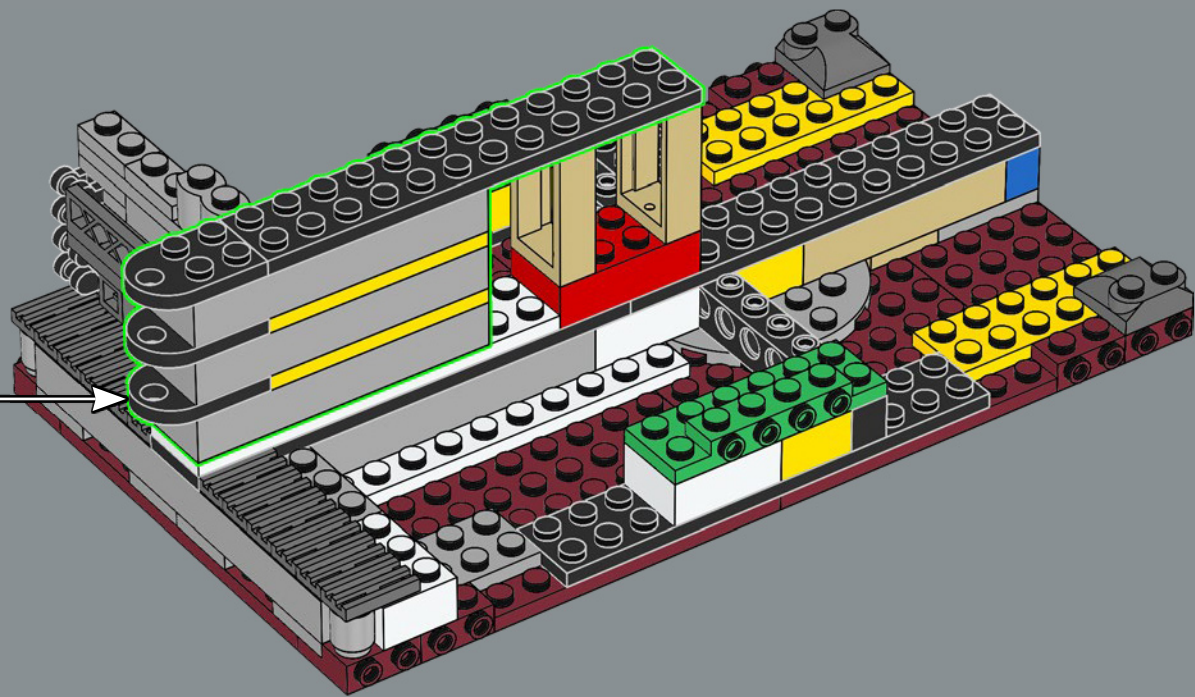

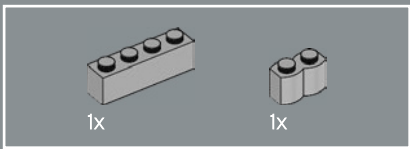

24

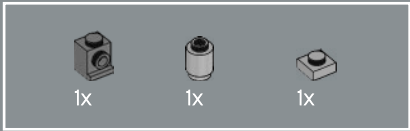
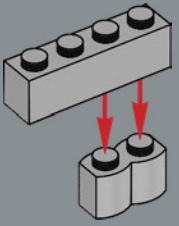

25

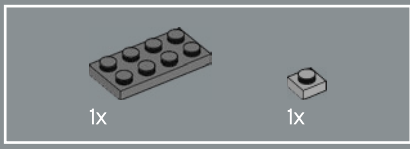
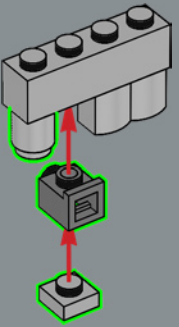

26

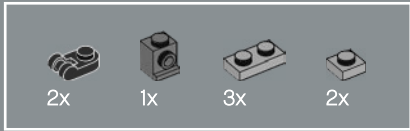
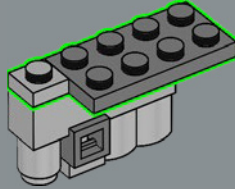

27

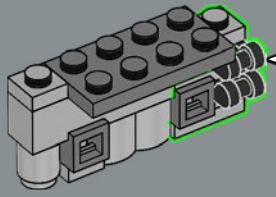
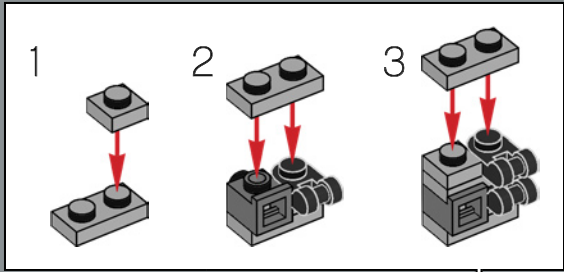

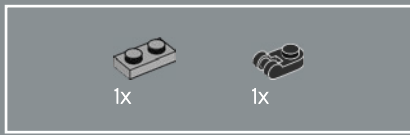

28

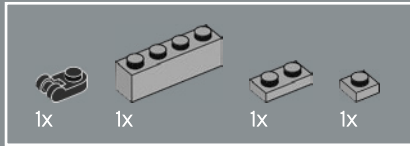
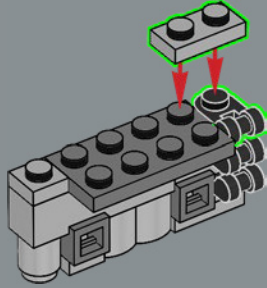

29

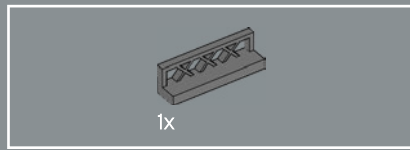
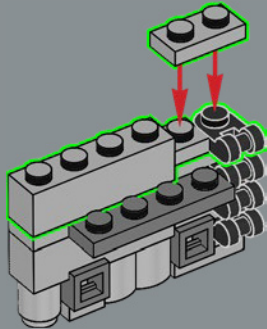

30

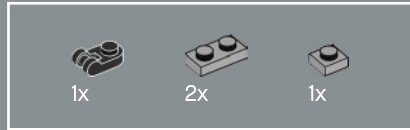
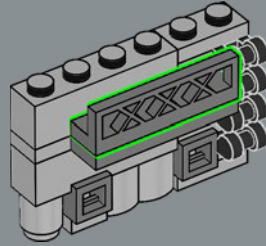

31

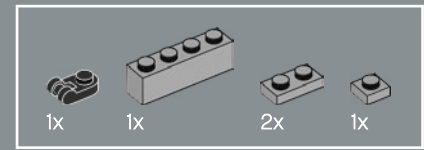
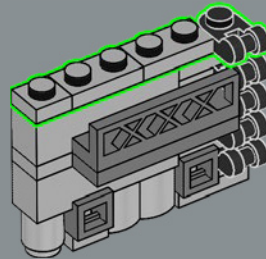

32

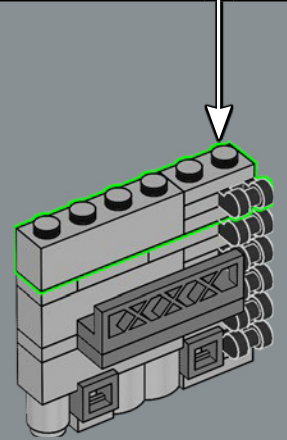
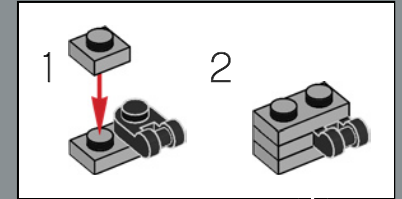

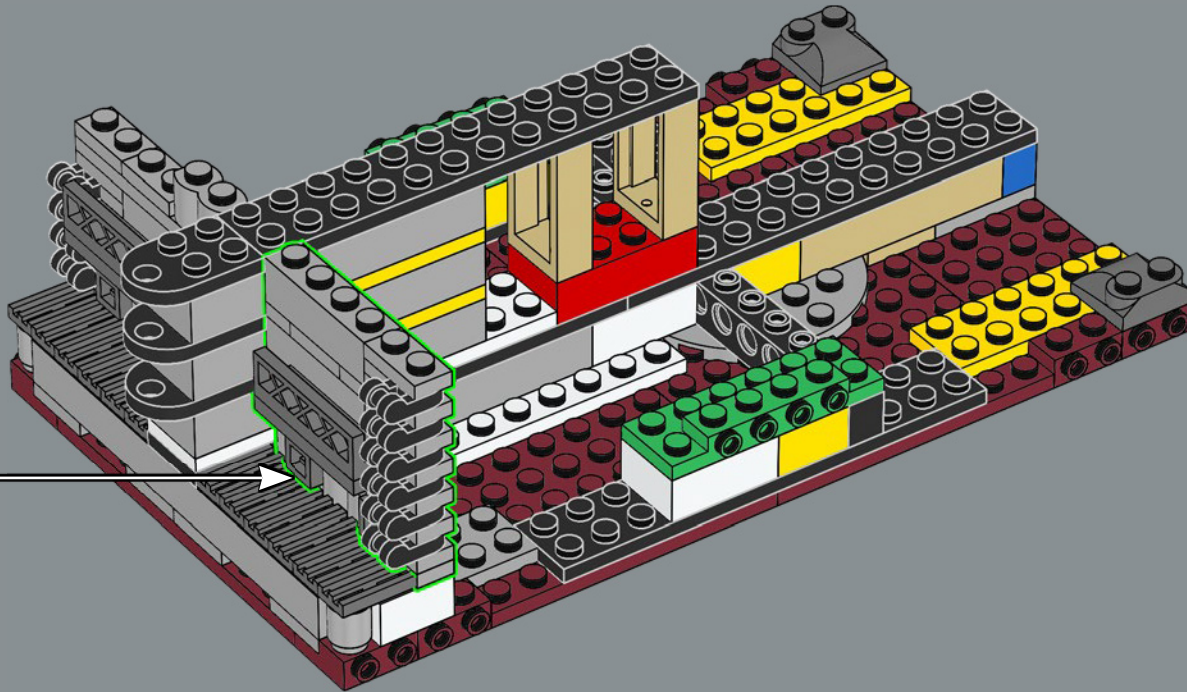



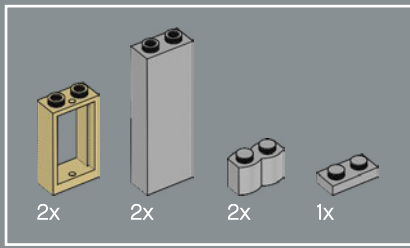

34

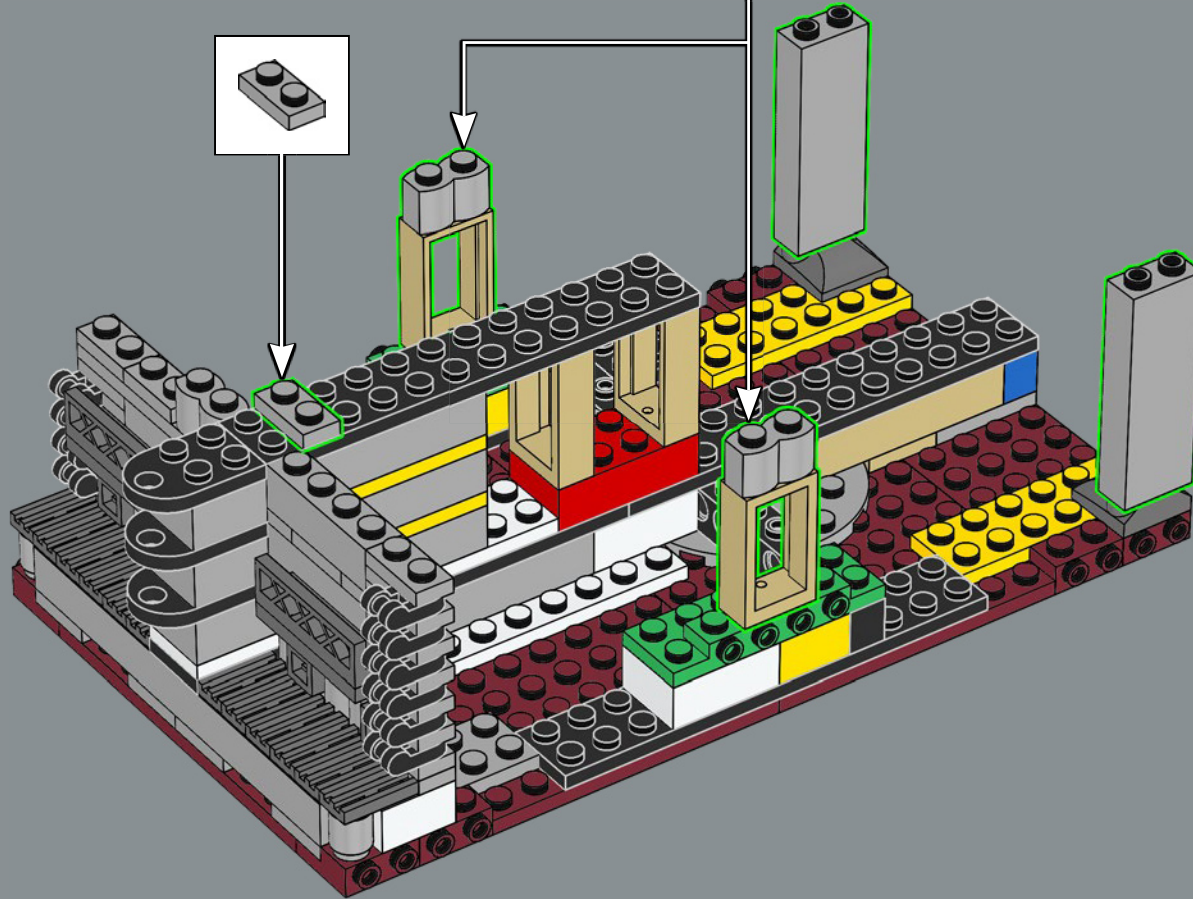
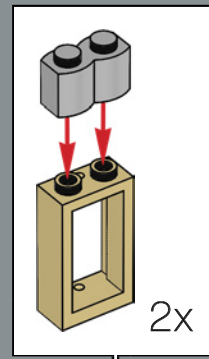



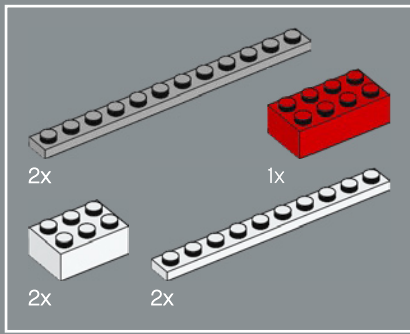

36

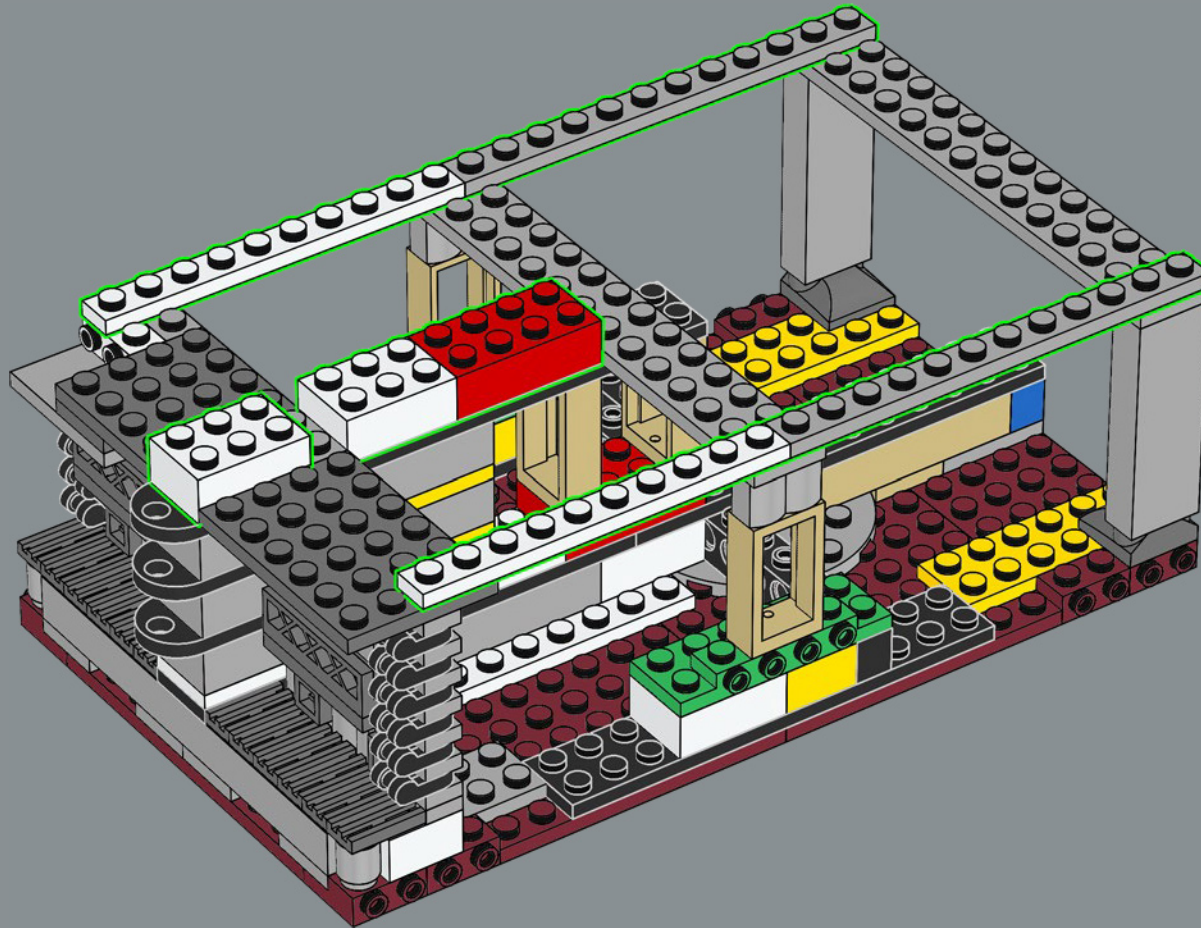

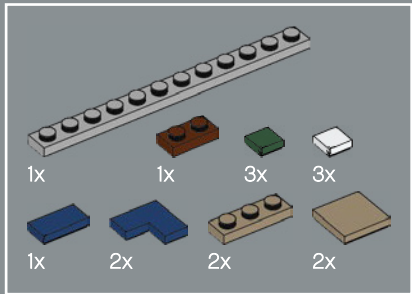
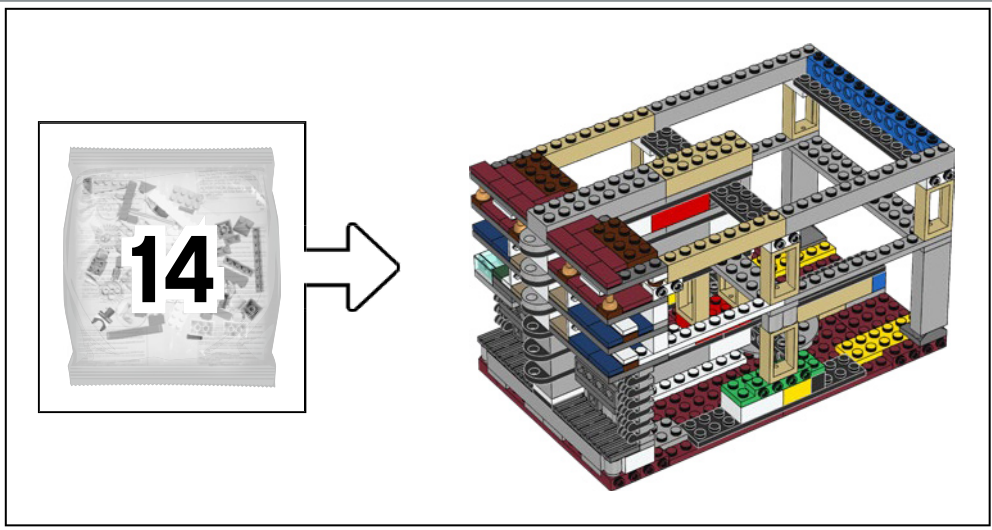

37

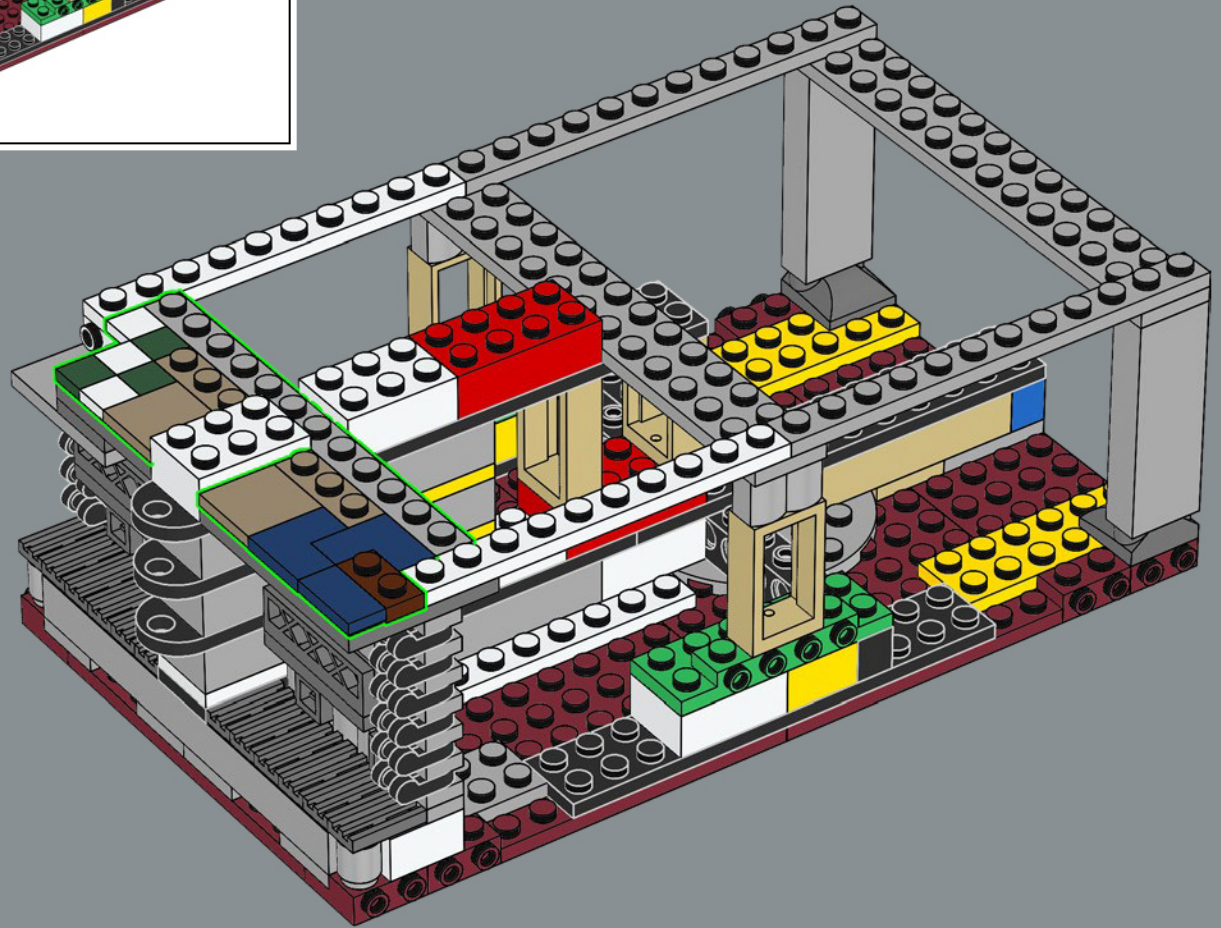

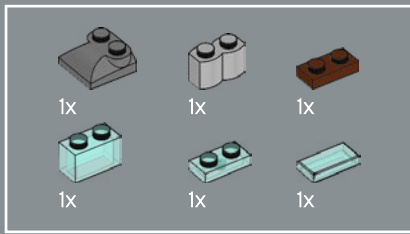

38

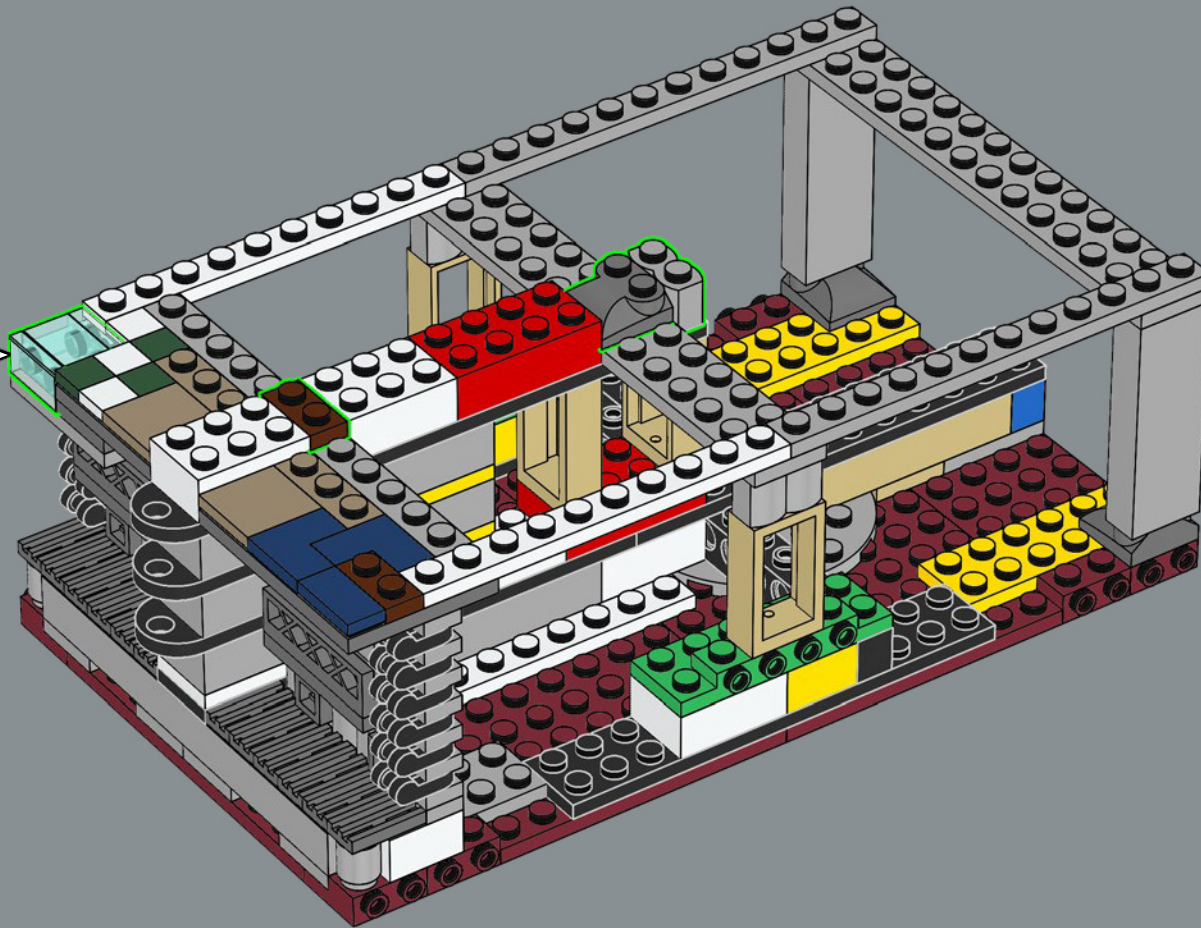
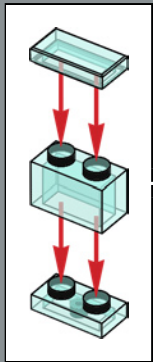



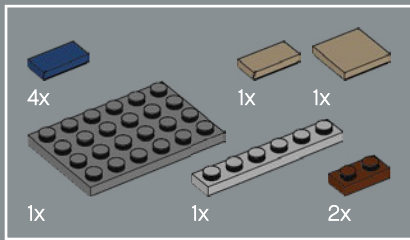

40

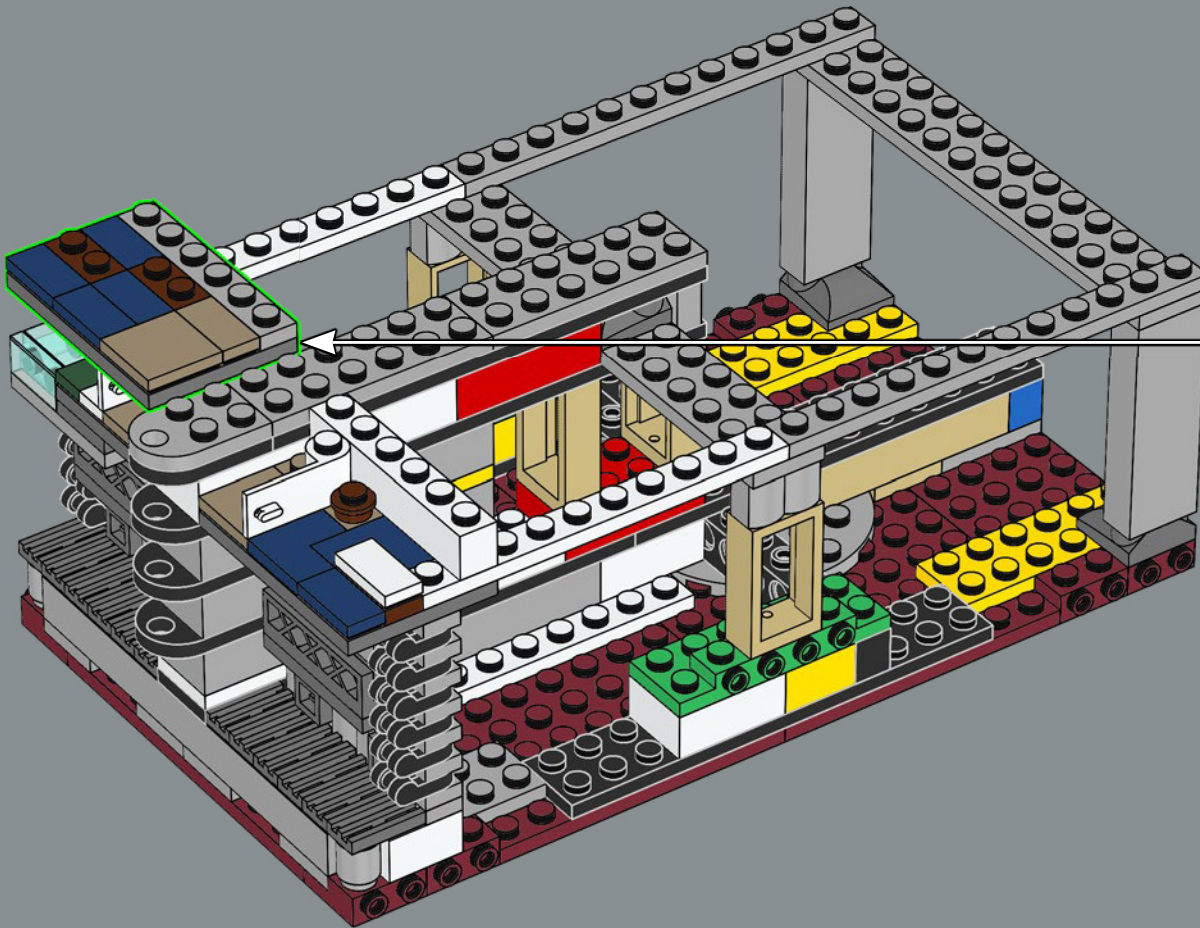
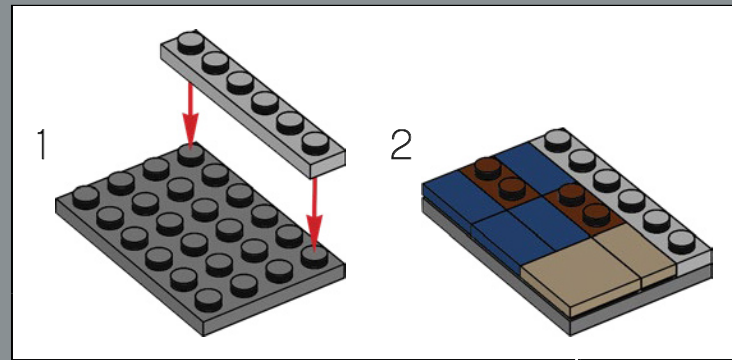

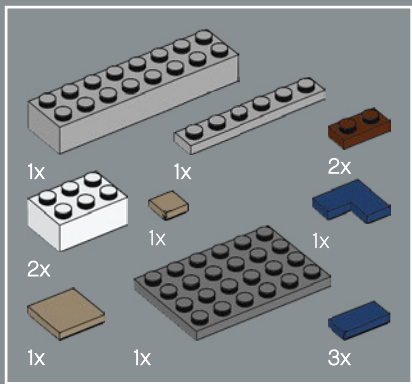

41

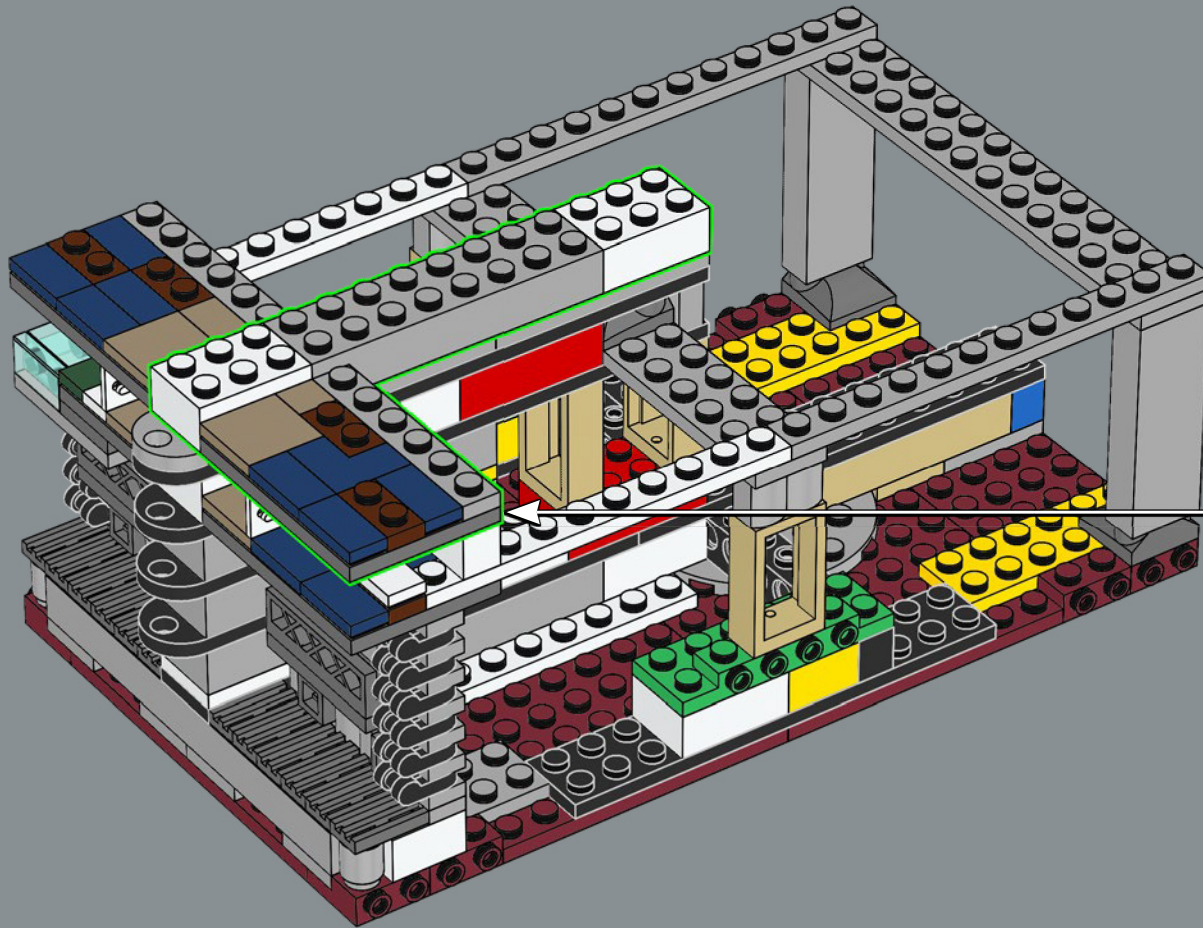
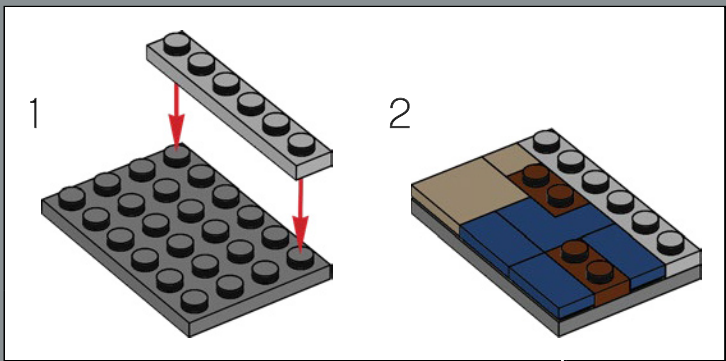



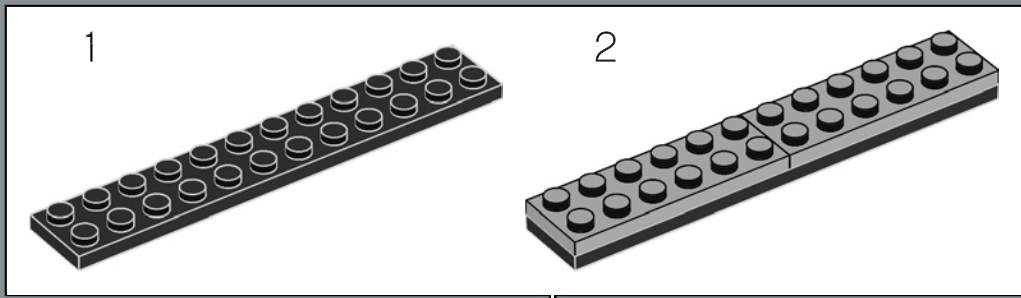
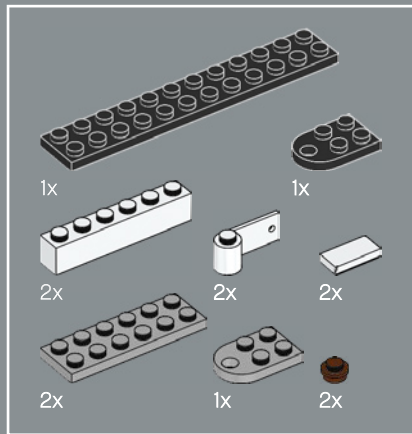

42

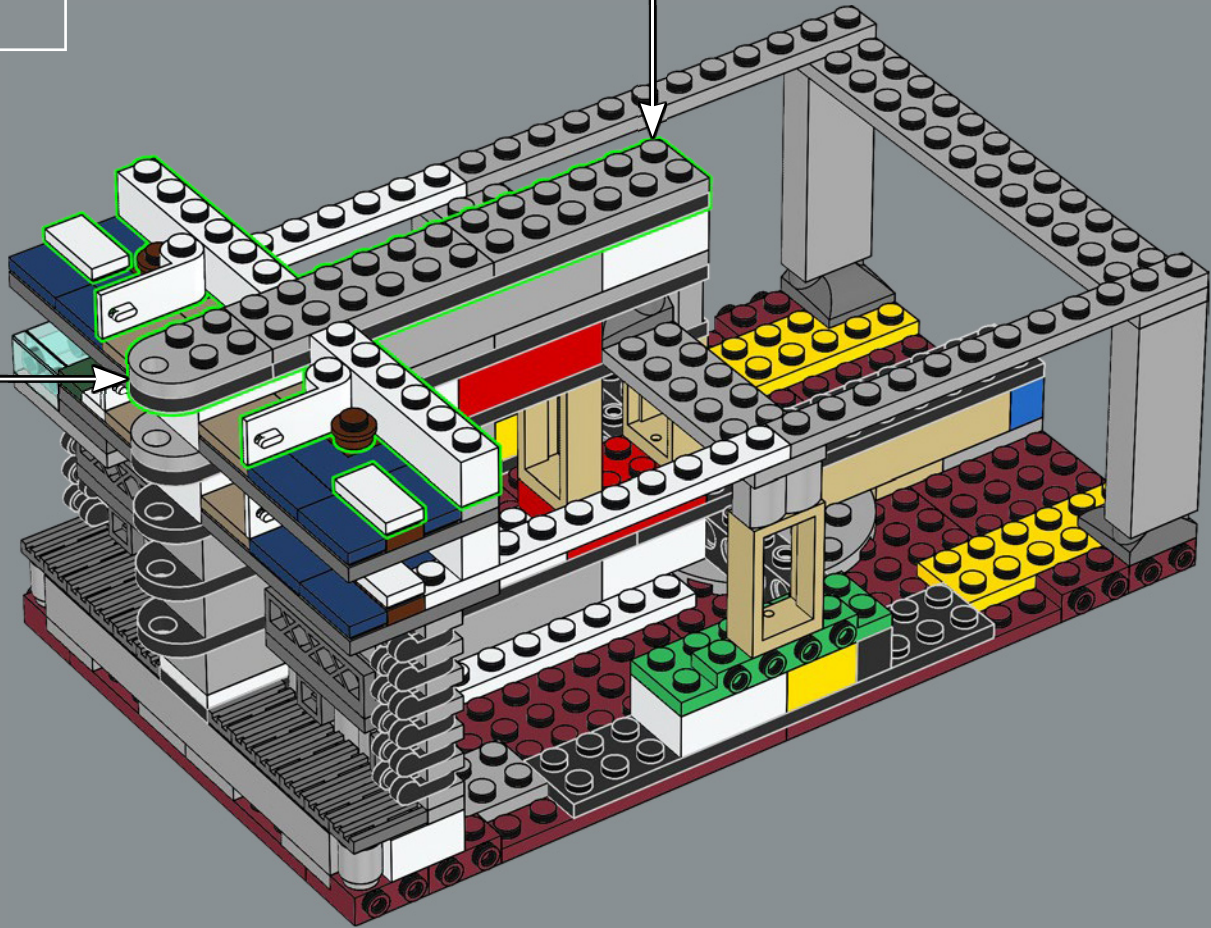
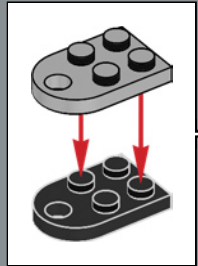

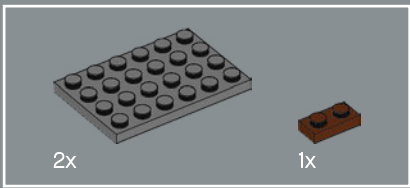

43

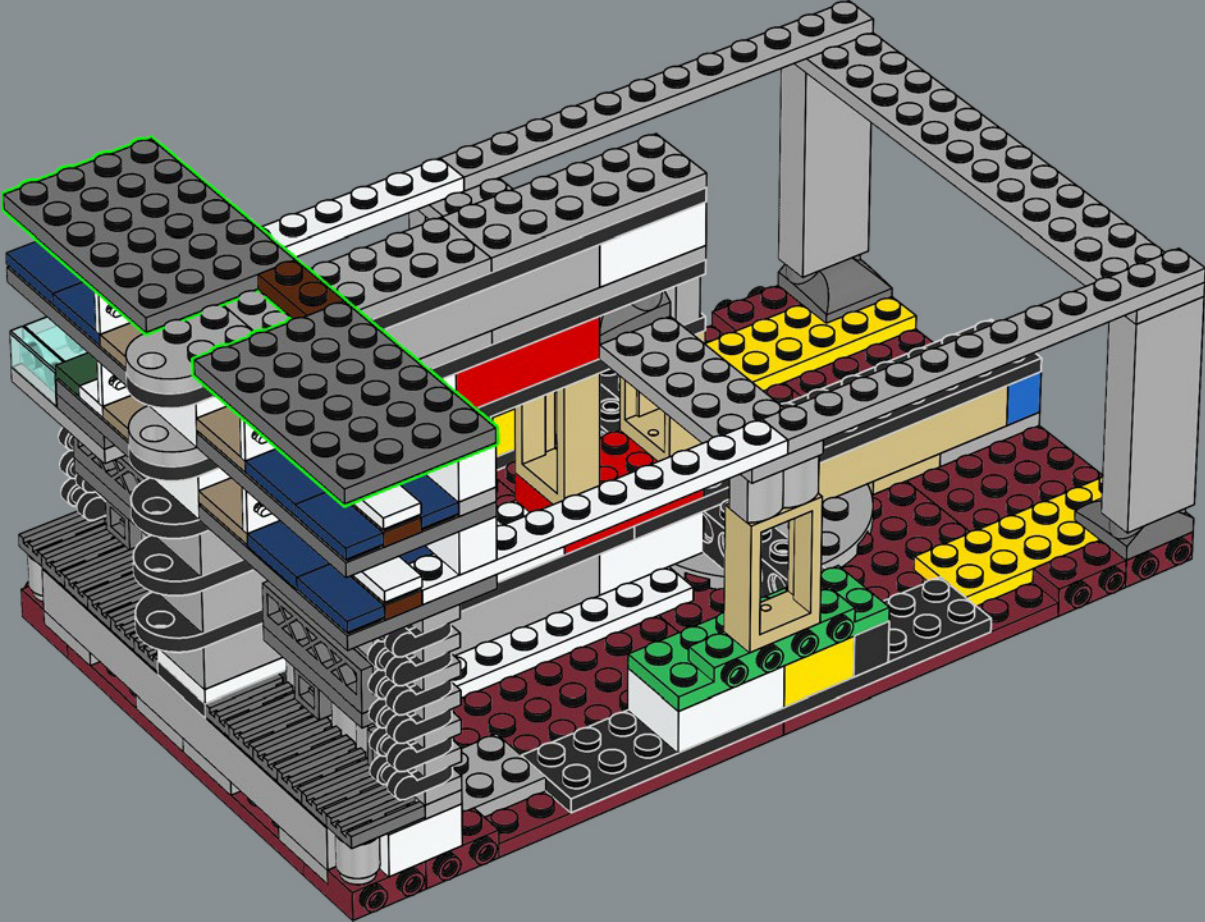

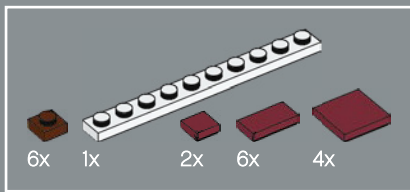

44

The ship was equipped with her own waterworks, capable of heating and pumping water to all parts of the vessel.

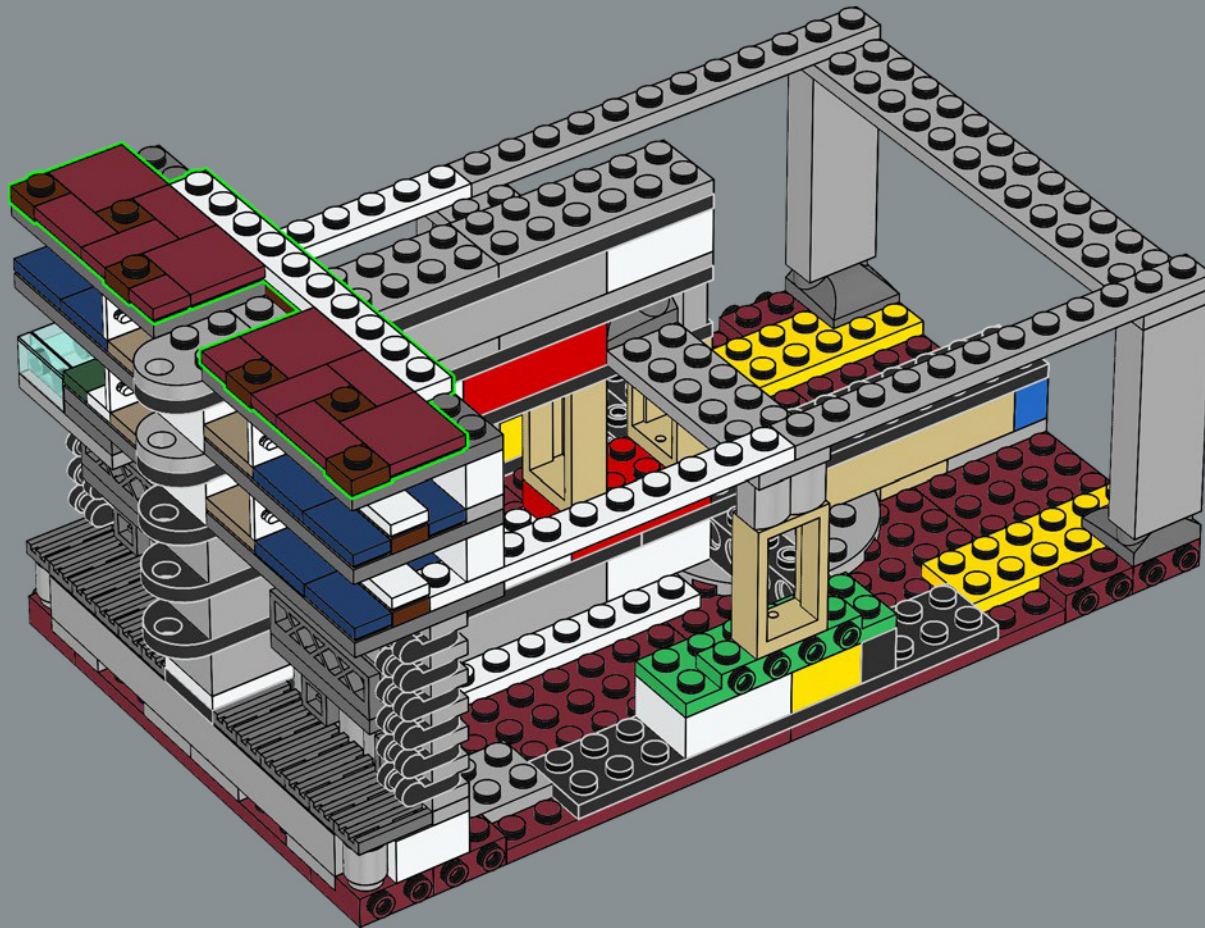

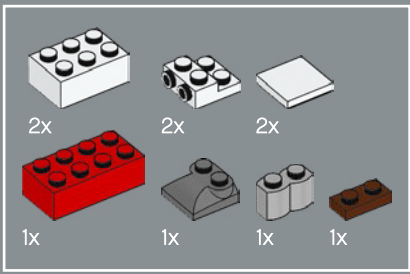

45

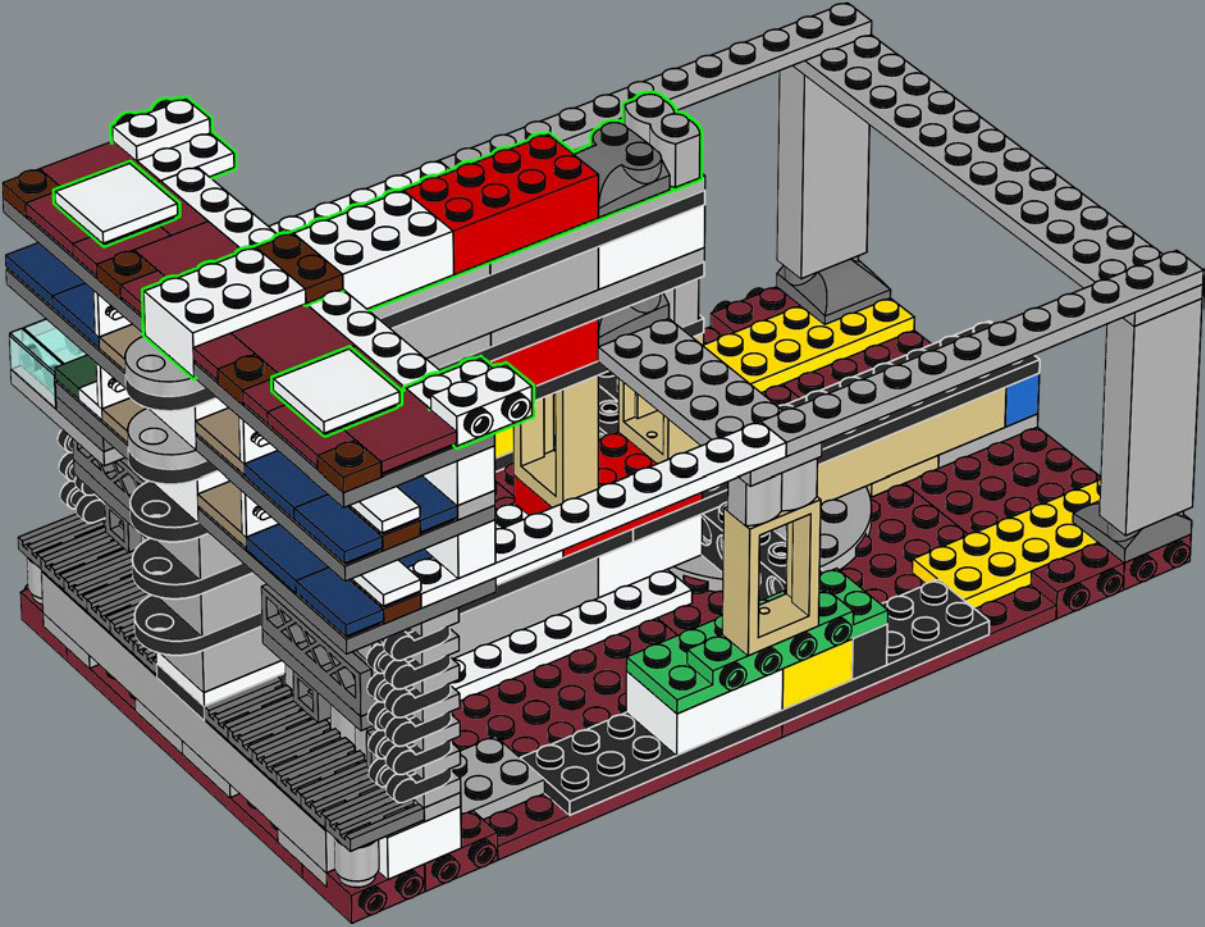

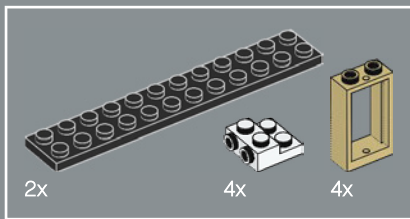

46

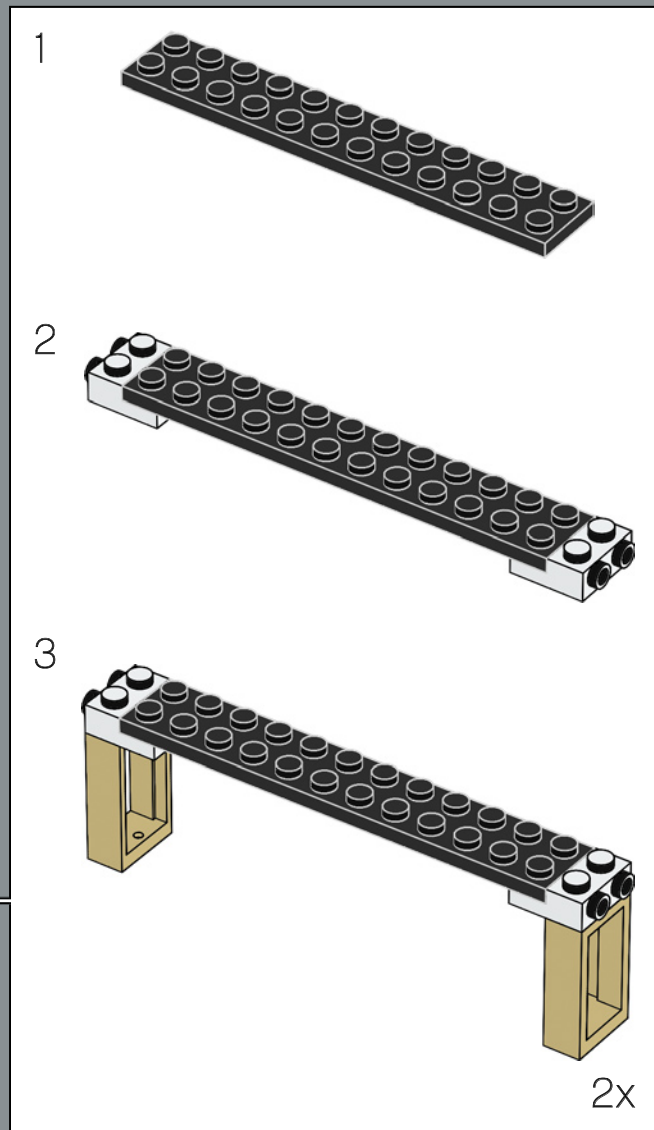
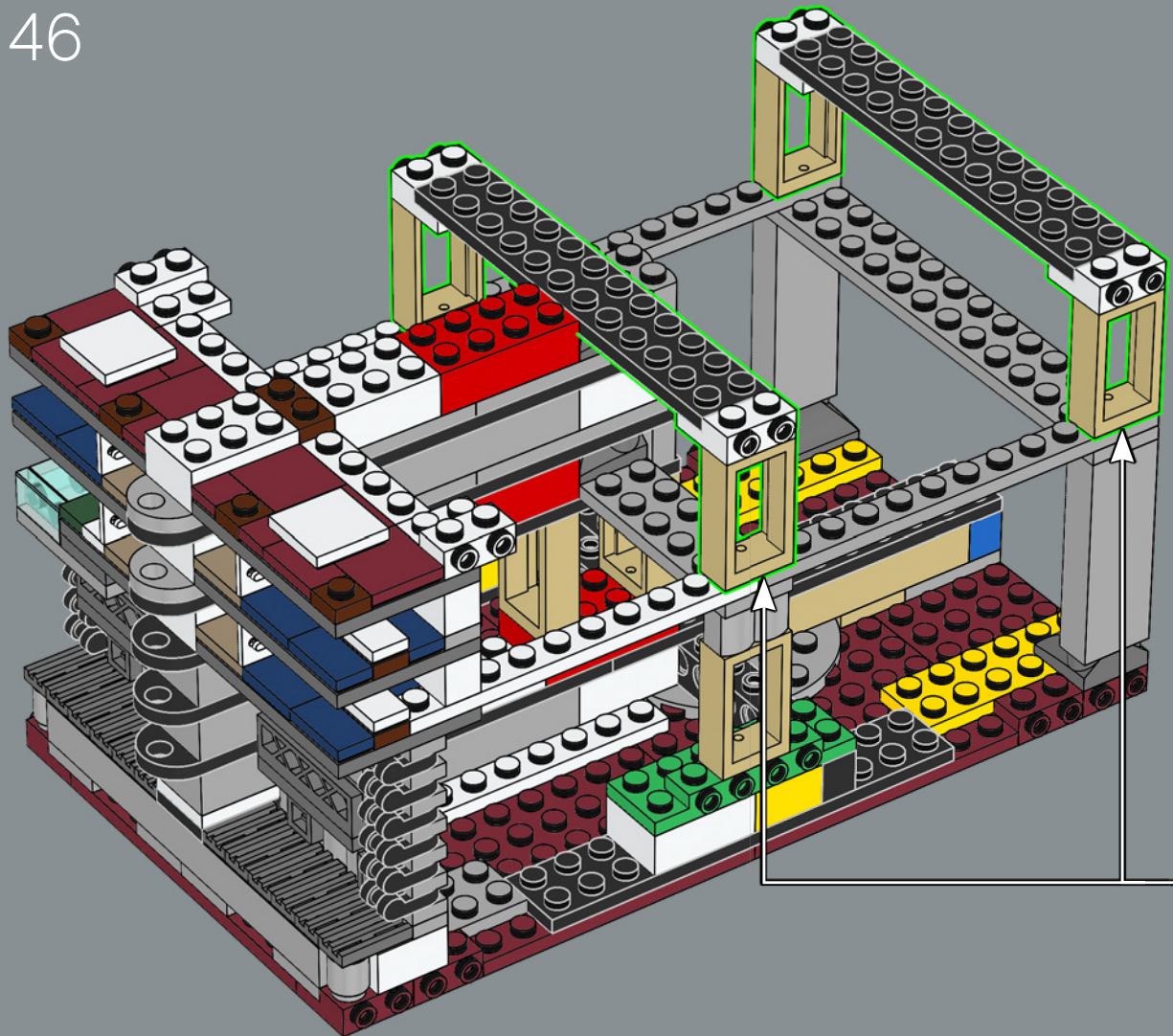

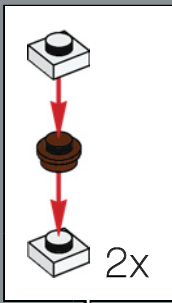
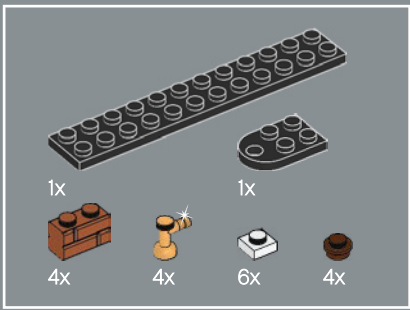

47

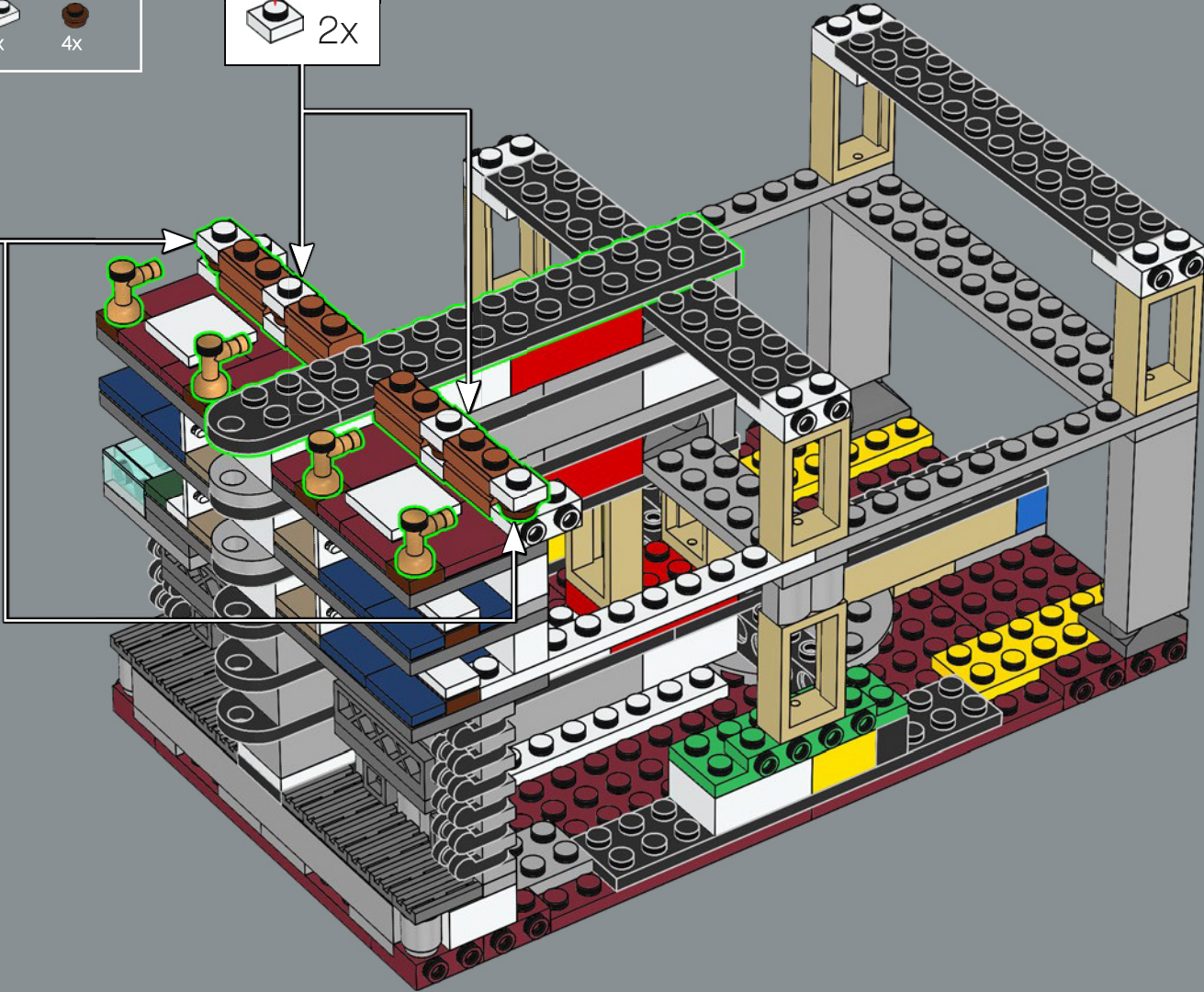
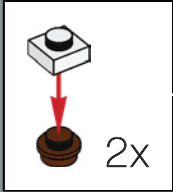

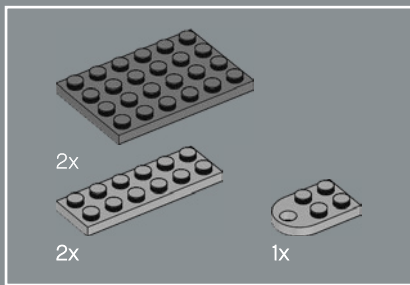

48

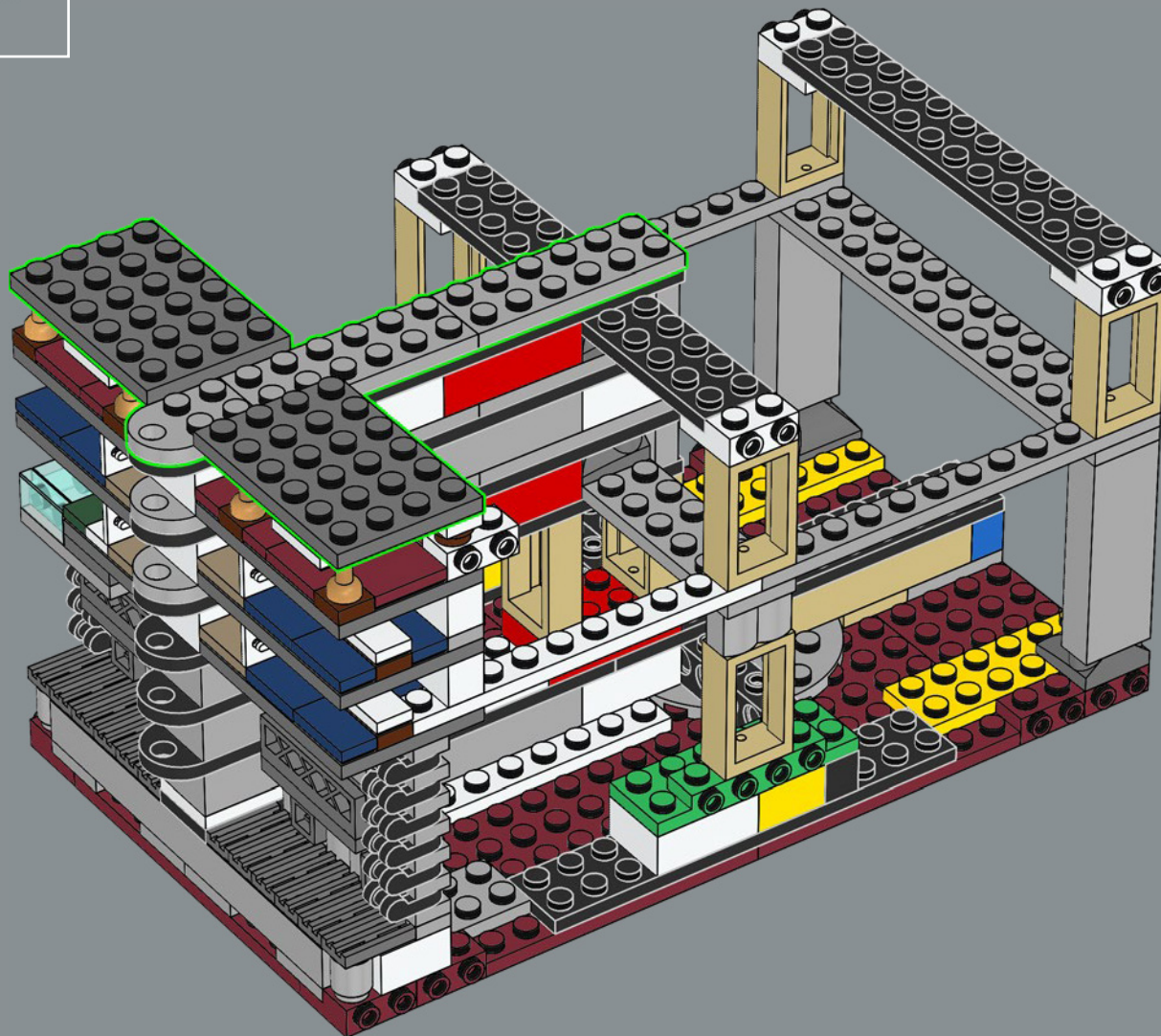



49

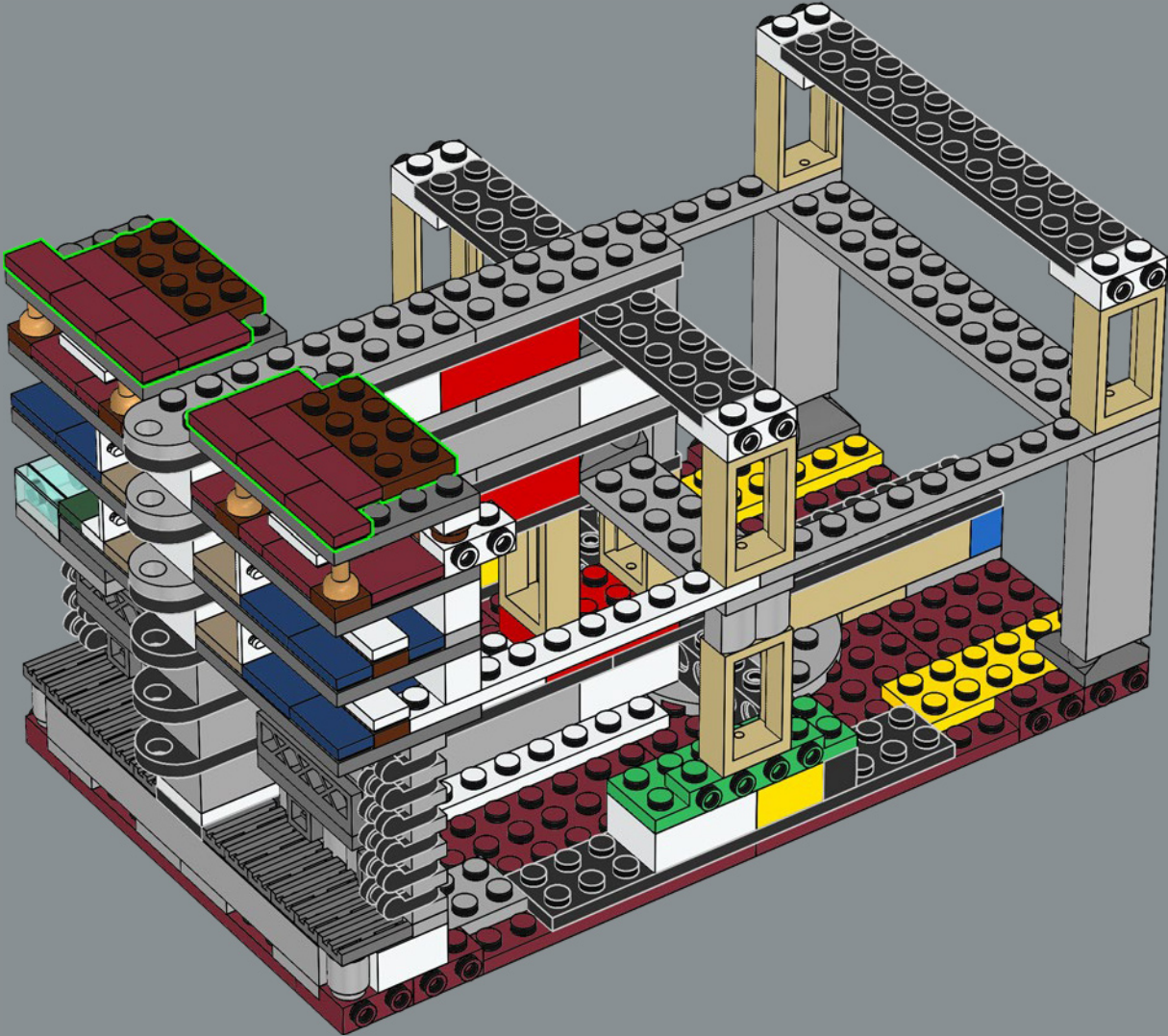



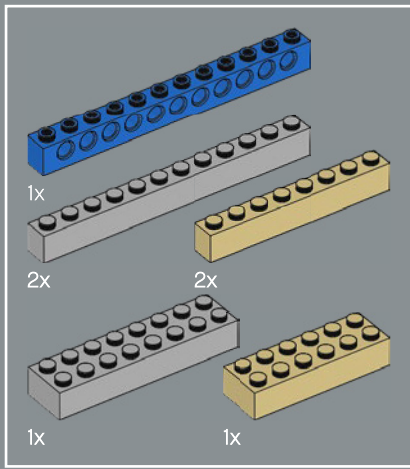

50

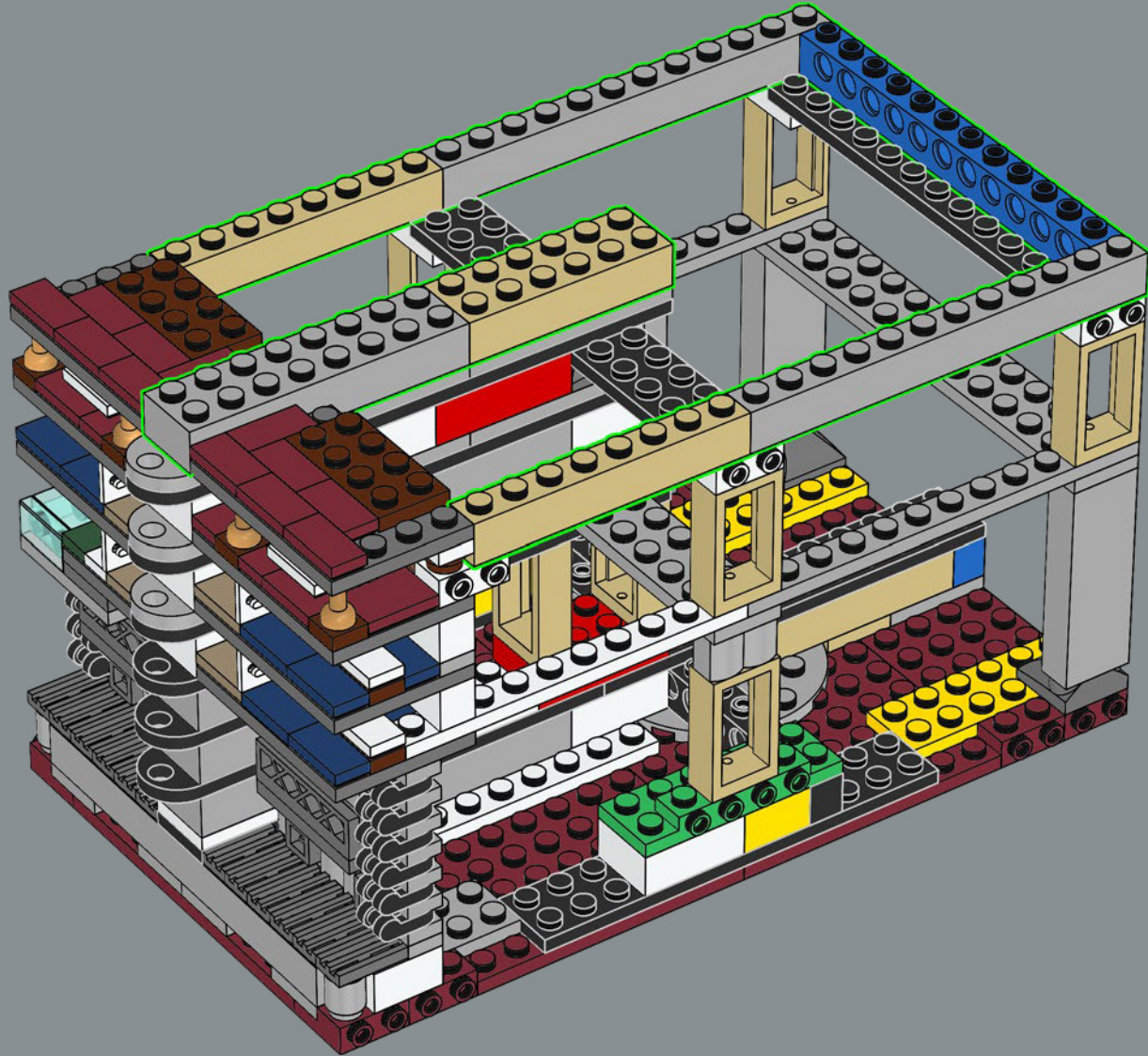

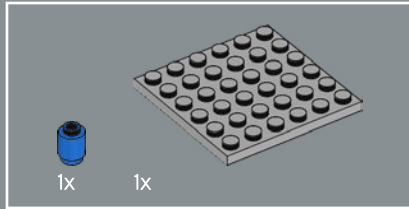
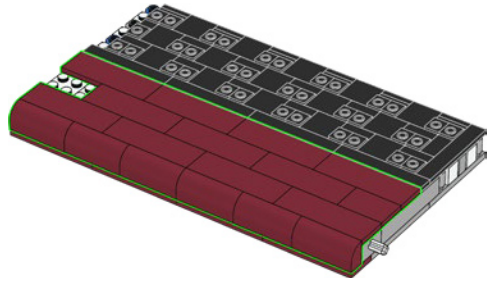
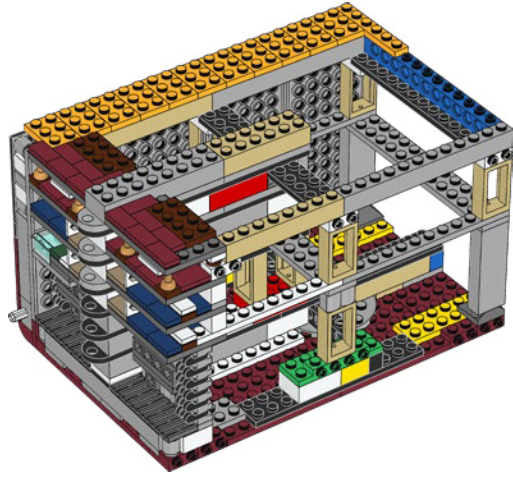
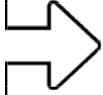

51

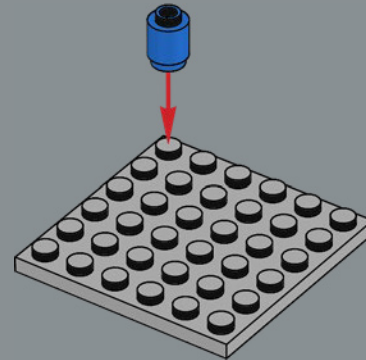

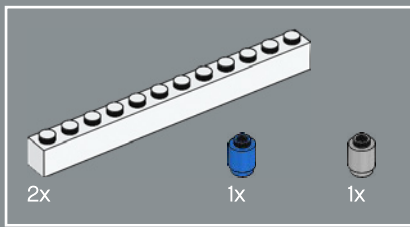

52

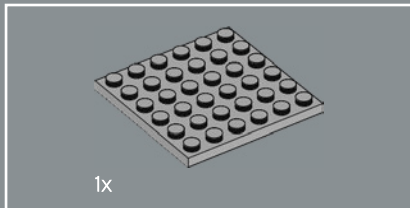
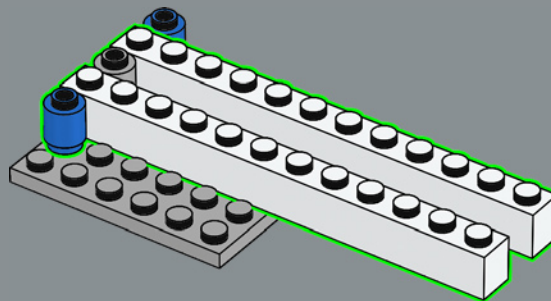

53

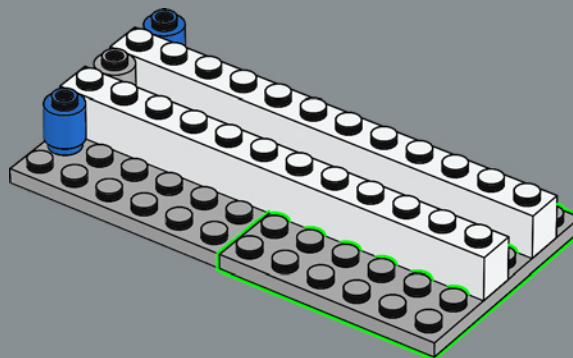

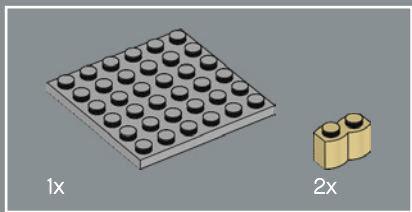

54

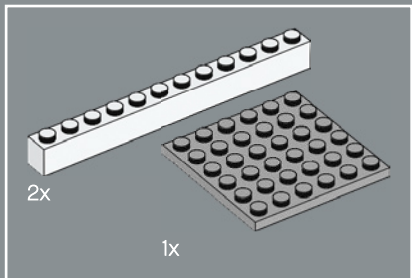
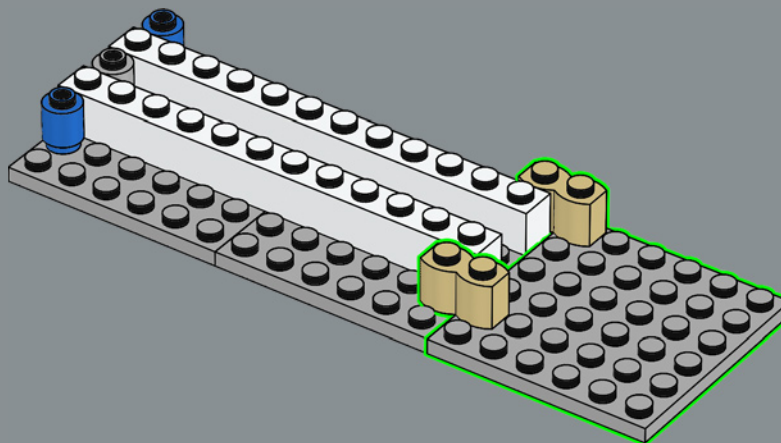

55

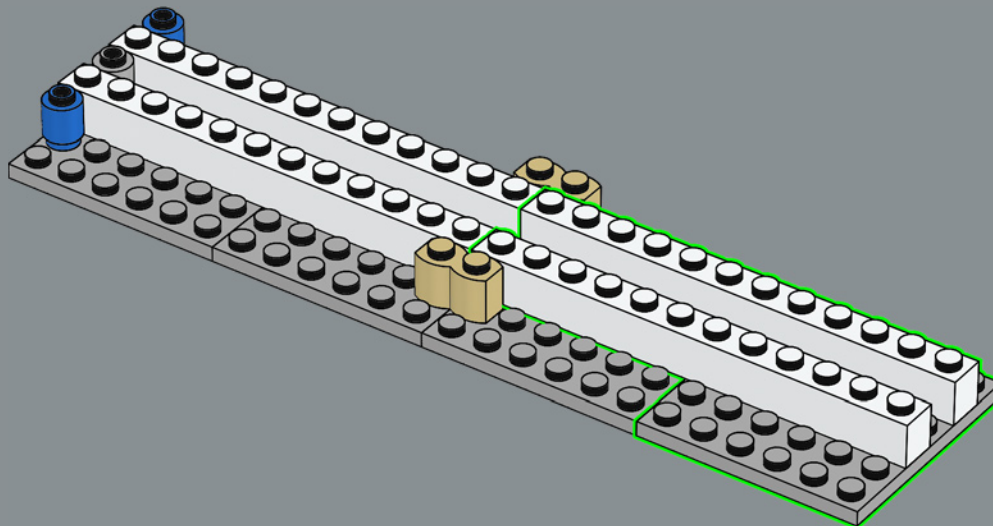



56

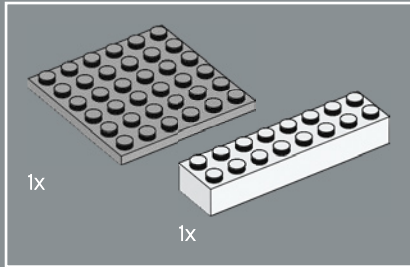
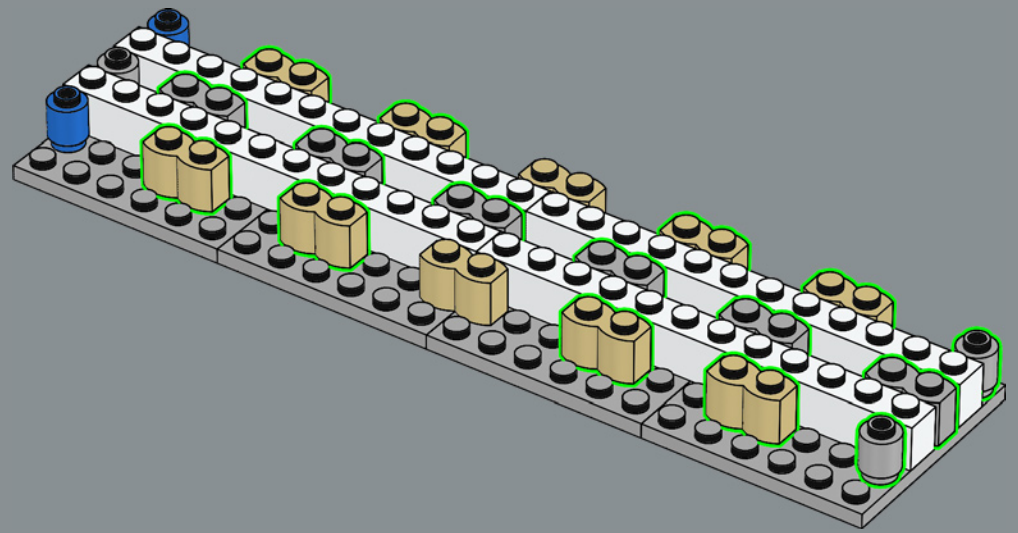

57

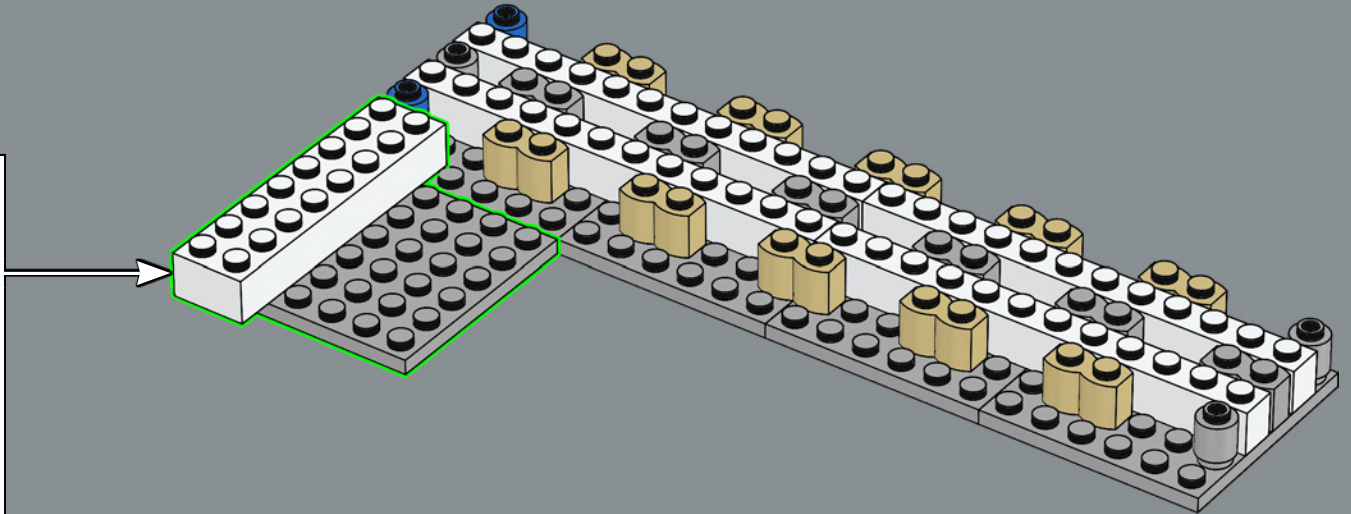
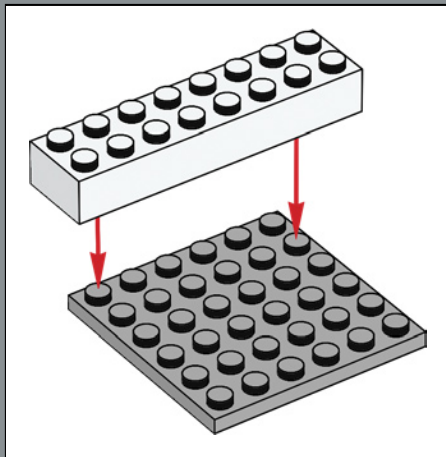

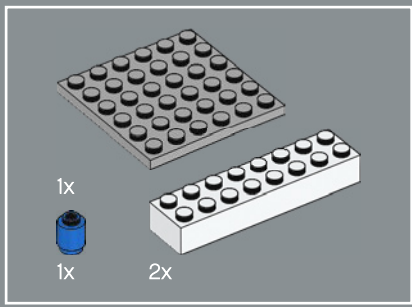

58

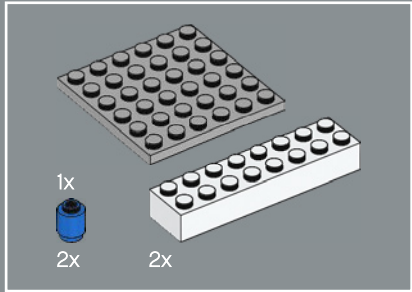
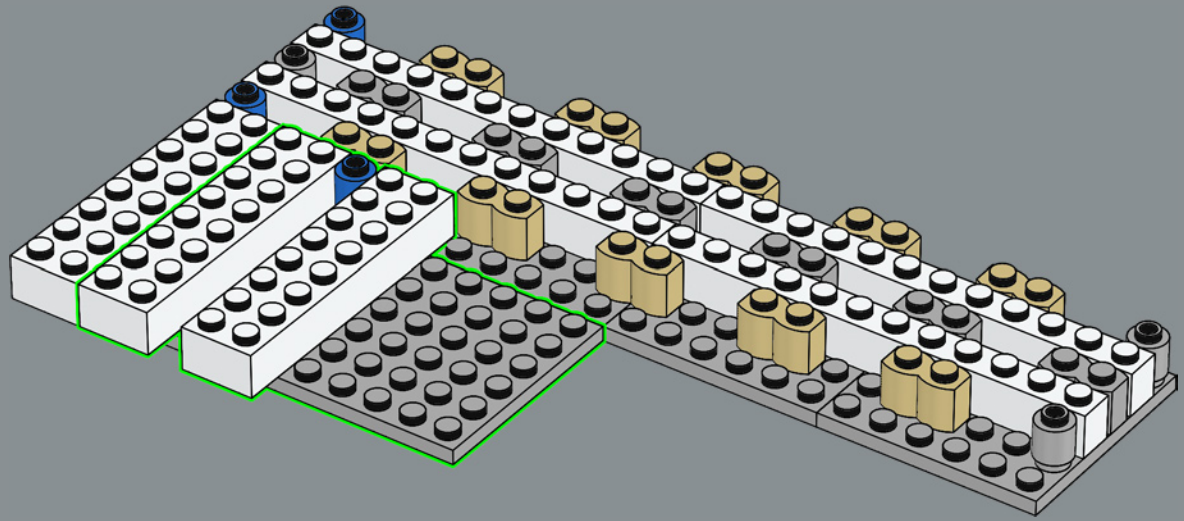

59

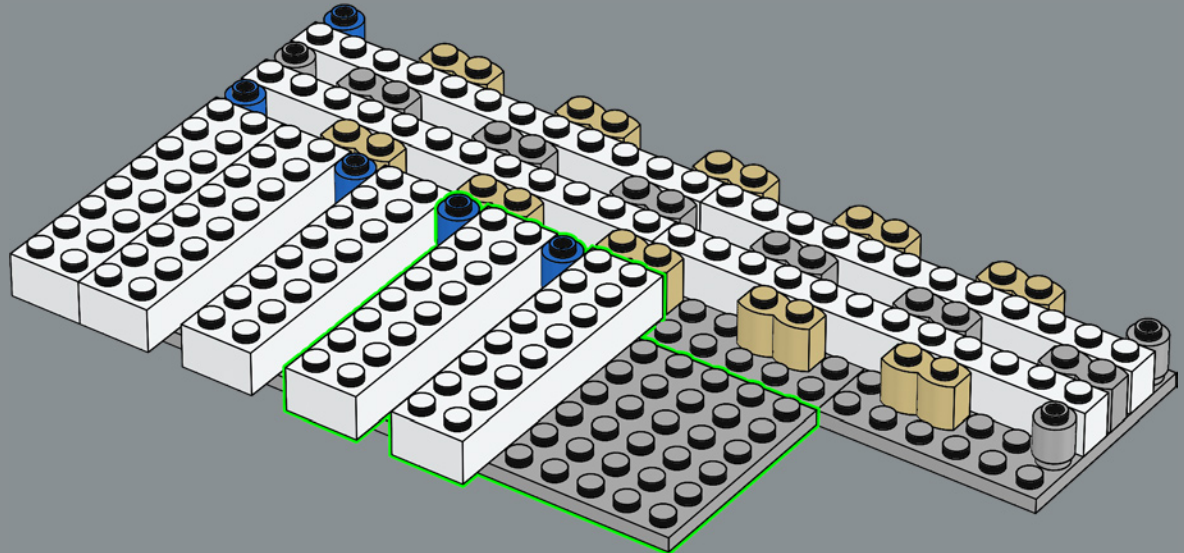

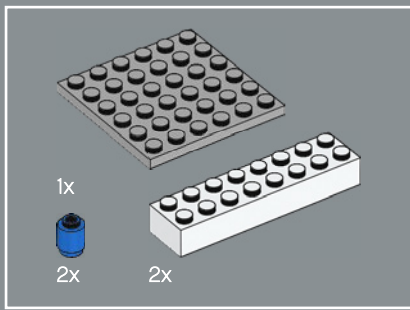

60

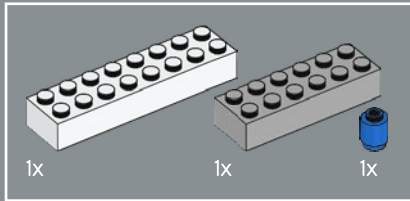
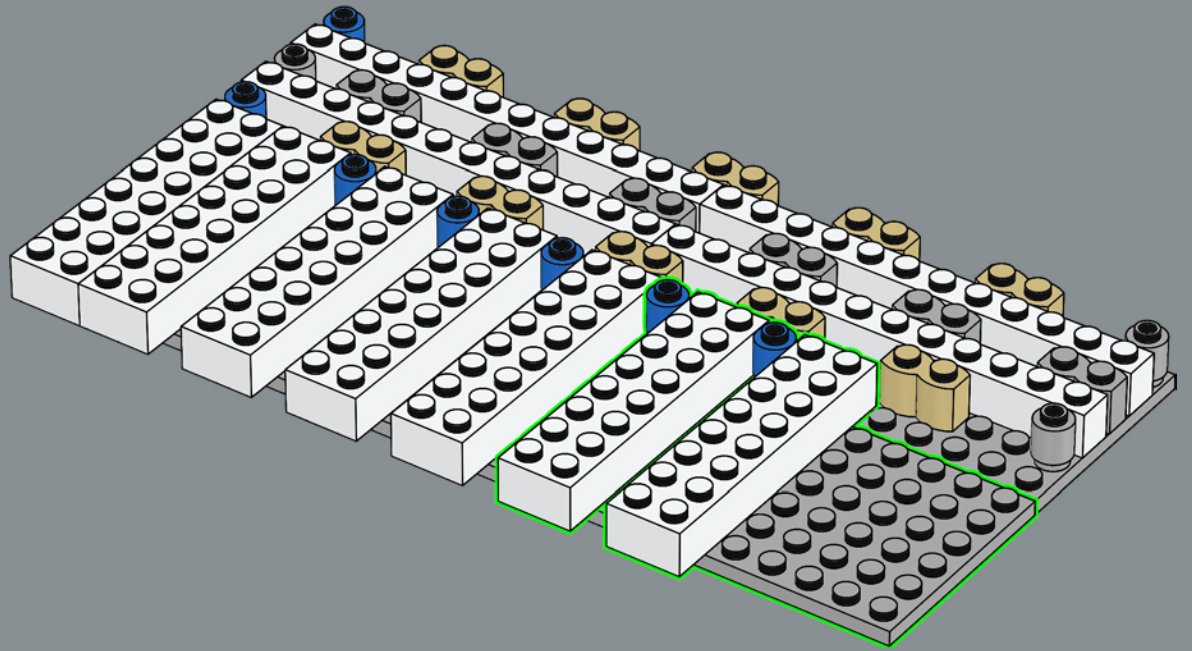

61

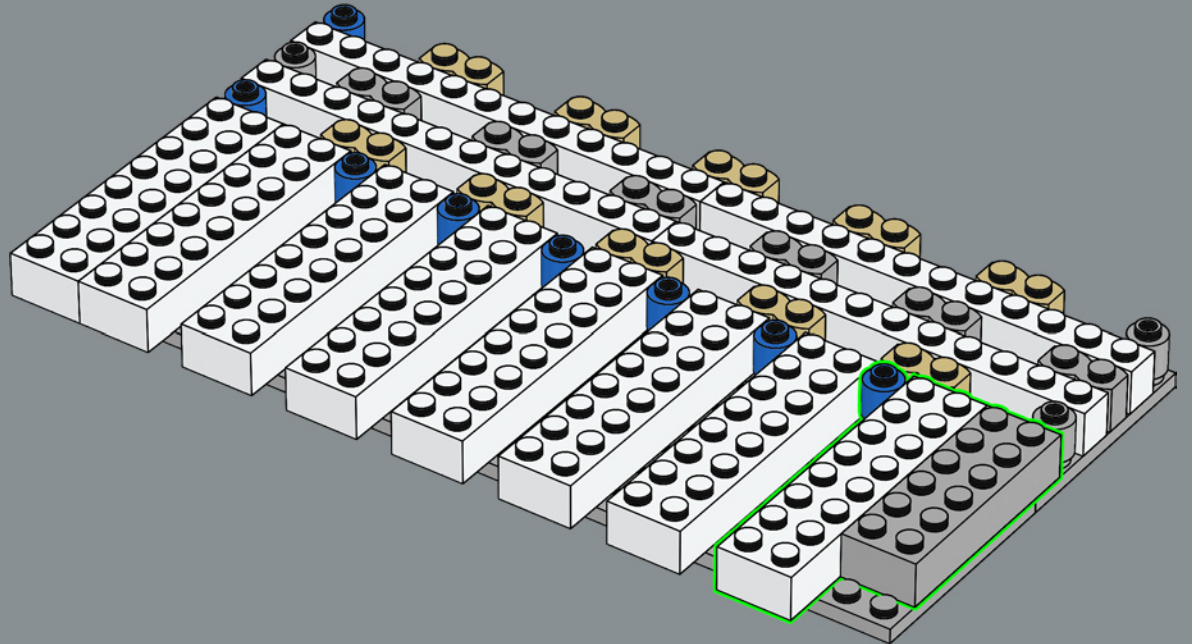

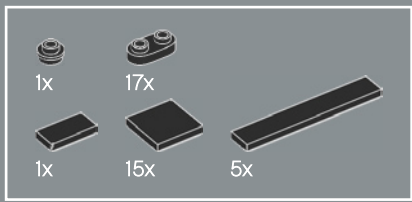

62

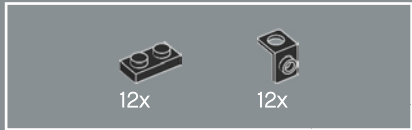
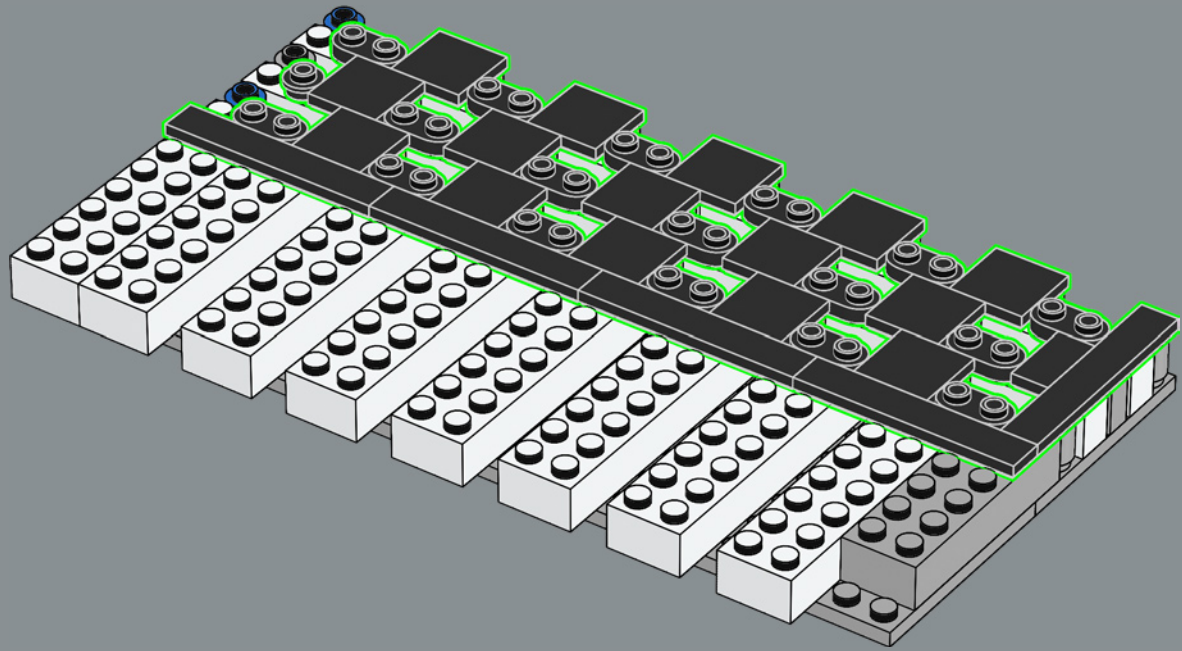

63

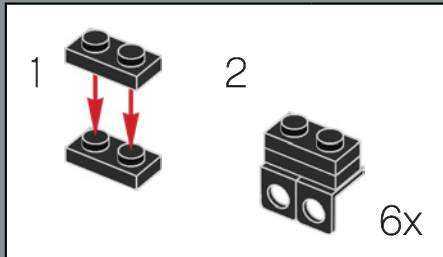
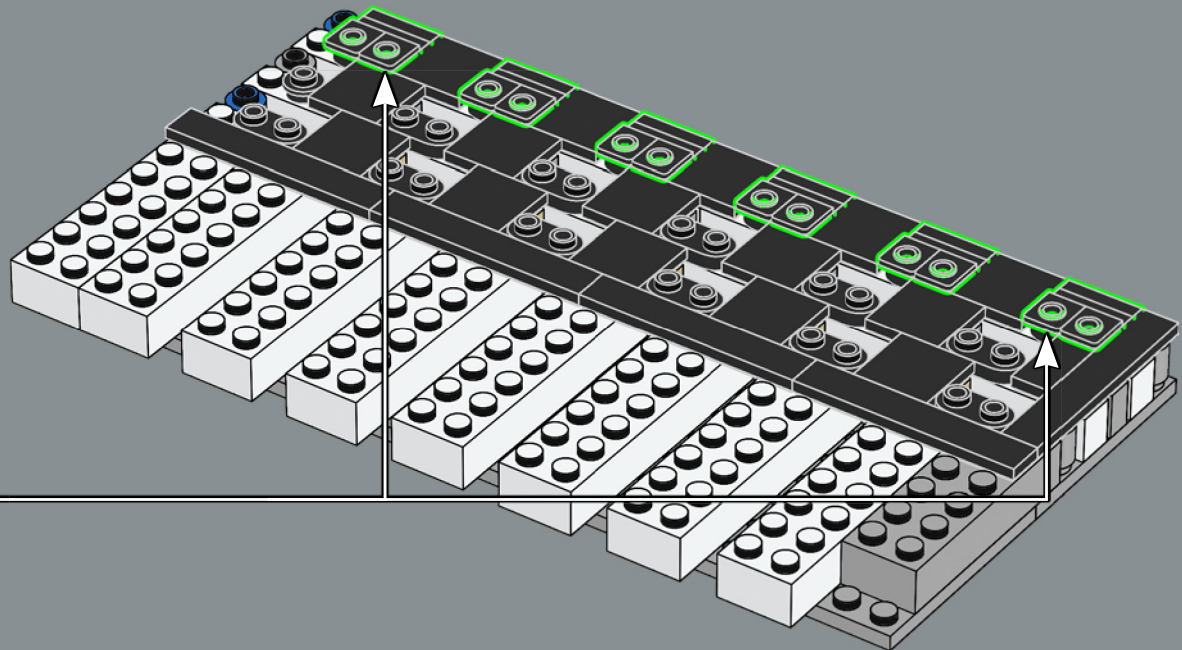





64

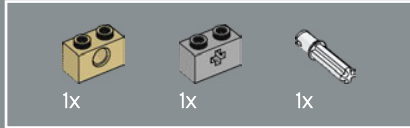
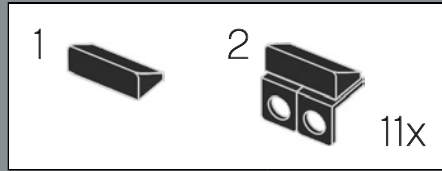
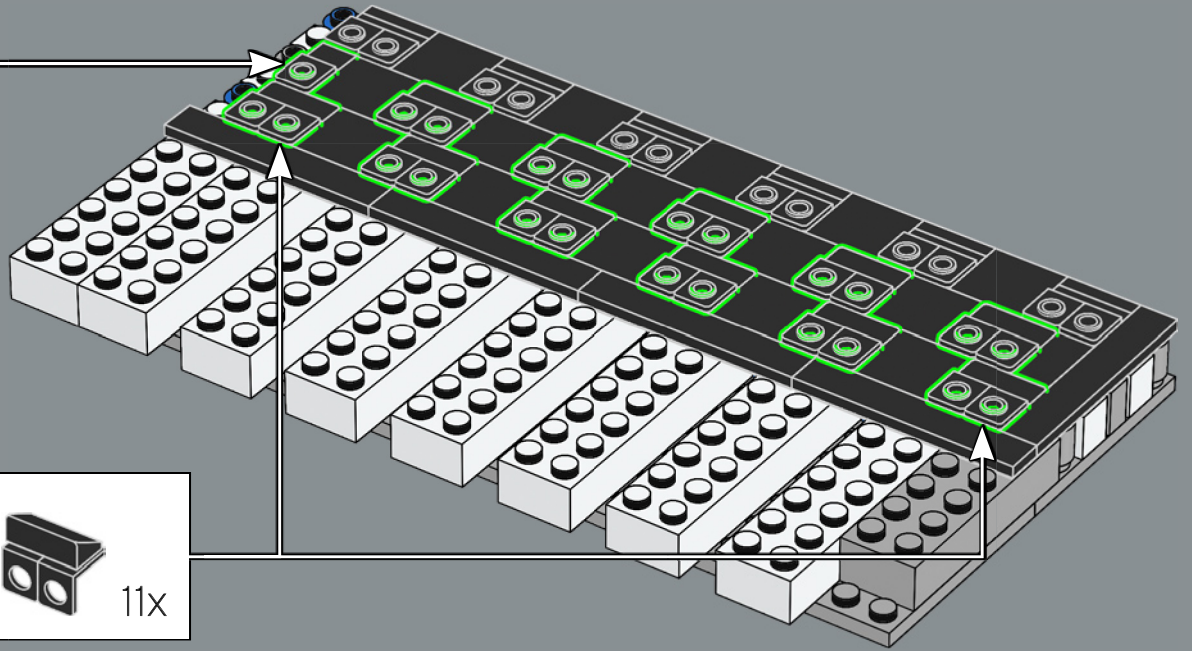
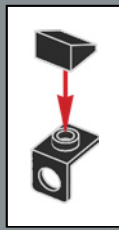

65

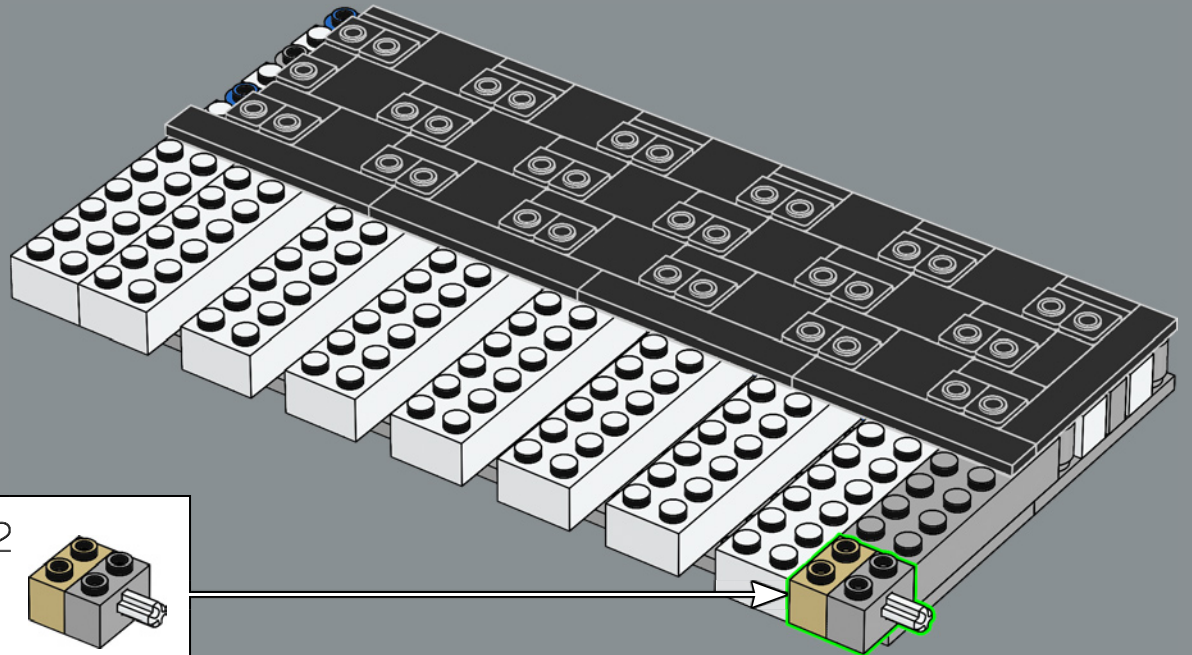
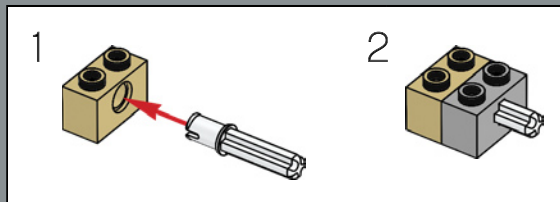

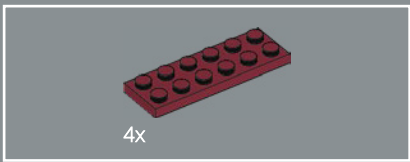

66

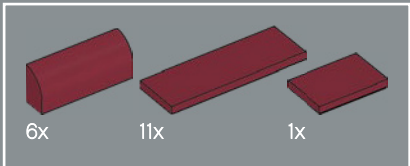
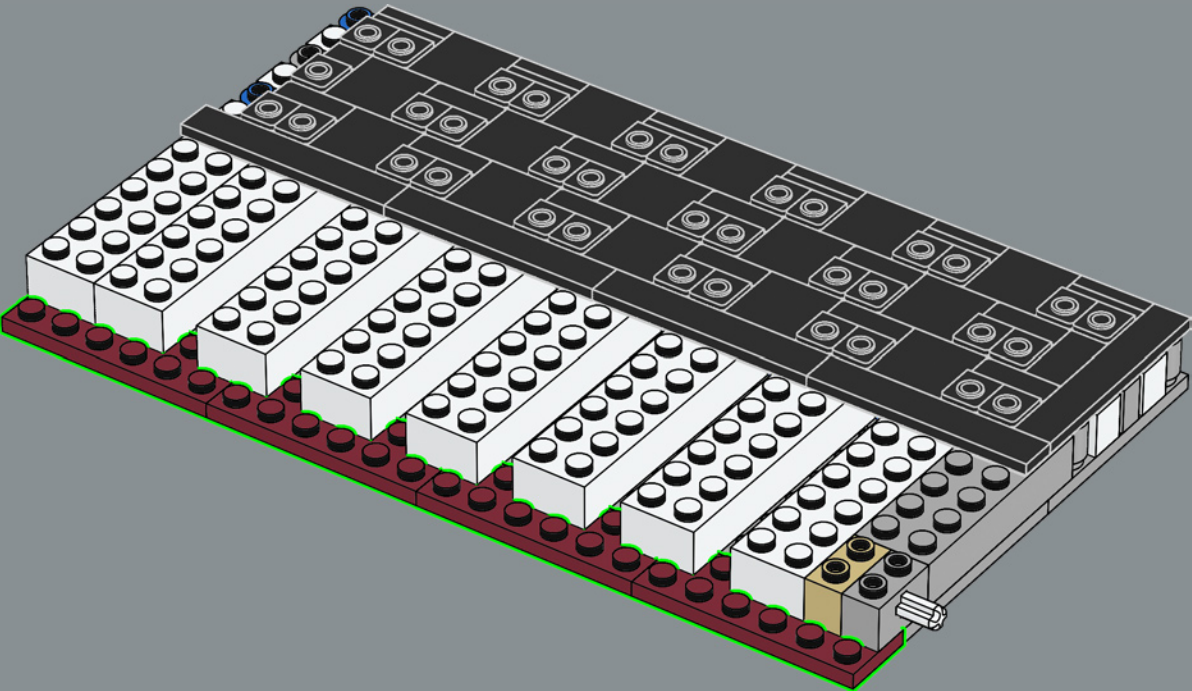

67

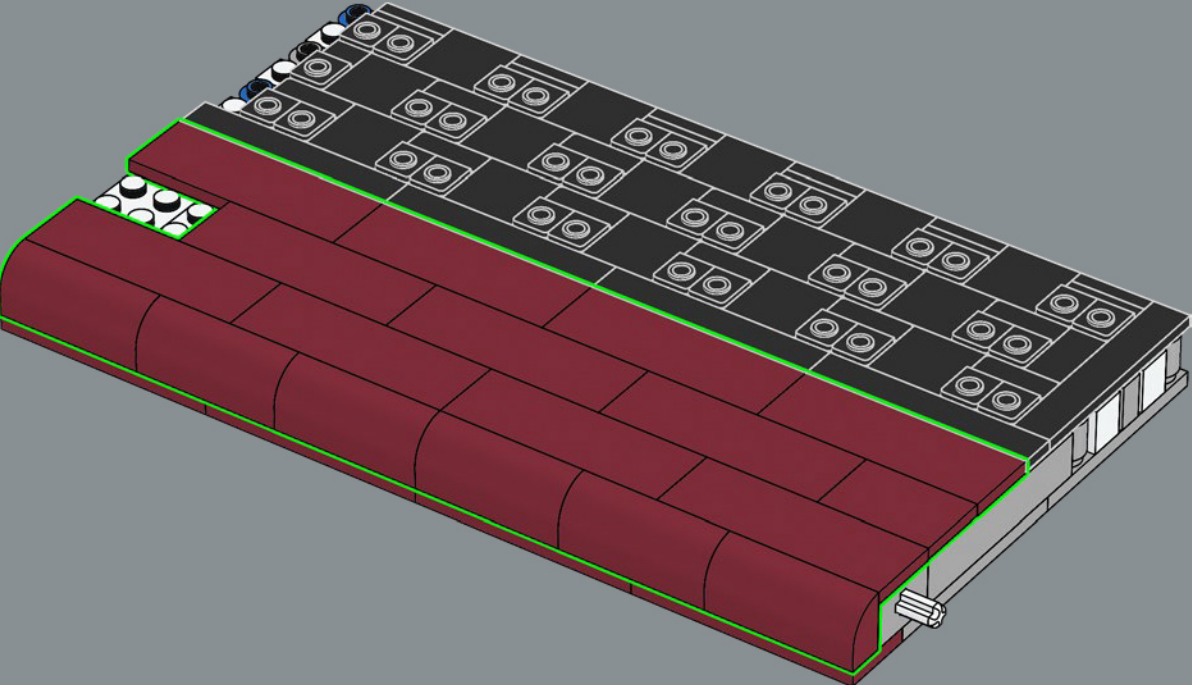

68

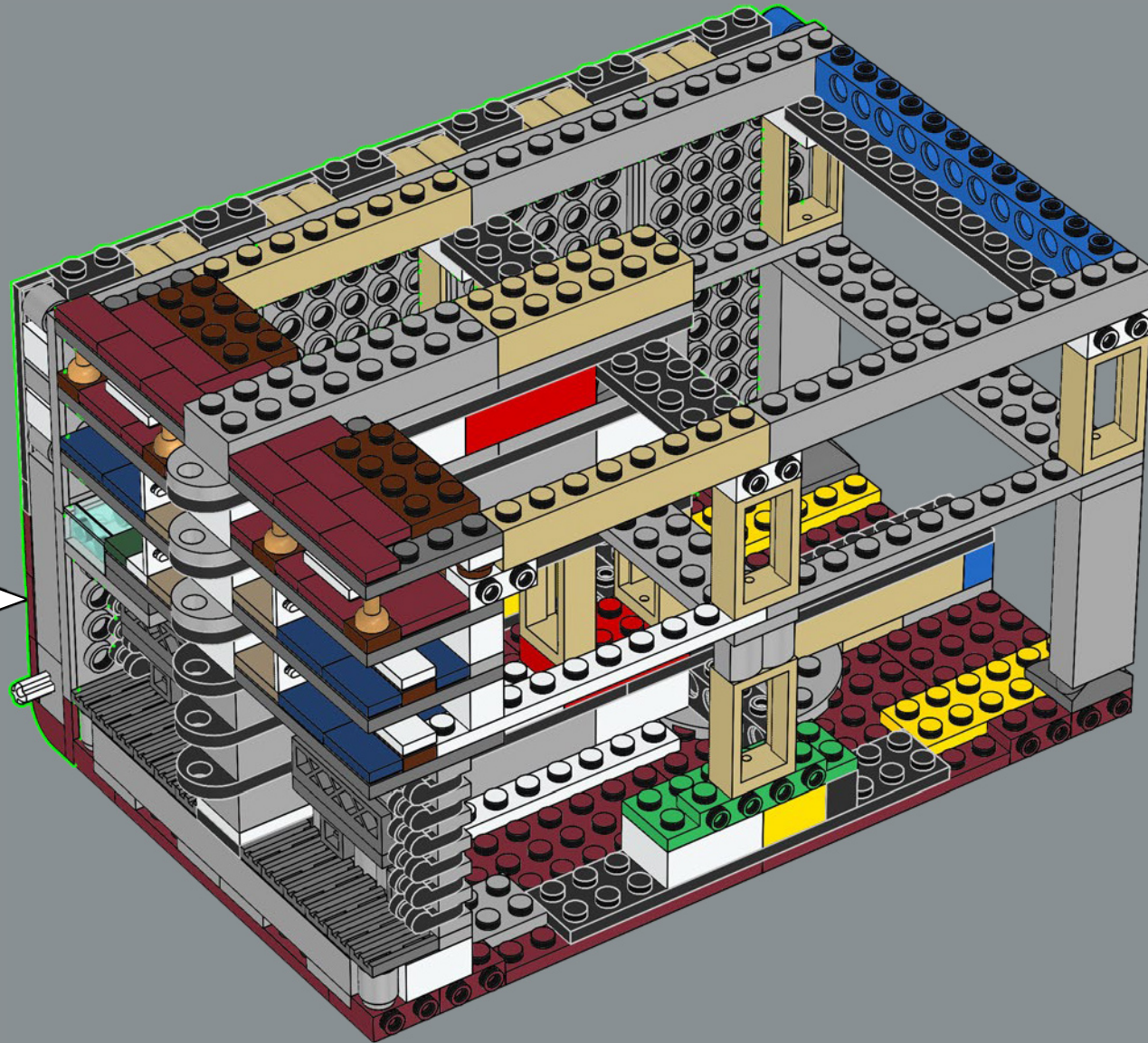

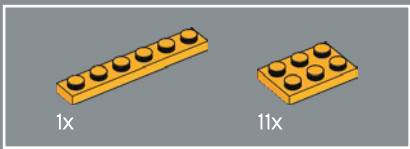

69

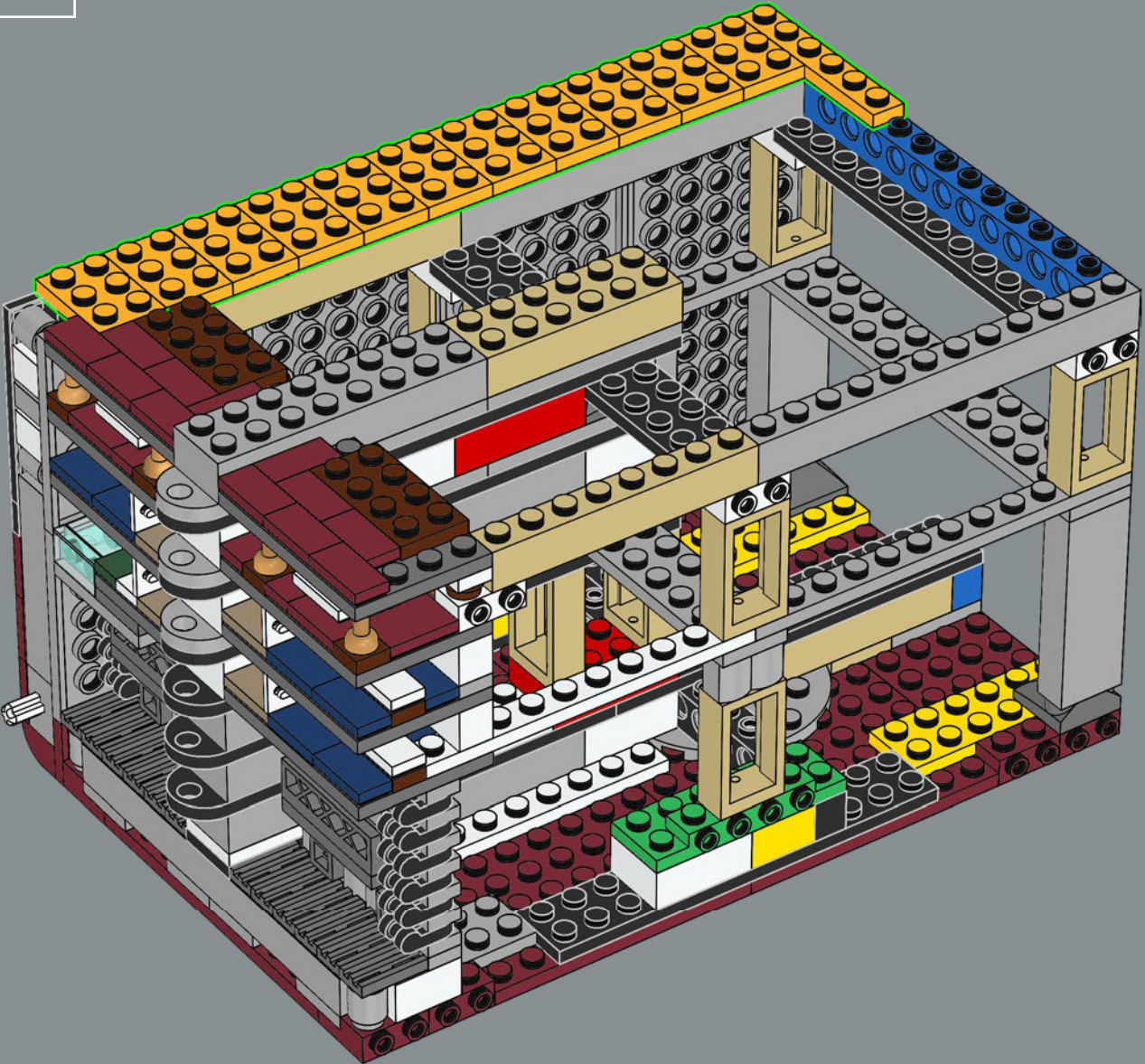

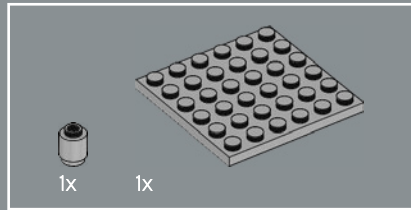
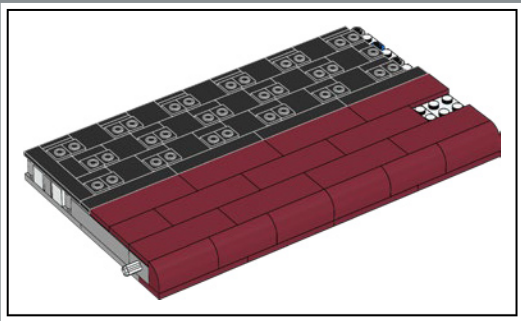
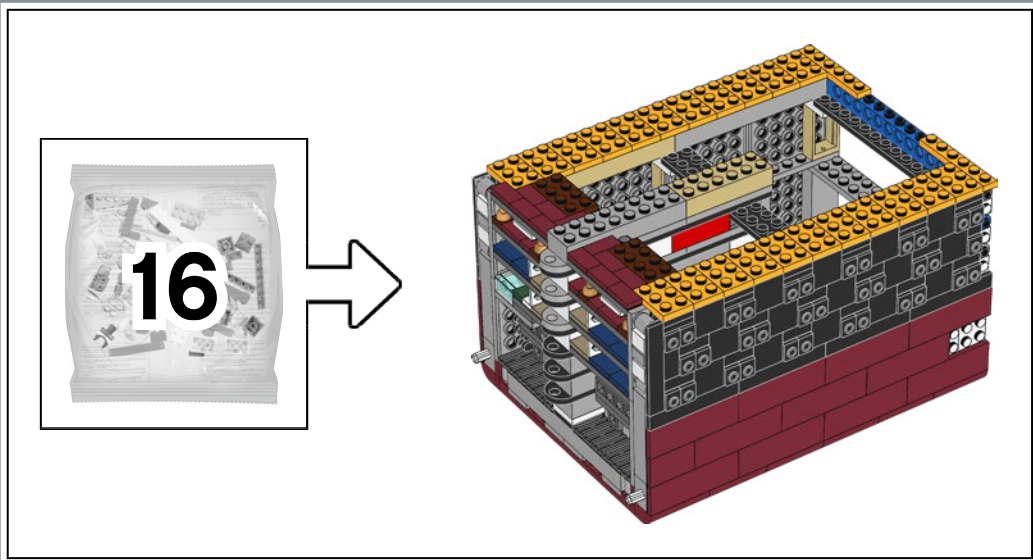

70

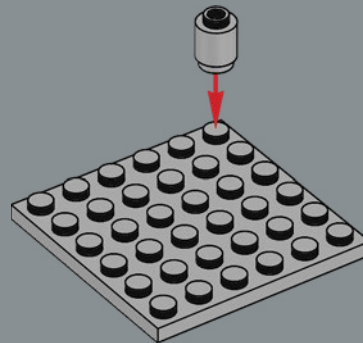

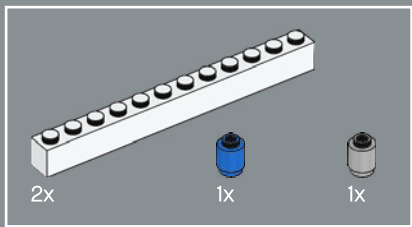

71

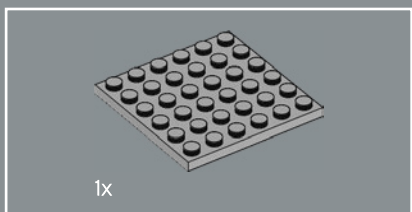
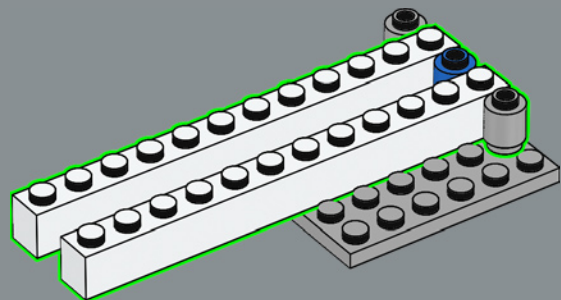

72

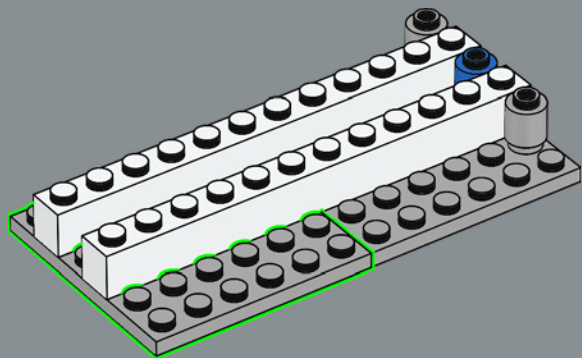

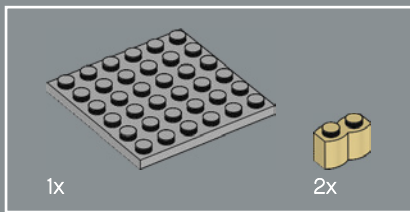

73

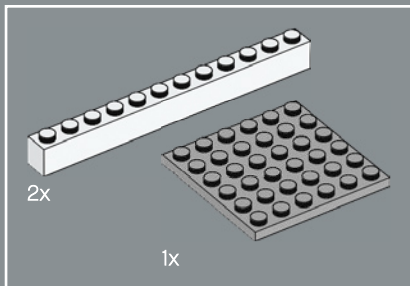
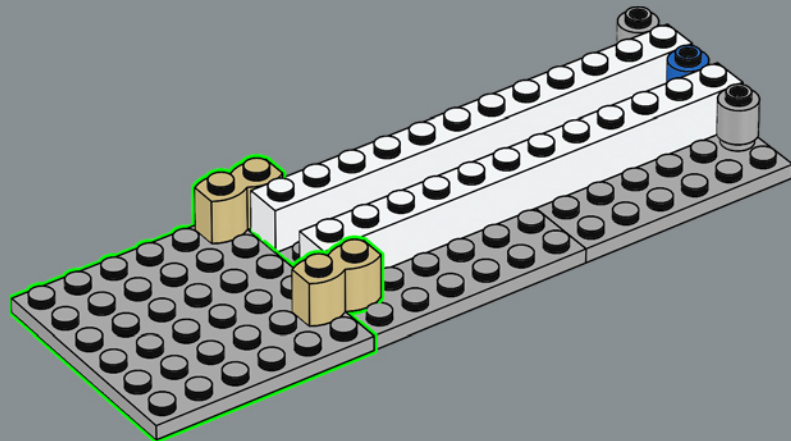

74

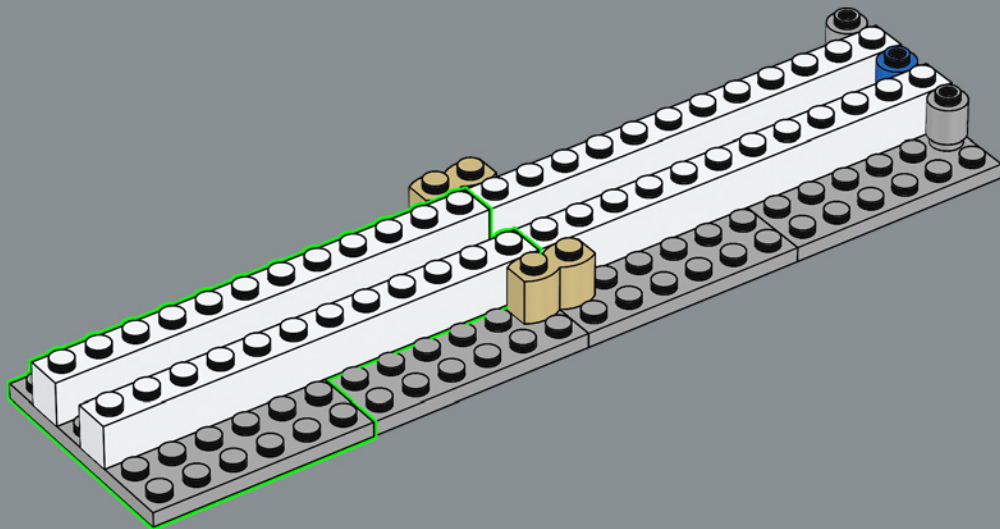

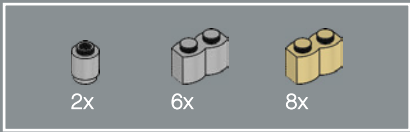

75

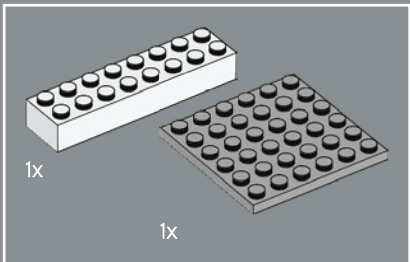
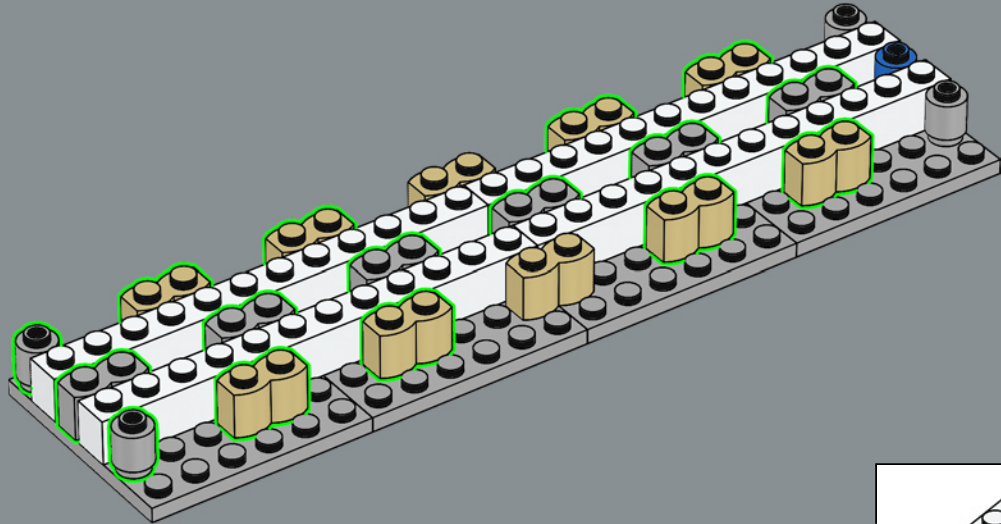

76

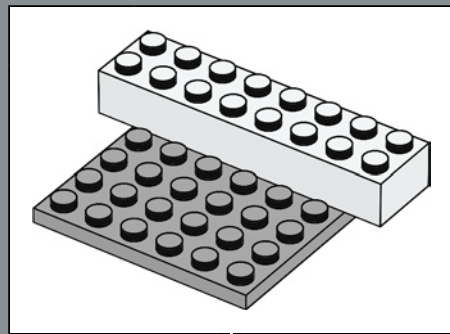
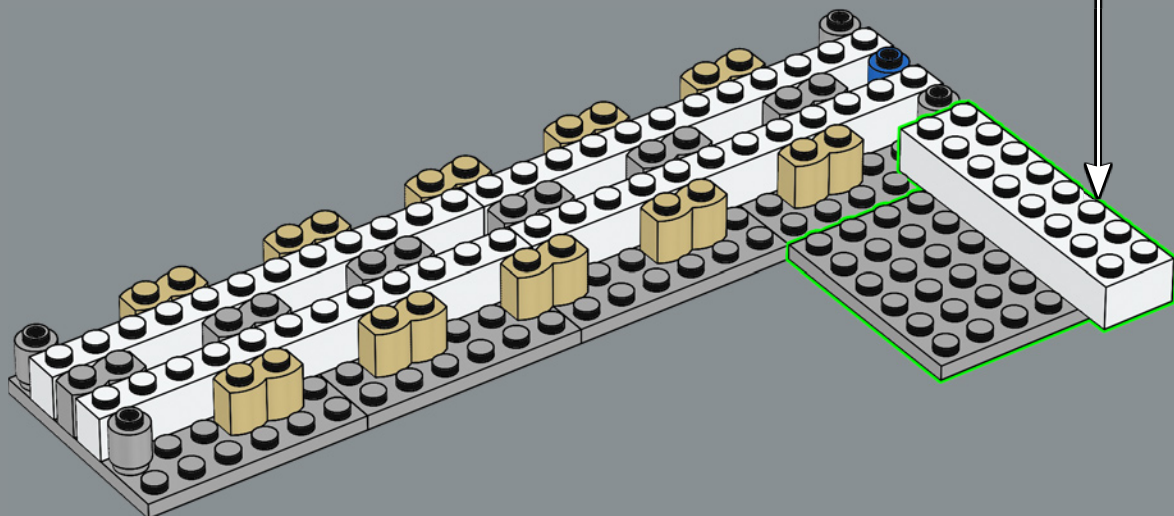



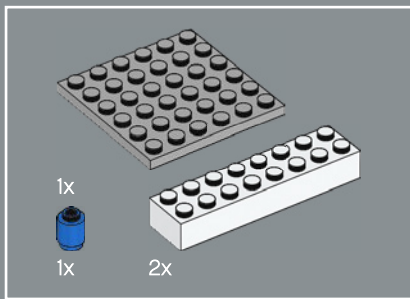

77

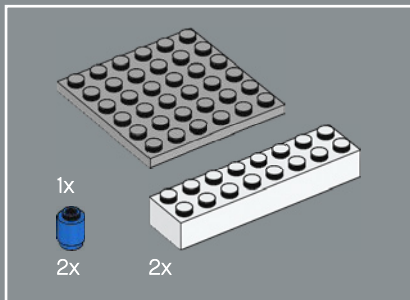
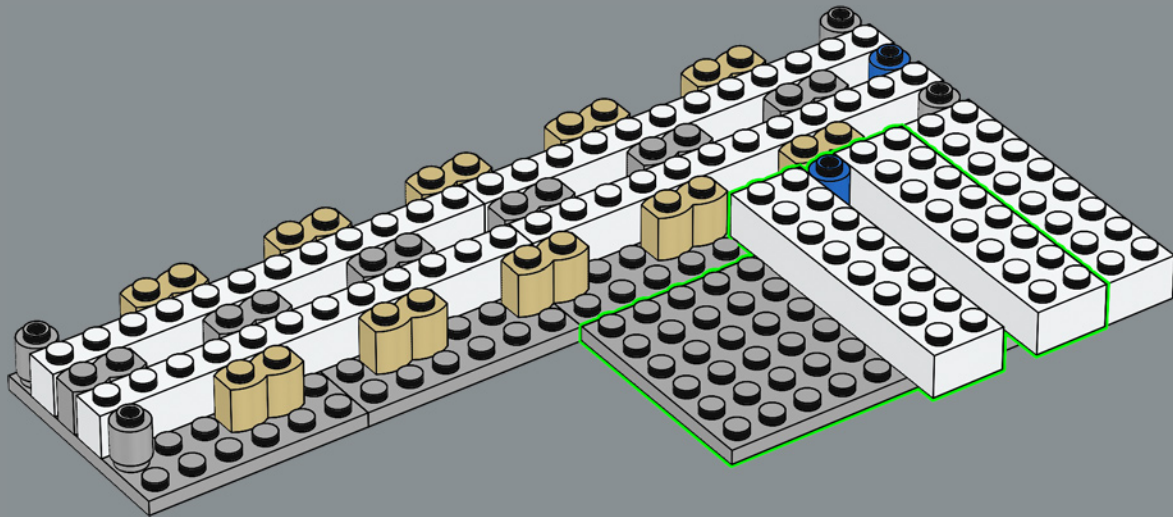

78

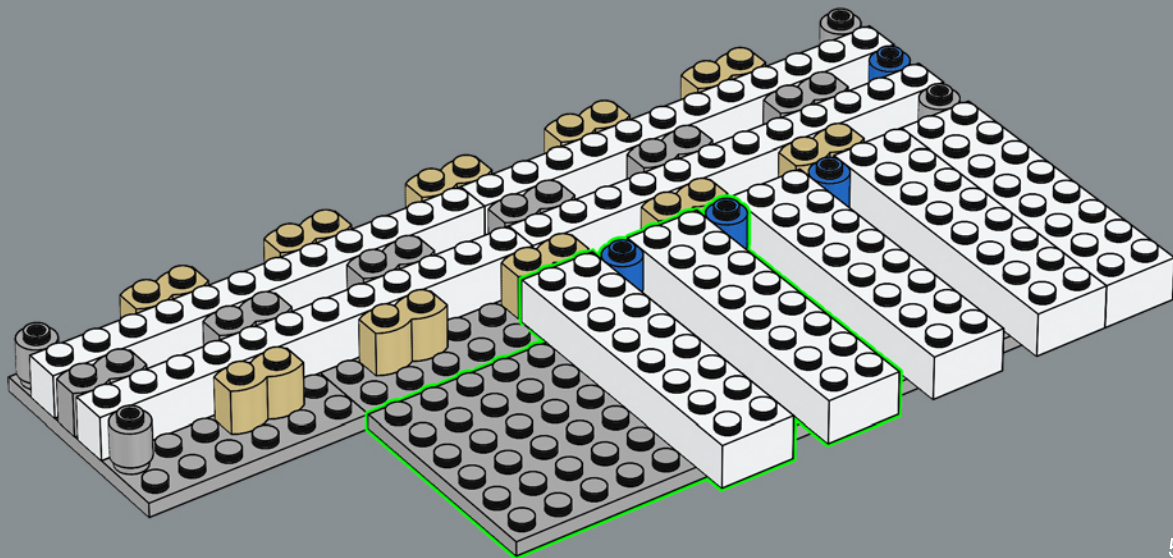

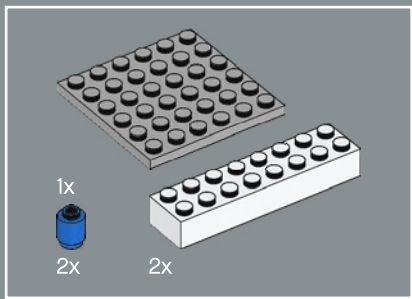

79

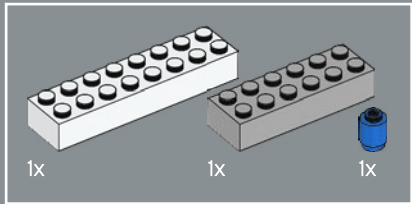
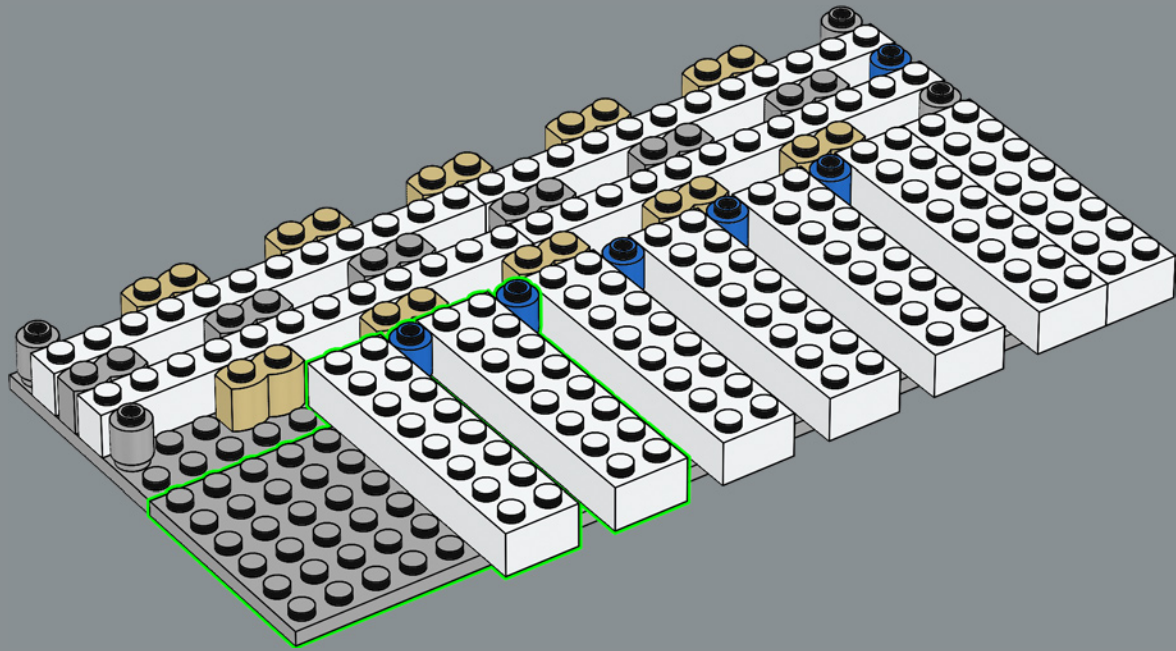

80

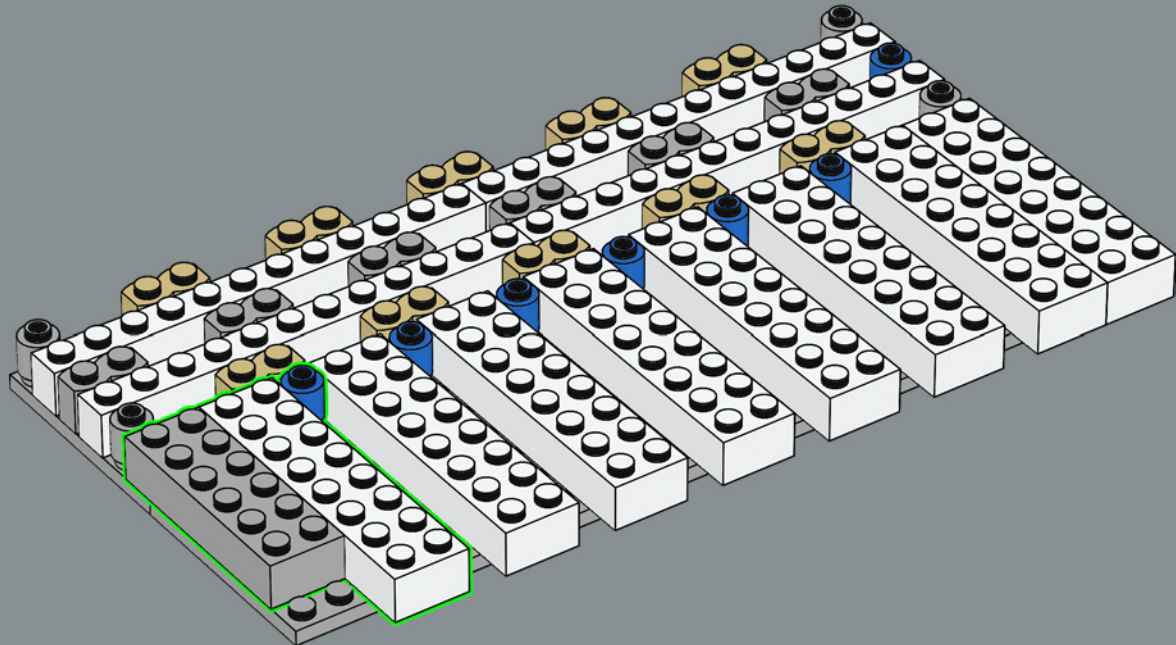

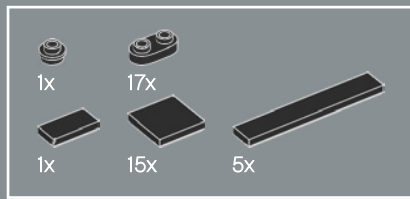

81

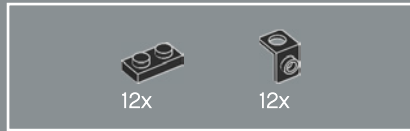
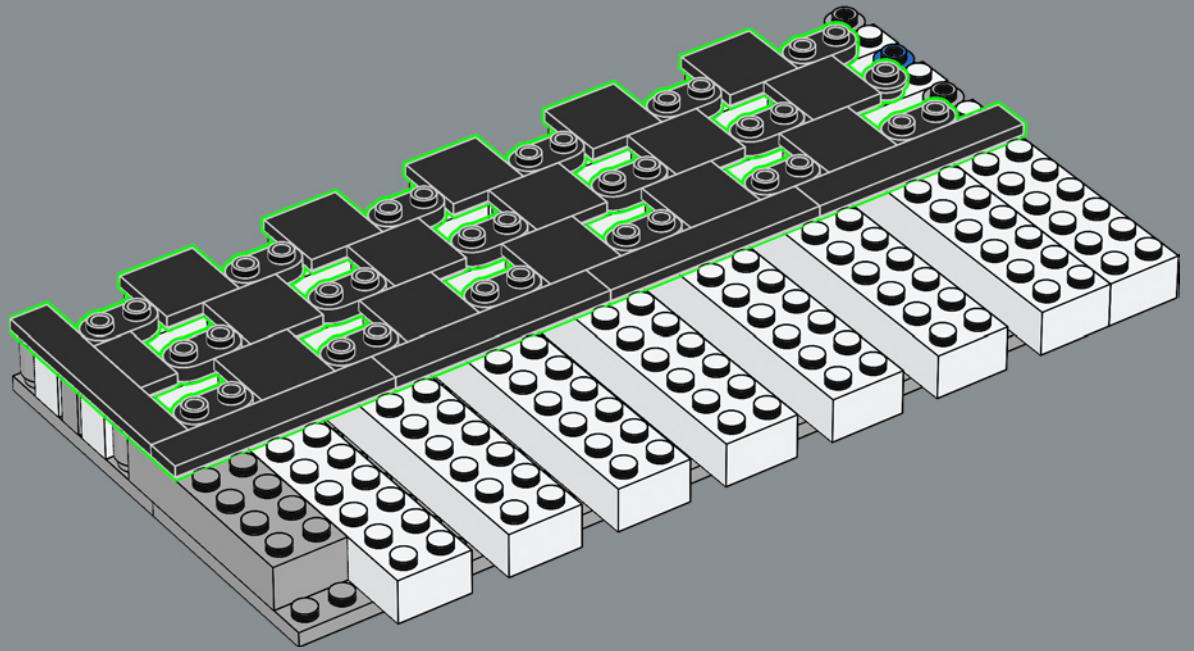

82

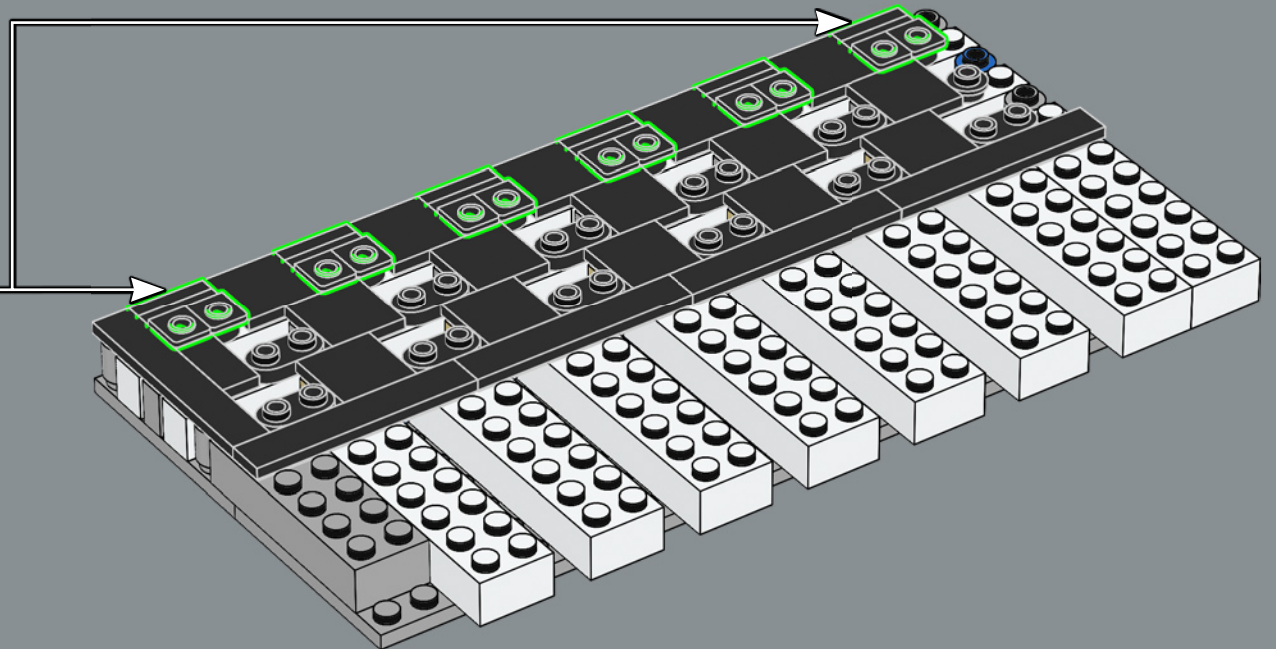
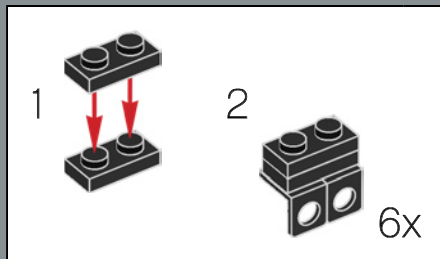



83

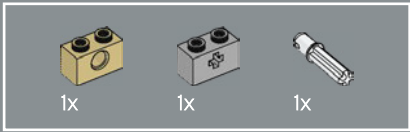
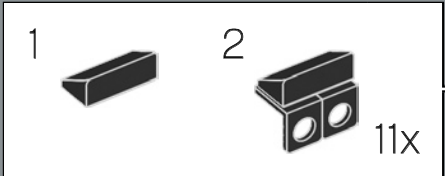
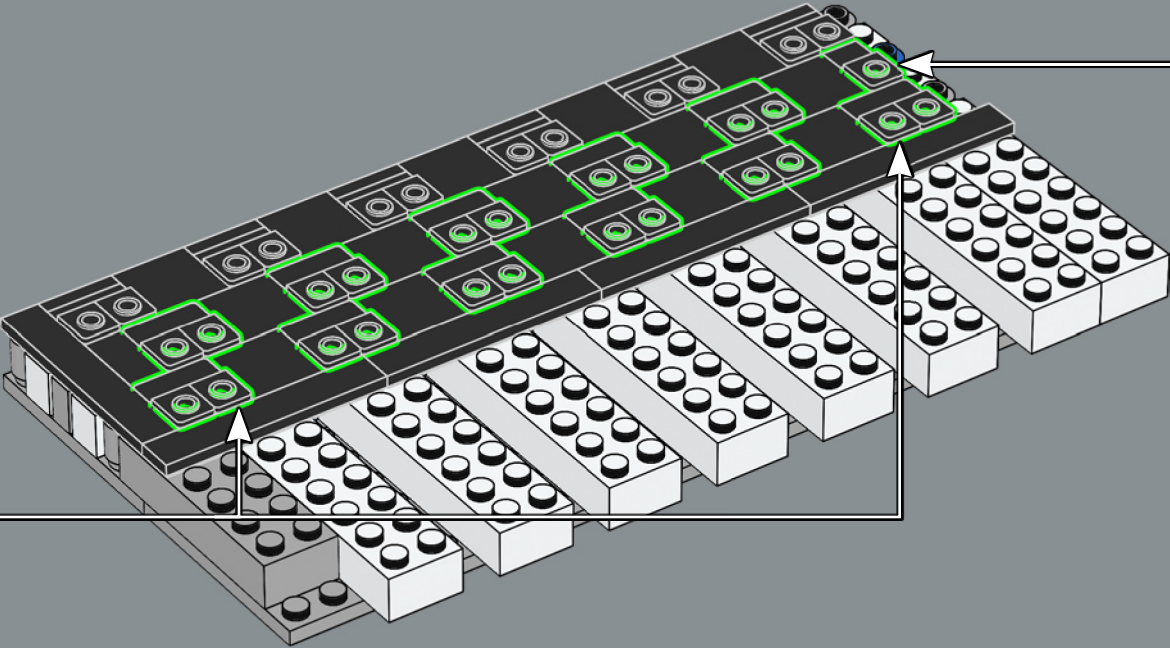
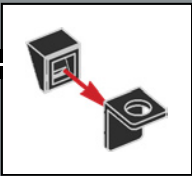

84

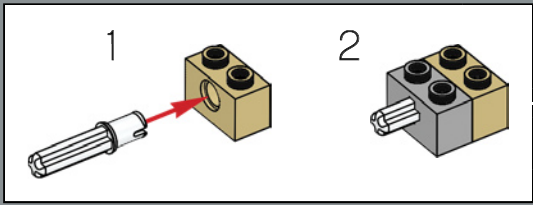
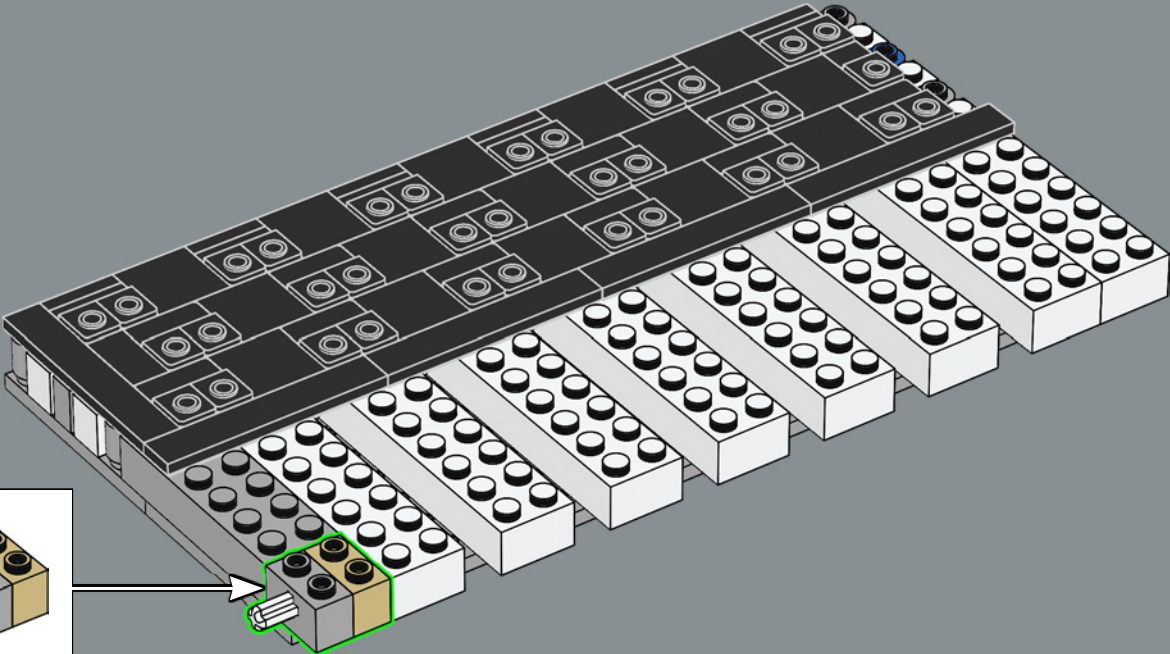

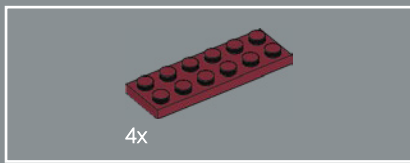

85

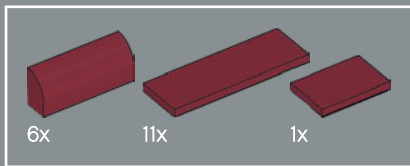
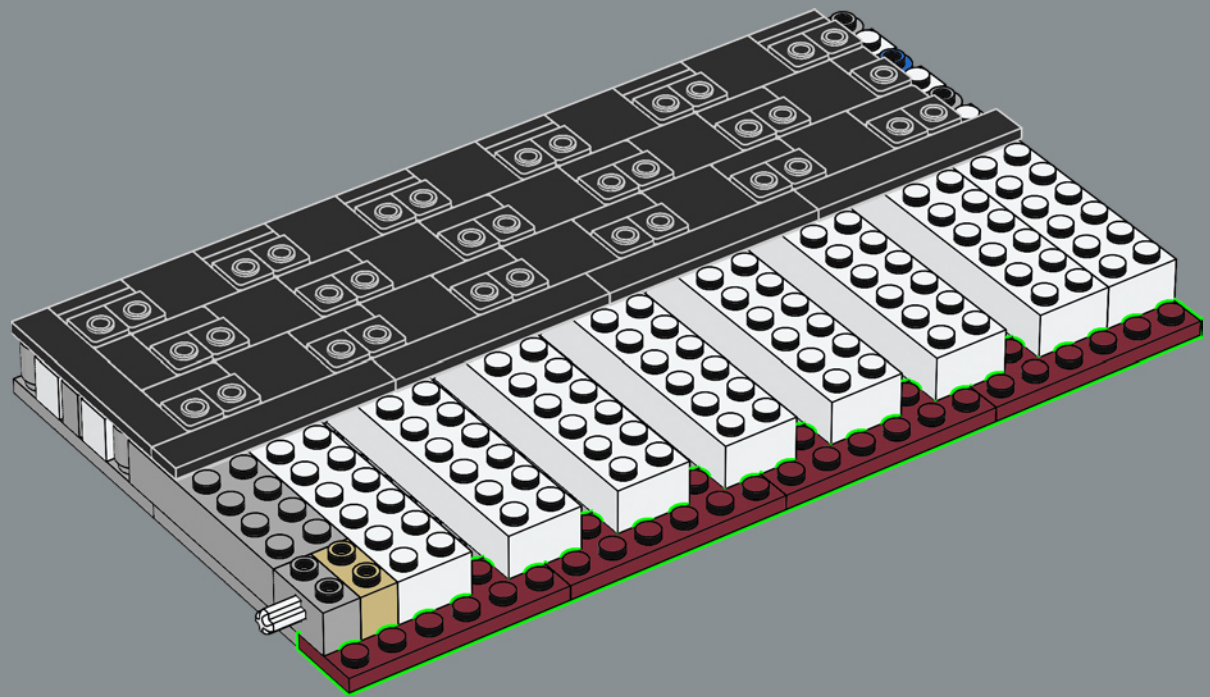

86

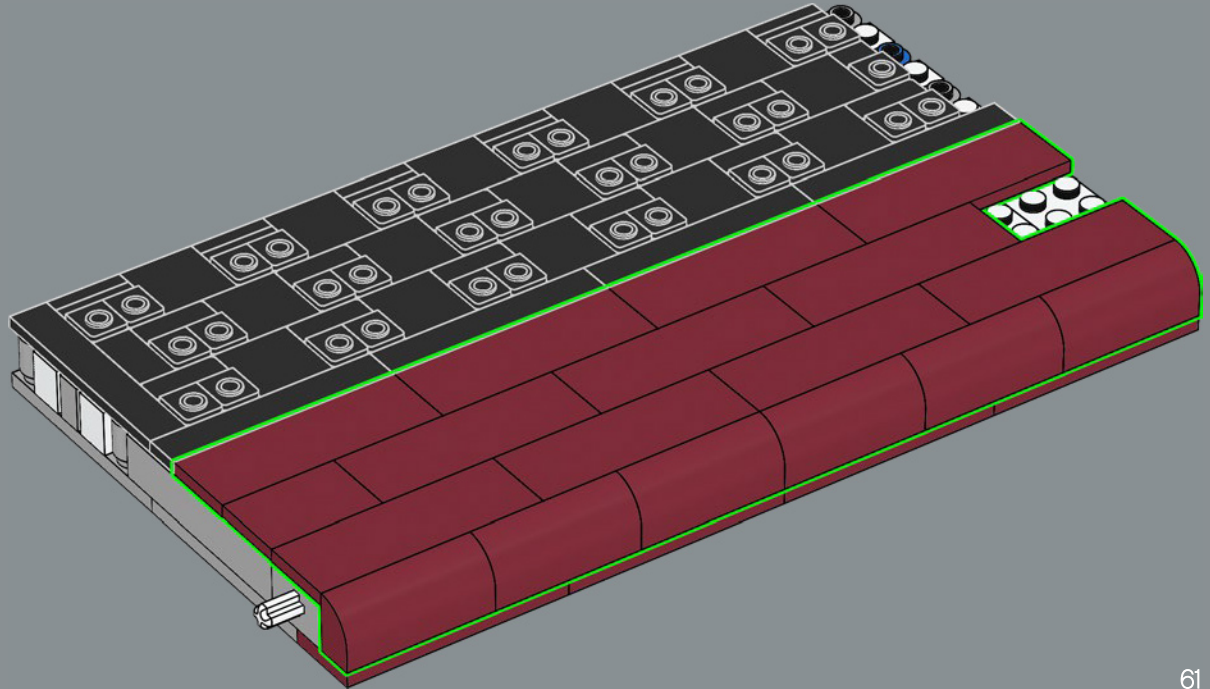

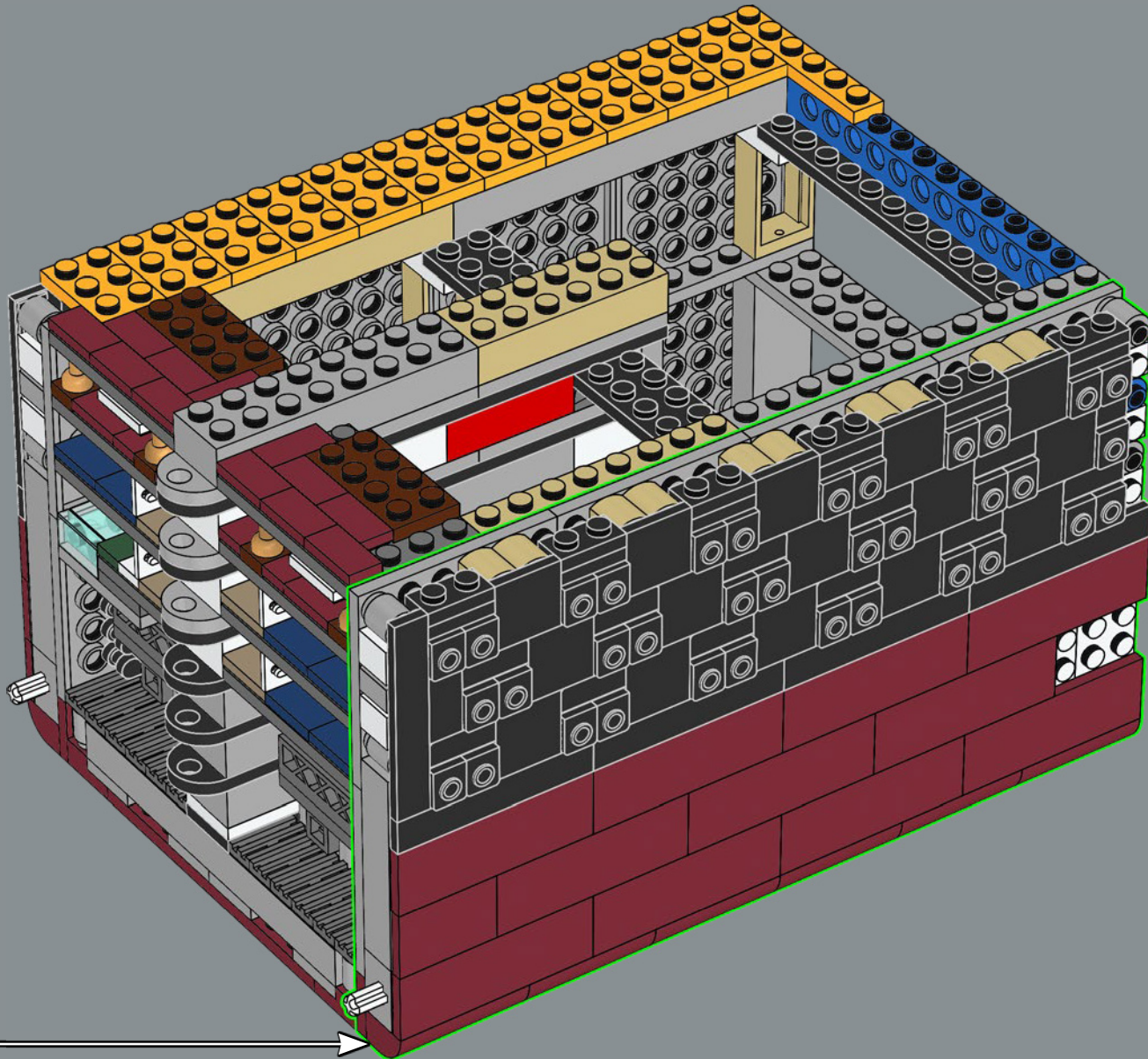

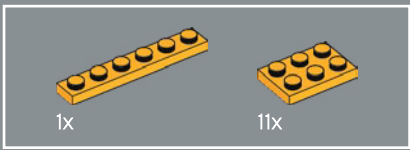

88

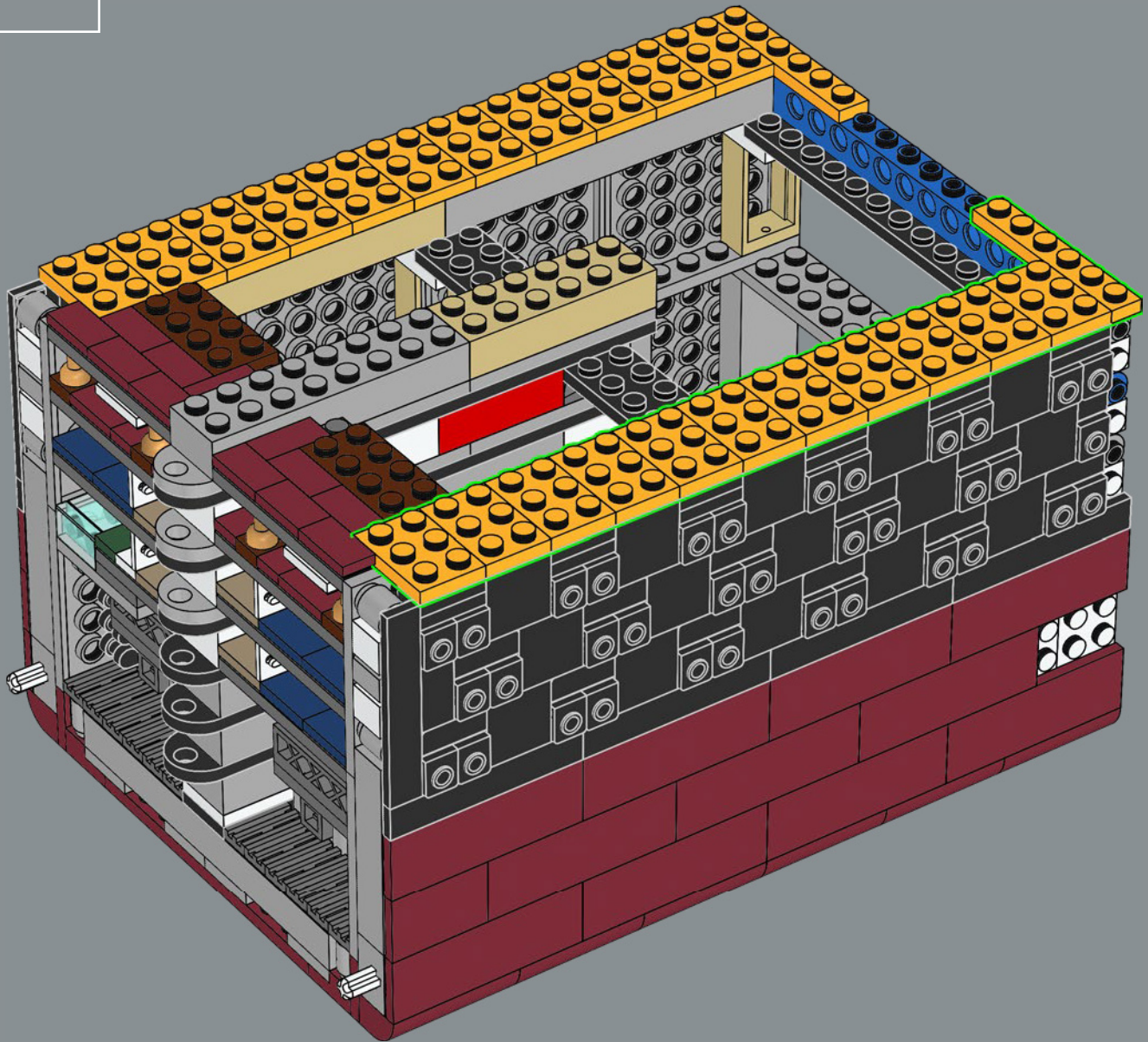

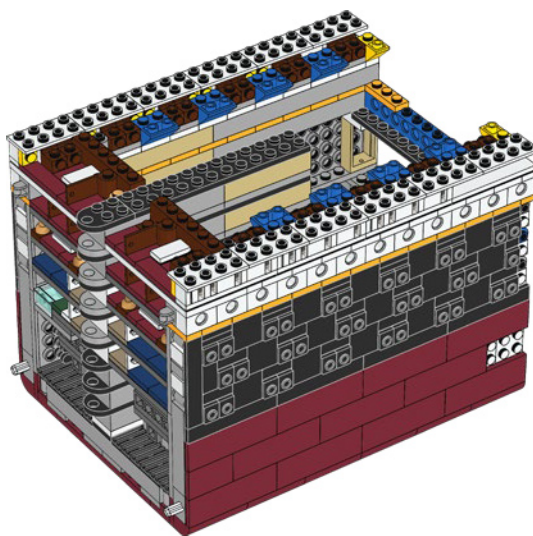
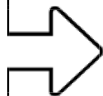



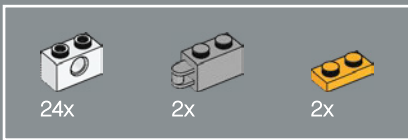

89

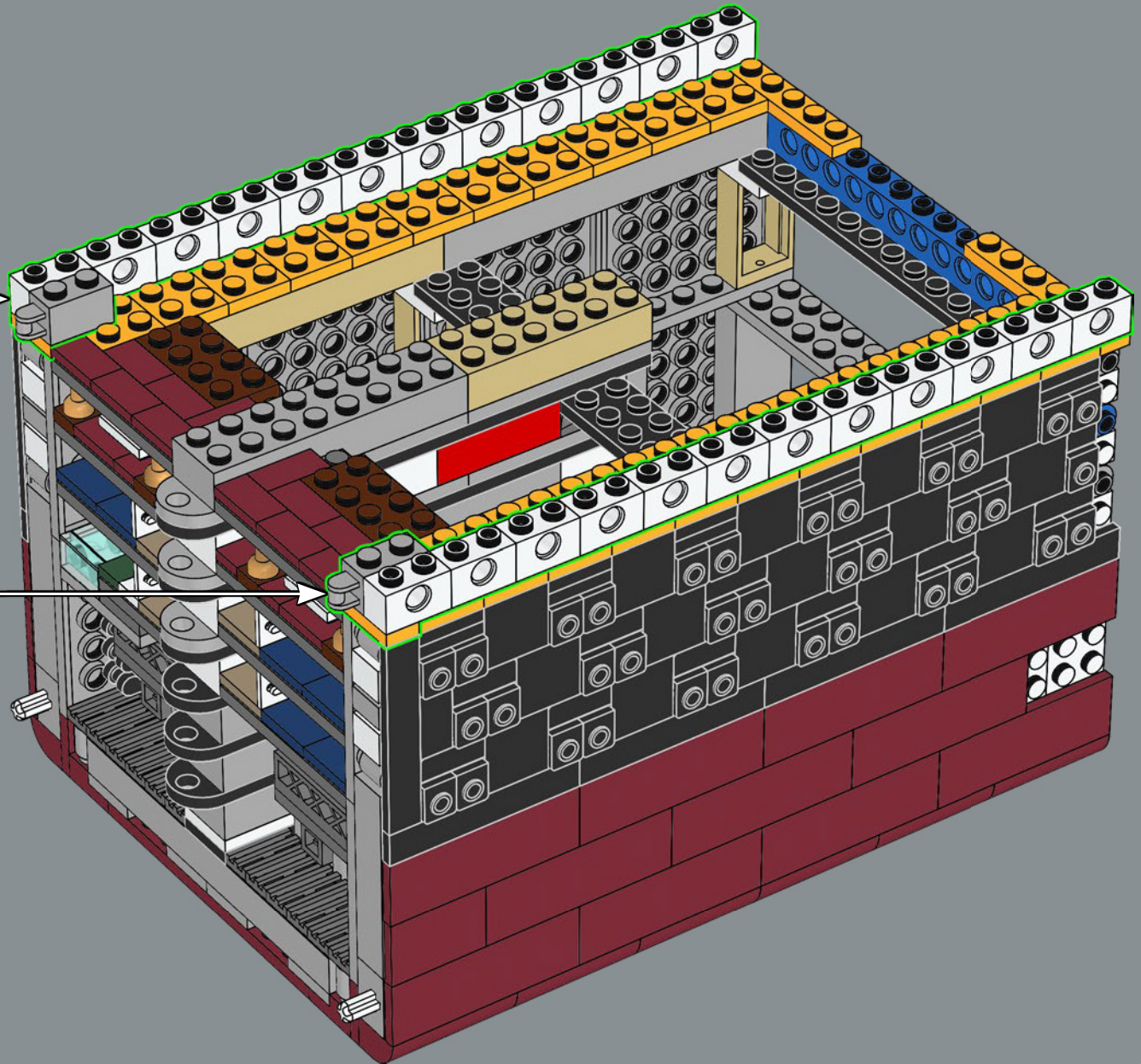
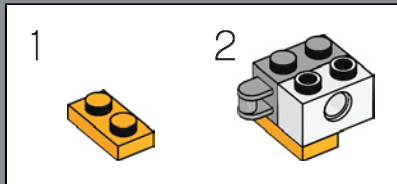
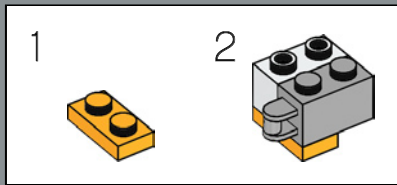

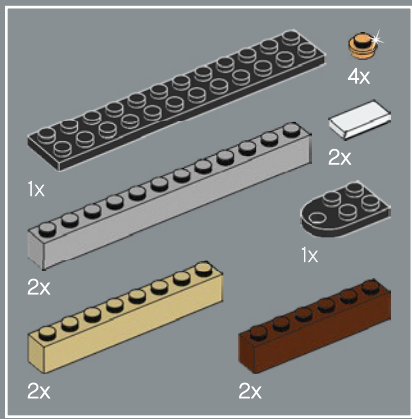

90

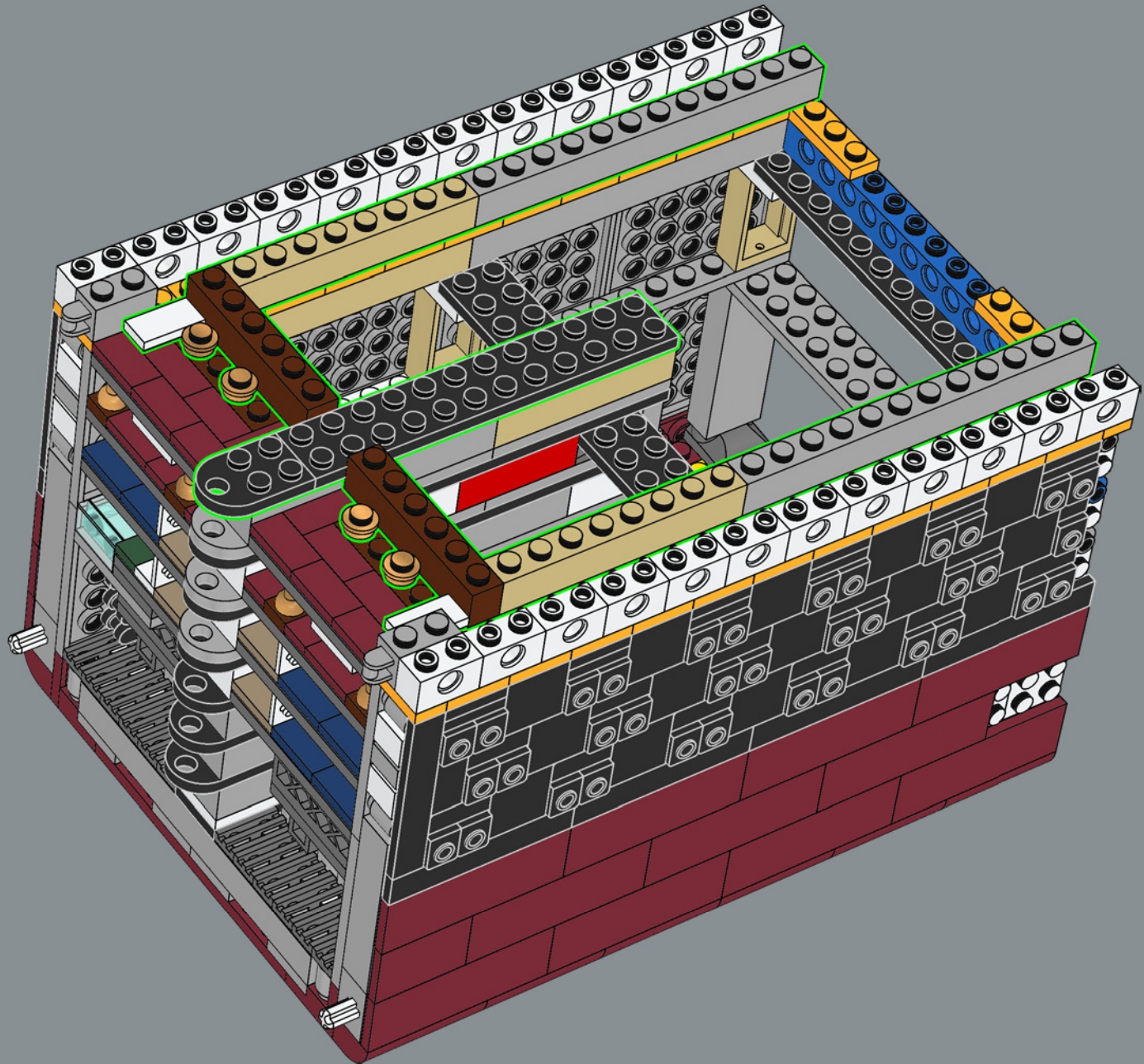

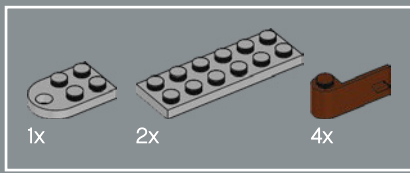

91

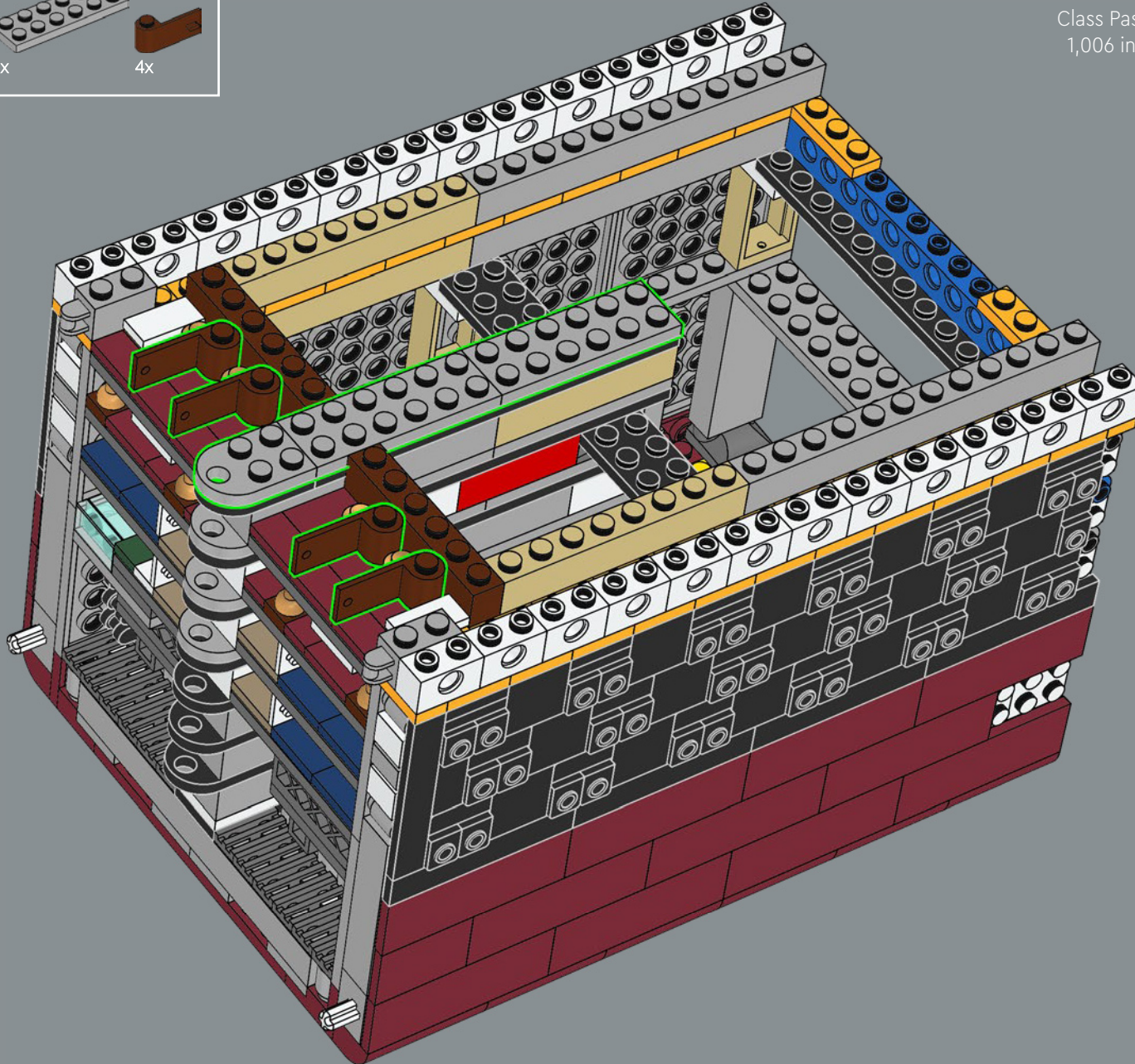

The *Titanic* could accommodate 833 First-Class Passengers, 614 in Second Class and 1,006 in Third Class, for a total passenger capacity of 2,453.

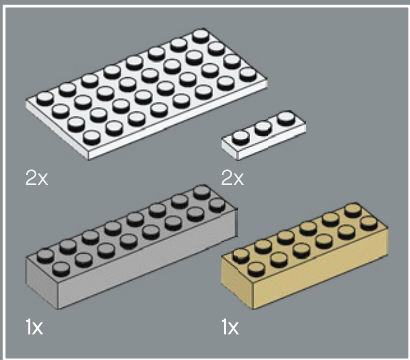

92

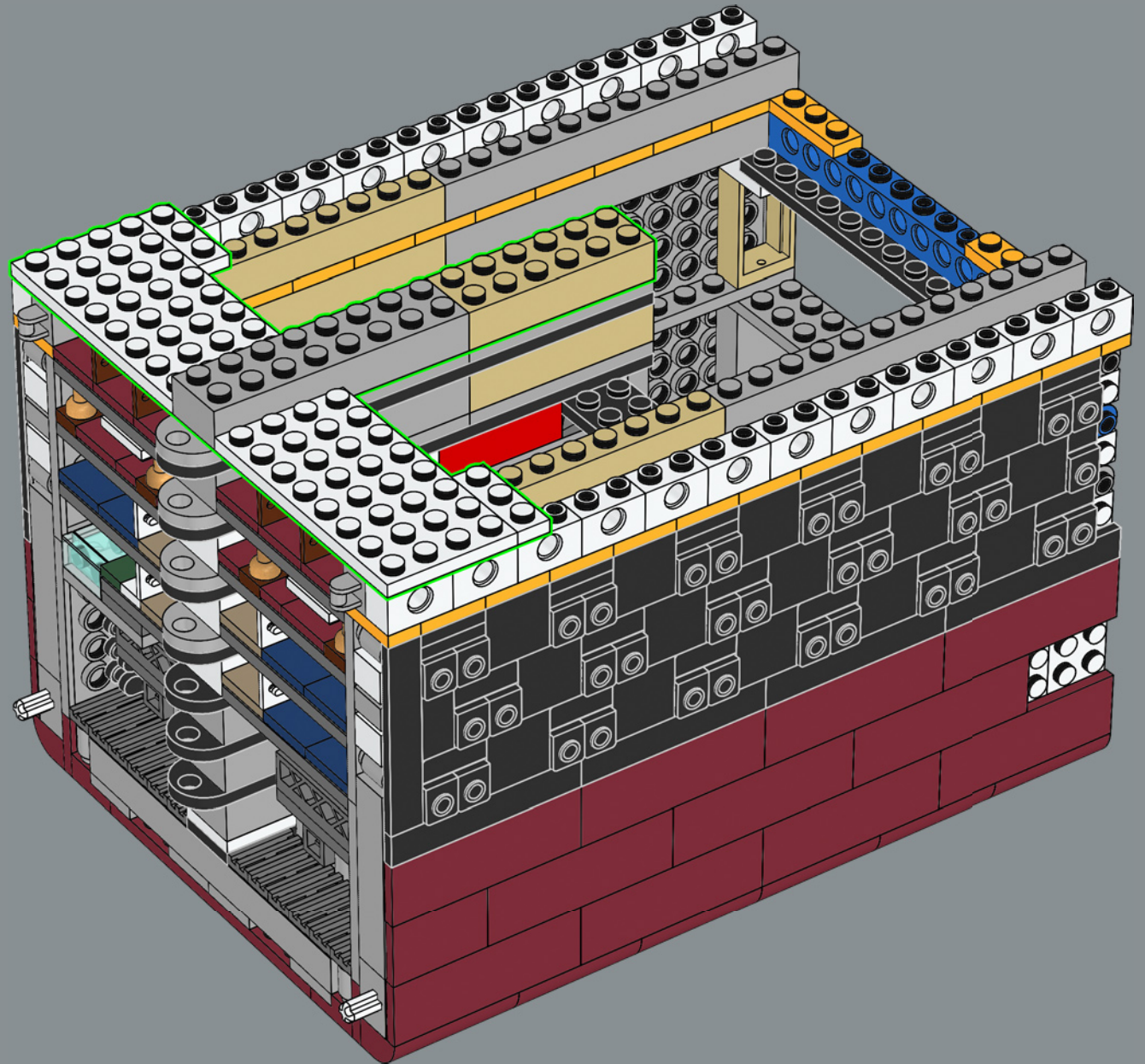

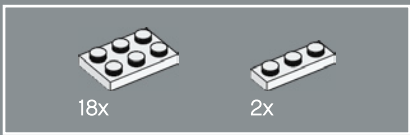

93

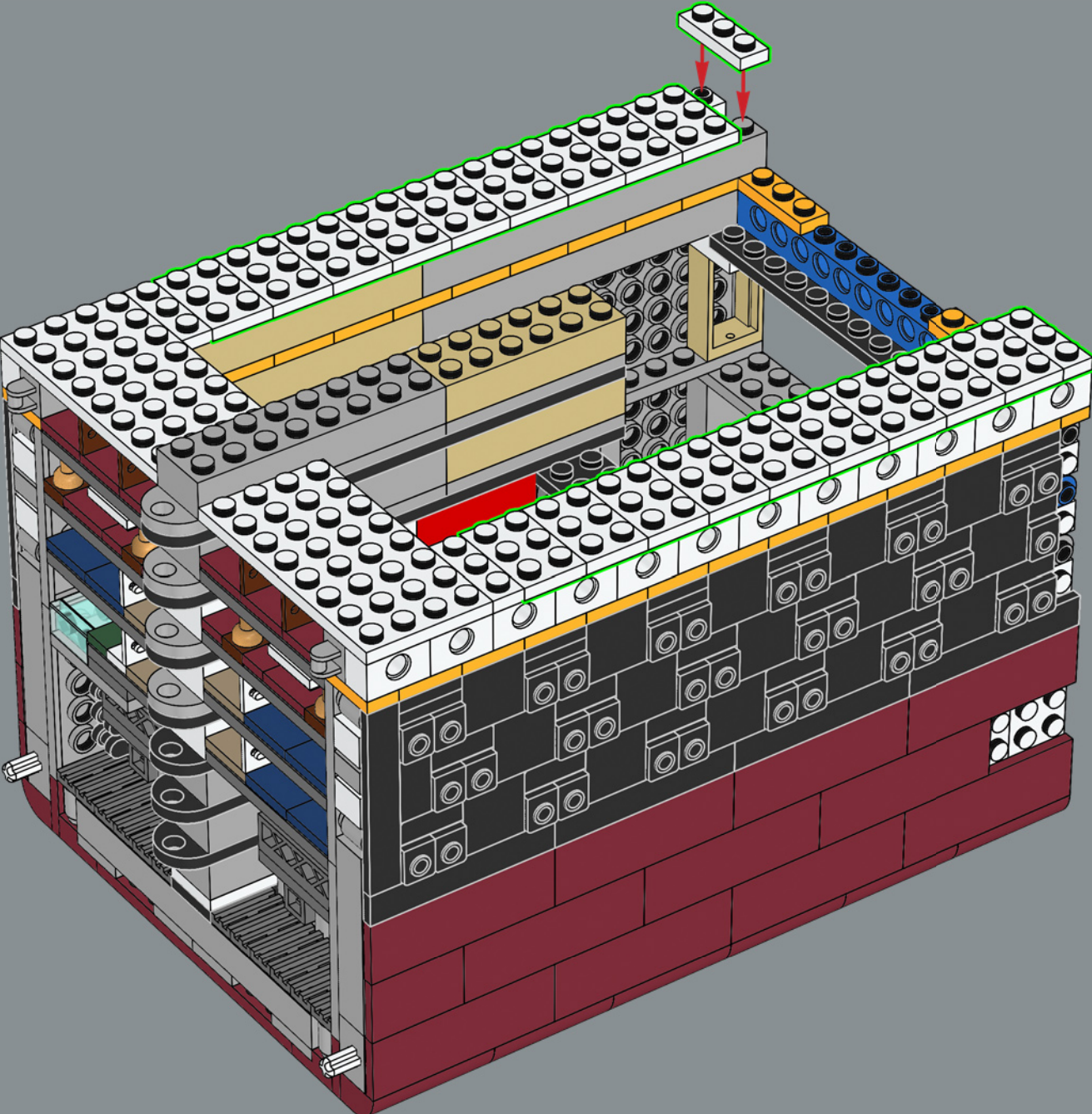

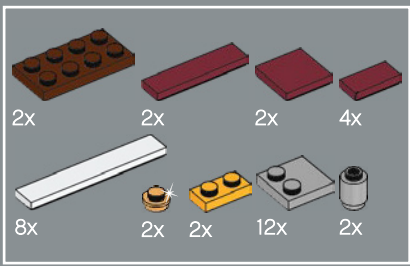

94

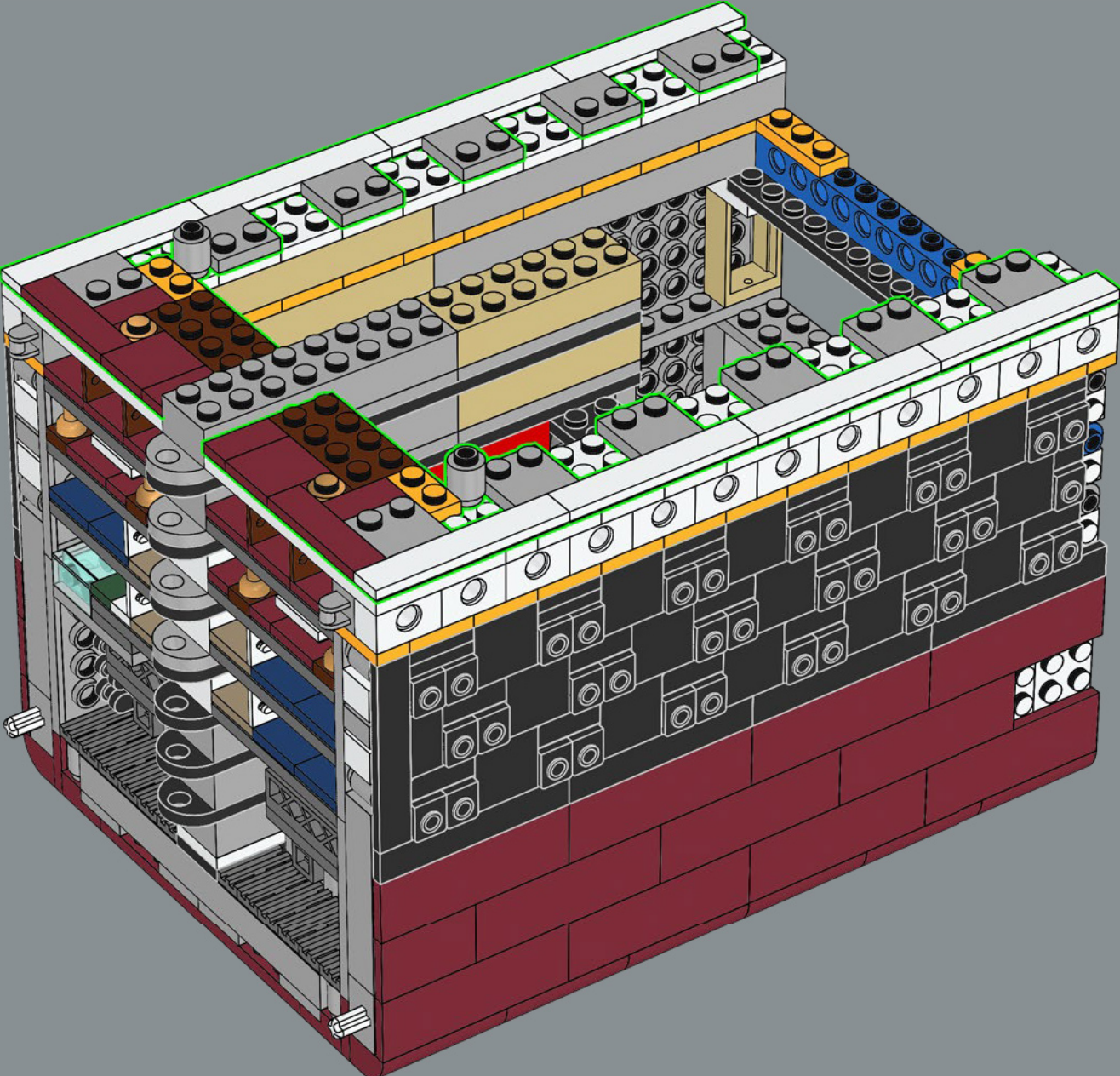

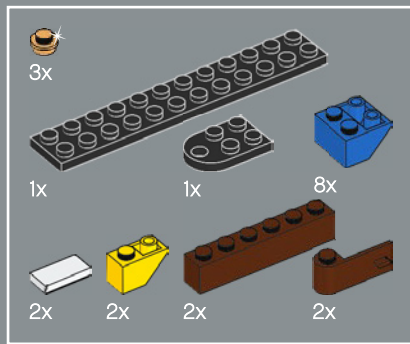

95

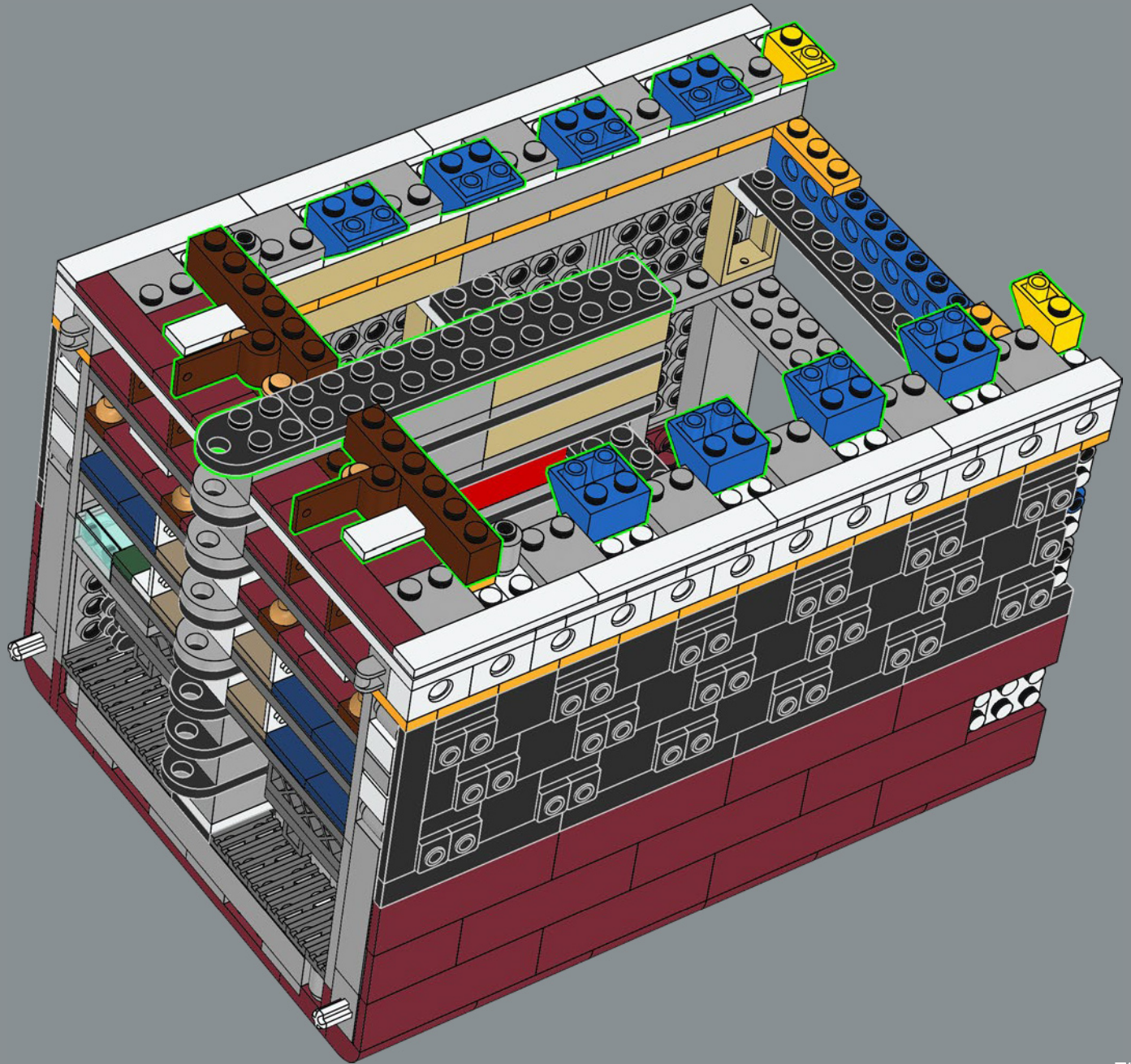

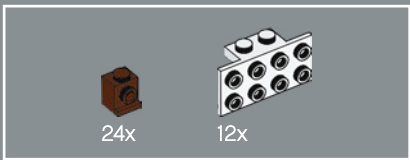

96

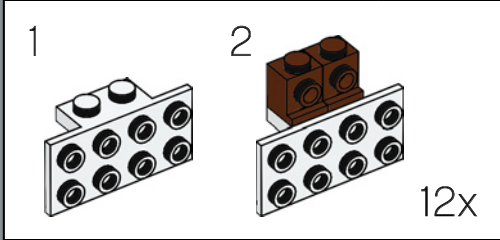
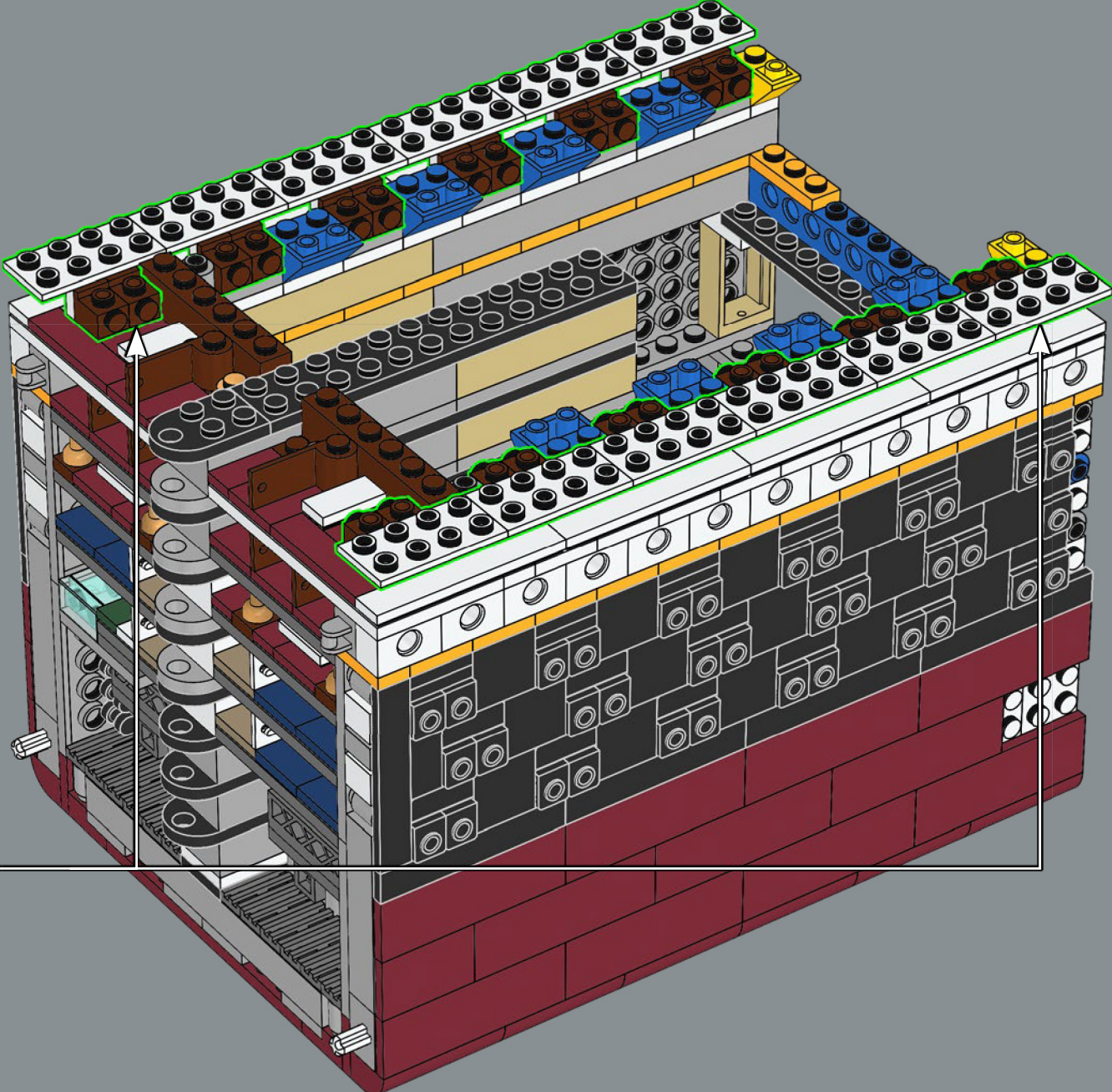



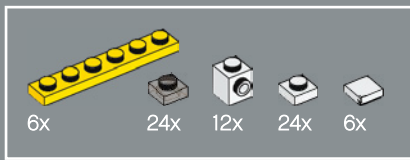

97

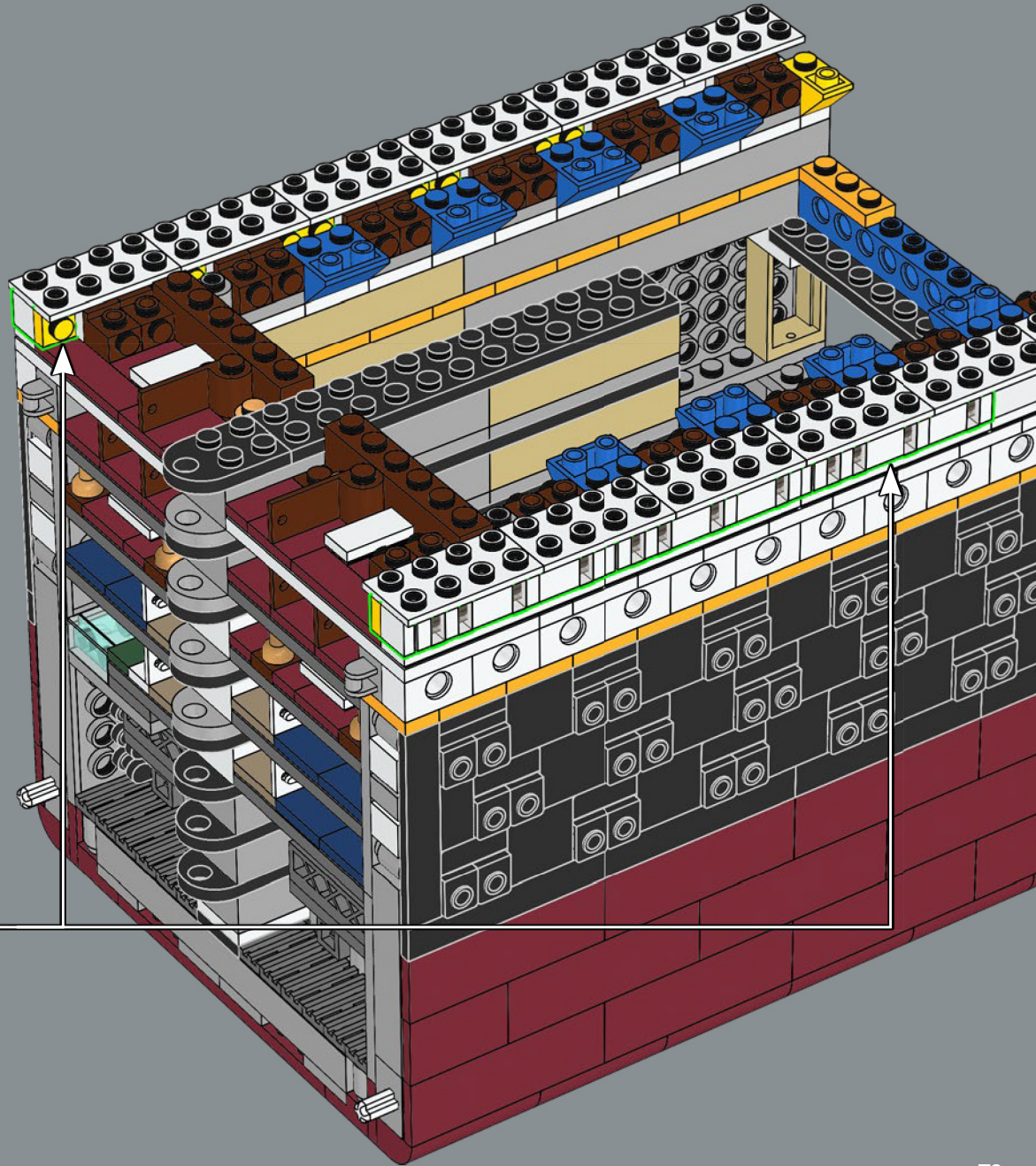
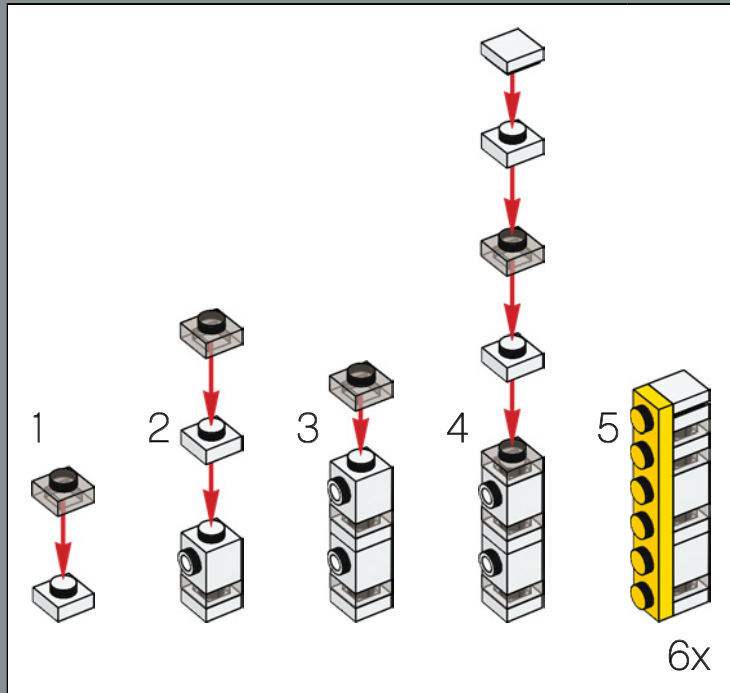

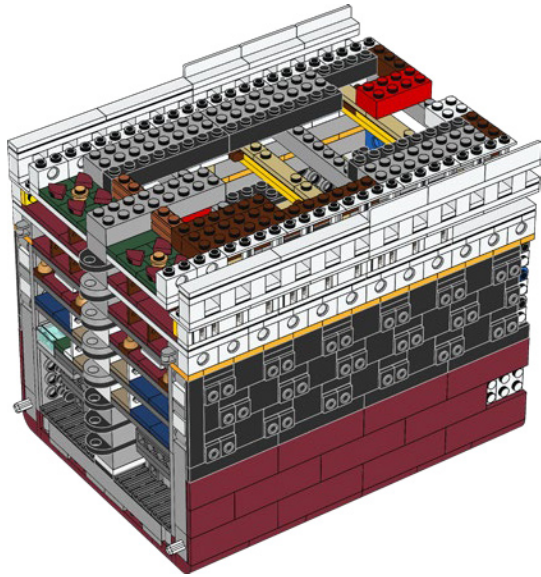
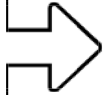

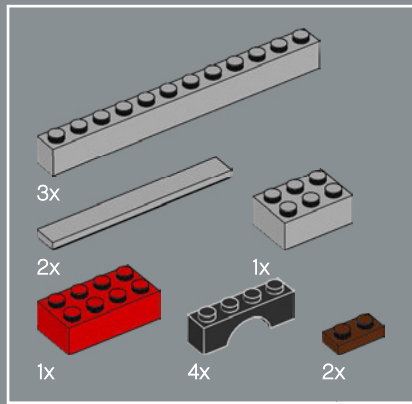

98

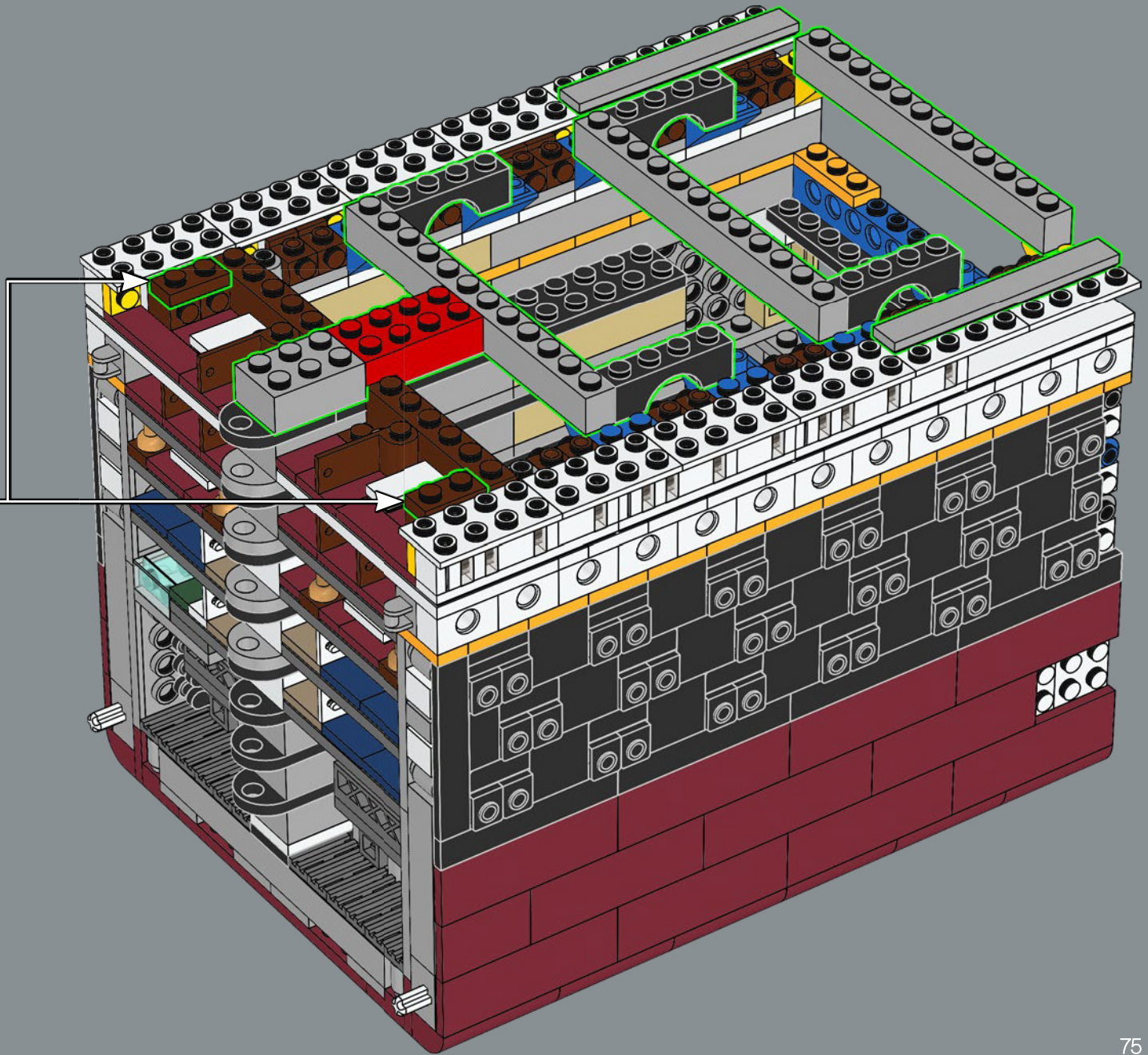
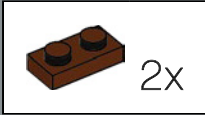

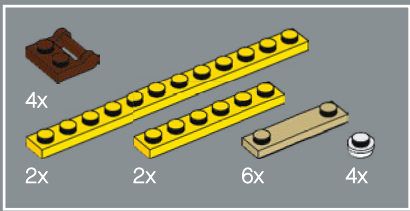

99

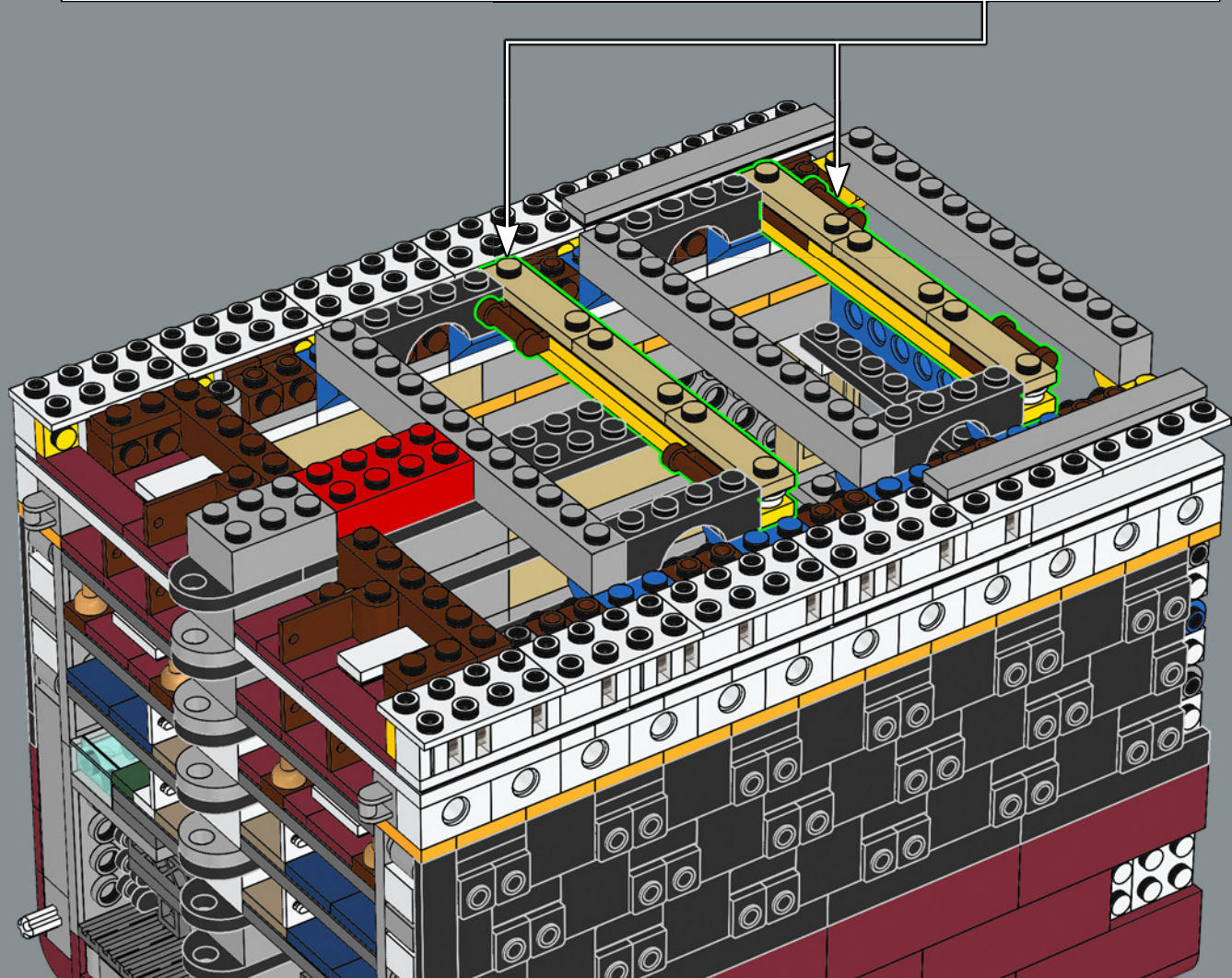
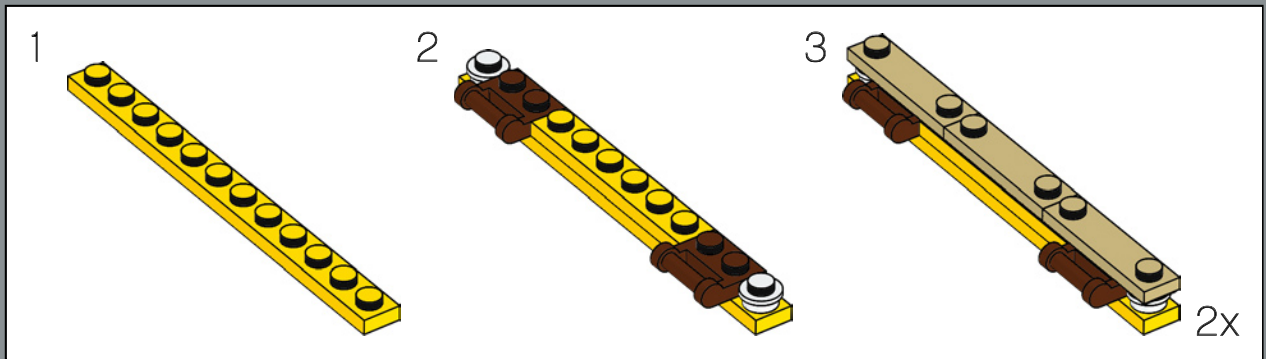

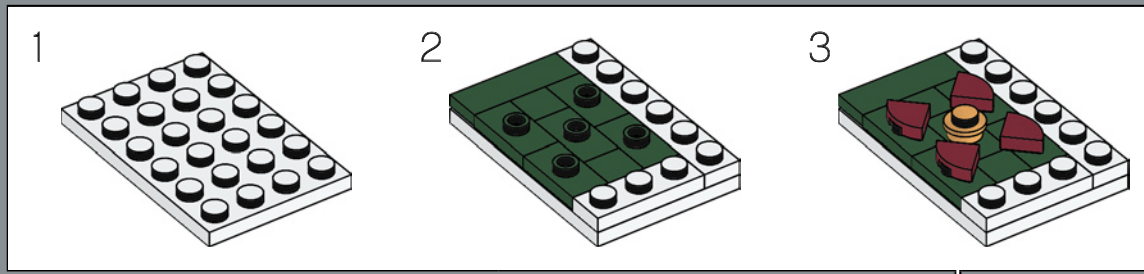
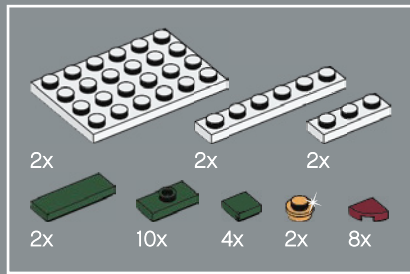

100

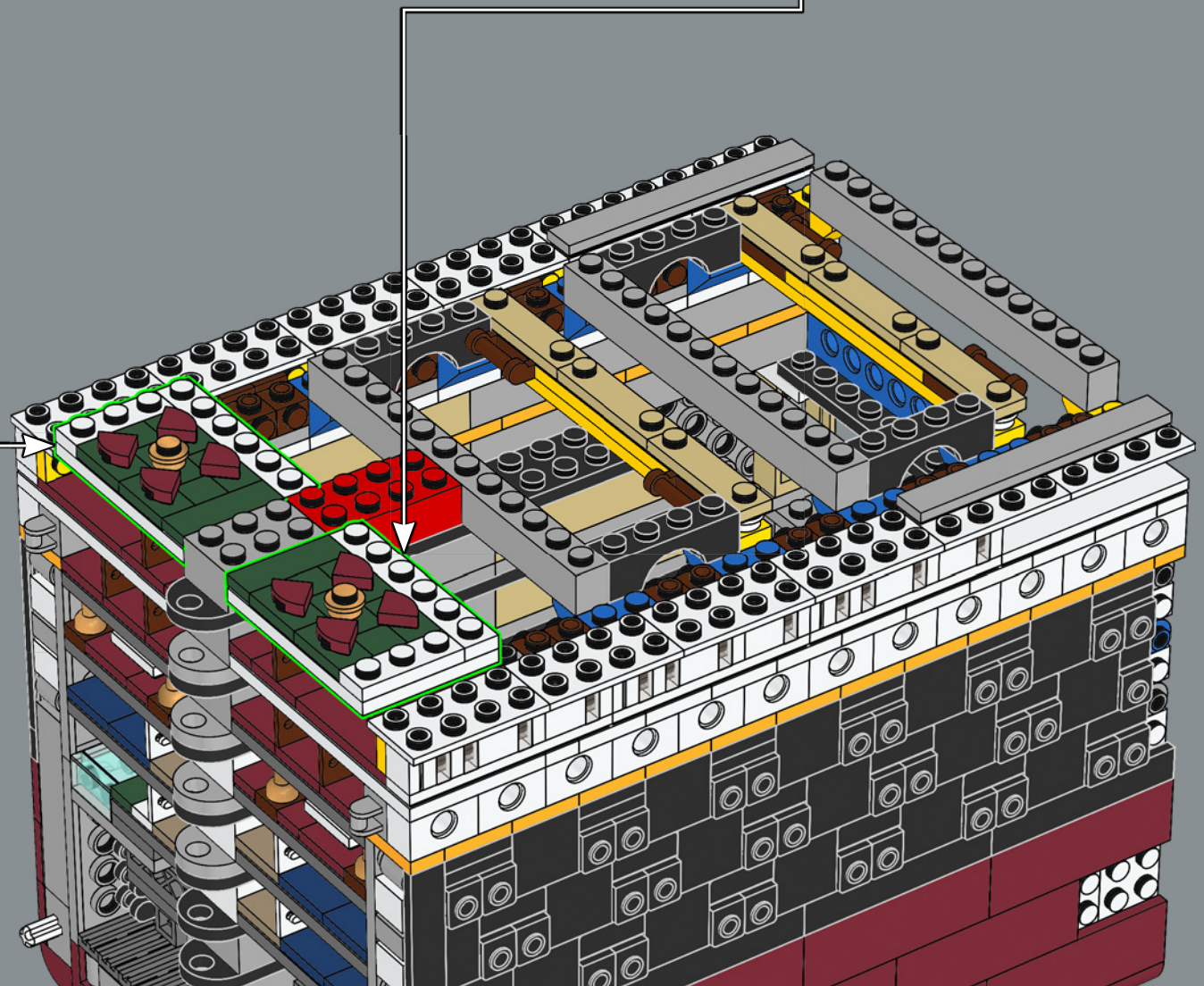
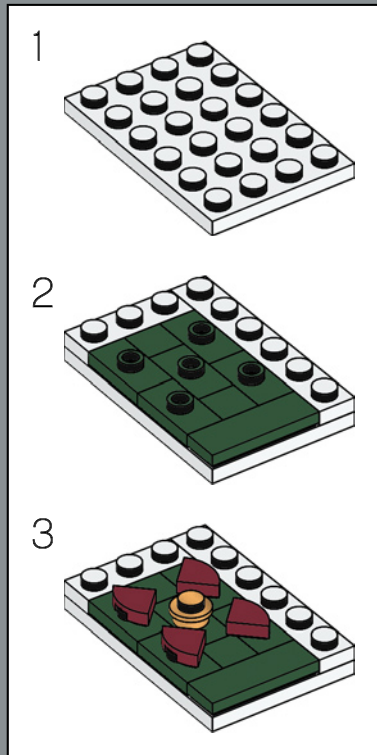



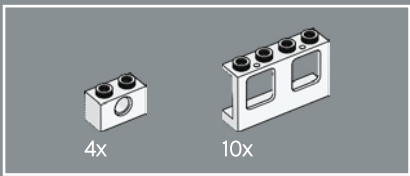

102

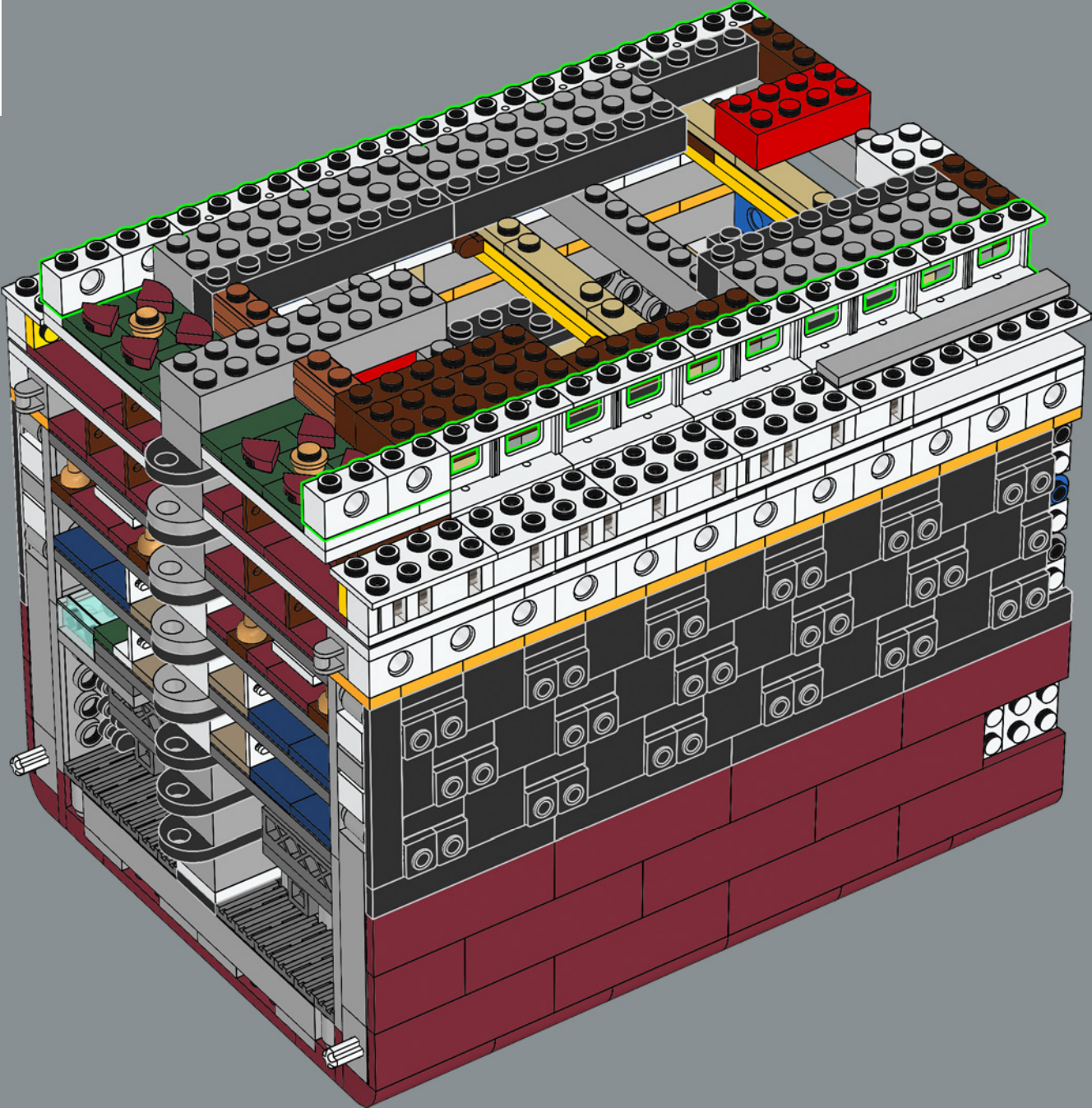

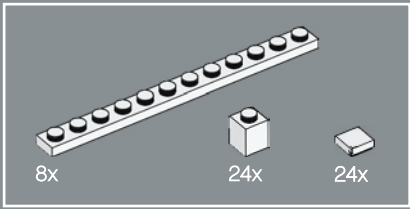

103

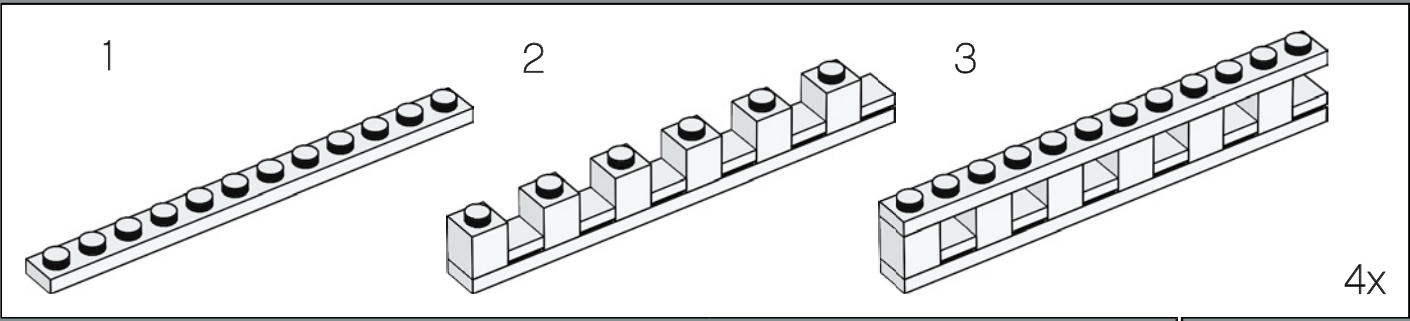

4x

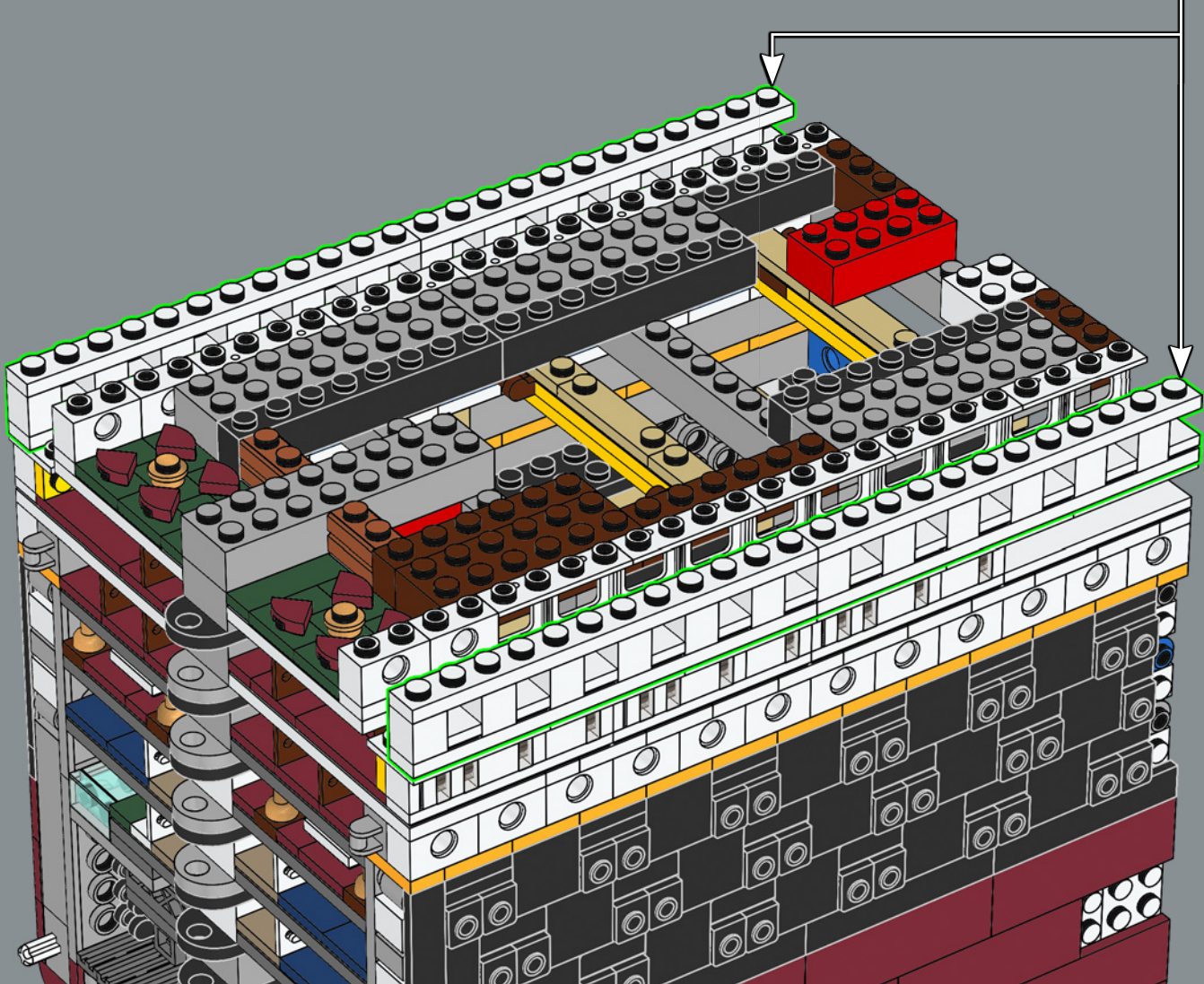



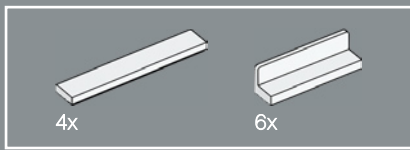

104

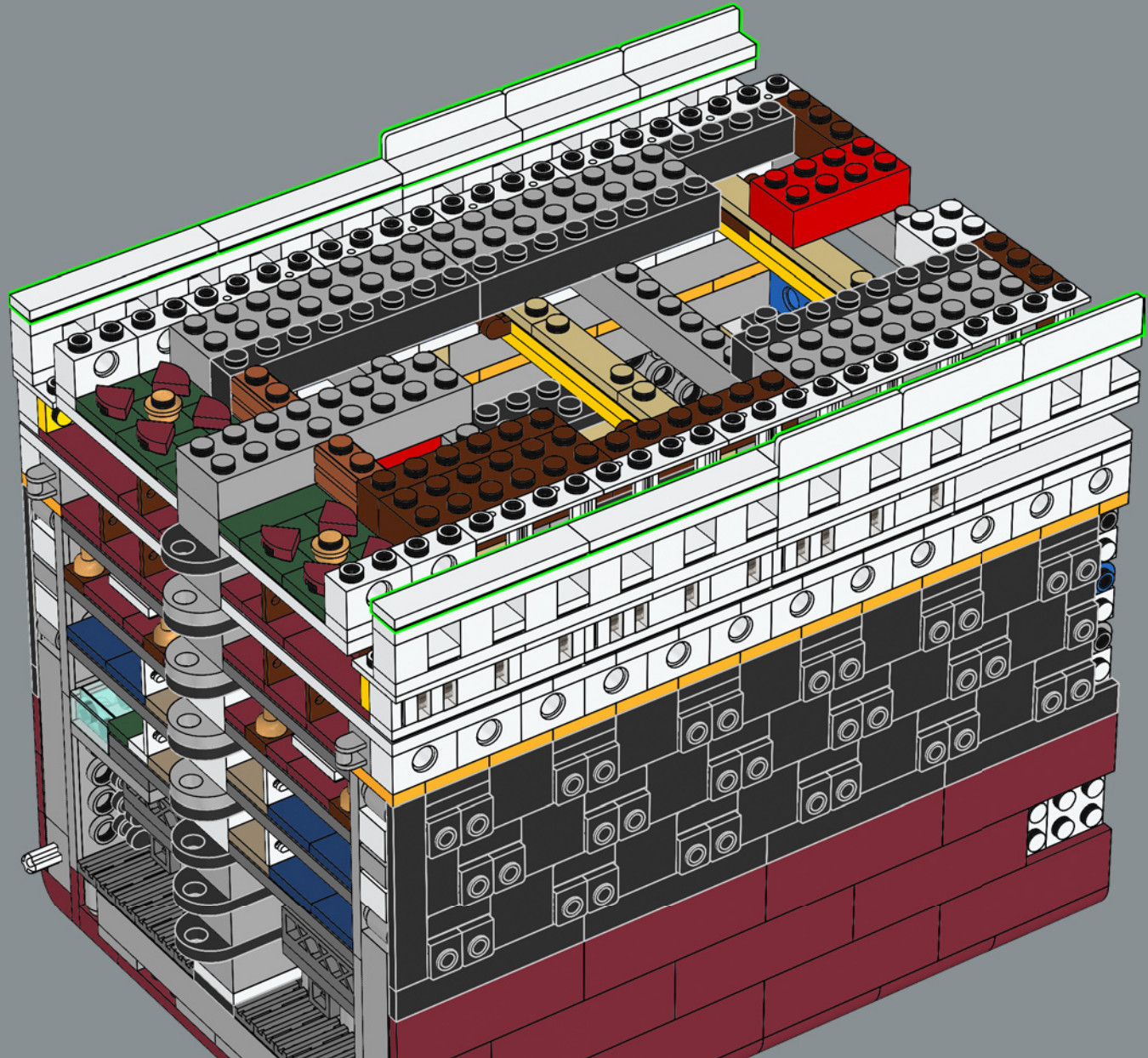

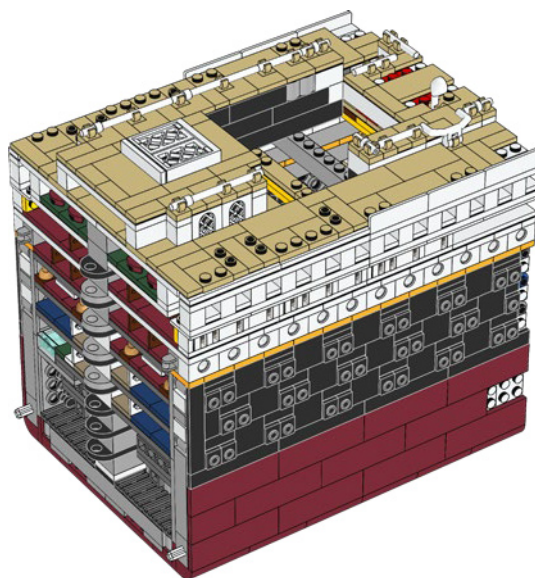
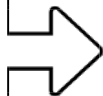

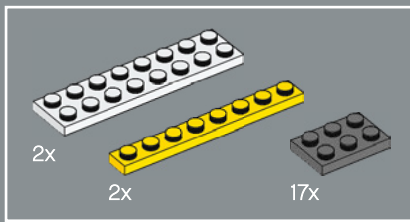

105

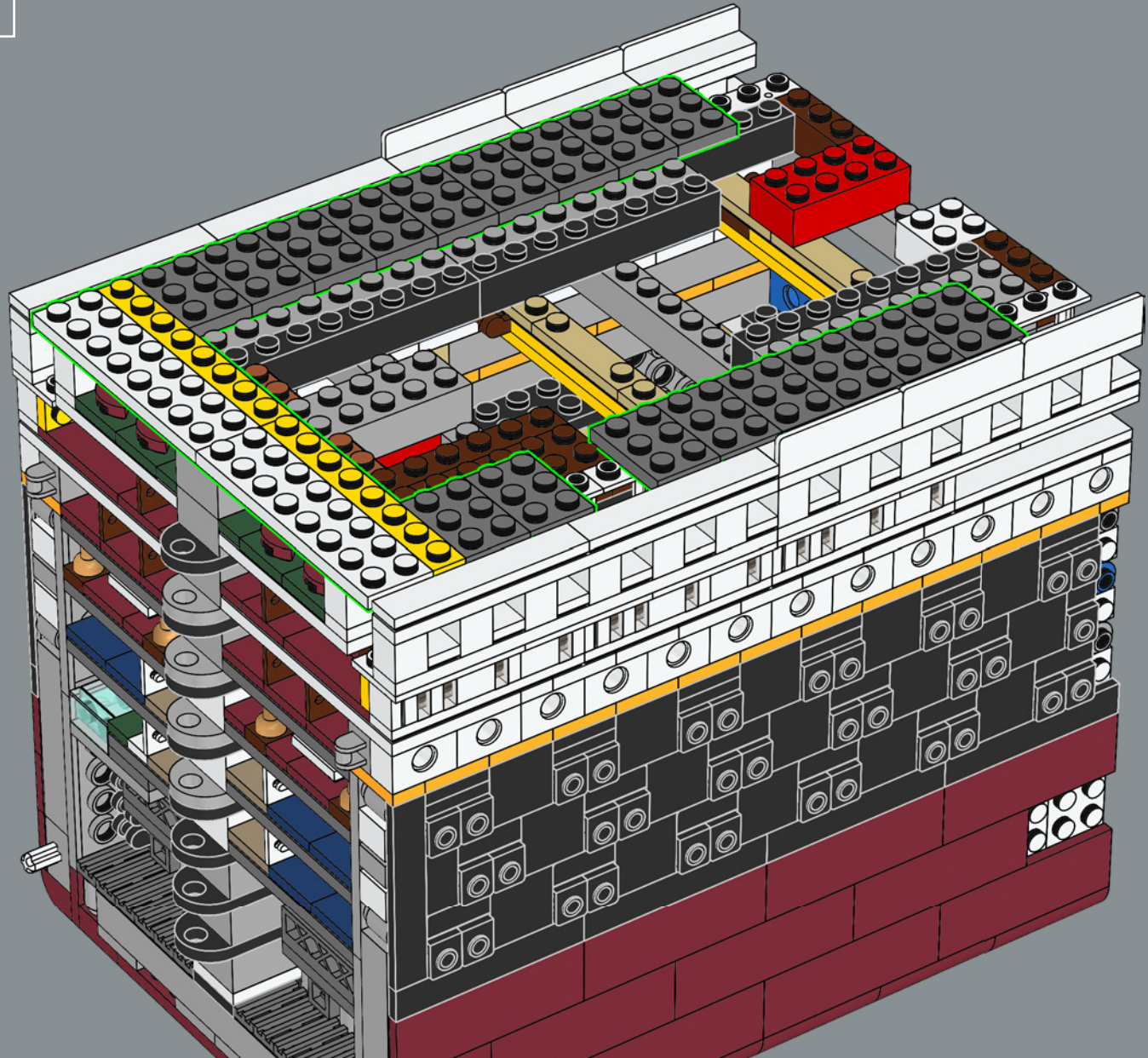

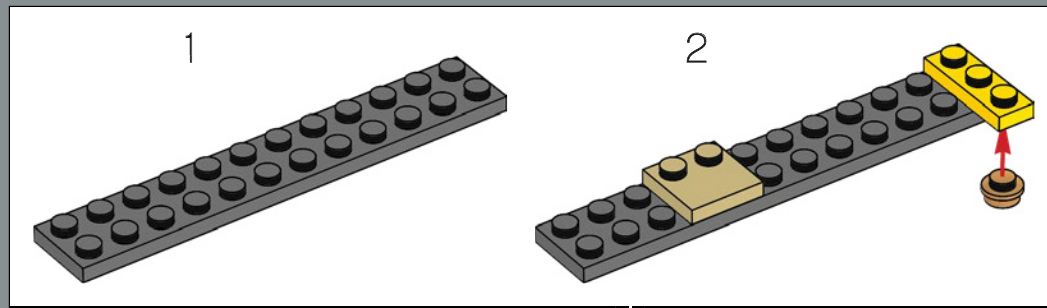
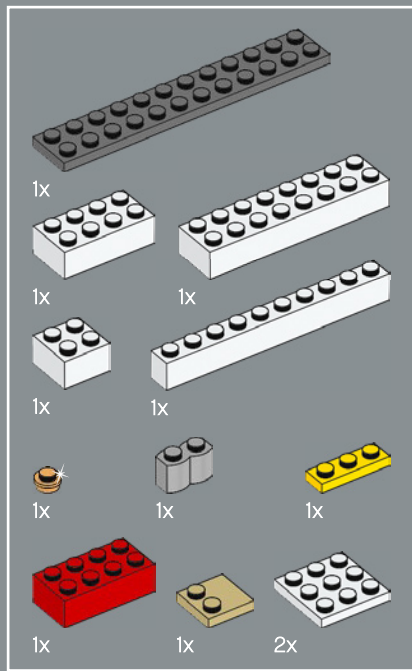

106

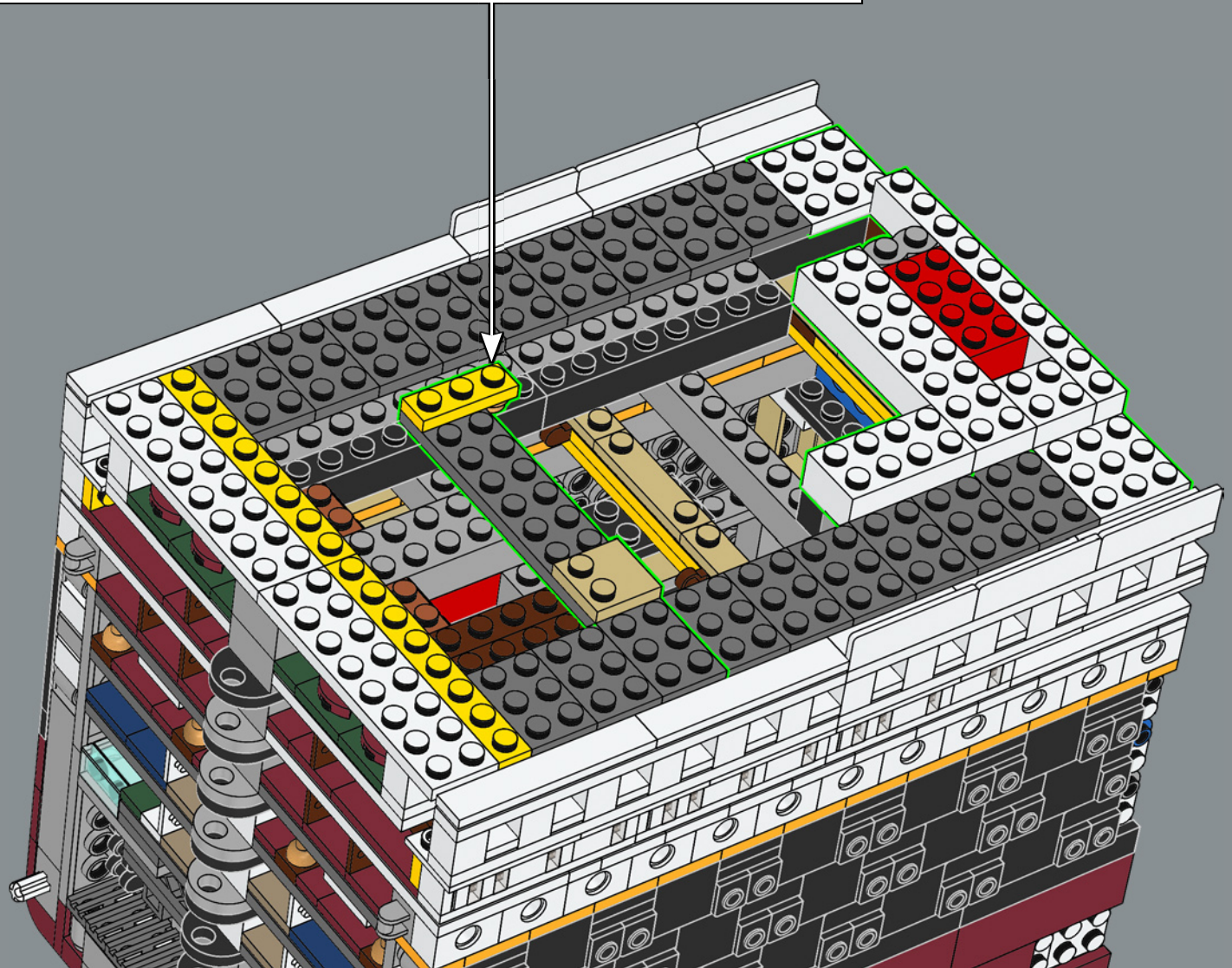

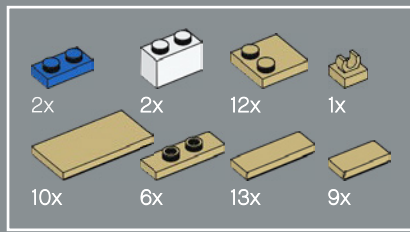

107

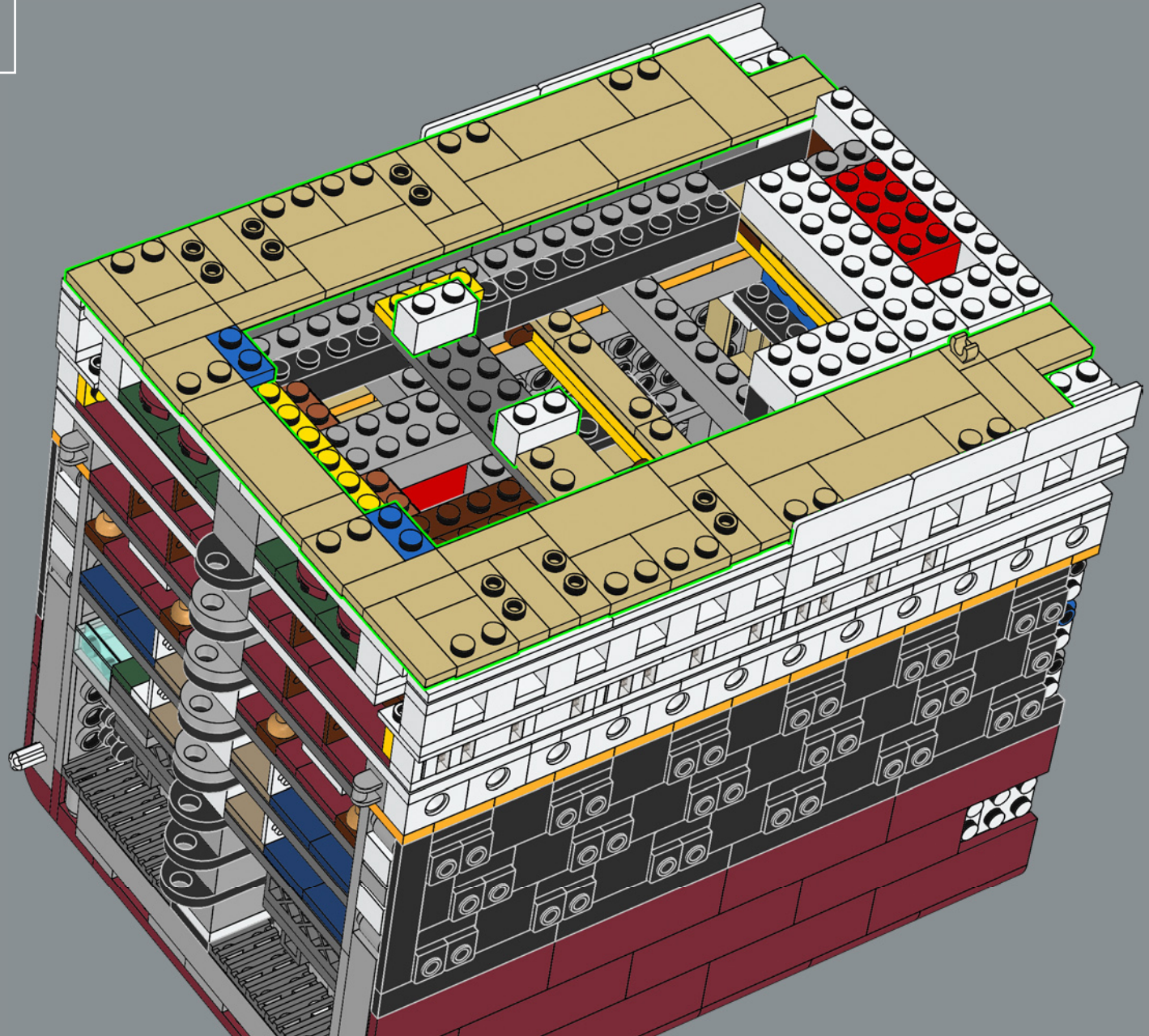

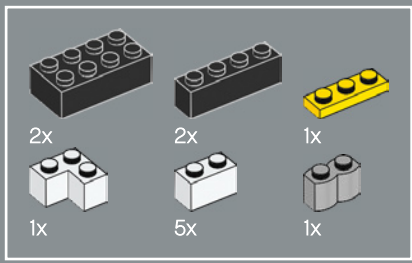

108

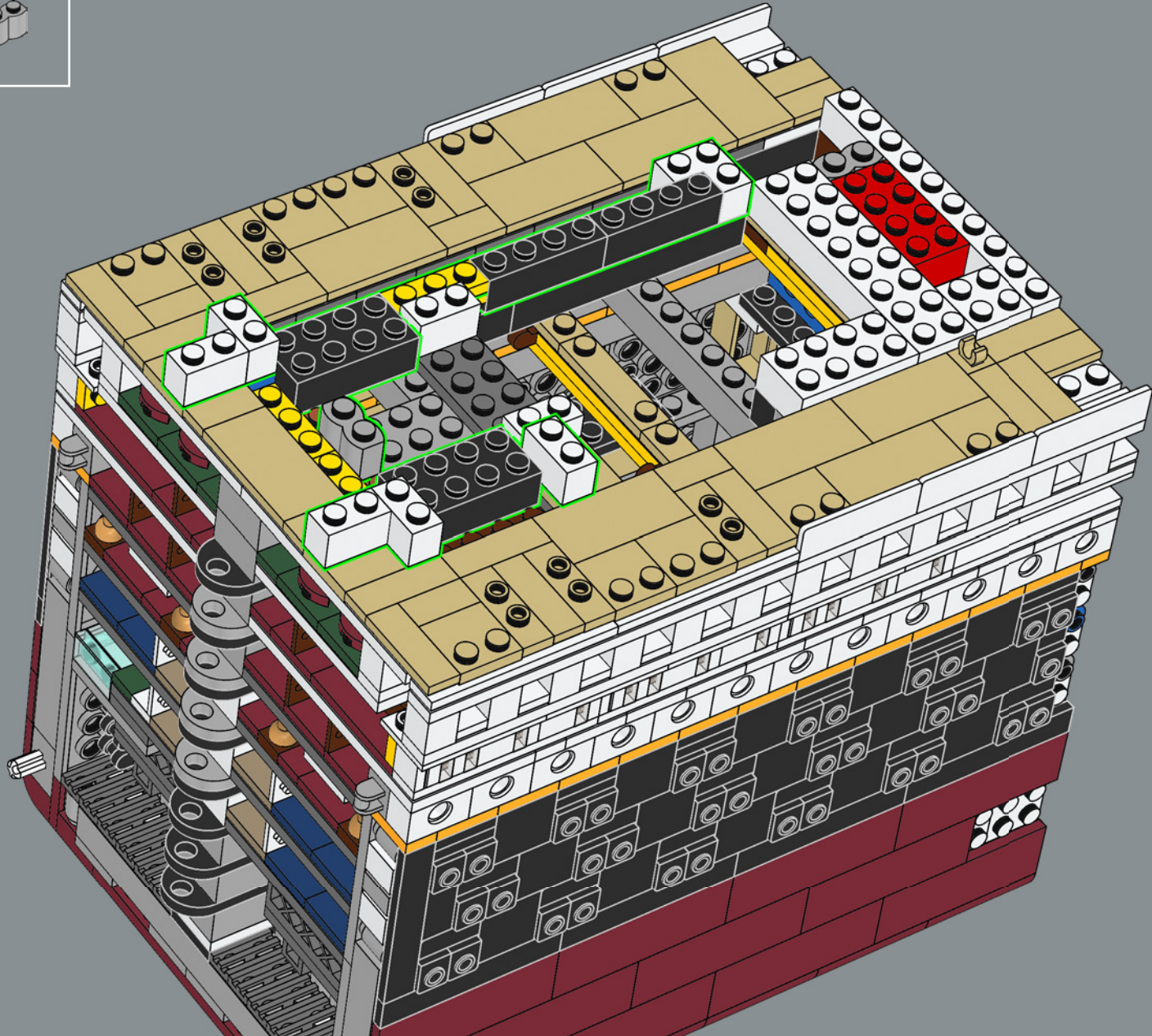

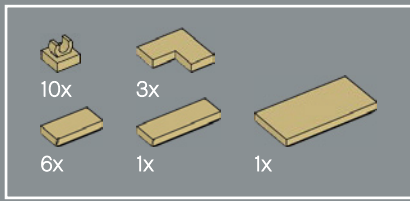

109

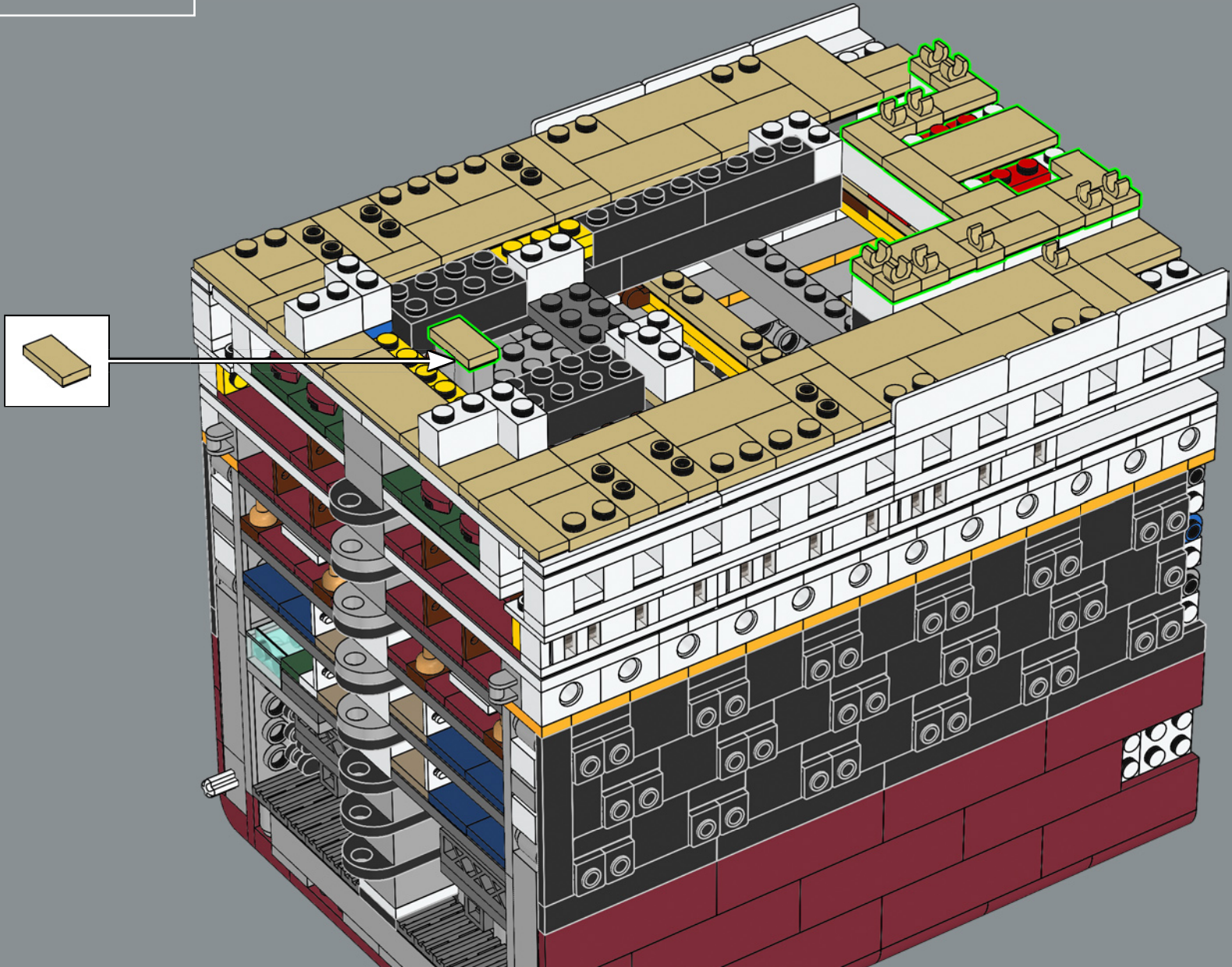





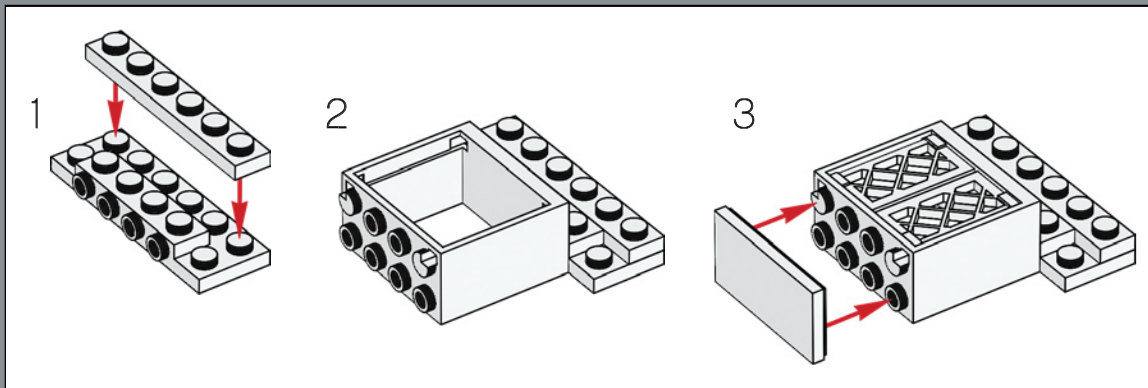
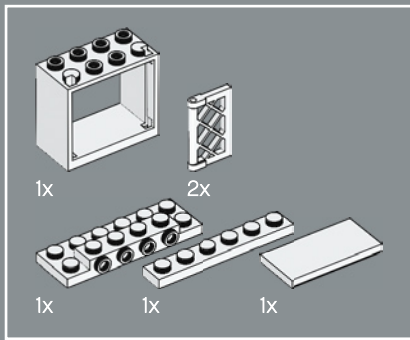

111

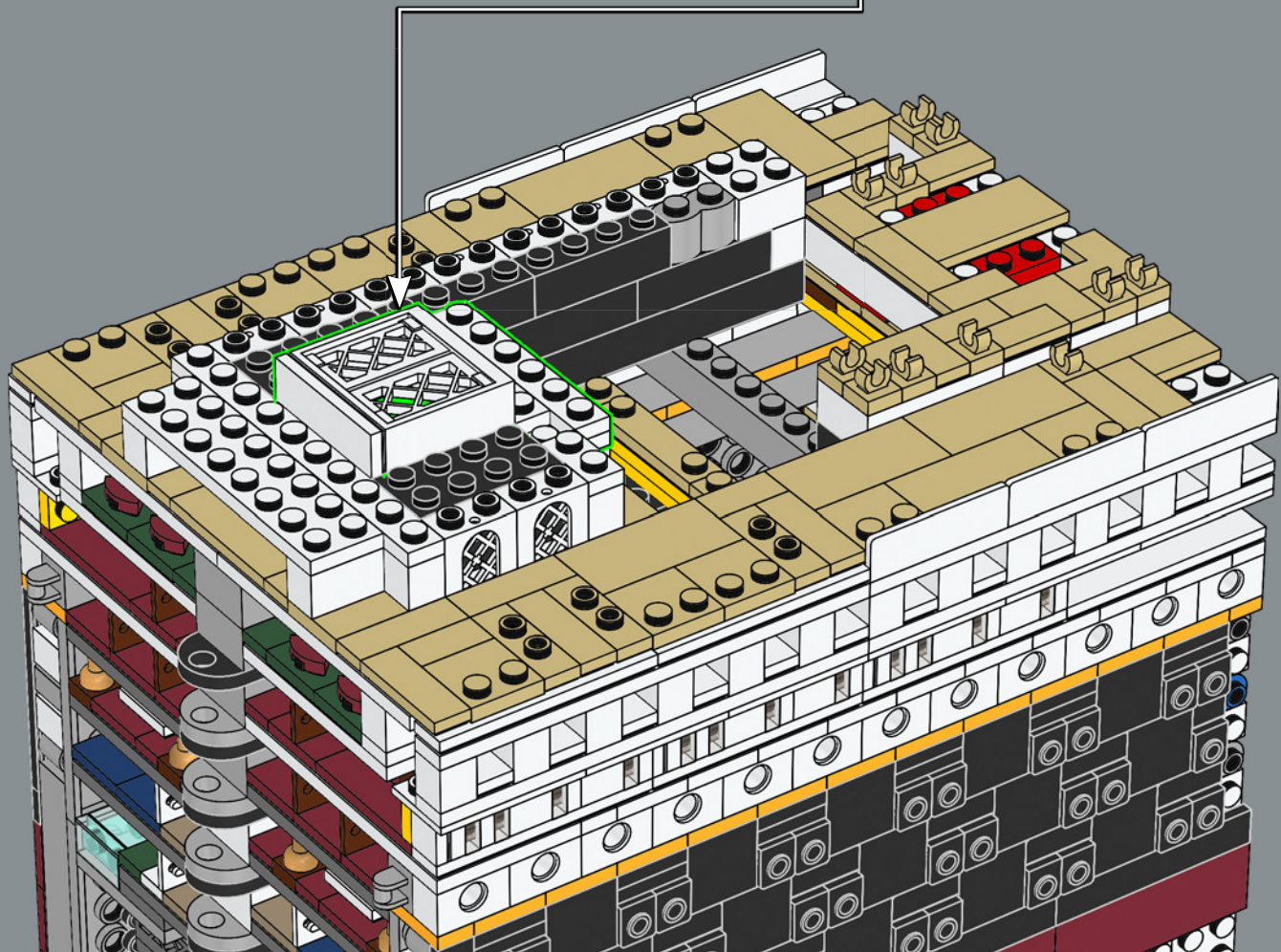

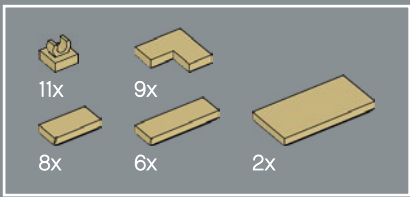

112

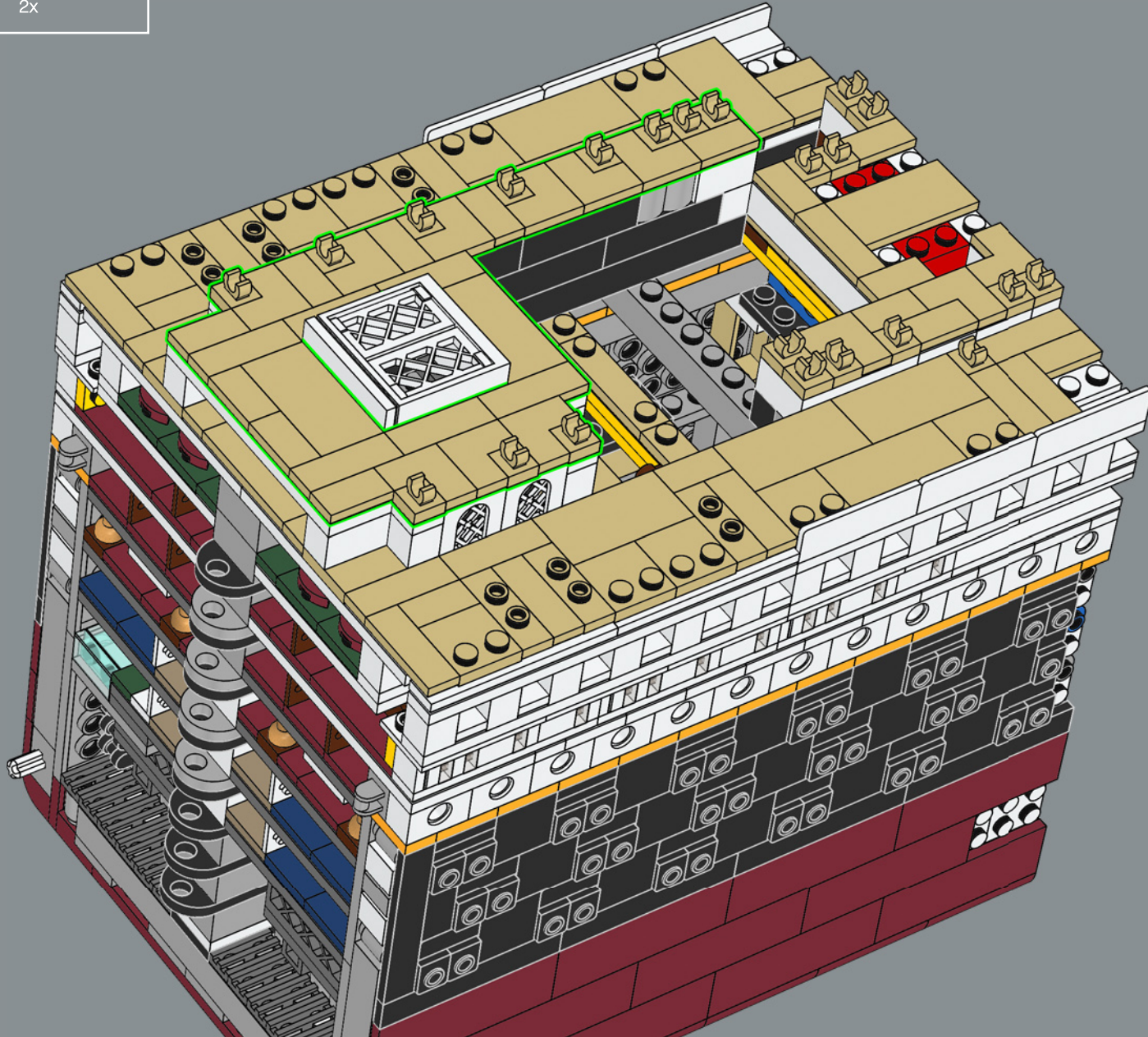

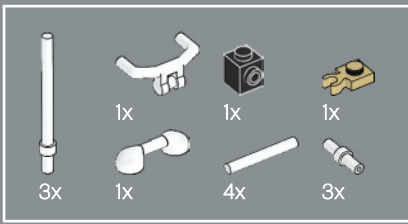

113

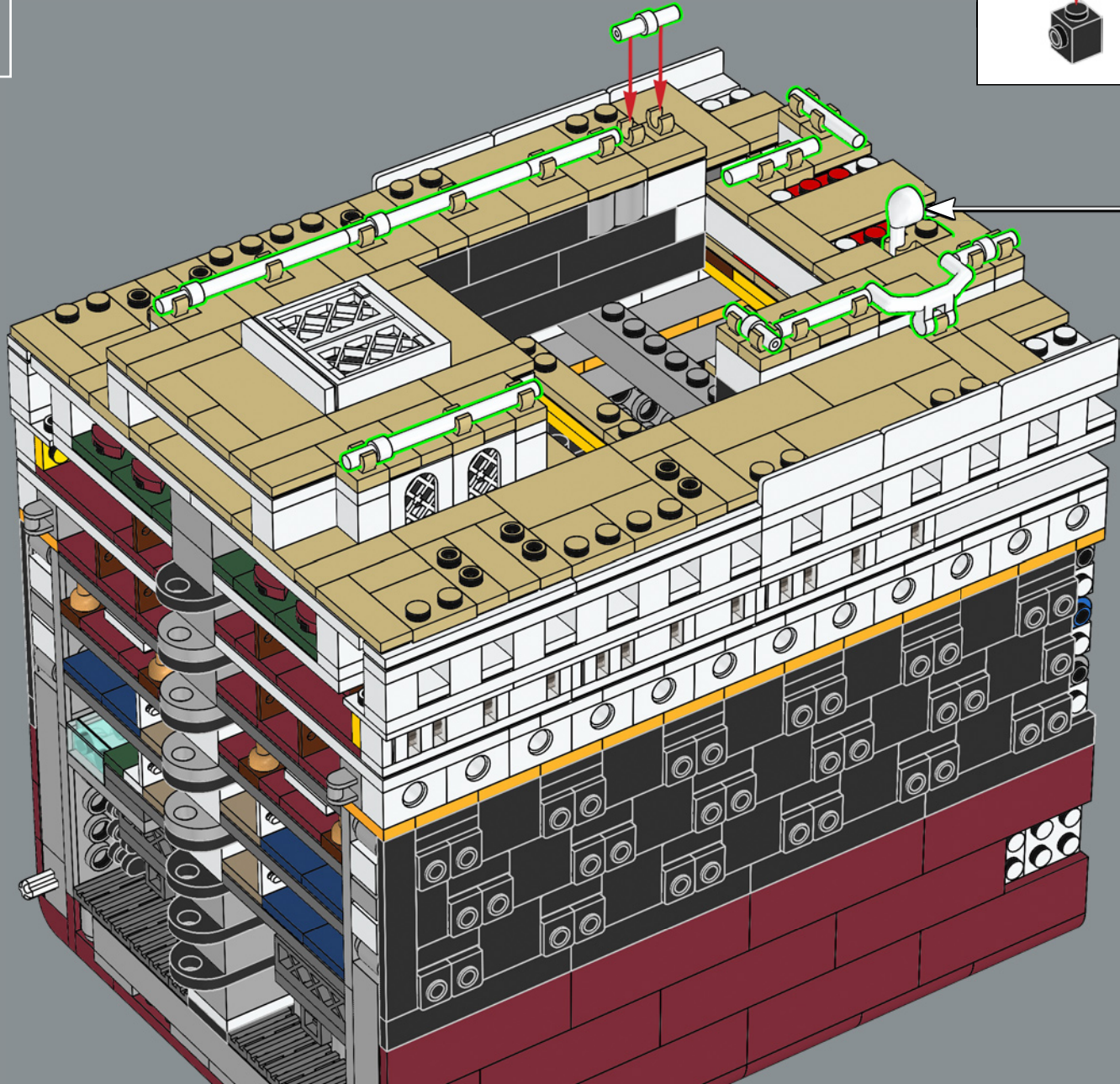
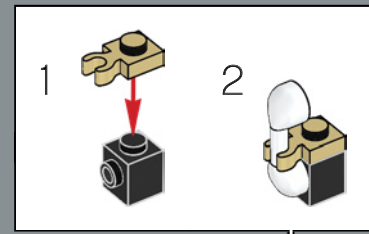

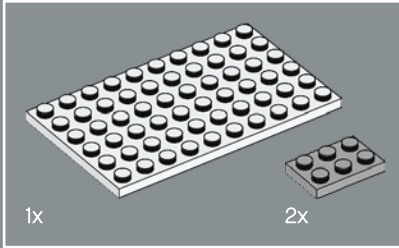
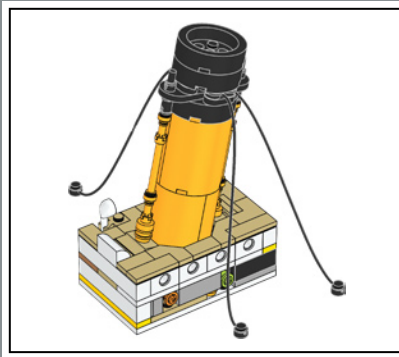
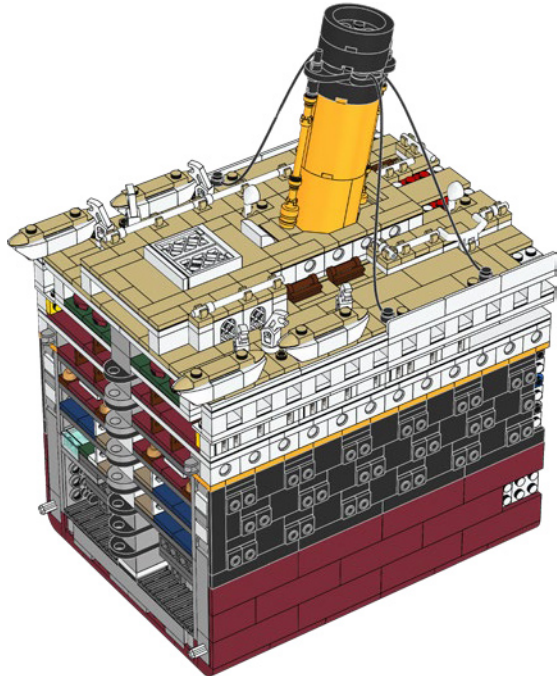
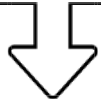

114

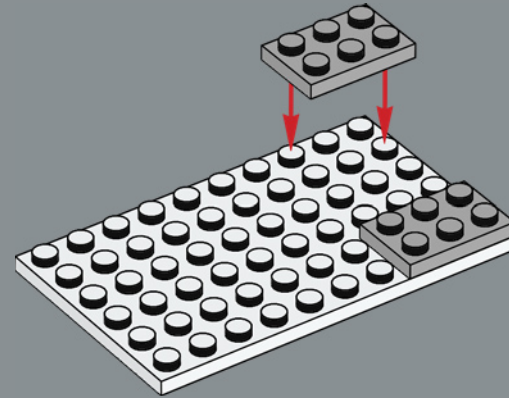

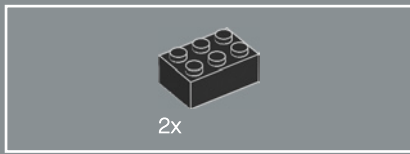

115

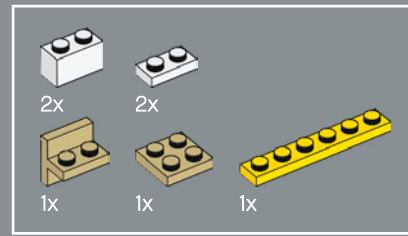
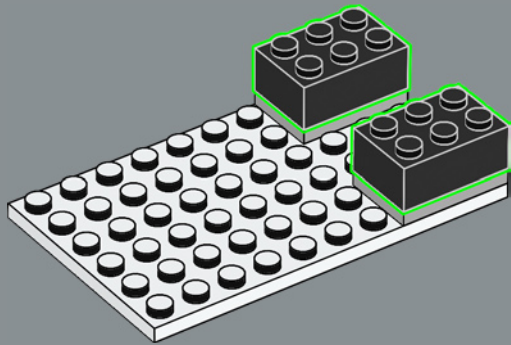

116

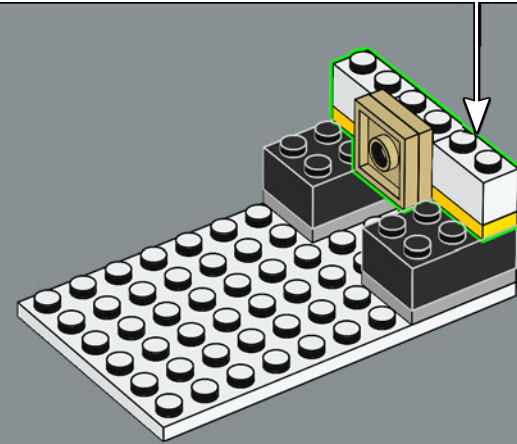
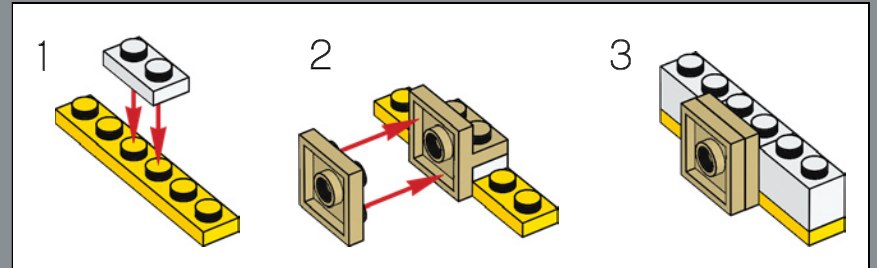

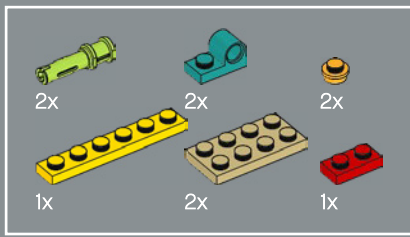

117

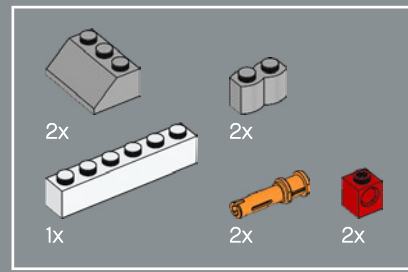
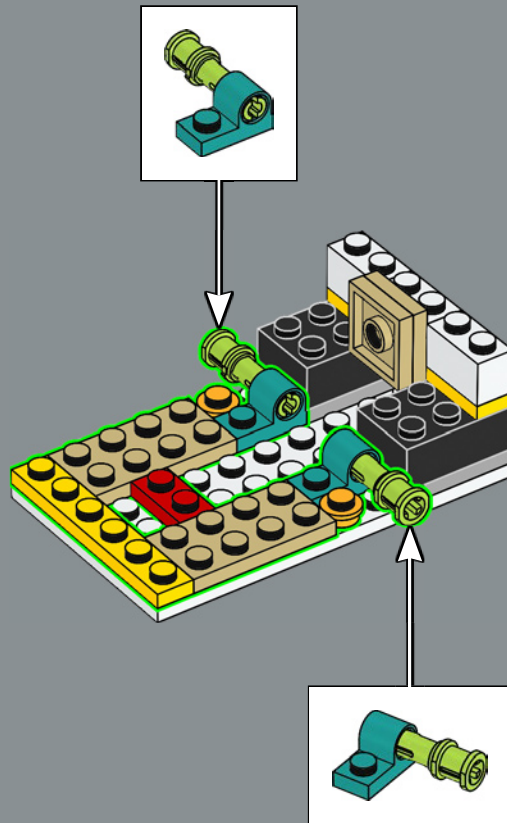

118

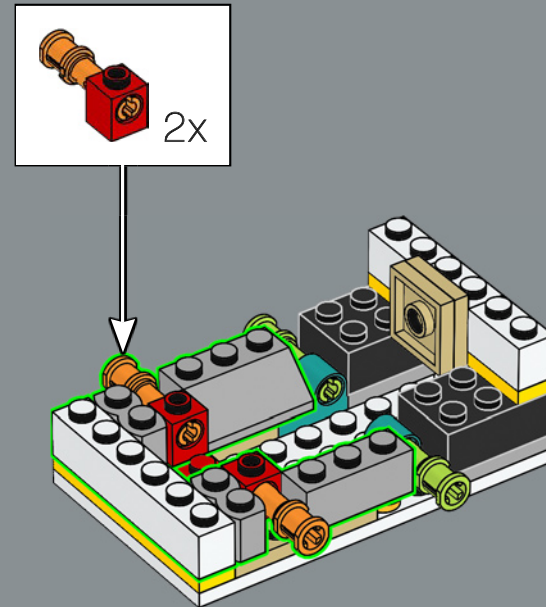

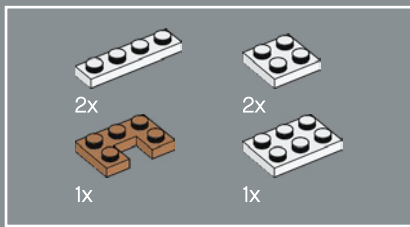

119

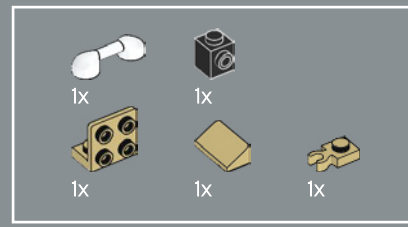
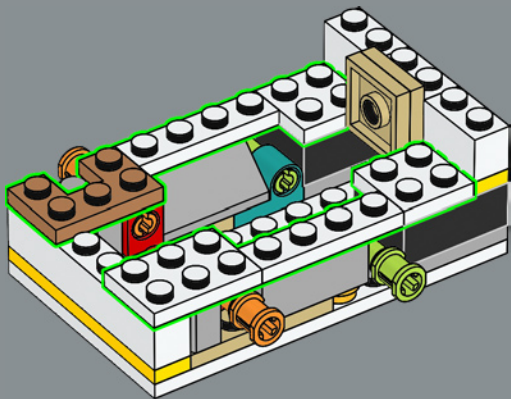

120

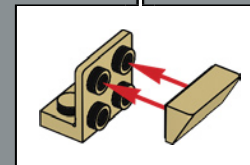
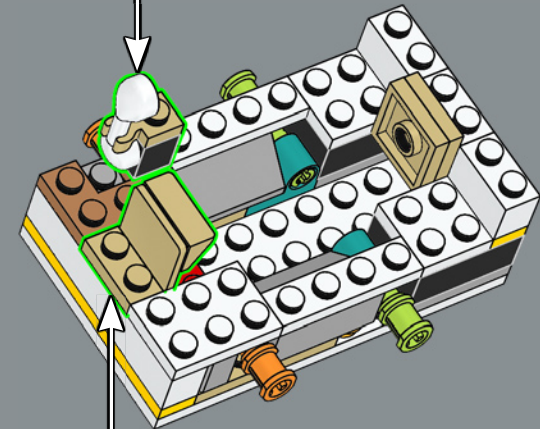
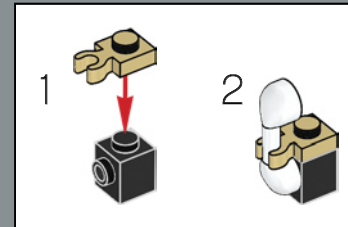

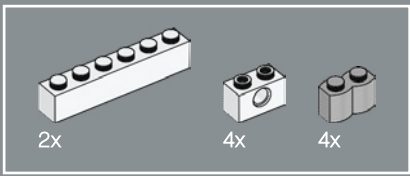

121

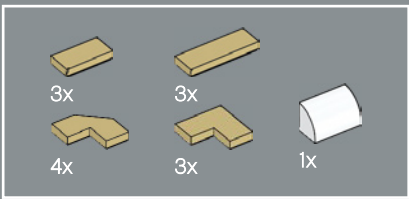
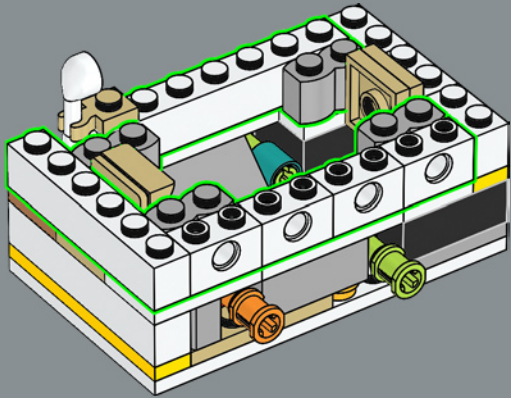

122

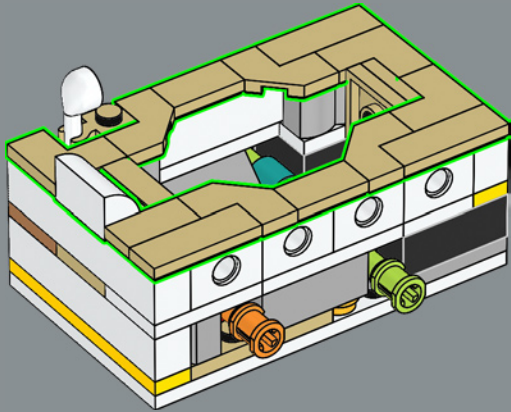



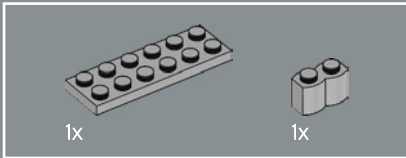
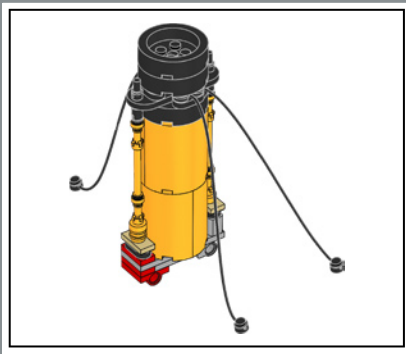

123

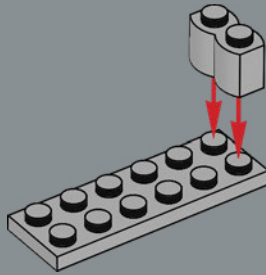

124

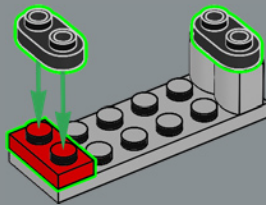

125

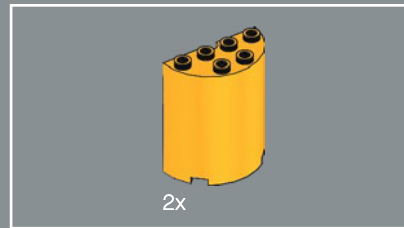
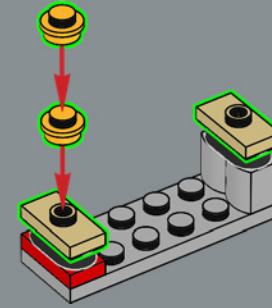

126

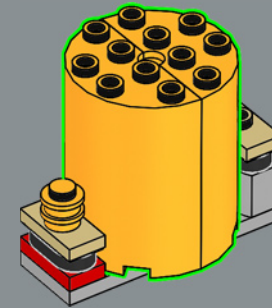

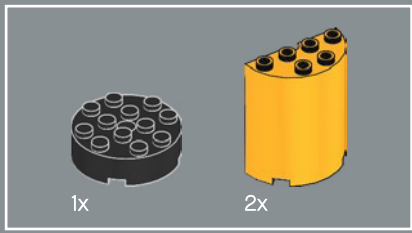

127

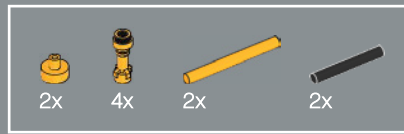
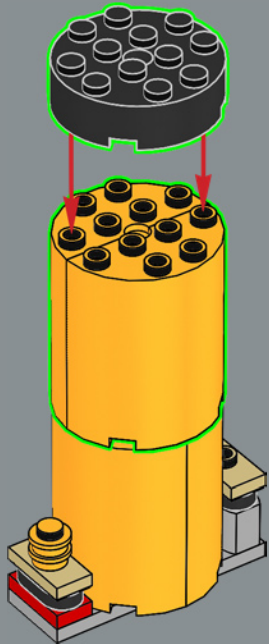

128

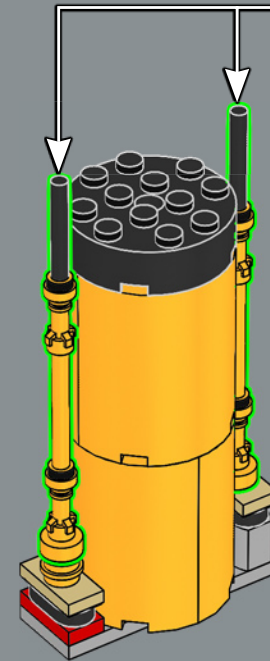
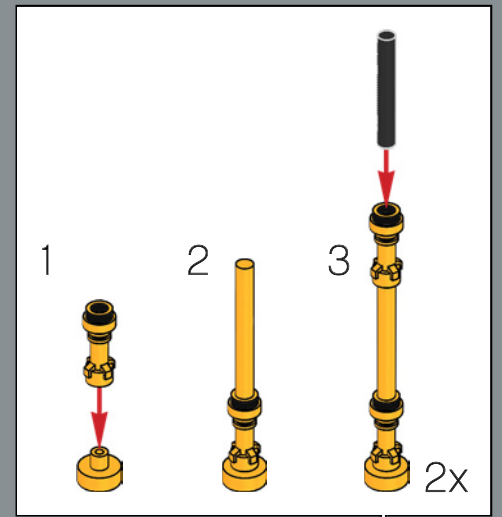

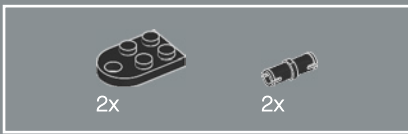

129

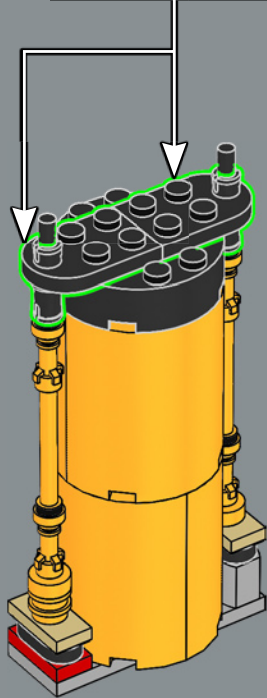
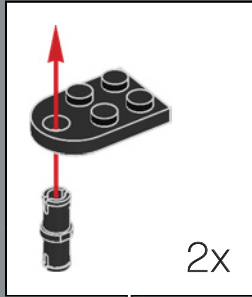

130

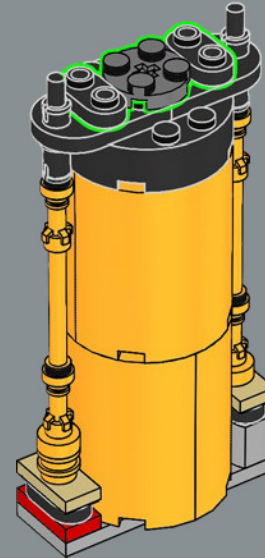

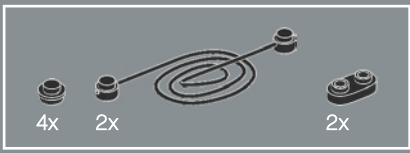

131

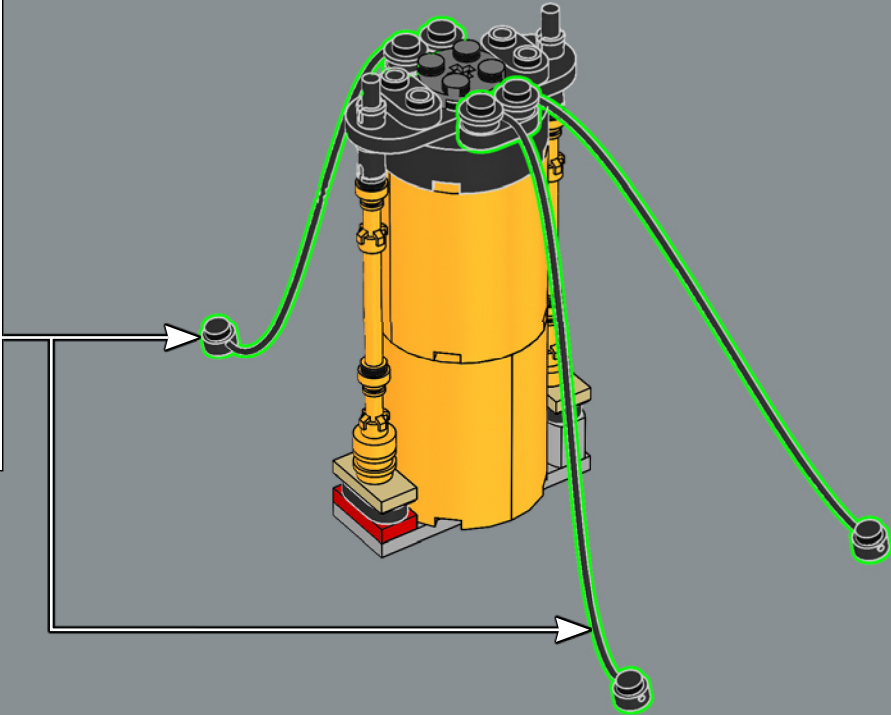
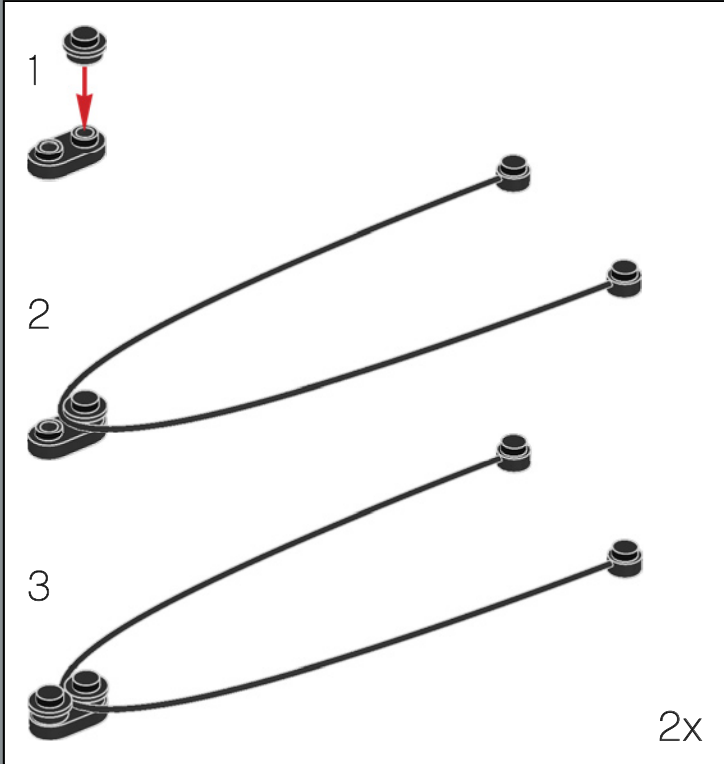

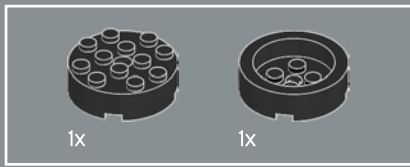

132

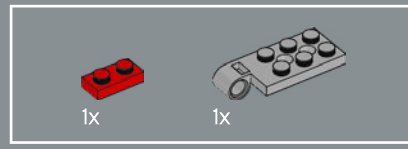
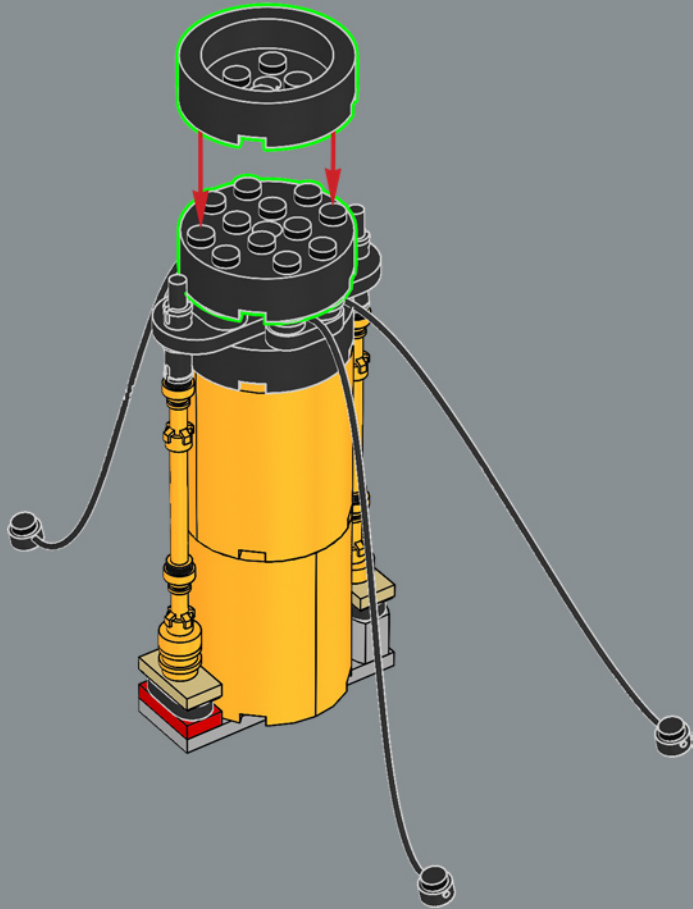

133

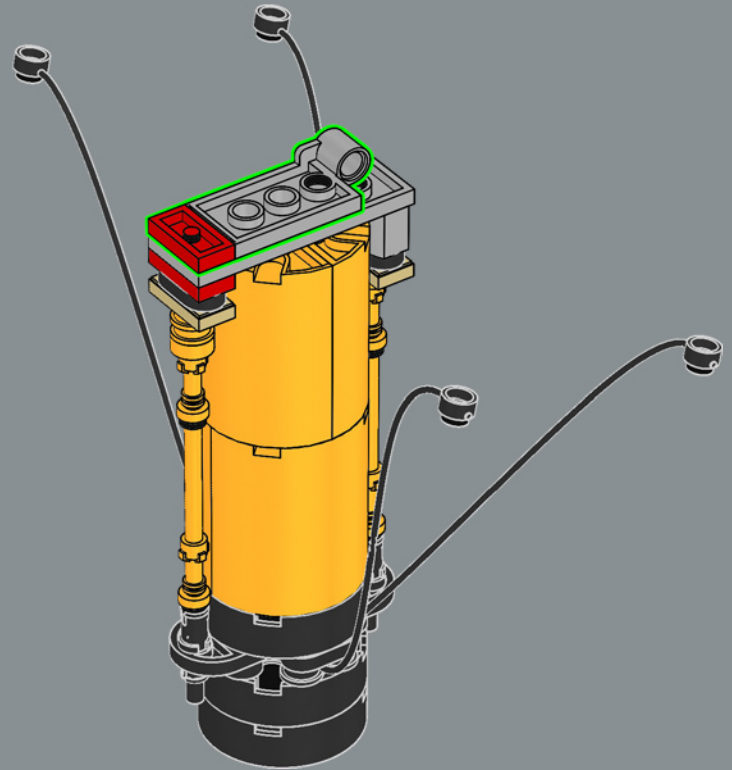

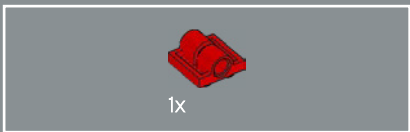

134

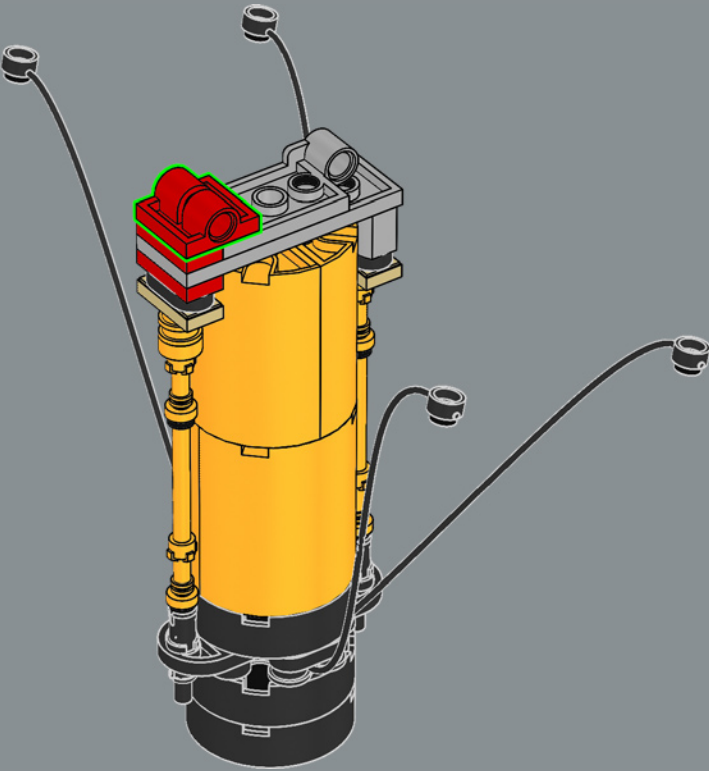

135

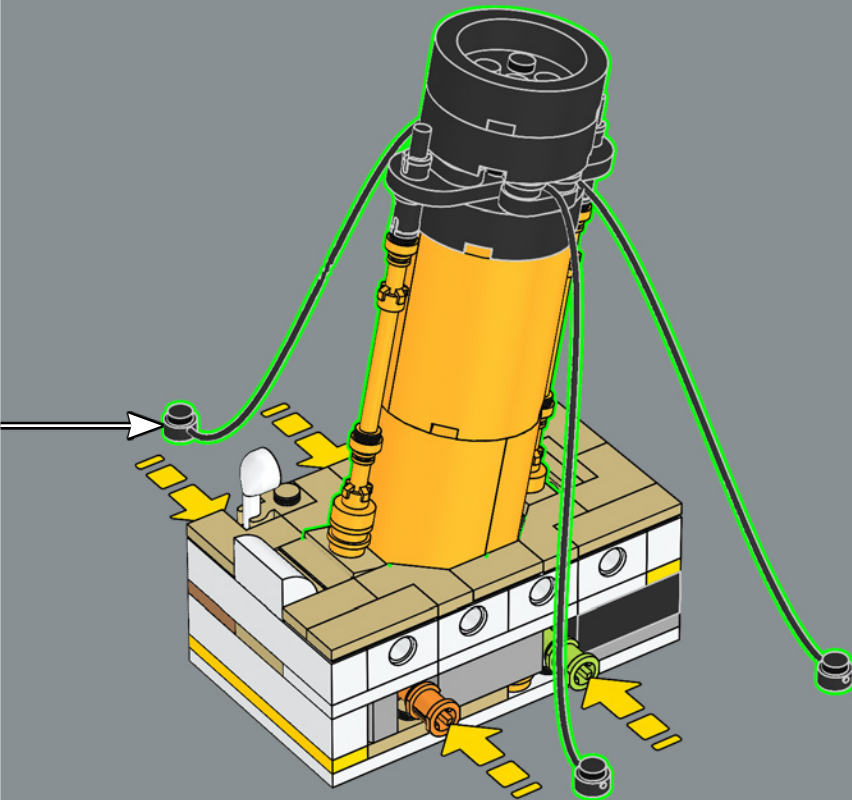

136

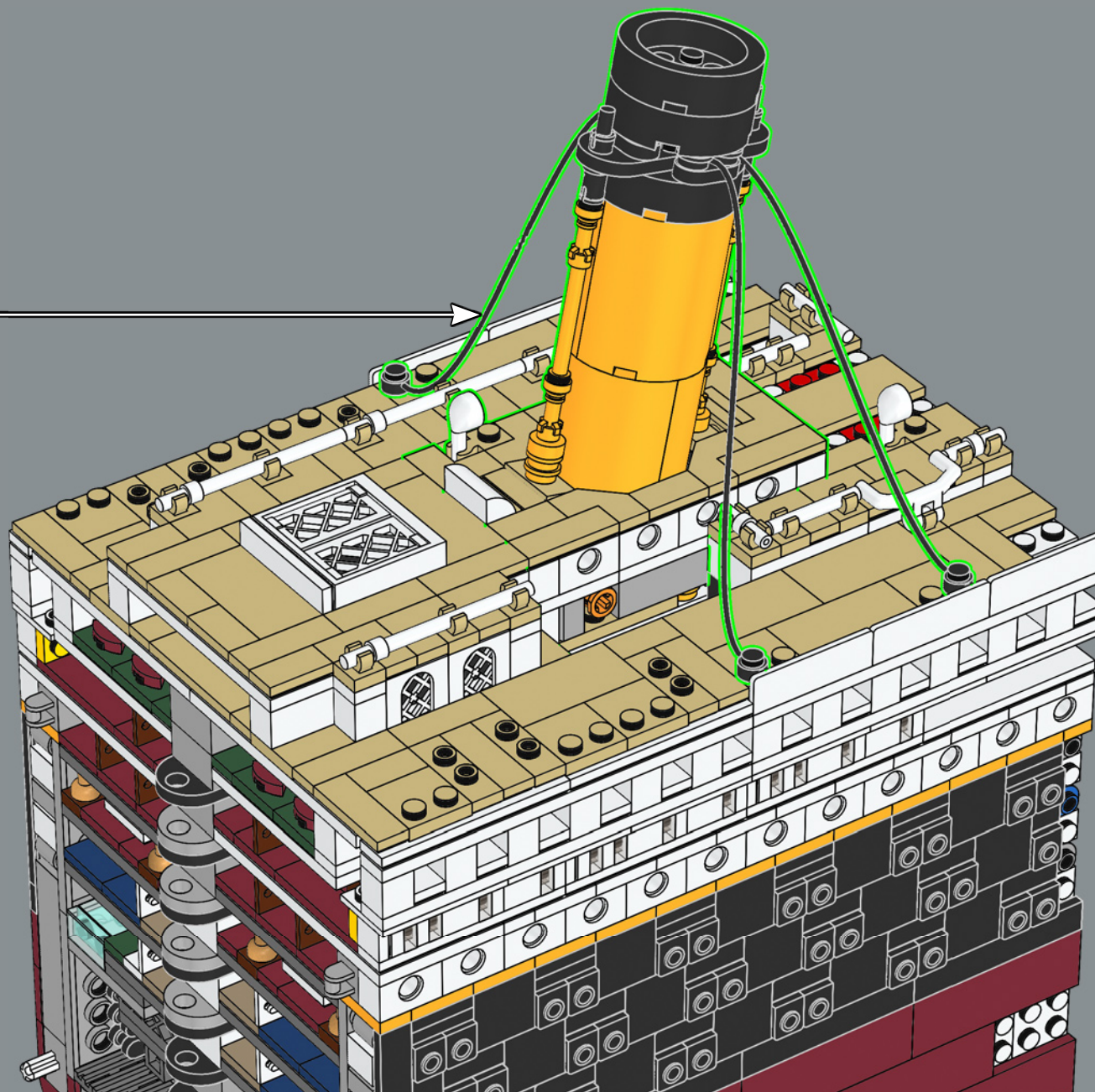

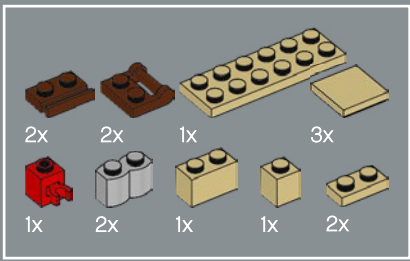

137

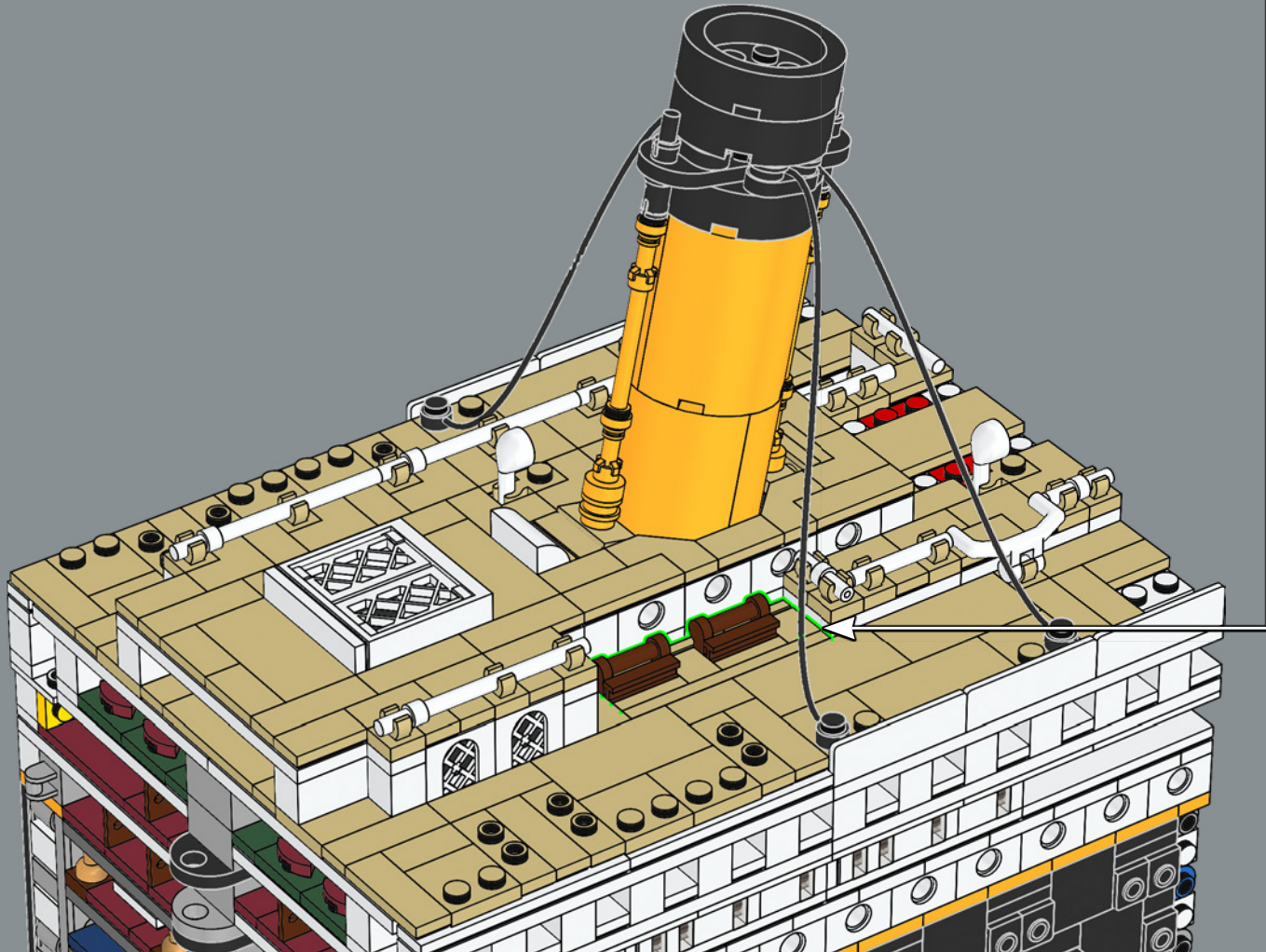
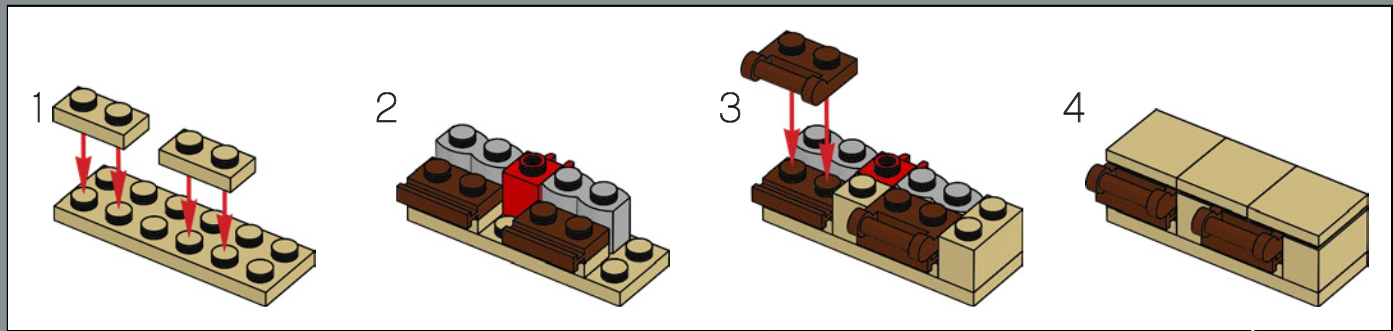





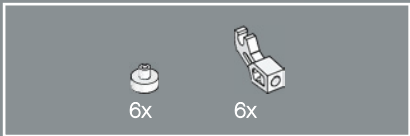

139

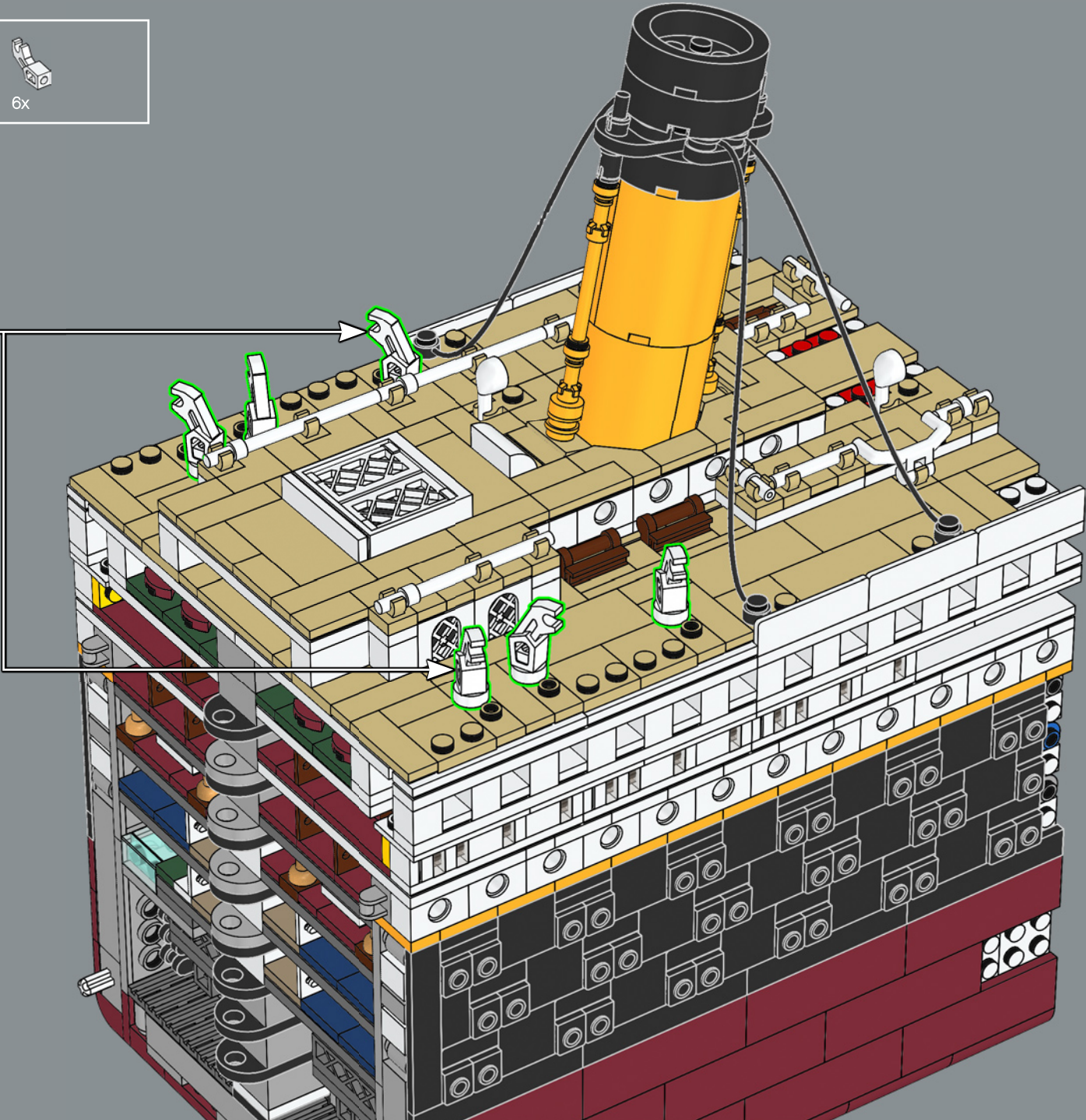
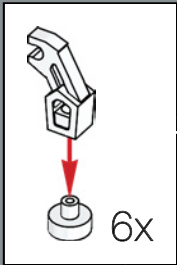

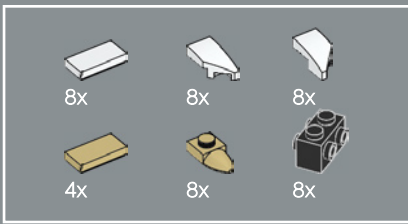

140

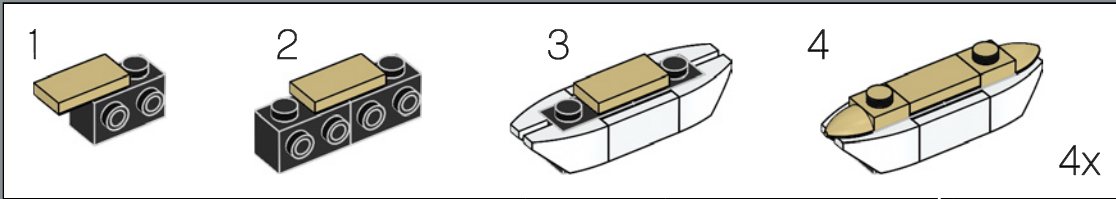

Of the 20 lifeboats onboard, 14 were standard wooden lifeboats with a capacity of 65 people each and four "collapsible" boats holding 47 people in each.

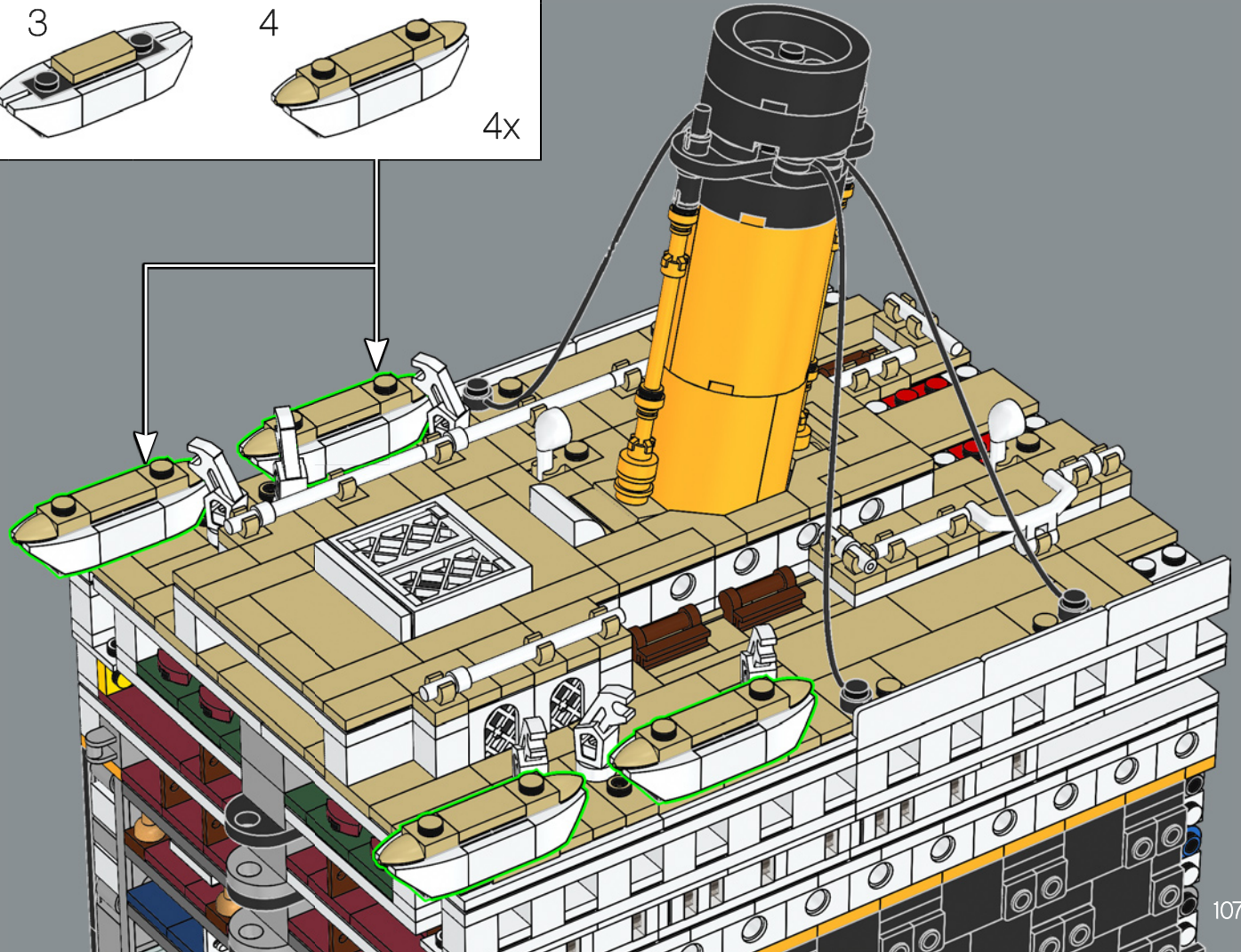

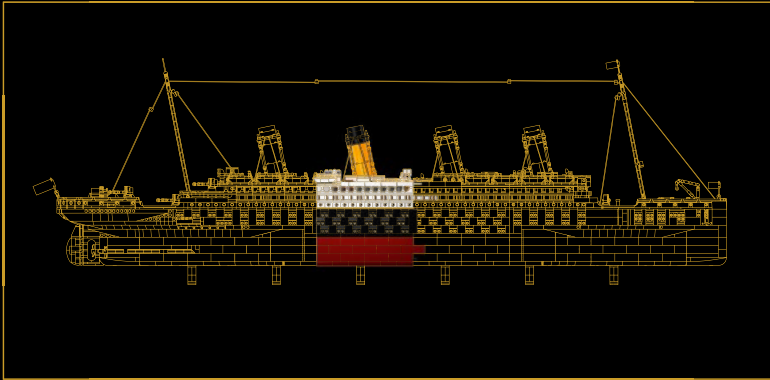

#### SECTION 4:

## FUNNEL & COMPASS

This section includes a portion of the *Titanic's* massive engine rooms and the elevated structure in the centre that housed the main compass. It was elevated to ensure the least amount of interference from the massive amount of iron in the ship's hull. There is also a small sub-assembly that represents a bench used by passengers enjoying the upper decks of the ship.



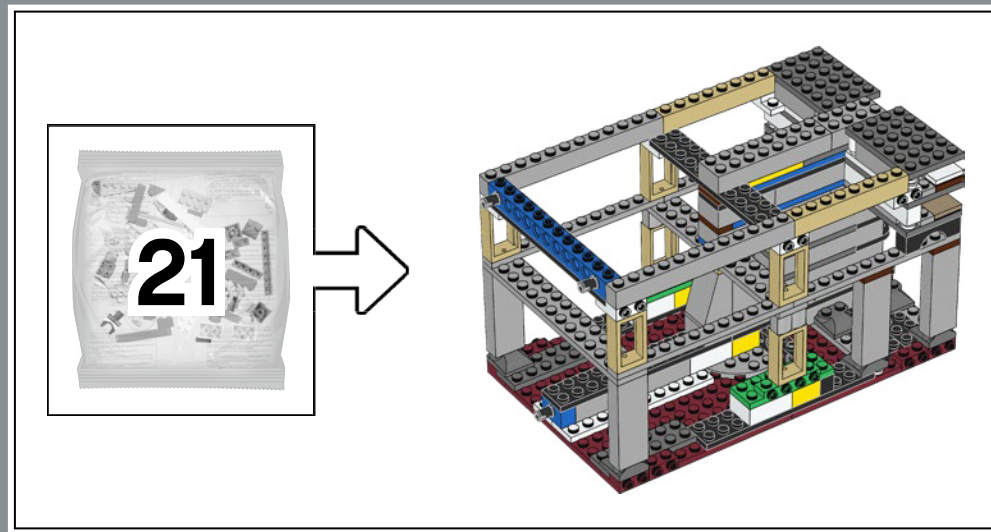

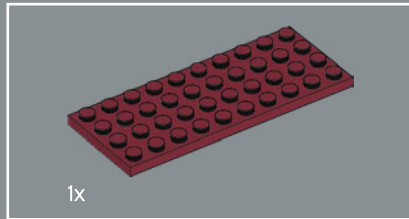
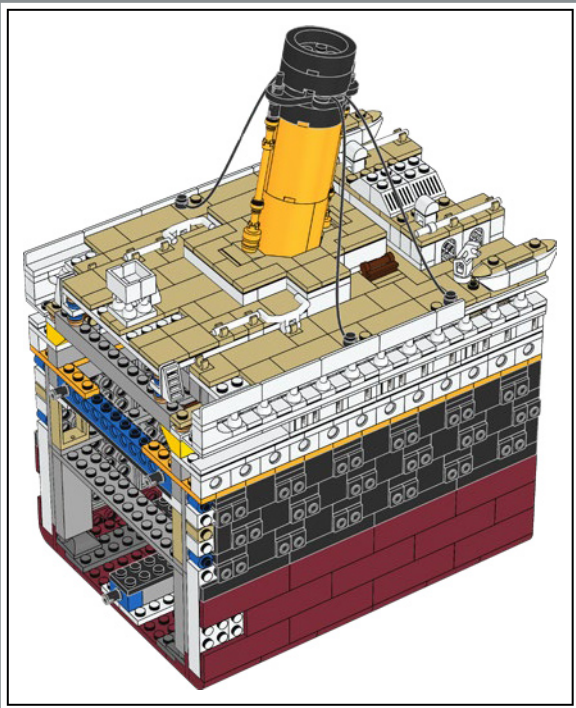

141

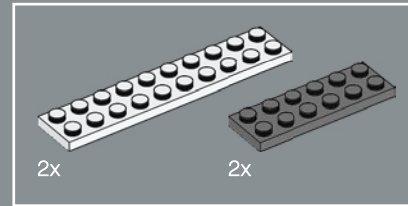
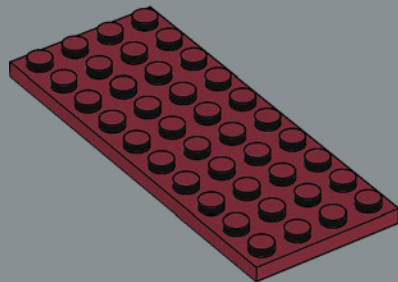

142

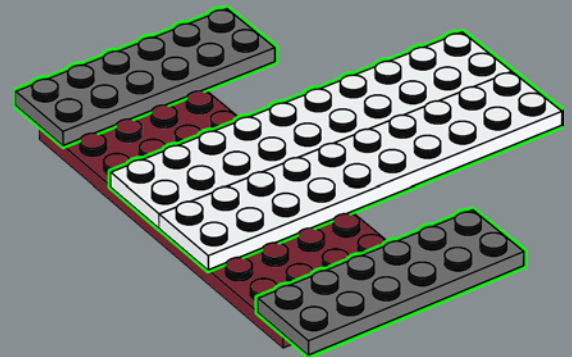

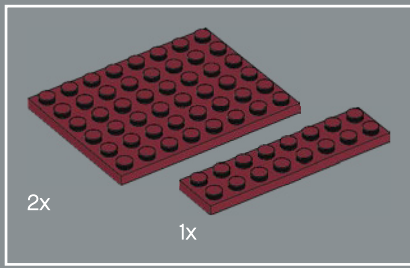

143

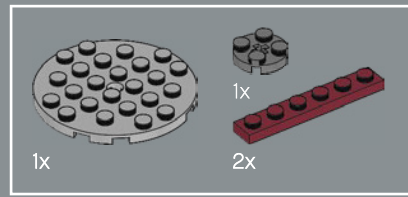
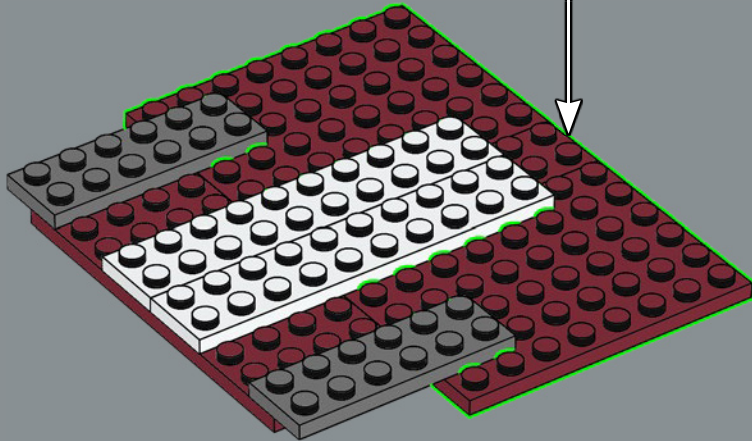
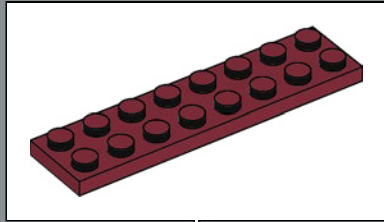

144

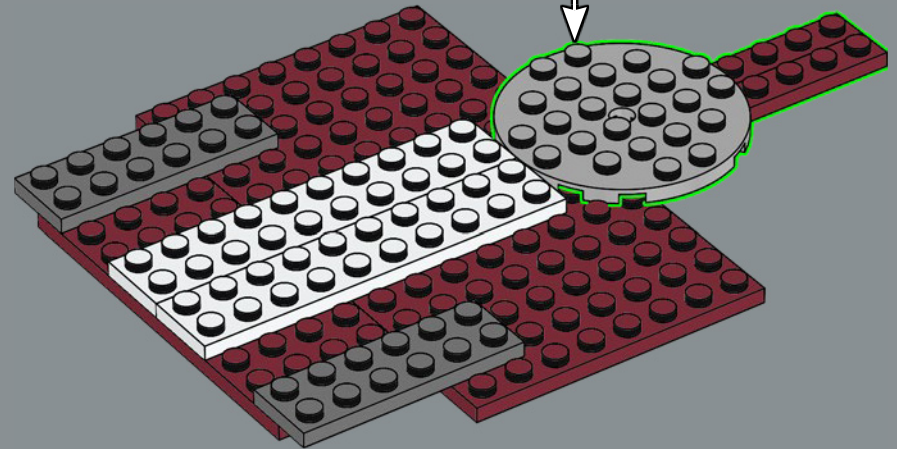
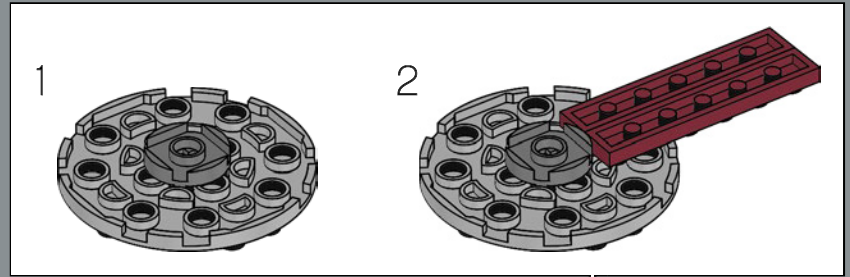





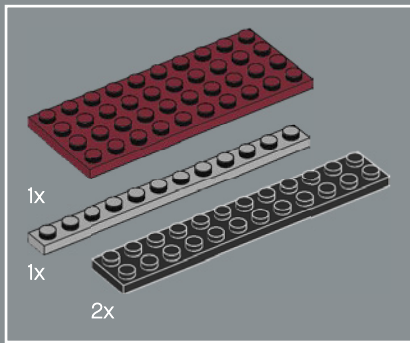

147

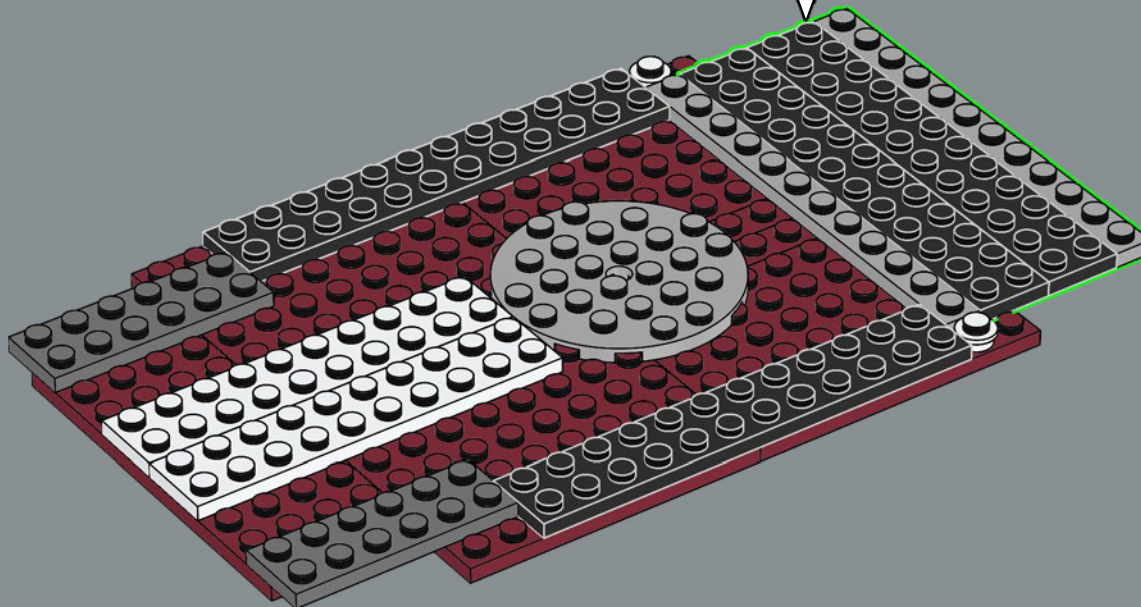
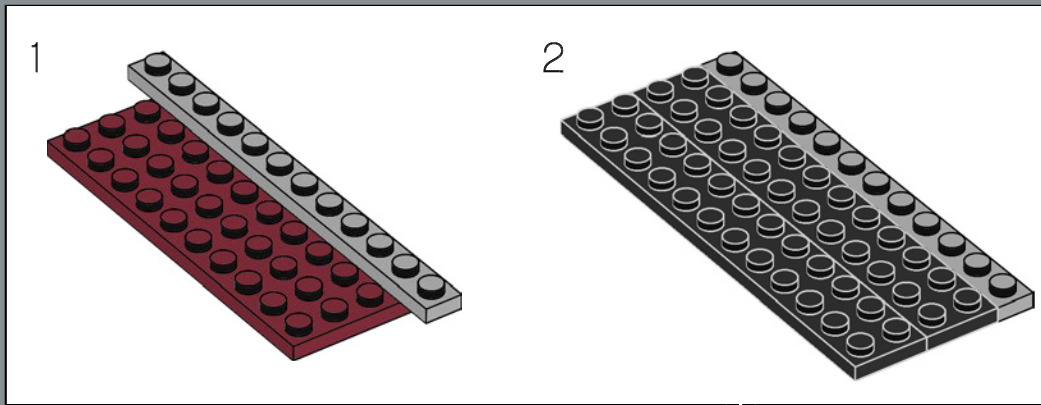



148

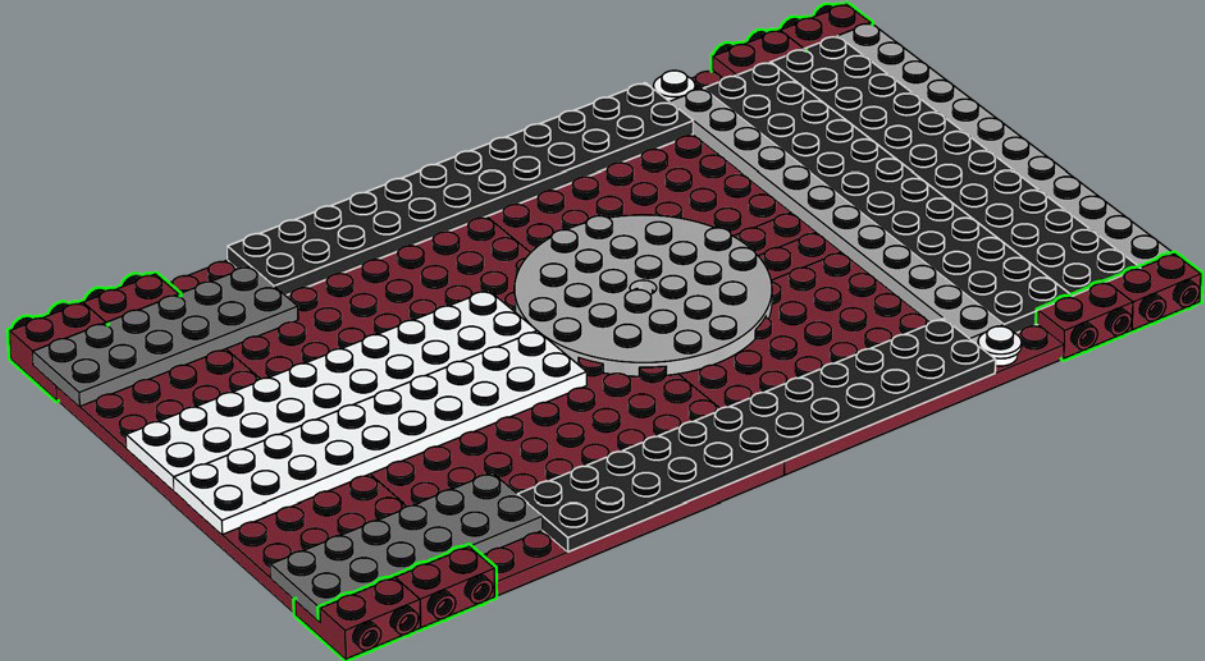

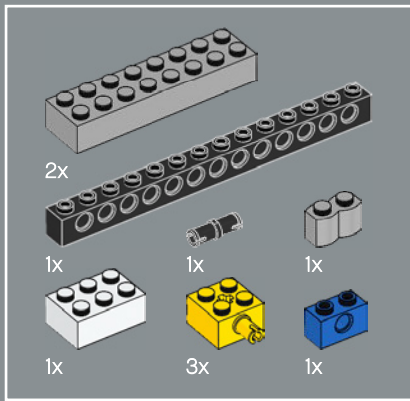

149

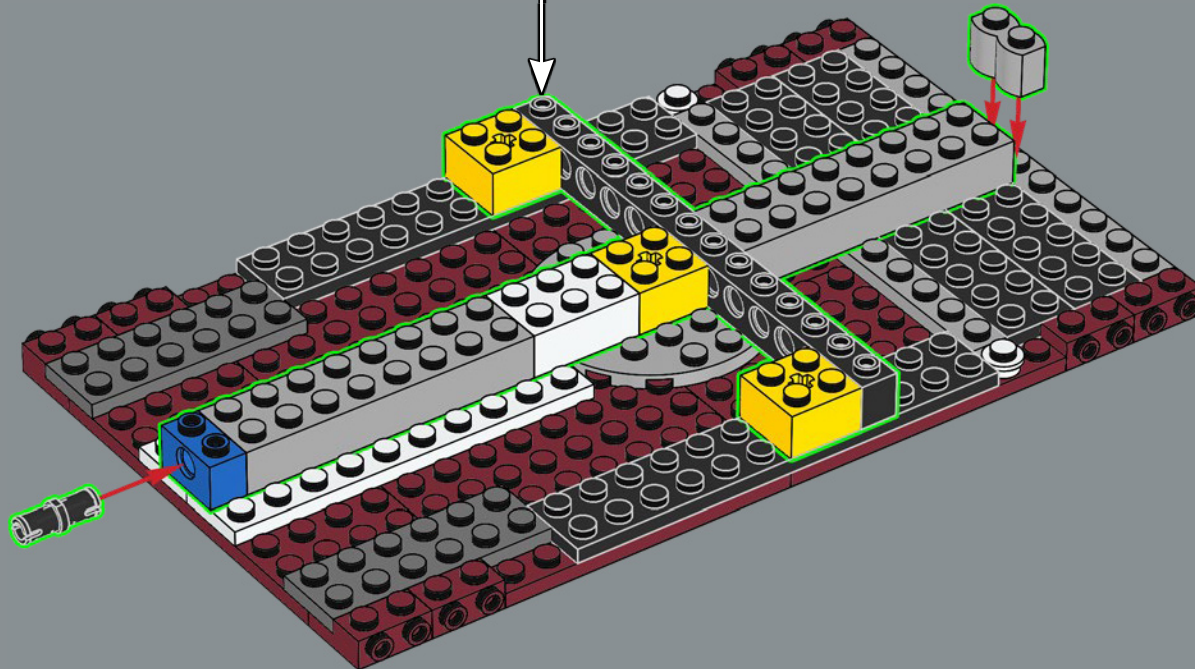
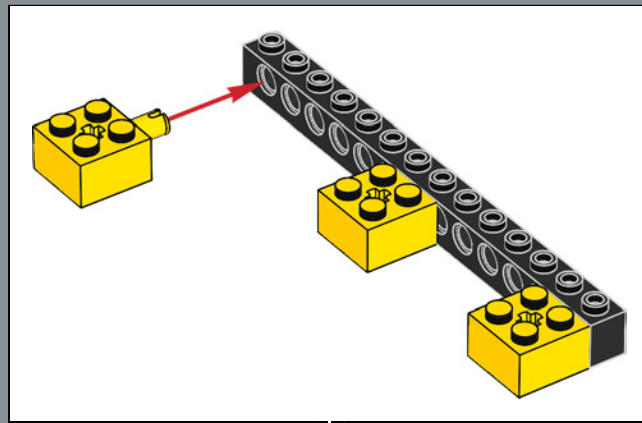

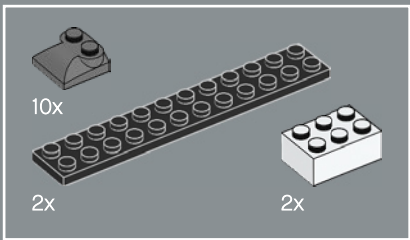

150

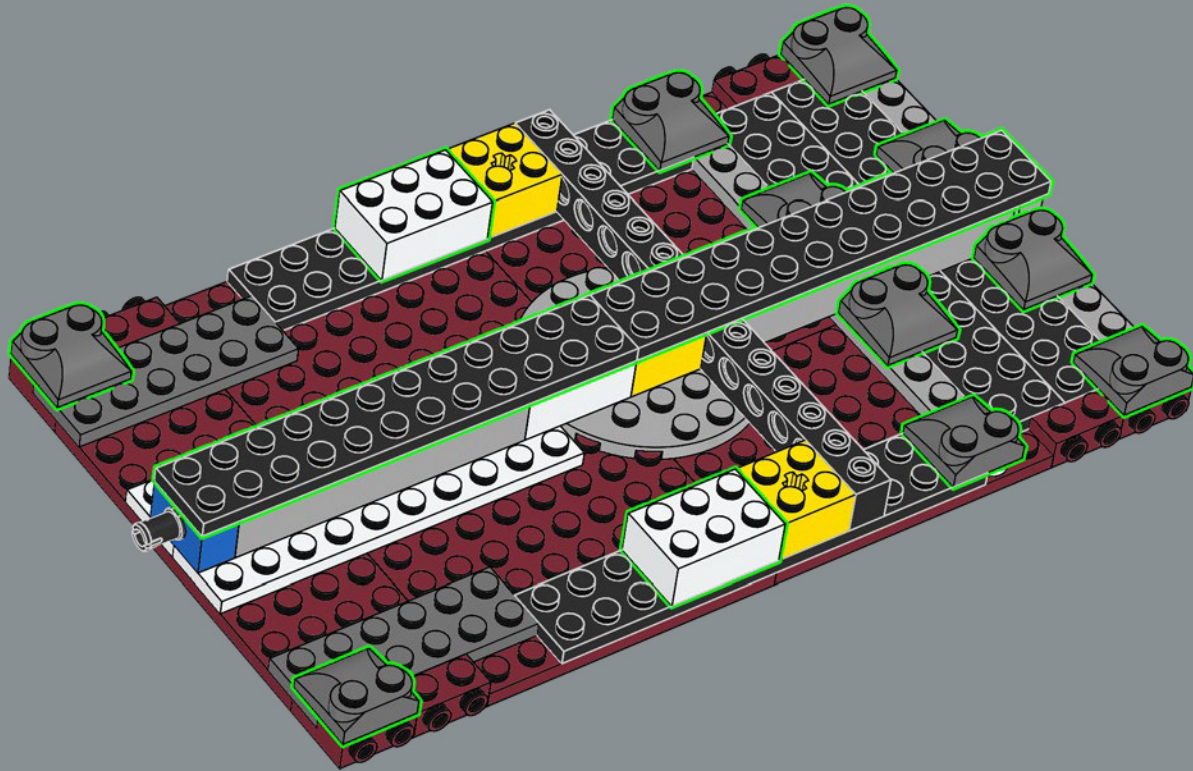

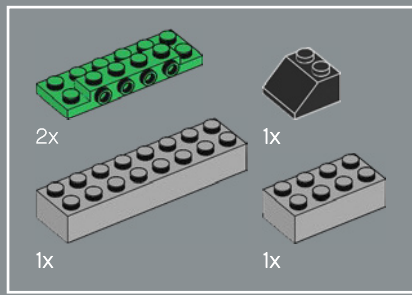

151

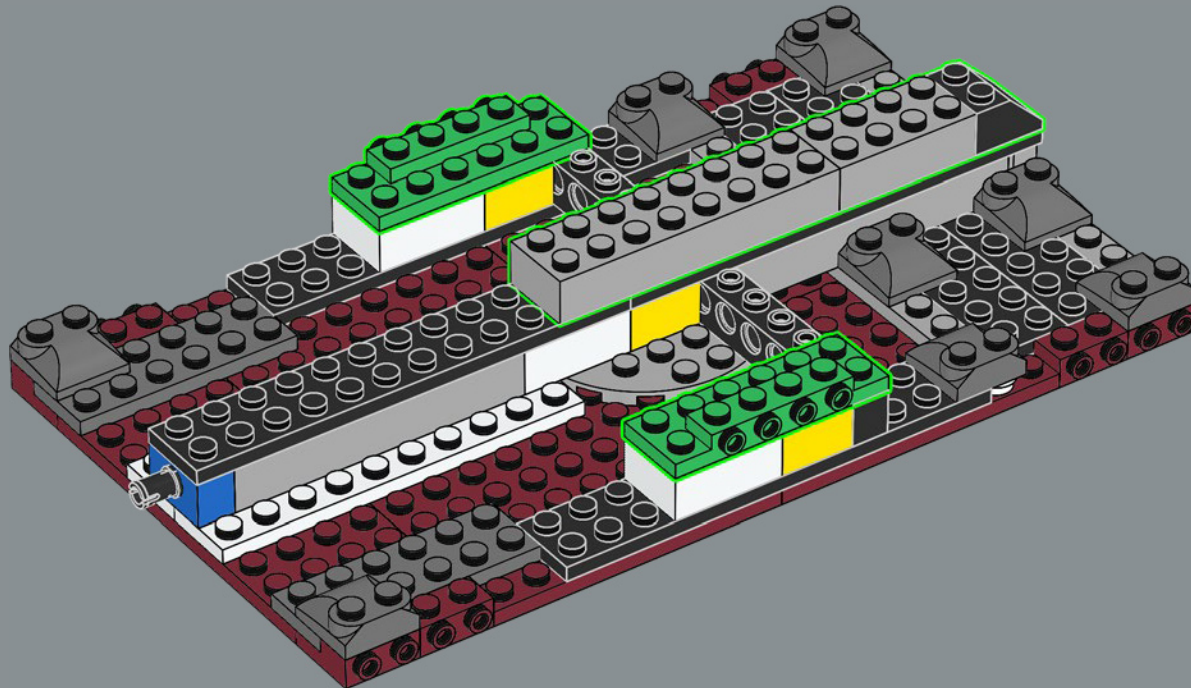

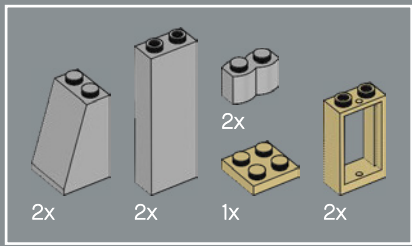

152

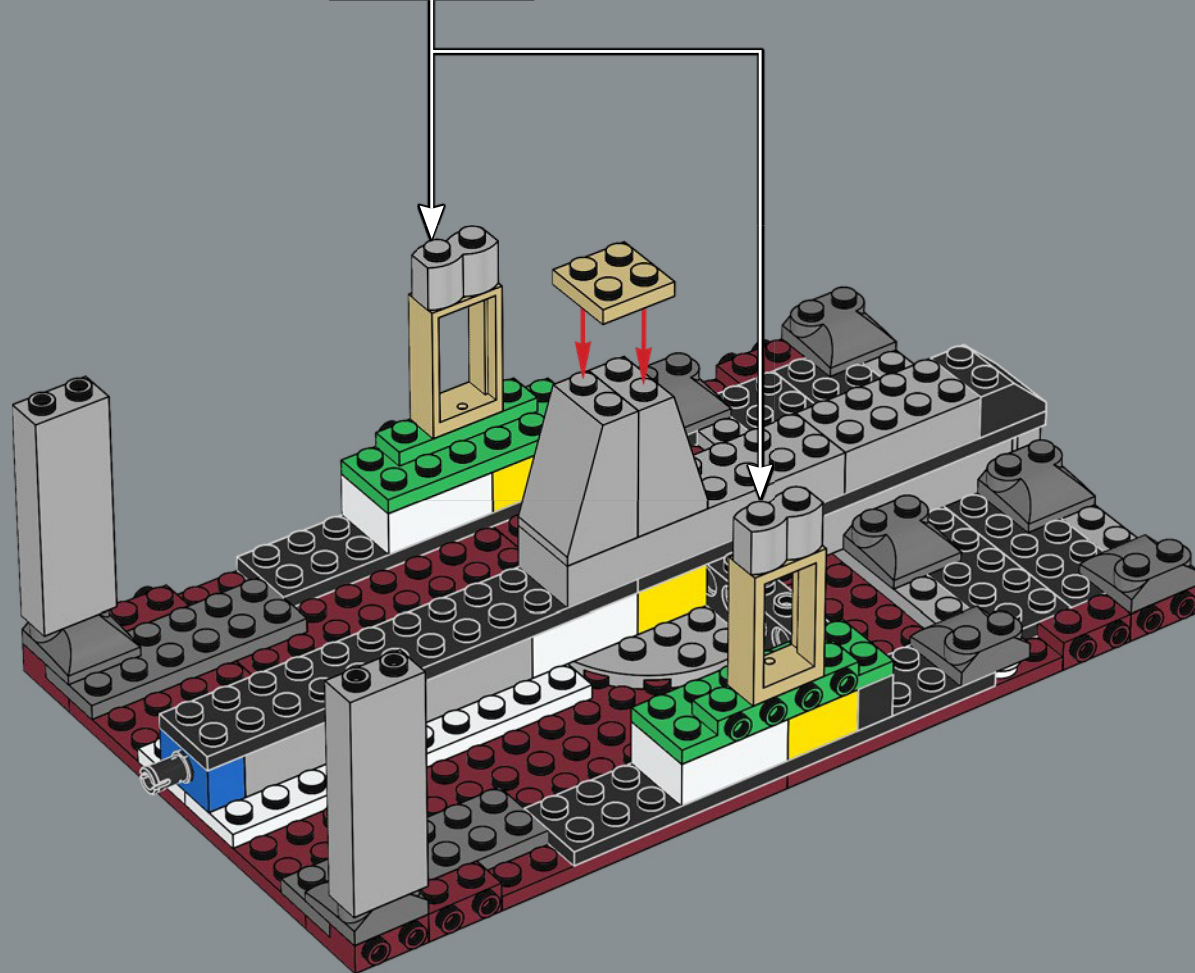
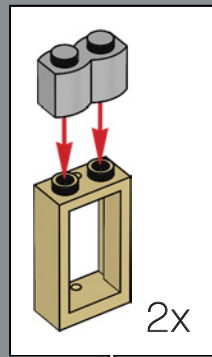

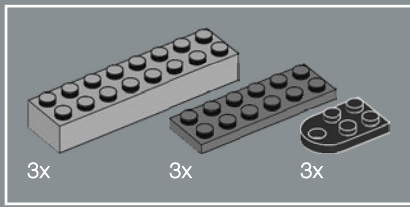

153

1

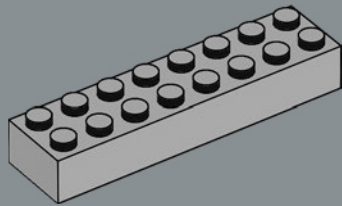

2

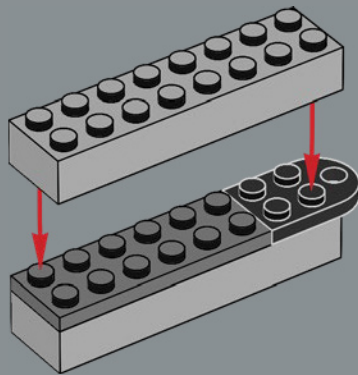

3

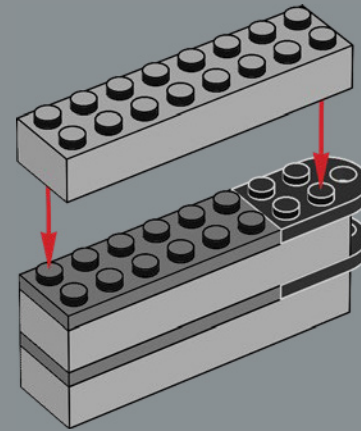

4

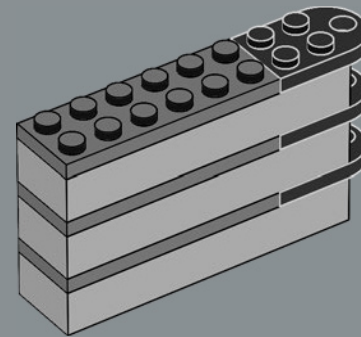

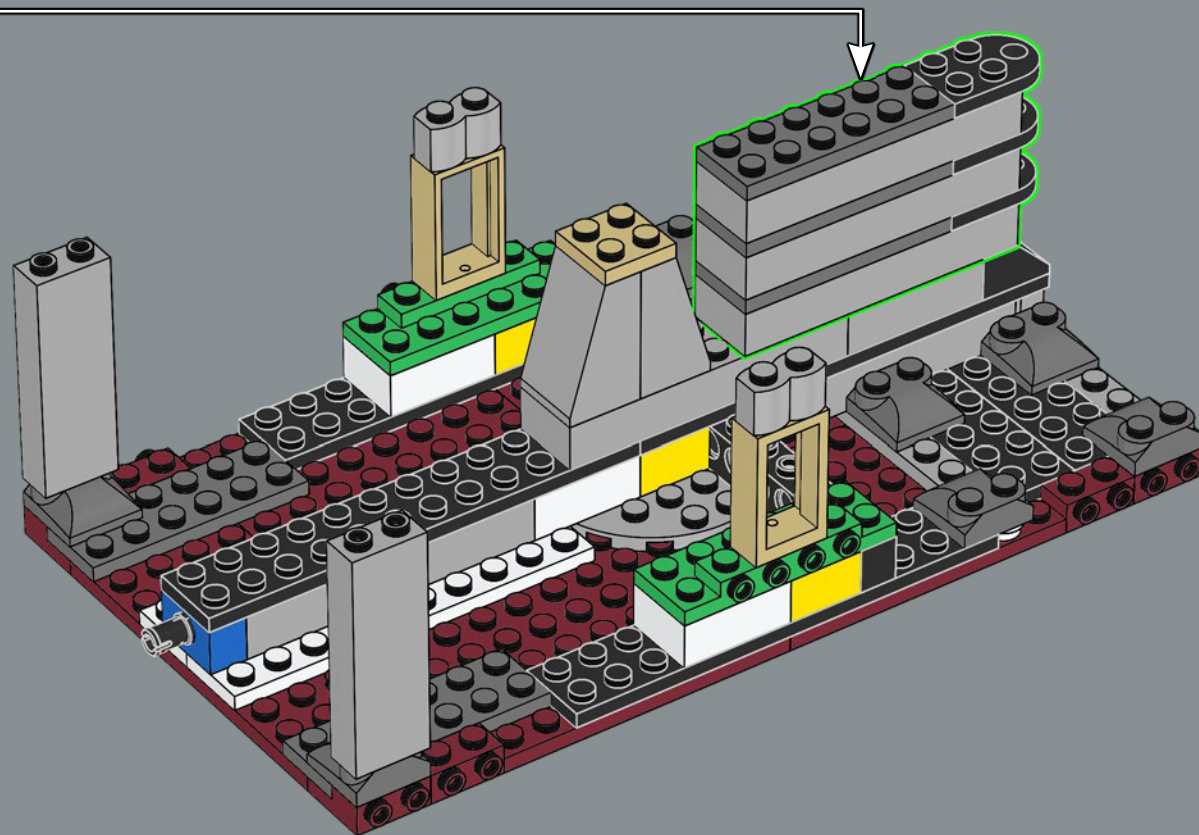



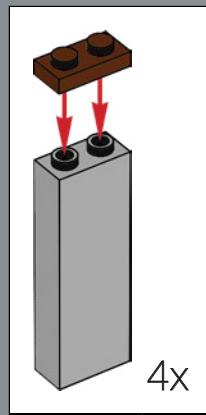
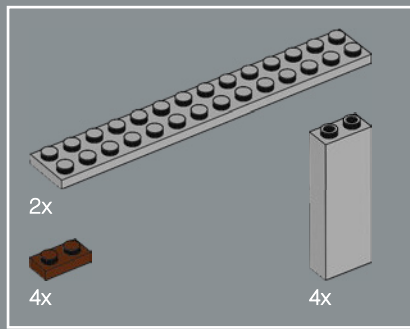

154

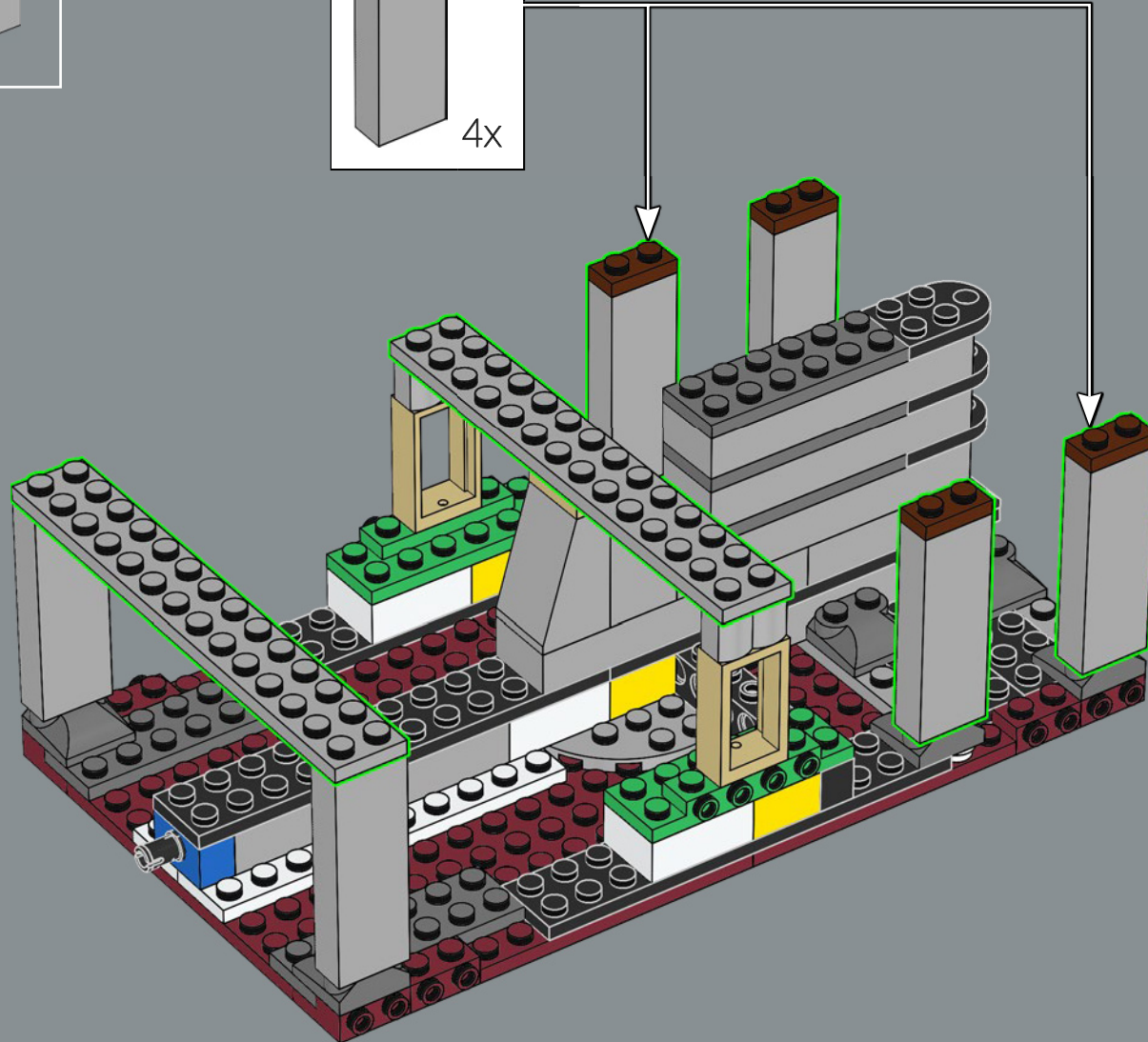

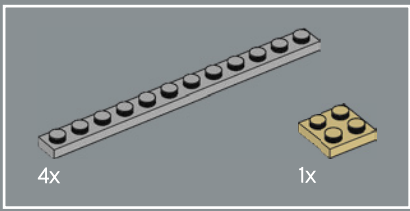

155

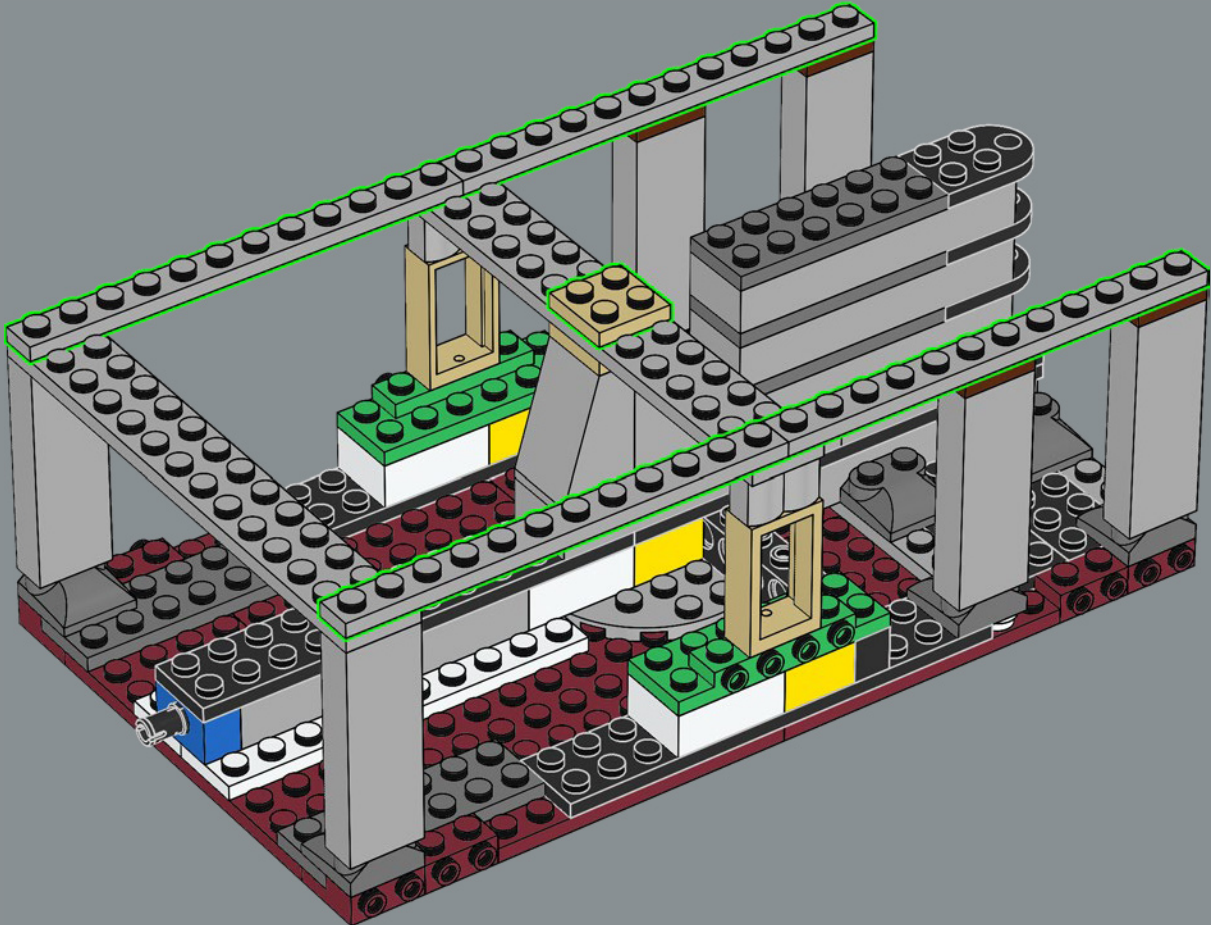

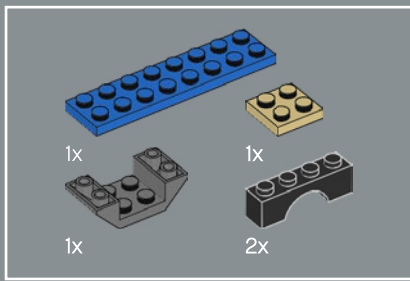

156

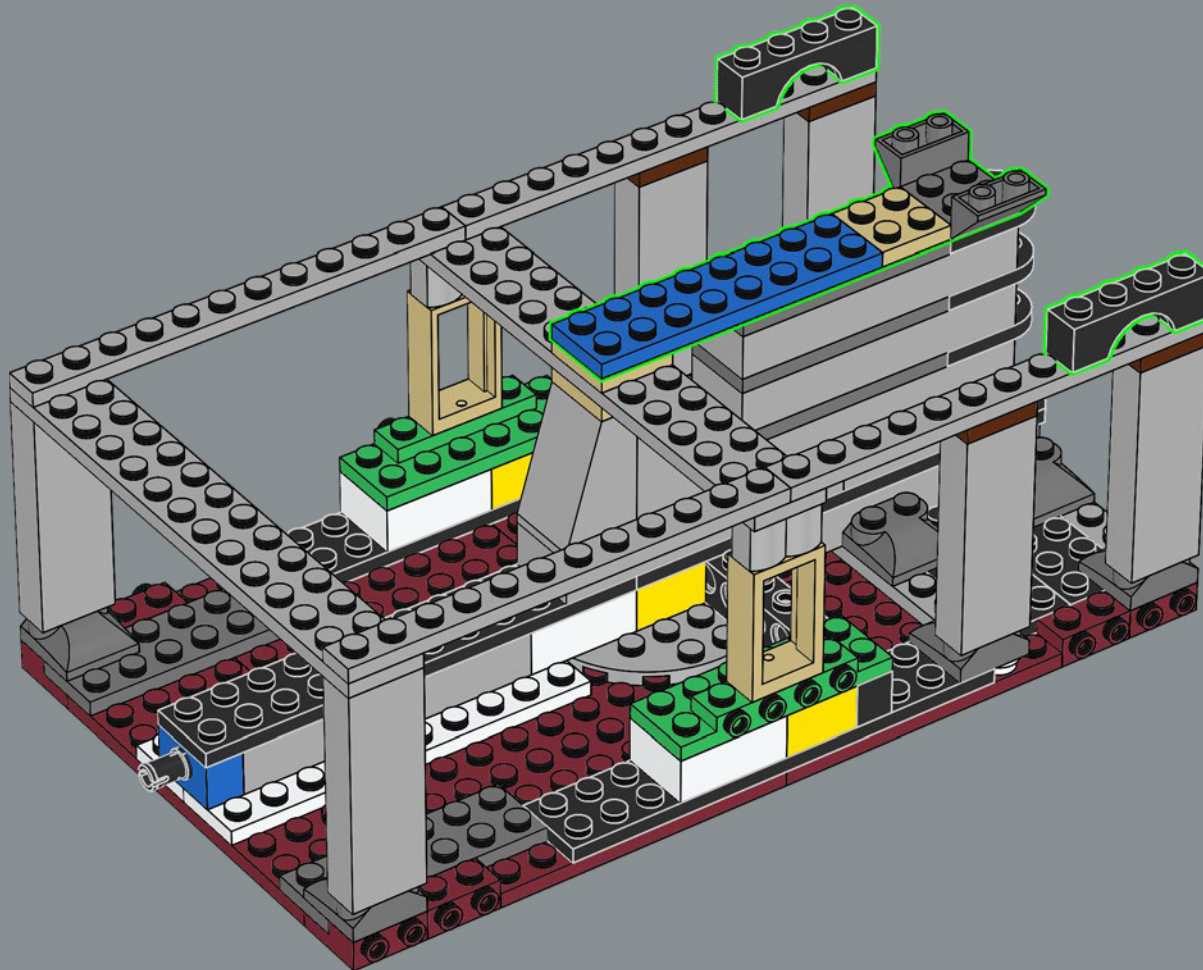

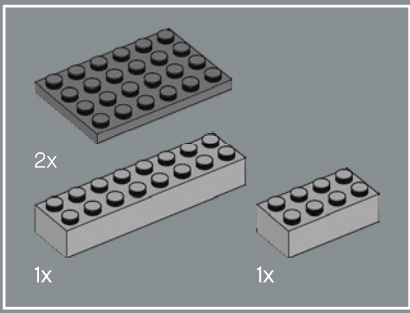

157

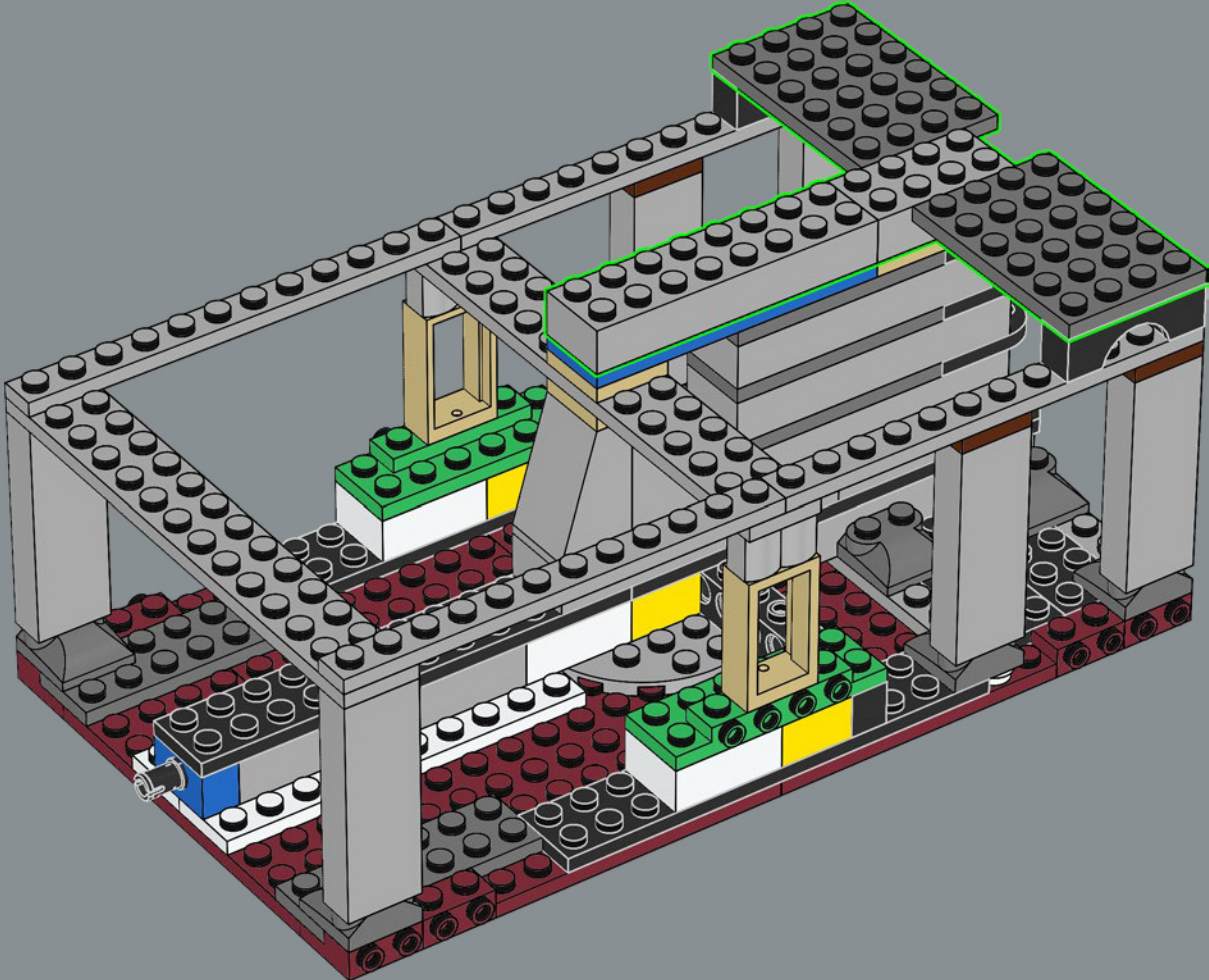

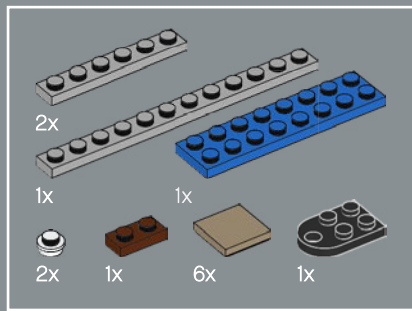

158

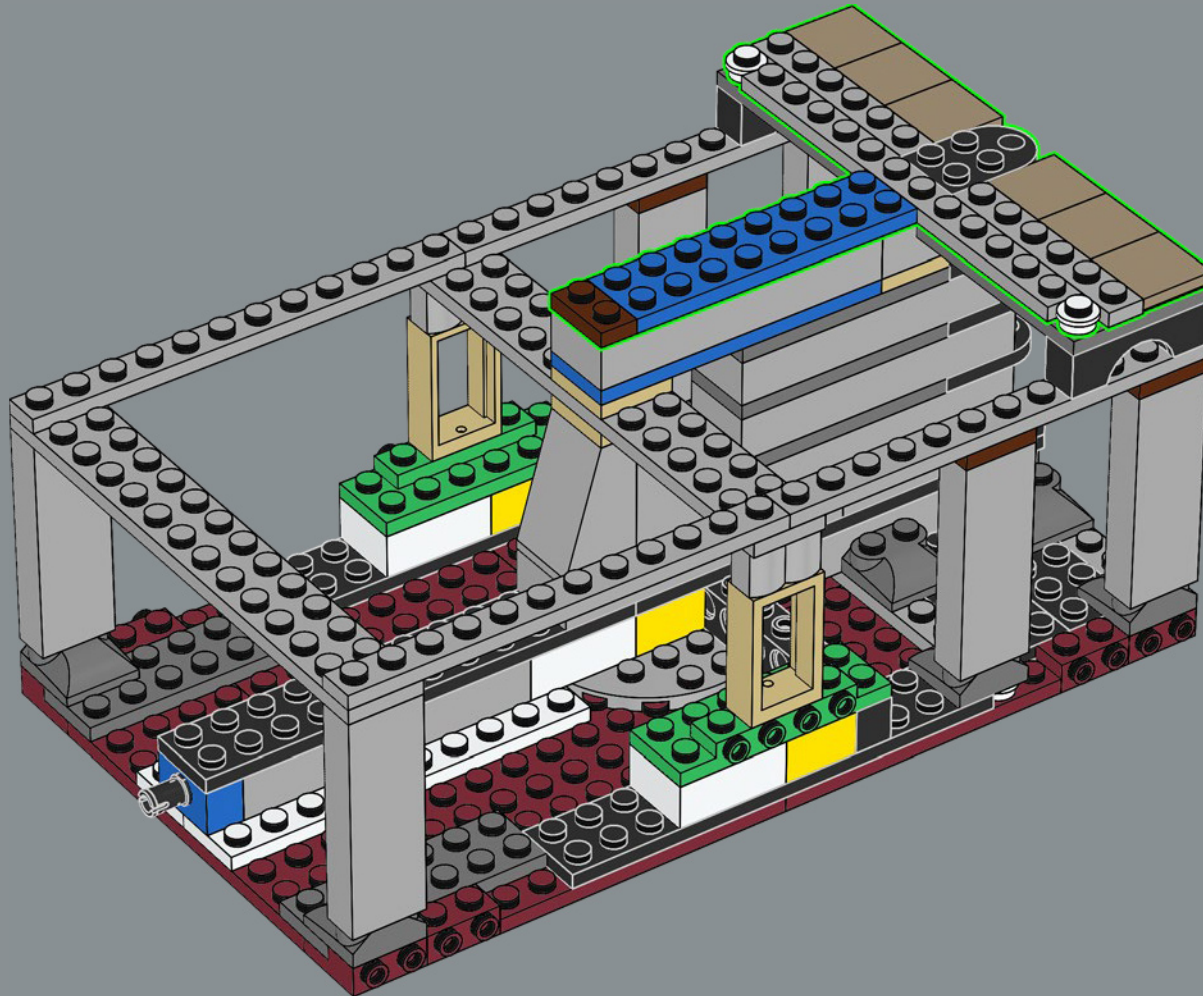

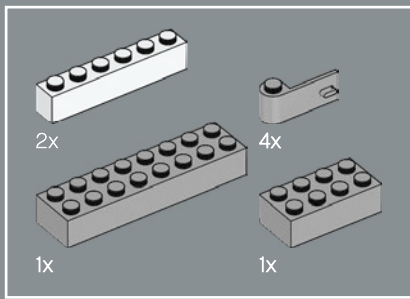

159

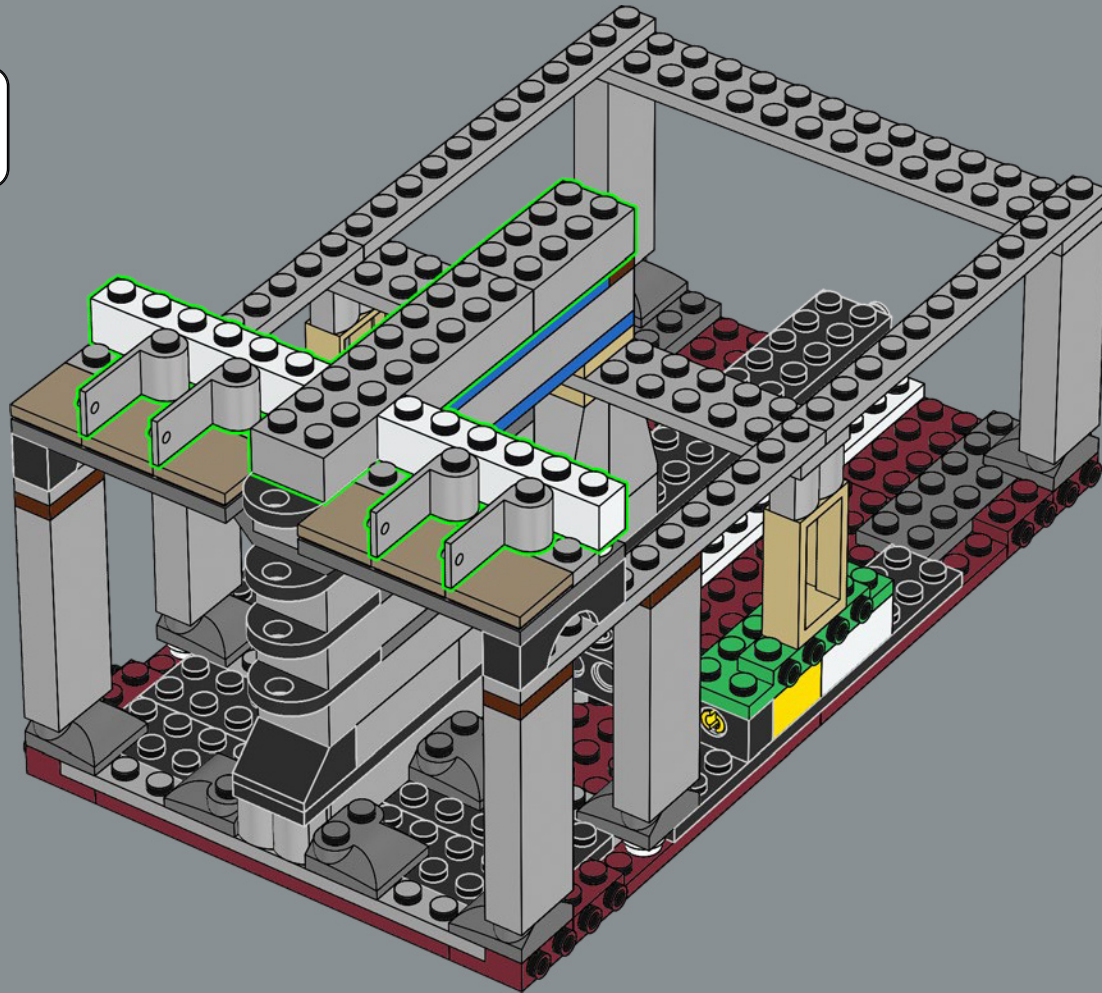

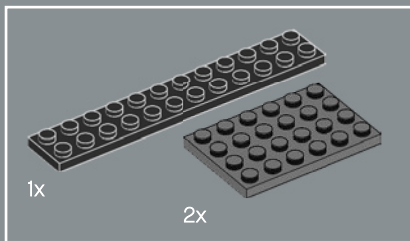

160

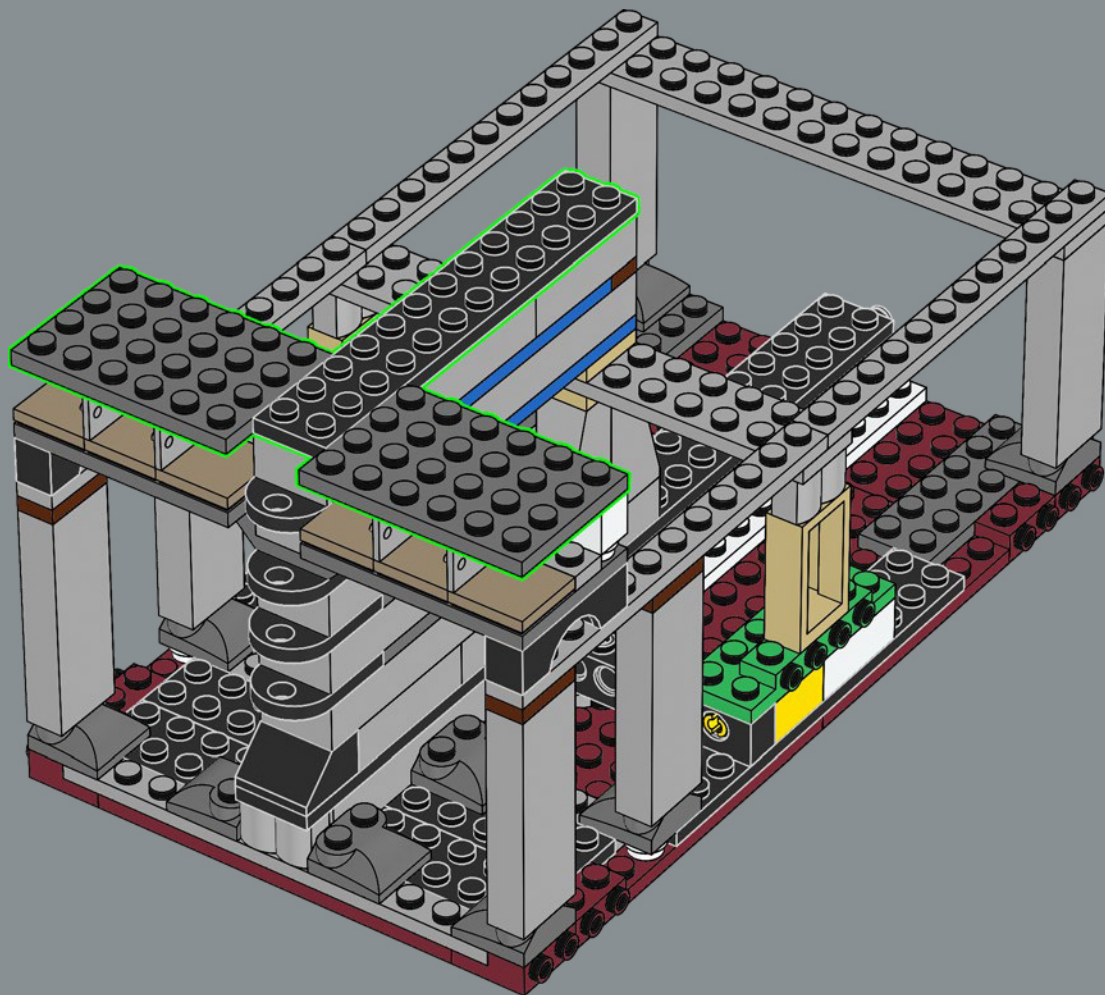





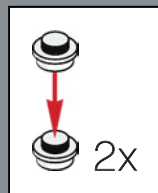
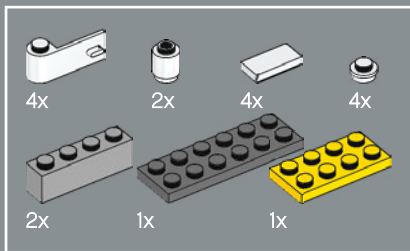

162

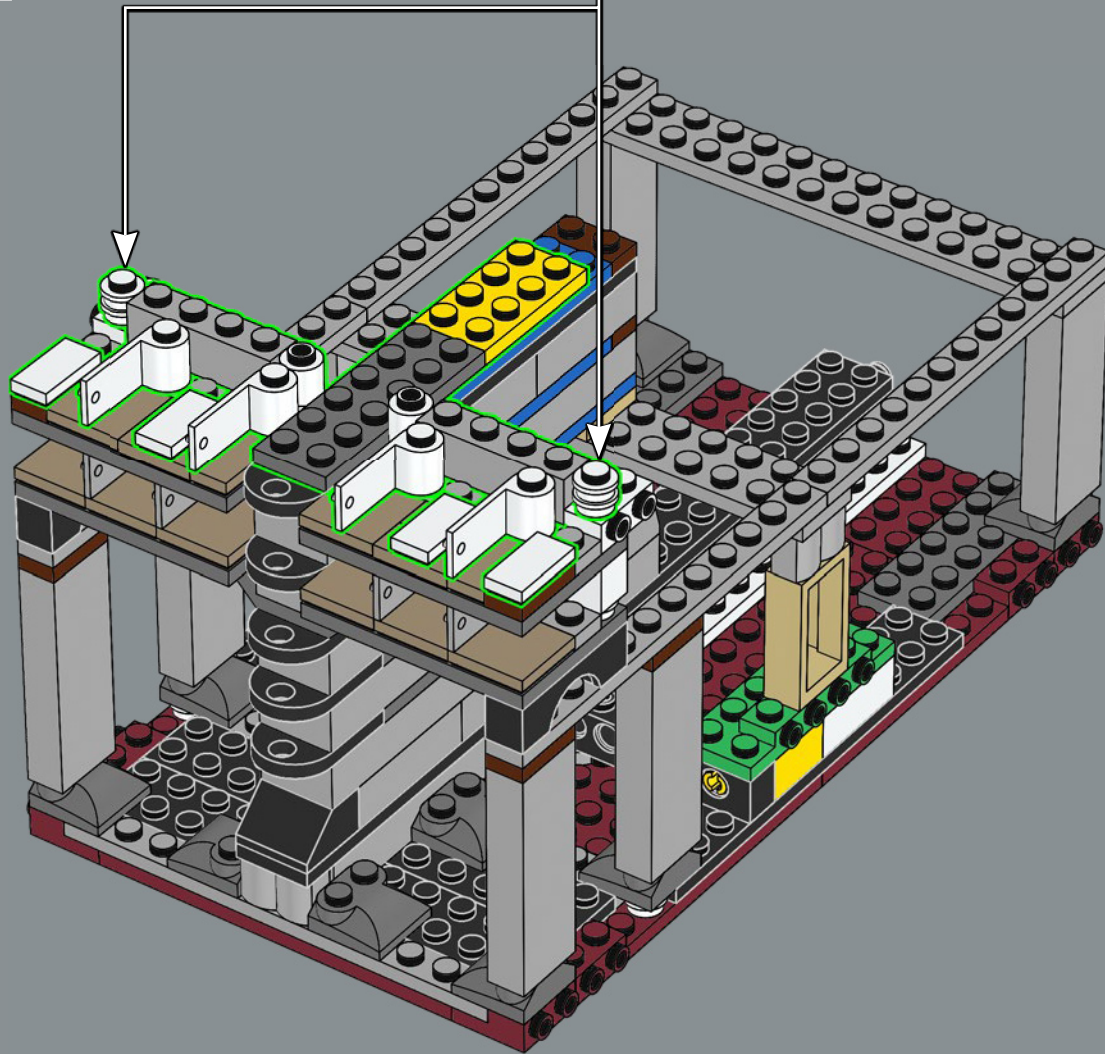

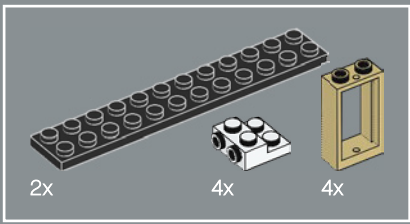

163

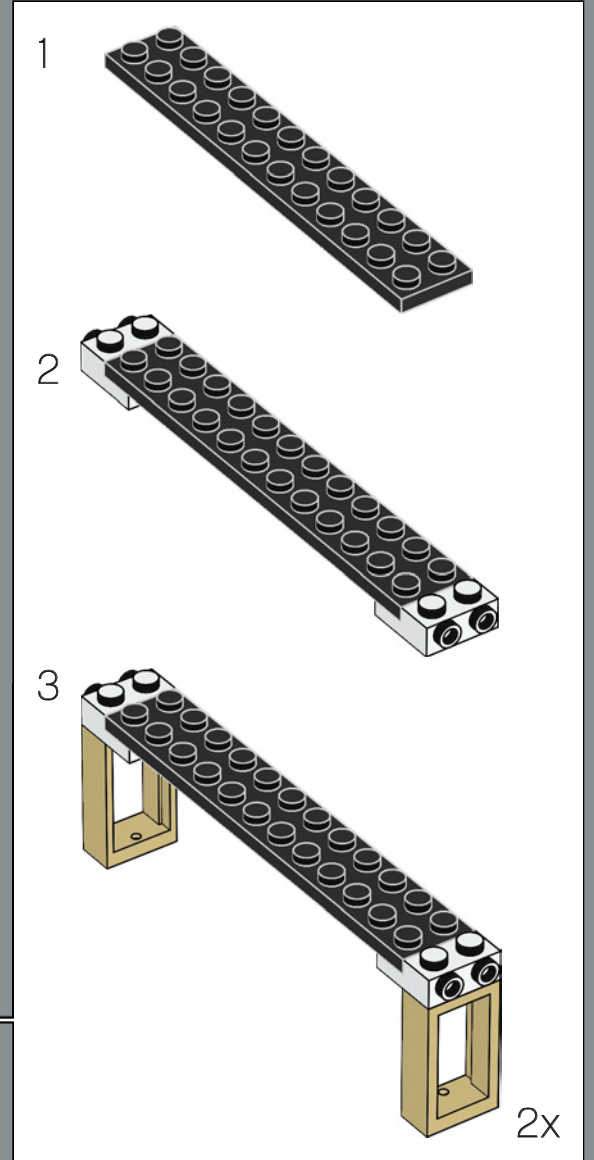
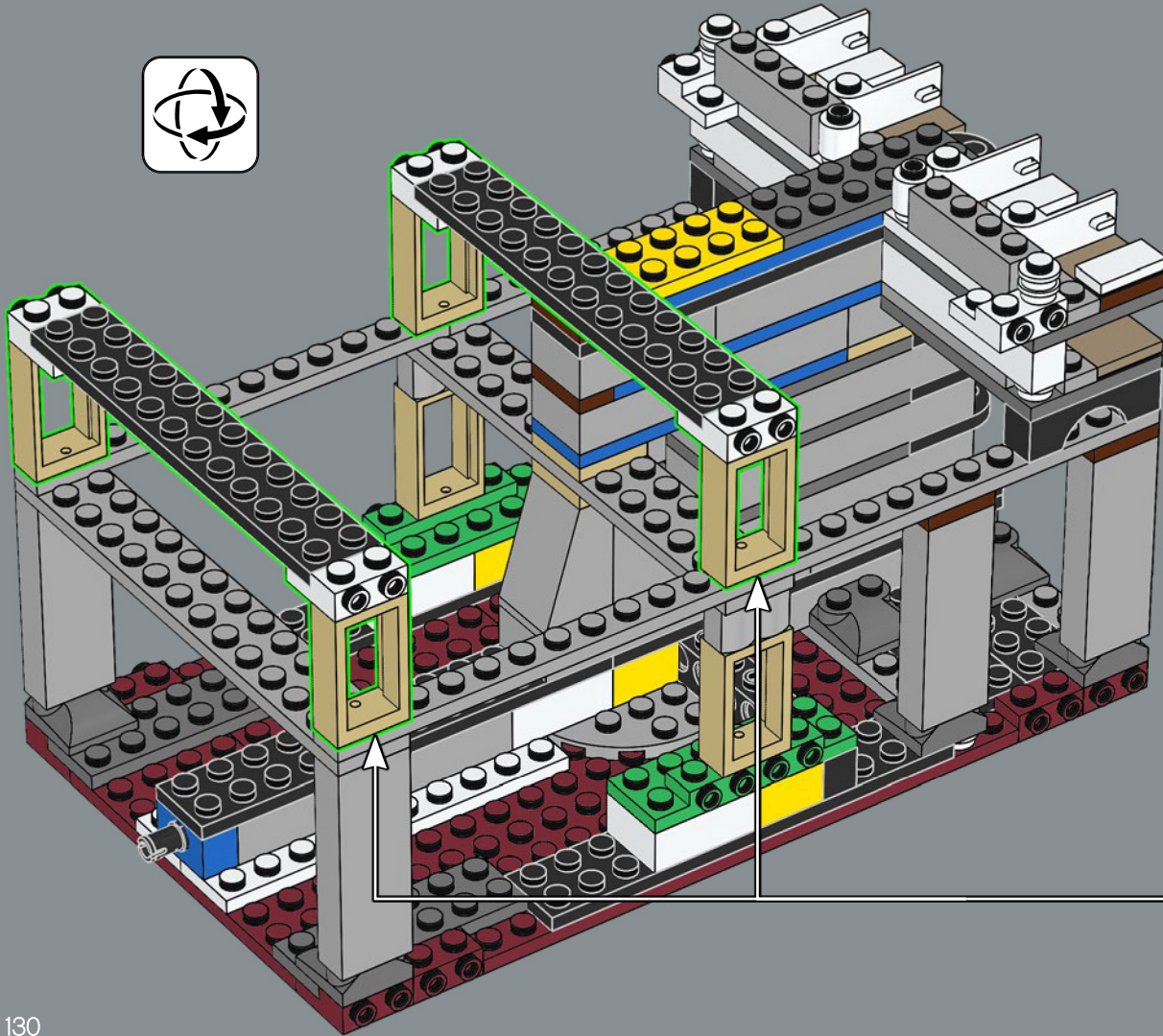

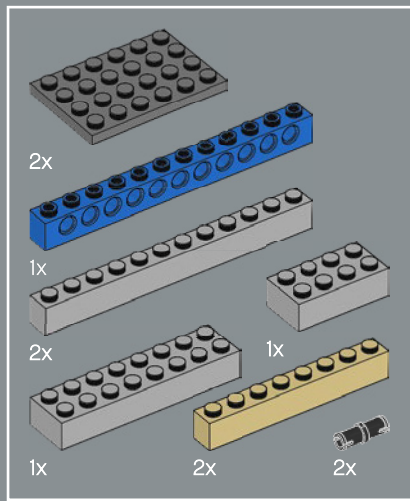

164

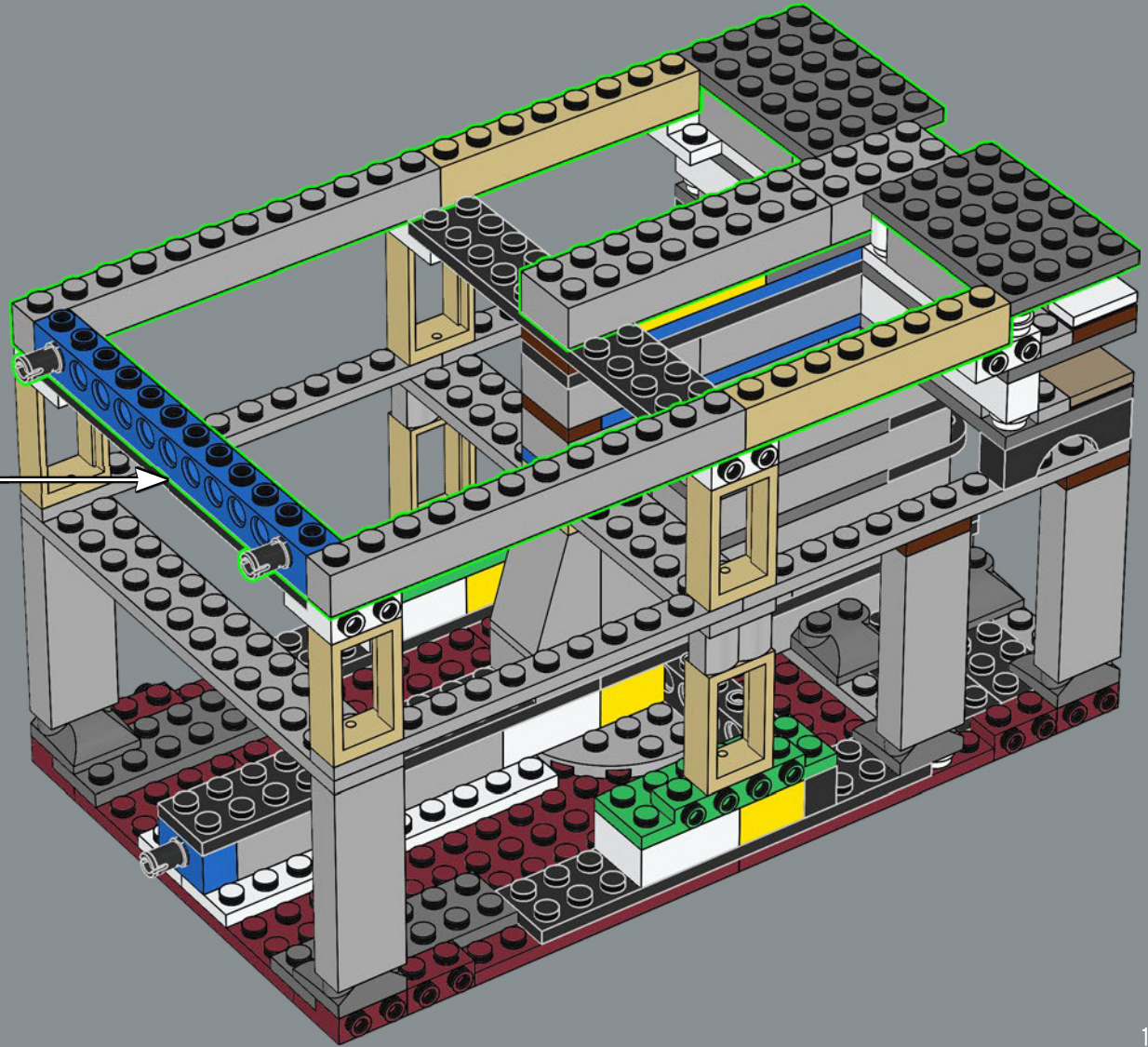
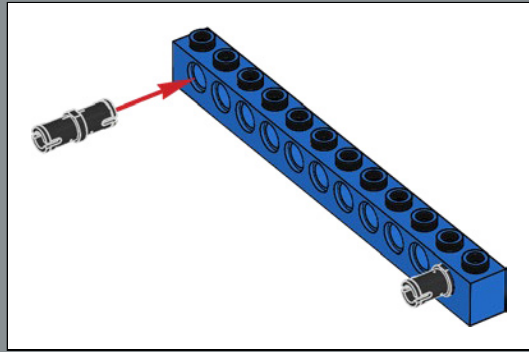

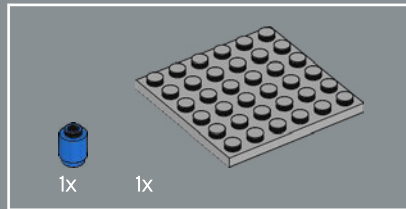
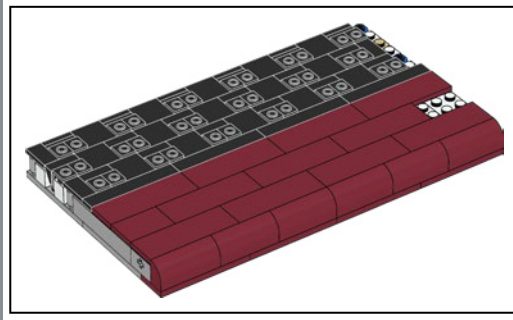
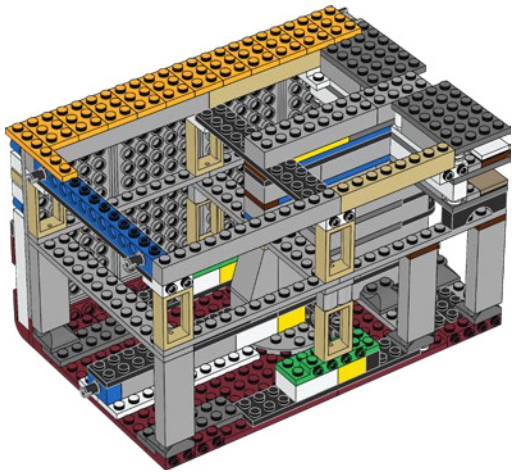
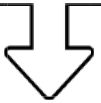

165

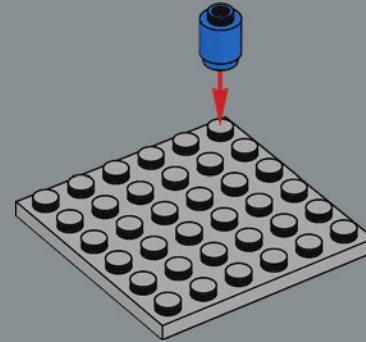

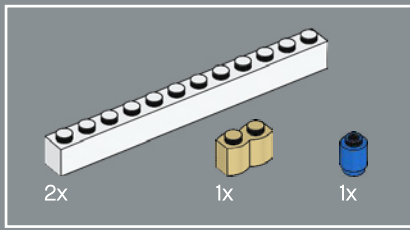

166

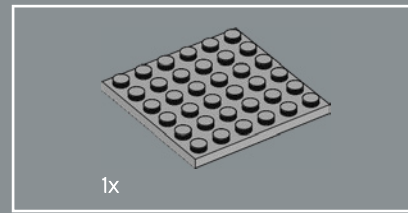
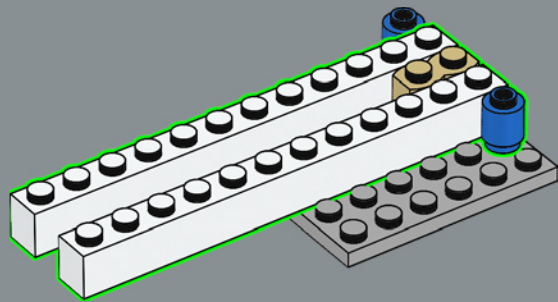

167

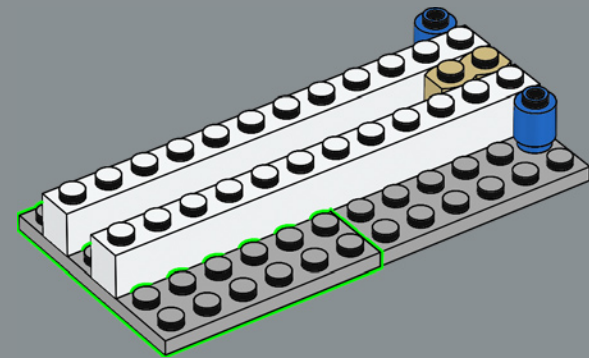

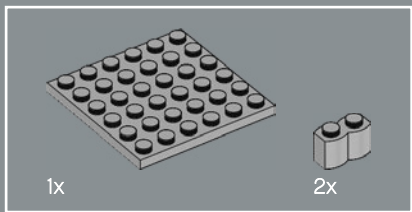

168

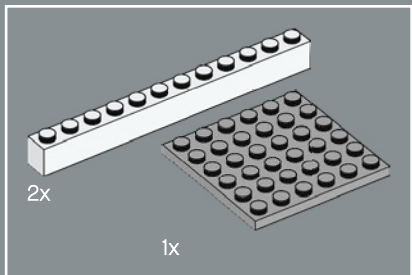
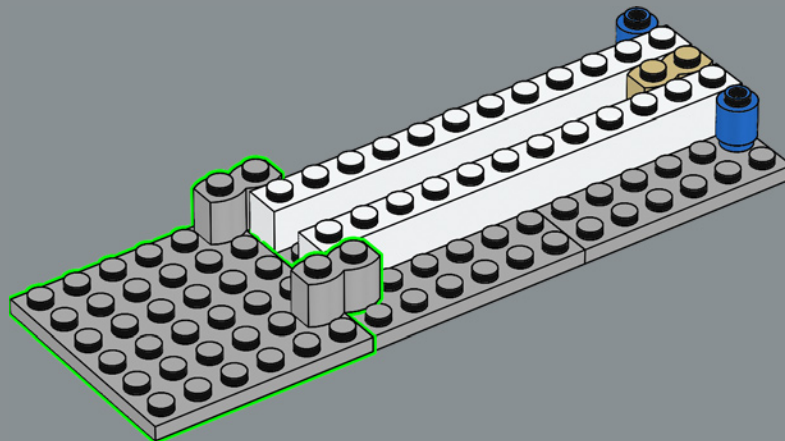

169

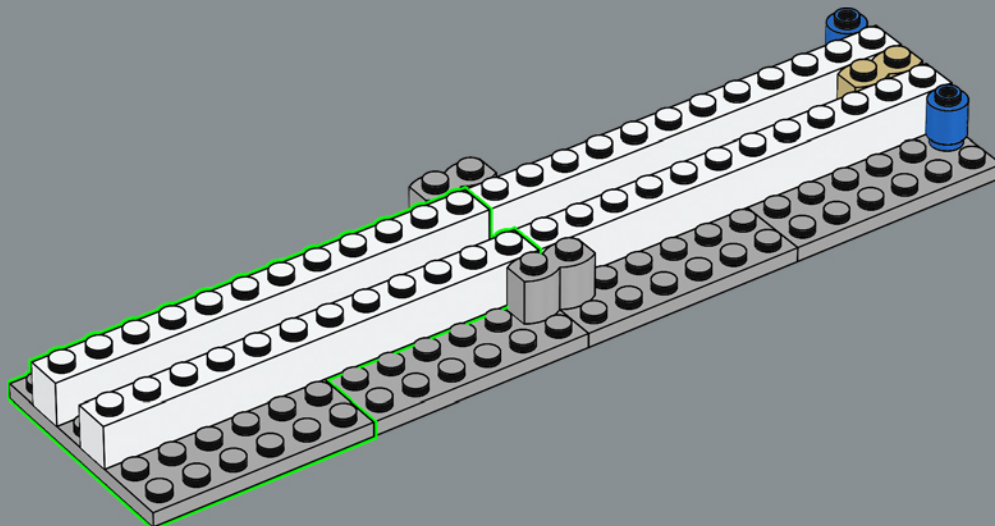



170

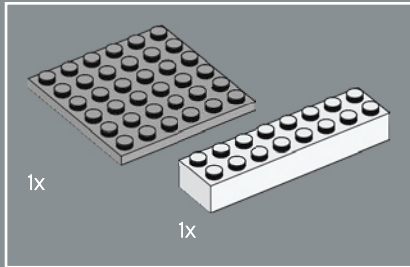
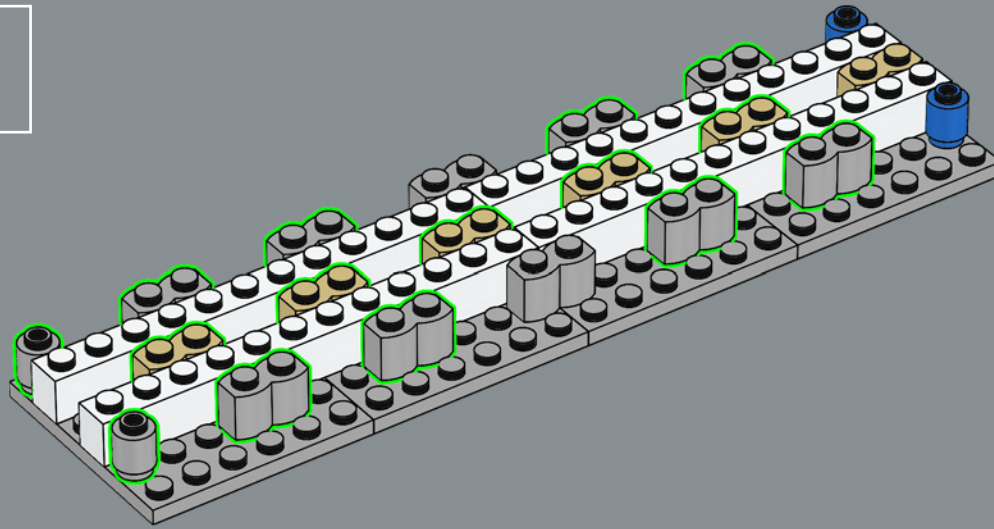

171

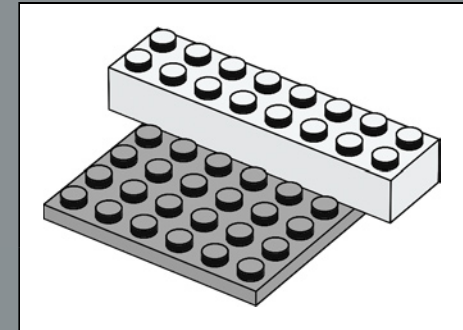
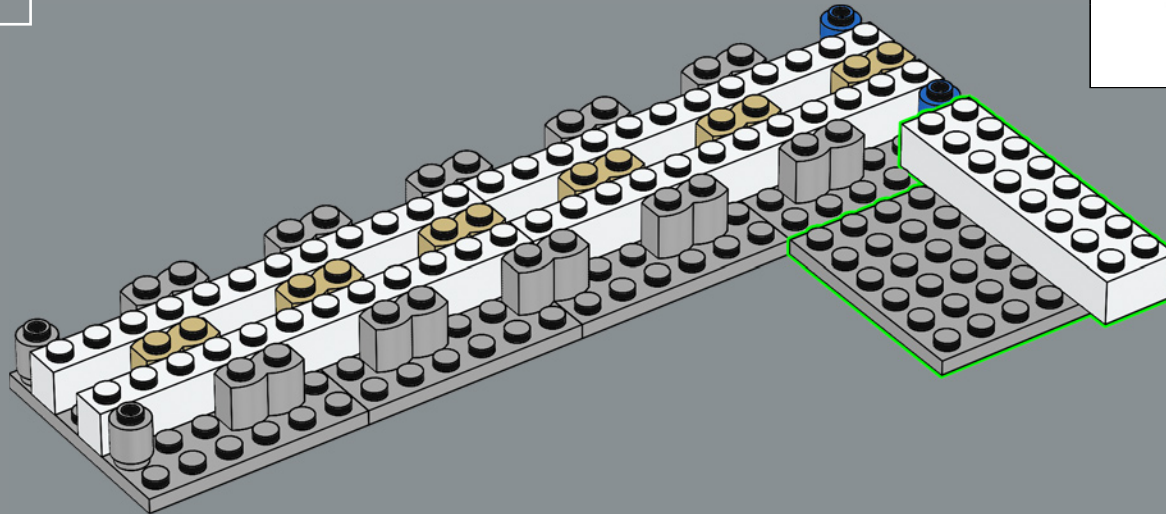

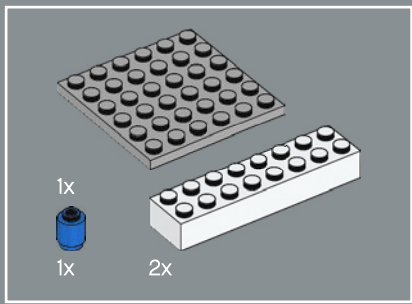

172

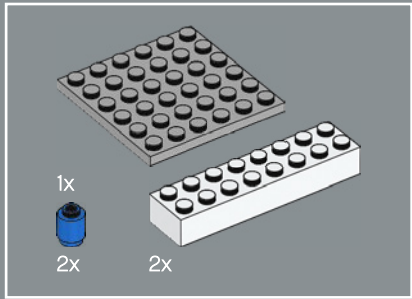
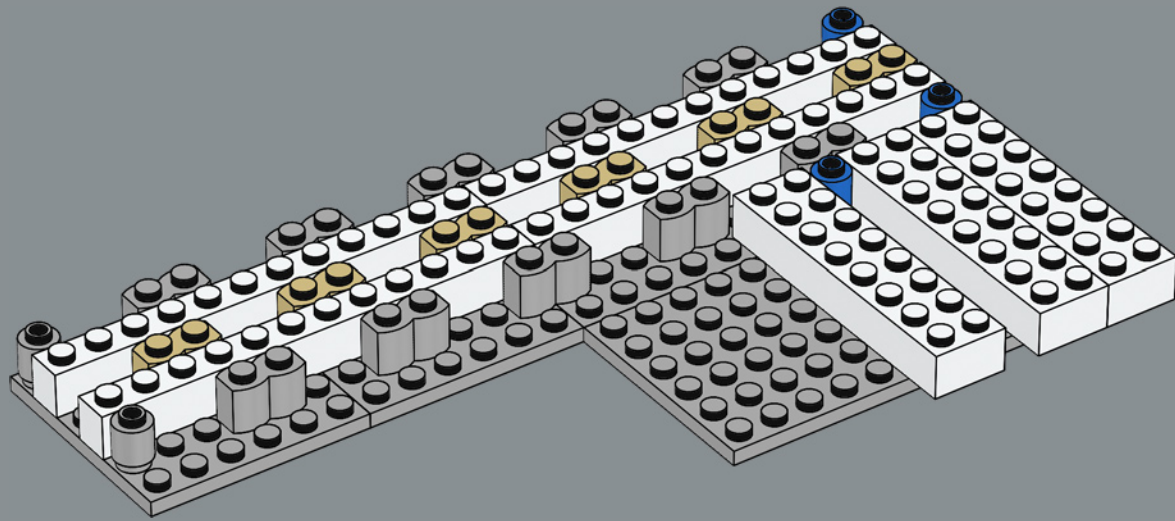

173

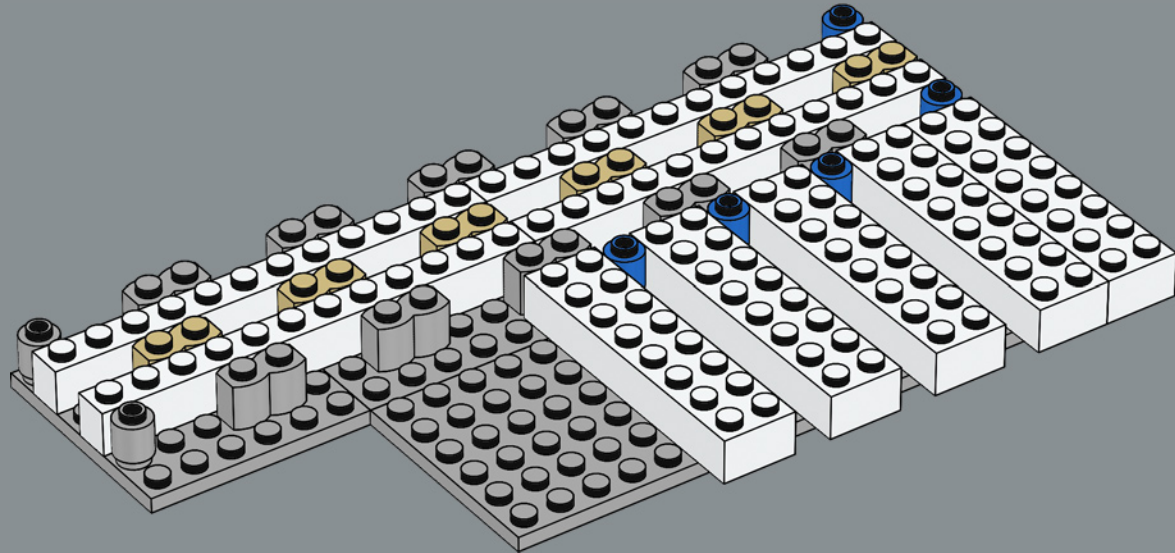



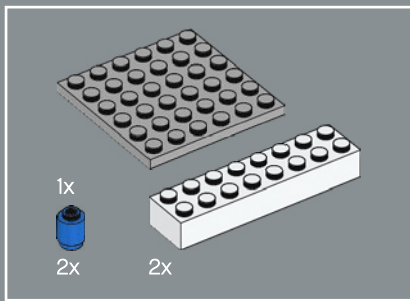

174

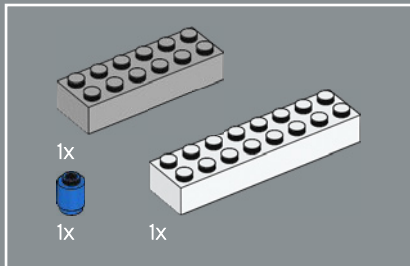
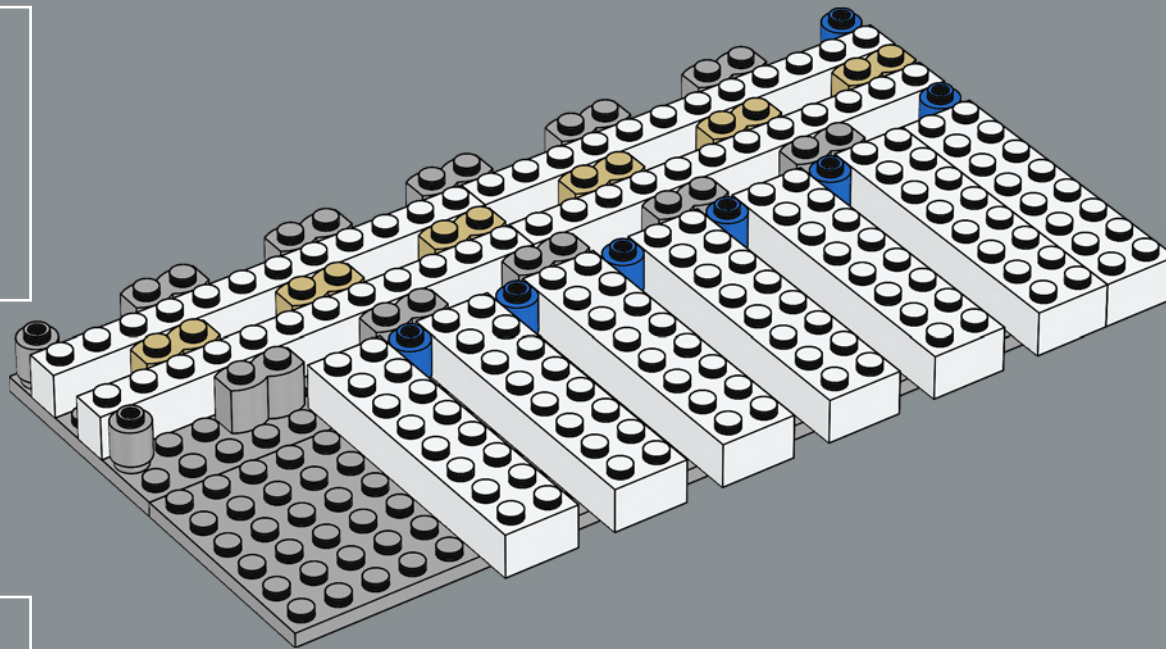

175



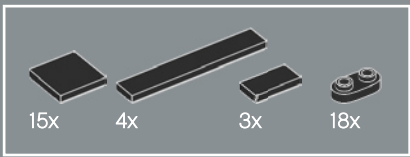

176

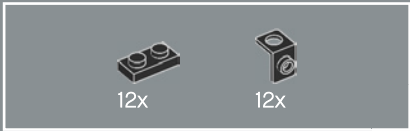
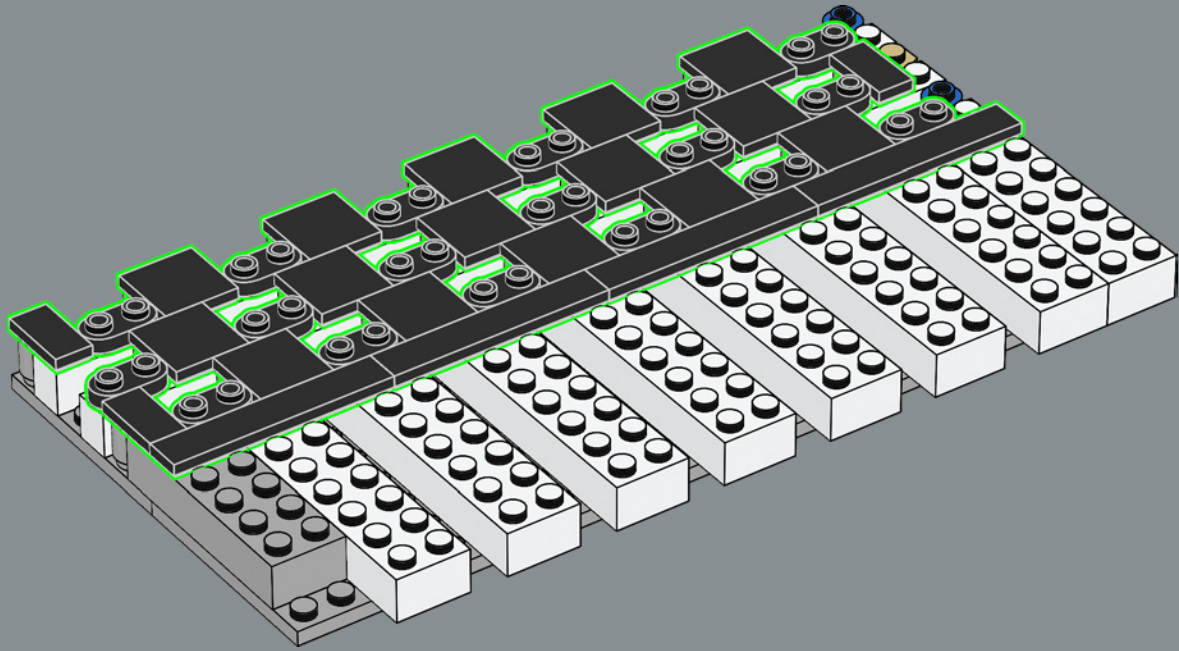

177

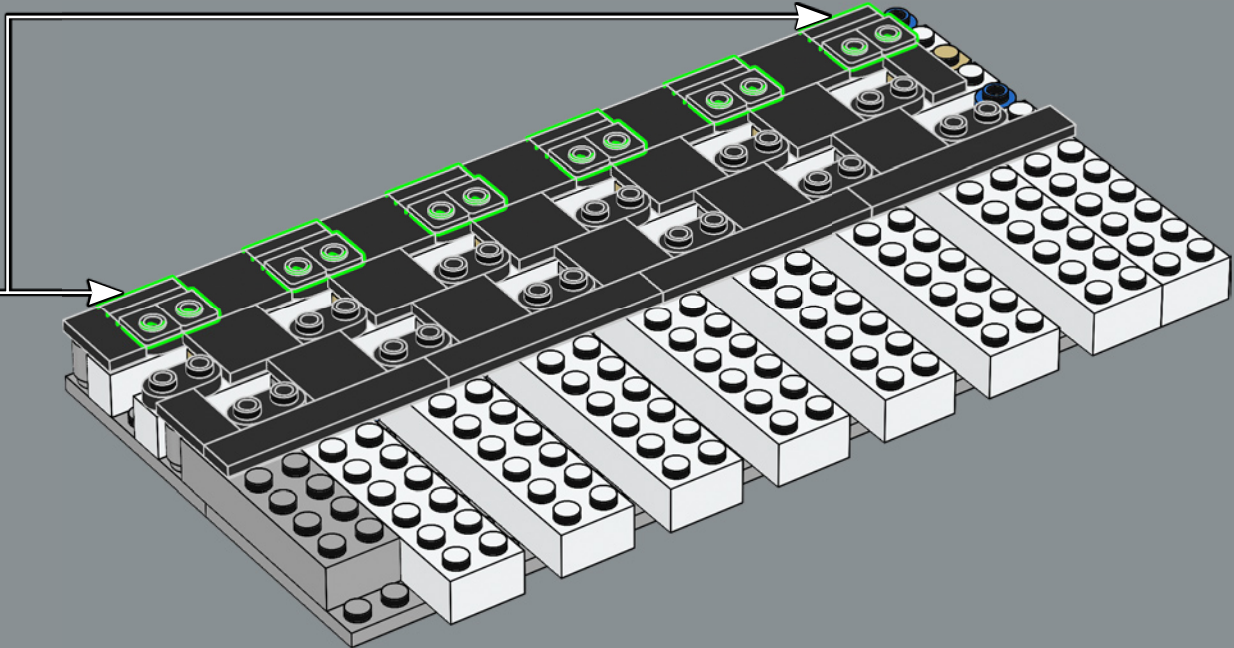
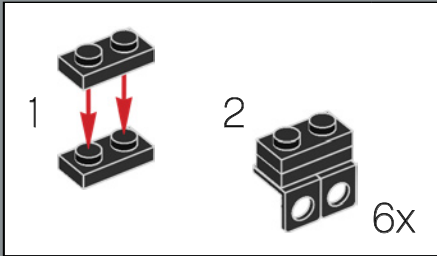



178

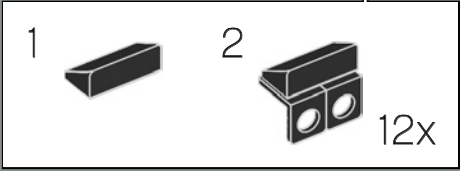
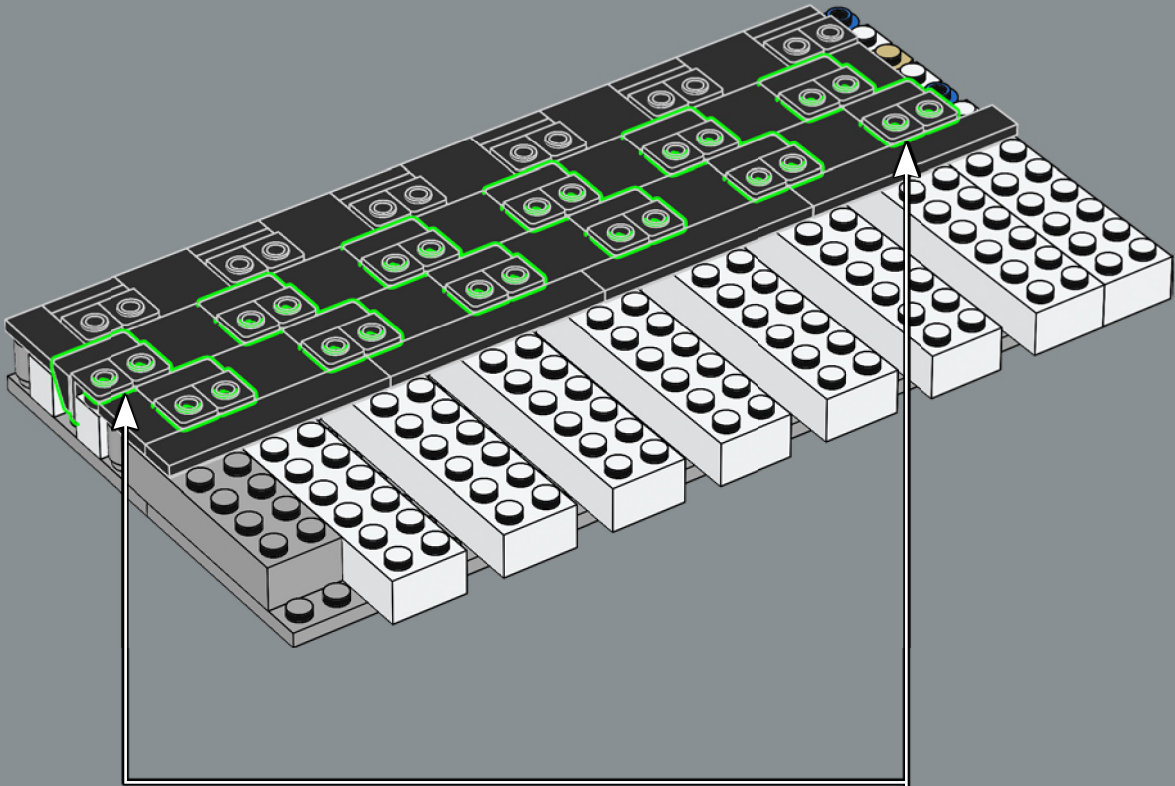

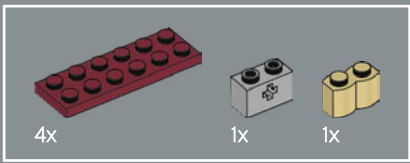

179

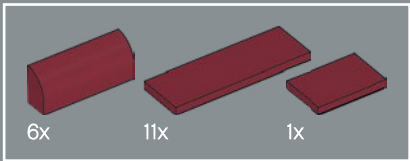
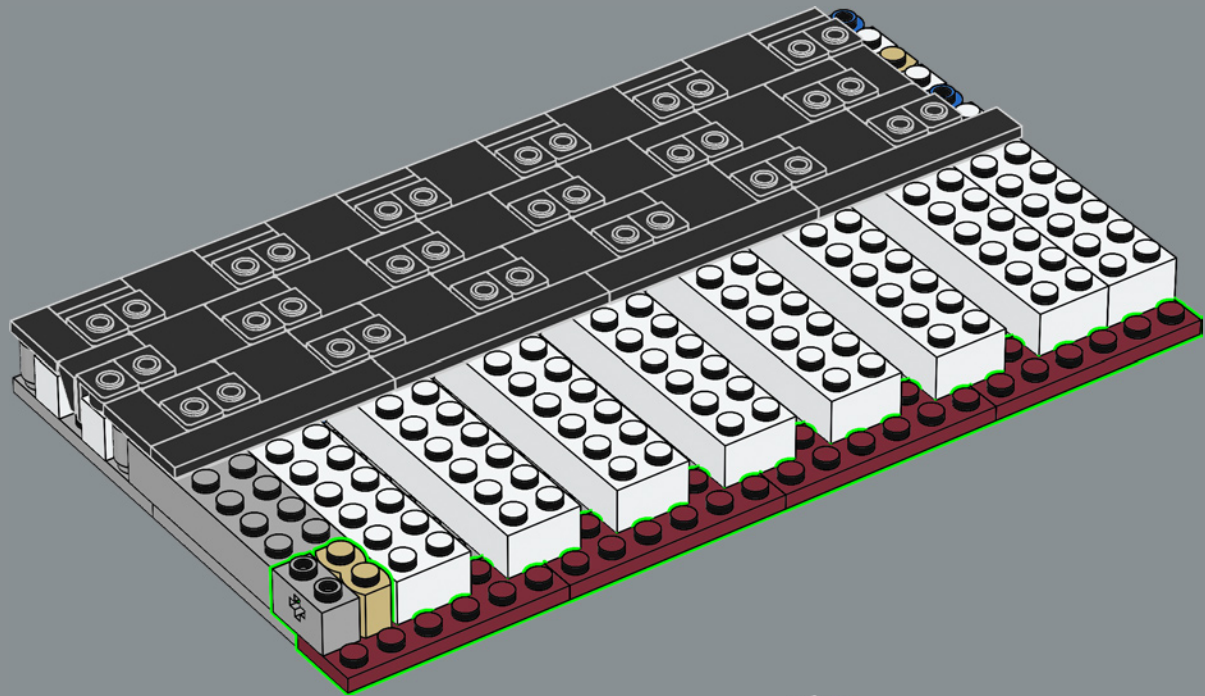

180

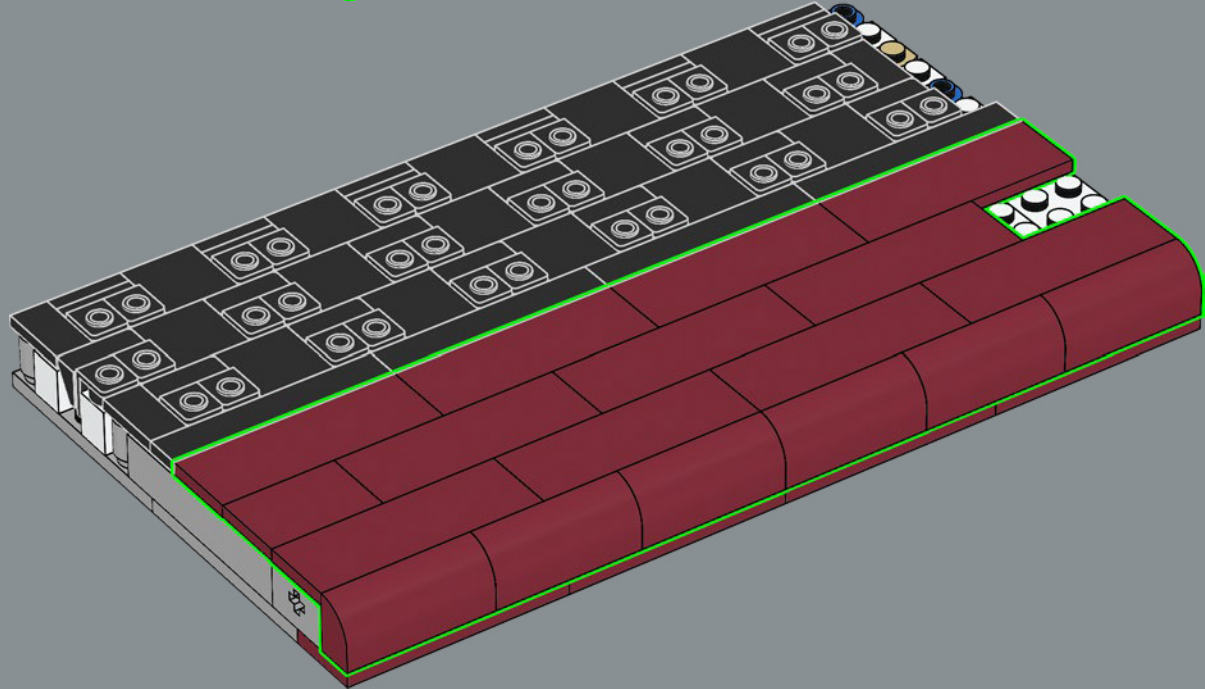

The ship's hull was held together with over three million iron and steel rivets weighing over 1,200 tonnes (1,322.7 US tons).

181

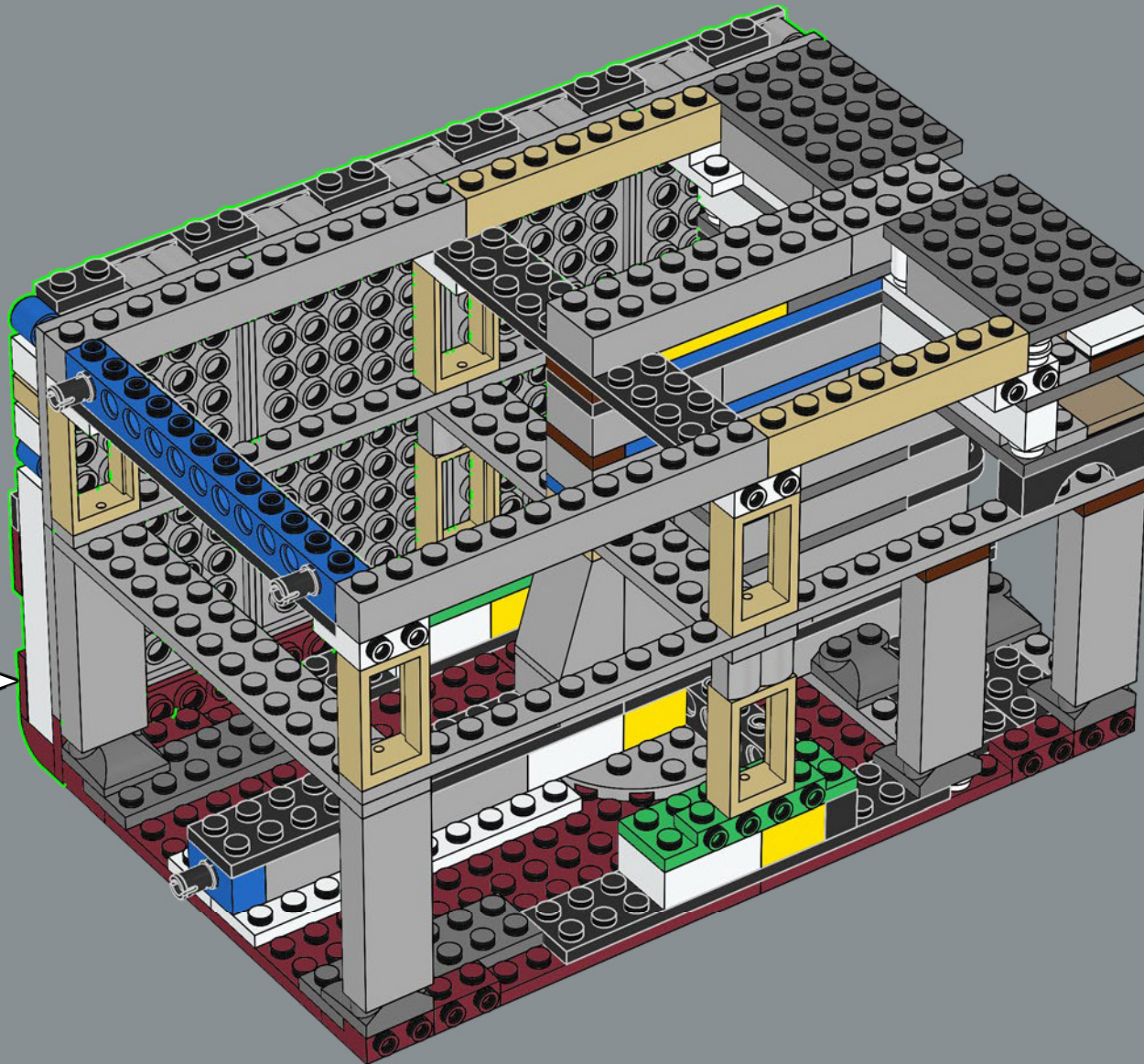

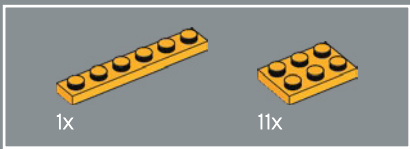

182

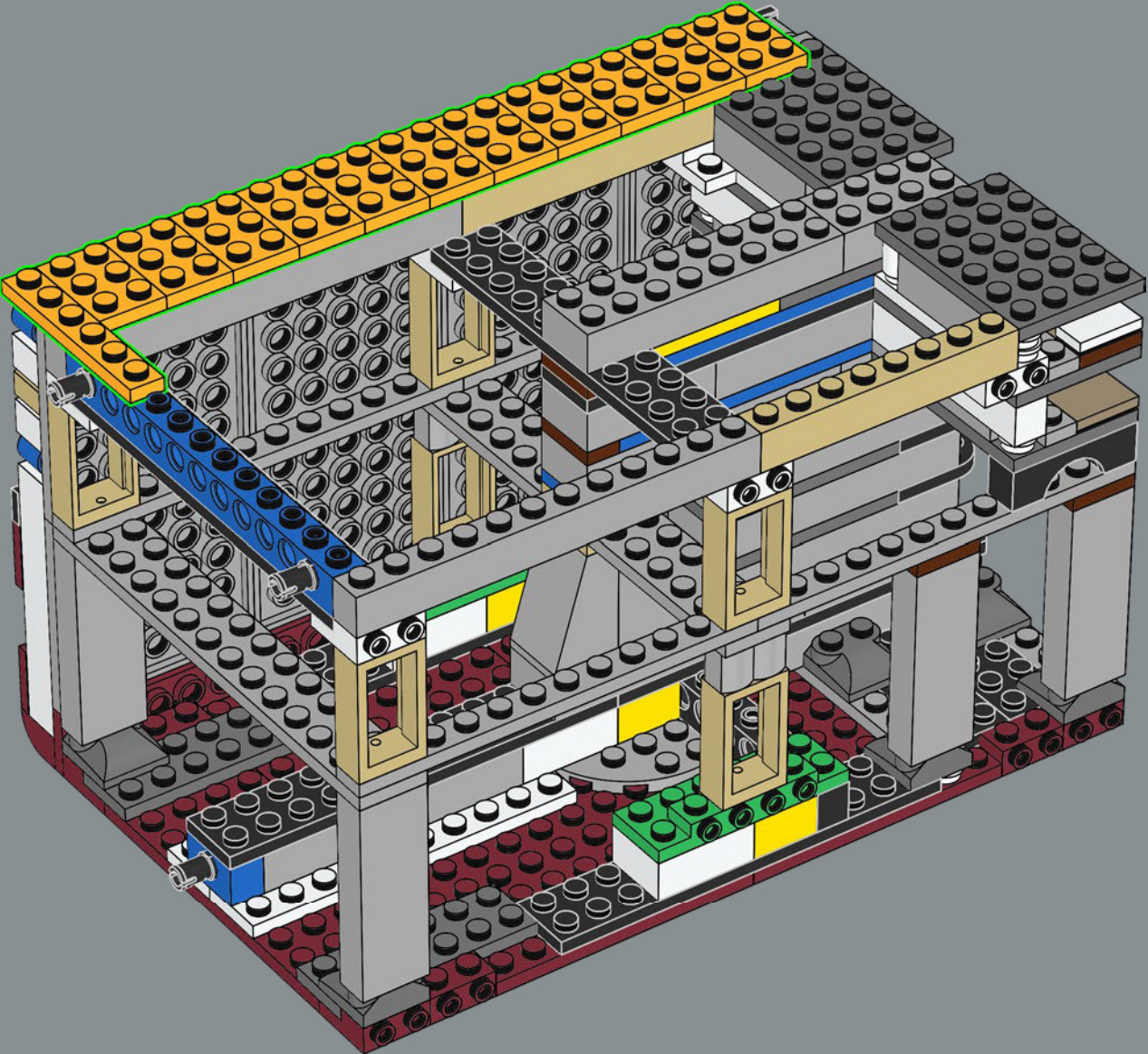

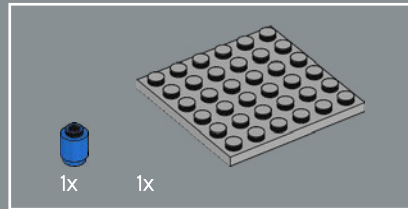
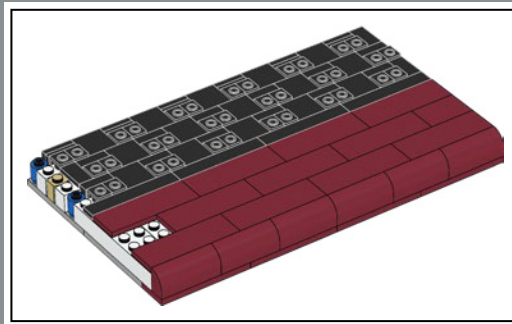
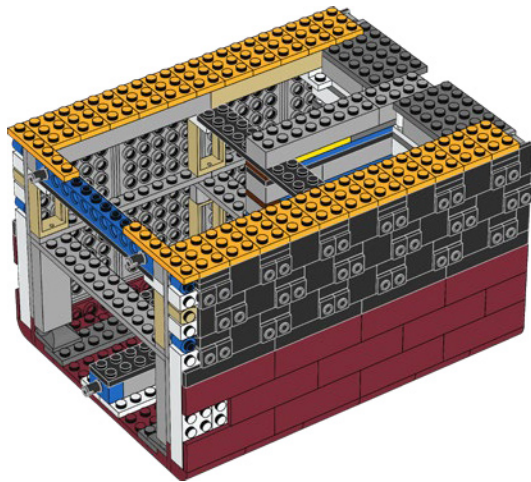
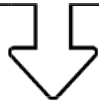

183

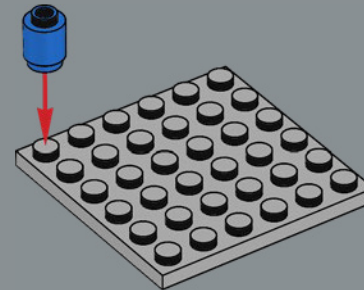

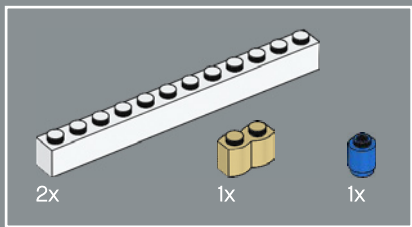

184

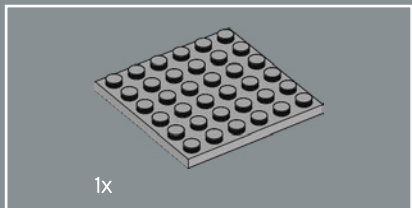
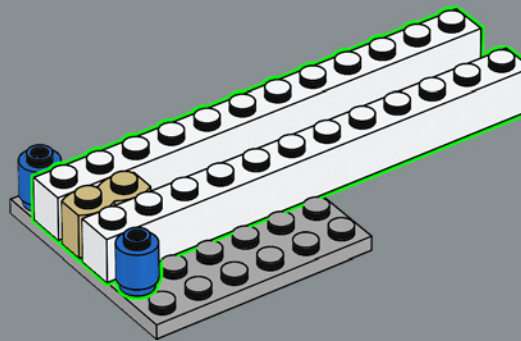

185

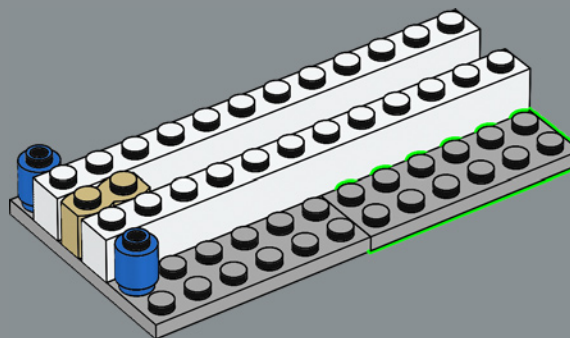



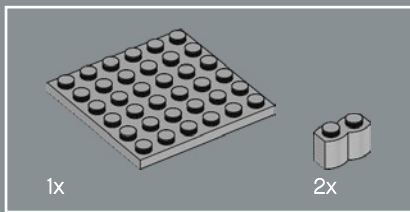

186

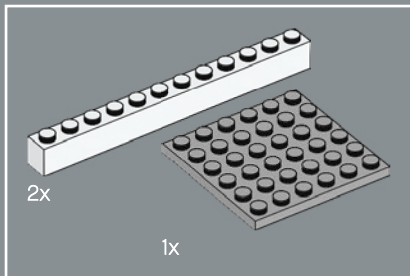
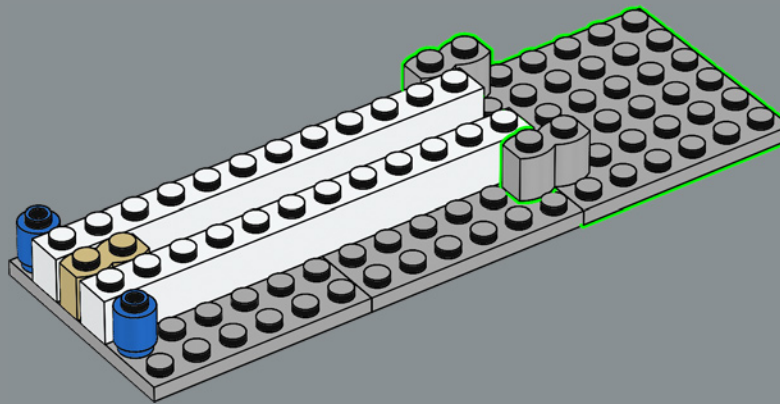

187

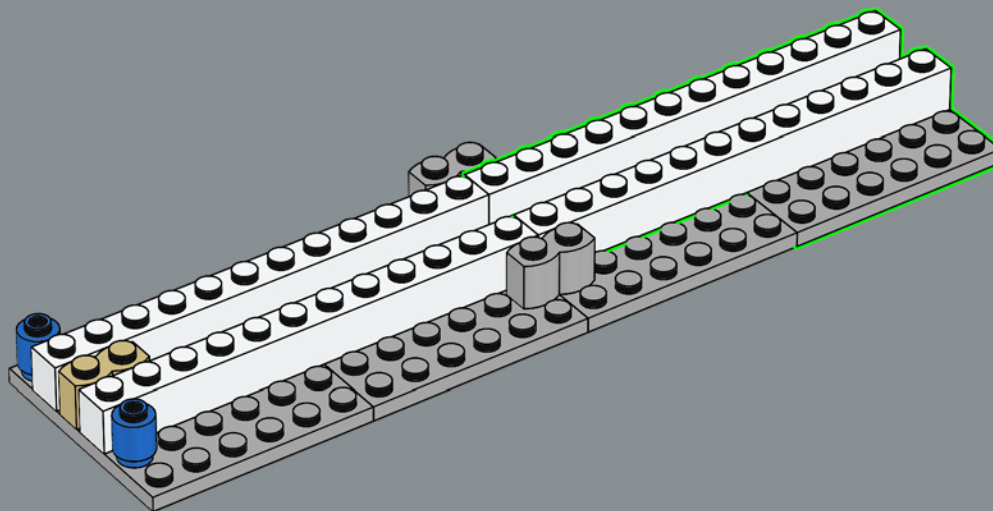



188

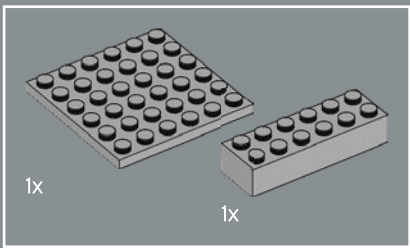
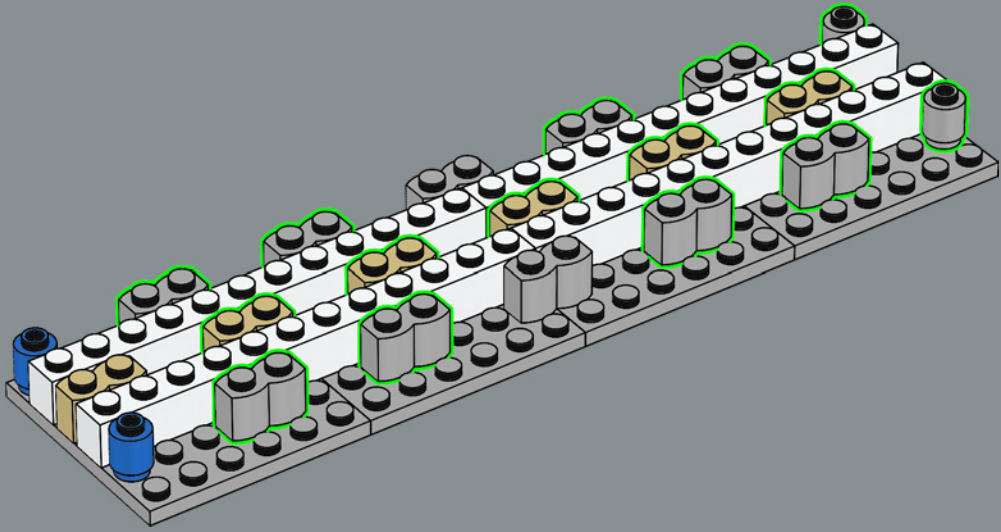

189

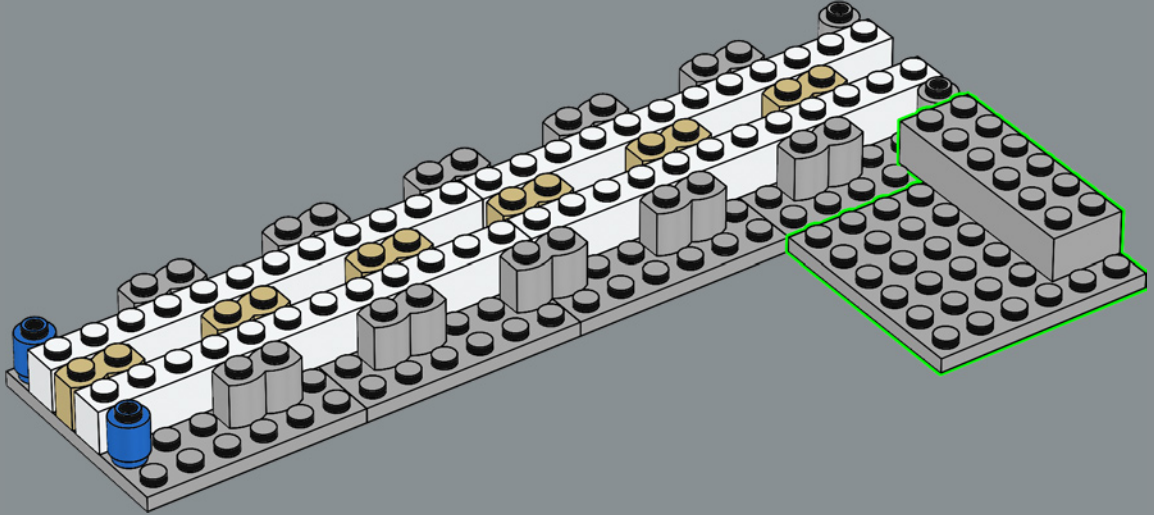

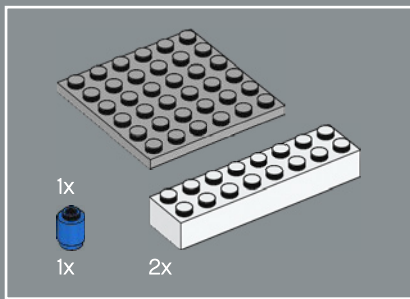

190

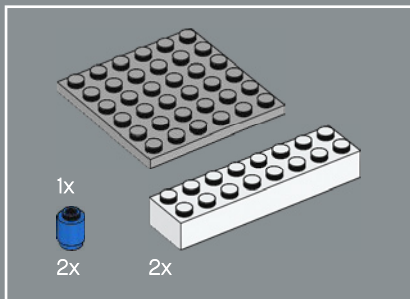
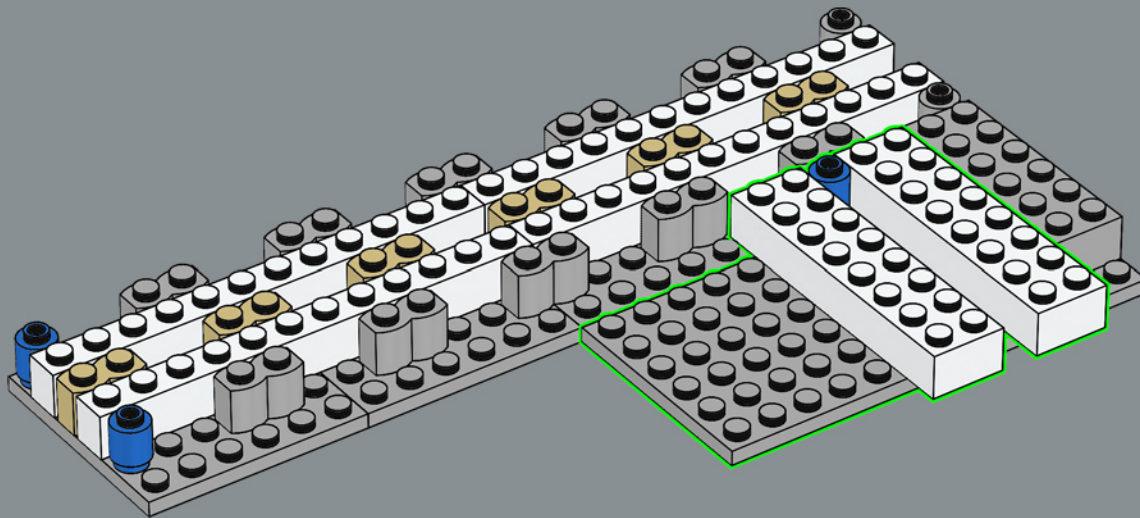

191

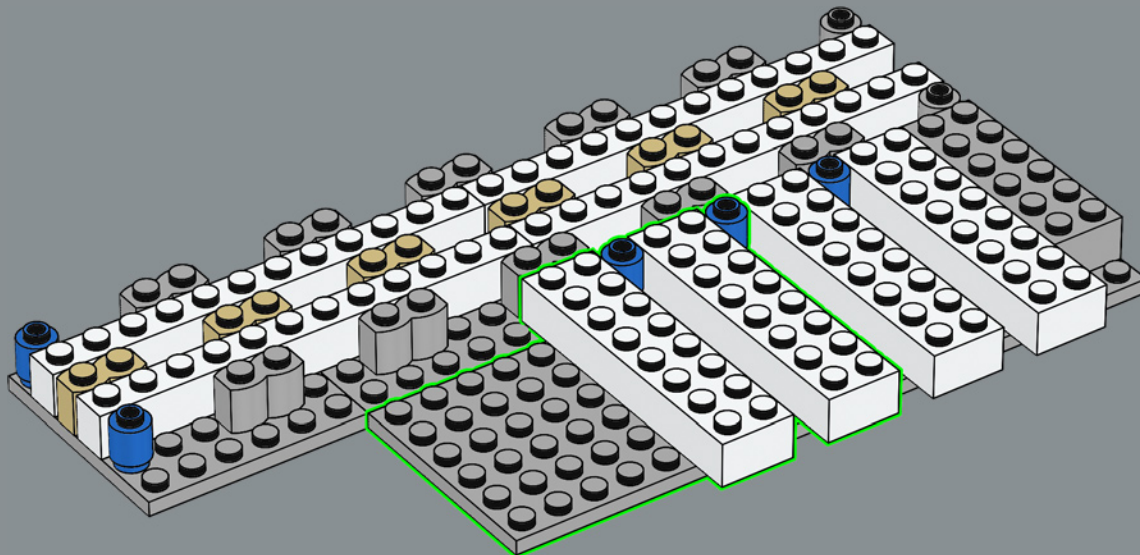

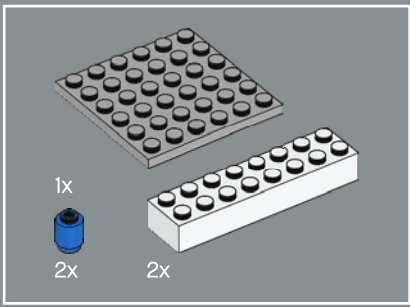

192

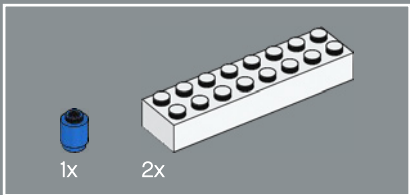
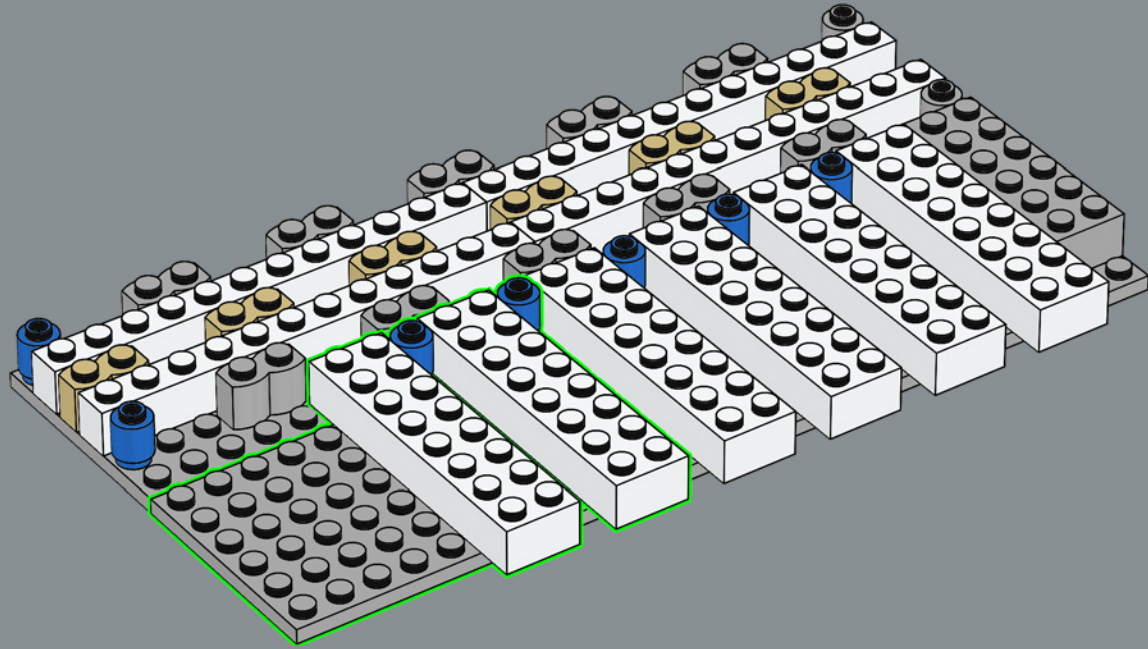

193

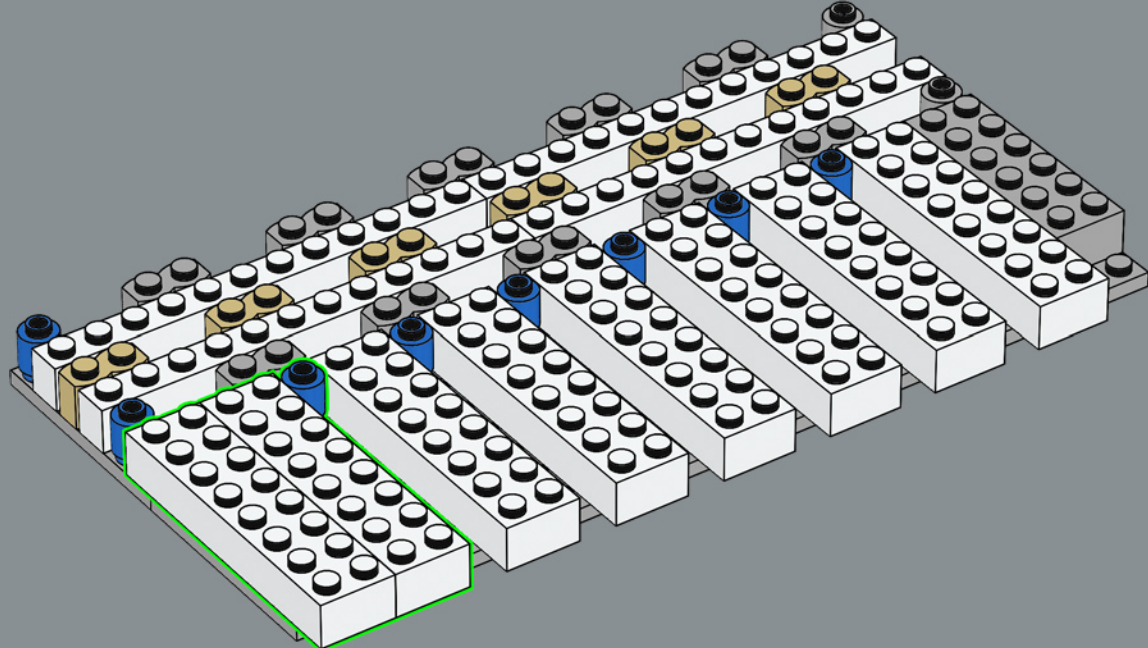

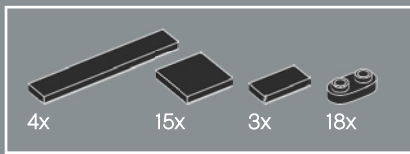

194

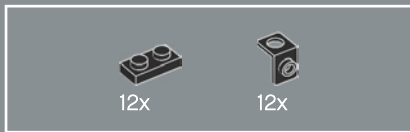
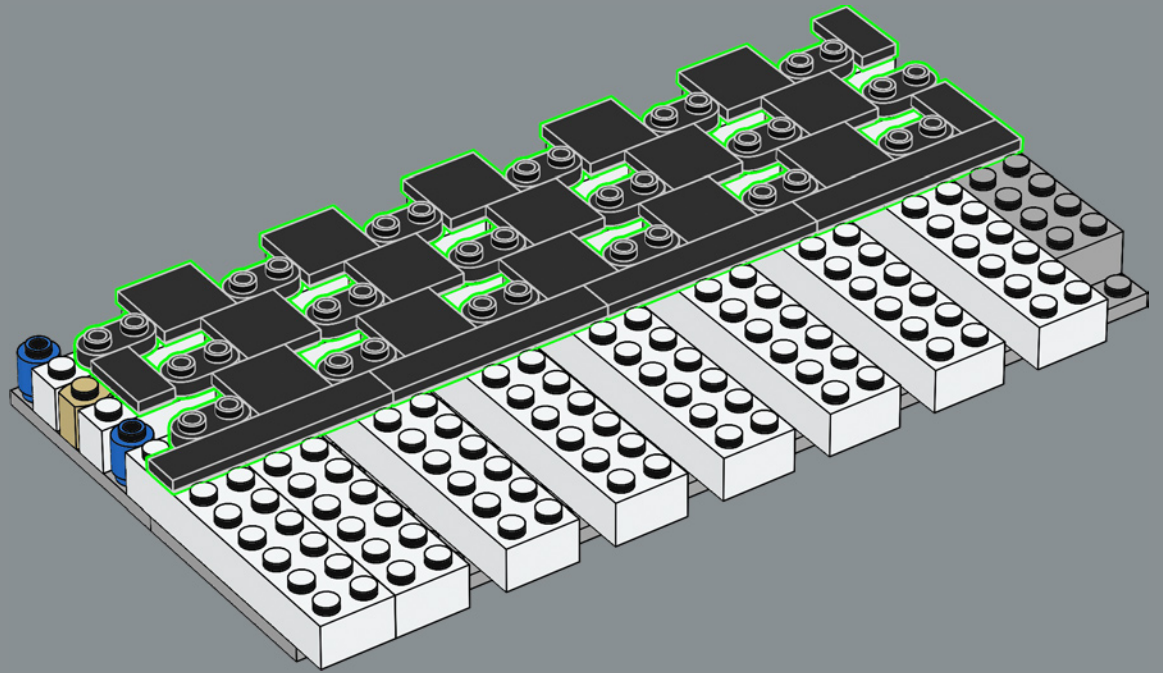

195

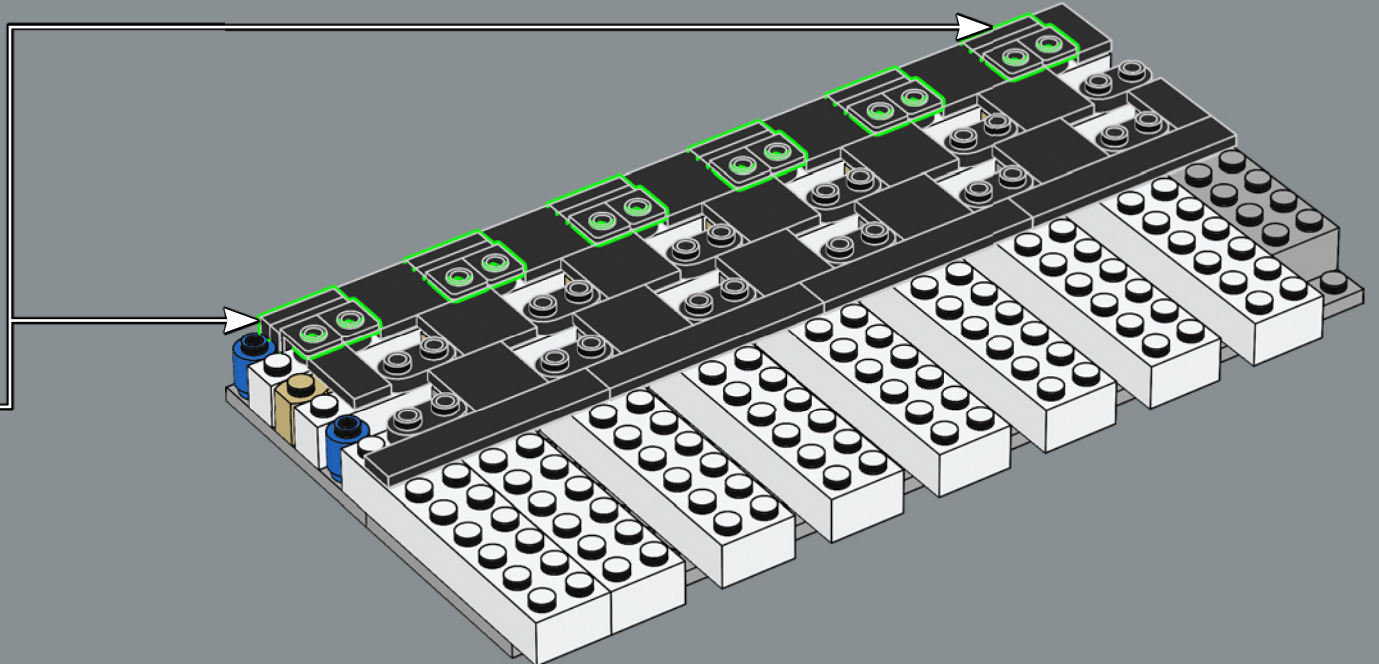
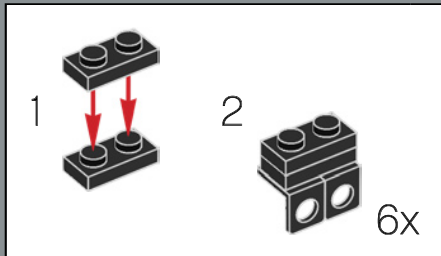



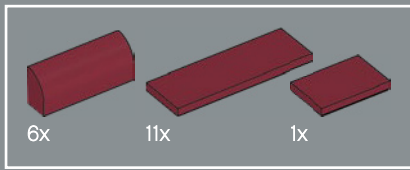

198

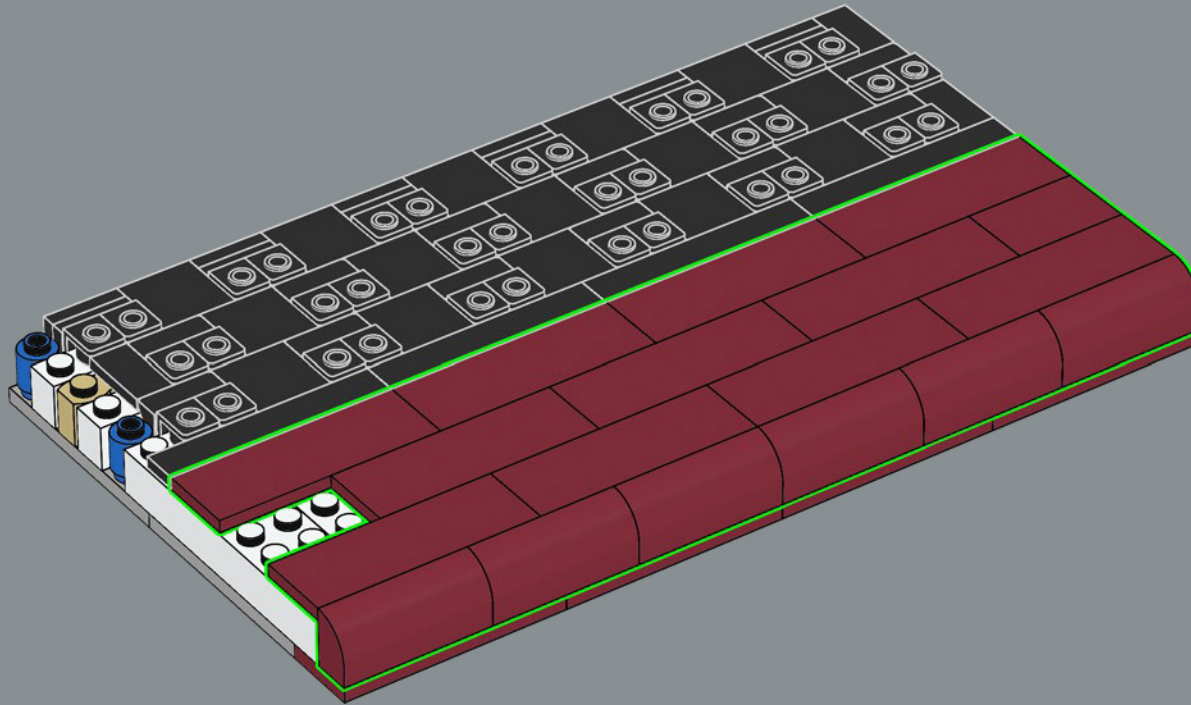

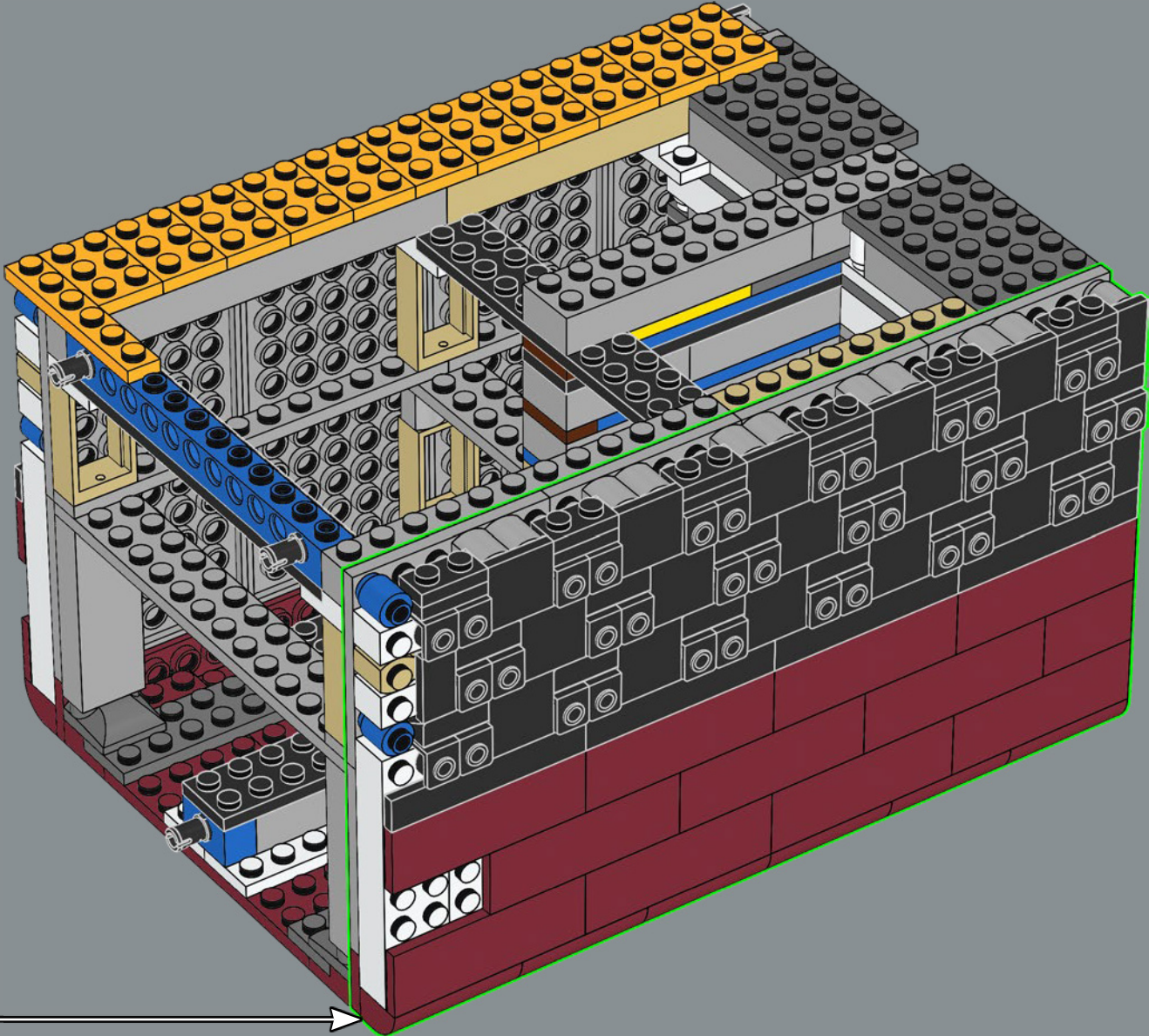



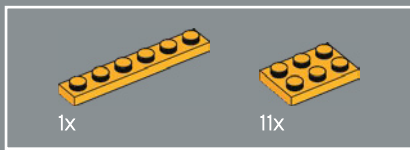

200

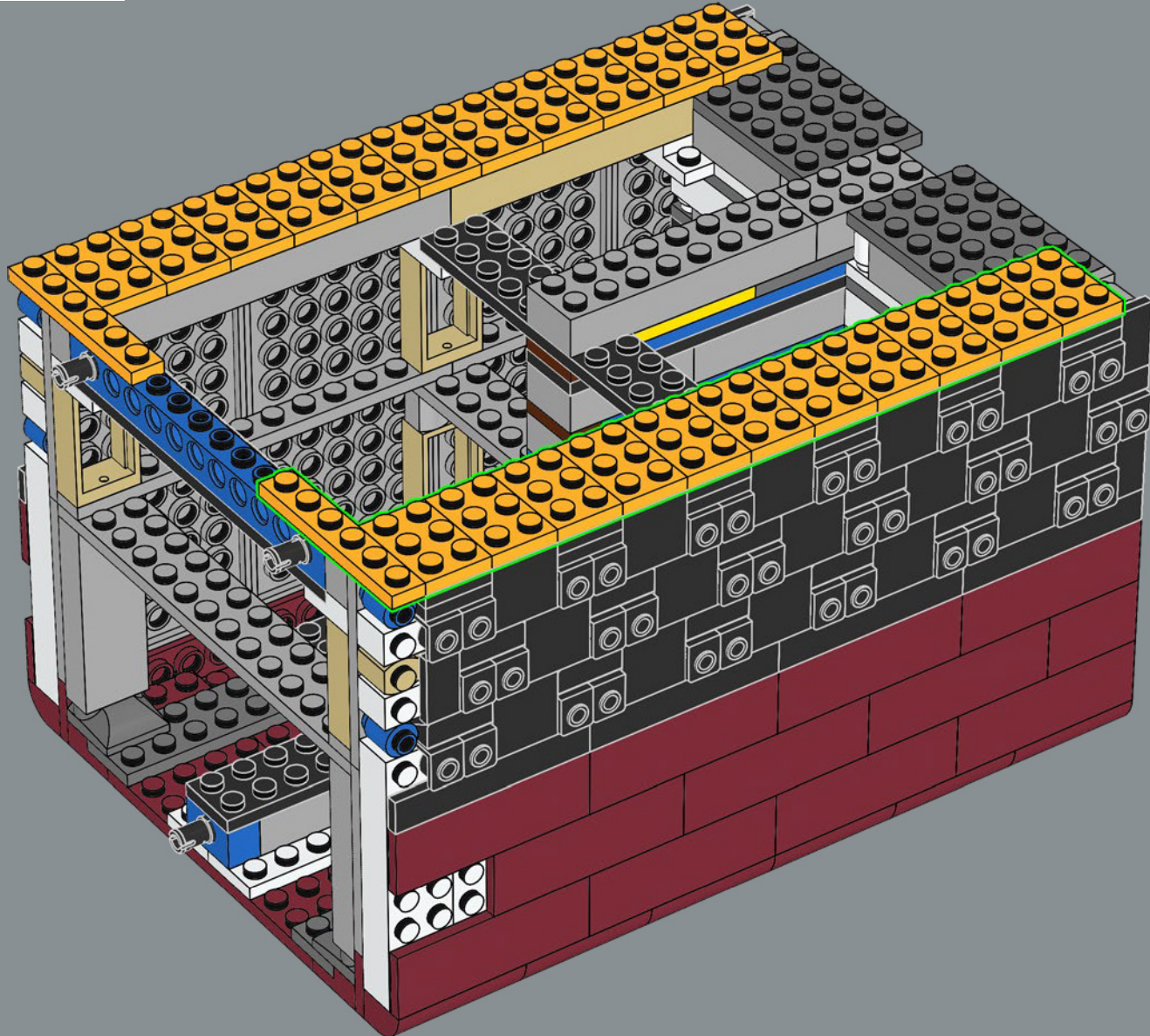

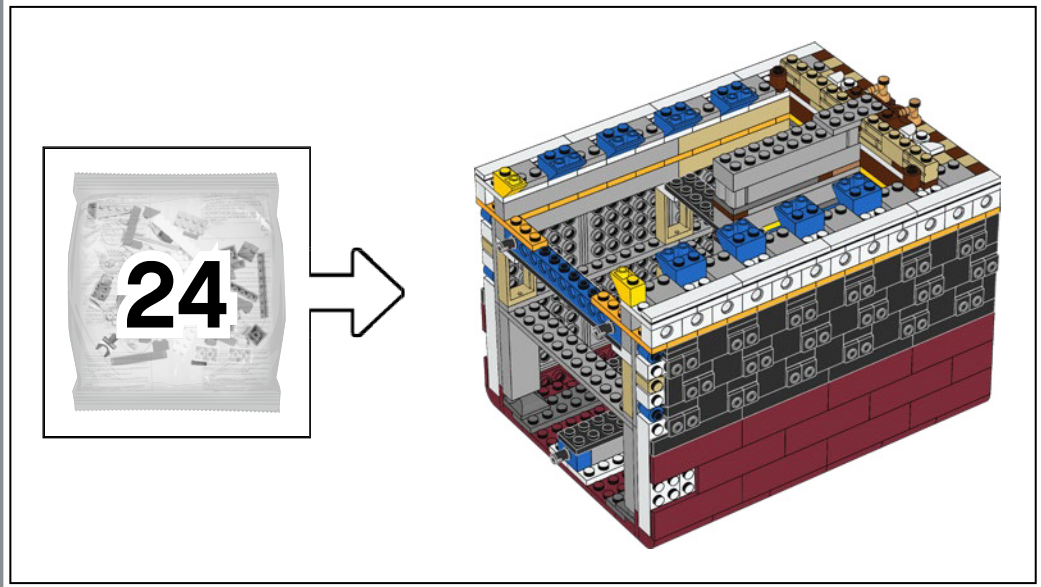



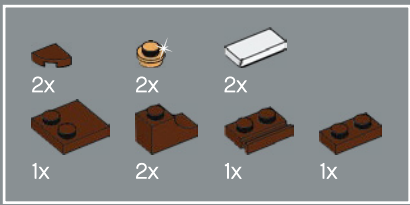

202

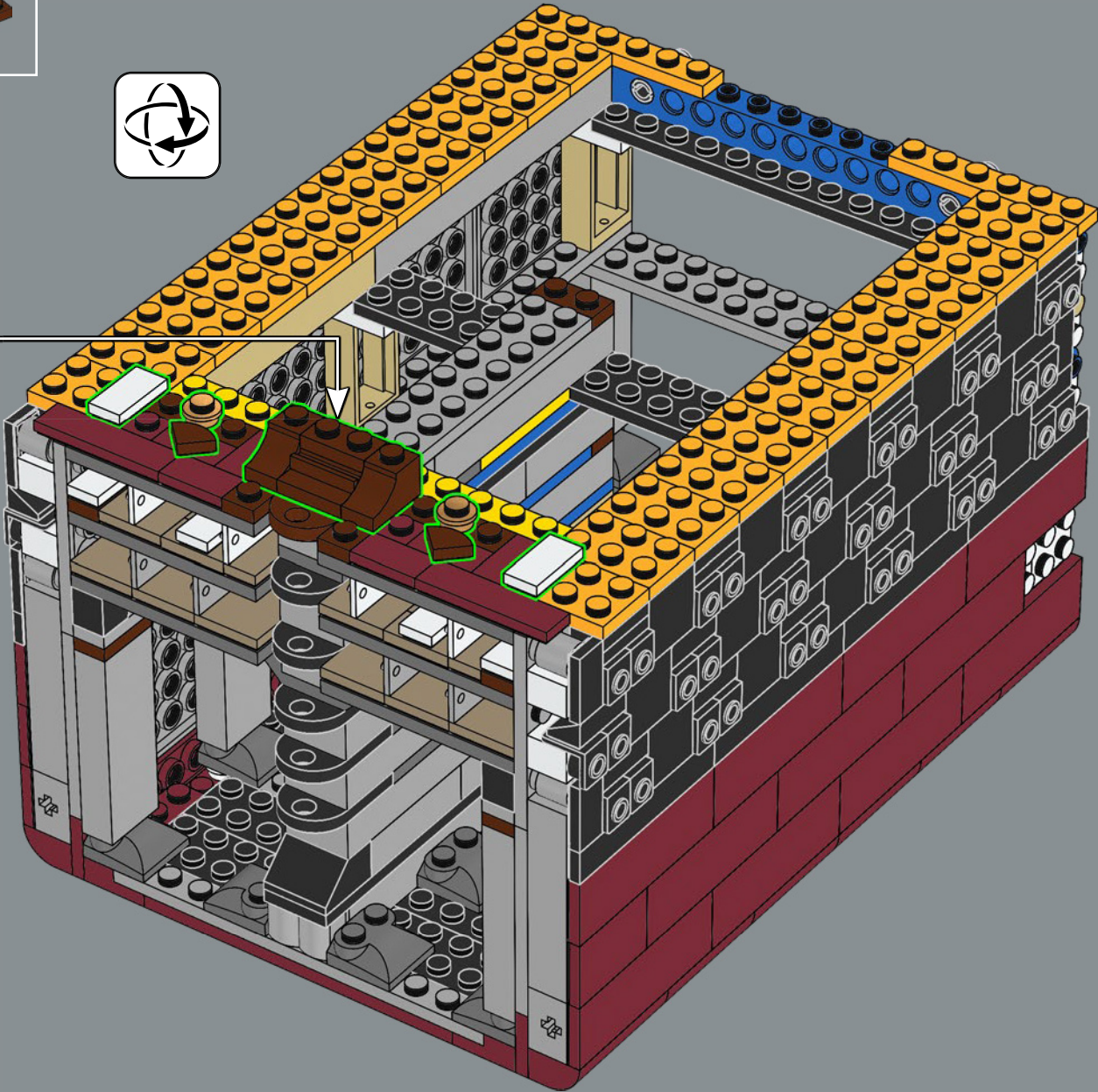
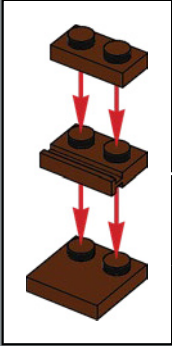

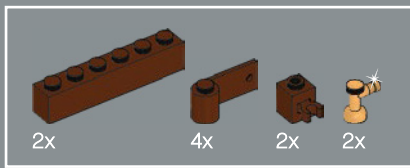

203

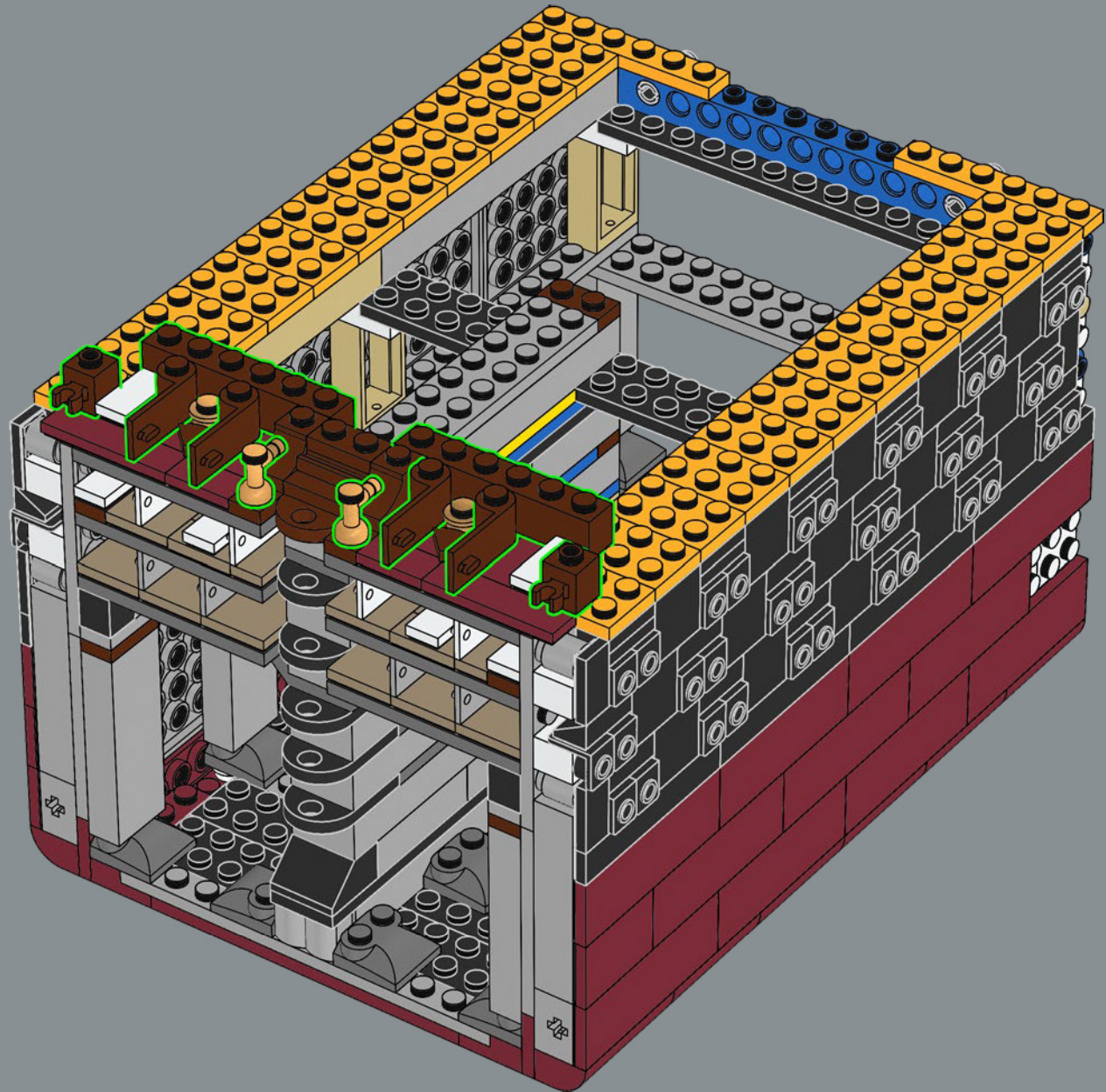

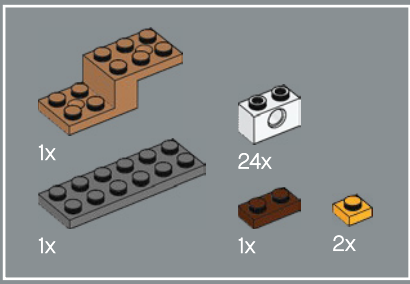

204

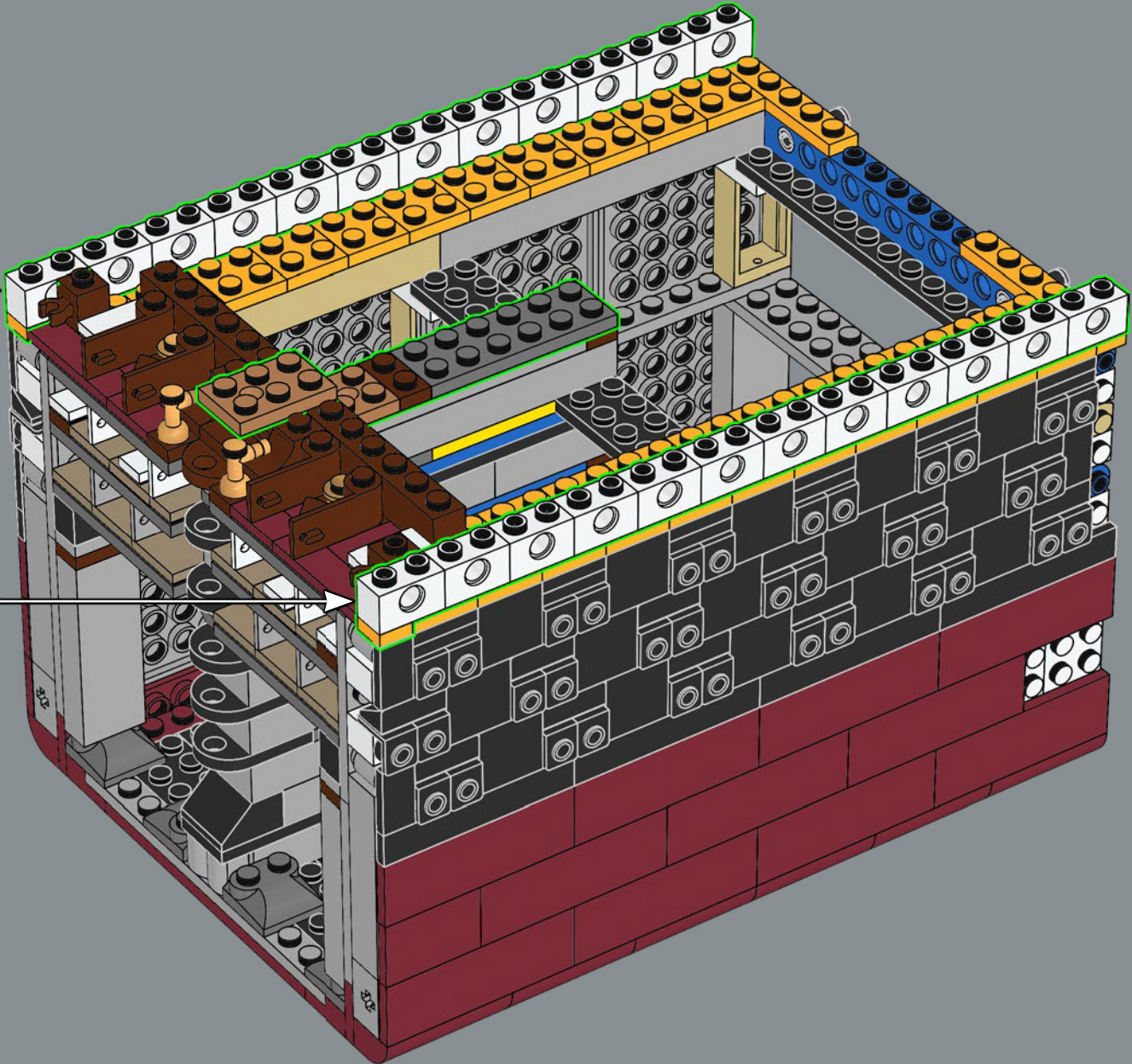
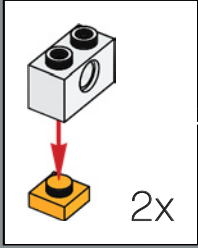

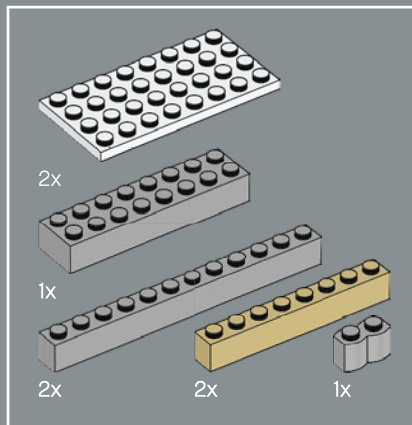

205

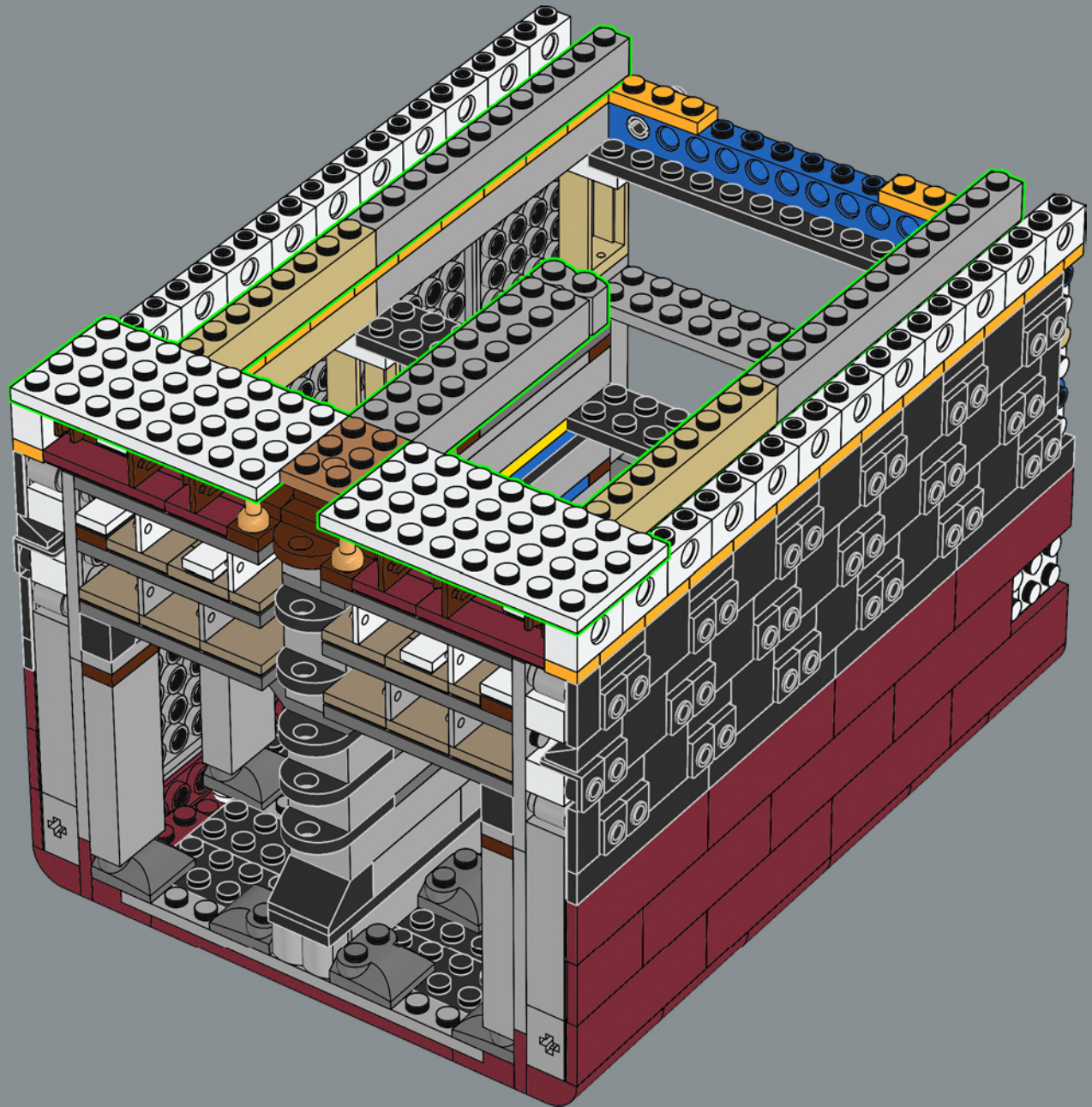

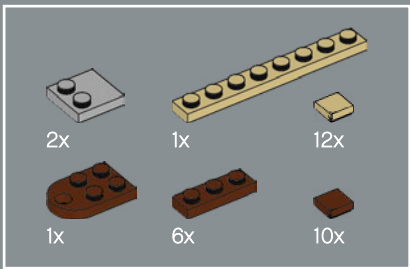

206

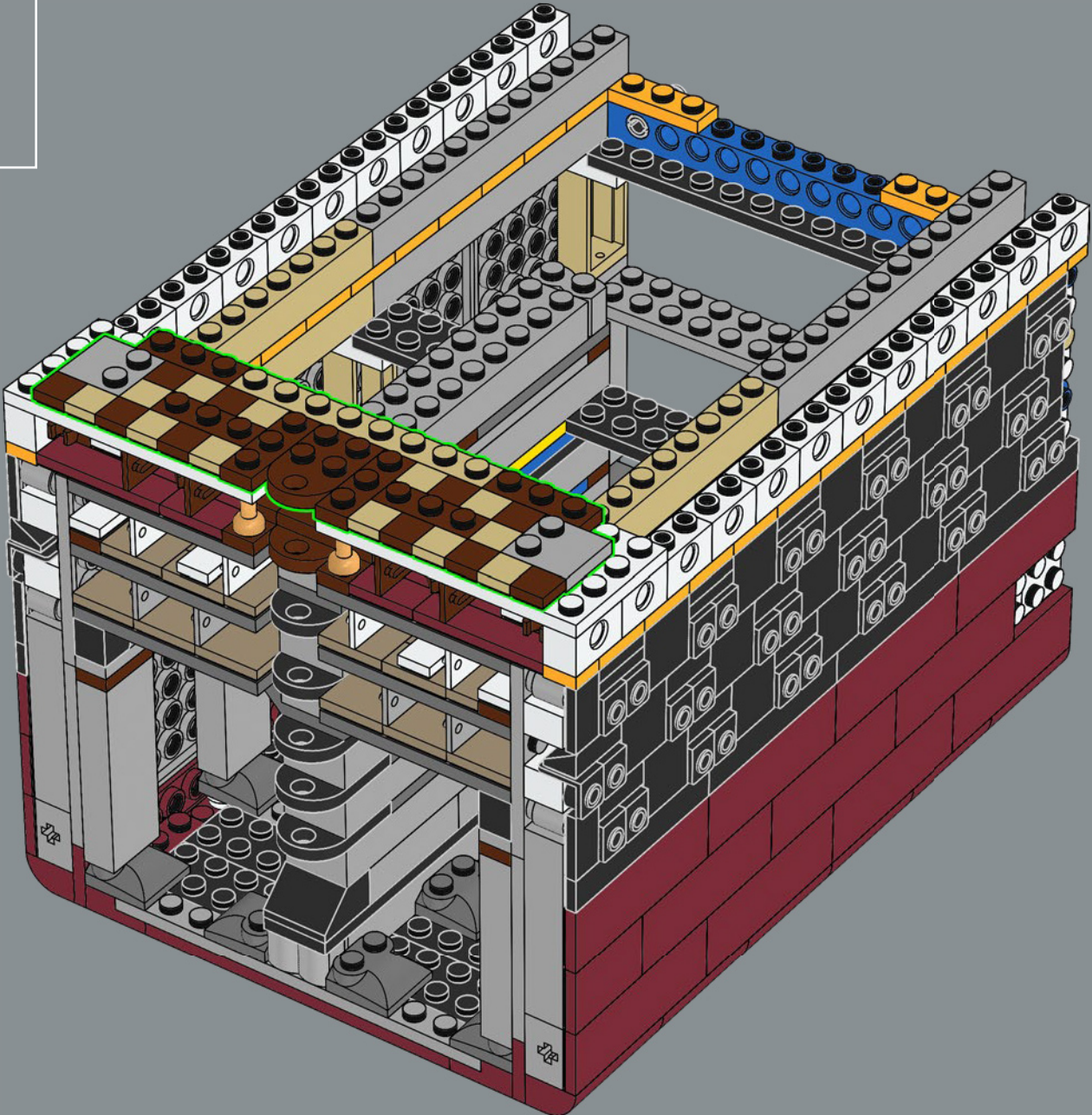



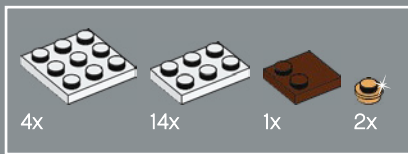

207

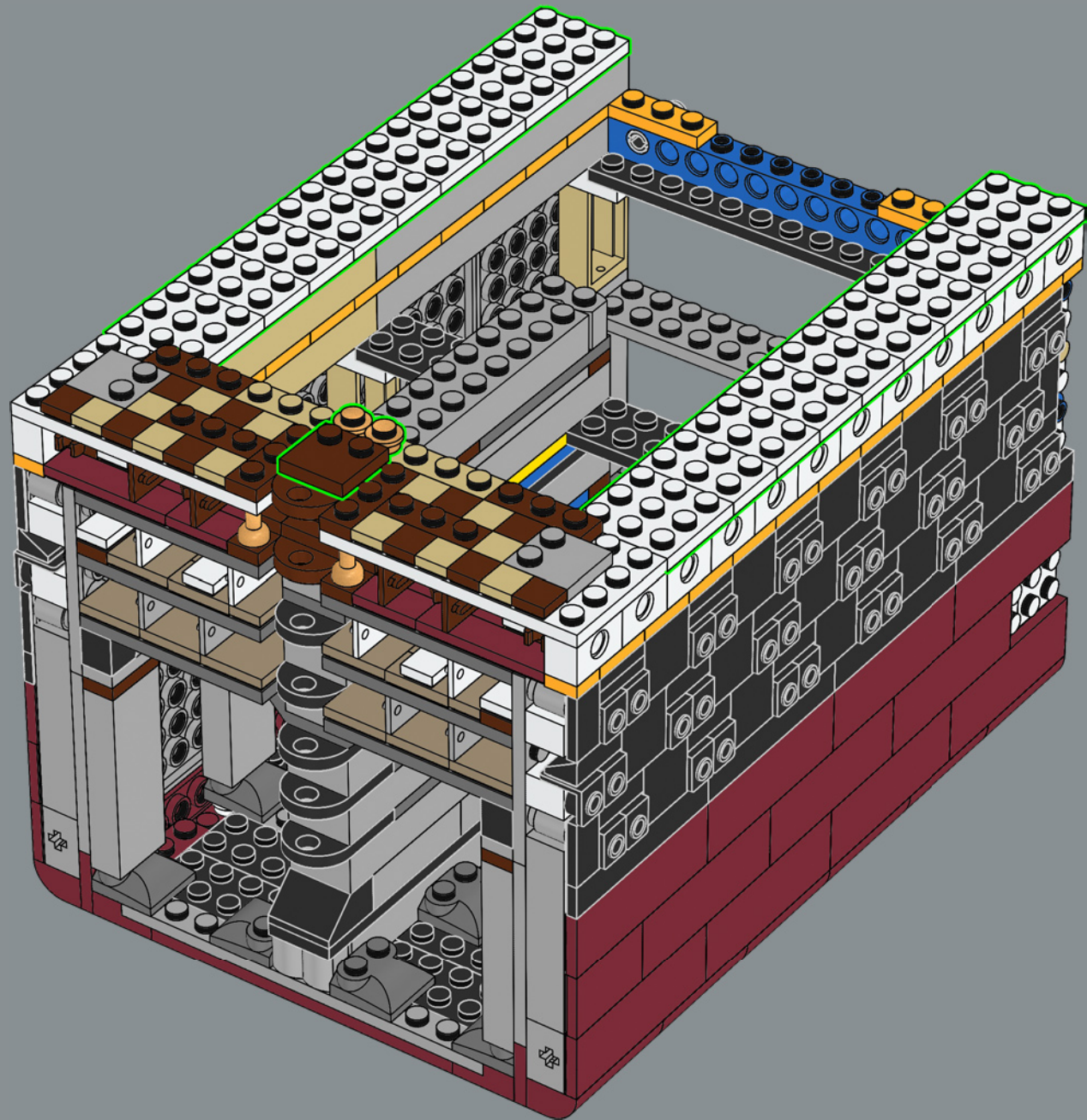

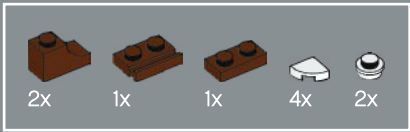

208

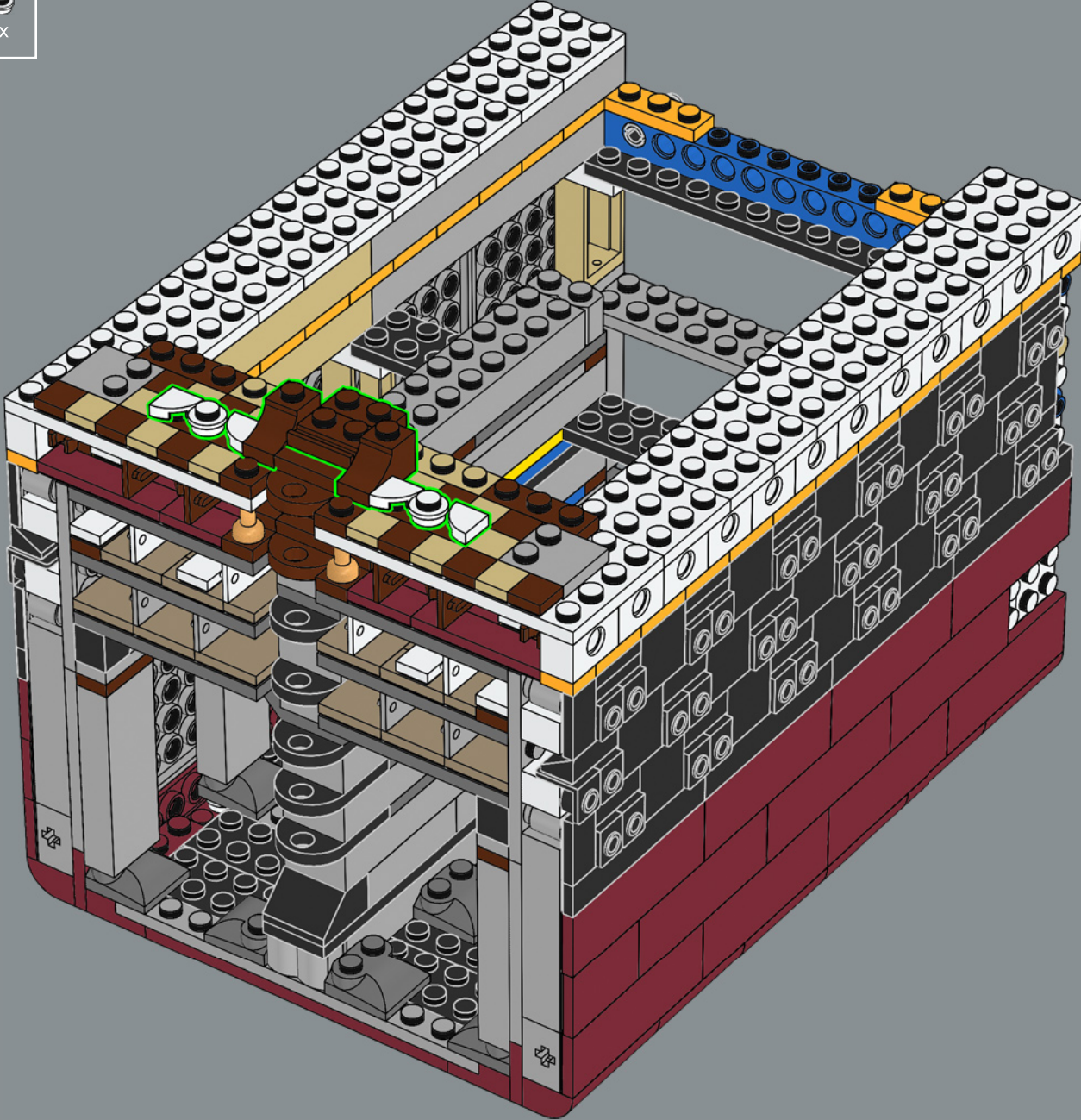

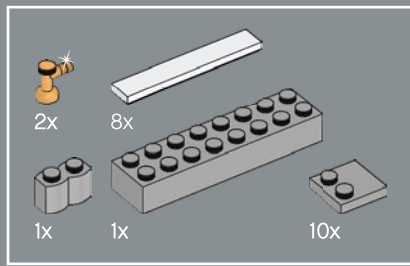

209

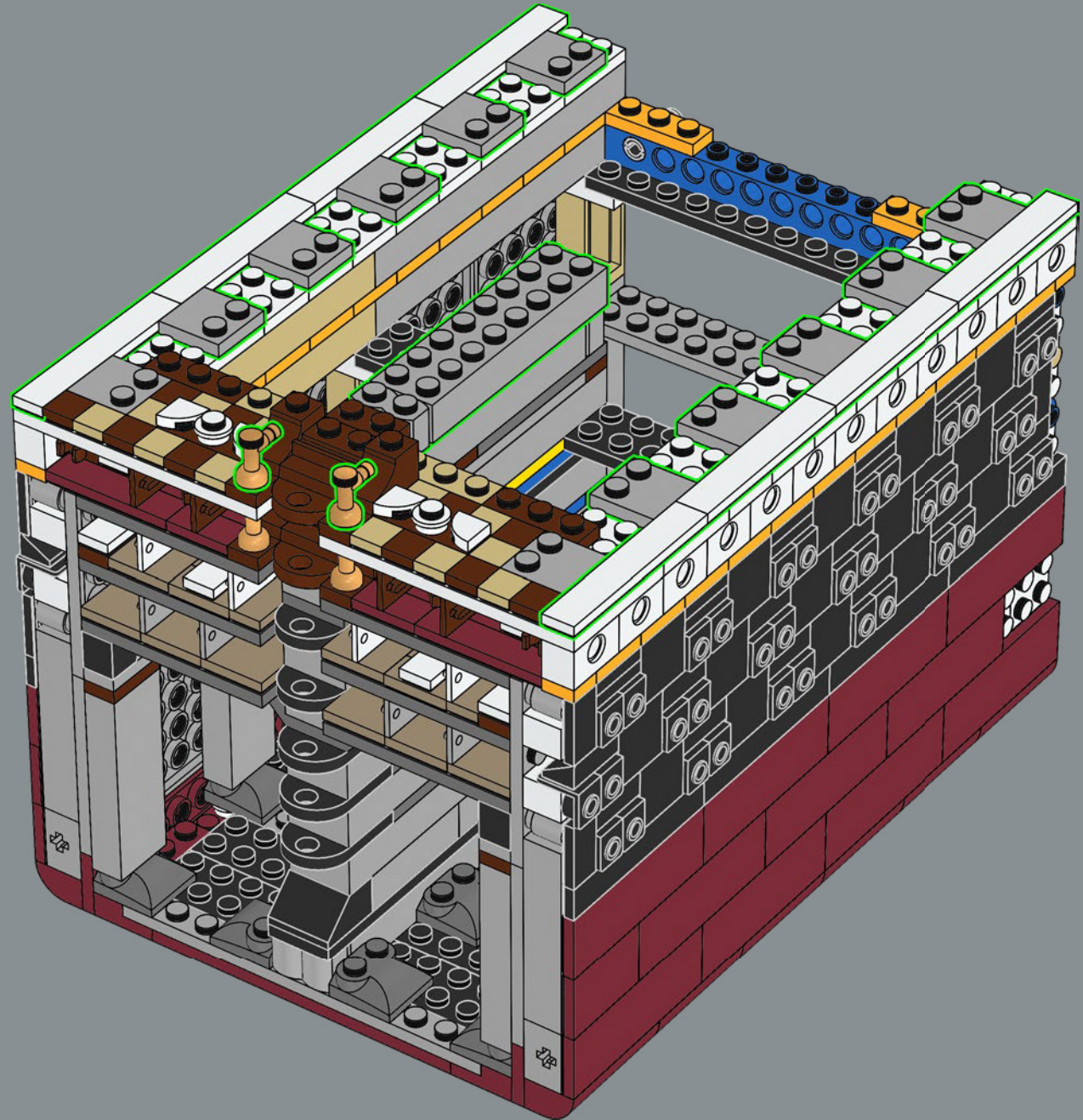

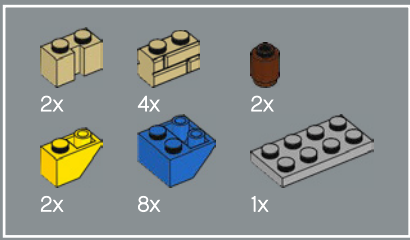

210

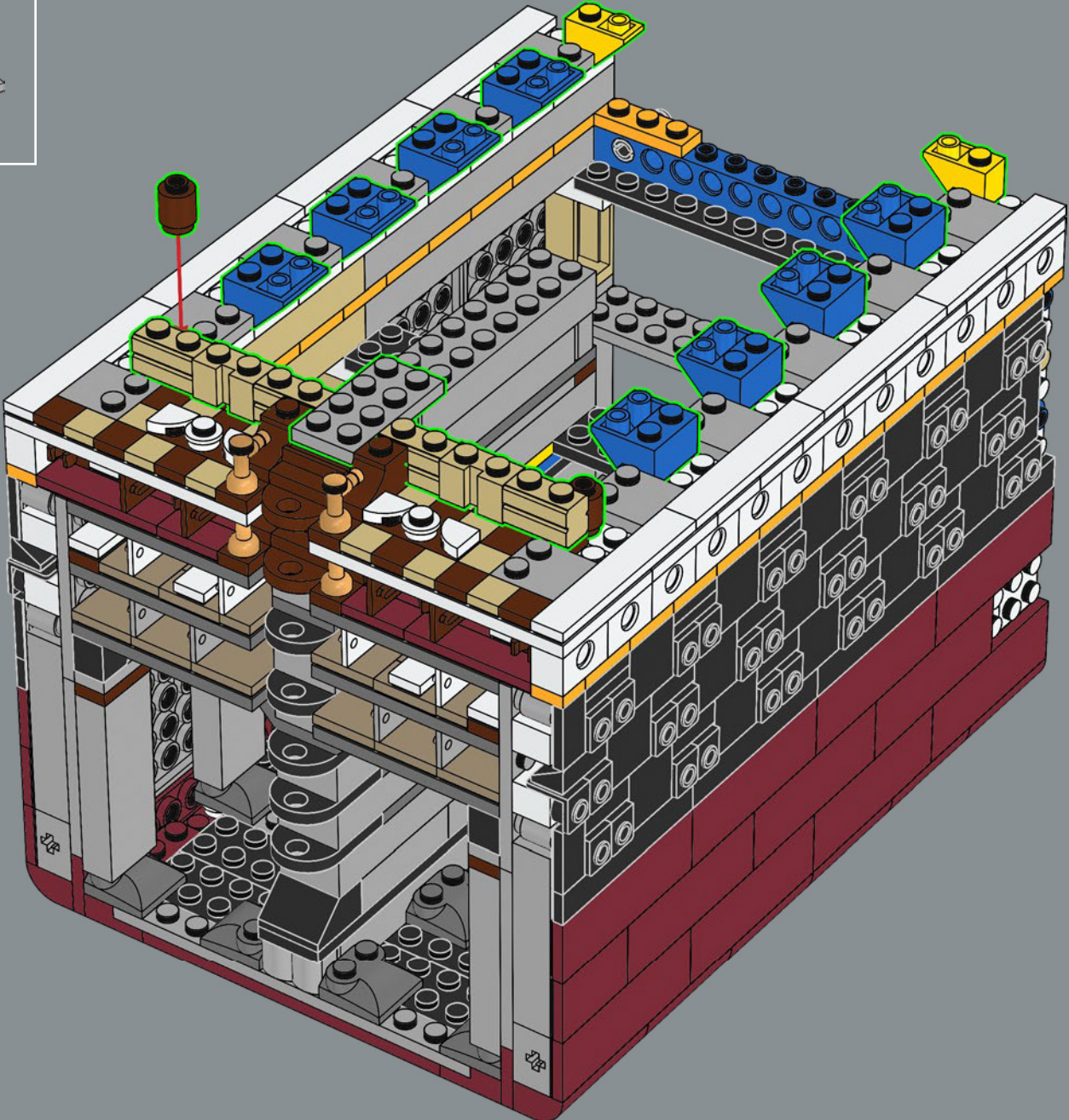

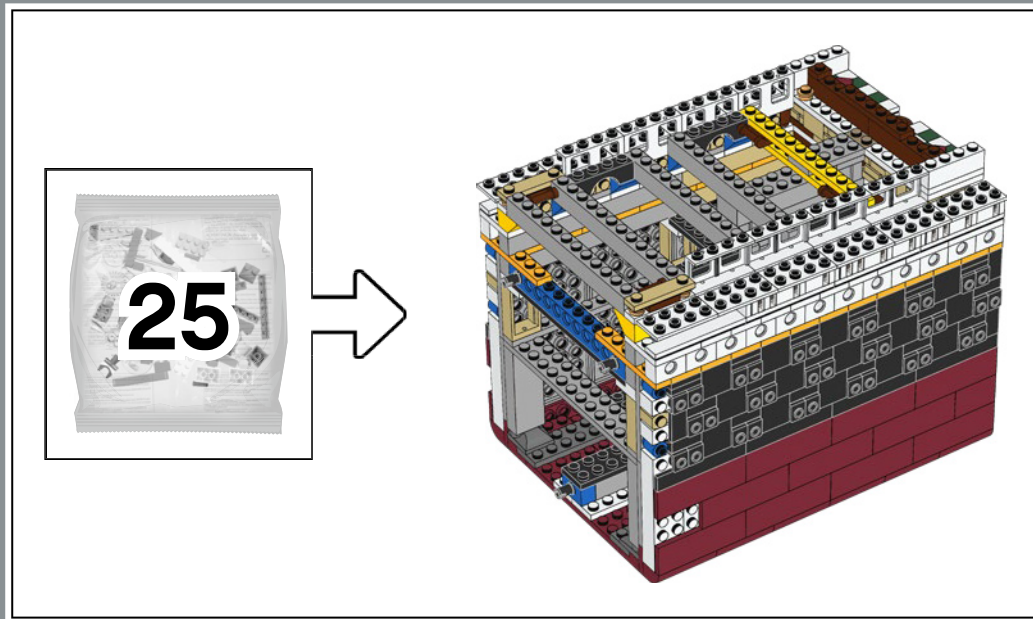



211

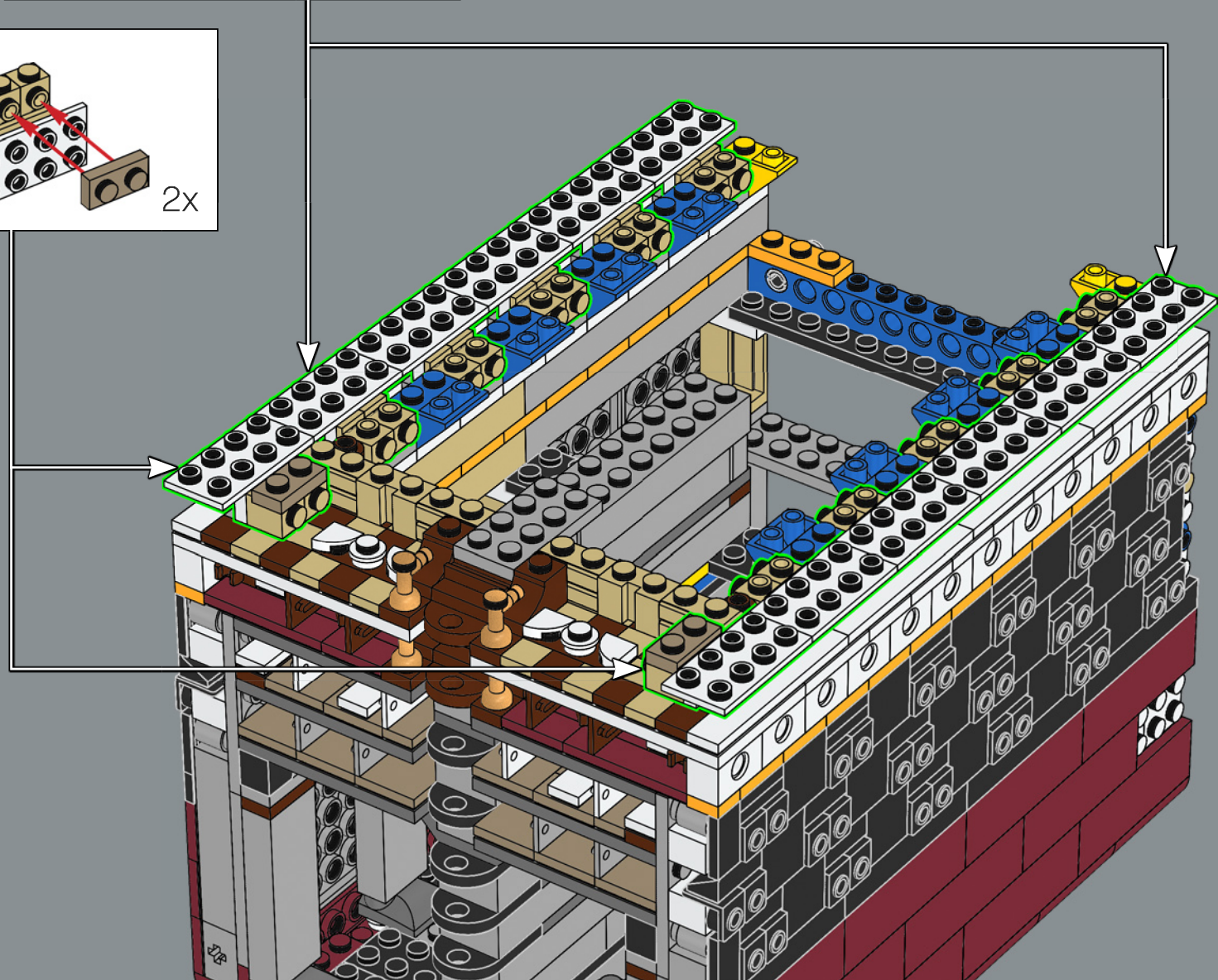
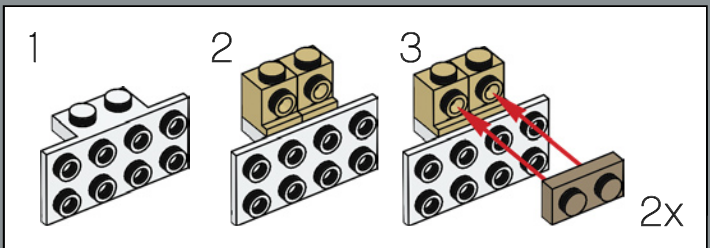
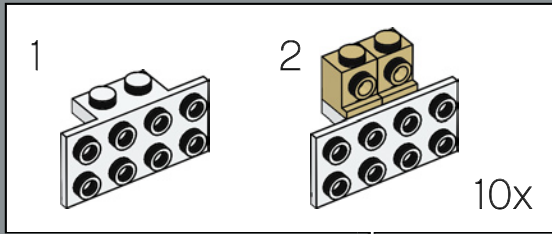

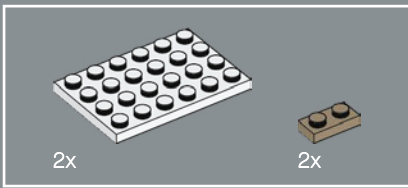

212

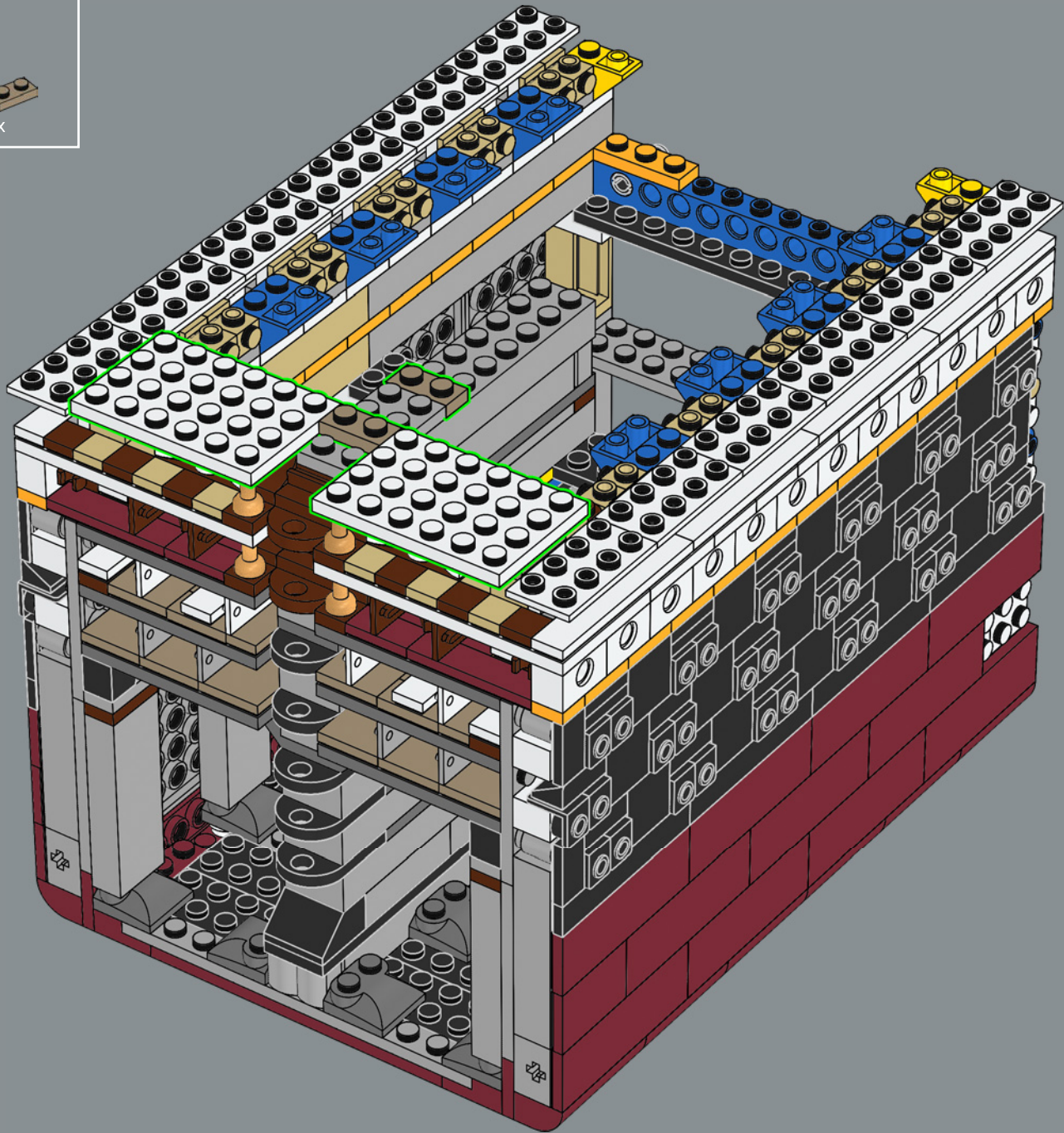

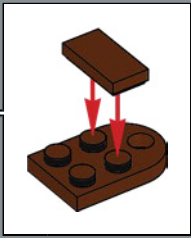
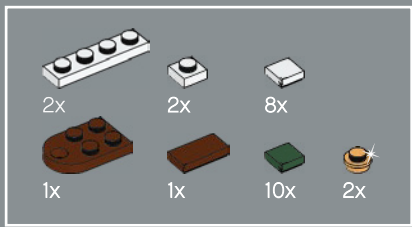

213

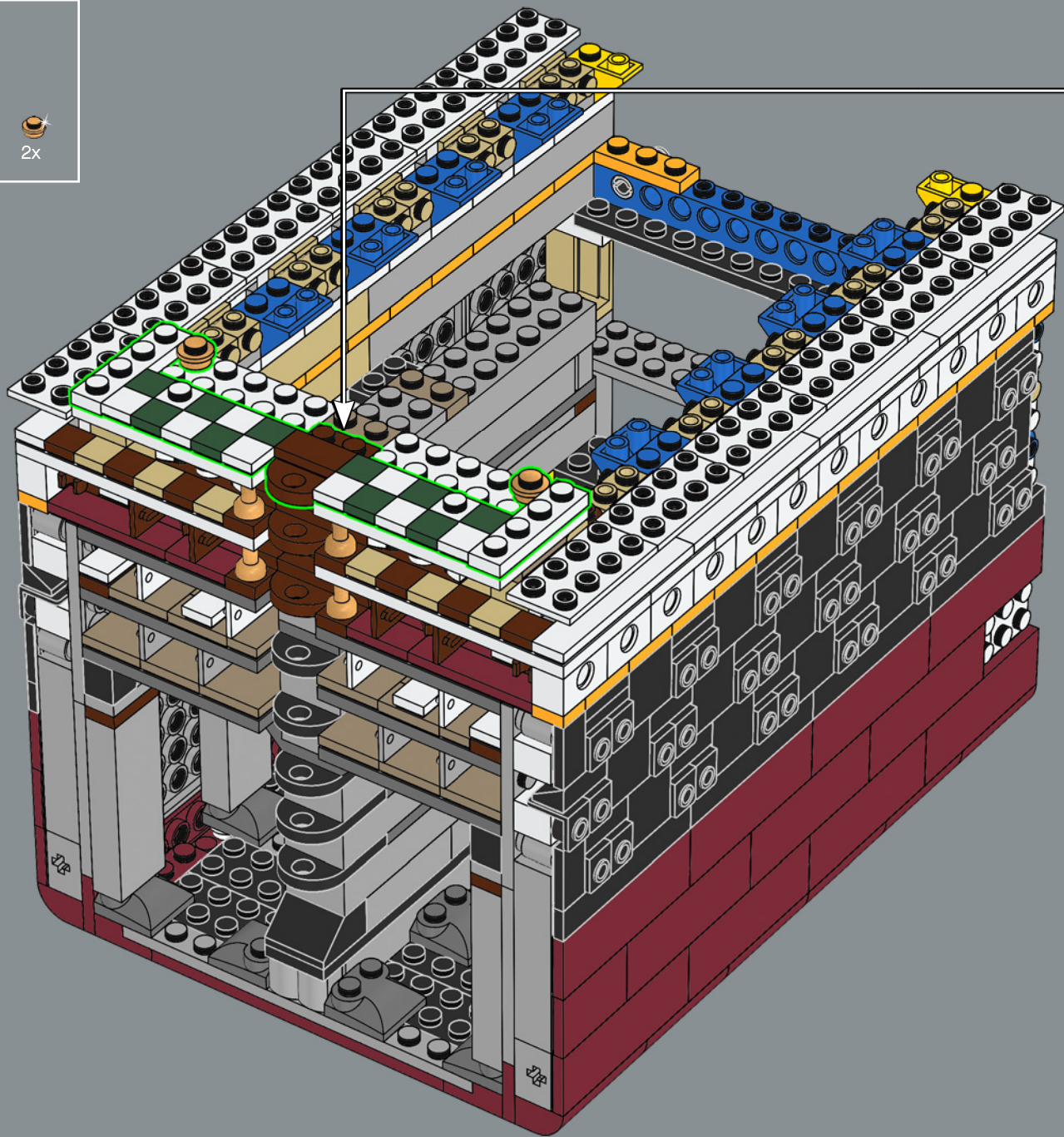



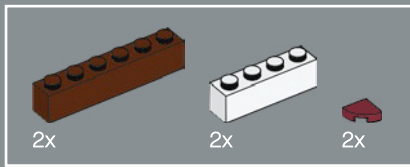

214

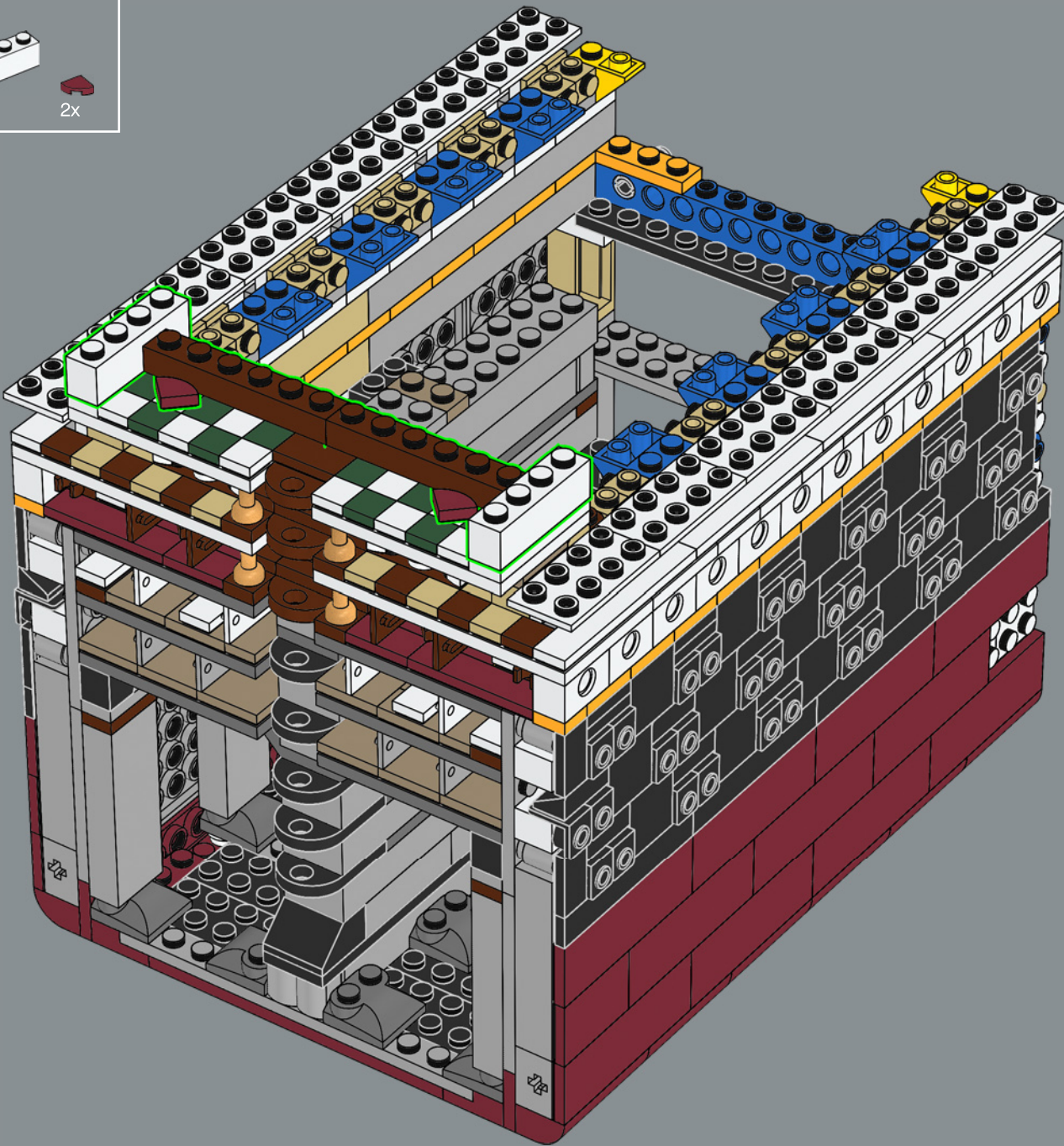

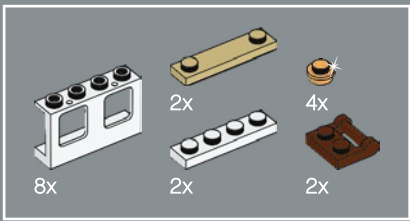

215

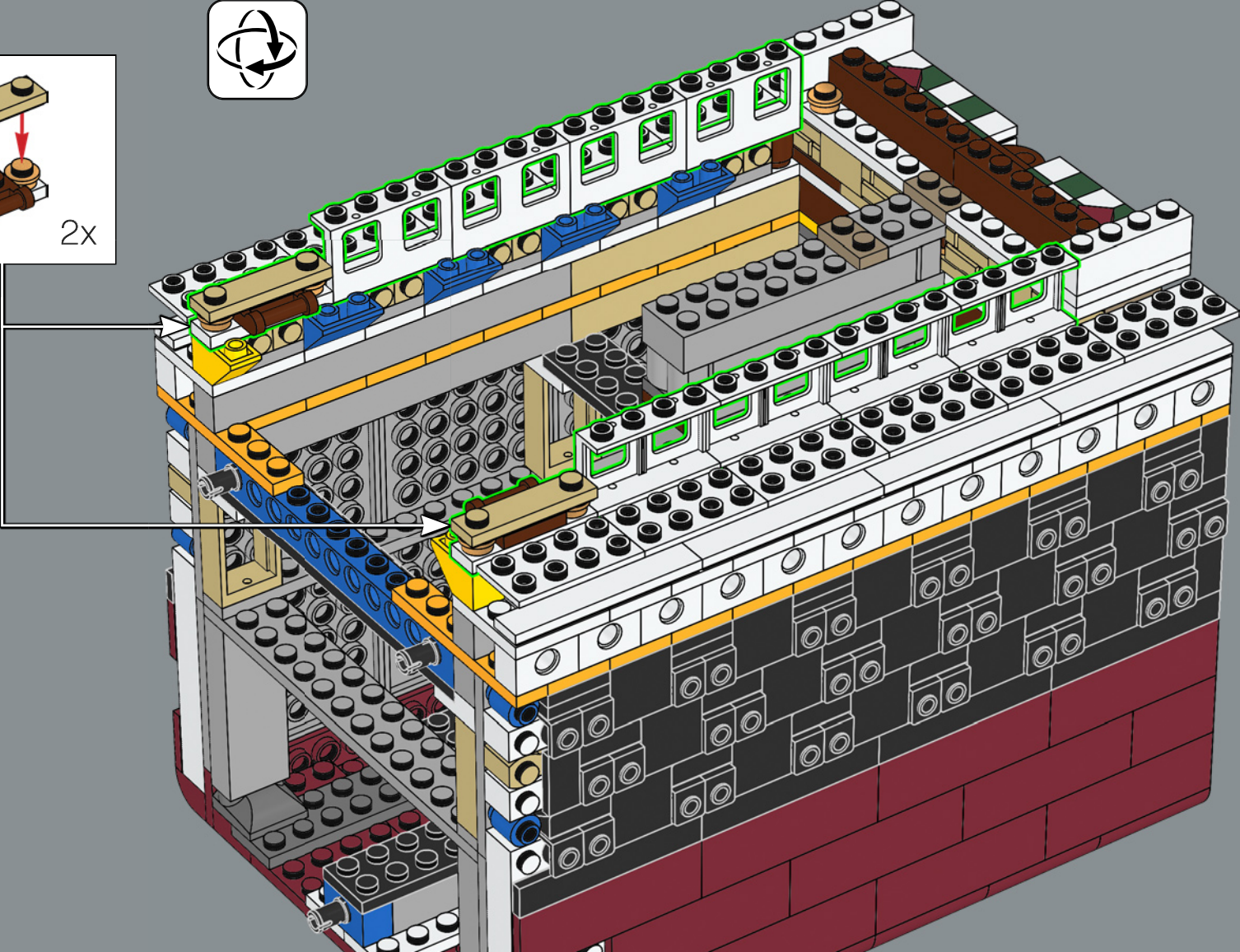
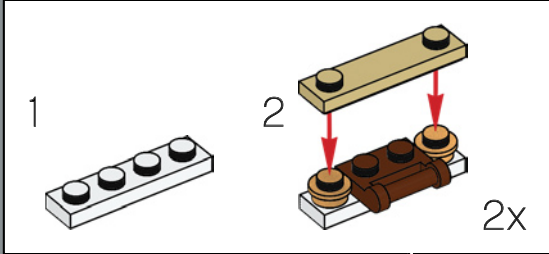

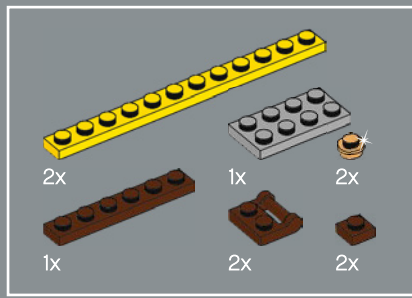

216

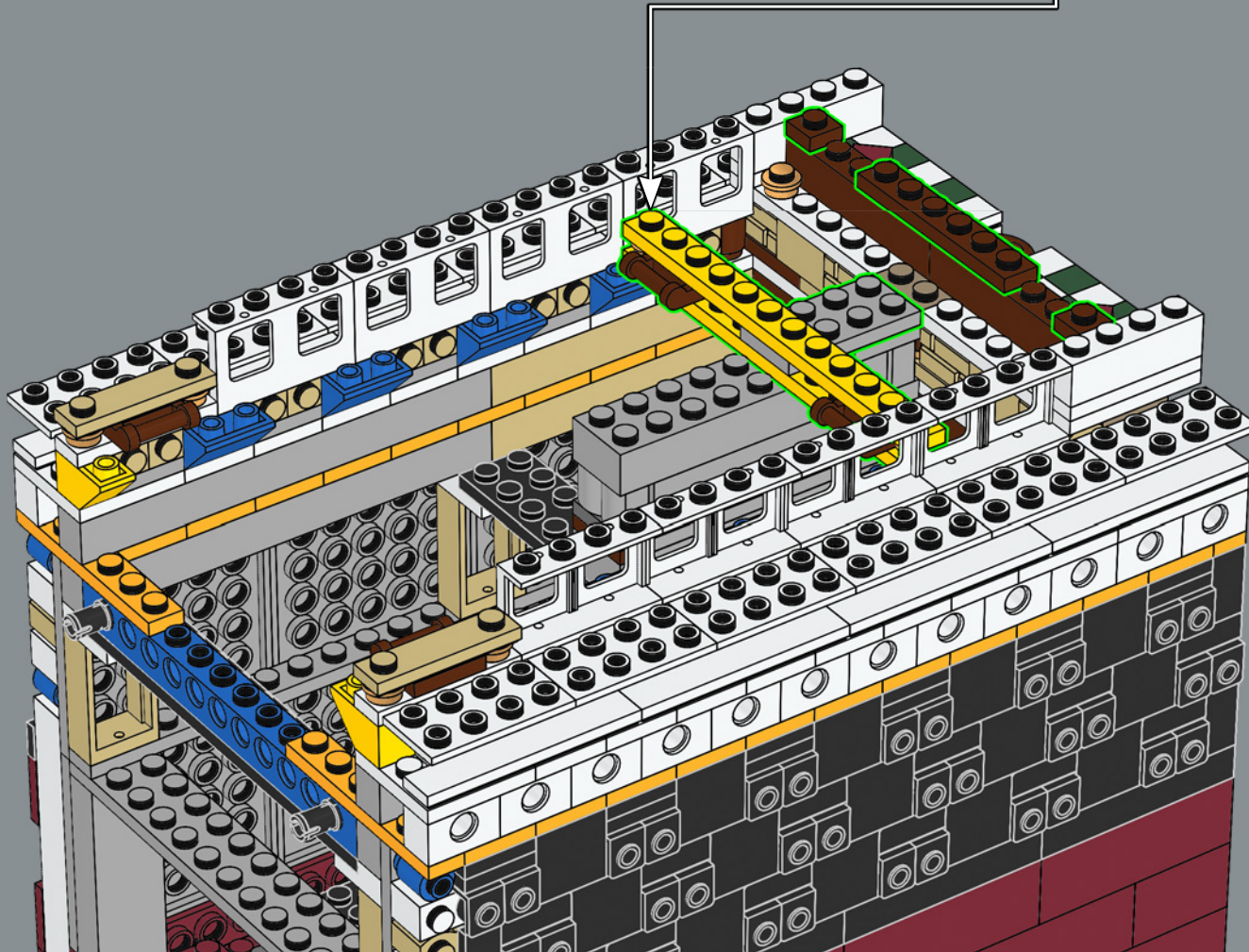
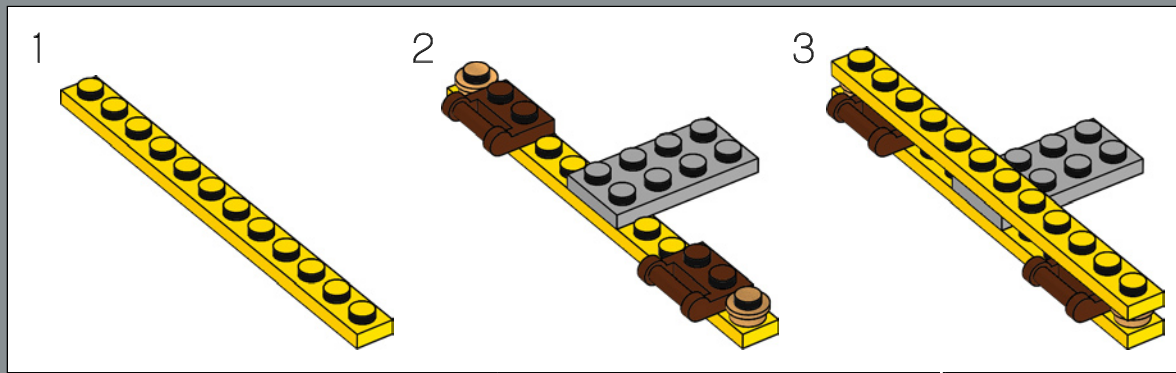

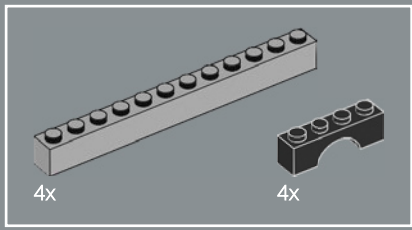

217

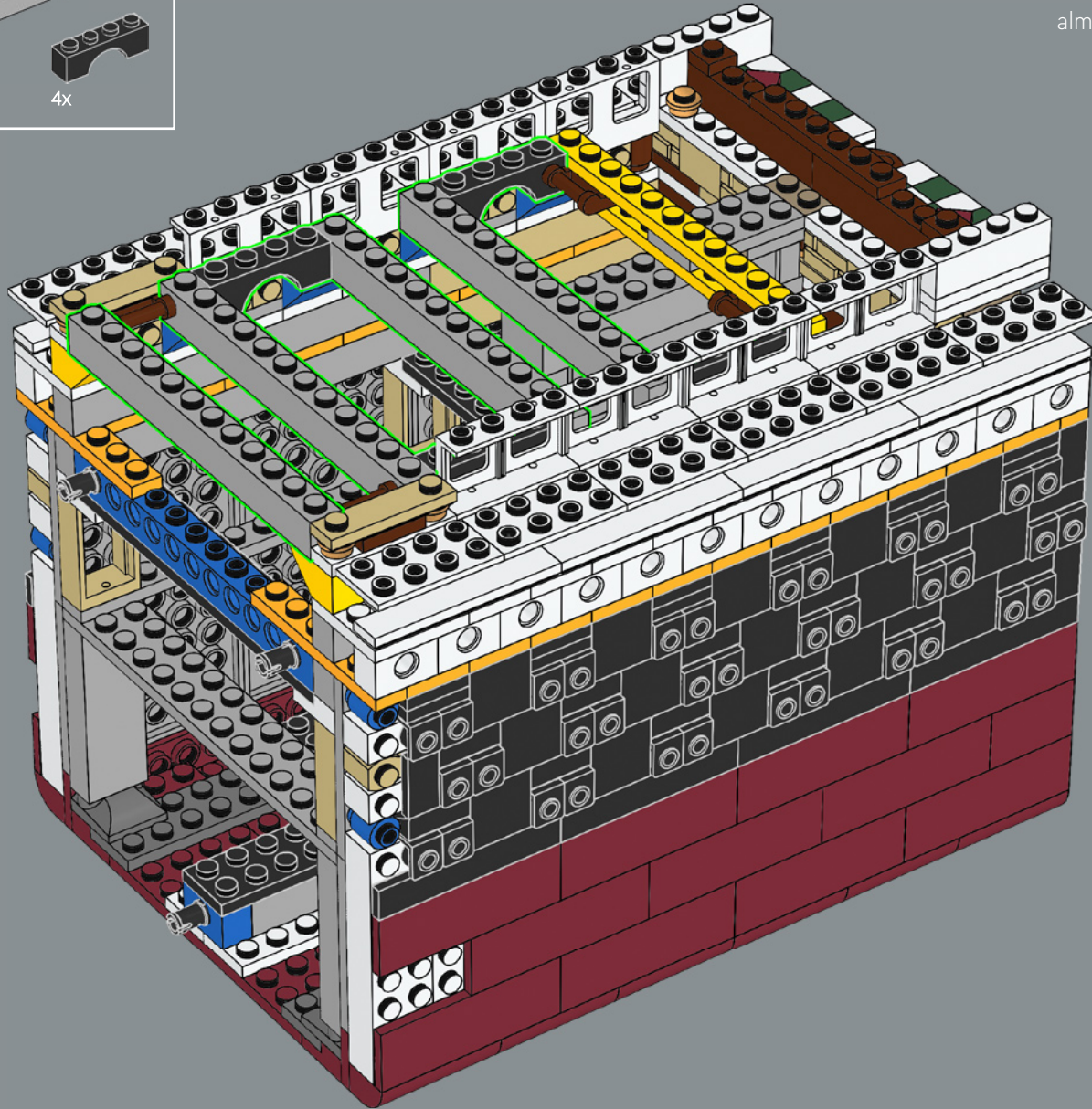

The *Titanic* and *Olympic* ships cost £3 million (approx. 4.1 million US dollars) to build - almost £300 million (416.7 million US dollars) in today's money.

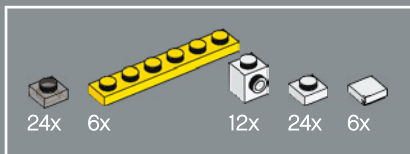

218

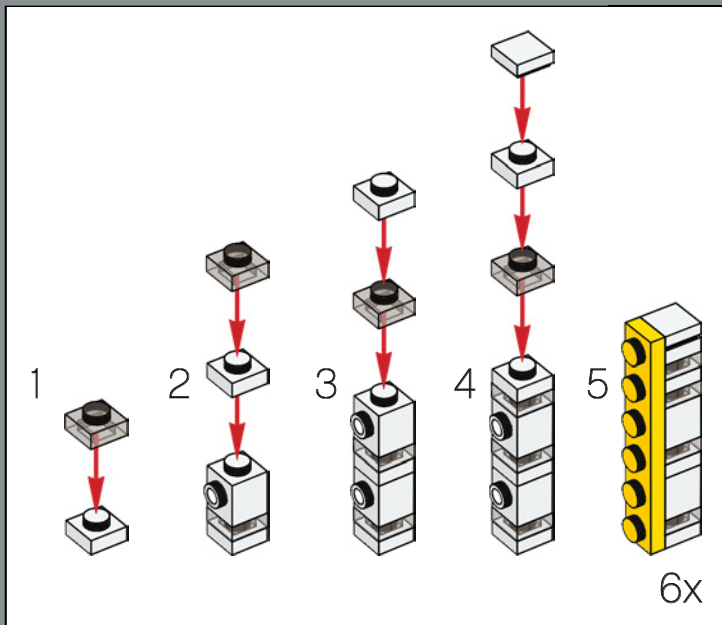
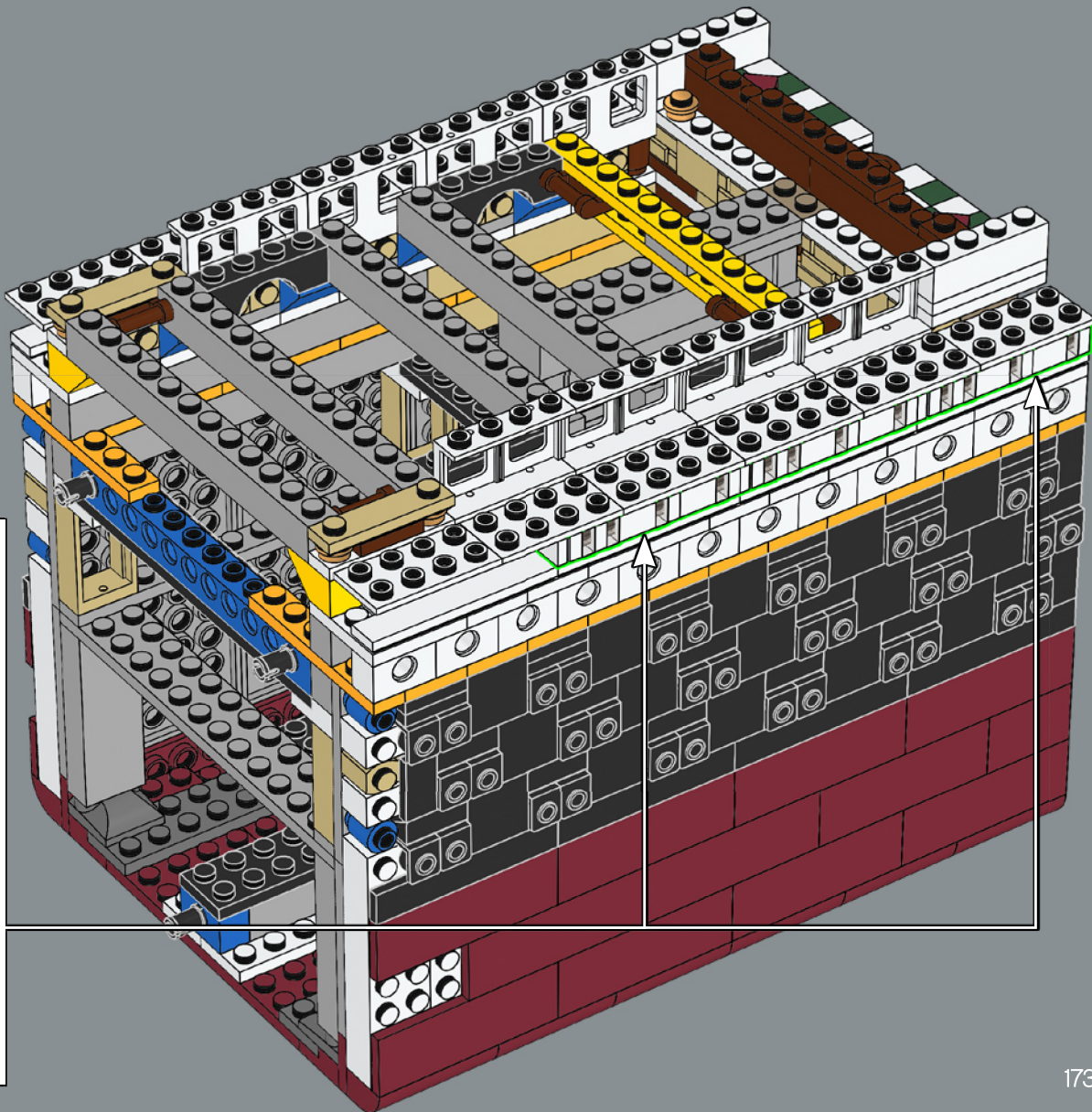

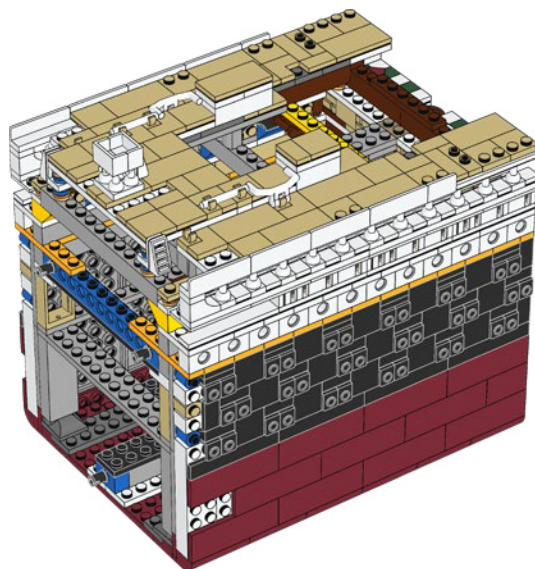
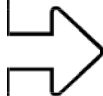

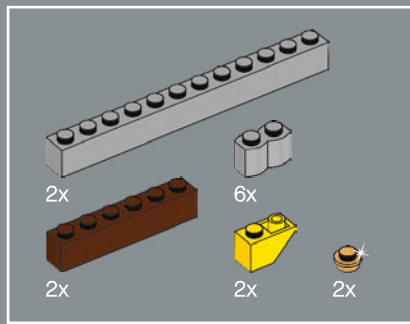

219

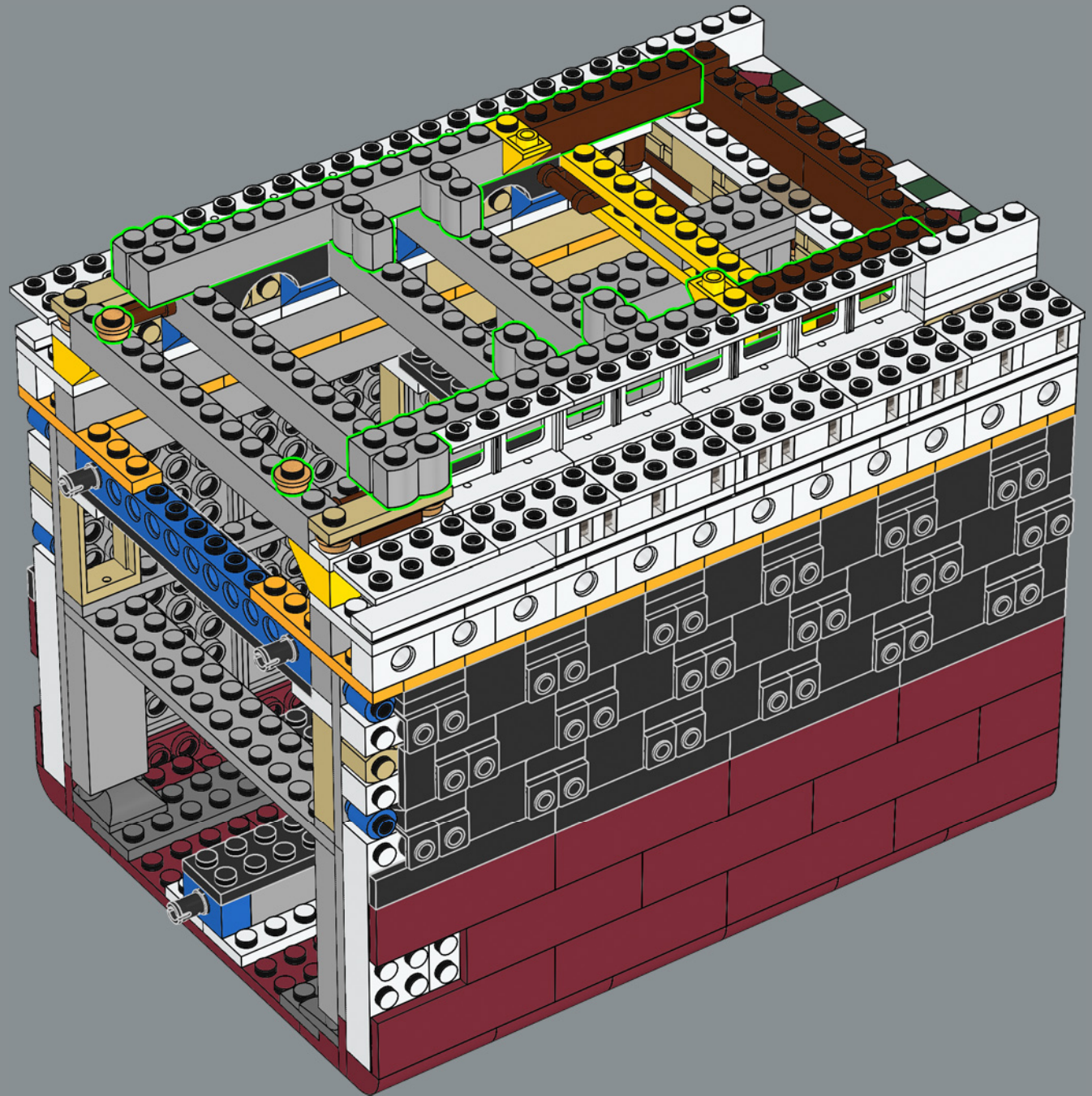

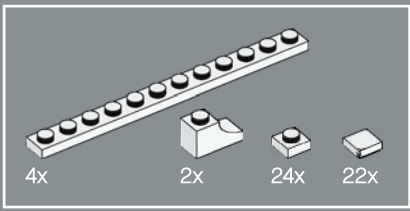

220

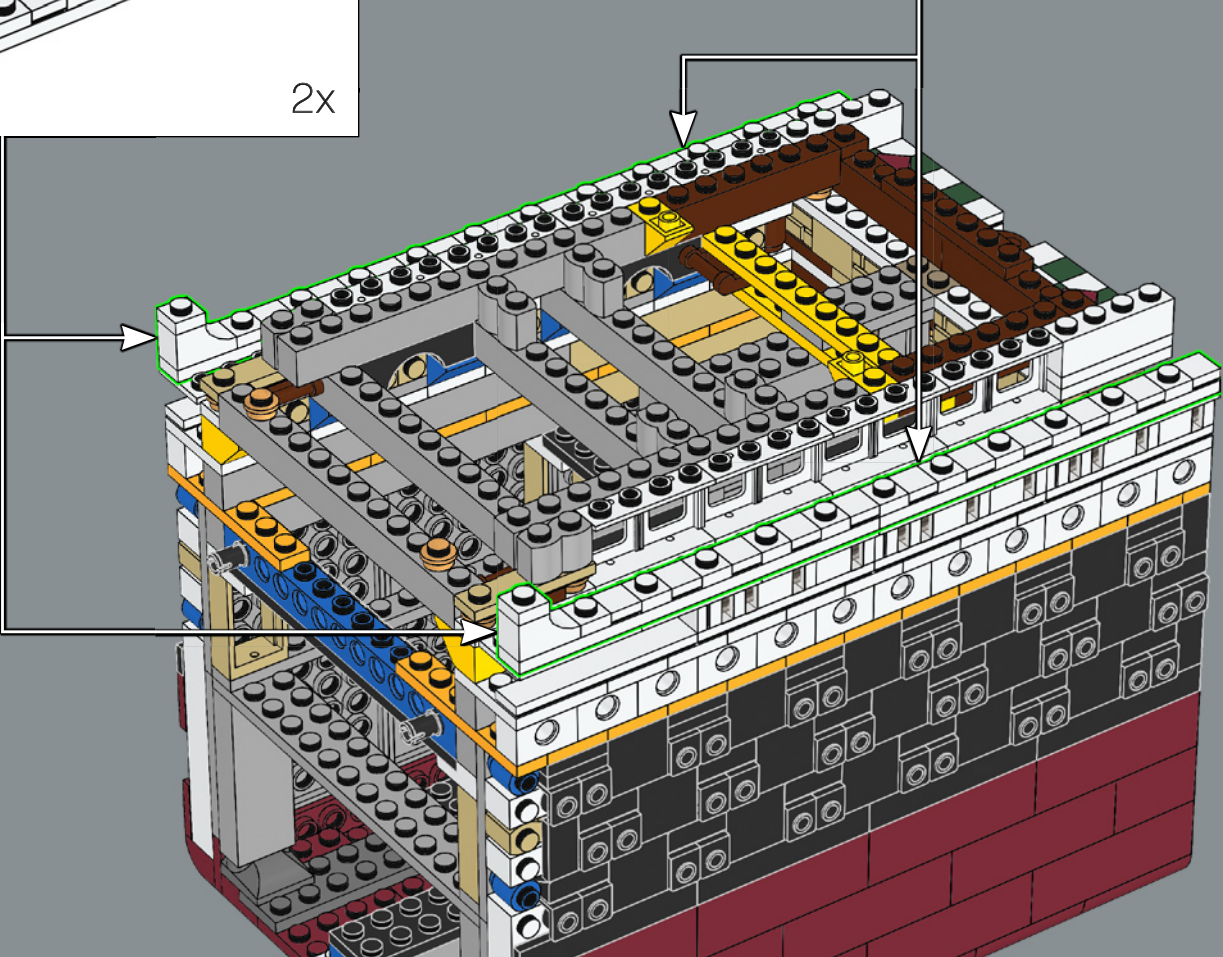
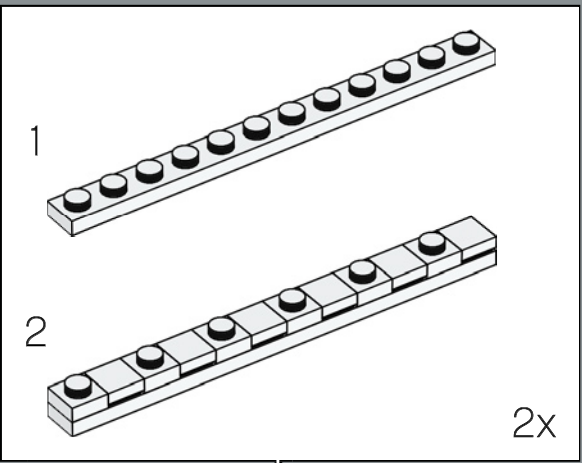
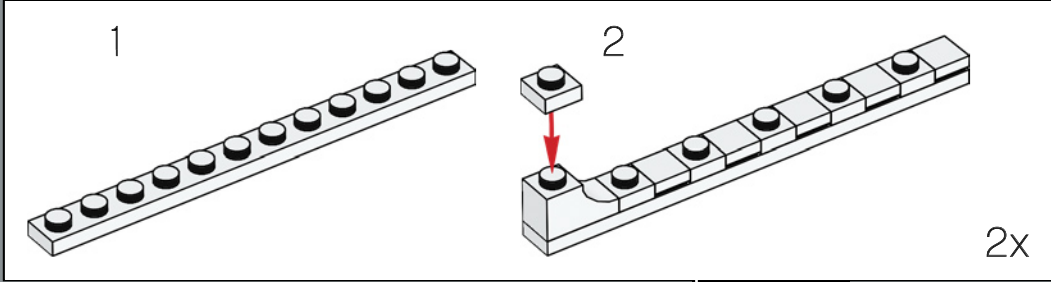



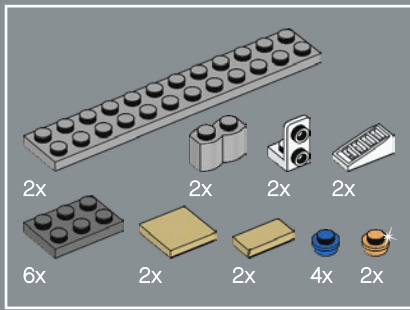

221

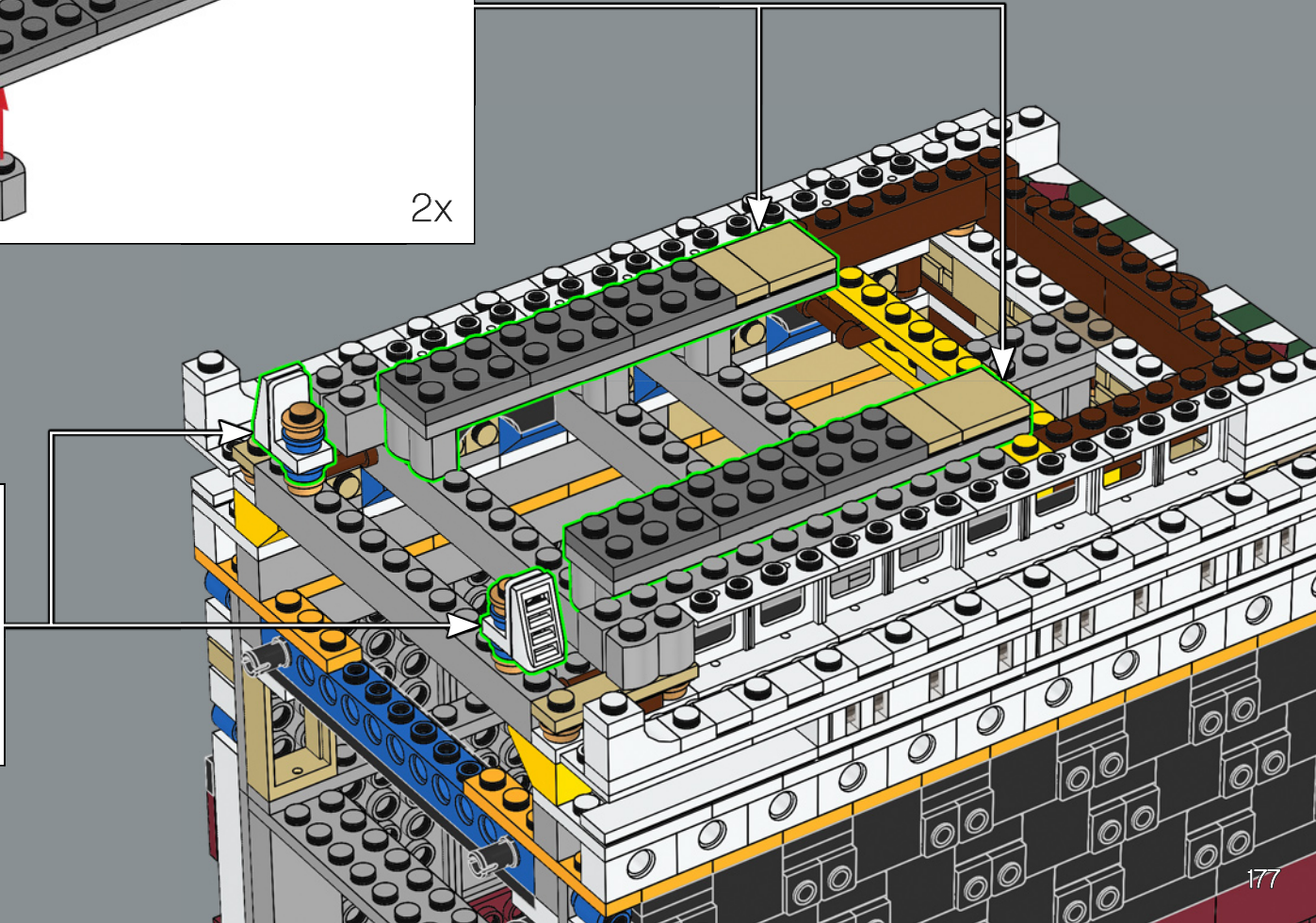
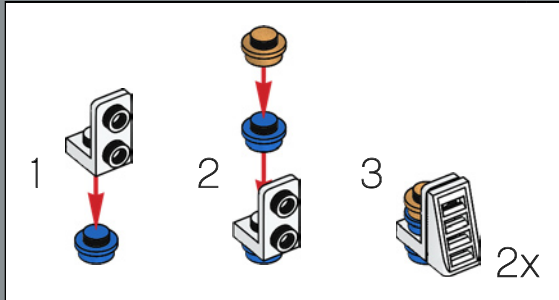
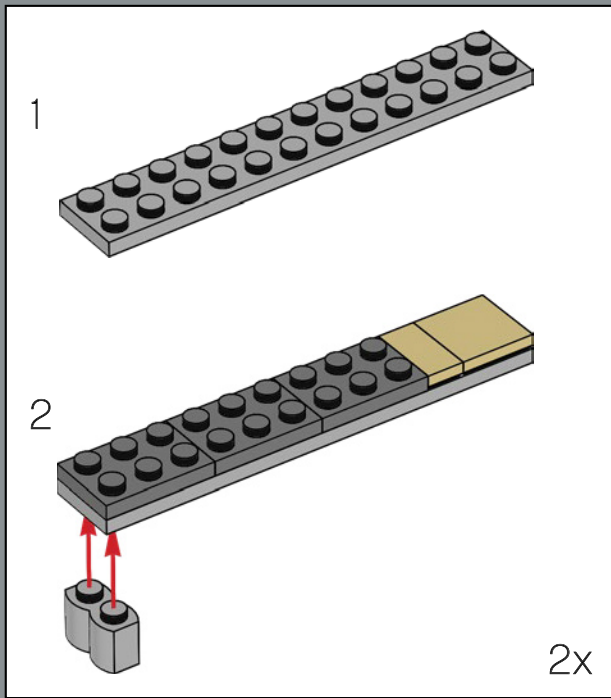

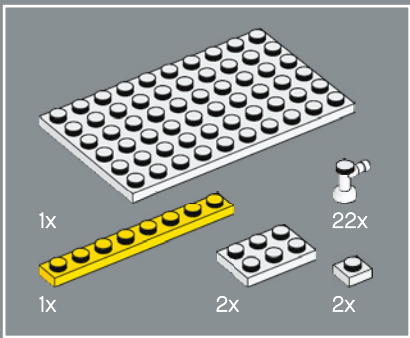

222

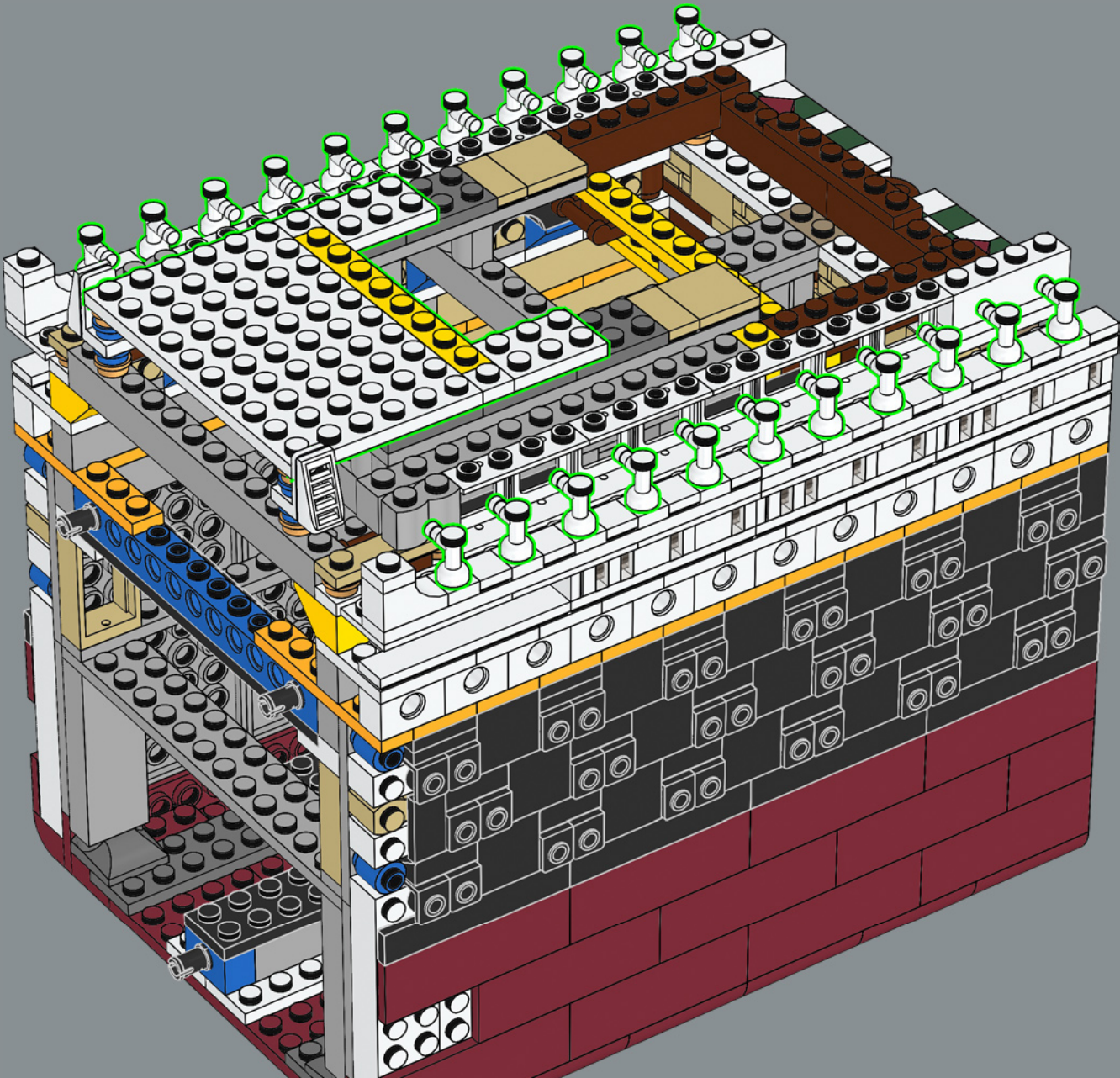

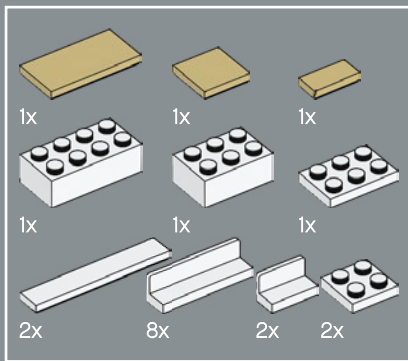

223

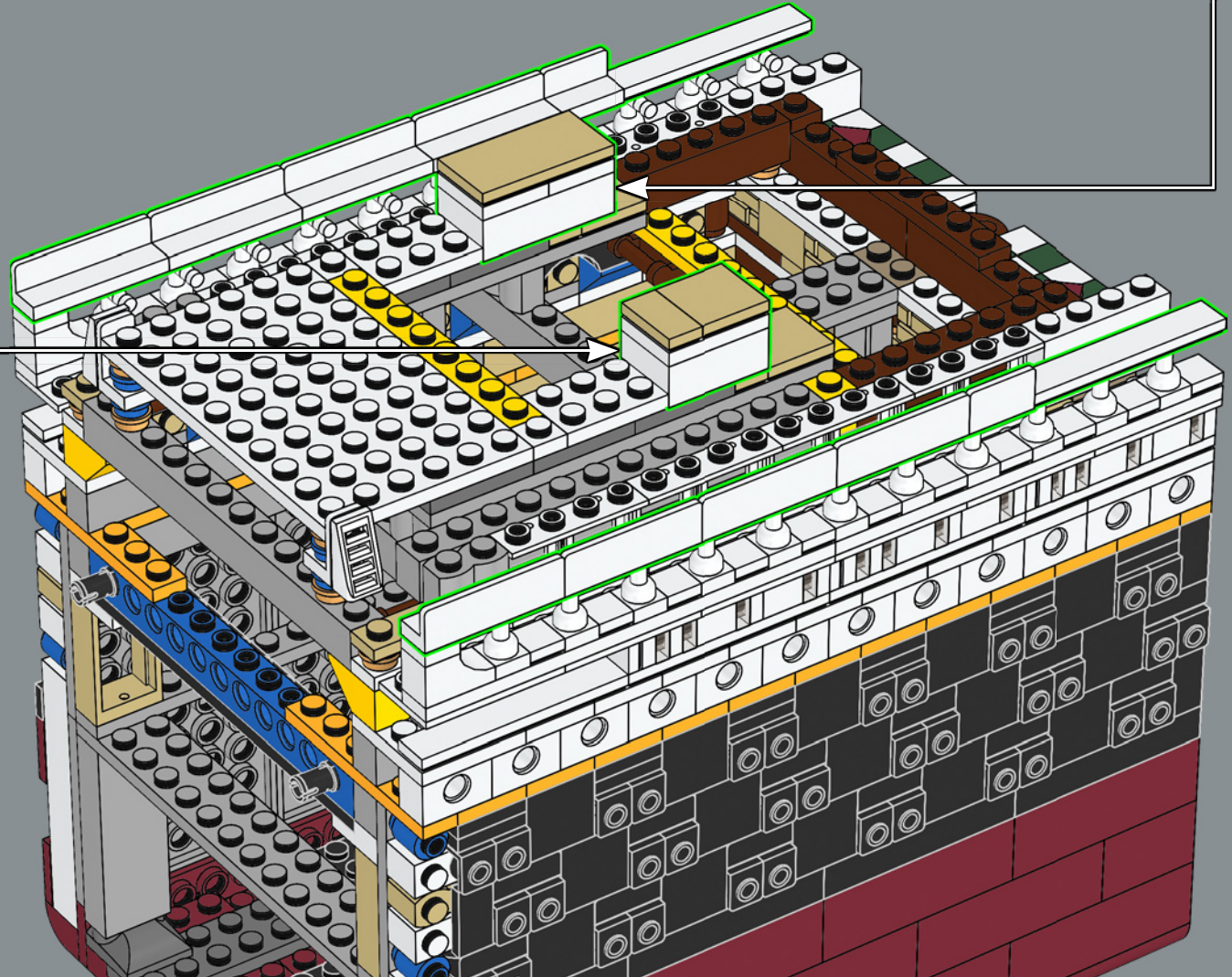
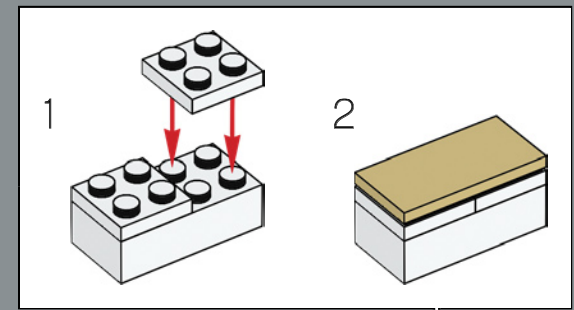
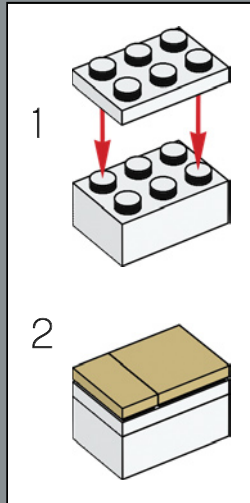

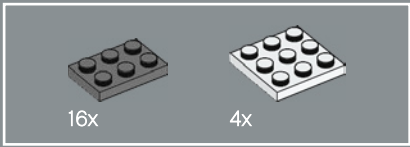

224

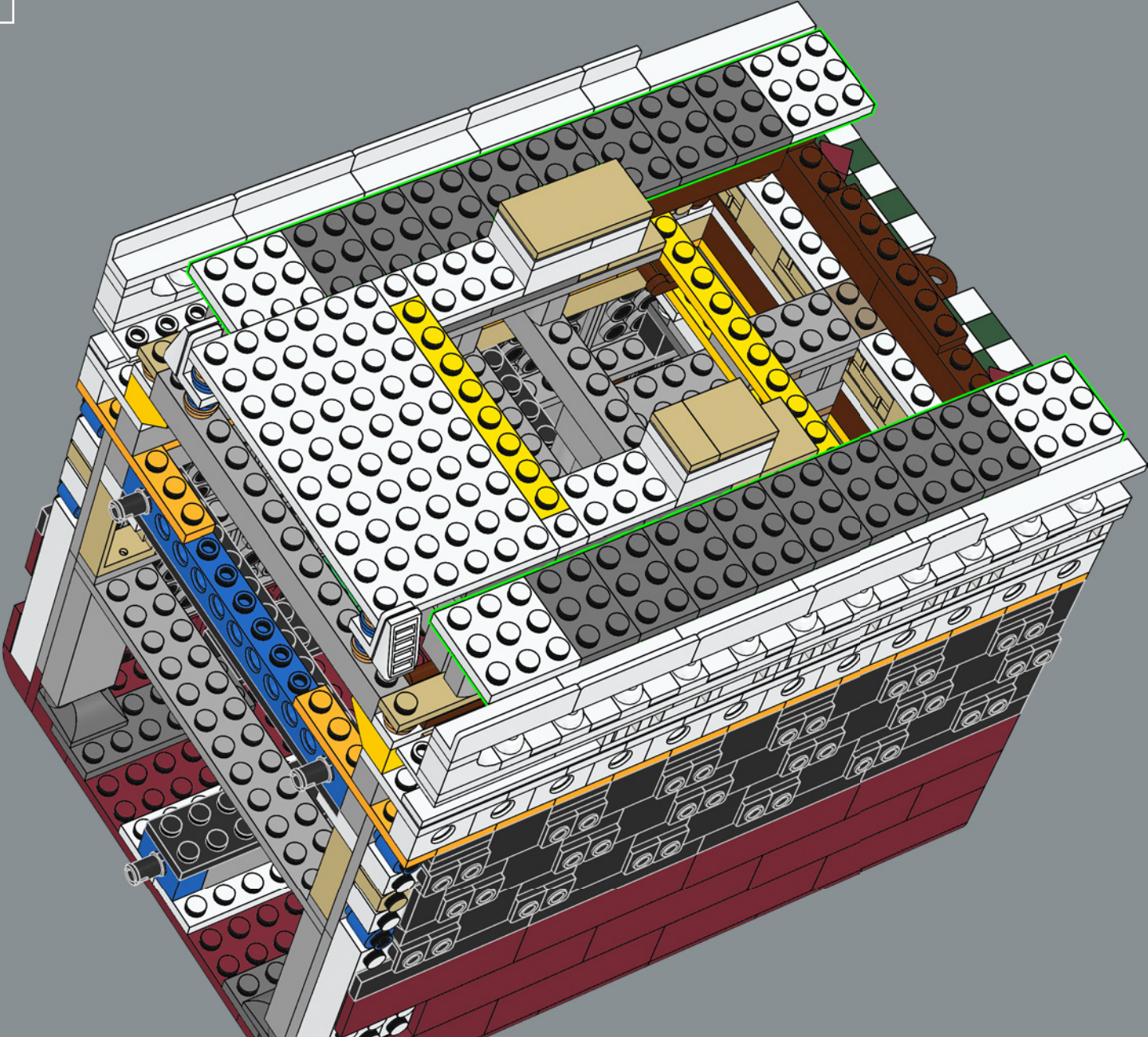

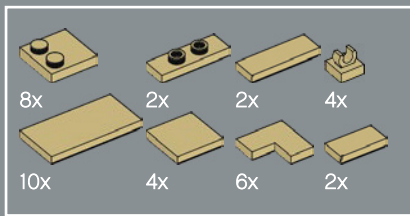

225

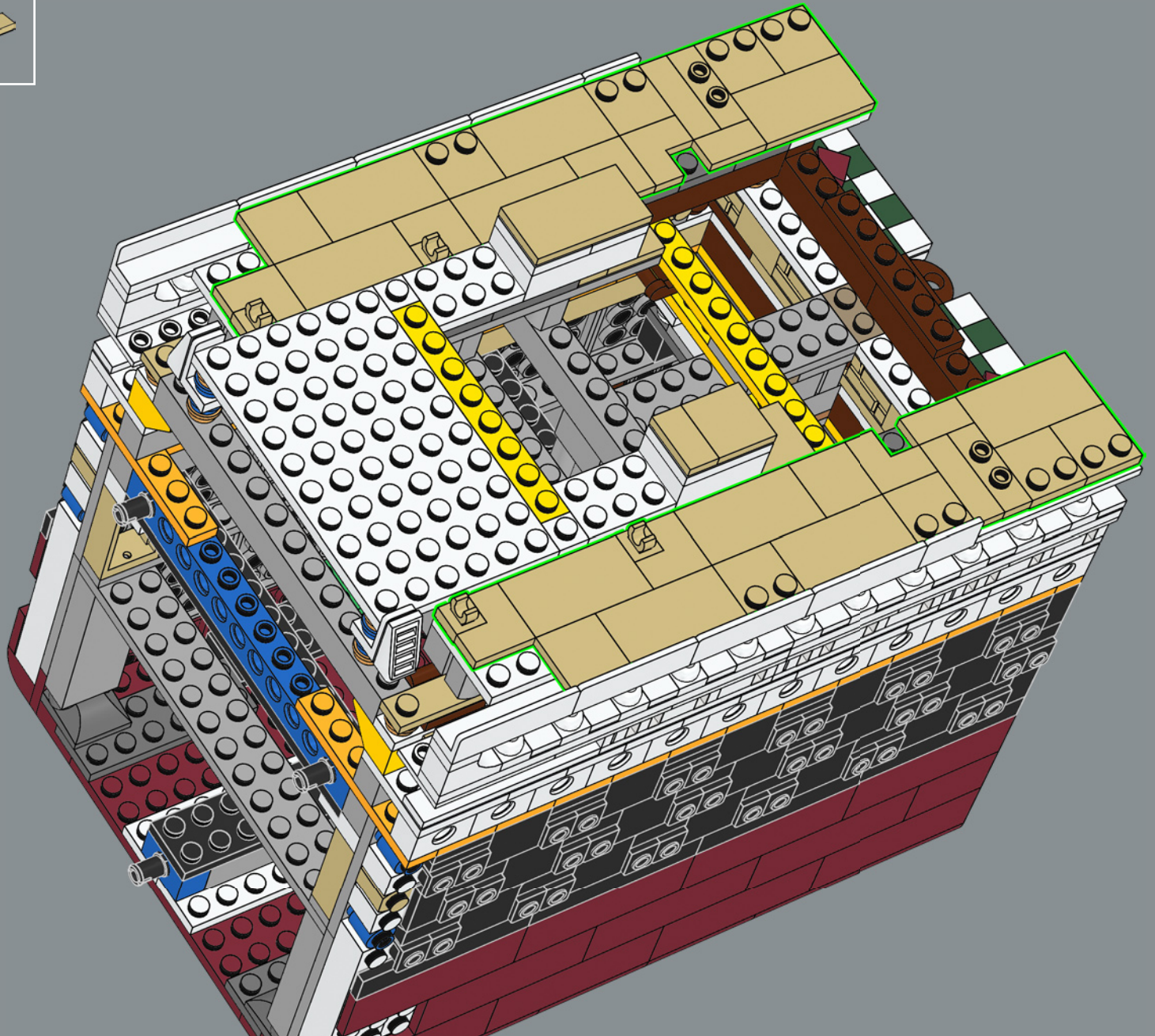

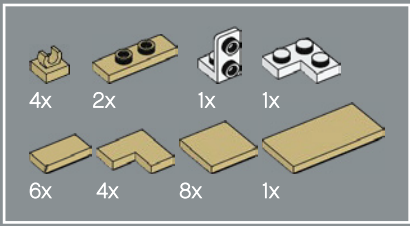

226

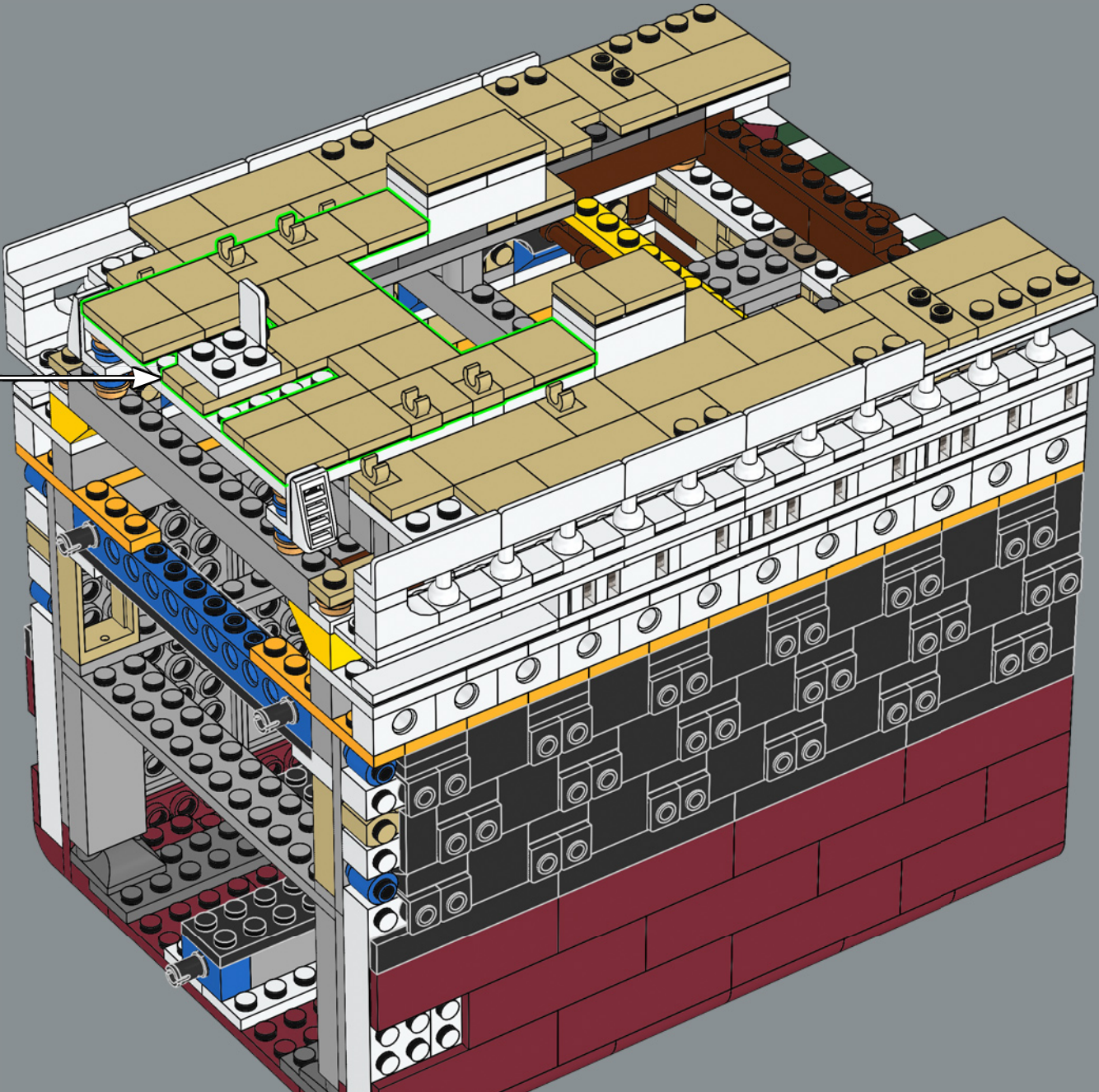
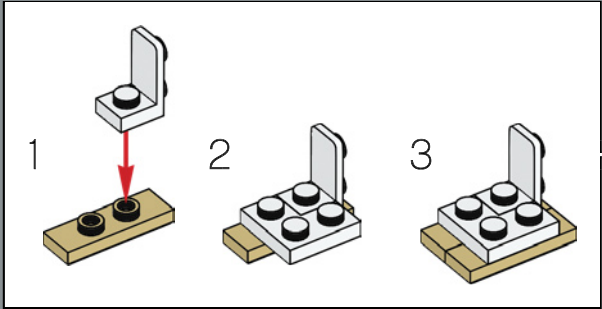



227

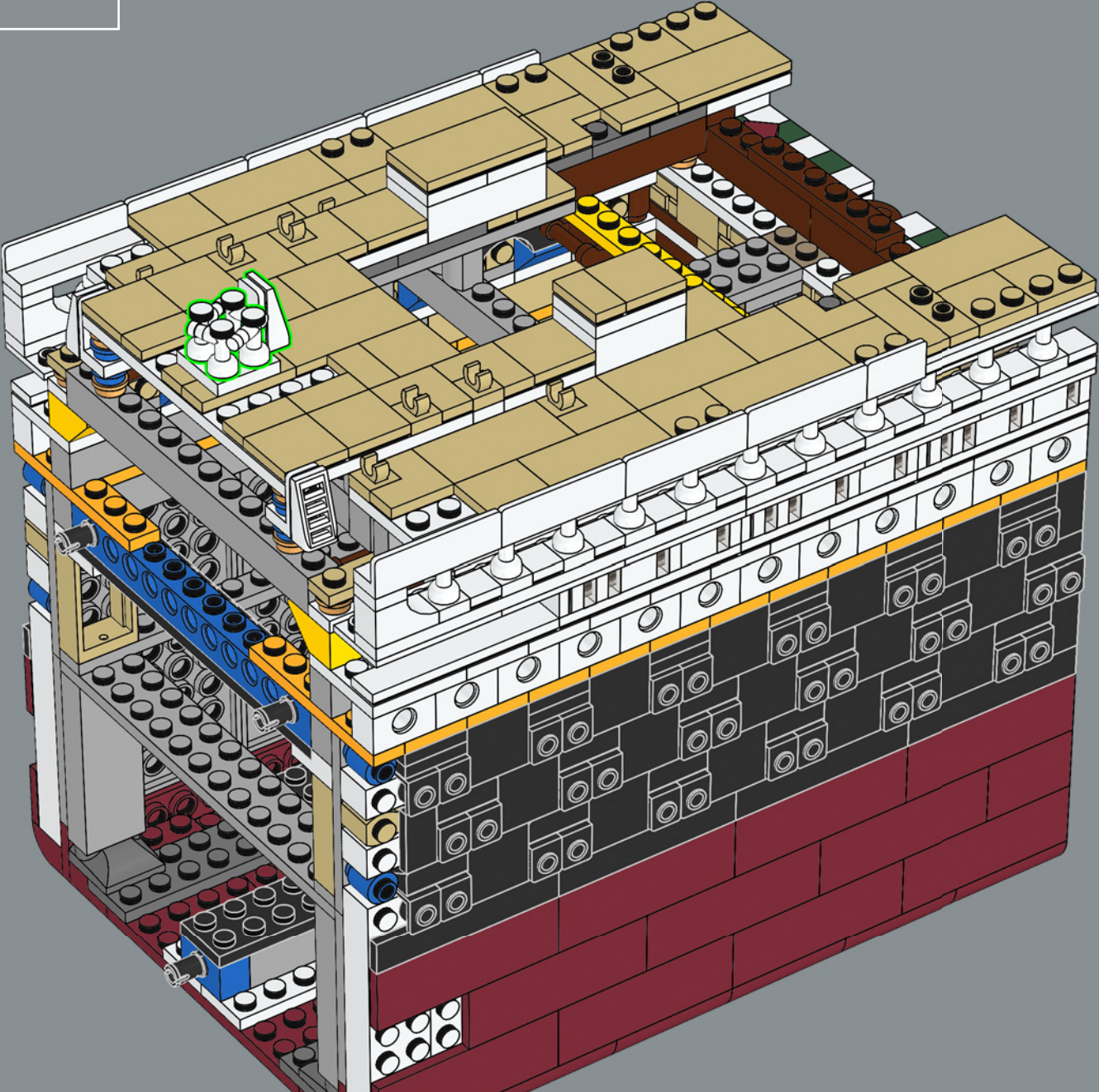





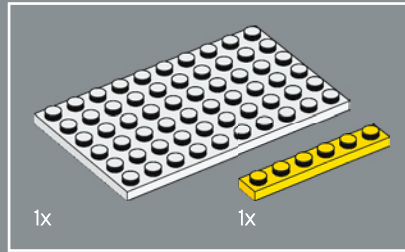
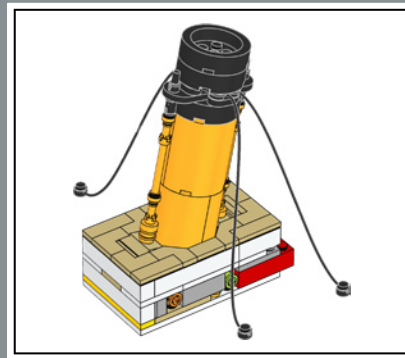
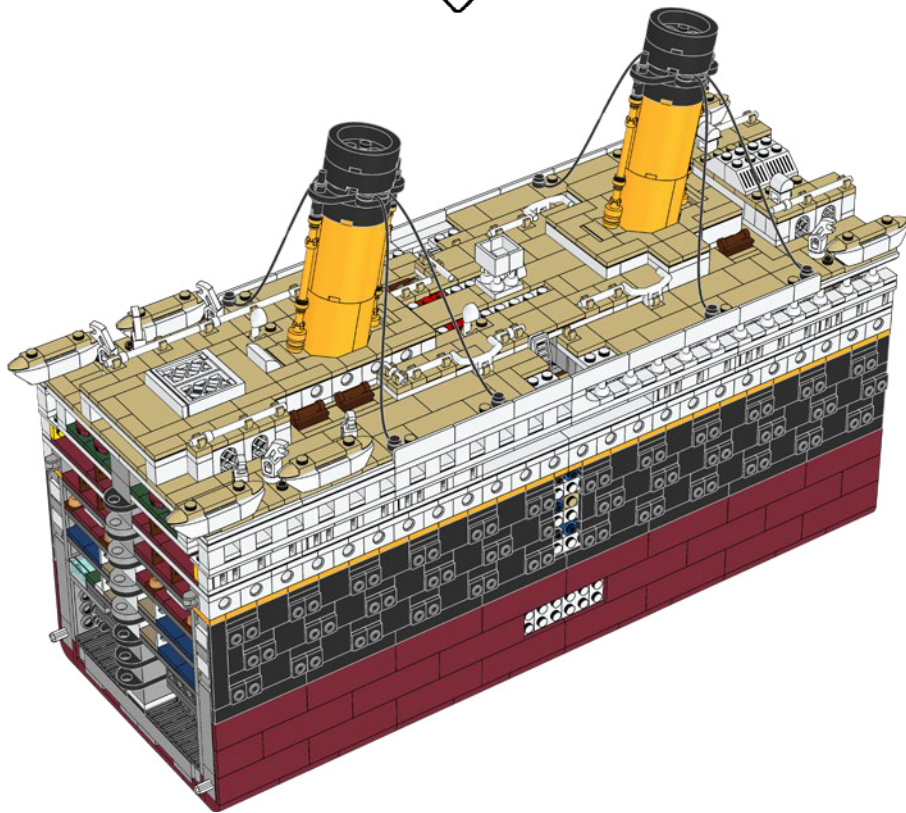
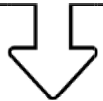

229

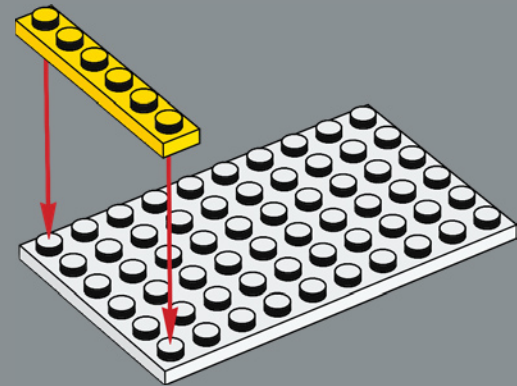

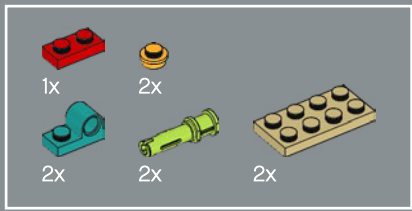

230

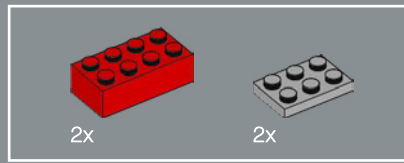
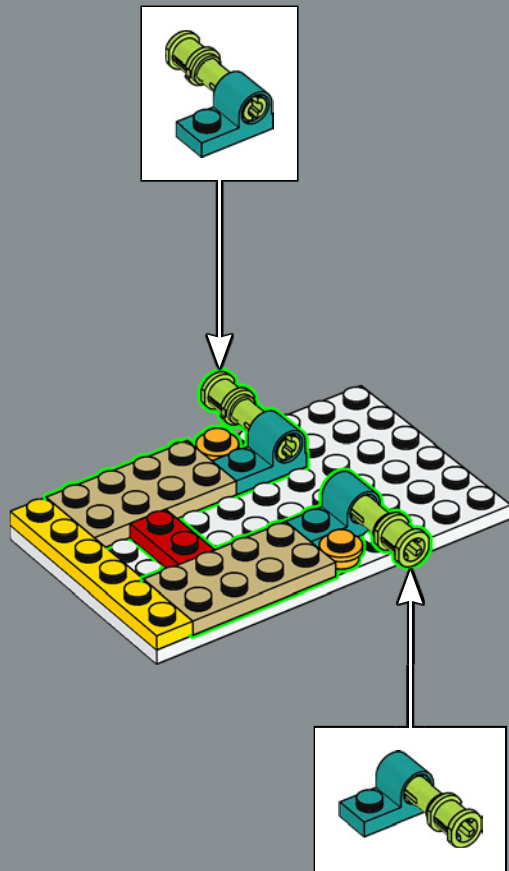

231

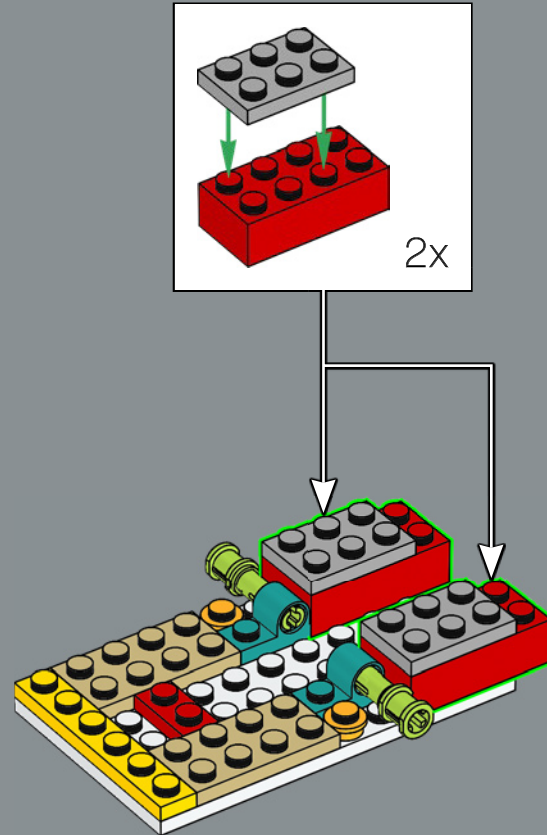

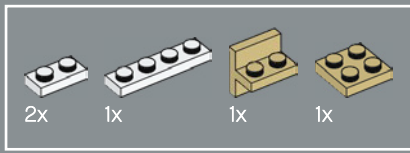

232

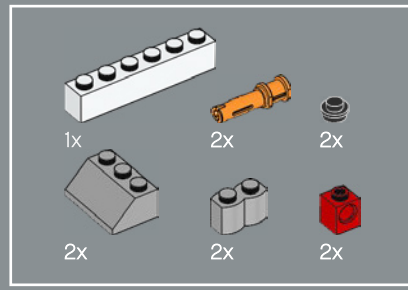
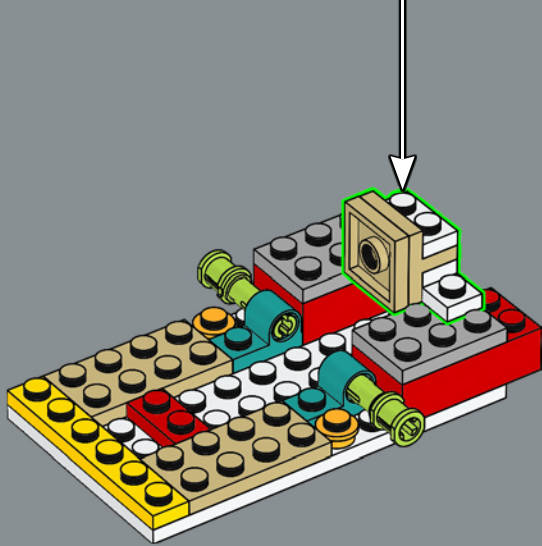
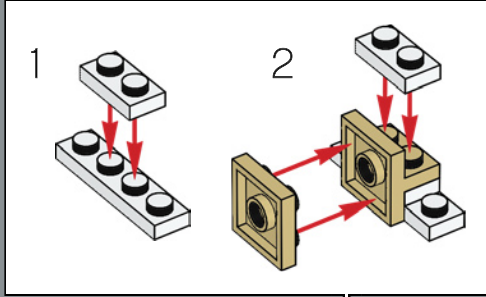

233

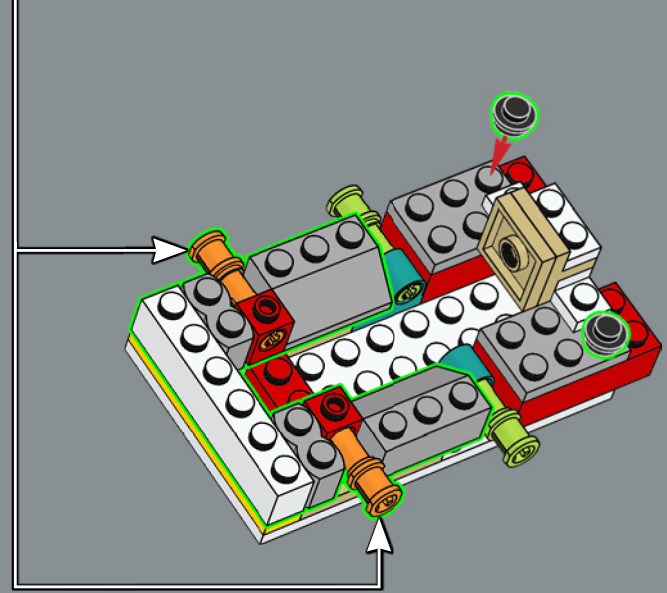
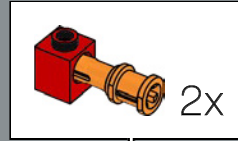

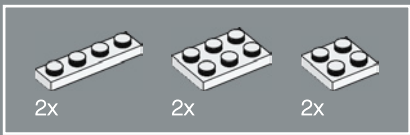

234

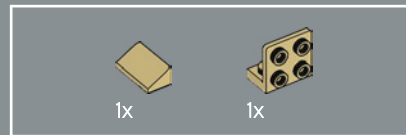
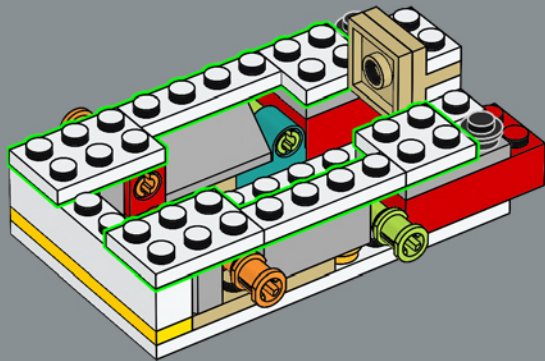

235

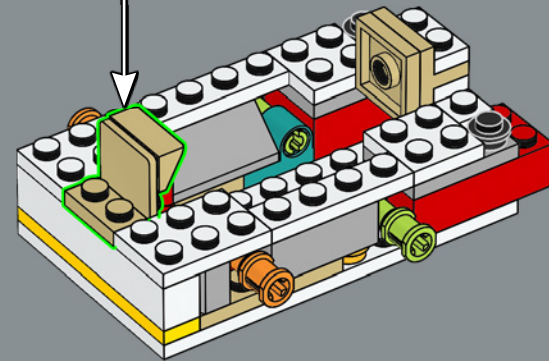
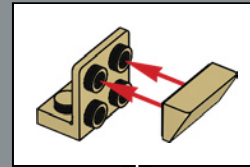

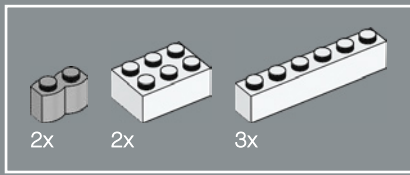

236

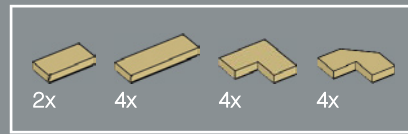
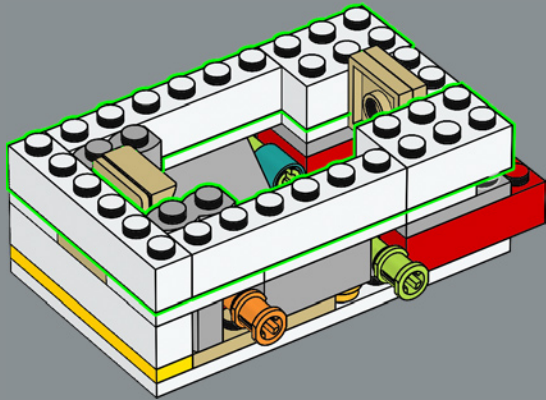

237

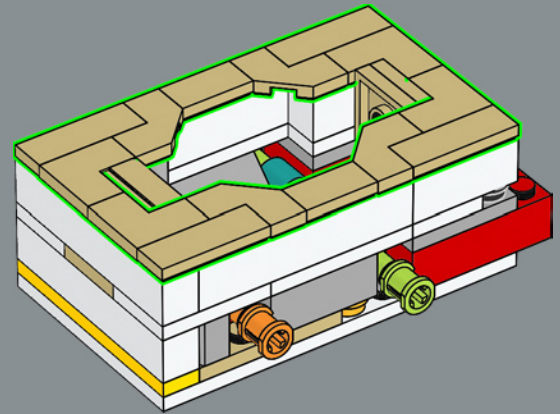

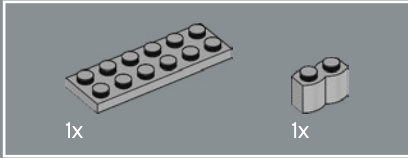
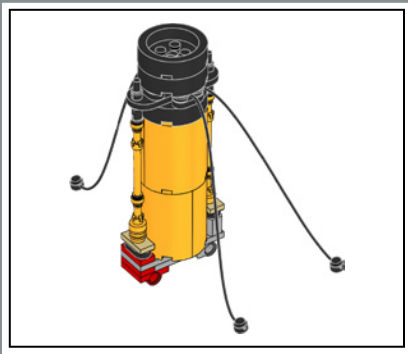

238

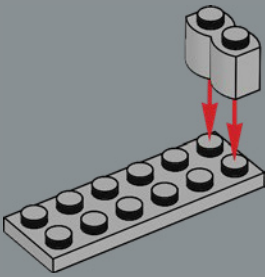

239

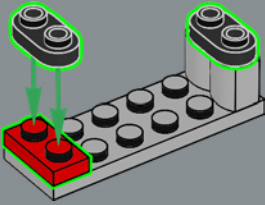

240

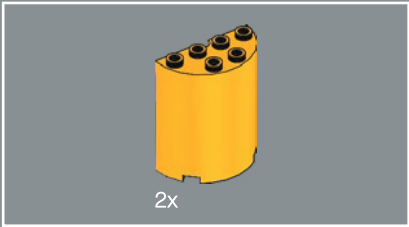
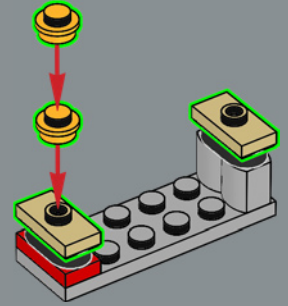

241

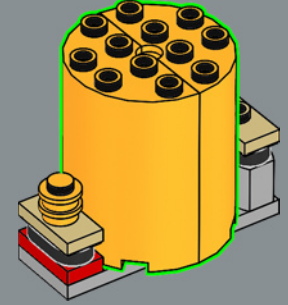

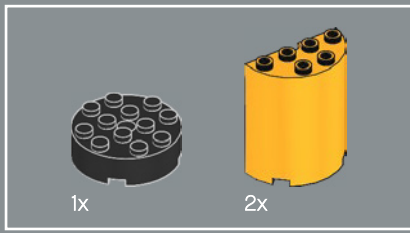

242

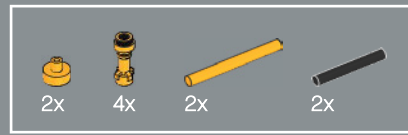
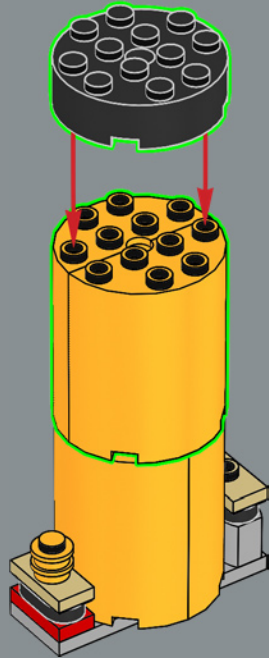

243

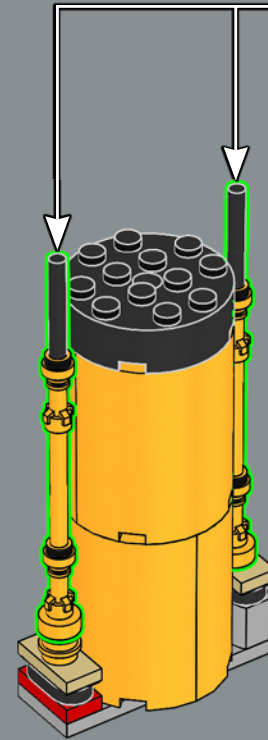
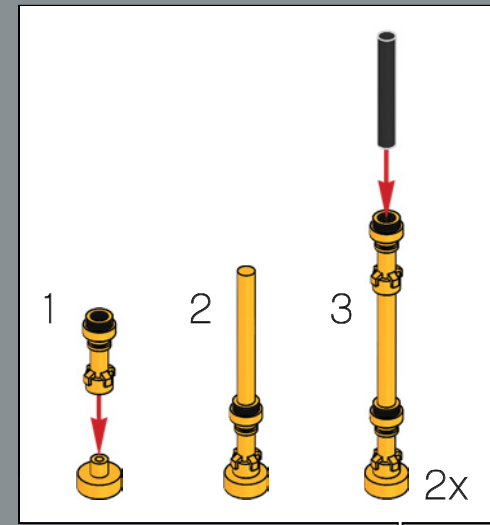

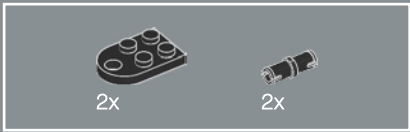

244

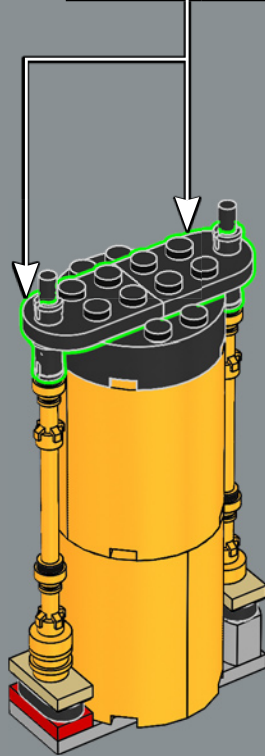
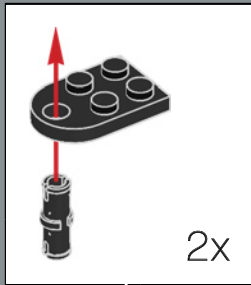

245

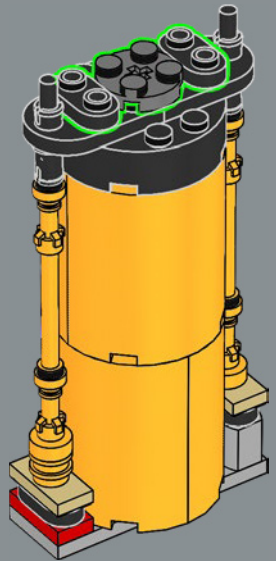





246

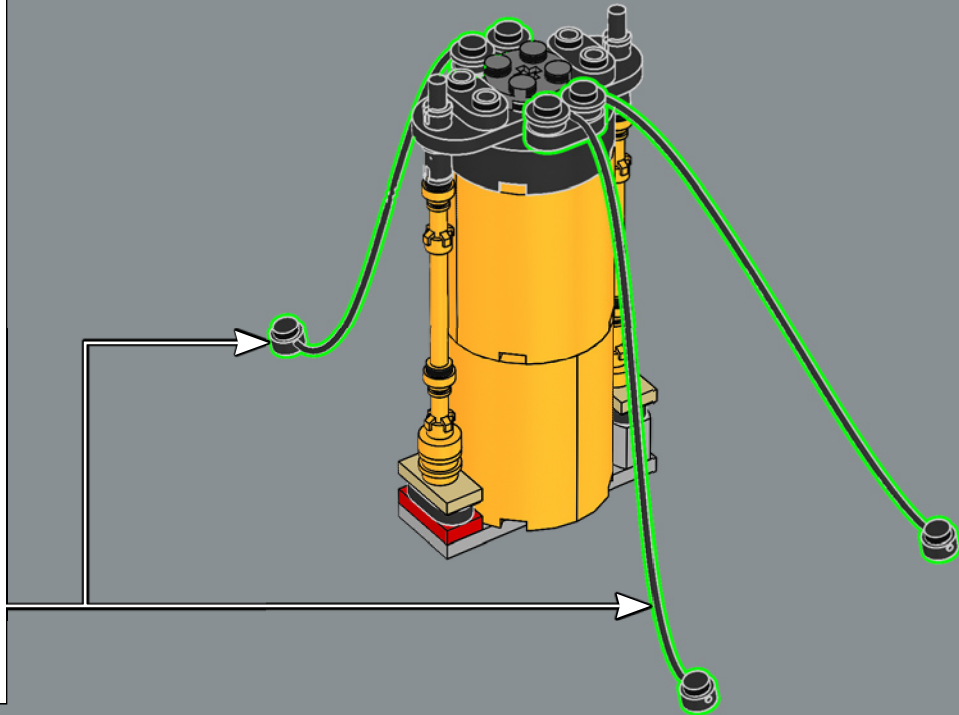
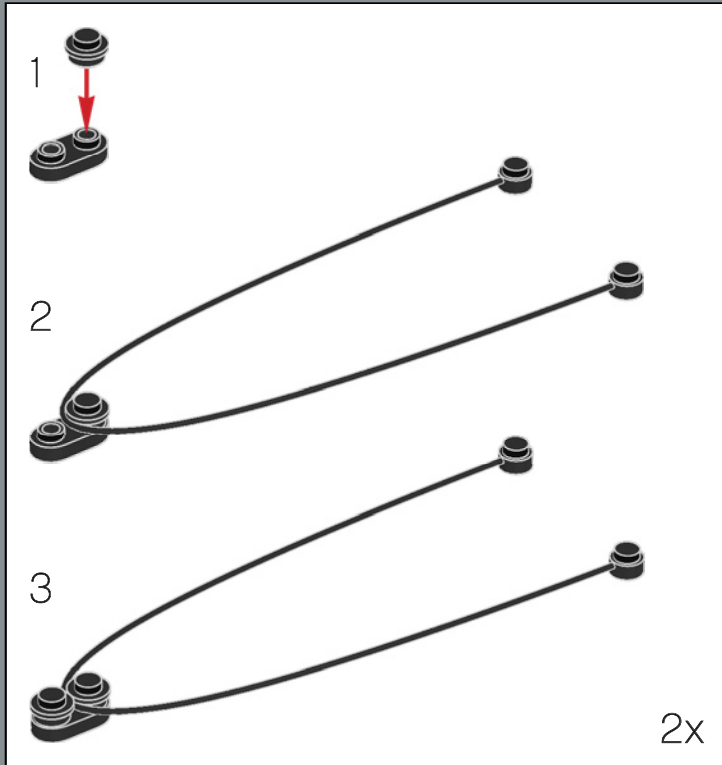

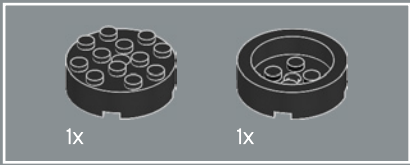

247

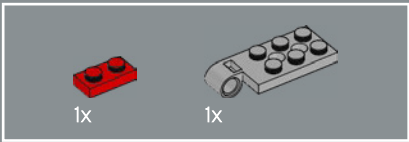
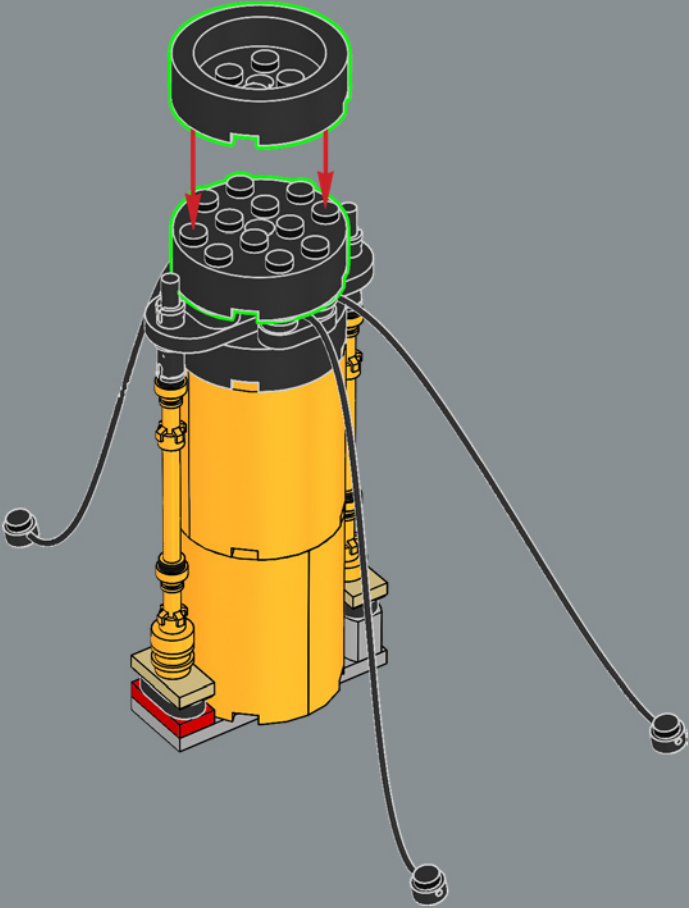

248

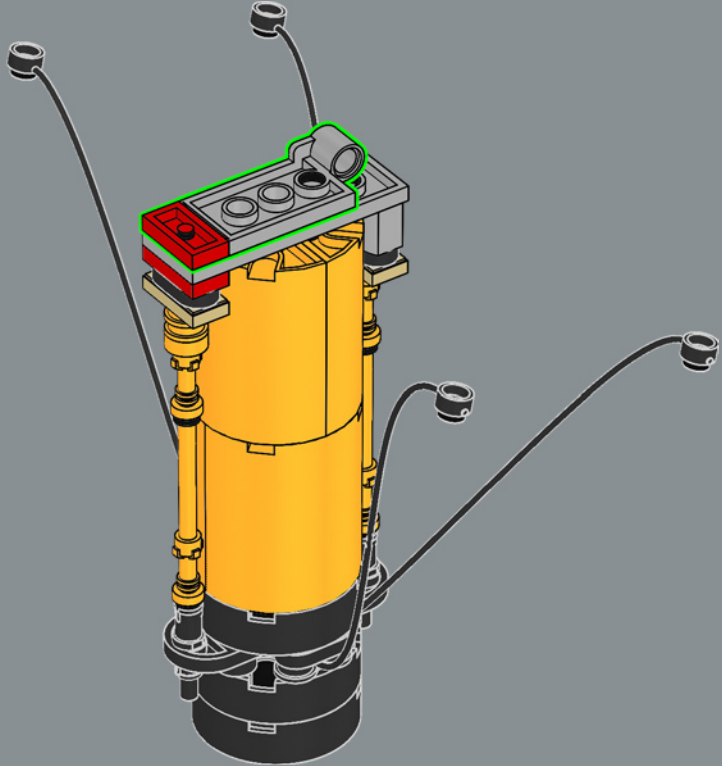

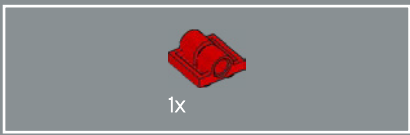

249

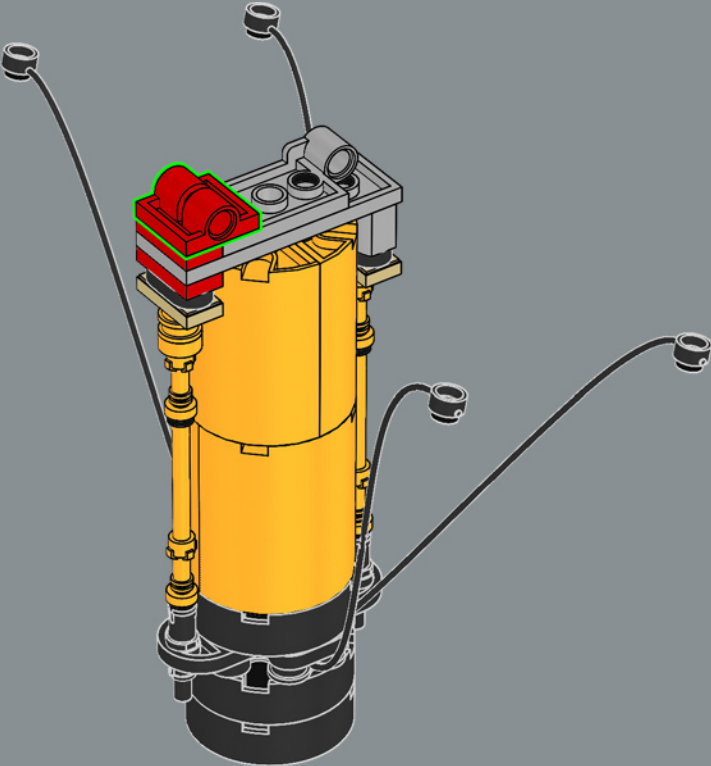

250

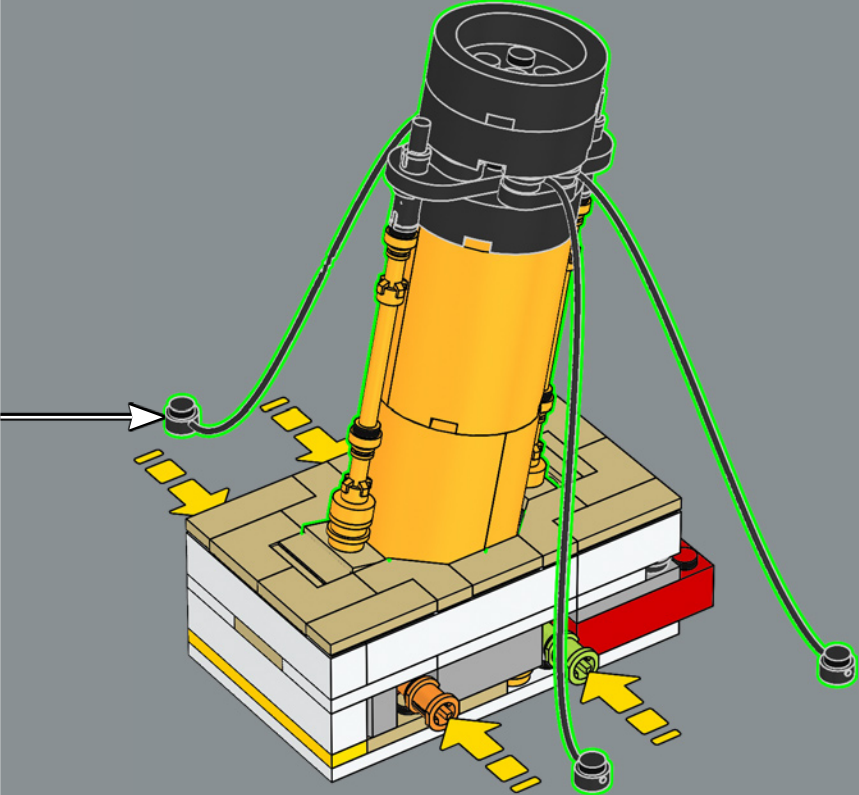

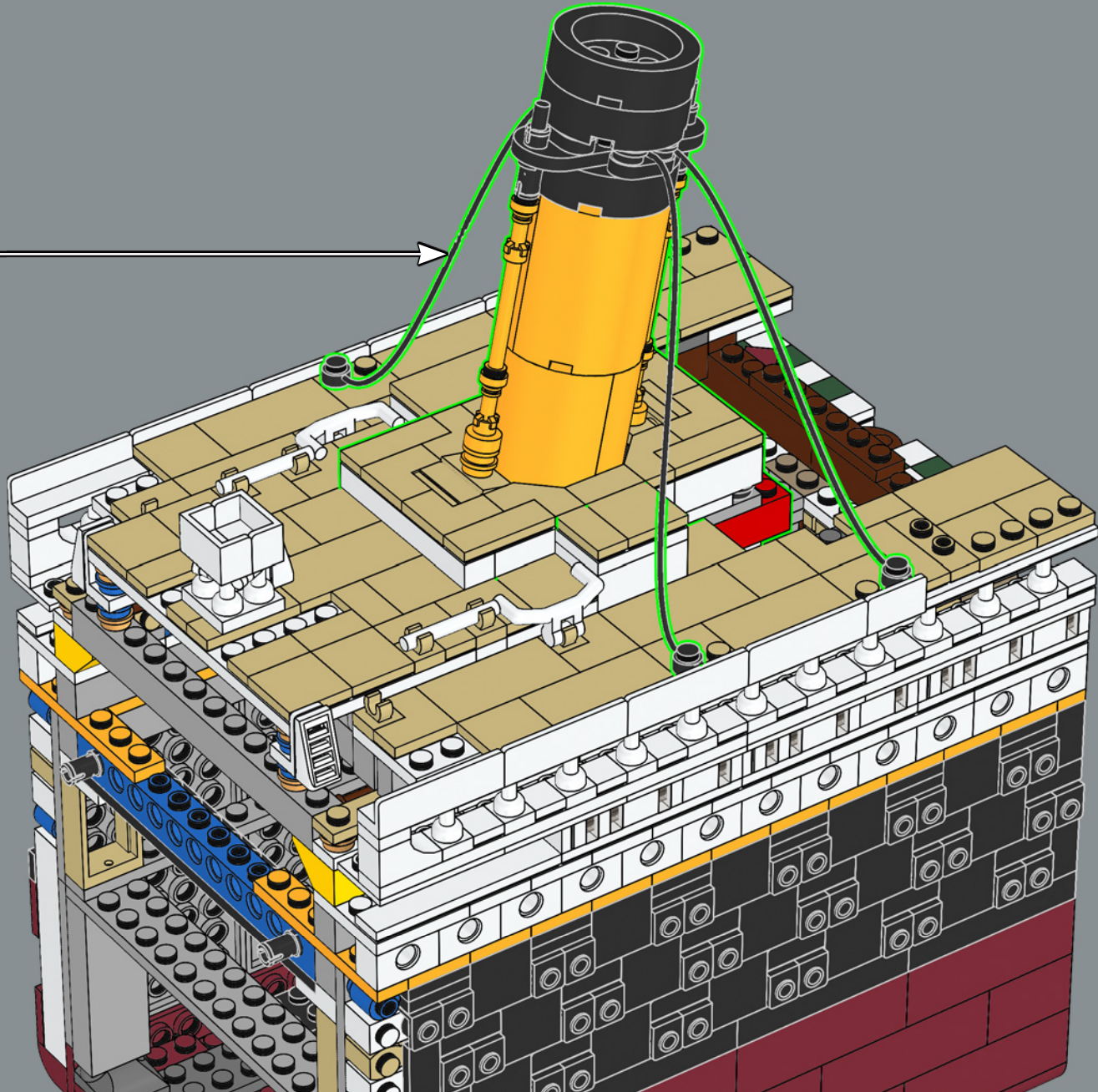

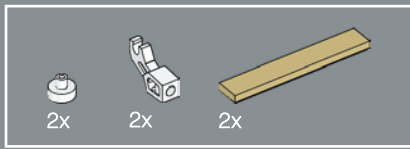

252

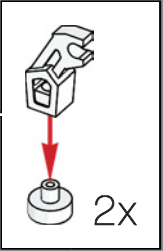
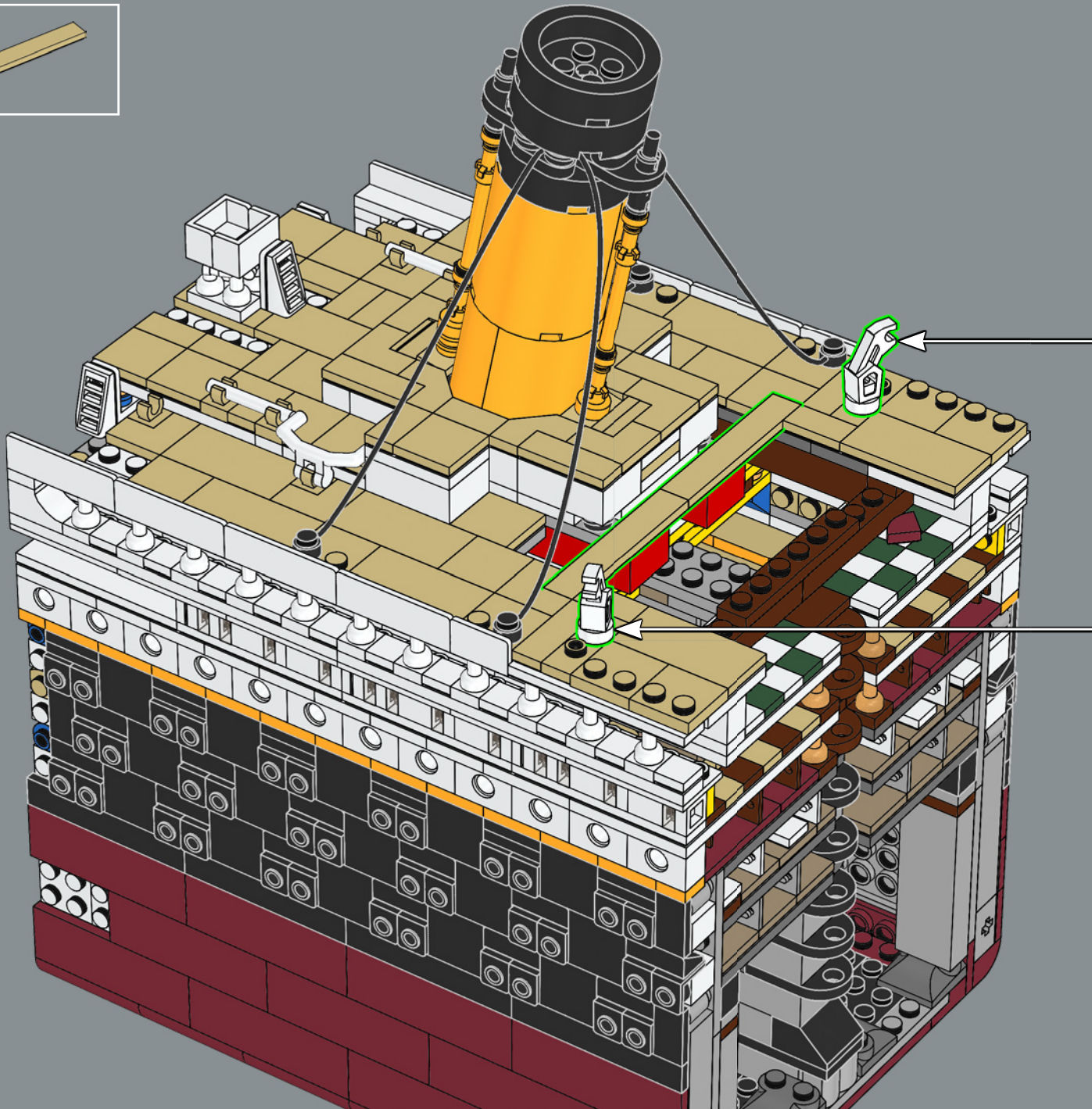

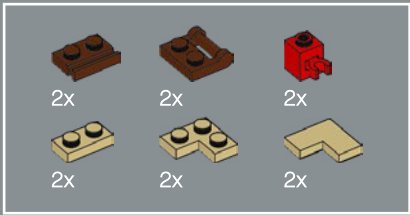

253

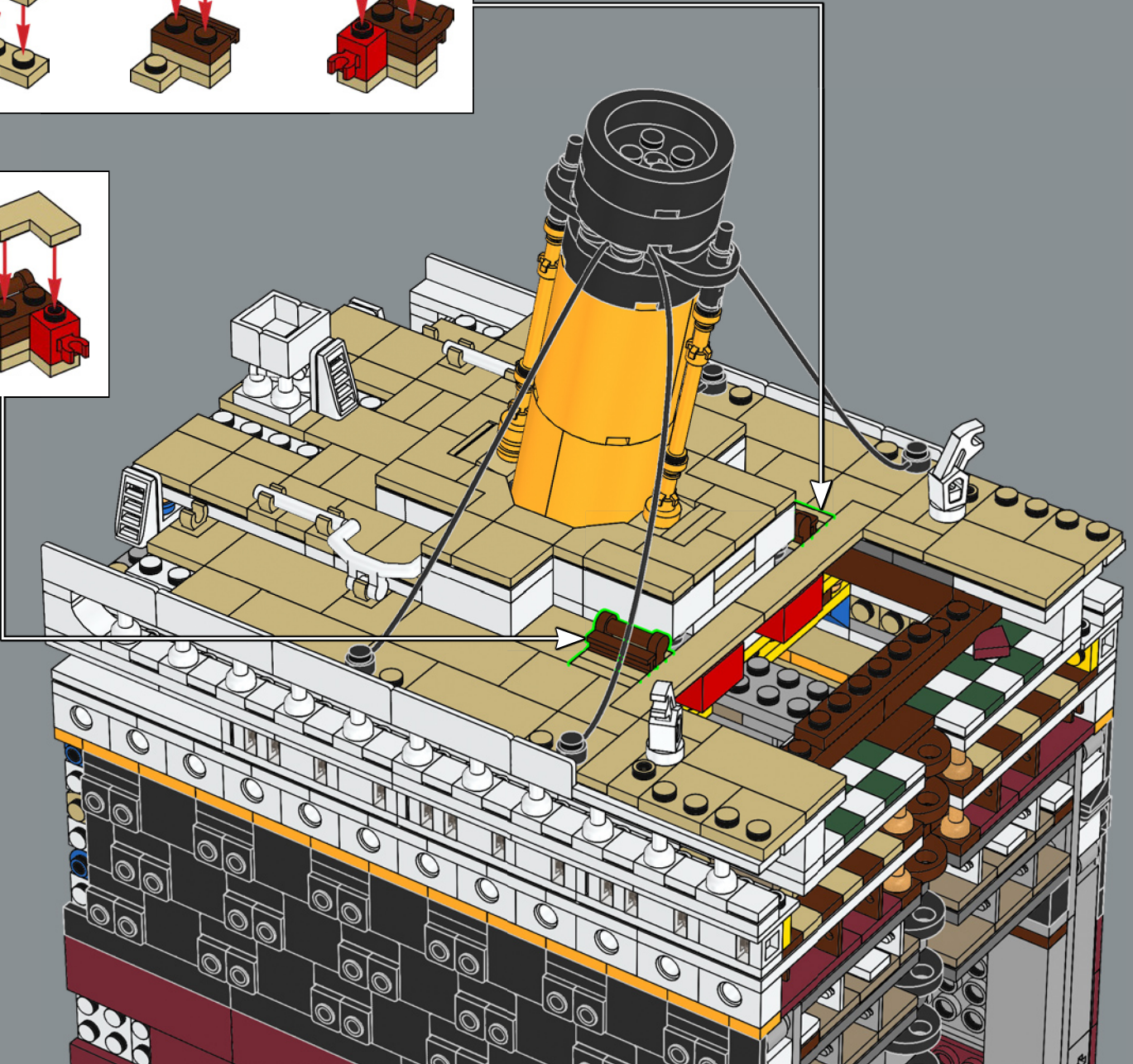
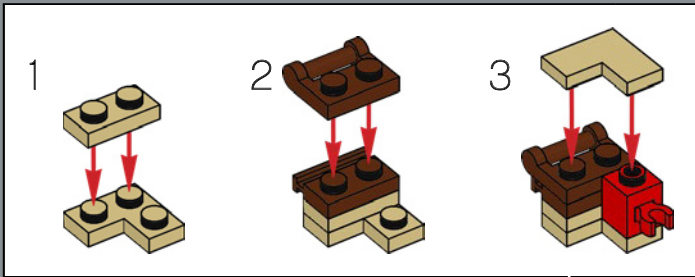
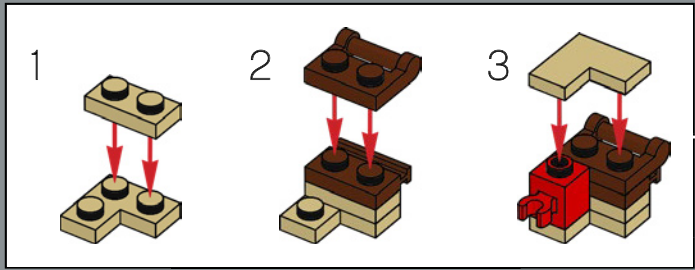

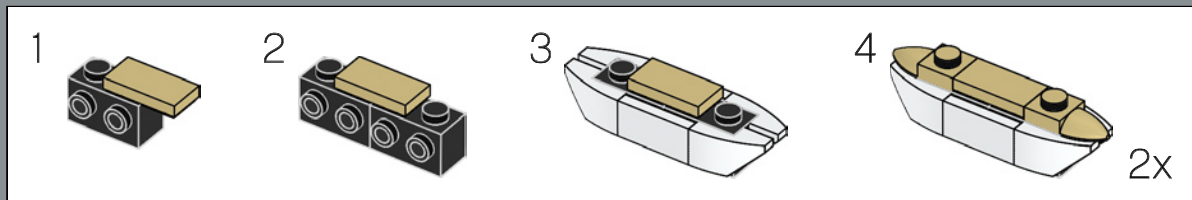
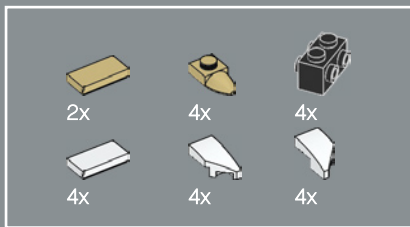

254

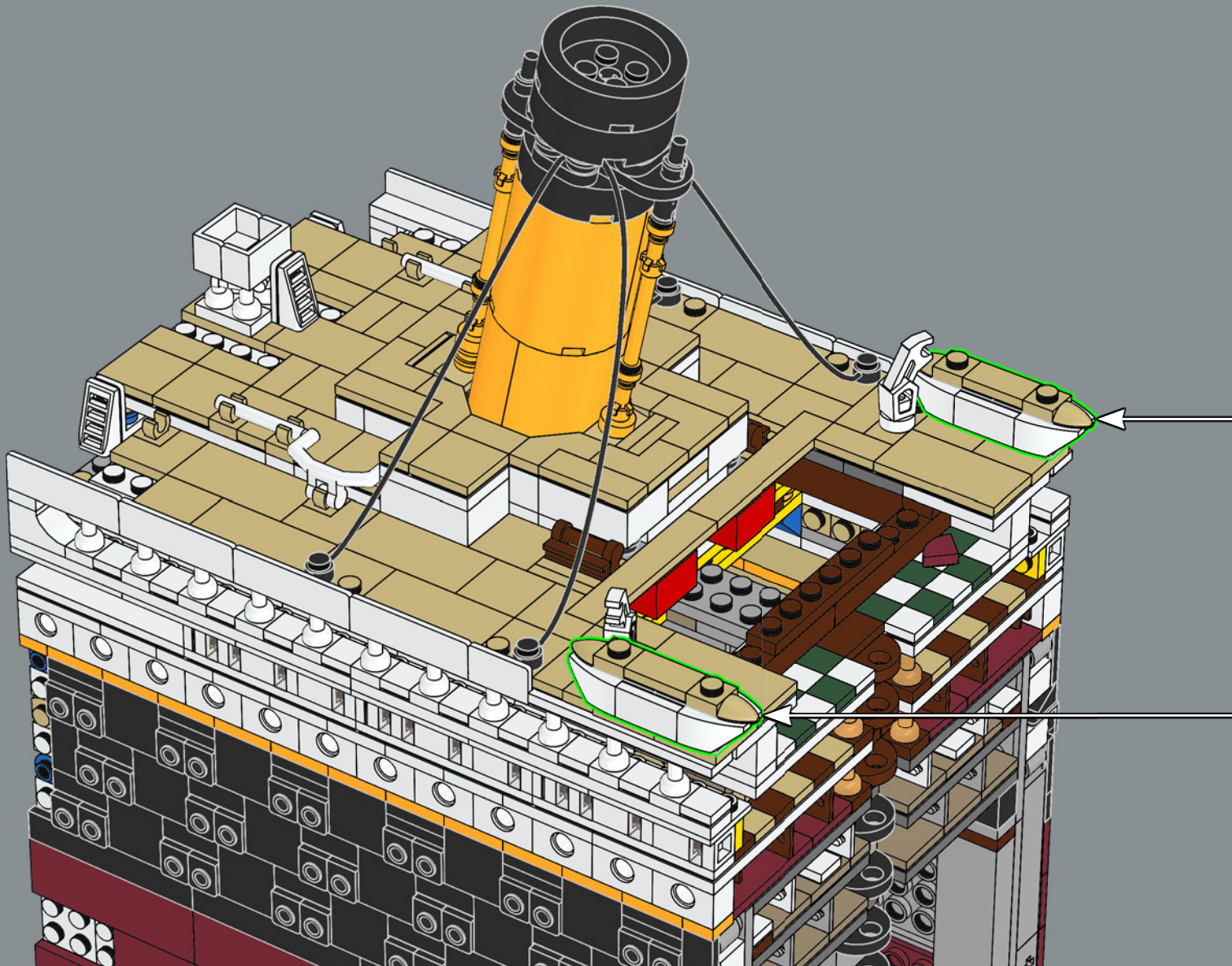

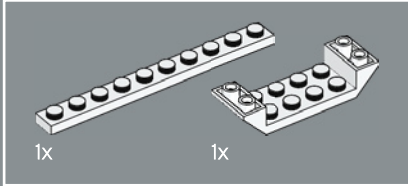
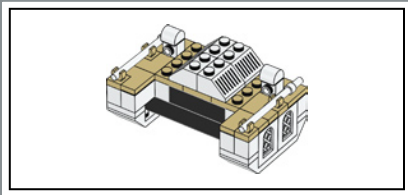

255

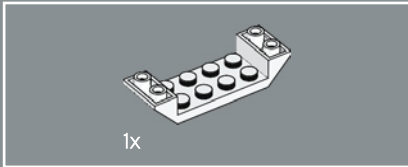
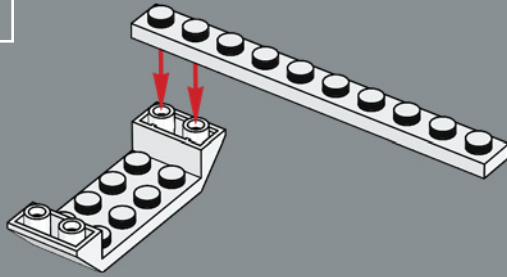

256

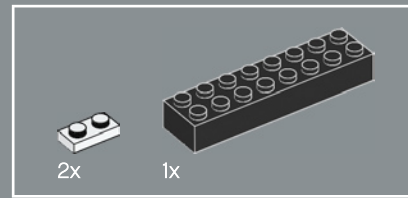
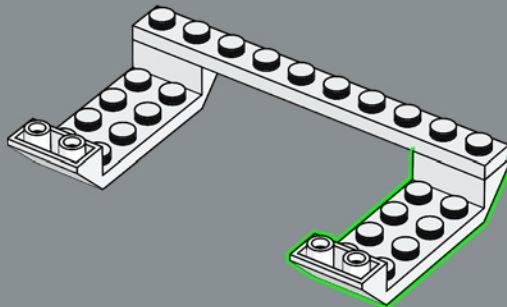

257

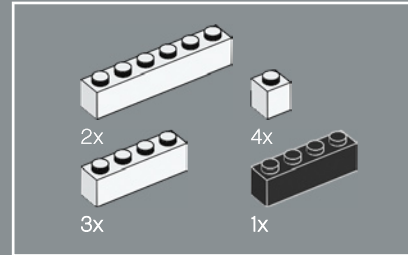
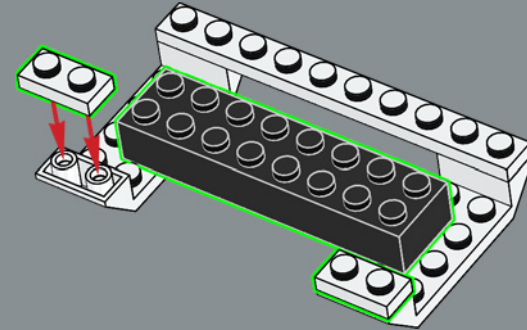

258

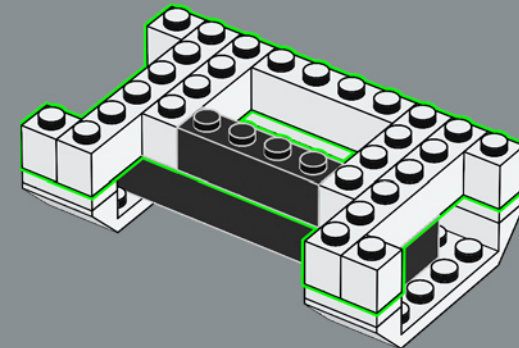



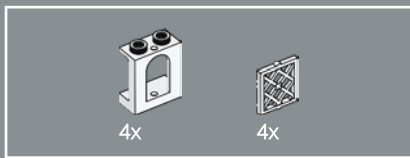

259

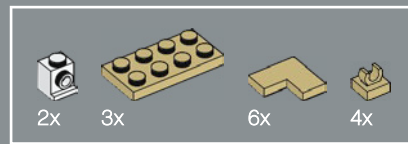
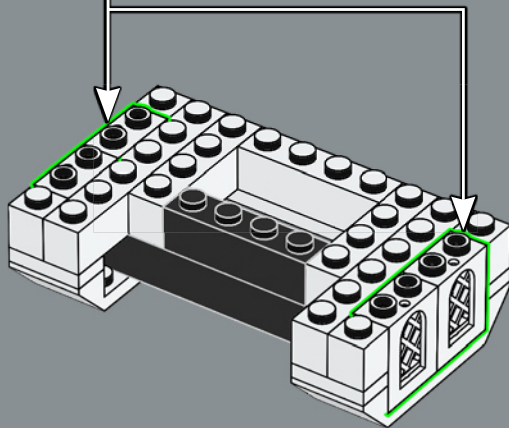
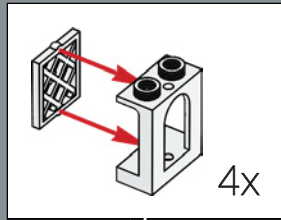

260

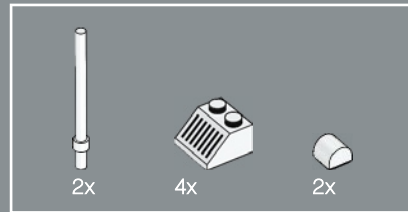
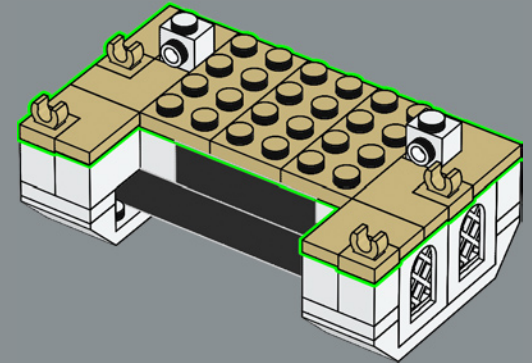

261

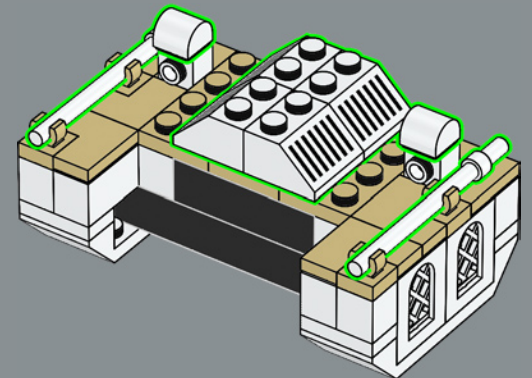

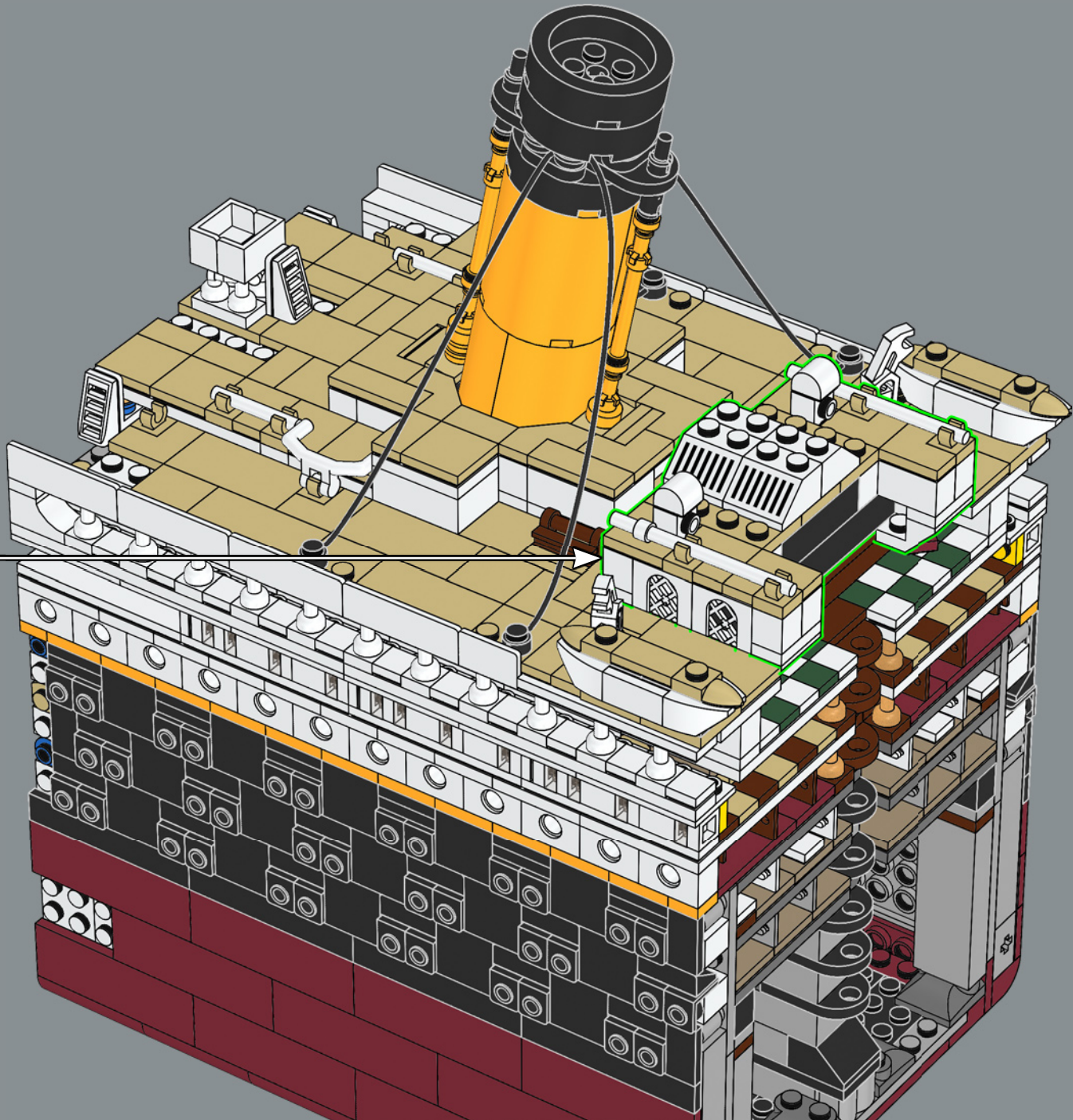

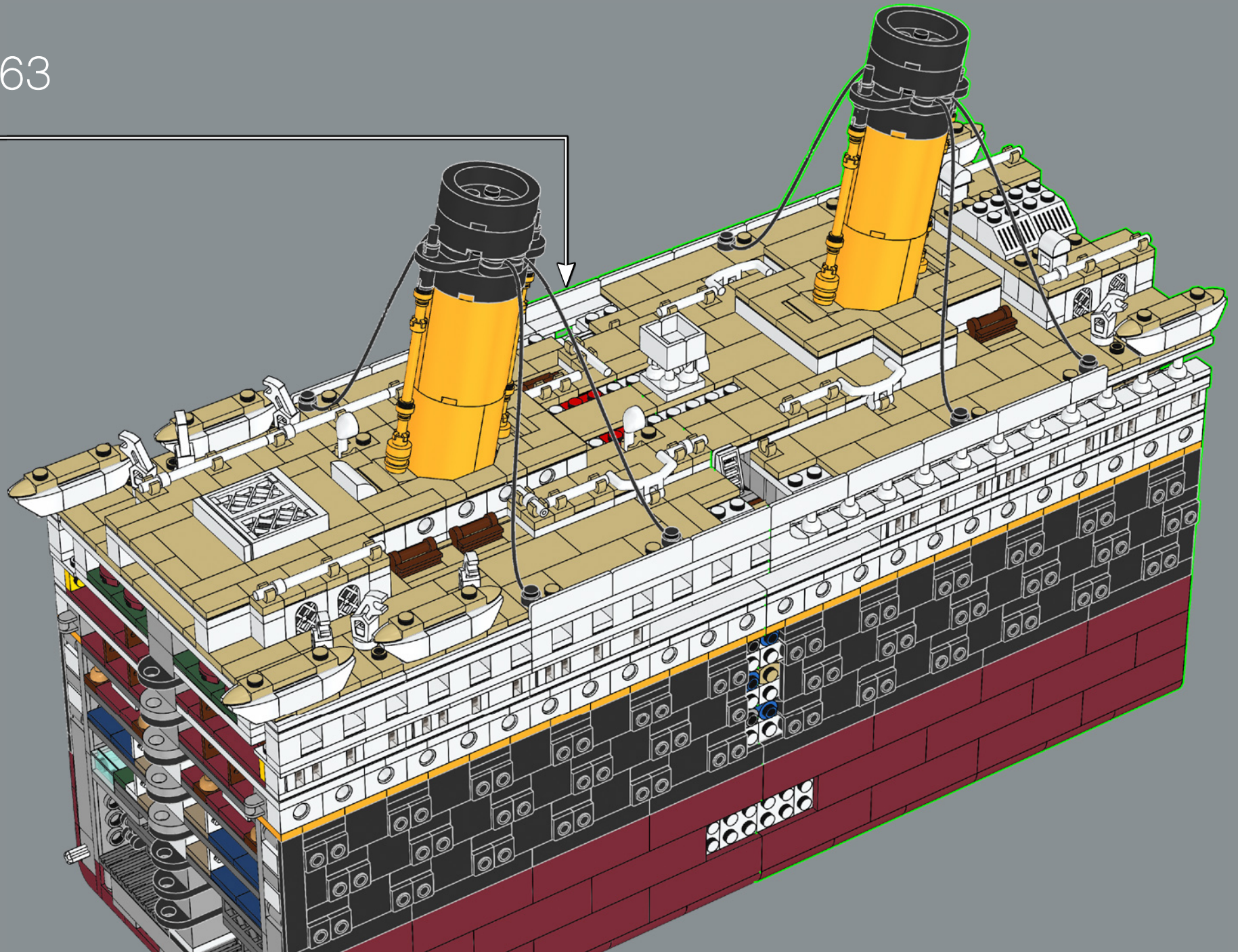

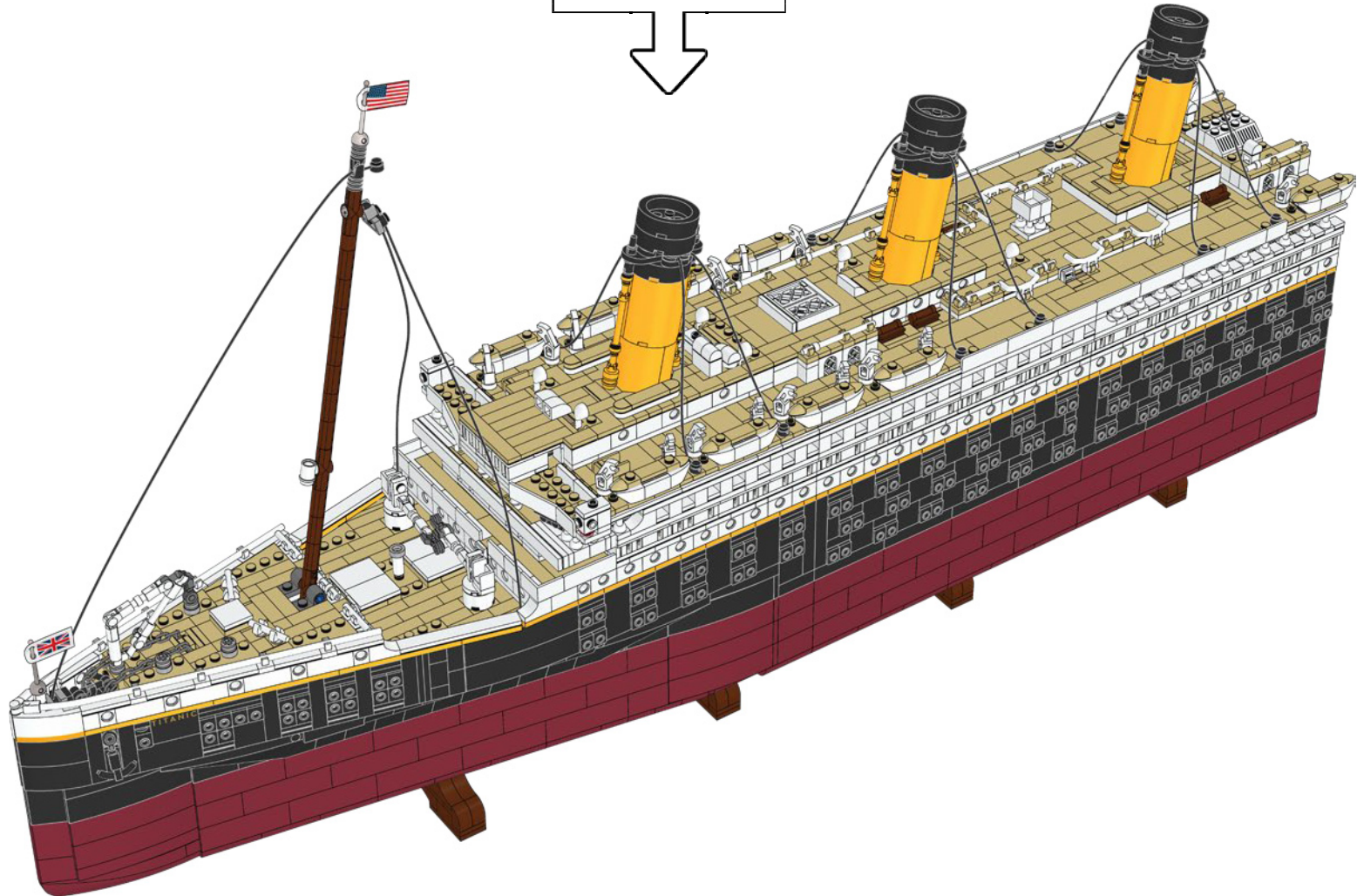
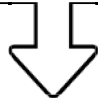

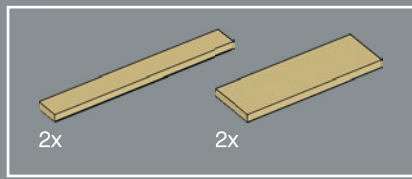

264

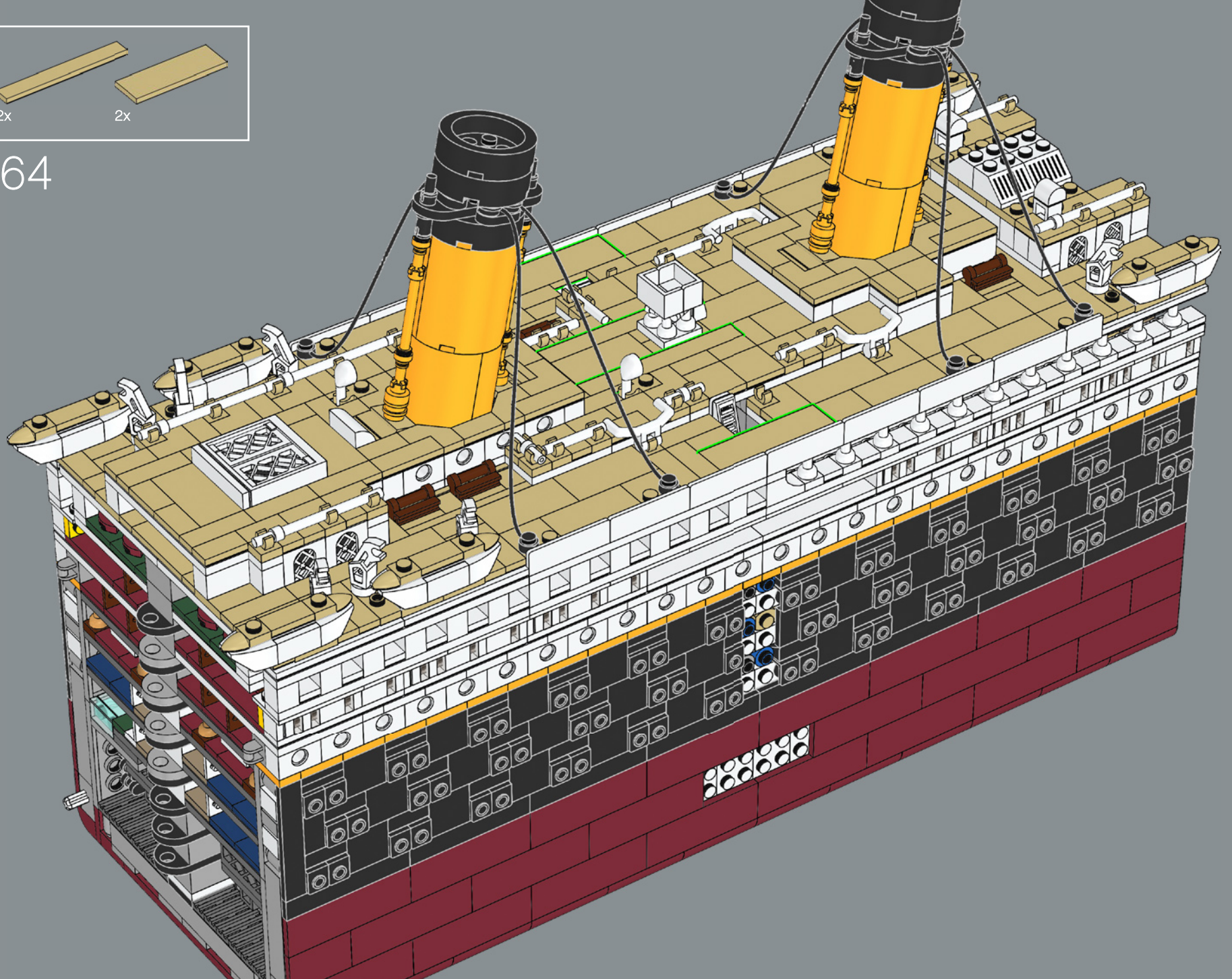

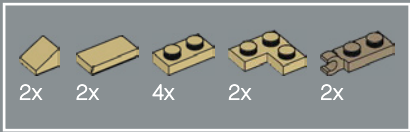

265

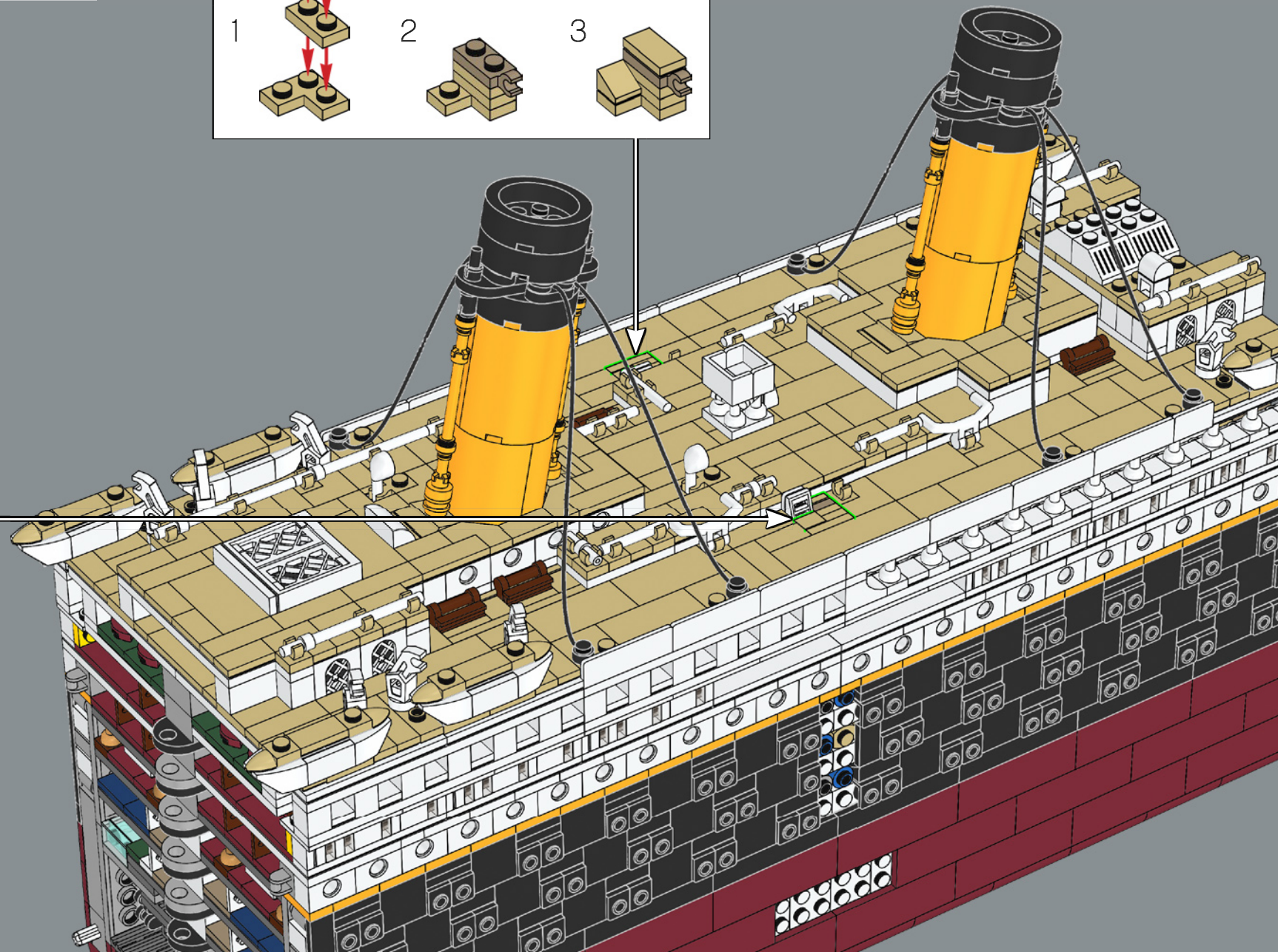
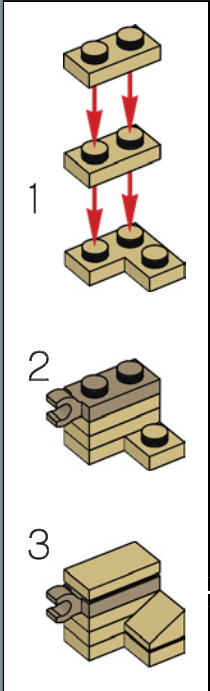
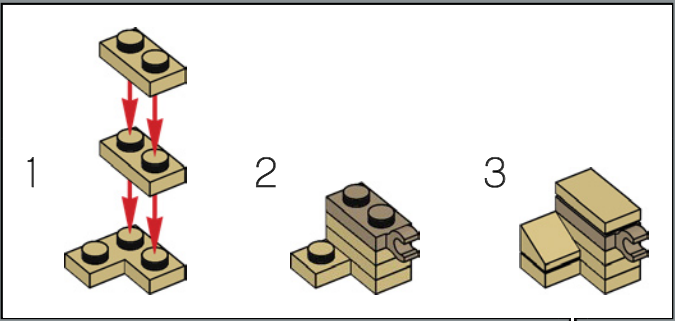

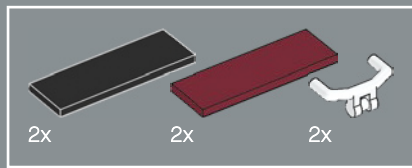

266

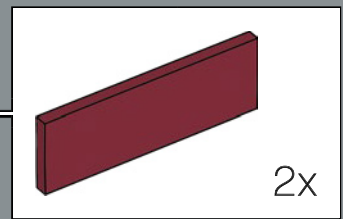
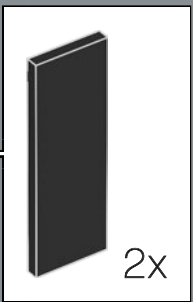
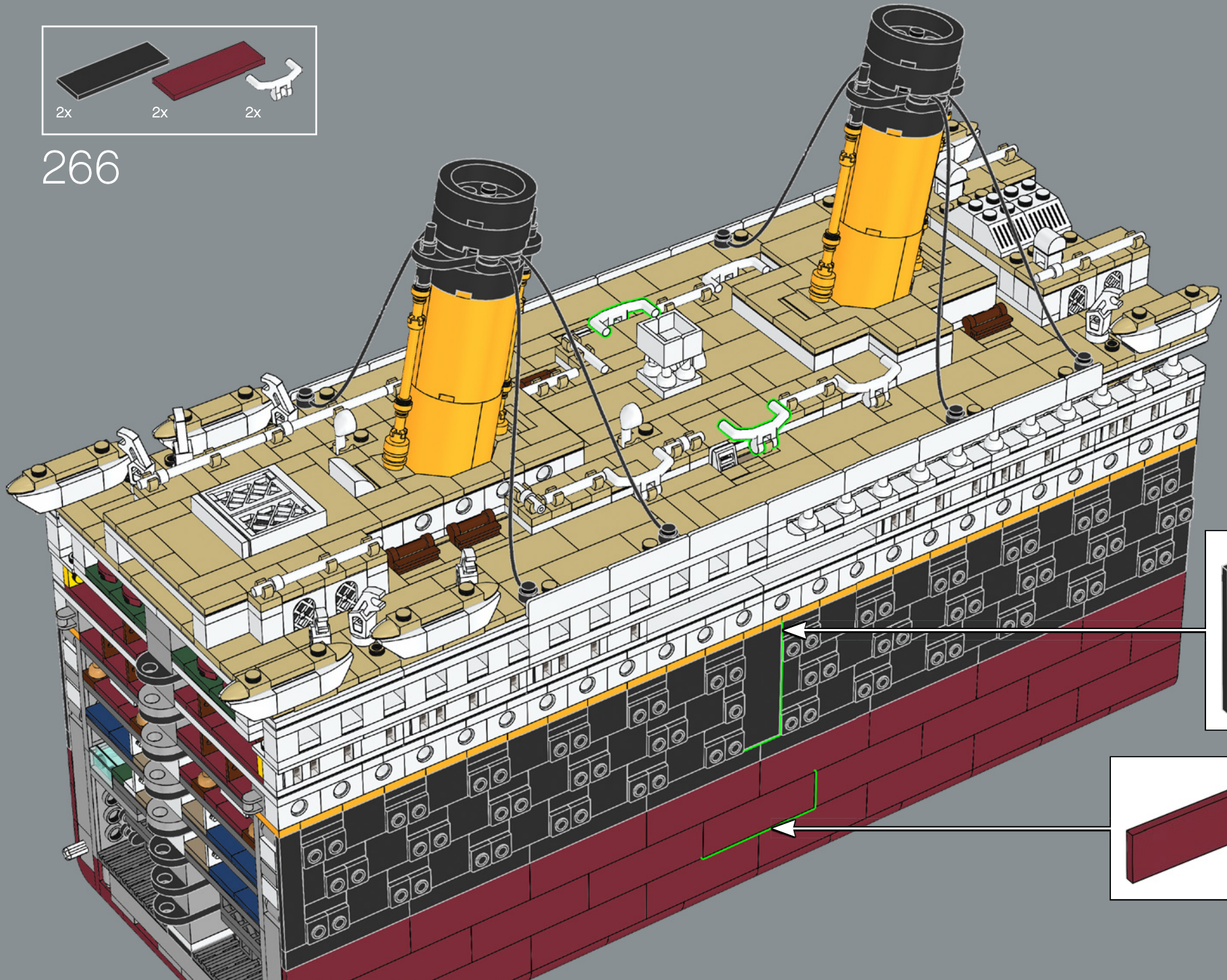

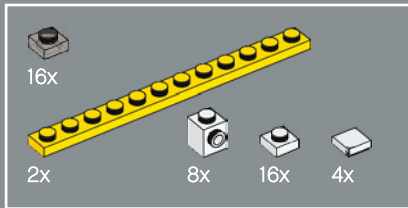
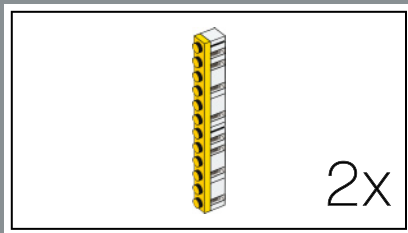

267

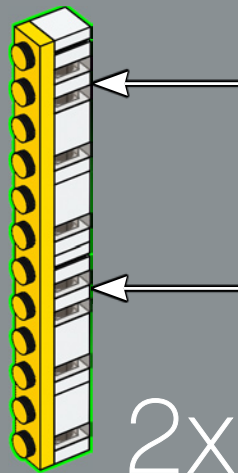
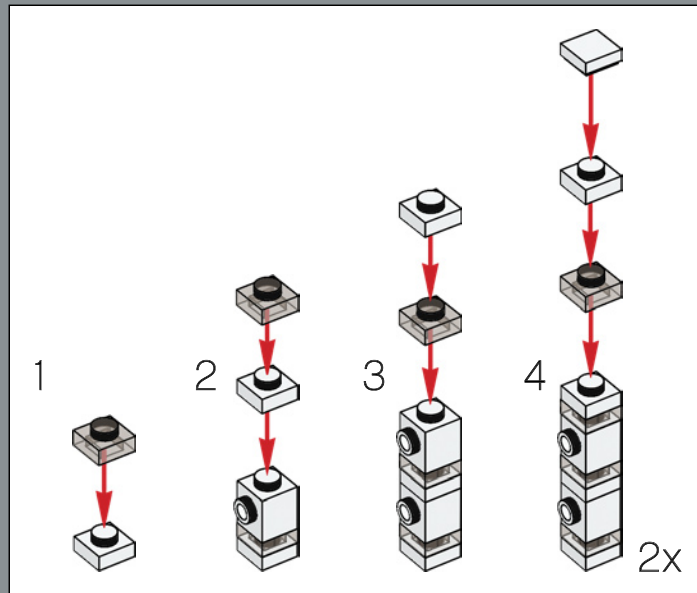



268

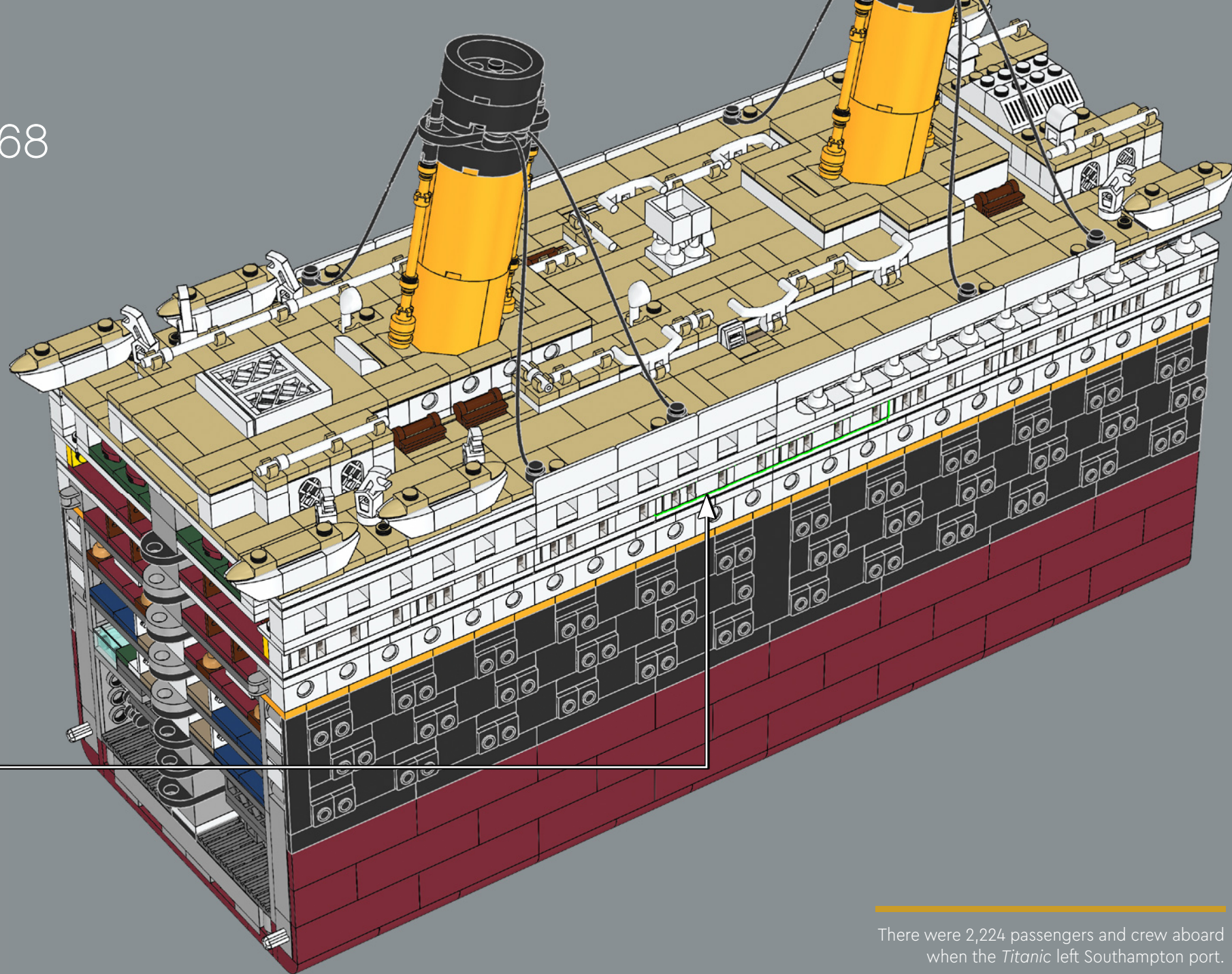

There were 2,224 passengers and crew aboard when the *Titanic* left Southampton port. 209

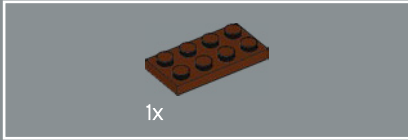
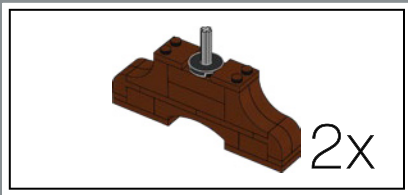

269

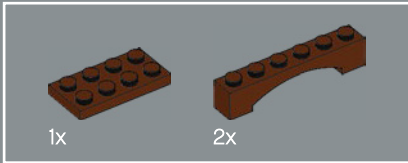
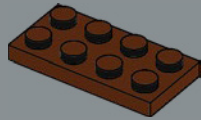

270

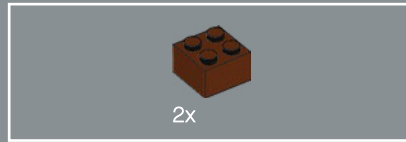
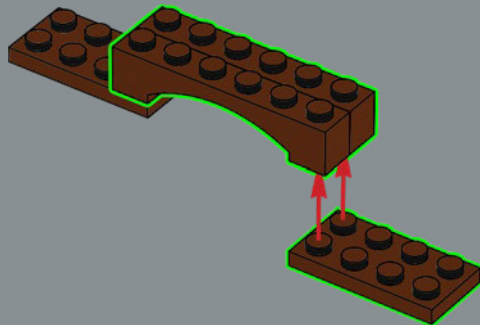

271

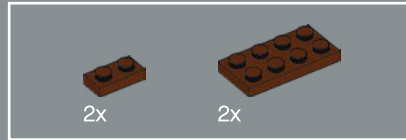
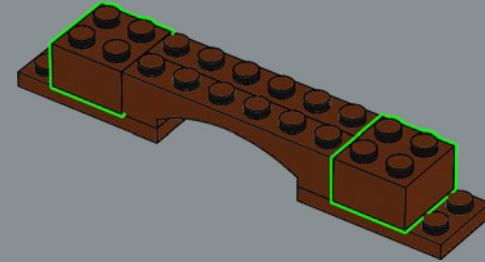

272

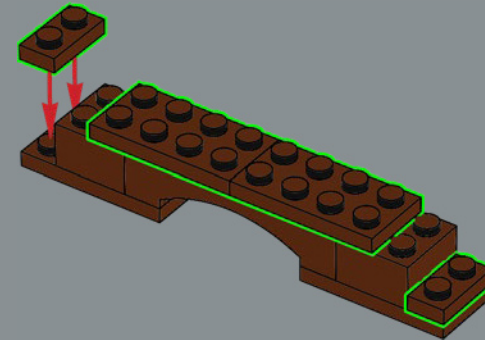



273

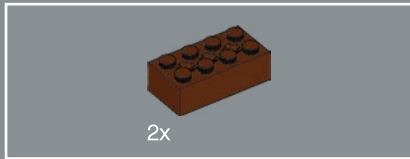
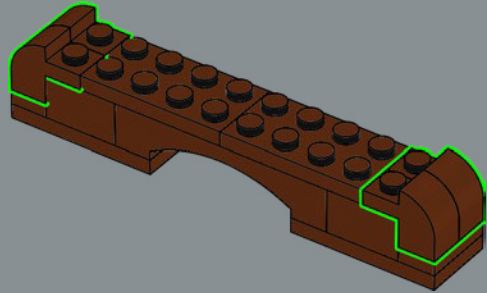

274

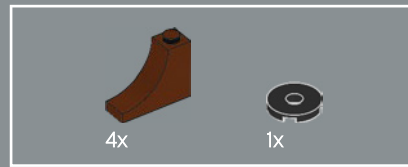
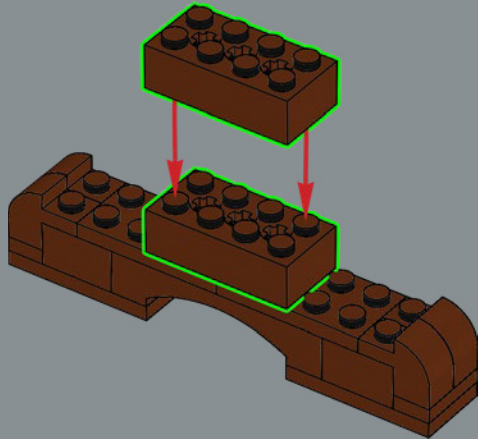

275

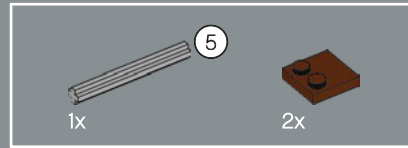
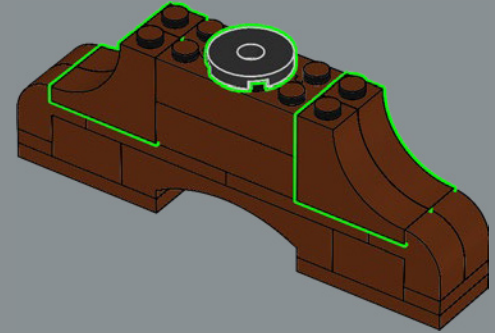

276

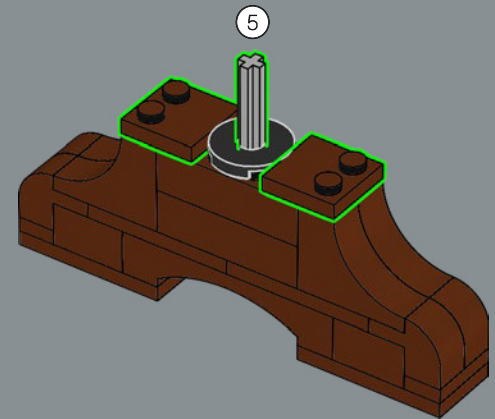

277

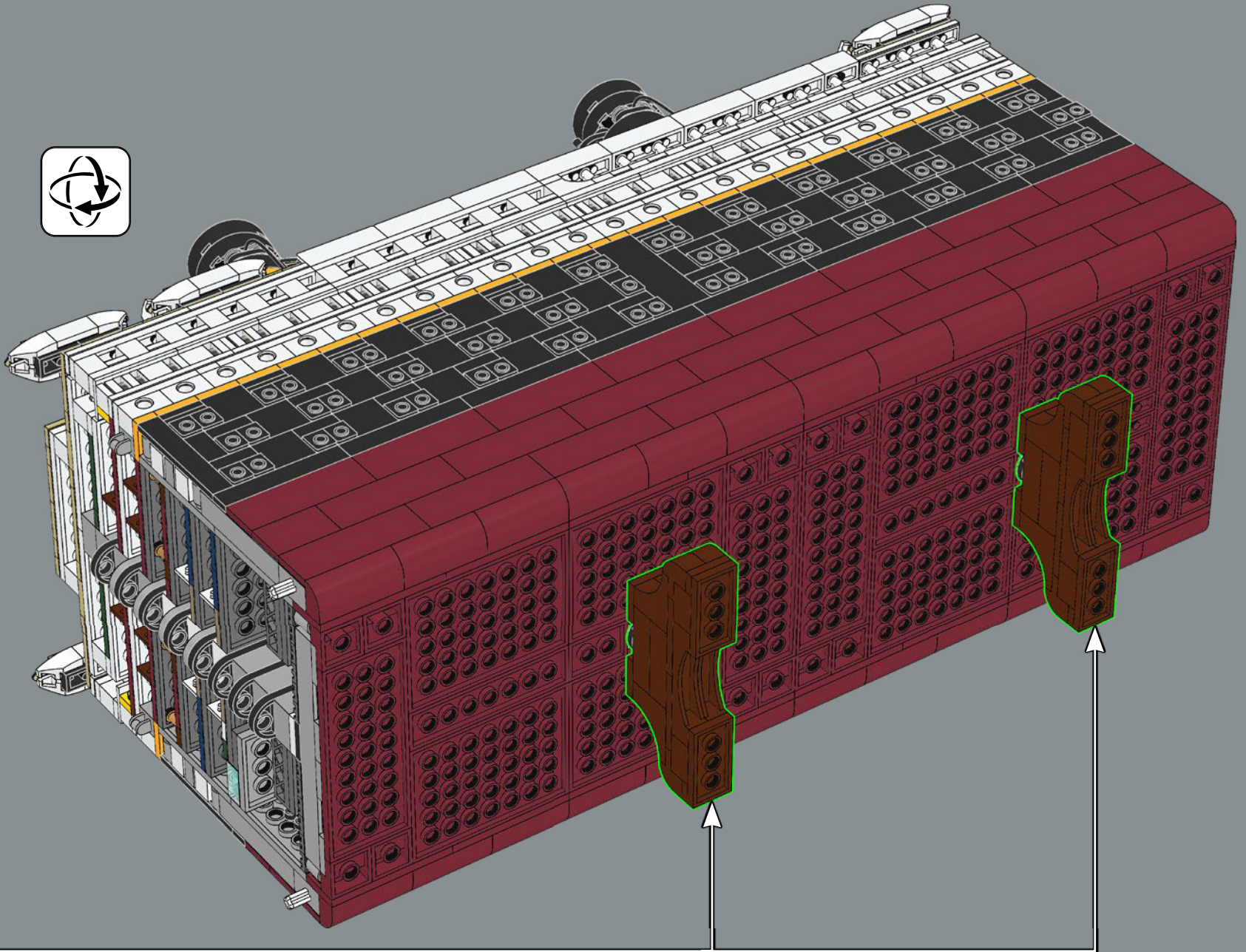

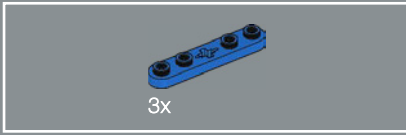
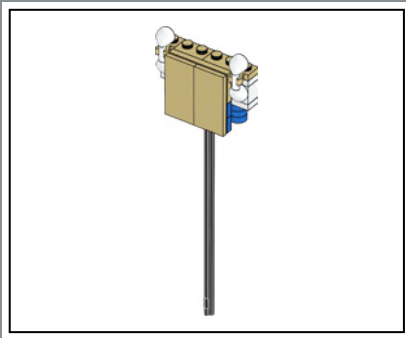

278

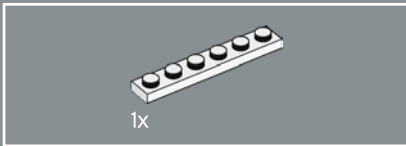
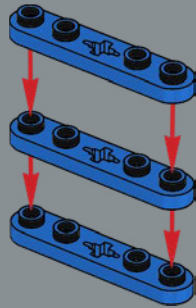

279

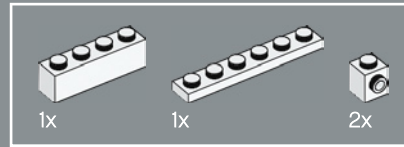
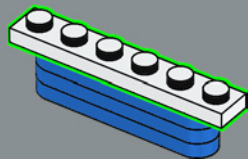

280

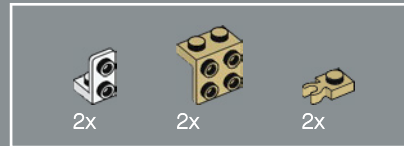
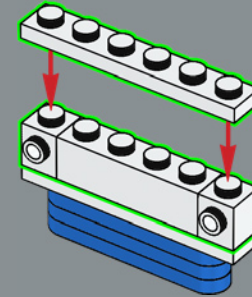

281

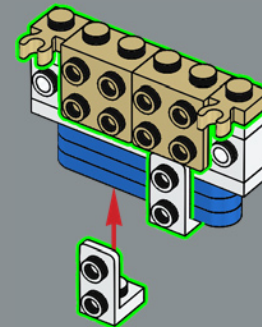

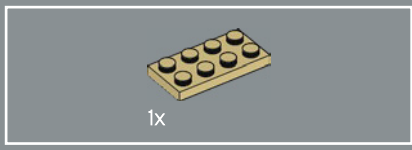

282

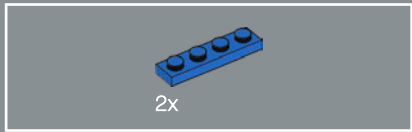
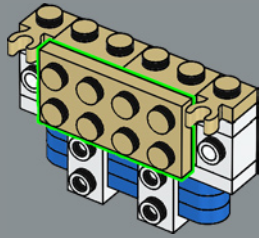

283

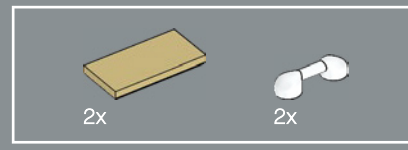
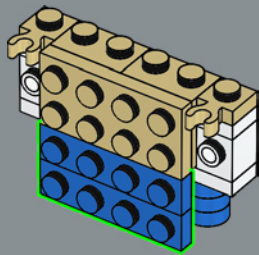

284

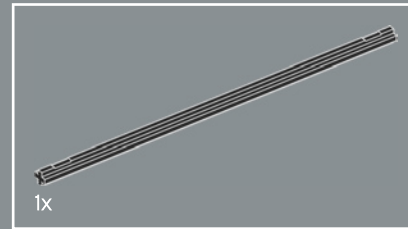
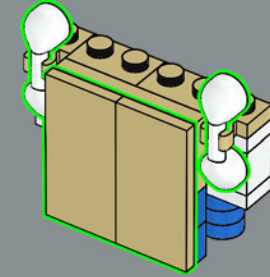

285

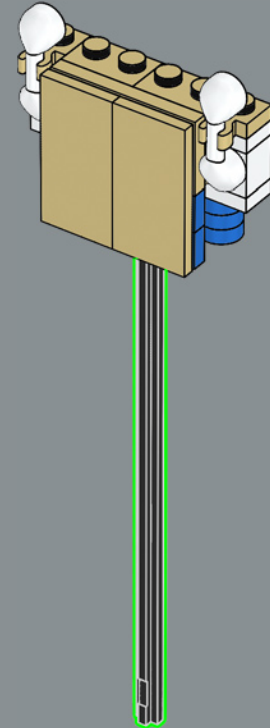

286

