



Welcome to
Animal Crossing

77055



Q LEGO® Builder



LEGO.com/sustainable-packaging



FR
DONNEZ
OU
RECYCLEZ



OU



OU



ASSOCIATION

MAGASIN

DÉCHÈTERIE

Adresses sur quefairedemesdechets.fr



🔍 LEGO® Builder

BUILDER

Download on the
App Store

GET IT ON
Google Play

腾讯应用宝
安卓应用商店

Apple and the Apple logo are trademarks of Apple Inc., registered in the U.S. and other countries and regions. App Store is a service mark of Apple Inc. Google Play and the Google Play logo are trademarks of Google LLC. Tencent and the Tencent logo are trademarks of Tencent Inc.

🔍 LEGO.com/devicecheck

EN Ask parents' permission before going online | **DE** Eltern um Erlaubnis bitten, bevor du online gehst | **FR** Demande l'autorisation d'un parent avant d'aller en ligne | **IT** Chiedi il permesso ai tuoi genitori prima di andare online | **ES** Pídeles permiso a tus papás antes de conectarte a Internet | **PT** Pede autorização aos pais antes de acederes online | **ZH** 上网前应先征得父母的同意 | **PL** Poproś rodziców o zgodę, zanim wejdiesz do Internetu | **CS** Než půjdeš na internet, požádej rodiče o svolení | **SK** Skôr než pôjdeš na internet, vypýtaj si povolenie od rodičov | **HU** Kérj szülői engedélyt, mielőtt online csatlakoznál! | **RO** Cere permisiunea părinților înainte de a te conecta online | **BG** Поискайте разрешение от родител, преди да влезете онлайн | **LV** Pirms došanās tiešsaistē palūdz atļauju vecākiem | **ET** Enne Interneti kasutamist küsi vanematelt luba | **LT** Prieš prisijungdami prie interneto, atsiklauskite tėvų



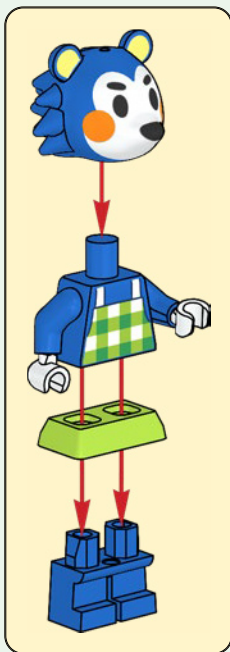

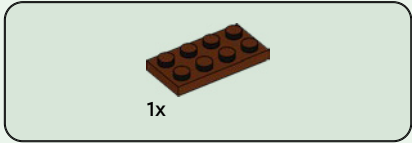
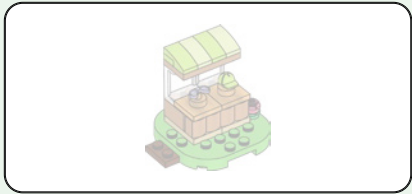

1



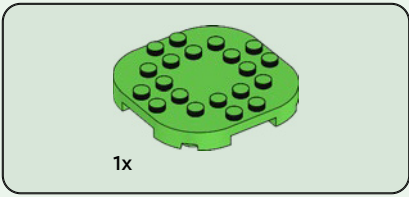

2

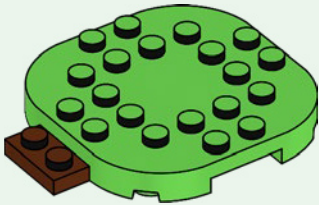

3

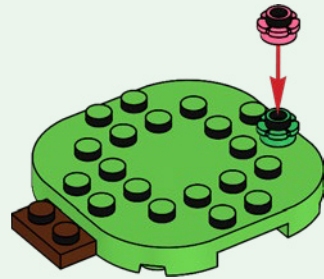

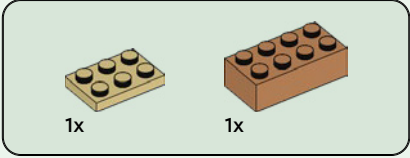
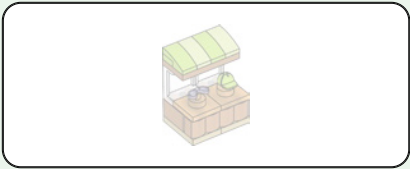

4

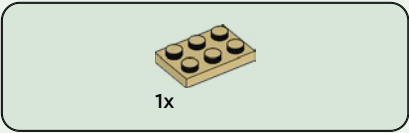
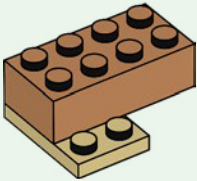

5

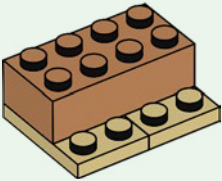

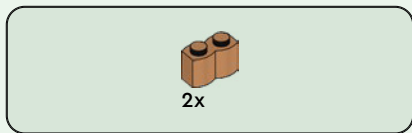

6

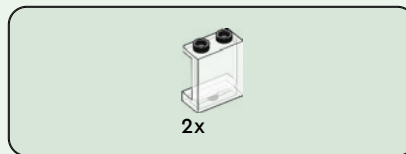
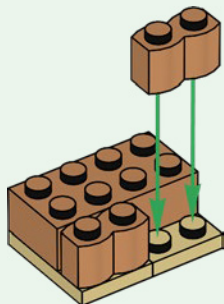

7

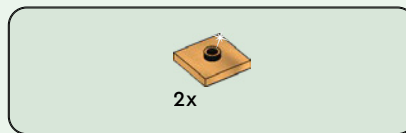

8

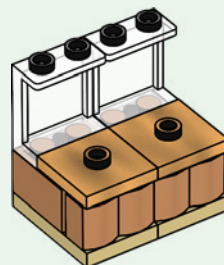



9

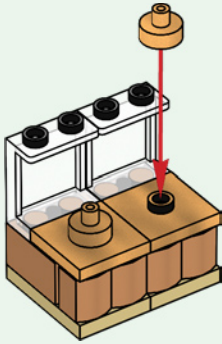

10





13

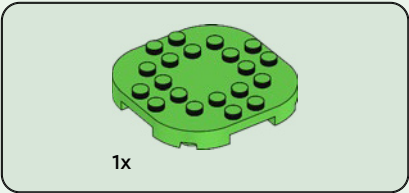

14

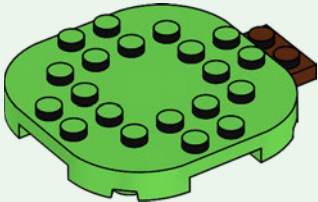



1x



1x

15

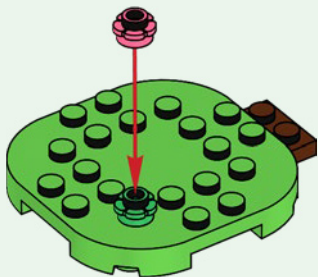

1x

16

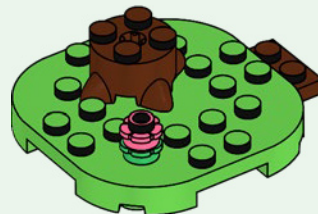

2x

17



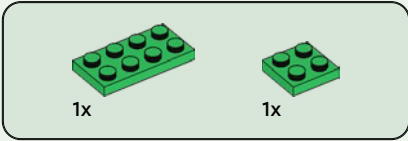
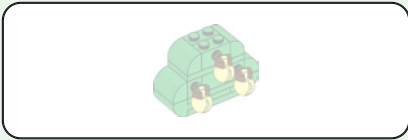

18

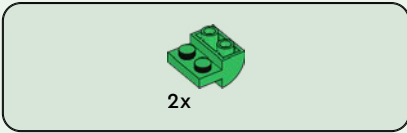
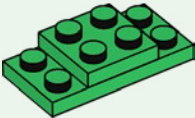

19

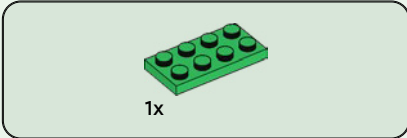
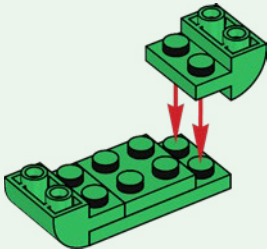

20

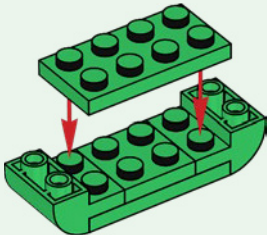



2x

21

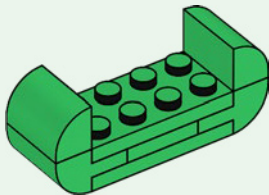

3x

22

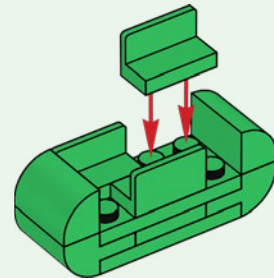

2x

23

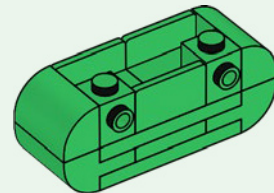

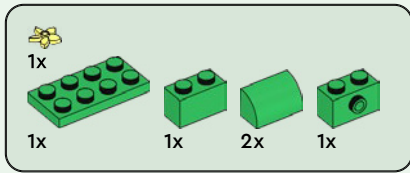

24

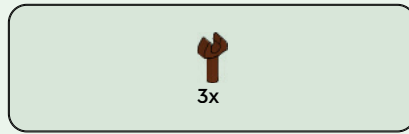
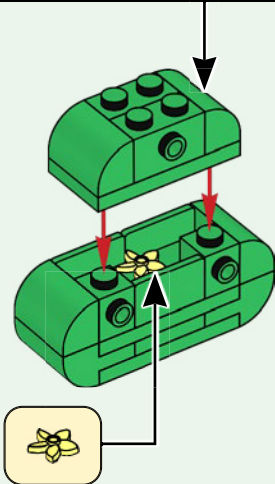
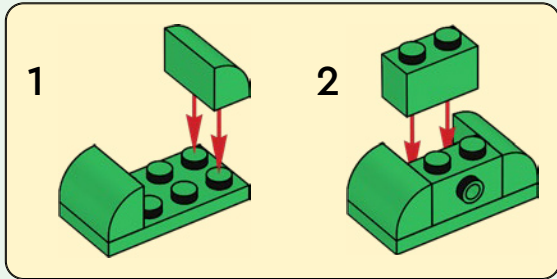

25



3x

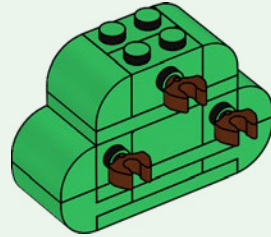

26



3x

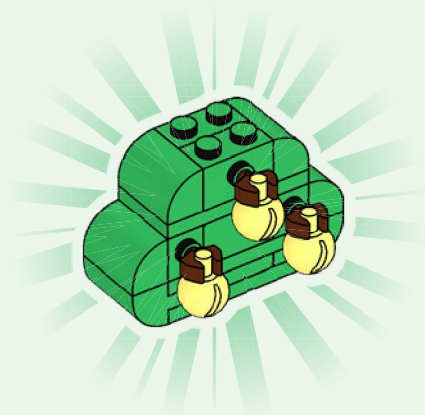

27

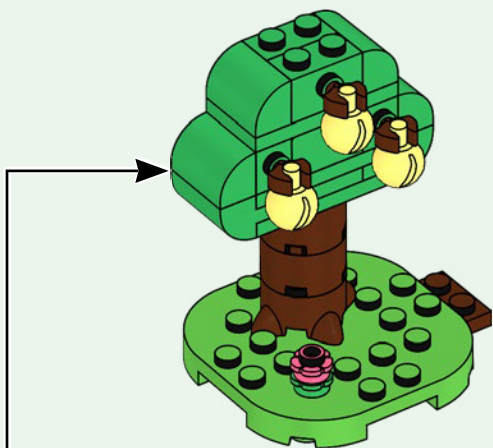

28

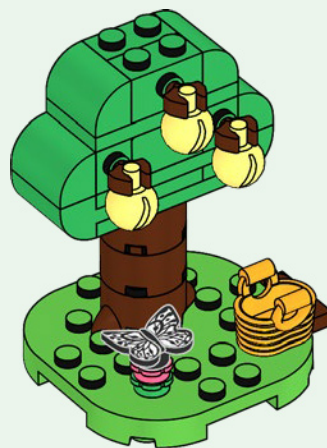
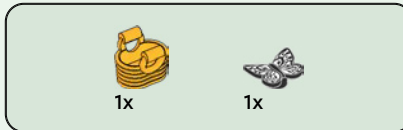

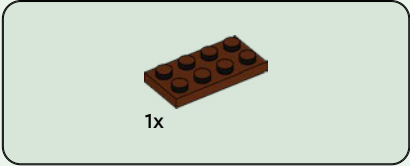
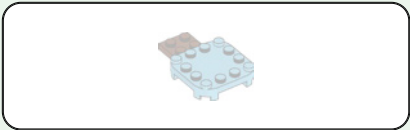

29

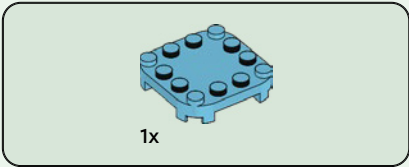

30

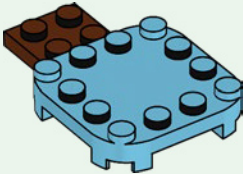

31



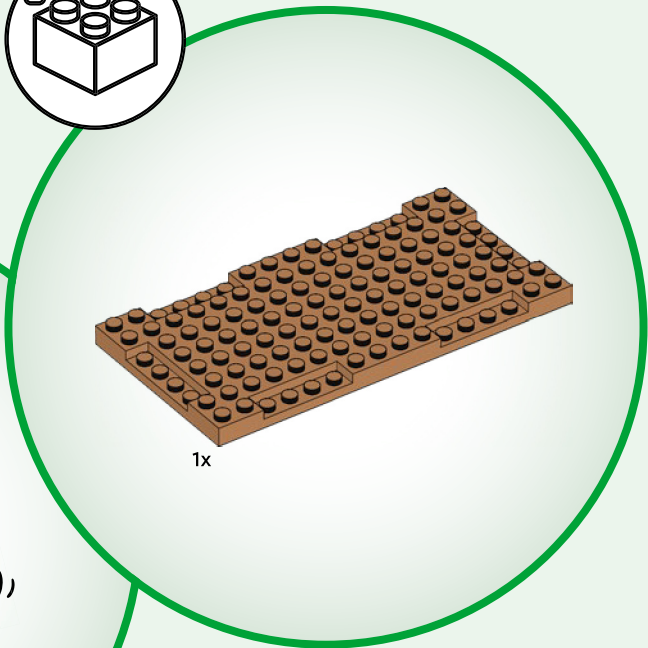
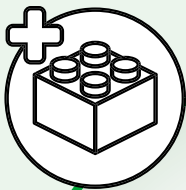

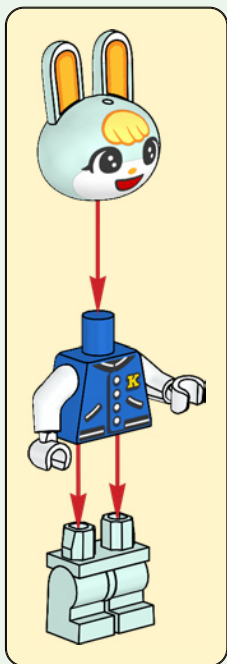

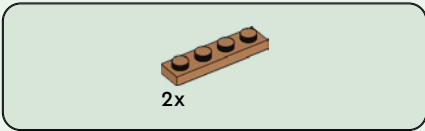

32

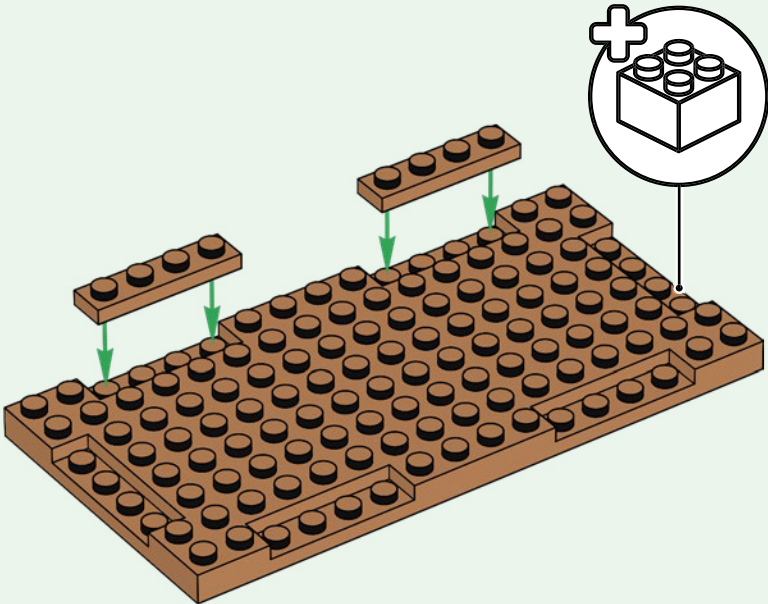

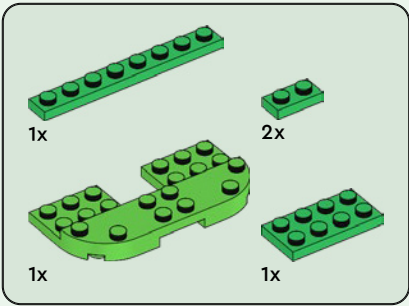

33

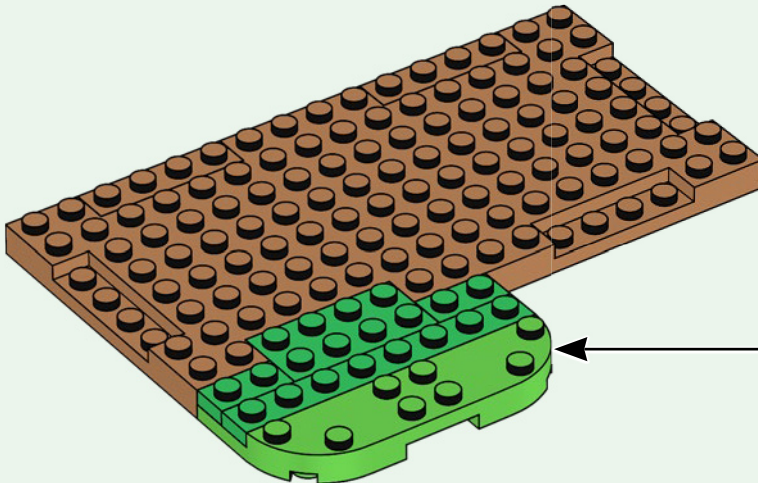
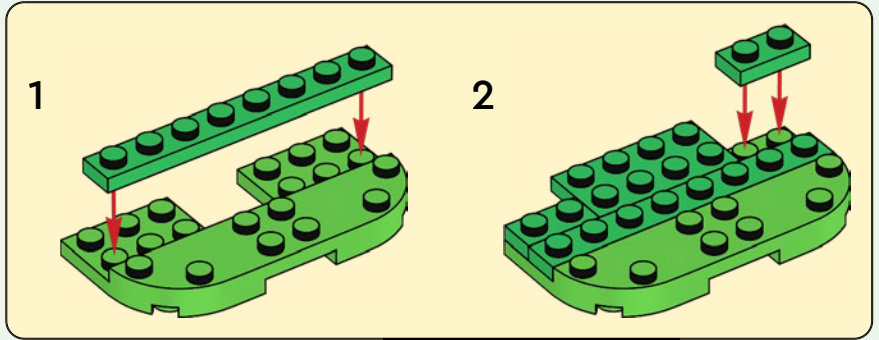

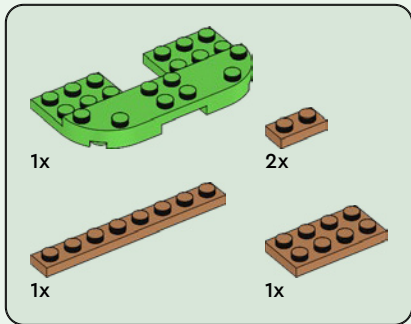

34

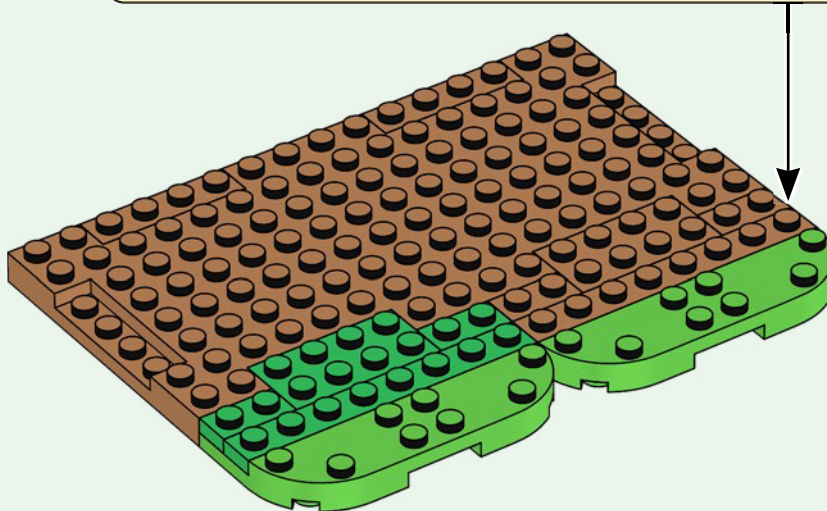
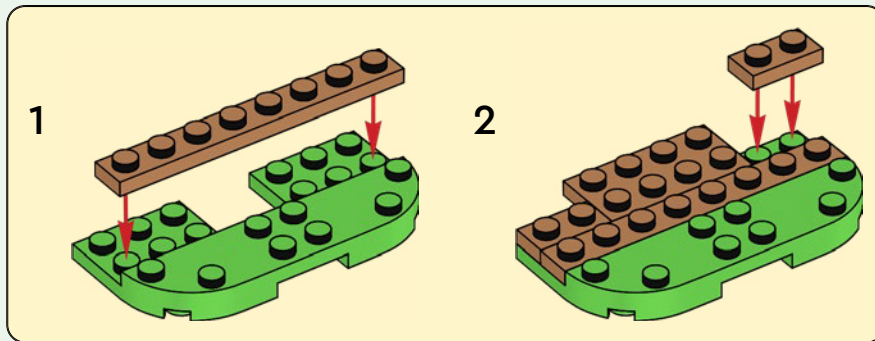

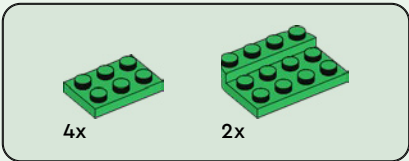

35

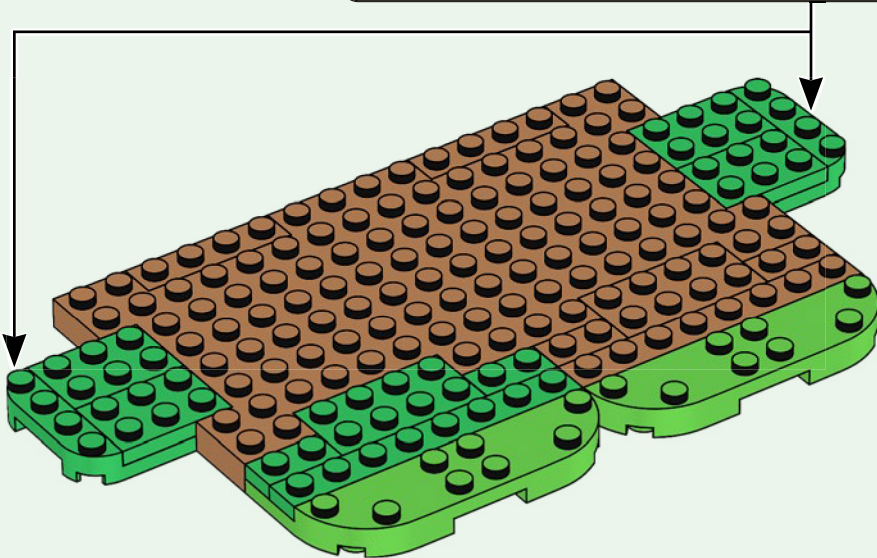
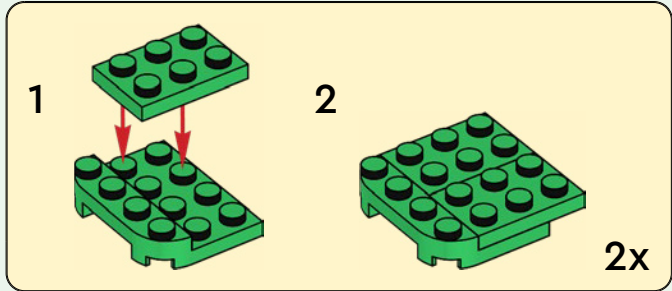

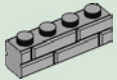

1x

36

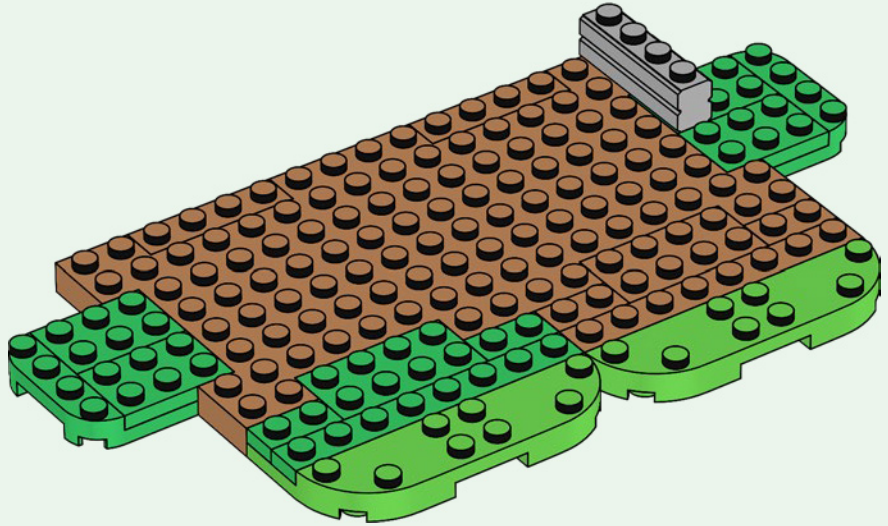

1x

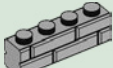

1x

37

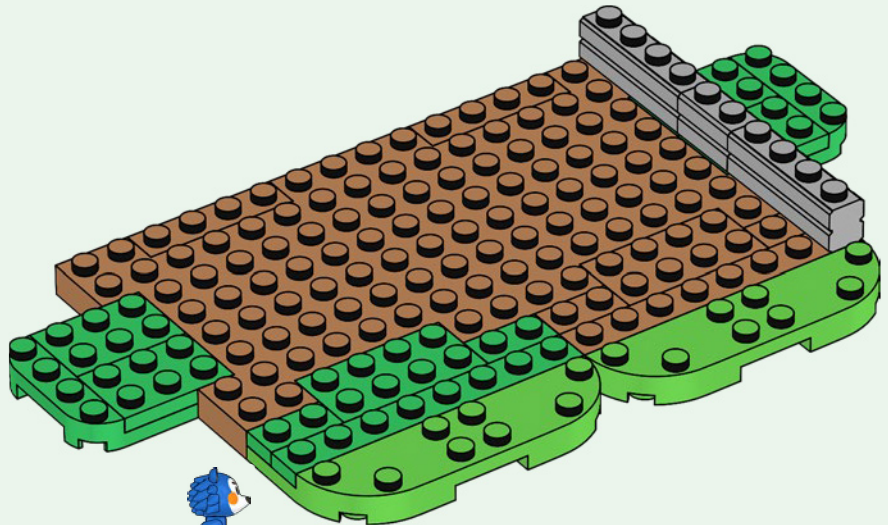



1x

38

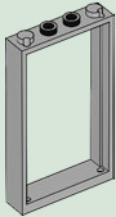
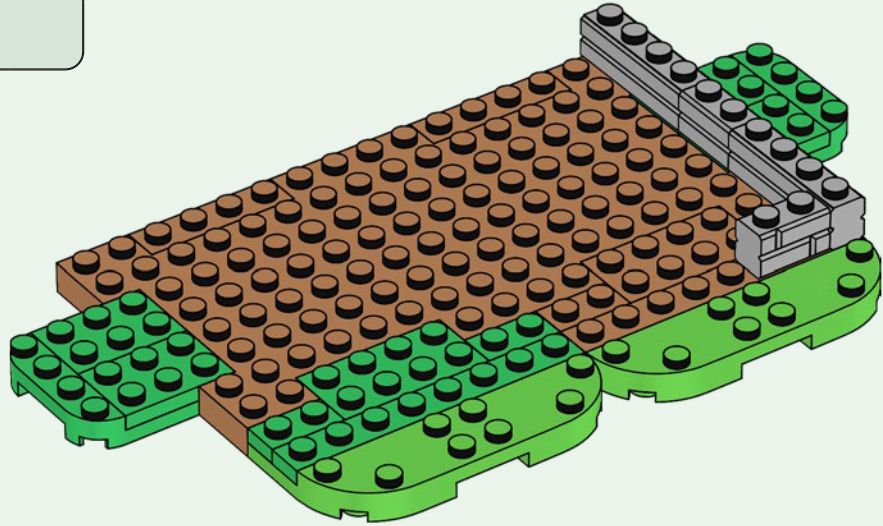

1x

39

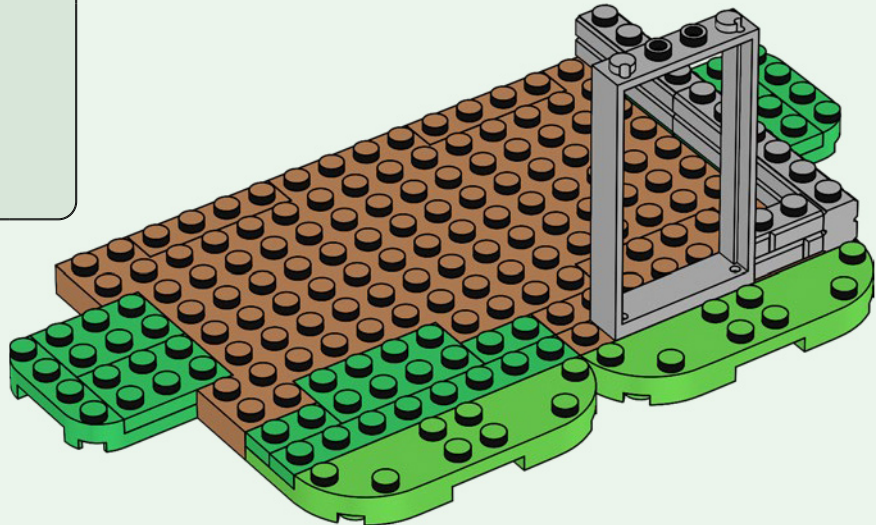

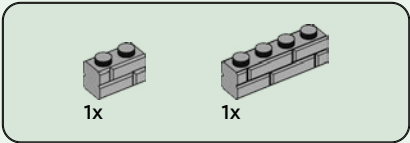

40

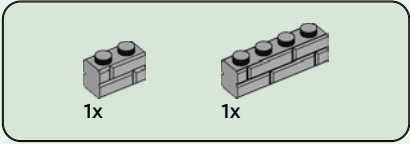
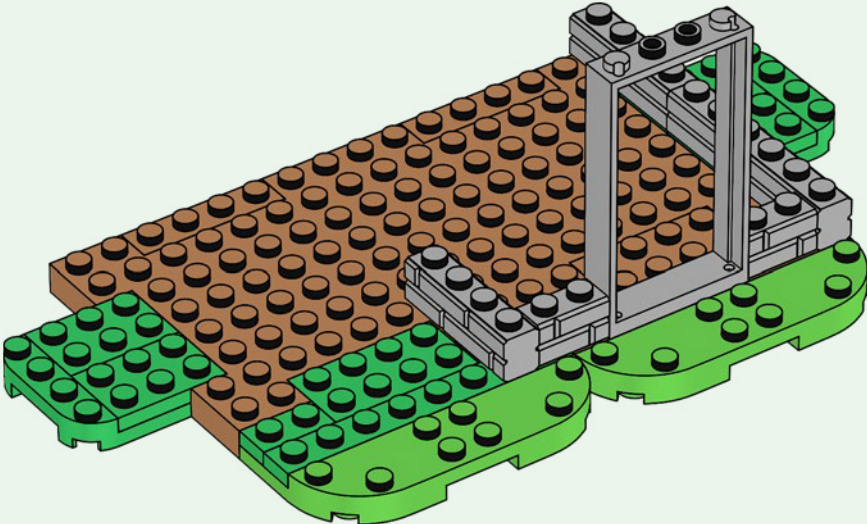

41

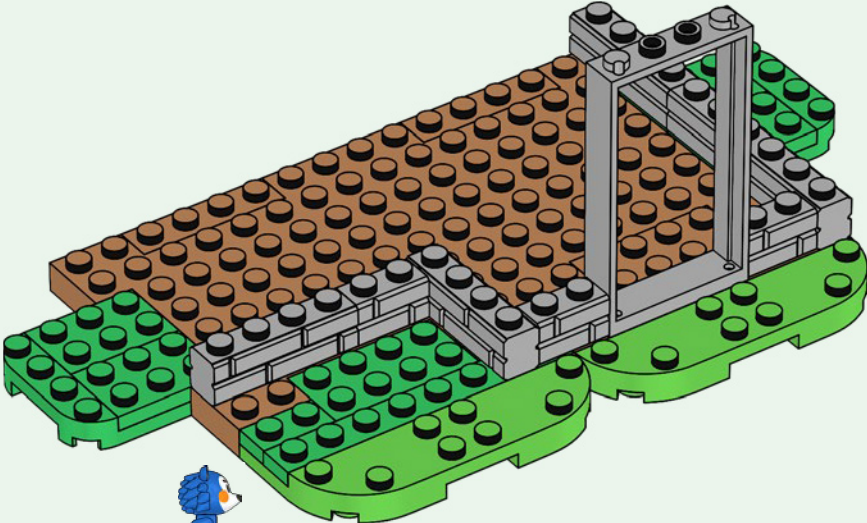

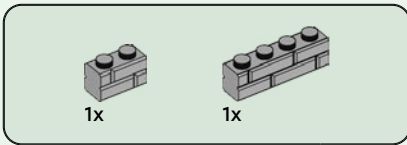

42

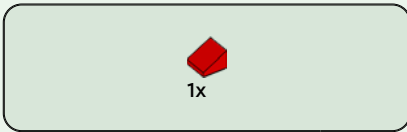
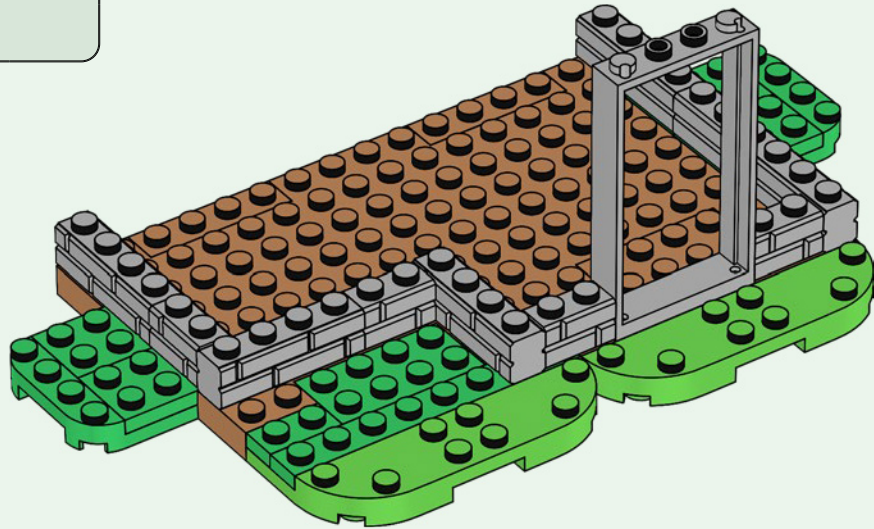

43

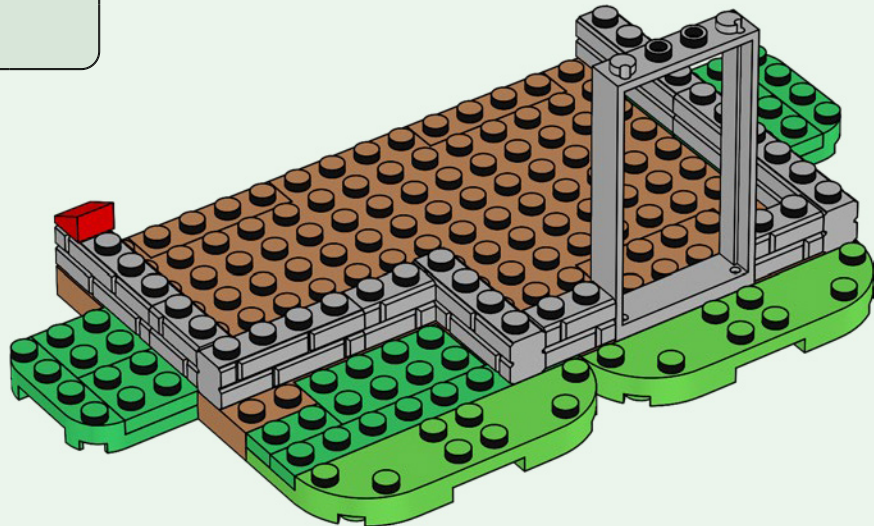

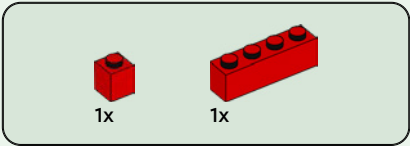

44

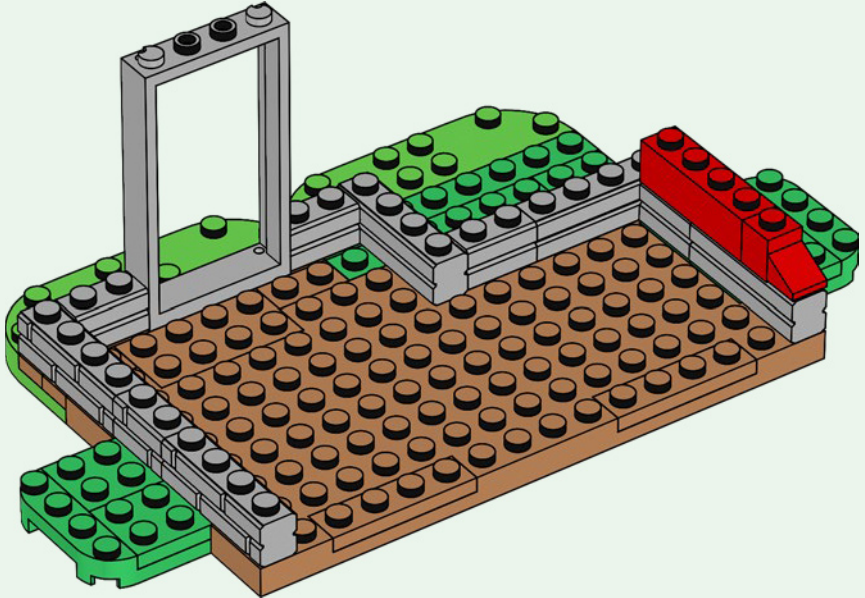

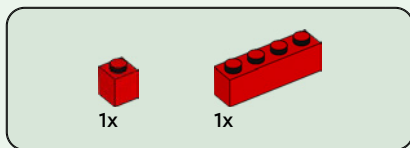

45

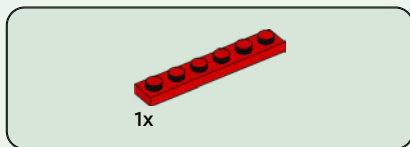
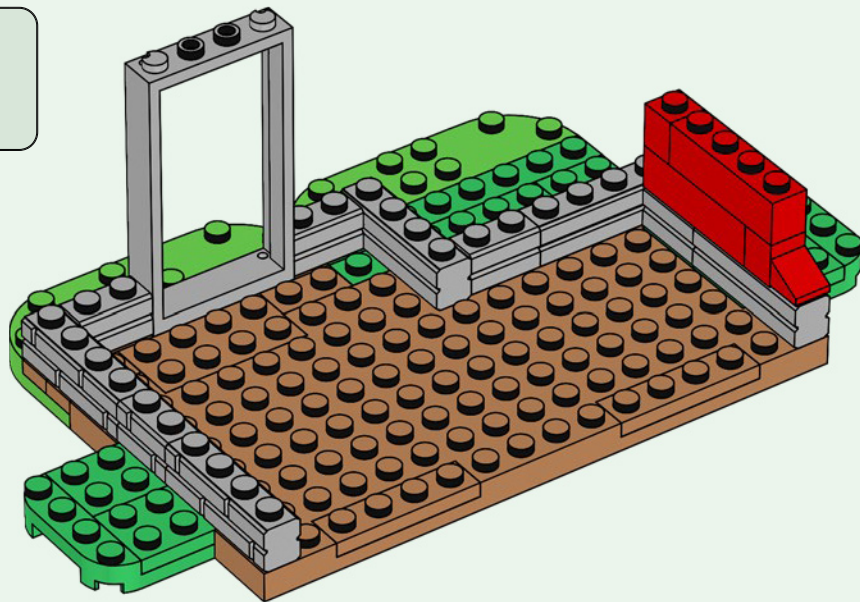

46

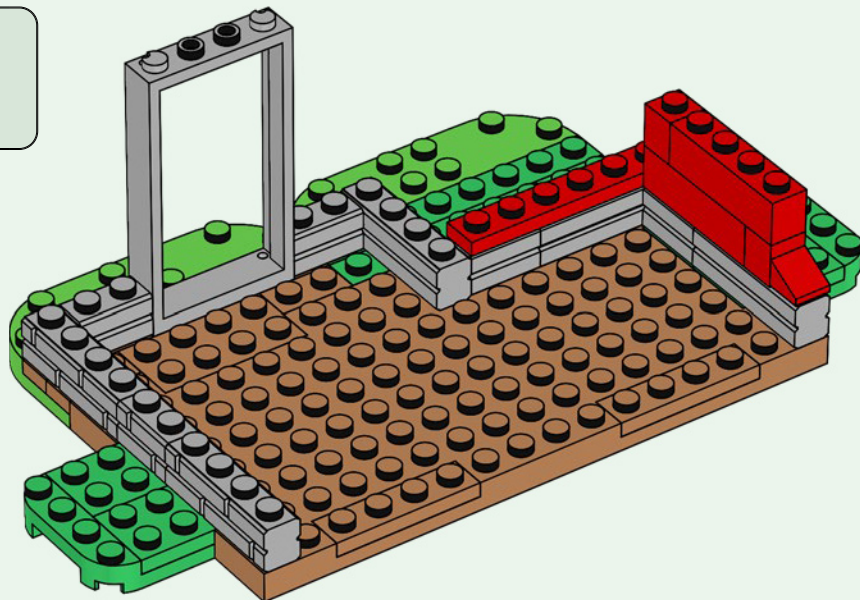

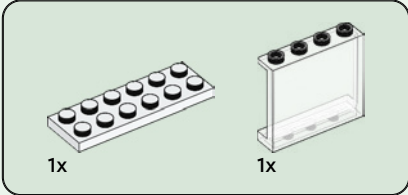
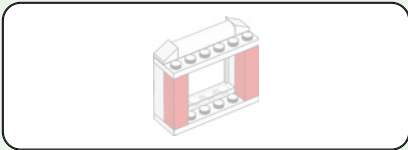

47

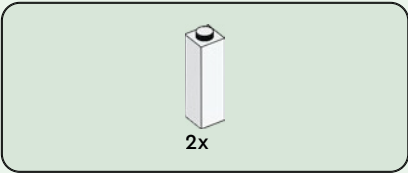
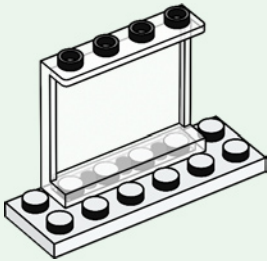

48

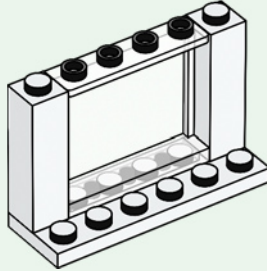

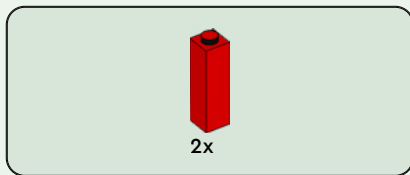

49

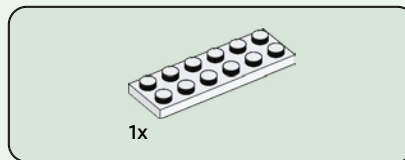
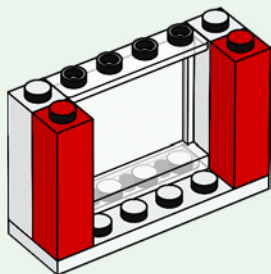

50

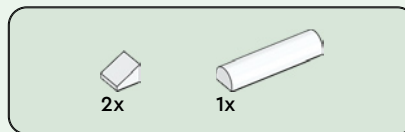
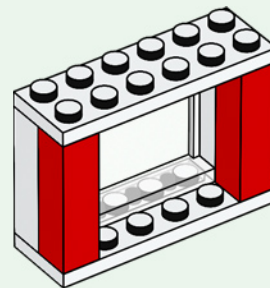

51

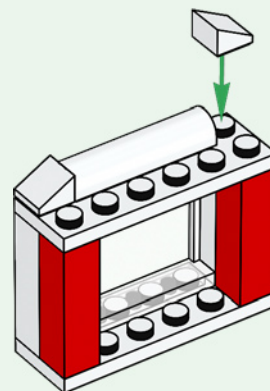

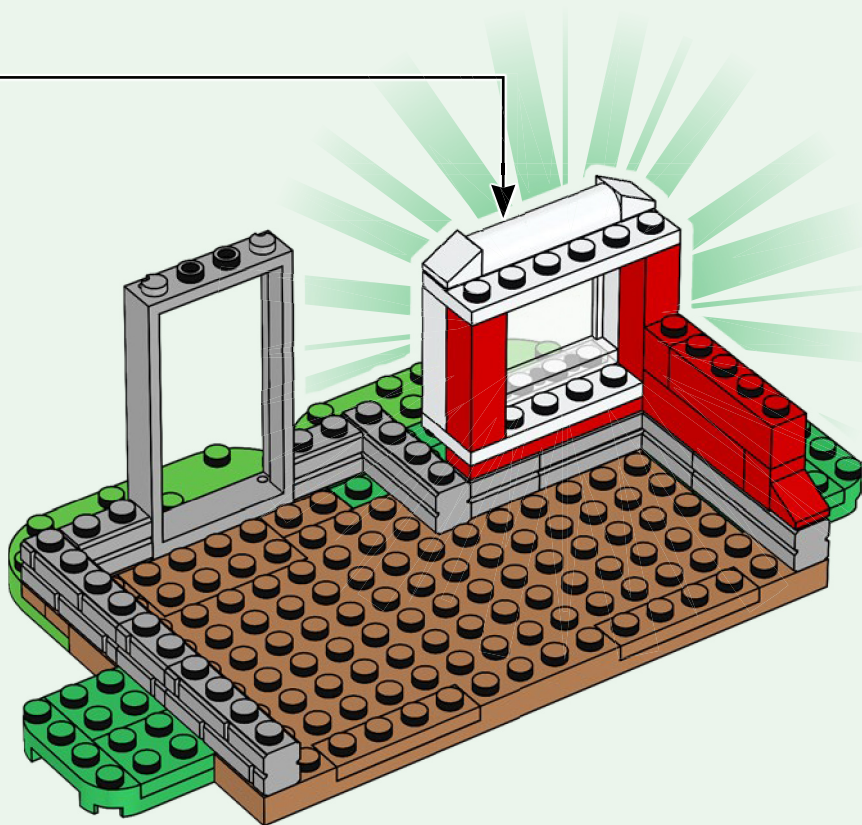

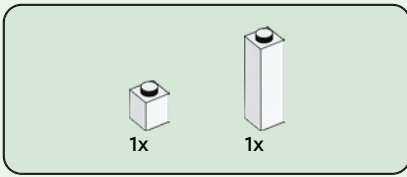

53

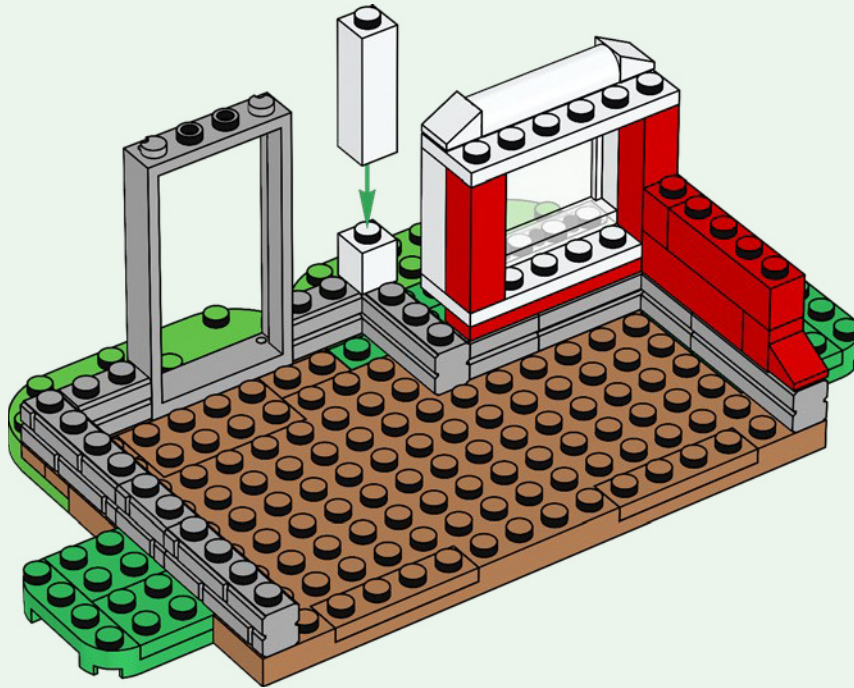

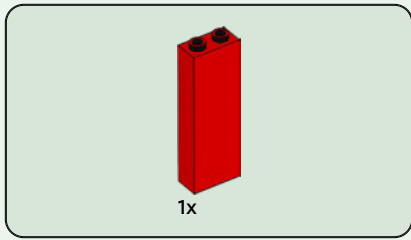

54

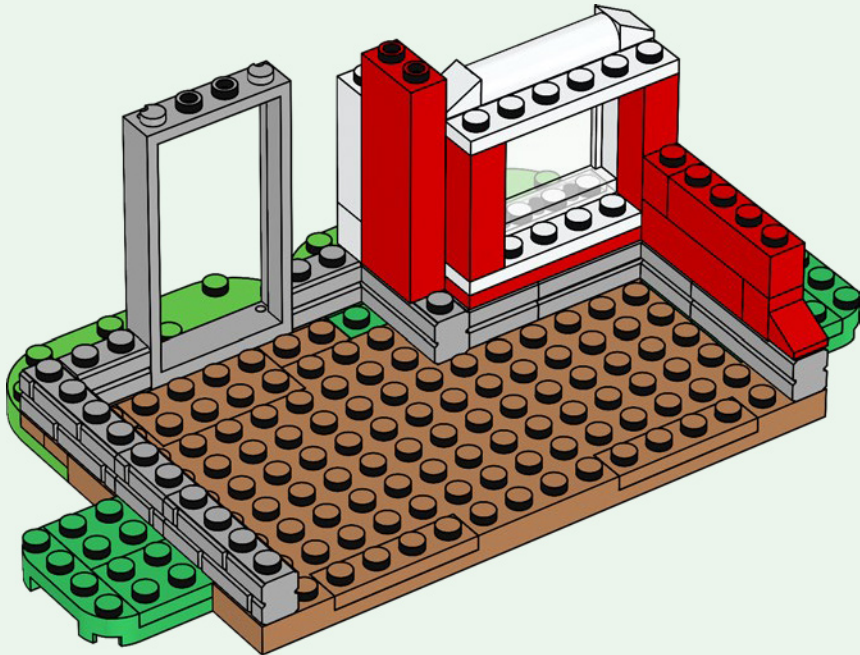

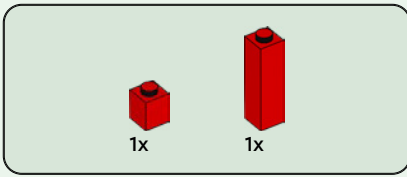

55

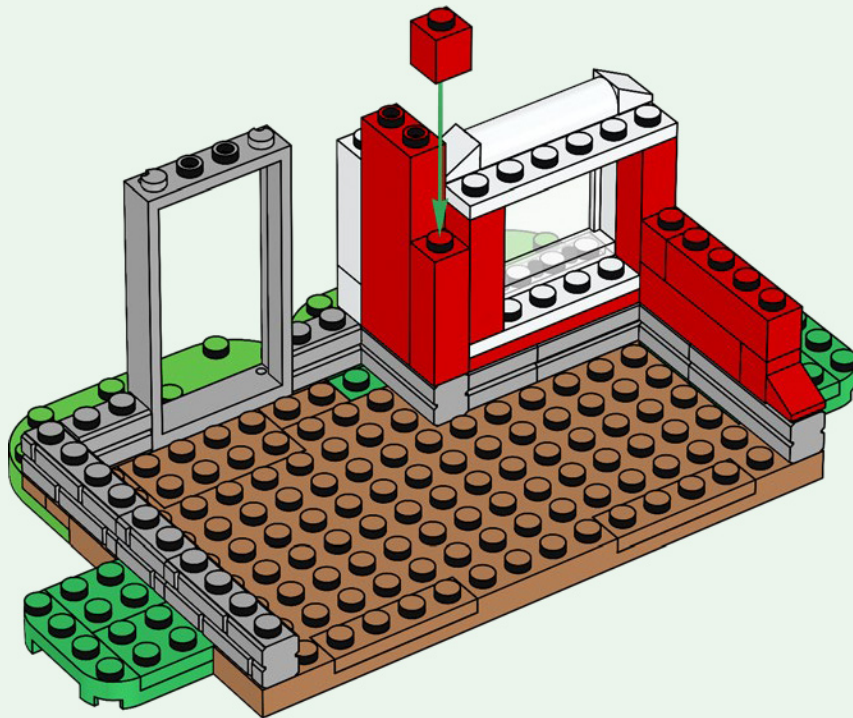

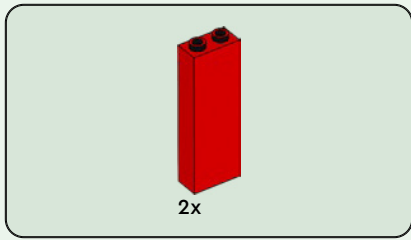

56

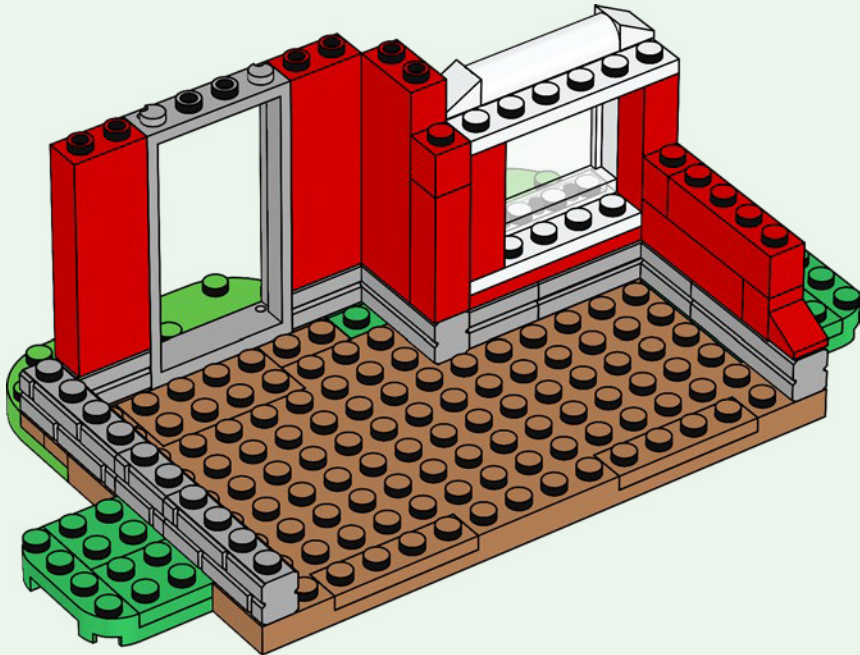

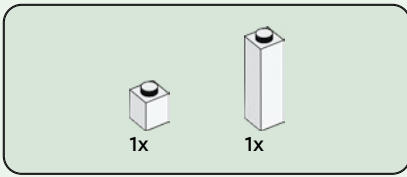

57

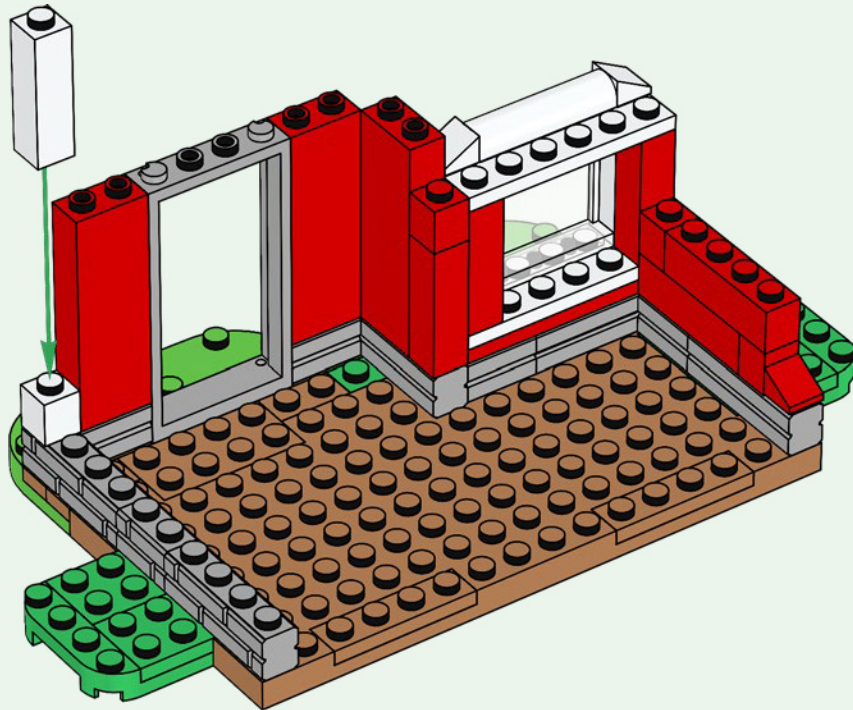

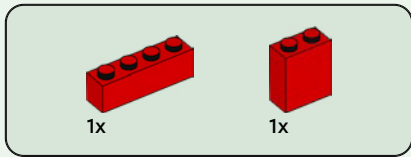

58

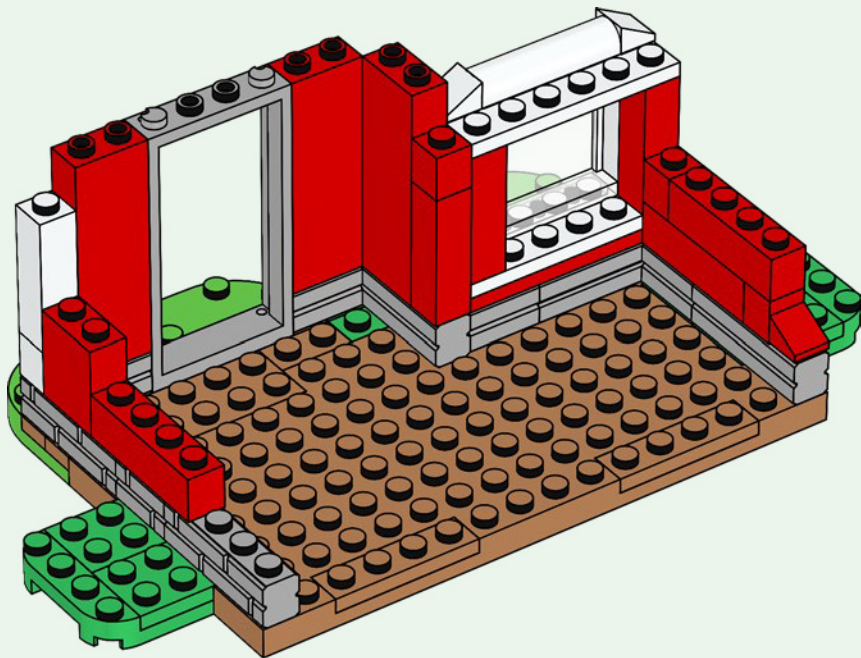

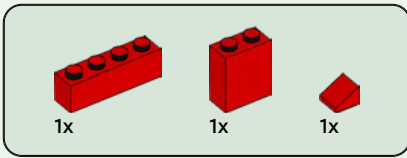

59

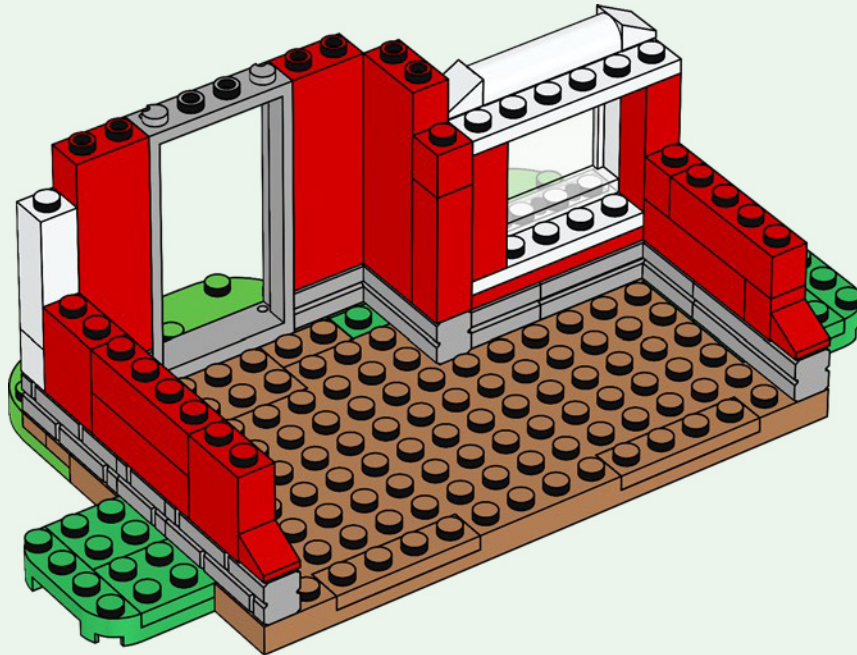



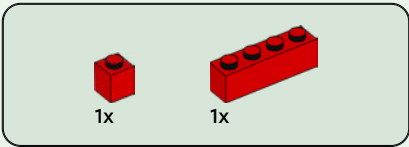

60

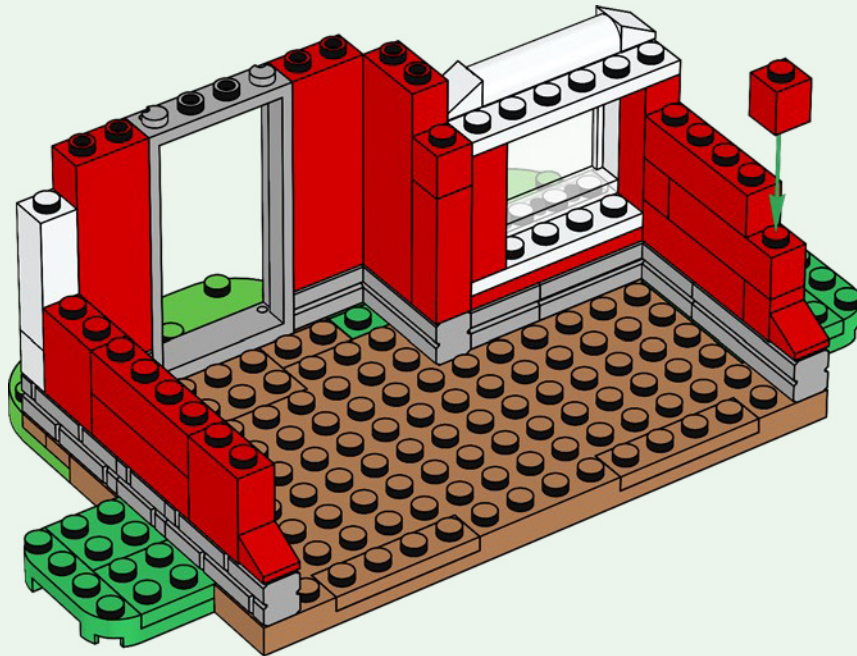



3x



1x

61

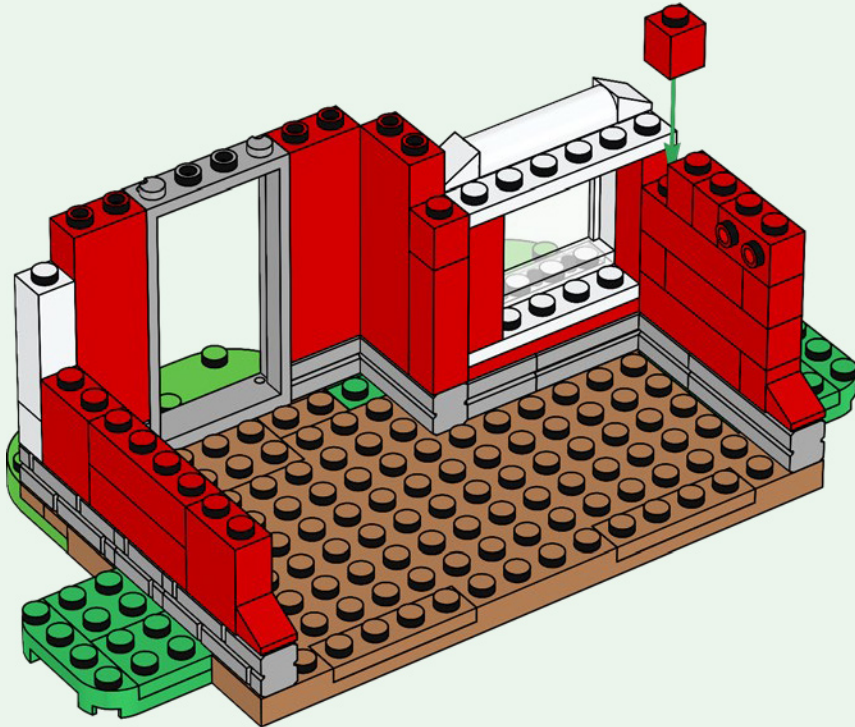

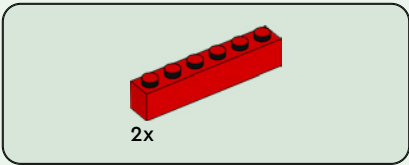

62

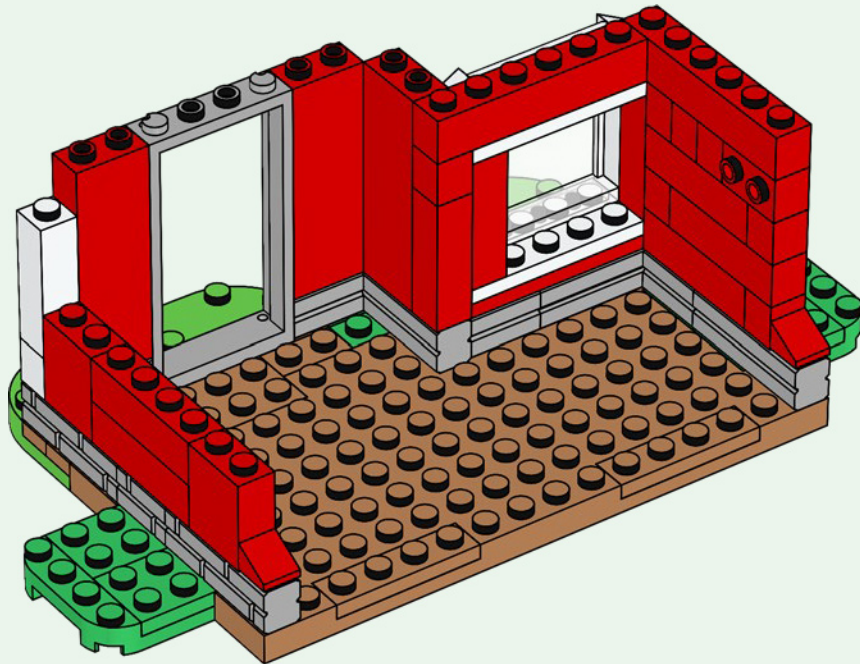

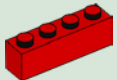

2x

63

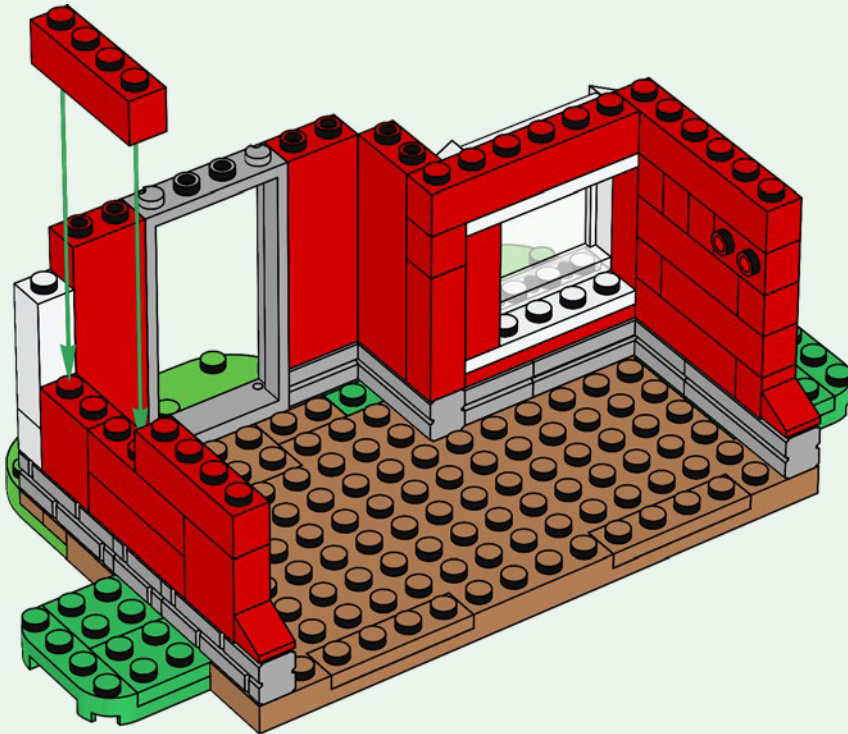

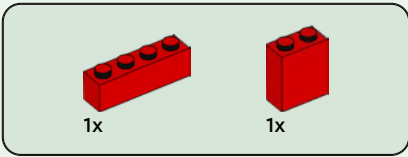

64

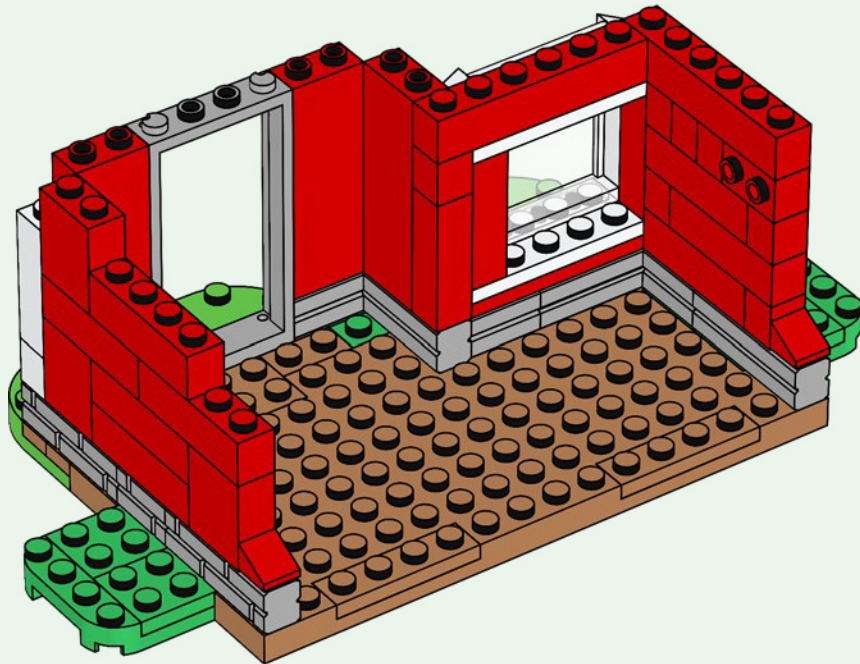

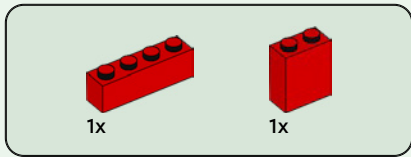

65

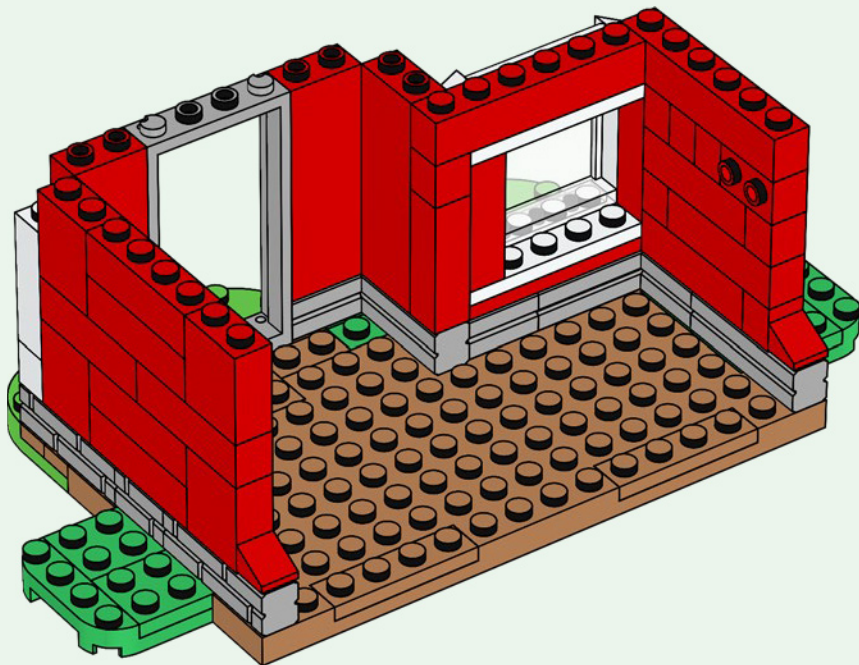



2x

66

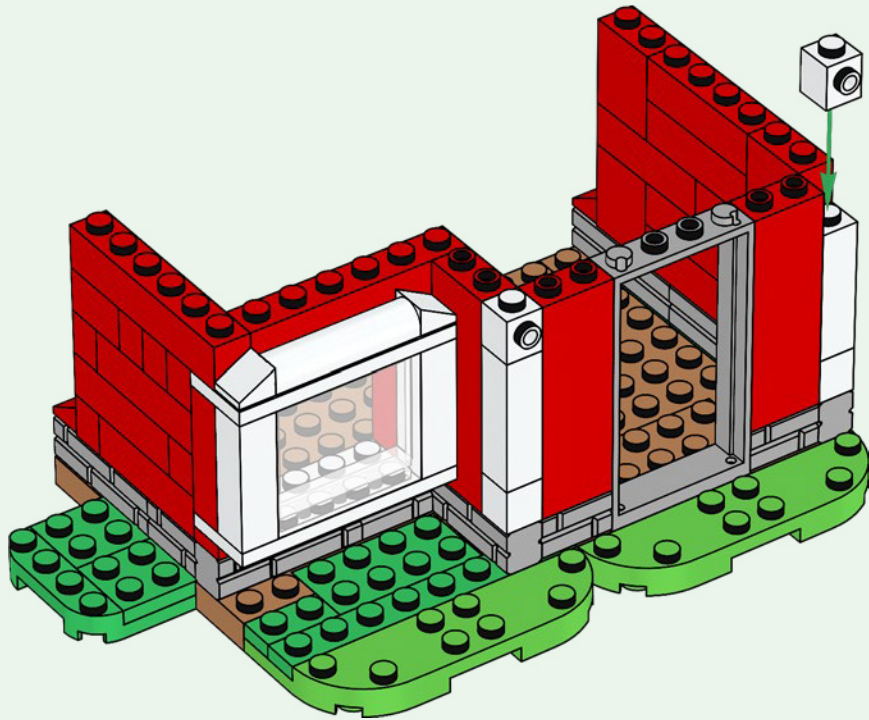

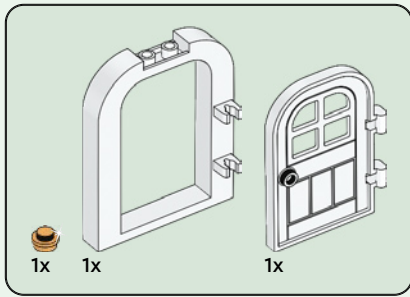

67

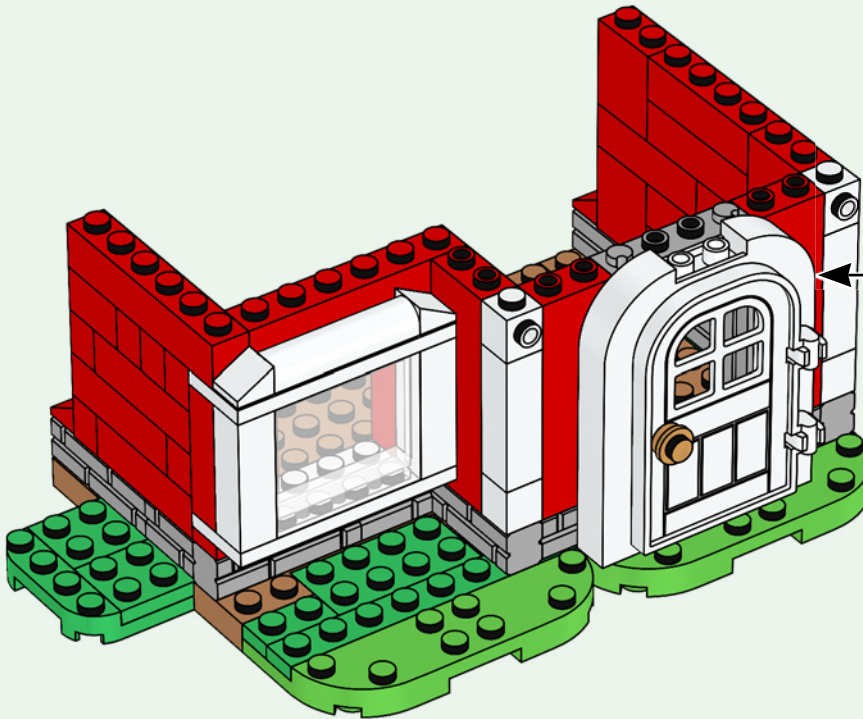
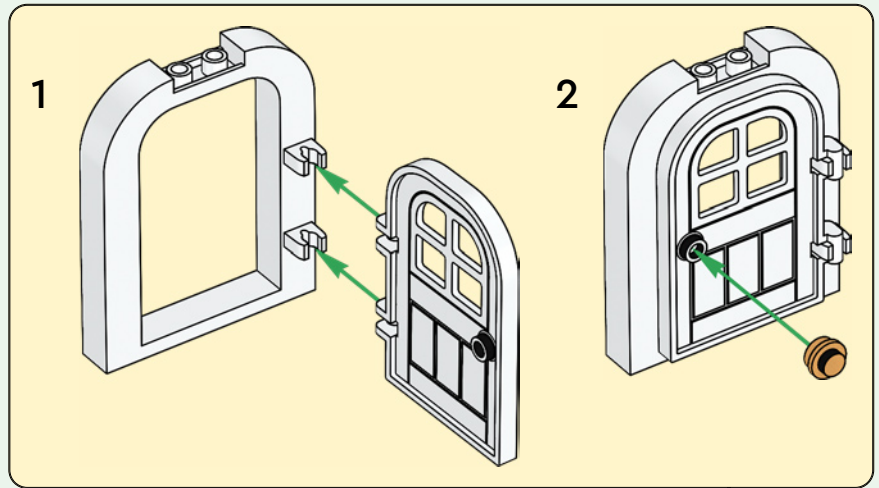



1x

68

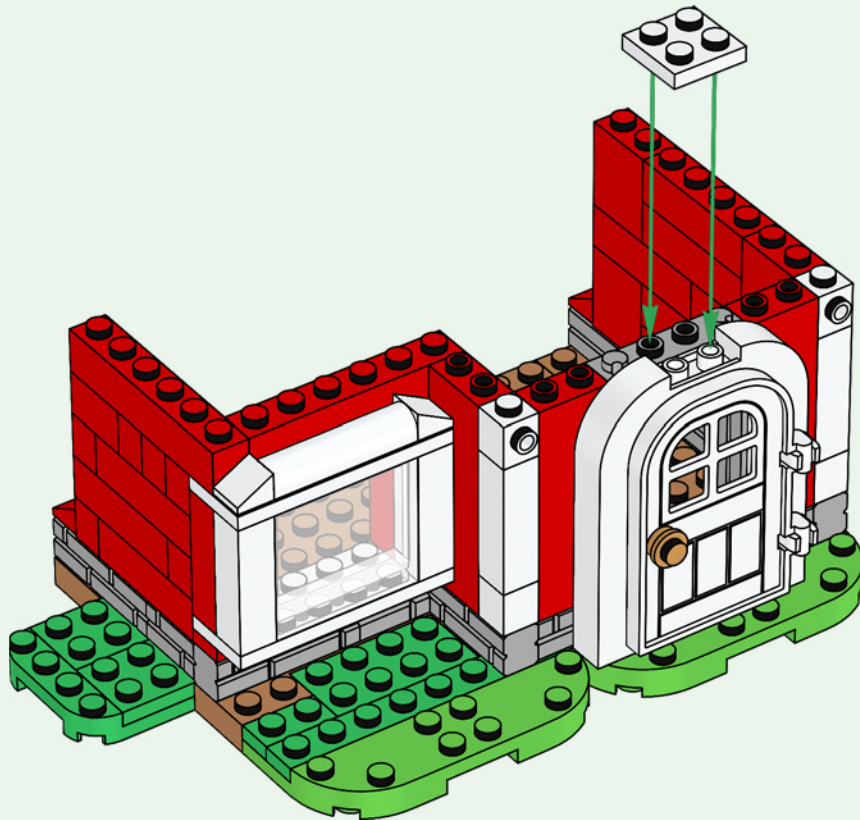

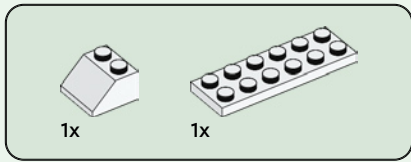

69

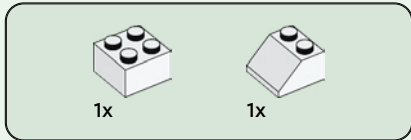
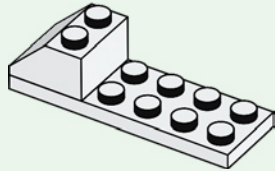

70

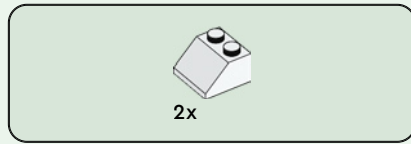
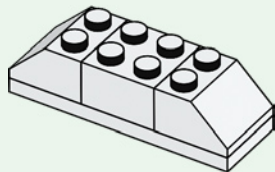

71

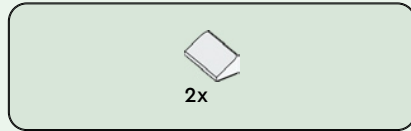
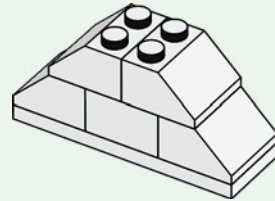

72

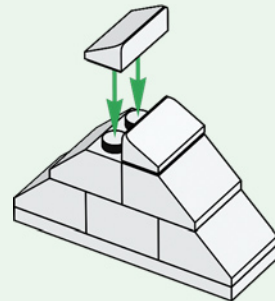

73

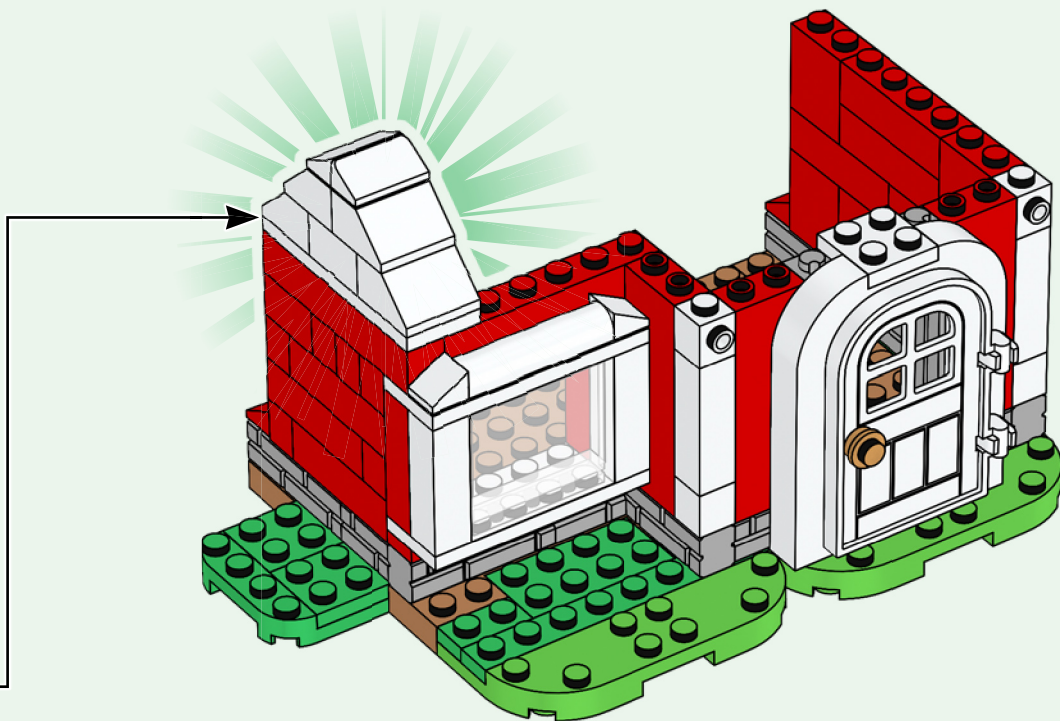

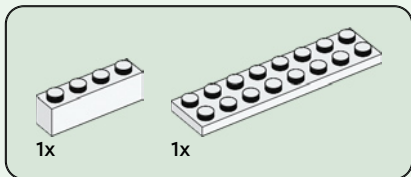
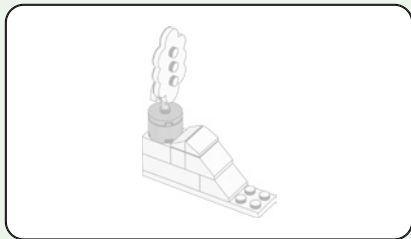

74

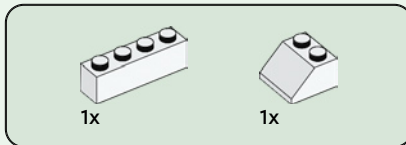
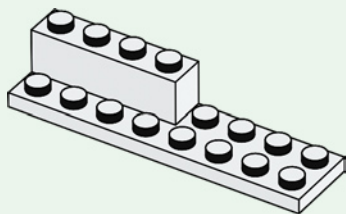

75

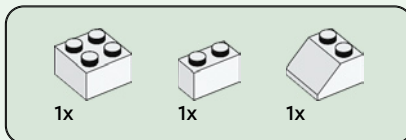
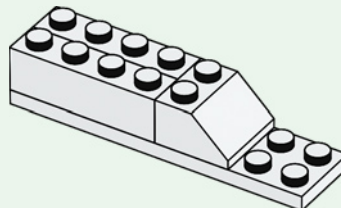

76

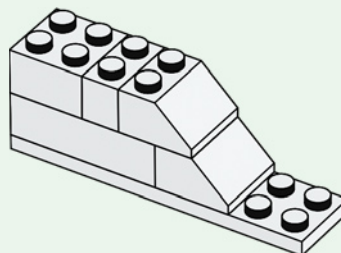



1x

1x

77

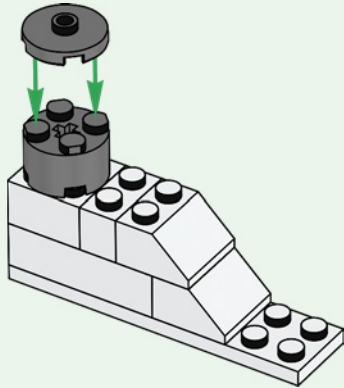

2x

78

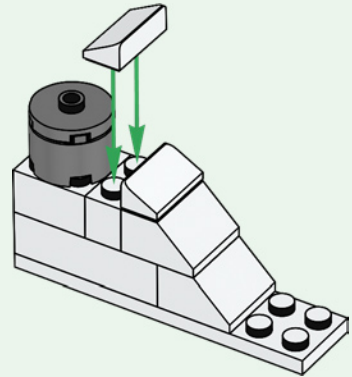

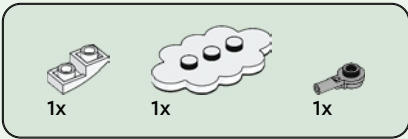

79

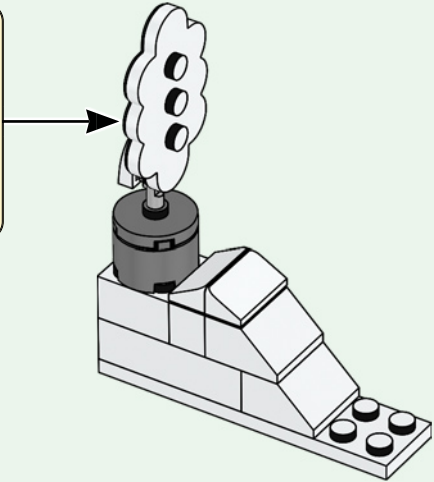
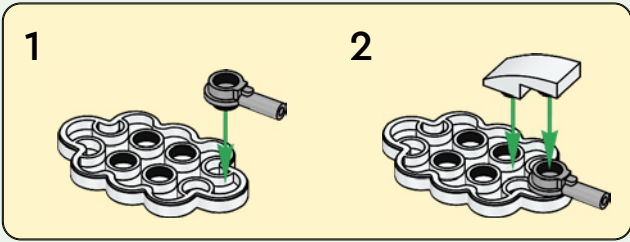

80

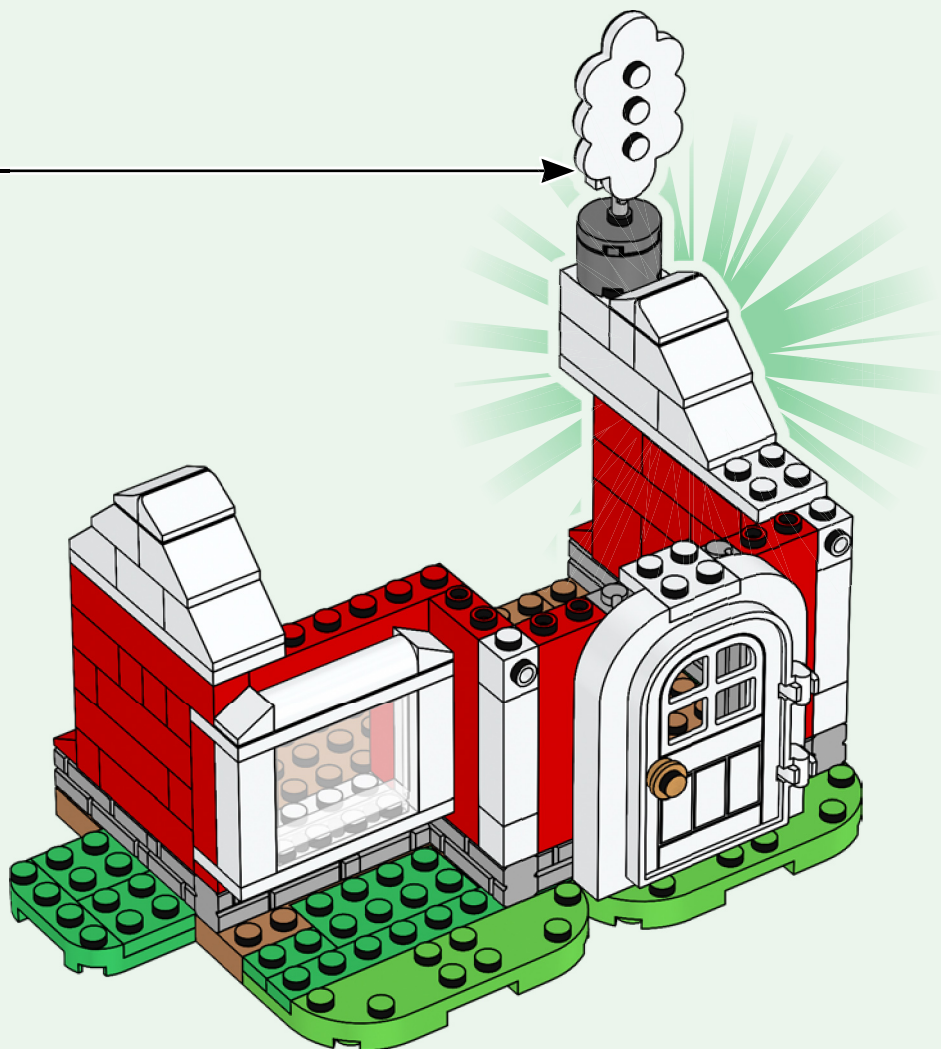

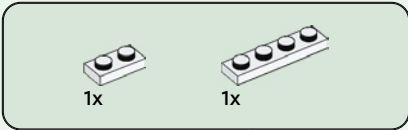

81

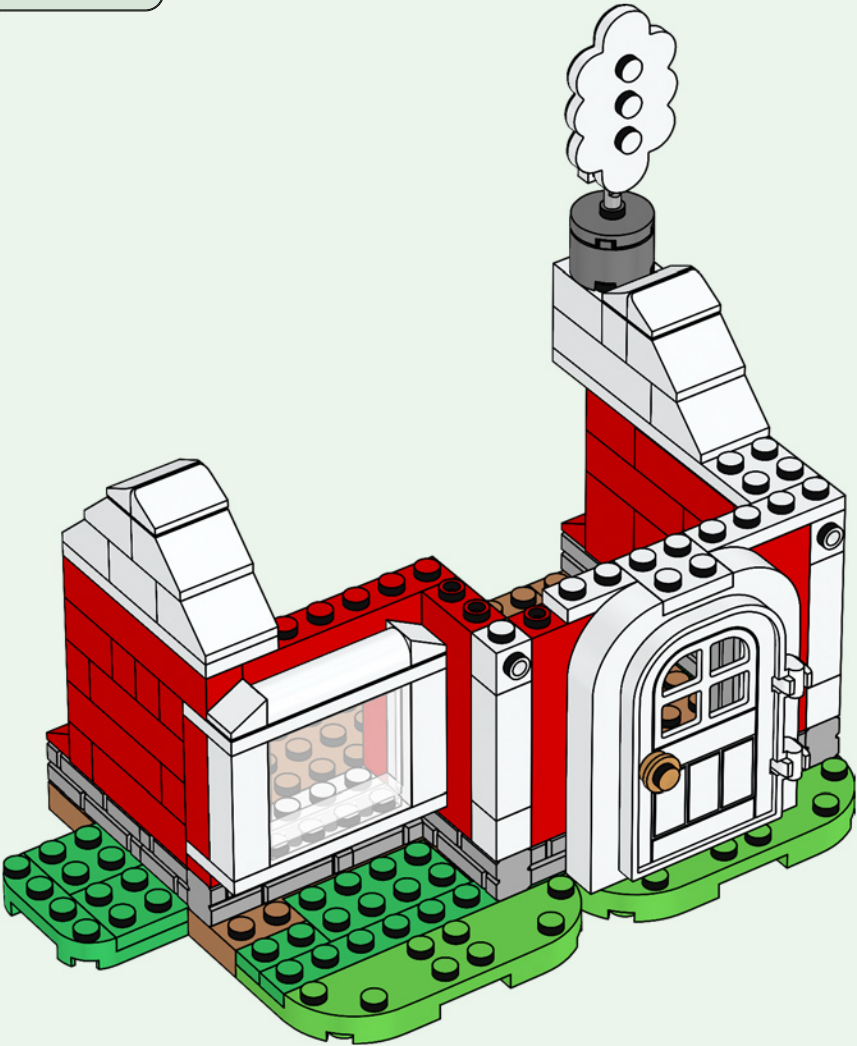

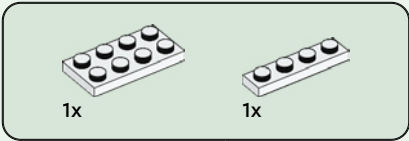

82

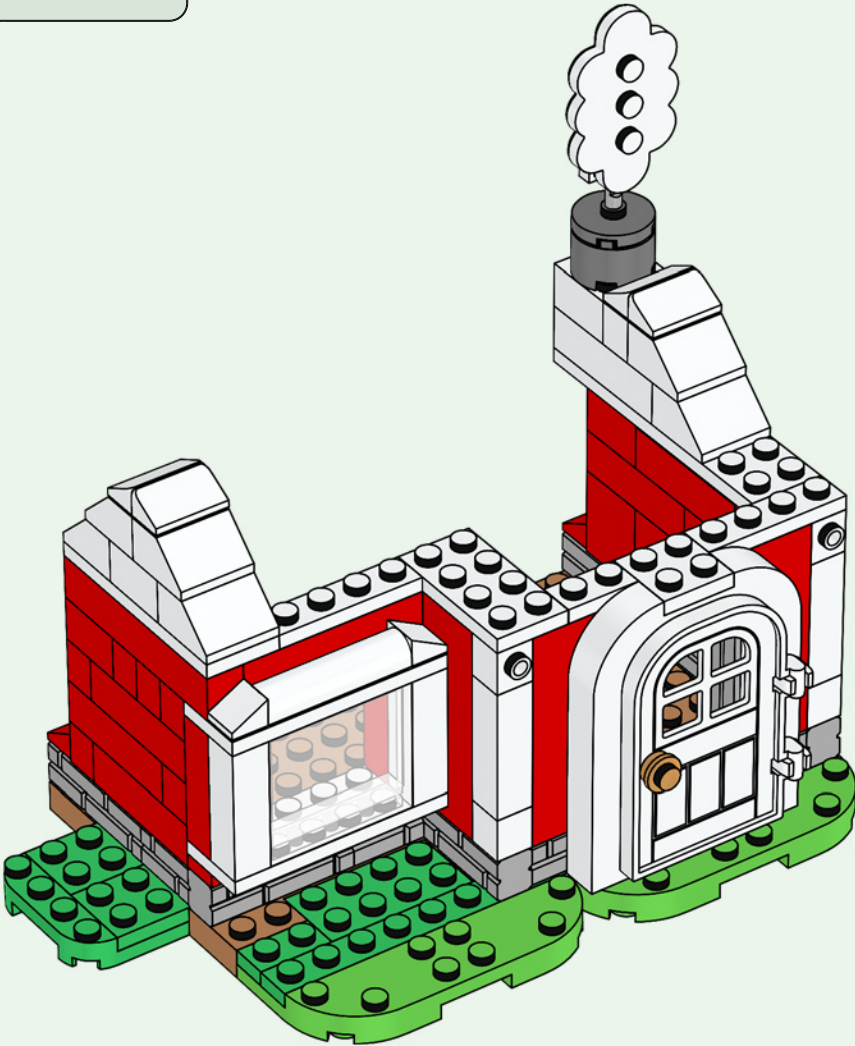

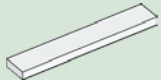

1x

83

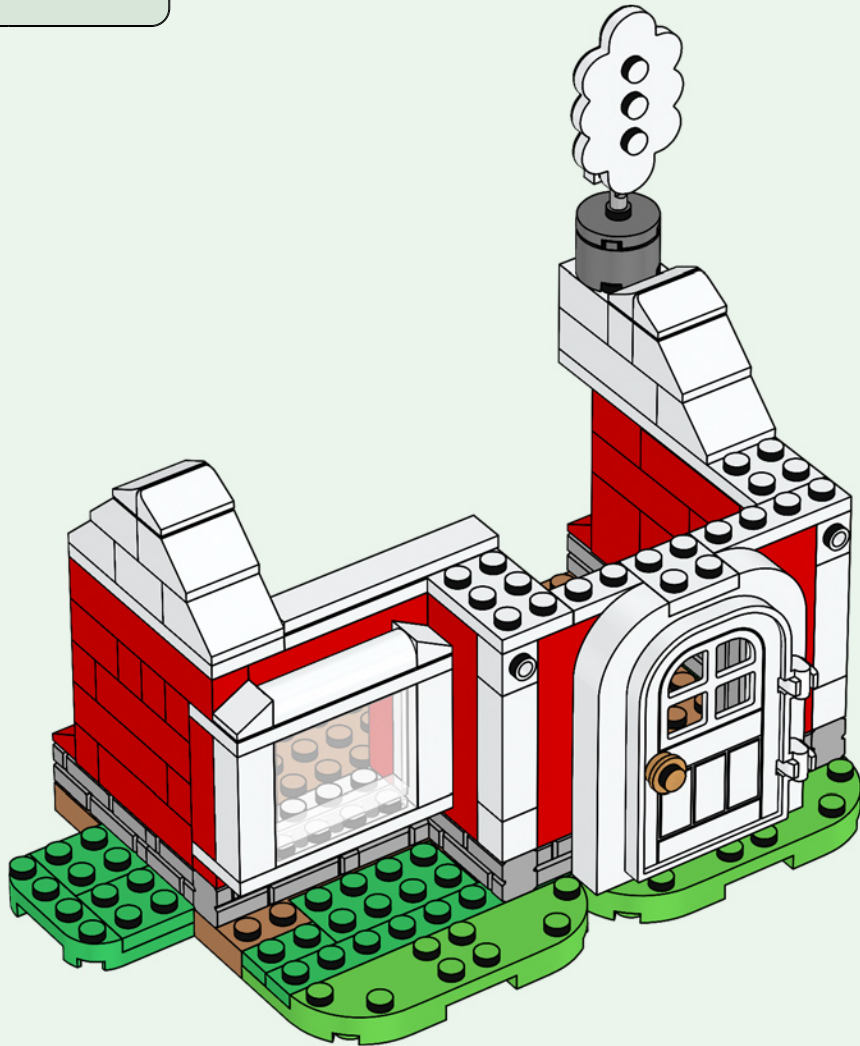



2x



2x

84

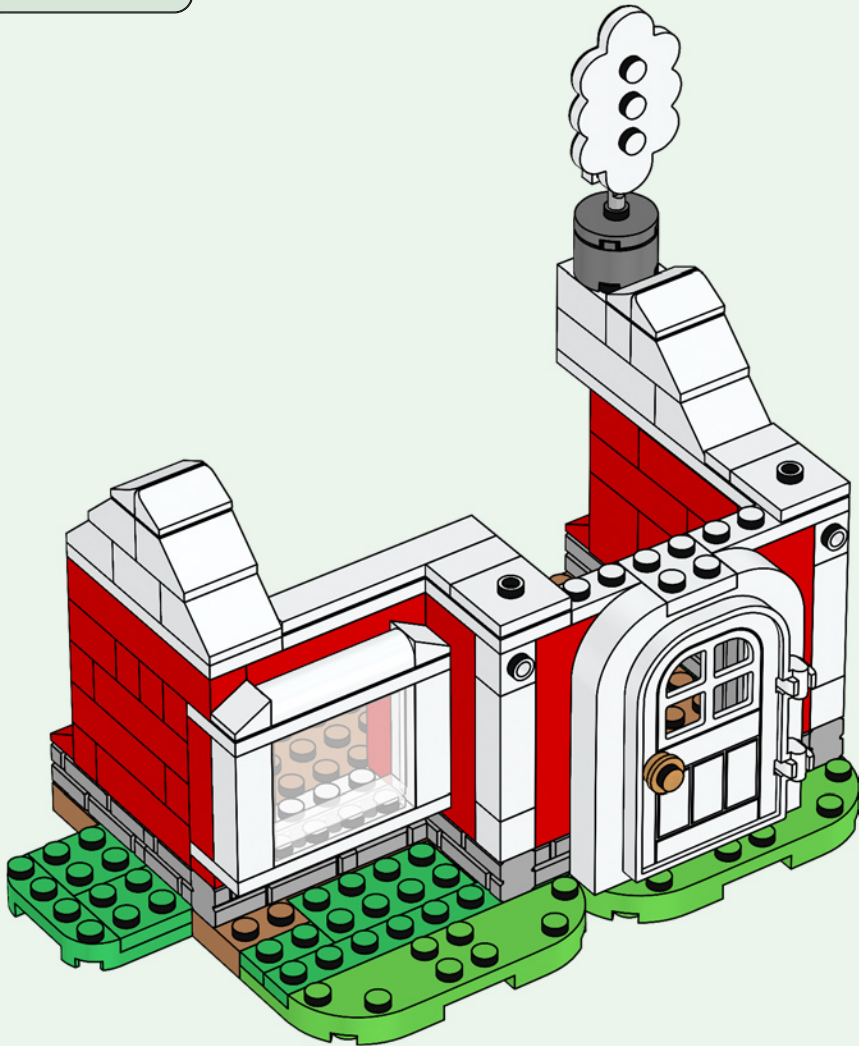

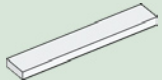

1x

85

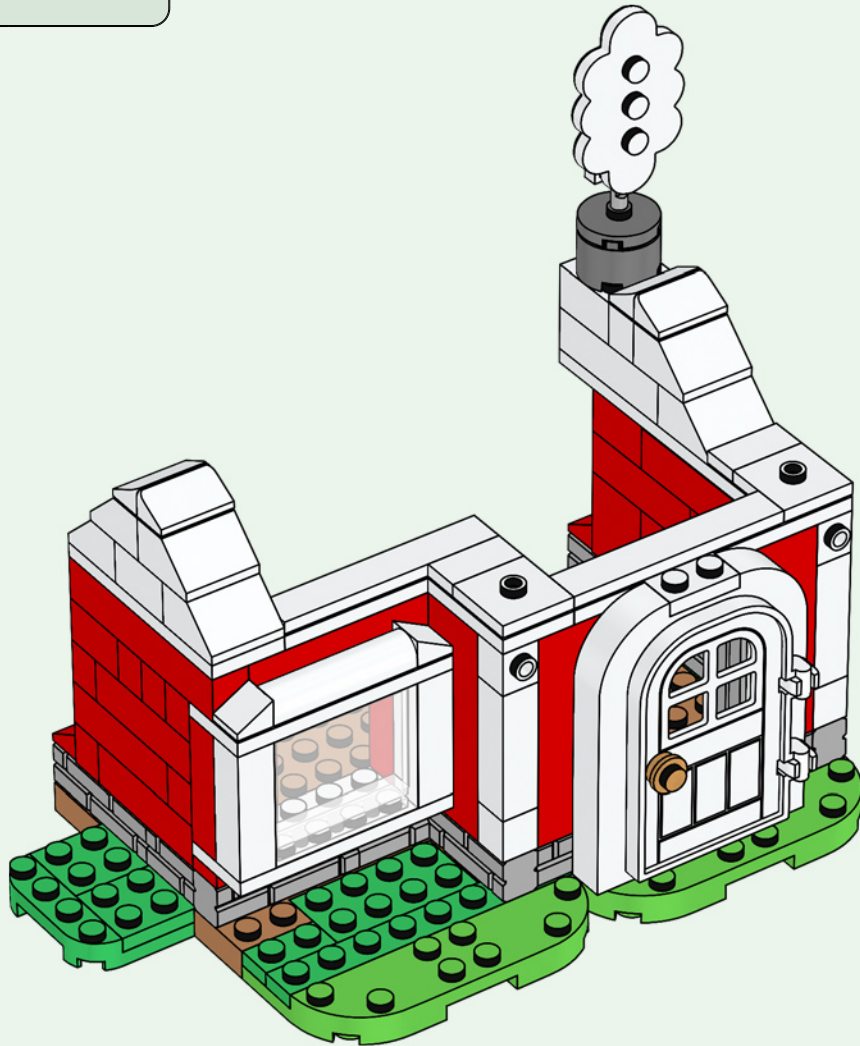



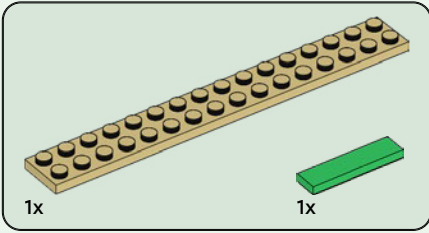
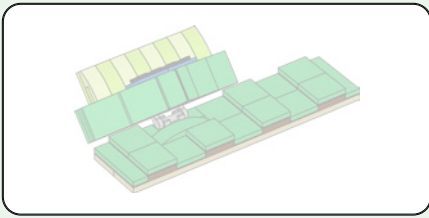

86

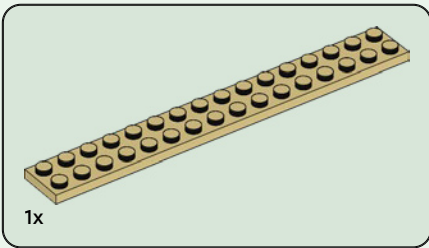
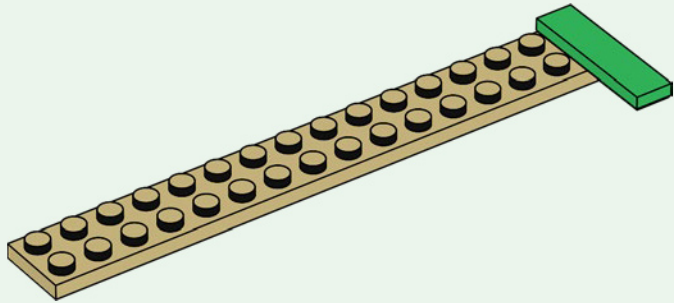

87

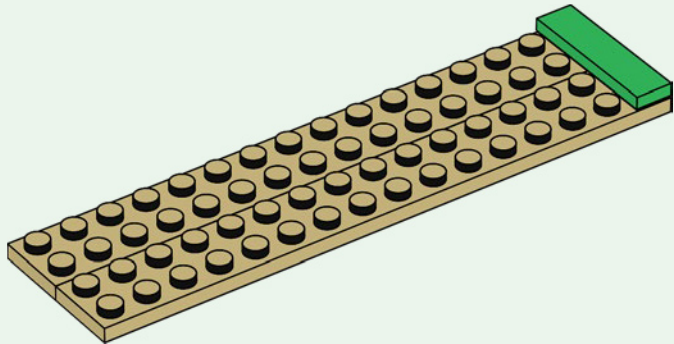



1x

88

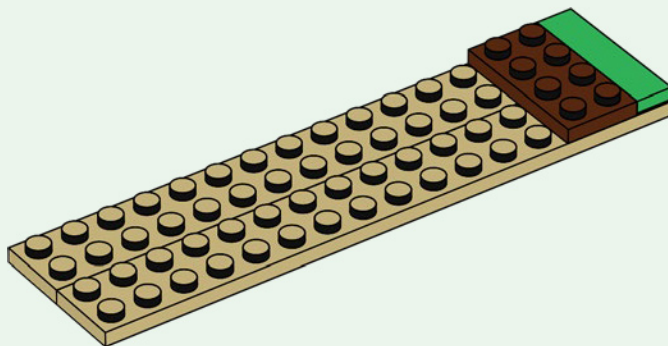

2x

89

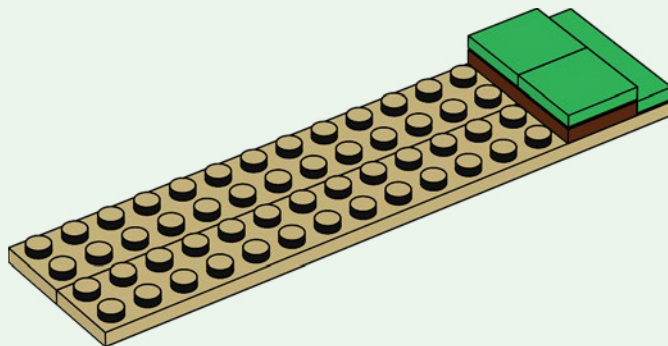

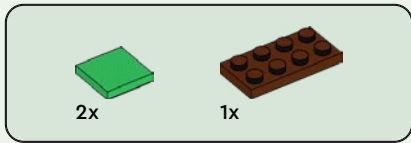

90

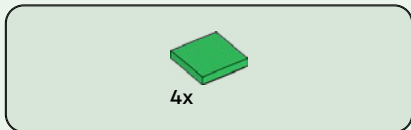
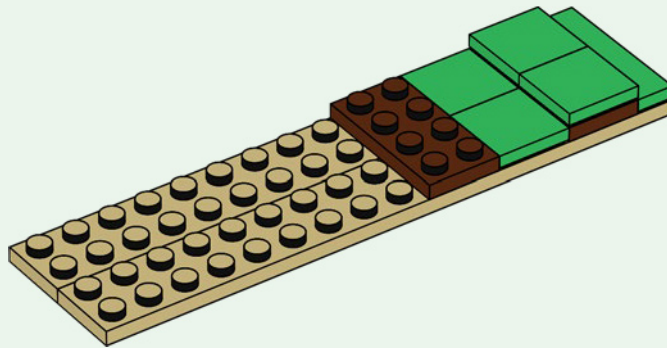

91

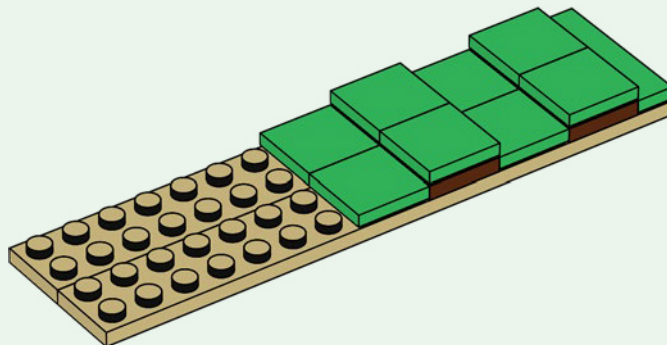

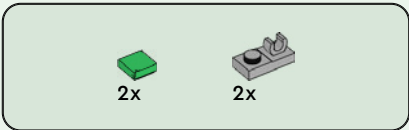

92

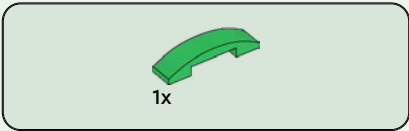
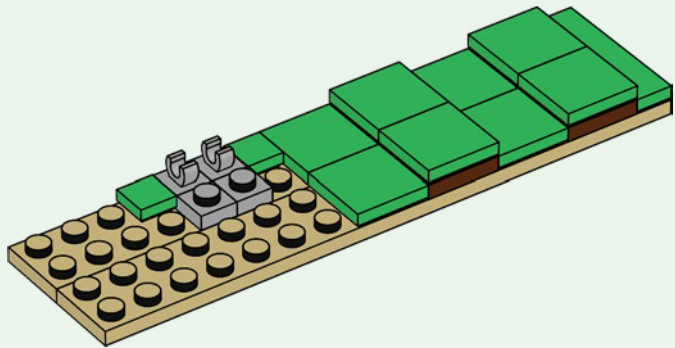

93

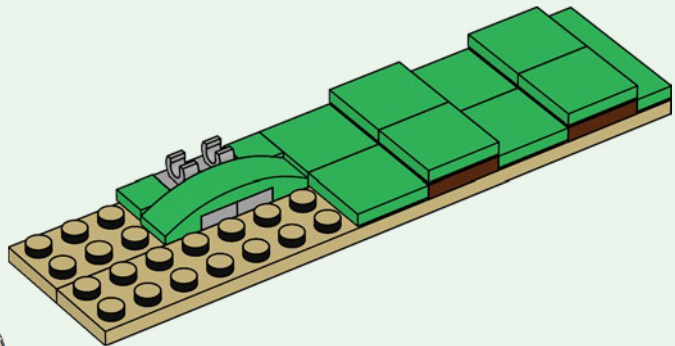



1x

94

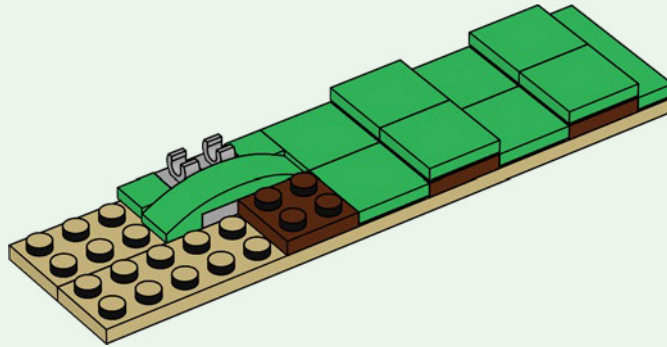

2x

95

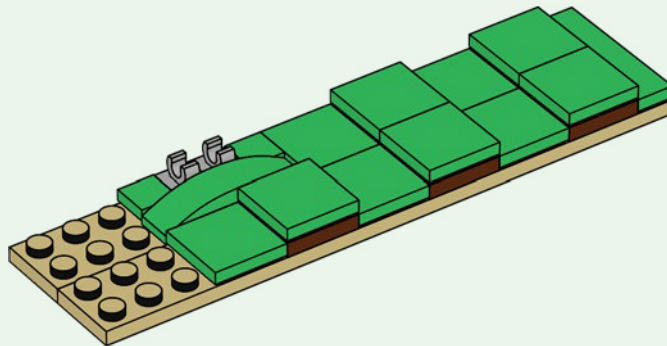

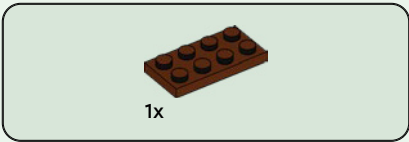

96

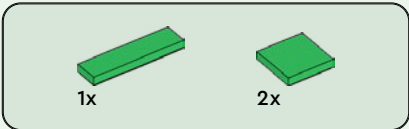
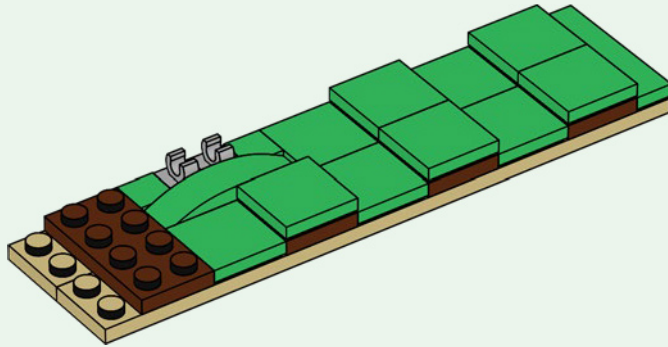

97

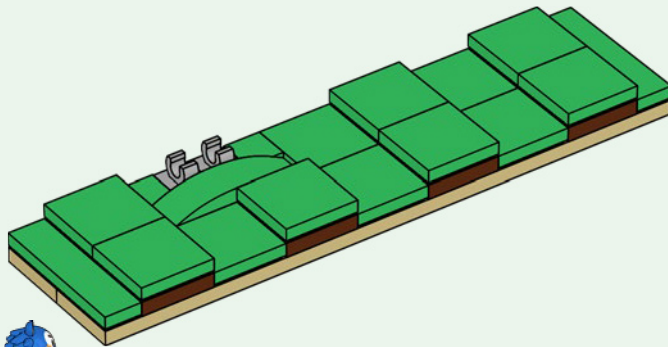

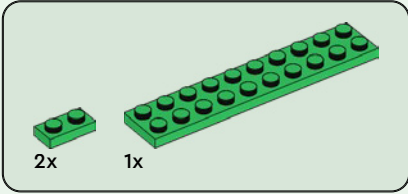
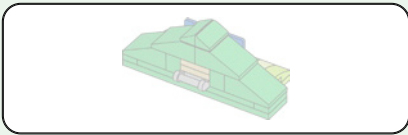

98

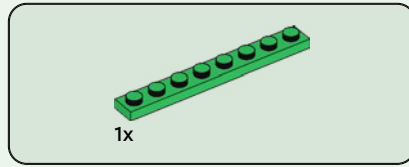
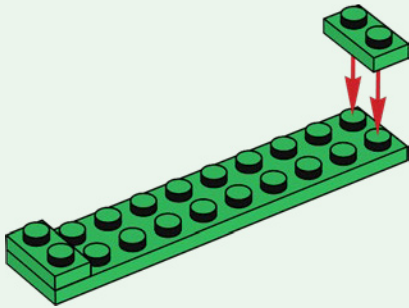

99

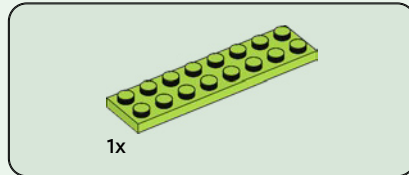
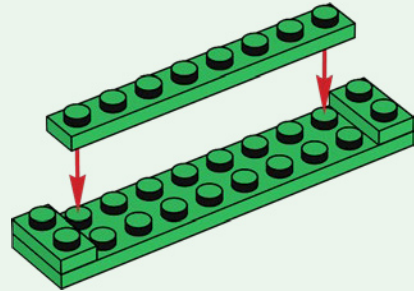

100

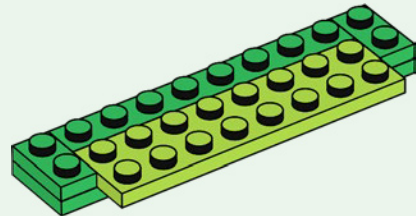

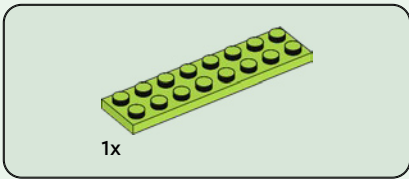

101

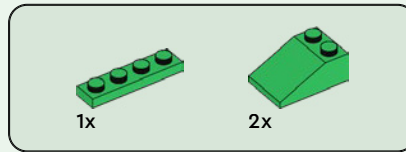
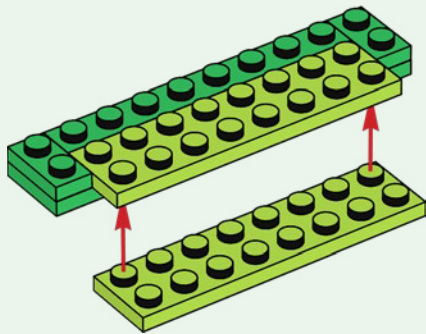

102

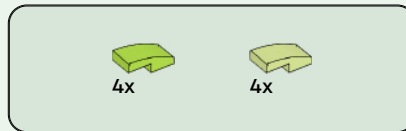
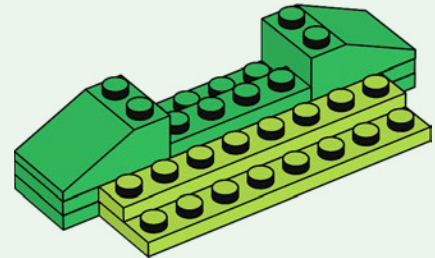

103

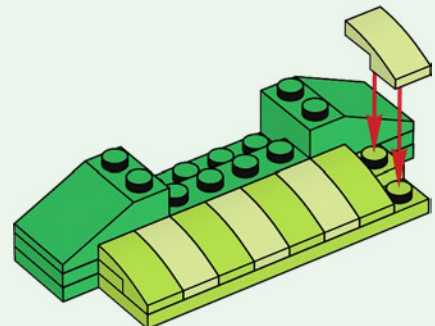



2x

104

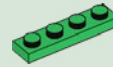
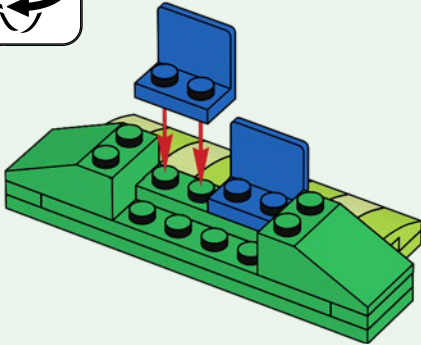

1x

105

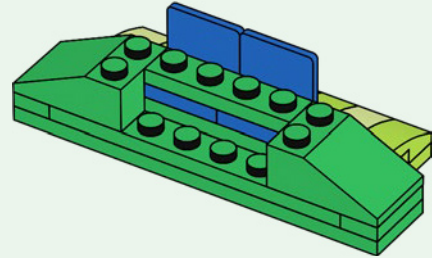

2x

106

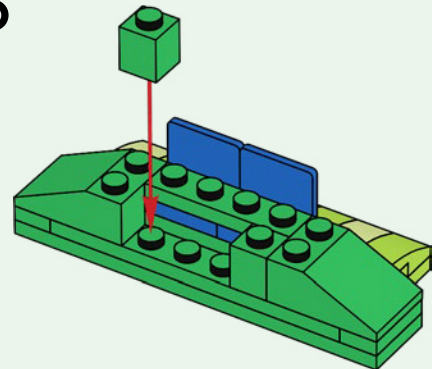

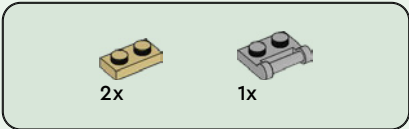

107

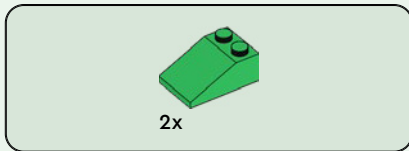
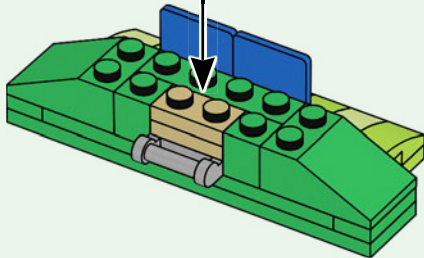
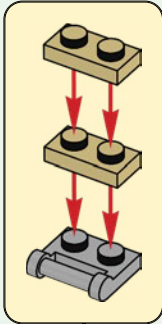

108

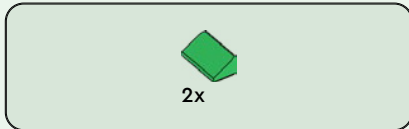
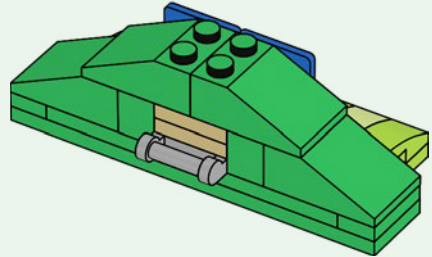

109

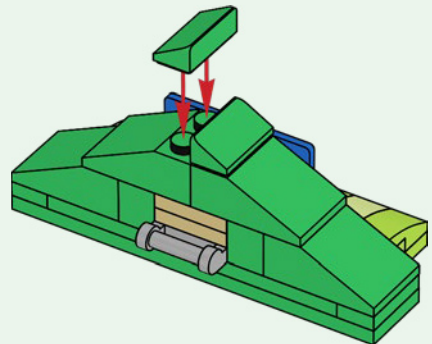

110

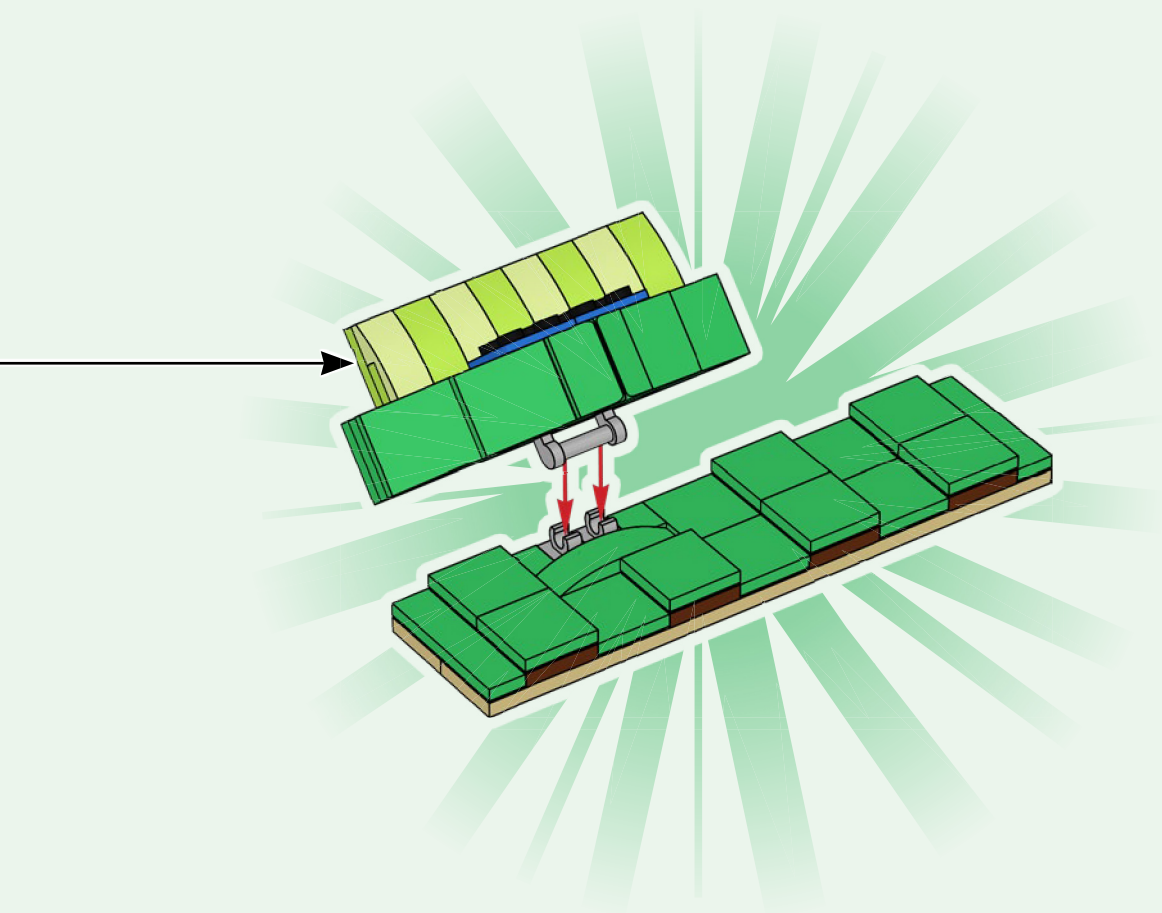

111

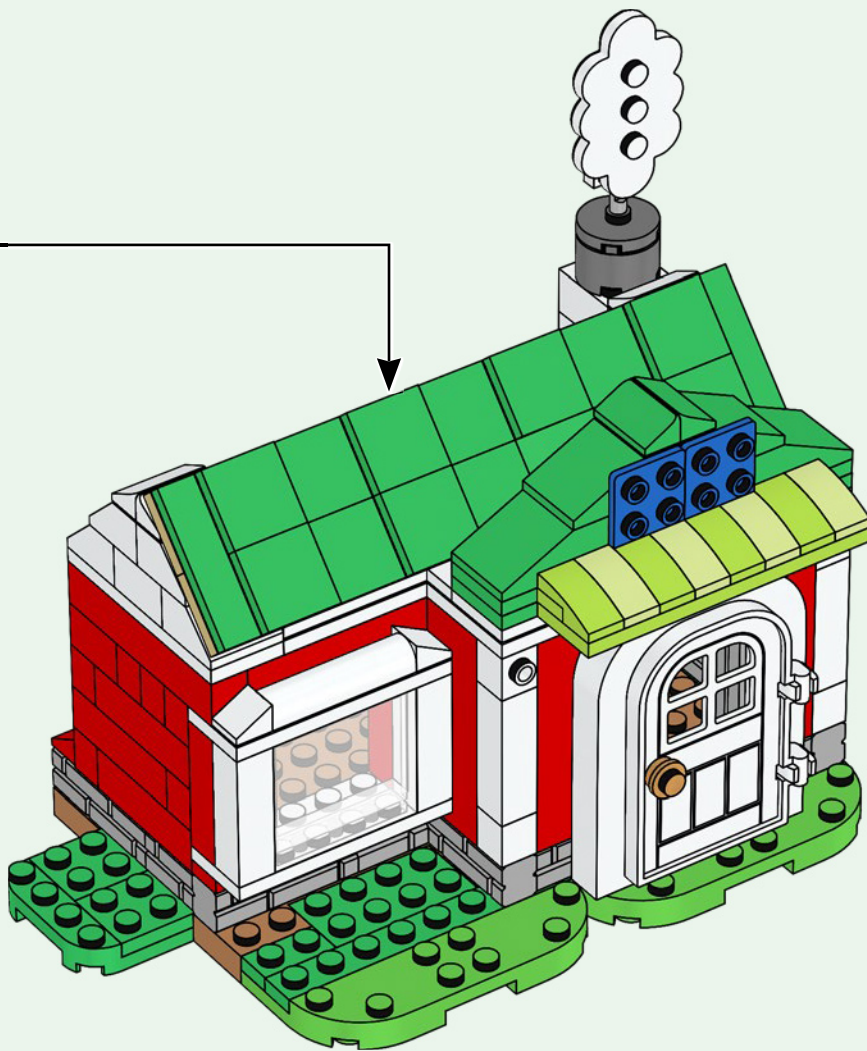



1x

112





1x



1x



1x

113

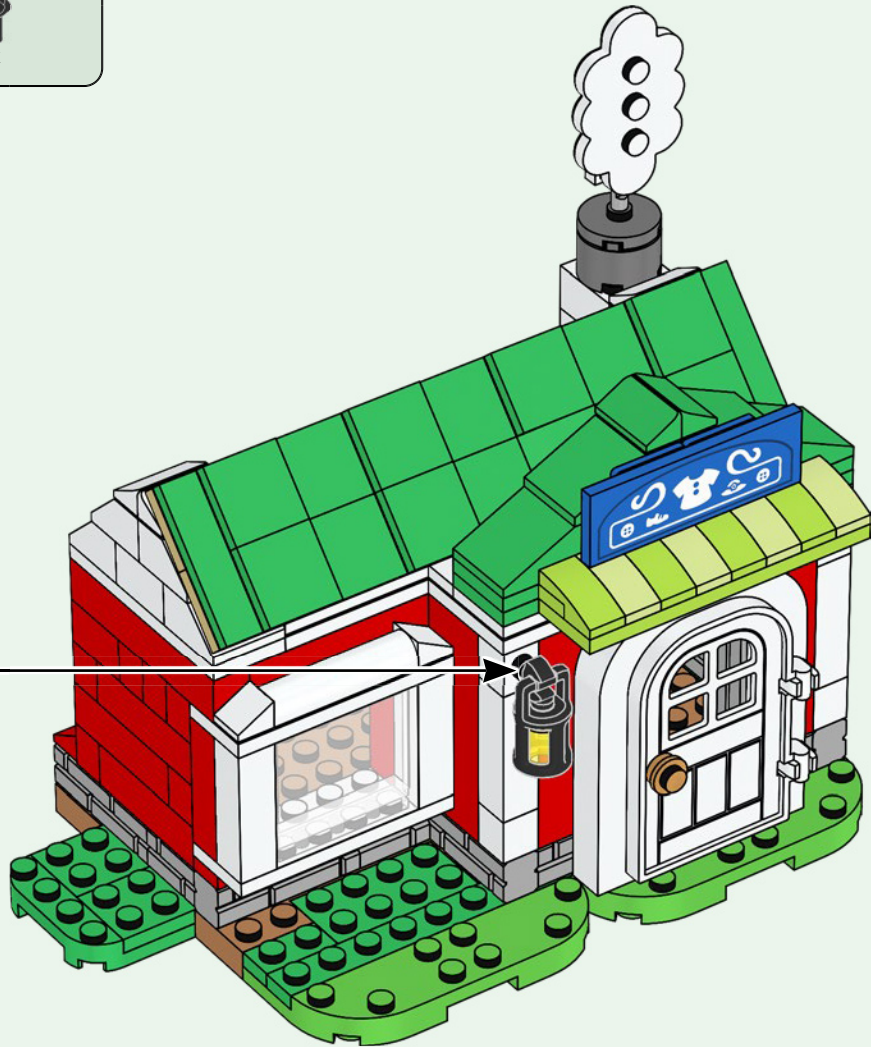
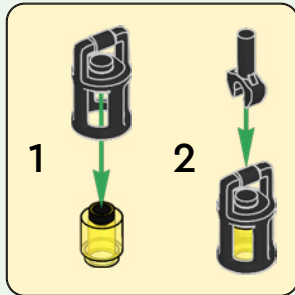



2x



2x

114

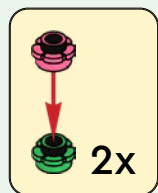

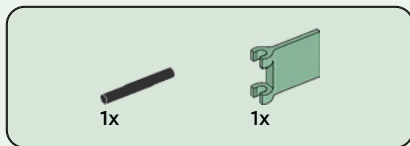

115

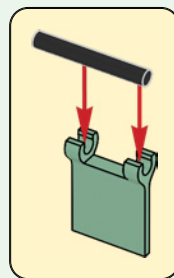



116

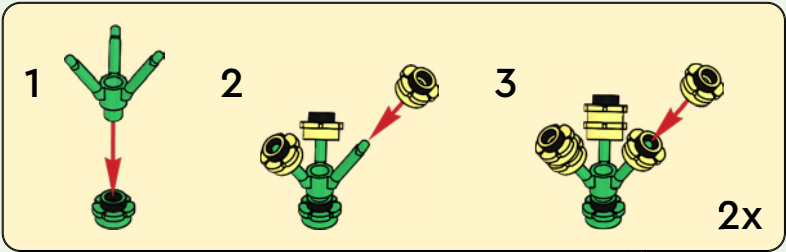

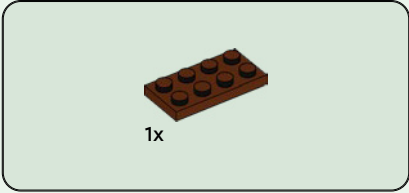
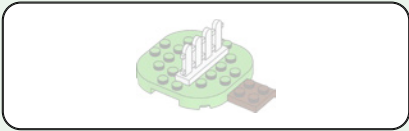

1x

117

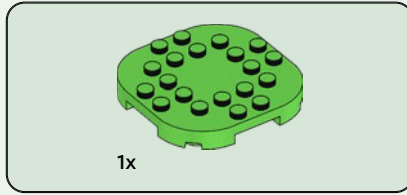
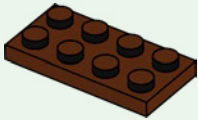

1x

118

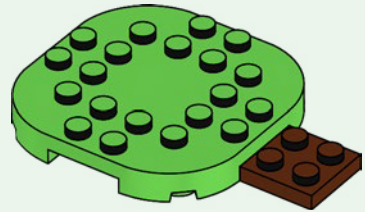

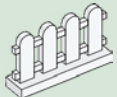

1x

119

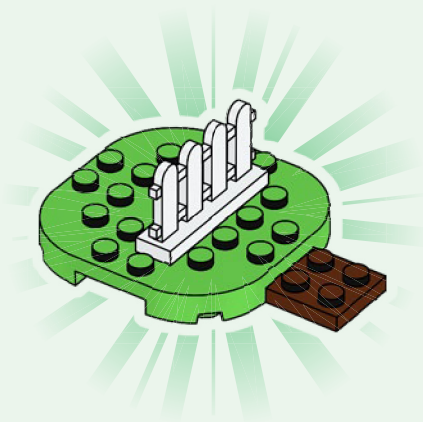

120



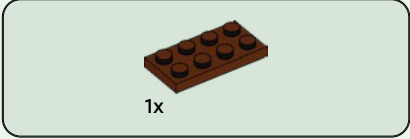
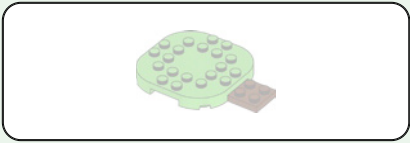

1x

121

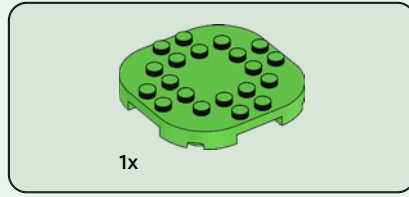
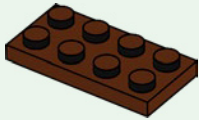

1x

122

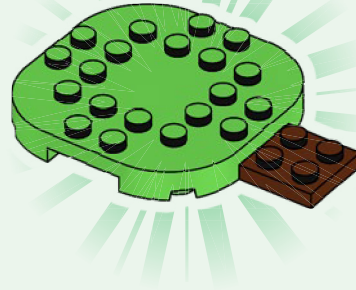

123

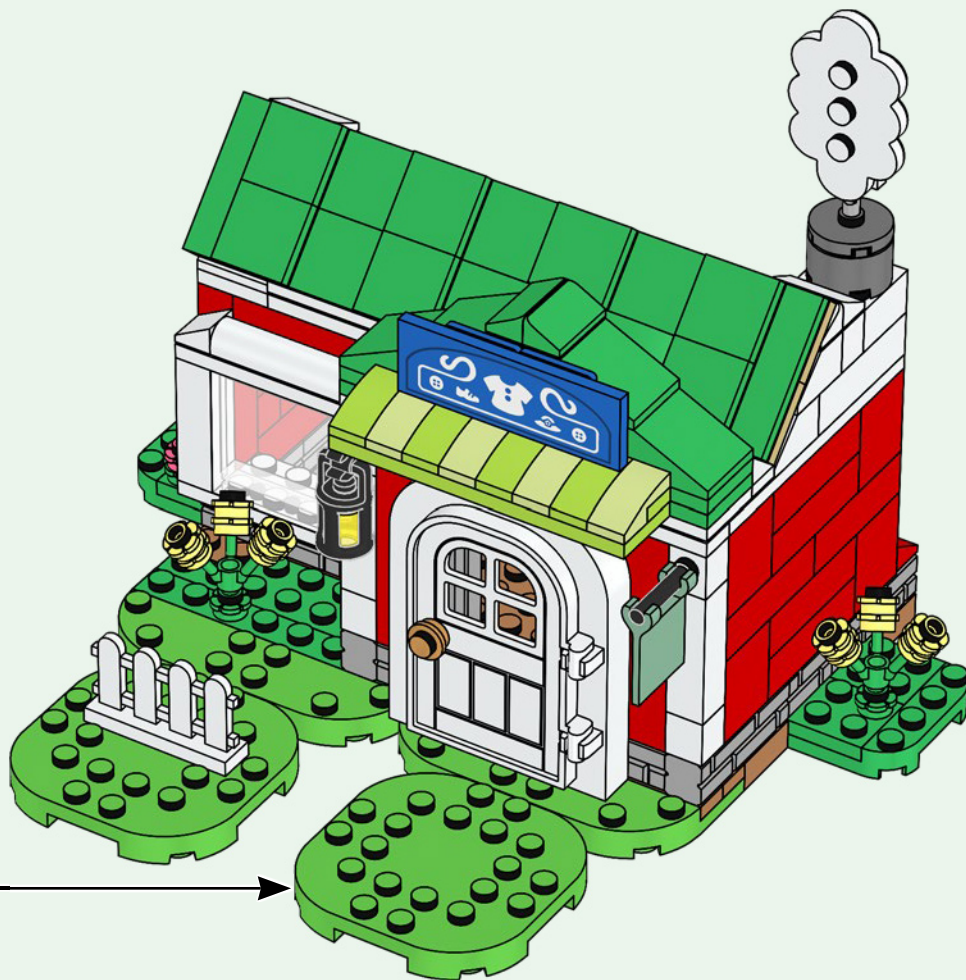





1x

124

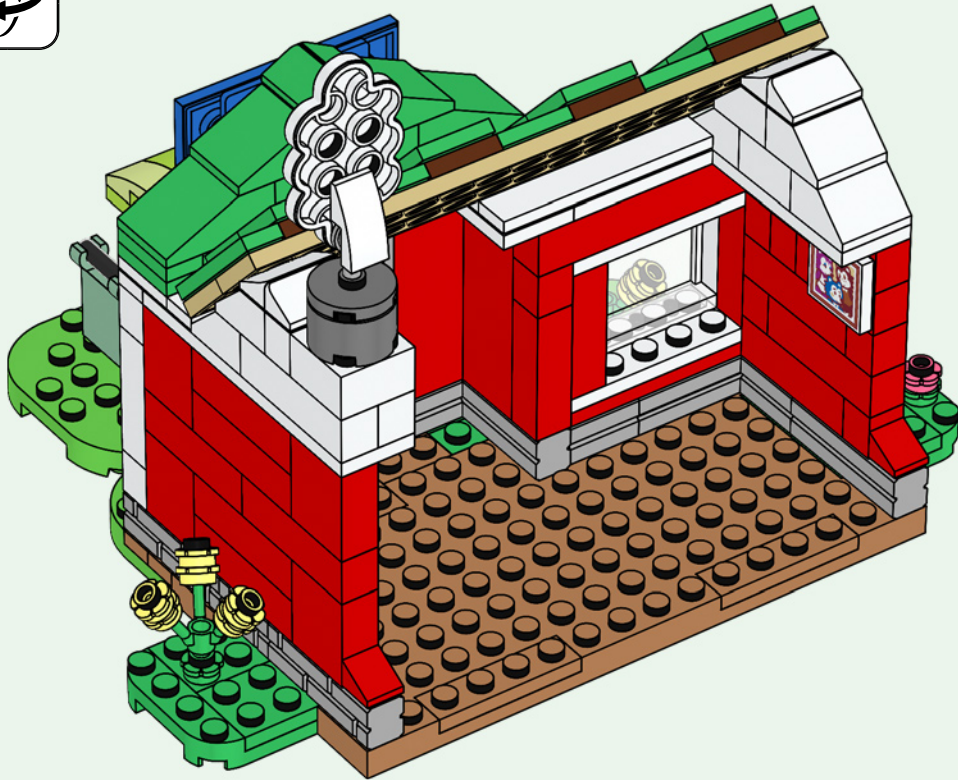

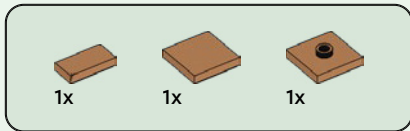

125

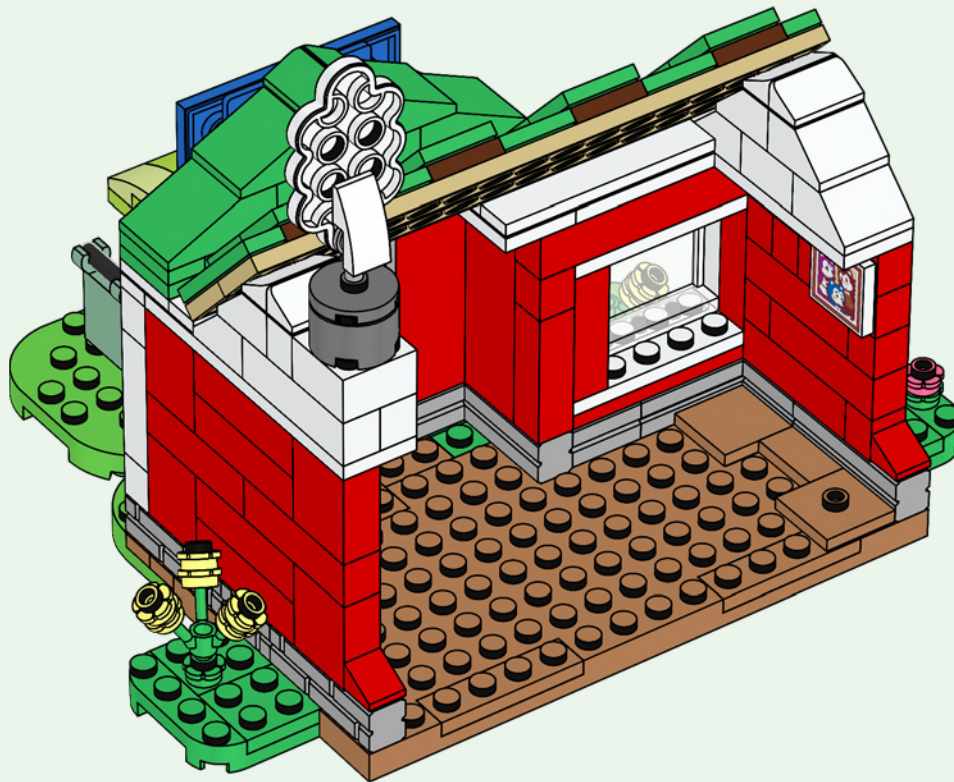

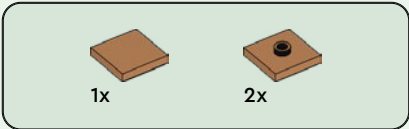

126

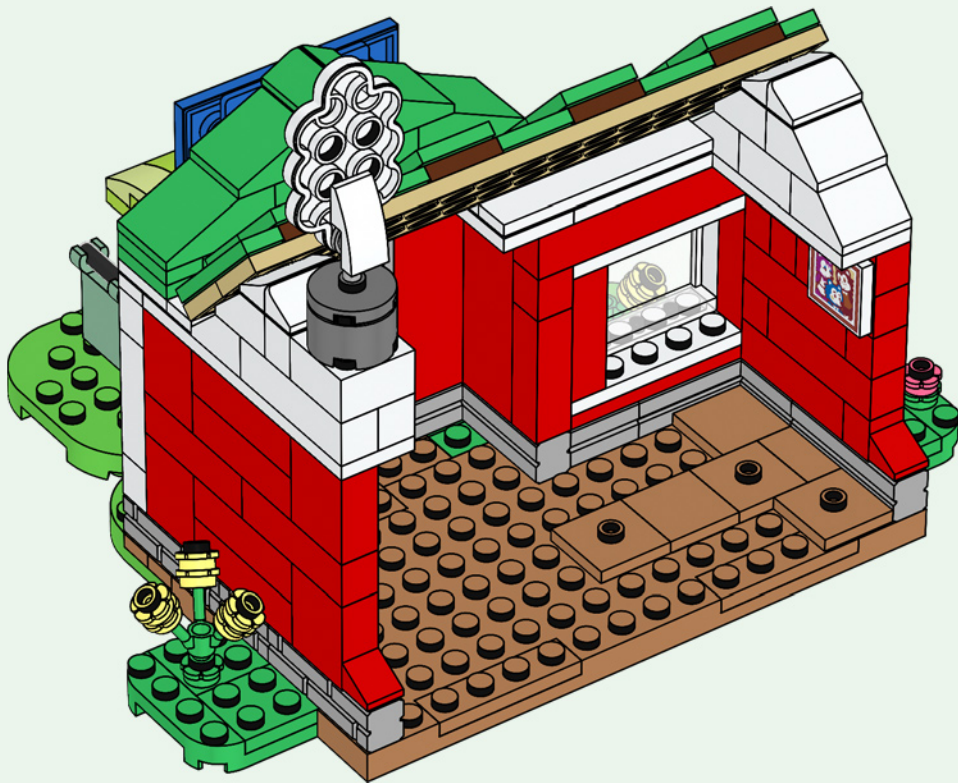



1x

127

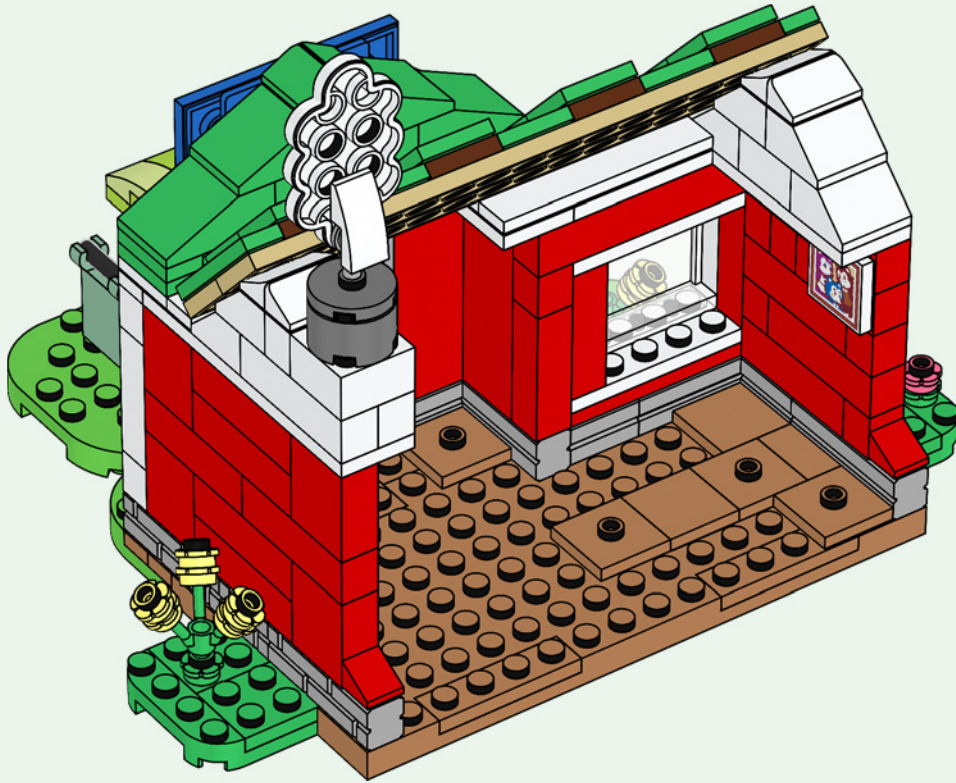

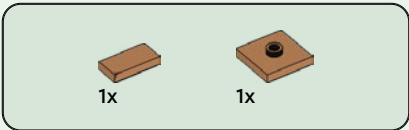

128

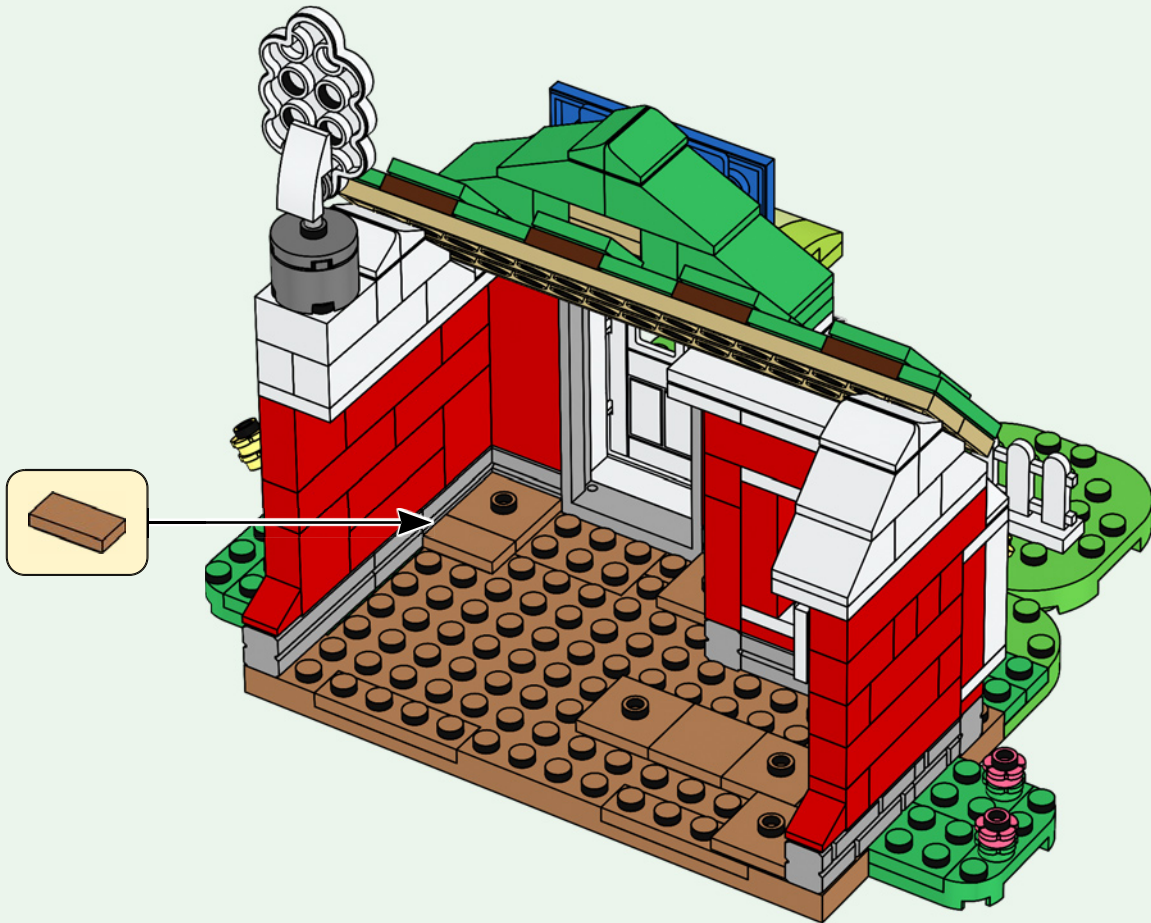



1x



2x

129

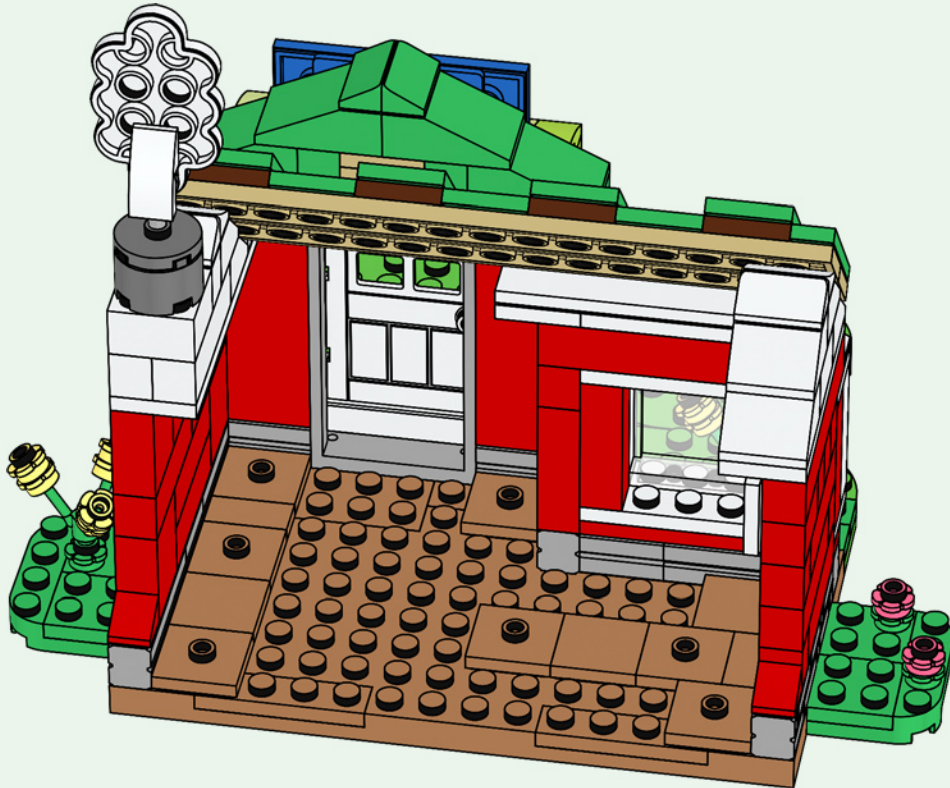

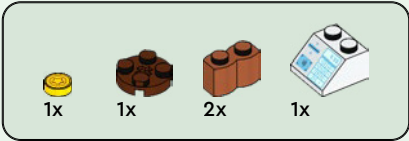

1x

1x

2x

1x

130

1

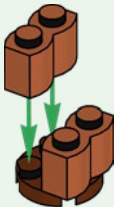

2



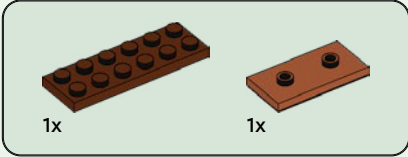
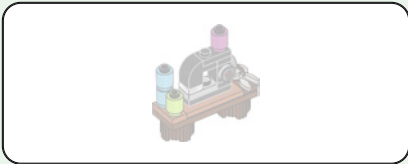

131

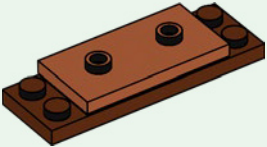

132

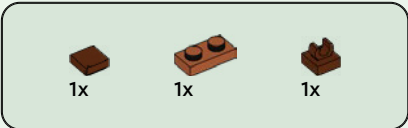
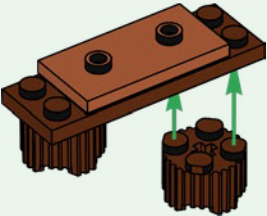

133

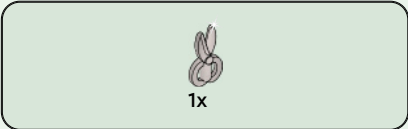
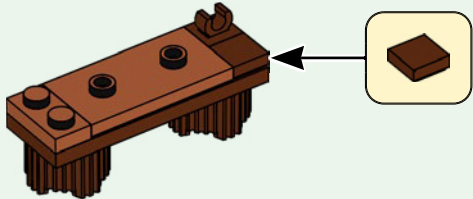

134

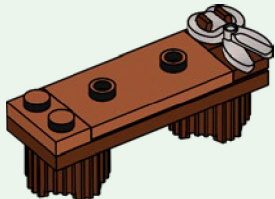



1x



1x

135

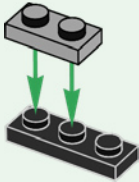

1x

136

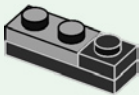

1x



1x

137



1x



1x

138



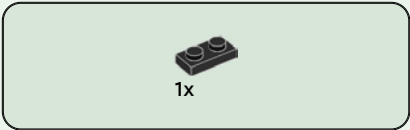

139



140

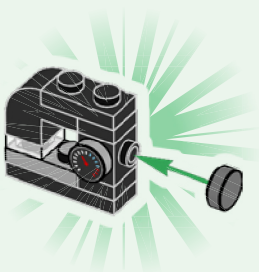

141

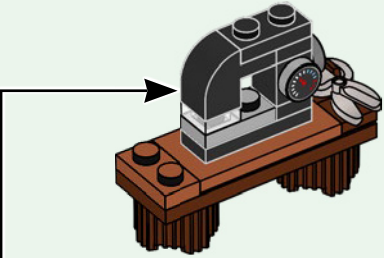



142

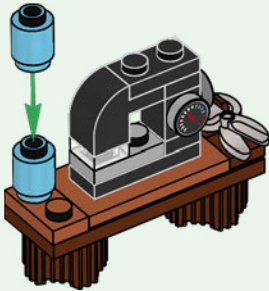

143

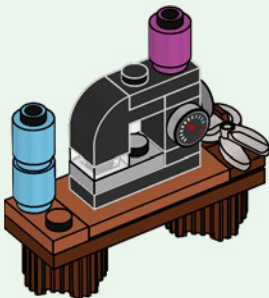

144





1x

145



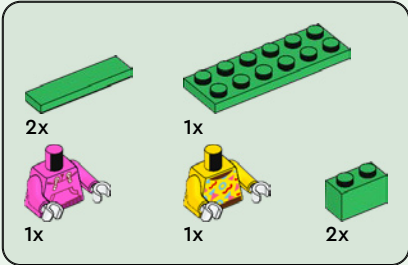
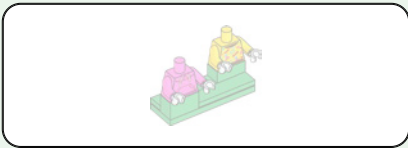

146

1

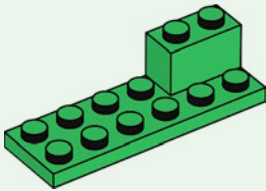

2

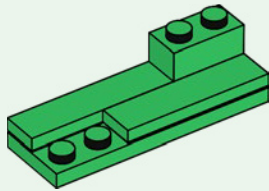

3

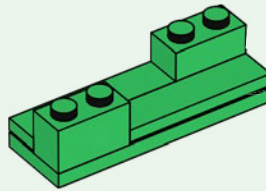

4

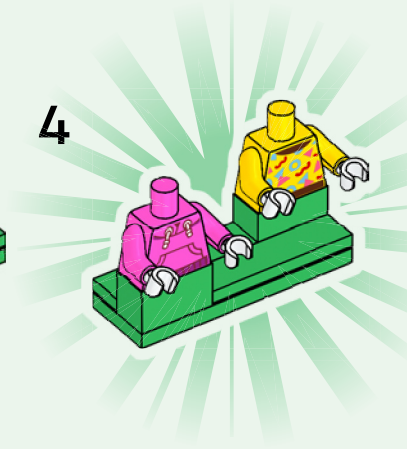

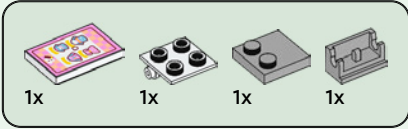

147

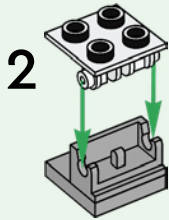
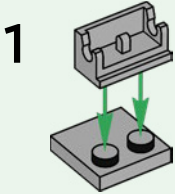

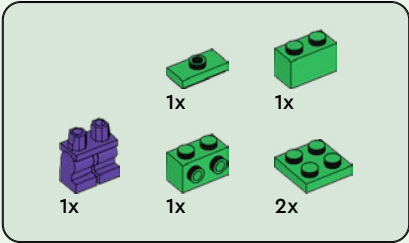
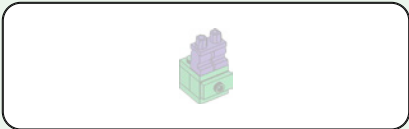

148

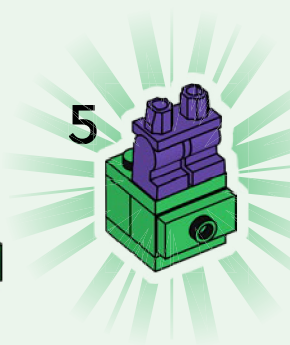
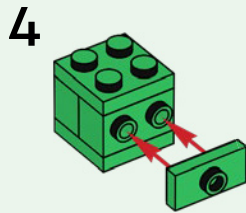
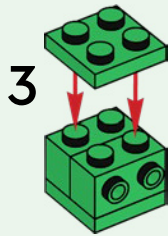
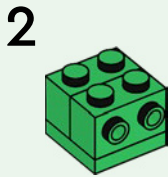
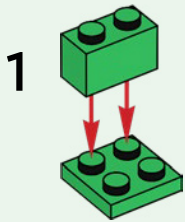





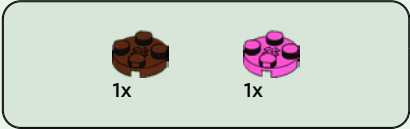

149

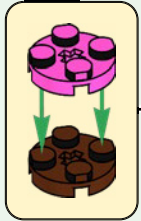



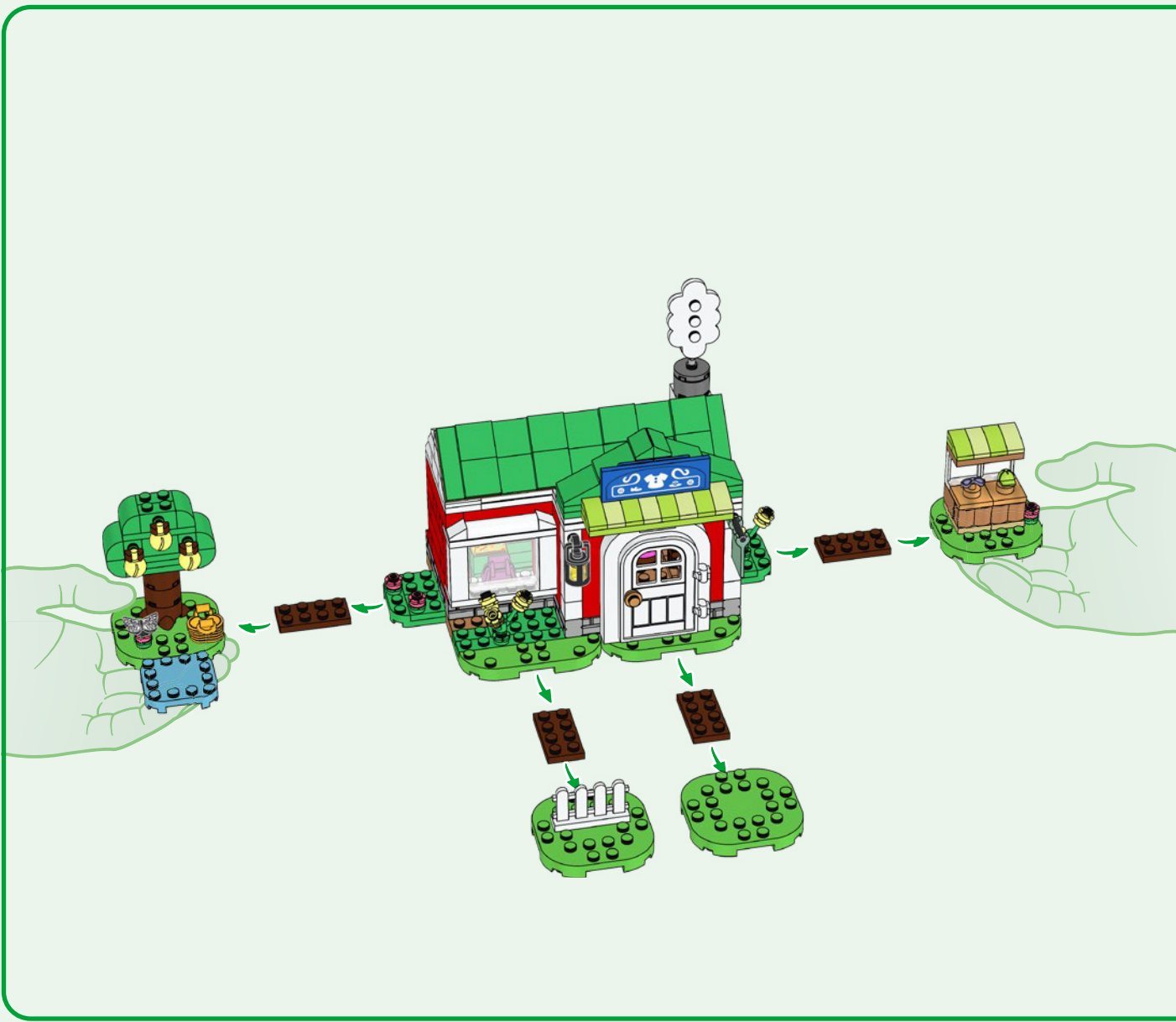



1



2



3

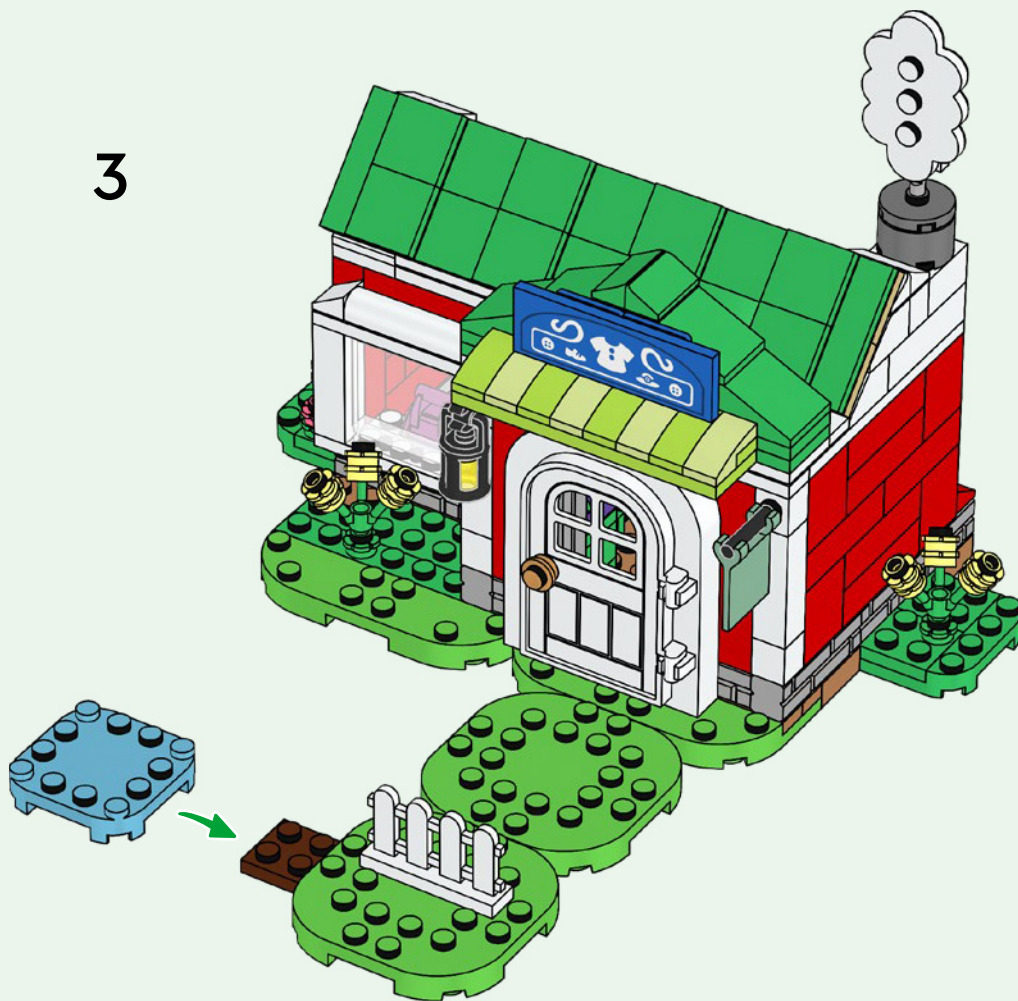

4



1



2



3





Welcome to Animal Crossing



77055

77054

77053





4x
6055541



2x
4558952



2x
4504369



2x
300501



4x
4547489



2x
306901



1x
302301



1x
300401



1x
6172927



1x
6523534



1x
6523549



6x
303901



2x
300301



1x
302201



1x
6329696



1x
4612342



1x
6523550



1x
4141607



2x
371001



1x
6378416



2x
301001



1x
6223667



1x
302001



2x
6126046



1x
6523596



2x
663601

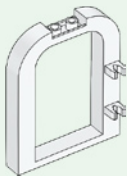

1x
6523470



3x
379501



1x
303401



2x
4113917



2x
4118790

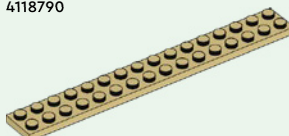

2x
6030980



3x
6061700



7x
300521



2x
4504379



4x
4143832



1x
6019155



3x
4212414



9x
301021



1x
366621



2x
300921

1x
6439039

1x
6227901

2x
302426

1x
6187572

1x
6475767

1x
302326

1x
6184784

1x
6093525

1x
362326

6x
6135287

2x
6385644

2x
300528

2x
4558593

2x
6000071

2x
6269971

4x
4107736

4x
6270719

1x
6469903

3x
6146227

4x
302328

1x
6129807

1x
6092586

2x
6469900

3x
302228

12x
4107762

4x
302128

4x
6226928

2x
371028

4x
243128

1x
6021539

4x
302028

2x
6425980

1x
379528

2x
346028

1x
383228

4x
6301631

2x
6340682

2x
4666352

1x
4570877

1x
6288614

1x
6513962

2x
6253231

1x
6514156

1x
6514236

1x
4212454

1x
6509777

6x
6069006

1x
6536171



1x
4187743

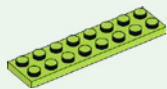

2x
6440107



1x
6172869



1x
6395609



1x
6096991



1x
6526488



1x
6096091



3x
6439053



1x
4211288



1x
6348057



2x
6036503



2x
4211159



2x
4211166



1x
6468829



1x
4216695



8x
4211186



1x
4211247



1x
6329581



1x
6227897



5x
6000066



1x
4211398



2x
6326078



1x
4211469



1x
4244627



1x
6212077



5x
6314891

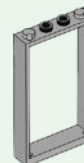

1x
6262961



1x
6326495



1x
6528454



1x
6284596



1x
4249139



1x
6115080



12x
6426463



1x
6451205



3x
6492704



1x
6509241



1x
4523159



2x
6186672



2x
6186383



2x
4651231



2x
6021997



2x
6218360



7x
6102994



3x
6102990



2x
6167700



2x
6093494



1x
6135191



1x
6347603

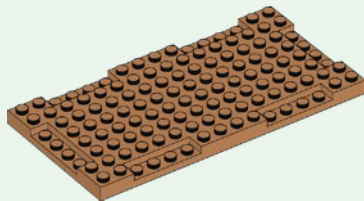

1x
6445924



1x
6469535



1x
6533556



1x
6528452



1x
4543857



2x
6133720



1x
6529181



1x
6523548



1x
6096993



2x
4620909



1x
6469904



1x
6529184



6x
6443914



4x
6295242



1x
6523535



 [LEGO.com/service](https://www.lego.com/service)

YOU COULD **WIN**



Scan this QR code or go to **LEGO.COM/PRODUCTFEEDBACK** and give us your short feedback about this LEGO® set for a chance to win a cool LEGO prize.

Terms and Conditions apply*

EN: YOU COULD WIN. Terms and Conditions apply* **DE: Du könntest GEWINNEN.** Es gelten die Teilnahmebedingungen* **FR: Tu pourrais GAGNER.** Des conditions s'appliquent* **IT: Potresti VINCERE tu.** Termini e condizioni sono applicabili* **ES: Puedes GANAR.** Aplican términos y condiciones* **PT: Poderá GANHAR.** Aplicam-se termos e condições* **ZH: 轻松获奖. 条款和条件适用*** **PL: Szansa na WYGRANĄ.** Obowiązują warunki korzystania* **CS: Máte šanci VYHRÁT.** Platí všeobecné smluvní podmínky* **SK: Máte šancu VYHRAŤ.** Platia všeobecné zmluvné podmienky* **HU: TE IS NYERHETSZ.** Felhasználási feltételek érvényesek* **RO: Ai putea CÂȘTIGA.** Se aplică termeni și condiții* **BG: Можете да СПЕЧЕЛИТЕ.** Има определени правила и условия* **LV: Tu vari LAIMĒT.** Ir spēkā noteikumi un nosacījumi.* **ET: Sul on võimalus VÕITA.** Kehtivad tingimused* **LT: Jūs galite LAIMĖTI.** Taikomos sąlygos*

*[LEGO.com/productfeedback-terms](https://www.lego.com/productfeedback-terms)