



SUPER MARIO

72036



4

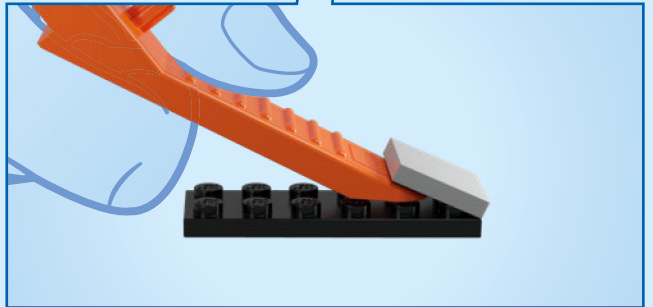
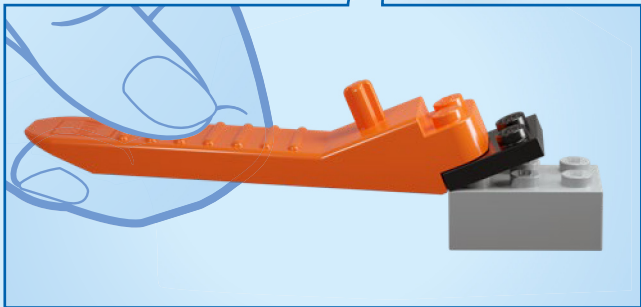
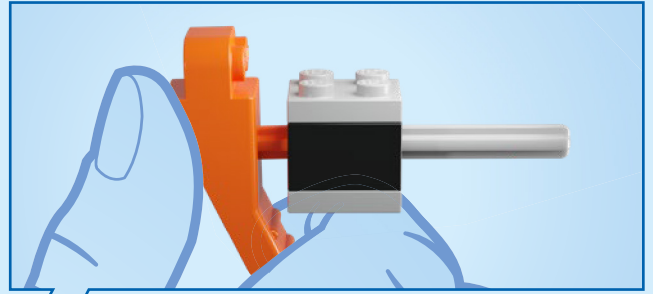
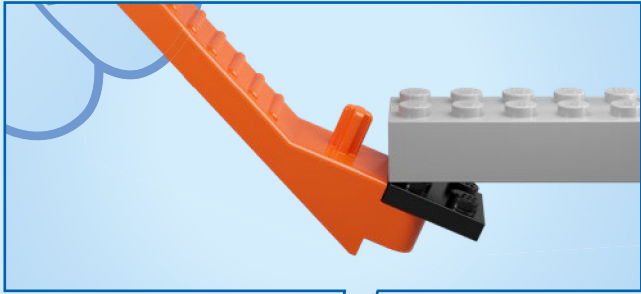



1

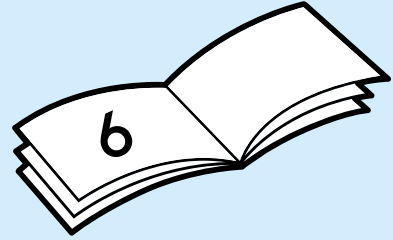
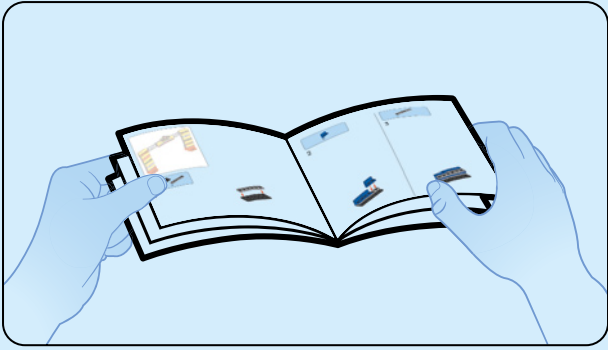

1

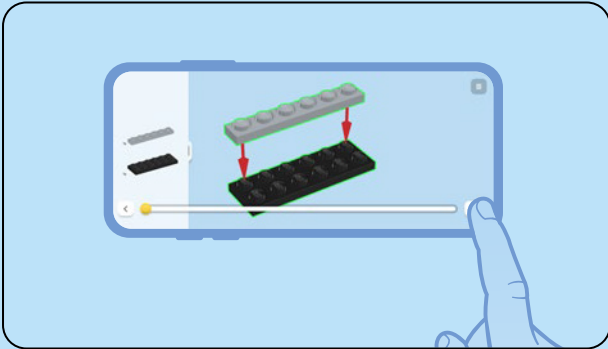

2



3

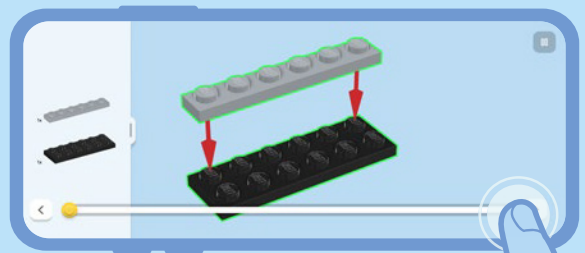

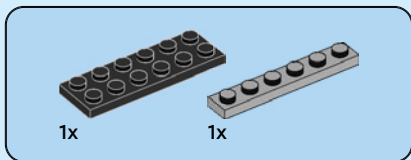
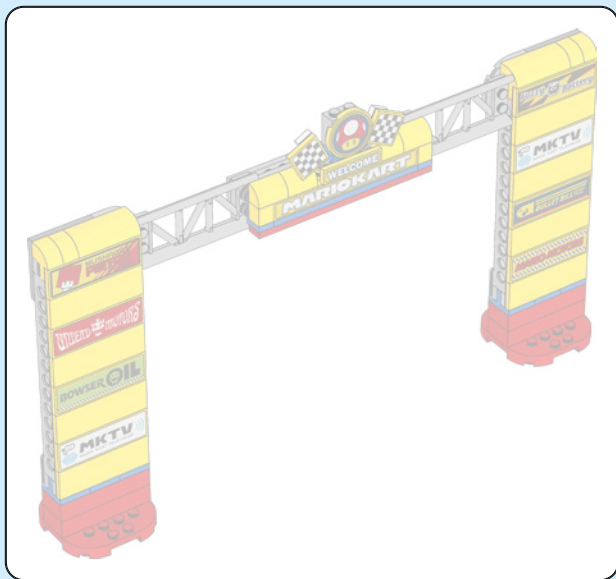

1

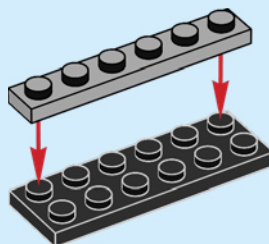

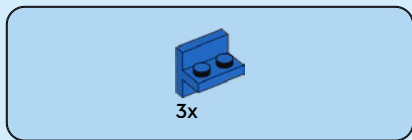

2

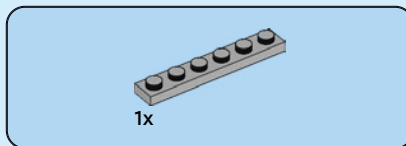
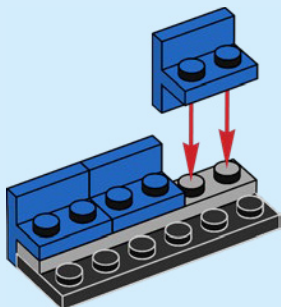

3

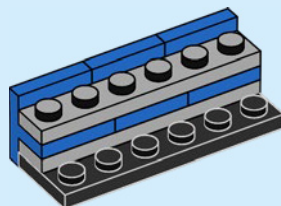

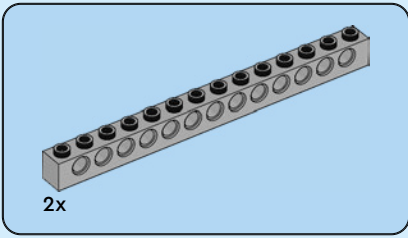

4

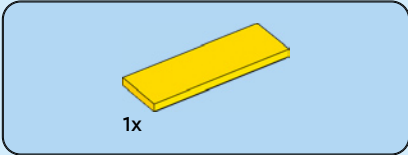
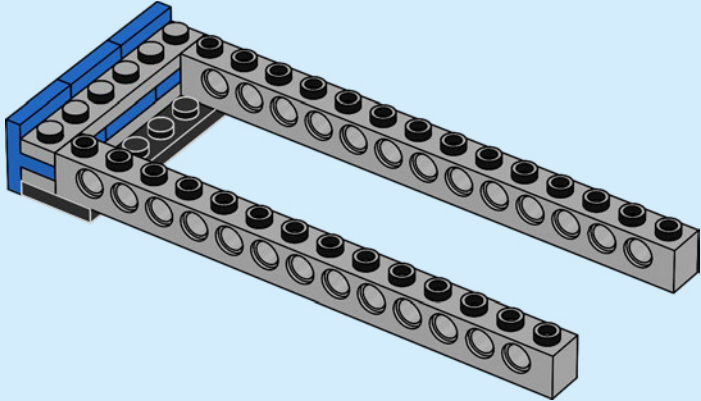

5

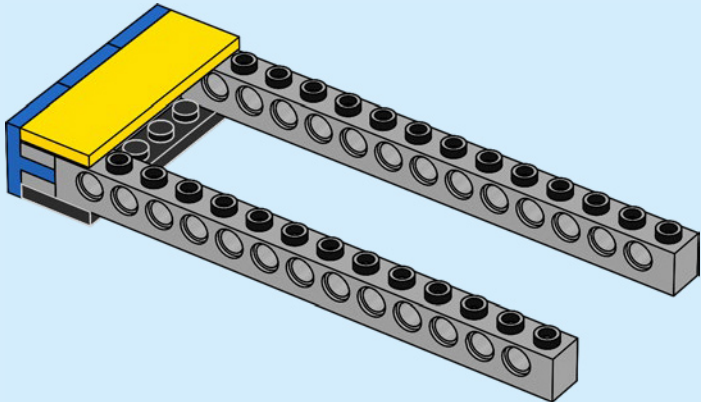

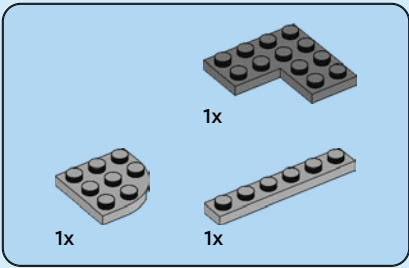

6

1

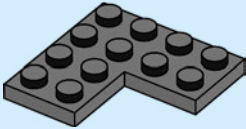

2

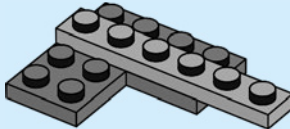

3

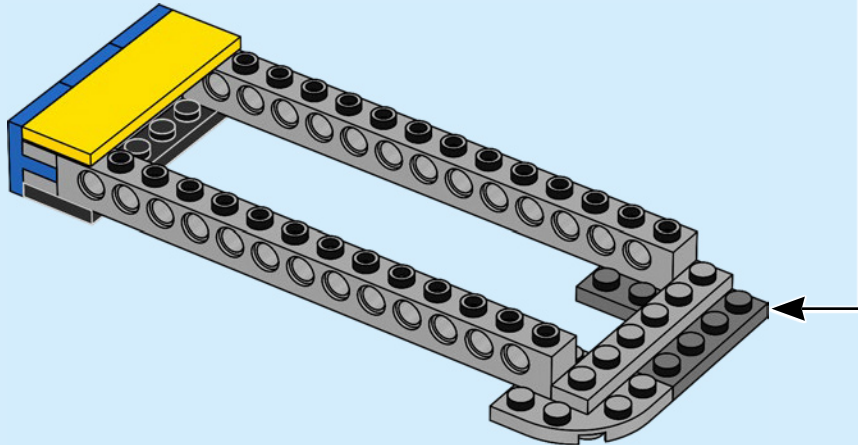
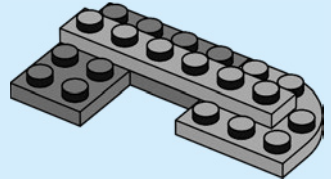

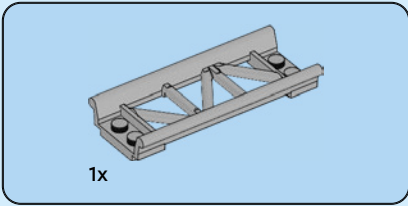

7

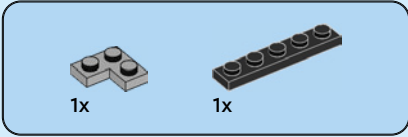
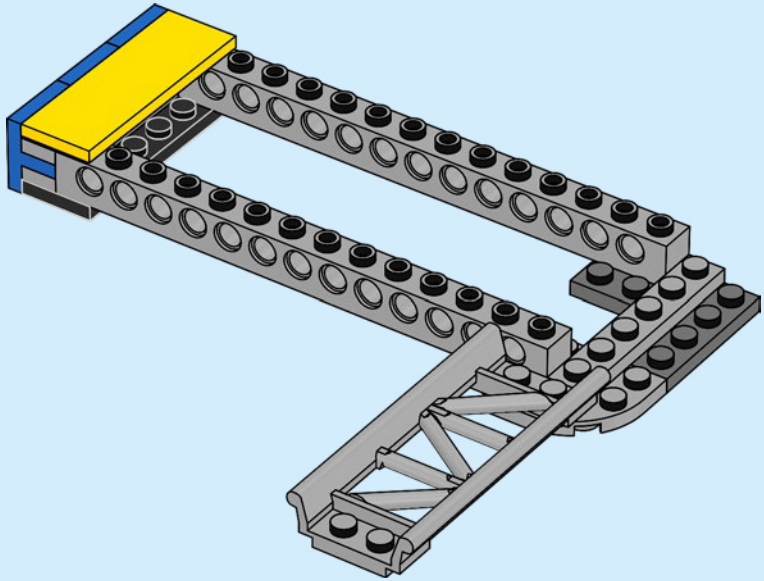

8

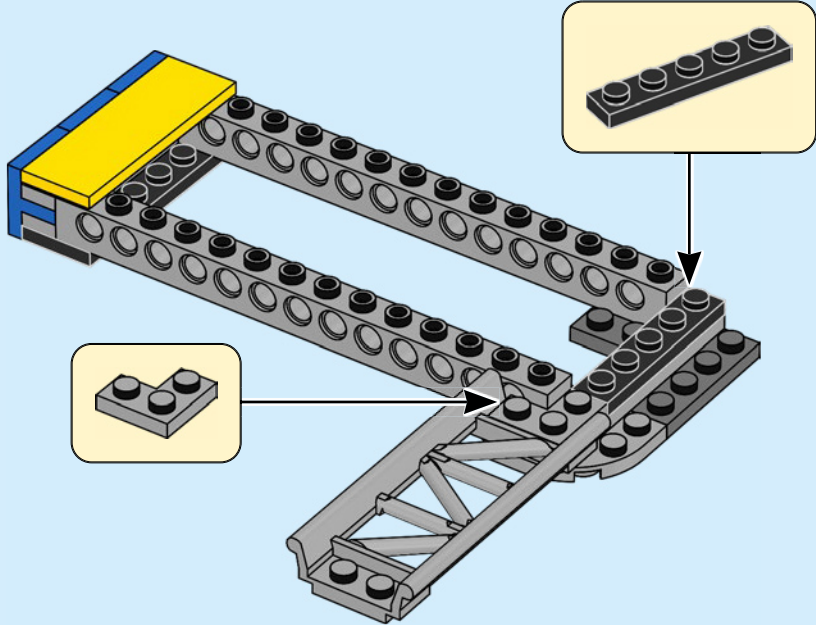

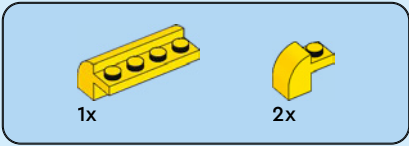

9

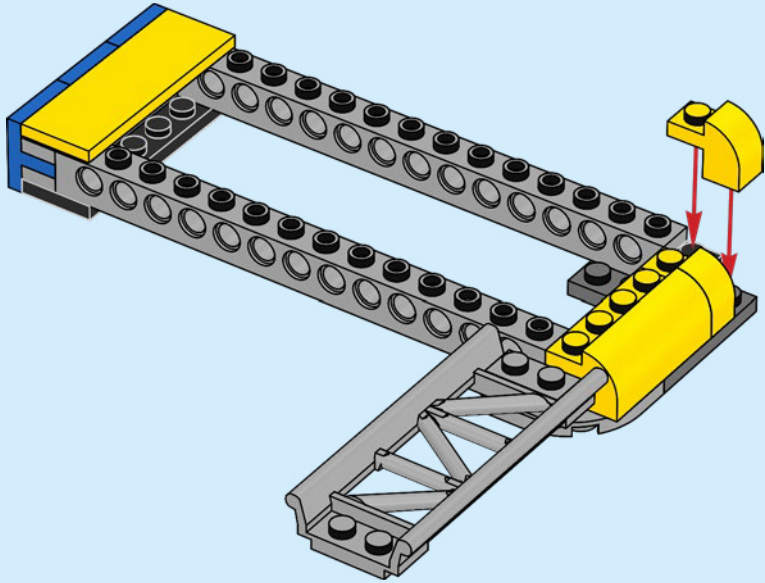

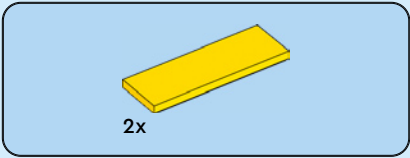

10

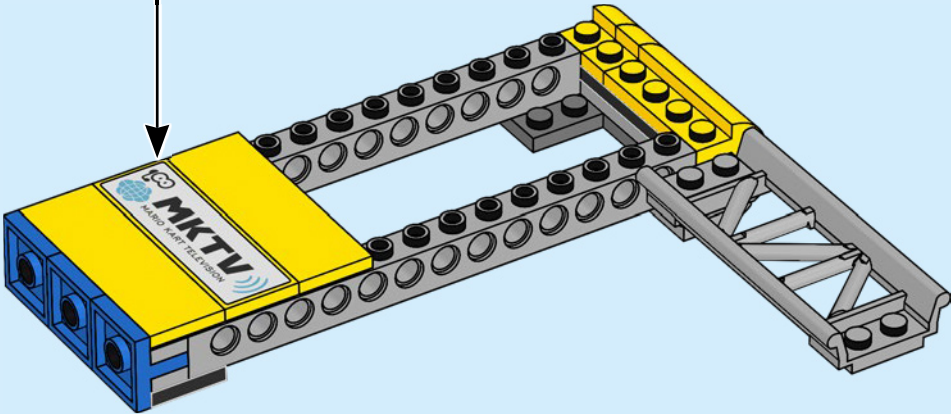
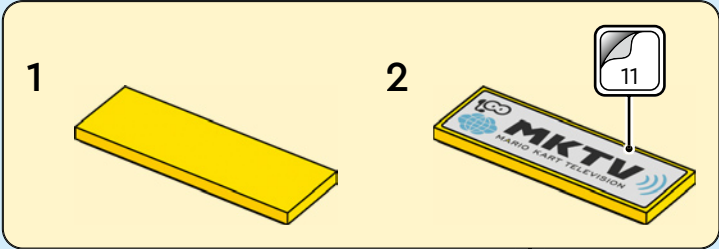

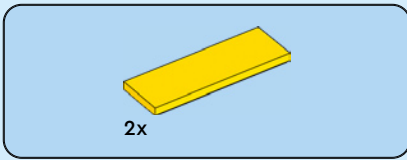

11

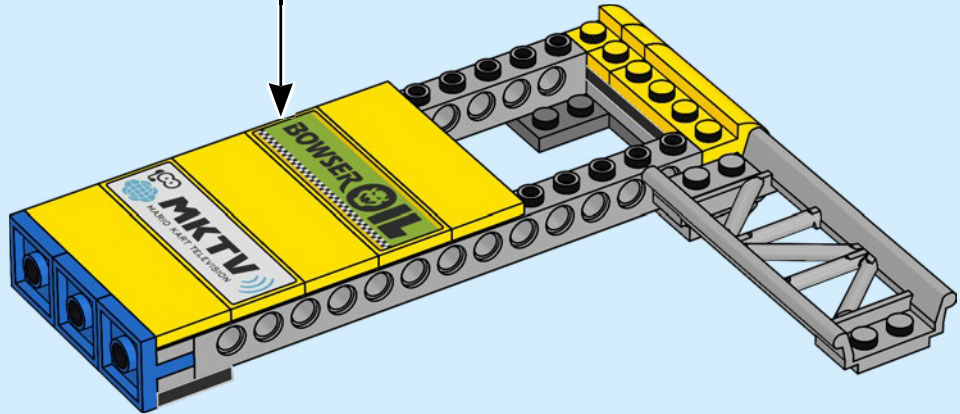
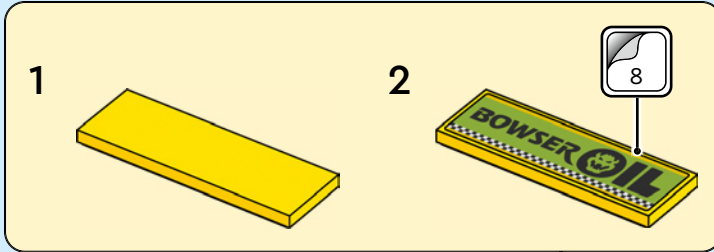

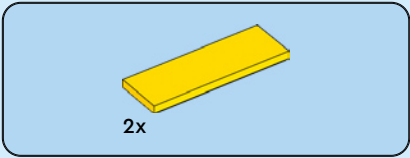

12

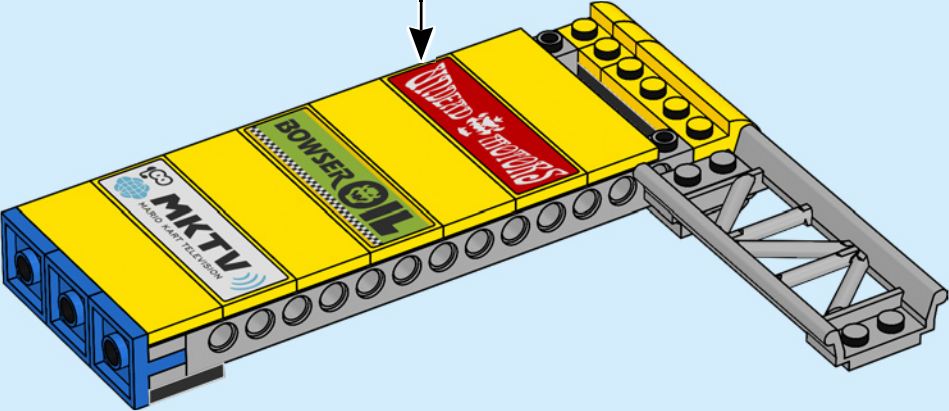
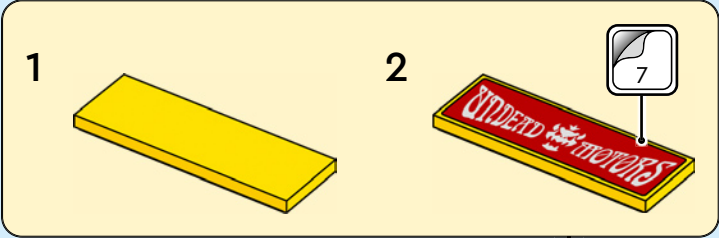

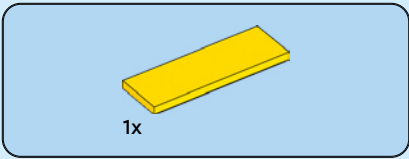

13

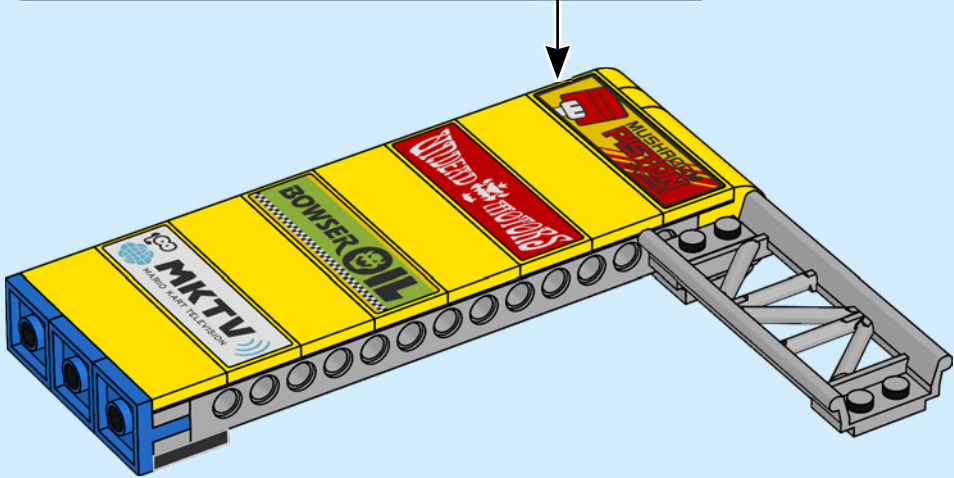
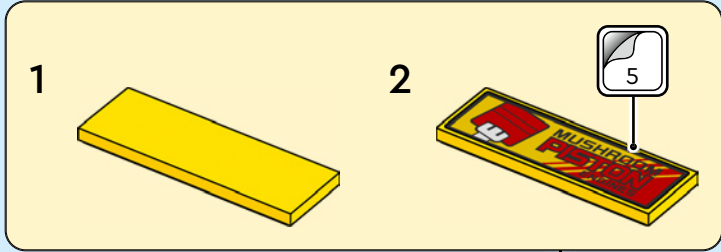

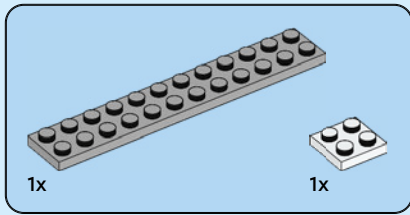

14

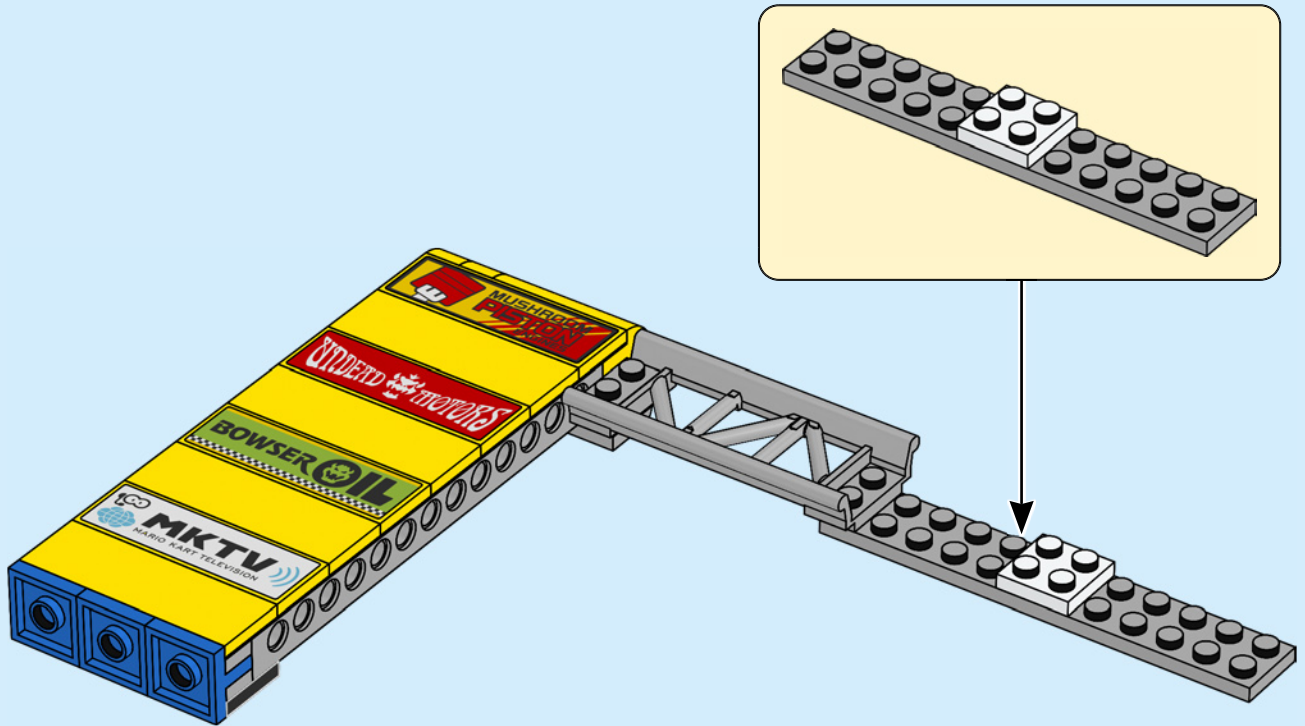

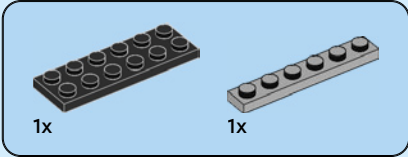
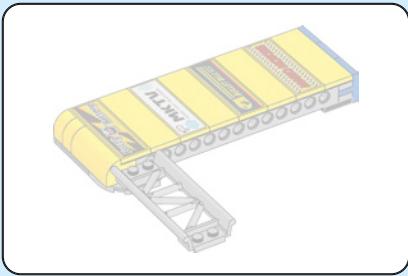

15

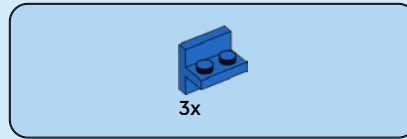
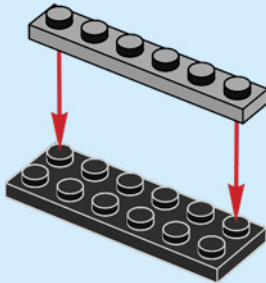

16

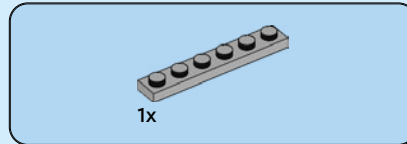
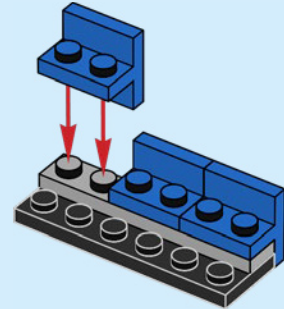

17

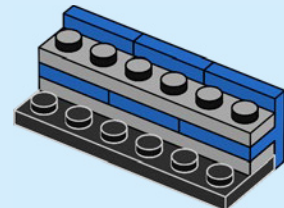

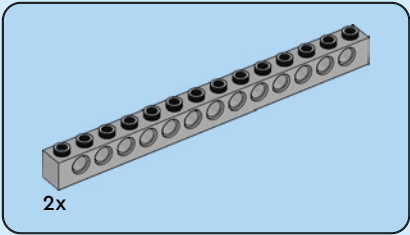

18

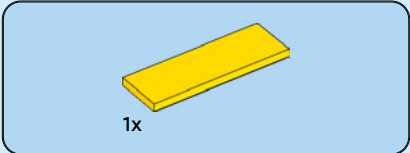
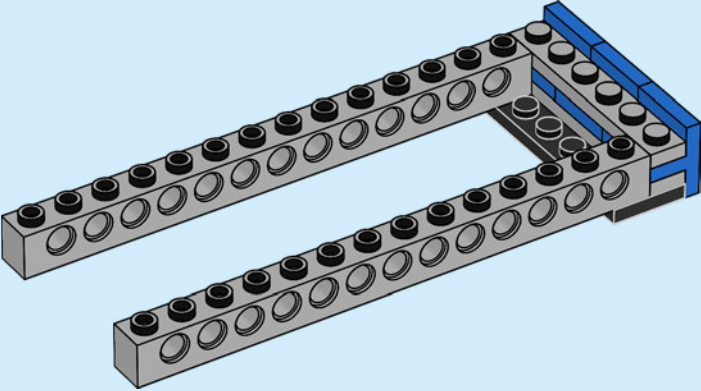

19

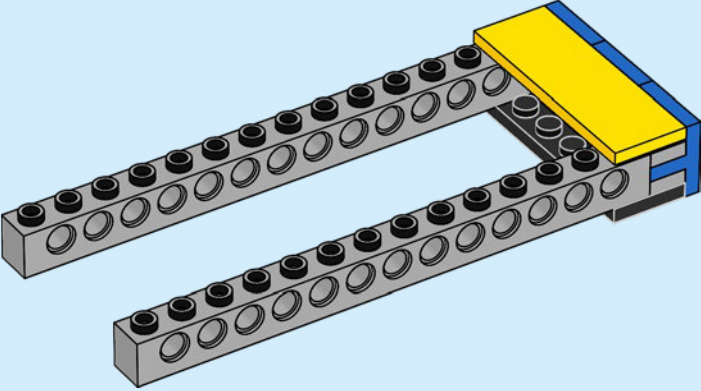

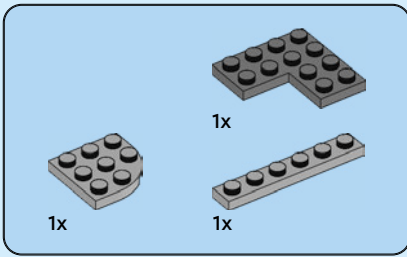

20

1

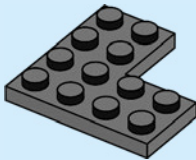

2

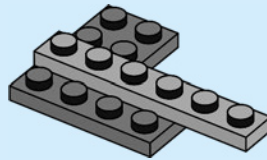

3

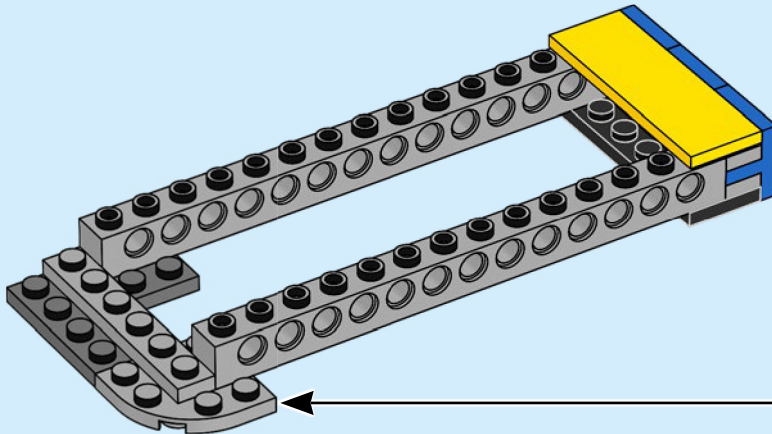
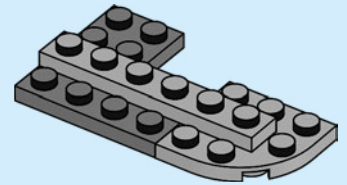

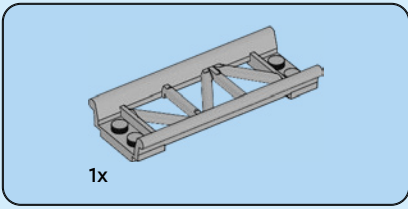

21

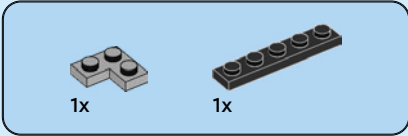
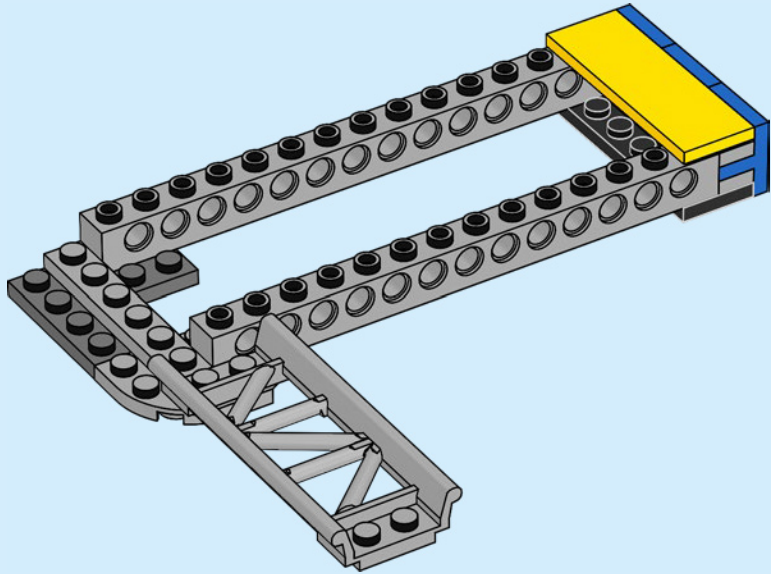

22

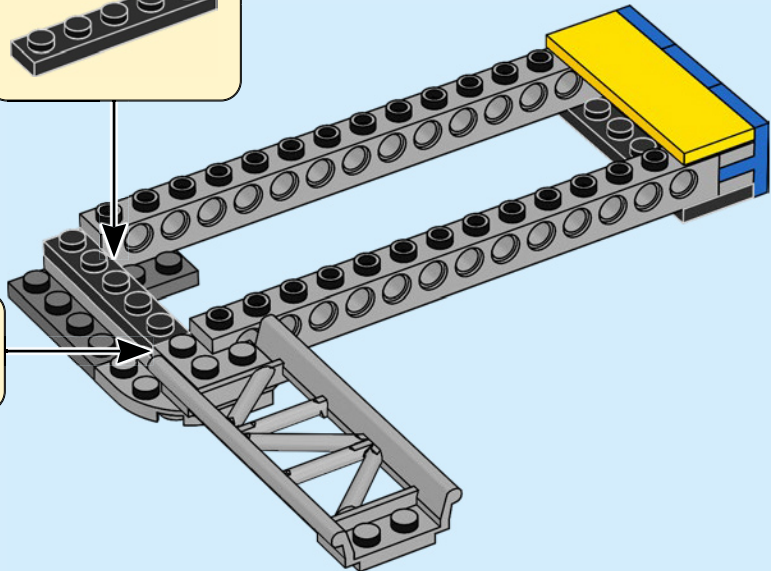
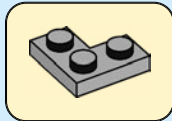
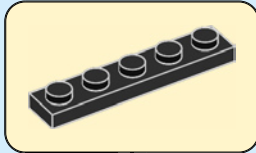

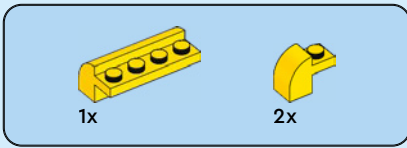

23

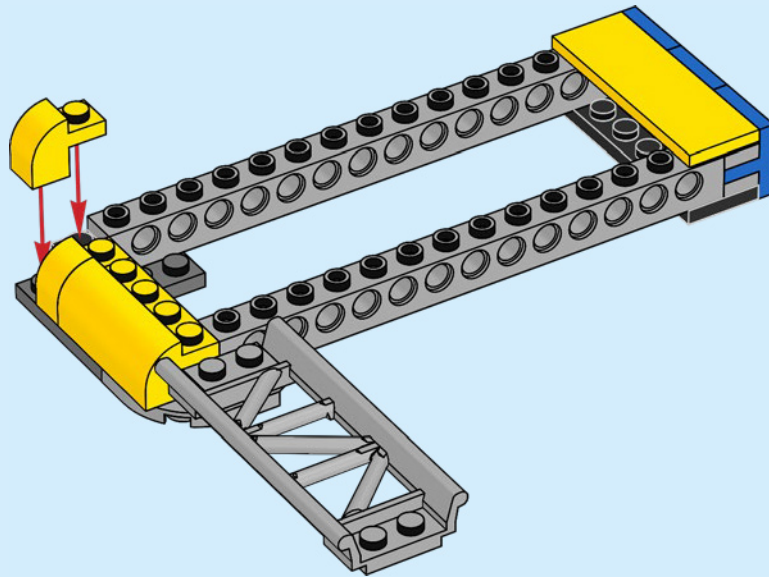

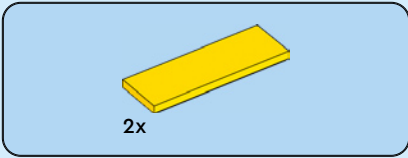

24

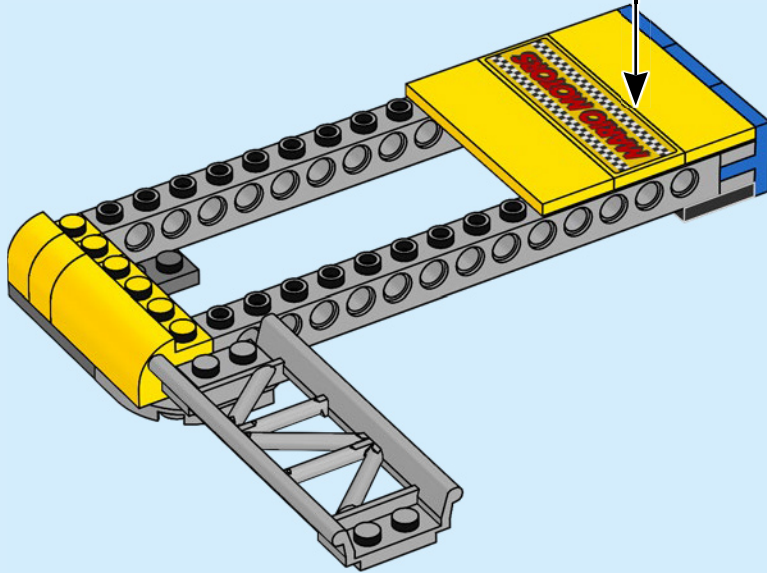
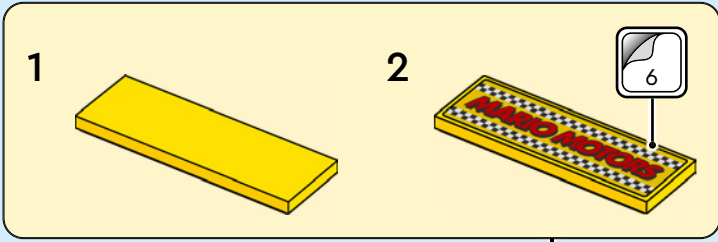

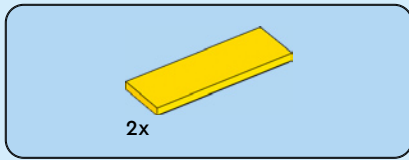

25

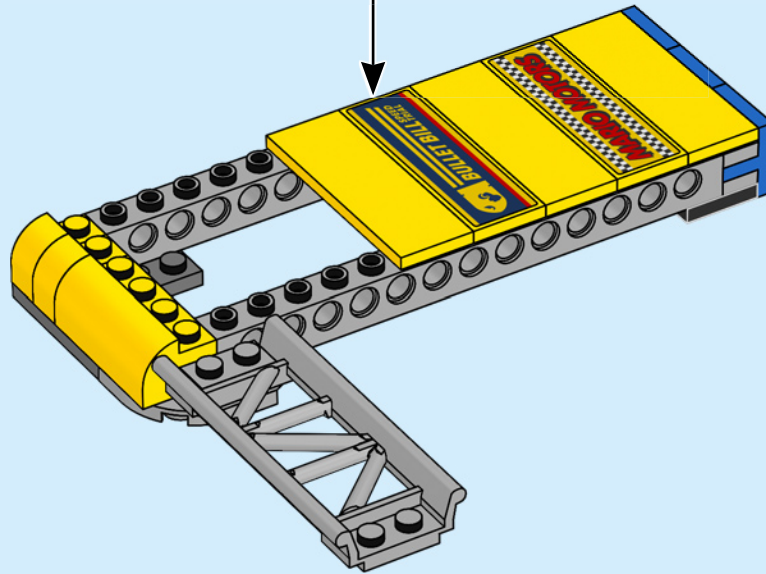
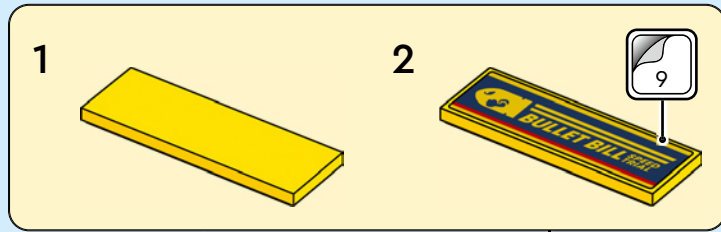

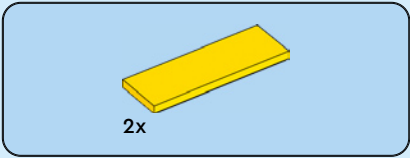

26

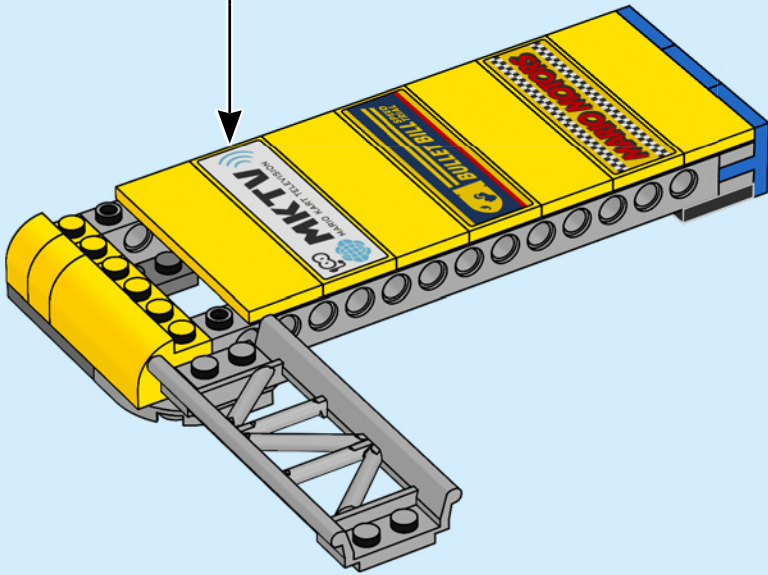
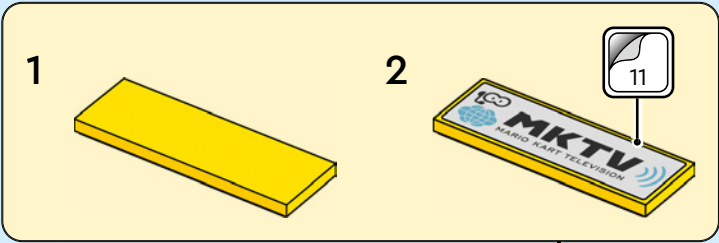

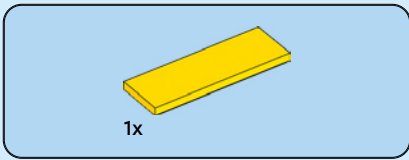

27

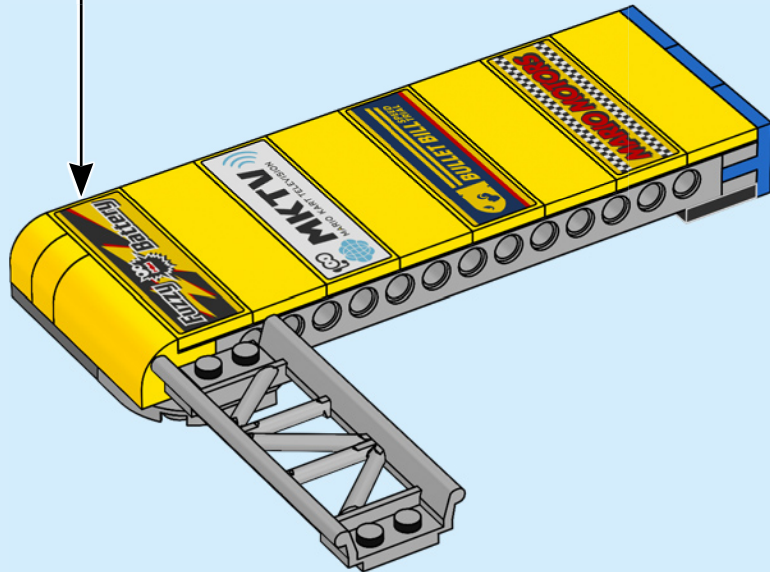
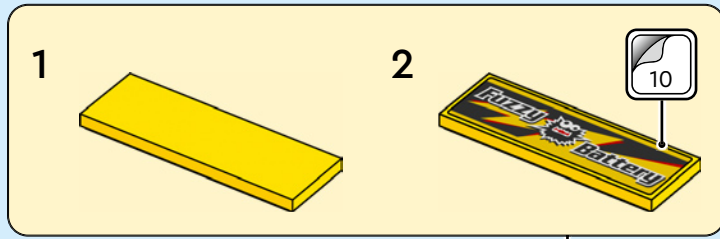

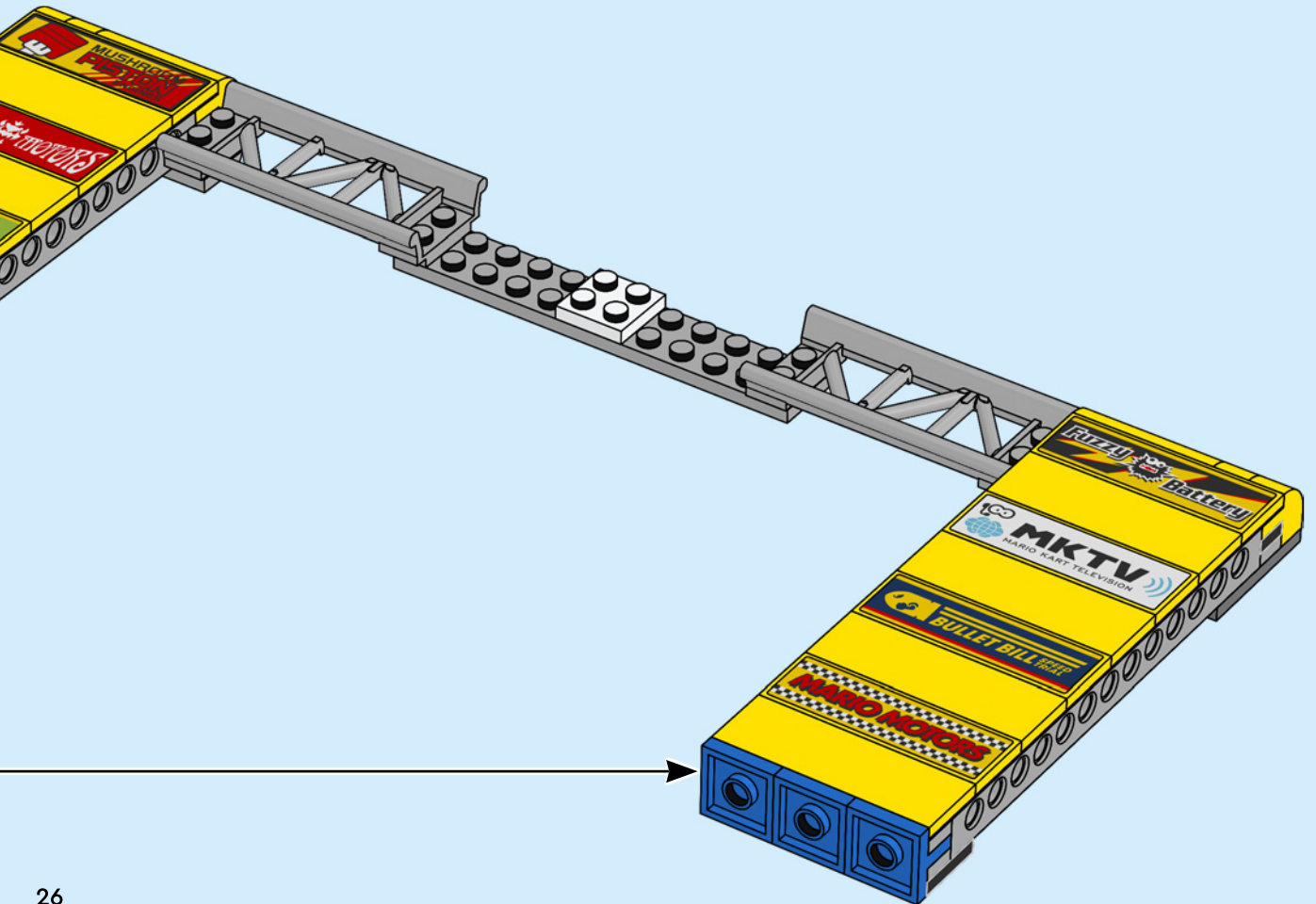

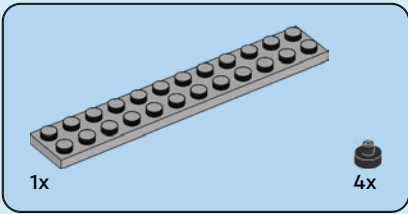

29

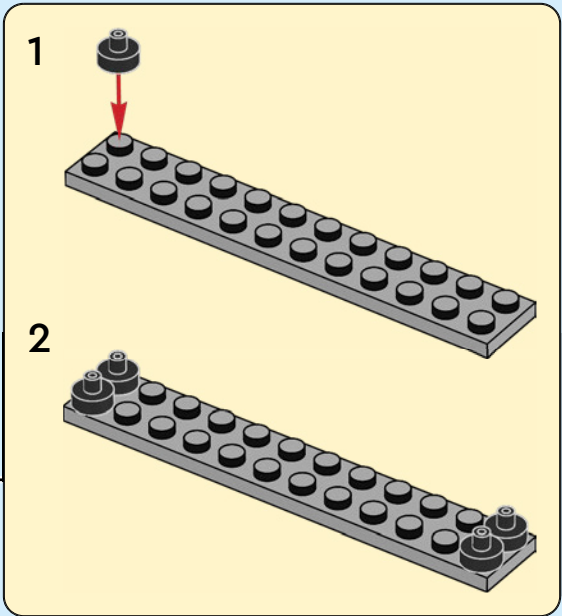
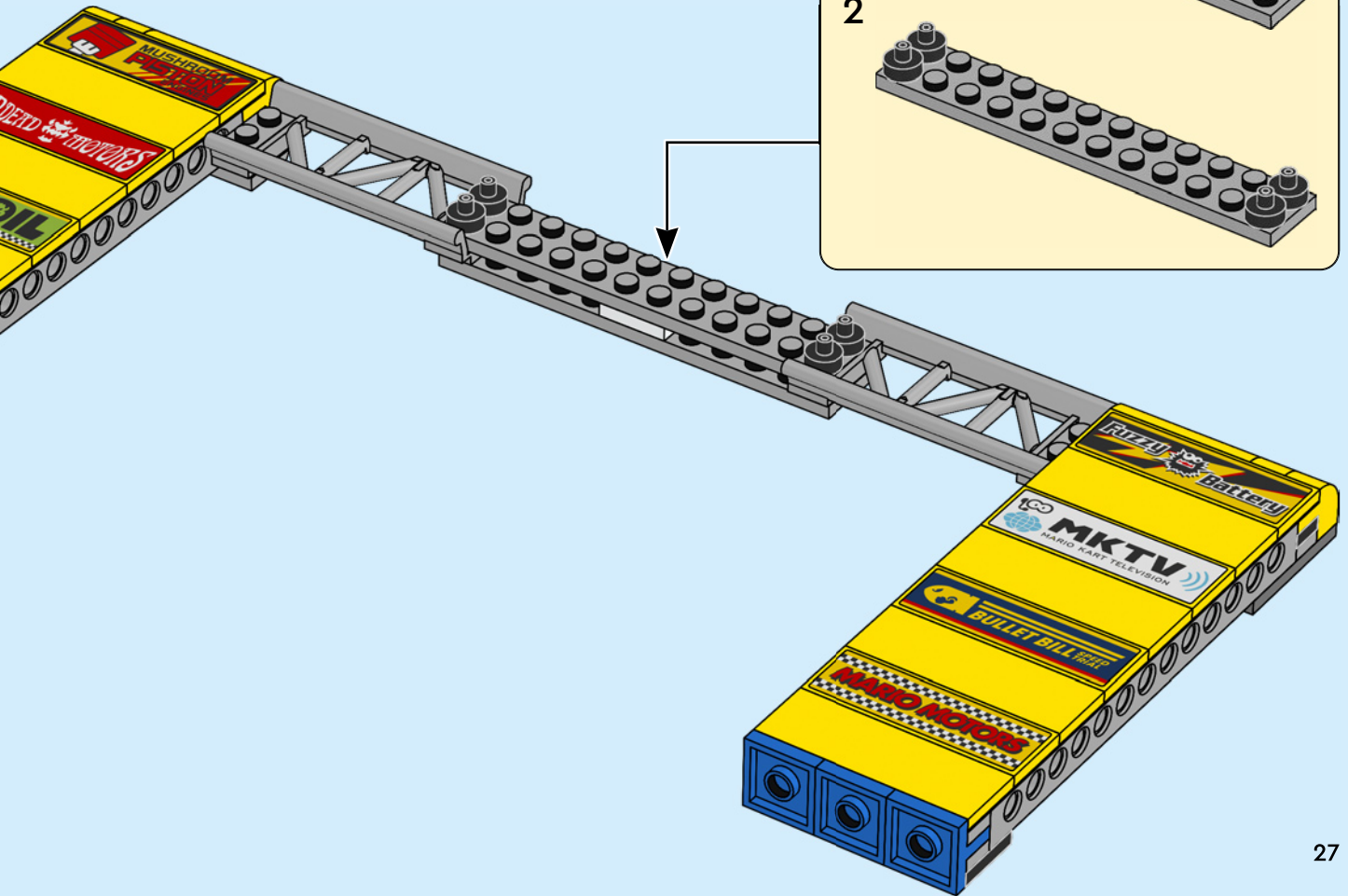

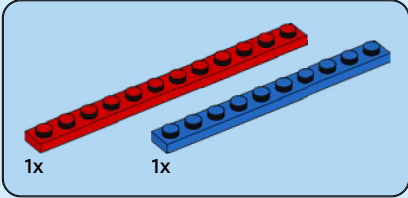

30

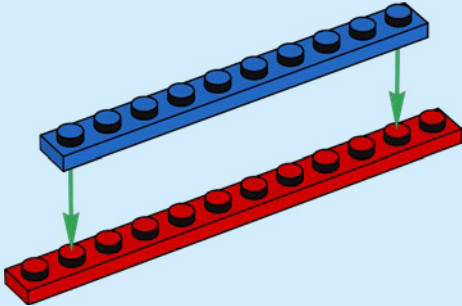

31

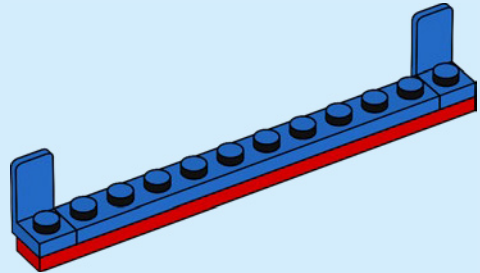

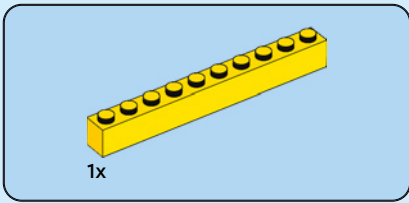

32

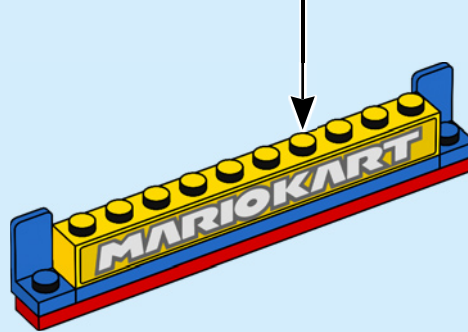
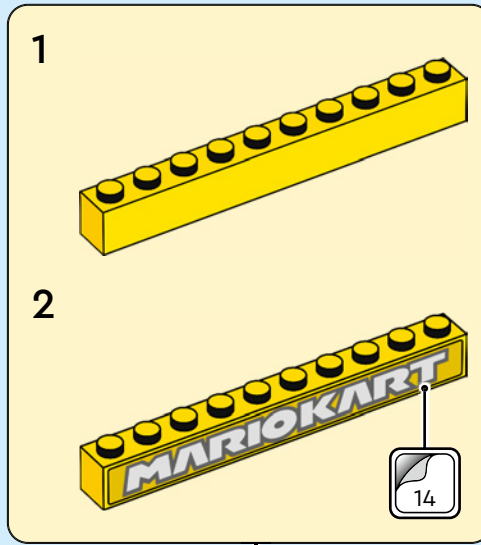



2x

33

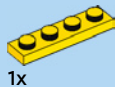
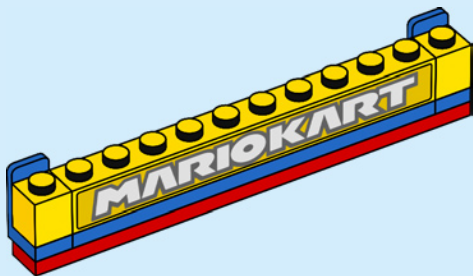

1x



4x

34

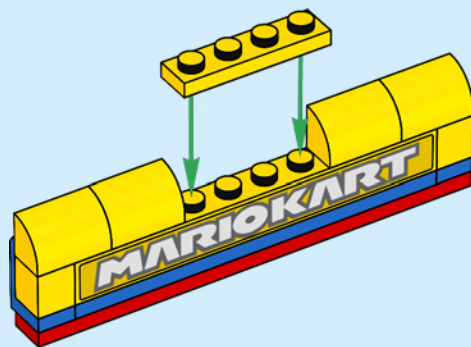



35

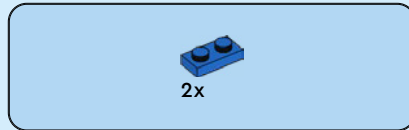
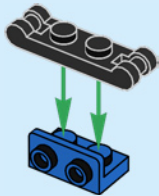

36

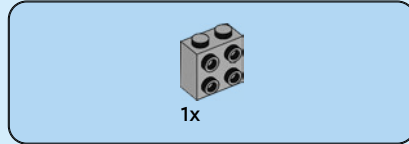
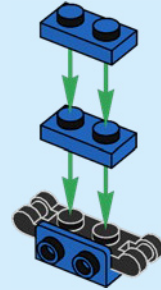

37

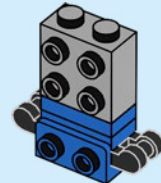

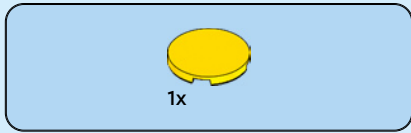

38

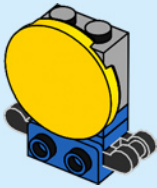

39

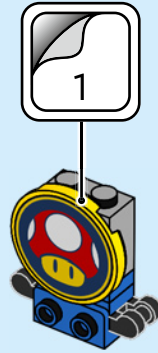

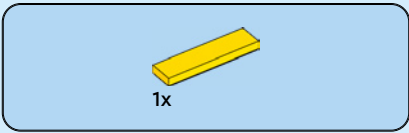

40

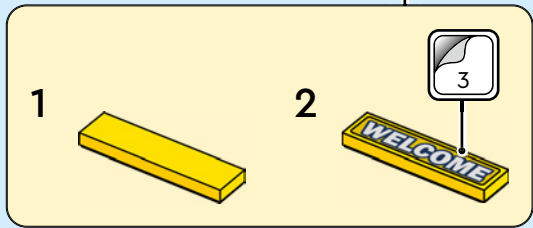

41

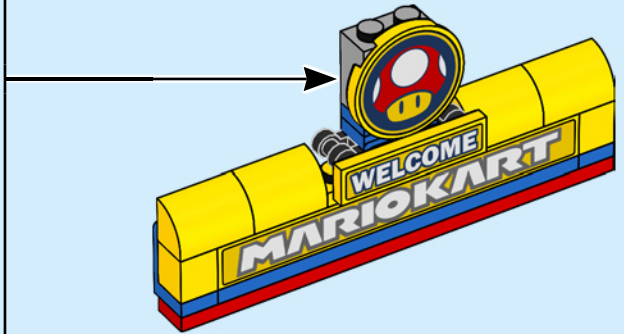

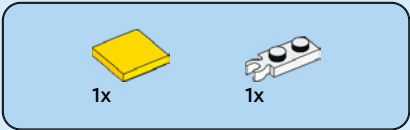

42

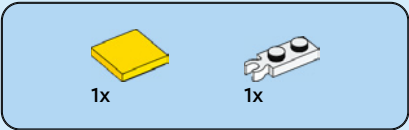
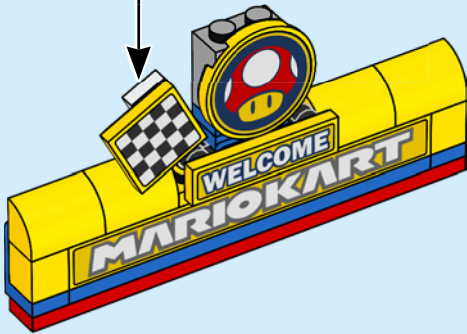
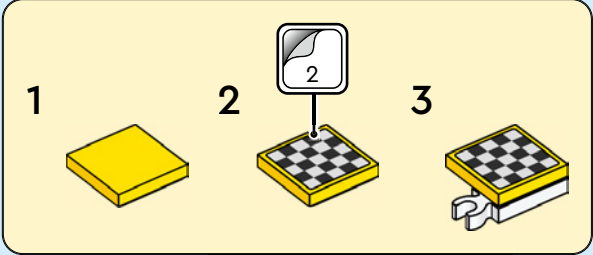

43

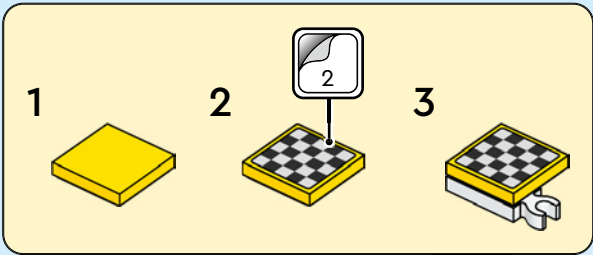

44

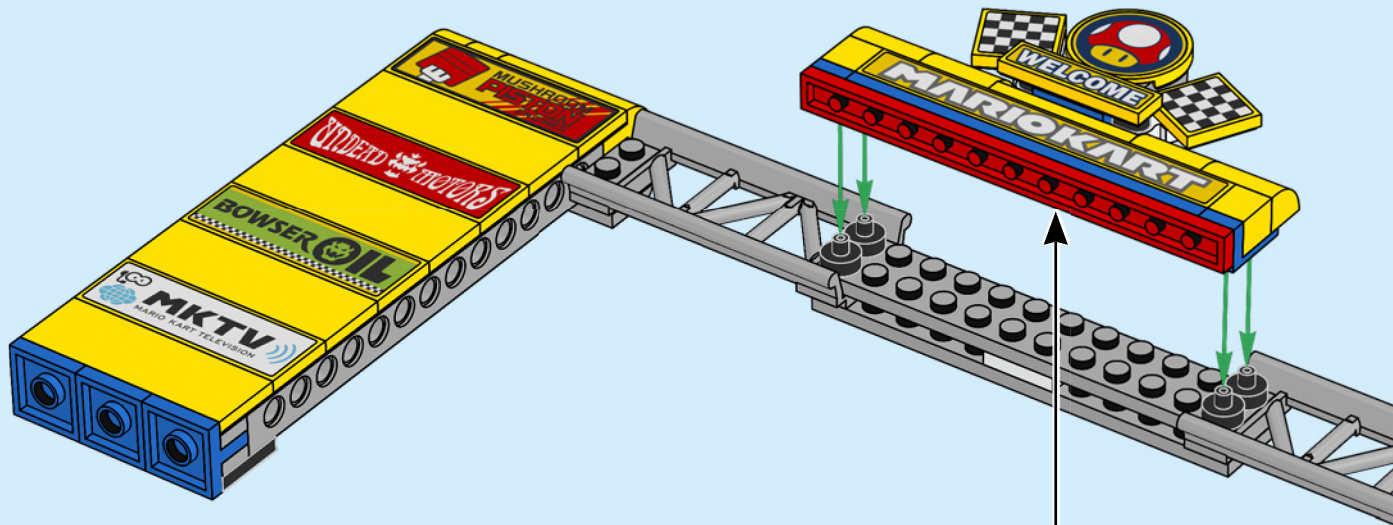

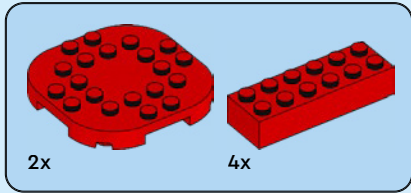
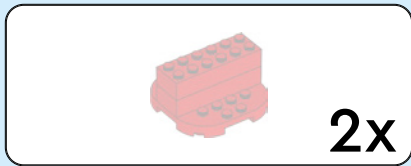

45

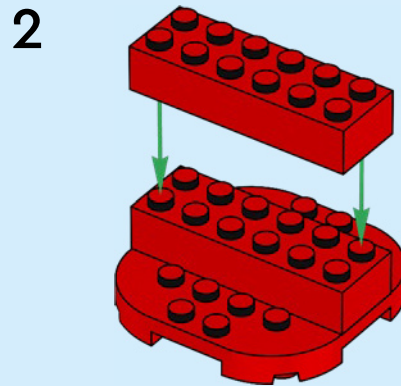
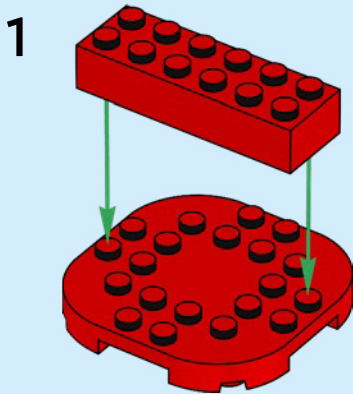

2x

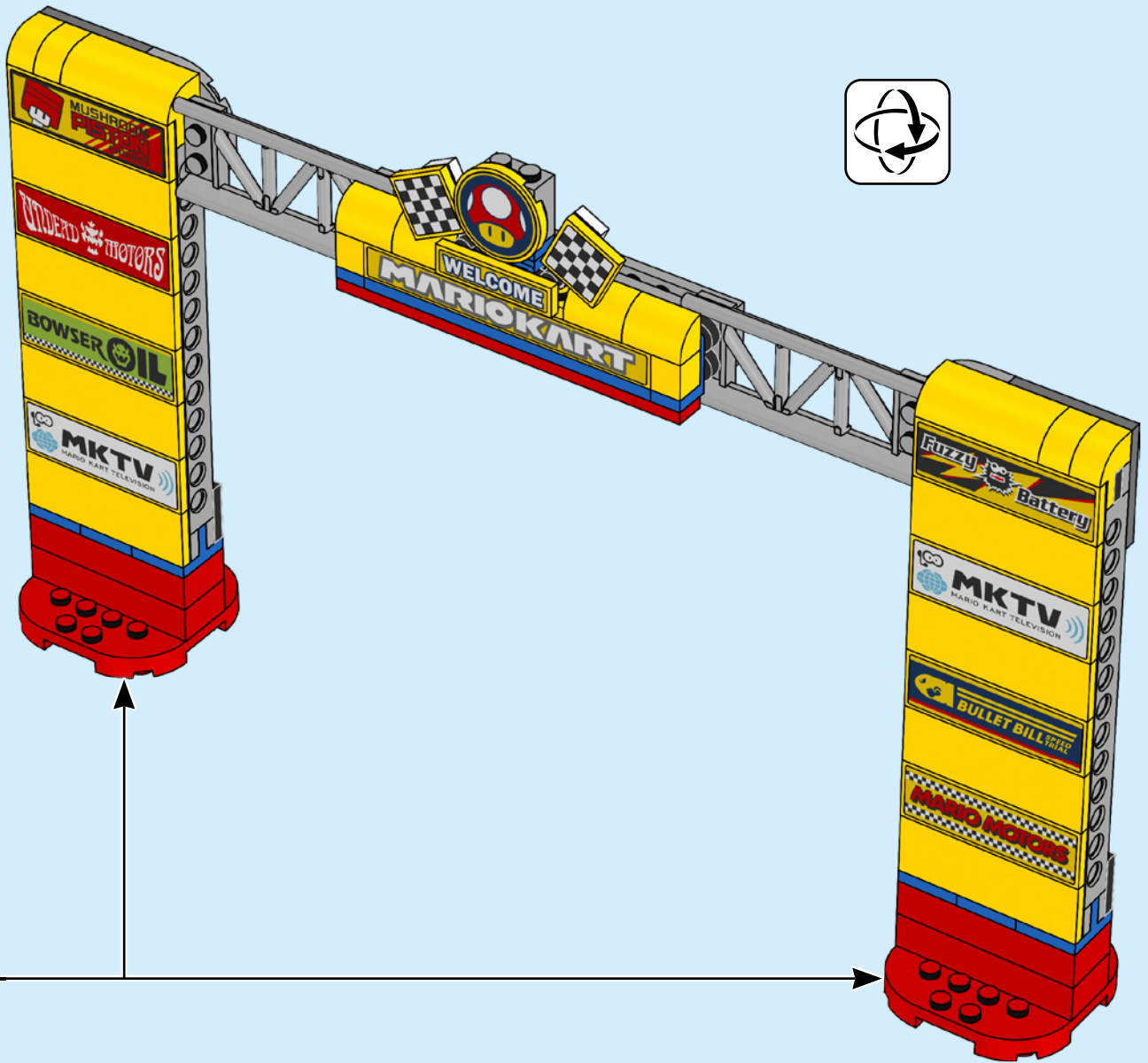
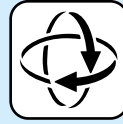

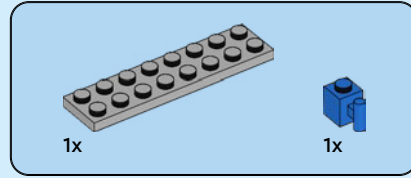
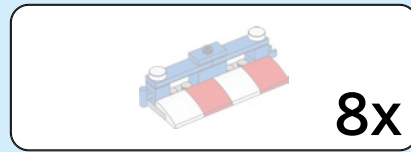

1

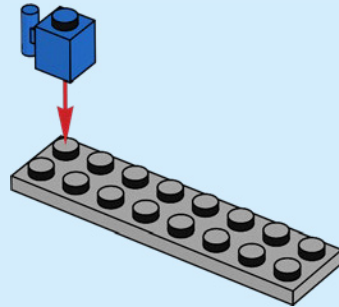

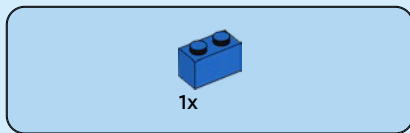

2

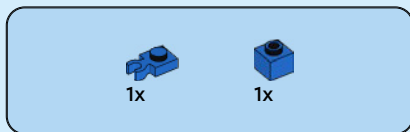
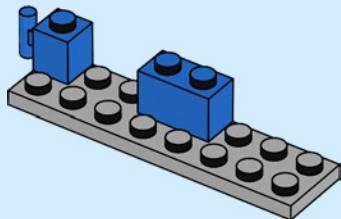

3

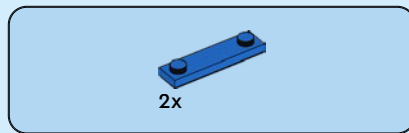
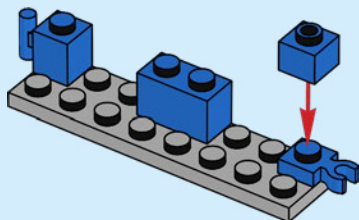

4

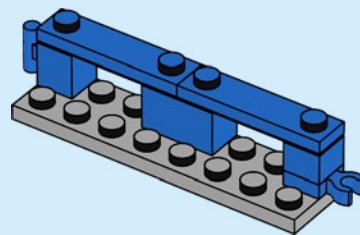

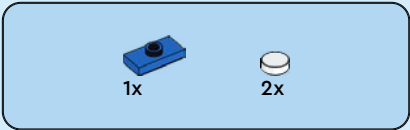

5

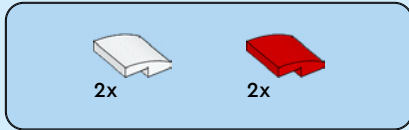
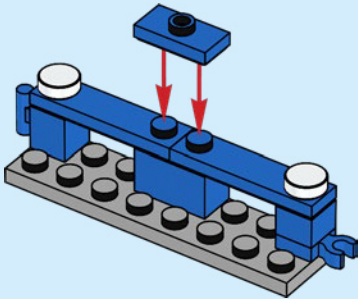

6

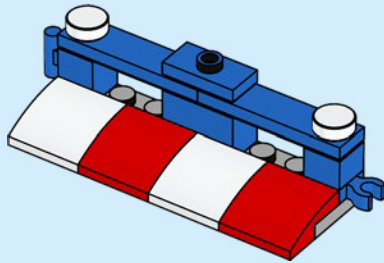

8x

7

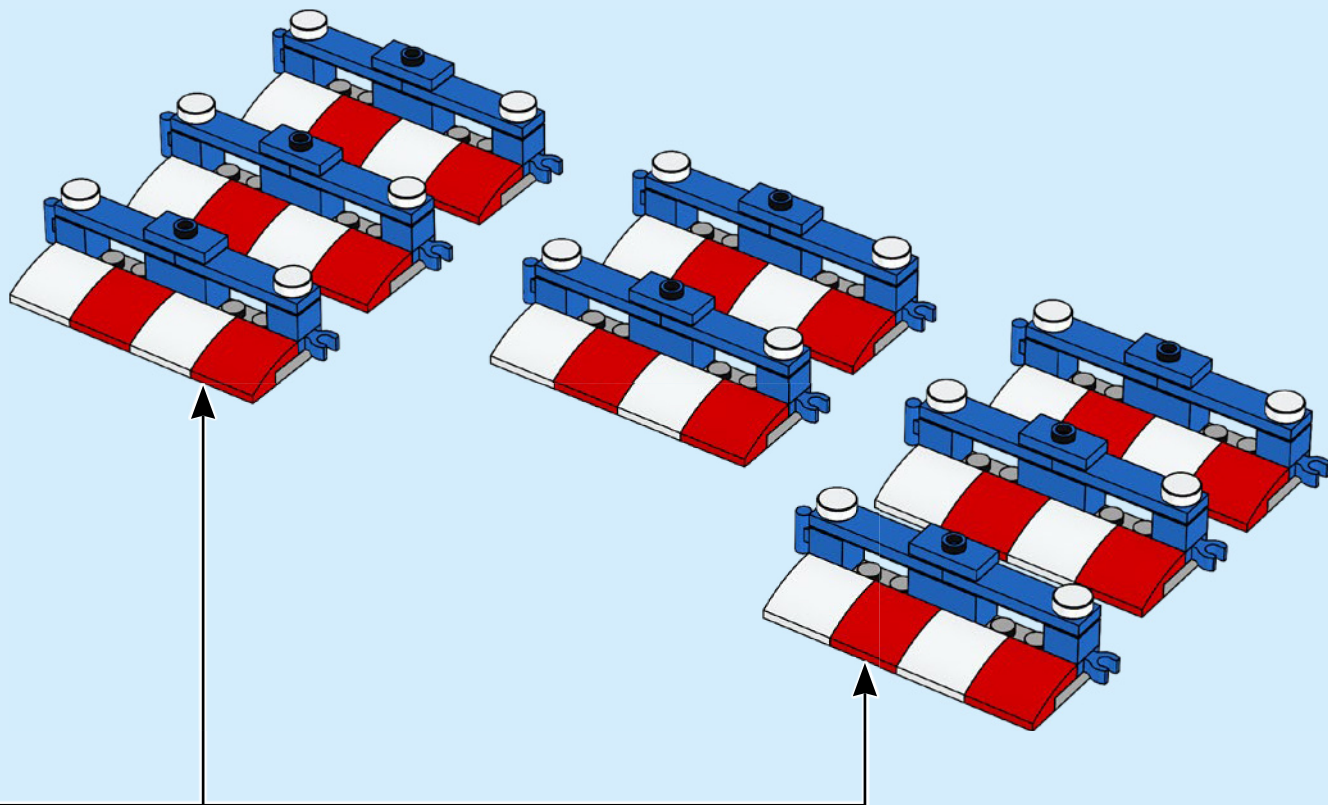



8

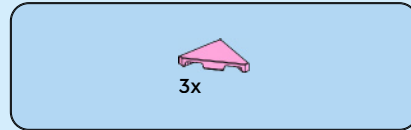

9



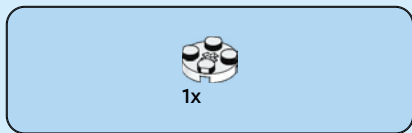

10

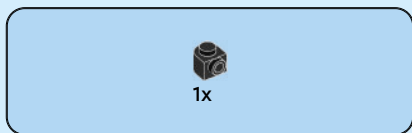
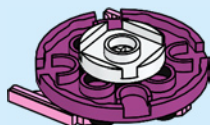

11

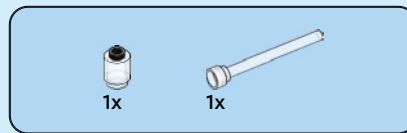
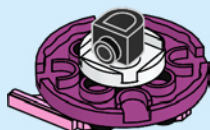

12

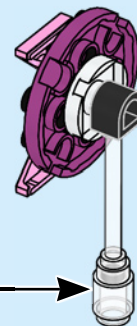
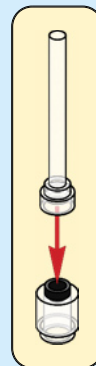
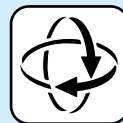

3x

13

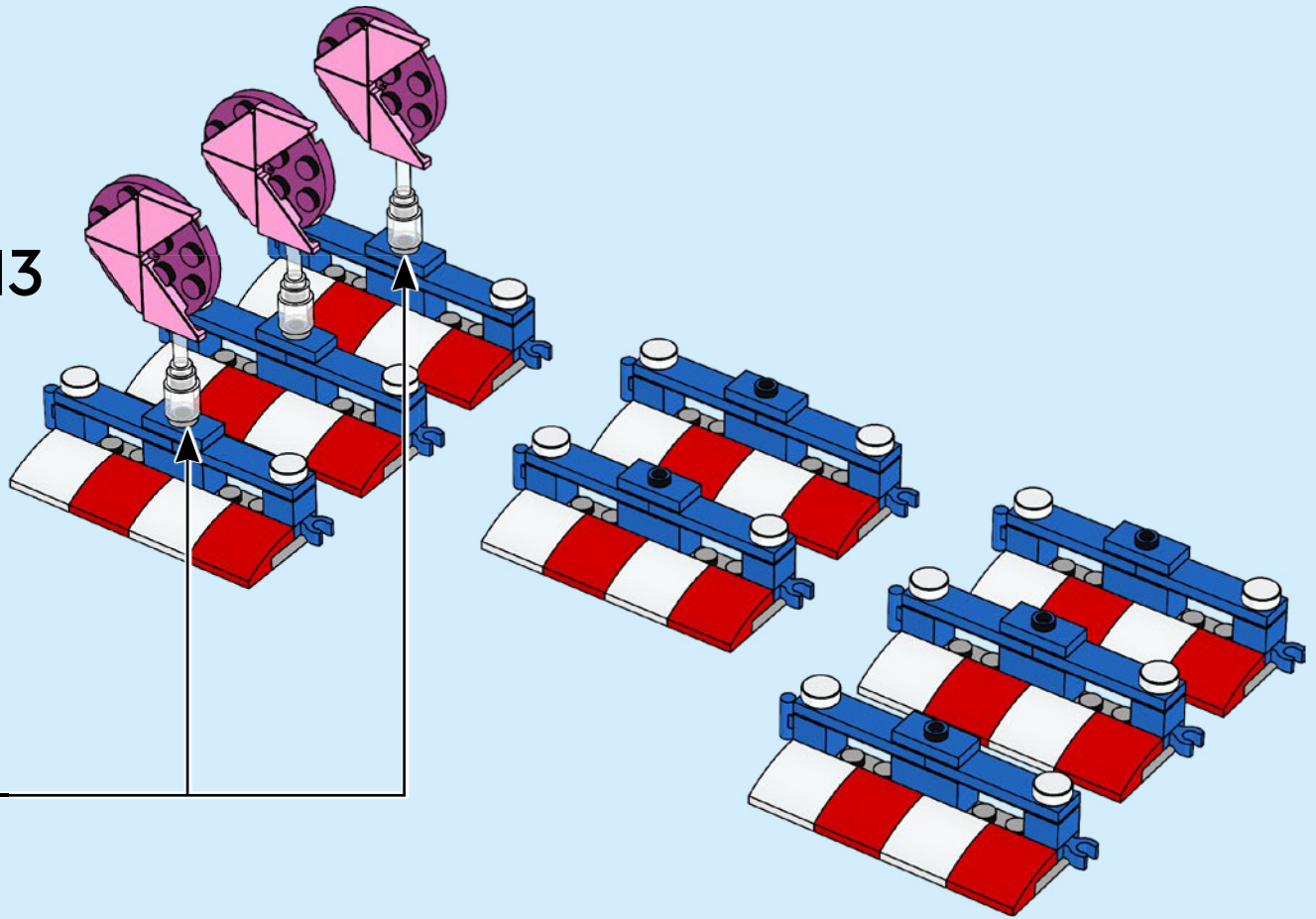

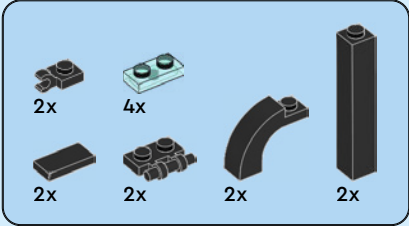
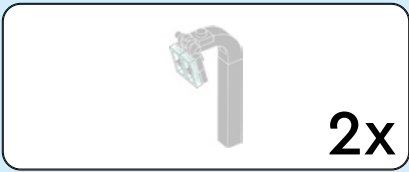

14

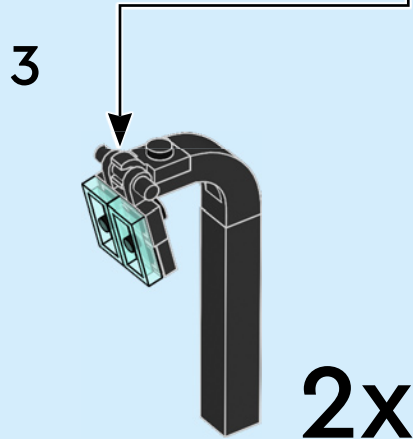
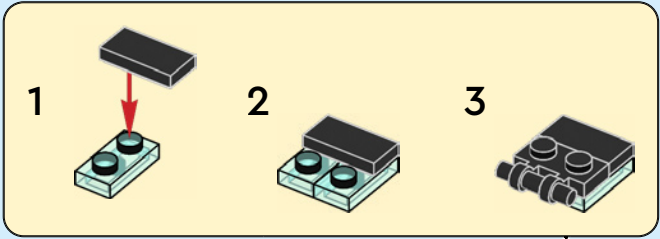
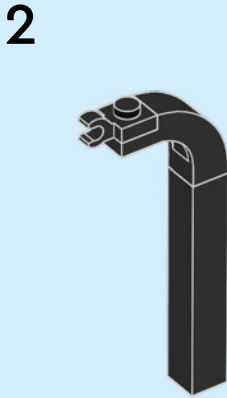
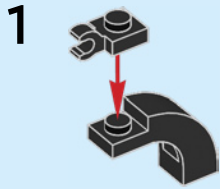

15

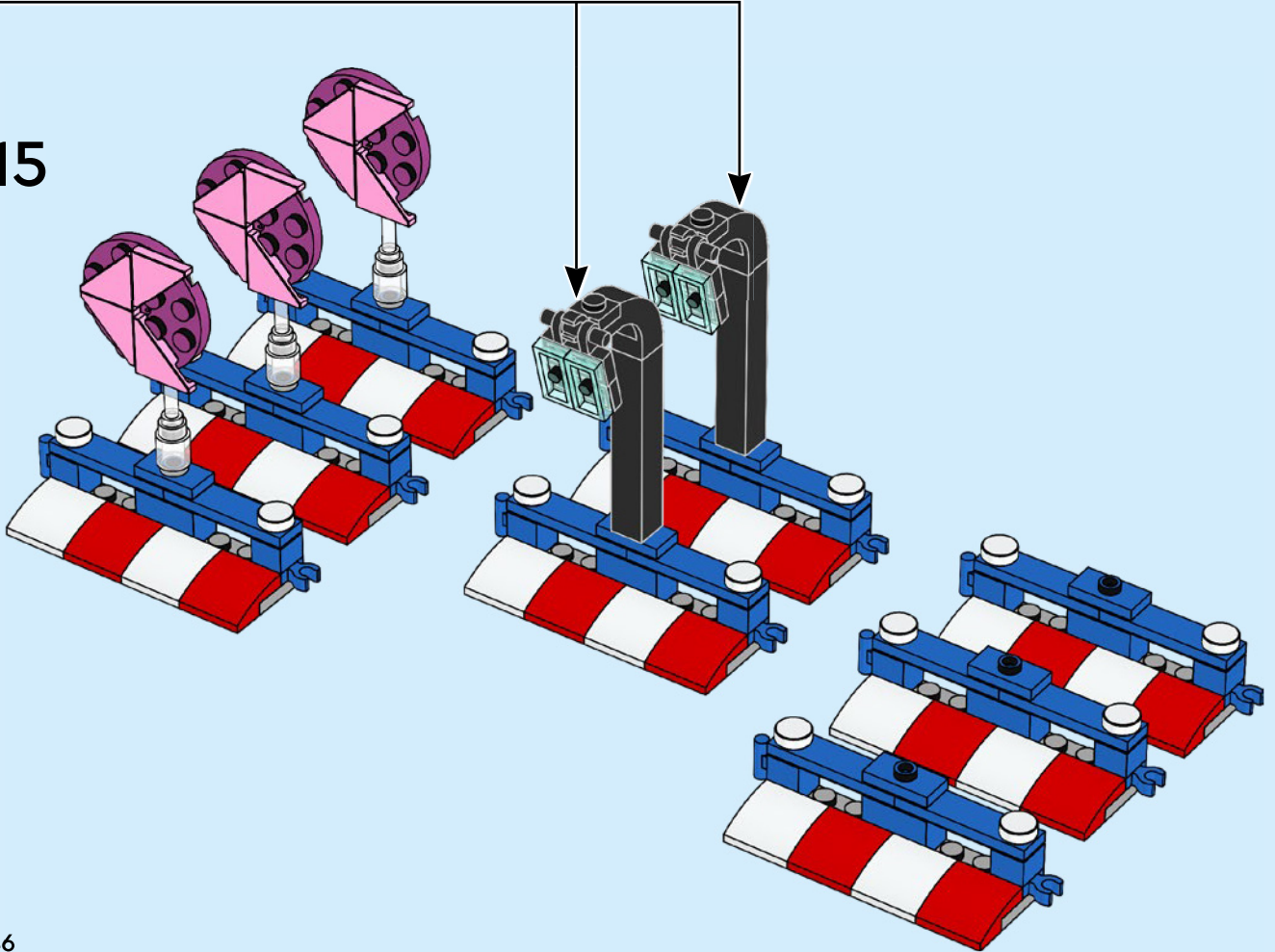

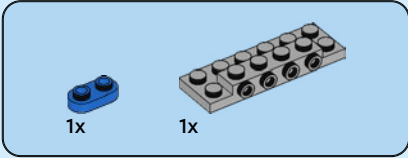
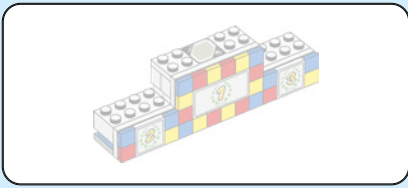

1x

1x

1

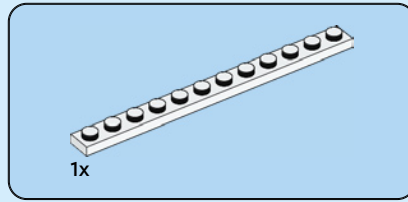
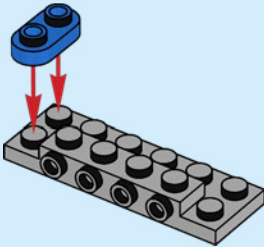

1x

2

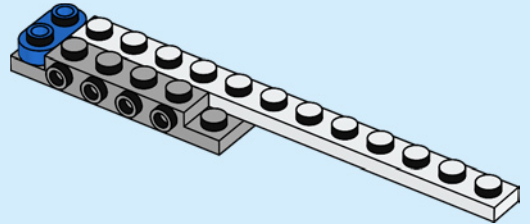

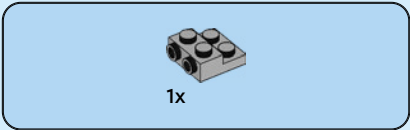

3

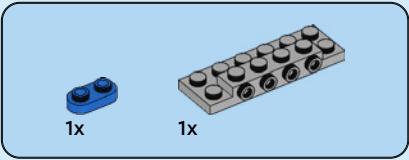
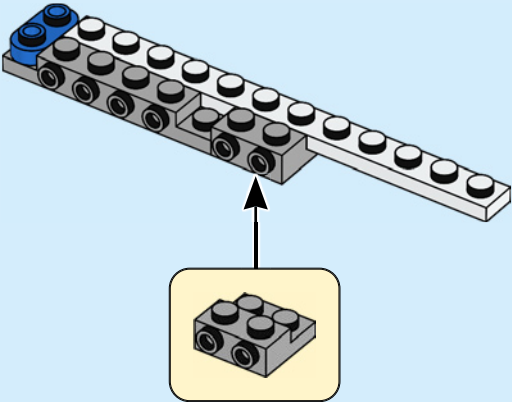

4

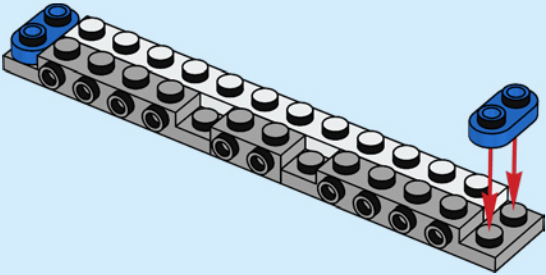

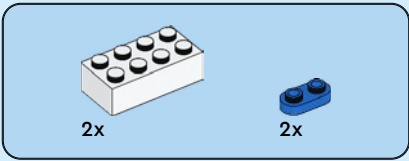

5

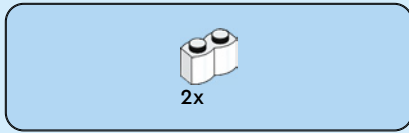
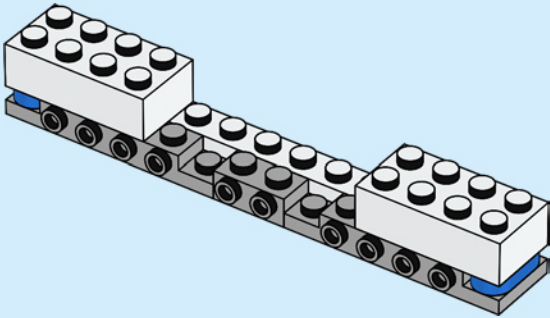

6

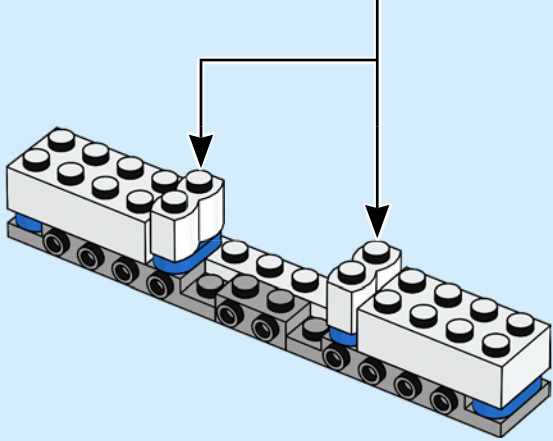
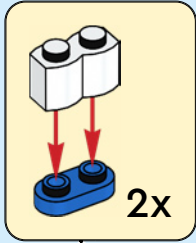

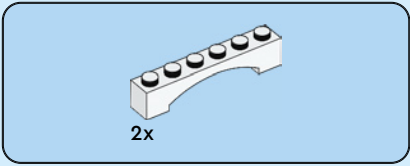

7

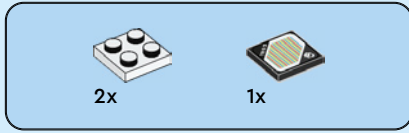
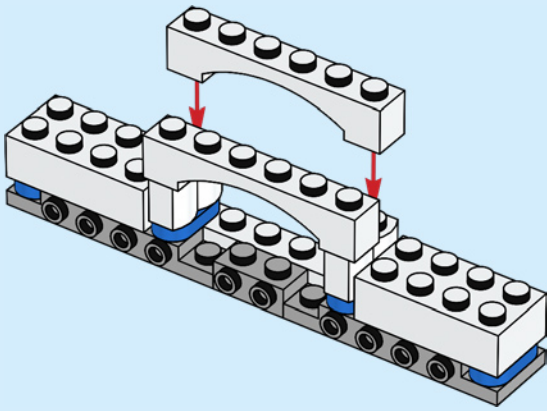

8

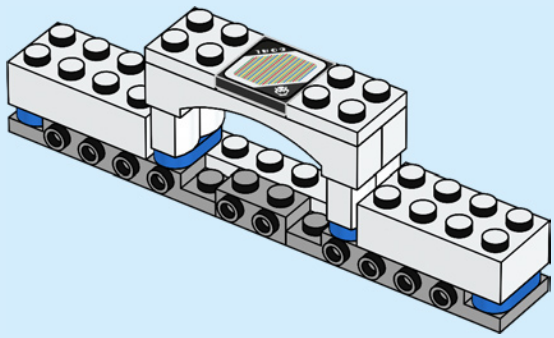

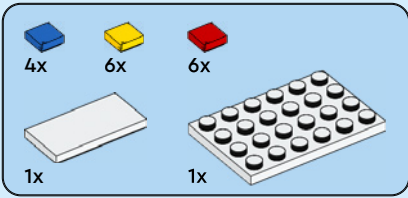

9

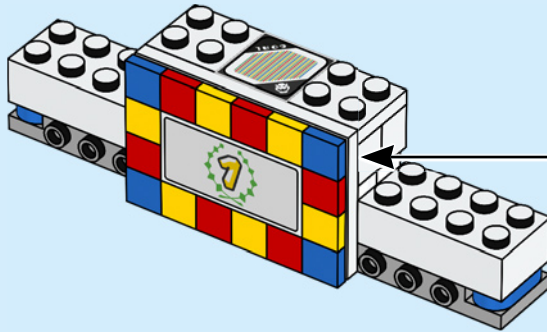
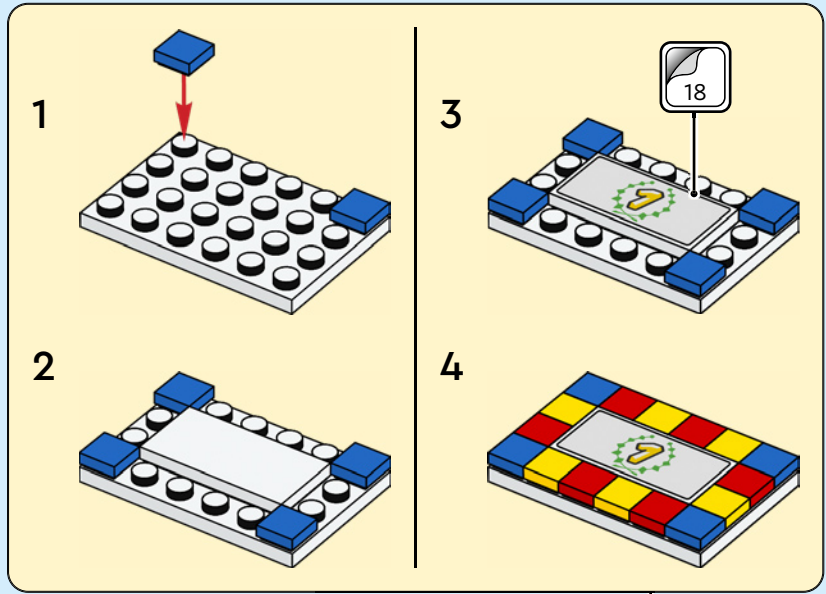

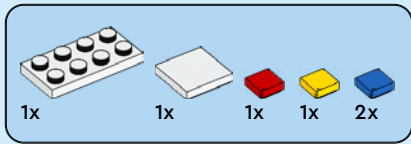

10

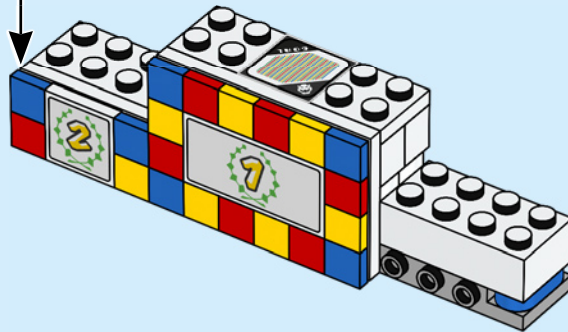
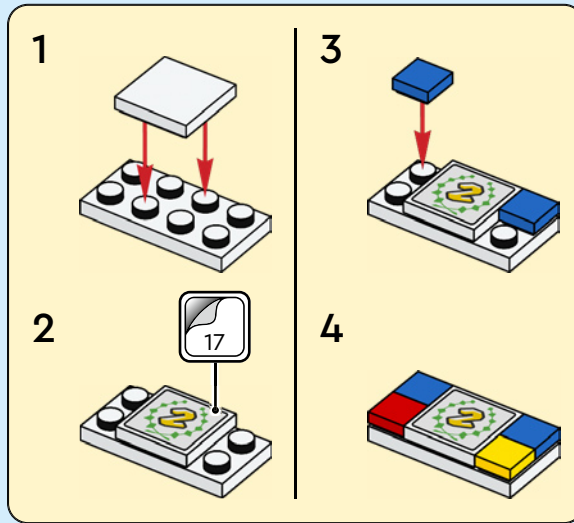

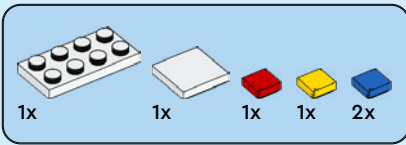

11

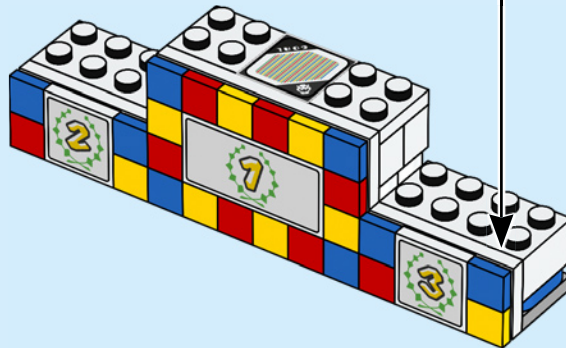
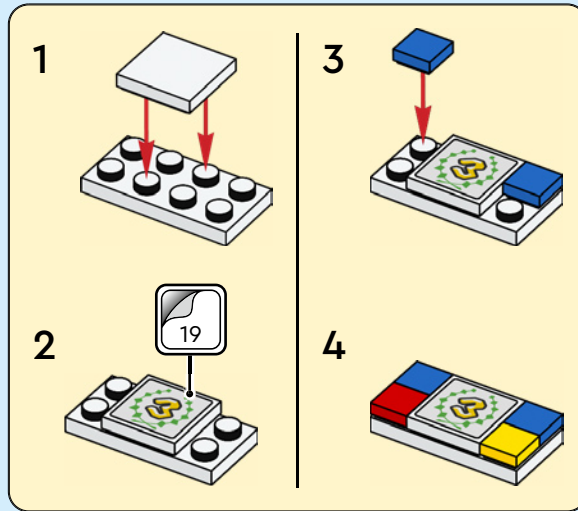

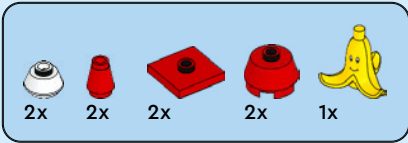

12

1

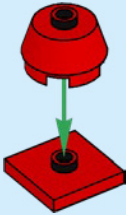

2

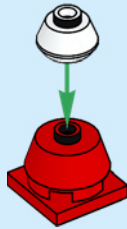

3

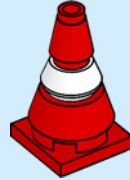

2x

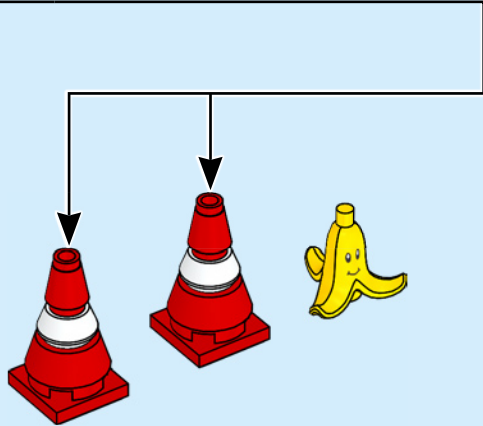

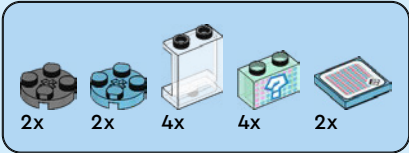

13

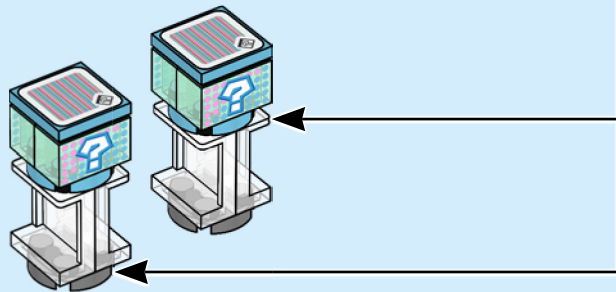
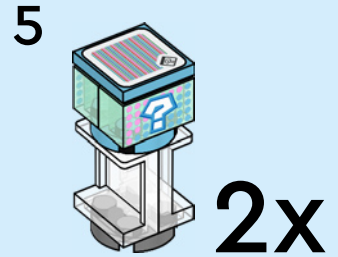
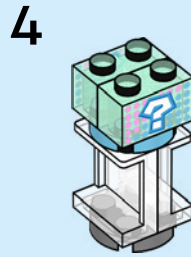
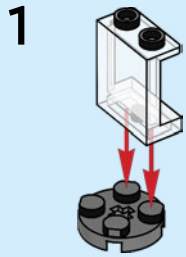

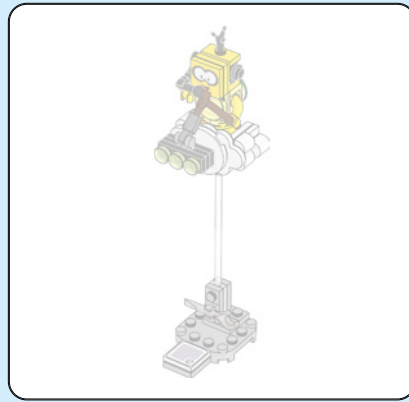

1

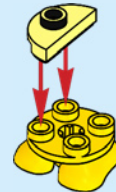



2



3



4



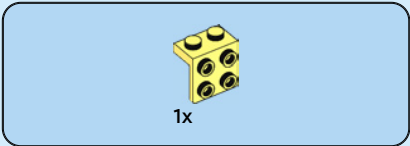

5

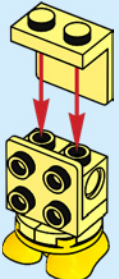

6



7

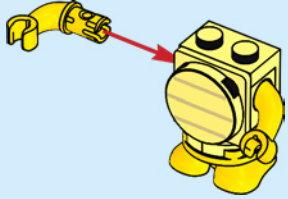

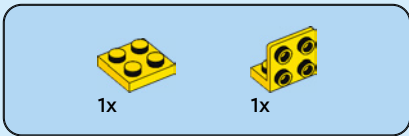

8

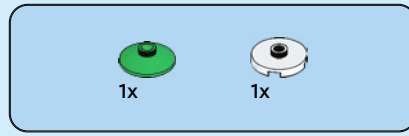
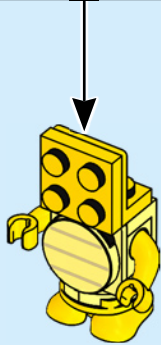
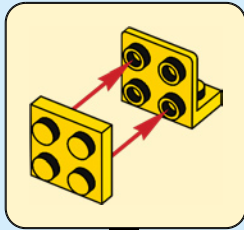

9

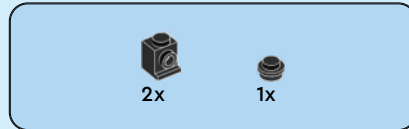
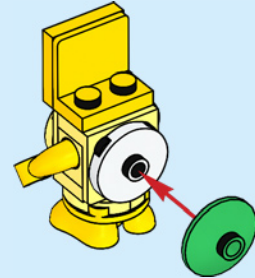
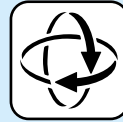

10

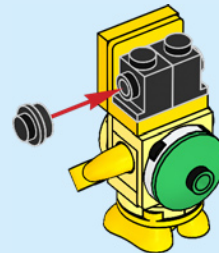

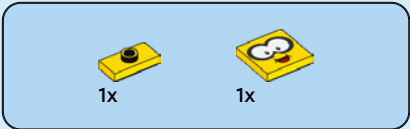

11

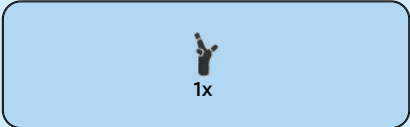
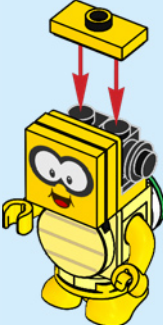

12

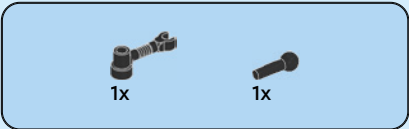
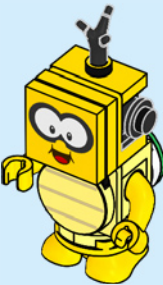

13

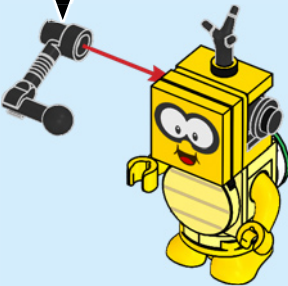
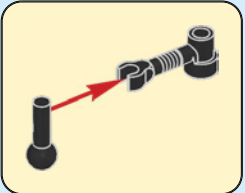

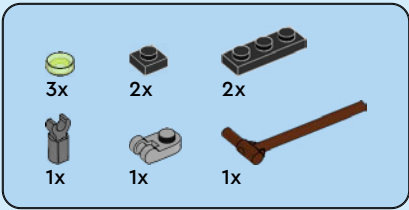

14

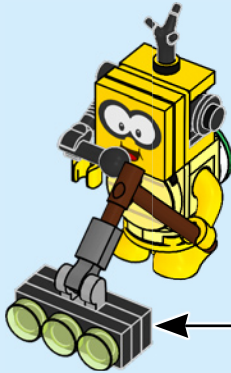
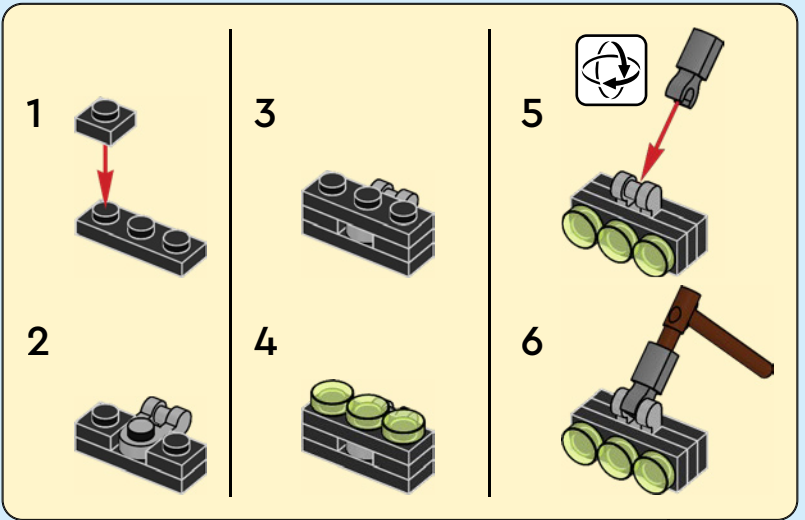

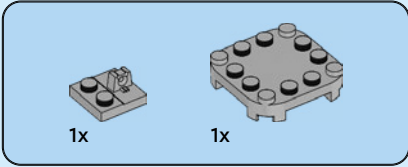
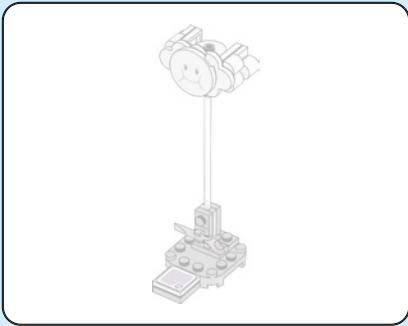

15

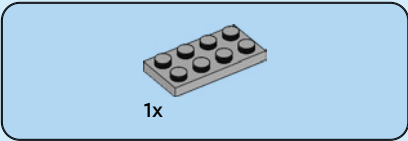
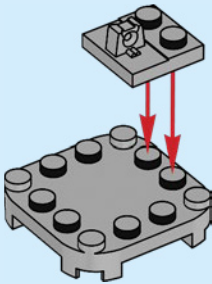

16

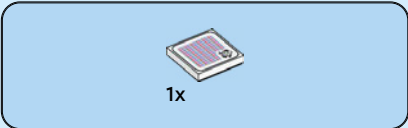
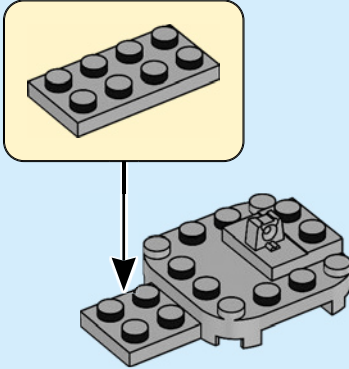

17

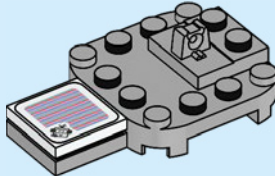

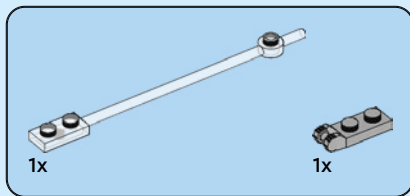

18

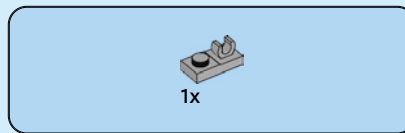
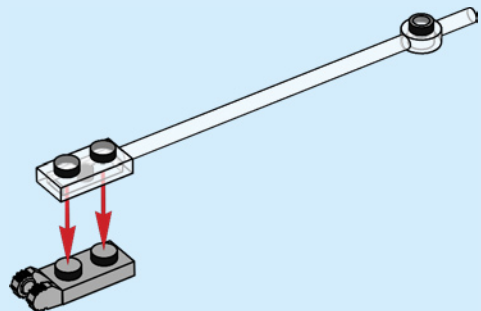

19

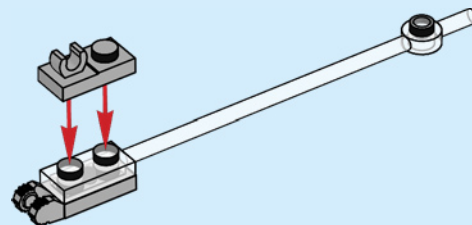

20

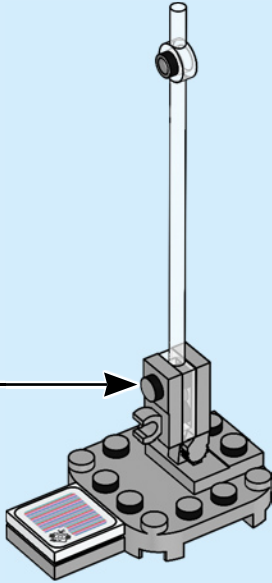

21

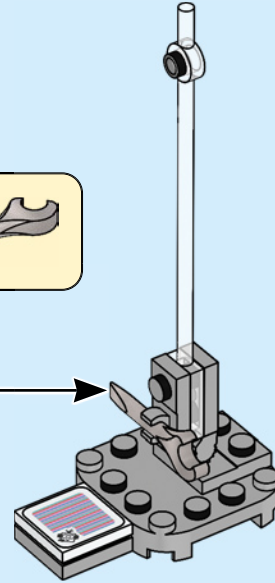
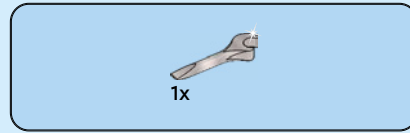

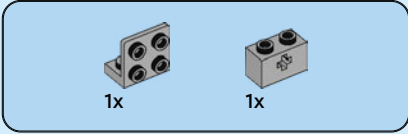

22

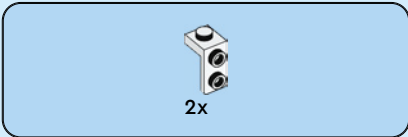
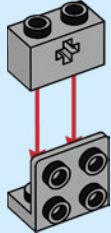

23

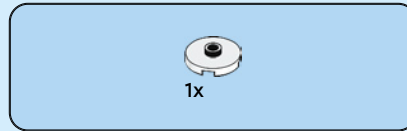
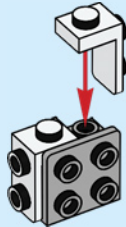

24

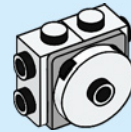

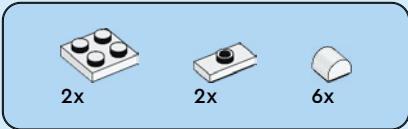

25

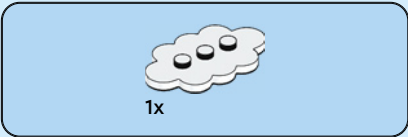
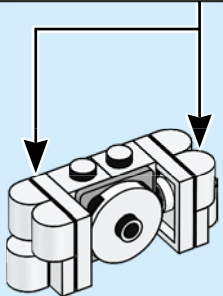
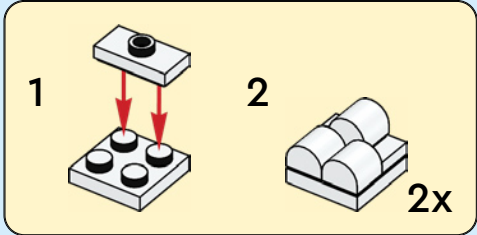

26



27

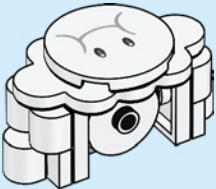

28

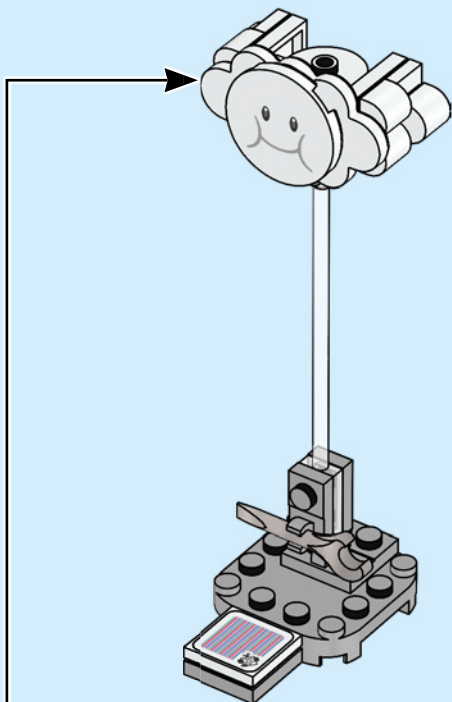

29

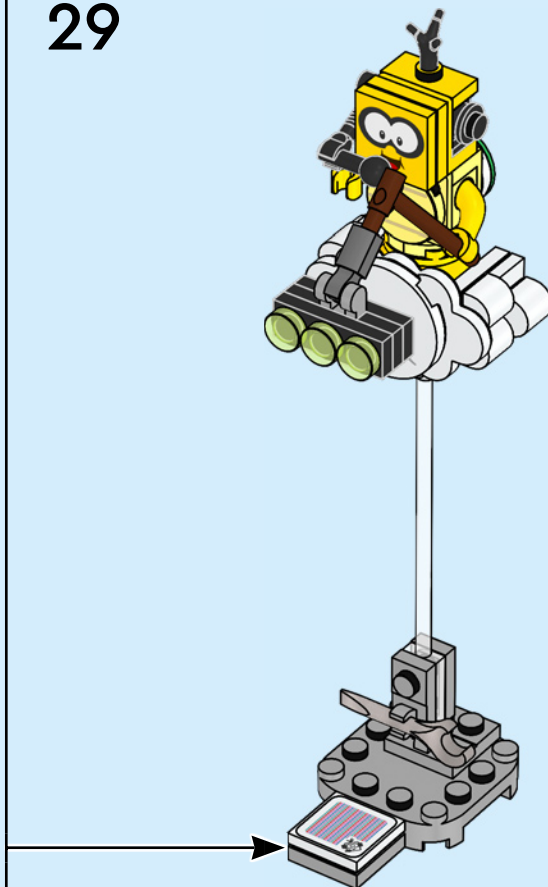

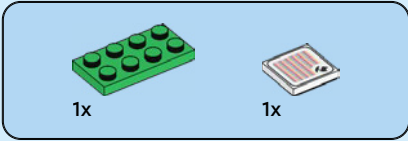
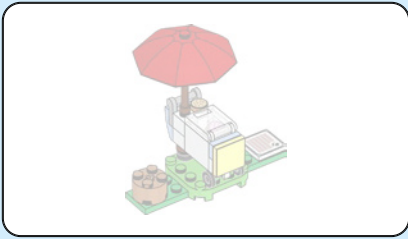

1

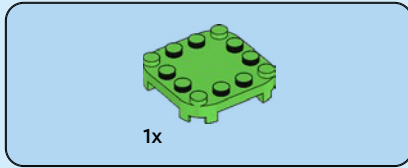
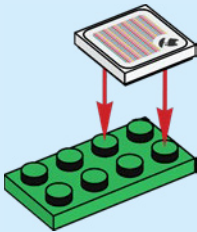

2

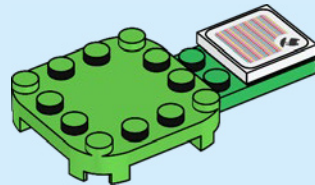

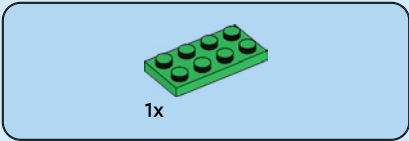

3

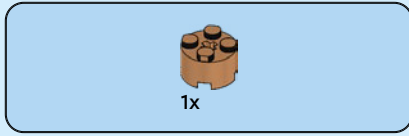
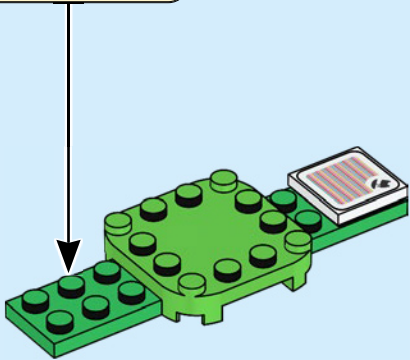
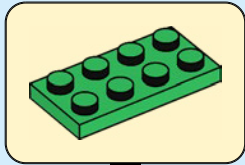

4

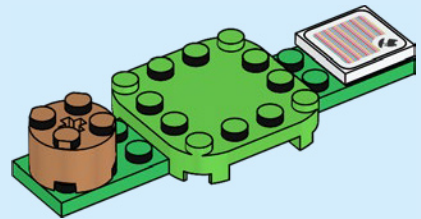

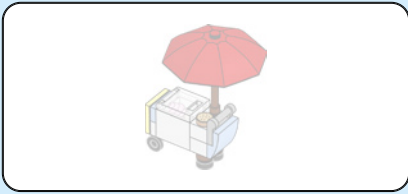

5

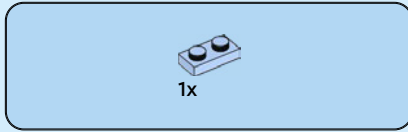
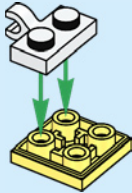

6

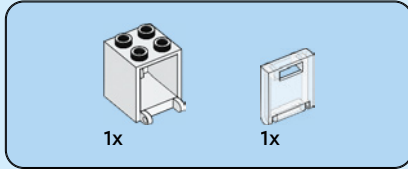

7

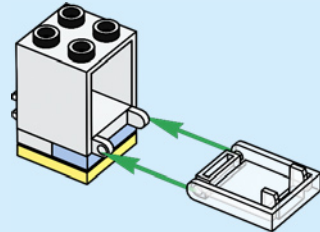



2x

8

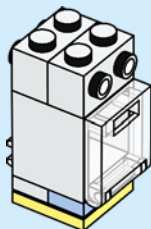

1x

9

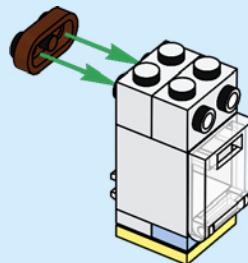



10

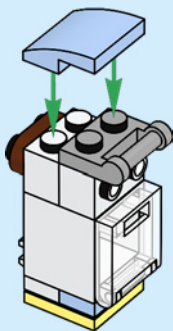

11

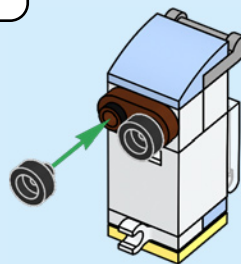
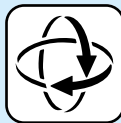



1x

12

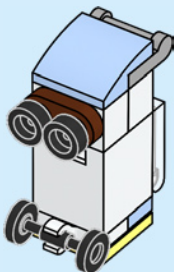

1x

13

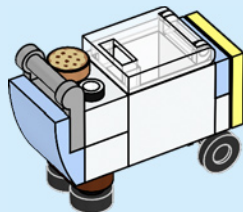

1x



1x

14

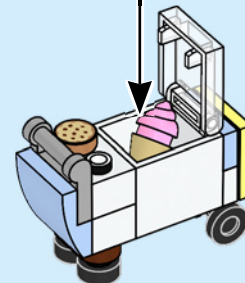
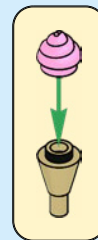

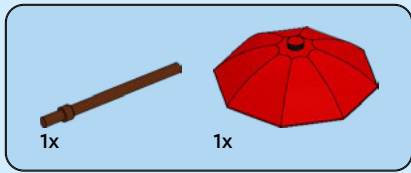

15

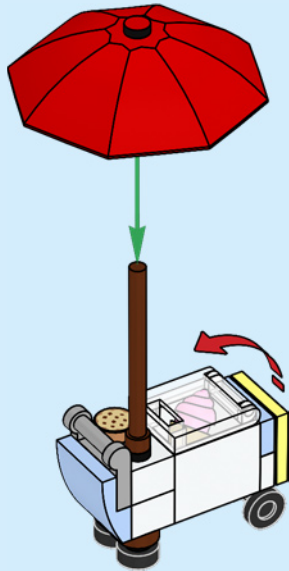

16

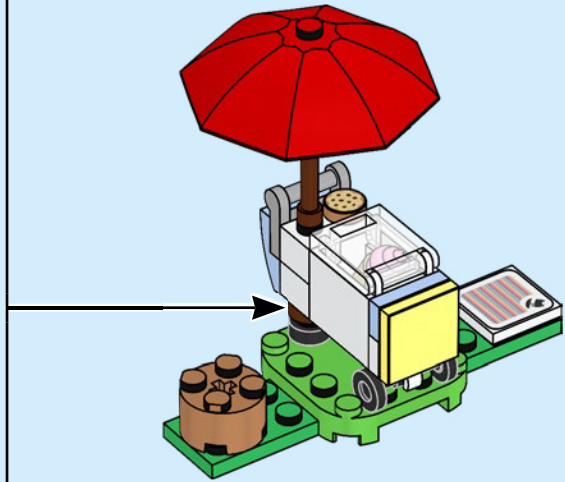





**UPDATE YOUR
INTERACTIVE
FIGURE IN THE LEGO®
SUPER MARIO™ APP
TO BE READY TO PLAY**

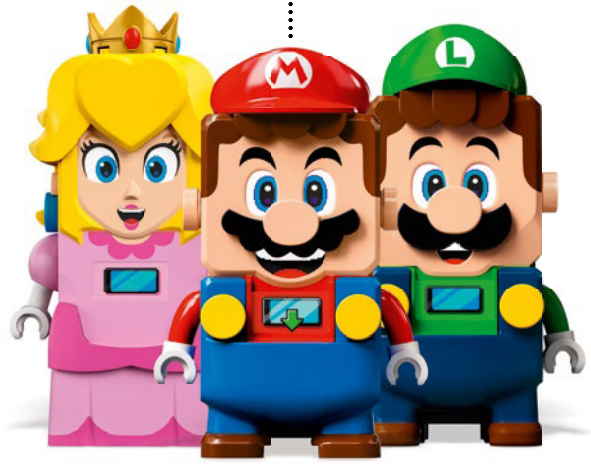

**METTEZ À JOUR LA
FIGURINE INTERACTIVE
DANS L'APPLICATION
LEGO® SUPER MARIO™
POUR POUVOIR JOUER**

**ACTUALIZA TU FIGURA
INTERACTIVA EN LA APP
LEGO® SUPER MARIO™ Y
PREPÁRATE PARA JUGAR**



**LEGO® Super Mario™ app
Application LEGO® Super Mario™
App LEGO® Super Mario™**

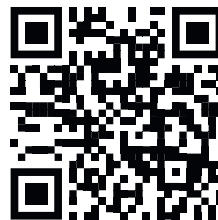

**[LEGO.com/super-mario-
trouble-shooting-guide](https://www.lego.com/super-mario-trouble-shooting-guide)**



72036

+



71439

OR/
OU/
O



71440

OR/
OU/
O



71441

**DISCOVER
MORE ABOUT
YOUR SET IN
THE APP**



**TROUVEZ PLUS
D'INFORMATIONS
SUR L'ENSEMBLE DANS
L'APPLICATION**

**DESCUBRE MÁS
ACERCA DE TU SET
EN LA APP**





72031



72032



72033



72034



72035



72036

**ADD SET FOR
INTERACTIVE
PLAY**



71439



71440



**AJOUTEZ UN
ENSEMBLE POUR UN
JEU INTERACTIF**

**JUEGO
INTERACTIVO CON
ESTOS SETS**



71441



71439

OR/
OU/O



71440

OR/
OU/O



71441

16x 6284572	3x 6313115	2x 6524449	1x 303201	8x 307021	8x 6432005	2x 6354661
4x 6446788	4x 6034044	2x 6524448	1x 4514842	2x 6523394	8x 4206330	2x 6354661
1x 6452532	2x 6058177	1x 6173064	1x 4514842	1x 6066342	8x 6469321	1x 4514398
6x 6258135	2x 6372037	1x 6482842	2x 4161734	2x 6252037	2x 6344218	2x 6116786
2x 6523388	3x 6365712	1x 6482842	1x 6538442	1x 6330891	8x 6315482	1x 6523129
2x 6442358	16x 6047220	2x 6170524	2x 6145570	16x 6105976	8x 6352221	4x 6524454
1x 4179875	6x 302201	2x 6339103	4x 4666579	2x 6126048	1x 4498156	16x 6292291
1x 4179874	1x 6536222	1x 6223667	1x 6316911	4x 6129995	1x 4498155	2x 302023
5x 403201	2x 6172674	3x 302001	4x 4278422	1x 371021	1x 6309081	1x 447723
2x 6093053	1x 6536257	2x 4560178	2x 6092587	1x 6483104	8x 300423	4x 6168644
2x 6059185	2x 306801	1x 4560178	4x 6321305	4x 4181138	8x 6092582	4x 4504381
1x 302301	2x 4515364	2x 300101	2x 4114084	2x 6294705	2x 302323	2x 407024
2x 6347309	1x 434501	2x 6350399	1x 6407822	1x 4514843	1x 6133721	8x 307024
2x 6051511	1x 6483012	2x 4620761	2x 4529234	2x 6294705	6x 6446707	
	1x 6266253	2x 4620761	2x 6378120			

 2x 6532053	 2x 366524	 2x 6302719	 2x 4204625	 2x 4566308	 1x 6092585	 3x 6428167	 1x 6407820
 2x 302424	 1x 6092583	 4x 302224	 16x 6329869	 1x 6509664	 2x 306926	 1x 6099483	 1x 6405103
 2x 300524	 2x 6069170	 1x 6126050	 1x 4200026	 2x 6371584	 1x 6117973	 4x 302126	 2x 6343326
 8x 6330893	 4x 6297284	 1x 6483009	 2x 4514844	 2x 6534695	 1x 4141580	 2x 370926	 1x 6314378
 2x 6280475	 4x 6361082	 1x 6079007	 2x 4548180	 2x 4140588	 2x 4140588	 2x 302026	 1x 6161772
 2x 6248971	 1x 6117938	 2x 306824	 1x 6302576	 4x 403226	 1x 6532045	 2x 6350415	 1x 6294513
 2x 6381923	 3x 6185994	 1x 6469455	 1x 614126	 2x 6281993	 1x 6532046	 1x 6457556	 2x 6228839
 9x 4550348	 5x 6208753	 1x 6466834	 2x 4529236	 4x 6282140	 1x 6536262	 2x 379526	 1x 6104344
 2x 6281992	 3x 6310247	 9x 6228602	 2x 4529236	 1x 249626	 1x 6315659	 1x 6510190	 1x 6487827
 1x 6029947	 1x 6337231	 3x 6424674	 3x 6424674	 2x 6282140	 1x 4124096	 1x 4567908	 1x 6487827
 1x 6167223	 4x 6315218	 2x 6524452	 2x 6227901	 4x 4512363	 1x 6506033	 2x 302028	 3x 6514232
 3x 302324	 1x 6523455	 1x 243124	 2x 4226995	 4x 6192309	 2x 362326	 2x 6328327	 1x 6499105
 2x 370024	 1x 6523455	 1x 371024	 2x 407026	 1x 6138173	 2x 4618880	 2x 6314376	 4x 6253231
 1x 6482826	 1x 6253273						



3x
6514014



1x
6276993



4x
6514007



2x
6514236



2x
6284582



1x
6407665



4x
6092770



5x
6109909

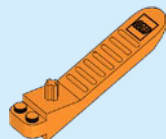

1x
6240515



2x
4183133



5x
4537937



2x
6472552



3x
6248970



4x
6532061



4x
6070763



3x
6096210



4x
6223719



4x
6524455



4x
6472546



1x
6248944



2x
4211159



1x
6037289



3x
4211150



4x
6075287



2x
6174856



1x
6300006



1x
6167644



1x
6135494



3



2x
6177697



1x
6170468



1x
6214343



1x
6070442

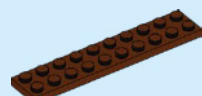

1x
4211214



2x
6168647



2x
6258831



2x
6336539



1x
6225246



4x
6052200



1x
4211526



2x
6186657



1x
6134378



1x
6206249



1x
6326078



1x
4211469



1x
6123809



2x
6004990



1x
4654580



1x
4244627



2x
6265742



2x
4211353



1x
6338962



1x
6267048



3x
6469440



2x
4645412



1x
4211395



1x
6294703

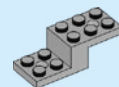

1x
6028811



6x
4211438

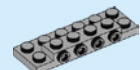

2x
6430550



8x
4211406



2x
6472961



2x
4211360



4x
4211705



4x
6097501

1x
6340333

3x
6360675

9x
4211042

4x
4211063

2x
6473748

1x
6308045

1x
6532062

1x
6344820

2x
4212075

4x
6370946

1x
6338470

1x
4211056

2x
4539429

1x
6336970

4x
6100030

1x
6362254

1x
6372227

1x
6326495

1x
6057387

1x
6132918

1x
6404150

1x
6284587

1x
6519699

1x
6523127

12x
6532058

2x
6316263

2x
6503683

1x
6310506

1x
6503668

1x
6298527

1x
6296485

2x
6315196

4x
6297281

1x
6523128

1x
6533961

2x
6329282

1x
6382134

1x
6503258

1x
6405108

3x
6514198

1x
6287854

1x
6532065

2x
6057986

2x
6215606

2x
6517675

1x
6532063

1x
6454167

2x
4569382

1x
6167642

4x
6492538

2x
6346464

1x
6102998

2x
6093494

1x
6295464

2x
6313600

1x
6378154

1x
6532059

1x
6167576

1x
4632100

1x
6137300

1x
6236583

1x
6153538

2x
6097493

2x
6109752

3x
6097419

2x
6529271

1x
6022000

4x
6523454



 [LEGO.com/service](https://www.LEGO.com/service)

YOU COULD **WIN**

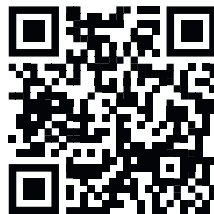

Scan this QR code or go to **LEGO.COM/PRODUCTFEEDBACK** and give us your short feedback about this LEGO® set for a chance to win a cool LEGO prize.

Terms and Conditions apply*

EN: YOU COULD WIN. Terms and Conditions apply* **DE: Du könntest GEWINNEN.** Es gelten die Teilnahmebedingungen* **FR: Tu pourrais GAGNER.** Des conditions s'appliquent* **IT: Potresti VINCERE tu.** Termini e condizioni sono applicabili* **ES: Puedes GANAR.** Aplican términos y condiciones* **PT: Poderá GANHAR.** Aplicam-se termos e condições* **ZH: 轻松获奖. 条款和条件适用*** **PL: Szansa na WYGRANĄ.** Obowiązują warunki korzystania* **CS: Máte šanci VYHRÁT.** Platí všeobecné smluvní podmínky* **SK: Máte šancu VYHRAŤ.** Platia všeobecné zmluvné podmienky* **HU: TE IS NYERHETSZ.** Felhasználási feltételek érvényesek* **RO: Ai putea CÂȘTIGA.** Se aplică termeni și condiții* **BG: Можете да СПЕЧЕЛИТЕ.** Има определени правила и условия* **LV: Tu vari LAIMĒT.** Ir spēkā noteikumi un nosacījumi.* **ET: Sul on võimalus VÕITA.** Kehtivad tingimused* **LT: Jūs galite LAIMĖTI.** Taikomos sąlygos*

*[LEGO.com/productfeedback-terms](https://www.lego.com/productfeedback-terms)

LEGO, the LEGO logo and the Brick and Knob configurations are trademarks of the/son des marques de commerce du/son marcas registradas de LEGO Group. ©2025 The LEGO Group.