



SUPER MARIO

72036



3

**Let's build
Construisions
Vamos a construir**



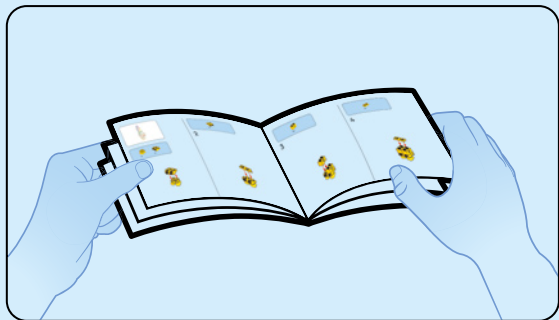

1

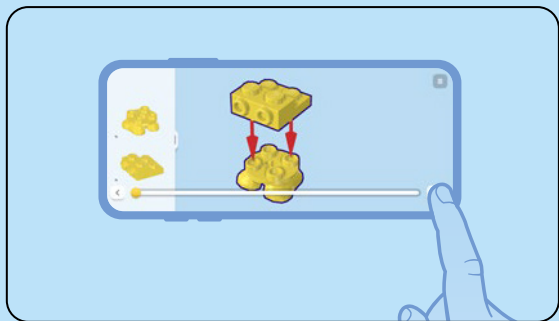
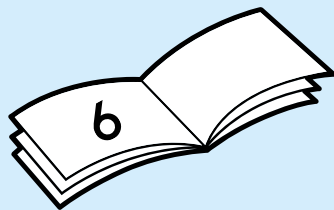

1



2

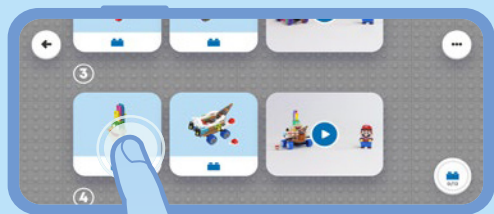

3

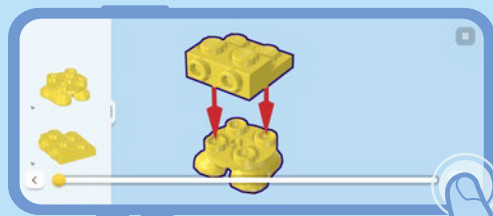

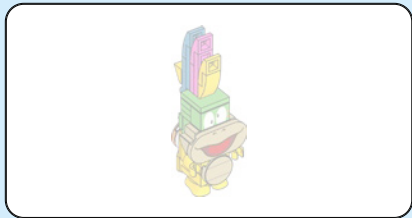

1

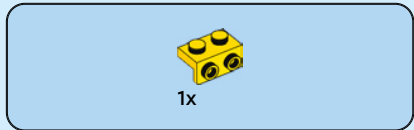
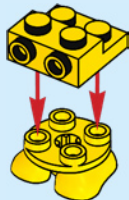

2

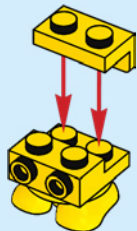



2x

3

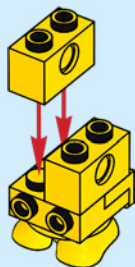

1x

4

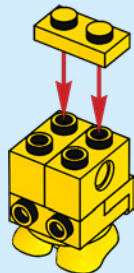



2x

5

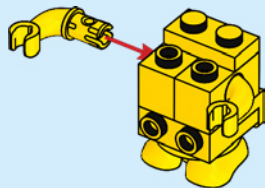

8



1x

6

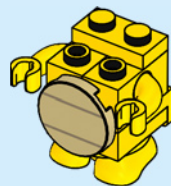

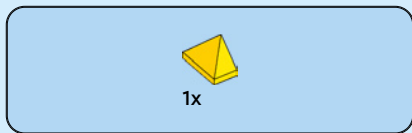

7

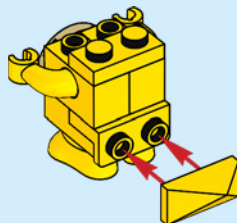

8

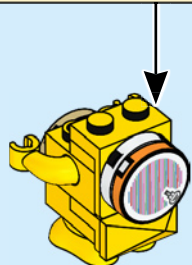
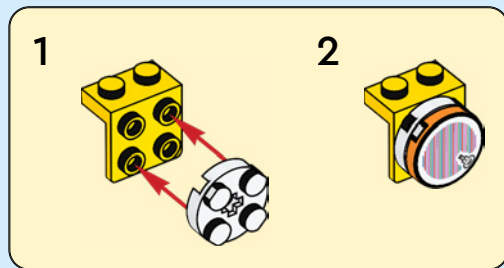

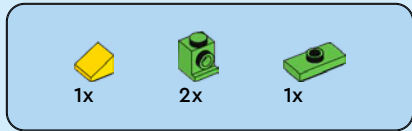

9

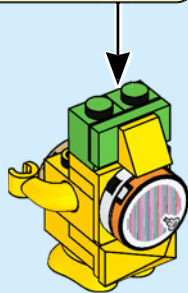
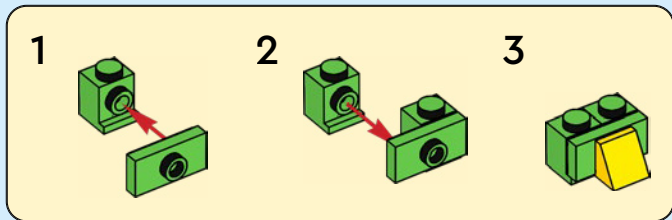



10

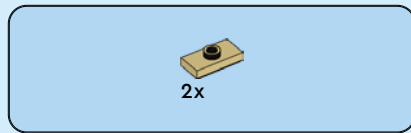
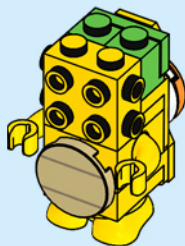

11

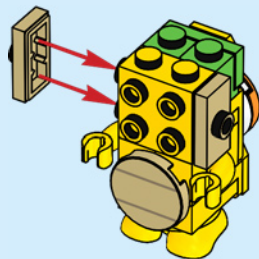



2x

12

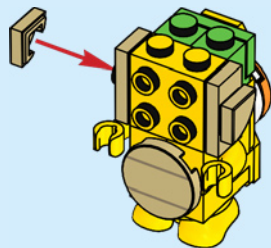

12



1x

13

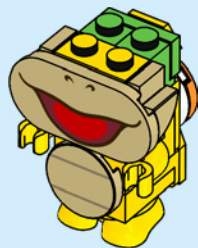



2x



1x

14

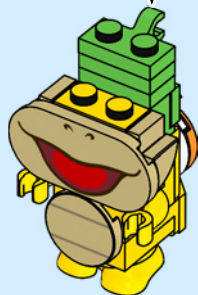
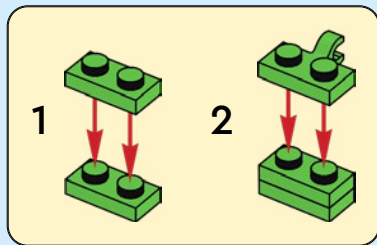

1x



1x

15

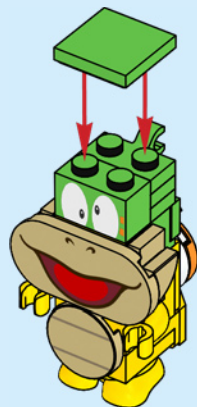



1x



1x



1x



1x



1x



1x



1x



1x



1x

16

1

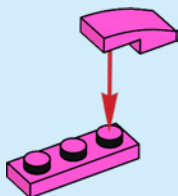

2

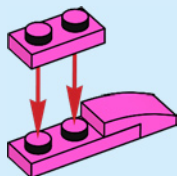

3

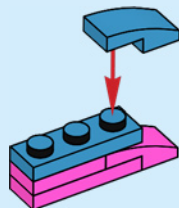

4

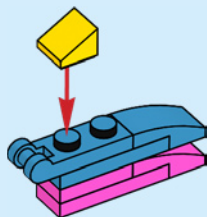

5

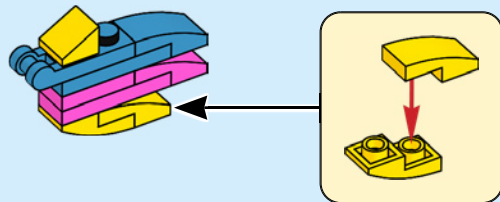

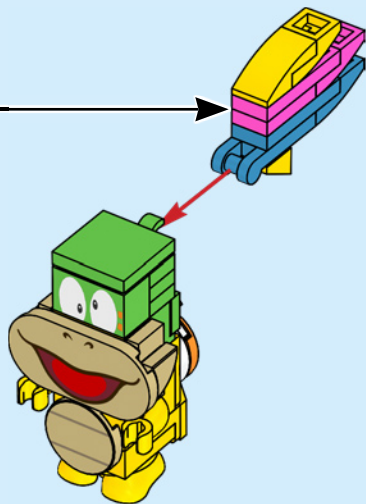

16

17

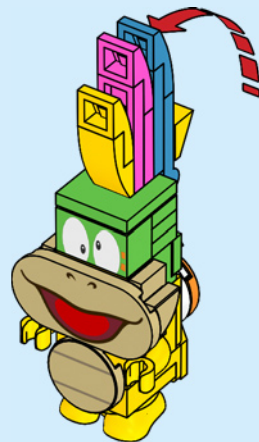

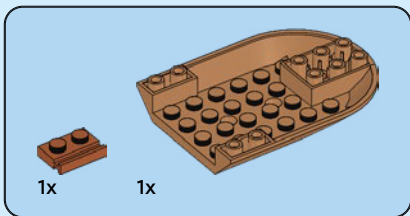
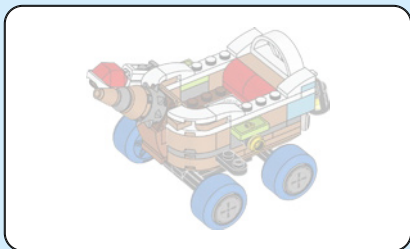

1

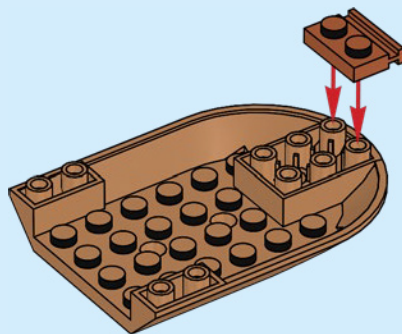



1x

2

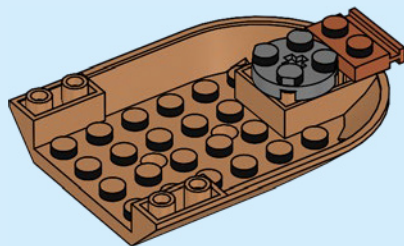

1x

3

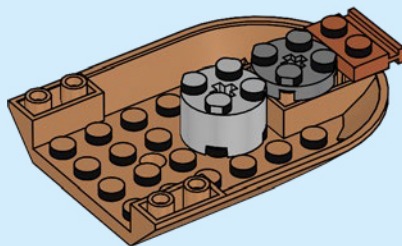



2x



2x

4

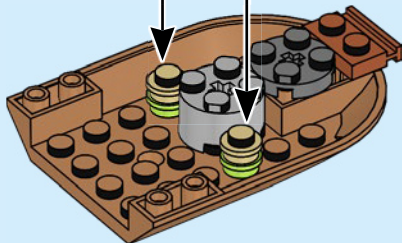
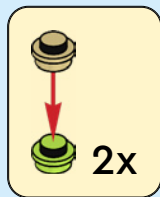

2x

5

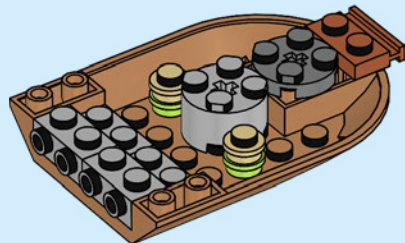

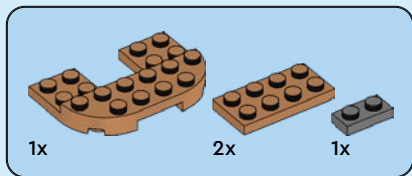

6

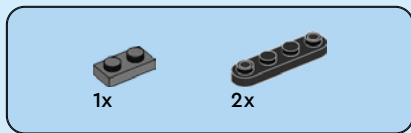
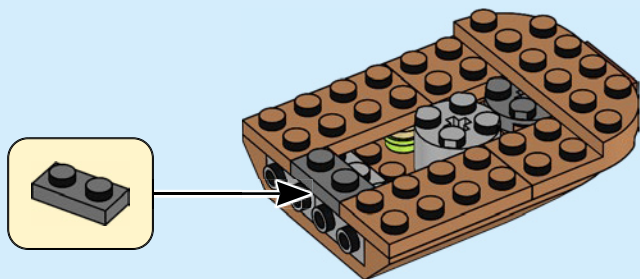

7

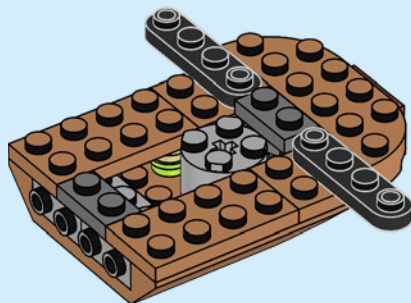

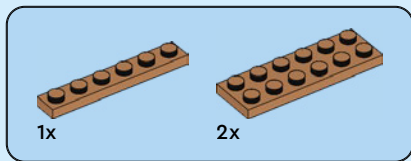

8

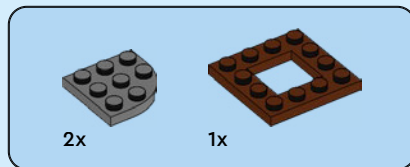
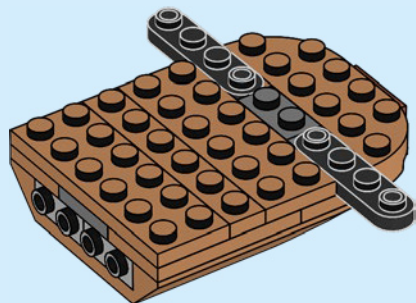

9

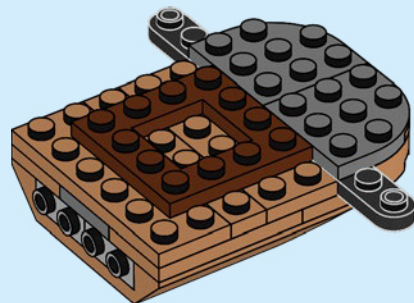

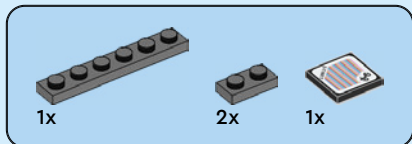

10

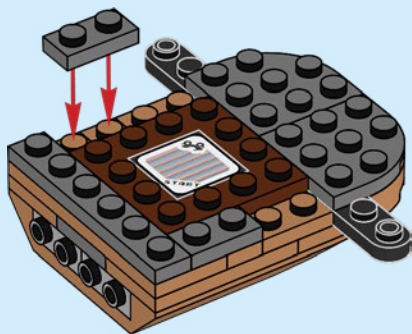

11

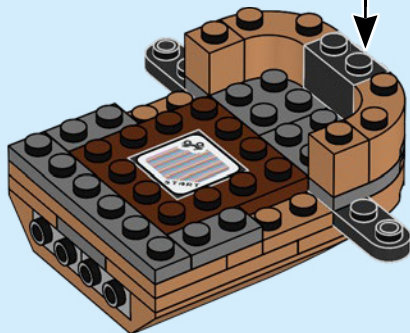
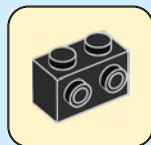



2x



2x



2x



2x



2x



2x

12

1

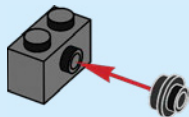

2

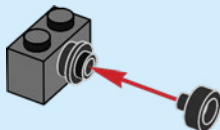

3

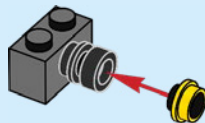

4

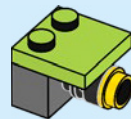

5

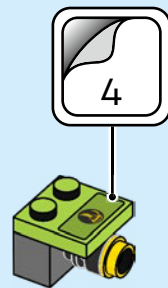

2x

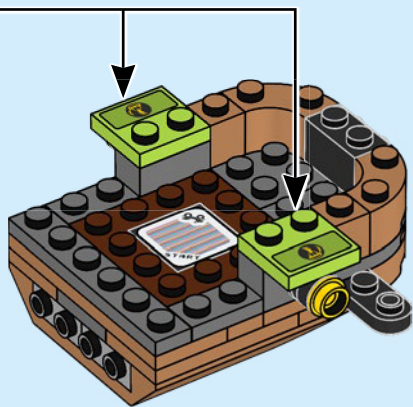

13

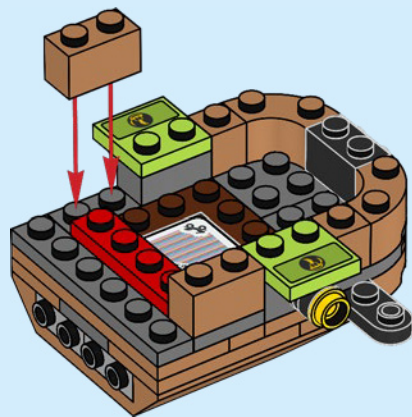

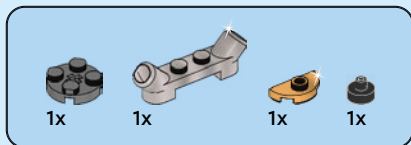

14

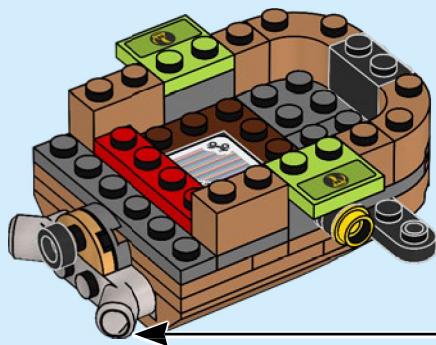
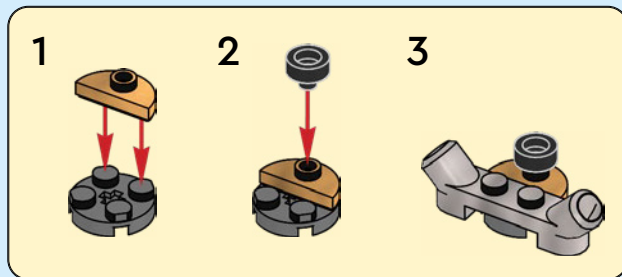

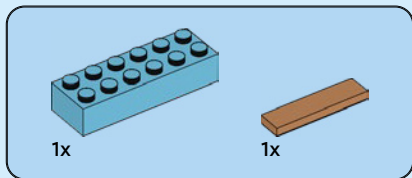
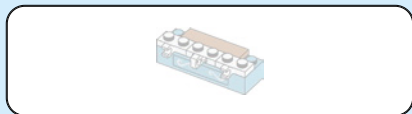

16

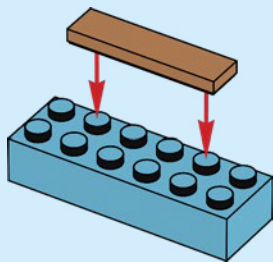

17

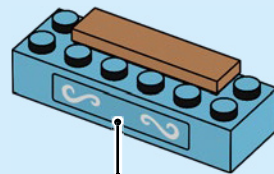



2x

18

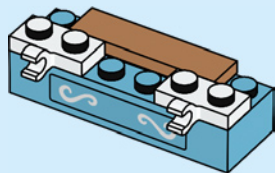

1x

19

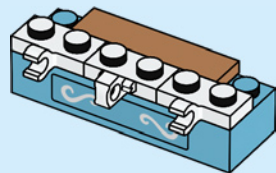

20

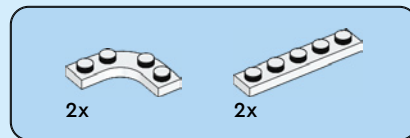
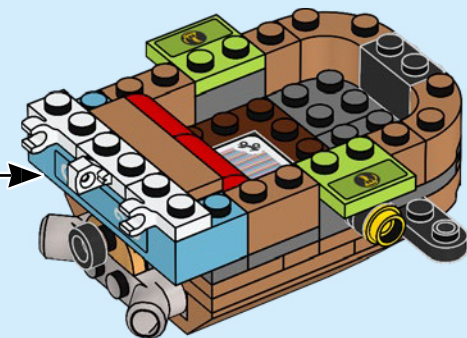

21

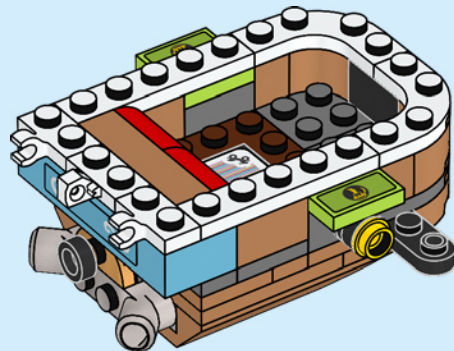



1x

22

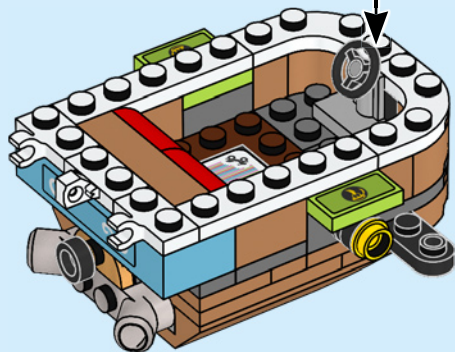

2x



2x

23

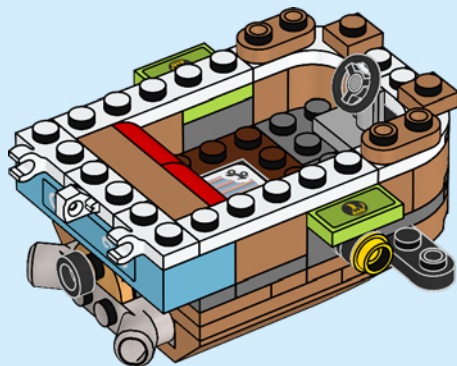

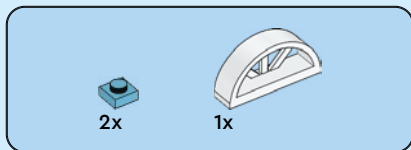

24

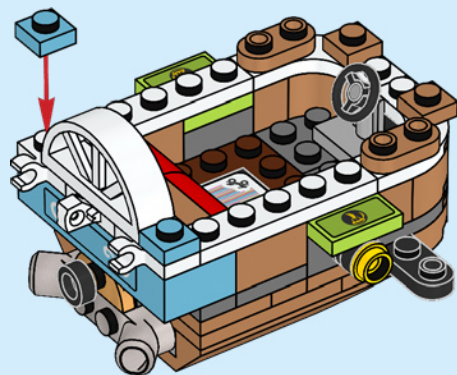



4x



2x

25

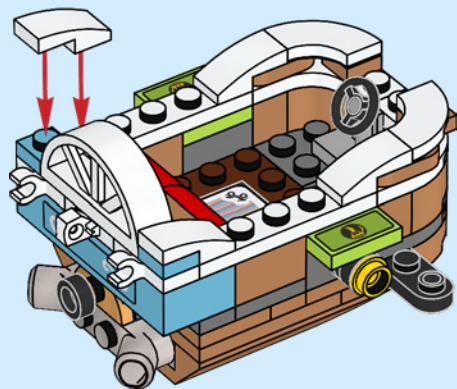

2x



2x

26



2x

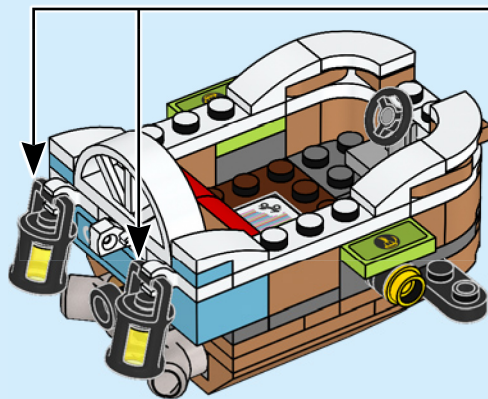

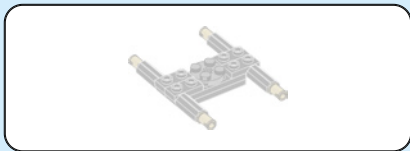

27

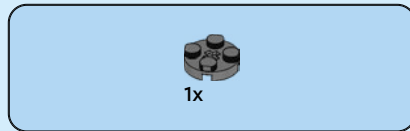
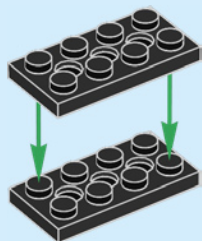

28

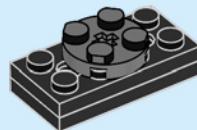



4x

29

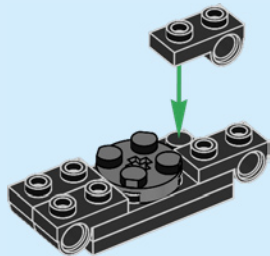

2x



2x

30

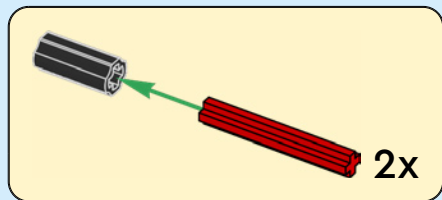

2x

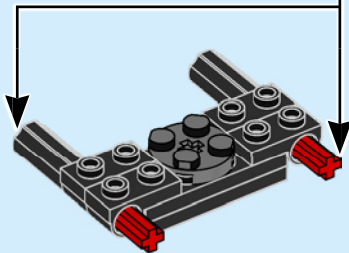

4

1:1



2x

31

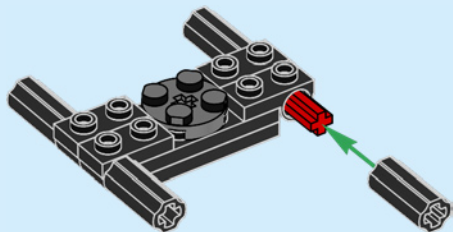

4x

32

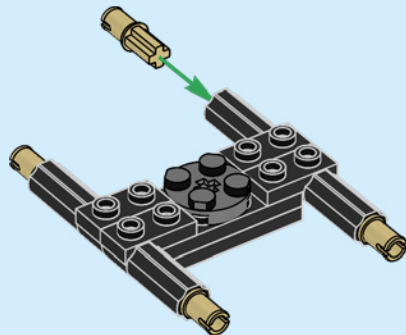

33

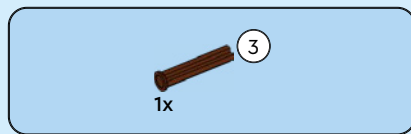
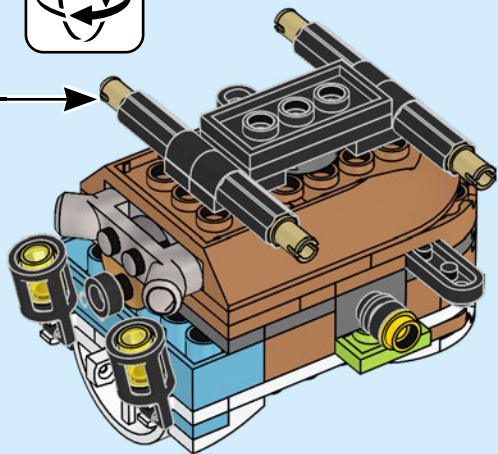
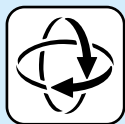

34

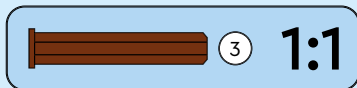
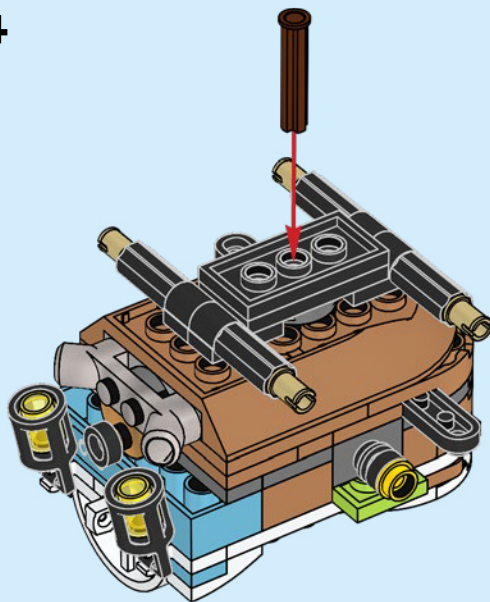



1x



1x

35

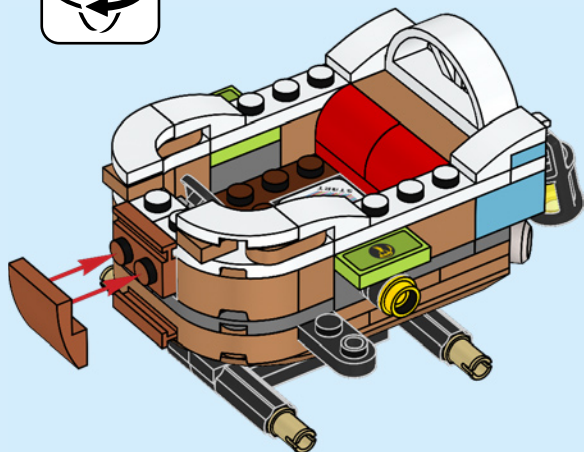

1x



1x

36

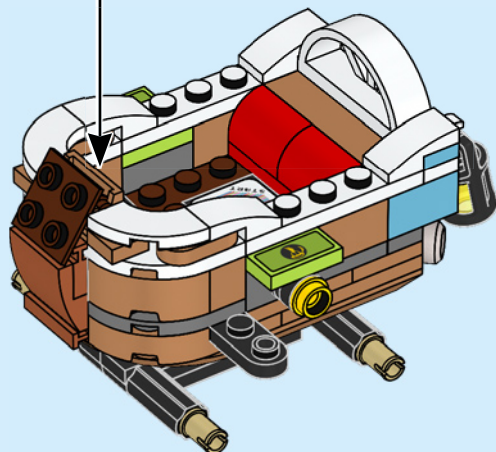
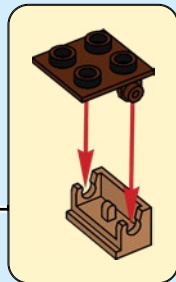

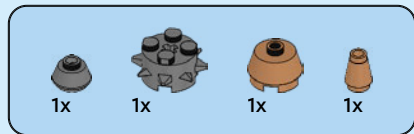

37

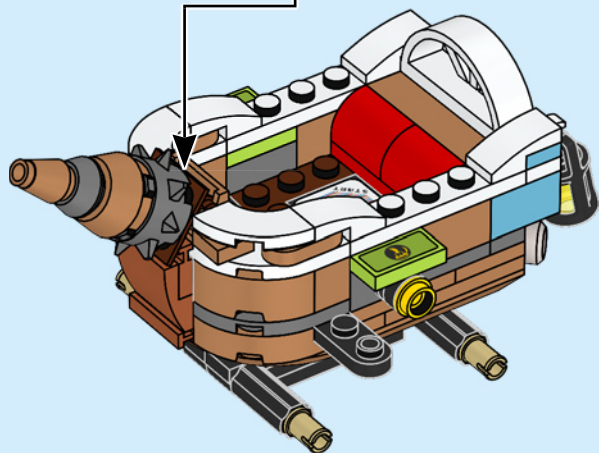
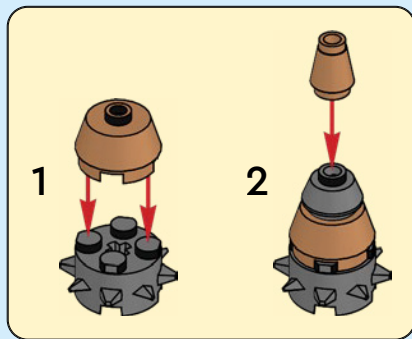

38

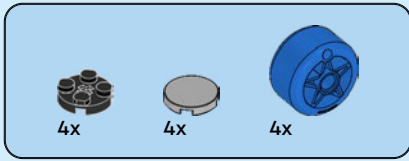

38

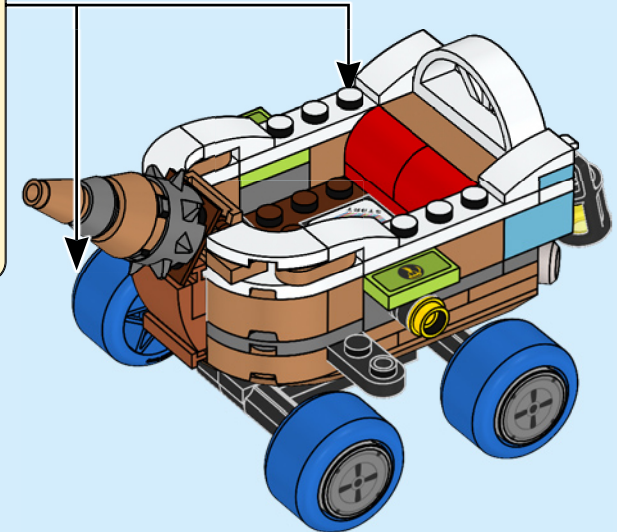
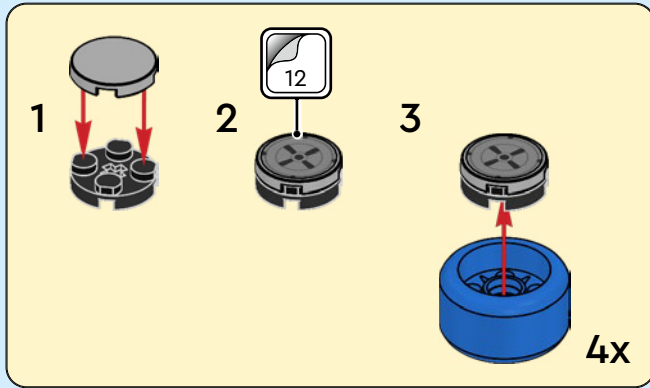

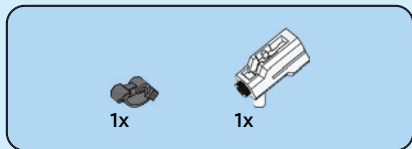

39

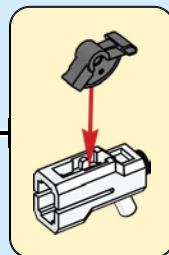
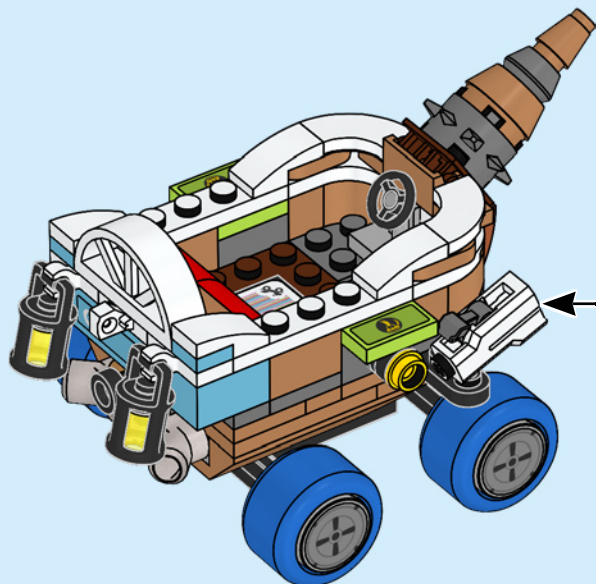



2x



2x

40

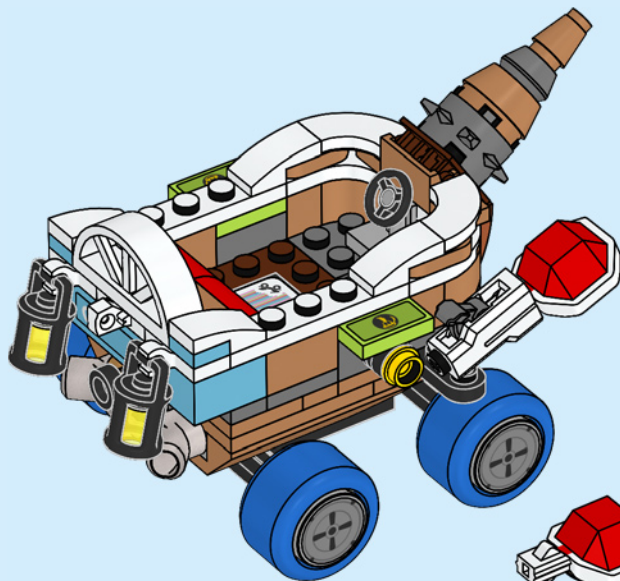

2x

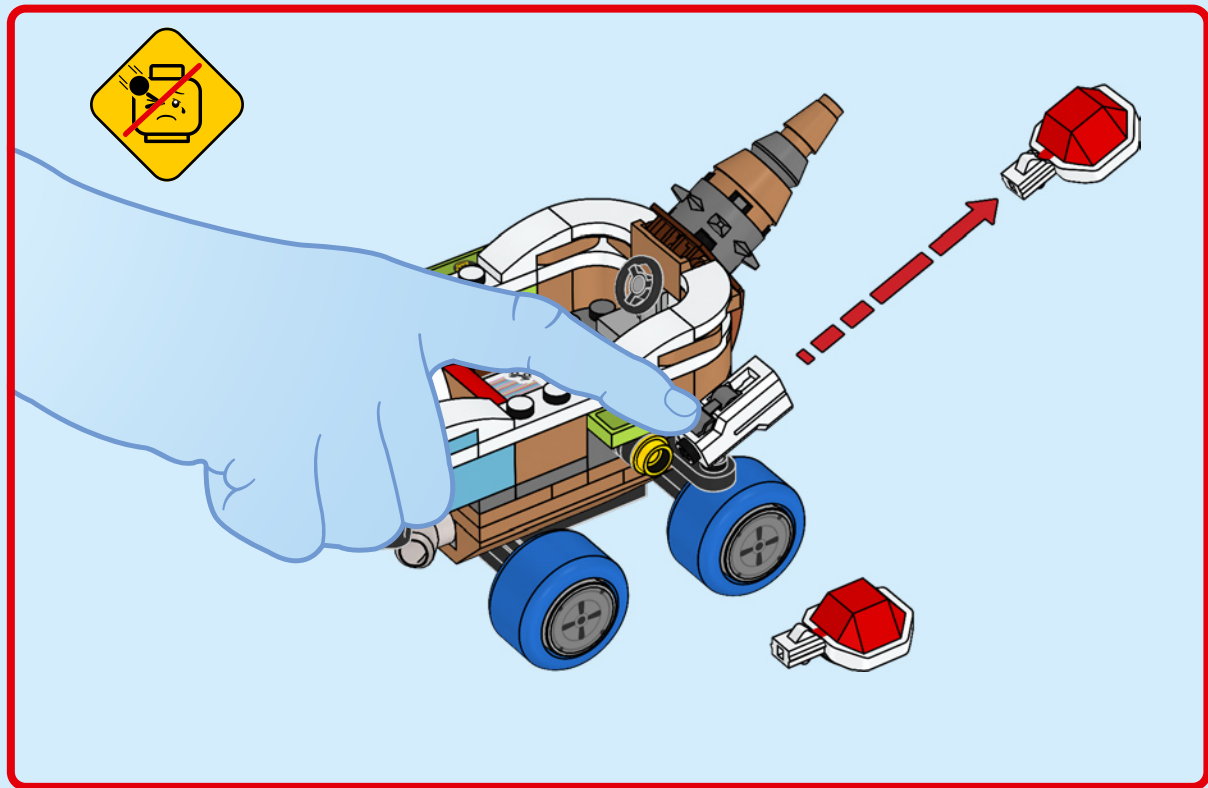

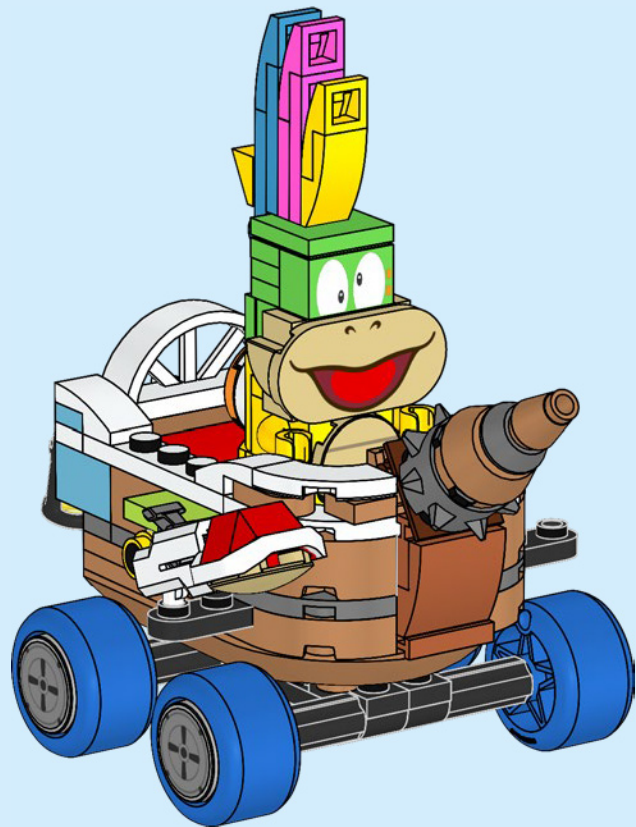



LEGO, the LEGO logo and the Brick and Knob configurations are trademarks of the/son des marques de commerce du/
son marcas registradas de LEGO Group. ©2025 The LEGO Group. 6554678

© Nintendo