



SUPER MARIO

72036



3

Let's build

Jetzt wird gebaut
Construisons
Costruiamo
Vamos a construir

Vamos construir
让我们开始拼搭
Klocki w dłoń
Pojďme stavět

Podĳme stavat'
Gyerünk, építsünk!
Să construim
Хайде да строим

Bŭvĕsim
Hakkame ehitama
Konstruokime



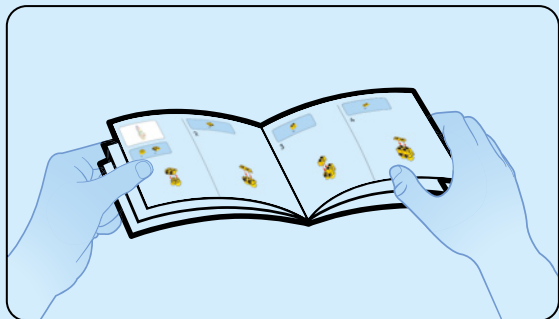

1

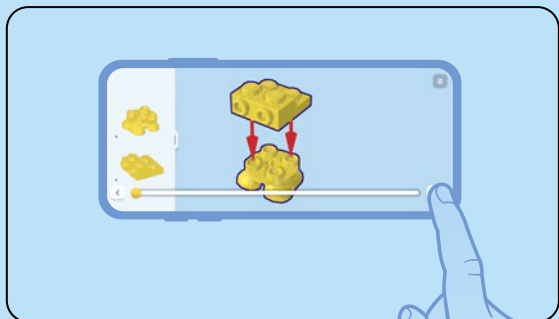
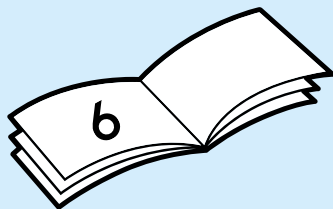

1



2

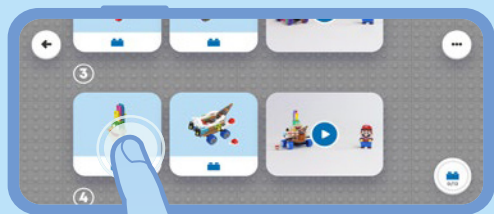

3

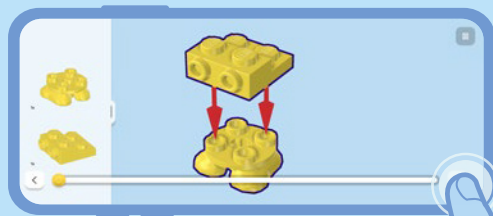



1

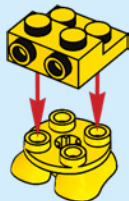

2

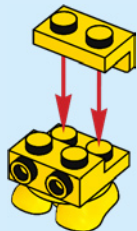



2x

3

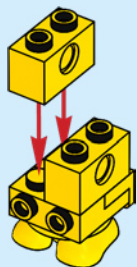

1x

4

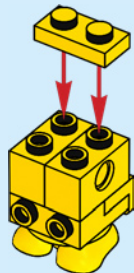



2x

5

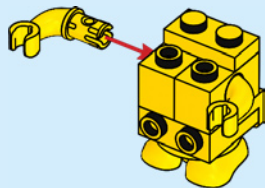

1x

6

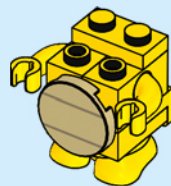

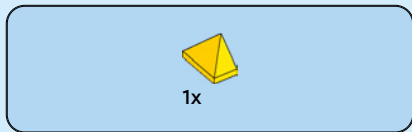

7

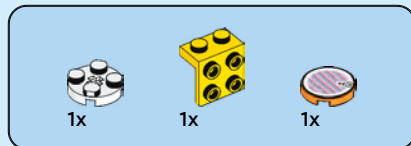
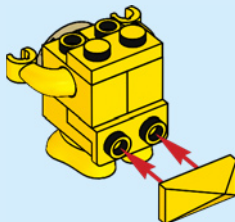
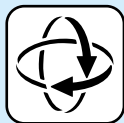

8

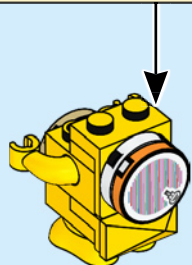
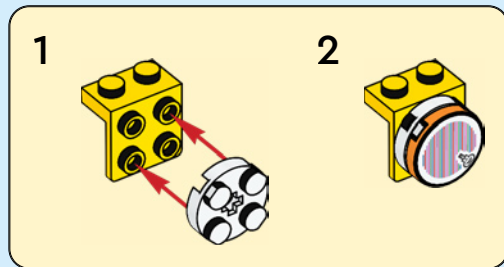



1x



2x



1x

9

1

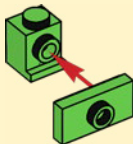

2

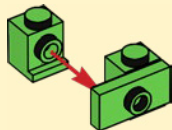

3

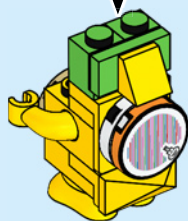



10

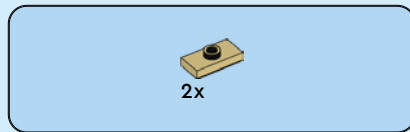
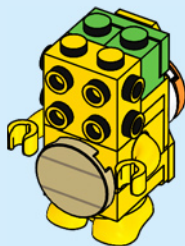

11

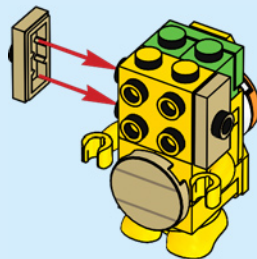



2x

12

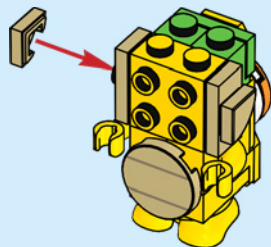

12



1x

13

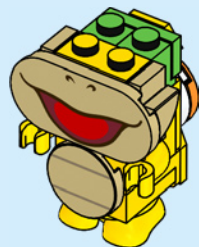



2x



1x

14

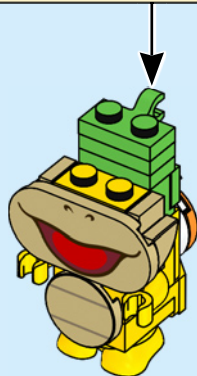
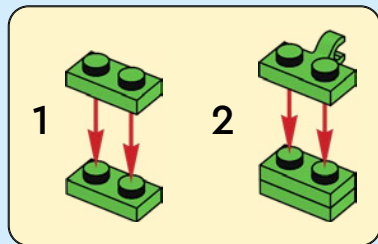

1x



1x

15

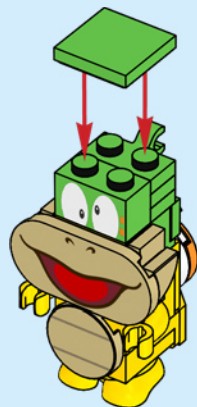



1x



1x



1x



1x



1x



1x



1x



1x



1x

16

1

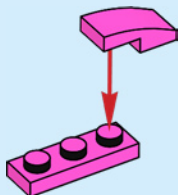

2

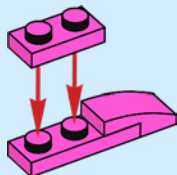

3

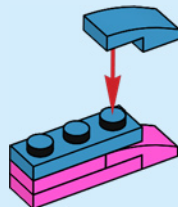

4

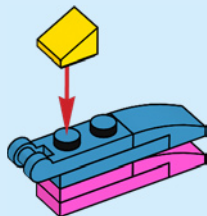

5

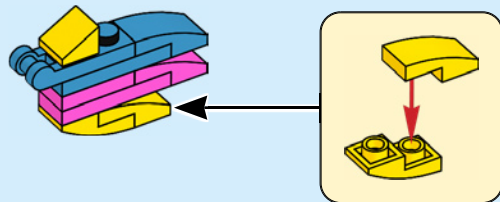

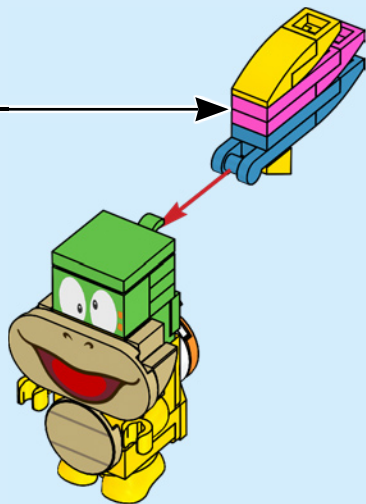

16

17

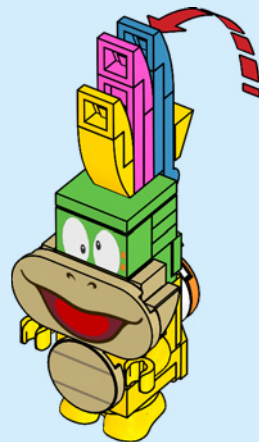

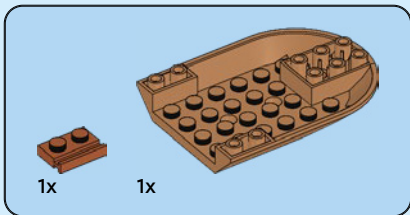
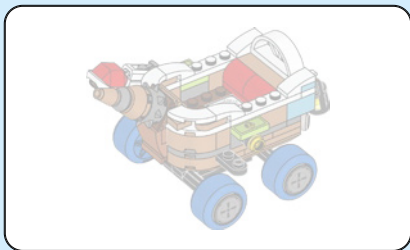

1

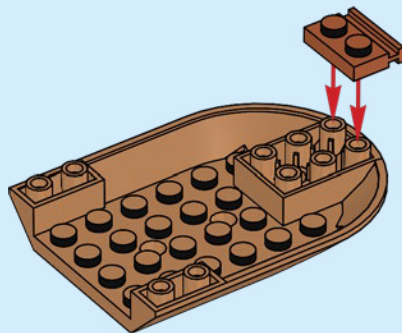



1x

2

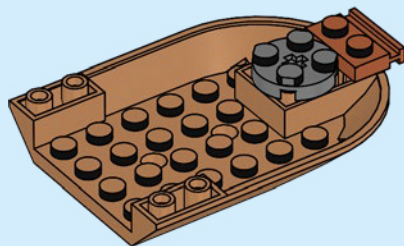

1x

3

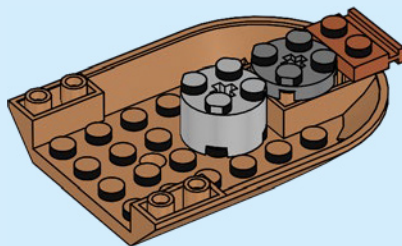



2x



2x

4

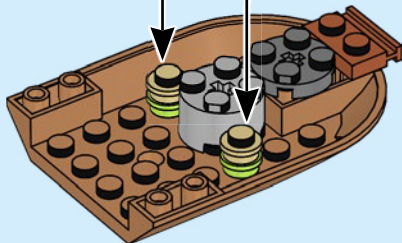
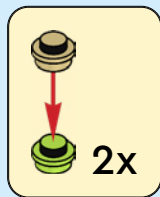

2x

5

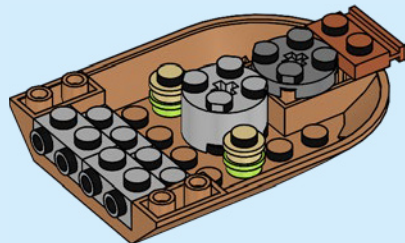

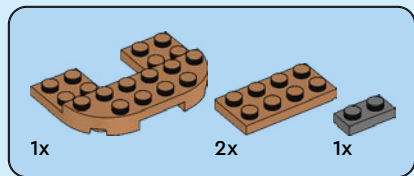

6

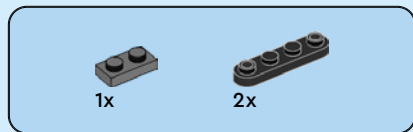
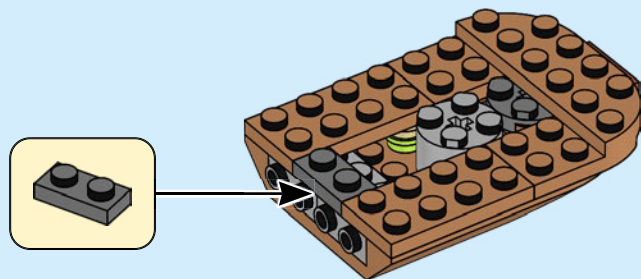

7

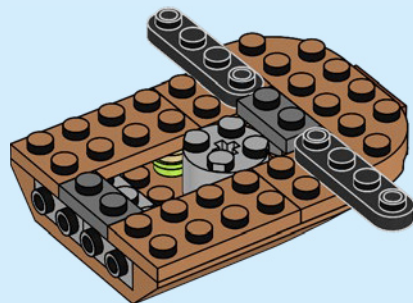

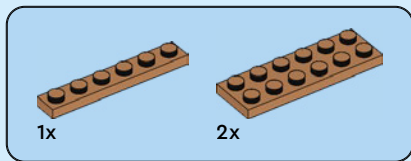

8

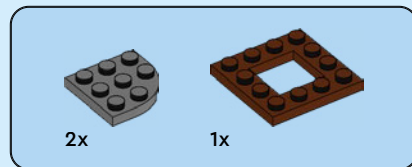
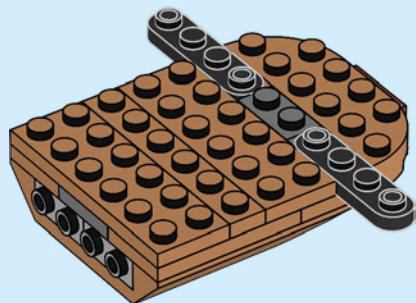

9

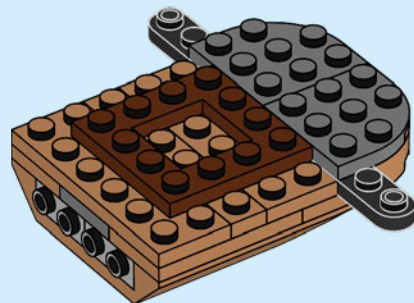

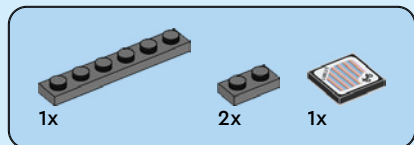

10

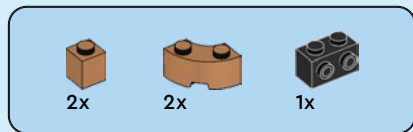
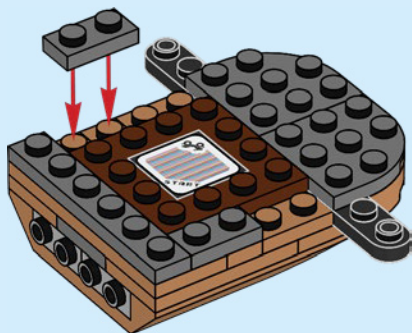

11

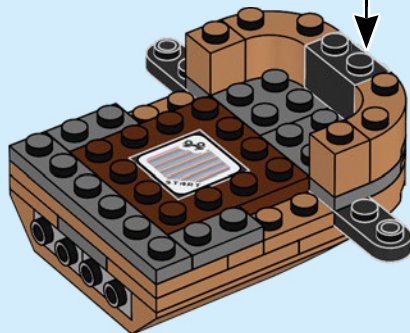
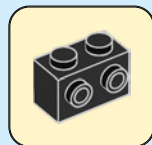



2x



2x



2x



2x



2x



2x

12

1

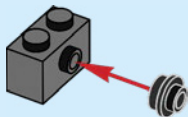

2

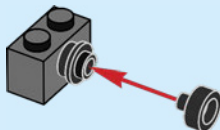

3

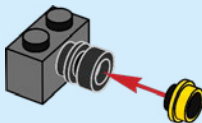

4

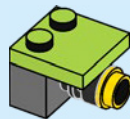

5

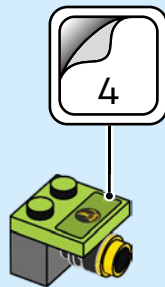

2x

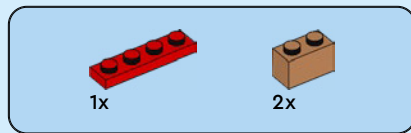
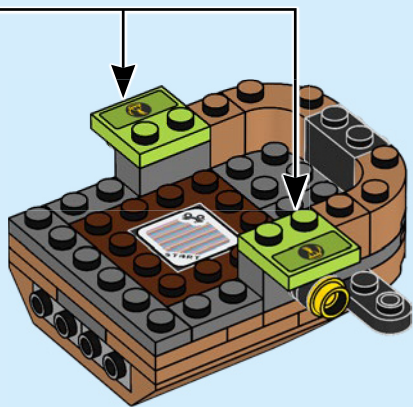

13

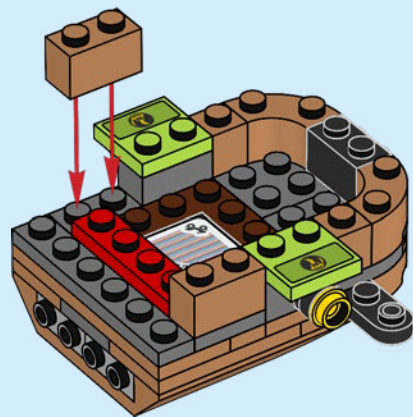

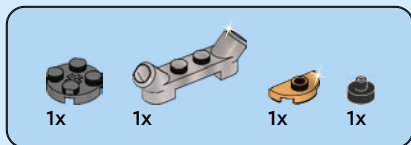

14

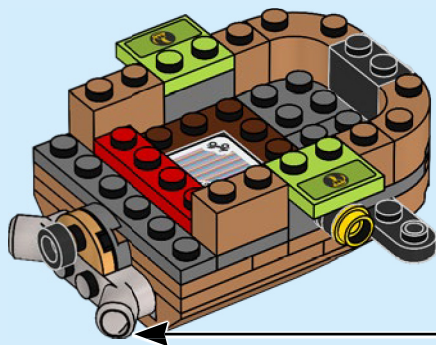
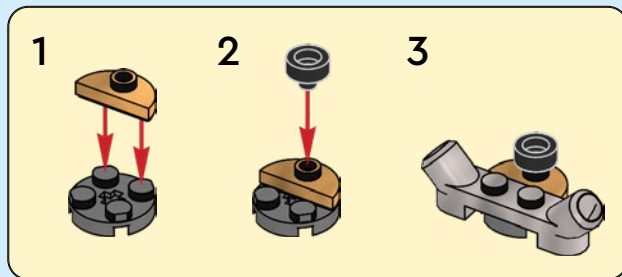



2x

15

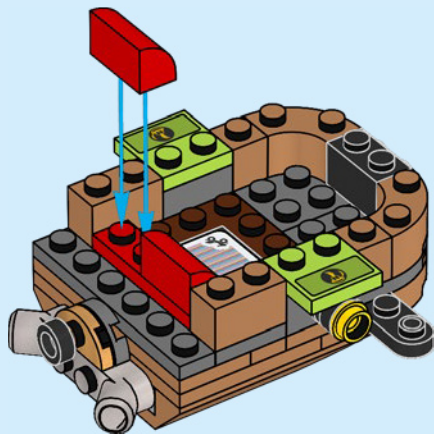

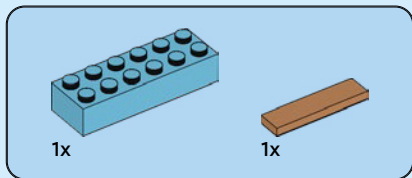
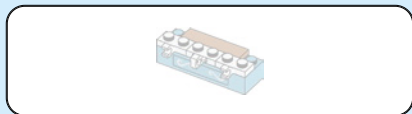

16

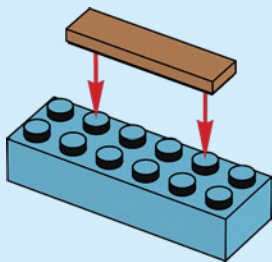

17

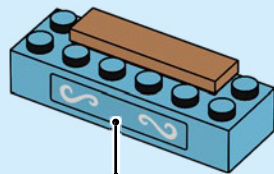



2x

18

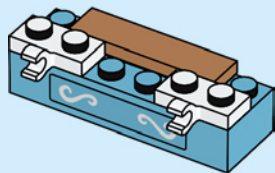

1x

19

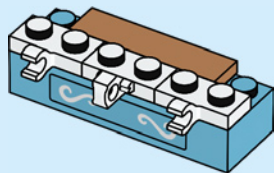

20

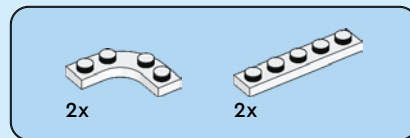
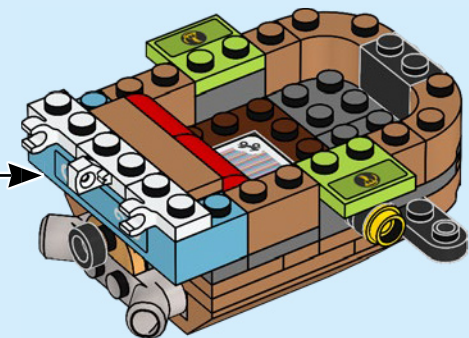

21

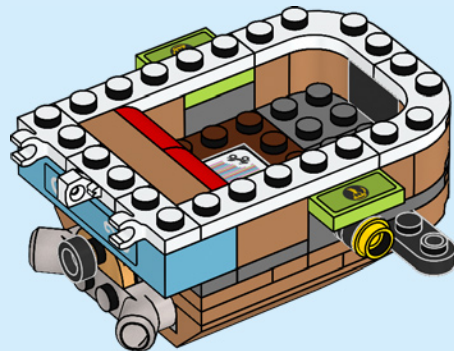



1x

22

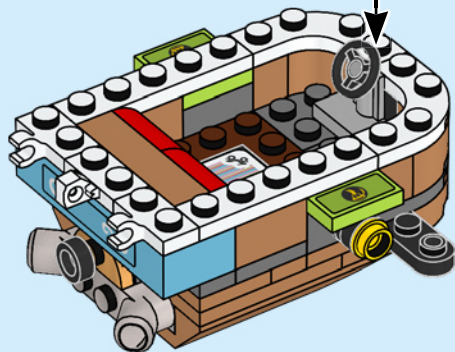

2x



2x

23

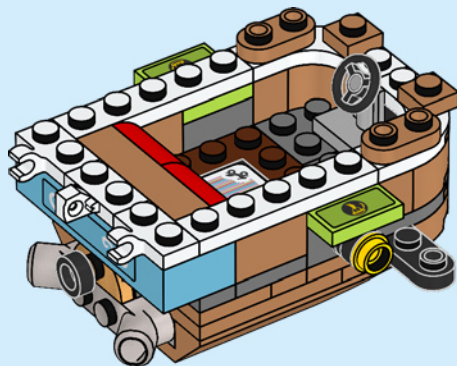

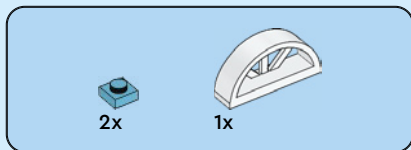

24

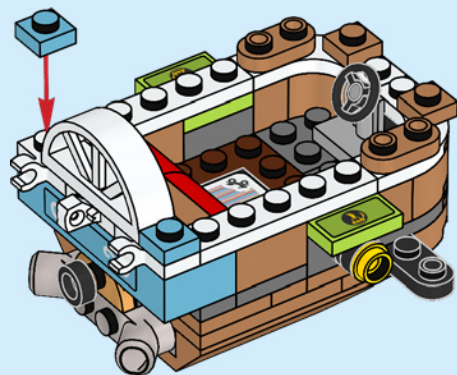



4x



2x

25

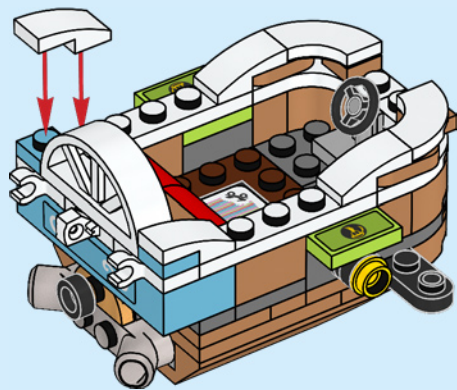

2x



2x

26



2x

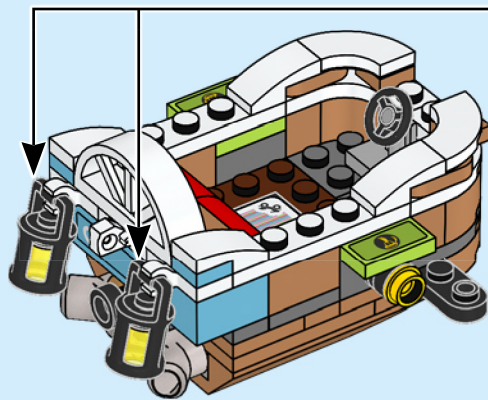

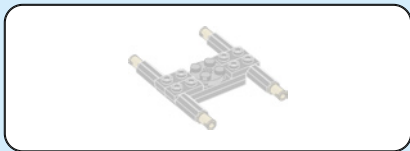

27

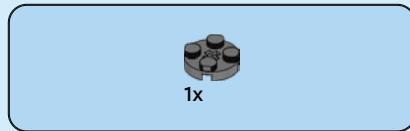
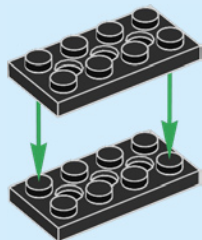

28

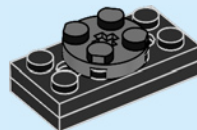



29

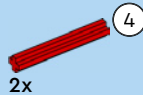
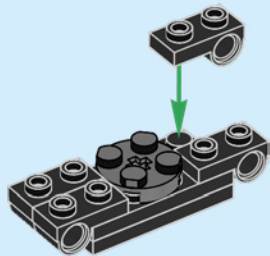

30

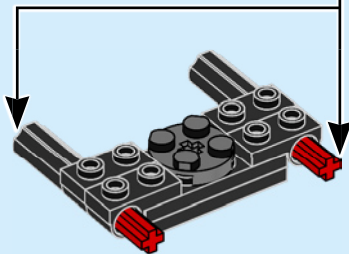
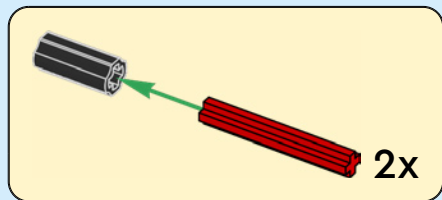

4

1:1



2x

31

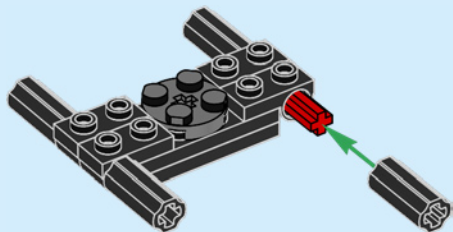

4x

32

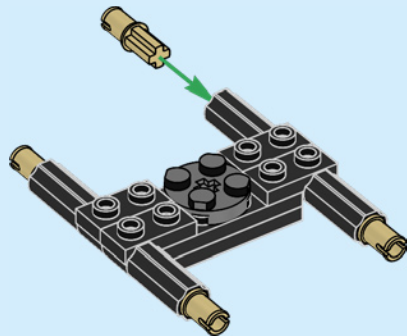

33

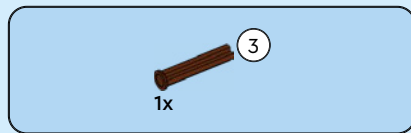
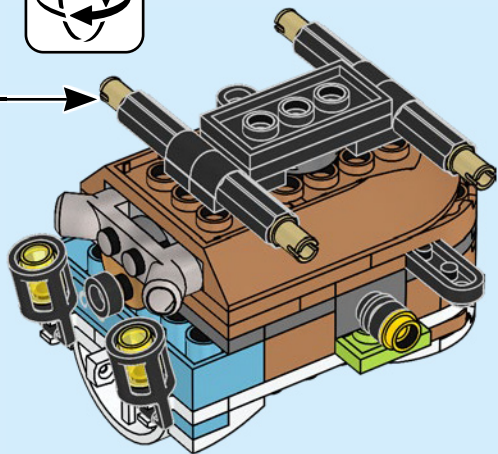

34

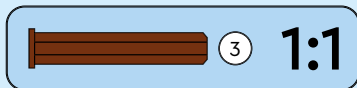
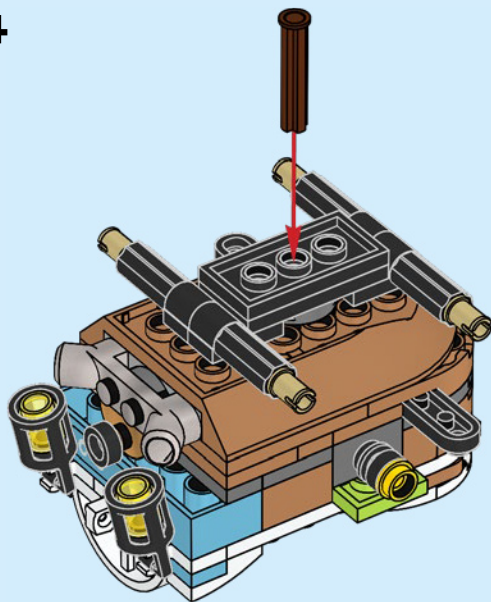



1x



1x

35

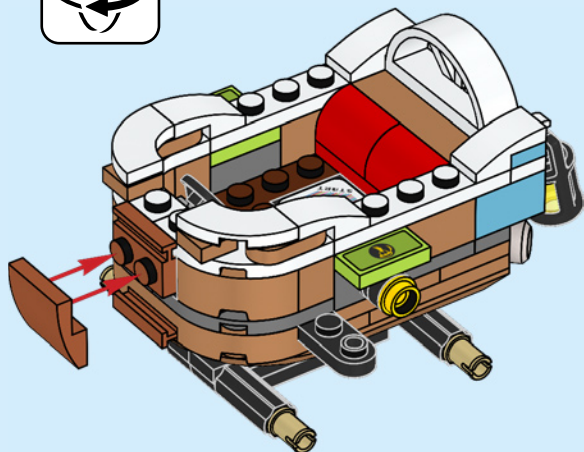

1x



1x

36

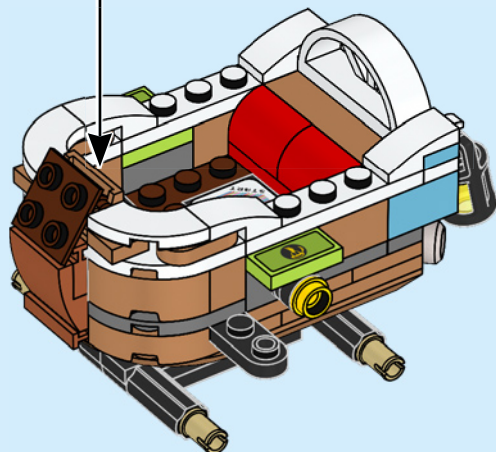
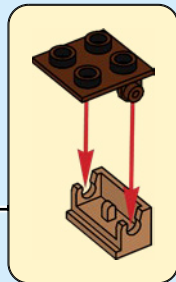

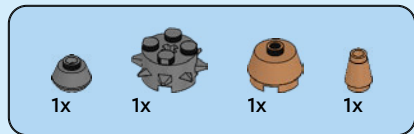

37

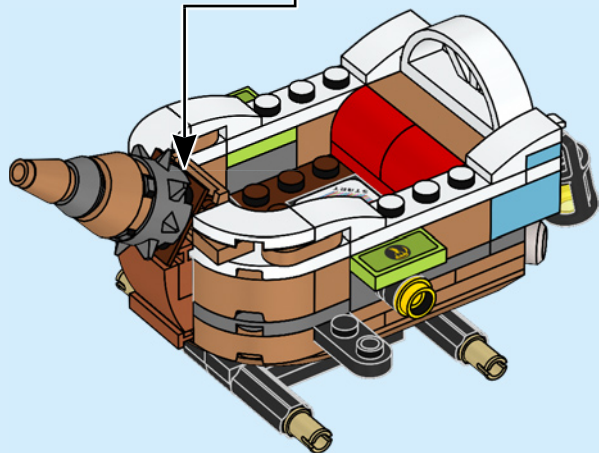
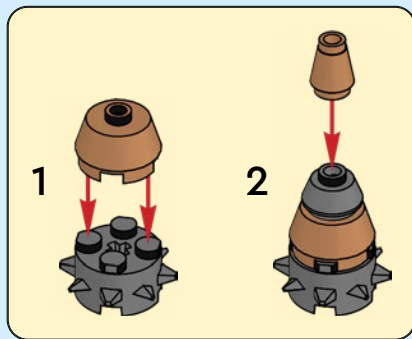

38

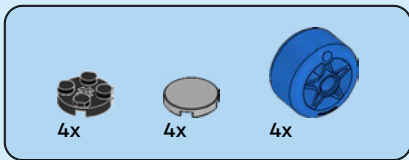

38

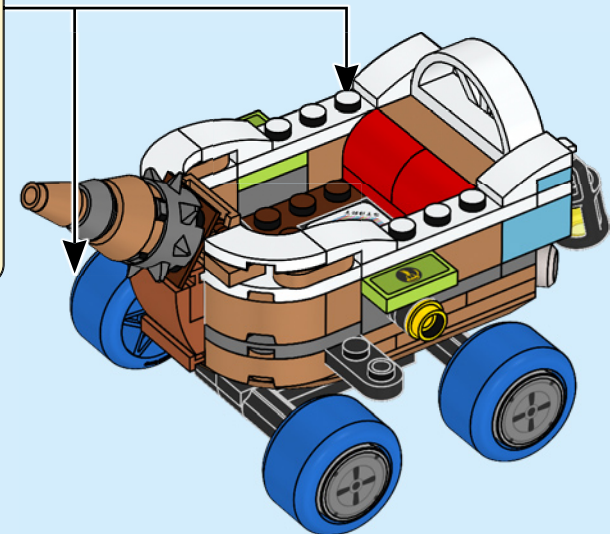
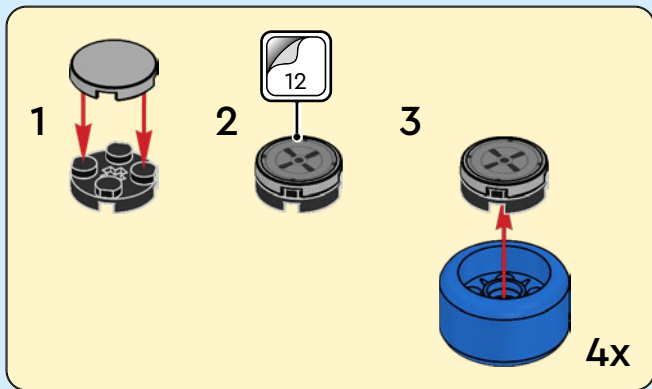

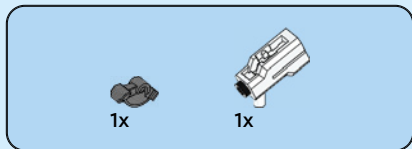

39

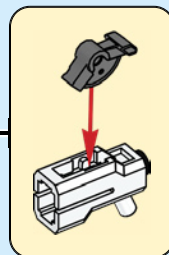
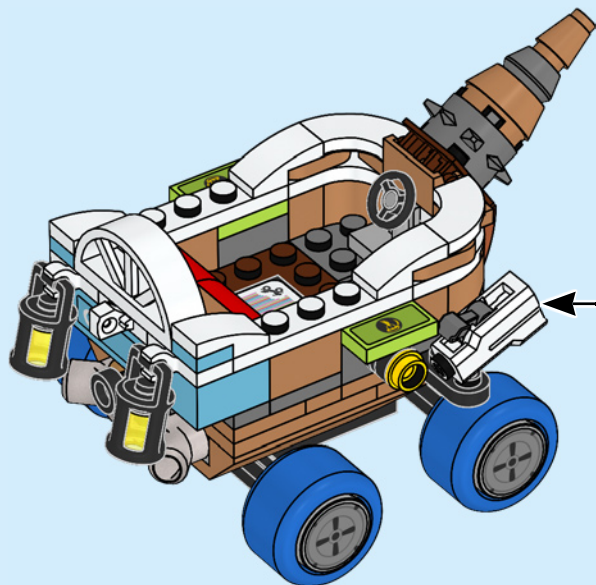



2x



2x

40

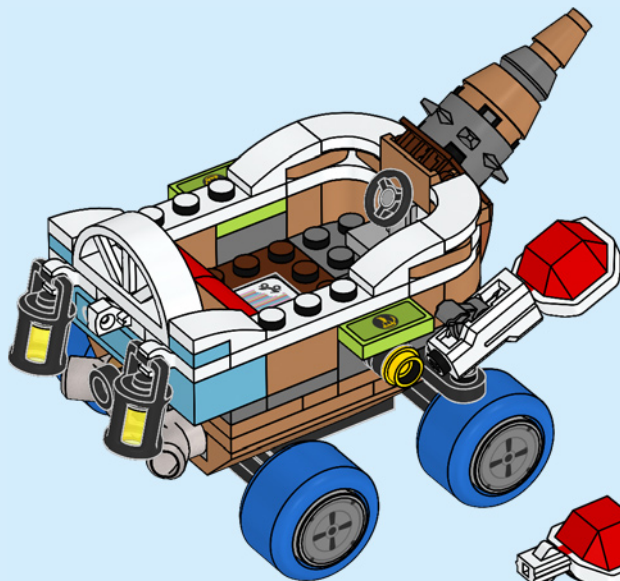

2x

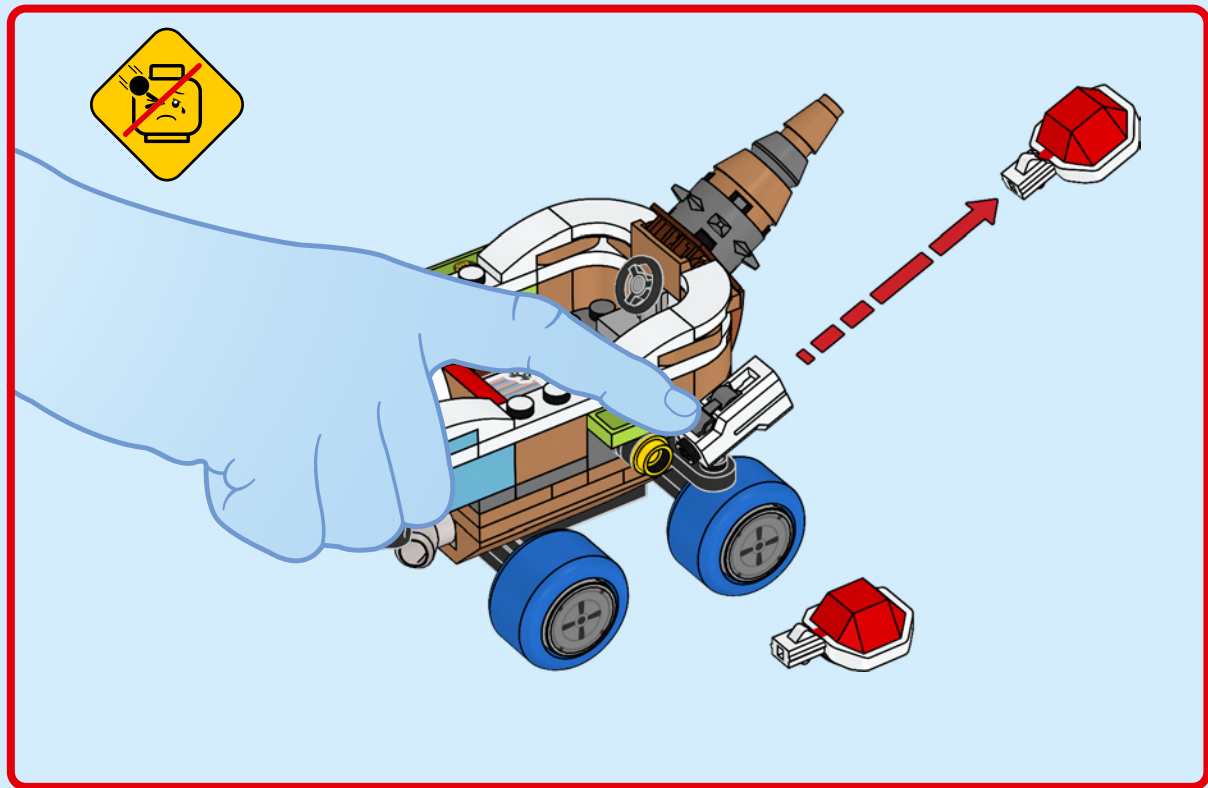

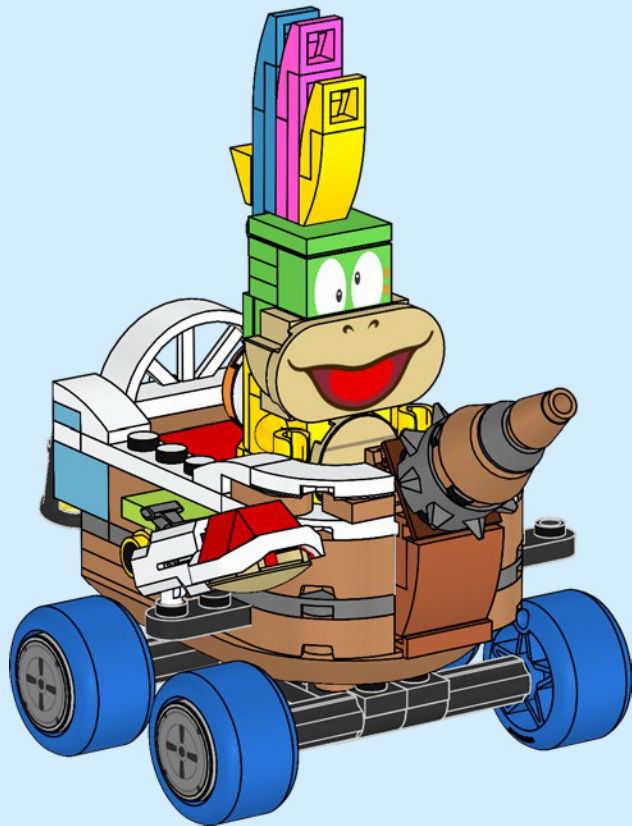



LEGO, the LEGO logo and the Brick and Knob configurations are trademarks and/or copyrights of the LEGO Group.

©2025 The LEGO Group. 6554667

© Nintendo