



**SUPER  
MARIO**™

72032







[LEGO.com/sustainable-packaging](https://LEGO.com/sustainable-packaging)



 **FR**  
**DONNEZ**  
OU  
**RECYCLEZ**

 OU  OU 

ASSOCIATION    MAGASIN    DÉCHÈTERIE

Adresses sur [quefairedemesdechets.fr](https://quefairedemesdechets.fr)



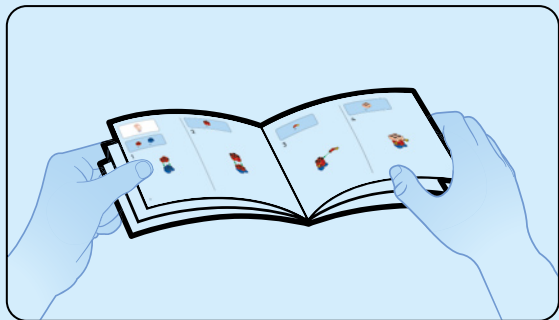

1

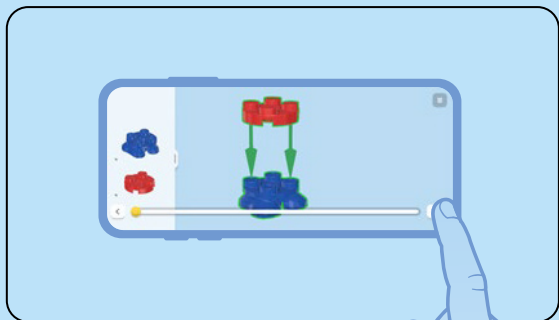
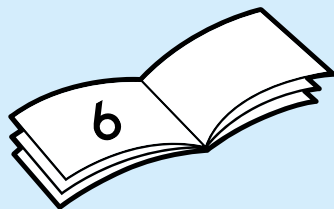

1





2

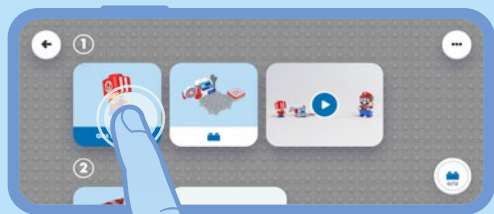

3

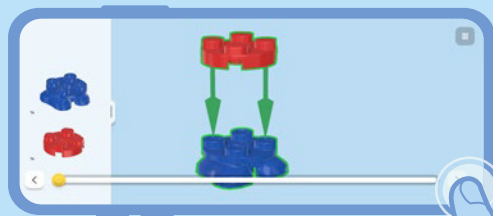

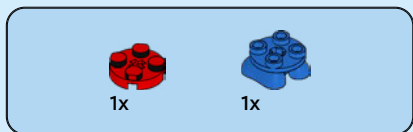
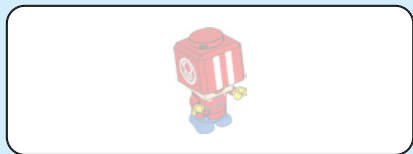

1

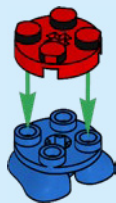

2

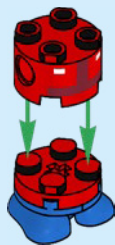



2x

3

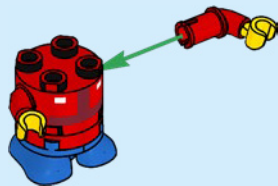

1x

4

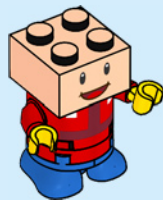



1x



1x

5



1x



1x

6

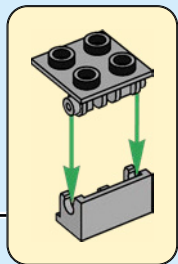



1x

7

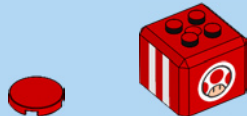
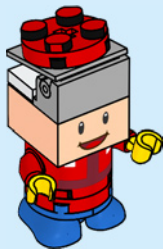

1x

1x

8



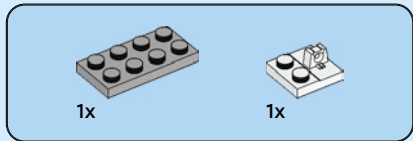
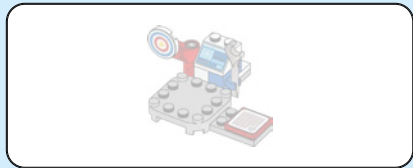

1

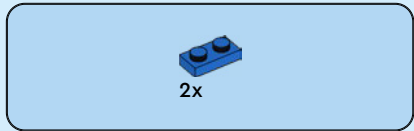
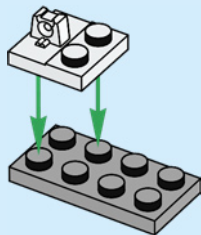

2

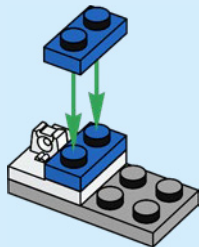

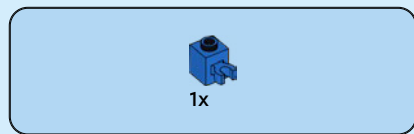

3

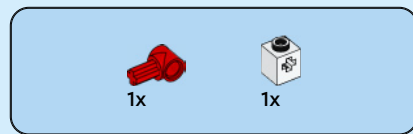
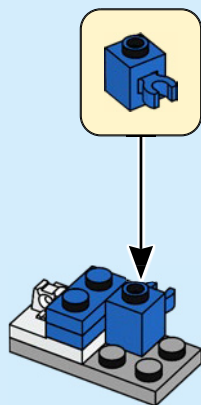

4

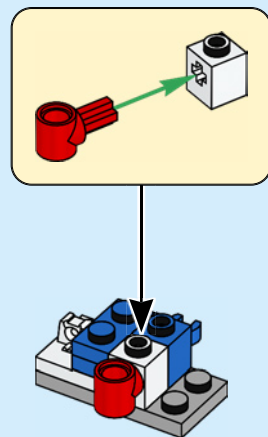





1x

5



1x



1x

6

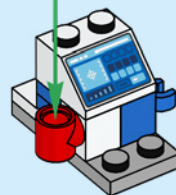
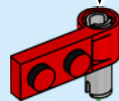
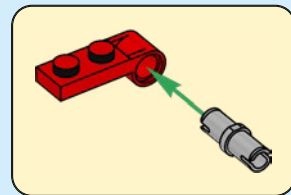



1x



1x

7

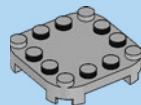
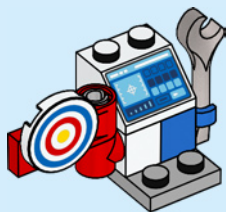

1x

8

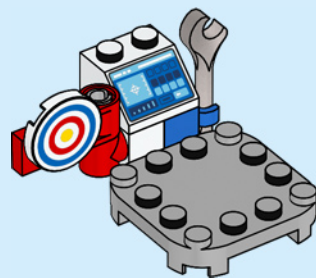



9

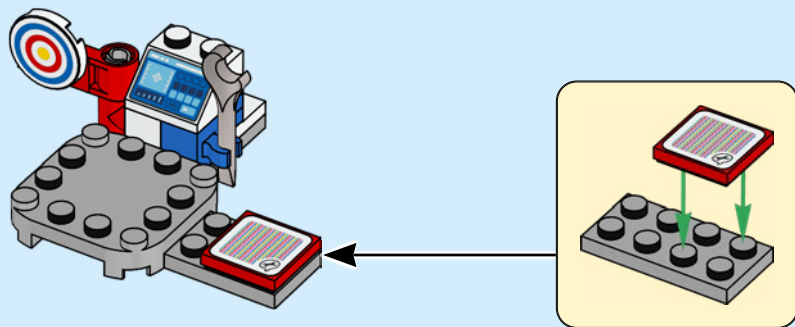

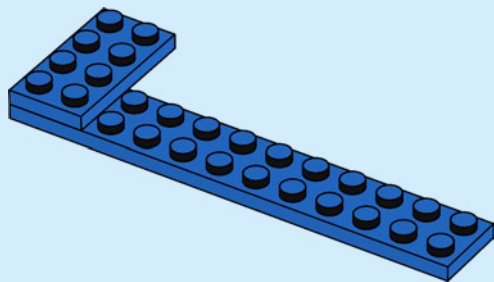
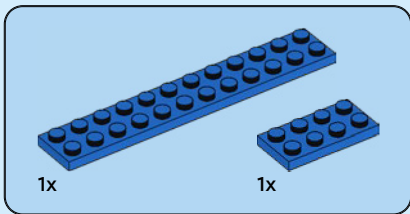
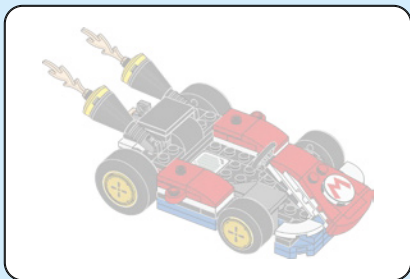

1

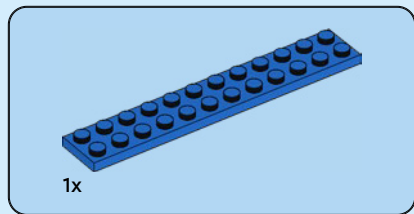

2

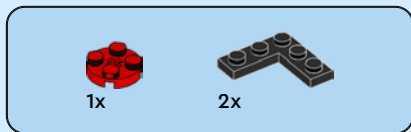
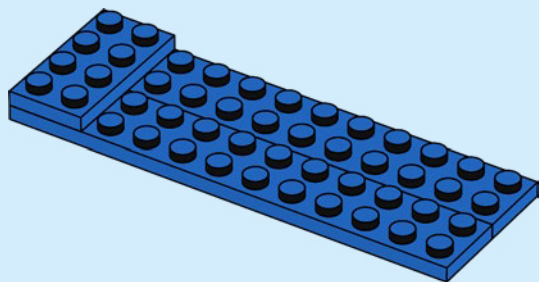

3

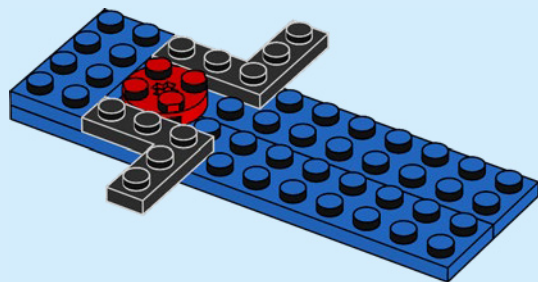



1x

4

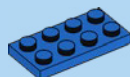
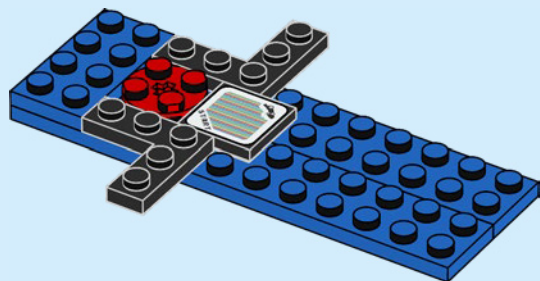

2x

5

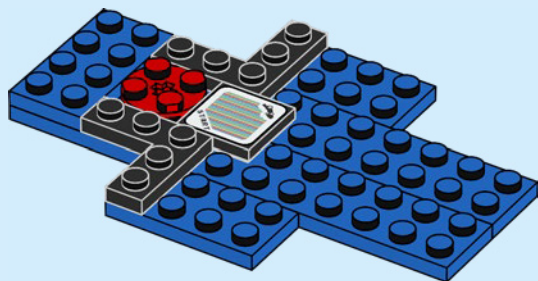

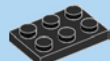

3x

6

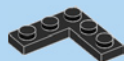
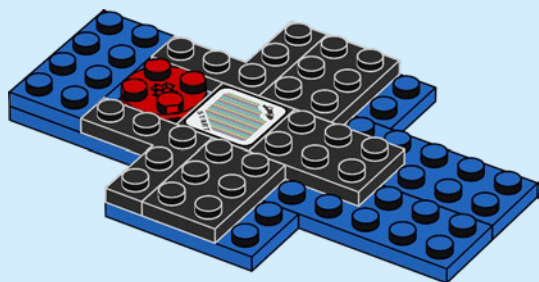

2x

7

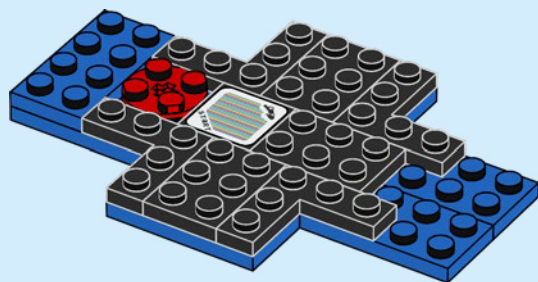





2x

8

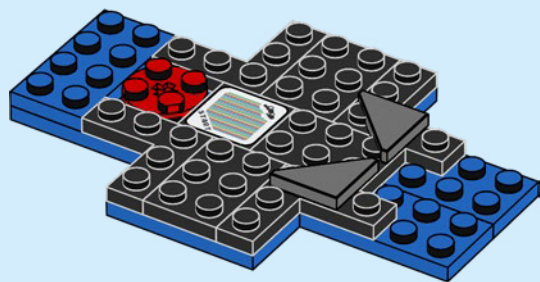

2x

9

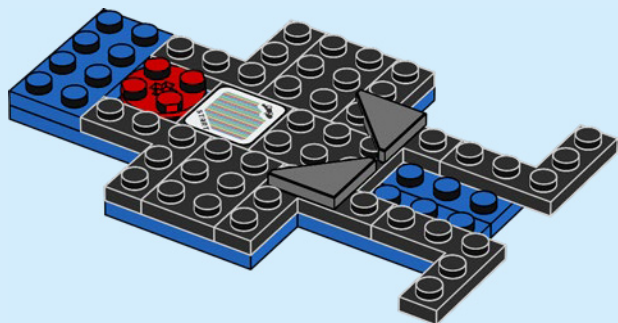



2x

10

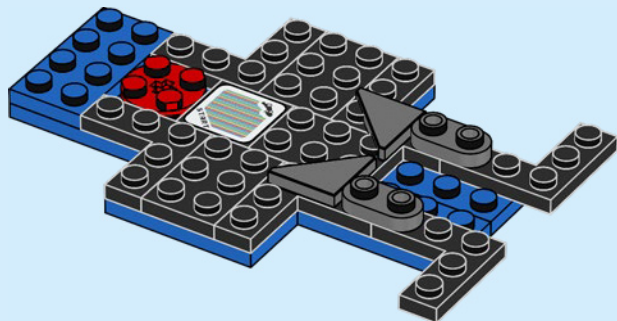

20

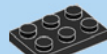

2x

11

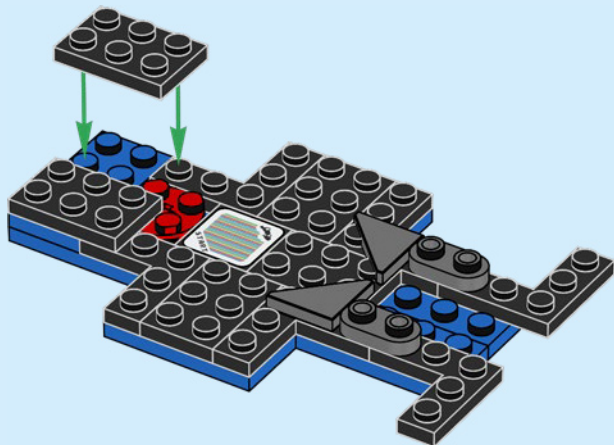

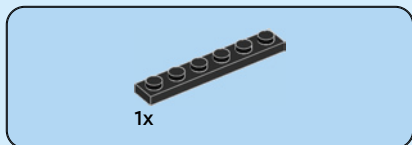

12

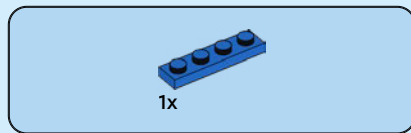
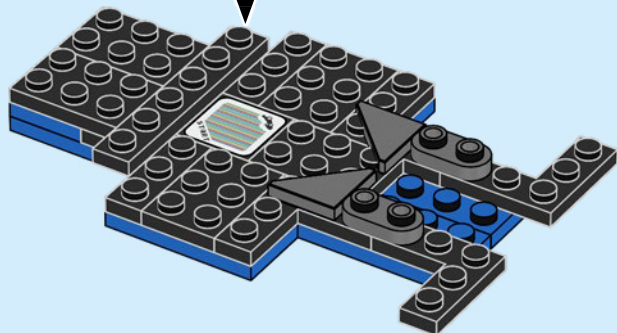
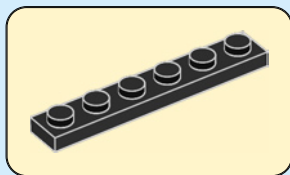

13

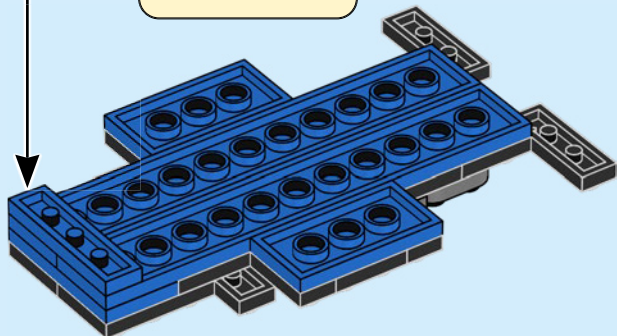
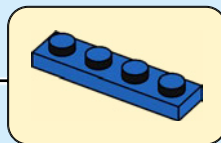

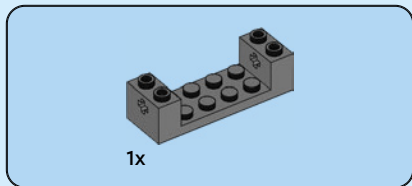

14

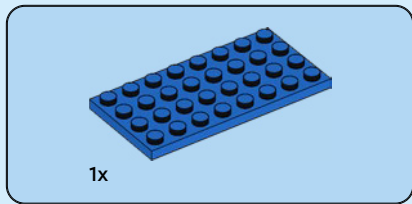
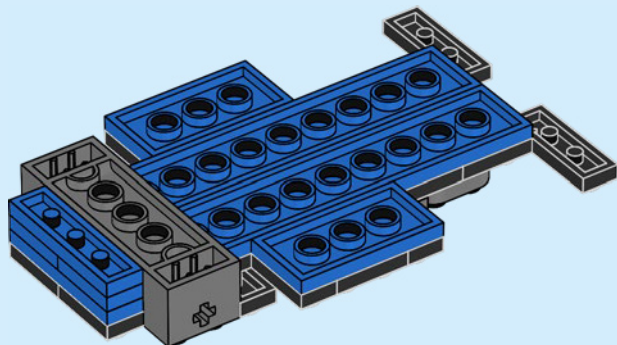

15

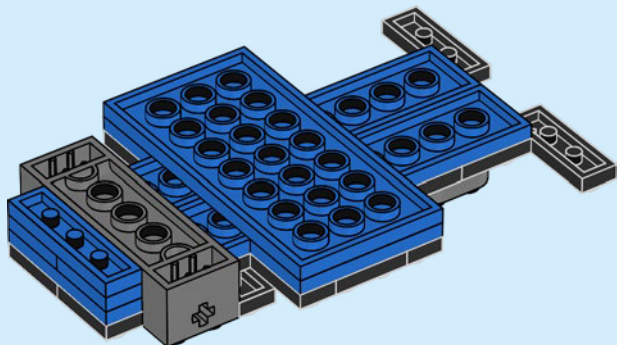

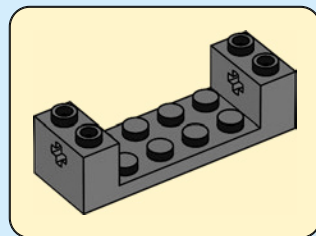
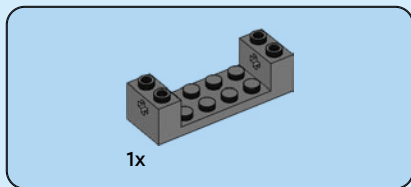

16

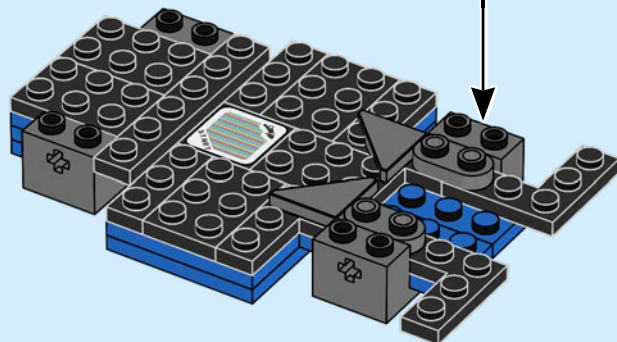



2x

17

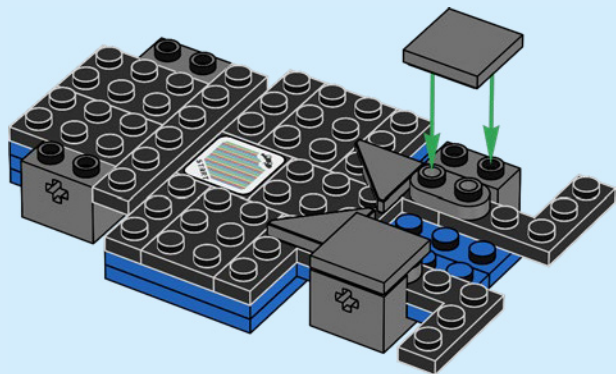

1x

18

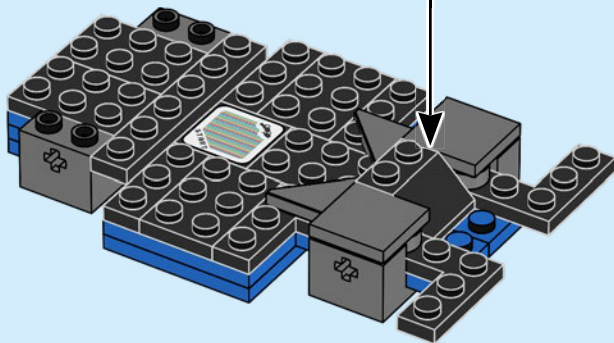
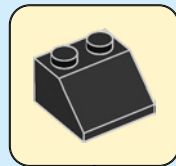

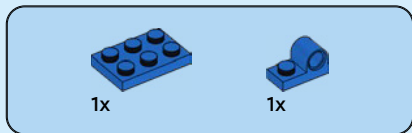
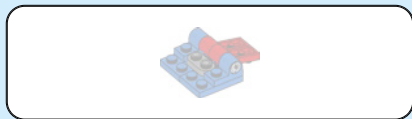

19

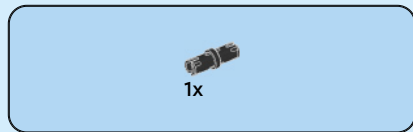
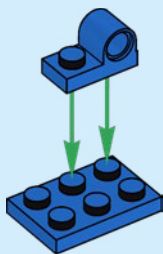

20

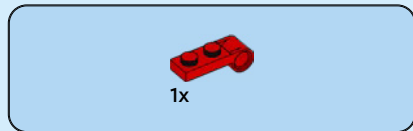
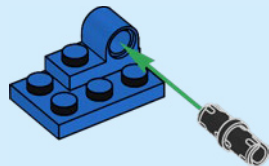

21

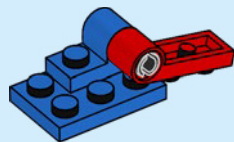



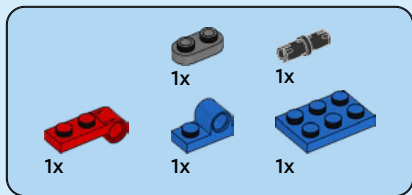

22

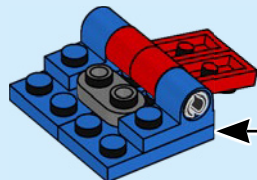
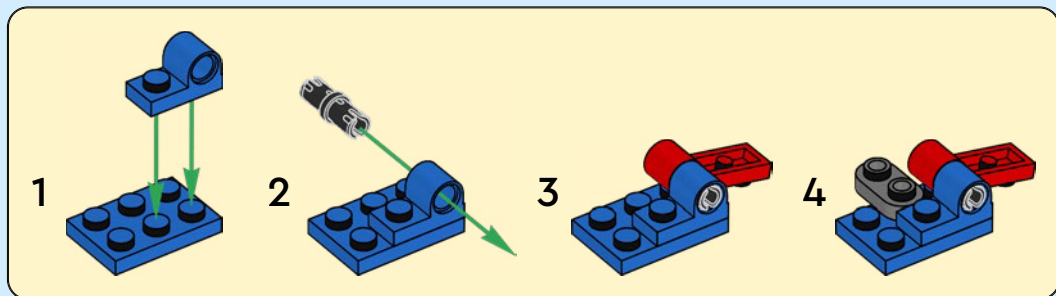

23

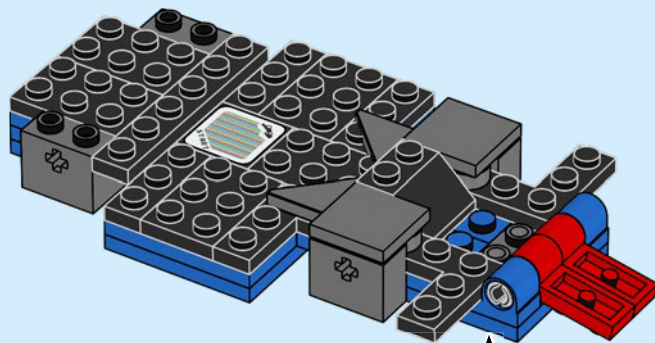



1x

24

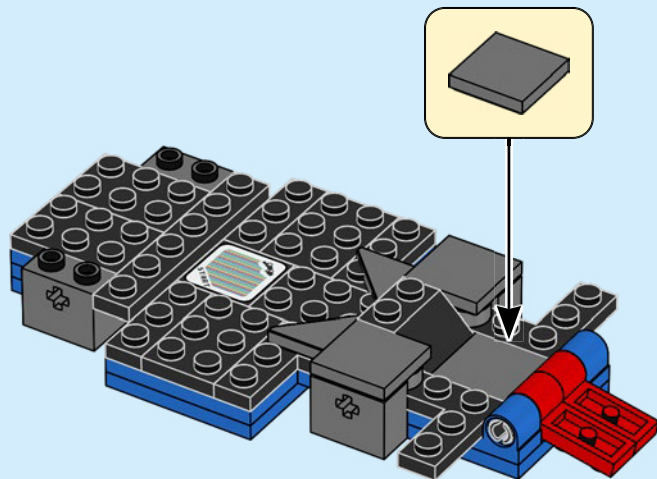



1x

25

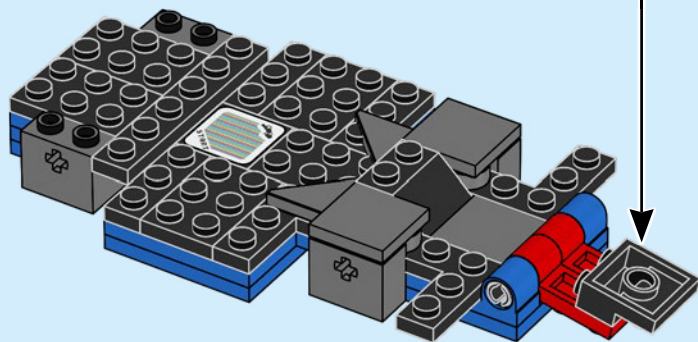
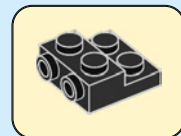

26

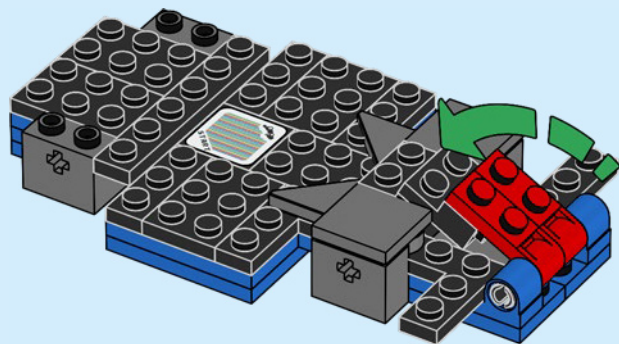

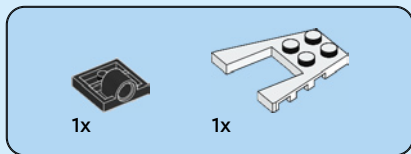

27

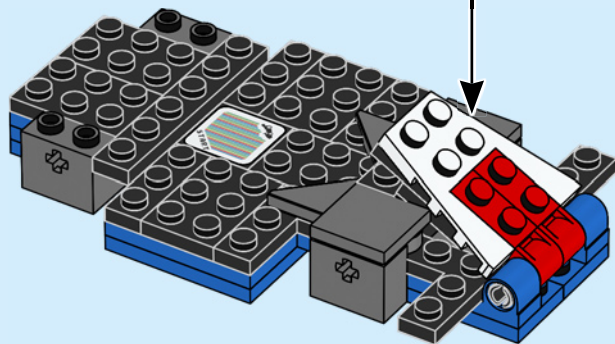
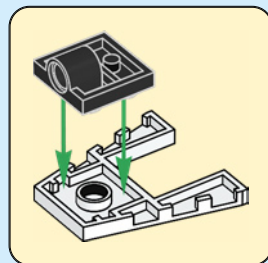



4x

28

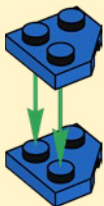
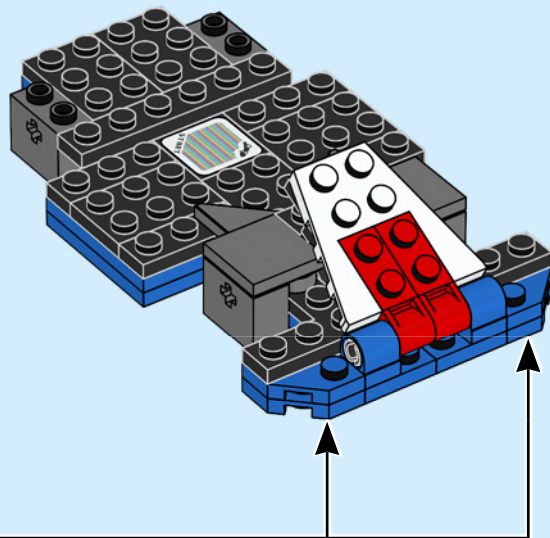

2x





2x

29

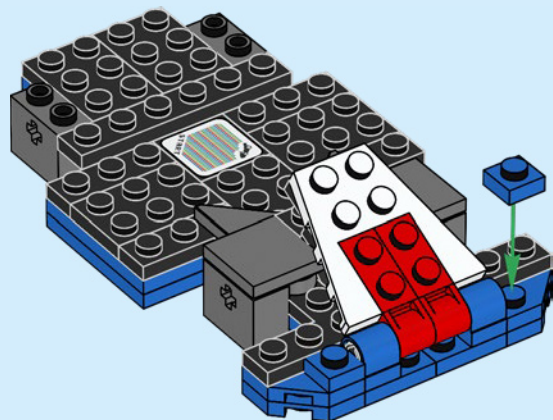

2x

30

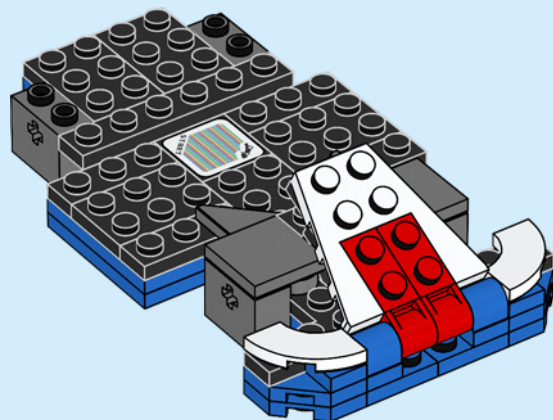

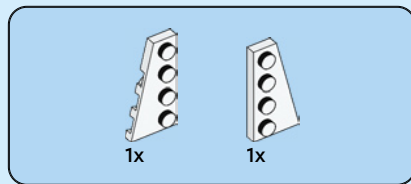
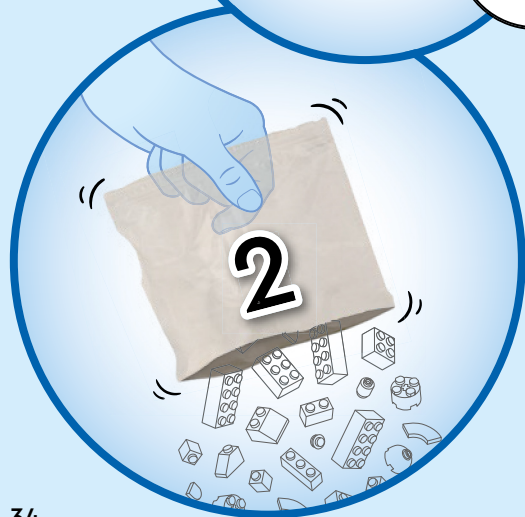
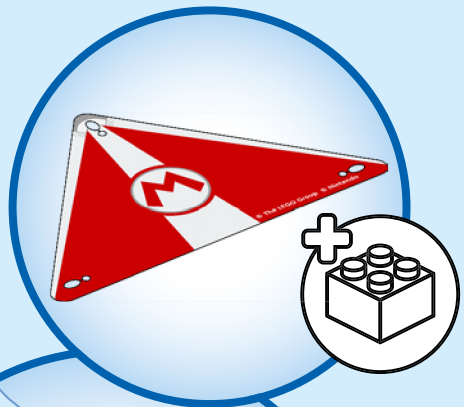

31

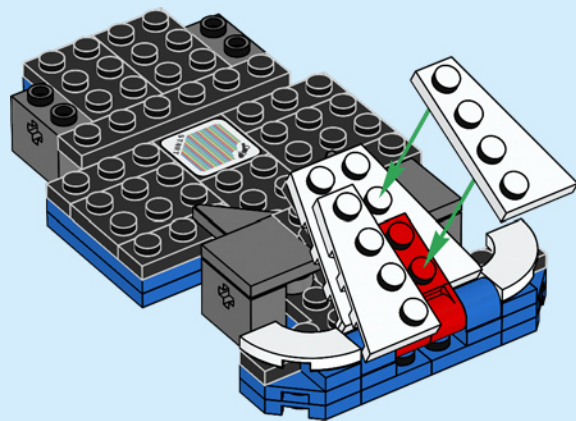



1x

32

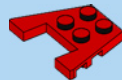
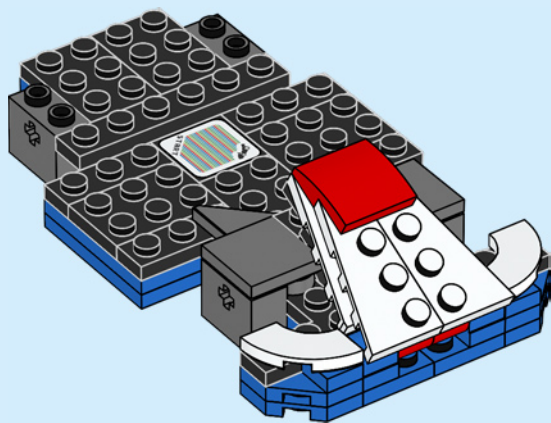

1x

33

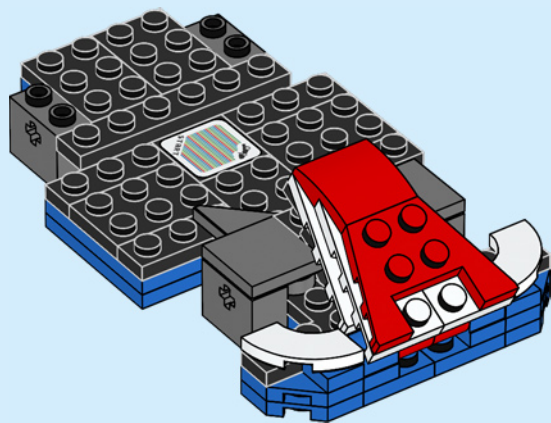

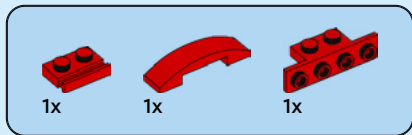

34

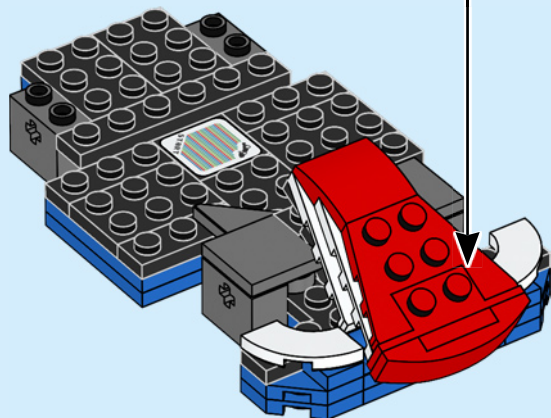
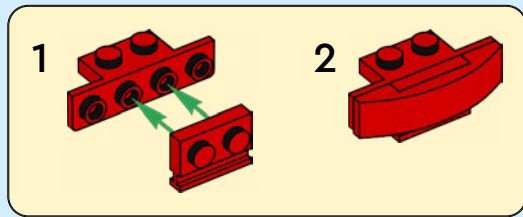



1x

35

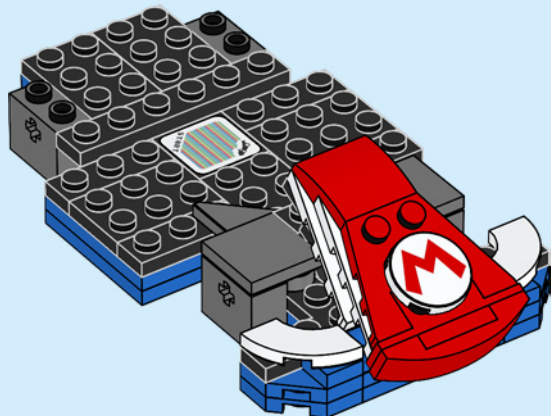

1x



1x

36

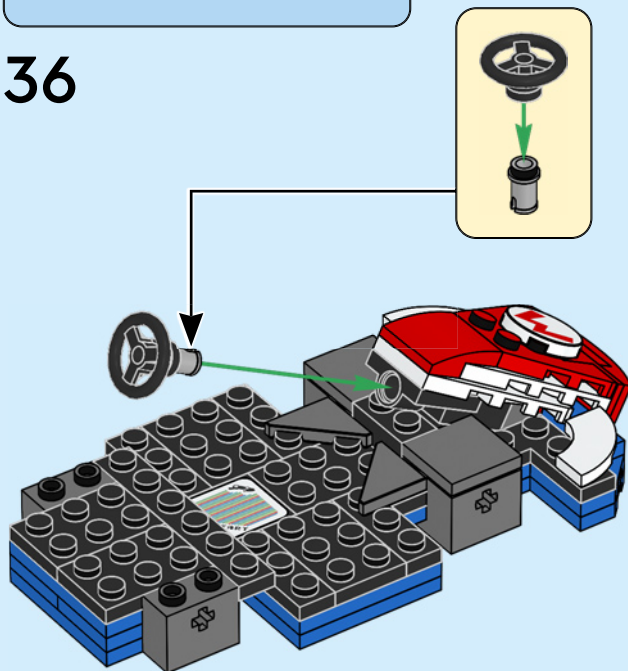

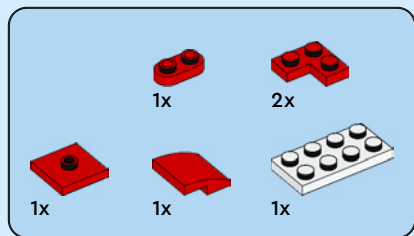

37

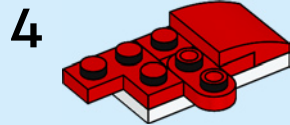
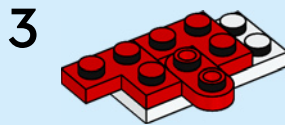
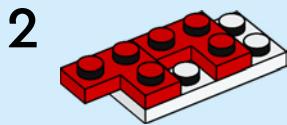
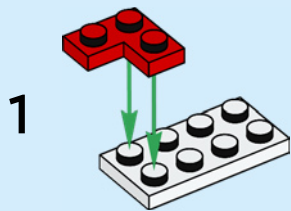

5

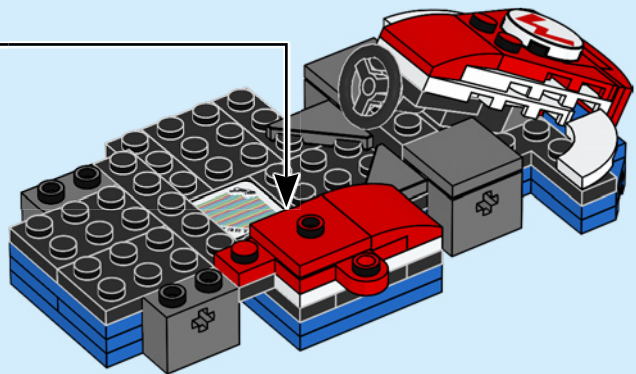
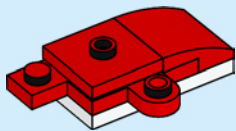

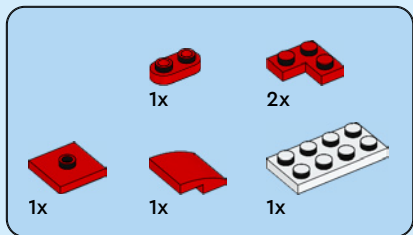

# 38

1



2

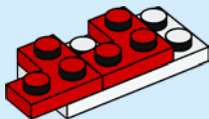

3

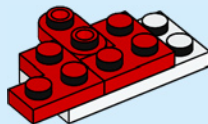

4

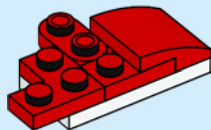



5

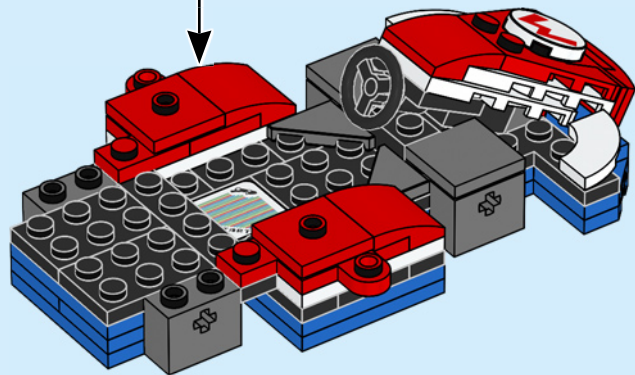
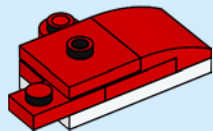



2x

39

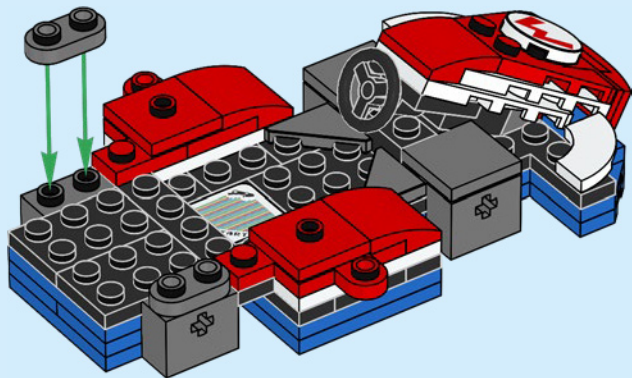

42

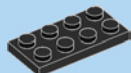

1x

40

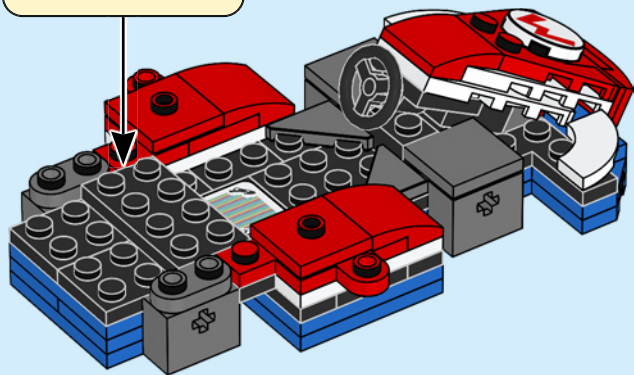
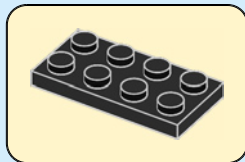



2x



3x

# 41

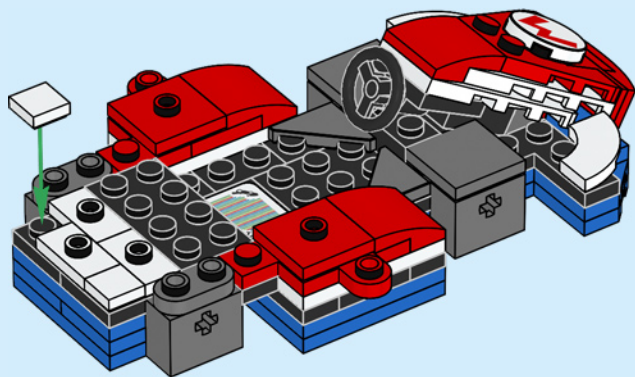

2x

# 42

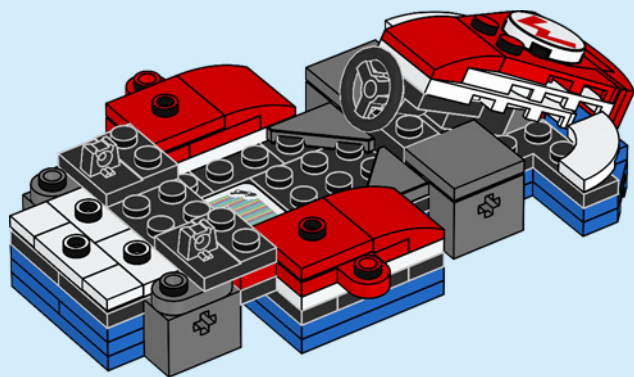



1x



1x

43

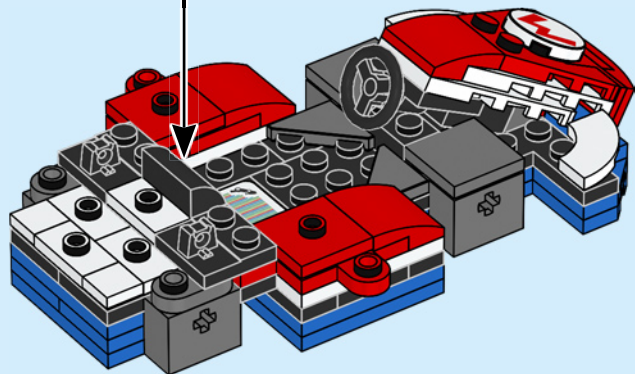
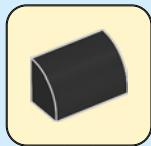

2x



1x

44

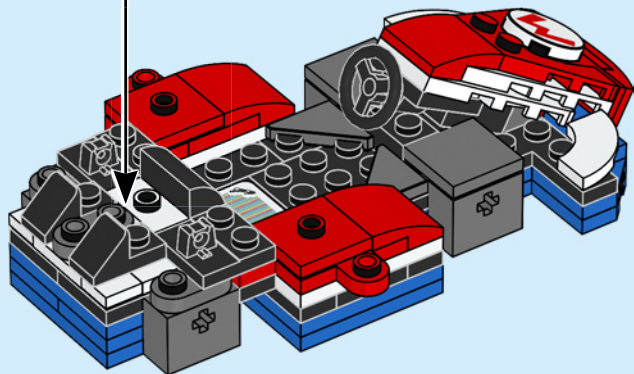

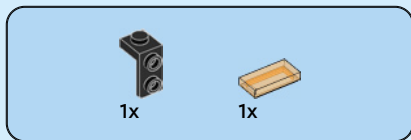

45

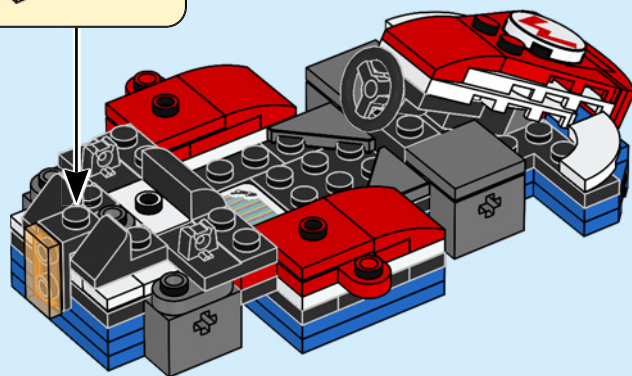
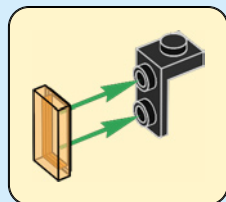

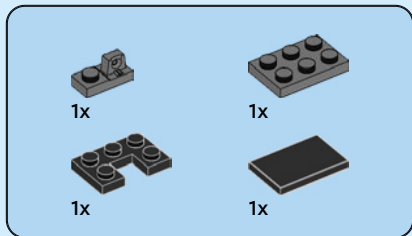

# 46

1

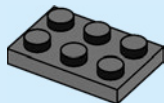

2

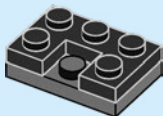

3

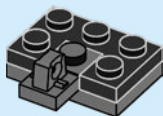

4

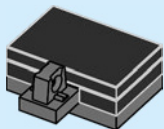

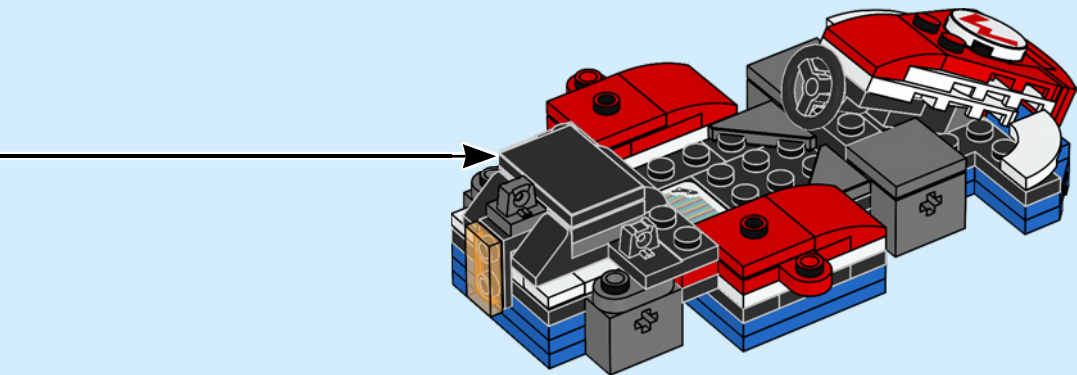

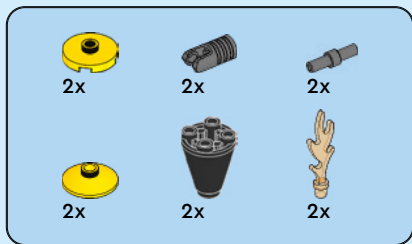
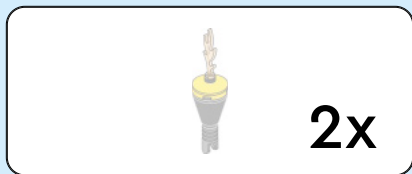

47

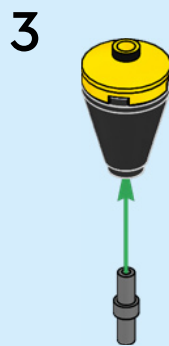
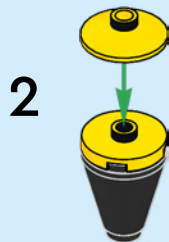
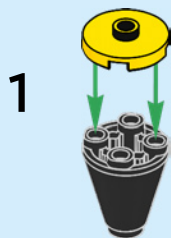

48



4



5

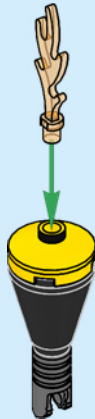

2x

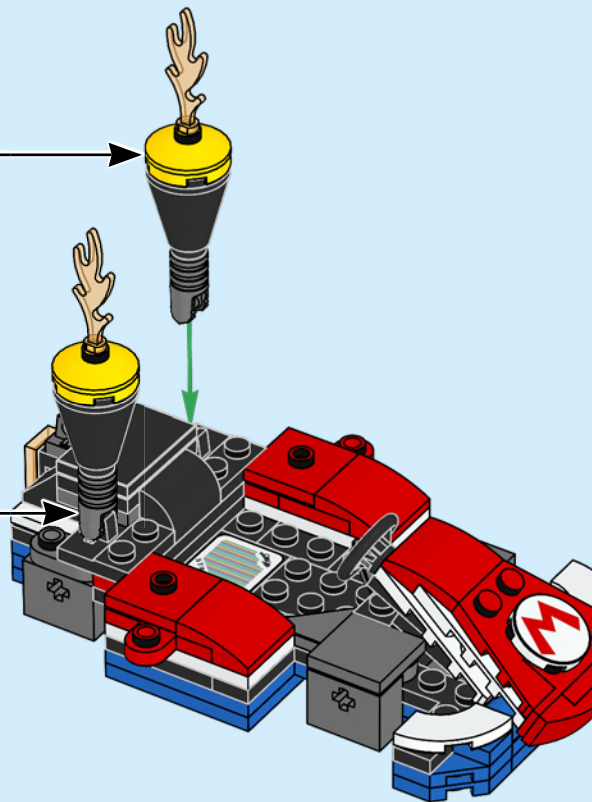

48

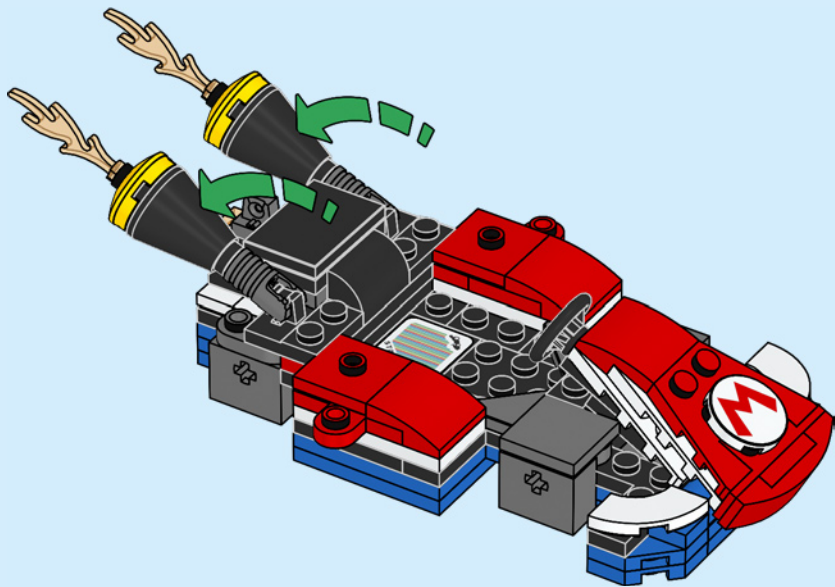

50



4x

49

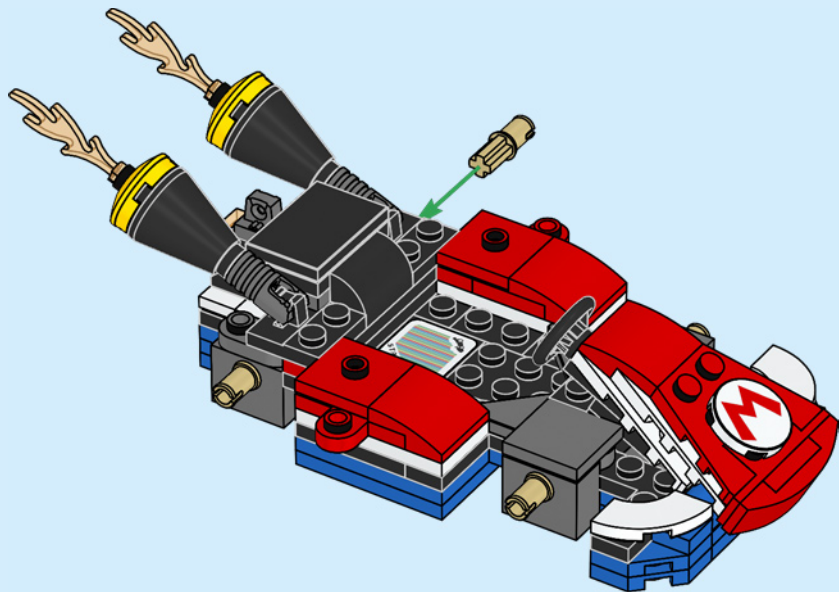

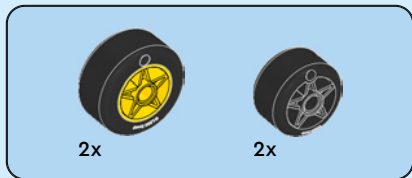

50

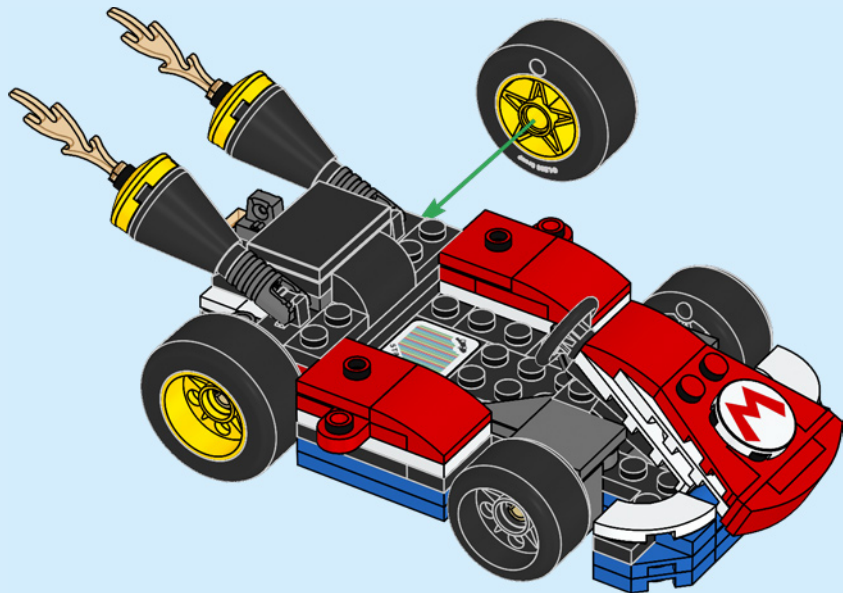

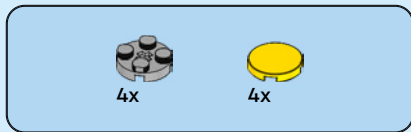

51

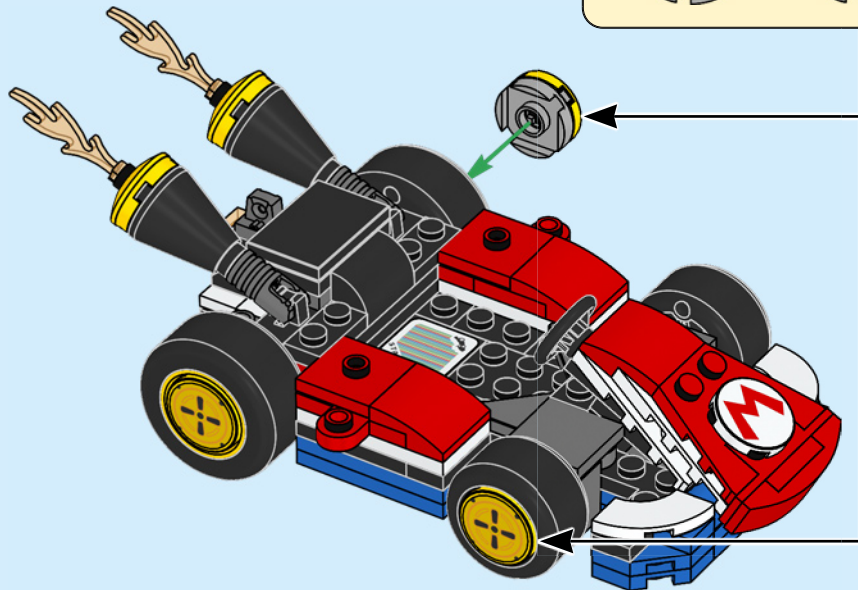
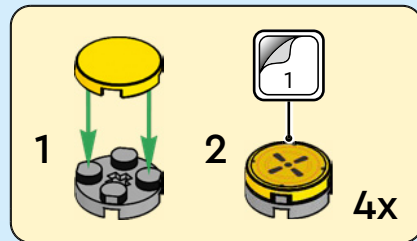

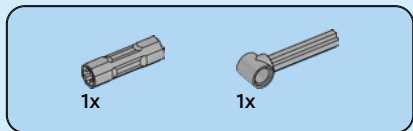

52

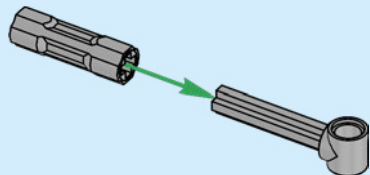

54

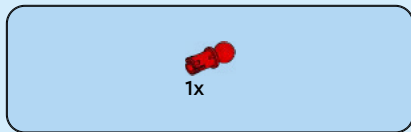

53

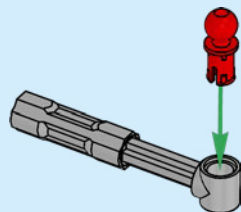

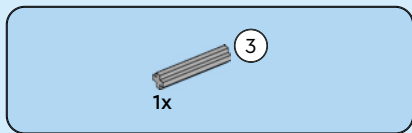

54

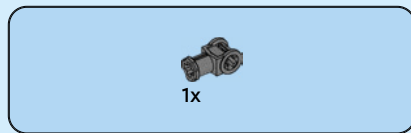
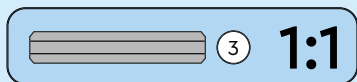
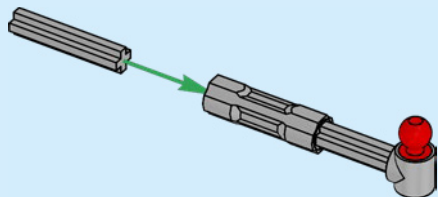

55

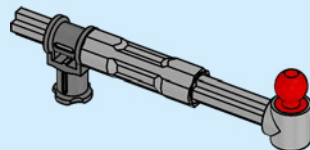

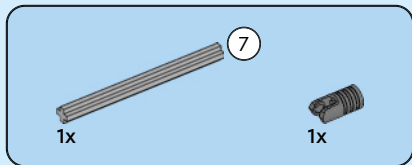

56

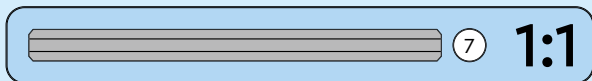
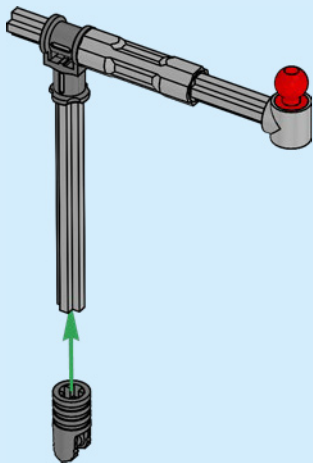

56



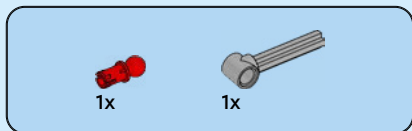
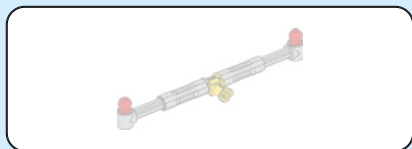

57

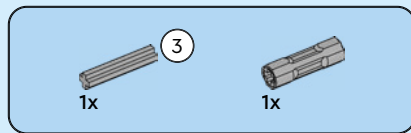
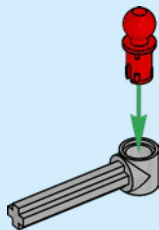

58

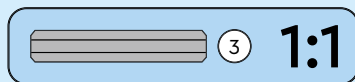
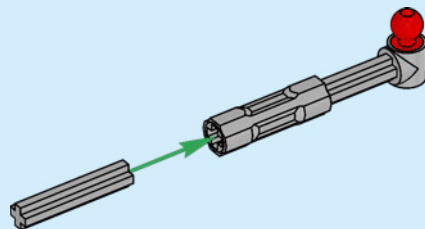



1x

59

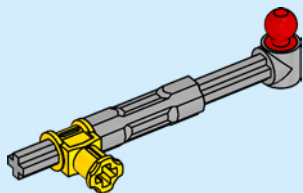

1x

60

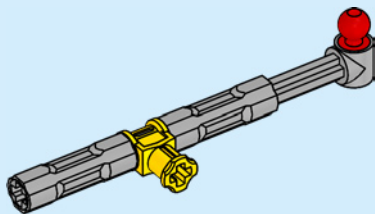

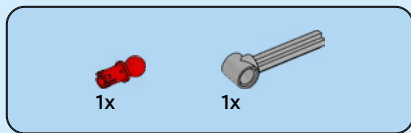

61

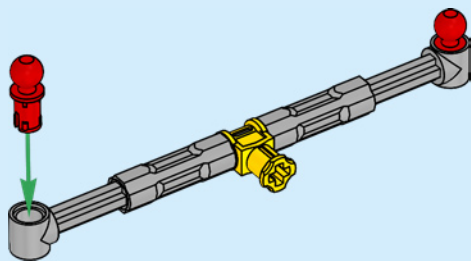

62

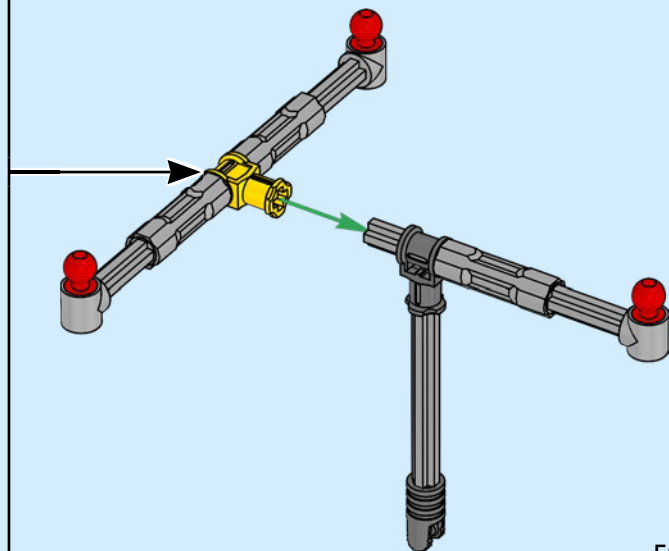

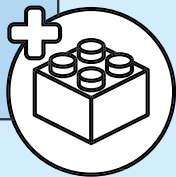
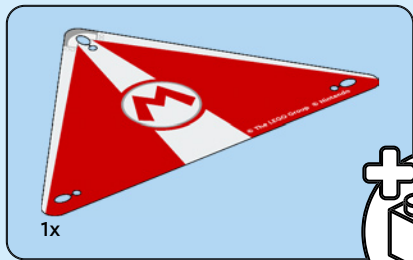

63

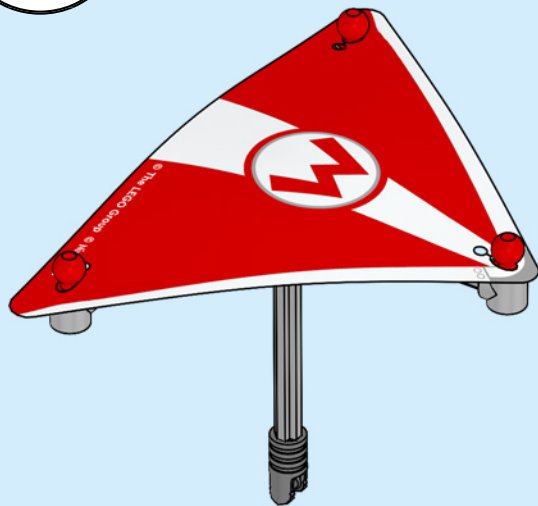

64

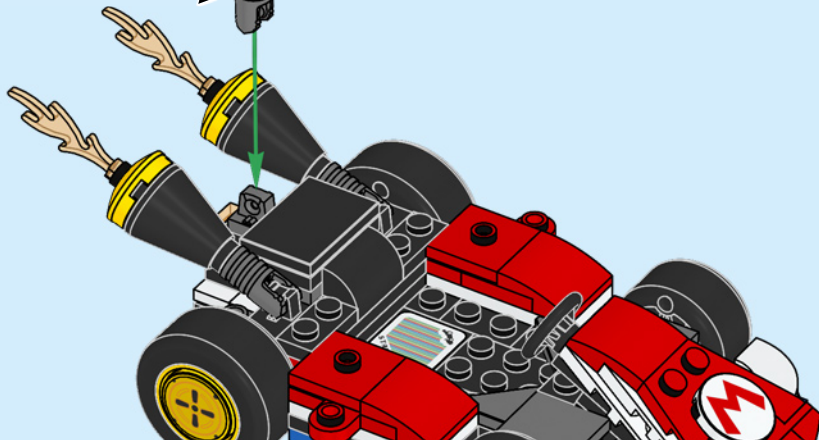
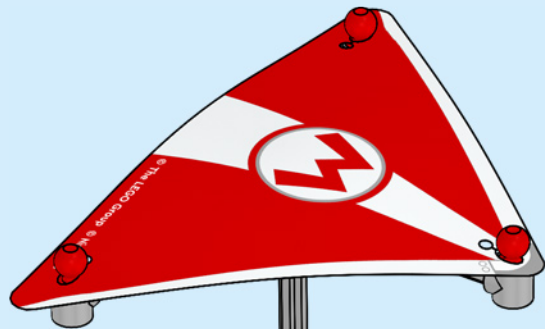

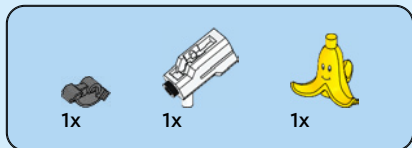

65

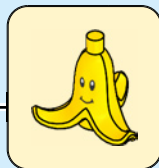
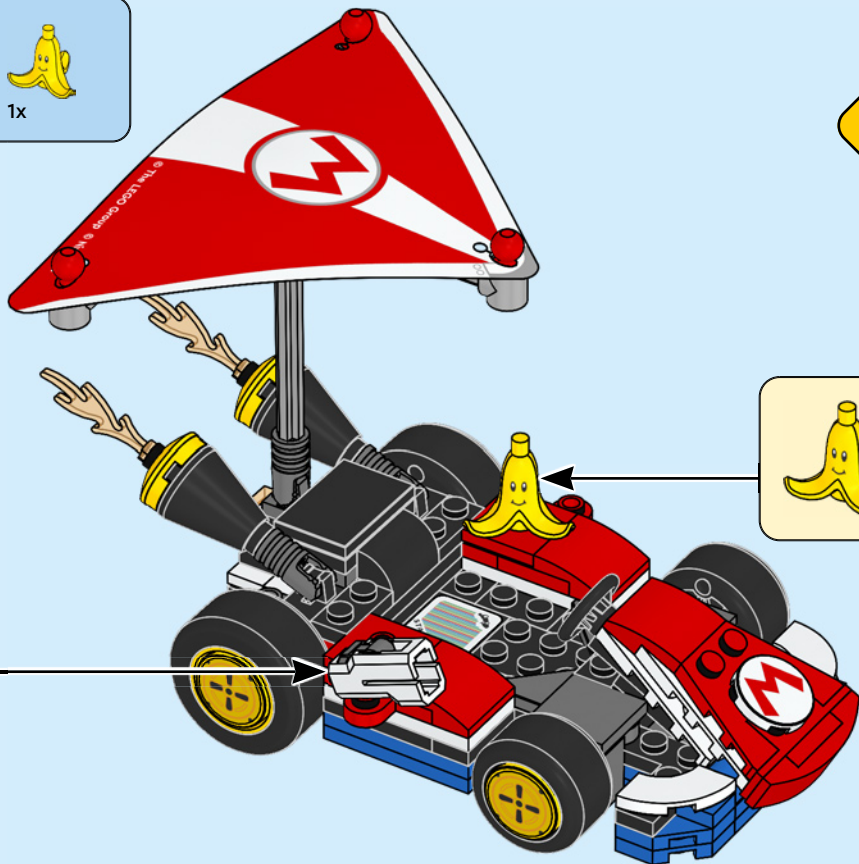
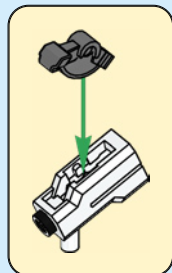

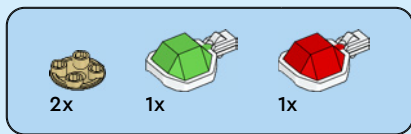

66

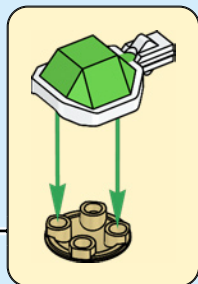
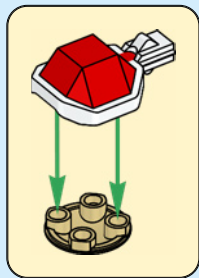
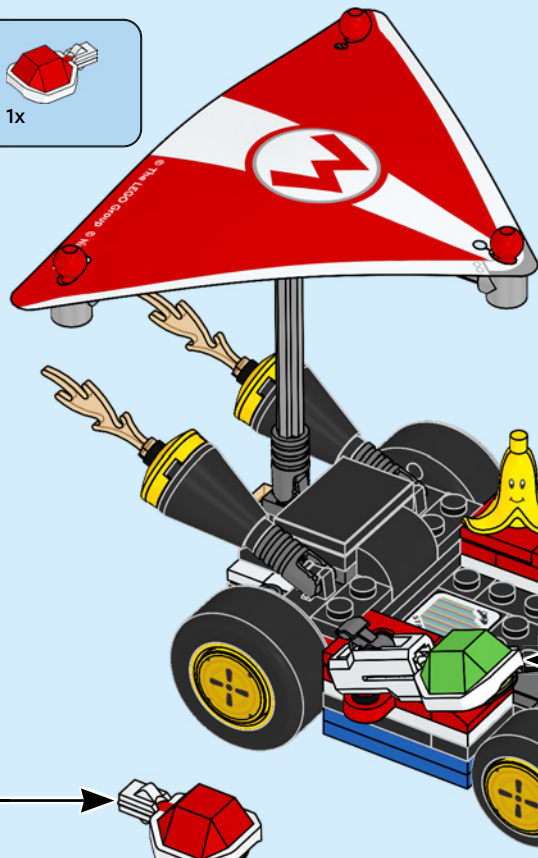

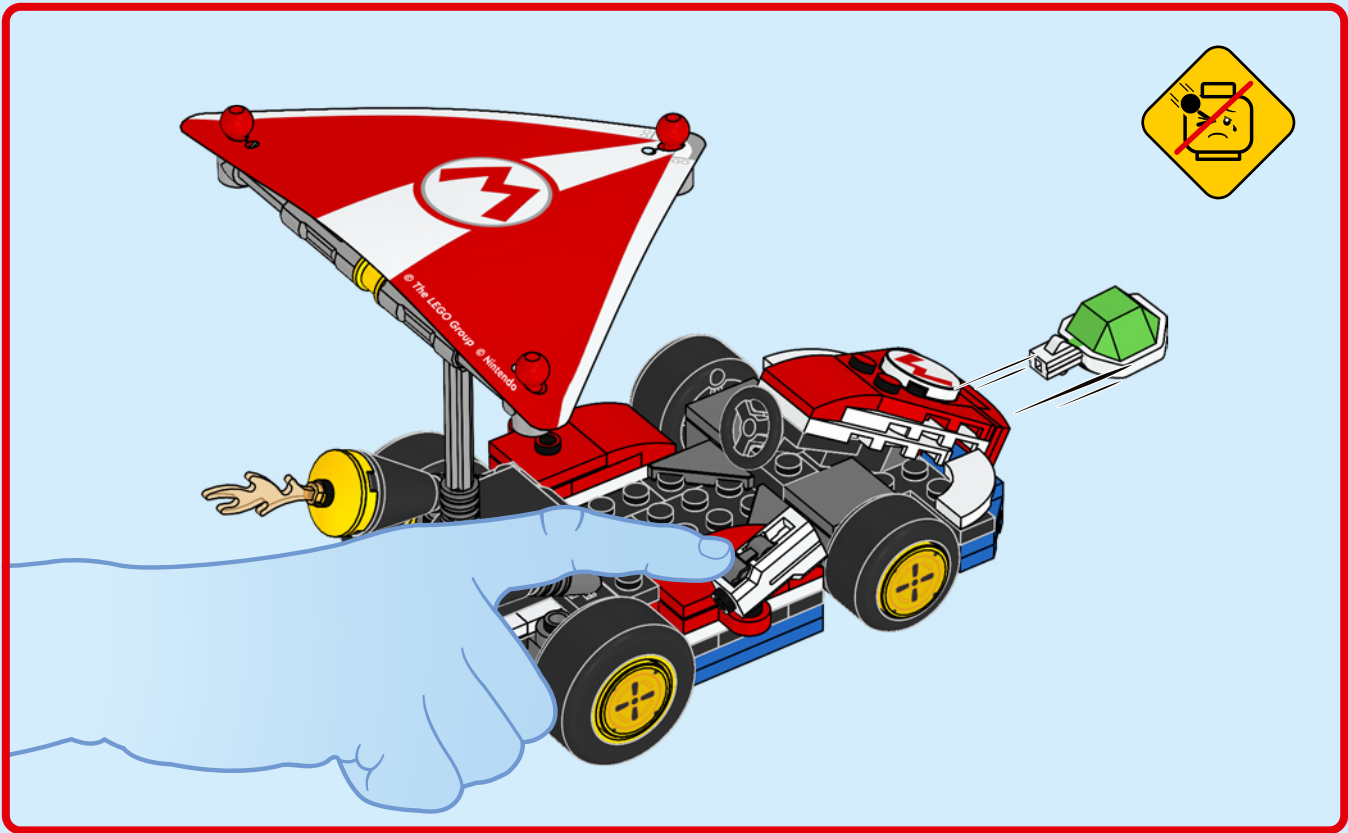



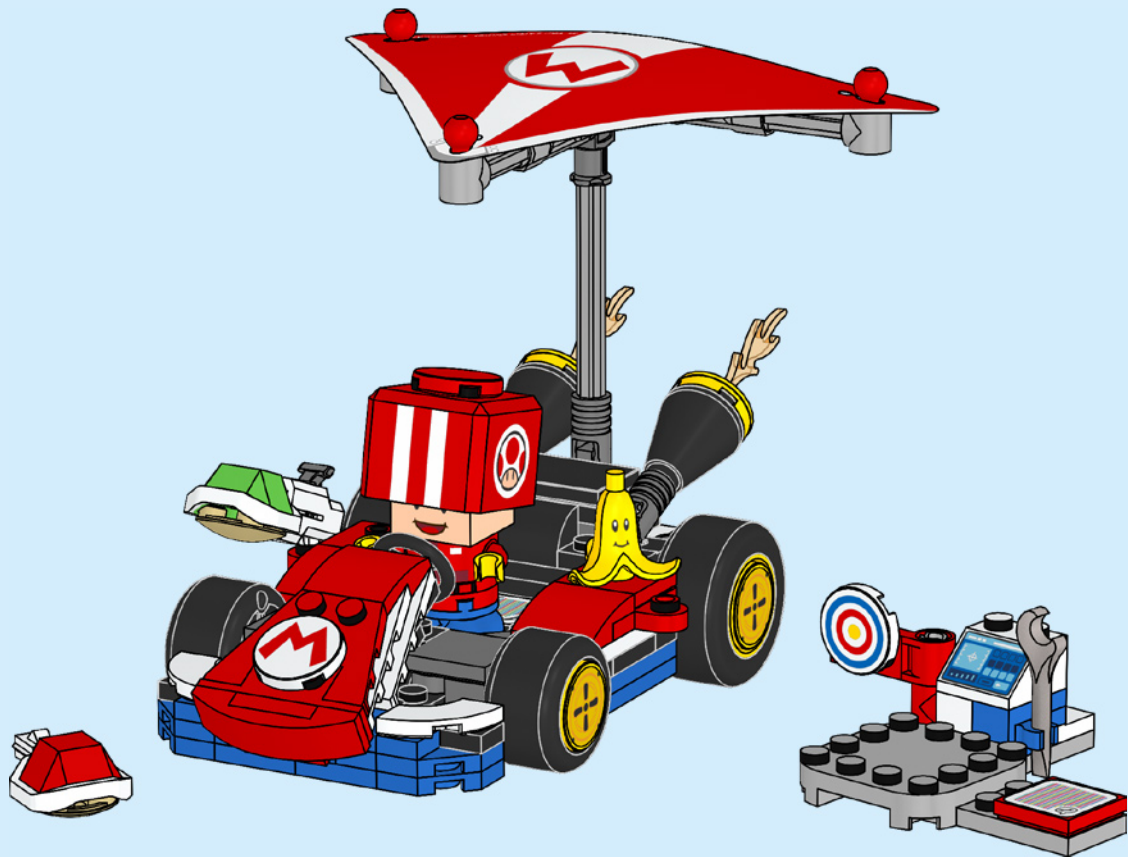



**UPDATE YOUR  
INTERACTIVE FIGURE IN  
THE LEGO® SUPER MARIO™  
APP TO BE READY TO PLAY**

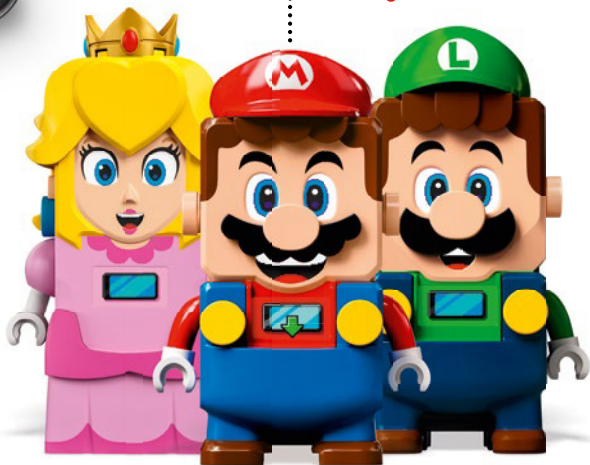

Update your interactive figure in the LEGO® Super Mario™ app to be ready to play  
Aktualisire deine interaktive Figur in der LEGO® Super Mario™ App und das Spiel kann beginnen

Mets à jour ta figurine interactive dans l'appli LEGO® Super Mario™ avant de jouer

Aggiorna il tuo personaggio interattivo nell'app LEGO® Super Mario™ perché sia pronto per giocare

Actualiza tu figura interactiva en la app LEGO® Super Mario™ y prepárate para jugar

Atualiza a tua figura interativa na aplicação LEGO® Super Mario™ para começar a jogar

在乐高®超级马力欧应用程序中更新你的交互式人偶，为玩乐做好准备

Zaktualizuj swoją interaktywną figurkę w aplikacji LEGO® Super Mario™, aby przygotować ją do zabawy

Aktualizujte interaktivní figurku v aplikaci LEGO® Super Mario™, abyste se mohli pustit do hrani

Aktualizujte interaktivnú figurku v aplikácii LEGO® Super Mario™, aby ste mohli pustiť do hrania

Frissítsd interaktív figurád a LEGO® Super Mario™ alkalmazásban és készülj fel a játékra!

Actualizează-ți figurina interactivă în aplicația LEGO® Super Mario™ pentru a fi gata de joacă

Актуализирайте интерактивната фигура в приложението LEGO® Super Mario™, за да сте готови за игра

Atjaunini savu interaktīvo figūru LEGO® Super Mario™ lietotnē, lai būtu gatavs rotāties

Värskenda oma interaktiivset figuuri rakenduses LEGO® Super Mario™, et olla mängimiseks valmis

Atnaujinkite interaktyvią figurėlę programėleje „LEGO® Super Mario™“ ir pasiruoškite žaisti



## LEGO® Super Mario™ app

LEGO® Super Mario™ App

Appli LEGO® Super Mario™

App LEGO® Super Mario™

Aplicação LEGO® Super Mario™

乐高®超级马力欧™应用程序

Aplikacja LEGO® Super Mario™

Aplikace LEGO® Super Mario™

Aplikácia LEGO® Super Mario™

LEGO® Super Mario™ alkalmazás

Aplicația LEGO® Super Mario™

Приложение LEGO® Super Mario™

Lietotne LEGO® Super Mario™

LEGO® Super Mario™ rakendus

Programėlė „LEGO® Super Mario™“

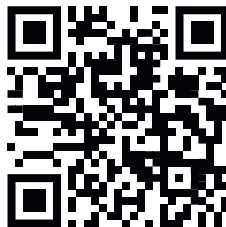

[LEGO.com/super-mario-trouble-shooting-guide](https://www.lego.com/super-mario-trouble-shooting-guide)



72032

+



71439

OR



71440

OR



71441

ODER / OU / OPPURE / O /  
或 / LUB / NEBO / ALEBO /  
VAGY / SAU / ИЛИ / VAI /  
VÔI / ARBA

**DISCOVER MORE  
ABOUT YOUR SET  
IN THE APP**

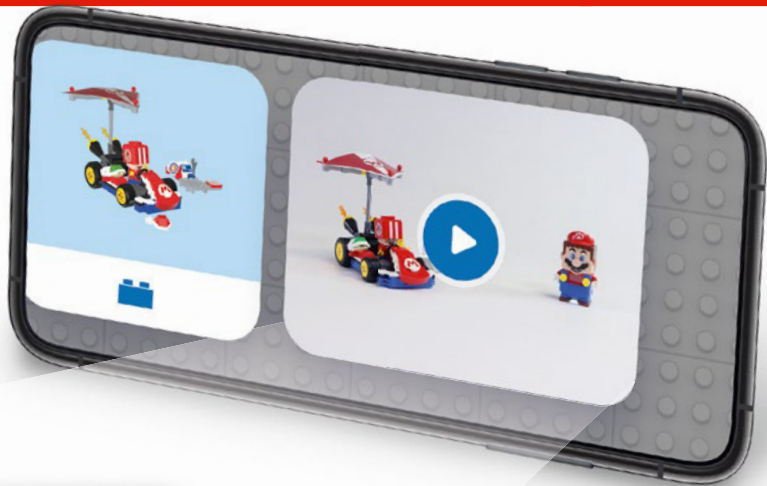

Entdecke in der App noch mehr über dein Set  
Découvre plus de détails sur ton set dans l'appli  
Scopri di più sul tuo set nell'app  
Descubre más acerca de tu set en la app  
Conhece melhor o teu set na aplicação  
可通过应用程序了解更多关于此套装的信息  
Dowiedz się więcej sprawdzając w aplikacji  
Zjistěte více o své stavebnici v aplikaci  
Zisti viac o svojej stavebnici v aplikácii  
Tudj meg többet a készletről az alkalmazásban!  
Descoperă mai multe despre setul tău în aplicație  
Откройте повече за комплекта в приложението  
Atklāj vairāk par komplektu lietotnē  
Avasta oma komplekti kohta lisateavet rakendusest  
Sužinokite daugiau apie rinkinį programėleje







72031



72032



72033



72034



72035



72036







71441



71439

OR



71440

OR



71441

ODER / OU / OPPURE / O / 或 / LUB / NEBO / ALEBO / VAGY / SAU / ИЛИ / VAI / VÕI / ARBA



1x  
6345886



2x  
307001



1x  
4161326



1x  
4160857



1x  
6139454



1x  
6522879



5x  
6051511



1x  
6365712



1x  
6265740



1x  
6329580



2x  
6172674



1x  
6524448



1x  
6524449



2x  
302001



1x  
6275403



4x  
4666579



2x  
4278422



2x  
6210269



3x  
403221



1x  
6066342



1x  
6522881



1x  
6167939



2x  
6524896



1x  
4612575



1x  
6529260



4x  
242021



2x  
6126048



3x  
6105976



3x  
6433069



1x  
6168619



1x  
4633914



3x  
6360104



1x  
6170523



1x  
6522880



4x  
6390153



2x  
6248822



1x  
6524580



2x  
302123



1x  
371023



3x  
302023



2x  
244523

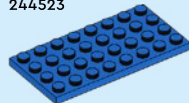

1x  
303523



2x  
302423



1x  
6345427



2x  
302323



1x  
6284577



4x  
6078279



2x  
6299764



2x  
4169960



1x  
6375678



1x  
6523455



2x  
6524452



2x  
6167741



1x  
6514225

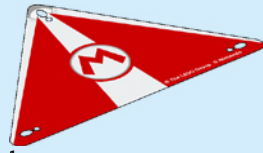

1x  
6556850

2x  
6279875



2x  
6524895



1x  
6057397



1x  
6275732



2x  
6069000



1x  
303926



1x  
6529257



2x  
6265730



1x  
6061032

1x  
6469445



2x  
6524453



5x  
302126



1x  
6493691



1x  
6162892



6x  
6439175



1x  
302026



1x  
366626

1x  
6380236



1x  
4211483



1x  
4211807



4x  
4211475



1x  
4211469



1x  
4211881



2x  
4211815

3x  
6273212



3x  
6484902



2x  
4211395



1x  
6294703

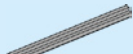

1x  
4211805



1x  
6360675



2x  
6350724



6x  
6221607

3x  
6271538



1x  
6375679



1x  
6265693



2x  
6262025



1x  
6167576

3x  
4211055



1x  
4211043



2x  
6454959



1x  
6382134

7

3



 [LEGO.com/service](https://www.LEGO.com/service)

YOU COULD **WIN**

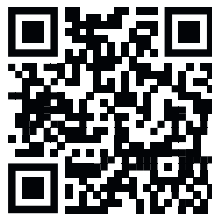

Scan this QR code or go to **LEGO.COM/PRODUCTFEEDBACK** and give us your short feedback about this LEGO® set for a chance to win a cool LEGO prize.

Terms and Conditions apply\*

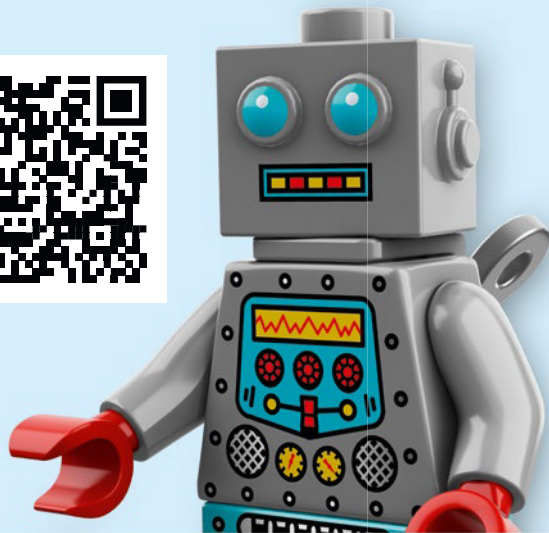

**EN: YOU COULD WIN.** Terms and Conditions apply\* **DE: Du könntest GEWINNEN.** Es gelten die Teilnahmebedingungen\* **FR: Tu pourrais GAGNER.** Des conditions s'appliquent\* **IT: Potresti VINCERE tu.** Termini e condizioni sono applicabili\* **ES: Puedes GANAR.** Aplican términos y condiciones\* **PT: Poderá GANHAR.** Aplicam-se termos e condições\* **ZH: 轻松获奖. 条款和条件适用\*** **PL: Szansa na WYGRANĄ.** Obowiązują warunki korzystania\* **CS: Máte šanci VYHRÁT.** Platí všeobecné smluvní podmínky\* **SK: Máte šancu VYHRAŤ.** Platia všeobecné zmluvné podmienky\* **HU: TE IS NYERHETSZ.** Felhasználási feltételek érvényesek\* **RO: Ai putea CÂȘTIGA.** Se aplică termenii și condiții\* **BG: Можете да СПЕЧЕЛИТЕ.** Има определени правила и условия\* **LV: Tu vari LAIMĒT.** Ir spēkā noteikumi un nosacījumi.\* **ET: Sul on võimalus VÕITA.** Kehtivad tingimused\* **LT: Jūs galite LAIMĖTI.** Taikomos sąlygos\*

\*[LEGO.com/productfeedback-terms](https://www.lego.com/productfeedback/terms)

LEGO, the LEGO logo and the Brick and Knob configurations are trademarks and/or copyrights of the LEGO Group. ©2025 The LEGO Group.

© Nintendo

6554660