



# Harry Potter

76447



LEGO® Builder



LEGO.com/sustainable-packaging



 **FR**  
**DONNEZ**  
OU  
**RECYCLEZ**

 OU  OU   
ASSOCIATION MAGASIN DÉCHÈTERIE

Adresses sur [quefairedemesdechets.fr](http://quefairedemesdechets.fr)



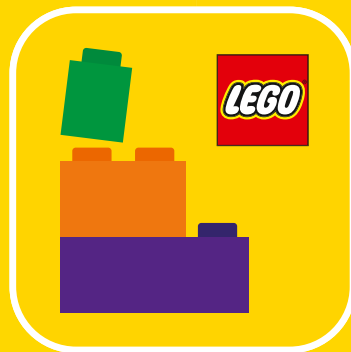

🔍 LEGO® Builder

# BUILDER

Download on the  
App Store

GET IT ON  
Google Play

腾讯应用宝  
安全 应用商店

Apple and the Apple logo are trademarks of Apple Inc., registered in the U.S. and other countries and regions. App Store is a service mark of Apple Inc. Google Play and the Google Play logo are trademarks of Google LLC. Tencent and the Tencent logo are trademarks of Tencent Inc.

EN Ask parents' permission before going online | DE Eltern um Erlaubnis bitten, bevor du online gehst | FR Demande l'autorisation d'un parent avant d'aller en ligne | IT Chiedi il permesso ai tuoi genitori prima di andare online | ES Pídeles permiso a tus papás antes de conectarte a Internet | PT Pede autorização aos pais antes de acederes online | ZH 上网前应先征得父母的同意 | PL Poproś rodziców o zgodę, zanim wejdziesz do Internetu | CS Než půjdeš na internet, požádej rodiče o svolení | SK Skôr než pôjdeš na internet, vypýtaj si povolenie od rodičov | HU Kérj szülői engedélyt, mielőtt online csatlakoznál! | RO Cere permisiunea părinților înainte de a te conecta online | BG Поискайте разрешение от родител, преди да влезете онлайн | LV Pirms došanās tiešsaistē palūdz atļauju vecākiem | ET Enne Interneti kasutamist küsi vanematelt luba | LT Prieš prisijungdami prie interneto, atsklauskite tėvų

🔍 [LEGO.com/devicecheck](https://LEGO.com/devicecheck)

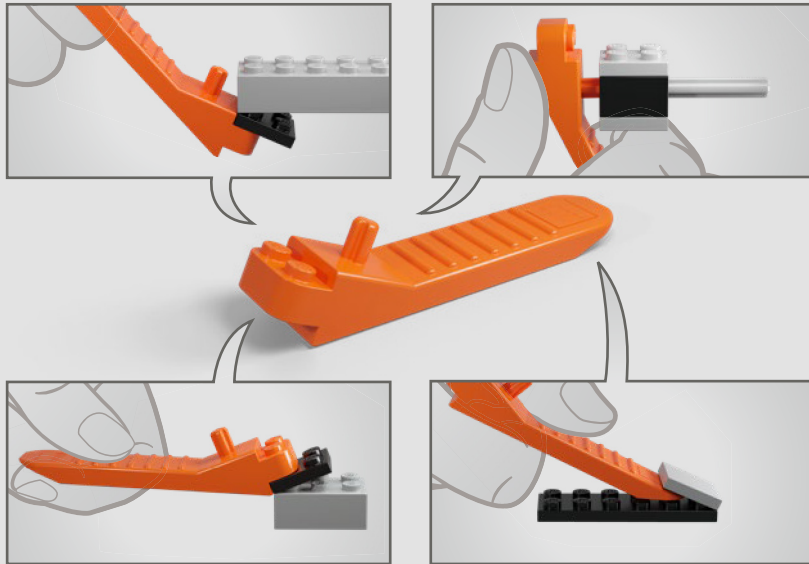



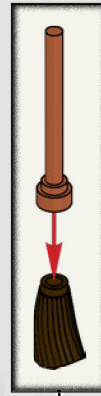
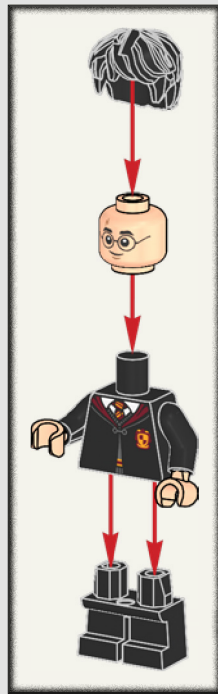

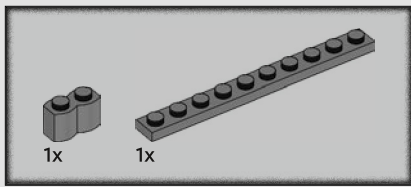

1

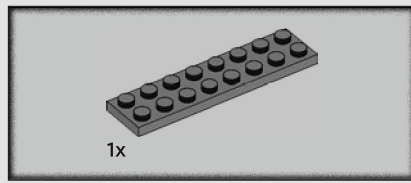
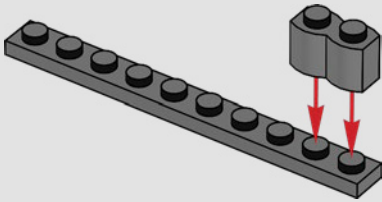

3

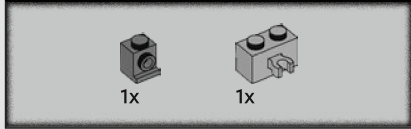
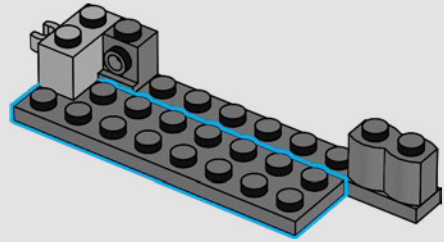

2

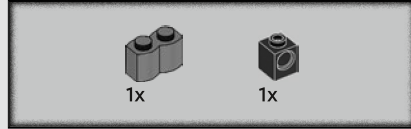
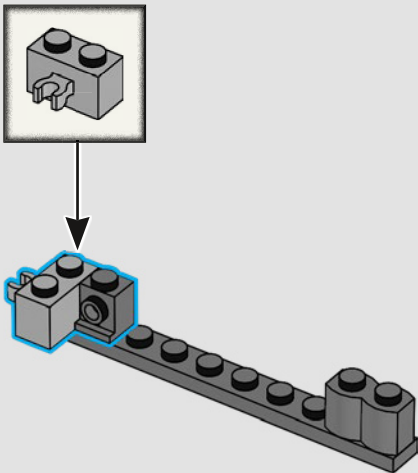

4

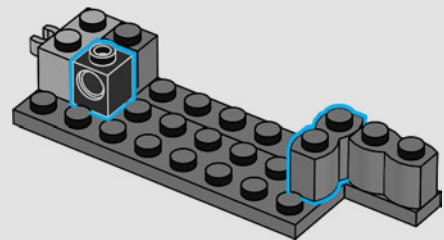



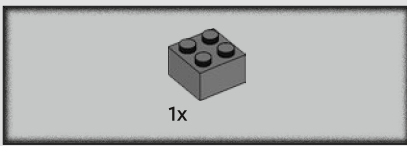

5

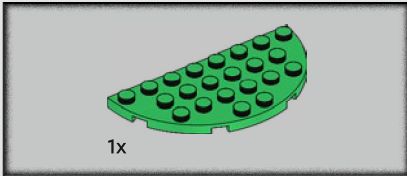
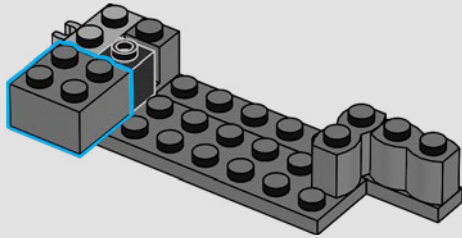

6

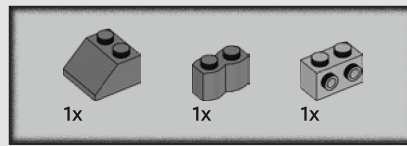
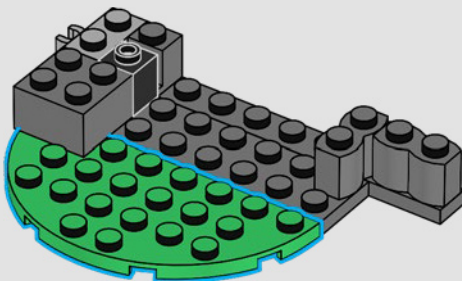

7

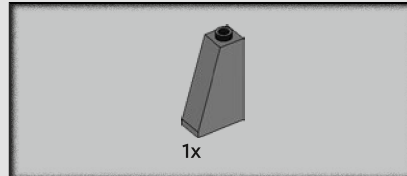
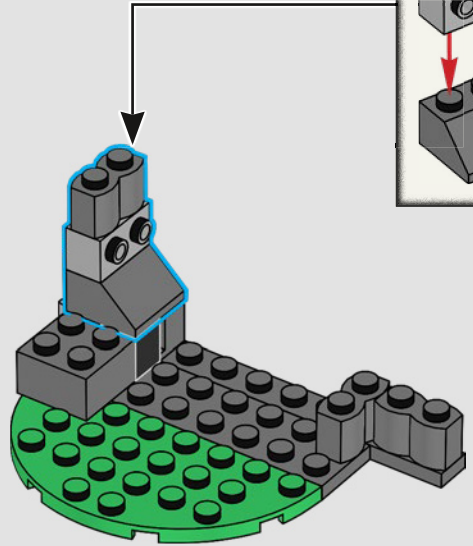

8

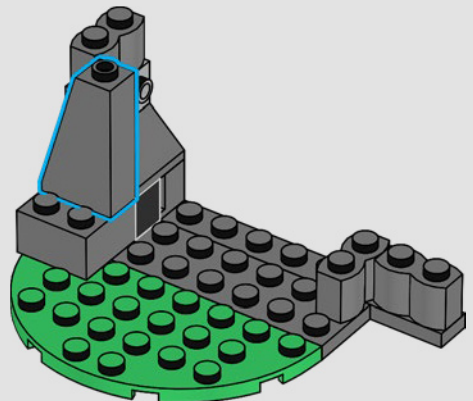

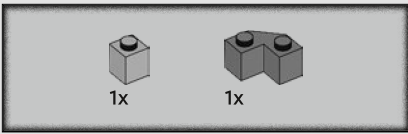

9

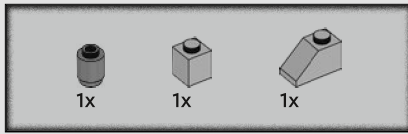
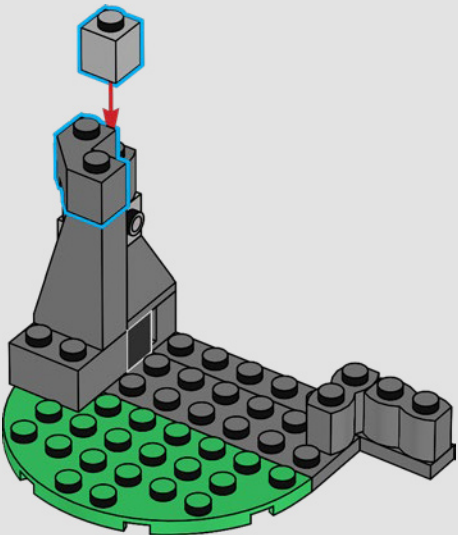

10

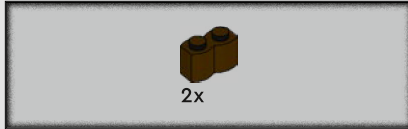
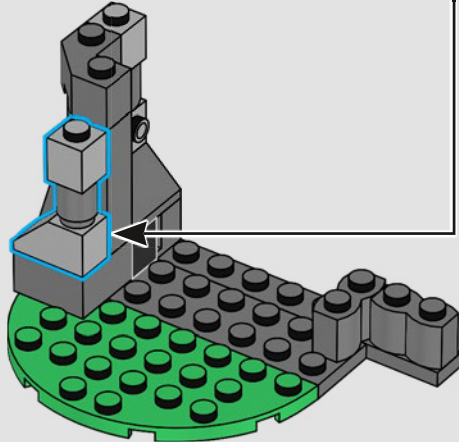
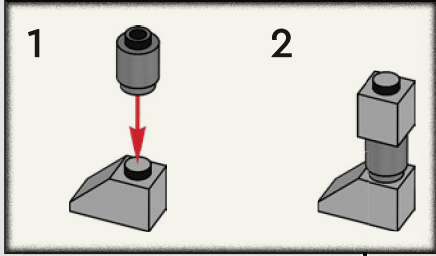

11

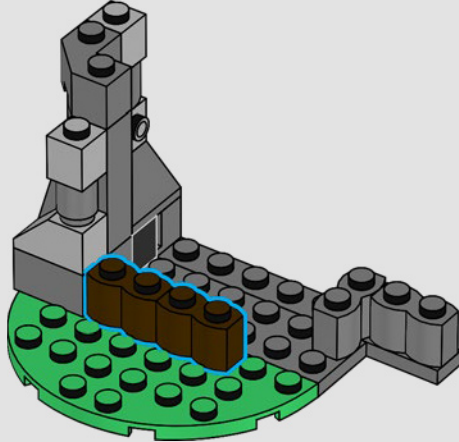





12

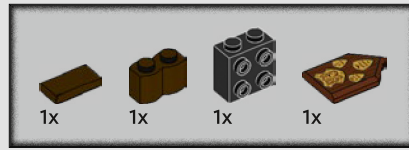

13

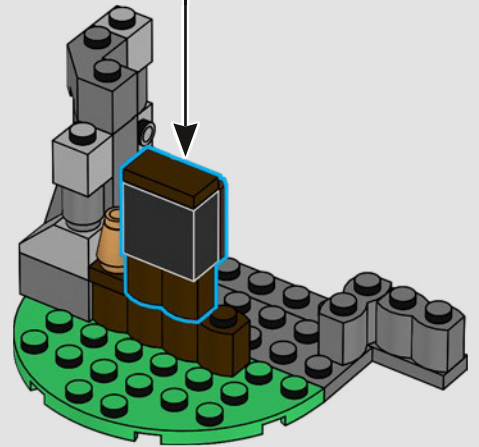
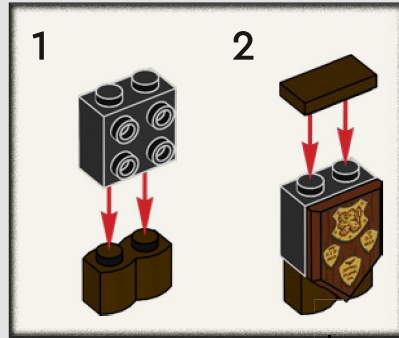

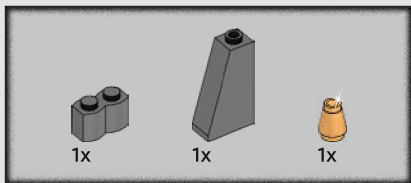

14

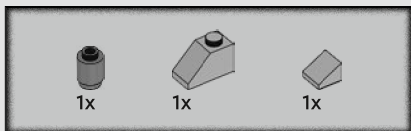
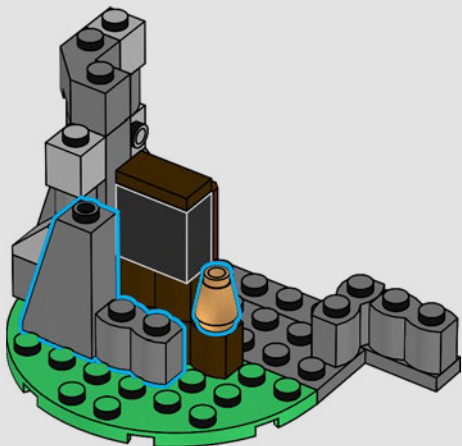

15

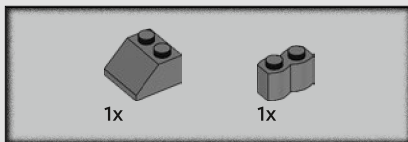
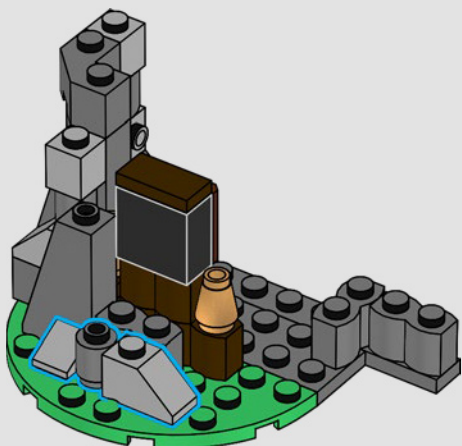

16

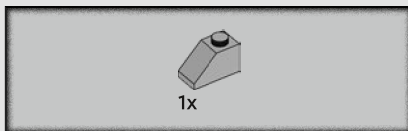
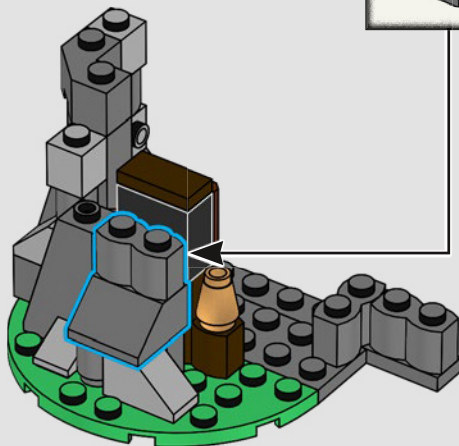
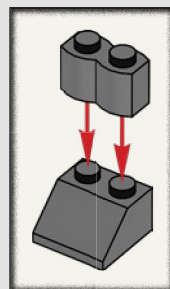

17

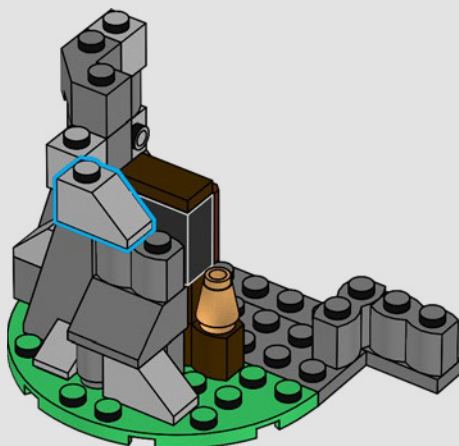



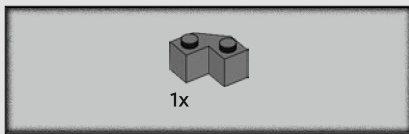

18

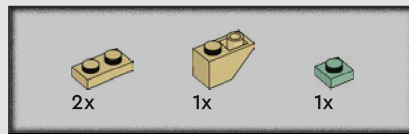
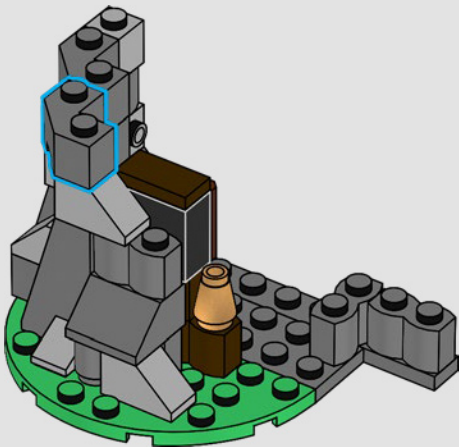

19

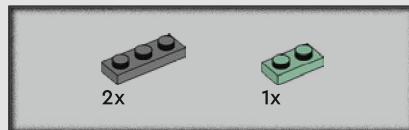
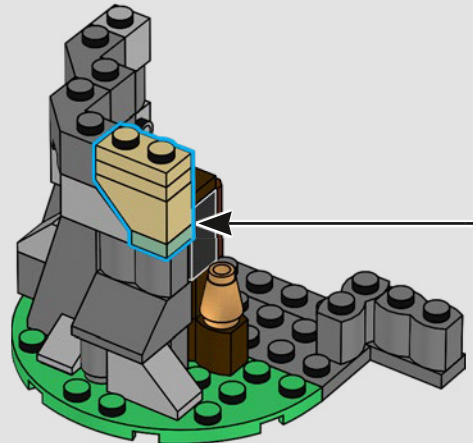
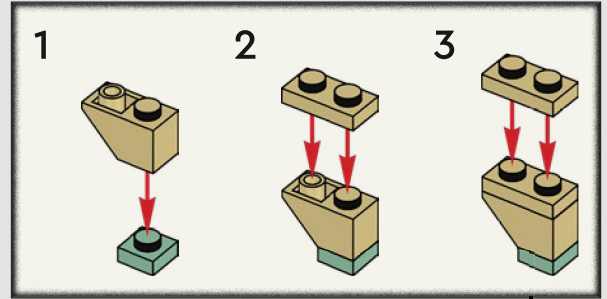

20

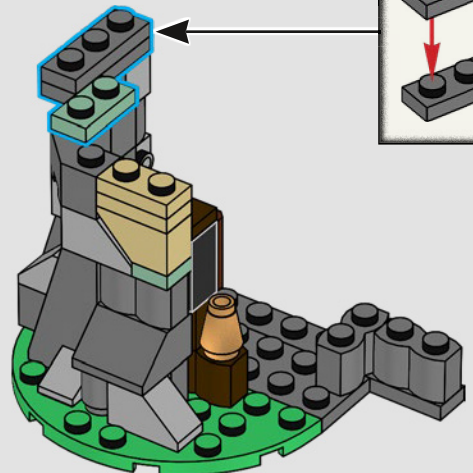
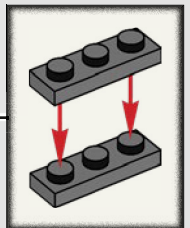

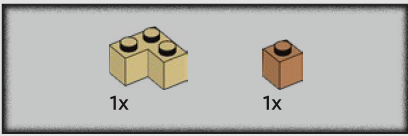

21

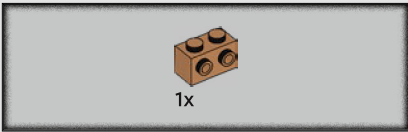
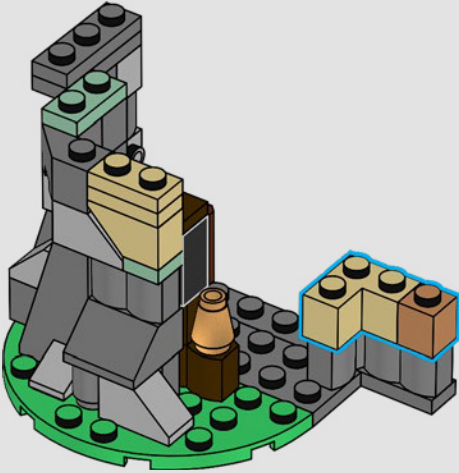

22

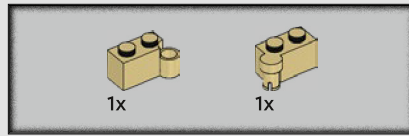
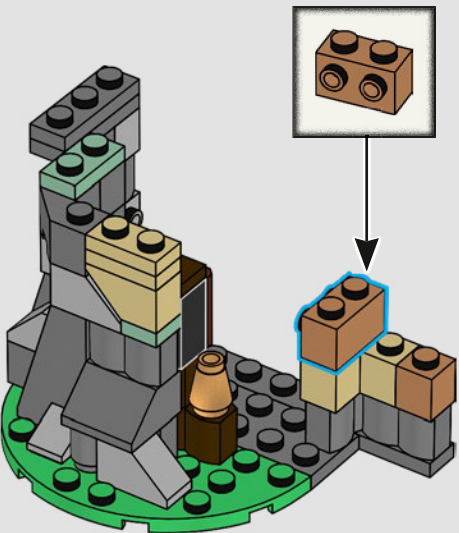

23

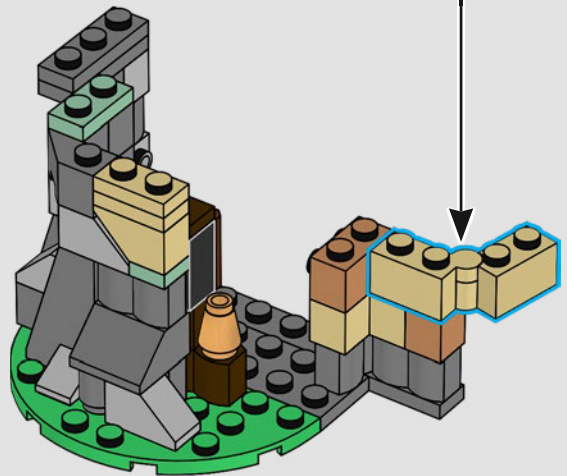
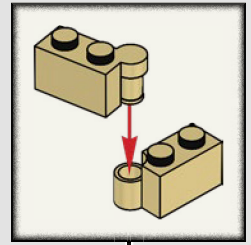

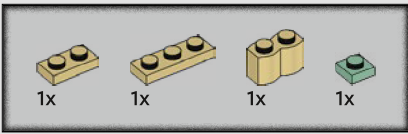

24

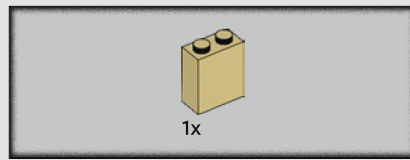
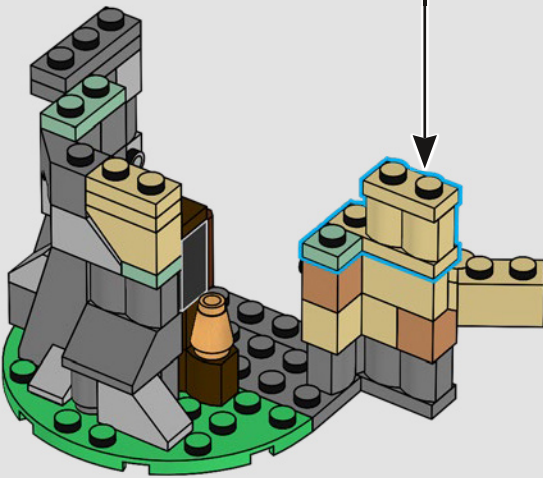
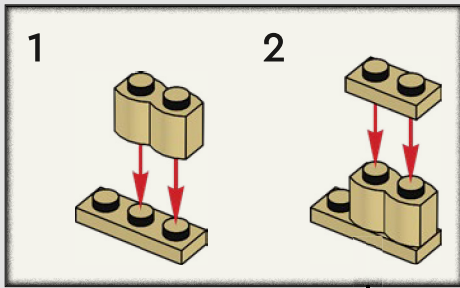

25

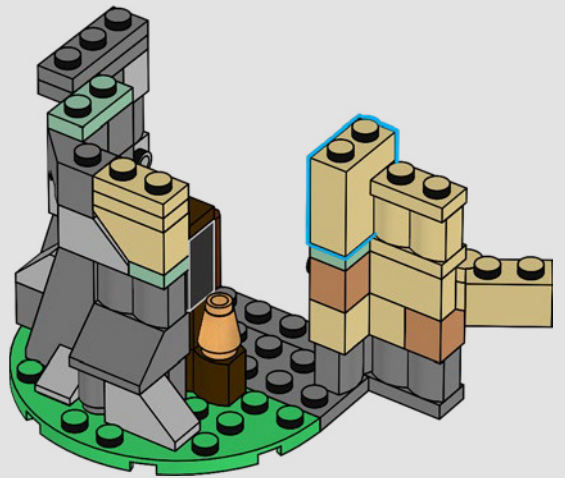

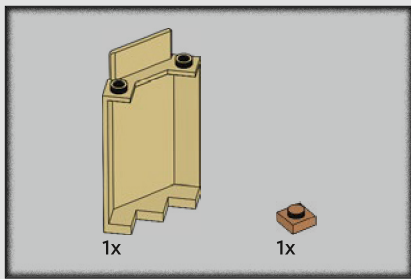

26

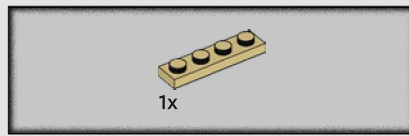
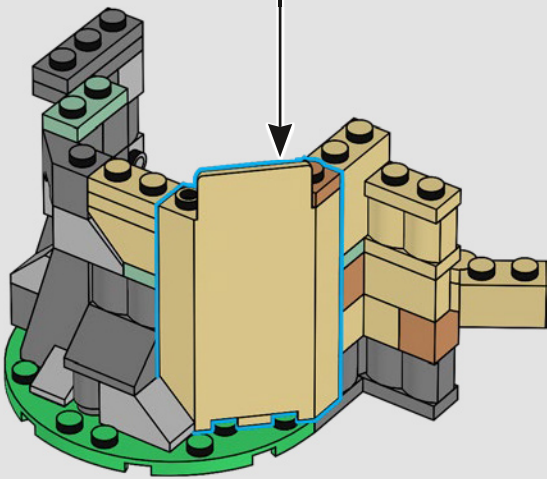
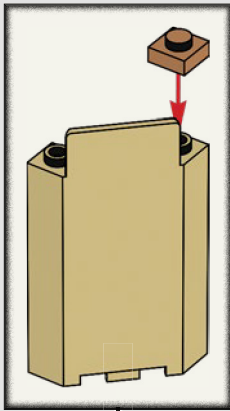

27

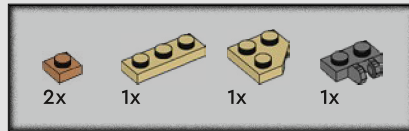
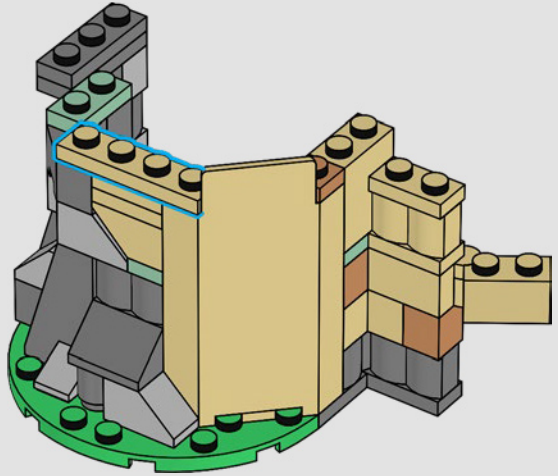

28

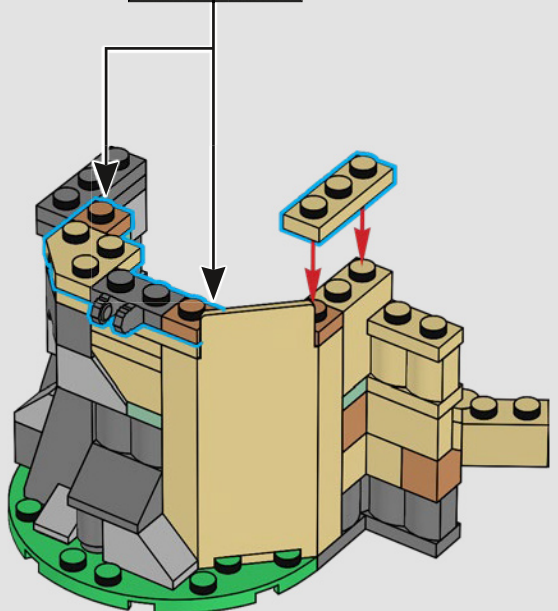



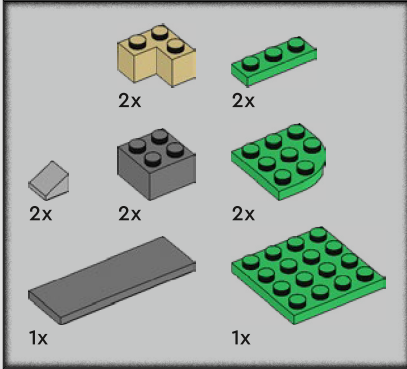
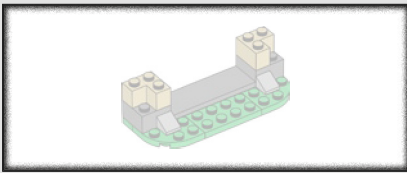

29

1

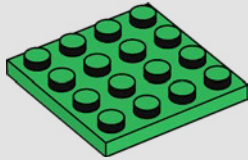

2

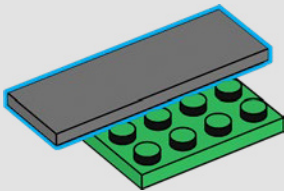

3

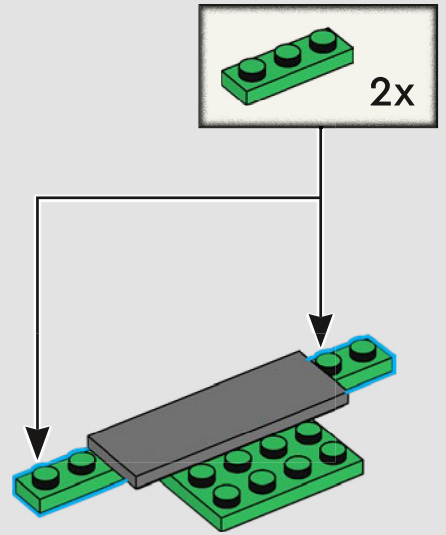

4

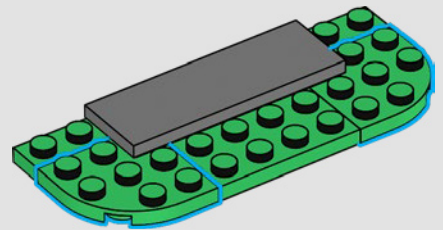

5

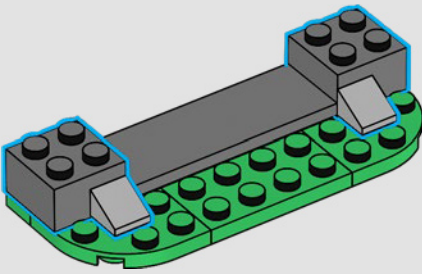

6

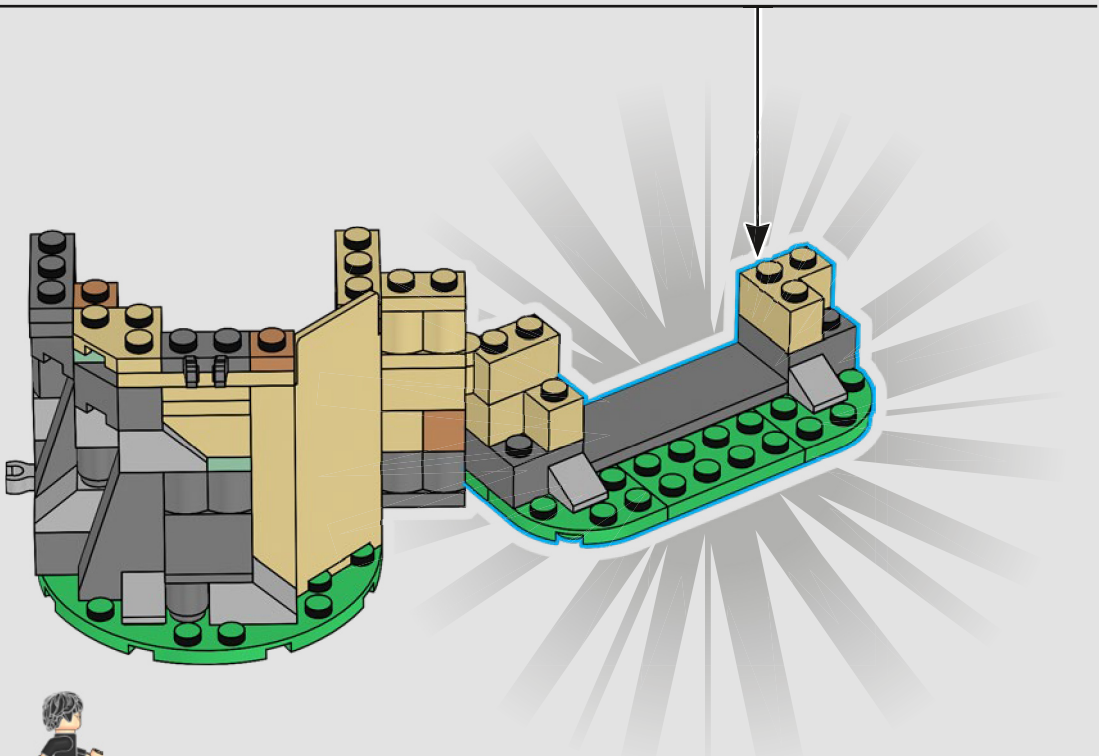
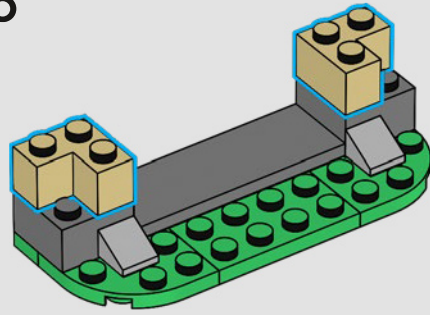

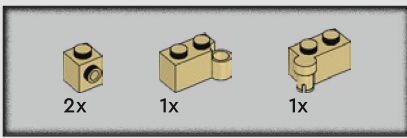

30

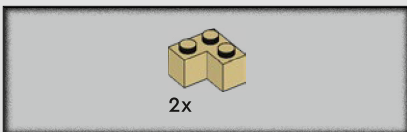
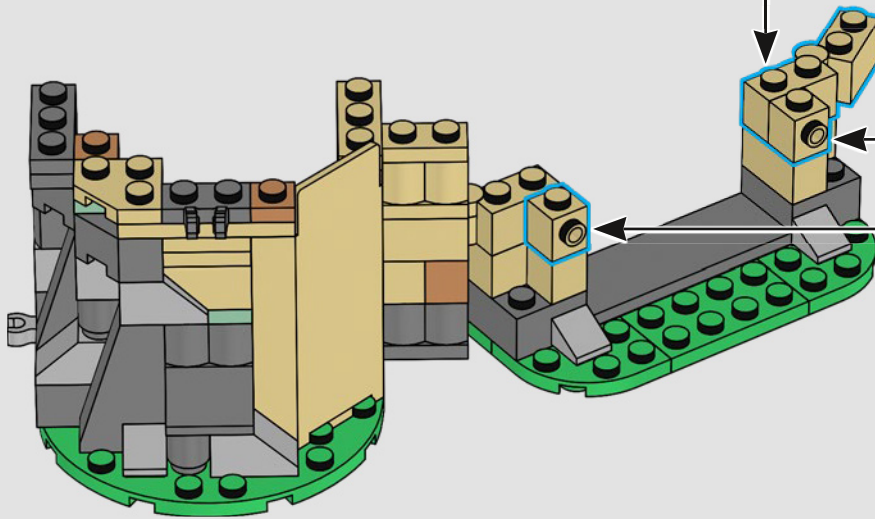
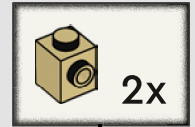
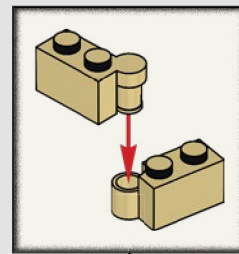

31

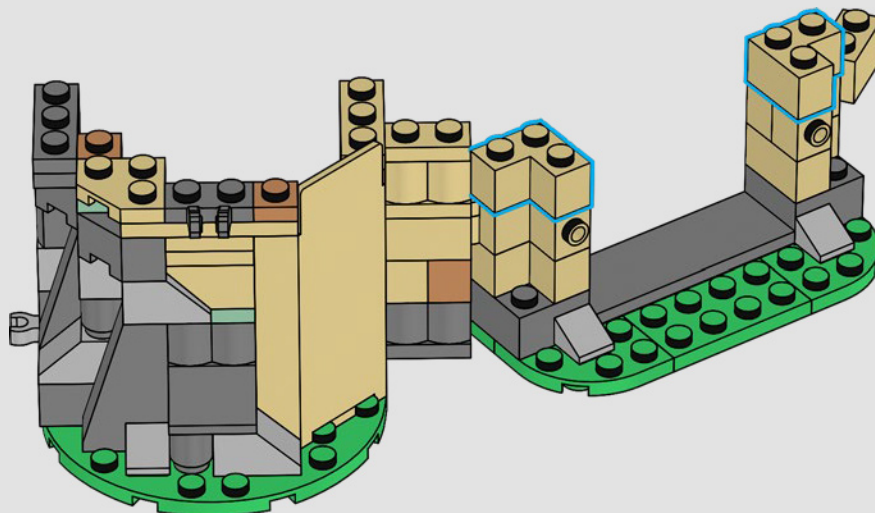

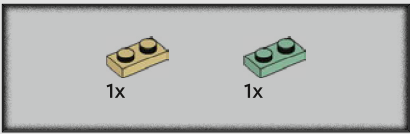

32

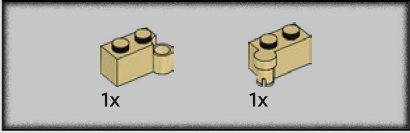
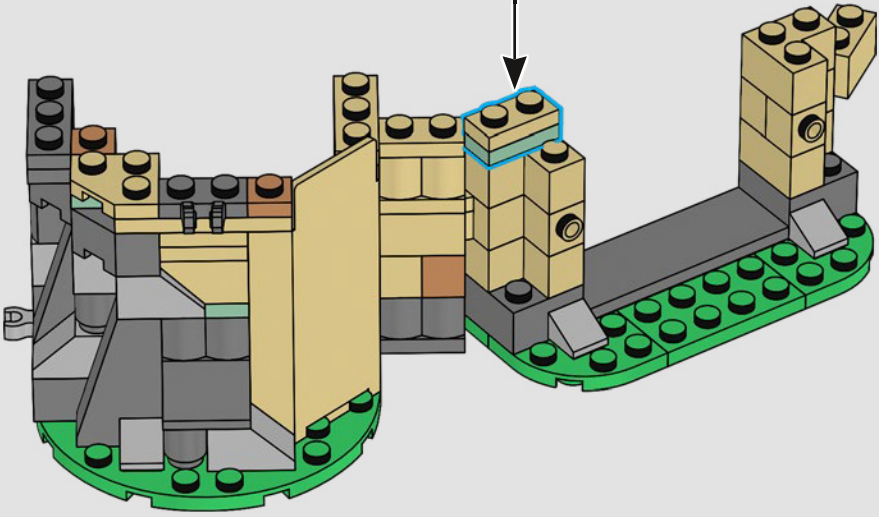
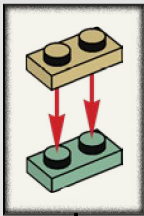

33

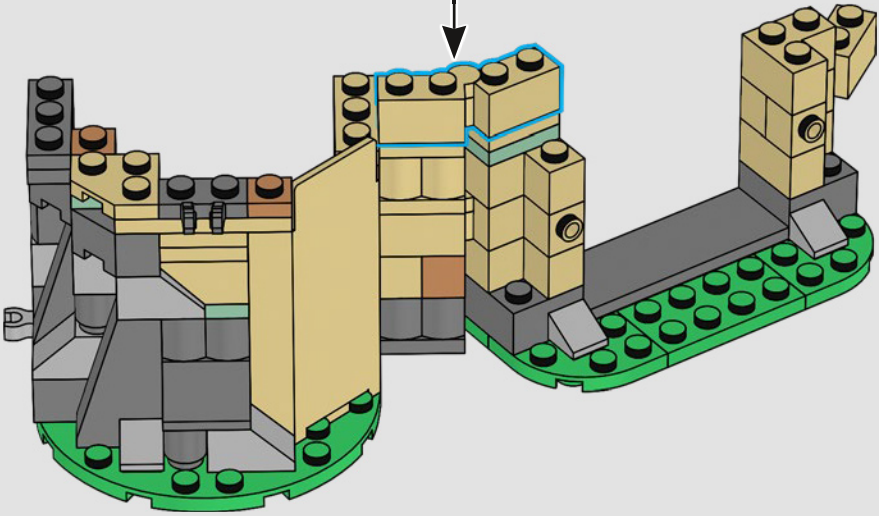
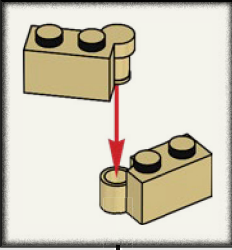



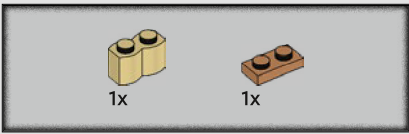

34

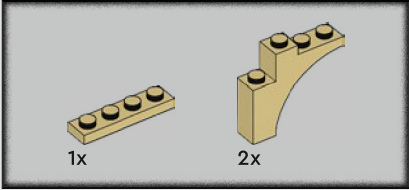
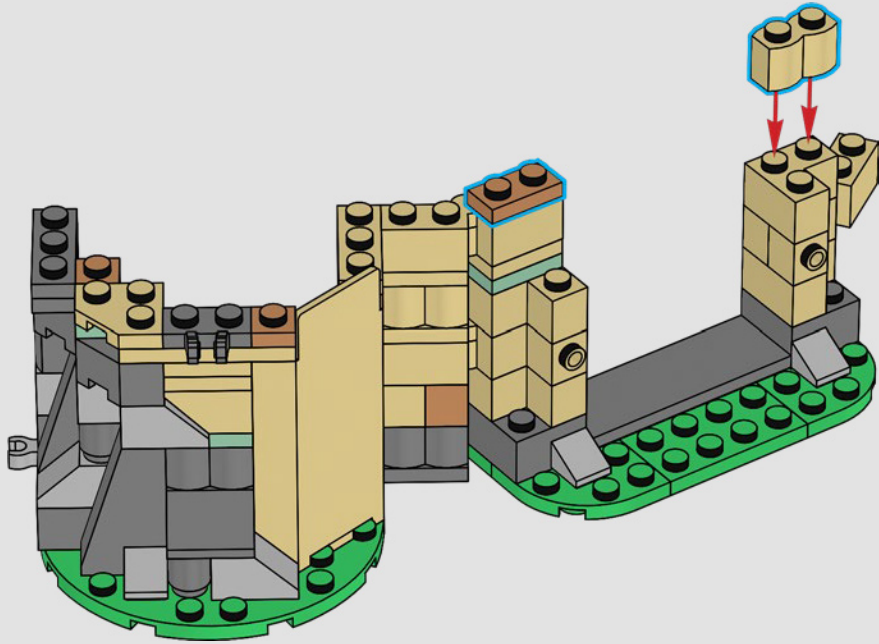

35

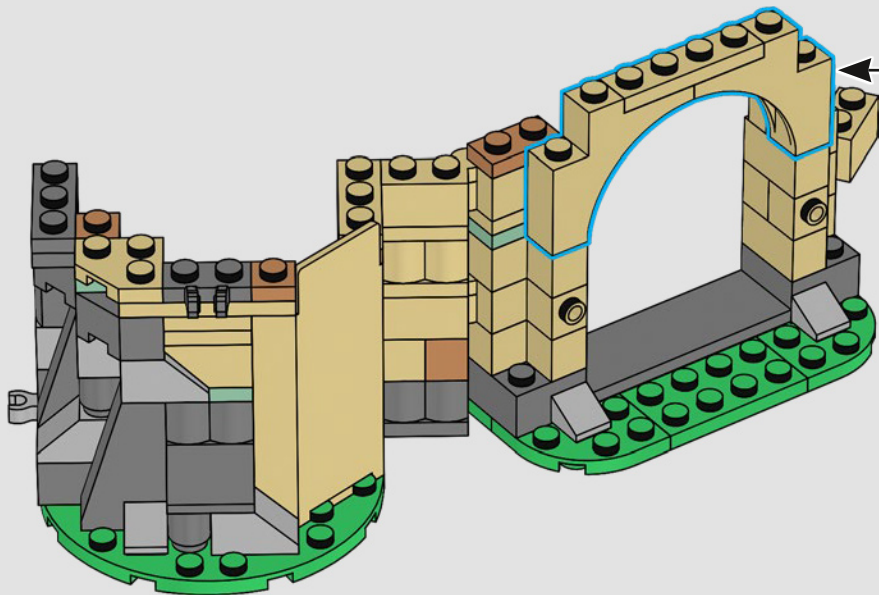
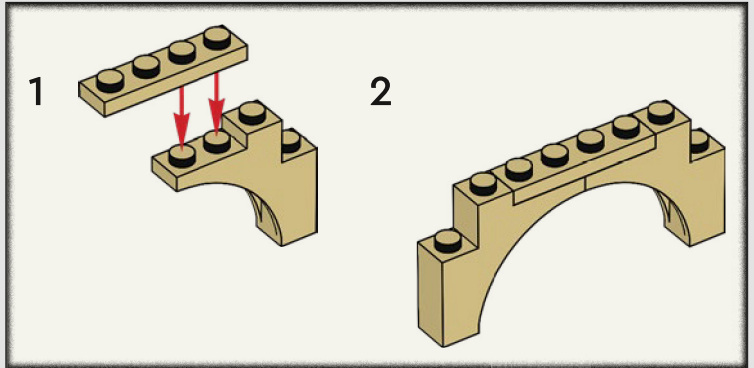

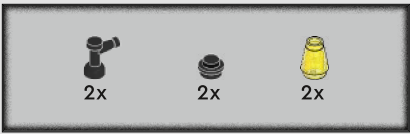

36

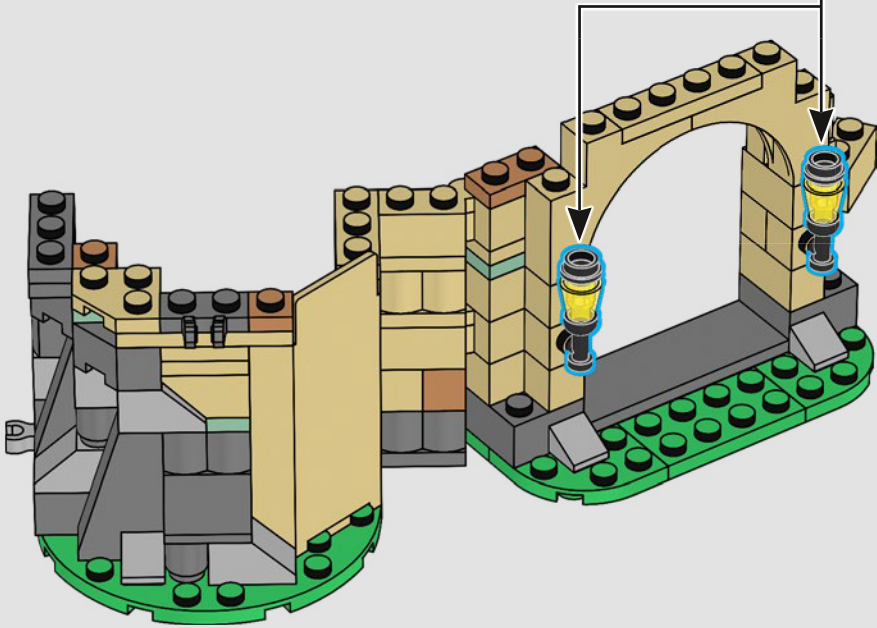
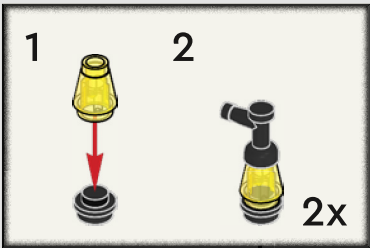

37

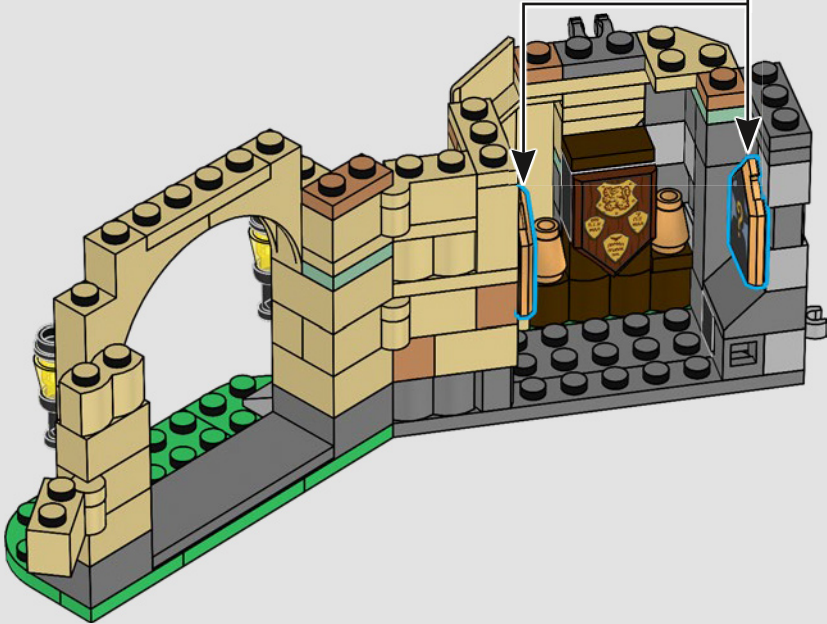

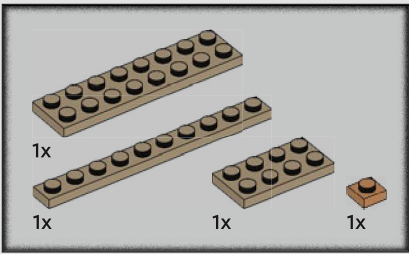

38

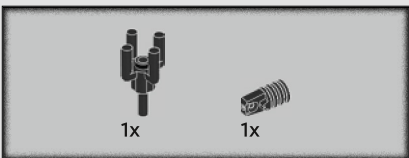
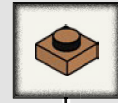

39

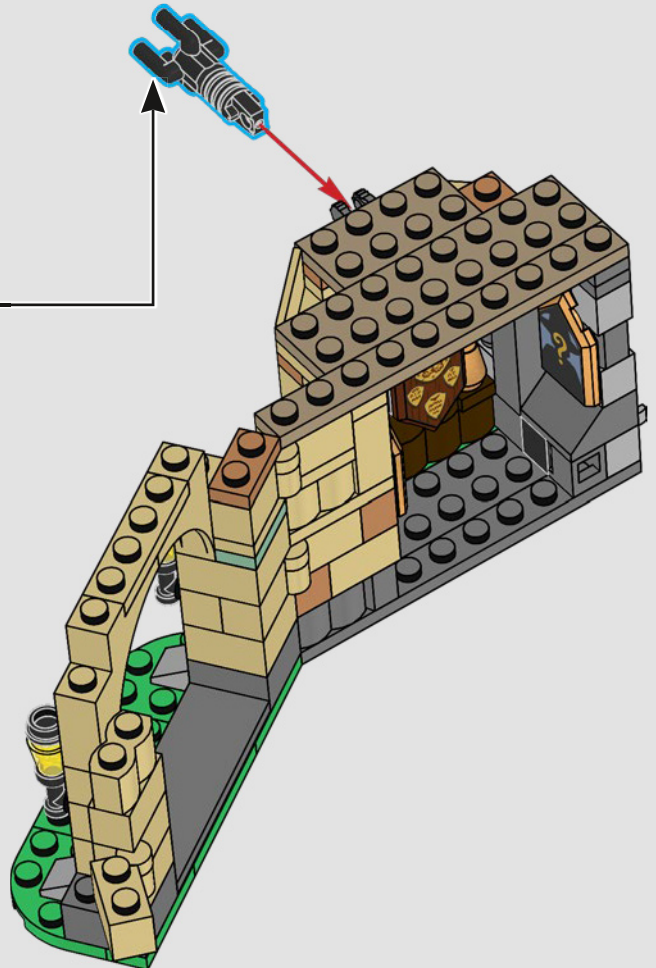
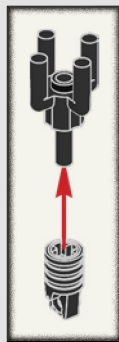

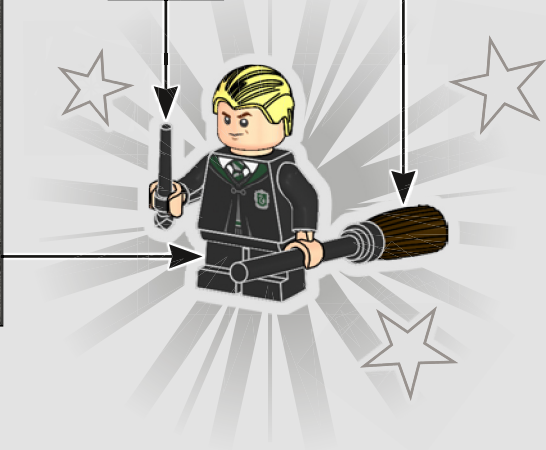
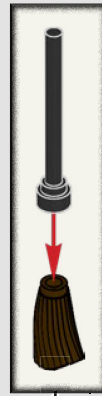
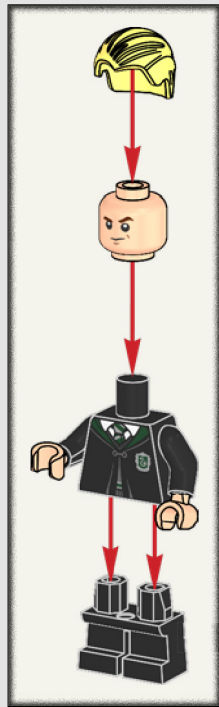



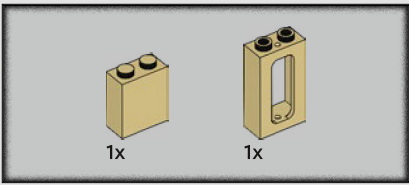

40

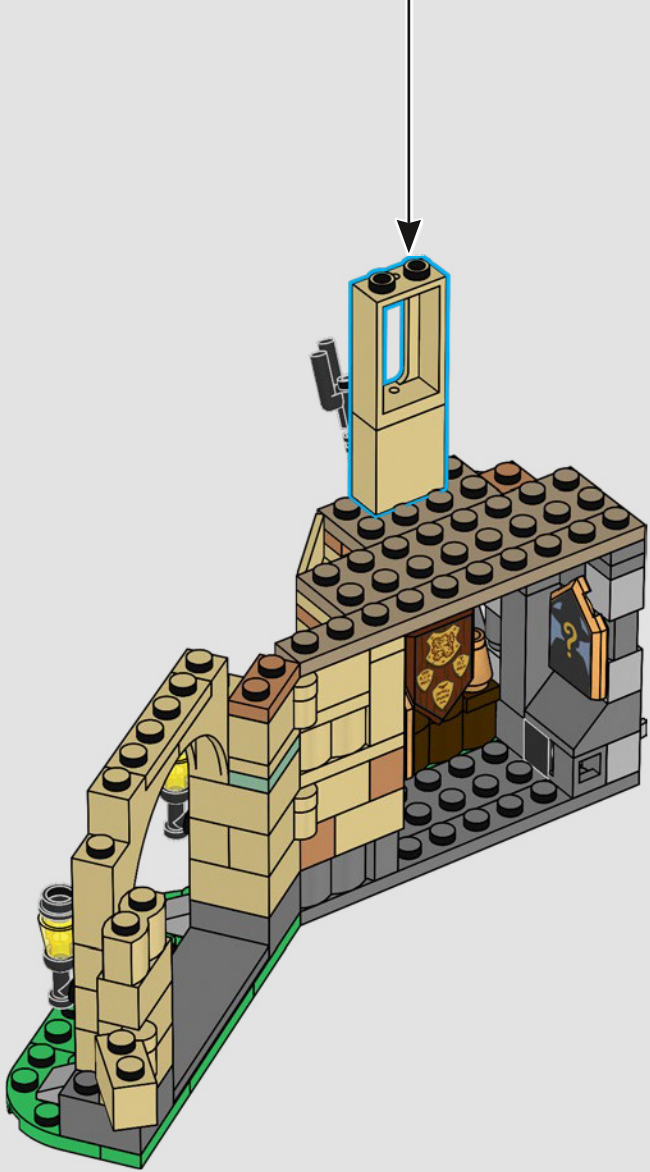
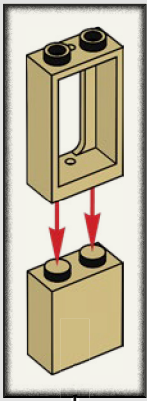

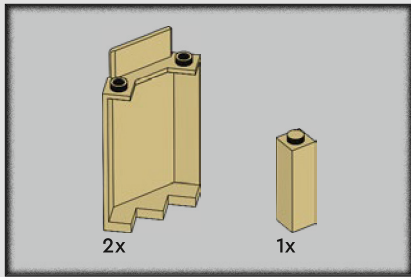

41

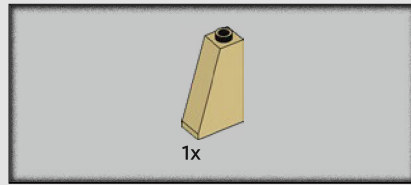
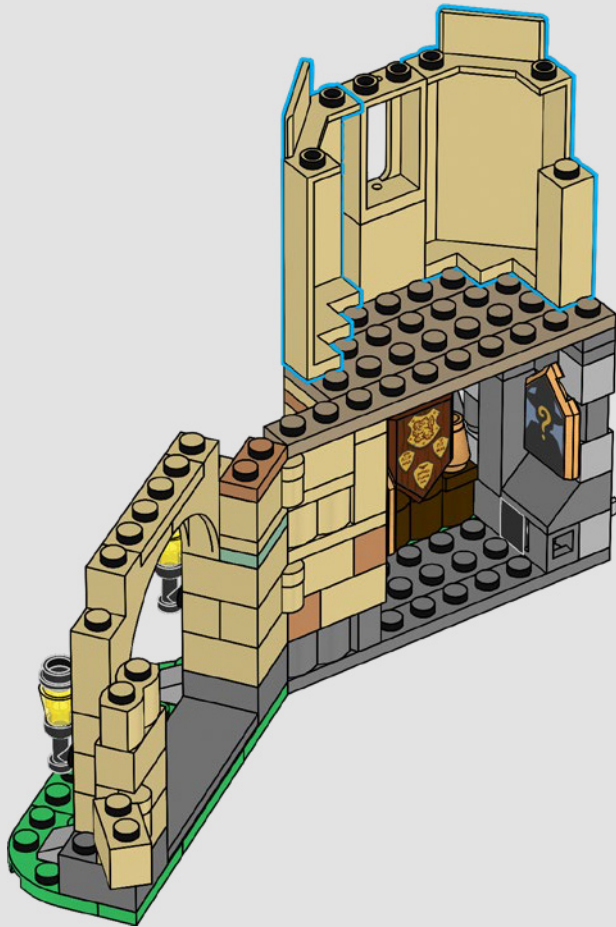

42

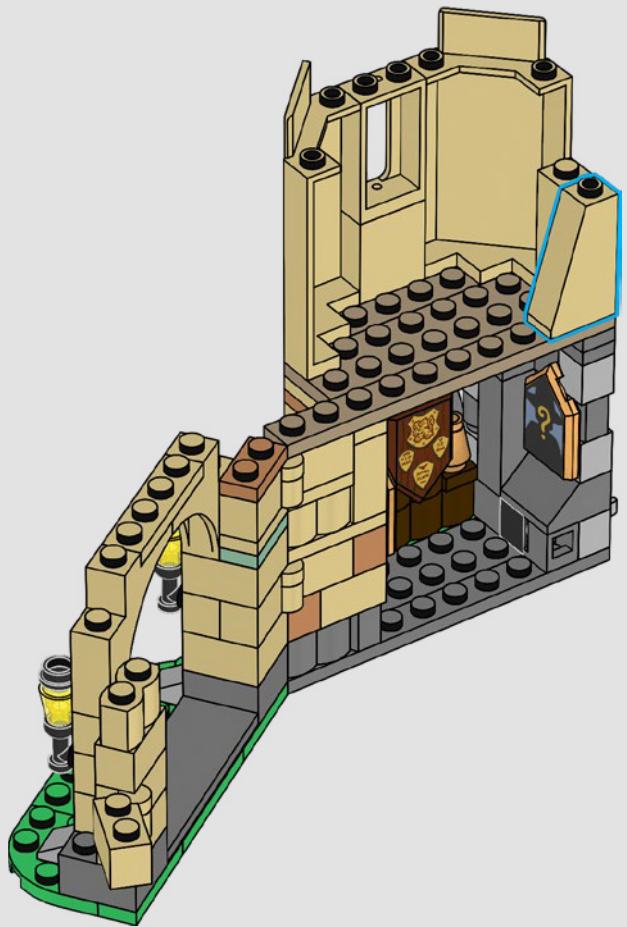

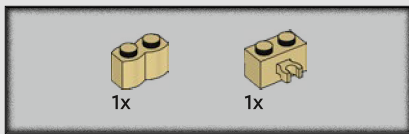

43

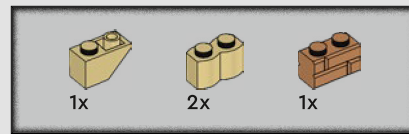
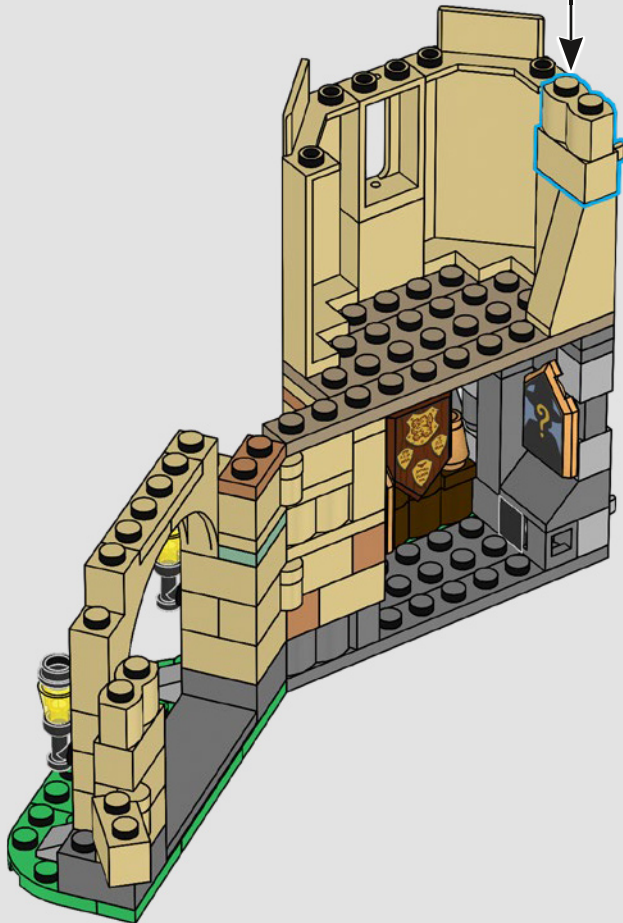
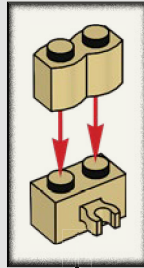

44

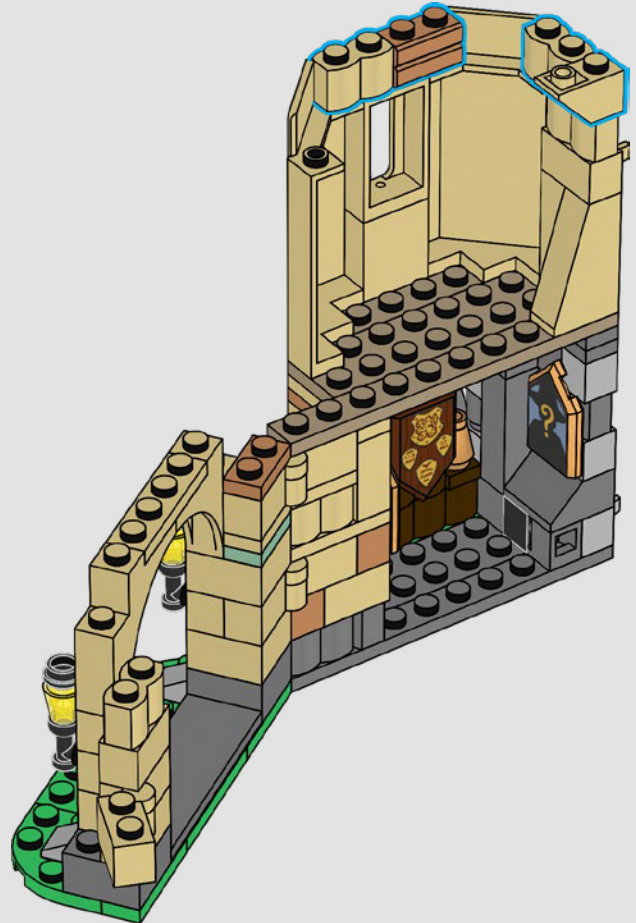

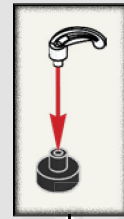
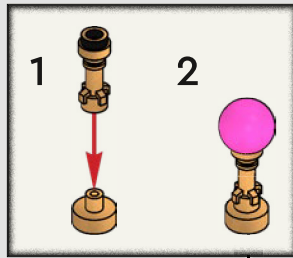
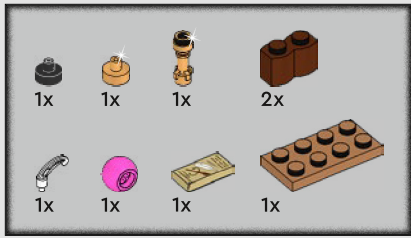

45

1

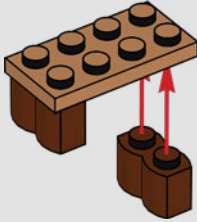

2



3





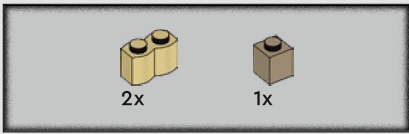

46

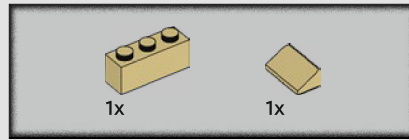
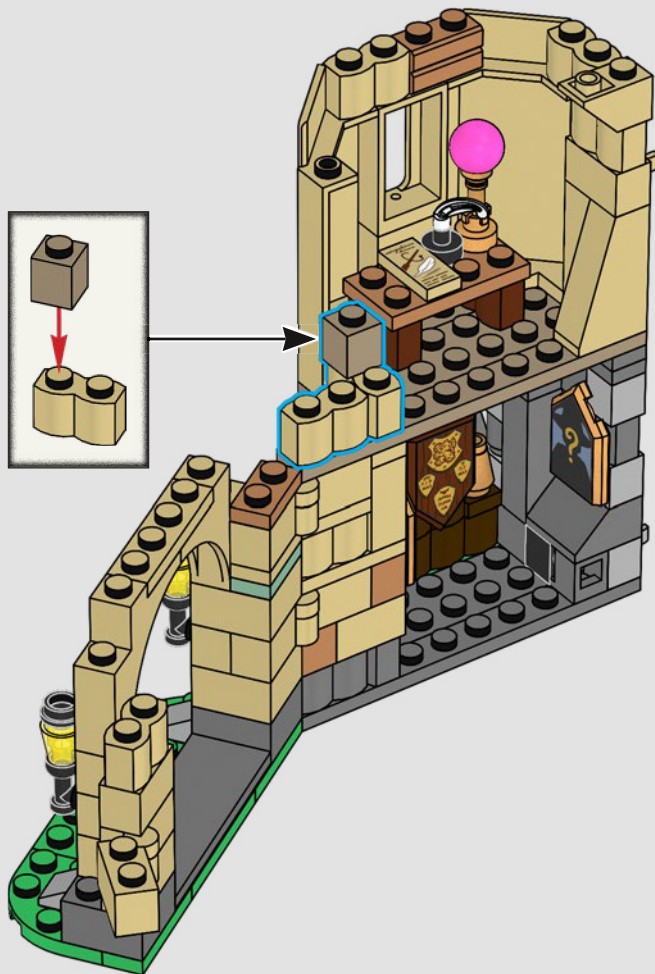

47

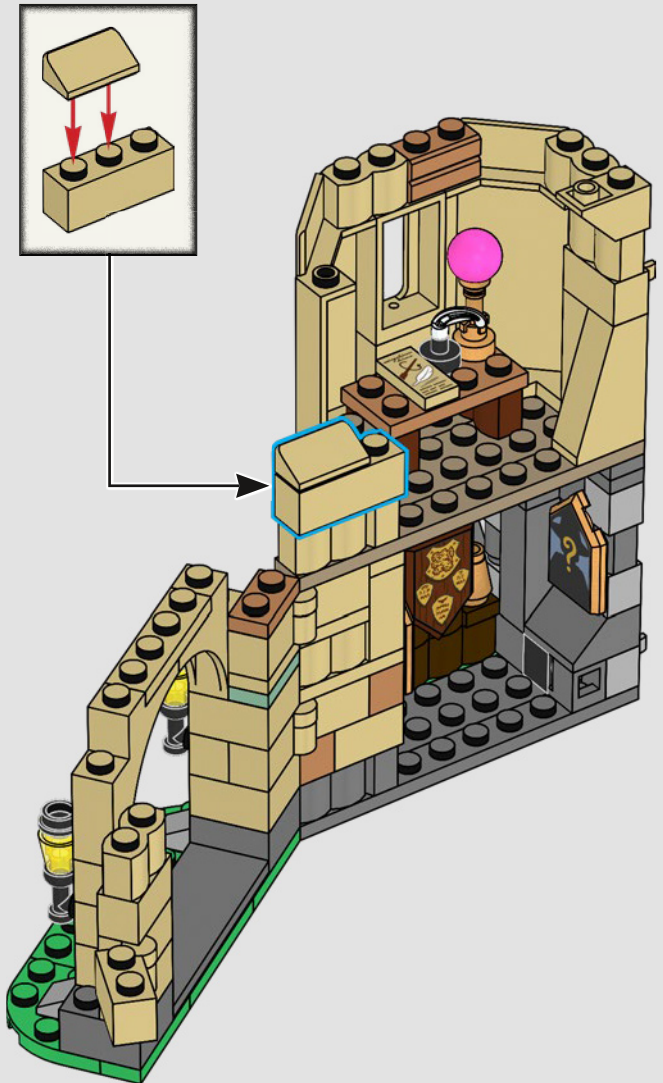

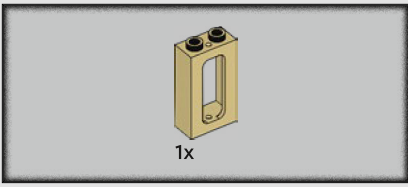

48

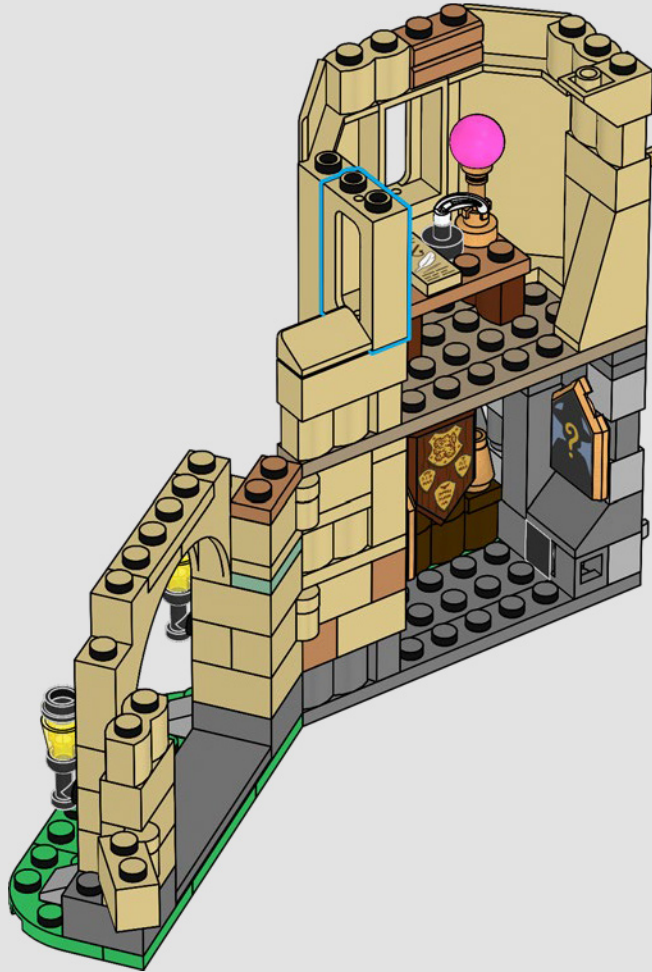

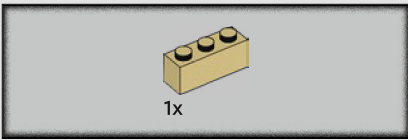

49

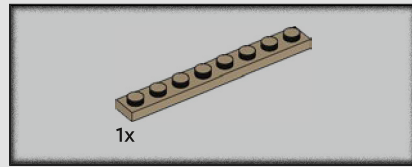
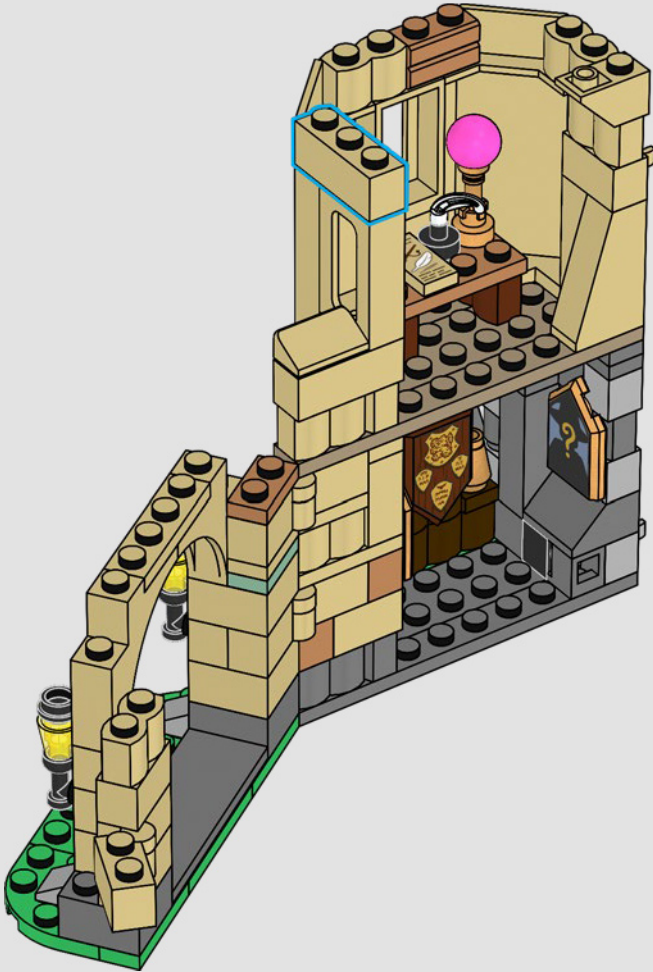

50

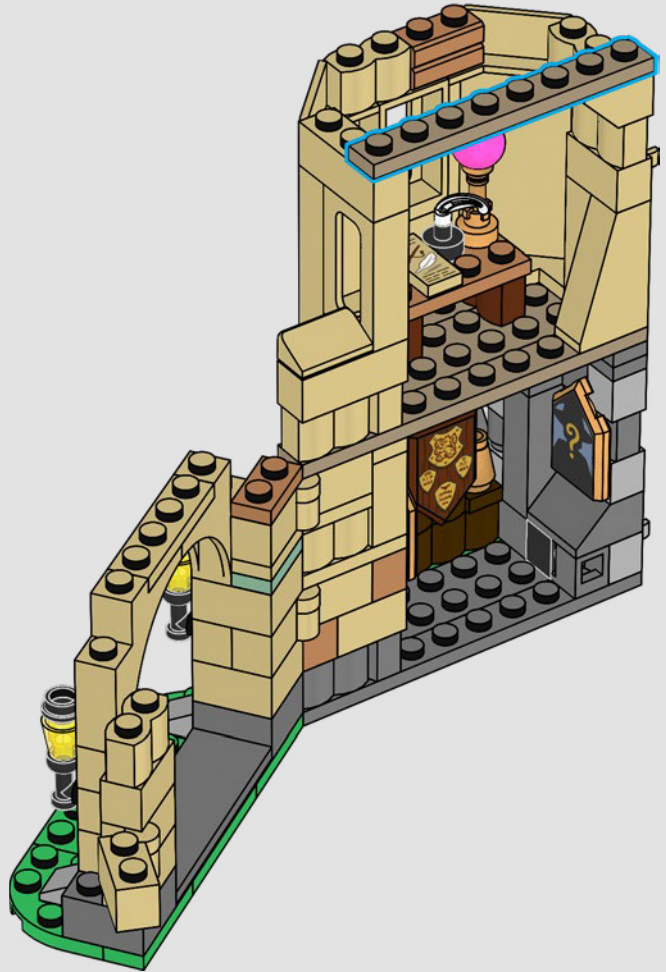



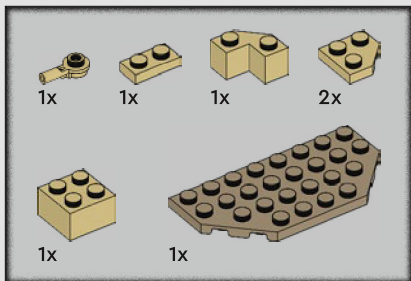

51

1

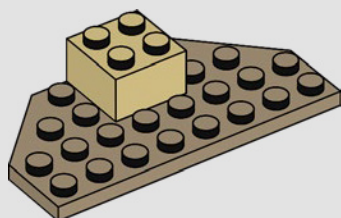

2

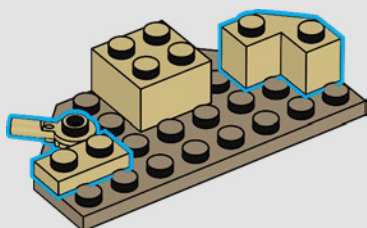

3

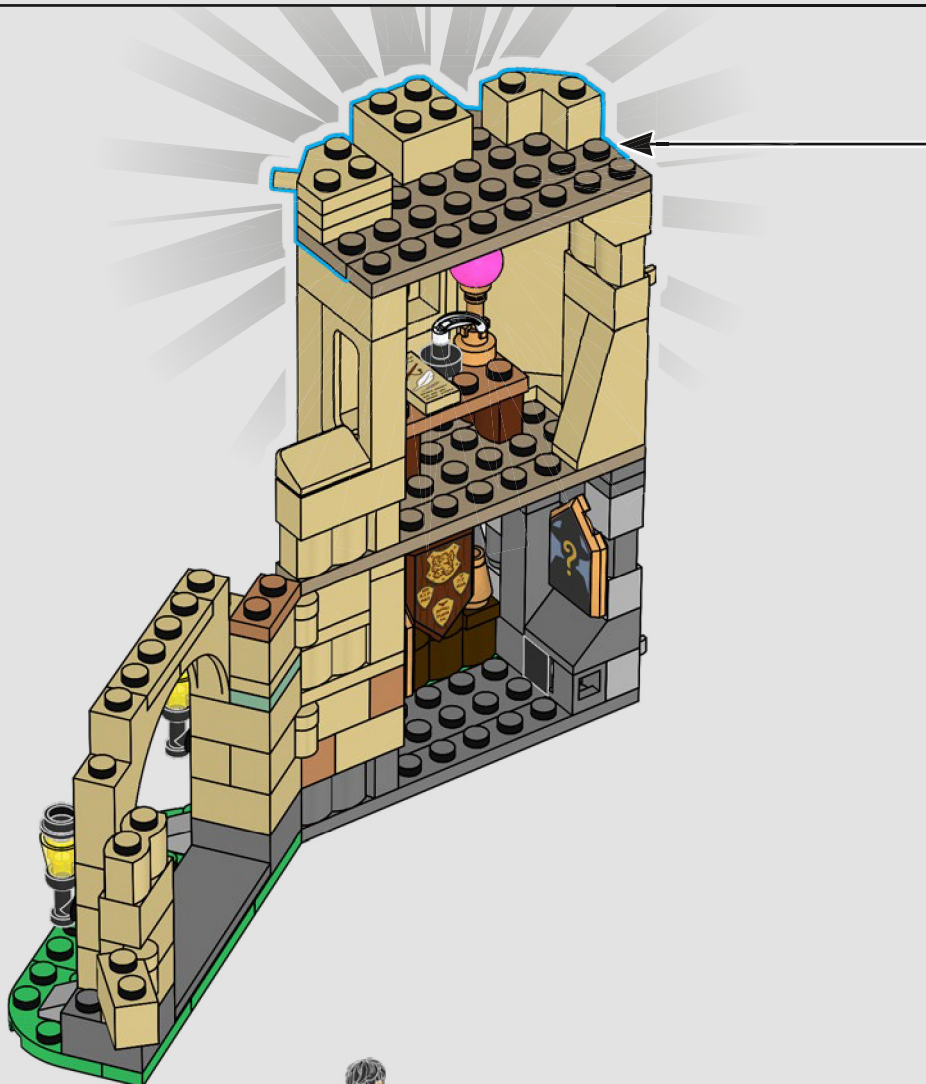
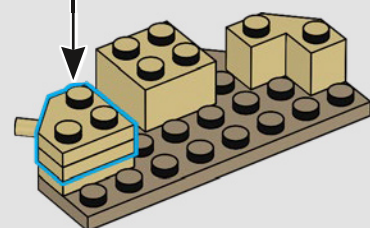
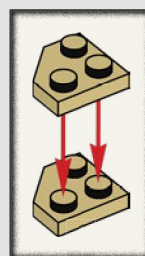



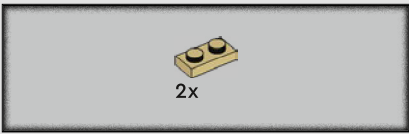

52

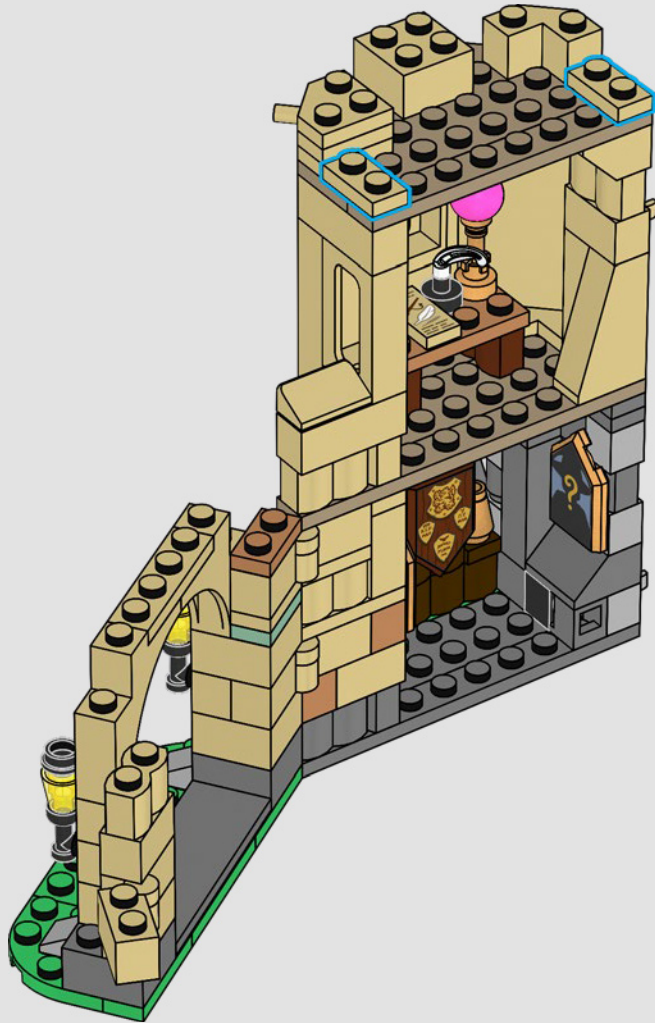

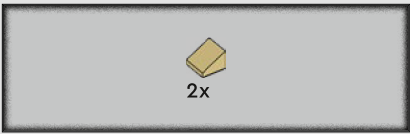

53

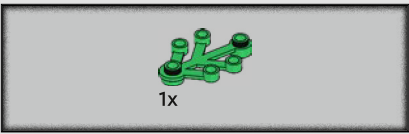
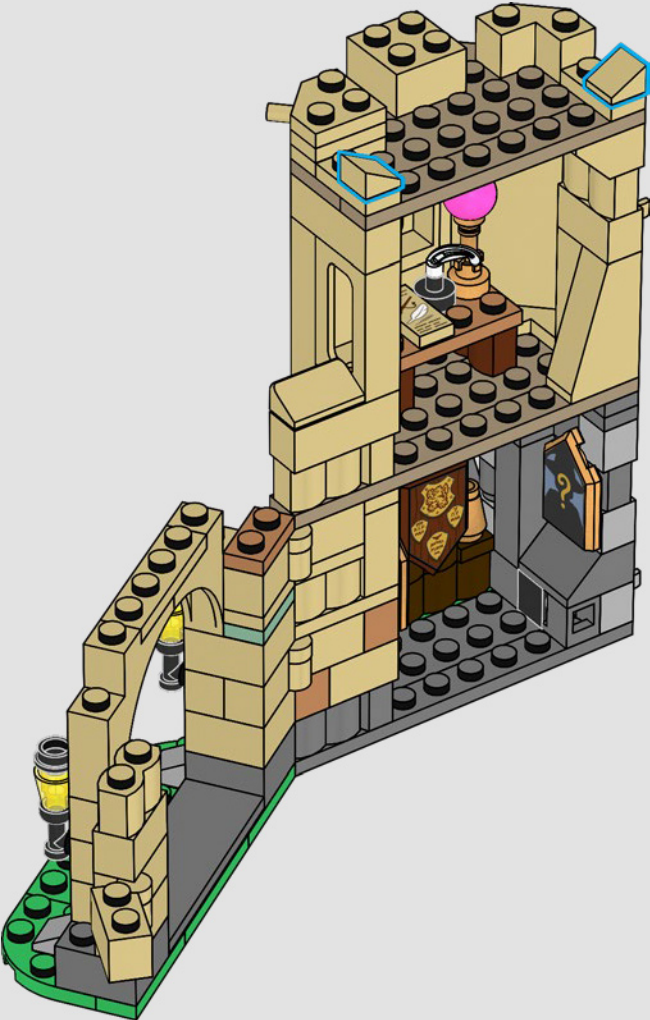

54



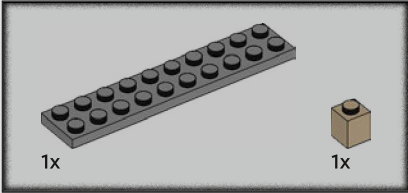
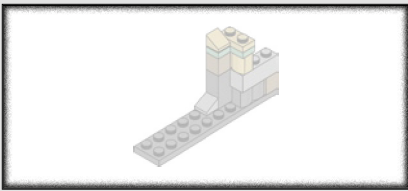

55

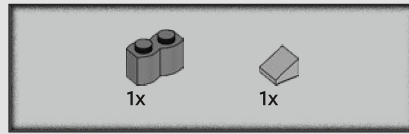
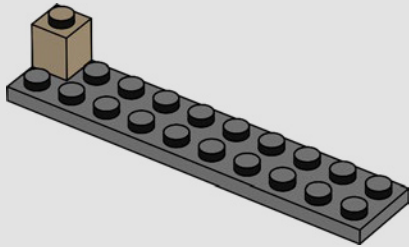

56

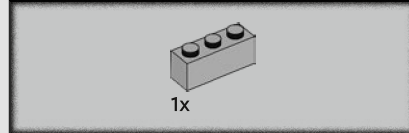
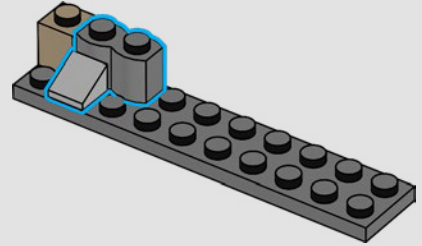

57

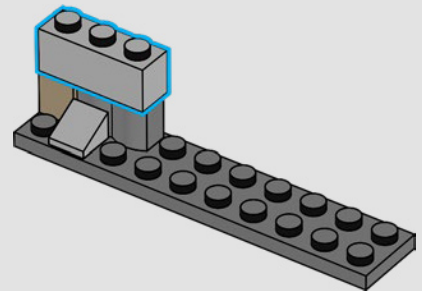

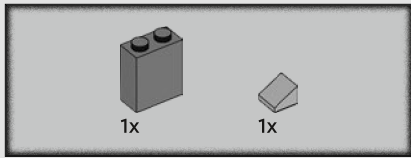

58

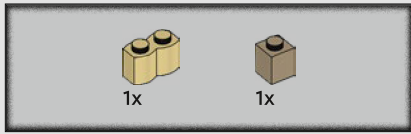
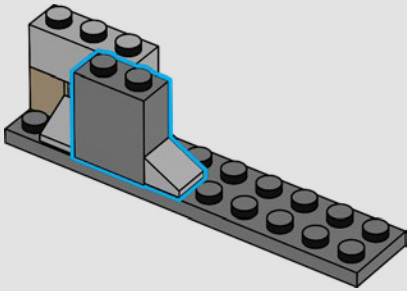

59

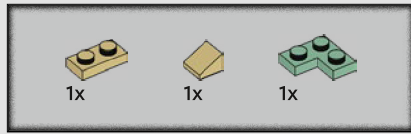
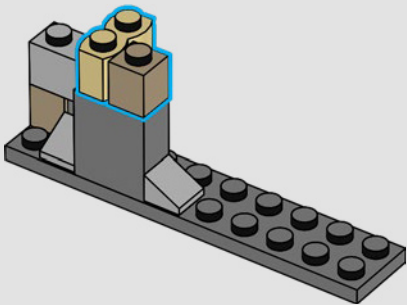

60

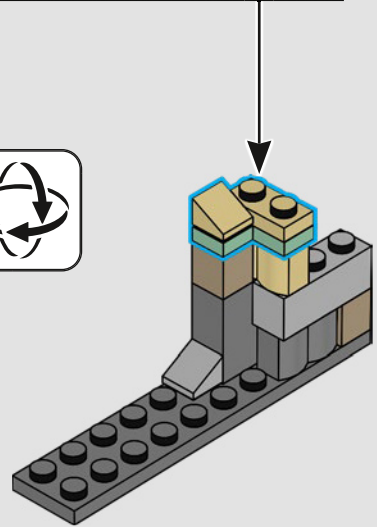
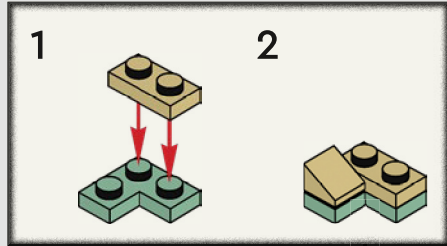



61

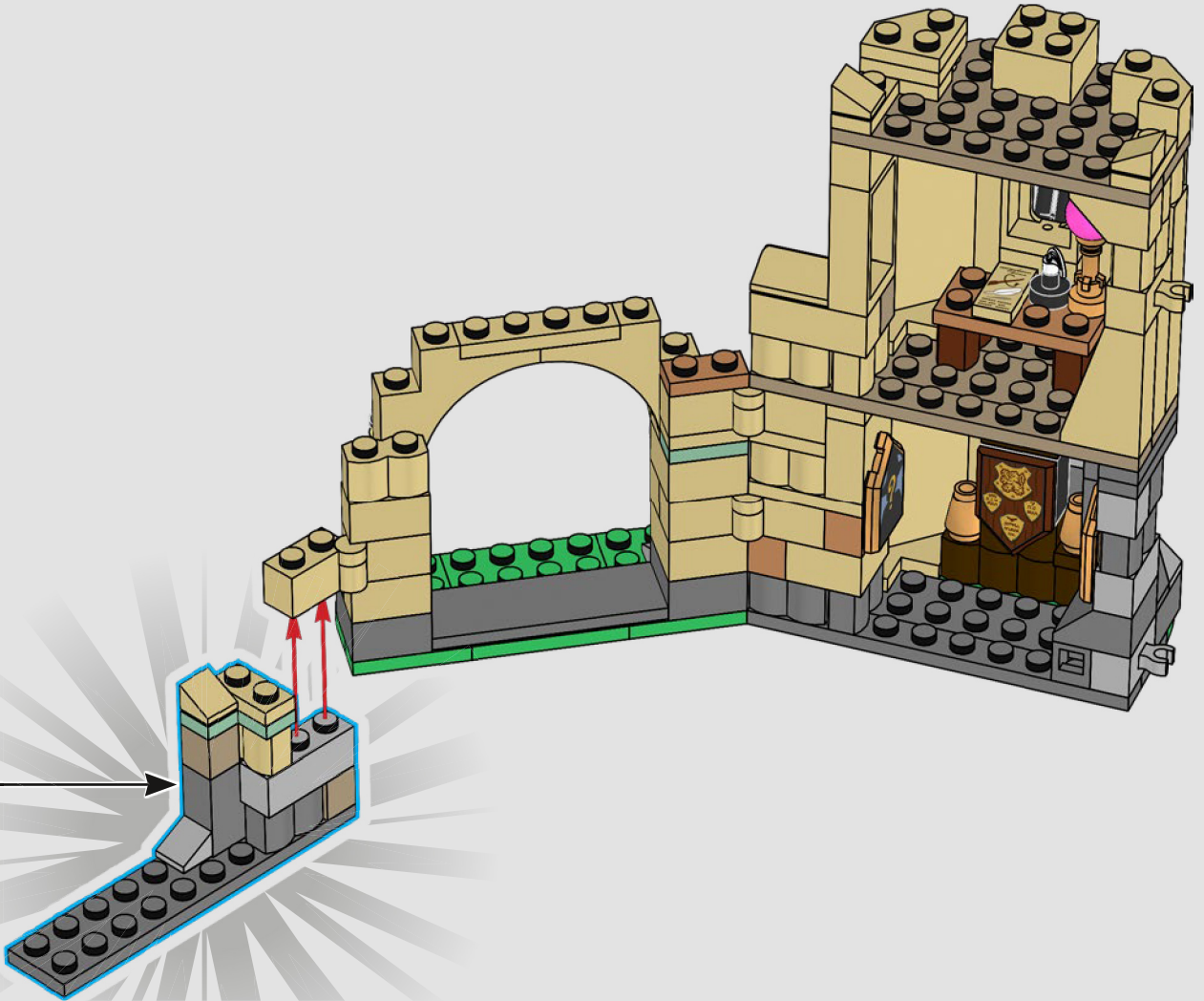

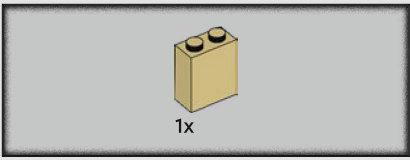

62

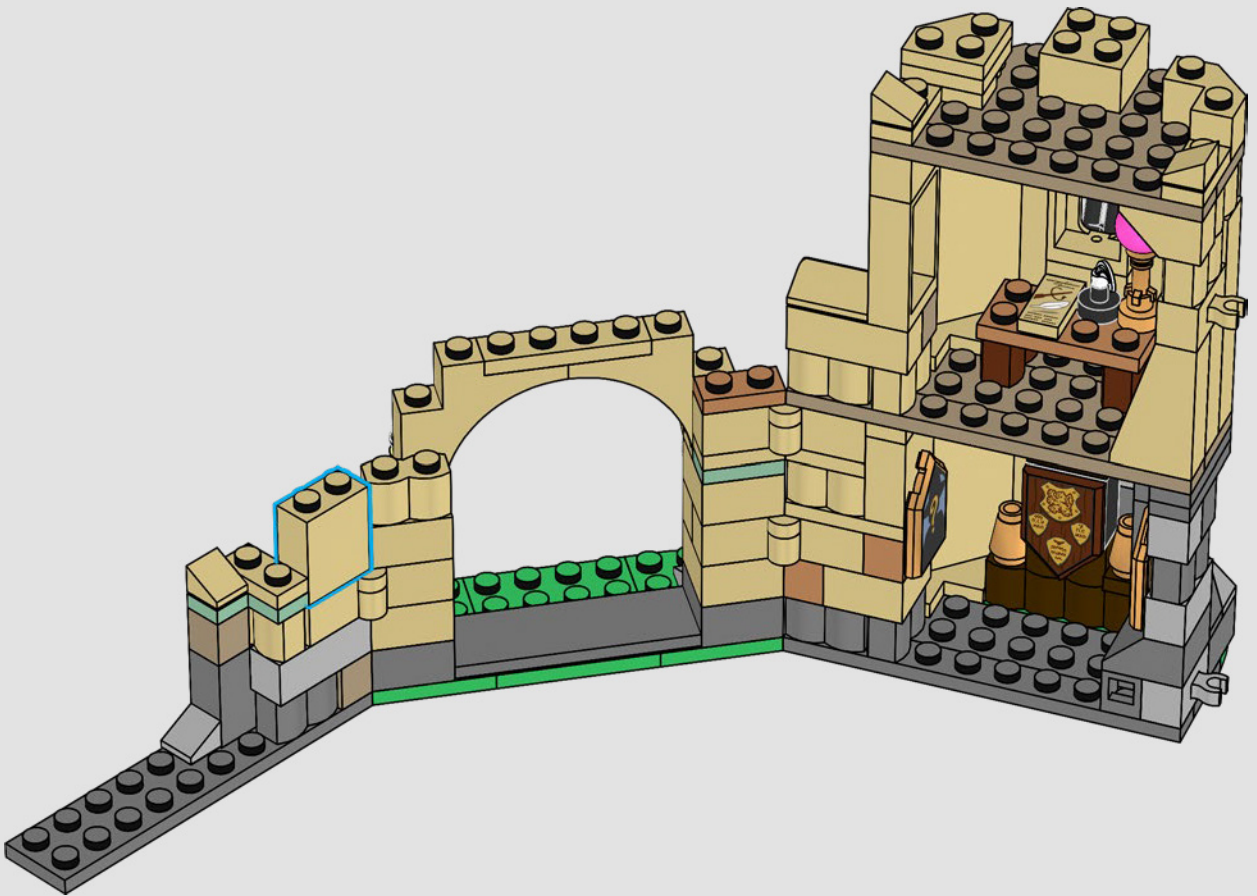

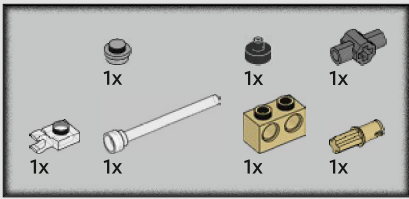

# 63

1

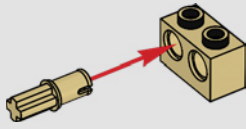

2

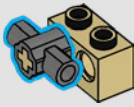

3



4

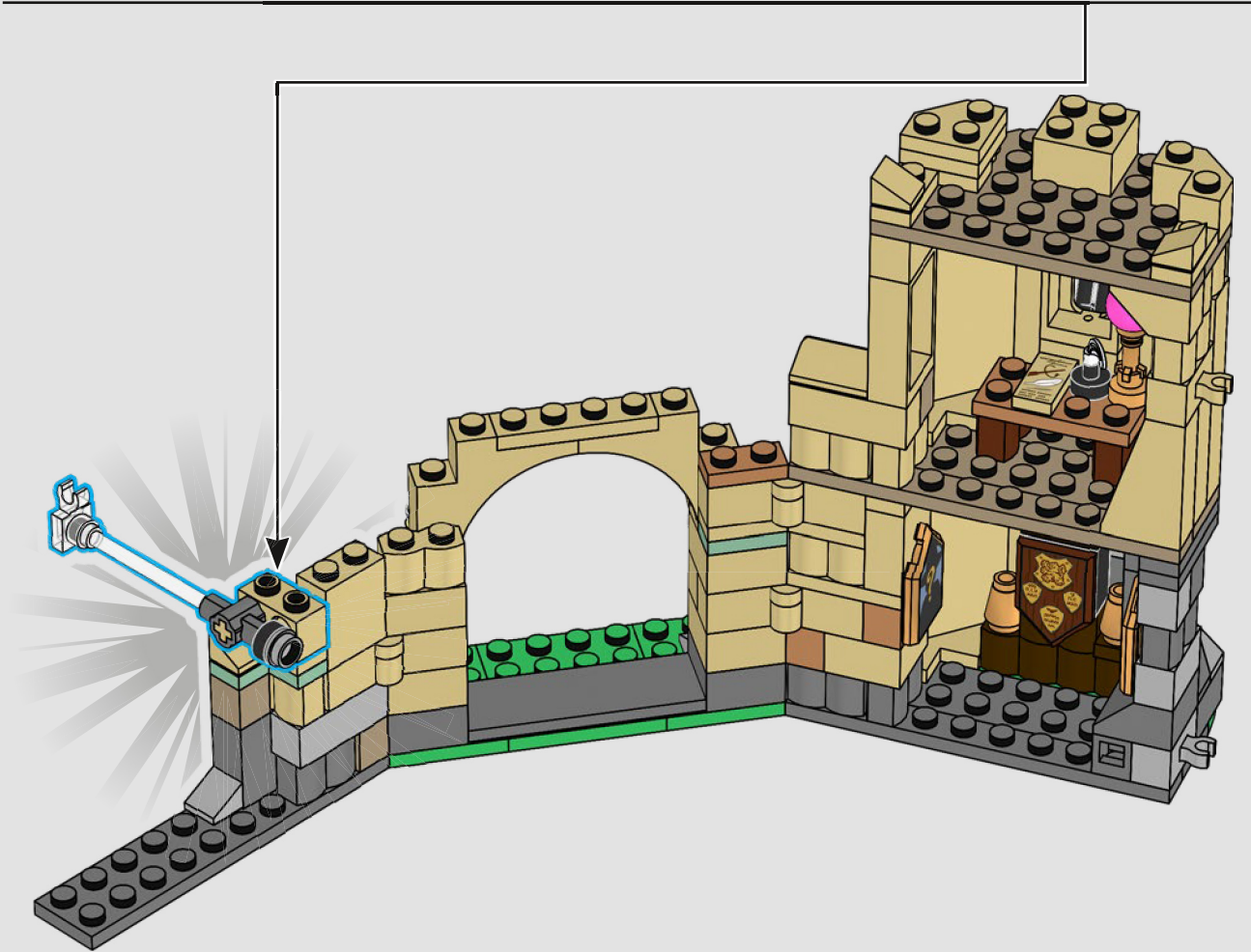
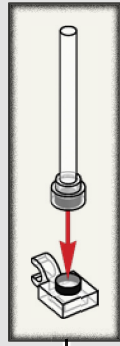
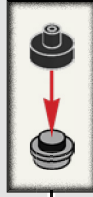
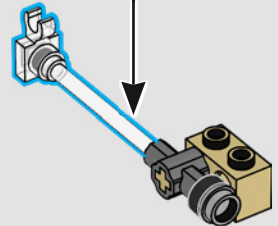



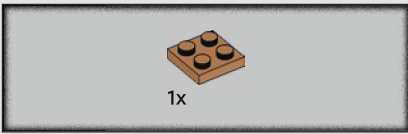

64

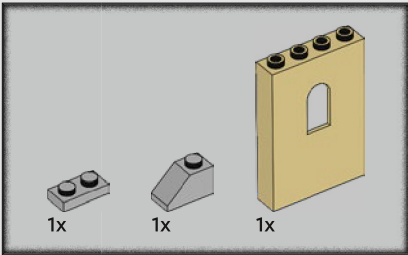

65





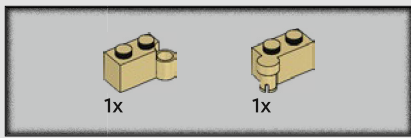

66

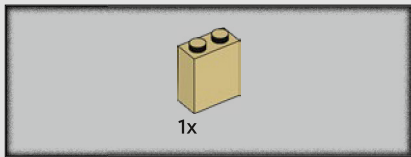
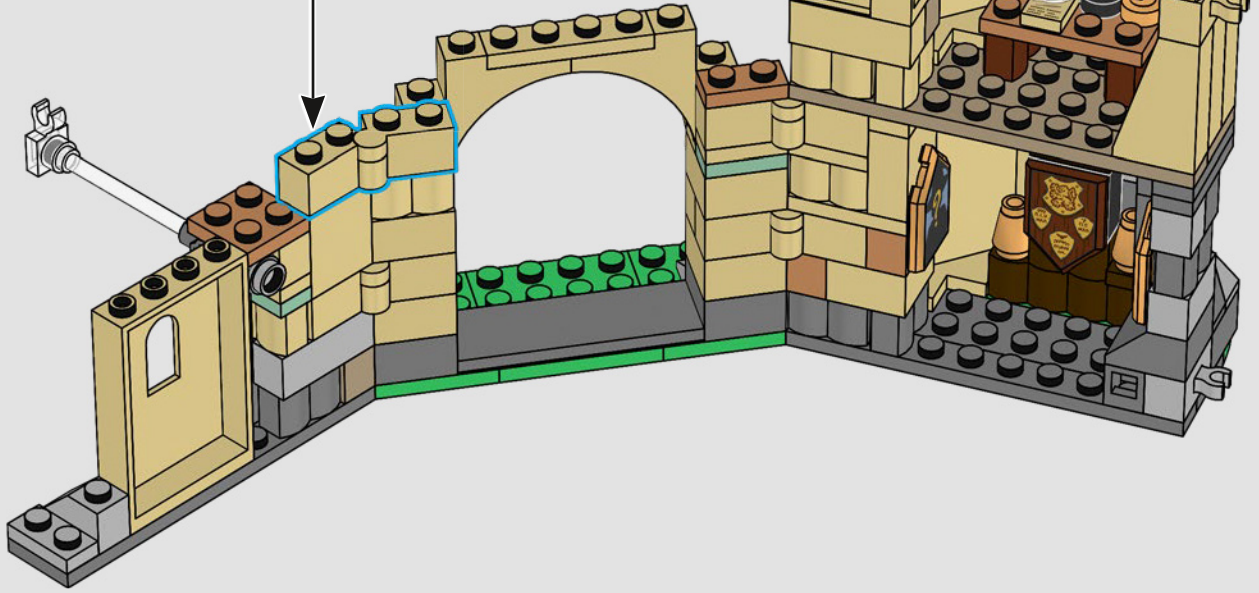
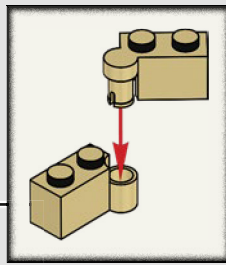

67

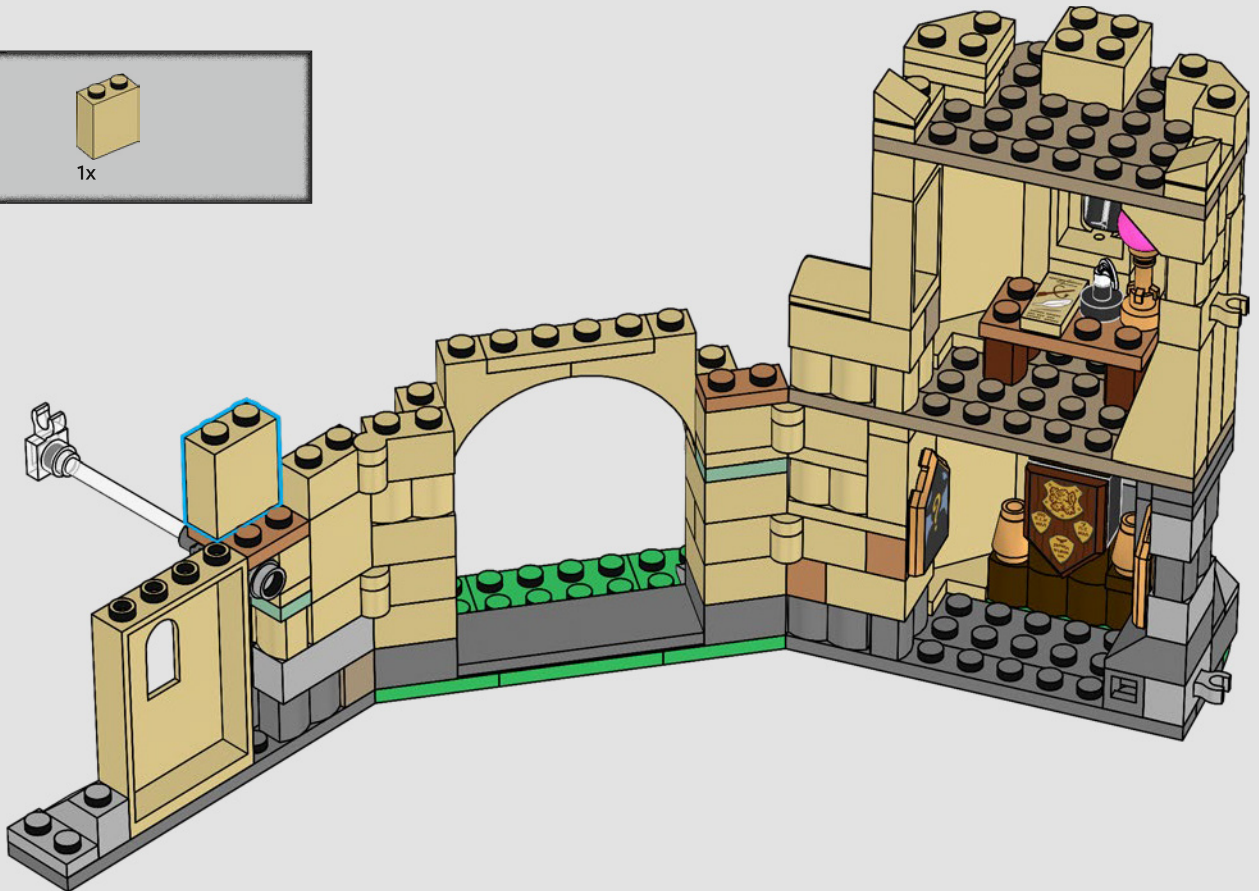

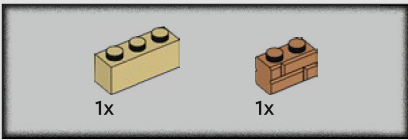

68

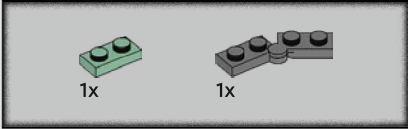
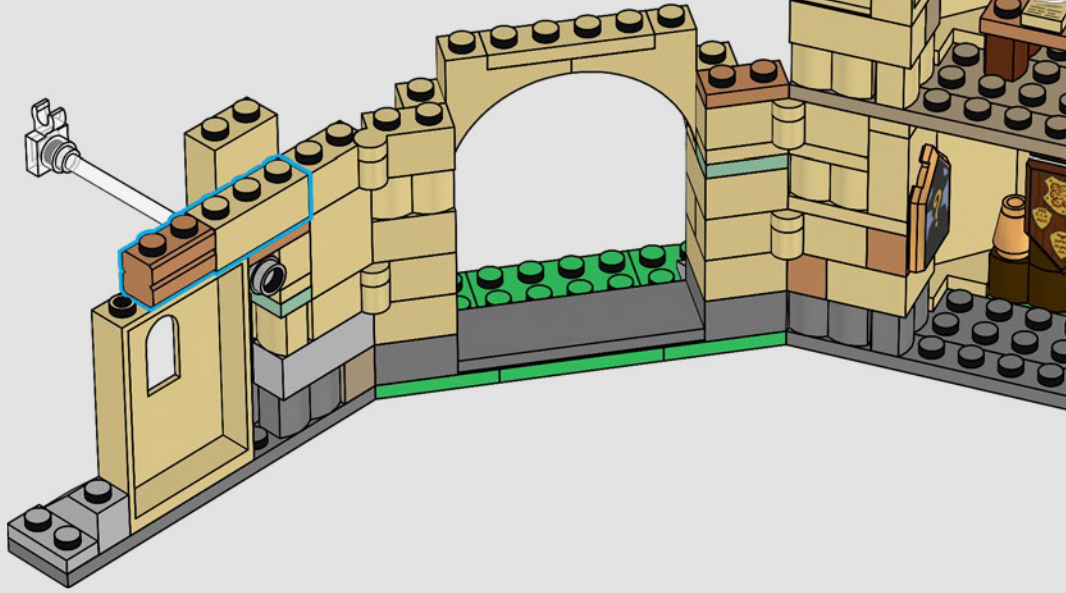

69

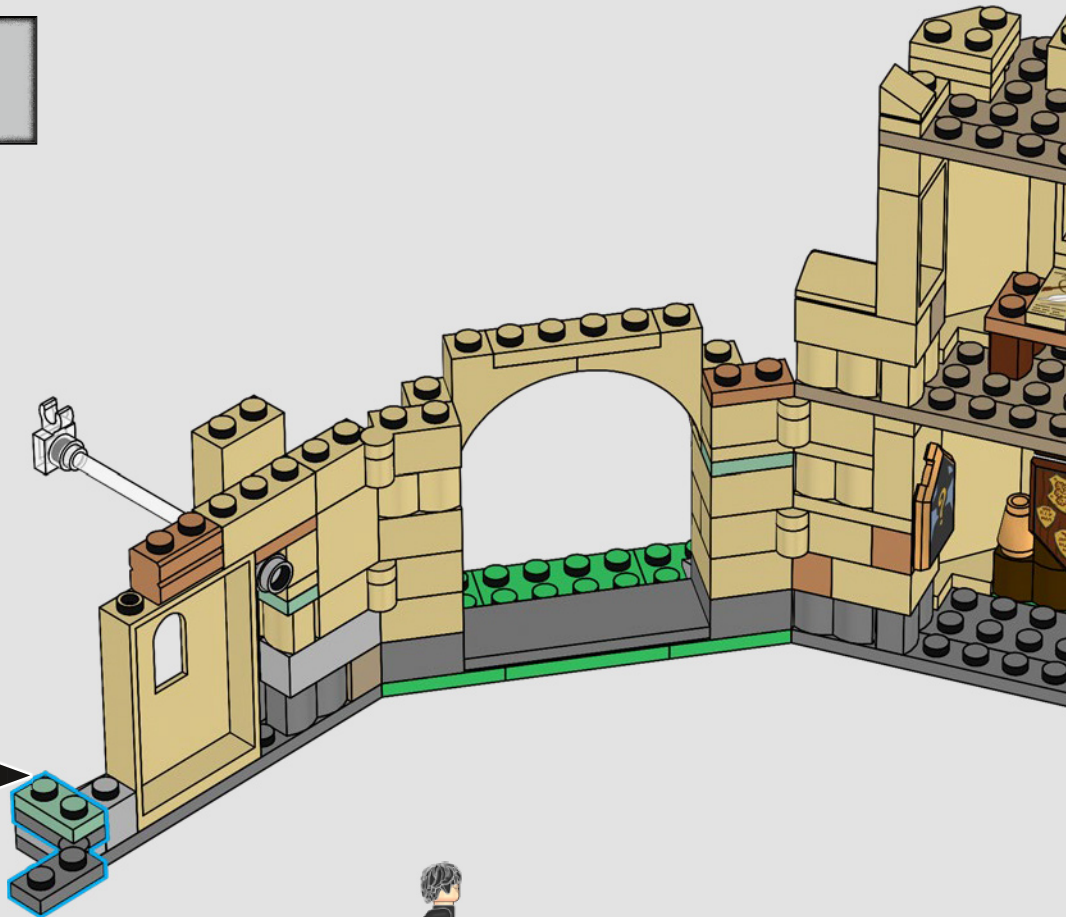
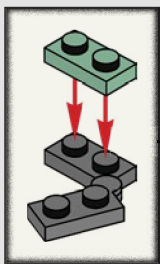



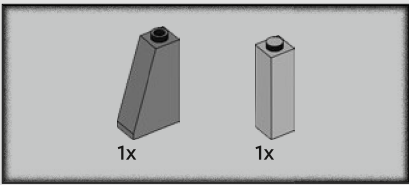

70

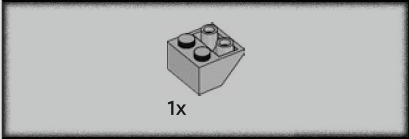
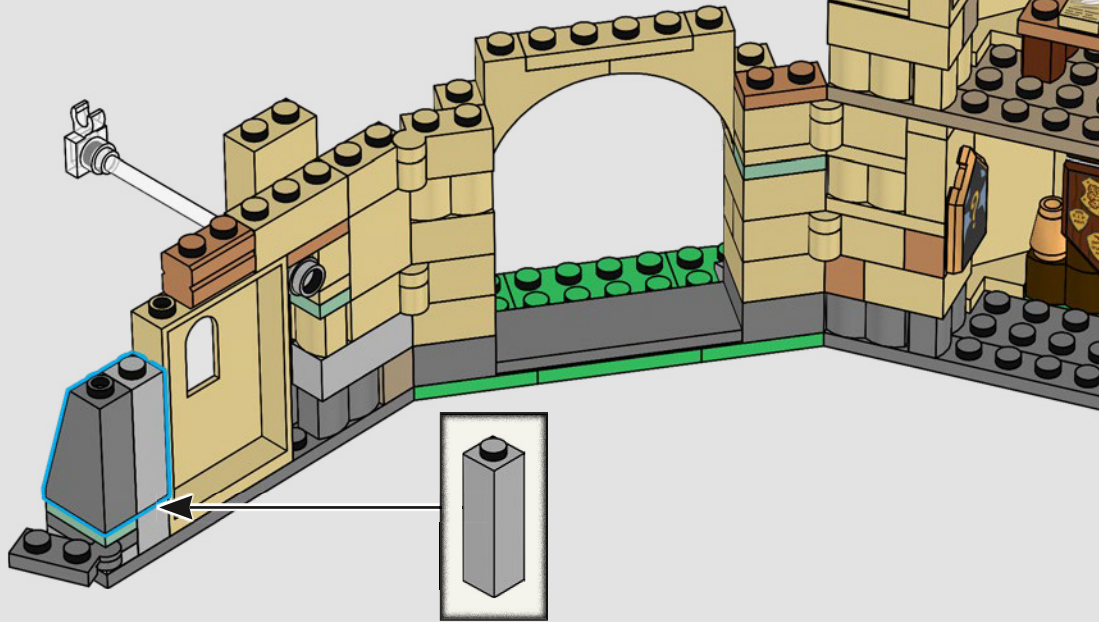

71

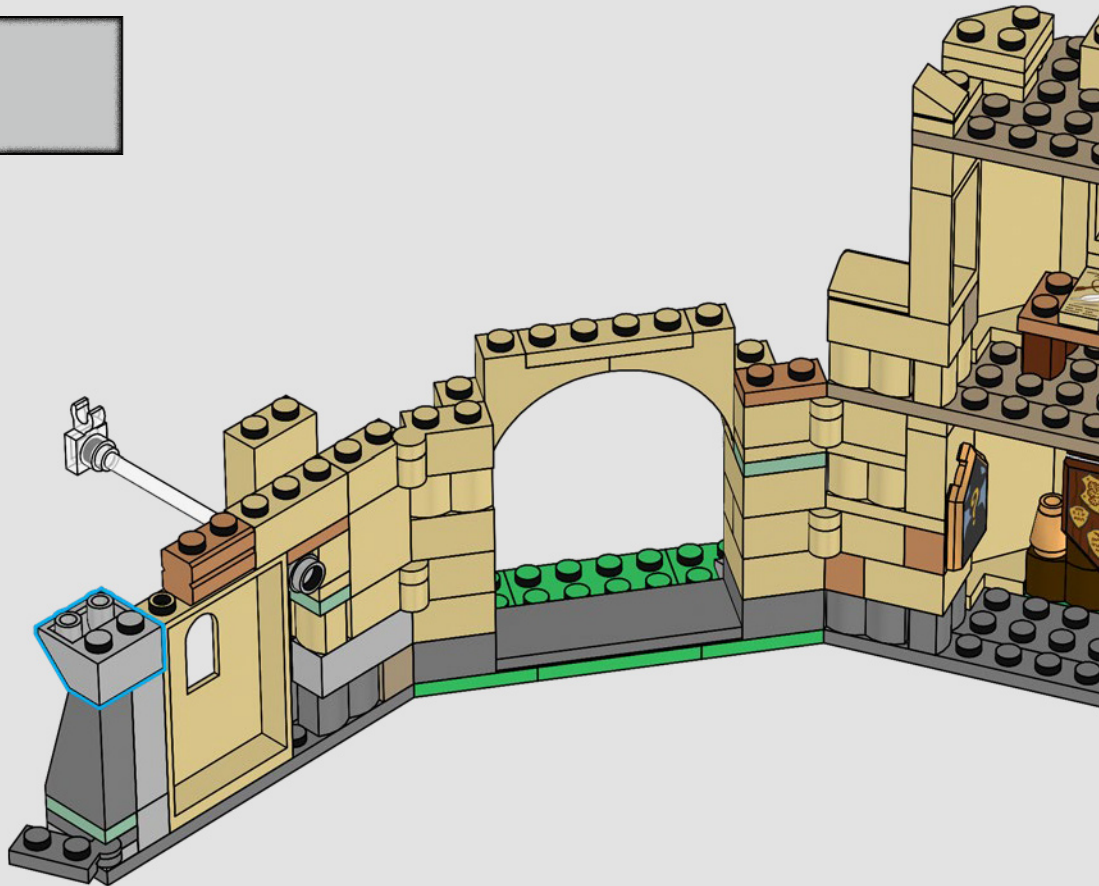

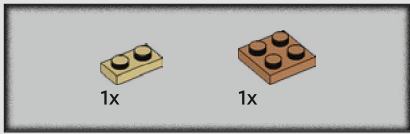

72

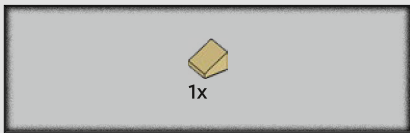
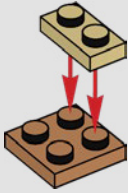

73

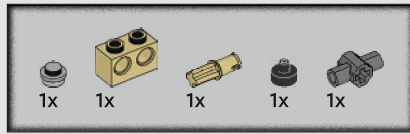

74

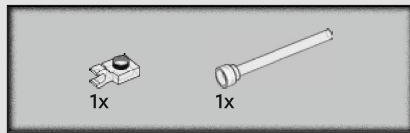
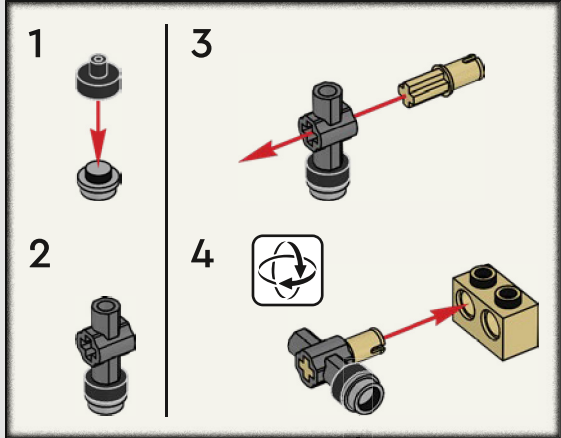

75

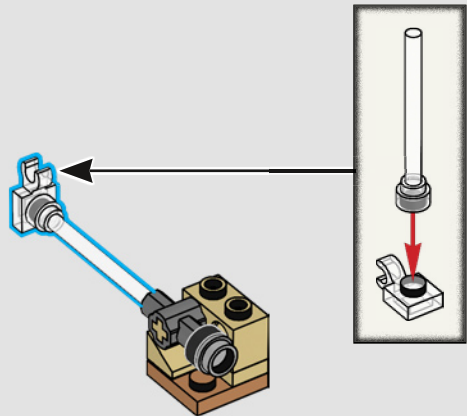



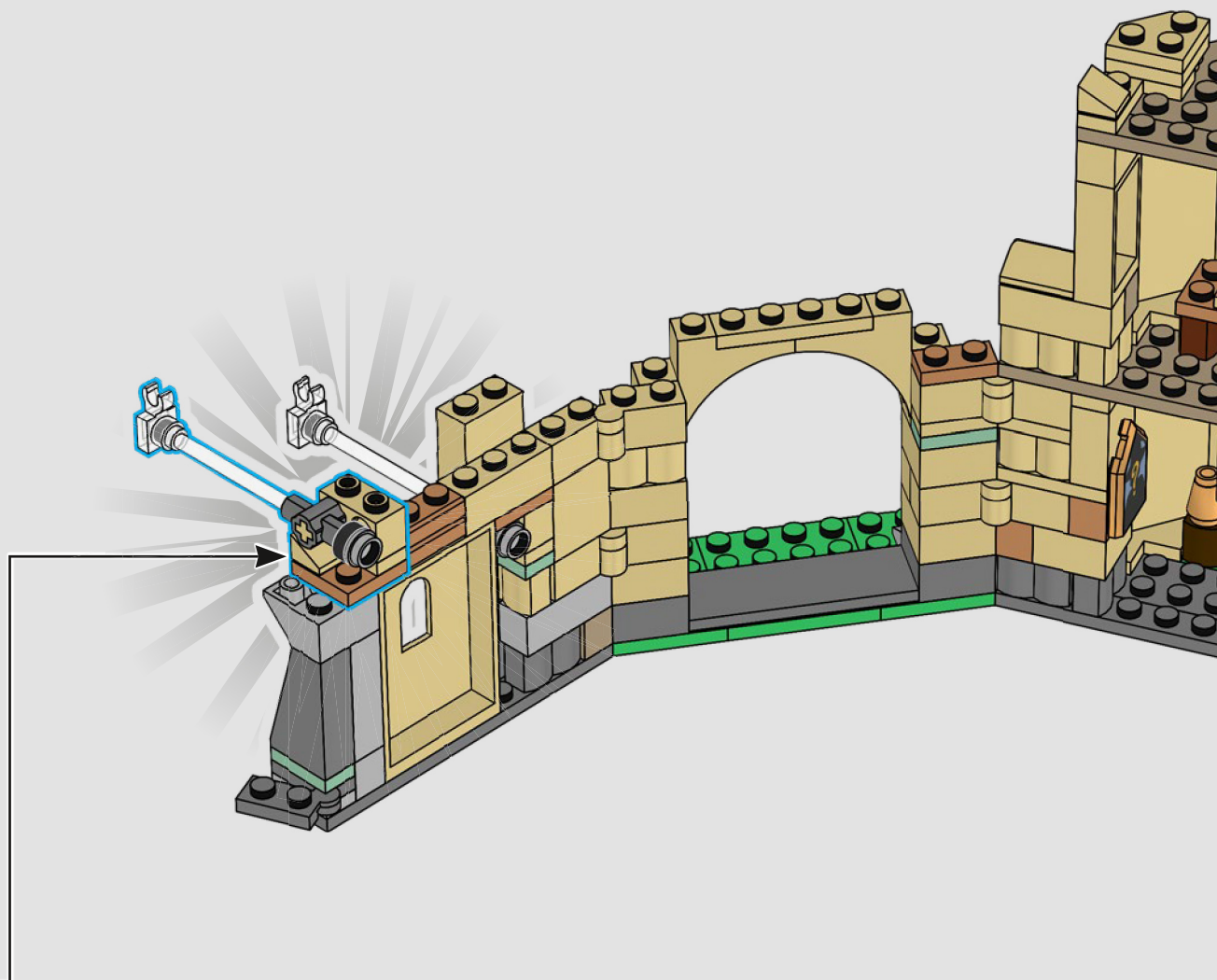

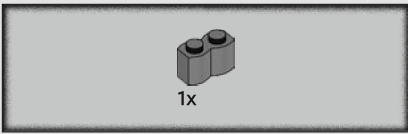

77

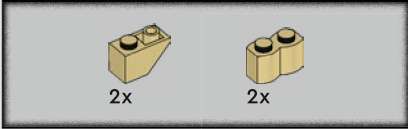
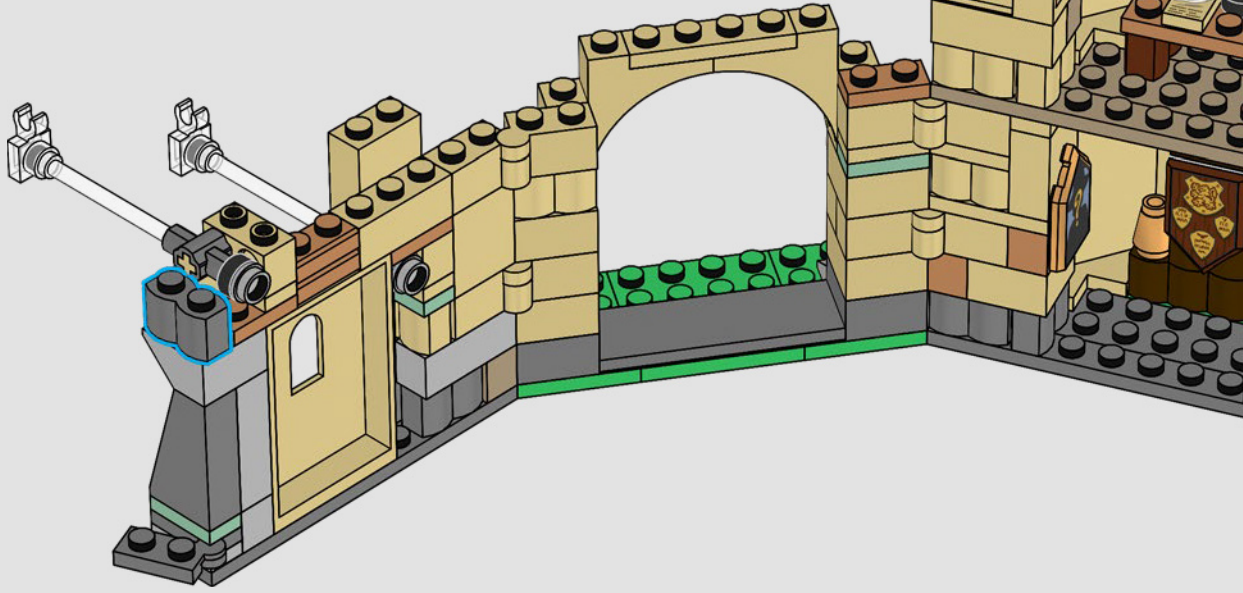

78

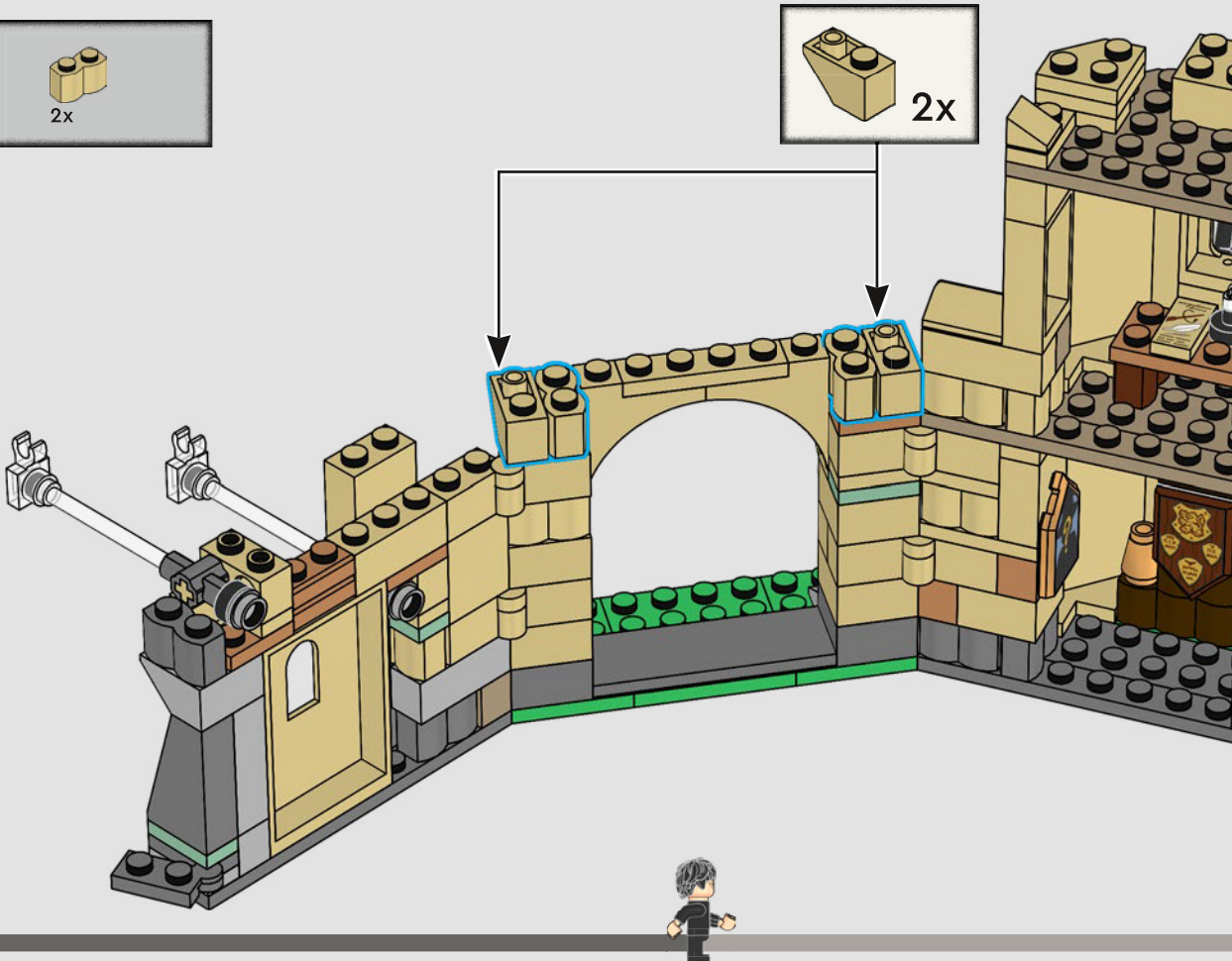

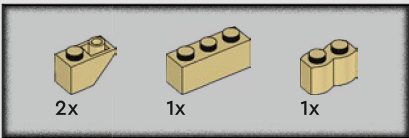

79

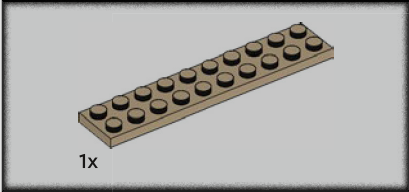
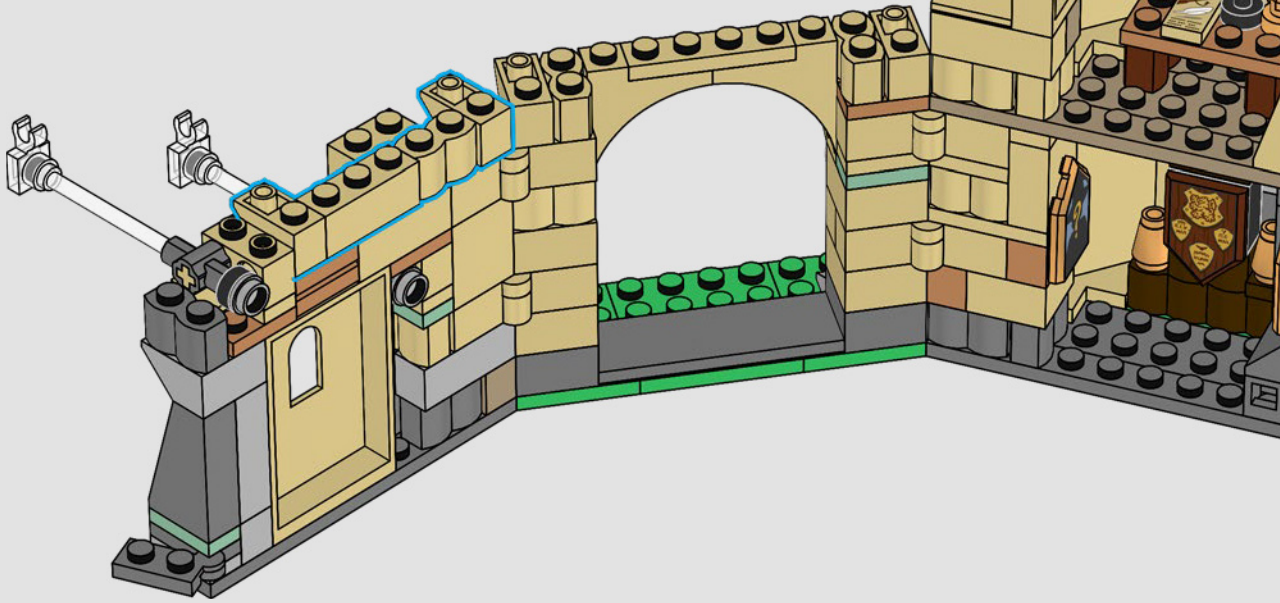

80

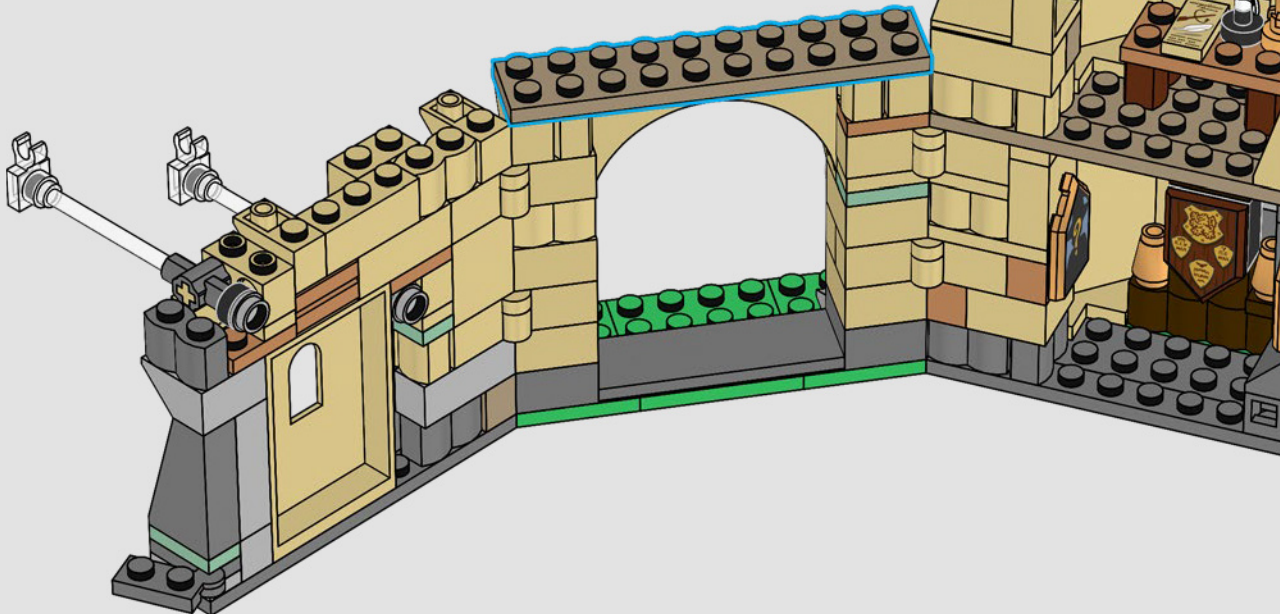



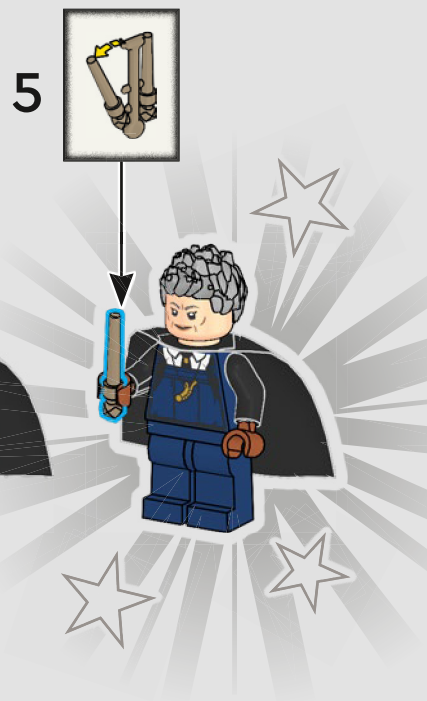
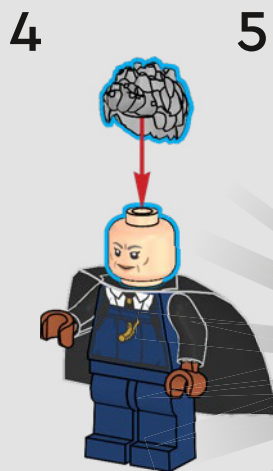
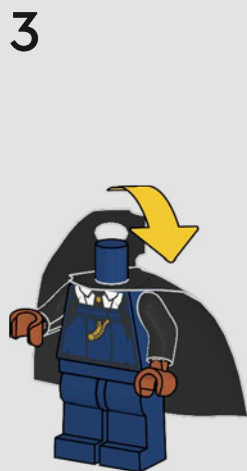
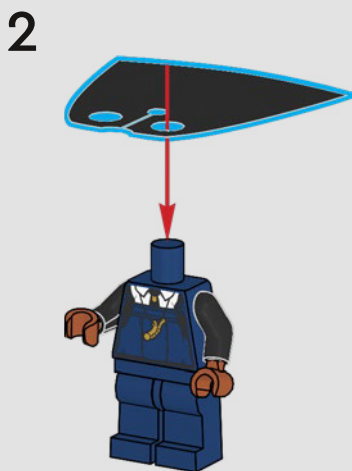
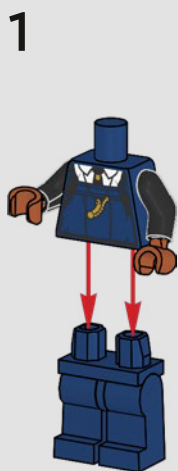



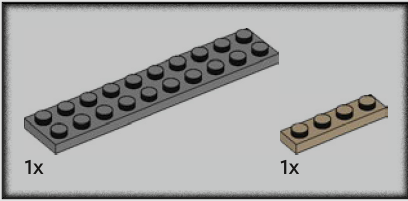
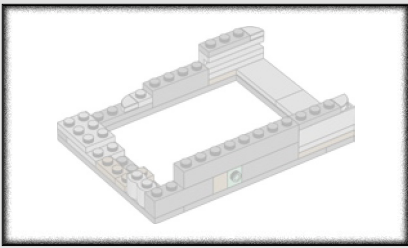

81

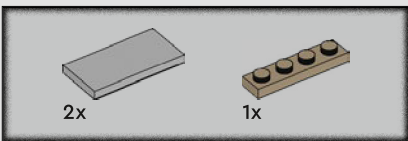
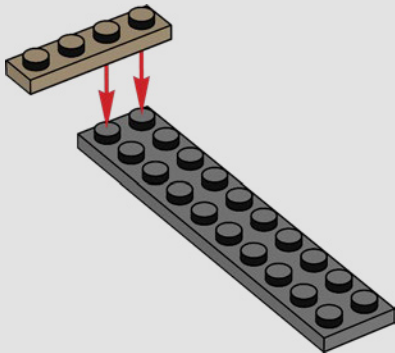

82

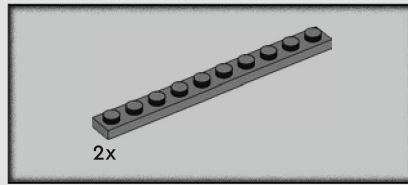
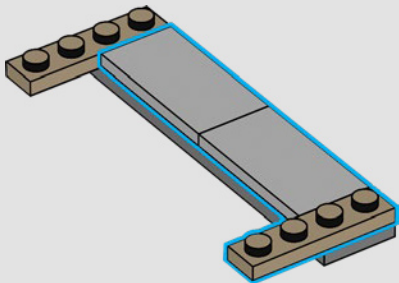

83

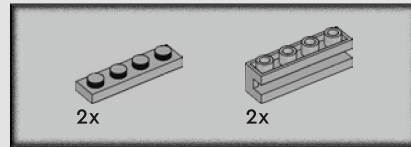
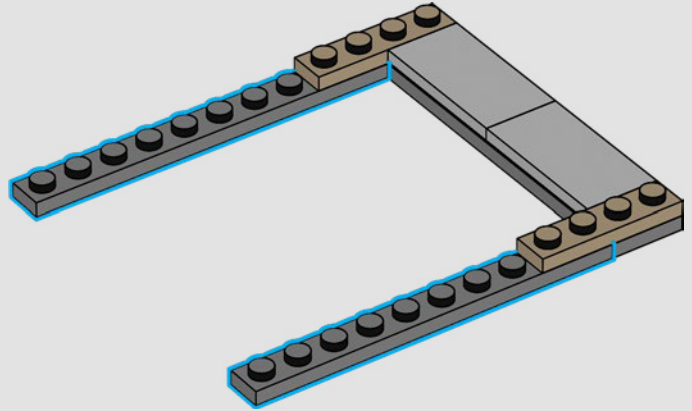

84

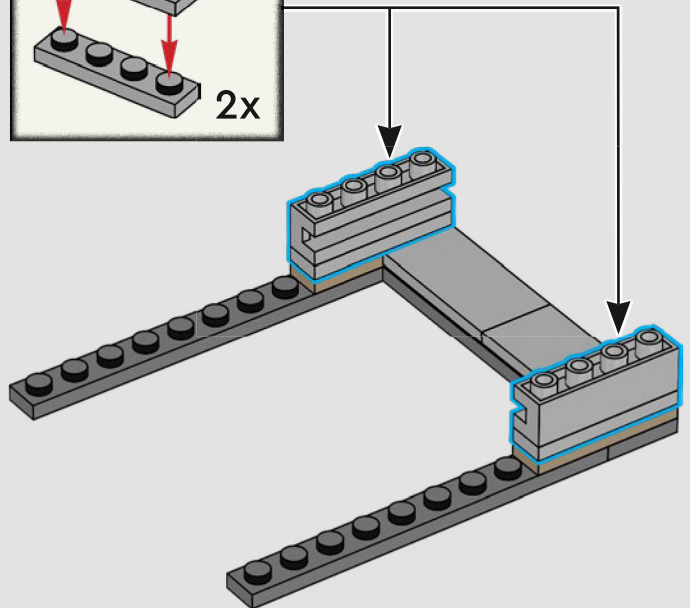
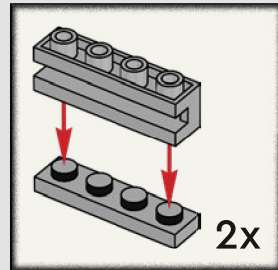

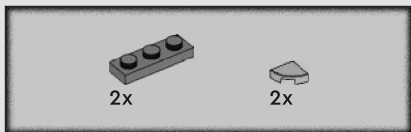

85

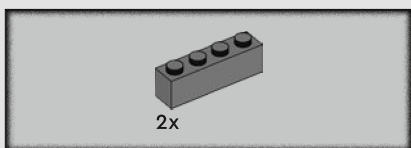
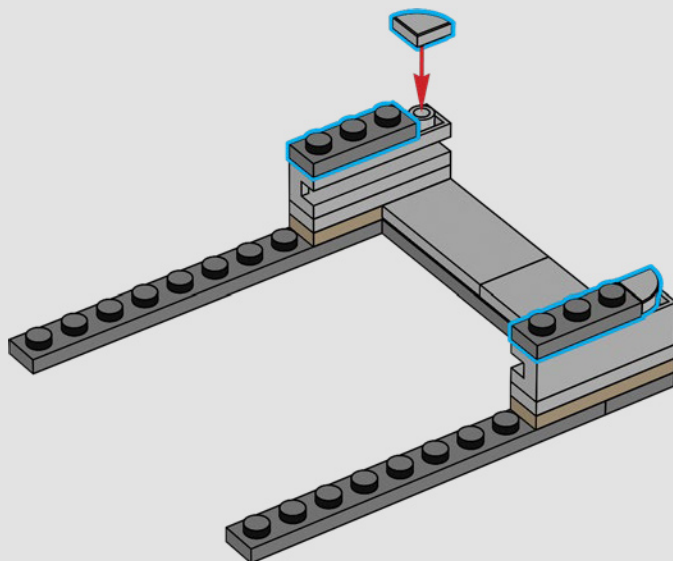

86

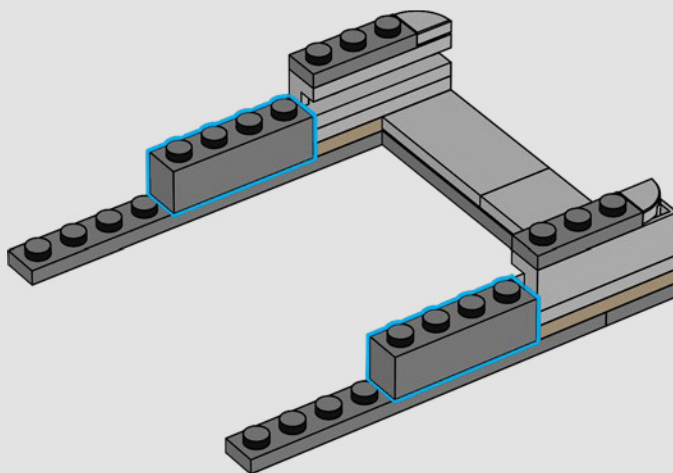

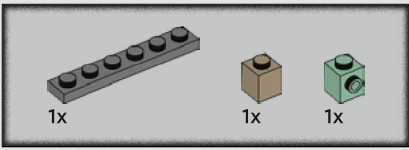

87

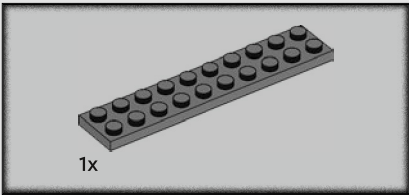
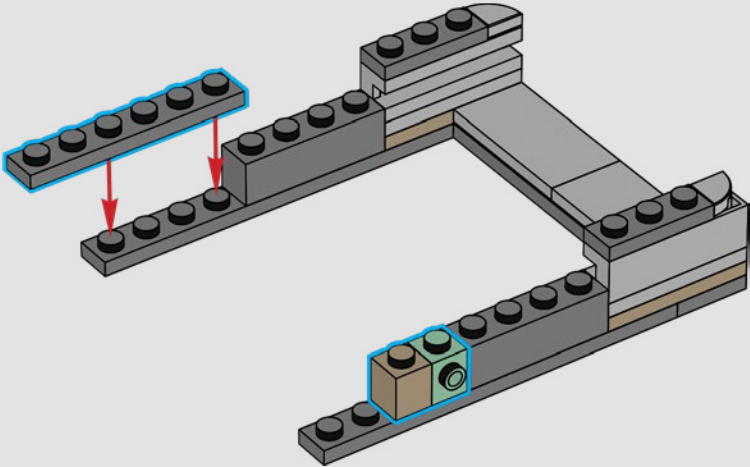

88

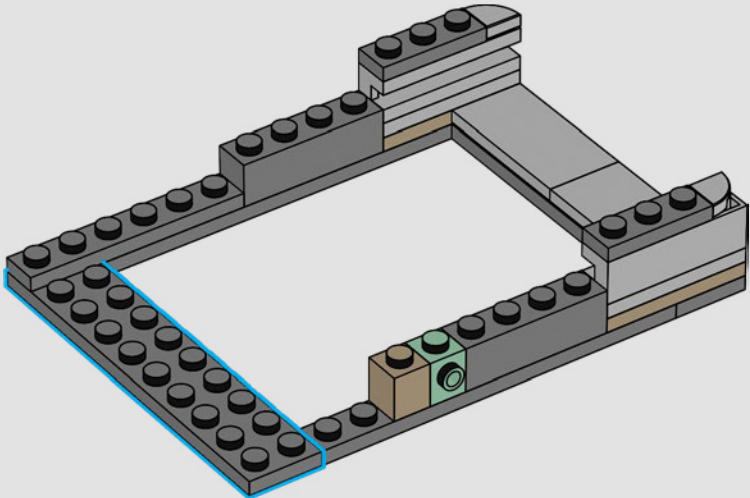

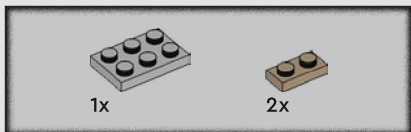

89

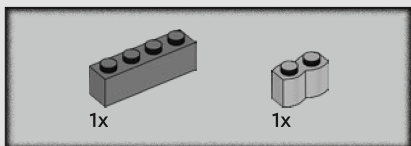
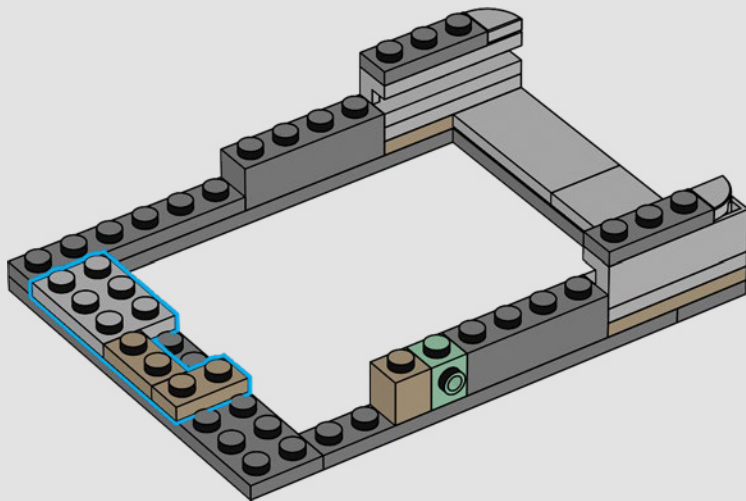

90

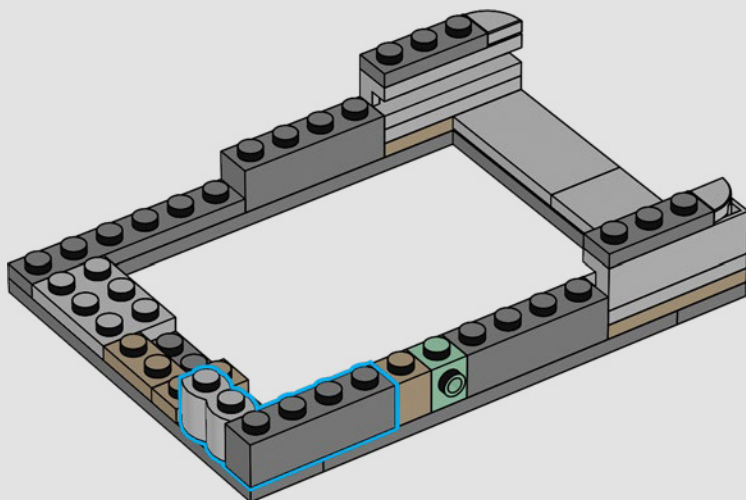



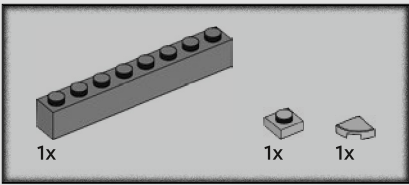

91

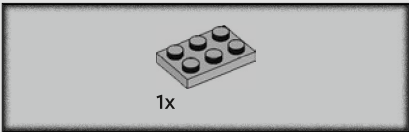
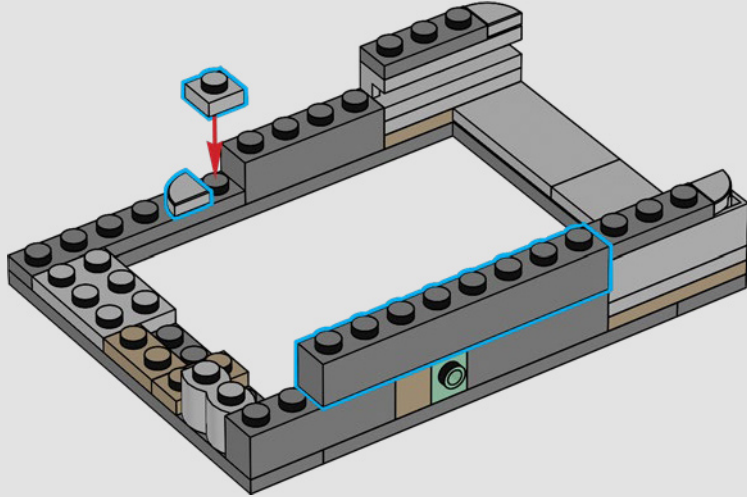

92

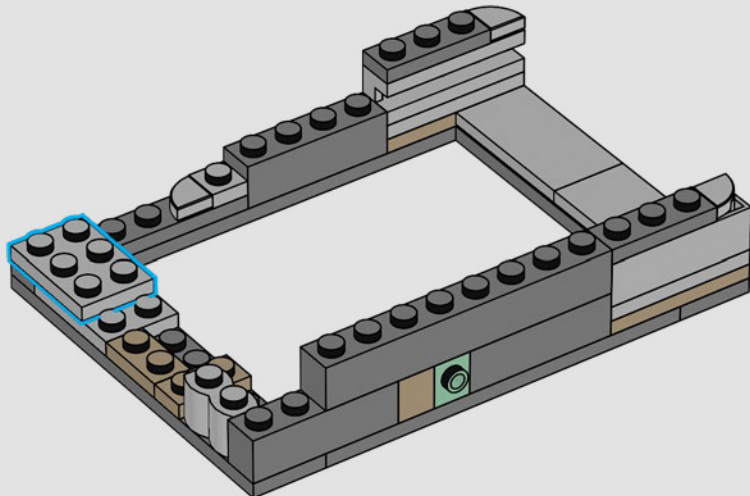

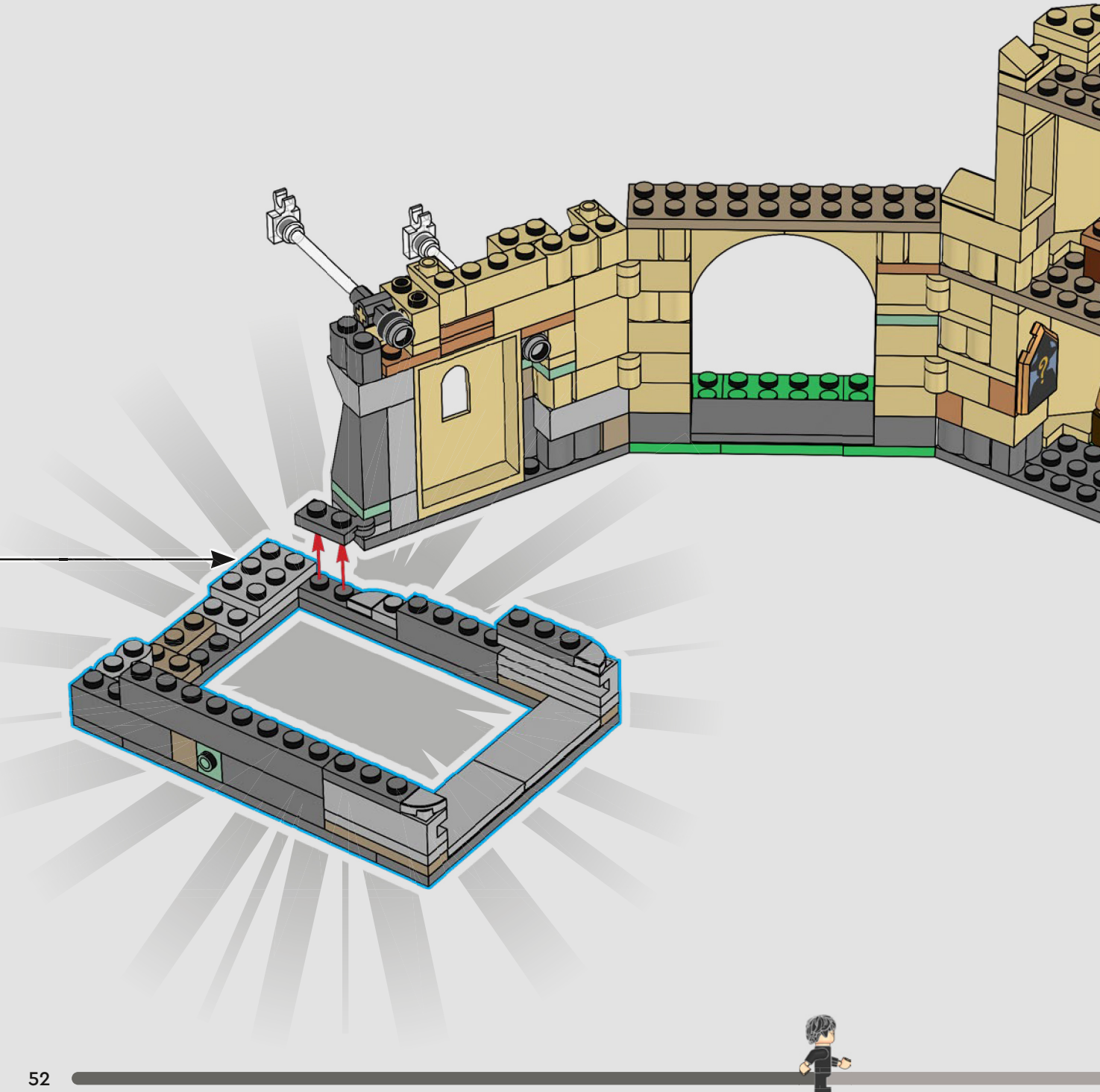

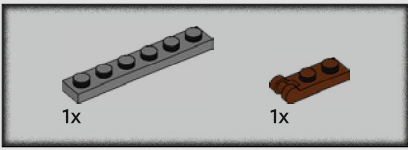

94

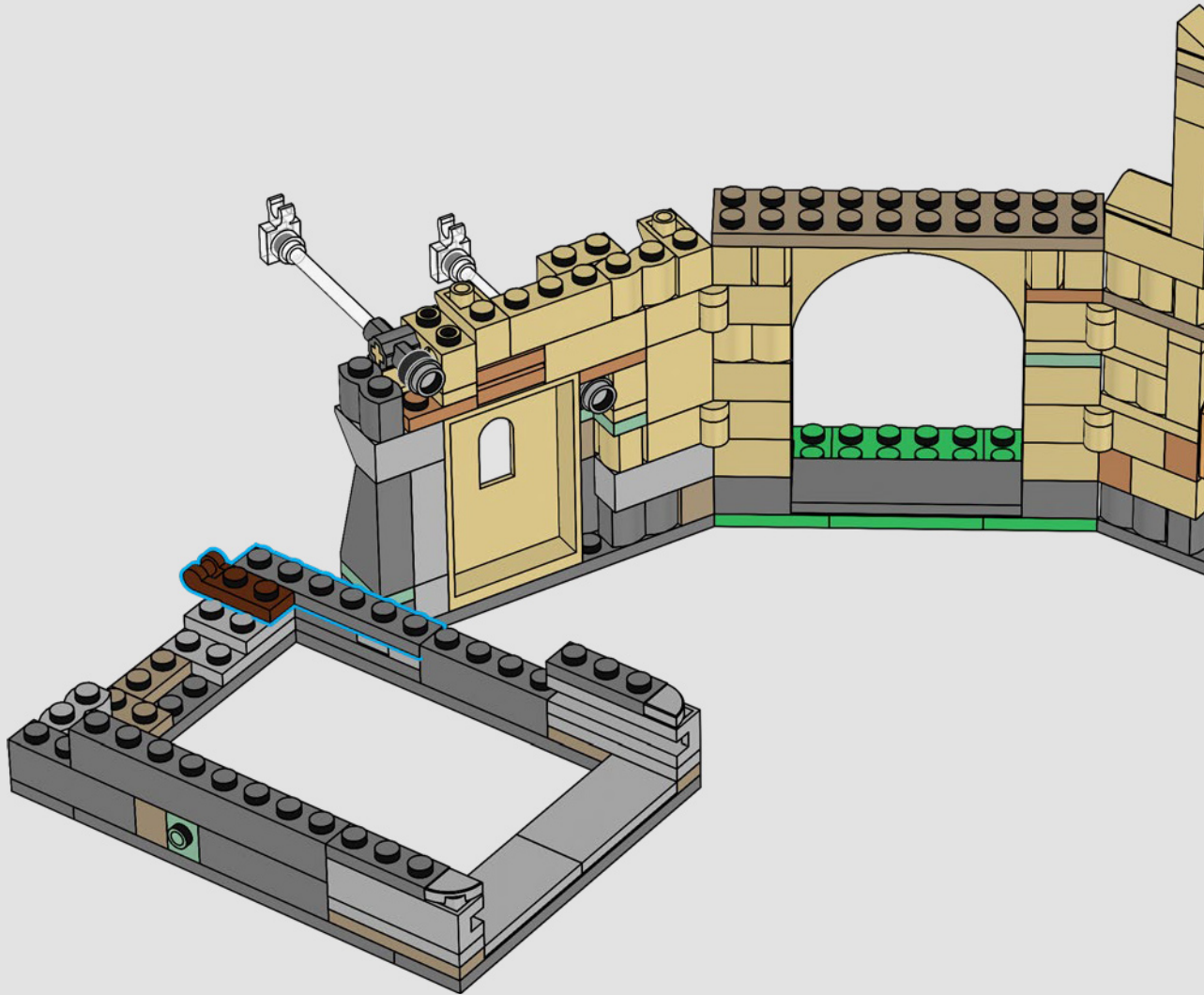

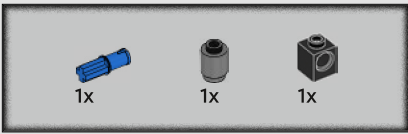

95

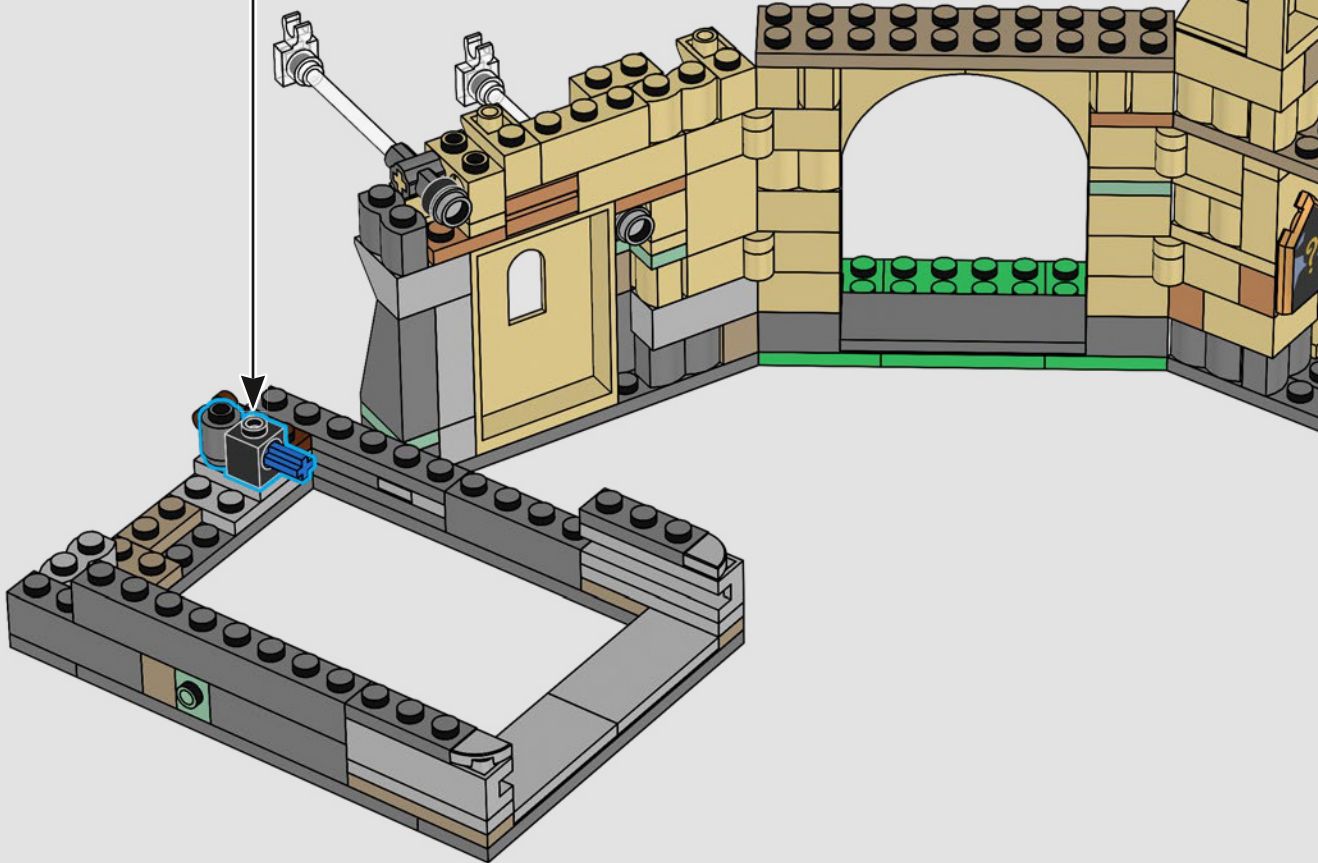
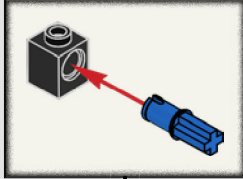



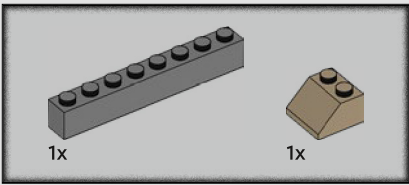

96

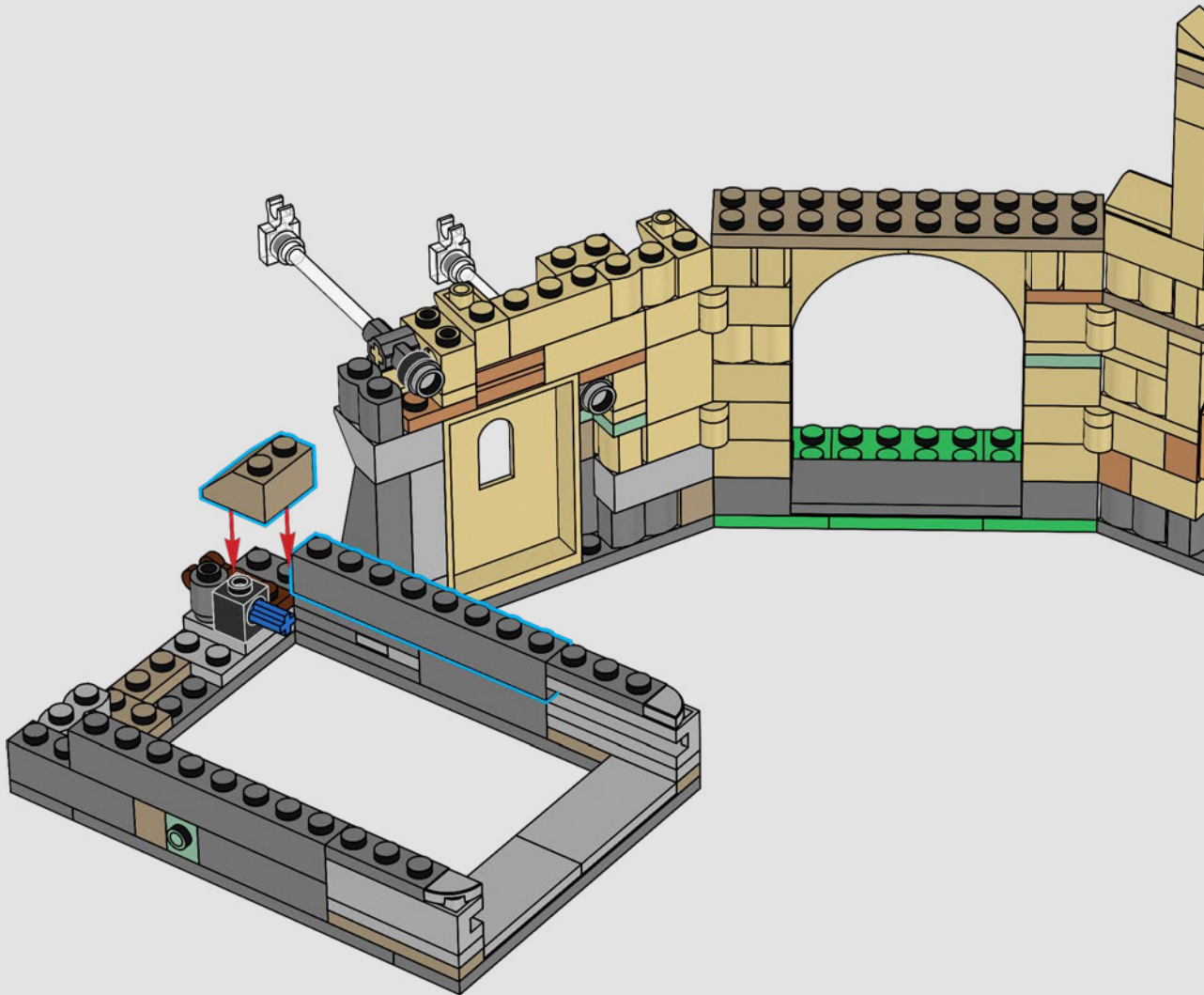

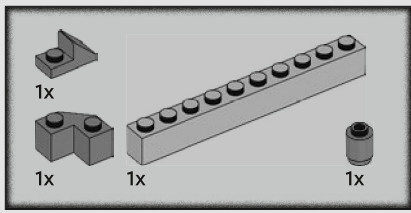

97

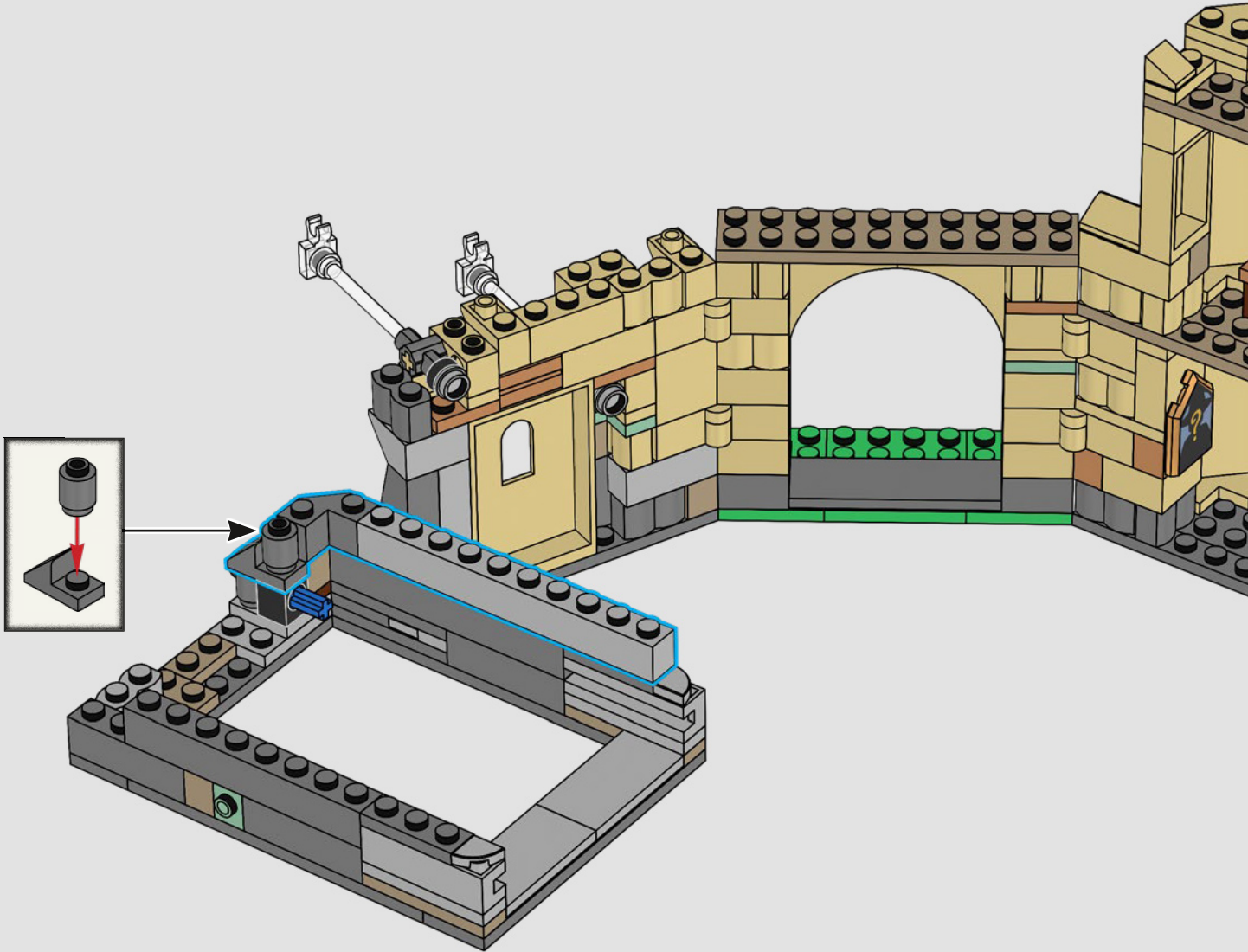

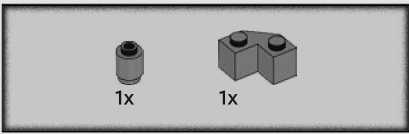

98

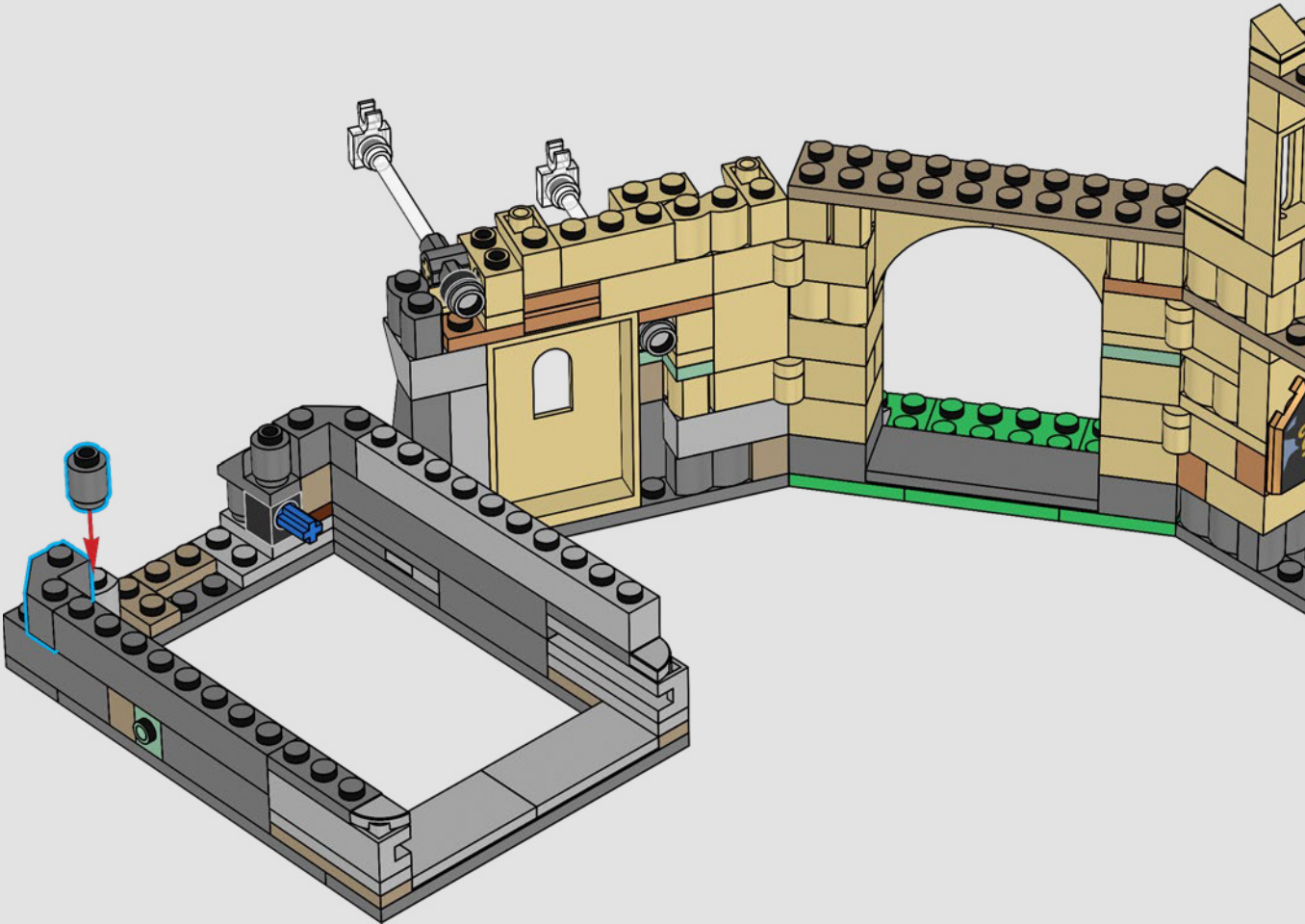

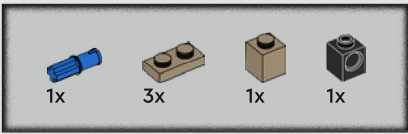

99

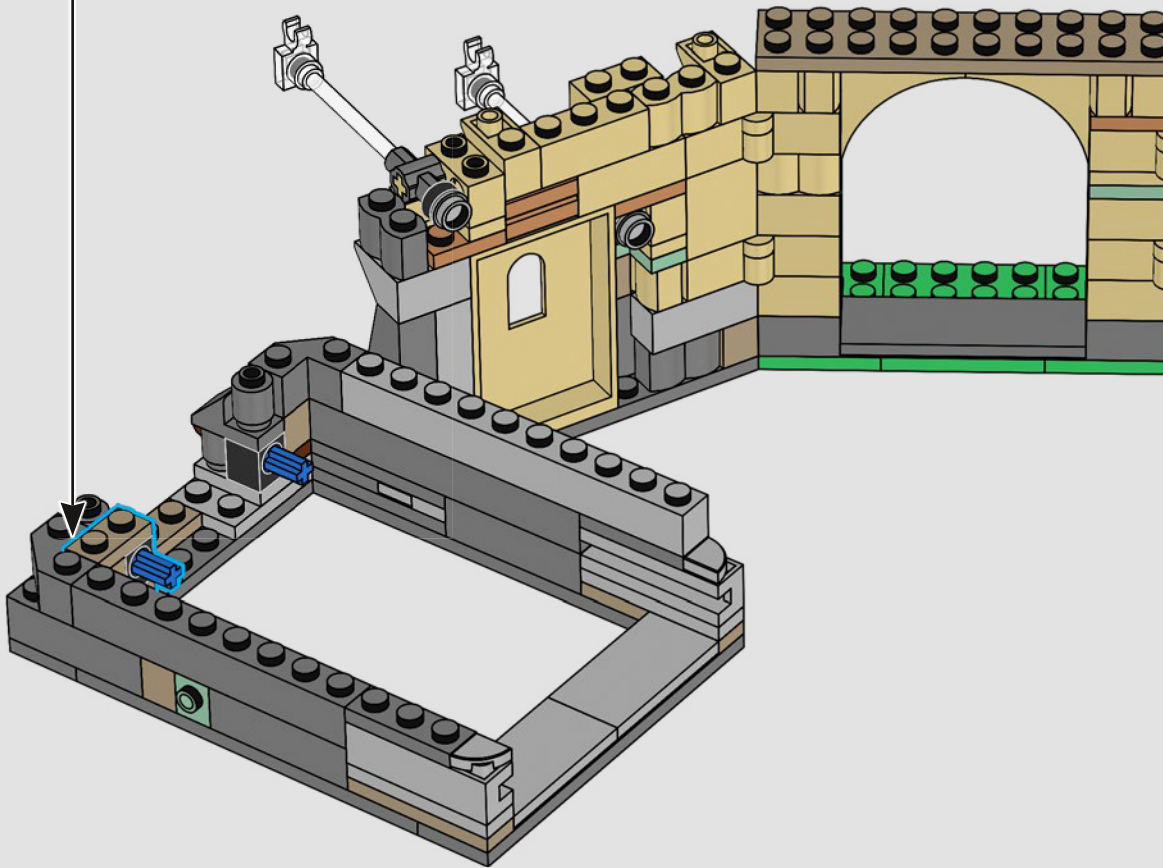
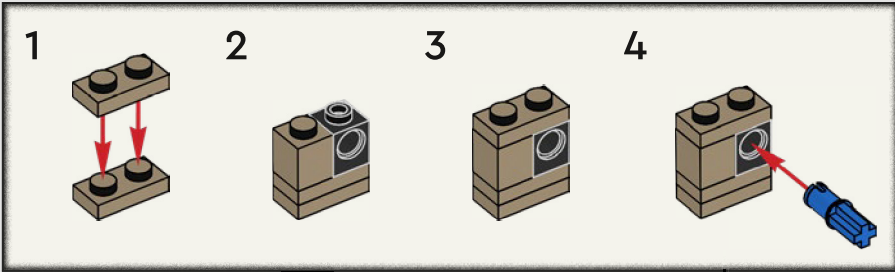



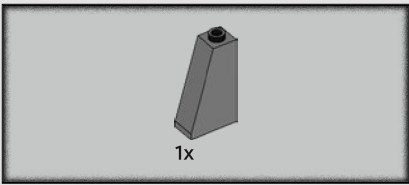

100

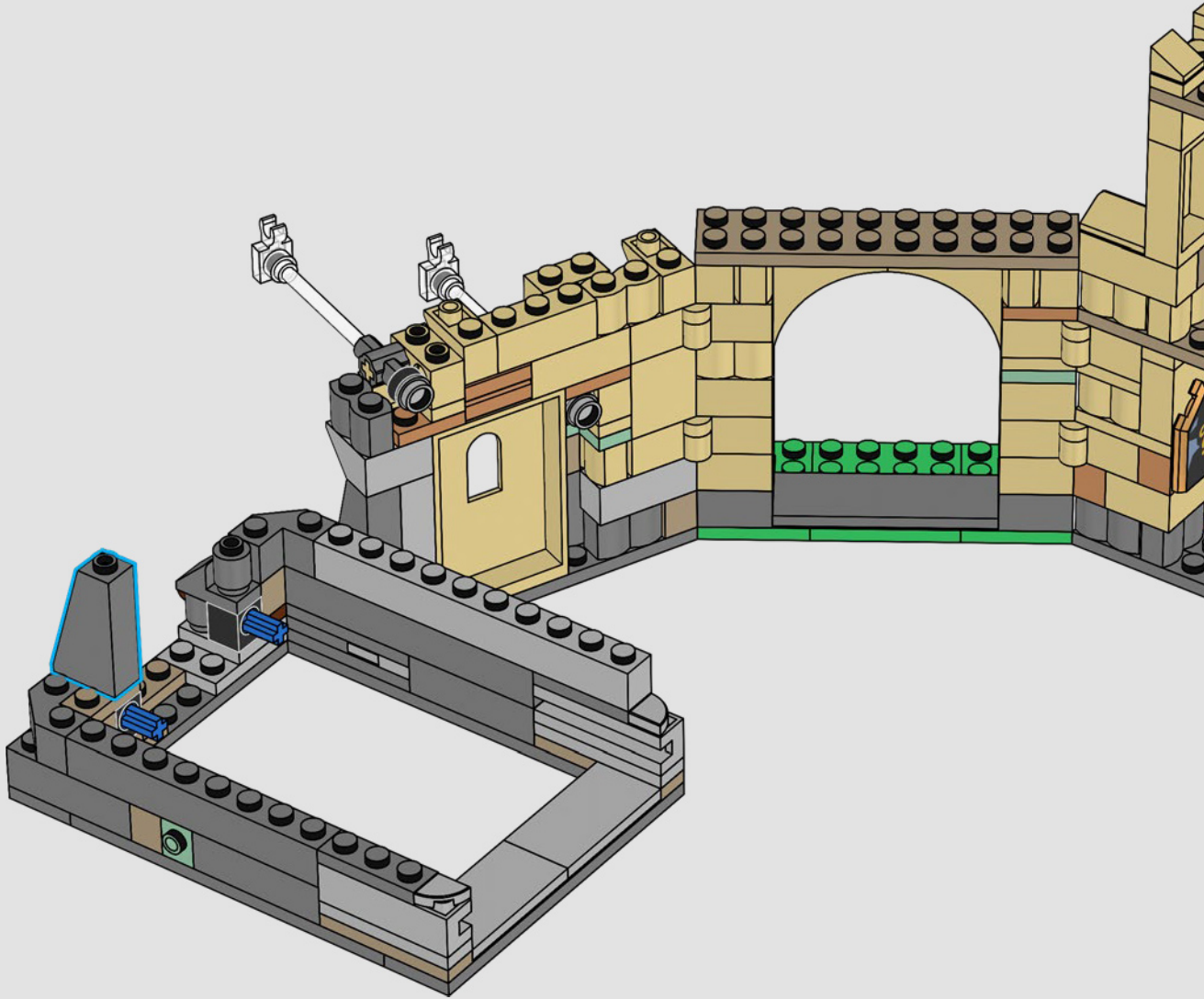

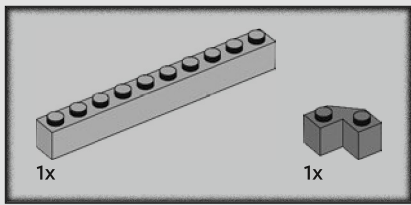

101

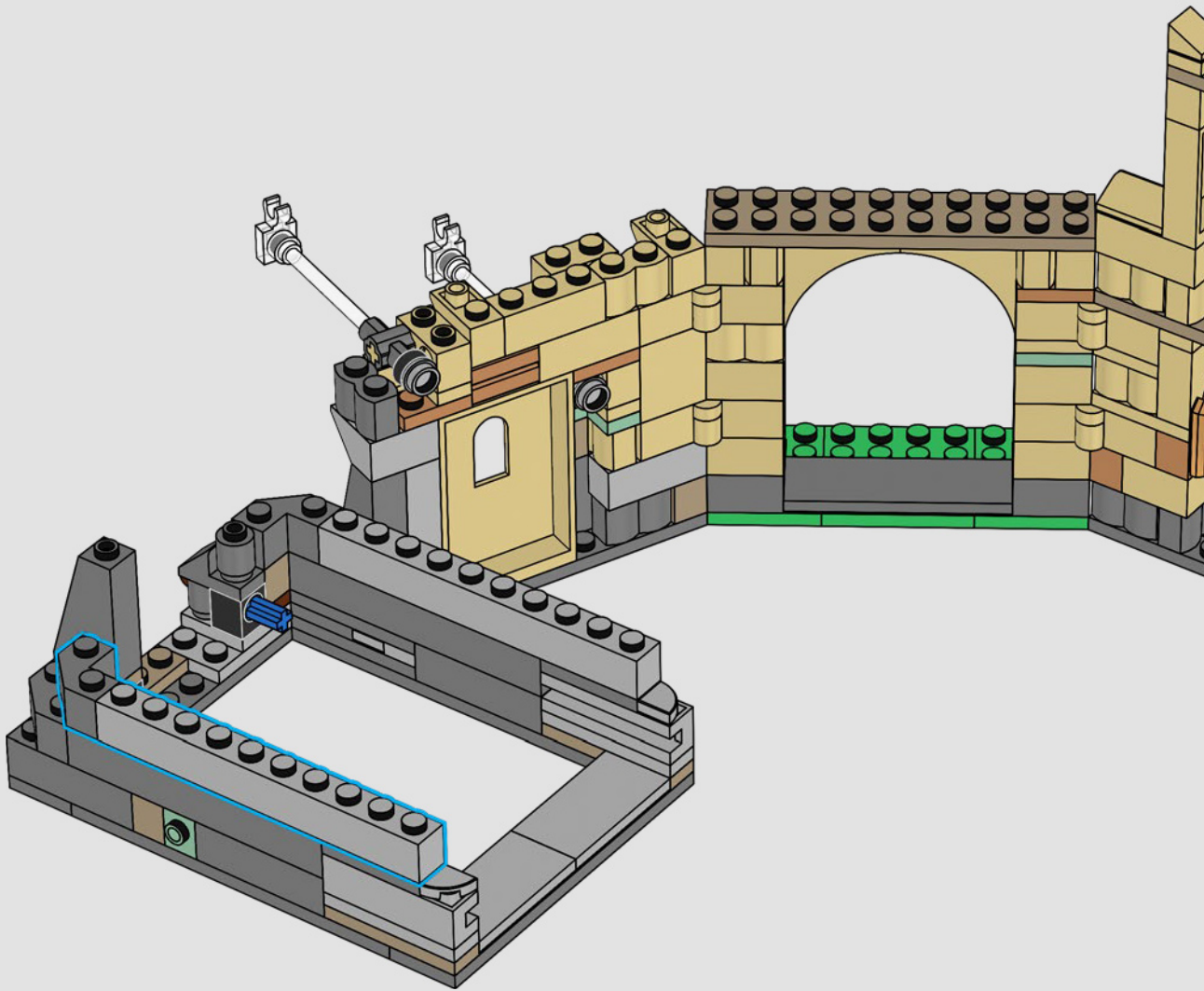

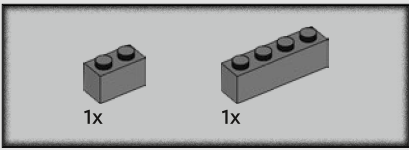

# 102

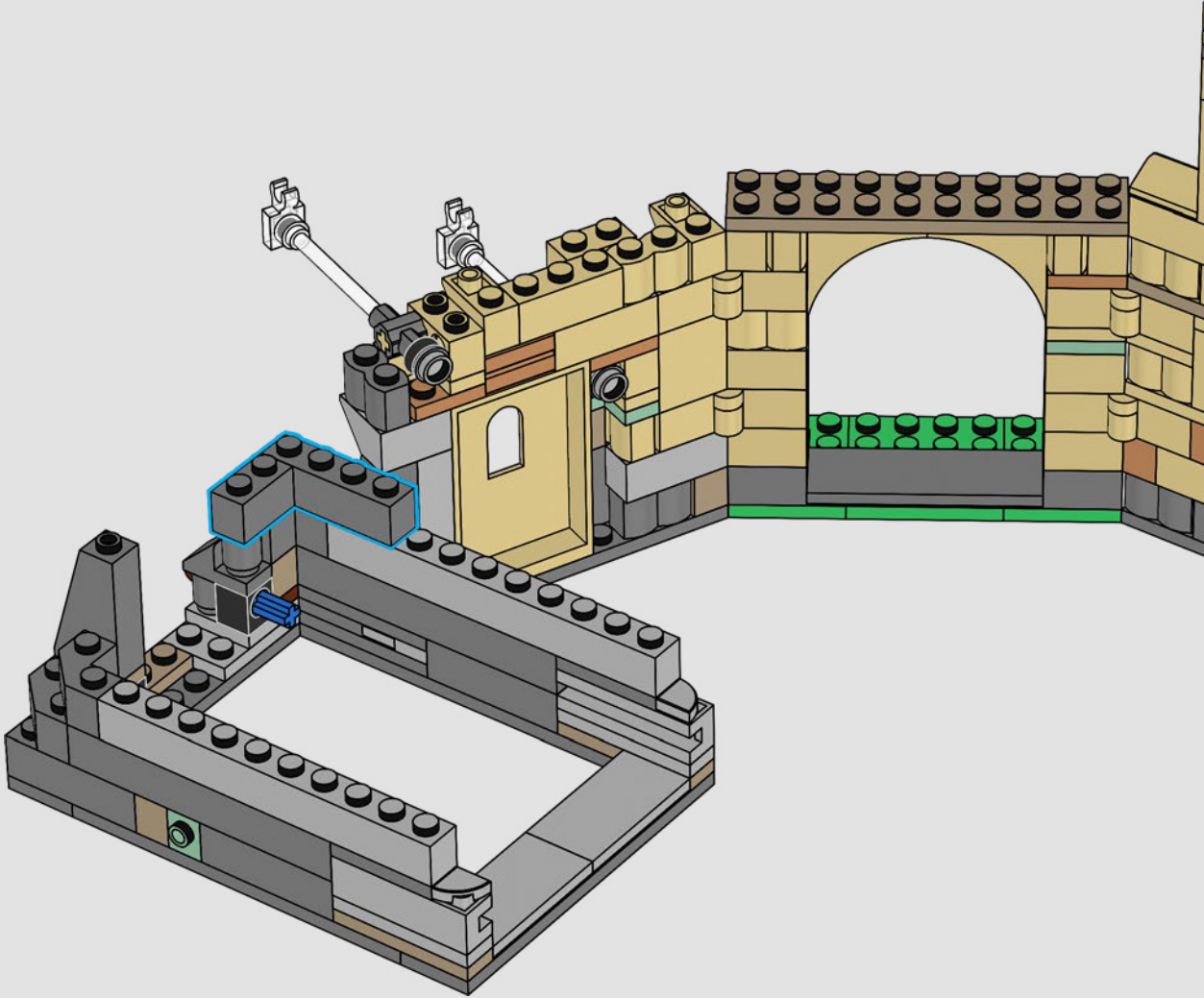

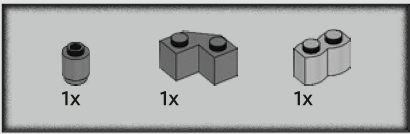

# 103

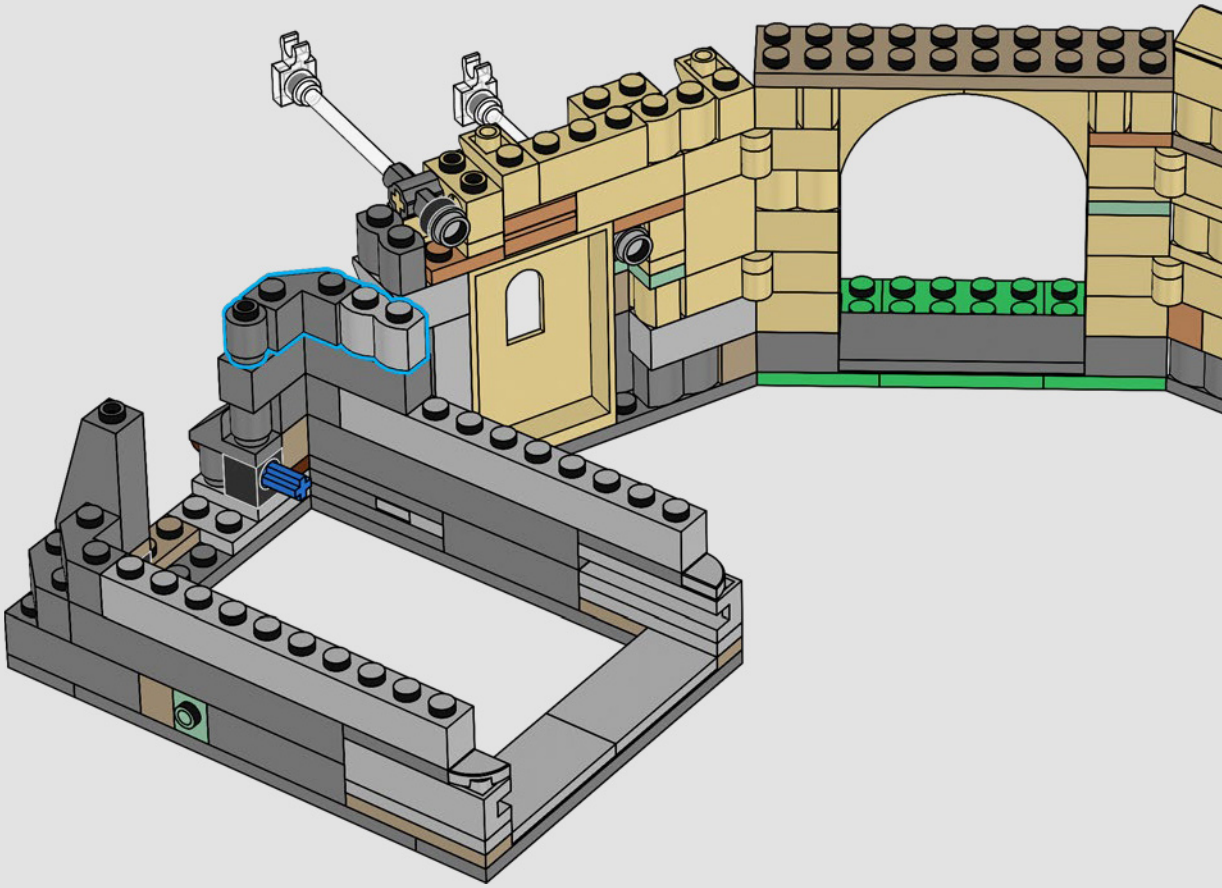



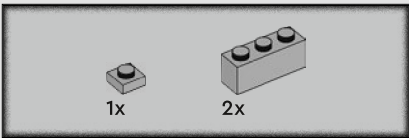

# 104

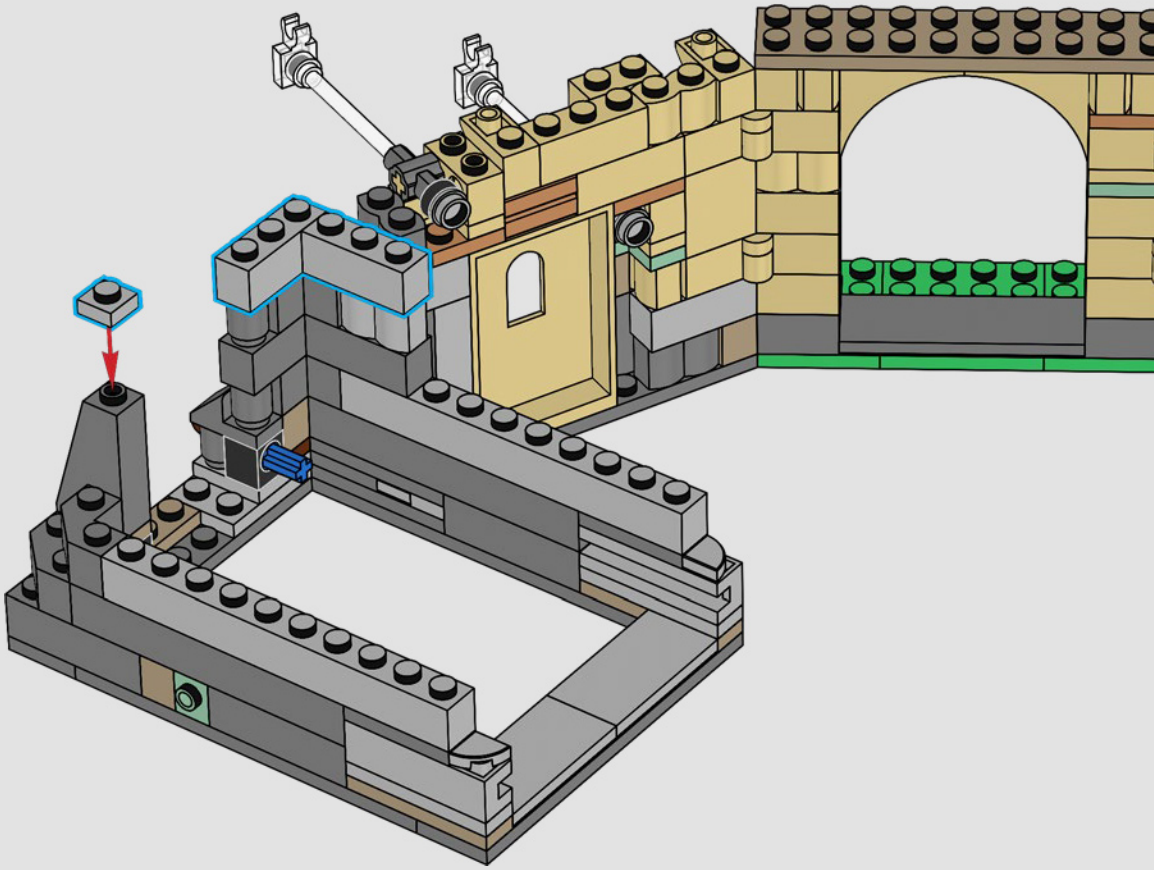

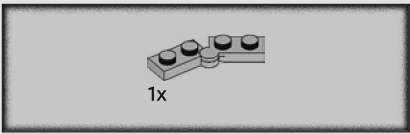

105

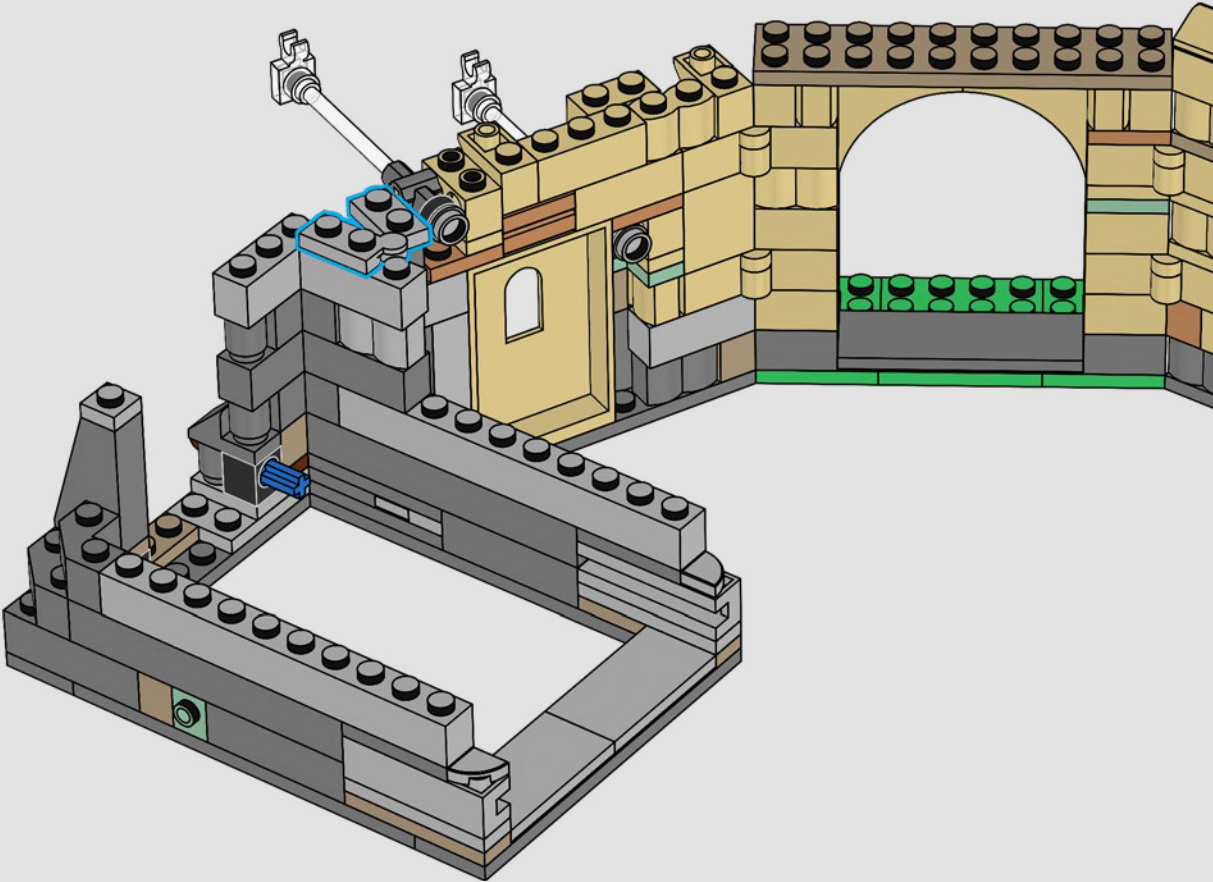

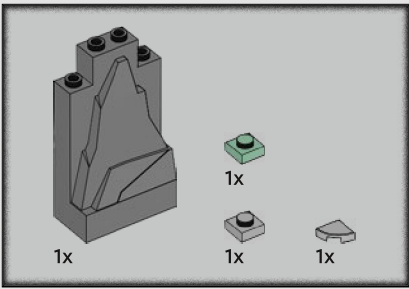

106

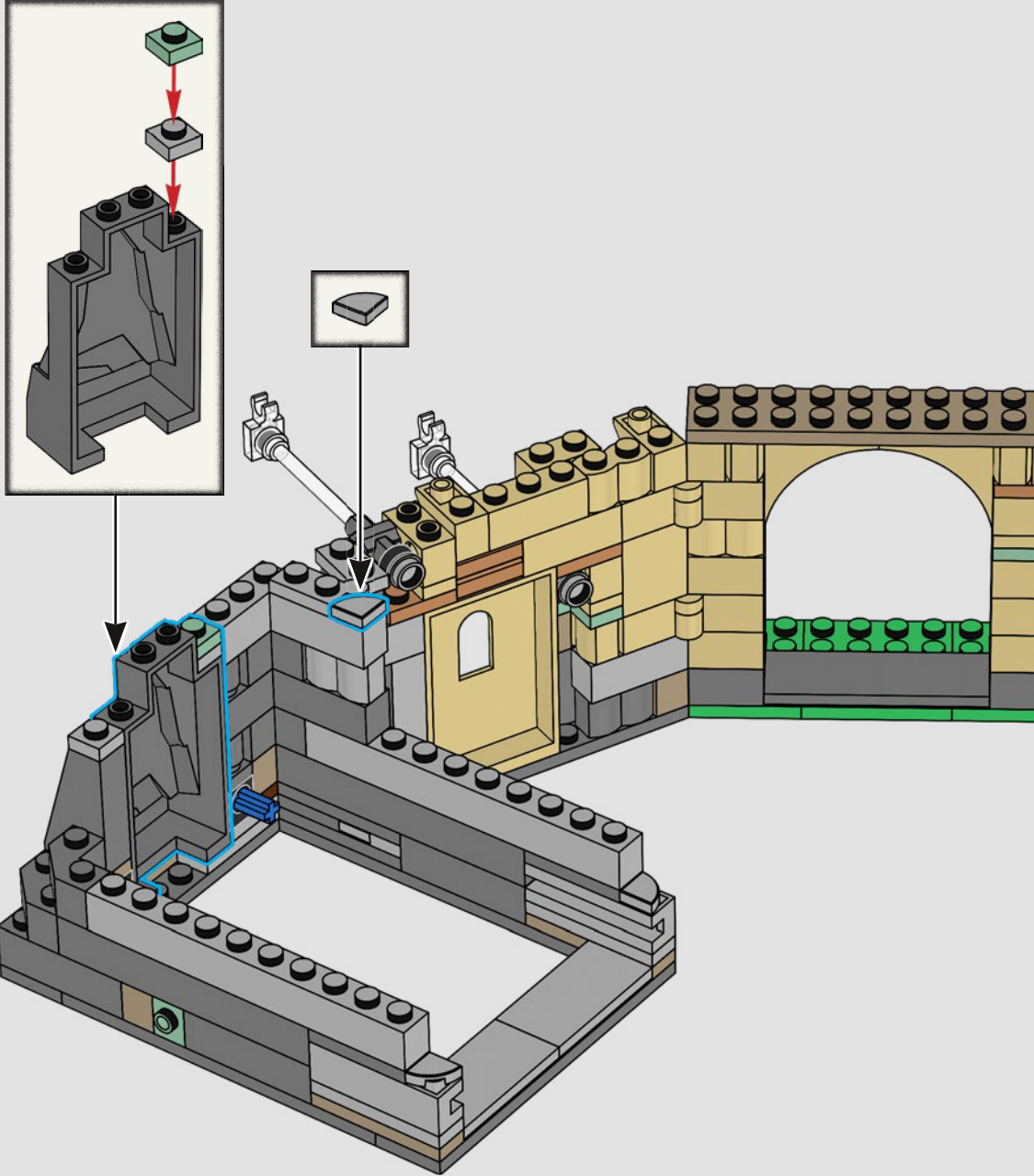

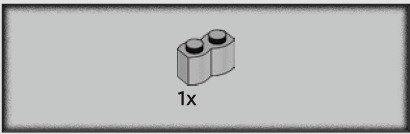

107

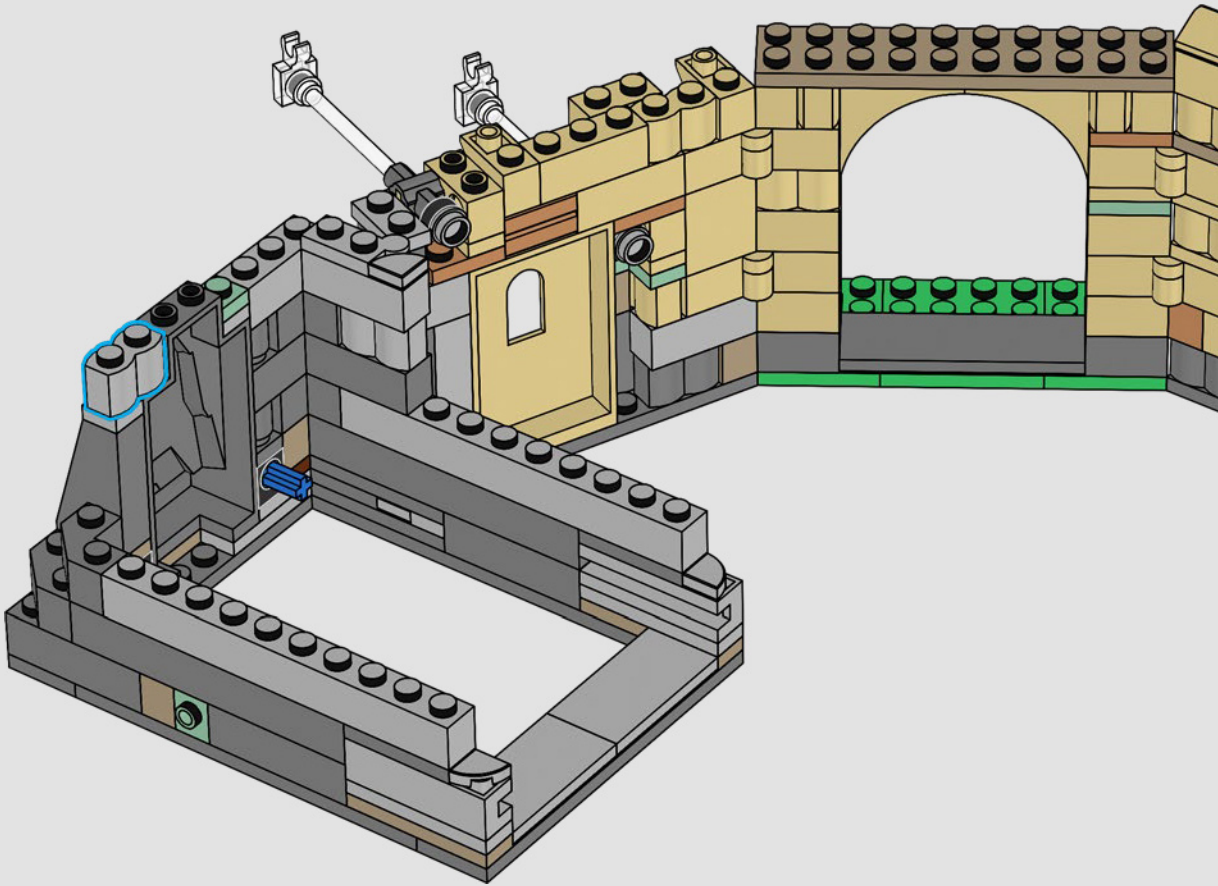



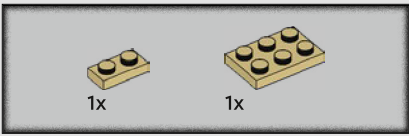

# 108

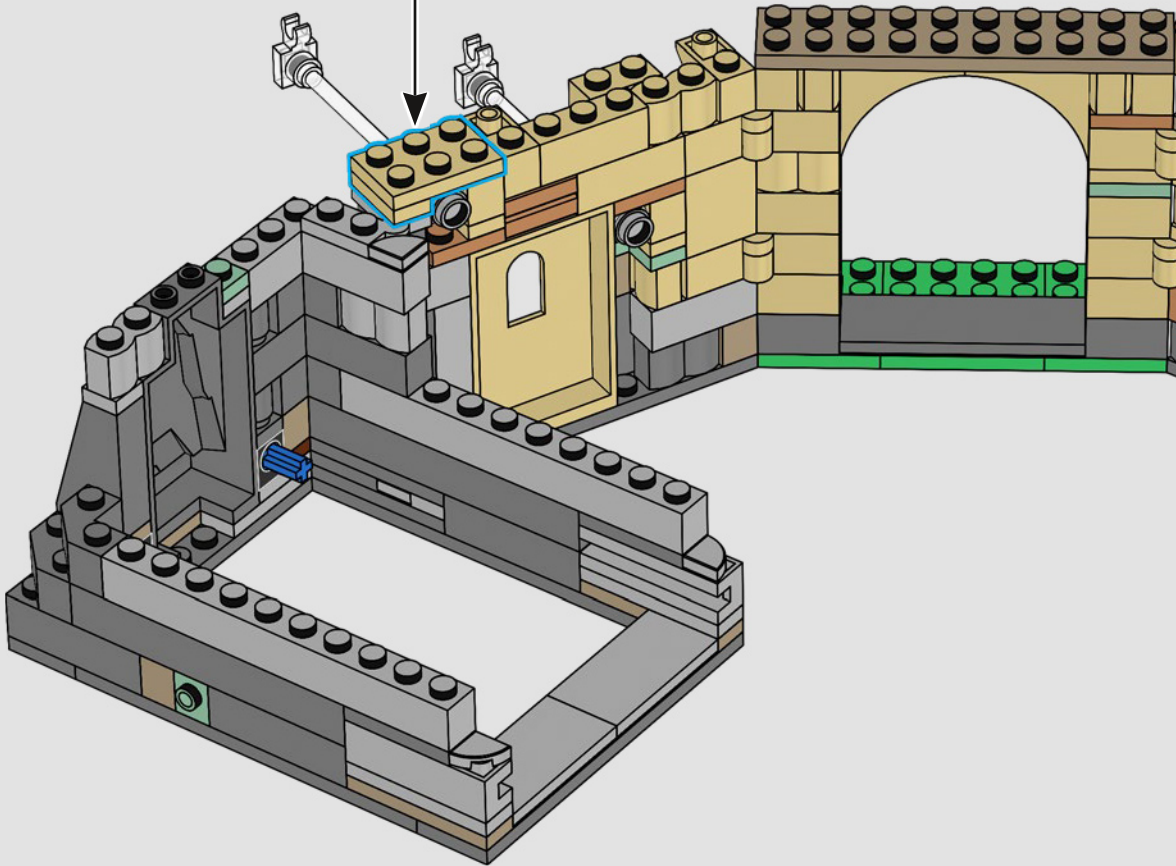
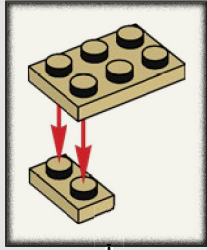

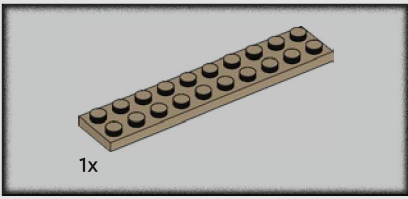

109

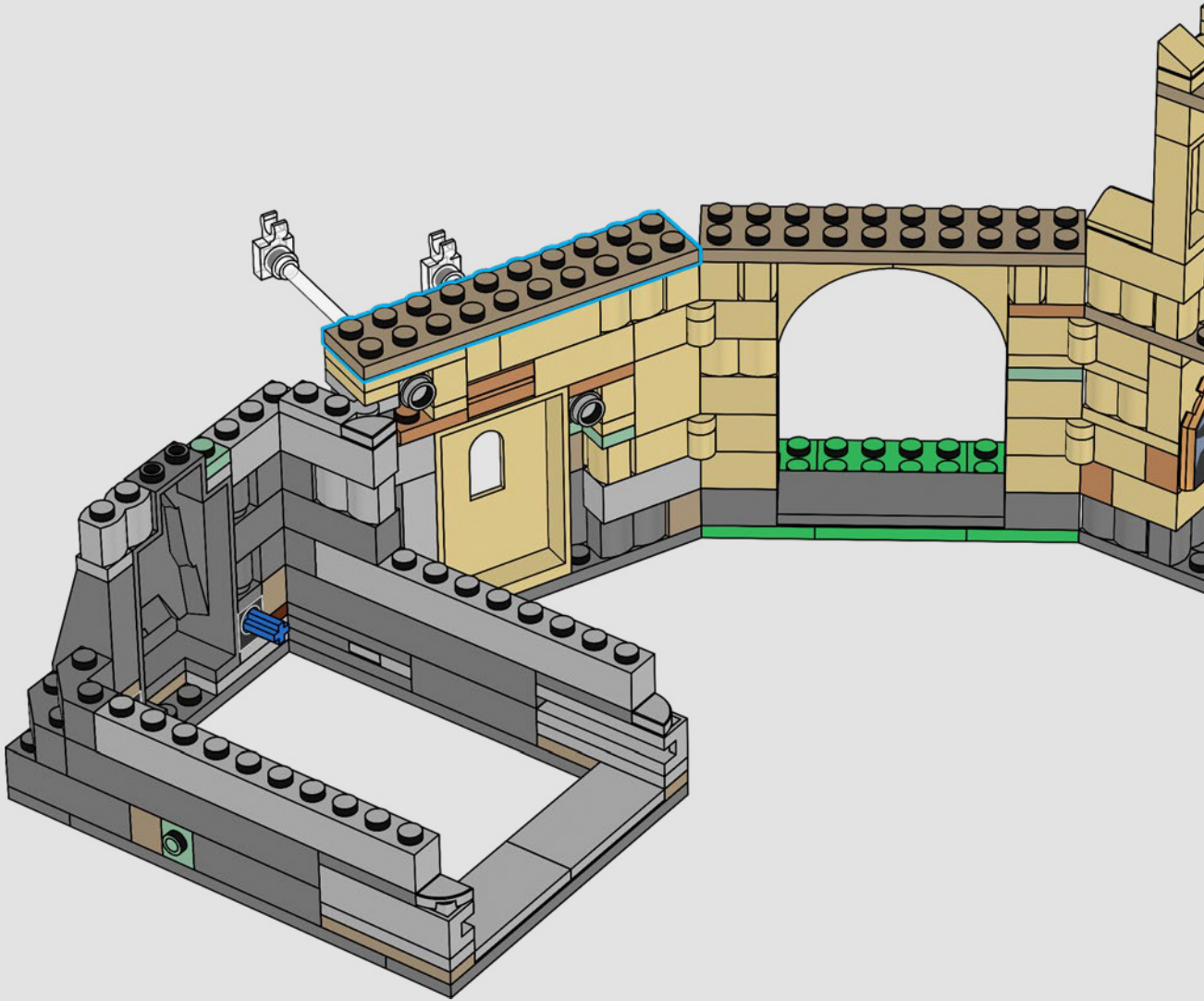

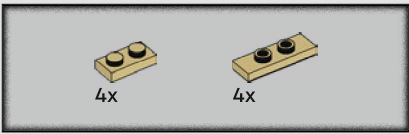

110

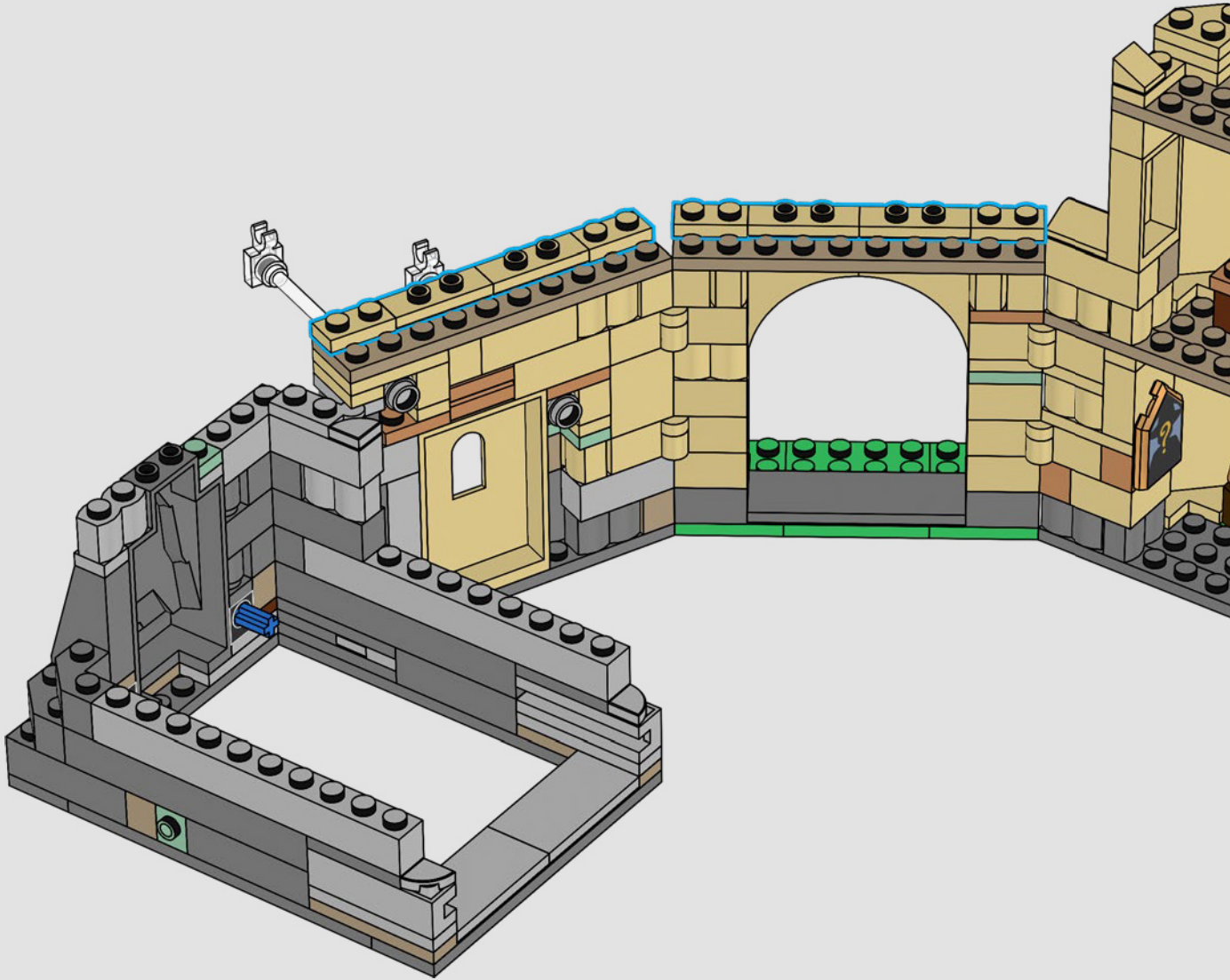

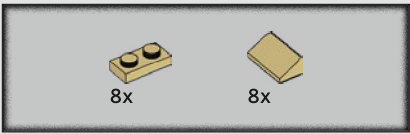

111

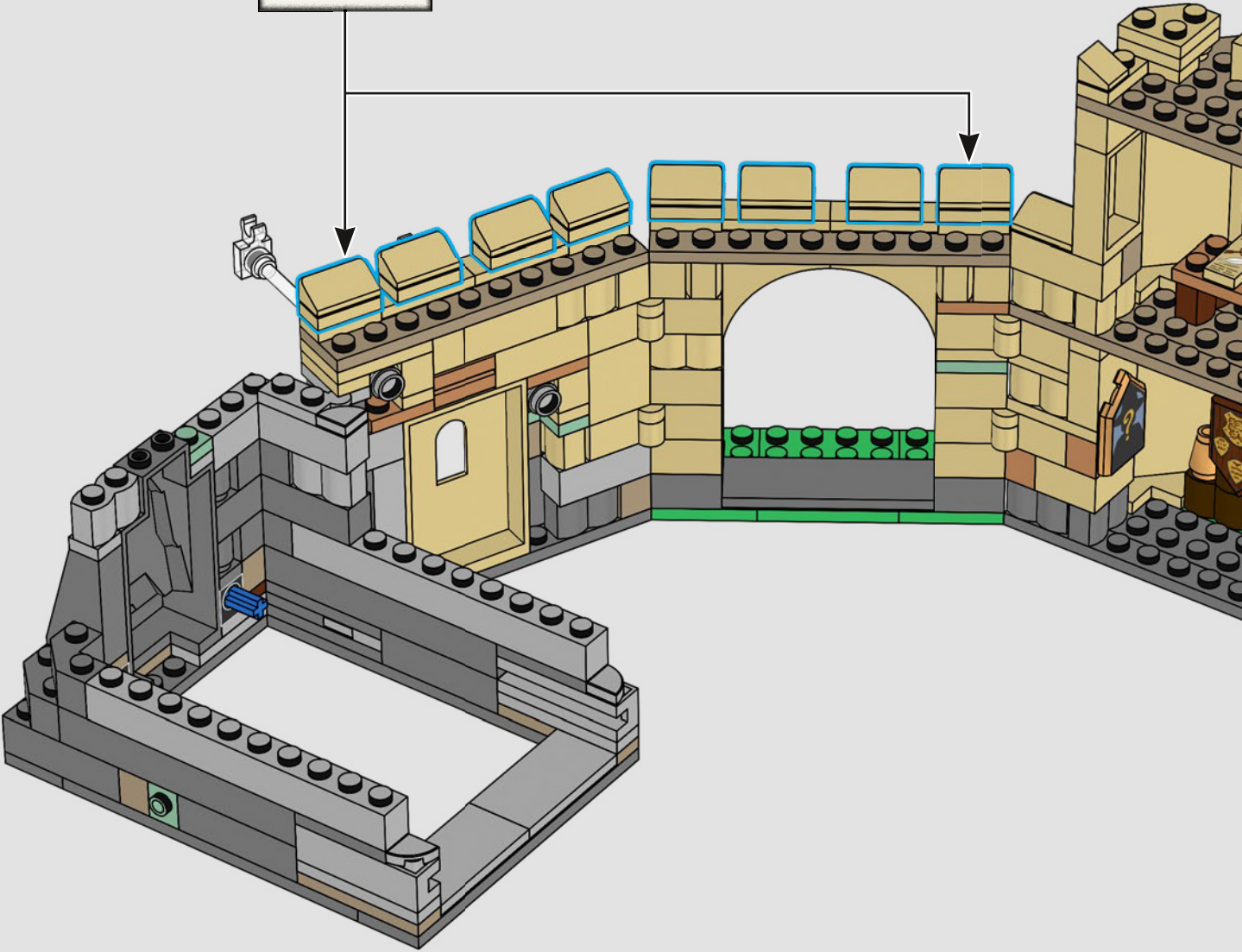
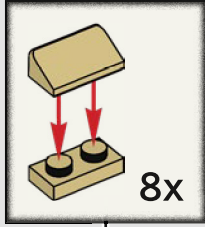



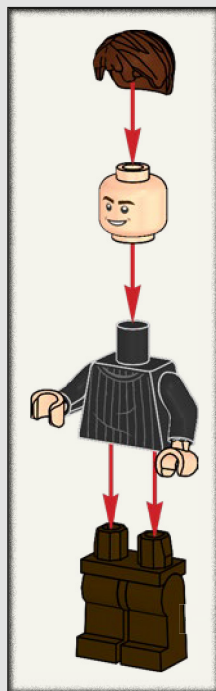

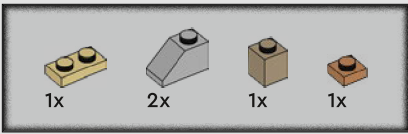

# 112

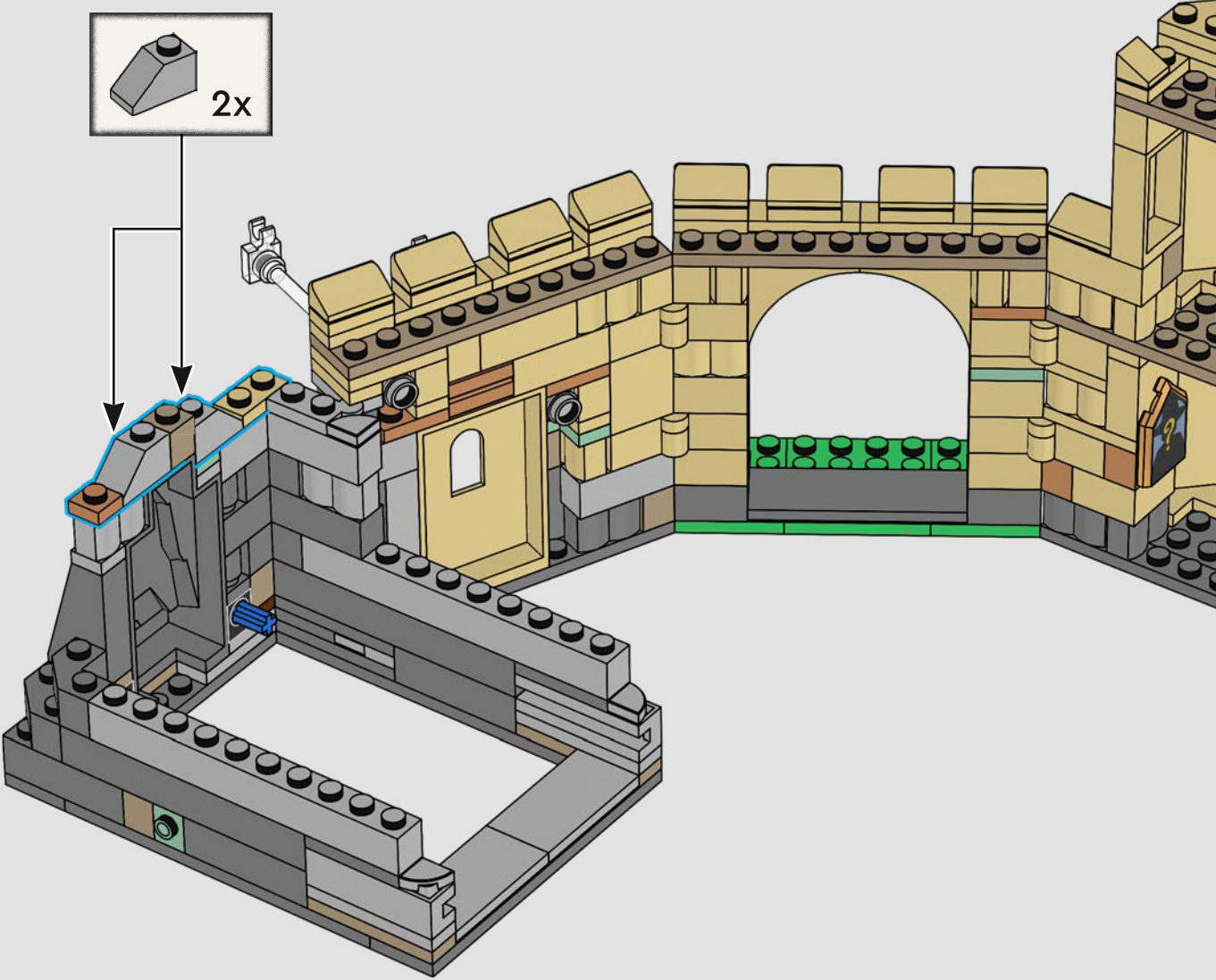
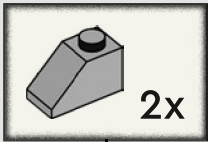

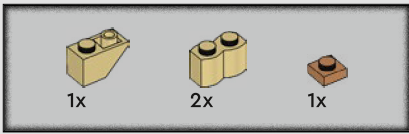

113

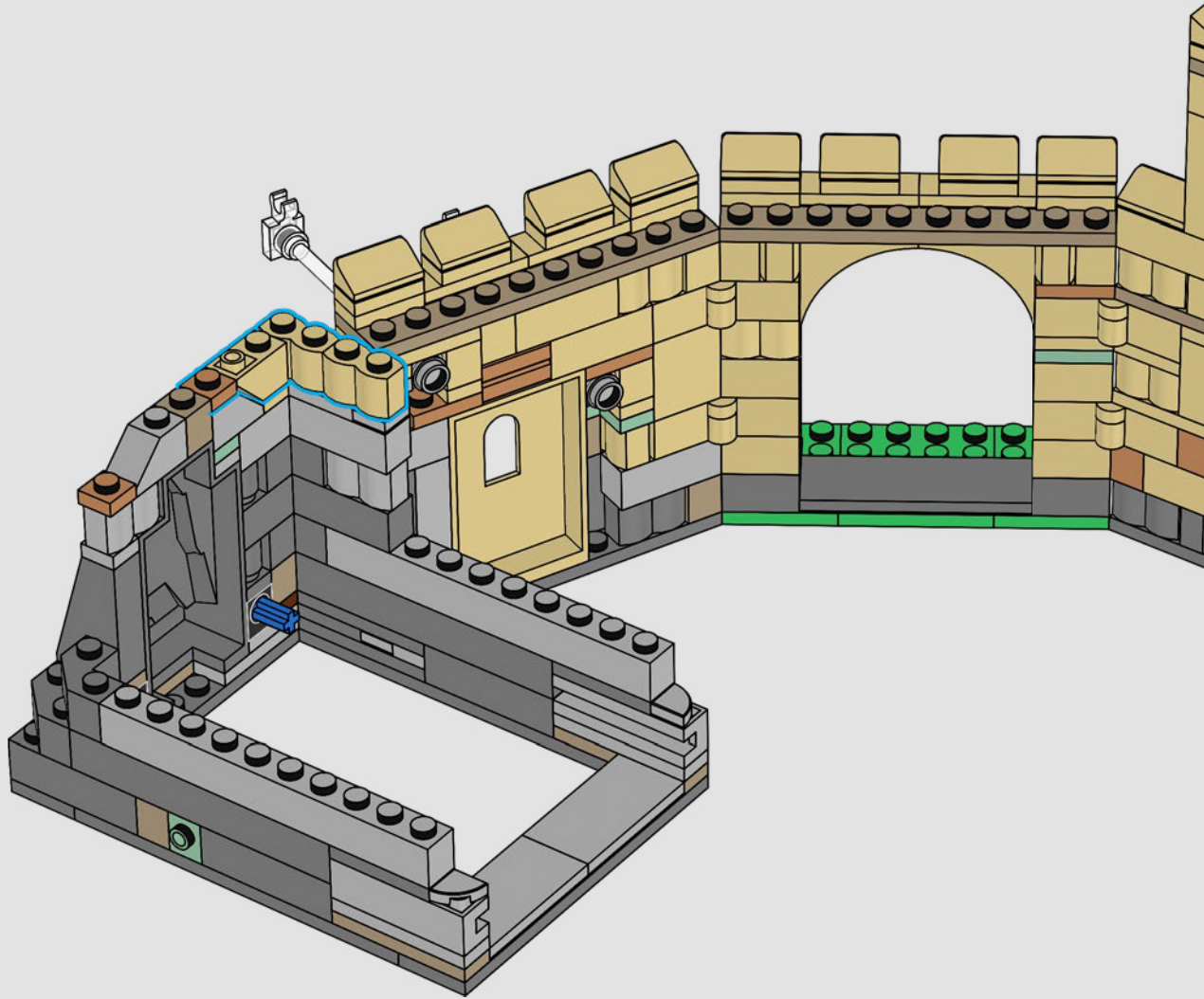

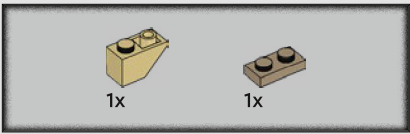

# 114

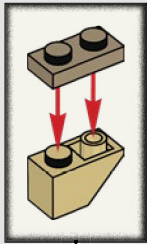
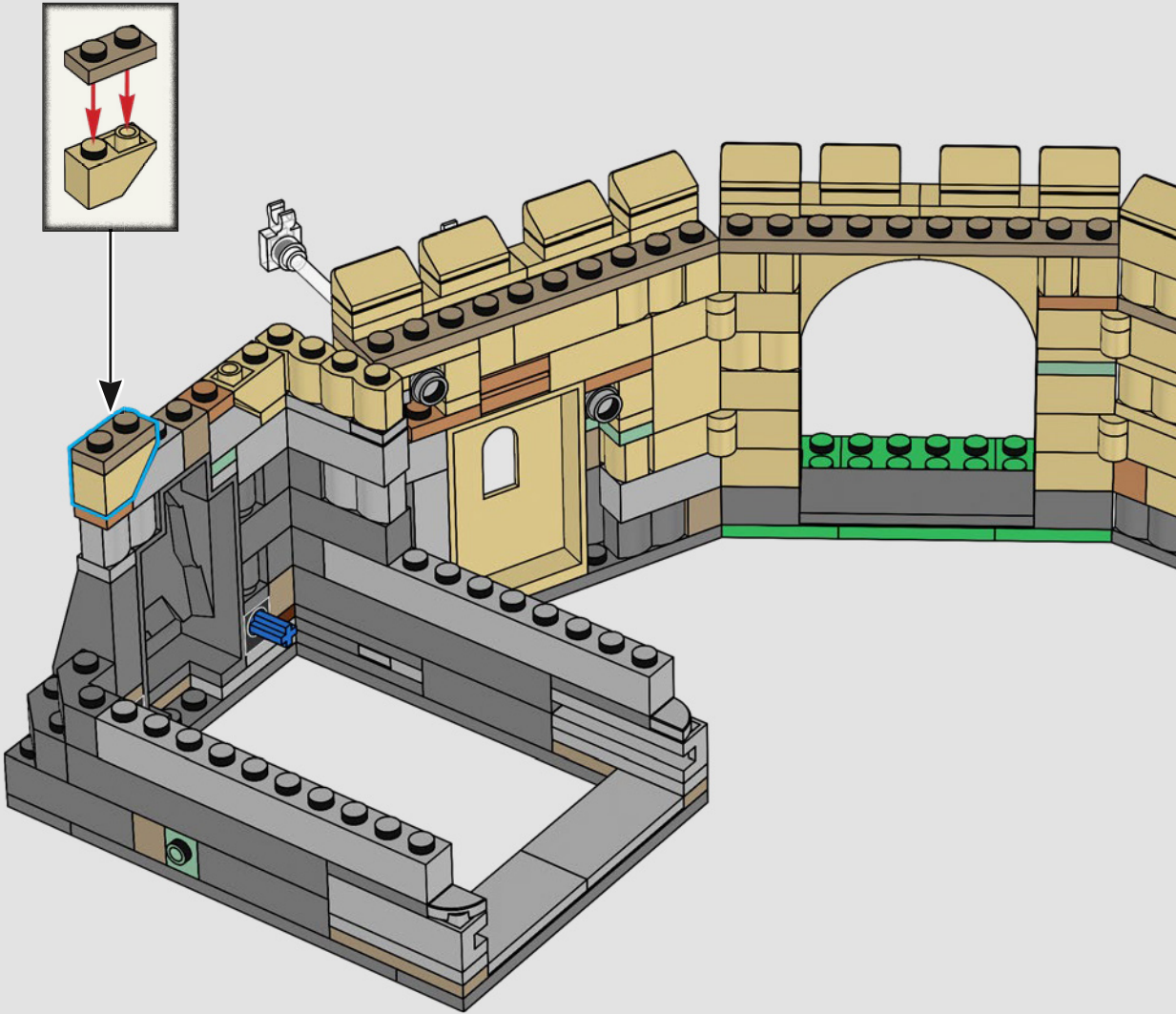



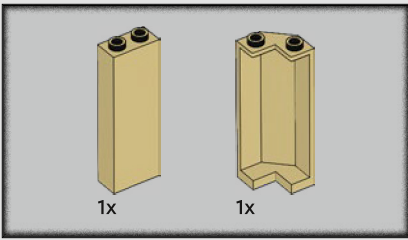

115

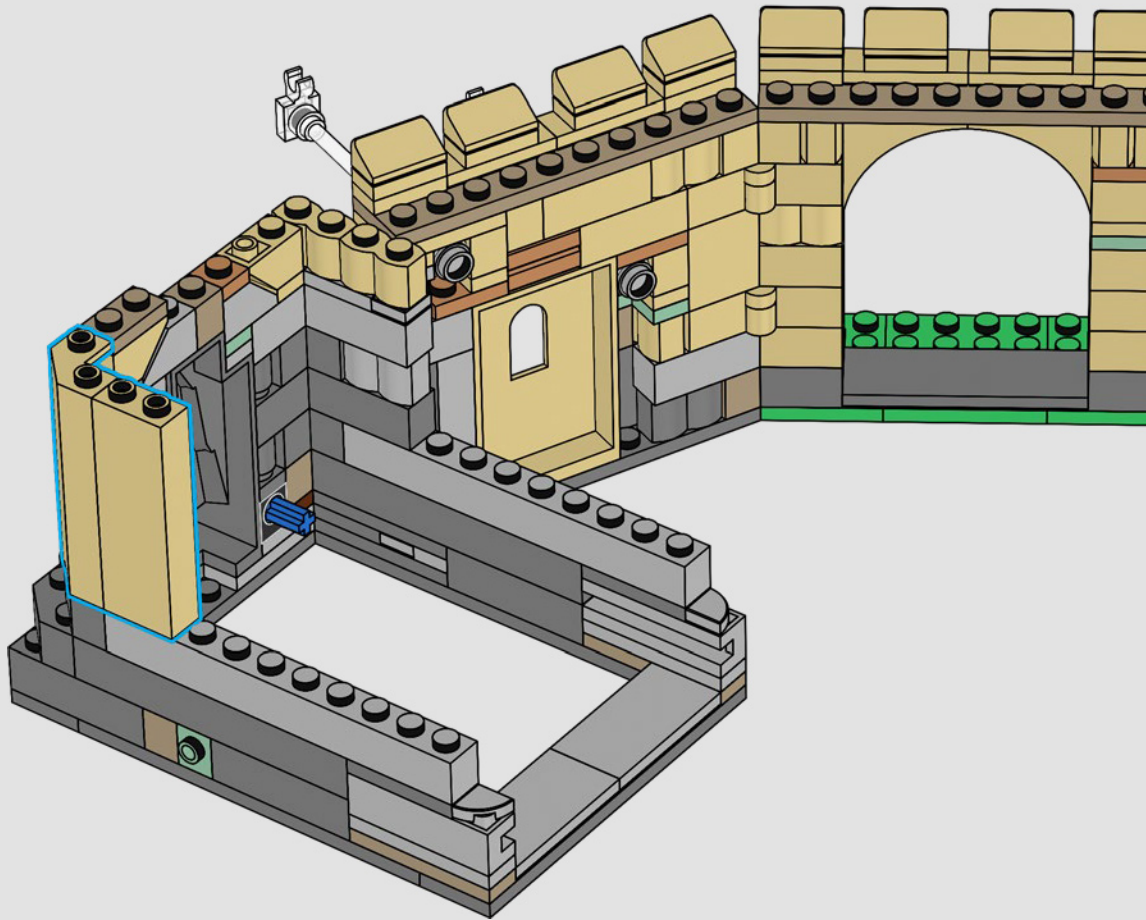

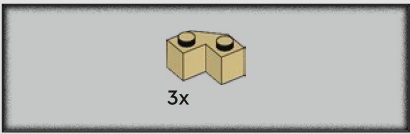

116

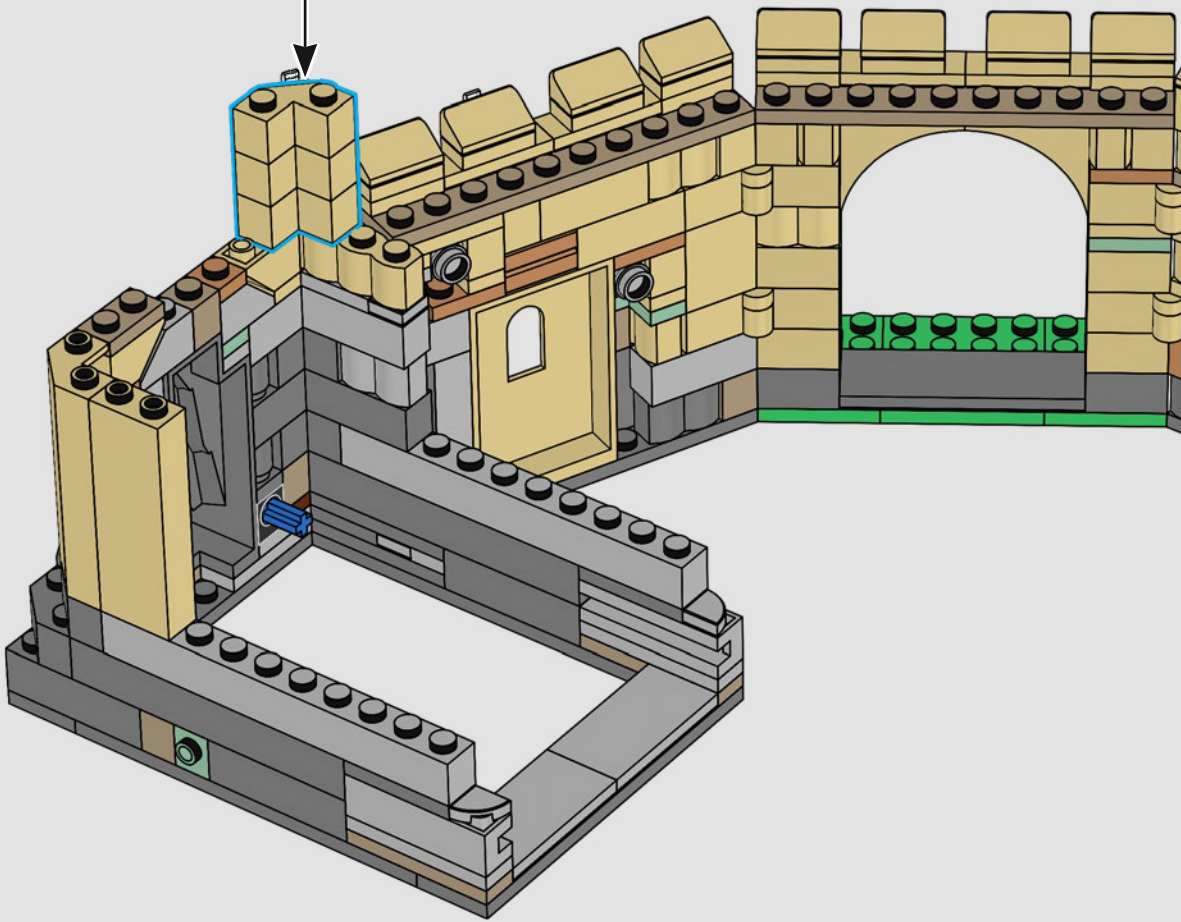
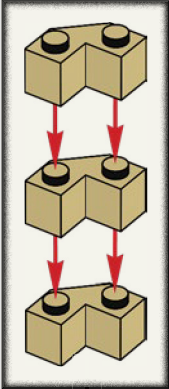

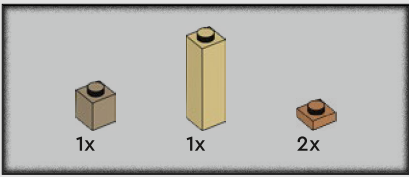

117

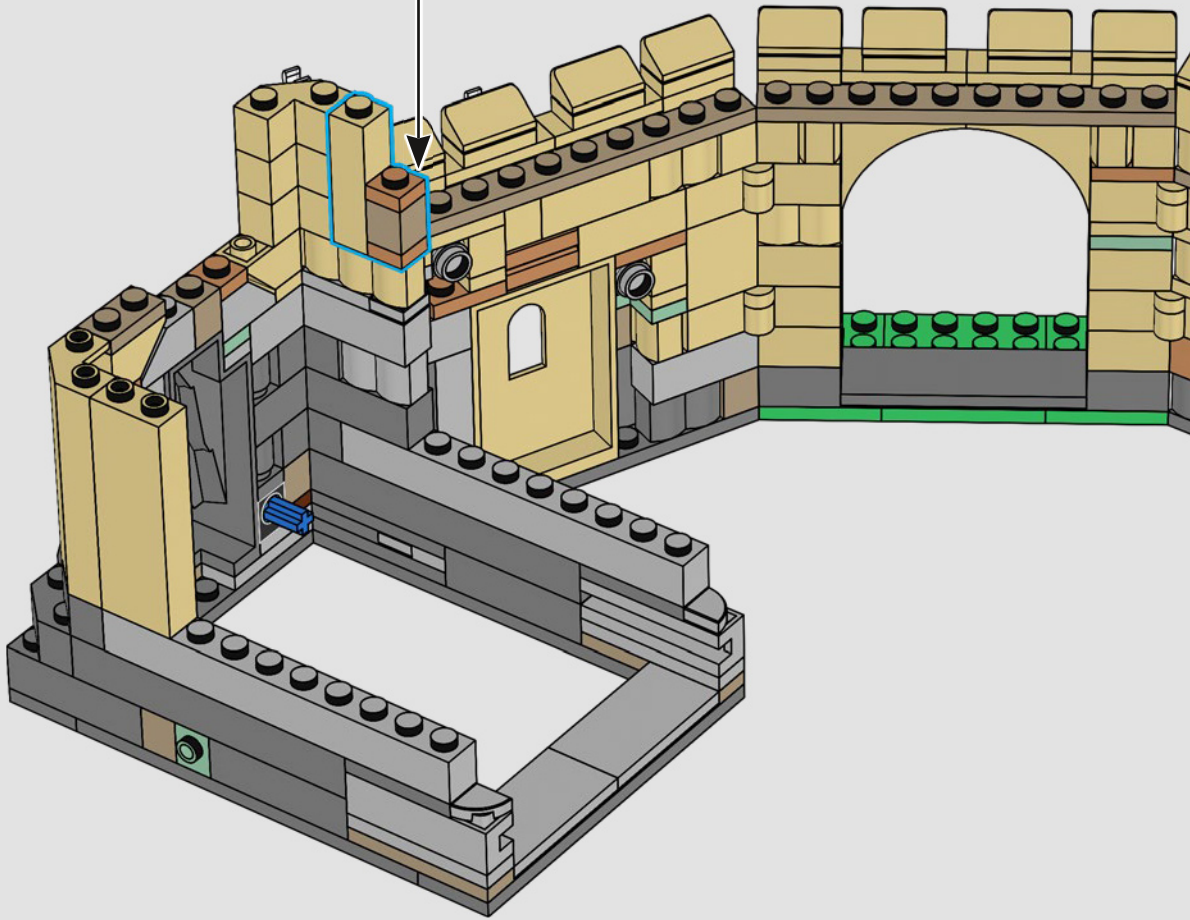
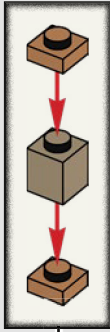

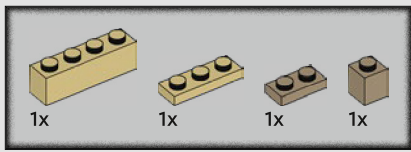

118

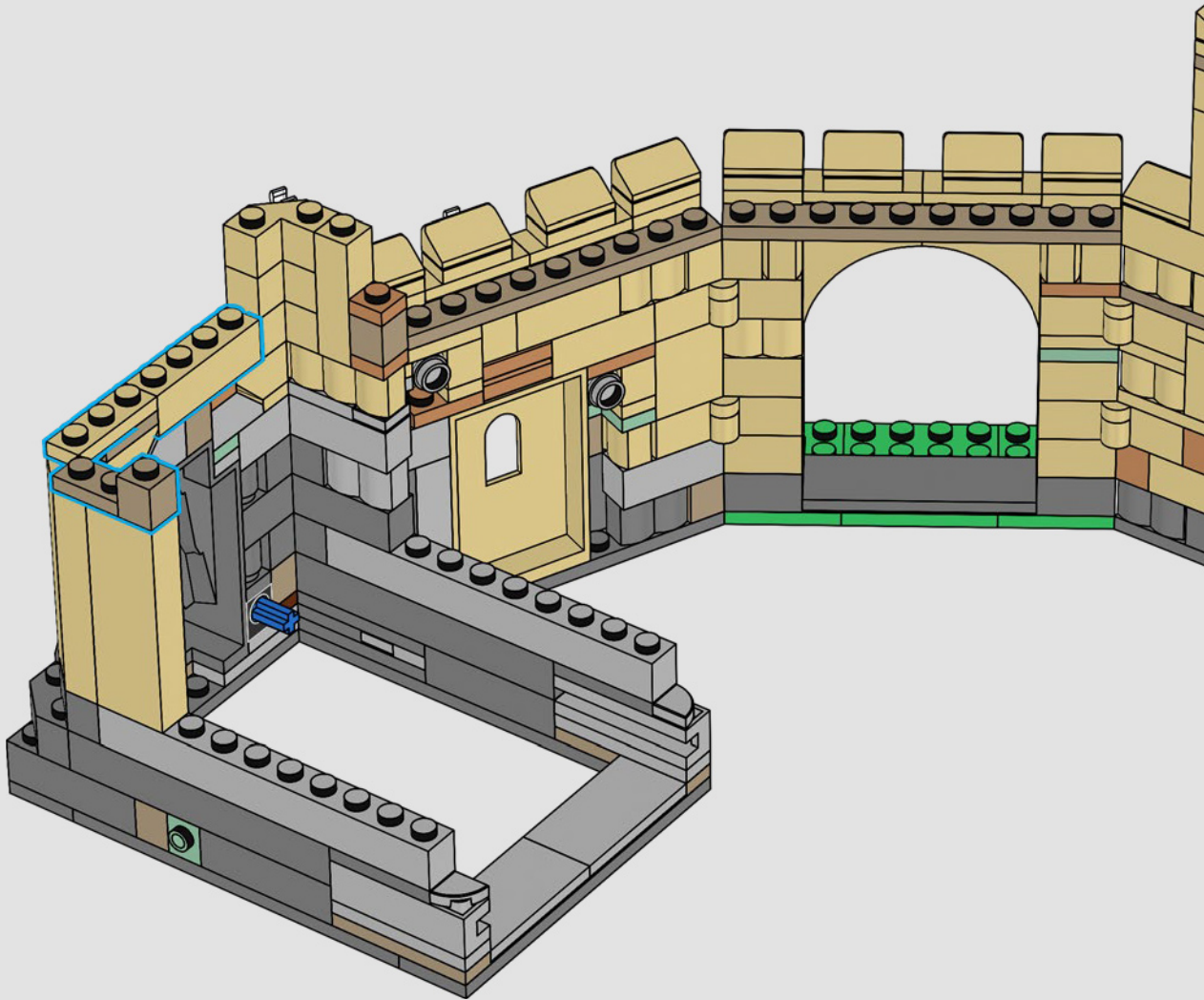



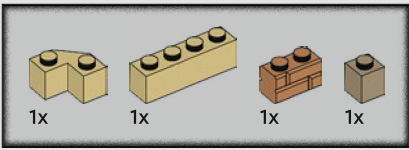

119

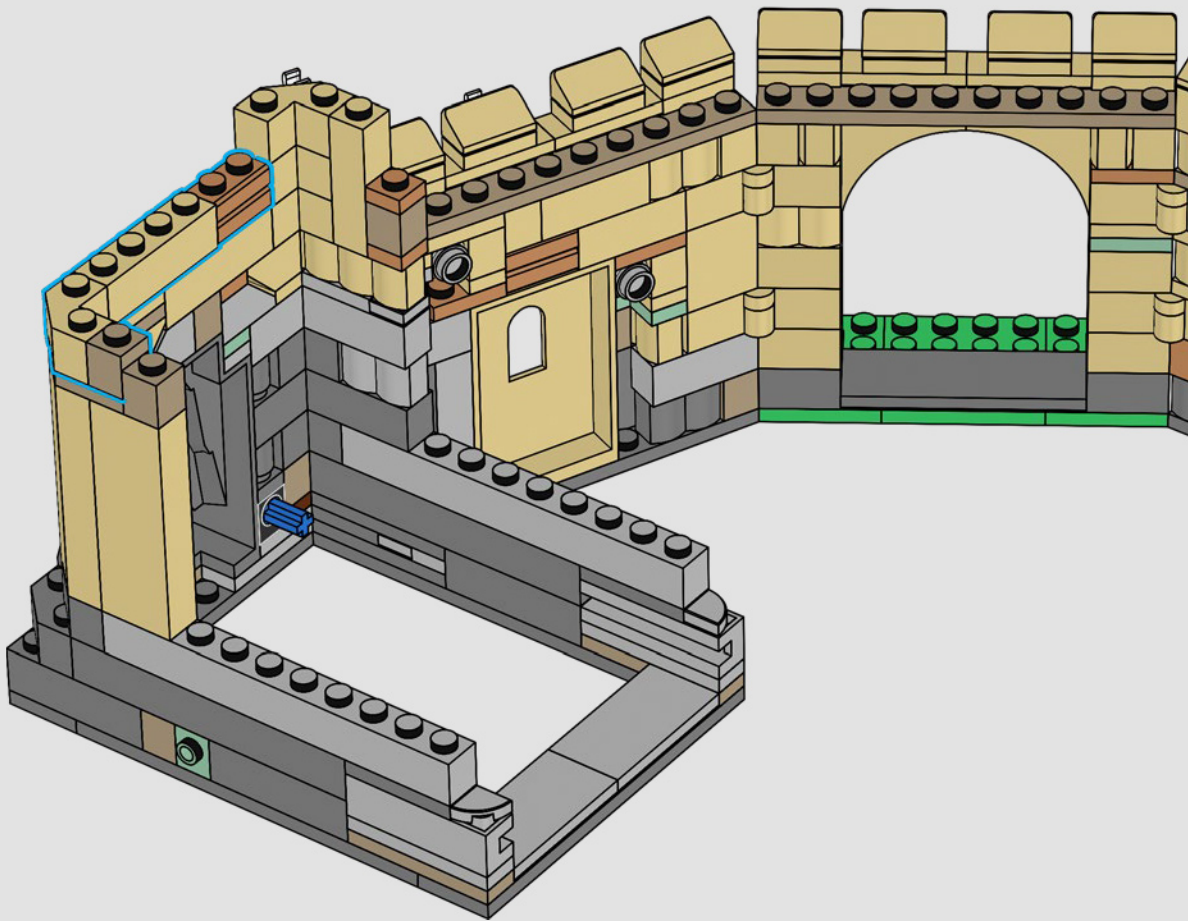

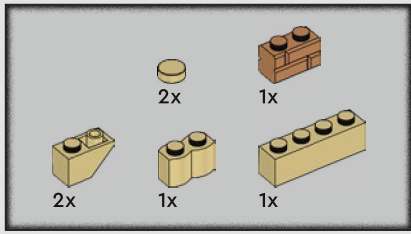

120

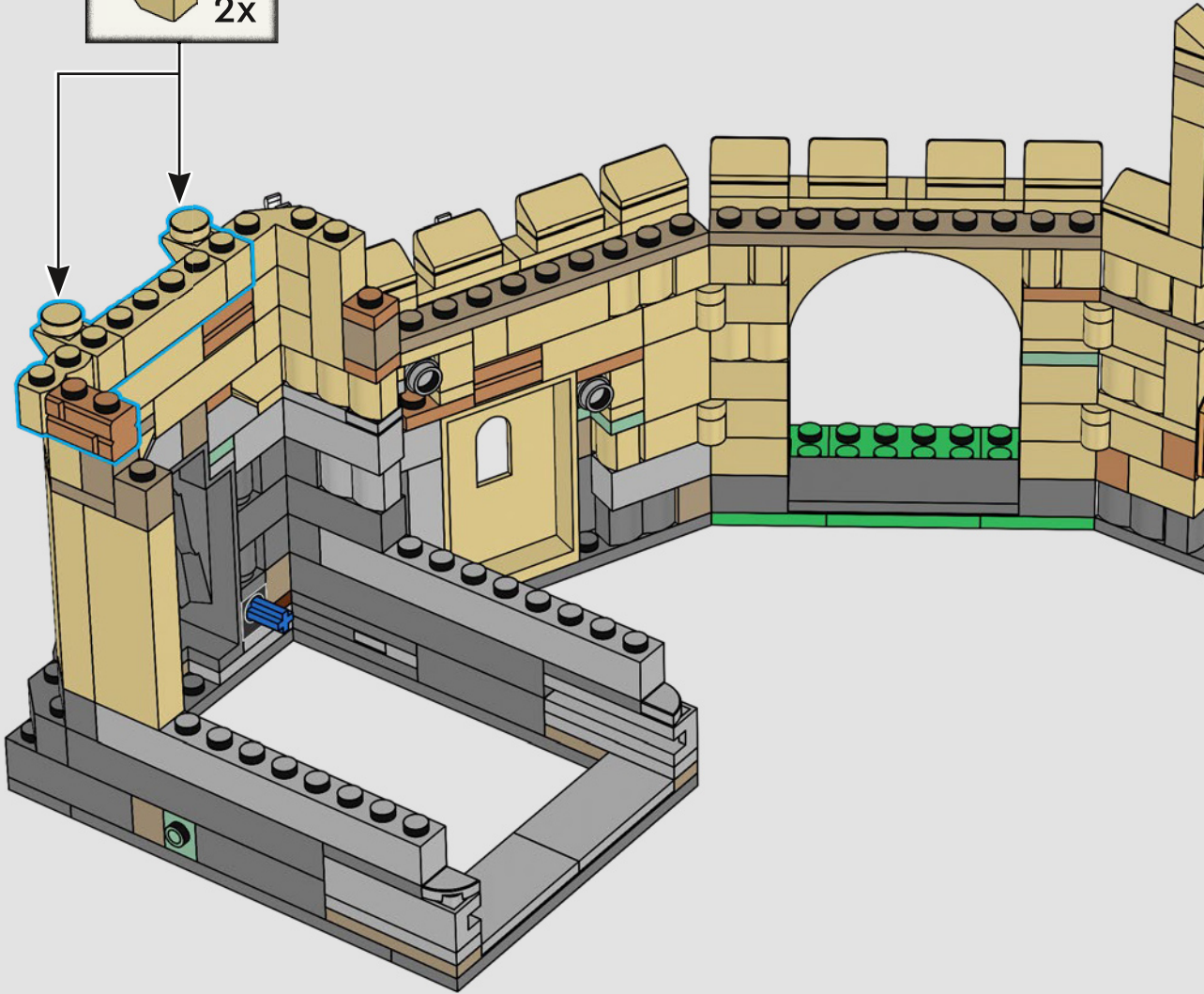
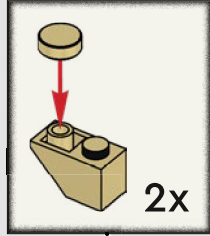

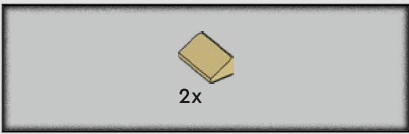

121

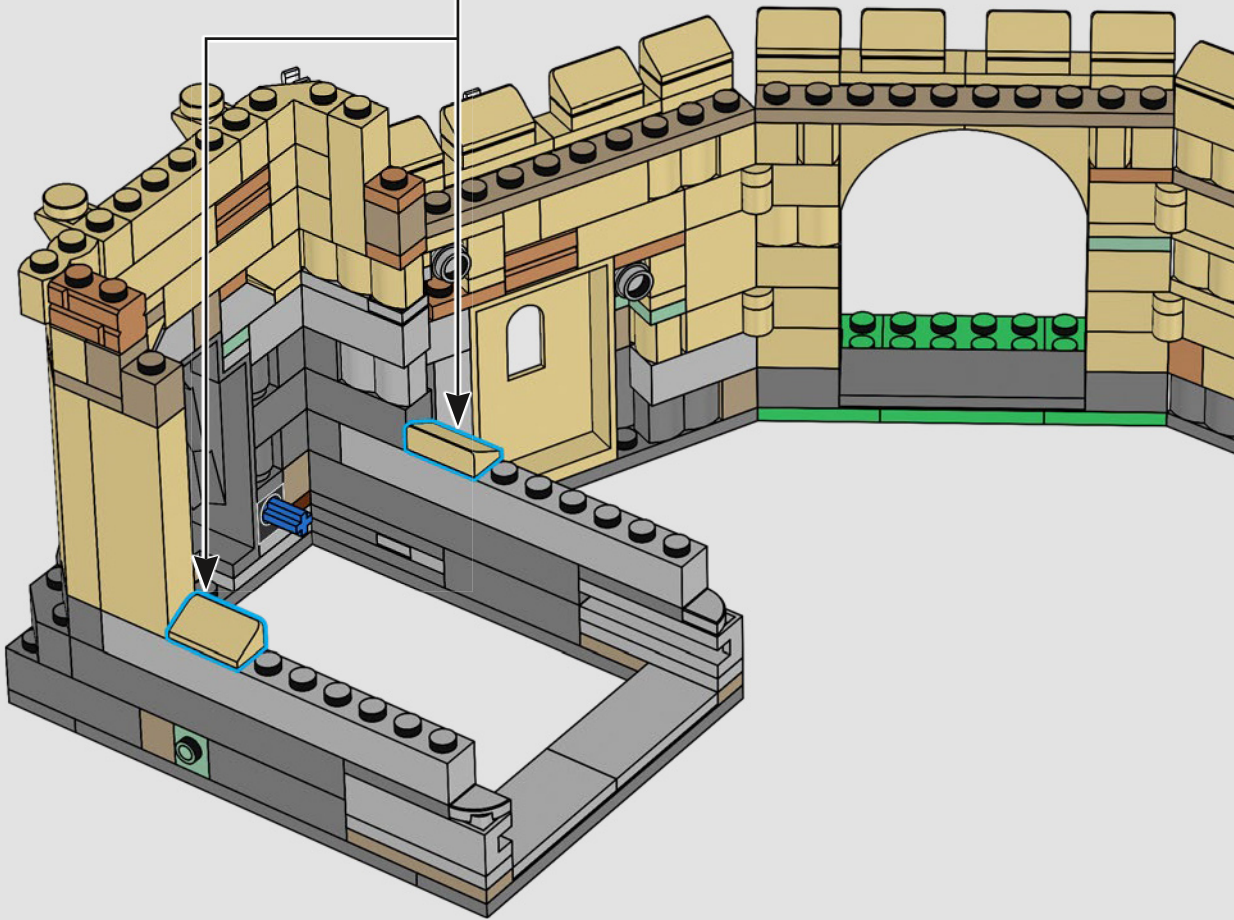
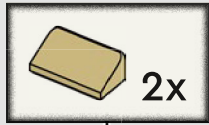



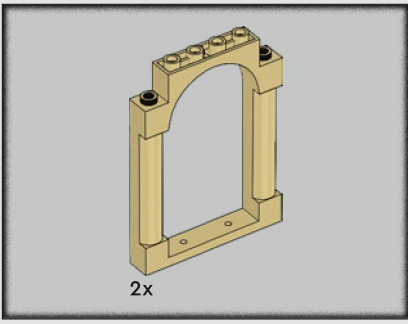

122

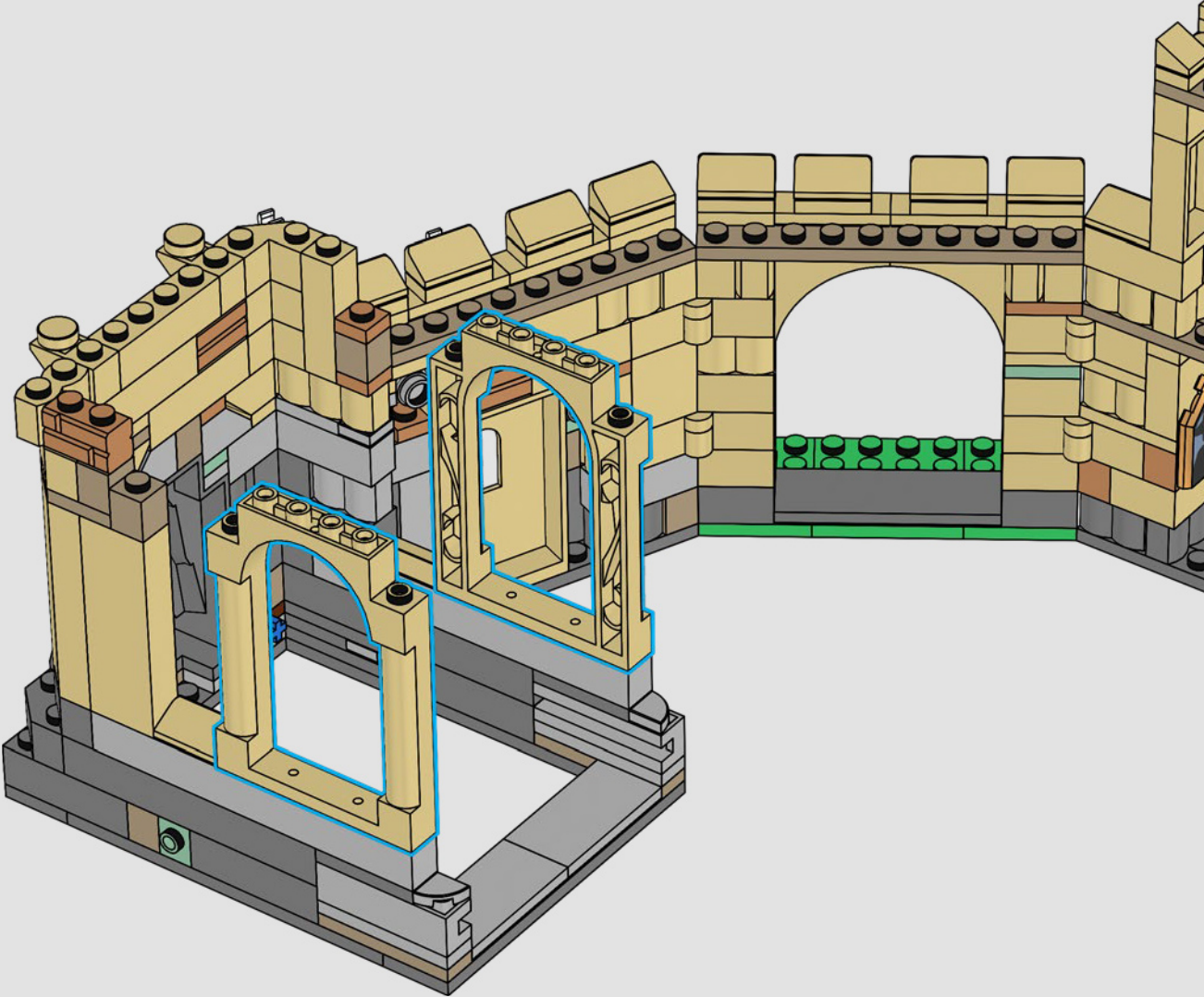



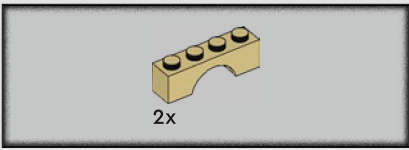

123

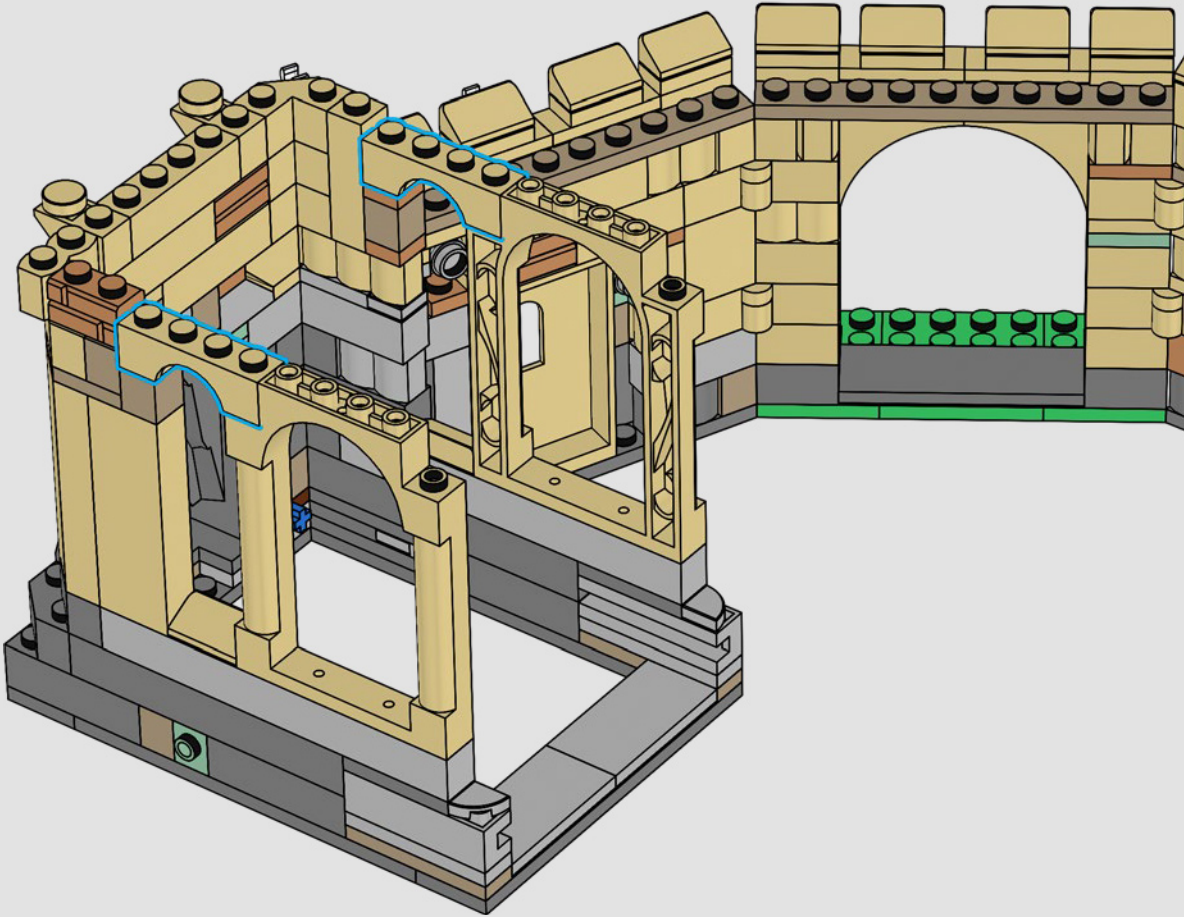

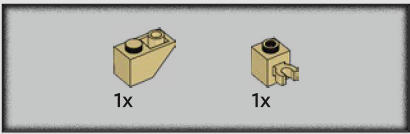

# 124

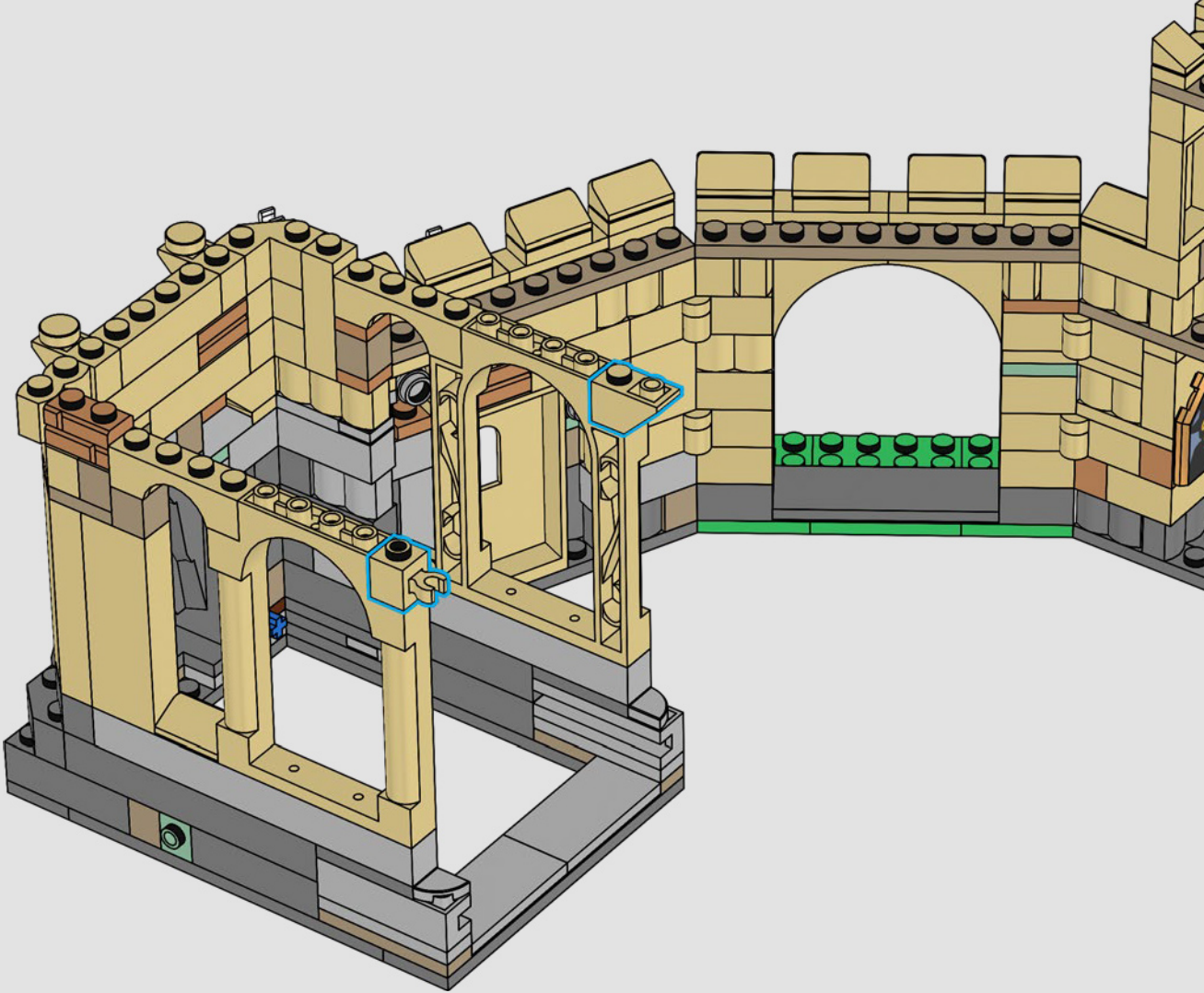

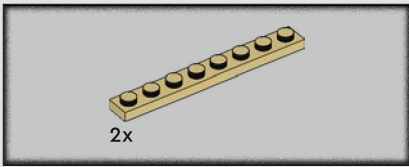

125

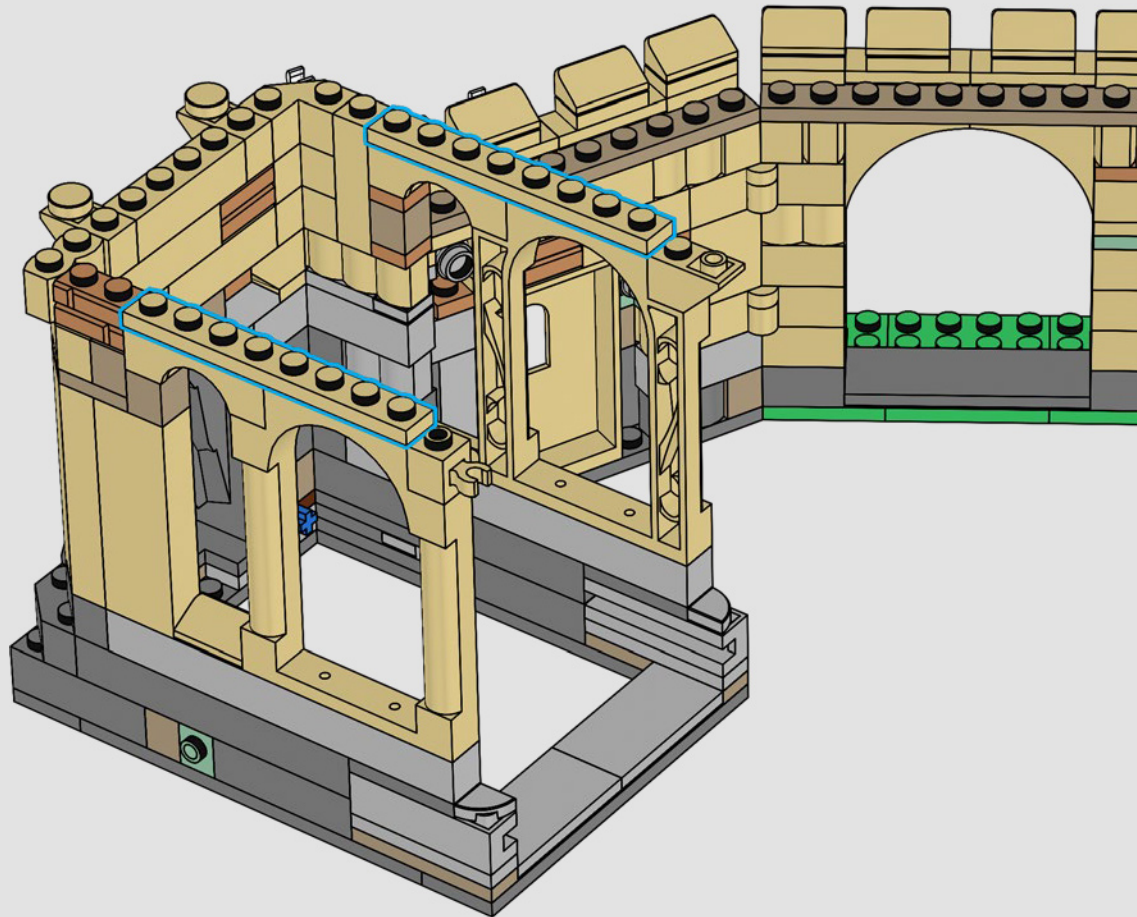



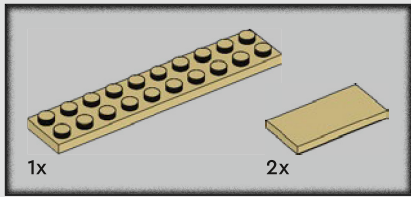

# 126

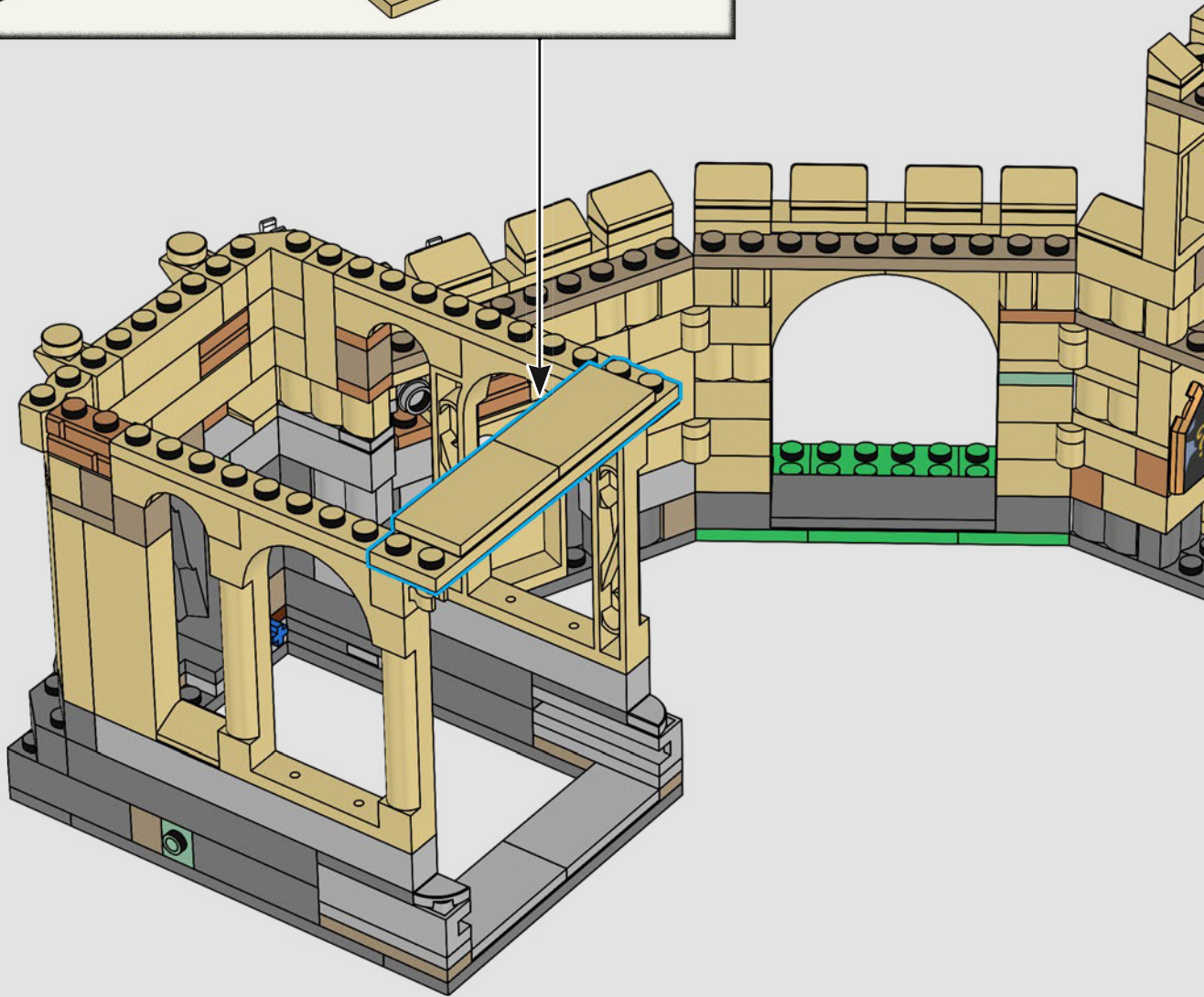
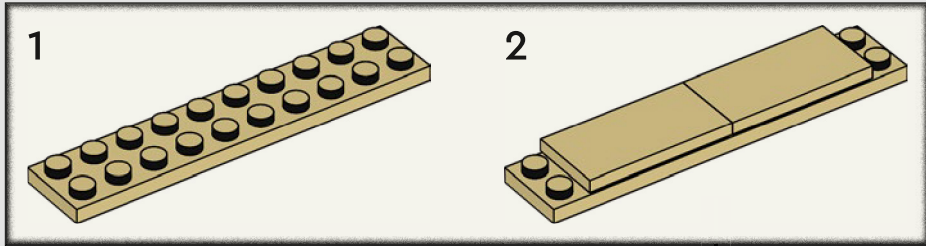



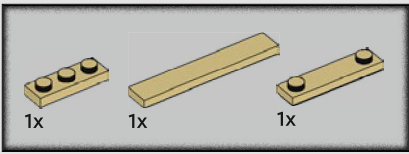

127

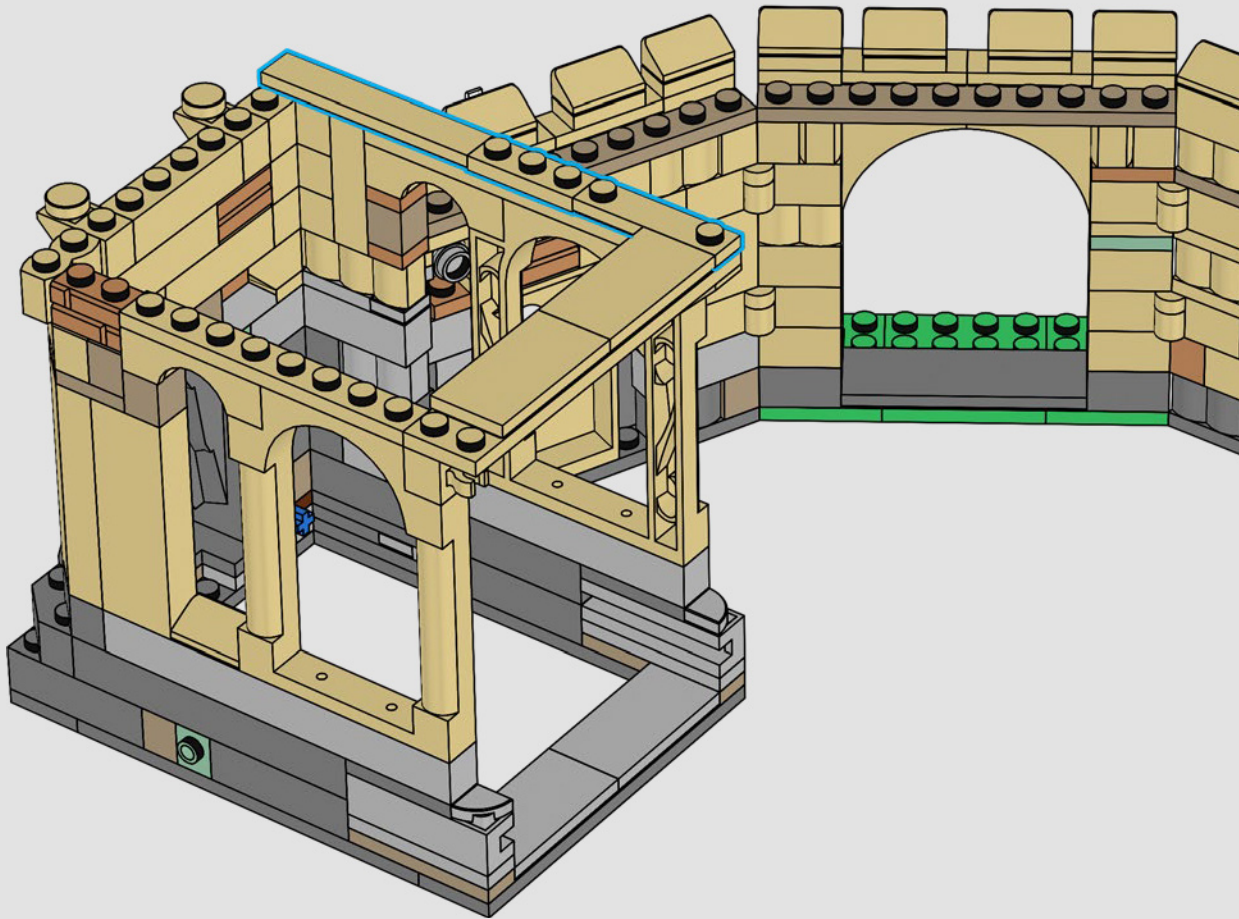

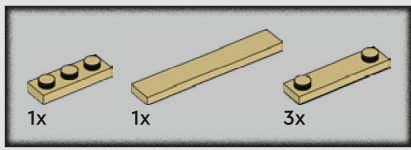

128

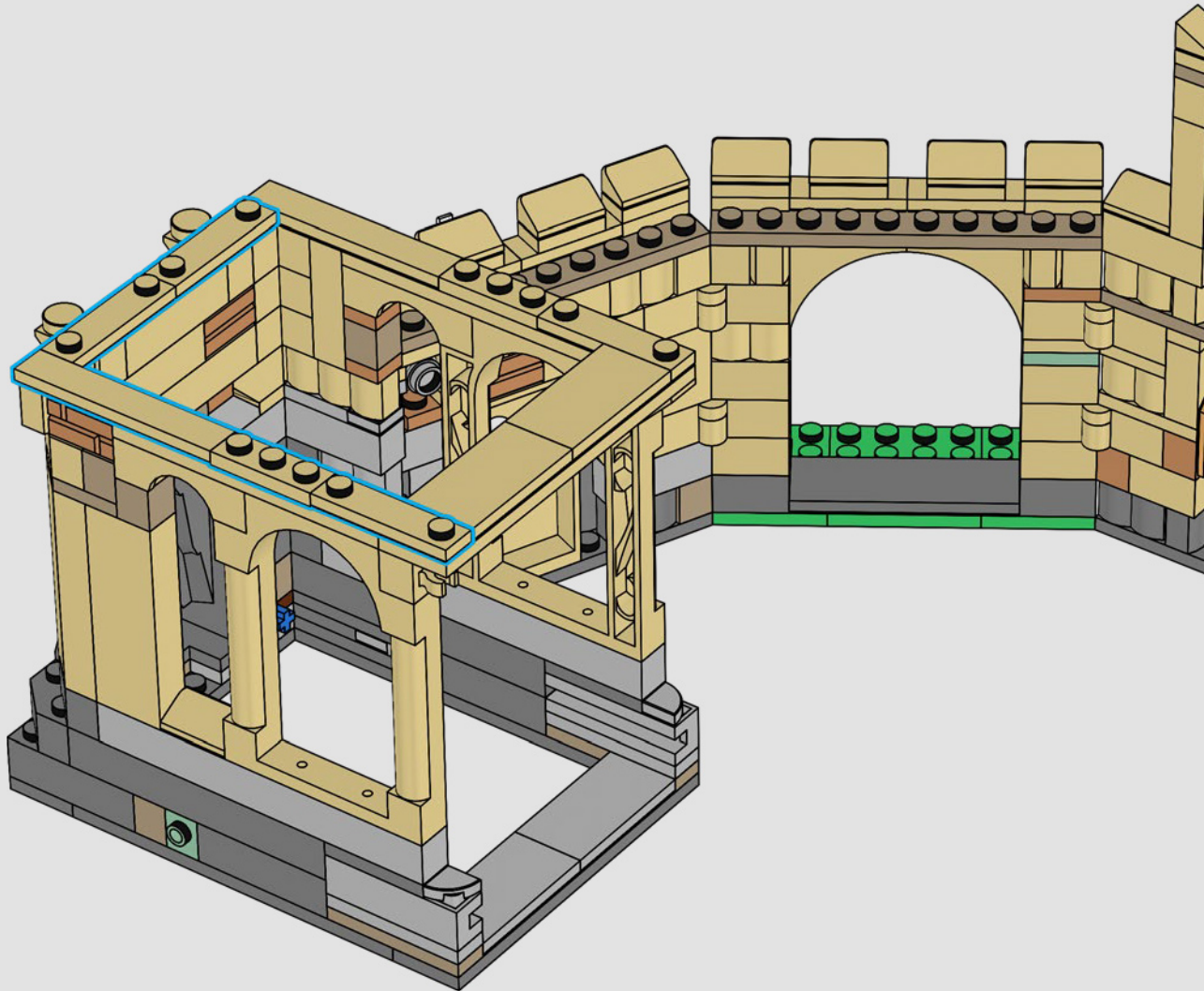

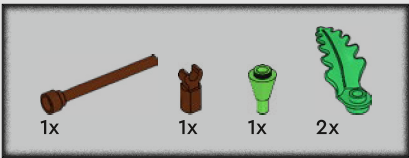

129

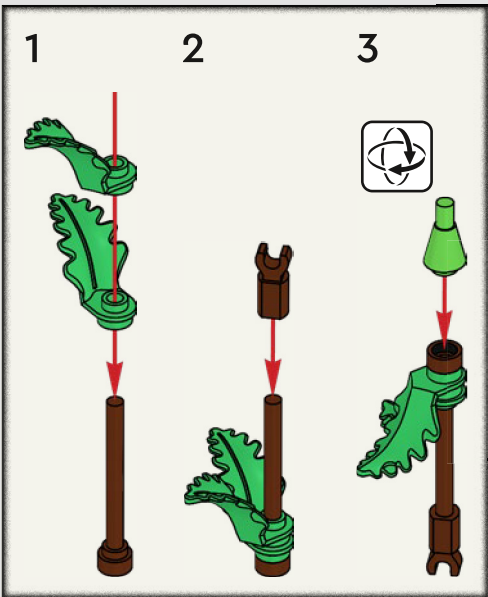
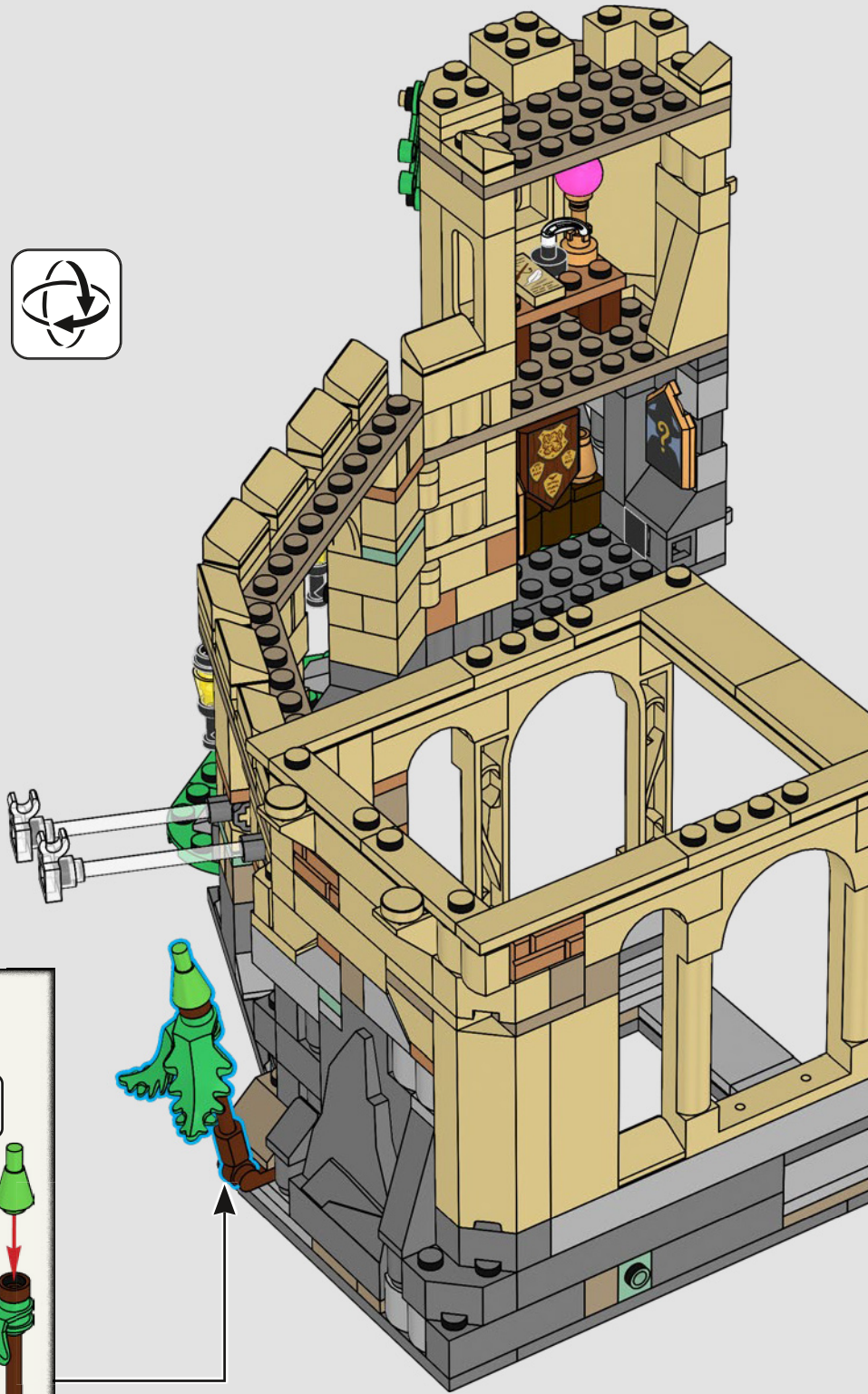



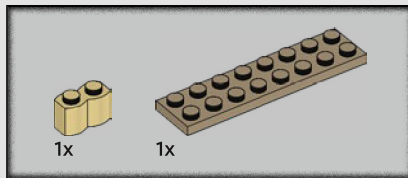
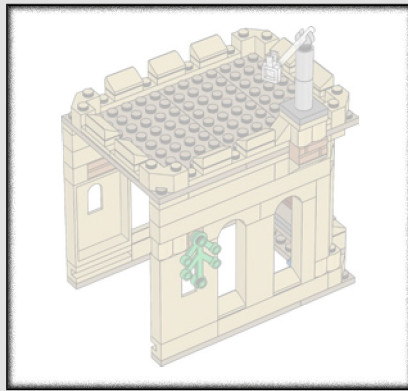

130

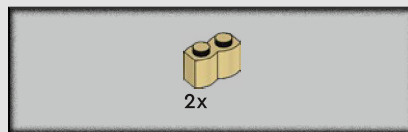
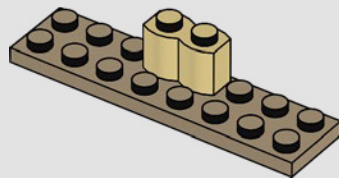

131

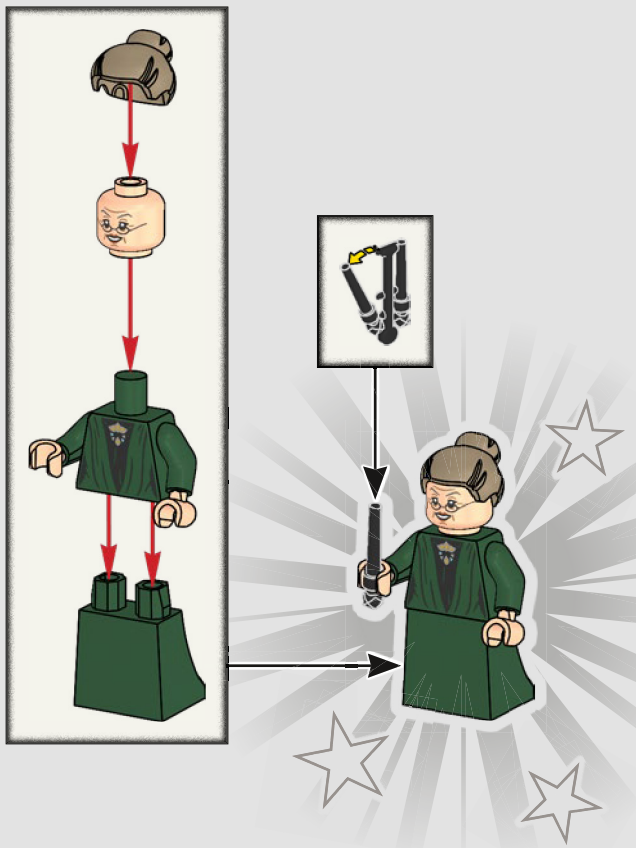
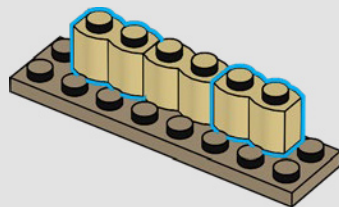



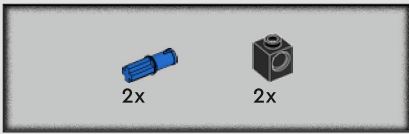

132

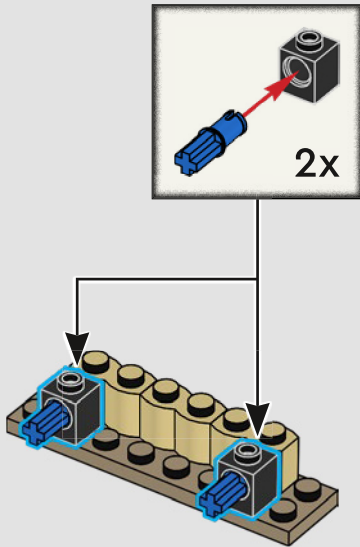

133

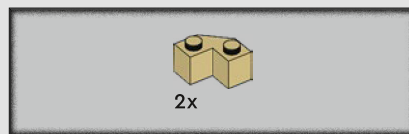
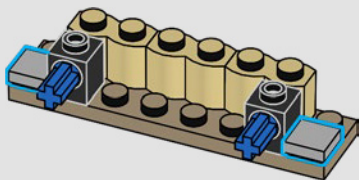

134

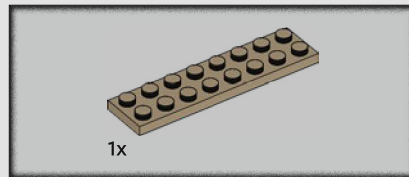
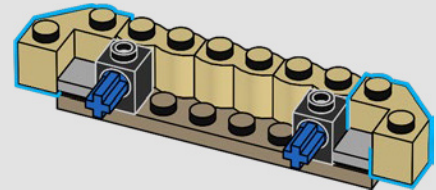

135

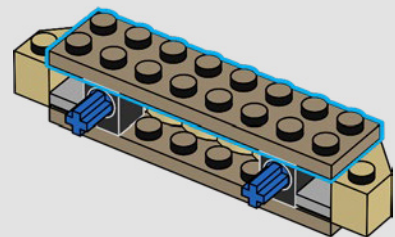

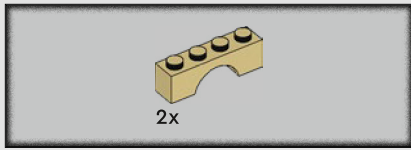

136

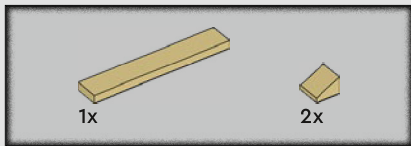
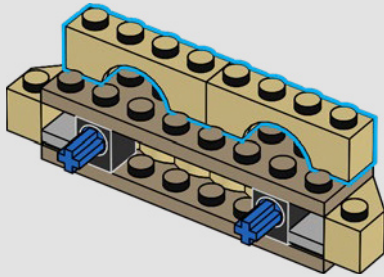

137

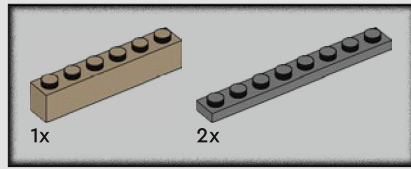
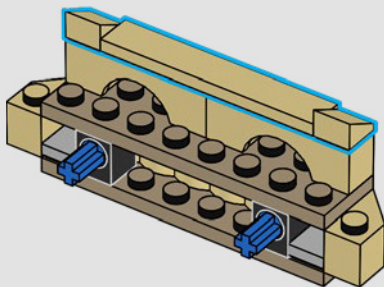

138

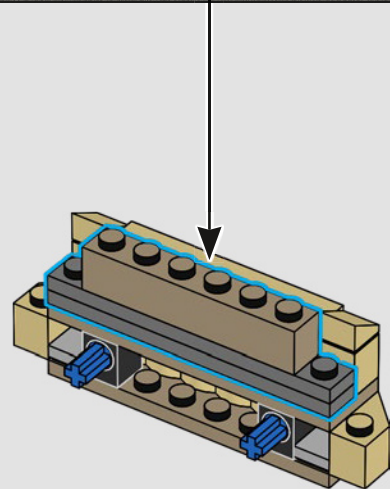
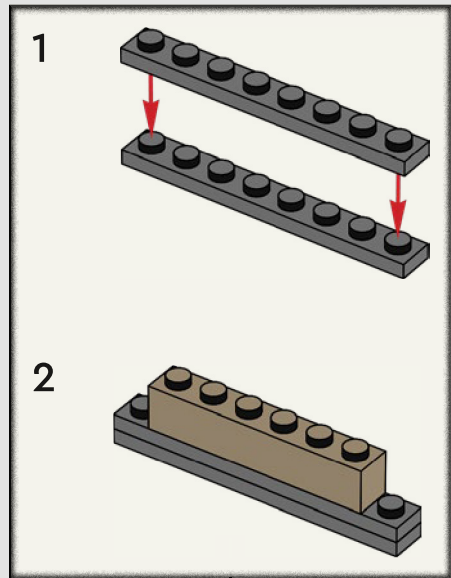

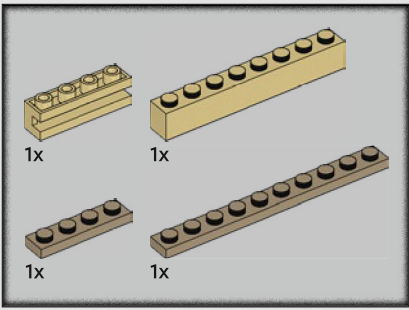

139

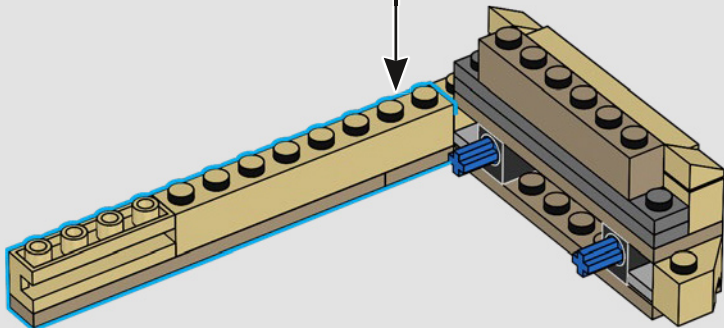
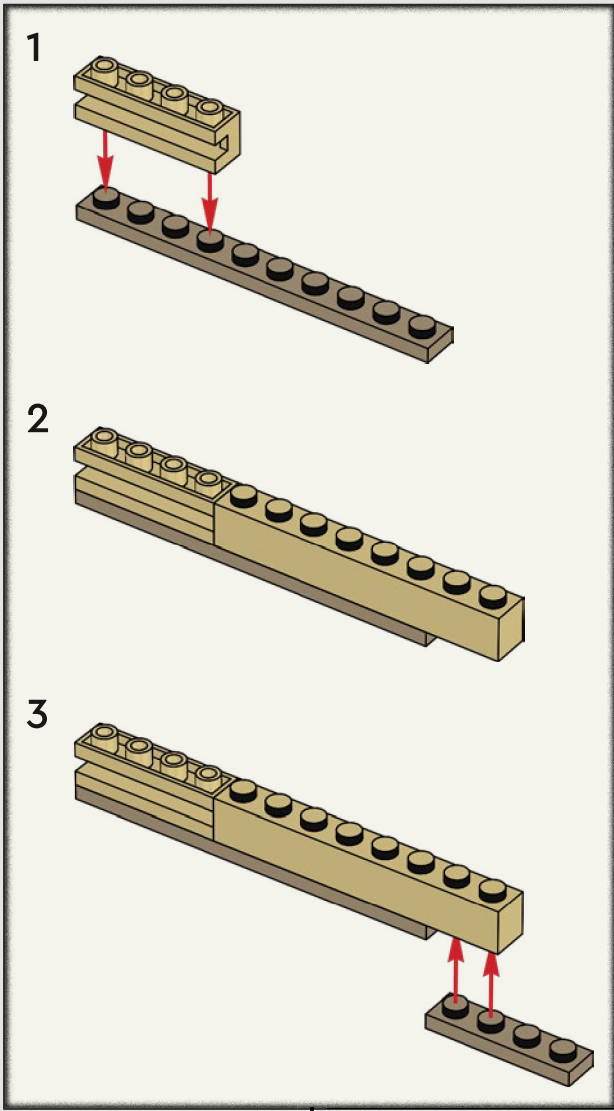

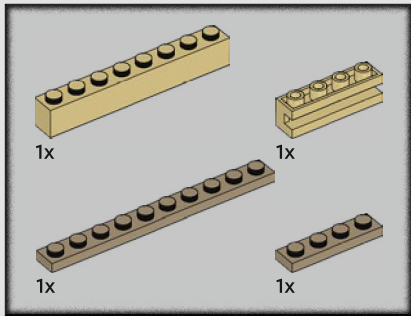

140

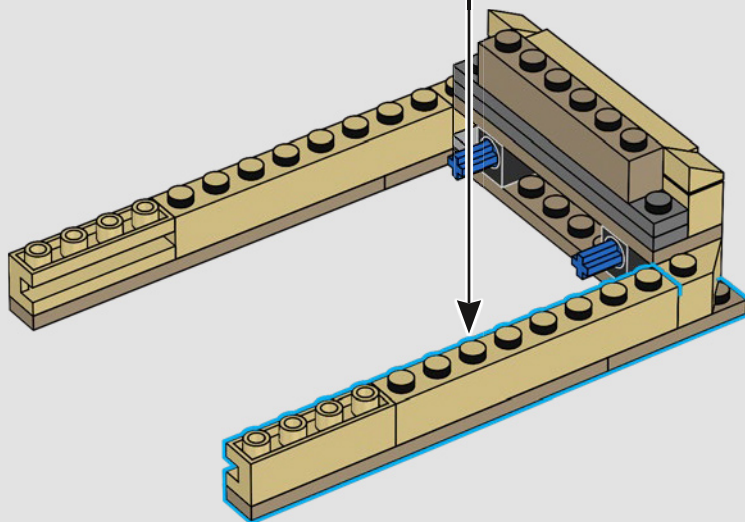
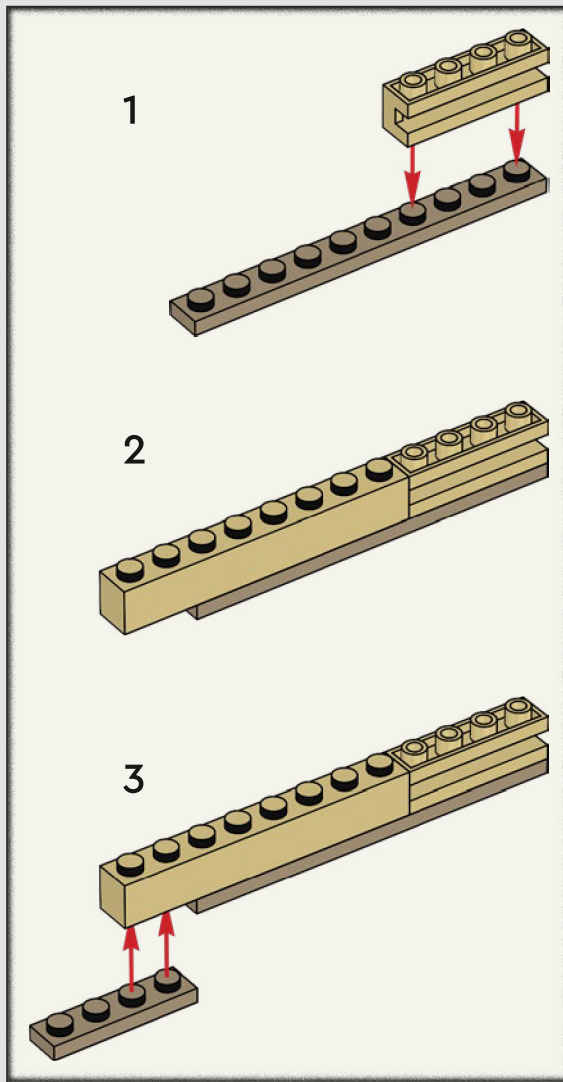



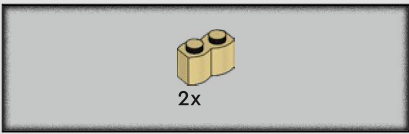

141

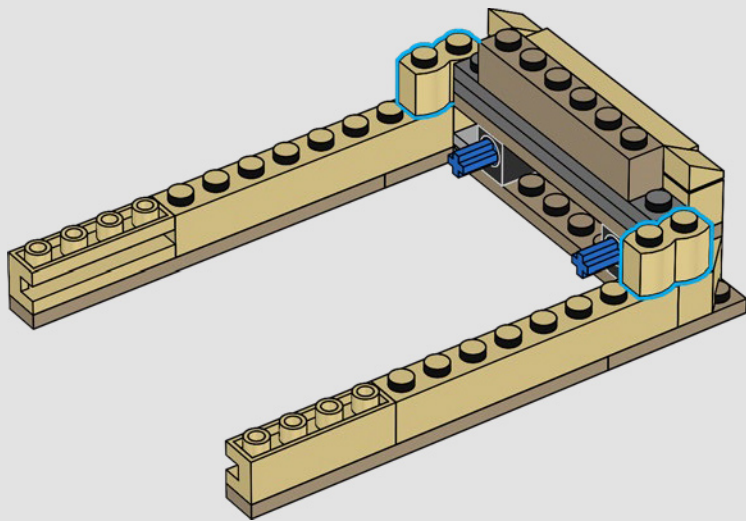

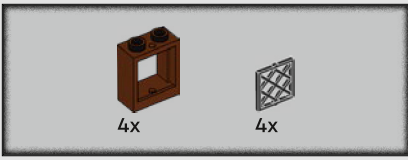

142

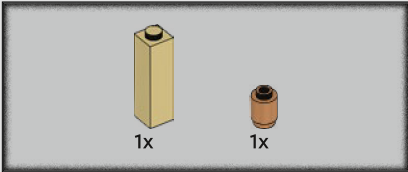
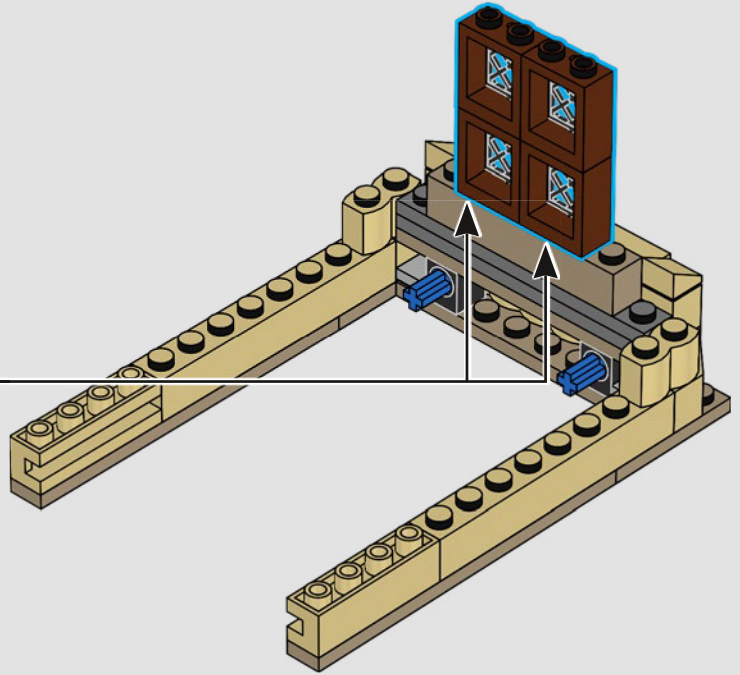
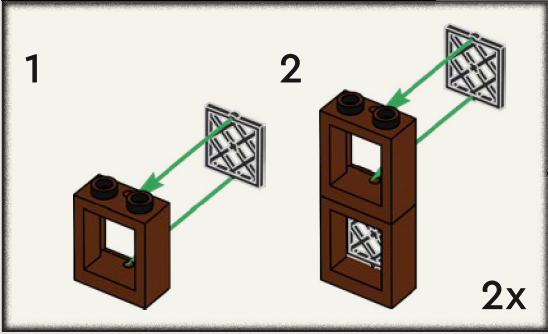

143

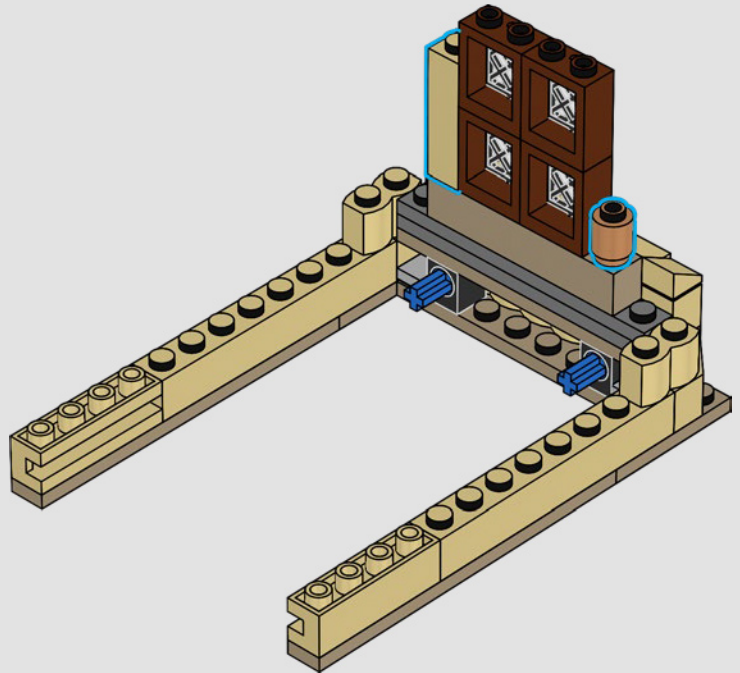

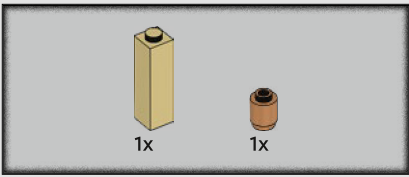

144

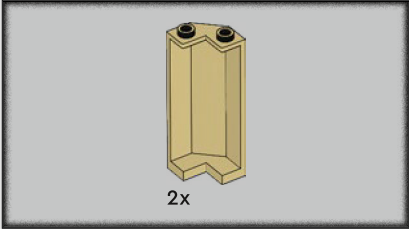
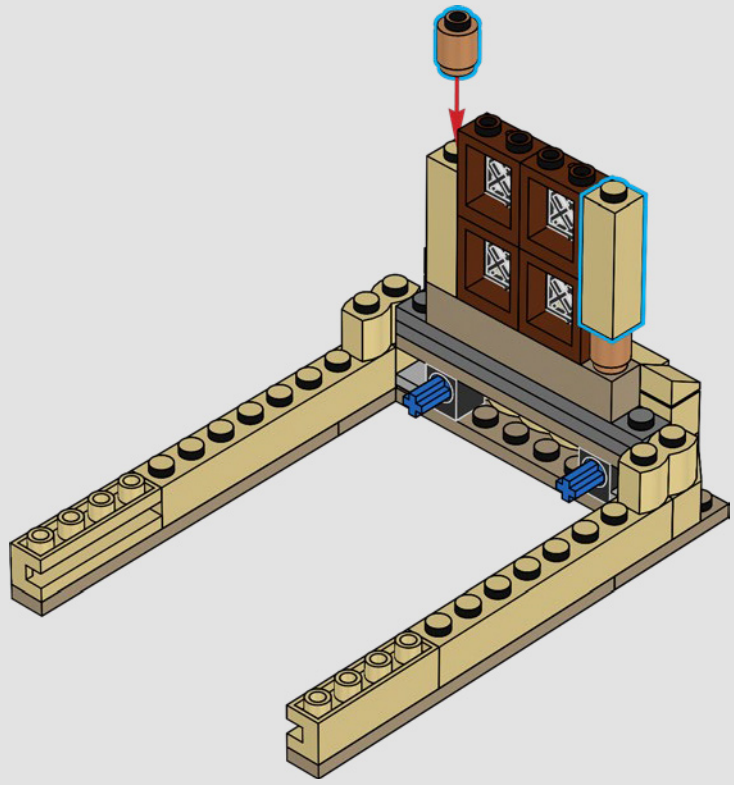

145

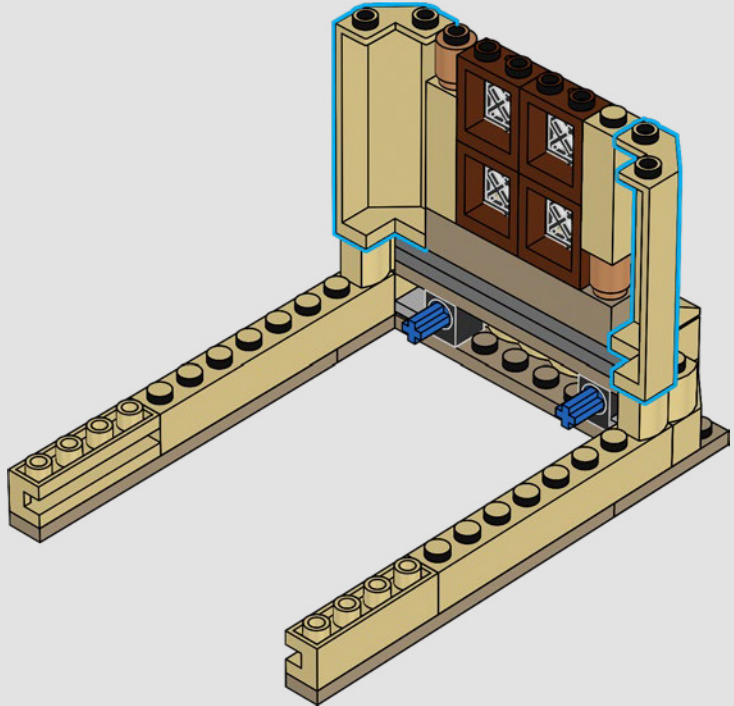

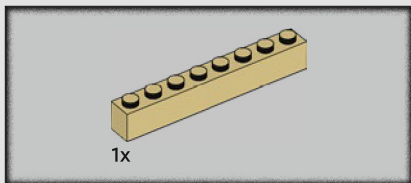

146

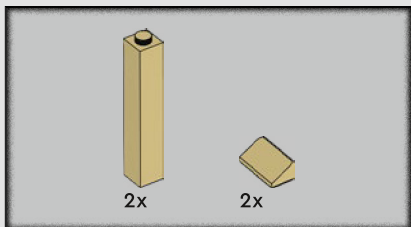
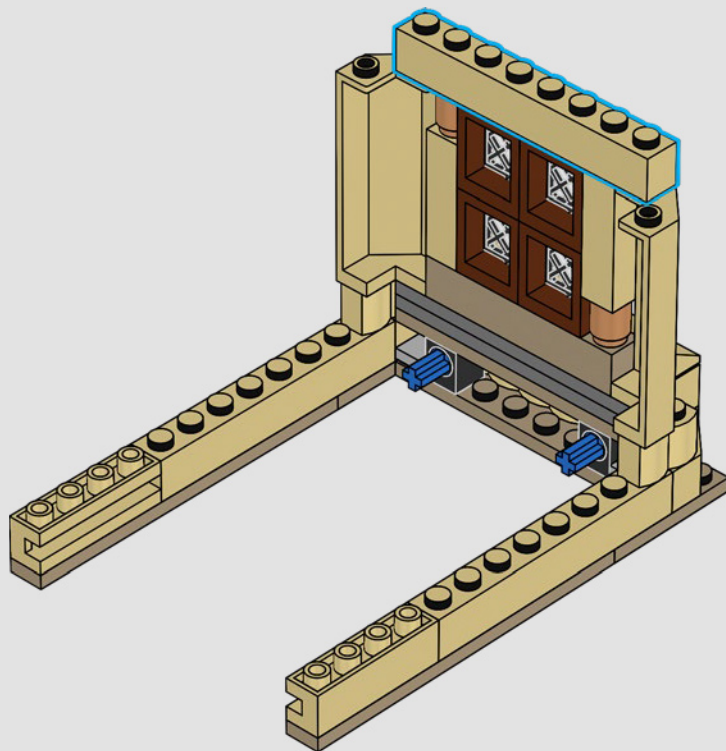

147

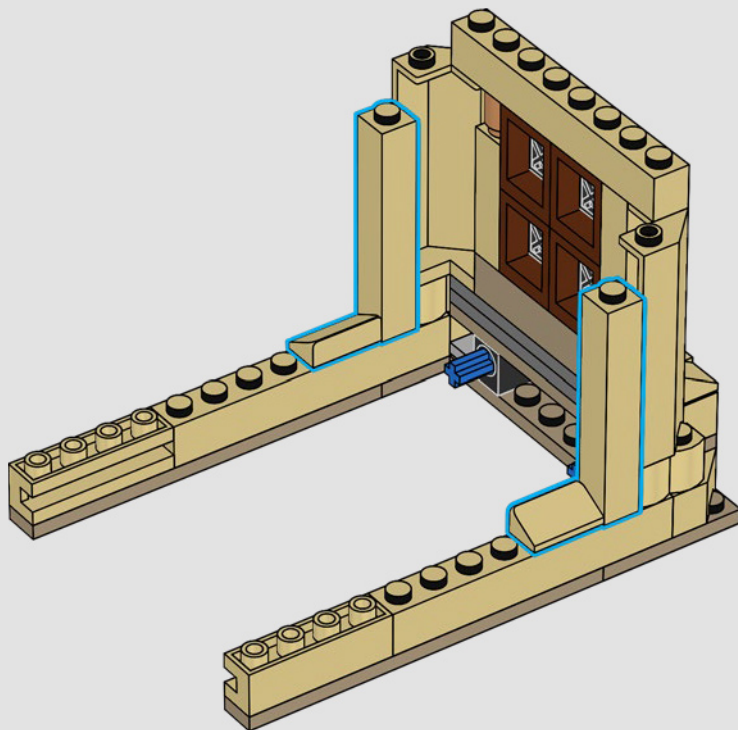



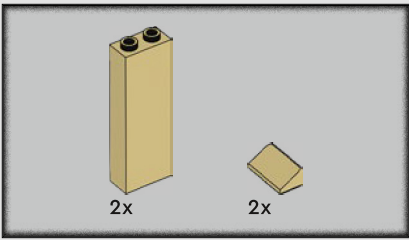

148

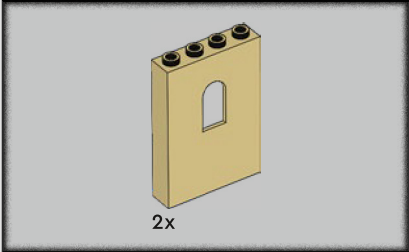
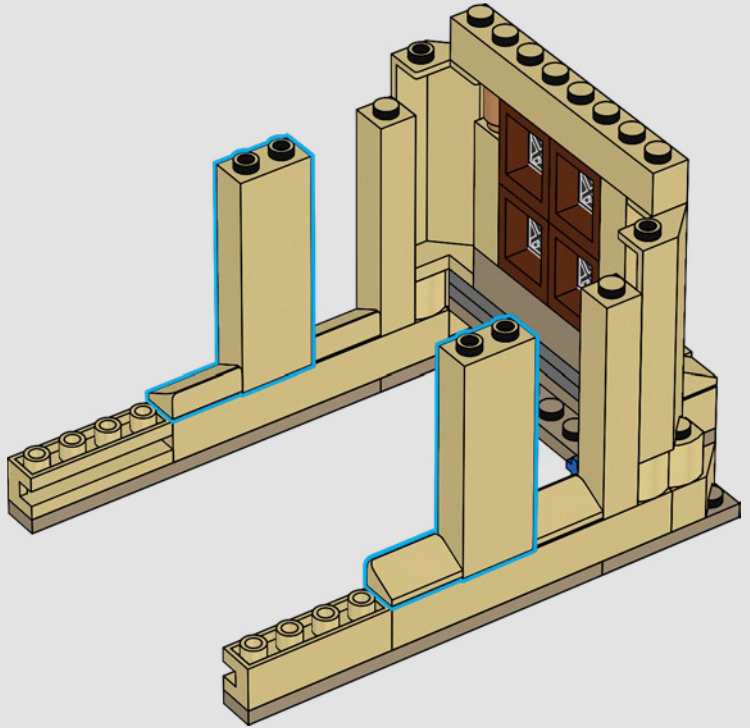

149

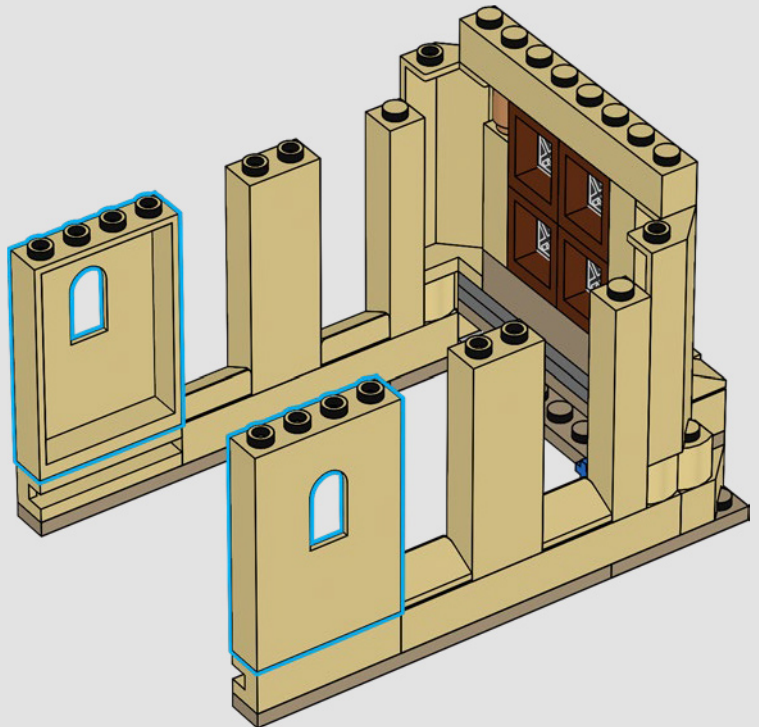

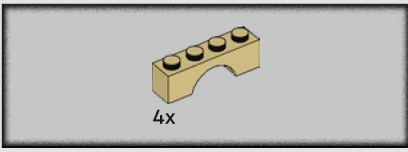

150

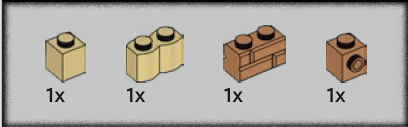
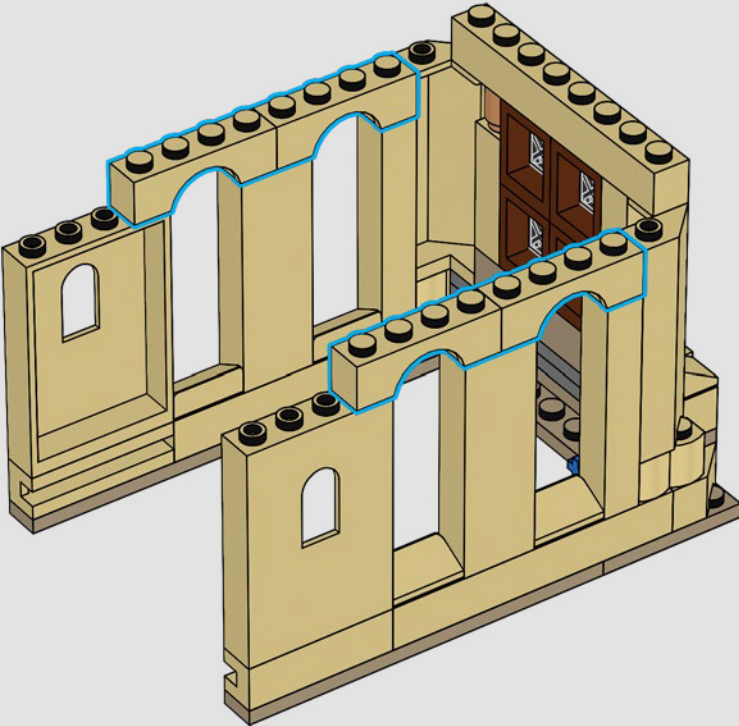

151

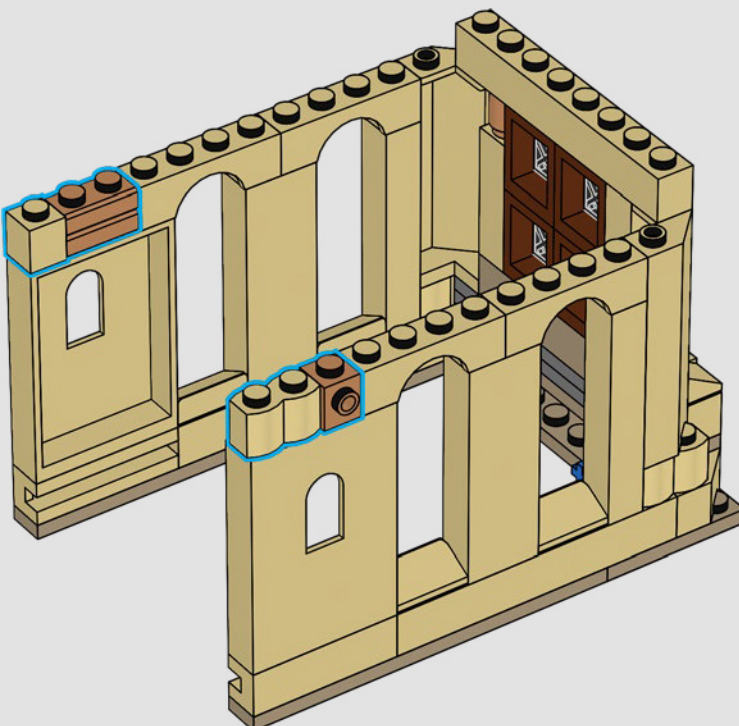

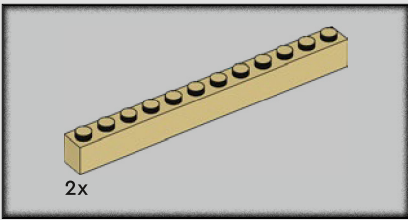

152

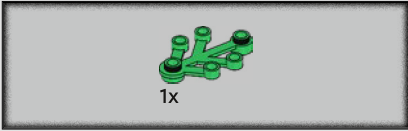
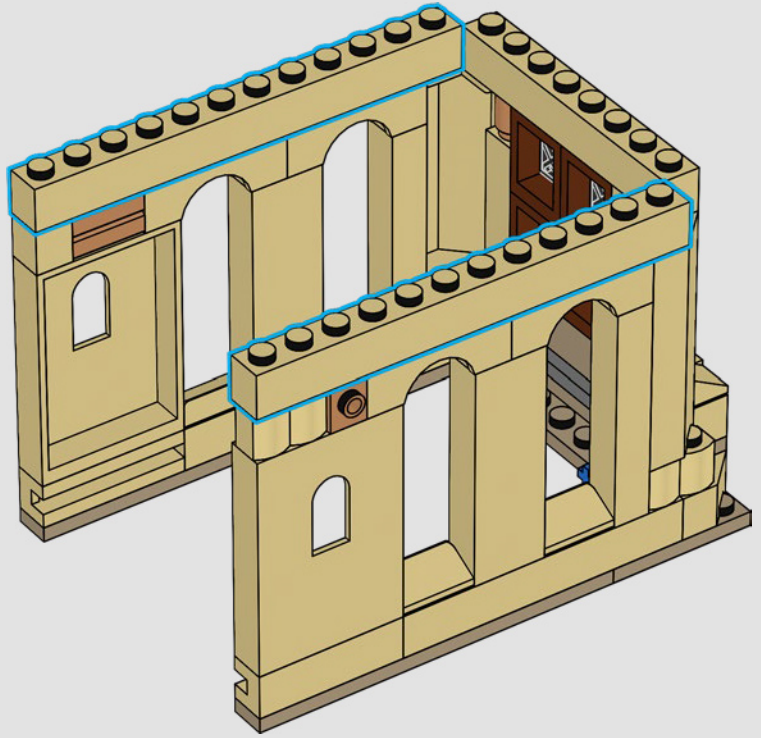

153

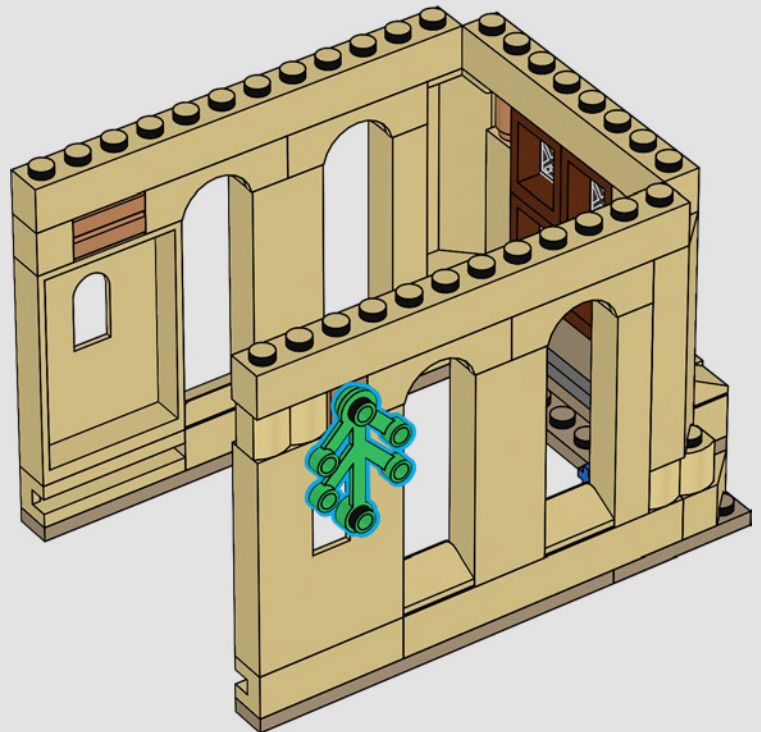



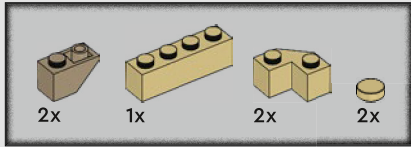
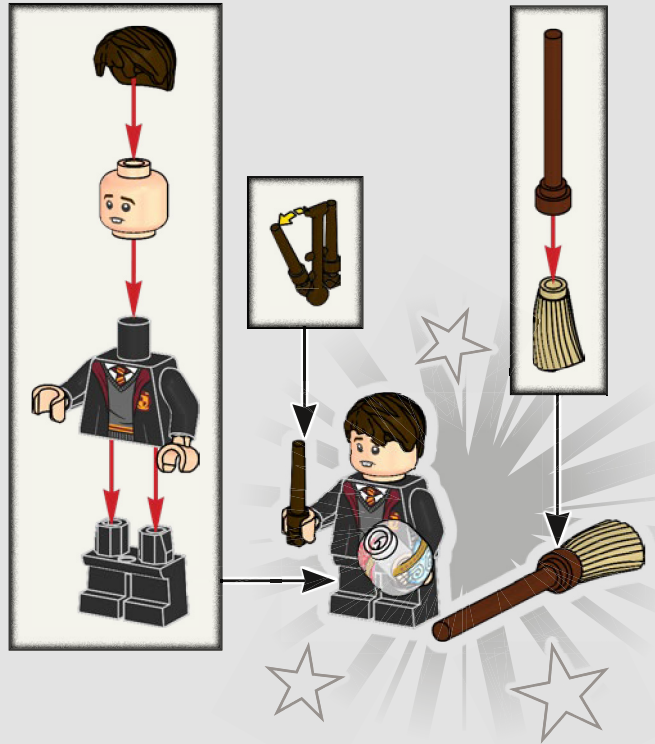

154

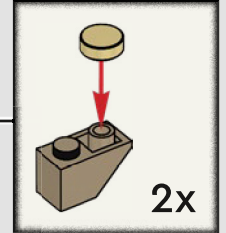
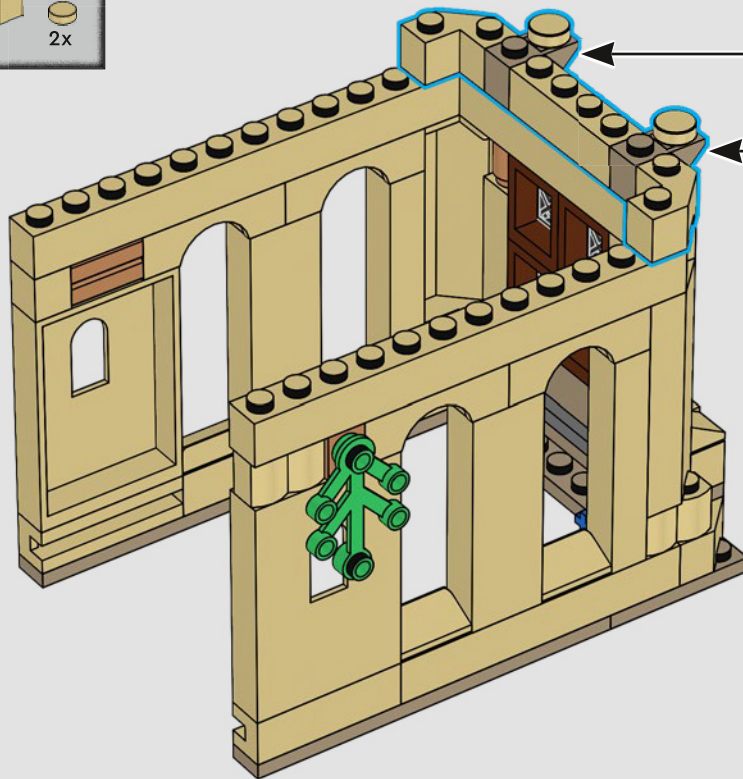



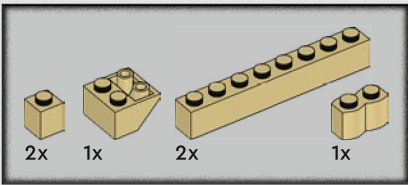

155

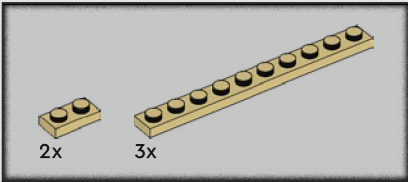
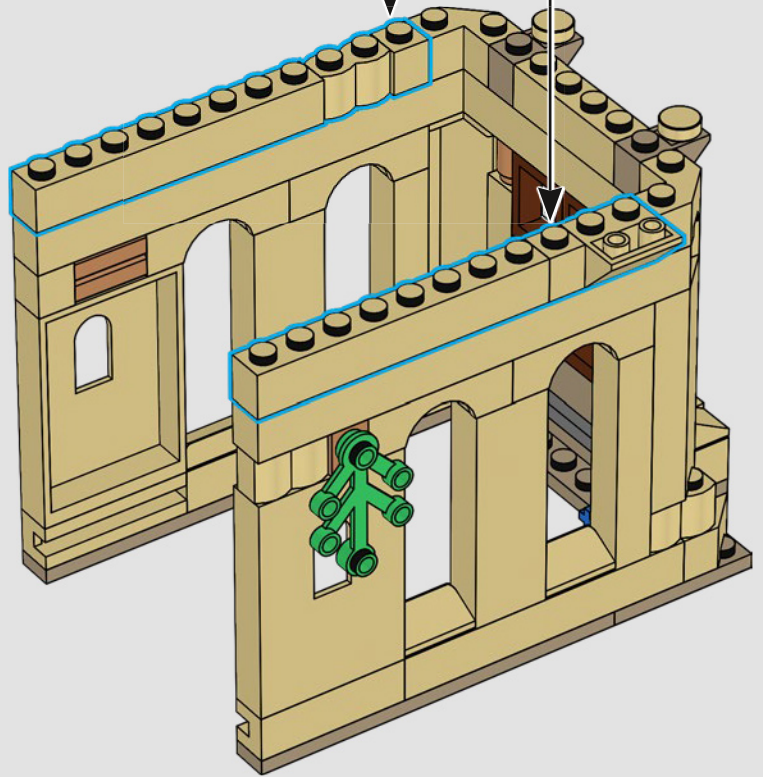
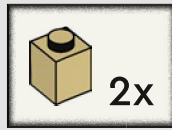

156

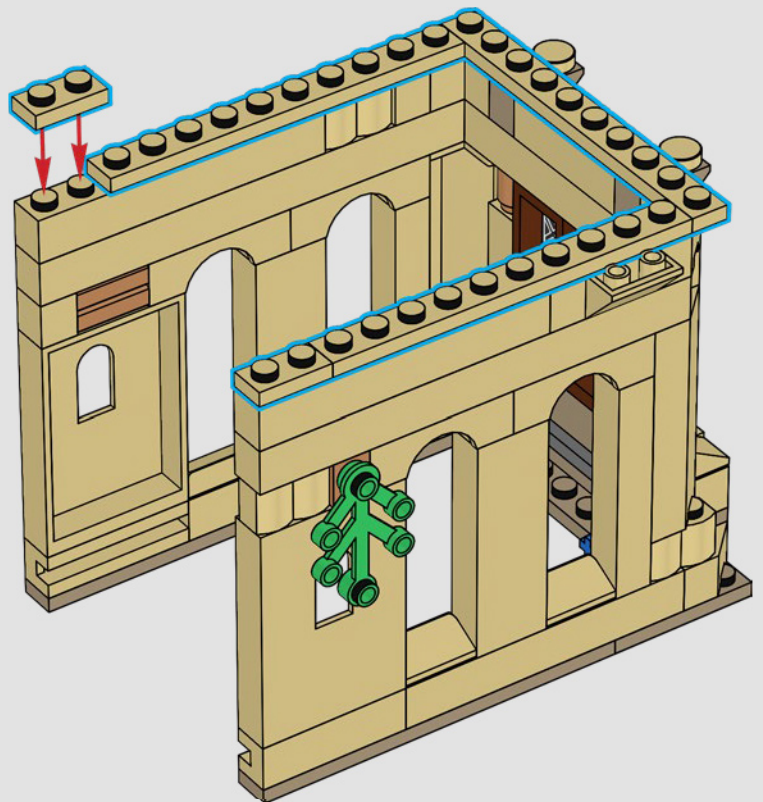

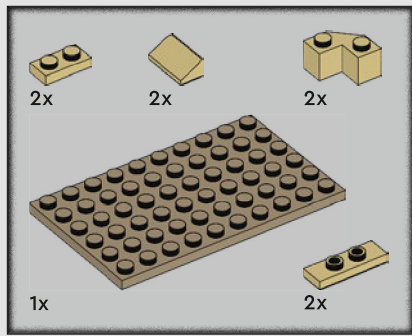

157

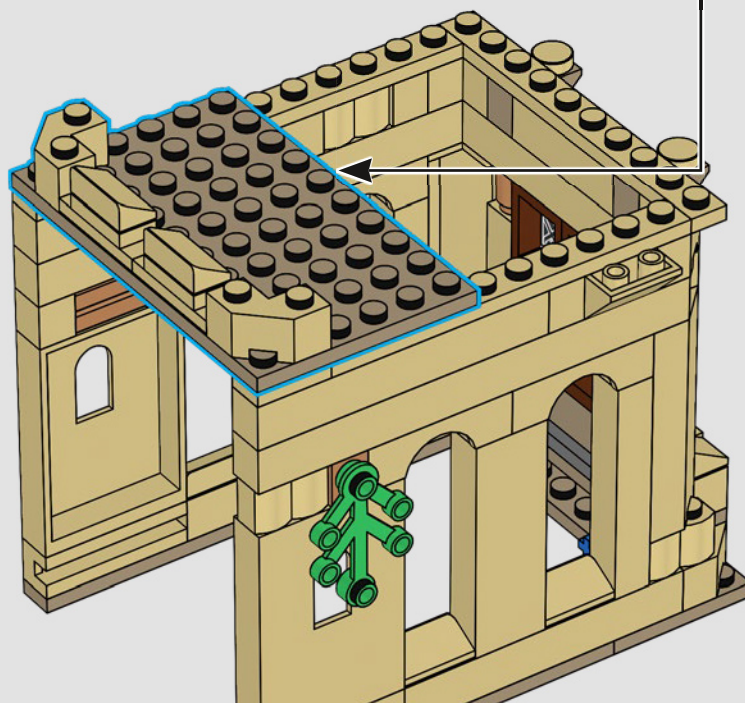
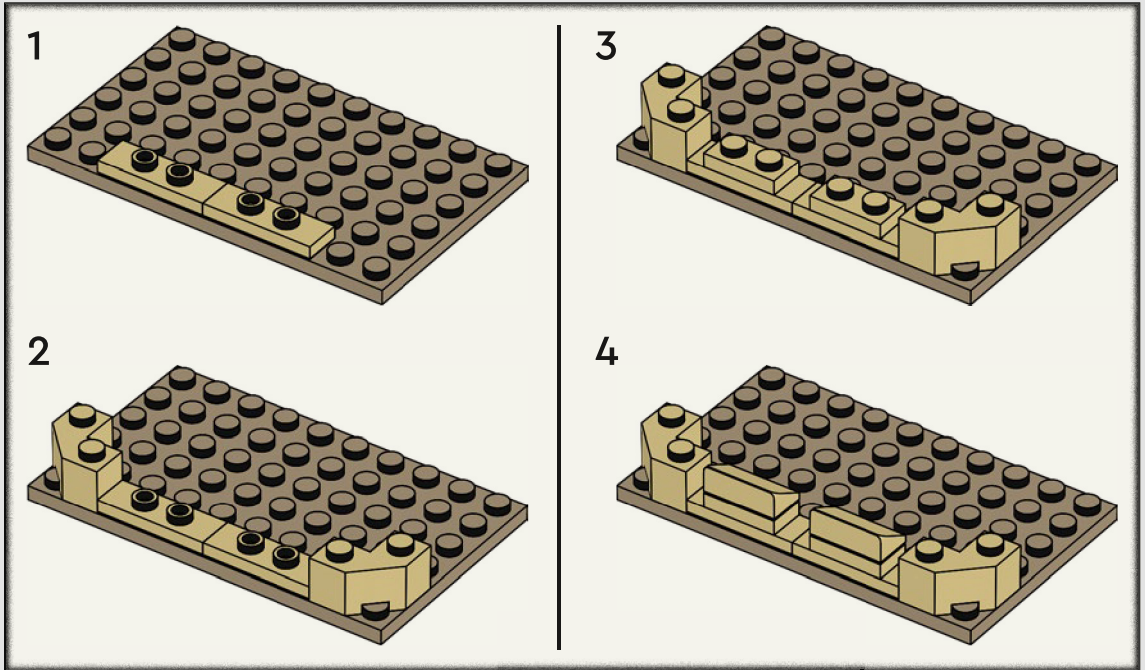



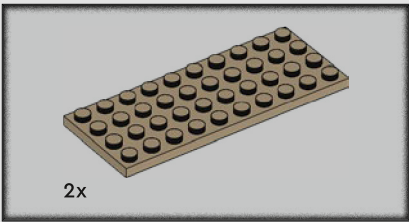

158

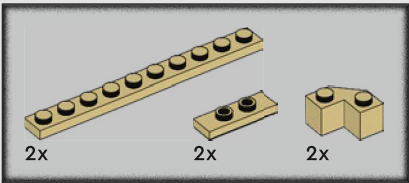
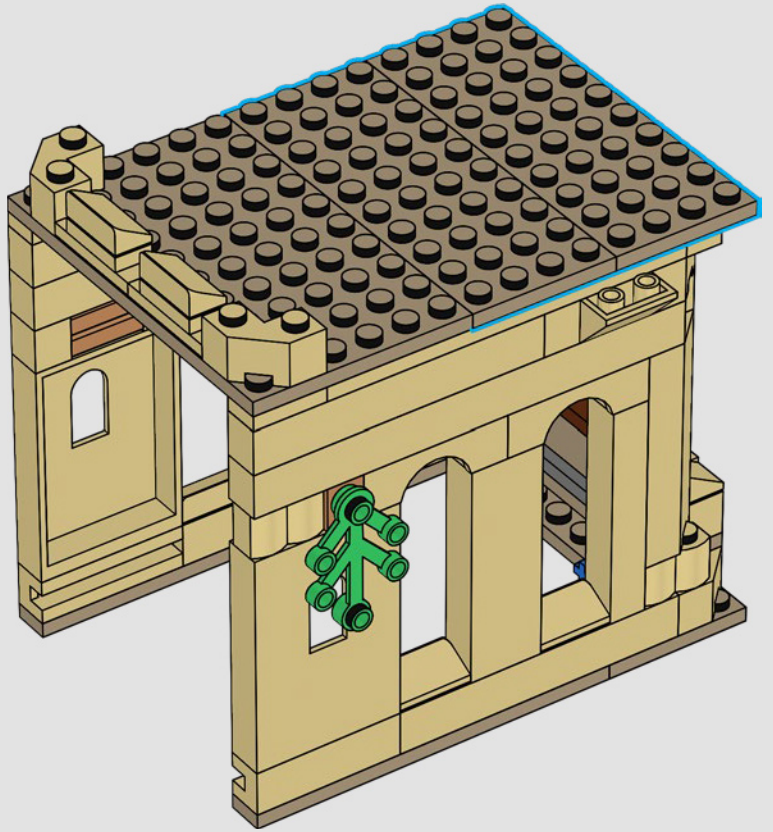

159

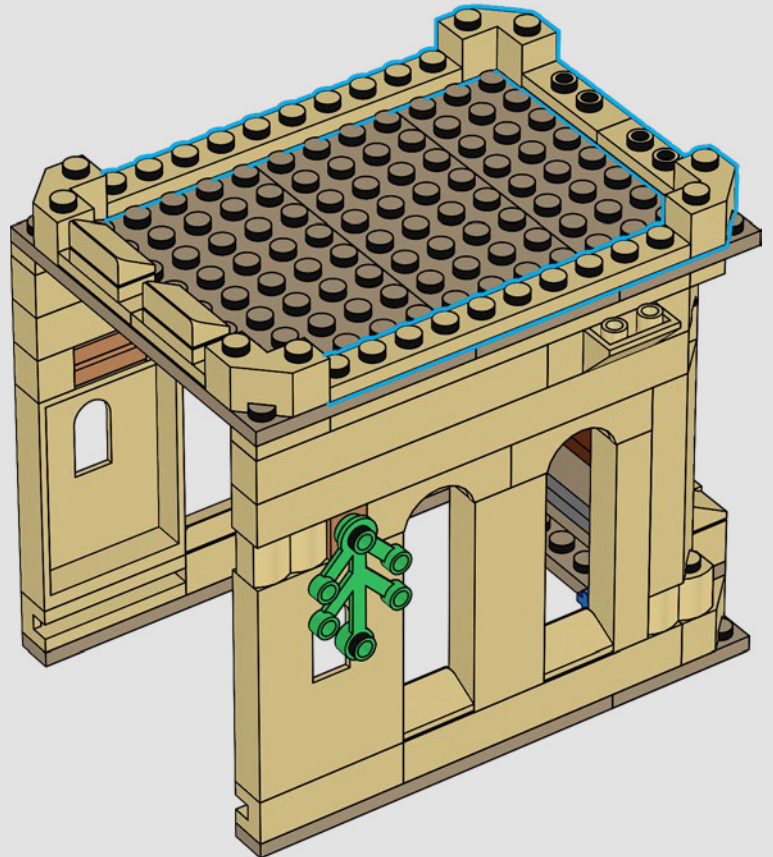

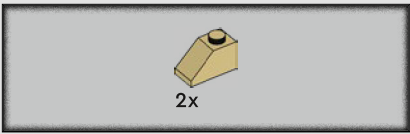

160

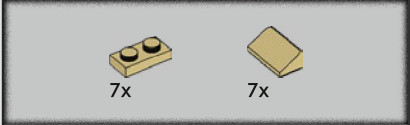
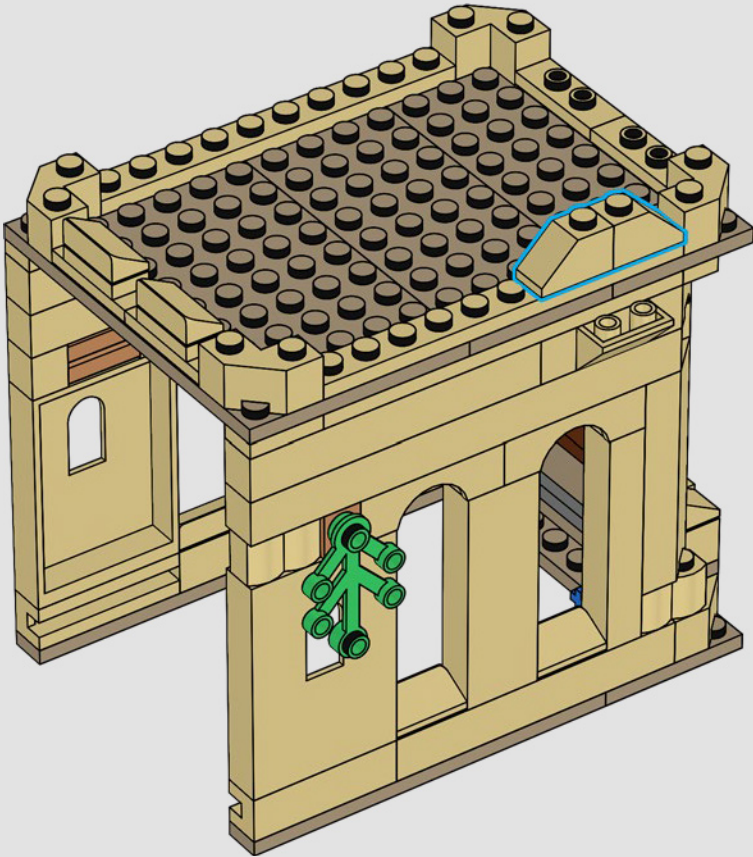

161

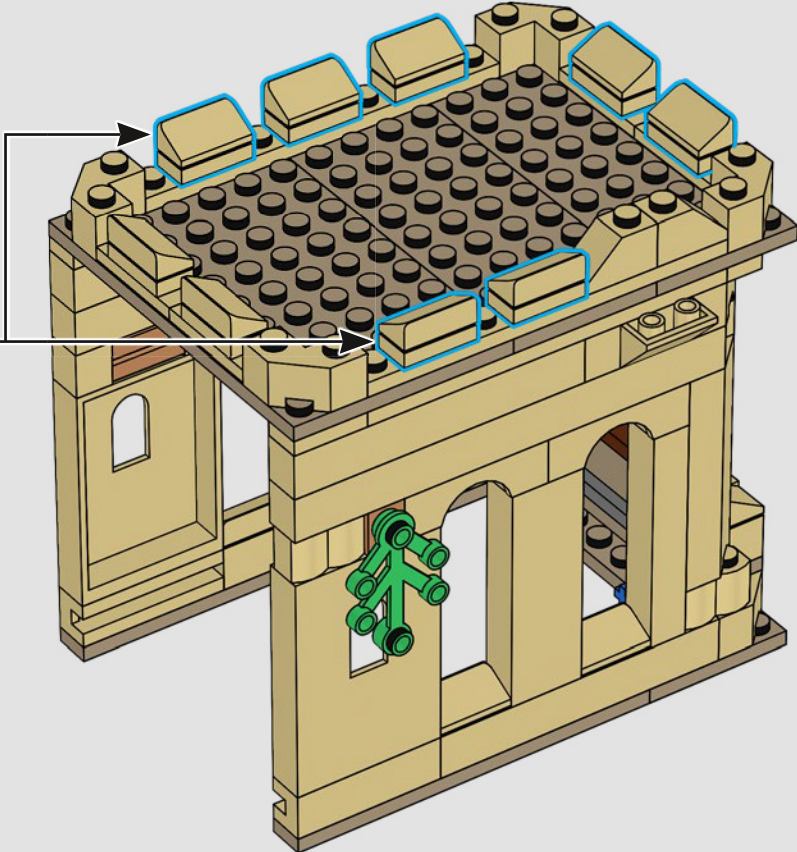
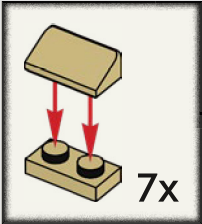



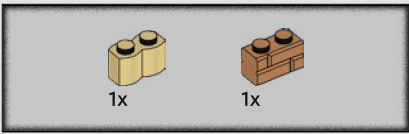

162

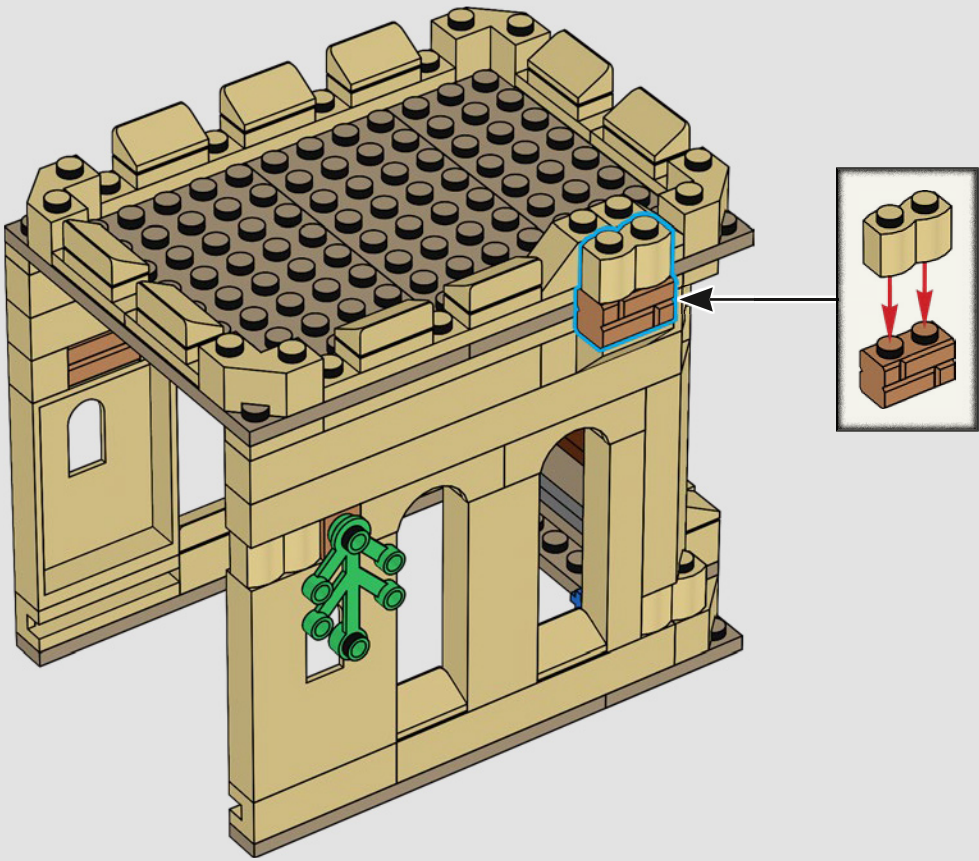

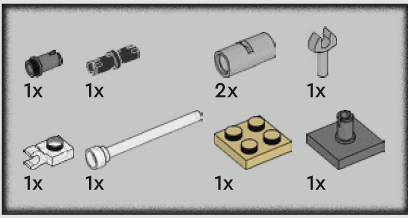

# 163

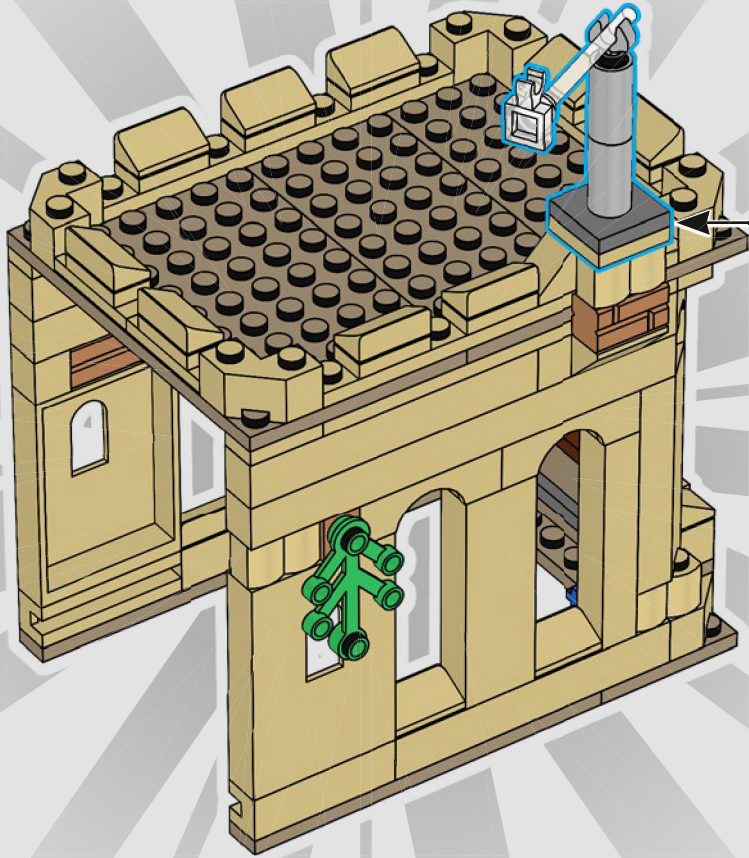
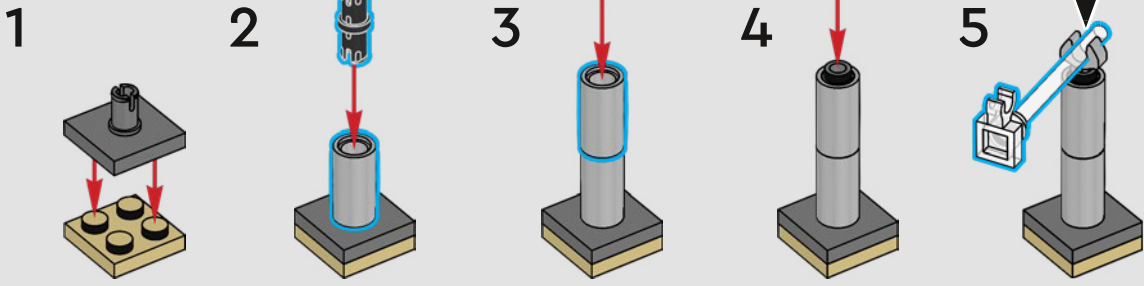
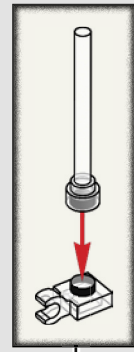

164

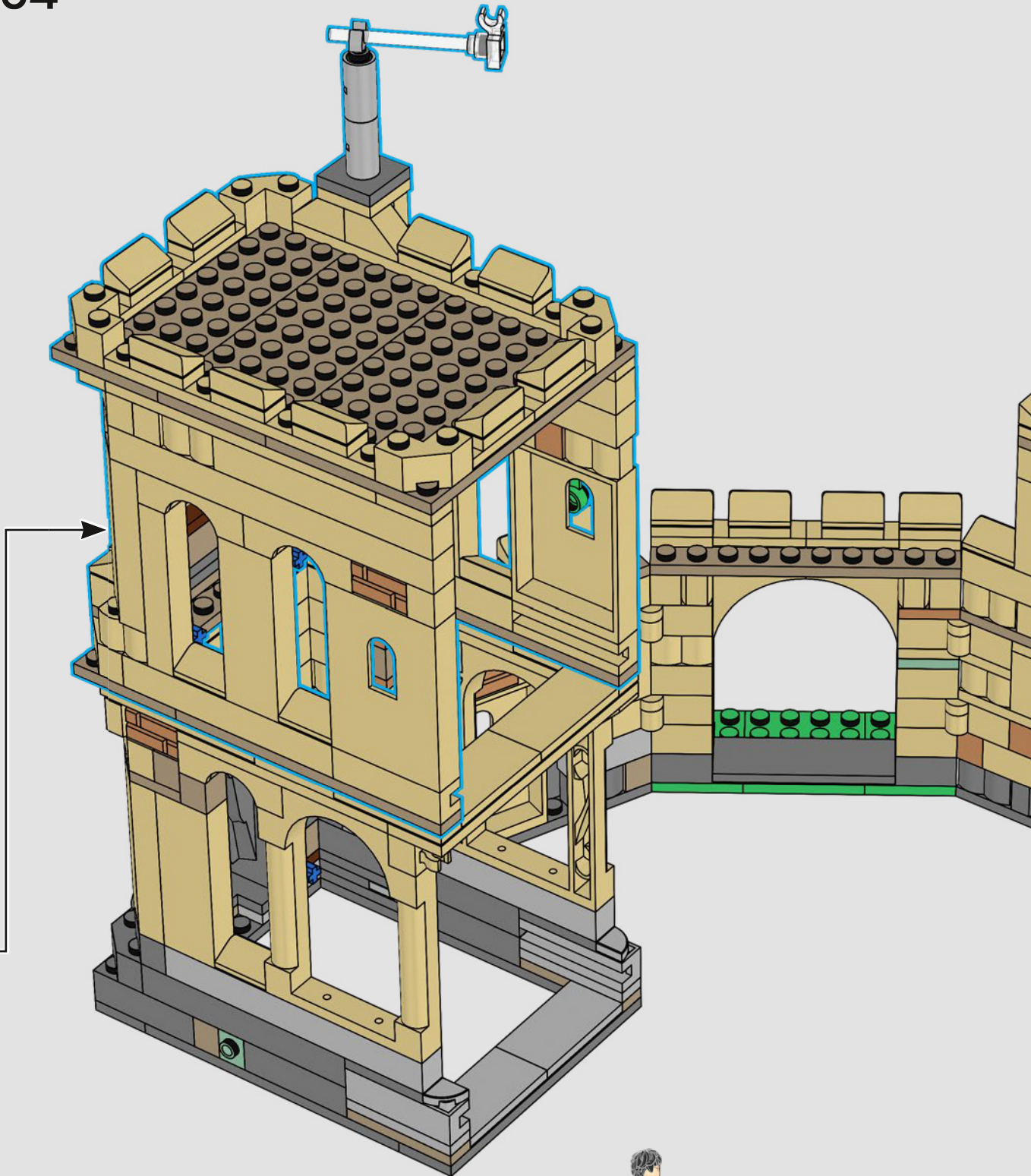



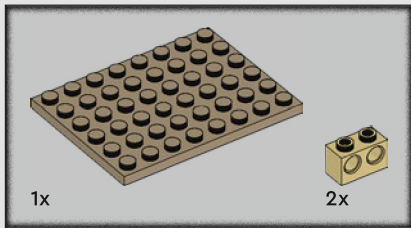
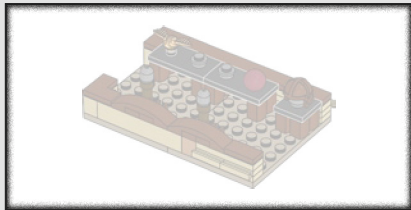

165

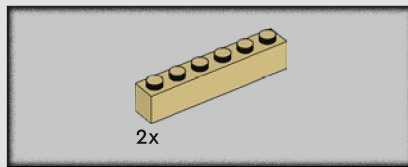
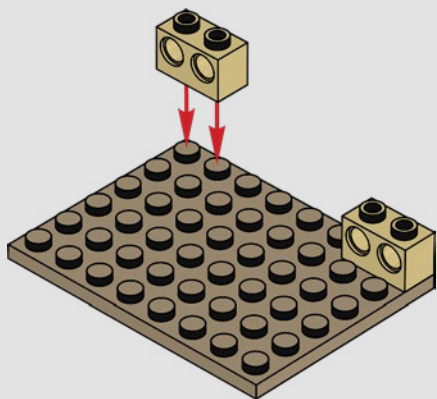

166

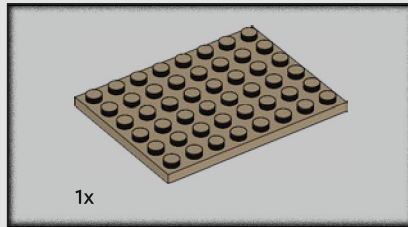
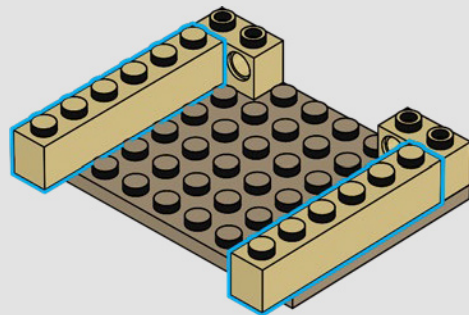

167

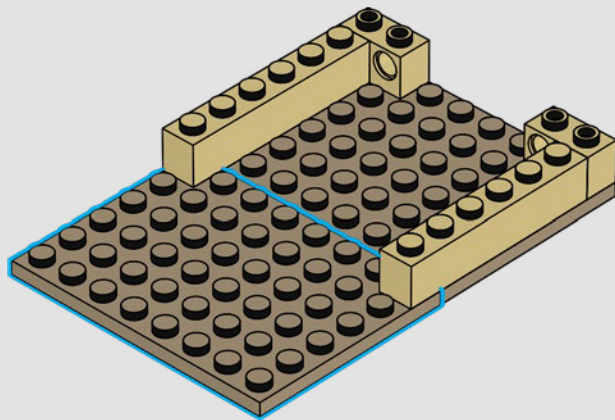





168

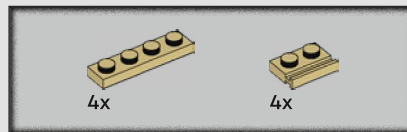

169

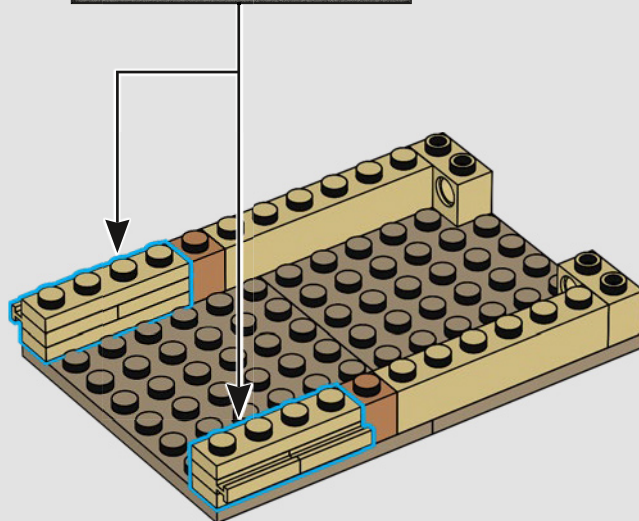
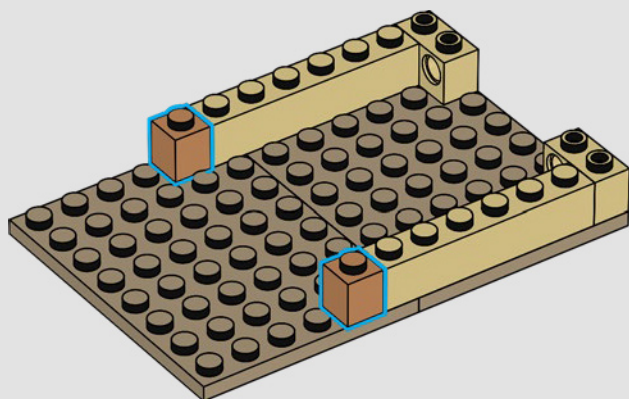
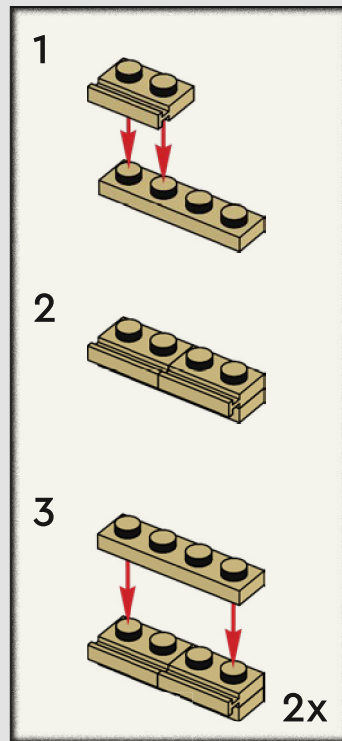

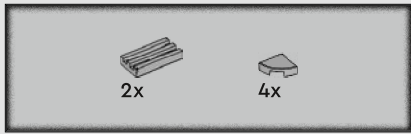

170

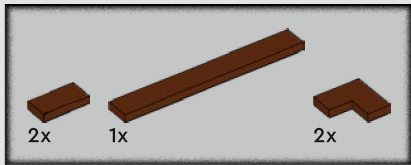
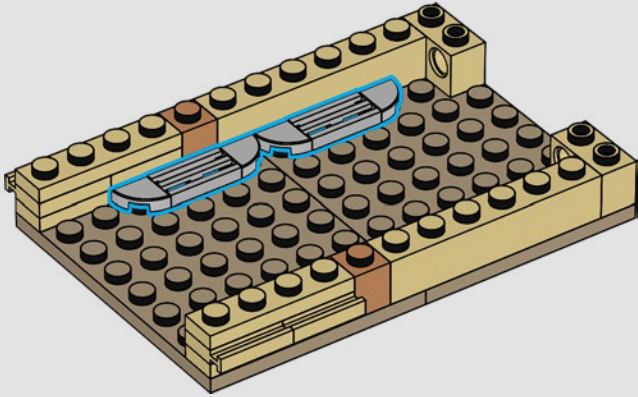

171

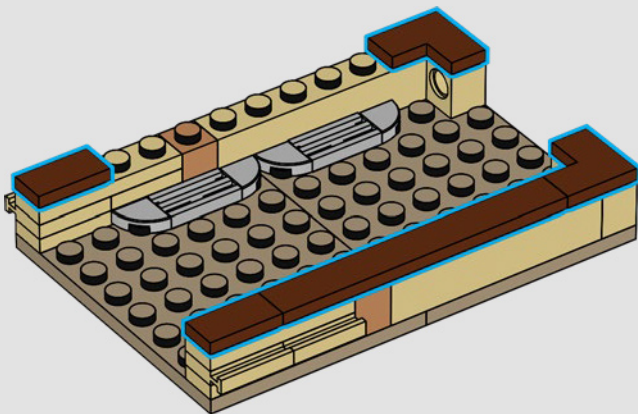

172

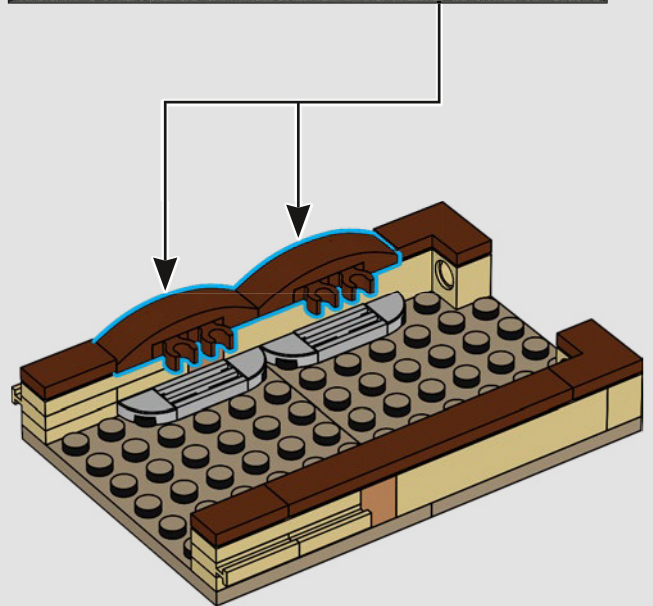
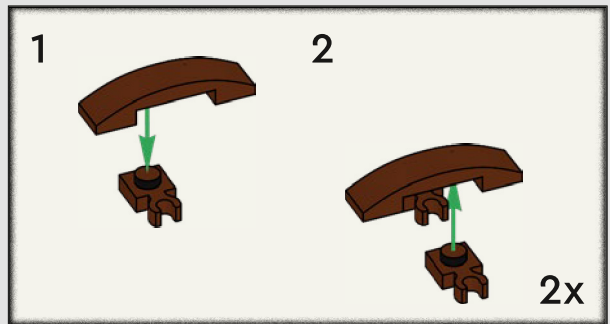

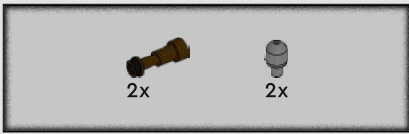

# 173

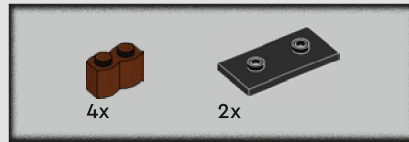
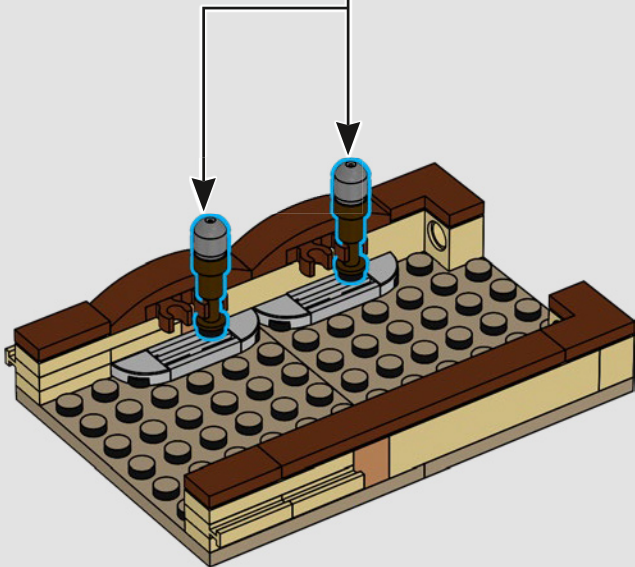
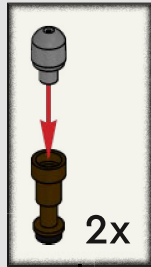

# 174

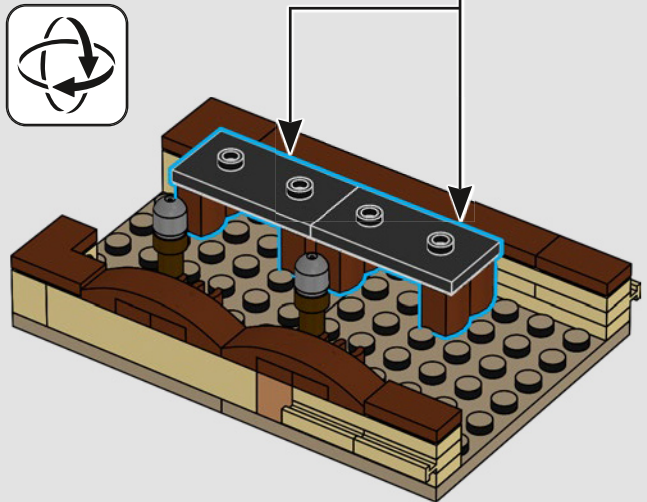
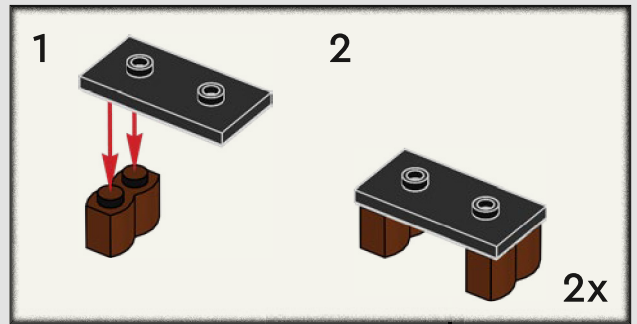



175

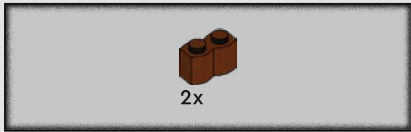
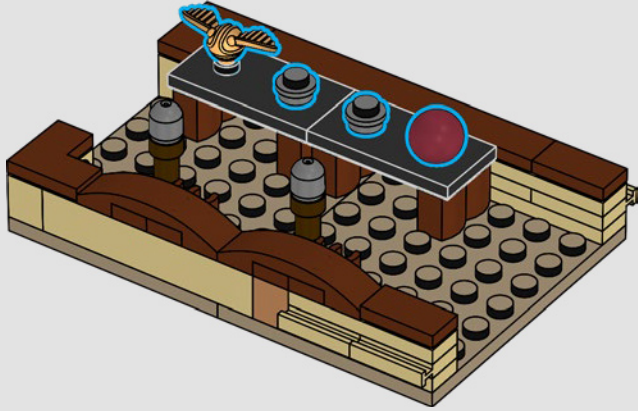

176

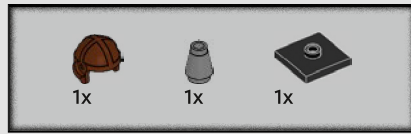
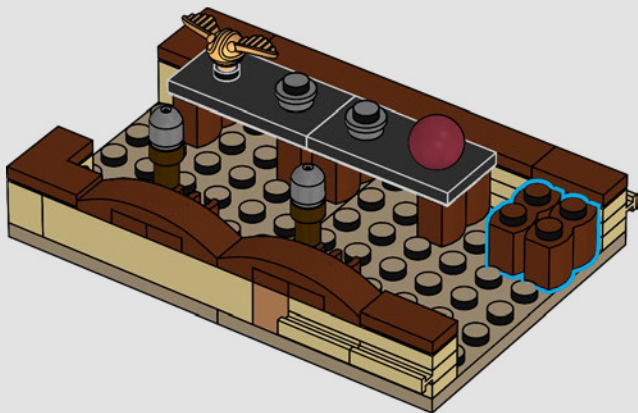

177

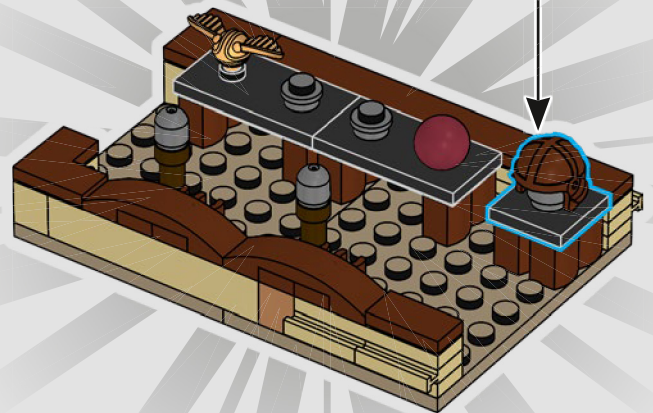
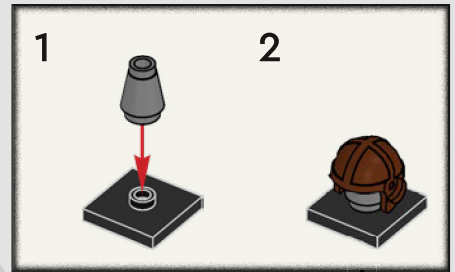



178

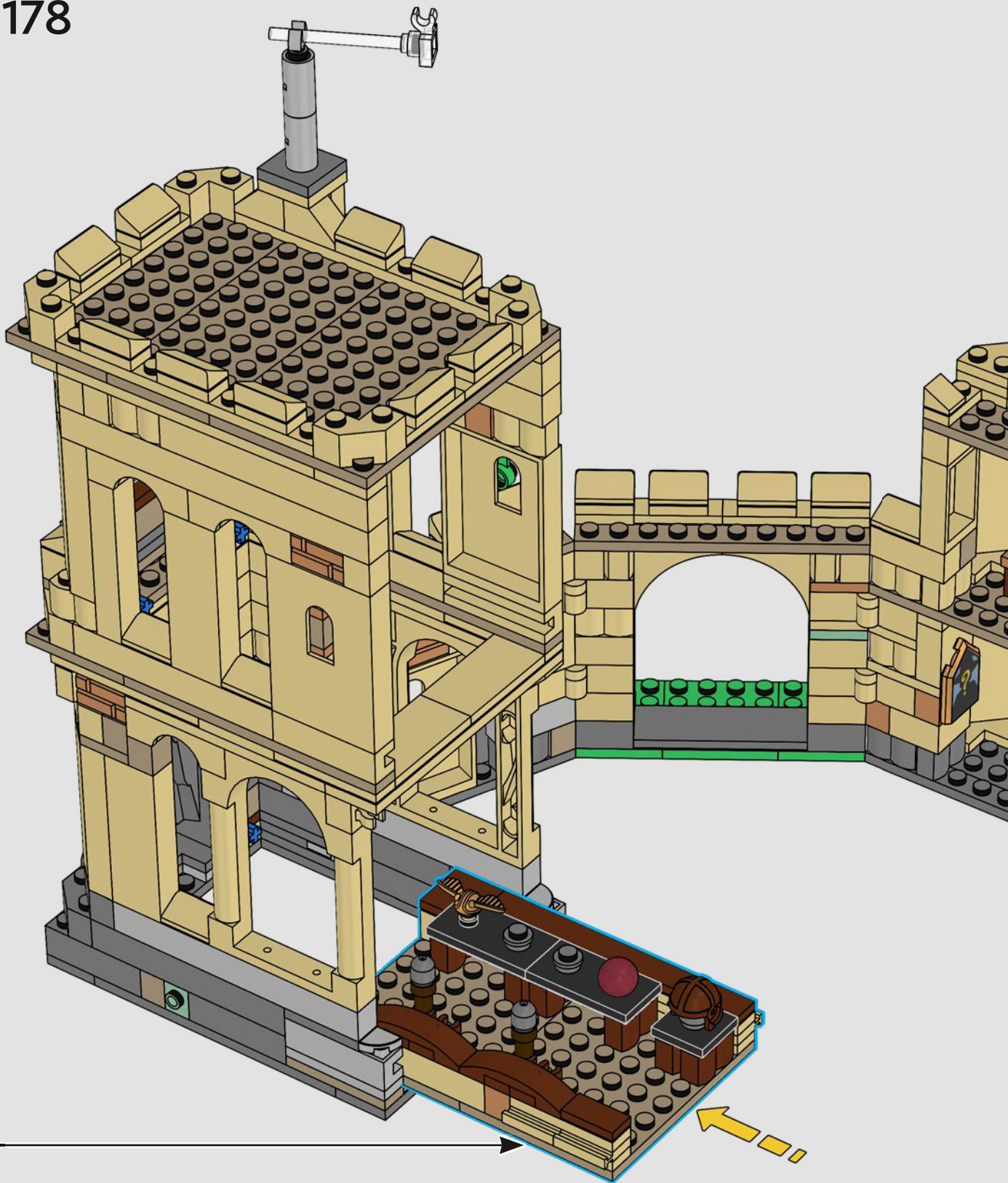

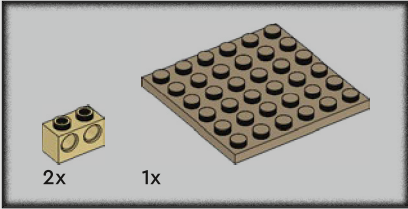
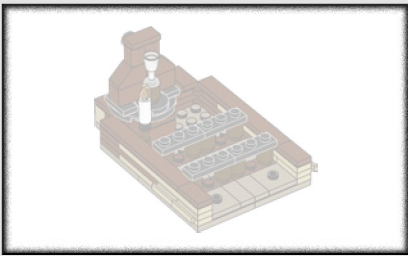

179

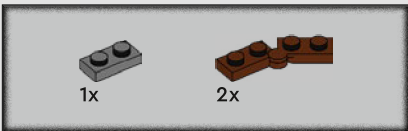
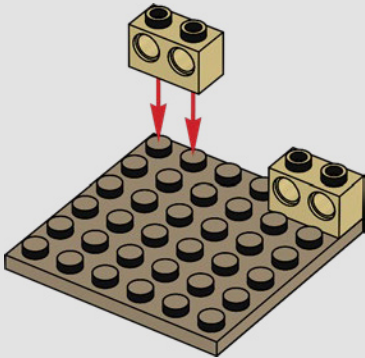

180

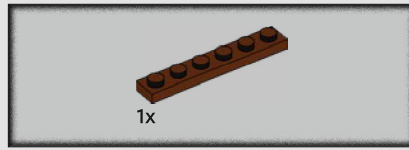
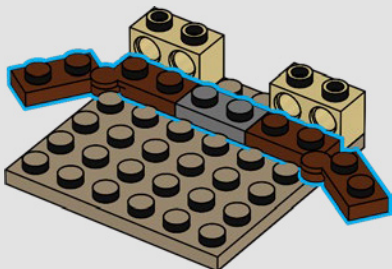

181

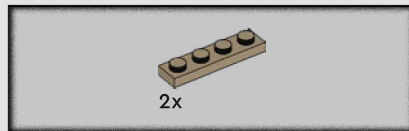
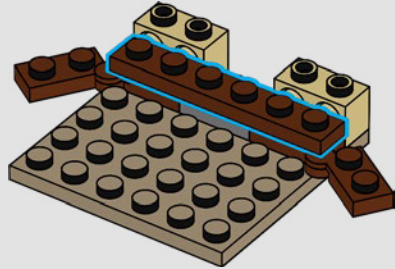

182

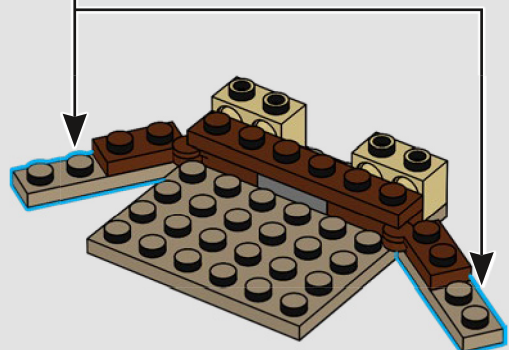
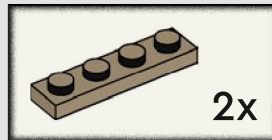

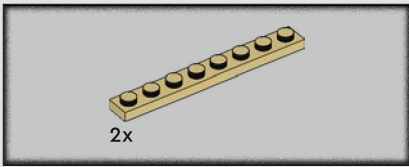

183

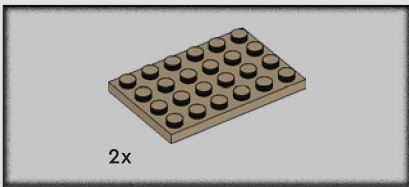
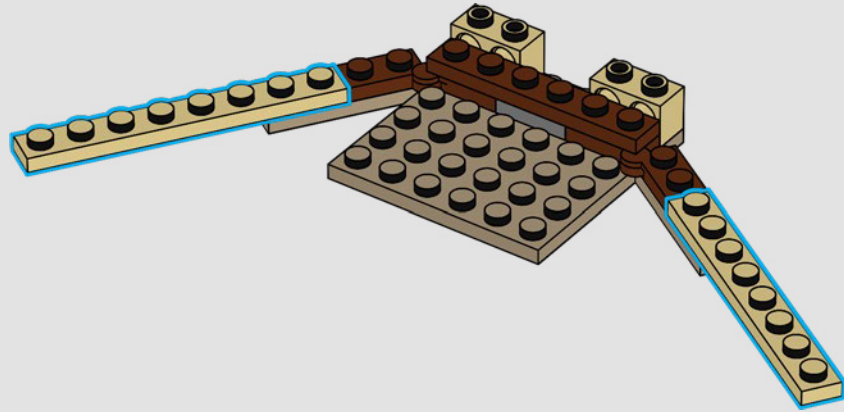

184

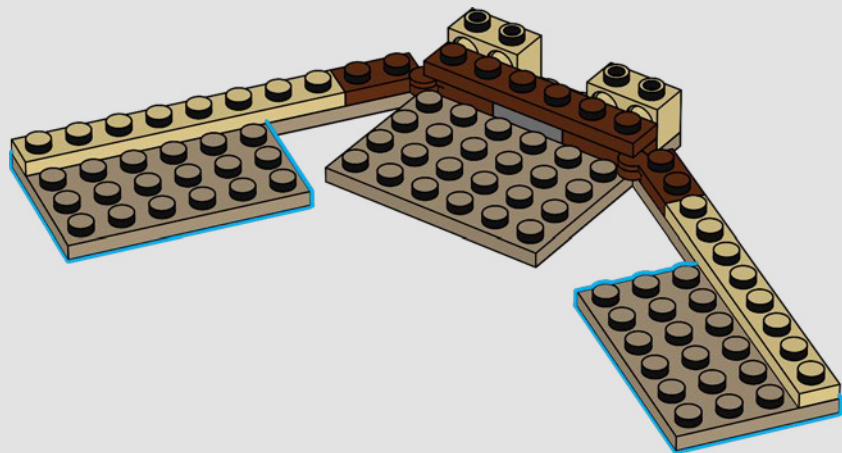



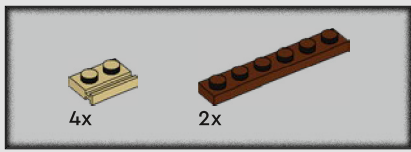

185

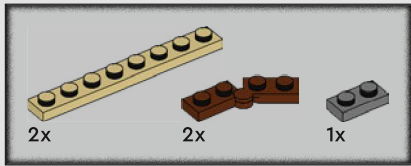
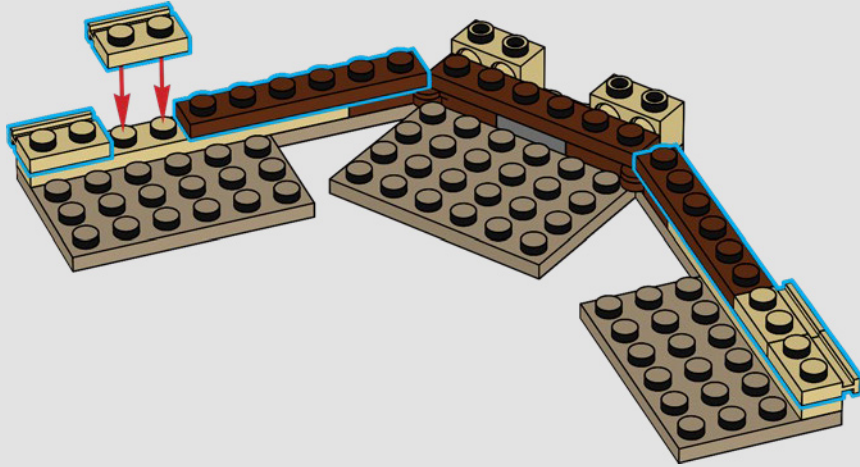

186

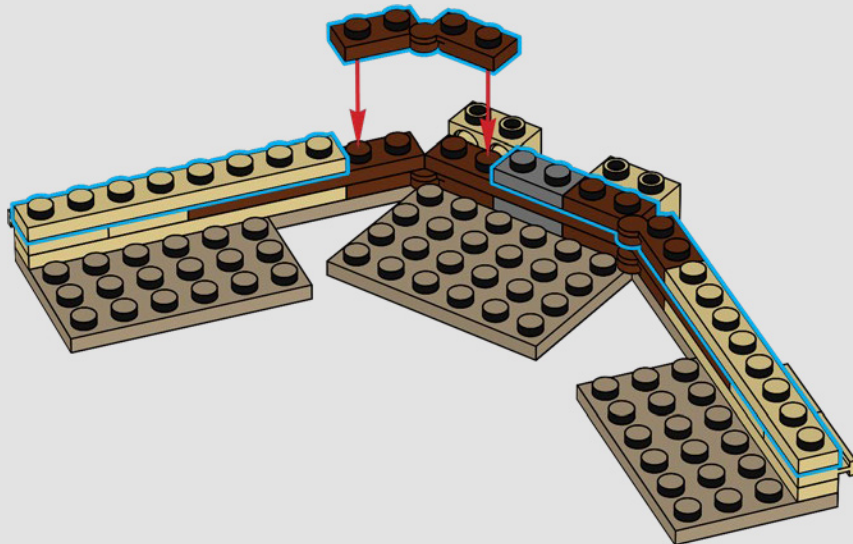



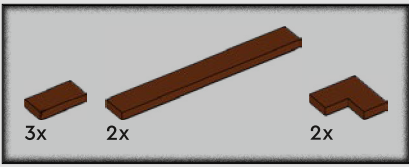

187

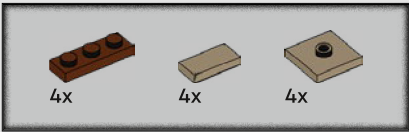
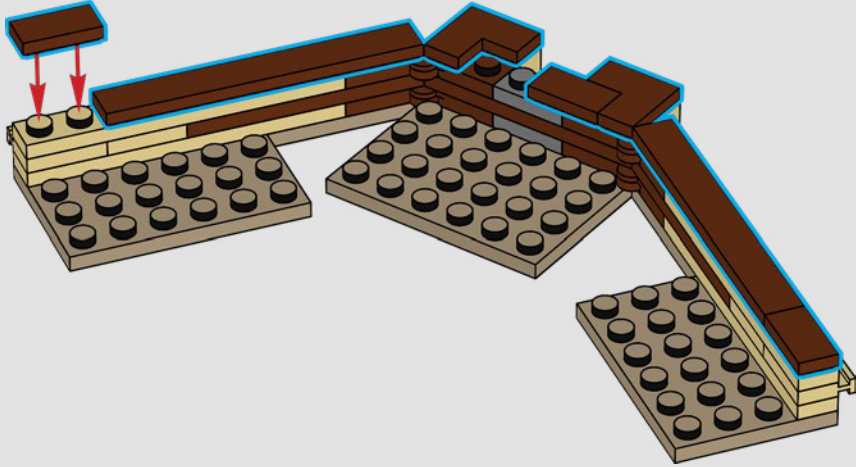

188

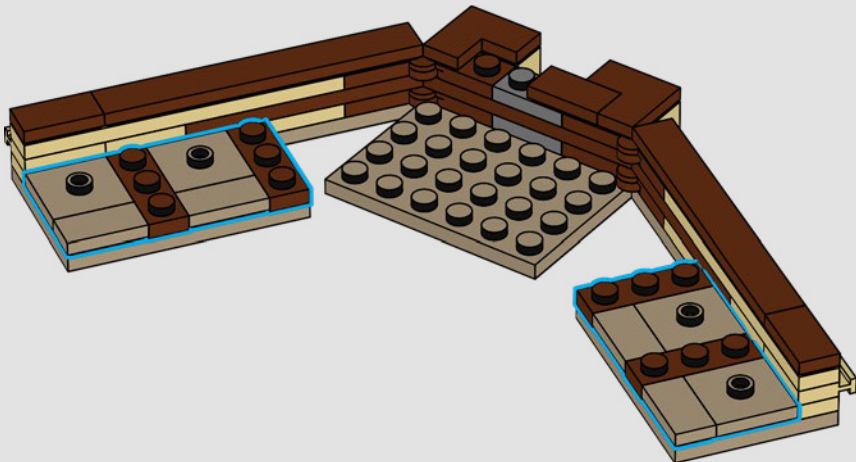



189

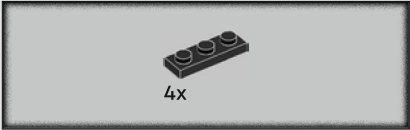
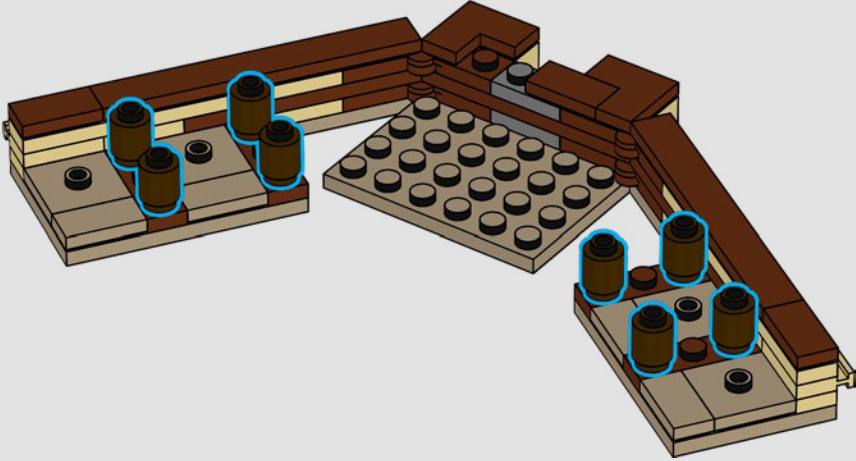

190

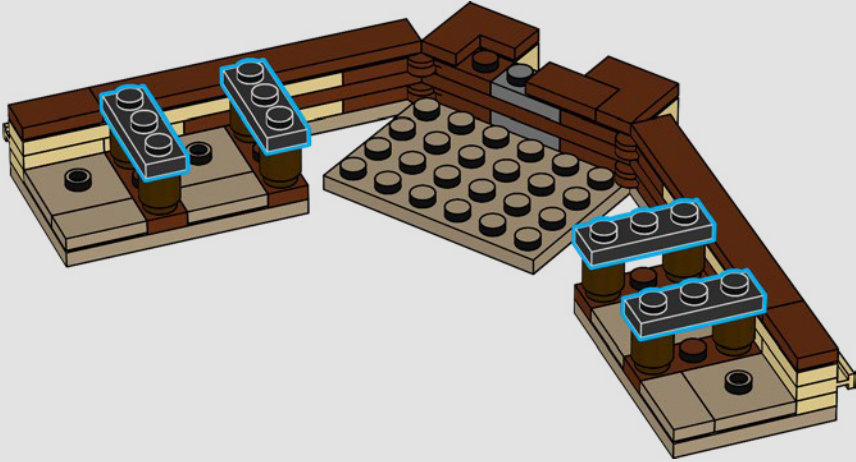

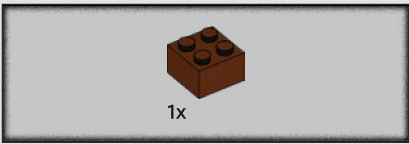

191

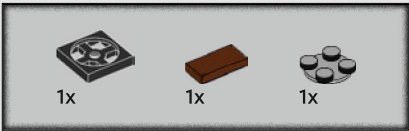
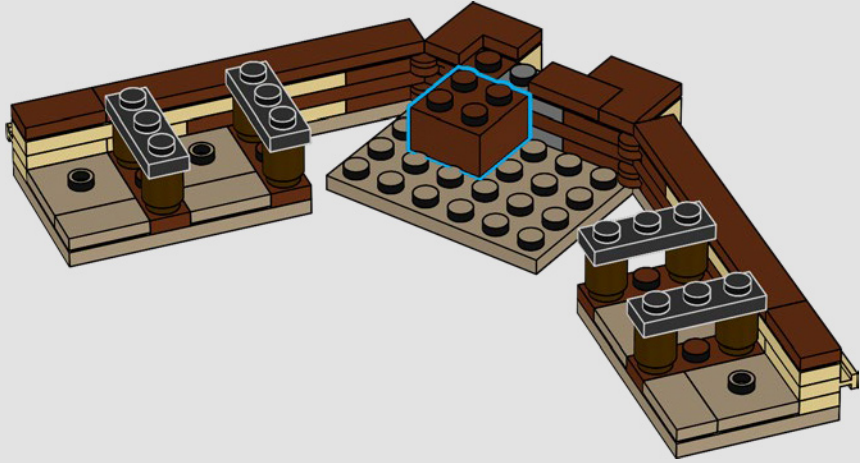

192

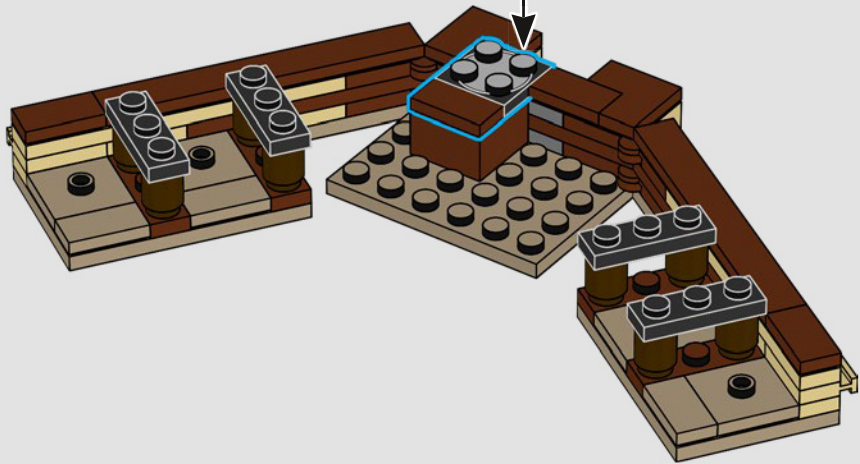
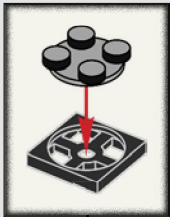

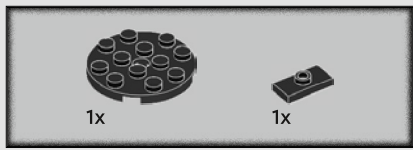

193

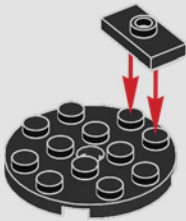

194

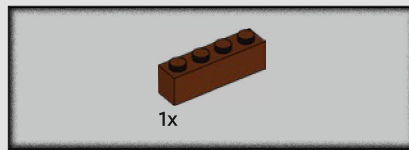
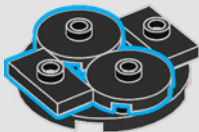

195

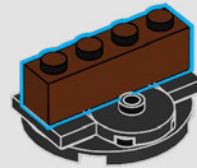

196

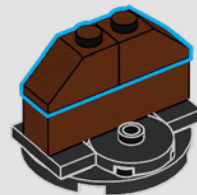



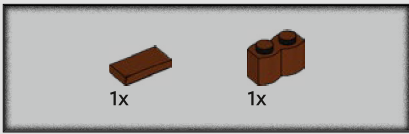

197

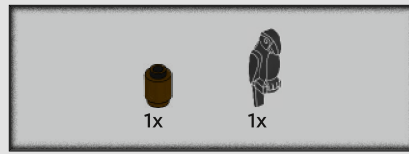
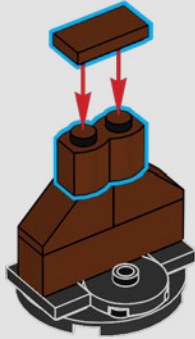

198

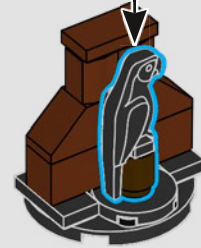
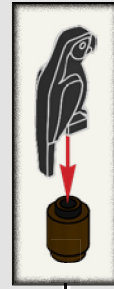

199



200

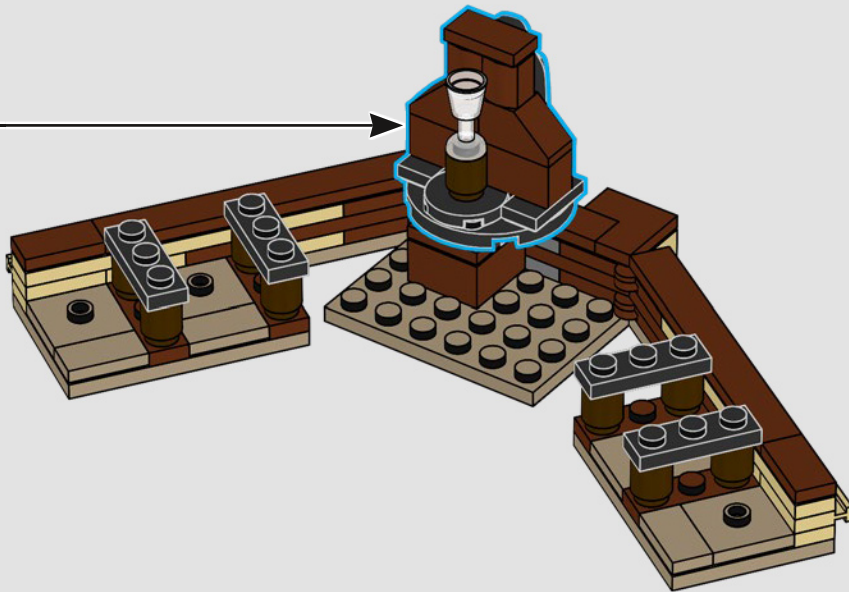

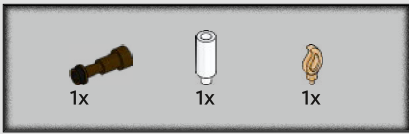

201

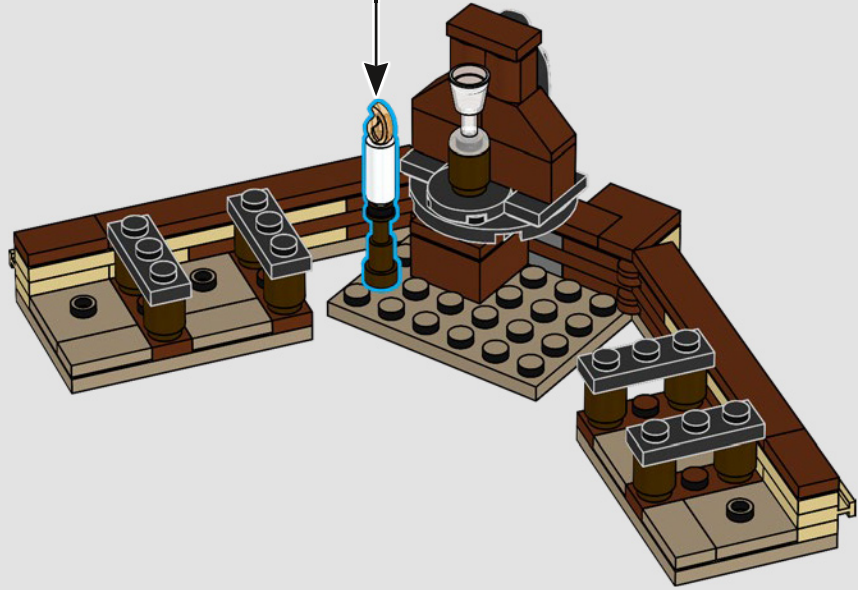
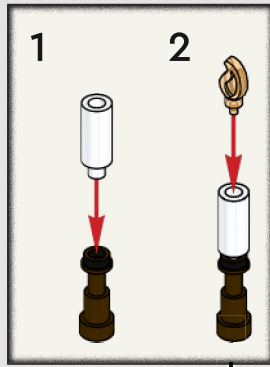

202

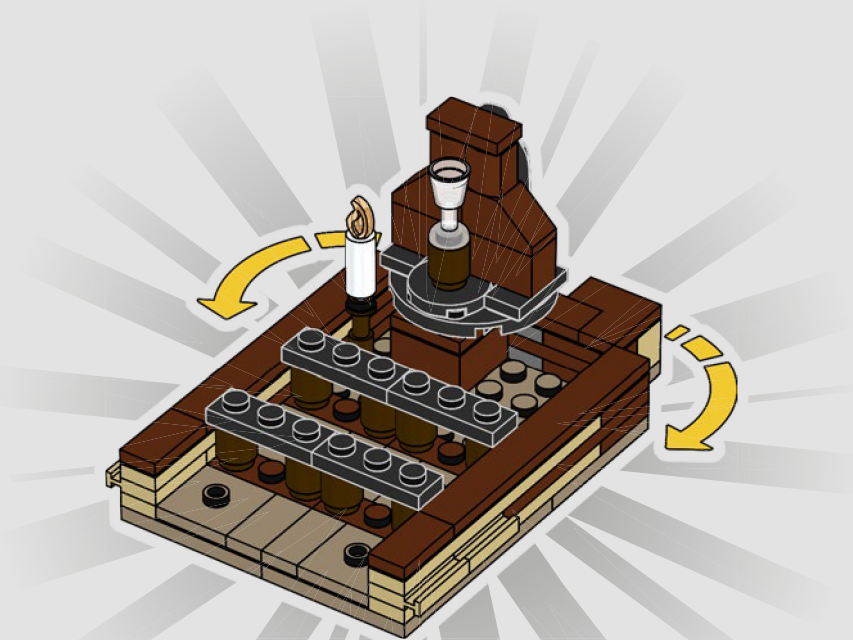

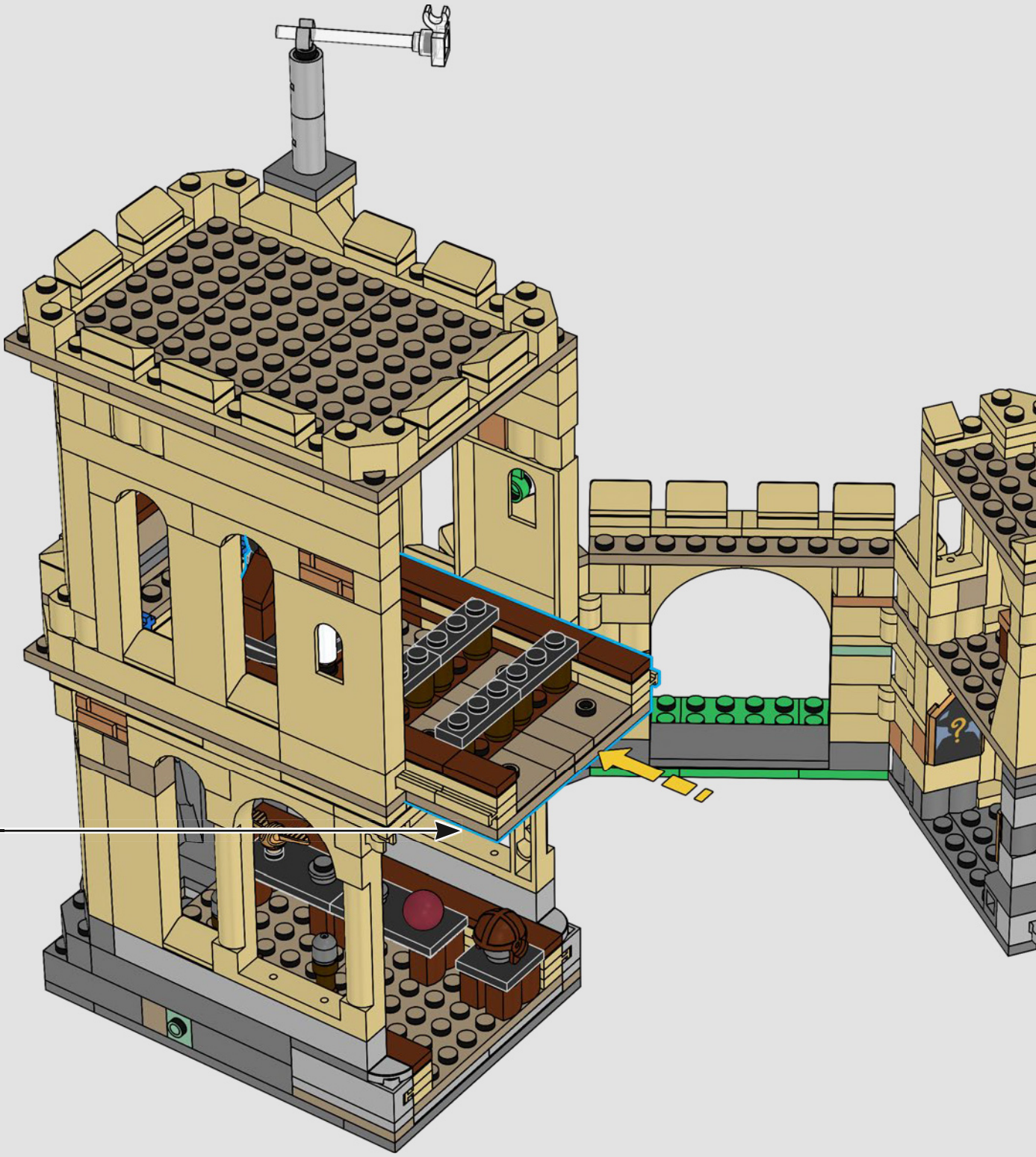



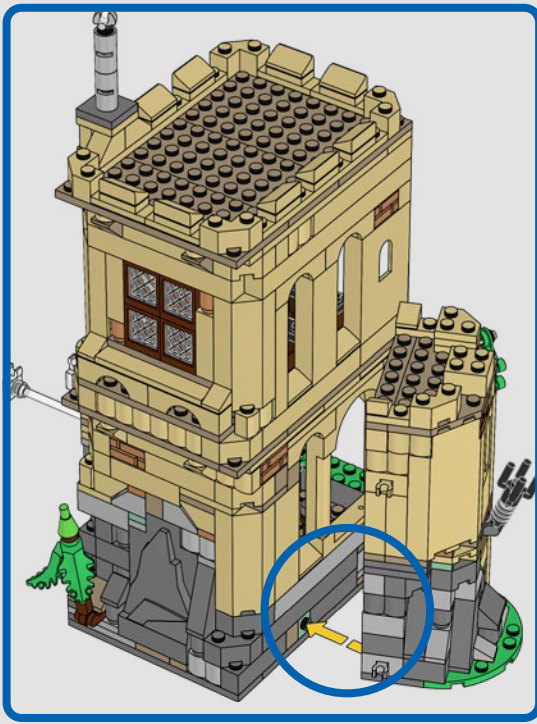











# Harry Potter



76435



Baue das detailreiche Schloss Hogwarts™ / Construisez le château de Poudlard le plus détaillé / Costruisci il Castello di Hogwarts™ più dettagliato di sempre / Construye el Castillo de Hogwarts™ más detallado / Construa o mais detalhado Castelo de Hogwarts™ / 拼搭精美的霍格沃茨™城堡 / Zbuduj najbardziej szczegółowy zamek Hogwart™ / Postavte si ten najdetailnejší Bradavický hrad / Postavte si najdetailnejší Rokfortský hrad / Építsd meg a legrészletgazdagabb Roxfort™ kastélyt / Construieste cel mai detaliat Castel Hogwarts™ / Постройте най-детальную версию на замька Хогвортс / Uzbūvē visdetailizētāko Čūkkārpas pili / Pane kokku kõige üksikasjalikum Sigatüüka™ loss / Sukonstruokite nepaprastai detalią Hogvartso pilį



# Build the most detailed HOGWARTS™ CASTLE



76447

76426

Each set sold separately and available for different periods of time / Jedes Set ist separat und in unterschiedlichen Zeiträumen erhältlich. / Chaque set est vendu séparément et sera disponible à des périodes différentes. / Ogni set è venduto separatamente ed è disponibile per periodi di tempo diversi. / Cada set se vende por separado y está disponible durante un cierto período de tiempo. / Os sets são vendidos separadamente e estão disponíveis por diferentes períodos de tempo. / 每款套装于不同时间段单独出售。 / Zestawy są sprzedawane osobno i są dostępne w różnym czasie / Každá stavebnice se prodává samostatně a je k dispozici v různých časových obdobích / Každá stavebnice sa predáva samostatne a je k dispozícii v rôznych časových obdobiach / Minden egyes készlet külön-külön és más-más időszokban kapható. / Seturile se vând separat și sunt disponibile pentru perioade diferite de timp / Всеки комплект се продава отделно и е наличен за различен период от време. / Katrs komplekts tiek pārdots atsevišķi, un to pieejamības periodi atšķiras. / Kõik komplektid on müügil eraldi ja saadaval erinevates ajavahemikes. / Kiekvienas rinkinys parduodamas atskirai ir tik ribotą laiką



# Harry Potter



76442



Baue das detailreiche Schloss Hogwarts™ / Construisez le château de Poudlard le plus détaillé / Costruisci il Castello di Hogwarts™ più dettagliato di sempre / Construye el Castillo de Hogwarts™ más detallado / Construa o mais detalhado Castelo de Hogwarts™ / 拼搭精美的霍格沃茨™城堡 / Zbuduj najbardziej szczegółowy zamek Hogwart™ / Postavte si ten najdetailnejší Bradavický hrad / Postavte si najdetailnejší Rokfortský hrad / Építsd meg a legrészletgazdagabb Roxfort™ kastélyt! / Construieste cel mai detaliat Castel Hogwarts™ / Постройте най-детайлната версия на замъка Хогвортс / Uzbüv visdetalizetäko Cükkärpas pili / Pane kokku kõige üksikasjalikum Sigatüüka™ loss / Sukonstruokite nepaprastai detalią Hogvartso pilį



# Build the most detailed HOGWARTS™ CASTLE



76435

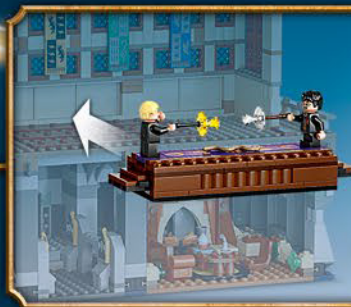

76441



76431

Each set sold separately and available for different periods of time / Jedes Set ist separat und in unterschiedlichen Zeiträumen erhältlich. / Chaque set est vendu séparément et sera disponible à des périodes différentes. / Ogni set è venduto separatamente ed è disponibile per periodi di tempo diversi. / Cada set se vende por separado y está disponible durante un cierto período de tiempo. / Os sets são vendidos separadamente e estão disponíveis por diferentes períodos de tempo. / 每款套装于不同时间段单独出售。 / Zestawy są sprzedawane osobno i są dostępne w różnym czasie / Každá stavebnice se prodává samostatně a je k dispozici v různých časových obdobích / Každá stavebnica sa predáva samostatne a je k dispozícii v rôznych časových obdobiach / Minden egyes készlet külön-külön és más-más időszakban kapható. / Seturile se vând separat și sunt disponibile pentru perioade diferite de timp / Всеки комплект се продава отделно и е наличен за различен период от време. / Katrs komplekts tiek pārdots atsevišķi, un to pieejamības periodi atšķiras. / Kõik komplektid on müügil eraldi ja saadaval erinevates ajavahemikes. / Kiekvienas rinkinys parduodamas atskirai ir tik ribotą laiką

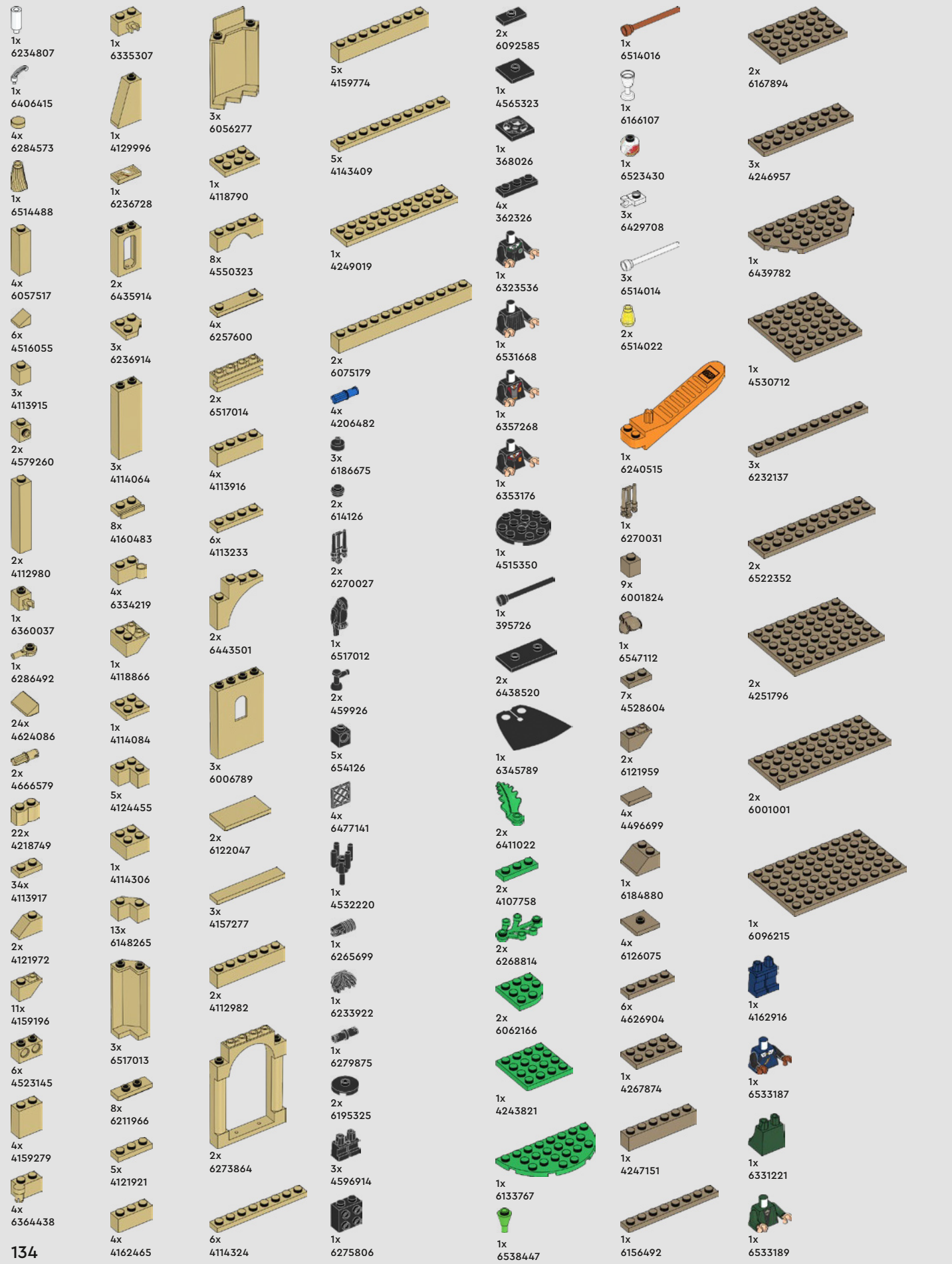

1x 6234807  
 1x 6406415  
 4x 6284573  
 1x 6514488  
 4x 6057517  
 6x 4516055  
 3x 4113915  
 2x 4579260  
 2x 4112980  
 1x 6360037  
 1x 6286492  
 24x 4624086  
 2x 4666579  
 22x 4218749  
 34x 4113917  
 2x 4121972  
 11x 4159196  
 6x 4523145  
 4x 4159279  
 4x 6364438

1x 6335307  
 1x 4129996  
 1x 6236728  
 2x 6435914  
 3x 6236914  
 3x 4114064  
 8x 4160483  
 4x 6334219  
 1x 4118866  
 1x 4114084  
 5x 4124455  
 1x 4114306  
 13x 6148265  
 3x 6517013  
 8x 6211966  
 5x 4121921  
 4x 4162465

3x 6056277  
 1x 4118790  
 8x 4550323  
 4x 6257600  
 2x 6517014  
 4x 4113916  
 6x 4113233  
 2x 6443501  
 3x 6006789  
 2x 6122047  
 3x 4157277  
 2x 4112982  
 2x 6273864  
 6x 4114324

5x 4159774  
 5x 4143409  
 1x 4249019  
 2x 6075179  
 4x 4206482  
 3x 6186675  
 2x 614126  
 2x 6270027  
 1x 6517012  
 2x 459926  
 5x 654126  
 4x 6477141  
 1x 4532220  
 1x 6265699  
 1x 6233922  
 1x 6279875  
 2x 6195325  
 3x 4596914  
 1x 6275806

2x 6092585  
 1x 4565323  
 1x 368026  
 4x 362326  
 1x 6531668  
 1x 6357268  
 1x 6353176  
 1x 4515350  
 1x 395726  
 2x 6438520  
 1x 6345789  
 2x 6411022  
 2x 4107758  
 2x 6268814  
 2x 6062166  
 1x 4243821  
 1x 6133767  
 1x 6538447

1x 6514016  
 1x 6166107  
 1x 6523430  
 3x 6429708  
 3x 6514014  
 2x 6514022  
 1x 6240515  
 1x 6270031  
 9x 6001824  
 1x 6547112  
 7x 4528604  
 2x 6121959  
 4x 4496699  
 1x 6184880  
 4x 6126075  
 6x 4626904  
 1x 4267874  
 1x 4247151  
 1x 6156492

2x 6167894  
 3x 4246957  
 1x 6439782  
 1x 4530712  
 3x 6232137  
 2x 6523352  
 2x 4251796  
 2x 6001001  
 1x 6096215  
 1x 4162916  
 1x 6533187  
 1x 6331221  
 1x 6533189



3x 6099189  
1x 6009656  
3x 4655080  
1x 6282619  
1x 6451151  
1x 6514274  
1x 6341968  
1x 6227107  
1x 4507049  
4x 6337003  
9x 4211180  
4x 6382102  
7x 4211151  
2x 4211199  
4x 6221608  
1x 4211210  
1x 6102975  
1x 6532241  
4x 4211152  
2x 4658005  
1x 4211225

4x 6416695  
3x 4221590  
2x 4538252  
3x 4585337  
2x 4211525  
1x 6439041  
1x 6454730  
2x 4211415  
8x 6176433  
3x 4211399  
1x 6061702  
5x 4521921  
2x 4211389  
1x 6533186  
1x 4540203  
3x 4550325  
2x 6173127  
6x 4211614  
1x 4211398  
1x 6320297  
1x 6015344  
2x 4211350  
1x 6266841

1x 6435857  
3x 4211428  
1x 6435437  
2x 4211396  
2x 4211445  
2x 4211613  
1x 6416524  
2x 4560183  
2x 4211521  
1x 6228091  
2x 6344216  
6x 4211090  
2x 4210633  
1x 4529240  
1x 6395635  
1x 4211044  
7x 4211095  
2x 6310174  
4x 4221745  
1x 4211088  
1x 6069164

1x 4210978  
1x 6342558  
2x 4211063  
1x 6313189  
3x 4211060  
2x 4211054  
6x 4624186  
4x 4211133  
4x 4211103  
1x 6416526  
1x 4513326  
2x 4211056  
1x 6321746  
2x 4210998  
2x 4211099  
1x 4210997  
3x 4257526

3x 4210678  
1x 6174125  
1x 6236027  
1x 6523427  
1x 6192037  
1x 6478295  
1x 6329308  
1x 6233910  
1x 6003147  
2x 4529247  
1x 6186672  
1x 6342678  
2x 6478297  
10x 6022105  
3x 6270032  
2x 6514487  
1x 6194729  
1x 4535553

3x 4519970  
1x 4529672  
1x 4566688  
3x 4538950  
2x 6300103  
1x 6314190  
8x 6215606  
3x 6057986  
6x 4656783  
1x 6218360  
1x 6411587  
2x 6056383  
1x 6093494  
1x 4611883



YOU COULD

WIN

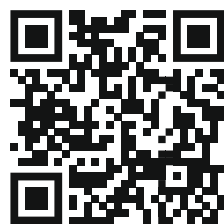

Scan this QR code or go to **LEGO.COM/PRODUCTFEEDBACK** and give us your short feedback about this LEGO® set for a chance to win a cool LEGO prize.

Terms and Conditions apply\*

**EN: YOU COULD WIN.** Terms and Conditions apply\* **DE: Du könntest GEWINNEN.** Es gelten die Teilnahmebedingungen\* **FR: Tu pourrais GAGNER.** Des conditions s'appliquent\* **IT: Potresti VINCERE tu.** Termini e condizioni sono applicabili\* **ES: Puedes GANAR.** Aplican términos y condiciones\* **PT: Poderá GANHAR.** Aplicam-se termos e condições\* **ZH: 轻松获奖. 条款和条件适用\*** **PL: Szansa na WYGRANĄ.** Obowiązują warunki korzystania\* **CS: Máte šanci VYHRÁT.** Platí všeobecné smluvní podmínky\* **SK: Máte šancu VYHRAŤ.** Platia všeobecné zmluvné podmienky\* **HU: TE IS NYERHETSZ.** Felhasználási feltételek érvényesek\* **RO: Ai putea CÂȘTIGA.** Se aplică termenii și condiții\* **BG: Можете да СПЕЧЕЛИТЕ.** Има определени правила и условия\* **LV: Tu vari LAIMĒT.** Ir spēkā noteikumi un nosacījumi.\* **ET: Sul on võimalus VÕITA.** Kehtivad tingimused\* **LT: Jūs galite LAIMĖTI.** Taikomos sąlygos\*

\*[LEGO.com/productfeedback-terms](https://www.lego.com/productfeedback-terms)