



Friends

42646







LEGO® Builder



LEGO.com/sustainable-packaging



 **FR**
DONNEZ
OU
RECYCLEZ

 OU  OU 

ASSOCIATION MAGASIN DÉCHÈTERIE

Adresses sur quefairedemesdechets.fr

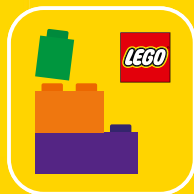

LEGO® Builder

BUILDER



Apple and the Apple logo are trademarks of Apple Inc., registered in the U.S. and other countries and regions. App Store is a service mark of Apple Inc. Google Play and the Google Play logo are trademarks of Google LLC. Tencent and the Tencent logo are trademarks of Tencent Inc.

LEGO.com/devicecheck

EN Ask parents' permission before going online | **DE** Eltern um Erlaubnis bitten, bevor du online gehst | **FR** Demande l'autorisation d'un parent avant d'aller en ligne | **IT** Chiedi il permesso ai tuoi genitori prima di andare online | **ES** Pídeles permiso a tus papás antes de conectarte a Internet | **PT** Pede autorização aos pais antes de acederes online | **ZH** 上网前应先征得父母的同意 | **PL** Poproś rodziców o zgodę, zanim wejdiesz do Internetu | **CS** Než půjdeš na internet, požádej rodiče o svolení | **SK** Skôr než pôjdeš na internet, vypýtaj si povolenie od rodičov | **HU** Kérj szülői engedélyt, mielőtt online csatlakoznál! | **RO** Cere permisiunea părinților înainte de a te conecta online | **BG** Поискайте разрешение от родител, преди да влезете онлайн | **LV** Pirms došanās tiešsaistē palūdz atļauju vecākiem | **ET** Enne Interneti kasutamist küsi vanematelt luba | **LT** Prieš prisijungdami prie interneto, atsiklauskite tėvų



**BUILD IT
YOUR
WAY**

EN Build It Your Way | **DE** Bau, wie du willst | **FR** Construisez à votre façon | **IT** Costruiscilo come vuoi tu
| **ES** Constrúyelo a tu manera | **PT** Constrói à Tua Maneira | **ZH** 自由拼搭 | **PL** Zbuduj po swojemu | **CS**
Postavte to po svém | **SK** Postavte to po svojom | **HU** Építs kedved szerint! | **RO** Construięște așa cum dorești
| **BG** Постройте го по своя начин | **LV** Būvē tieši tā, kā vēlies | **ET** Ehita enda moodi | **LT** Sukonstruokite savaip



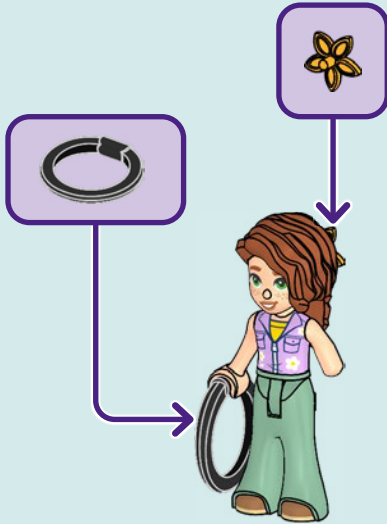
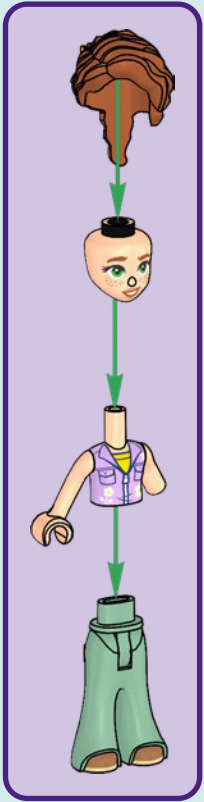

AUTUMN





1x



1x

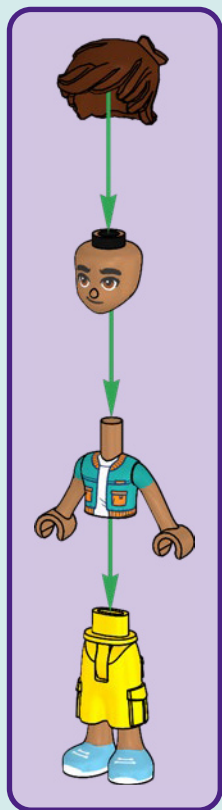

LEO





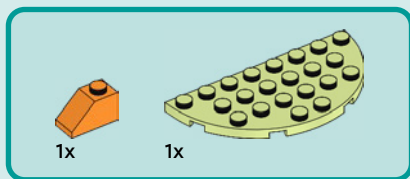

1

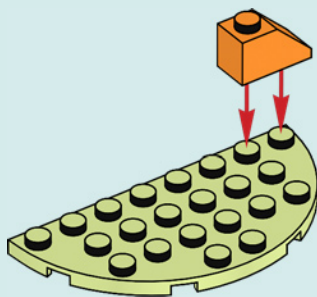



1x



1x

2

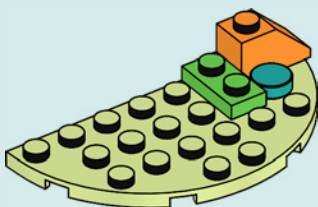

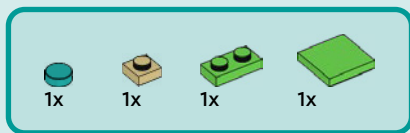

3

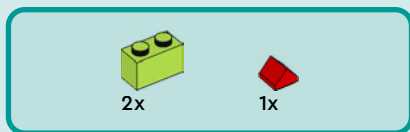
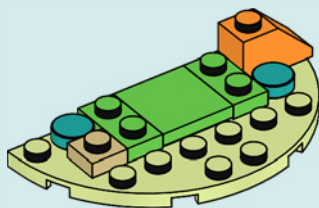

4

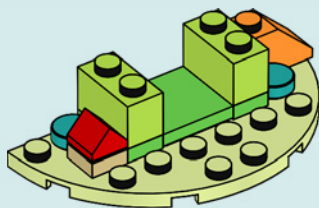



2x

5

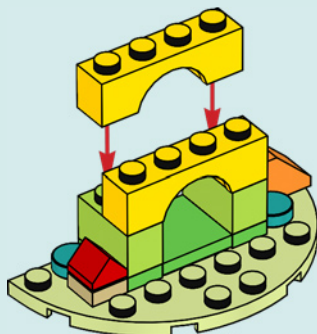



1x

6

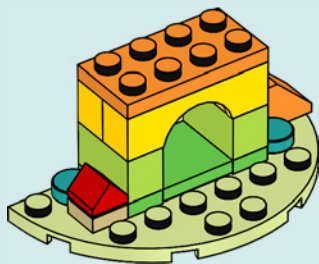

1x



2x

7

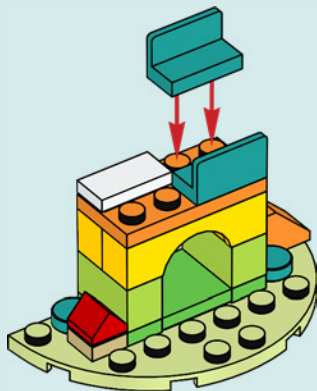



1x



1x

8

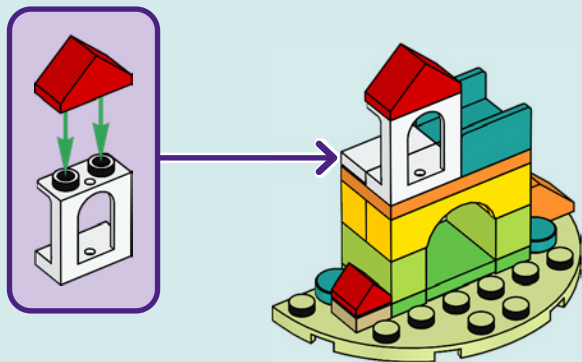



1x



1x

9

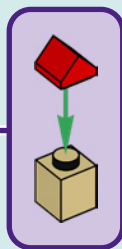
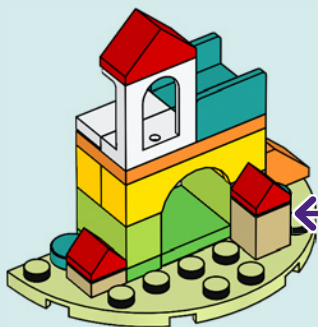



1x



1x

10

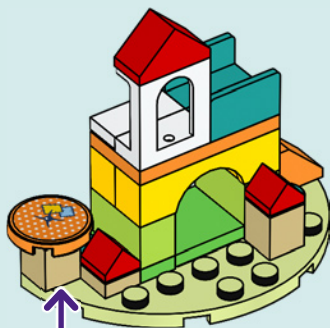

1

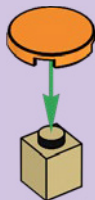

2





1x



1x



1x

11



1



2





1x

12

BANDIT



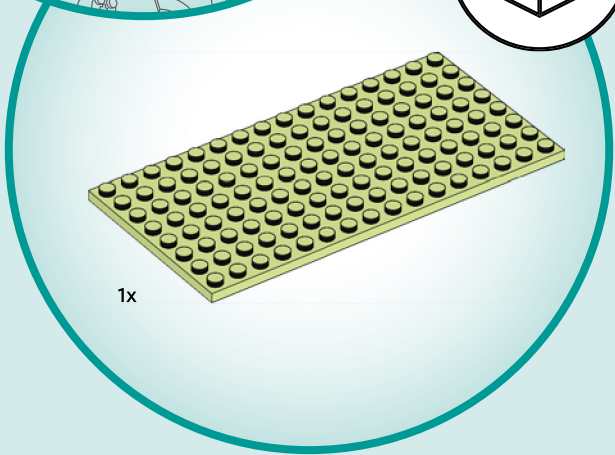
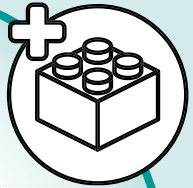
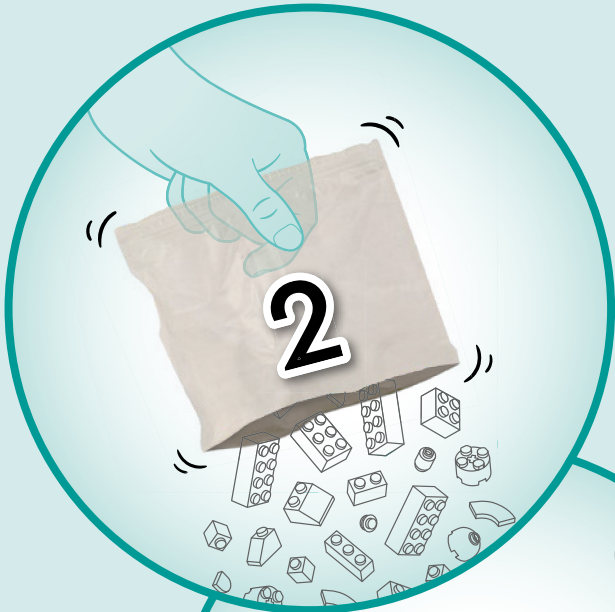

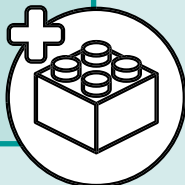
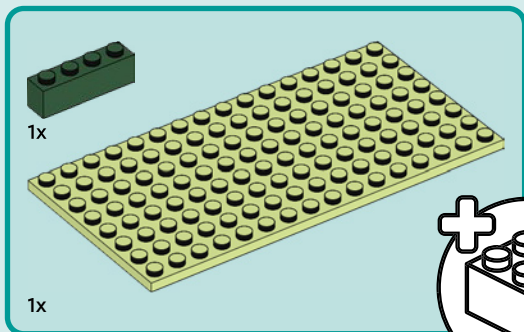

13

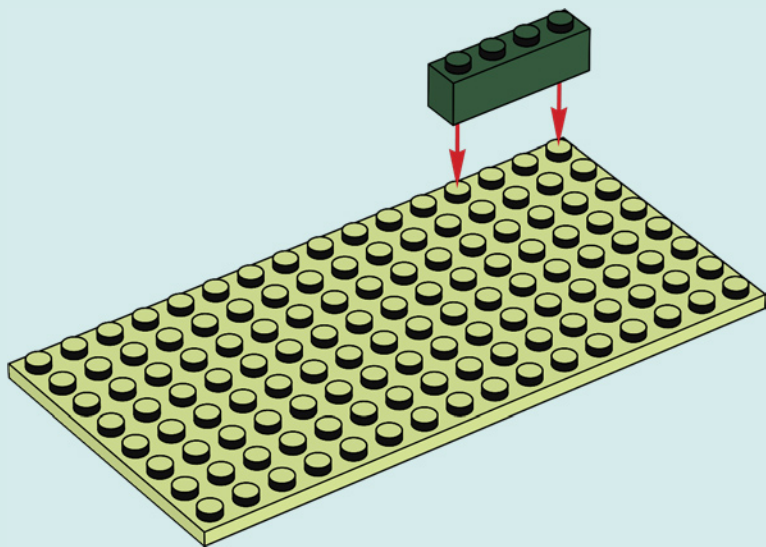

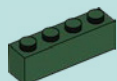

3x

14

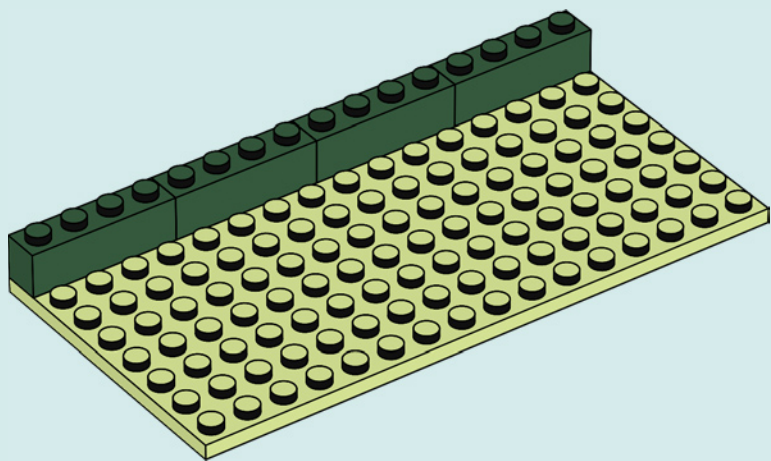

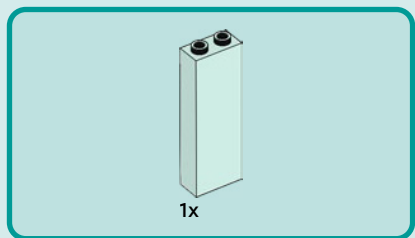

15

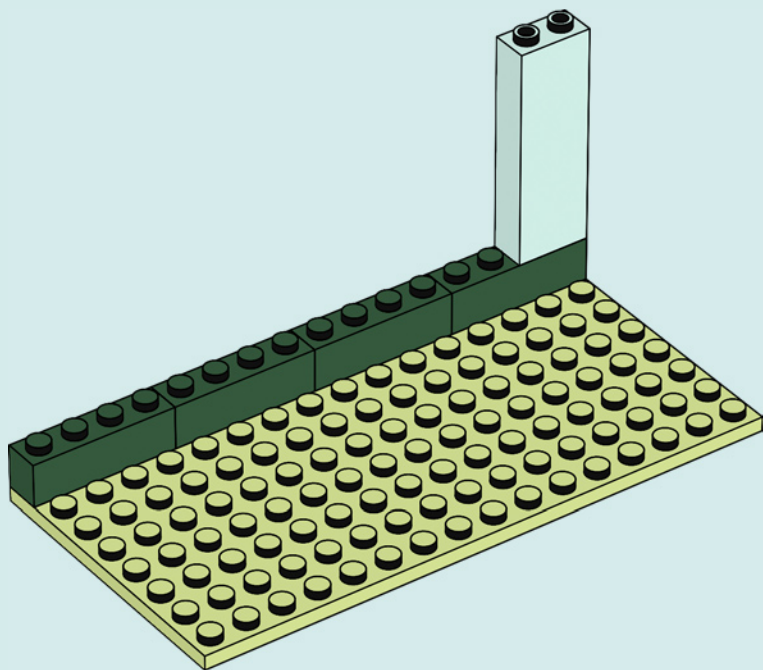

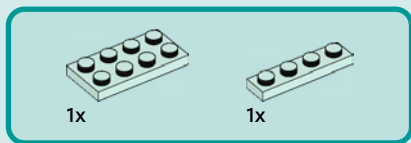

16

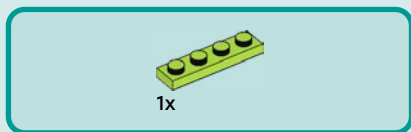
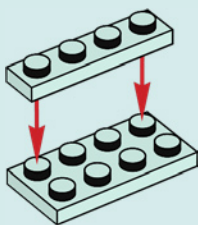

17

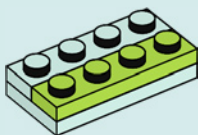

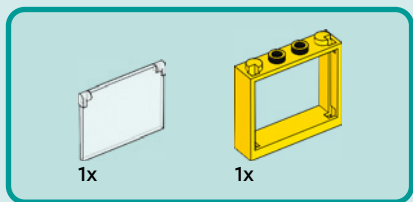

18

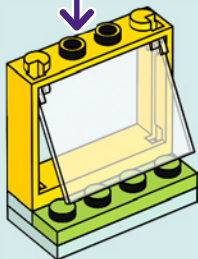
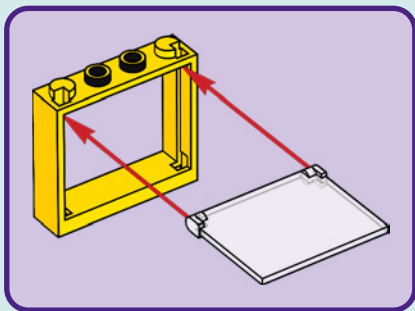



1x



1x

19

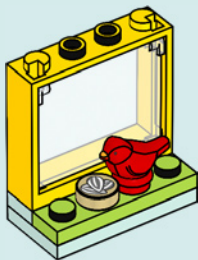



1x



1x

20

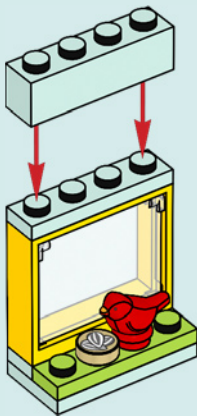

21

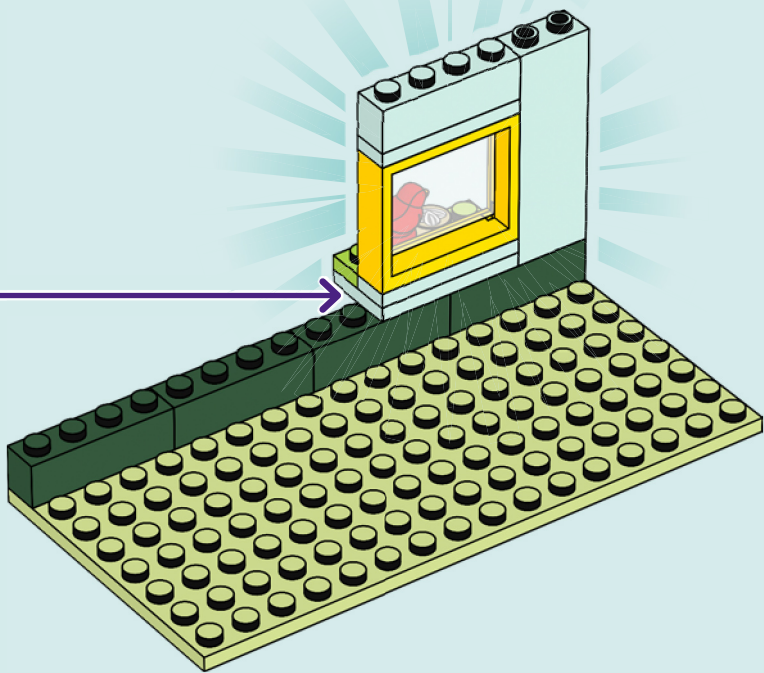

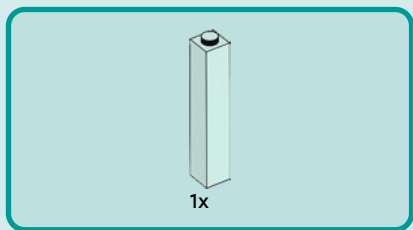

22

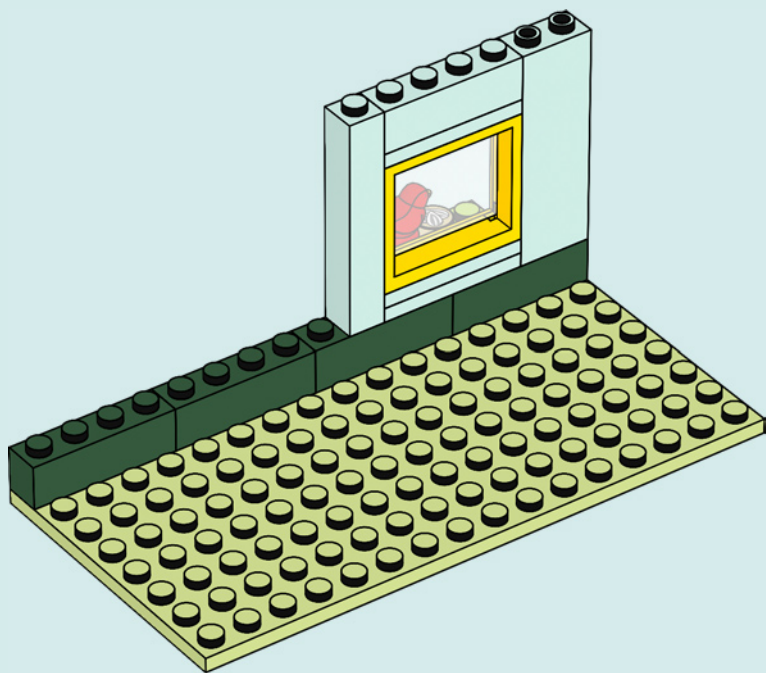

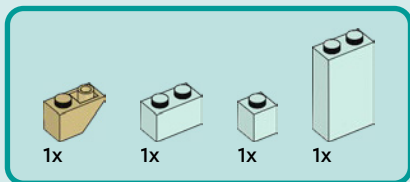
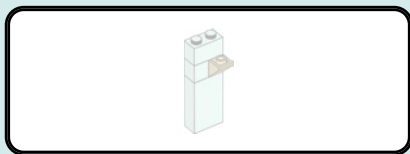

23

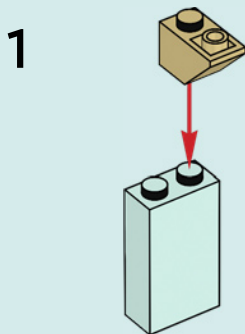

2

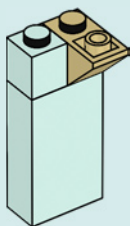

3

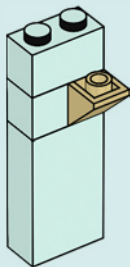

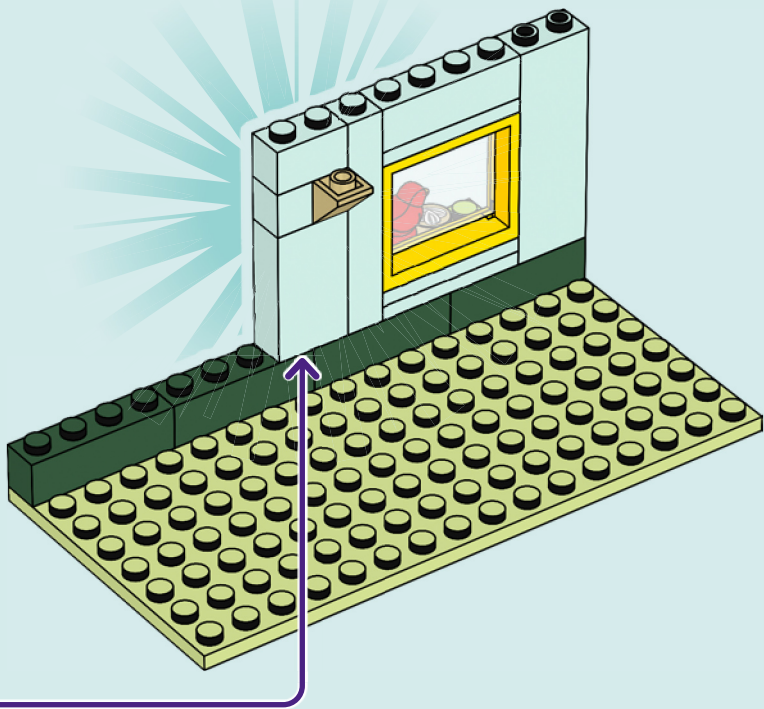

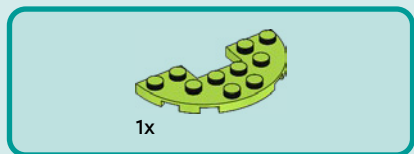
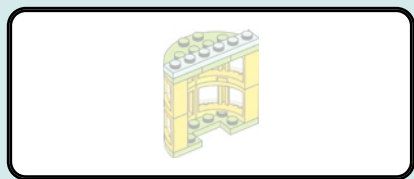

24

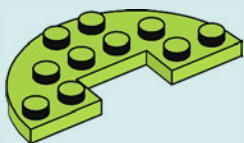

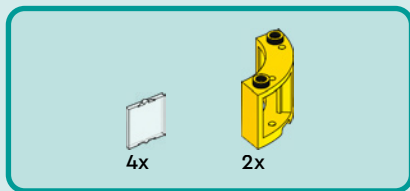

25

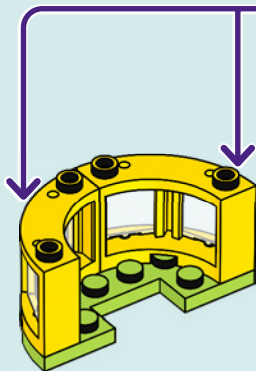
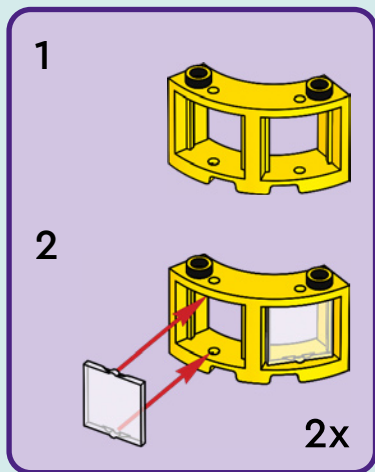

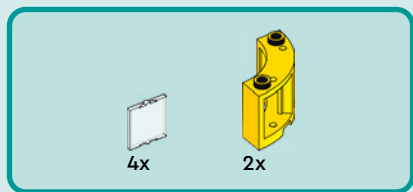

26

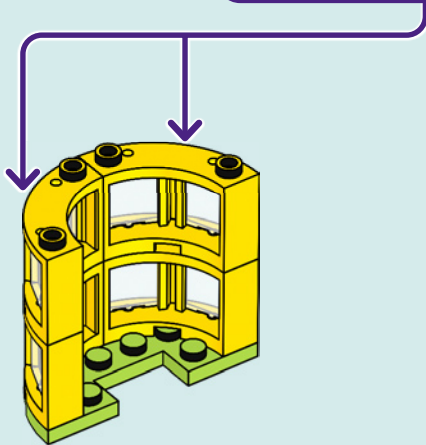
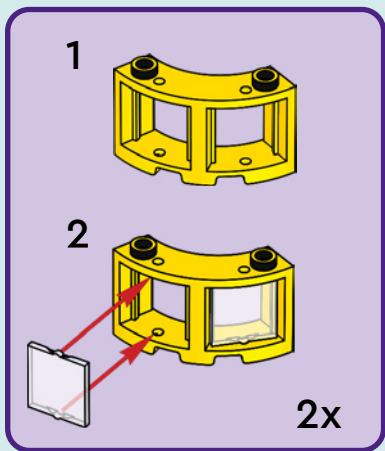



1x

27

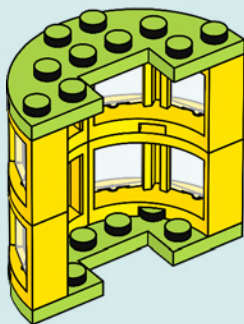

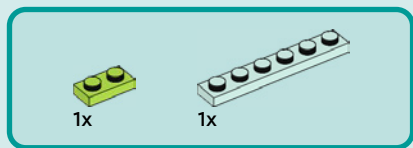

28

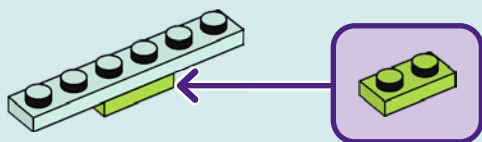

29

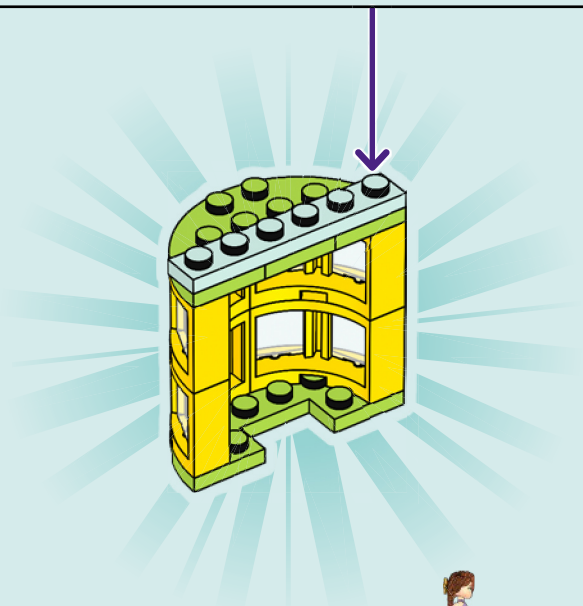

30

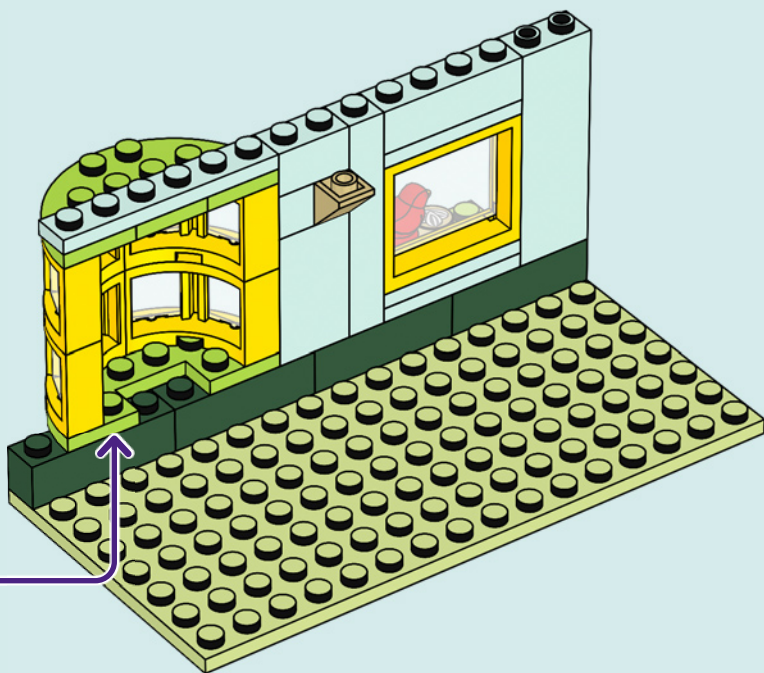



1x



1x

31

1

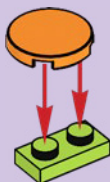

2

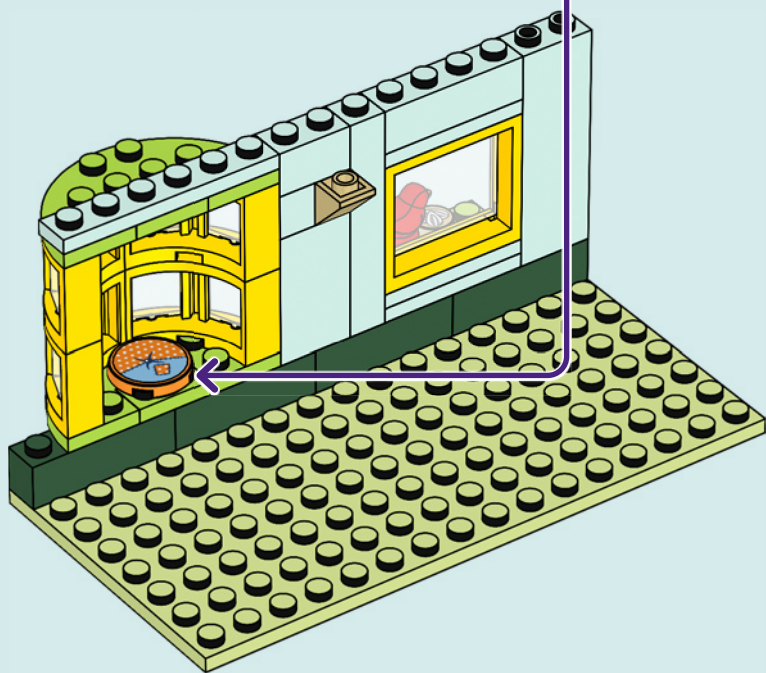
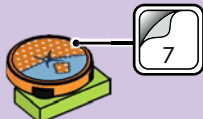

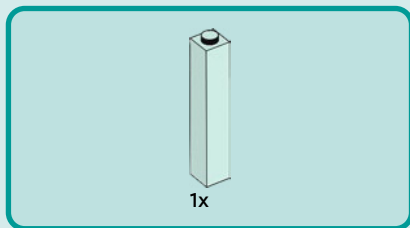

32

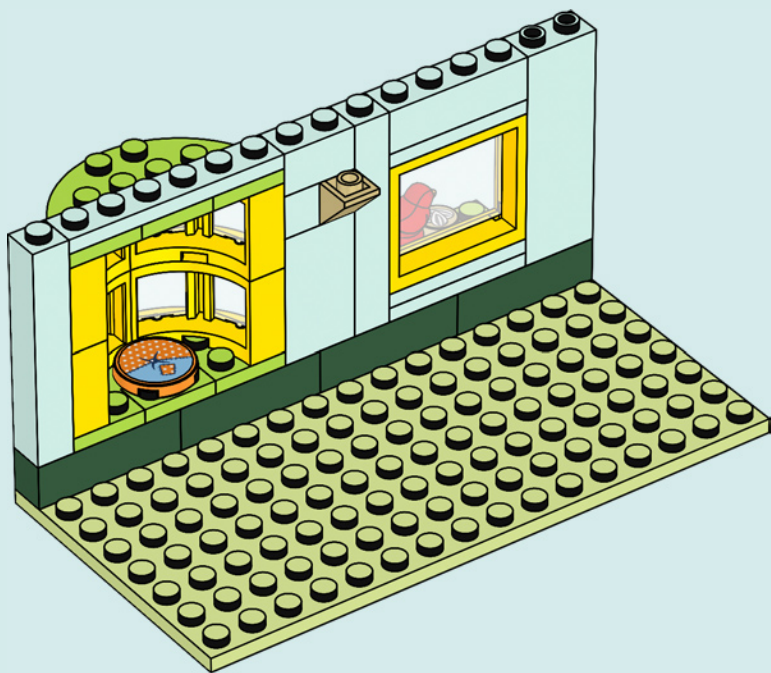



1x



2x

33

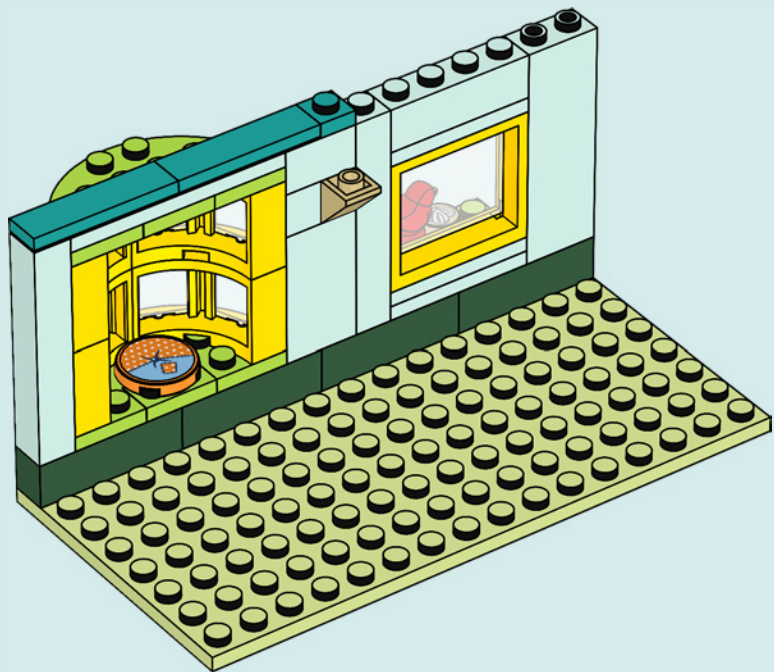

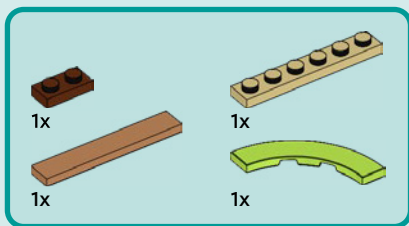

34

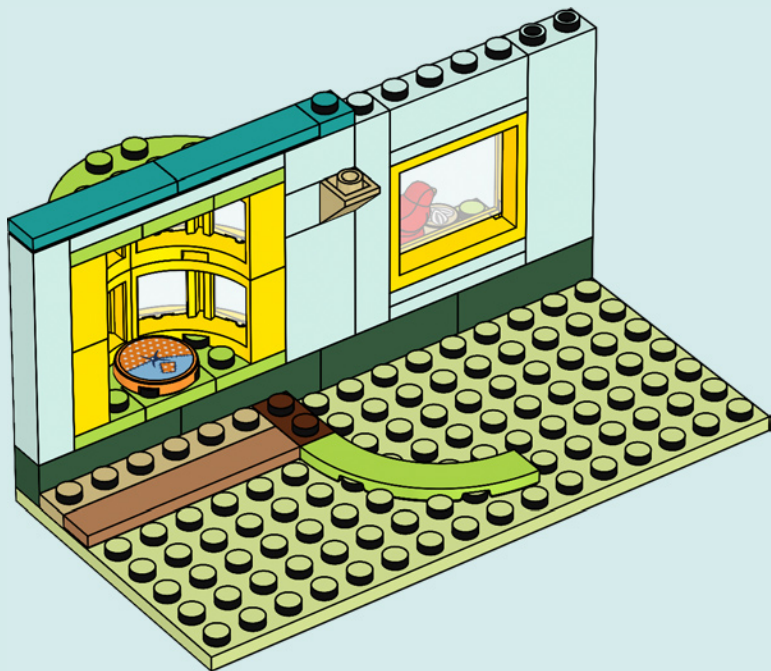



1x



2x



1x

35

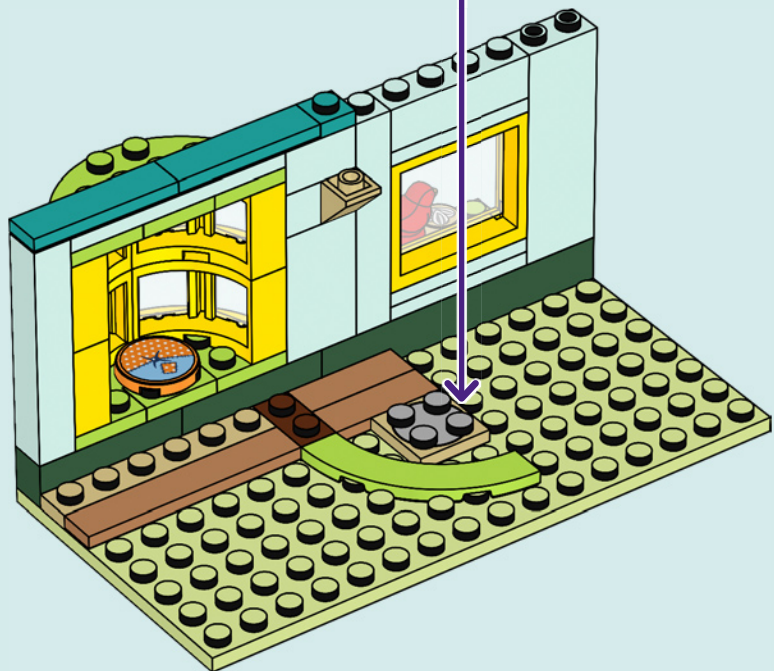
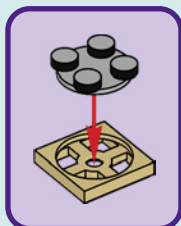



1x



1x

36

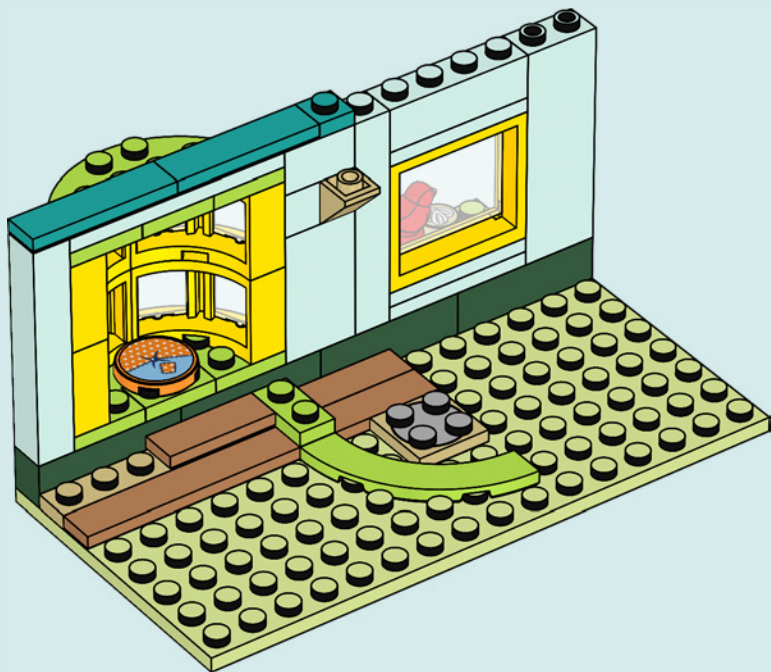

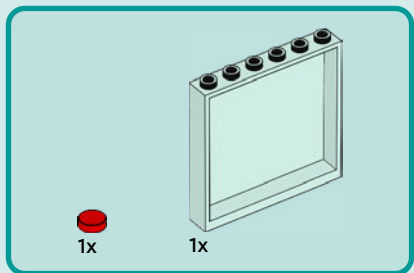

37

1

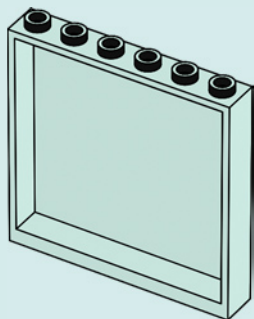

2



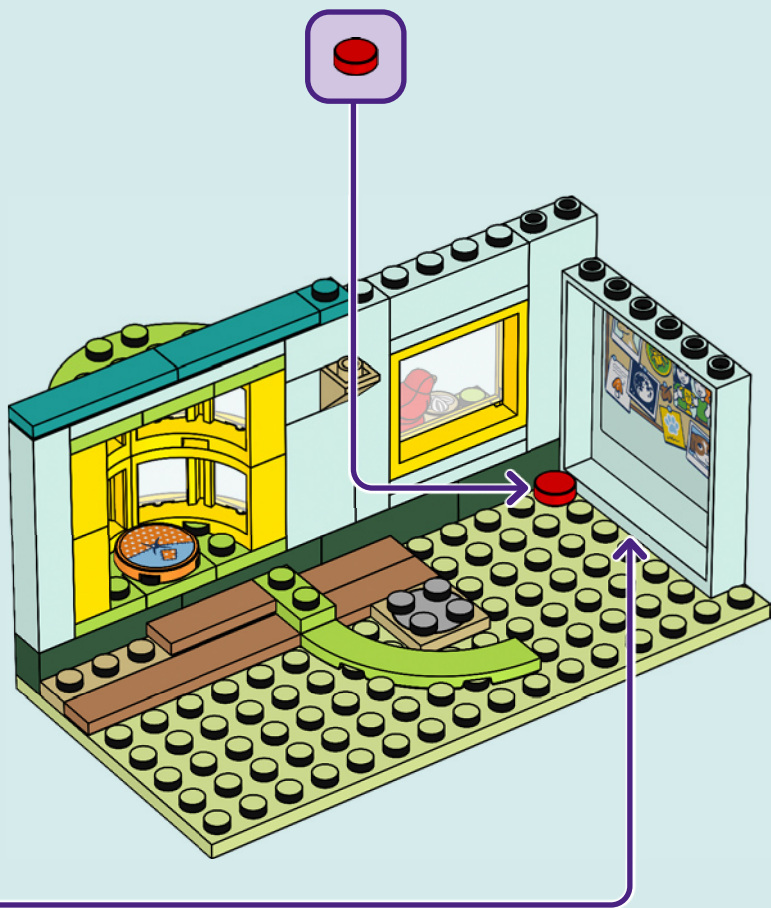

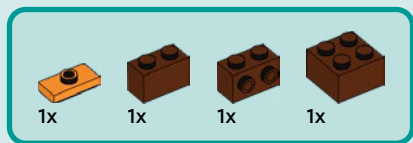

38

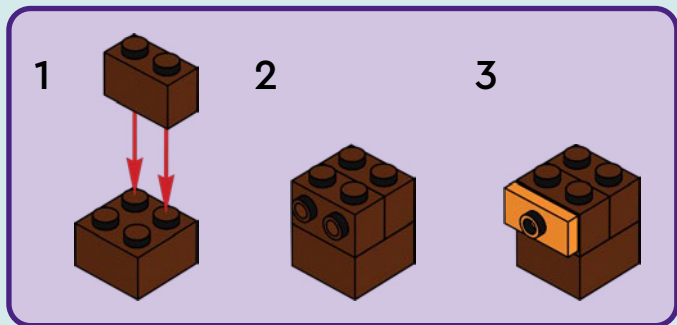



1x



1x

40



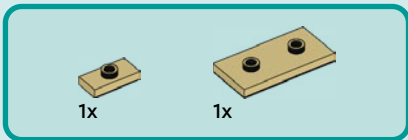

41



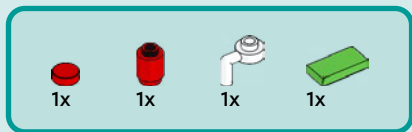

42

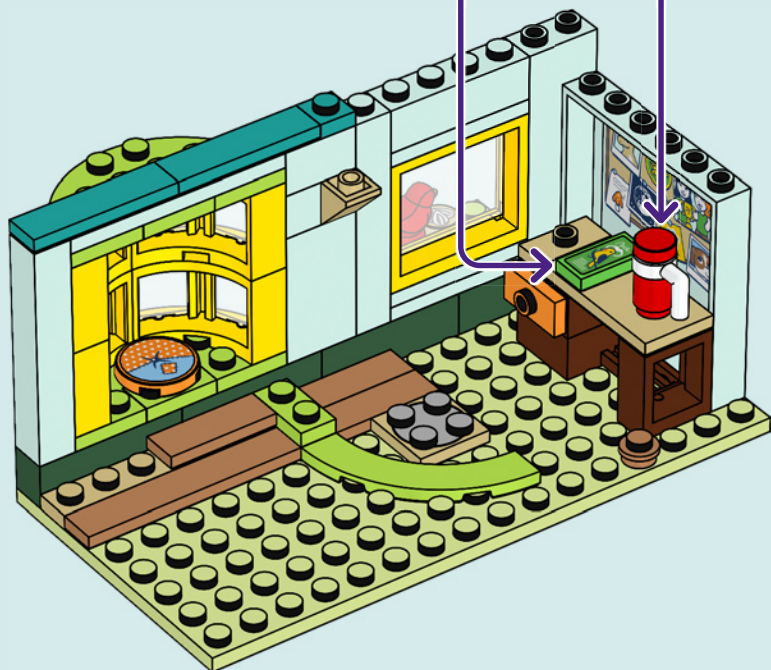
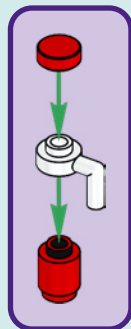
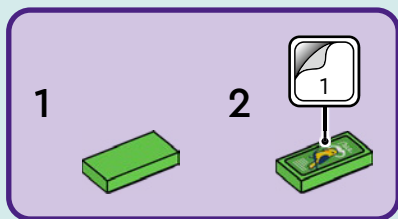

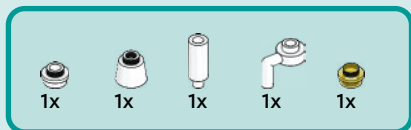

43

1



2

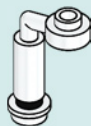

3

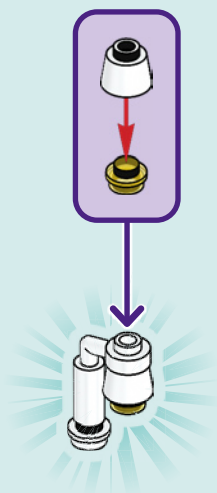

44





1x



1x



1x



1x



1x



1x

45

1

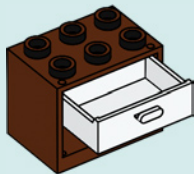

2

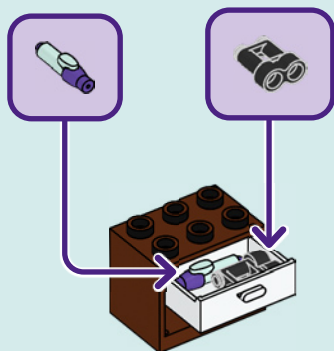

3







1x



1x



1x



1x

46



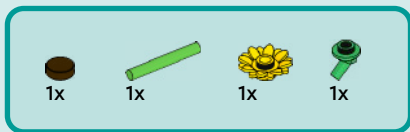

47

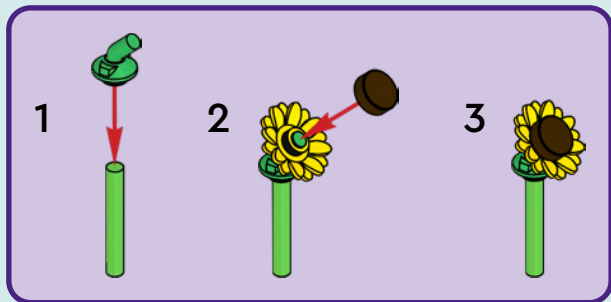





48

1

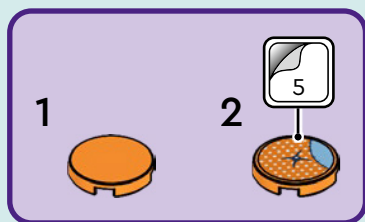

2

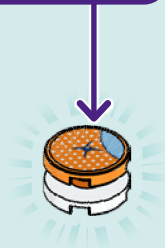



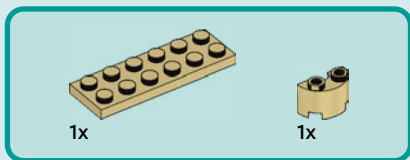
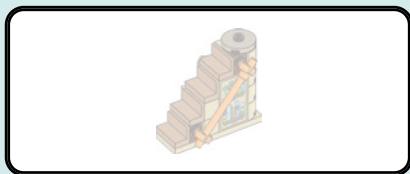

49

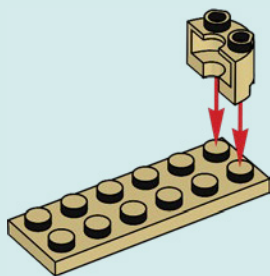

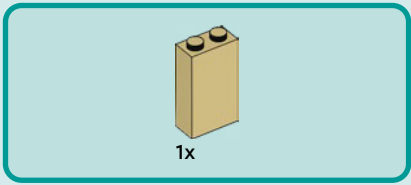

50

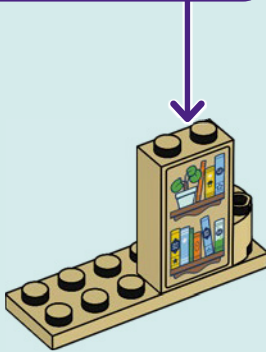
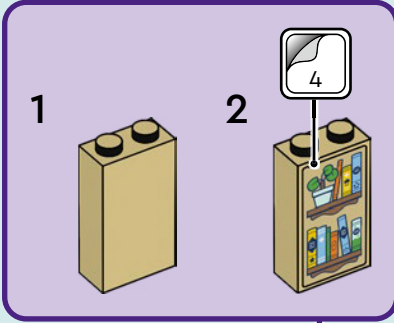



2x

53

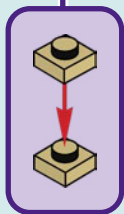
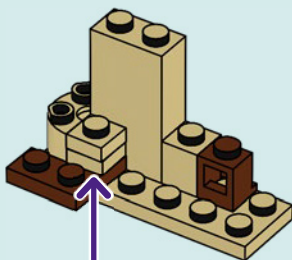



1x



1x

54

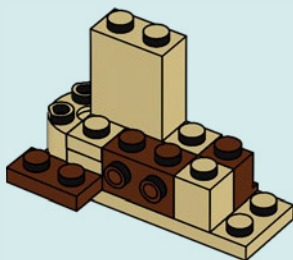



2x

55

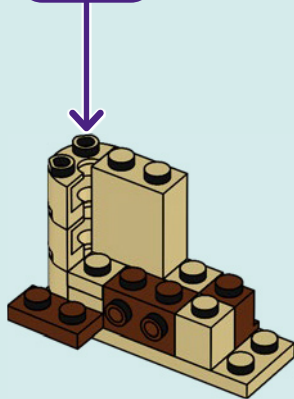
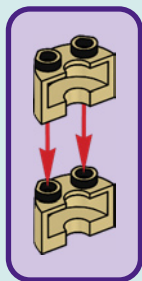



2x

56

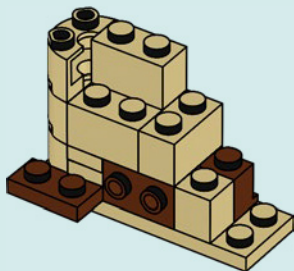

1x



1x



1x

57

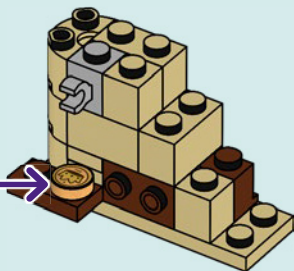



1x

58

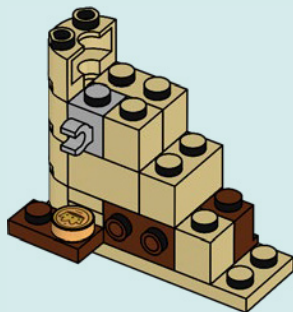



1x



1x

59

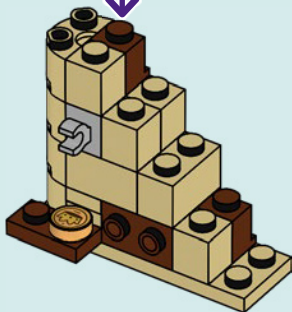



1x

60

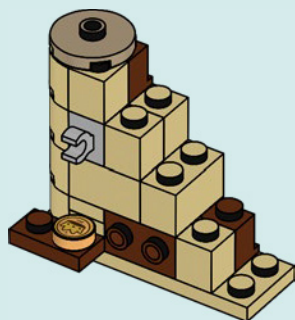



4x

61

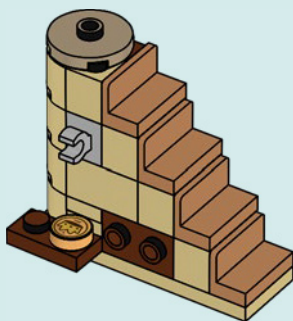



1x

62

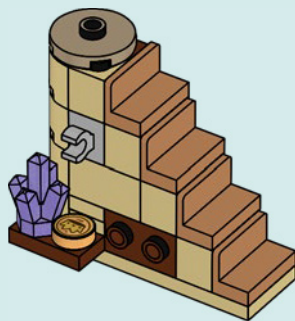



1x

63

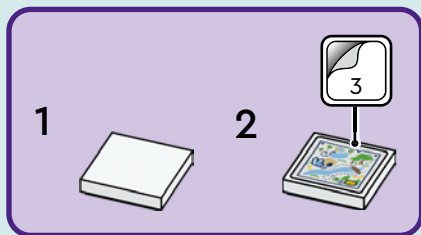



1x



1x

64

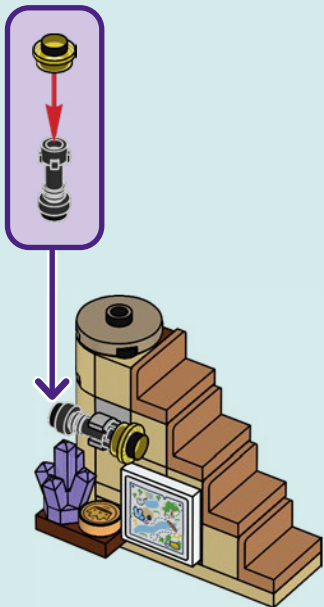



2x

65



2x

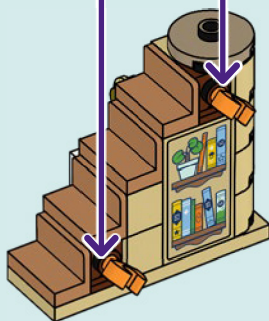

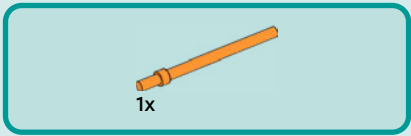

66



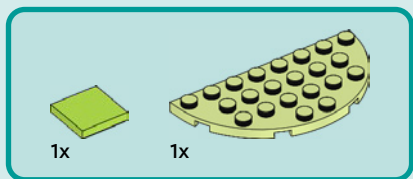

68

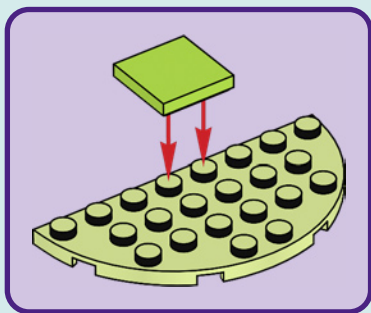



2x



2x

69





2x



4x

70



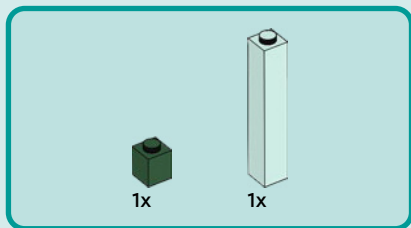

71

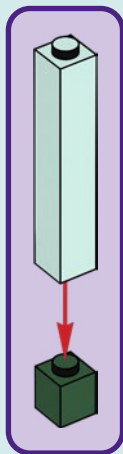



1x

72



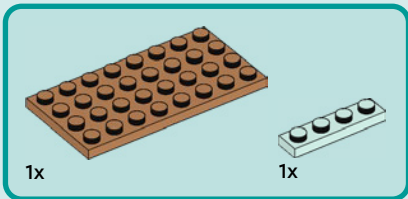
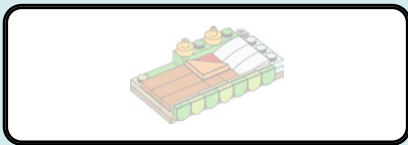

73

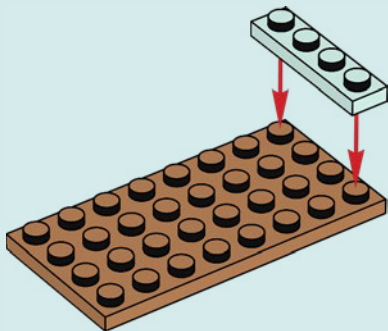

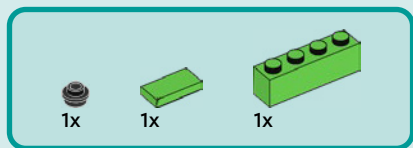

74

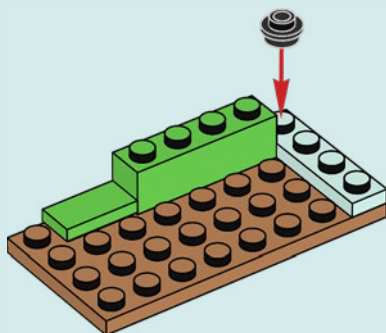

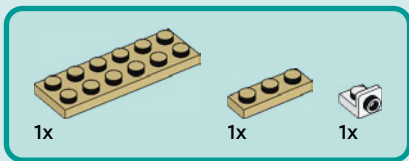

75

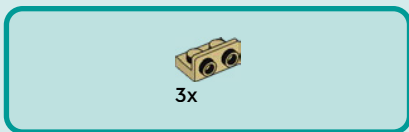
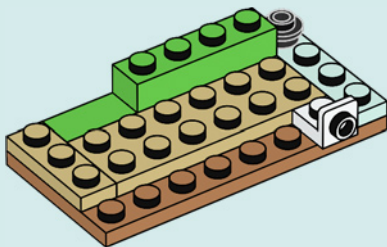

76

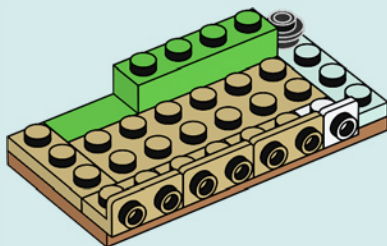



1x

77

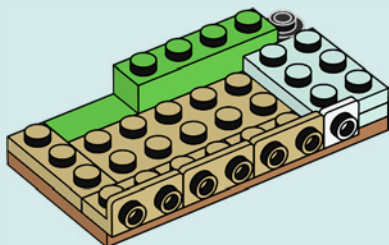



3x

78

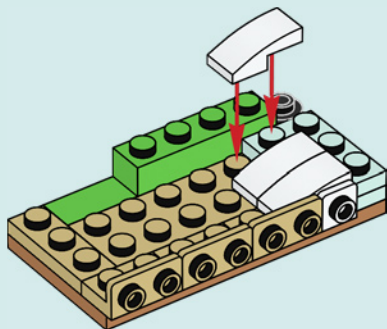

1x



2x

79

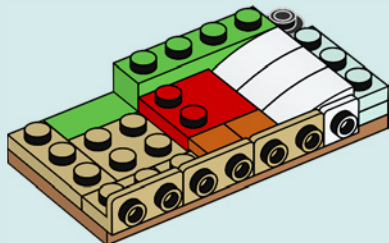



3x

80

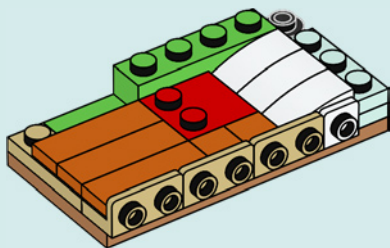



2x



1x

81

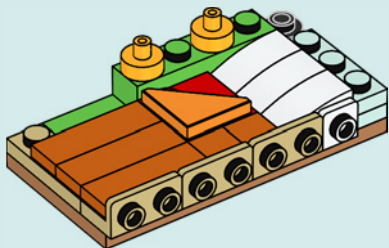



3x



4x

82

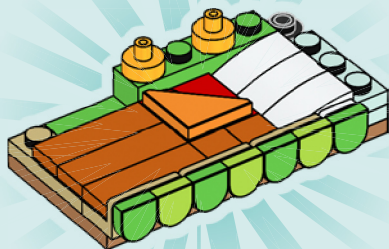

83



84



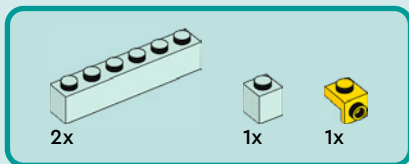

85



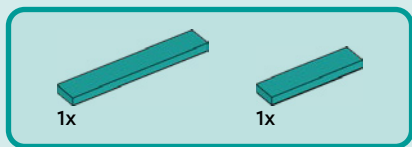

86





1x



2x

87





1x



1x

88





1x



1x



1x

89

1



2

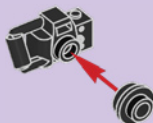

3





1x

90







Friends™

WATCH
SERIES
ONLINE



WATCH SERIES ONLINE / SCHAU DIR DIE SERIE ONLINE AN / REGARDE
LA SÉRIE EN LIGNE / GUARDA LA SERIE ONLINE / MIRA LA SERIE EN
INTERNET / ASSISTIR À SÉRIE ONLINE / 在线观剧 / OGLAĐAJ SERIAL
W INTERNECIE / SLEDUJ SERIÁL ONLINE / POZRI SI SERIÁL ONLINE
/ NÉZD A SOROZATOT ONLINE / VIZIONEAZĂ SERIALUL ONLINE /
ГЛЕДАЙТЕ СЕРИАЛА ОНЛАЙН / SKATĪES SĒRIĀLU TĪEŠSAĪSTĒ /
VAATA SARJA VEEBIST / ŽIŪRĒK SERIALĀ INTERNETU

LEGO

Friends

42663



42652



42650



42649



LEGO

Friends





**Rebuild
the
World™** 

1x
6234807

1x
6168642

1x
6173141

1x
6242241

2x
6508268

1x
6139454

1x
6093053

1x
6322480

1x
306901

3x
6034044

1x
306801

1x
4520636

1x
6466742

6x
4113915

3x
4159553

4x
6351413

2x
6092587

1x
4159196

1x
6445058

2x
4109995

3x
6313611

1x
4565387

1x
6472370

1x
4121921

1x
6294227

1x
4124067

1x
4113993

1x
6515613

2x
6284574

1x
306221

1x
6399031

2x
6224794

1x
4157124

1x
6219819

1x
6280475

1x
6430246

4x
6523878

1x
6509767

2x
6310246

2x
243124

1x
6316742

1x
4598897

2x
6168646

1x
6391688

1x
6003301

1x
6476480

1x
6510190

1x
6476620

4x
6375605

1x
6182261

2x
6343326

6x
6195258

1x
6161772

1x
6294513

1x
6310856

1x
6409765

1x
6514191

8x
6254552

1x
6514142

2x
6514056

1x
6220715

2x
6439042

3x
6092770

1x
6329699

1x
4121967

1x
6092599

1x
6346092

1x
4158355

1x
6472965

2x
6311437

1x
6213782

1x
6213778

2x
6430965

2x
6491442

3x
6292786

1x
6264986

7x
6250601

2x
4164022

3x
4164037

1x
4518611

1x
4187743

2x
6109765

1x
6458173

1x
6132767



1x
6481630



1x
4521915



4x
4245571



1x
6481629



2x
6223719



1x
6097098



2x
4225469



1x
6424457



1x
4211149



2x
6397820



1x
4224243



1x
4211150



1x
4211257



1x
6382102



1x
4211210



1x
6132732



1x
6320306



1x
6248890



1x
4540203



1x
6416668



1x
6527907



1x
6375358



1x
6322813



1x
6287856



2x
6167641



1x
6416551



4x
6226646



1x
6527694



3x
6365746



1x
6102995

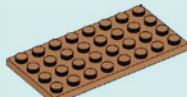

1x
6218145



1x
6467587



1x
6507866



1x
6475523



1x
6491212



2x
6475042



3x
6483781



1x
6213681



2x
6236576



1x
6426724



3x
6141592



2x
6022032



1x
6218162



1x
6138662



1x
6146702



2x
6227921



1x
6329423

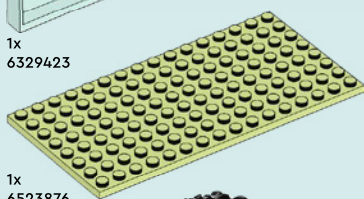

1x
6523876



1x
6514192



1x
6328085



3x
6298819



1x
6135112



2x
6523877

[LEGO.com/service](https://www.lego.com/service)

YOU COULD

WIN



Scan this QR code or go to
LEGO.COM/PRODUCTFEEDBACK
and give us your short feedback
about this LEGO® set for a chance
to win a cool LEGO prize.

Terms and Conditions apply*

EN: YOU COULD WIN. Terms and Conditions apply* **DE: Du könntest GEWINNEN.** Es gelten die Teilnahmebedingungen* **FR: Tu pourrais GAGNER.** Des conditions s'appliquent* **IT: Potresti VINCERE tu.** Termini e condizioni sono applicabili* **ES: Puedes GANAR.** Aplican términos y condiciones* **PT: Poderá GANHAR.** Aplicam-se termos e condições* **ZH: 轻松获奖. 条款和条件适用*** **PL: Szansa na WYGRANĄ.** Obowiązują warunki korzystania* **CS: Máte šanci VYHRÁT.** Platí všeobecné smluvní podmínky* **SK: Máte šancu VYHRAŤ.** Platia všeobecné zmluvné podmienky* **HU: TE IS NYERHETSZ.** Felhasználási feltételek érvényesek* **RO: Ai putea CÂȘTIGA.** Se aplică termenii și condiții* **BG: Можете да СПЕЧЕЛИТЕ.** Има определени правила и условия* **LV: Tu vari LAIMĒT.** Ir spēkā noteikumi un nosacījumi.* **ET: Sul on võimalus VÕITA.** Kehtivad tingimused* **LT: Jūs galite LAIMĖTI.** Taikomos sąlygos*

*[LEGO.com/productfeedback-terms](https://www.lego.com/productfeedback-terms)