



10350



Booklet available in English  
Heft in deutscher Sprache erhältlich  
Livret disponible en français  
Libretto disponibile in italiano  
Folleto disponible en español  
如需中文版手册



LEGO® Builder

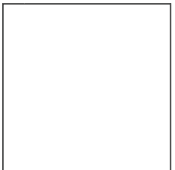





LEGO.com/sustainable-packaging



FR  
**DONNEZ  
OU  
RECYCLEZ**



OU



OU



ASSOCIATION    MAGASIN    DÉCHÈTERIE

Adresses sur [quefairedemesdechets.fr](http://quefairedemesdechets.fr)



# BUILDER



Apple and the Apple logo are trademarks of Apple Inc., registered in the U.S. and other countries and regions. App Store is a service mark of Apple Inc. Google Play and the Google Play logo are trademarks of Google LLC. Tencent and the Tencent logo are trademarks of Tencent Inc.

Q [LEGO.com/devicecheck](https://www.lego.com/devicecheck)



Q LEGO® Builder





FRANÇOIS ZAPF  
LEGO® Icons Designer

## Timeless Tudor charm

Welcome to a modular corner with a strong, undeniably British accent! This is the first time we are celebrating Tudor architecture in the Modular Buildings Collection. This gave us a chance to create new, interesting building experiences, specifically for the upper section, with its steeply pitched roof, prominent cross gables and half-timbered jettied top floor. We hope you will have as much fun building it as we had designing it.





## Make yourself at home

If these walls could talk! Inside and out, the Tudor Corner is buzzing with activity, as it might have been since it was built five centuries ago. Times have ushered in more modern amenities, but the atmosphere is saturated with a rich history. Stories of everyday events and local legends are still told over delicious meals in the cosiest venue in town, the Old Guarded Inn. A deep affection for craftsmanship and traditional British culture are felt in the finest haberdashery. The clockmaker proudly repairs precious family heirlooms. The tenant upstairs always has time for visitors (and room for more cats). Yes, this place truly feels like home for all who walk through the doors. (Or climb down the chimney!)





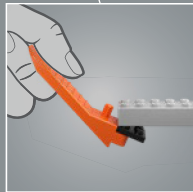
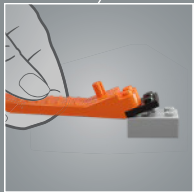
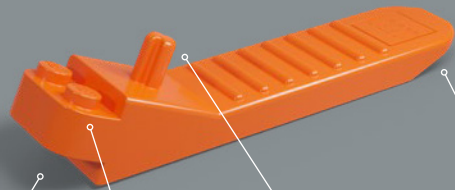



The weather forecast is predicting rain! Fortunately, this lady is well prepared. Her hat fashion style was influenced by passengers on the LEGO® Ideas The Orient Express Train (21344).

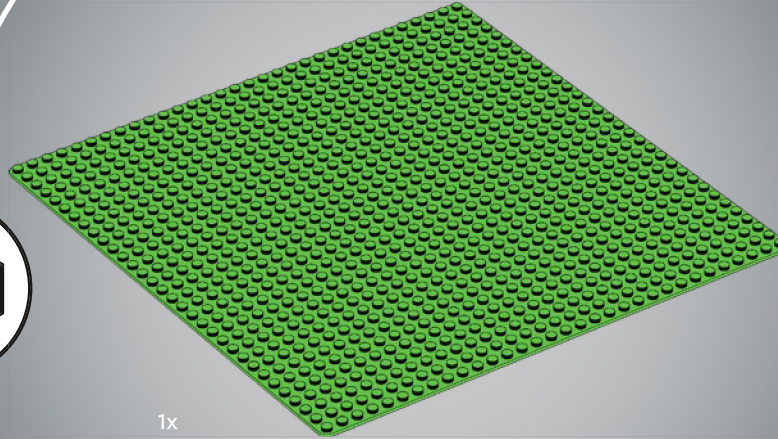

1x

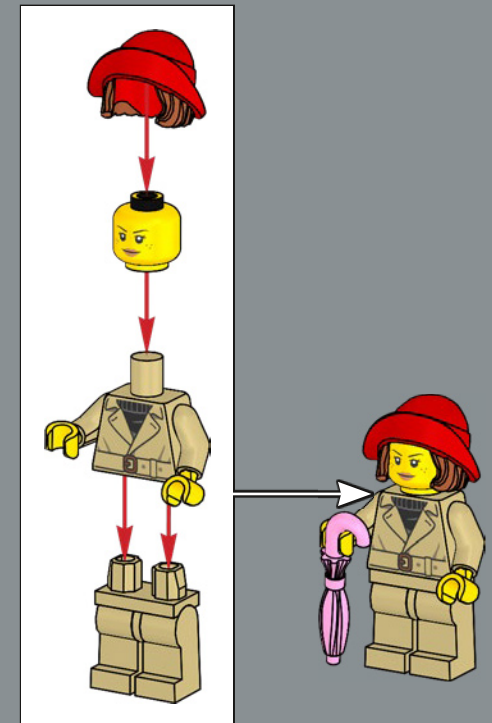



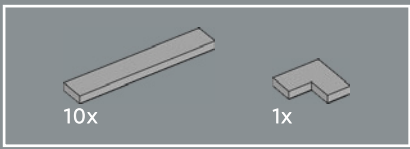

1

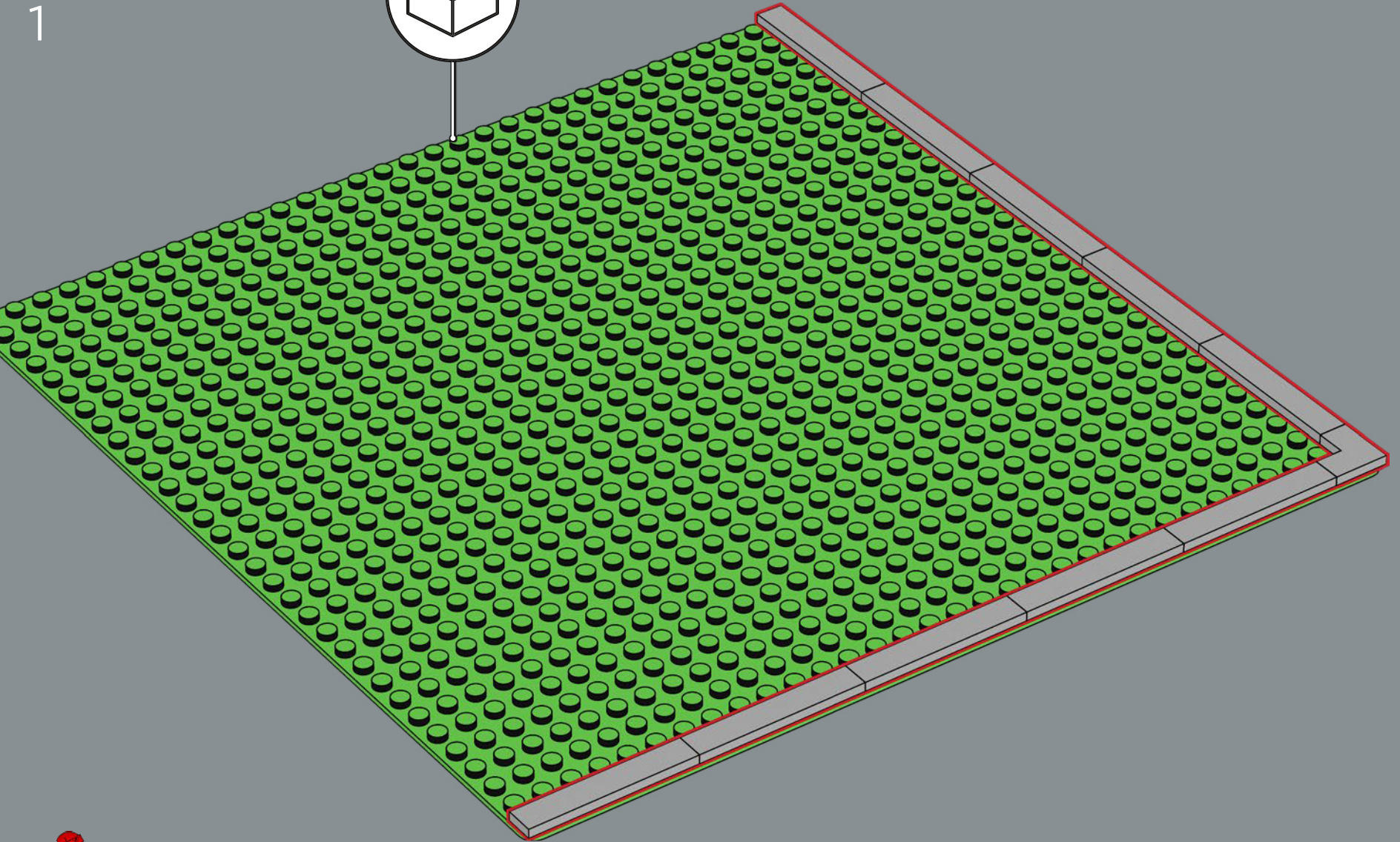
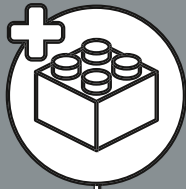



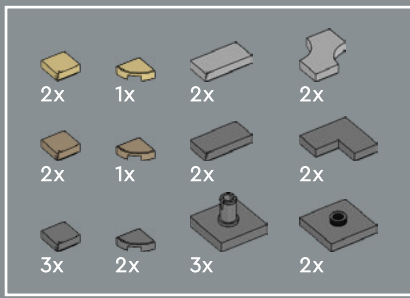

2

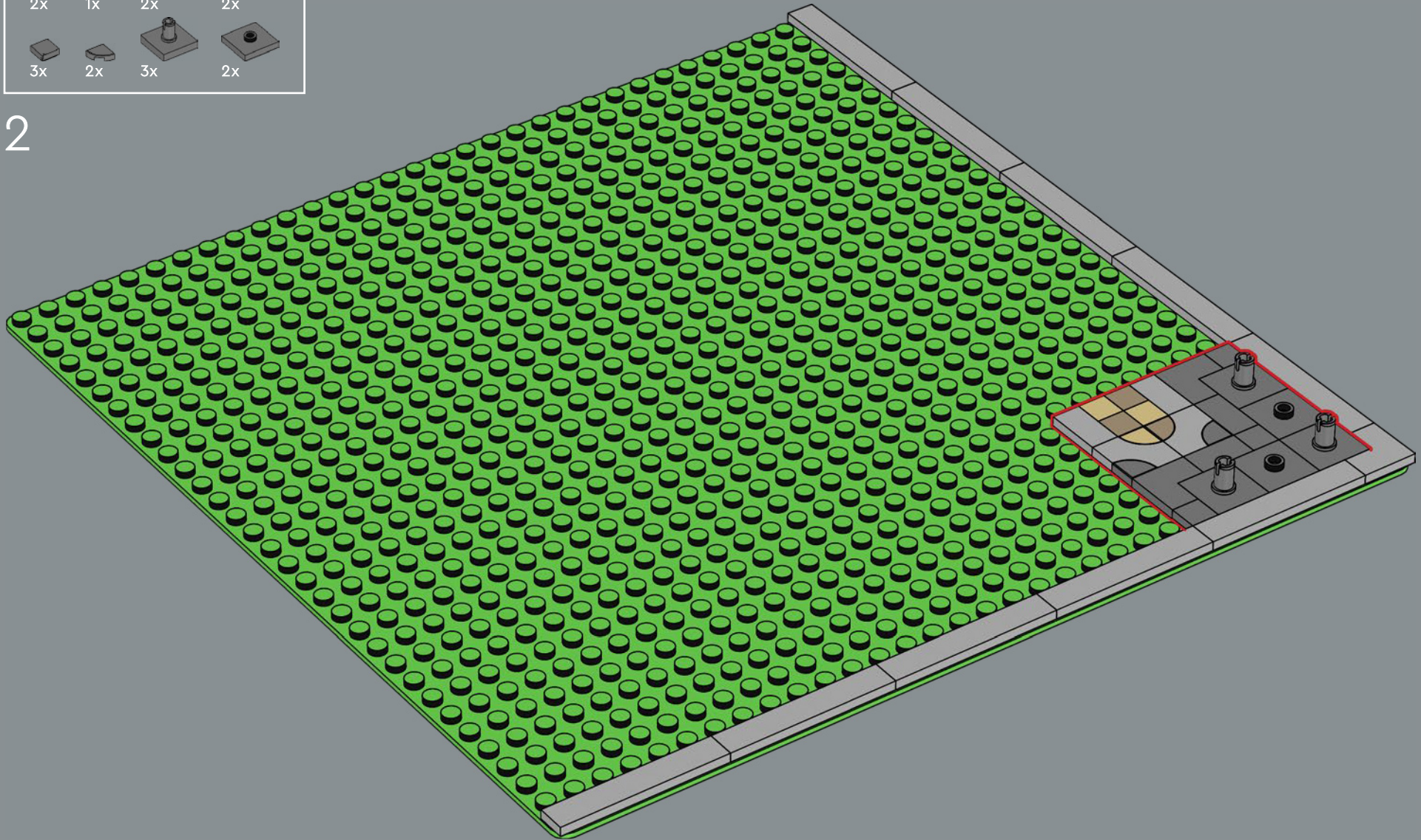



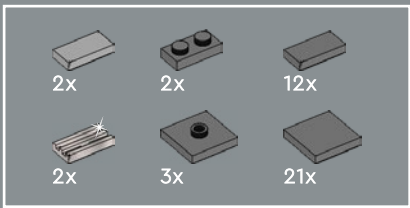

This coat of arms embedded in the pavement testifies to the rich history of this street corner.

3

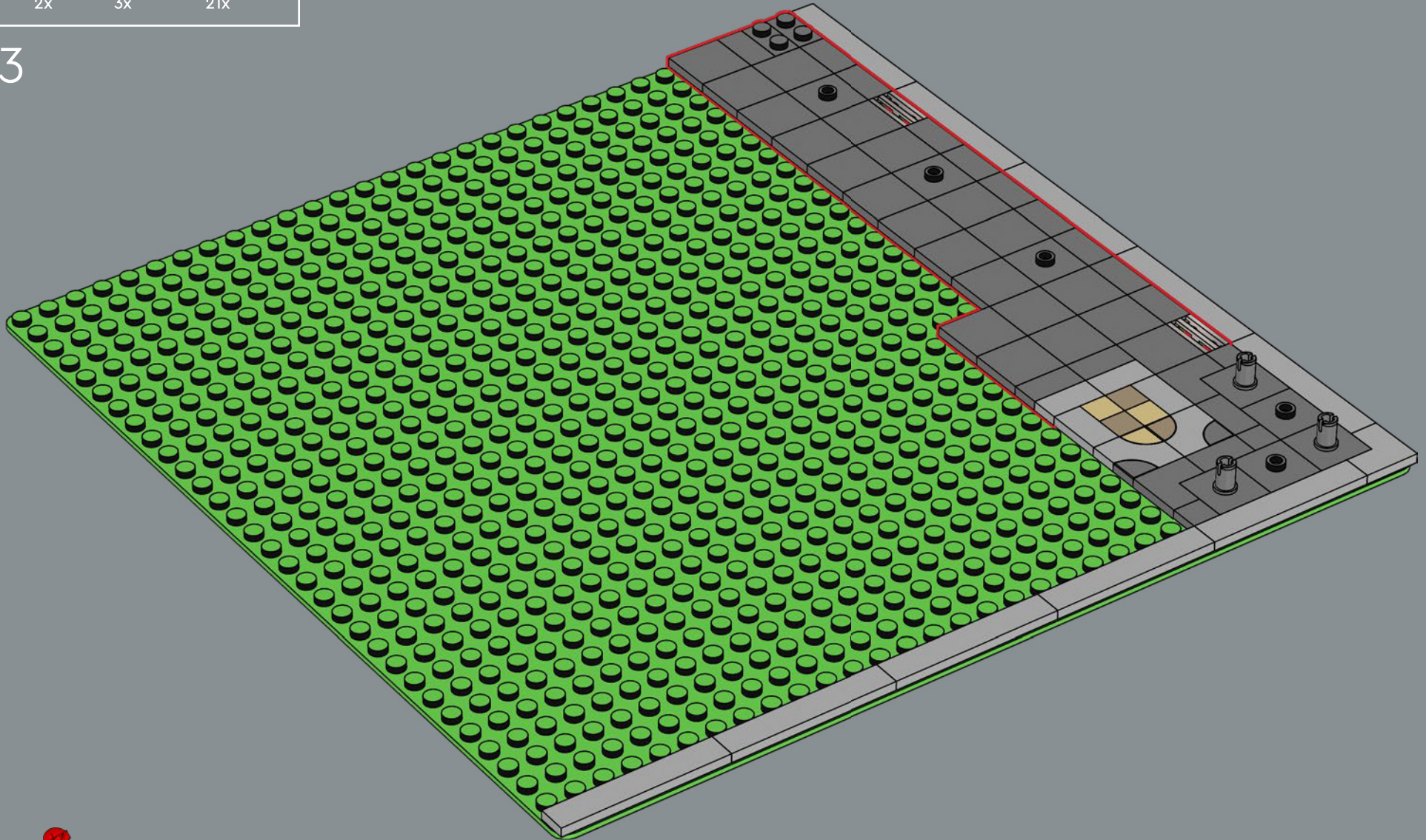



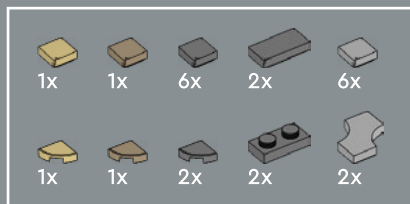

4

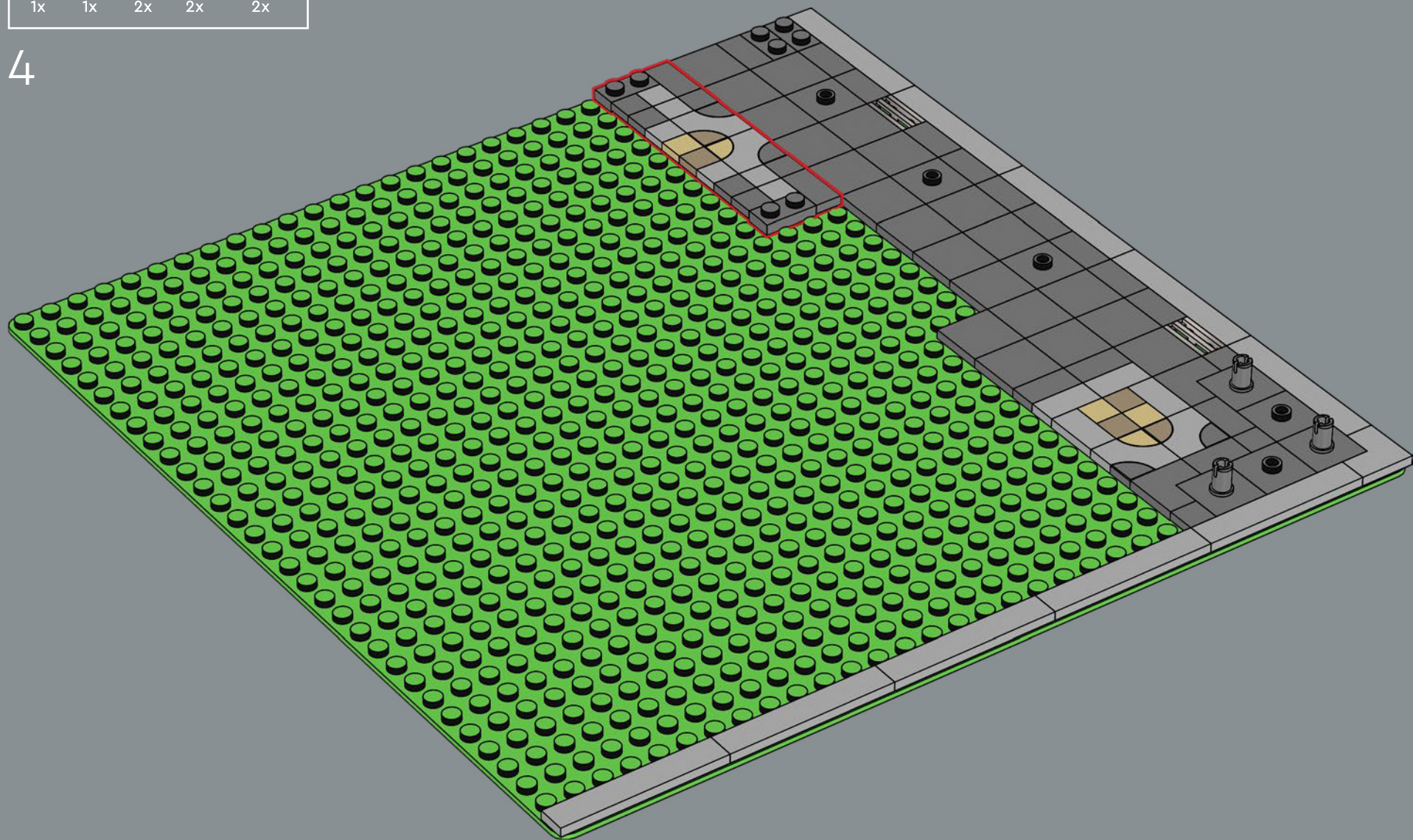



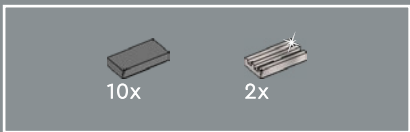

5

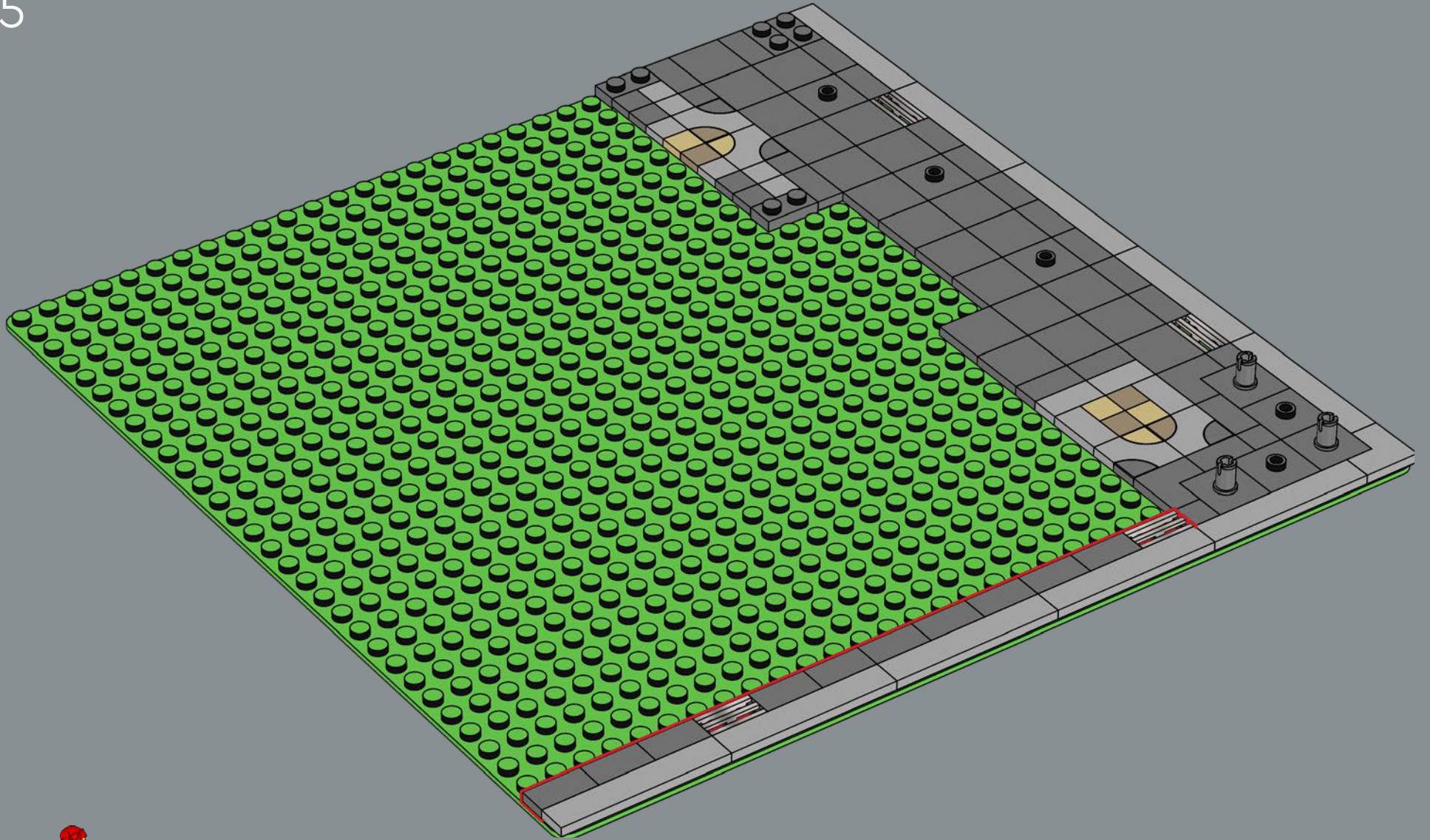



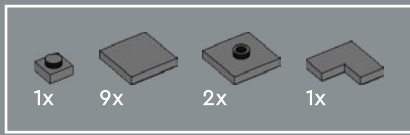

6

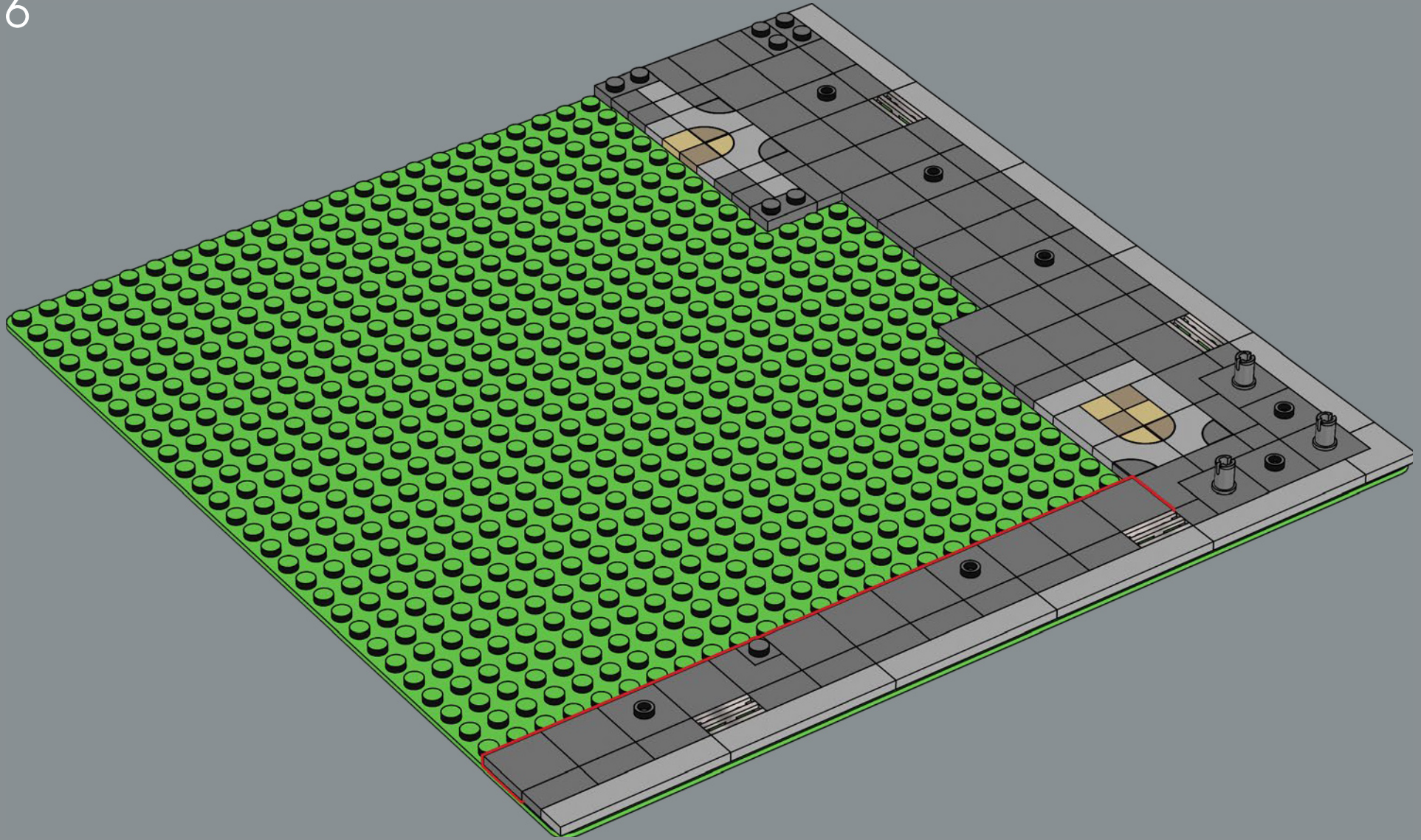



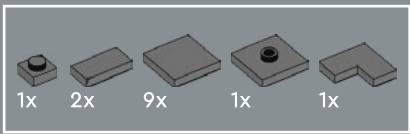

7

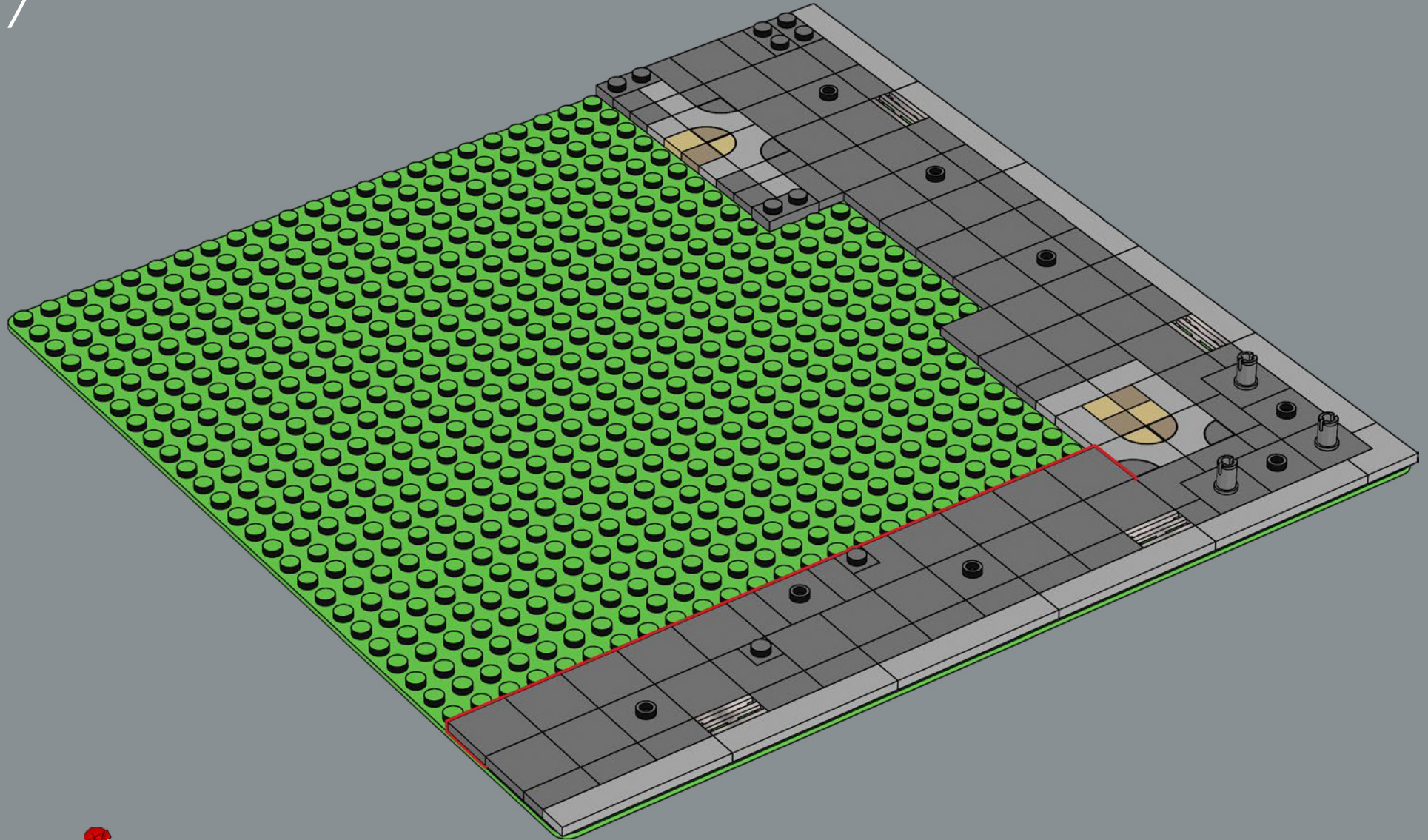



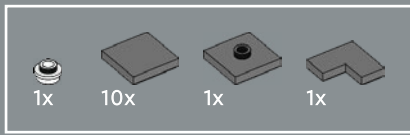

8

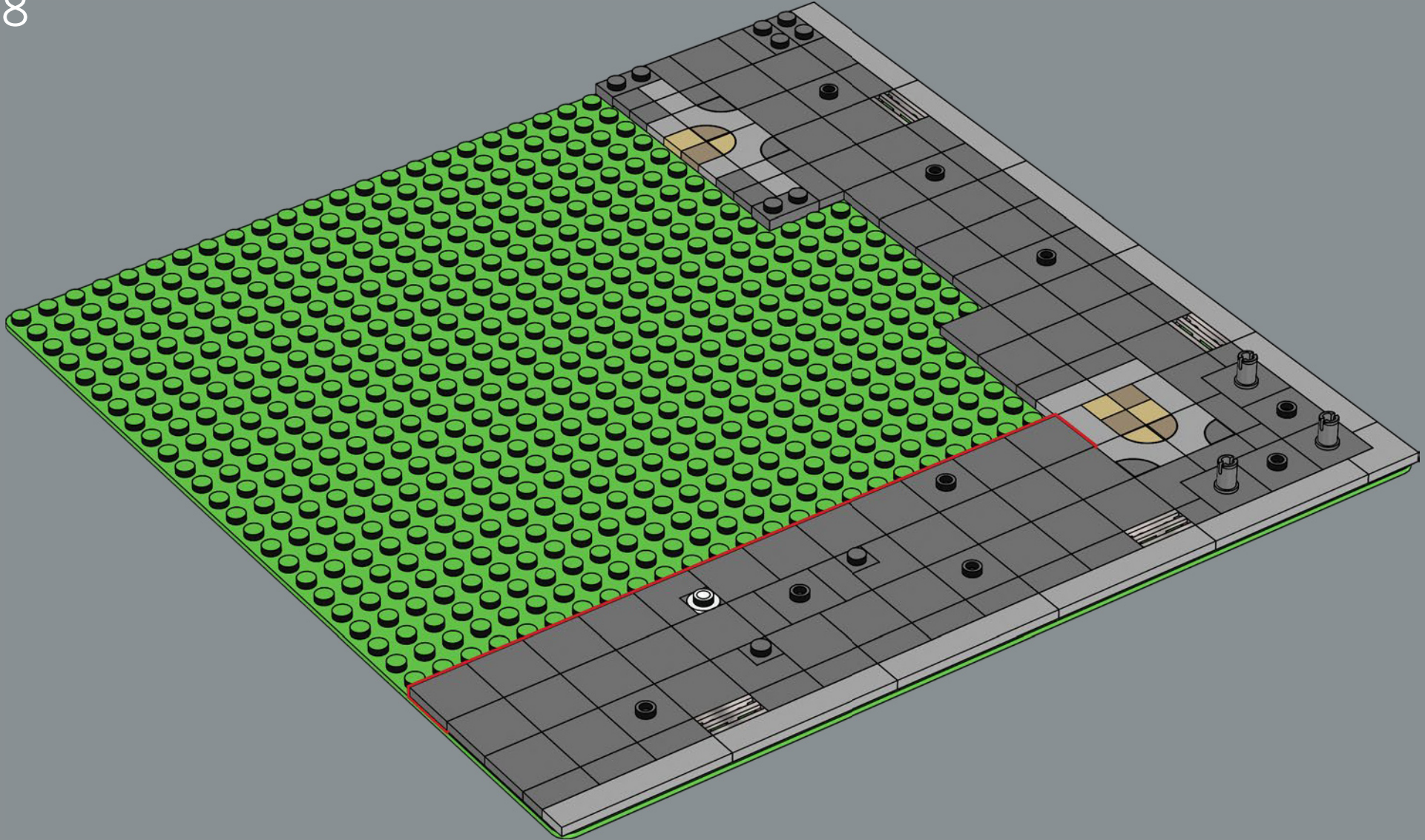



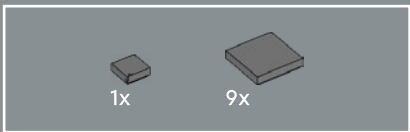

9

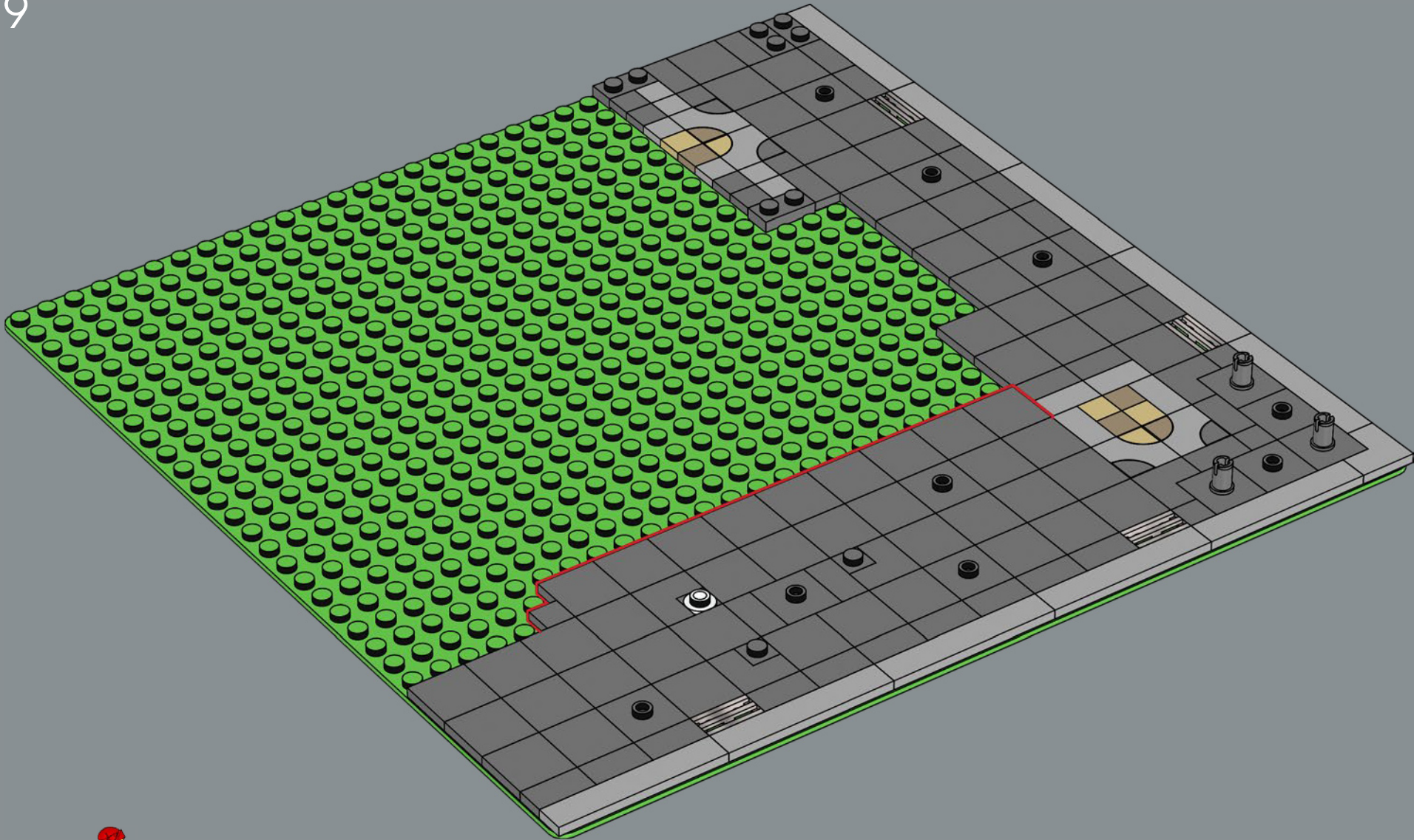

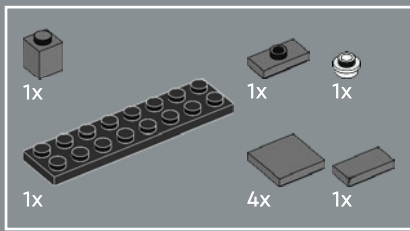

10

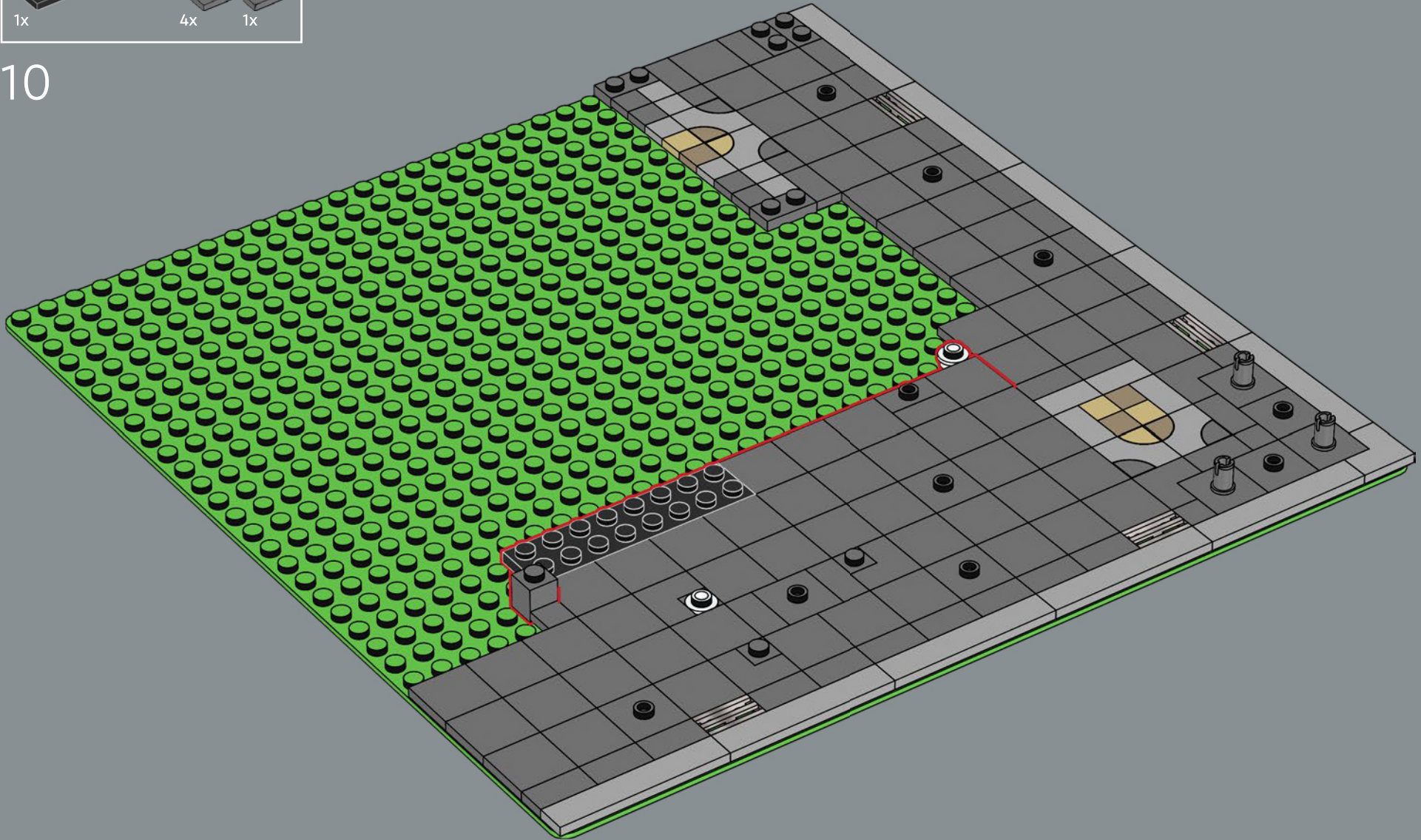



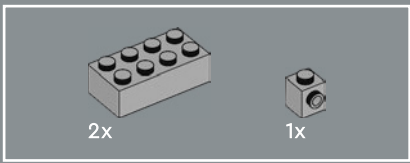

11

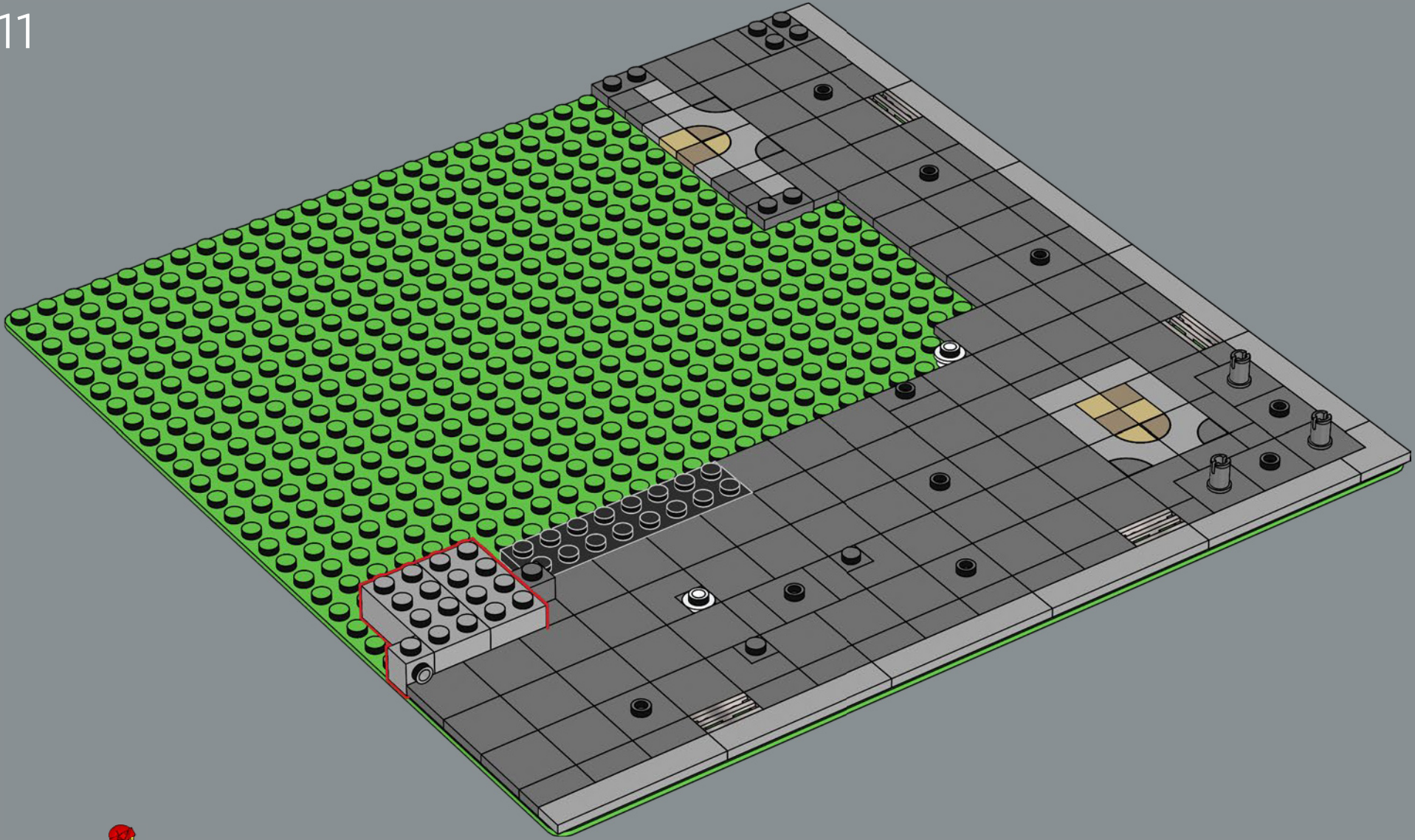

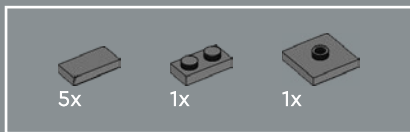

12

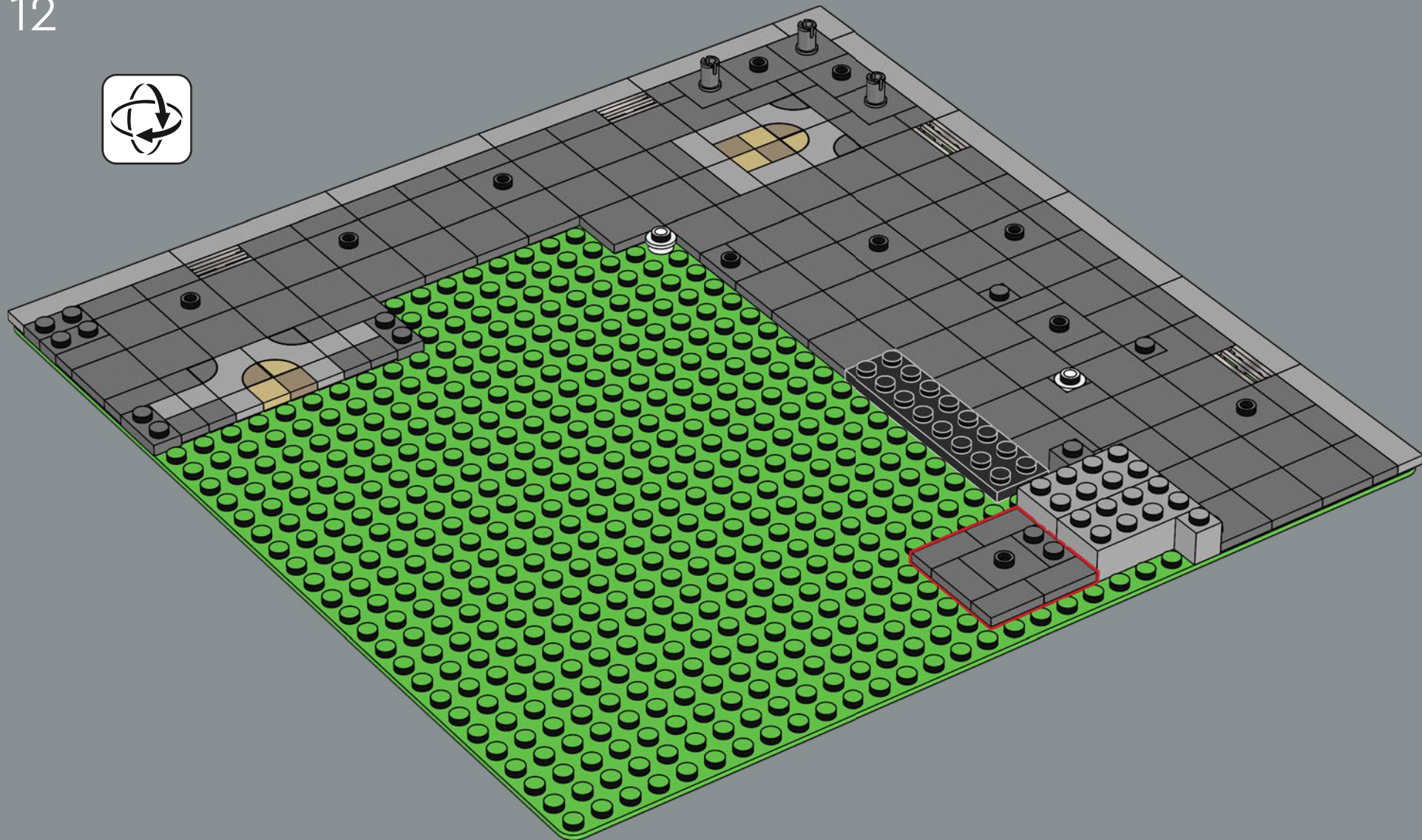



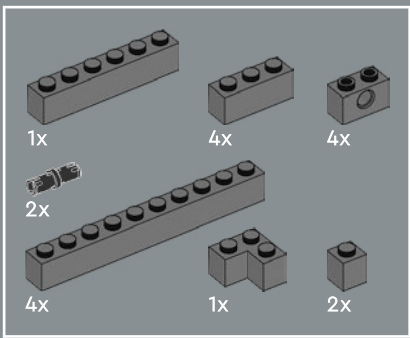

13

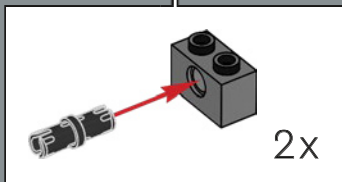
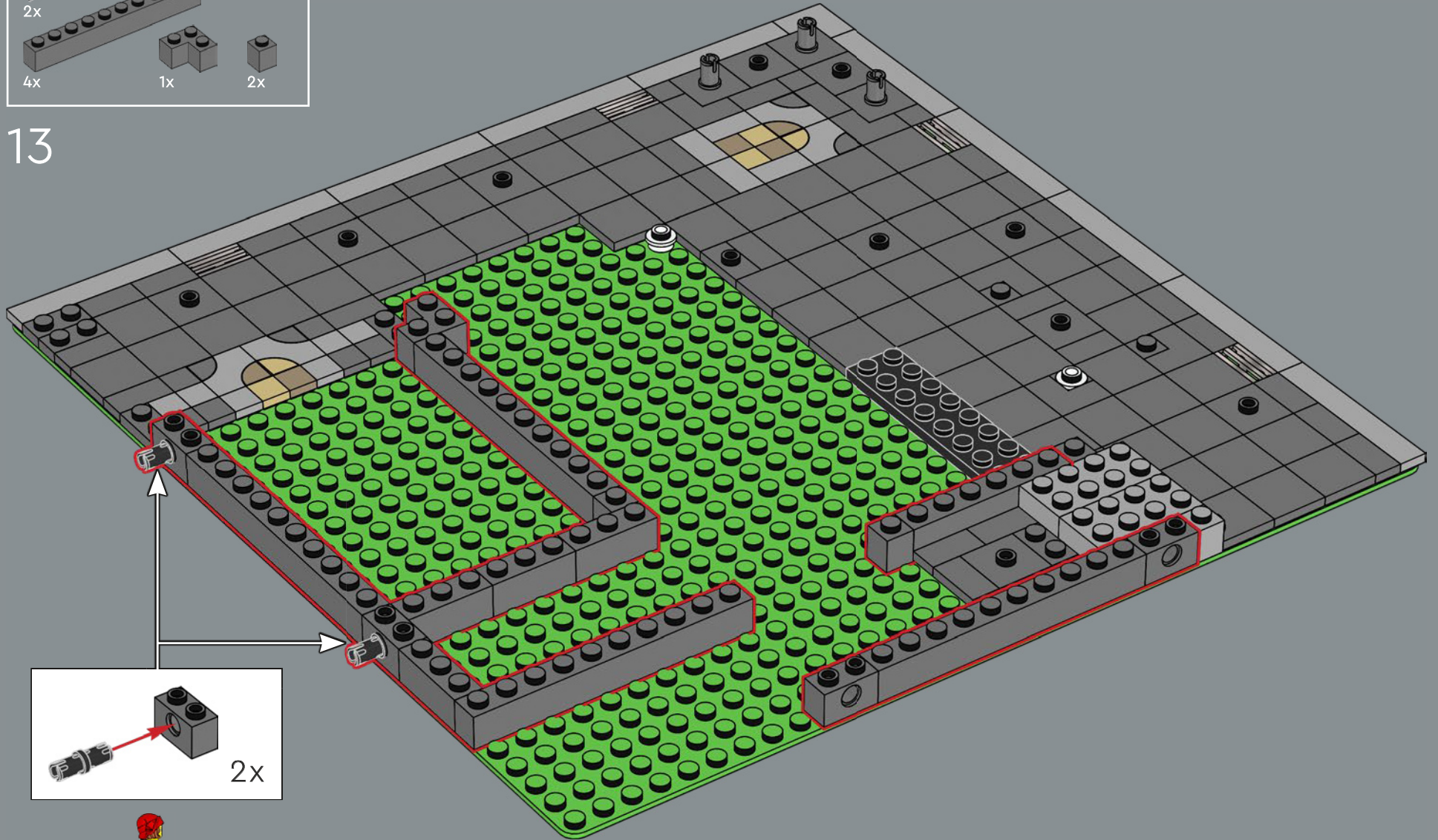

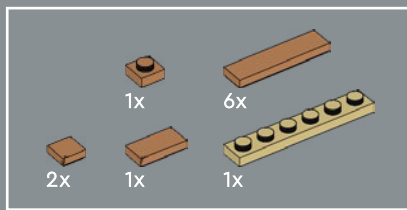

14

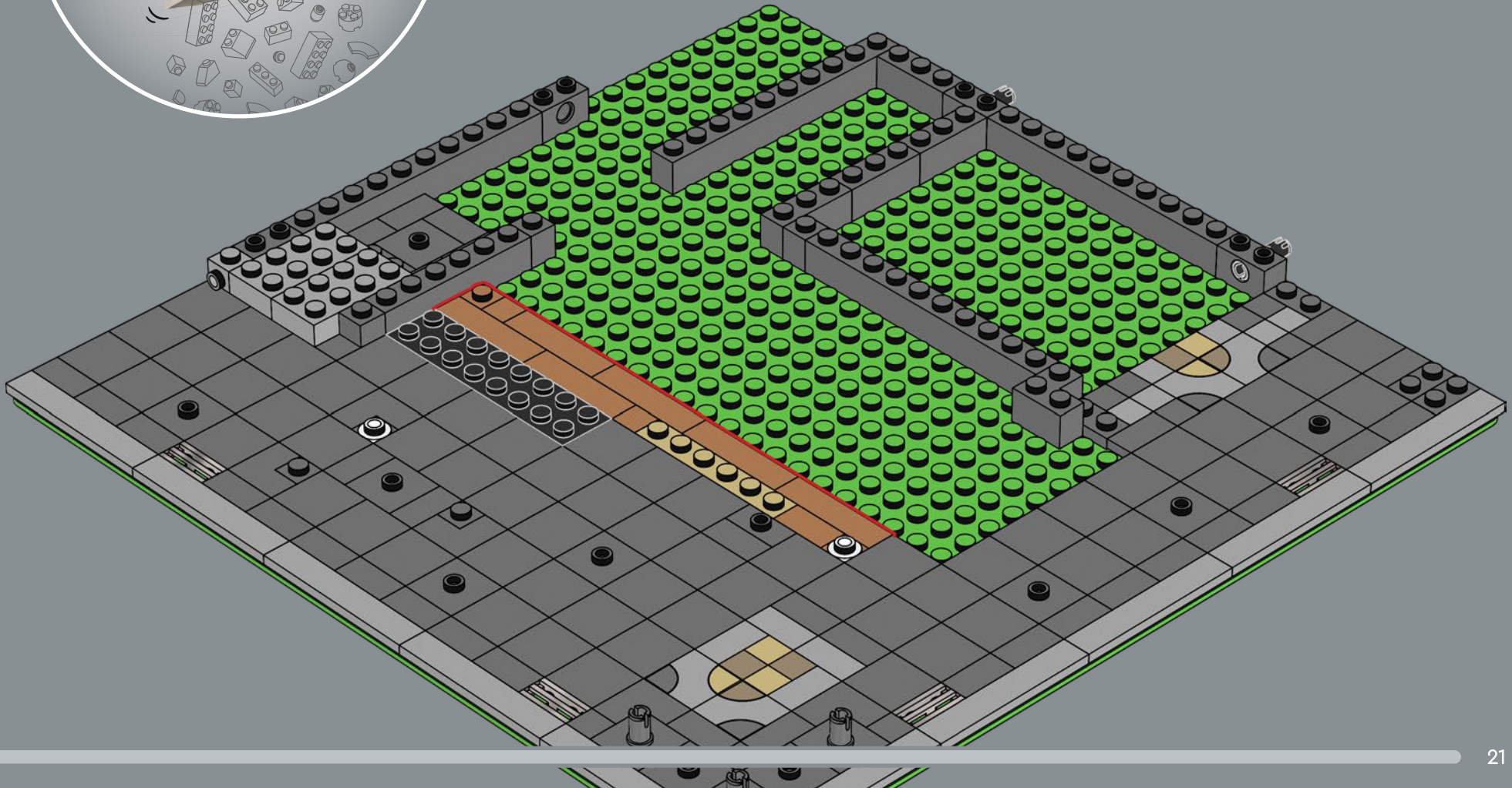



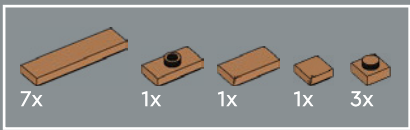

15

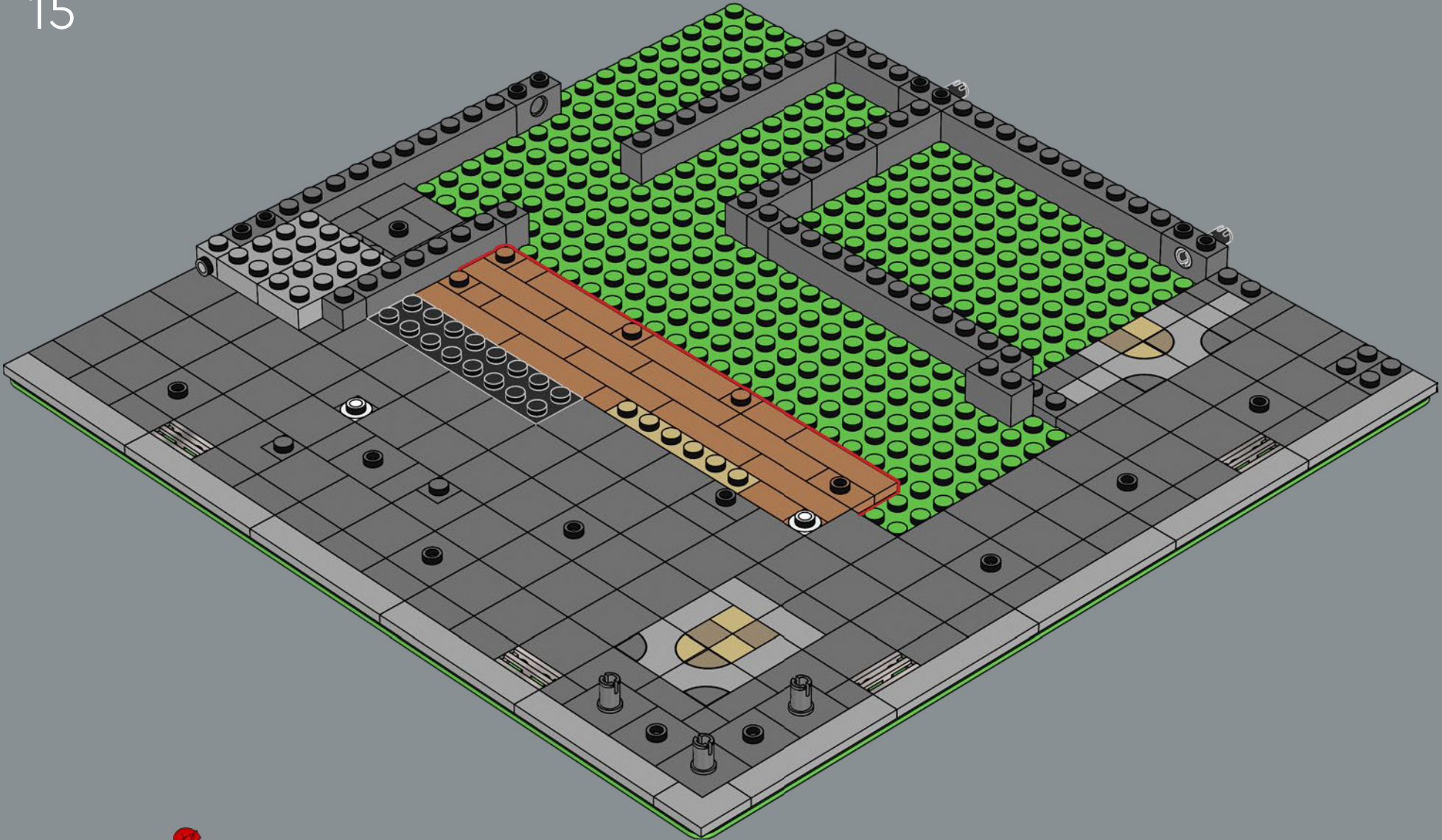

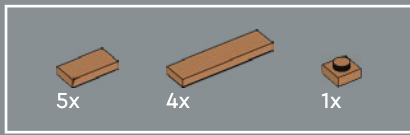

16

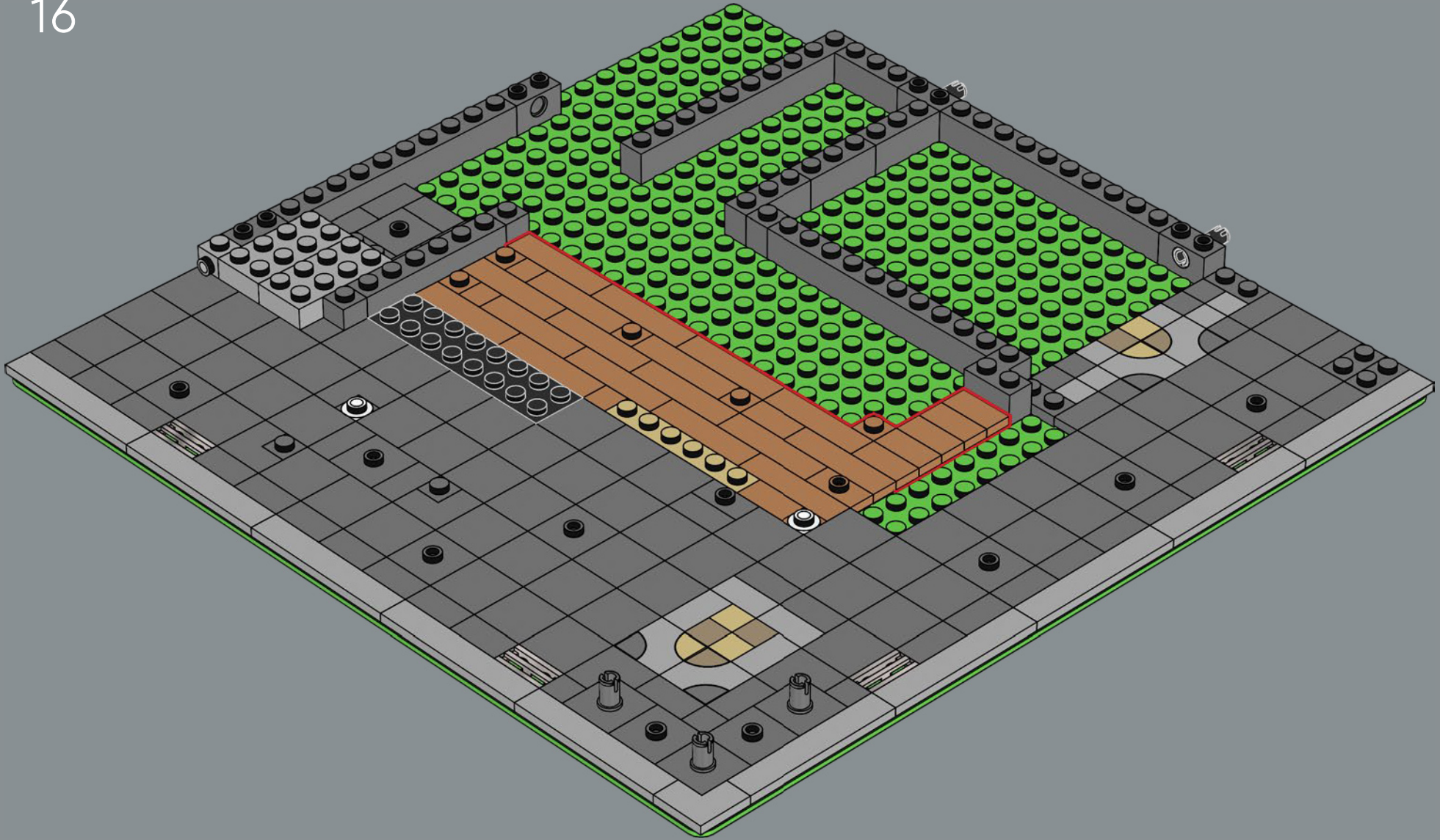



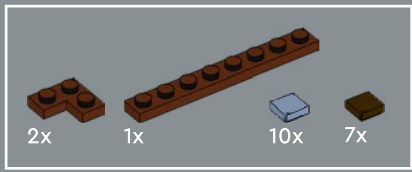

17

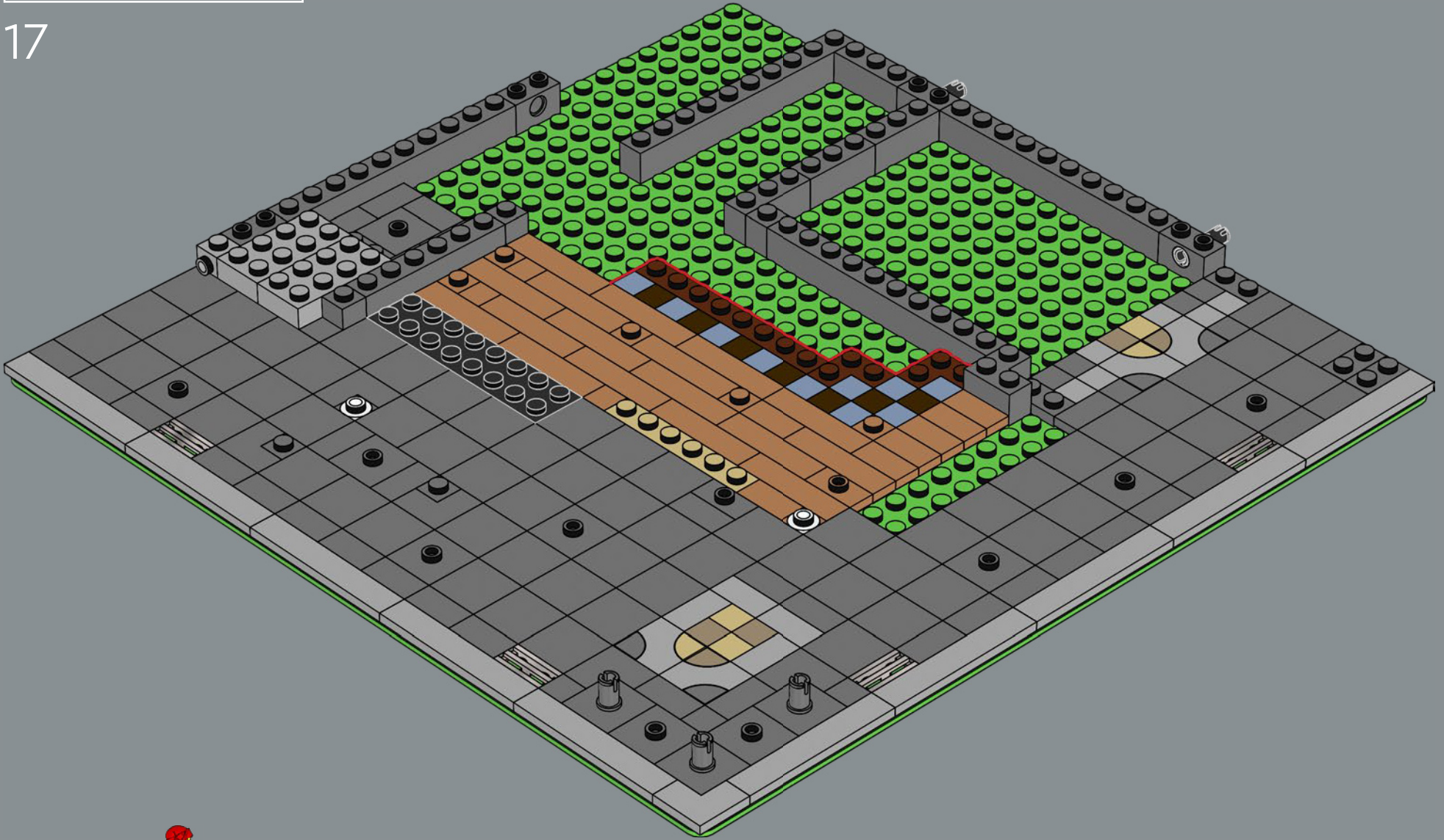

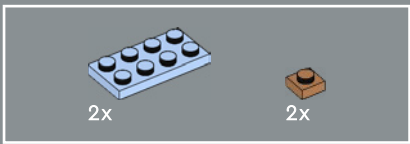

18

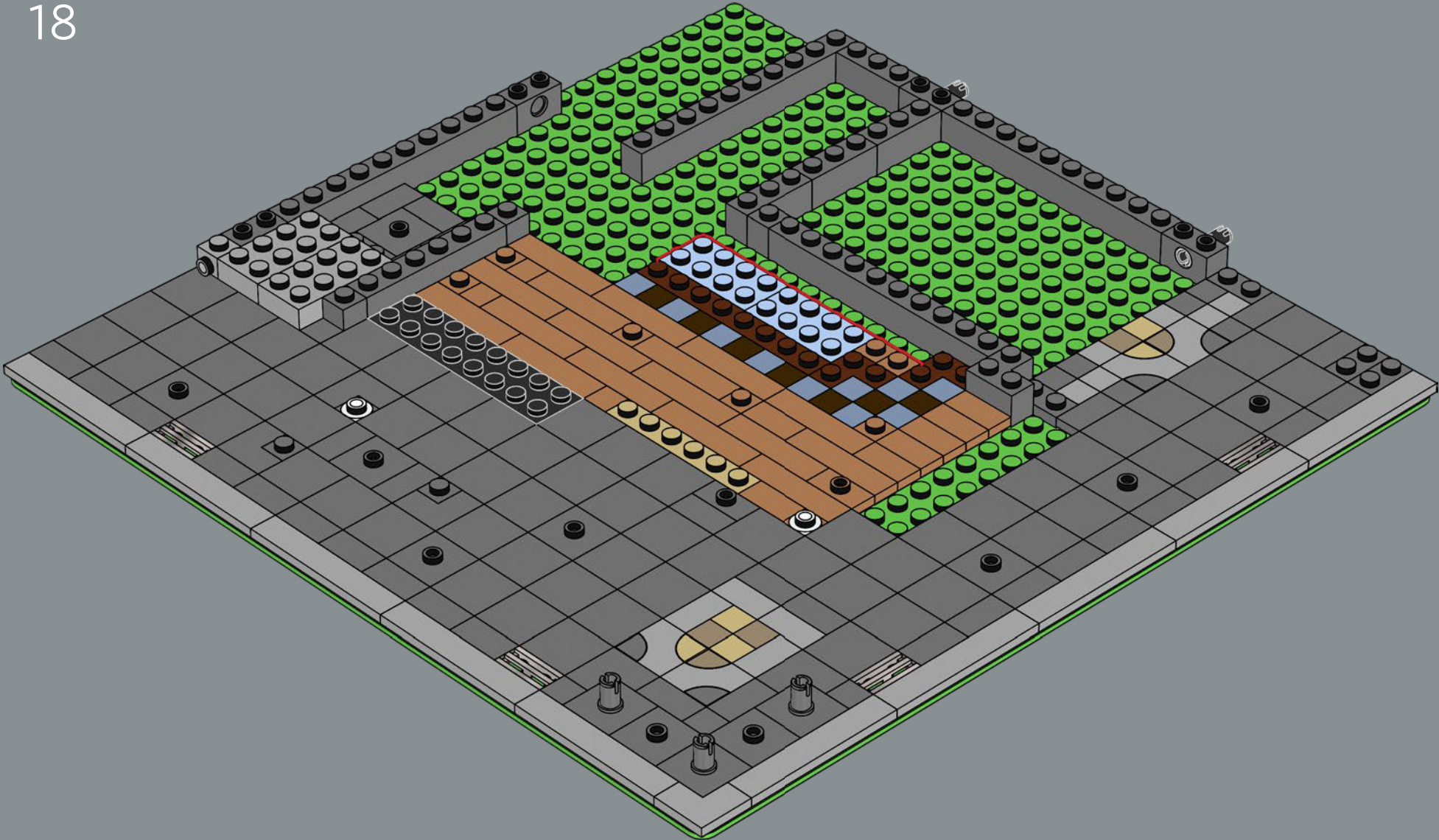



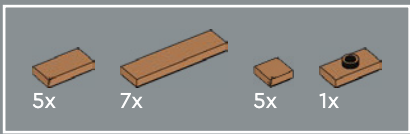

19

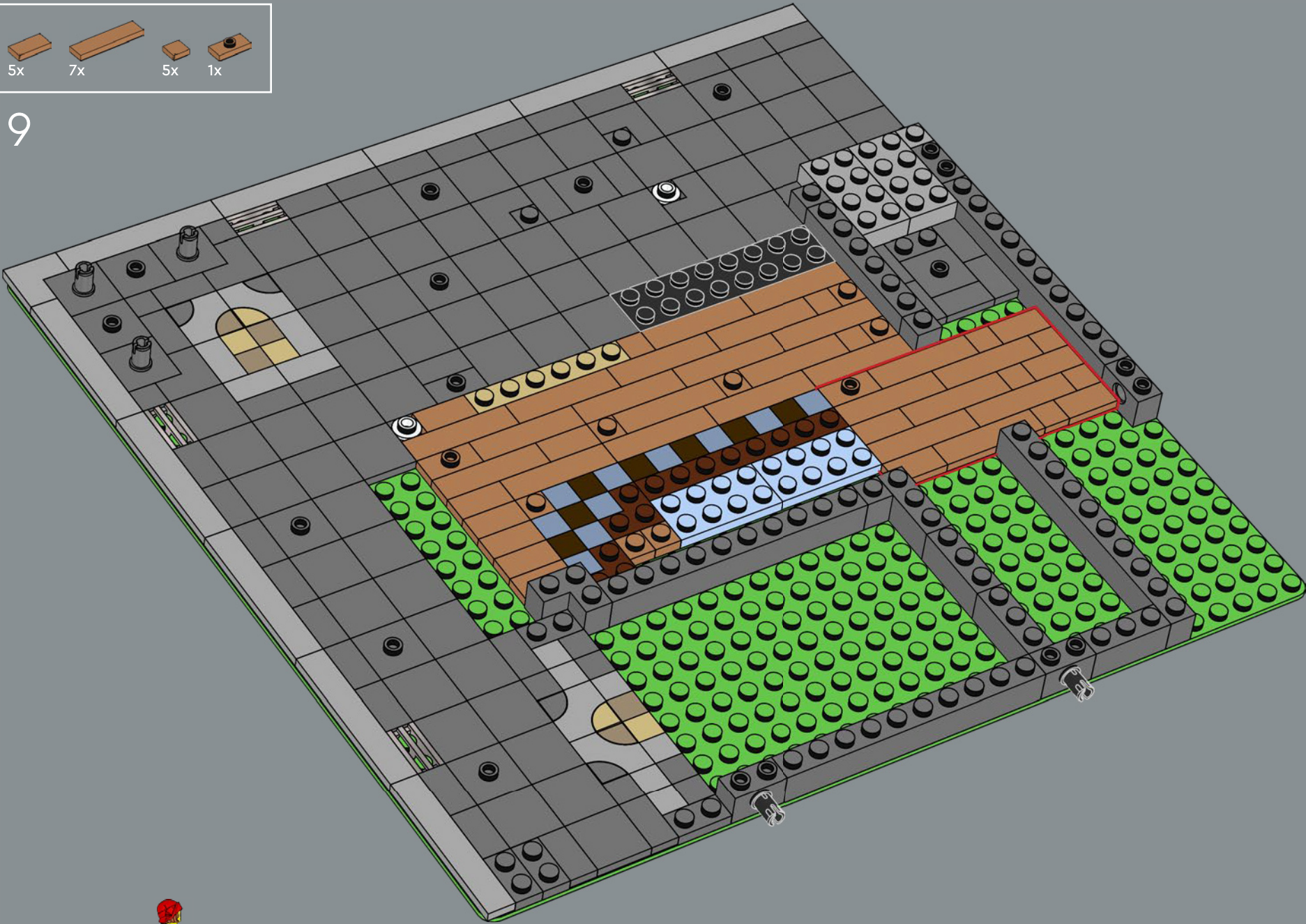



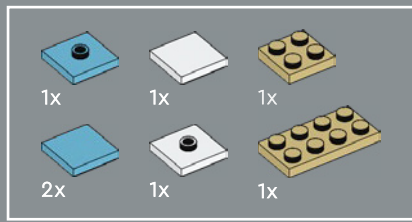

20

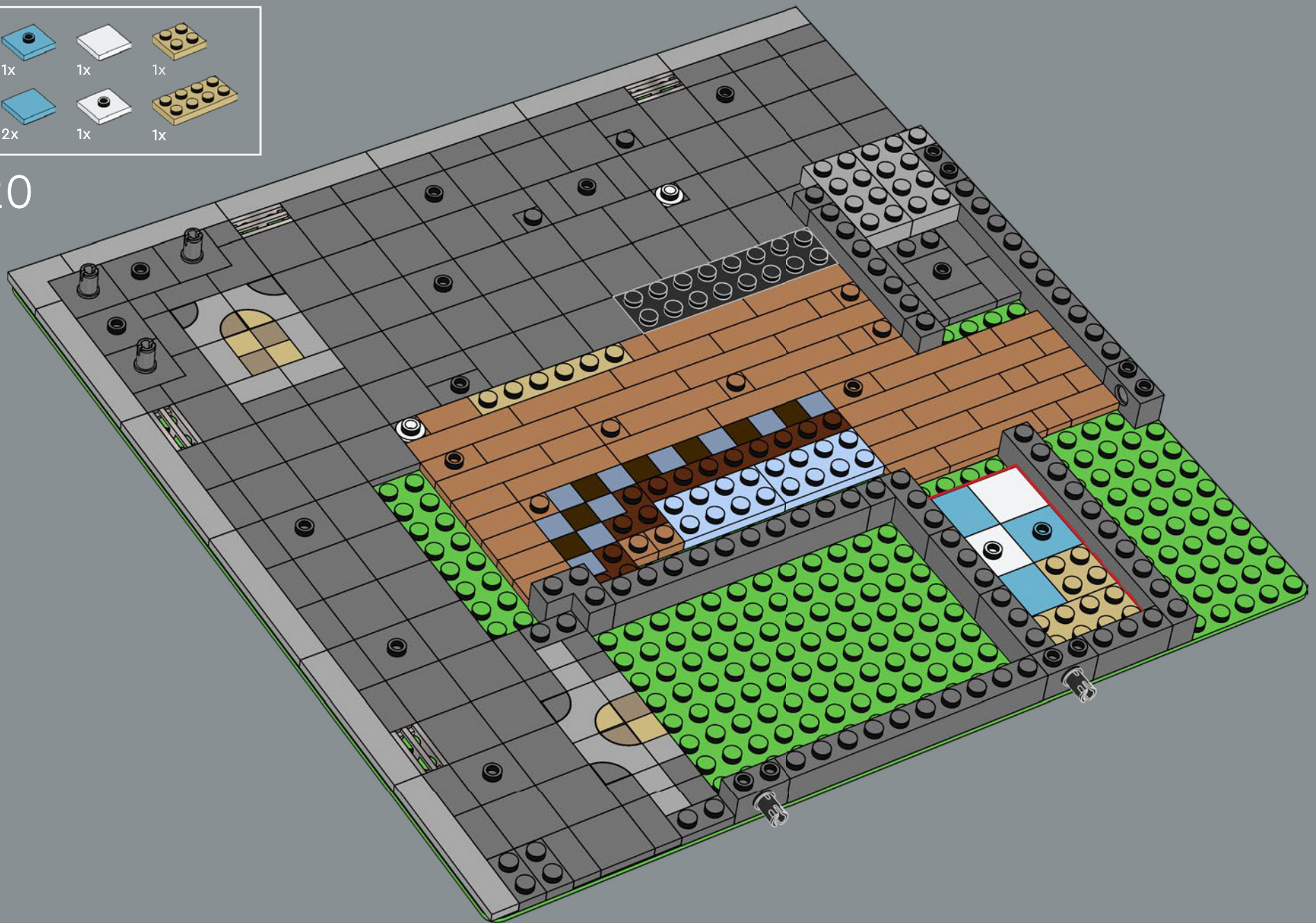



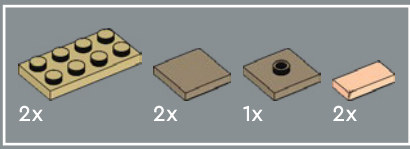

21

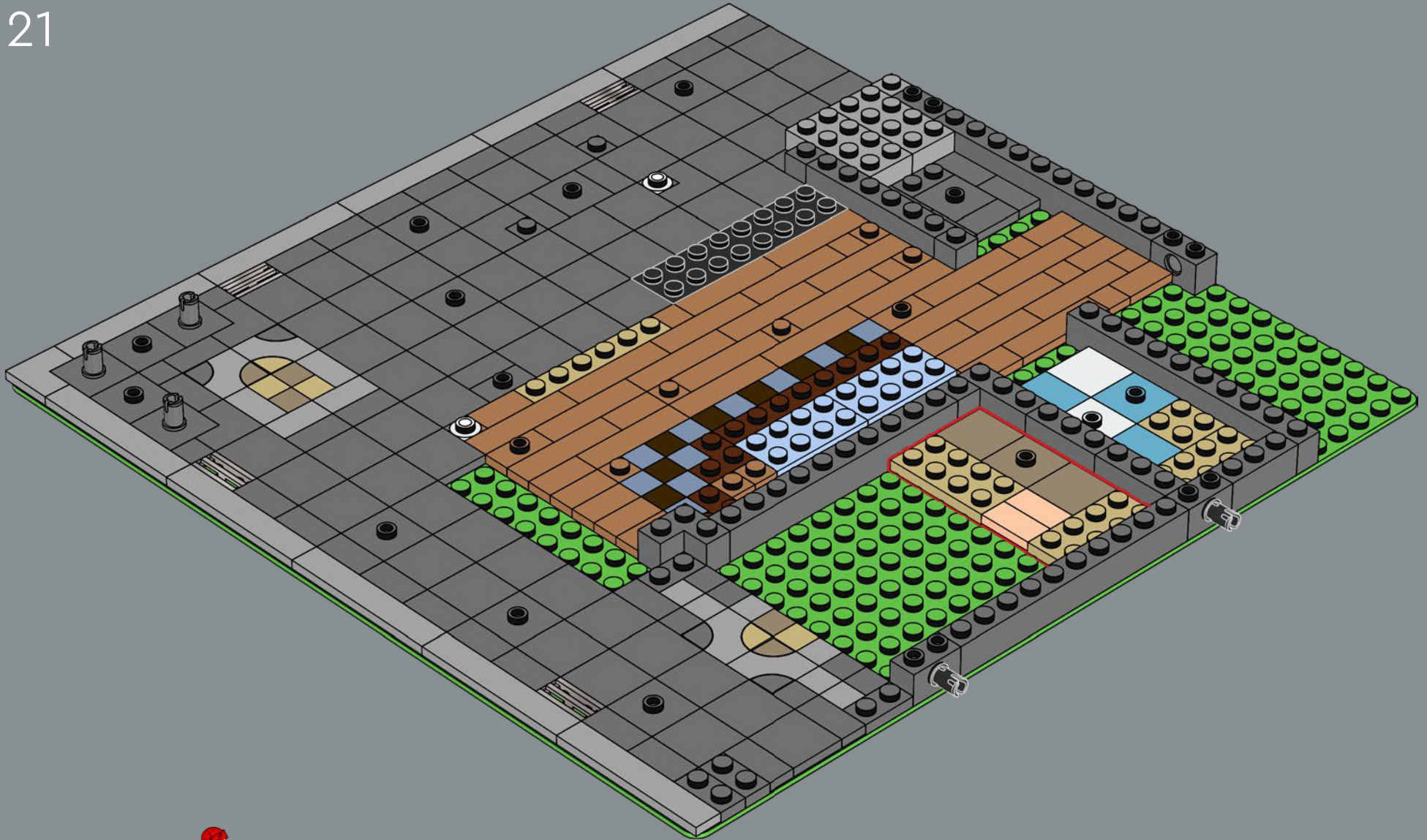



22

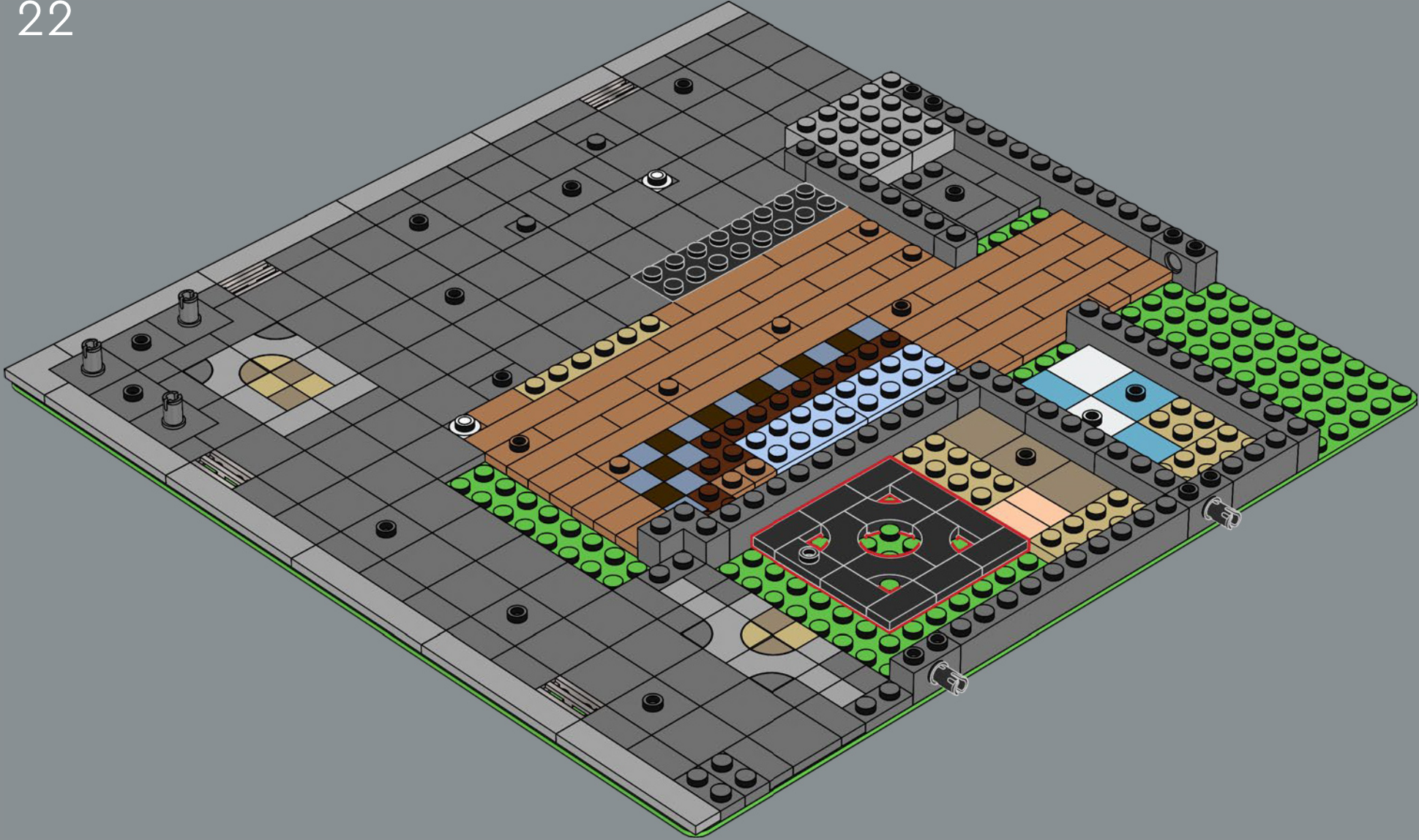



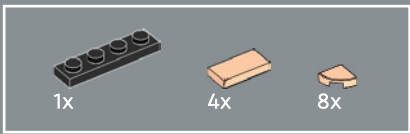

23

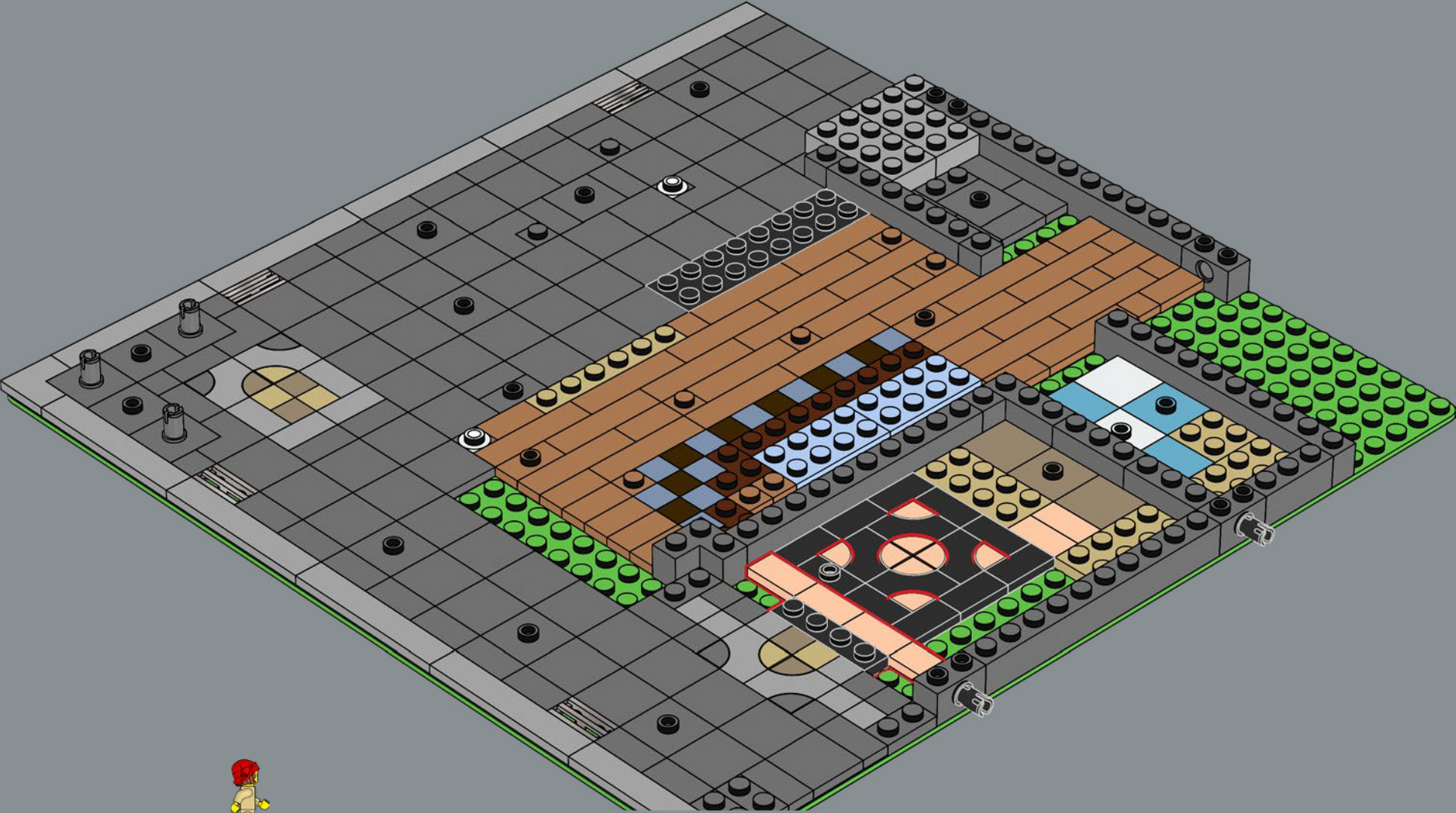

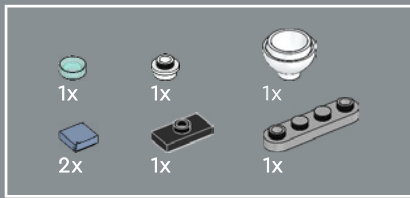

24

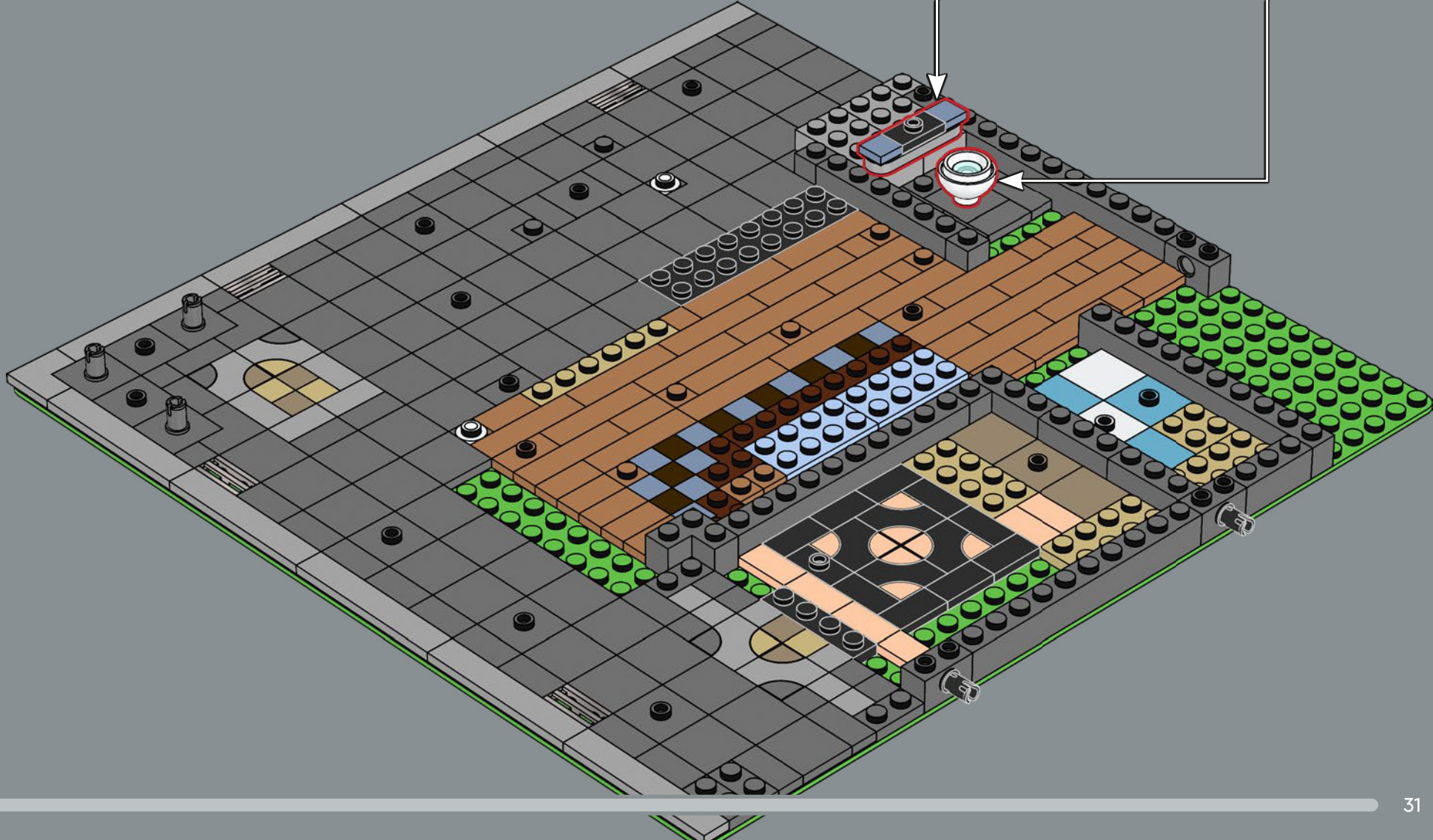
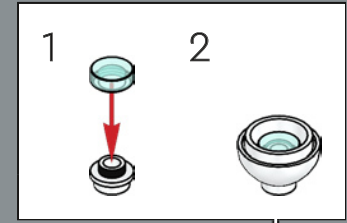
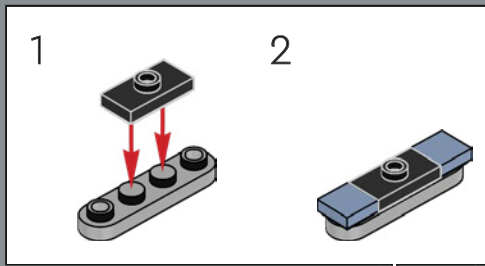



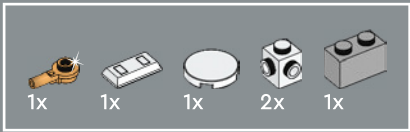

25

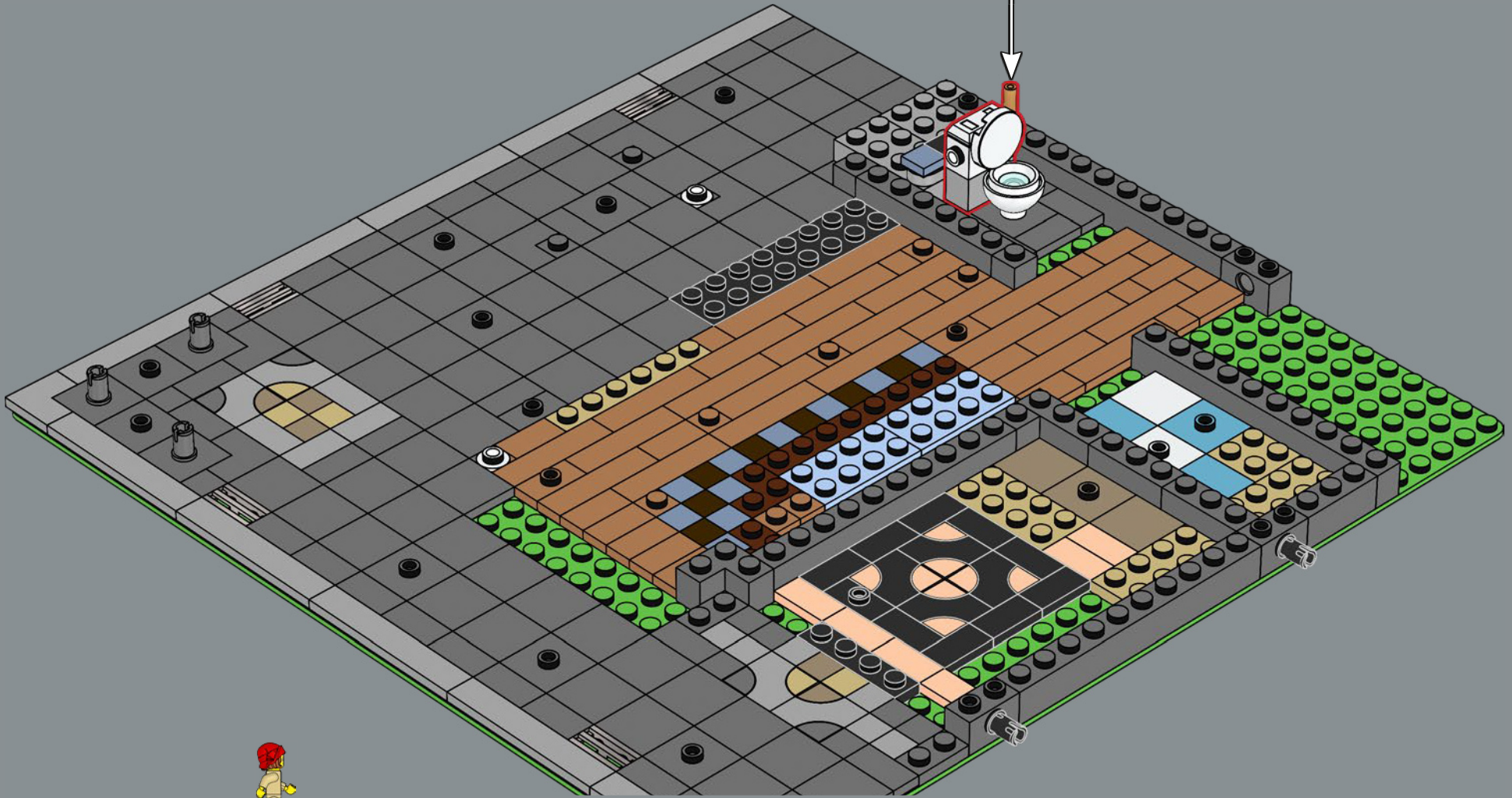
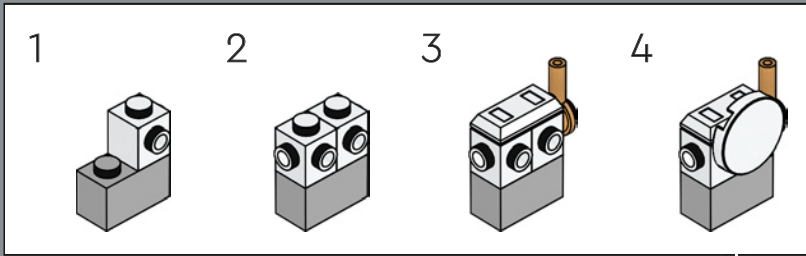

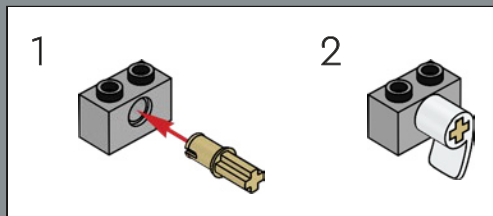
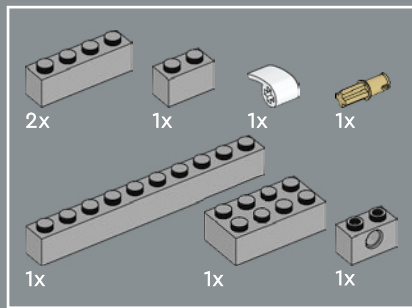

26

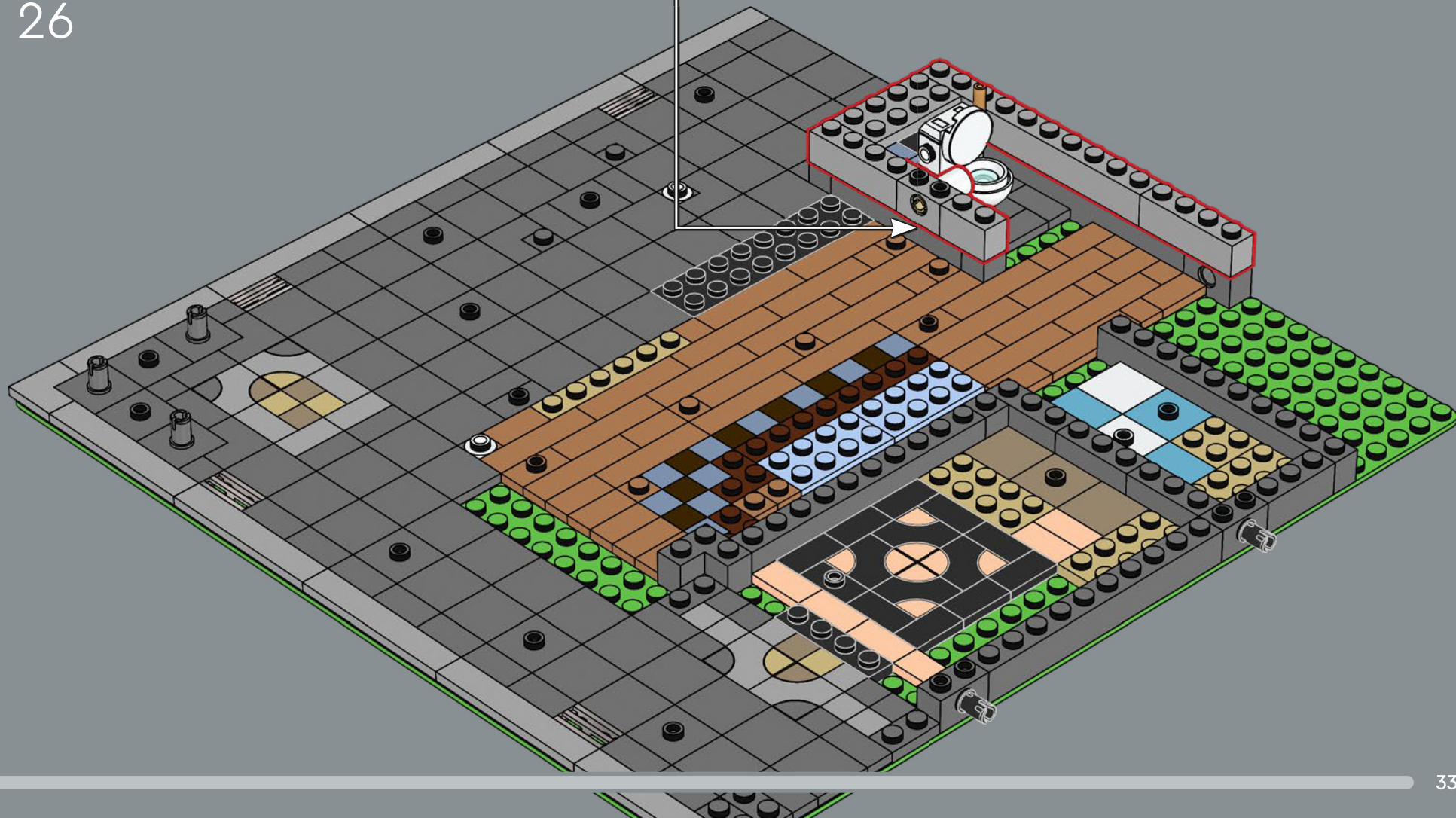



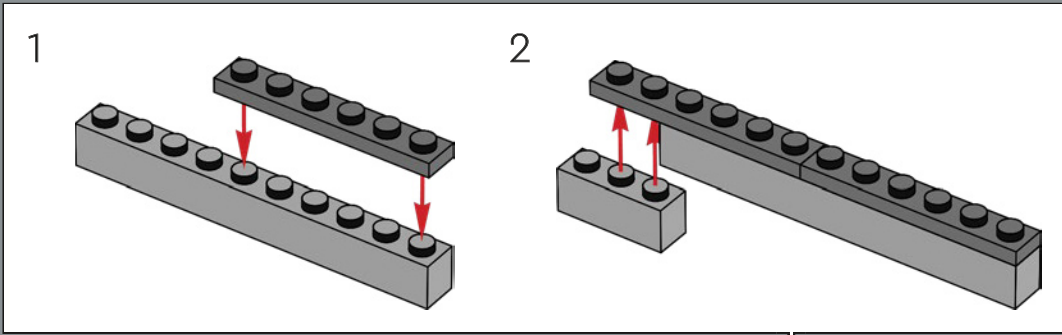
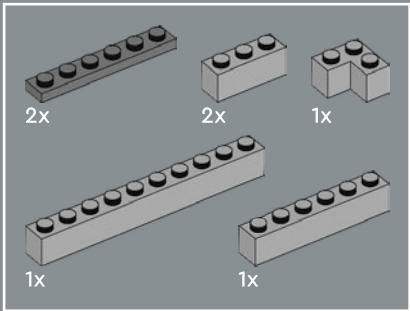

27

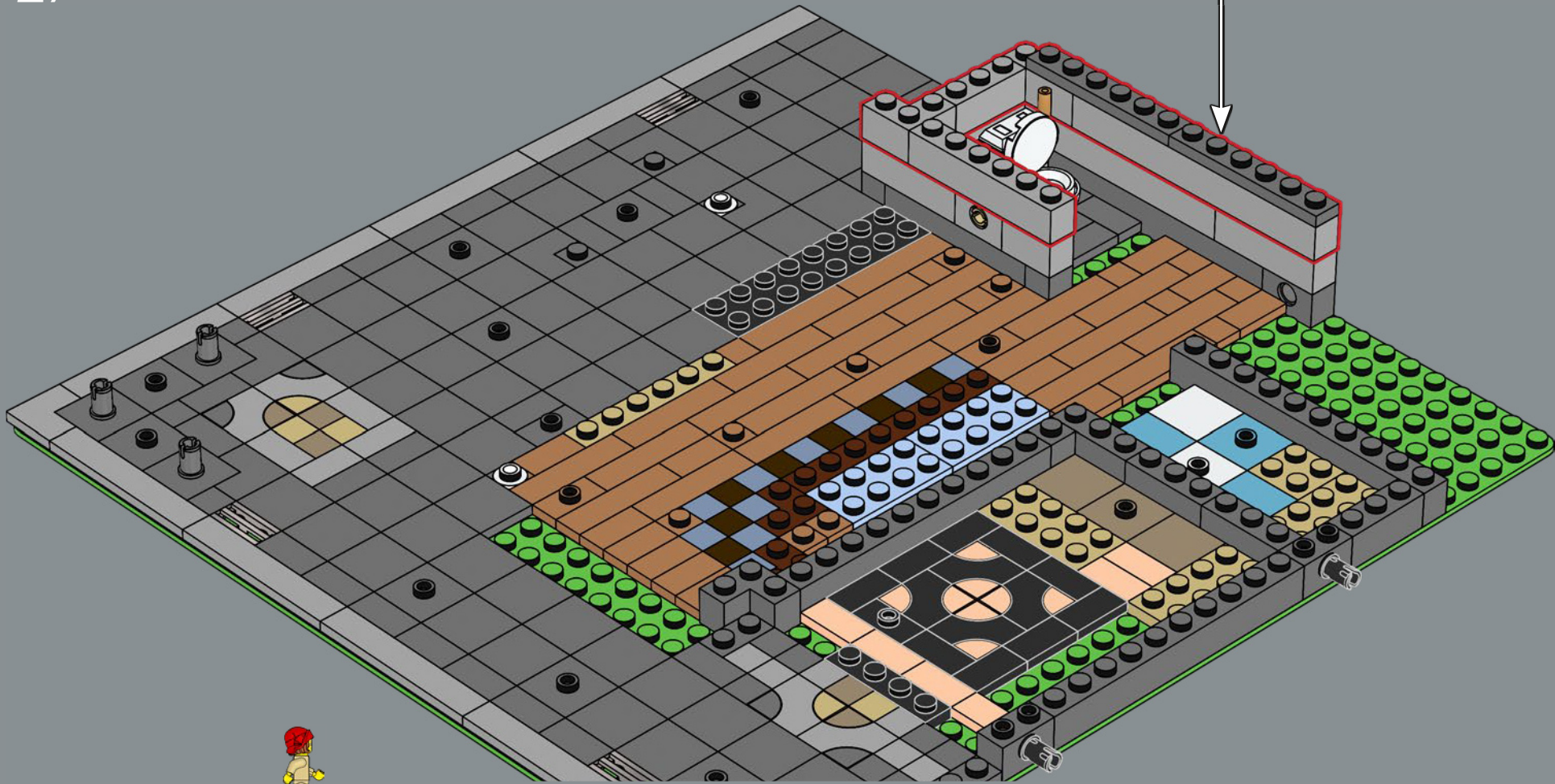

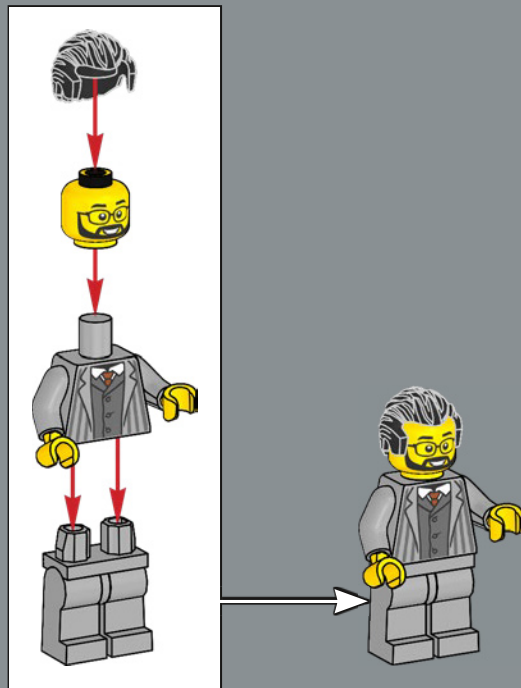



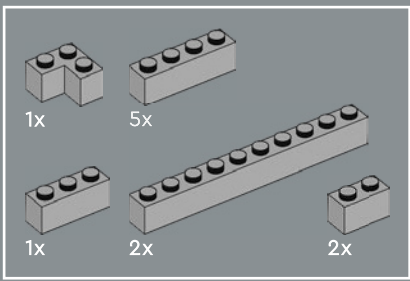

28

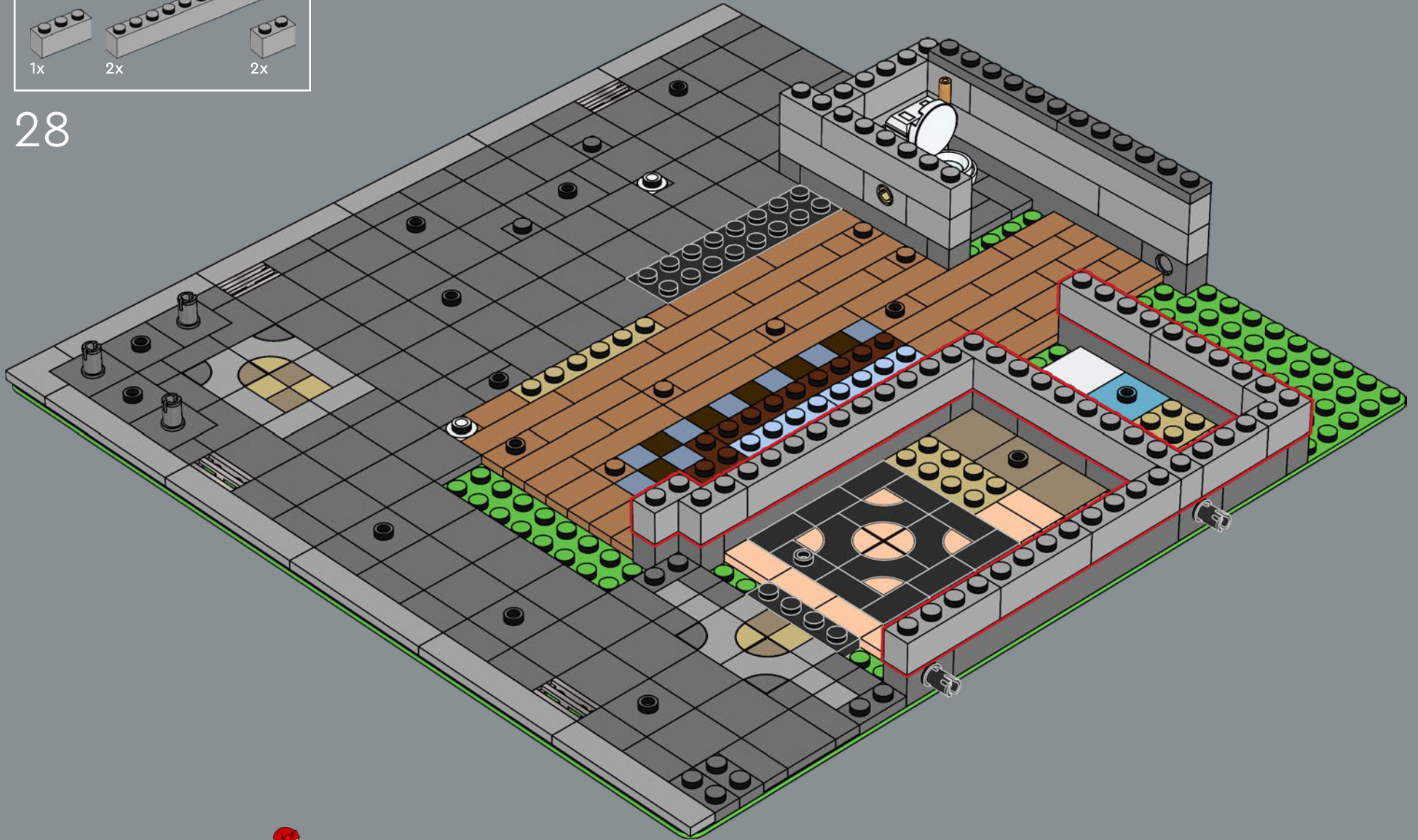

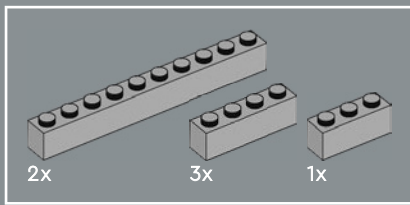

29

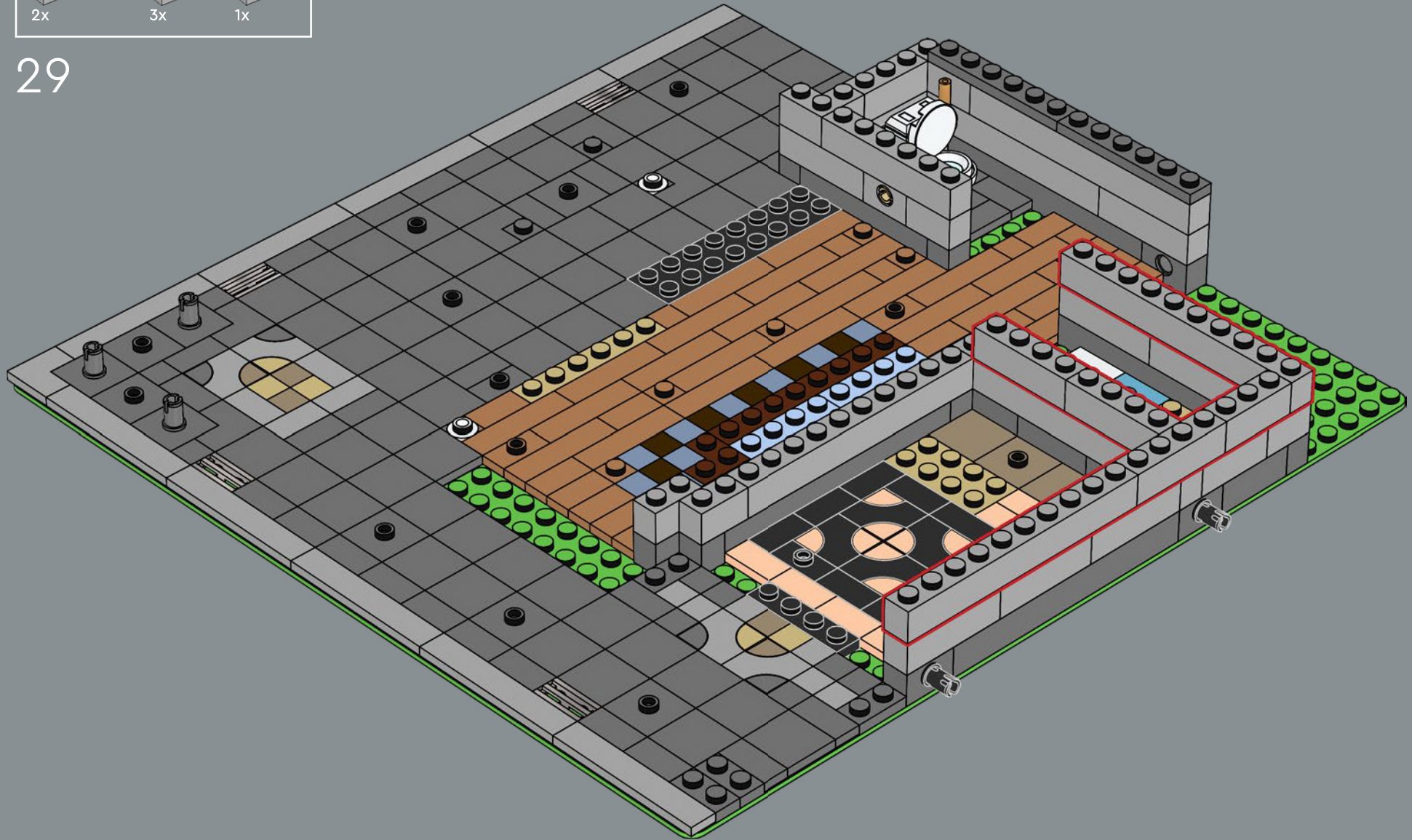



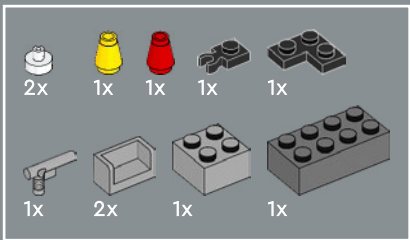

30

1

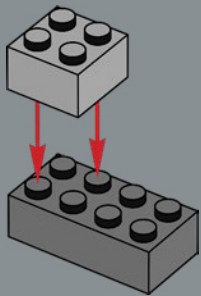

2

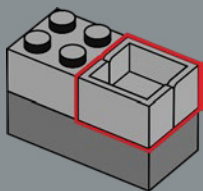

3

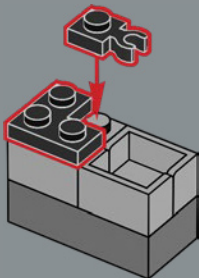

4

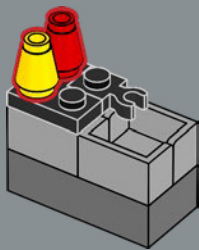

5

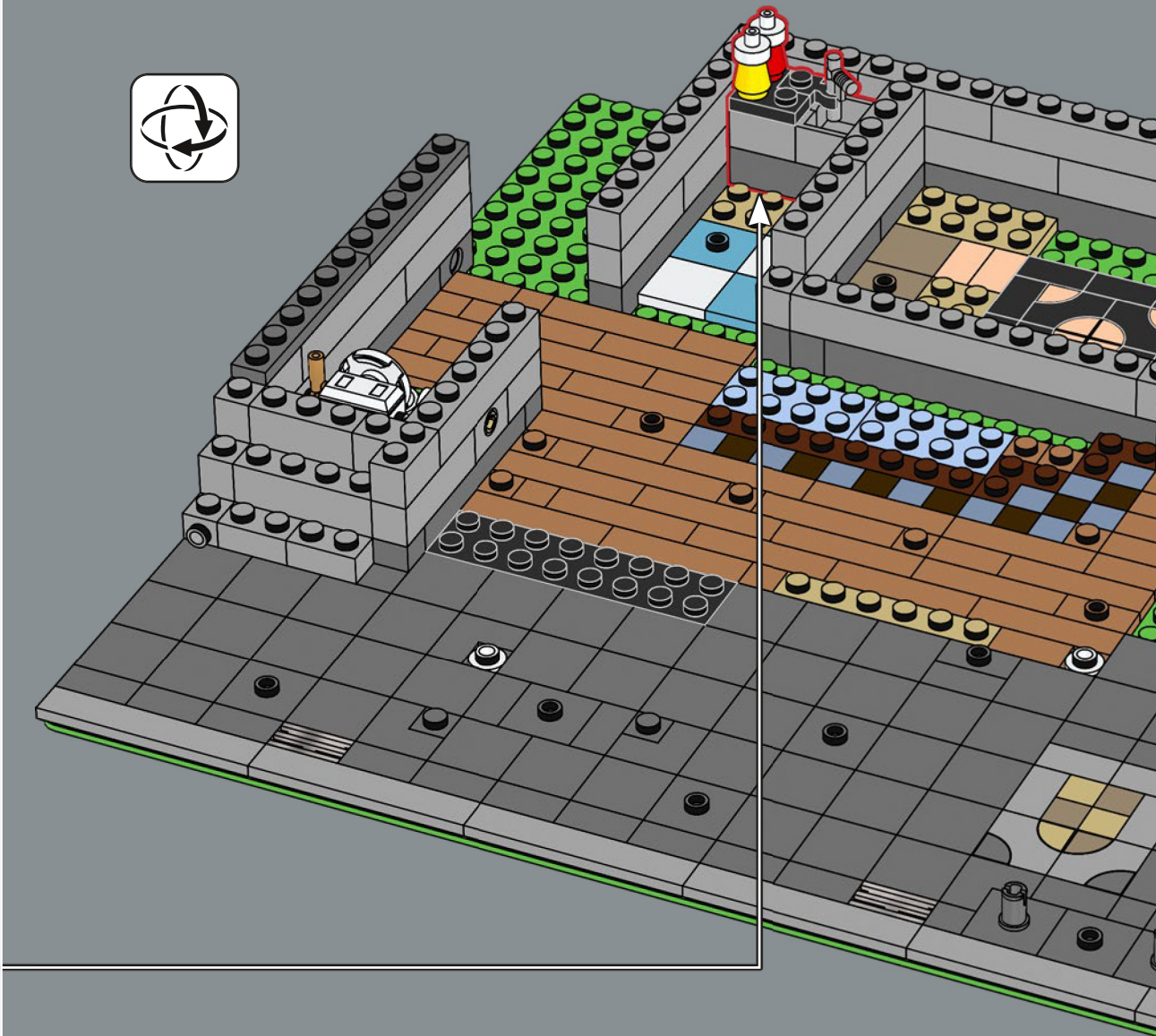
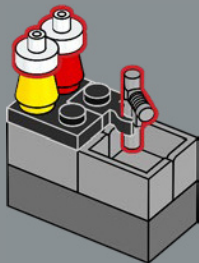

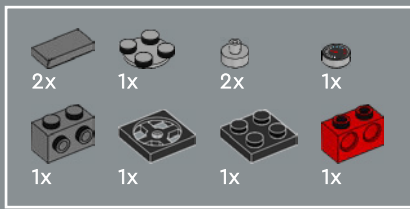

31

1



2



3



4

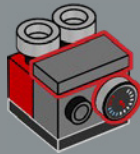

5

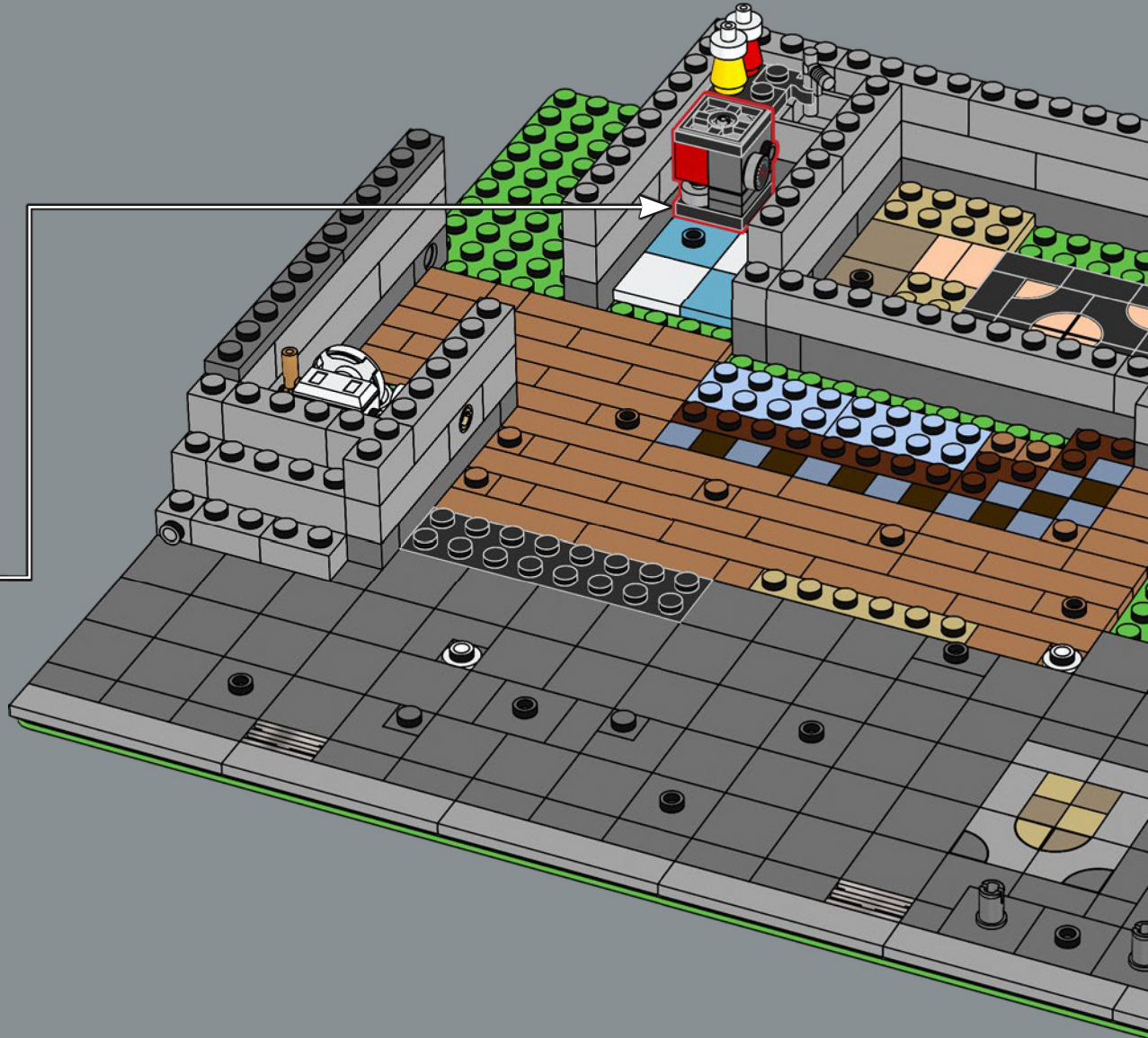
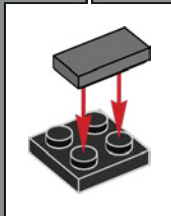



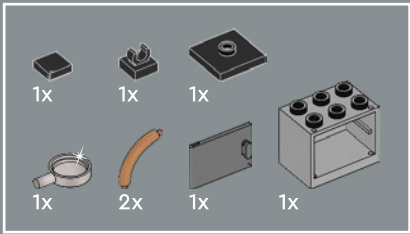

32

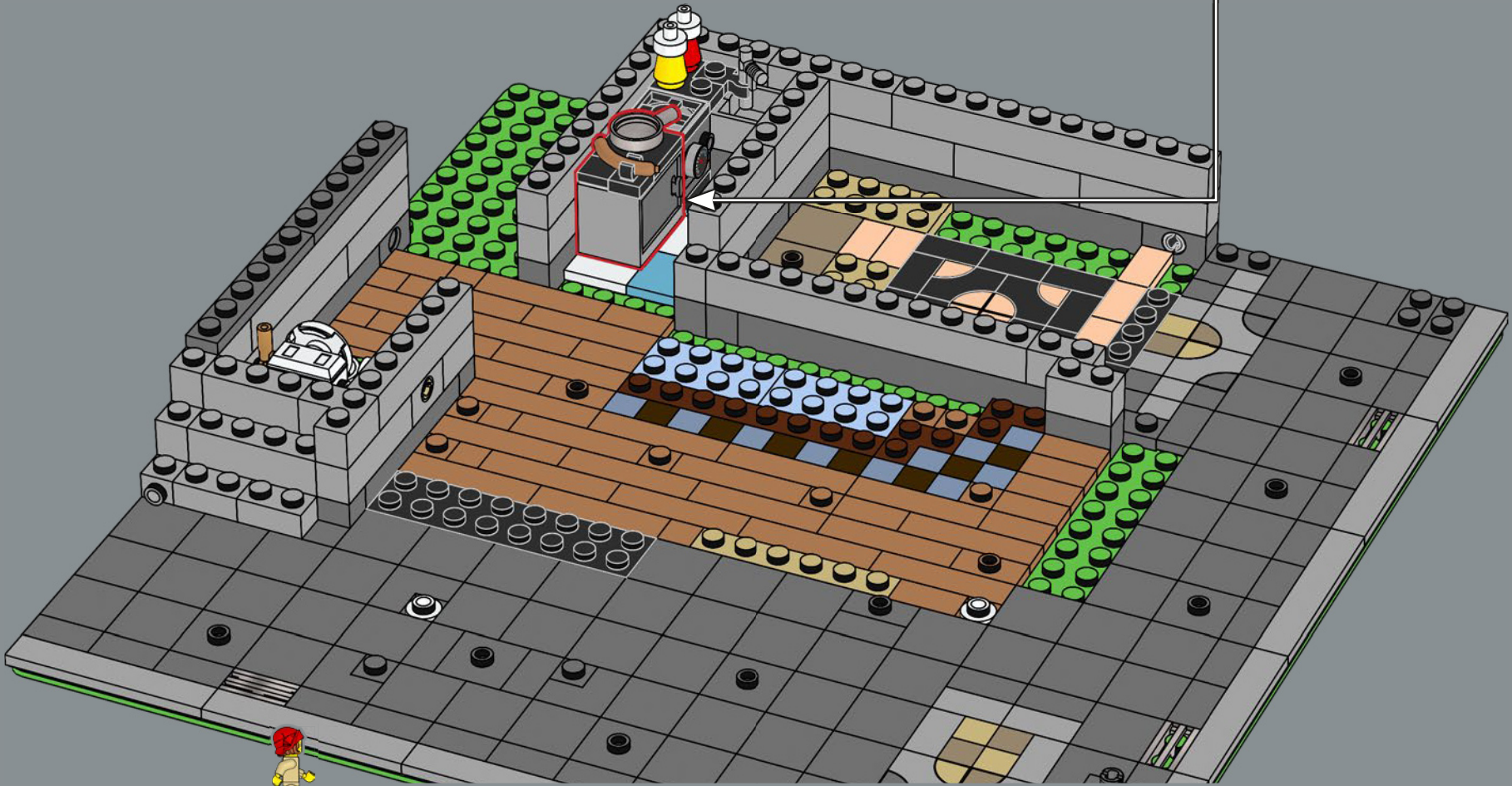
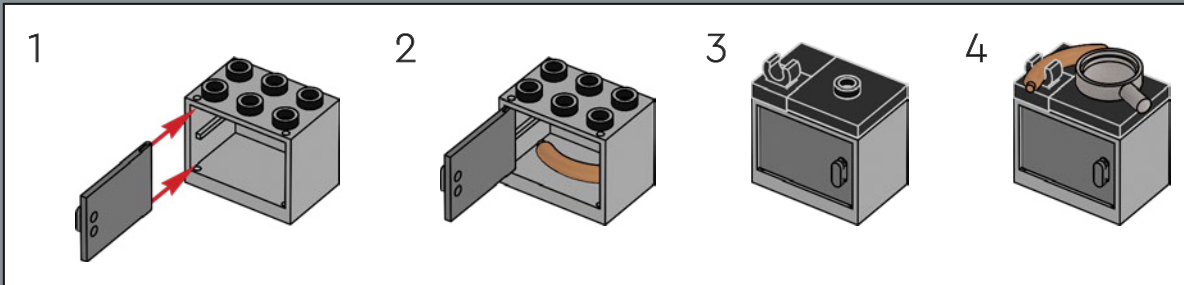

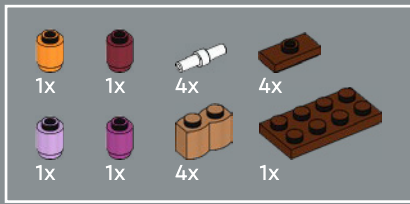

33

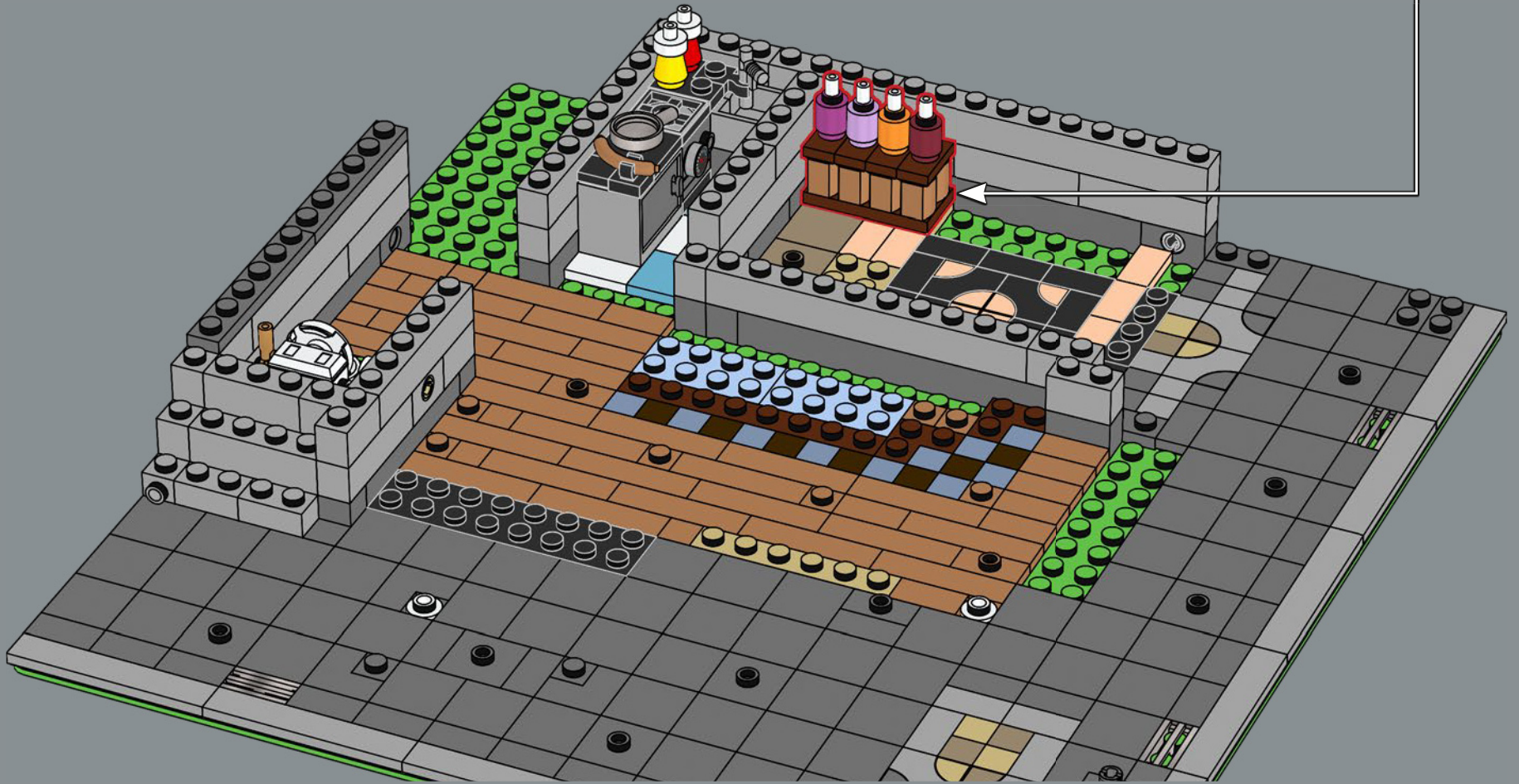
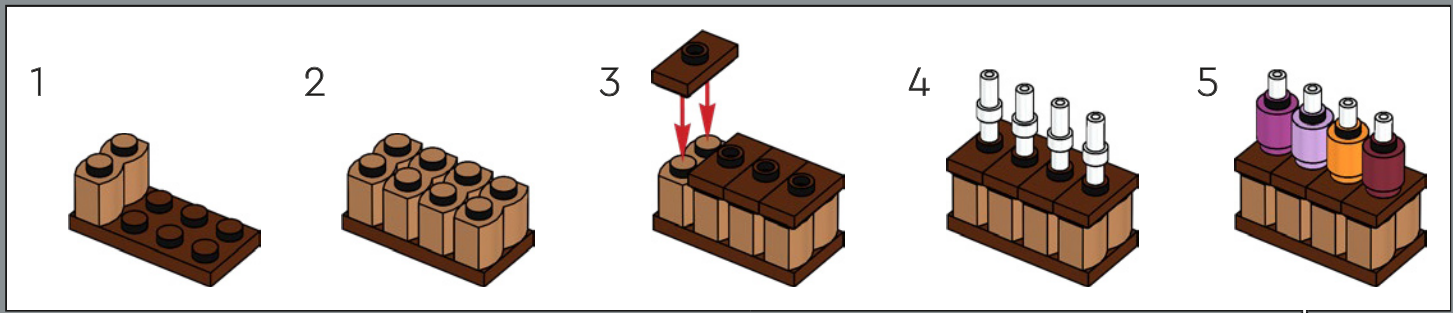



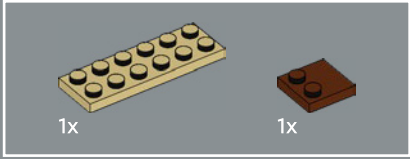

34

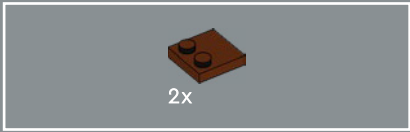
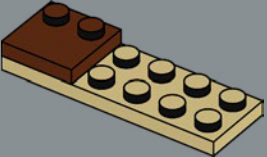

35

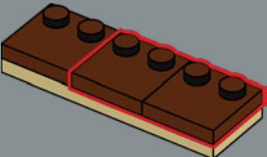

36

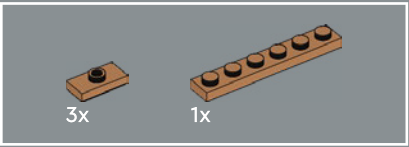
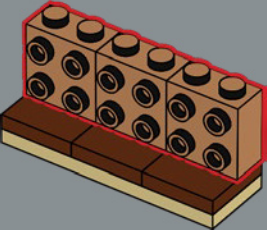

37

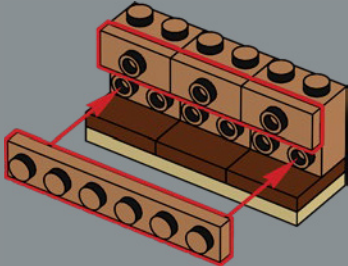

38

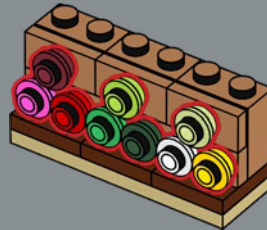

39

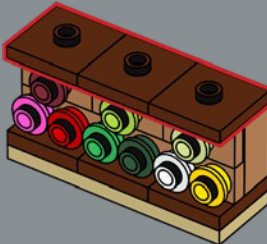



It is in this haberdashery that the tailor from the LEGO® Icons Jazz Club (10312) obtains the supplies for many of his sumptuous creations.



3x

40

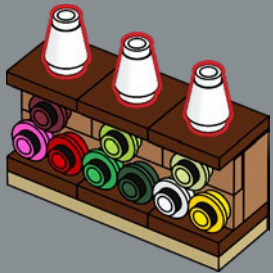

1x



1x



1x

41



42





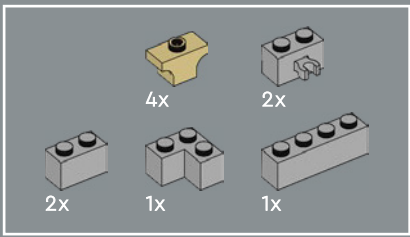

43

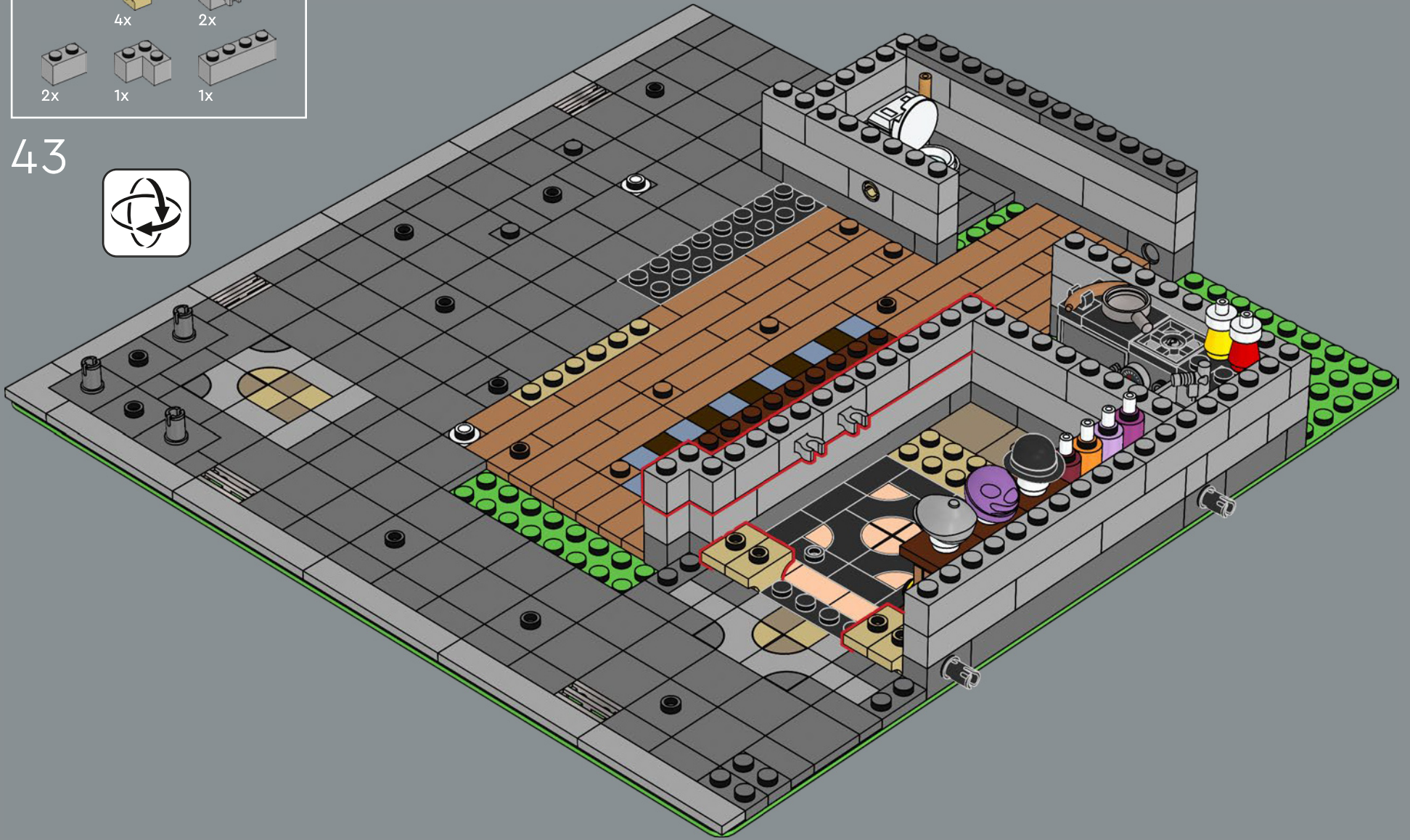

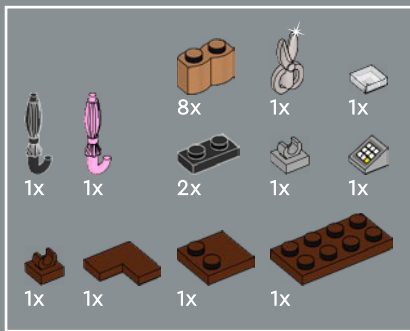

44

1

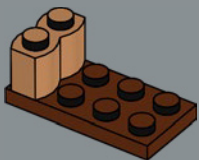

2

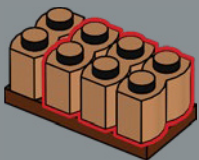

3

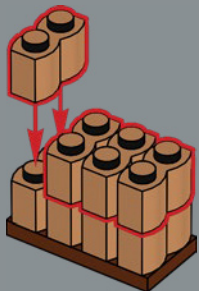

4

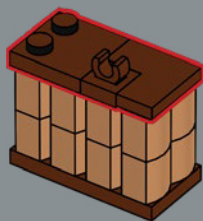

5

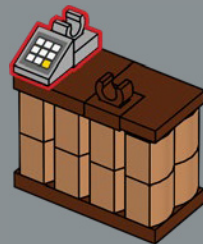

6

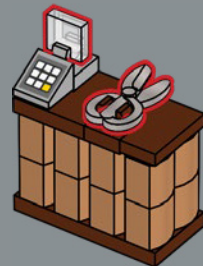



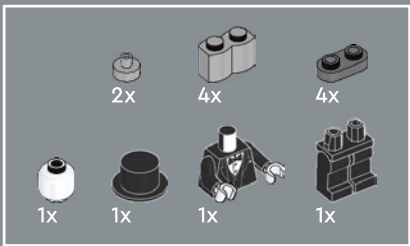

45

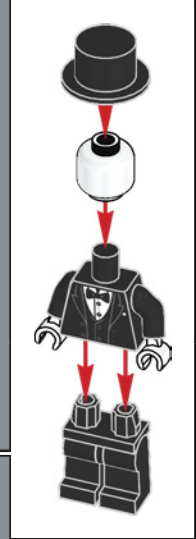
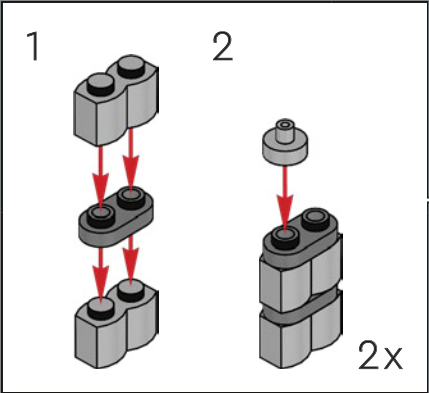

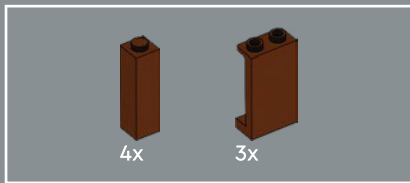

46





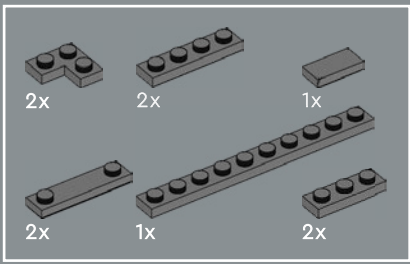

47



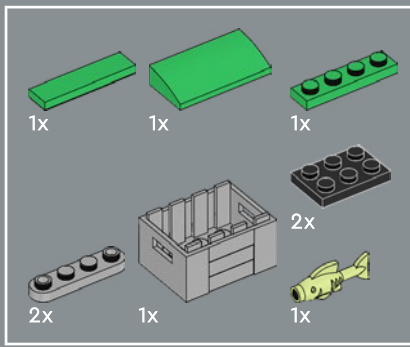

48

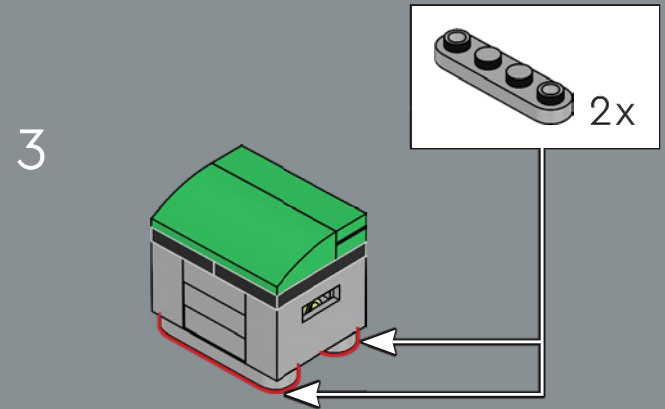
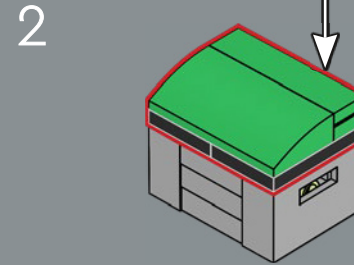
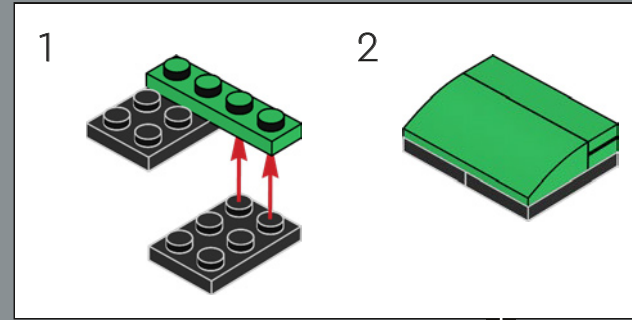
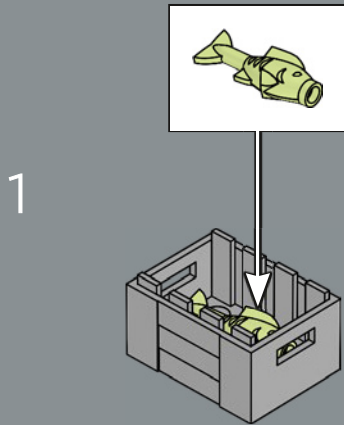





Although this fish might not be fresh from the kitchen, the local kittens are very excited to get a free meal!



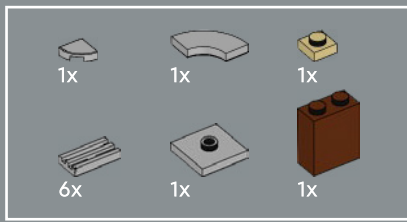

49

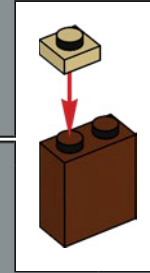



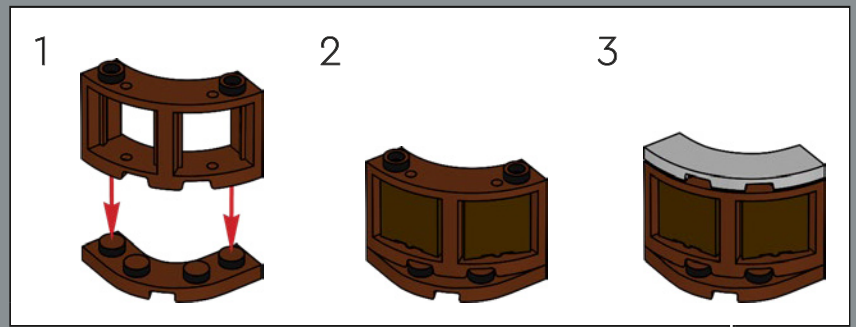
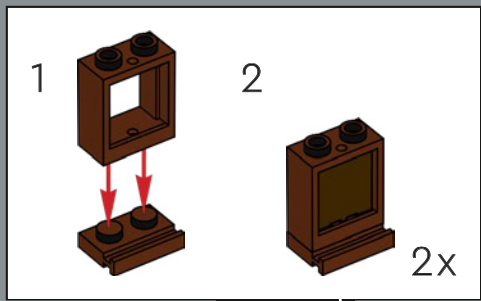
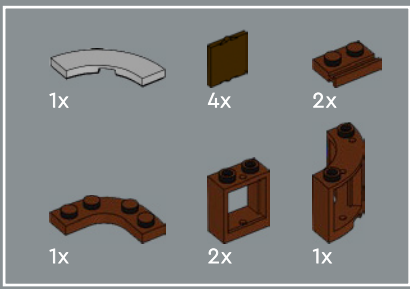

50

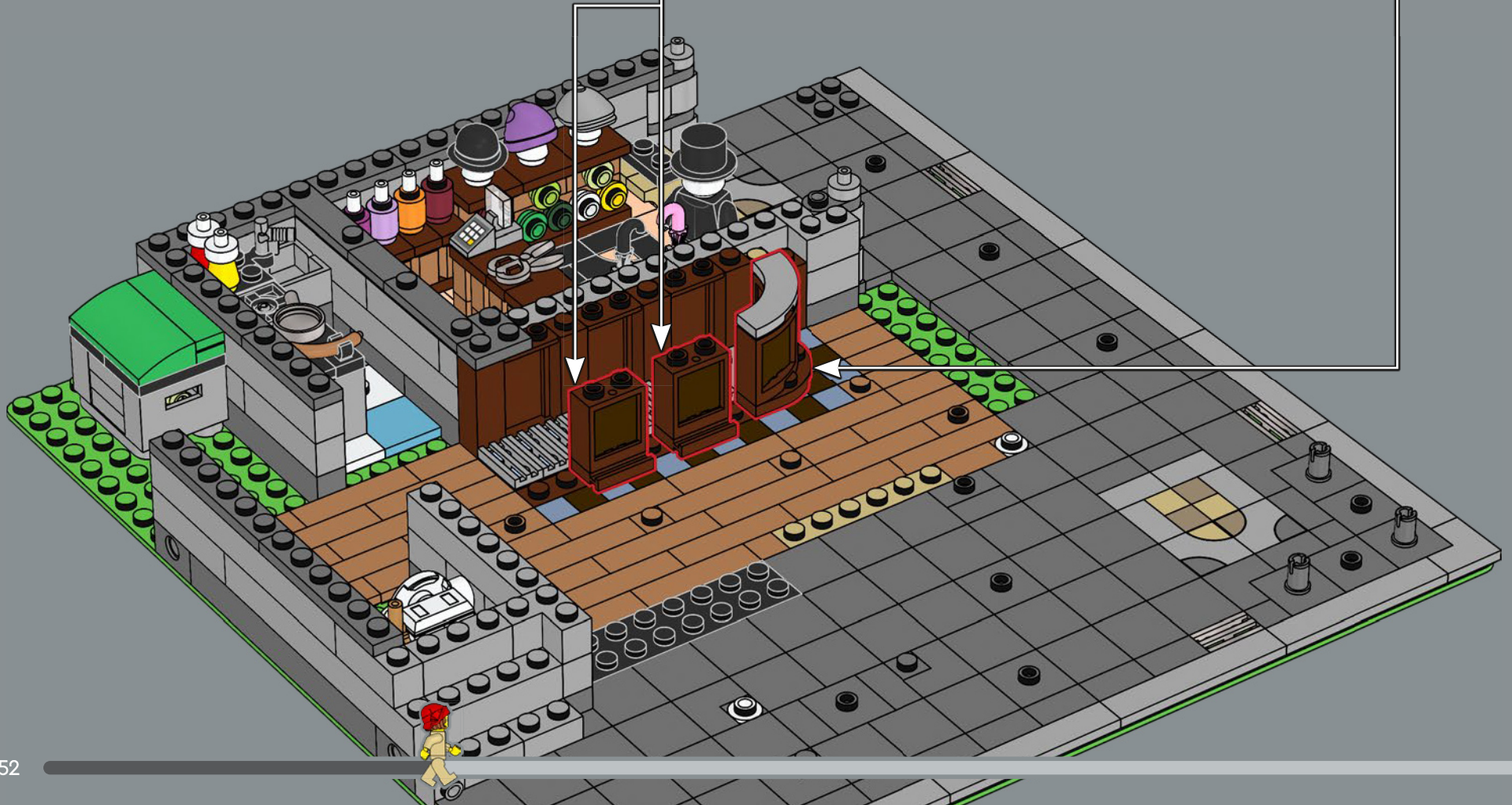

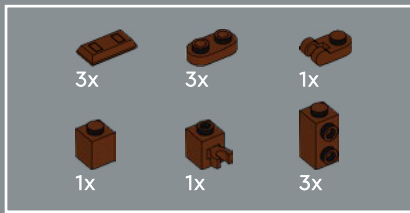

51

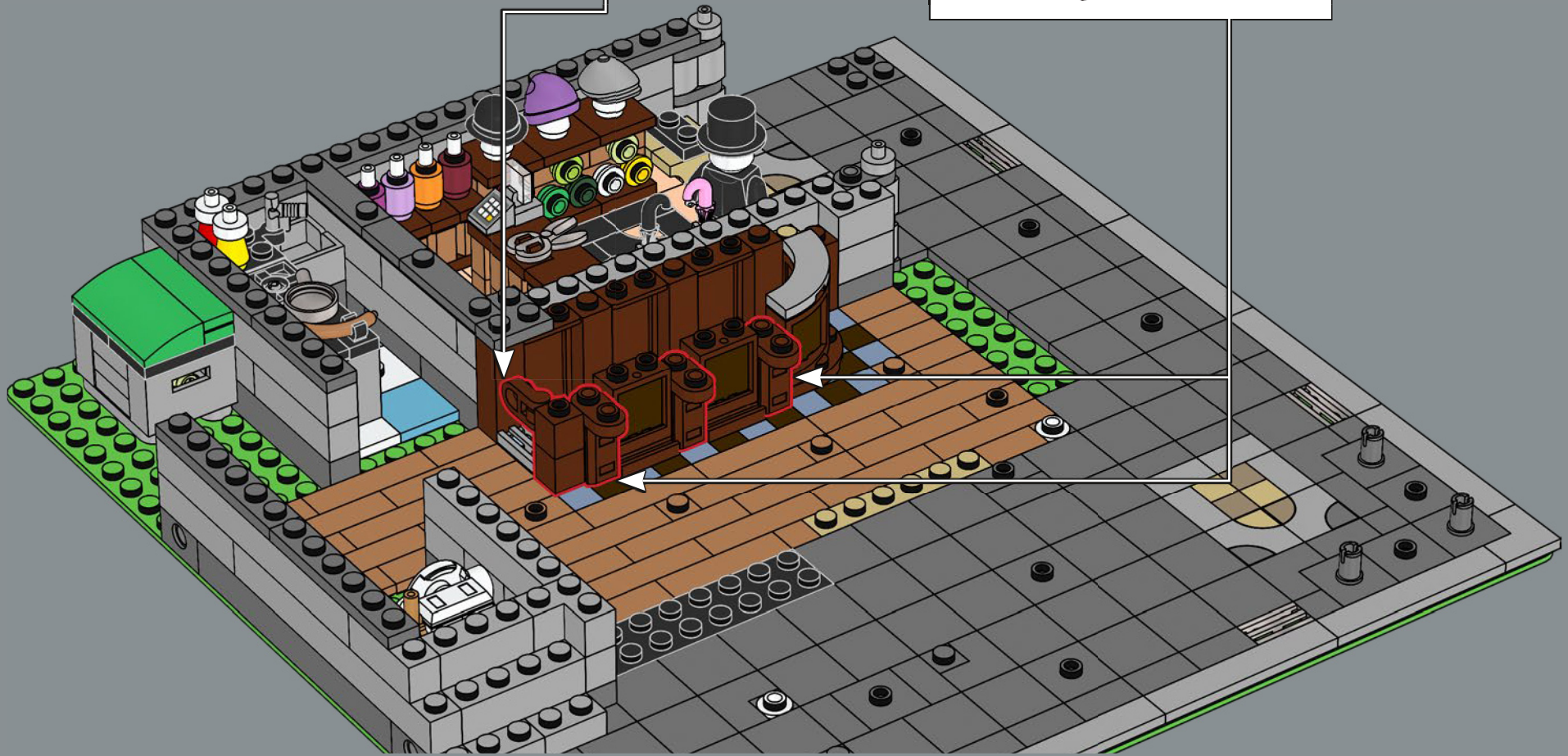
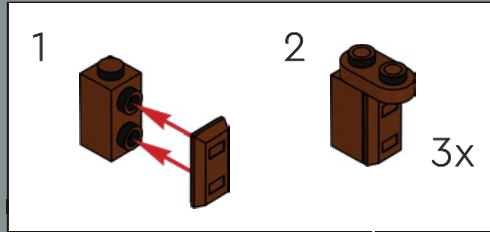
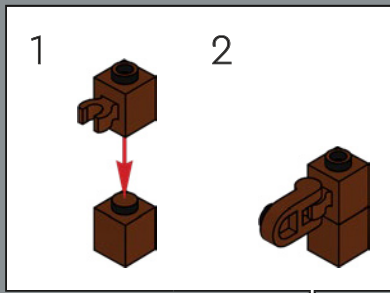



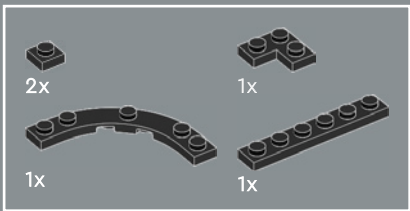

52



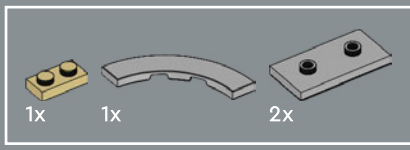

53

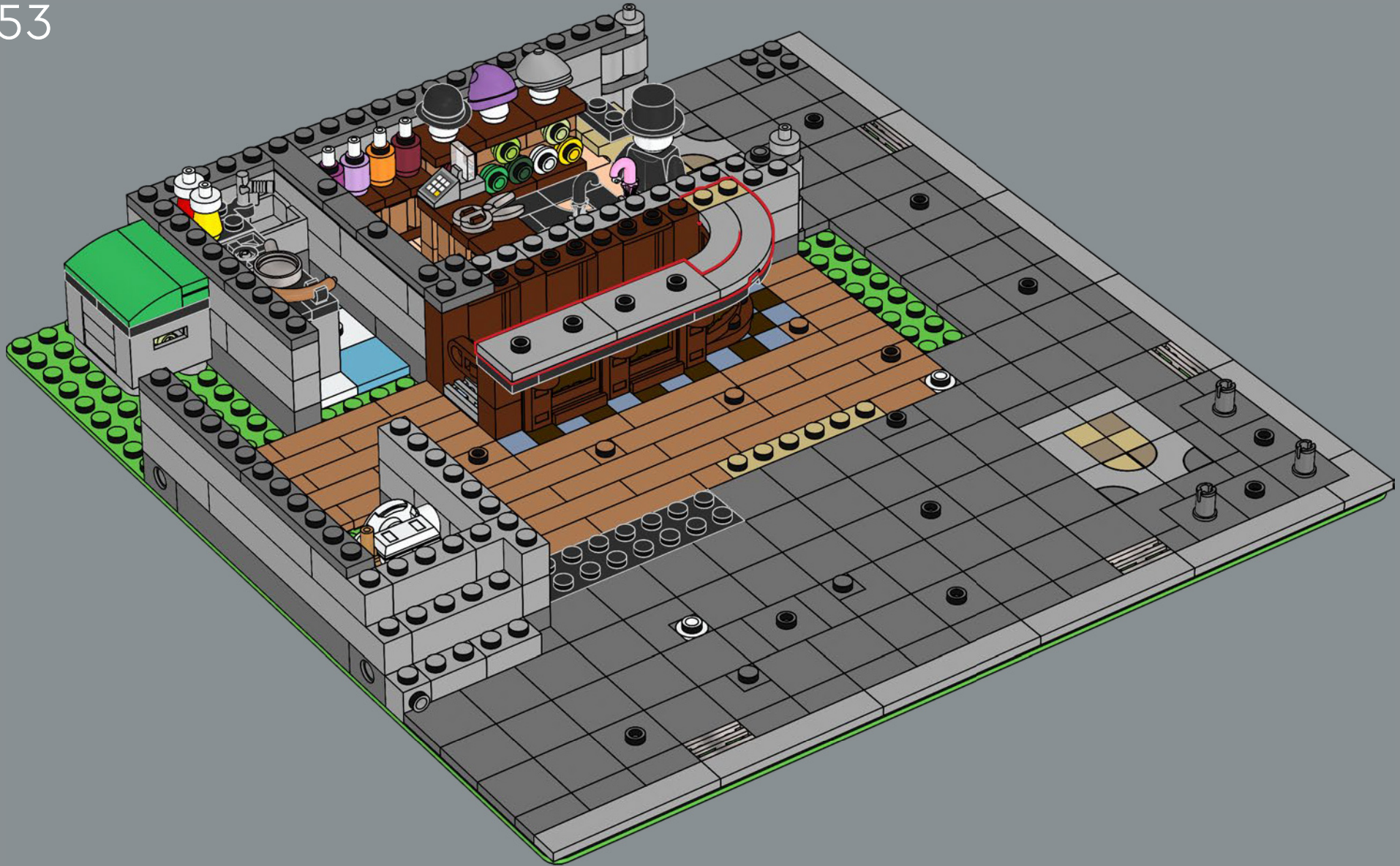



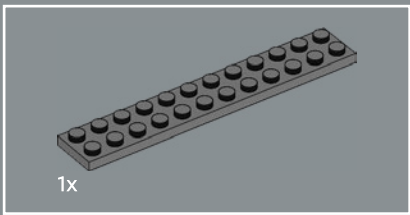

54



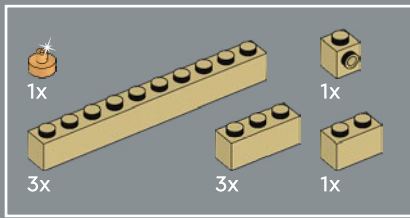

55

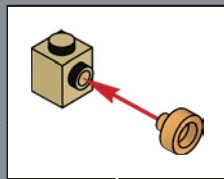



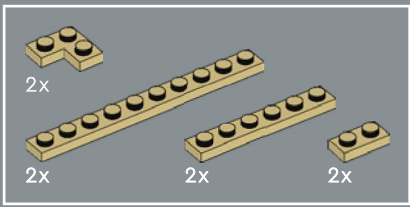

56





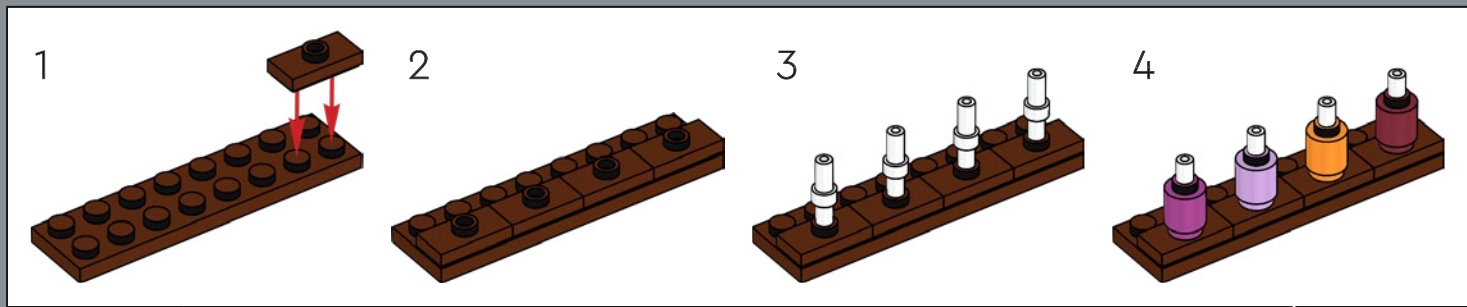
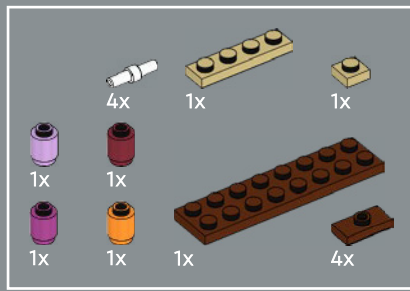

57

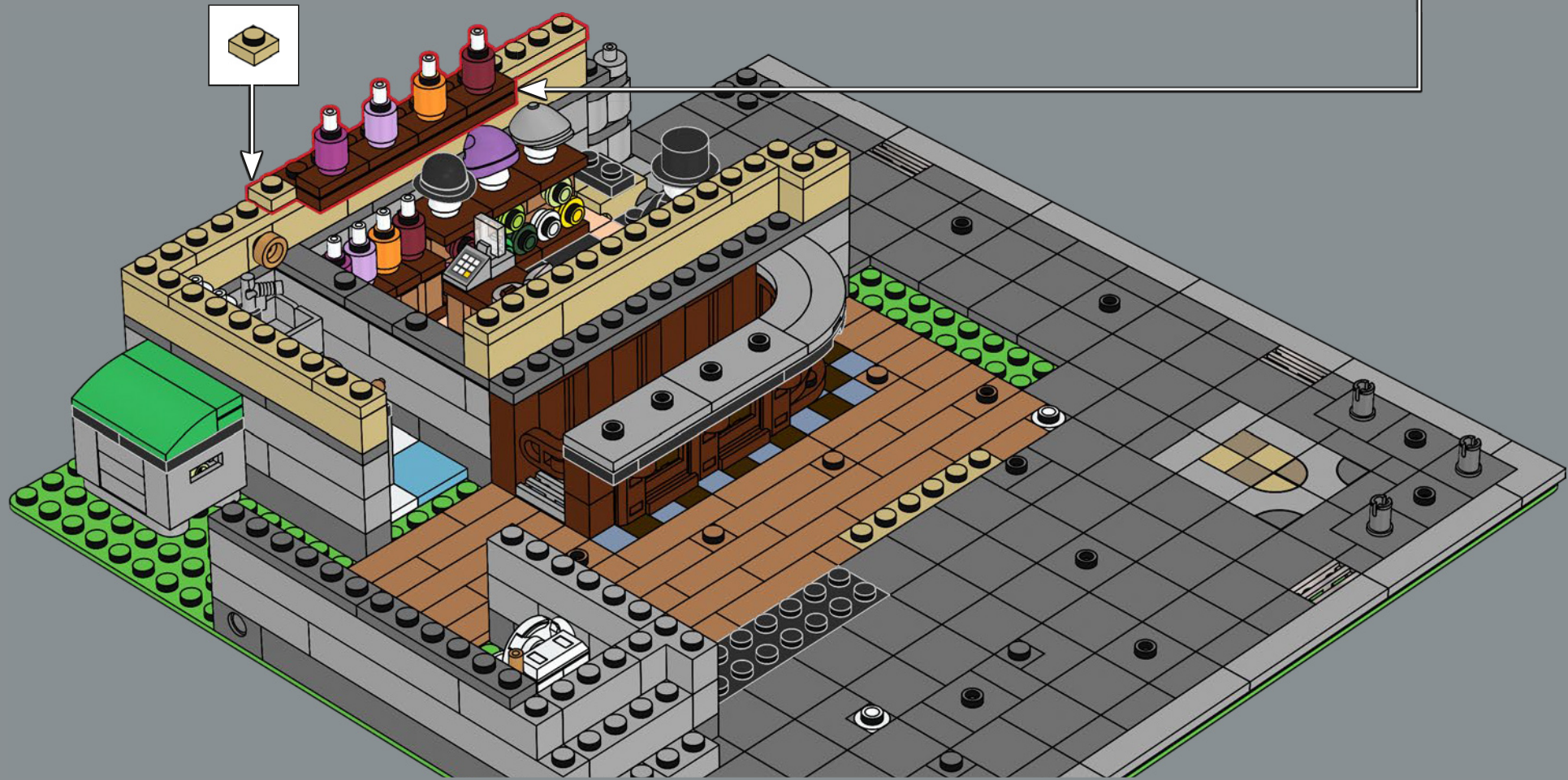



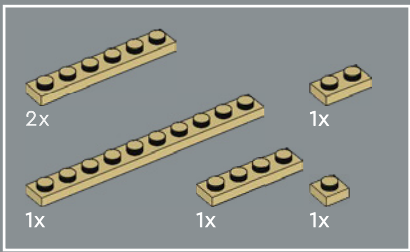

58





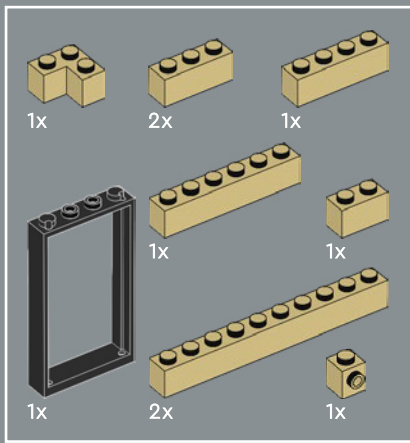

59





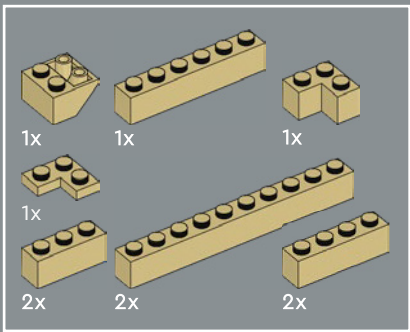

60

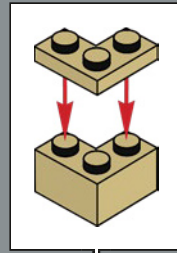

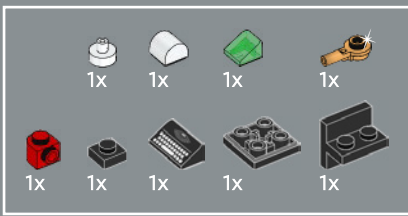

61

1

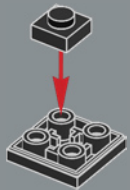

2



3



4



5

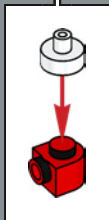



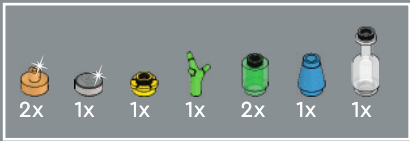

62

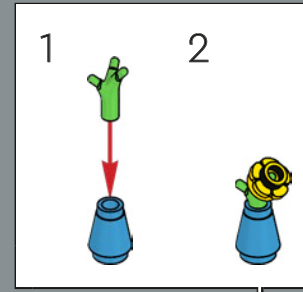
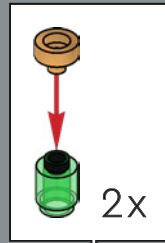





63

1



2



3

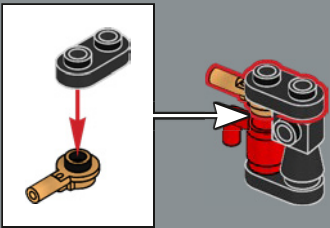

4





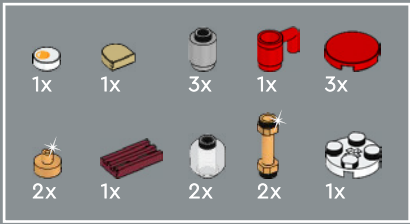

64

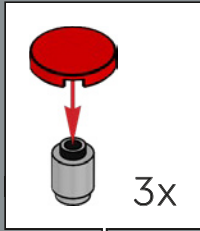
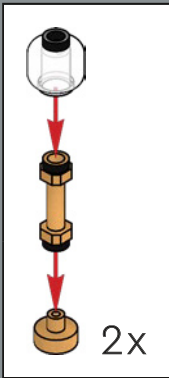
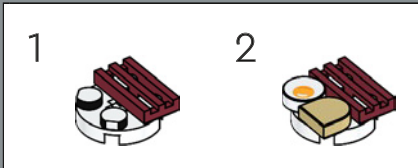

This gigantic, richly decorated counter is as old as the building itself. The perfect corner to drink your coffee in (according to the owner!).





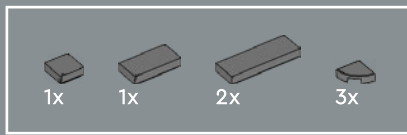

65





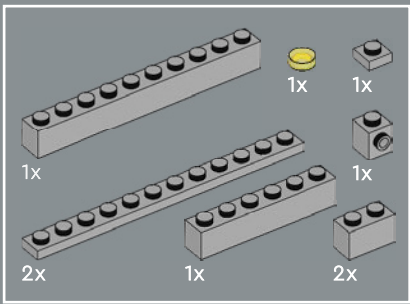

66

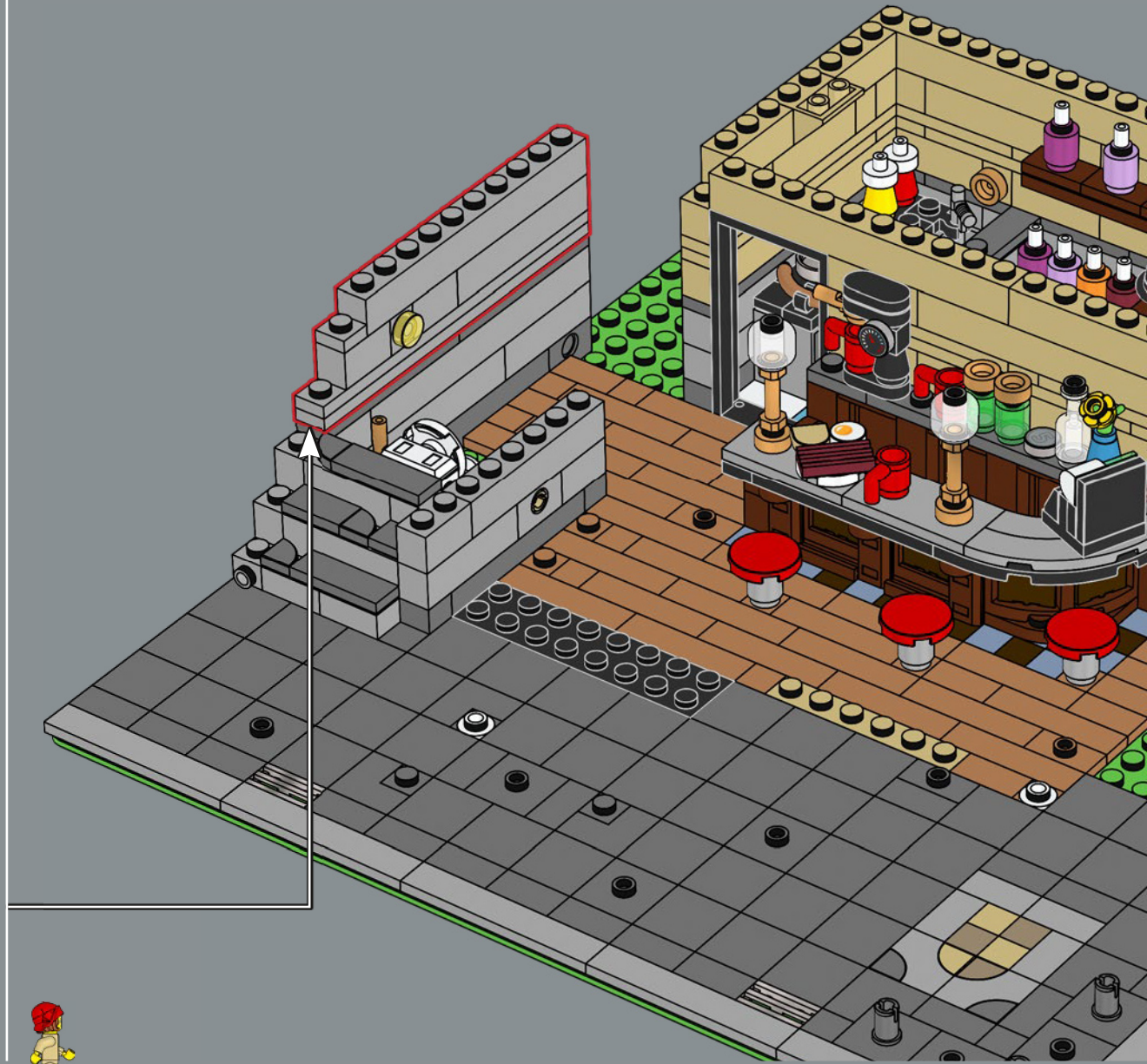
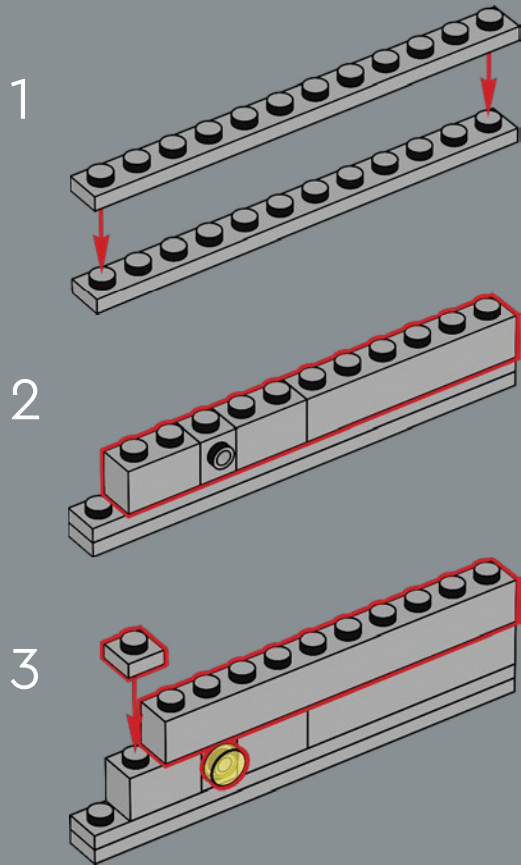

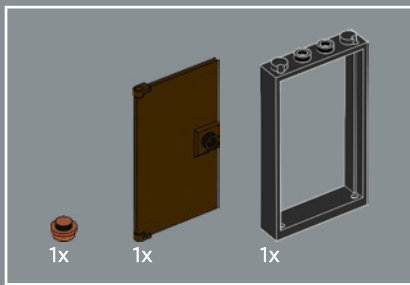

67

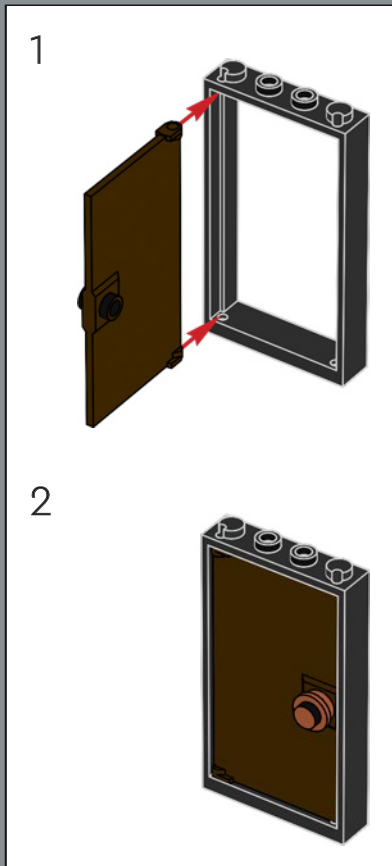



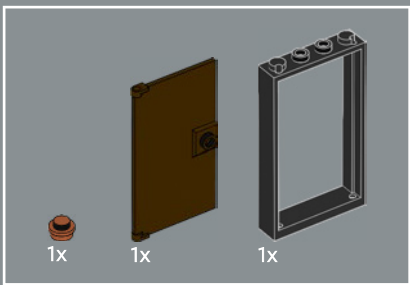

68

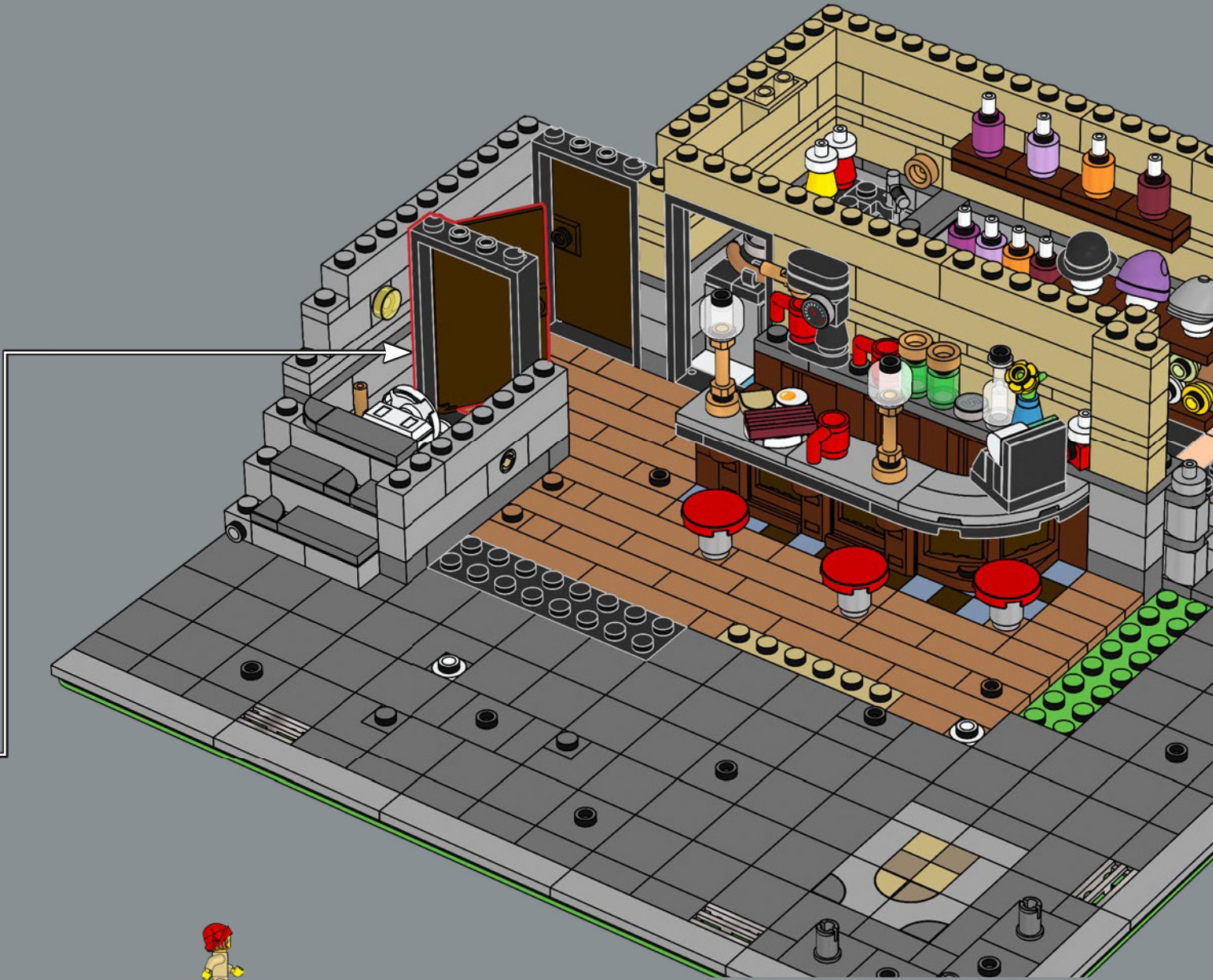
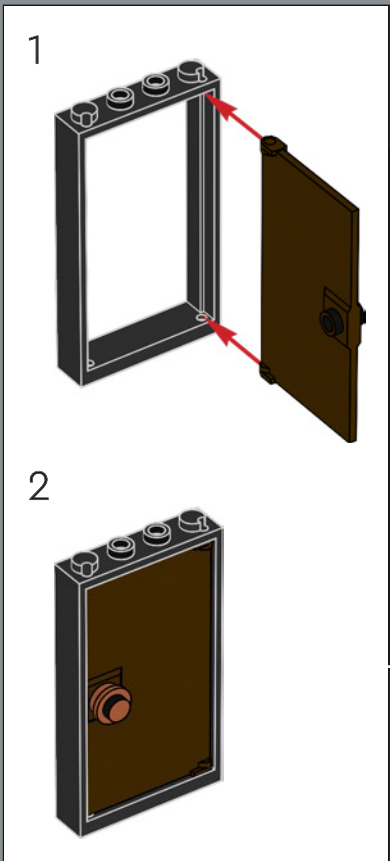

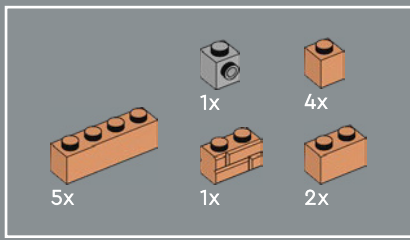

69

1

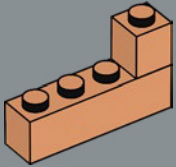

2

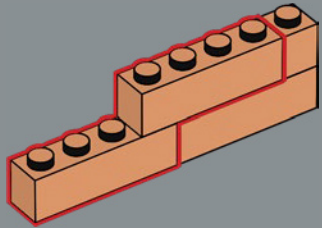

3

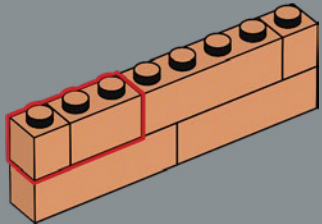

4

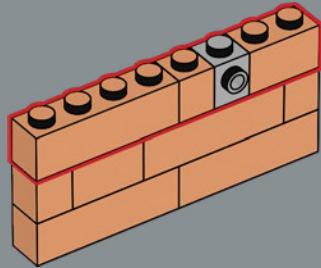

5

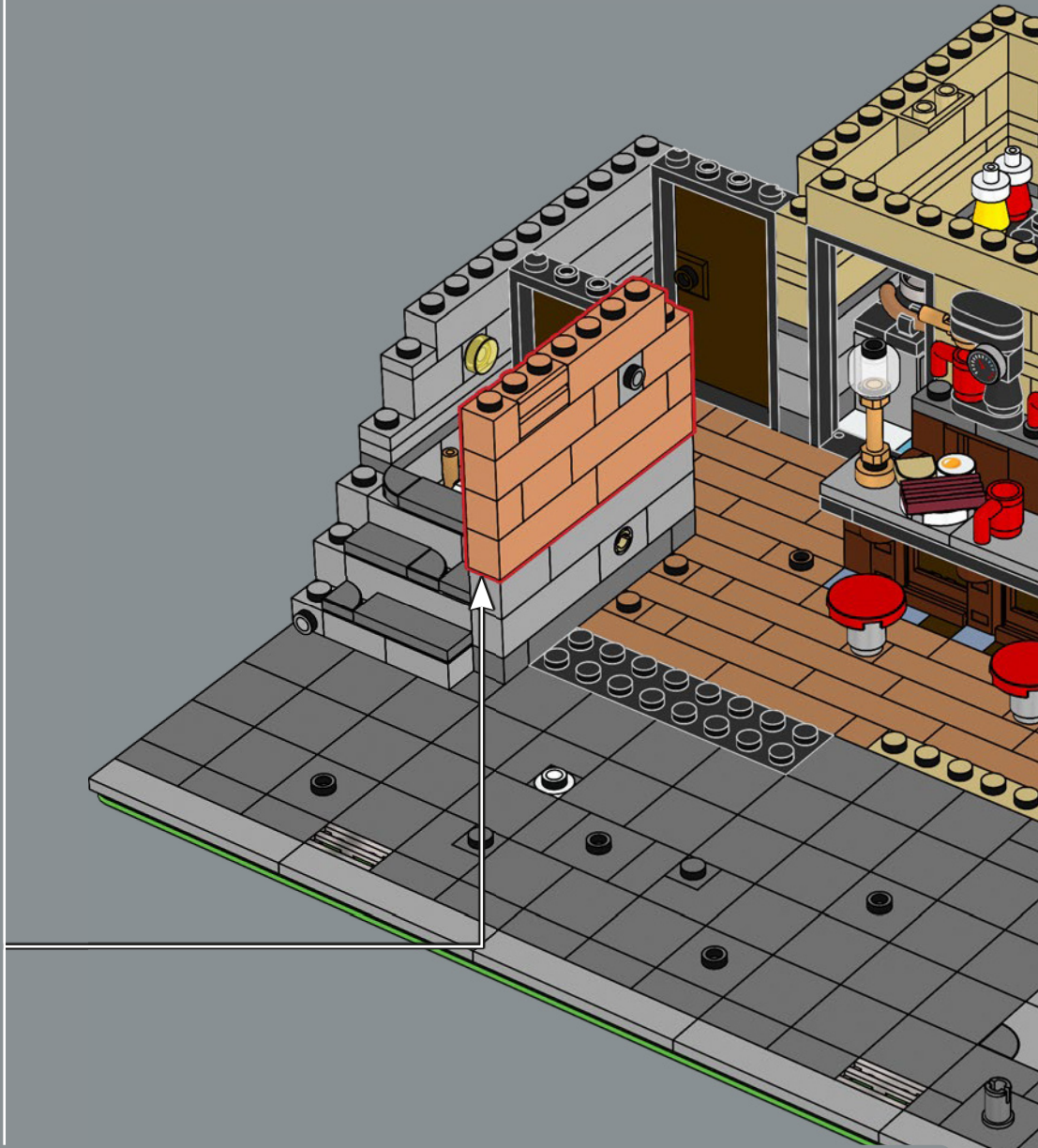
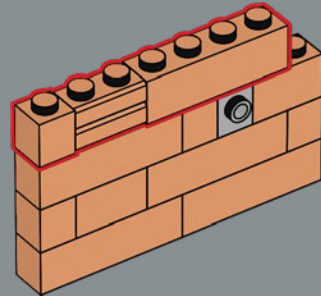



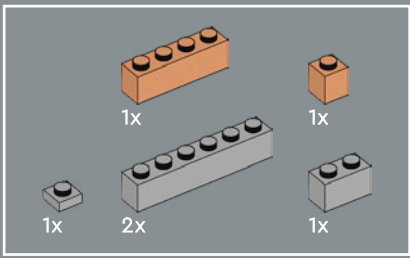

70





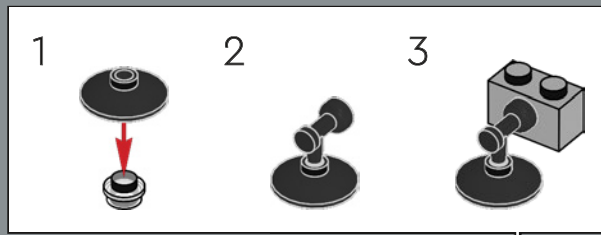
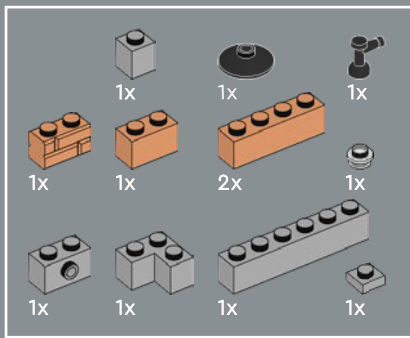

71





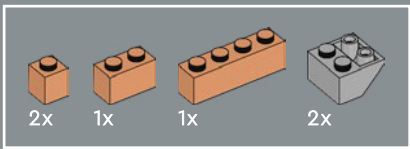

72





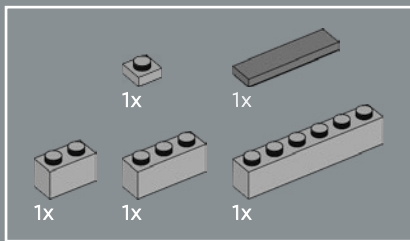

73





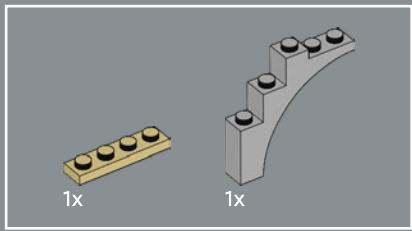

74

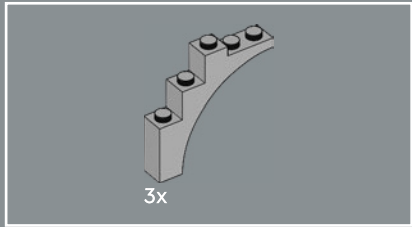
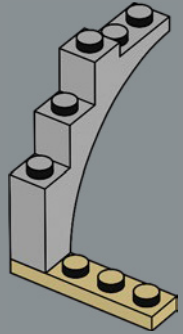

75

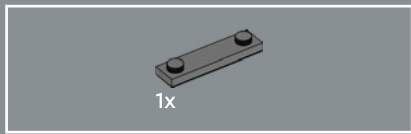
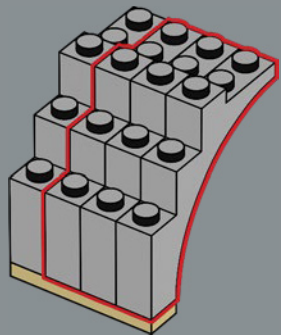

76

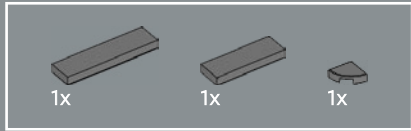
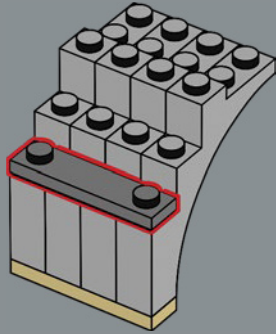

77

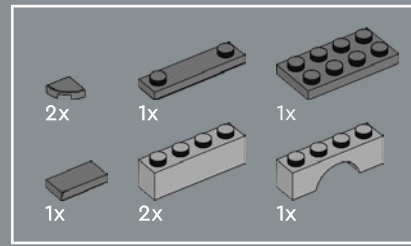
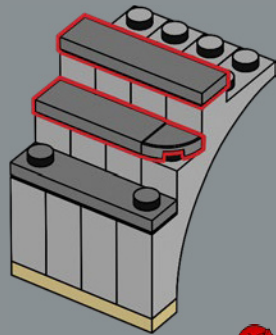

78

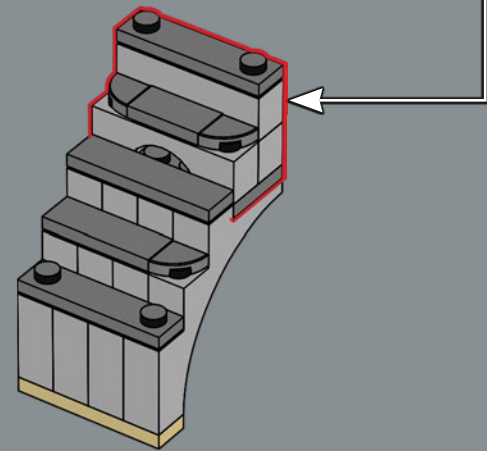
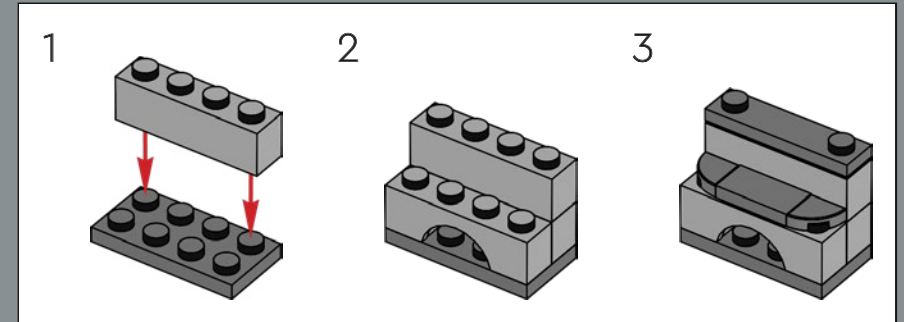





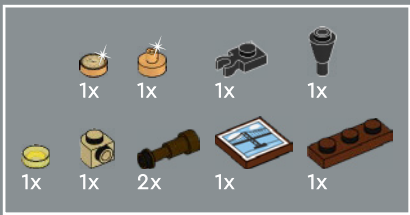

80

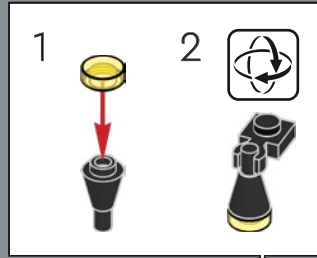
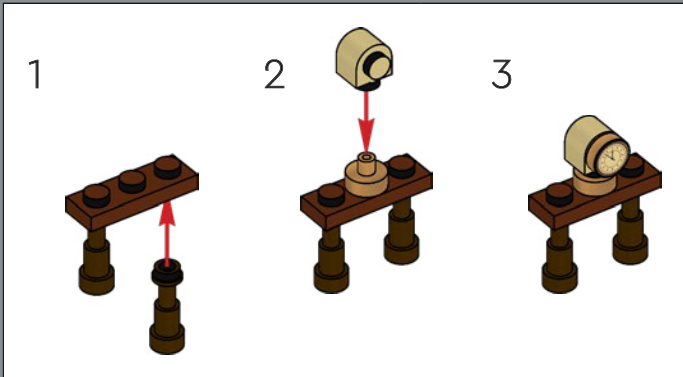

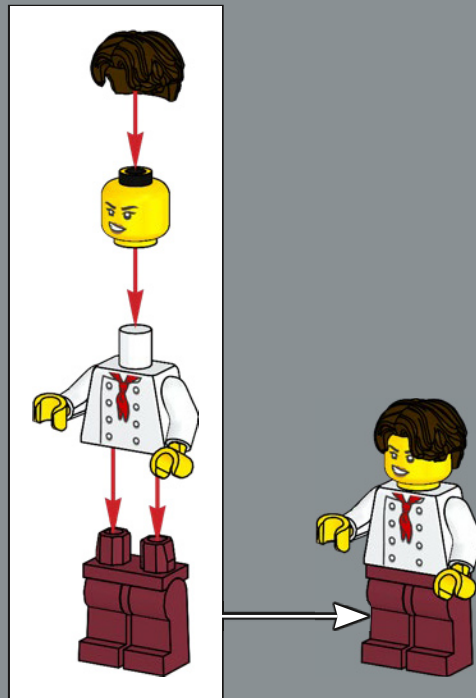



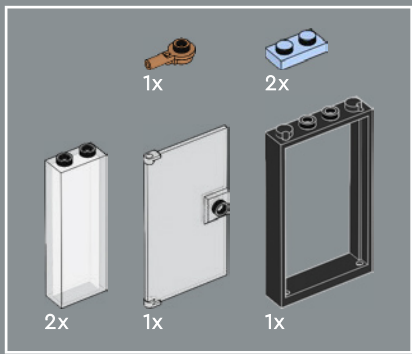

81

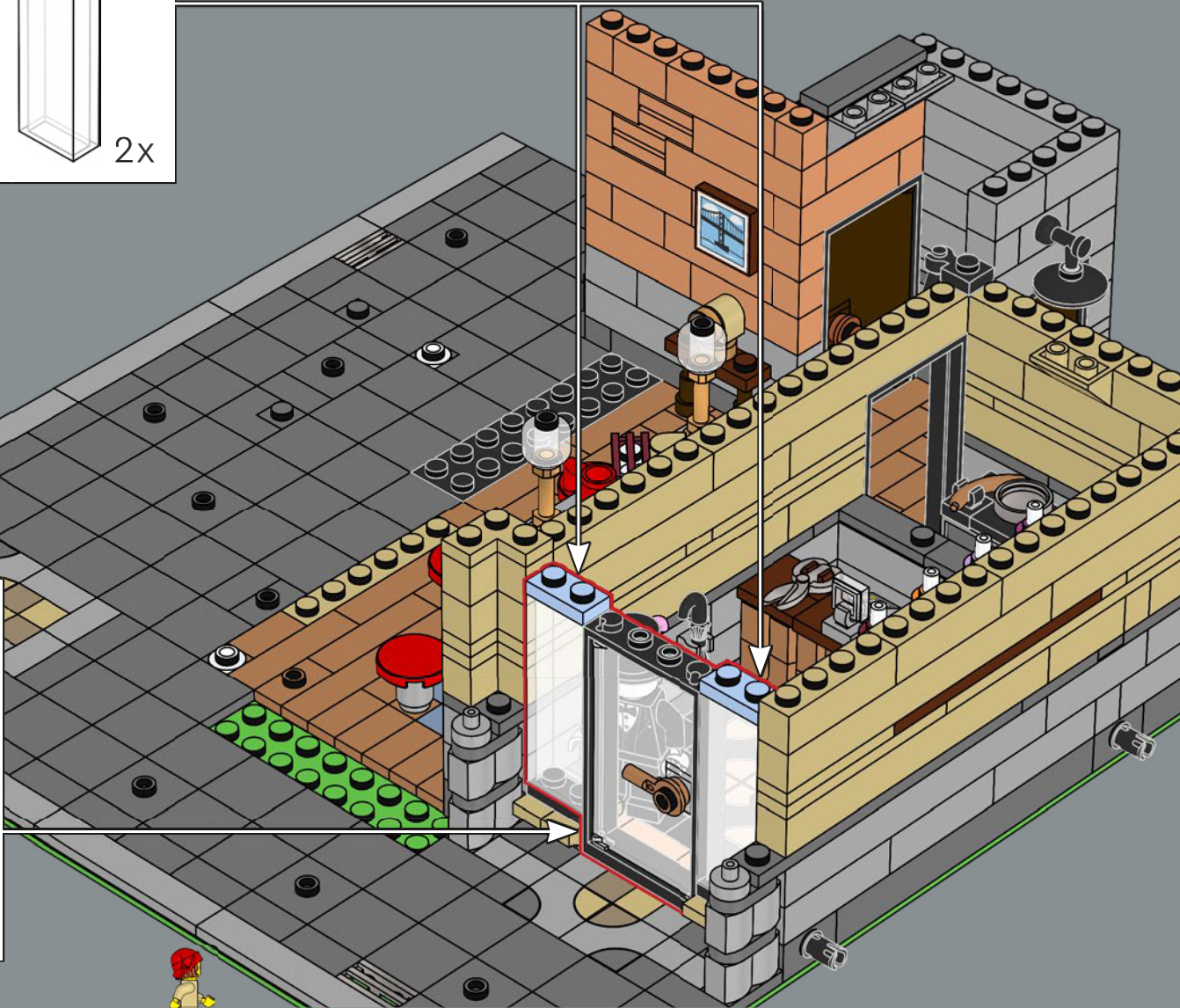
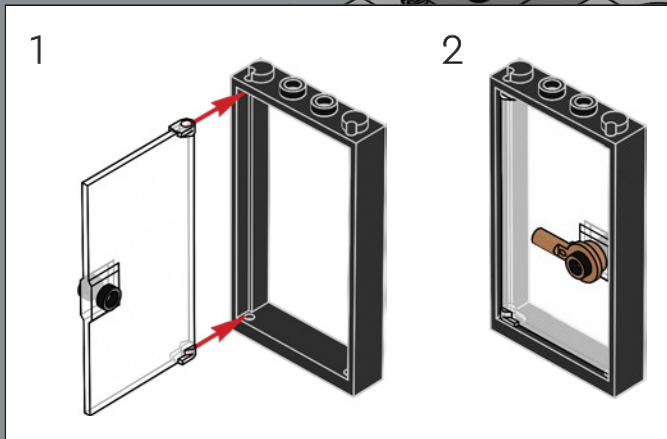
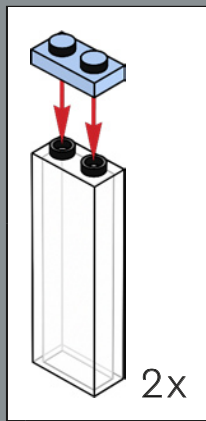



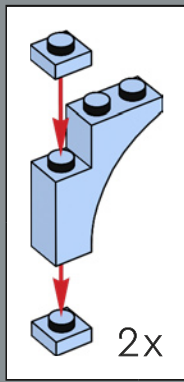
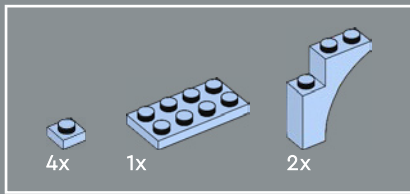

82

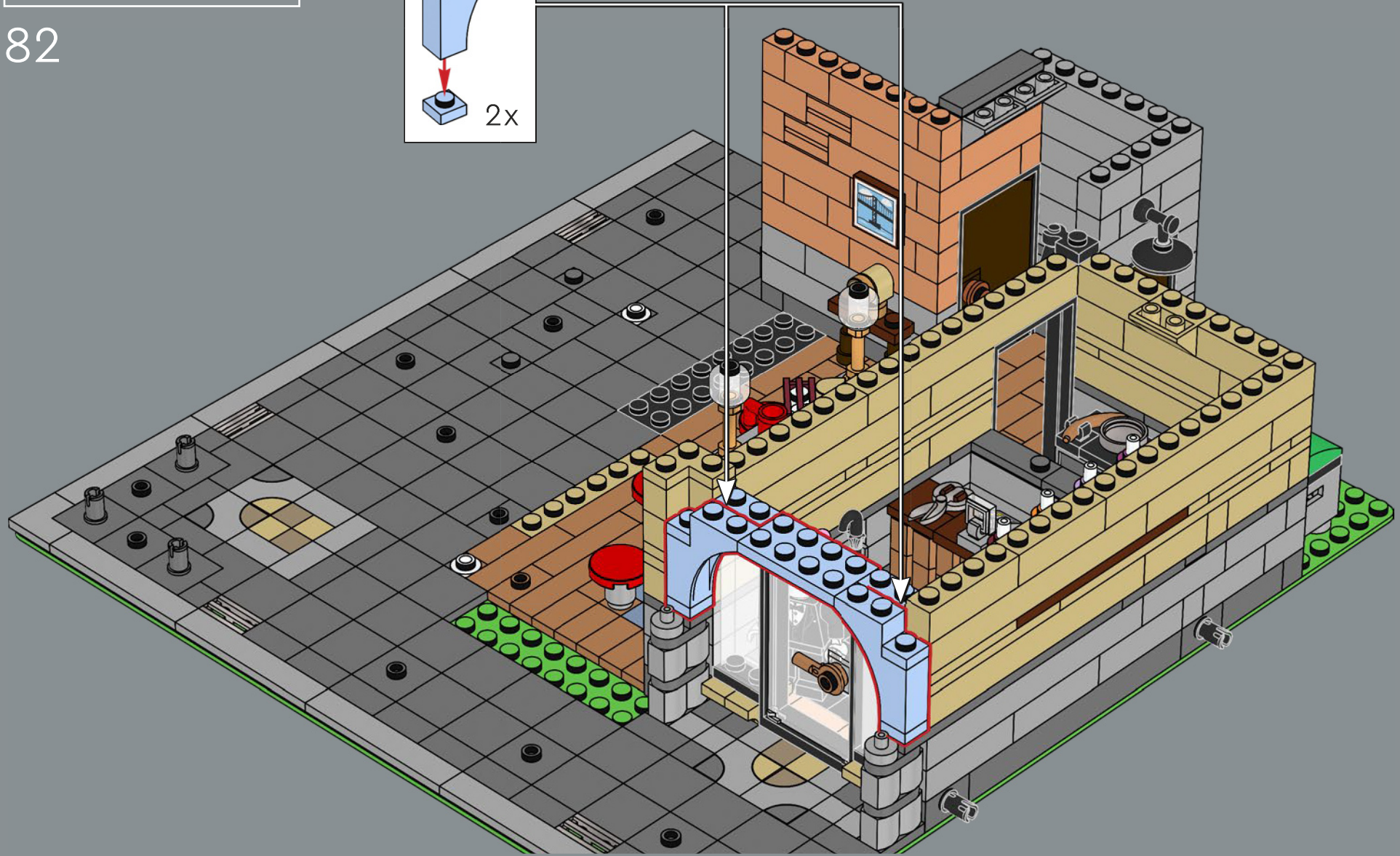



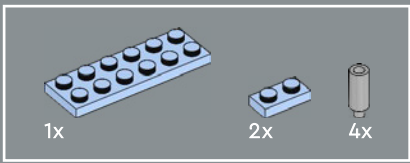

83

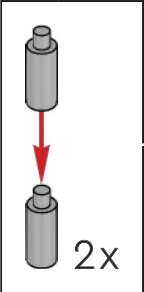



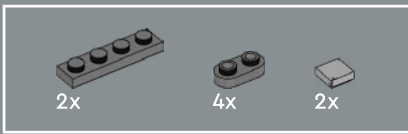

84

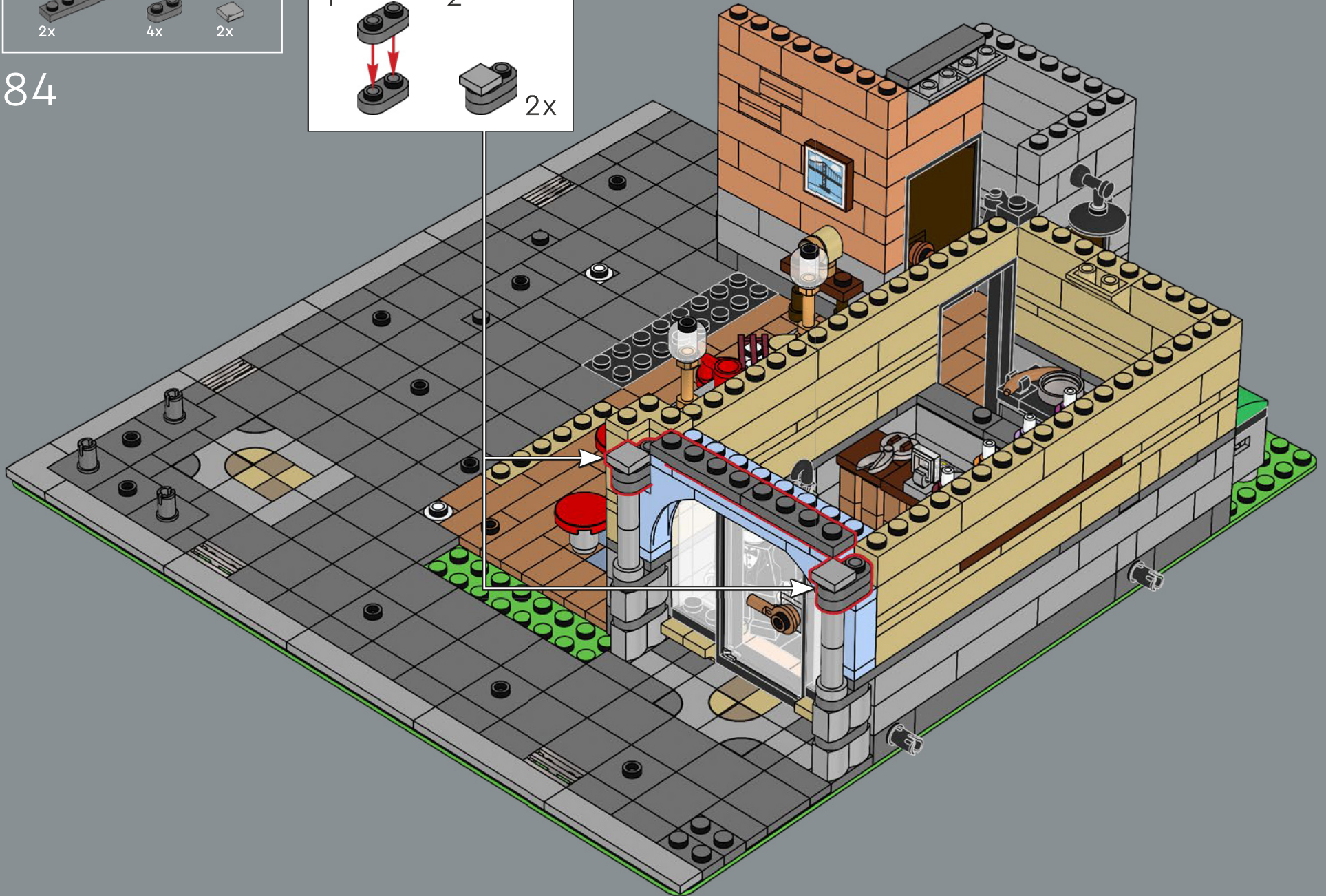
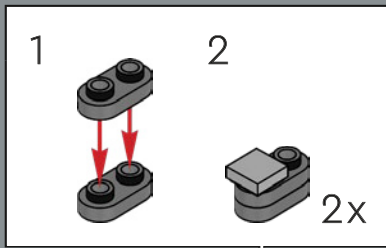



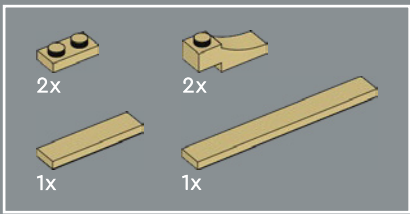

85

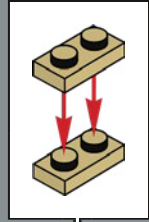



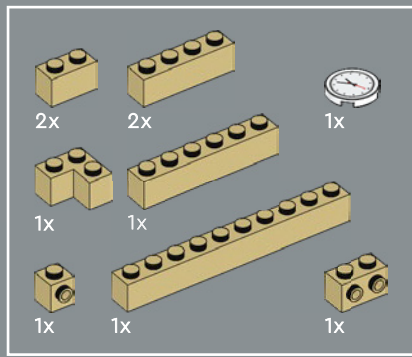

86

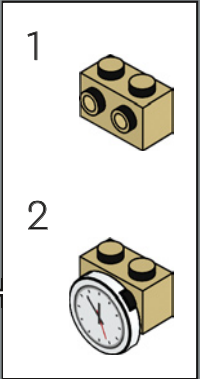
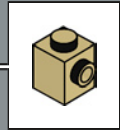
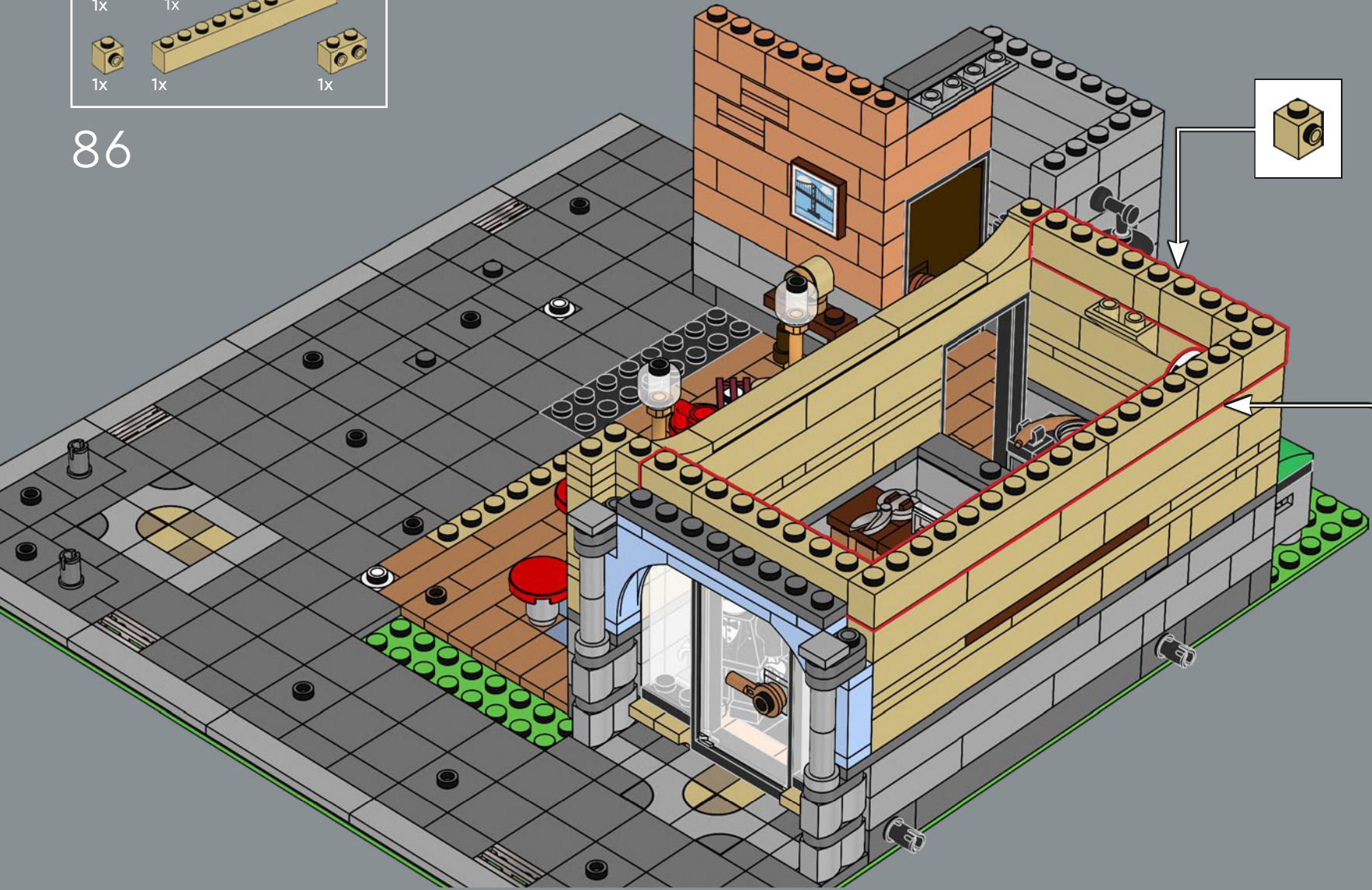



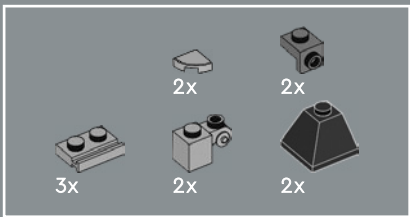

87

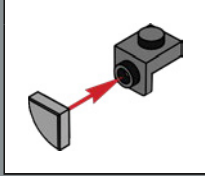
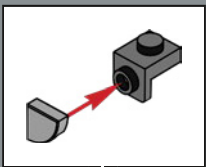

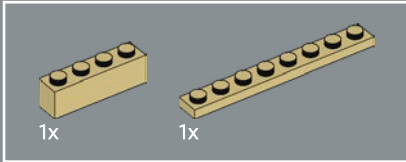
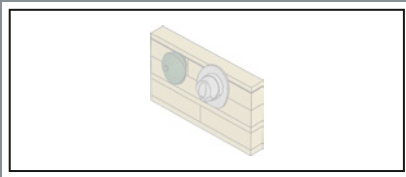

88

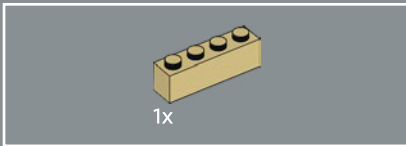
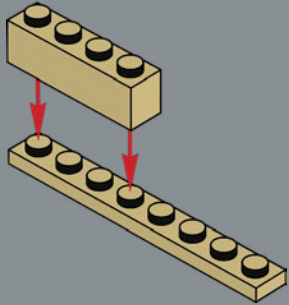

89

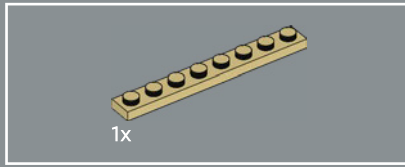
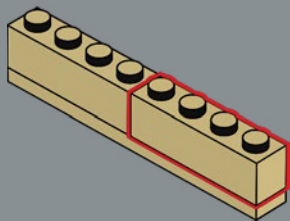

90

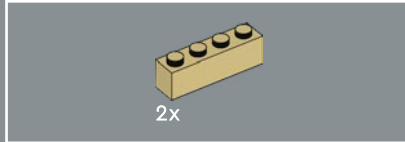
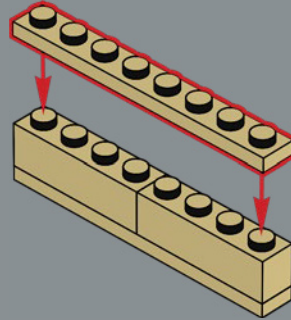

91

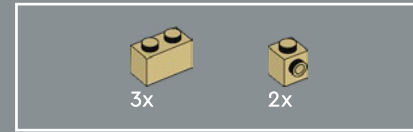
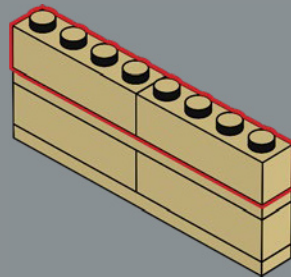

92

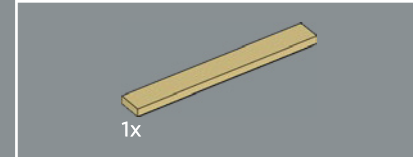
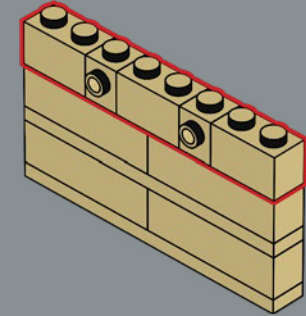

93

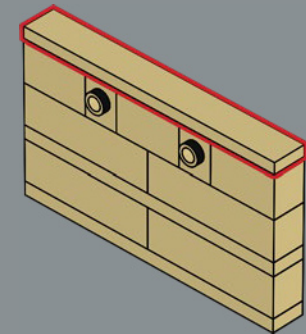





4x

94

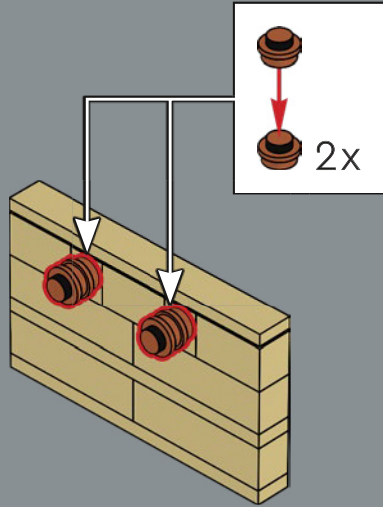

1x



1x

95

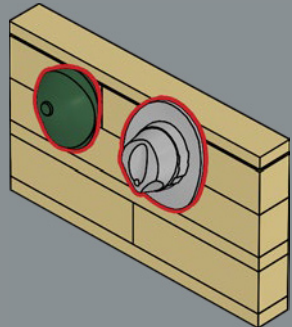

96

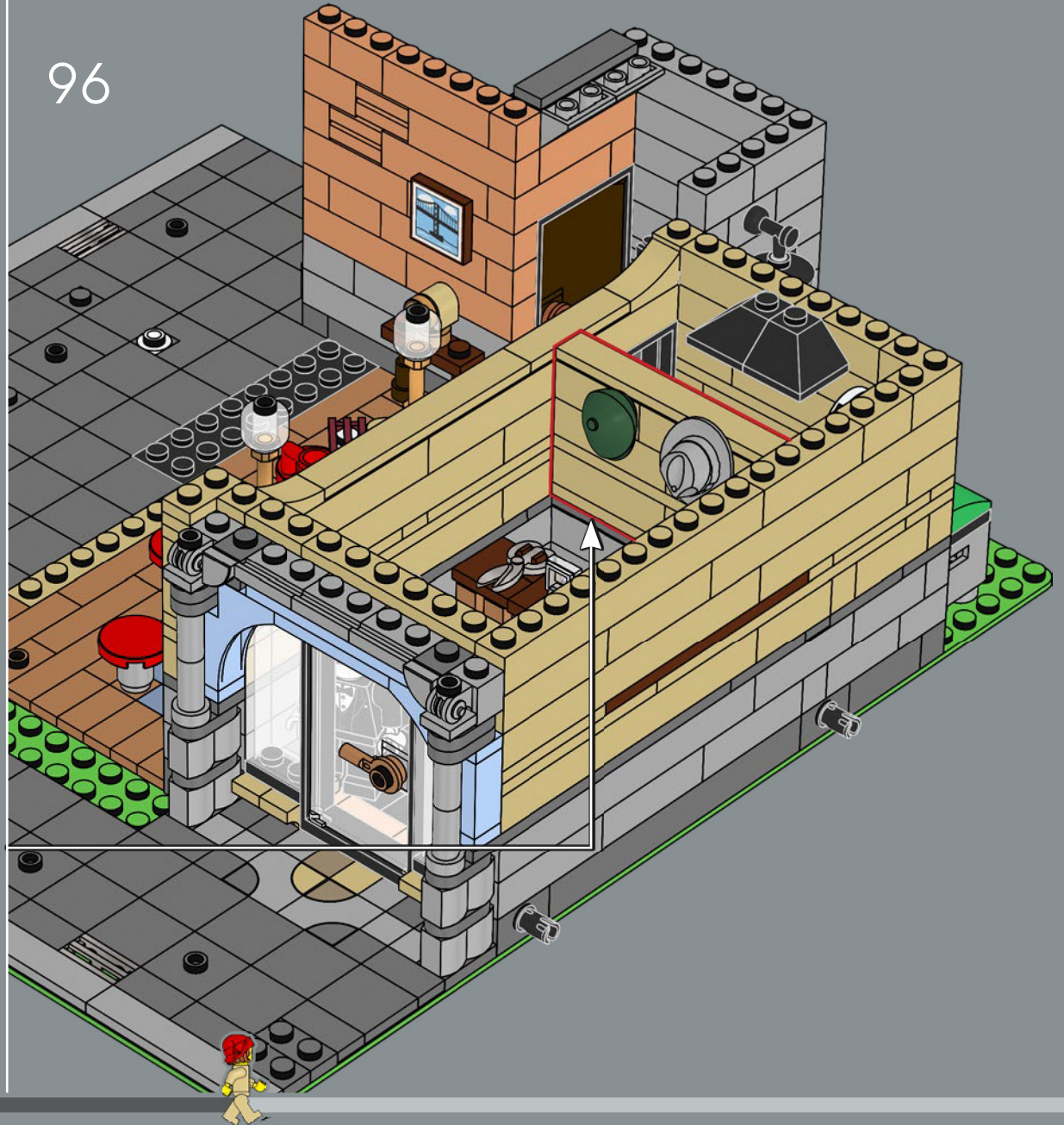



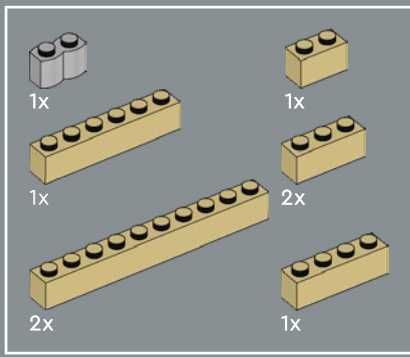

97

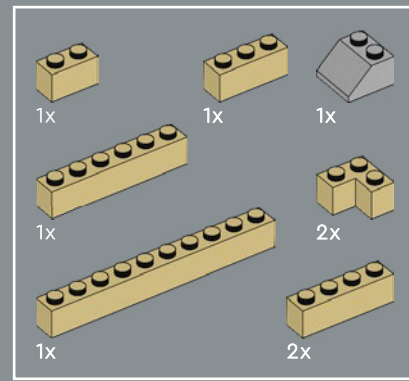
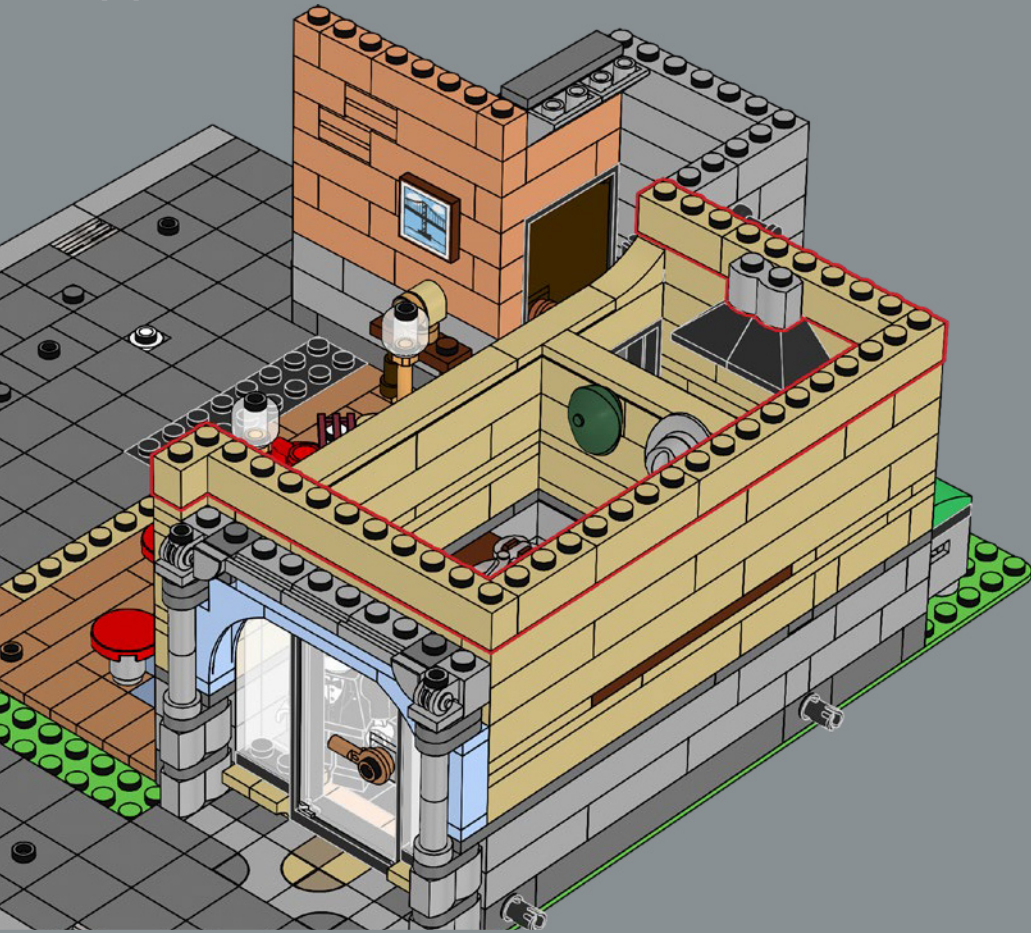

98







99

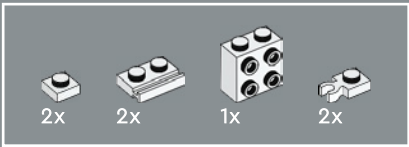

100

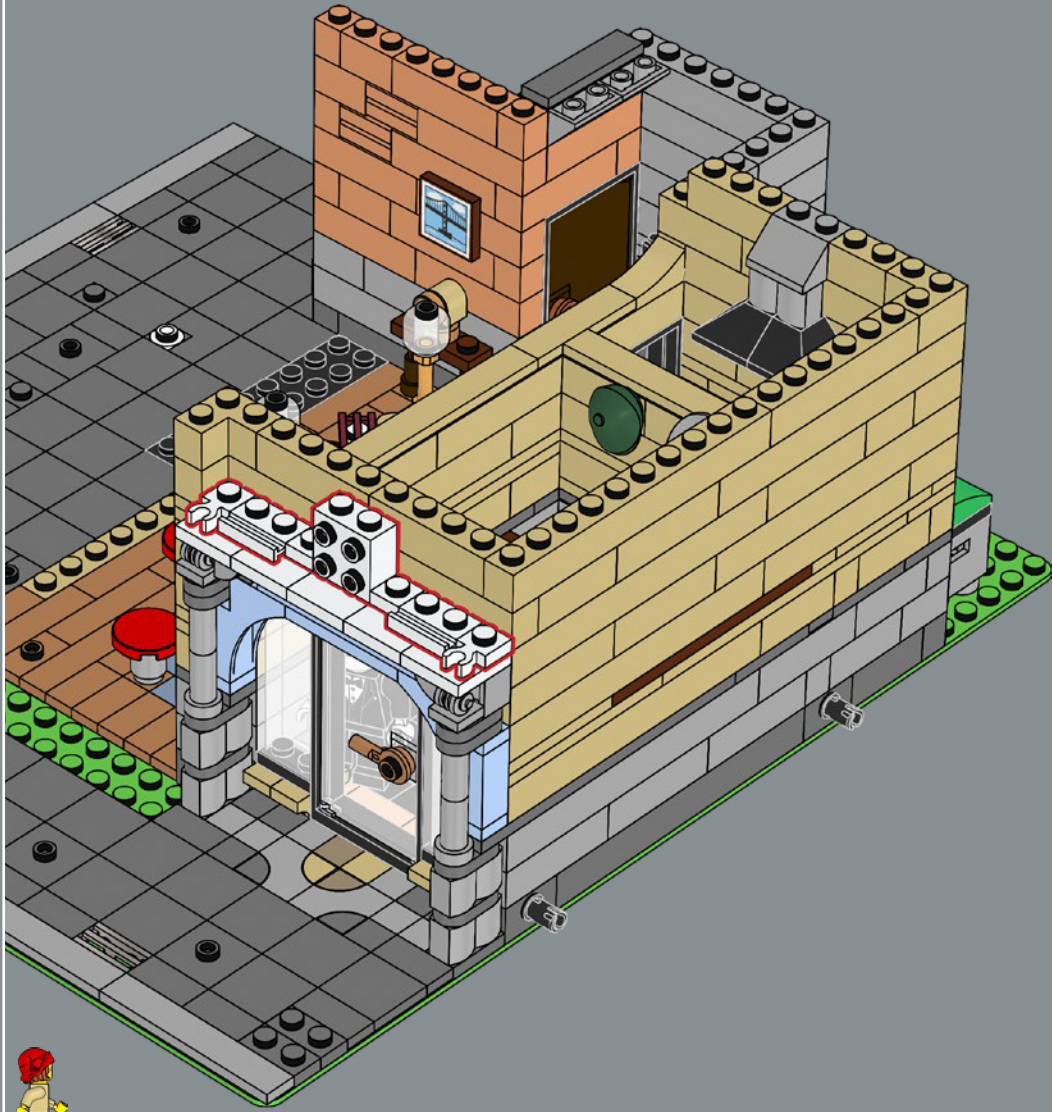



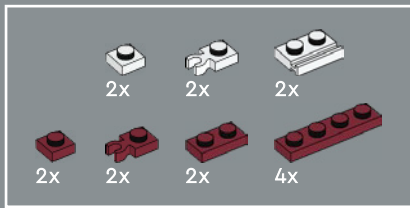

101

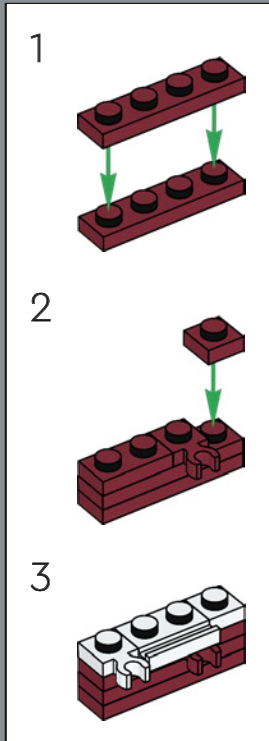
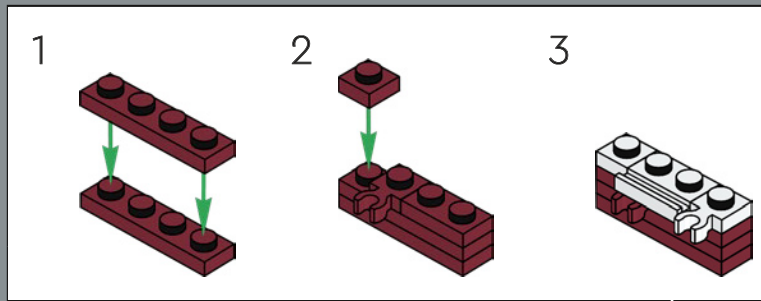



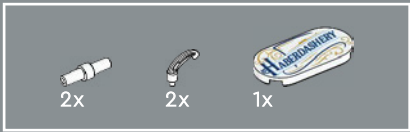

102



103





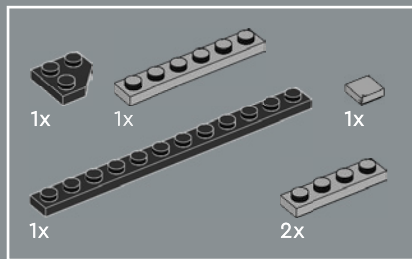

104

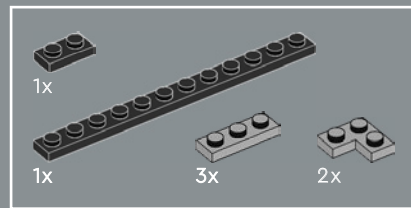

105





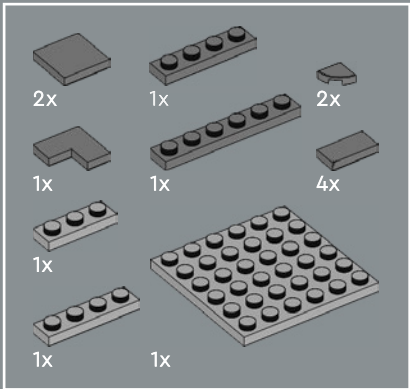

106

1

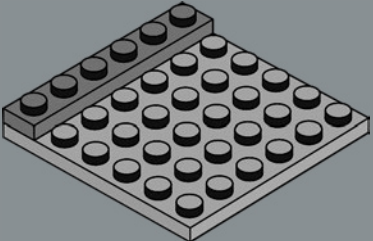

2

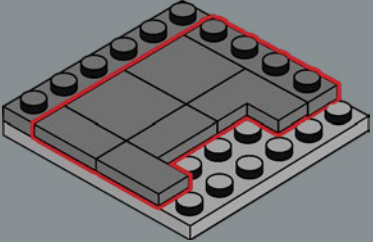

3

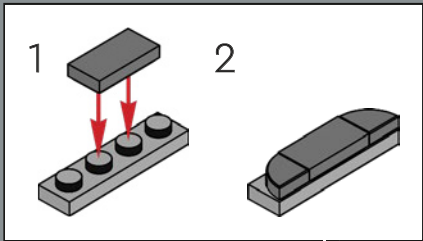
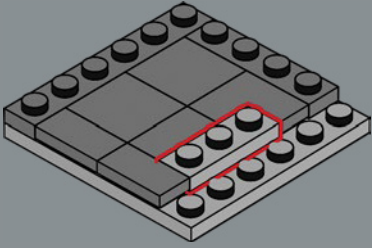

4

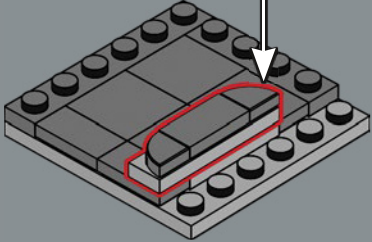



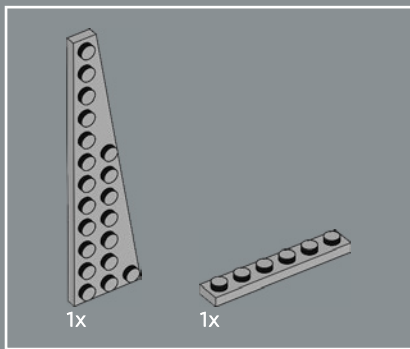

107

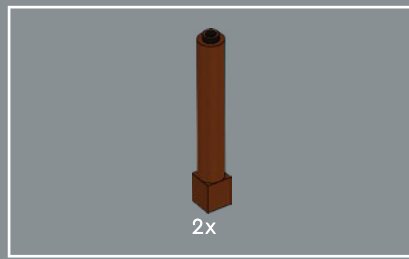

108





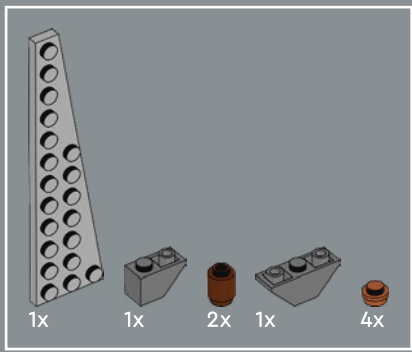

109

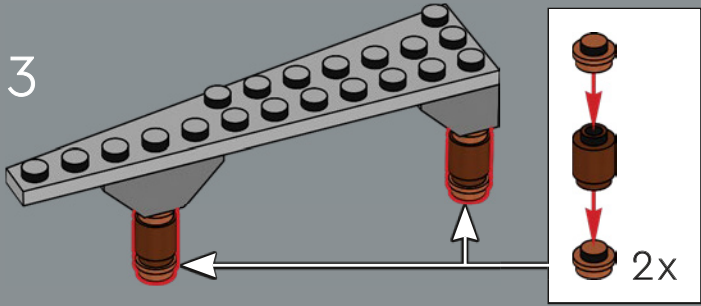
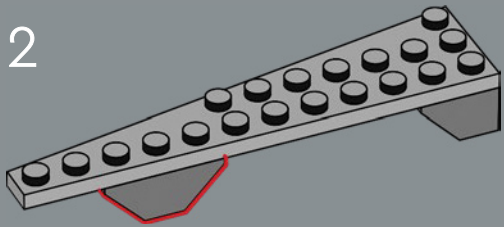
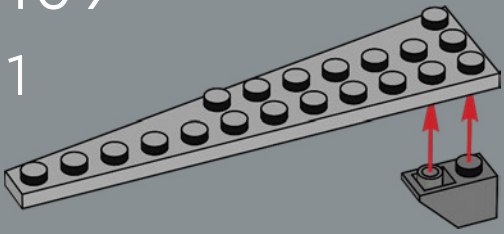



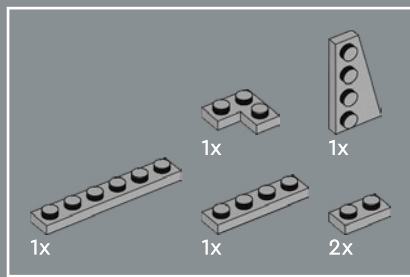

110





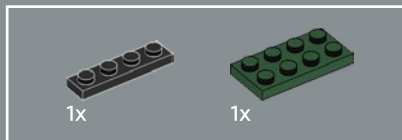
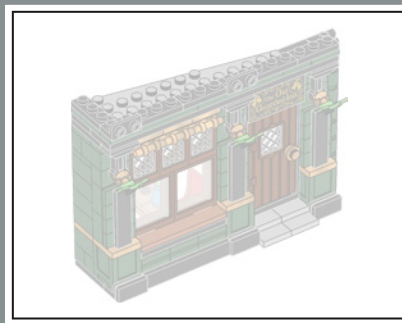
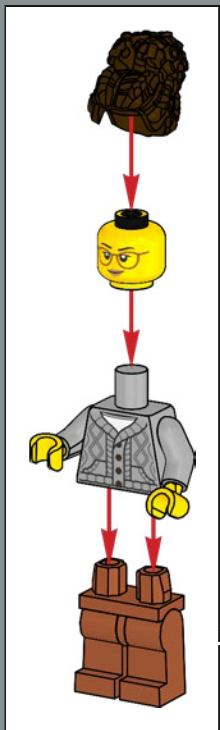

111

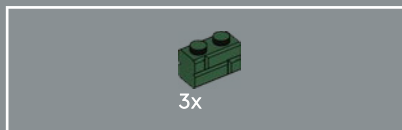
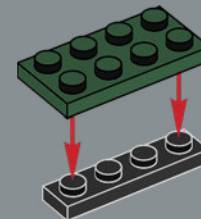

112

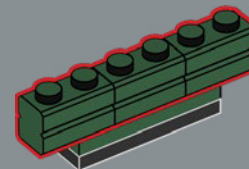



113

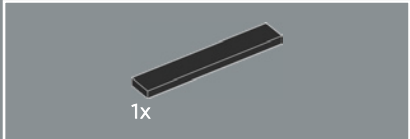
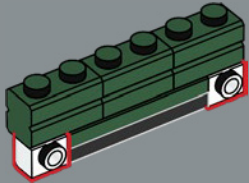

114

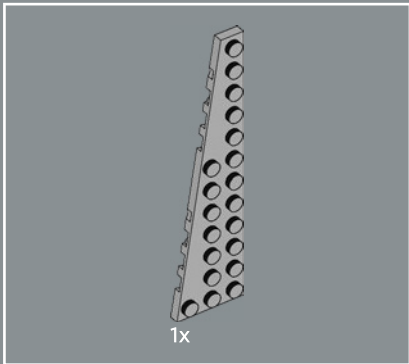
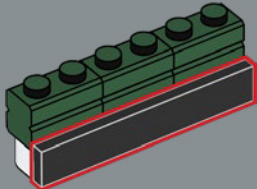

115

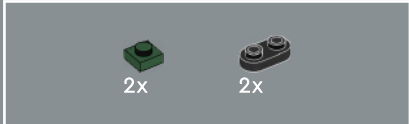
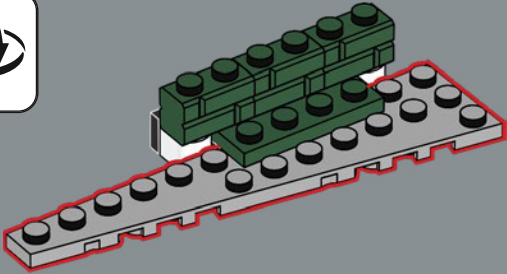

116

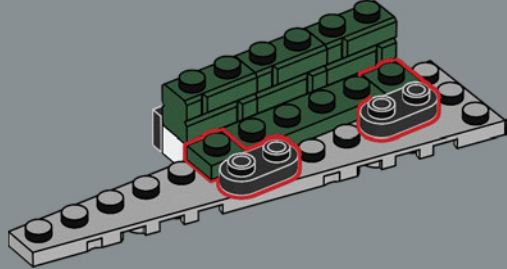



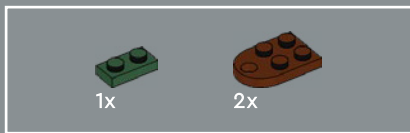

117

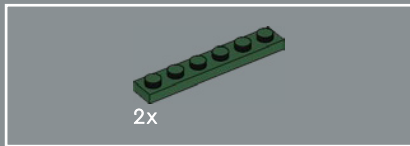
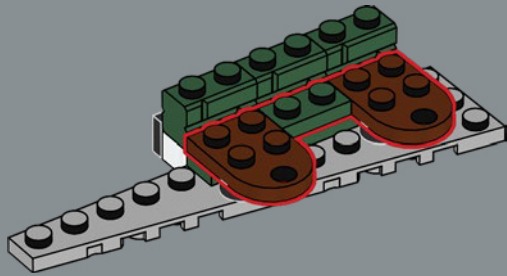

118

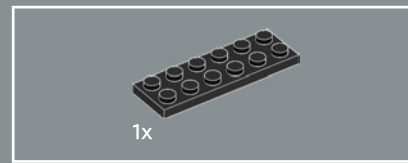
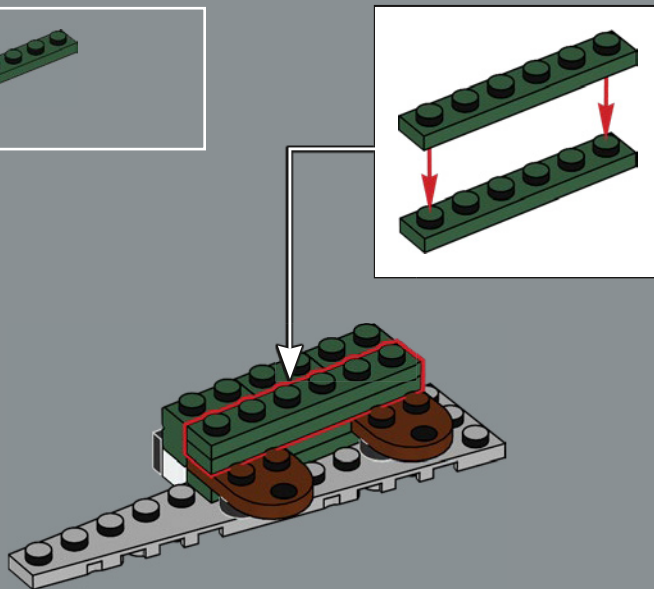

119

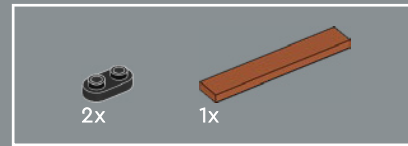
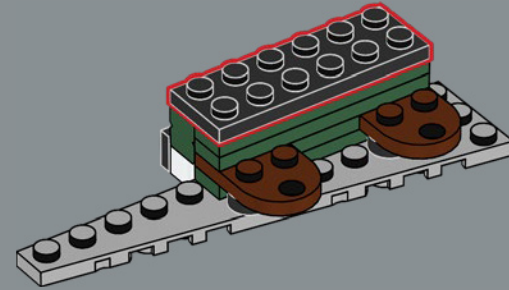

120

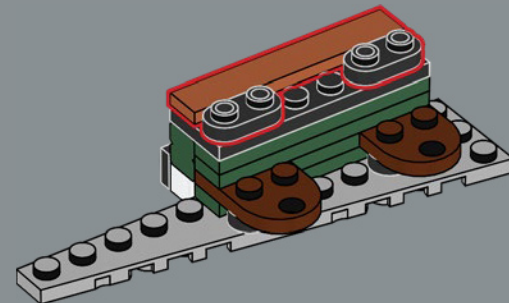

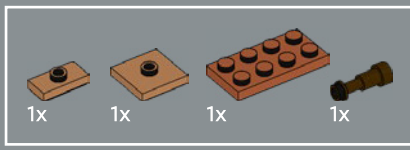

121

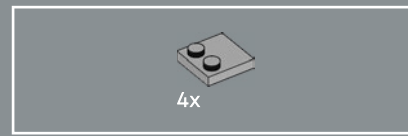
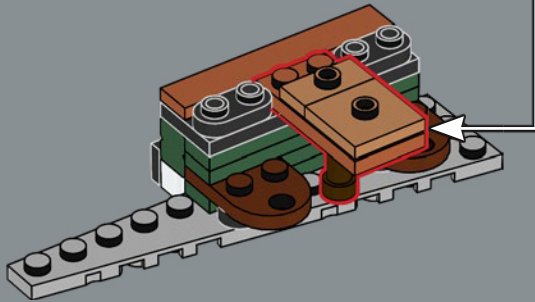
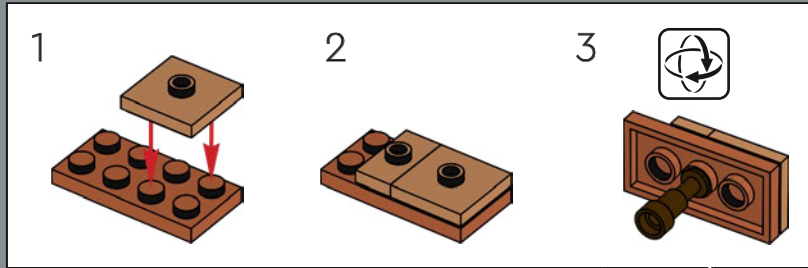

122

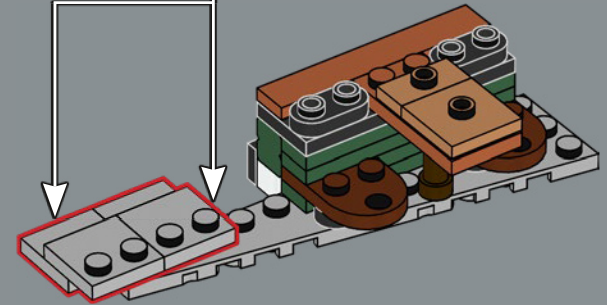
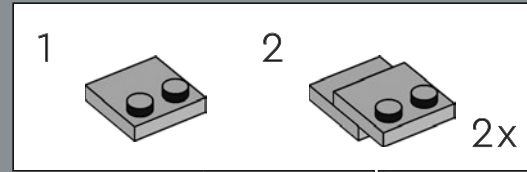



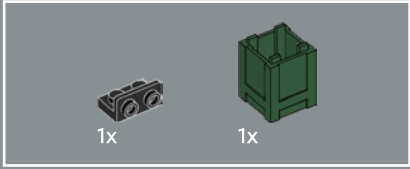
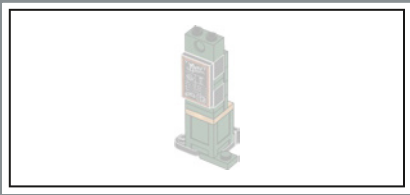

123

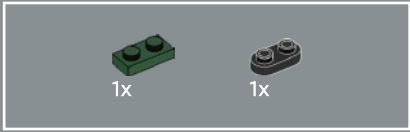
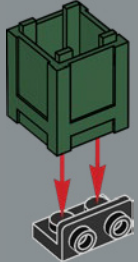

124

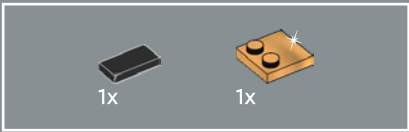
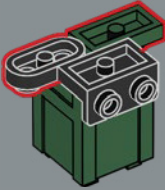

125

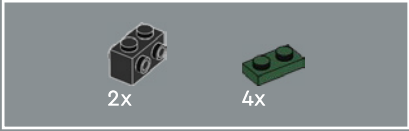
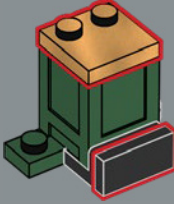

126

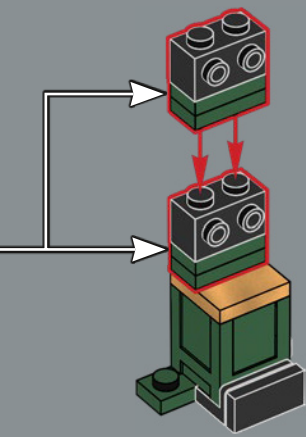
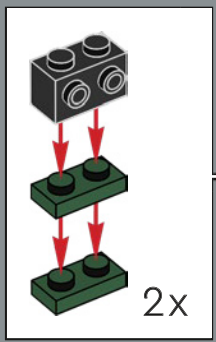



127

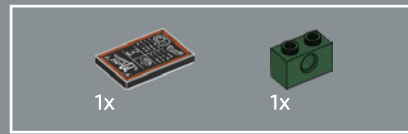
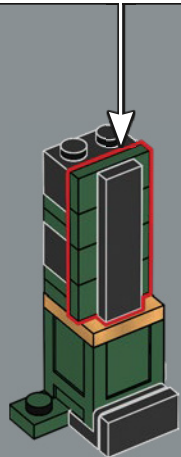
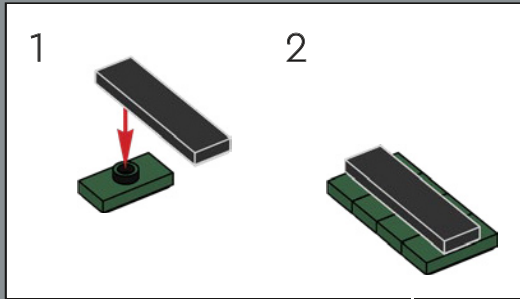

128

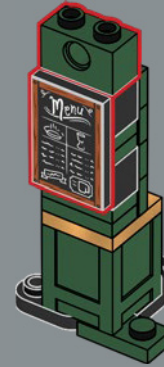

129

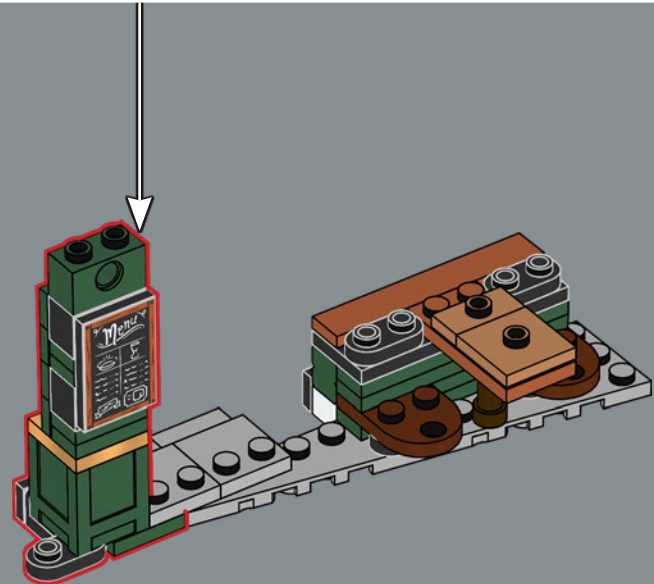



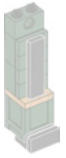

2x

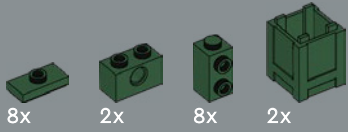

130

1

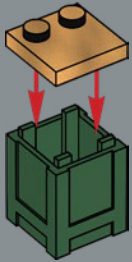

2



3

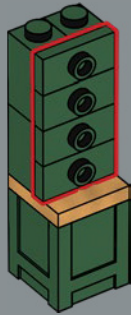

4

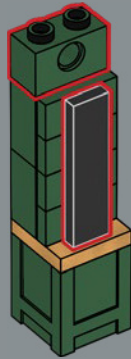

5

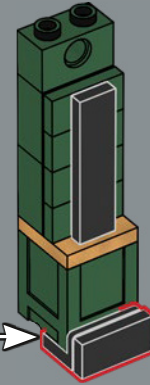
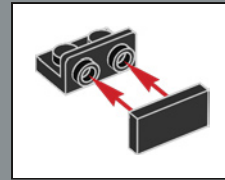

2x

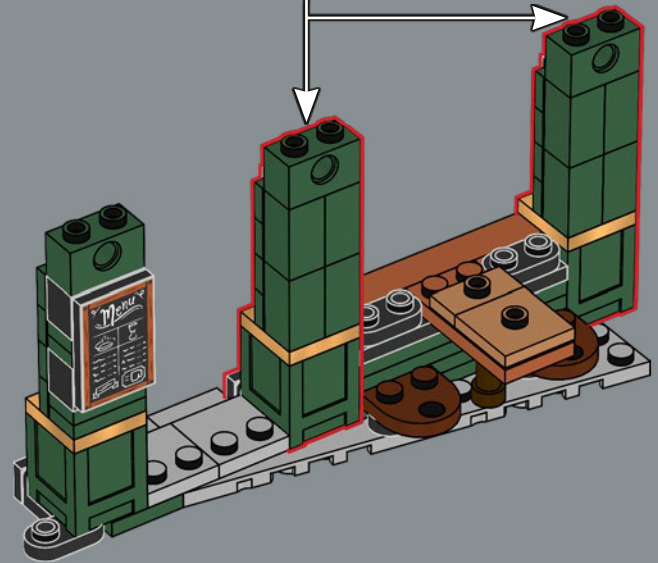

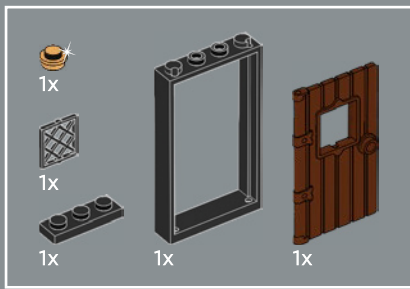

131

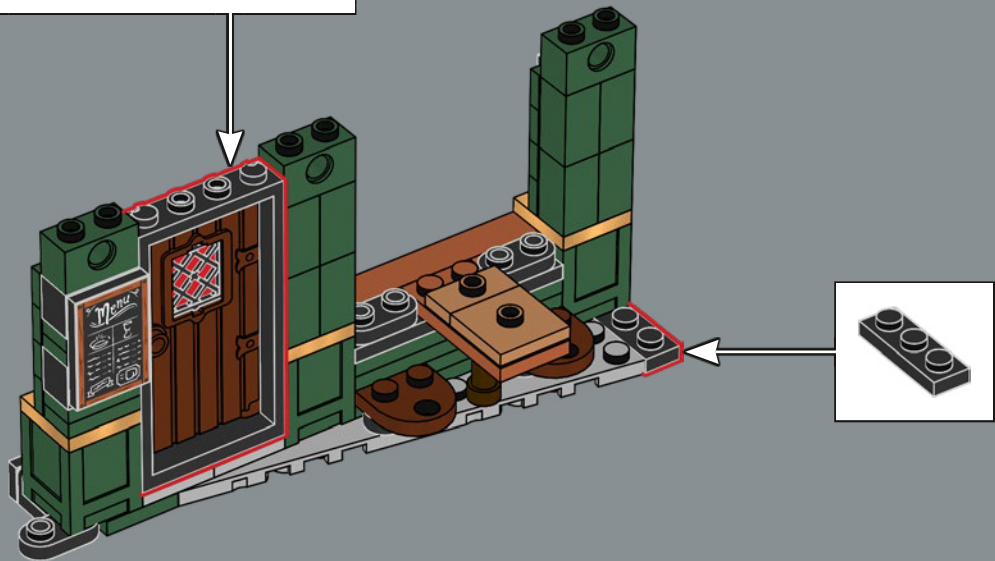
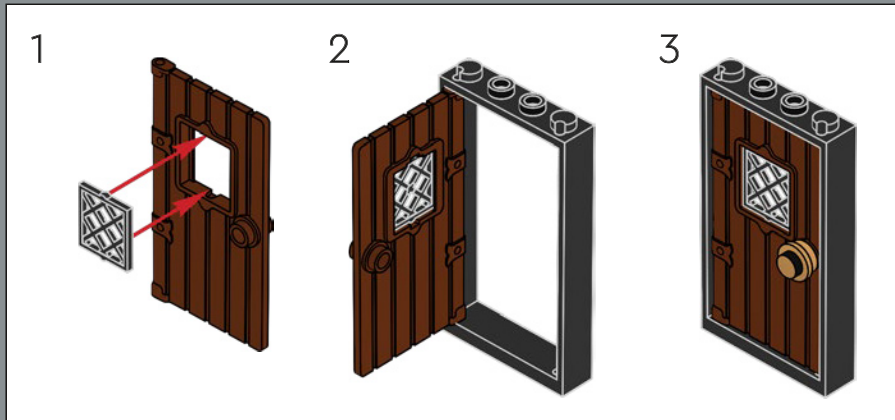



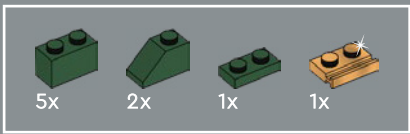

132

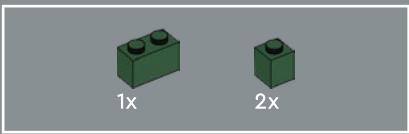
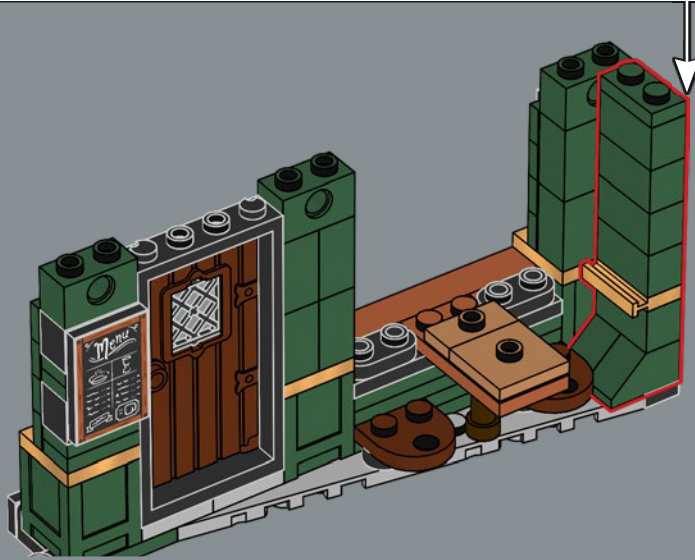
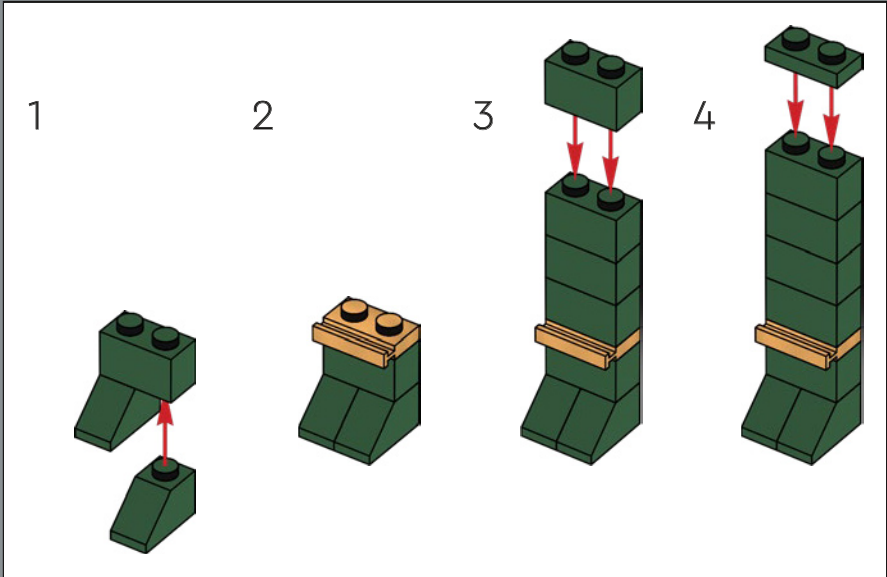

133

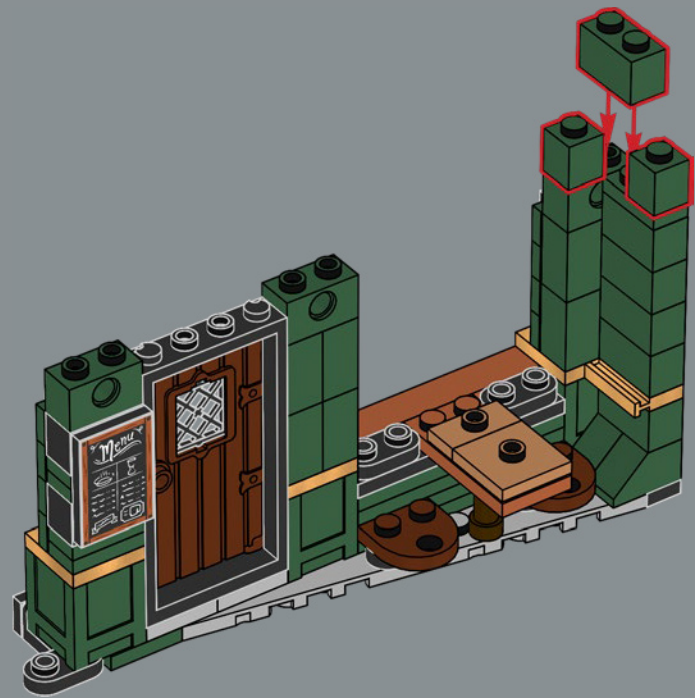

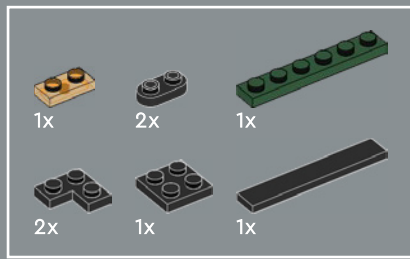

134

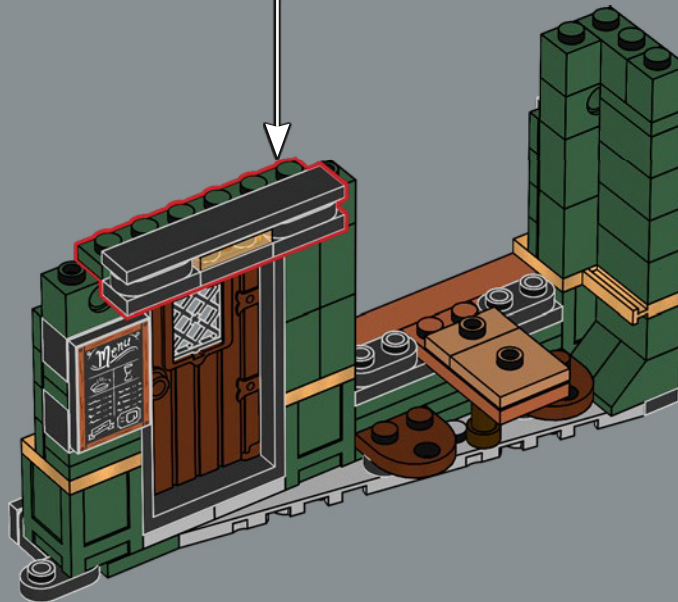
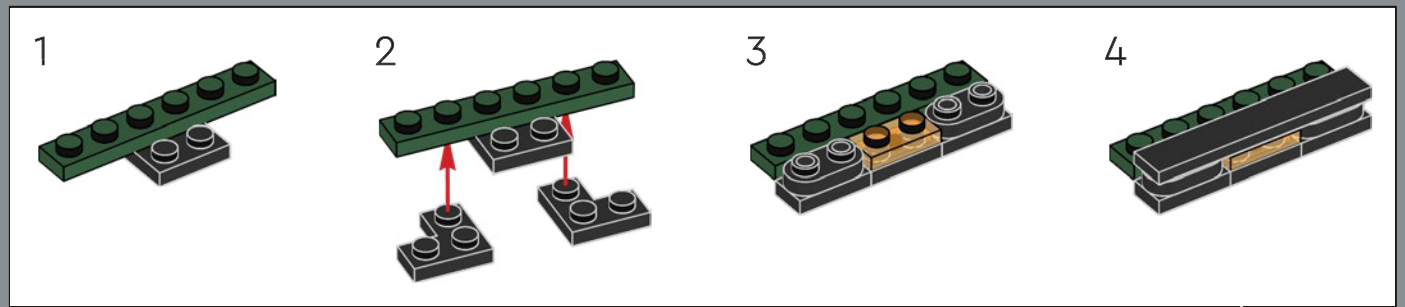





2x

135

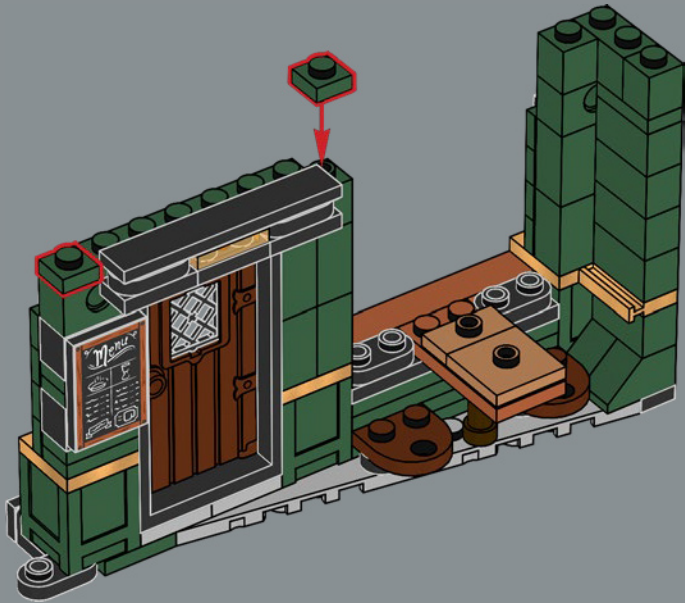

1x



2x



2x



2x

136

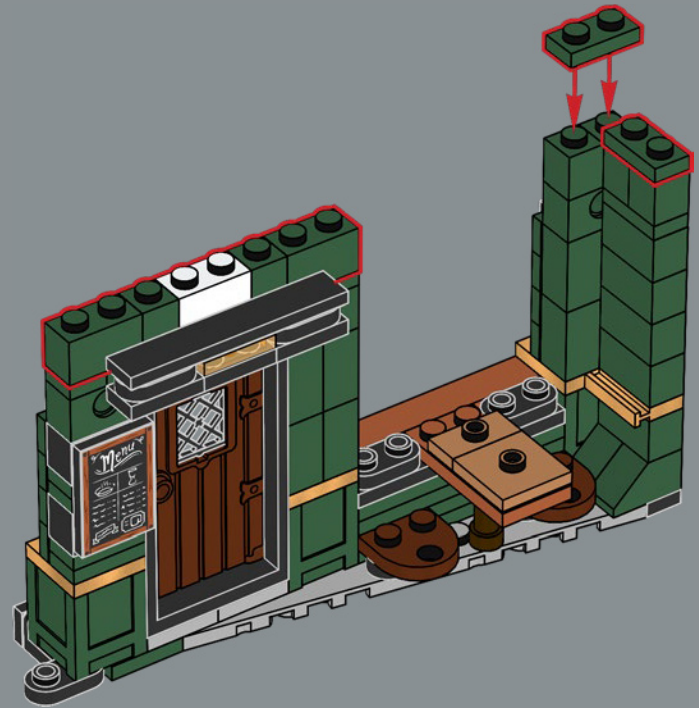

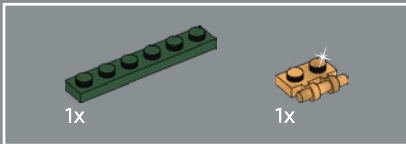

137

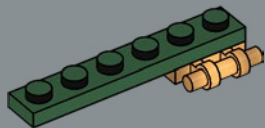

138

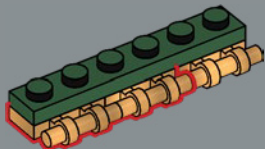

139

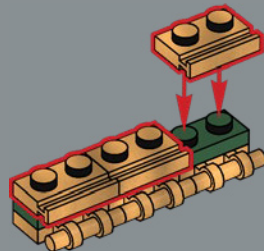

140

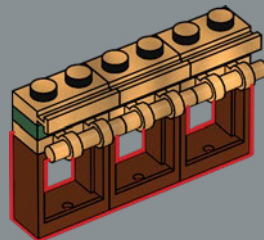

141

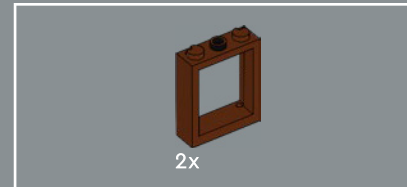
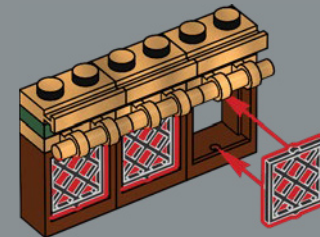

142

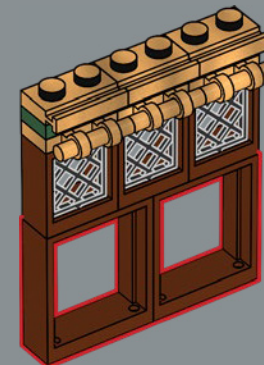





2x

143

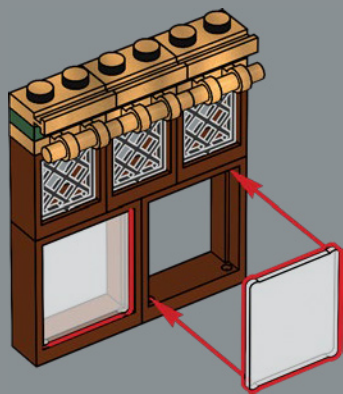

144

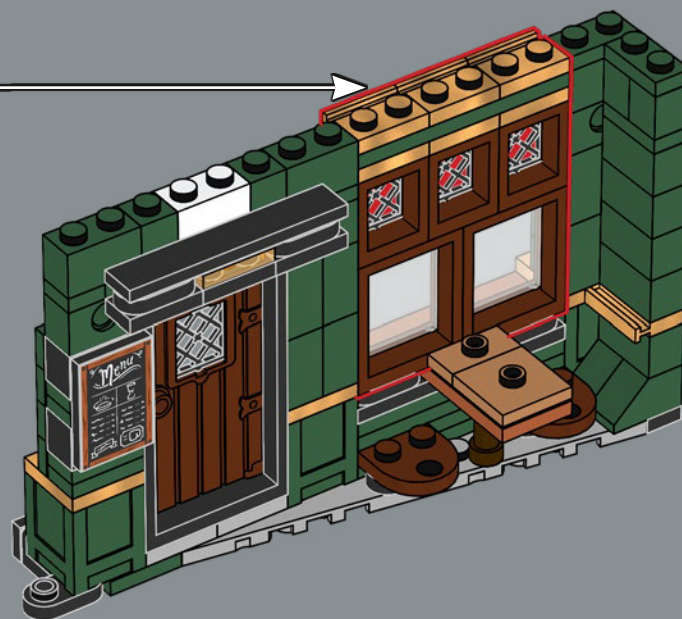

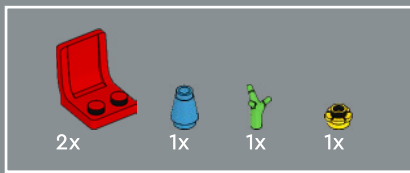

145

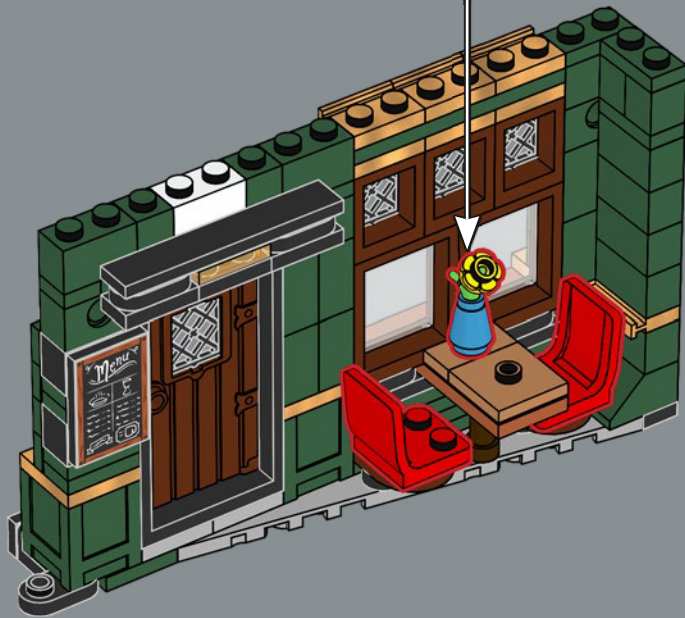
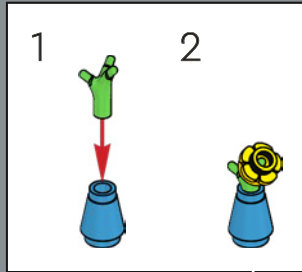

146

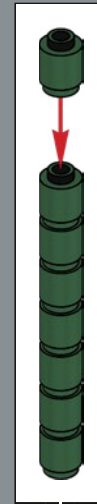



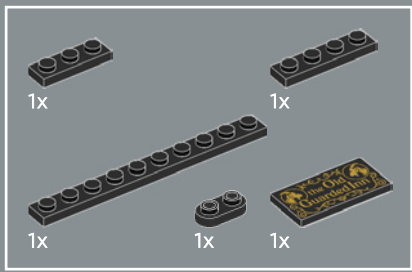

147

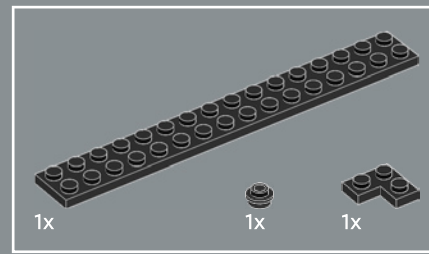

148



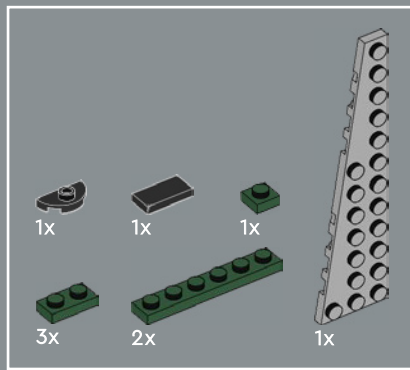

149

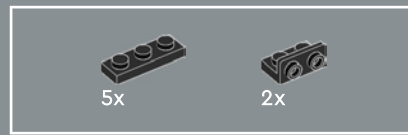

150







151

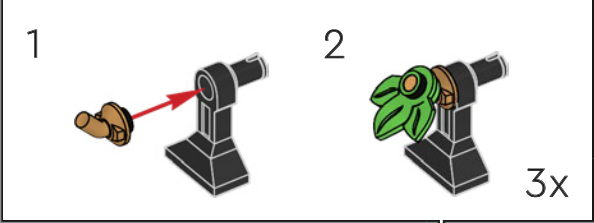

What a peculiar angle! Is it a leftover from a time when the route of the street was not yet clearly defined? Or maybe the restaurant owner just wanted to add an extension after seeing the LEGO® Icons Boutique Hotel (10297) on the other street corner!

152





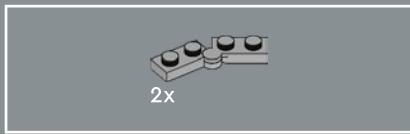

153

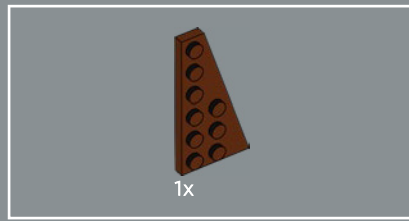

154





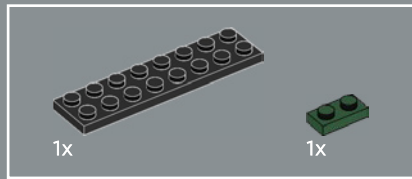
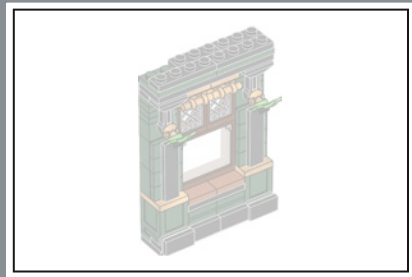

155

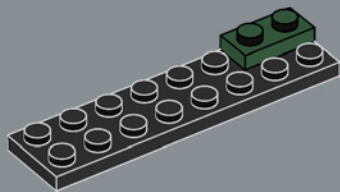

156

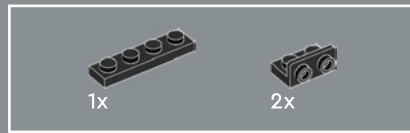
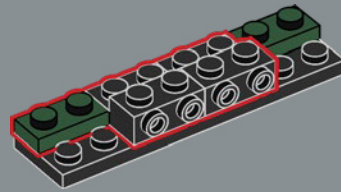

157

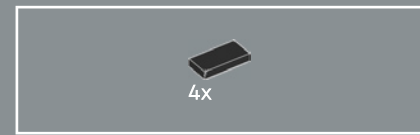
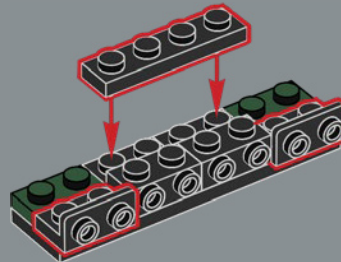

158

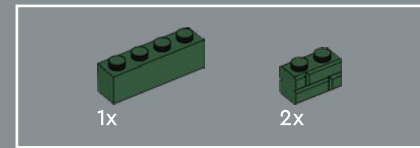
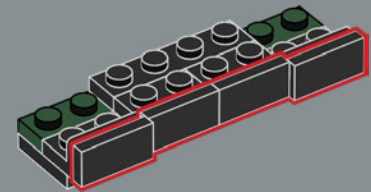

159

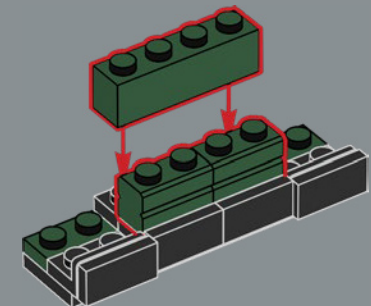

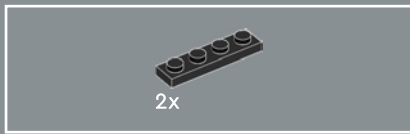

160

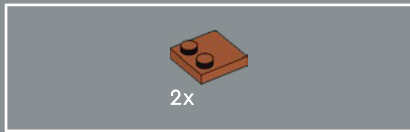
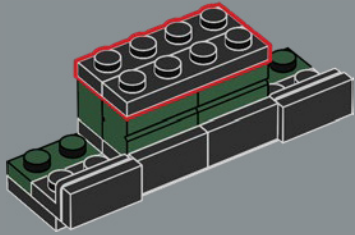

161

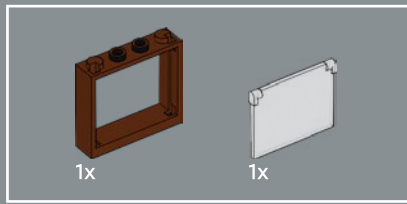
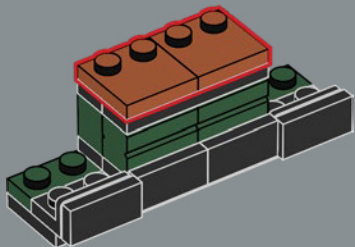

162

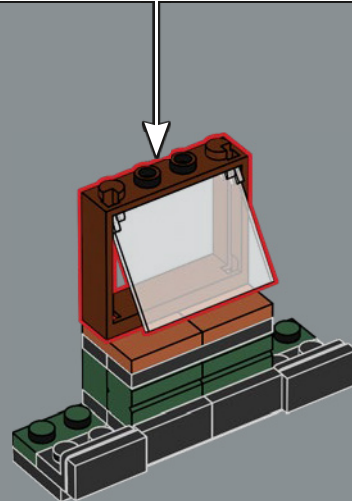
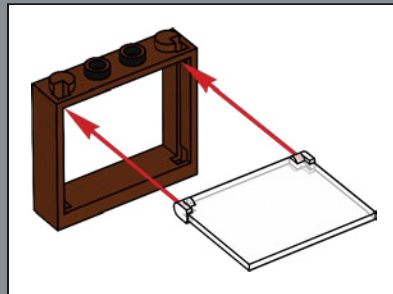

163

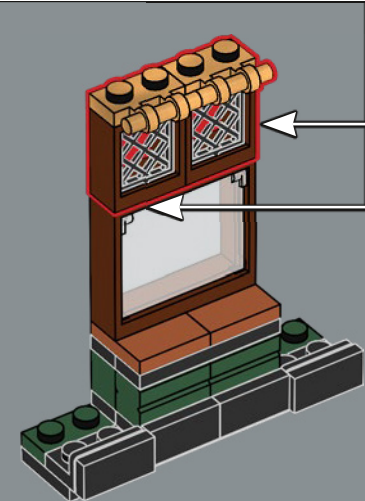
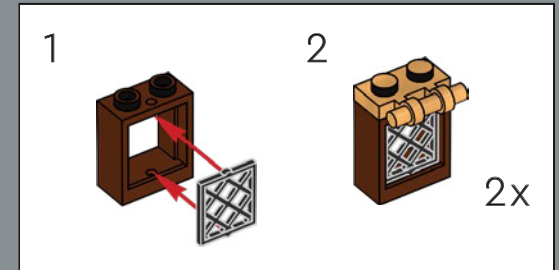



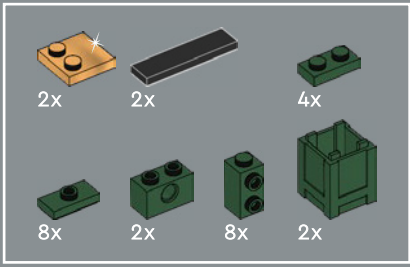

164

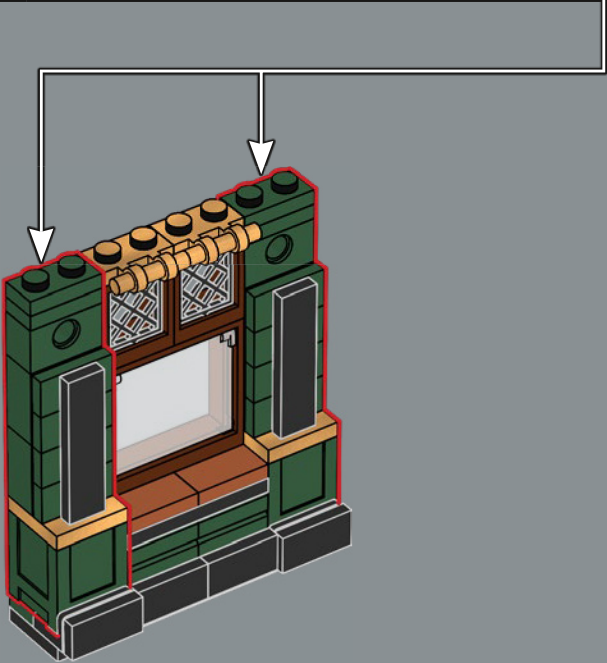
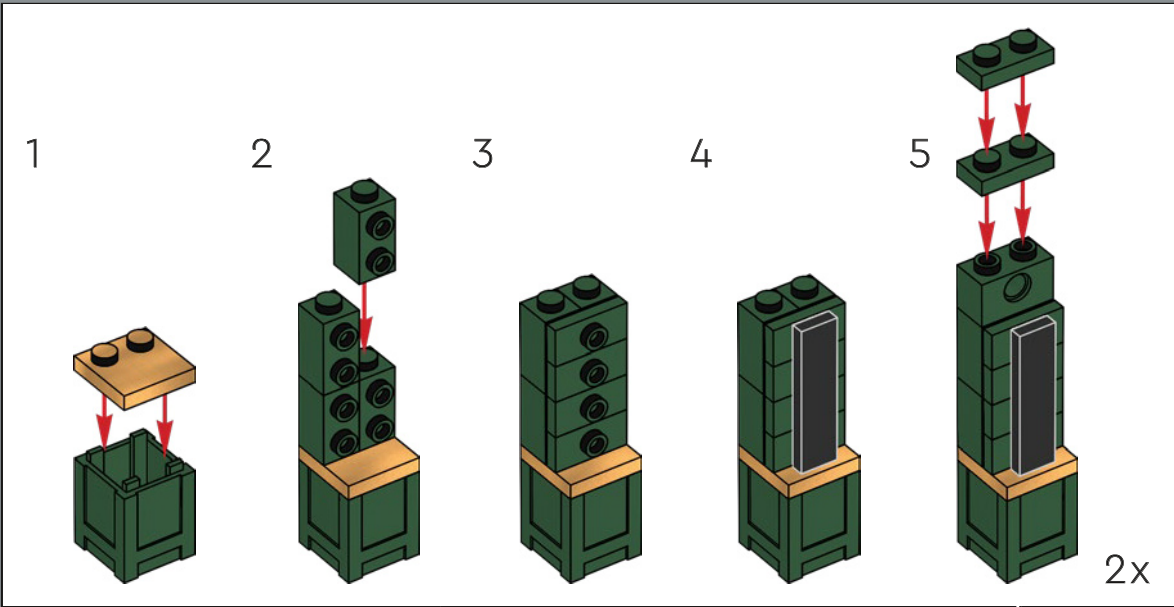

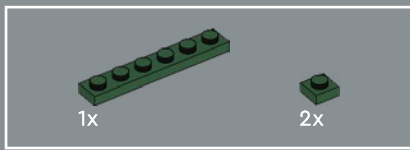

165

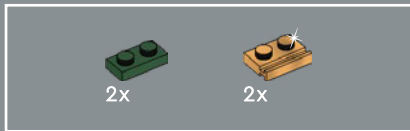
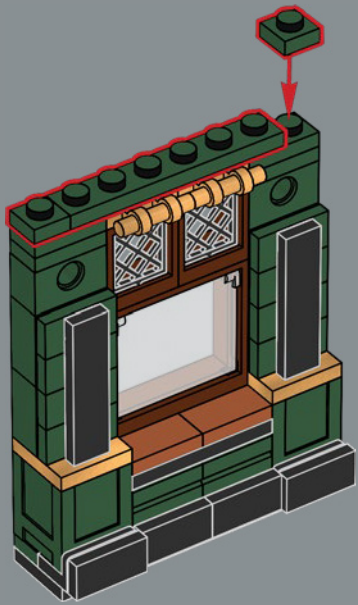

166

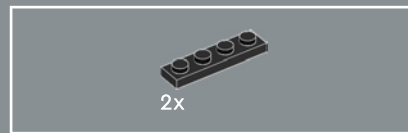
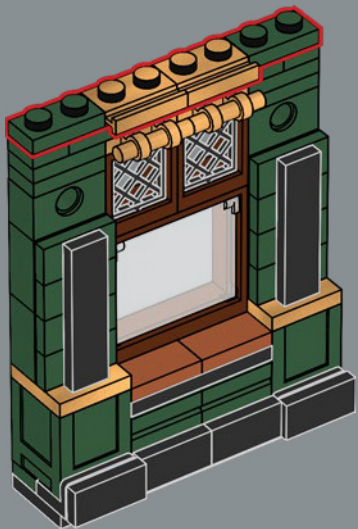

167

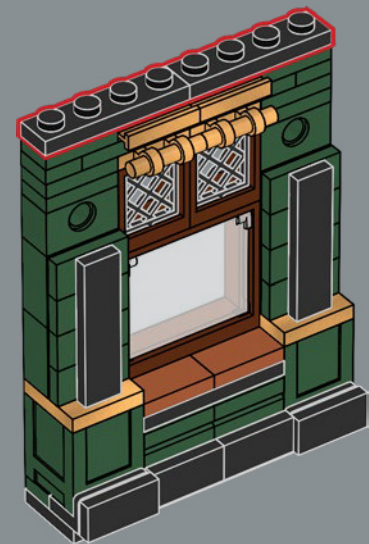



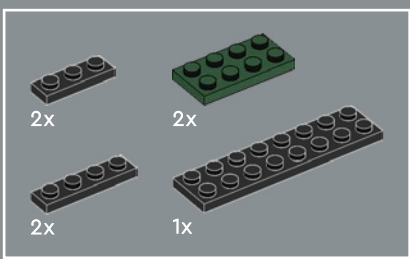

168

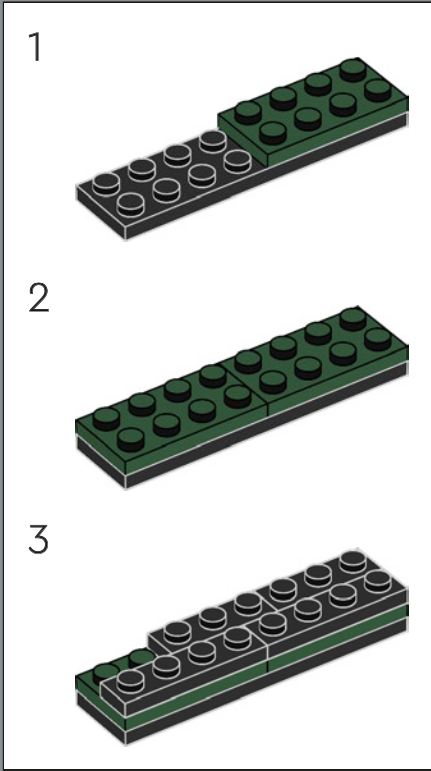

169

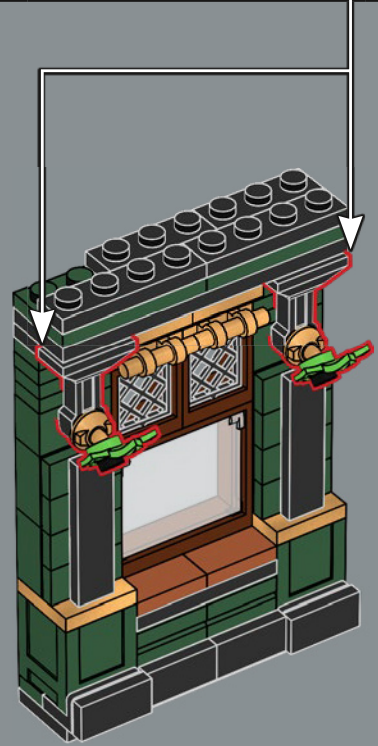
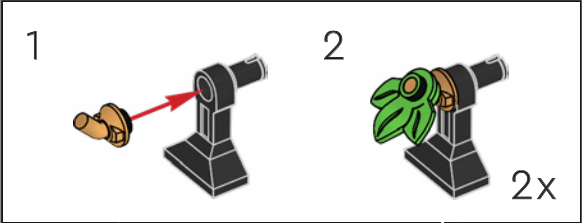

170





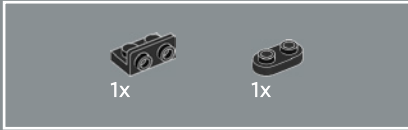
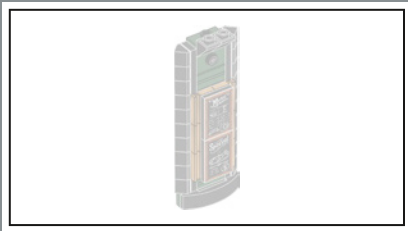

171

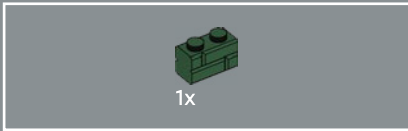
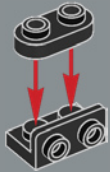

172

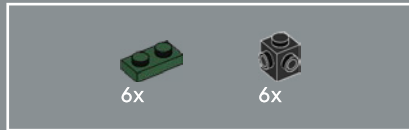

173

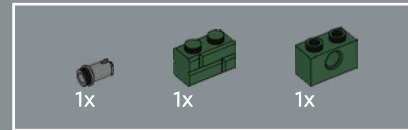
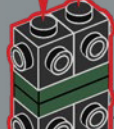
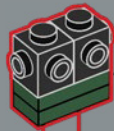
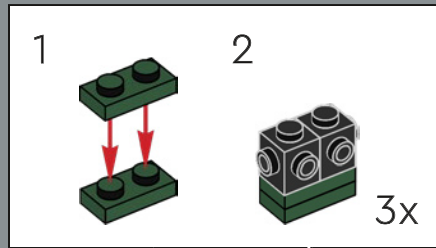

174

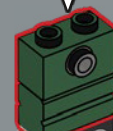
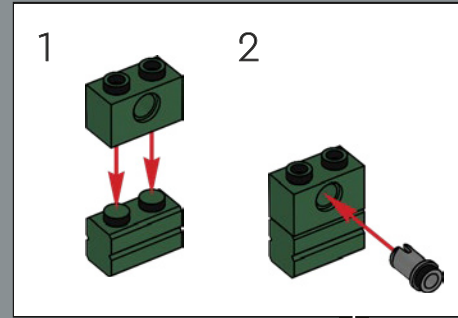



175

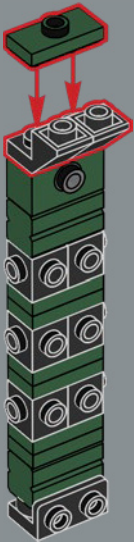

176

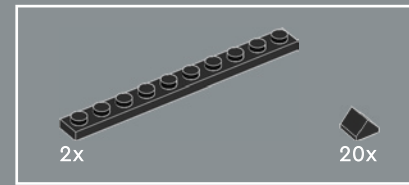
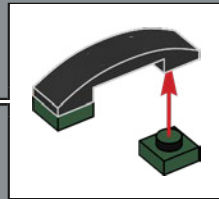
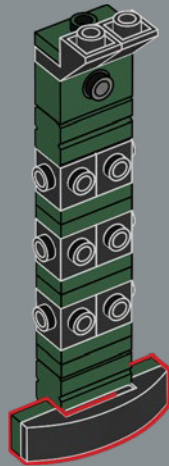

177

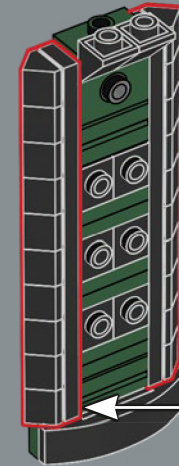
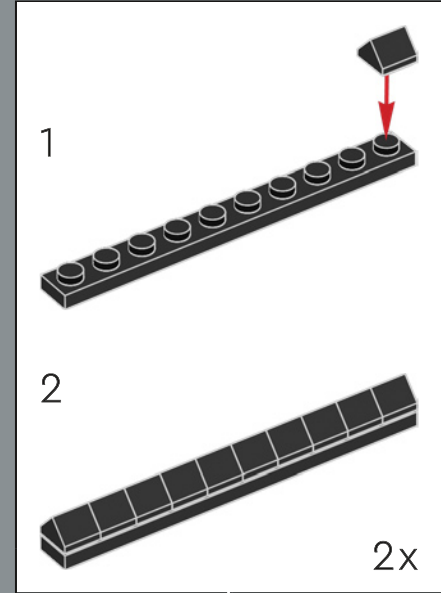





6x

178

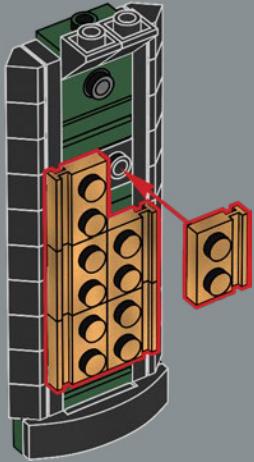

1x



1x

179



180





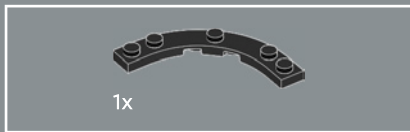

181





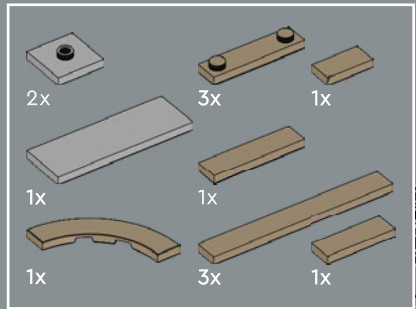

182







What might the Old Guarded Inn have looked like back in the day? The curator of the LEGO® Icons Natural History Museum (10326) must surely have more information in his archives.

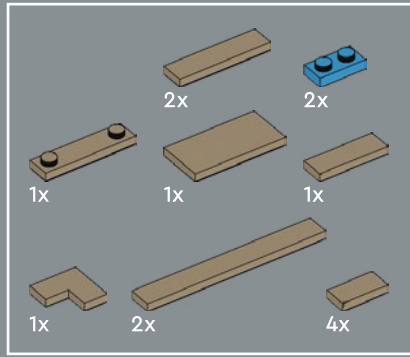

183





1x  1x 

184



2x 

185





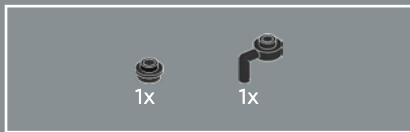

186



187





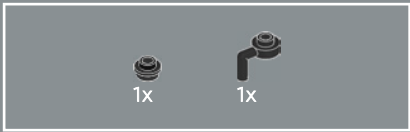

188

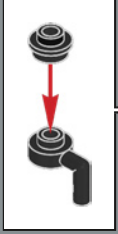

189







190

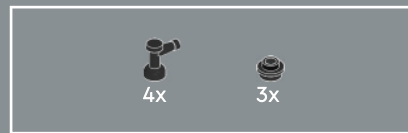
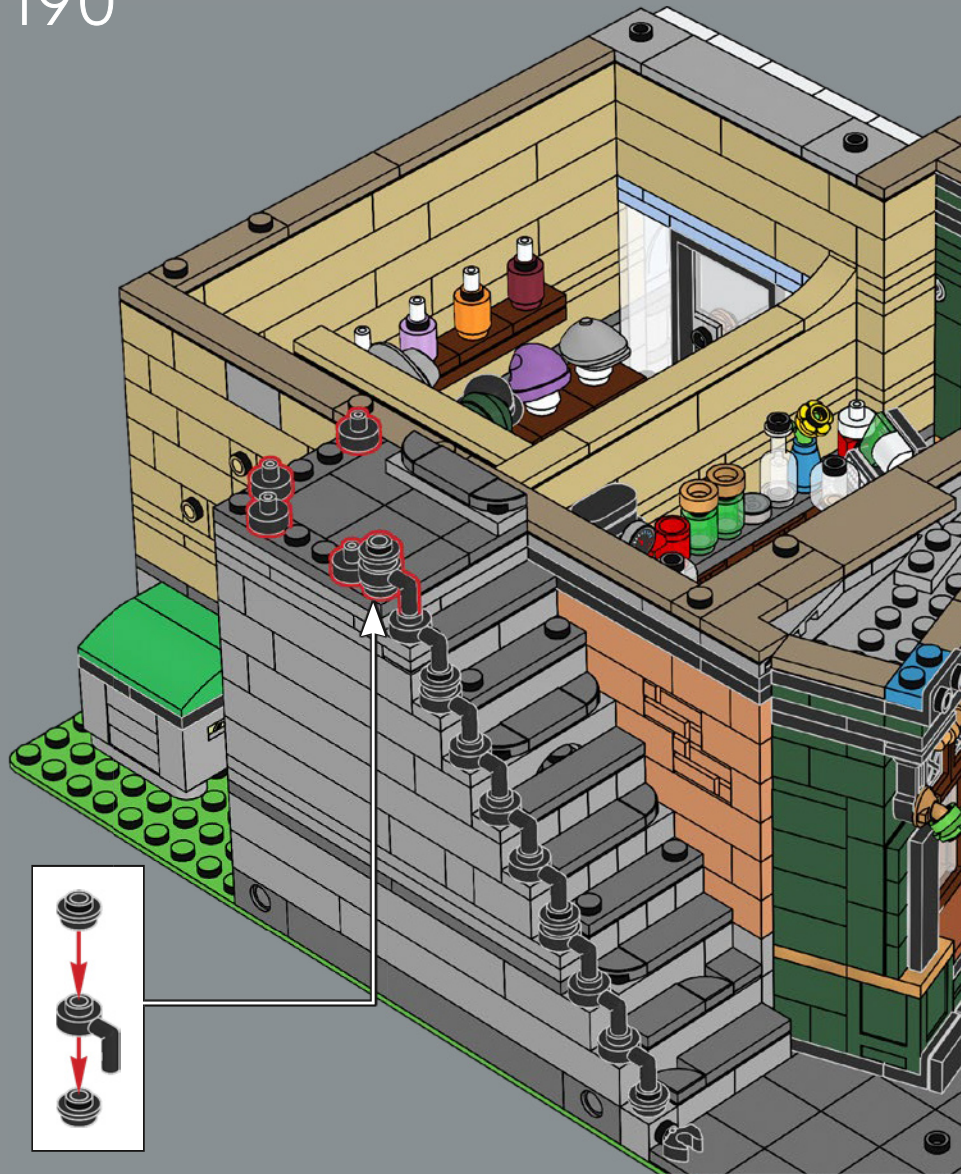

191





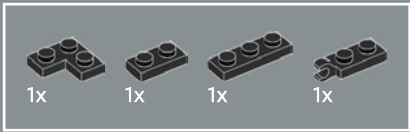

192

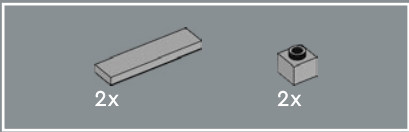

193





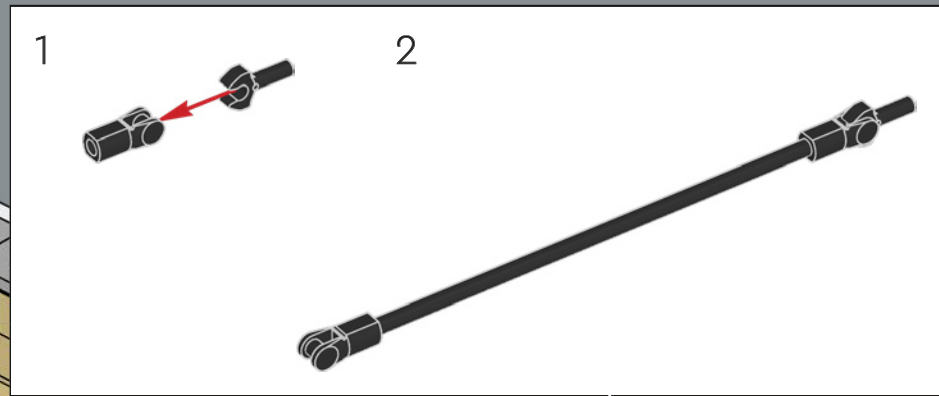
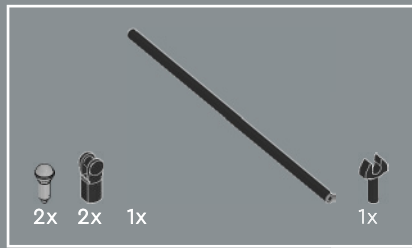

194

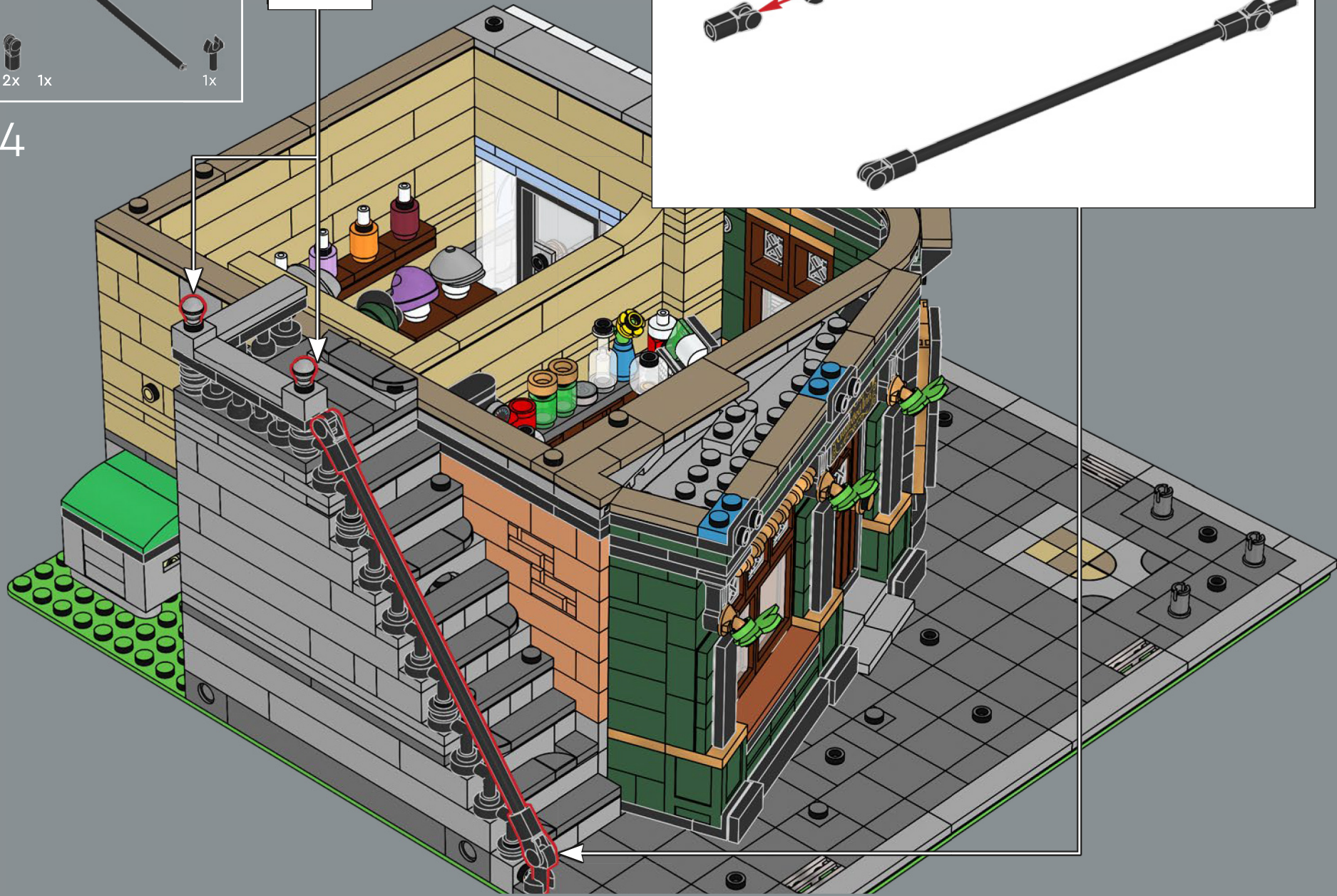



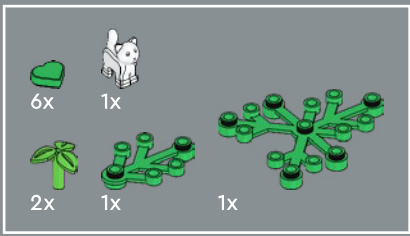

195

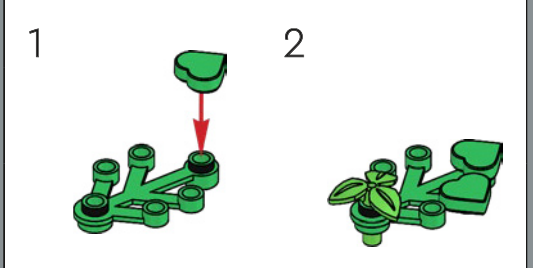
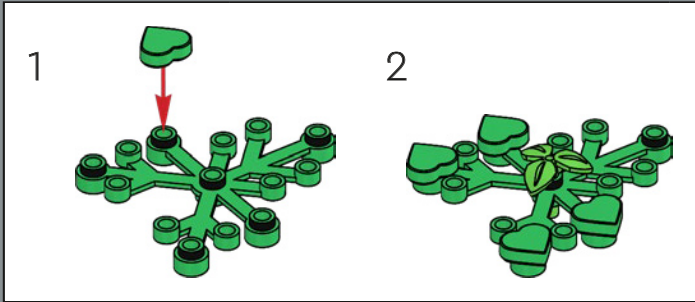





196

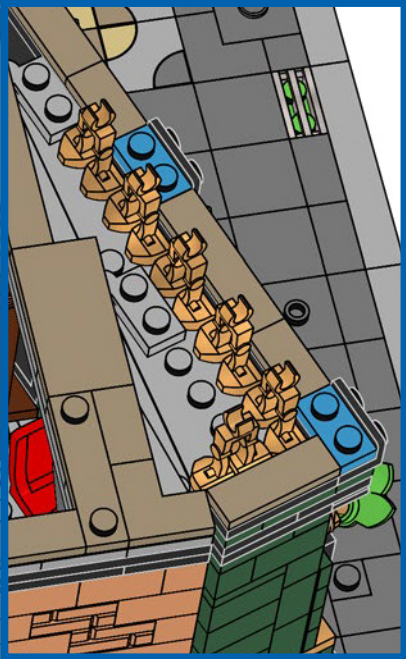



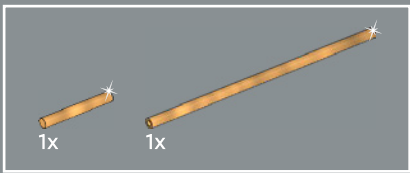

197







198





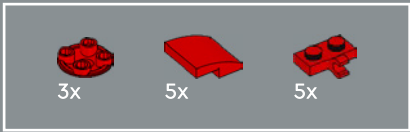

199

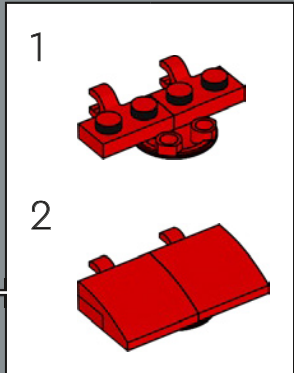
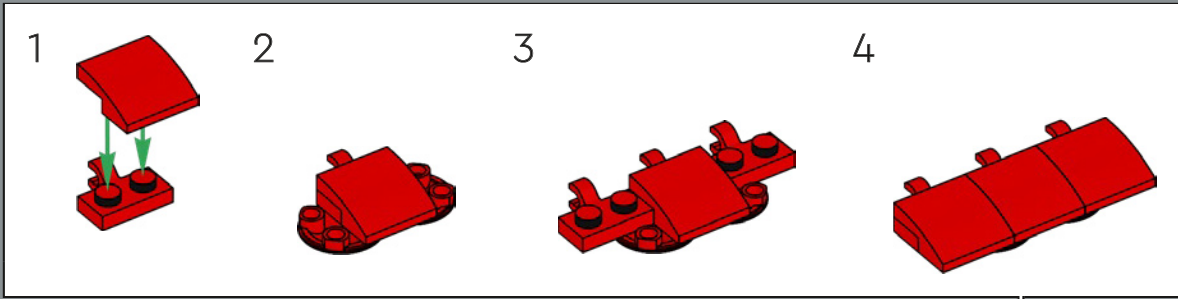





200

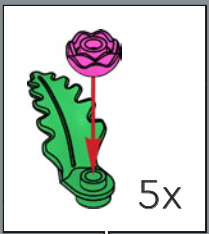





8x



4x



4x

201

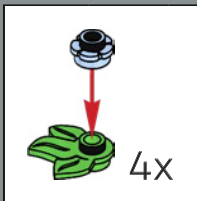
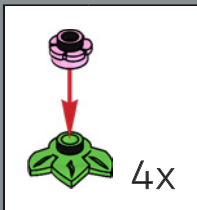

All these flowers come from the florist in LEGO® Creator Expert Assembly Square (10255). She always manages to find new floral arrangements!

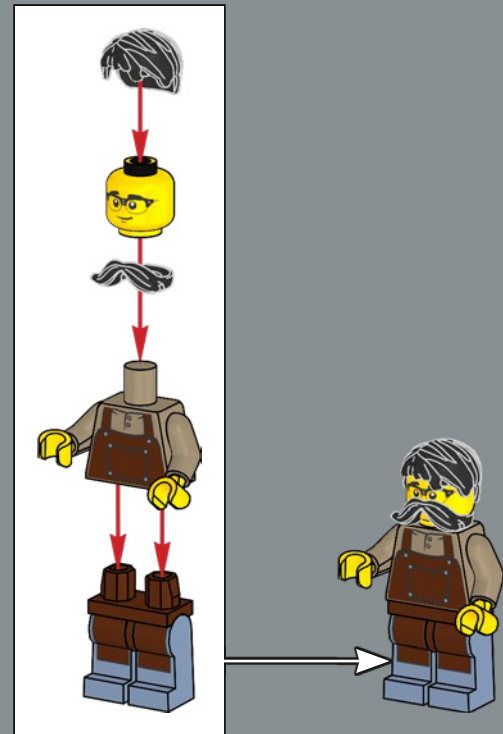
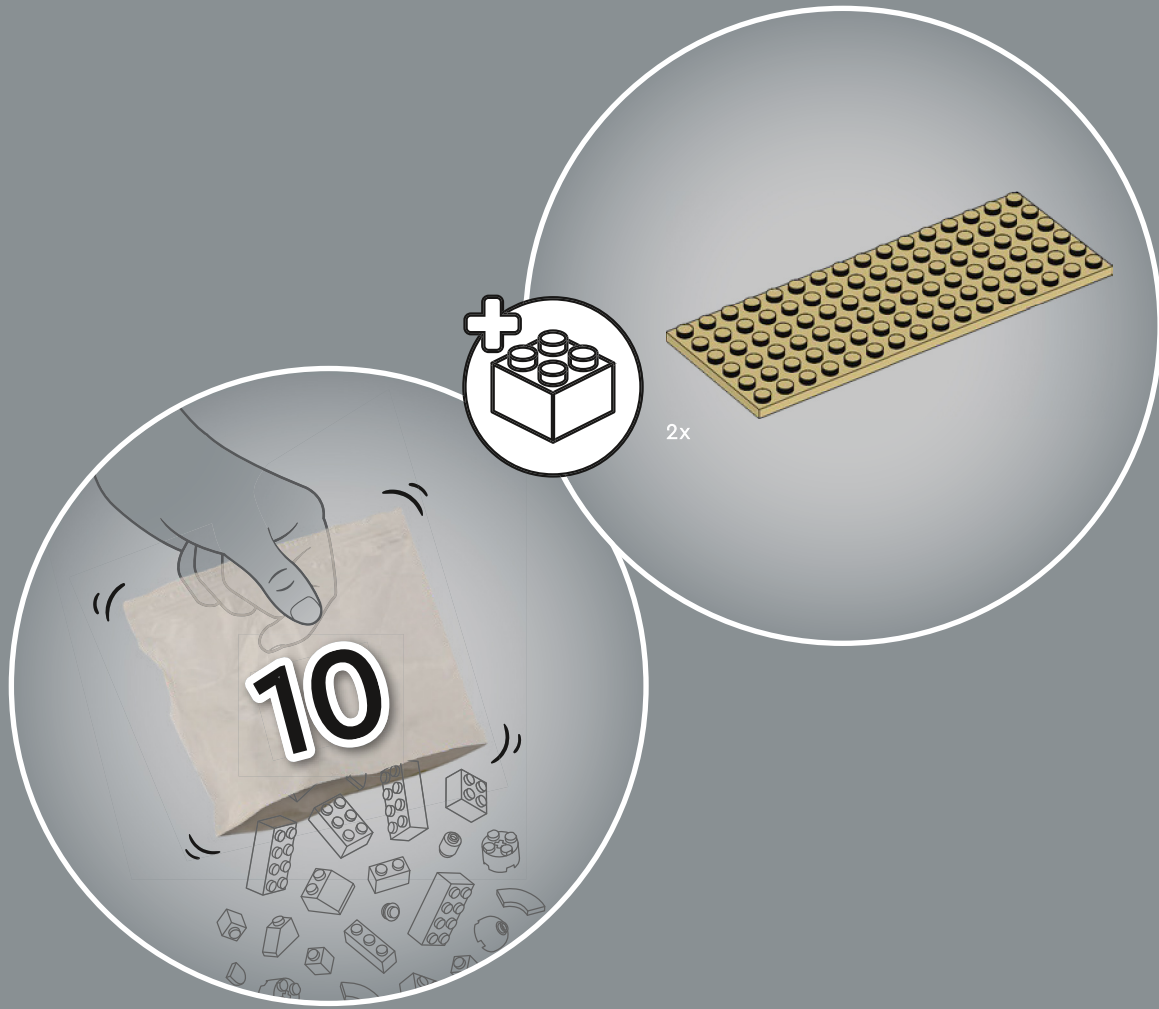



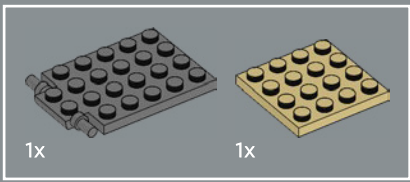

202

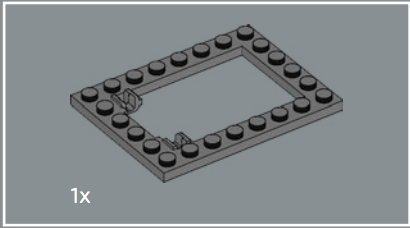
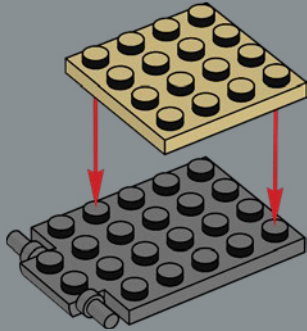

203

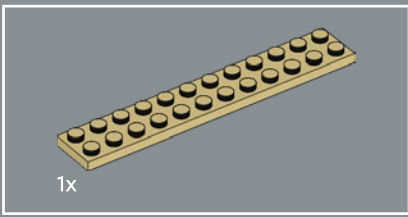
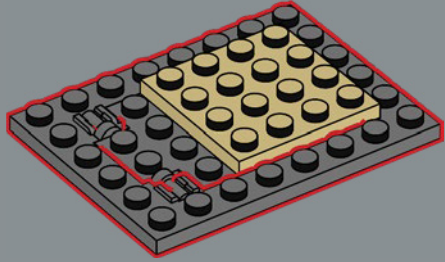

204

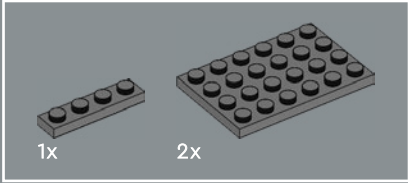
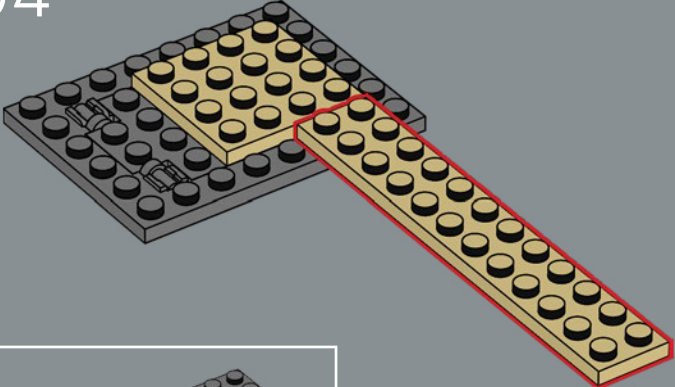

205

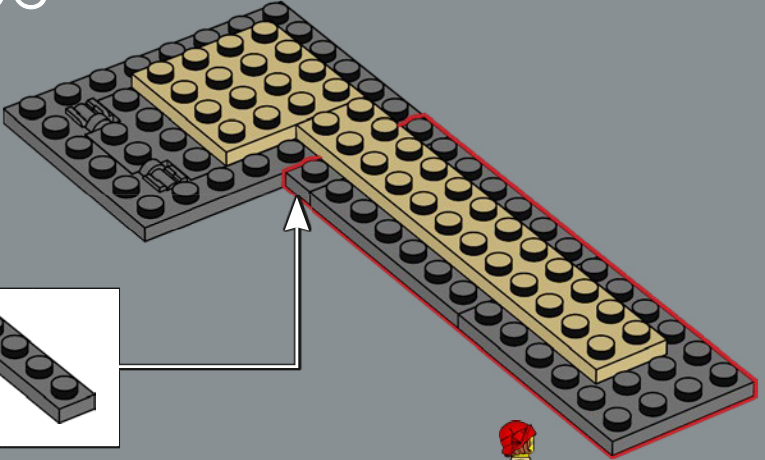

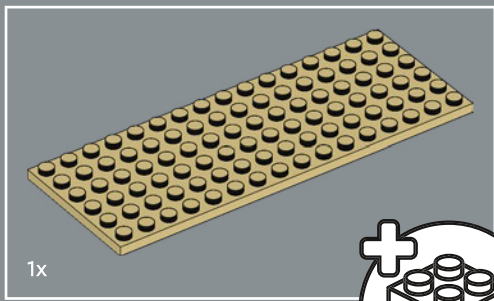

1x

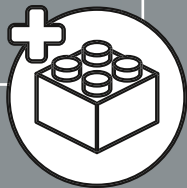

206

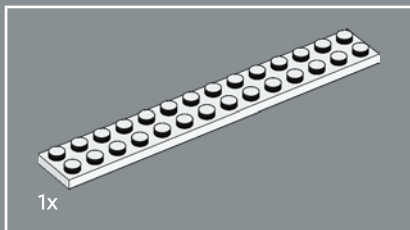
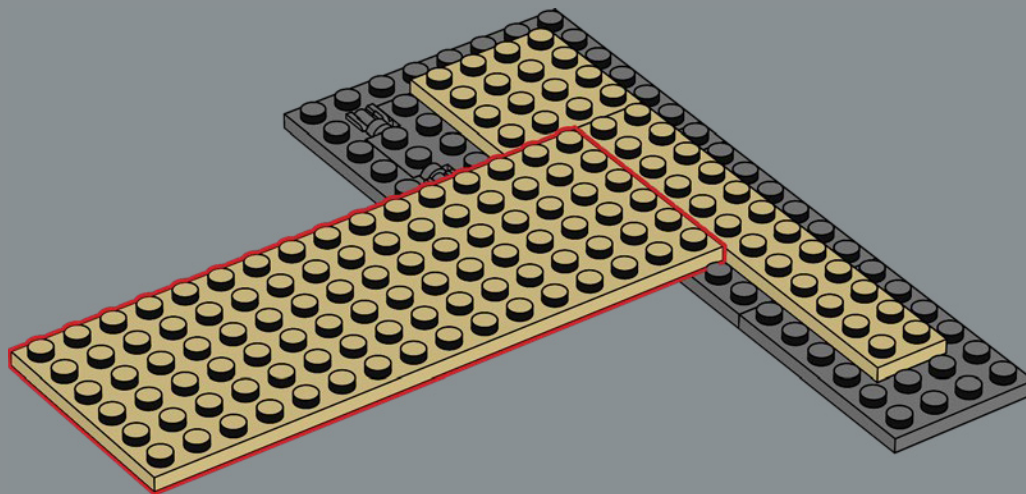

1x

207

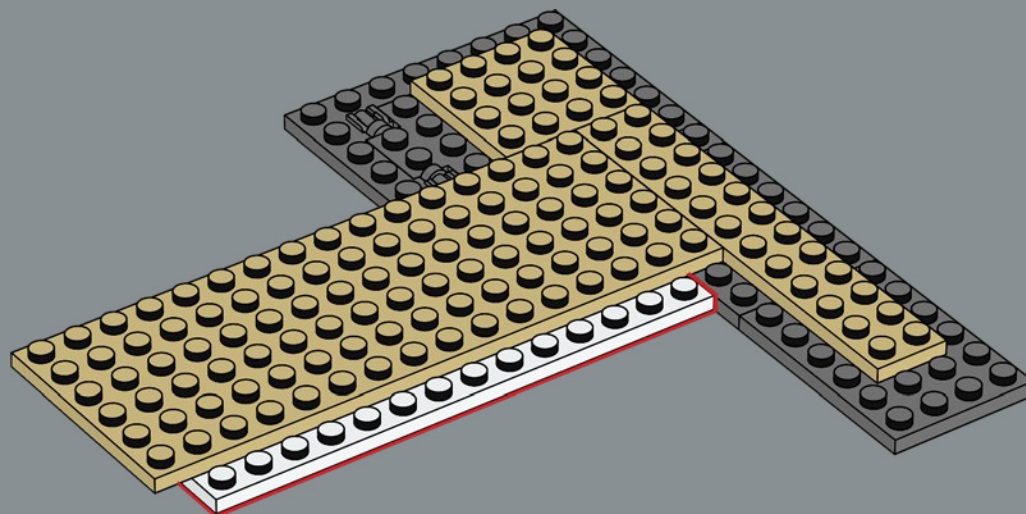



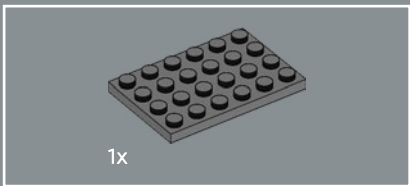

208

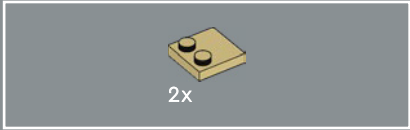
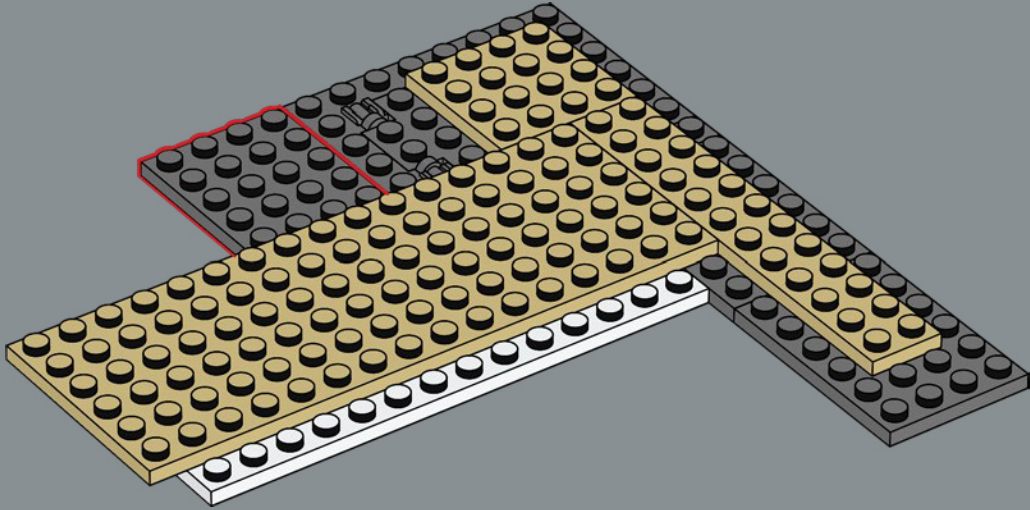

209

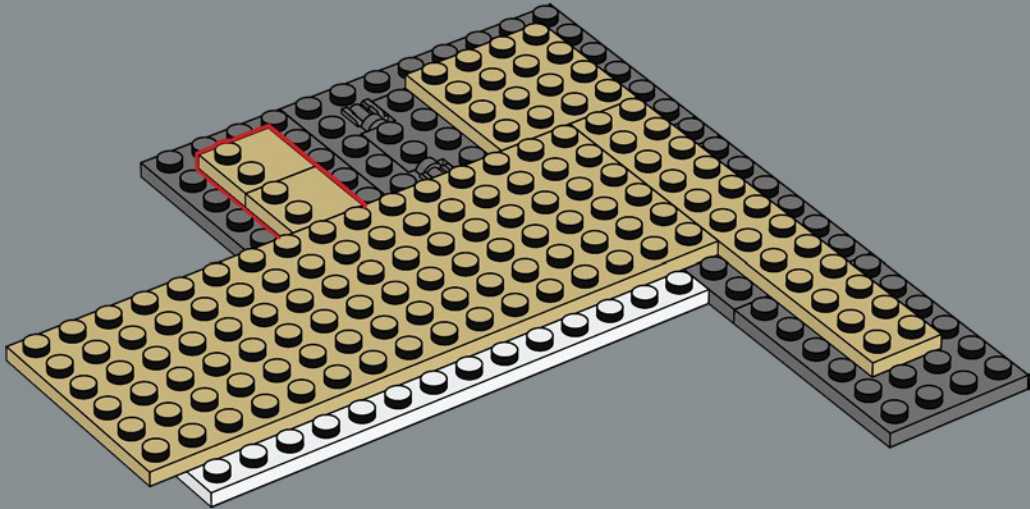

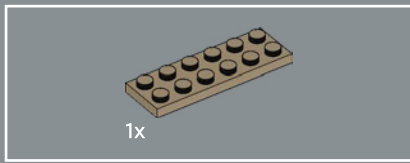

210

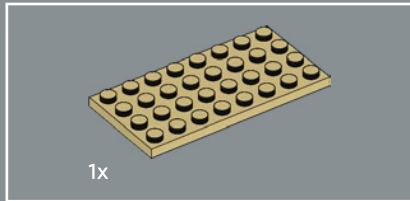
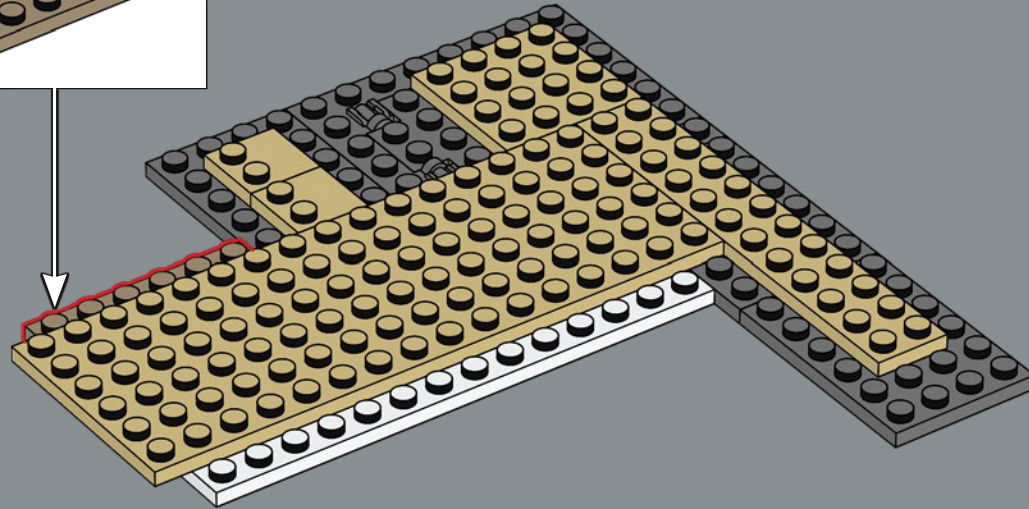
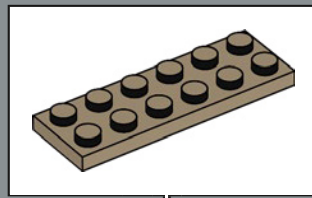

211

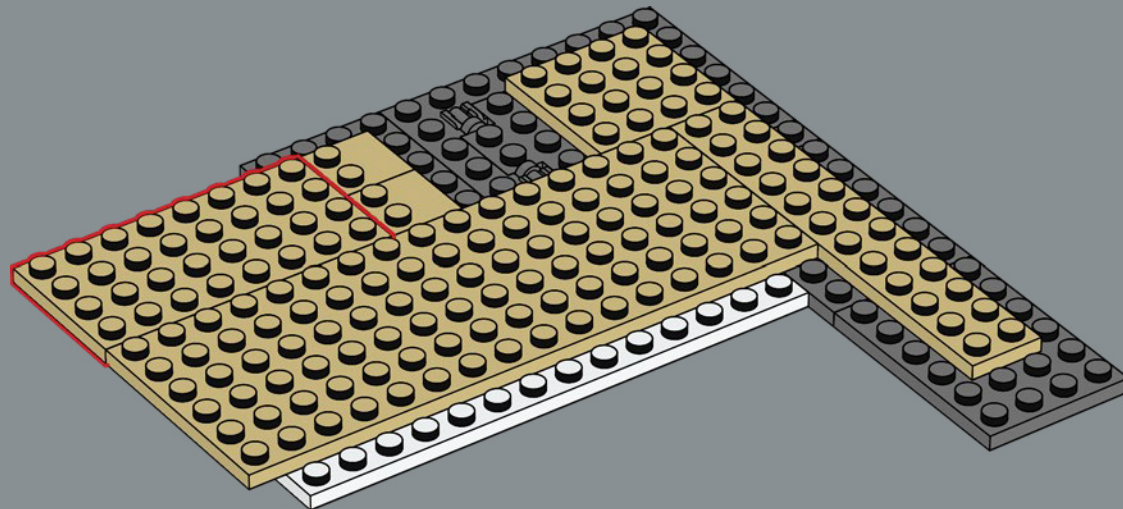



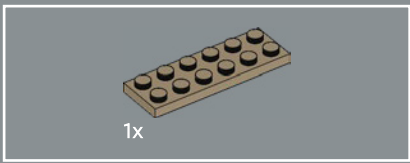

212

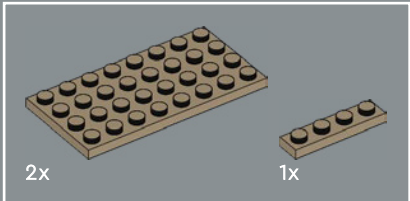
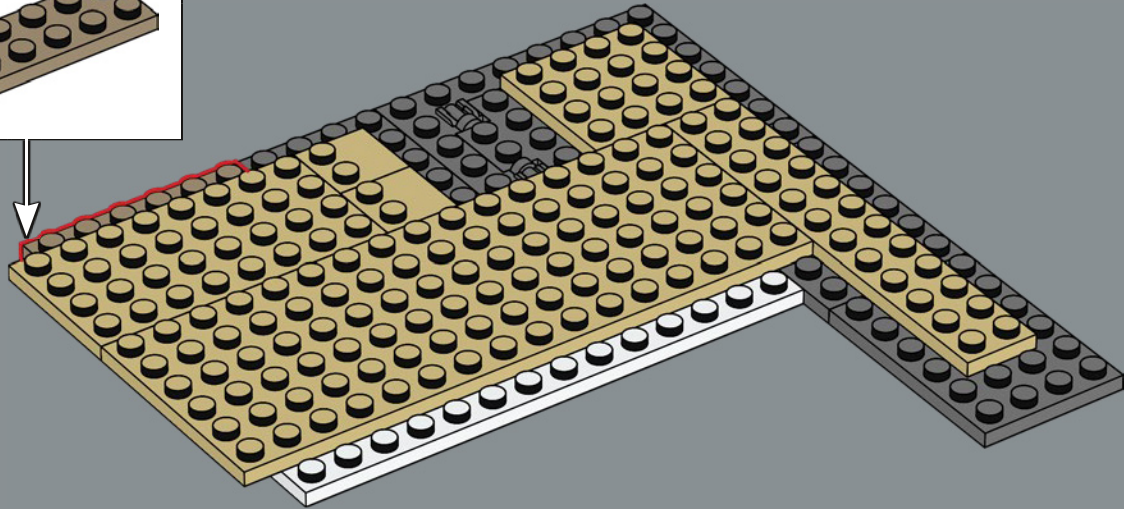
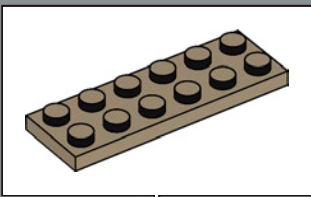

213

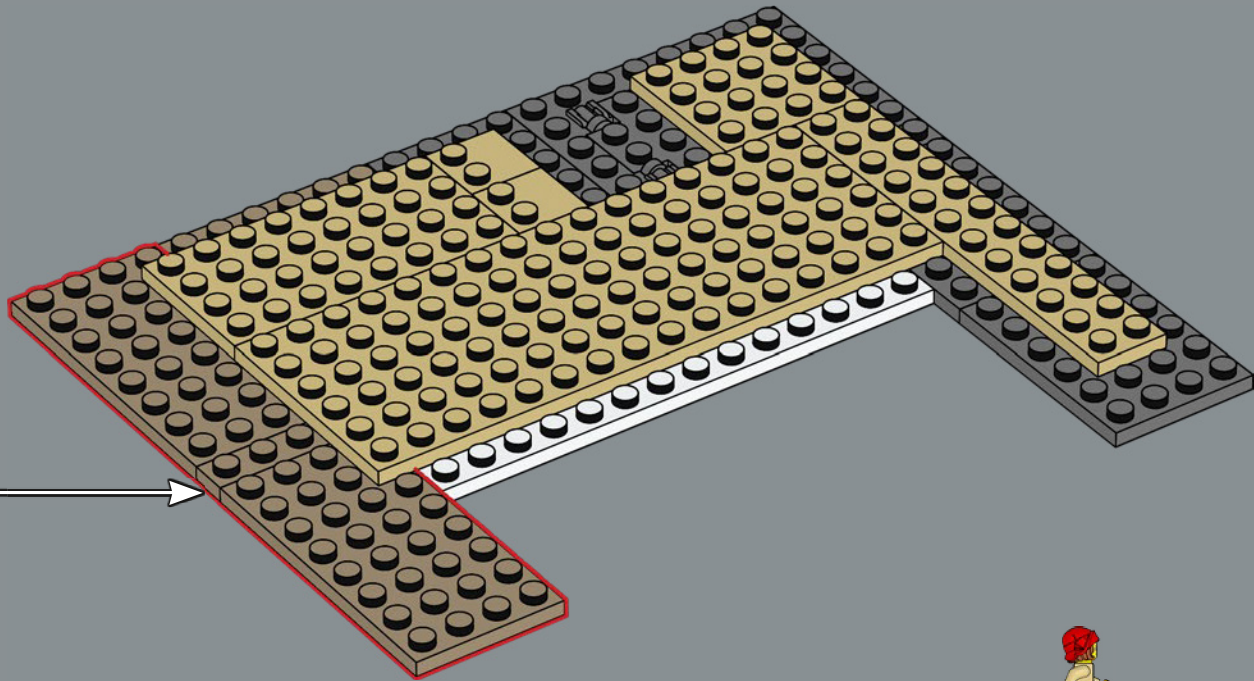
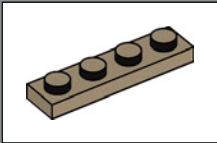

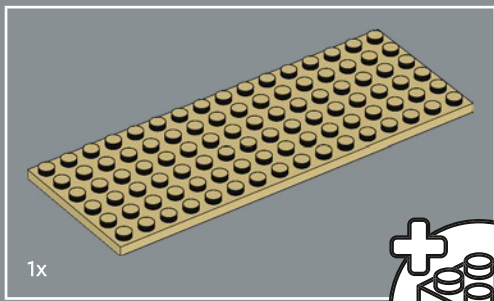

1x

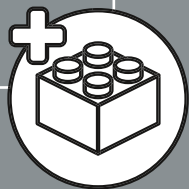

214

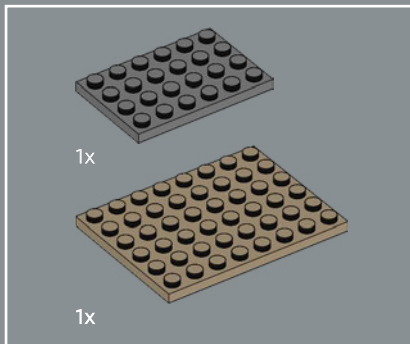
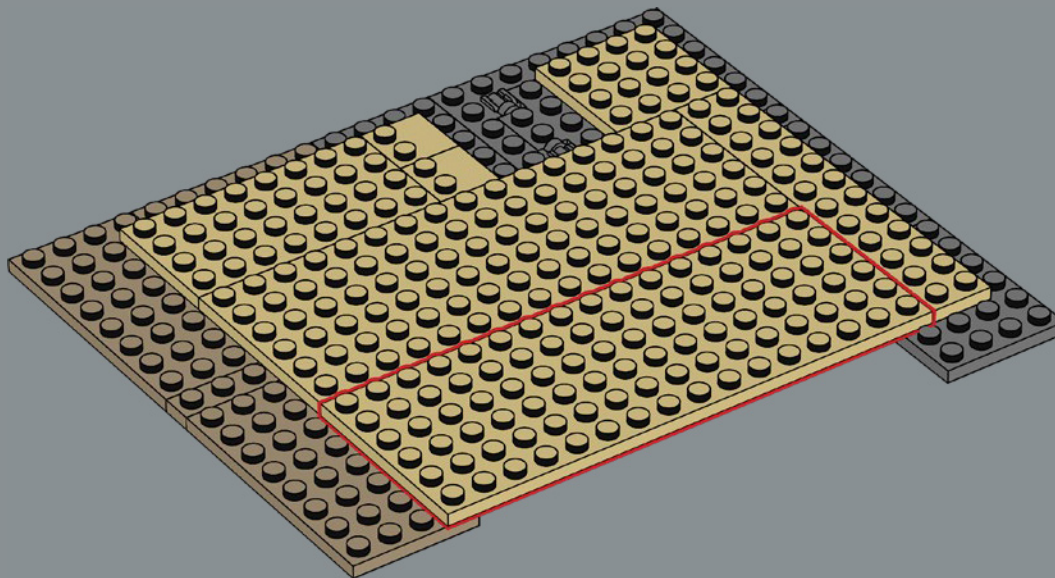

1x

1x

215

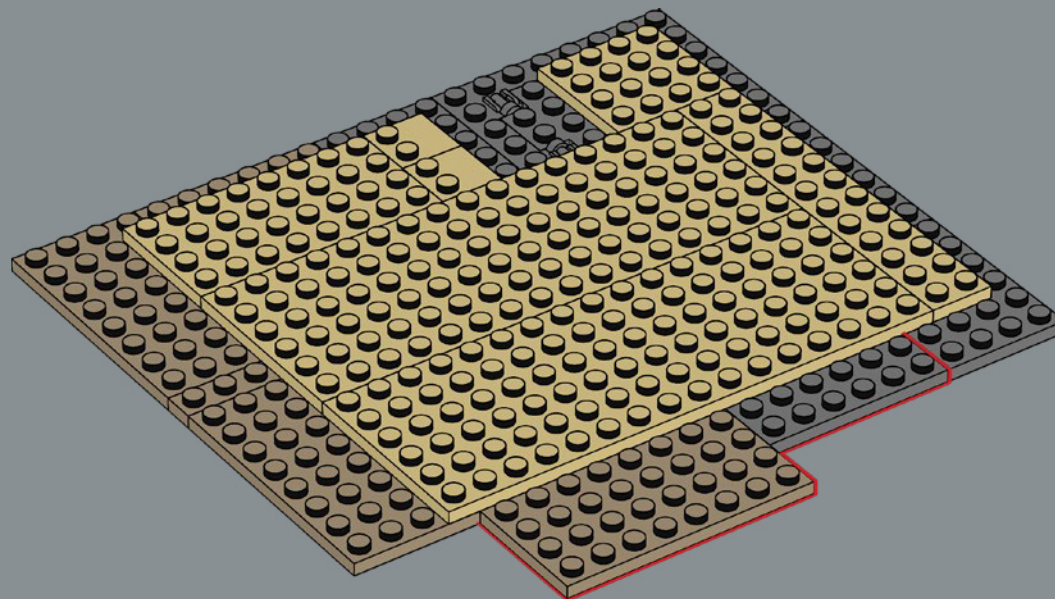



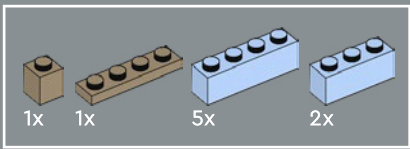

216

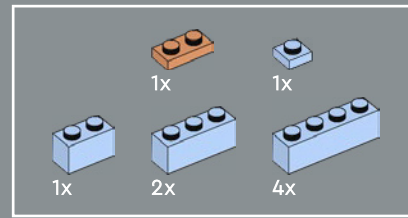
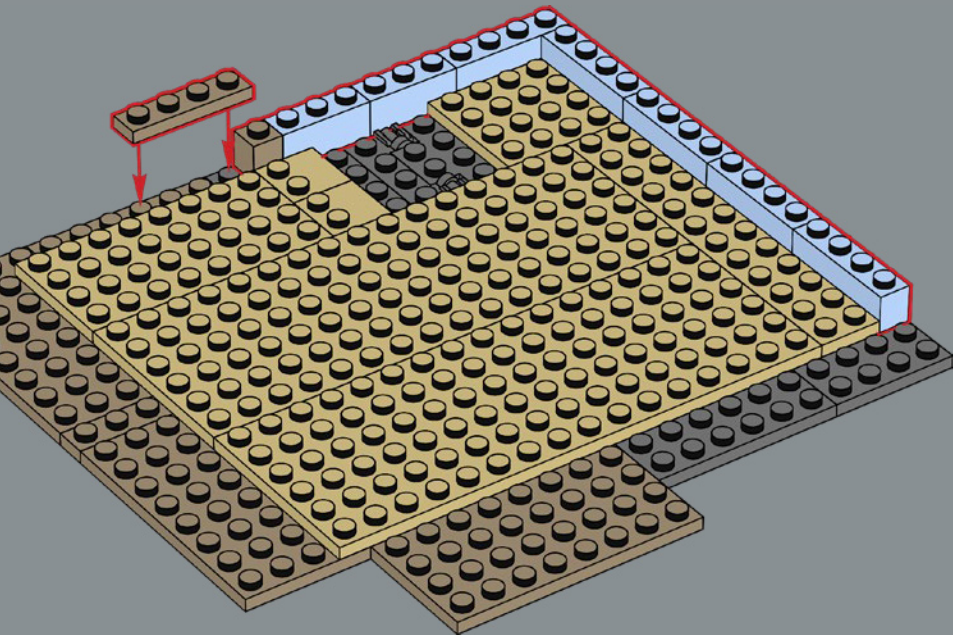

217

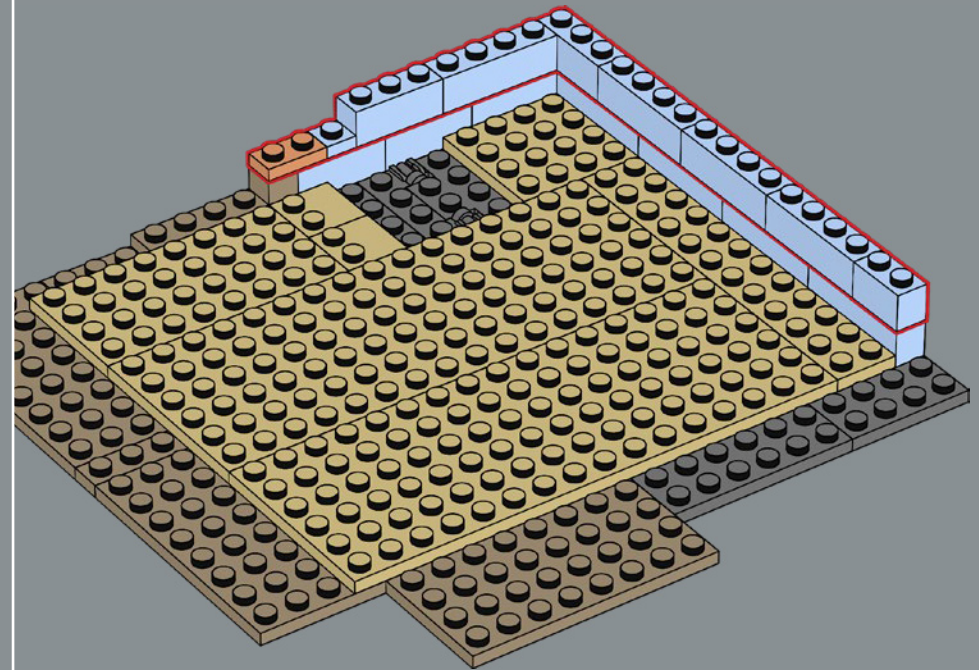

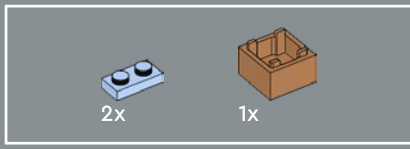

218

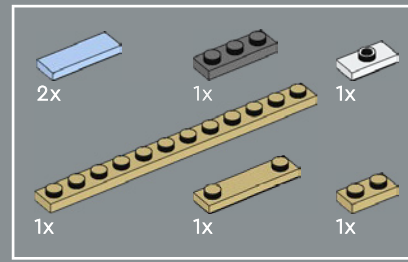
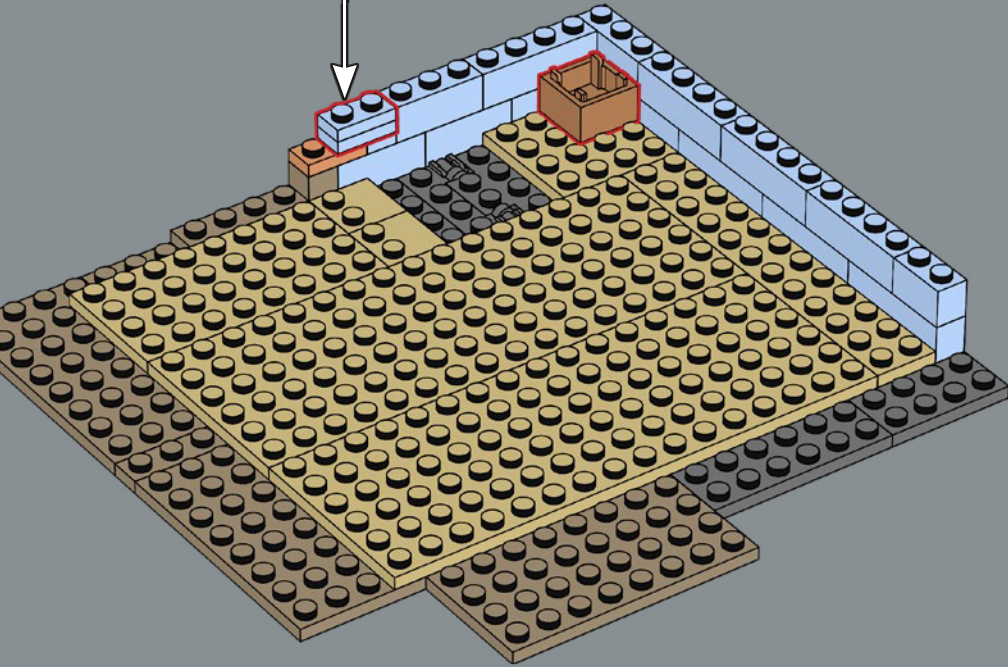
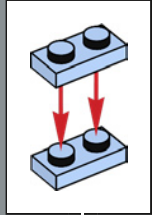

219

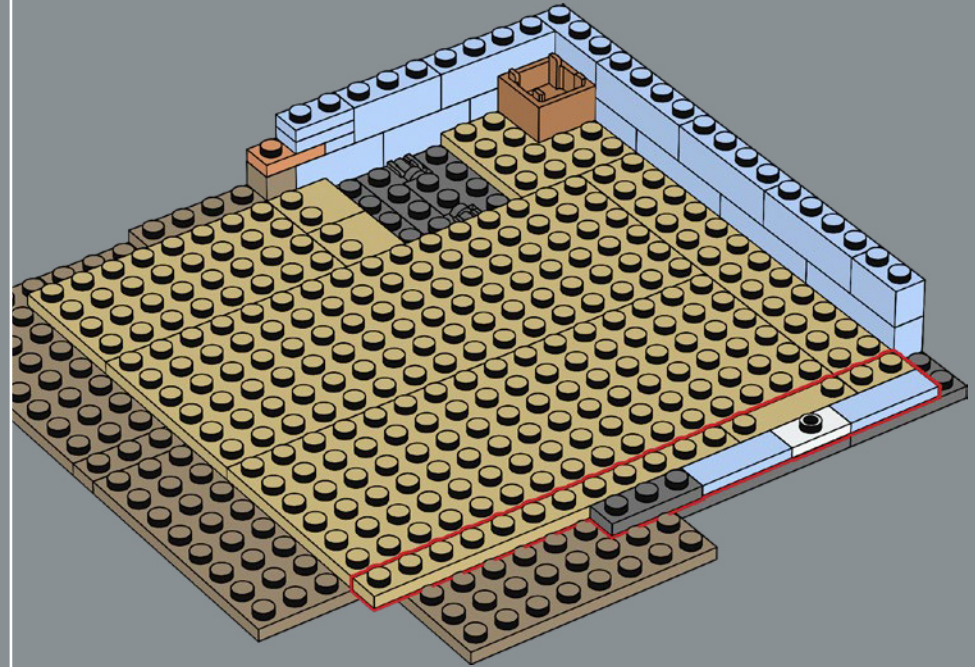



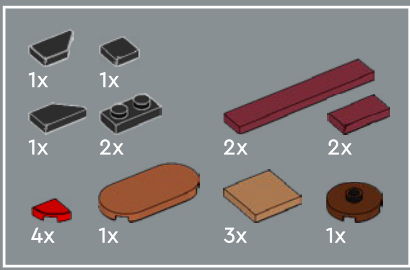

220

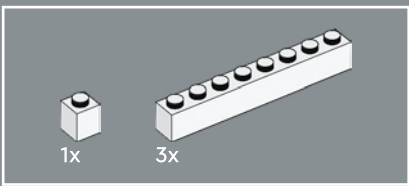
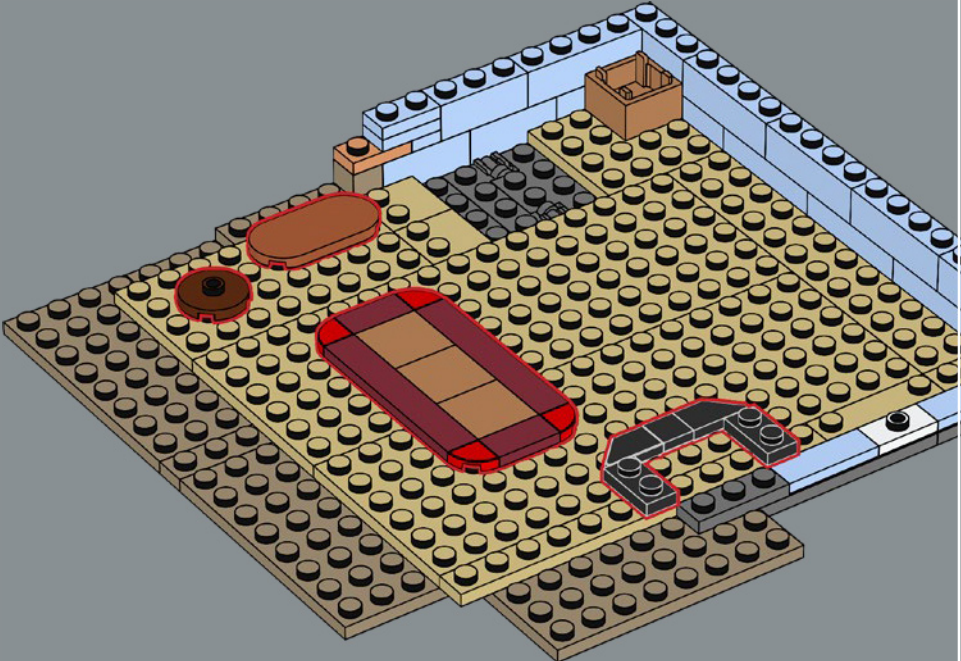

221

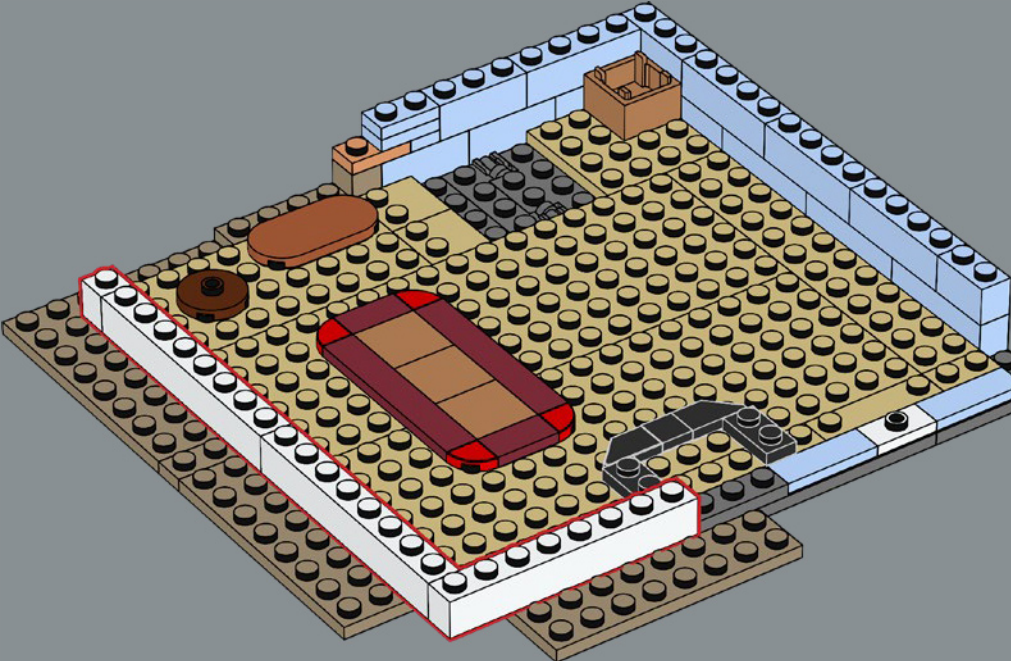

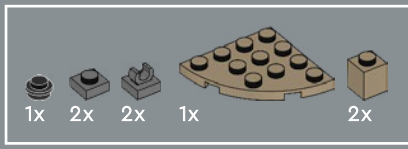

222

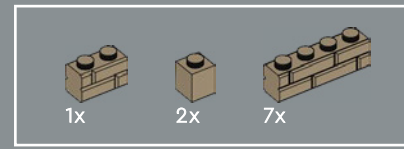
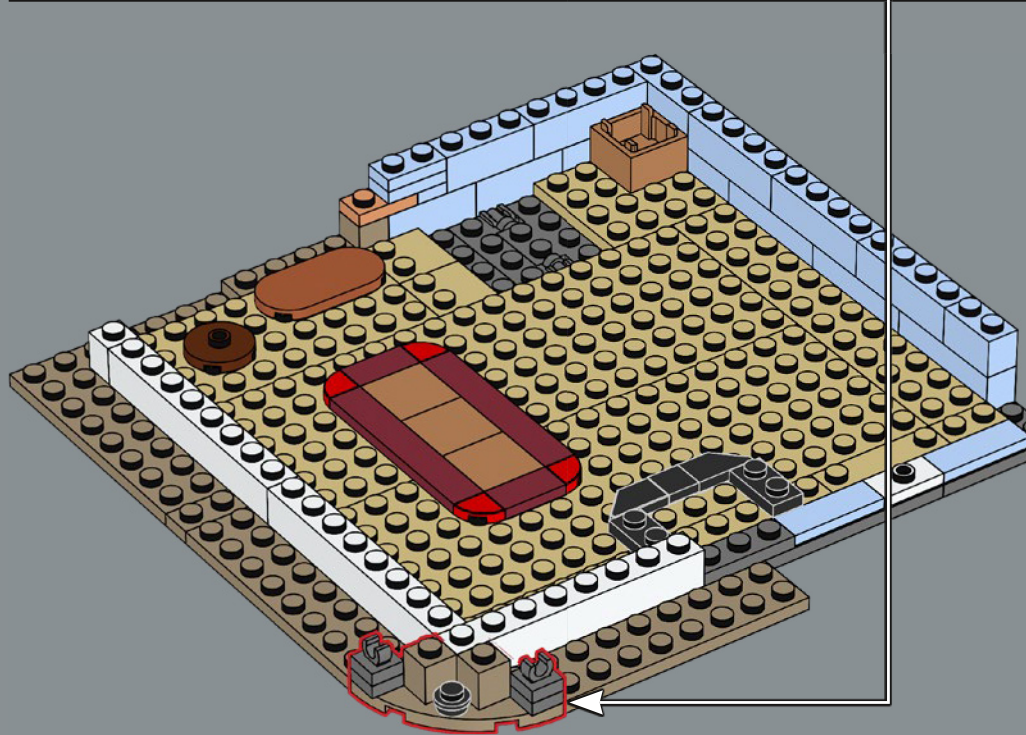
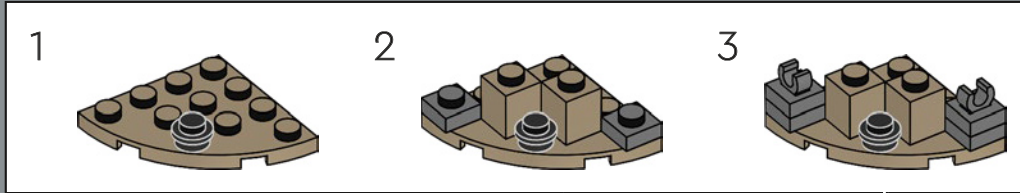

223

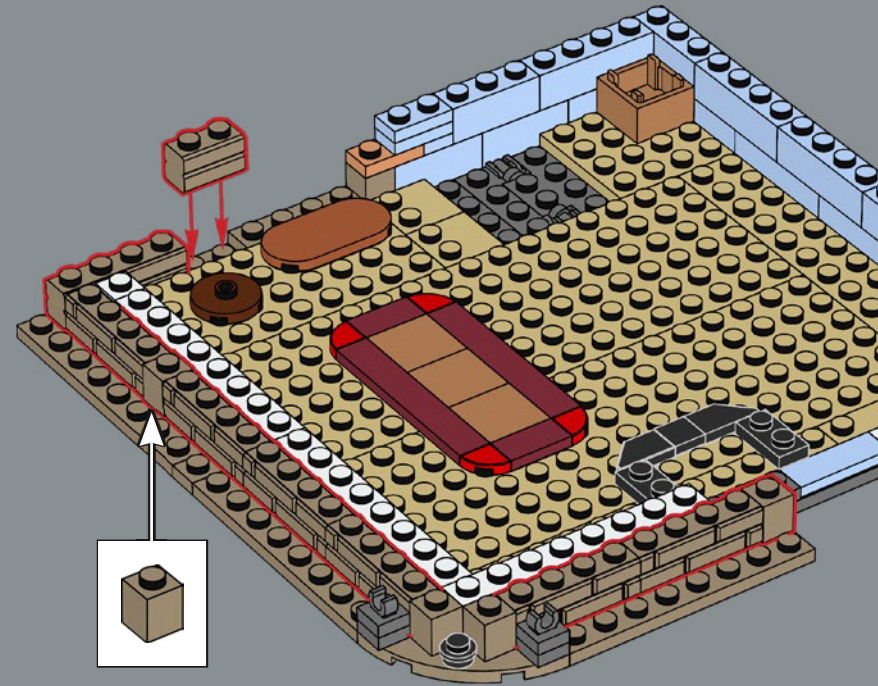



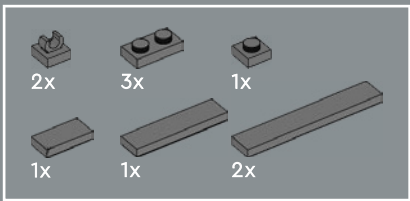

224

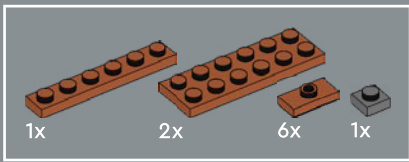
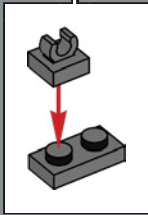
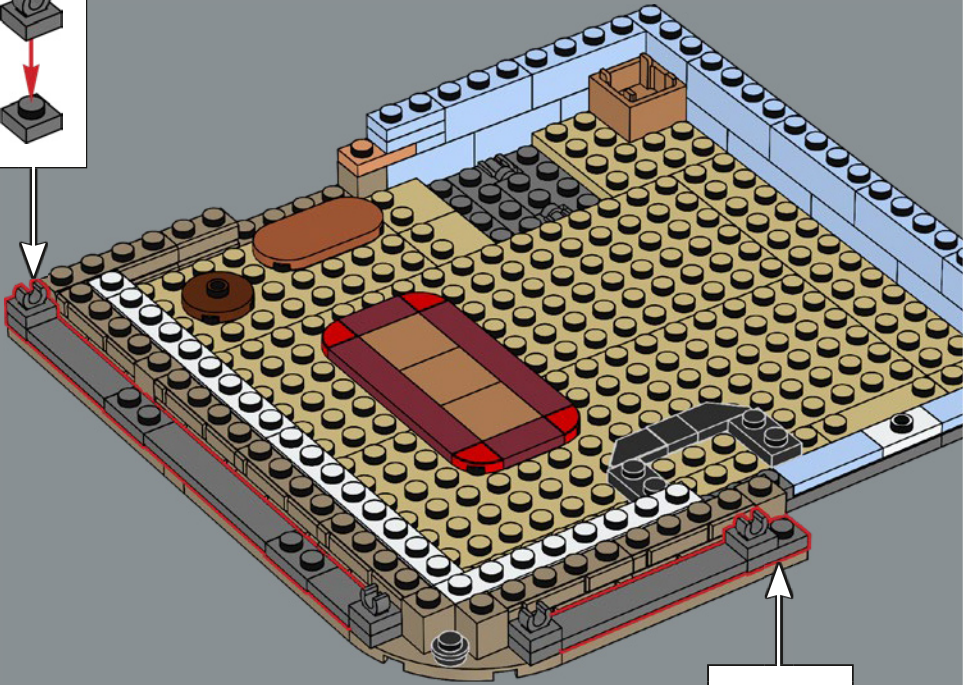
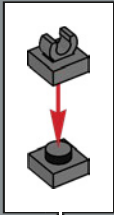

225

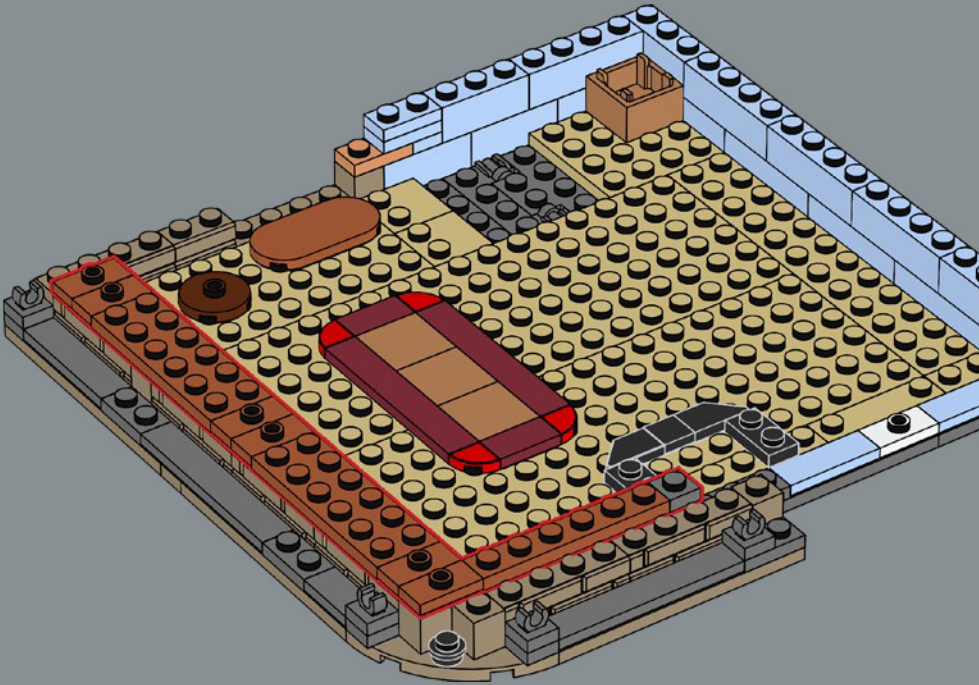

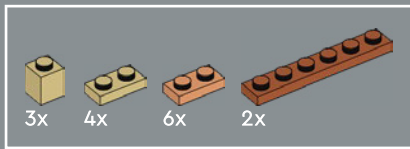

226

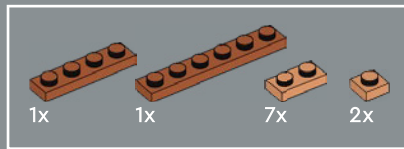
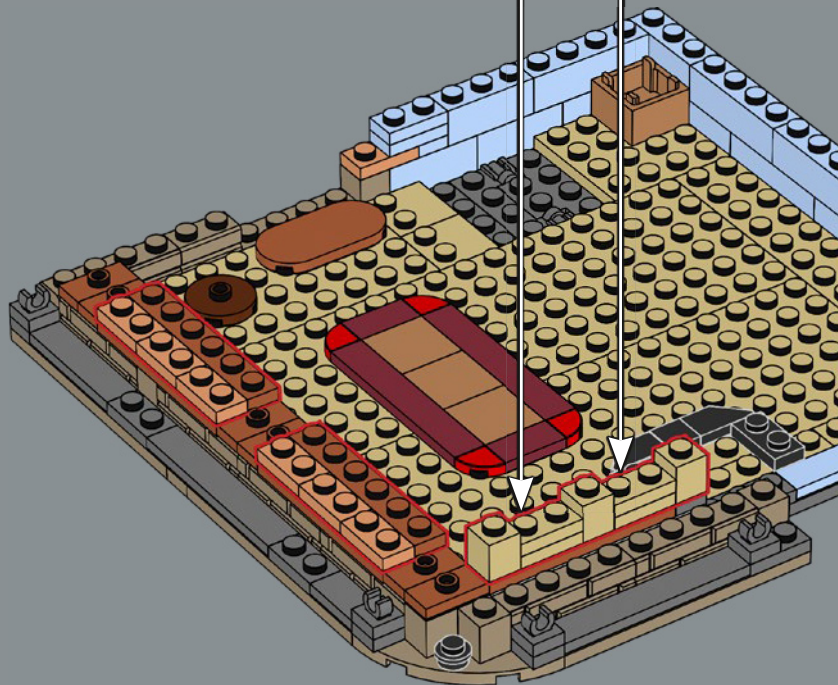
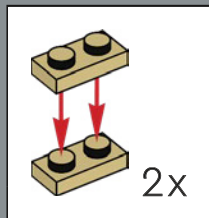

227

1

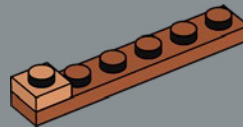

2

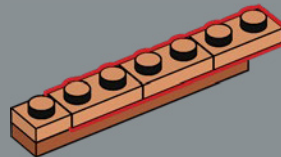

3

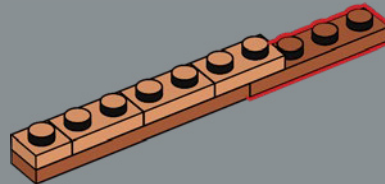

4

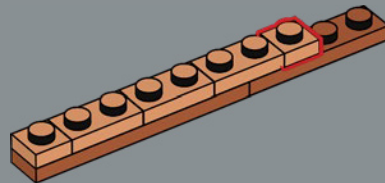

5

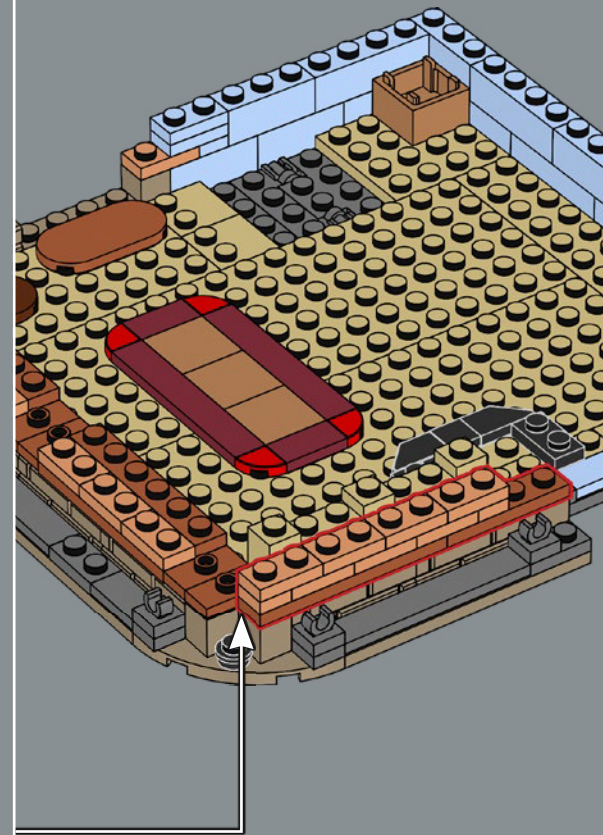
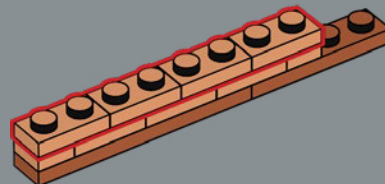





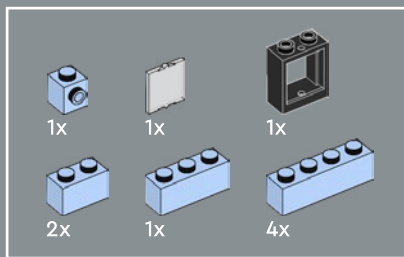

229

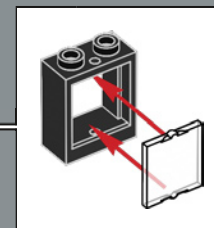
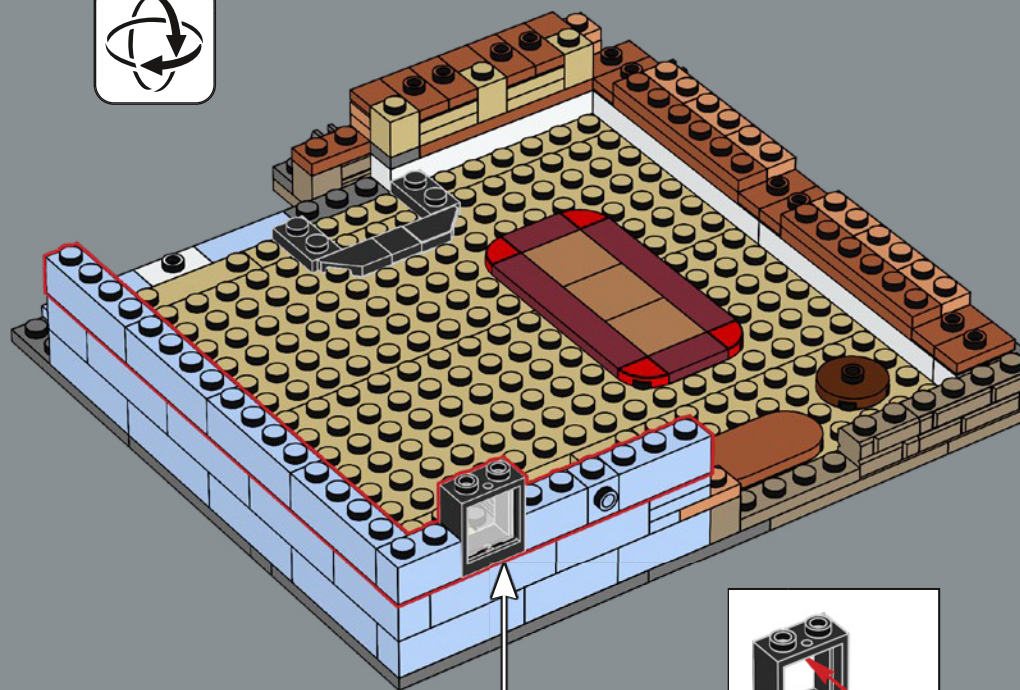



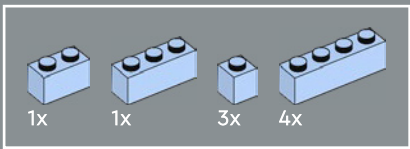

230

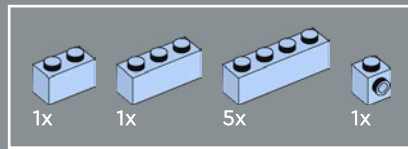
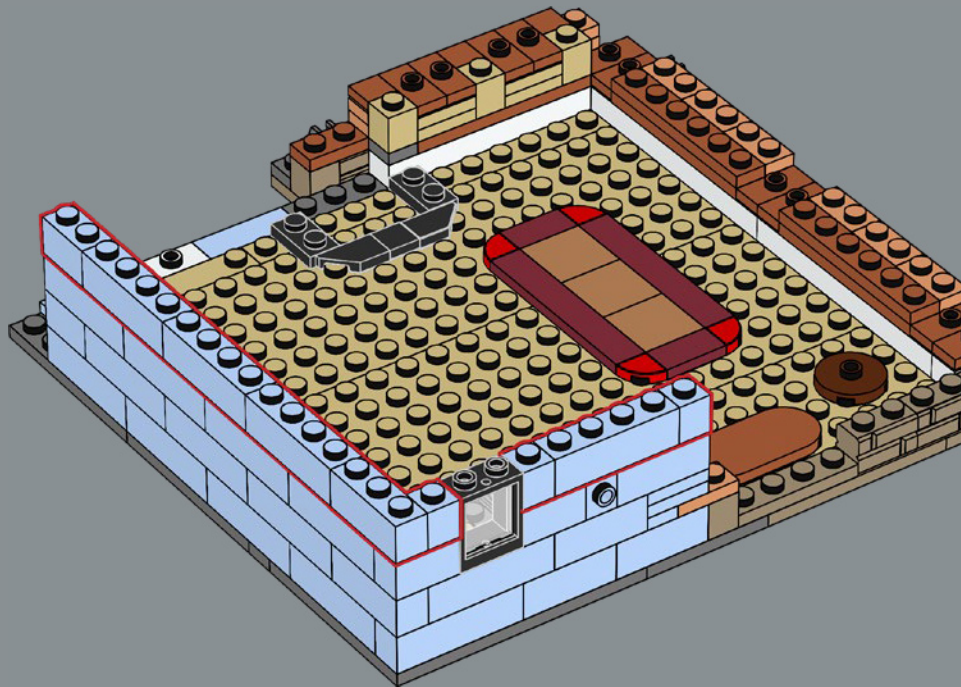

231

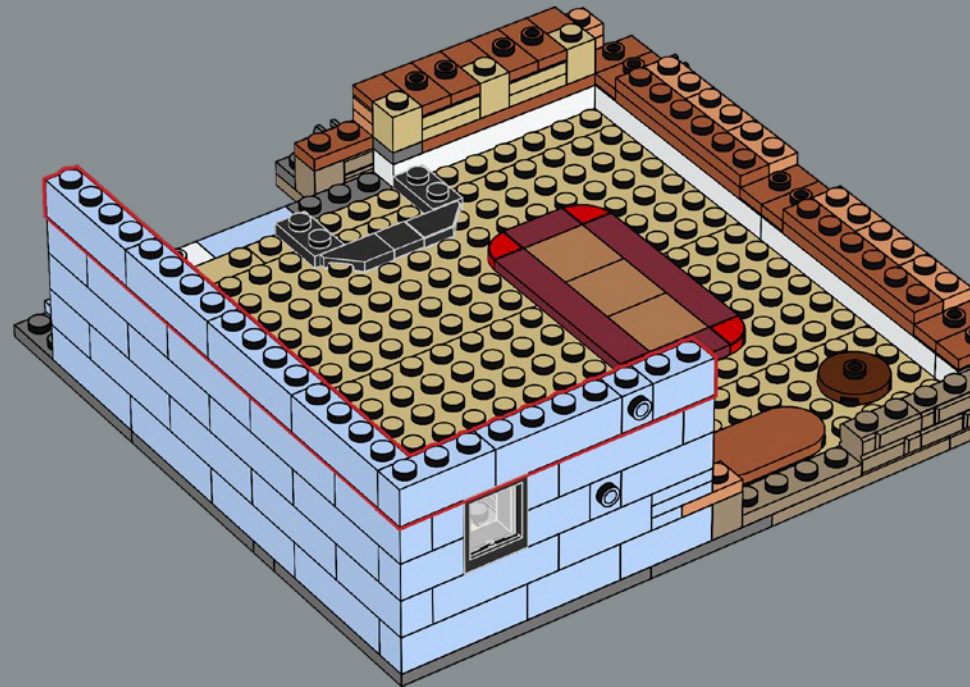

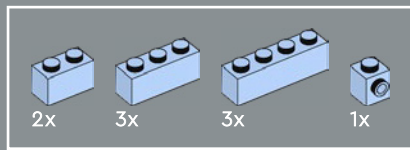

232

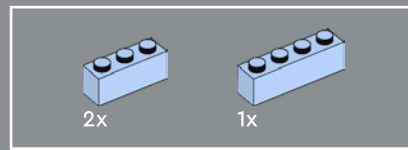
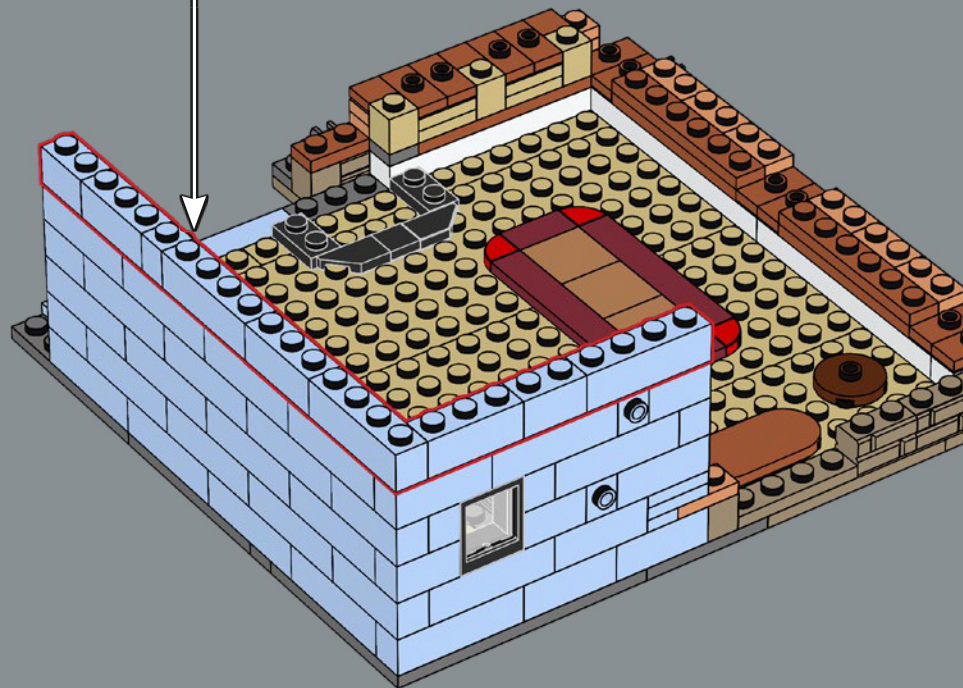
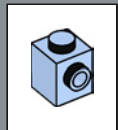

233

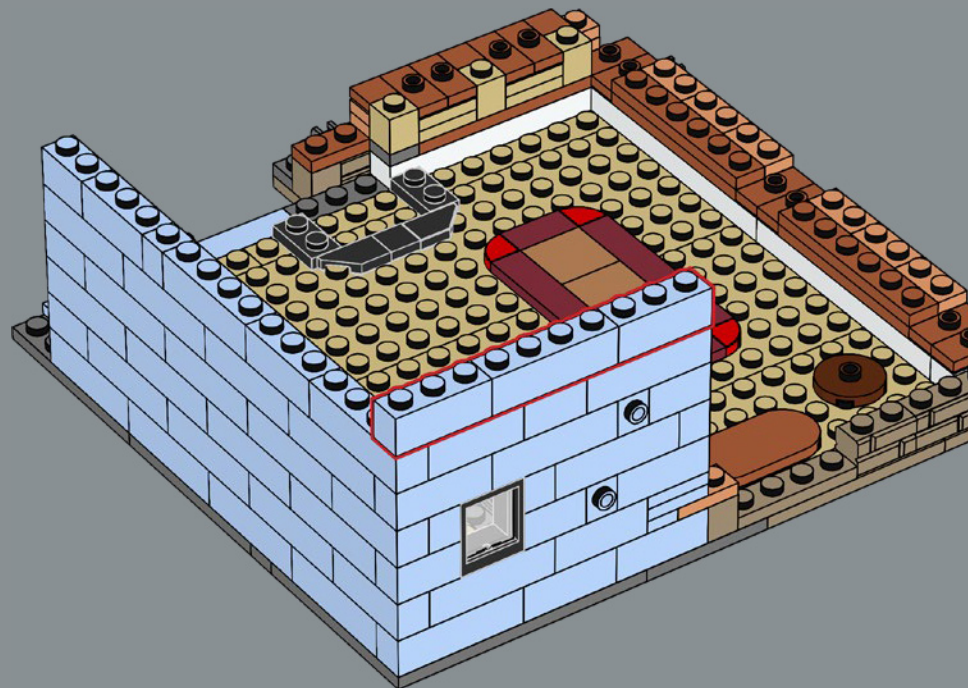



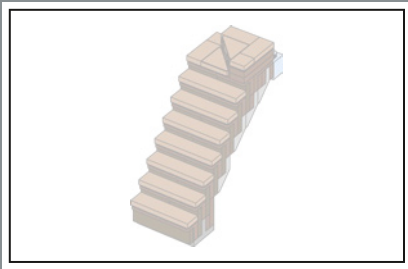

234

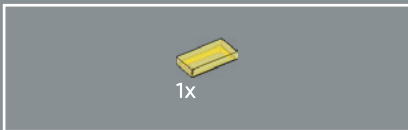
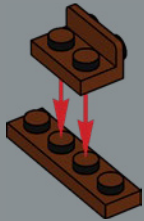

235

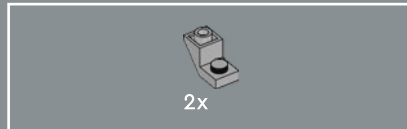
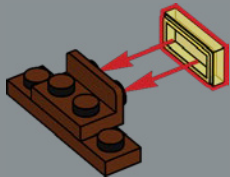

236

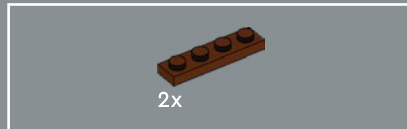
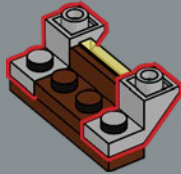

237

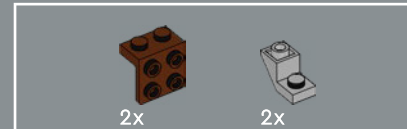
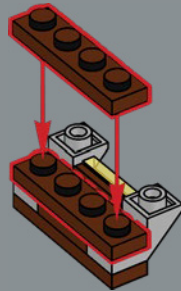

238

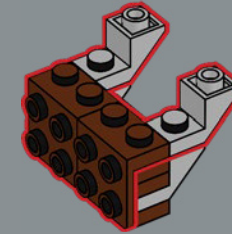

239

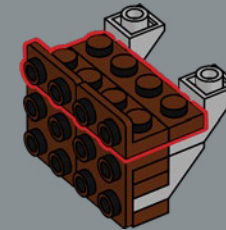

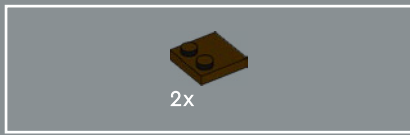

240

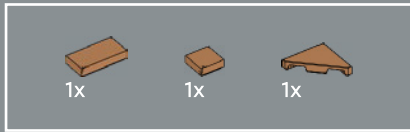
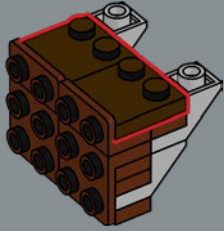

241

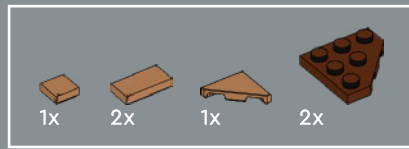
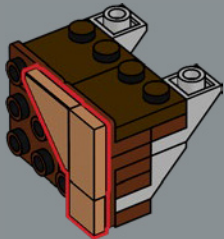

242

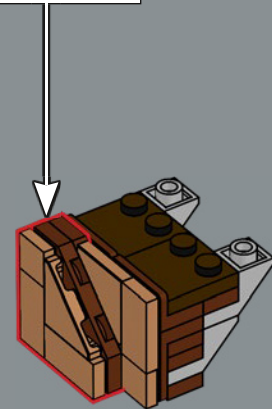
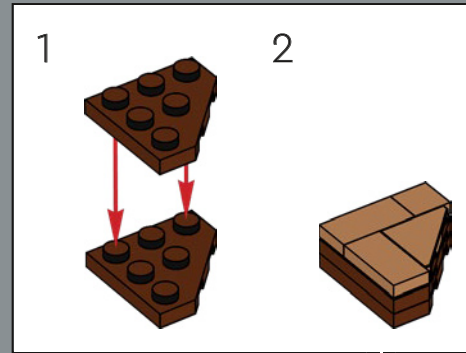



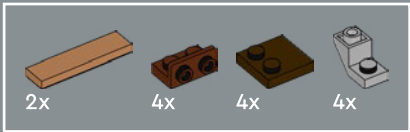
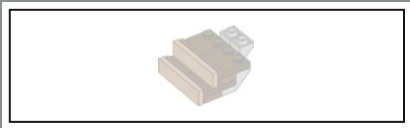

# 243

1

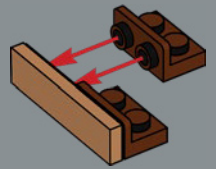

2

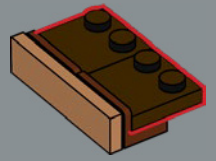

3

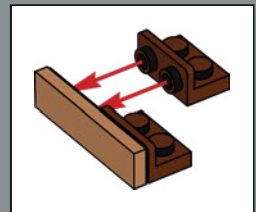
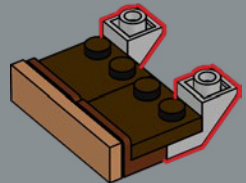

4

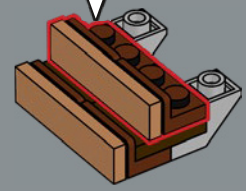

5

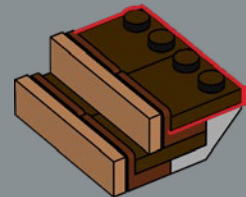

6

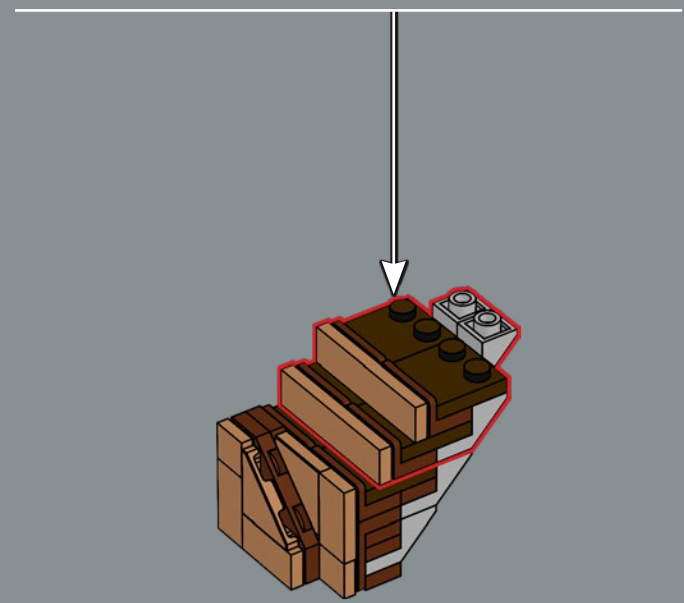
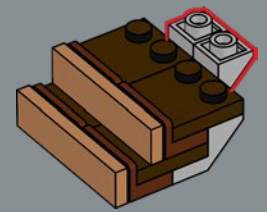

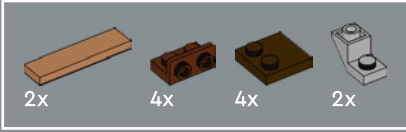
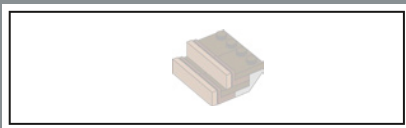

244

1

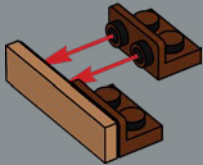

2

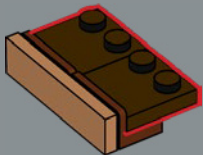

3

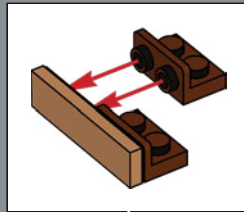
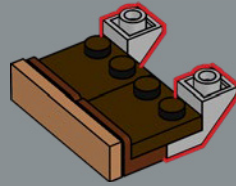

4

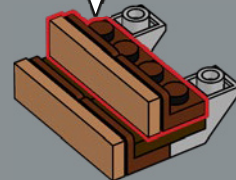

5

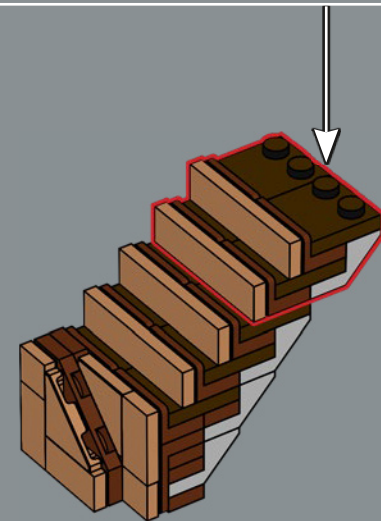
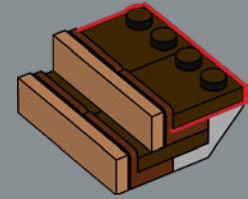



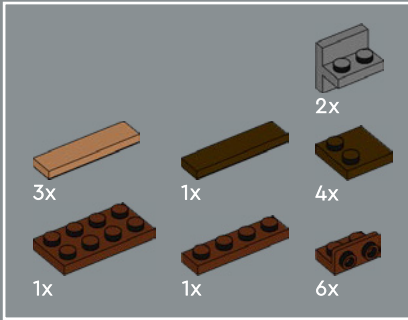
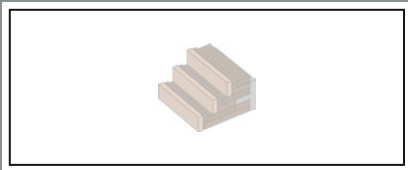

245

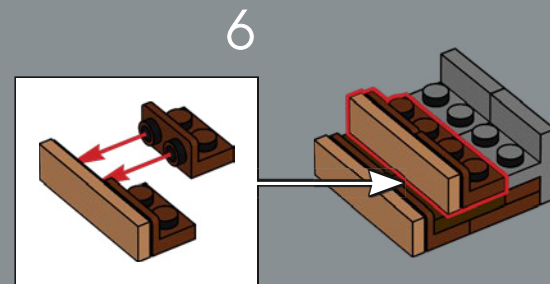
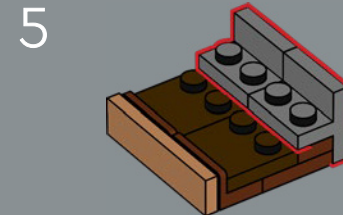
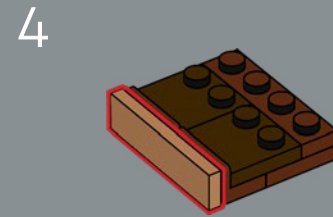
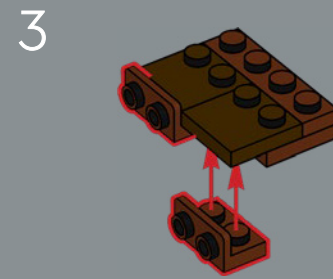
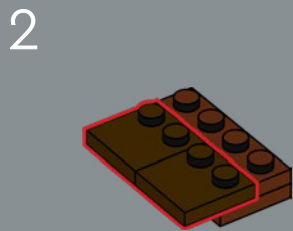
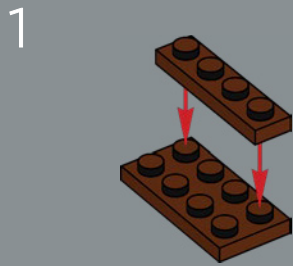

7

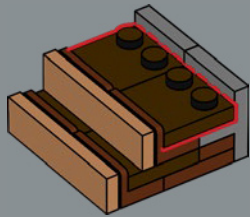

8

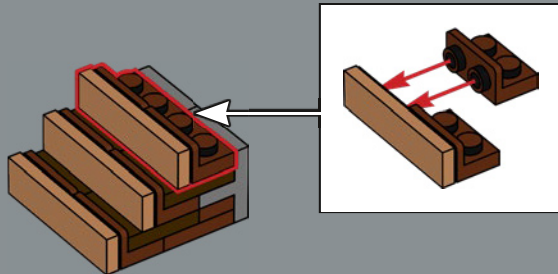

9

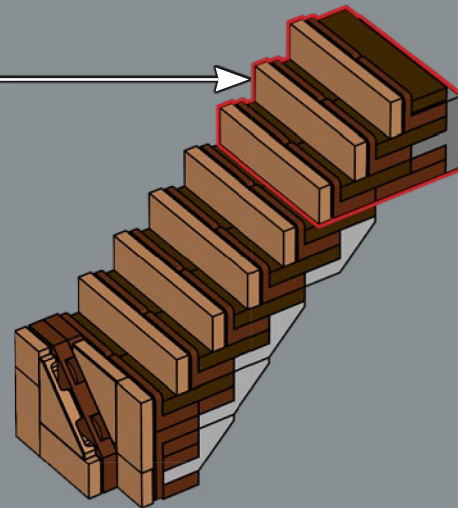
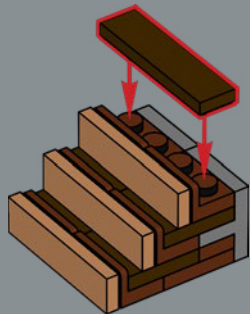





2x

246

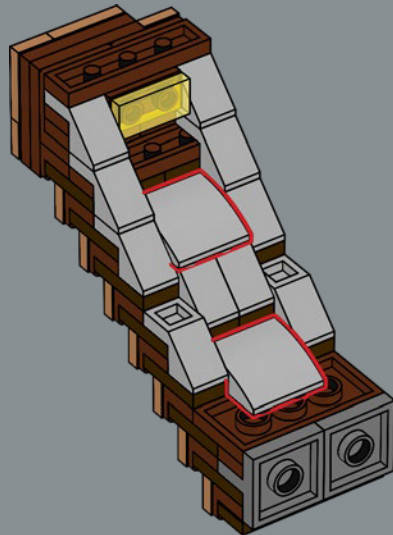

2x

247

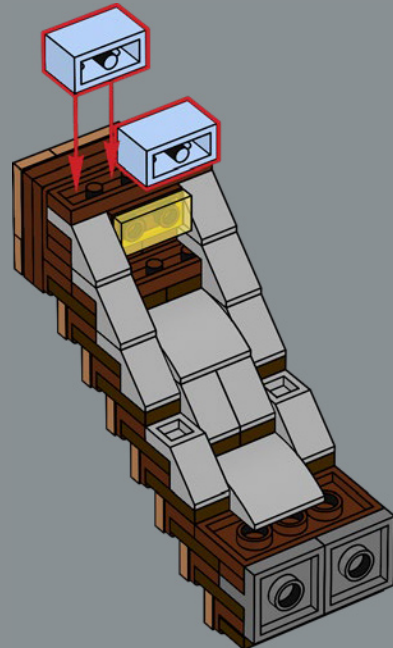

248

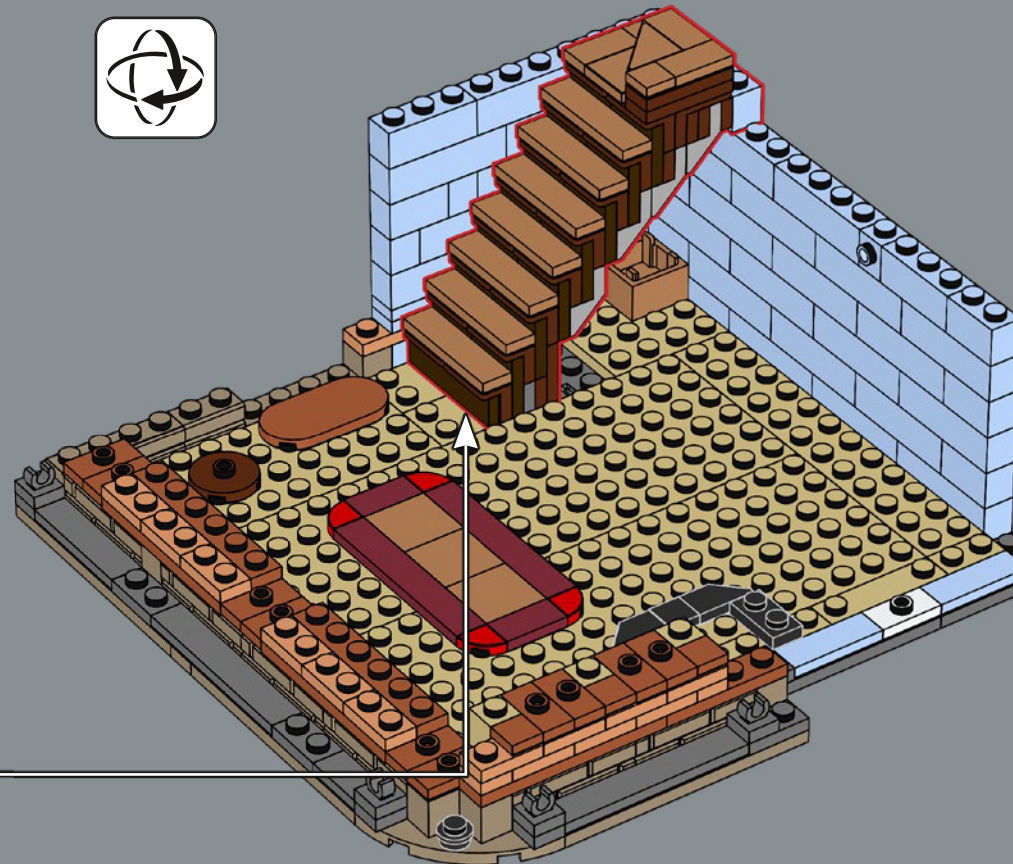

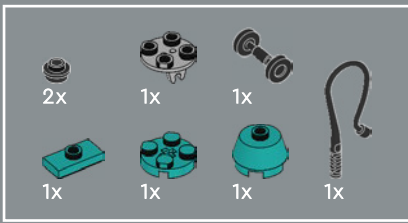

249

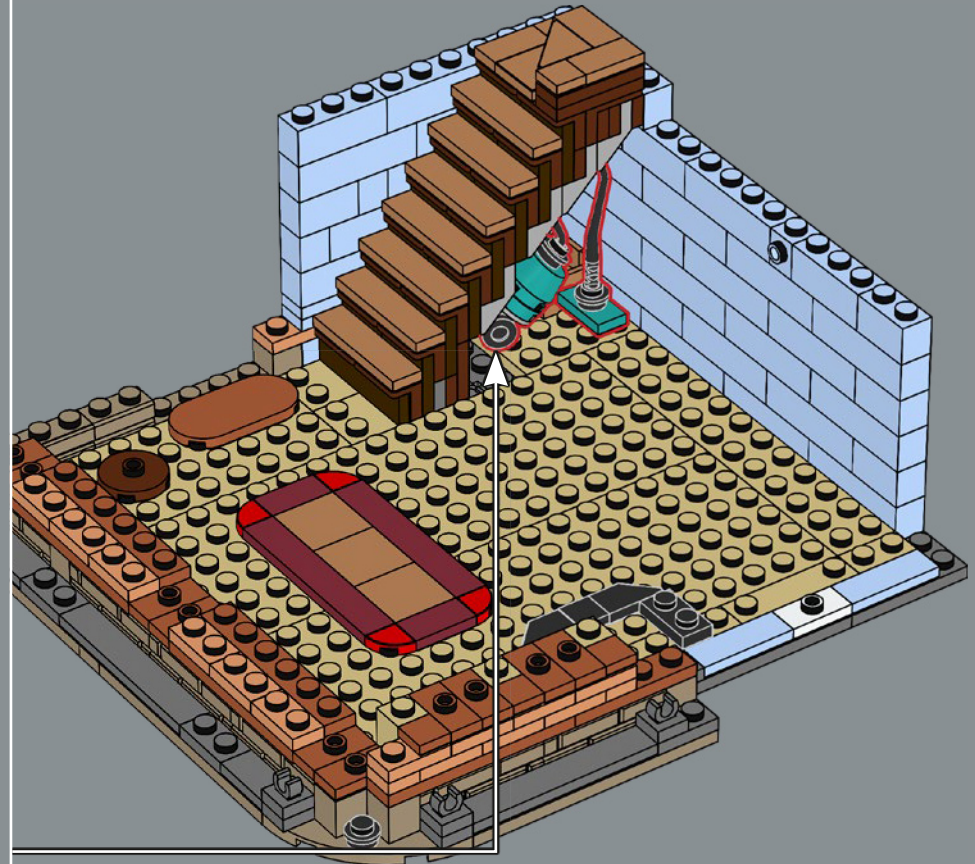
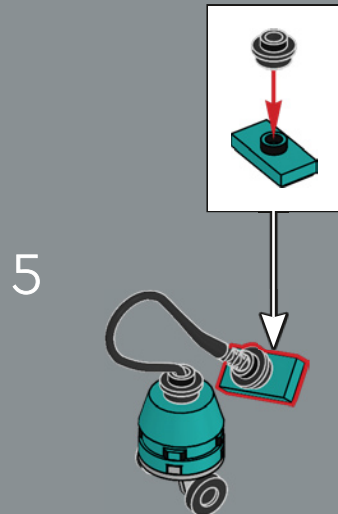
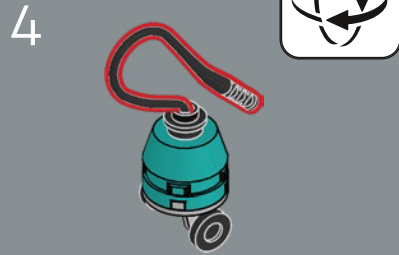
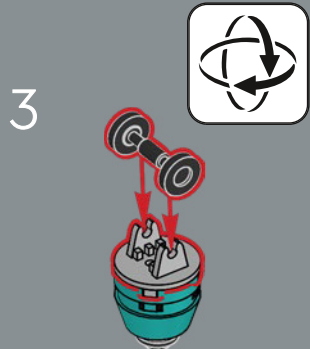
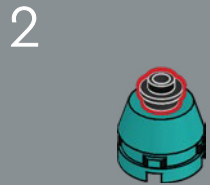
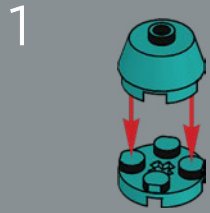



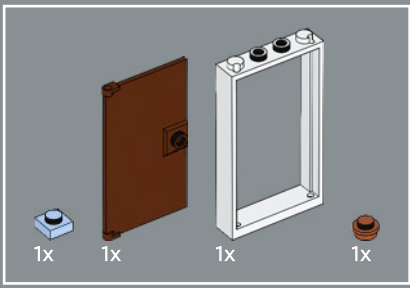

250

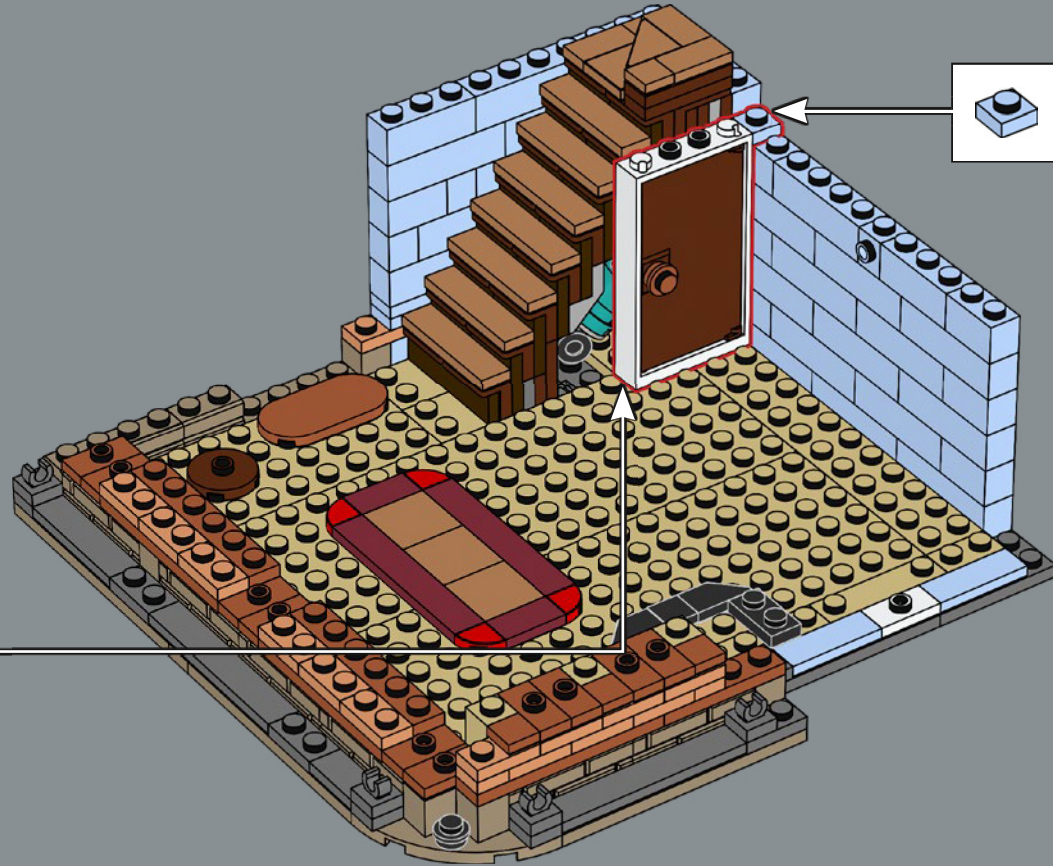
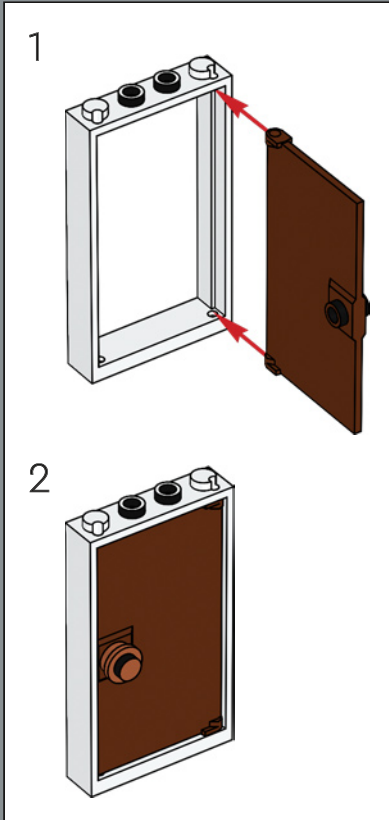

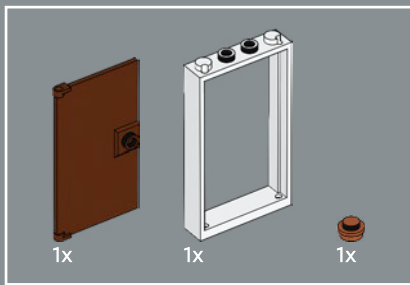

251

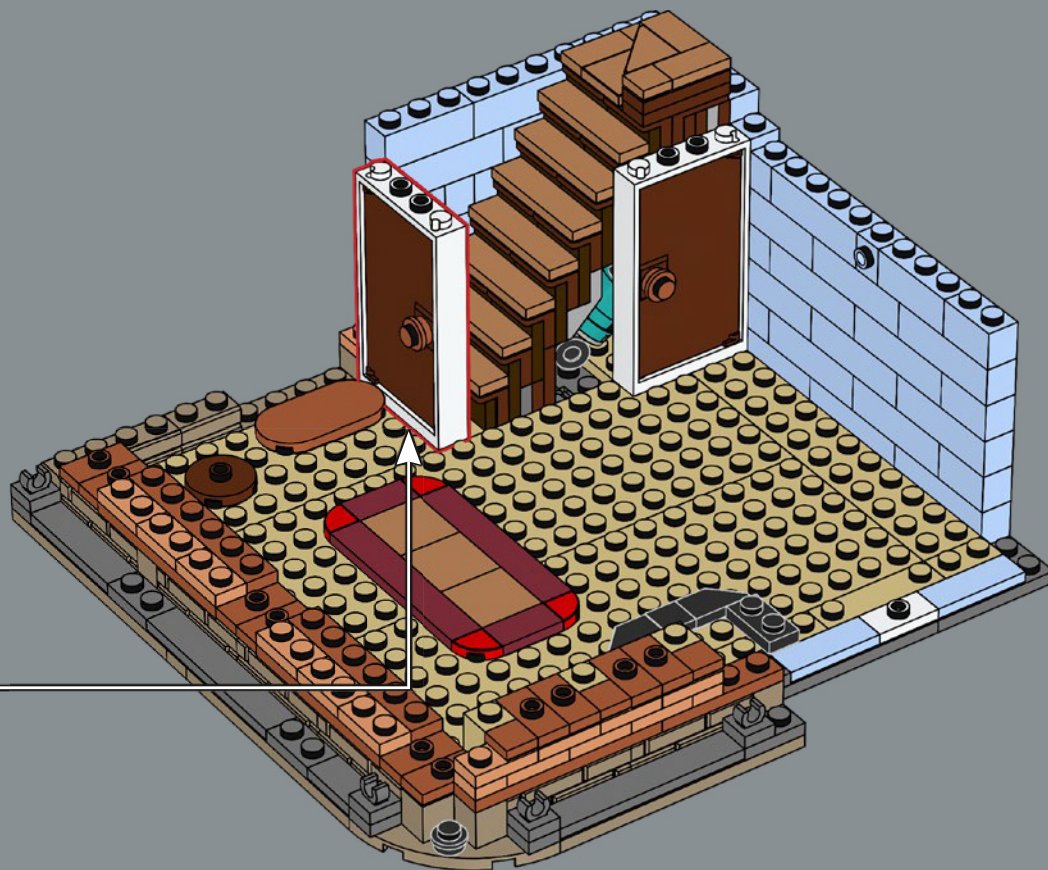
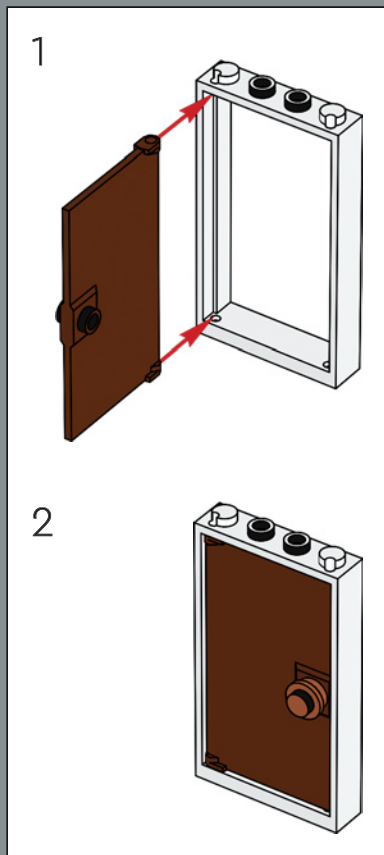



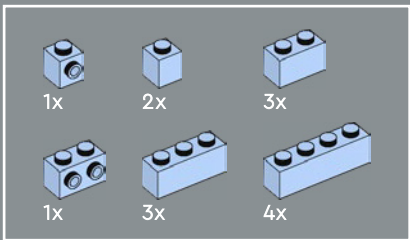

252

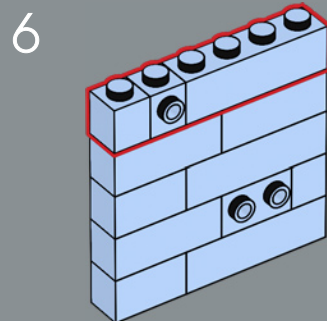
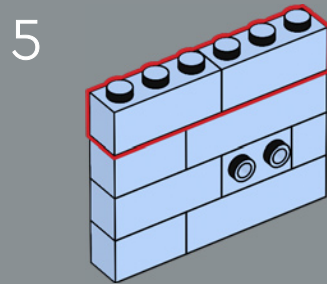
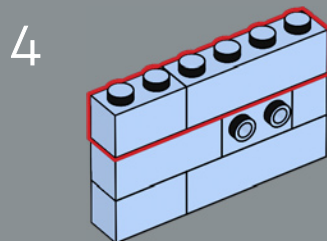
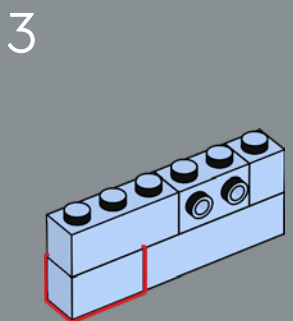
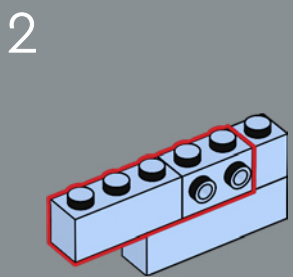
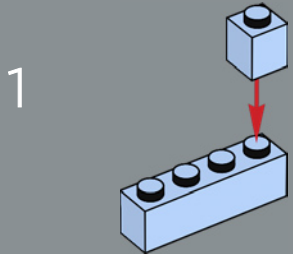

7

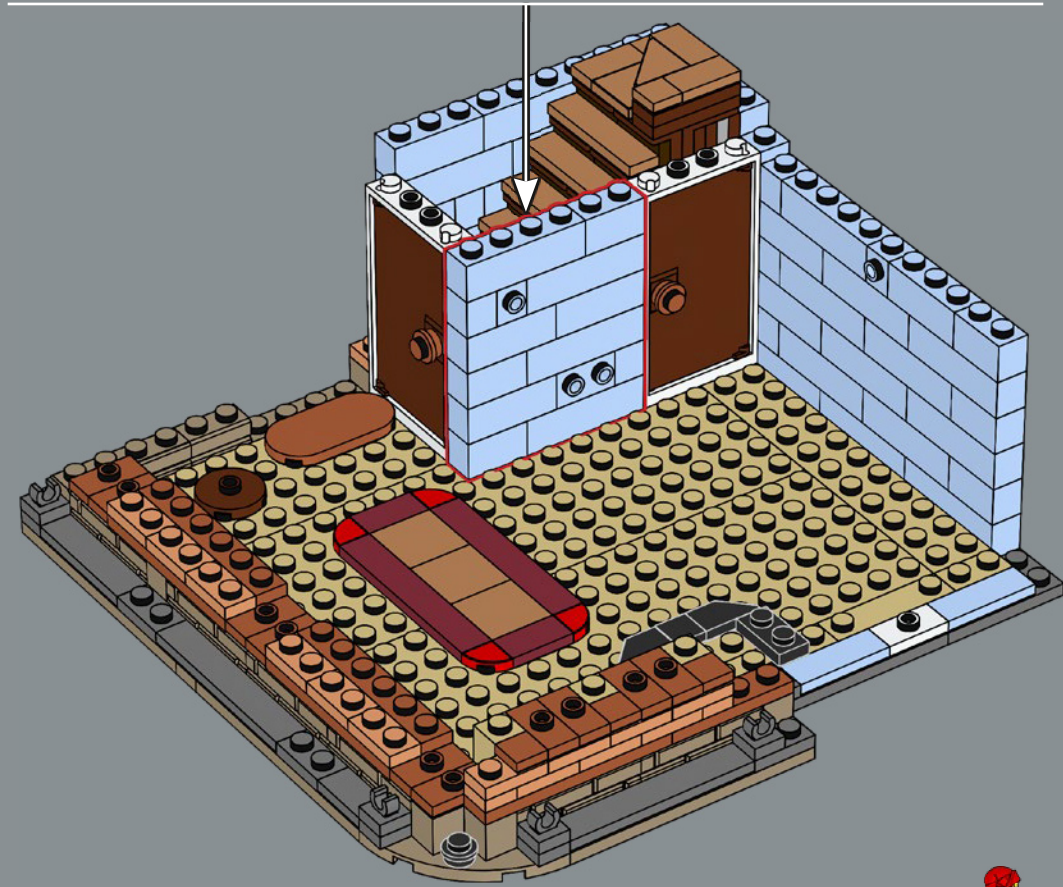
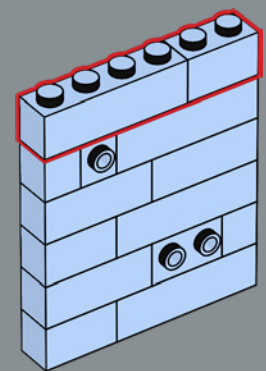

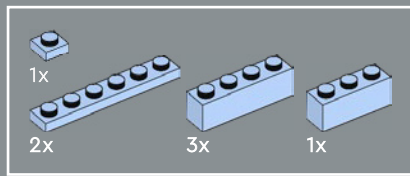

253

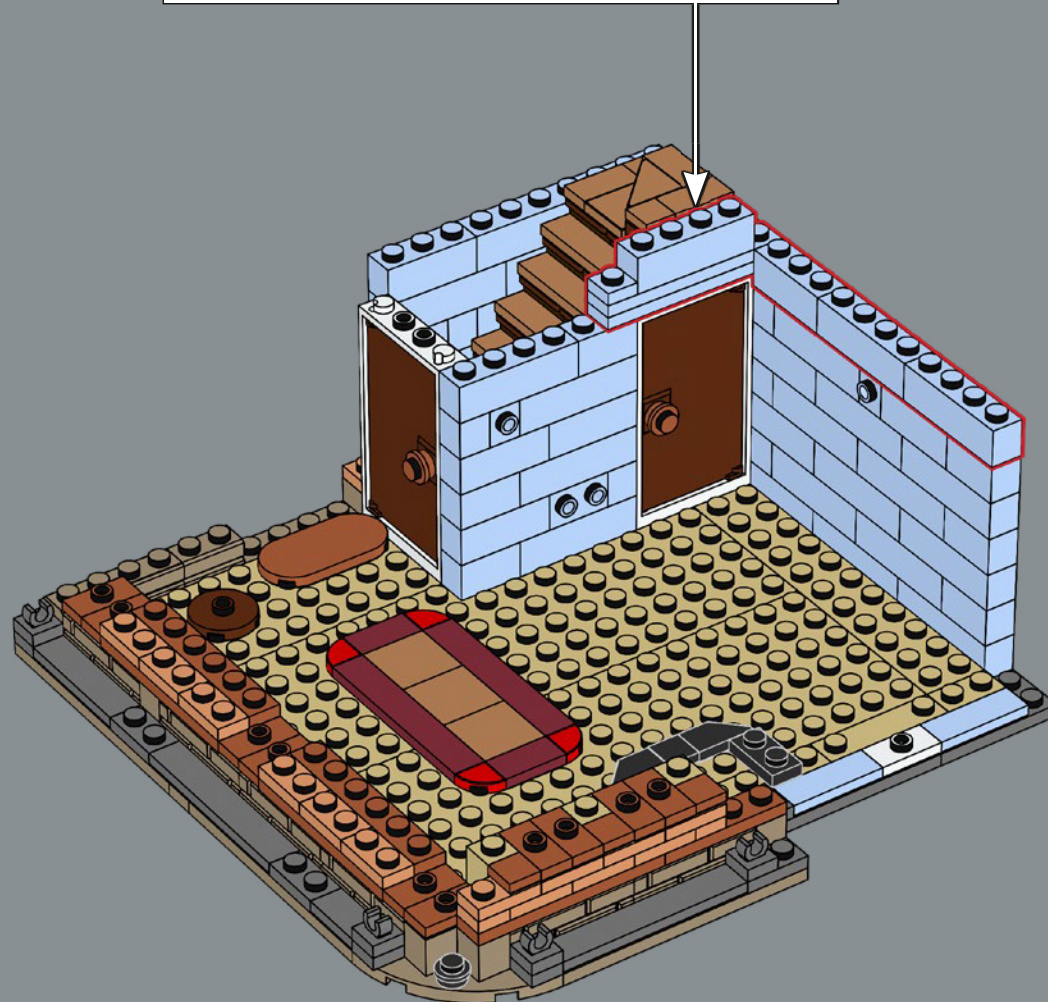
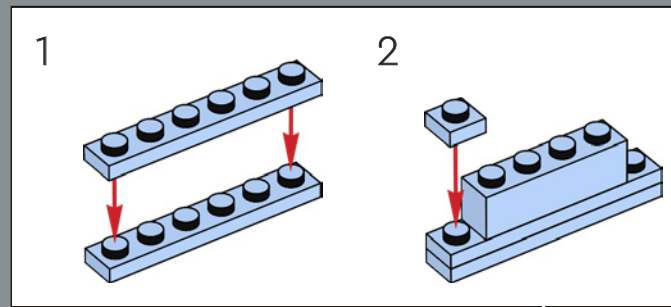



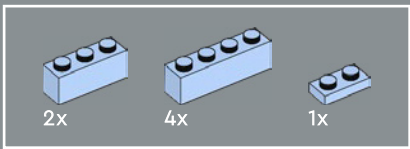

254

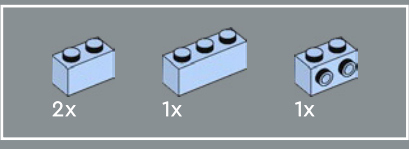
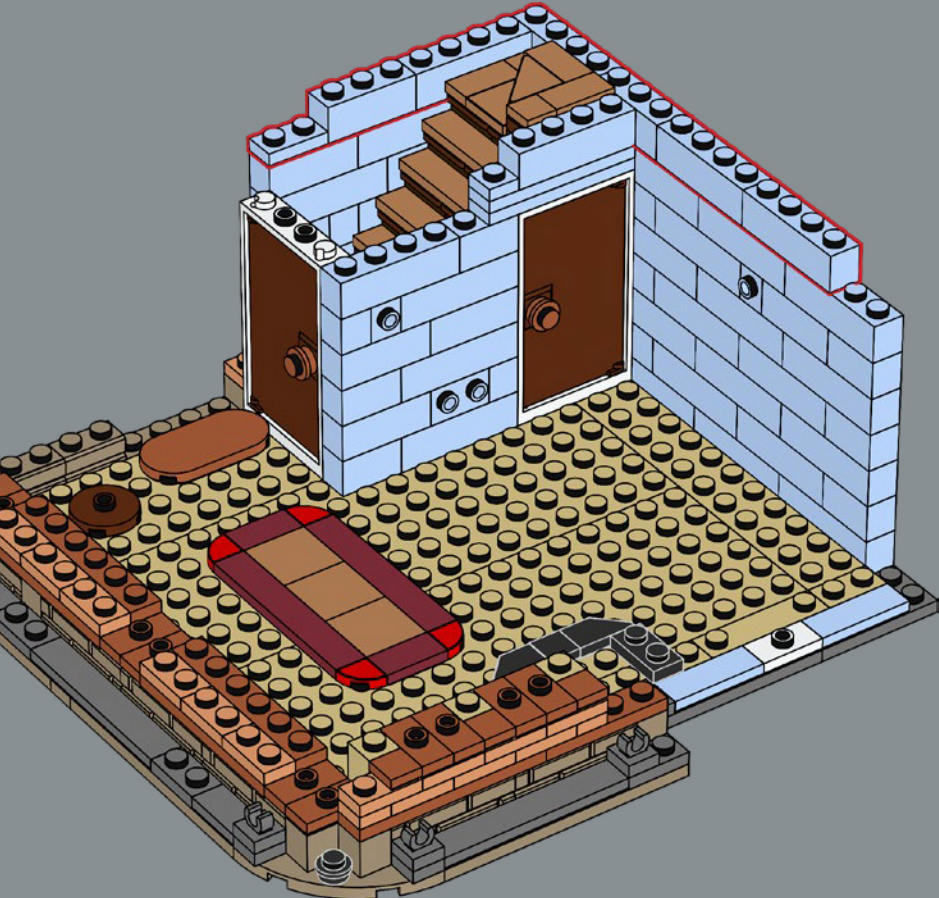

255

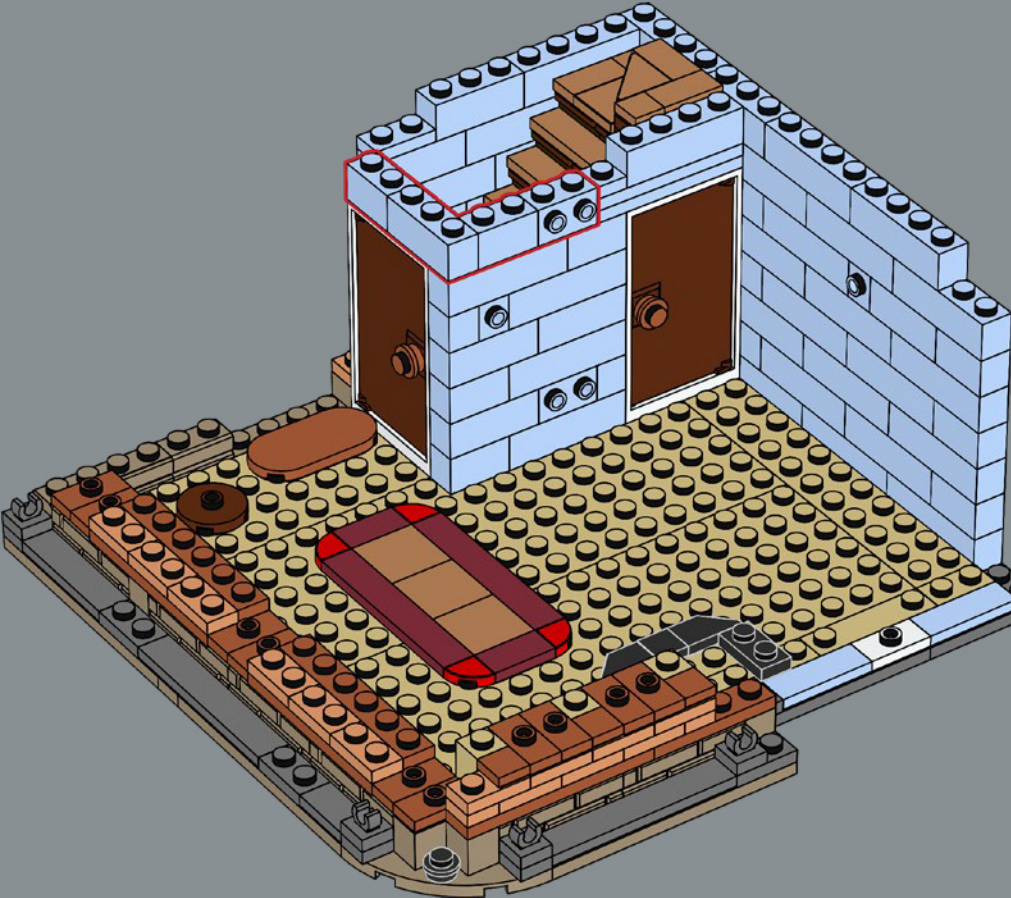



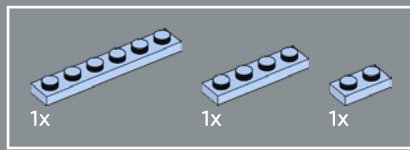

256

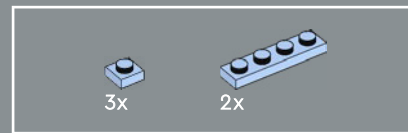
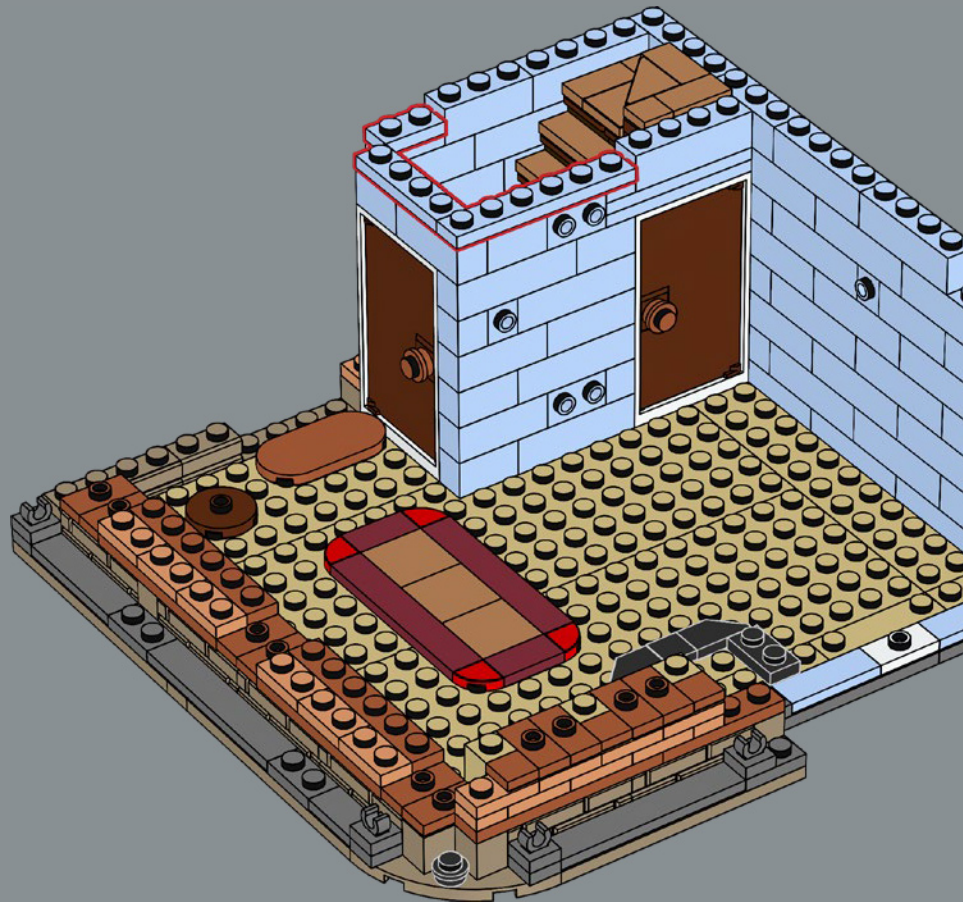

257

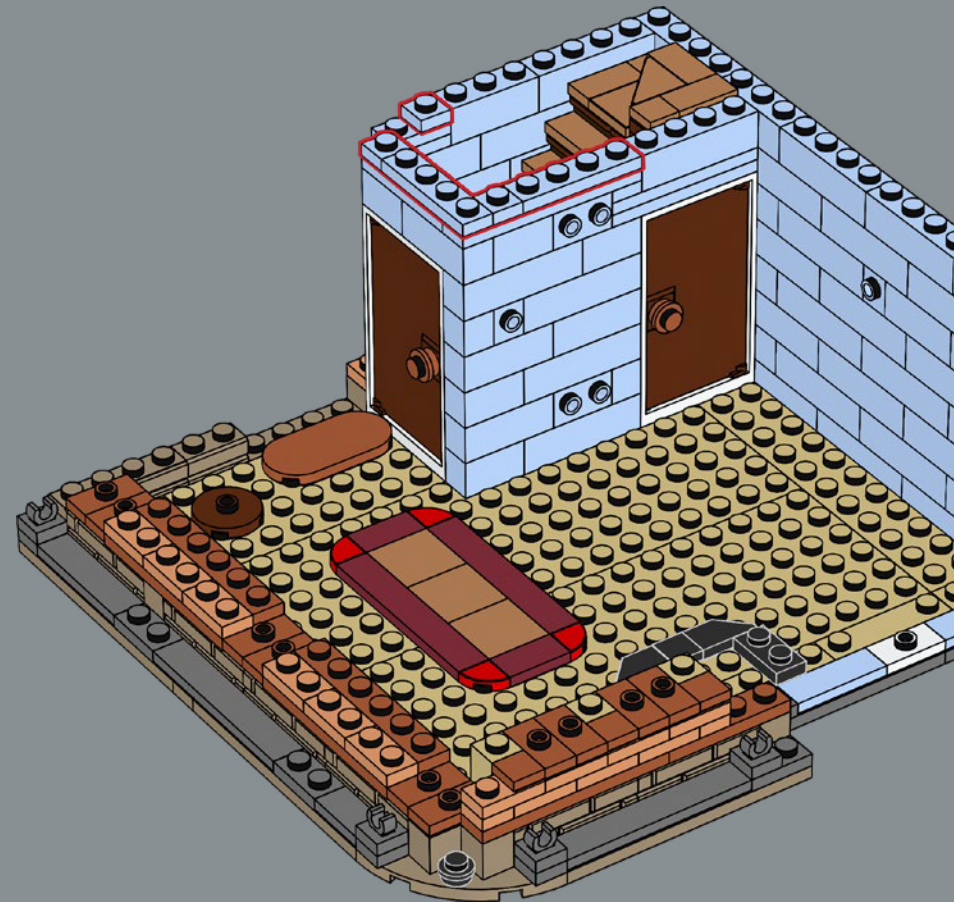



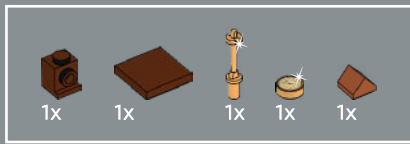

258

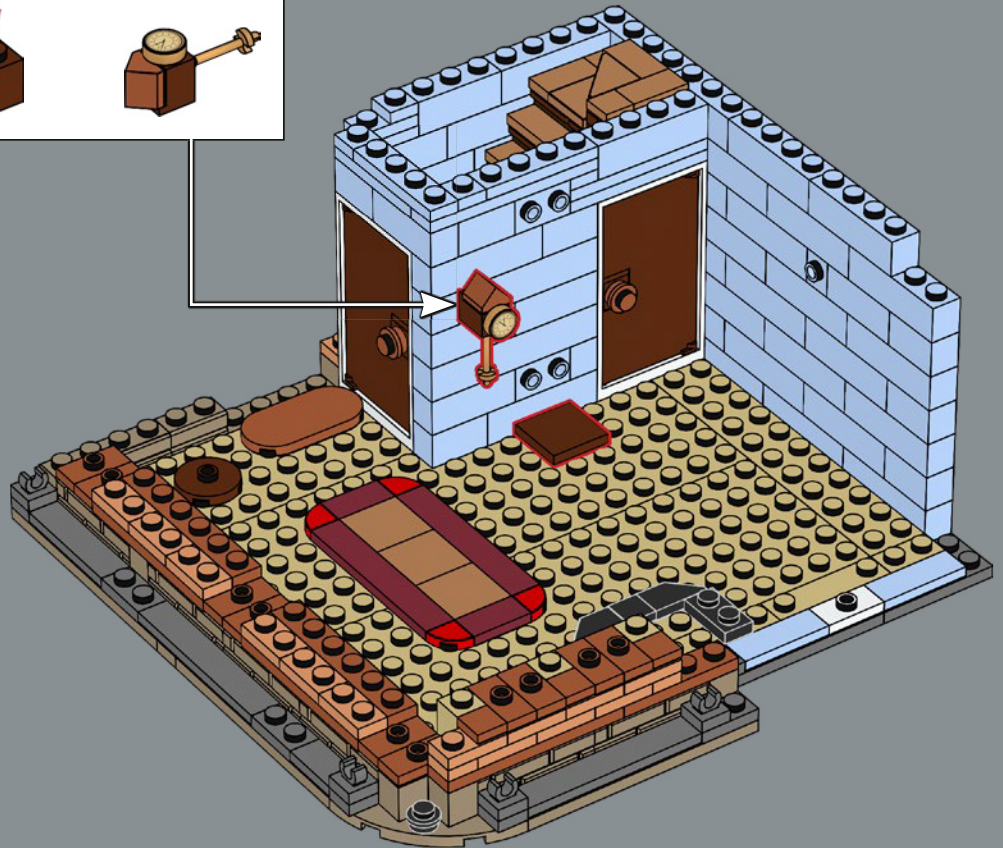
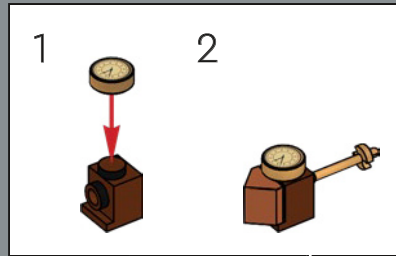





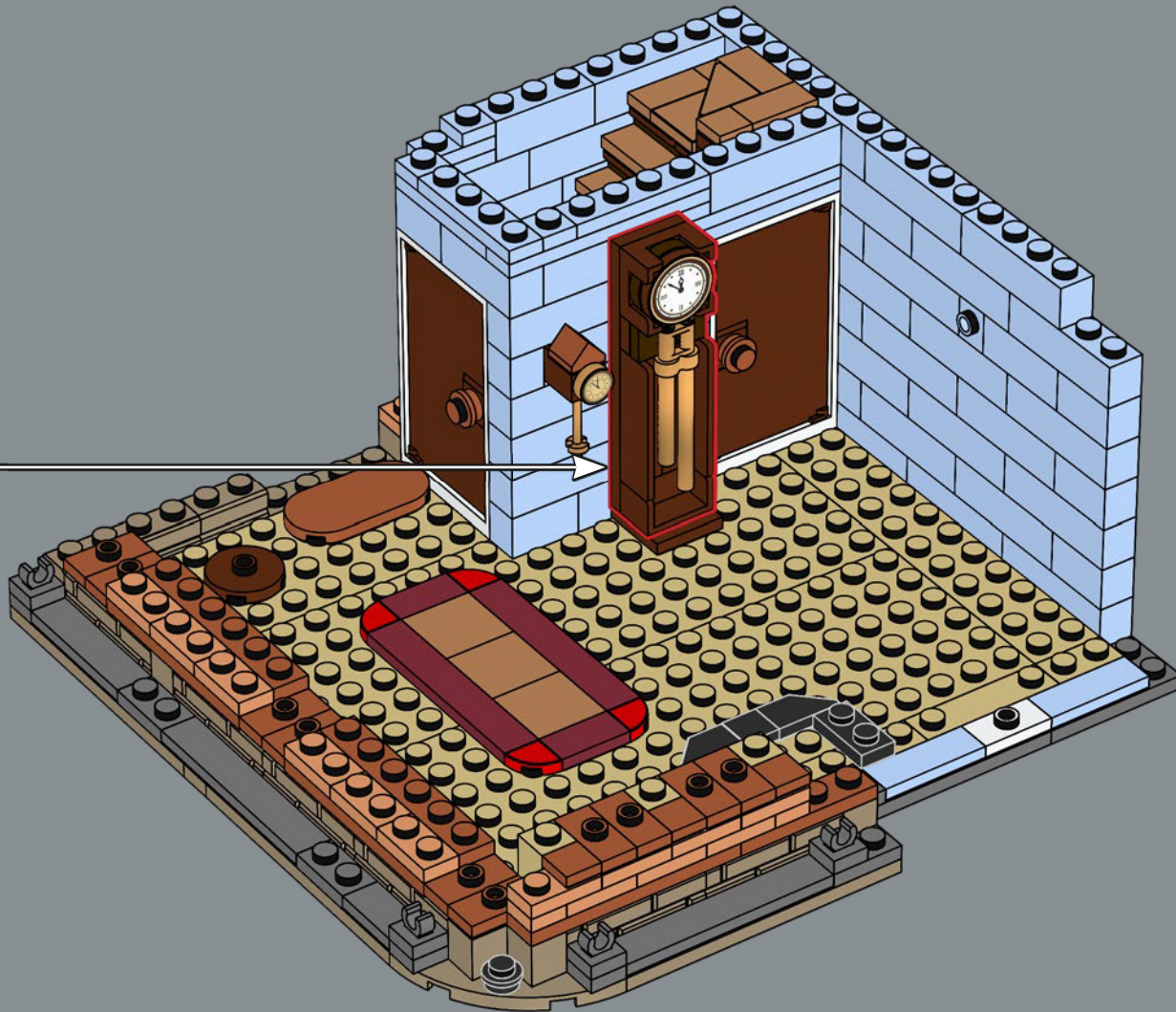

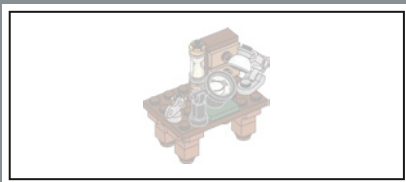

260

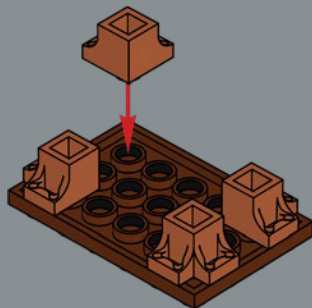

261

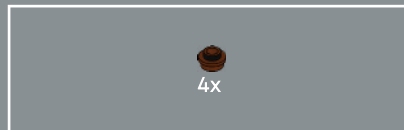
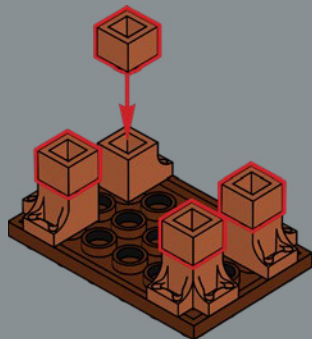

262

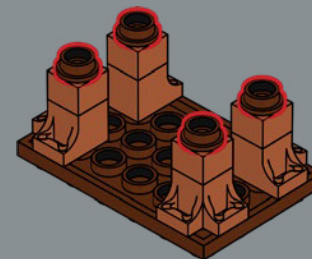

263

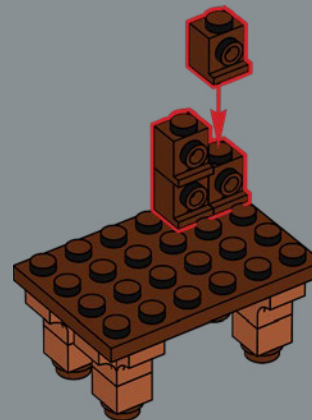



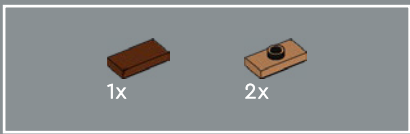

264

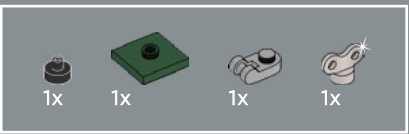
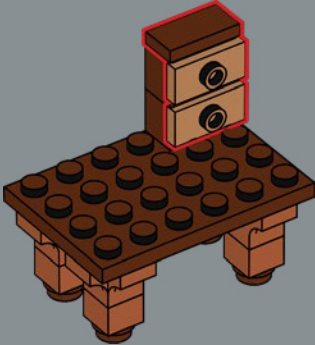

266

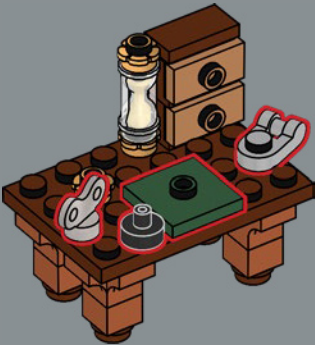

265

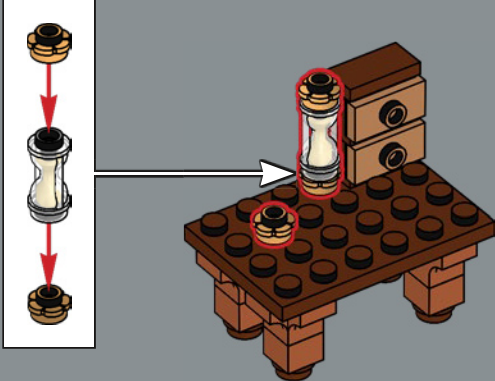

267

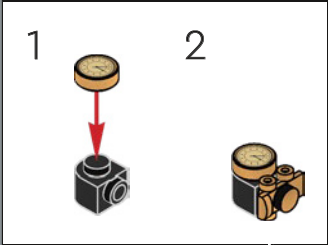



268

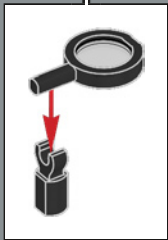
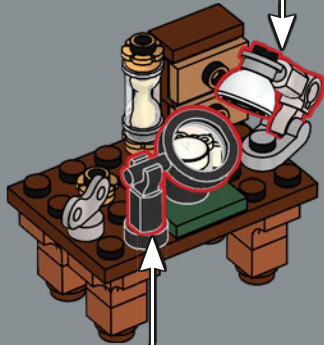
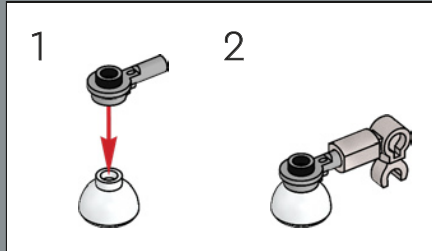

269





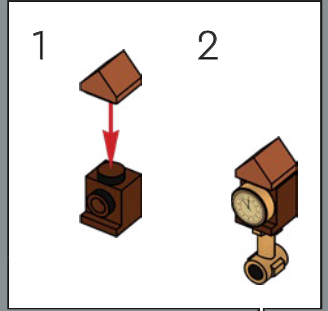
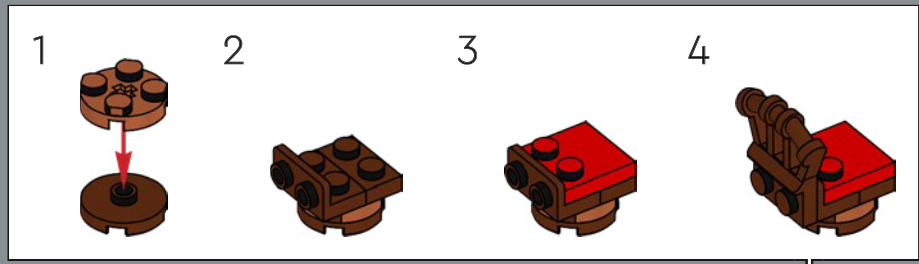
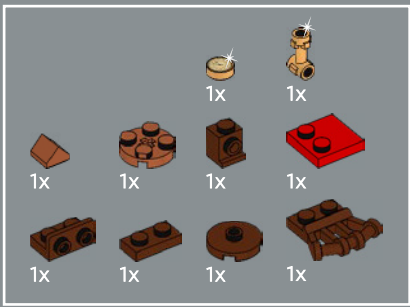

The clockmaker is a passionate craftsman appreciated by locals. His greatest pride is having designed the large clock on the LEGO® Creator Expert Town Hall (10224). He has fond memories of the mayor's long speech at the inauguration.

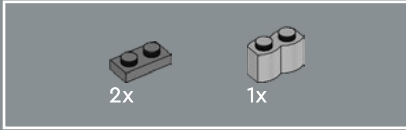
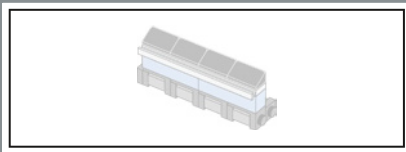

271

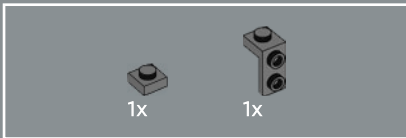
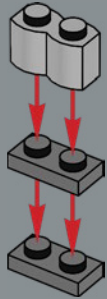

272

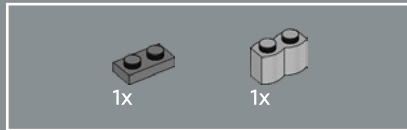

273

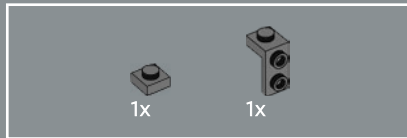
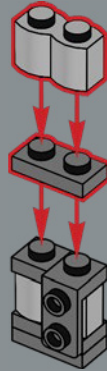

274

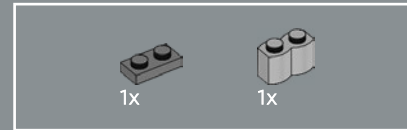
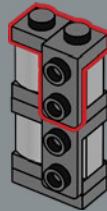

275

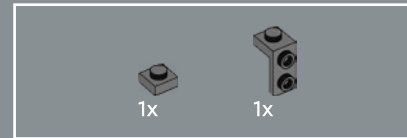
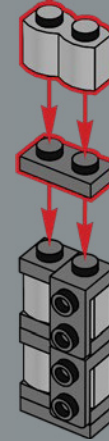

276

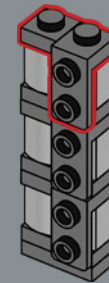



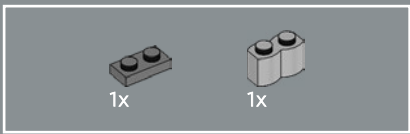

277

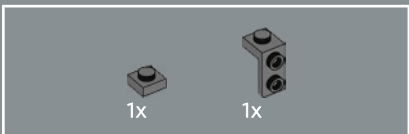
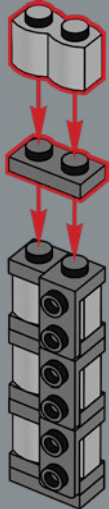

278

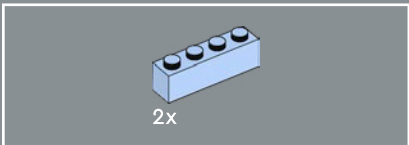
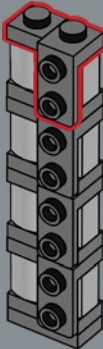

279

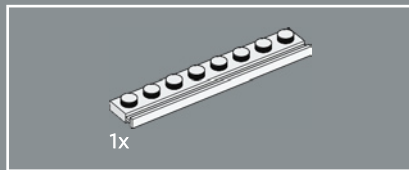
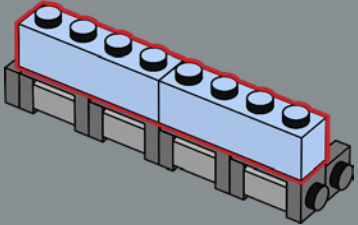

280

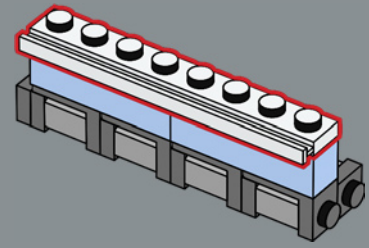

281

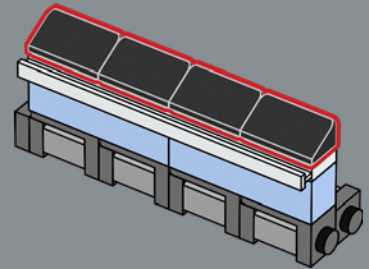

282



283

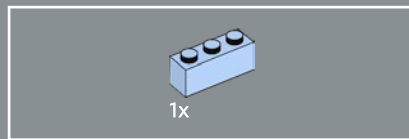



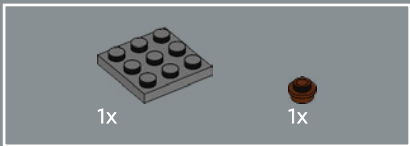

284

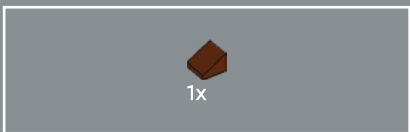
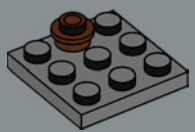

285

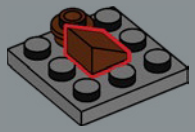

286

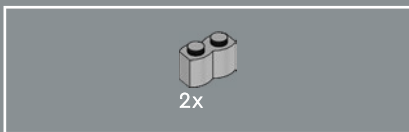
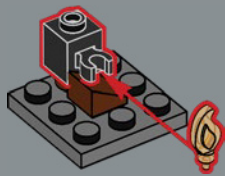

287

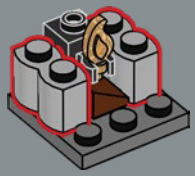

288

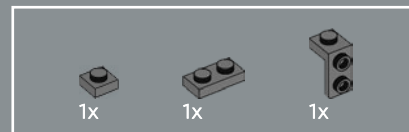
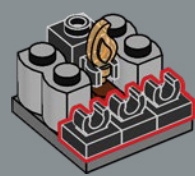

289

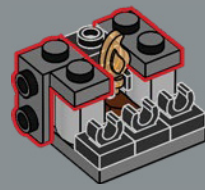

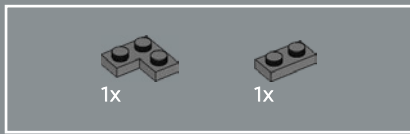

290

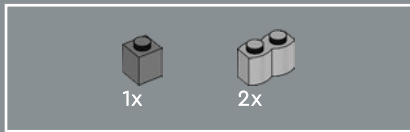
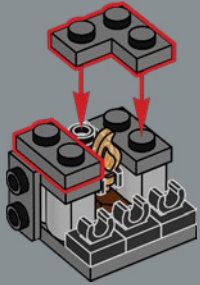

291

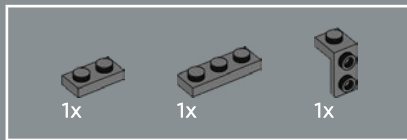
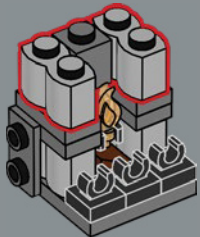

292

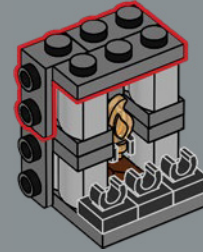

293





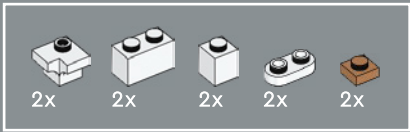

294

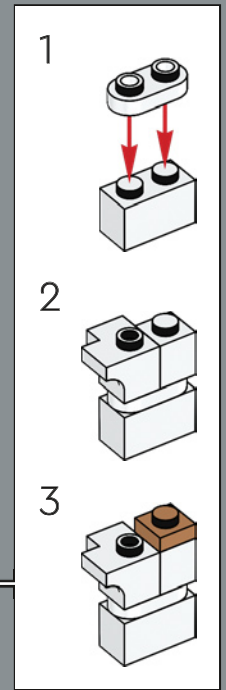
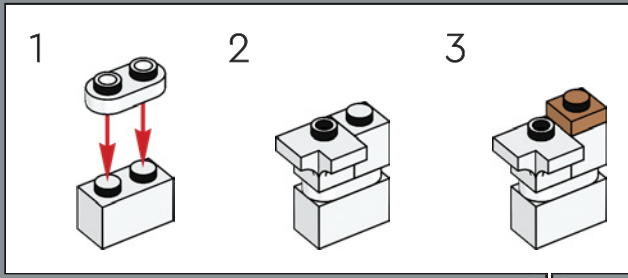

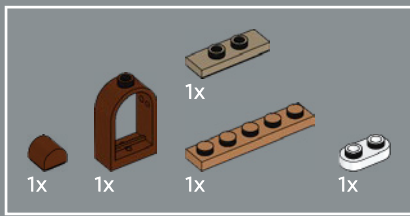

295

1

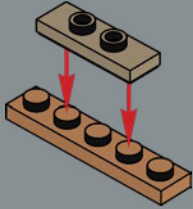

2

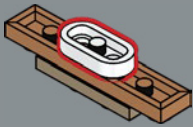

3

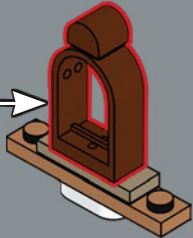
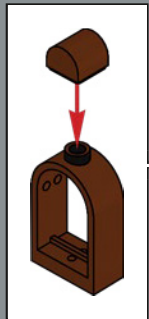



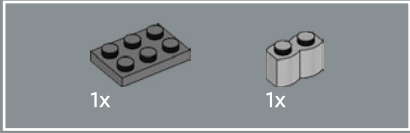
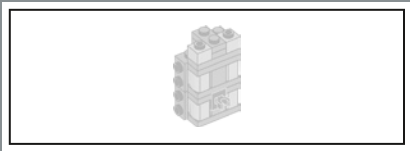

296

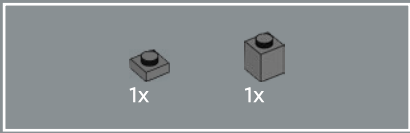
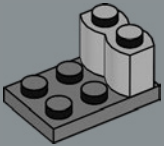

297

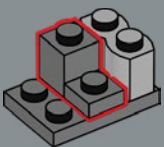

298

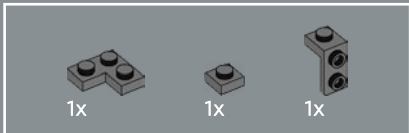
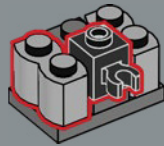

299

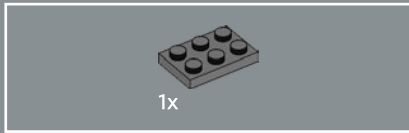
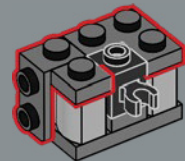

300

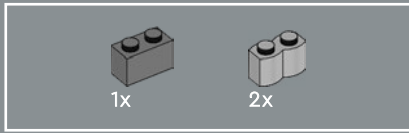
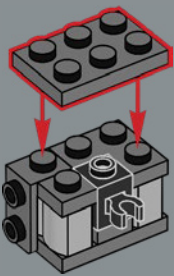

301

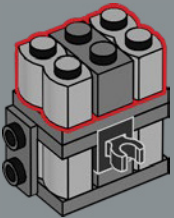

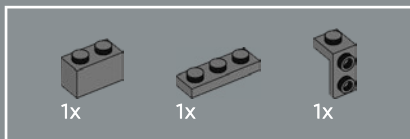

302

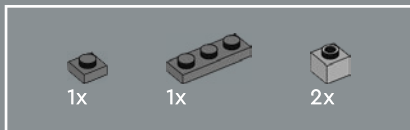
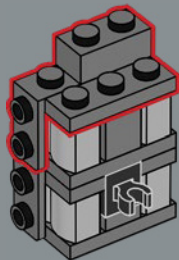

303

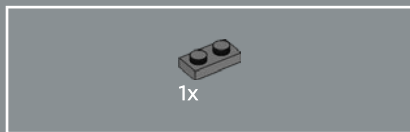
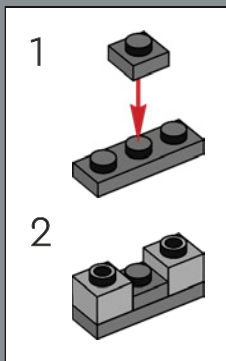

304

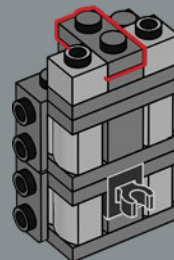

305







306

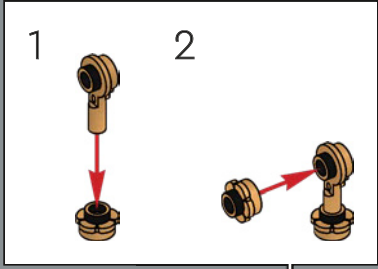

307



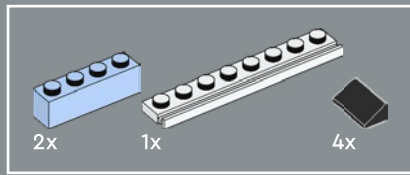

308

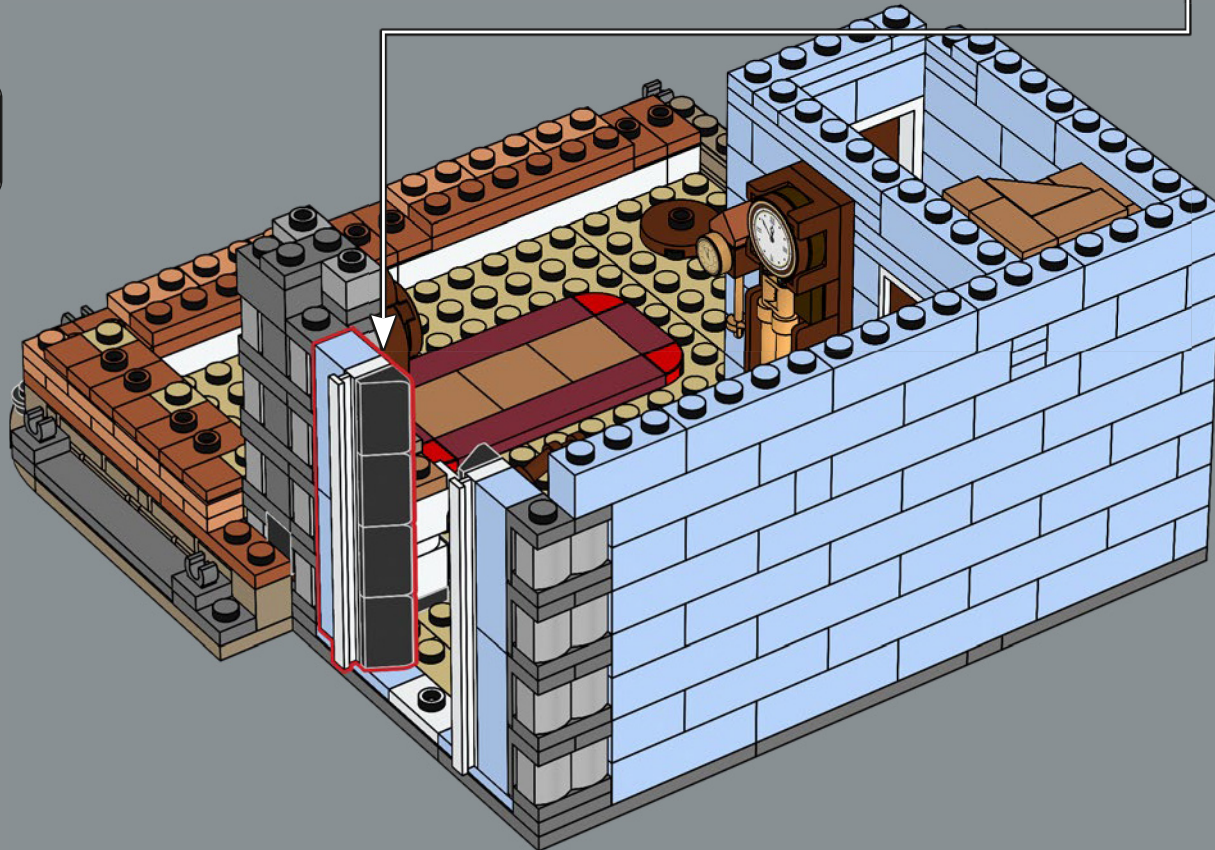
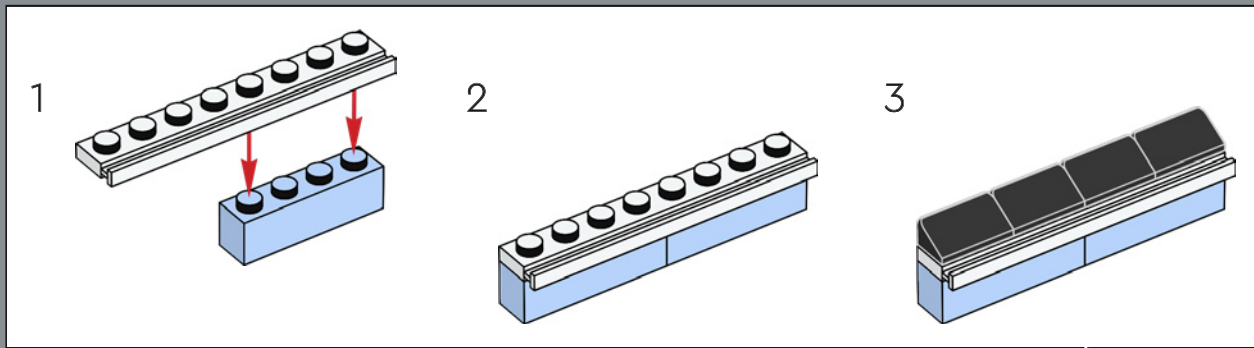



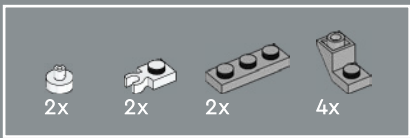

# 309

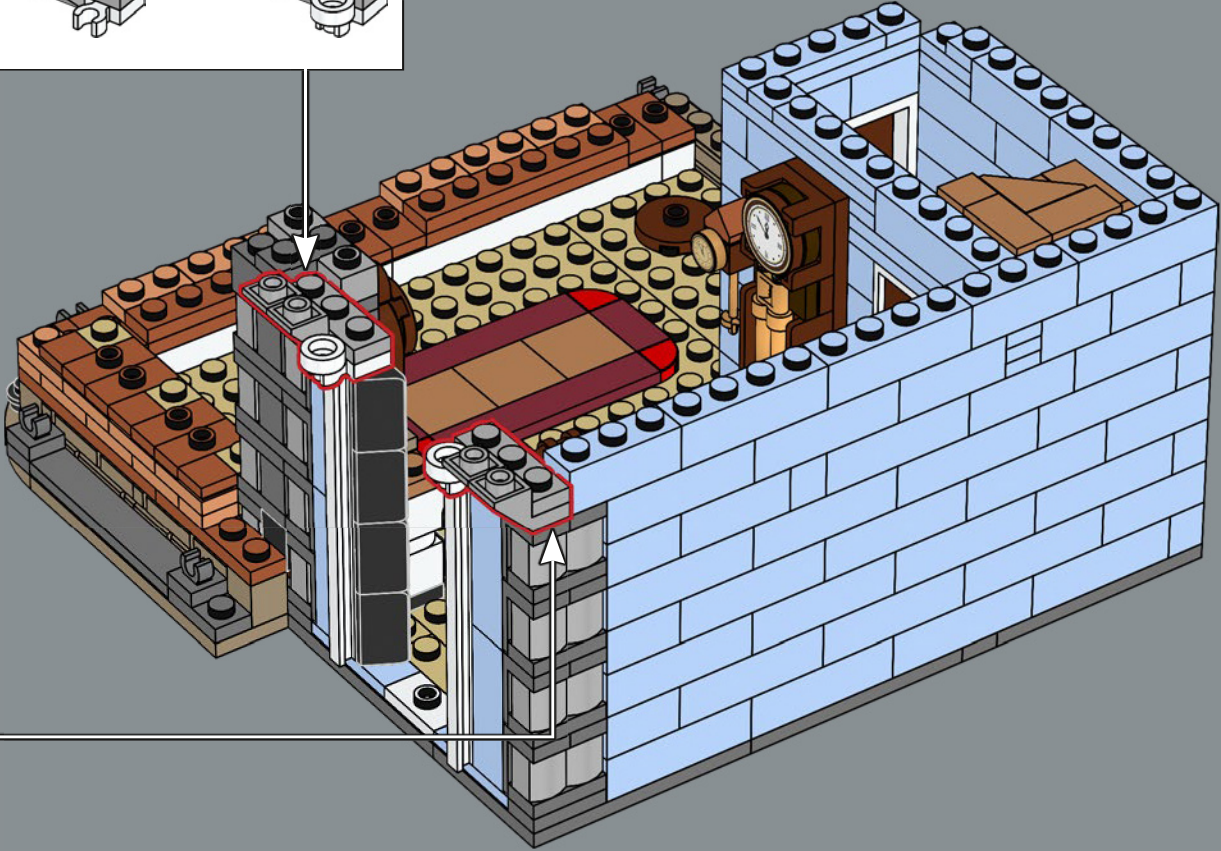
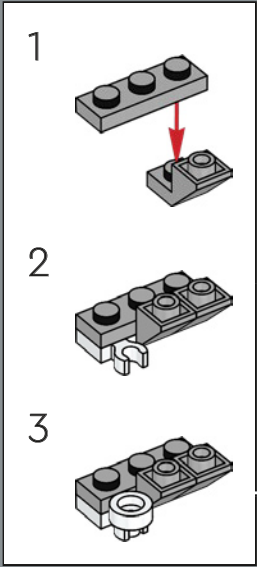
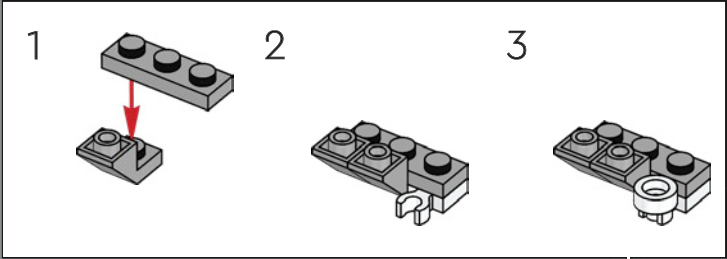

310

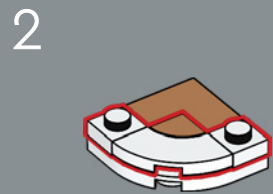
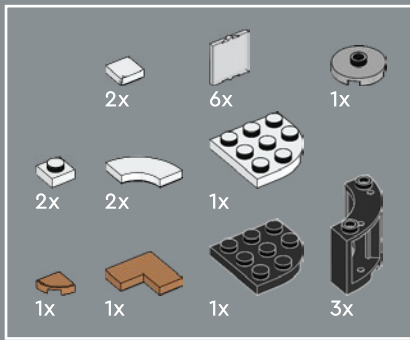

3

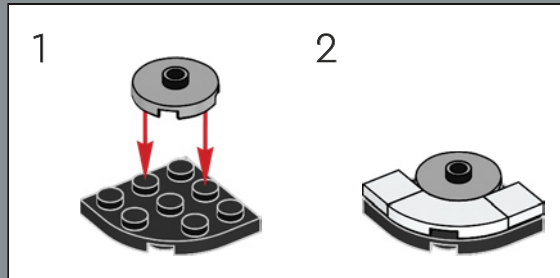
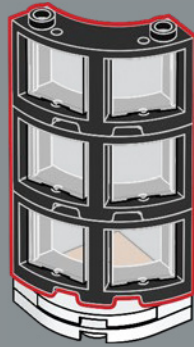
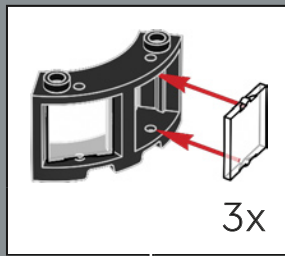

4

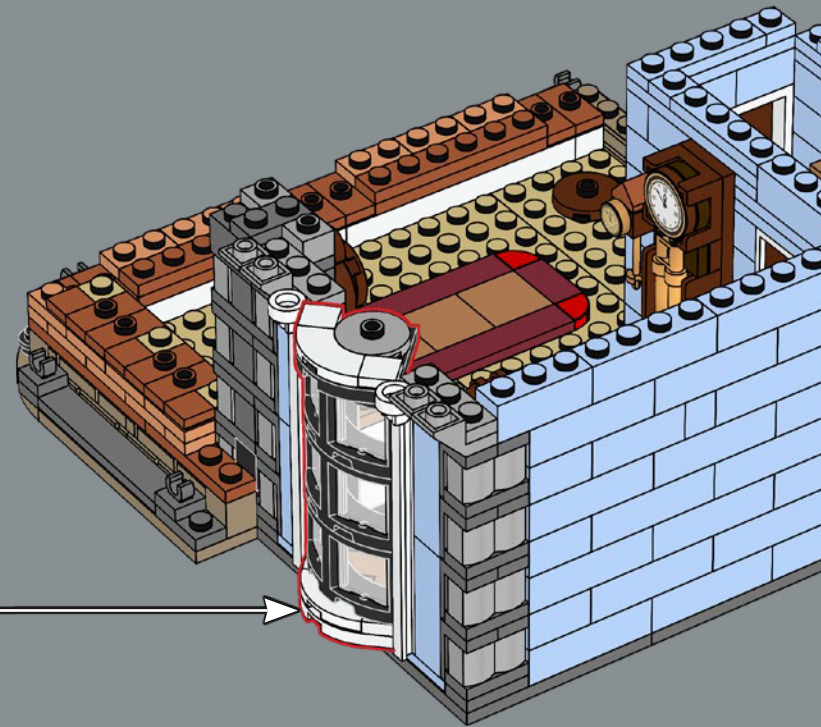
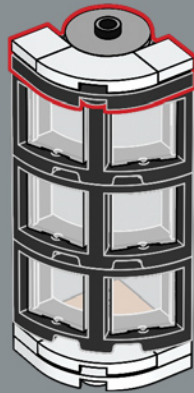



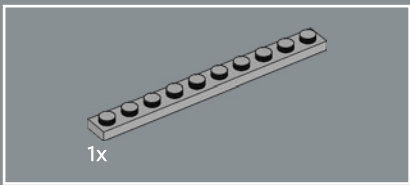

311

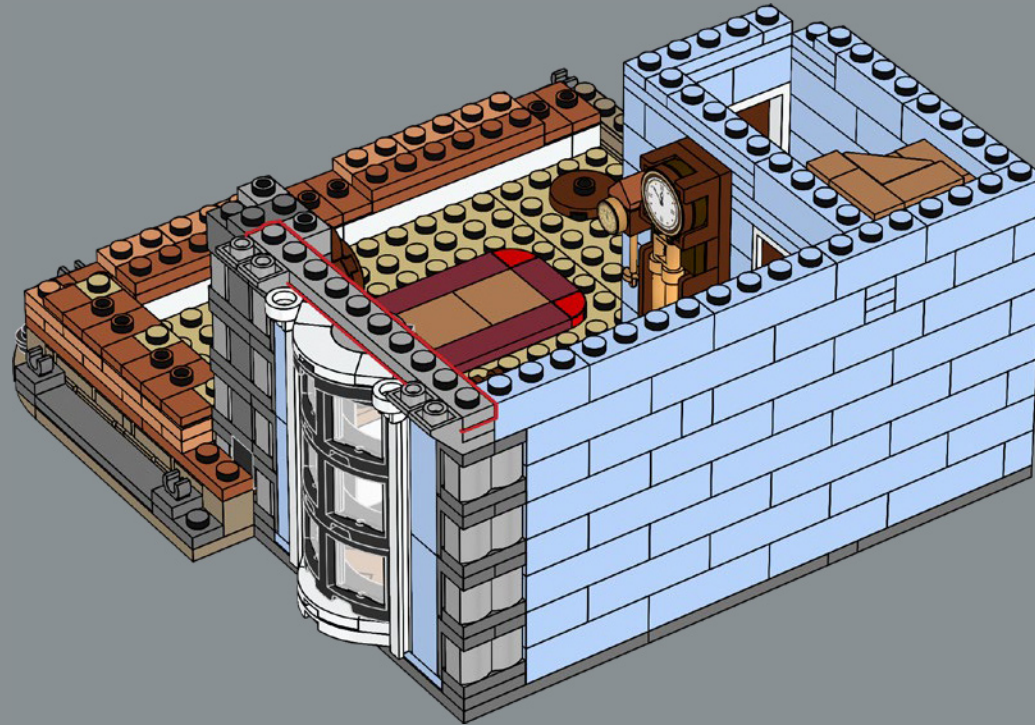

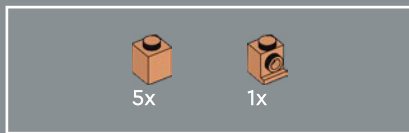

312

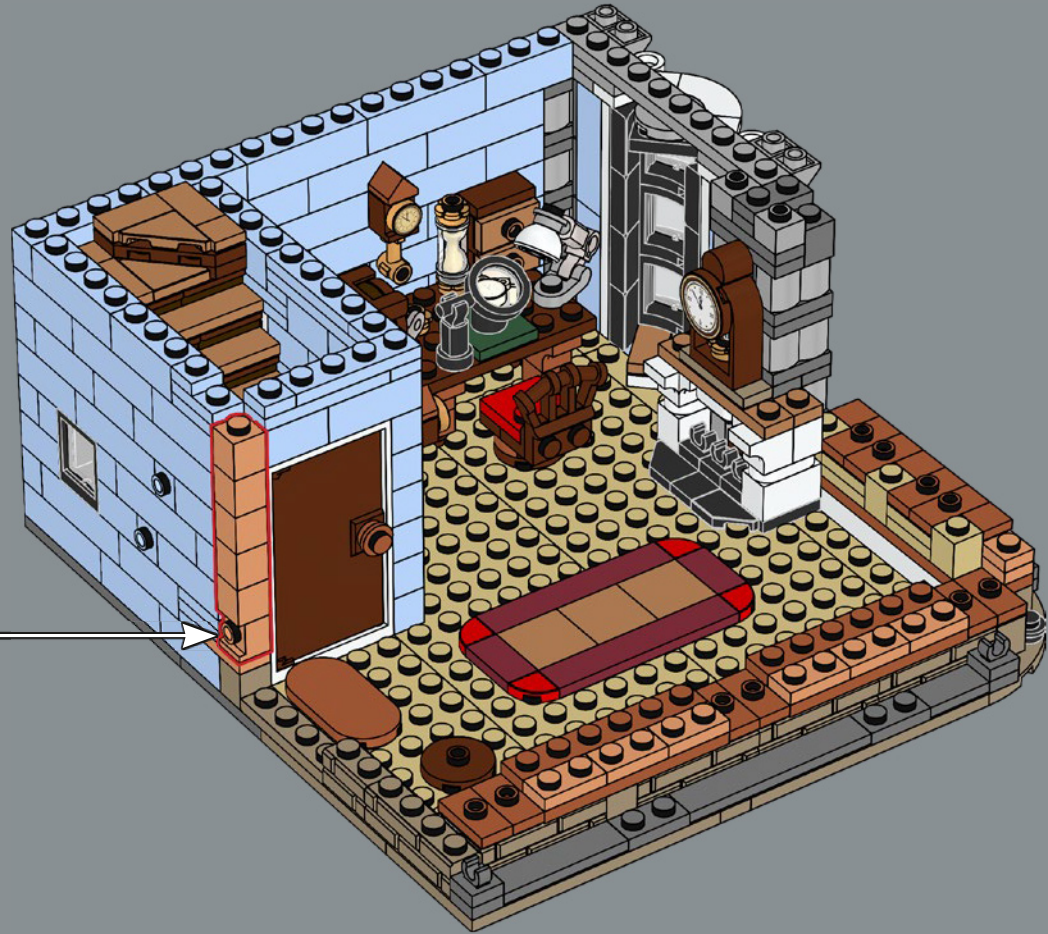
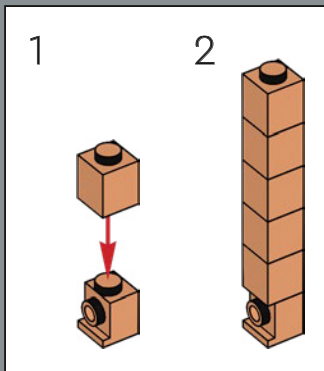



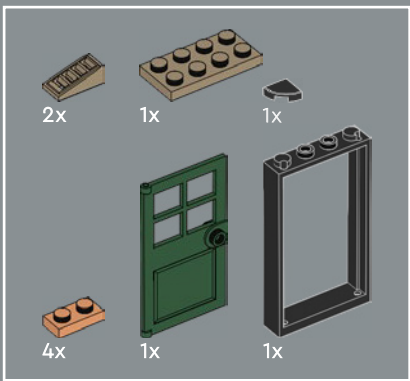

313

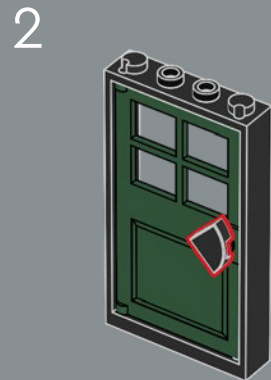
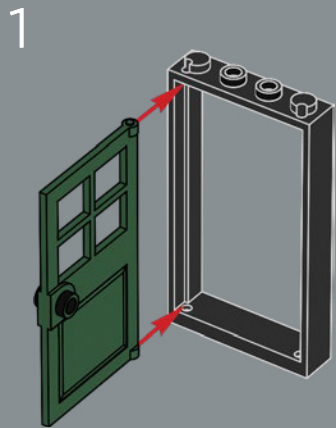
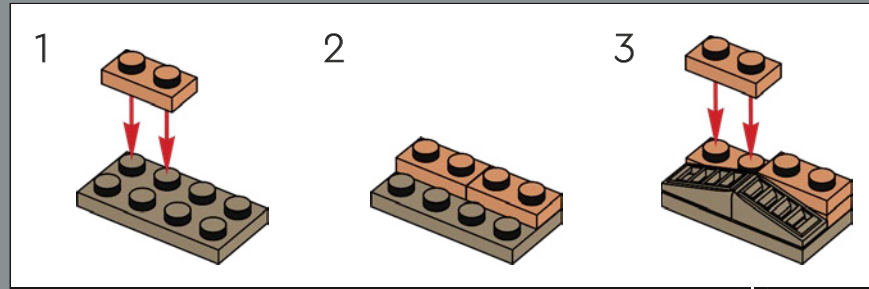

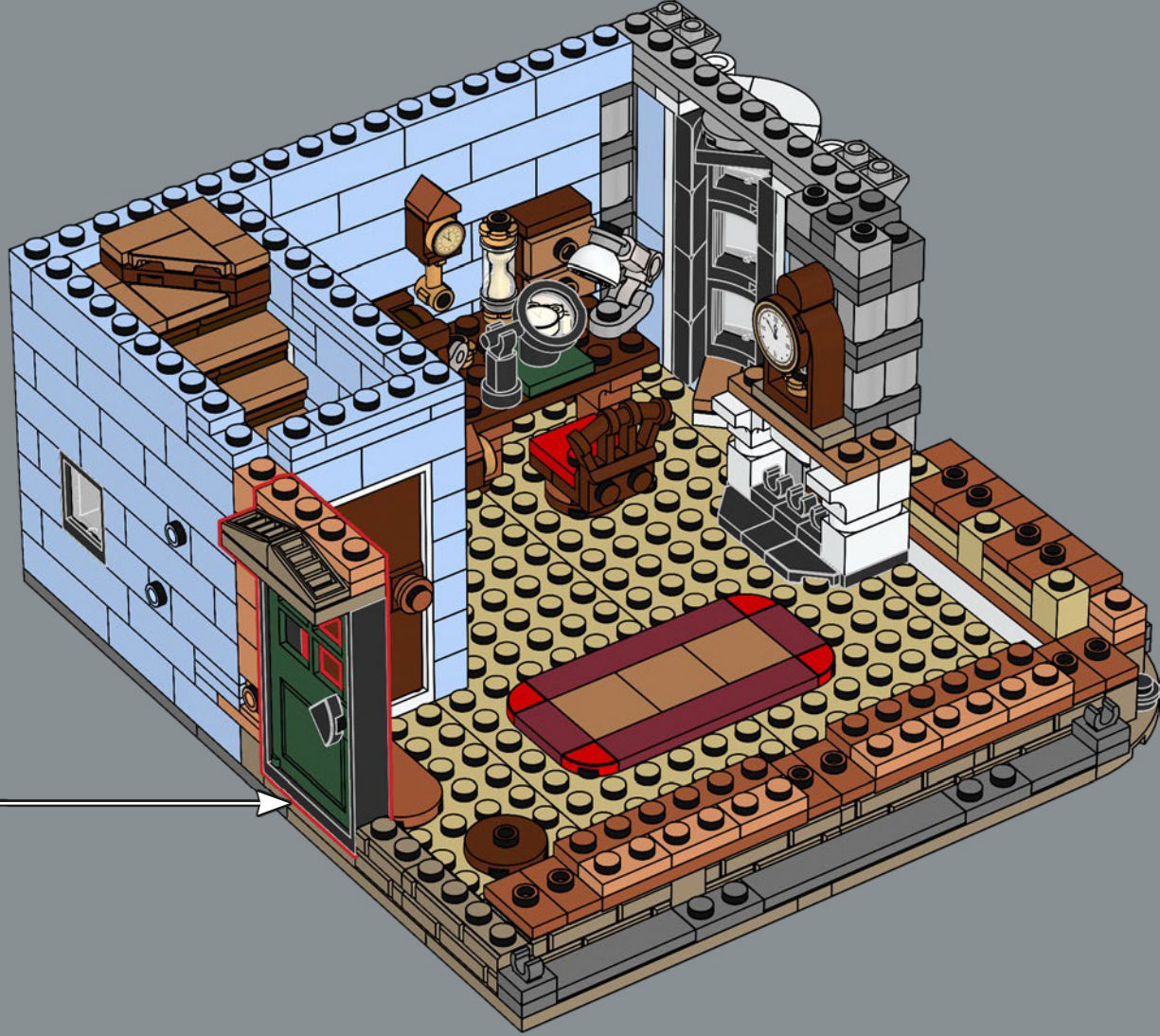



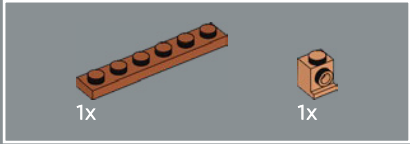
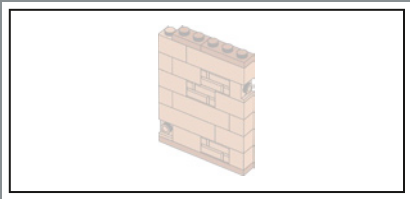

314

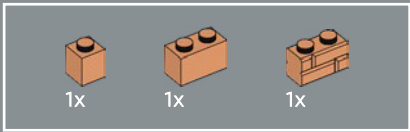
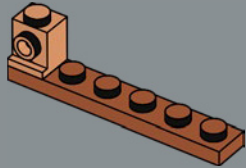

315

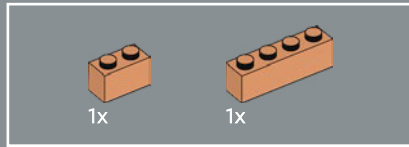
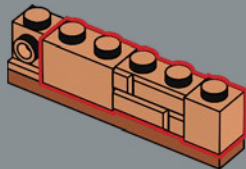

316

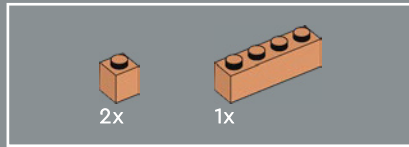
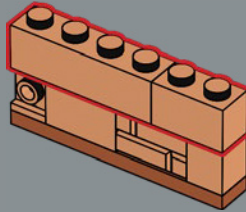

317

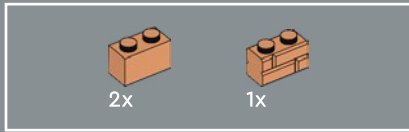
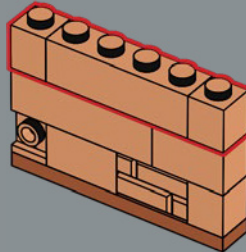

318

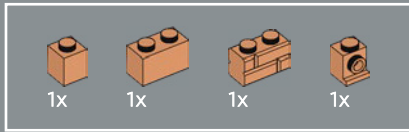
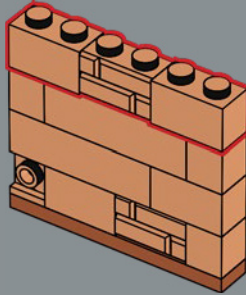

319

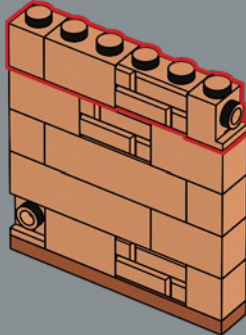

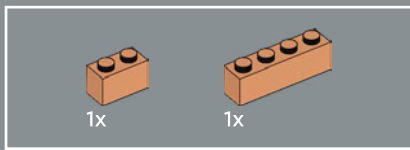

320

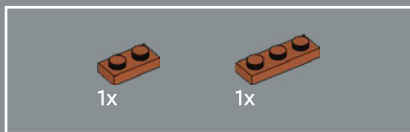
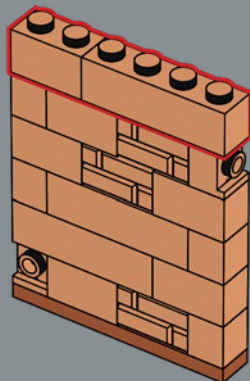

321

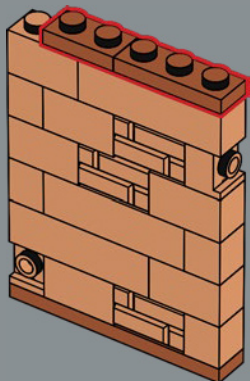

322

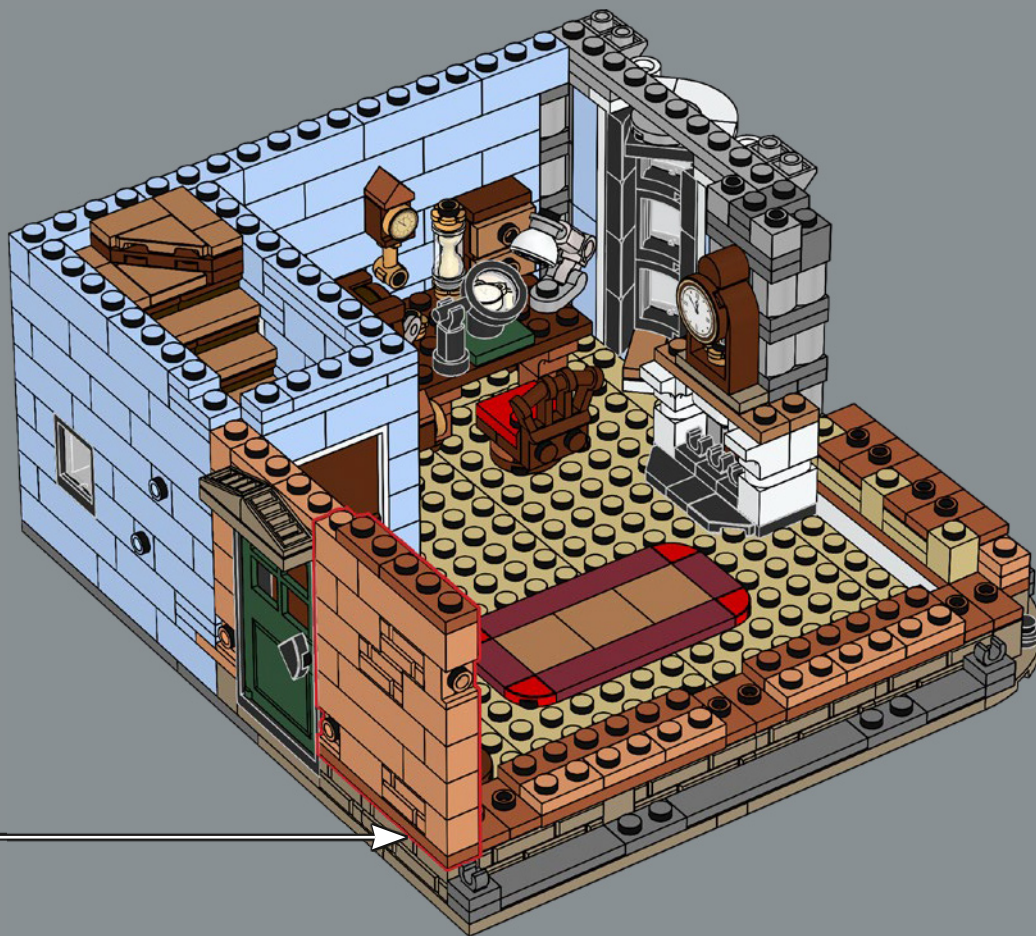



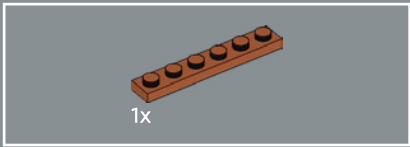

1x

323

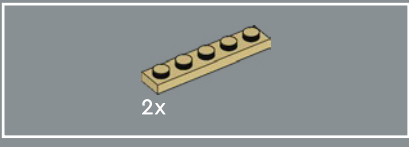
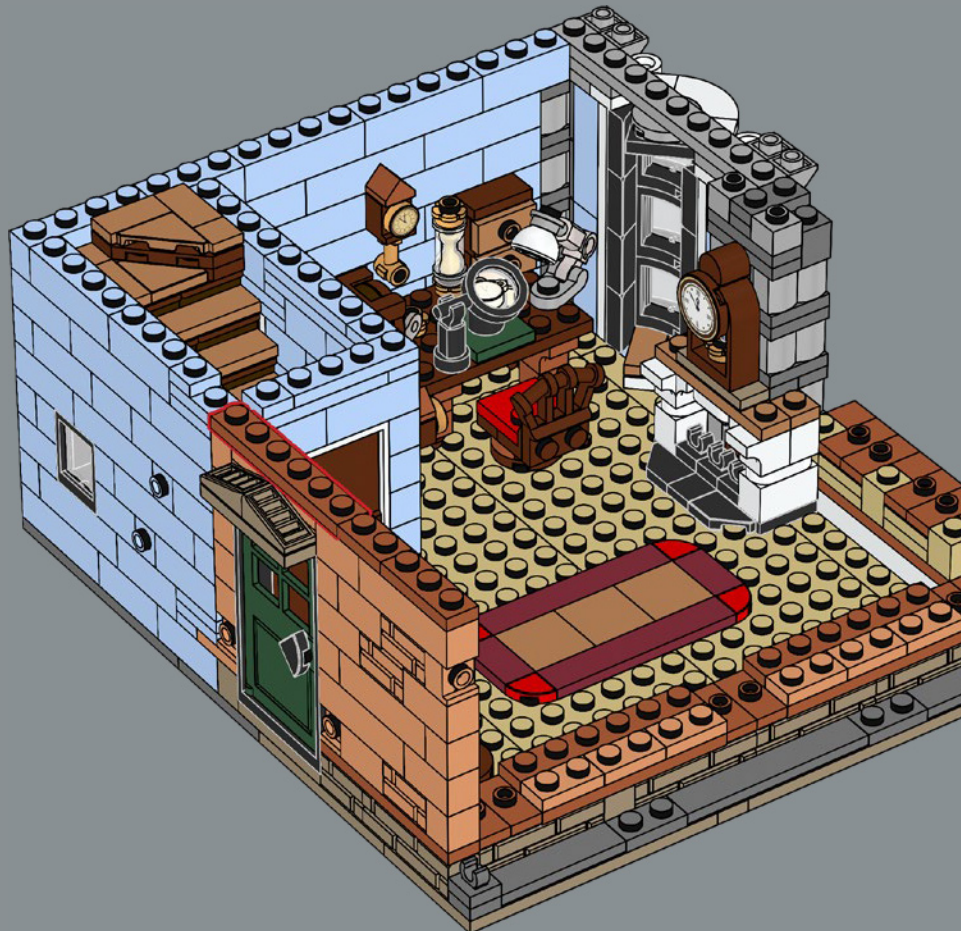

2x

324

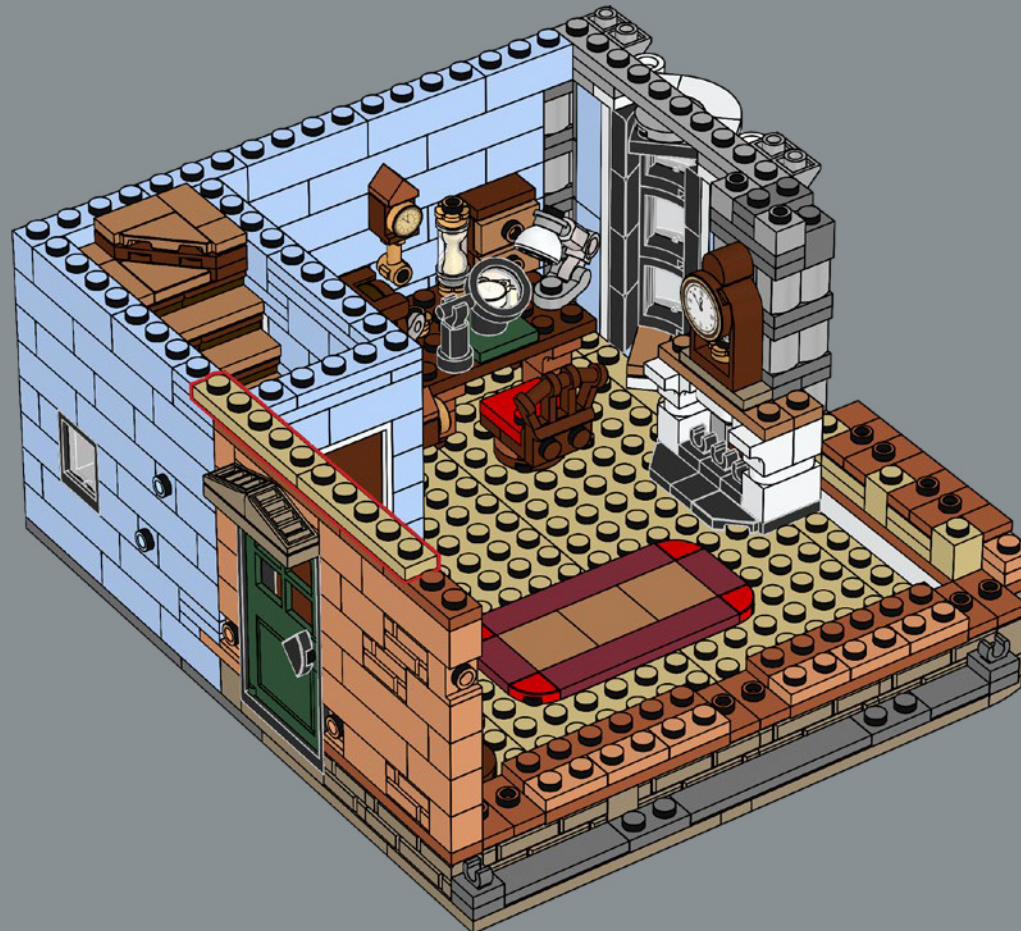

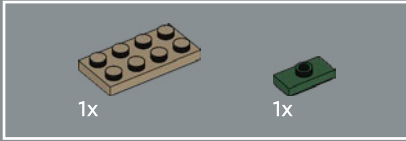

325

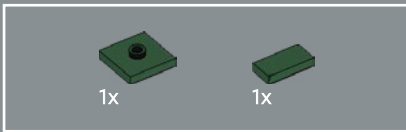
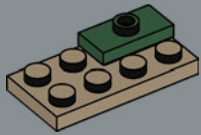

326

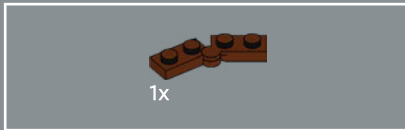
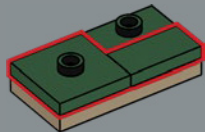

327

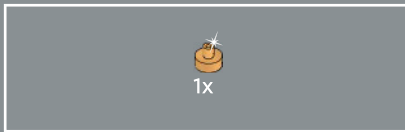
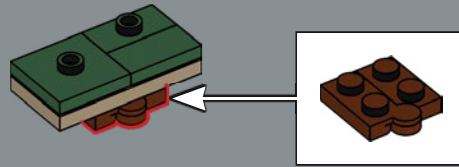

328

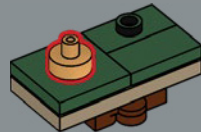

329

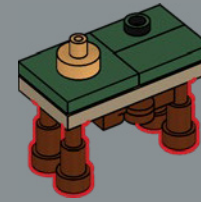

330

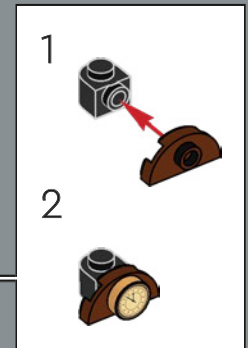
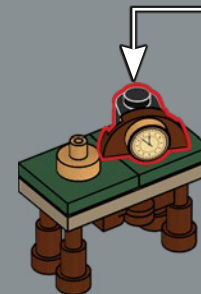



1x

1x

331

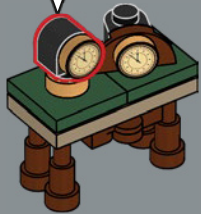
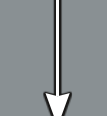
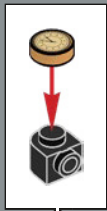

332



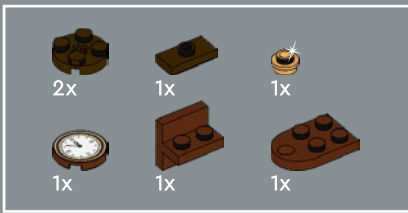

333

1

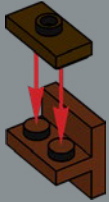

2

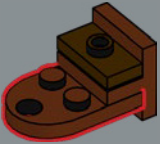

3

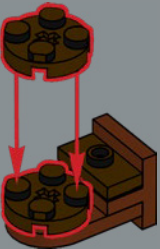

4

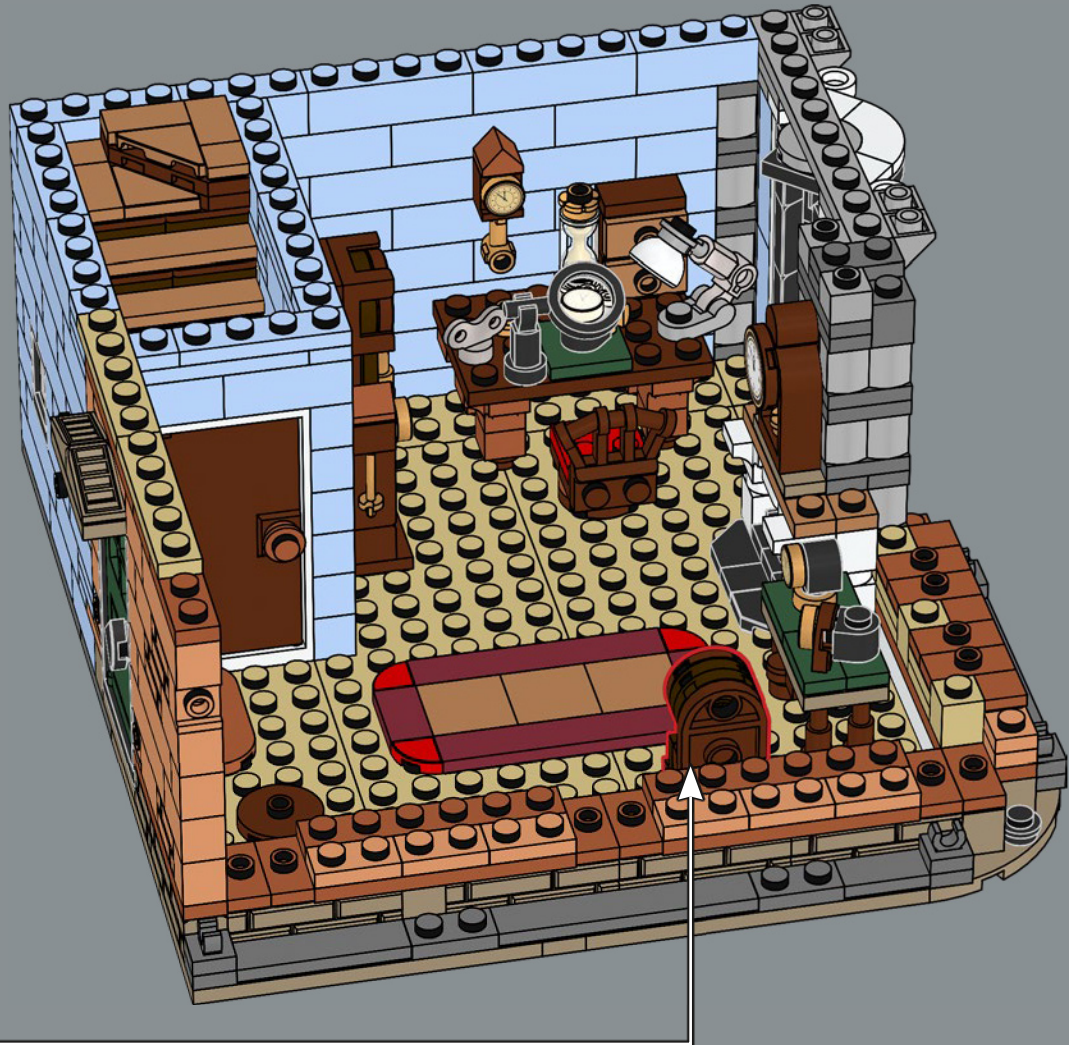





334

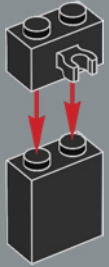

335

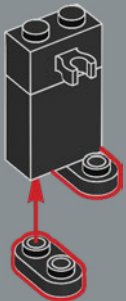

336



337

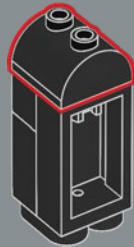

338



339



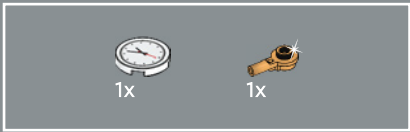

340



341

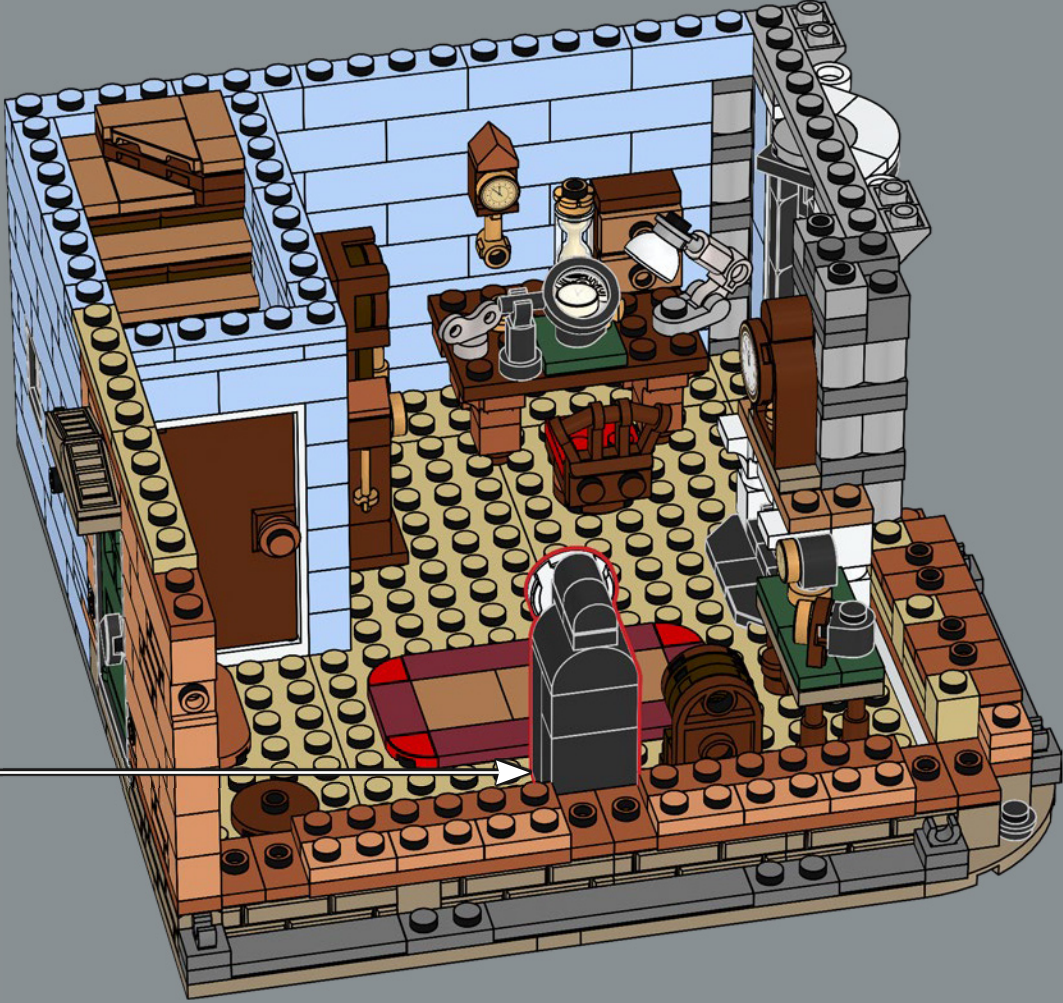





342

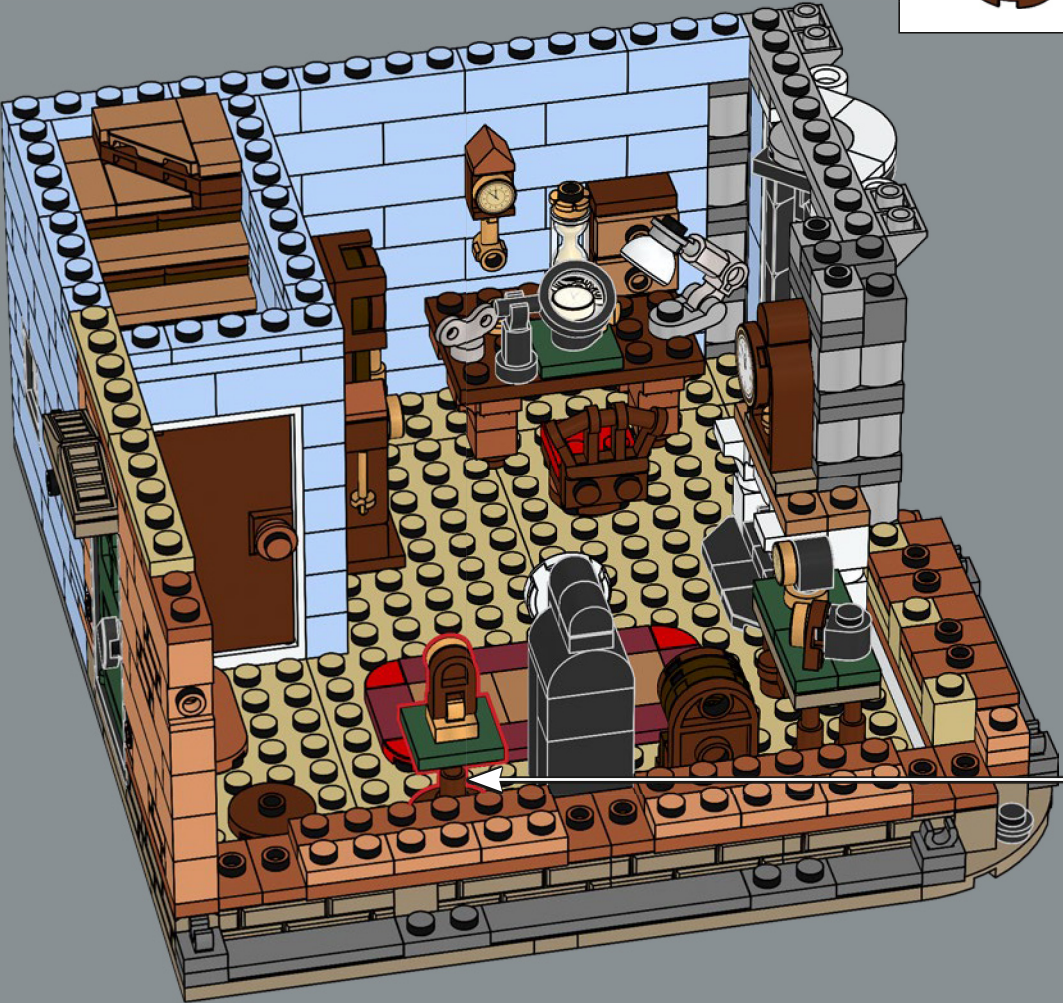
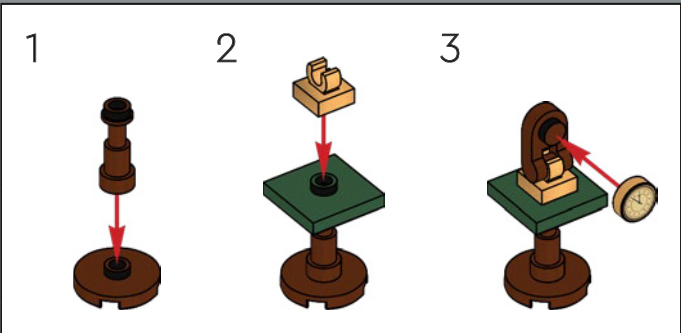

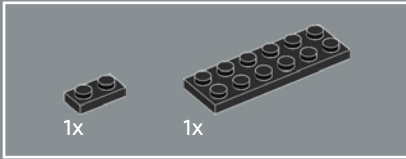
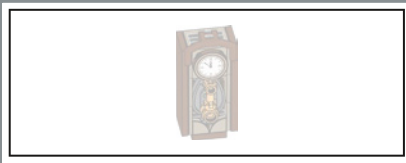

343

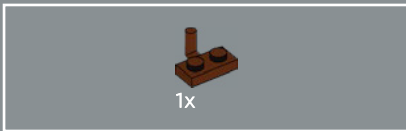
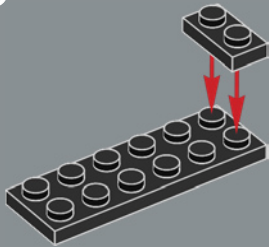

344

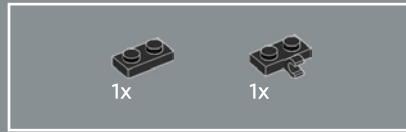
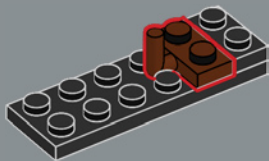

345

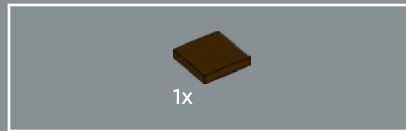
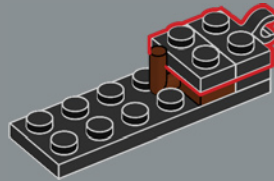

346

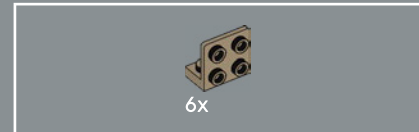
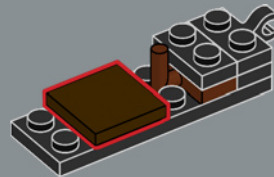

347

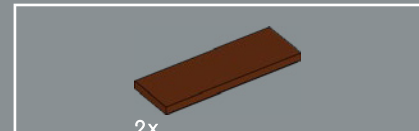
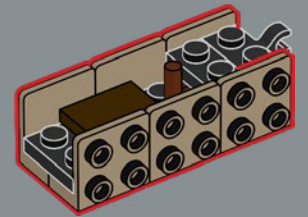

348

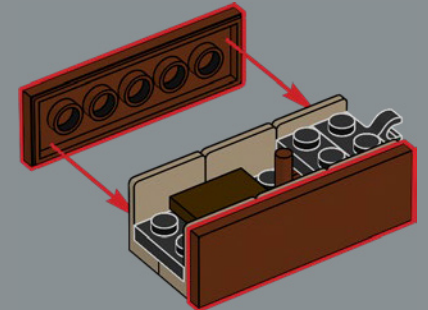



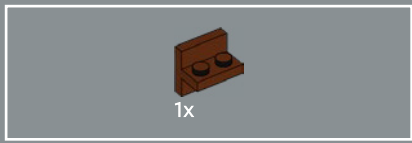

349

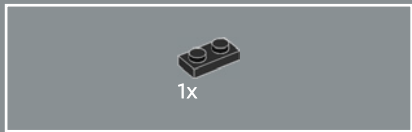
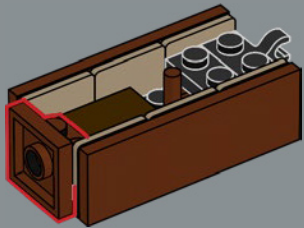

350

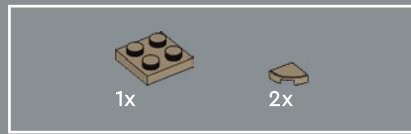
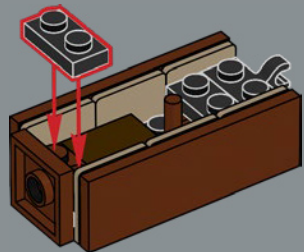

351

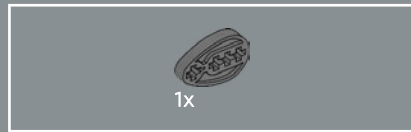
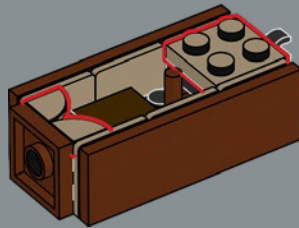

352

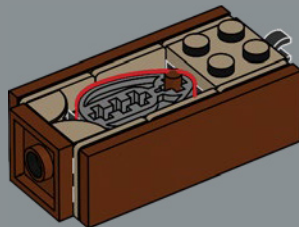

353

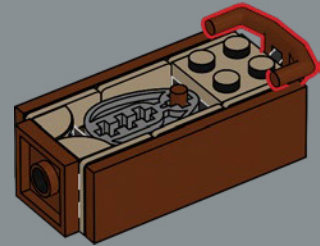

354

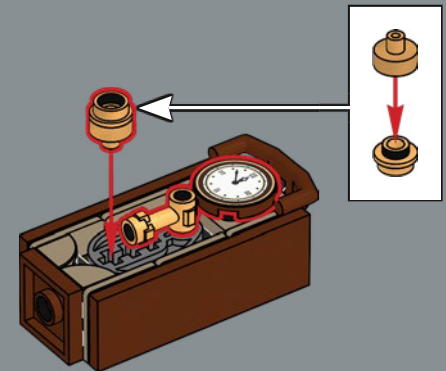

355





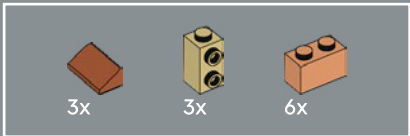

356

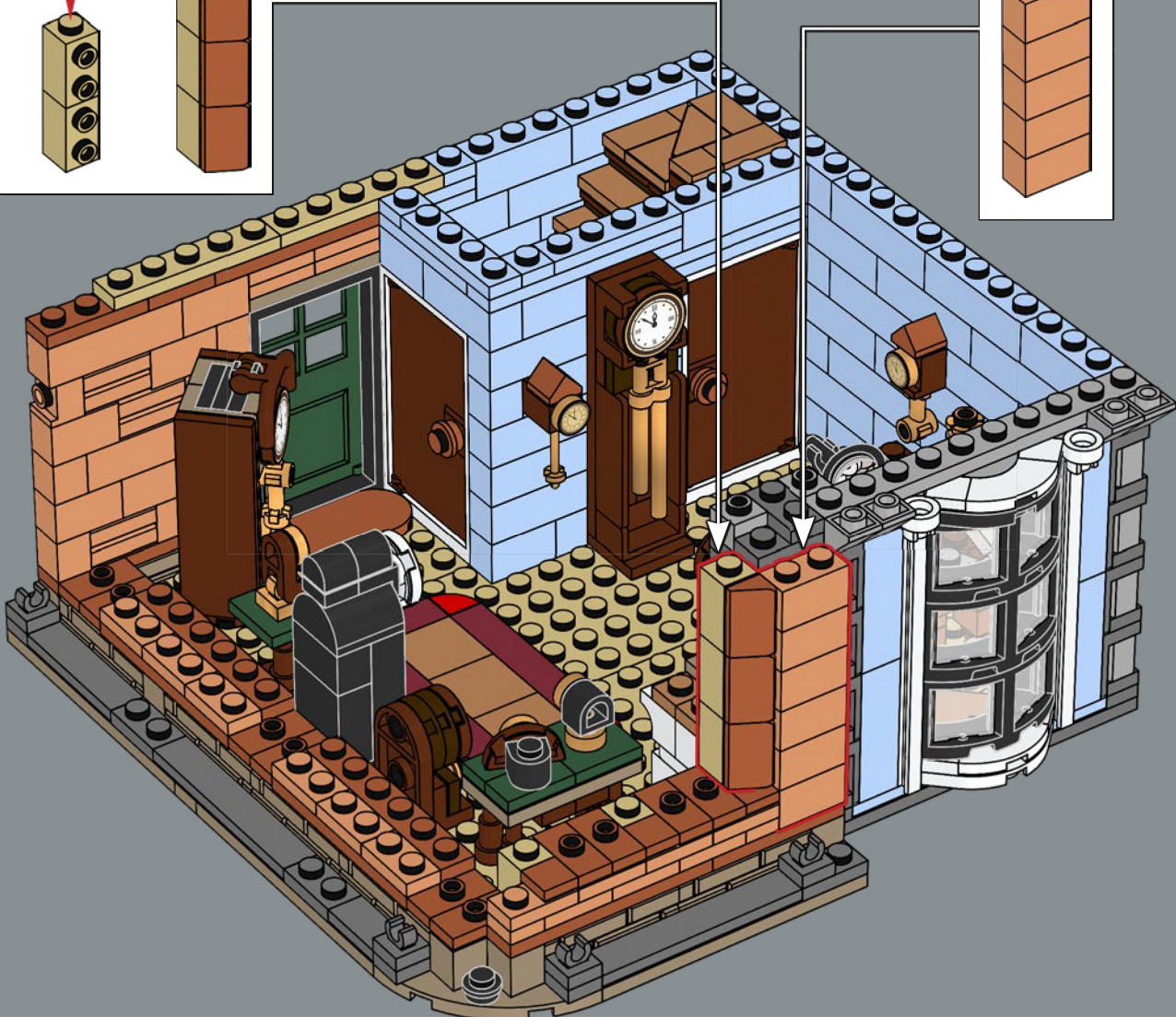
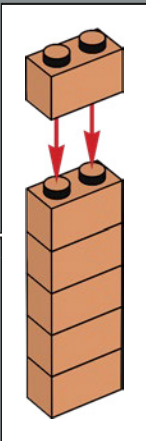
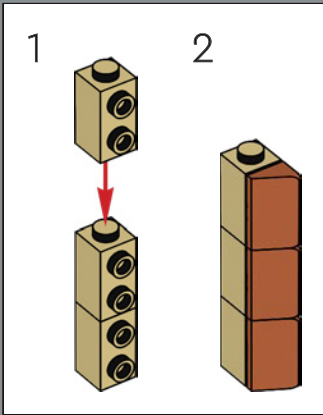

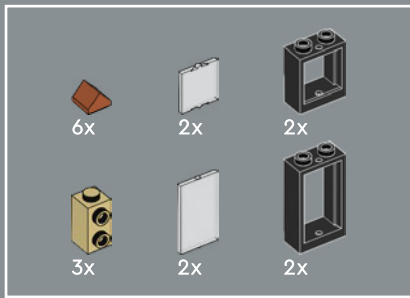



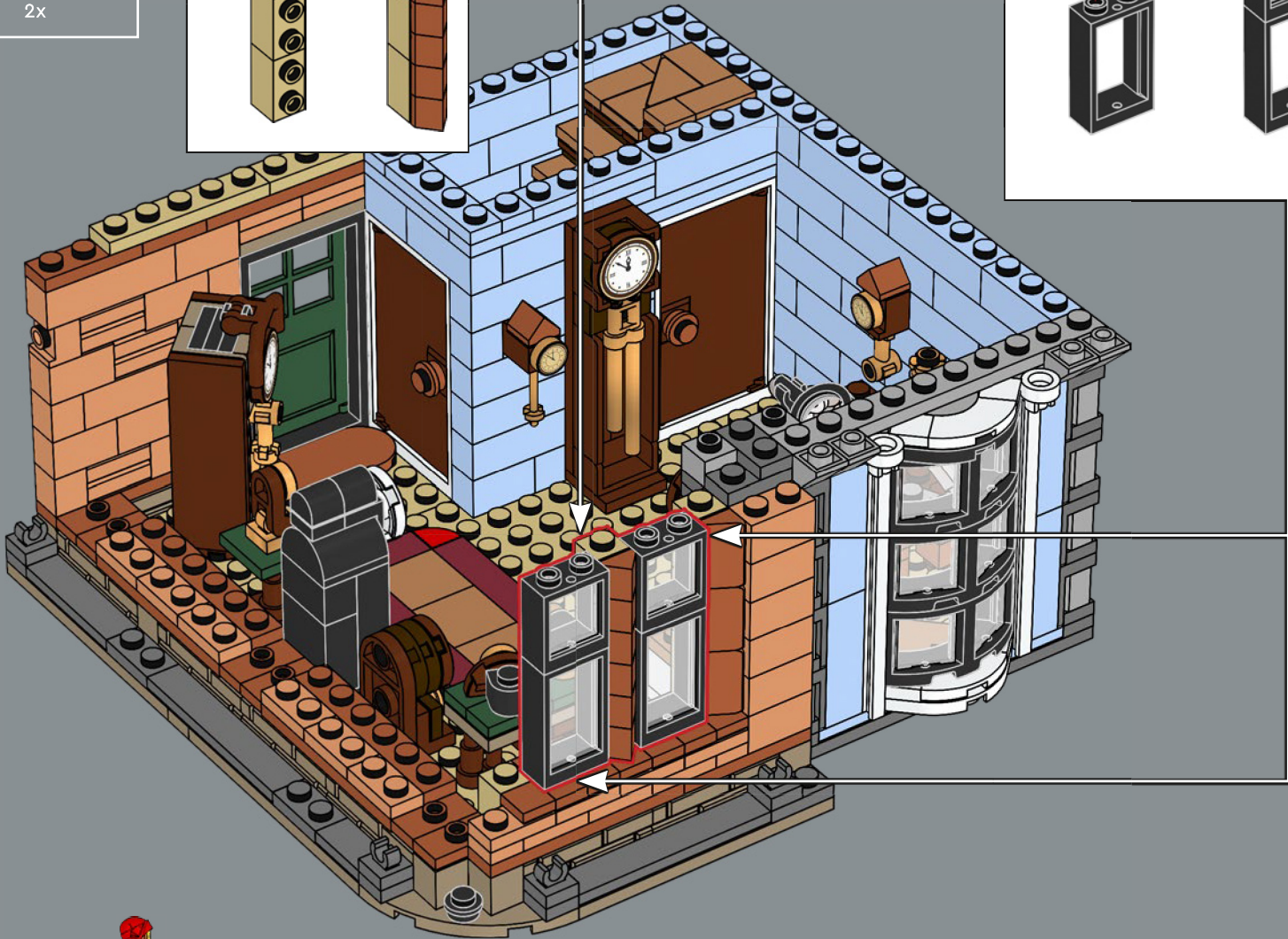
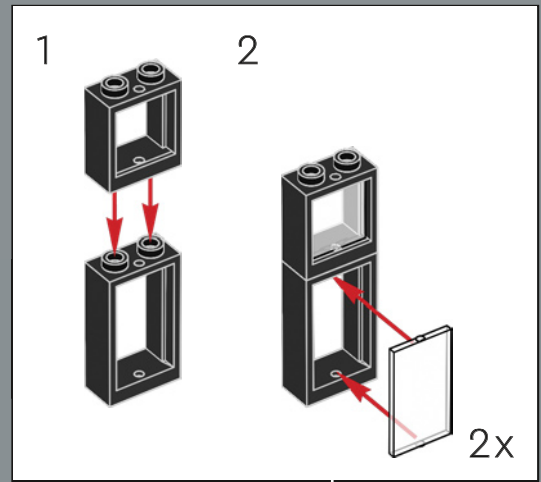
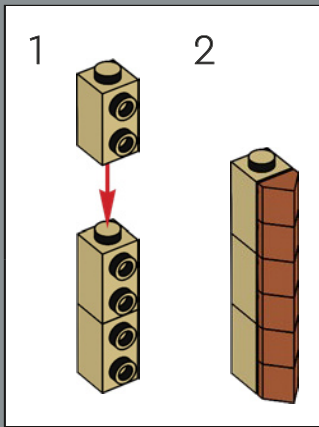

357





- 1x 
- 3x 
- 3x 
- 2x 

358

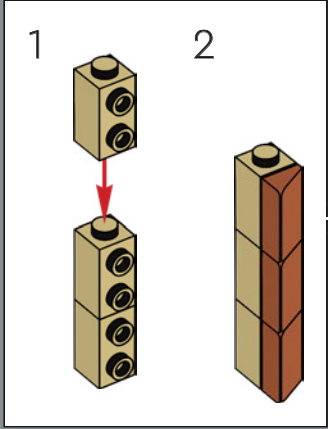
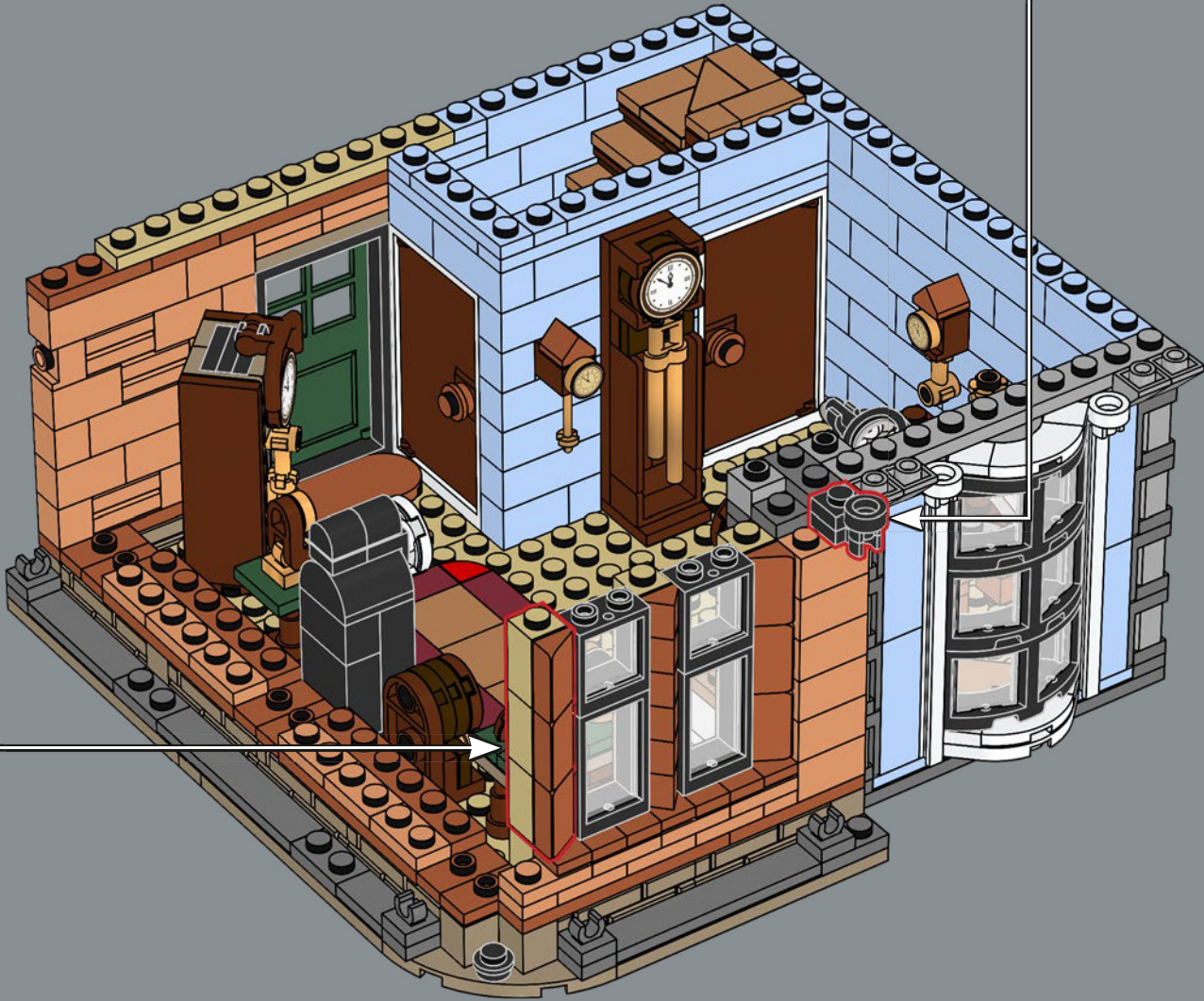
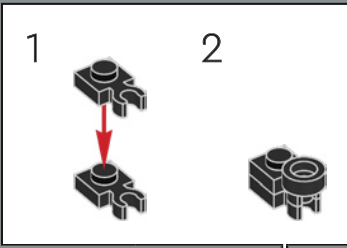

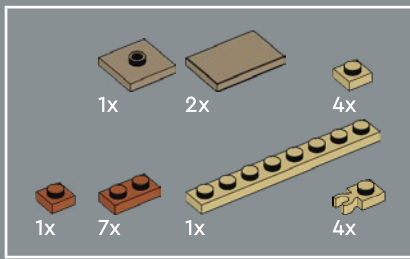

359

1

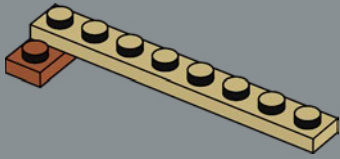

2

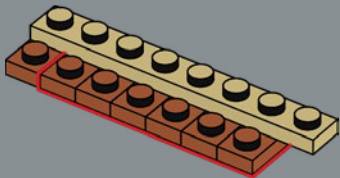

3

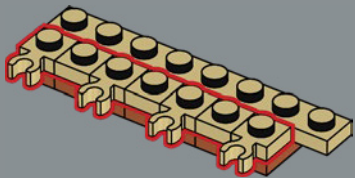

4

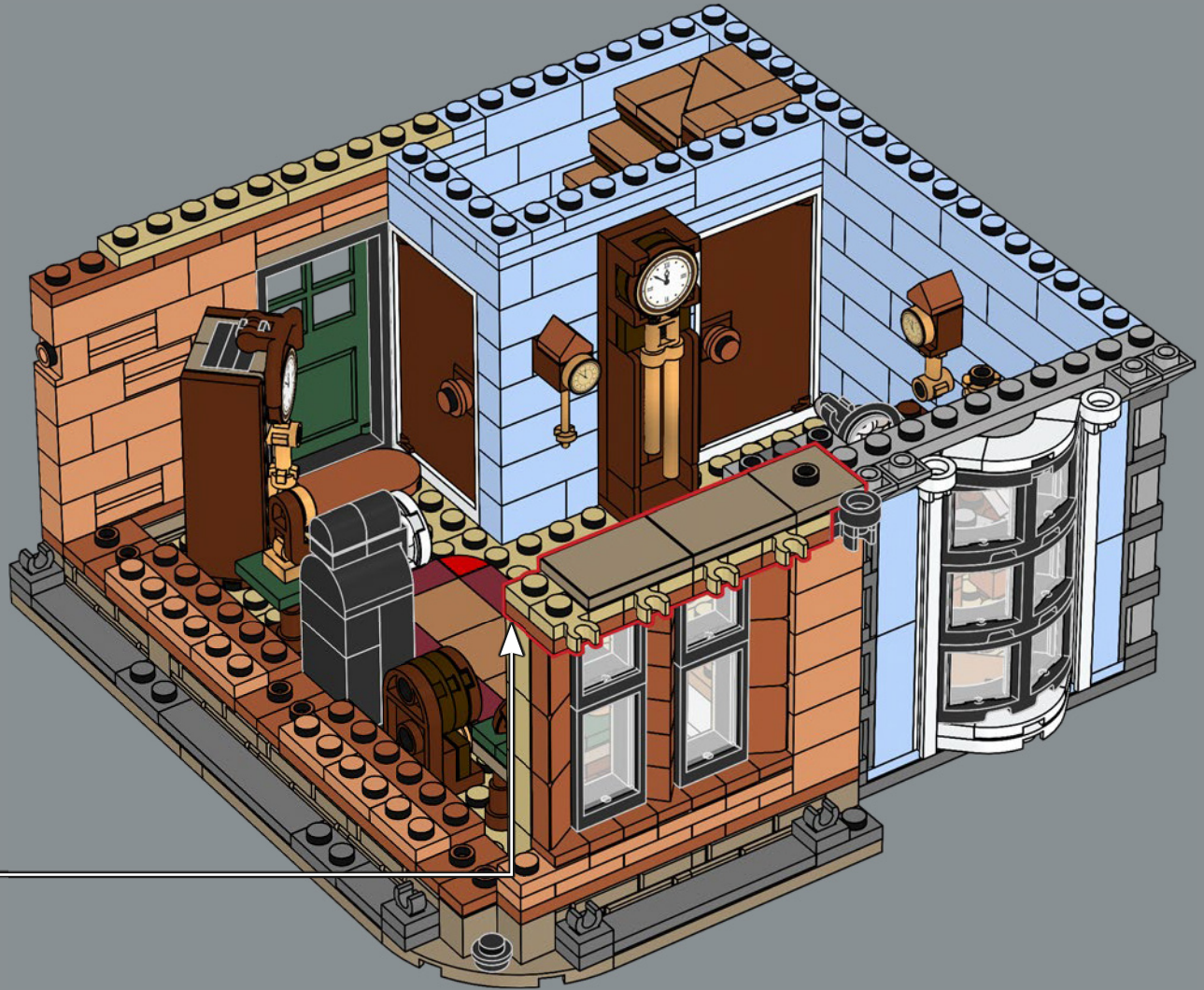
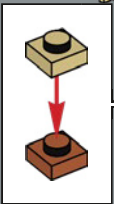
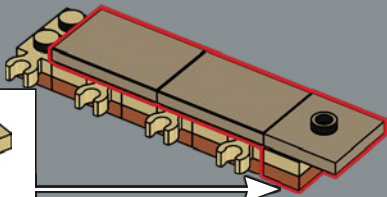



- 1x 
- 5x 
- 5x 

360

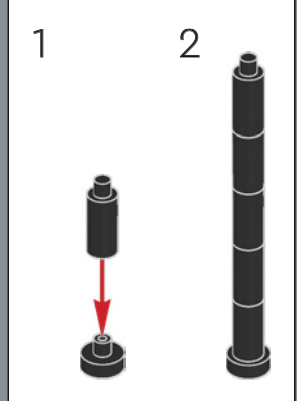
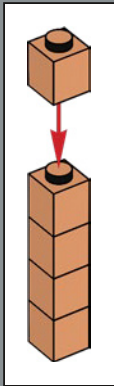
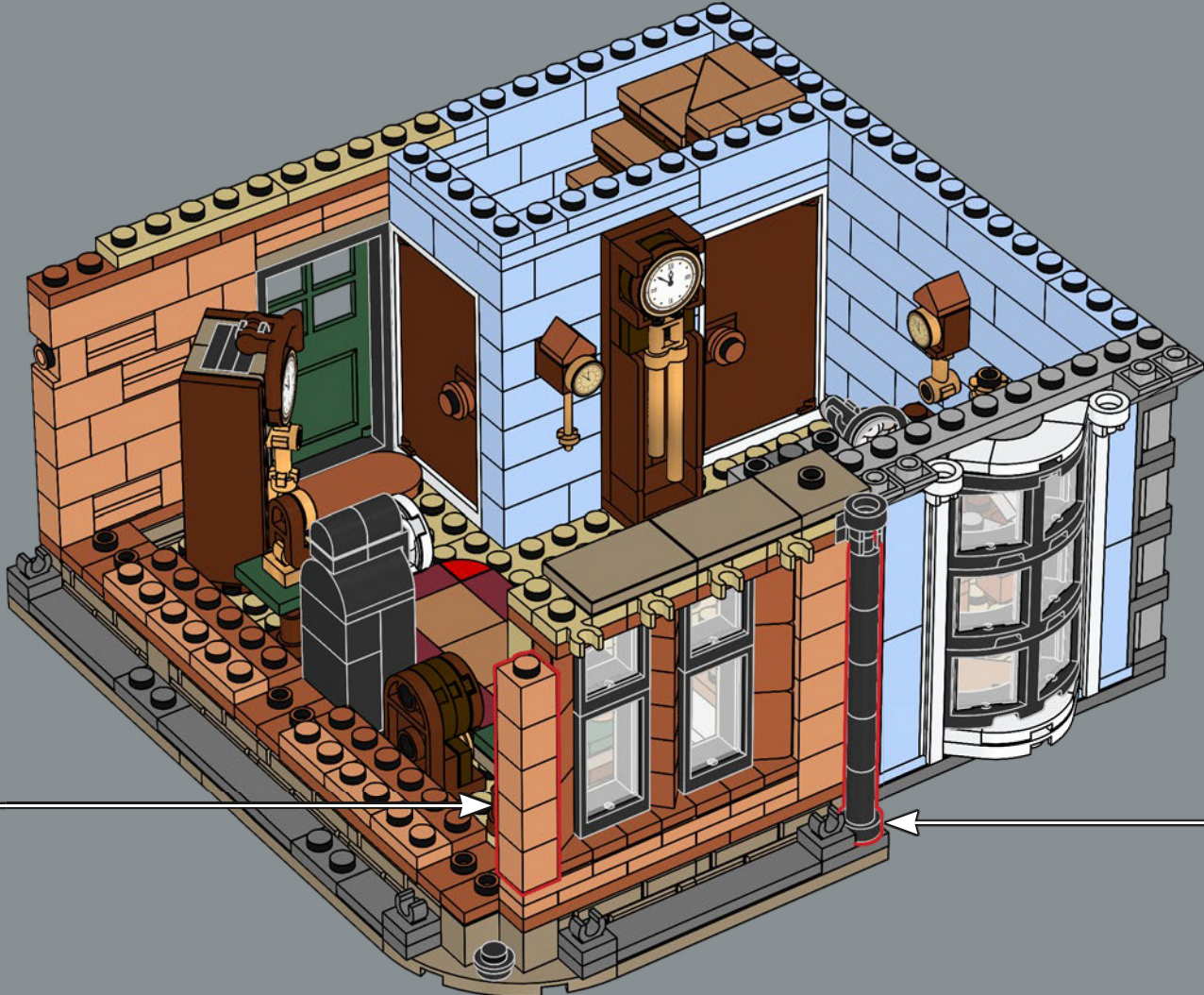

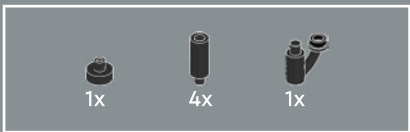

361

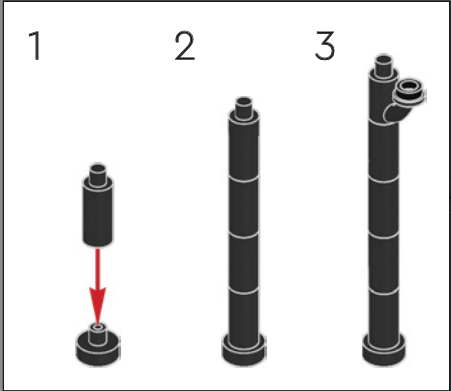
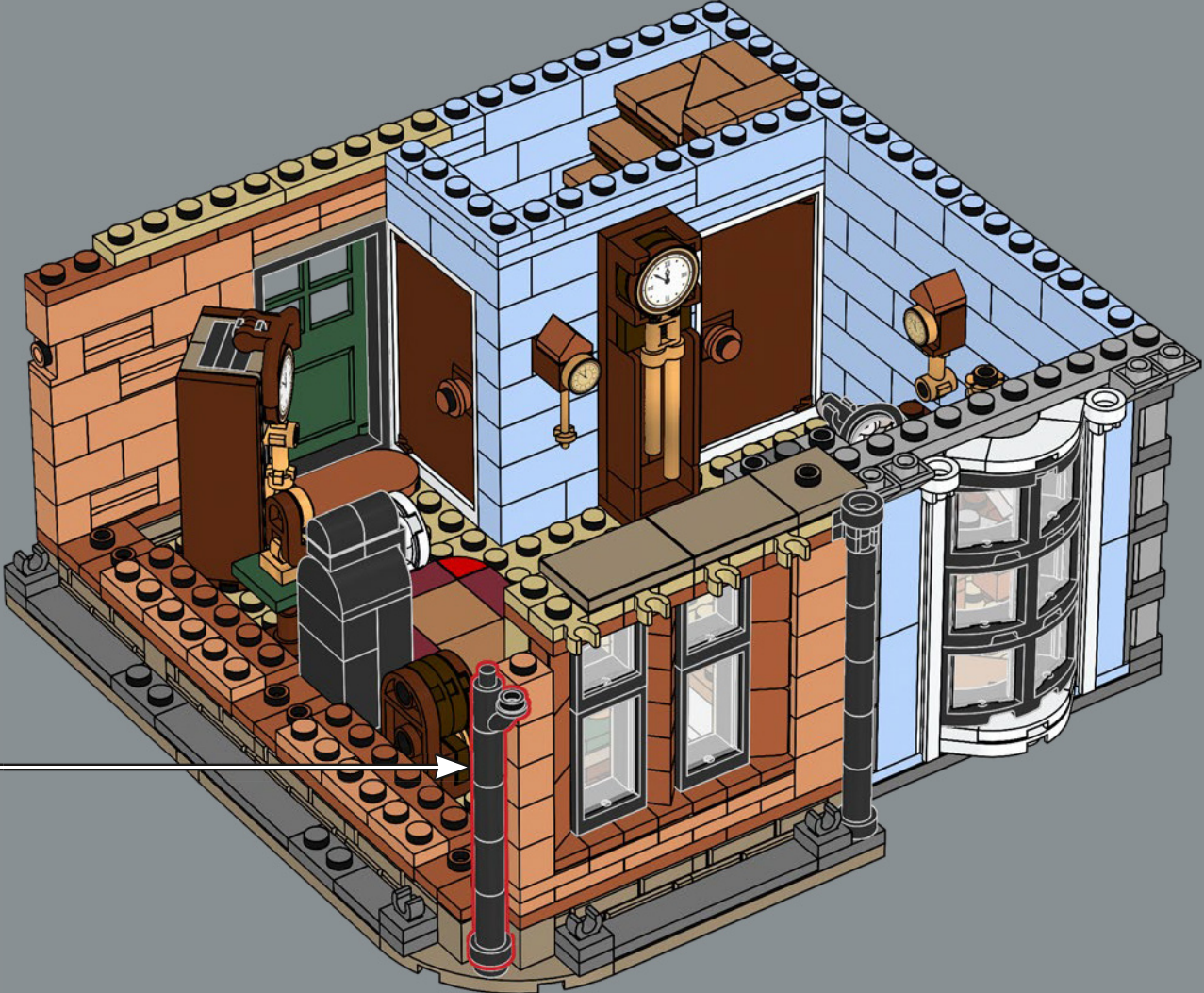



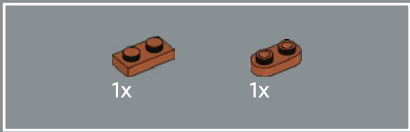

362

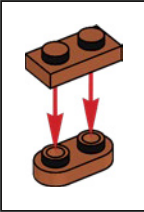
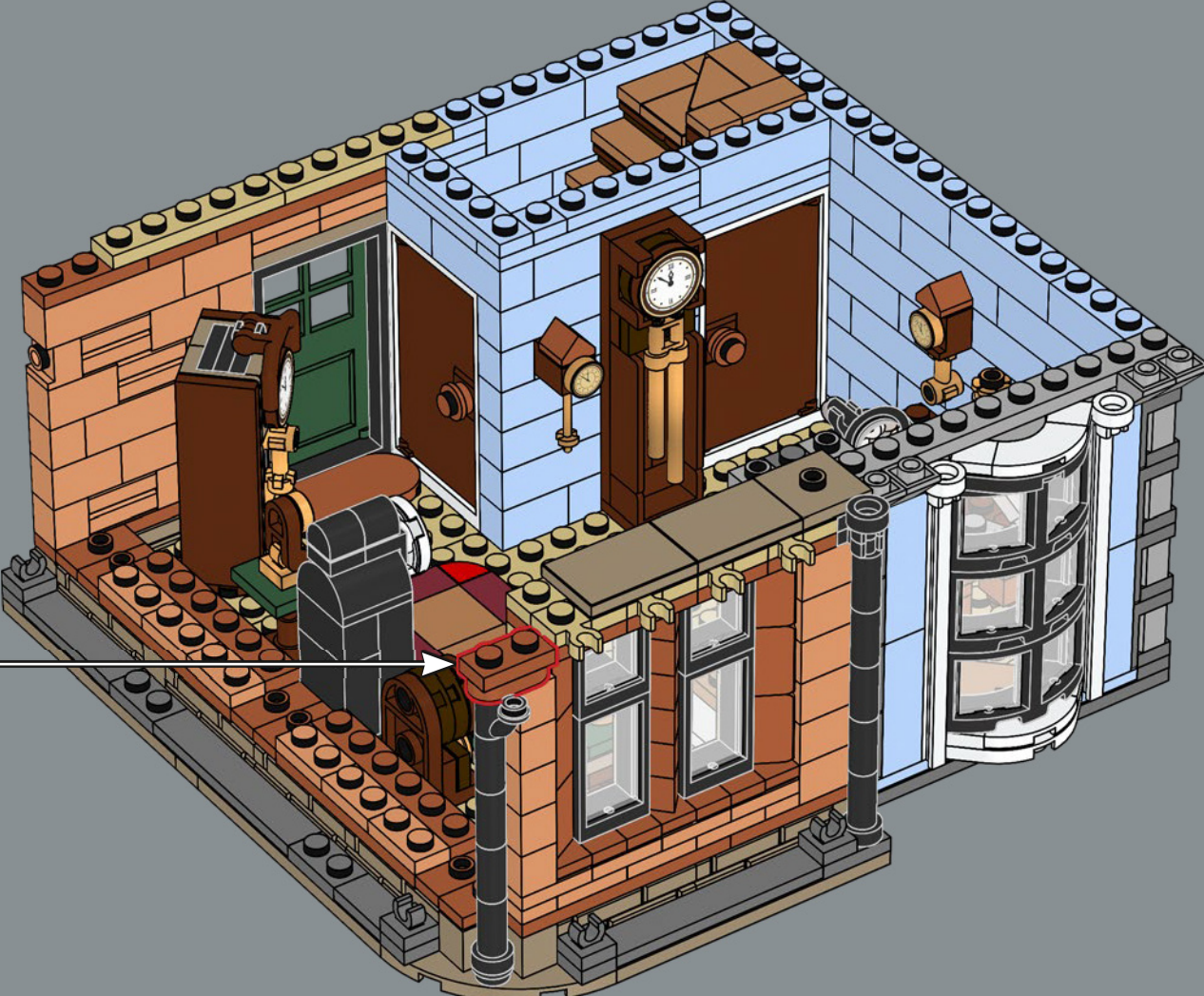

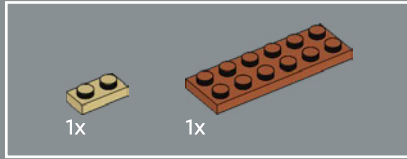
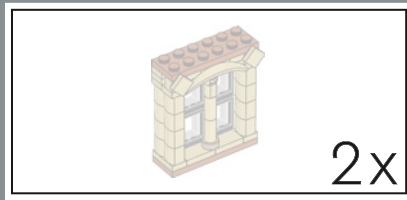

363

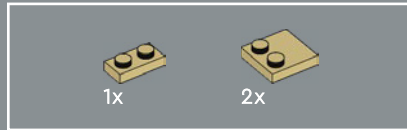
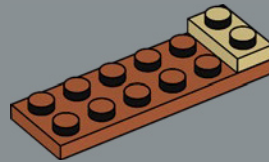

364

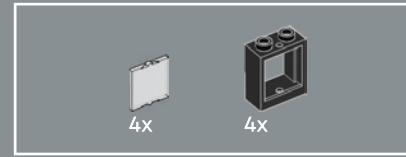
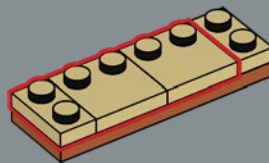

365

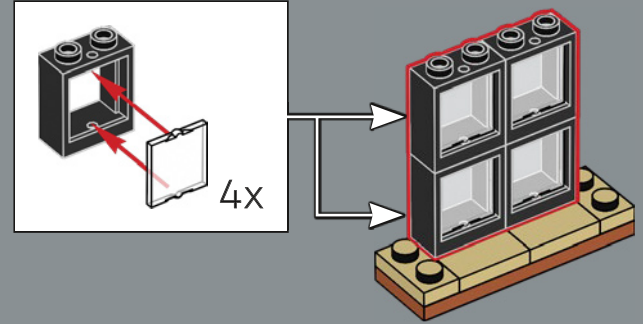

366

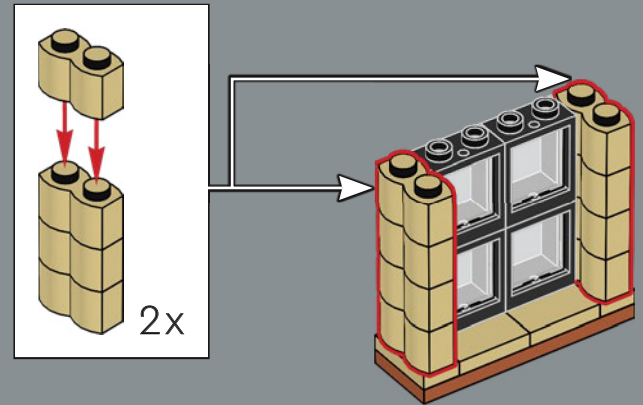



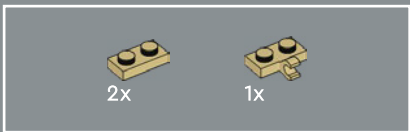

367

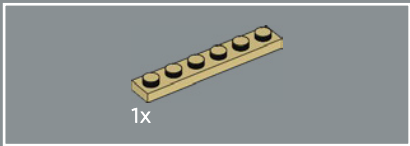
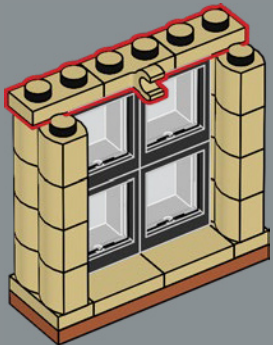

368

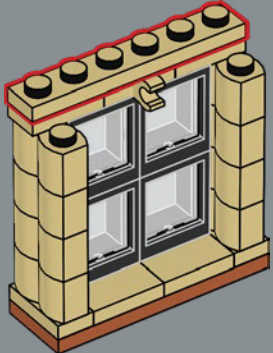

369

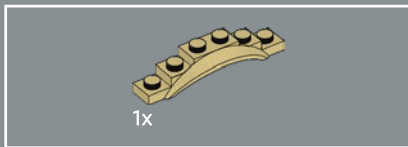
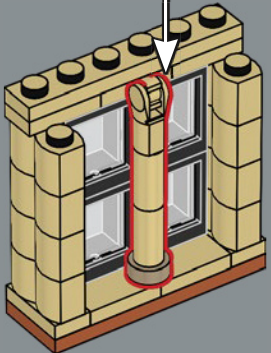
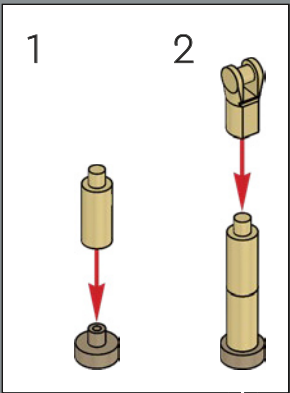

370

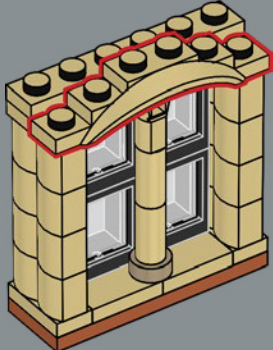

371

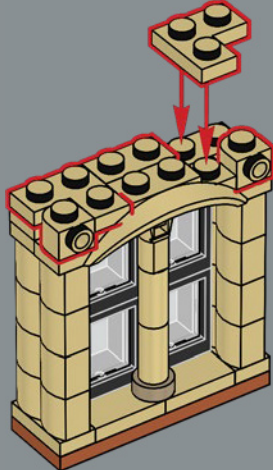

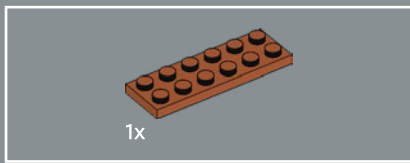

1x

372

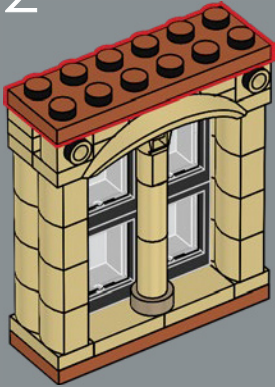

2x

373

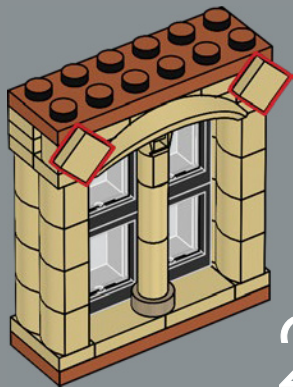

2x



374

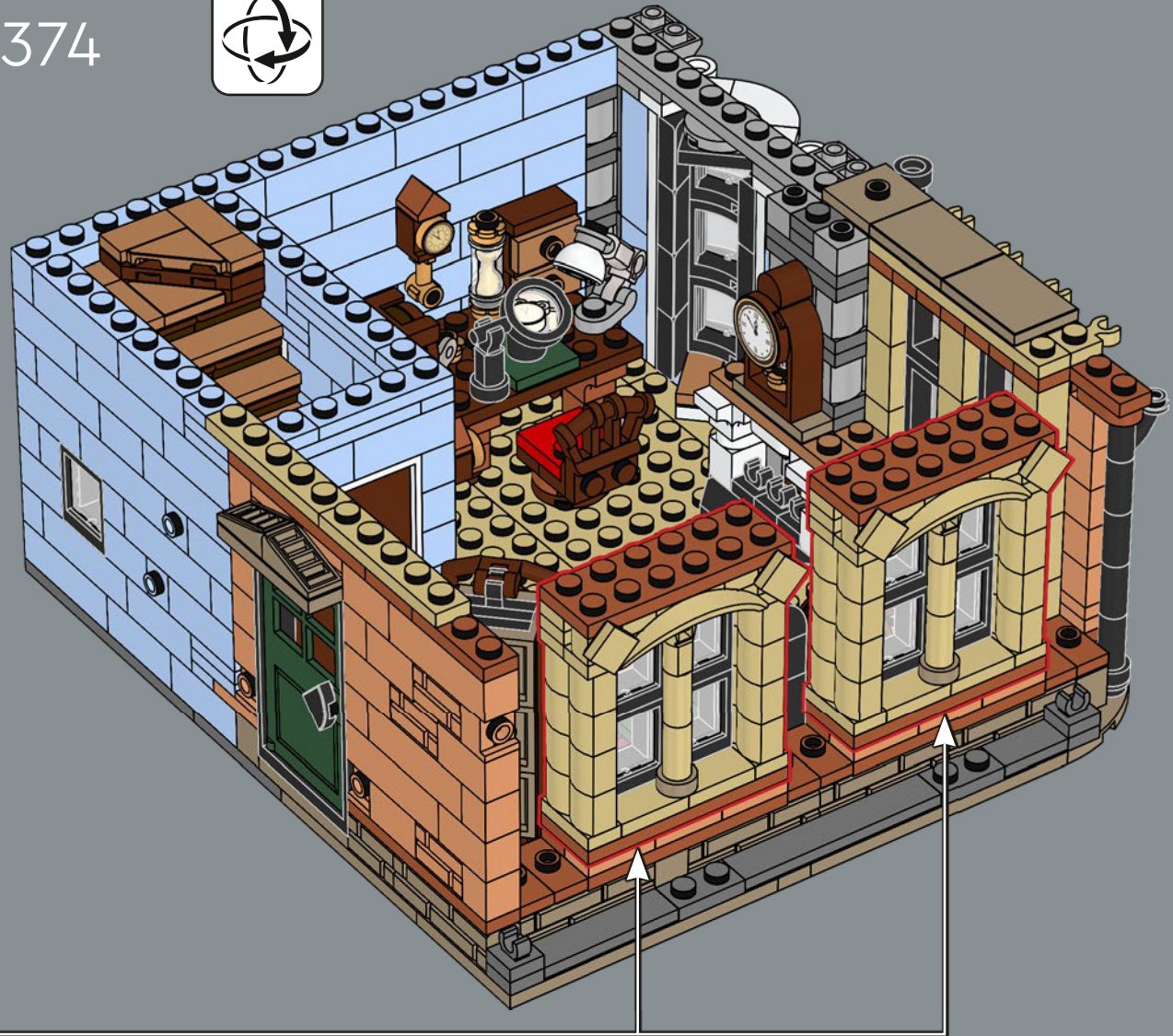



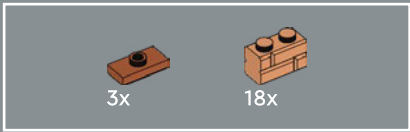

375

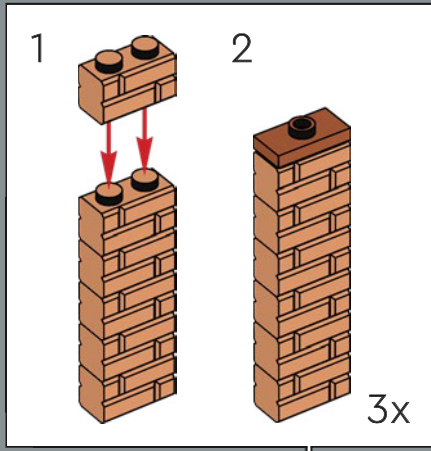
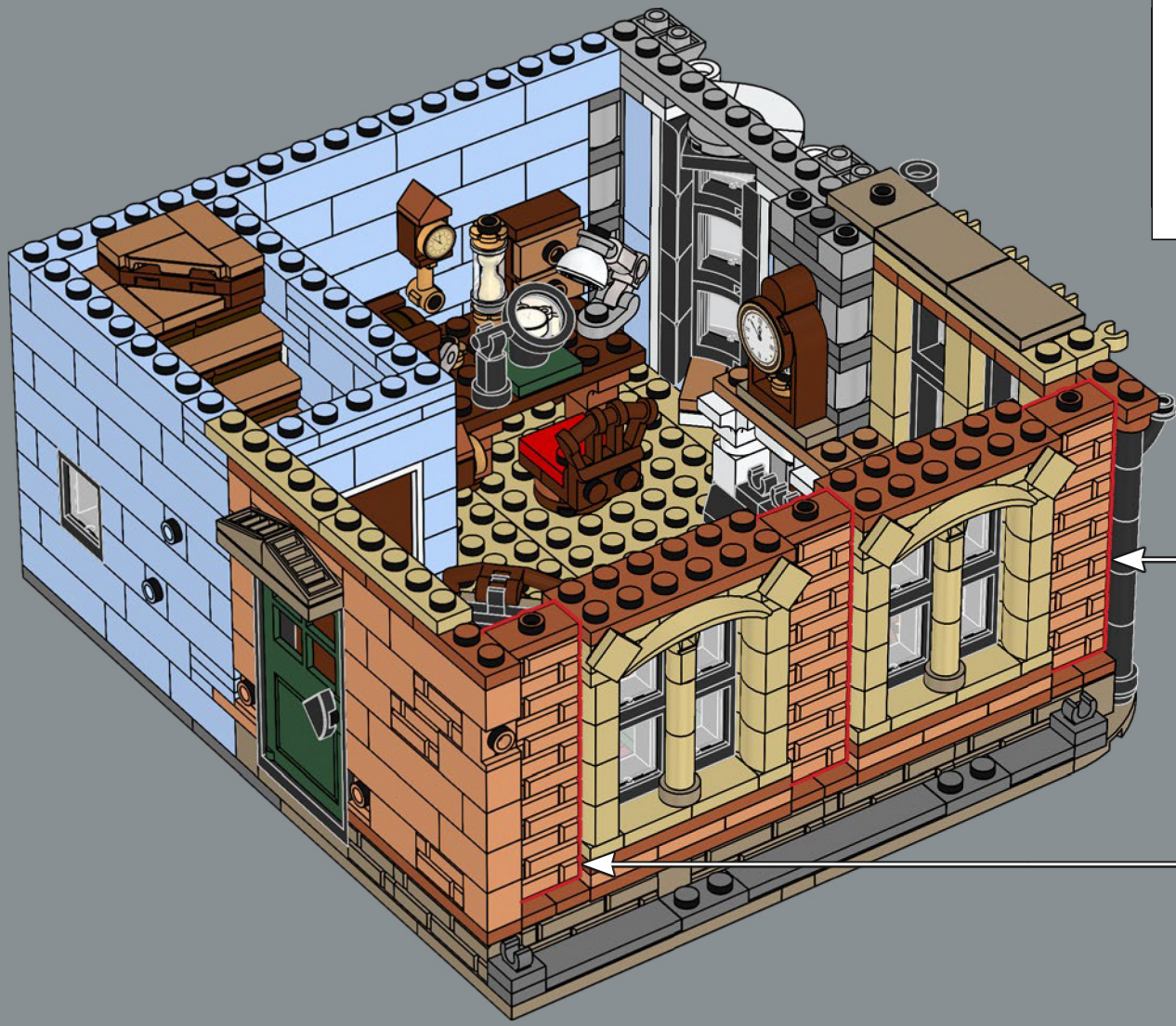

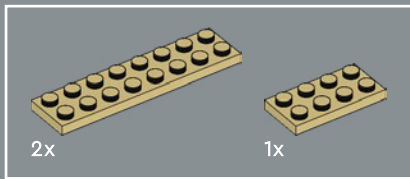

376





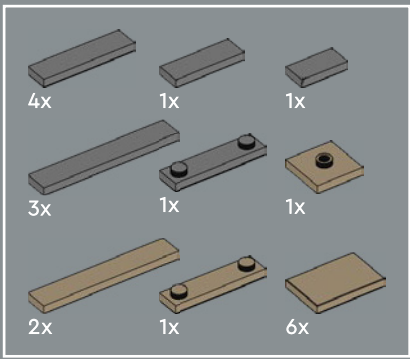

377



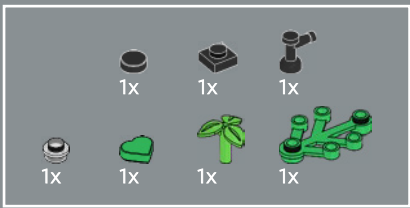

378

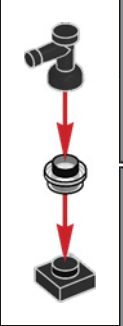
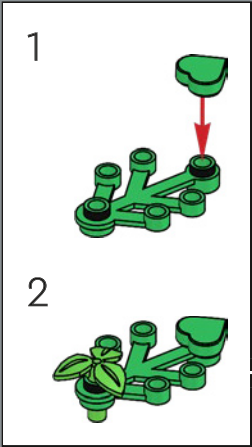



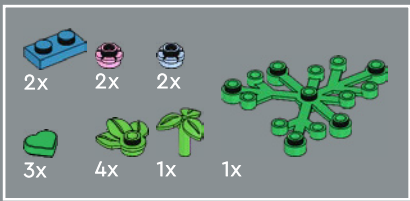

379

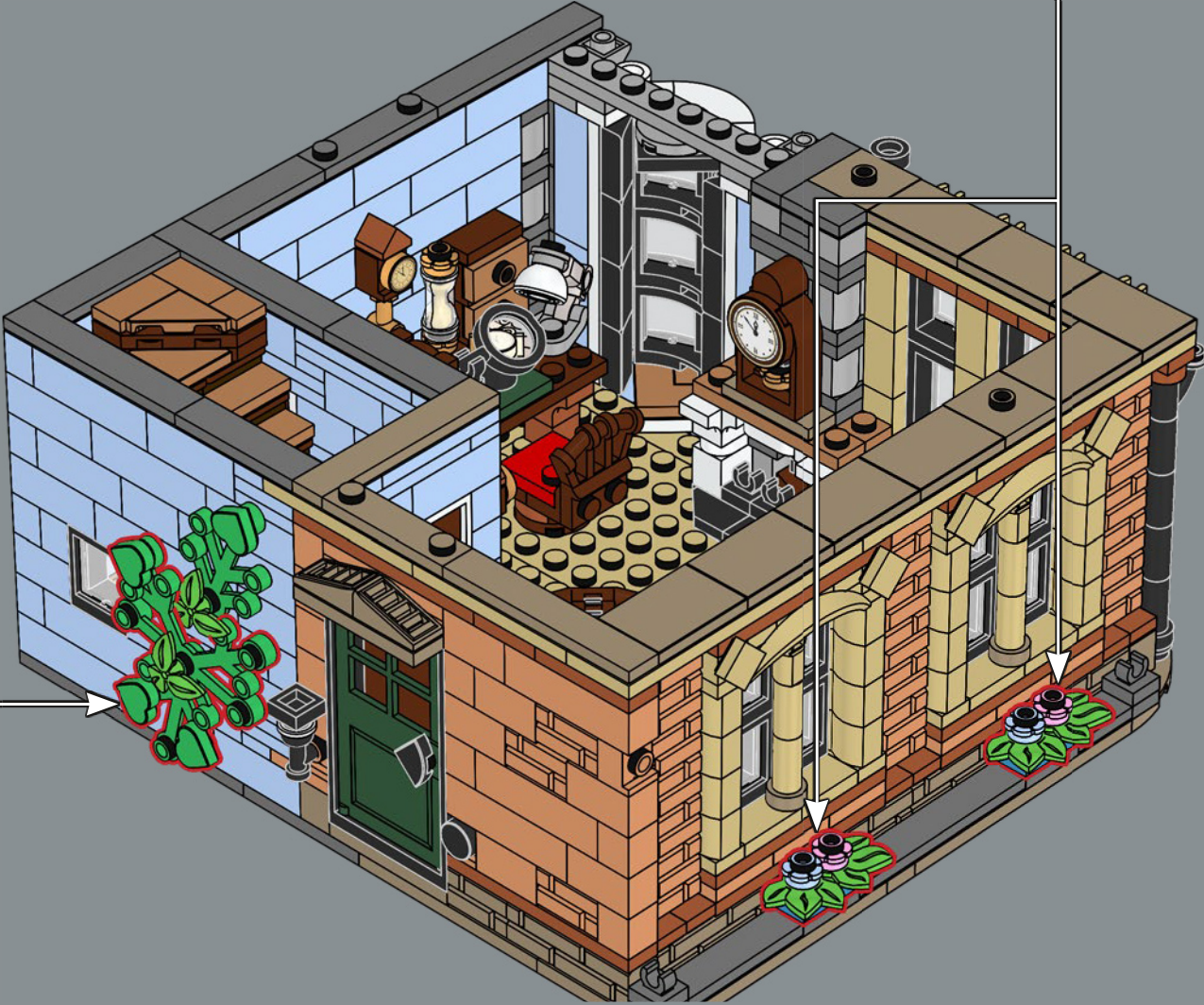
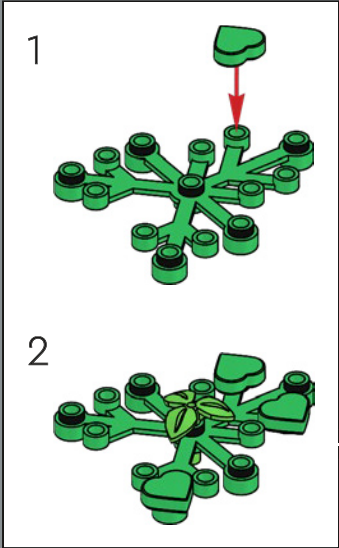
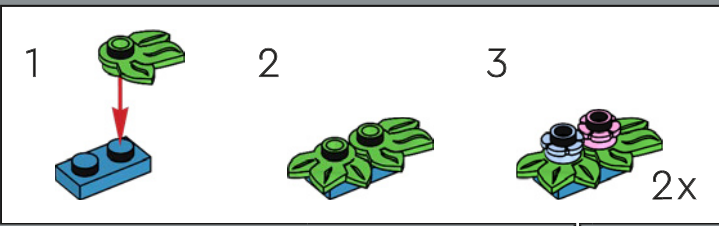

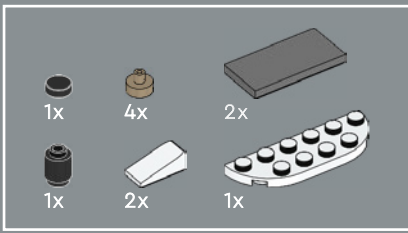

380

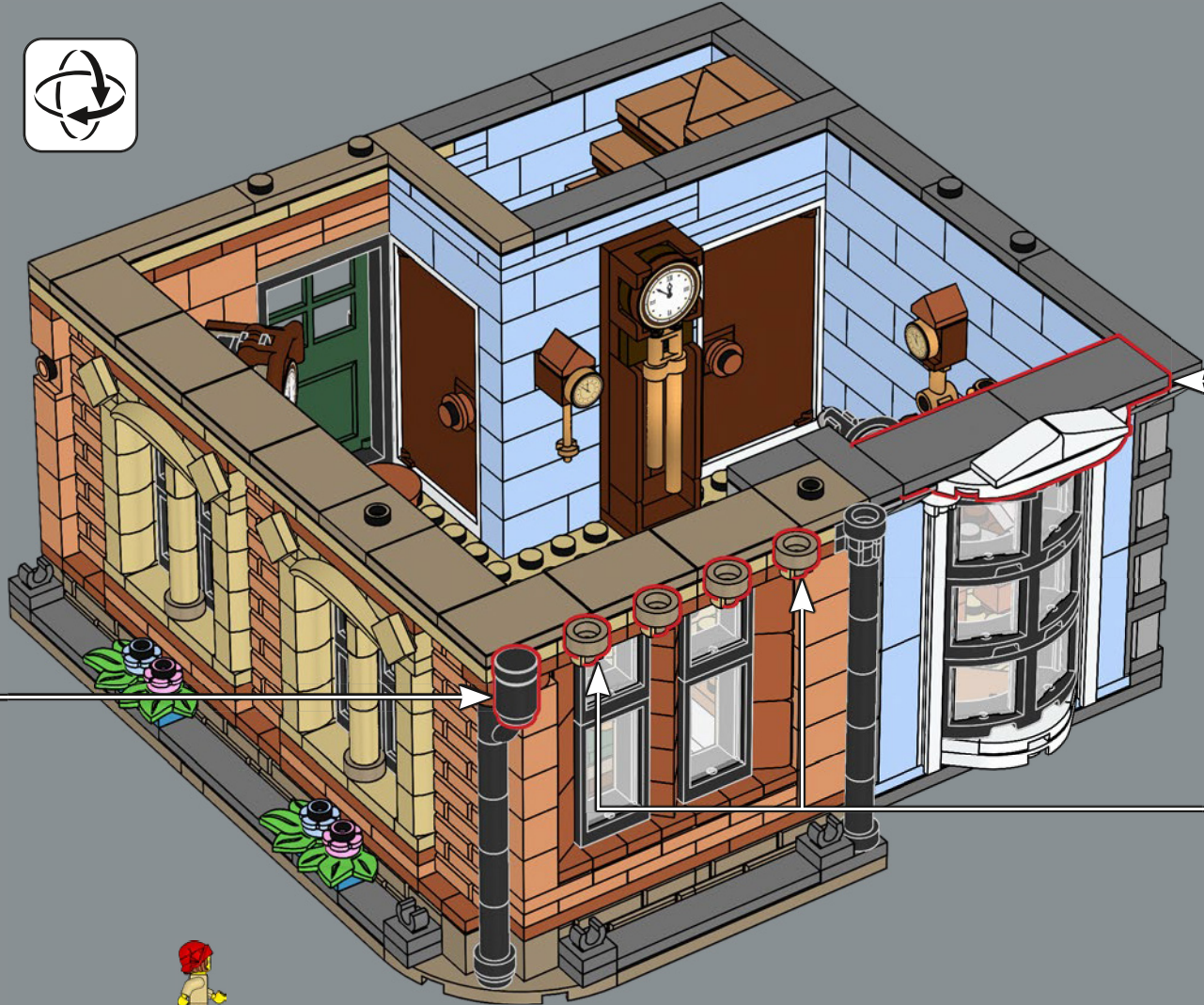
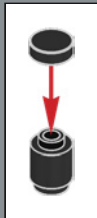
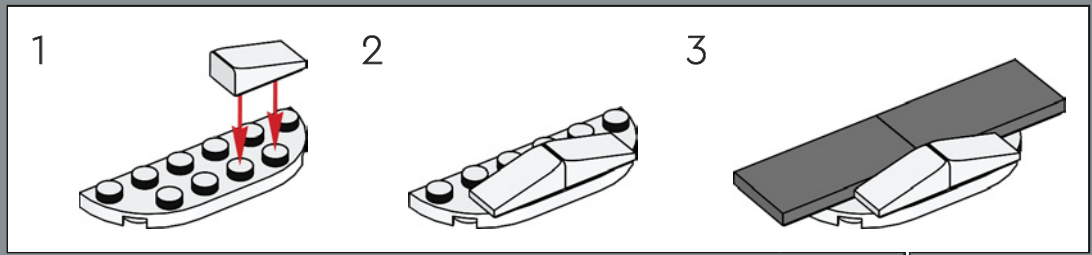





381

1

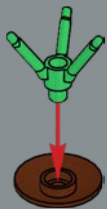

2



3

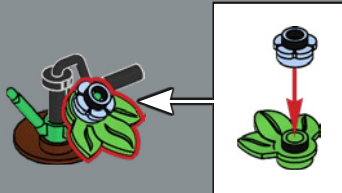

4

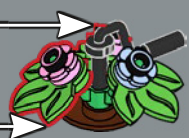
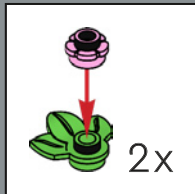

4x





382





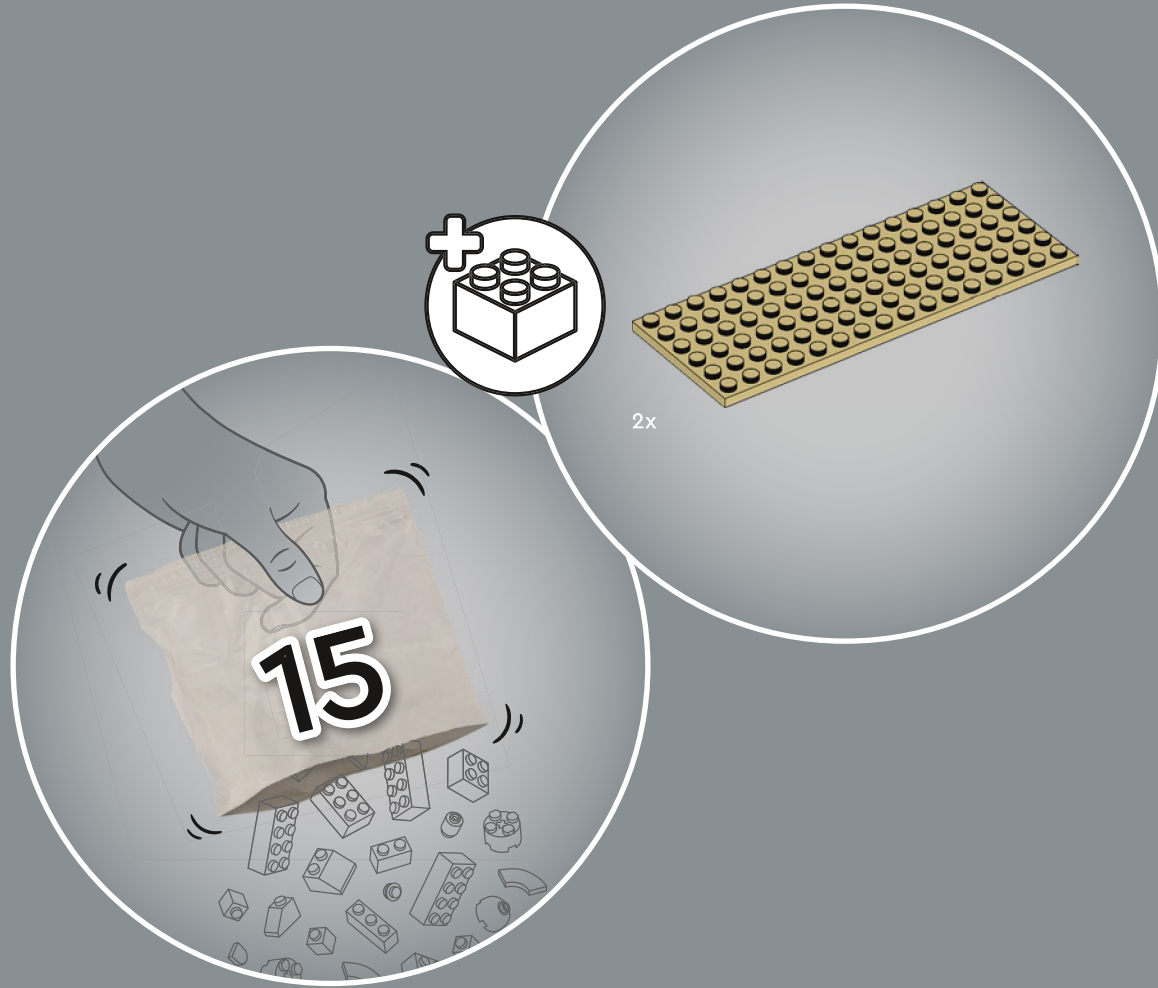

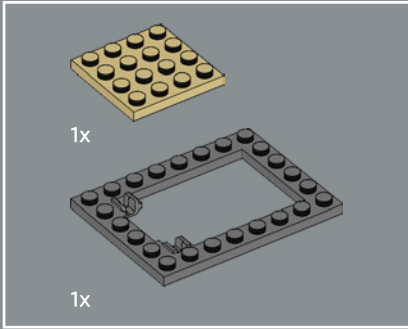
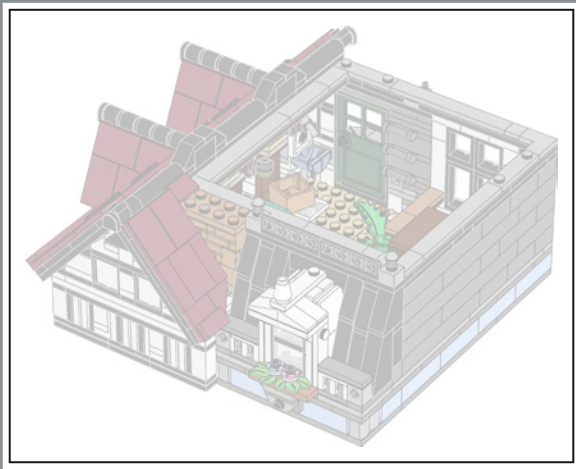

383

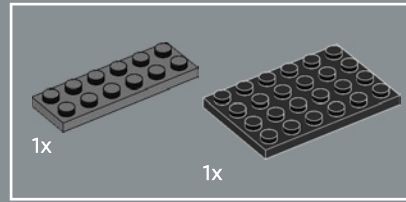
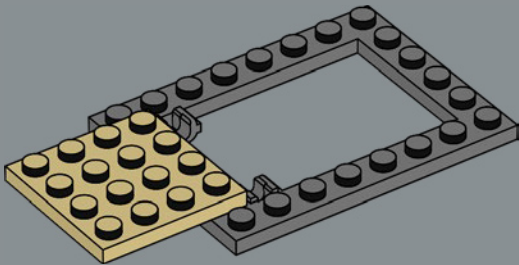

384

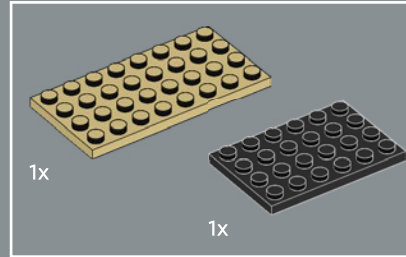
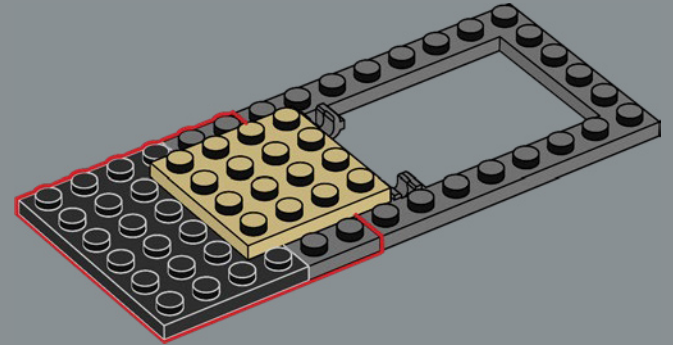

385

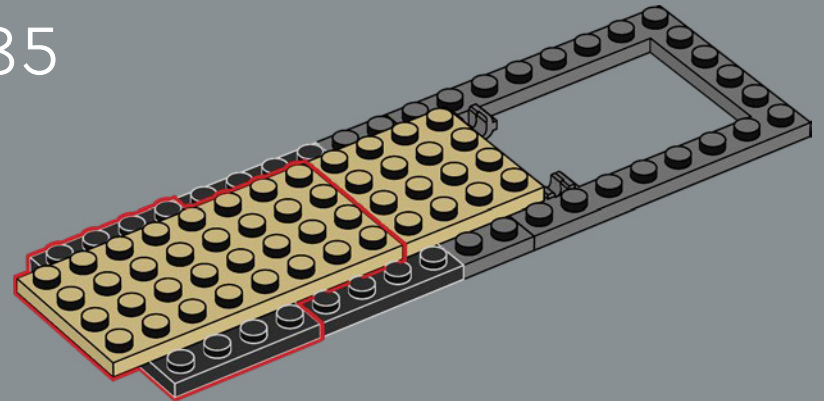



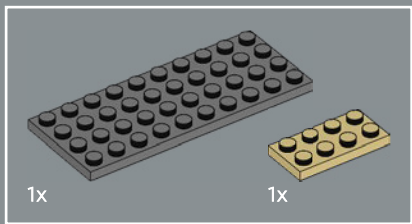

386

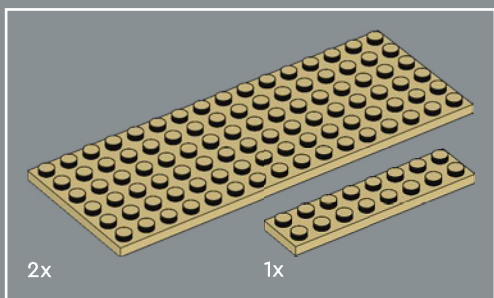
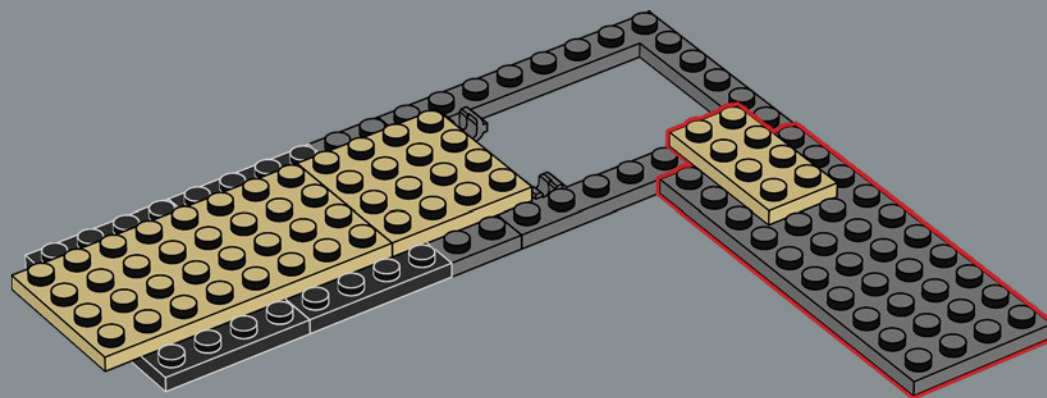

387

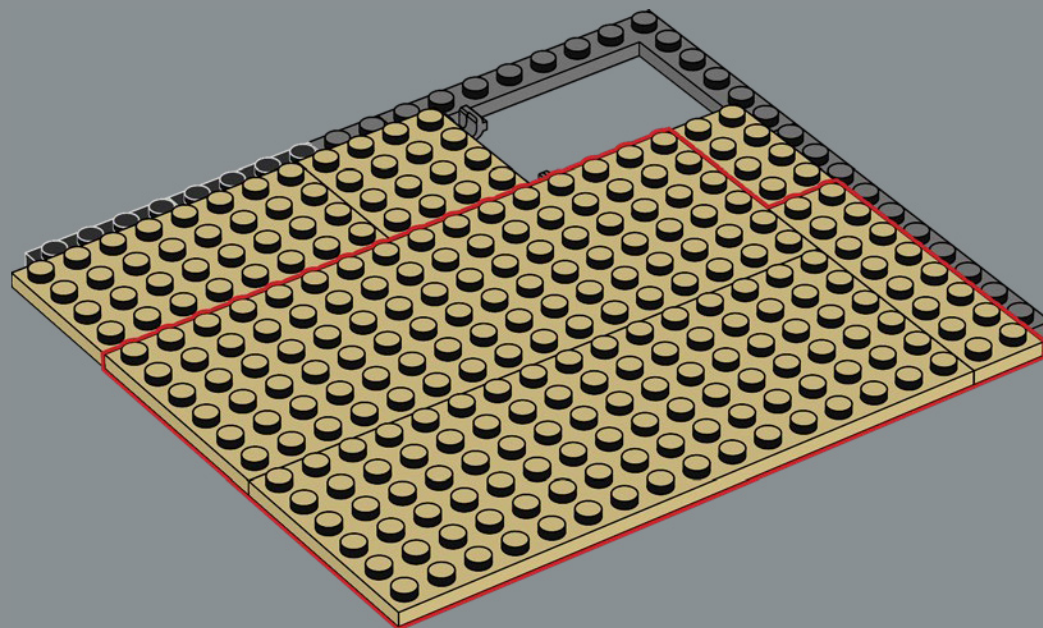

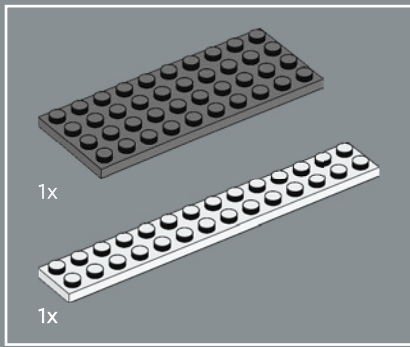

388

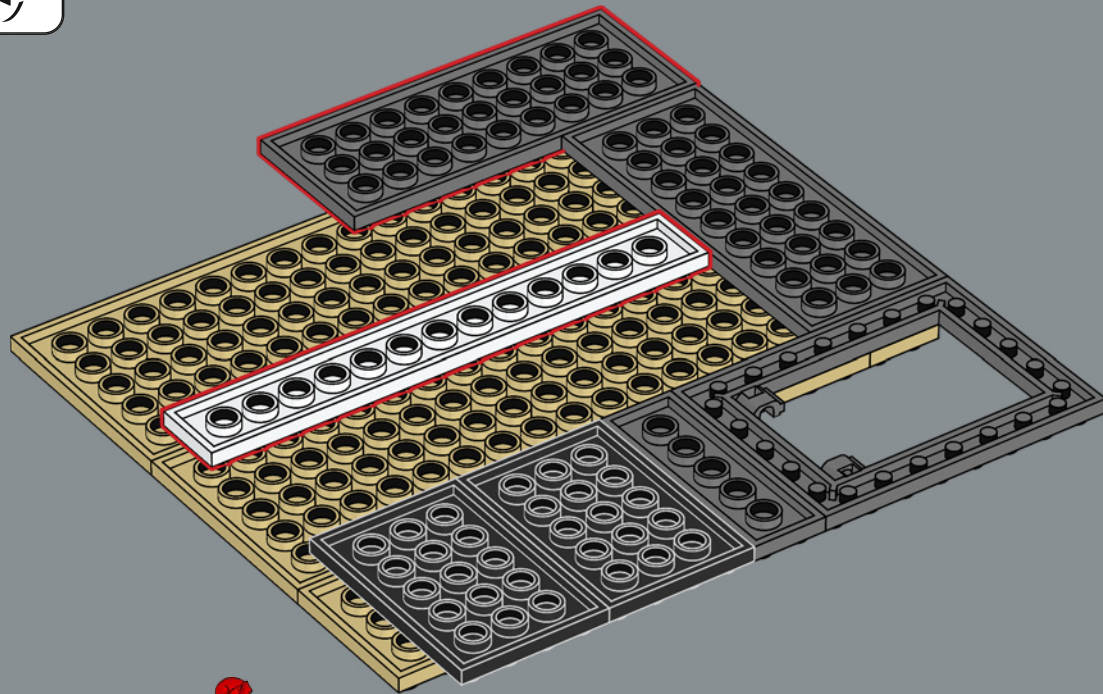



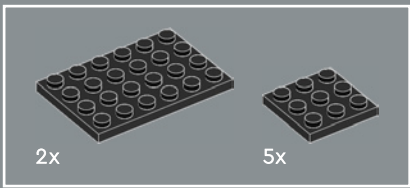

389

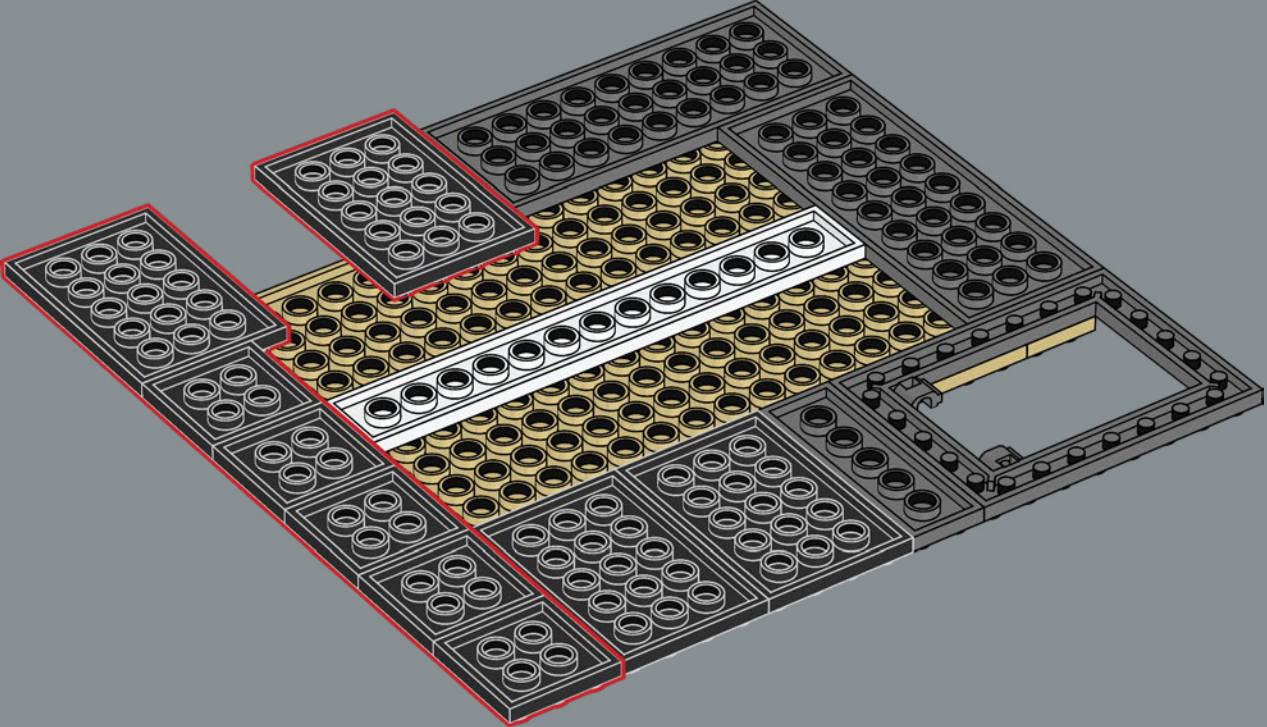

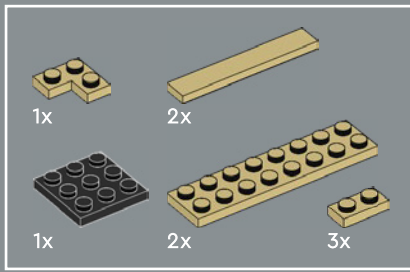

390

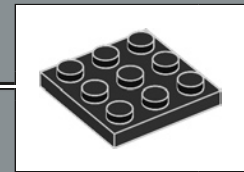
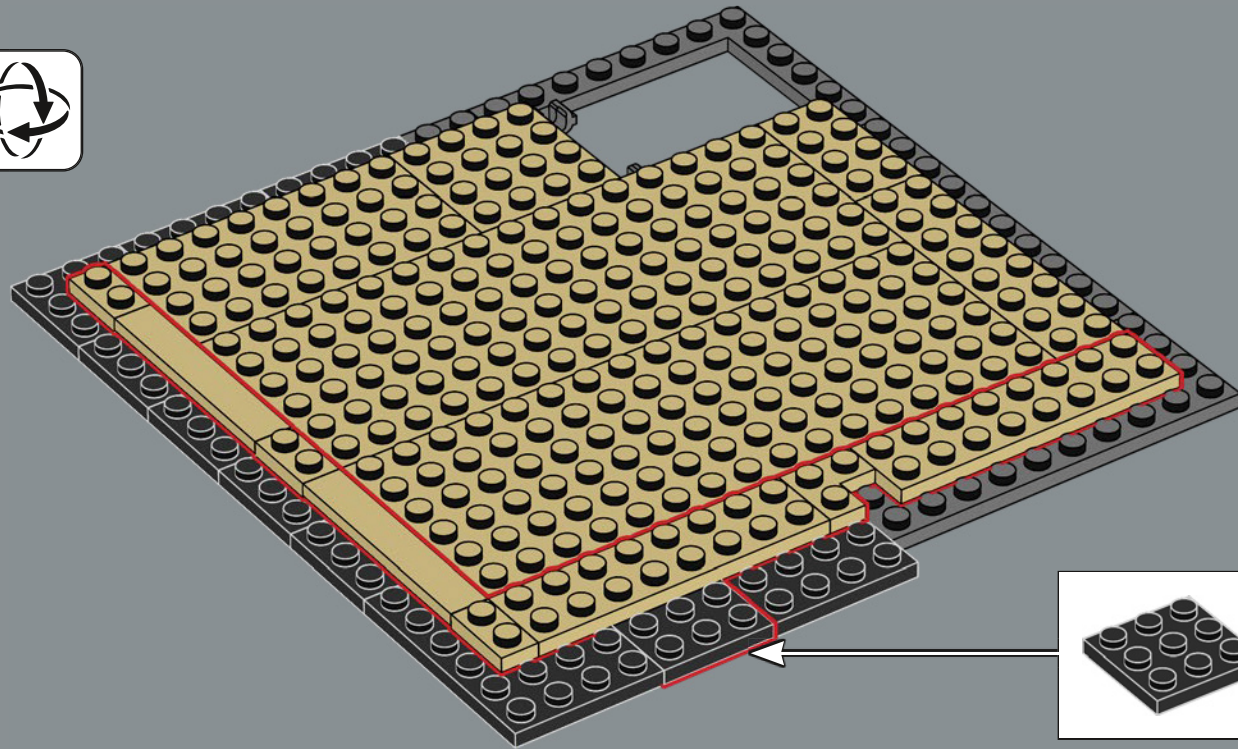



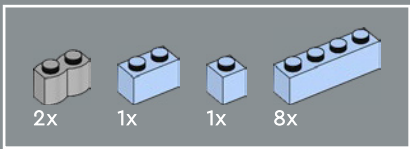

391

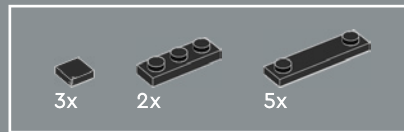
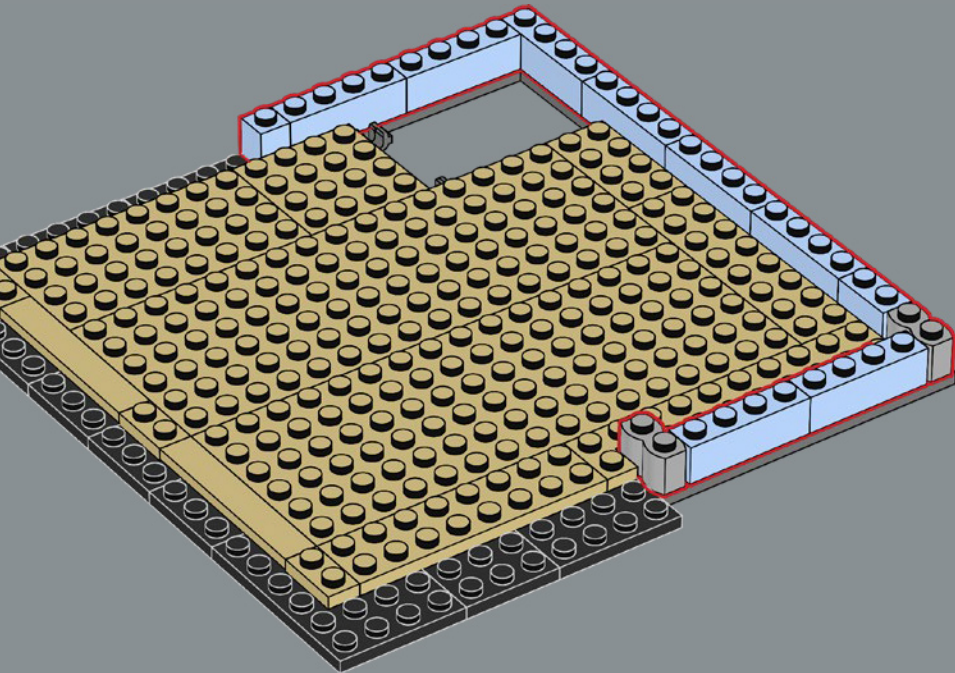

392

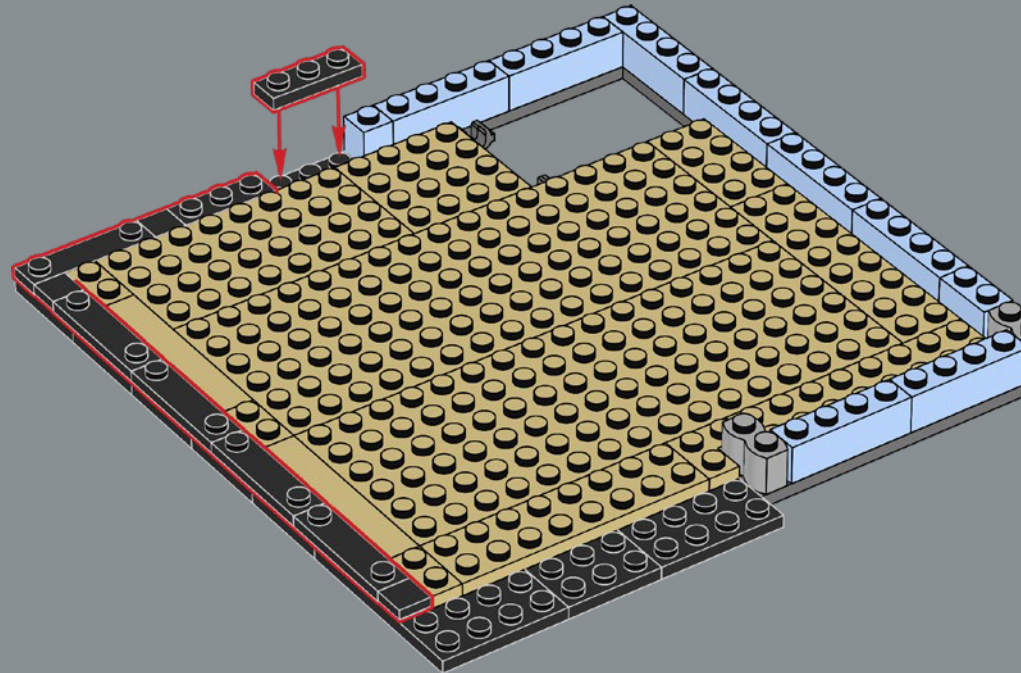

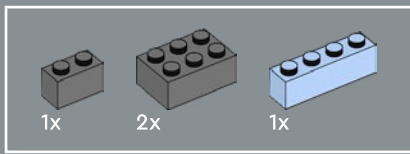

393

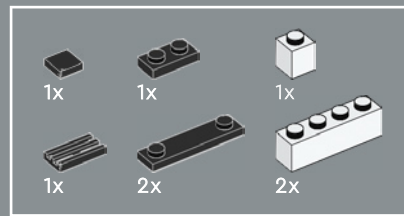
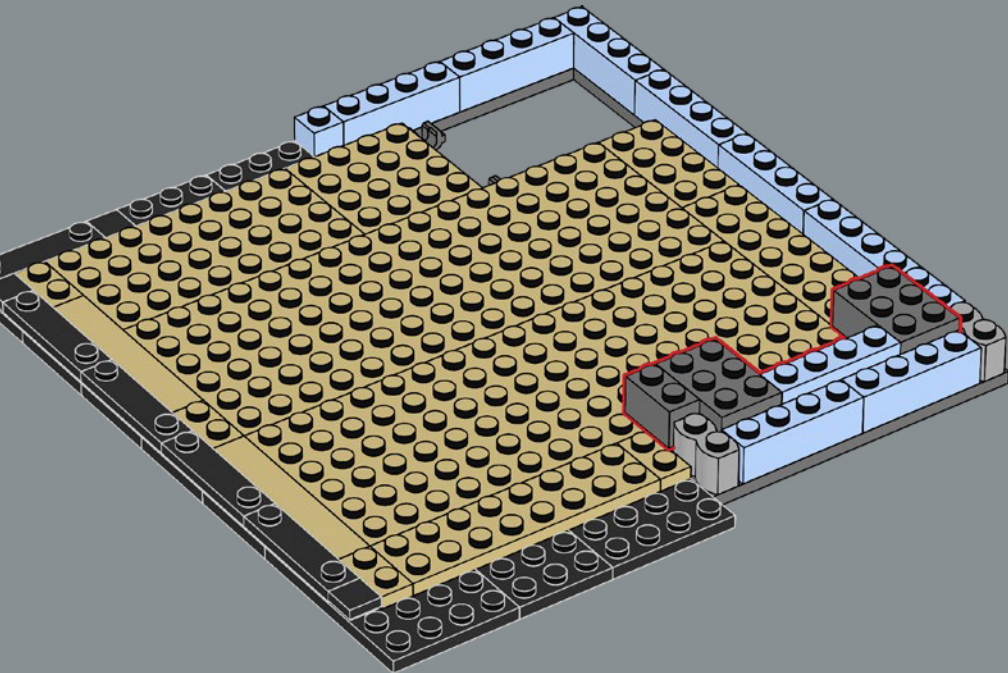

394

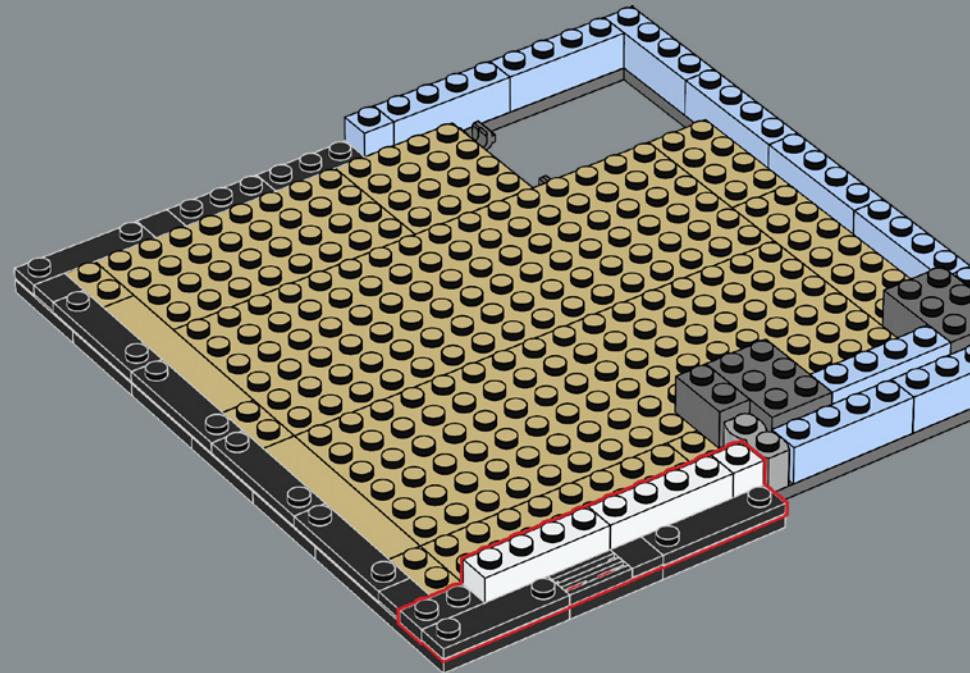



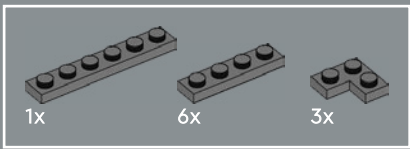

395

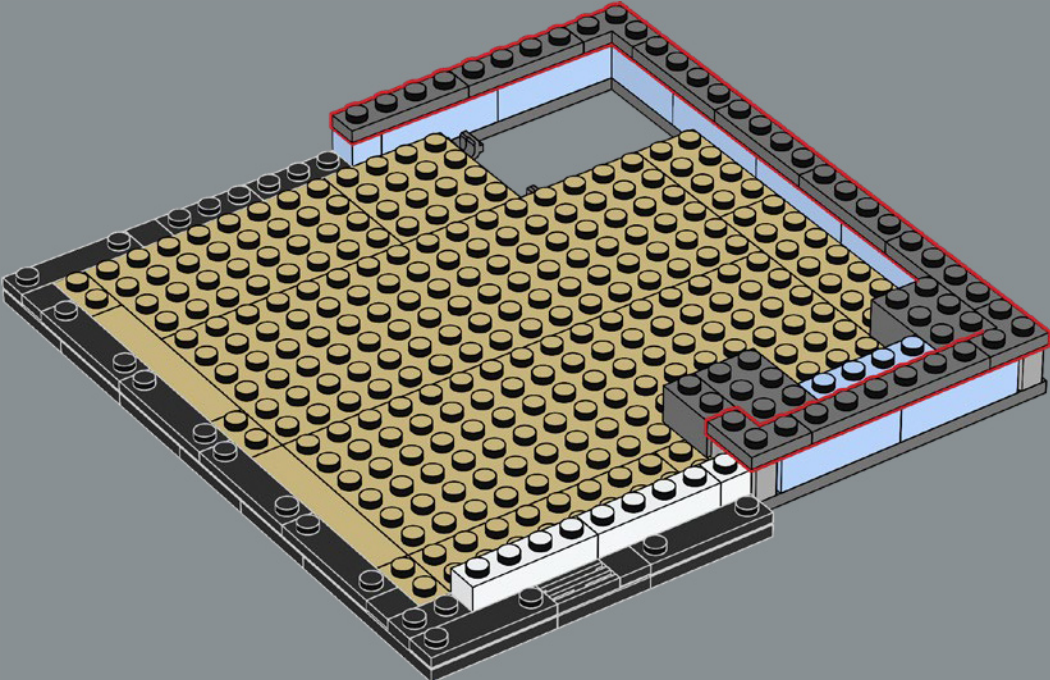

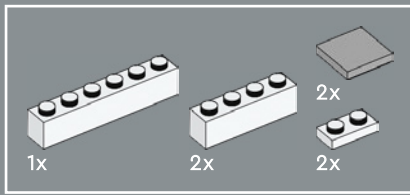

396

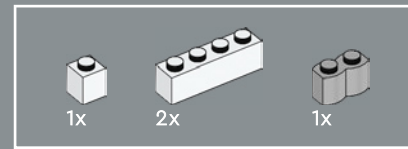
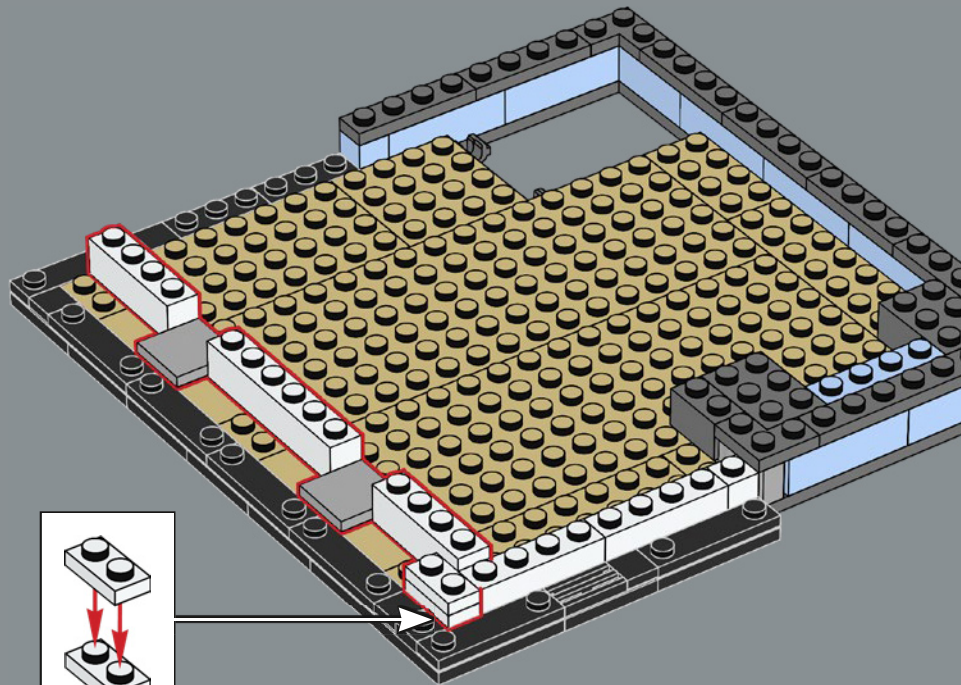

397

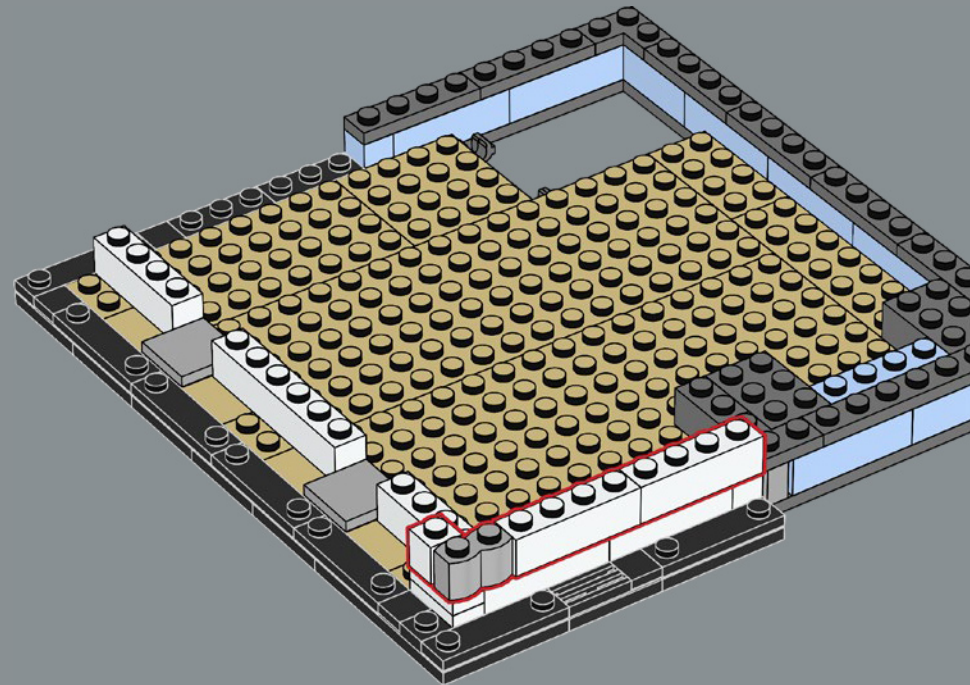



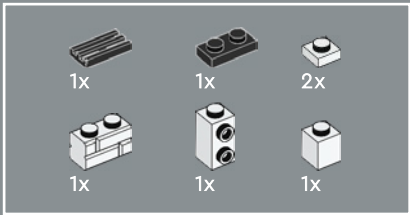

398

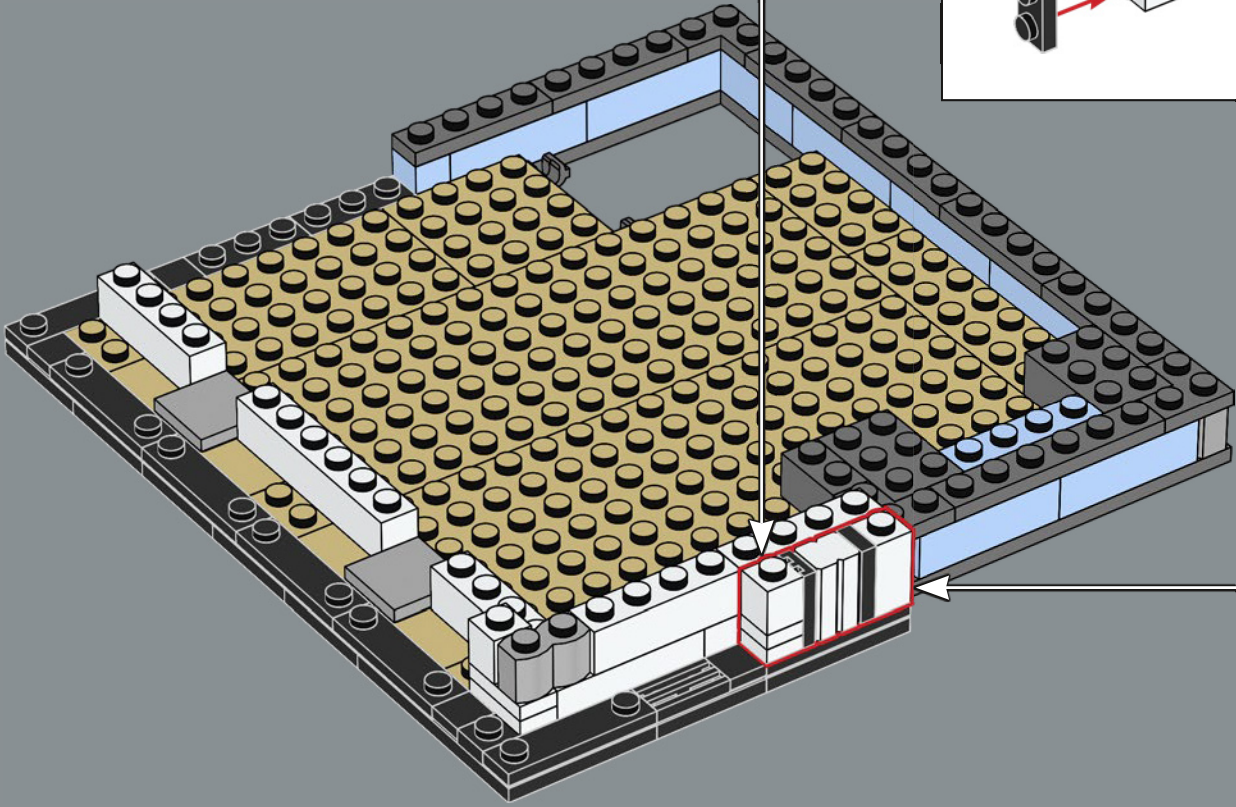
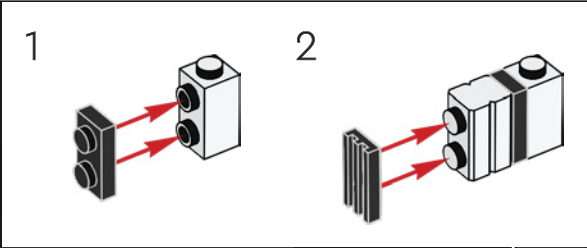
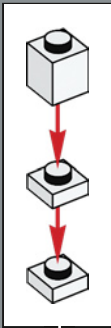

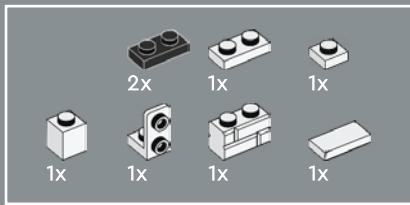

399

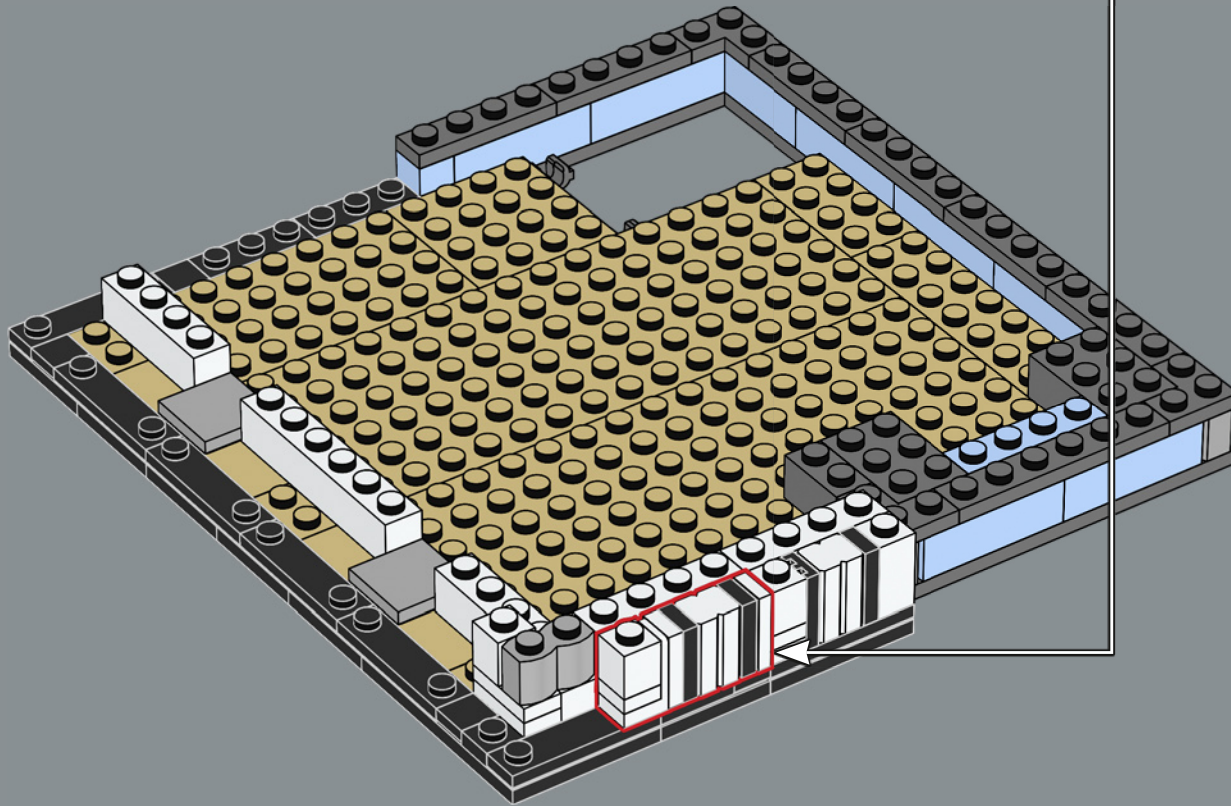
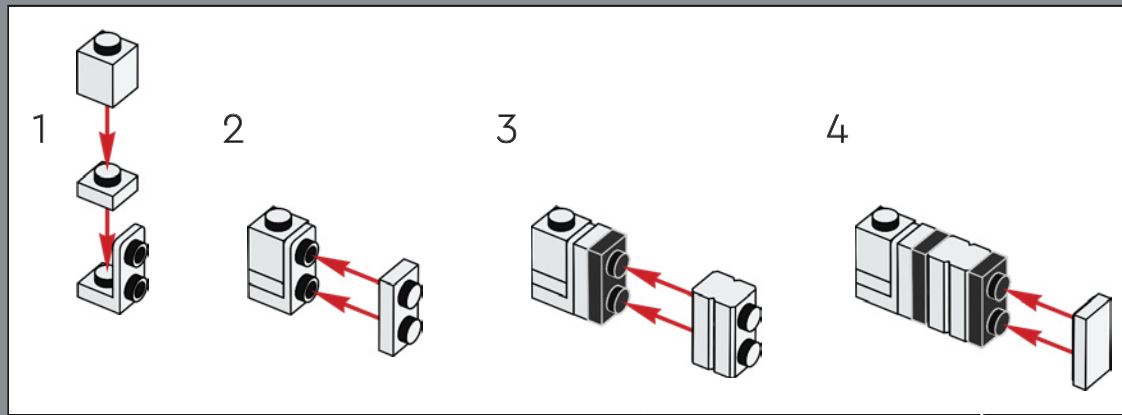



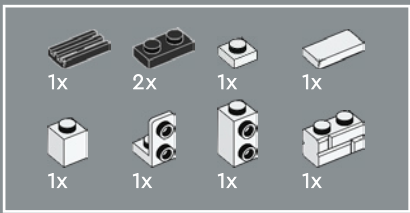

400

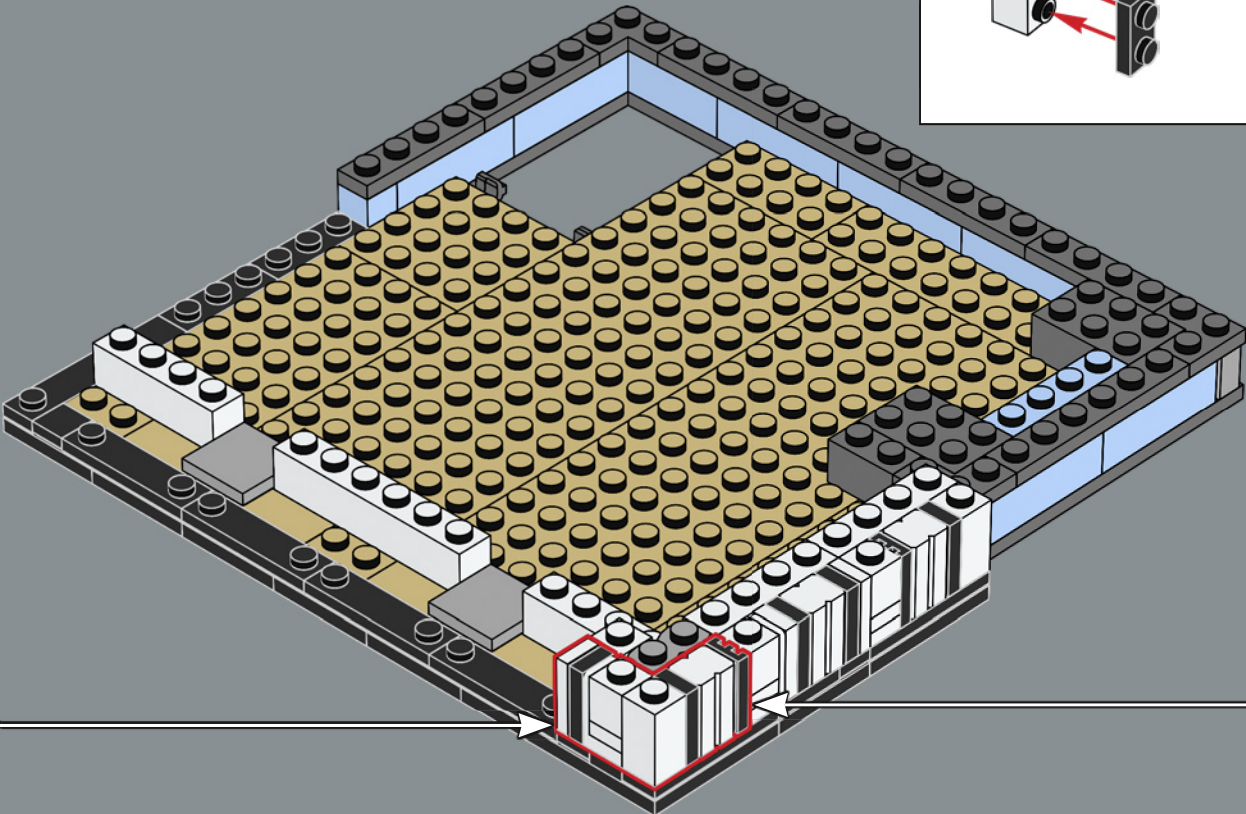
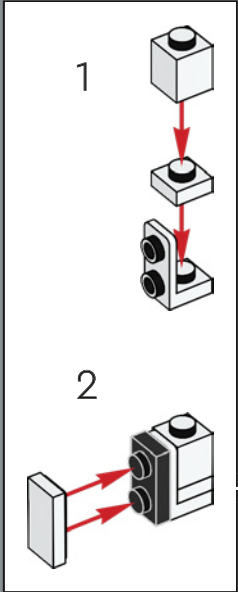
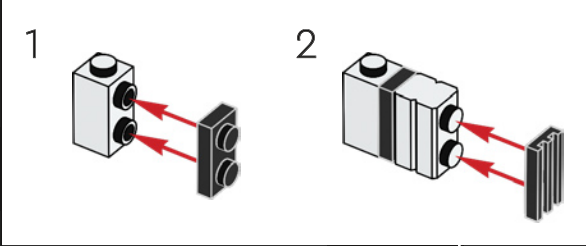

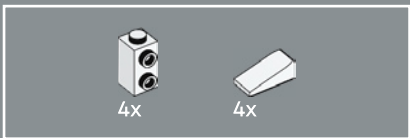

401

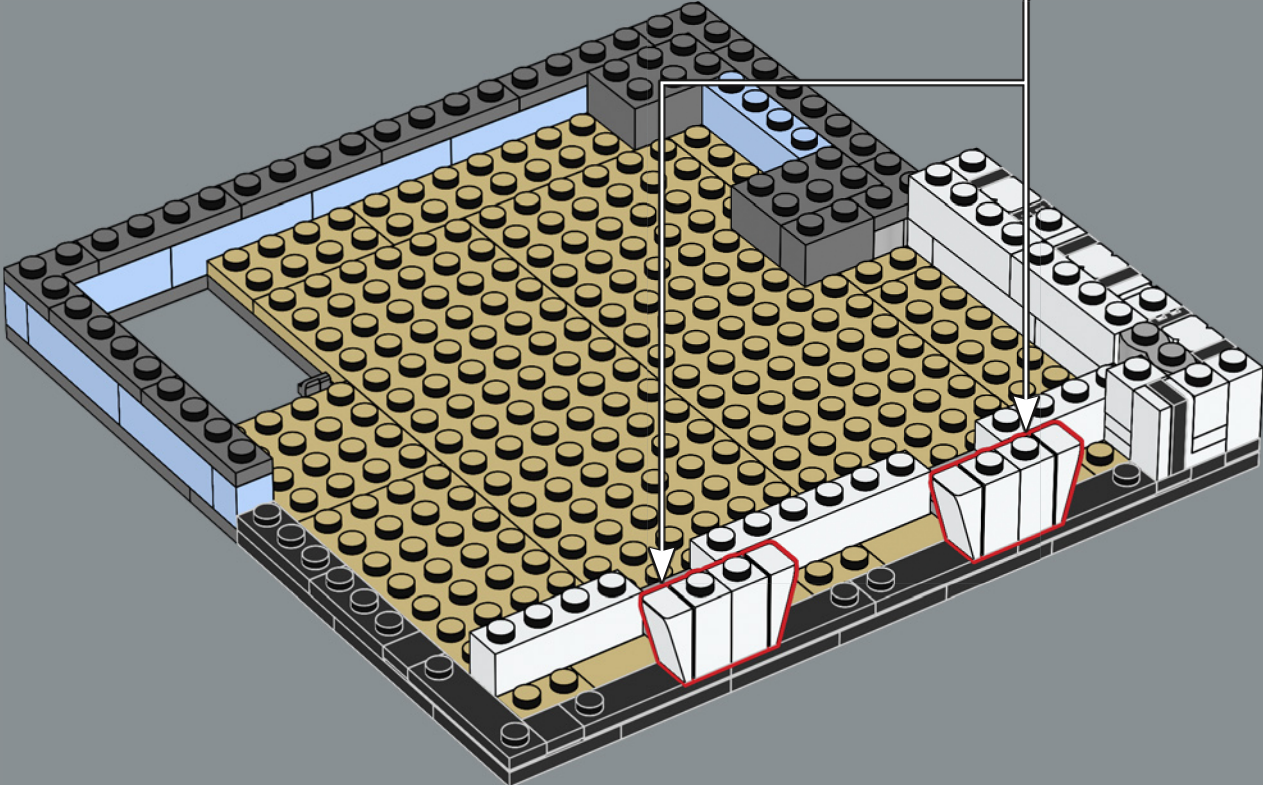
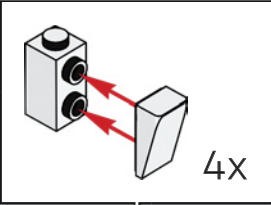





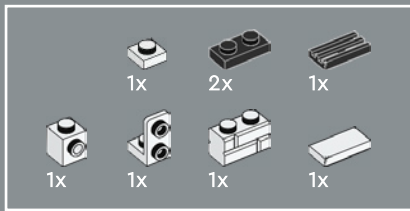

403

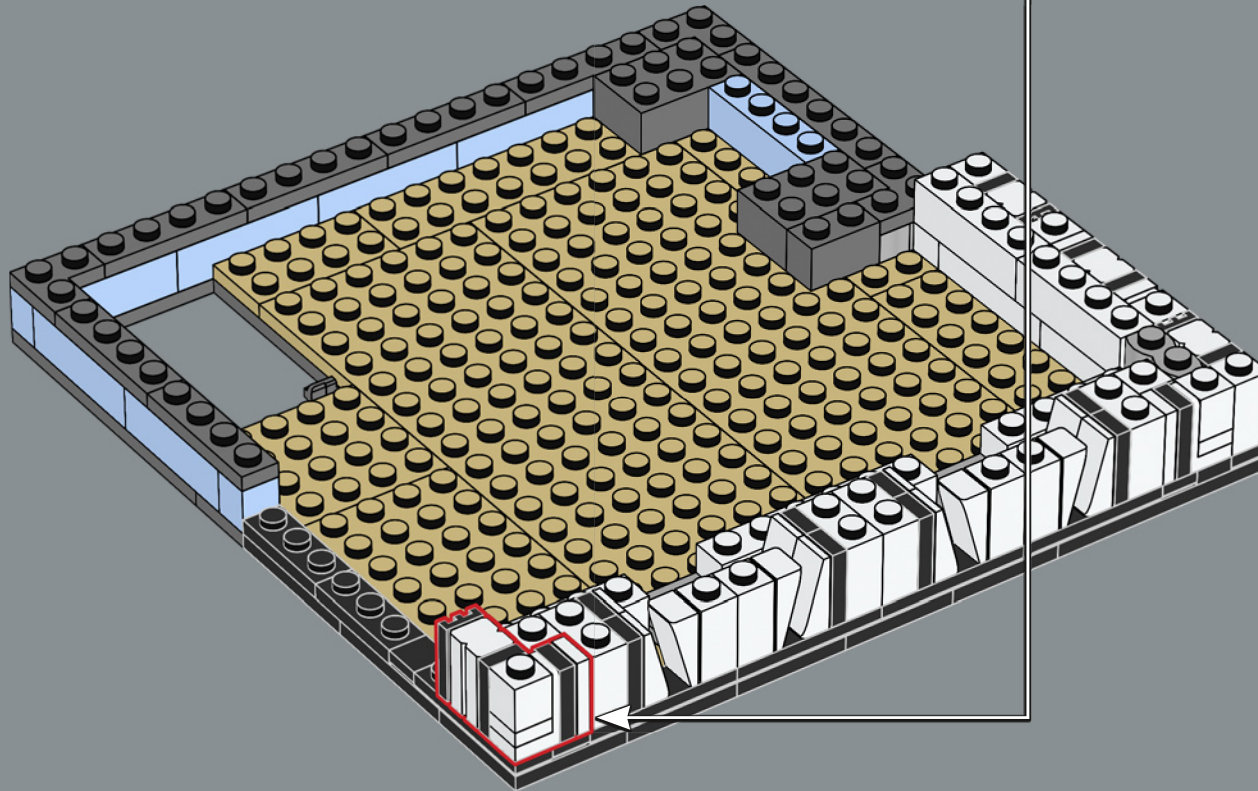
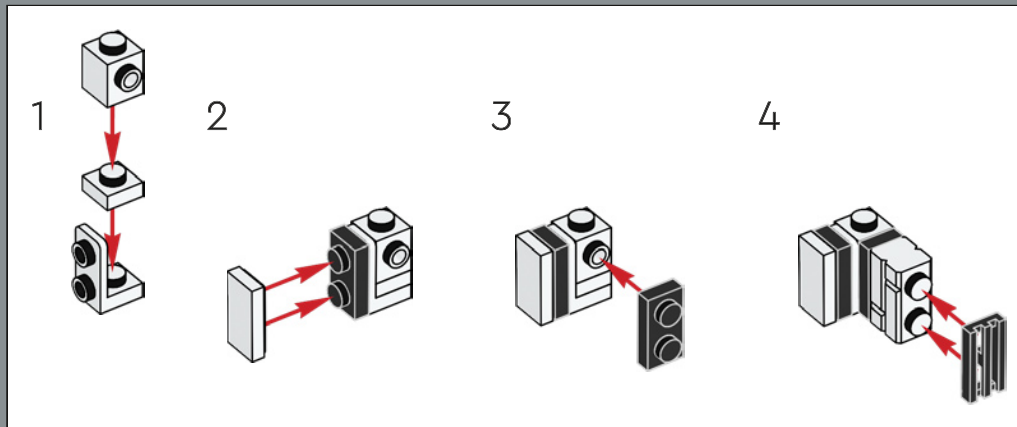



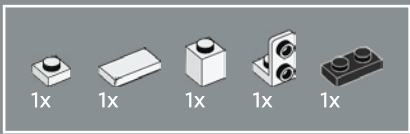

404

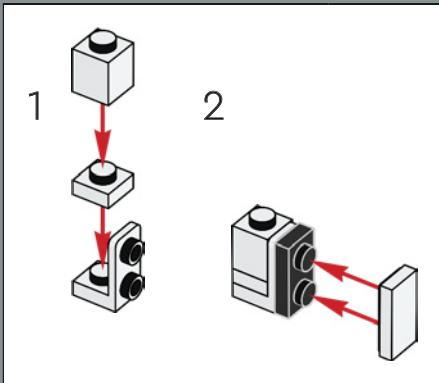
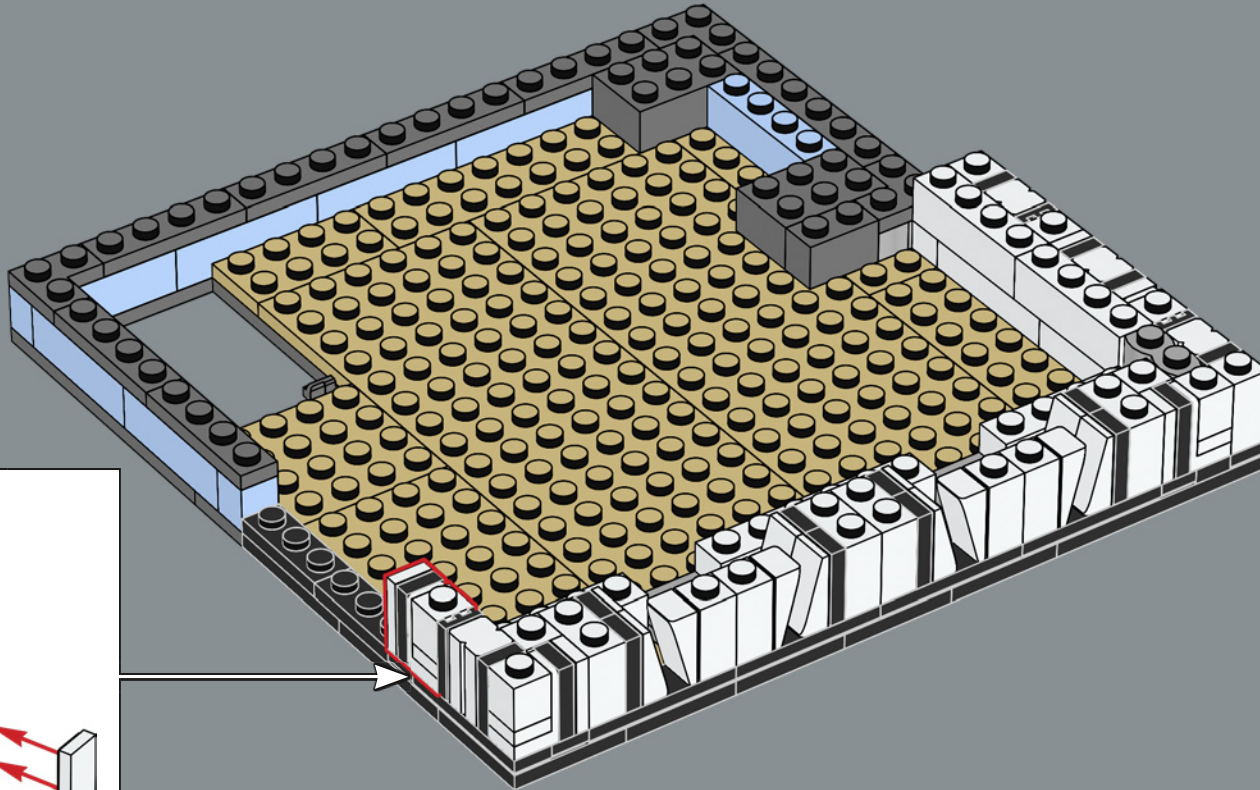

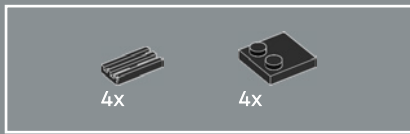

405

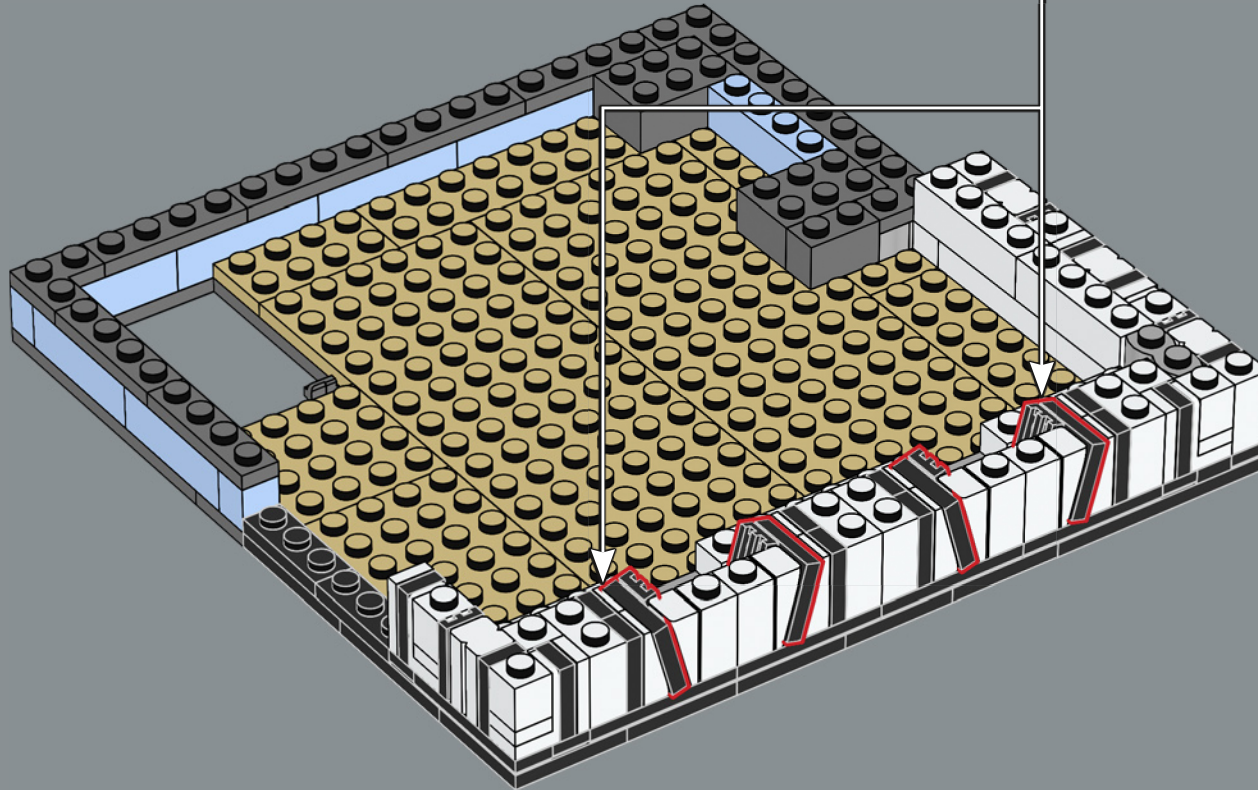
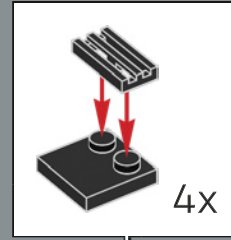



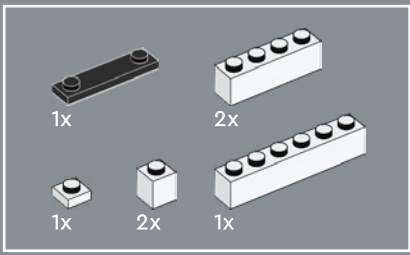

406

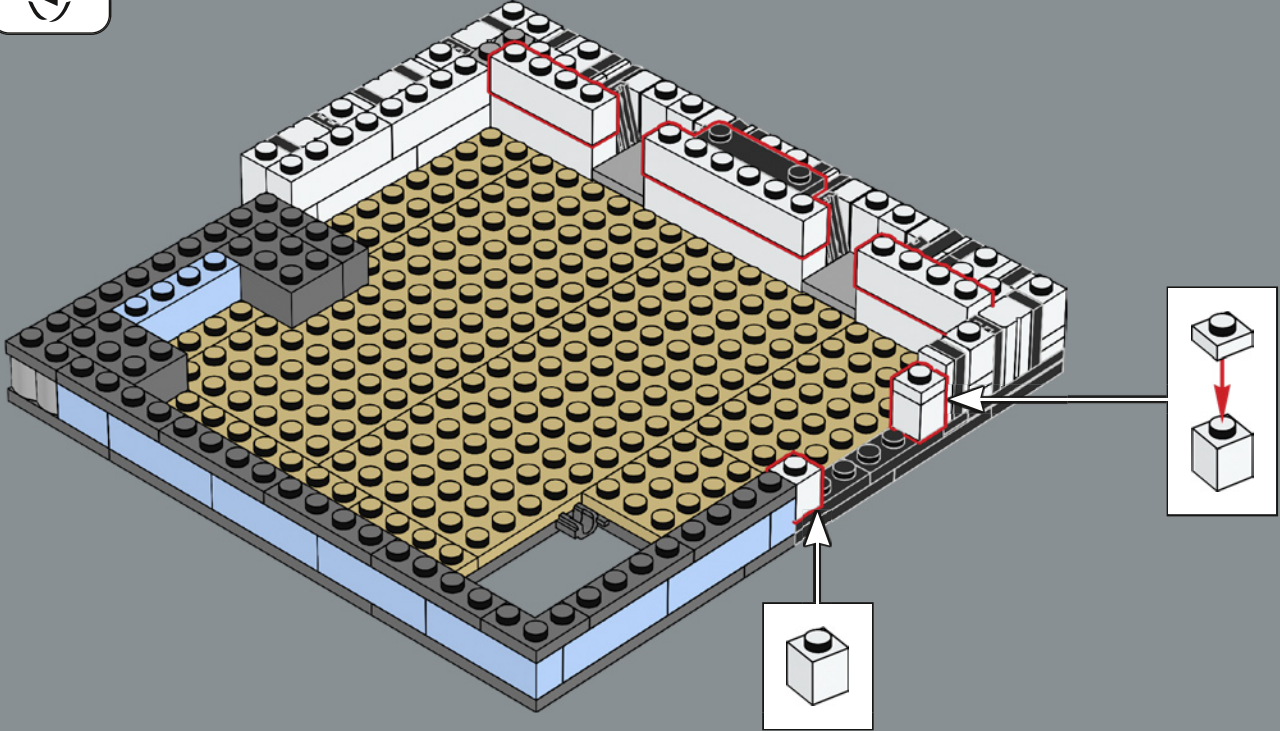

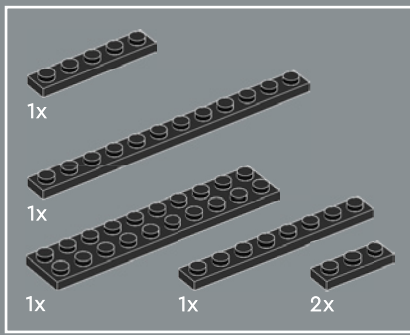

407

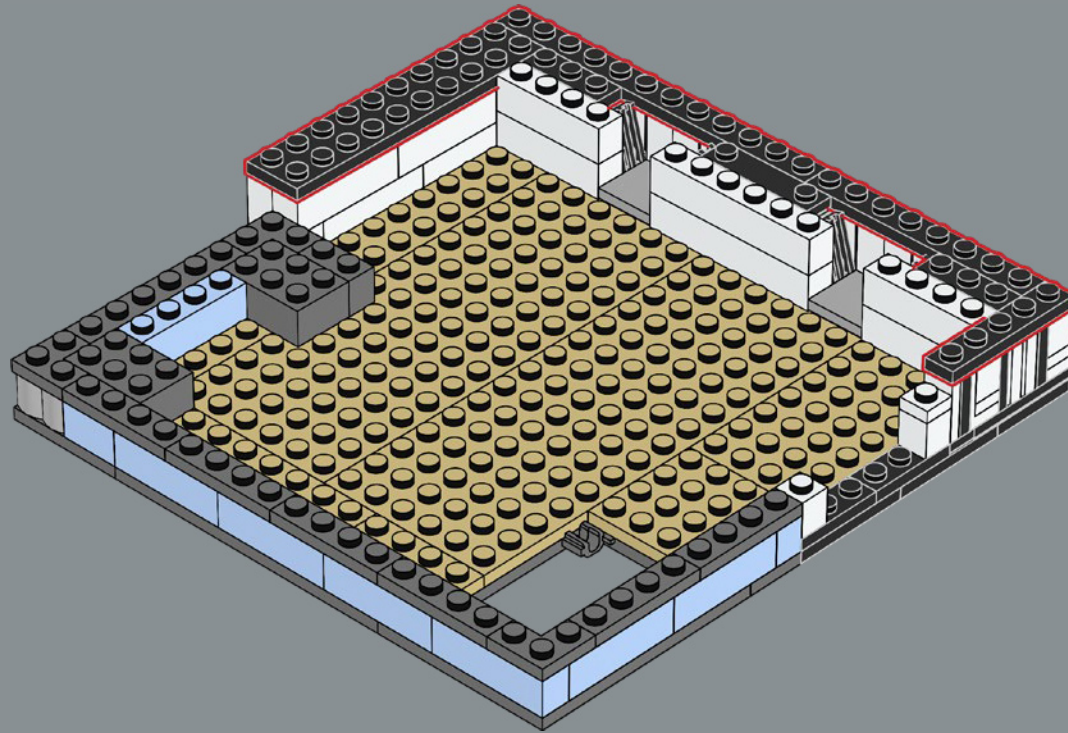



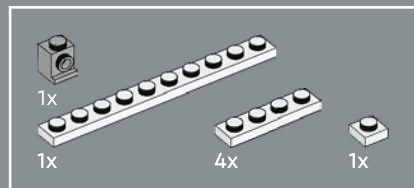

408

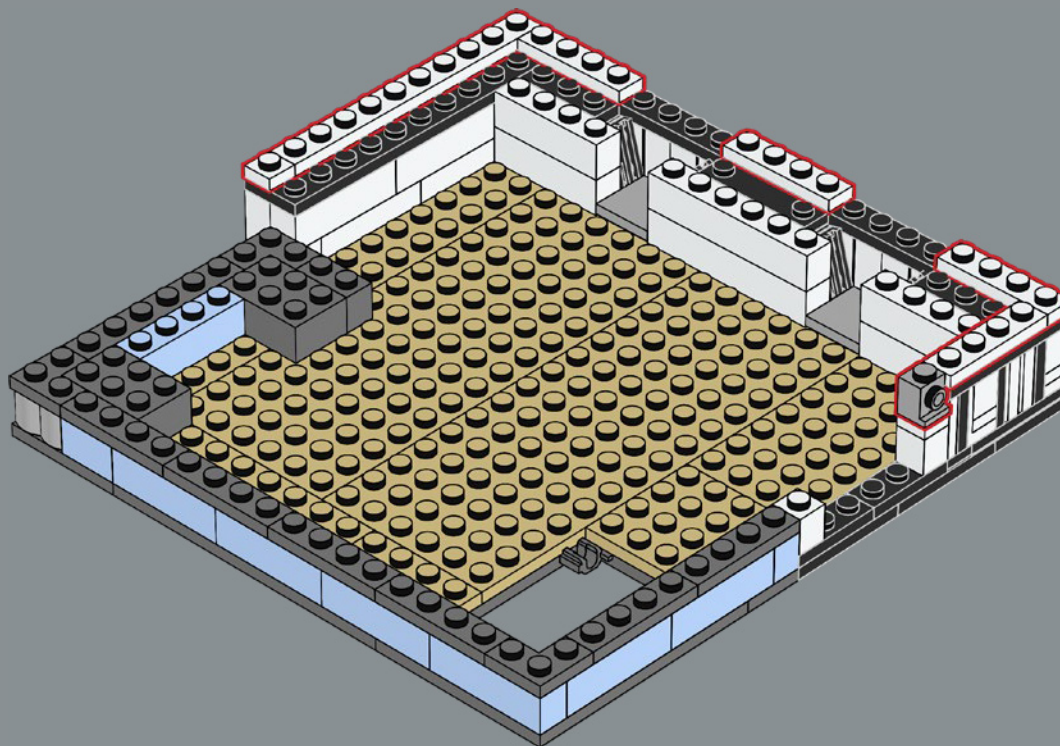

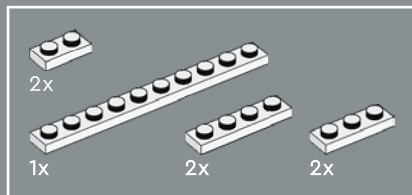

409

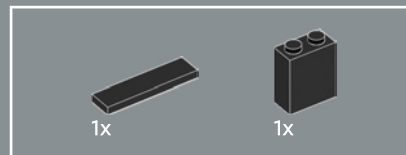
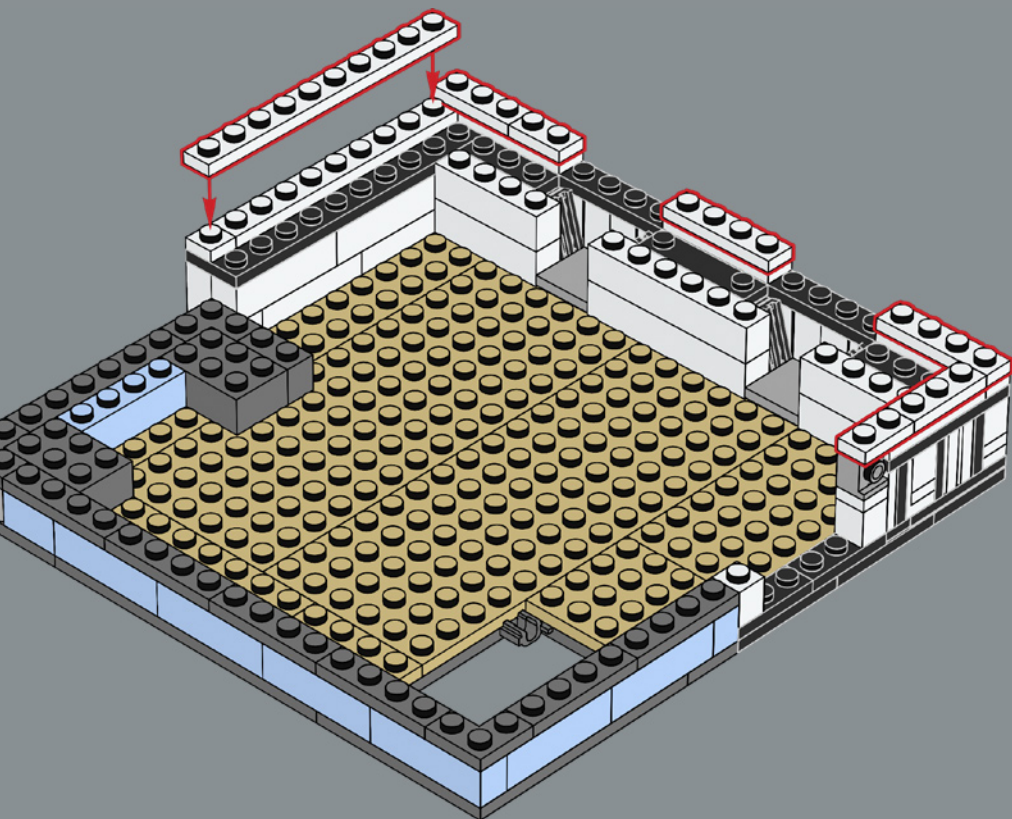

410

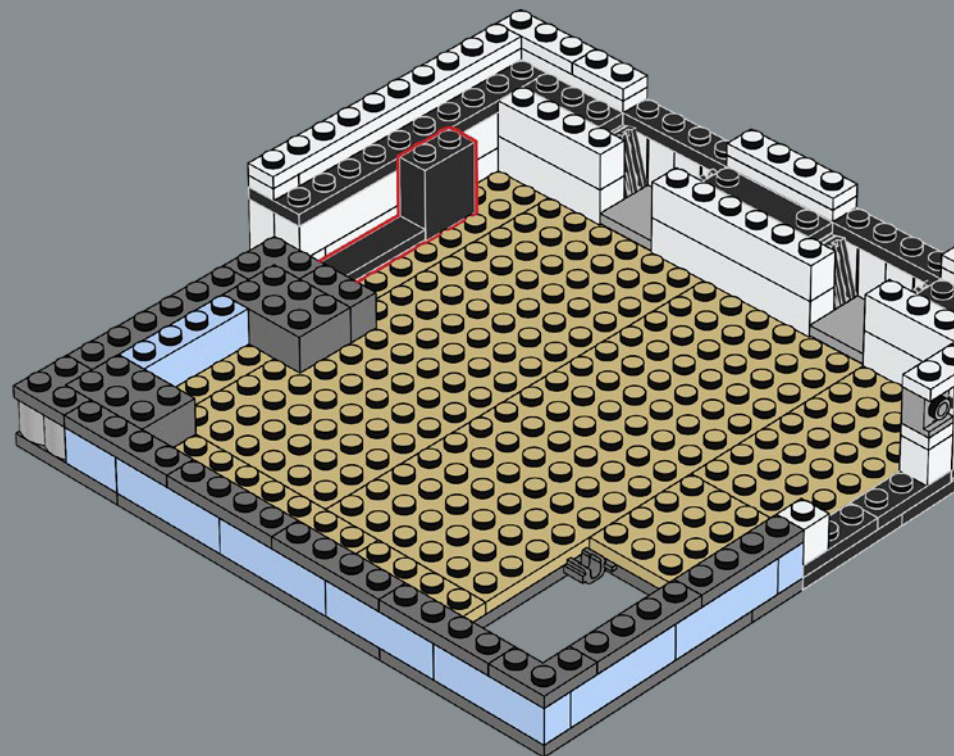



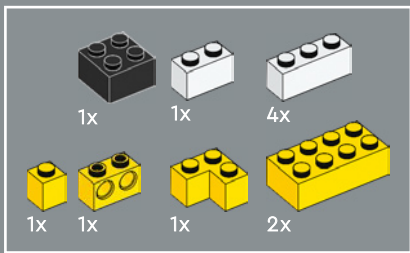

411

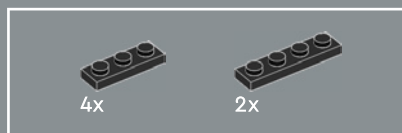
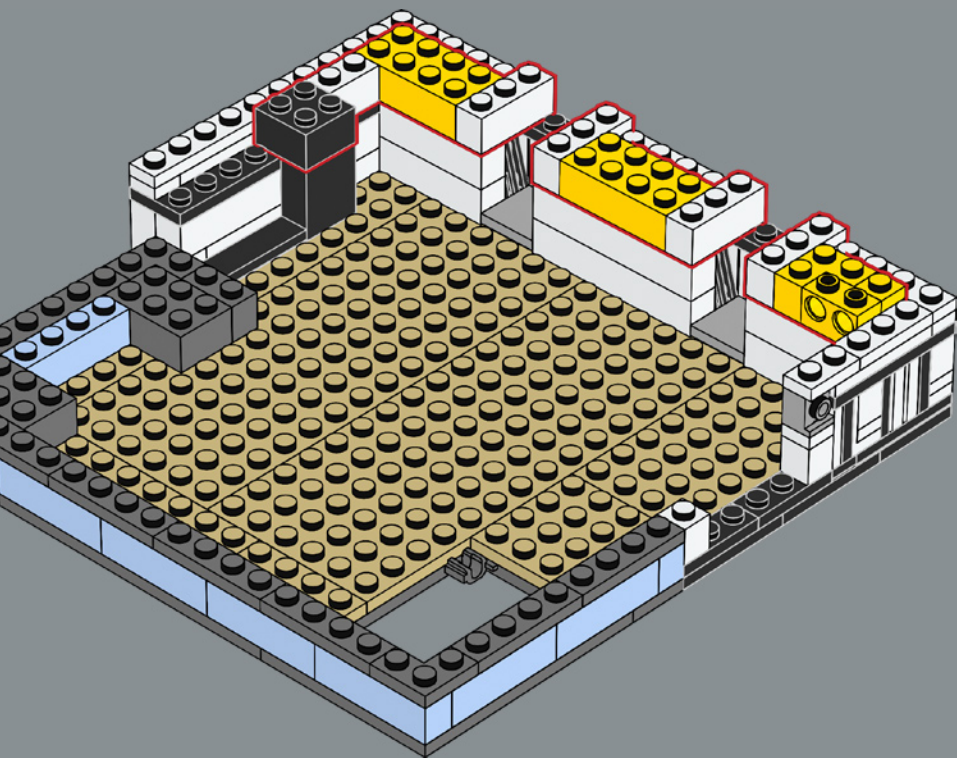

412

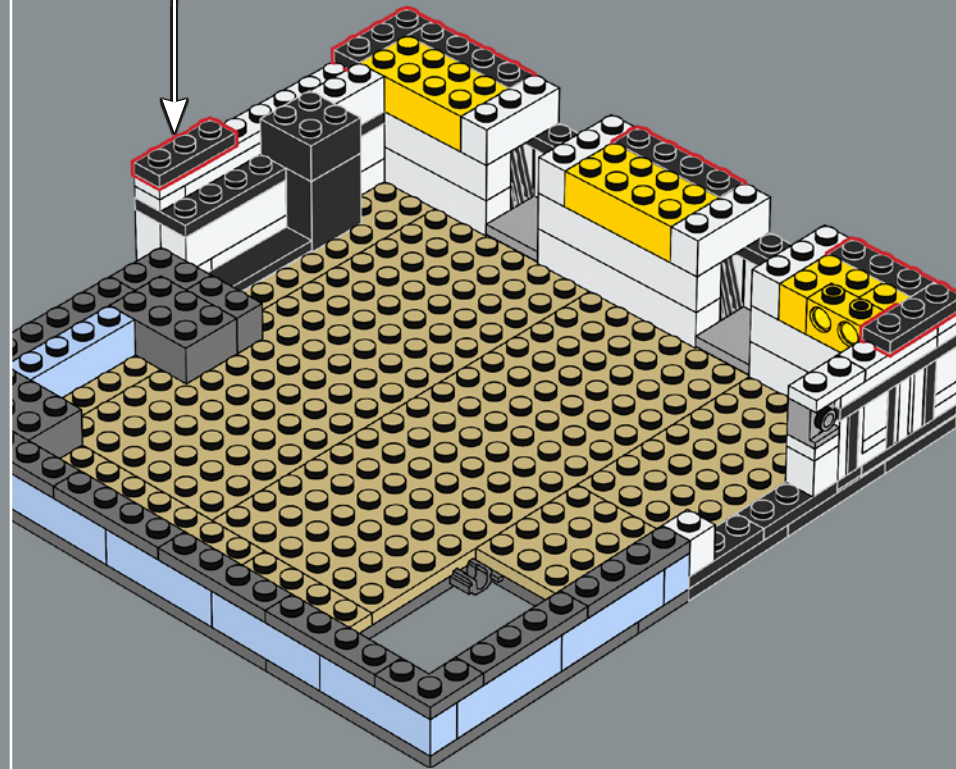
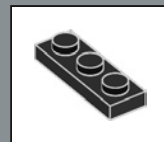

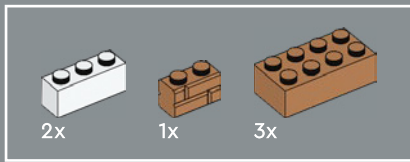

413

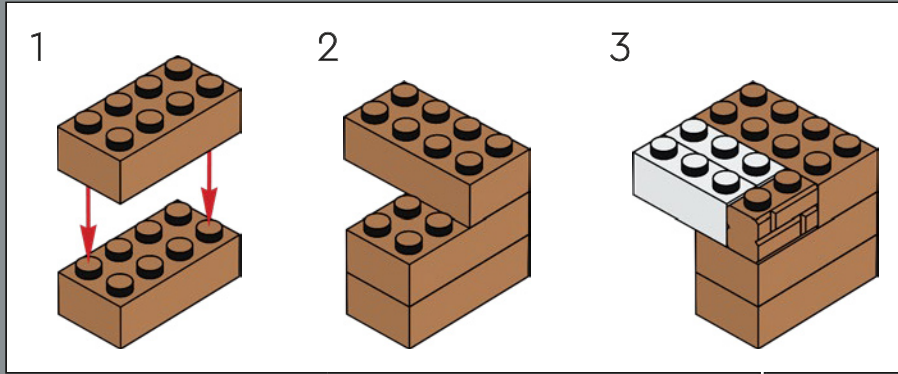

414

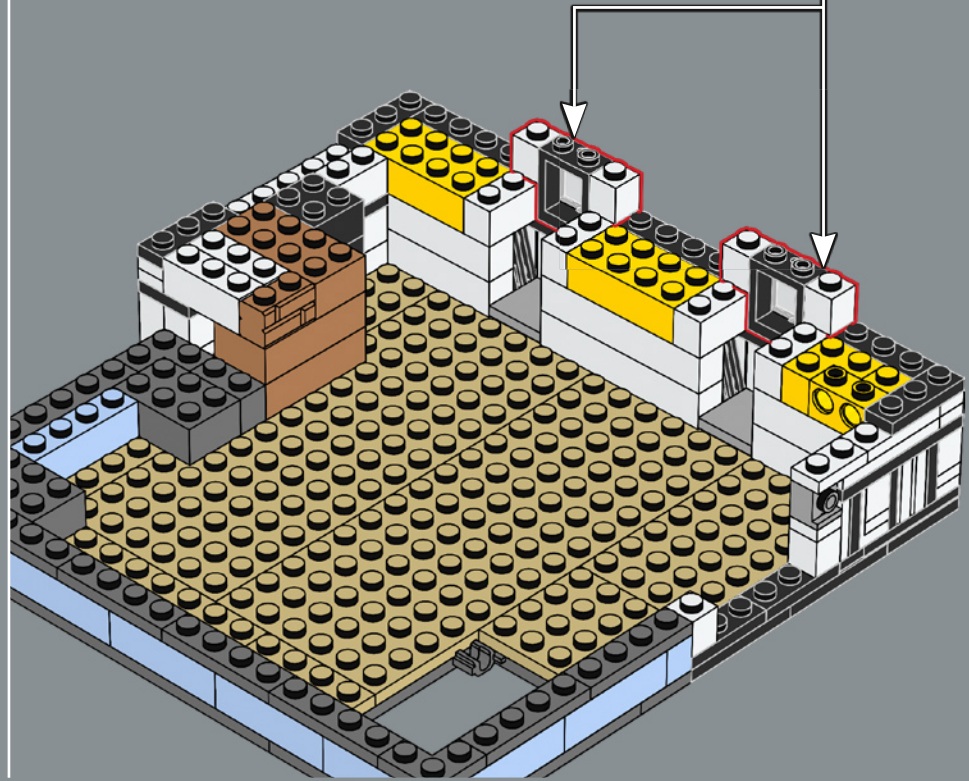
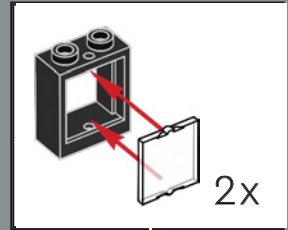



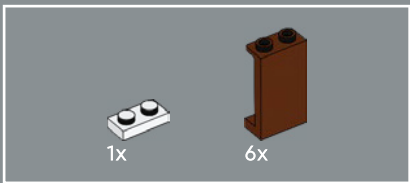

415

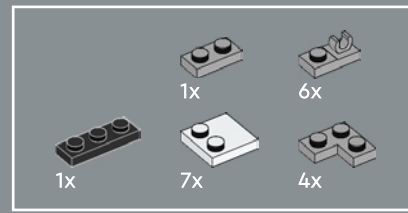
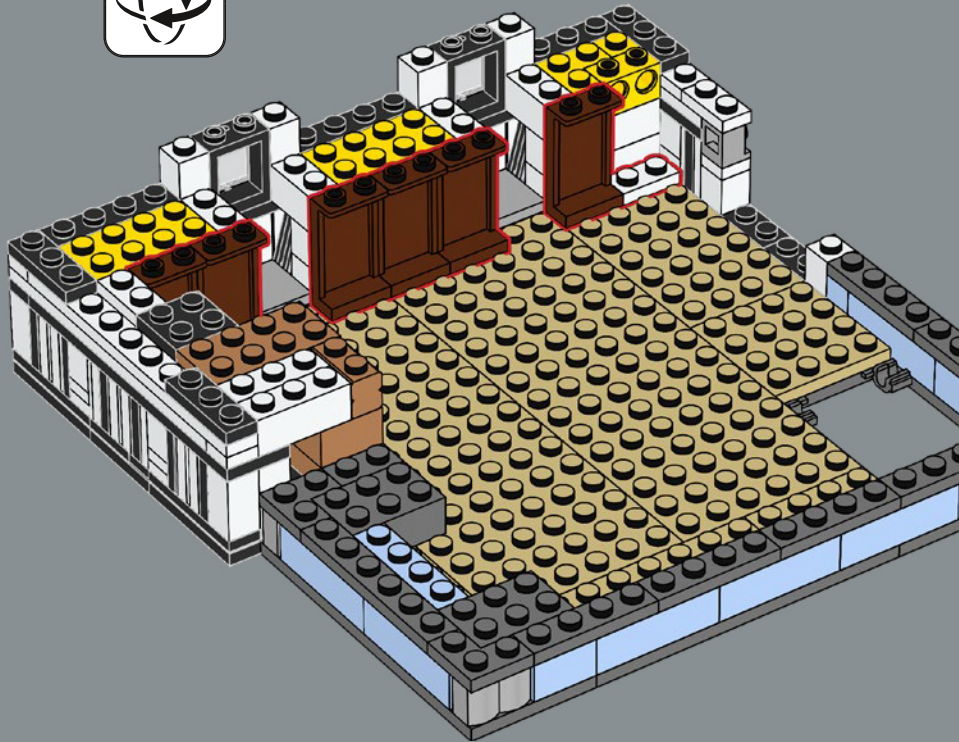

416

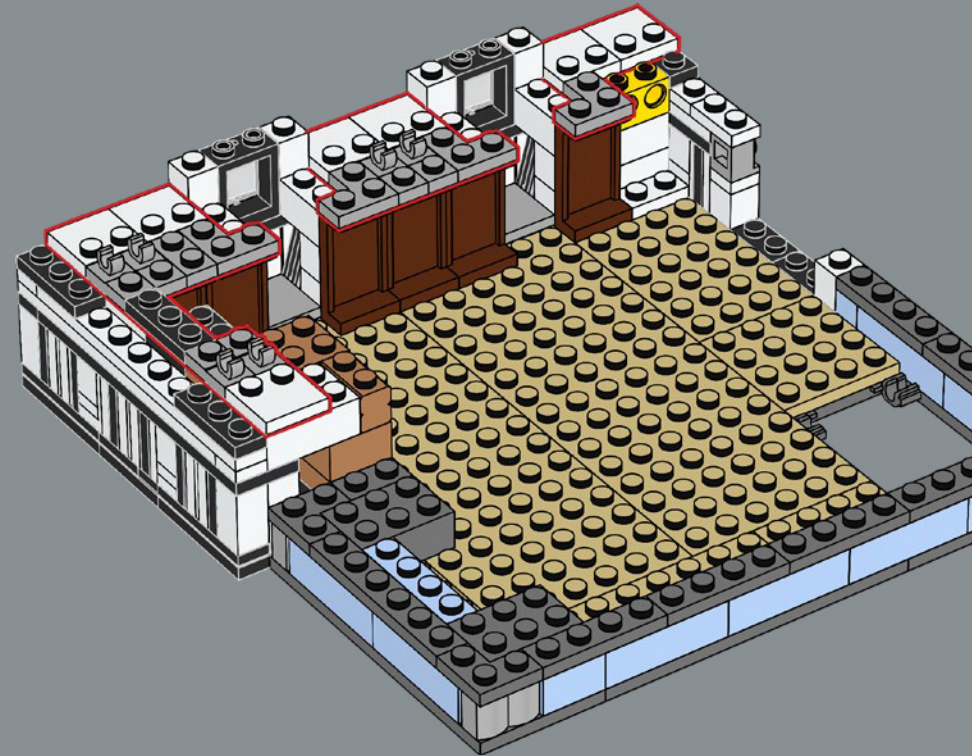

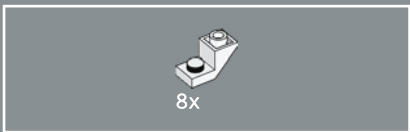

417

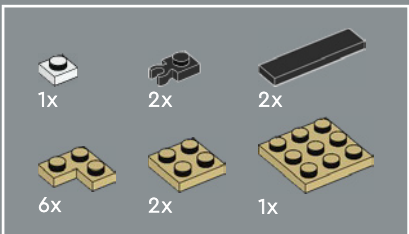
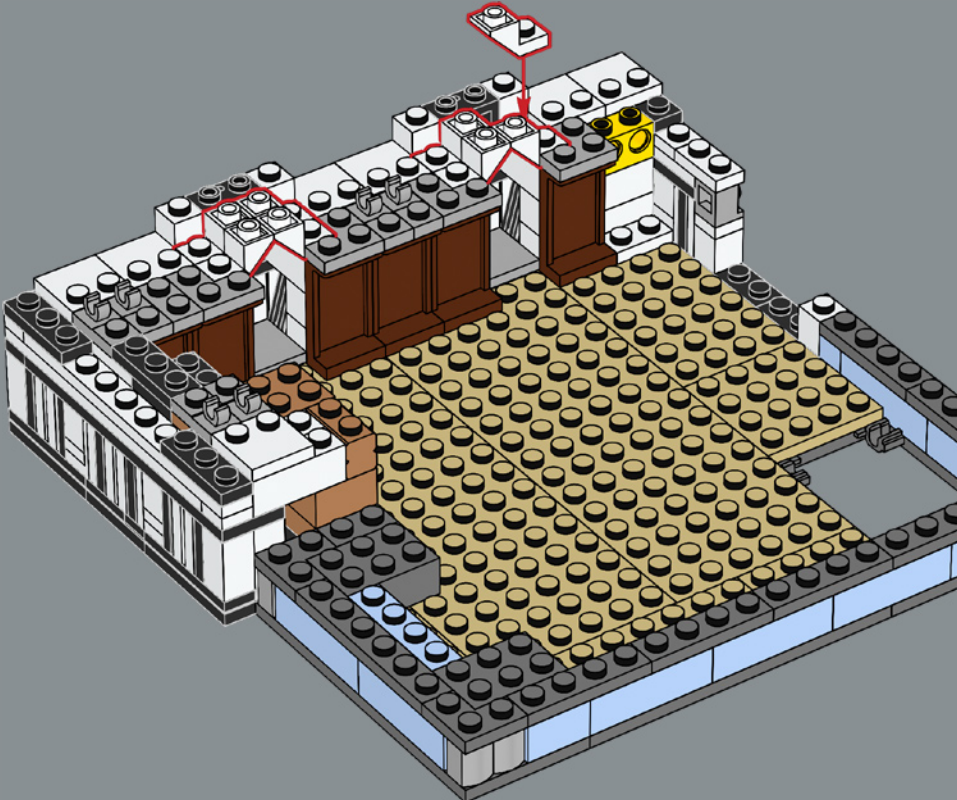

418

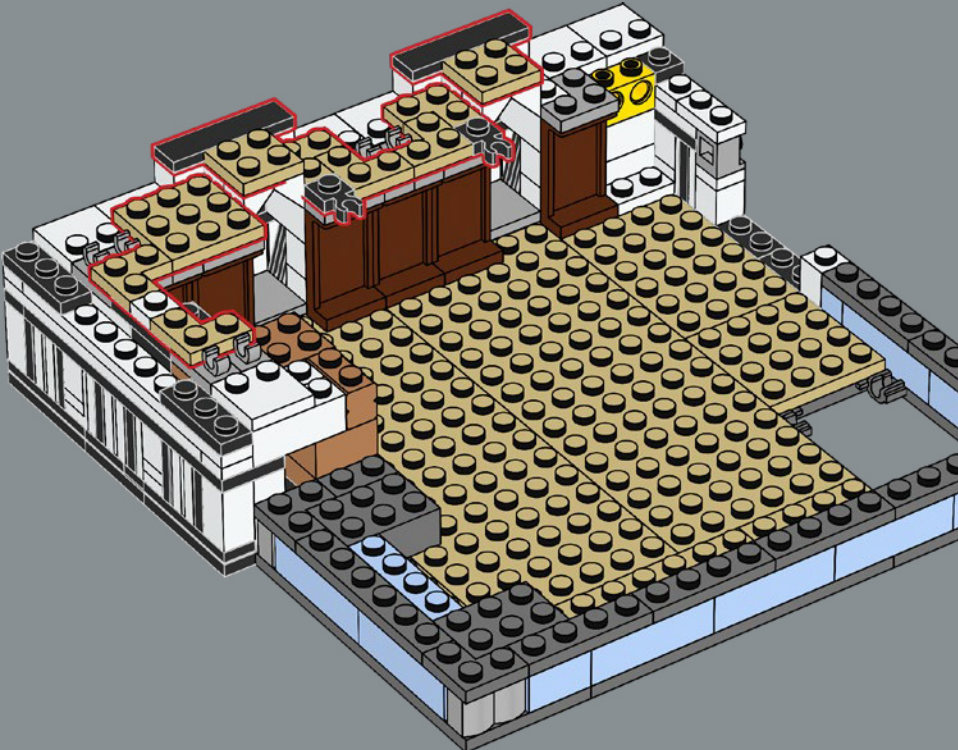





419

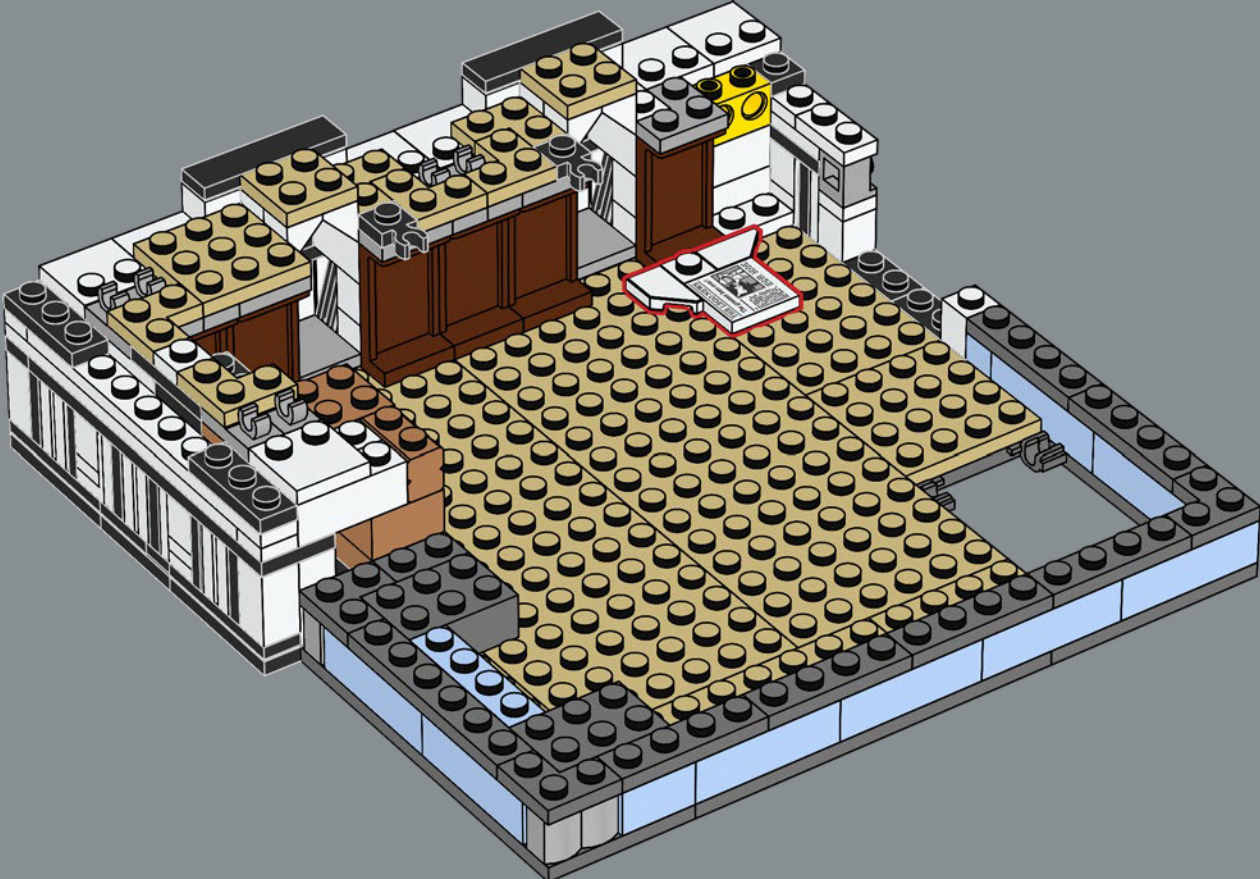

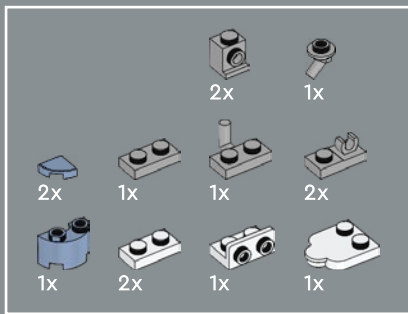

420

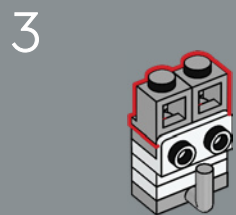
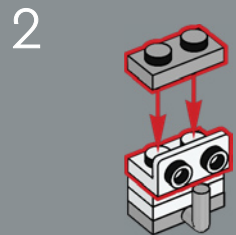
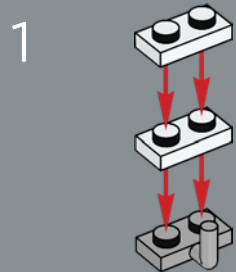

4

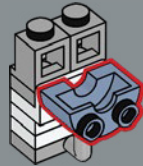

5

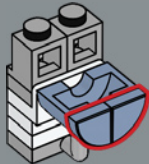

6

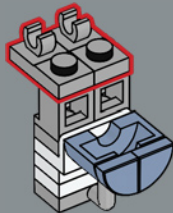

7

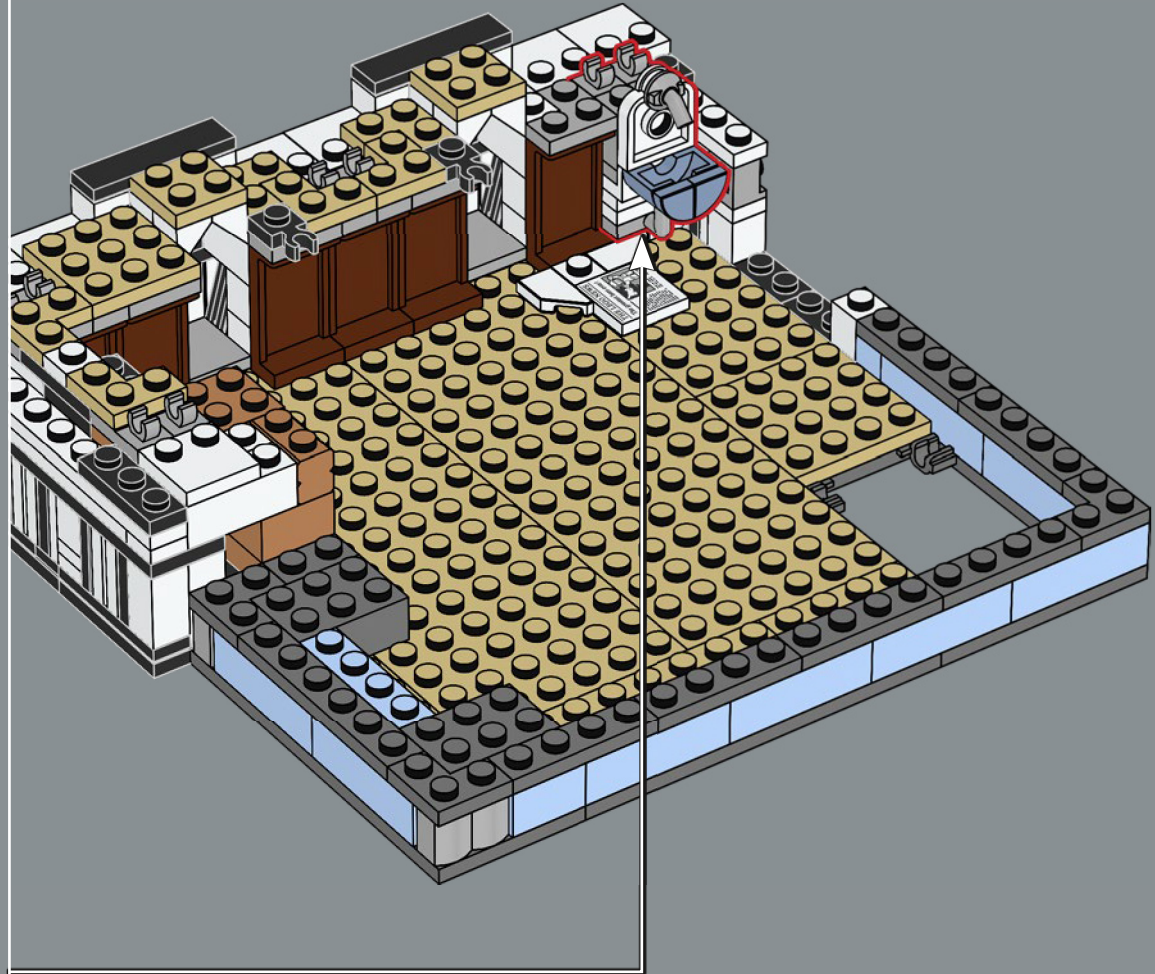
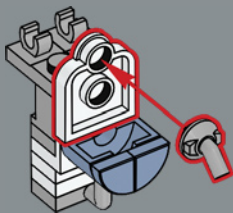



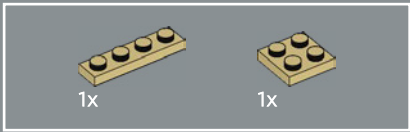

421

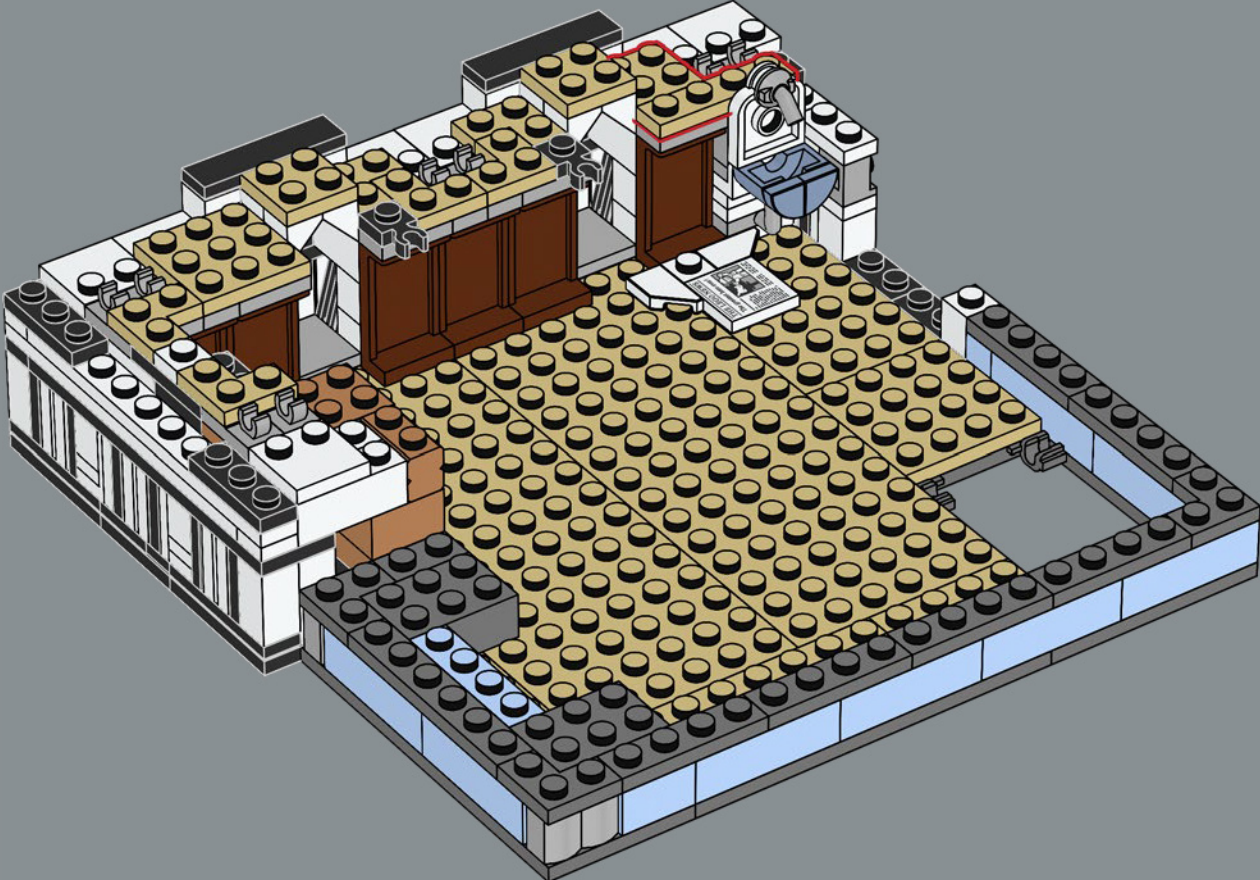

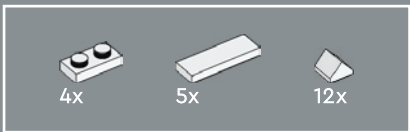

422

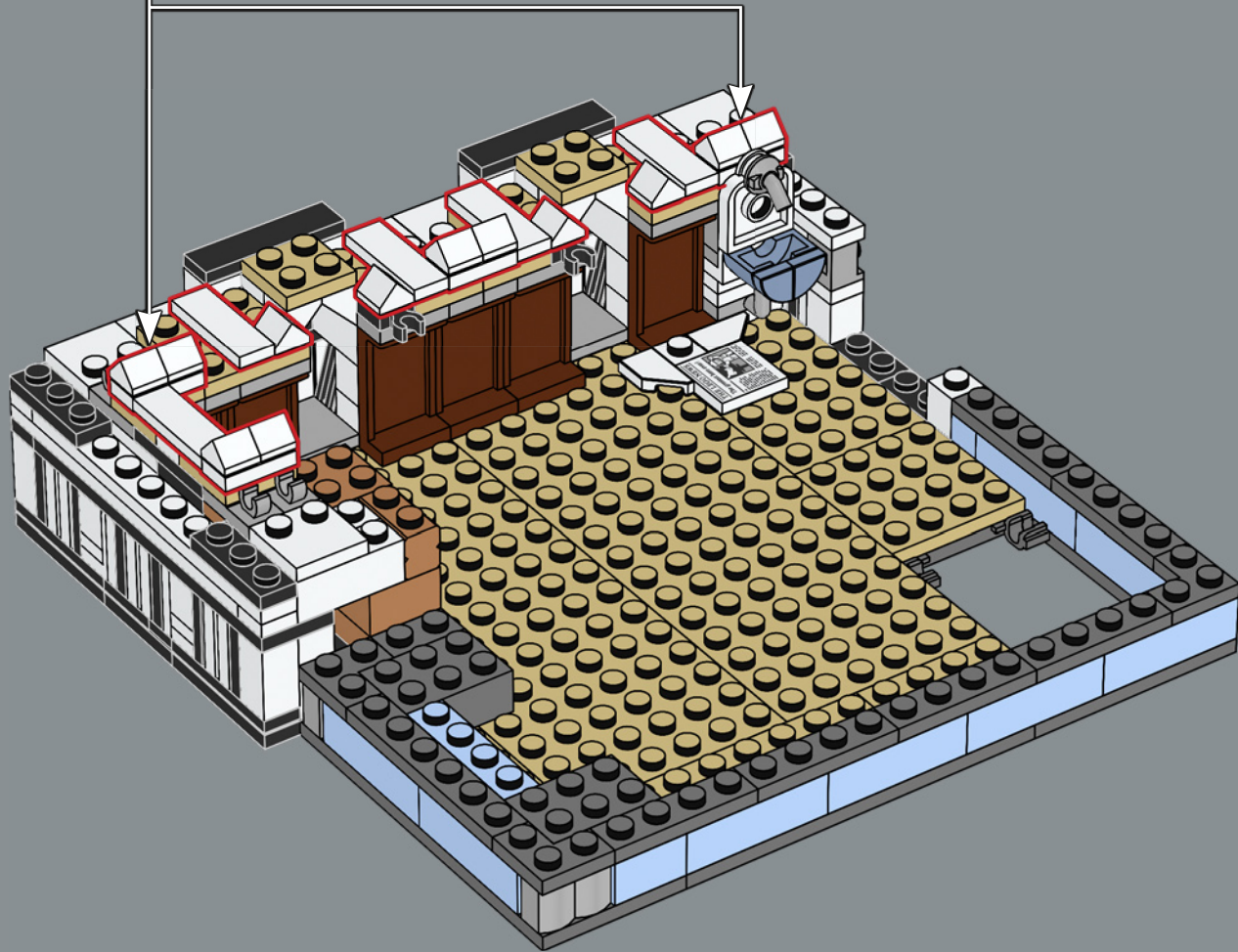
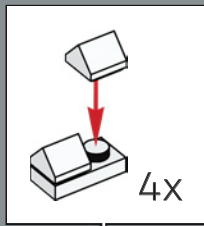



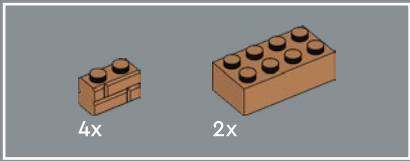

423

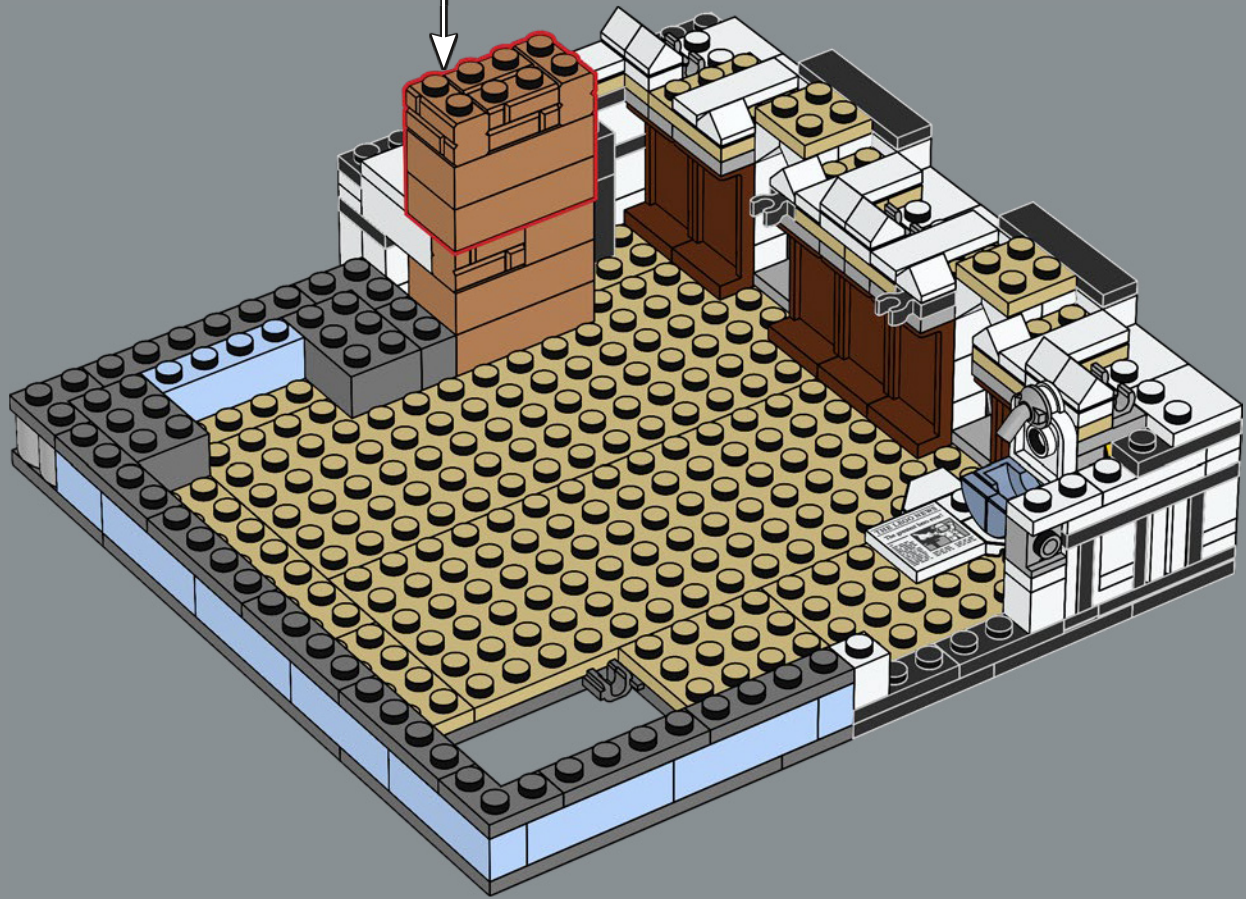
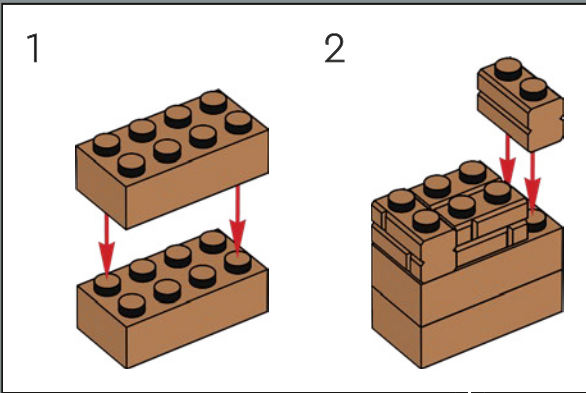



424

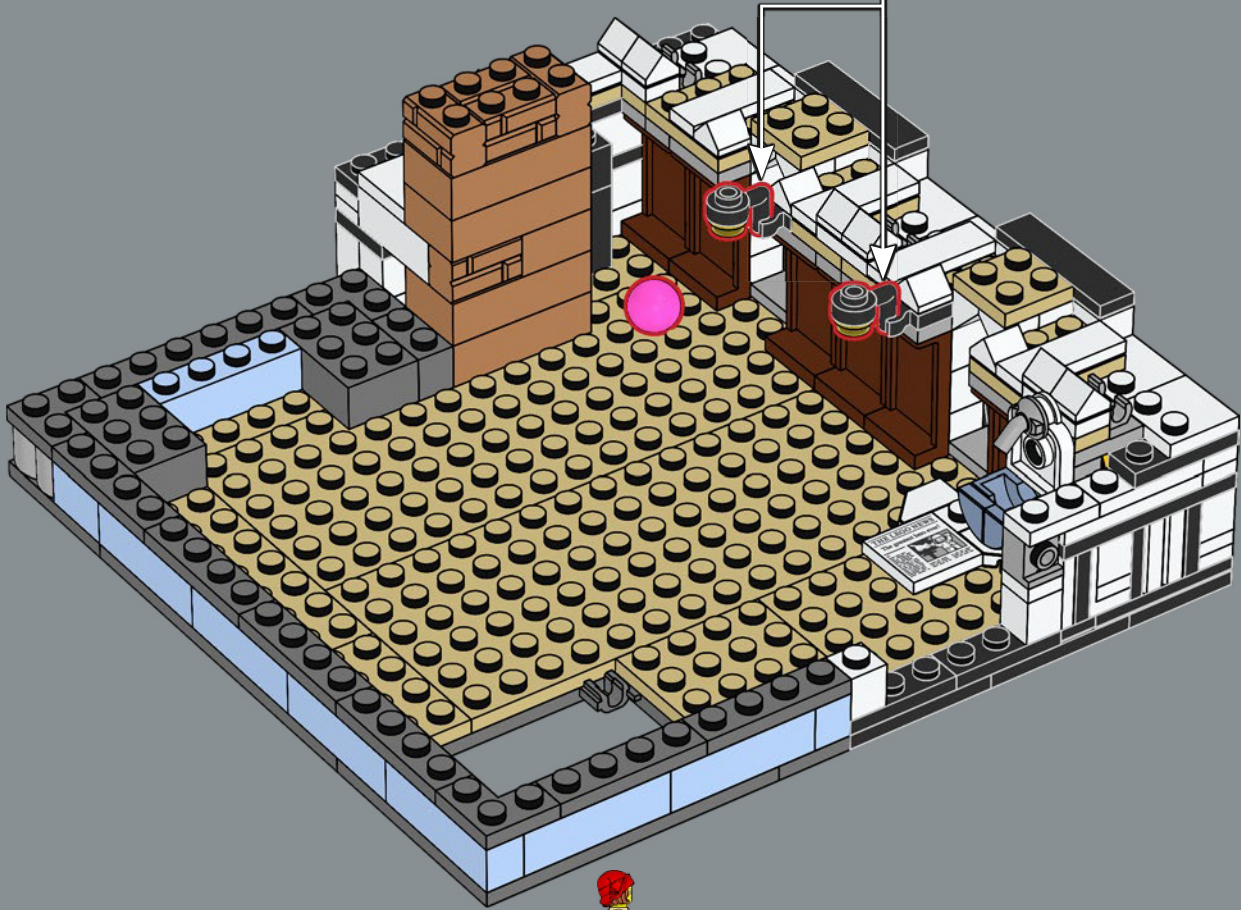



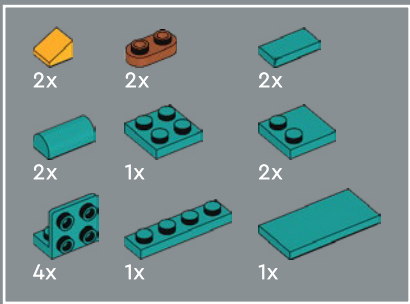

425

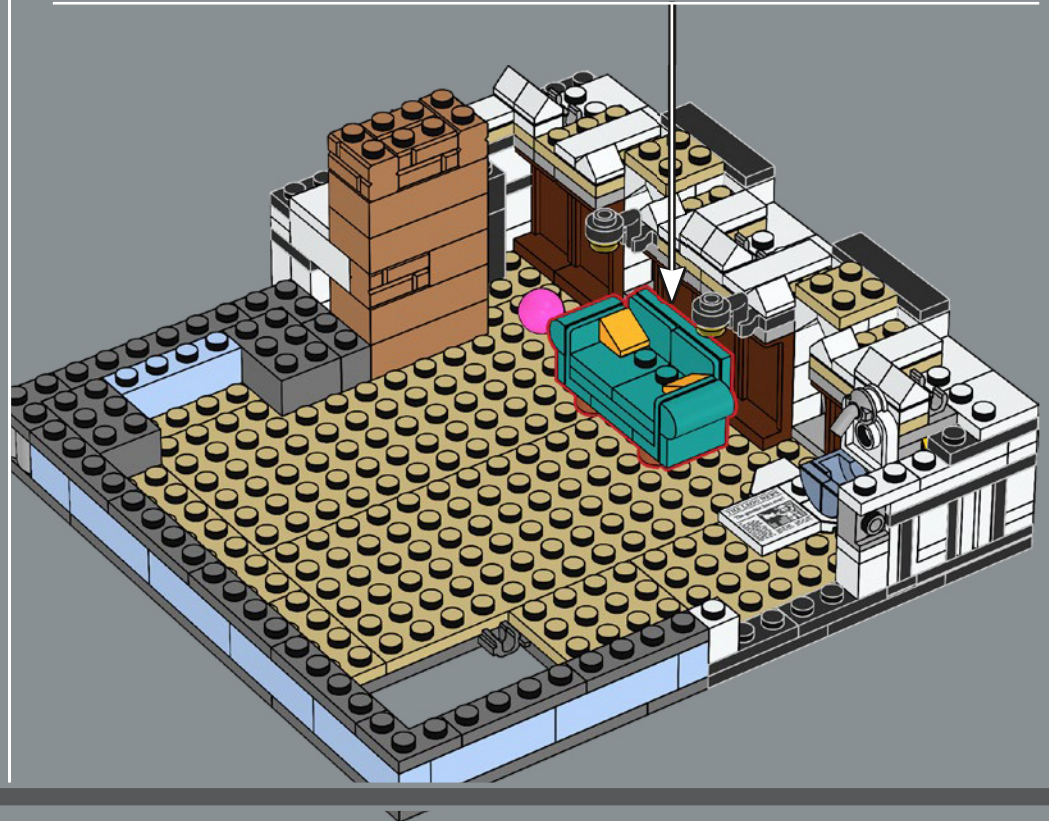
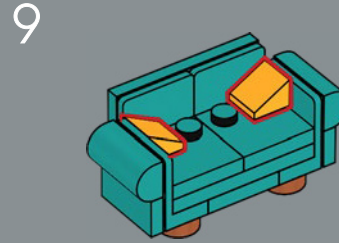
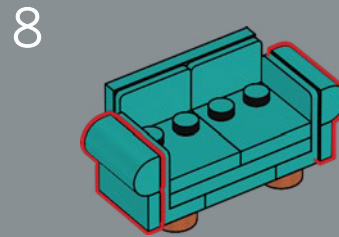
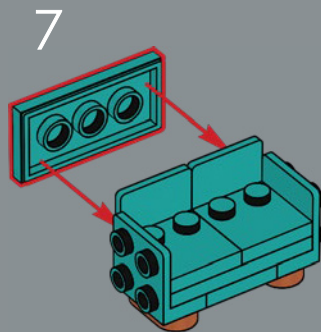
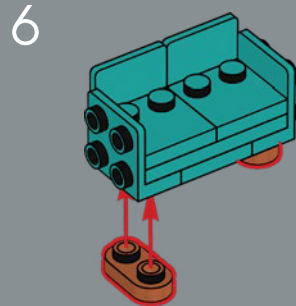
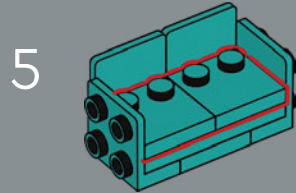
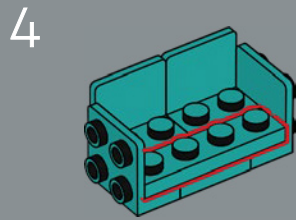
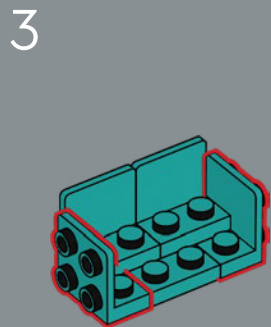
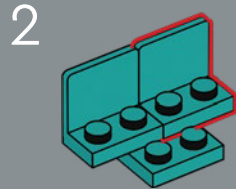
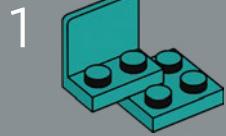

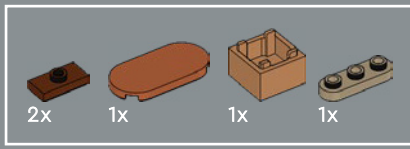

426

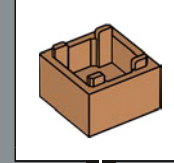
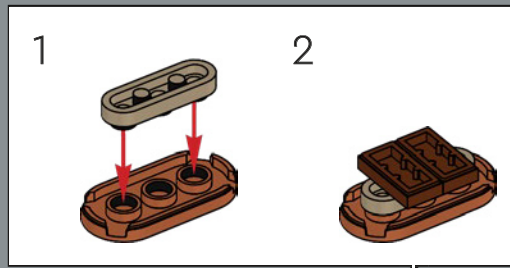



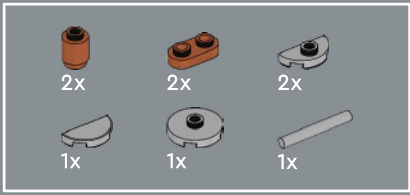

427

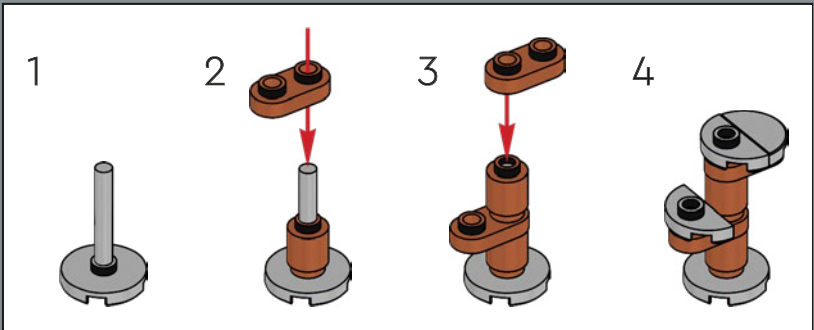

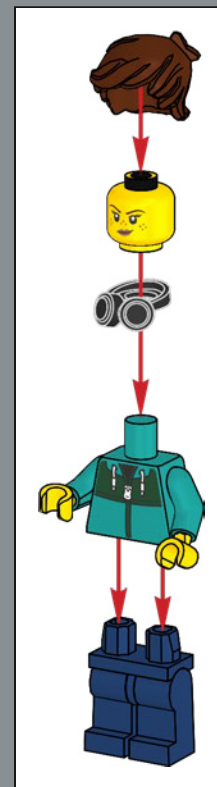



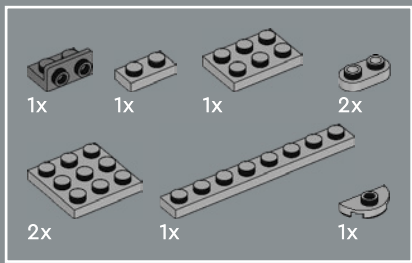

428

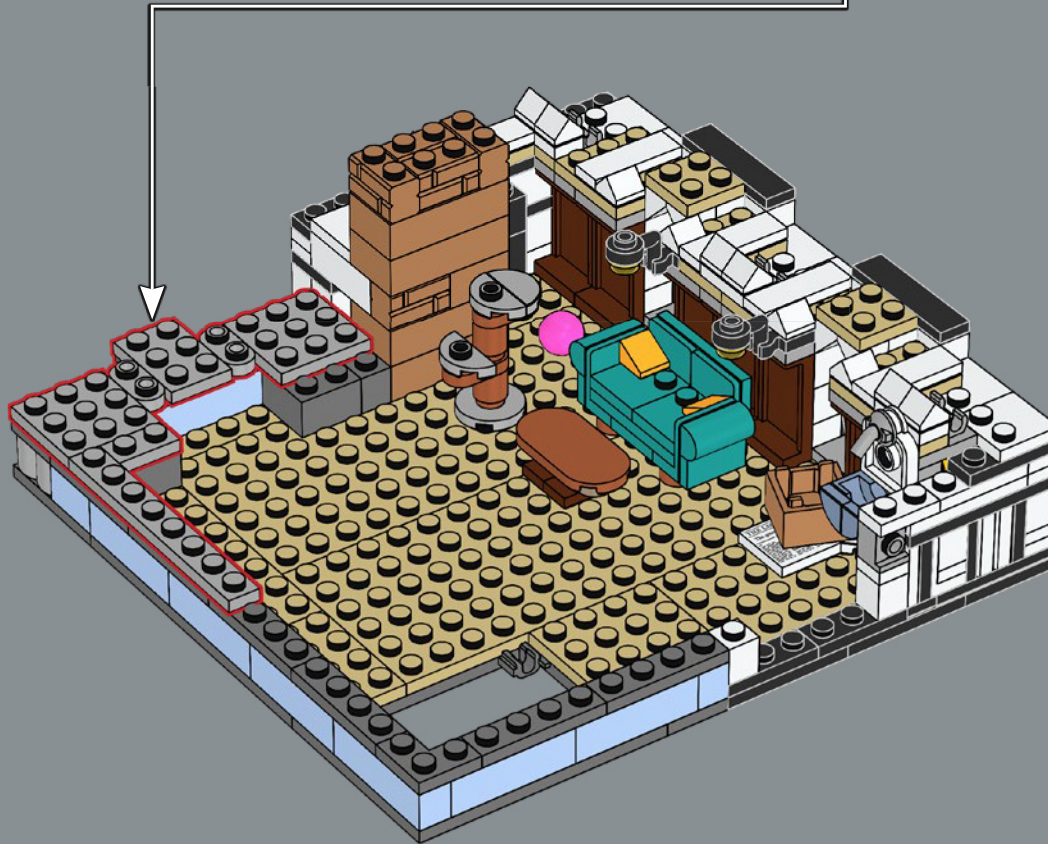
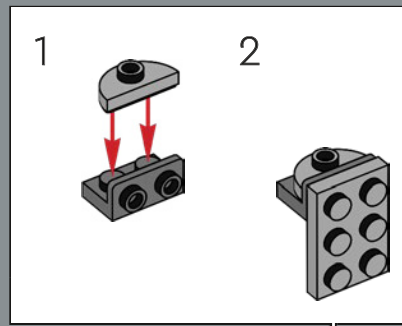

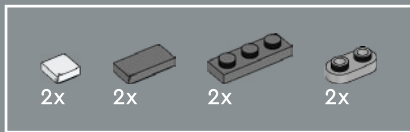

429

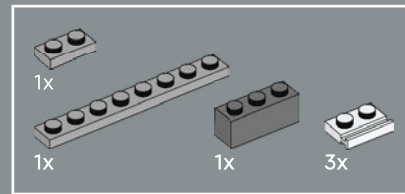

430

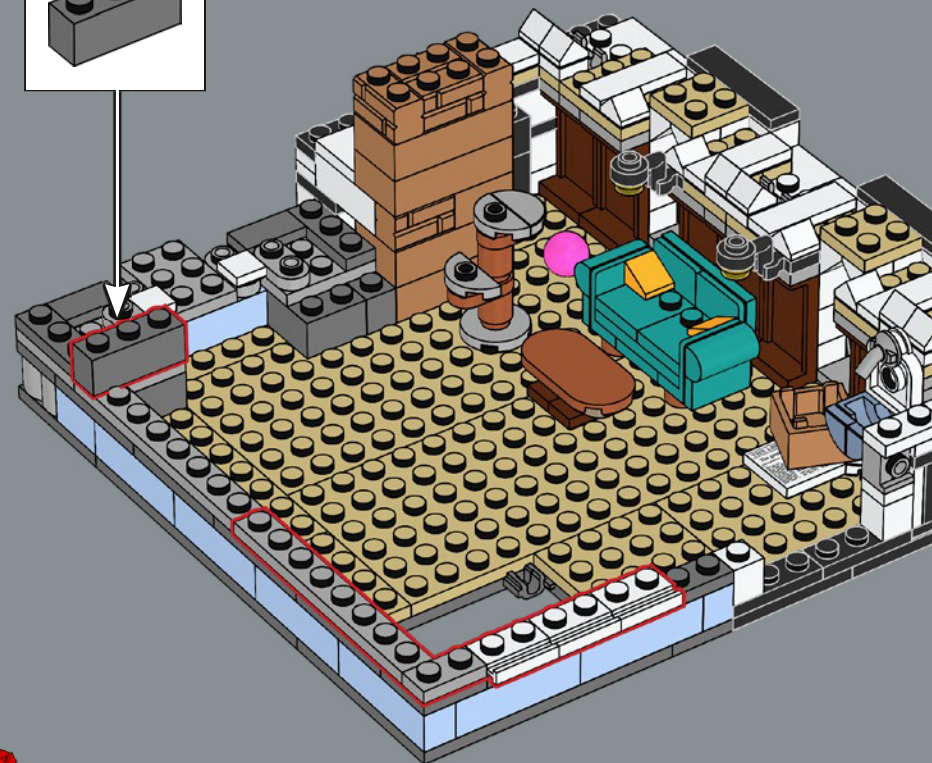
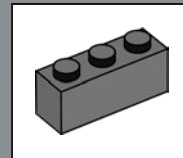



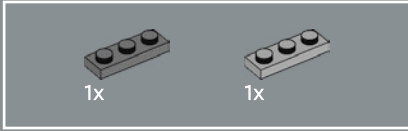

431

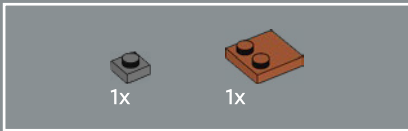
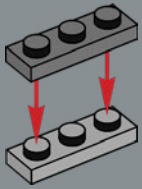

432

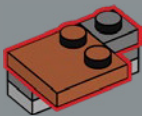

433

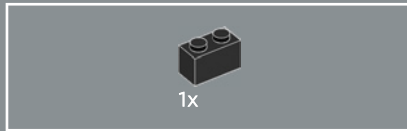
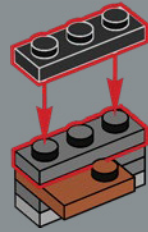

434

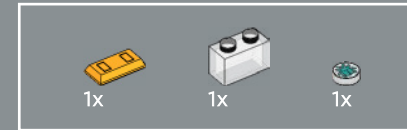
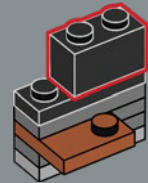

435

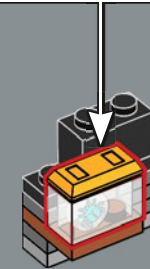
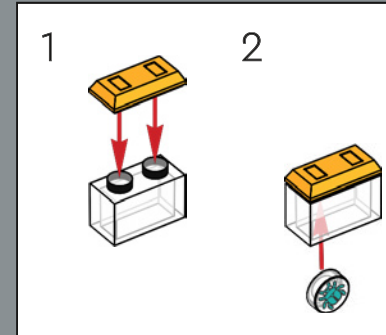

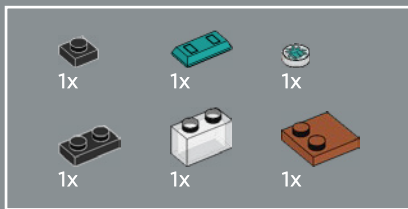

436

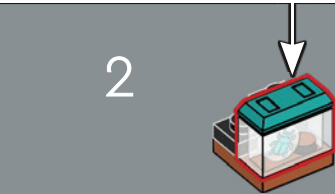
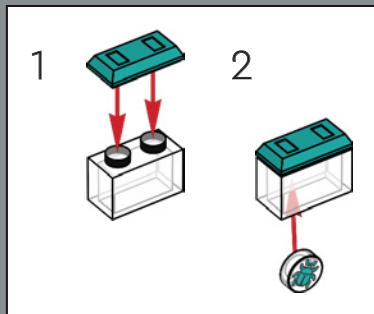
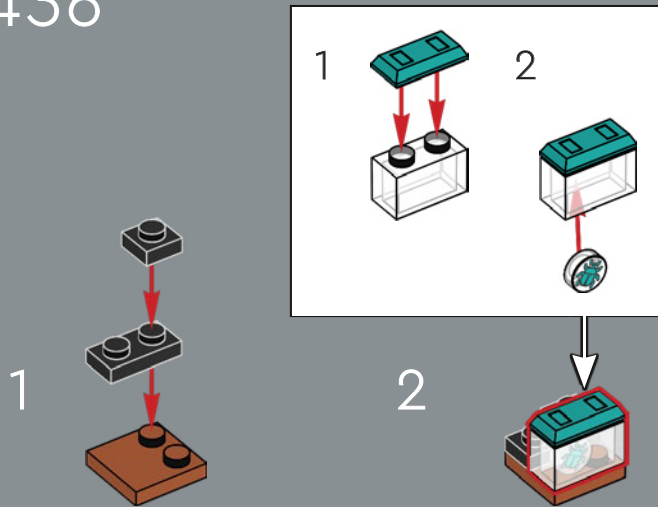

437

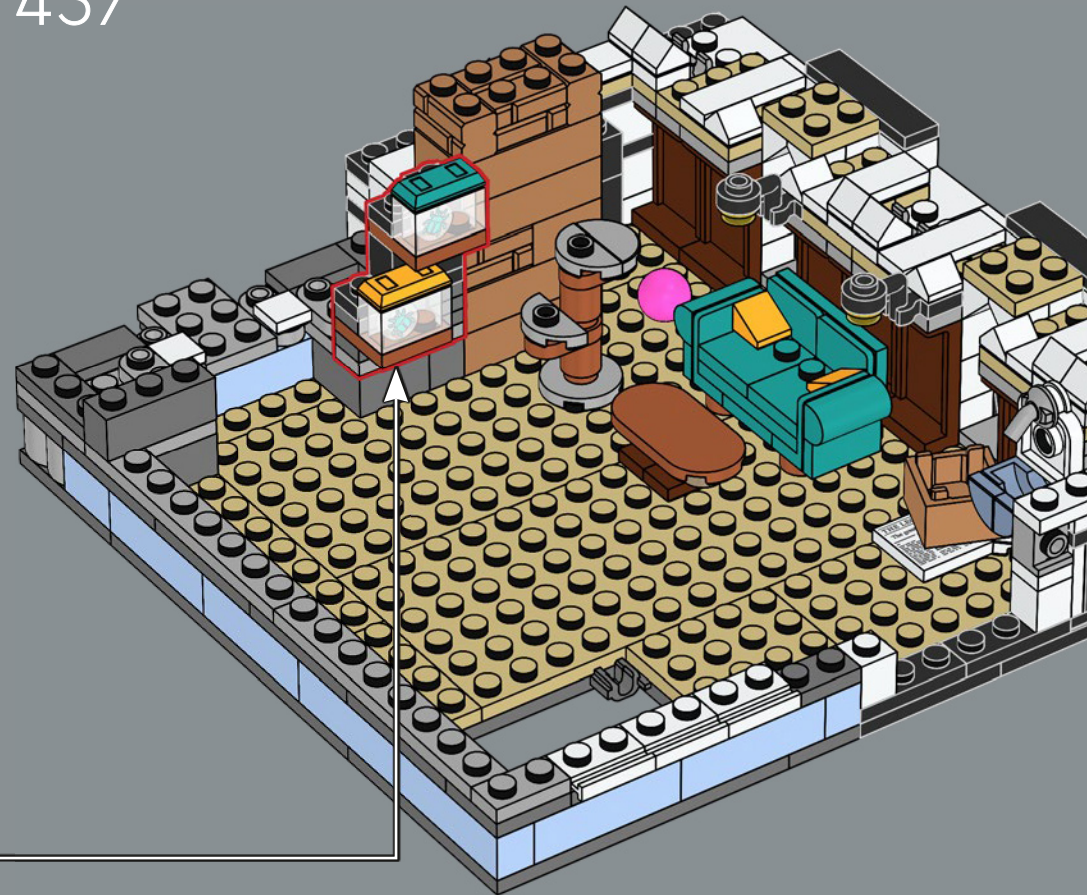

The tenant's collection of insects is very valuable. This is why she will never let her friend's chameleon, which lives next to the bookshop, come over.





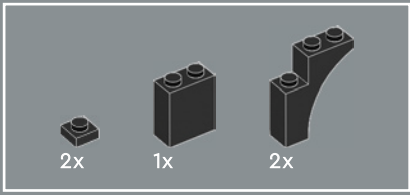

438

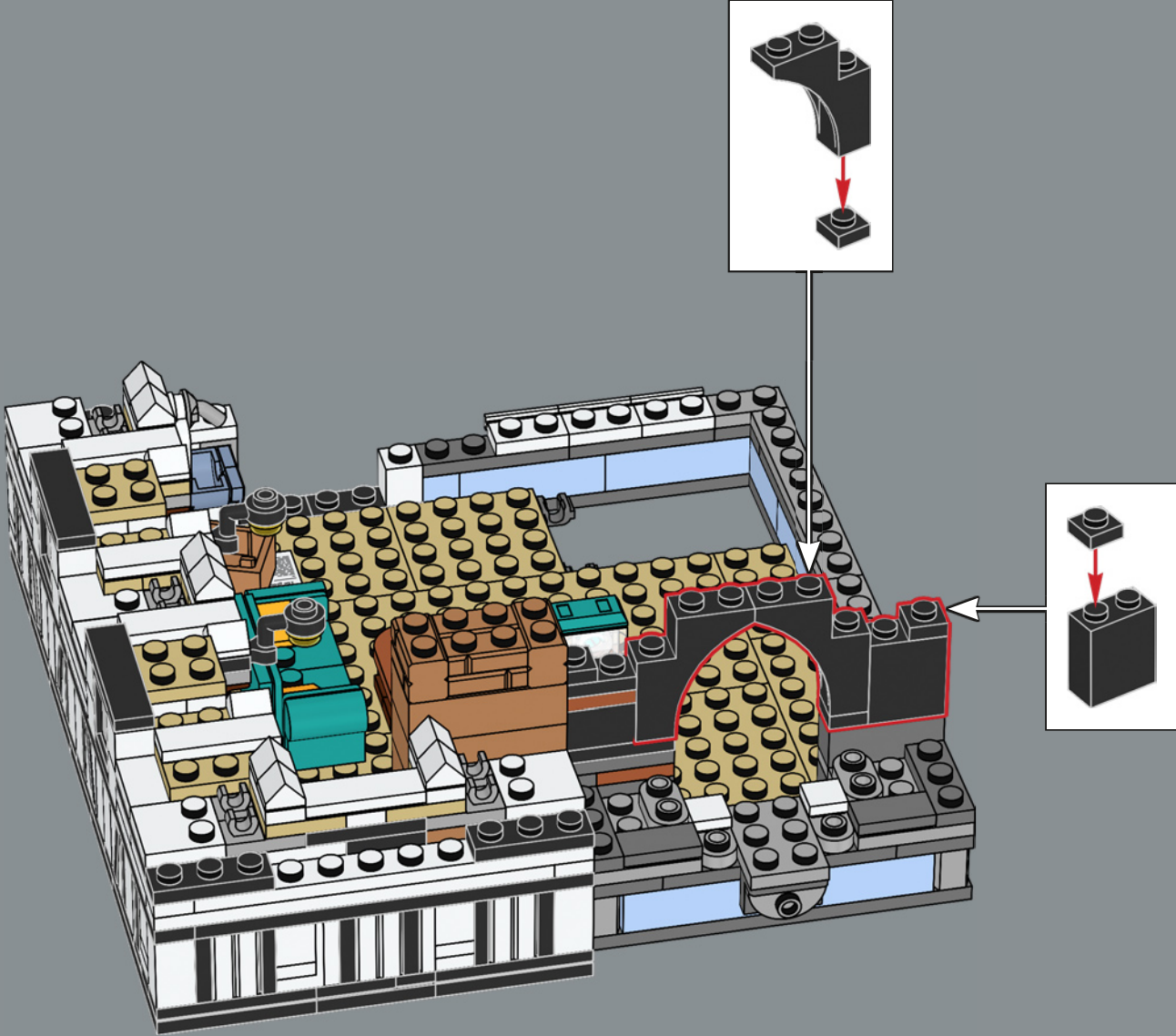

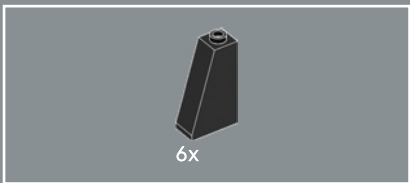

439

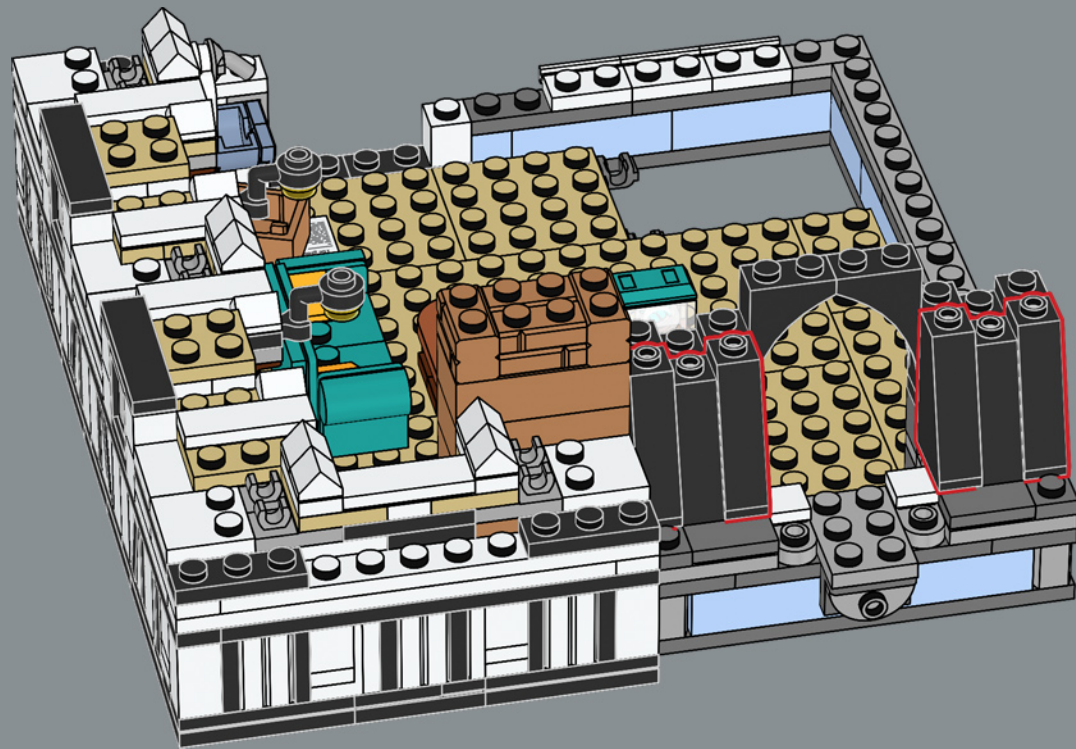



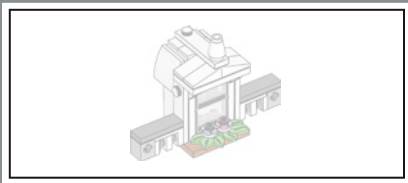

440

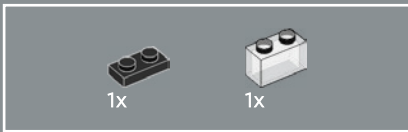
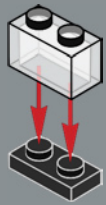

441

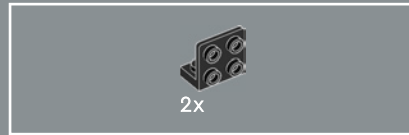
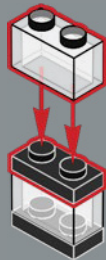

442

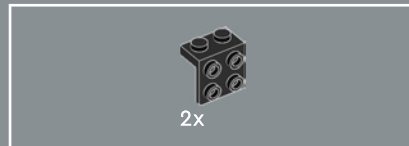
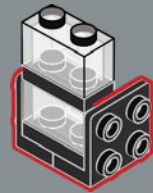

443

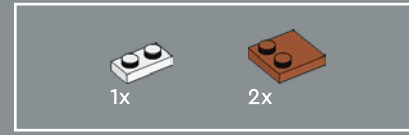
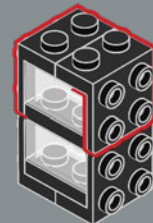

444

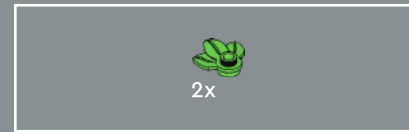
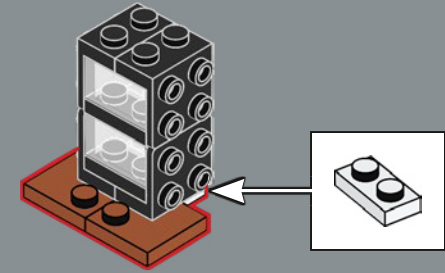

445





446

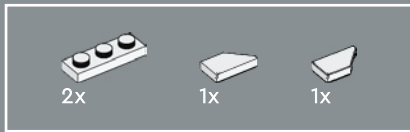

447

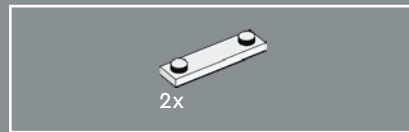

448

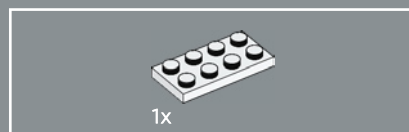
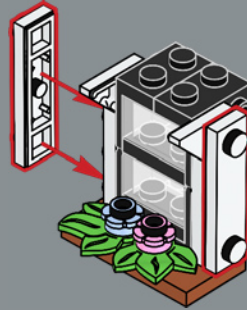

449

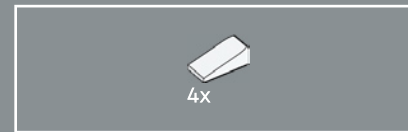

450





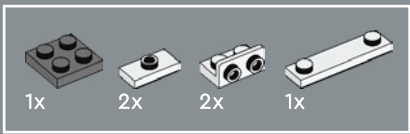

451

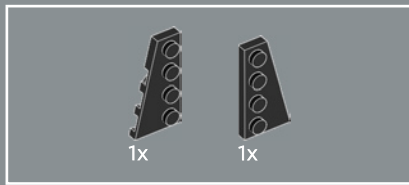
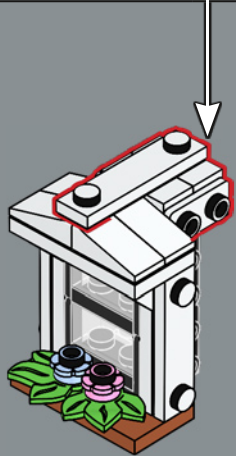
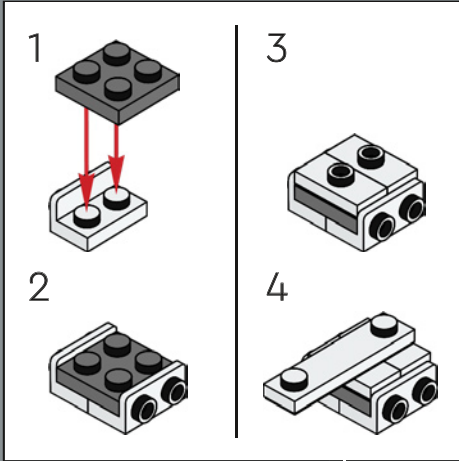

452

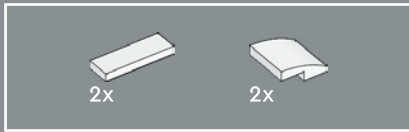
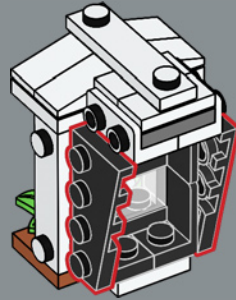

453

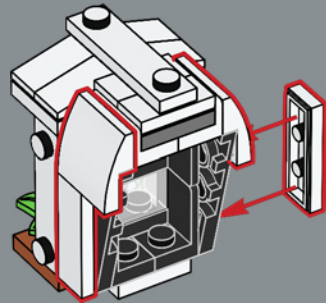

454



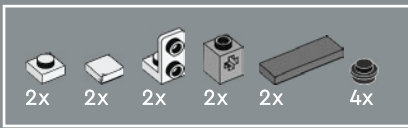

455

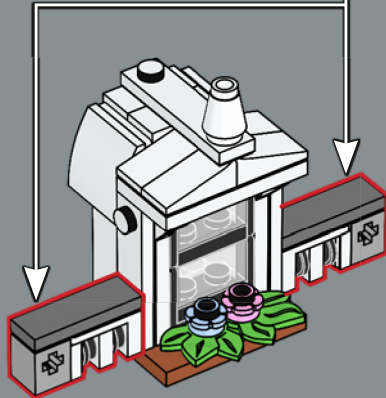
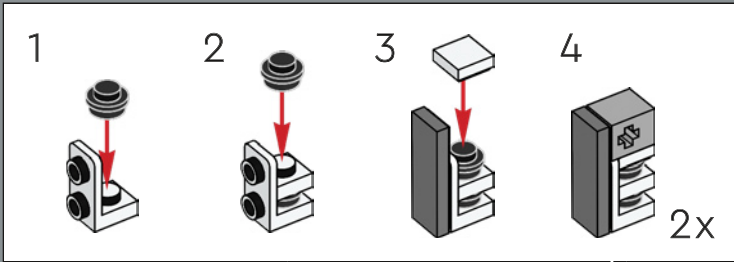

456

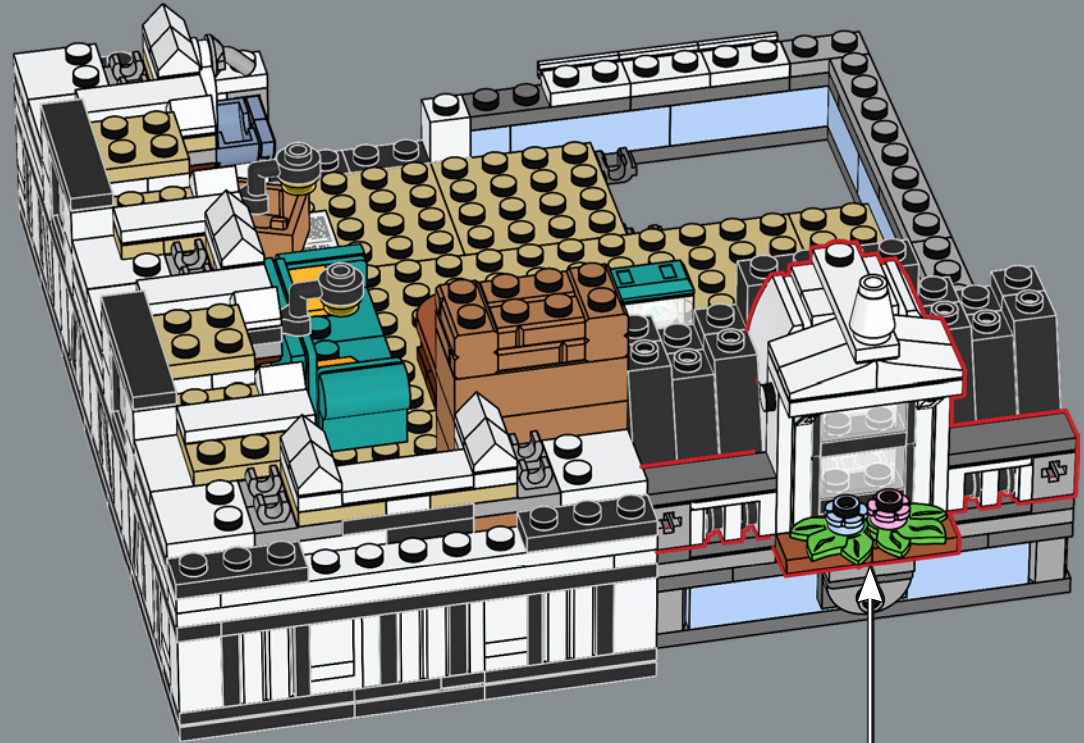



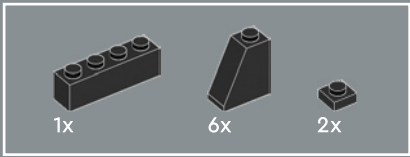

457

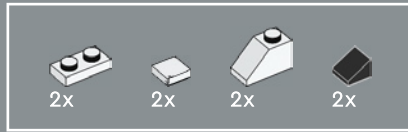
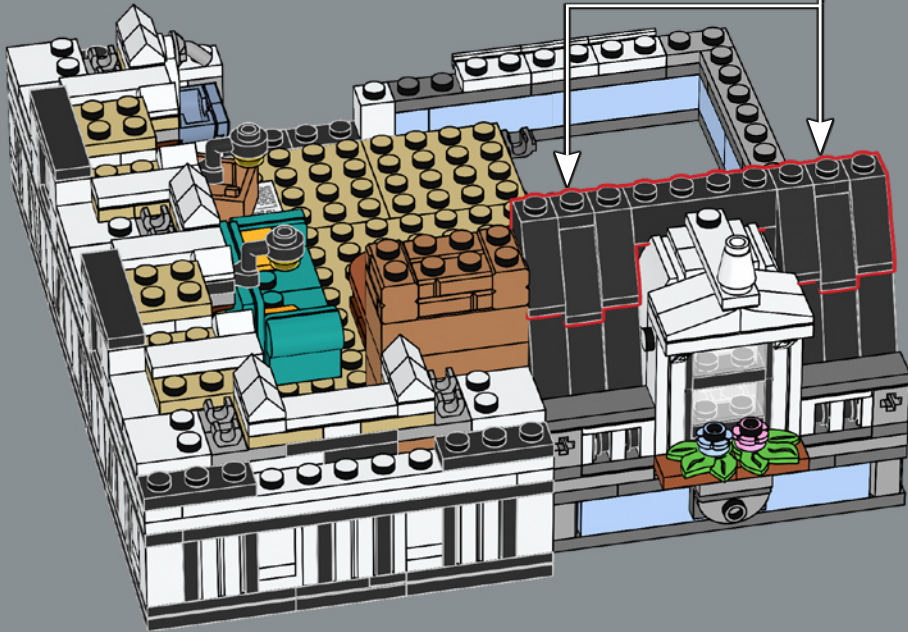
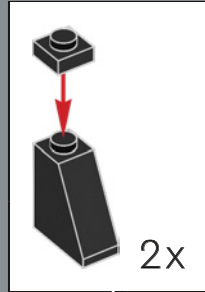

458

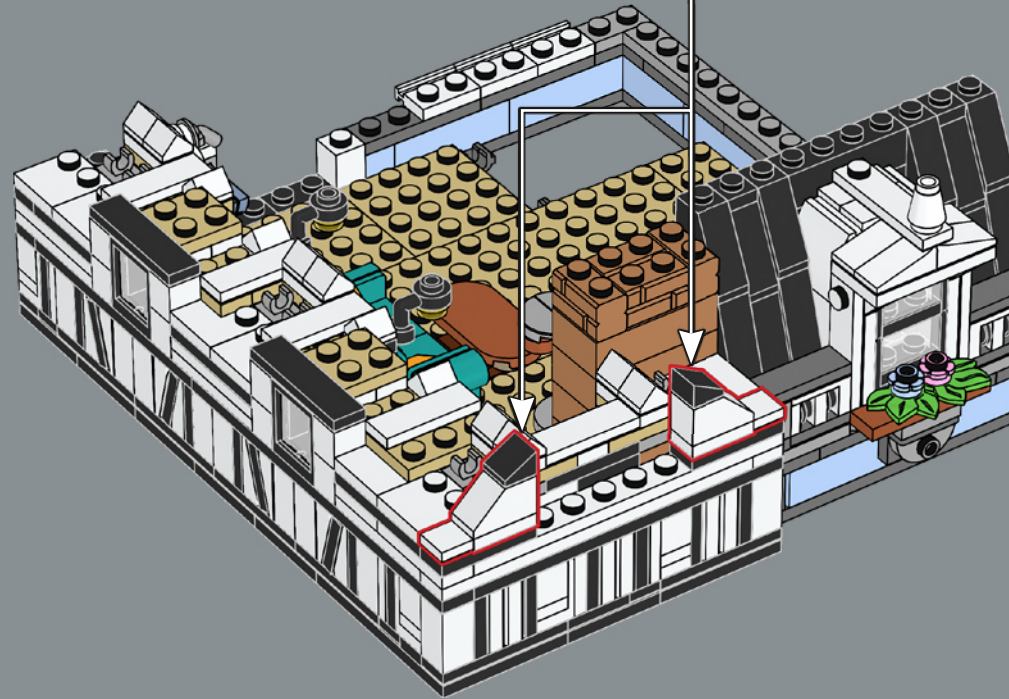
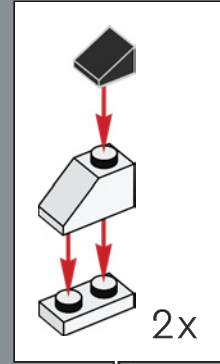

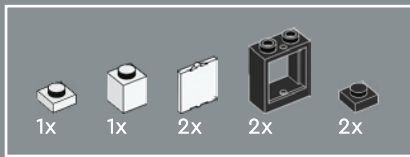

459

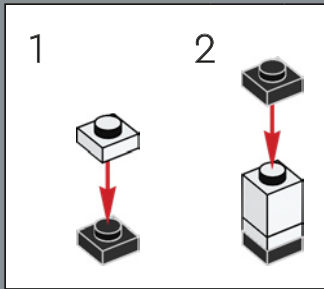
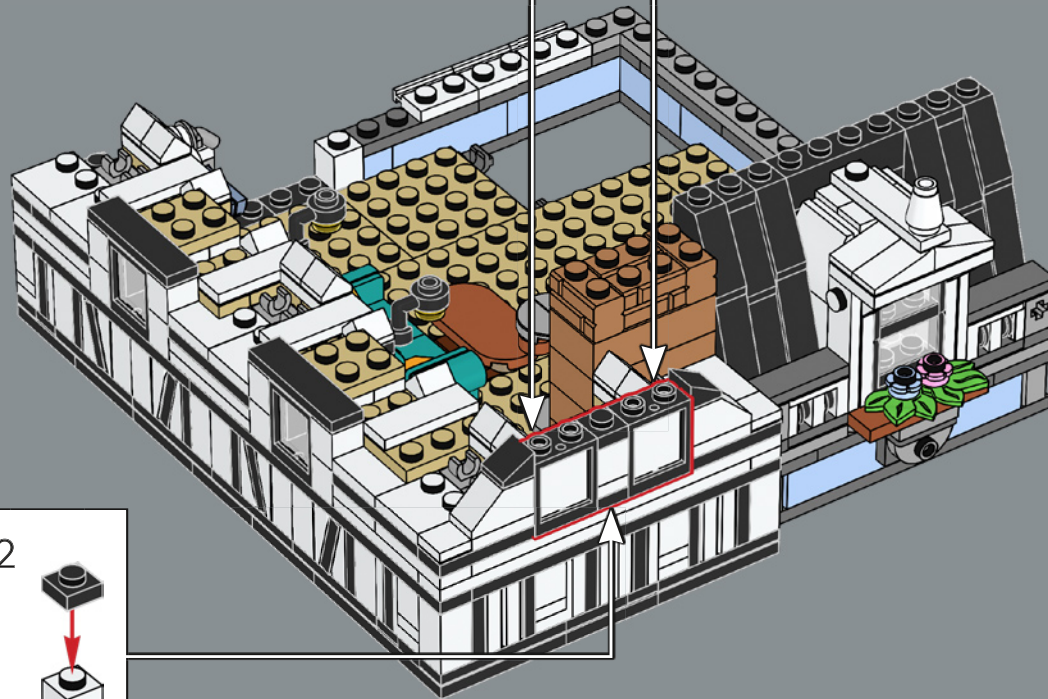
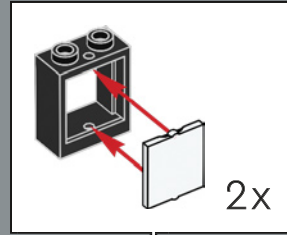



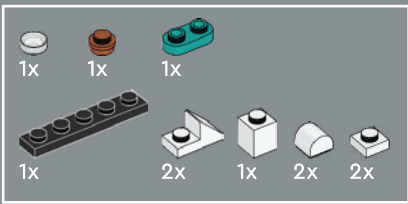

460

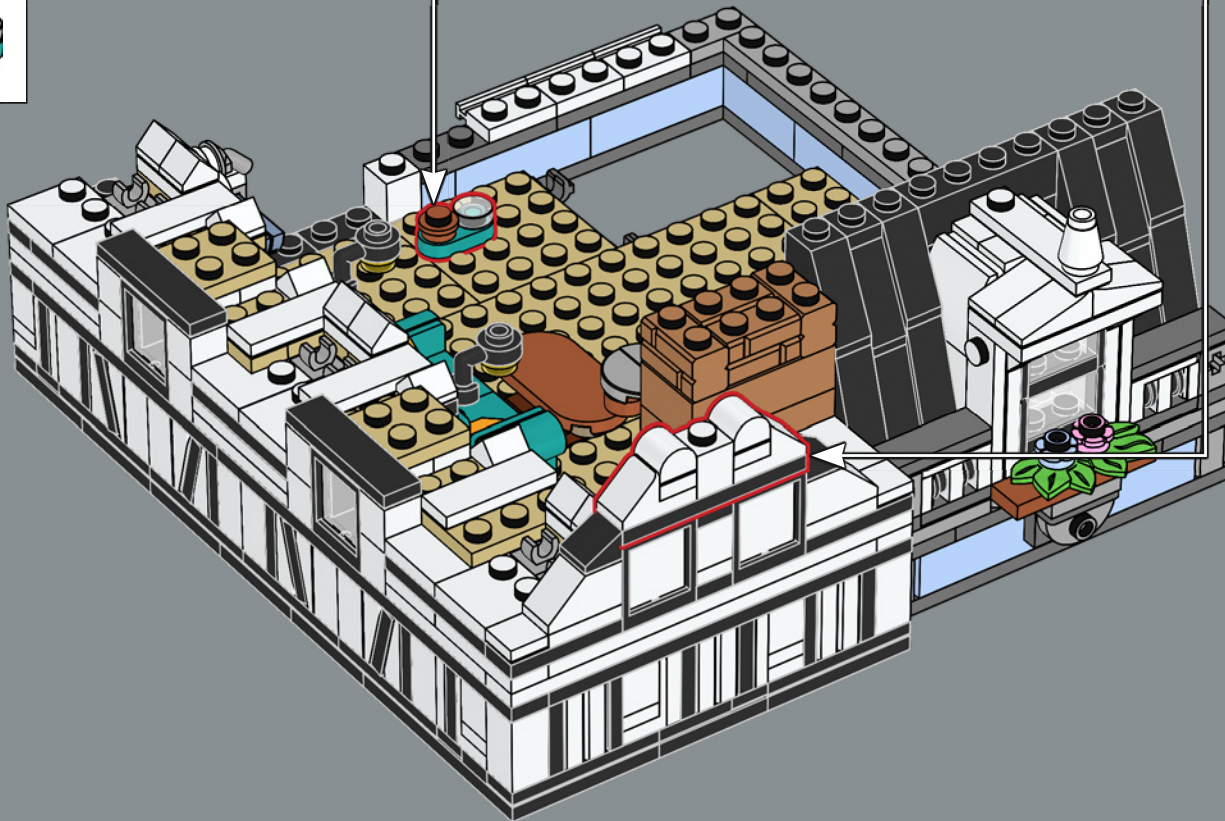
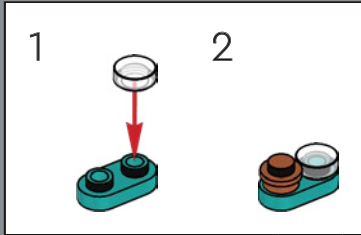
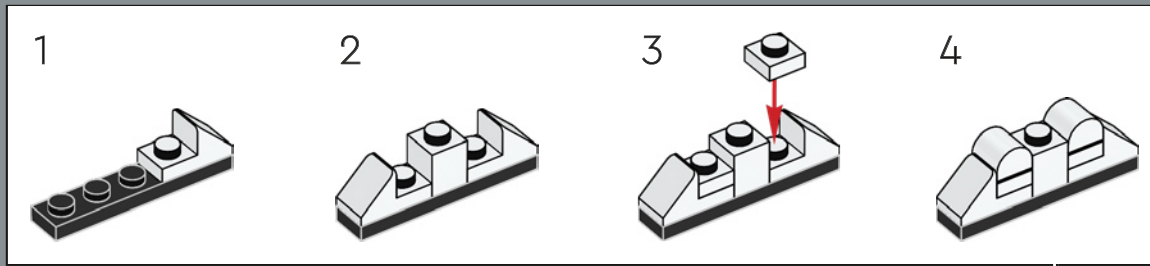

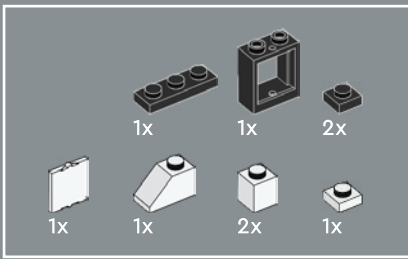

# 461

1

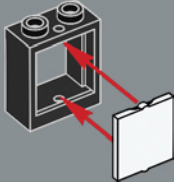

3



1



2



2



4

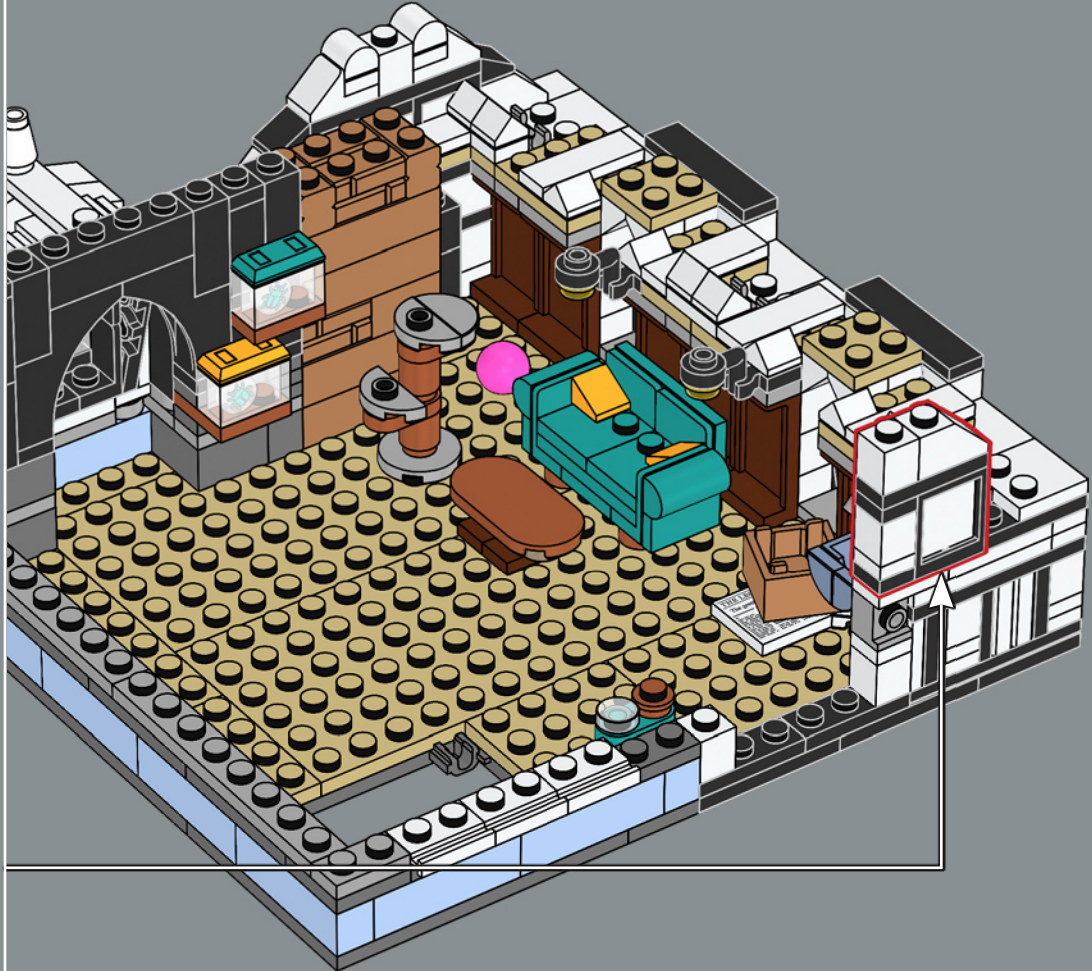
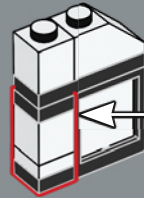



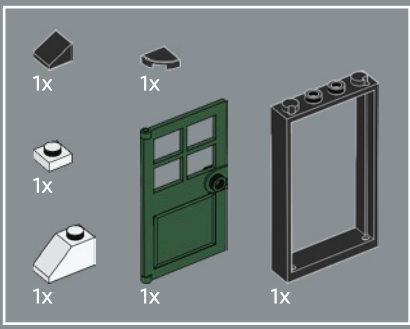

462

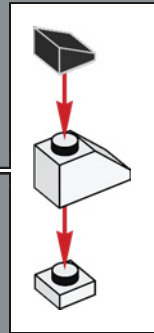
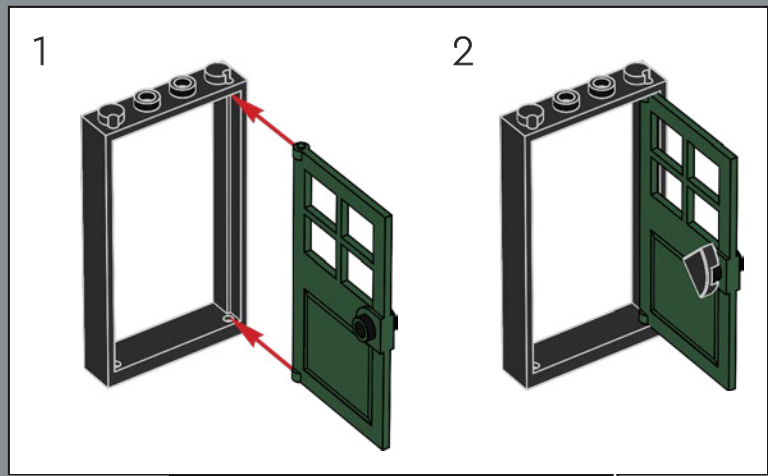

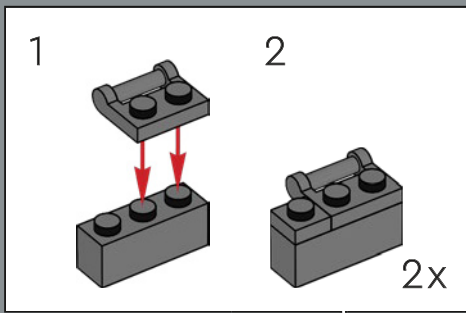
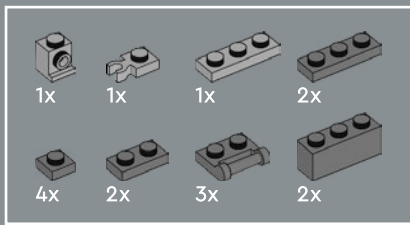

463

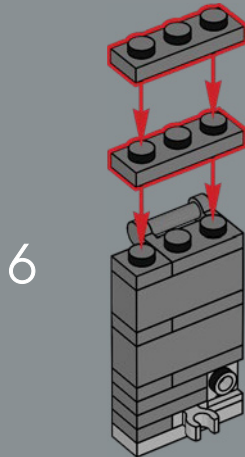
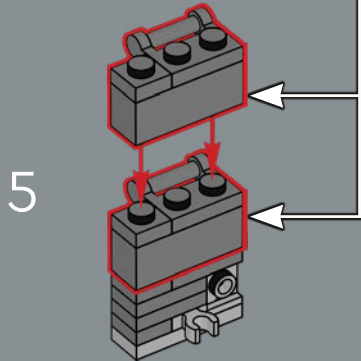
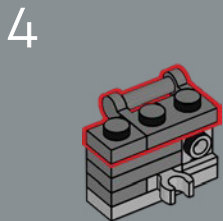
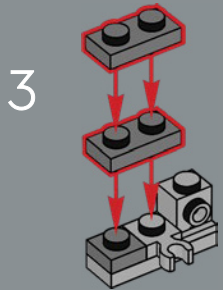
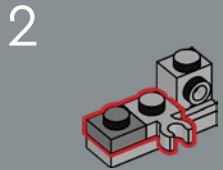
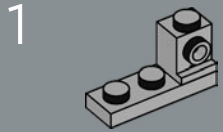



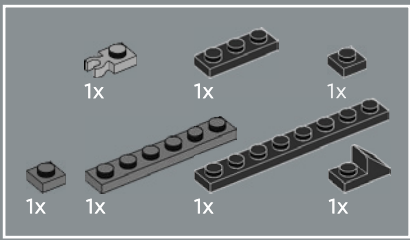

464

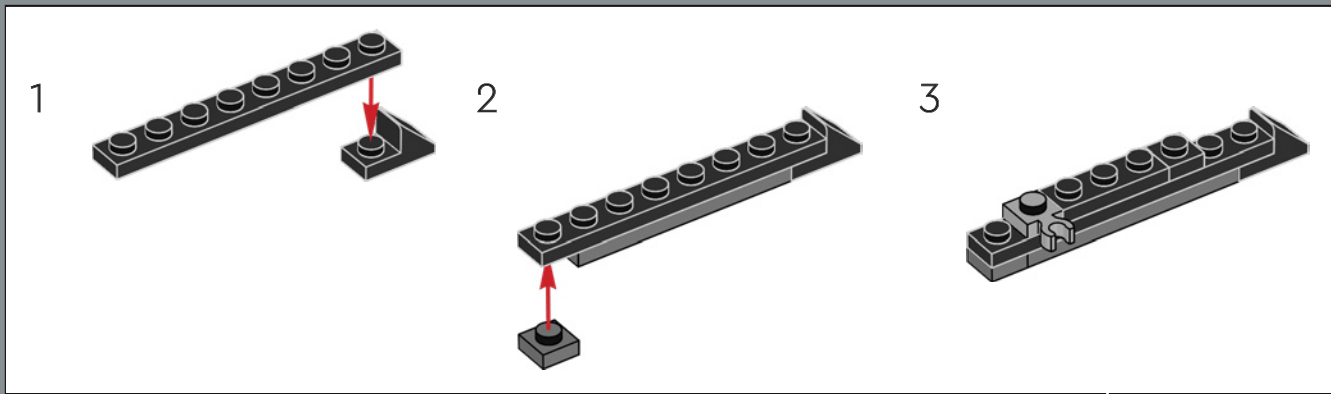

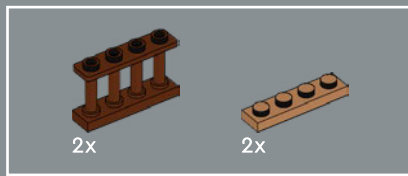

2x

2x

465

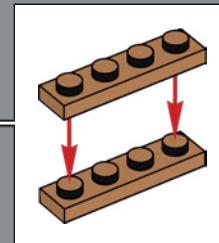



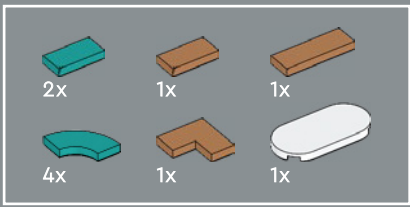

466





467

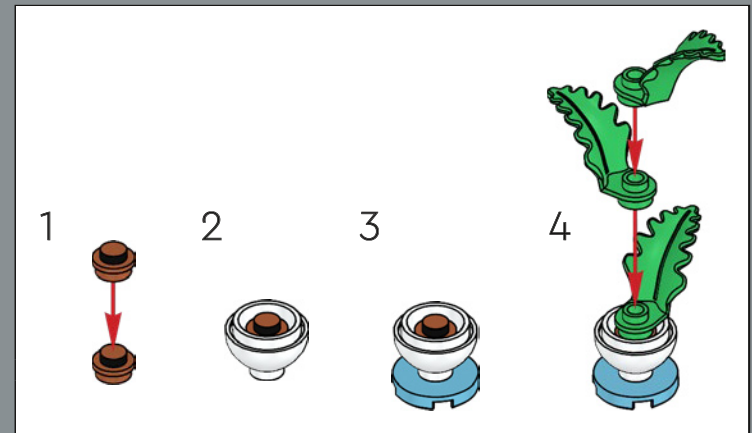



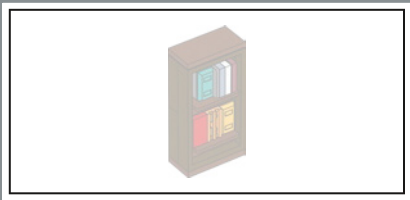

468

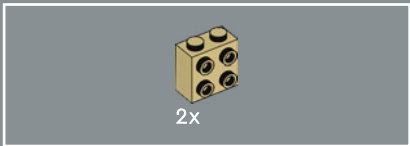
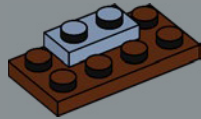

469

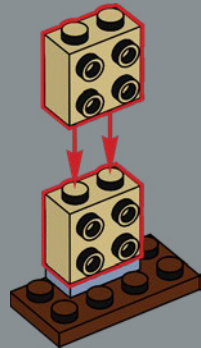

470

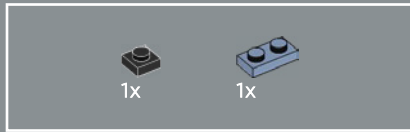
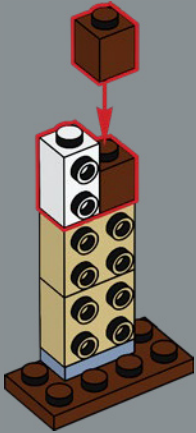

471

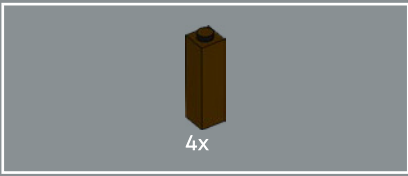
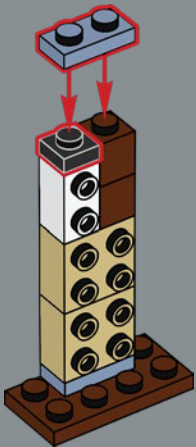

472

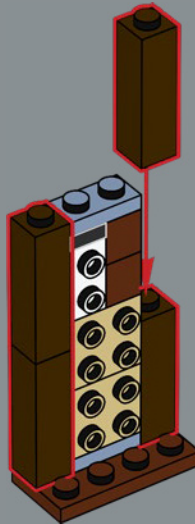

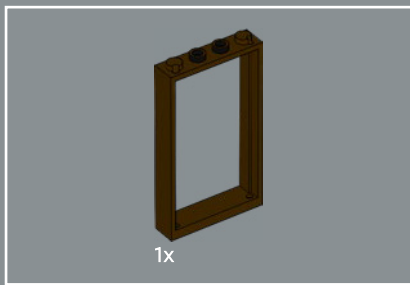

473

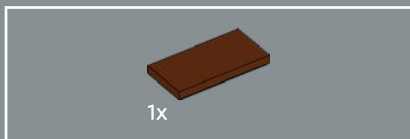

474

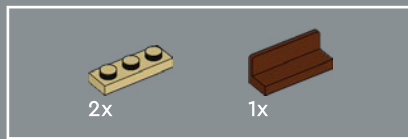
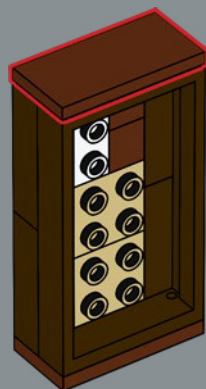

475

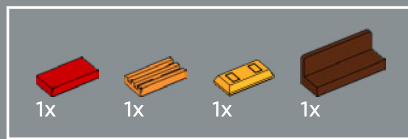
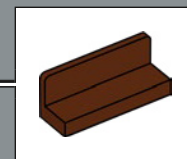
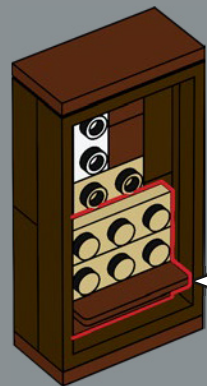

476

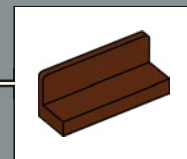



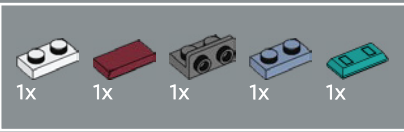

477

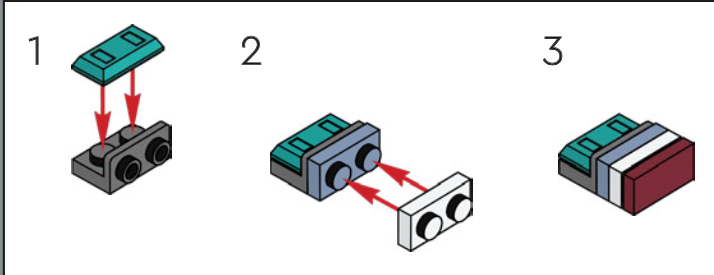

478

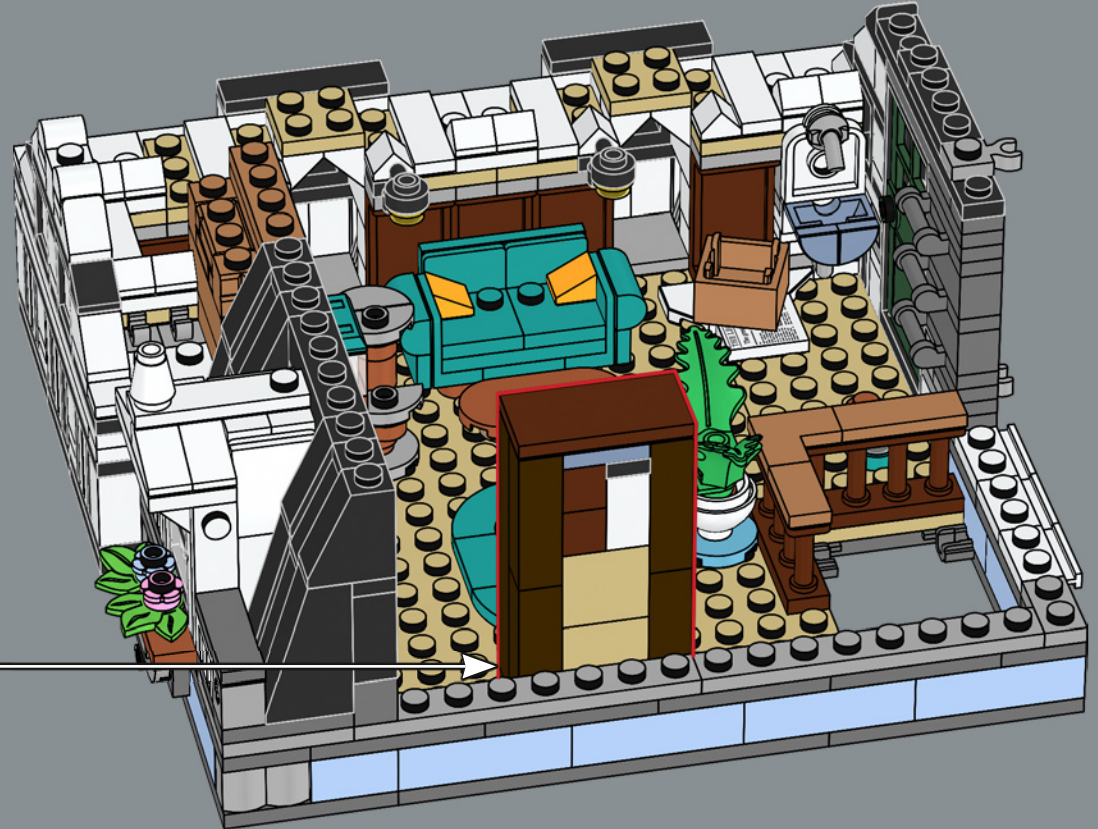

The tenant of this cosy studio loves rainy days so she can stay at home and read the new books that she bought at the LEGO® Creator Expert Bookshop (10270).

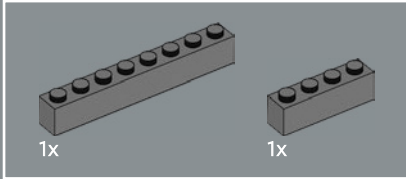
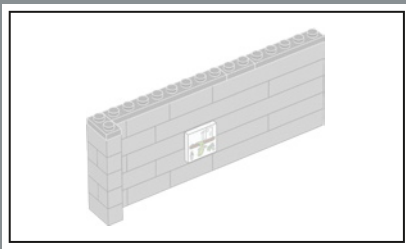

479

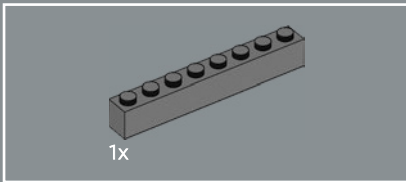
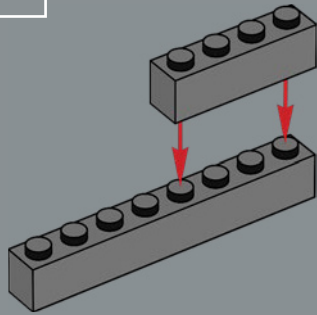

480

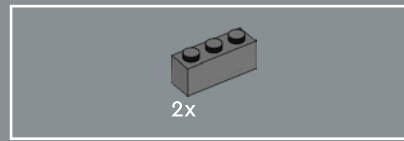
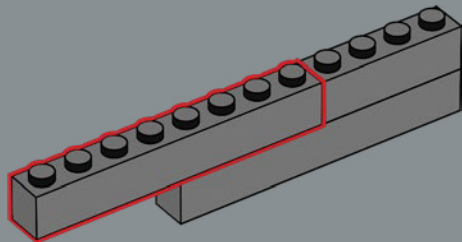

481

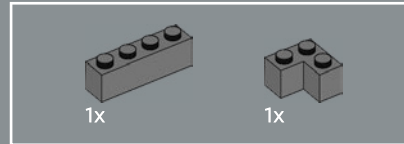
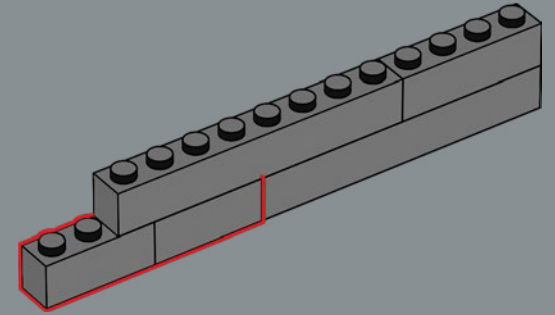

482

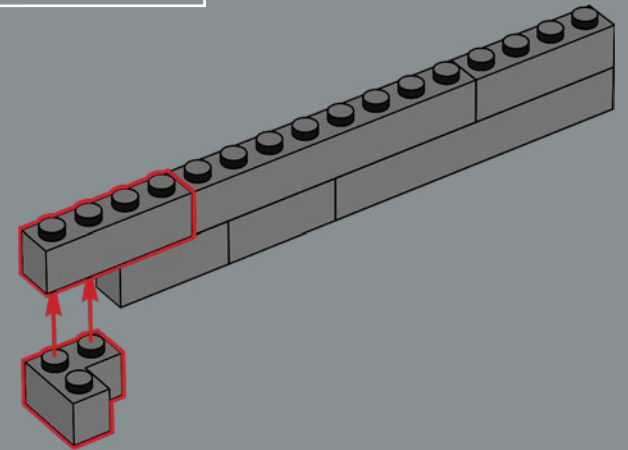





1x

483

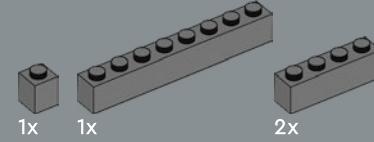
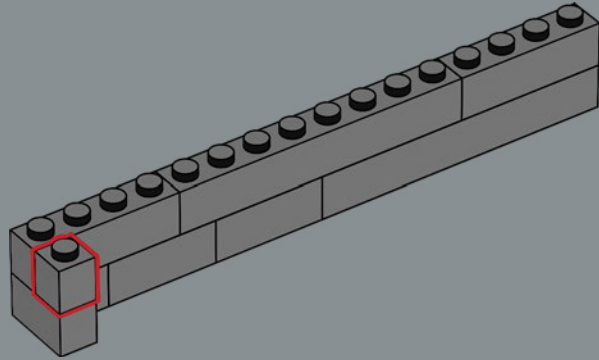

485

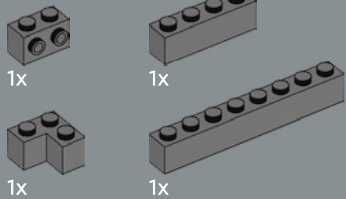
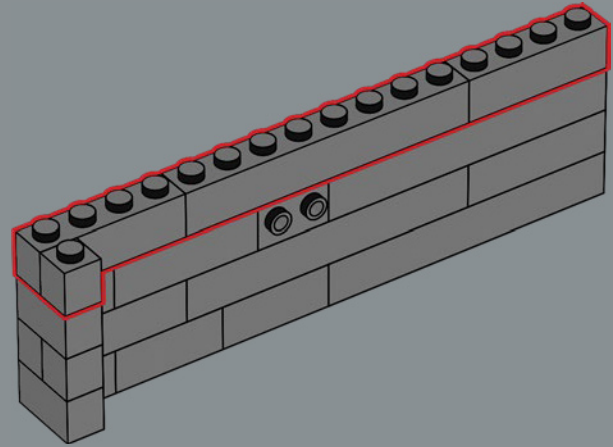

484

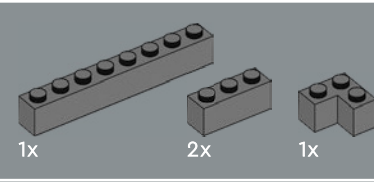
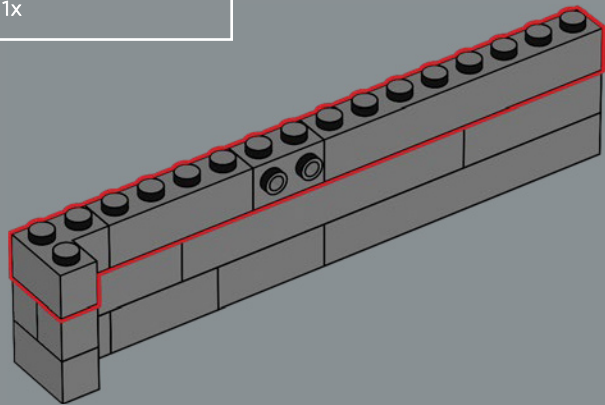

486

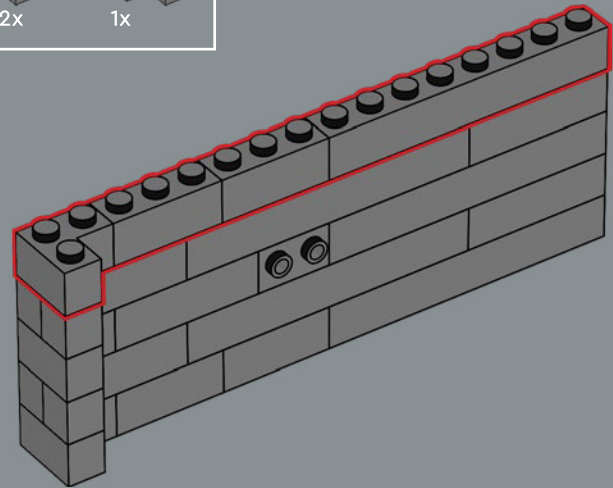

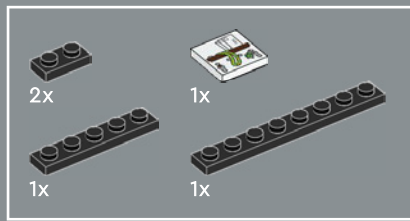

487

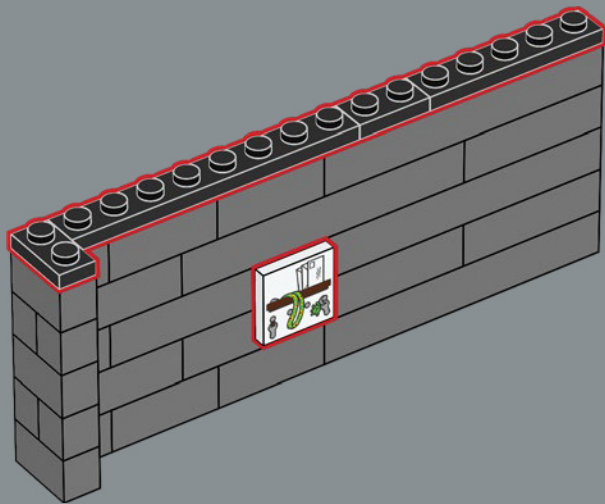

488





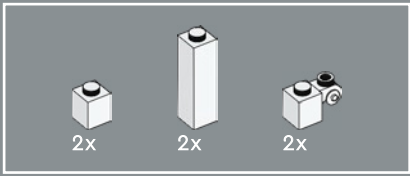

489

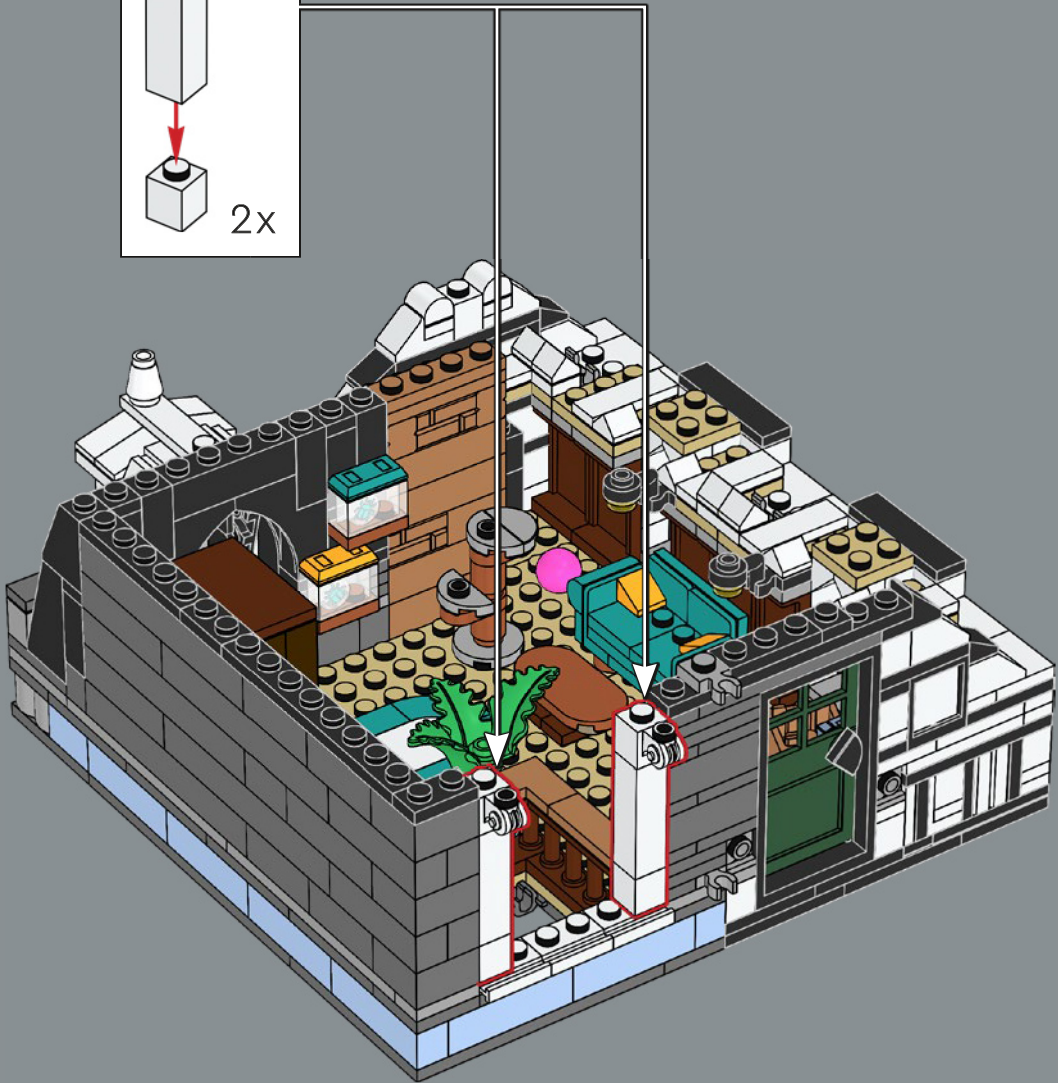
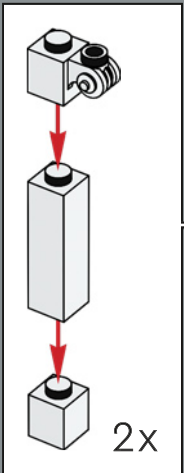

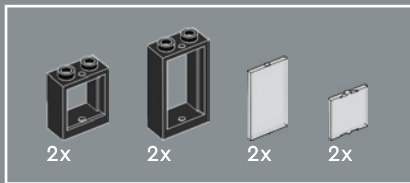

490

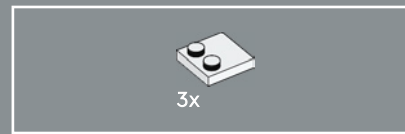
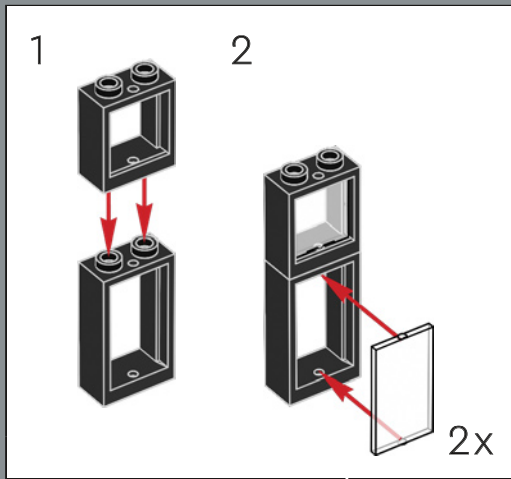

491





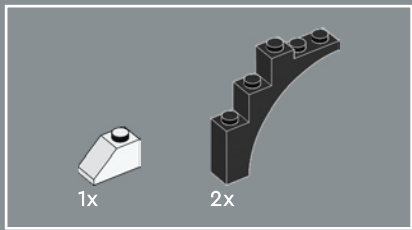

492

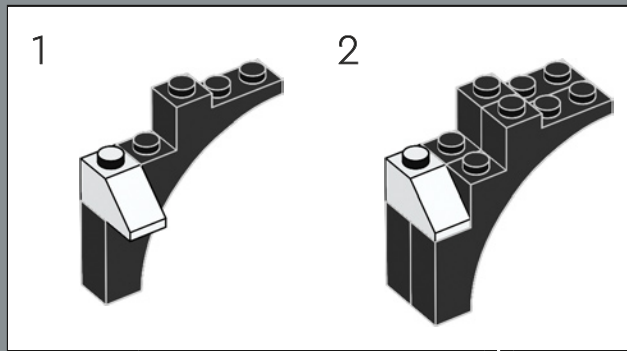

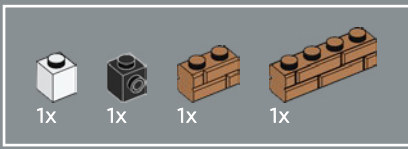

493





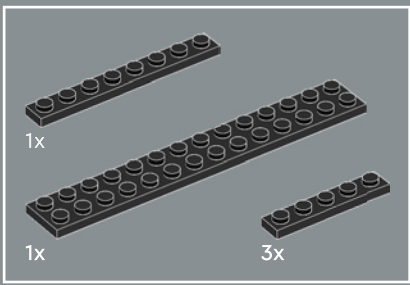

494

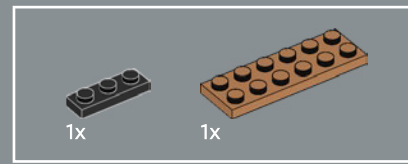

495



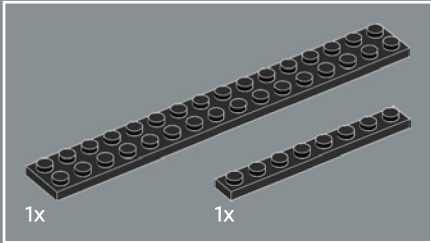
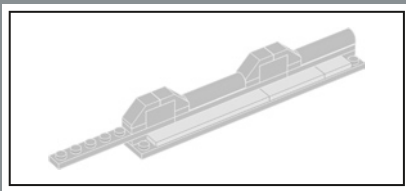

496

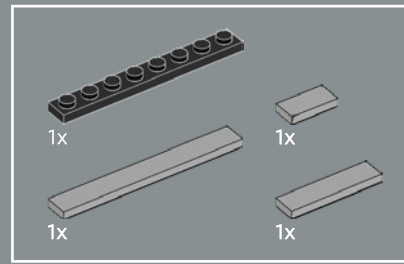
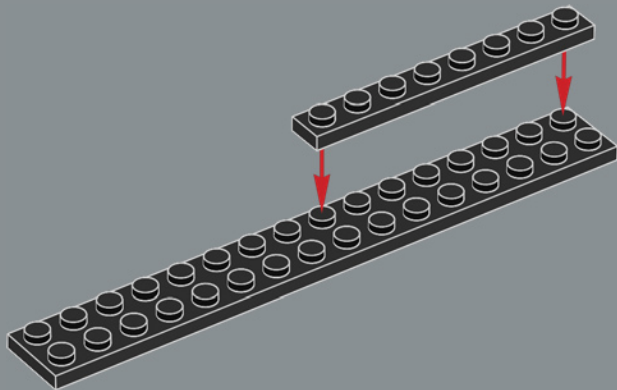

497

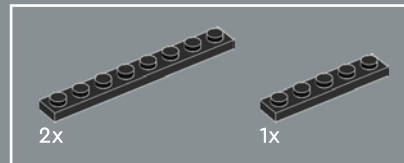
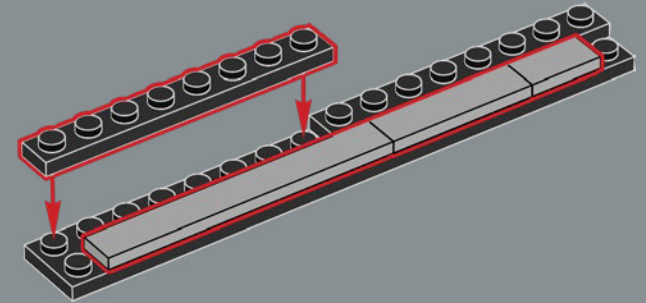

498

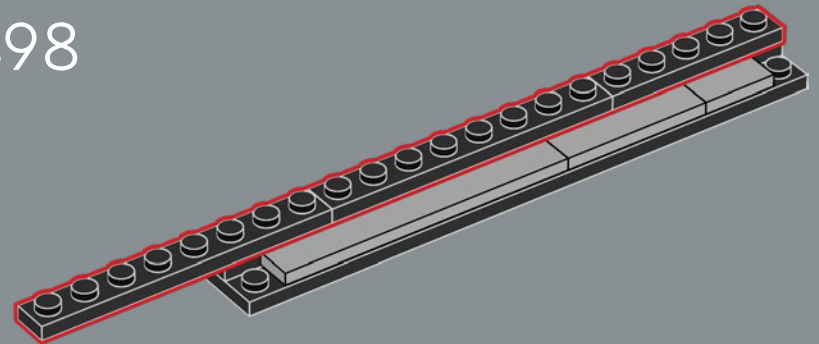





499

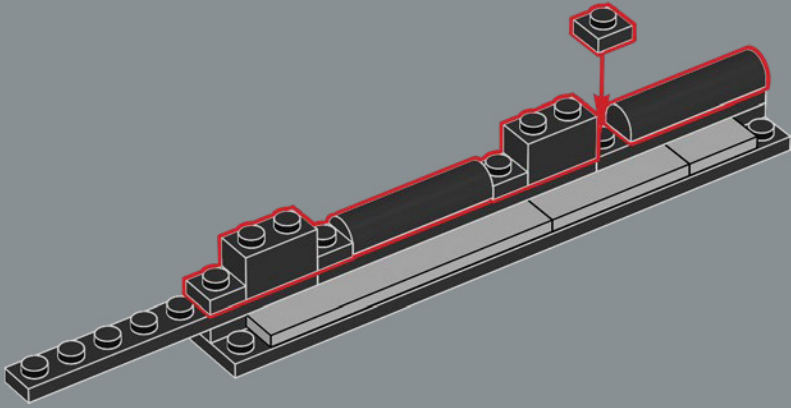

500

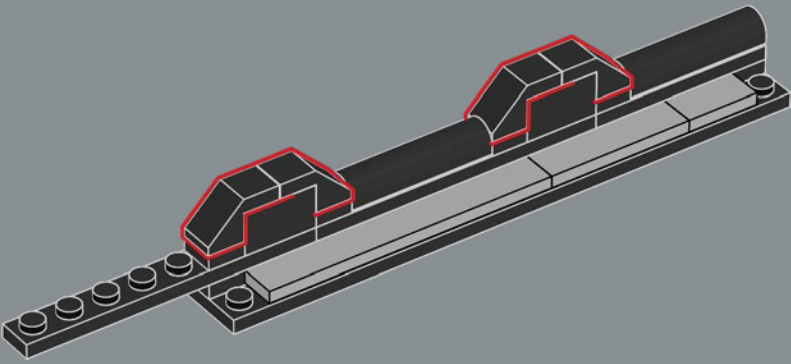

501



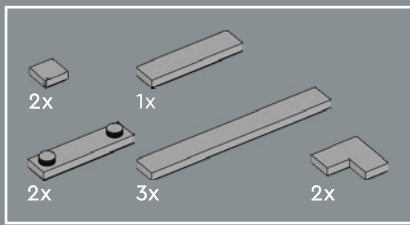

502







503



504



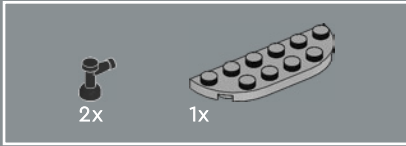

505

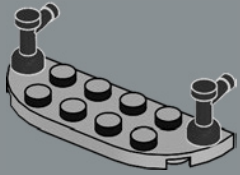

506

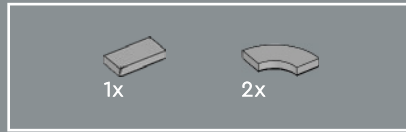
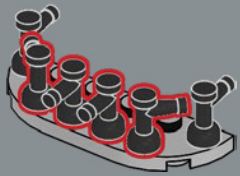

507

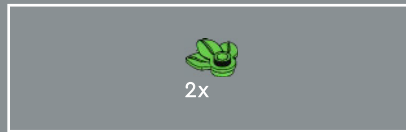
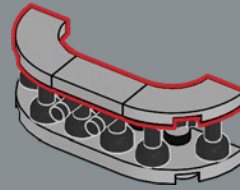

508

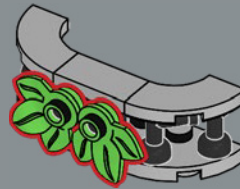

509

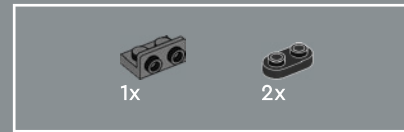
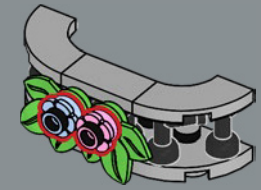

510







1x



2x

511

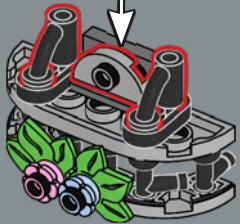
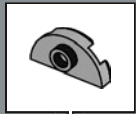

512



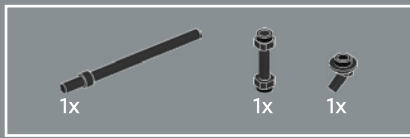

513

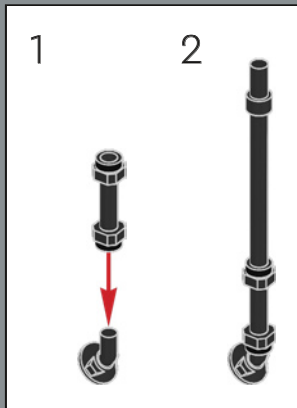





514



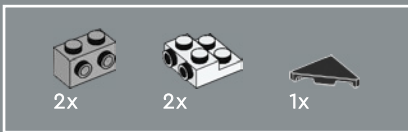

515

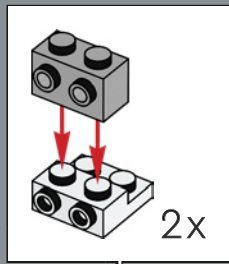



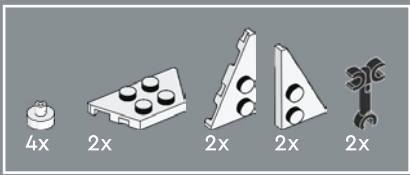

# 516

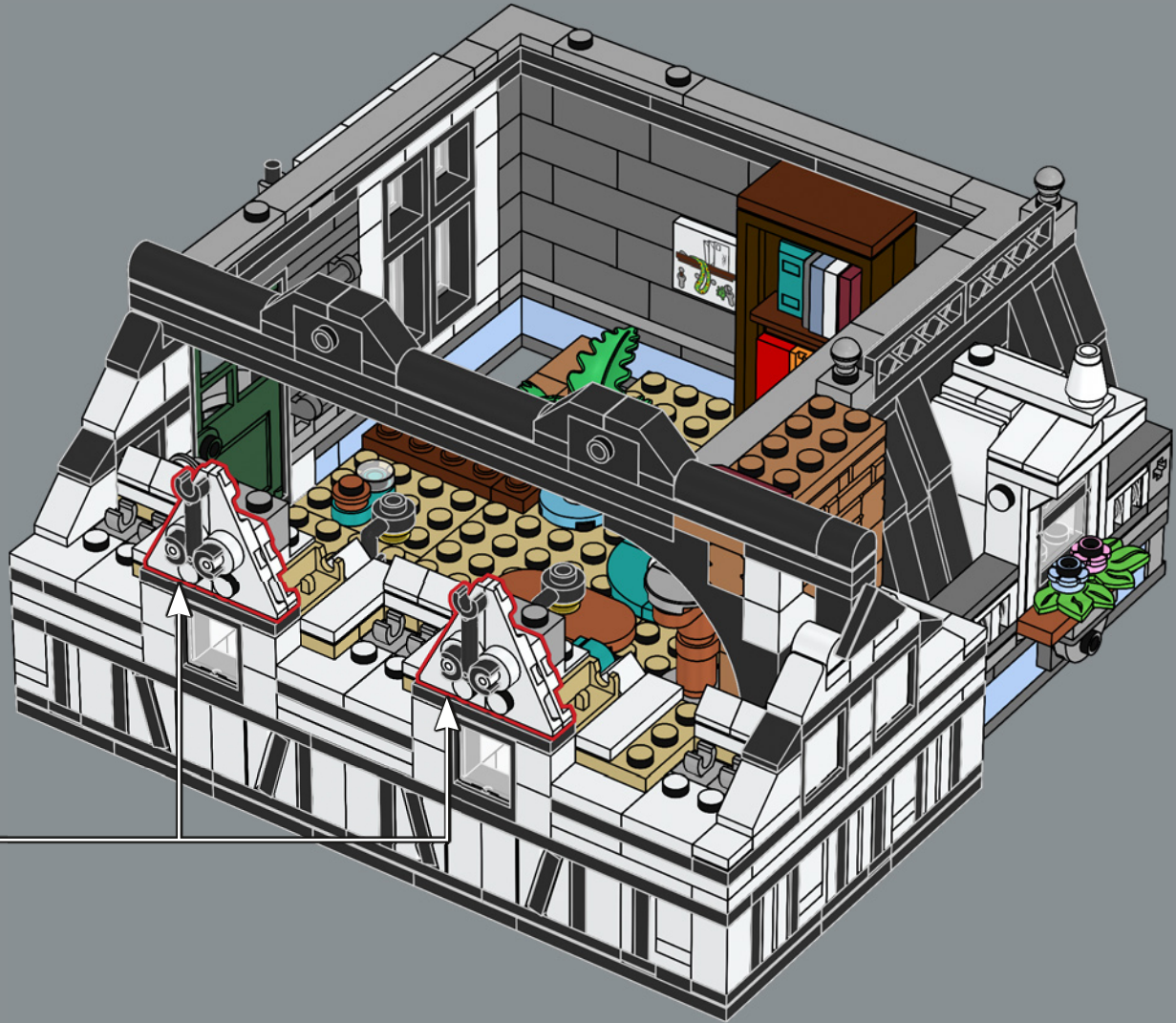
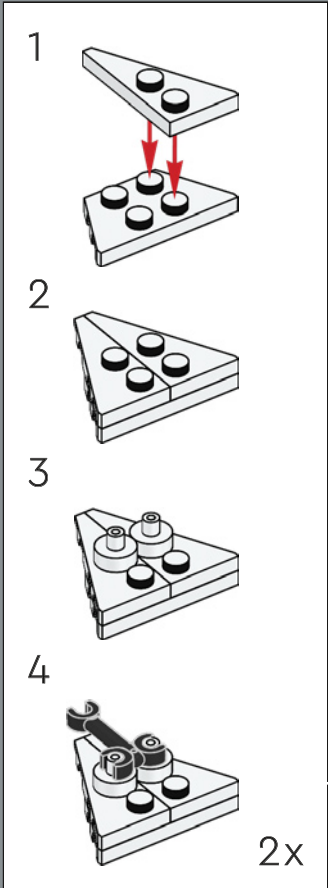

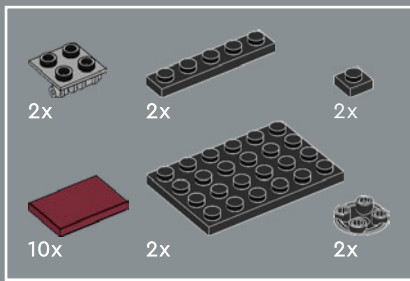

517

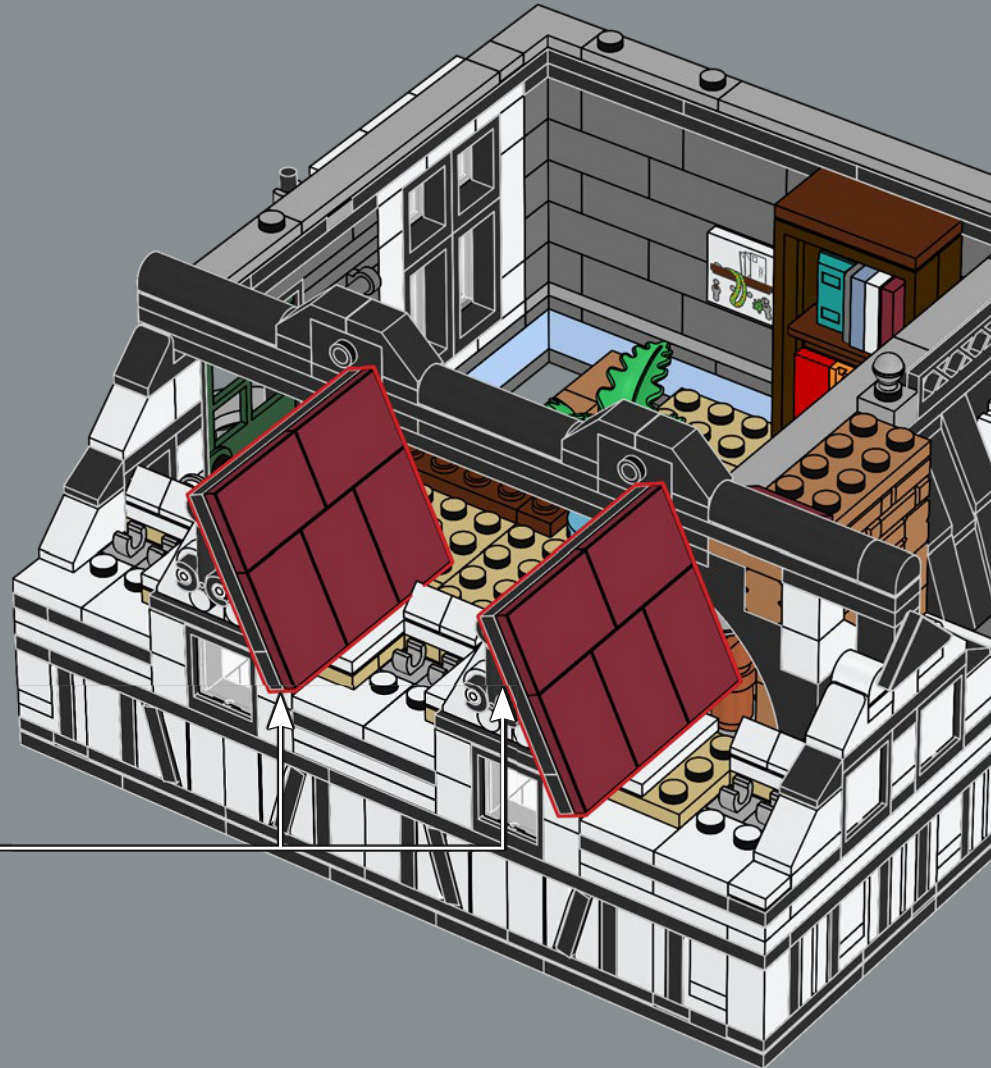
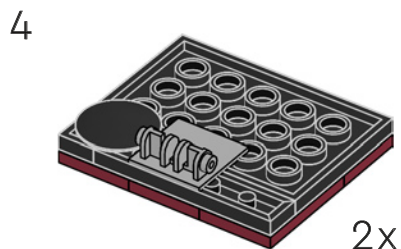
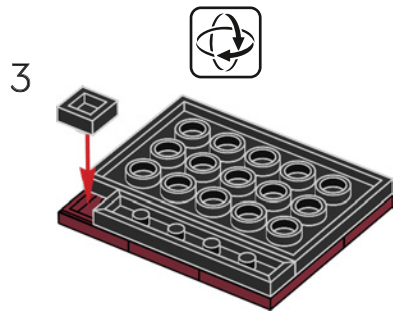
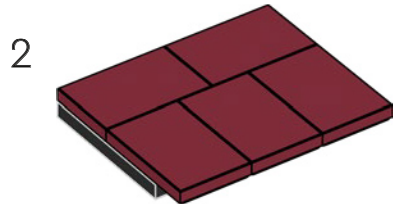
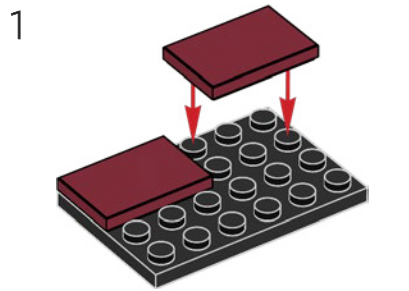



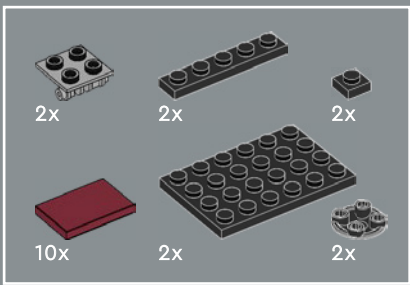

518

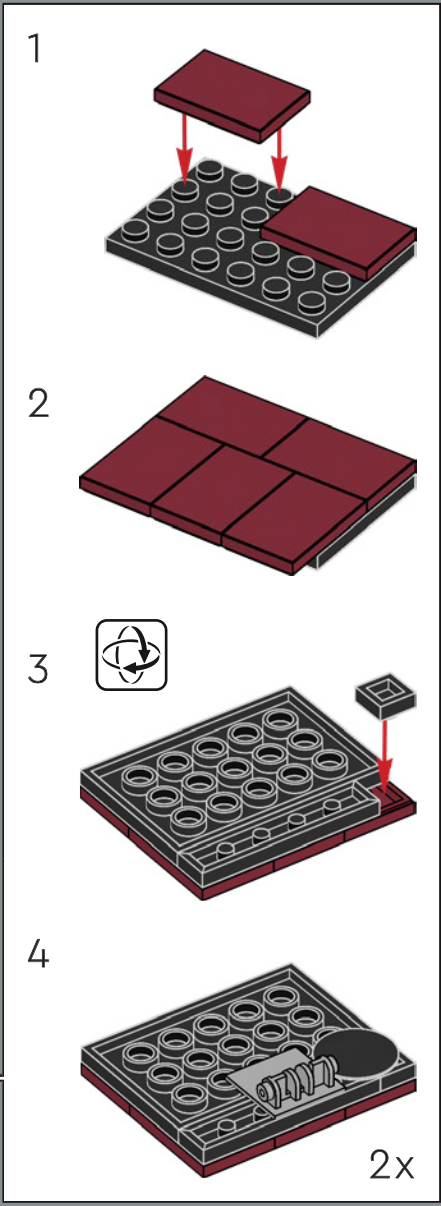

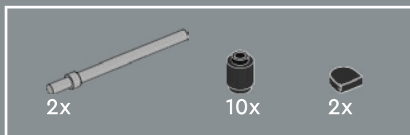

519

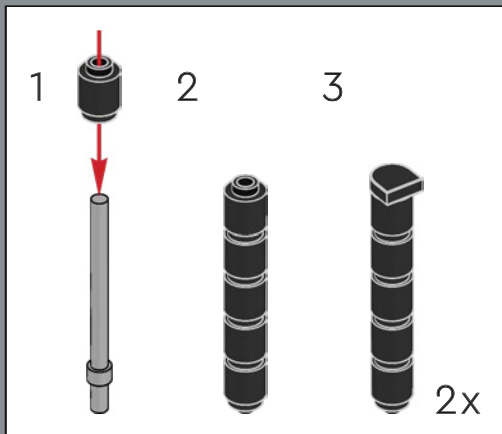



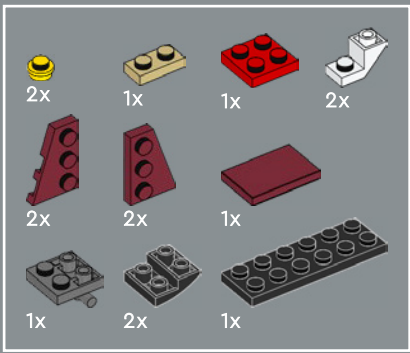

520

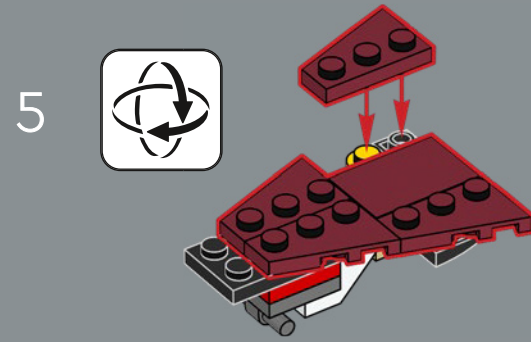
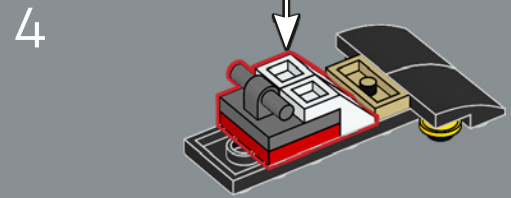
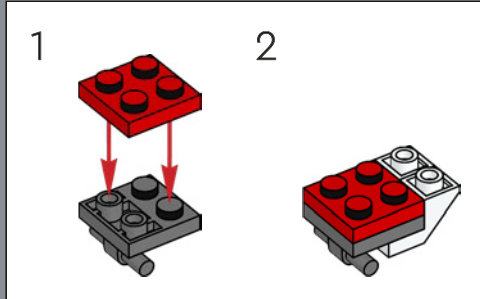
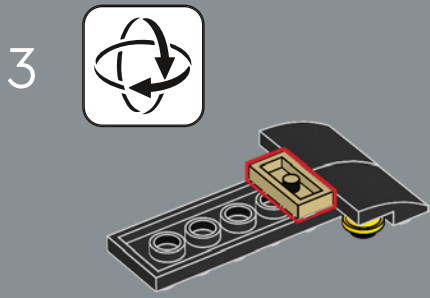
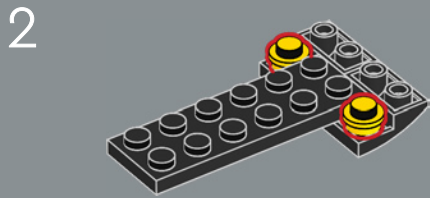
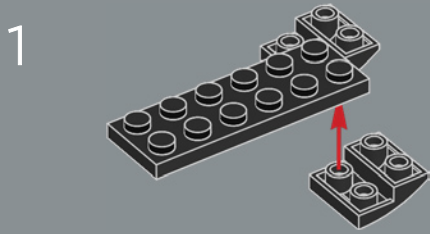

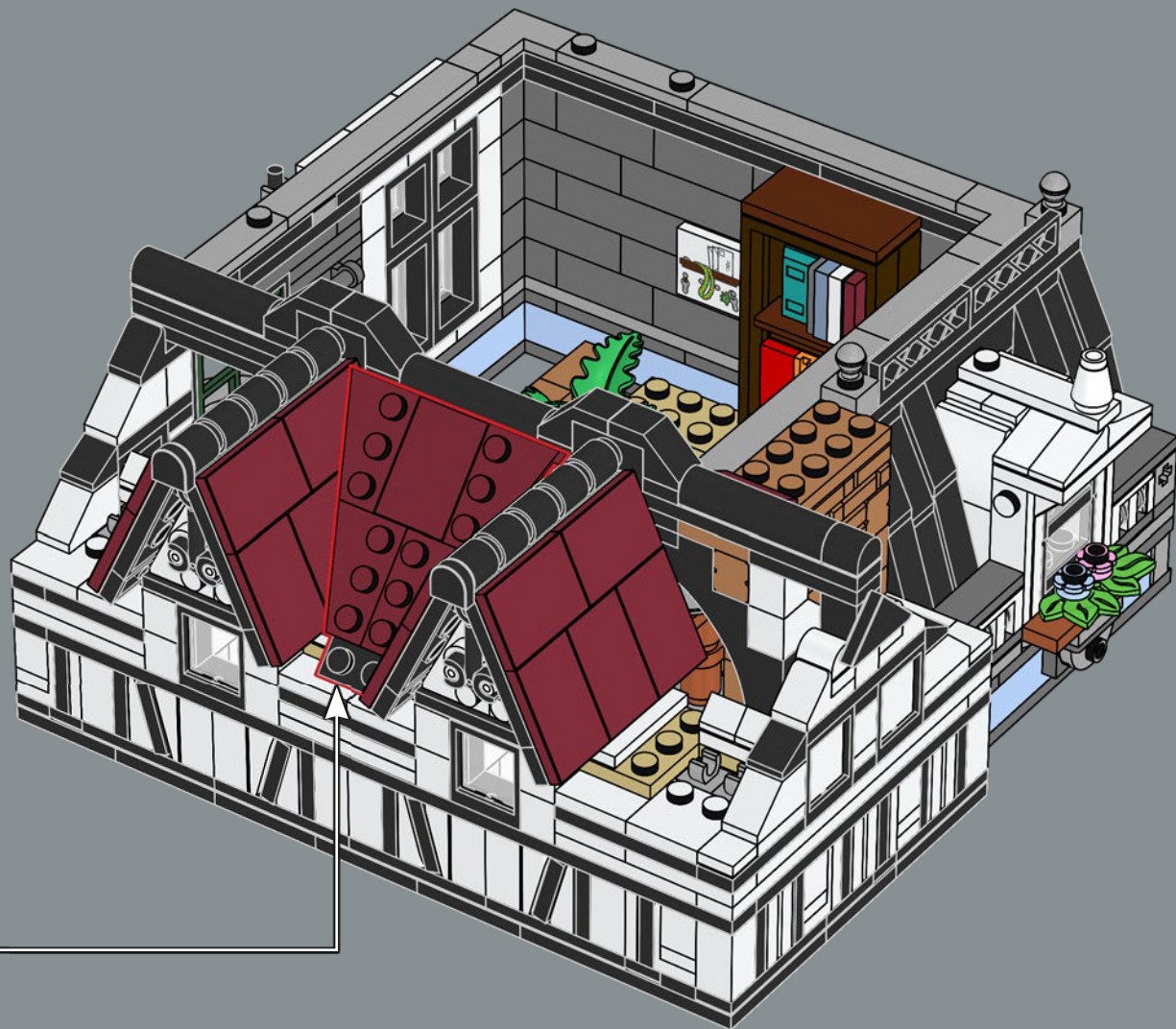



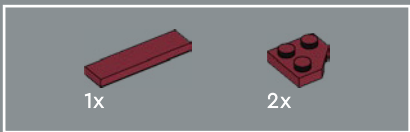

521

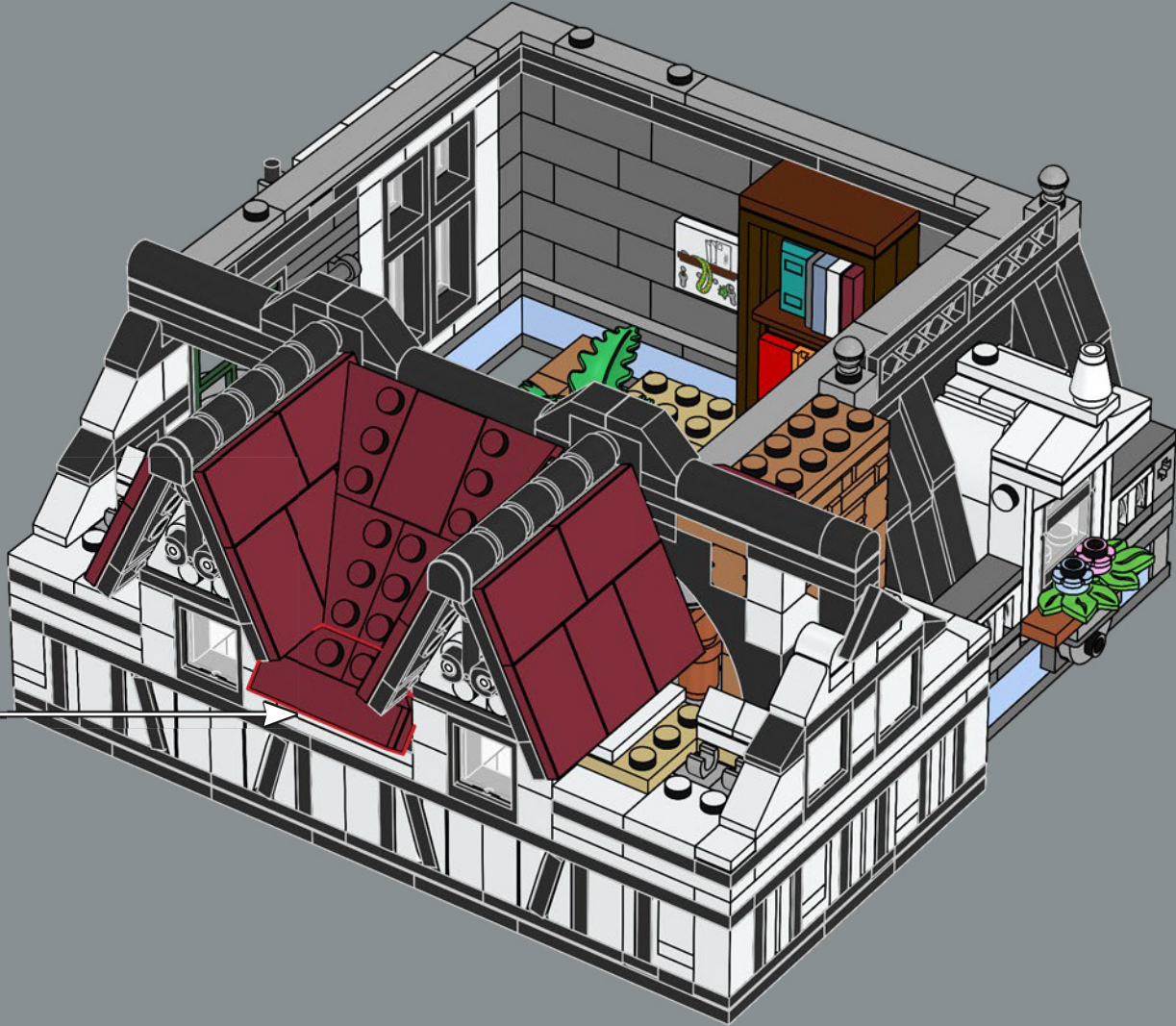
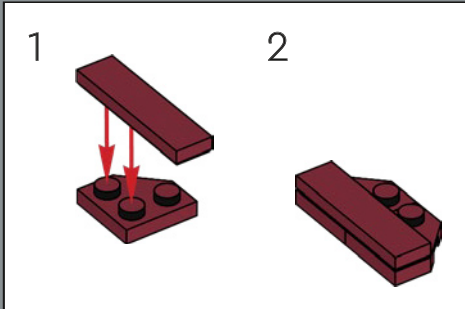

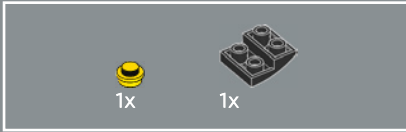
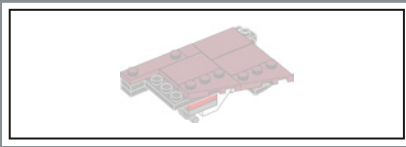

522

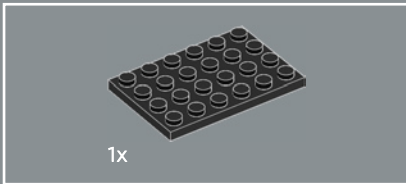
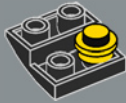

523

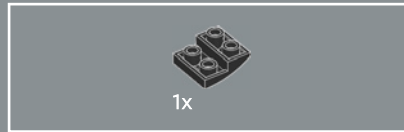
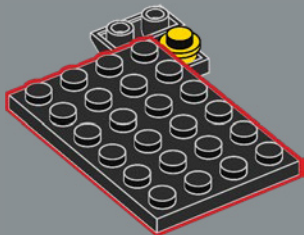

524

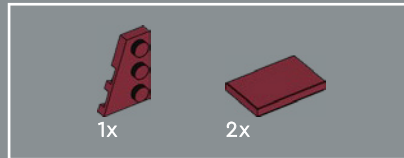
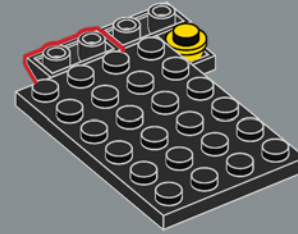

525

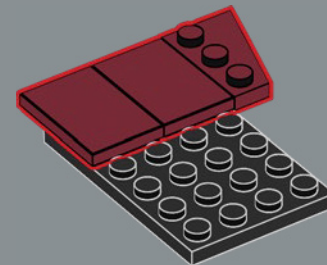



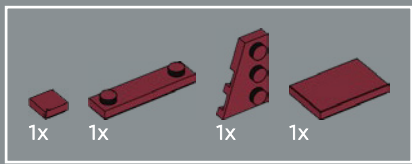

526

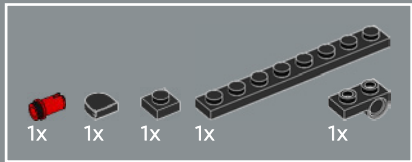
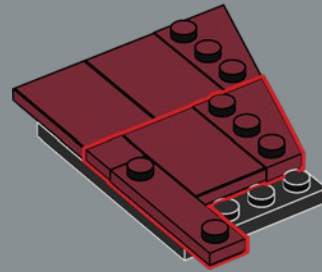

527

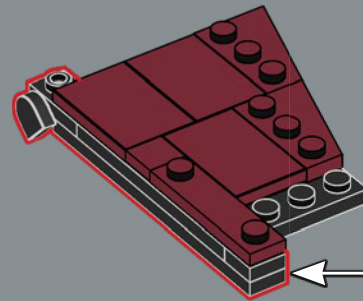
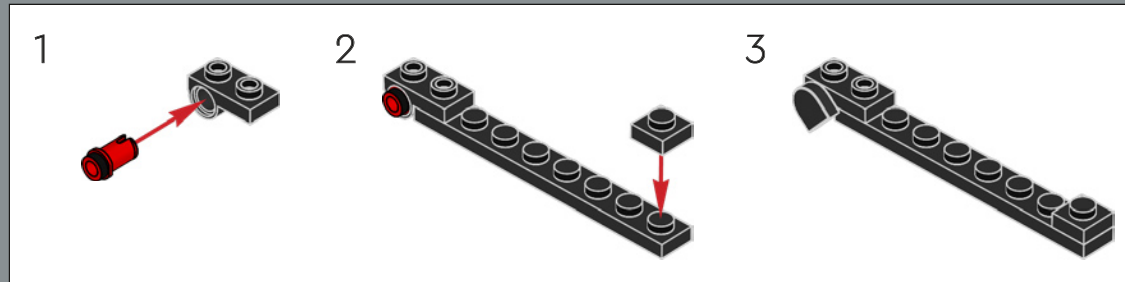

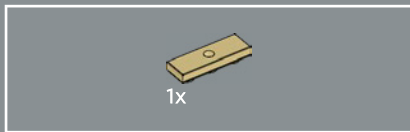

528

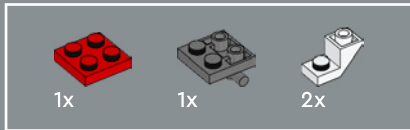
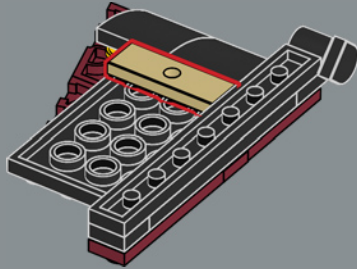

529

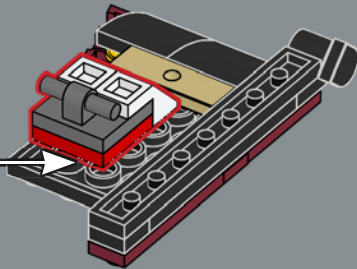
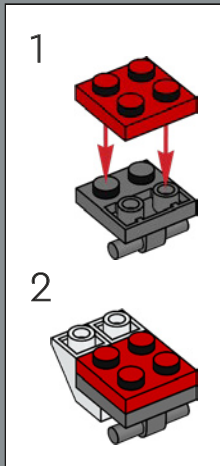

530

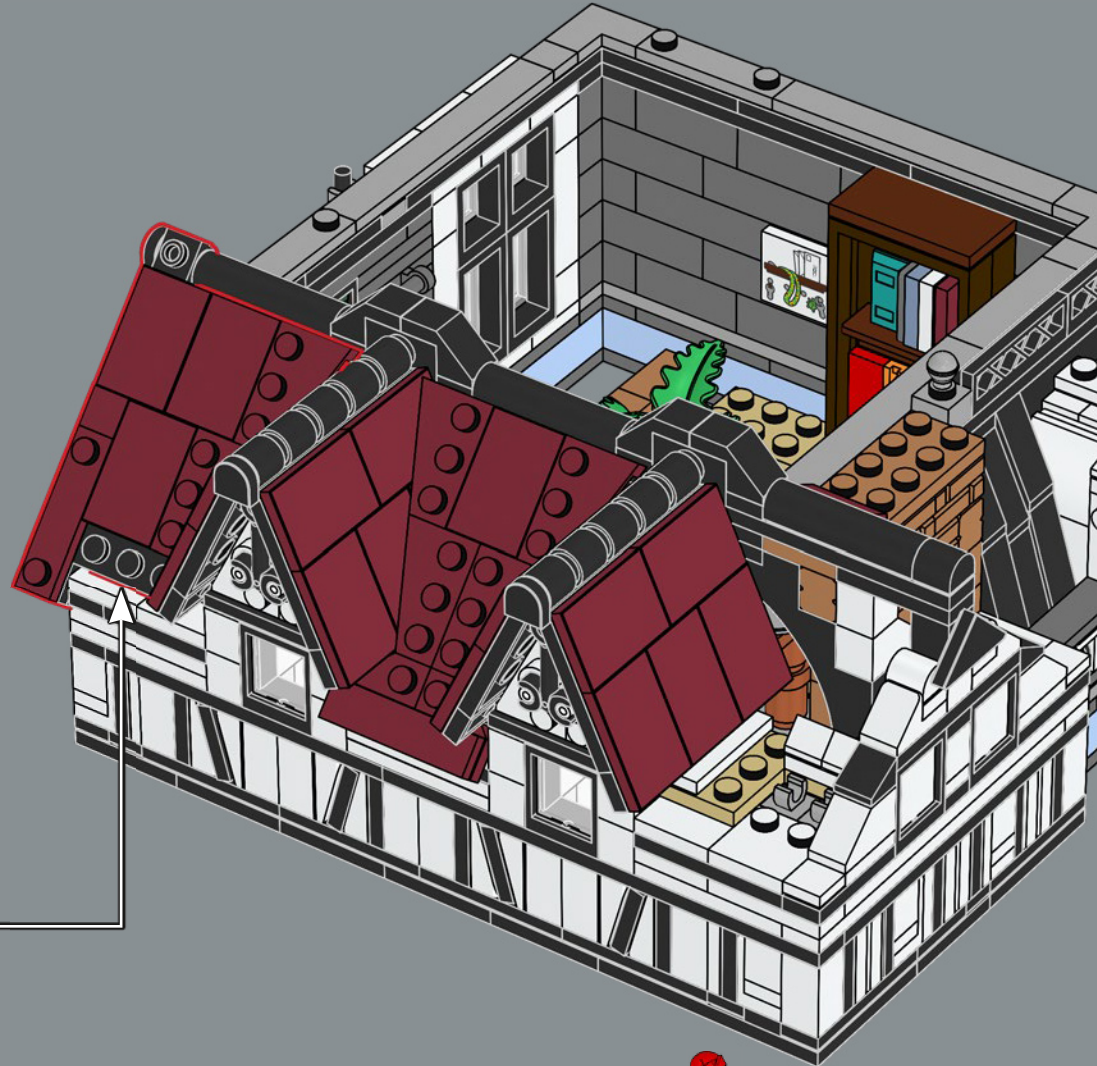



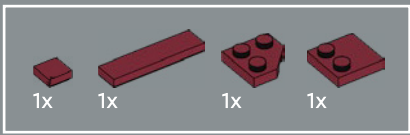

531

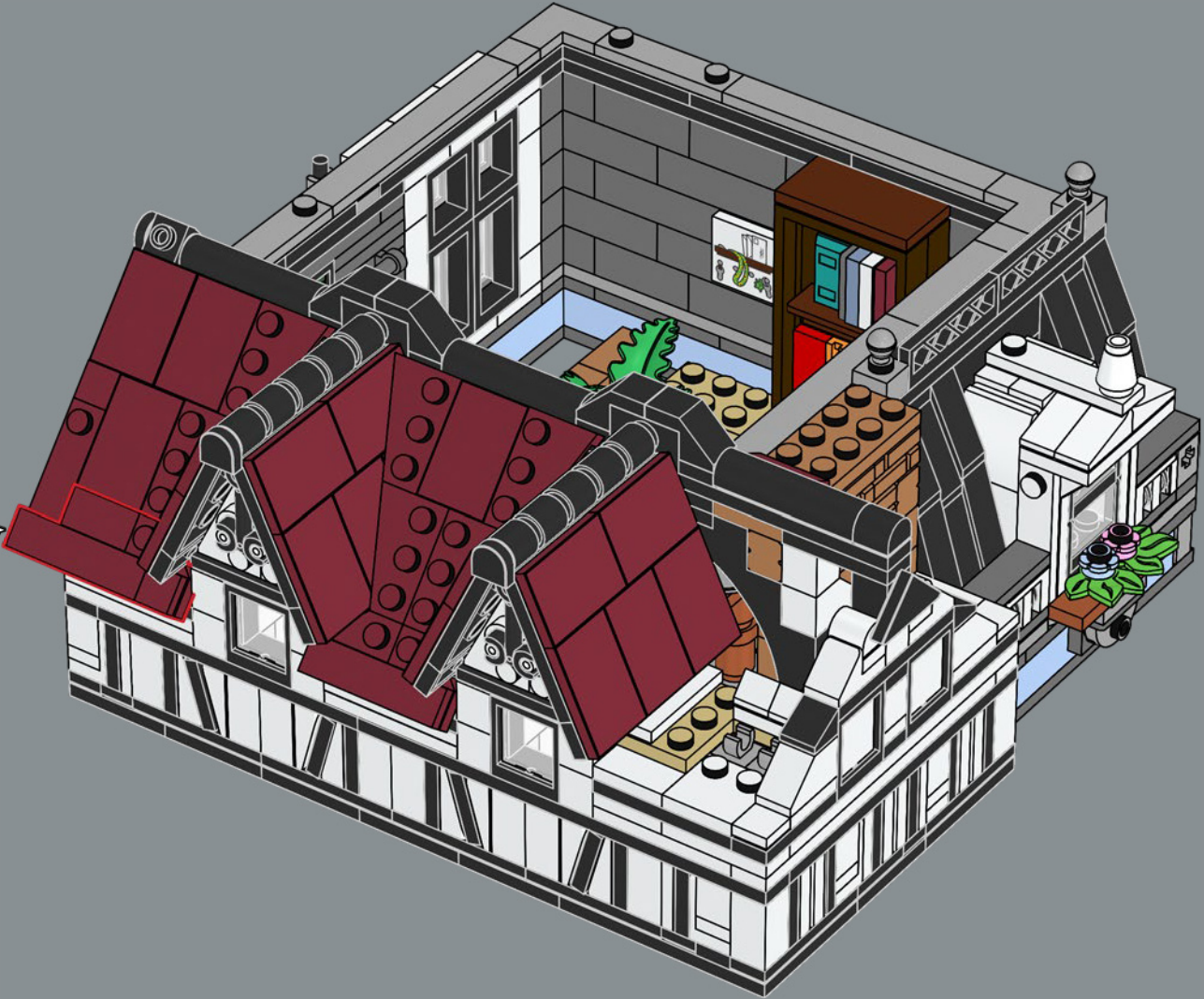
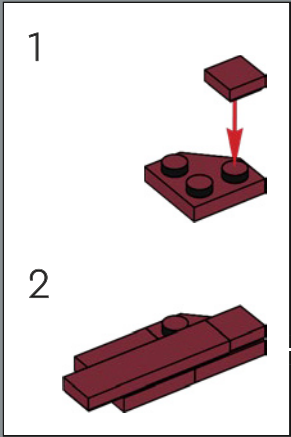

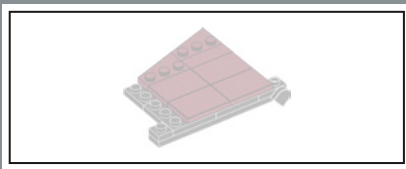

532

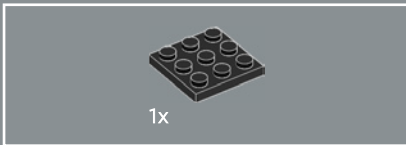

533

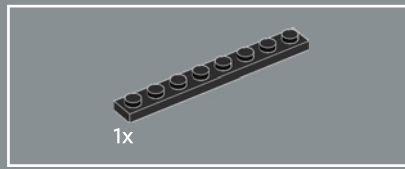
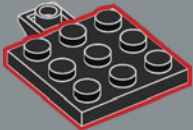

534

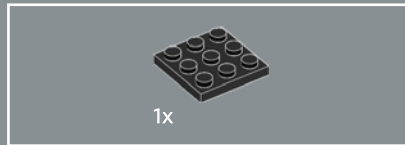
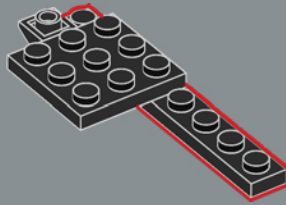

535

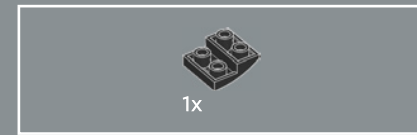
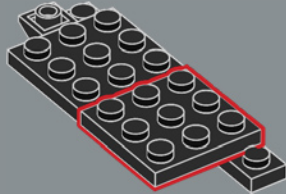

536

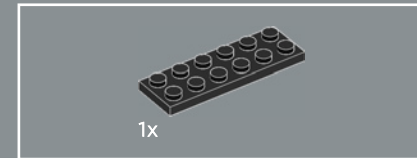
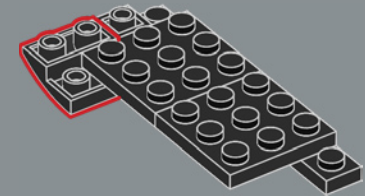

537

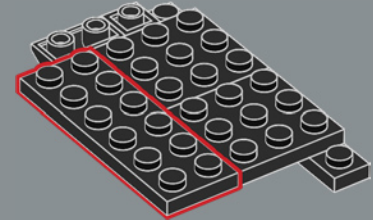





538

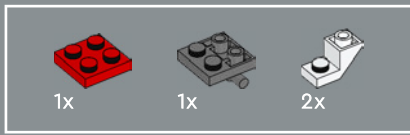
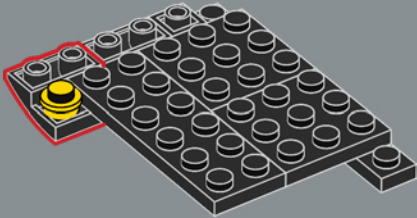

540

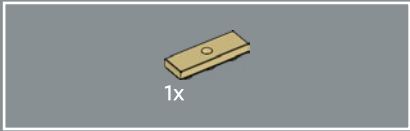
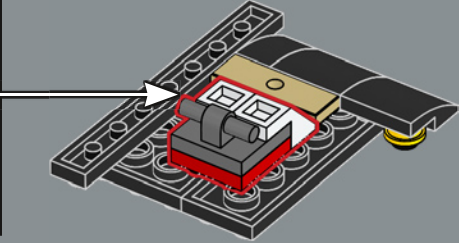
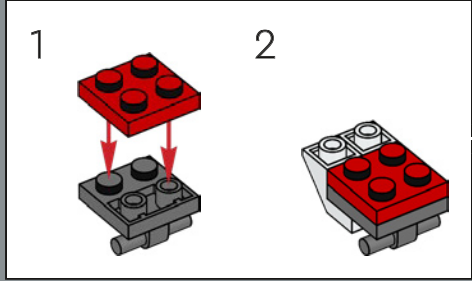

539

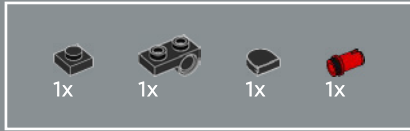
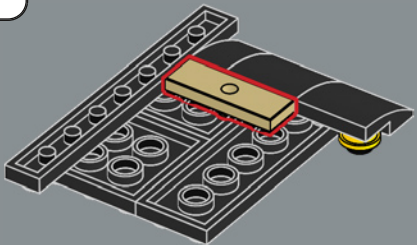

541

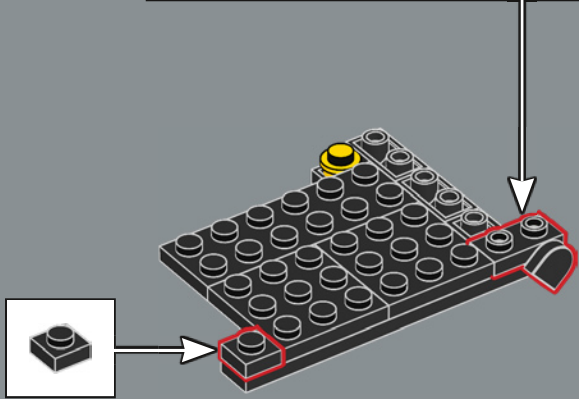
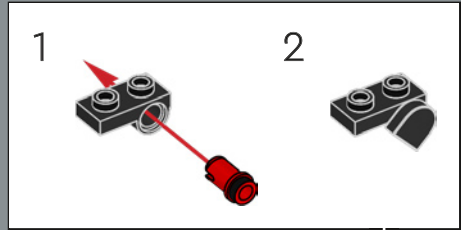

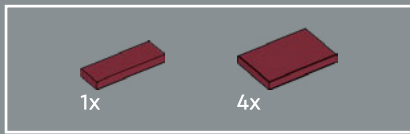

542

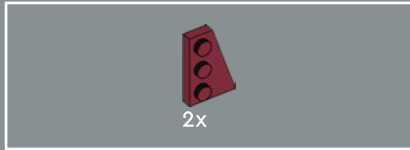
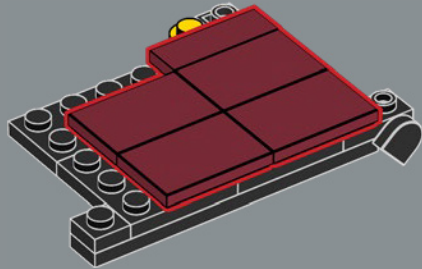

543

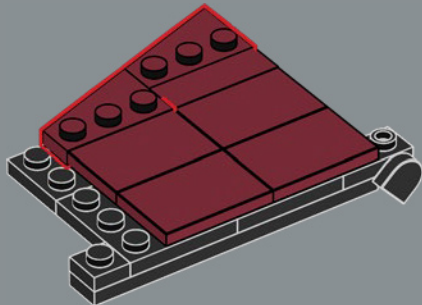

544

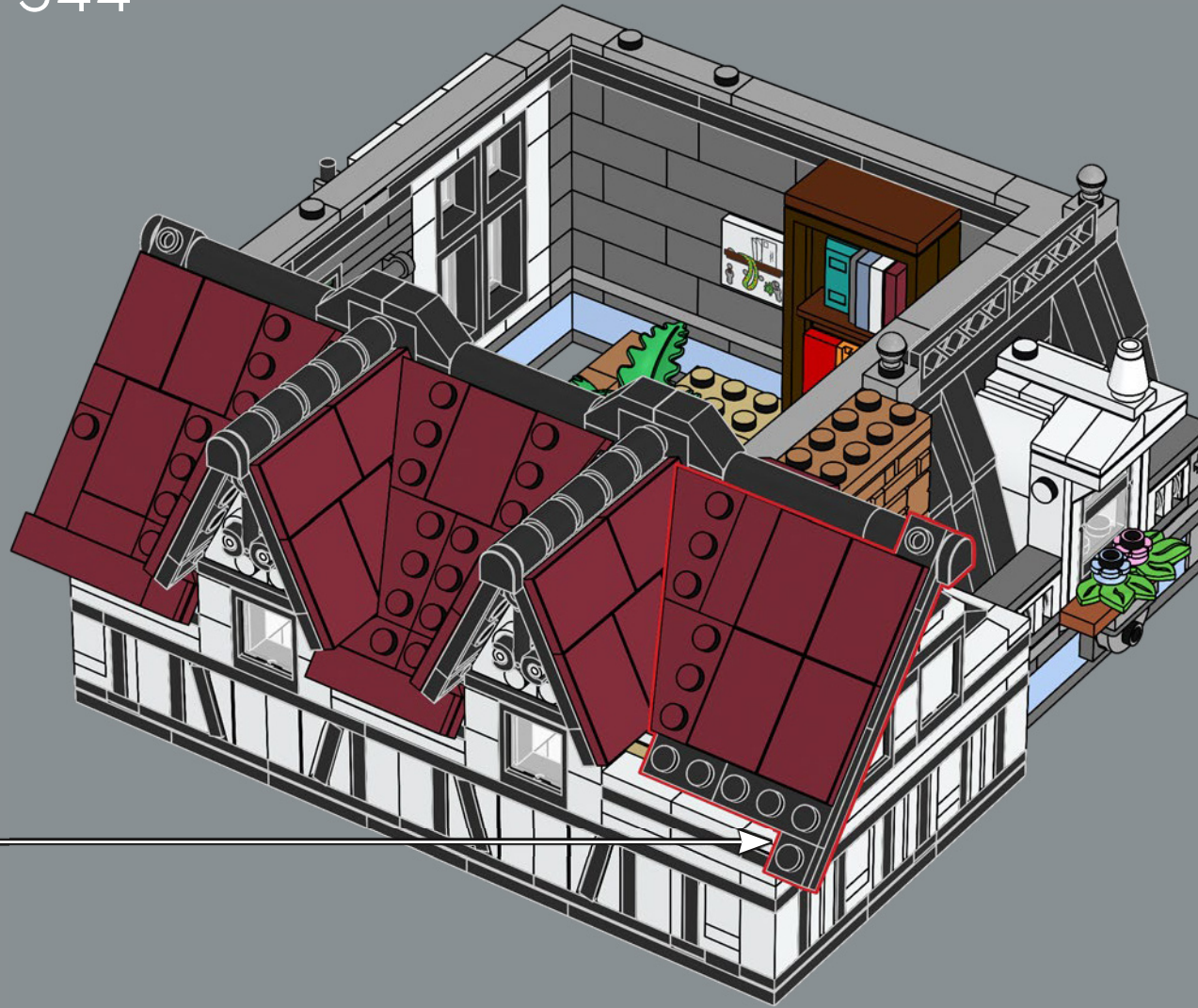



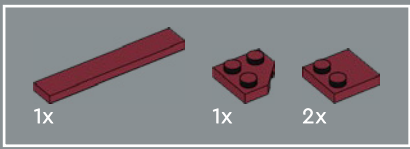

545

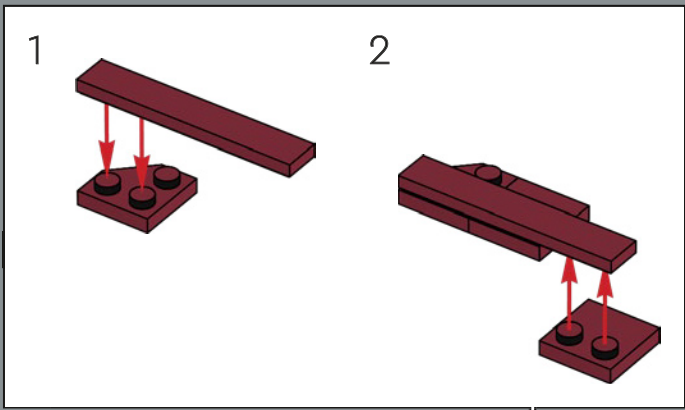
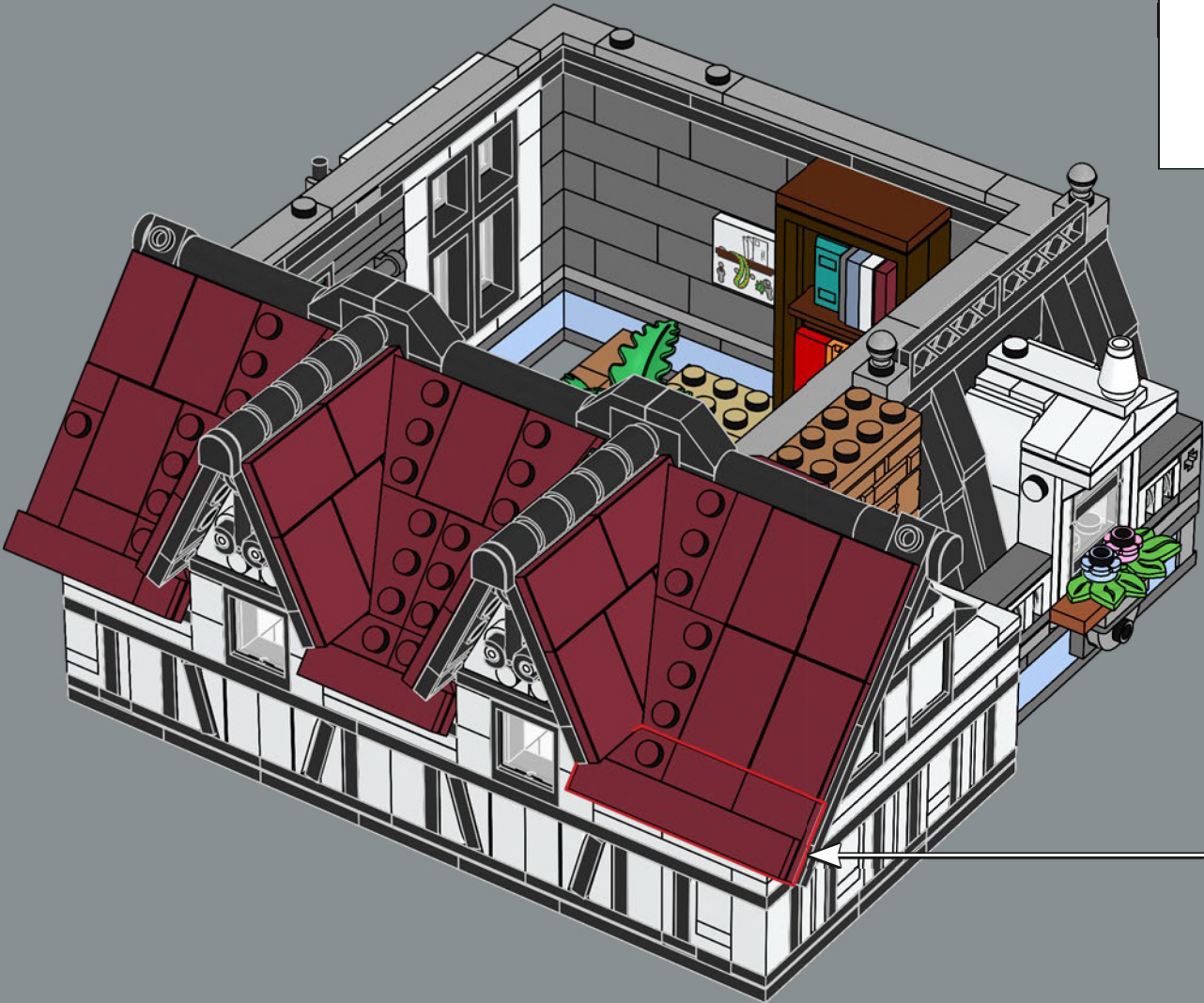

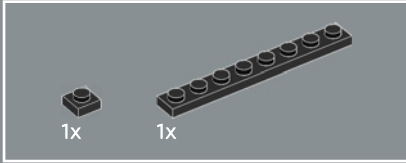
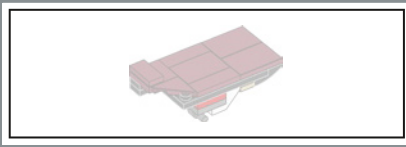

546

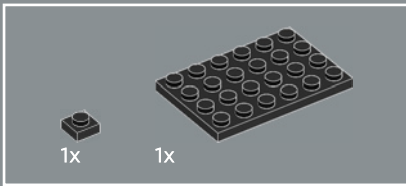
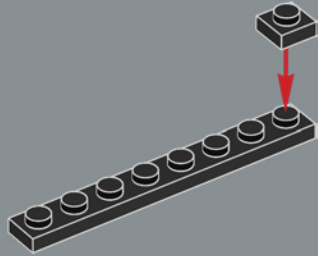

547

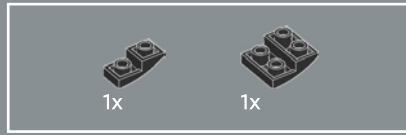
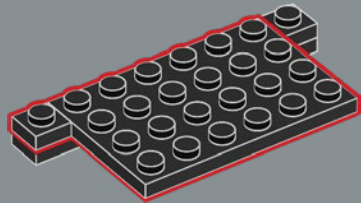

548

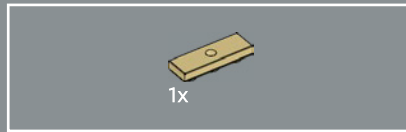
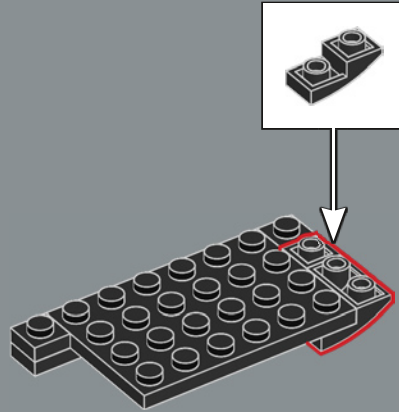

549

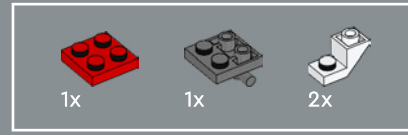
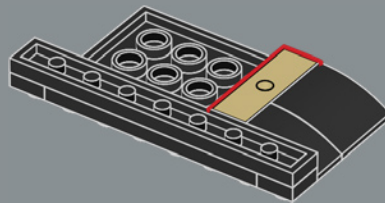

550

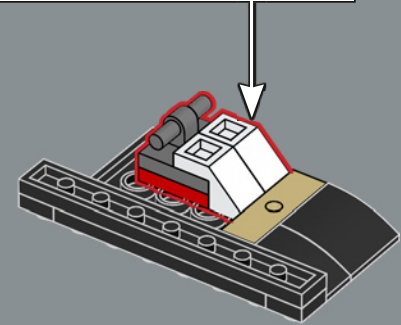
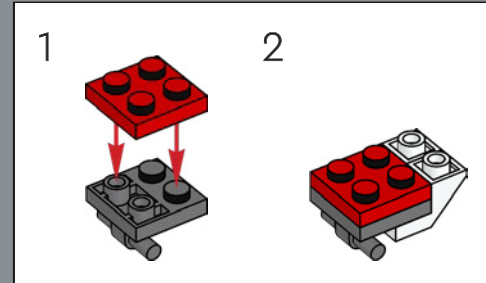



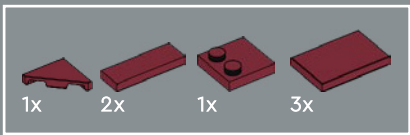

551

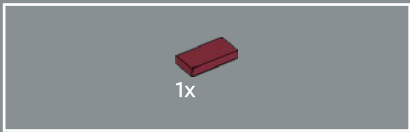
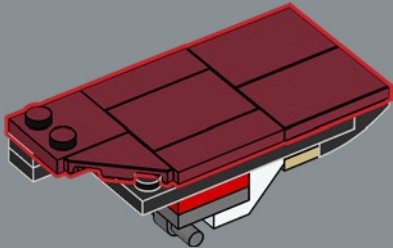

552

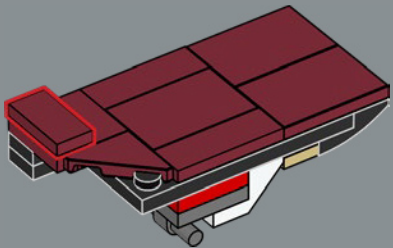

553

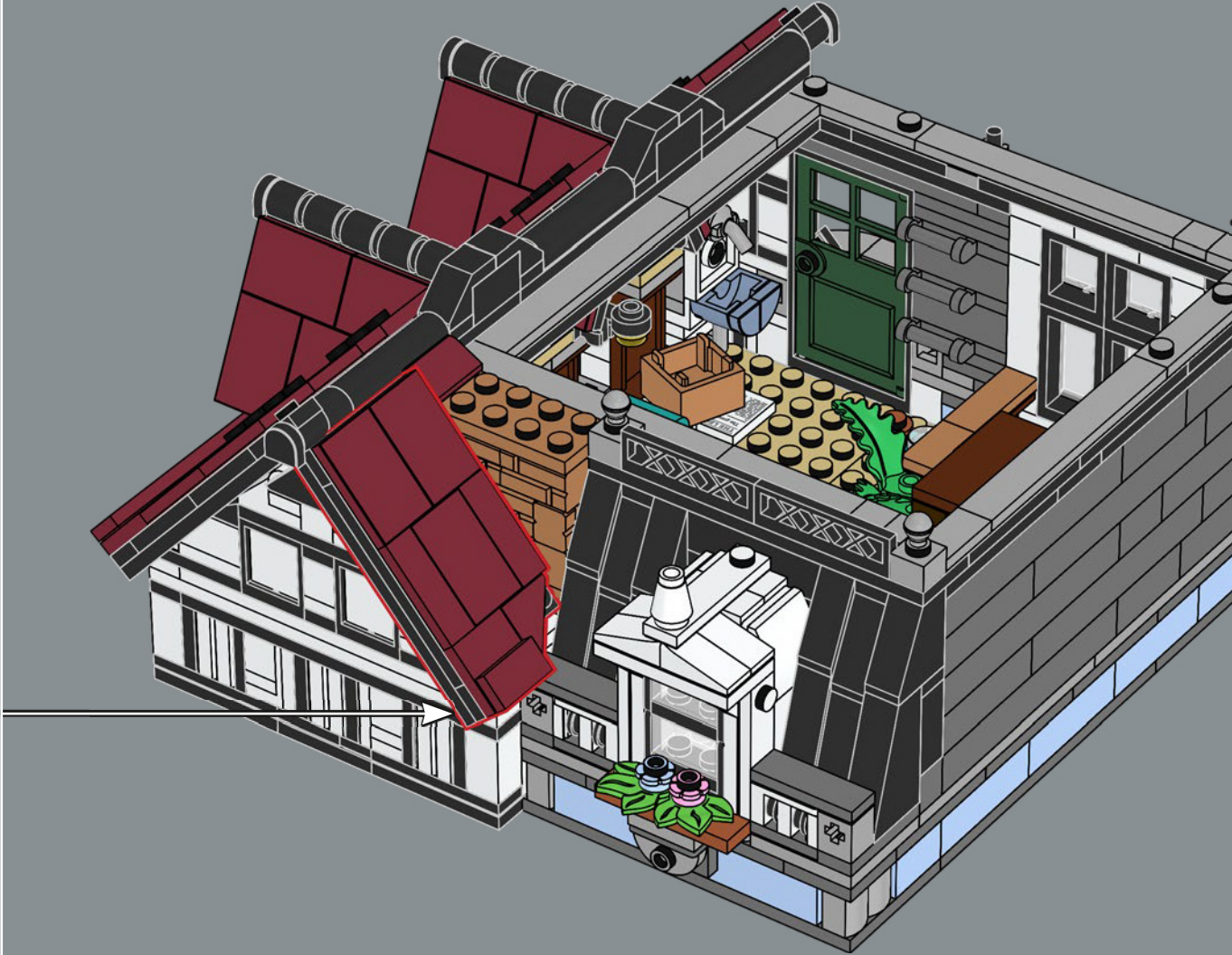

554

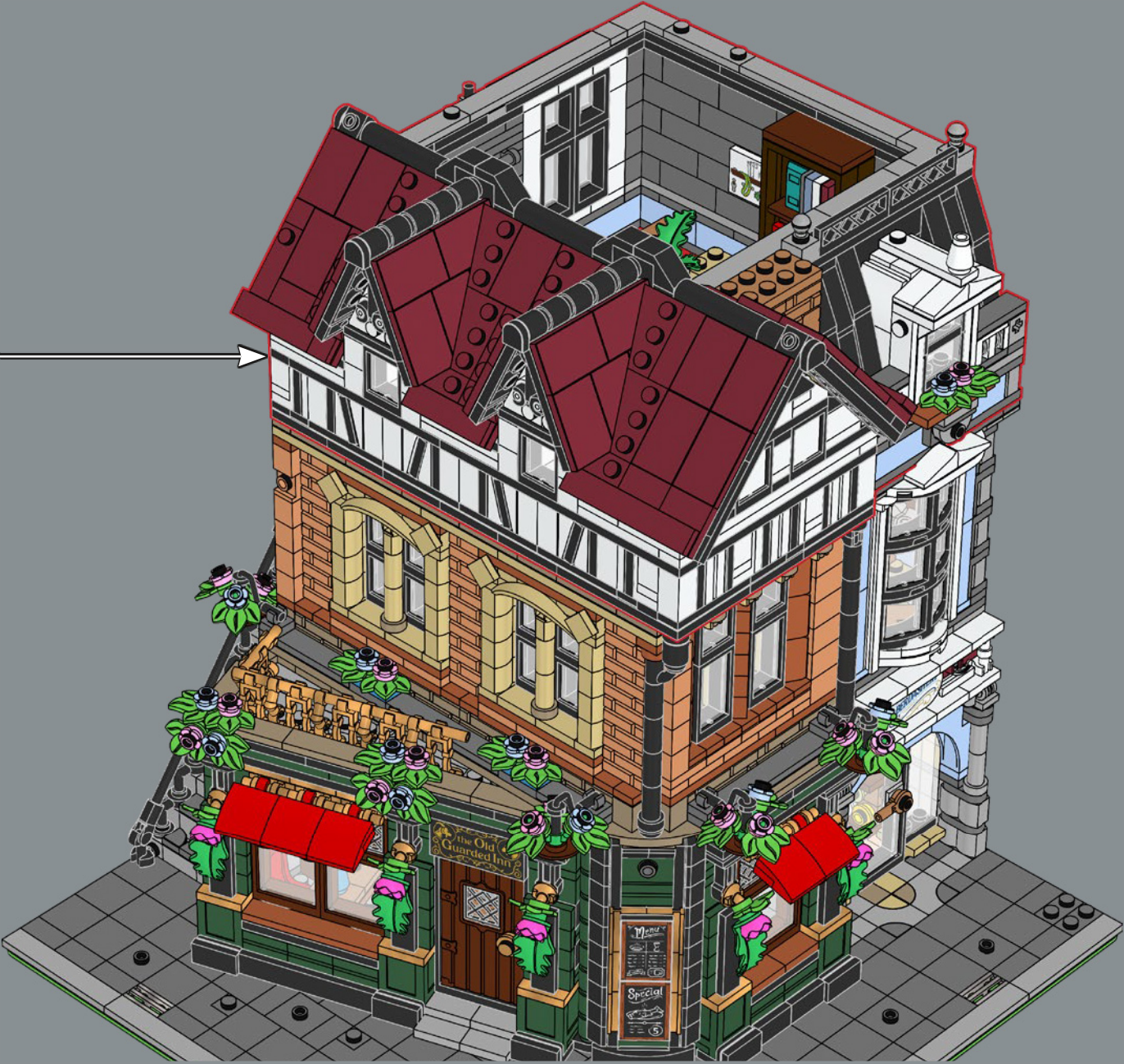



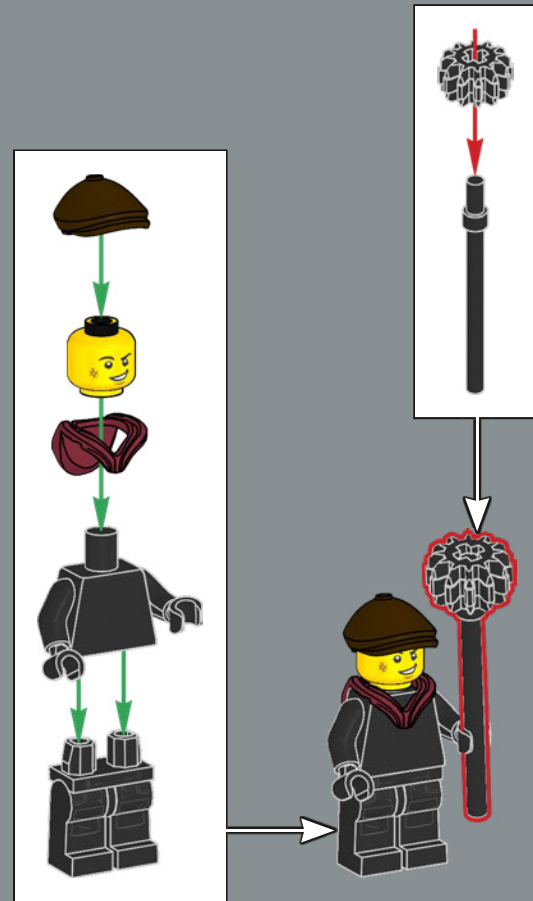
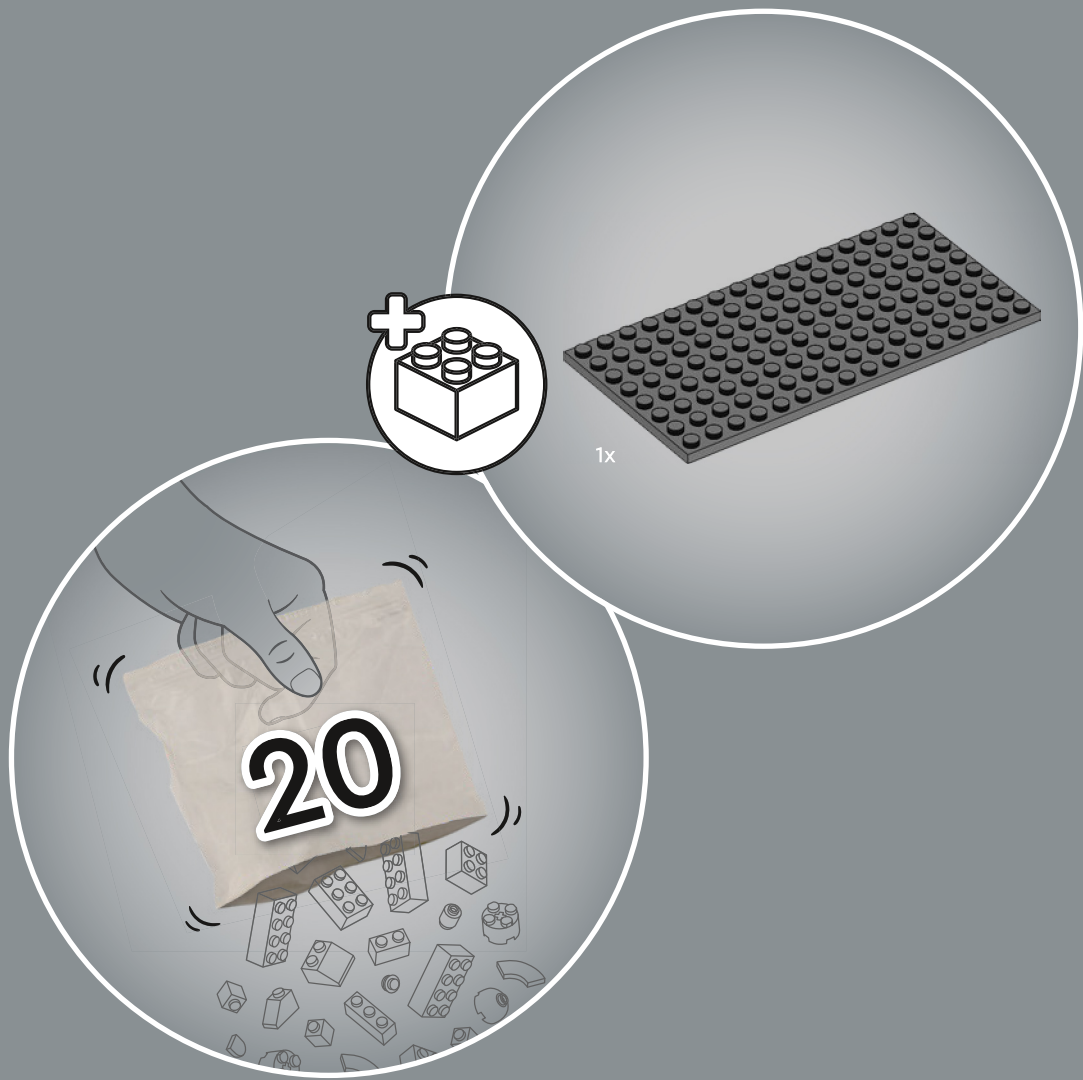

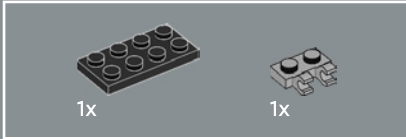
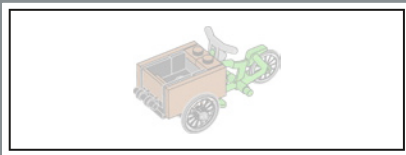

555

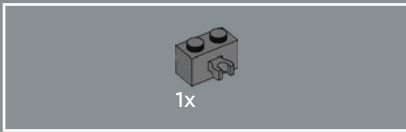
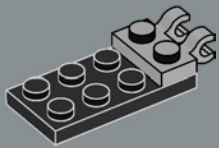

556

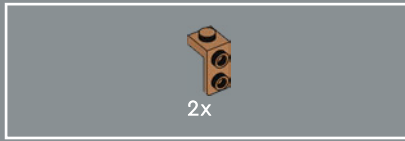
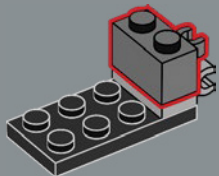

557

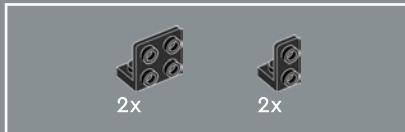
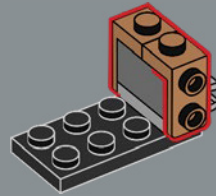

558

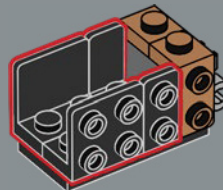

559

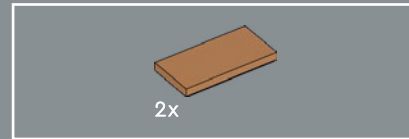
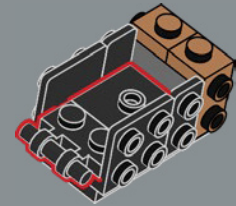

560

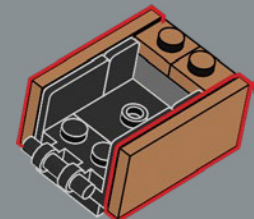





1x

561

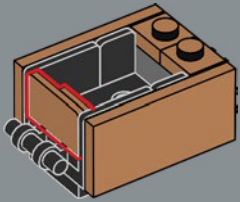

2x

563

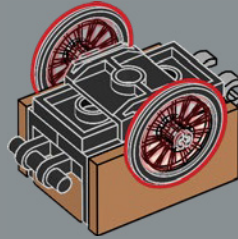

1x

565

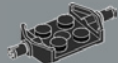
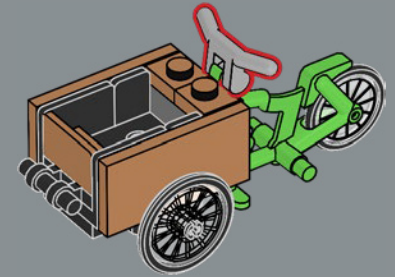

1x

562

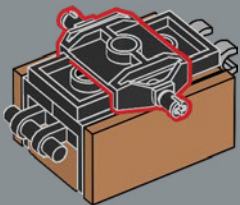

1x



1x

564

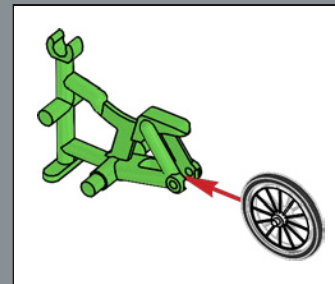
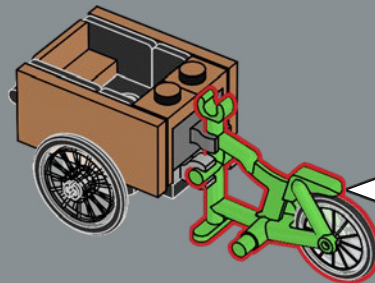

This cargo bike is perfect for getting around town and transporting your groceries and books - or even taking your cats to the vet above the LEGO® Creator Expert Corner Garage (10264).

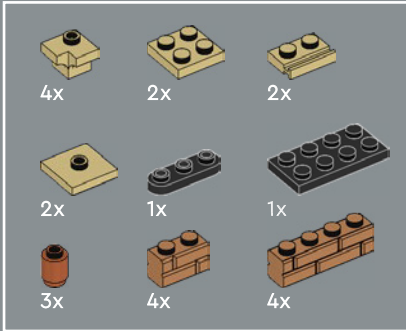
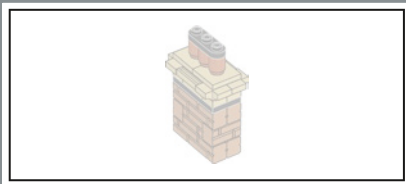

566

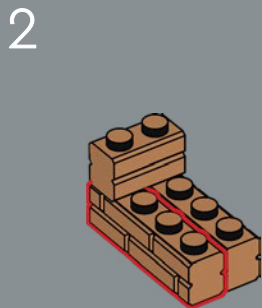
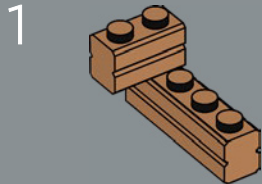

3

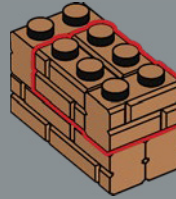

4

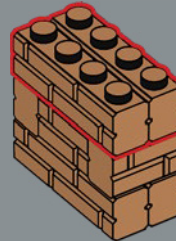

5

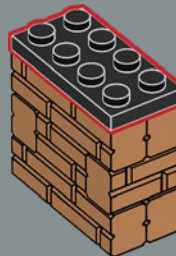

6

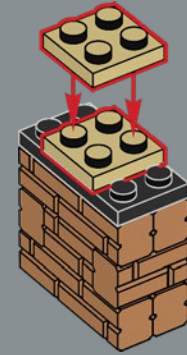

7

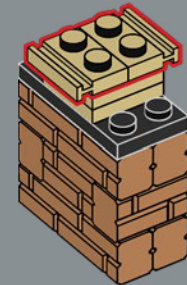

8

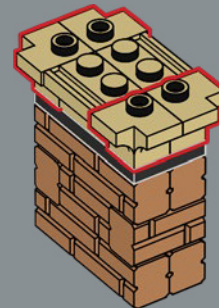



9

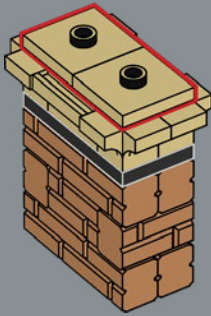

10

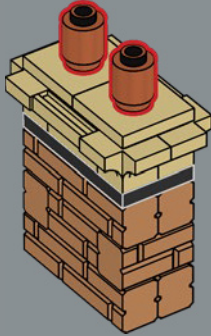

11

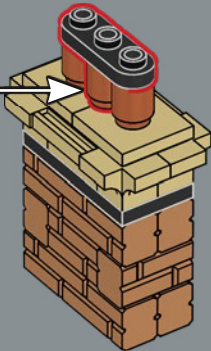
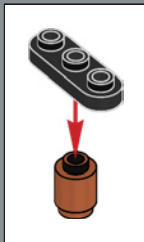

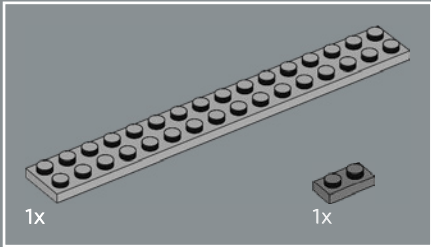
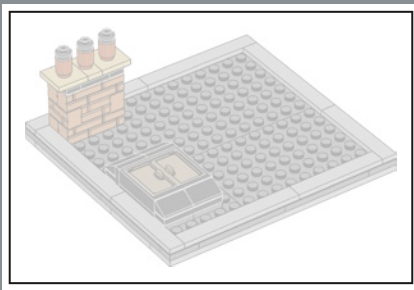

567

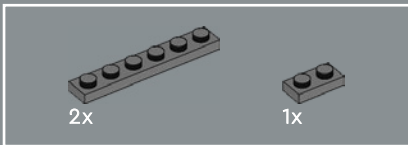
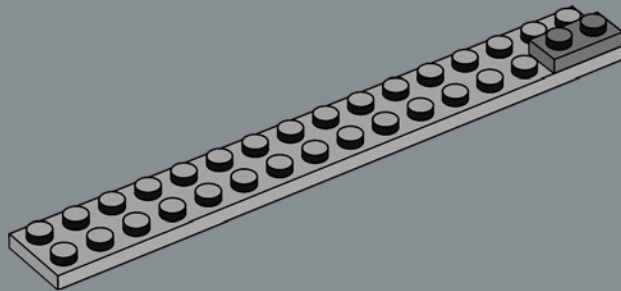

568

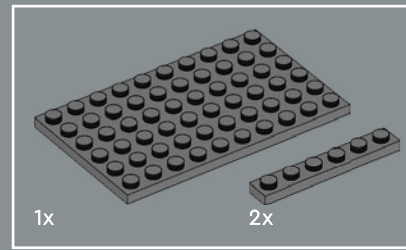
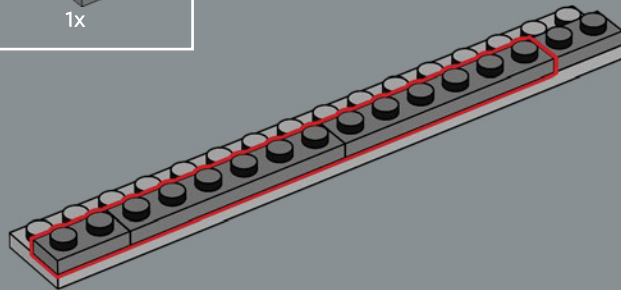

569

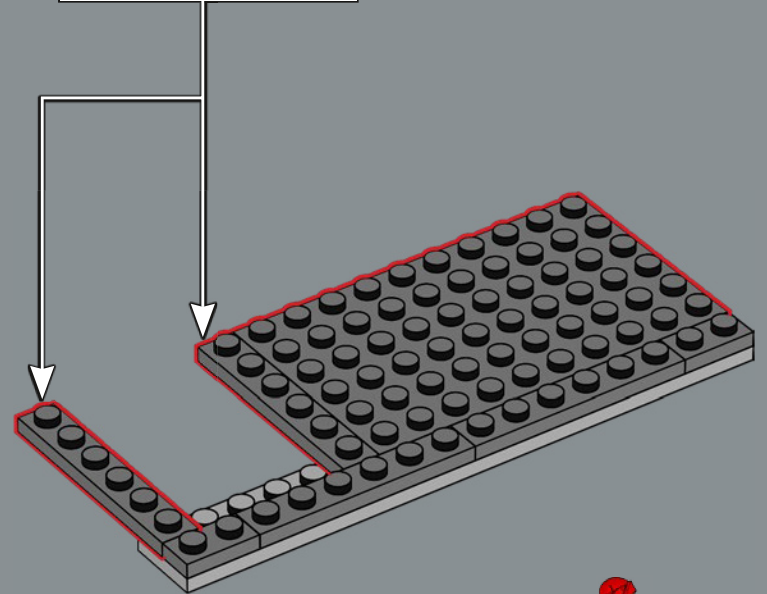
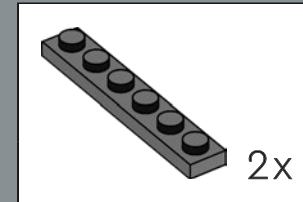



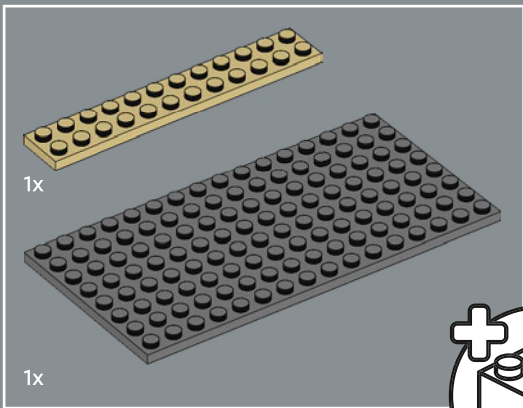

1x

1x

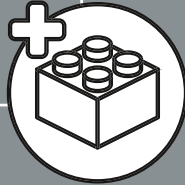

570

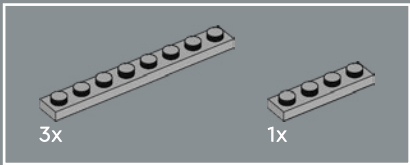
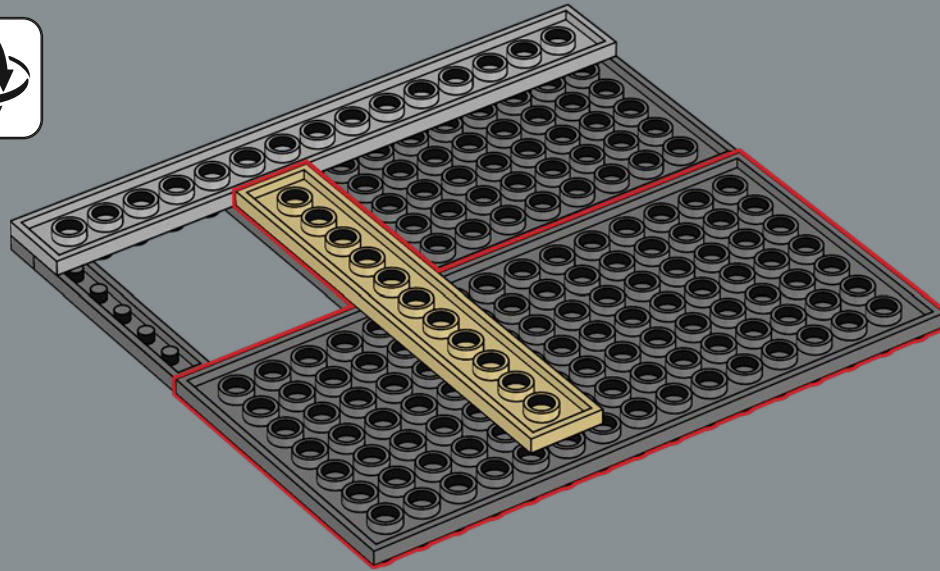

3x

1x

571

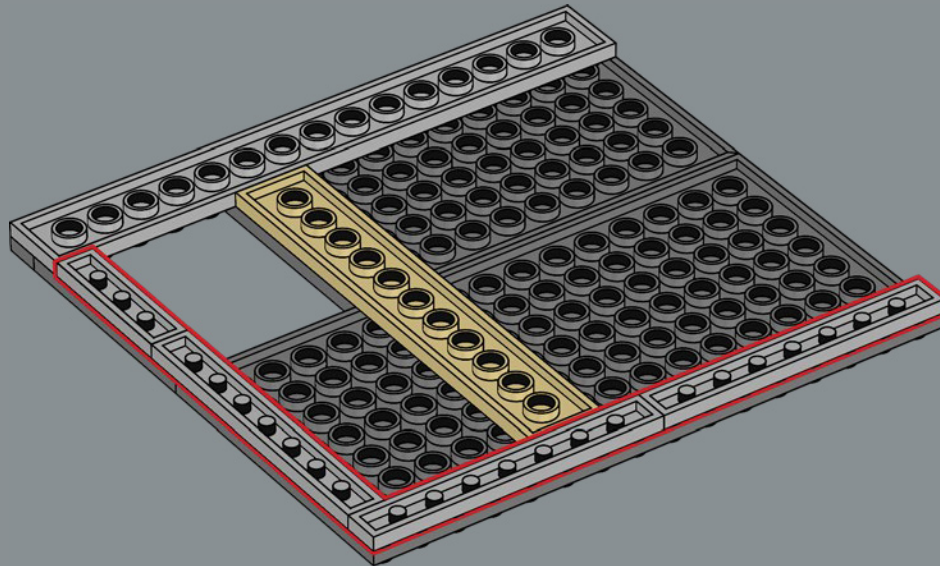

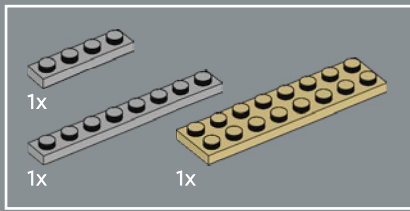

572

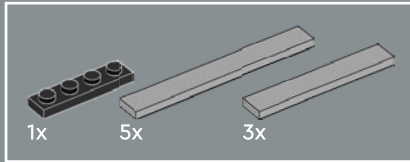
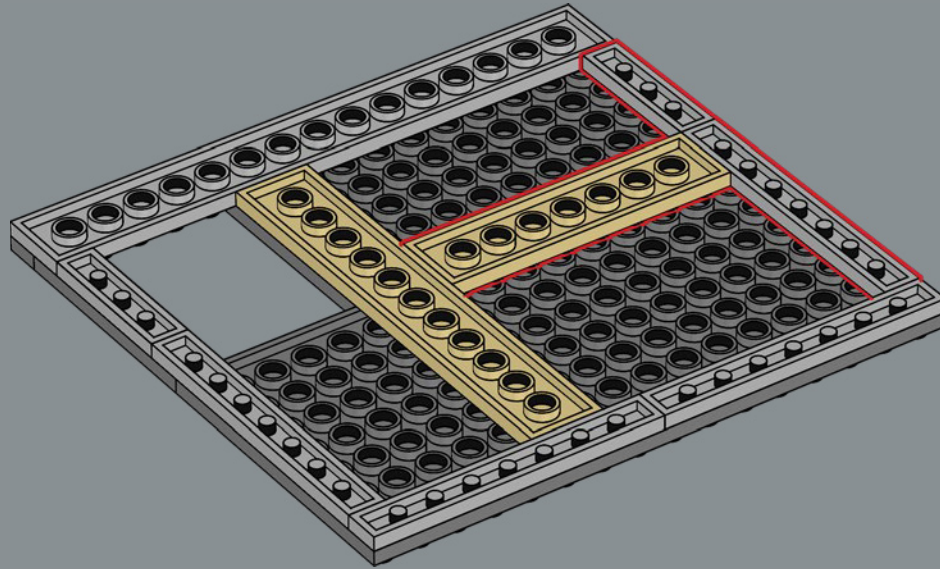

573

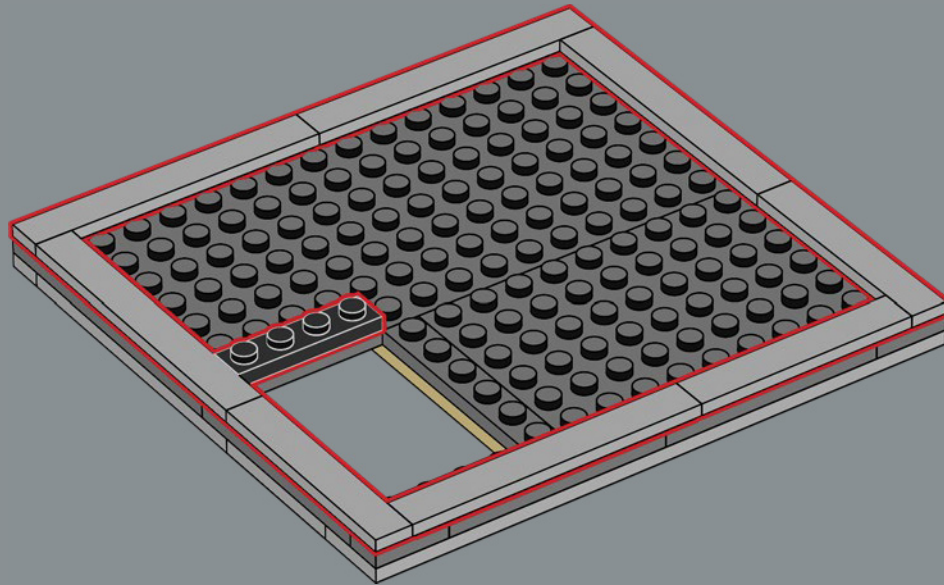



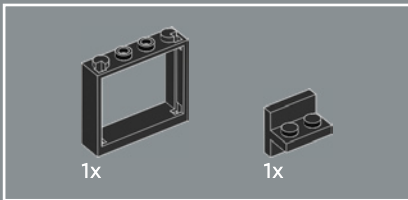
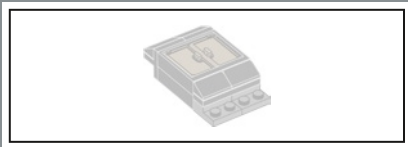

574

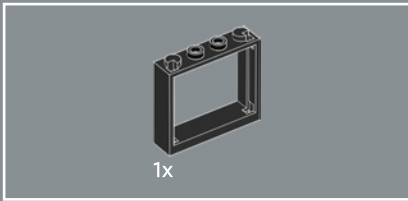
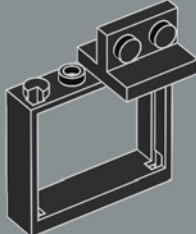

575

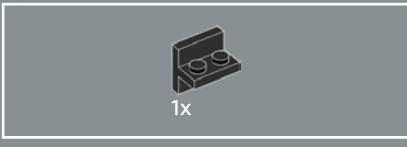
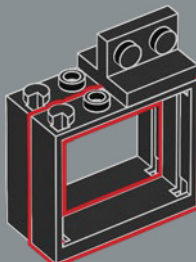

576

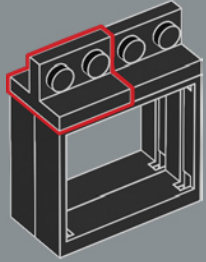

577

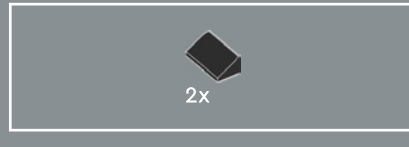
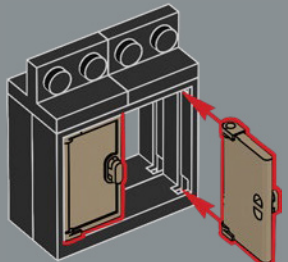

578

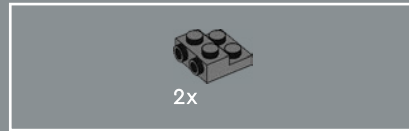
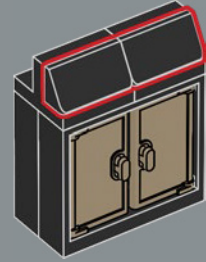

579

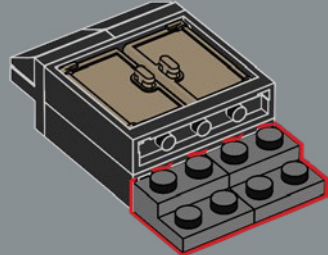

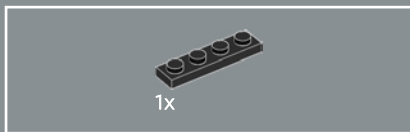

580

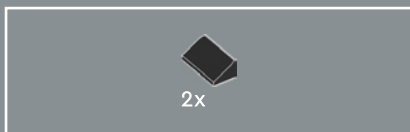
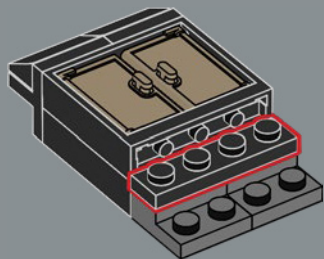

581

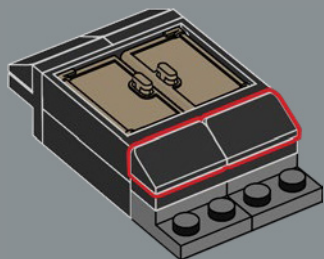

582

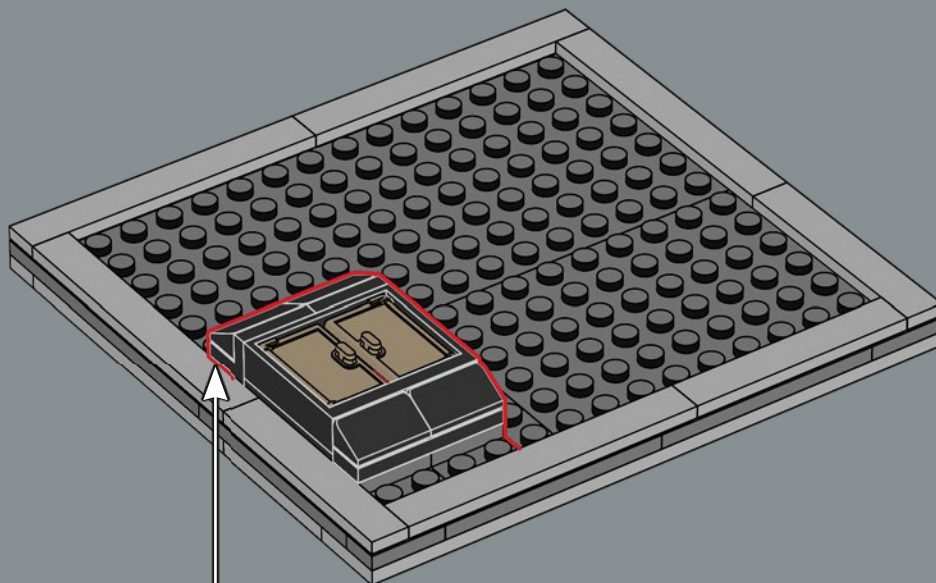



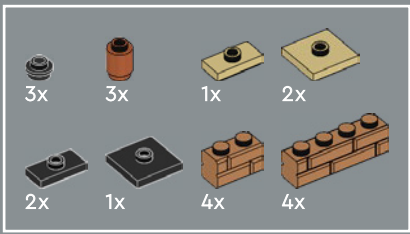

583

1

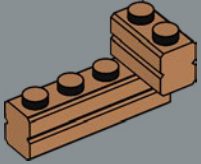

2

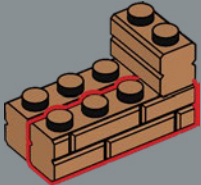

3

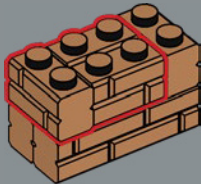

4

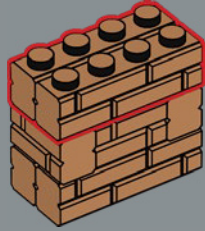

5

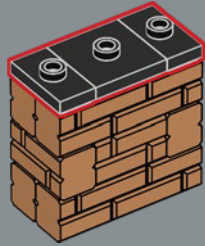

6

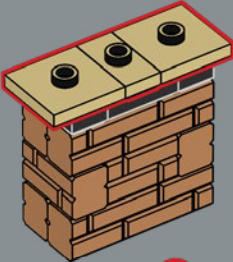

7

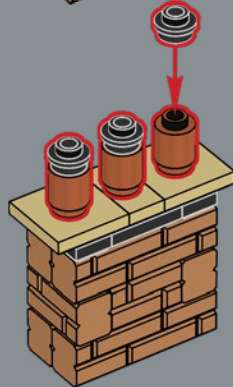

This chimney was condemned after the attic conversion work. It was, nevertheless, preserved for aesthetic reasons after a petition from the chimney sweep.

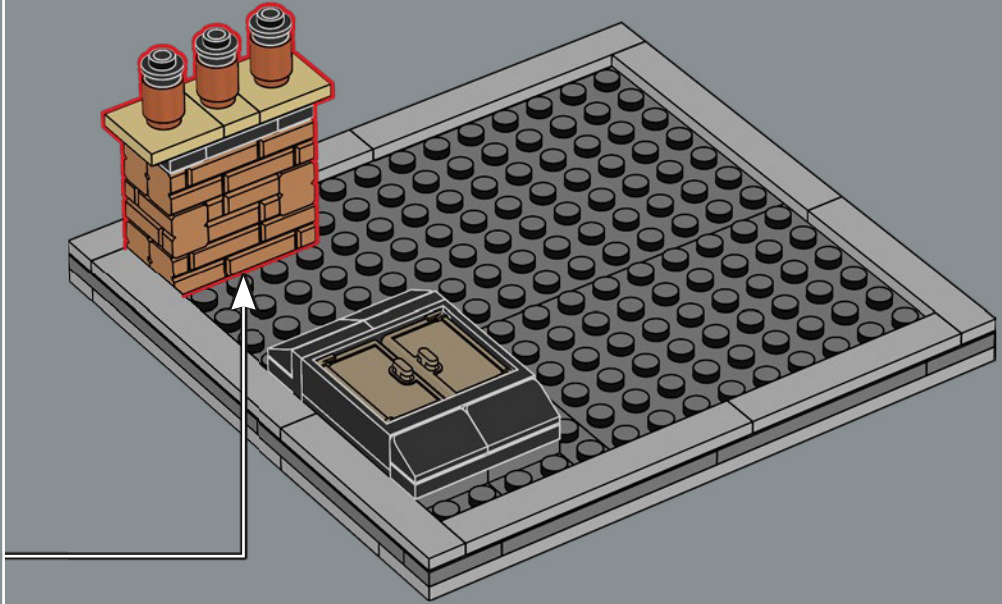

584



From the top, the chimney sweep enjoys a breathtaking view of the city's rooftops! All the beautiful buildings together make for quite a skyline!





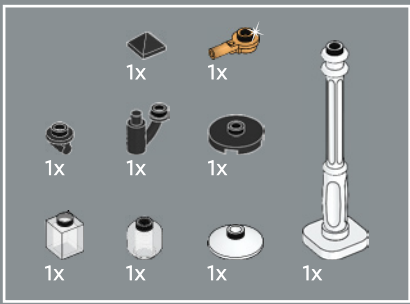

585

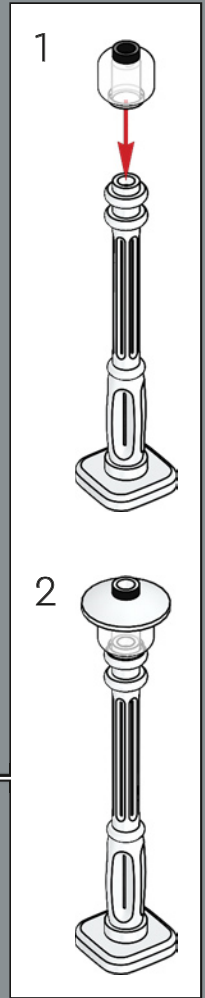
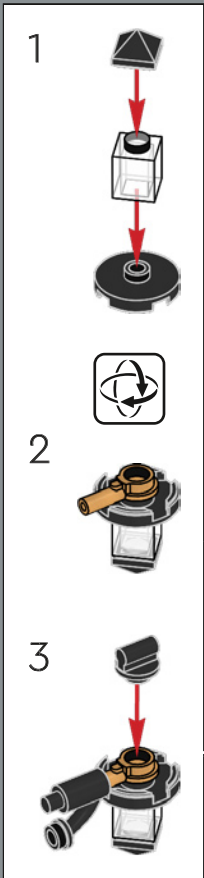

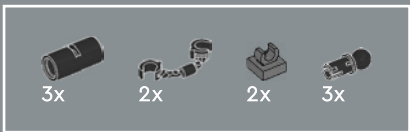

# 586



These bollards are, in fact, old cannons planted in the ground, trophies from a distant naval victory aboard the Sea Hawk from the LEGO® Pirates Caribbean Clipper (6274).

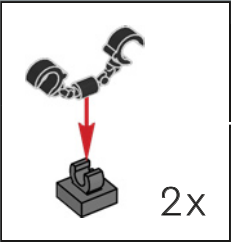
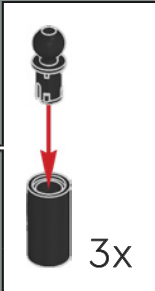





587

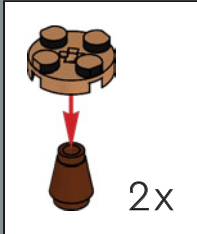
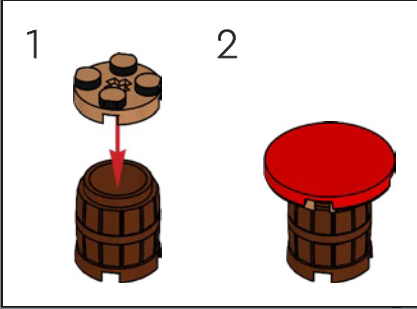

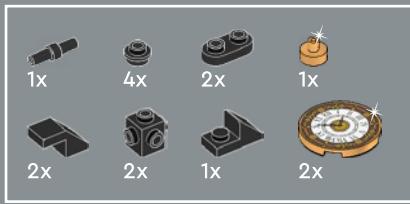

588

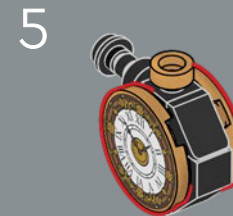
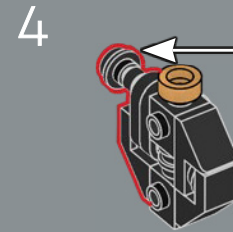
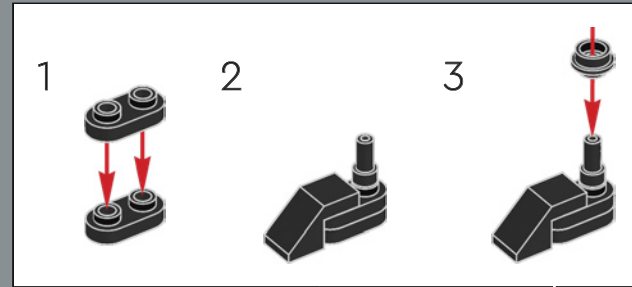
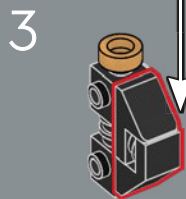
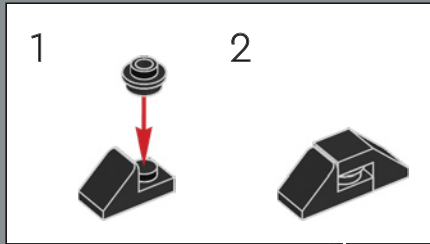
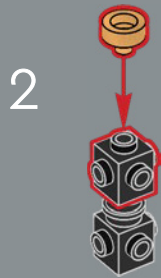
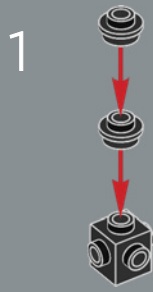



589



Hmm, the old clock is running a little slow...  
The clockmaker can take care of it after his  
lunch break.





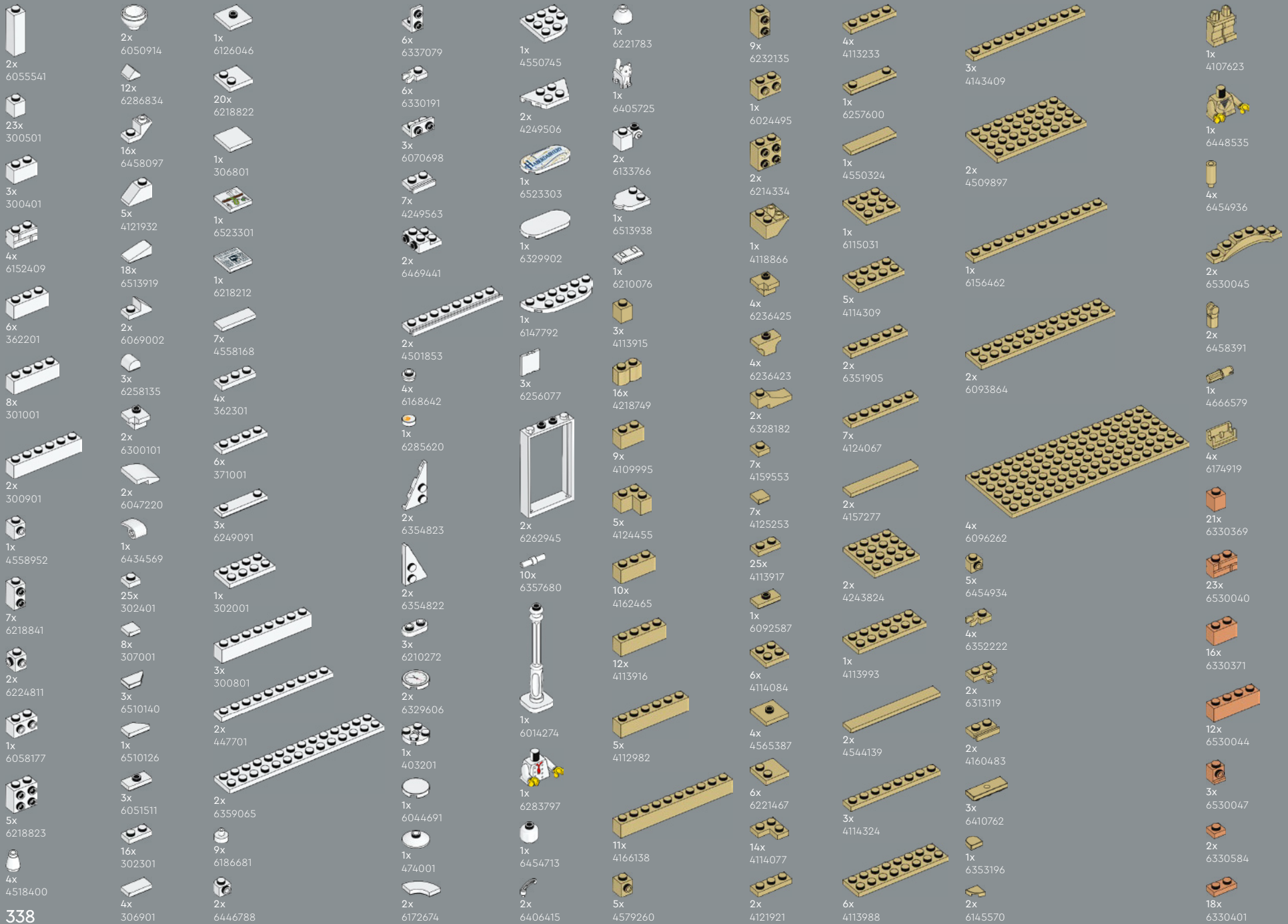





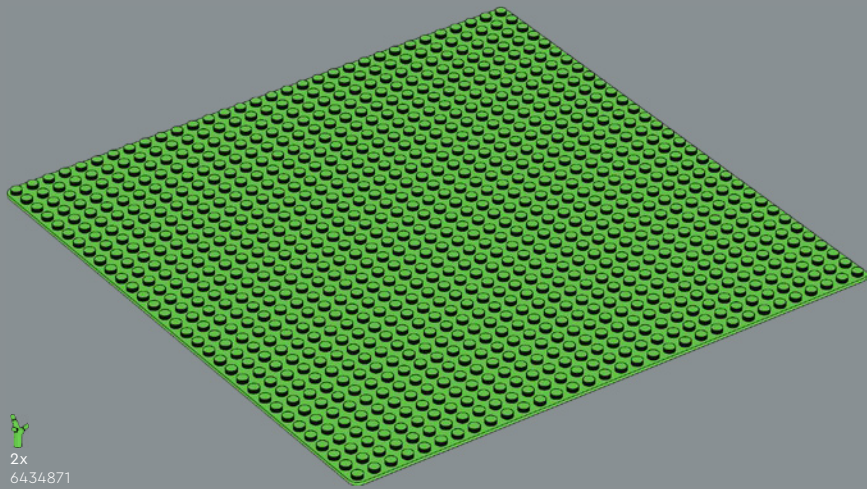

2x  
6434871

4x  
6235080

33x  
6182261

1x  
6513728

8x  
6074890

8x  
6374150

6x  
6188477

4x  
6517935

4x  
6382577

3x  
6143431

340

1x 6097276

1x 6186012

13x 6092602

9x 4570877

6x 6394948

1x 6186007

1x 6074892

1x 4535928

6x 6253418

1x 6359696

6x 6219673

15x 6315782

5x 6369194

1x 4616027

2x 6359041

1x 6172566

4x 6514262

2x 6251285

1x 6220959

1x 6254254

2x 6514052

2x 6532094

1x 6514191

21x 6254552

4x 6252258

1x 6514119

2x 6278710

1x 6514142

3x 6513992

1x 6507876

1x 6514192

1x 6514221

2x 6514056

2x 6514193

2x 6514234

1x 6245270

2x 6278710

1x 6514142

3x 6513992

1x 6507876

1x 6514192

1x 6514221

2x 6514056

2x 6514193

2x 6514234

1x 6245270

2x 6220715

1x 4125254

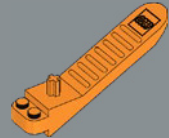

1x 6240515

1x 6278463

2x 6466044

1x 6210399

4x 6213779

2x 6422225

1x 6249390

1x 6350418

1x 6223065

4x 6513766

1x 6482693

1x 6210400

4x 6213876

1x 6494418

2x 6391344

1x 6190251

2x 6172869

12x 6138232

3x 6198156

2x 6400305

1x 6492725

1x 6202224

5x 6001824

1x 4646577

7x 6502374

3x 6055172

5x 4496699

3x 6126075

1x 6398654

1x 6047415

2x 4507045

2x 6015452

1x 6449594

8x 6328307

3x 6175927

5x 6257599

2x 4626904

2x 4267874

1x 6164288

2x 4507047

2x 4550329

5x 6395744

2x 6006524

1x 4251796

6x 6300320

6x 6330148

4x 6362967

1x 6449564

1x 6490609

1x 4570451

2x 6428821

1x 6335769

1x 6523305

2x 6446789

1x 4162916

4x 4521915

7x 6400283

8x 4245570

1x 4245571

16x 6252591

8x 6253282

6x 6530046

2x 4255624

9x 6055169

22x 6192250

26x 6013102

1x 6326011

3x 6186827

3x 4586057

7x 4245566

1x 6230571

2x 6314882

5x 6530042

1x 6454462

2x 4539099

1x 6083977

2x 4550169

2x 4539114

2x 4539097

4x 4539090

1x 4541506

1x 6288635

4x 6214309

3x 4583299

31x 6359681

4x 4539061

2x 4539060

1x 6257594

3x 4650865

2x 6359695

1x 6168645

4x 6267490

4x 6267492

4x 6210310

1x 4541496

1x 6443359

1x 6514005

1x 6514274

2x 6023173

2x 6236454

4x 6177699

3x 4211242

1x 6172808

3x 6201911

6x 4225469

1x 6325717

2x 4211183

2x 4529242

2x 4520612

1x 4504376

1x 6371437

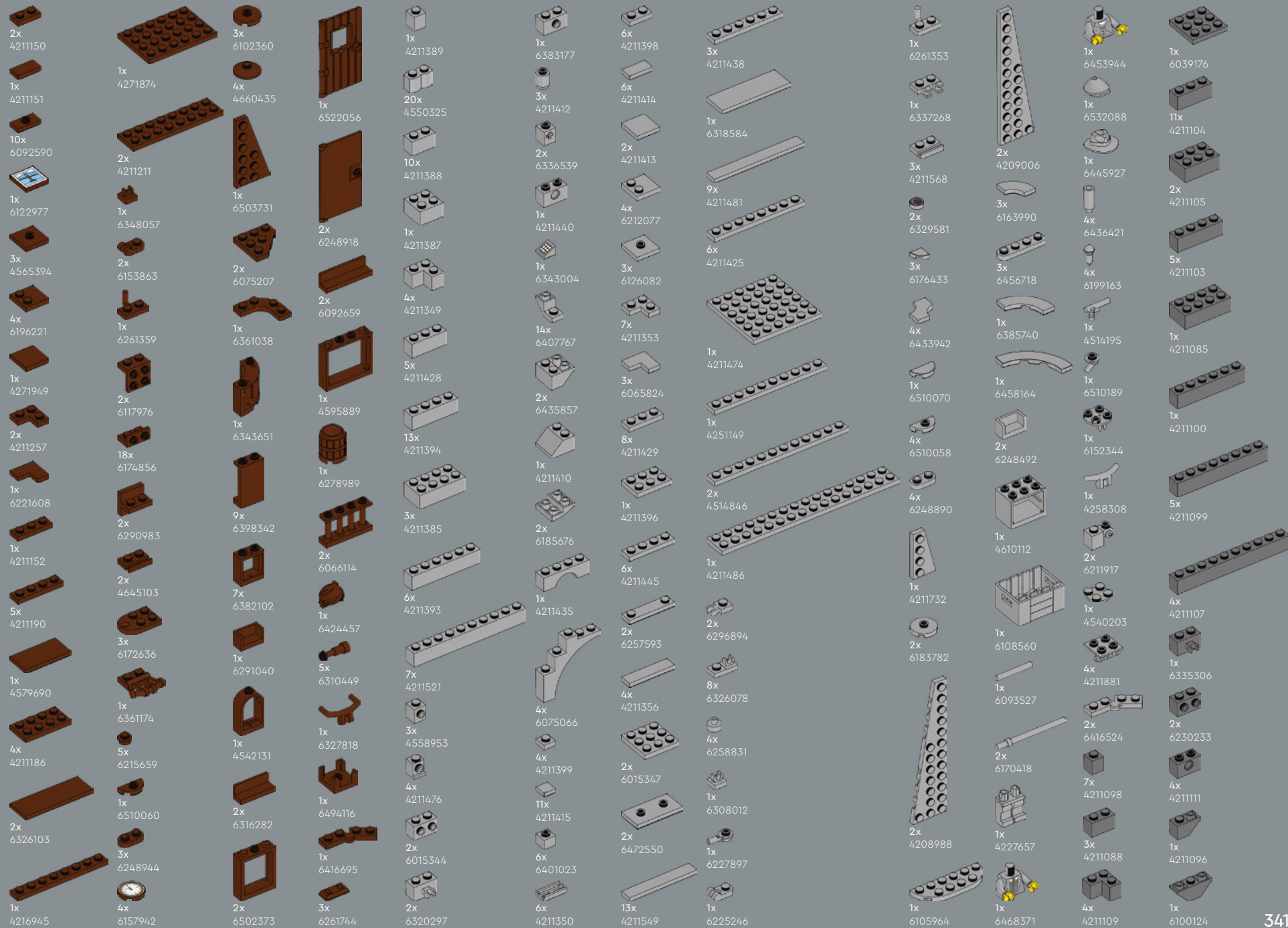



- 2x 4560184
- 1x 4211065
- 5x 42110651
- 5x 6257592
- 9x 4211056
- 1x 4211002
- 4x 4211115
- 1x 4257526
- 1x 4211114
- 1x 4211067
- 12x 6199549
- 20x 4210719
- 11x 4210848
- 1x 6092572
- 21x 4211063
- 47x 4211052
- 6x 6247784
- 1x 4211094
- 10x 6126083
- 7x 4210635
- 64x 4211055
- 12x 4211001
- 12x 4211133
- 6x 4568734
- 2x 4211043
- 7x 4211053
- 6x 6344022
- 8x 6435043
- 2x 6413106
- 3x 6000606
- 2x 6250018
- 3x 6146321
- 4x 6457961
- 3x 6313189
- 2x 6469463
- 1x 4595710
- 8x 6221607
- 1x 4210759
- 1x 4210811
- 1x 6395635
- 2x 4211122
- 1x 4654613
- 6x 6285271
- 13x 6100322
- 20x 6182777
- 50x 6287903
- 4x 6383074
- 4x 6361990
- 2x 6387467
- 1x 4210759
- 1x 4210811
- 1x 6395635
- 2x 4211122
- 1x 4654613
- 6x 6285271
- 13x 6100322
- 20x 6182777
- 50x 6287903
- 4x 6383074
- 4x 6361990
- 2x 6387467
- 2x 4595708
- 1x 6435762
- 8x 6362254
- 2x 6372225
- 3x 6361988
- 10x 6184484
- 12x 6209683
- 3x 6132418
- 3x 6361985
- 1x 6132422
- 1x 6228091
- 1x 6230582
- 5x 6513737
- 6x 6330199
- 8x 6275872
- 16x 6212501
- 2x 6359834
- 1x 4523159
- 7x 6372427
- 2x 6190252
- 2x 6523304
- 5x 6209691
- 2x 6093529
- 1x 6147169
- 6x 6523396
- 6x 6530041
- 1x 6292254
- 1x 6132266
- 1x 6034543
- 5x 6508090
- 9x 6186672
- 1x 6262138
- 6x 6445911
- 12x 6338242
- 5x 6279731
- 2x 6378168
- 2x 6328909
- 5x 6501270
- 4x 6443652
- 7x 6516867
- 2x 6404033
- 1x 6179803
- 14x 6347604
- 3x 4623298
- 4x 6492338
- 2x 6272143
- 1x 6337282
- 1x 6436364
- 1x 6372359
- 1x 6501311
- 3x 4538950
- 1x 6313874
- 12x 4651231
- 14x 6346783
- 9x 6055309
- 5x 6135191
- 3x 6431328
- 9x 6215606
- 10x 6177146
- 8x 6292154
- 16x 6021997
- 2x 6445925
- 3x 6102990
- 2x 6349274
- 1x 6102994
- 1x 6365746
- 2x 6167700
- 31x 6102998
- 2x 6218359
- 1x 6343854
- 1x 6295464
- 1x 6313600
- 2x 6474266
- 1x 6433634
- 1x 6248536
- 3x 6167643
- 1x 6226646
- 2x 635640
- 2x 6417964
- 4x 4619636
- 1x 6329604
- 1x 6096993
- 1x 6363150
- 1x 4624615
- 1x 6338570
- 2x 6404754
- 4x 4653988
- 2x 6060857
- 1x 6126090
- 1x 6136419
- 1x 6354763
- 2x 6209673
- 1x 6256092
- 1x 6291414



 [LEGO.com/service](https://www.LEGO.com/service)



# YOU COULD WIN



## YOU COULD WIN

Your feedback will help shape the future development of this product series.

Visit:

## DU KÖNNTEST GEWINNEN

Dein Feedback trägt zur Weiterentwicklung dieser Produktreihe bei.

Geh auf:

## VOUS POURRIEZ GAGNER

Vos commentaires nous aideront à concevoir les futurs produits de cette gamme.

Visitez :

## POTRESTI VINCERE TU

La tua opinione ci aiuterà a migliorare la creazione futura di questa linea di prodotti.

Visita:

## PUEDES GANAR

Tu opinión contribuirá al futuro de esta serie de productos.

Visita:

## 轻松获奖

您的反馈将有助于我们在今后改进本产品系列。

请访问:

---

[LEGO.com/productfeedback](https://www.lego.com/productfeedback)

---

You also have the chance to win a LEGO® set.

Terms and conditions apply.\*

Außerdem hast du die Chance, ein LEGO® Set zu gewinnen.

Es gelten die Teilnahmebedingungen.\*

Vous pourriez également gagner un ensemble LEGO®.

Des conditions s'appliquent.\*

Hai anche la possibilità di vincere un set LEGO®.

Termini e condizioni sono applicabili.\*

También tienes la oportunidad de ganar un set LEGO®.

Aplican términos y condiciones.\*

您还有机会赢取乐高®套装。

条款和条件适用。\*

\*[LEGO.com/productfeedback-terms](https://www.lego.com/productfeedback-terms)





LEGO and the LEGO logo are trademarks of the LEGO Group.  
©2025 The LEGO Group. 6553214