



40821





Get excited about our new packaging!

We're switching from plastic to paper-based packaging. That's why you might find a mix of paper and plastic in our boxes!

Nos nouveaux emballages vous emballeront !

Nous passons des emballages en plastique aux emballages à base de papier. C'est pourquoi vous pourriez trouver un mélange de papier et de plastique dans nos boîtes !

¡Te presentamos nuestros nuevos empaques!

Estamos sustituyendo las bolsas de plástico por bolsas con base de papel. ¡Por eso, puedes encontrar una mezcla de papel y de plástico en nuestras cajas!

[LEGO.com/sustainable-packaging](https://www.lego.com/sustainable-packaging)

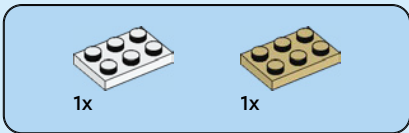

1

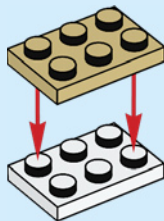



2x



4x

2

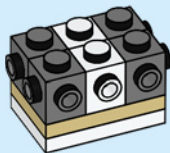



1x

3



2x

4

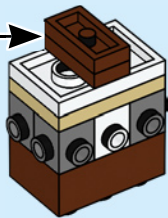
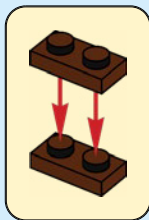



2x



2x

5



2x

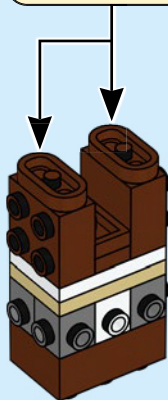

6





6

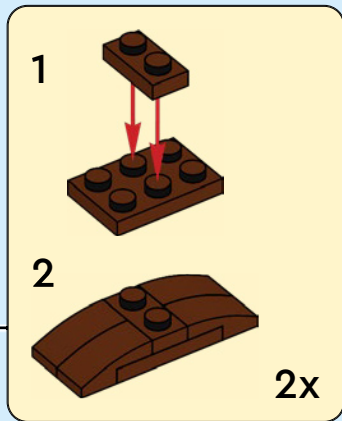
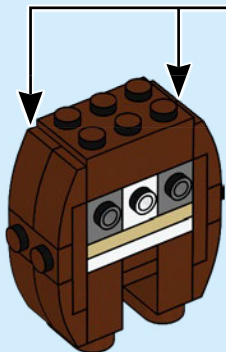

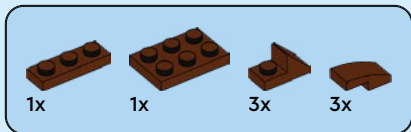

7

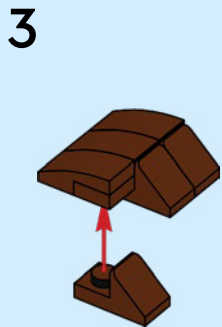
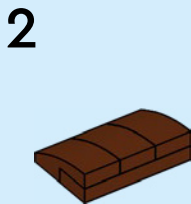
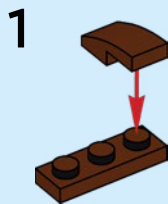

4

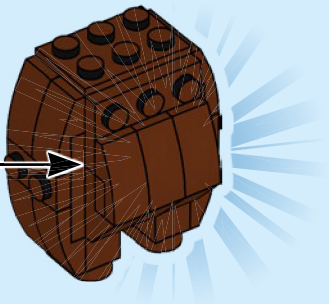
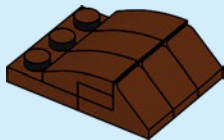



1x



2x

8

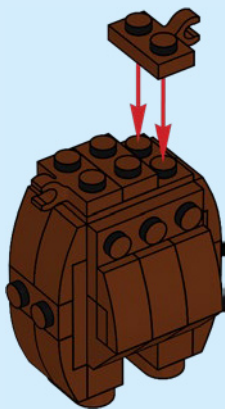

1x



1x



1x

9

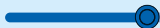

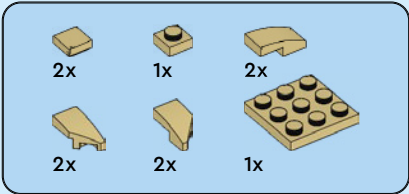
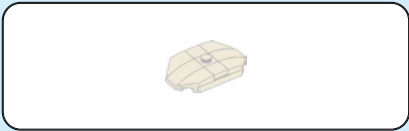

10

1

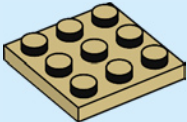

2

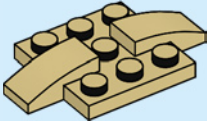

3

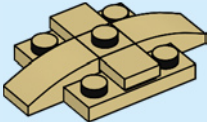

4

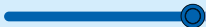
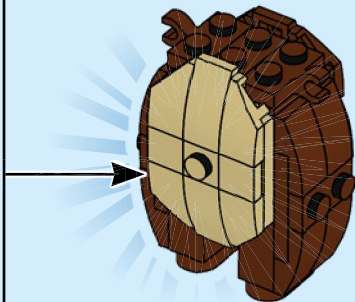
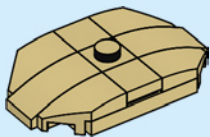

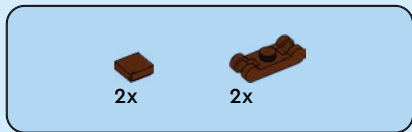

11

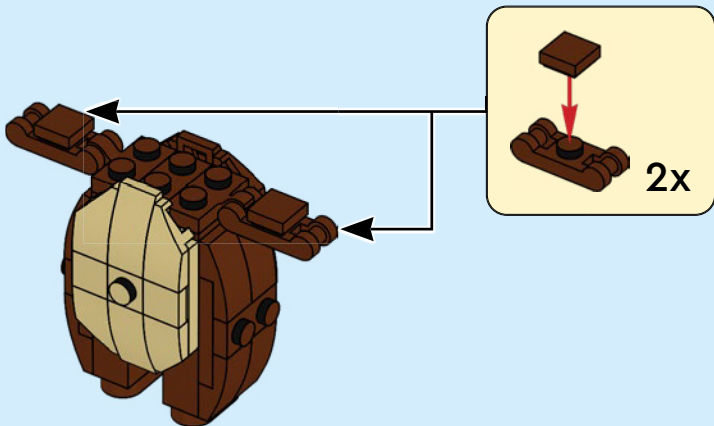

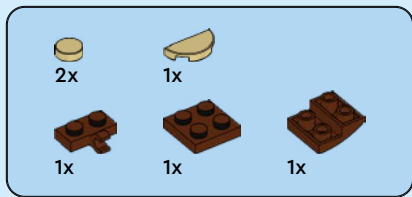

12

1

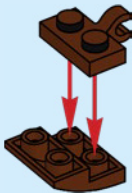

2



3

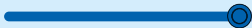

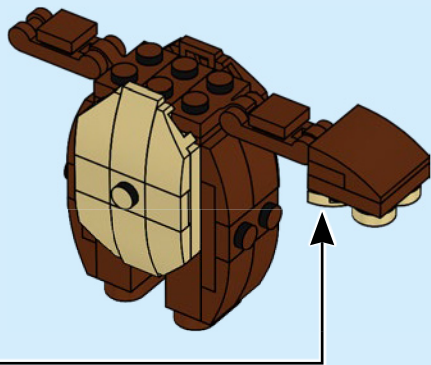

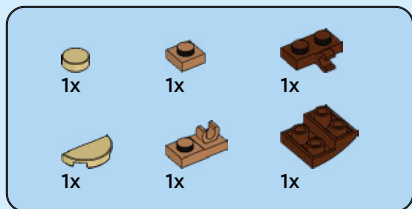

13

1

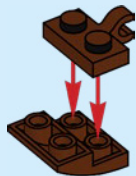

2



3

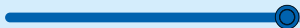

4

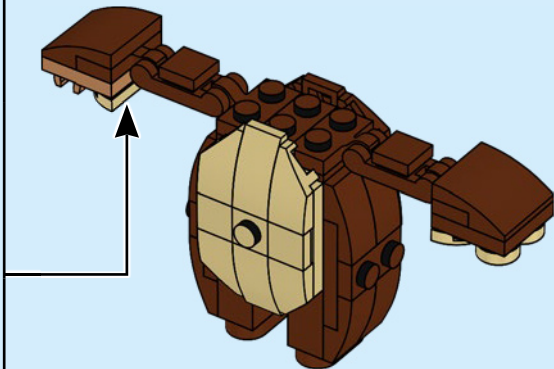



1x



1x

14

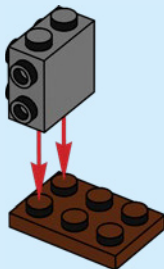



2x



1x

15



2x

16





1x



1x

17

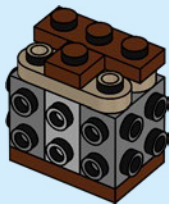

1x

18





1x



2x

19



7x

20

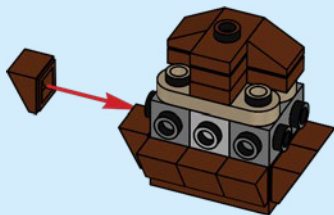



1x



1x



1x

21

1

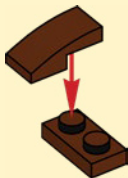

2

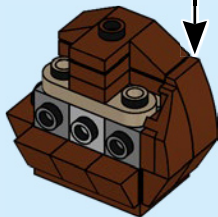



1x



1x



1x

22

1

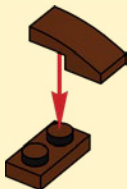

2

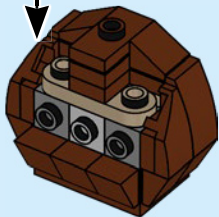



1x



3x

23

1

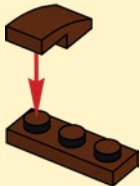

2

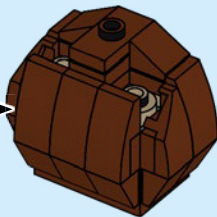



2x



2x

24

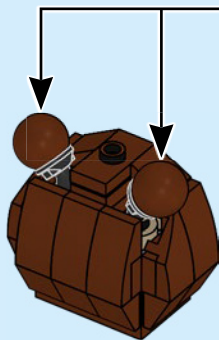

2x



1x

25



1x

26

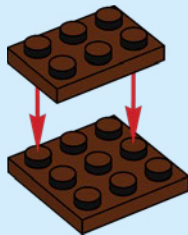



1x



1x



2x

27



2x



2x

28

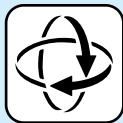



1x



1x

29

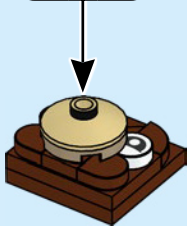
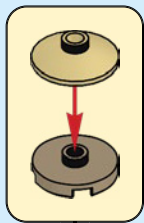

1x

30



31

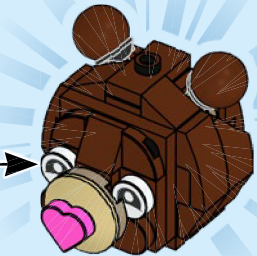

32

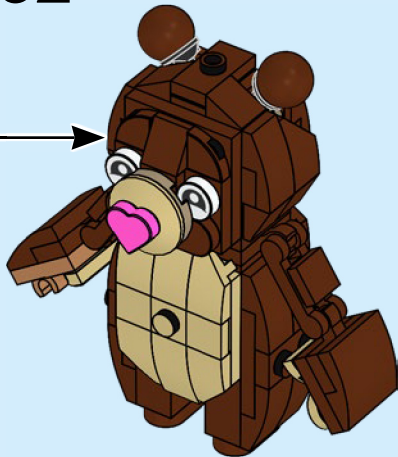

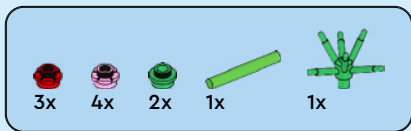

33

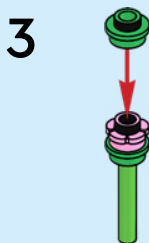
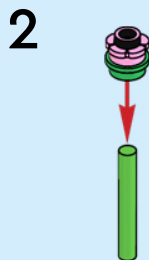
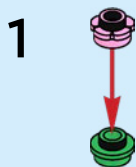

4



5

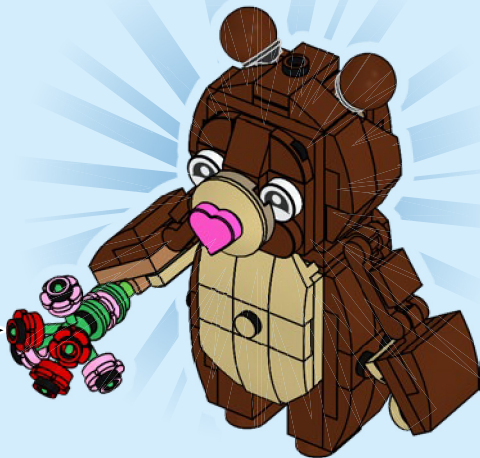
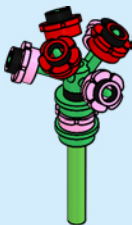



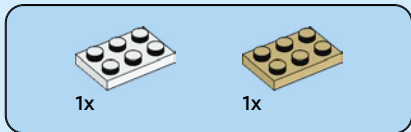
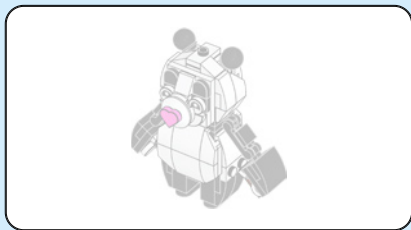

34

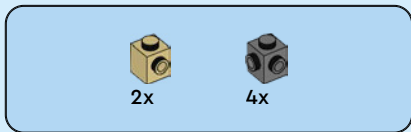
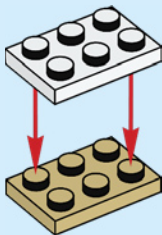

35

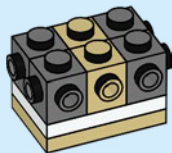

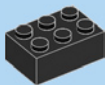

1x

36

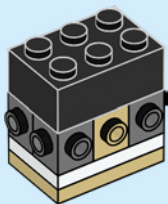



2x

37

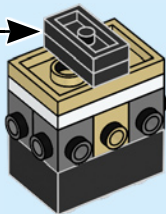
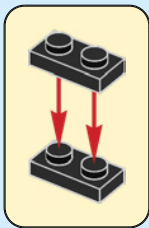



2x



2x

38

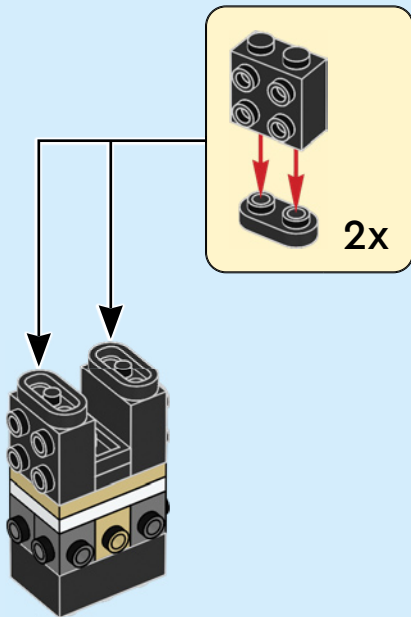

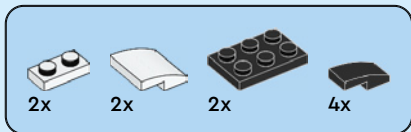

39

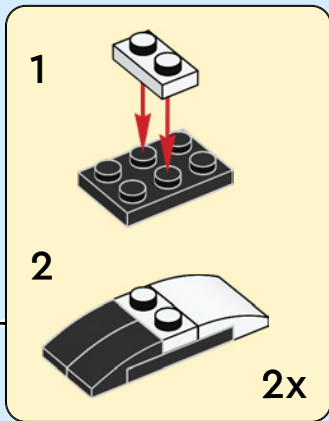
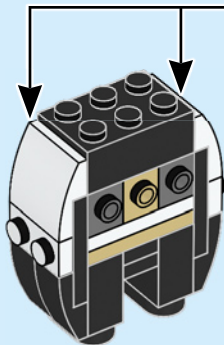

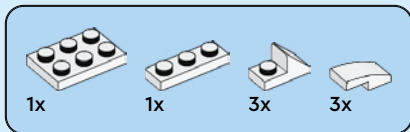

40

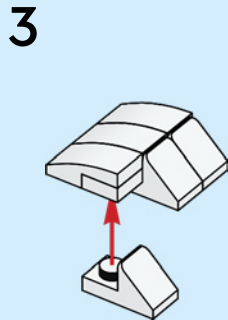
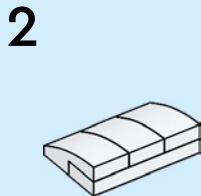
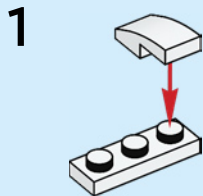

4

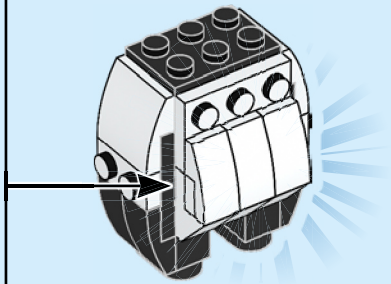
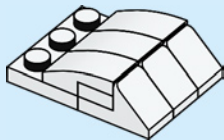



1x



2x

41

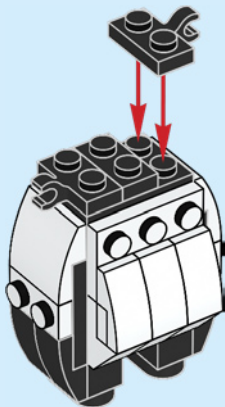

1x



1x



1x

42

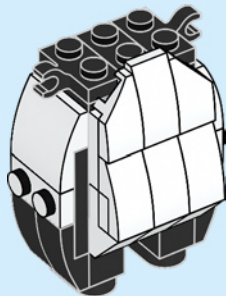

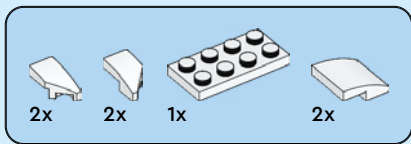

43

1

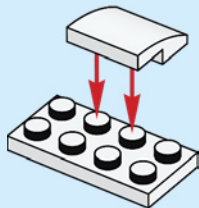

2

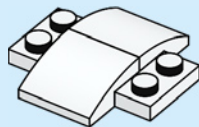

3

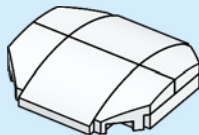

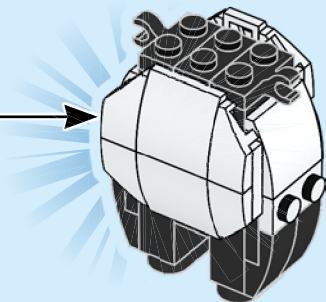



2x



2x

44

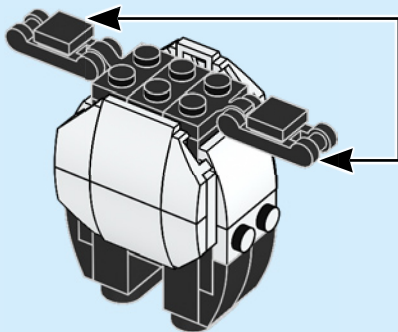

2x

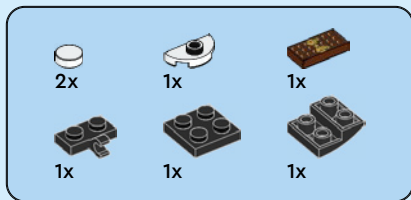

45

1

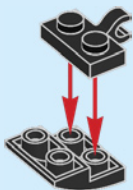

2

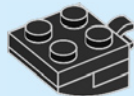

3



4

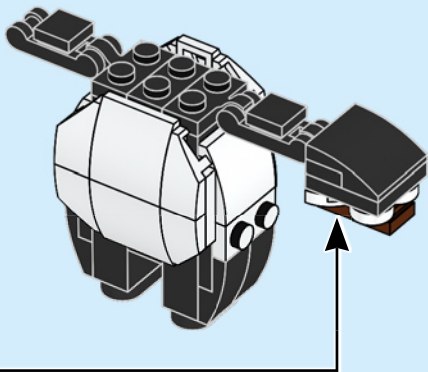

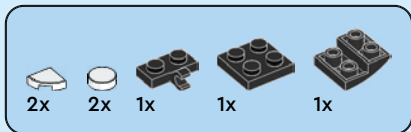

46

1

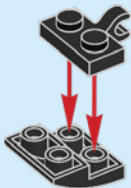

2

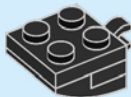

3



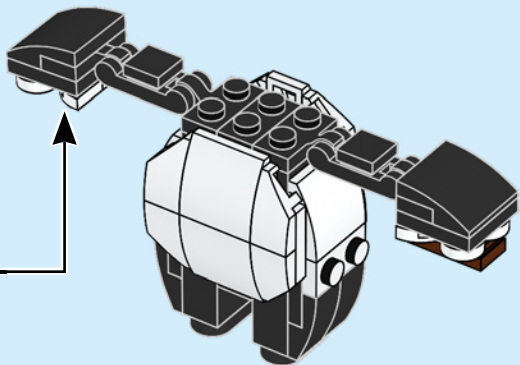

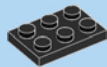

1x



1x

47

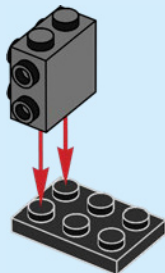



2x



1x

48

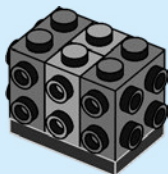

2x

49





1x



1x

50

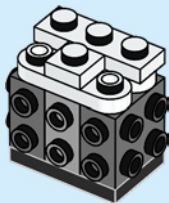

1x

51

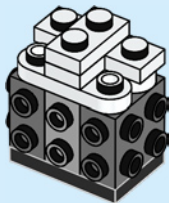



1x



2x

52

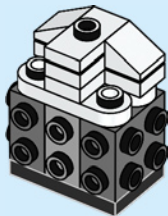

7x

53

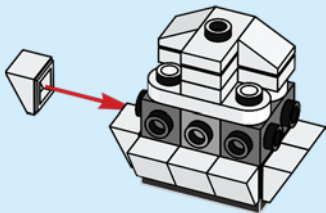



1x



1x



1x

54

1



2

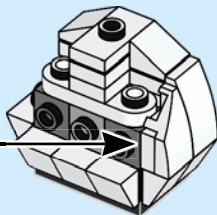



1x



1x



1x

55

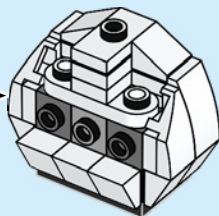
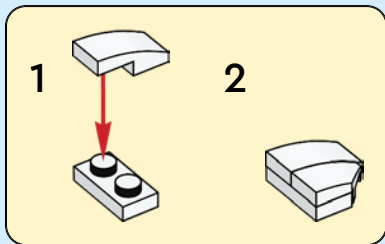



1x



3x

56

1

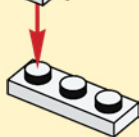

2

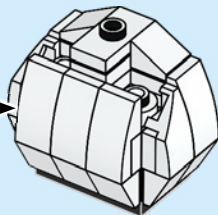
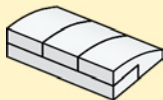



2x



2x

57

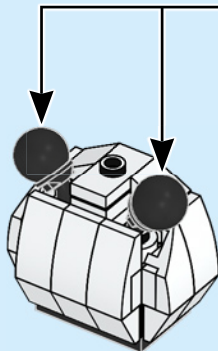

2x



1x

58



1x



1x

59

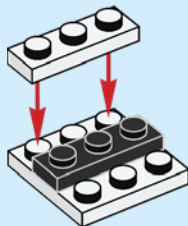



1x



1x



2x

60

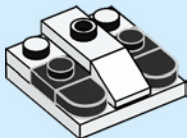

2x



2x

61





1x



1x

62

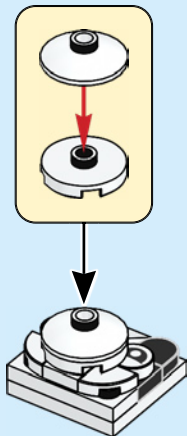

63



1x

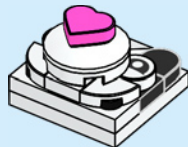

64

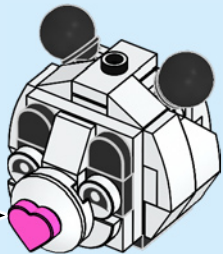

65

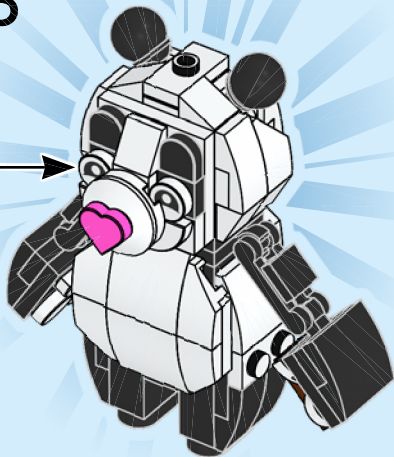



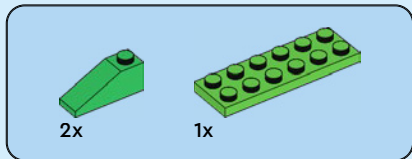
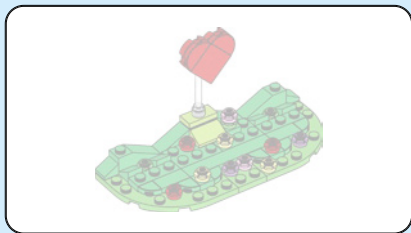

66

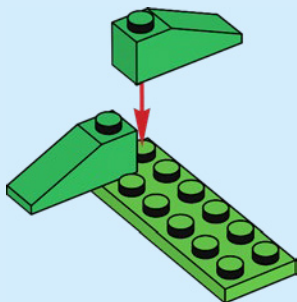

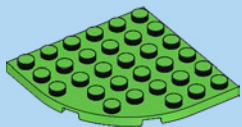

2x

67

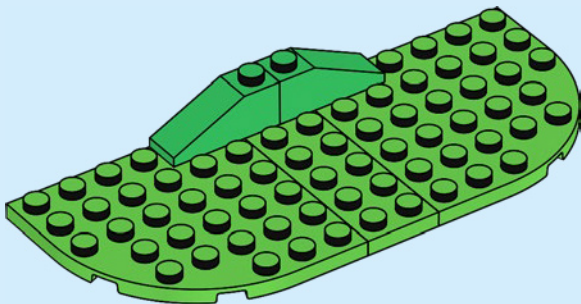

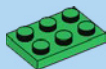

2x

68

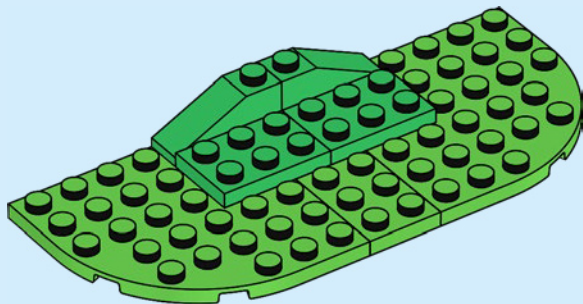



1x



1x

69

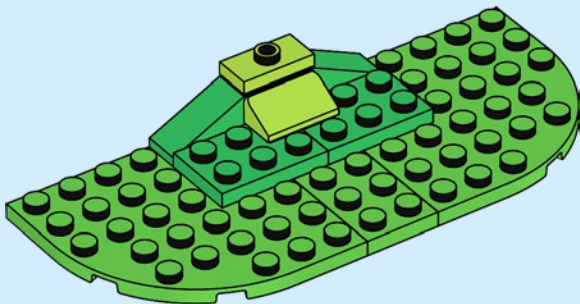



2x



2x

70

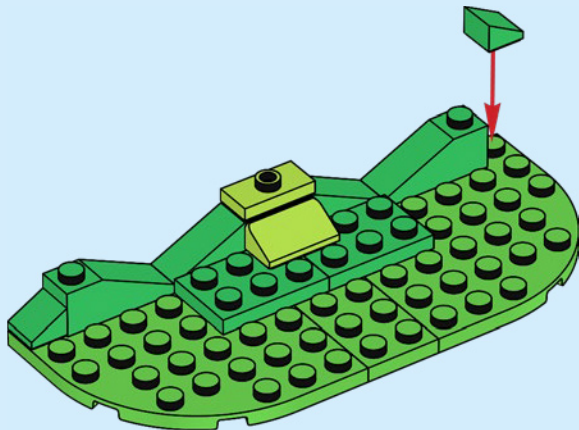



4x



2x

71

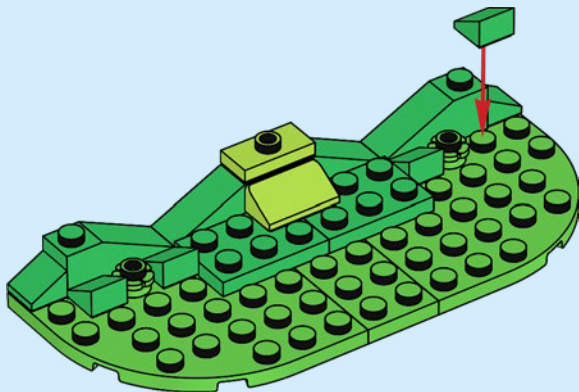



2x

72

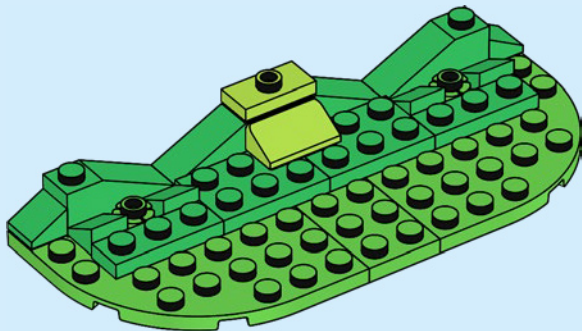

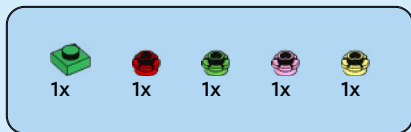

73

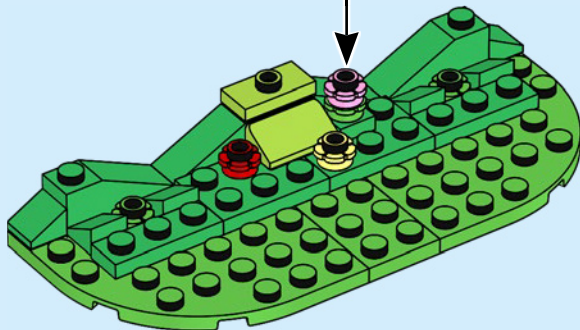
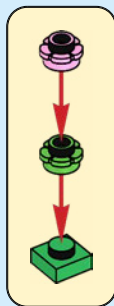

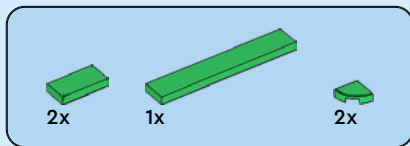

74

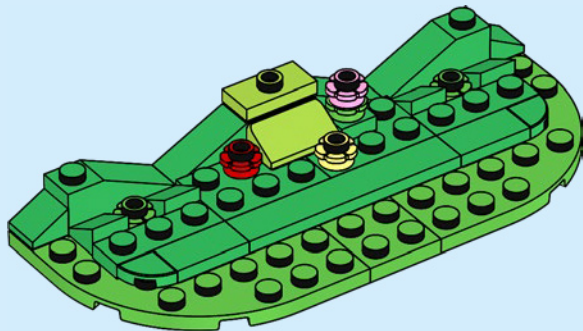



2x



4x



1x



1x

75

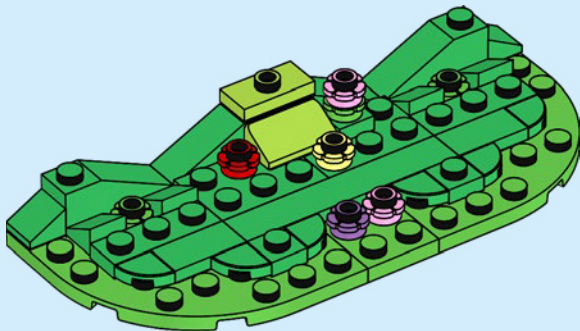



2x



1x



2x

76

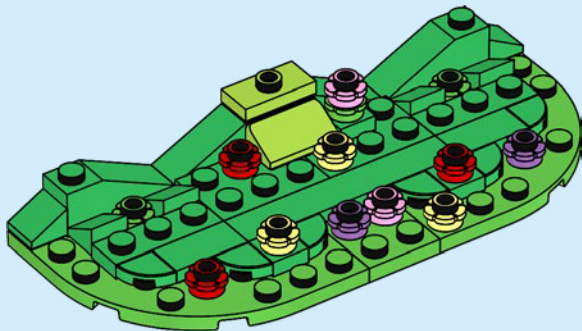



1x

77

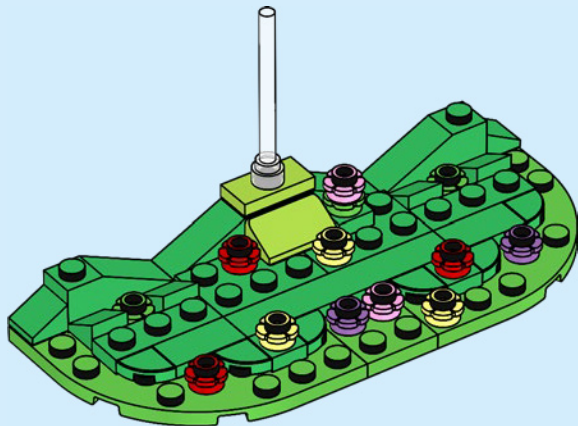

72

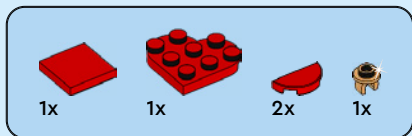

78

1



2

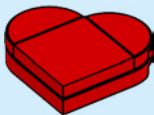

3

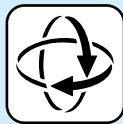

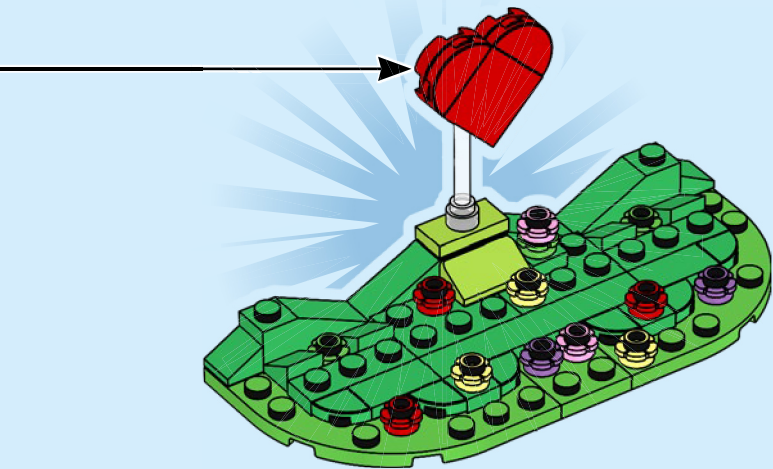

79

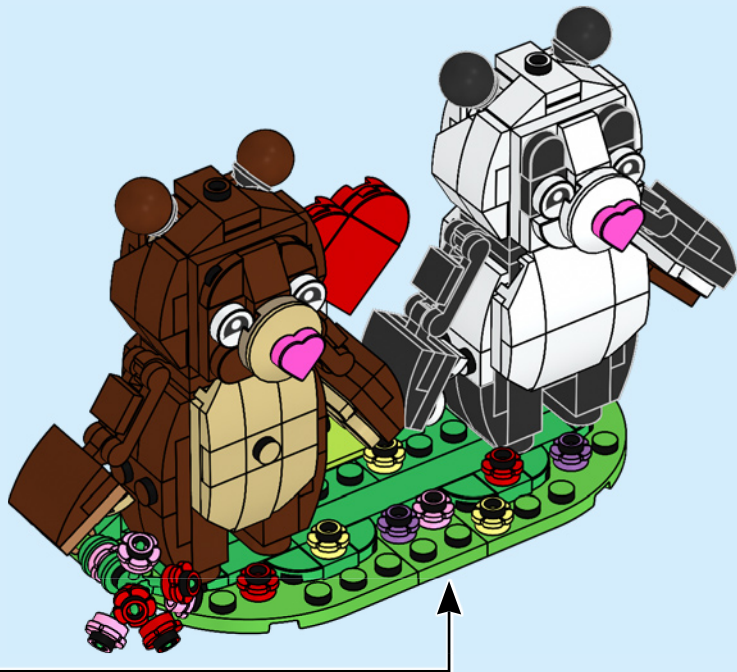



4x
6329607

4x
6284572

2x
4558952

10x
4504369

4x
6172366

4x
6213880

1x
302401

1x
6510064

4x
6213881

1x
6093053

1x
474001

5x
302301

2x
6051511

9x
6034044

3x
6069002

2x
6450820

4x
6047220

4x
362301

3x
302101

1x
6104805

1x
302001

3x
6284573

2x
4125253

2x
6299936

1x
4159553

2x
4579260

2x
6510069

2x
6299935

1x
4617765

2x
6046922

2x
4118790

1x
6115031

6x
6206148

2x
6516544

1x
306821

1x
6276193

4x
6510193

2x
6256435

2x
4290713

2x
307026

2x
6210270



2x
6275806



3x
302326



4x
6313116



4x
6047276



2x
6398391



2x
302226



2x
6211476



1x
362326

78



3x
302126



1x
300226



2x
6338221



6x
6150607



6x
4546705



3x
302428



2x
306928



1x
6269940



4x
4107637



2x
4107758



2x
302128

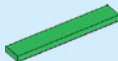

1x
6035336



3x
6206150



1x
6161772

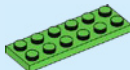

1x
6399741

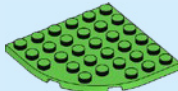

2x
6517740



1x
6514014



1x
6025026



1x
6092592



1x
6132767



2x
6449564



2x
6328180



2x
6361175



10x
4504376



2x
6149677



2x
4211288



2x
6290397



1x
4221744



2x
6248944



2x
6290396



8x
4211150



2x
6500421



4x
6313124



2x
6092590



17x
6069984



3x
6075287



1x
6139435



2x
6383143



1x
4216695



2x
6481564



3x
4211152



5x
4211189



1x
4216668



1x
6497747



4x
6225242



8x
6332045



4x
6314192



2x
6486304



6x
6212501



3x
6426463



1x
6520665



1x
6215606



1x
6347304



2x
6209684



[LEGO.com/service](https://www.LEGO.com/service)

YOU COULD
WIN



Scan this QR code or go to
LEGO.COM/PRODUCTFEEDBACK and give us
your short feedback about this LEGO® set
for a chance to win a cool LEGO prize.

Terms and Conditions apply*

EN: YOU COULD WIN. Terms and Conditions apply* **DE: Du könntest GEWINNEN.** Es gelten die Teilnahmebedingungen* **FR: Tu pourrais GAGNER.** Des conditions s'appliquent* **IT: Potresti VINCERE tu.** Termini e condizioni sono applicabili* **ES: Puedes GANAR.** Aplican términos y condiciones* **PT: Poderá GANHAR.** Aplicam-se termos e condições* **ZH: 轻松获奖, 条款和条件适用*** **PL: Szansa na WYGRANĄ.** Obowiązują warunki korzystania* **CS: Máte šanci VYHRÁT.** Platí všeobecné smluvní podmínky* **SK: Máte šancu VYHRÁŤ.** Platia všeobecné zmluvné podmienky* **HU: TE IS NYERHETSZ.** Felhasználási feltételek érvényesek* **RO: Ai putea CÂȘTIGA.** Se aplică termenii și condițiile* **BG: Можете да СПЕЧЕЛИТЕ.** Има определени правила и условия* **LV: Tu vari LAIMĒT.** Ir spēkā noteikumi un nosacījumi.* **ET: Sul on võimalus VÕITA.** Kehtivad tingimused* **LT: Jūs galite LAIMĖTI.** Taikomos sąlygos*

*[LEGO.com/productfeedback-terms](https://www.lego.com/productfeedback-terms)