



80116



The Spring Festival
Das Frühlingsfest
La fête du Printemps
La Festa di Primavera
Fiesta de la Primavera
O Festival da Primavera
春节
Festival Wiosny
Jarní festival
Jarný festival
Tavaszi Fesztivál
Festivalul Primăverii
Пролетният фестивал
Pavasara svētki
Kevadfestival
Pavasario šventė

1



Q LEGO® Builder



LEGO.com/sustainable-packaging



FR
DONNEZ
OU
RECYCLEZ



ASSOCIATION

OU



MAGASIN

OU



DÉCHÈTERIE

Adresses sur quefairedemesdechets.fr



BUILDER



Apple and the Apple logo are trademarks of Apple Inc., registered in the U.S. and other countries and regions. App Store is a service mark of Apple Inc. Google Play and the Google Play logo are trademarks of Google LLC. Tencent and the Tencent logo are trademarks of Tencent Inc.

LEGO.com/devicecheck

EN Ask parents' permission before going online | DE Eltern um Erlaubnis bitten, bevor du online gehst | FR Demande l'autorisation d'un parent avant d'aller en ligne | IT Chiedi il permesso ai tuoi genitori prima di andare online | ES Pídeles permiso a tus papás antes de conectarte a Internet | PT Pede autorização aos pais antes de acederes online | ZH 上网前应先征得父母的同意 | PL Poproś rodziców o zgodę, zanim wejdiesz do Internetu | CS Než půjdeš na internet, požádej rodiče o svolení | SK Skôr než pôjdeš na internet, vypýtaj si povolenie od rodičov | HU Kérj szülői engedélyt, mielőtt online csatlakoznál! | RO Cere permisiunea părinților înainte de a te conecta online | BG Поискайте разрешение от родител, преди да влезете онлайн | LV Pirms došanās tiešsaistē palūdz atļauju vecākiem | ET Enne Interneti kasutamist küsi vanematelt luba | LT Prieš prisijungdami prie interneto, atsiklauskite tėvų



Enjoying the sights of beautiful lanterns is one of the most important social activities to celebrate in the traditional Chinese New Year. Colourful lanterns are endowed with various auspicious meanings, among which the shadow-picture lantern is a classic that dates back to ancient times. With the movement and variation of its shadows and patterns, the shadow-picture lantern tells many different stories, implies joy and prosperity, and expresses wishes such as hopes for a good harvest or abundant wealth.

Das Bestaunen wunderschöner Laternen zählt zu den wichtigsten Gemeinschaftsaktivitäten bei der Feier des traditionellen chinesischen Mondneujahrsfests. Die farbenfrohen Laternen sind mit diversen glücksverheißenden Motiven verziert. Einer der absoluten Klassiker ist die Schattenbildlaterne, die bis in die frühesten Zeiten der chinesischen Kultur zurückreicht. Durch die Bewegung und Veränderung ihrer Schatten und Muster erzählt die Schattenbildlaterne viele verschiedene Geschichten. Sie symbolisiert Freude und Wohlstand und verheißt zudem eine gute Ernte oder großen Reichtum.

Admirer les magnifiques lanternes est l'une des activités sociales les plus appréciées des festivités du Nouvel An chinois traditionnel. Les lanternes colorées revêtent diverses significations de bon augure, comme la lanterne à ombres chinoises, un classique qui remonte à l'Antiquité. Avec ses motifs et jeux d'ombres, la lanterne à ombres chinoises raconte de nombreuses histoires, évoque la joie et la prospérité et exprime notamment des vœux de bonne récolte ou de richesse.

Ammirare la vista di una meravigliosa lanterna è una delle attività sociali più importanti celebrate nel tradizionale capodanno cinese. Le lanterne colorate presentano diversi significati di buon auspicio; per esempio, la lanterna delle ombre cinesi è un classico risalente all'antichità. Con il movimento e la variazione delle sue ombre e dei suoi motivi, la lanterna delle ombre cinesi racconta molte storie diverse, implica gioia e prosperità e augura, tra le altre cose, un buon raccolto o una ricchezza abbondante.

Disfrutar contemplando hermosos faroles es una de las actividades sociales más importantes de las fiestas tradicionales del Año Nuevo chino. Entre los vistosos faroles, portadores de buenos auspicios, destaca el farol de sombras, un clásico que se remonta a tiempos inmemoriales. Con el movimiento y la variación de sus sombras y patrones, el farol de sombras narra muchas historias diferentes, sugiere alegría y prosperidad, y expresa deseos de una cosecha abundante o riqueza copiosa, por mencionar algunos ejemplos.

Desfrutar das vistas incríveis proporcionadas pelas lanternas é uma das atividades sociais mais importantes na celebração tradicional do Ano Novo Chinês. As lanternas coloridas estão repletas de diversos significados auspiciosos, sendo que a lanterna com sombras é um clássico que remonta aos tempos antigos. Com o movimento e a variação das sombras e padrões, a lanterna com sombras conta muitas histórias diferentes, significa, por exemplo, felicidade e prosperidade e desejos de boas colheitas ou riqueza abundante.

Wspólne świętowanie przy pięknych lampionach to jedno z najważniejszych obchodzonych wspólnie wydarzeń podczas Chińskiego Nowego Roku. Kolorowe lampiony niosą ze sobą najróżniejsze znaczenia związane z pomyślnością, np. lampion tworzący grę cieni to klasyk, nawiązujący do czasów starożytnych. Ze względu na ruch i różnorodność cieni i wzorów lampion ten opowiada wiele różnych historii, wyraża radość i pomyślność oraz życzenia dobrych zbiorów czy bogactwa.

观花灯是庆祝传统春节重要的仪式活动之一，花灯彩灯更是被人们赋予了各种吉祥的寓意，五彩缤纷多种多样的花灯中，走马灯甚是经典。它通过光影图案的变化移动，形成不同的组合，或寓意喜庆兴旺，或祝愿五谷丰登，亦或祈禱财源滚滚等等。

Radost z podiváné na krásné lucerny je jednou z nejdůležitějších sociálních aktivit při oslavě tradičního čínského Nového roku. Barevné lucerny mají různé pozitivní významy, mezi nimiž je klasikou lucerna se stínovým obrazem, jejíž existence se datuje až do starověku. Pohybem a variacími stínů a vzorů stínová lucerna vypráví mnoho různých příběhů, vyjadřuje například radost a prosperitu a přeje dobrou úrodu nebo hojně bohatství.

Ak chcete osláviť tradičný čínsky nový rok, medzi najdôležitejšie spoločenské aktivity patrí kochanie sa pohľadom na nádherné lampáše. Farebné lampáše v sebe skrývajú rôzne významy plné nádeje. Klasickým kúskom je lampáš s tieňovým divadlom, ktorého pôvod siaha až do staroveku. Vďaka pohybu a rozličným tieňom a vzorom dokáže tento lampáš s tieňovým divadlom vypovedať množstvo rôznorodých príbehov a zosobňuje napríklad radosť, prosperitu a želanie dobrej úrody či hojného bohatstva.

A gyönyörű lámpások látványának élvezete az egyik legfontosabb közösségi esemény a hagyományos kínai újév ünneplése során. A színes lámpásokat különféle, sikert ígérő jelentésekkel ruházzák fel, amelyek közül az árnyéklámpás egy, egészen az ókorig visszanyúló klasszikus. Árnyékainak és mintáinak mozgásából és variációiból az árnyéklámpás sok különböző történetet mesél el, örömet és jólétet jelent, emellett többek között jó termést vagy bőséges gazdagságot kíván.

Admirarea spectacolului oferit de minunatele felinare este una dintre cele mai importante activități sociale prin care se sărbătorește Anul Nou tradițional chinezesc. Felinarele colorate sunt înzestrate cu diverse semnificații de bun augur, iar felinarul cu imagini în umbre este un element clasic care datează din timpuri străvechi. Prin mișcările și variația umbrelor și modelelor sale, felinarul cu imagini în umbre spune multe povești, sugerează bucurie și prosperitate și exprimă, de exemplu, dorința pentru o recoltă bună sau abundență.

Създаването на красивите фенери е едно от най-важните социални занимания за отпразнуване на традиционната китайска Нова година. Цветните фенери имат различни благоприятни значения, а фенерът със сенки е класика, която датира от древни времена. С движението и разнообразието на своите сенки и шарки, фенерът със сенки разказва много различни истории, символизира радост и просперитет и носи пожелания за добра реколта, изобилно богатство и други.

Skaisto laternu apskate ir viena no svariajākajām sociālajām aktivitātēm, svinot tradicionālo ķīniešu Jauno gadu. Krāsainajām laternām piemīt dažādas labas nozīmes, un to starpā ir arī klasiskā ēnu attēla laterna, kuras pirmsākumi meklējami sensenos laikos. Ar savu ēnu un rakstu kustību un variācijām ēnu attēla laterna stāsta dažādas stāstus, tostarp par prieku un labklājību, un novēl labu ražu vai bagātību.

Kaunite laternate vaatamise nautimine on üks tähtsamaid sotsiaalseid tegevusi, mida traditsiooniliselt Hiina uusaasta tähistada. Värvilised laternad on varustatud erinevate heaenduliste tähendustega, mille hulgas on varjupildiga latern klassika, mis pärineb iidsetest aegadest. Oma varjude ja mustrite liikumise ja varieerumisega räägib varjupildilatern palju erinevalid lugusid, mis tähistavad rõõmu ja jõukust ning soovivad näiteks head saaki või küllust.

Mégavámissis grazių žibintų vaidžais – vienas iš svarbiausių socialinių užsiėmimų švenčiant tradicinius kinų Naujuosius metus. Įvairių palankių reikšmių suteikiama spalvingiems žibintams. Šešėlių žibintas – senovė menanti klasika. Judant ir keičiantis šešėliams bei paveikslėliams, žibintas pasakoja daug įvairių istorijų, žada sėkmę ir klestėjimą bei linki tokių dalykų kaip geras derlius ar gausa.

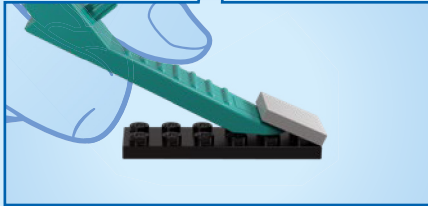
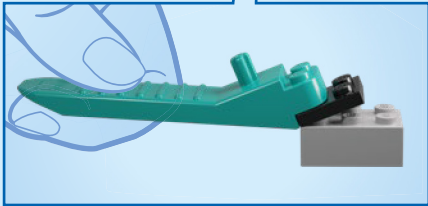
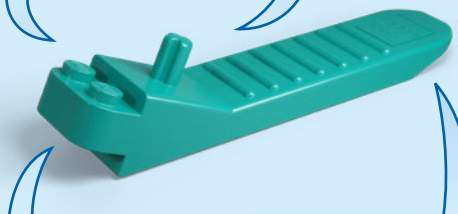
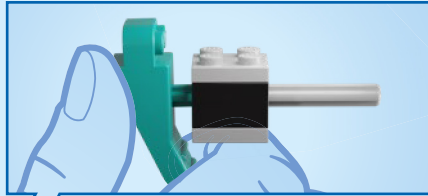
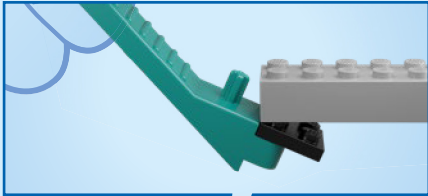

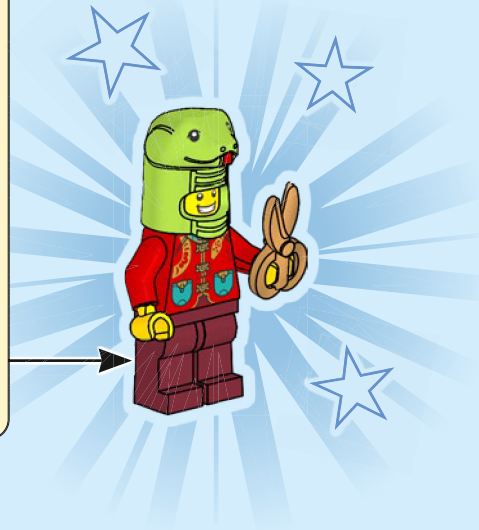
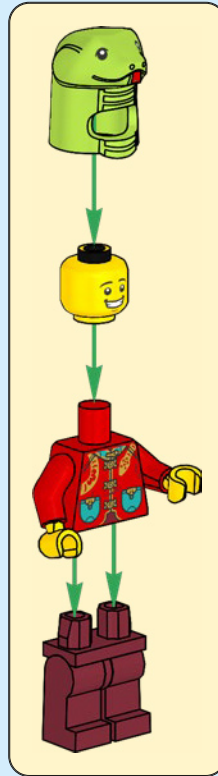

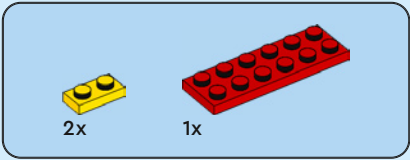

1

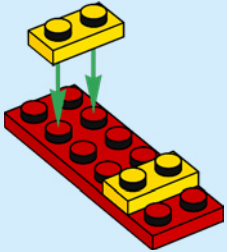

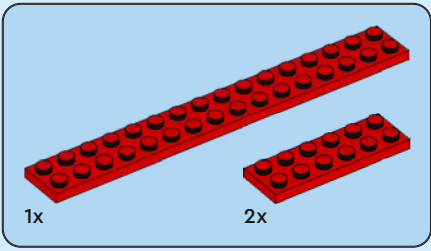

2

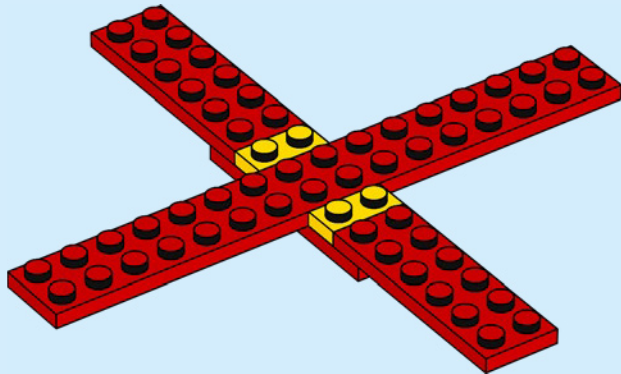



4x

3

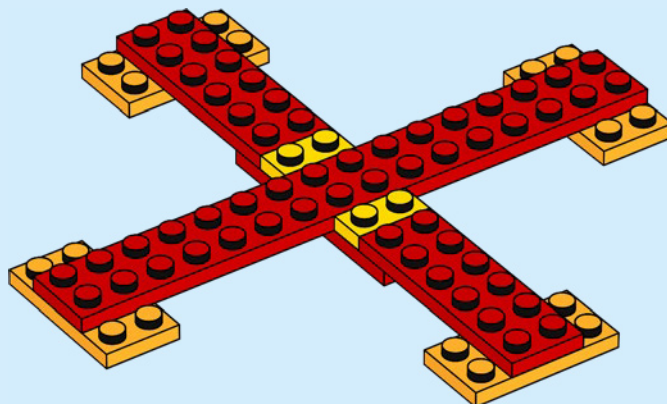



8x

4

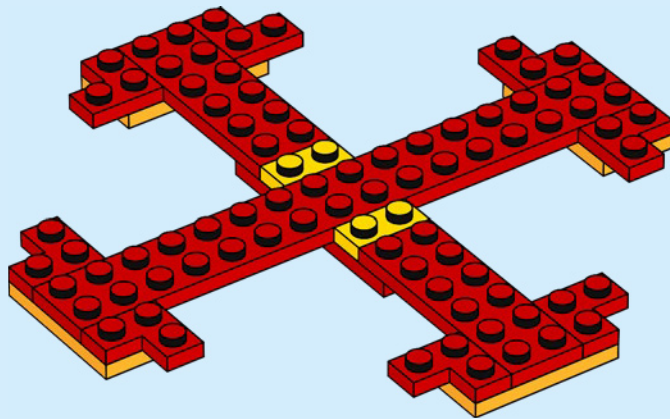



2x

5

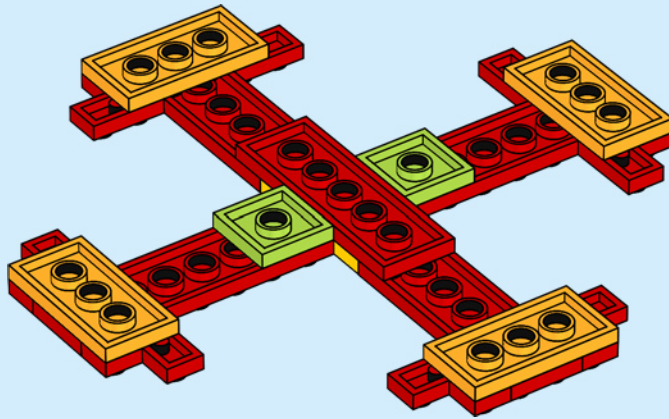

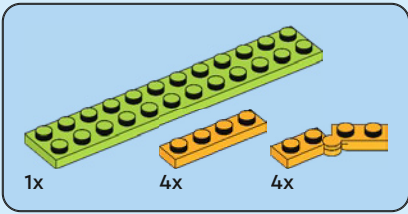

6

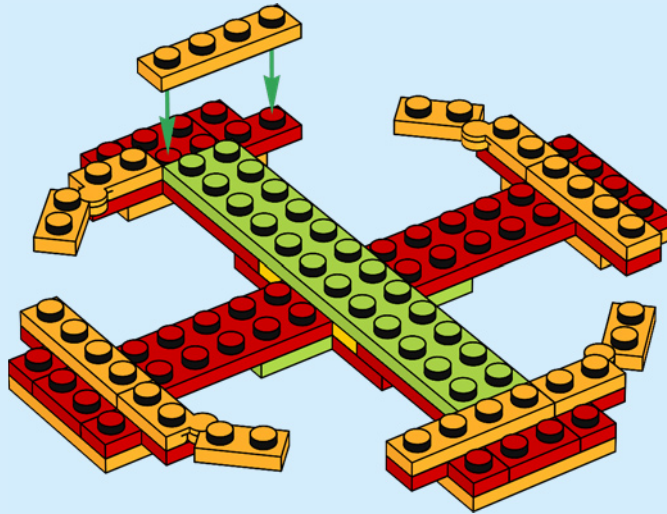

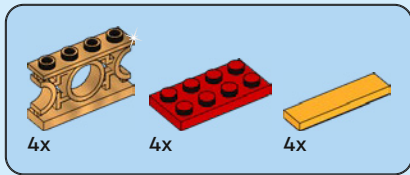

7

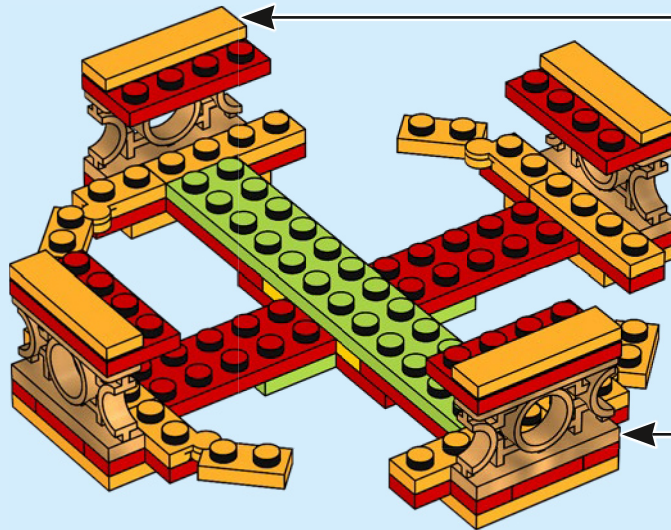
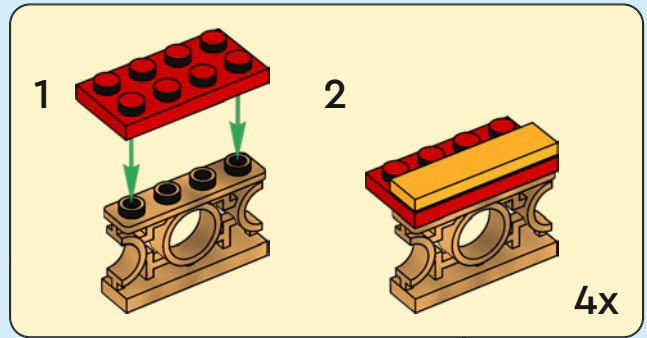



2x



2x

8

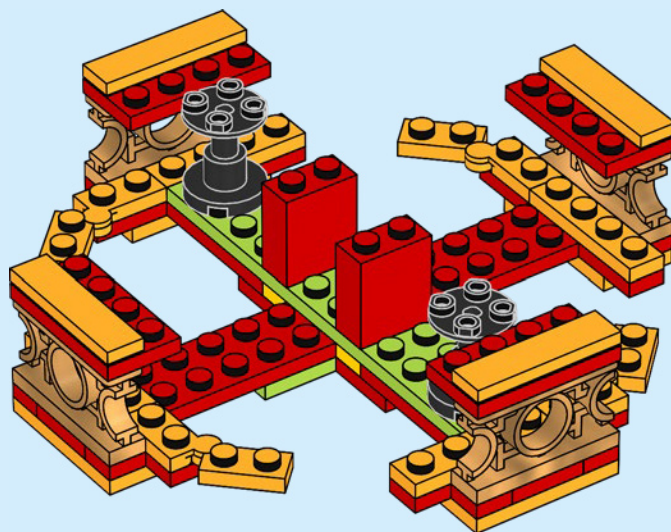

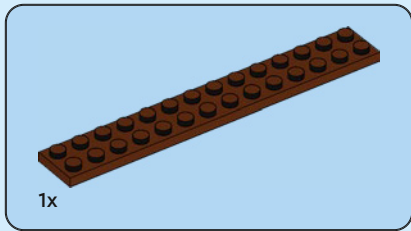

9

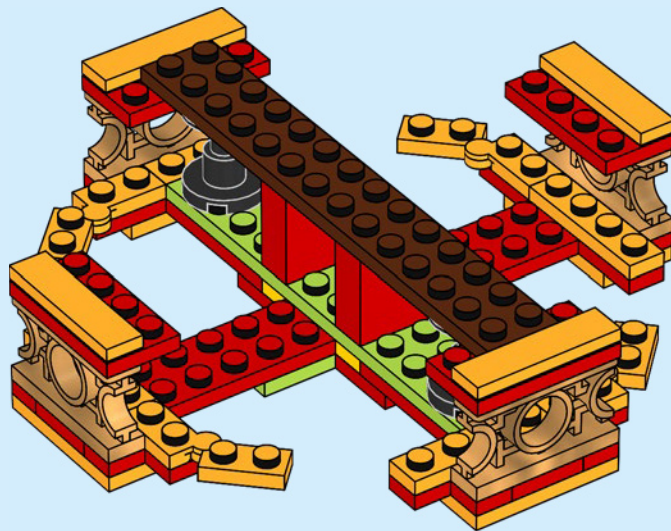

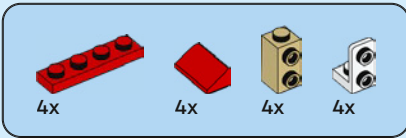

10

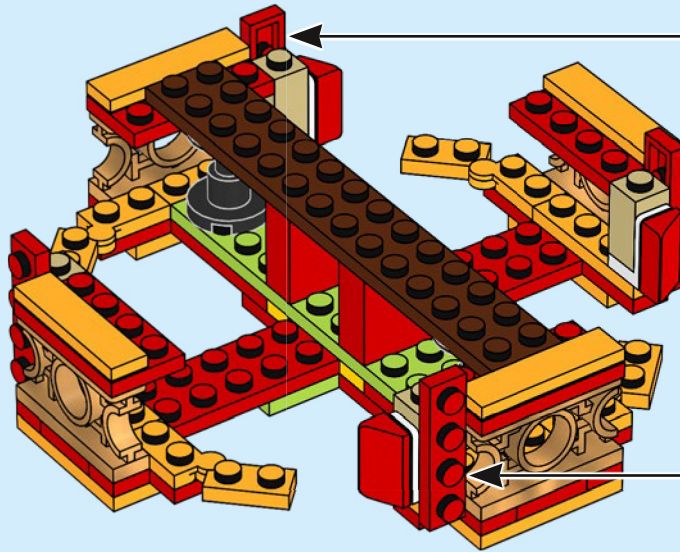
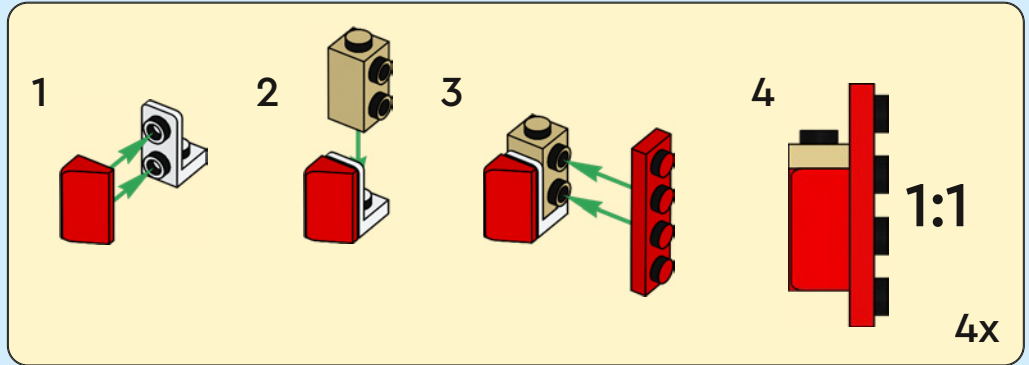



4x



1x

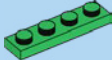

1x

11

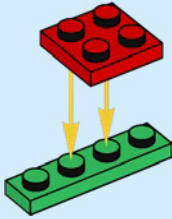

1x

12

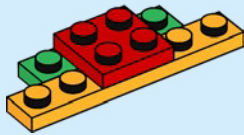

2x

13

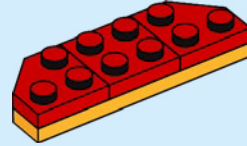

1x



2x

14

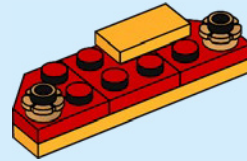

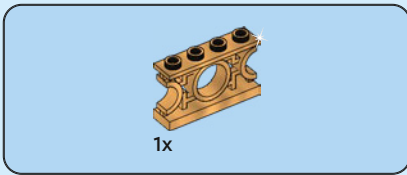

15

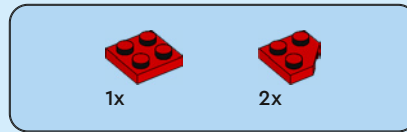
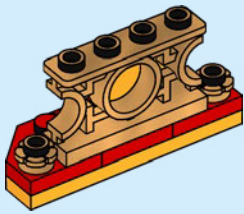

17

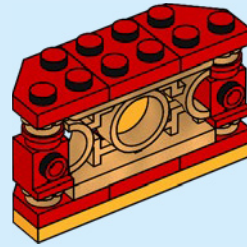

16

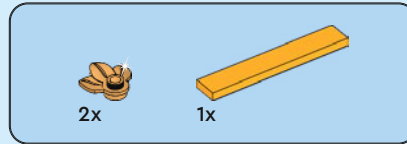
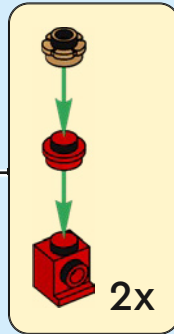
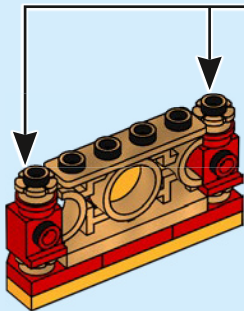

18

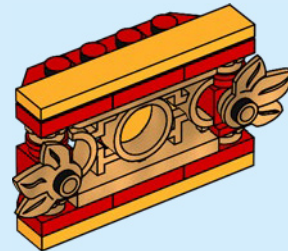

4x

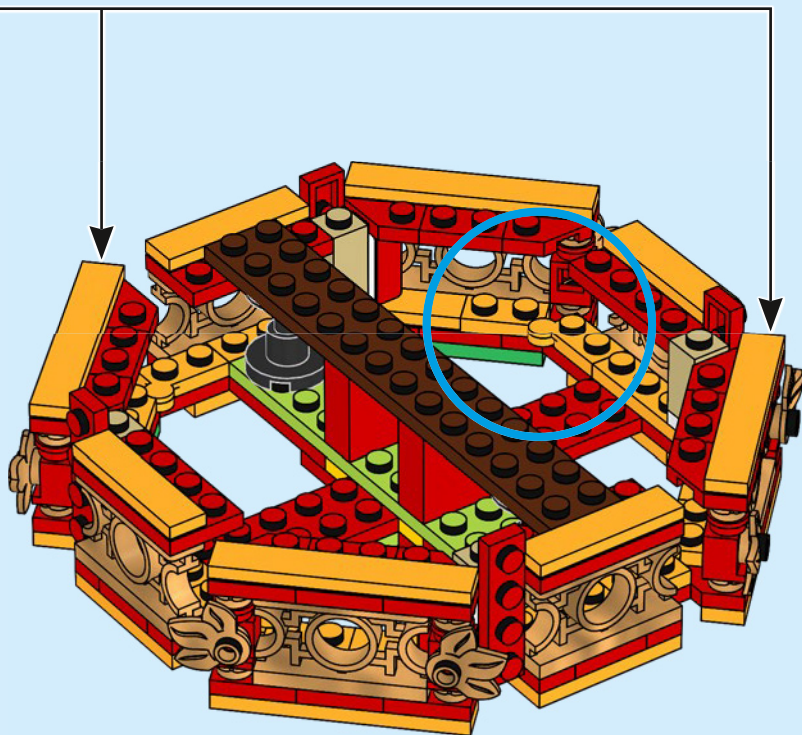

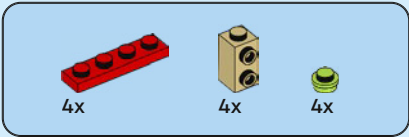

20

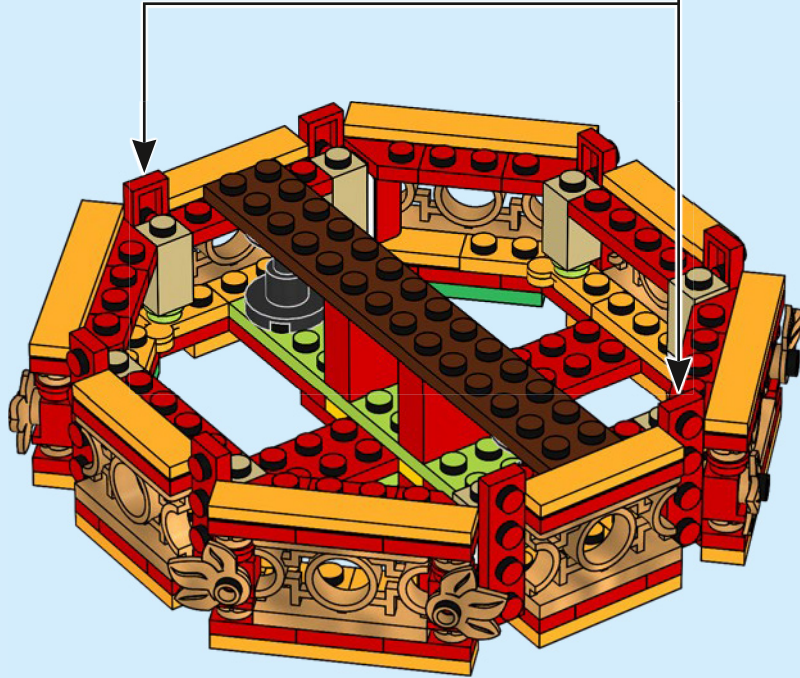
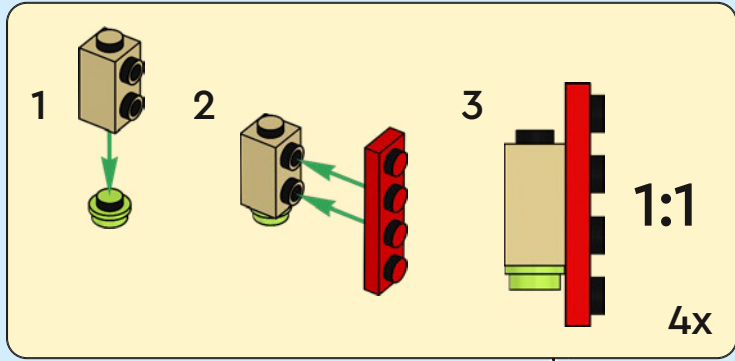

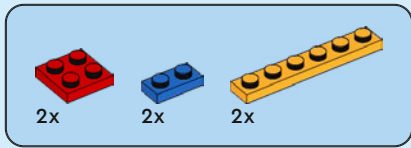

21

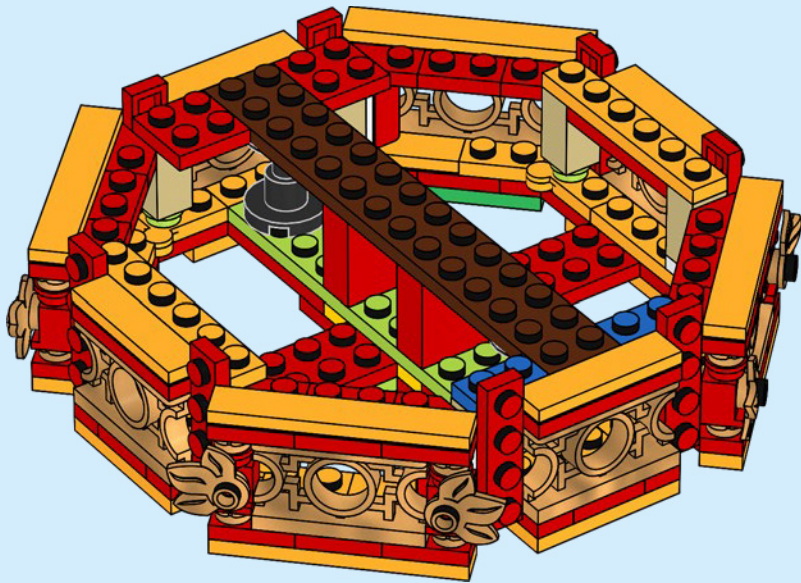

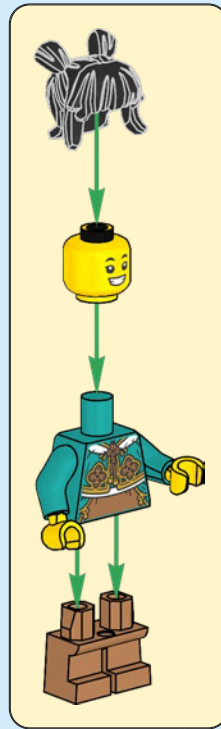

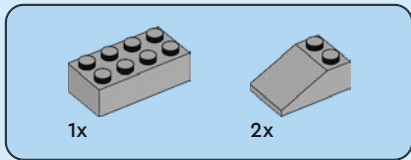

22

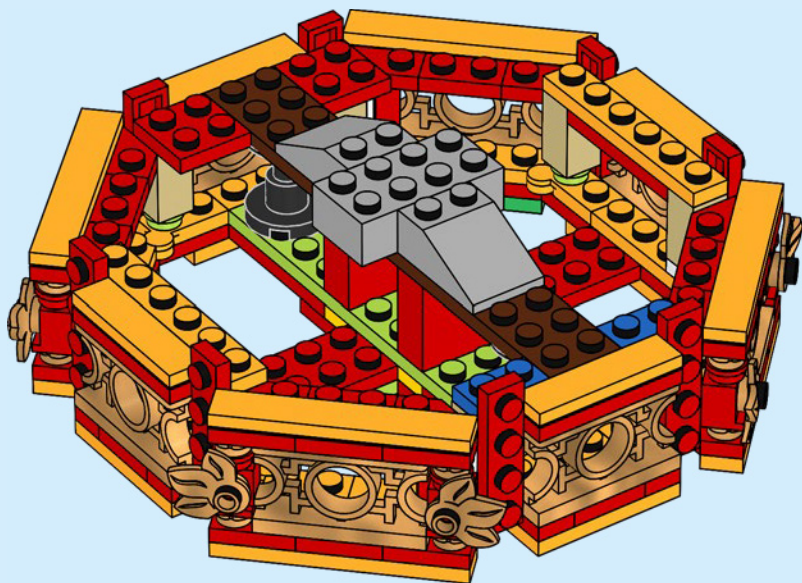



2x

26

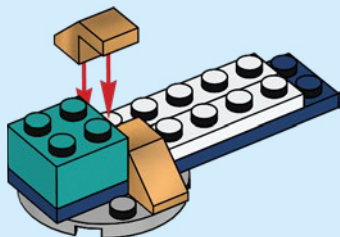

1x



1x



2x

27

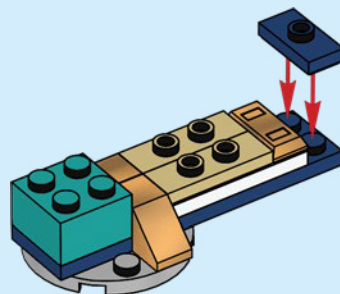

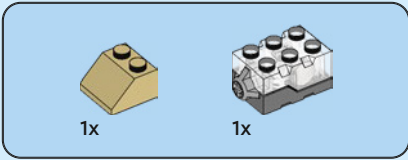

28

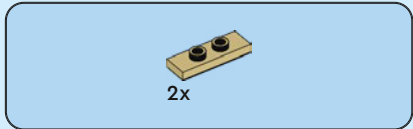
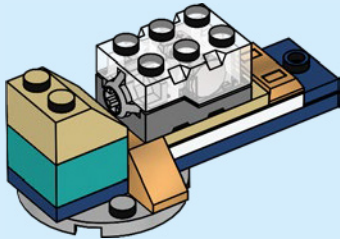
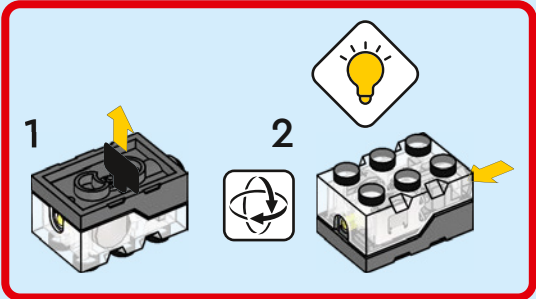

29

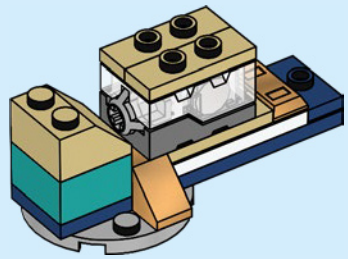

30

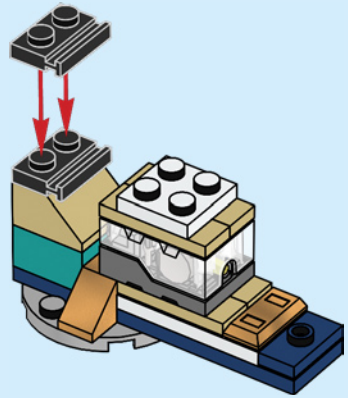

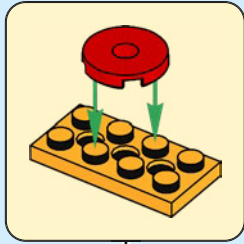
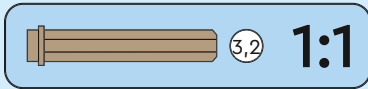
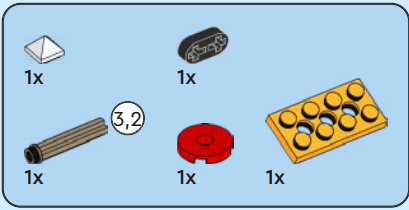

31

1

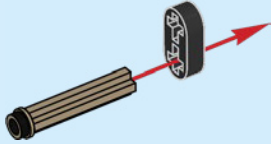

2

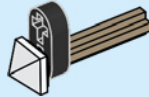

3

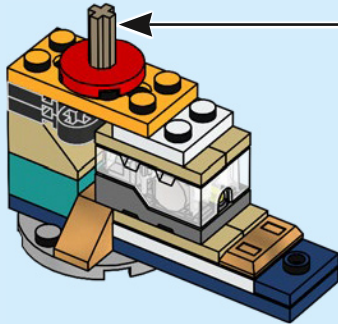
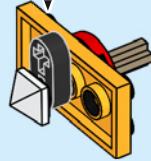

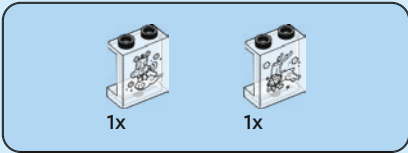

32

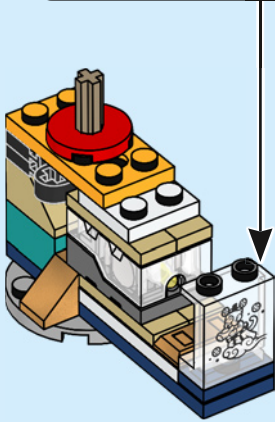
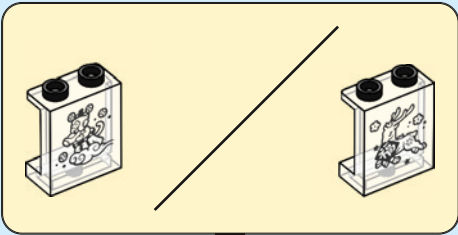

33

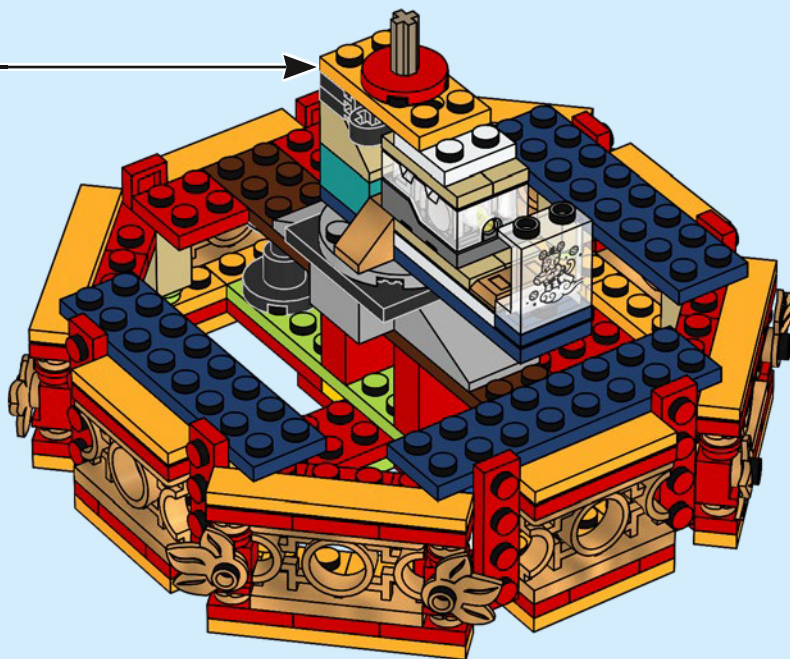

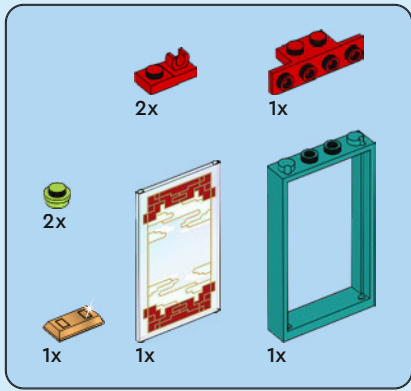

34

1

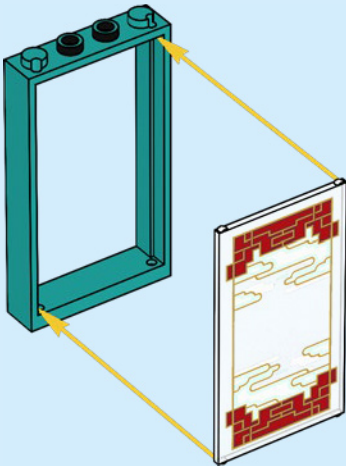

2



3

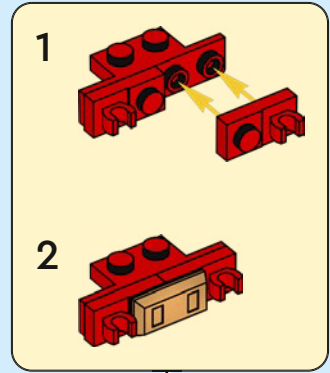
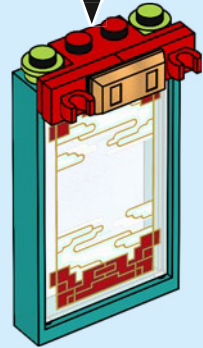



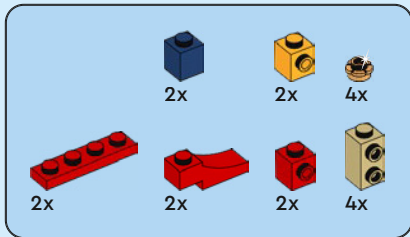

35

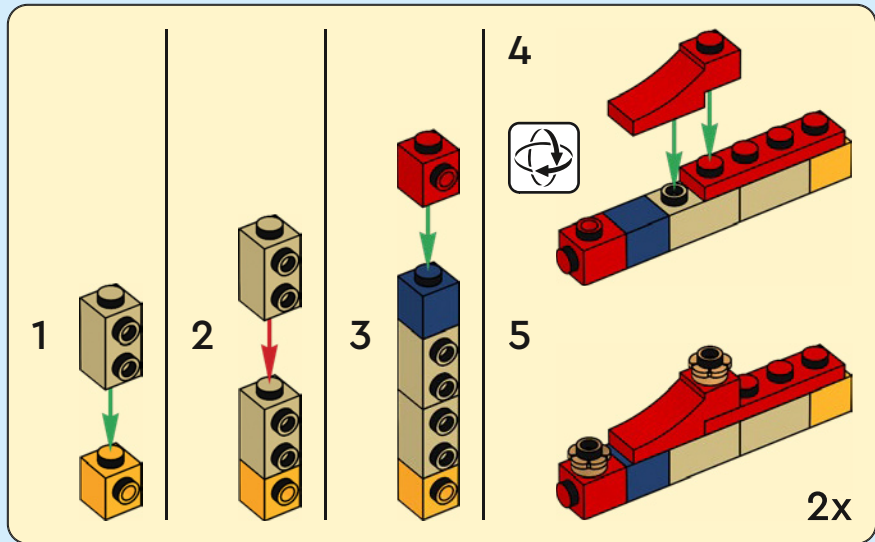

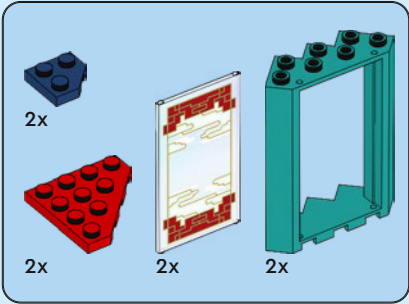

36

1

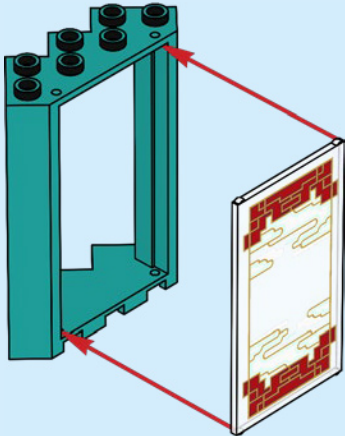

2

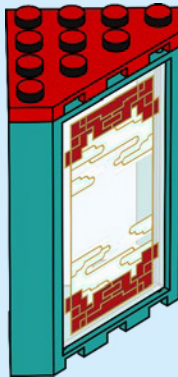

3

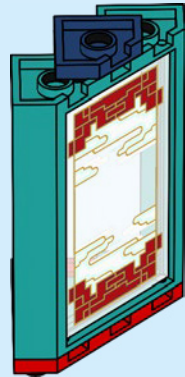

2x

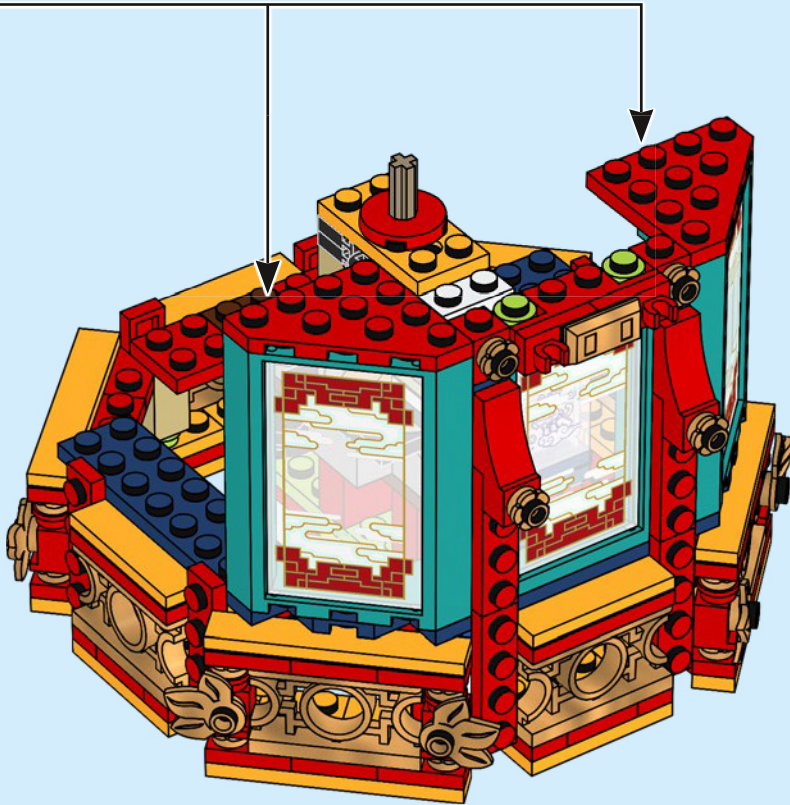

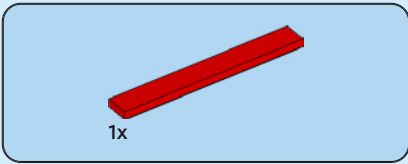

37

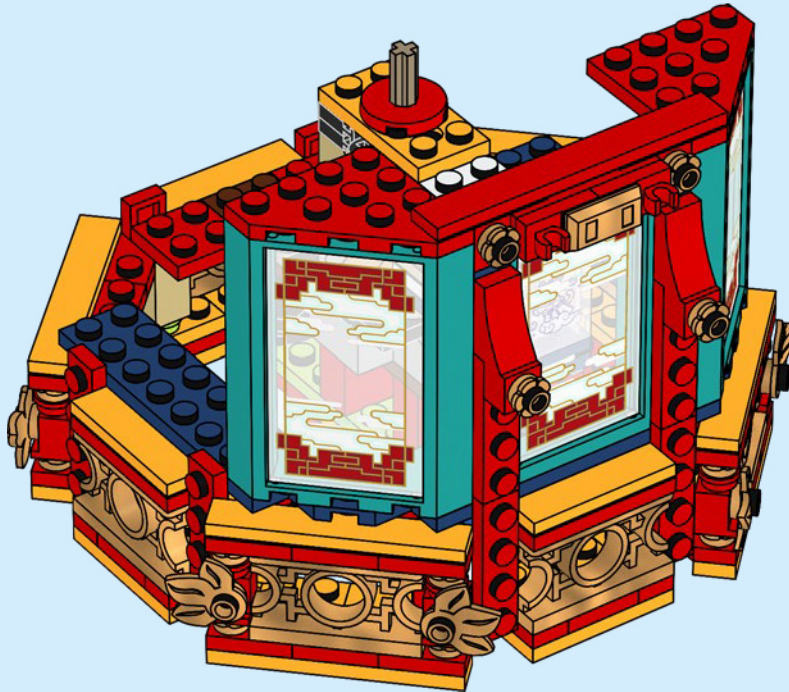



2x



2x



2x



4x



2x



2x



2x



4x

38

1

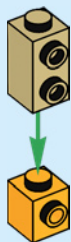

2



3

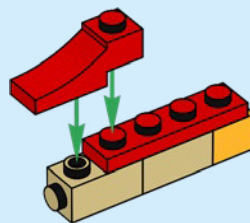



4

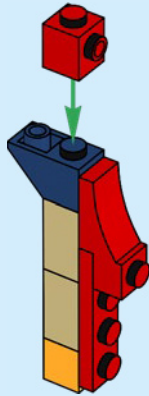

5

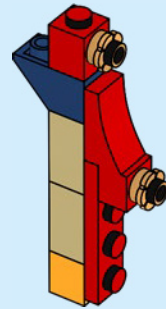

2x



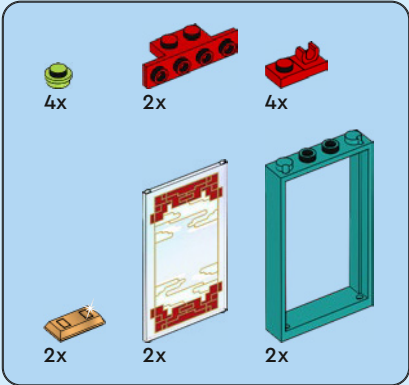

39

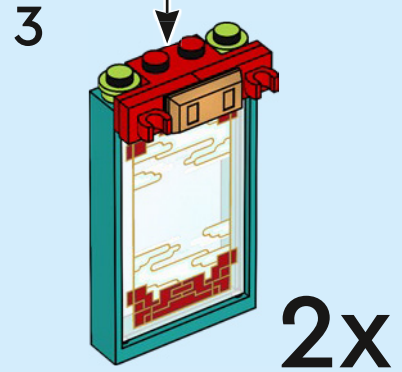
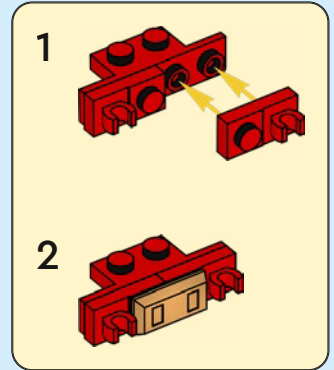
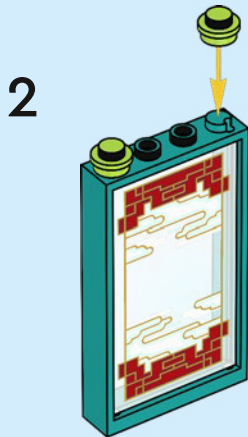
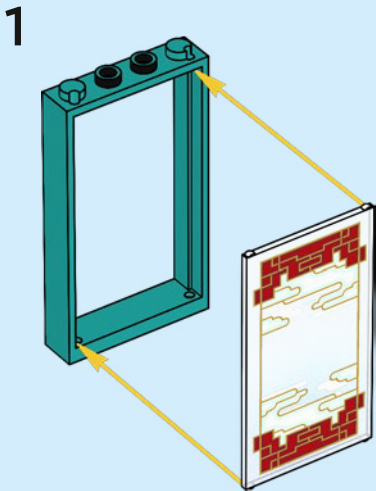





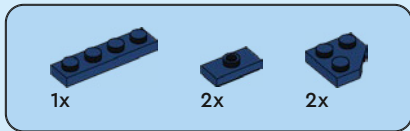

40

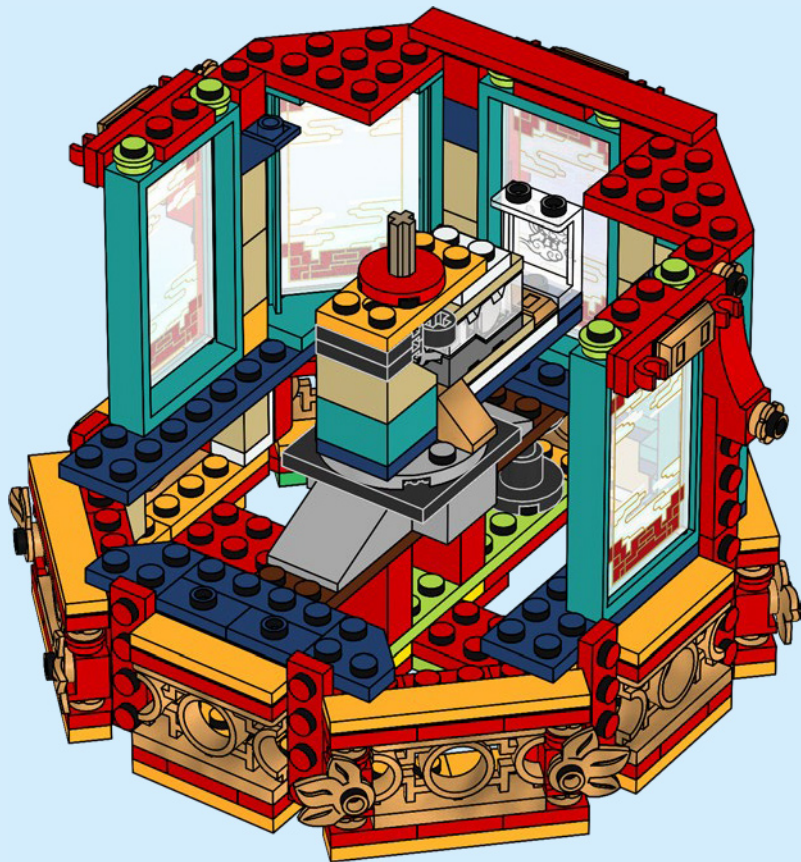

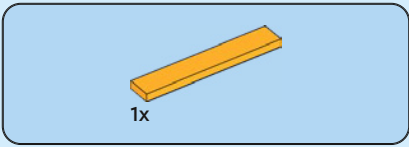

41



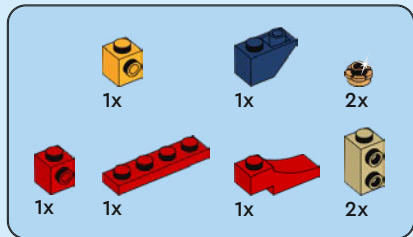
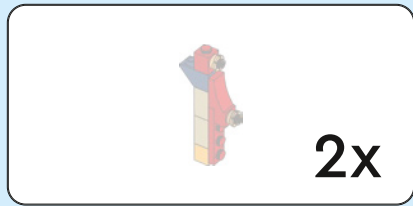

42

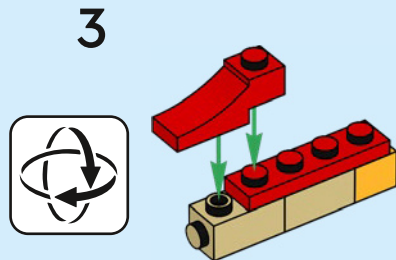
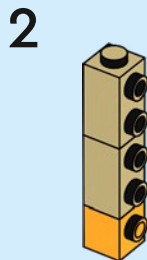
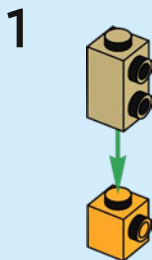

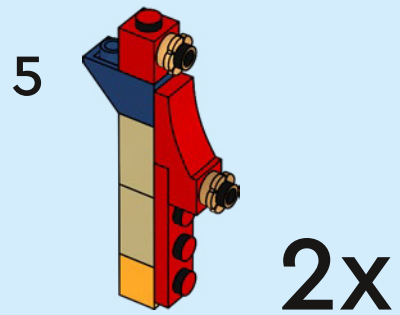
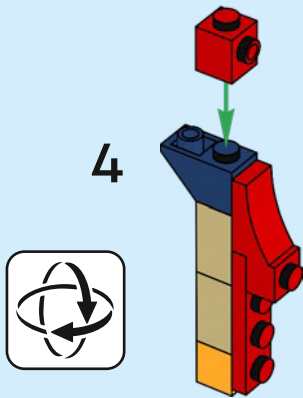

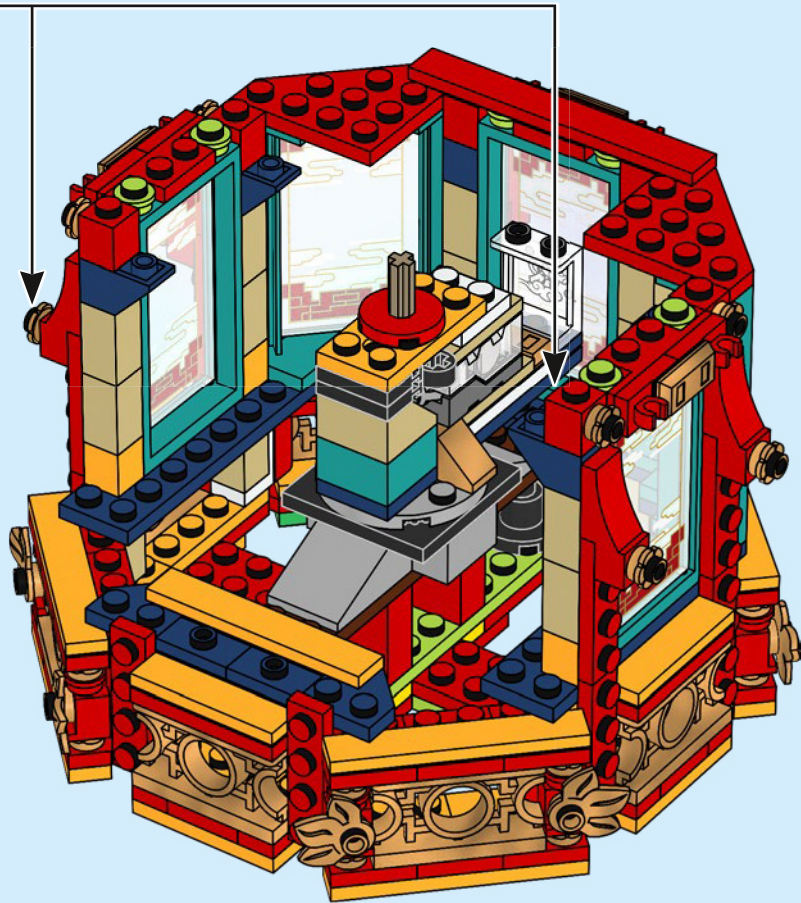

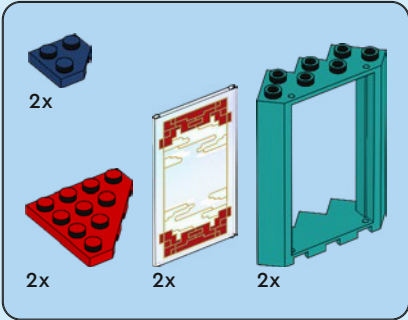

43

1

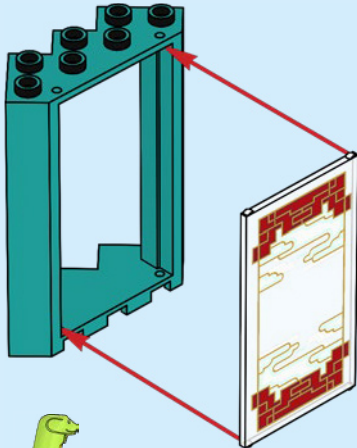

2

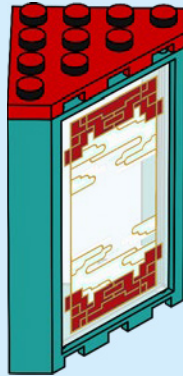

3

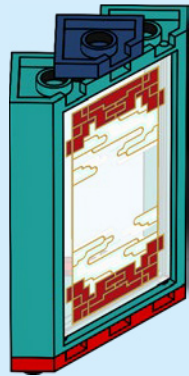

2x

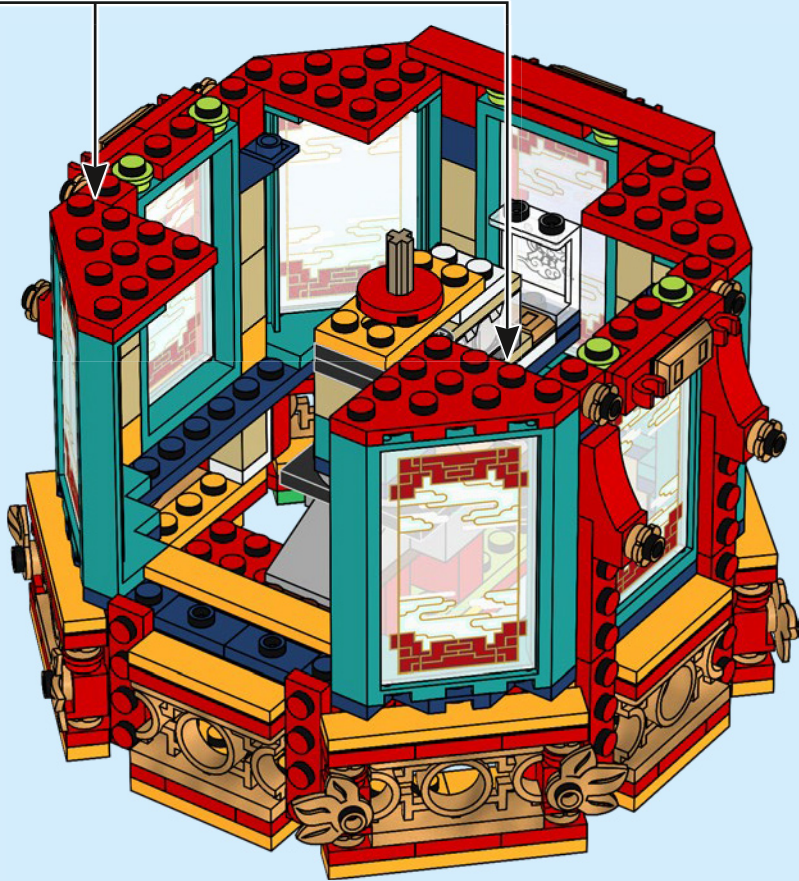

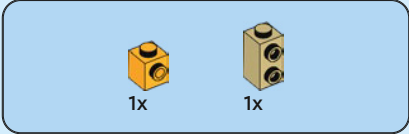
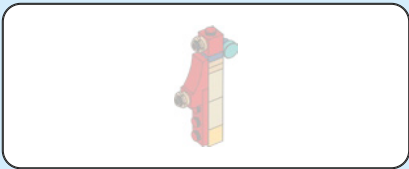

44

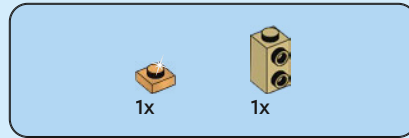
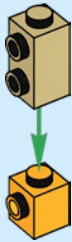

45



46



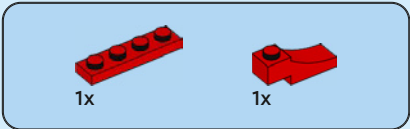

47

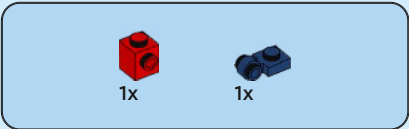
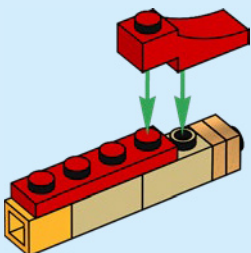

48

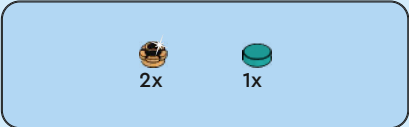
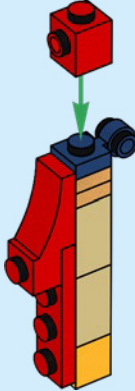

49

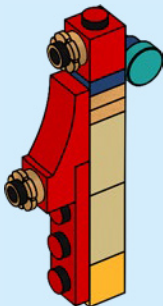

50

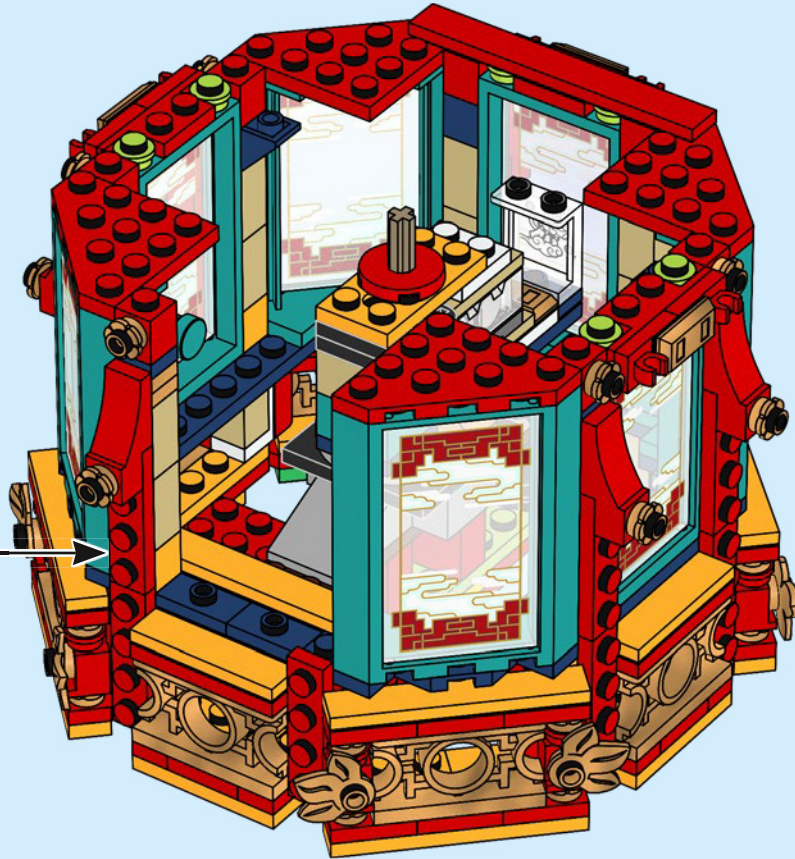

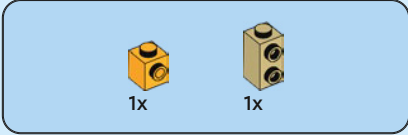
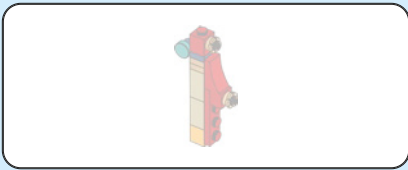

51

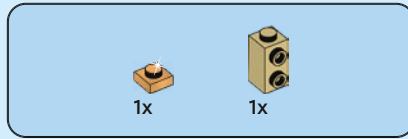
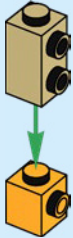

52



53



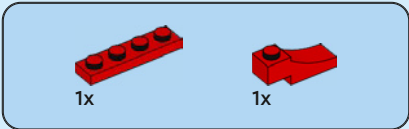

54

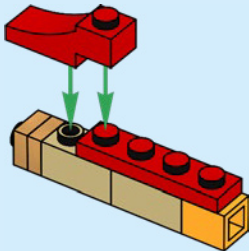

55

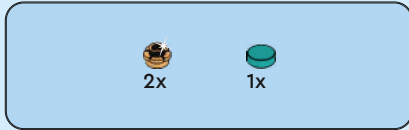
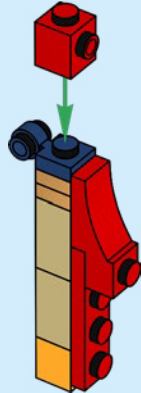

56

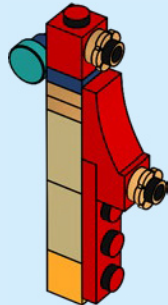

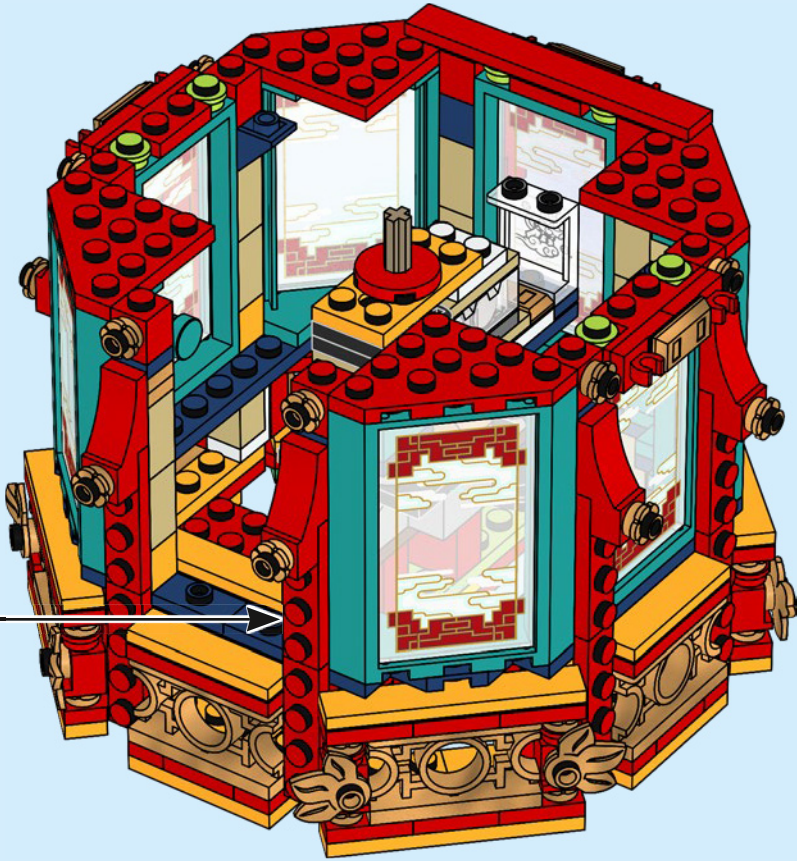

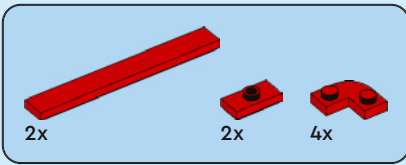

58

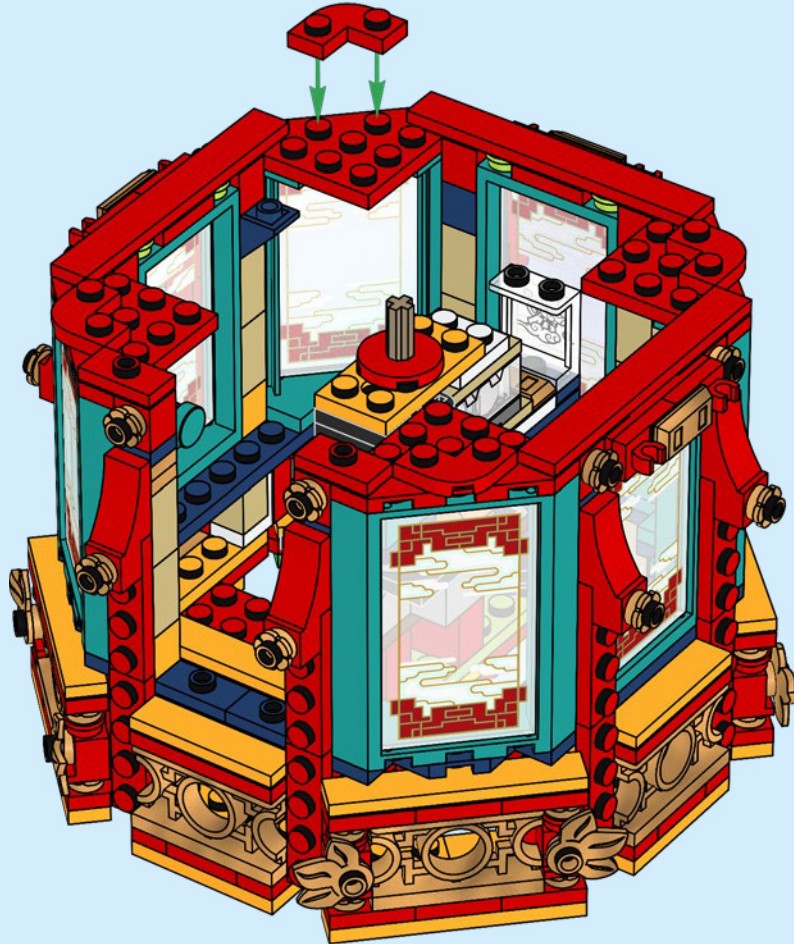

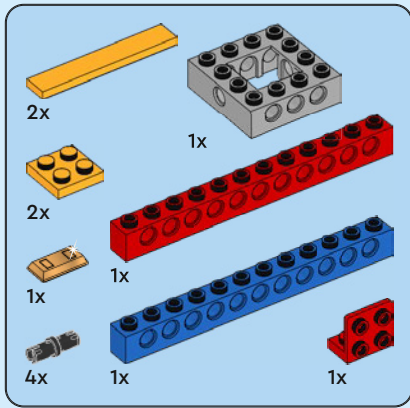

59

1

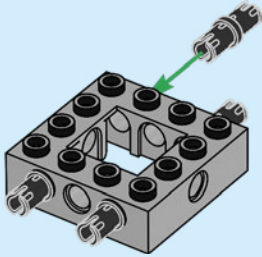

2

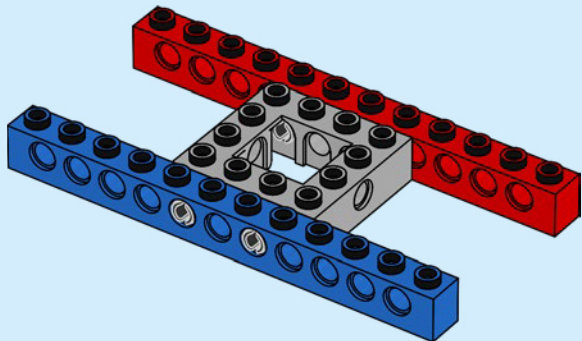

3

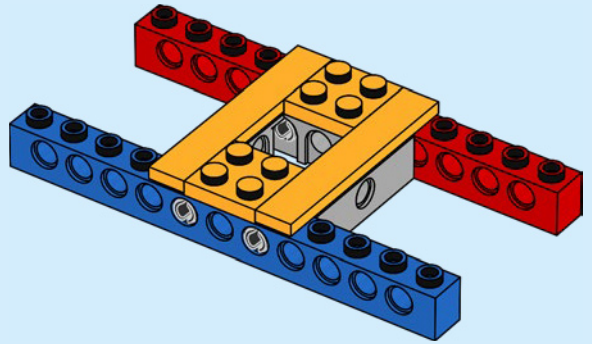

4

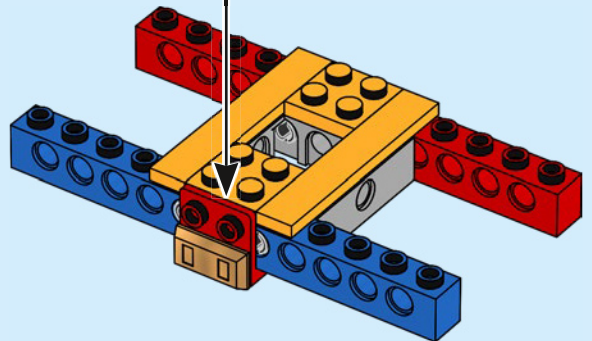
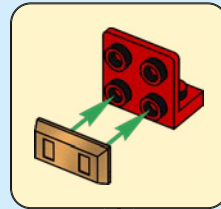

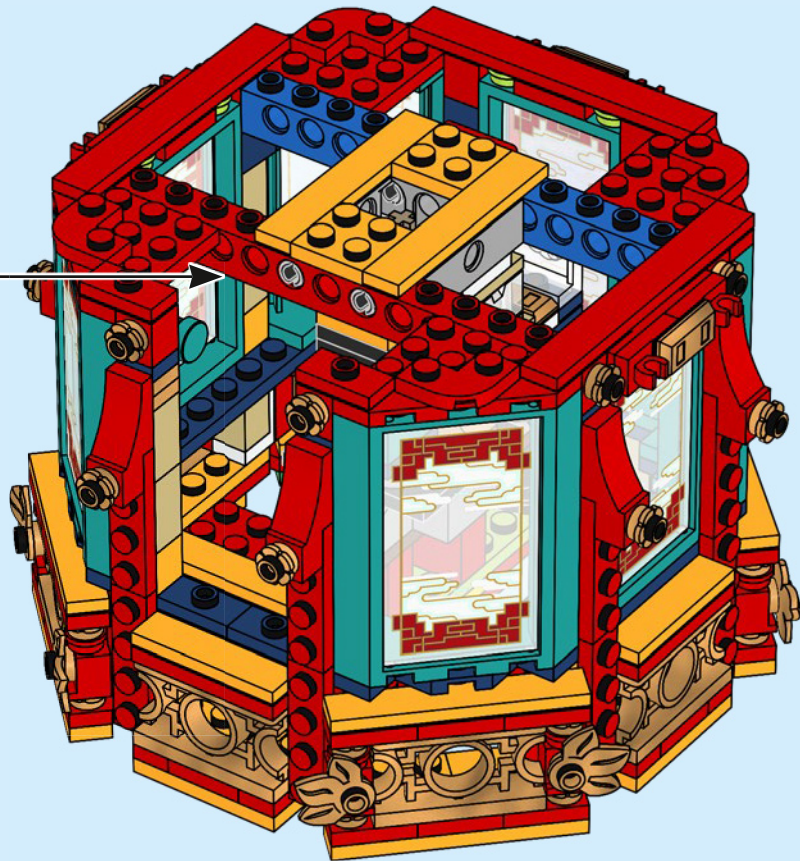

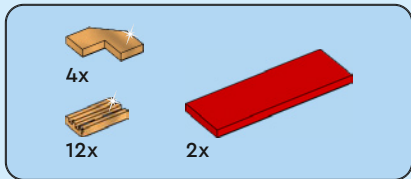

60

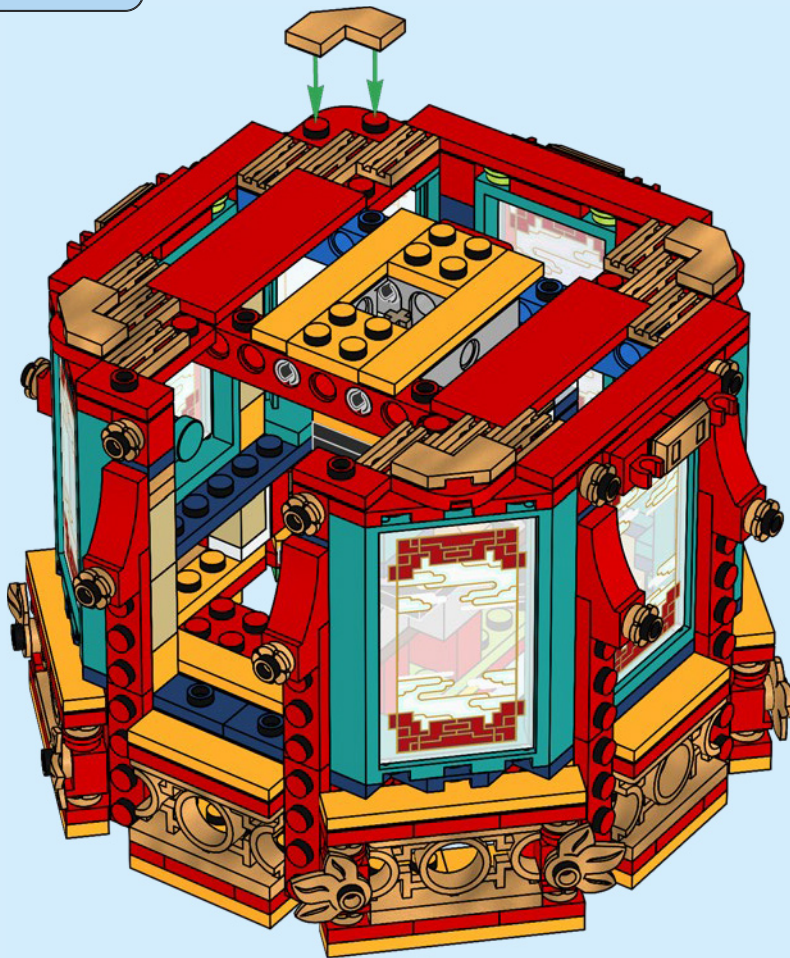



6x

61

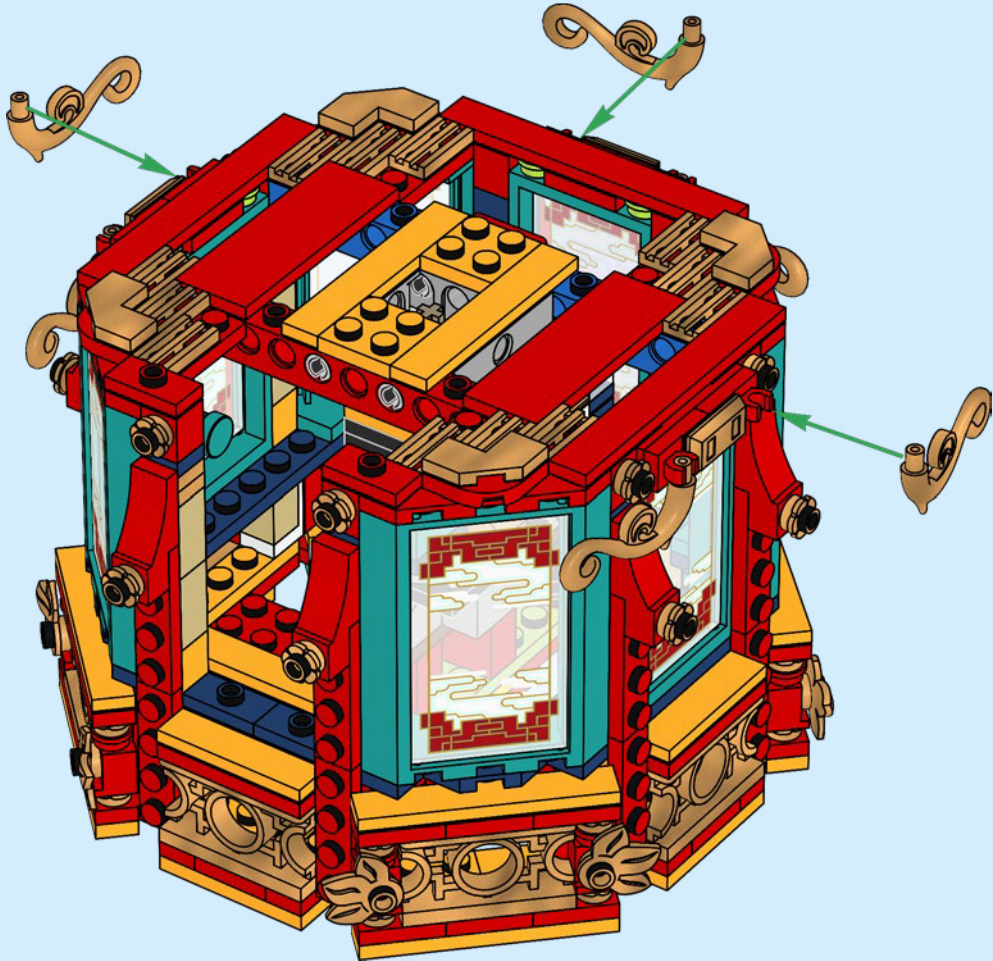





2x

62

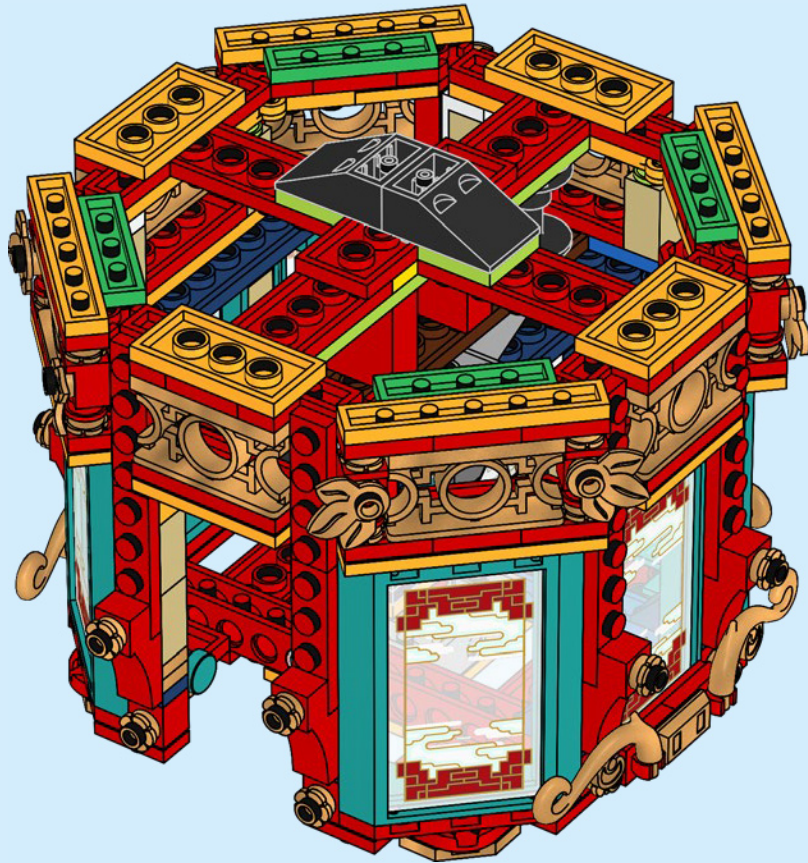



1x



1x

63

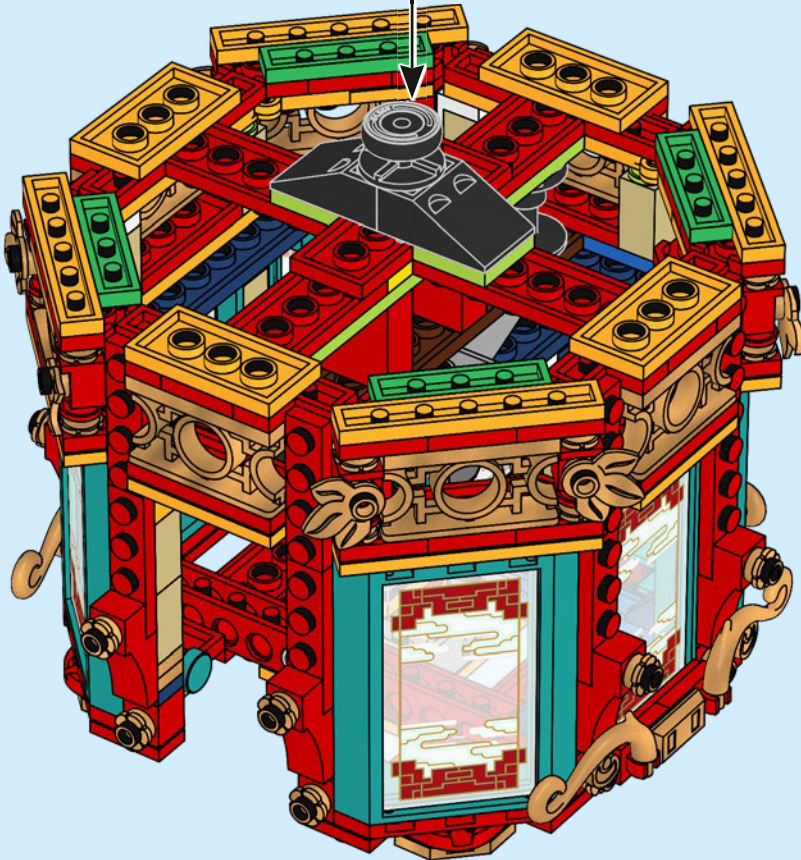
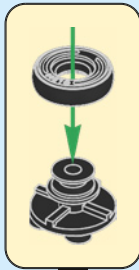

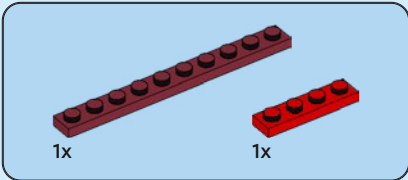
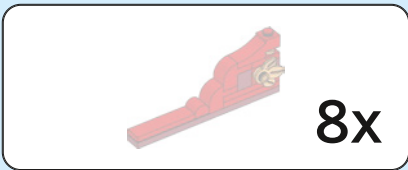

64

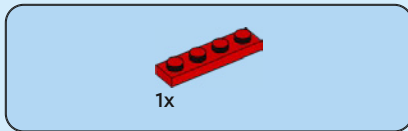
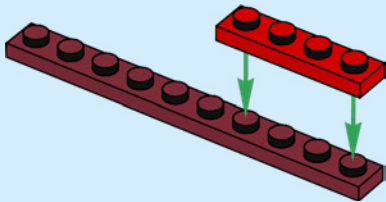

65

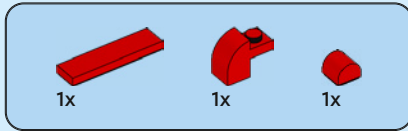
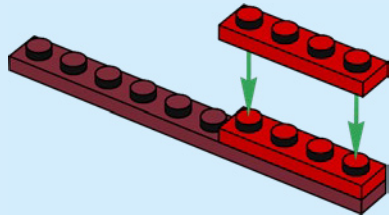

66

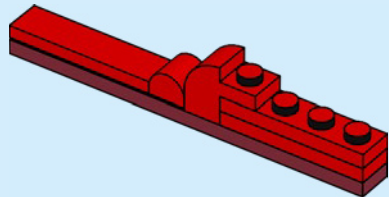



2x



1x

67

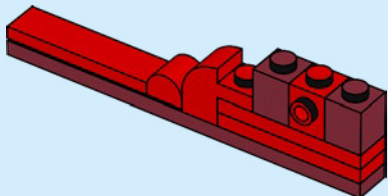

1x



1x

68

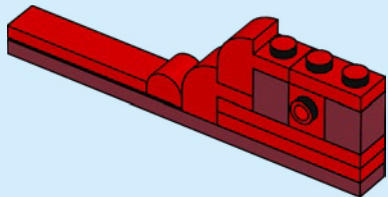

1x



1x

69

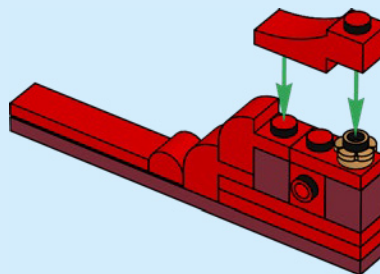

2x

70

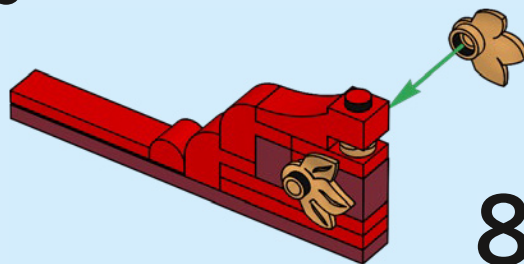

8x





1x



72

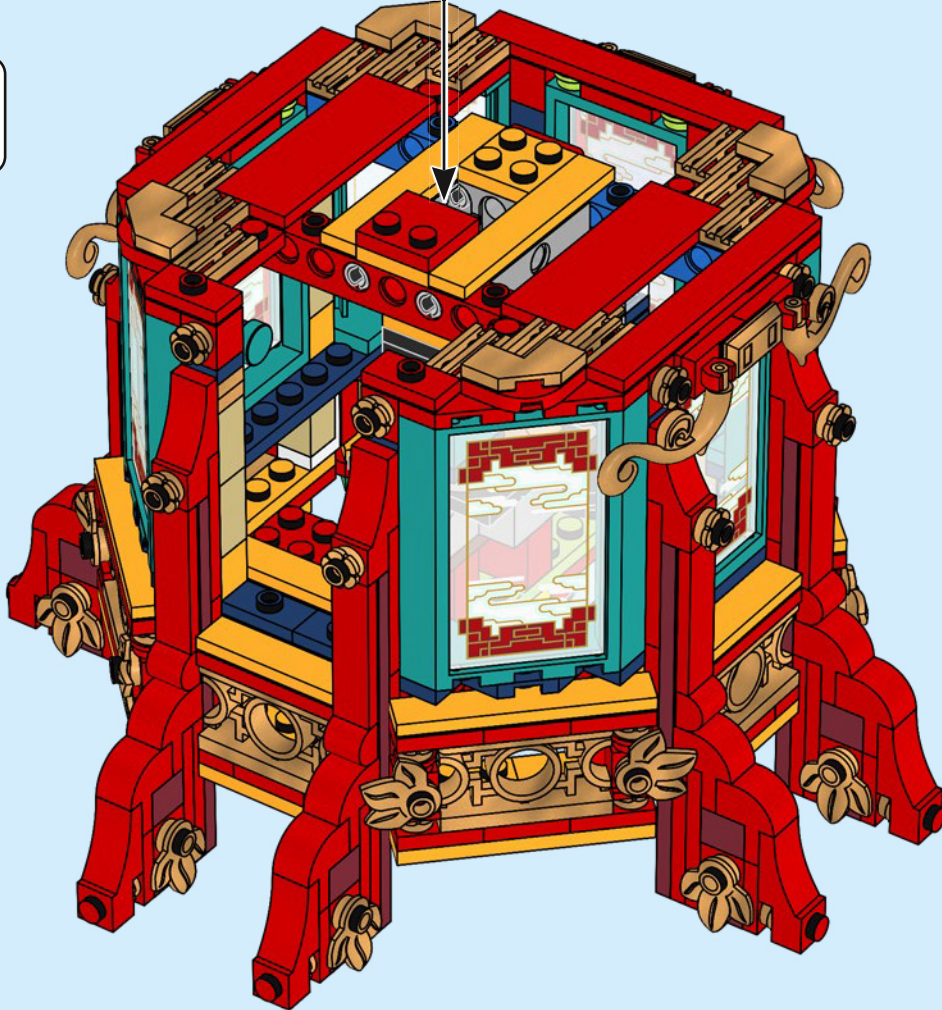

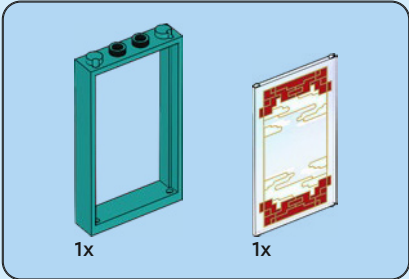
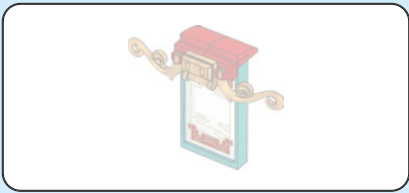

73

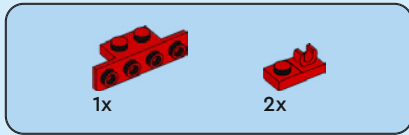
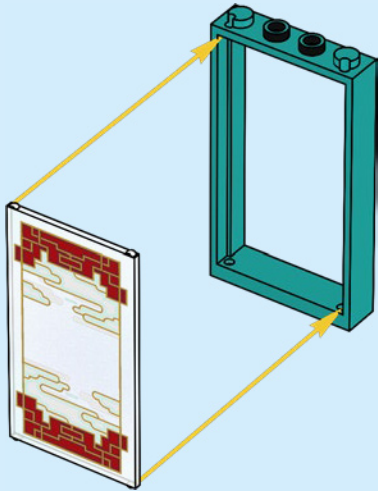

74

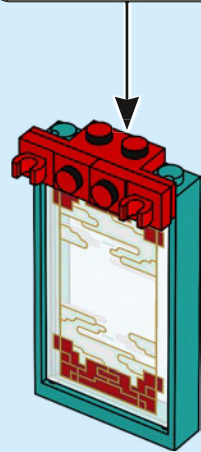
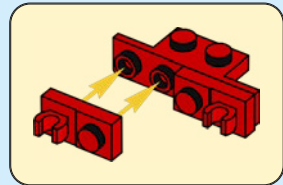



2x

75

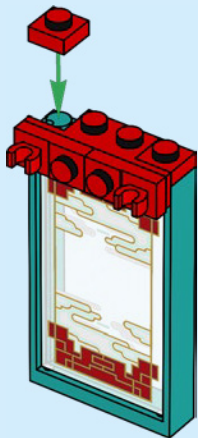

1x



1x

76

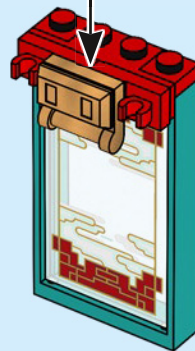
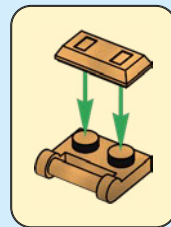



2x

77

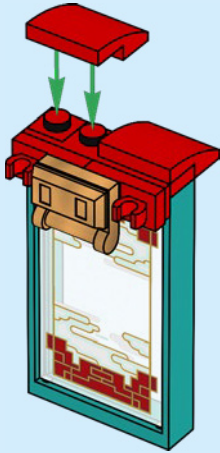

2x

78

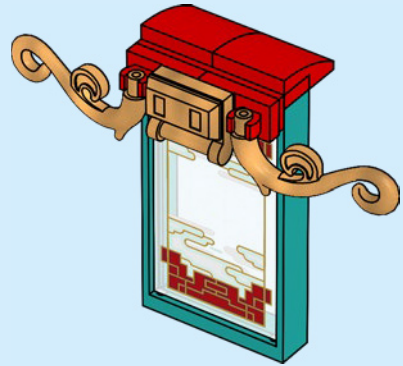

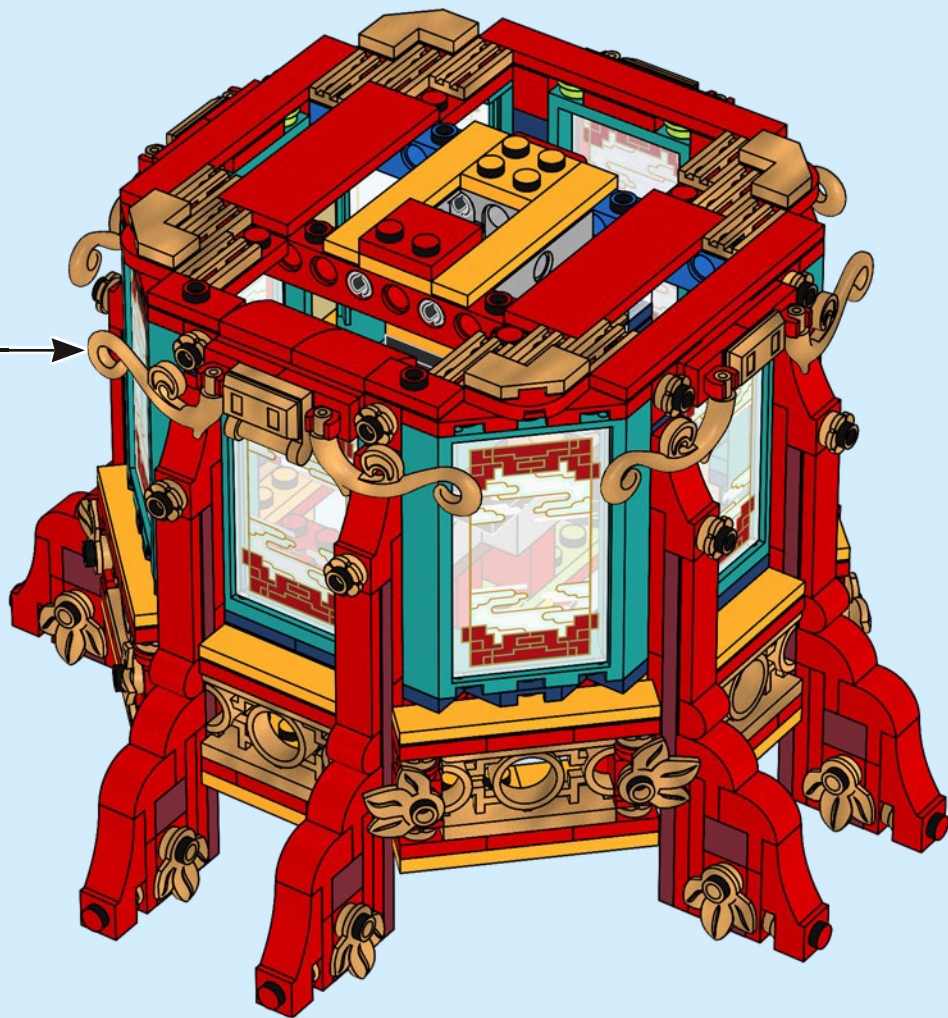

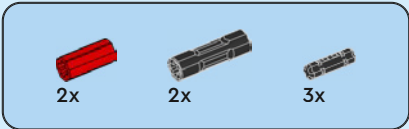

80

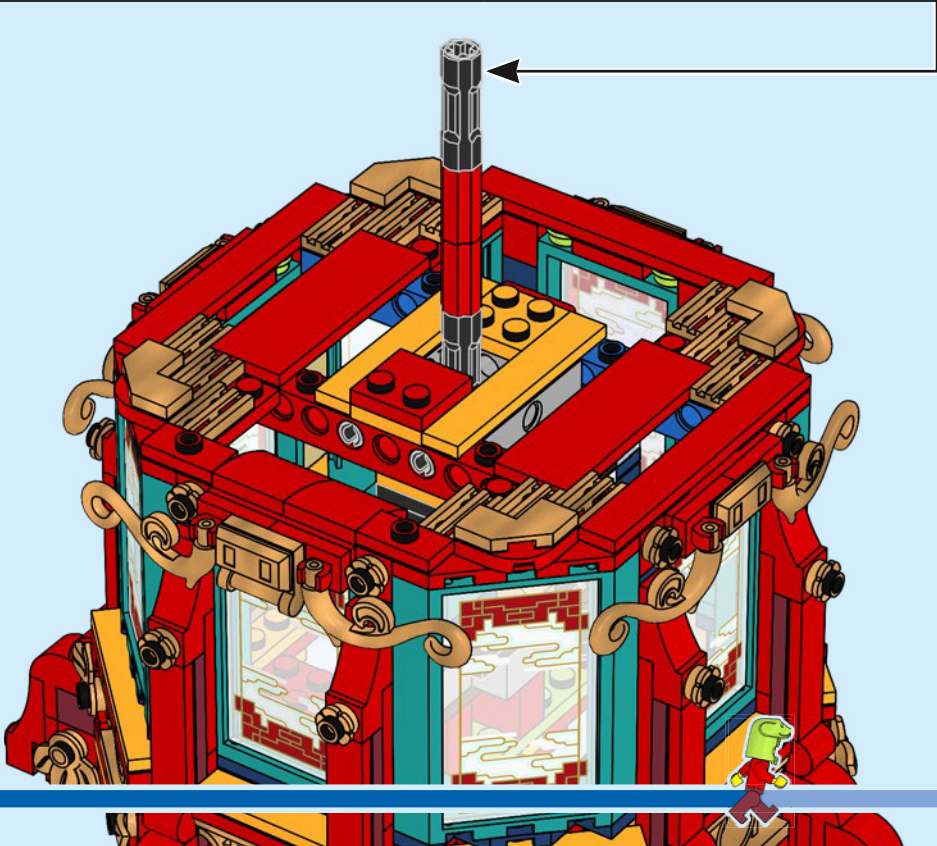
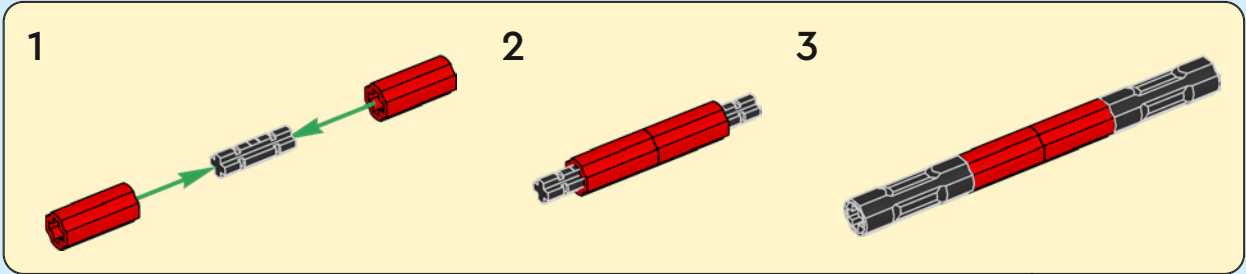

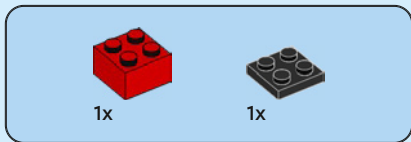

81

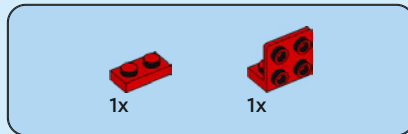
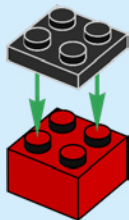

82

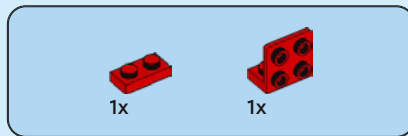
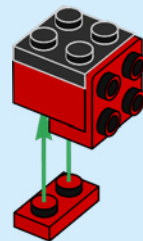

83

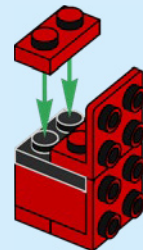

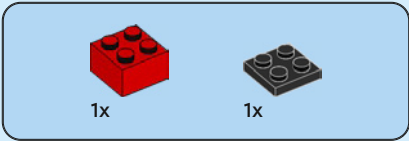

84

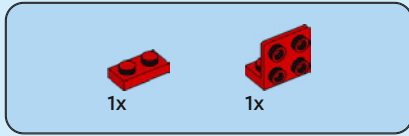
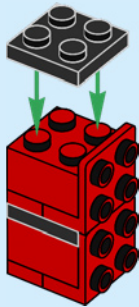

85

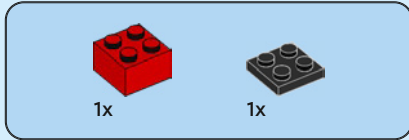
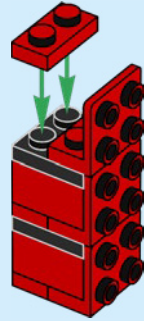

86

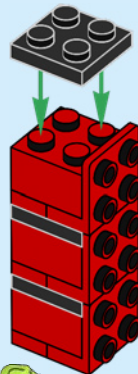

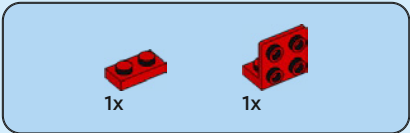

87

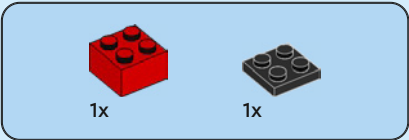
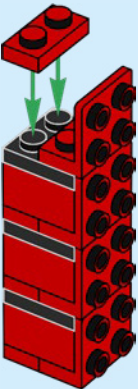

88

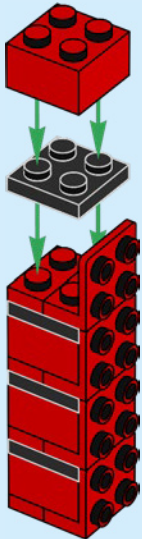

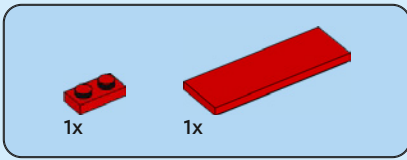

89

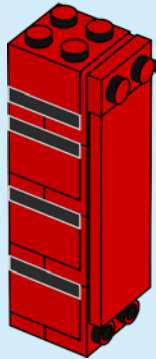

90

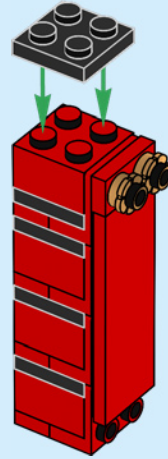

91

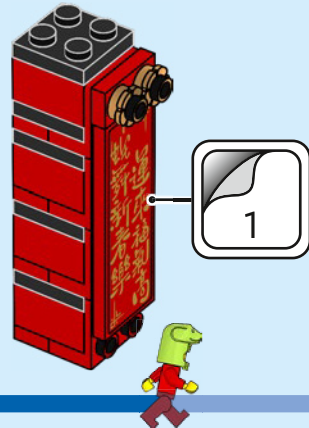

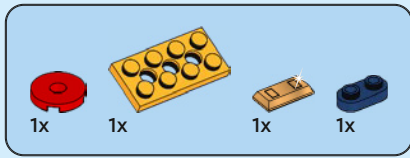

92

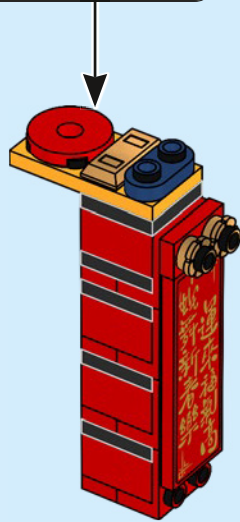
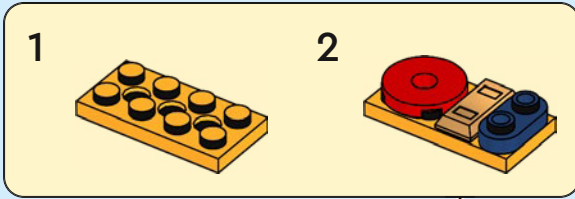

93

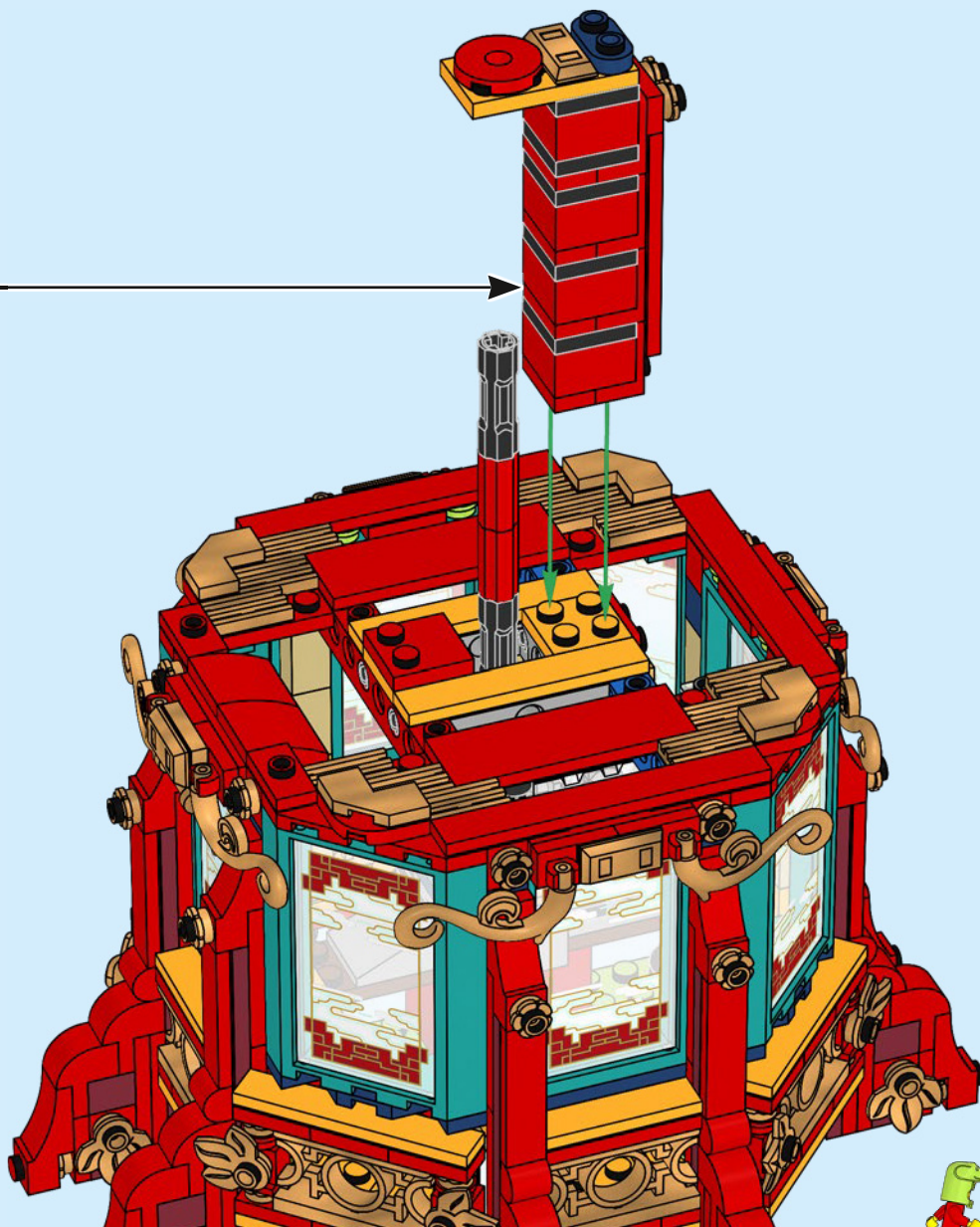

2x  1x 

94

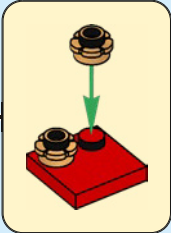
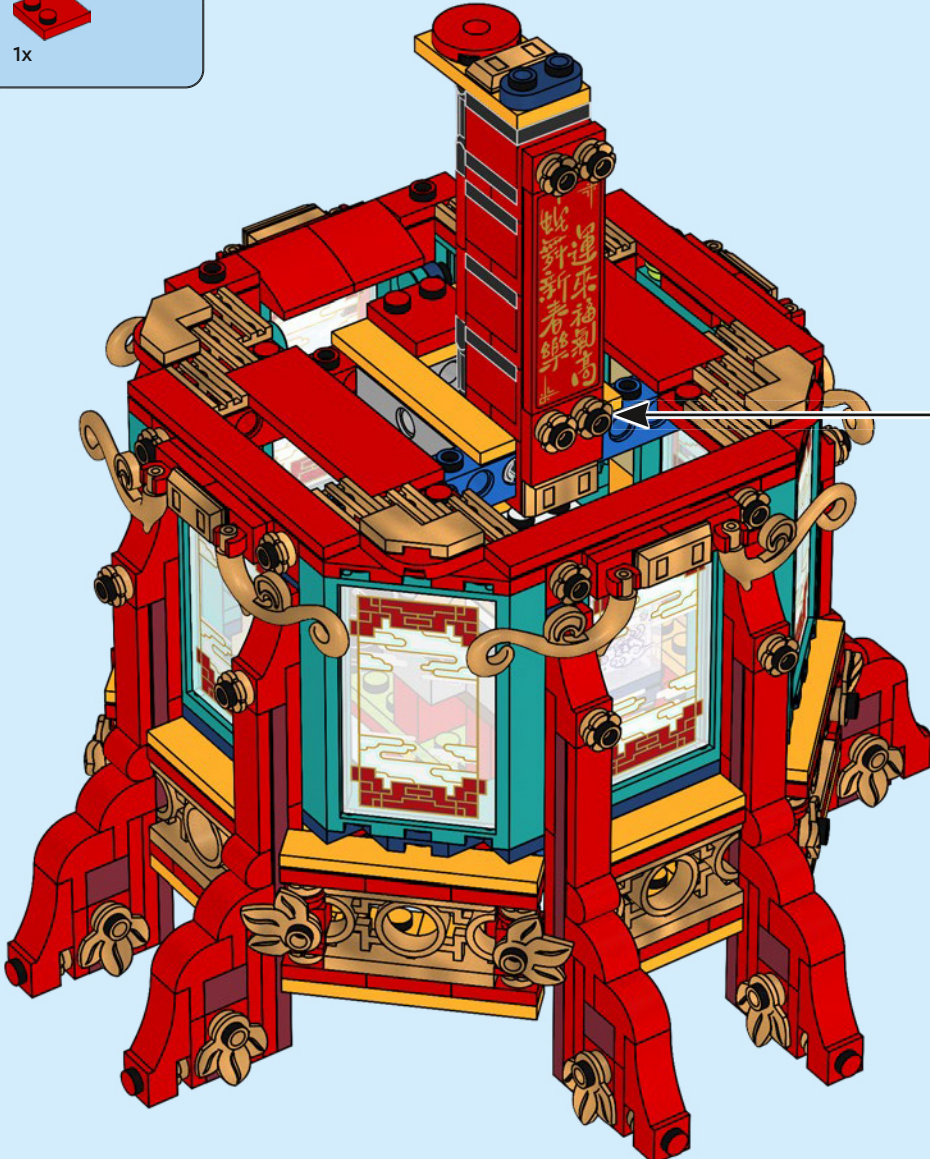

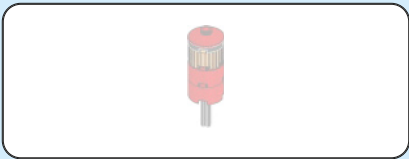

2x

95

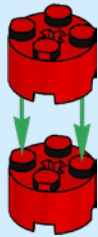

1x

96



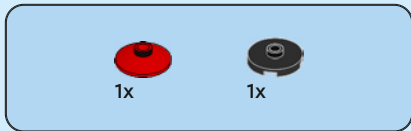

97

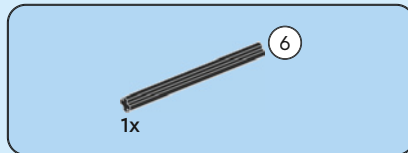

98

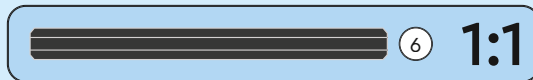

99

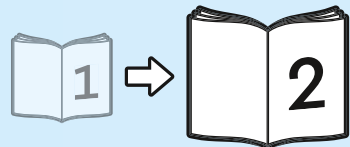
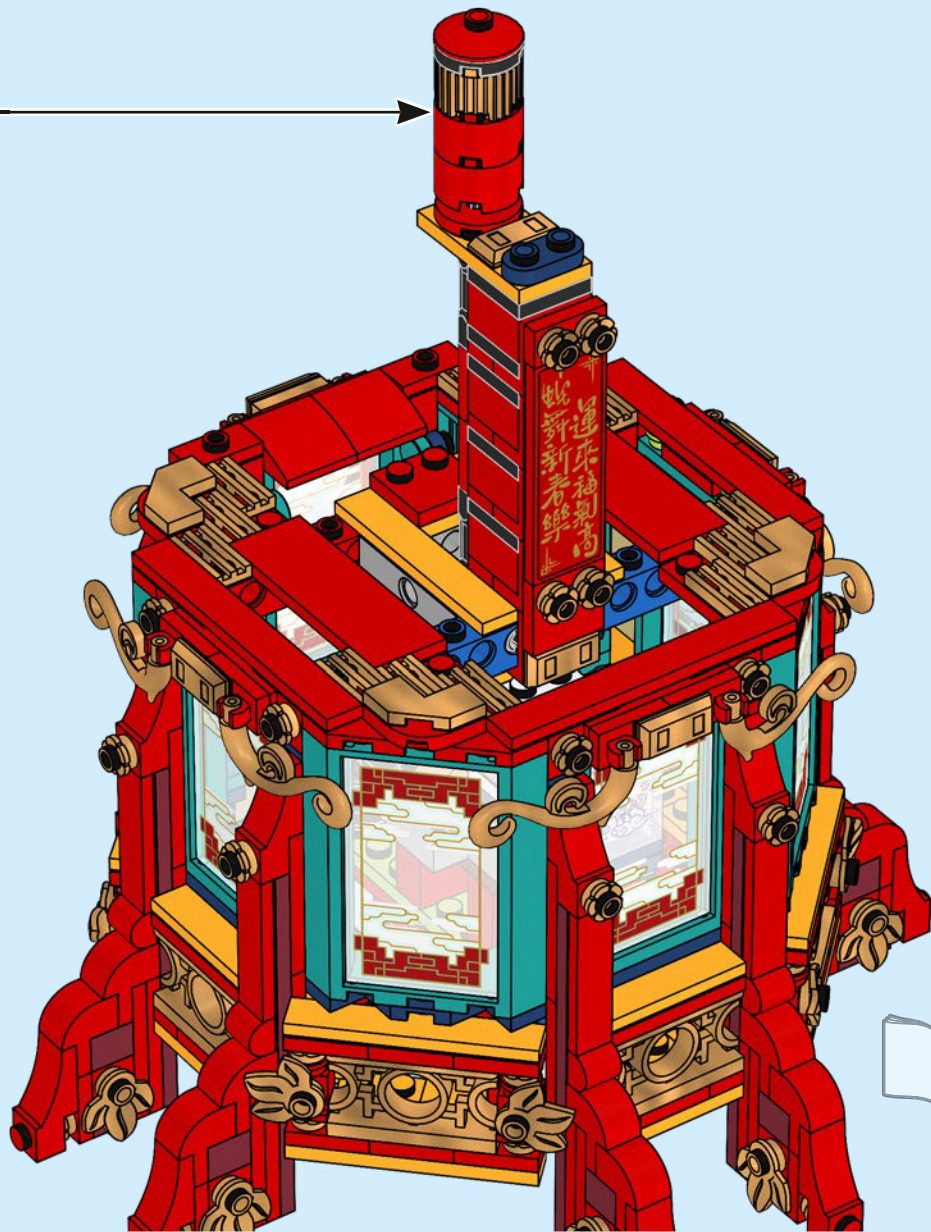

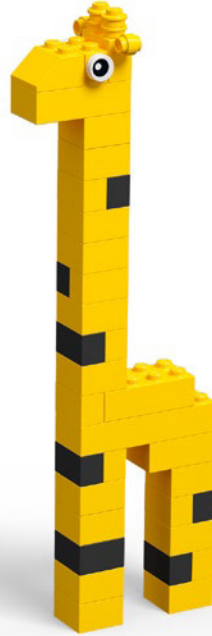

Rebuild
the
World™

