

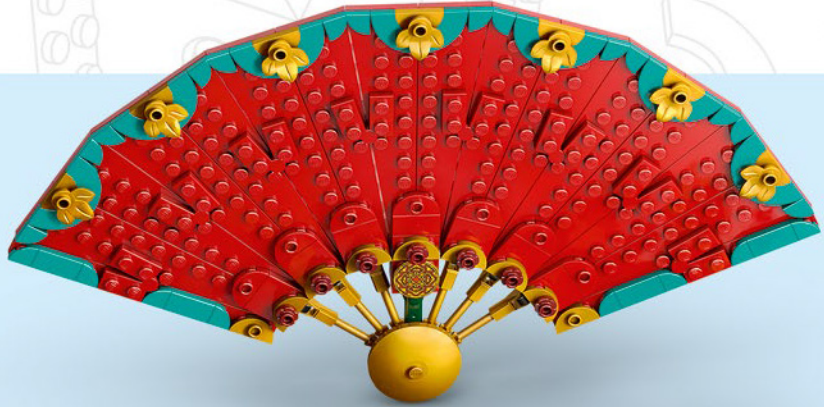

80117

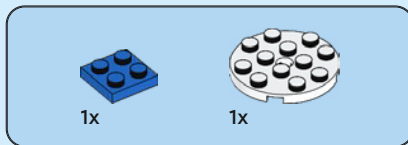

5 6 7 8



1





2x

2



4x

3

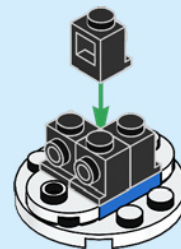

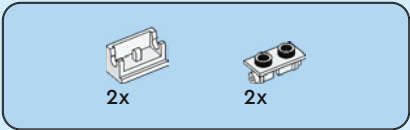

4

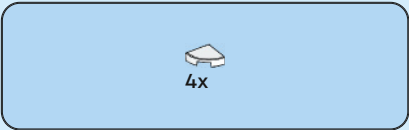
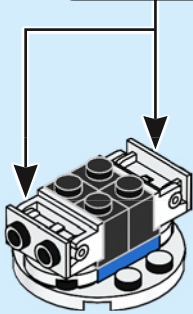
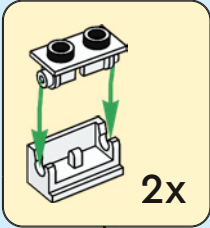

5

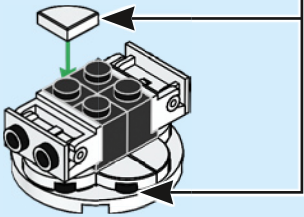
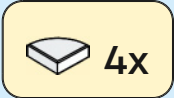





1x

6

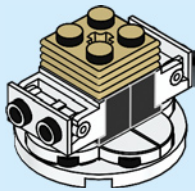

2x

7

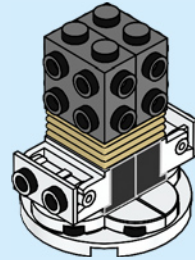



2x

8

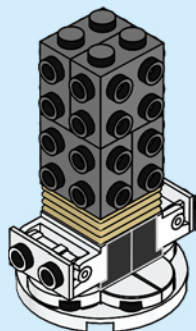

2x

9

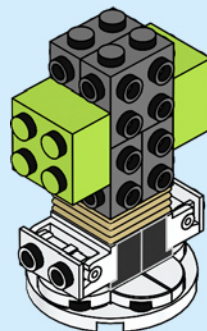



4x

10

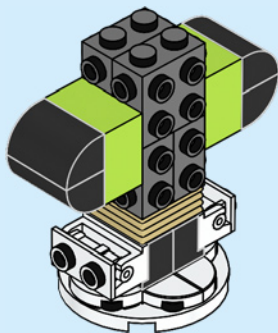

1x

11

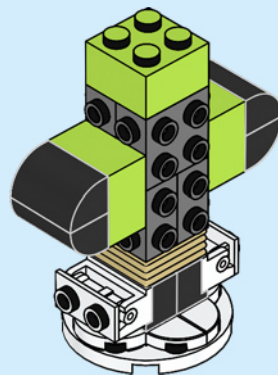



2x

12

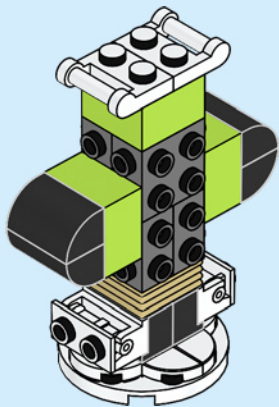

1x

13

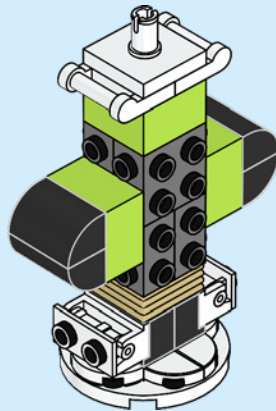

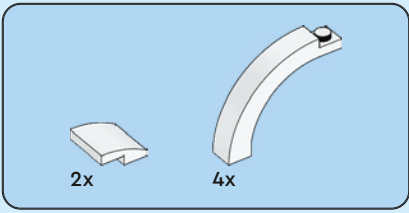

14

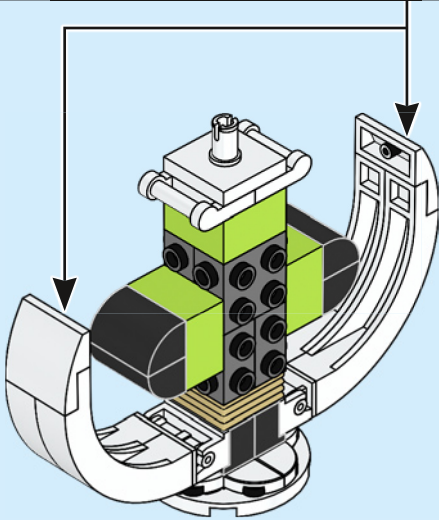
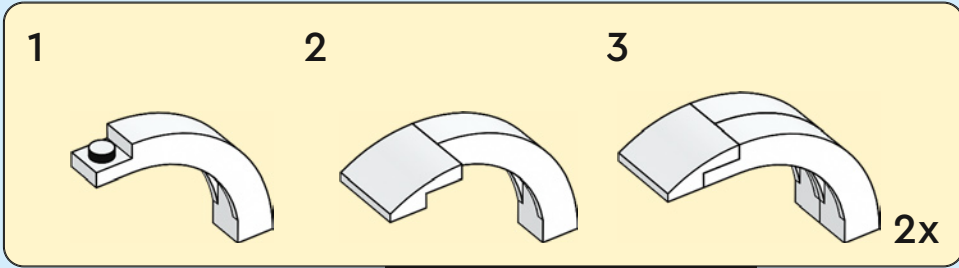

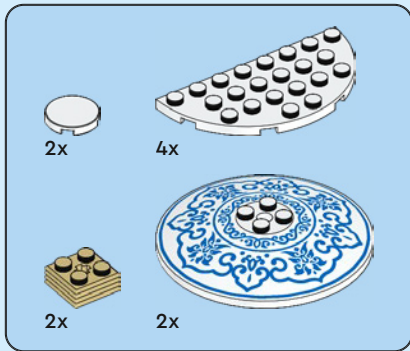

15

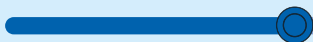
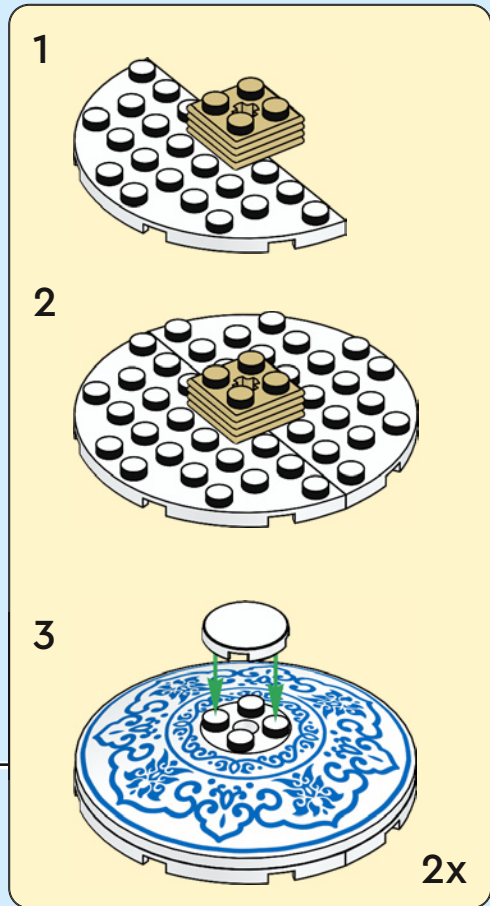
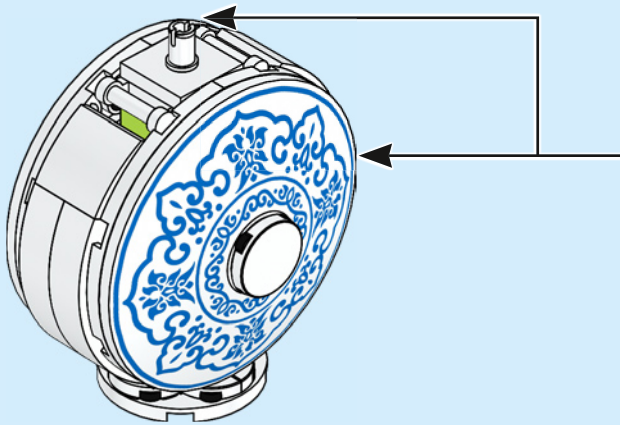

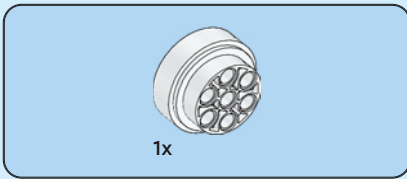

16

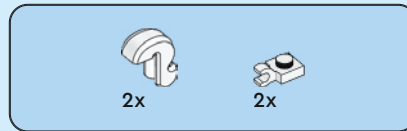
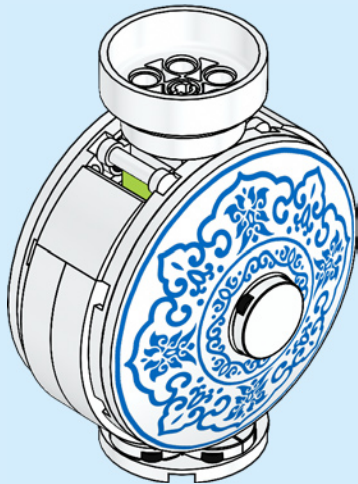

17

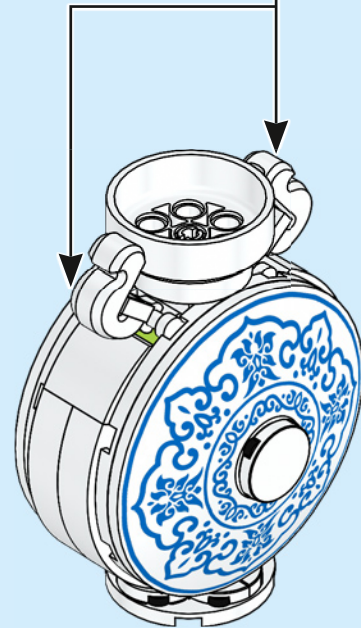
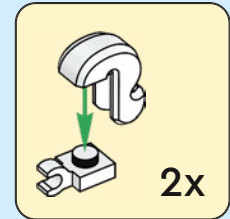



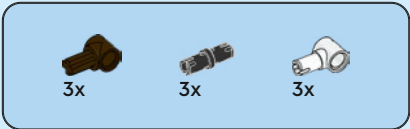

18

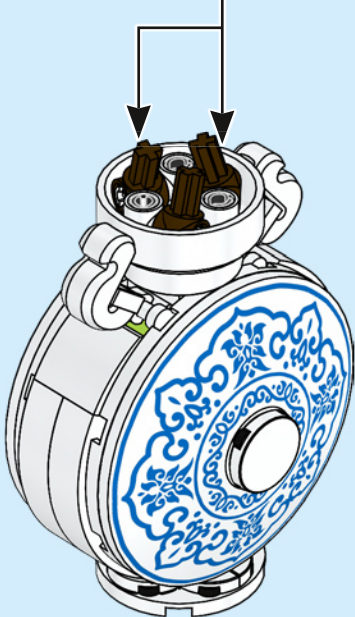
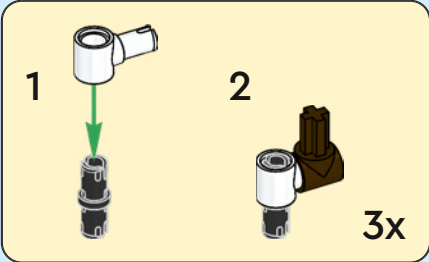

19

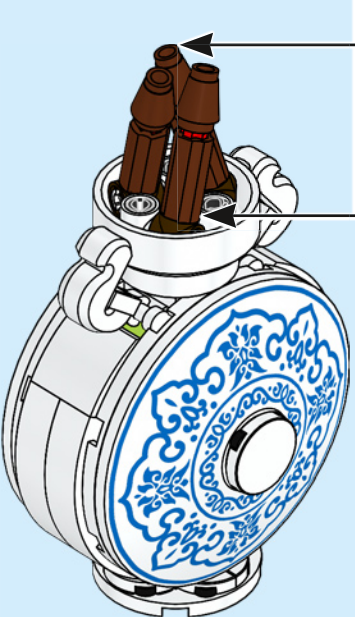
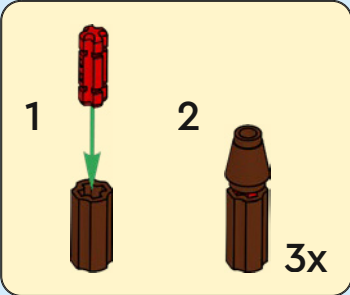

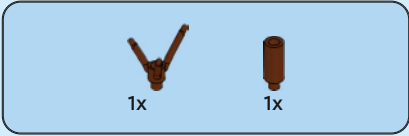
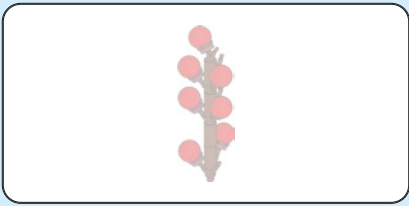

20

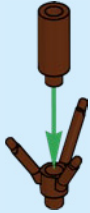

21

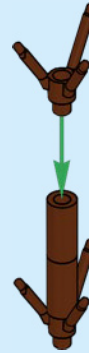



1x



1x

22



1x



1x

23





7x

24



7x

25

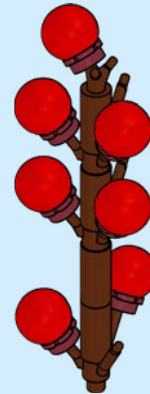

26

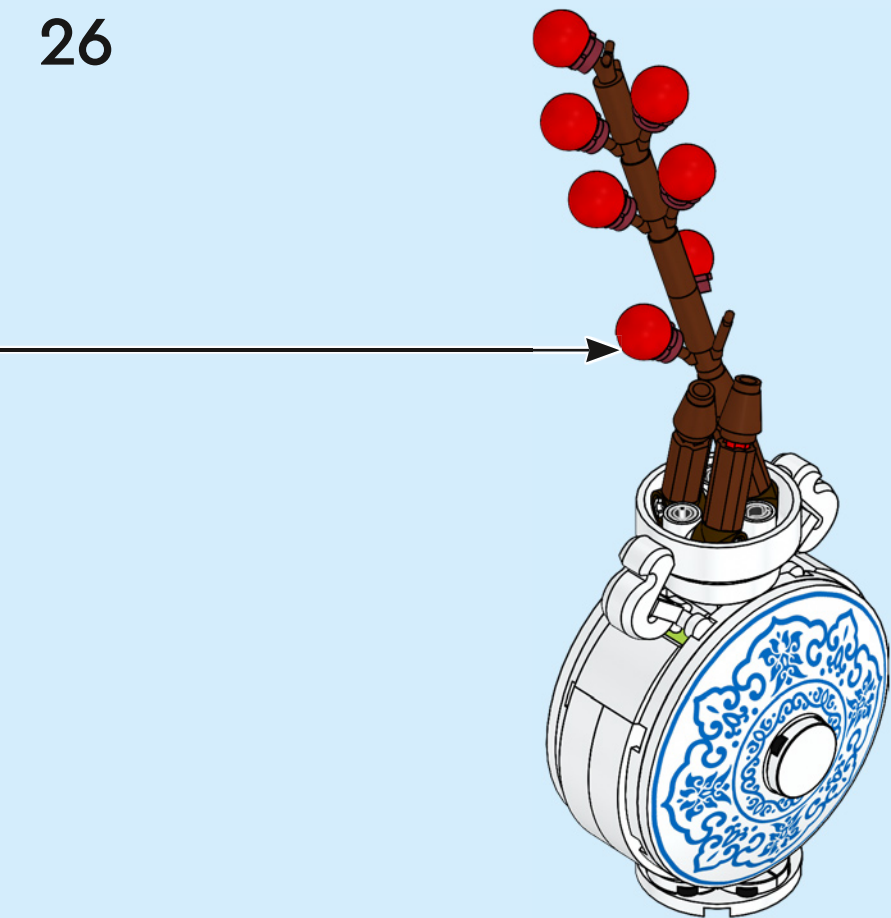

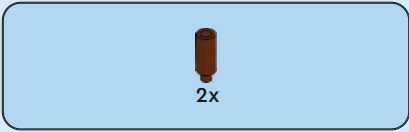
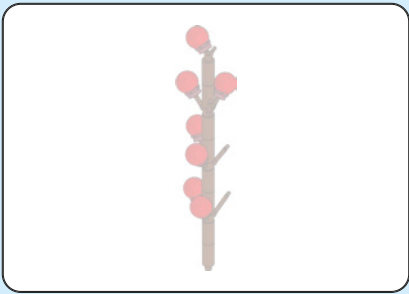

27

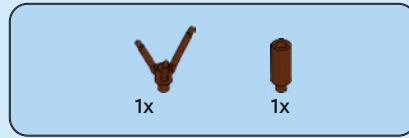

28





1x



1x

29



2x

30

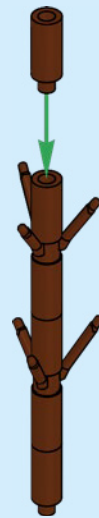





31

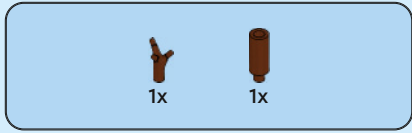
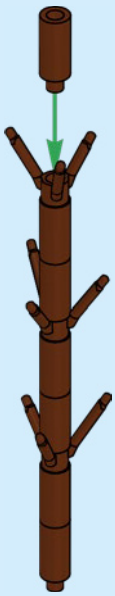

32

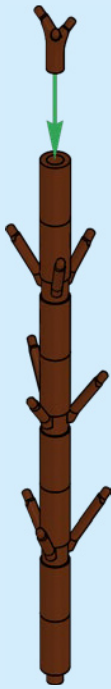



7x

33



7x

34

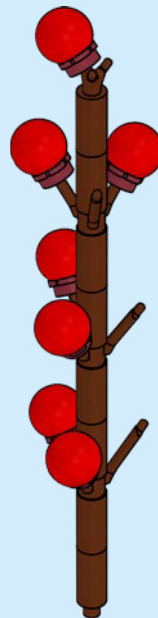

35



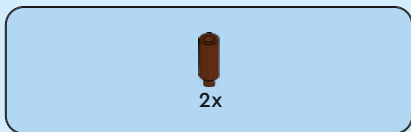
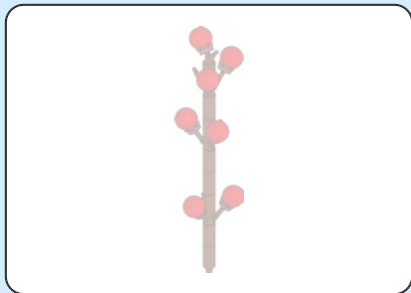

36

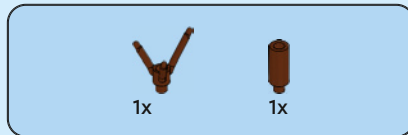

37



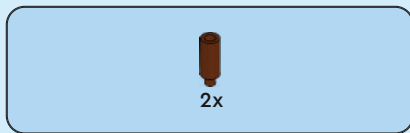

38



39

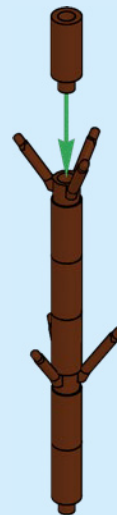



1x



1x

40

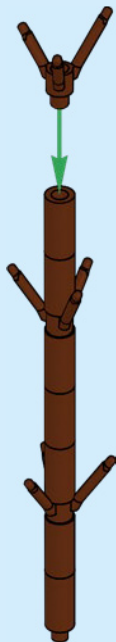

1x



1x

41



7x

42

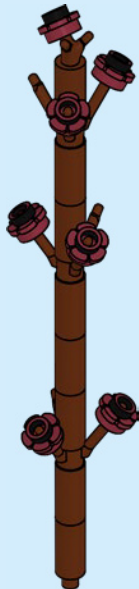

7x

43

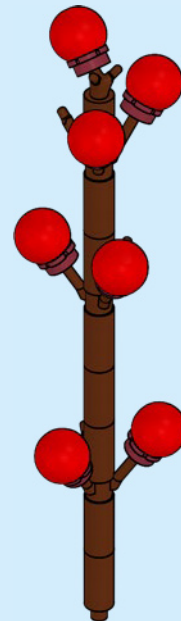



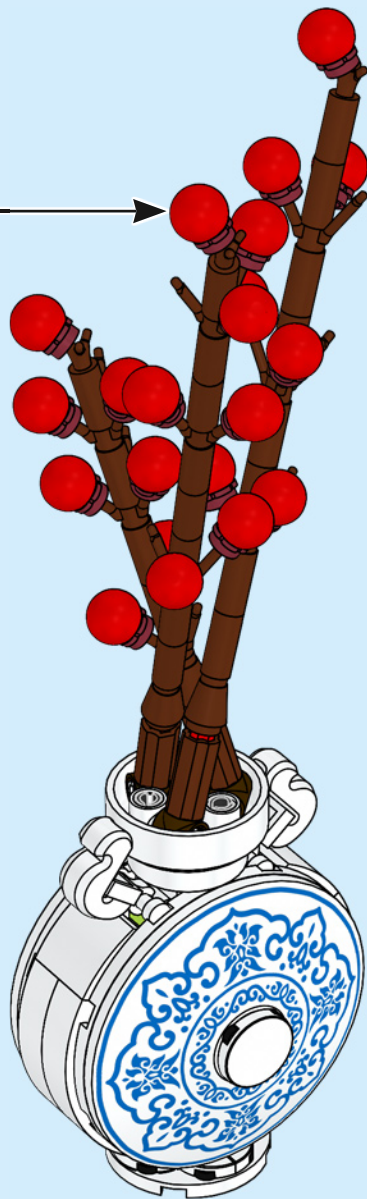

45



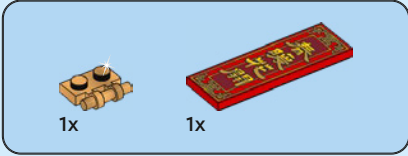
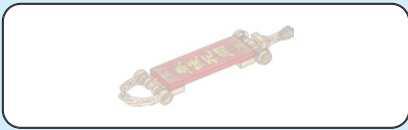

46



47

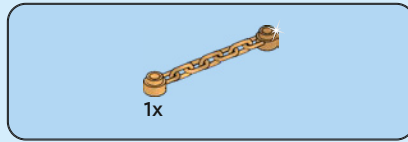

48

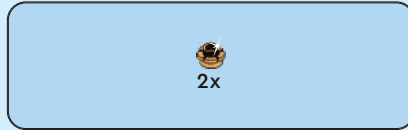

49

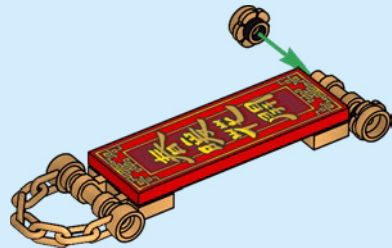



1x

50



1x

51



52



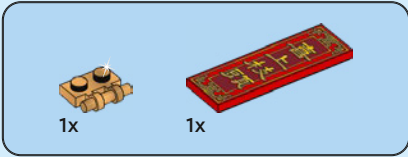
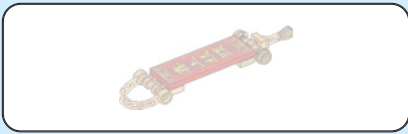

53

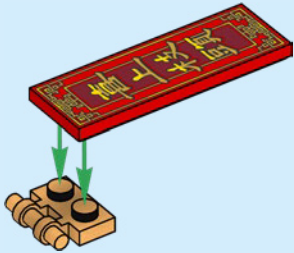

54

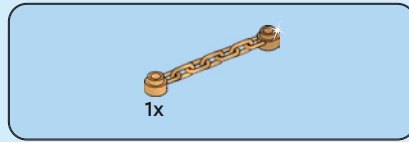
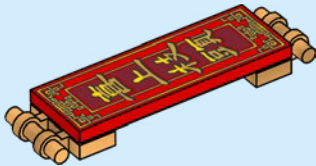

55

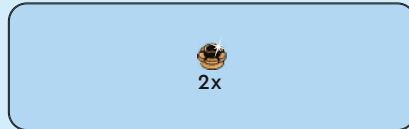

56







1x

57

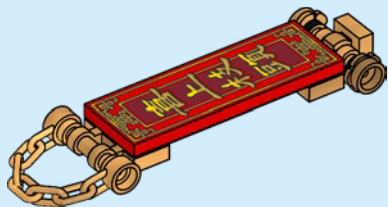

1x

58

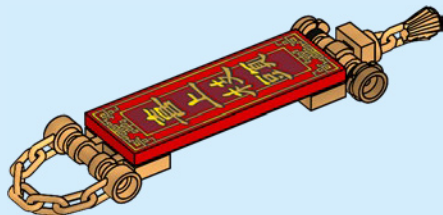

59



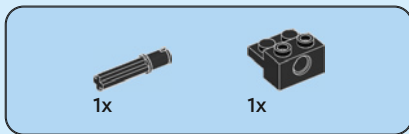
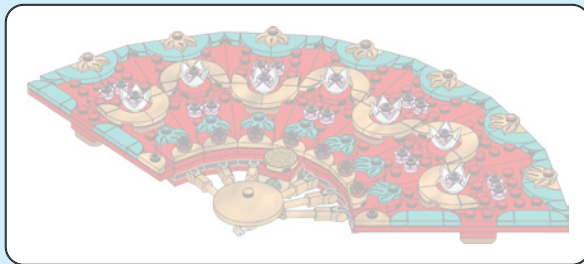

60

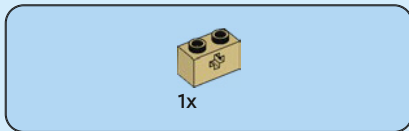
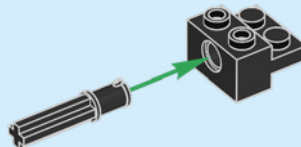

61

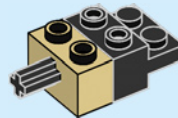

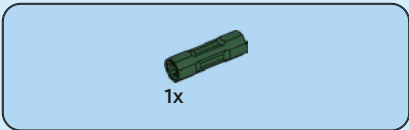

62

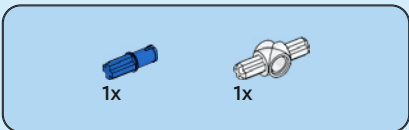
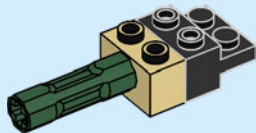

63

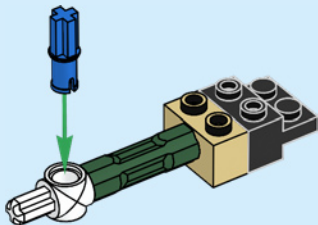



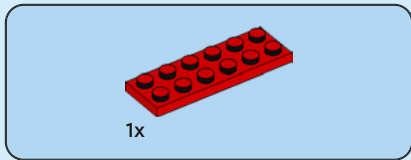

64

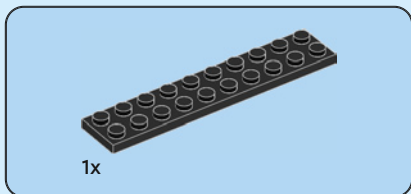
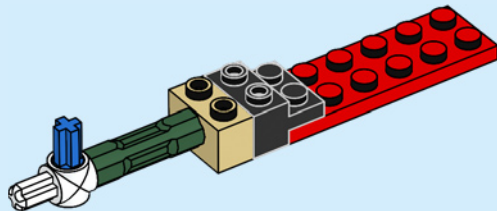

65

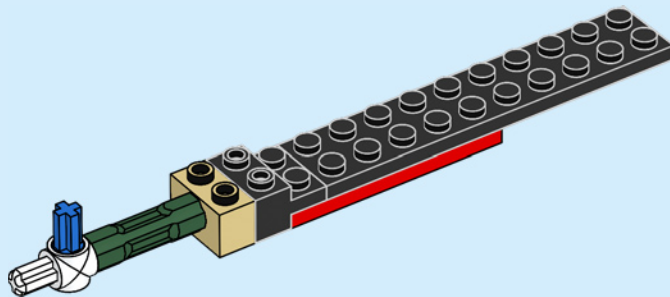

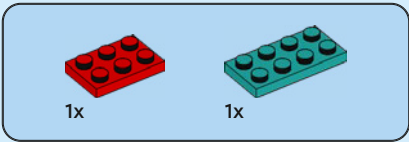

66

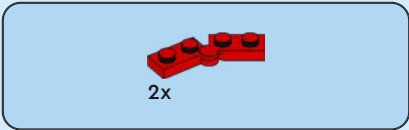
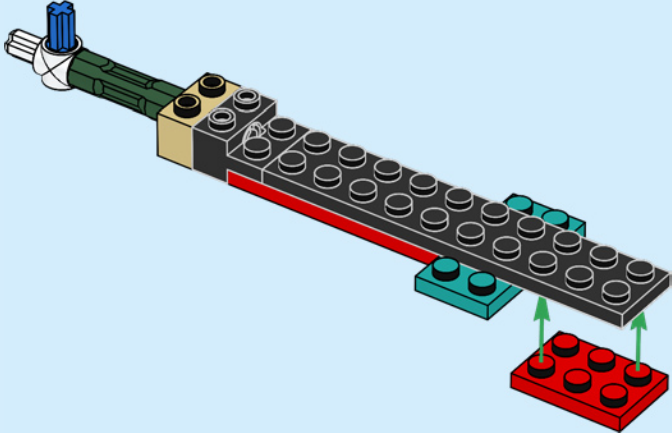

67

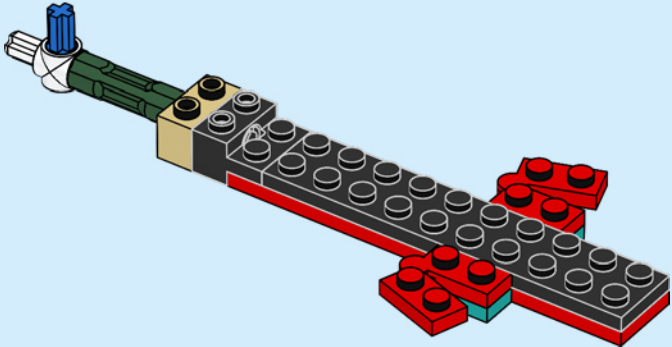

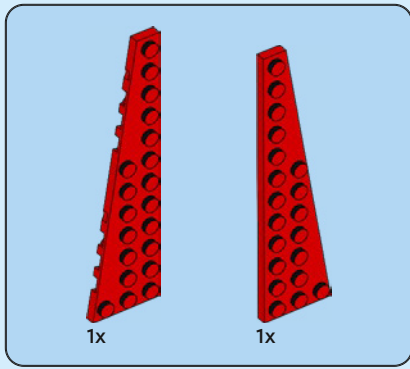

68

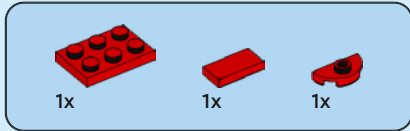
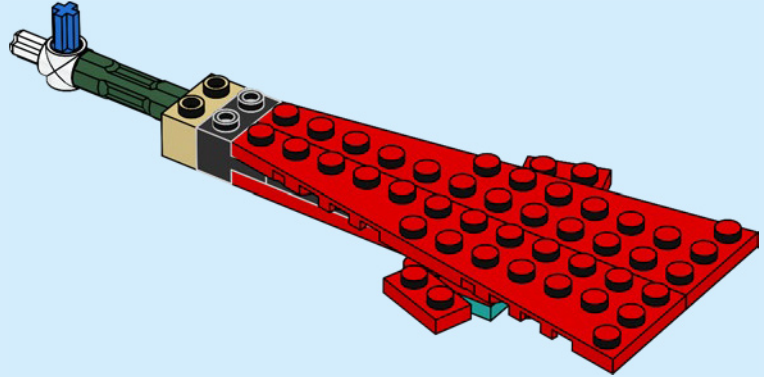

69

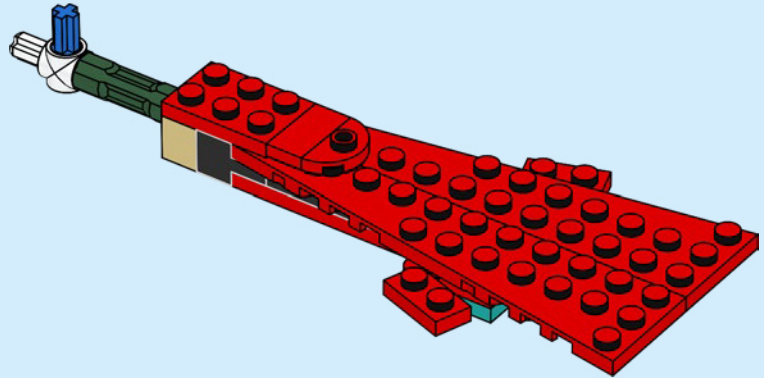



70

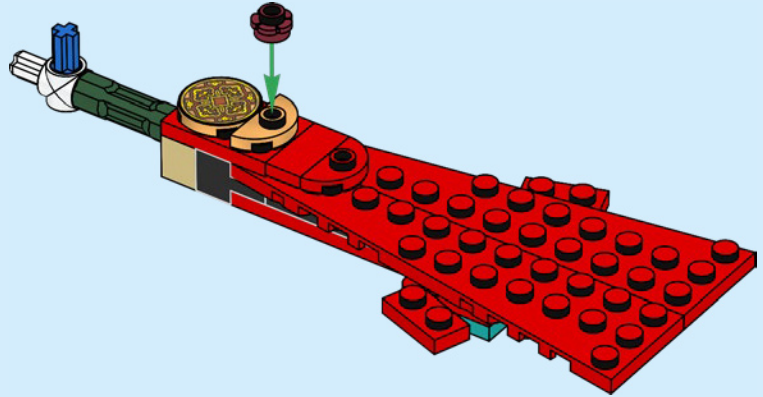

71

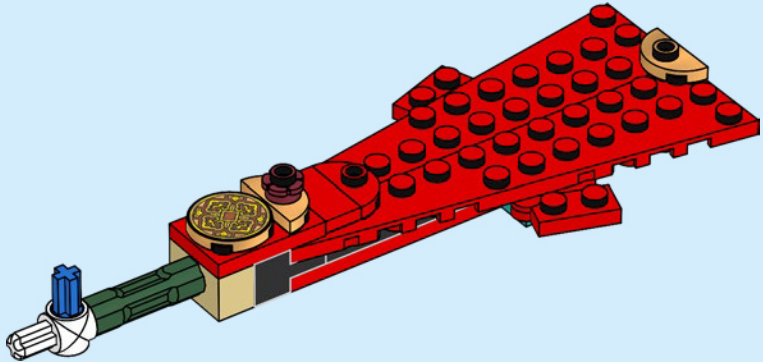



2x



2x

72

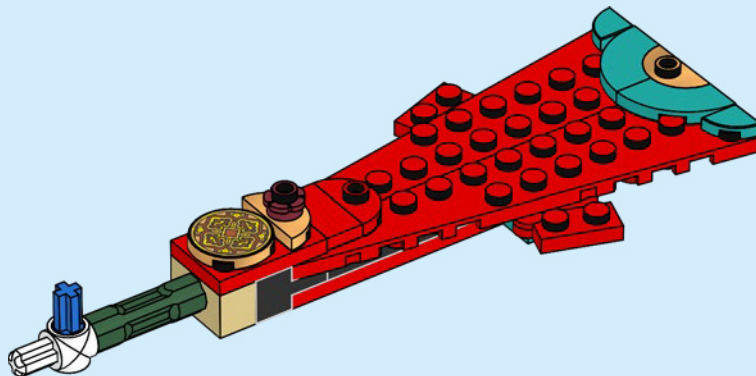

1x

73

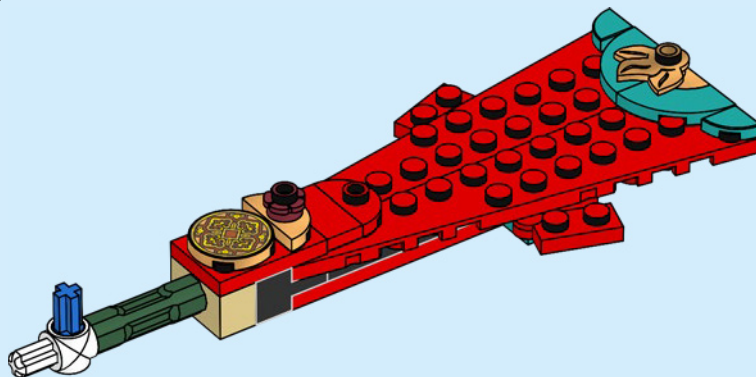

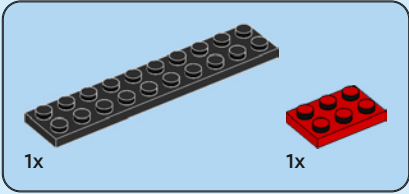
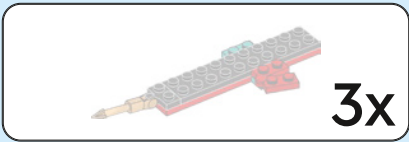

74

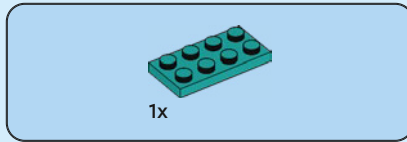
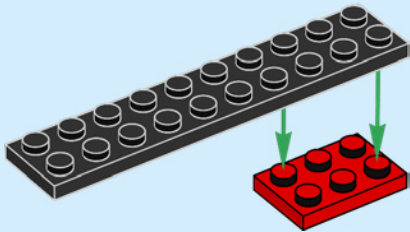

75

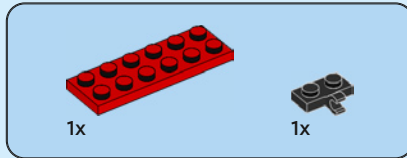
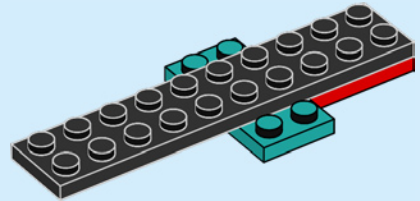

76

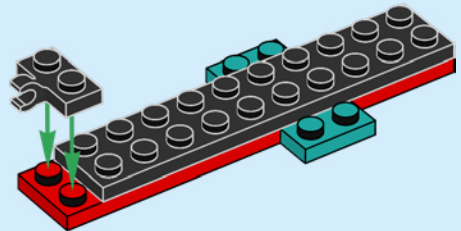

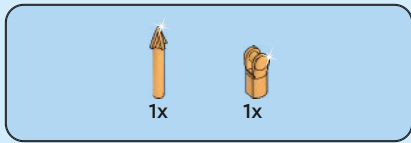

77

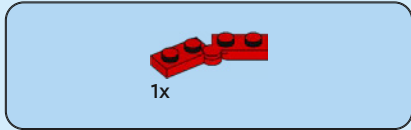
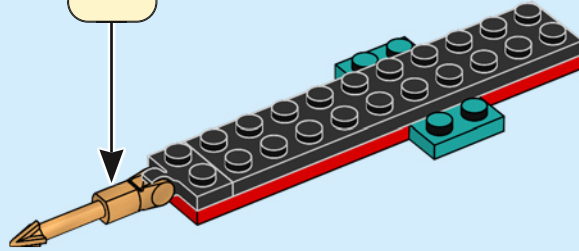
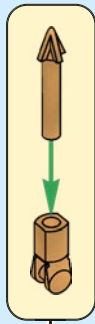

78

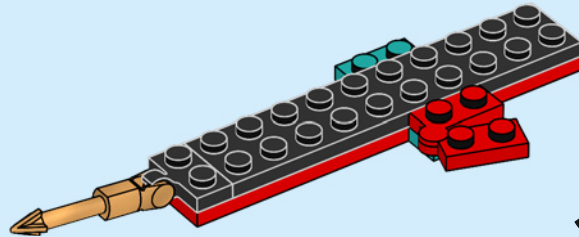

3x

79

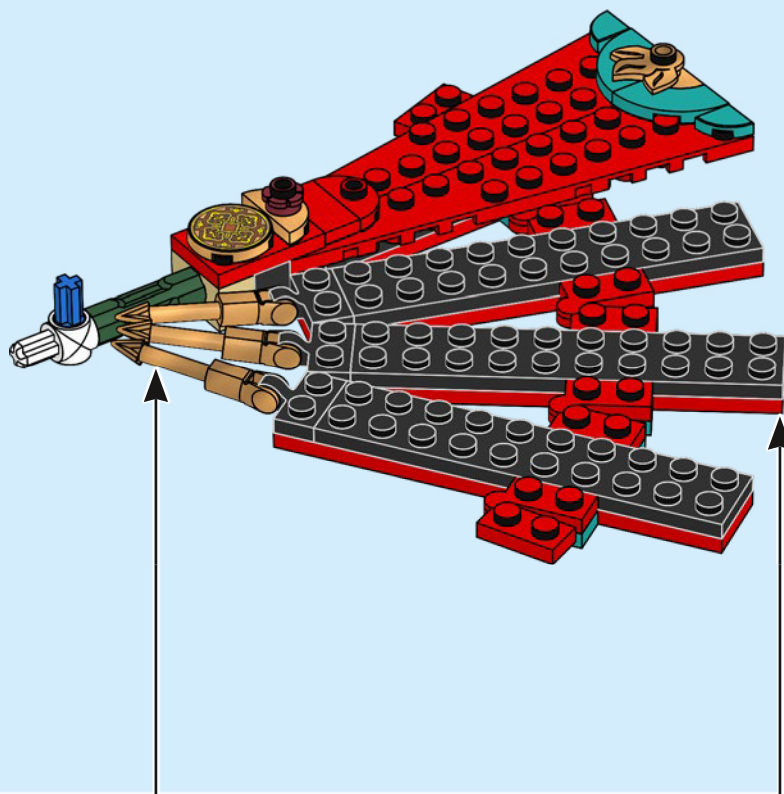



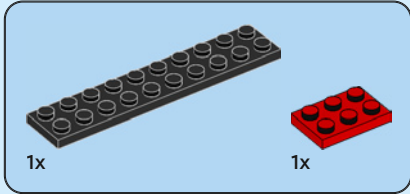
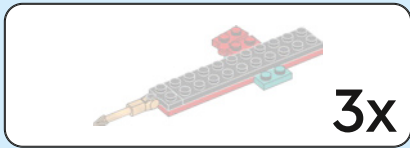

80

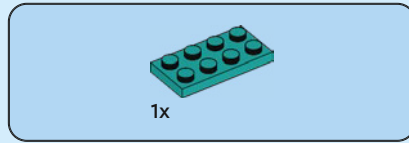
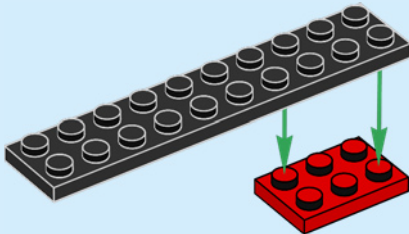

81

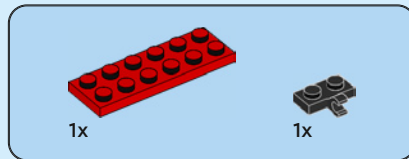
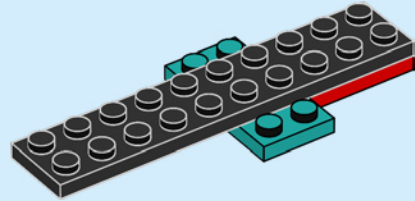

82

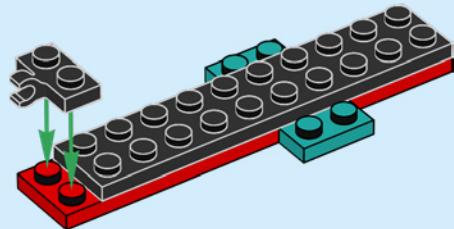

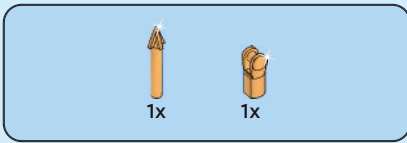

83

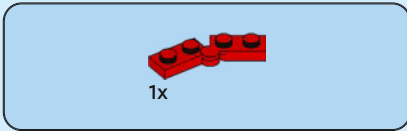
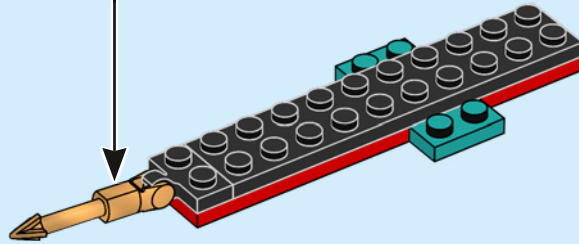
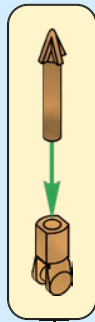

84

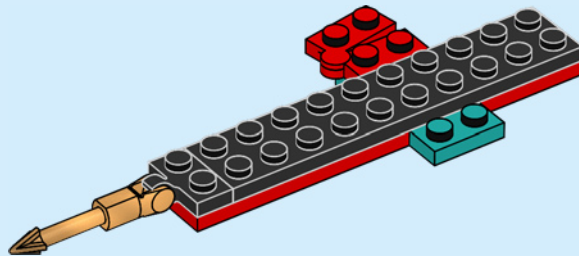

3x



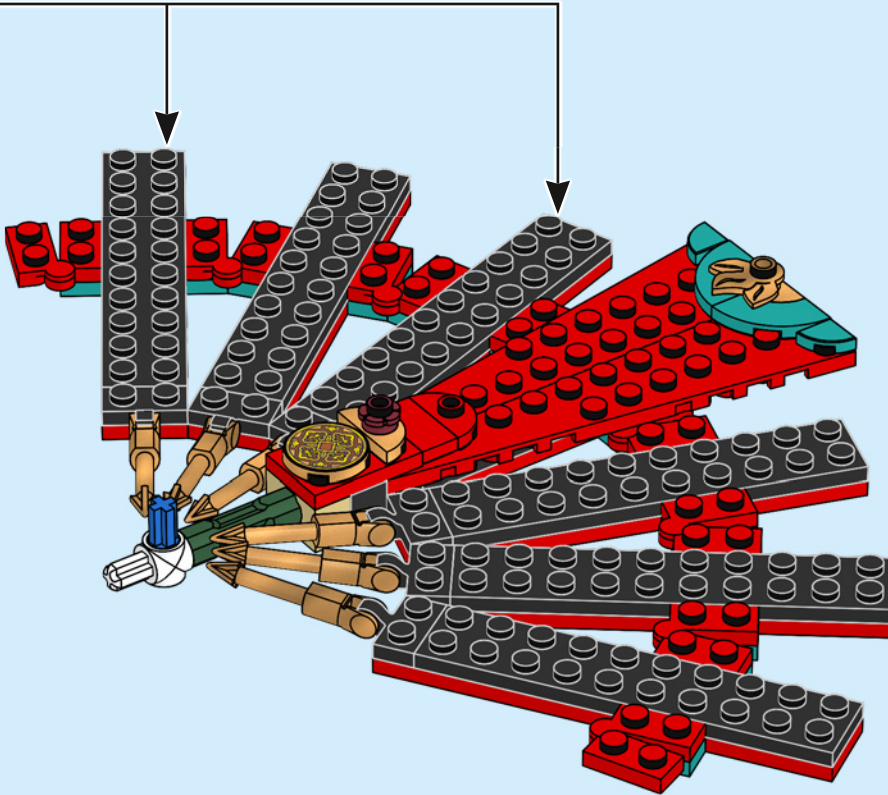



2x

86

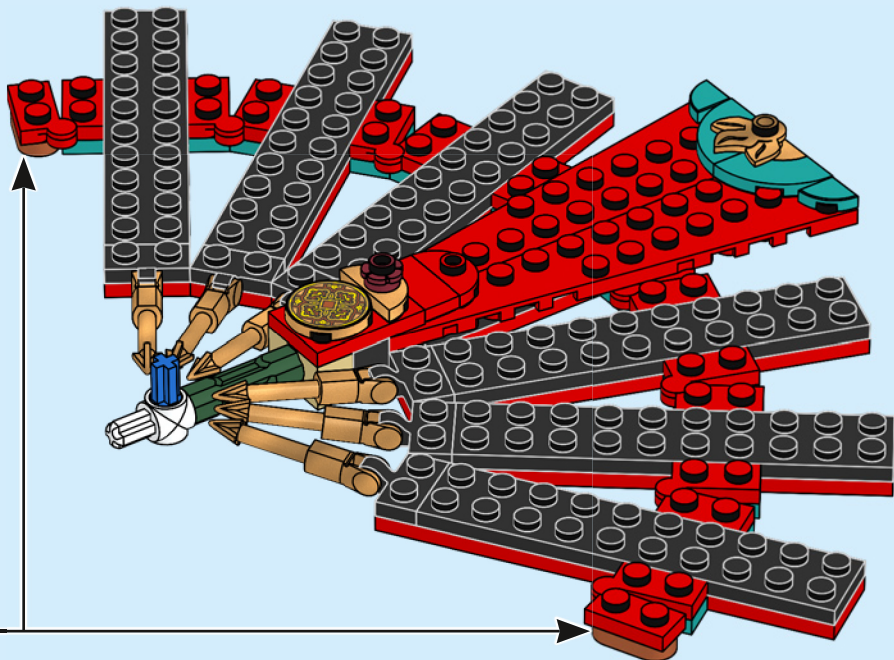

2x

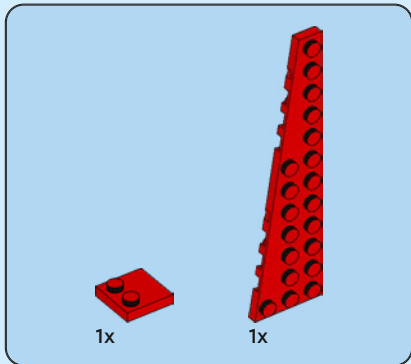
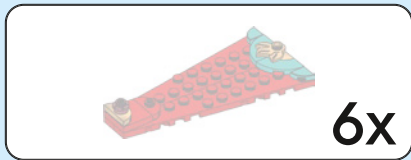

87

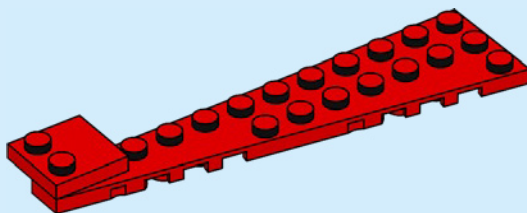

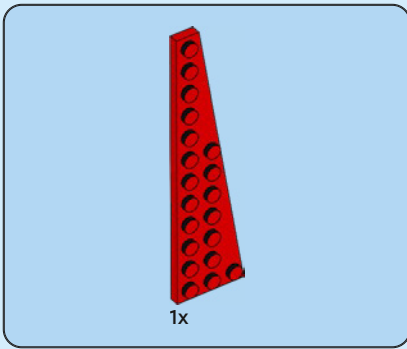

88

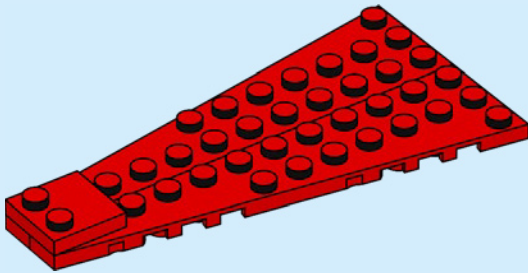

89

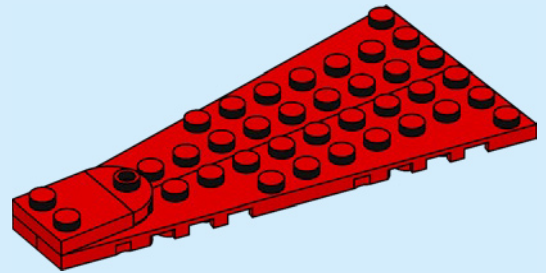

1x



1x

90

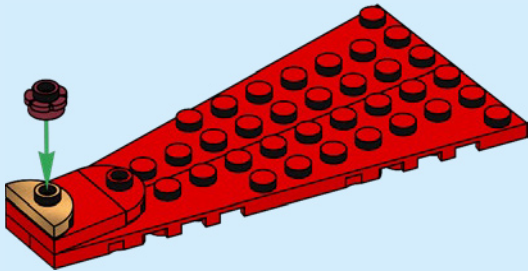

1x

91

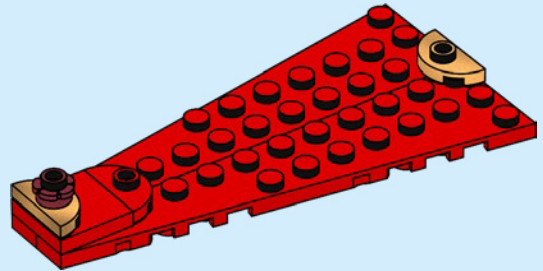



2x



2x

92

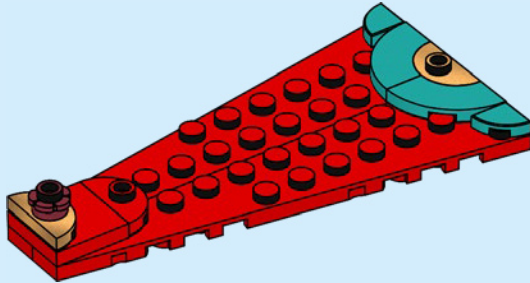

1x

93

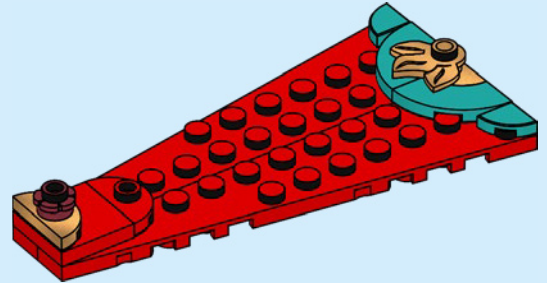

6x





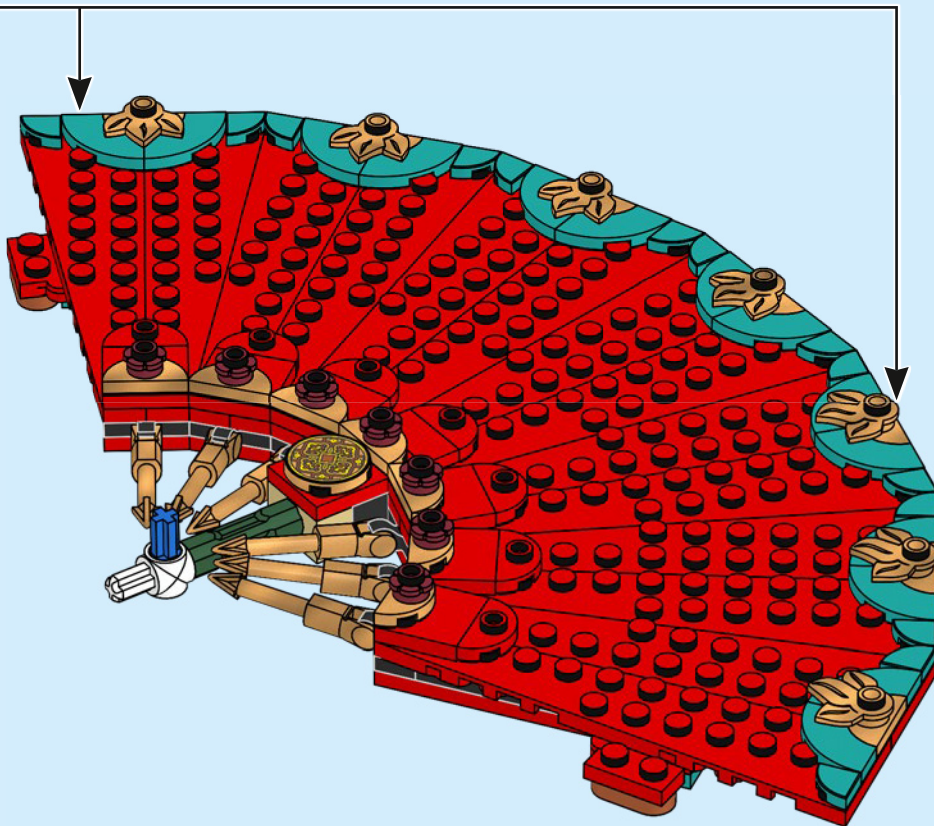

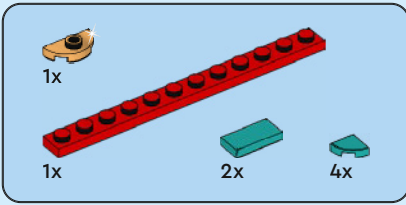

95

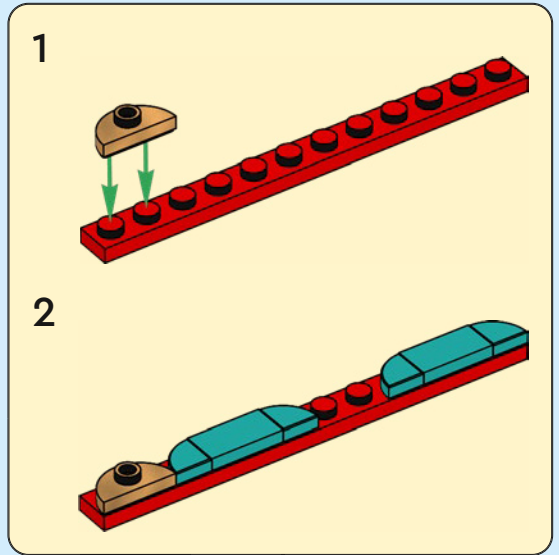
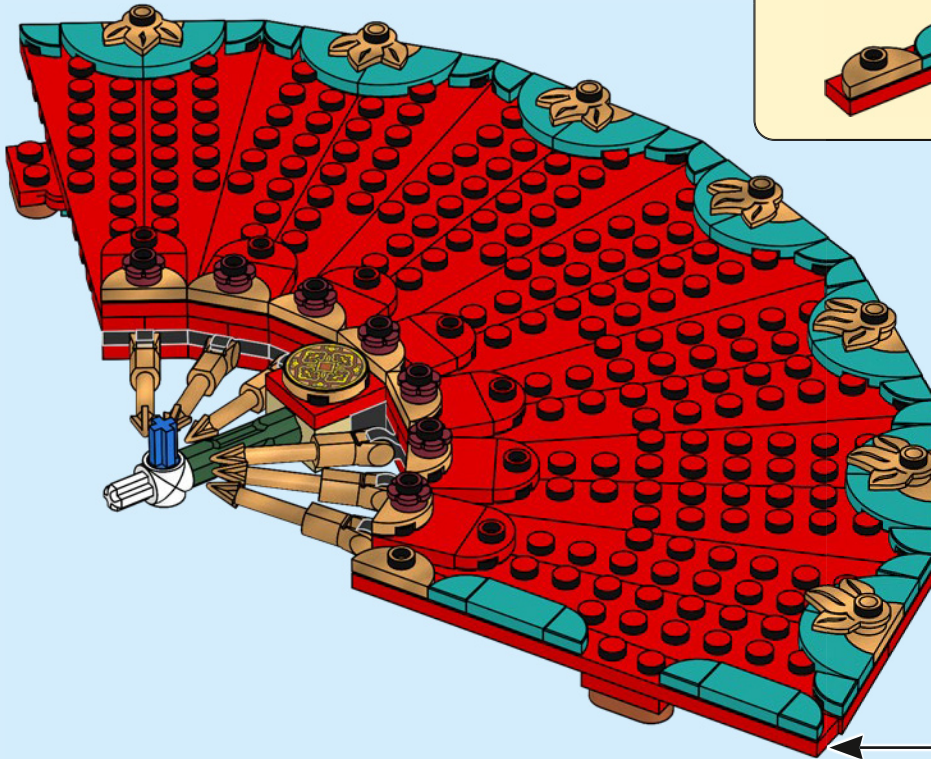

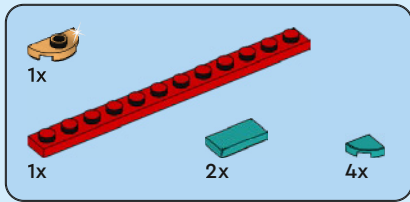

96

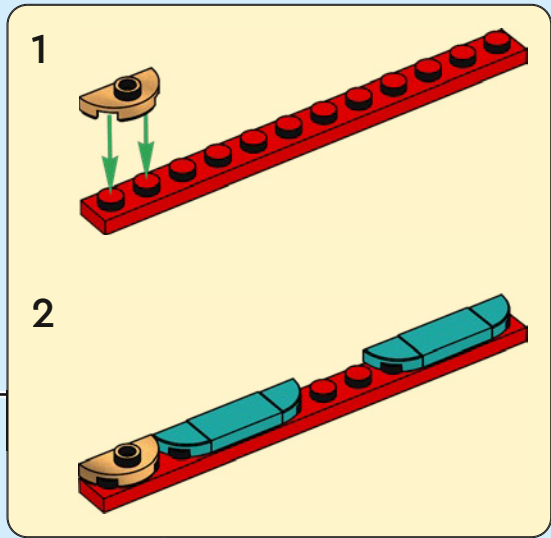
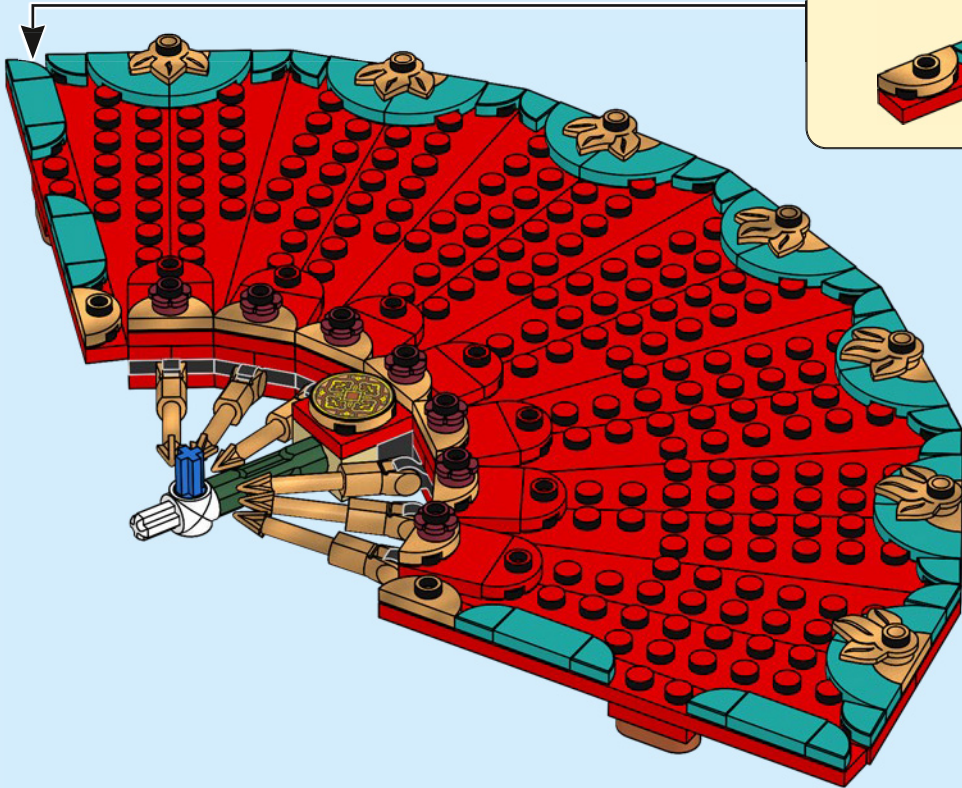



8x

97

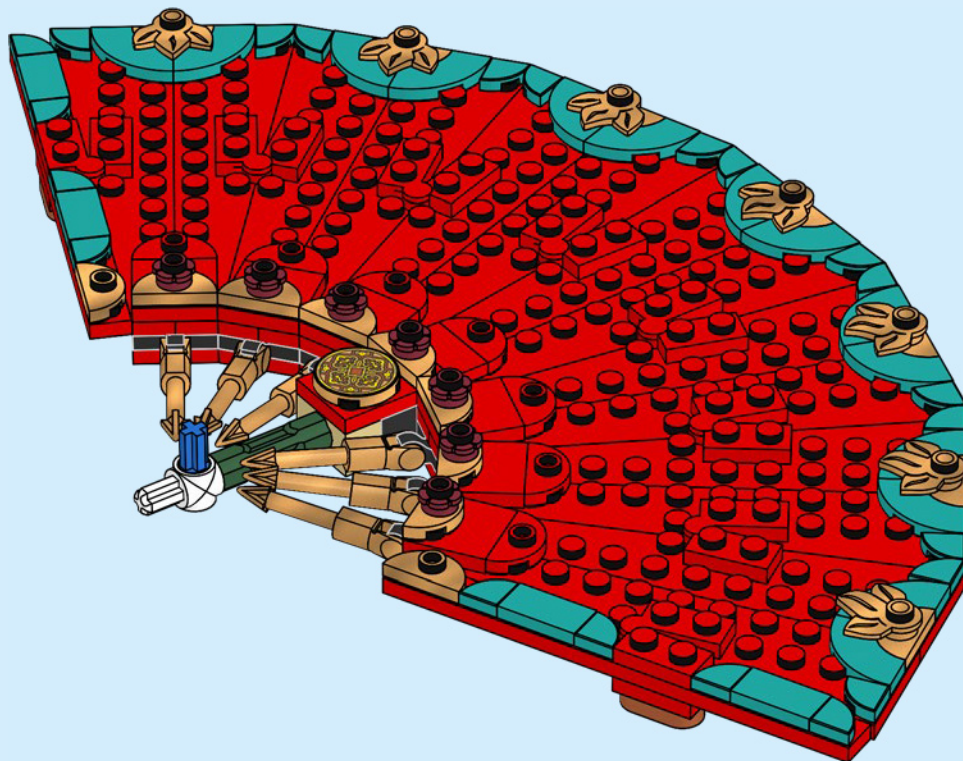





1x

98

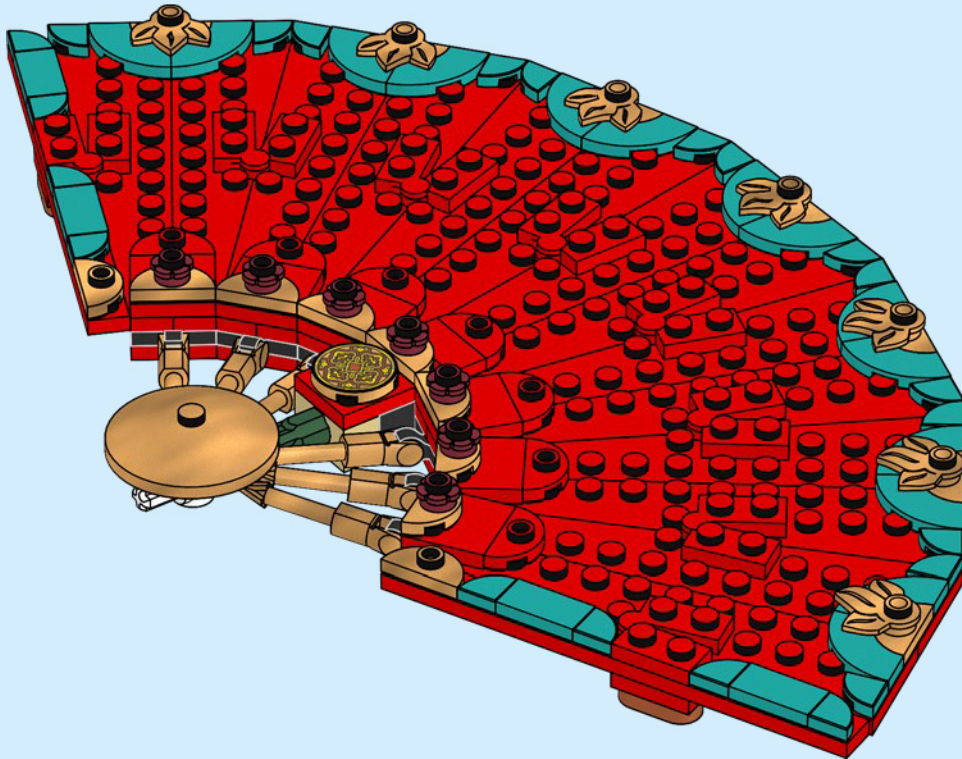

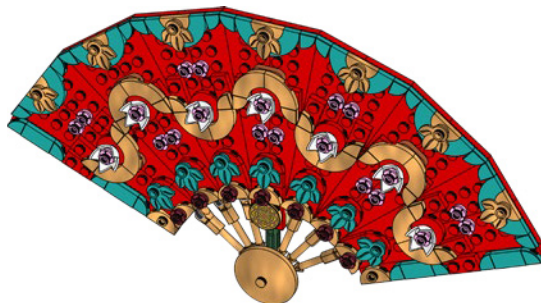
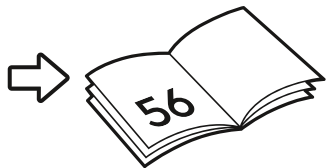

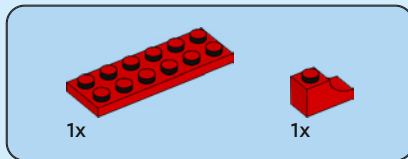

99

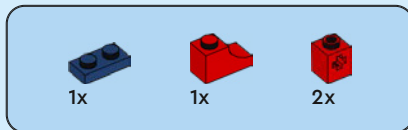
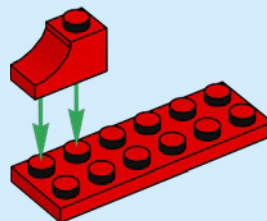

100

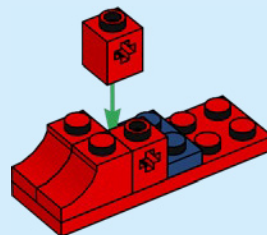



2x

101

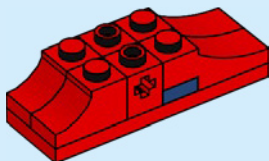

1x

102

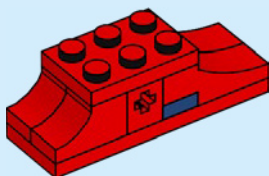

1x



1x

103

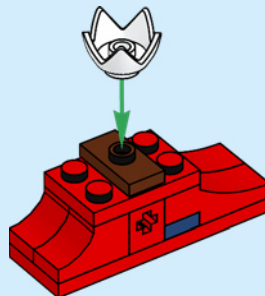

1x

104

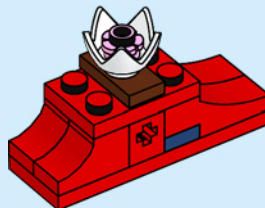



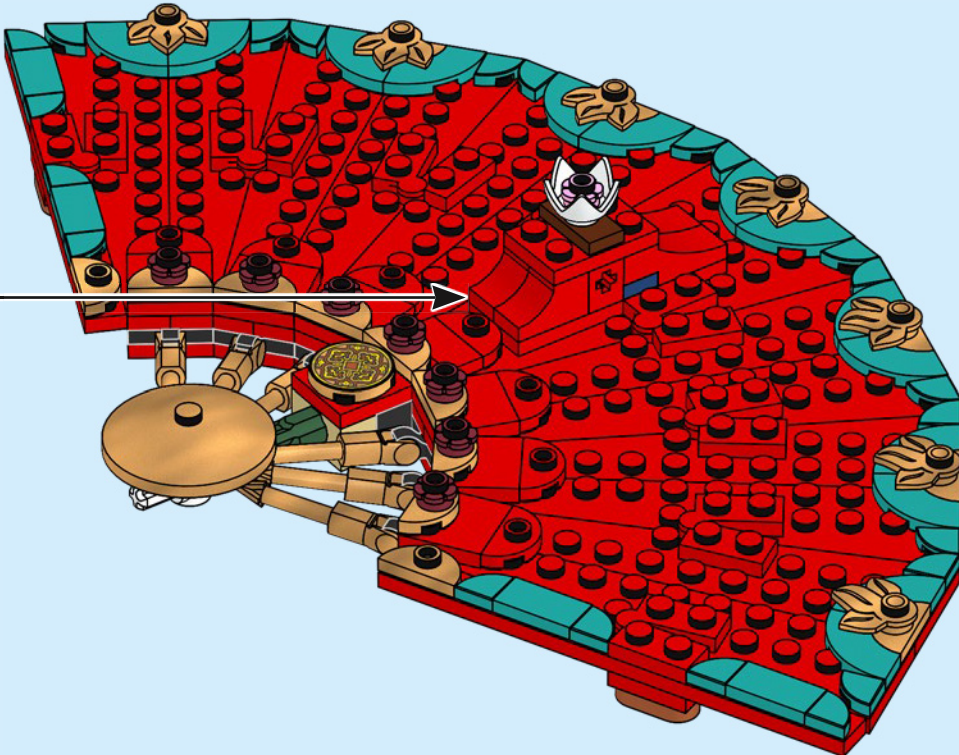

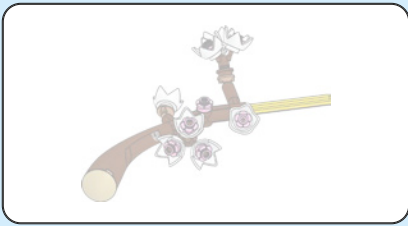

106

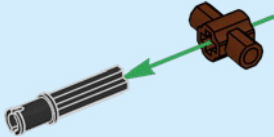

107

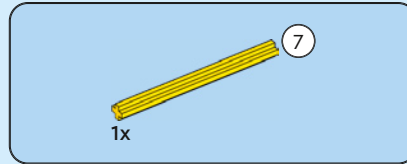
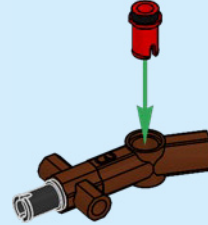

108

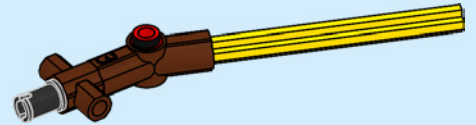



1x

109

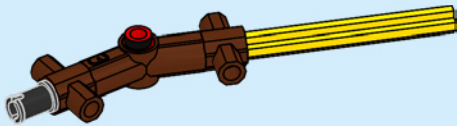

1x



1x

110

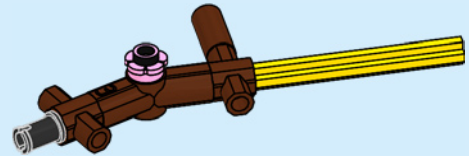

4x

111

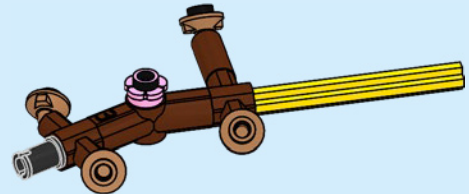



2x

# 112

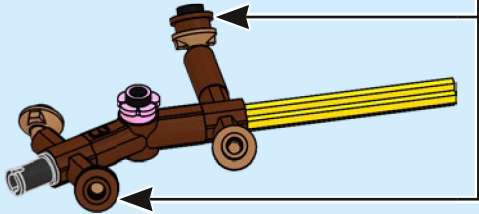

2x

# 113

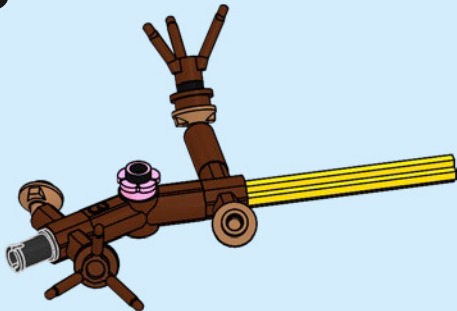

8x



8x

# 114

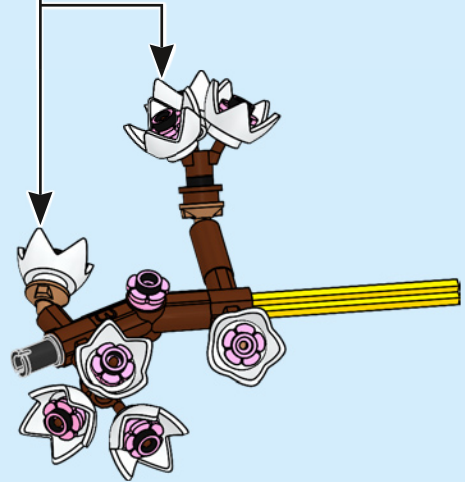
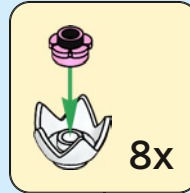

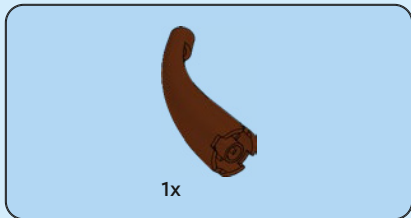

1x

115

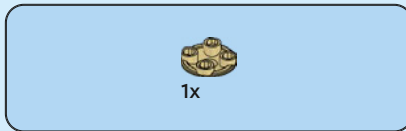
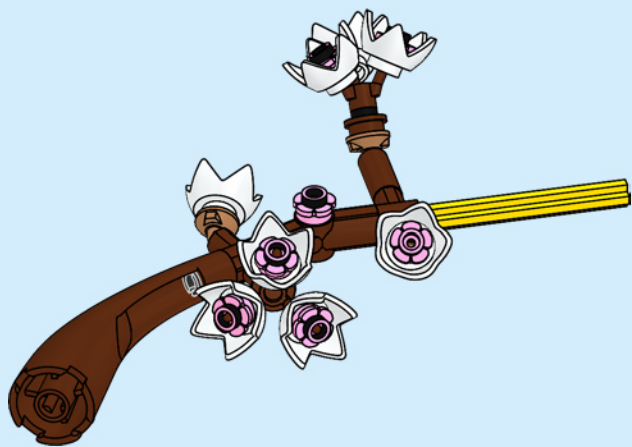

1x

116

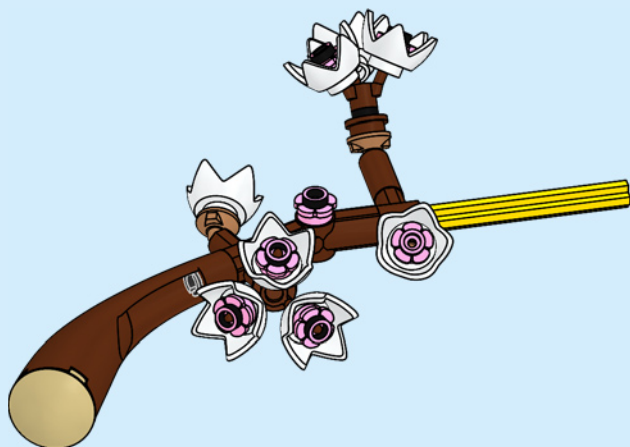

117

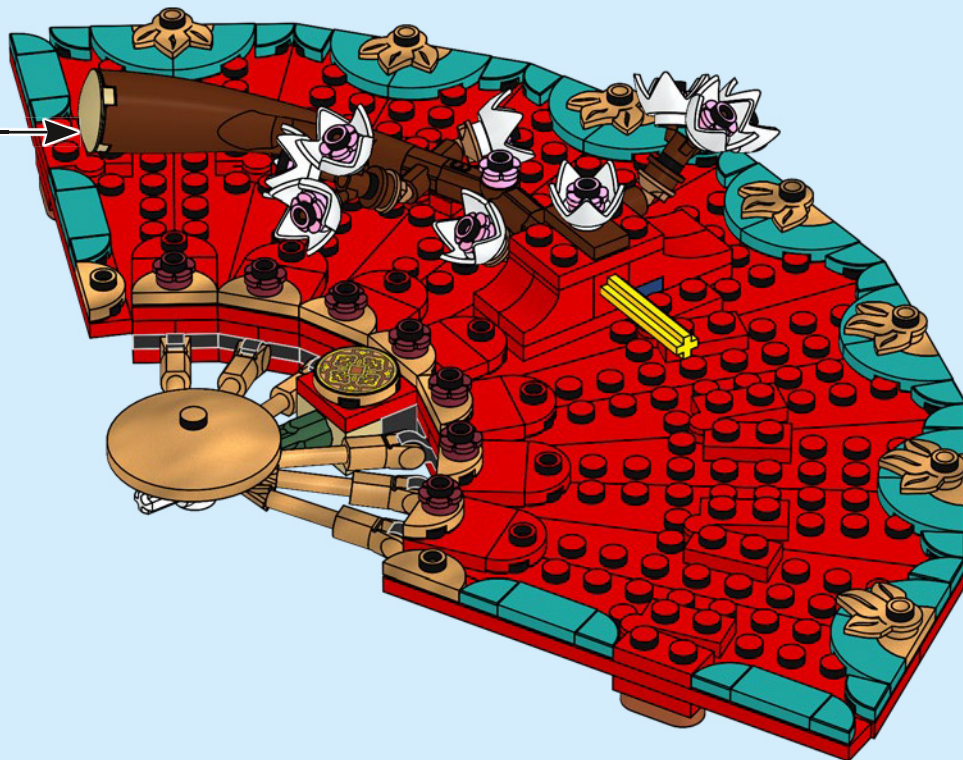



1x



1x

118

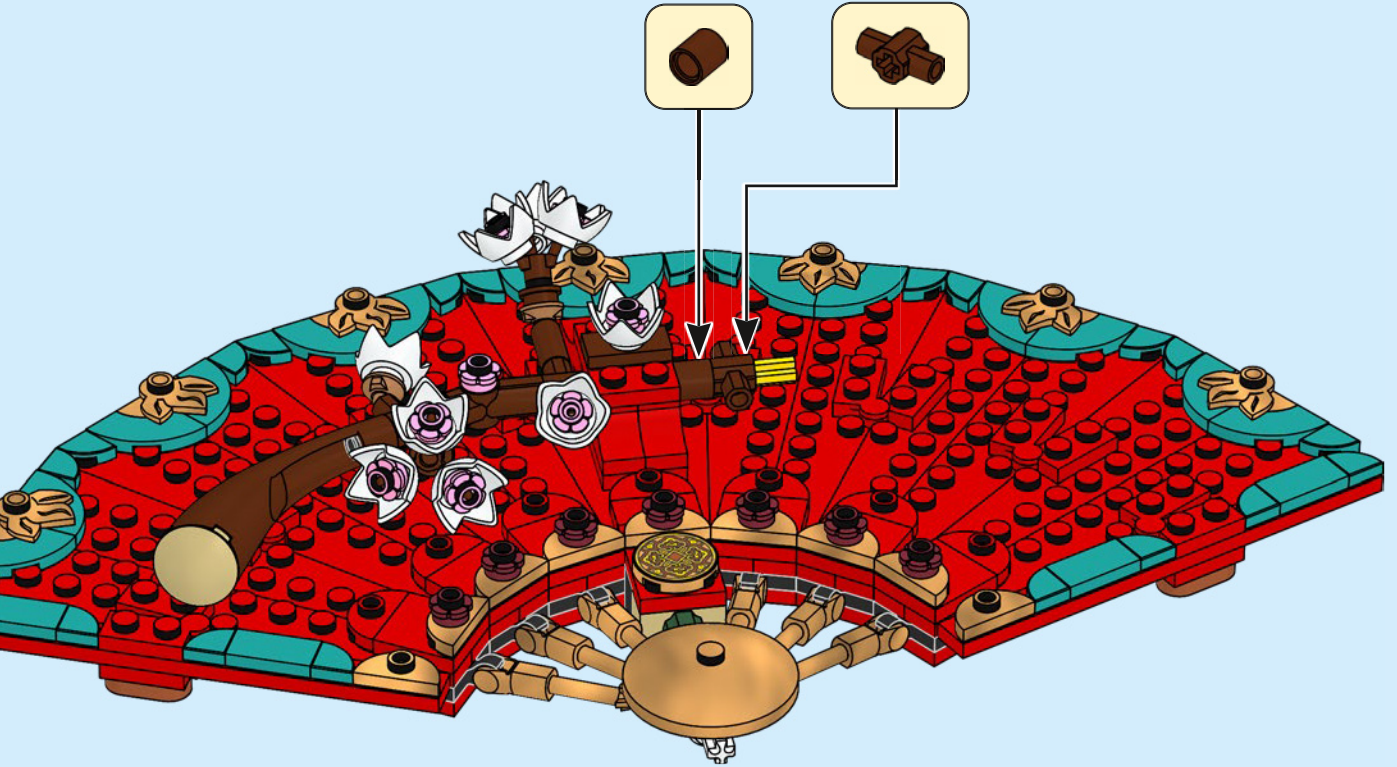





1x



1x



1x

# 119

1



2







120

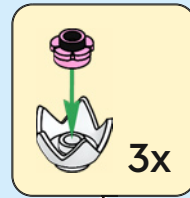

1



2



3

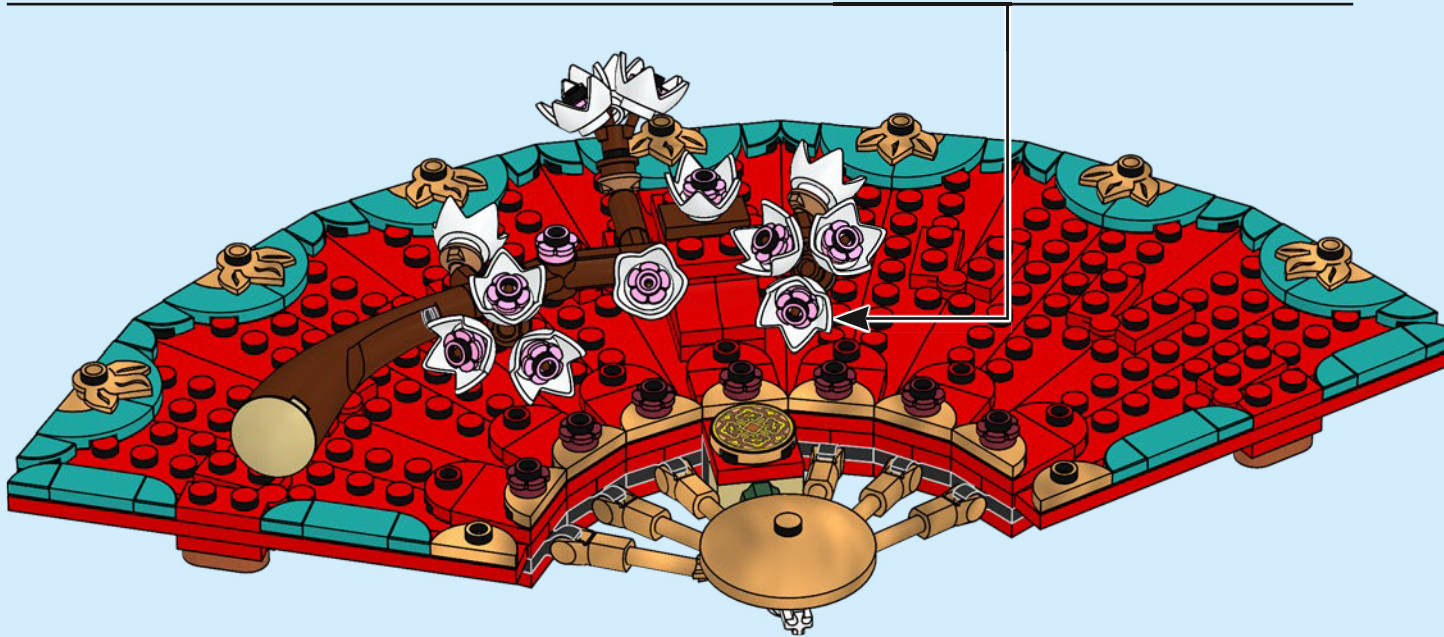
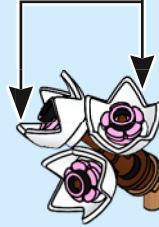

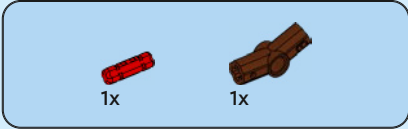
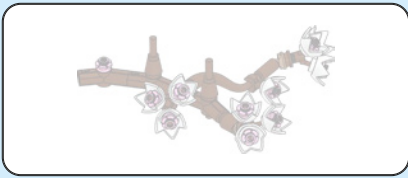

121

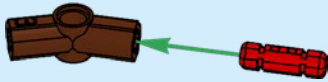

122

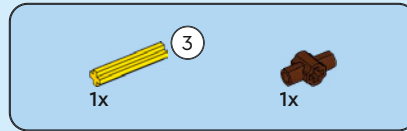

123

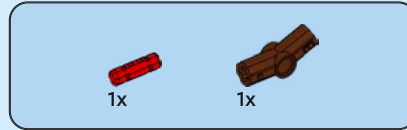
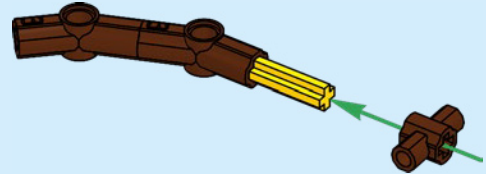

124

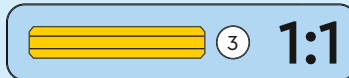
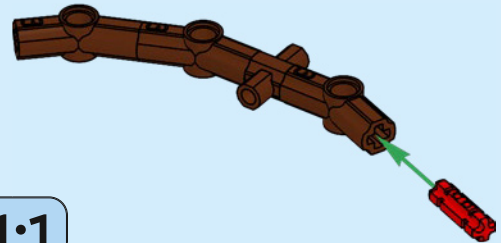

3x

125

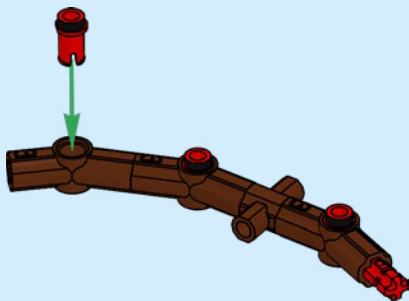

3x

1x

126

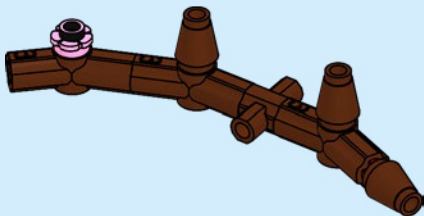

1x

1x

127

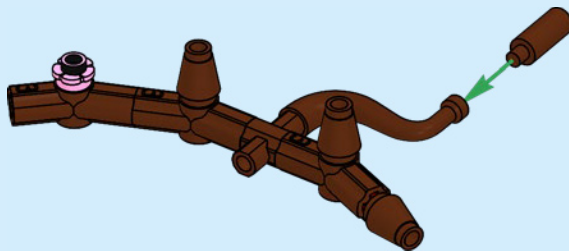

2x

1x

128

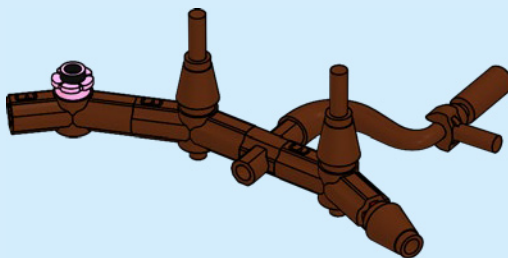



129

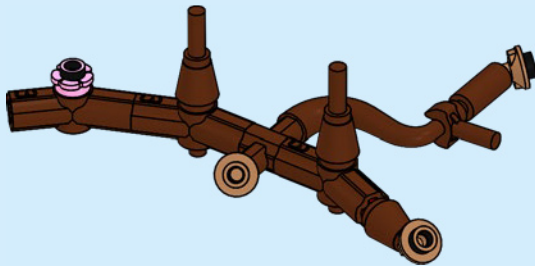

130

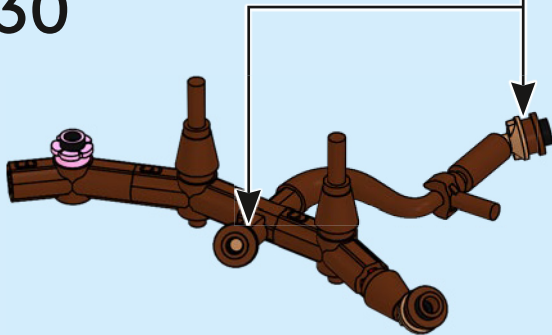

131

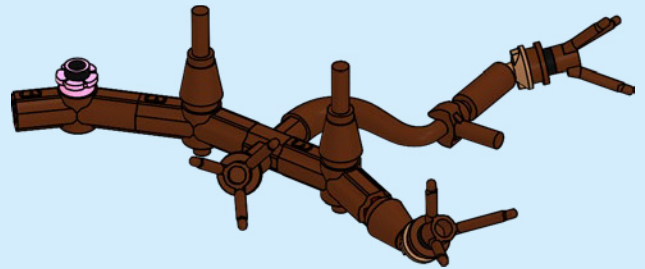

132

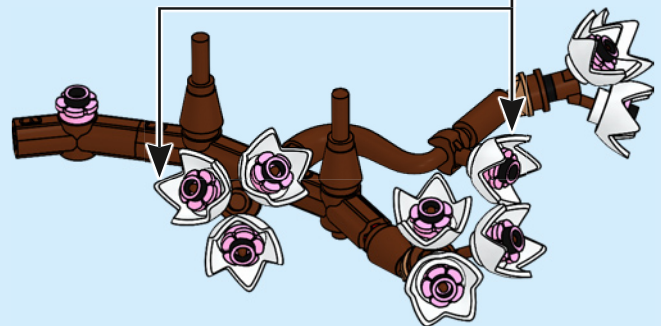

133

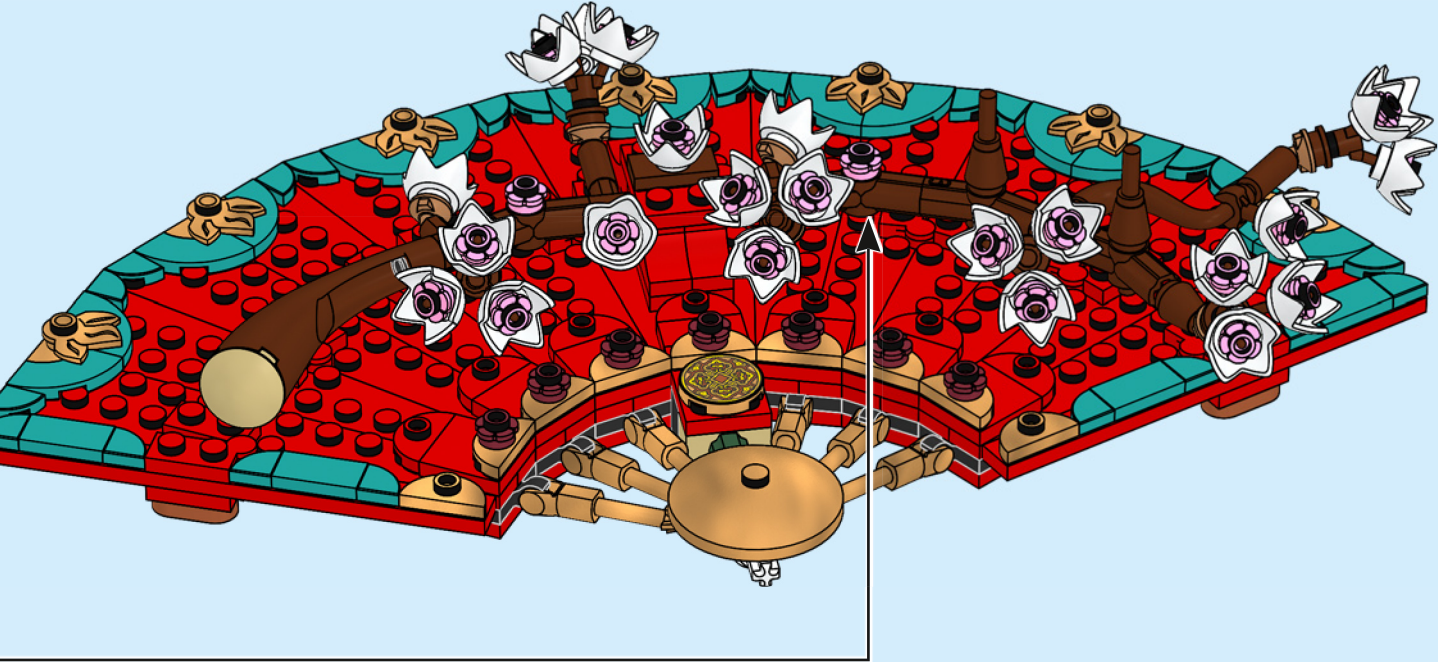



2x



1x



1x

134

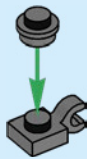

1x



1x

135

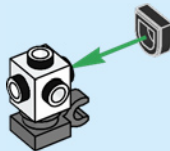

1x

136



1x

137



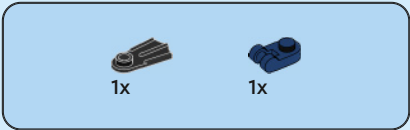

138

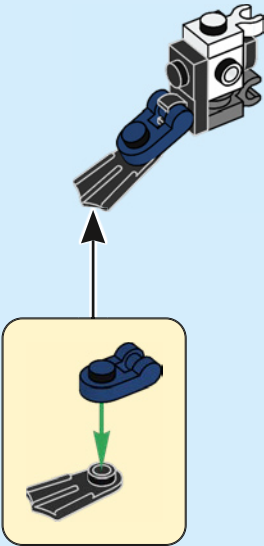

139

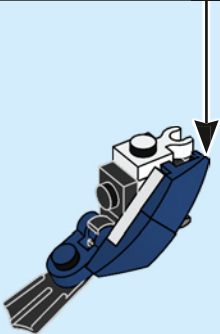
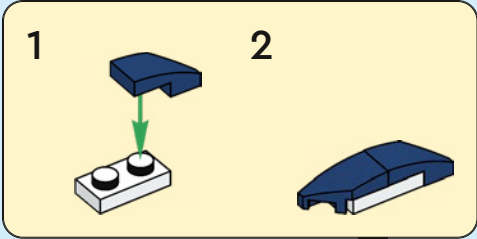

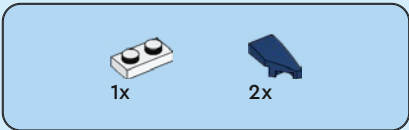

140

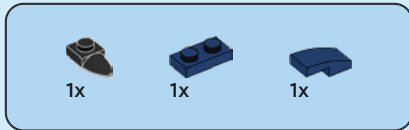
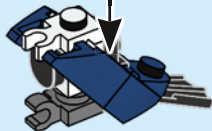
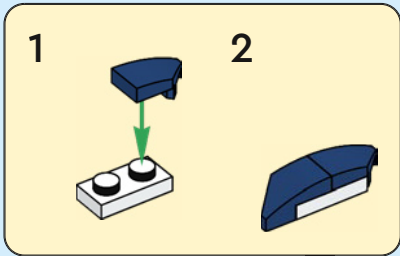

141

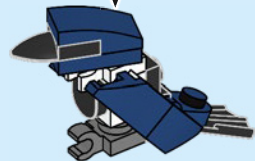
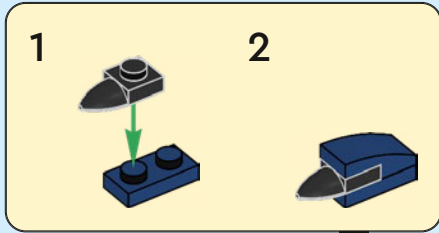

2x



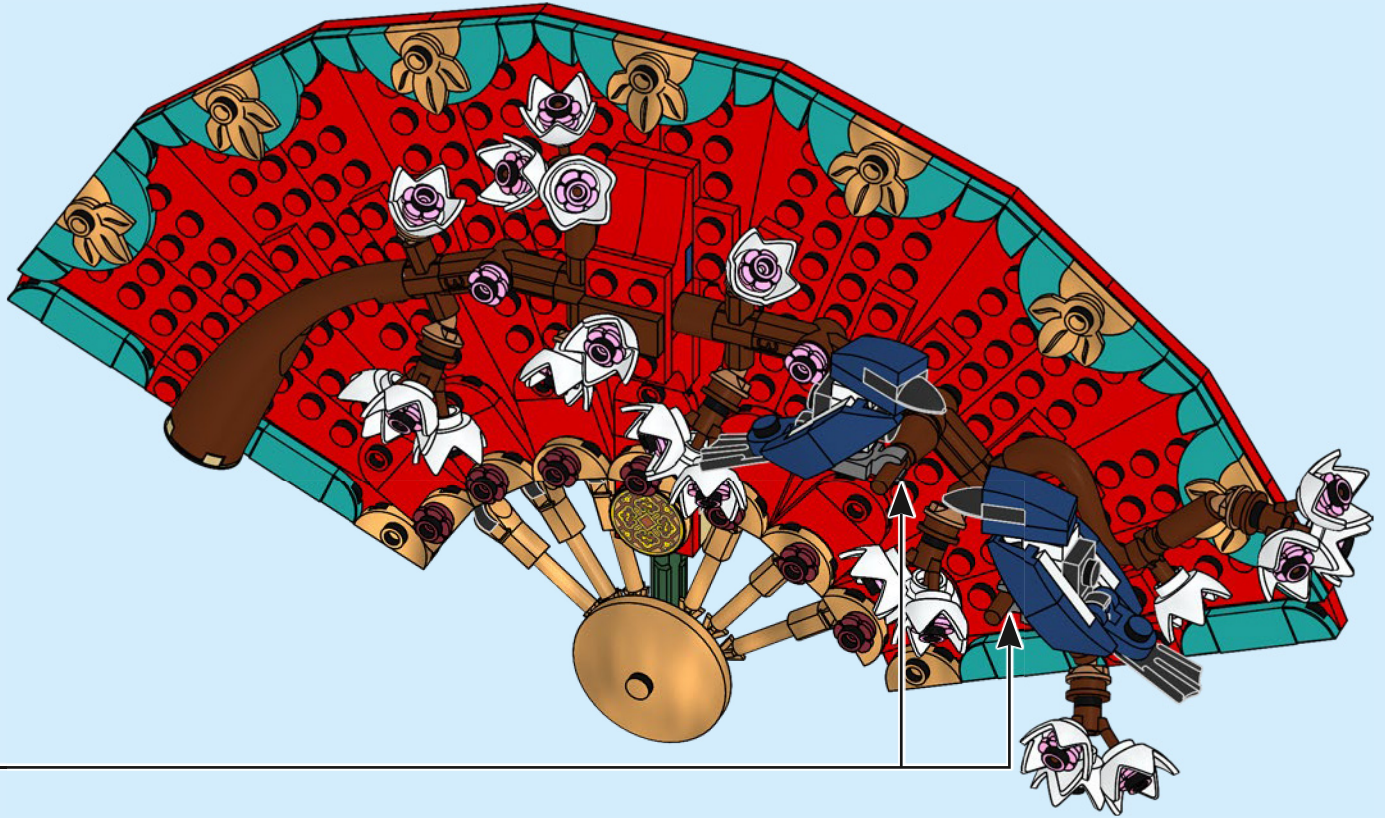

143

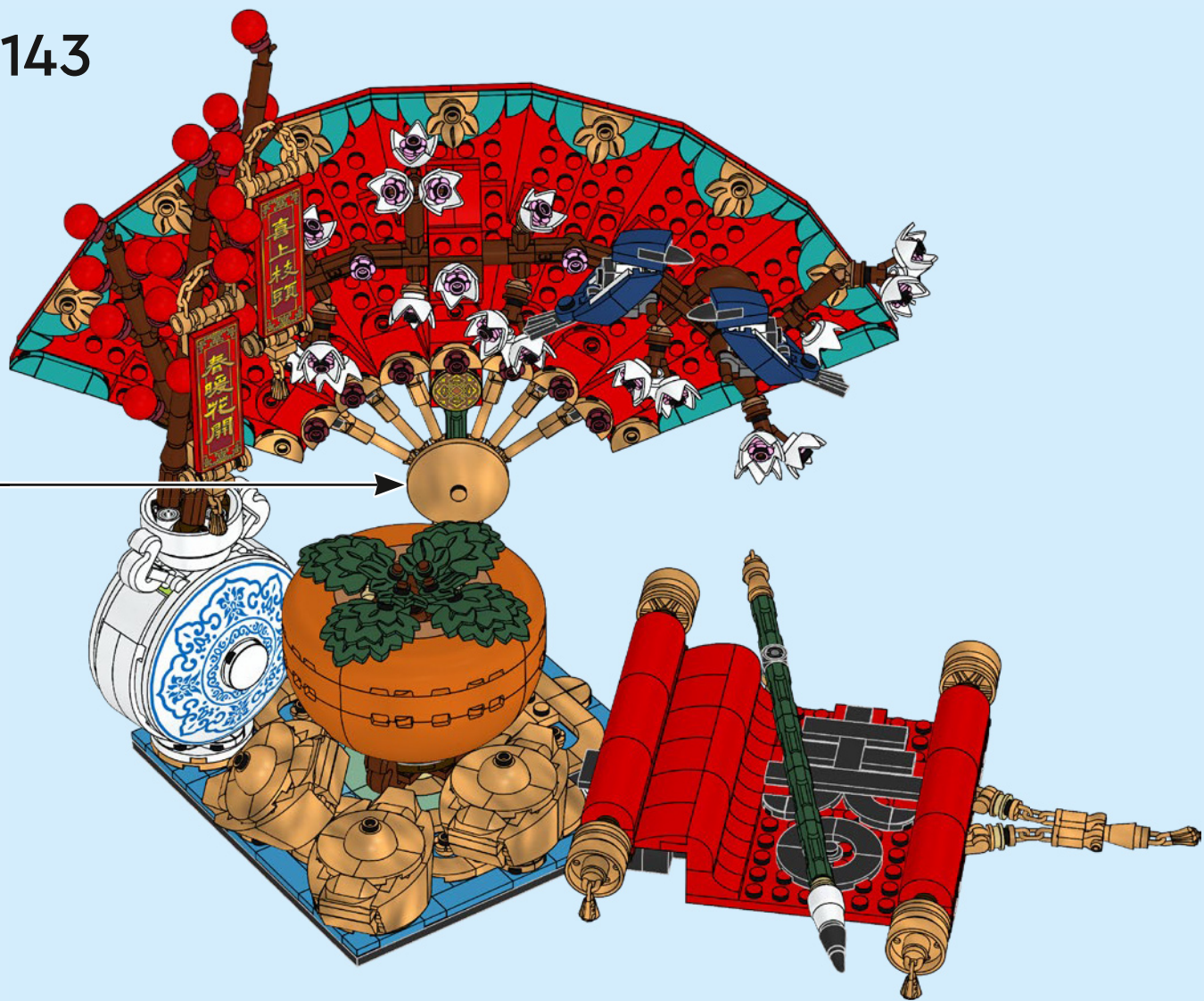

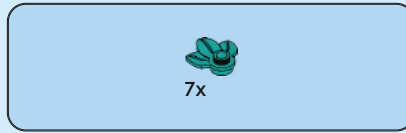

99

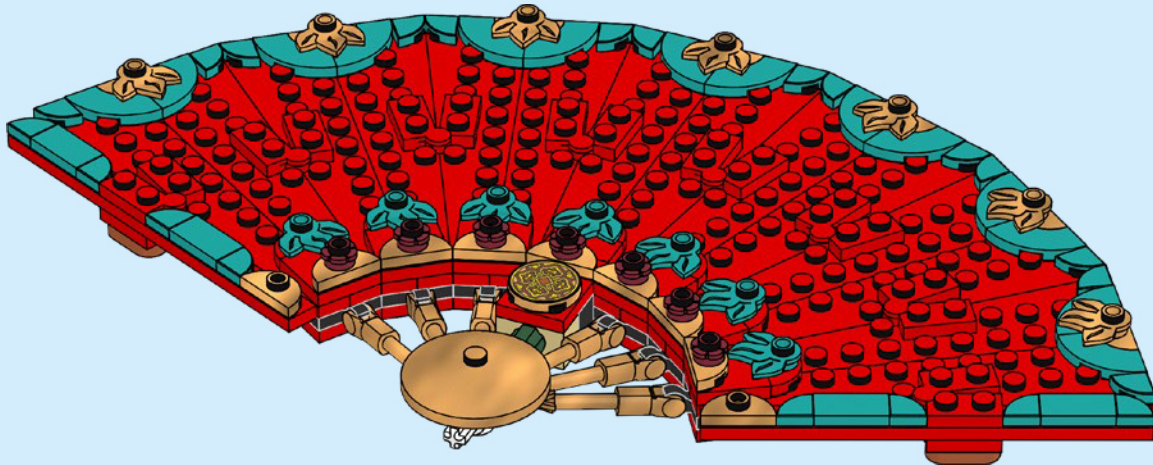





3x



3x

100



4x



4x

101





14x

102

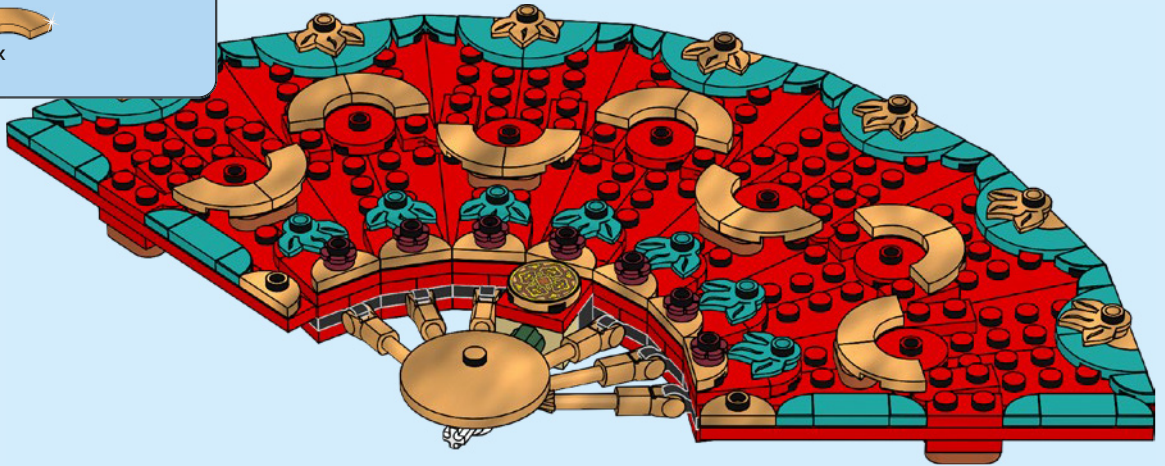

14x



14x

103

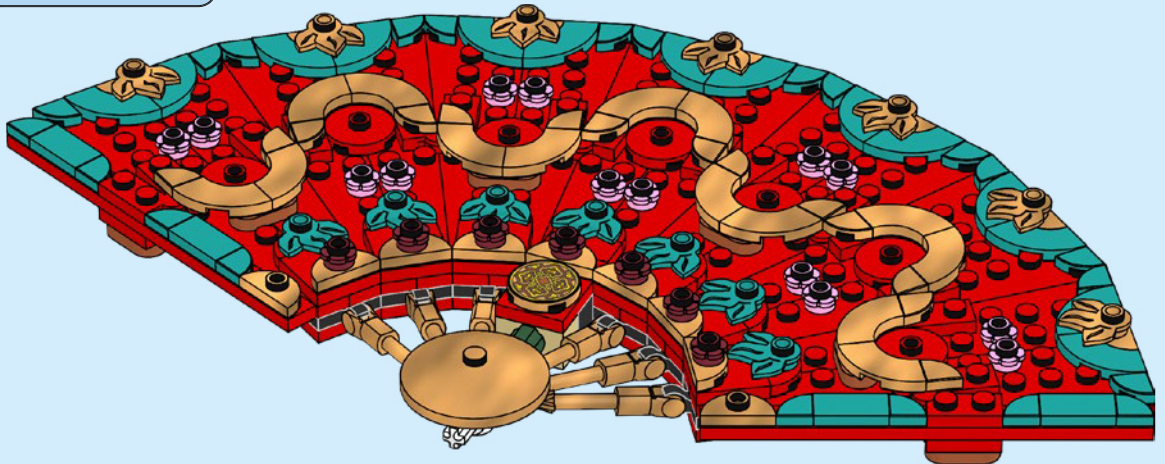



7x



7x

104

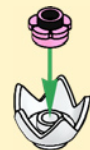

7x

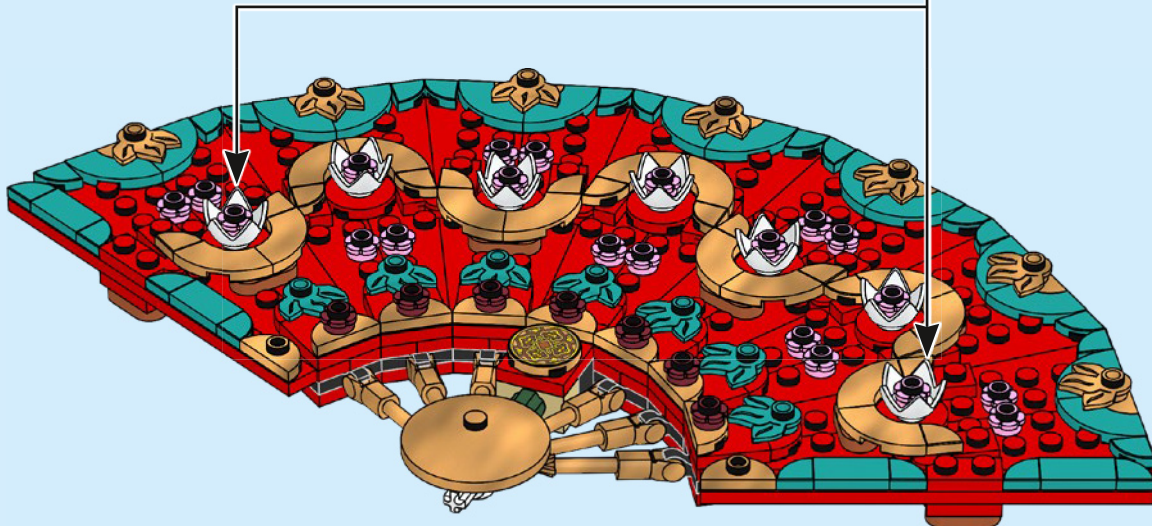



105





# MONKIE KID 悟空小侠





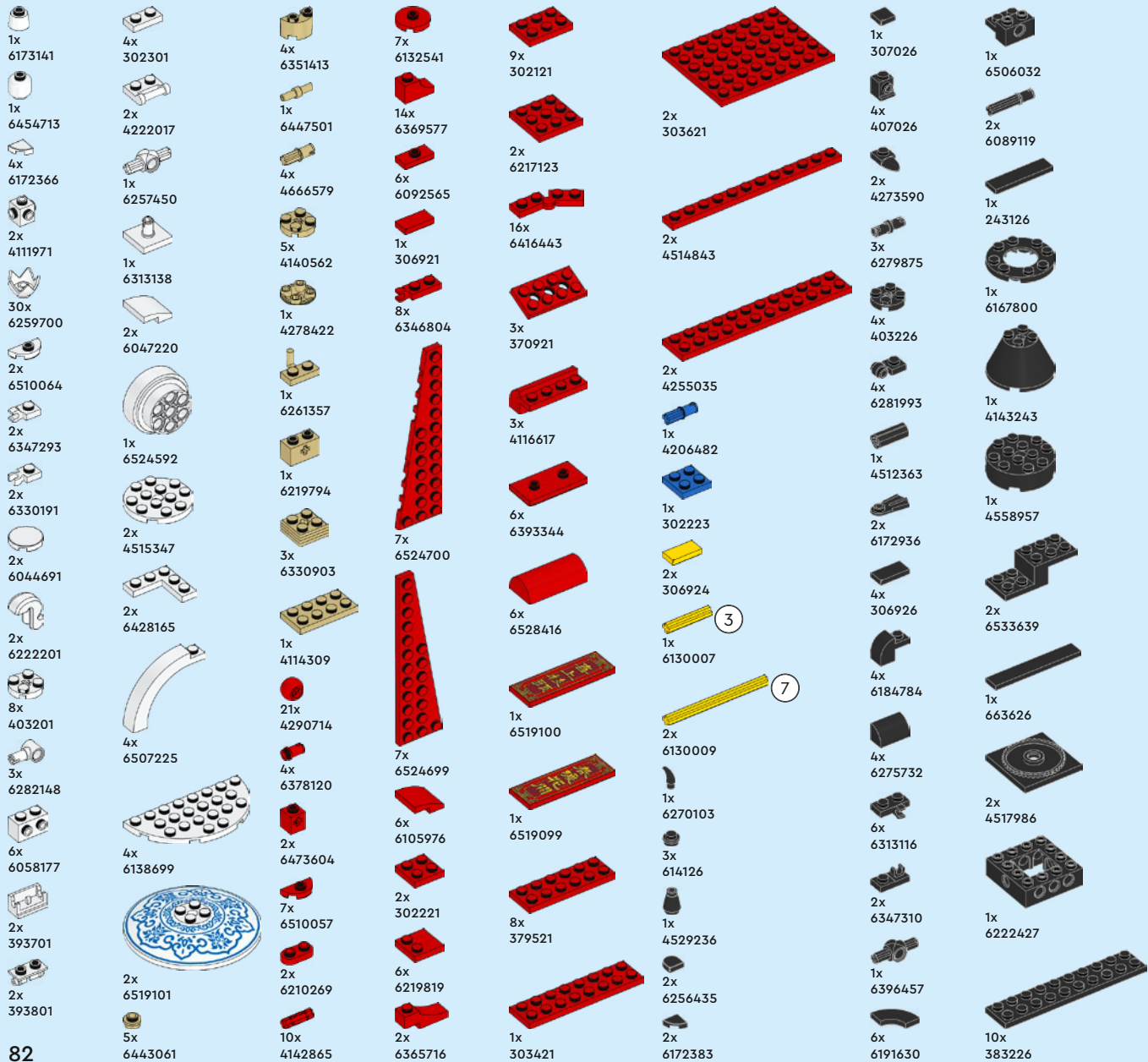

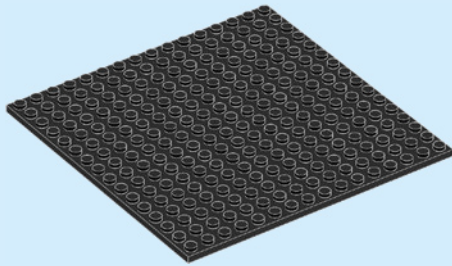

1x  
6306097



9x  
6369194



1x  
6147052



22x  
6240467



7x  
6270179



4x  
6213779



14x  
6213876



7x  
6338181

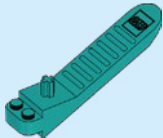

1x  
6254100



3x  
6314224



3x  
4220632



1x  
6133836



6x  
6328477



4x  
6214811



2x  
6251253



4x  
6214812



3x  
4528981



2x  
6094143



4x  
6400754



6x  
6330196



4x  
6507841



4x  
6516370



28x  
6458394



22x  
6422088



3x  
6345847



2x  
4211183



6x  
6215659



6x  
4529242



5x  
6439053



1x  
6170813



4x  
6528152



1x  
6429060



4x  
6459423



3x  
4531751



15x  
6269973



5x  
6092590



4x  
4211219



1x  
6382326



4x  
6261388



1x  
6383996



2x  
6116613



1x  
6439041



3x  
6183782



1x  
4244627



2x  
4612621



2x  
4210633



1x  
6395635



2x  
6360111



4x  
6314192



46x  
6212501



6x  
6162580



8x  
6274711



3x  
6252838



7x  
6296657



11x  
6209691



2x  
6520665



2x  
6186672



2x  
4529247



2x  
6262138



22x  
6508110



1x  
6452472



16x  
6503258



2x  
6212377



7x  
6219088



6x  
6134284



1x  
6107194



3x  
4569316



1x  
6516513



38x  
6218047



6x  
6107197



6x  
6375715



4x  
6279731



54x  
6173654



14x  
6347982



8x  
6388241



6x  
6502821



4x  
6109685



2x  
6512378



6x  
6502823



1x  
6062162



1x  
6062162



2x  
6323688



4x  
6265670



3x  
6134197



1x  
6005030



4x  
6524594



4x  
6524696



4x  
6524695

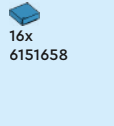

16x  
6151658

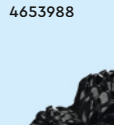

24x  
4653988



7x  
6029163



8x  
6412744



4x  
6210675



9x  
6510192



4x  
6438781



4x  
6493909



[LEGO.com/service](https://www.lego.com/service)

YOU COULD **WIN**



Scan this QR code or go to **LEGO.COM/PRODUCTFEEDBACK** and give us your short feedback about this LEGO® set for a chance to win a cool LEGO prize.

Terms and Conditions apply\*

**EN: YOU COULD WIN.** Terms and Conditions apply\* **DE: Du könntest GEWINNEN.** Es gelten die Teilnahmebedingungen\* **FR: Tu pourrais GAGNER.** Des conditions s'appliquent\* **IT: Potresti VINCERE tu.** Termini e condizioni sono applicabili\* **ES: Puedes GANAR.** Aplican términos y condiciones\* **PT: Poderá GANHAR.** Aplicam-se termos e condições\* **ZH: 轻松获奖. 条款和条件适用\*** **PL: Szansa na WYGRANĄ.** Obowiązują warunki korzystania\* **CS: Máte šanci VYHRÁT.** Platí všeobecné smluvní podmínky\* **SK: Máte šancu VYHRAŤ.** Platia všeobecné zmluvné podmienky\* **HU: TE IS NYERHETSZ.** Felhasználási feltételek érvényesek\* **RO: Ai putea CÂȘTIGA.** Se aplică termeni și condiții\* **BG: Можете да СПЕЧЕЛИТЕ.** Има определени правила и условия\* **LV: Tu vari LAIMĒT.** Ir spēkā noteikumi un nosacījumi.\* **ET: Sul on võimalus VÕITA.** Kehtivad tingimused\* **LT: Jūs galite LAIMĖTI.** Taikomos sąlygos\*

\*[LEGO.com/productfeedback-terms](https://www.lego.com/productfeedback-terms)

LEGO and the LEGO logo are trademarks of the/son des marques de commerce du/son marcas registradas de LEGO Group. ©2025 The LEGO Group.