

WIN
YOU COULD



Scan this QR code or go to [LEGO.COM/PRODUCTFEEDBACK](https://www.lego.com/productfeedback) and give us your short feedback about this LEGO® set for a chance to win a cool LEGO prize. Terms and Conditions apply*



EN: YOU COULD WIN. Terms and Conditions apply* **DE: Du könntest GEWINNEN.** Es gelten die Teilnahmebedingungen* **FR: Tu pourrais GAGNER.** Des conditions s'appliquent* **IT: Potresti VINCERE.** tu. Termini e condizioni applicabili* **ES: Puedes GANAR.** Aplican términos y condiciones* **PT: Poderás GANHAR.** Aplicam-se Termos e Condições* **ZH: 轻松获奖.** 条款和条件适用* **PL: Szansa na WYGRANA.** Obowiązują regulamin i zmienné podmínky* **VIỆT: Có thể trúng thưởng.** Điều kiện và quy định áp dụng* **TR: Kazanma şansın var.** Kurallara ve şartlara uygundur* **RU: Ты можешь выиграть.** Применяются условия и условия* **UK: Ти можеш виграти.** Застосовуються умови та умови* **UA: Ти можеш виграти.** Застосовуються умови та умови* **LT: Jūs galite laimėti.** Taikomos sąlygos* **LEGO.com/productfeedback-terms**



30698

DREAMZZ

6547417

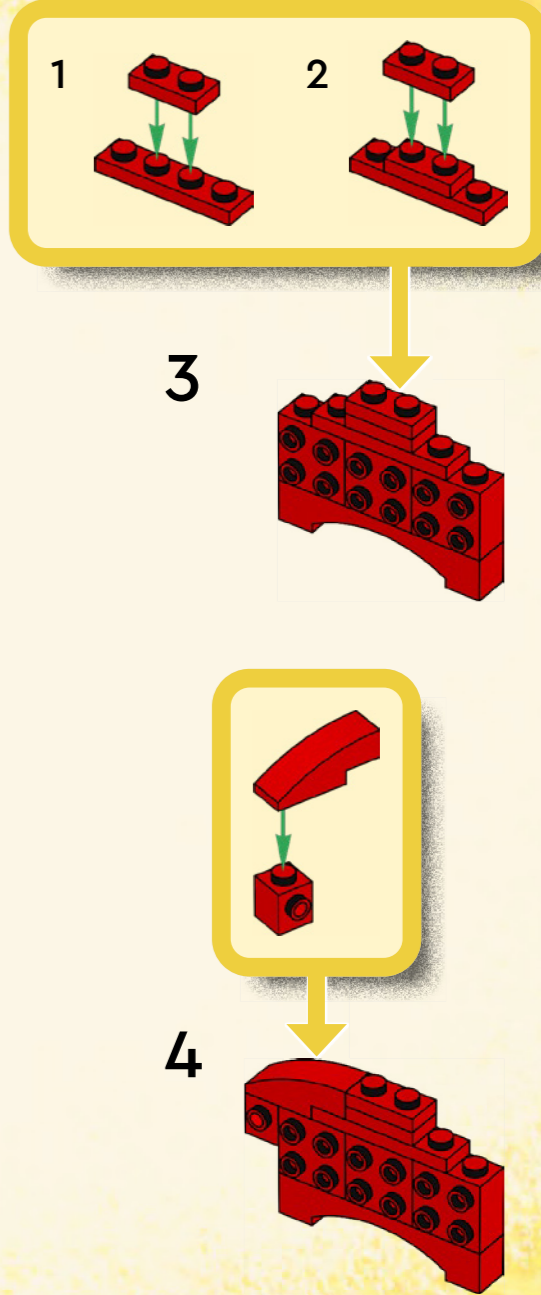
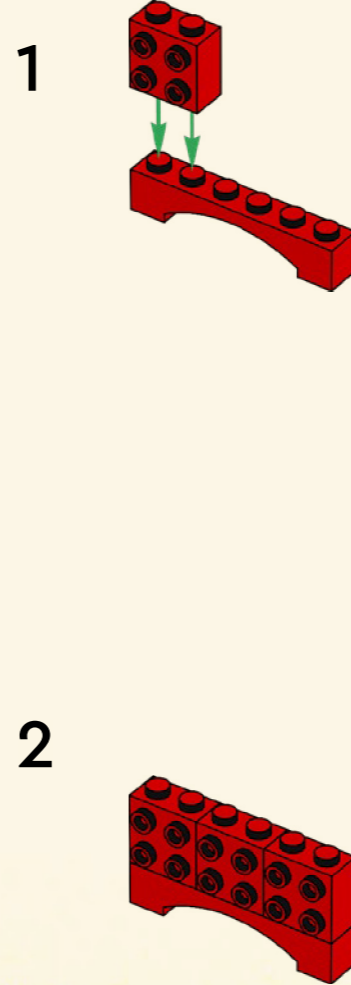
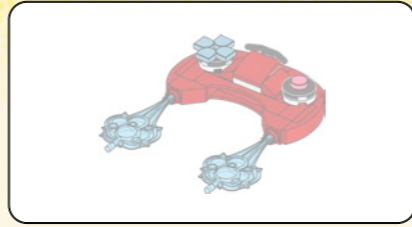
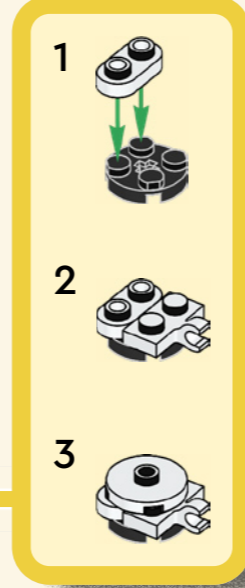
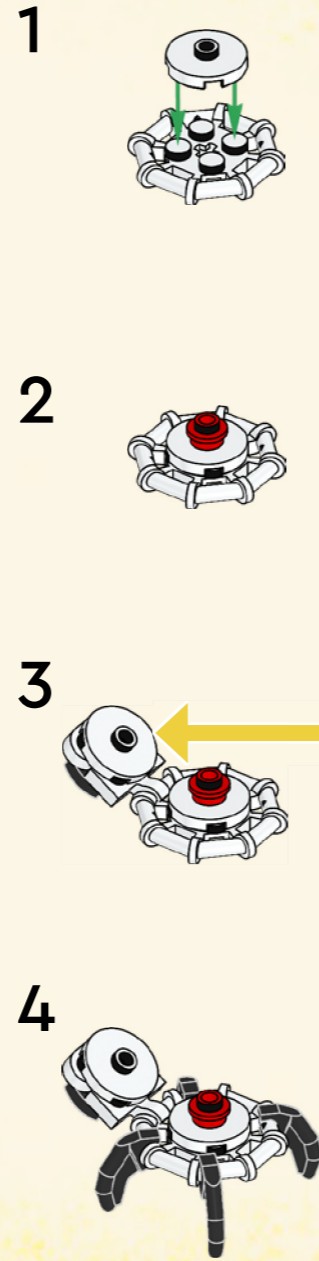
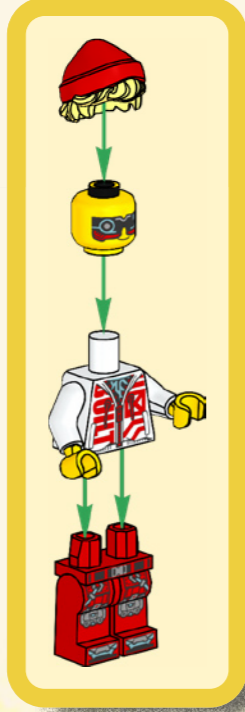

5

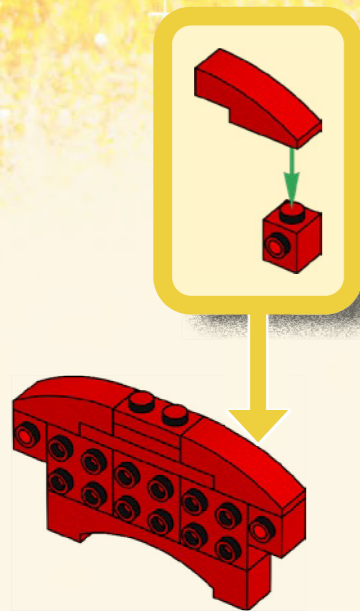

7

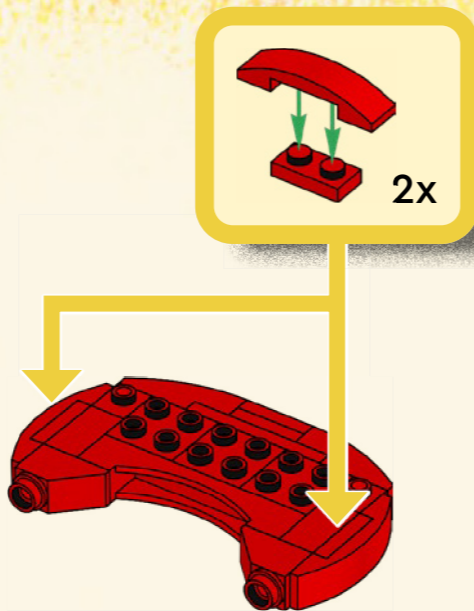

9

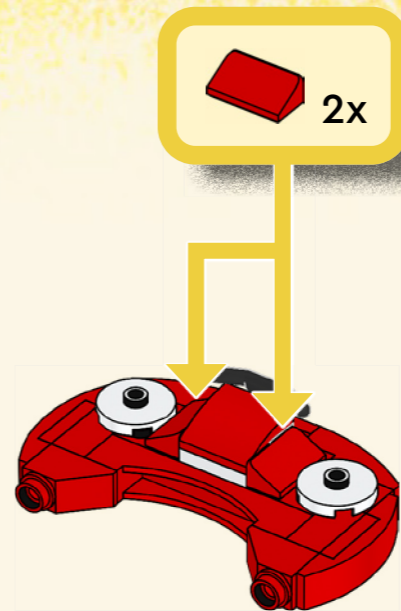

11

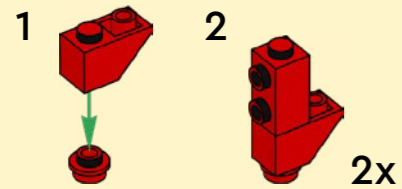
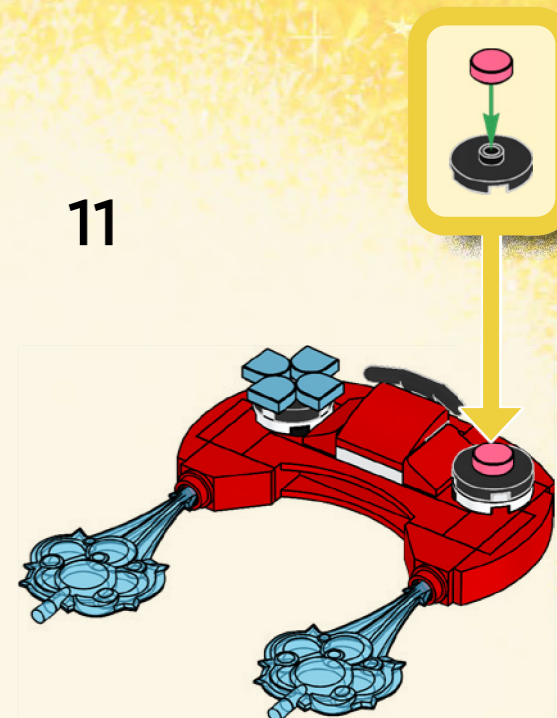

6

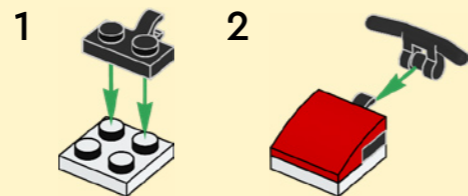
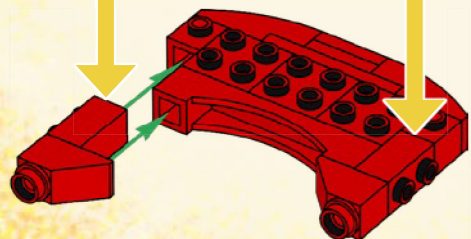

8

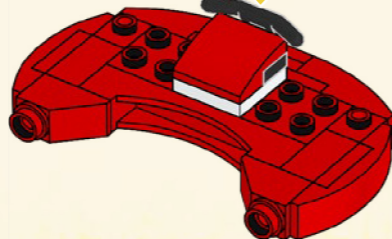

10



 [LEGO.com/DREAMZzz](https://www.lego.com/DREAMZzz)

[LEGO.com/service](https://www.lego.com/service)

LEGO, the LEGO logo, DREAMZzz and the DREAMZzz logo are trademarks of the/
sont des marques de commerce du/son marcas registradas de LEGO Group.
©2025 The LEGO Group. 6547417
All rights reserved/Tous droits réservés/Todos los derechos reservados.

