



# DREAMZZZ

71479



LEGO® Builder



[LEGO.com/sustainable-packaging](https://LEGO.com/sustainable-packaging)



 <sup>FR</sup> **DONNEZ**  
OU  
**RECYCLEZ**

 OU  OU 

ASSOCIATION MAGASIN DÉCHÈTERIE

Adresses sur [quefairedemesdechets.fr](https://quefairedemesdechets.fr)

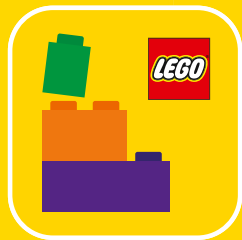

# BUILDER



Apple and the Apple logo are trademarks of Apple Inc., registered in the U.S. and other countries and regions. App Store is a service mark of Apple Inc. Google Play and the Google Play logo are trademarks of Google LLC. Tencent and the Tencent logo are trademarks of Tencent Inc.

Q [LEGO.com/devicecheck](https://www.lego.com/devicecheck)

**EN** Ask parents' permission before going online | **DE** Eltern um Erlaubnis bitten, bevor du online gehst | **FR** Demande l'autorisation d'un parent avant d'aller en ligne | **IT** Chiedi il permesso ai tuoi genitori prima di andare online | **ES** Pídeles permiso a tus papás antes de conectarte a Internet | **PT** Pede autorização aos pais antes de acederes online | **ZH** 上网前应先征得父母的同意 | **PL** Poproś rodziców o zgodę, zanim wejdziesz do Internetu | **CS** Než půjdeš na internet, požádej rodiče o svolení | **SK** Skôr než pôjdeš na internet, vypýtaj si povolenie od rodičov | **HU** Kérj szülői engedélyt, mielőtt online csatlakoznál! | **RO** Cere permisiunea părinților înainte de a te conecta online | **BG** Поискайте разрешение от родител, преди да влезете онлайн | **LV** Pirms došanās tiešsaistē palūdz atļauju vecākiem | **ET** Enne Interneti kasutamist küsi vanematelt luba | **LT** Prieš prisijungdami prie interneto, atsiklauskite tėvų







1x



1x

1

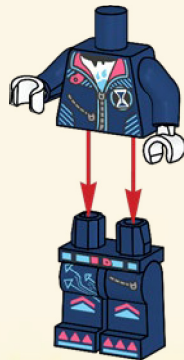



1x



1x



1x



1x

2

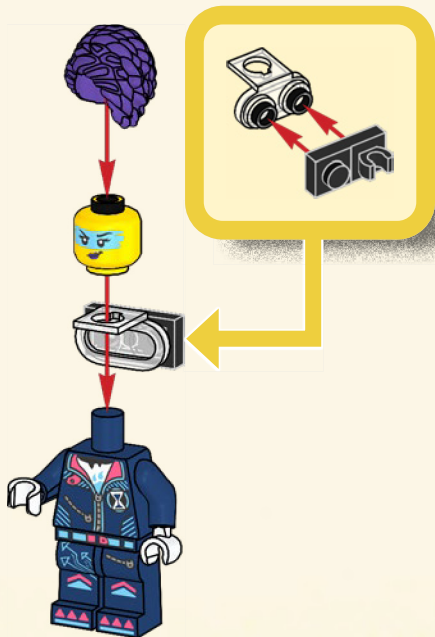

1x



3



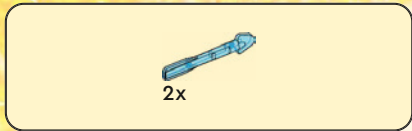

4

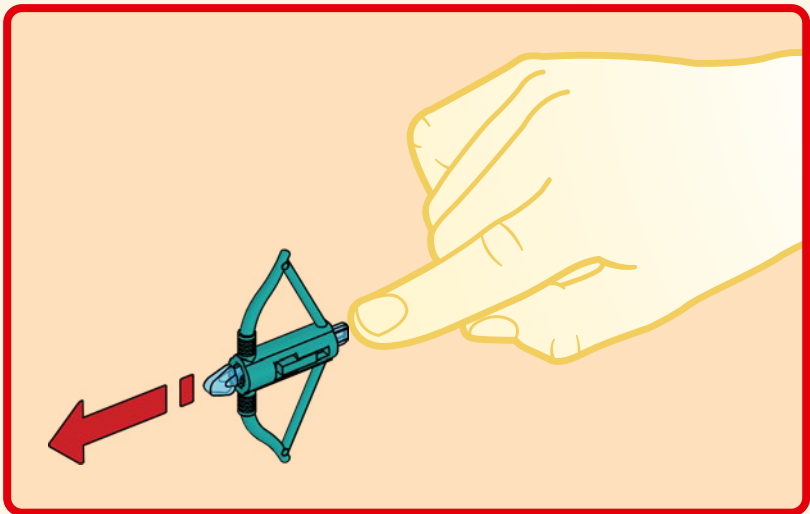
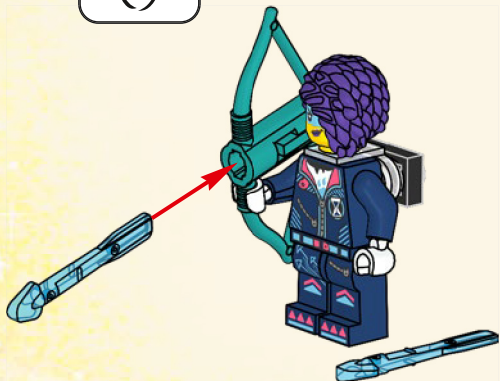





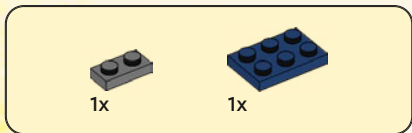
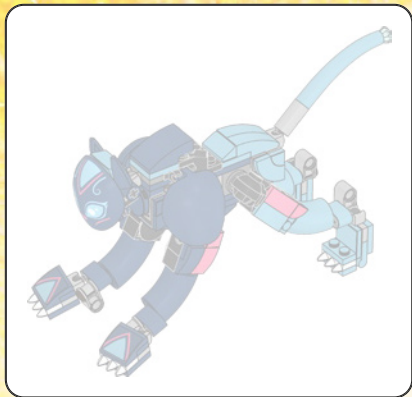

1

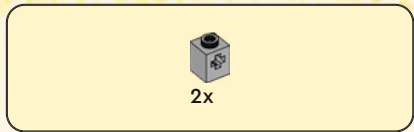
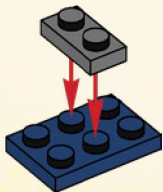

2

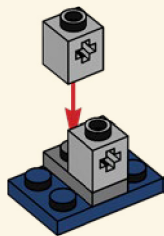



4x

3

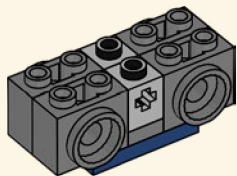

2x

4

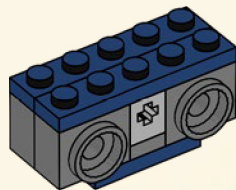

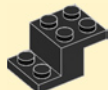

2x

5

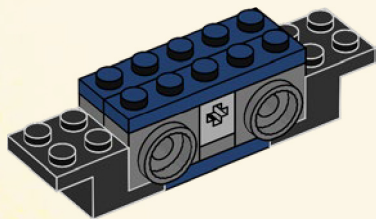

1x

6

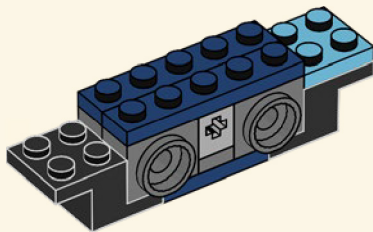



1x



2x

7

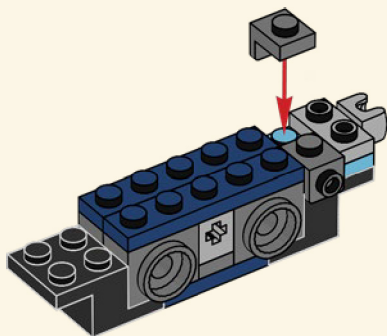

1x

8

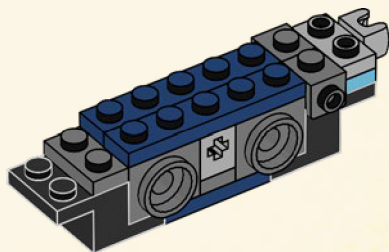



2x

9

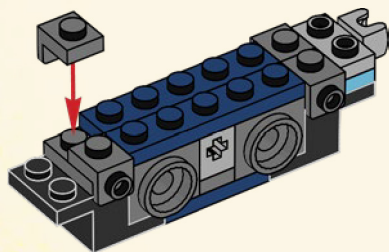

1x



2x

10

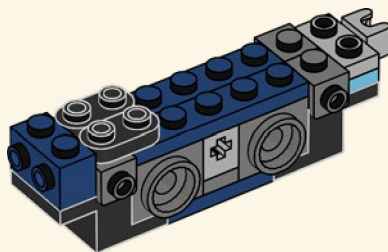



1x

11

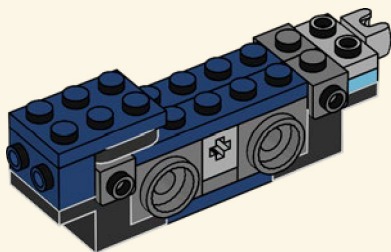

1x



2x

12

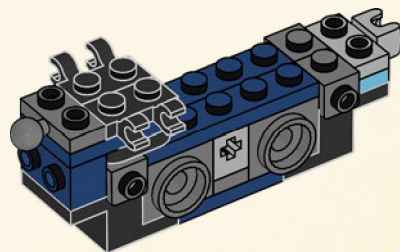

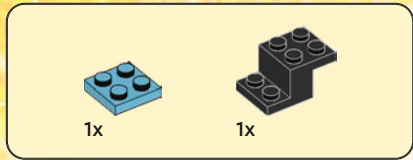

13

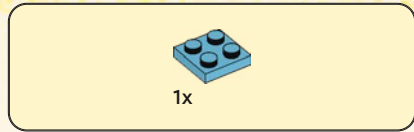
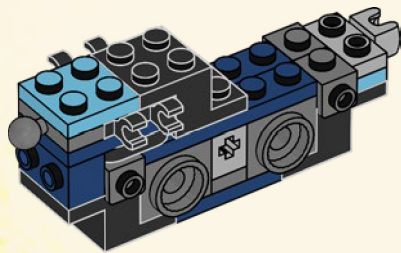

14

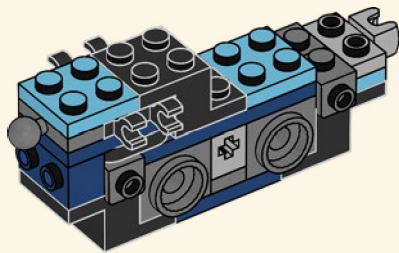





2x

15

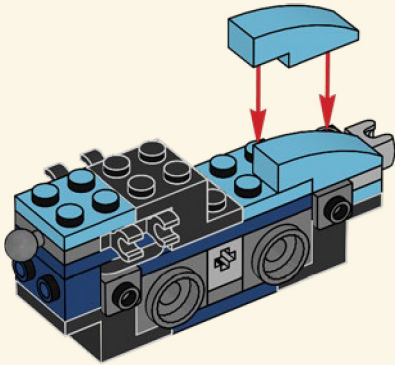

1x

16

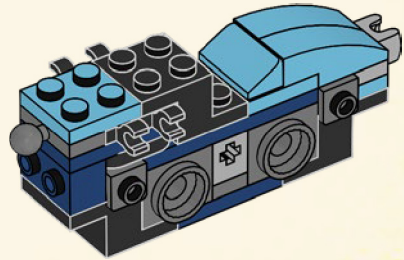



1x

17

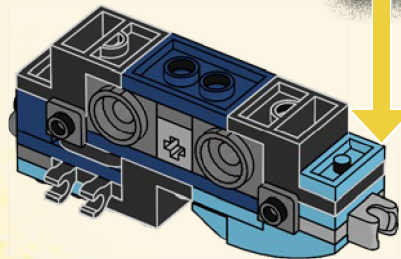
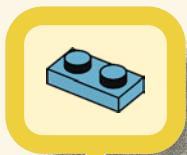

2x

18

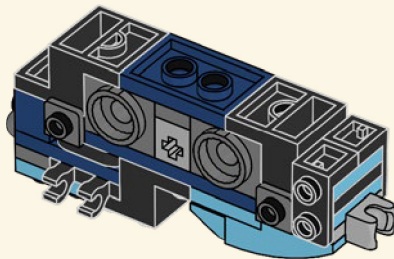



2x

19

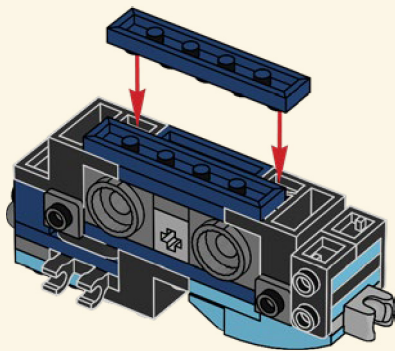

1x

20

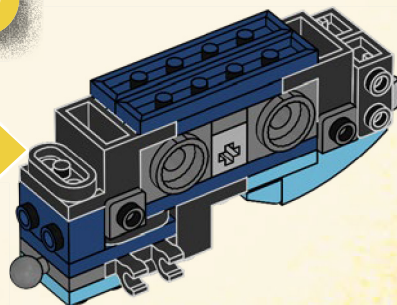



2x

21

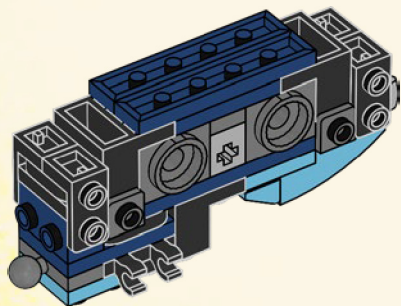

4x

22

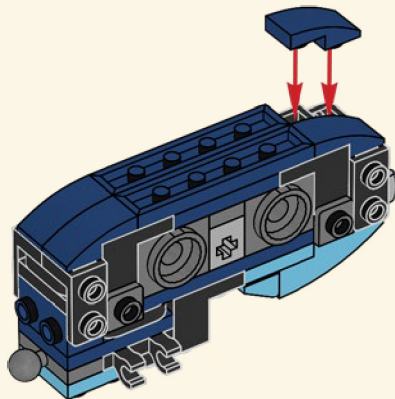



1x

23

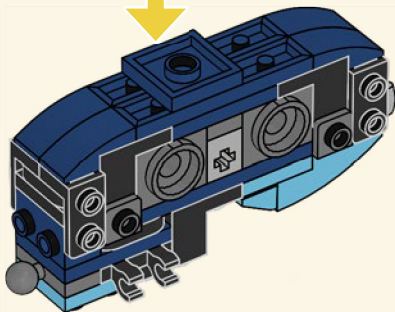

4x

24

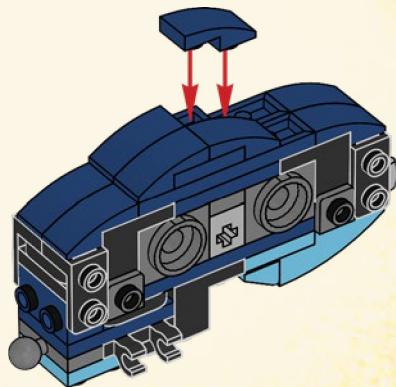



1x

25

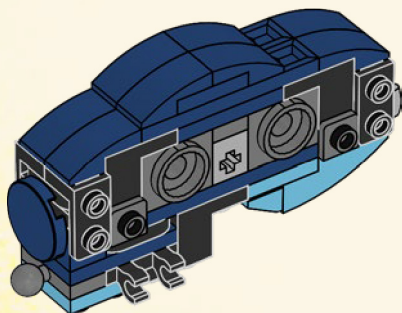

1x



1x

26

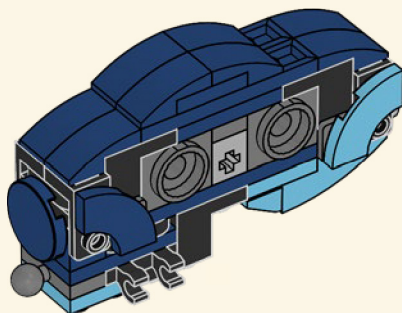



1x



1x

27

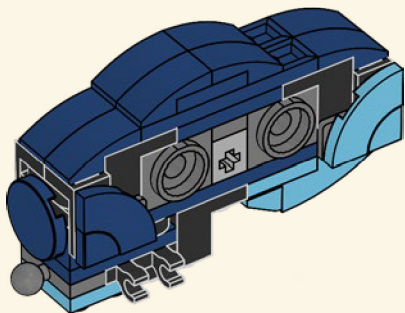

1x



1x

28

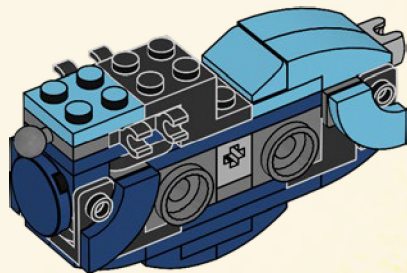



1x



1x

29

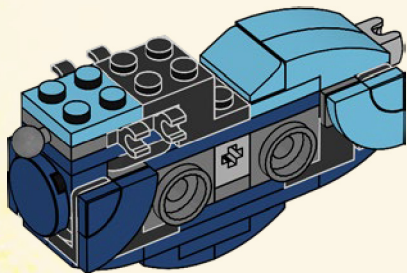

2x

30

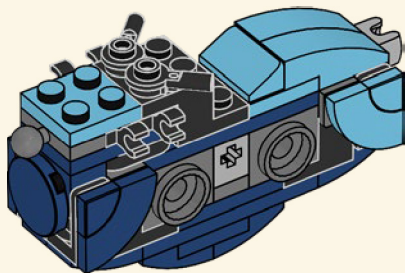





1x

31

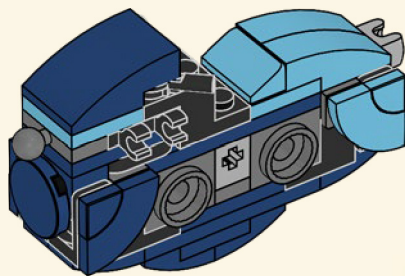

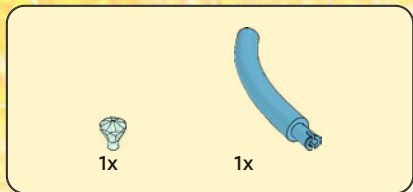

32

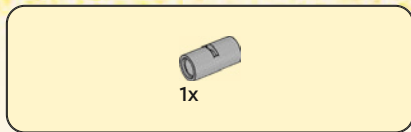
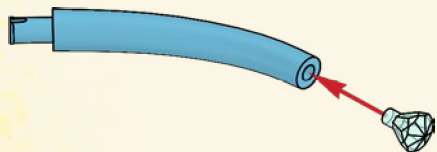

33

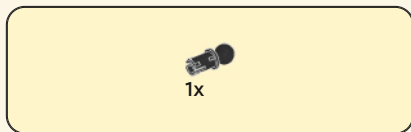
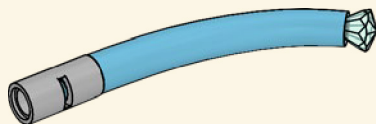

34

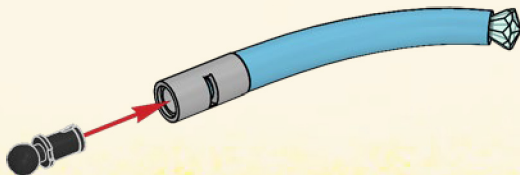

35

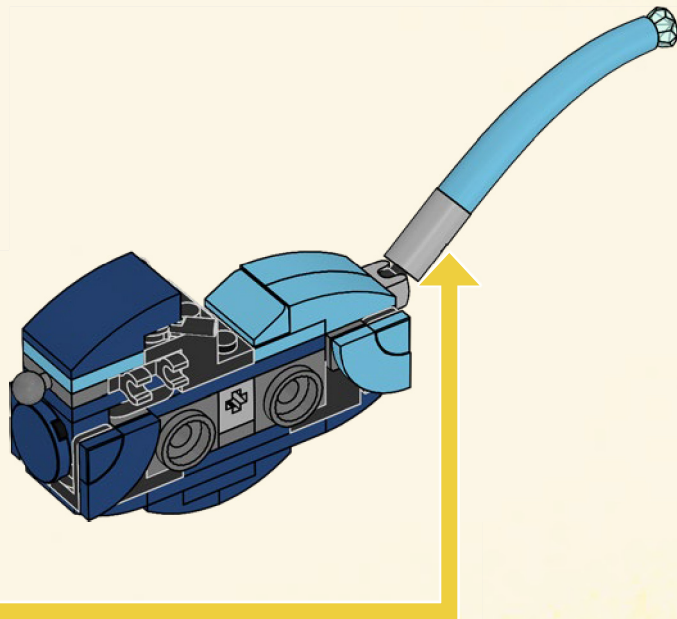



1x

36

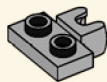

2x

37

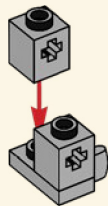

1x

38





1x

39

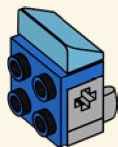

1x

40

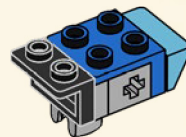

3x

41





42

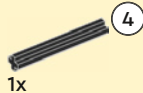
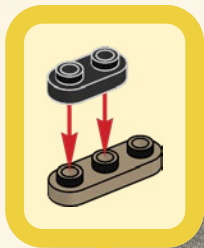

43

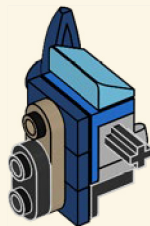
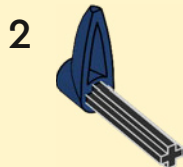
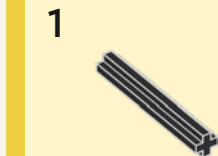

1:1



1x

44



1x

45



46

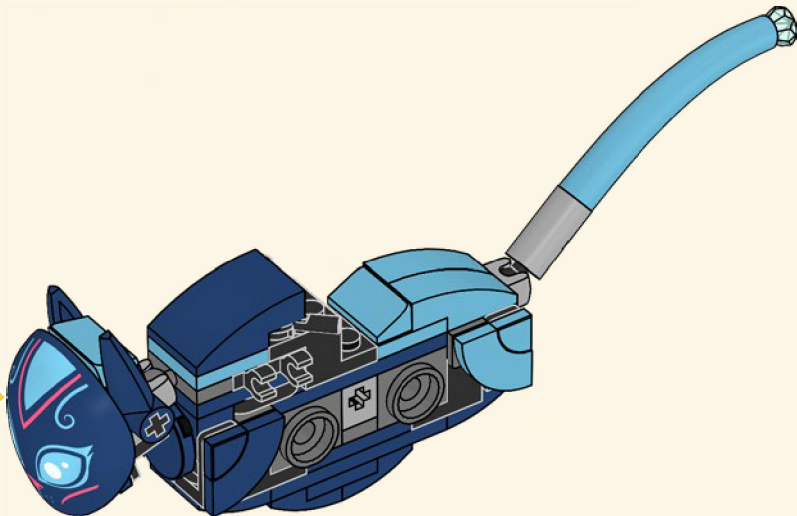





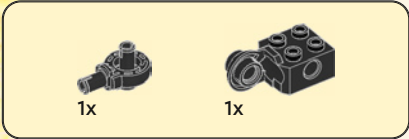
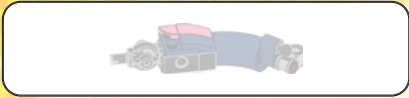

47

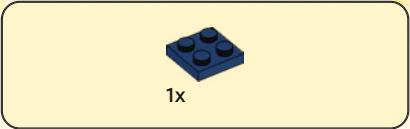
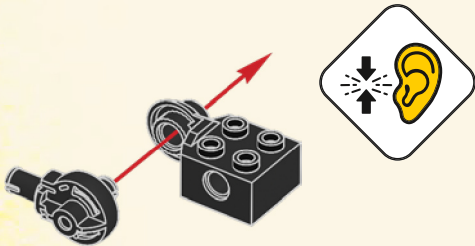

48

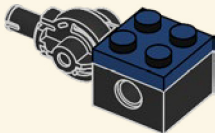



49

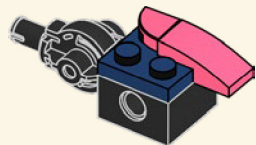

50

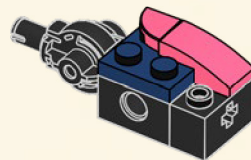



1x

51

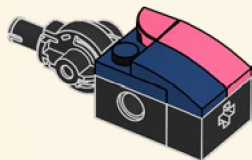

1x

52

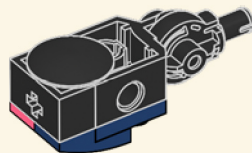



1x

53

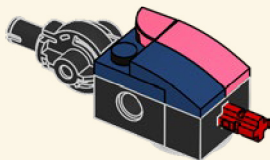

1x

54

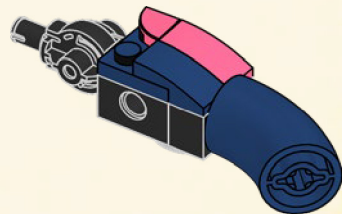

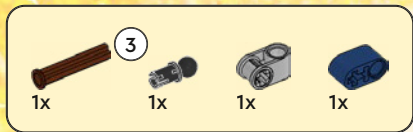

55

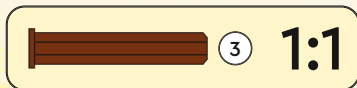
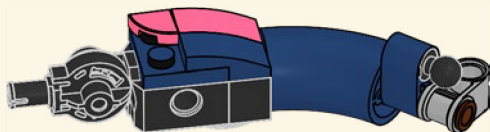
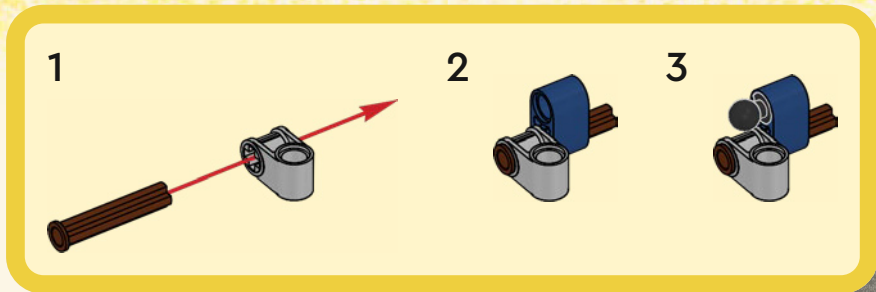

56

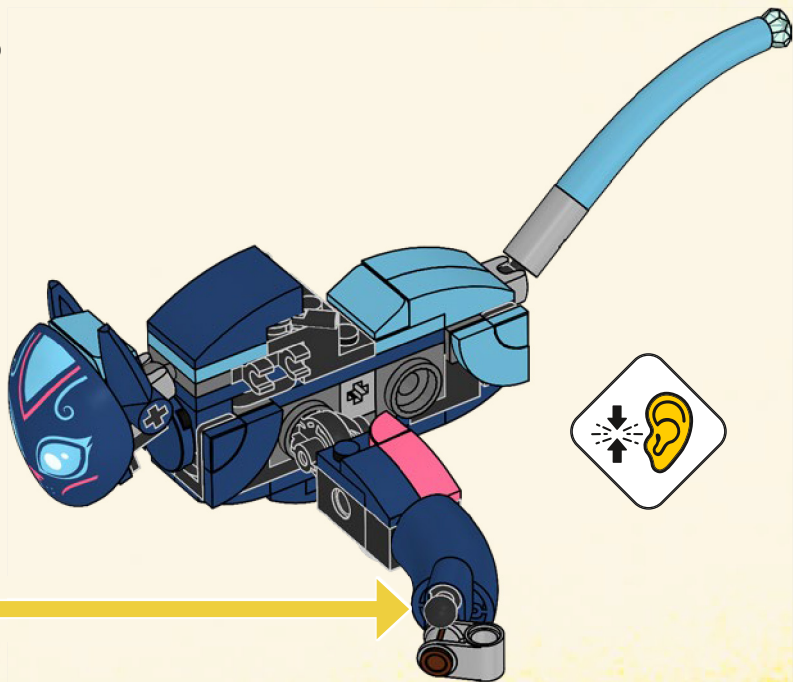

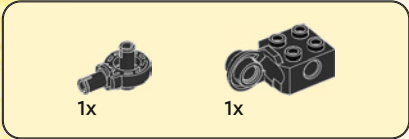
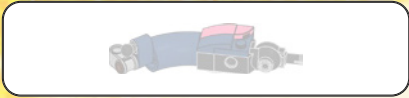

57

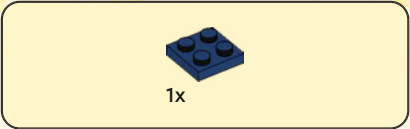
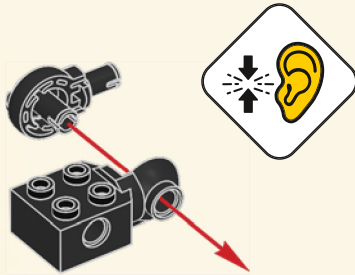

58

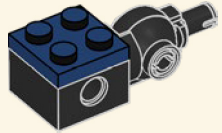





1x



1x

59

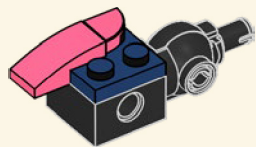

1x

60

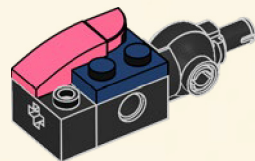



1x

61

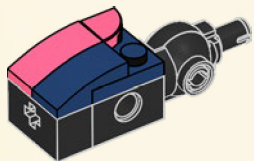

1x

62

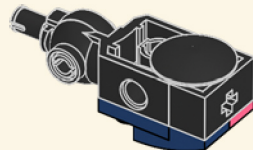



1x

63

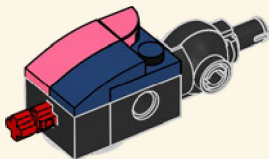

1x

64

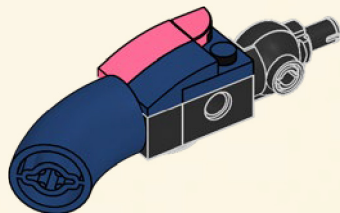

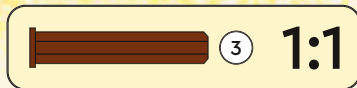
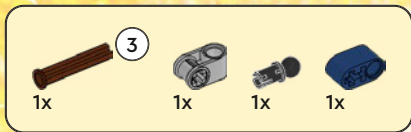

65

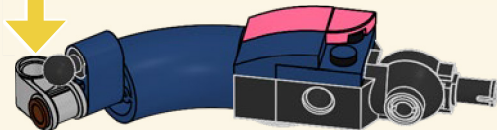
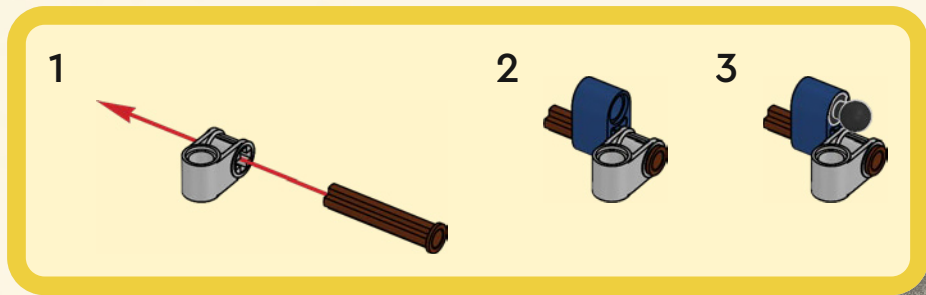

66

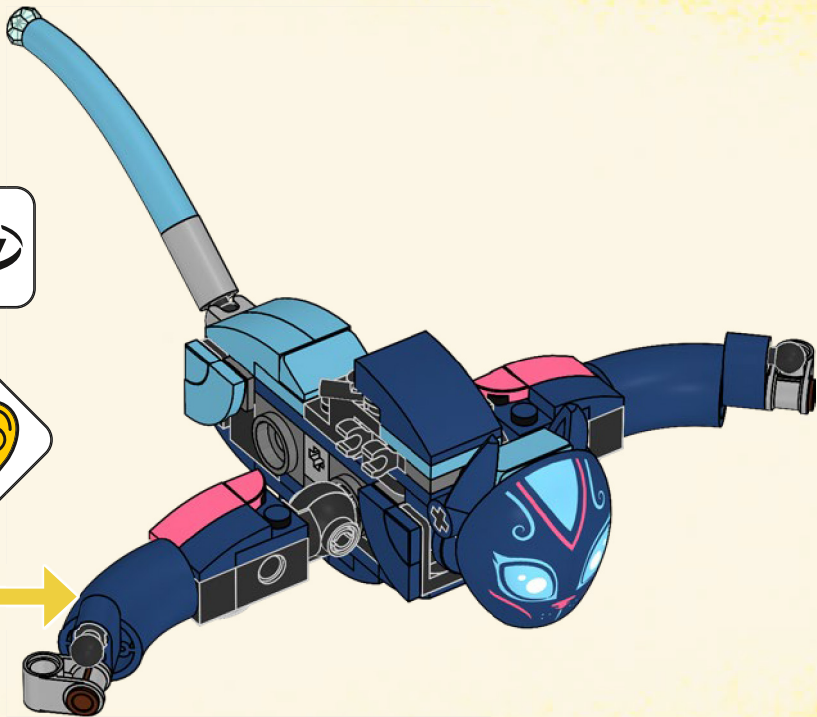

67

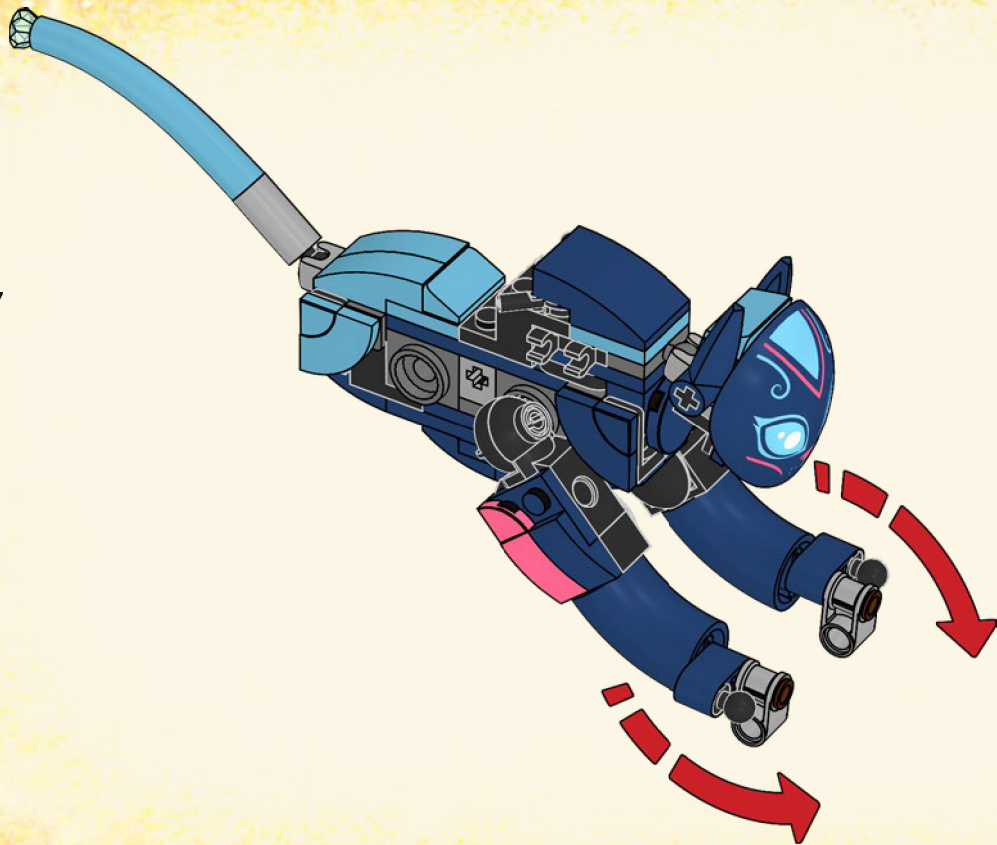



2x



1x



1x

68

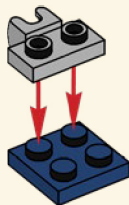

1x

69

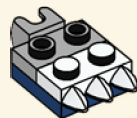

1x

70





1x

71

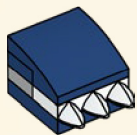

72



2x



73

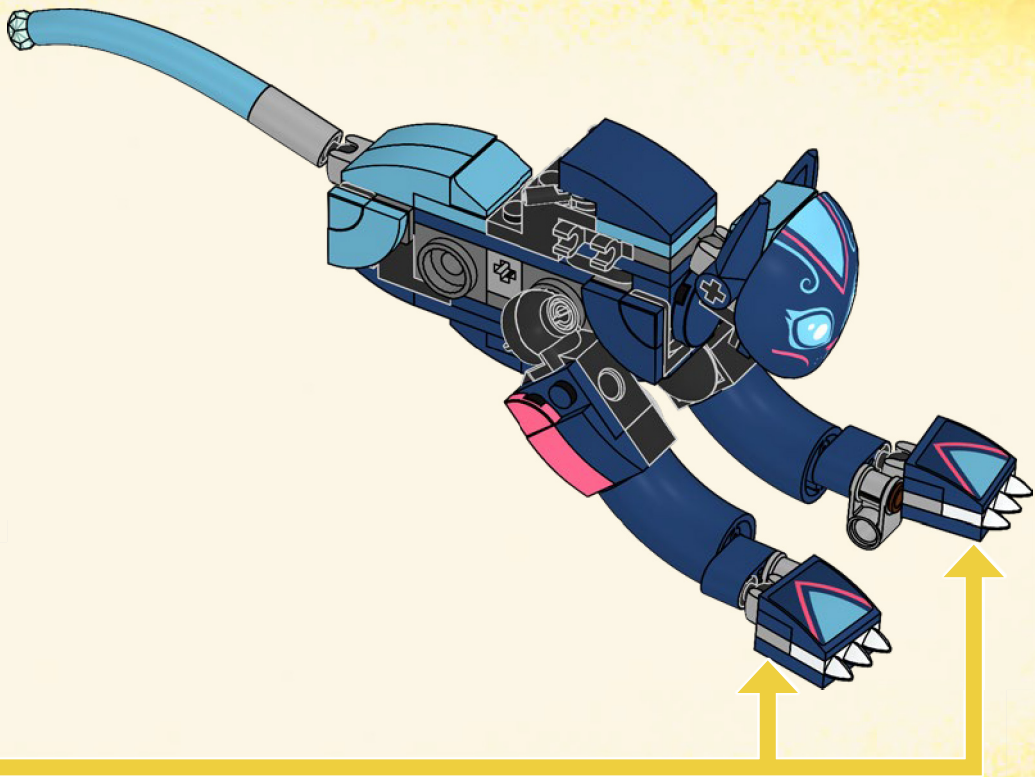

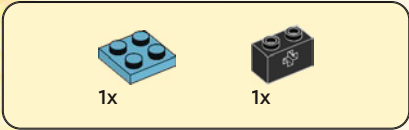
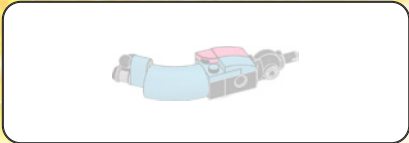

74

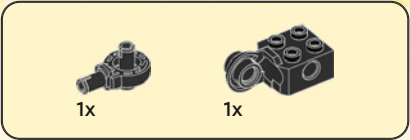
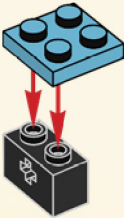

75

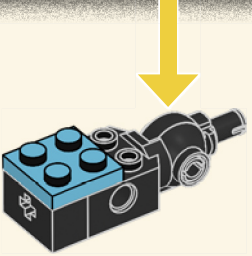
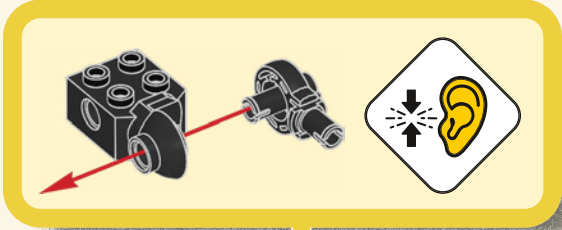



1x



1x

76

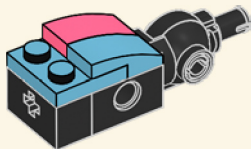

1x

77

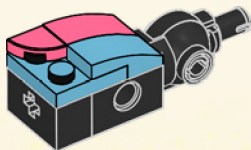

1x

78

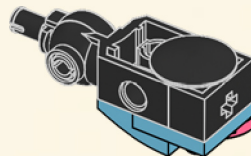



1x

79

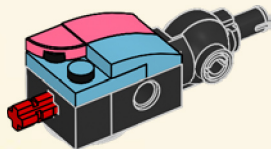

1x

80

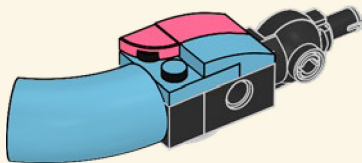

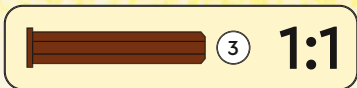
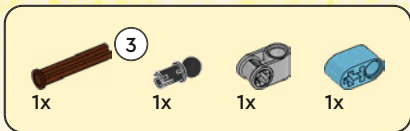

81

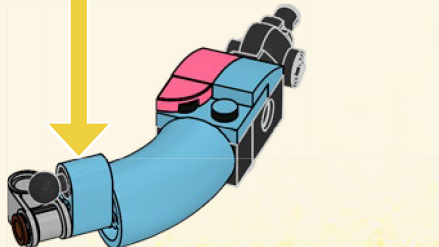
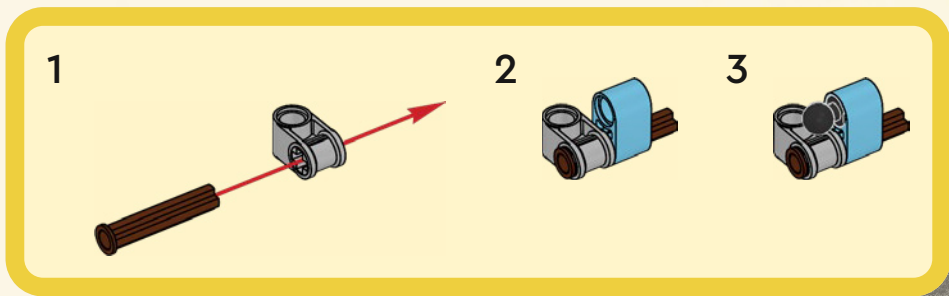

82

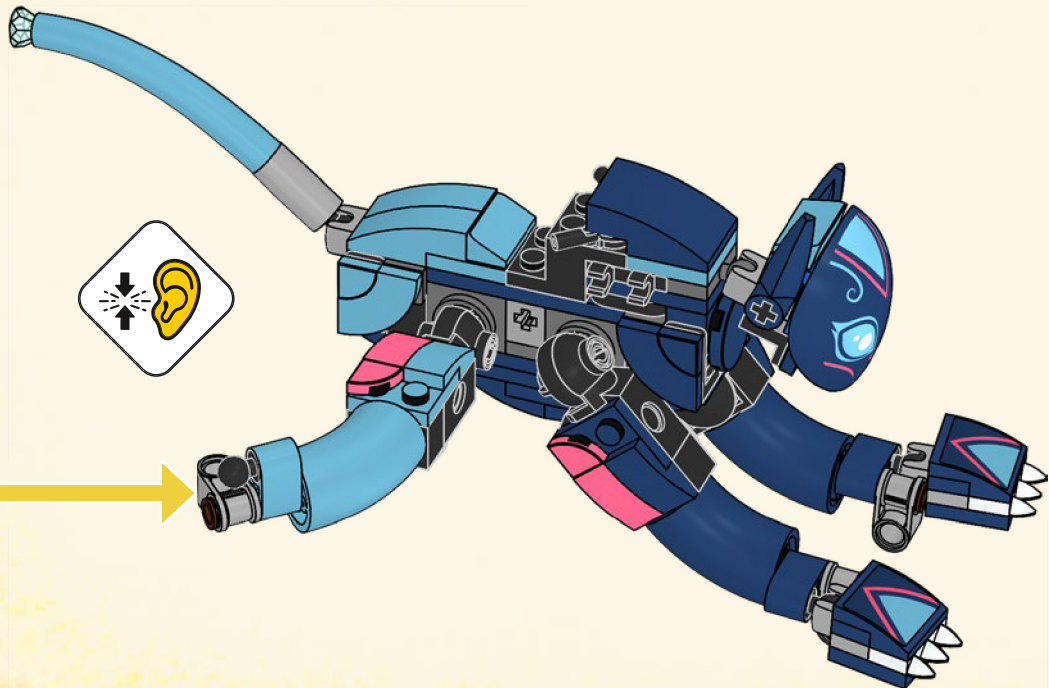

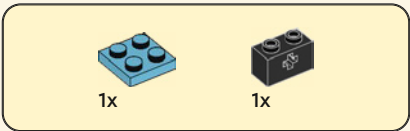
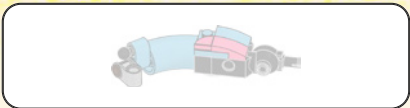

83

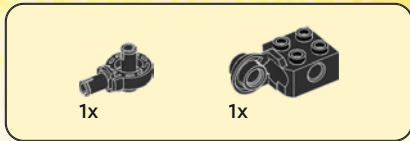
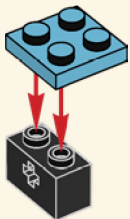

84

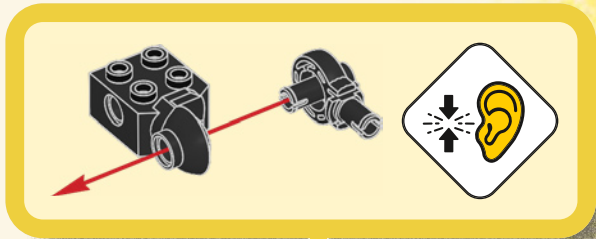



85

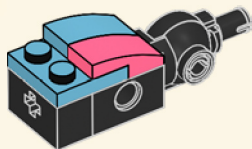

86

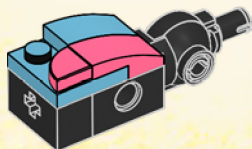

87

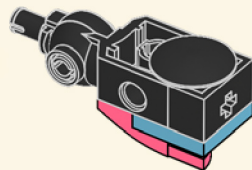





1x

88

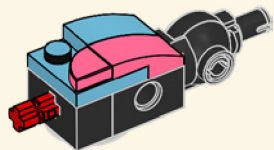

1x

89

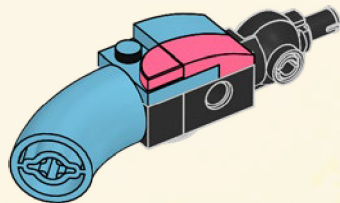

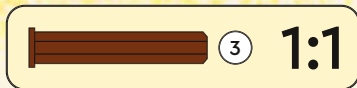
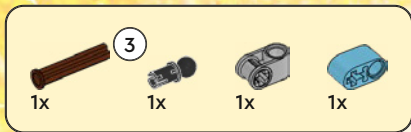

90

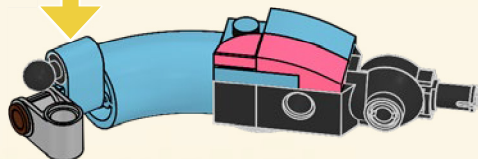
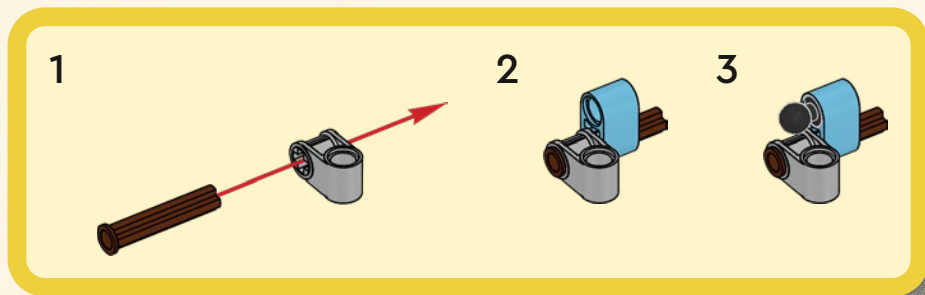

91

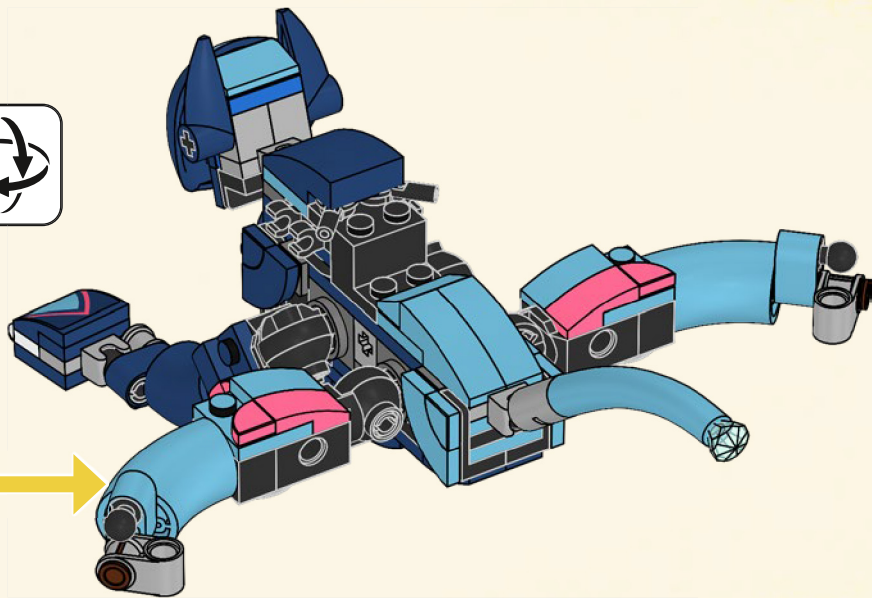

92

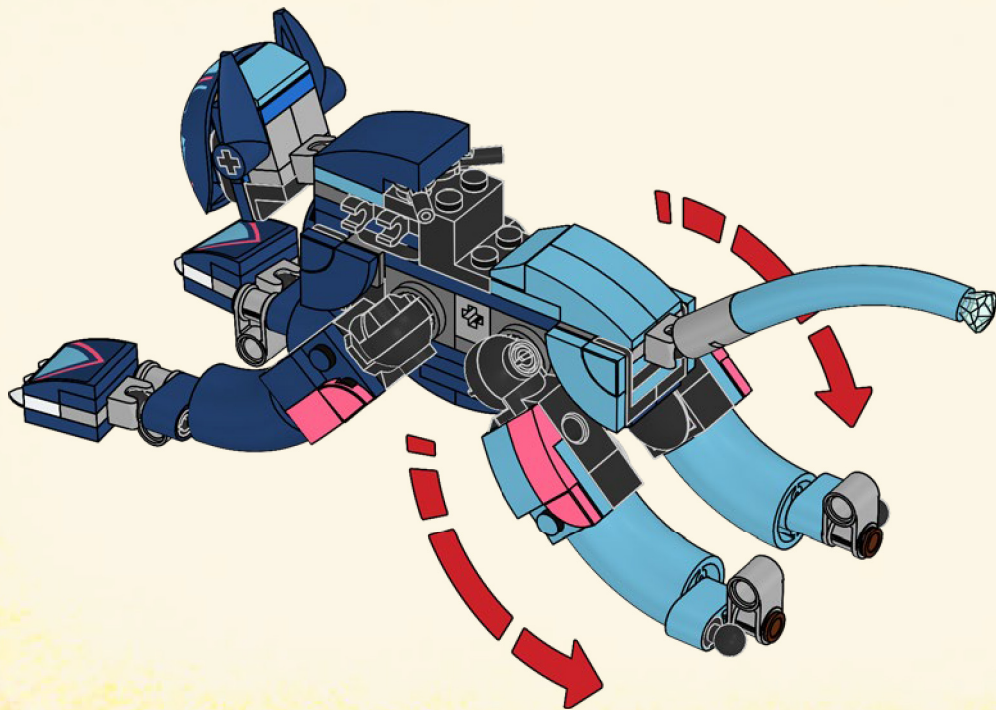



2x



1x



1x

93

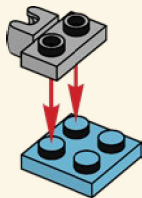

1x

94



1x

95

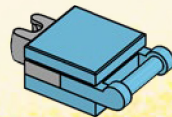

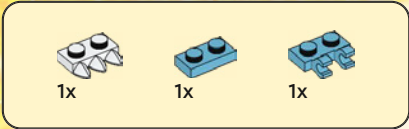

96

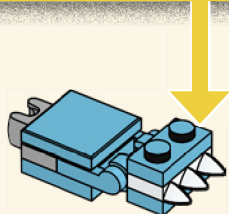
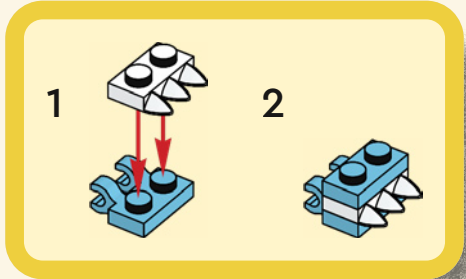

2x

97

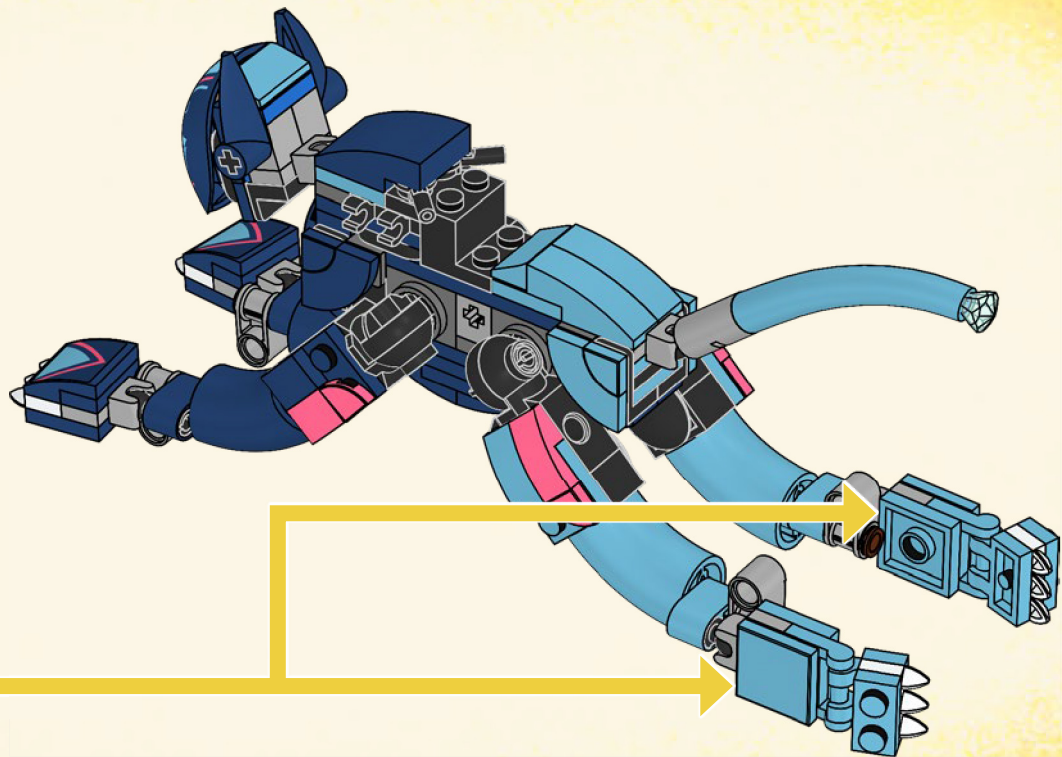



2x

98







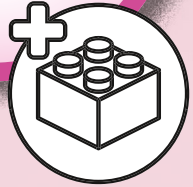
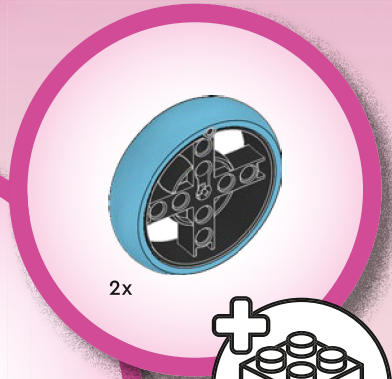



1x



1x

1

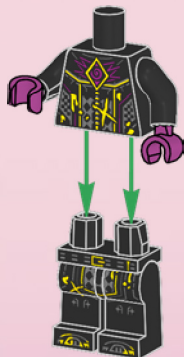

1x



1x



1x

2



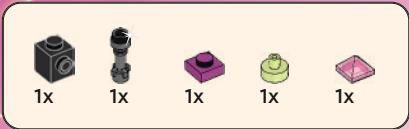

3

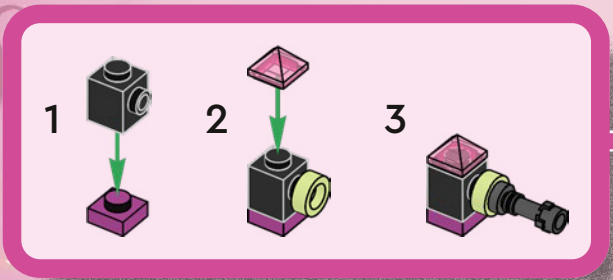





4



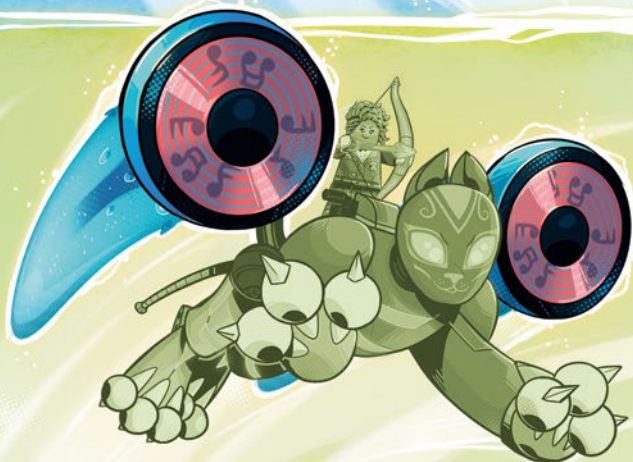



99

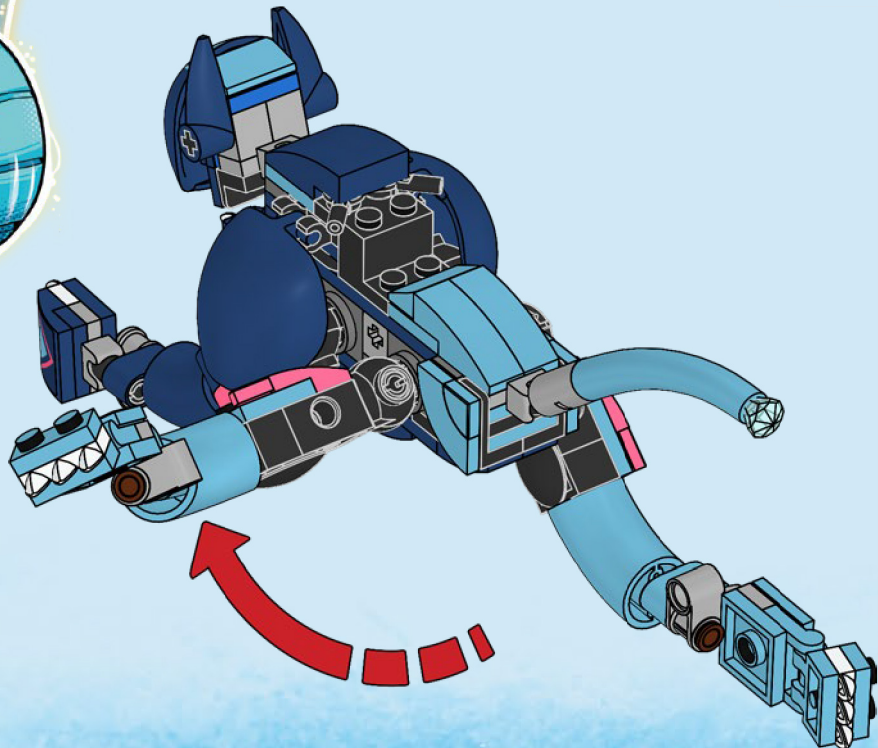



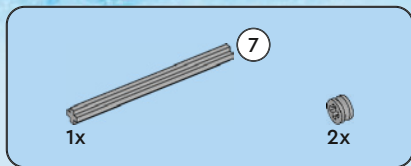

100

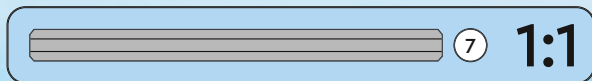
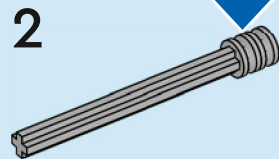
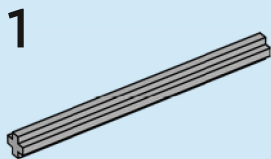

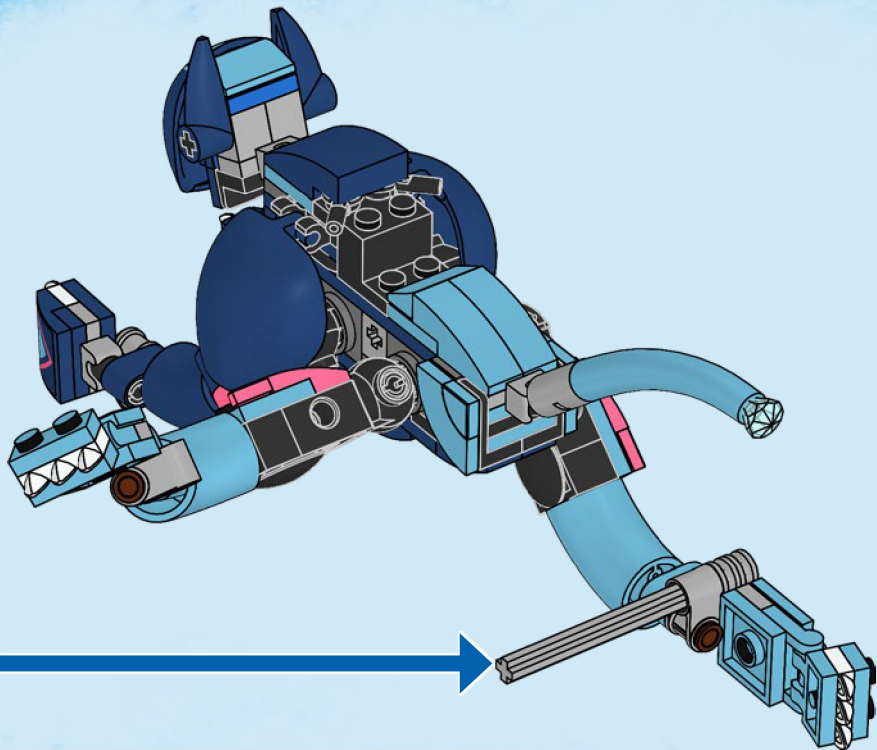



1x

101

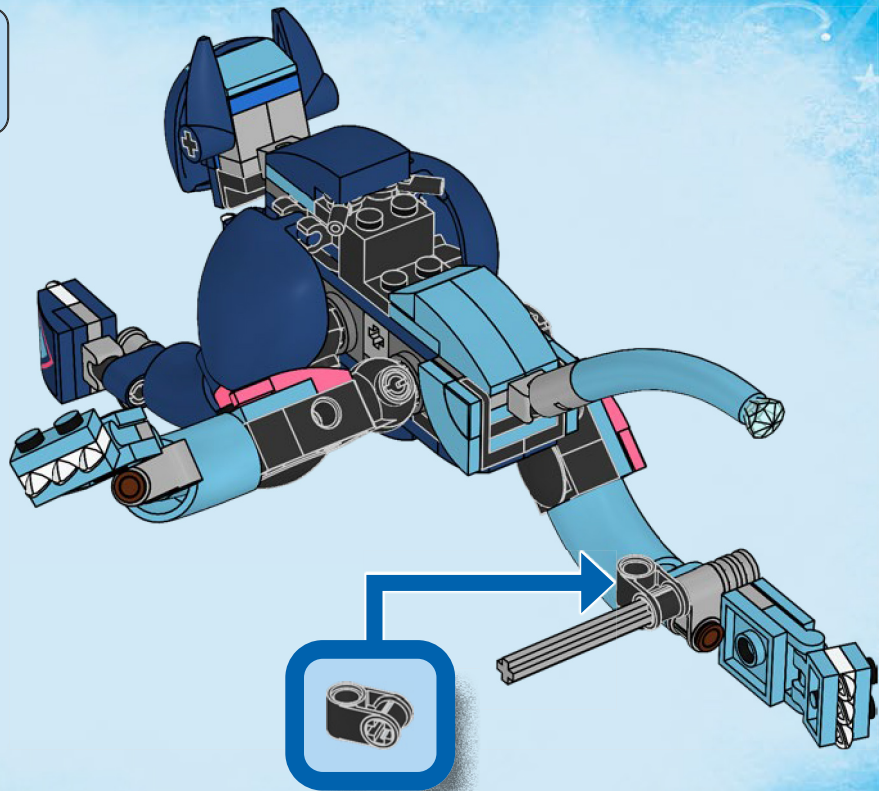

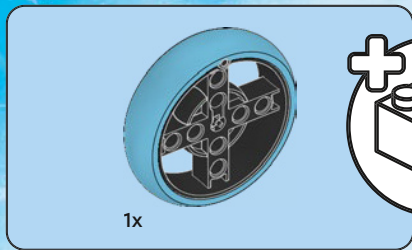

102

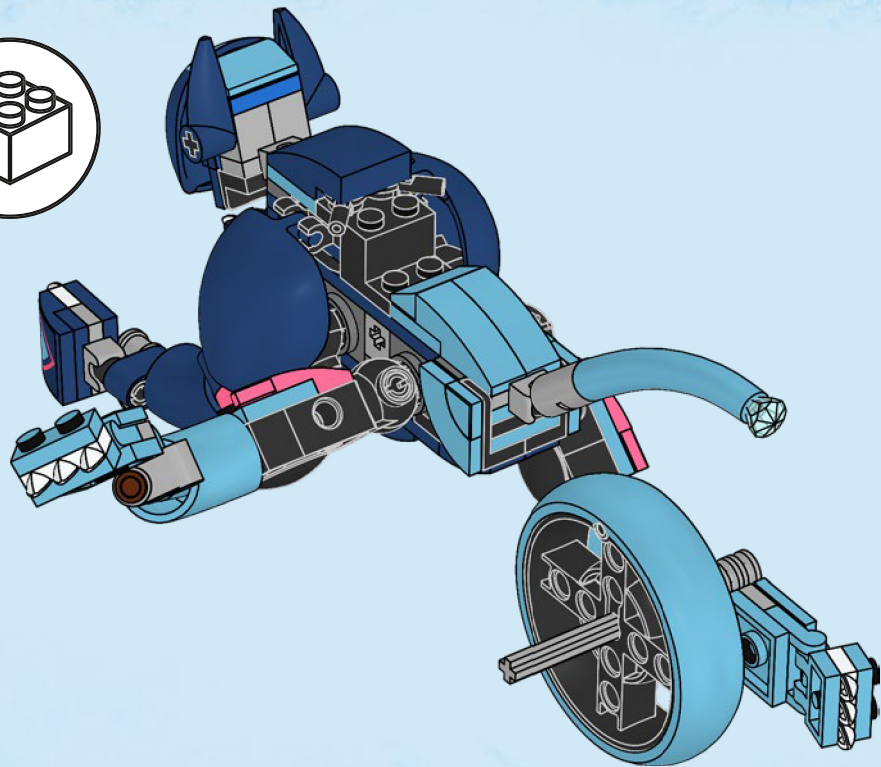



1x

103

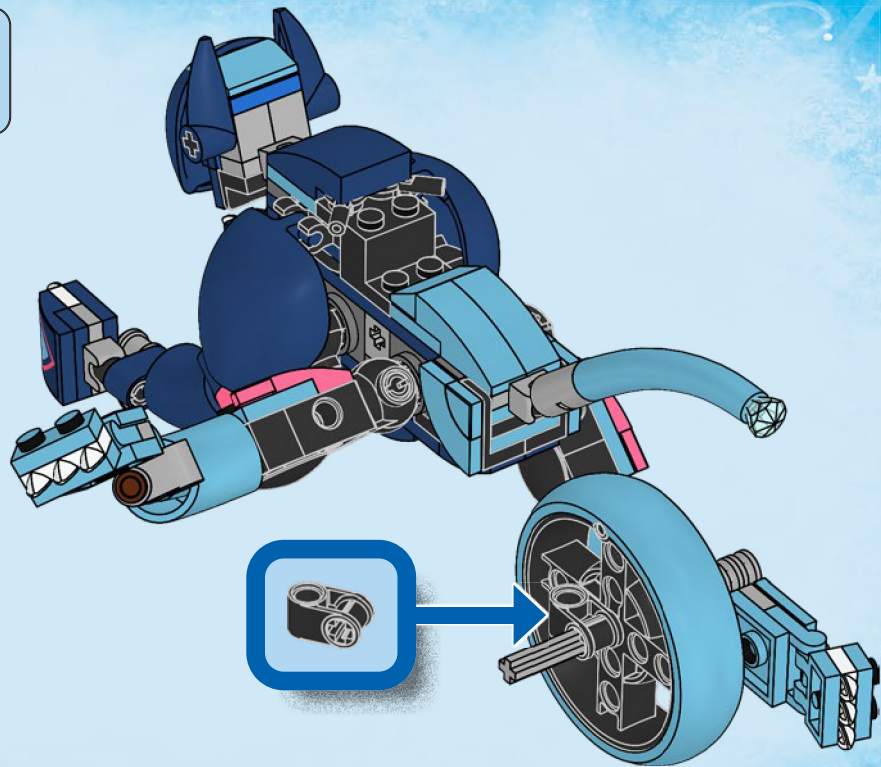

104

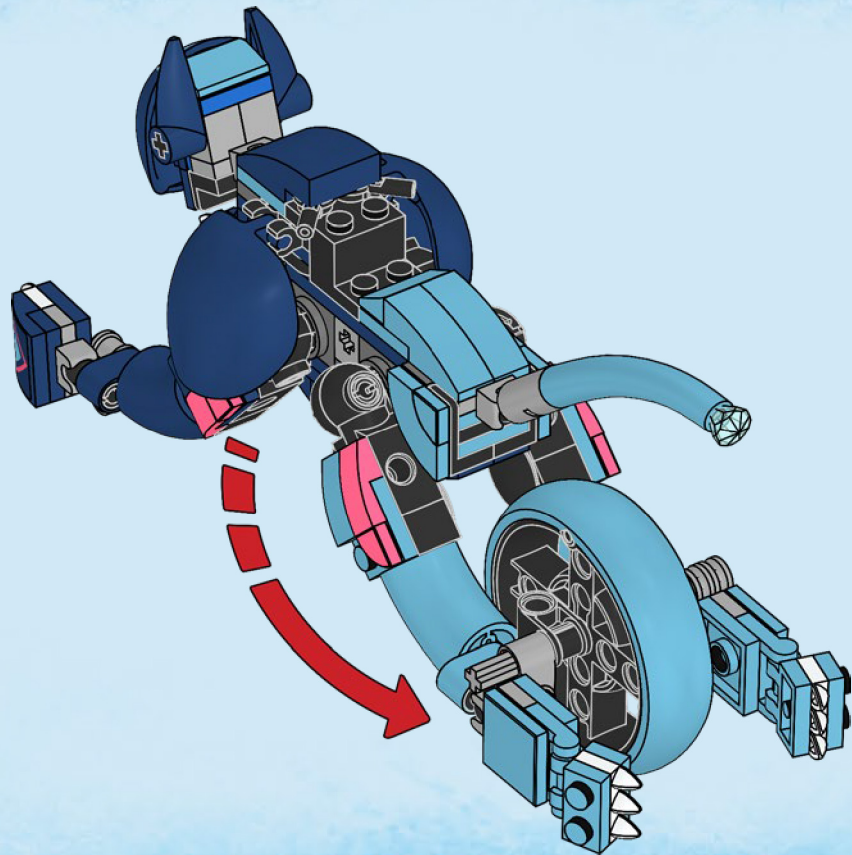



2x

105

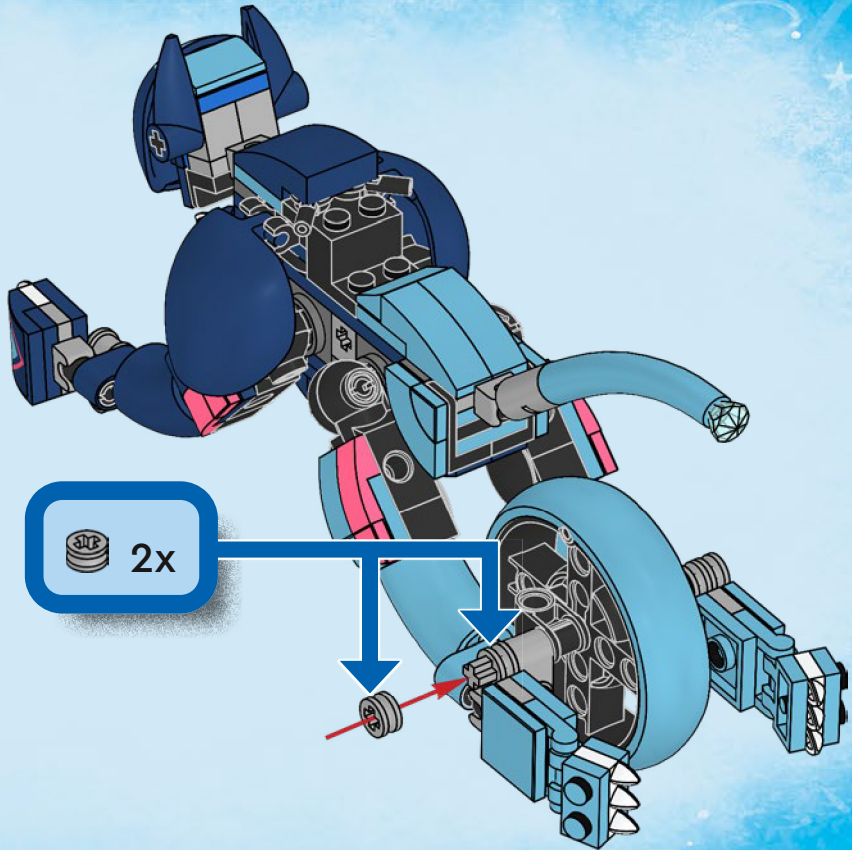

106

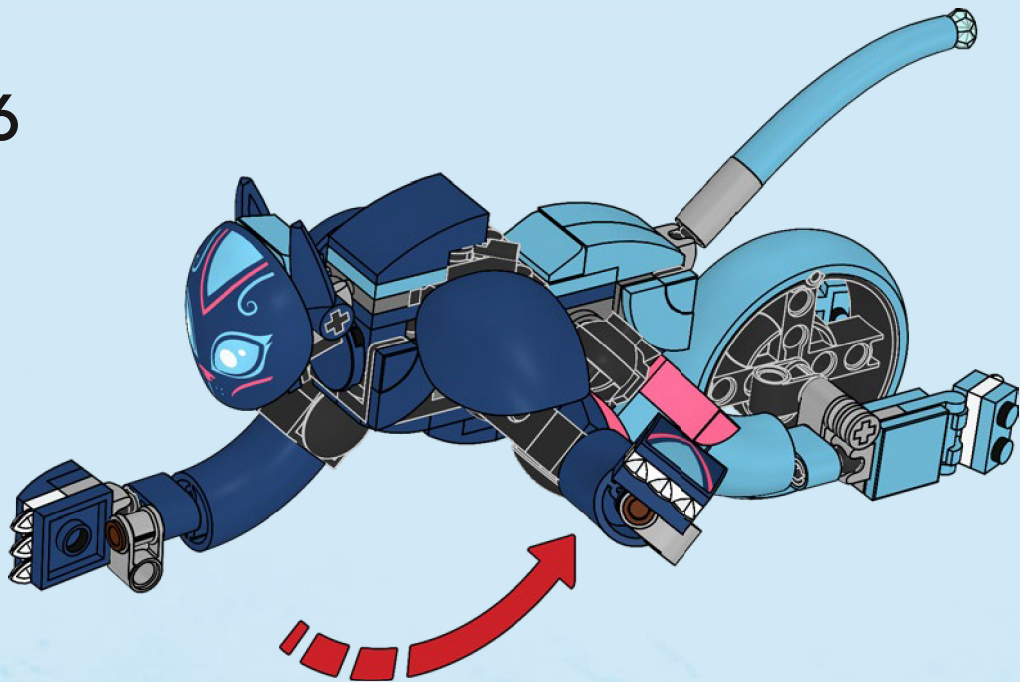



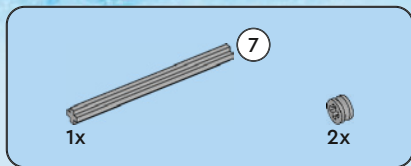

107

1

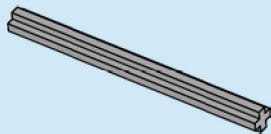

2

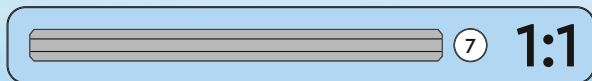
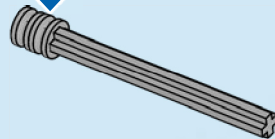
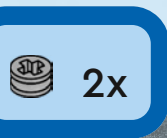

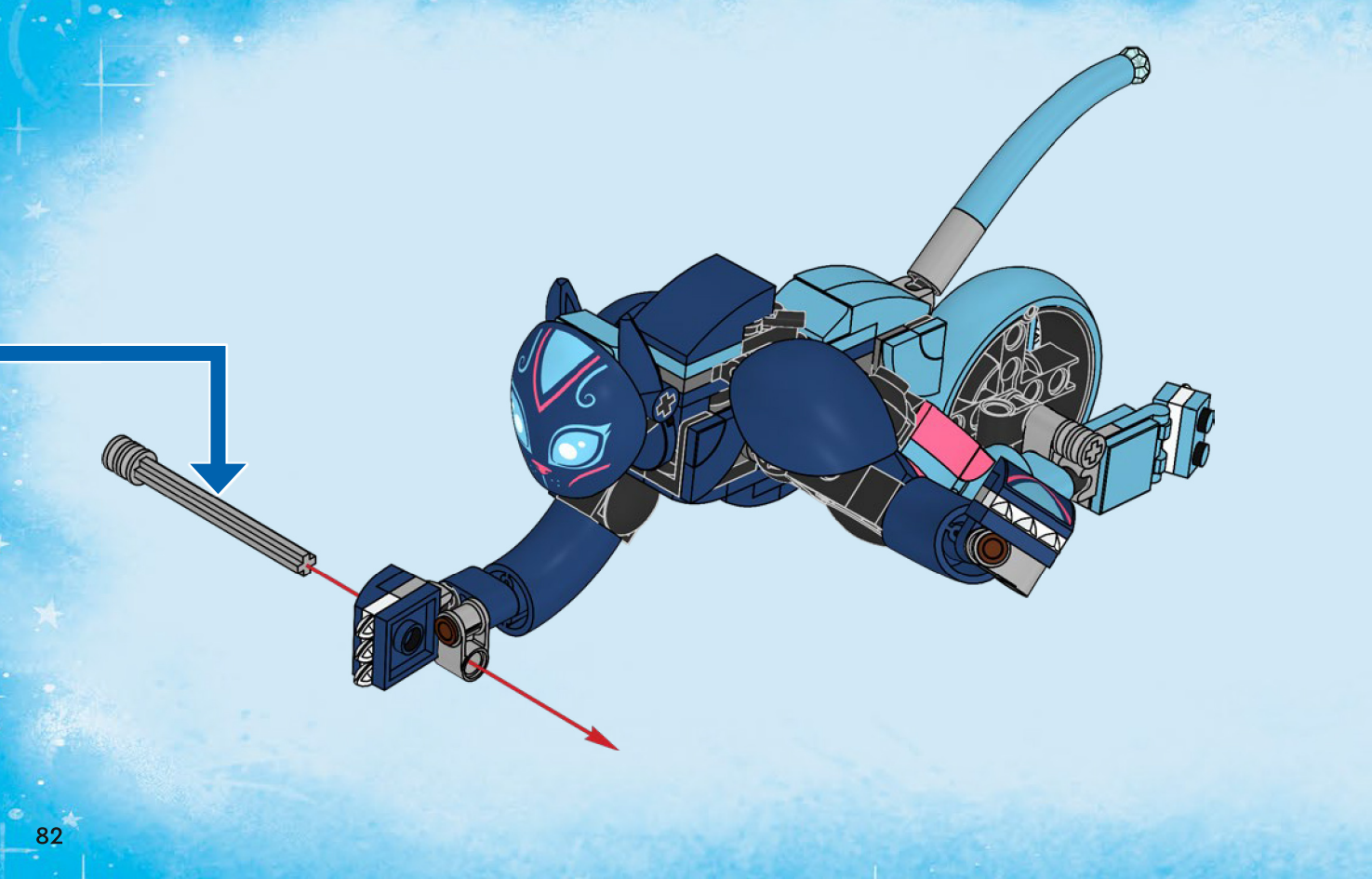



108

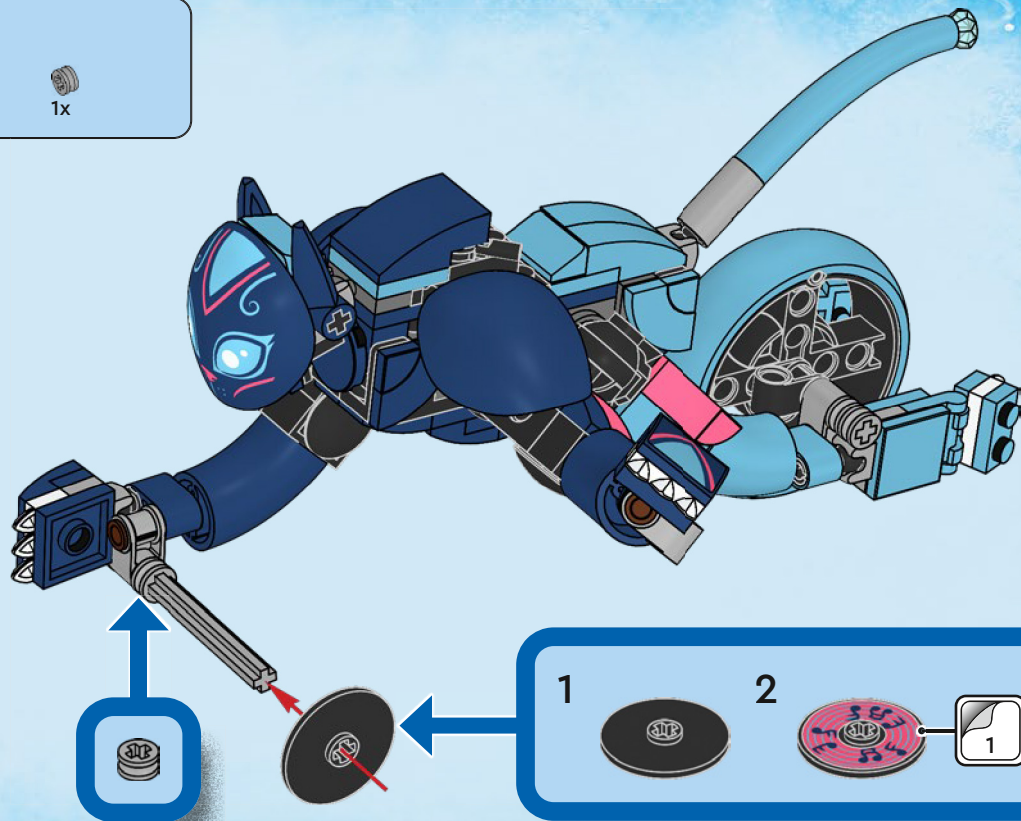

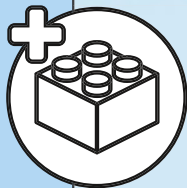
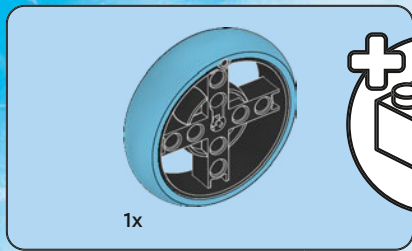

109

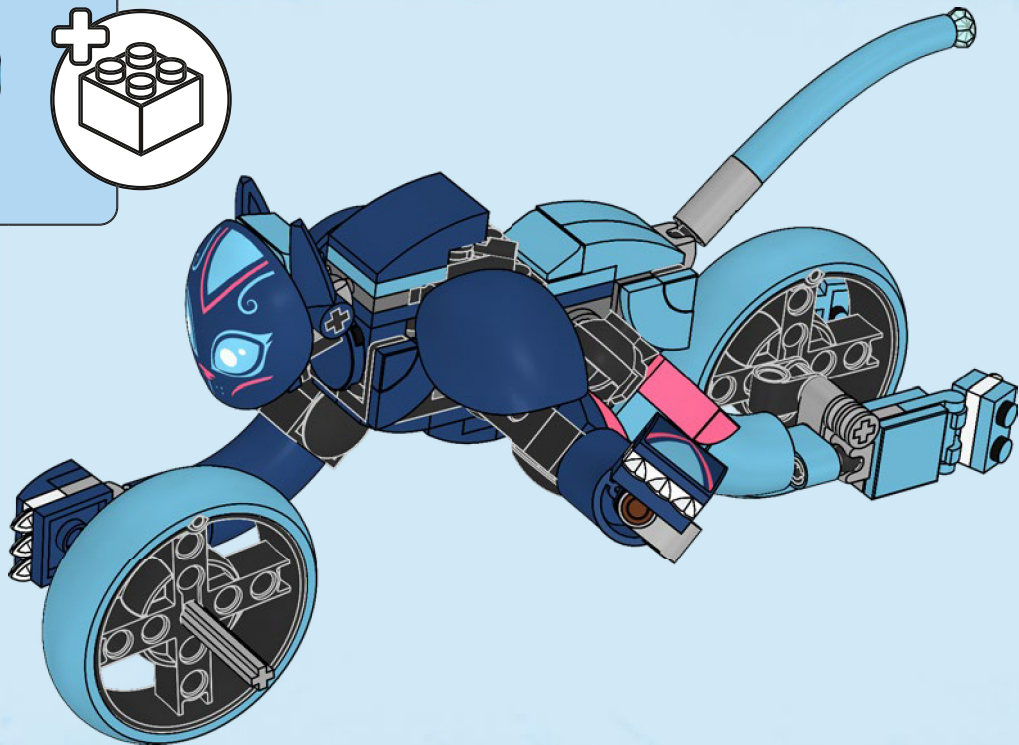

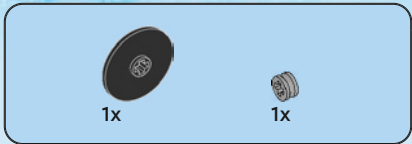

110

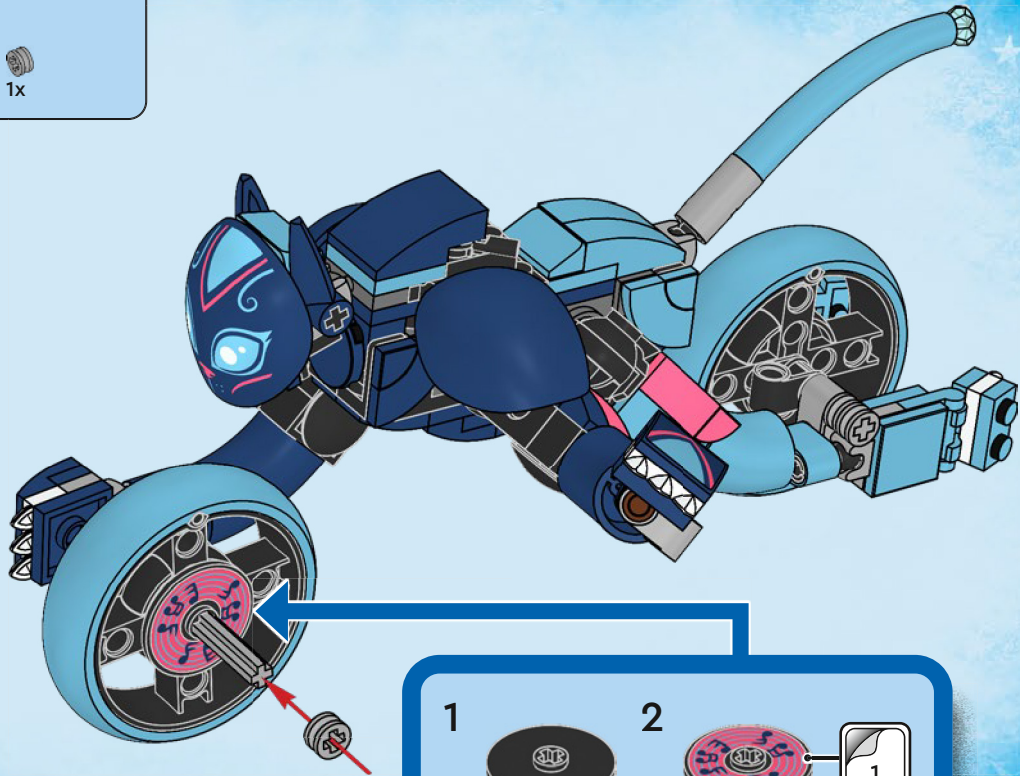

111

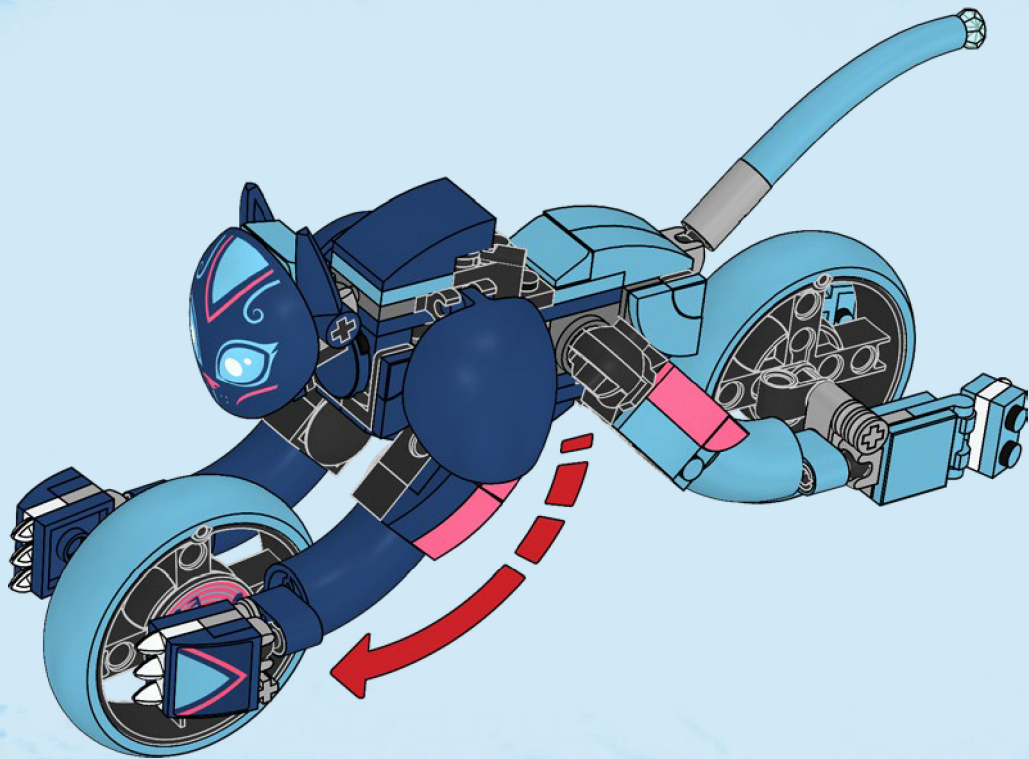



2x

112

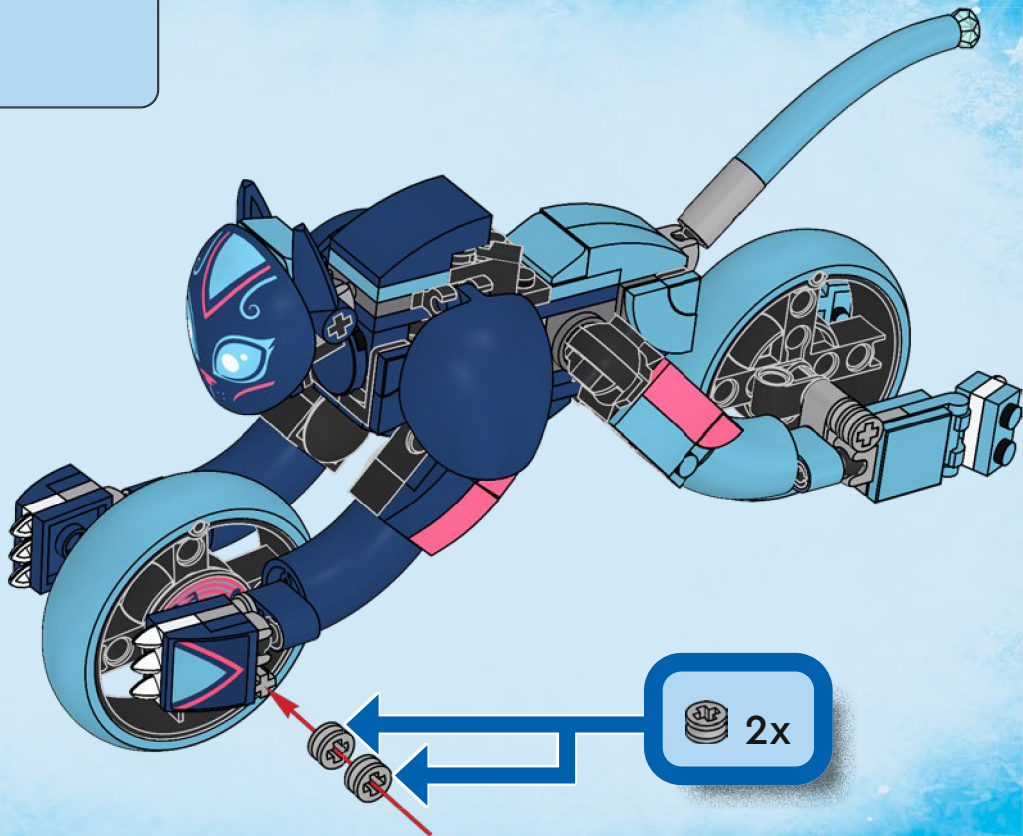

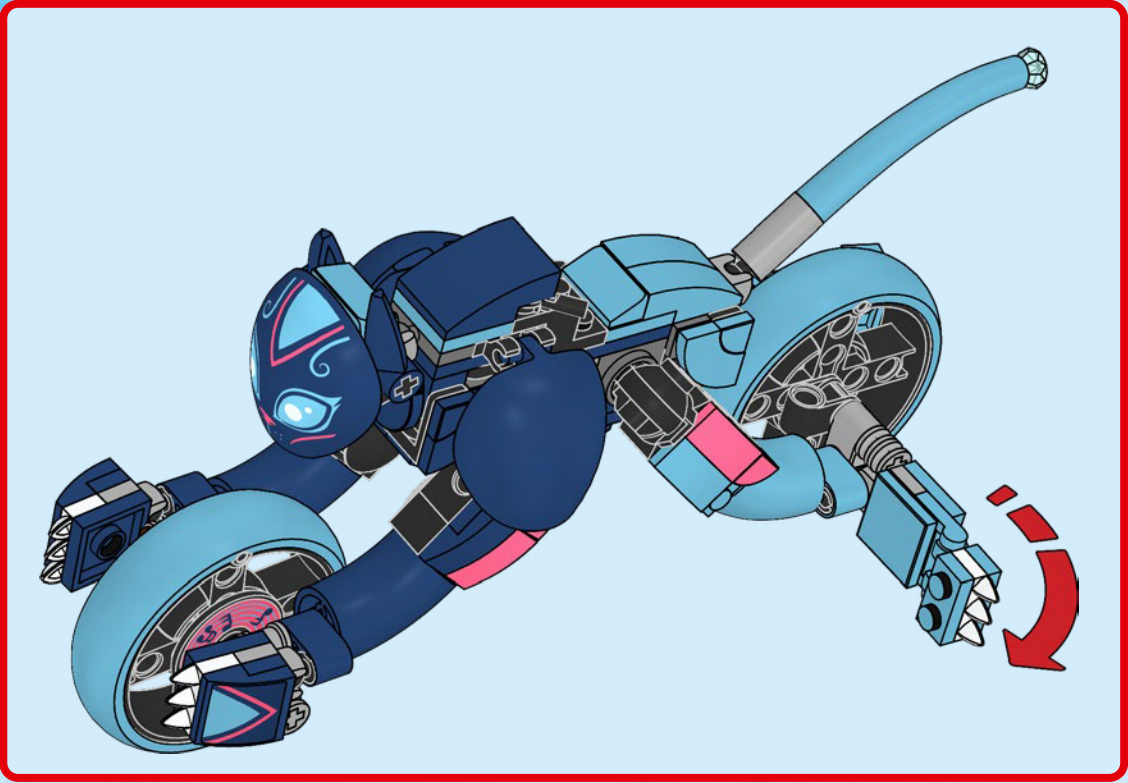



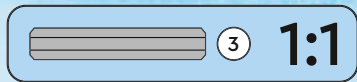
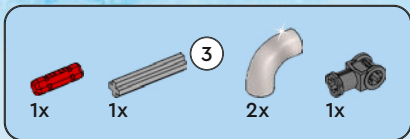

113

1

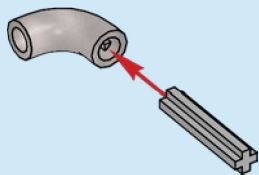

2

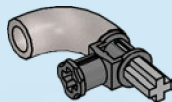

3

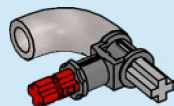

4

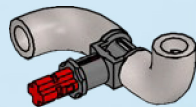

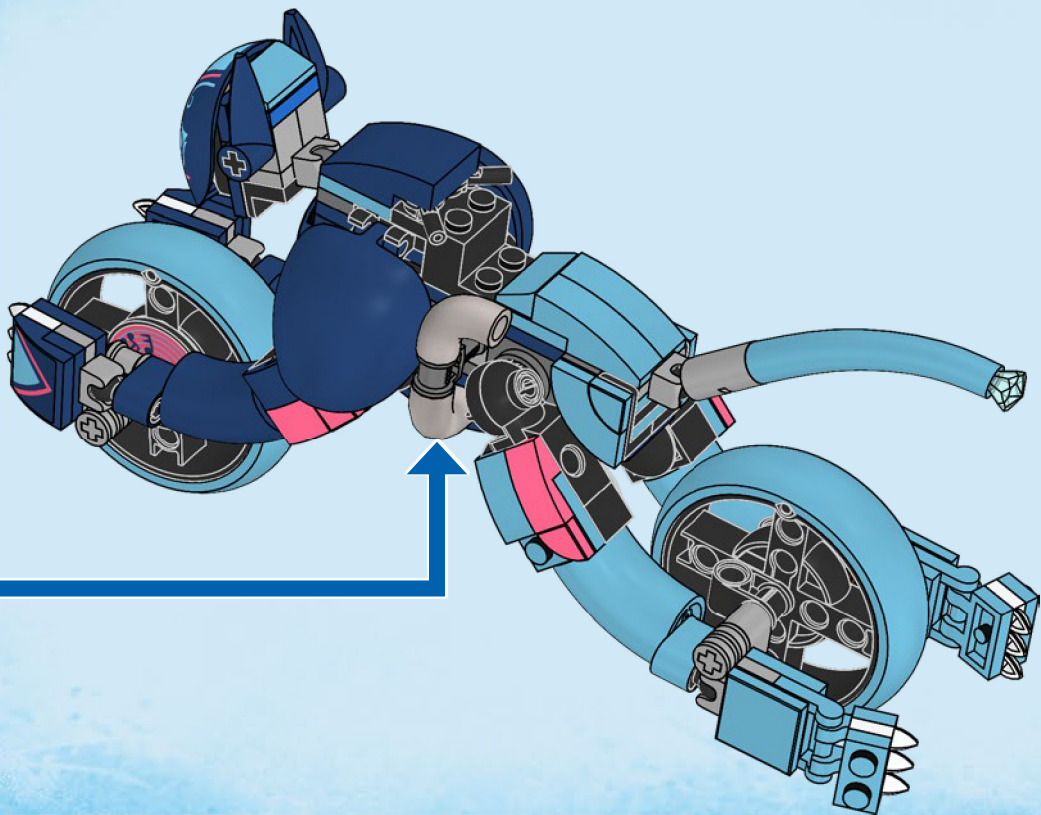

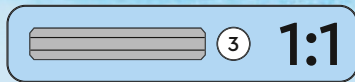
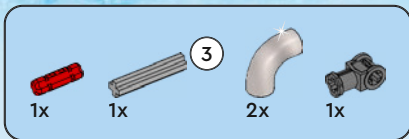

114

1

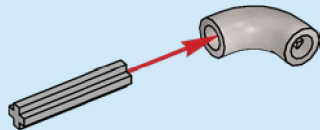

2



3

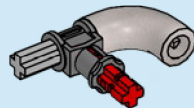

4

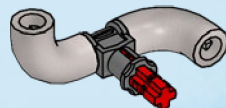

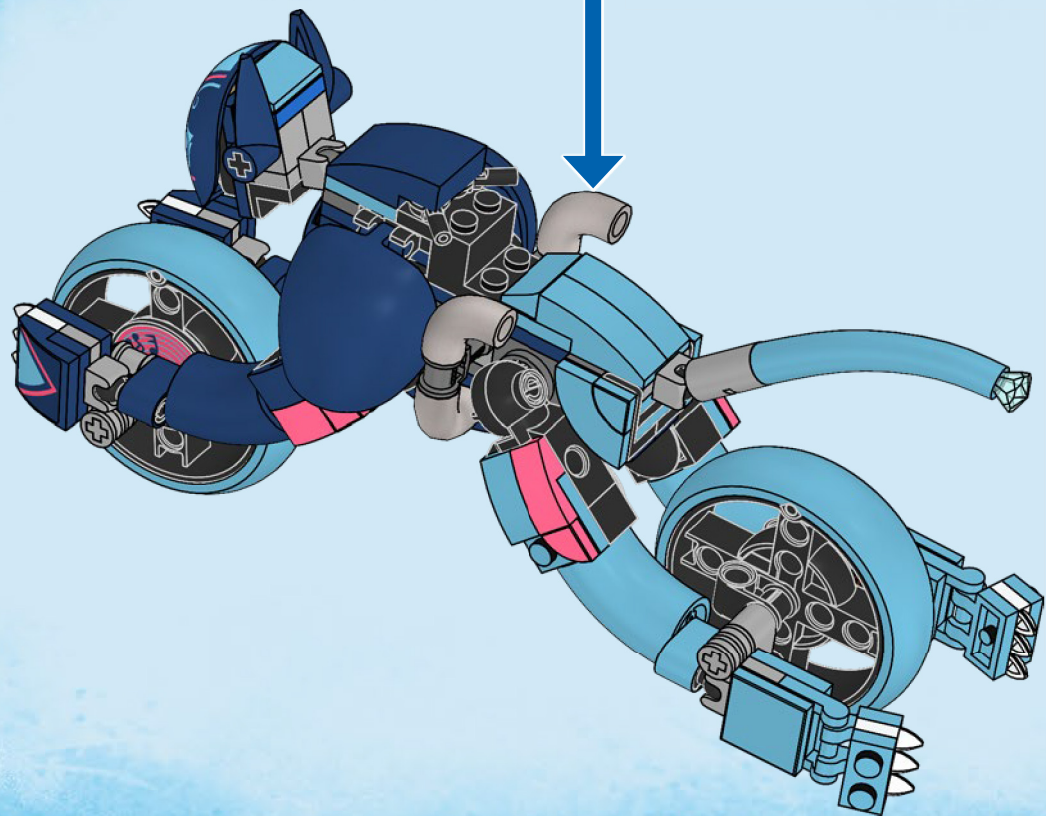

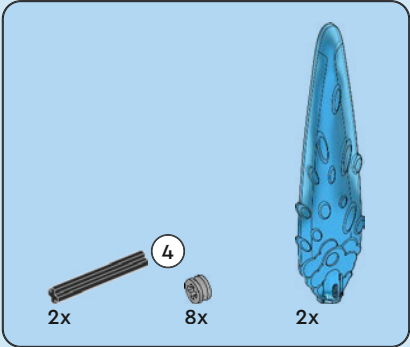
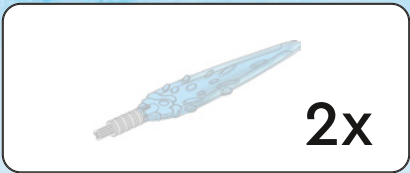

115

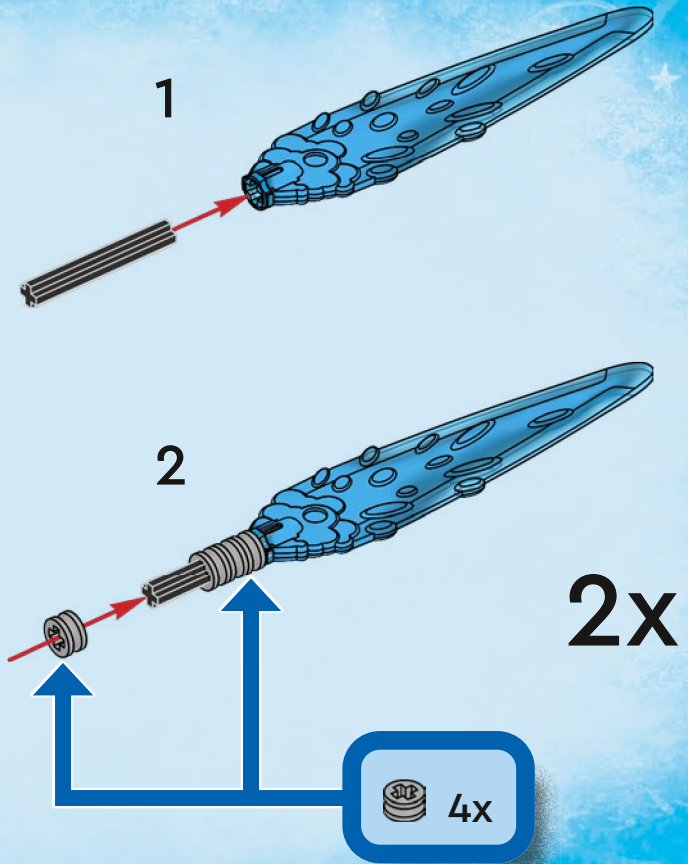
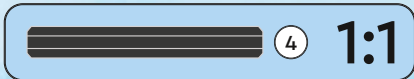

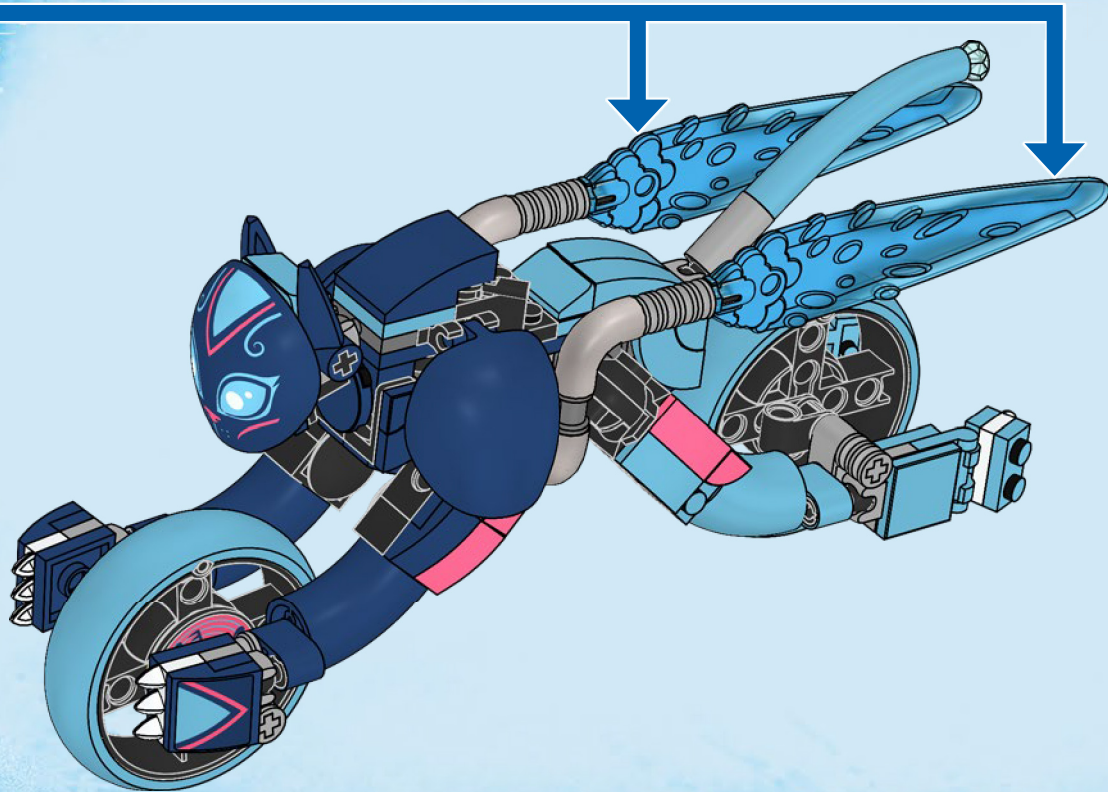



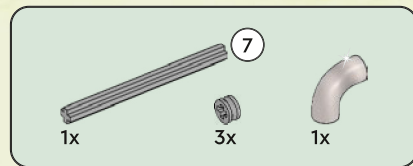

99

1

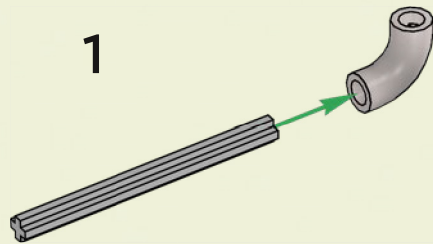

2

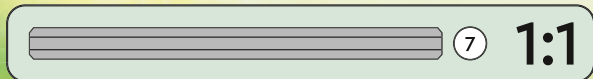
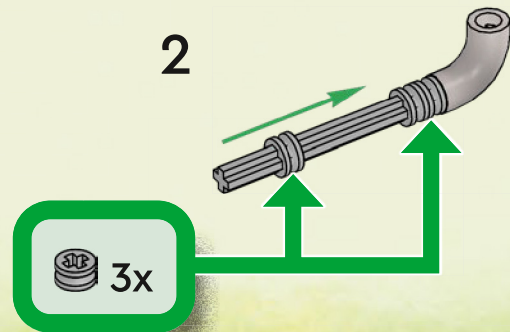



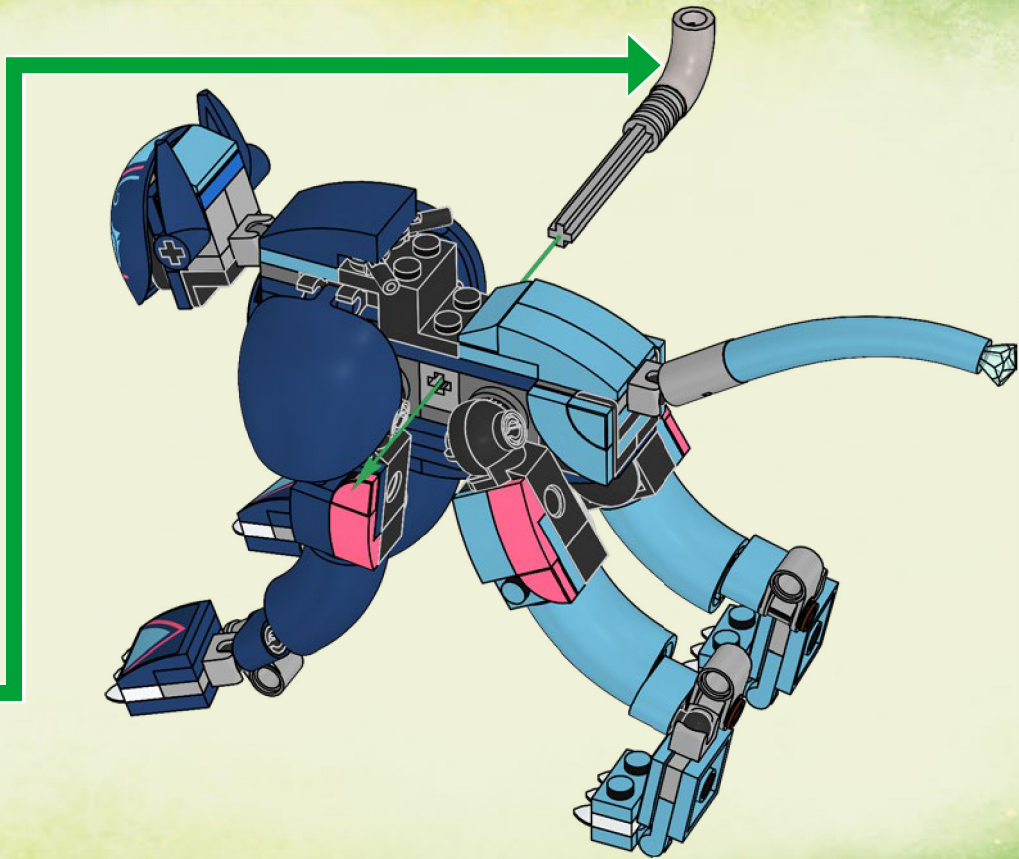



3x

100



3x

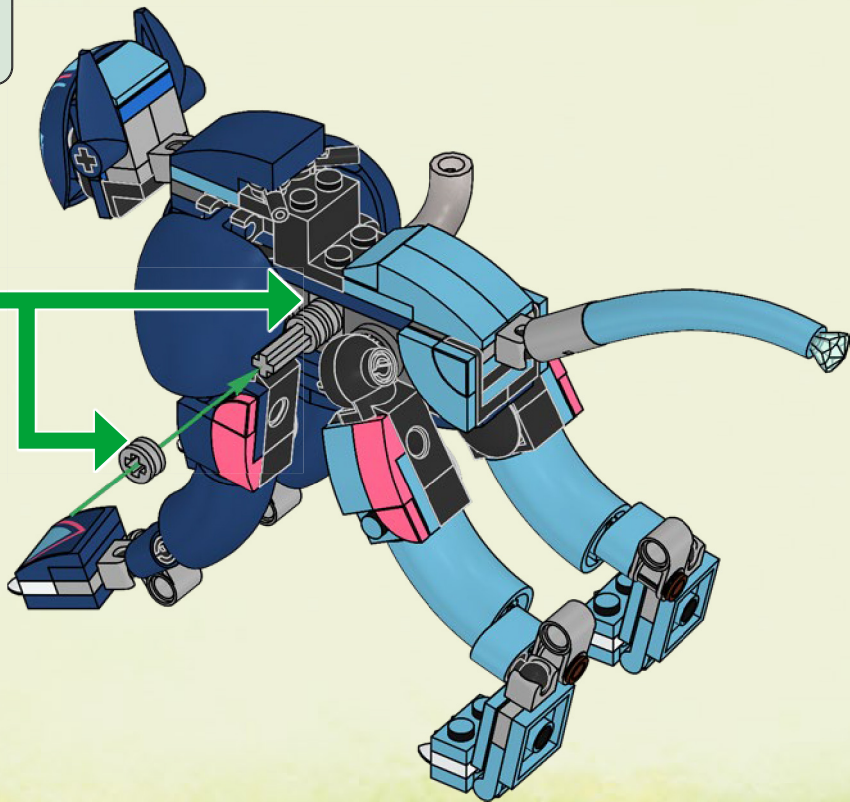



1x

101

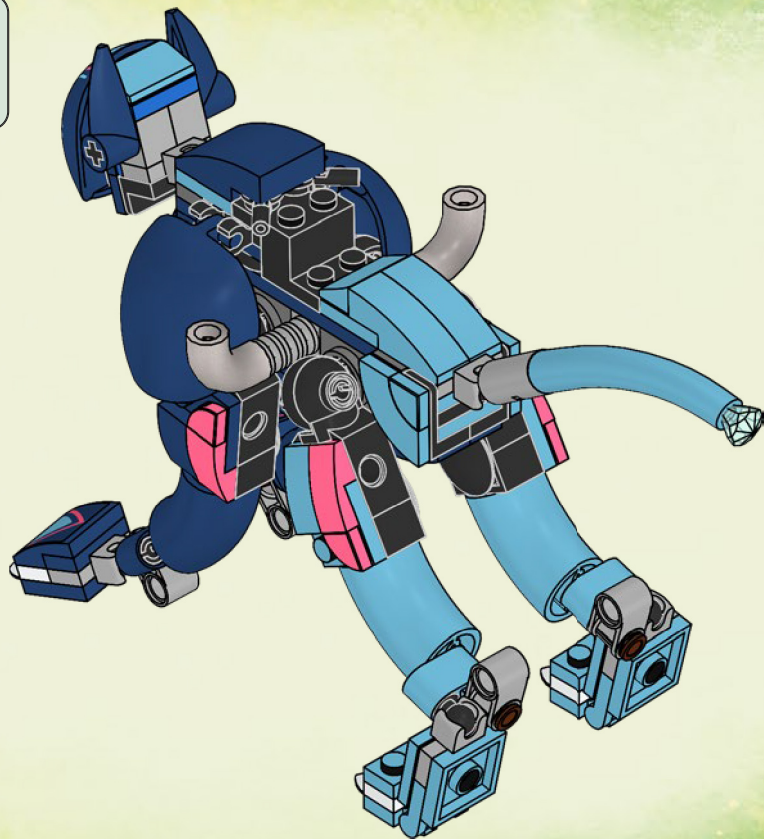



2x



3

1:1



2x



2x

3



4x



2x

102

1

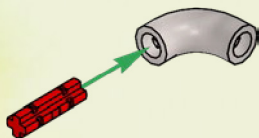

2

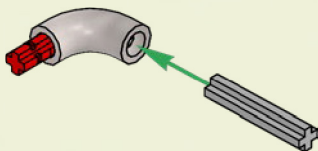

3

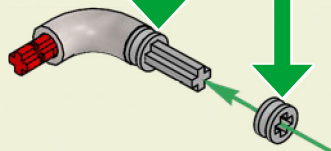

2x

2x

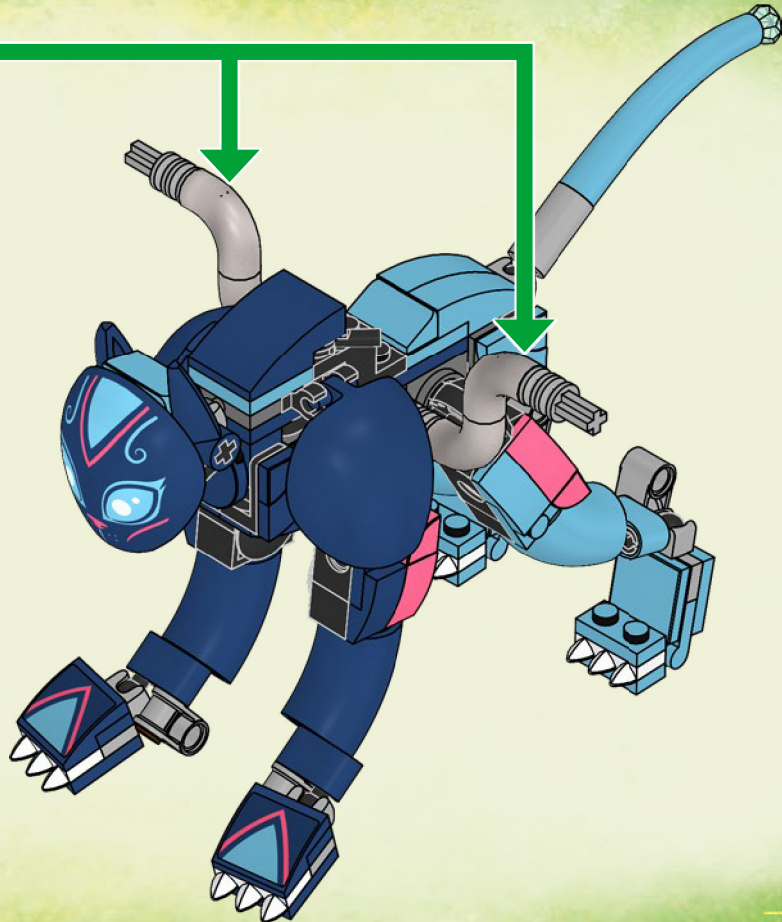



2x

103

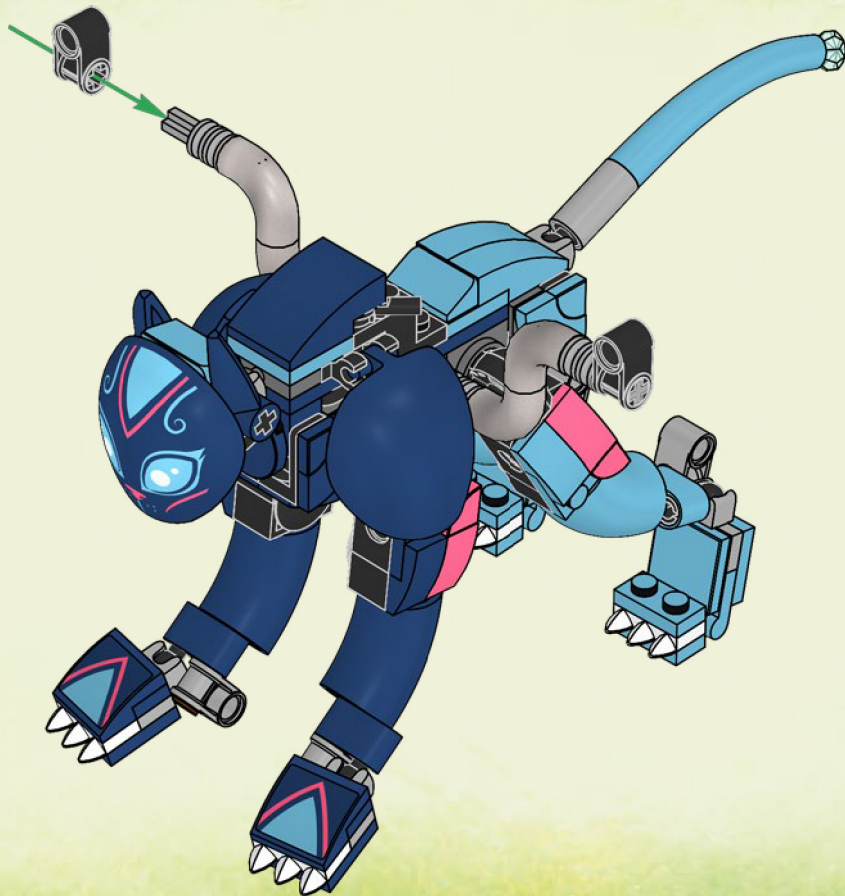

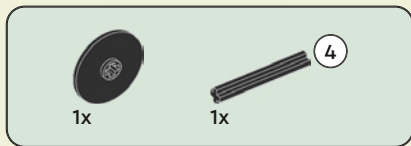

104

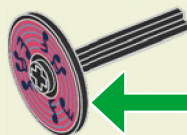

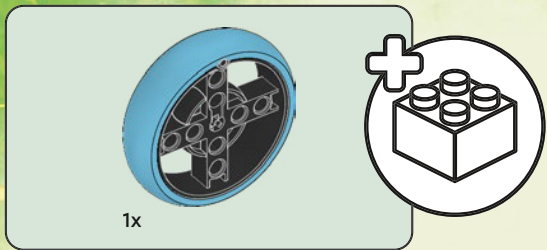

105

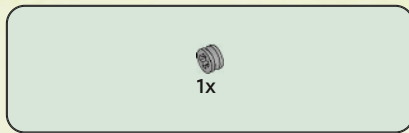
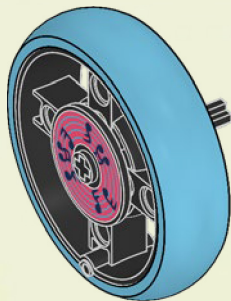

106

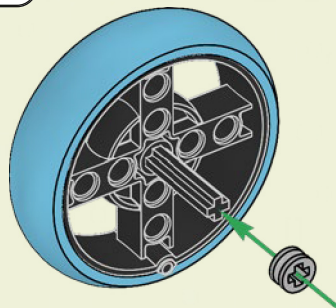

2x



107

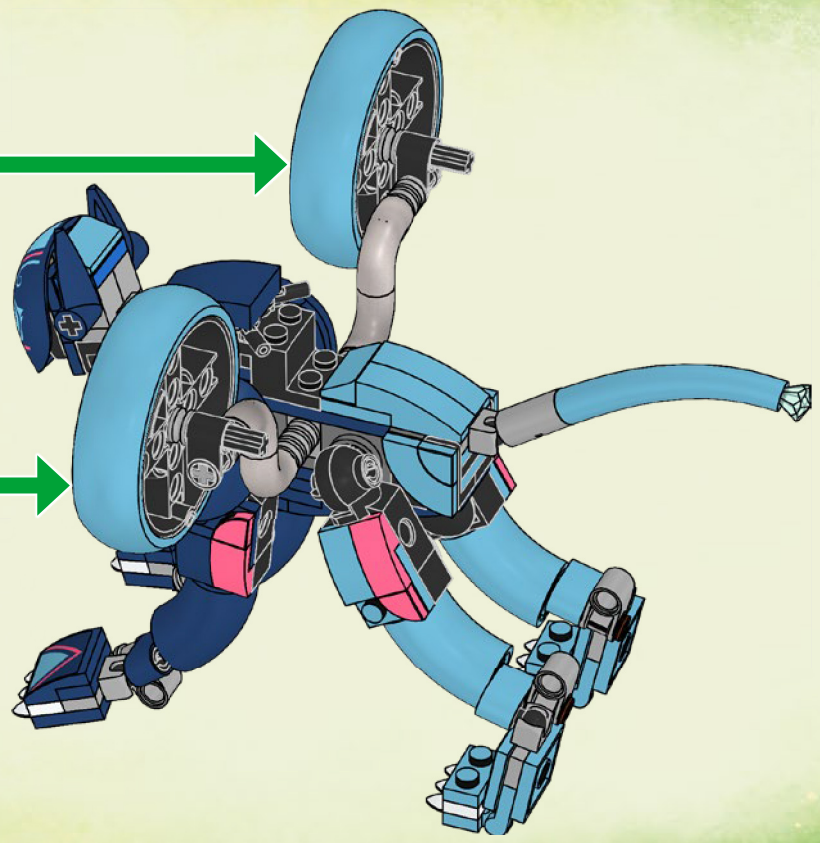



108

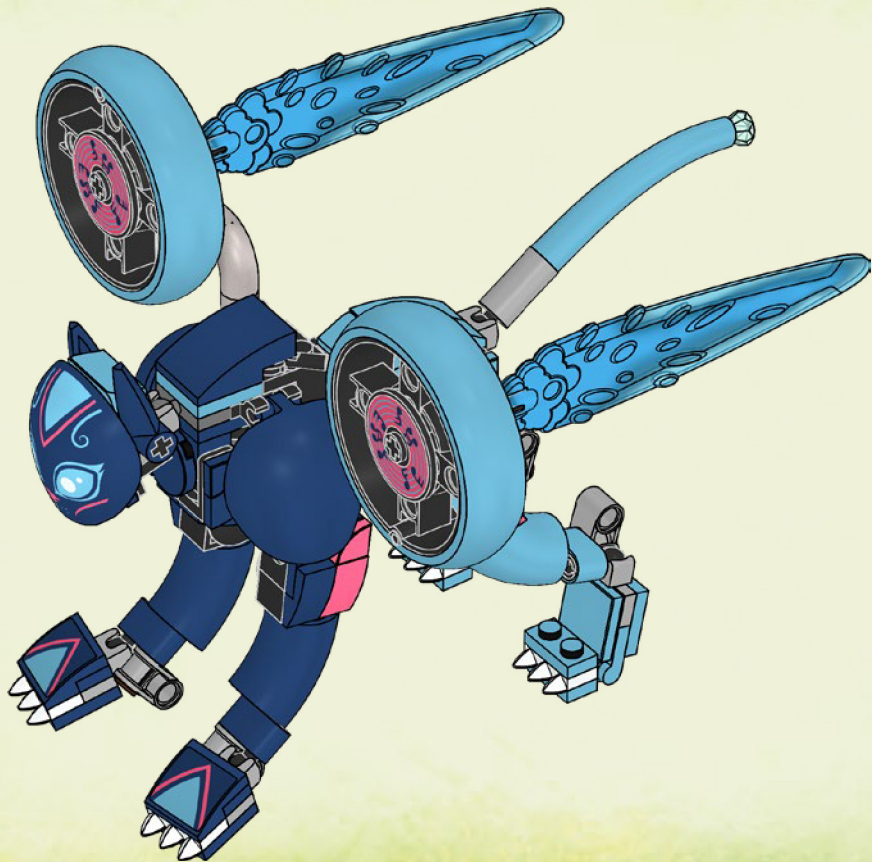



**LEGO**

# DREAMZZZ



71481



71480



71483



71479



71484



71485



71478



# DREAMZZZ



WATCH  
SERIES  
ONLINE 

Watch series online  
Schau dir die Serie online an  
Regarde la série en ligne  
Guarda la serie online

Mira la serie en Internet  
Assistir à série online  
在线观看  
Oglądaj serial w internecie

Sleduj seriál online  
Pozri si seriál online  
Nézd a sorozatot online  
Vizionează serialul online

Гледайте сериала онлайн  
Skaties seriālu tiešsaistē  
Vaata sarja veebist  
Žiūrėk serialą internetu



[LEGO.com/DREAMzzz](https://LEGO.com/DREAMzzz)



1x  
6487030



4x  
6046381



6x  
4142865



1x  
6117968



1x  
6487027



1x  
4558954



4x  
6335317



5x  
6344752



4x  
6210270



2x  
6261371



4x  
4278359



1x  
6487032



4x  
6178922



1x  
6347310



1x  
6016172



2x  
6310268



2x  
4218868



4x  
4213374



2x  
6196548



1x  
6490605



3x  
6395375



3x  
370526



4x  
6302828



1x  
6466880



1x  
6166106



2x  
6417847



1x  
6471922



1x  
6250590



1x  
6508633



1x  
6466858



1x  
6096942



1x  
6490140



1x  
6143445



4x  
6335563



1x  
6523618



18x  
6271165



4x  
6336539



4x  
6261375



1x  
6173127



6x  
6043656



2x  
4211815



2x  
4211805



1x  
6449564



4x  
6135494



1x  
6223506



4x  
6250022



4x  
6258075



1x  
6430879



1x  
6430879



1x  
6430879



2x  
6435597

2x  
6199890

1x  
6299536

2x  
6344867

1x  
6487029

8x  
6236573

1x  
6135606

3x  
6092588

2x  
6094143

2x  
4528981

1x  
6490590

2x  
6199898

2x  
6061569

2x  
6434422

5x  
6037890

2x  
4530028

1x  
6248491

2x  
6510158

1x  
6487033

2x  
6510984

4x  
6384913

1x  
6247792

1x  
6122727

4x  
6413106

2x  
6375679

2x  
4211063

4x  
6398662

1x  
6039479

2x  
6150307

2x  
6097444

2x  
6344813

2x  
6071246

7x  
4625032

2x  
6060857

3x  
6097419

2x  
6337269

2x  
6236582

2x  
6460453

2x  
6258069

2x  
6035598

1x  
6410520

2x  
6510153

 [LEGO.com/service](https://www.LEGO.com/service)



# FEEDBACK & REWARD



Scan this QR code or go to [LEGO.COM/PRODUCTSURVEY](https://LEGO.COM/PRODUCTSURVEY) and share your feedback about this LEGO® set. You will receive a free digital reward at the end of the survey via download link.

**EN: FEEDBACK AND REWARD.** Share your feedback and receive a free digital reward. **DE: FEEDBACK MIT BONUS.** Teile dein Feedback und erhalte einen digitalen Bonus geschenkt. **FR: AVIS ET RÉCOMPENSE.** Donnez votre avis et recevez une récompense numérique gratuite. **IT: DAI LA TUA OPINIONE E VINCI.** Condividi il tuo feedback e ricevi un premio digitale gratuito. **ES: RECOMPENSAMOS TU OPINIÓN.** Comparte tu opinión y recibe una recompensa digital gratis. **PT: DÊ O SEU FEEDBACK E GANHE RECOMPENSAS.** Partilhe o seu feedback e receba uma recompensa digital gratuita. **ZH: 反馈有奖. 分享您的反馈意见, 获取免费数字奖励.** **PL: WYRAŻ OPINIĘ, ODBIERZ NAGRODĘ.** Podziel się swoją opinią i odbierz cyfrową nagrodę zupełnie za darmo. **CS: ODMĚNA ZA ZPĚTNOU VAZBU.** Podělte se o zpětnou vazbu a obdržíte bezplatnou digitální odměnu. **SK: ODMENA ZA SPÄTNÚ VÄZBU.** Podel'te sa o svoj názor a získajte bezplatnú digitálnu odmenu. **HU: VISSZAJELZÉS ÉS JUTALOM.** Oszd meg véleményed az ingyenes digitális jutalomért! **RO: FEEDBACK ȘI RECOMPENSĂ.** Trimite feedback și primește o recompensă digitală gratuită. **BG: ОТЗИВИ И НАГРАДИ.** Споделете вашите отзиви и получите безплатна дигитална награда. **LV: ATSAUKSMES UN BĀLVAS.** Sniedz savu atsaukumi un saņem bezmaksas digitālo balvu. **ET: TAGASISIDE JA PREEMIA.** Jaga oma tagasisidet ja saad kingituseks digitaalse preemia. **LT: ATSLIEPIMAI IR ATLYGIS.** Bendrinkite savo atsiliepimą ir gaukite nemokamą skaitmeninį atlygį.

LEGO, the LEGO logo and DREAMZzz are trademarks of the LEGO Group.  
©2024 The LEGO Group.

6546665