

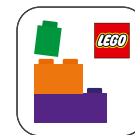

10337



Booklet available in English  
Heft in deutscher Sprache erhältlich  
Livret disponible en français  
Libretto disponibile in italiano  
Folleto disponible en español  
如需中文版手册



LEGO® Builder





[LEGO.com/sustainable-packaging](https://LEGO.com/sustainable-packaging)



FR  
**DONNEZ  
OU  
RECYCLEZ**



ASSOCIATION

OU



MAGASIN

OU



DÉCHÈTERIE

Adresses sur [quefairedemesdechets.fr](https://quefairedemesdechets.fr)





# BUILDER



Apple and the Apple logo are trademarks of Apple Inc., registered in the U.S. and other countries and regions. App Store is a service mark of Apple Inc. Google Play and the Google Play logo are trademarks of Google LLC. Tencent and the Tencent logo are trademarks of Tencent Inc.

LEGO.com/devicecheck



LEGO® Builder

LAMBORGHINI





# Perfect proportions



If you were a teenager in the 1980s, chances are you would recognise the silhouette of the Lamborghini Countach from a mile away. You might even still have a poster of it stashed away somewhere (or proudly on display). With a history spanning more than 50 years, from the first LP500 prototype revealed in 1971 to today, everything about the Countach is disruptive. The strikingly low silhouette, with sharp angles and scissor doors, and the exuberant roar of the V-12 engine cemented the Countach as a literal poster child of the 1980s and well into the 1990s and defined the super sports car genre of its time. Its groundbreaking, futuristic design fed right into the zeitgeist and pop culture, and, like a classic work of art, its appeal is timeless. Its story, shape and bright colours made it an indisputable candidate for the LEGO® Icons medium.

# The evolution of Lamborghini Countach

Over the decades, the Lamborghini Countach evolved with innovative technology and styles. This LEGO® model is inspired by the Lamborghini Countach 5000 Quattrovalvole (1985-1988), with nods to its distinguished predecessors.



## 1971 LP500

*The prototype revealed at the Geneva Motor Show became the foundation for all future editions.*



## 1973 COUNTACH LP400

*Modified based on learnings from the prototype, the LP400 was the first Countach production model.*



## 1978 COUNTACH LP400 S

*The updated exterior design included new wheel arch extensions and an optional V-shaped rear wing.*





### **1983** COUNTACH LP500 S

*While the exterior design remained largely unchanged, the interior was revamped, and a more powerful engine enhanced performance.*



### **1985** COUNTACH 5000 QUATTROVALVOLE

*The best-selling Lamborghini Countach in both the US and Europe and a coveted gem for super sports car enthusiasts.*



### **2021** COUNTACH LPI 800-4

*A hybrid-electric limited edition released for the Countach 50<sup>th</sup> anniversary.*







## From the LEGO® Design Team

"This magical aura around the Lamborghini Countach still persists among car enthusiasts today, making it a perfect match for a LEGO® model. While straight lines seem like a natural form for LEGO elements, shallow angles are some of the most challenging shaping tasks to accomplish with our building system. We developed several new elements and advanced building techniques for this model, including the iconic deep-dished rims and wheel arches to recreate the characteristic subtle angles, shapes and proportions of this futuristic Italian design. It was an exhilarating ride working with Automobili Lamborghini S.p.A. to bring this model to life in LEGO form, complete with working steering and opening doors and bonnet."

**SVEN FRANIC,**  
*LEGO® Senior Model Designer*

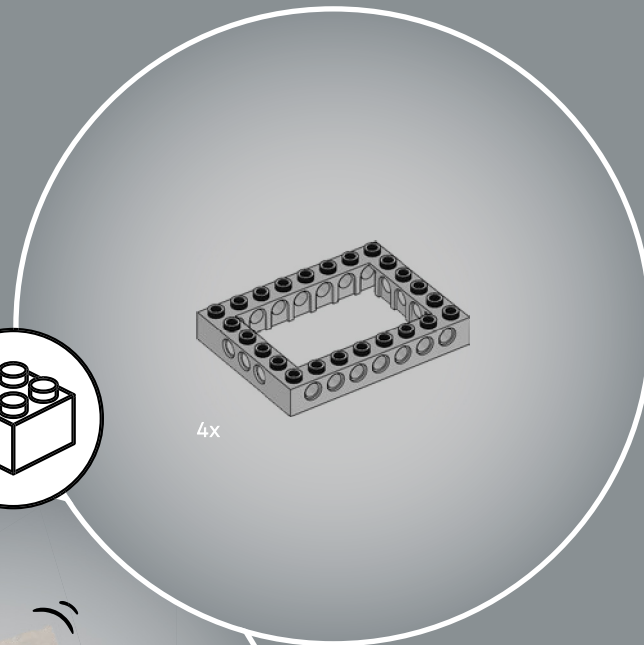
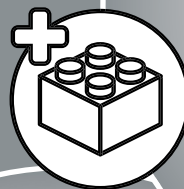
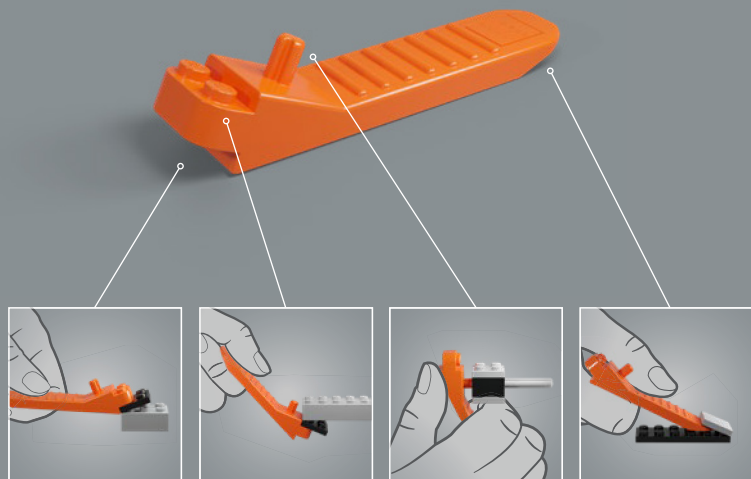



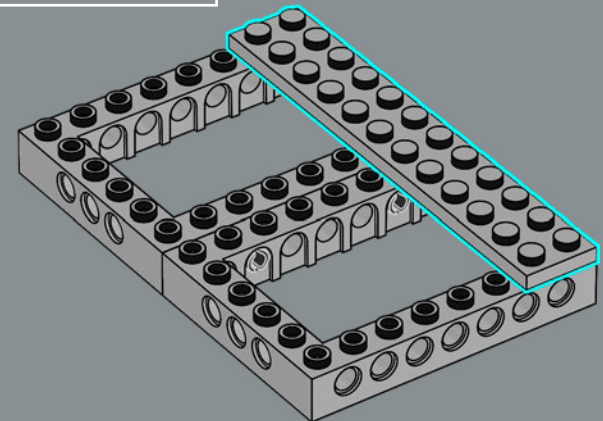
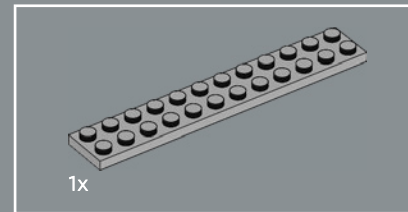
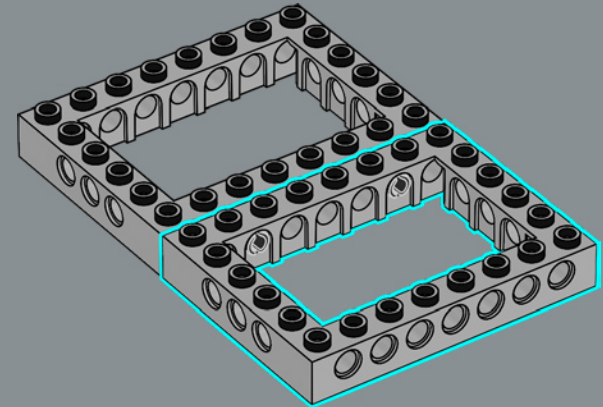
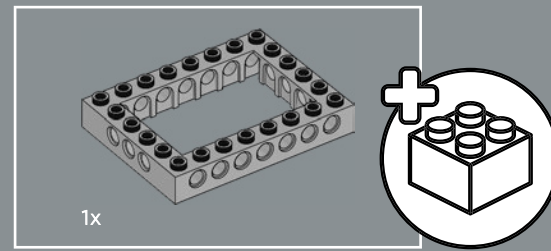
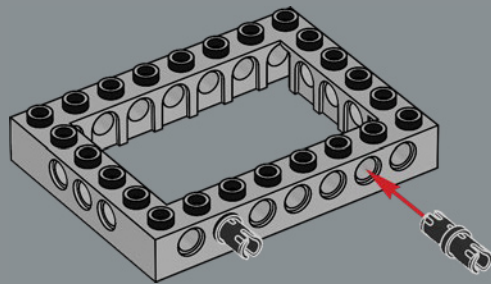
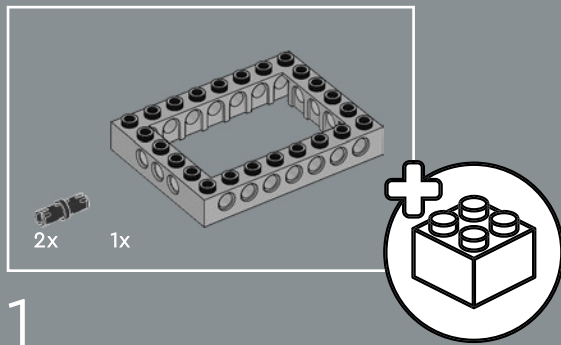

6x

4

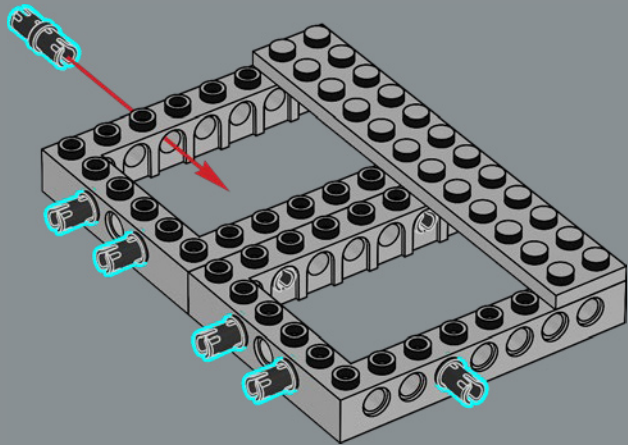

1x

2x

5

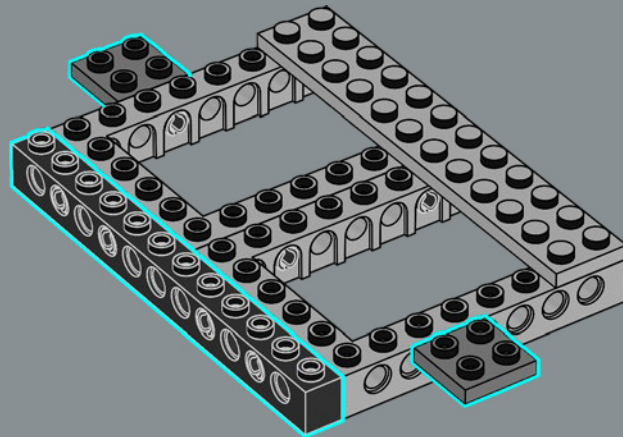

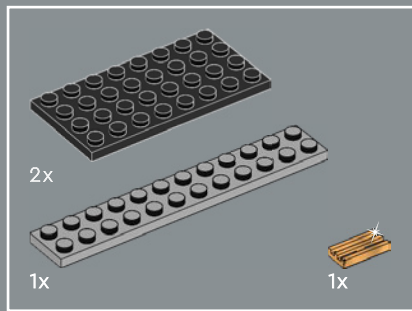

6

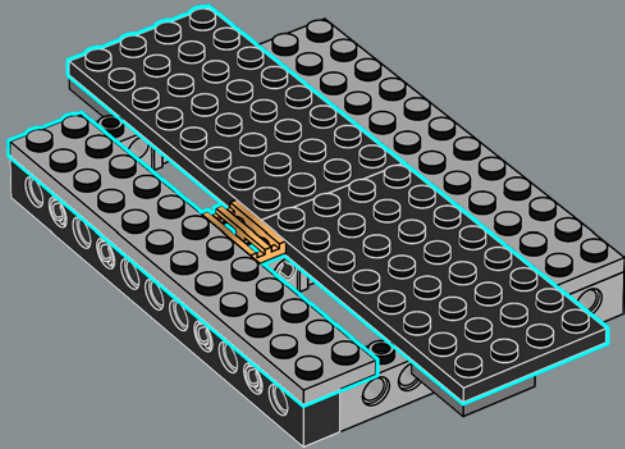

7

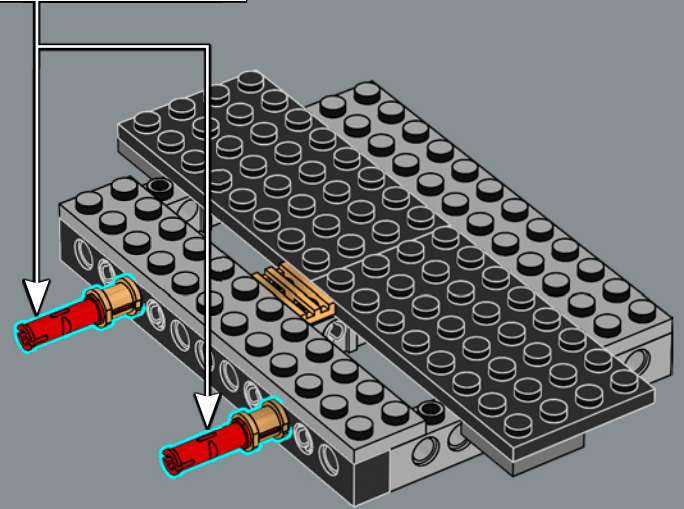
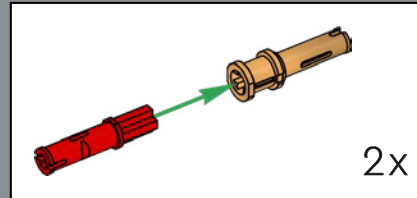

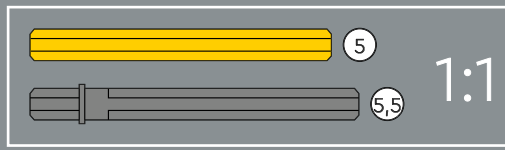
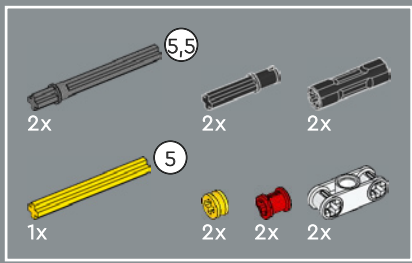

8

1

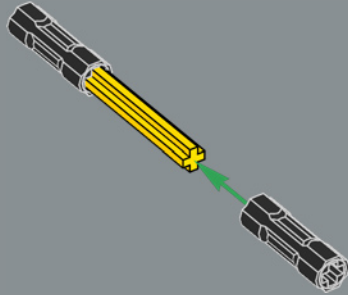

2

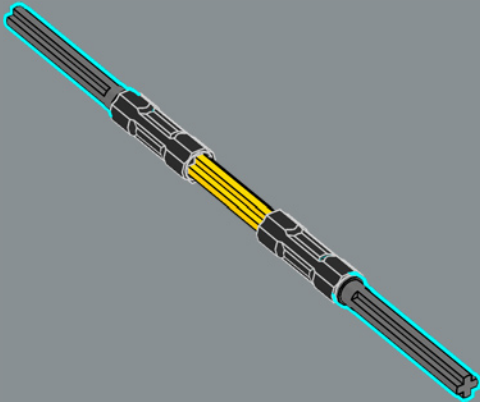

3

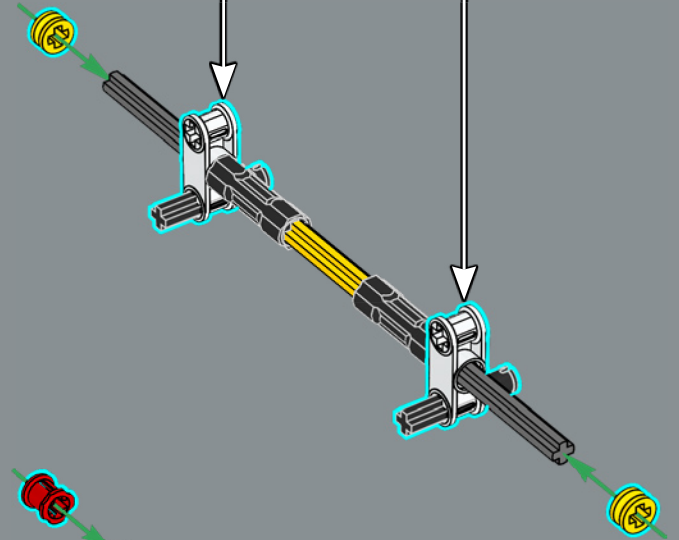

4

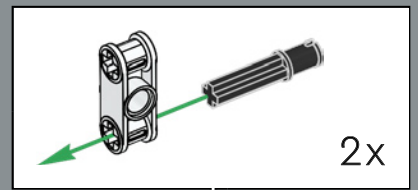
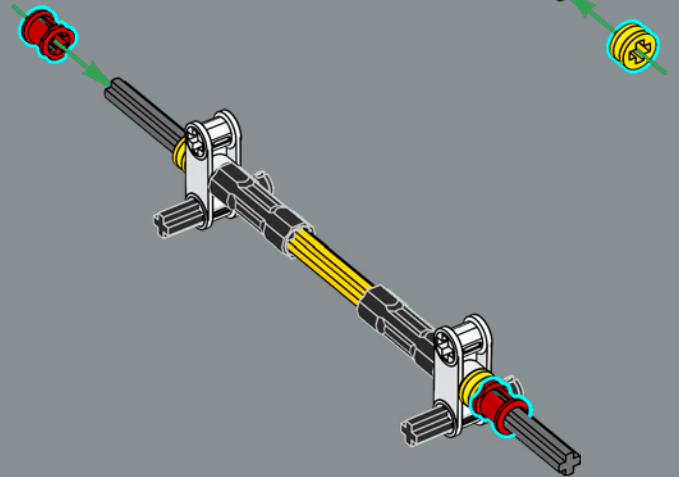

2x





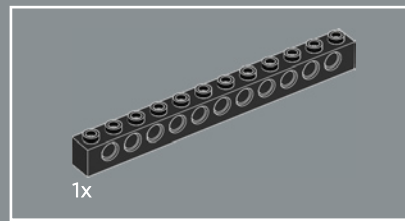
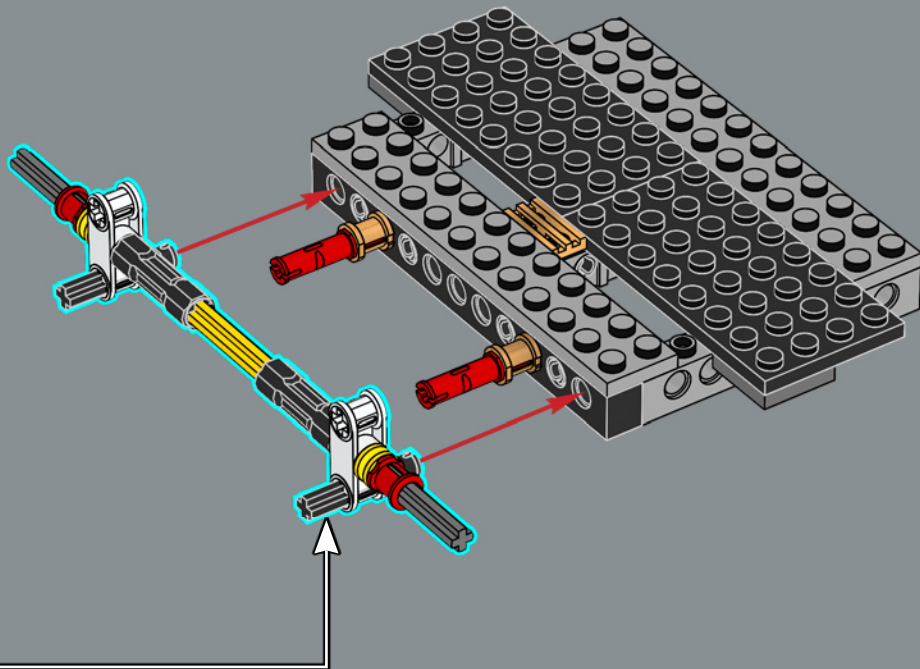

9

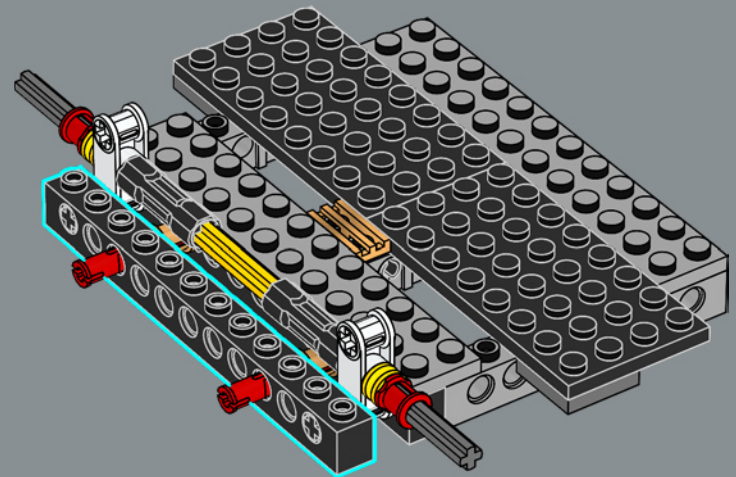



10

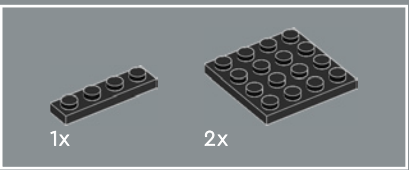
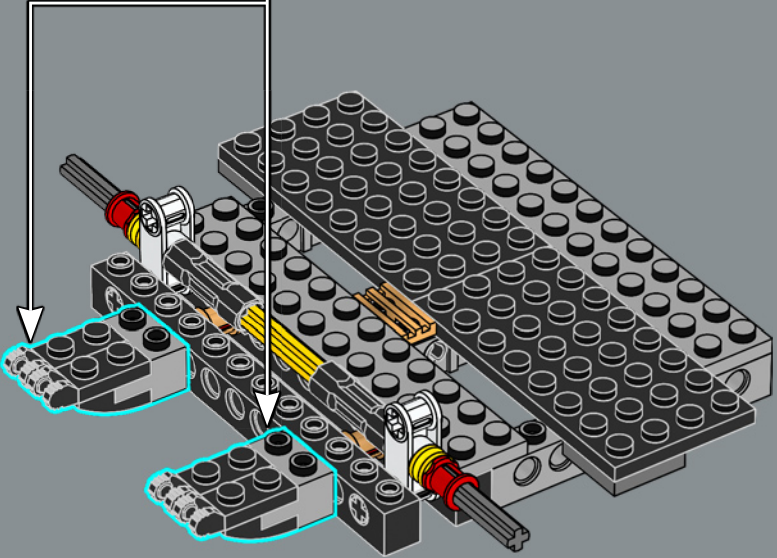
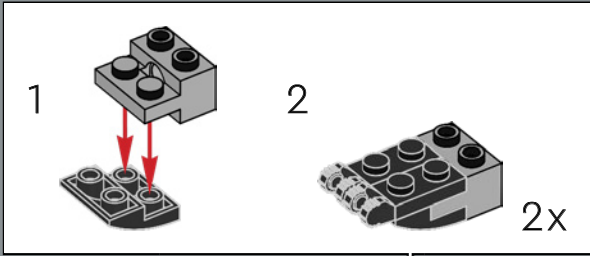

11

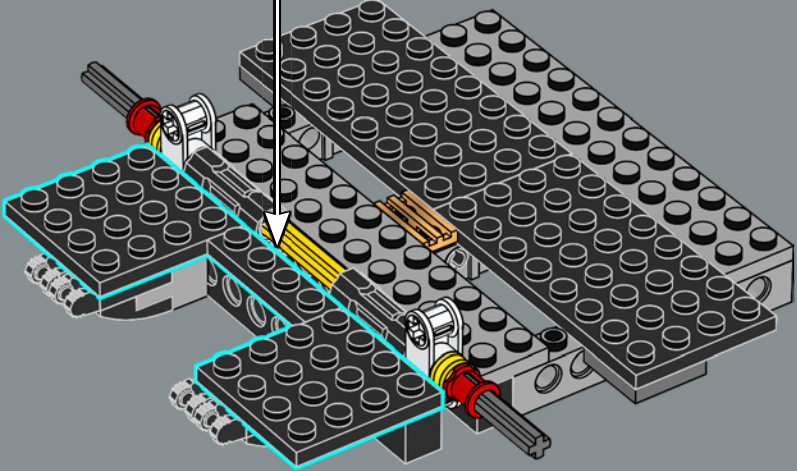
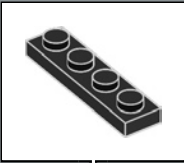

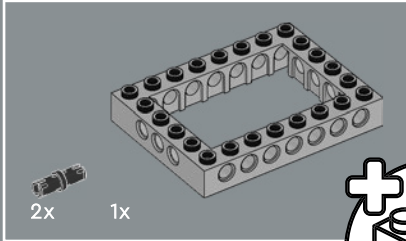
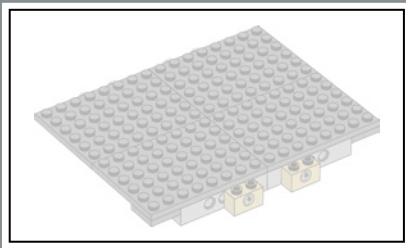

12

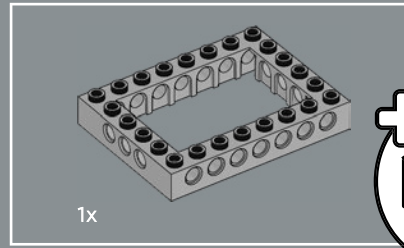
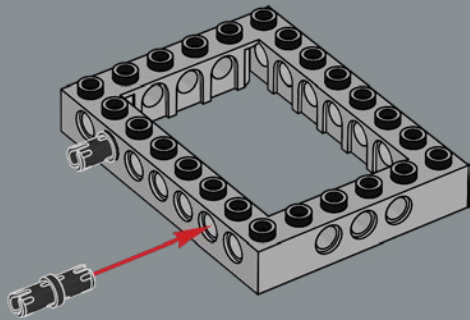
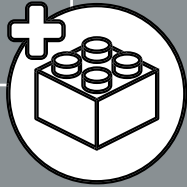

13

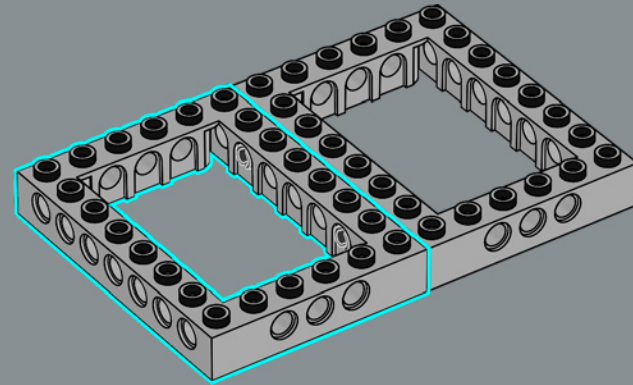
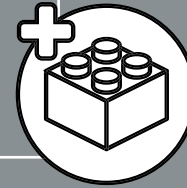

14

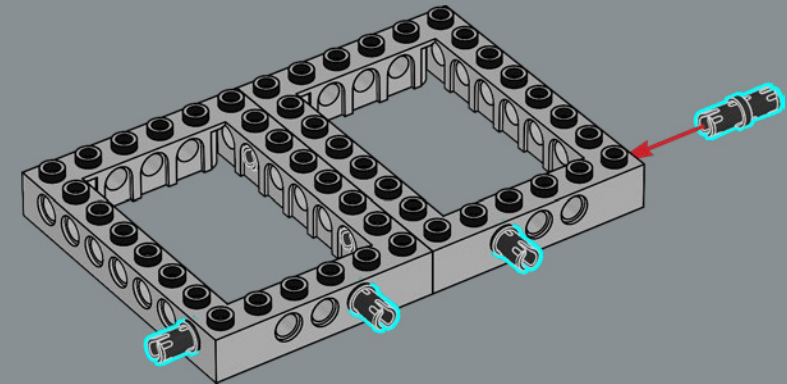

4x

15

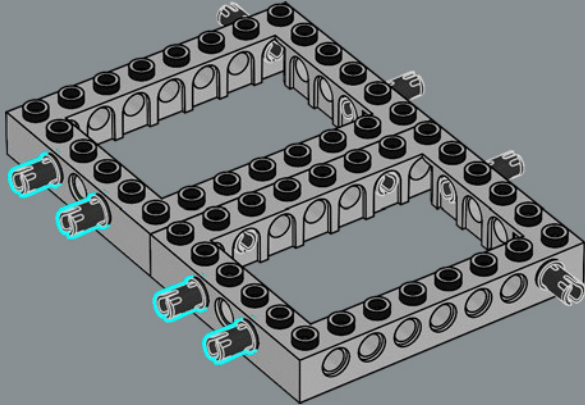

2x

16

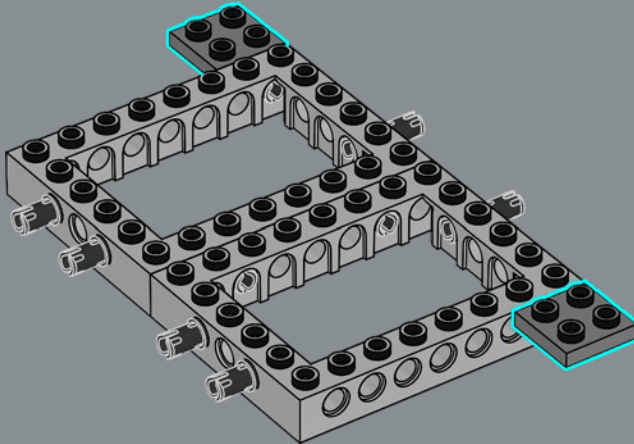

2x

17

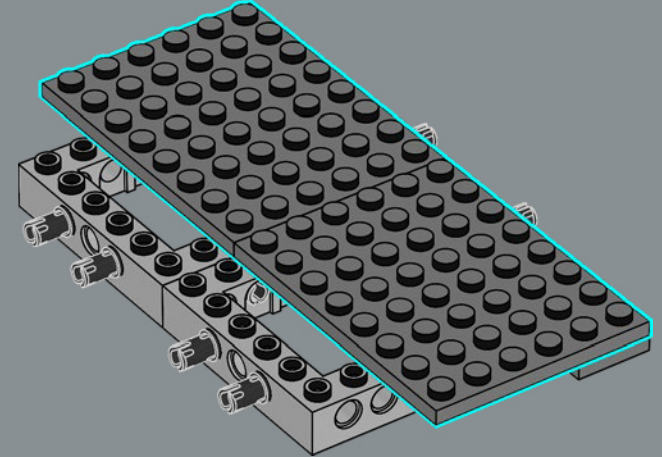

2x

18

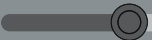
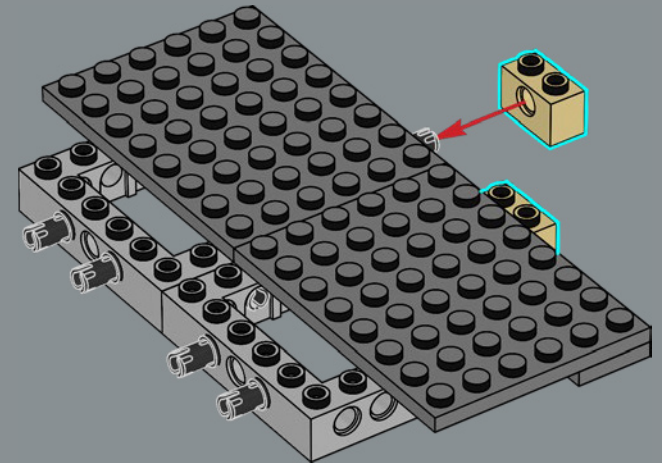



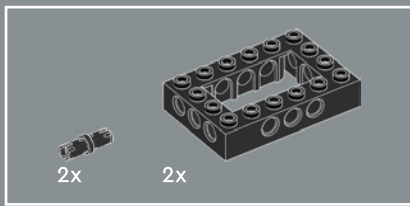

19

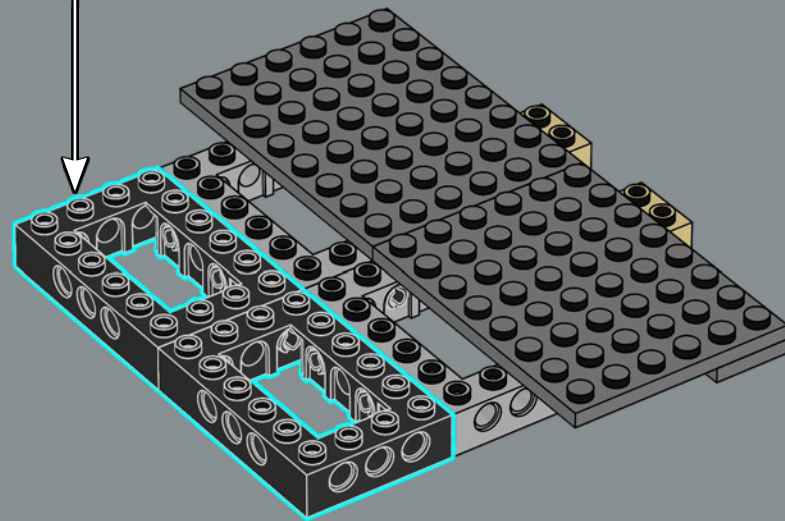
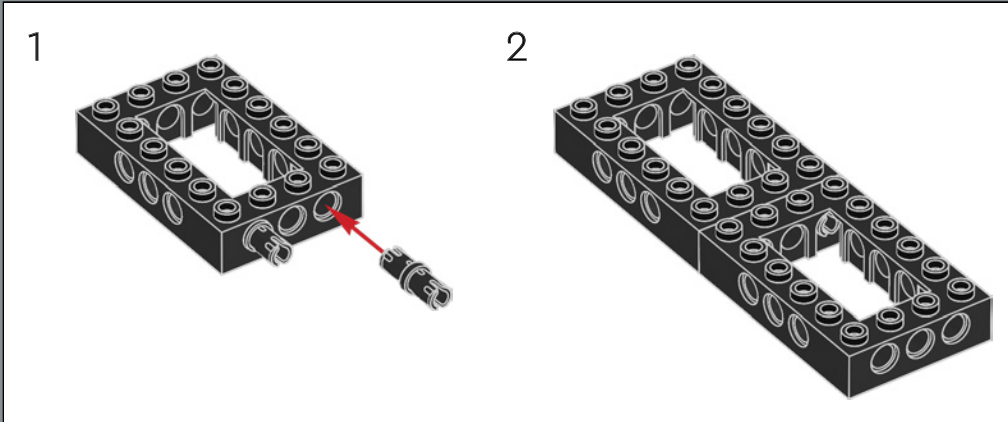

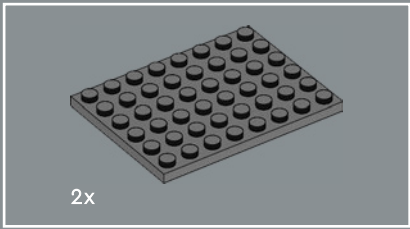

20

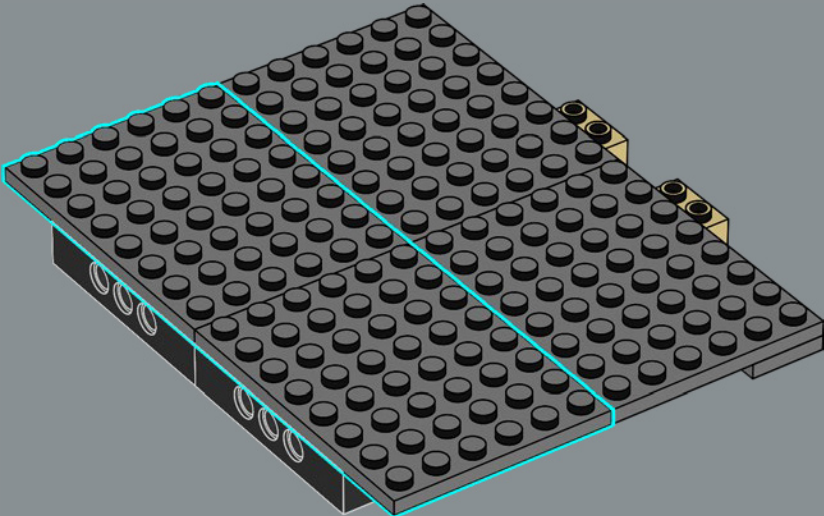

21

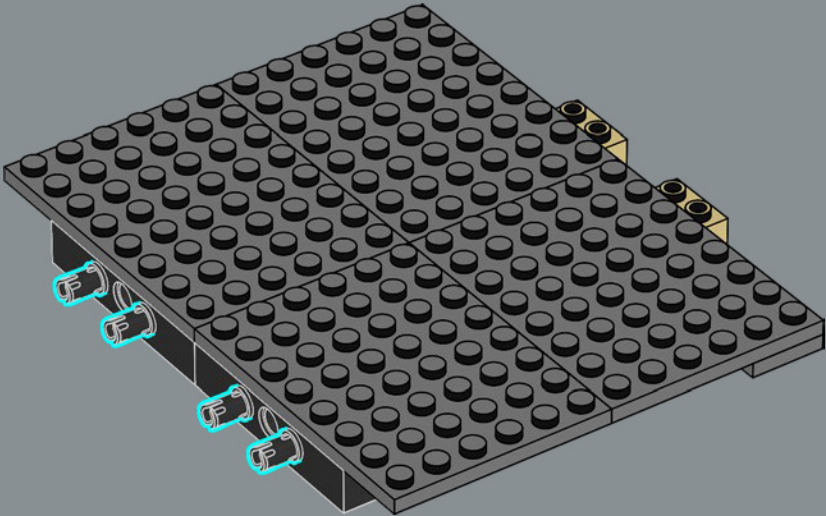



The Lamborghini Countach is known for memorable appearances in classic TV series and major blockbuster films throughout the 1980s.

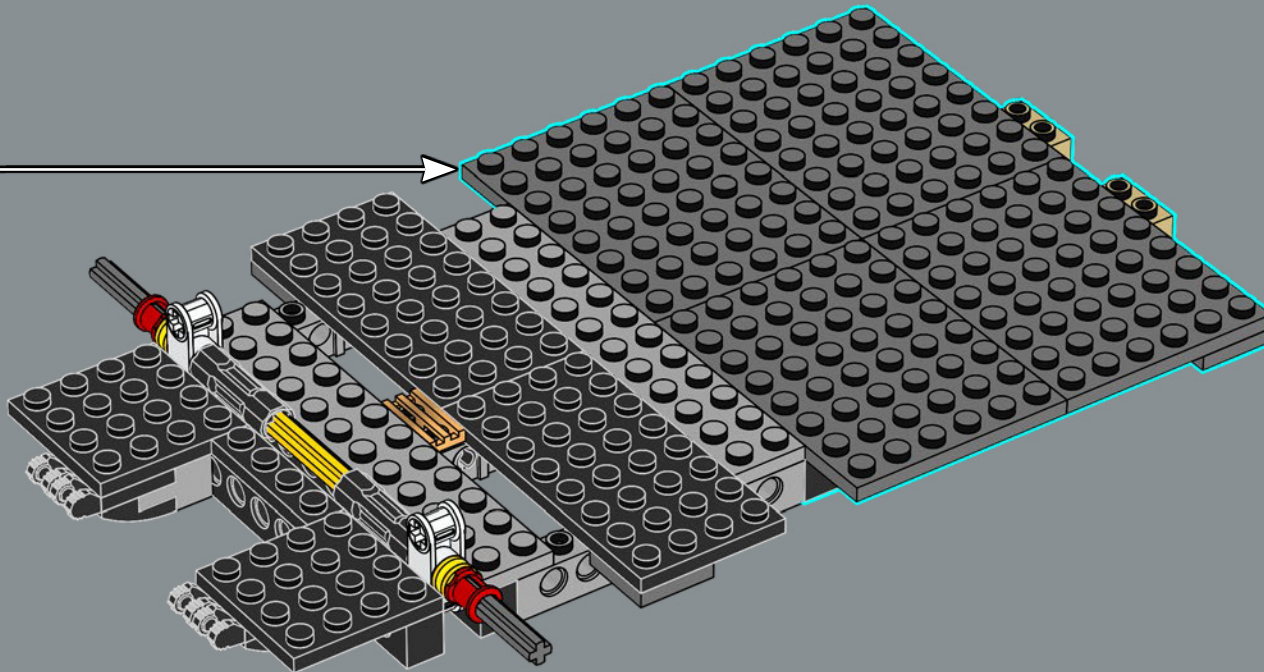

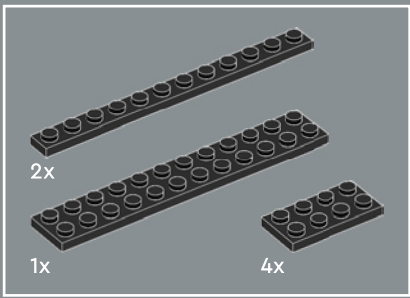

23

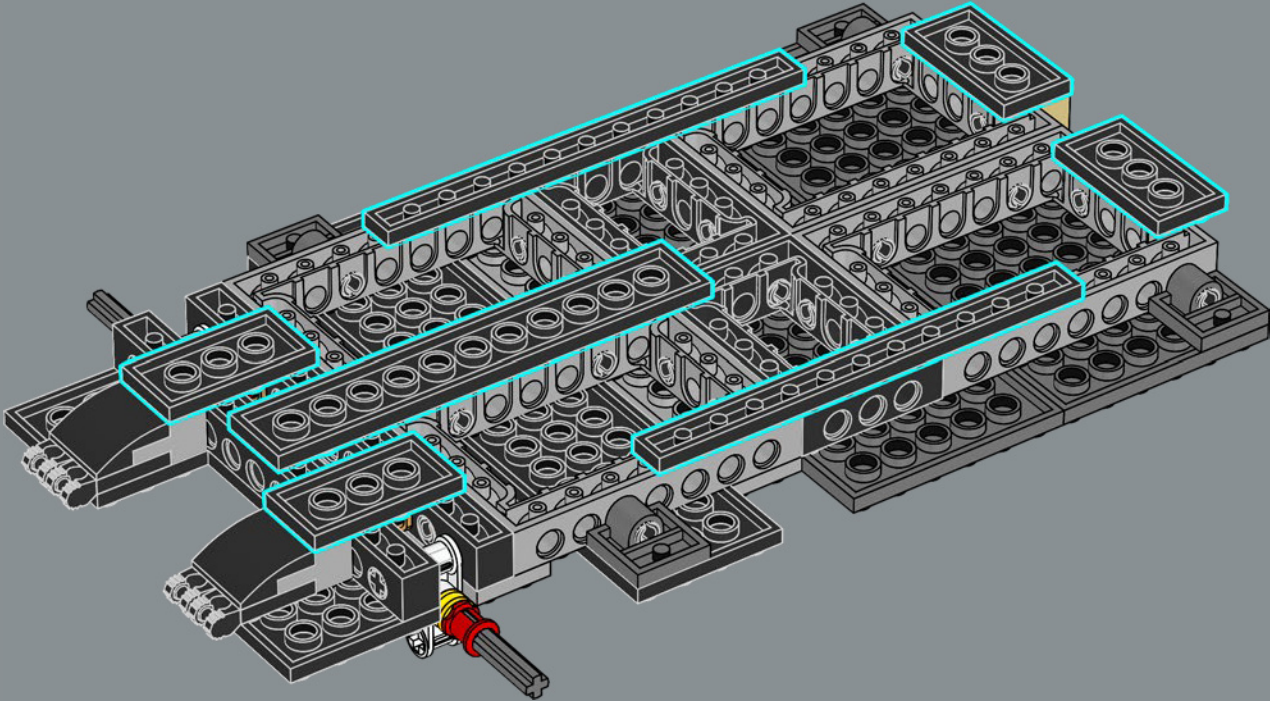



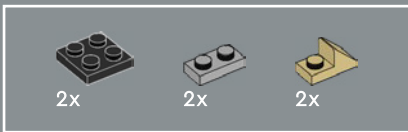

24

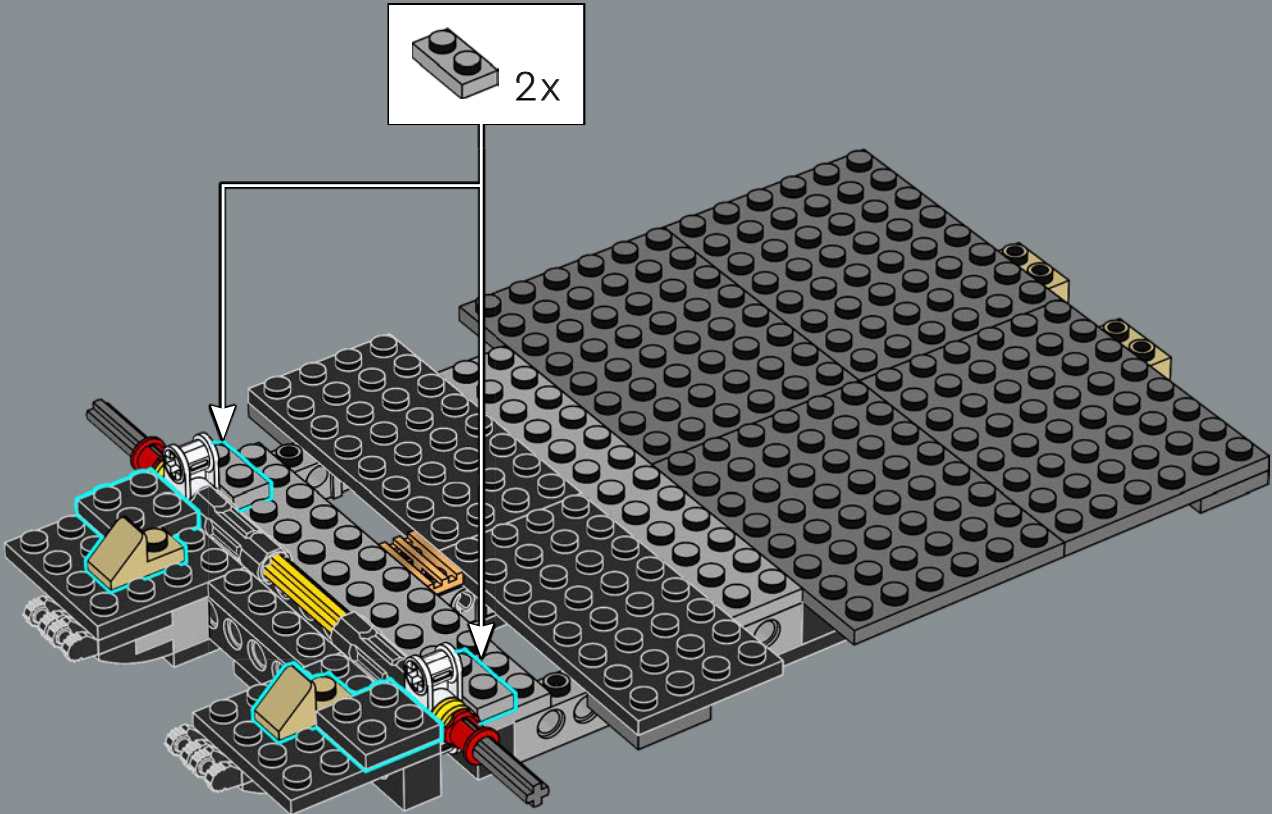

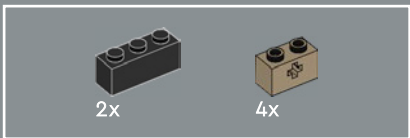

25

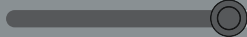
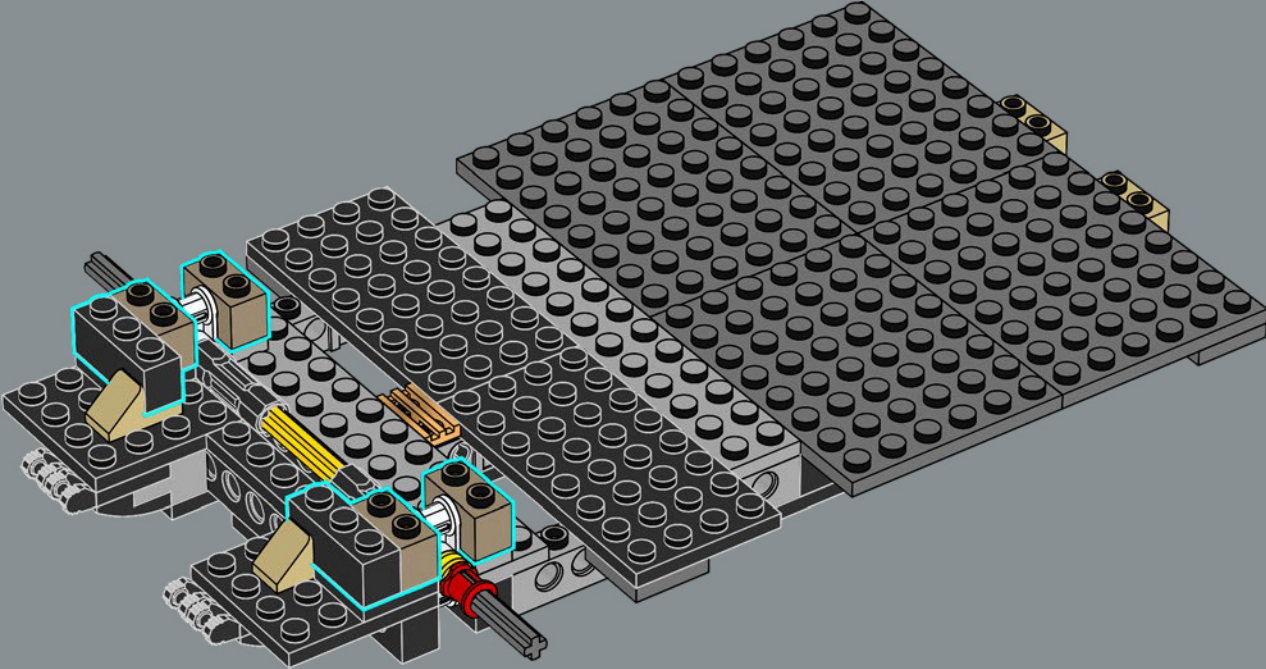

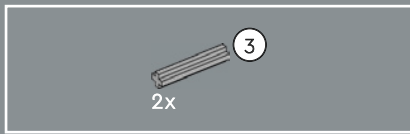

26

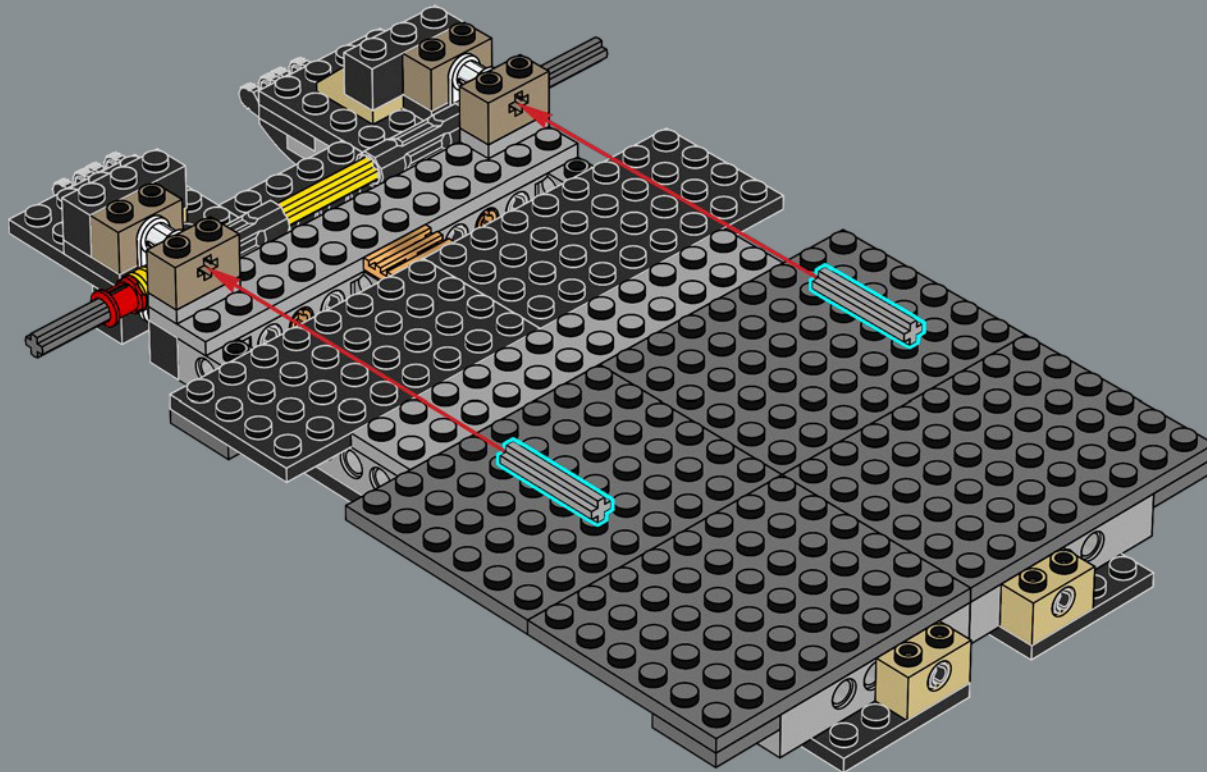

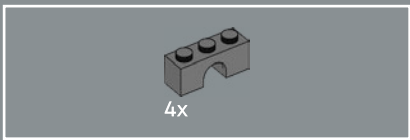

27

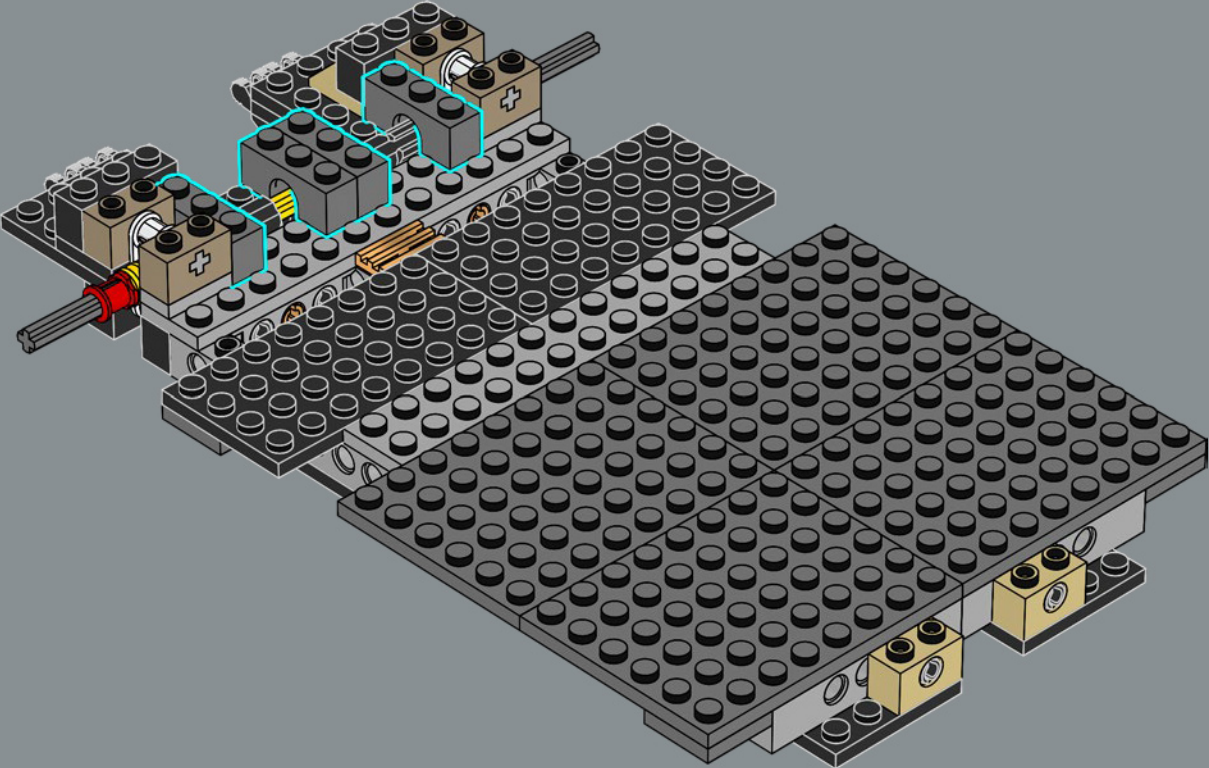



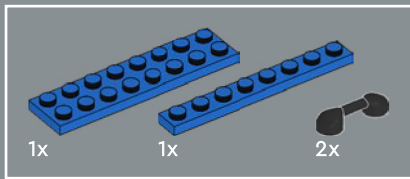

28

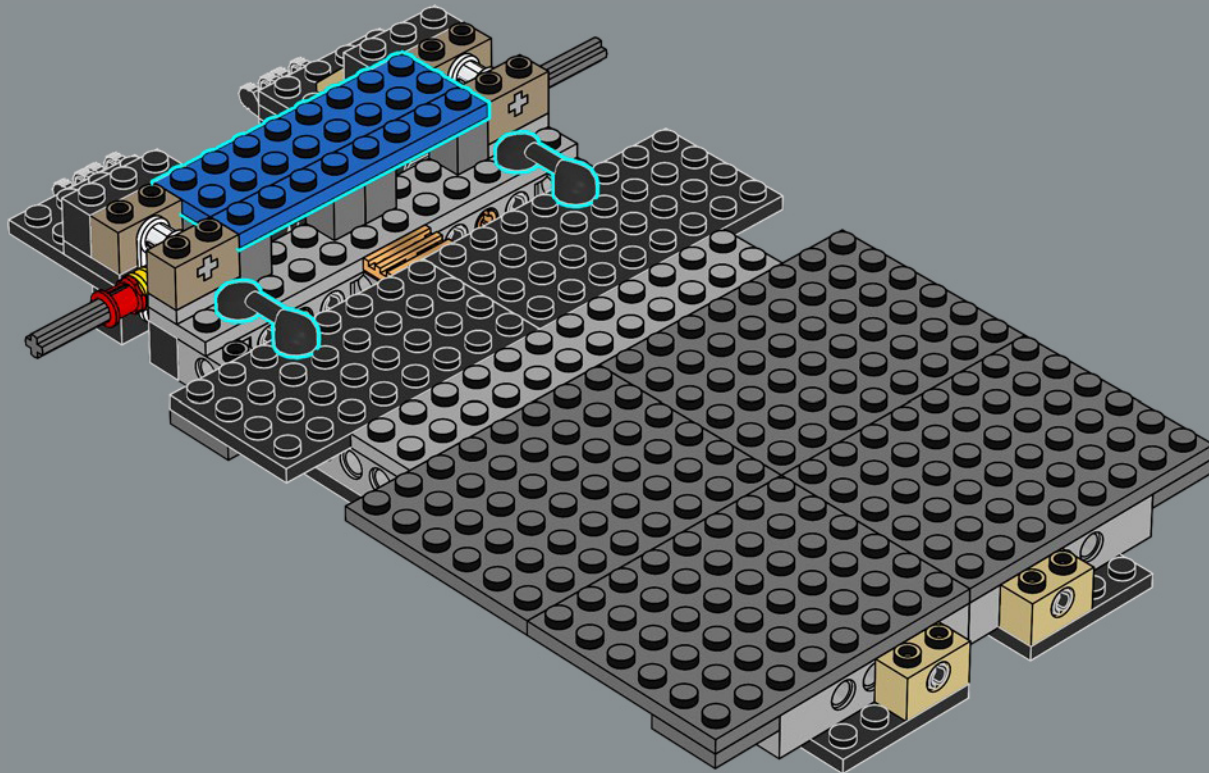

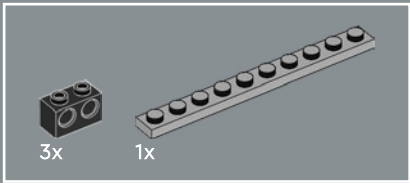

29

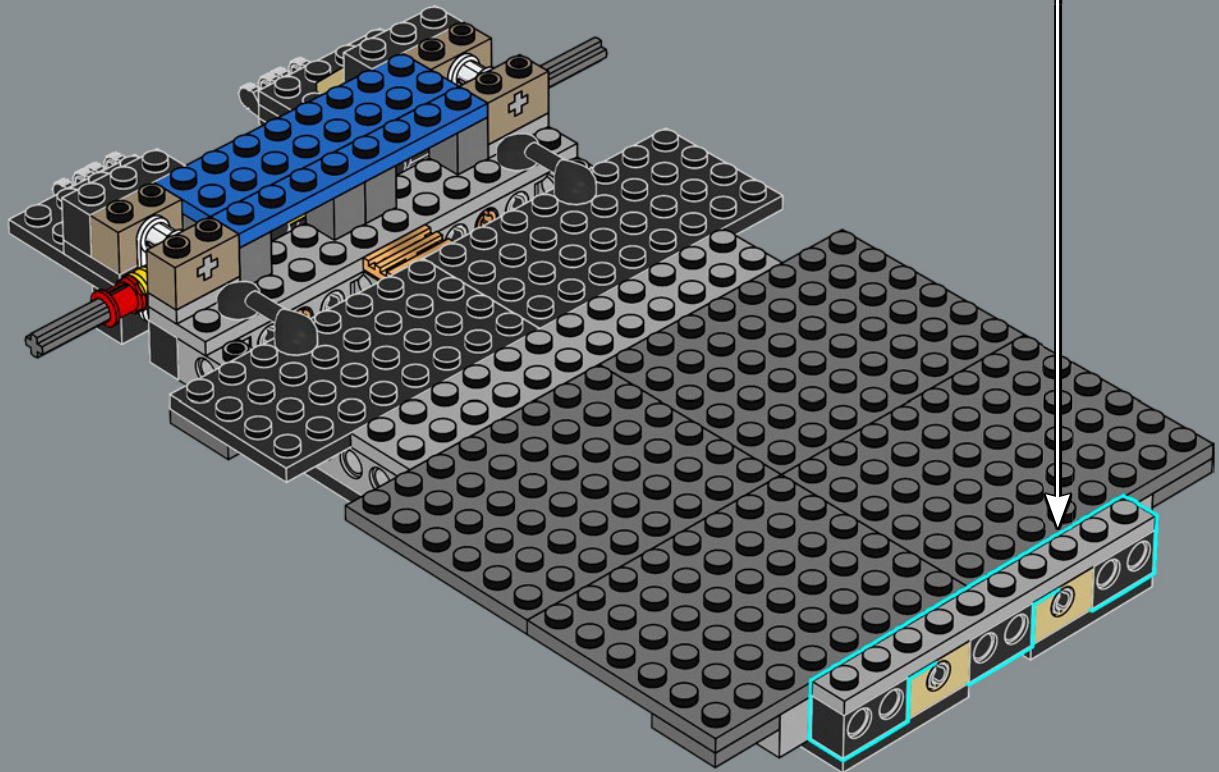
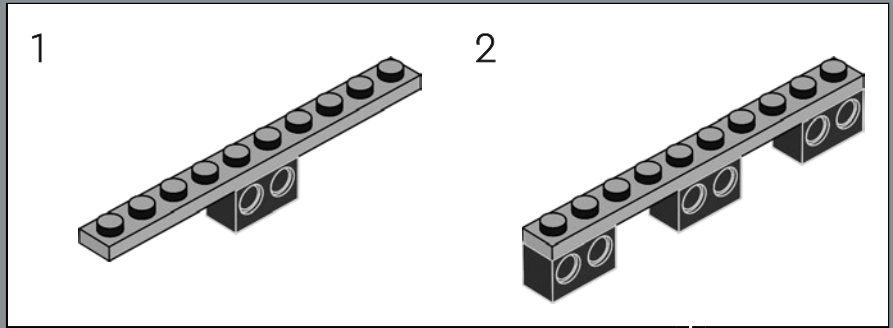

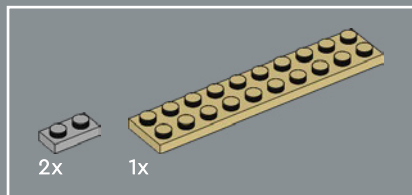

30

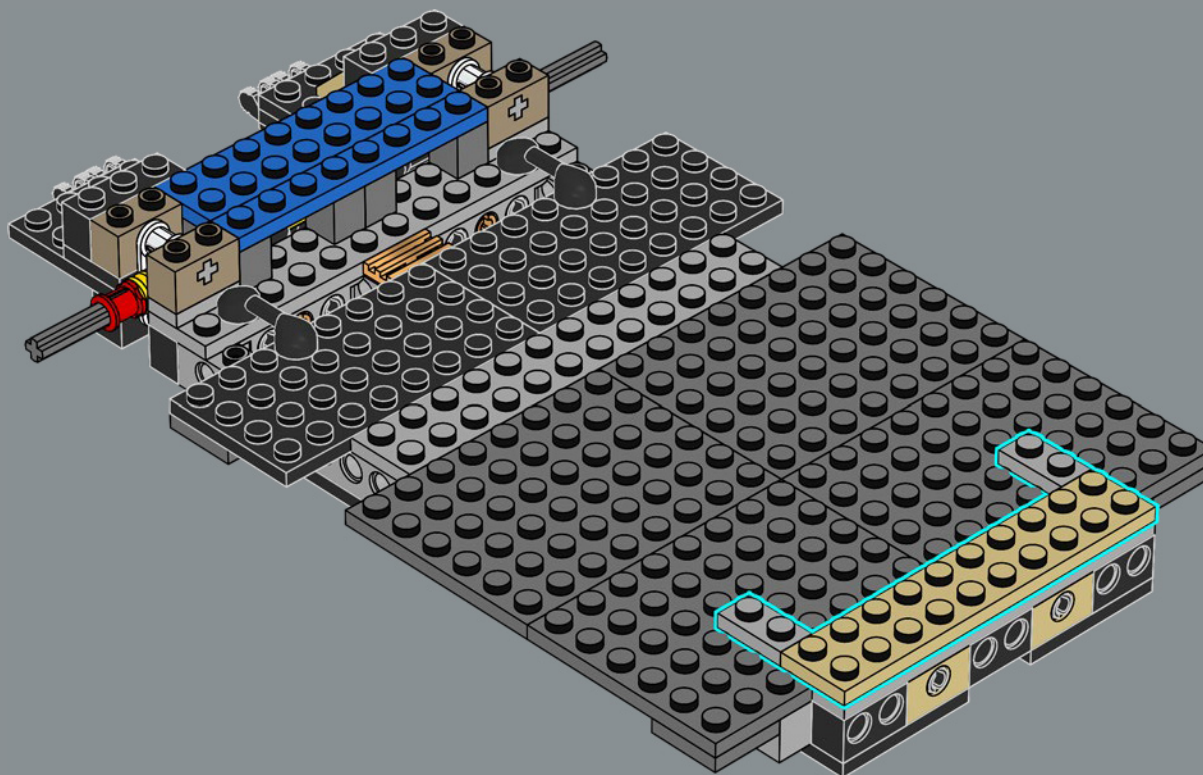

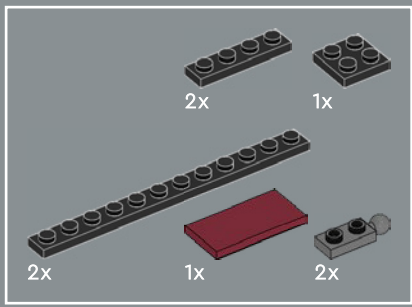

31

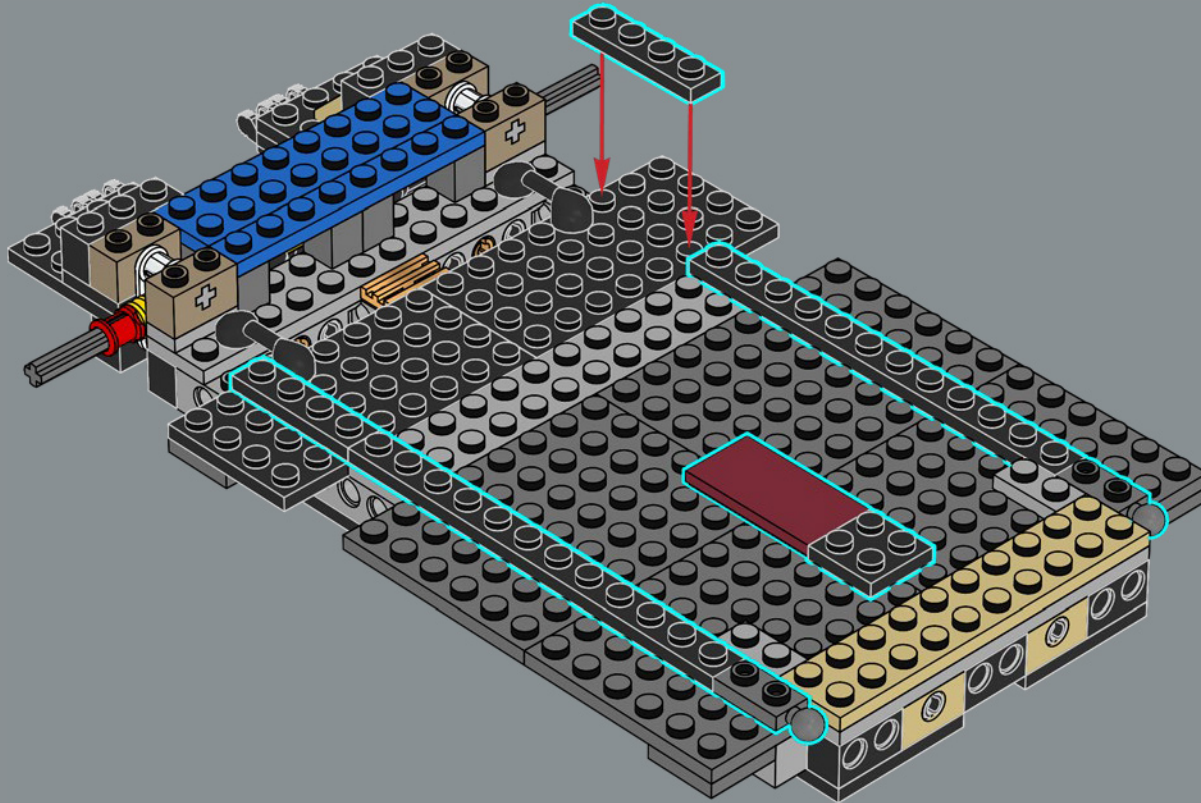





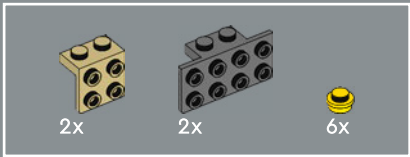

33

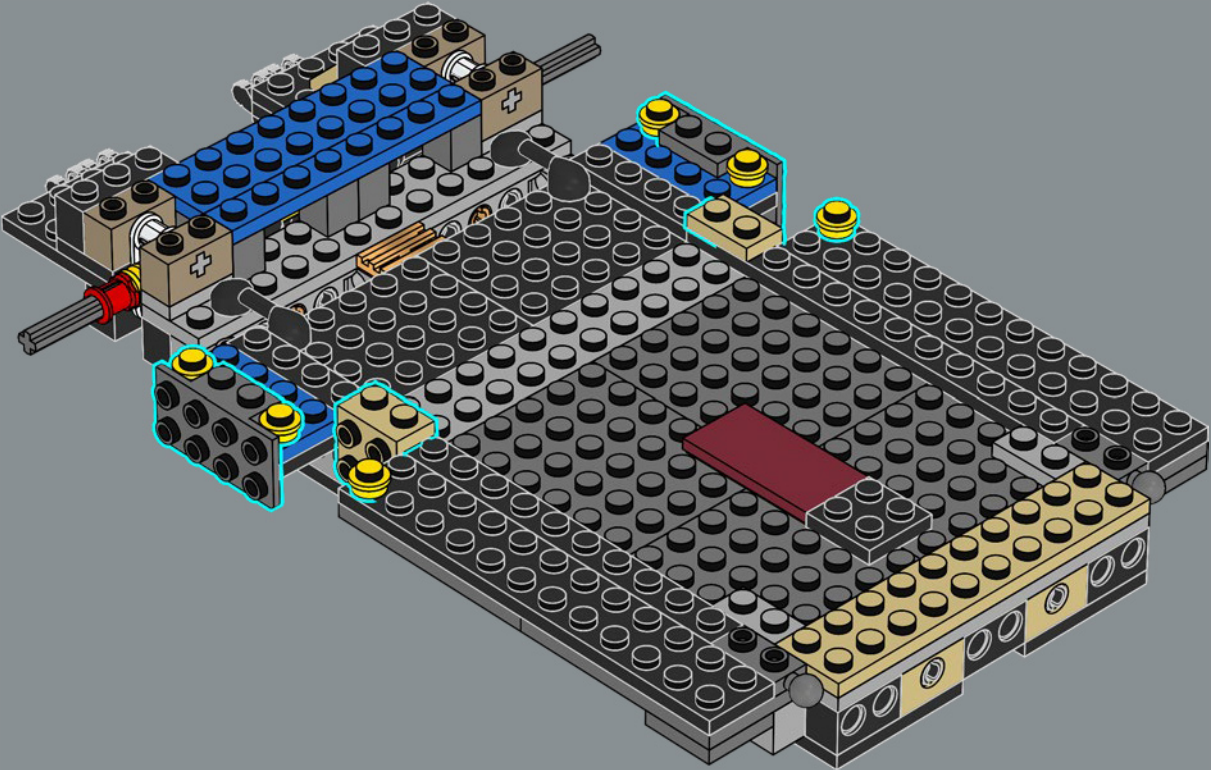

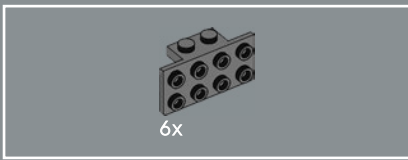

The original Lamborghini Countach was designed by Carrozzeria Bertone.

34

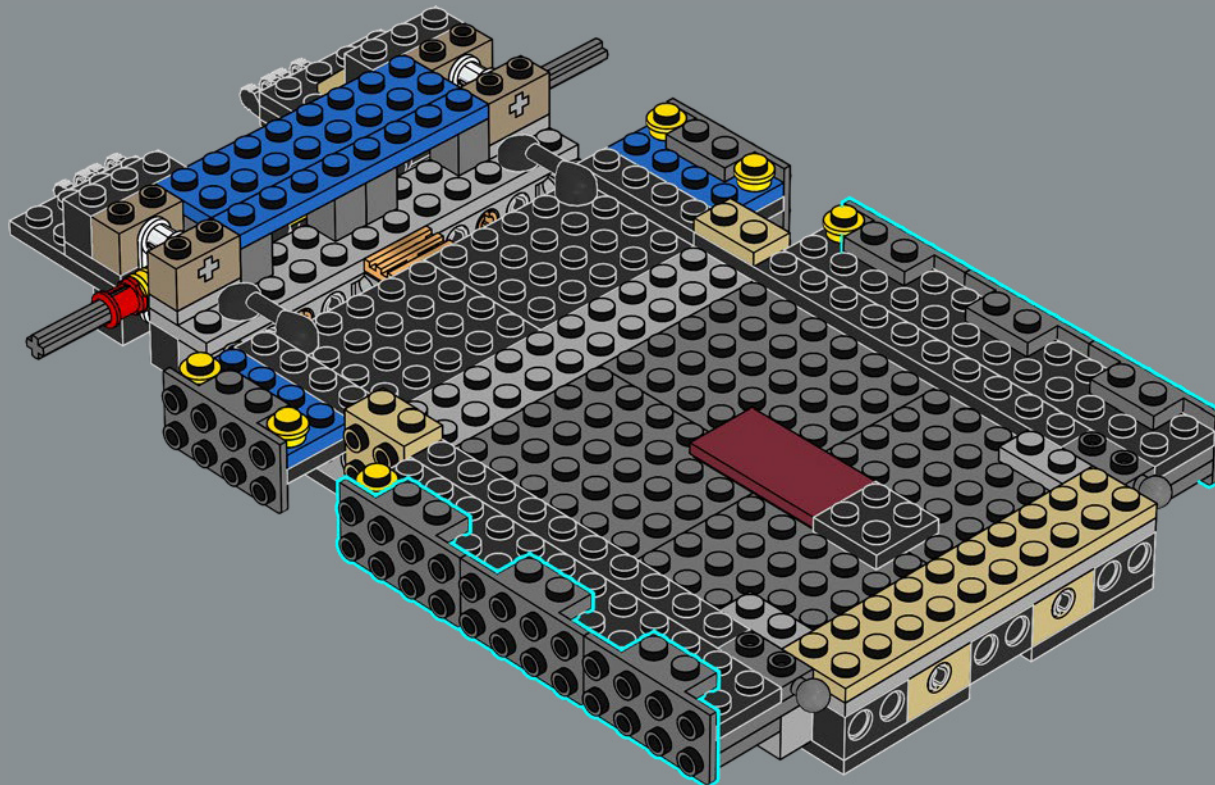



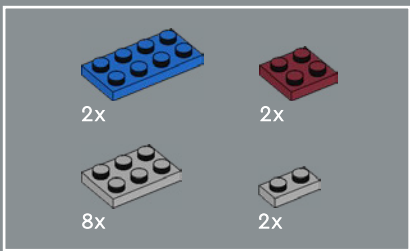

35

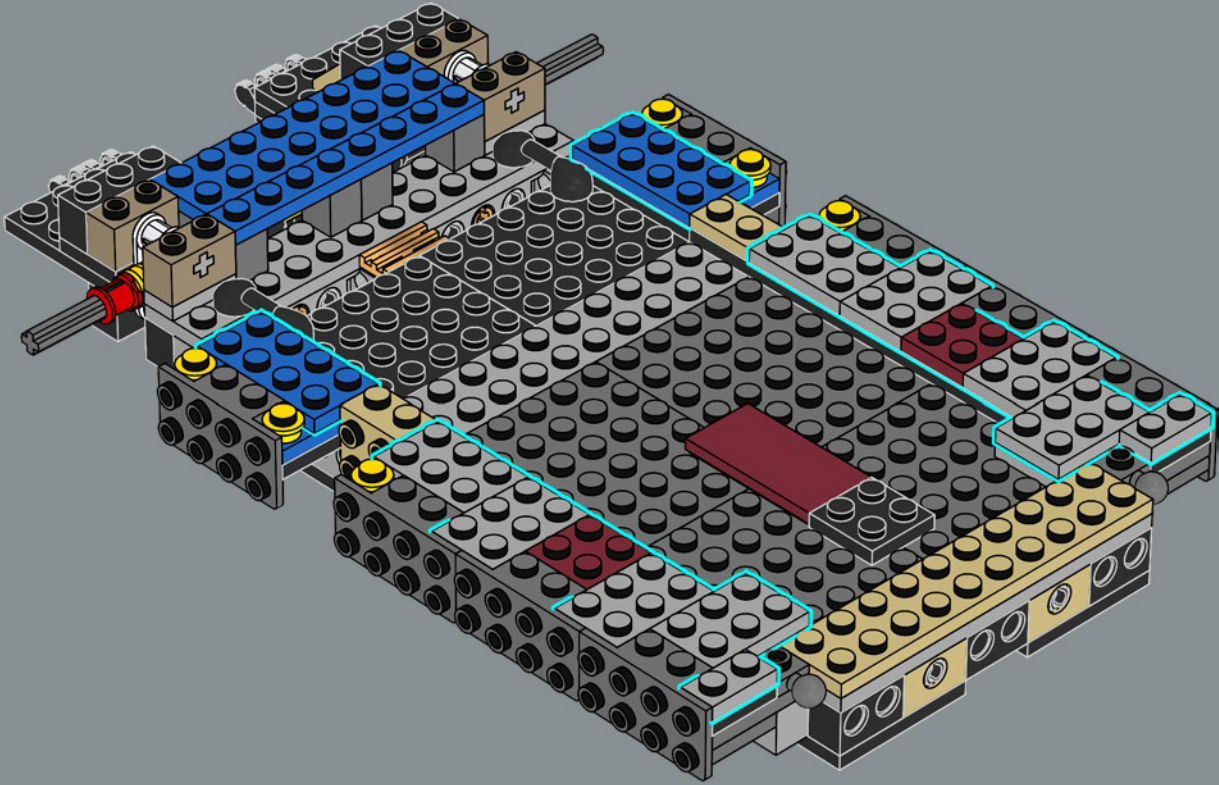



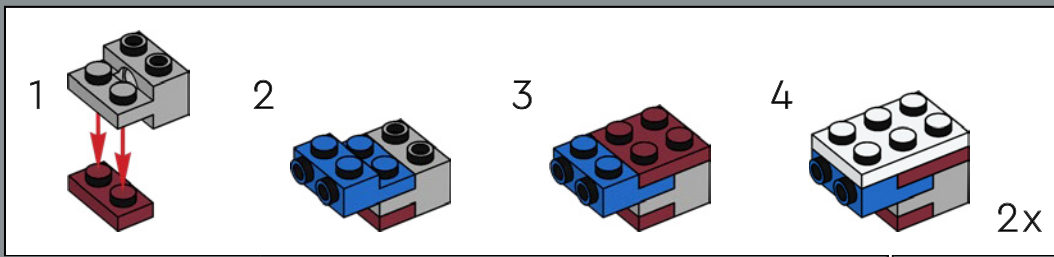
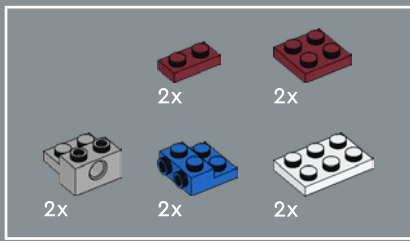

36

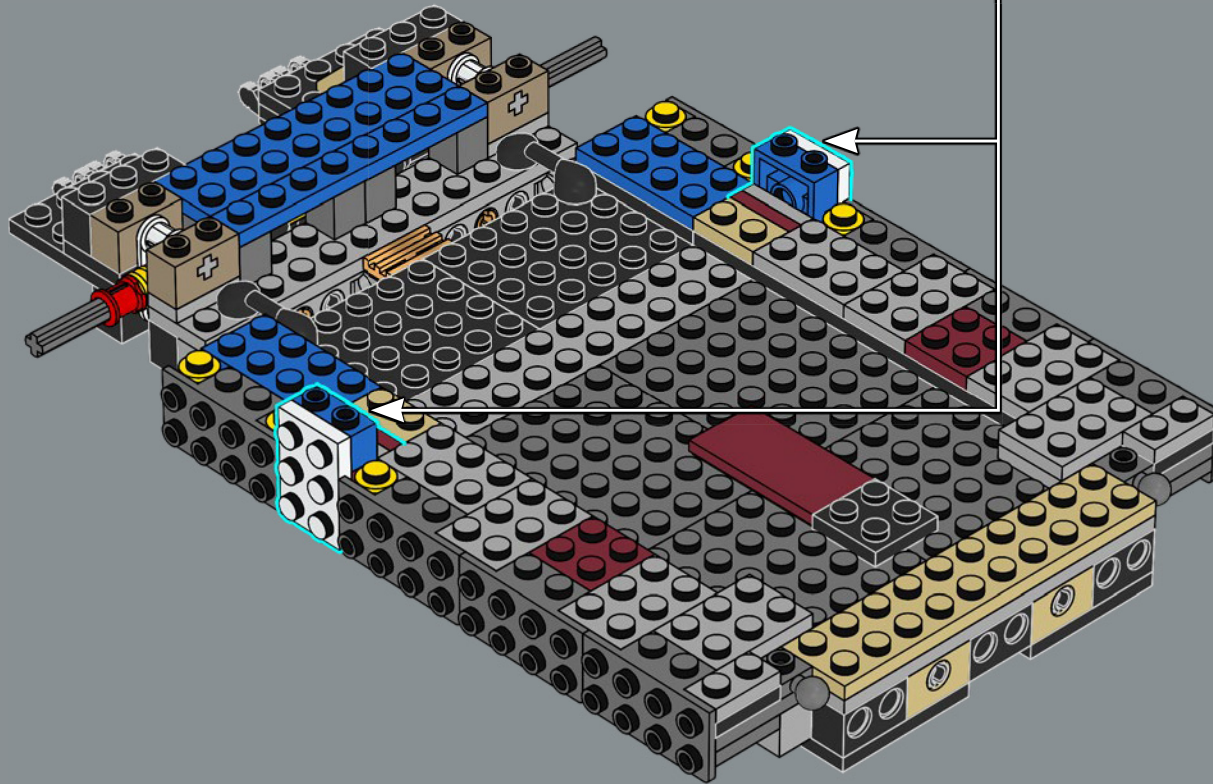

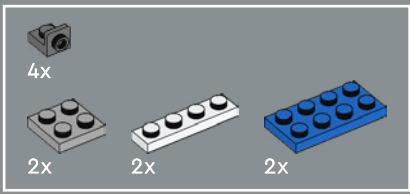

37

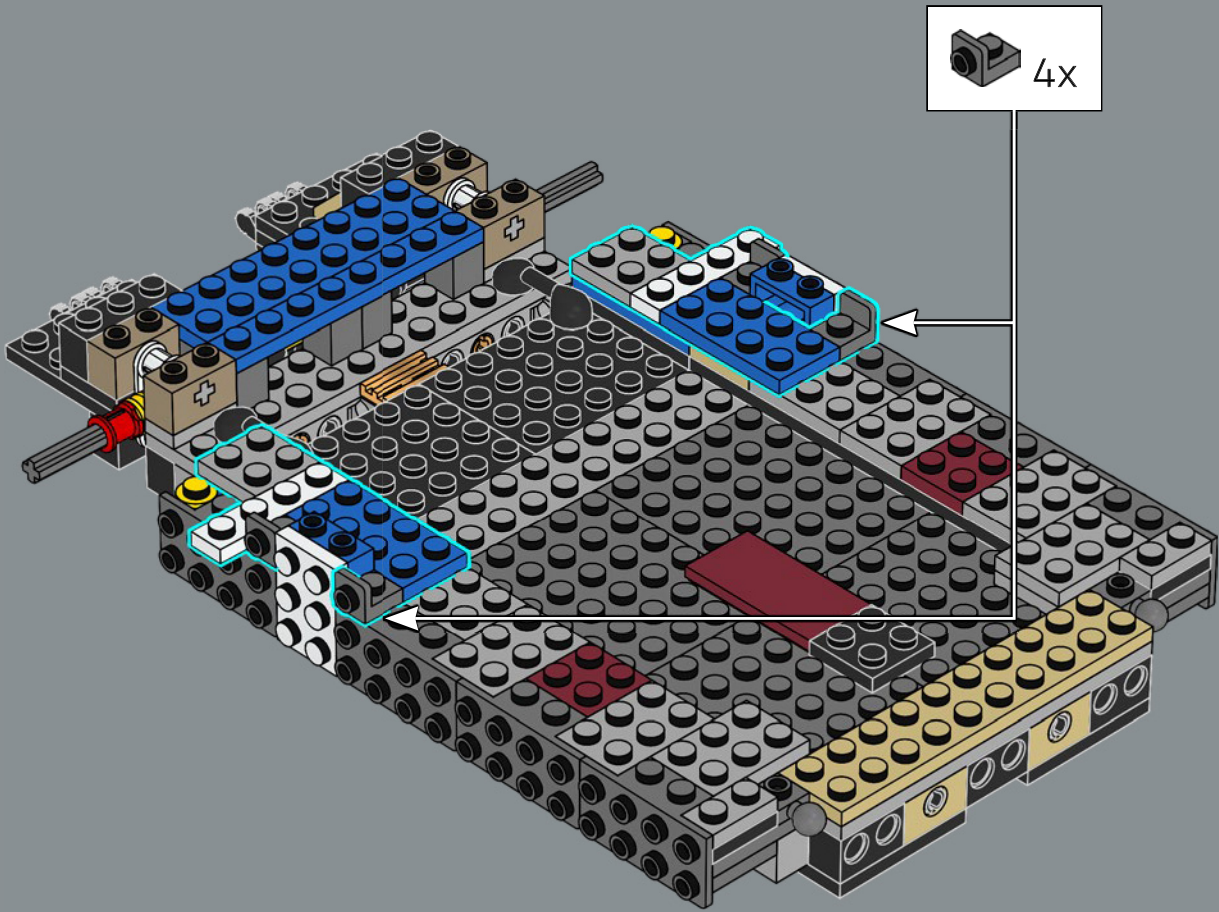



38

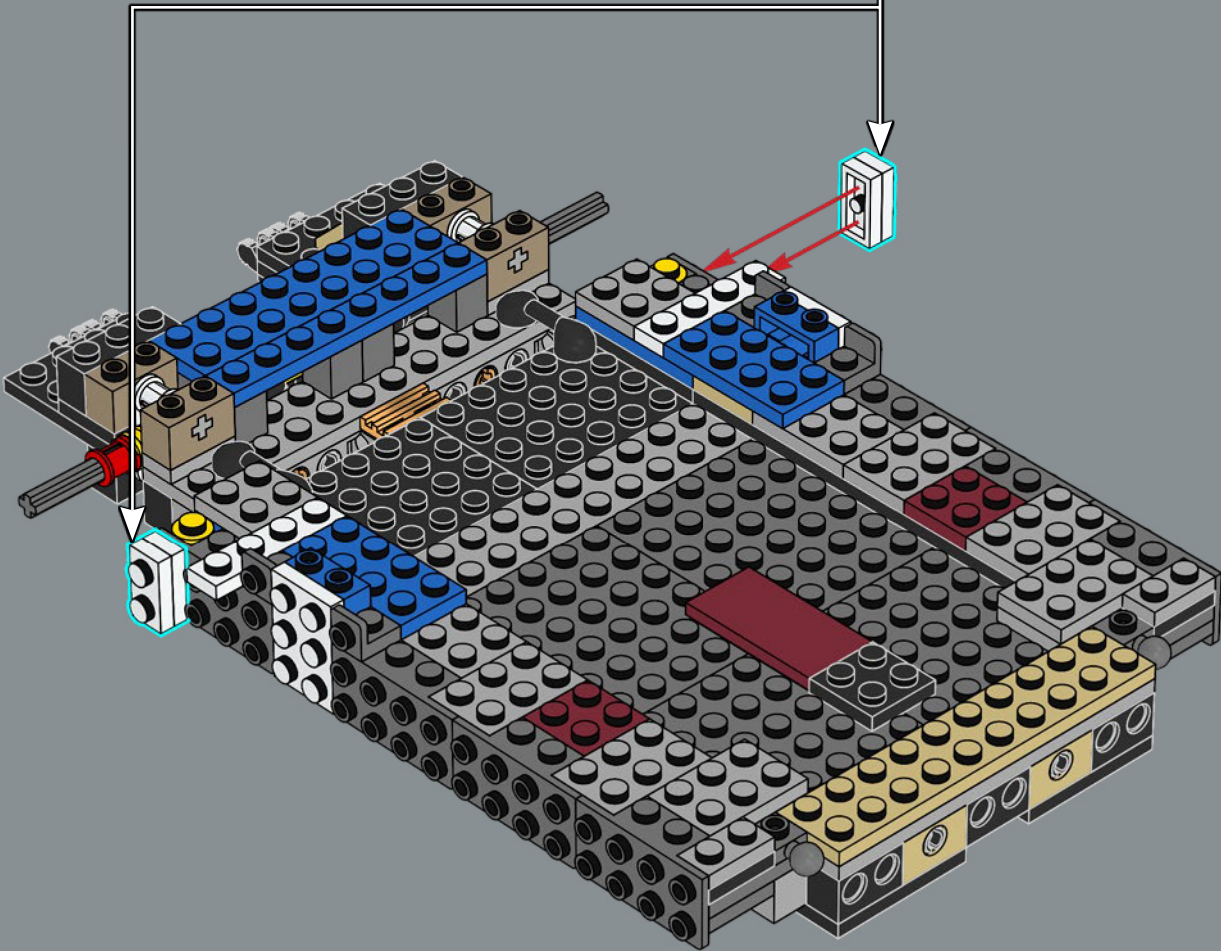
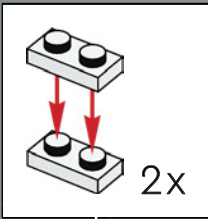



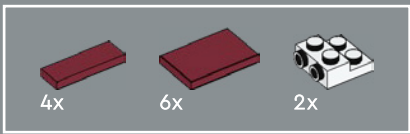

39

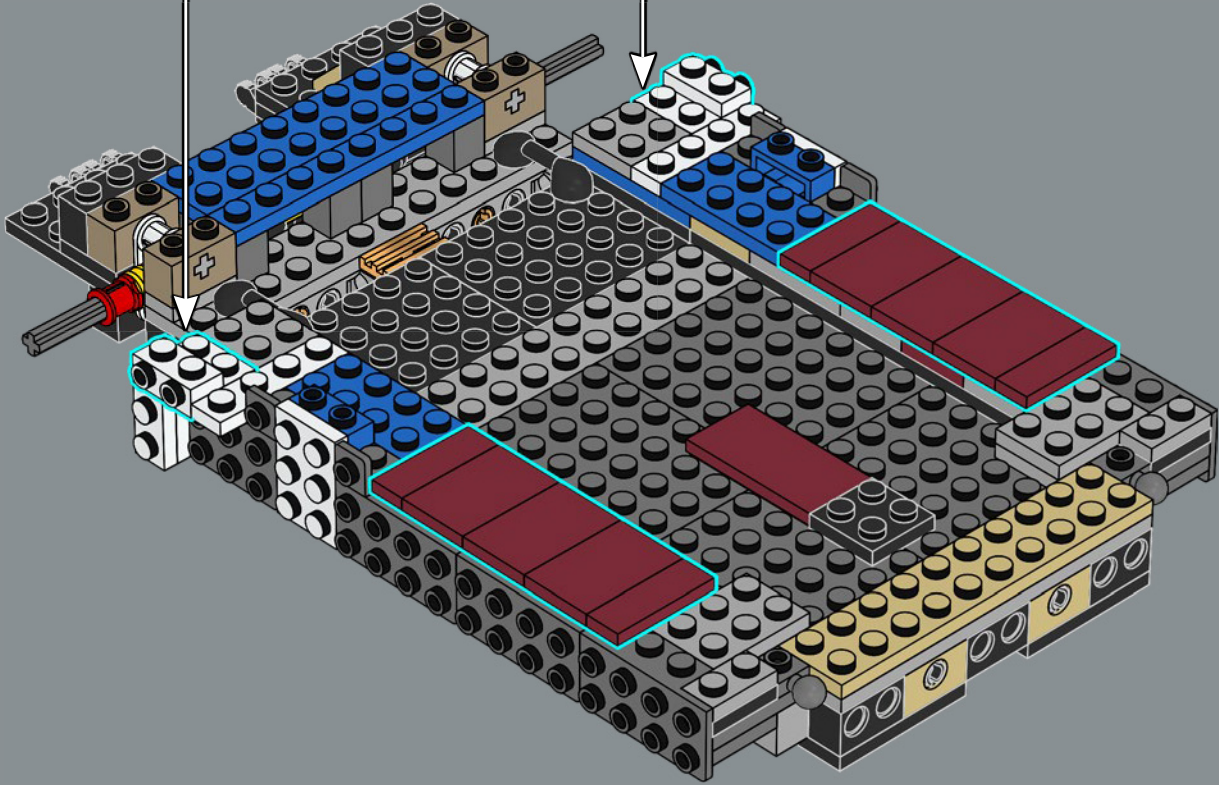
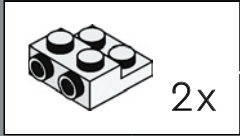



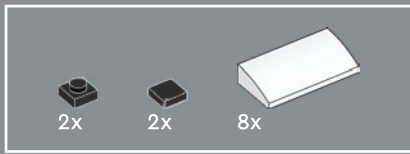

40

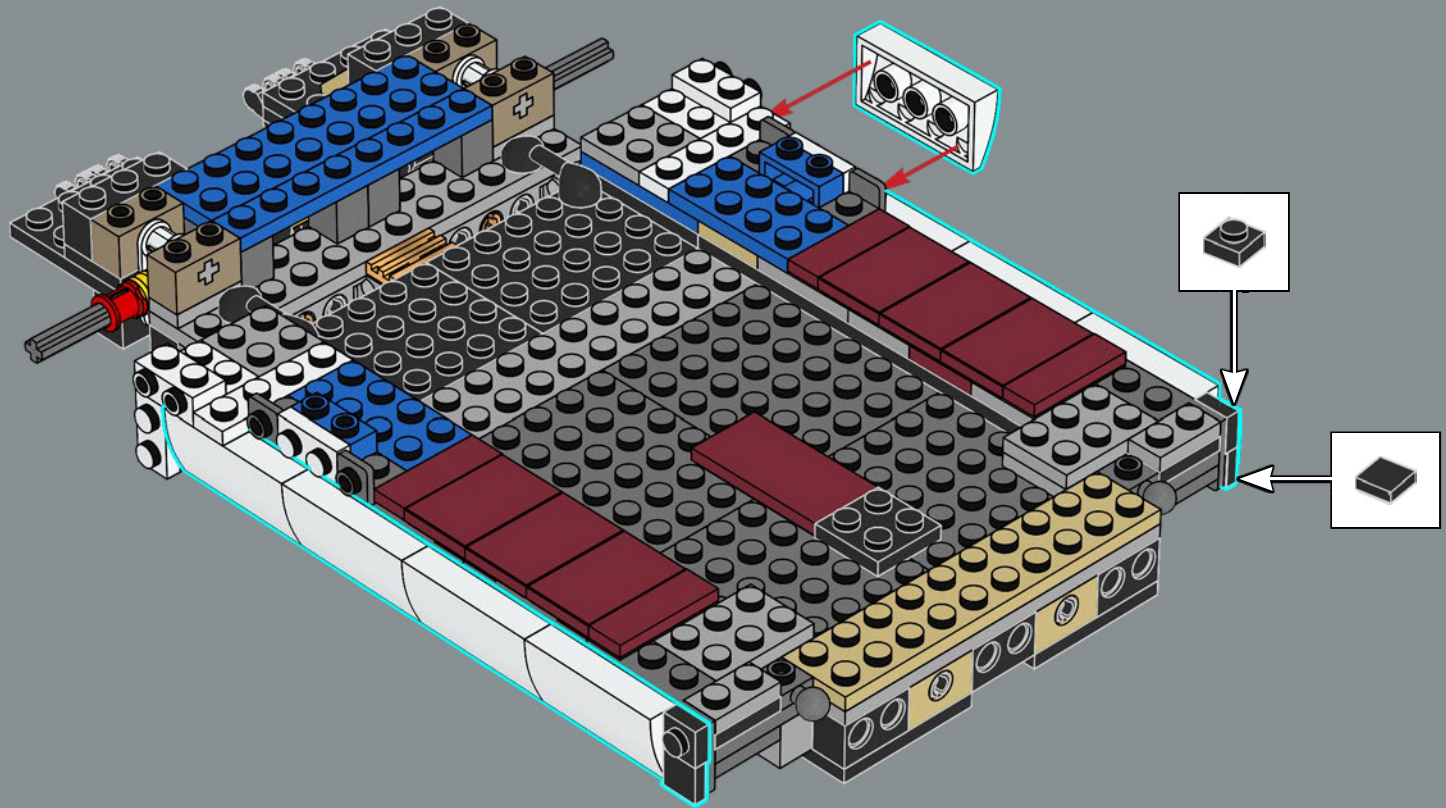

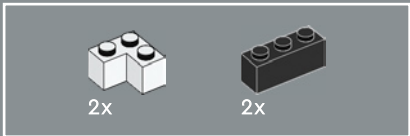

41

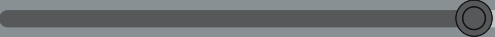
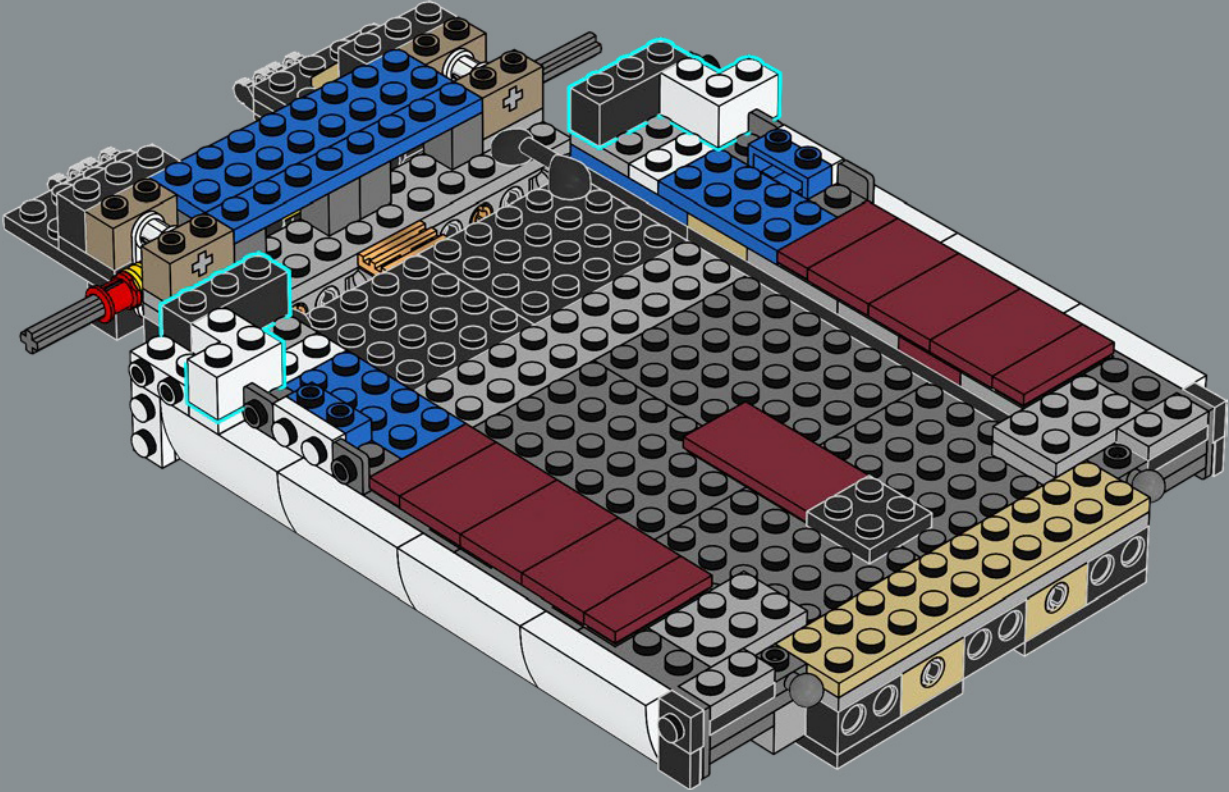

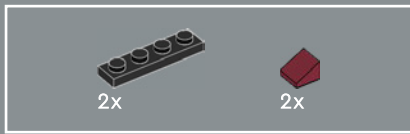

42

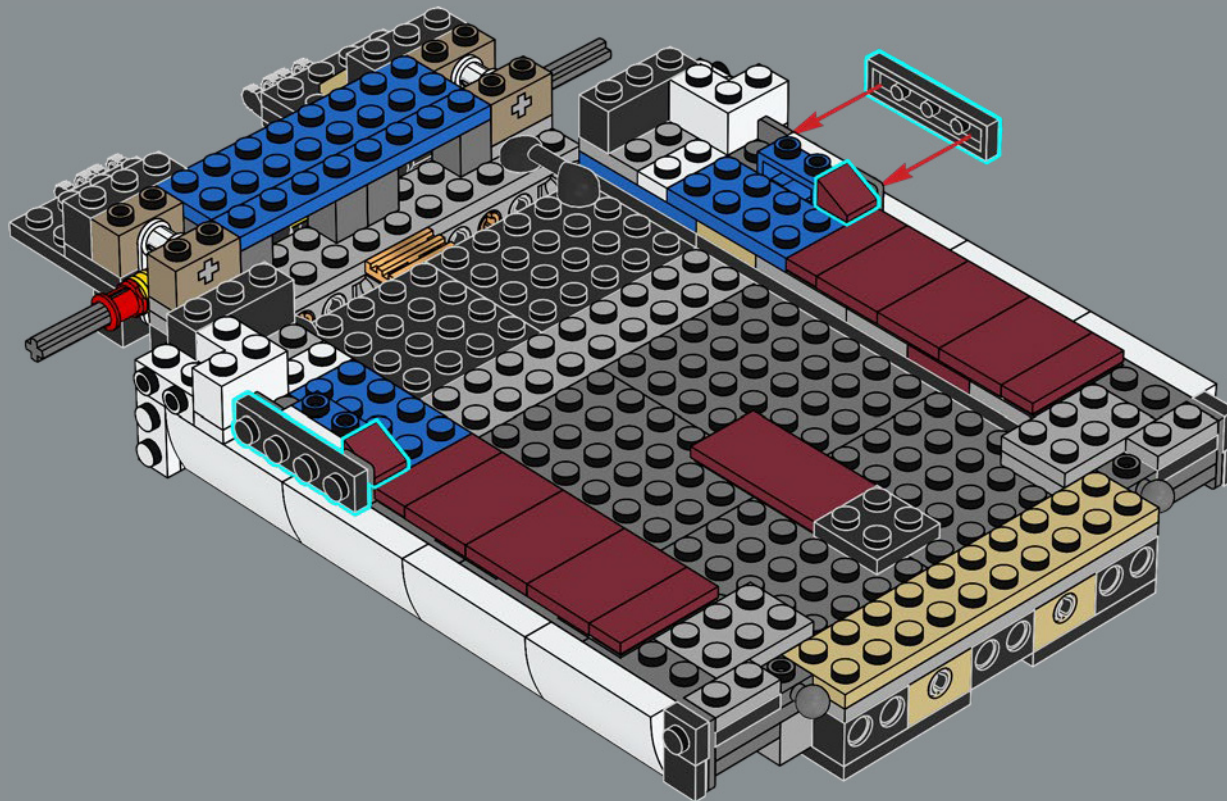





4x

43

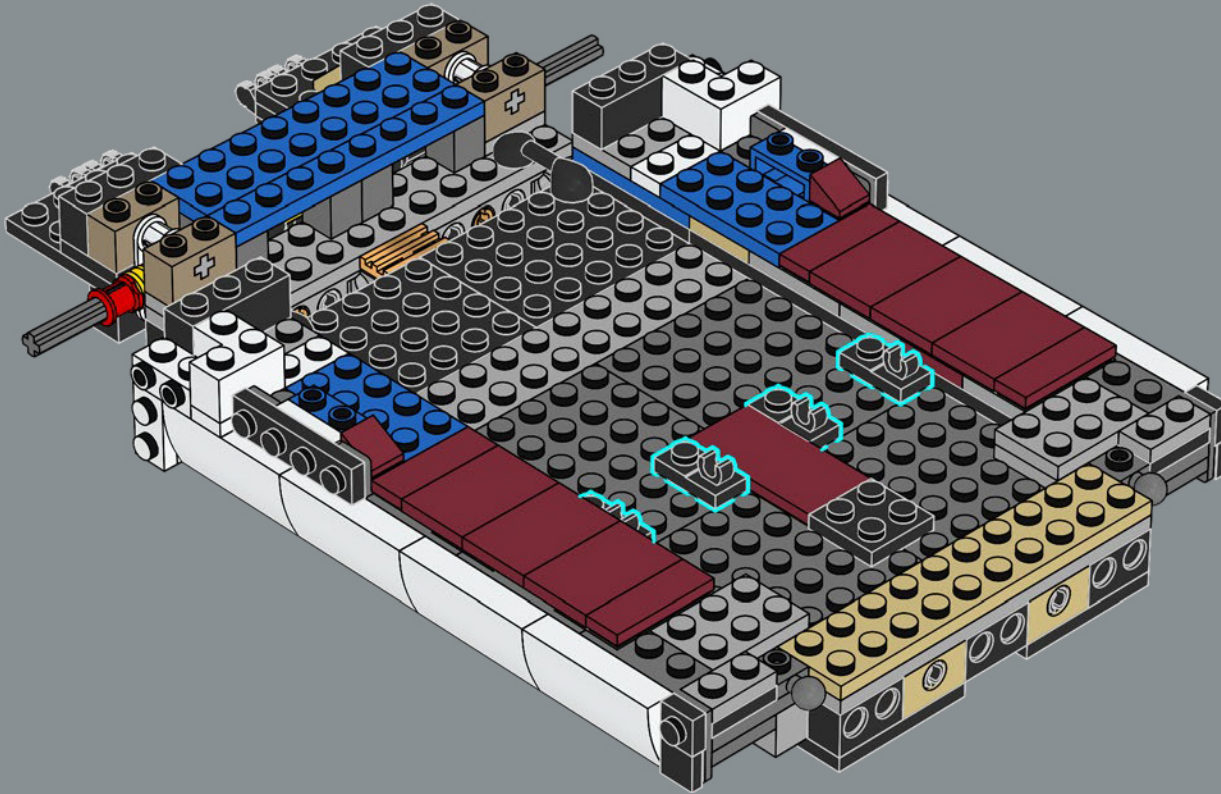



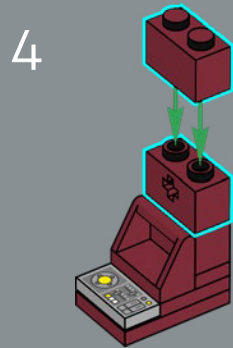
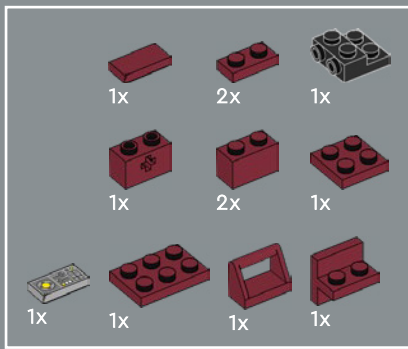

7

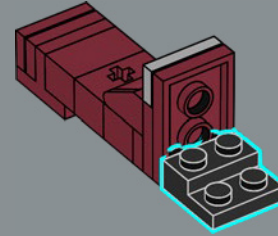

44

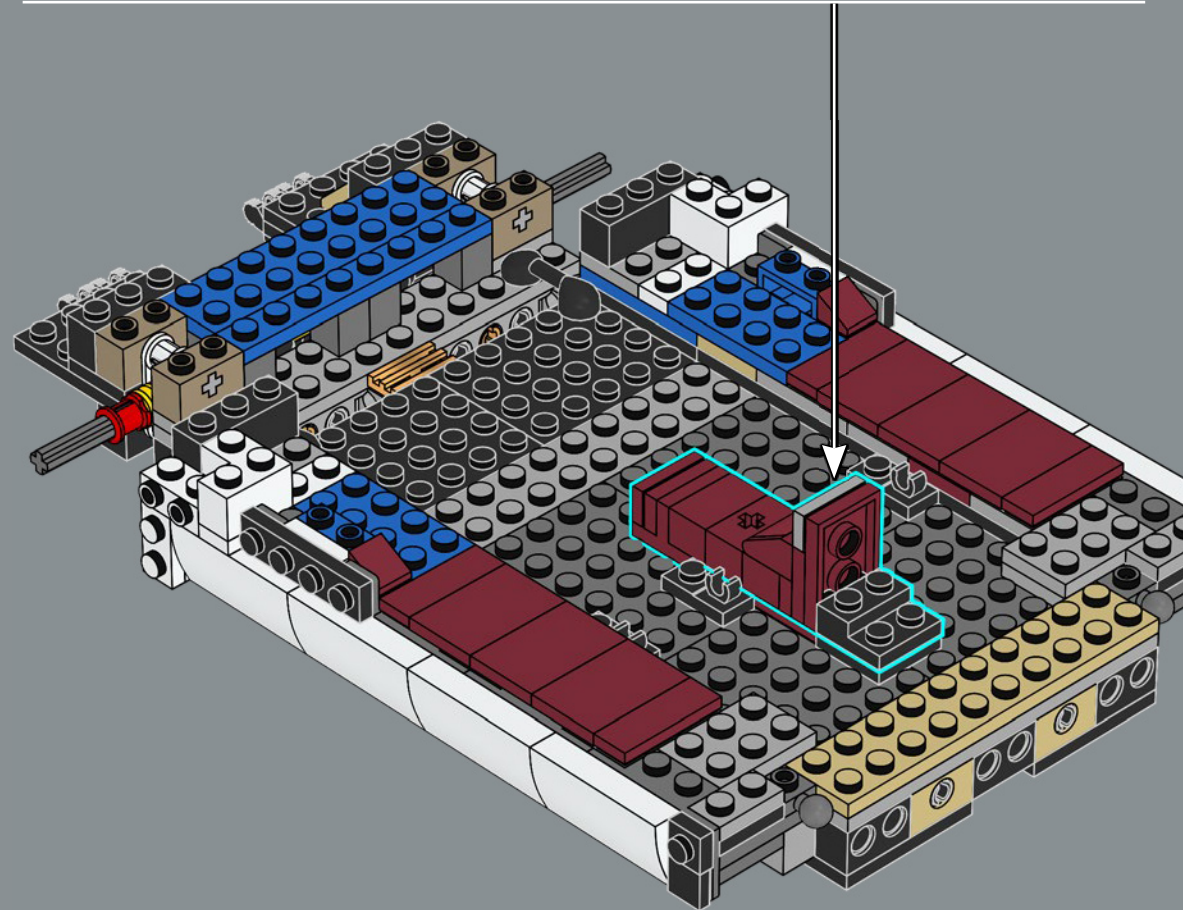
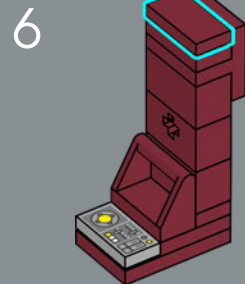
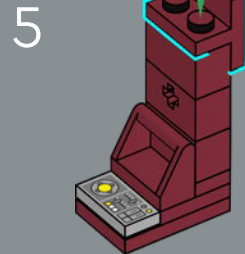
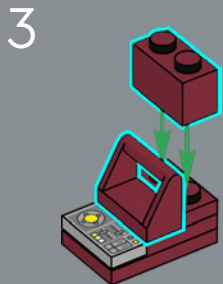
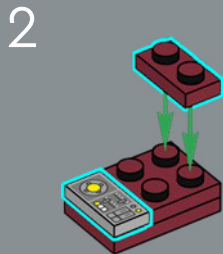
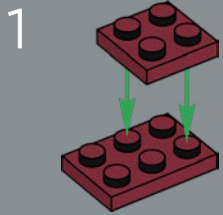



45

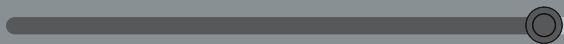
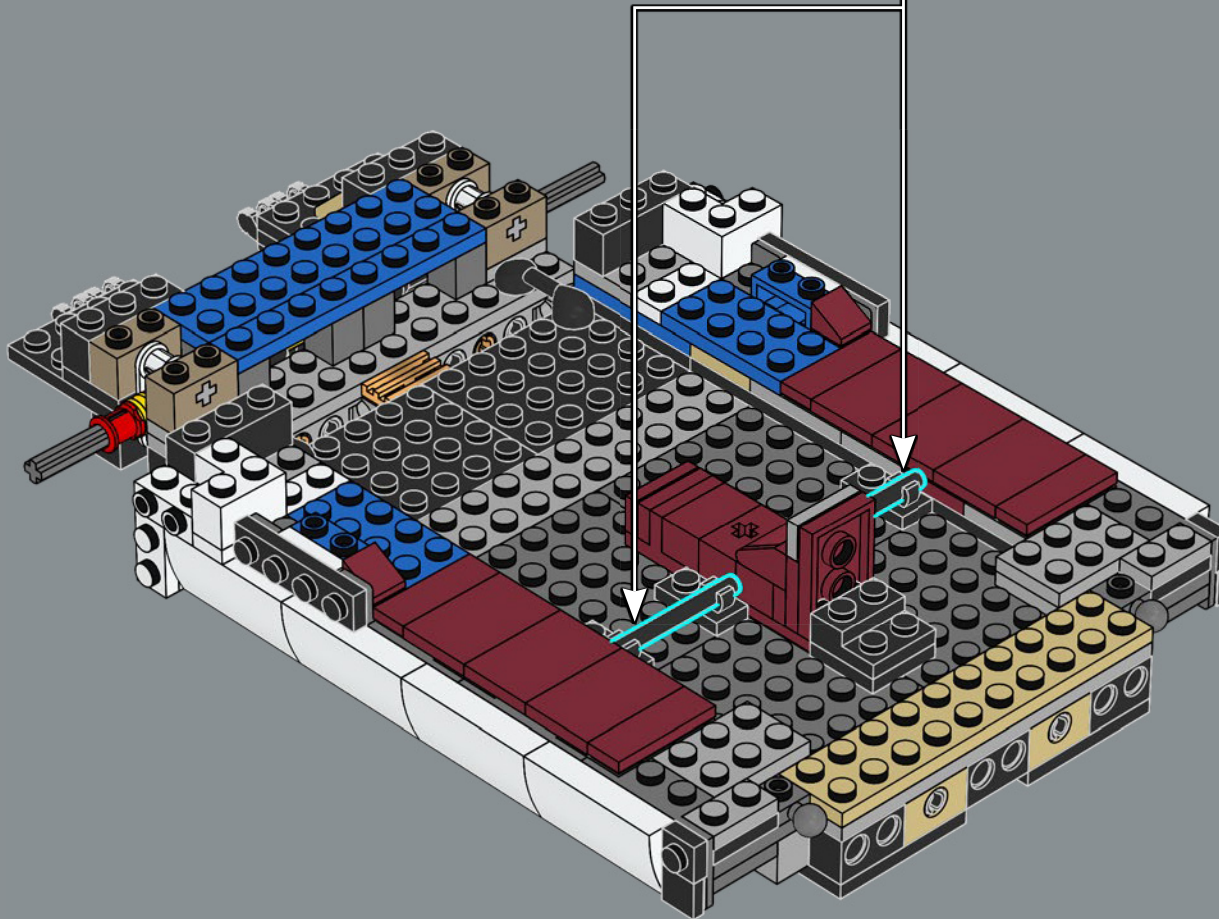

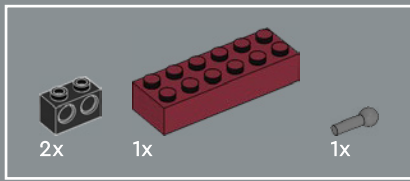

46

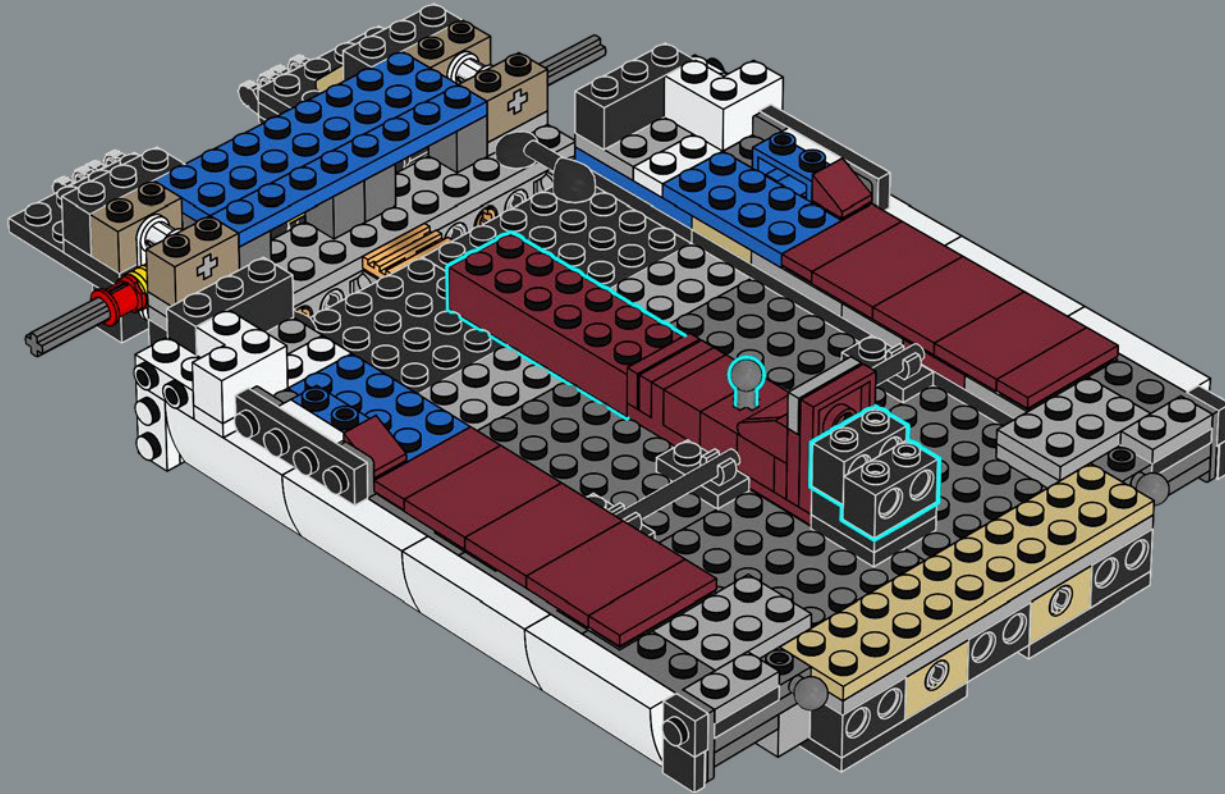



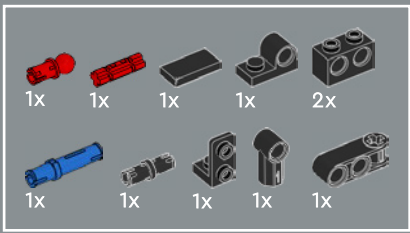

# 47

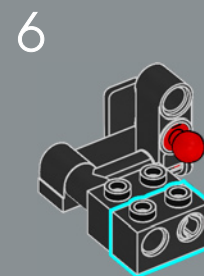
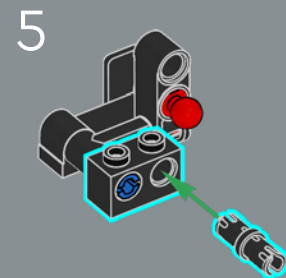
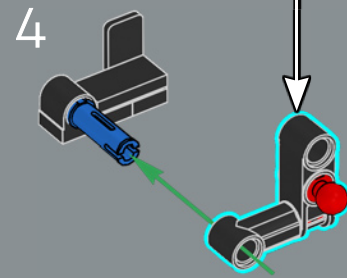
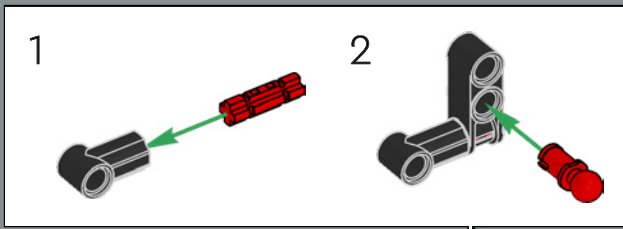
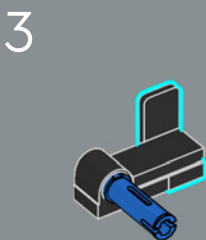
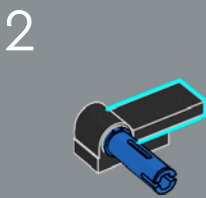
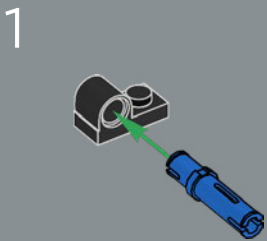





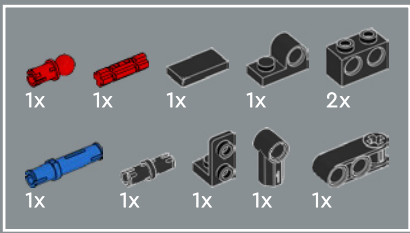

48

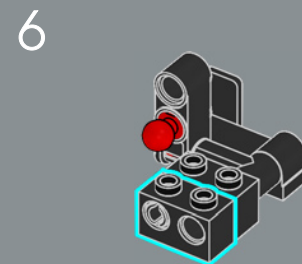
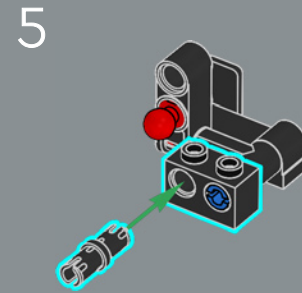
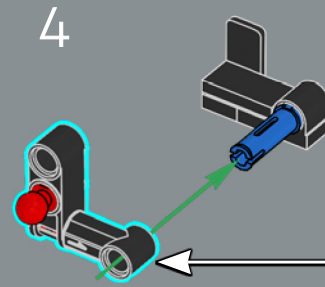
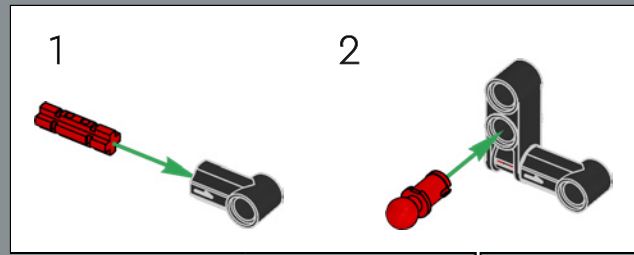
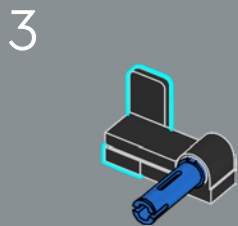
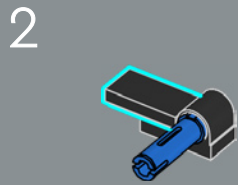
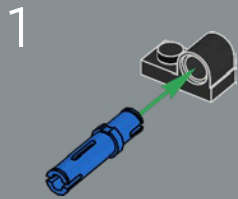

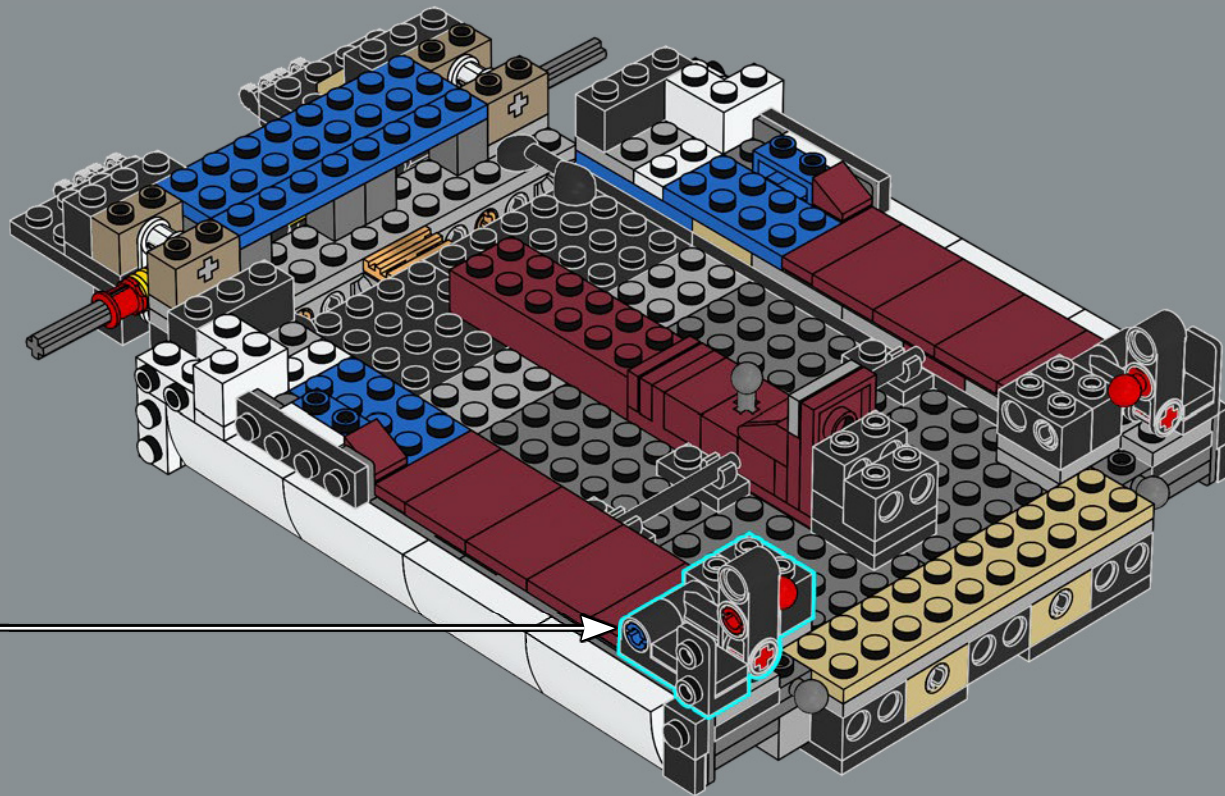

0  
2x

49

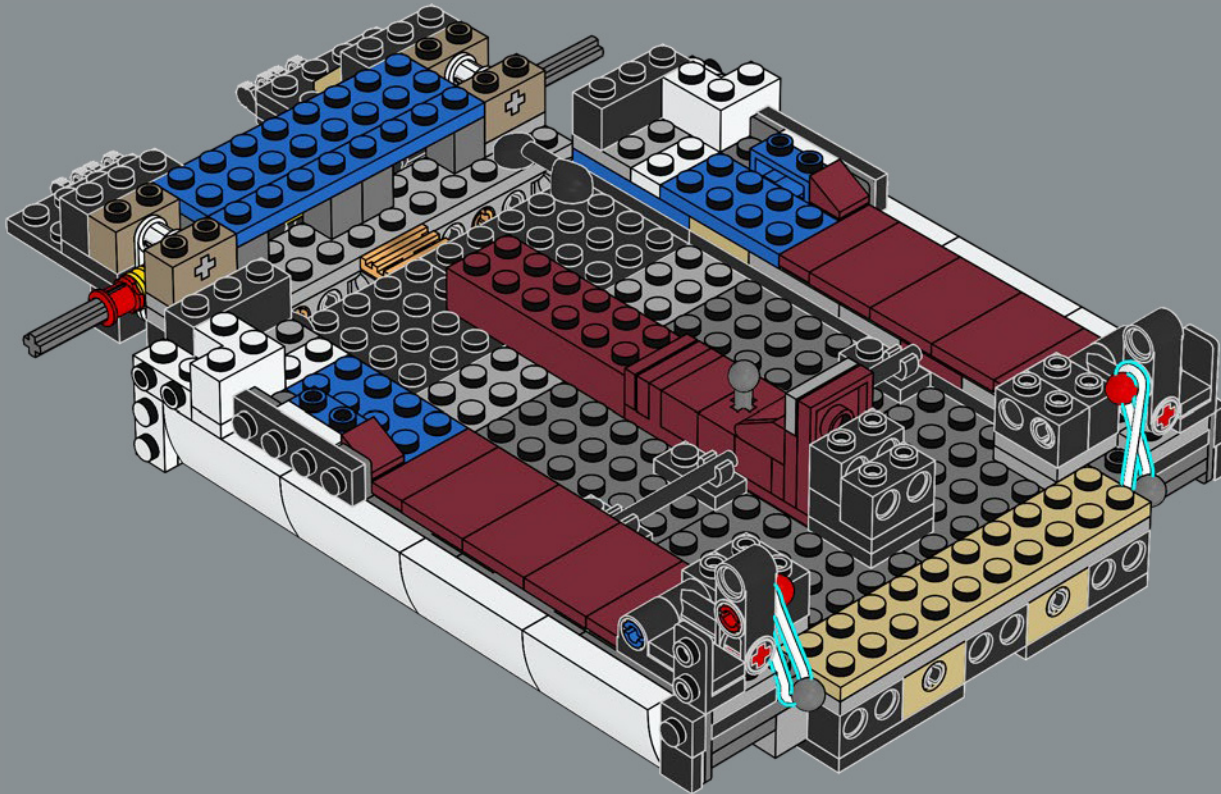



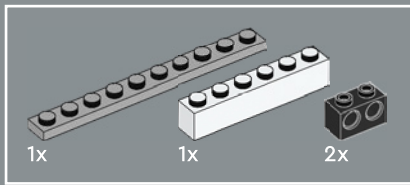

50

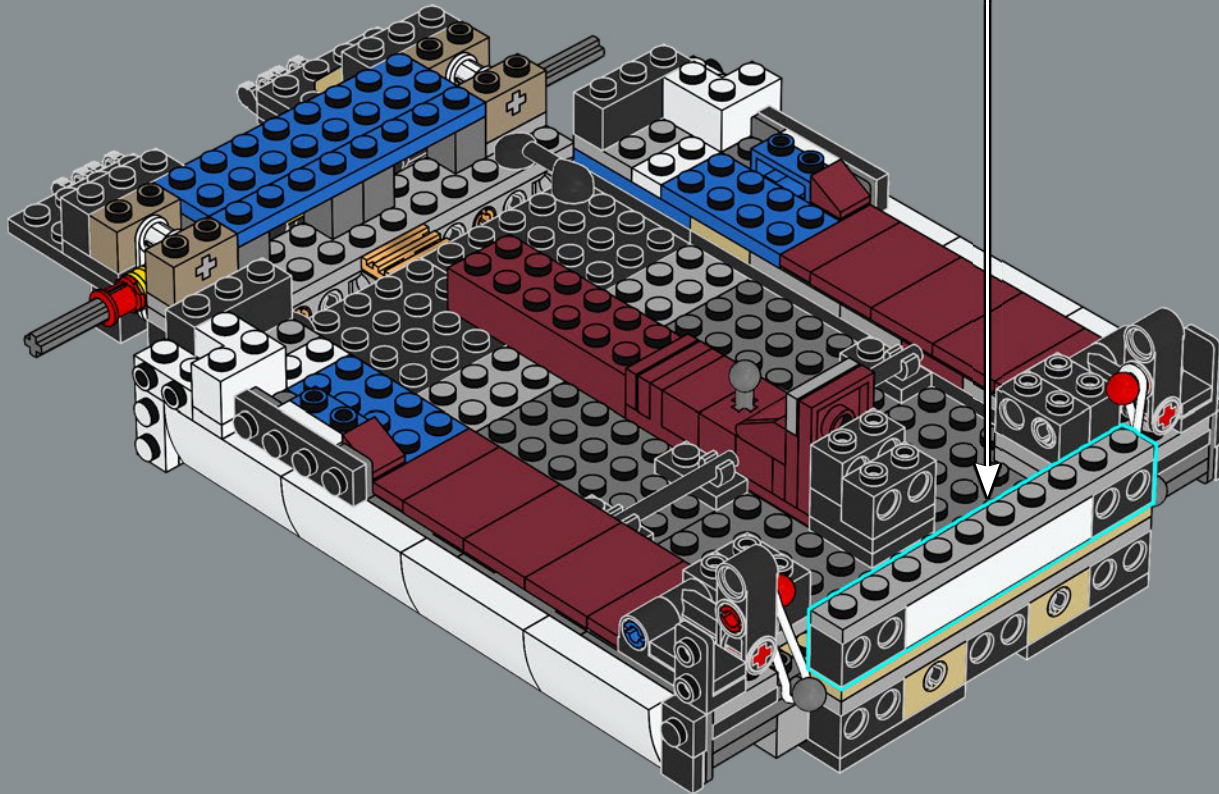
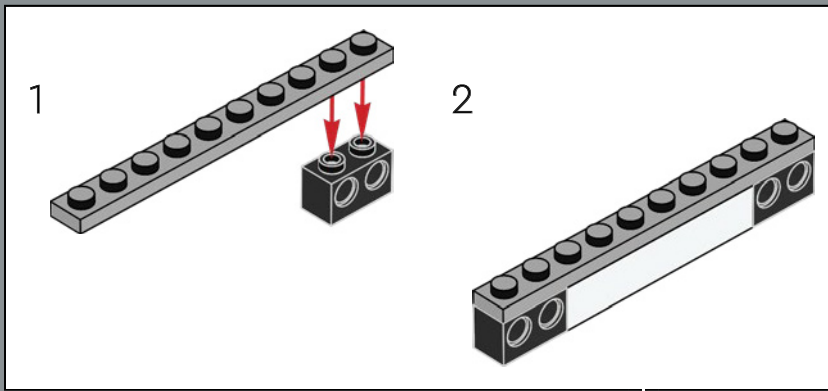

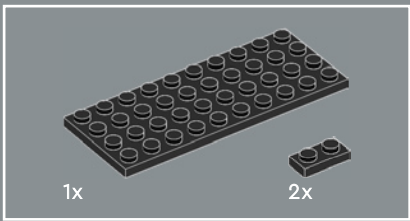

51

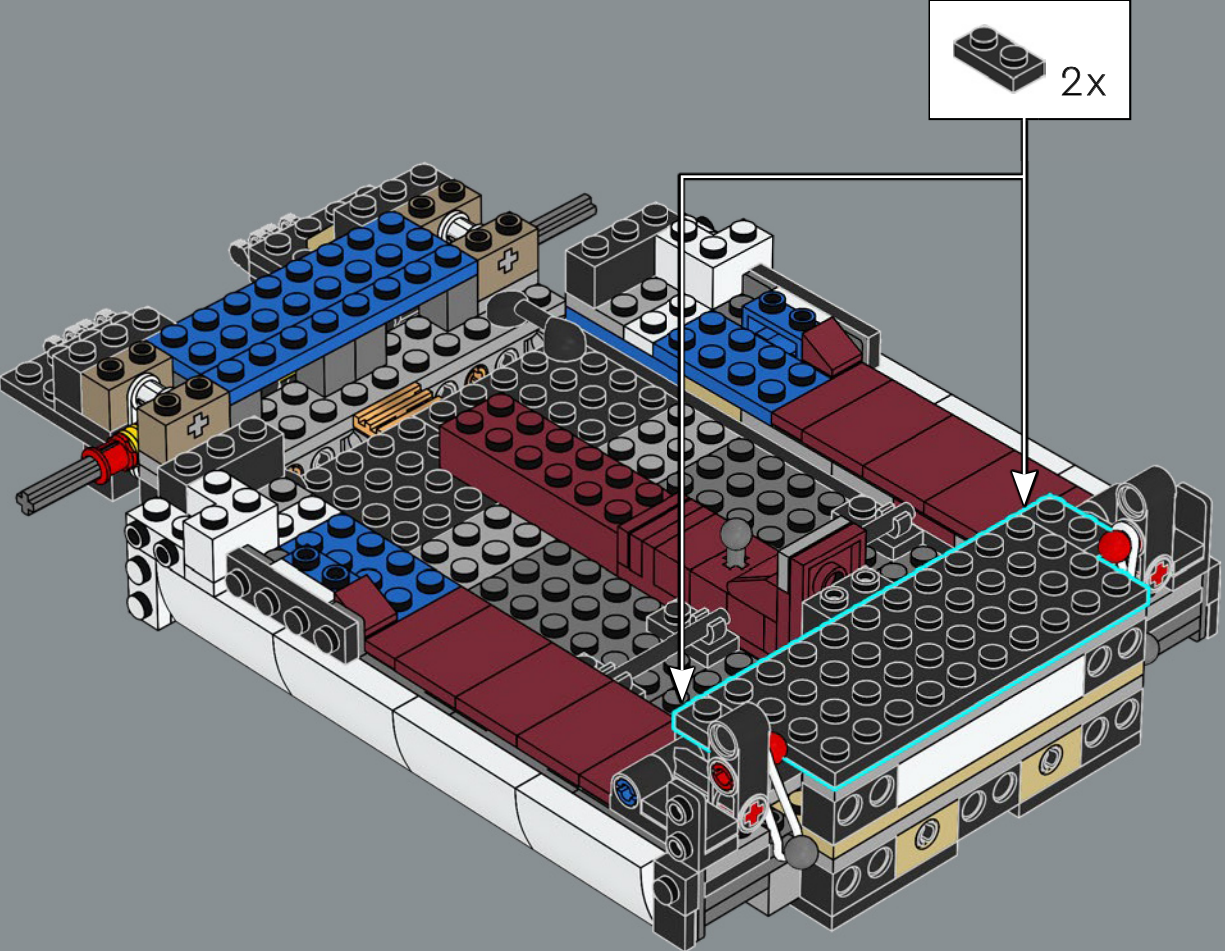

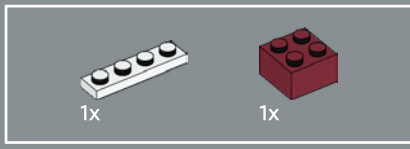

52

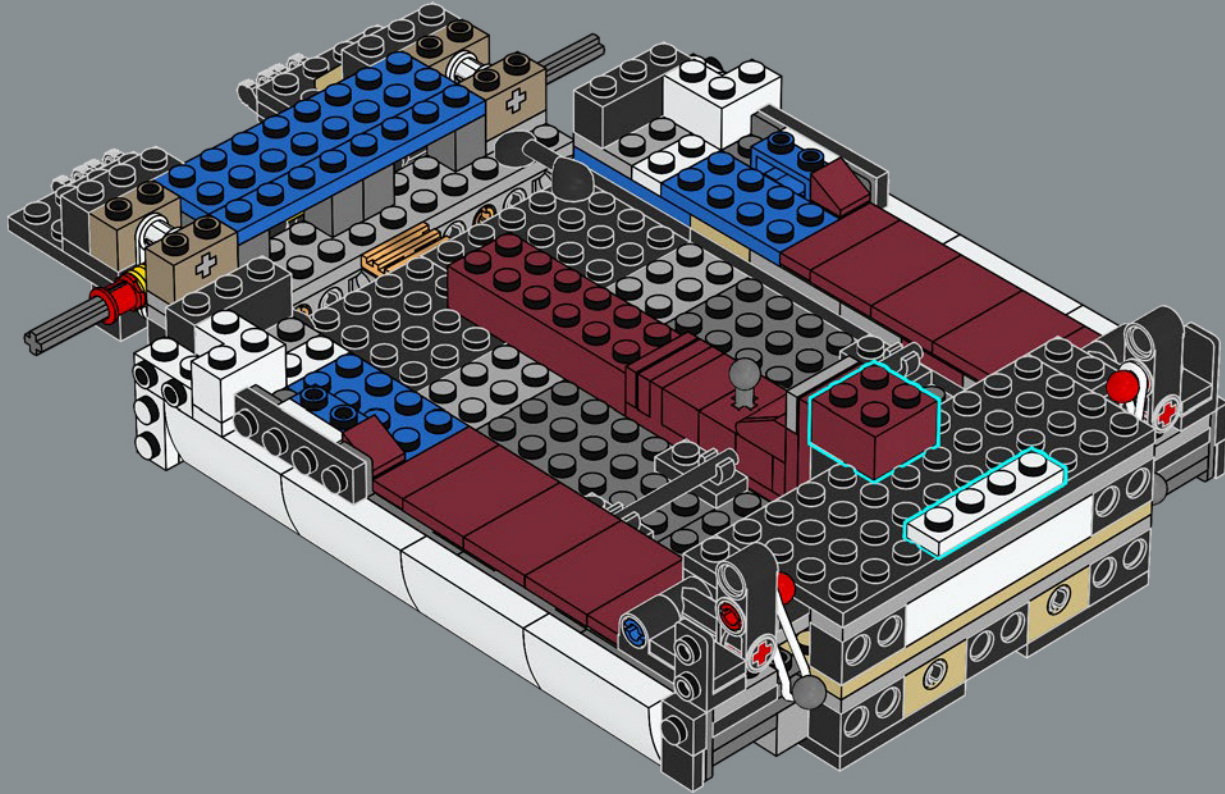



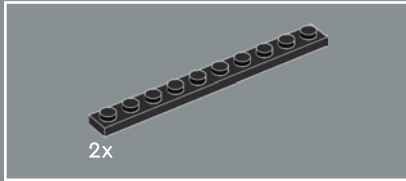
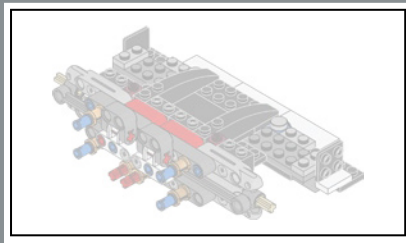

53

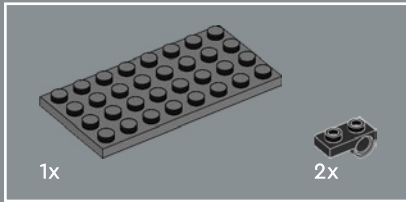
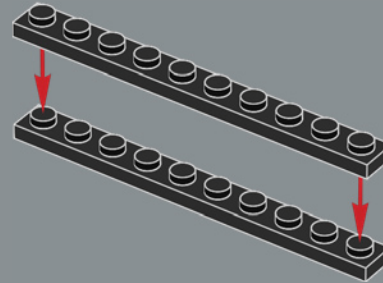

54

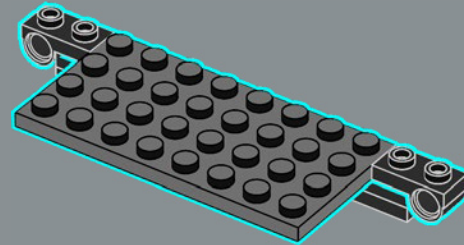



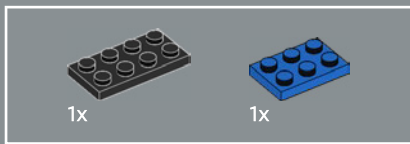

55

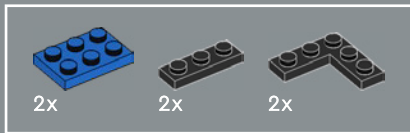
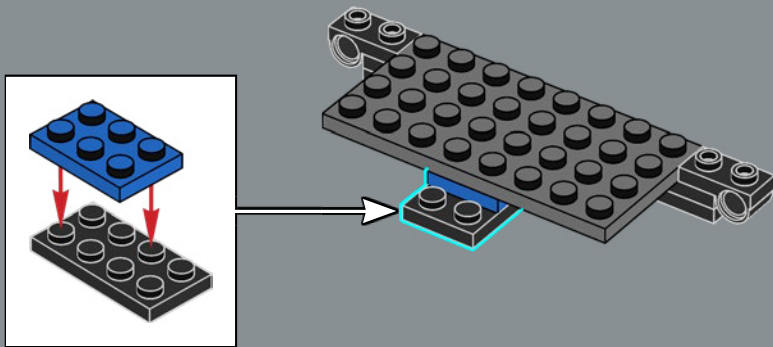

56

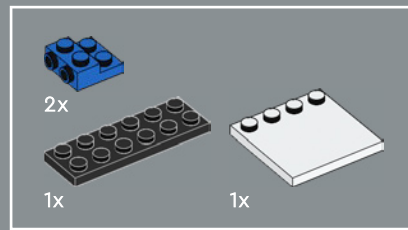
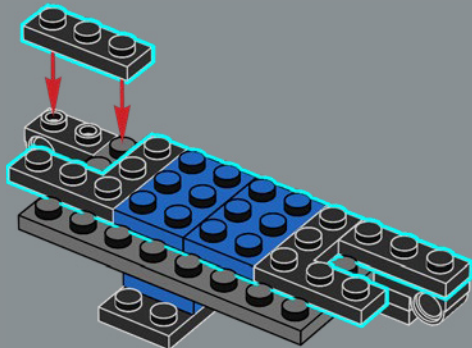

57

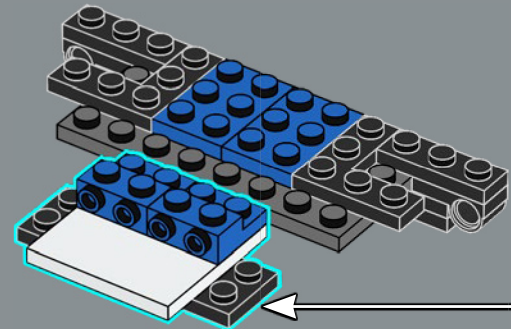
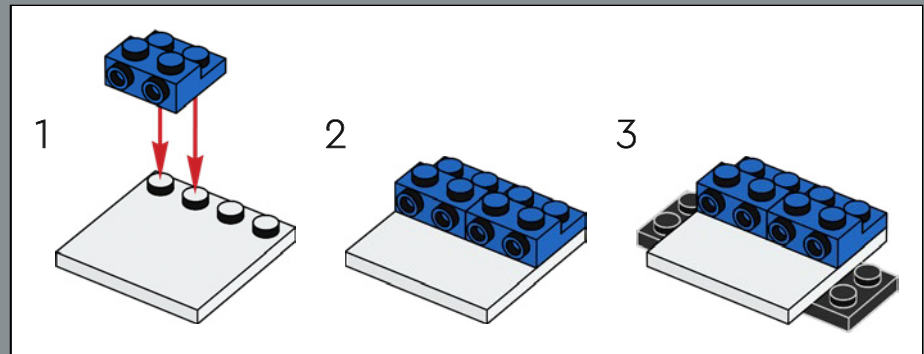

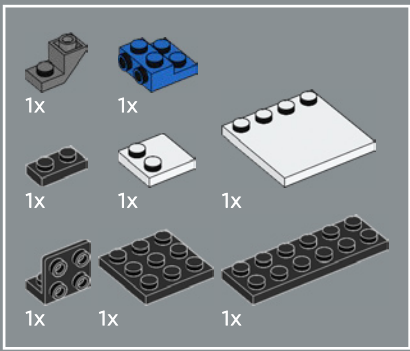

58

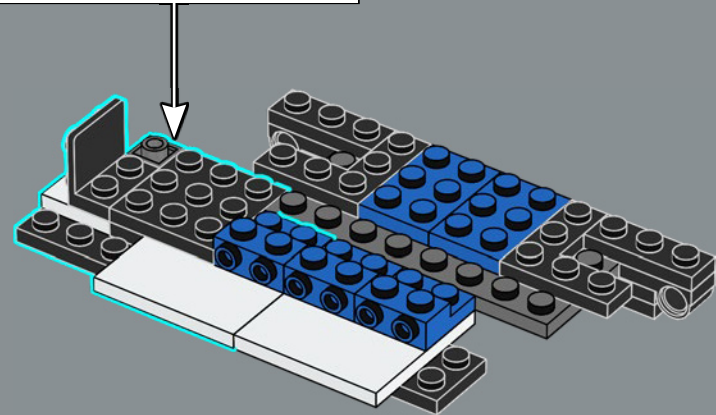
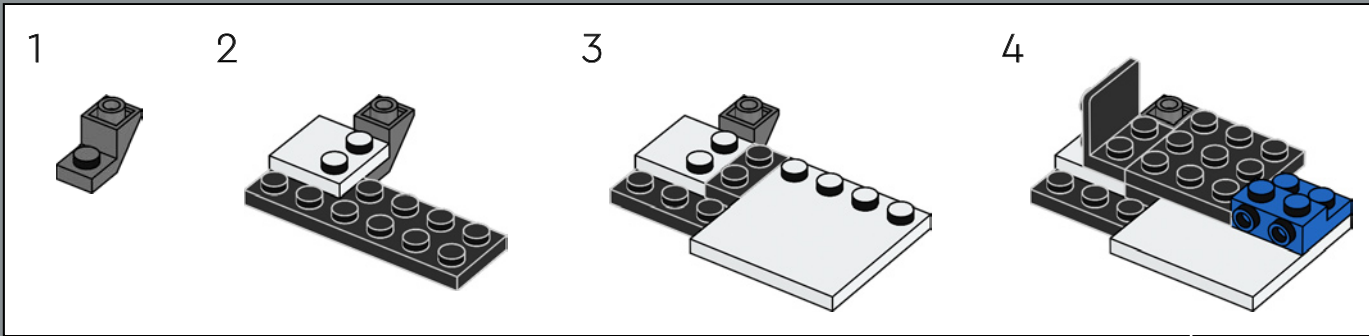

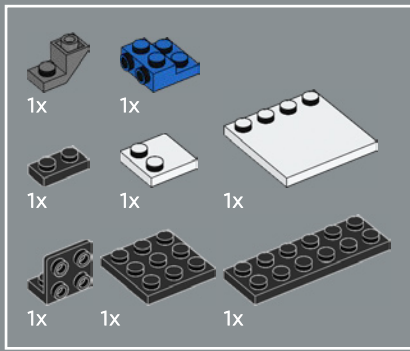

59

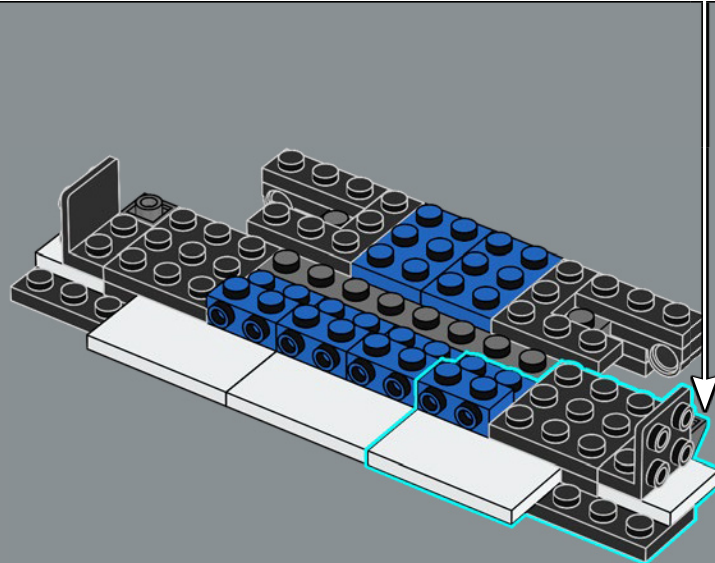
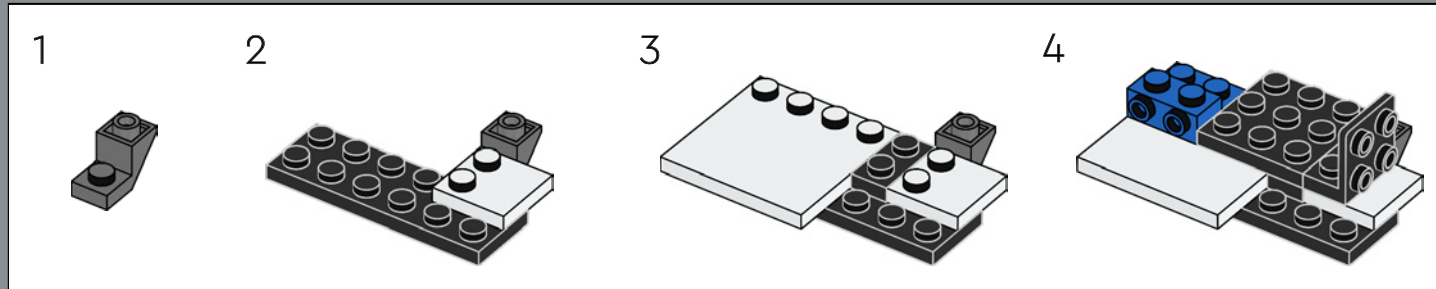

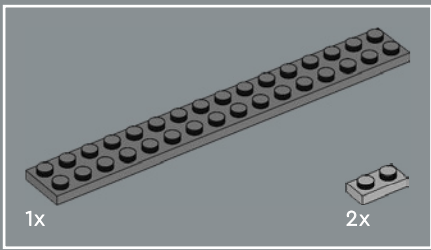

60

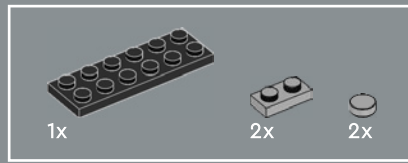
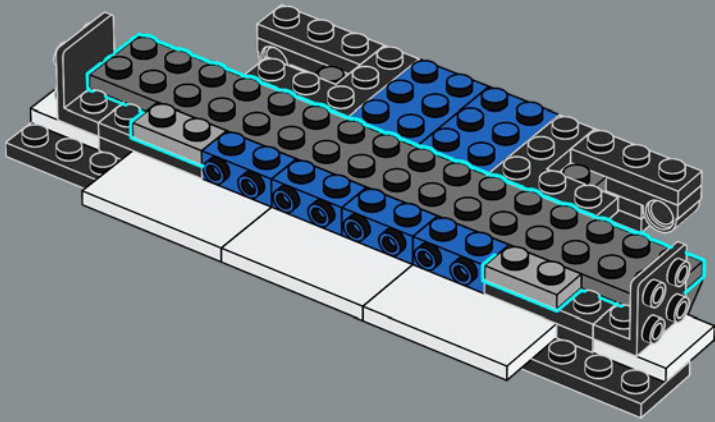

61

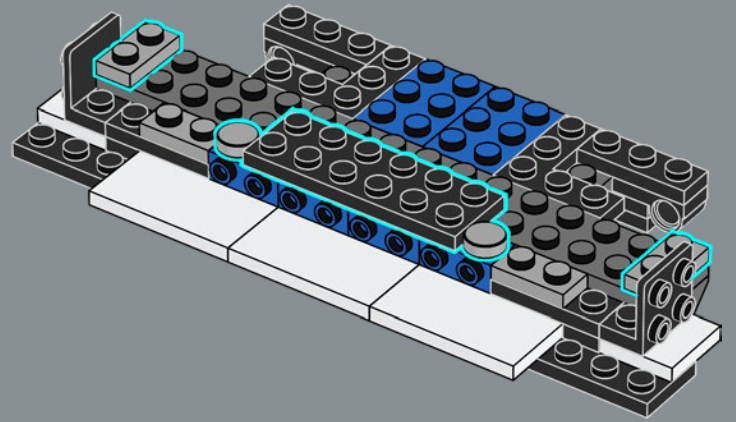



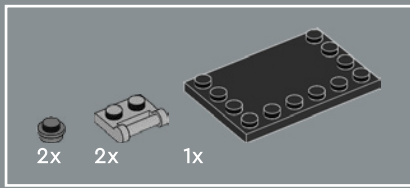

62

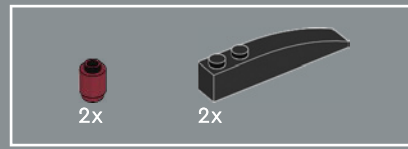
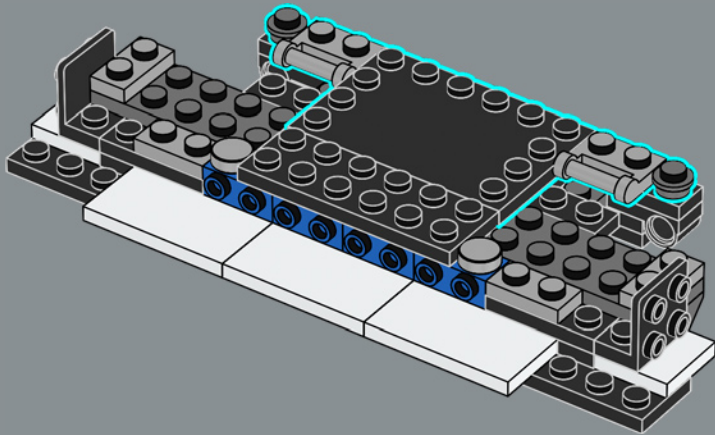

63

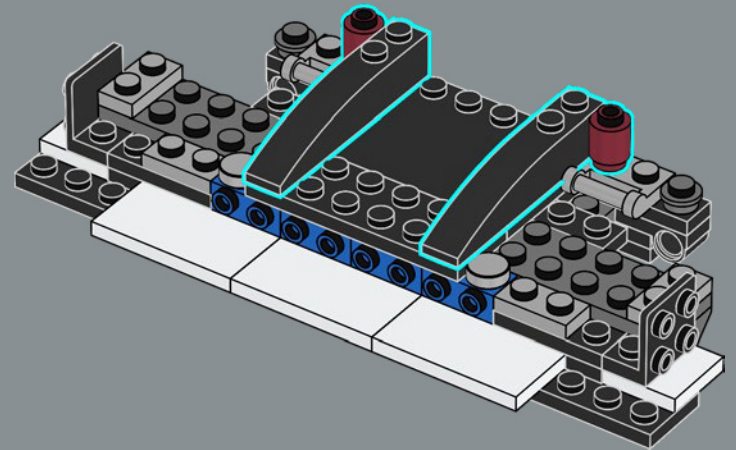

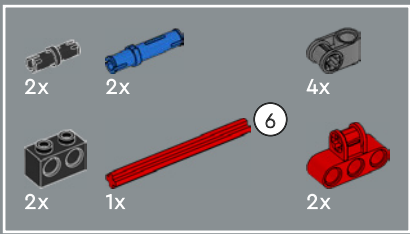

64

1

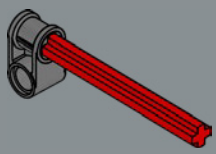

2

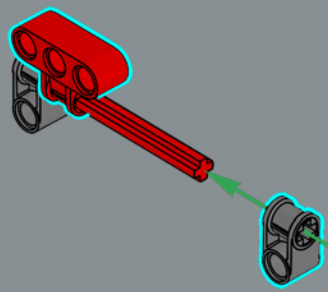

3

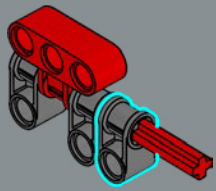

4

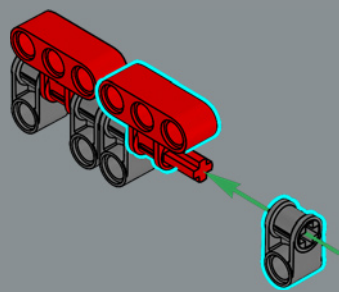

5

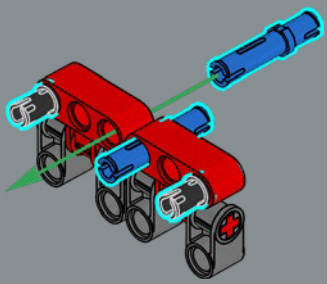

6

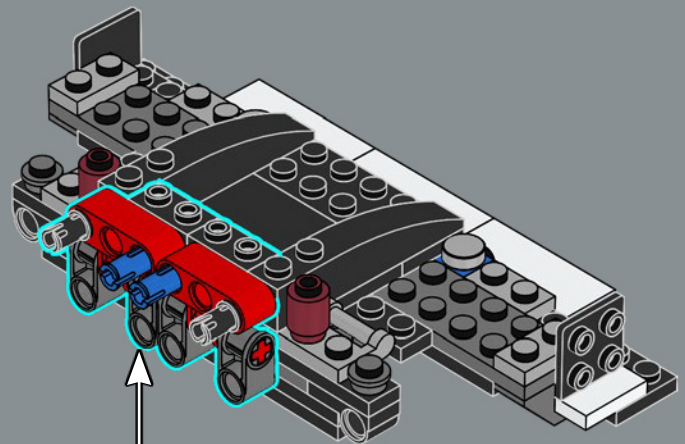
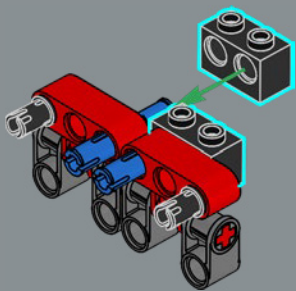

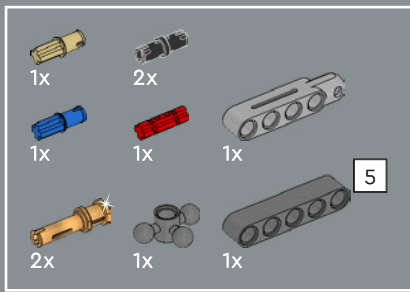

65

1

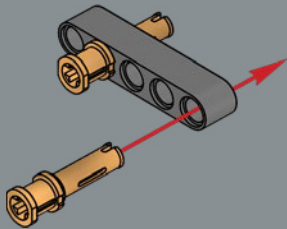

2

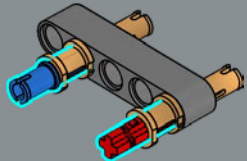

3

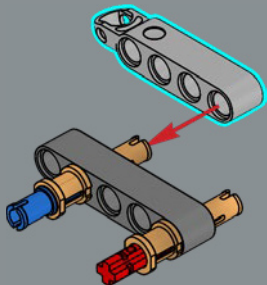

4

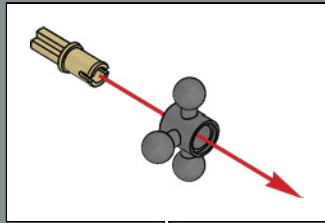
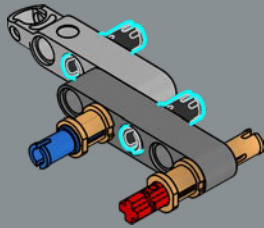

5

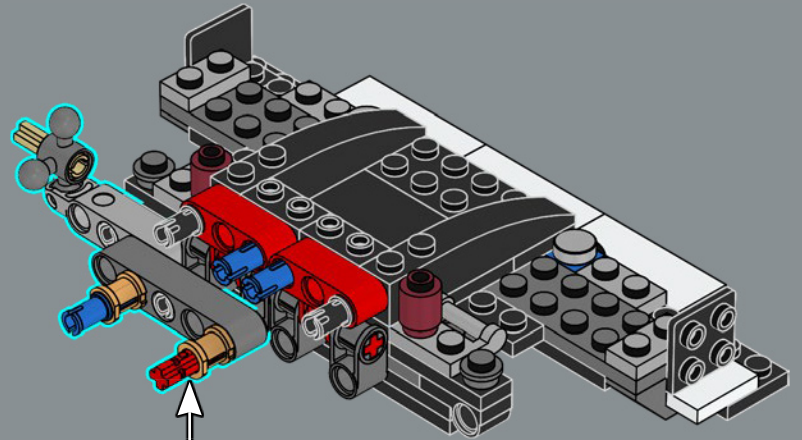
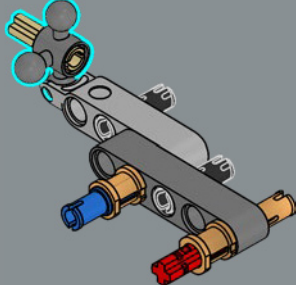

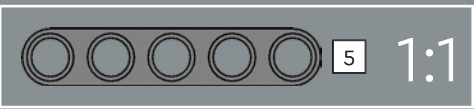
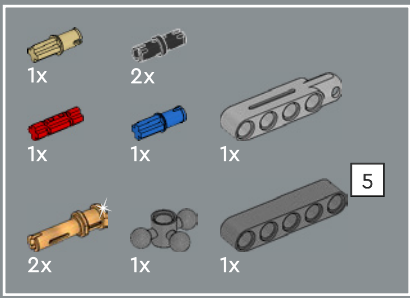

66

1

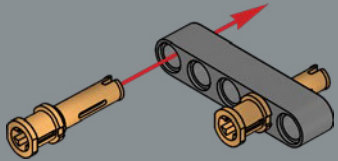

2

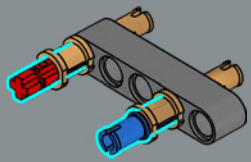

3

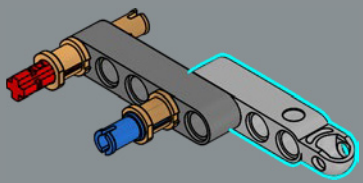

4

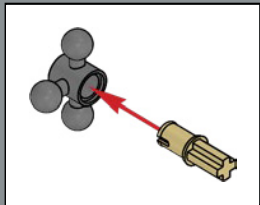
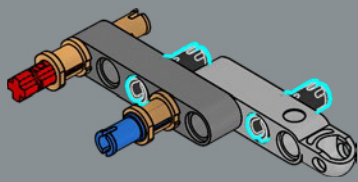

5

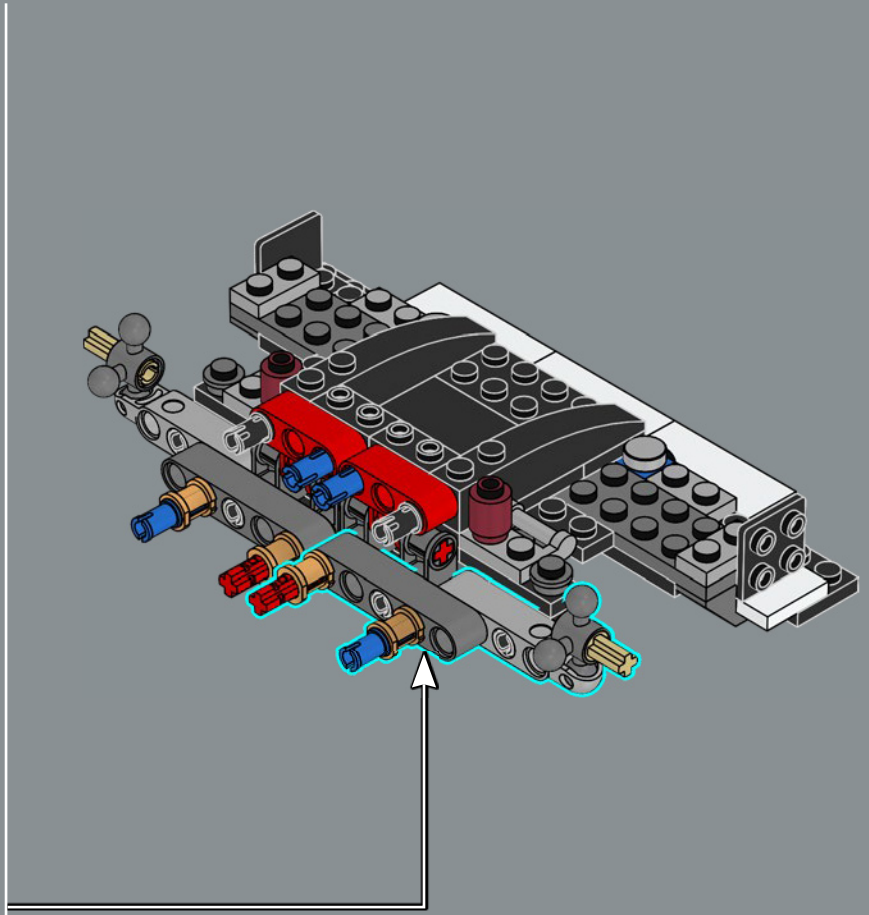
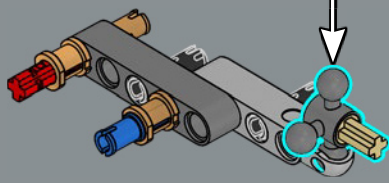



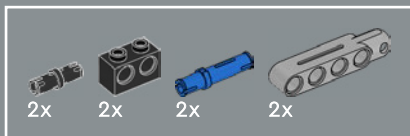

67

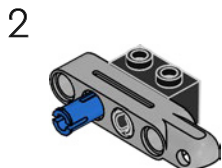
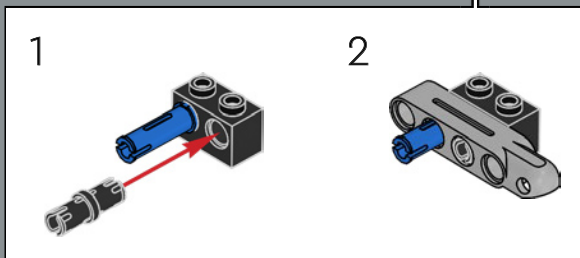
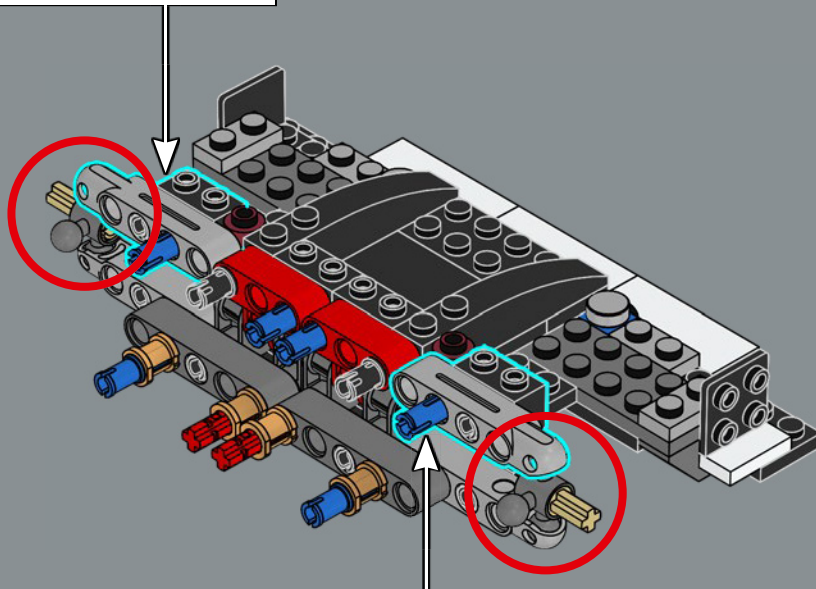
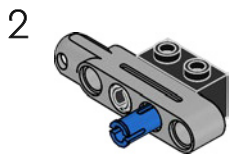
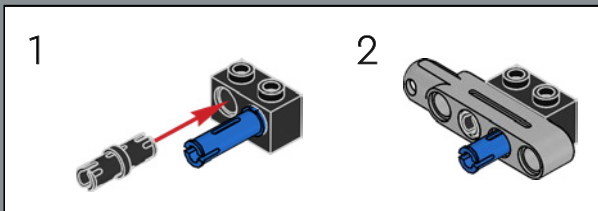

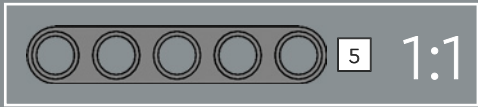
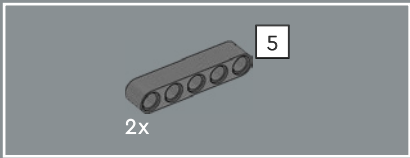

68

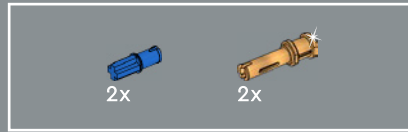
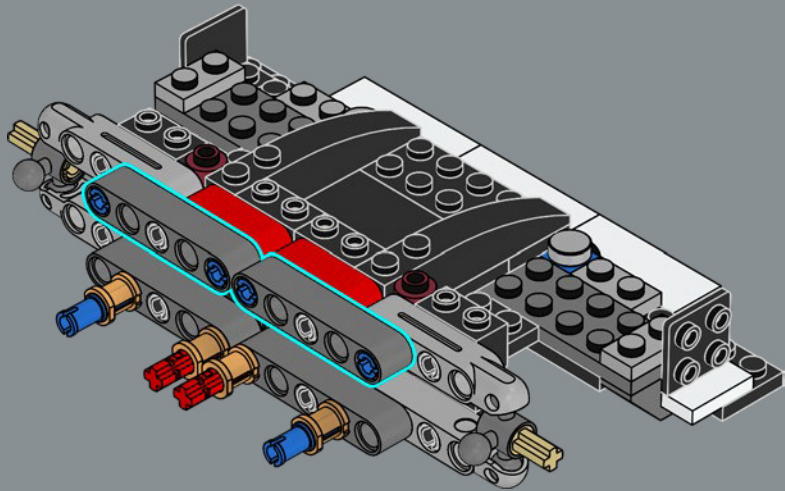

69

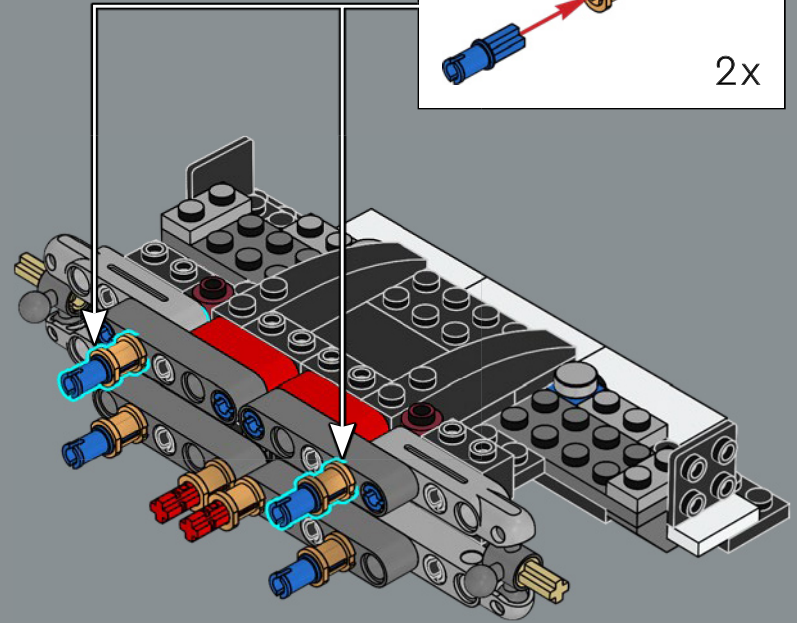
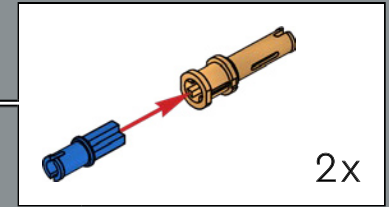

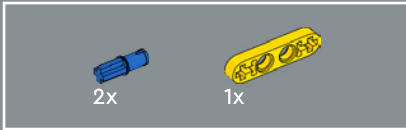
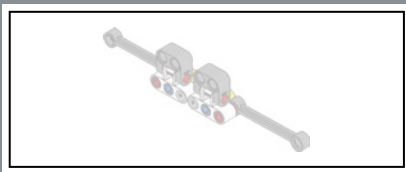

70

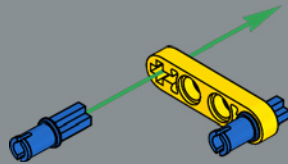

71

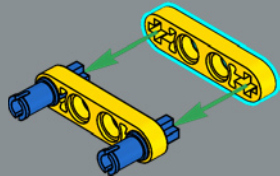

72

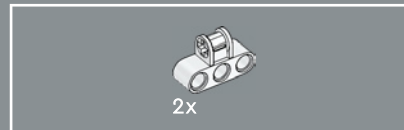
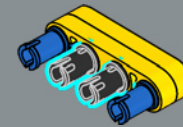

73

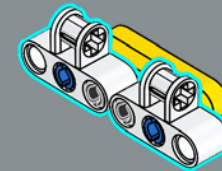

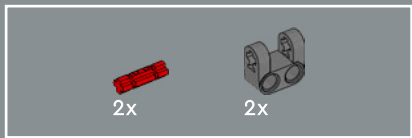

74

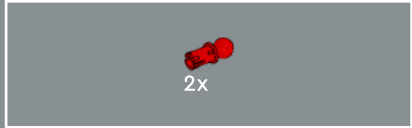
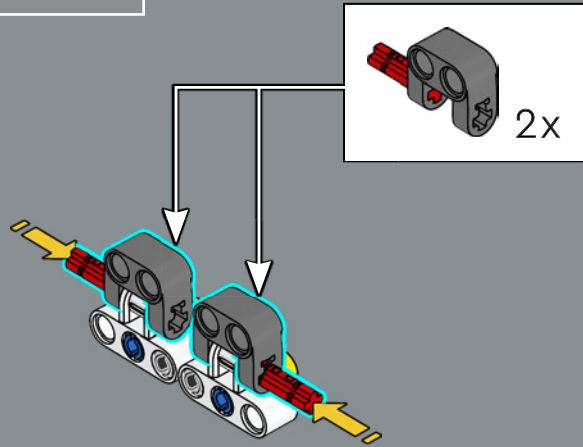

75

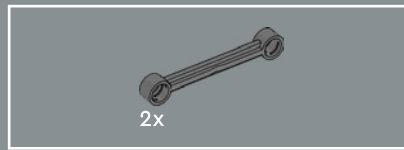
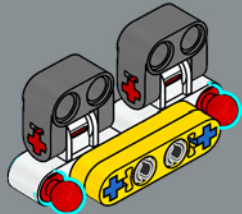

76

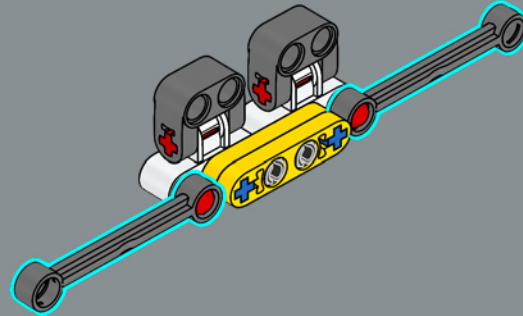

77

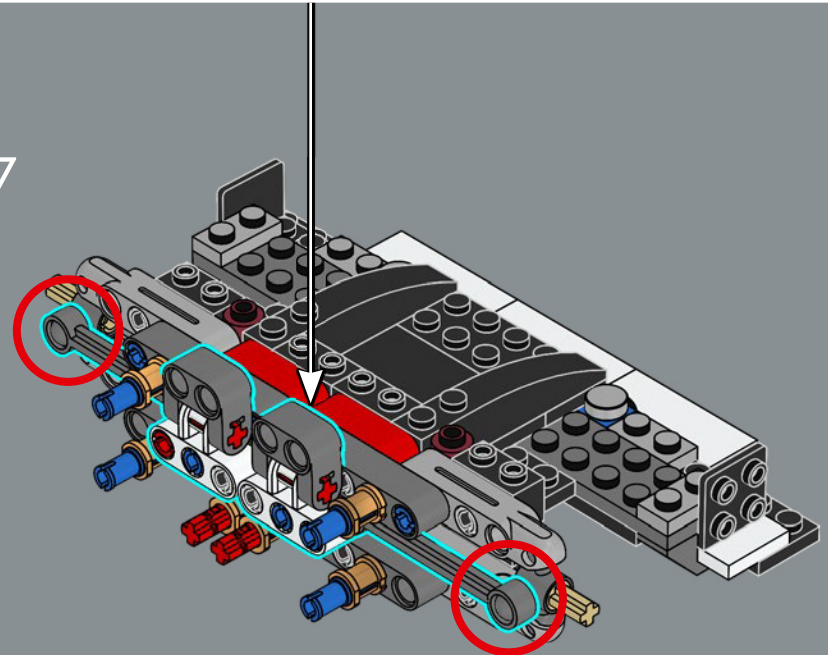



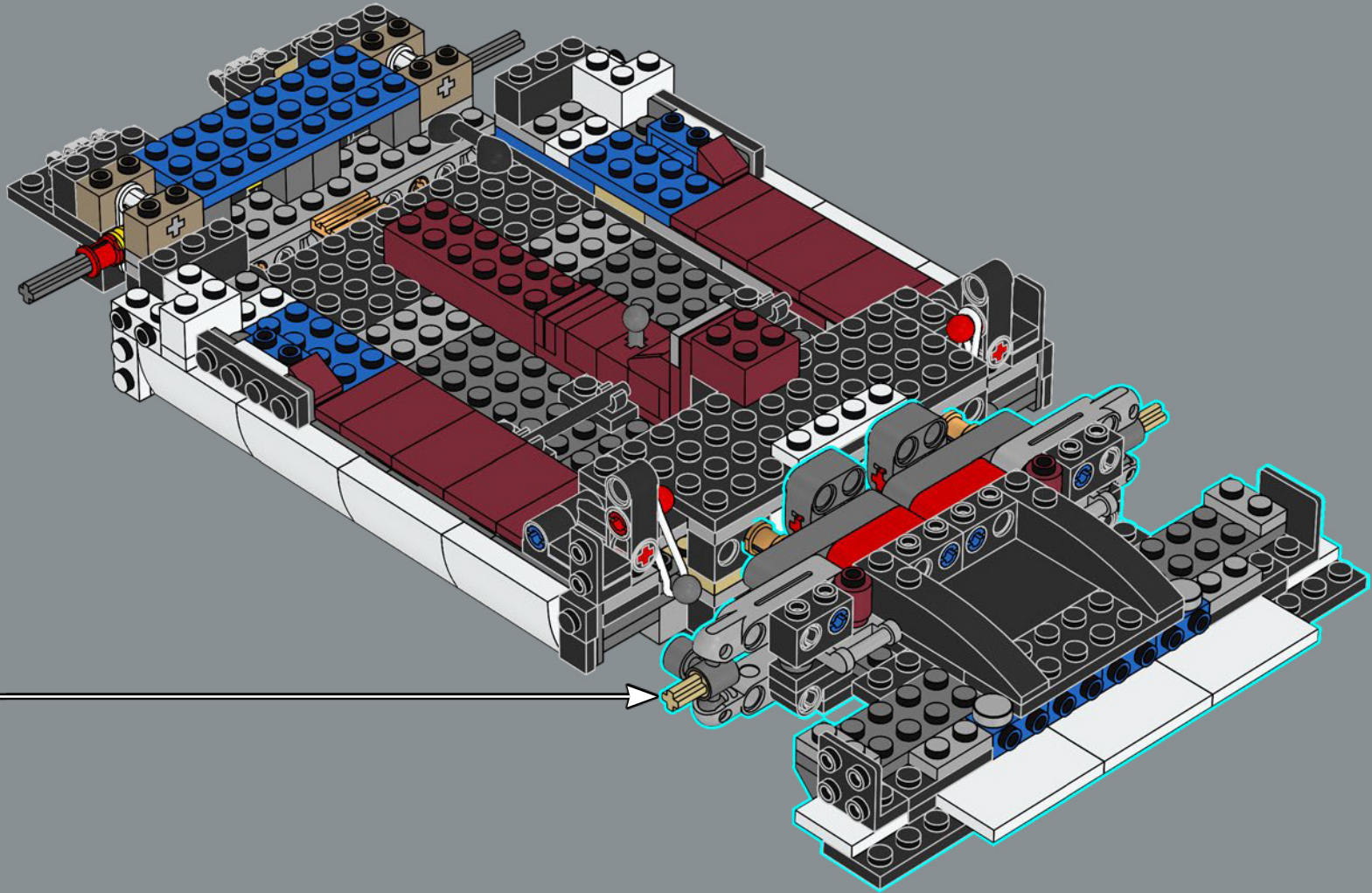

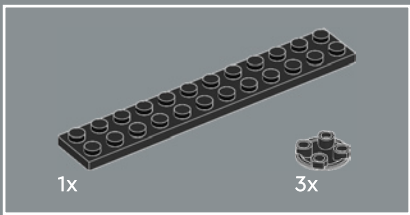

79

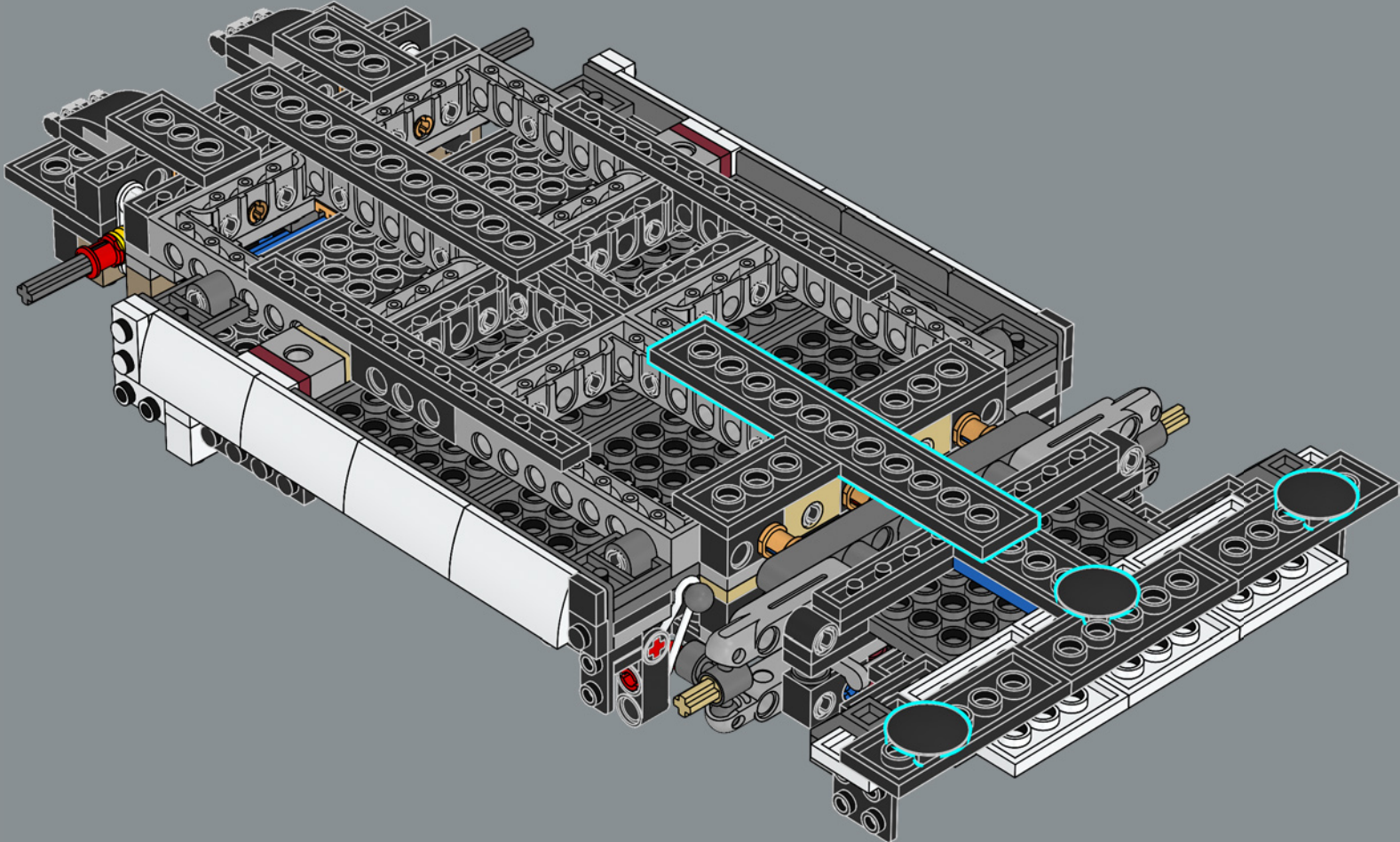



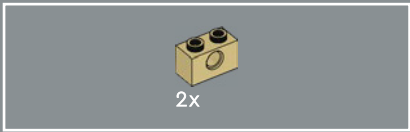

80

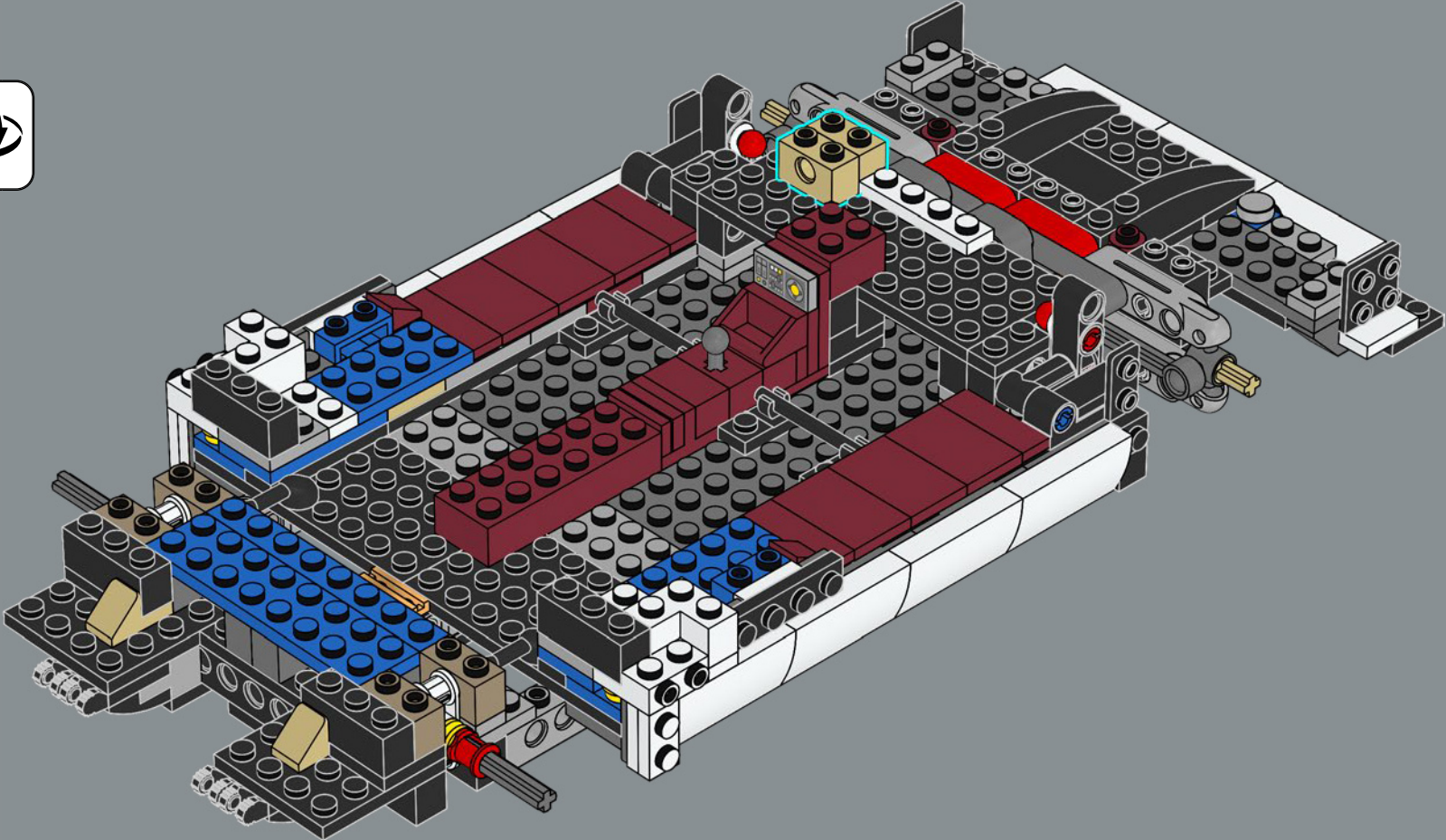

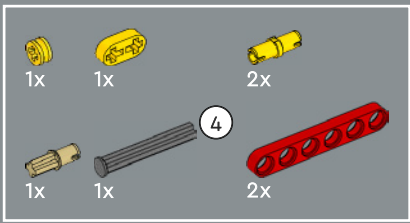

81

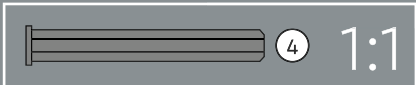
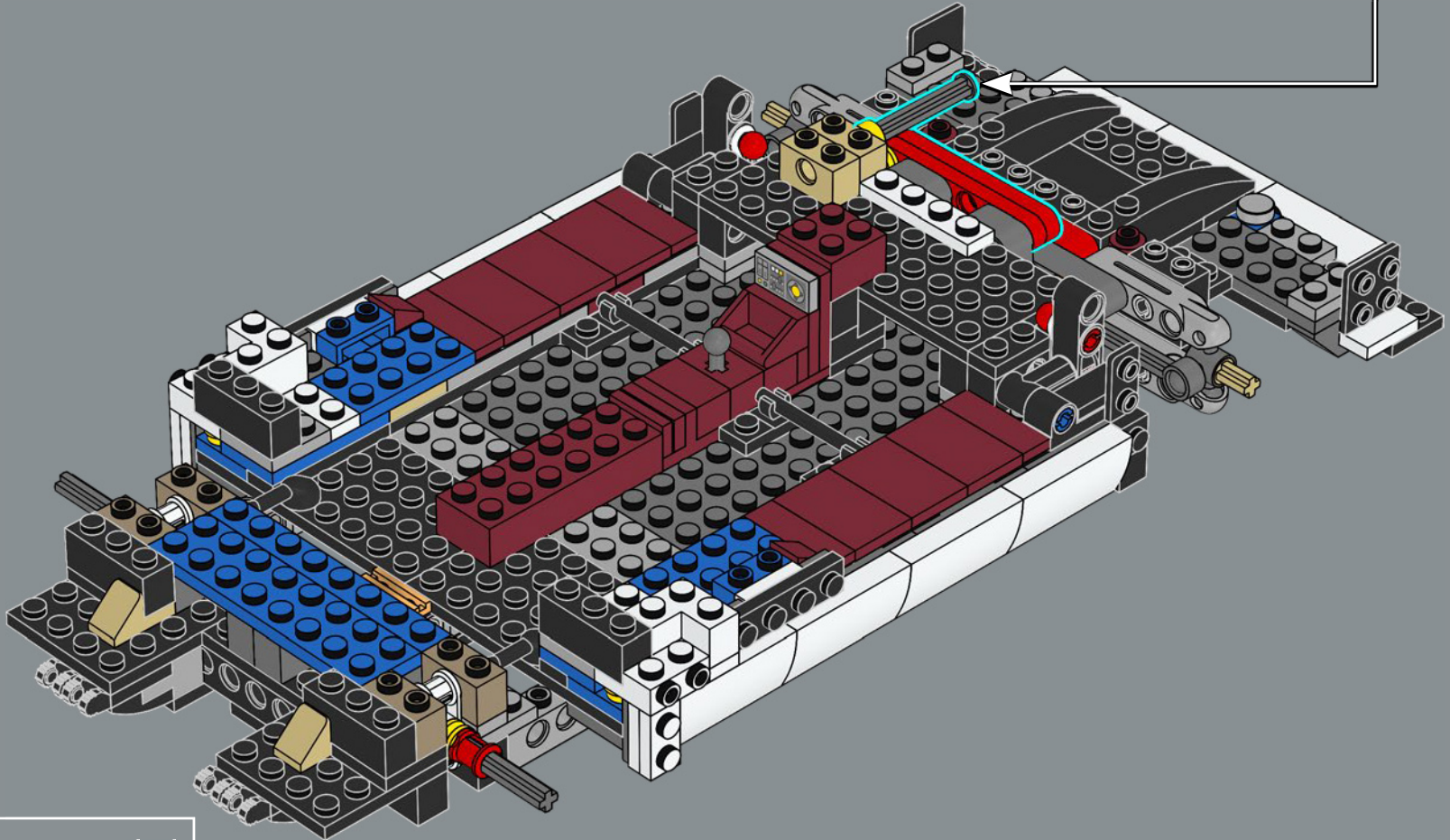
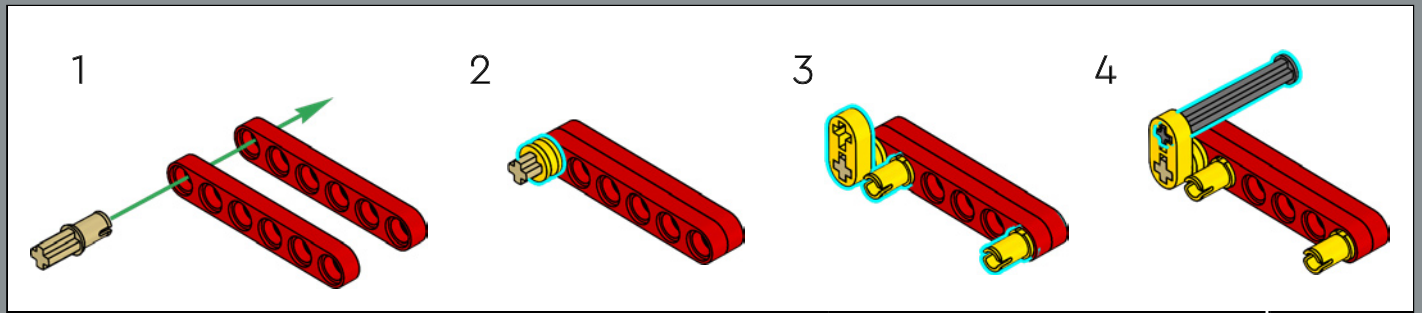





1x

82

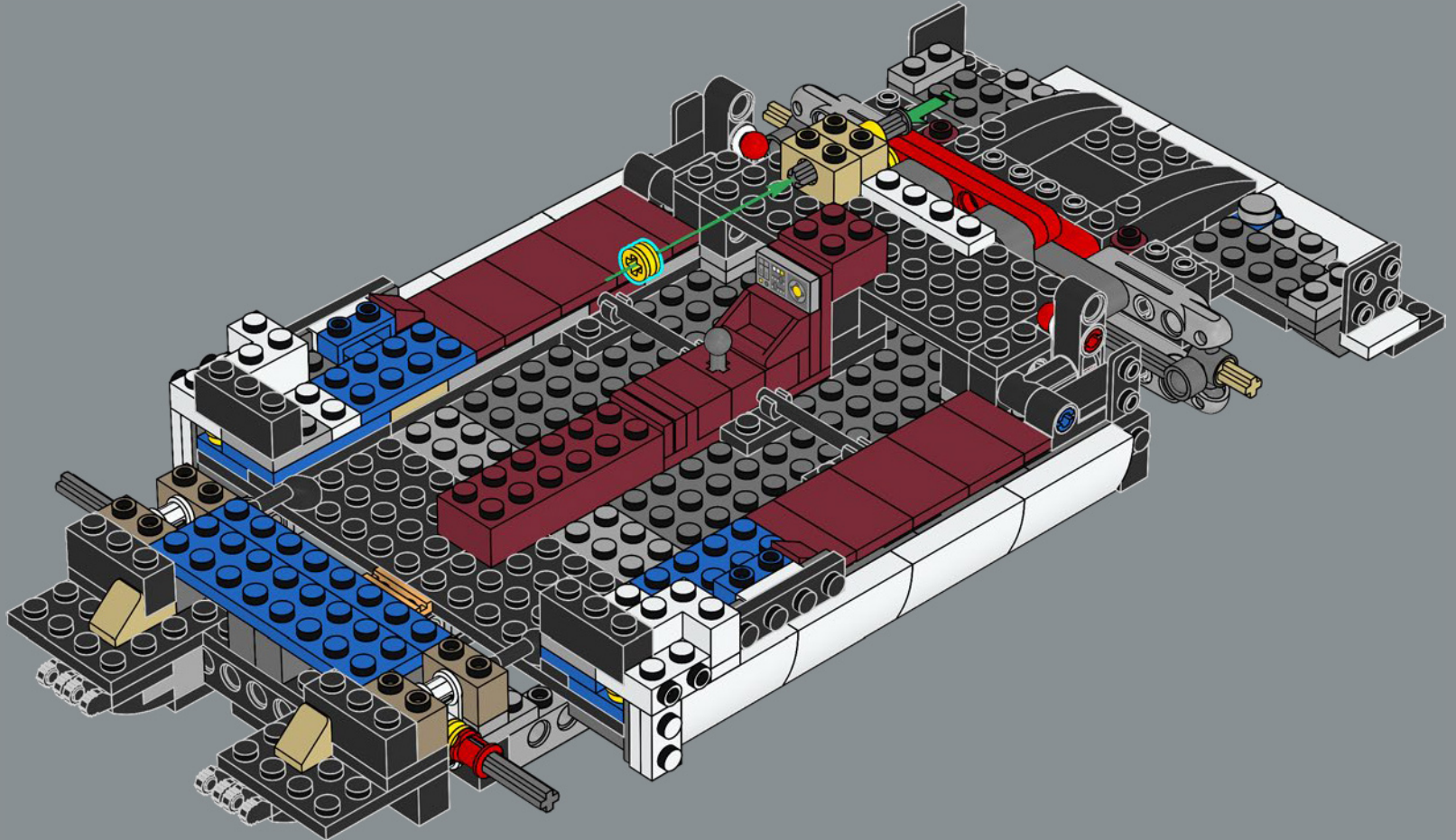

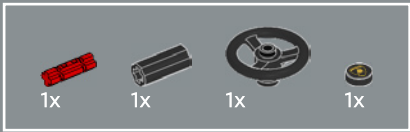

83

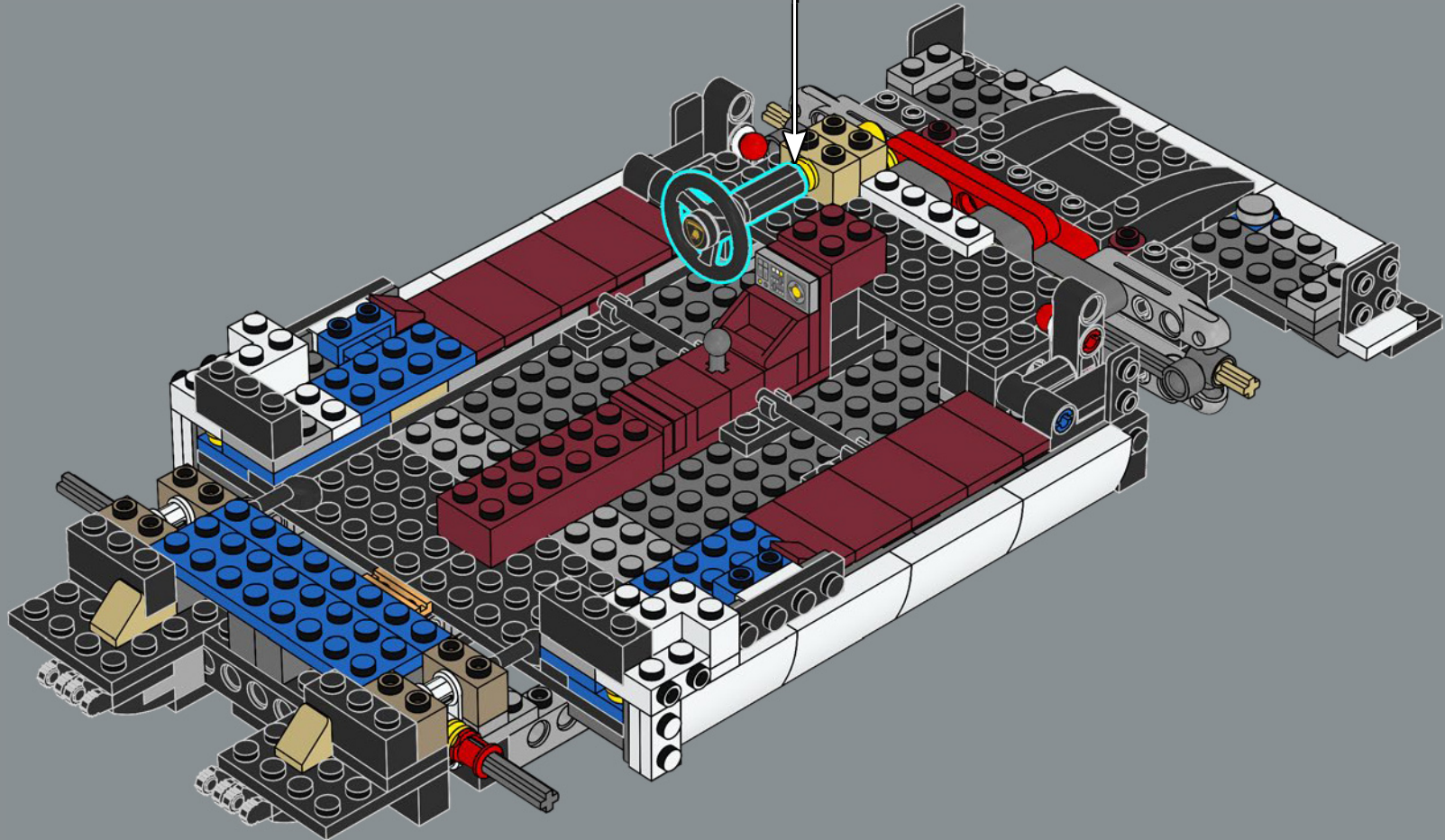
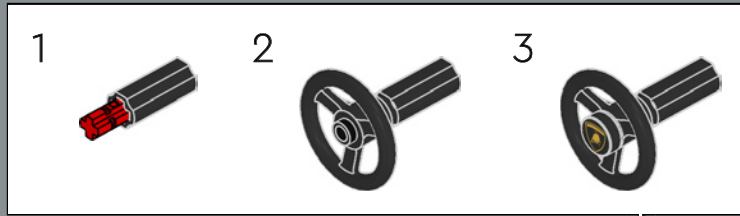



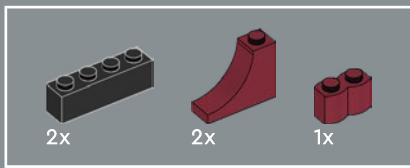

84

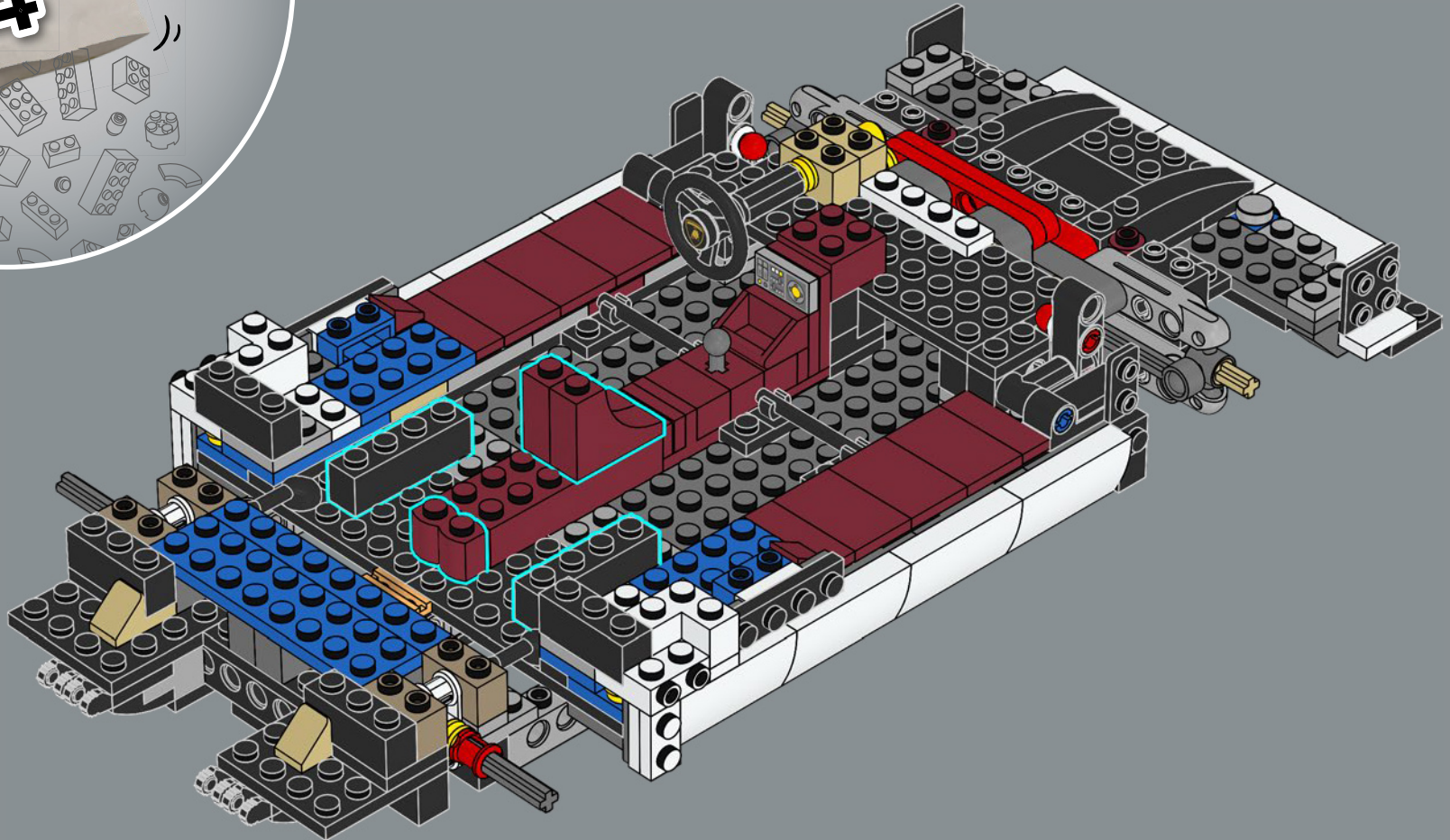

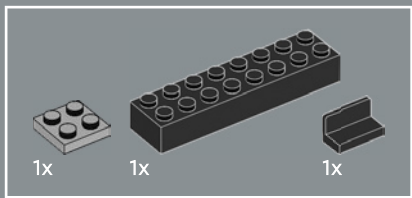

85

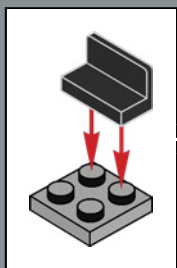
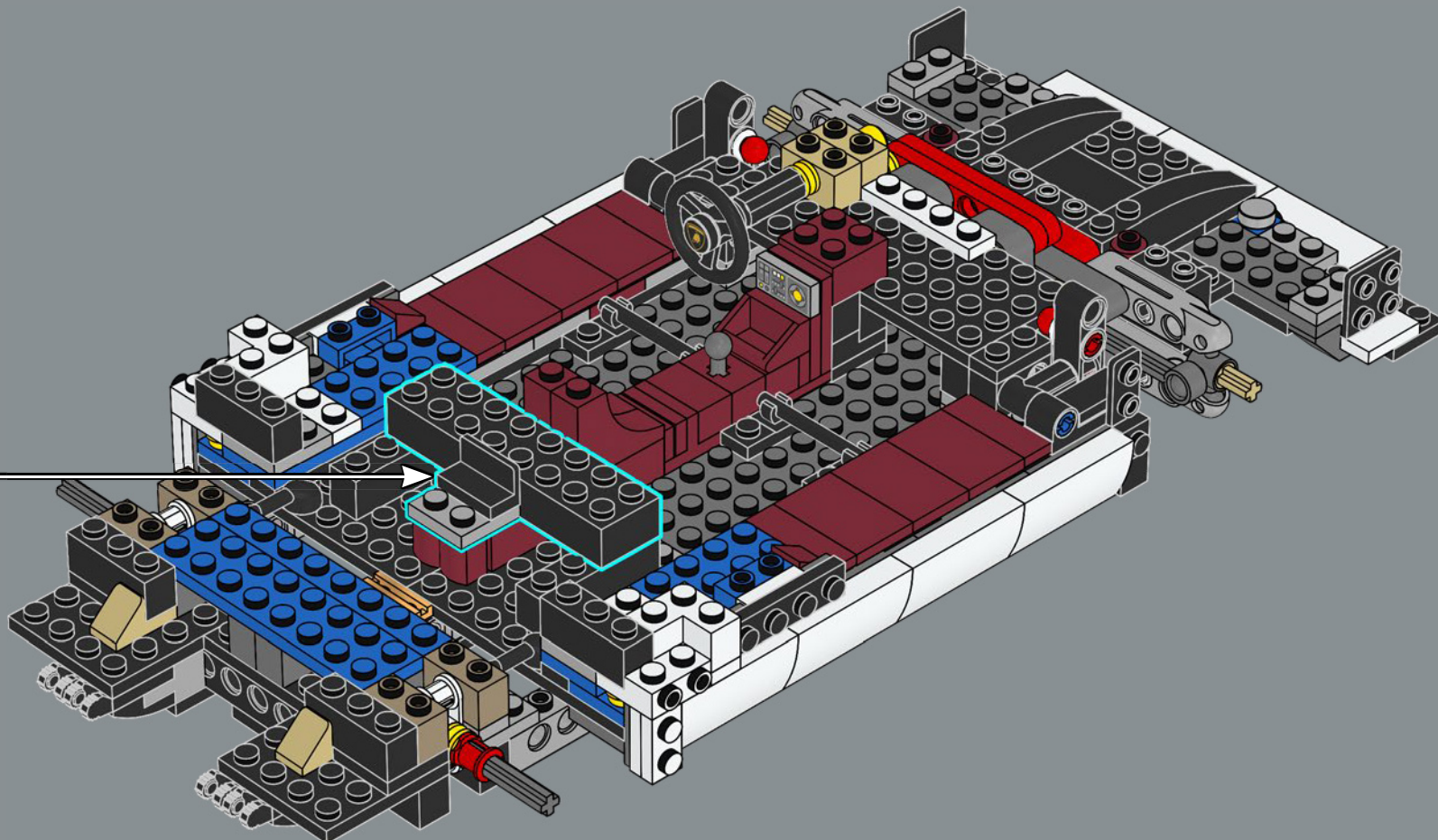



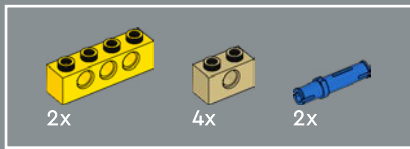

86

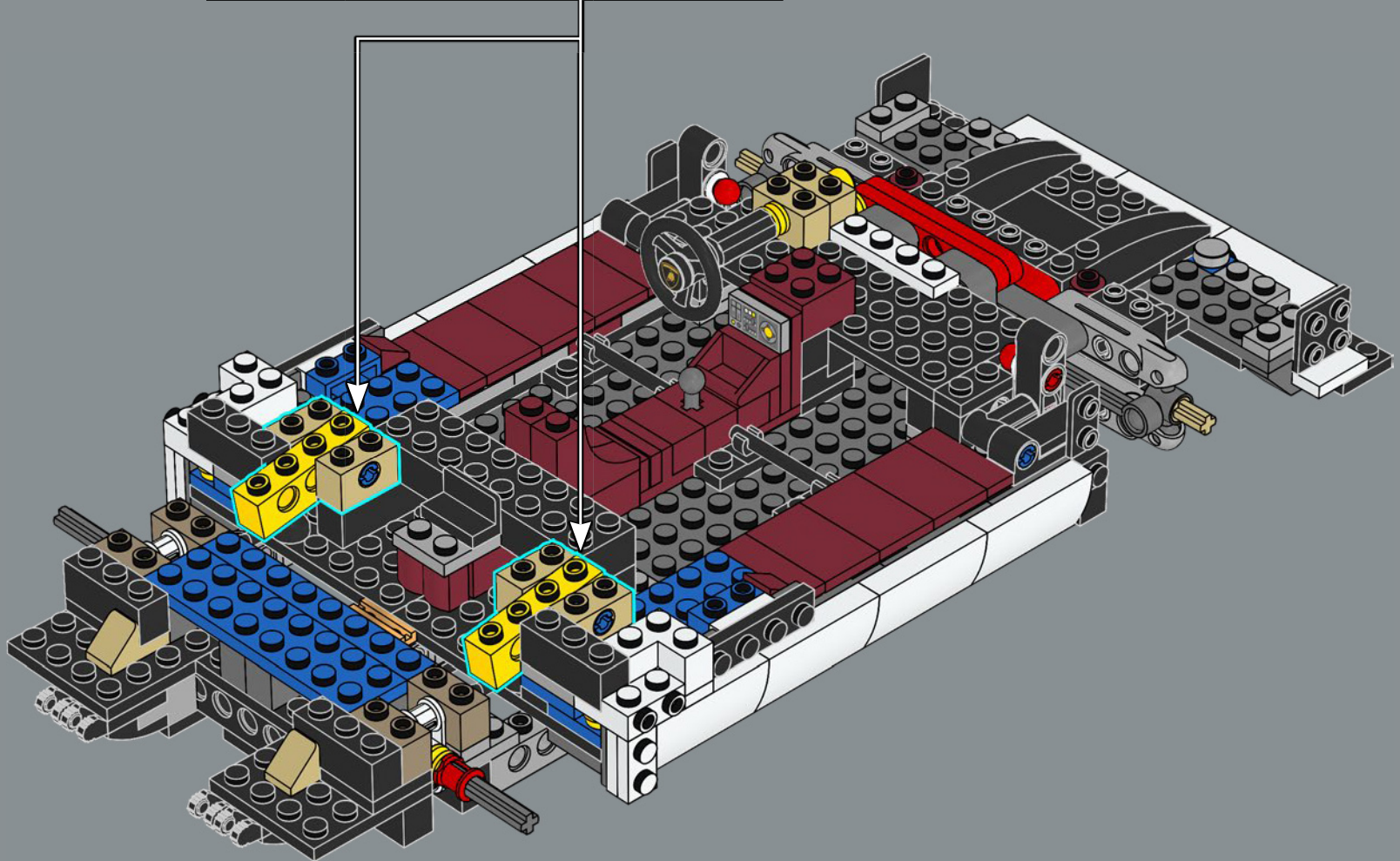
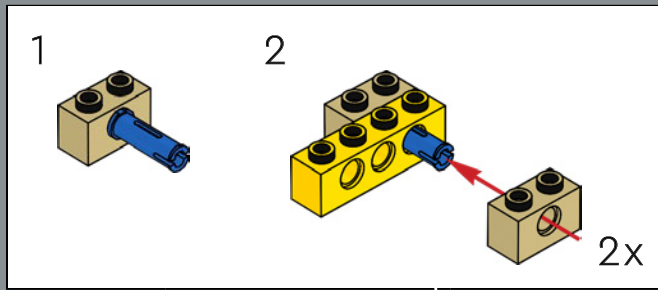

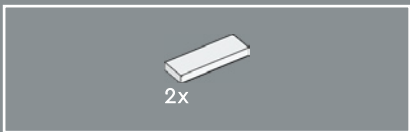

87

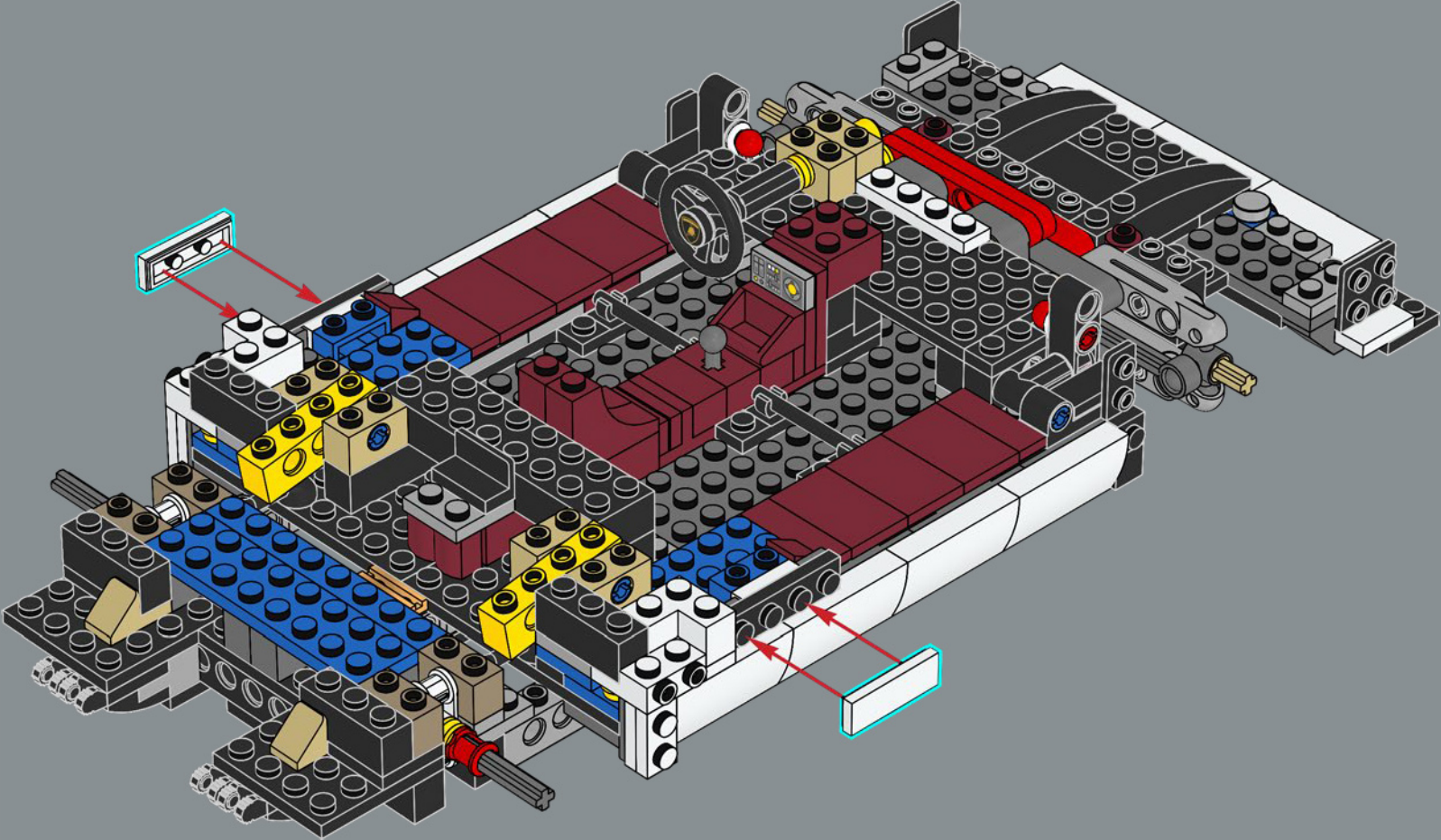



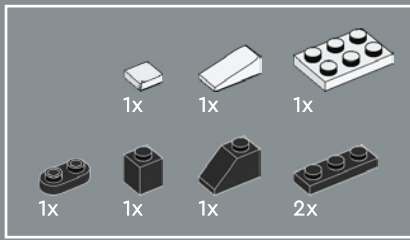

88

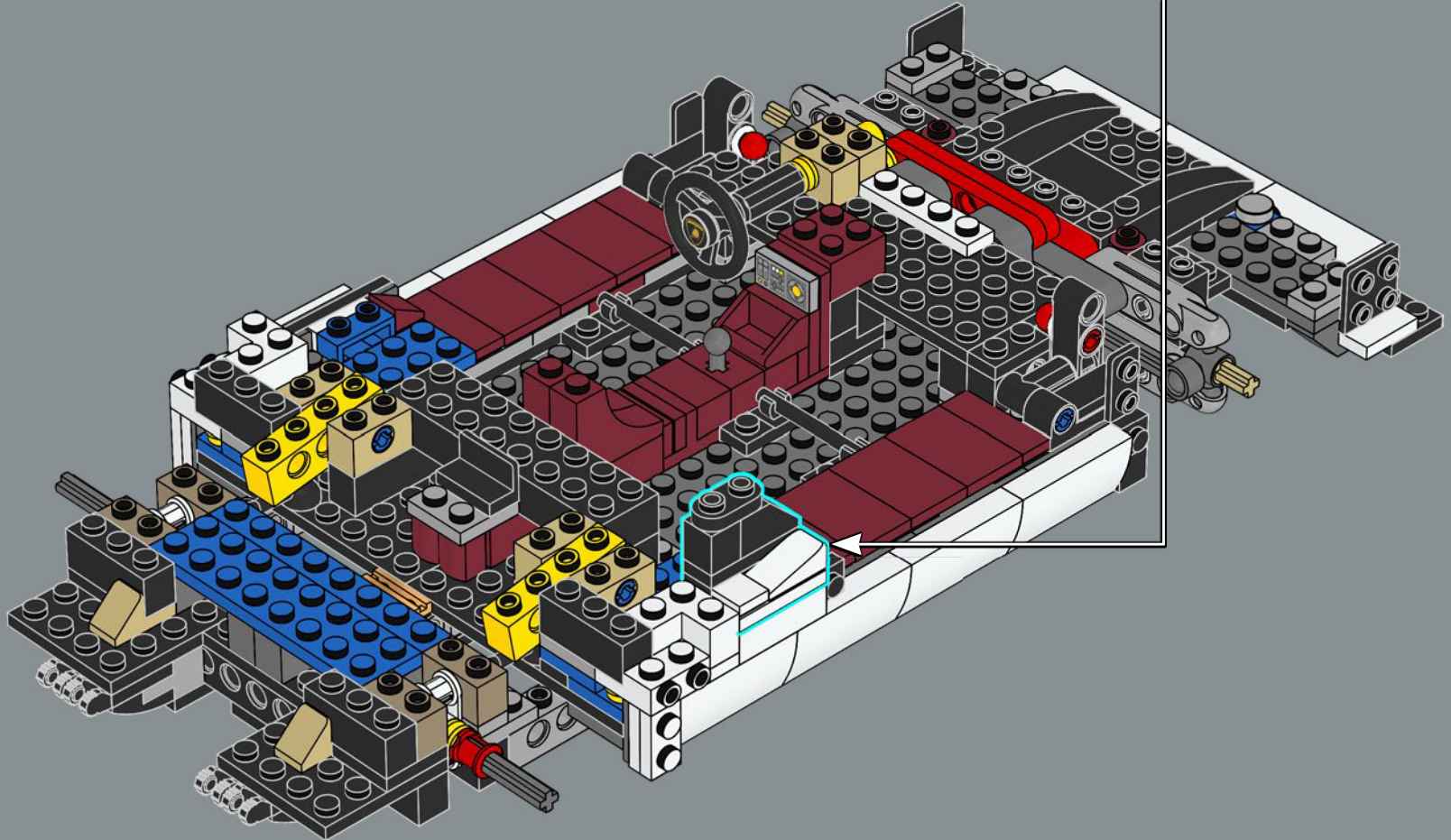
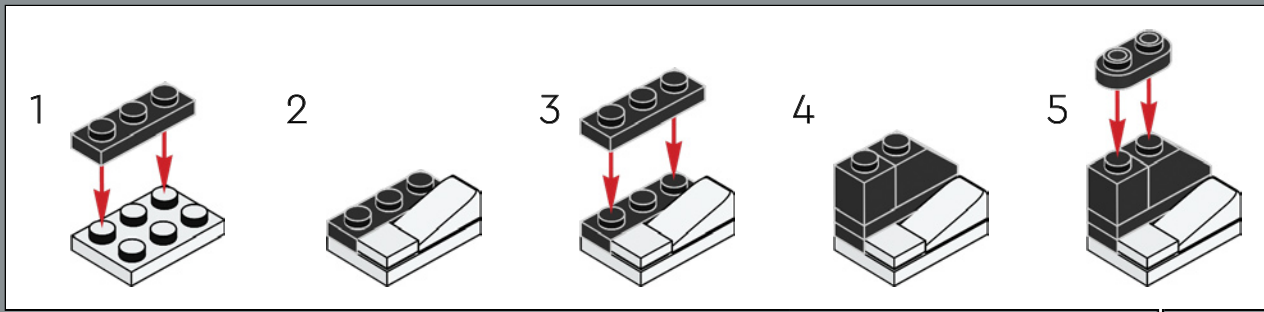

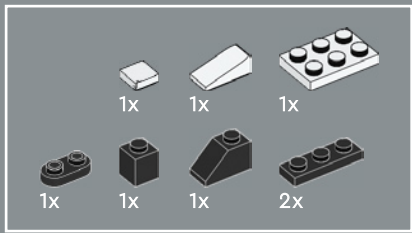

89

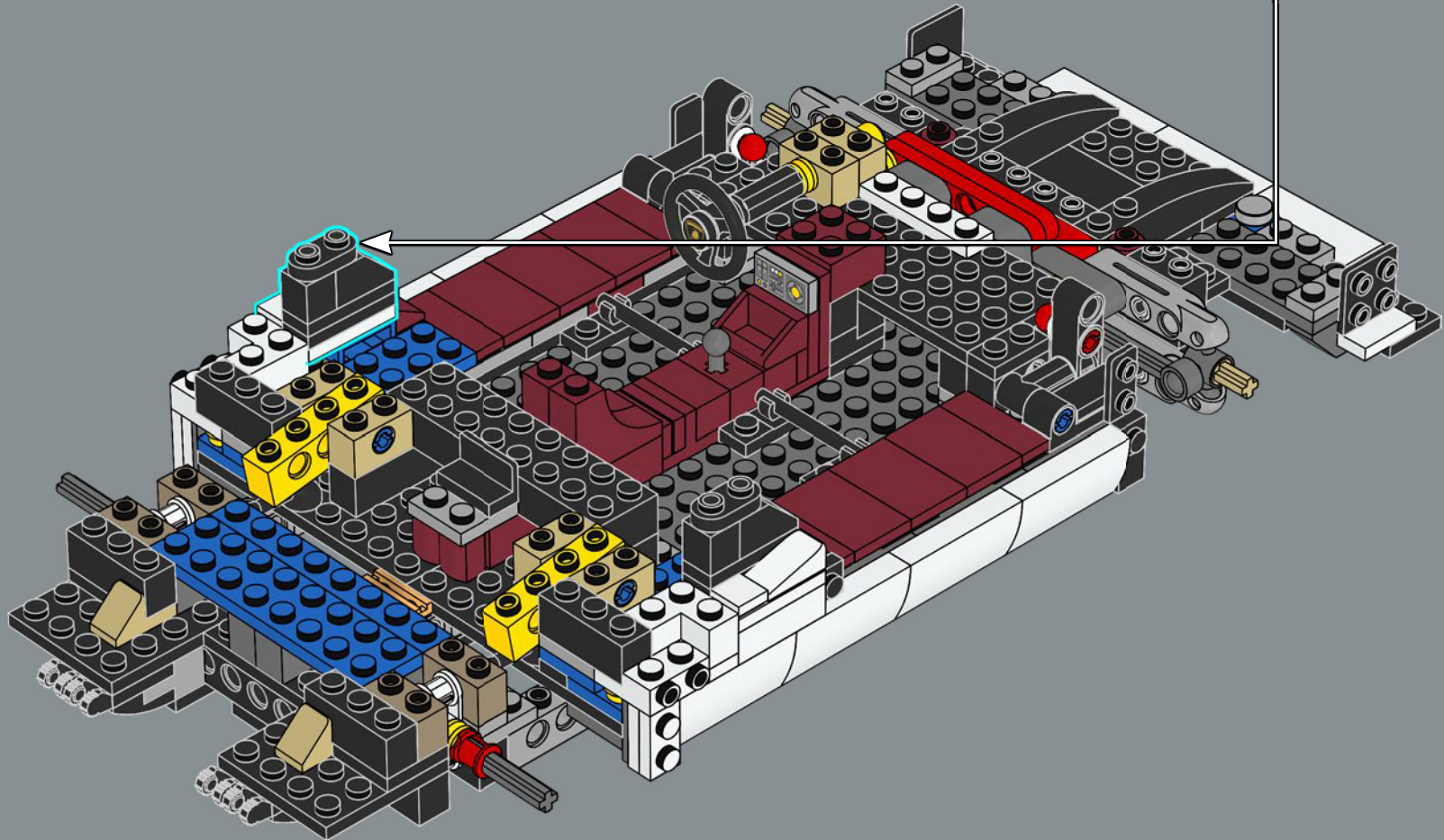
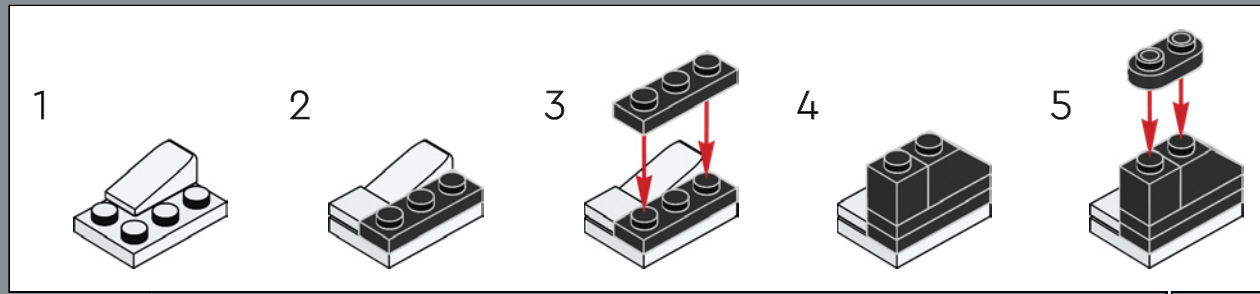



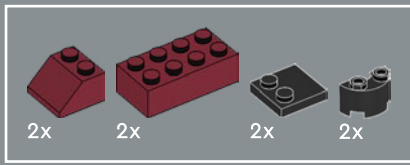

90

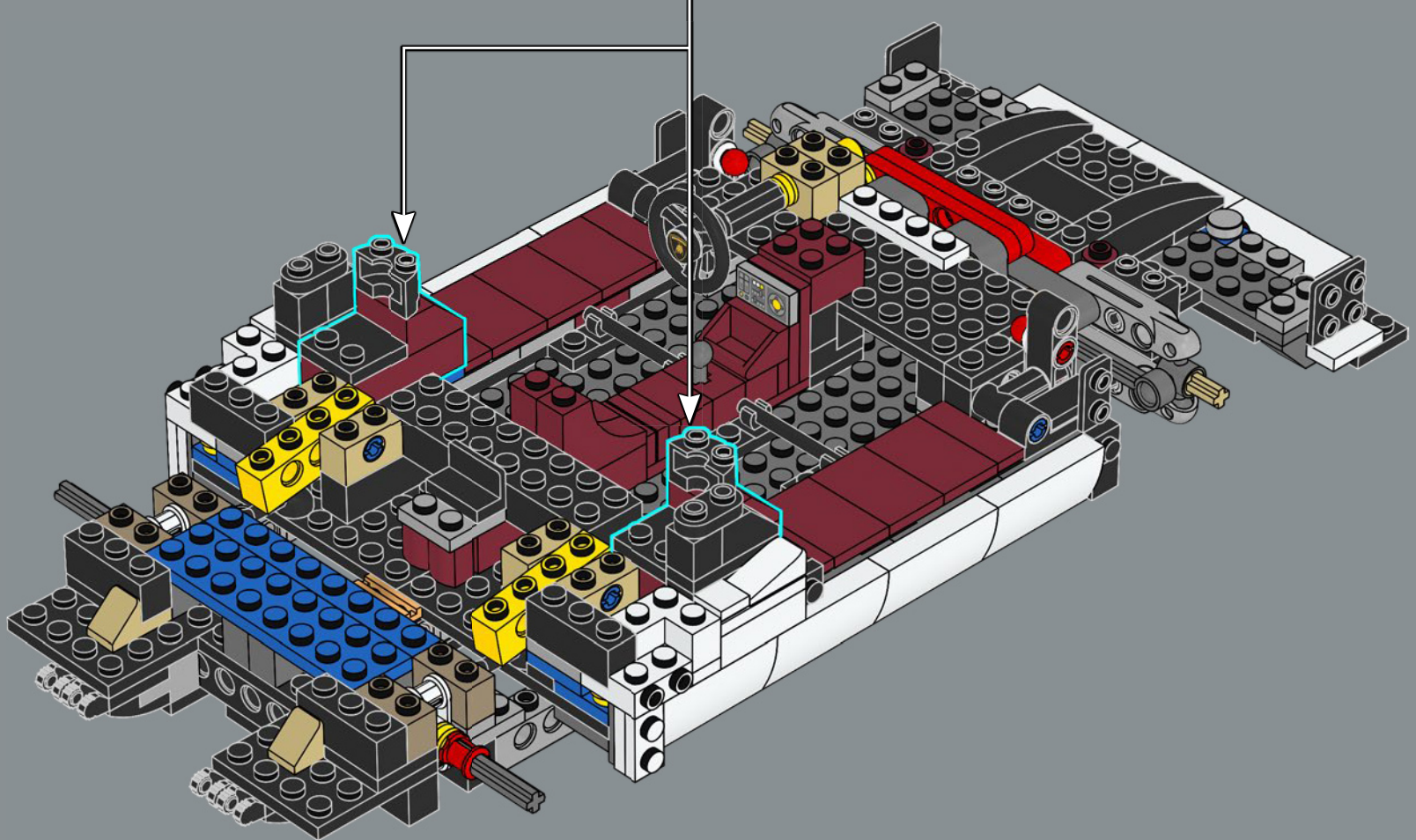
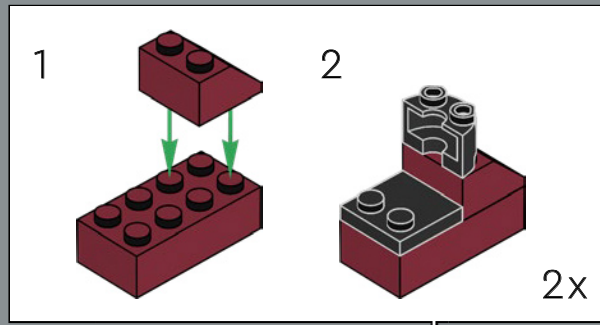

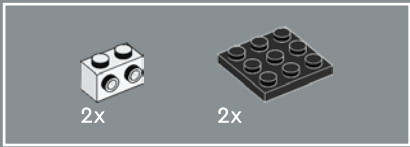

91

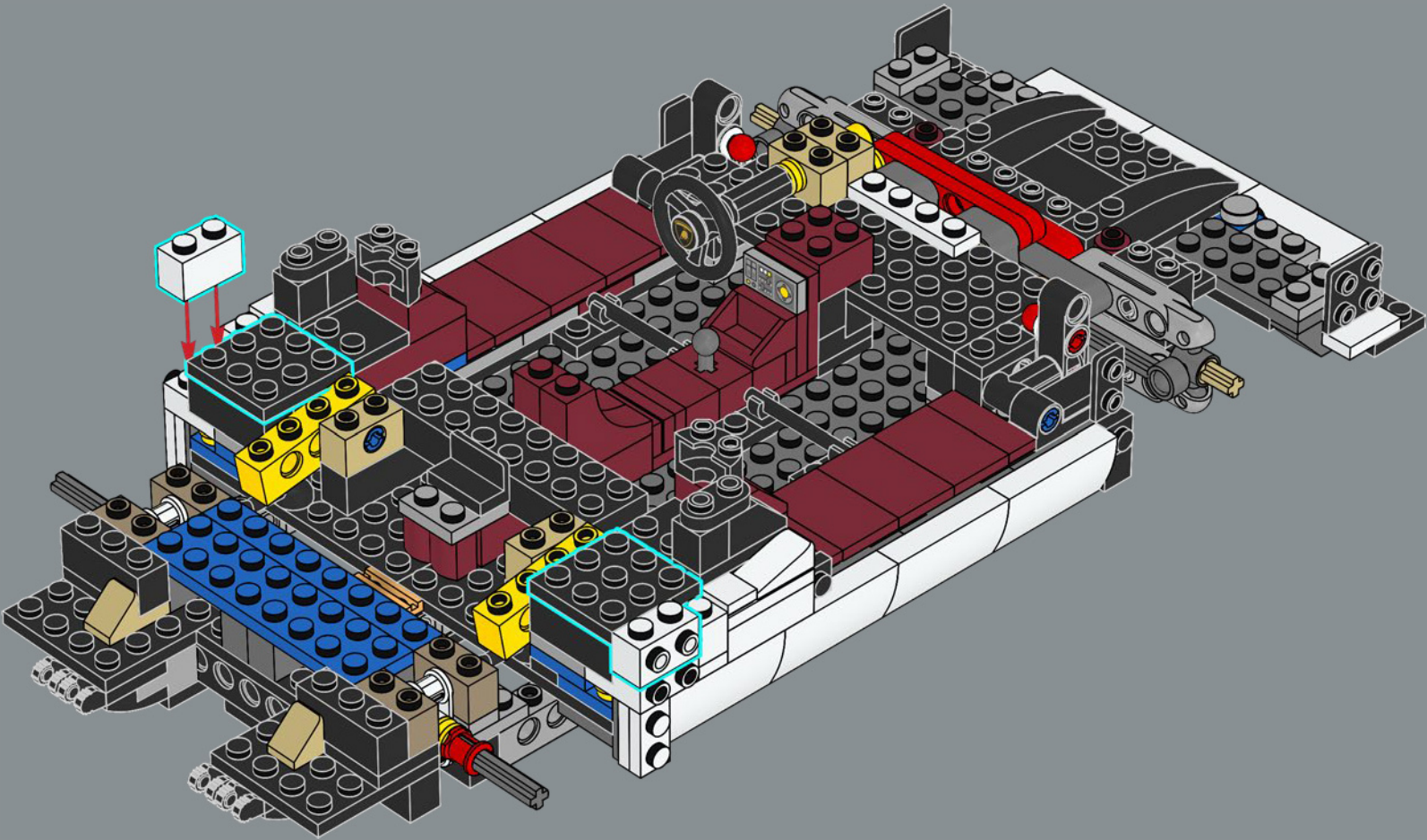



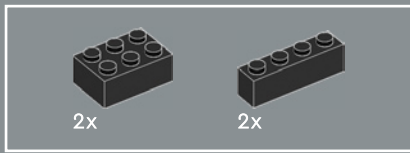

92

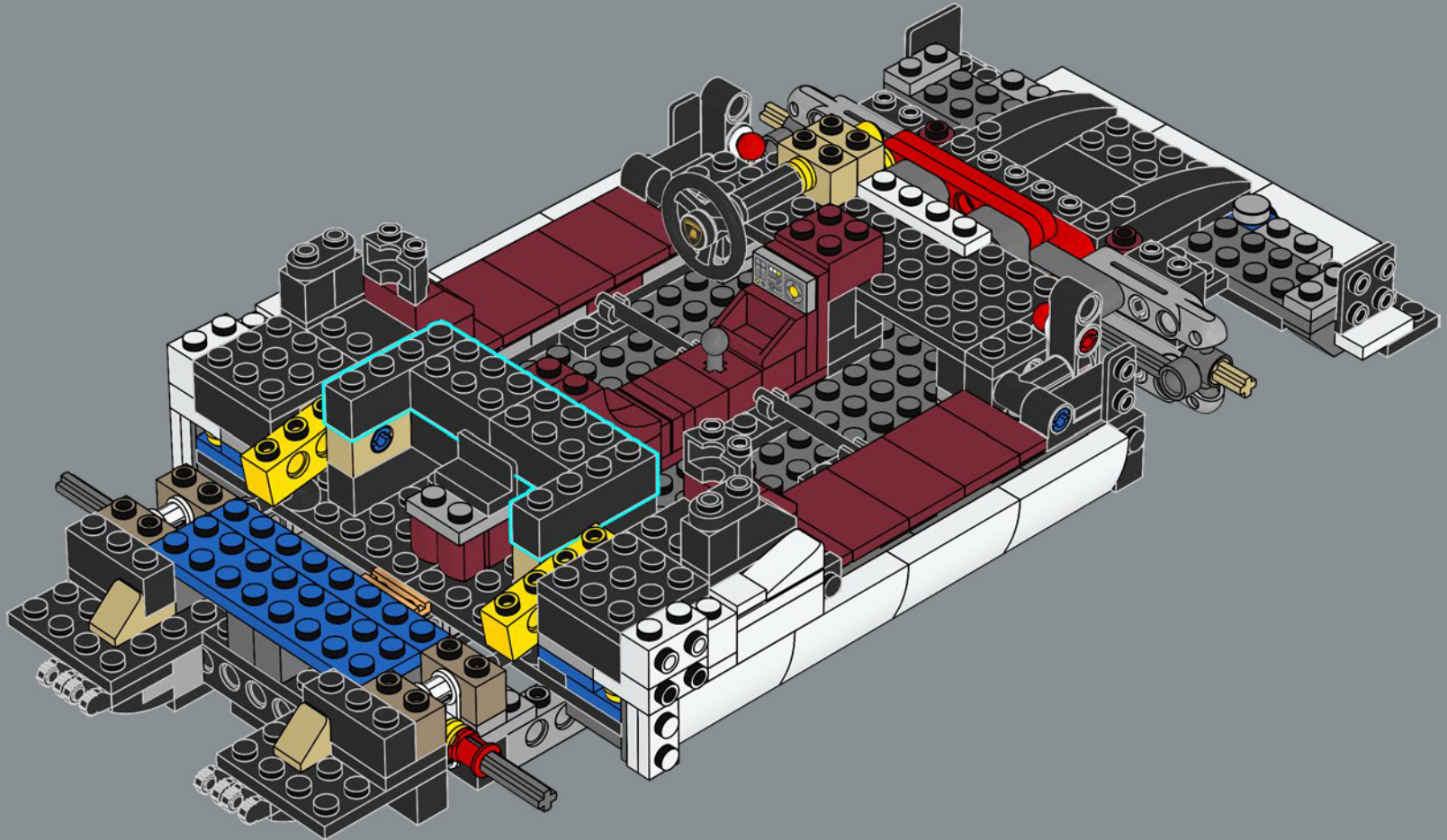

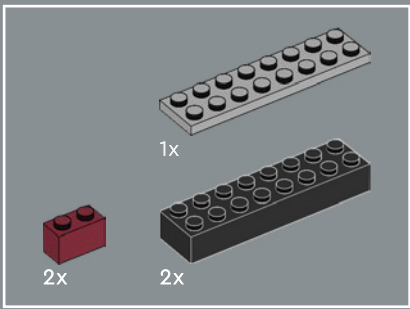

93

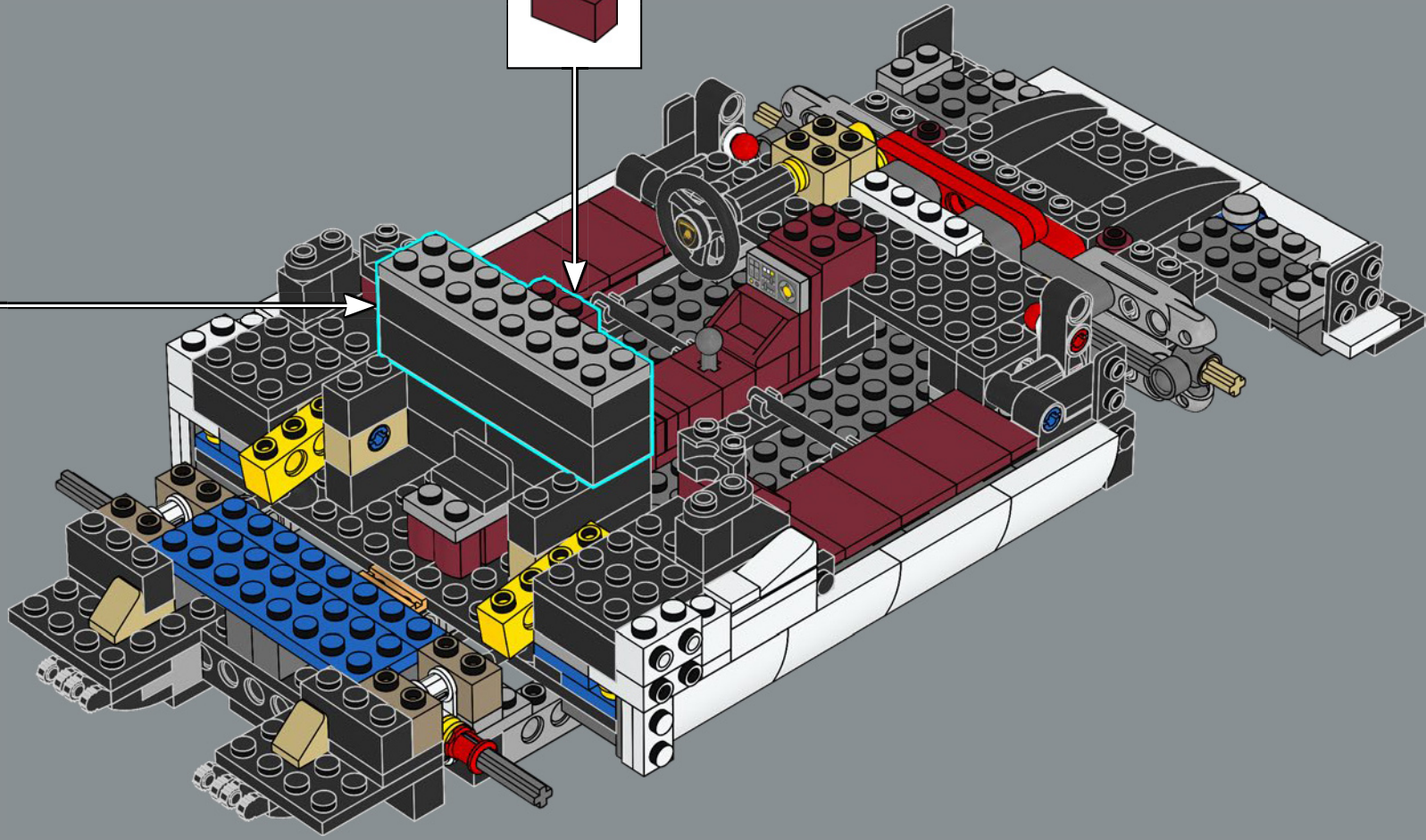
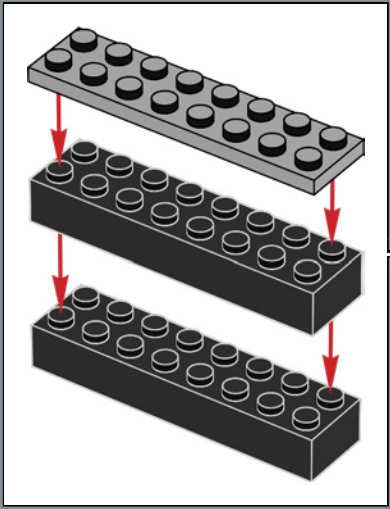
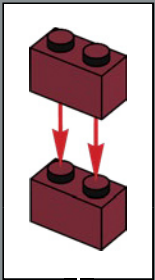



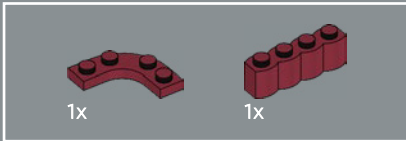
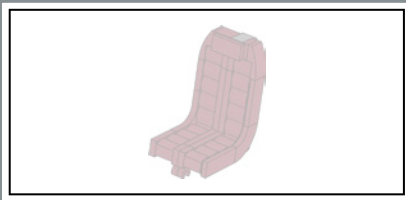

94

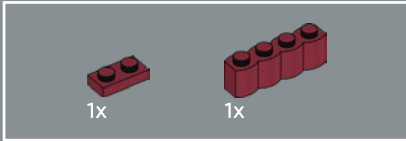
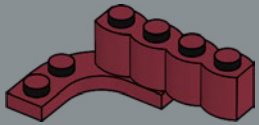

95

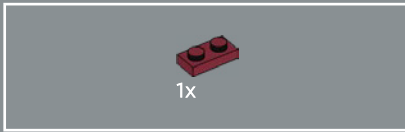
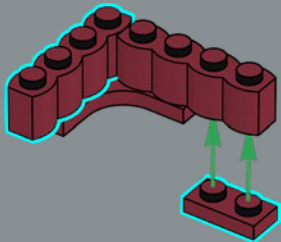

96

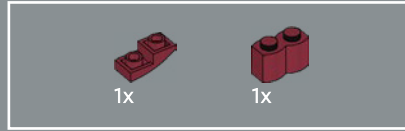
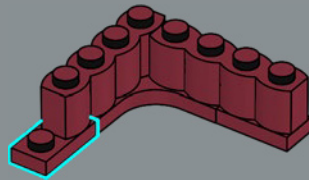

97

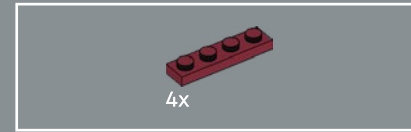
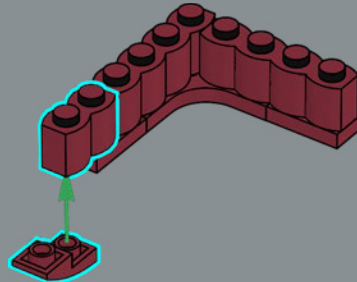

98

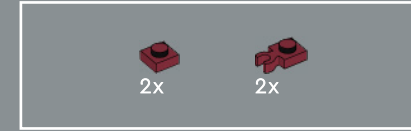
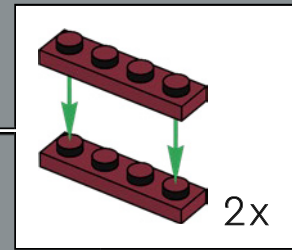
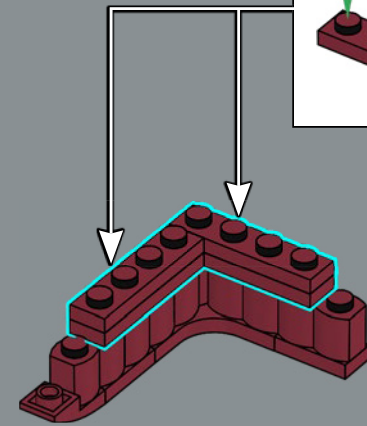

99

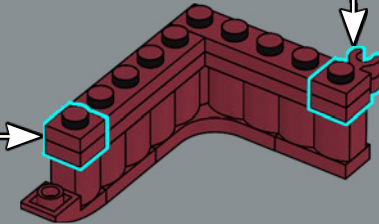
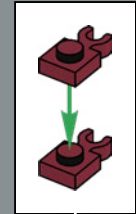
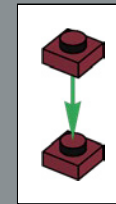

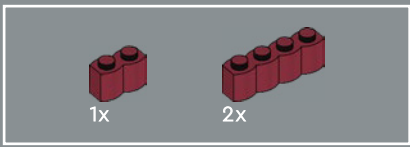

100

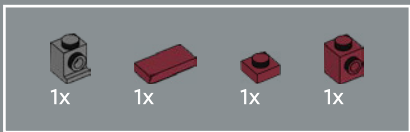
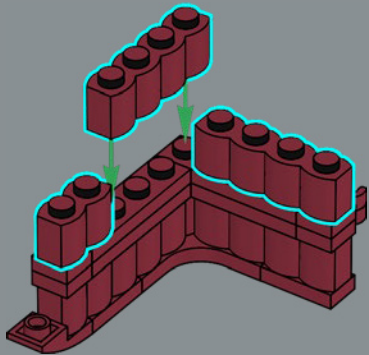

101

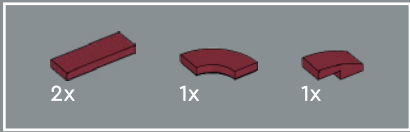
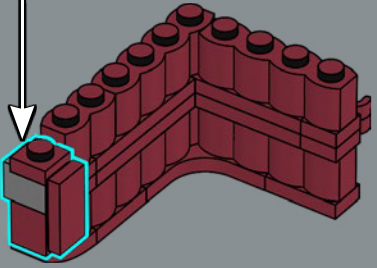
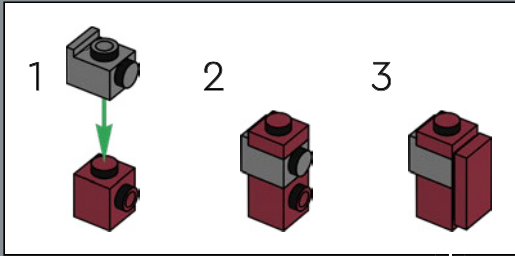

102

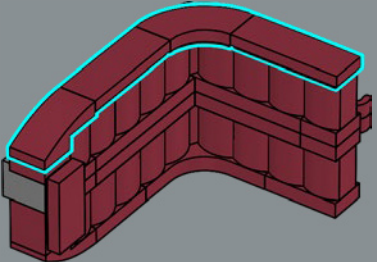

103

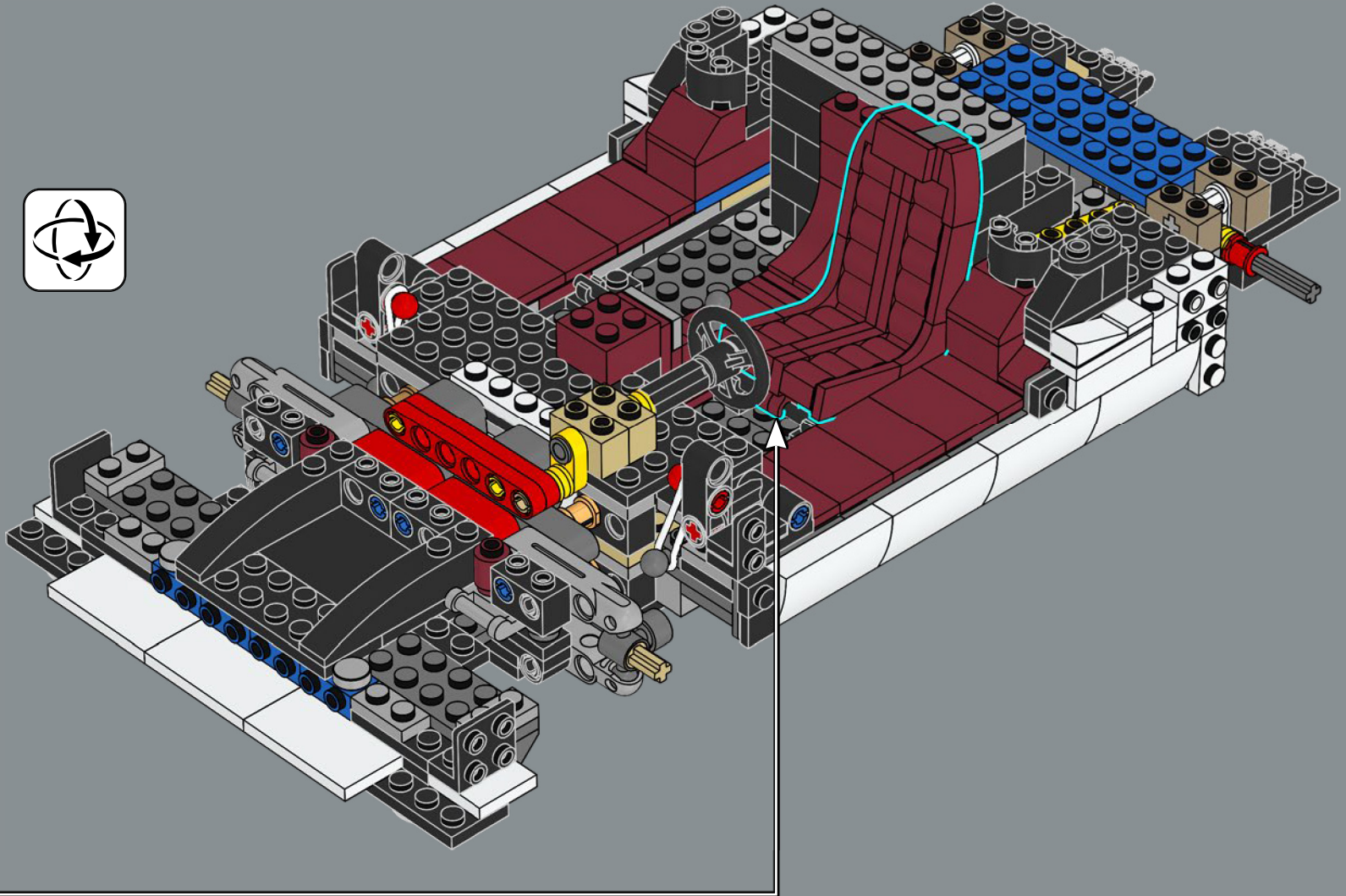



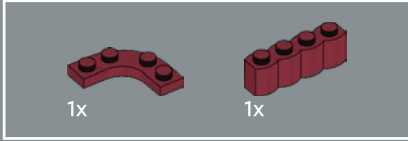

104

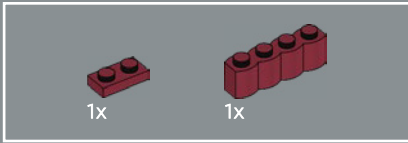
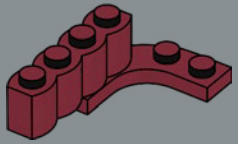

105

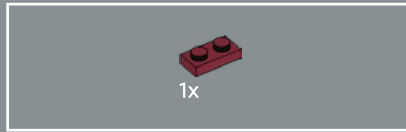
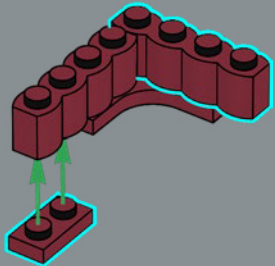

106

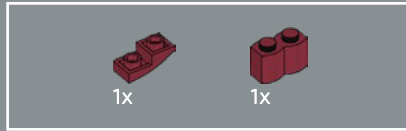
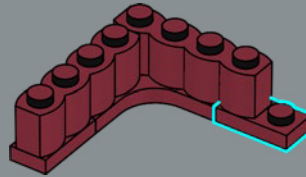

107

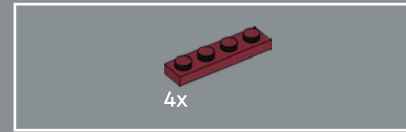
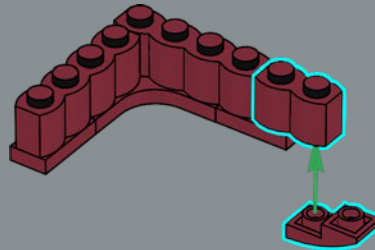

108

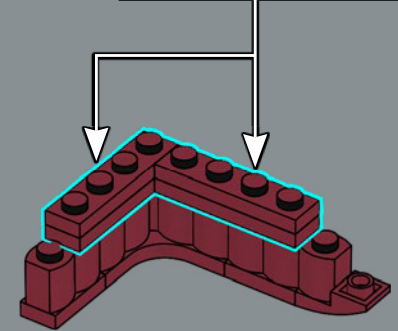
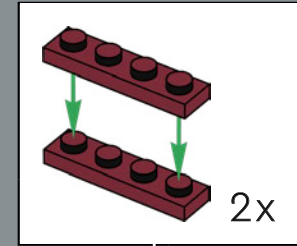



109

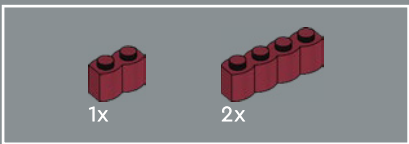
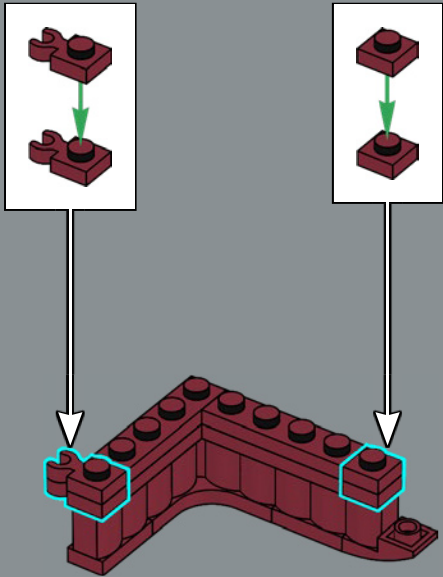

110

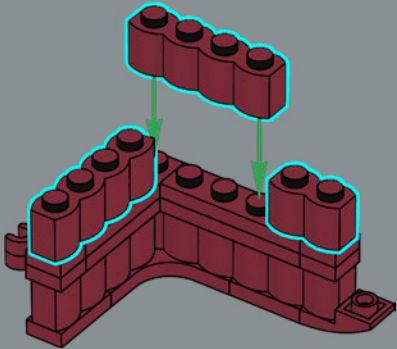

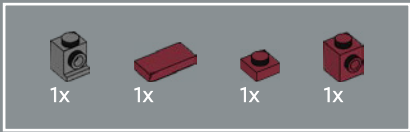

111

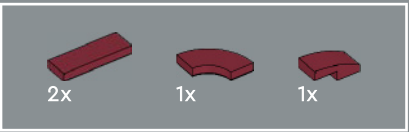
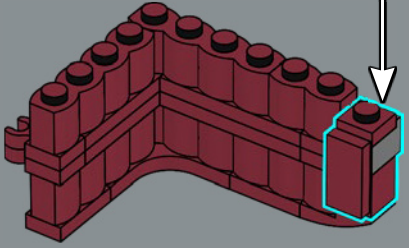
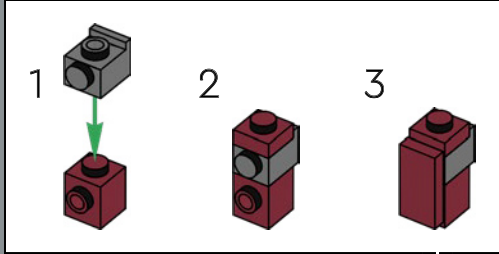

112

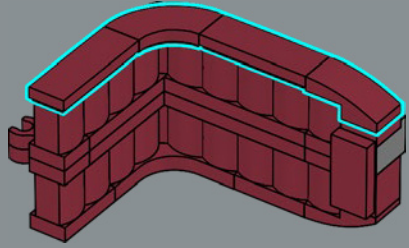



113

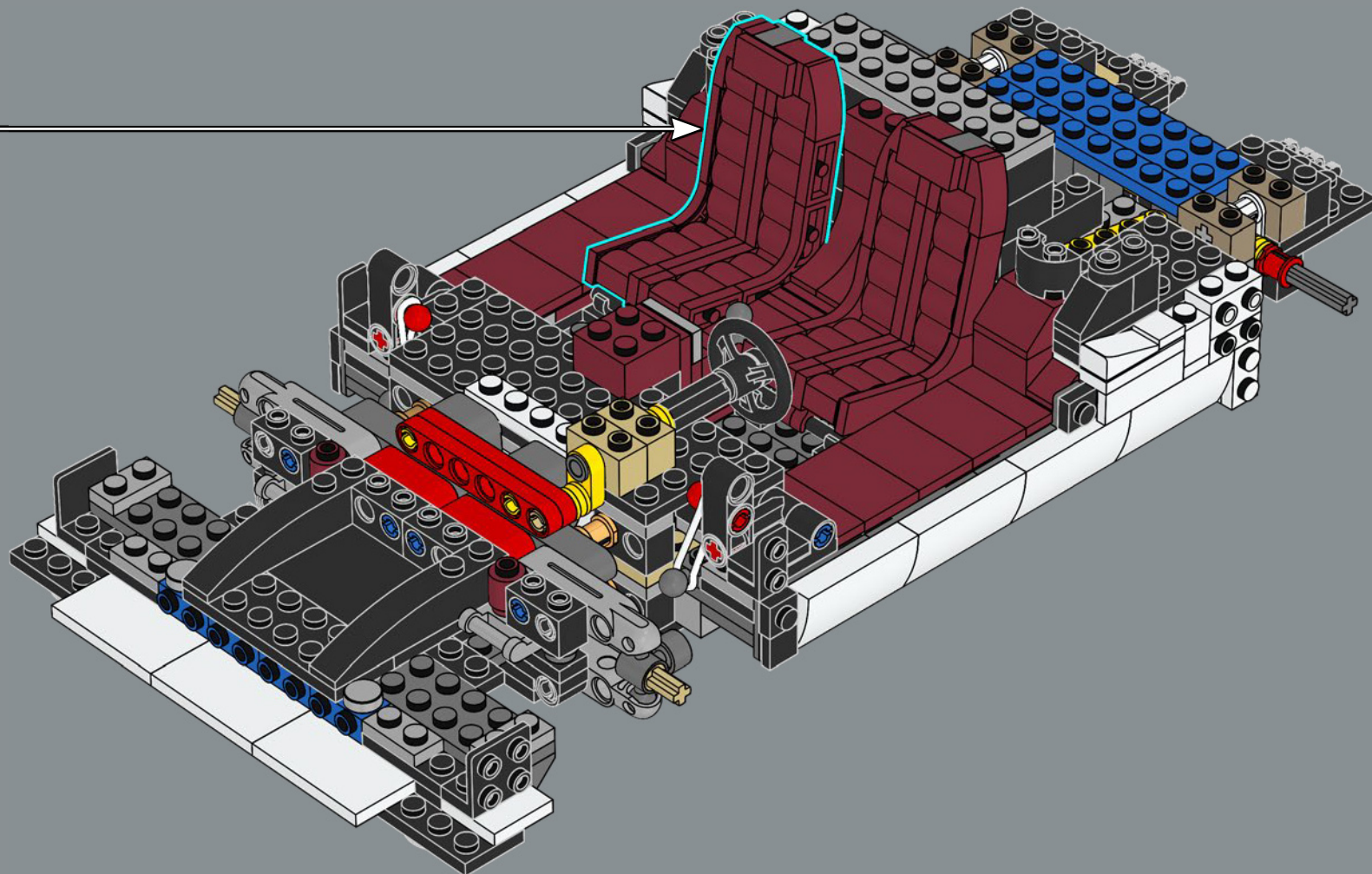

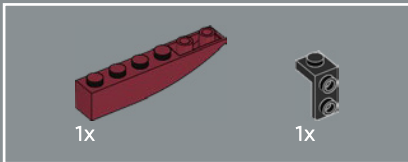
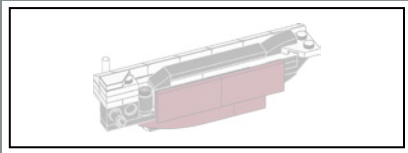

114

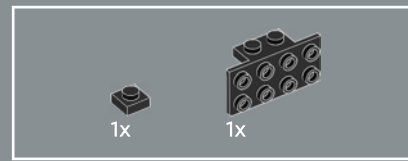
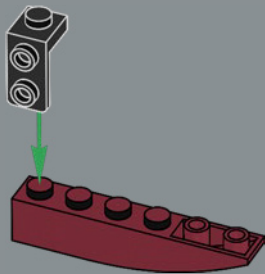

115

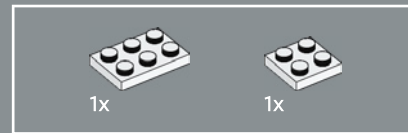
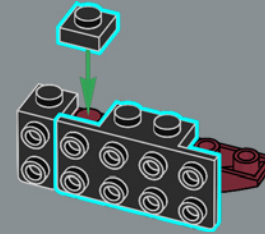

116

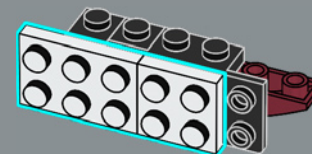

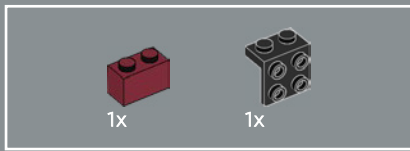

117

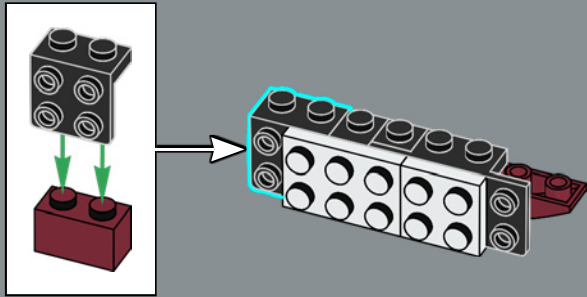

118

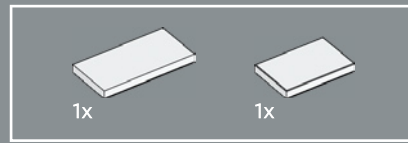
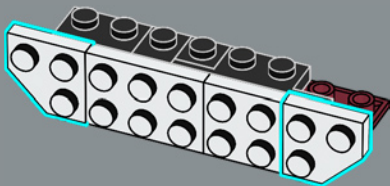

119

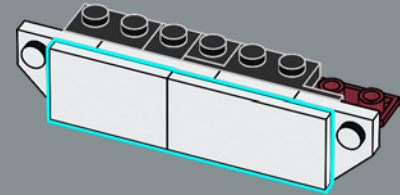

120

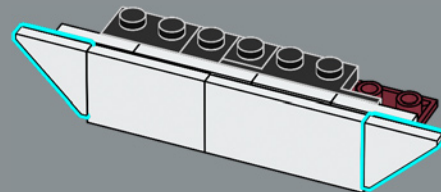



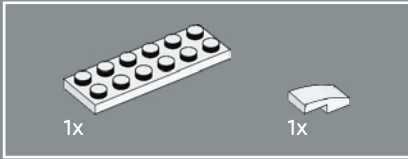
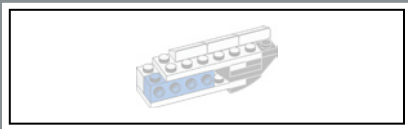

121

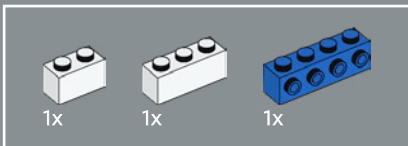
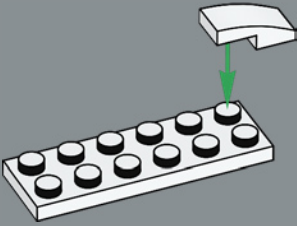

122

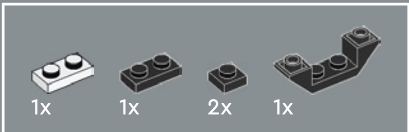
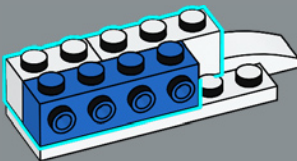

123

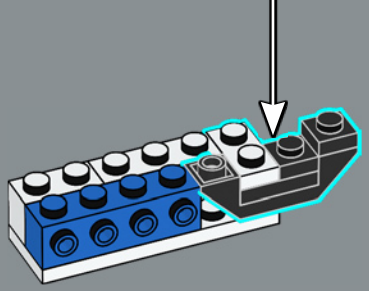
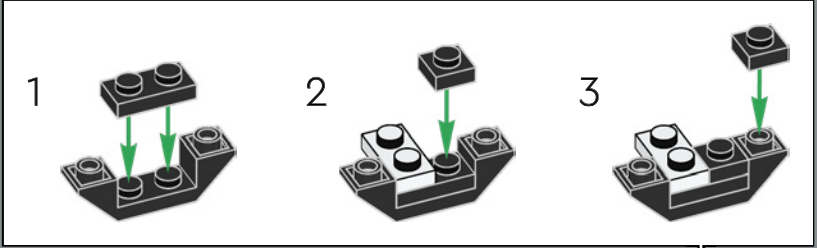

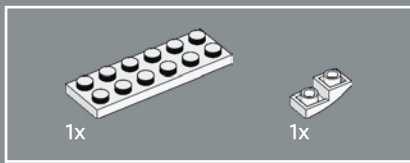

124

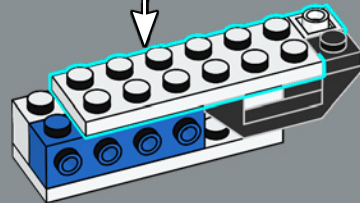
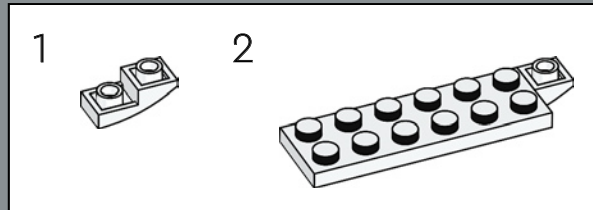

125

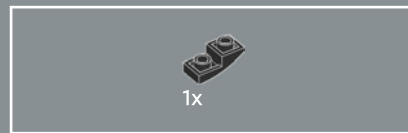
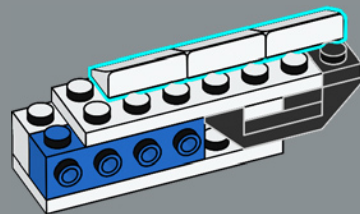

126

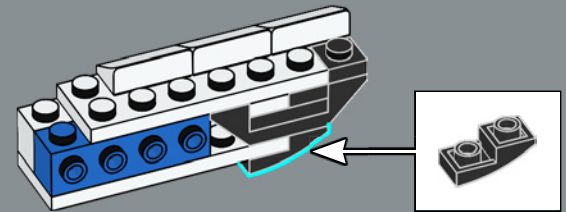

127

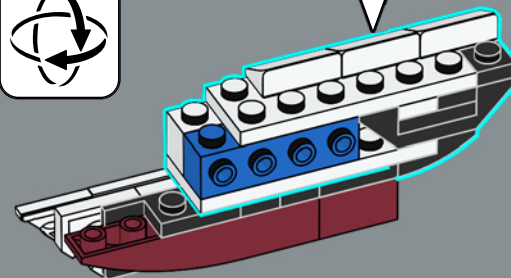

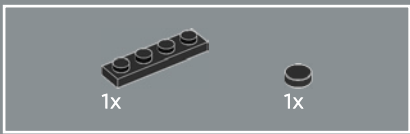

128

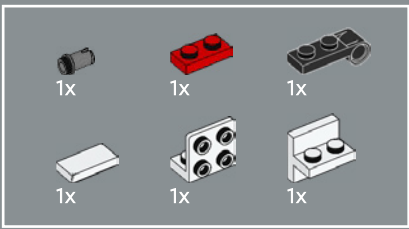
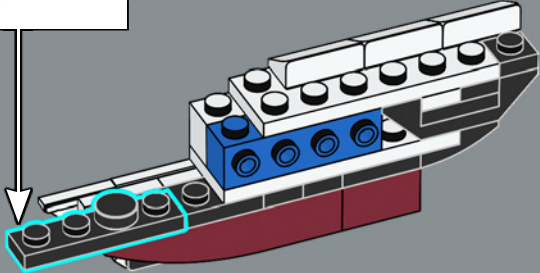
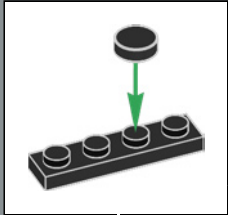

129

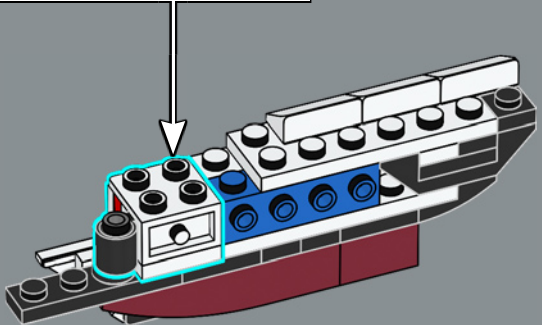
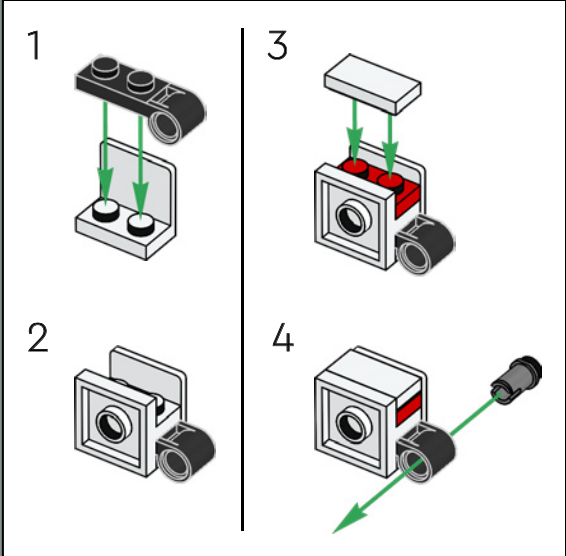

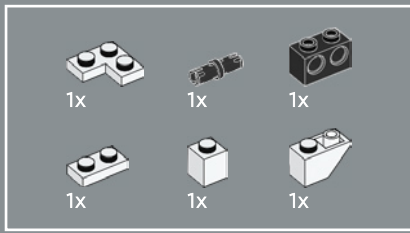

130

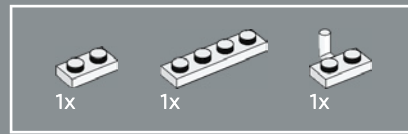
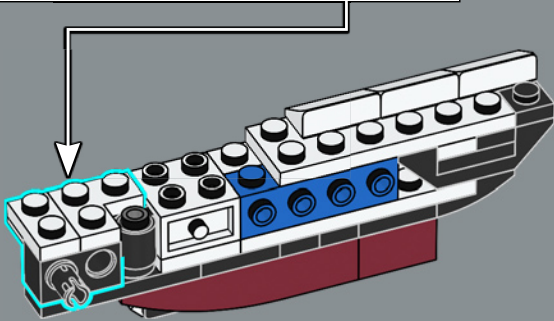
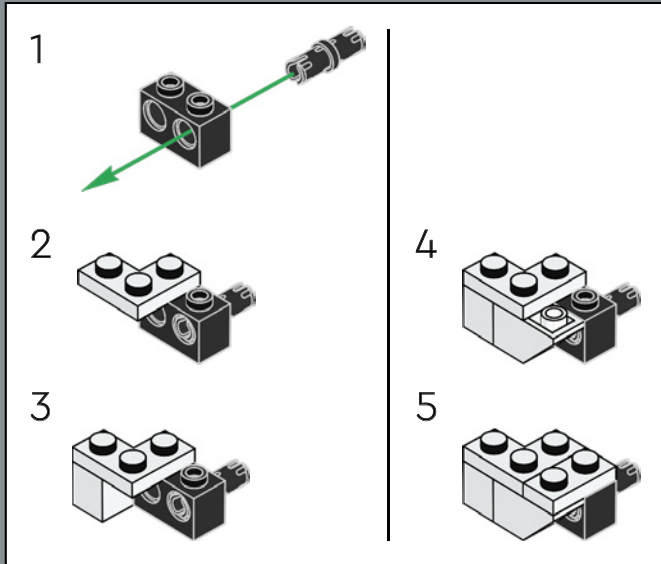

131

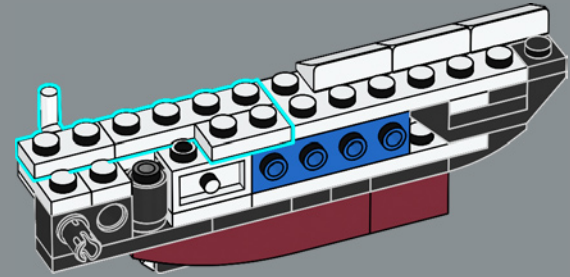

132

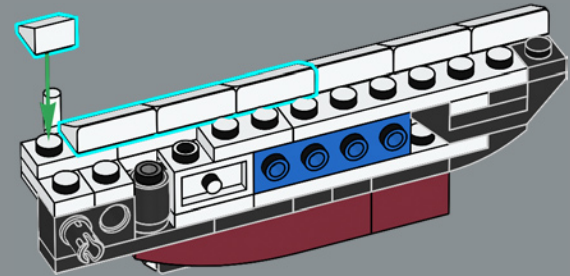





133

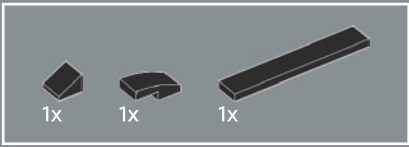
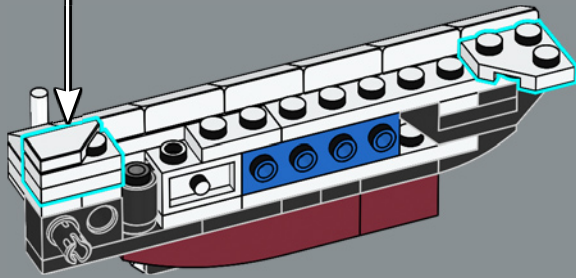
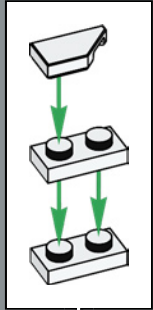

134

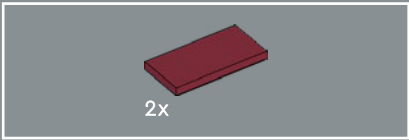
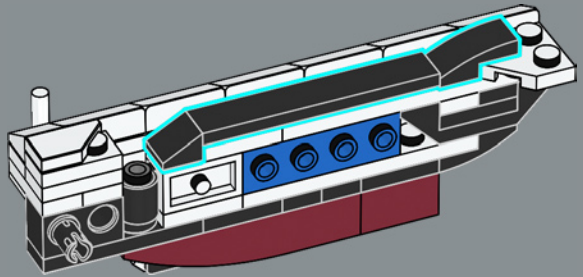

135

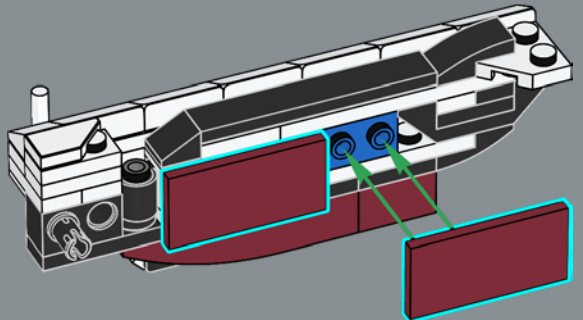

136

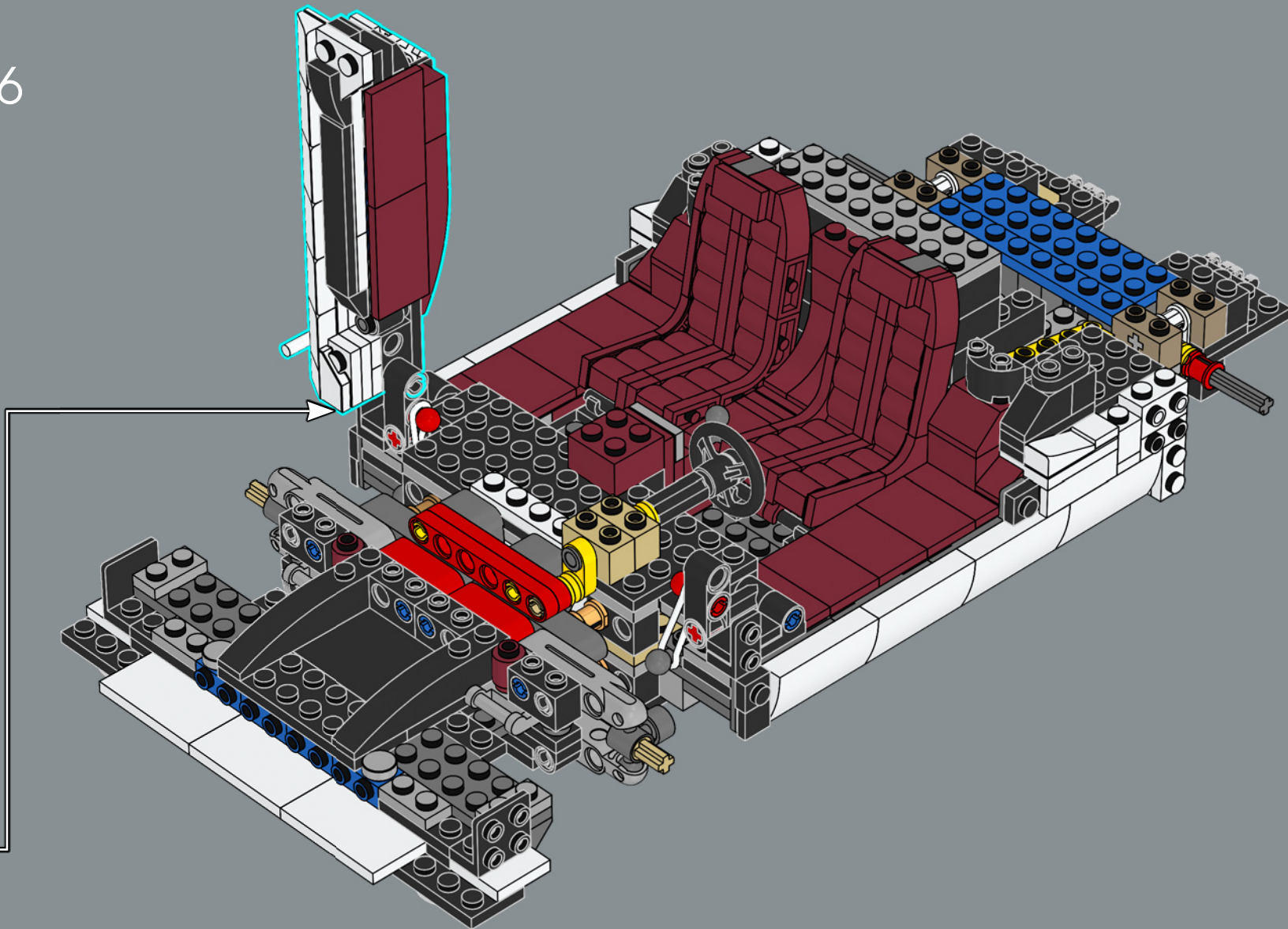

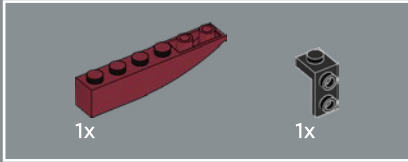
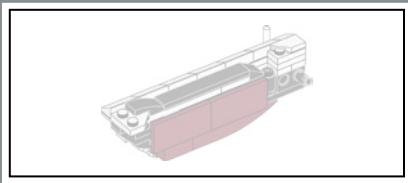

137

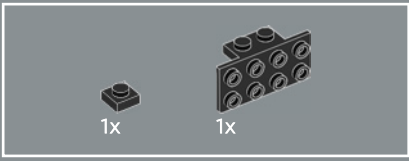
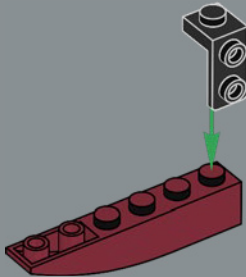

138

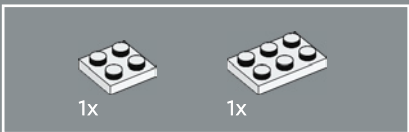
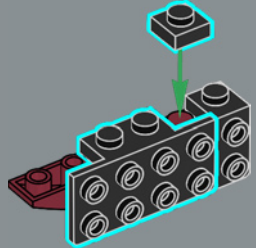

139

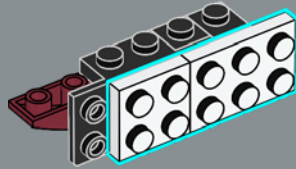

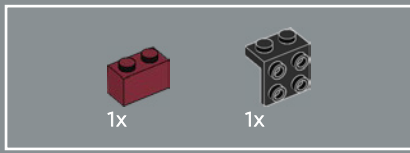

140

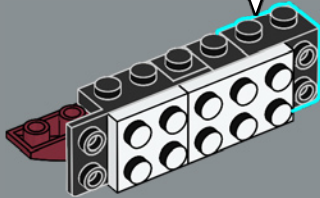
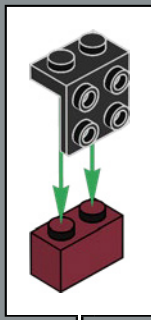

141

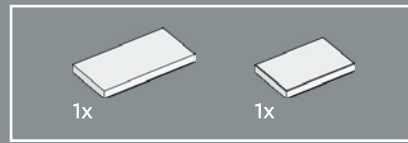
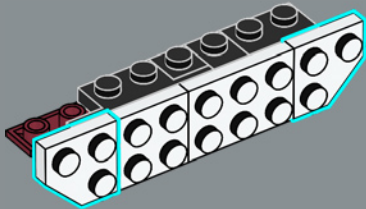

142

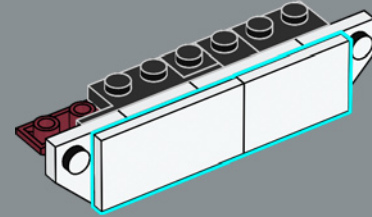

143

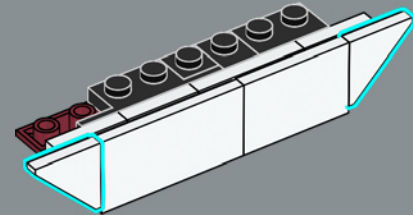



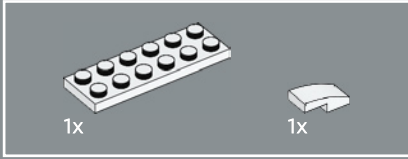
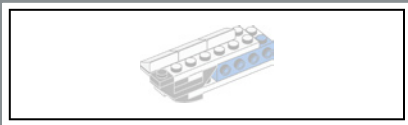

144

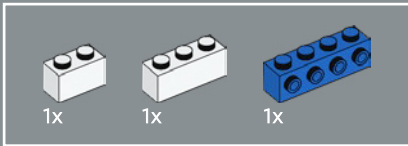
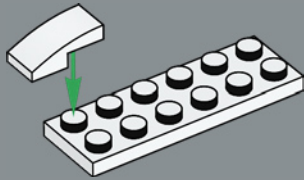

145

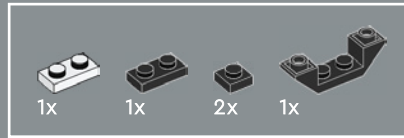
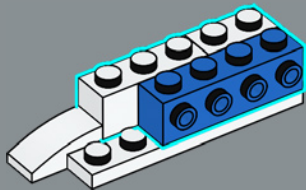

146

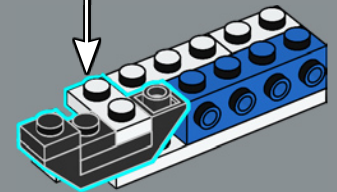
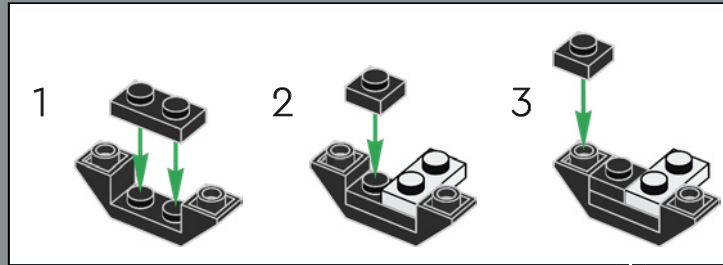

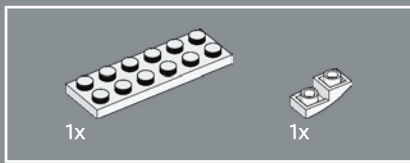

147

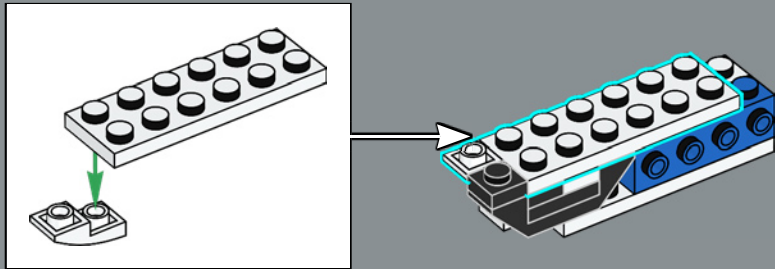

148

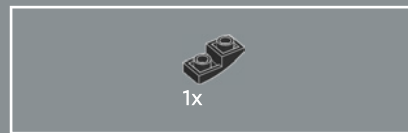
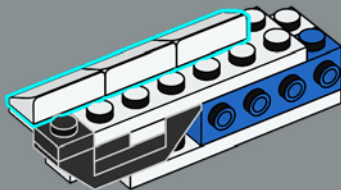

149

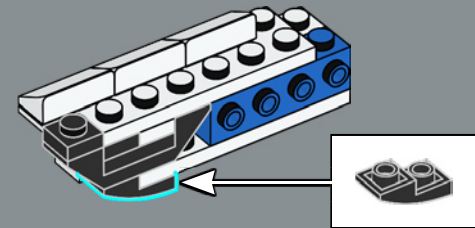

150

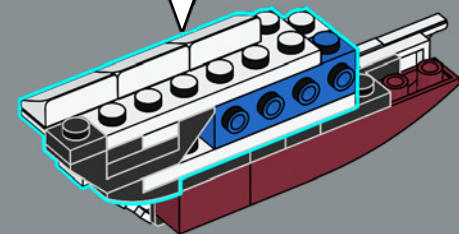

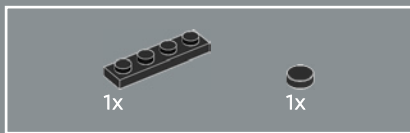

151

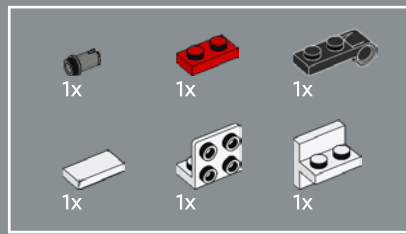
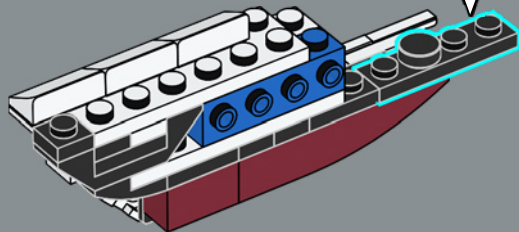
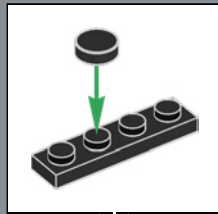

152

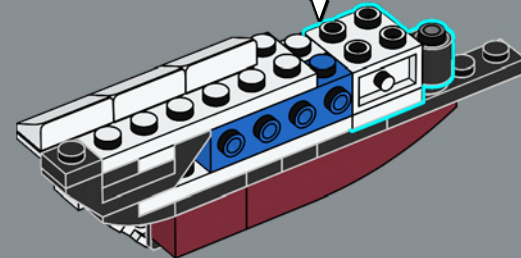
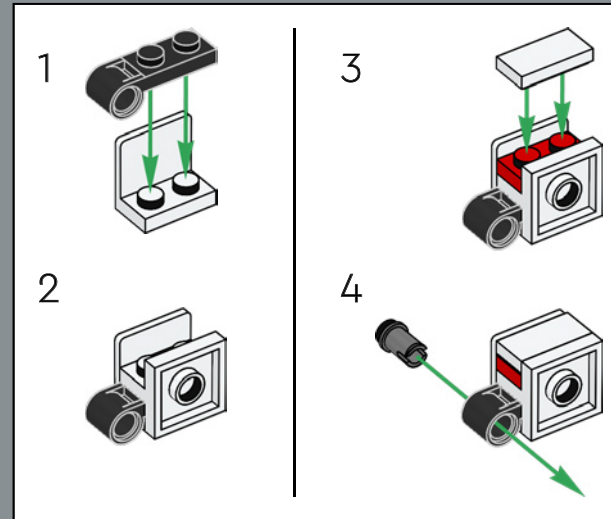

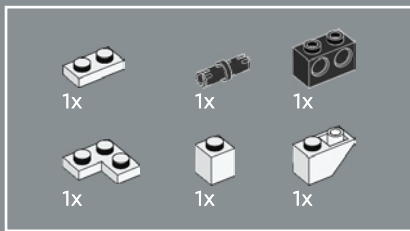

153

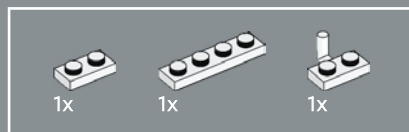
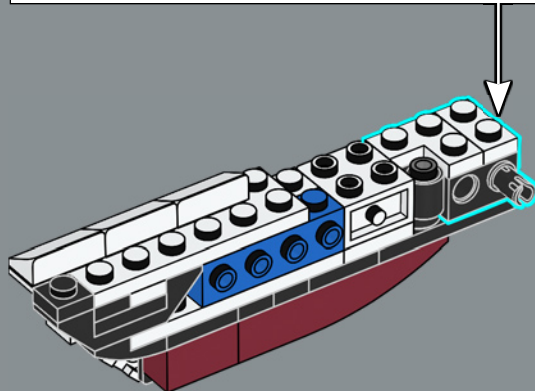
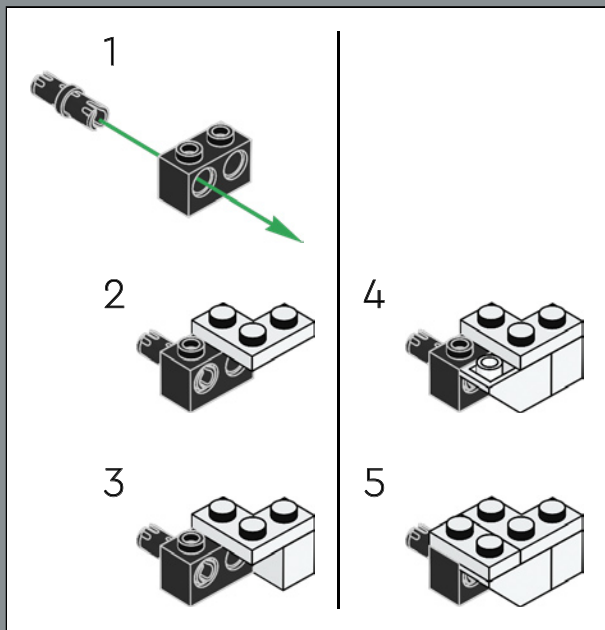

154

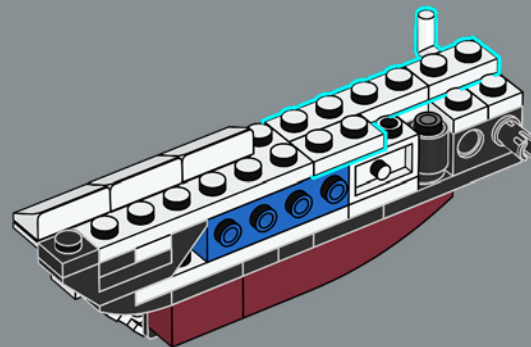





155

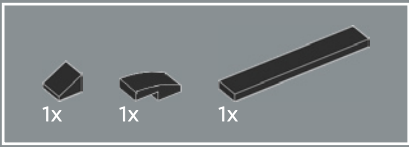
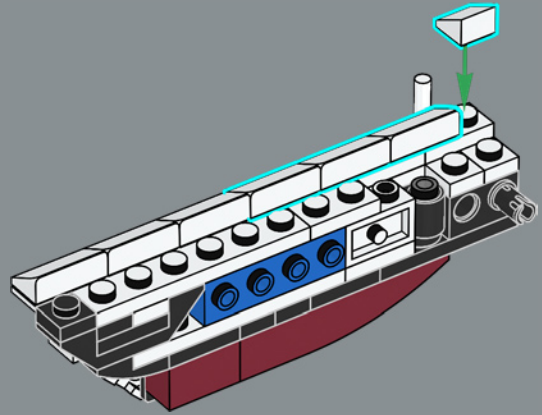

157

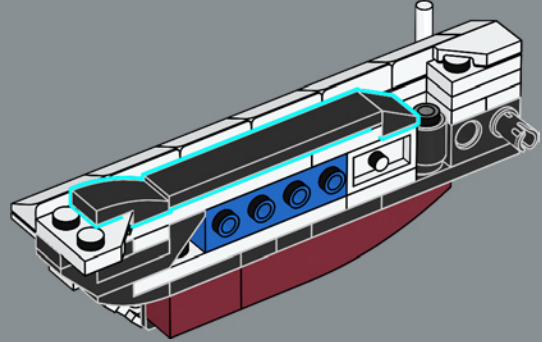

156

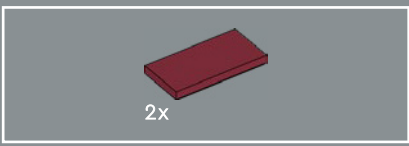
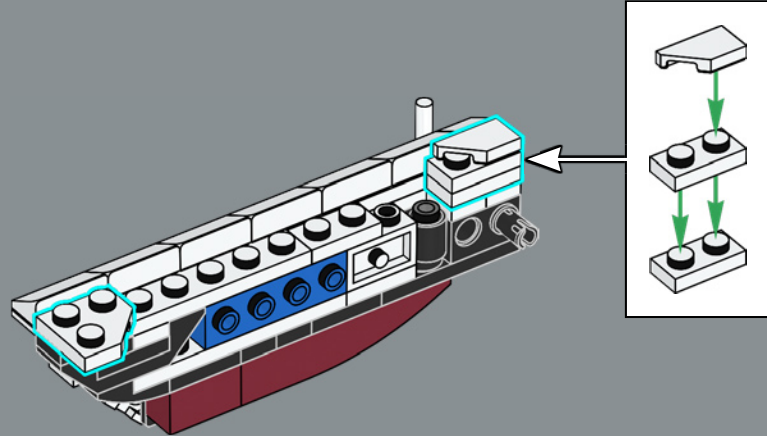

158

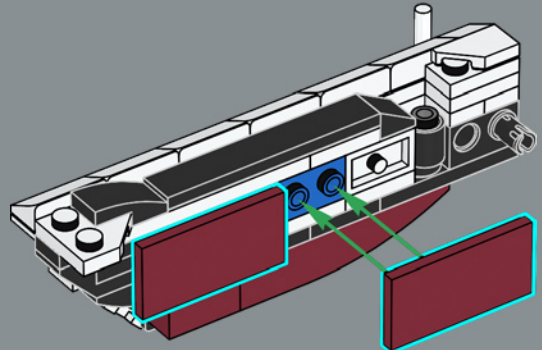



The upwards-opening doors are commonly known as 'scissor doors'.

159

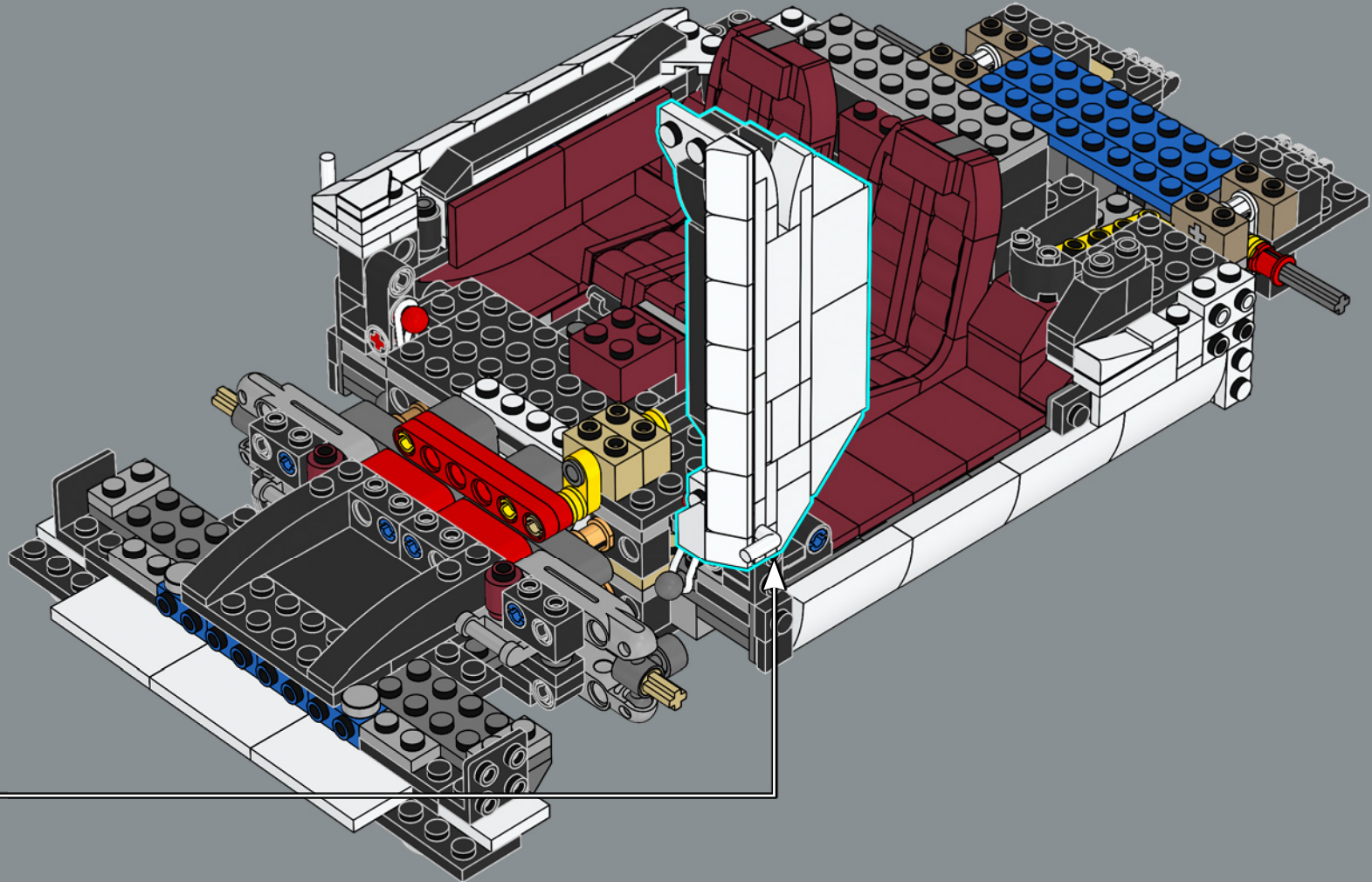

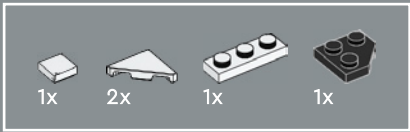

160

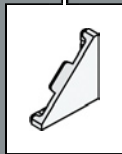
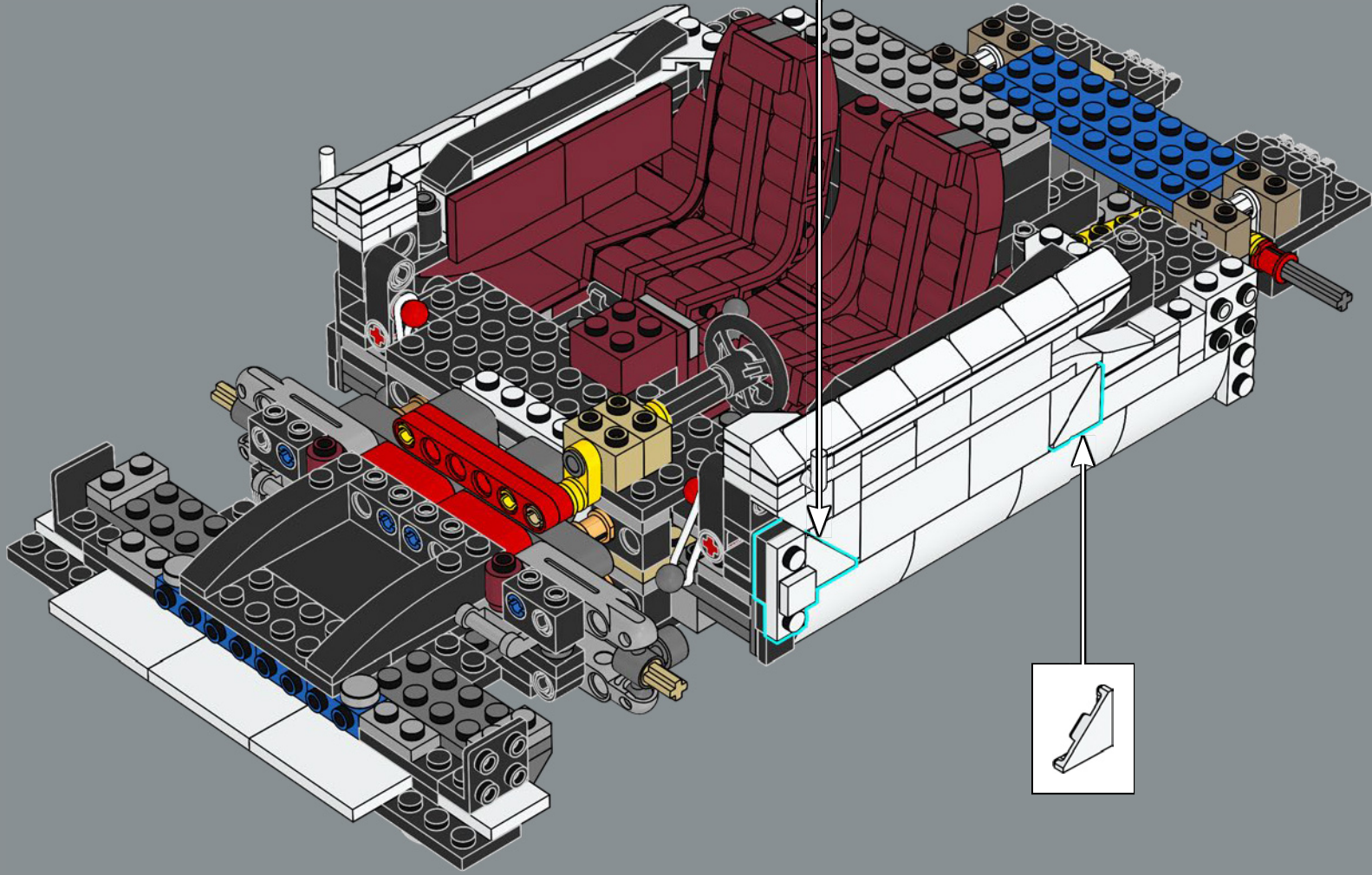
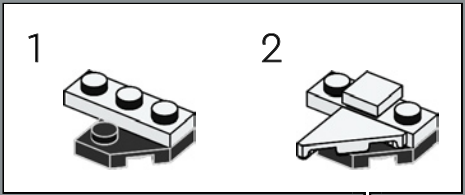



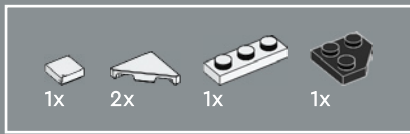

161

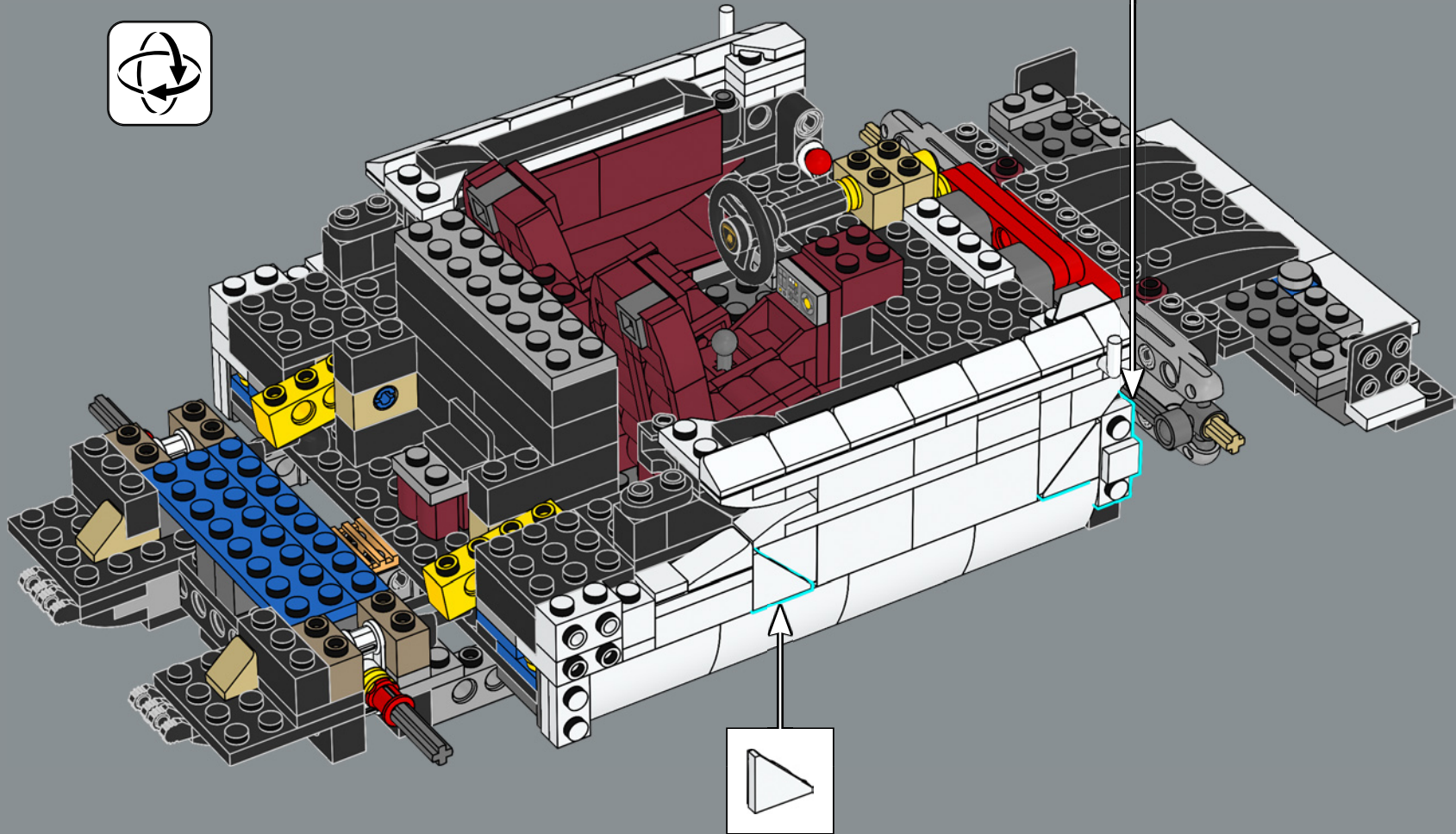
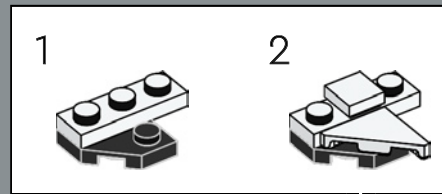



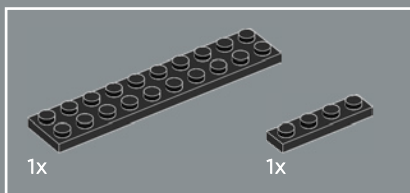
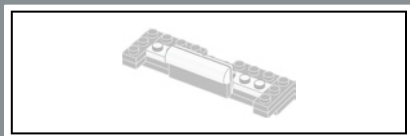

162

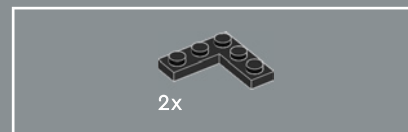
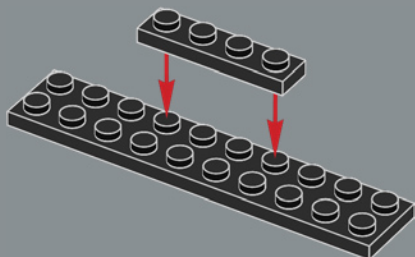

163

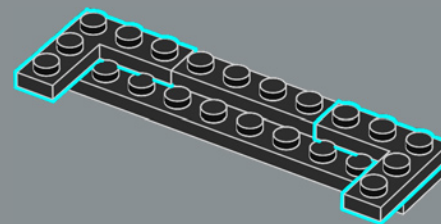

164

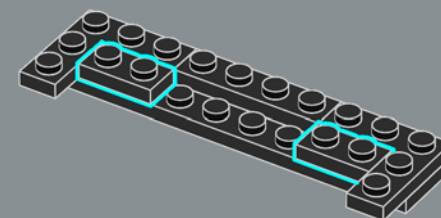



165

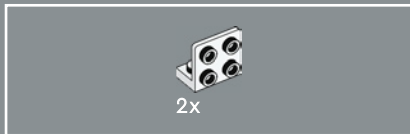
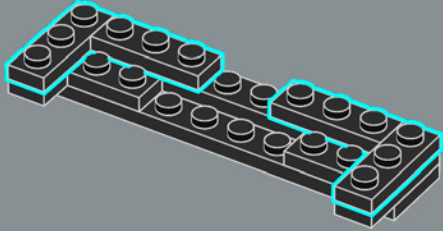

166

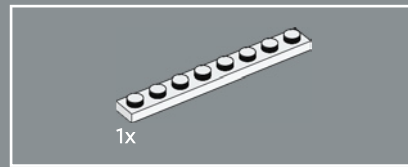
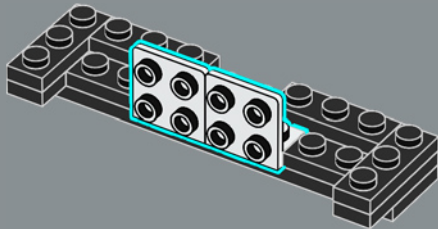

167

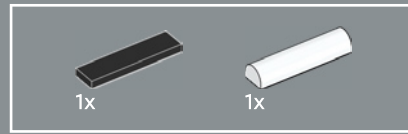
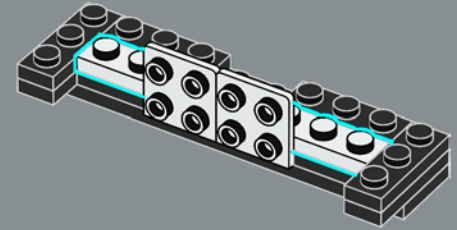

168

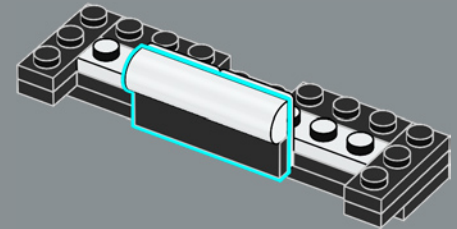

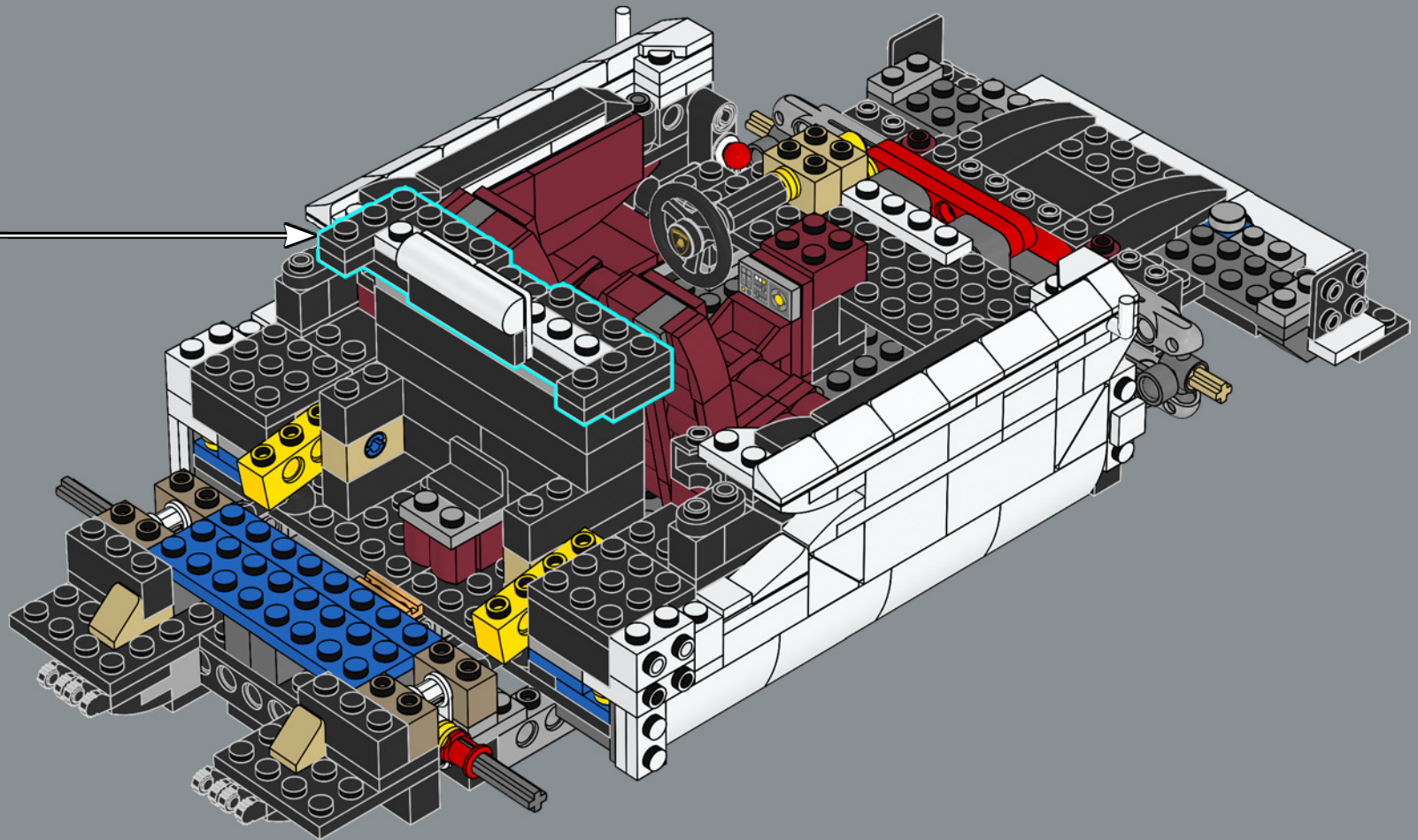

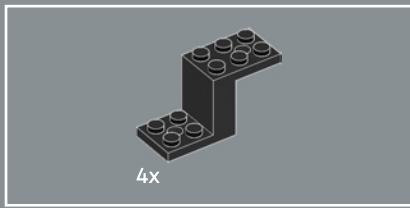

170

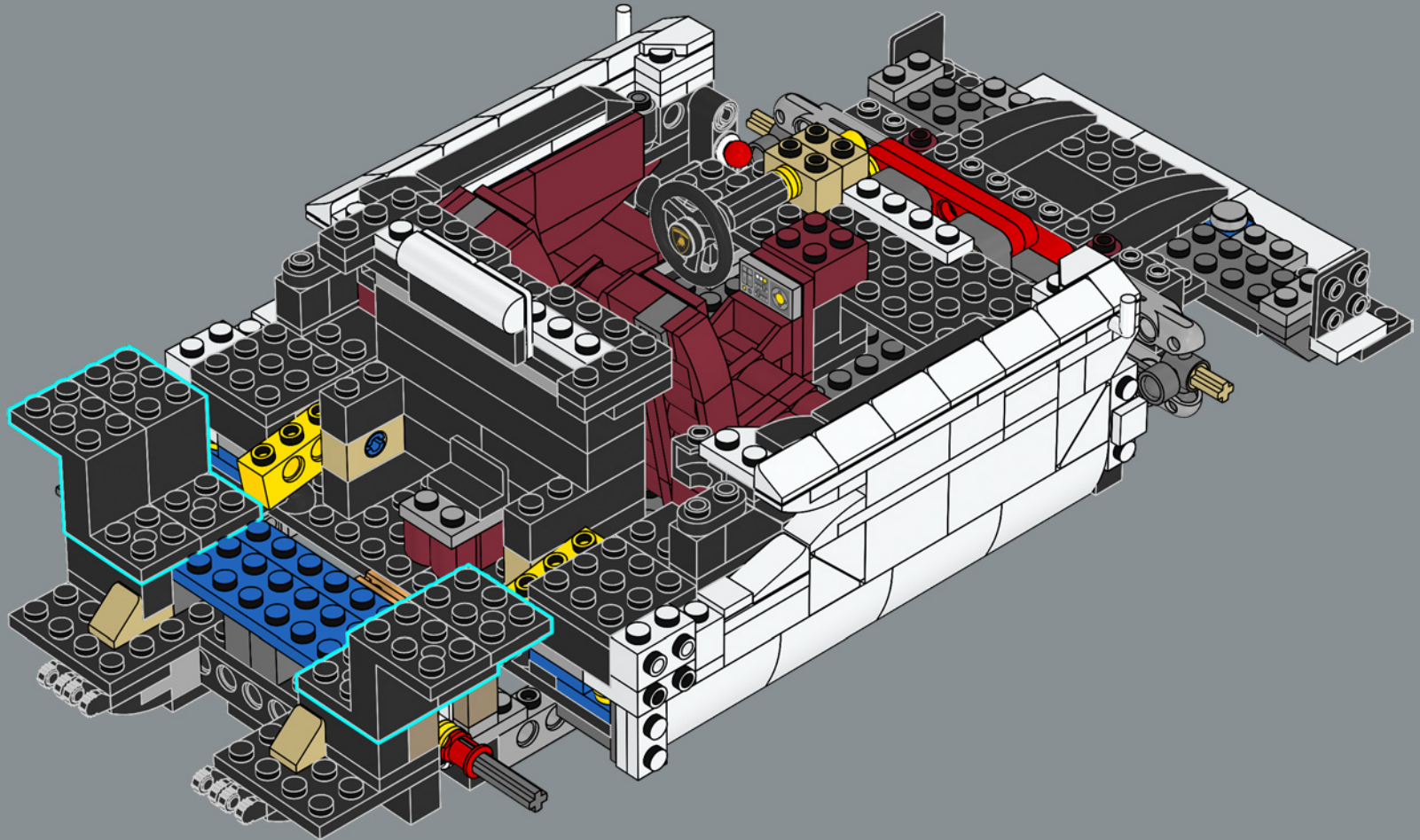



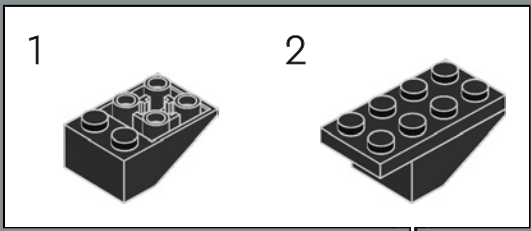
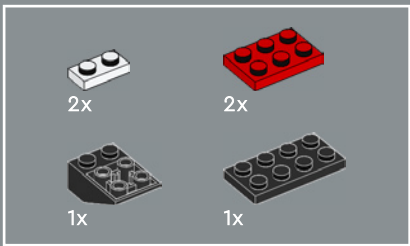

171

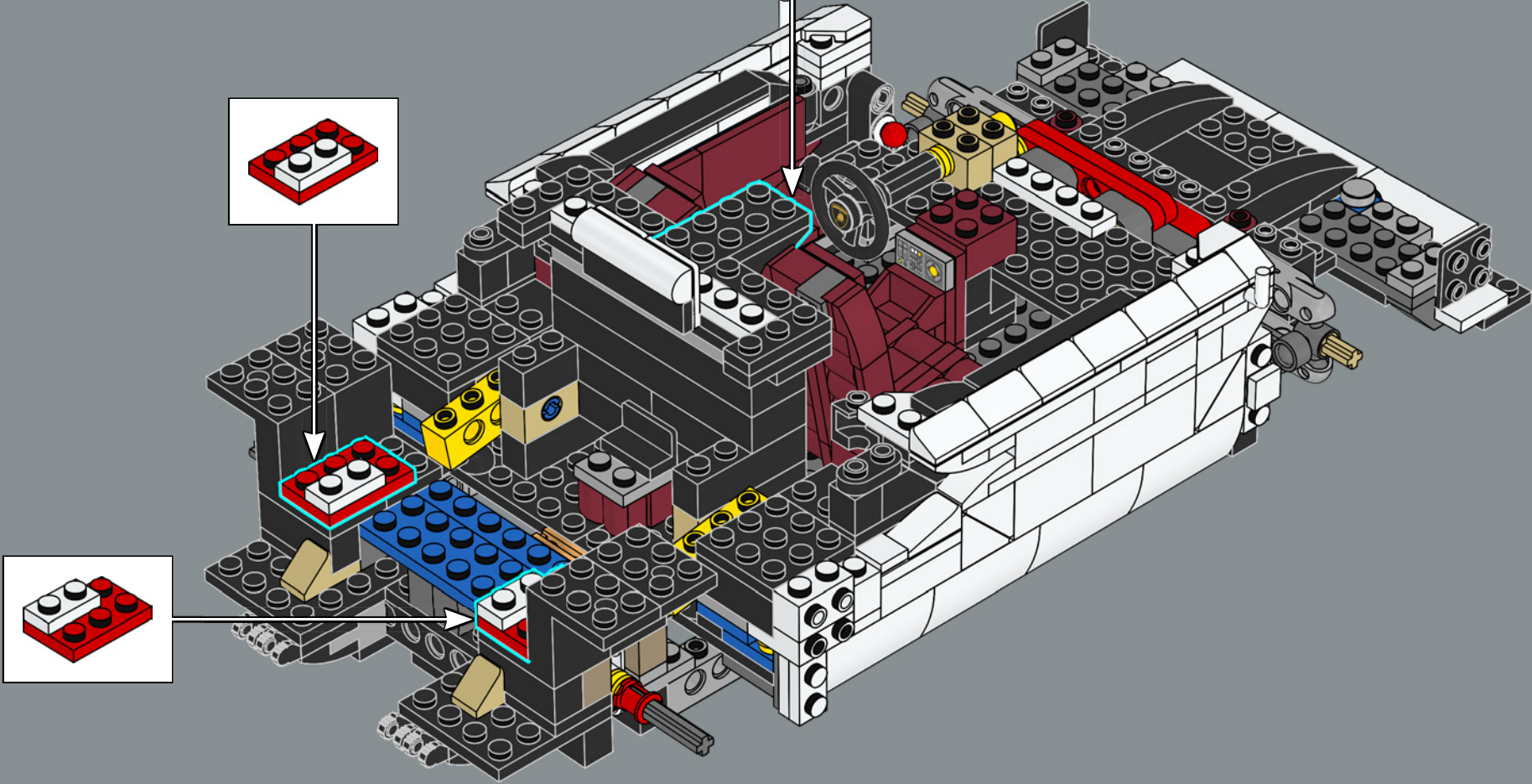

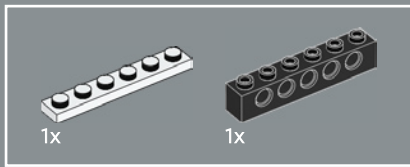

172

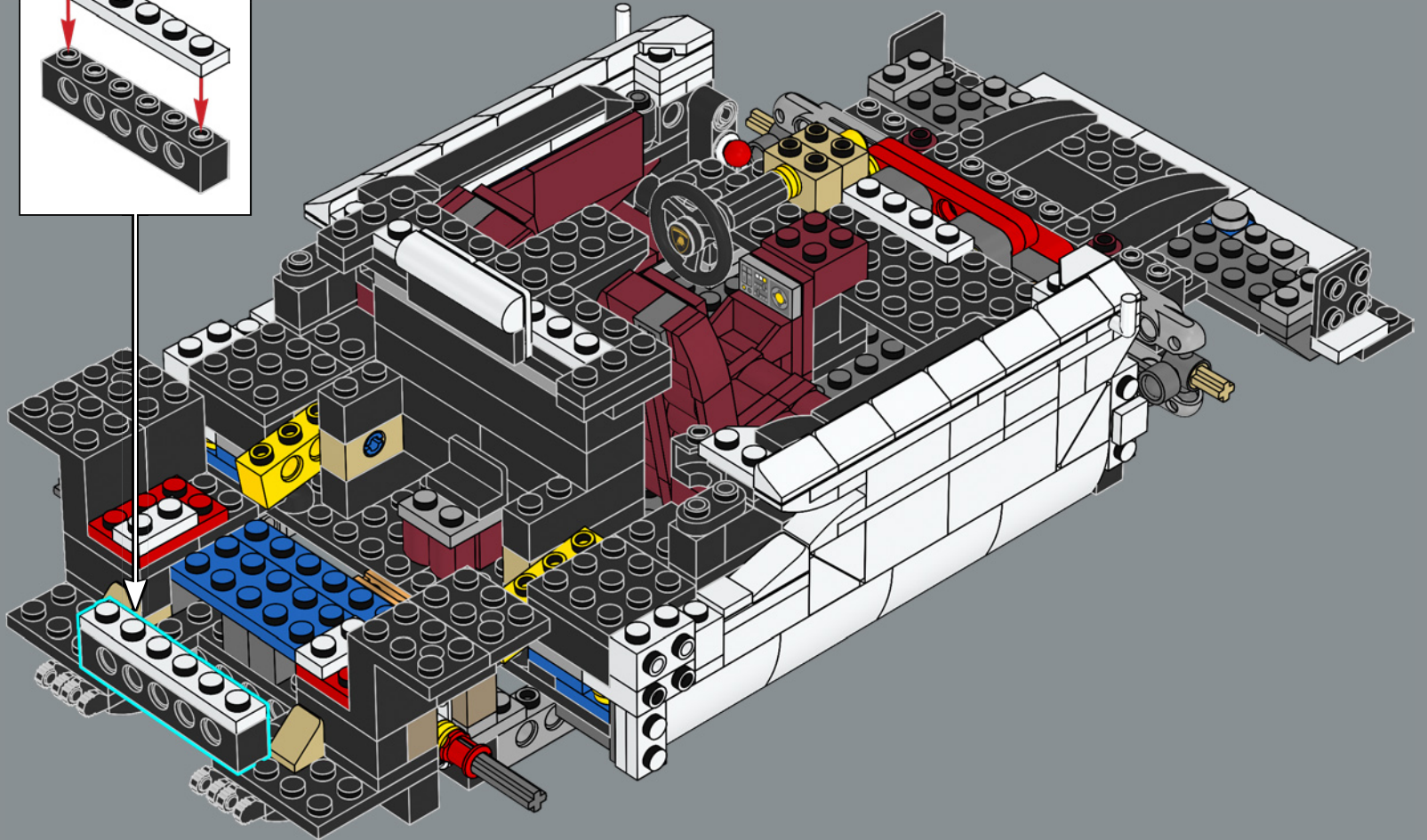
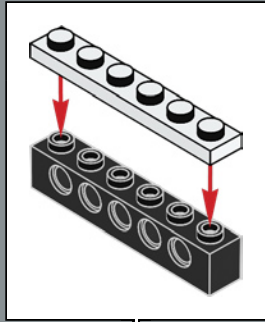



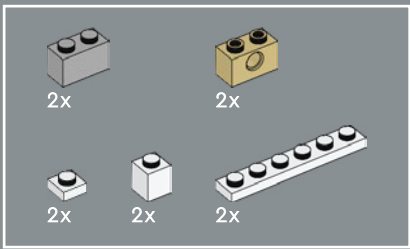

173

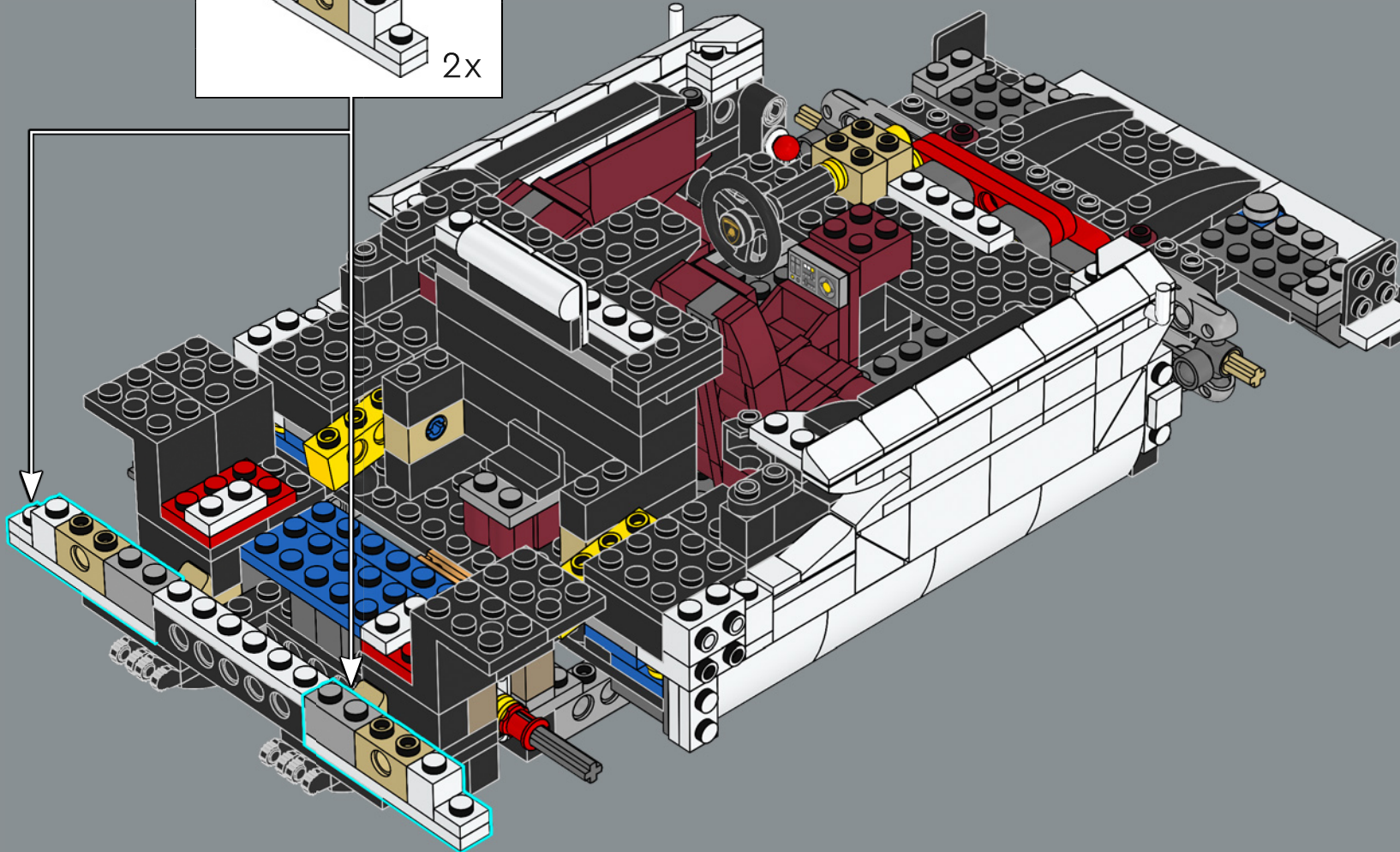
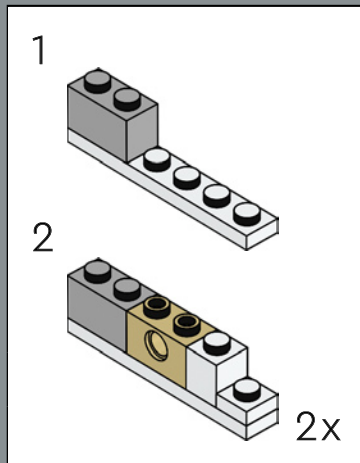

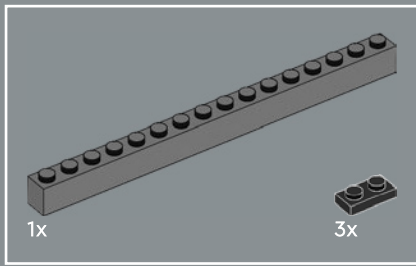

174

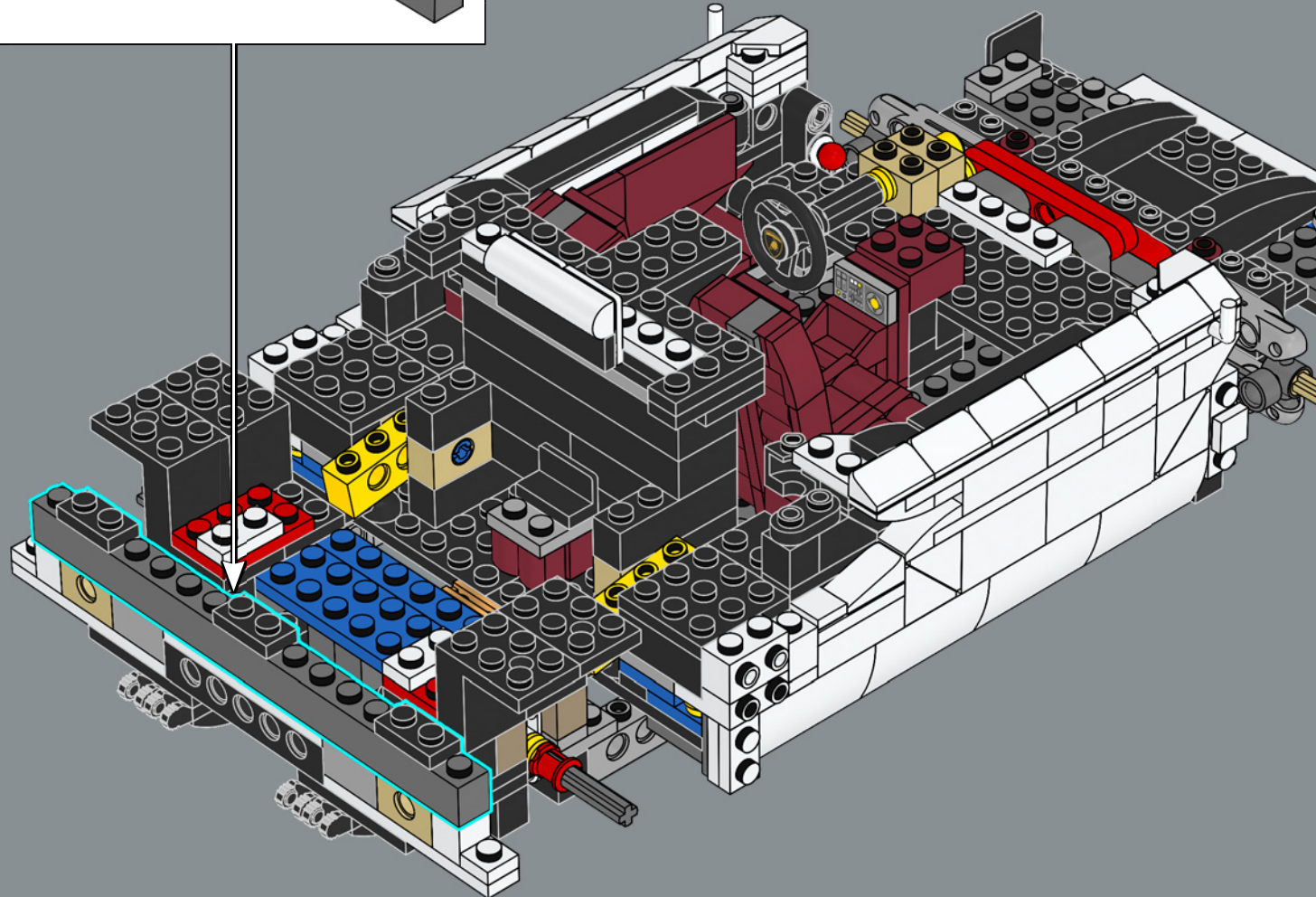
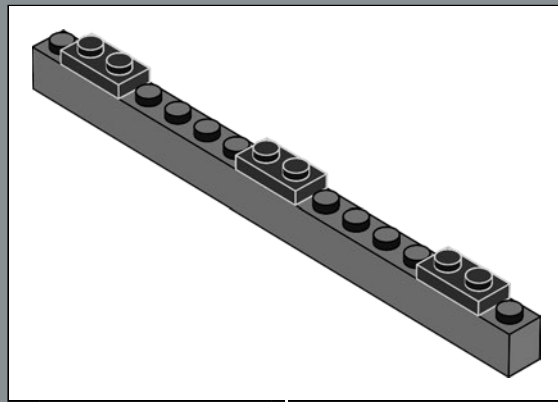



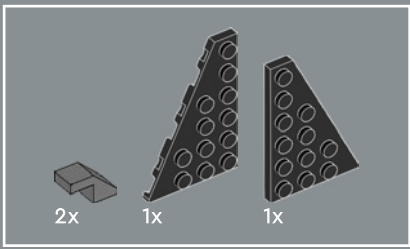

175

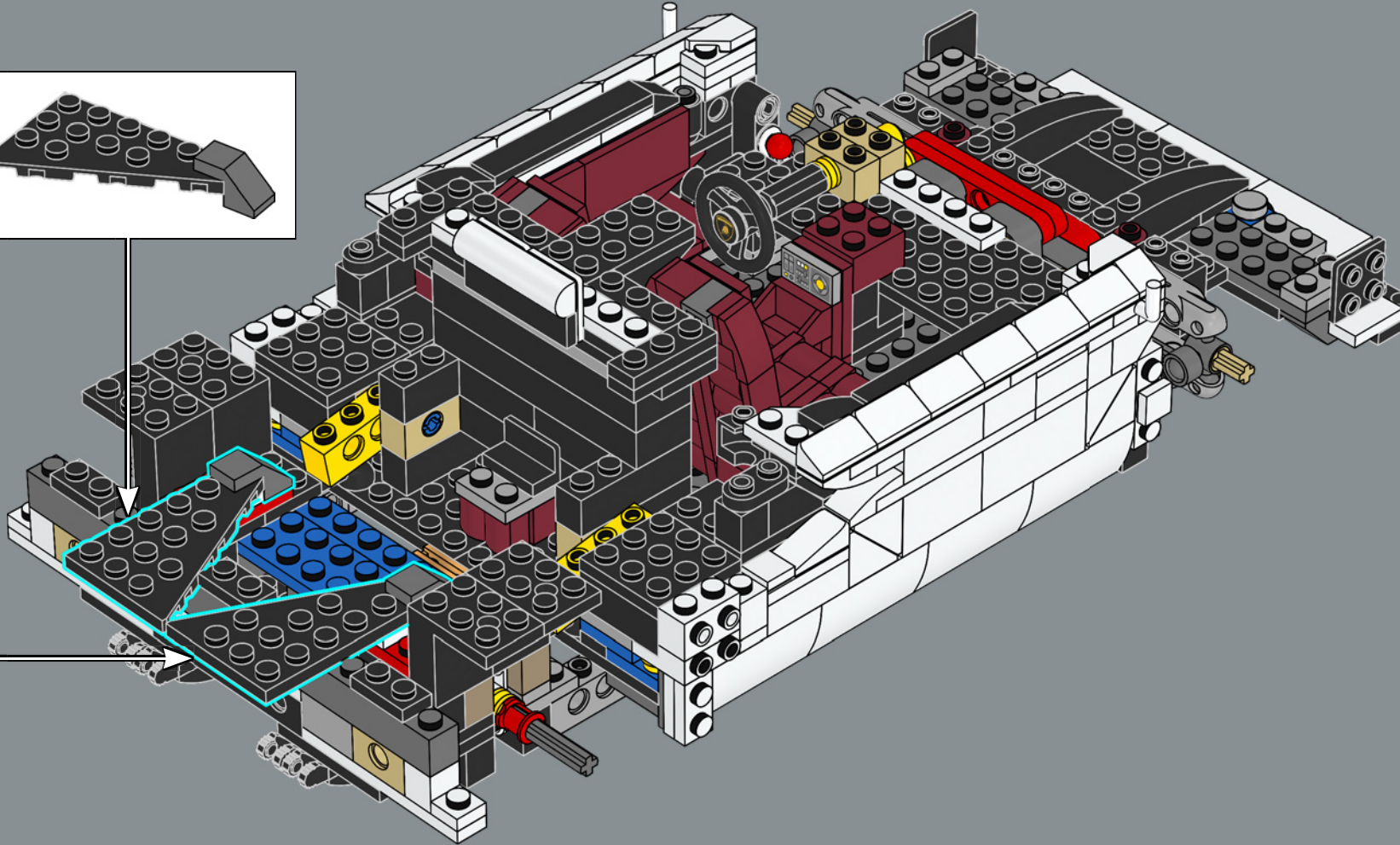
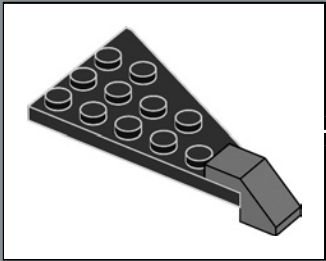
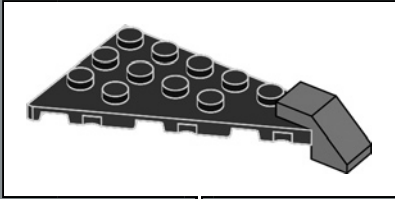

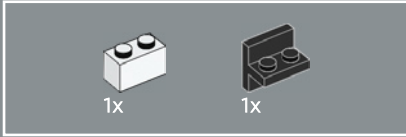
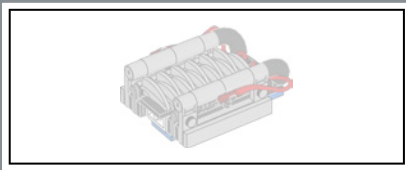

176

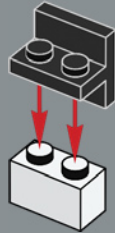

177

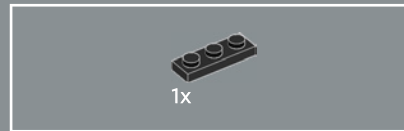
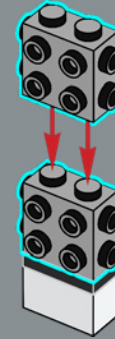

178



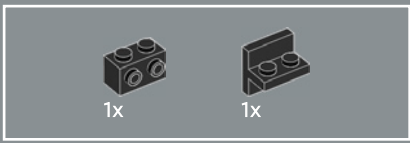

179

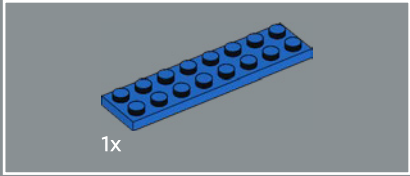
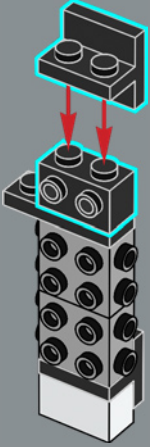

180

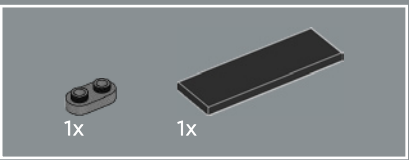
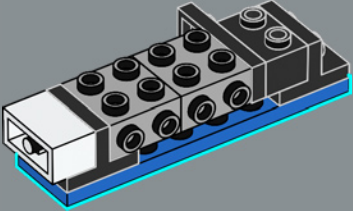

181

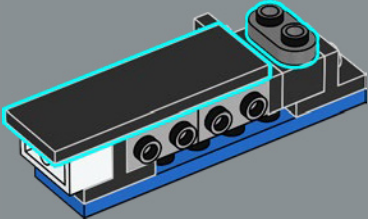

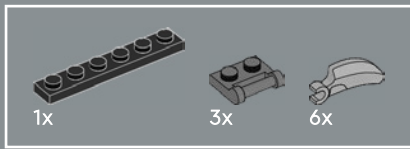

182

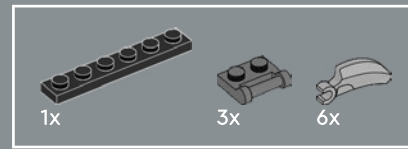
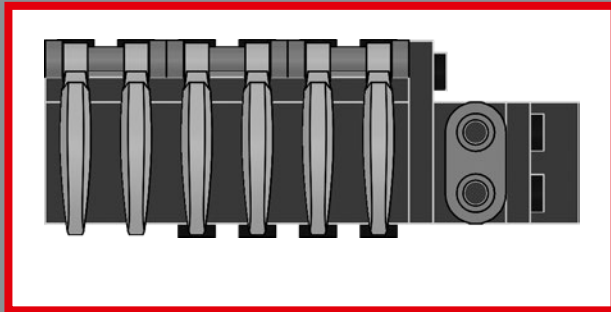
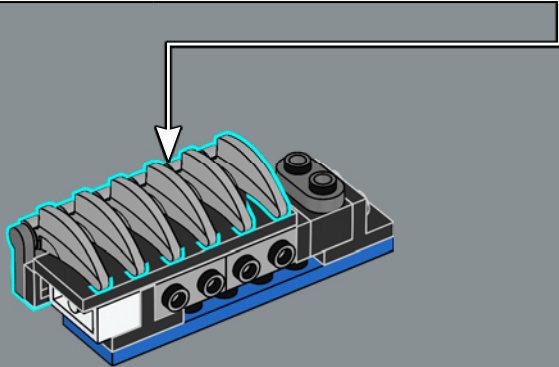
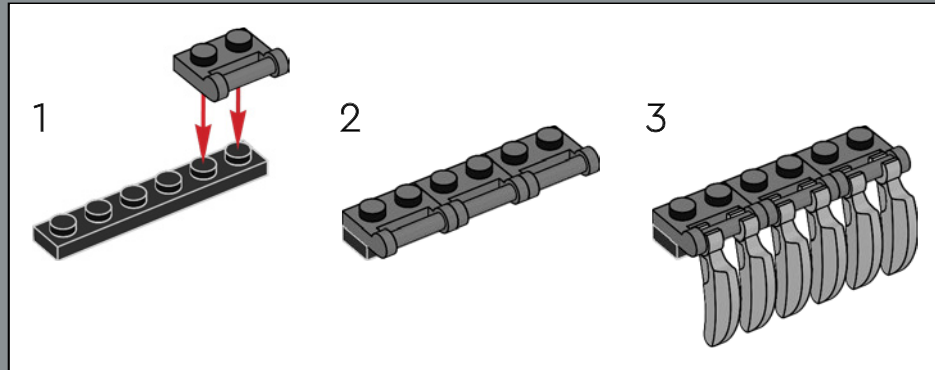

183

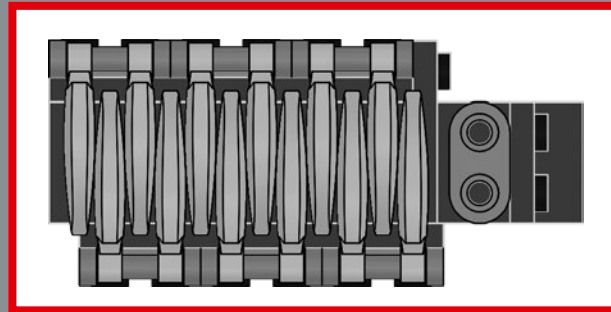
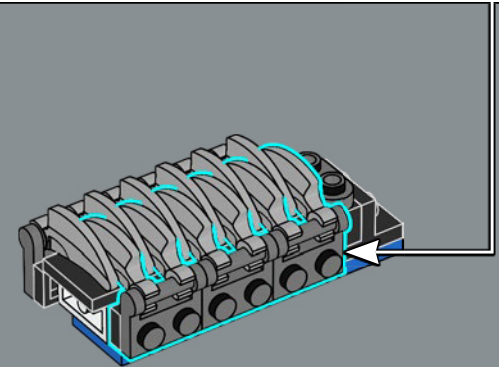
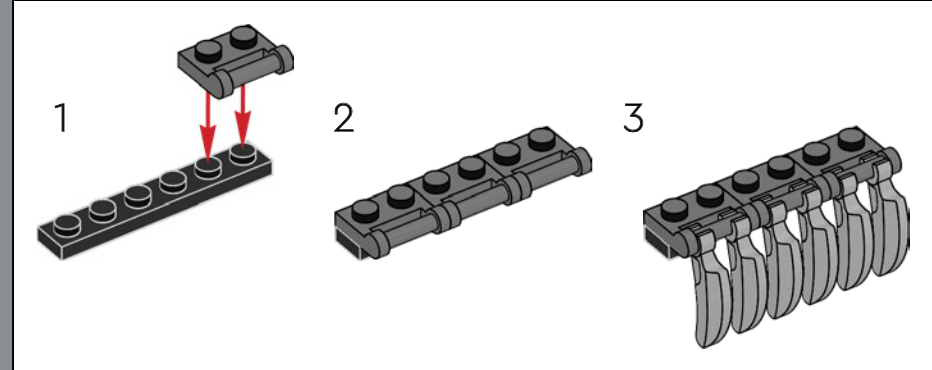



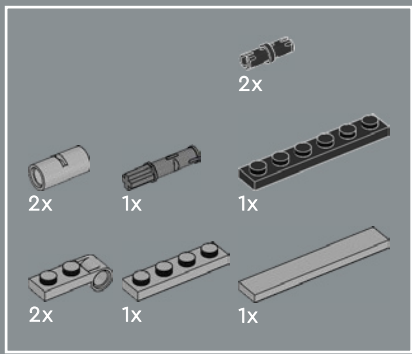

184

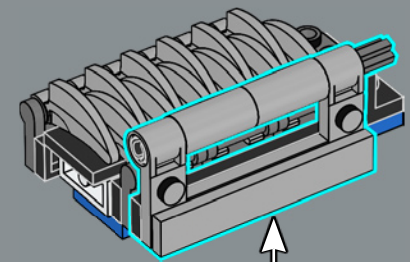
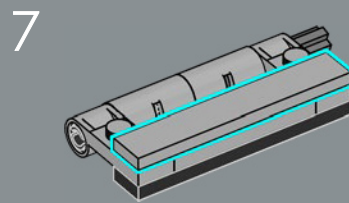
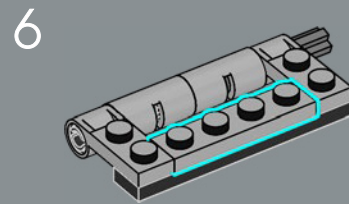
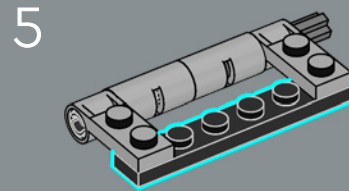
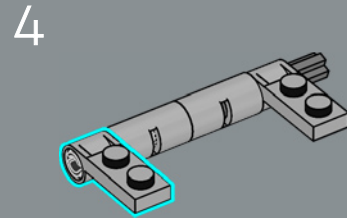
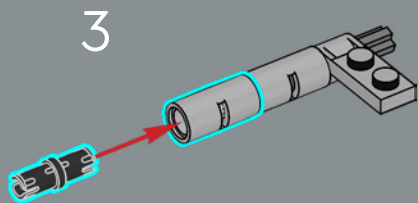
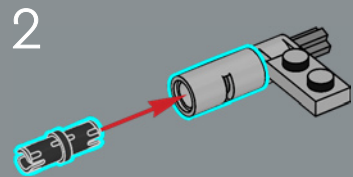
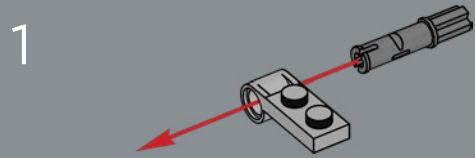

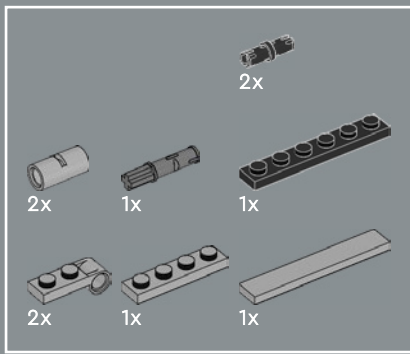

185

1

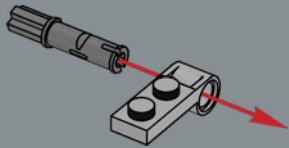

2

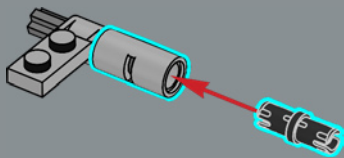

3

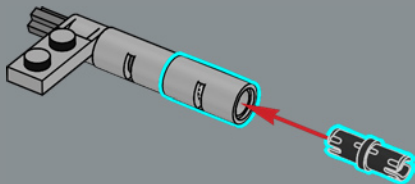

4

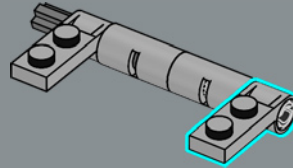

5

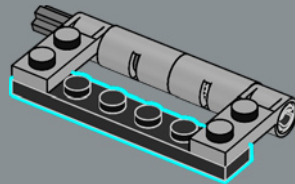

6

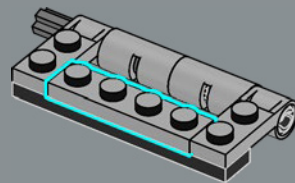

7

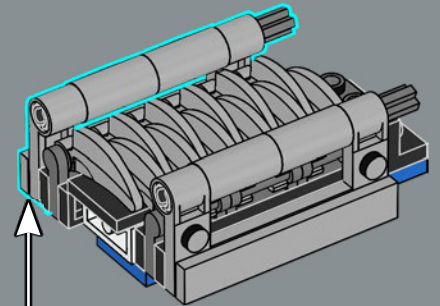
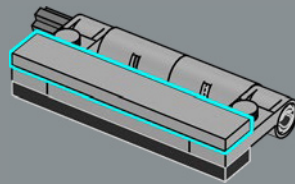

2x

186

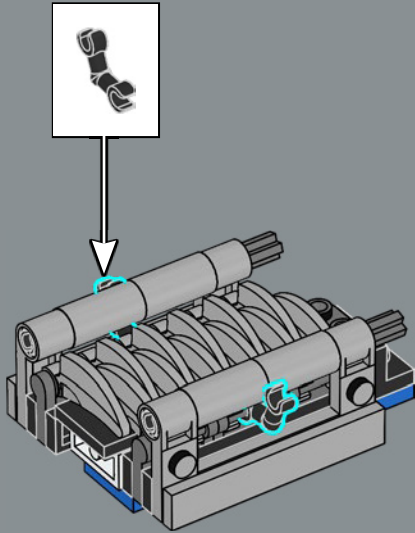

2x

187

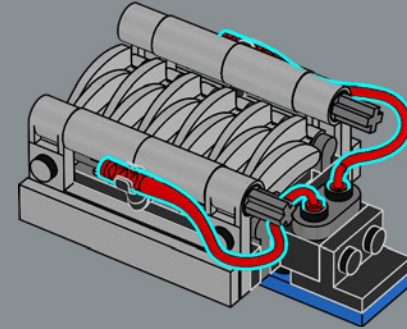

2x

188

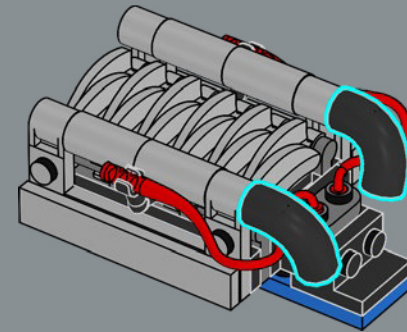



The LP in Countach names stands for Longitudinale Posteriore (rear longitudinal in English), as that is the position of the engine.

189

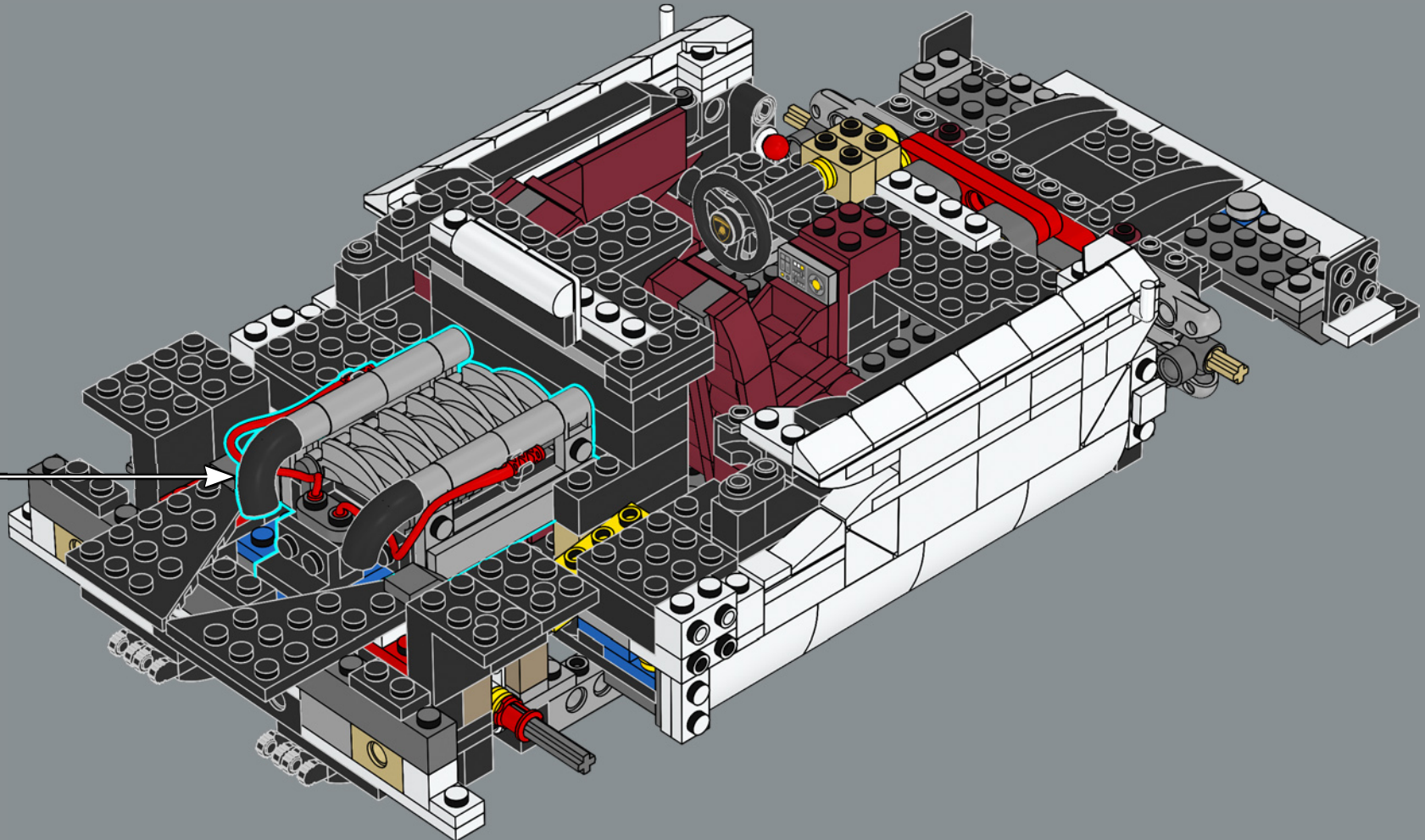



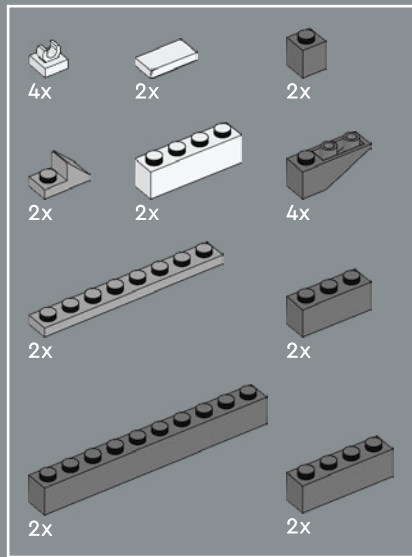
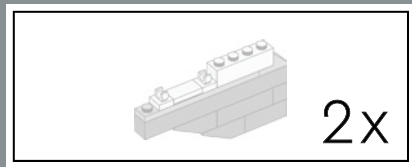

190

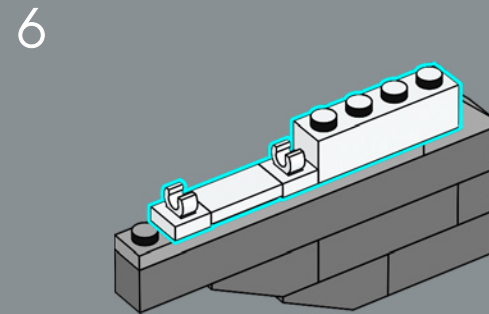
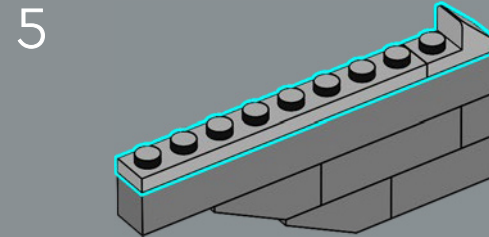
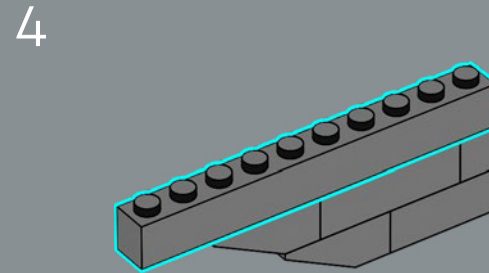
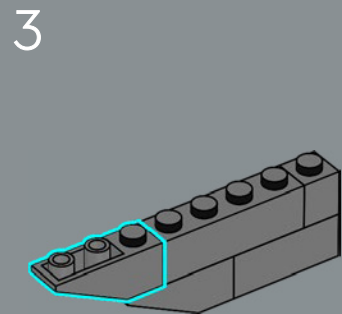
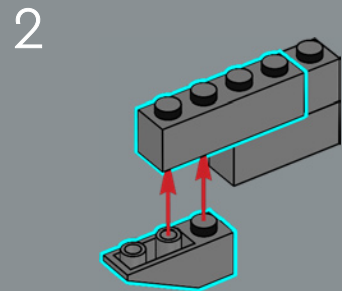
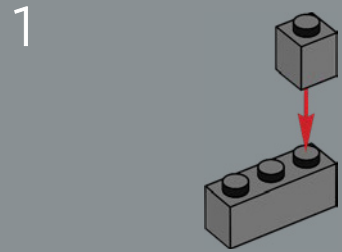

2x

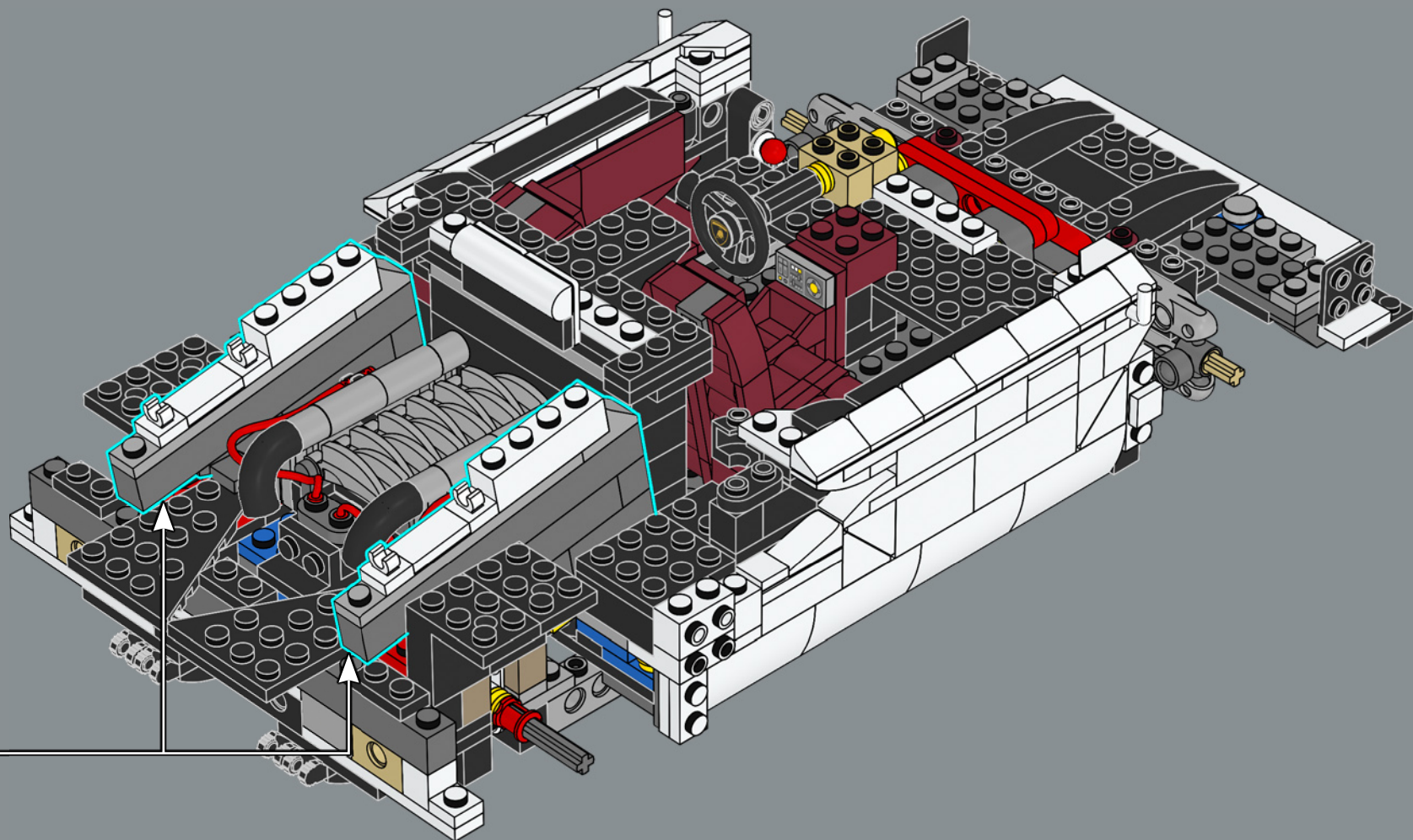

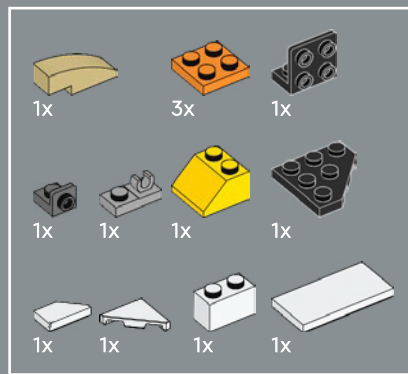

191

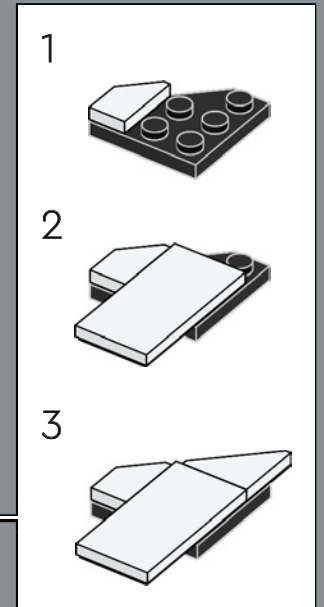
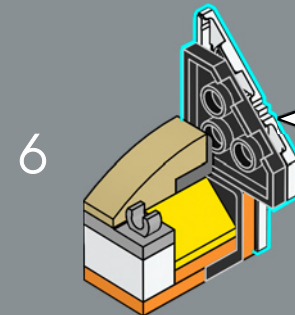
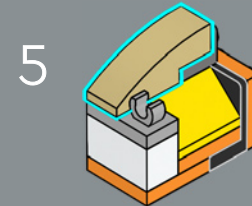
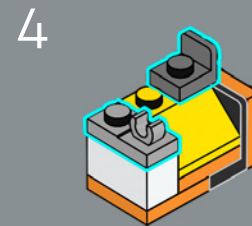
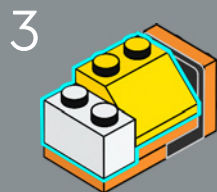
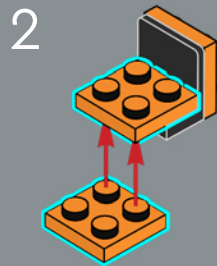
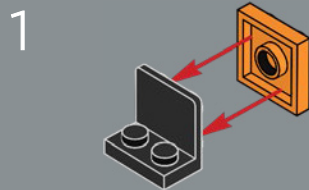

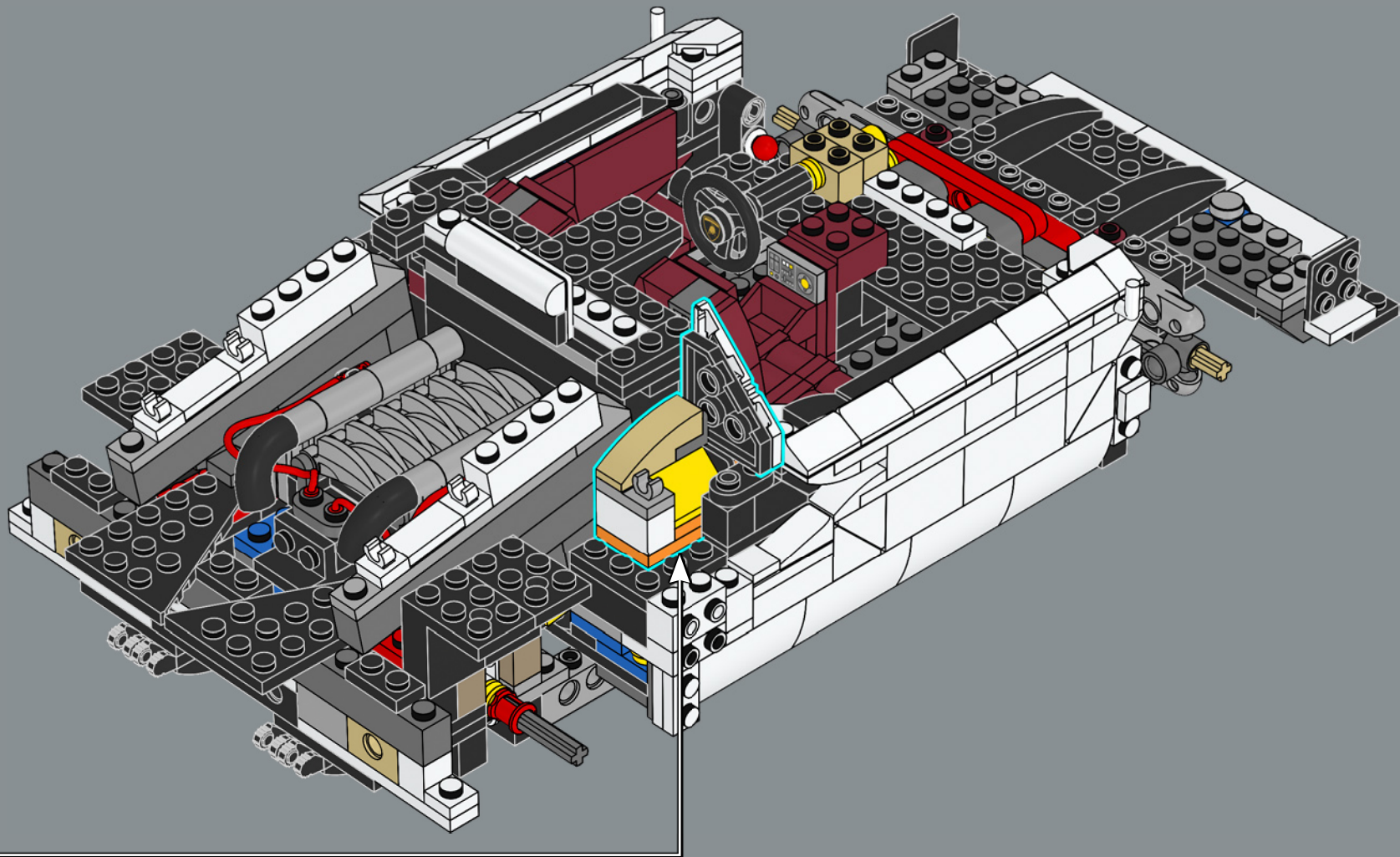



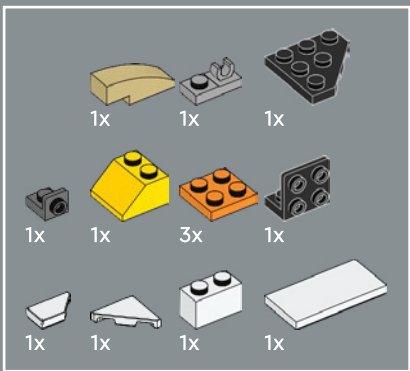

192

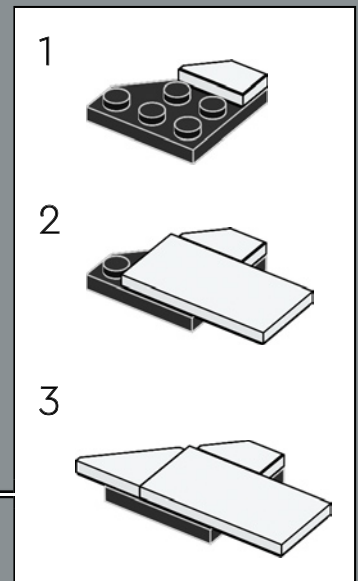
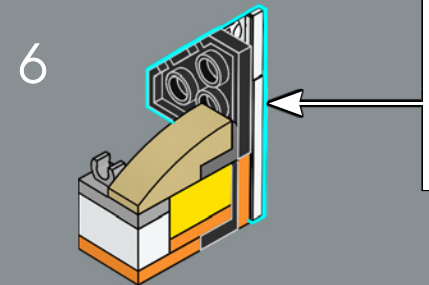
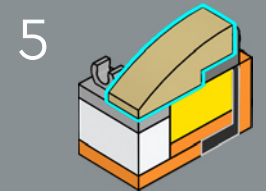
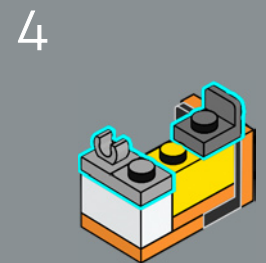
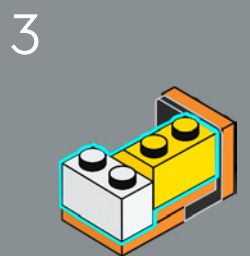
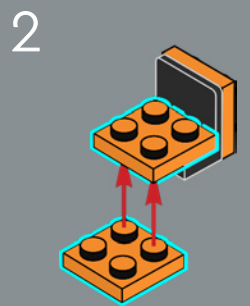
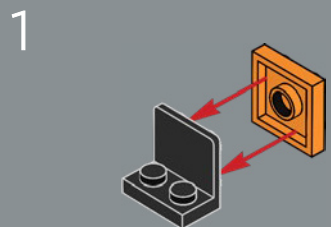

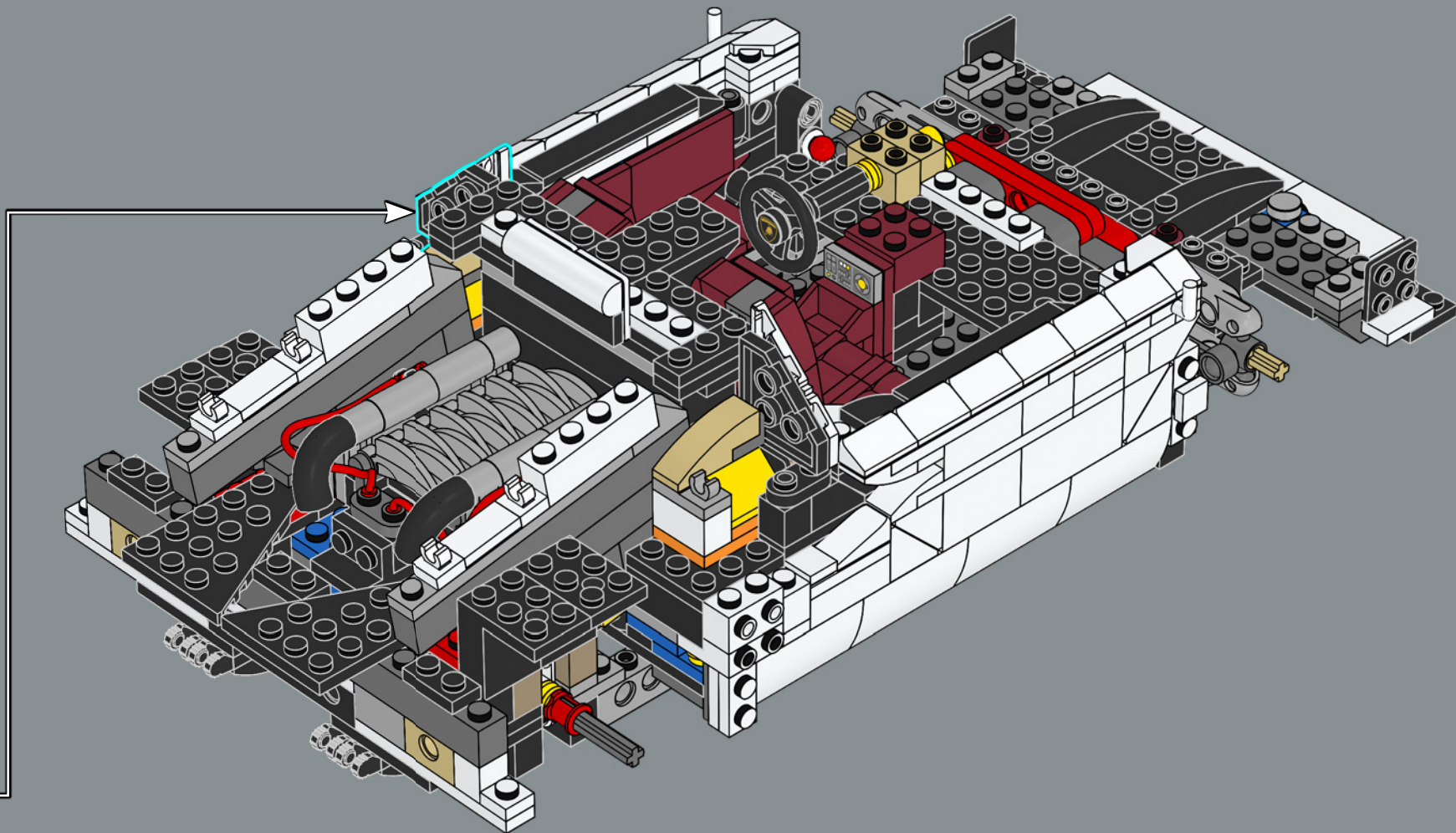

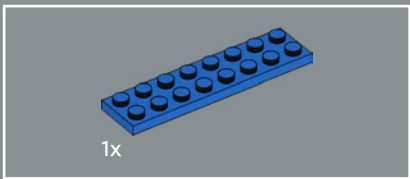

193

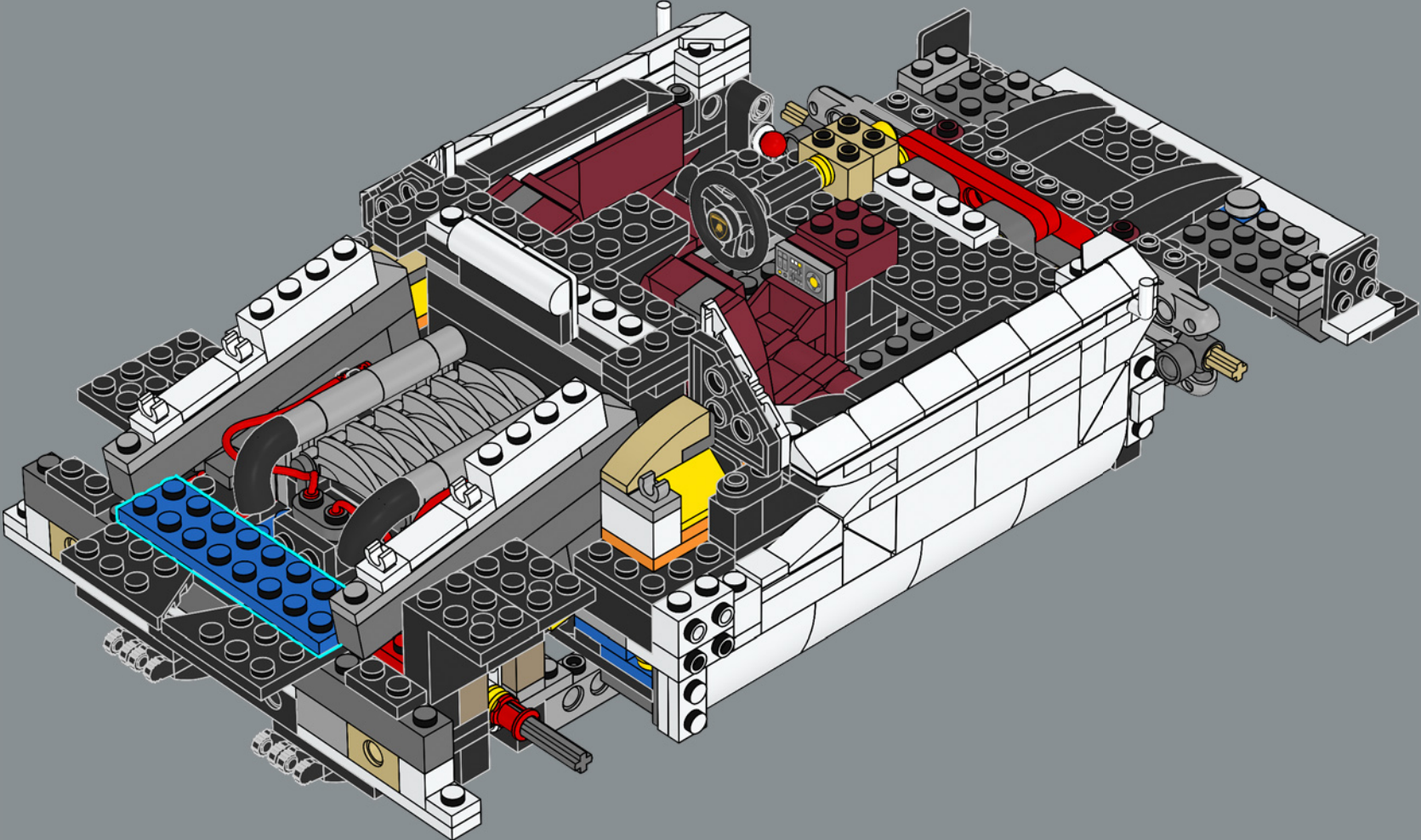



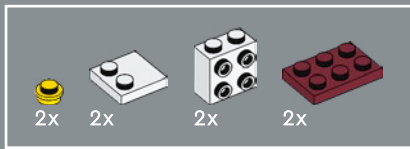

194

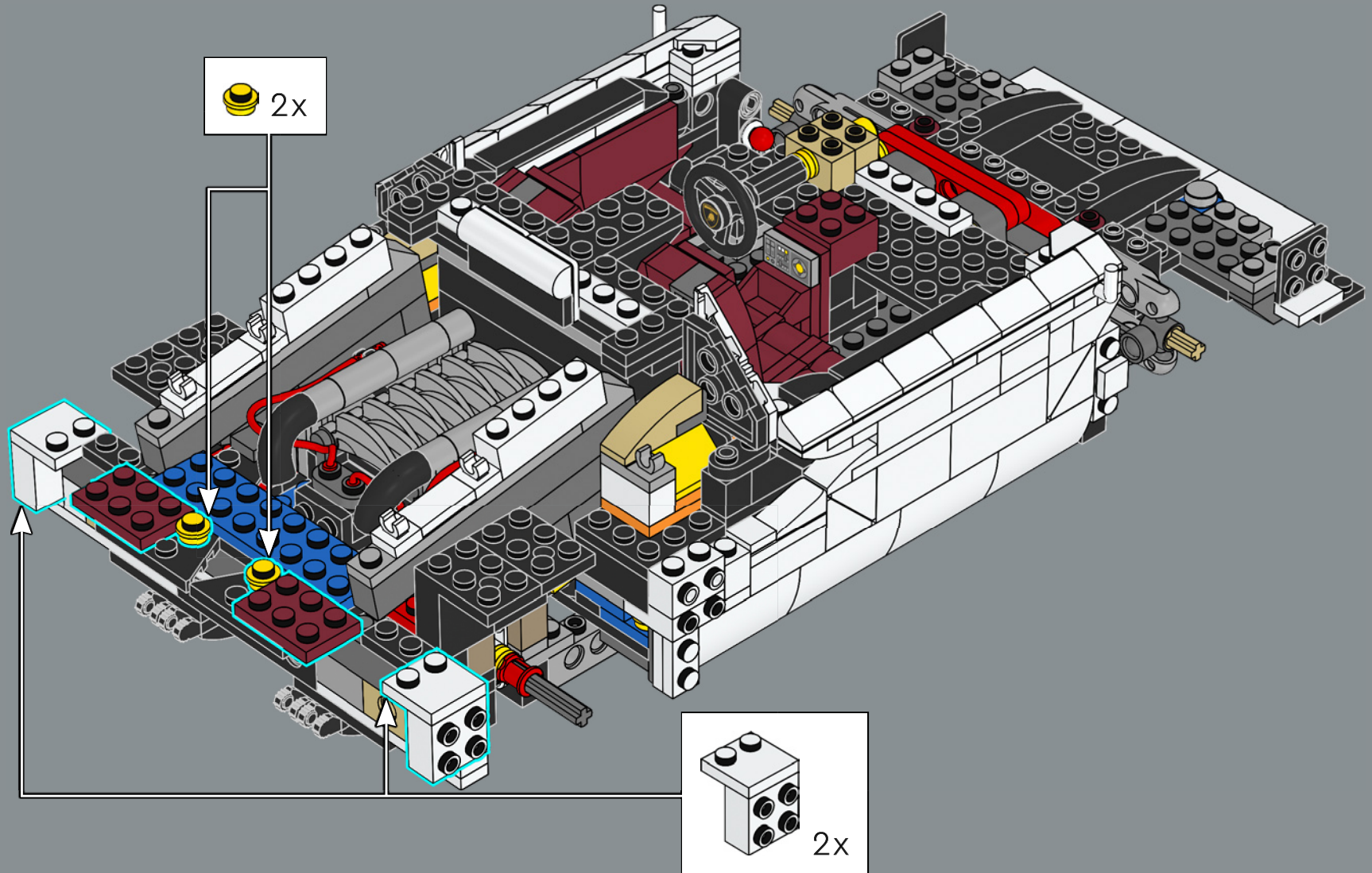





2x

195

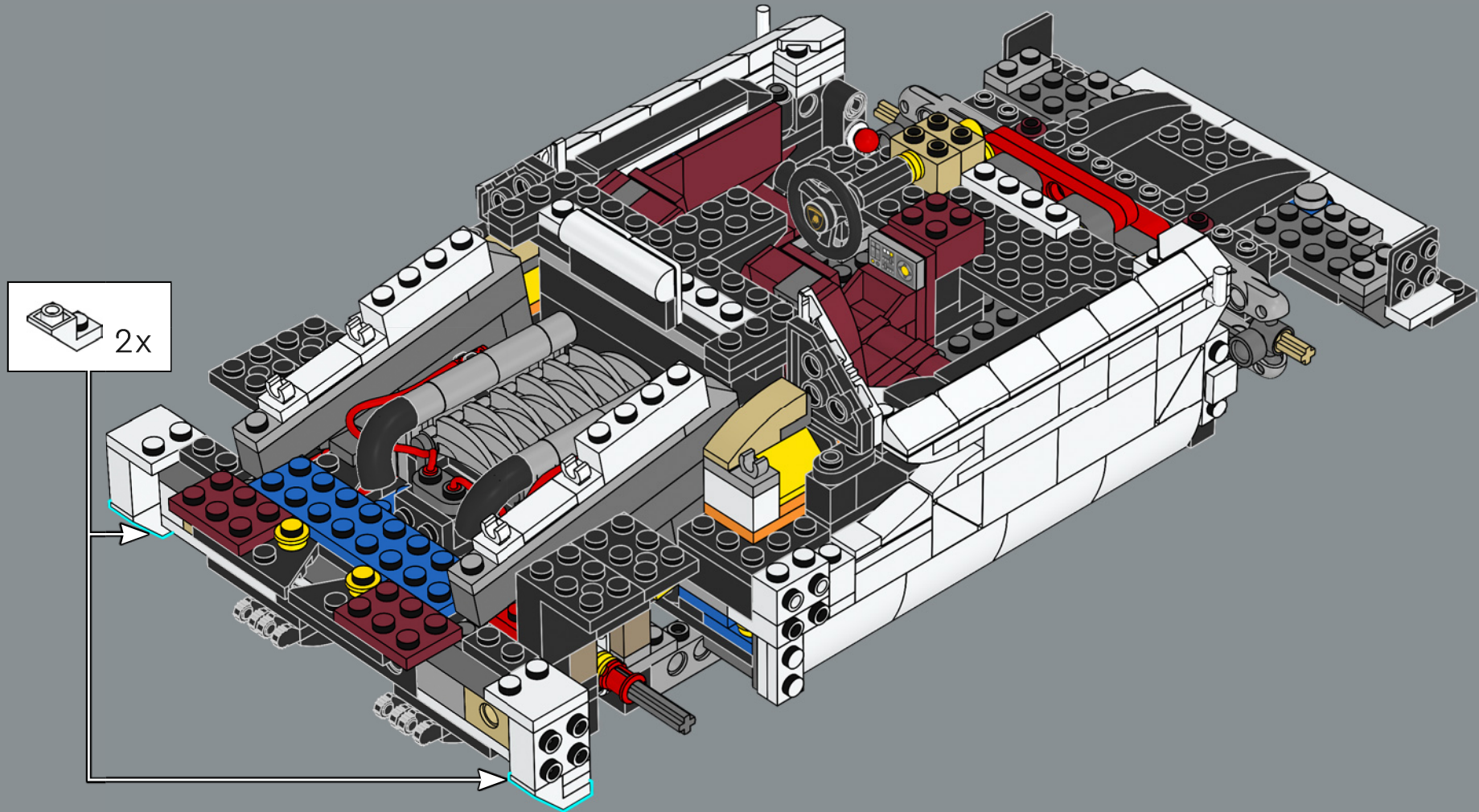

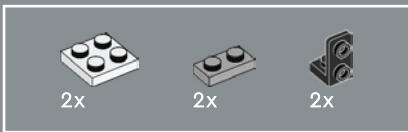

196

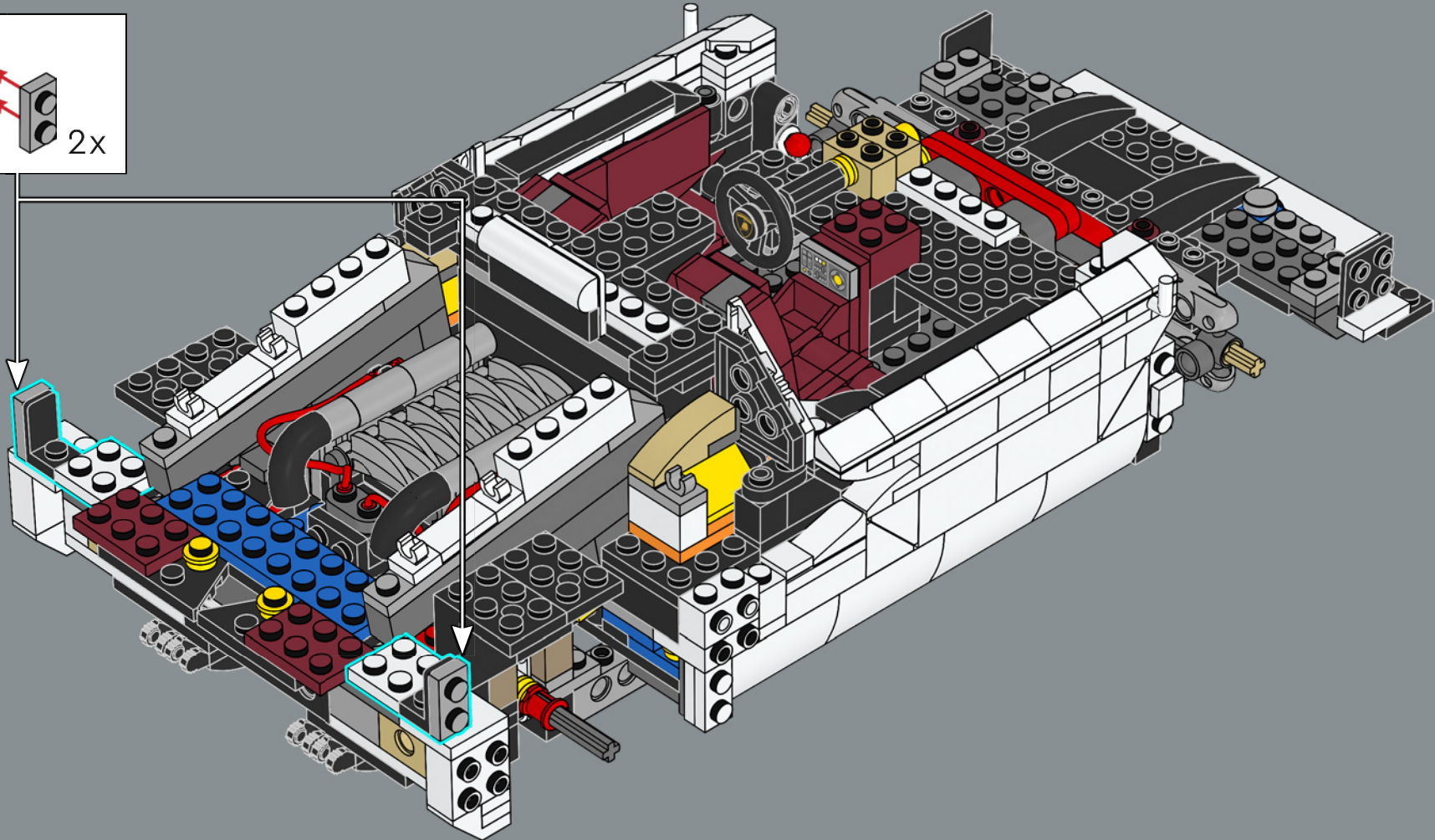
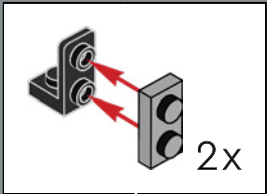



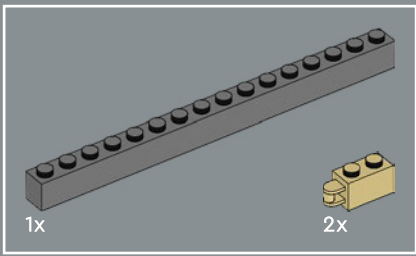

197

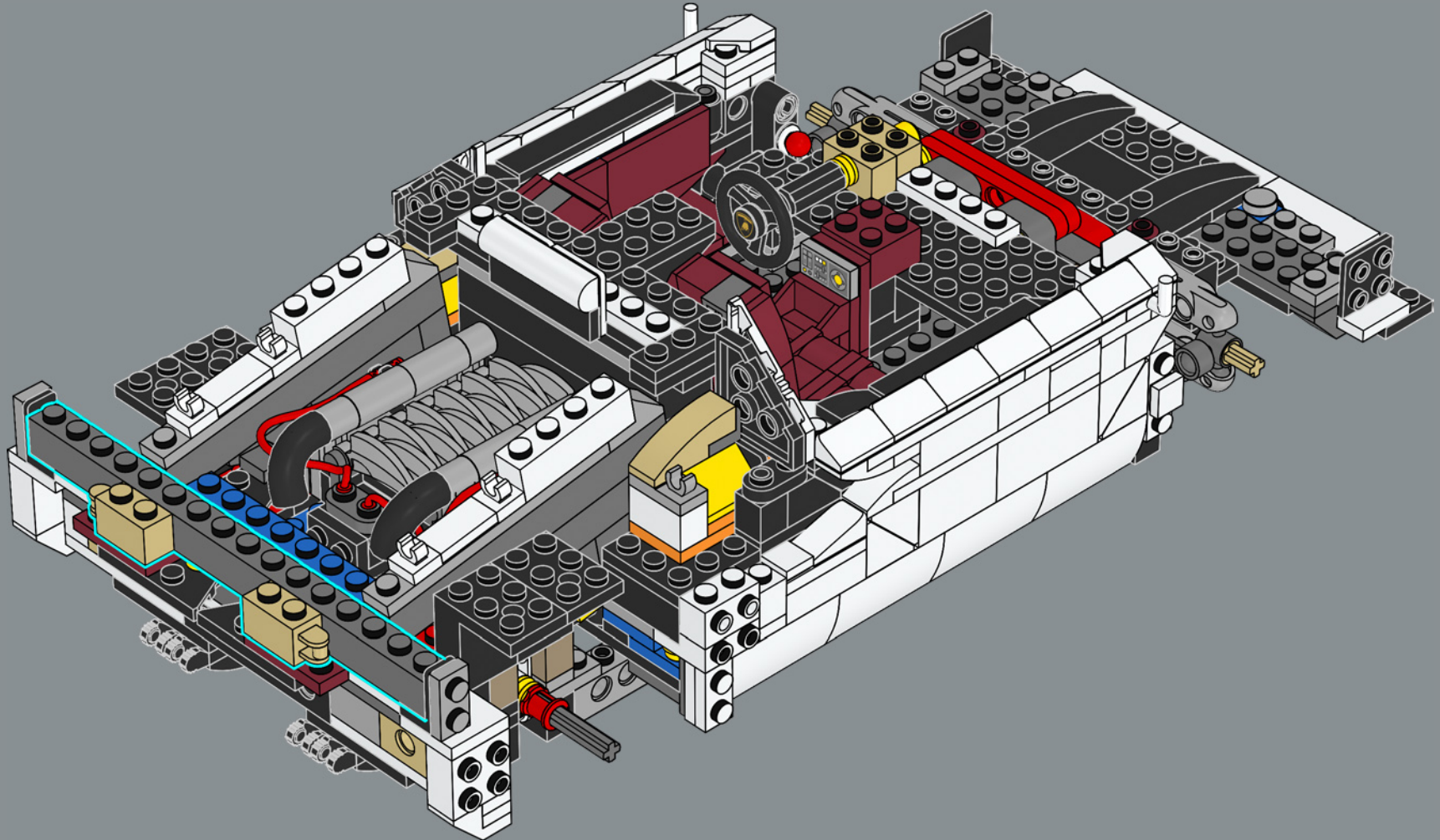

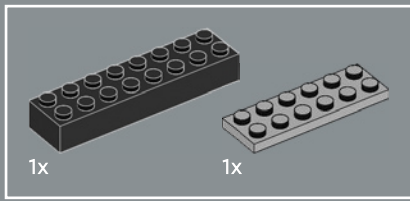

198

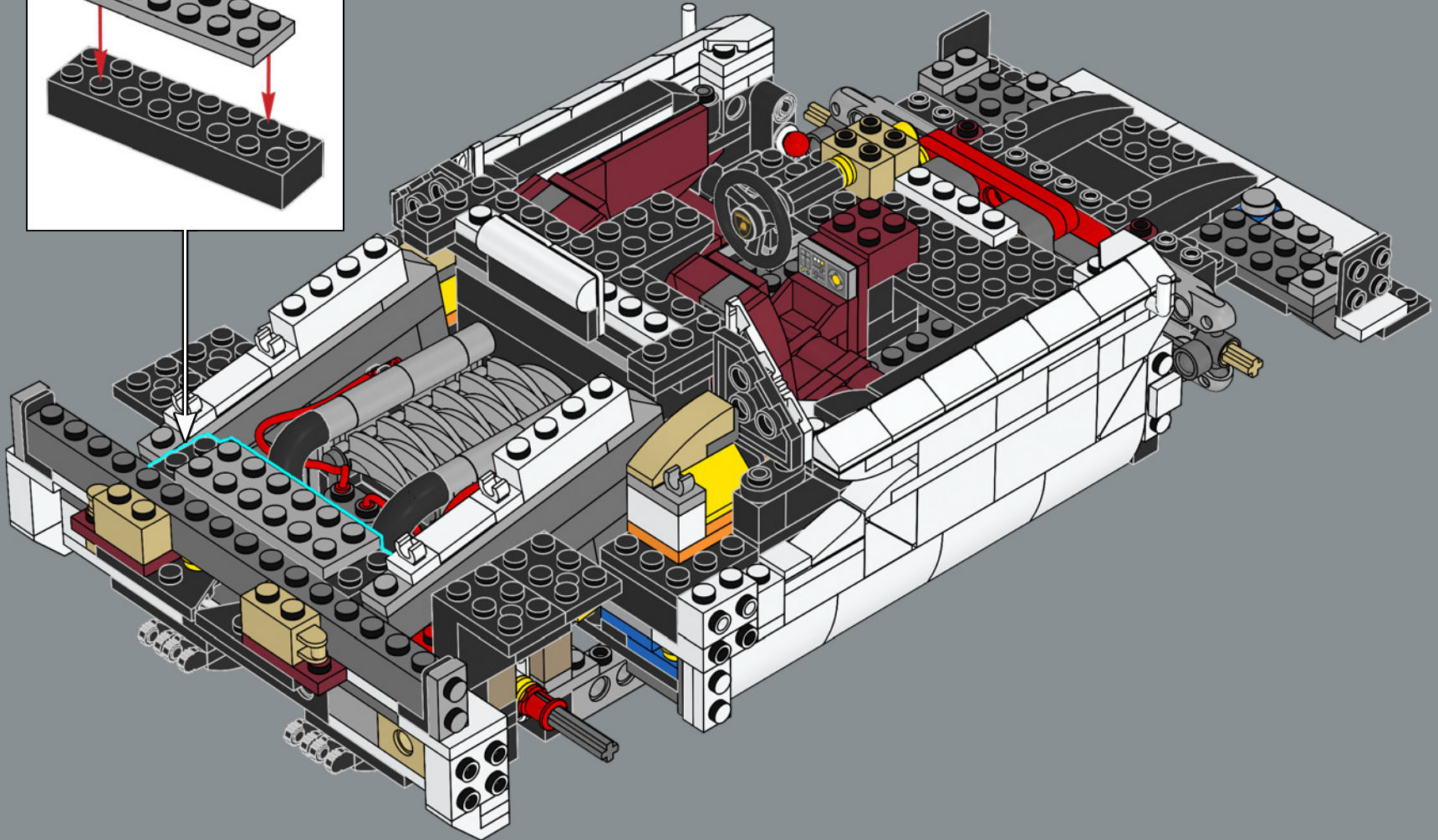
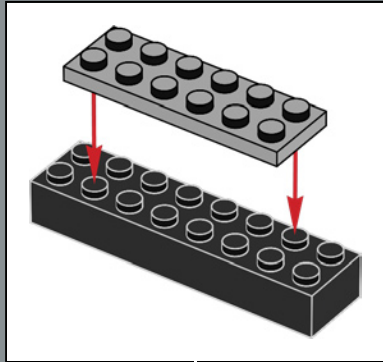



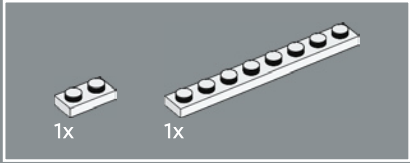
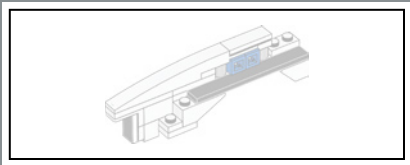

199

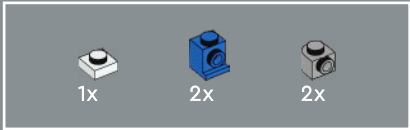
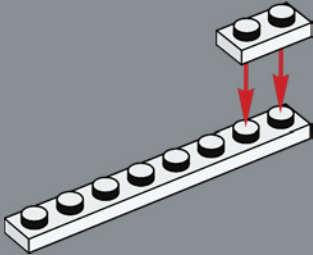

200

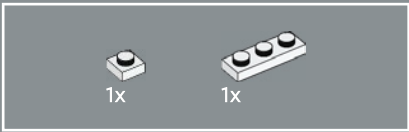
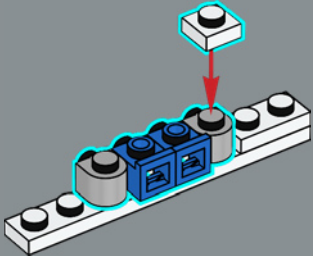

201

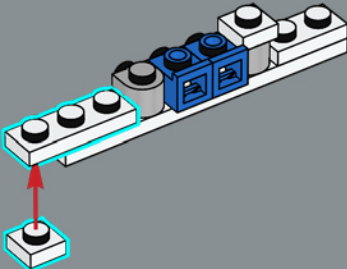

202

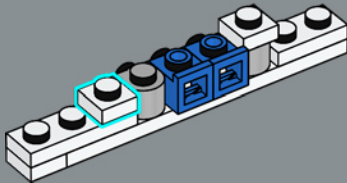

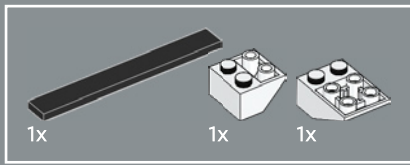

203

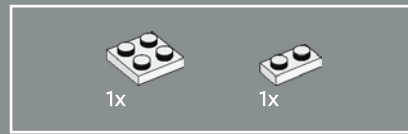
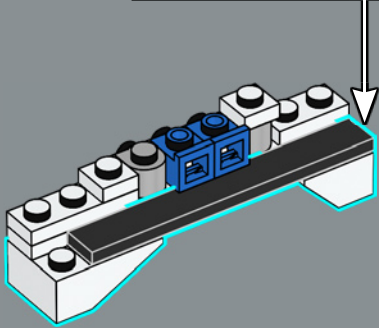
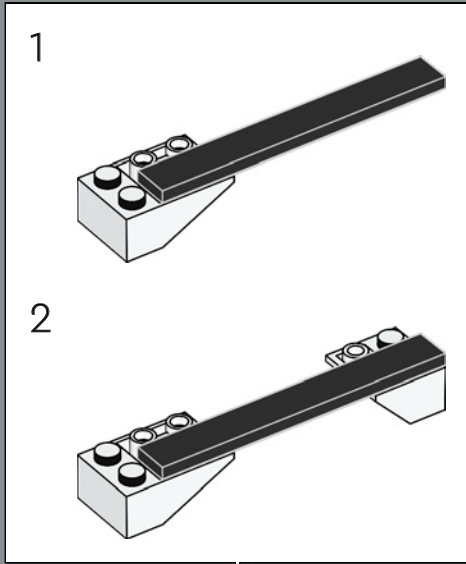

204

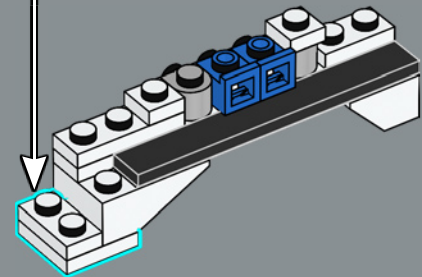
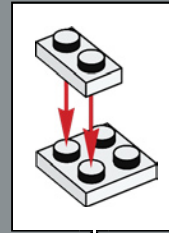

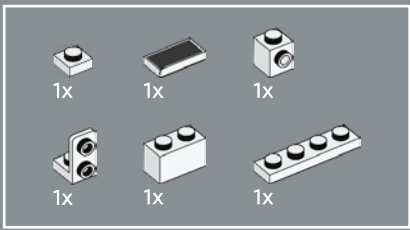

# 205

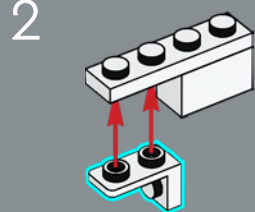
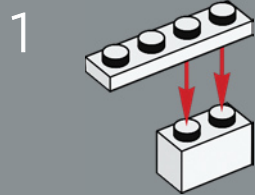

3

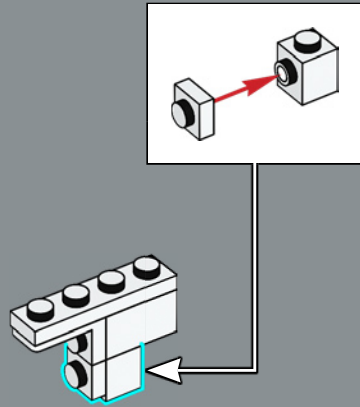

4

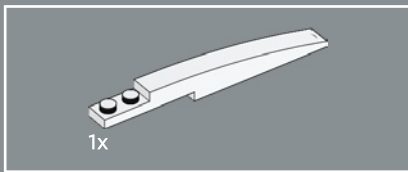
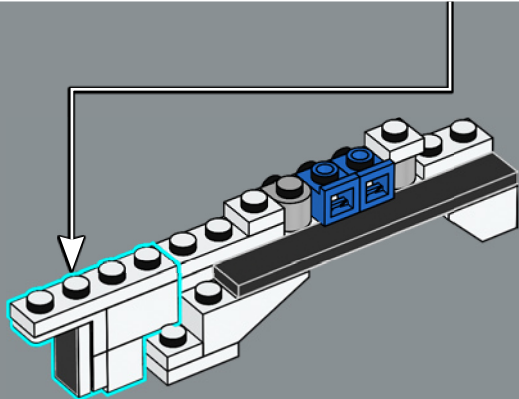
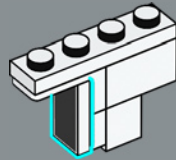

# 206

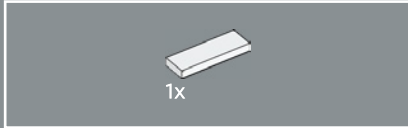
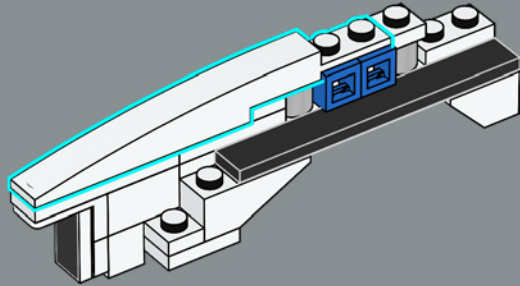

# 207

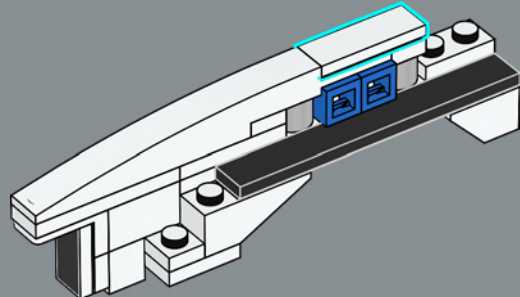

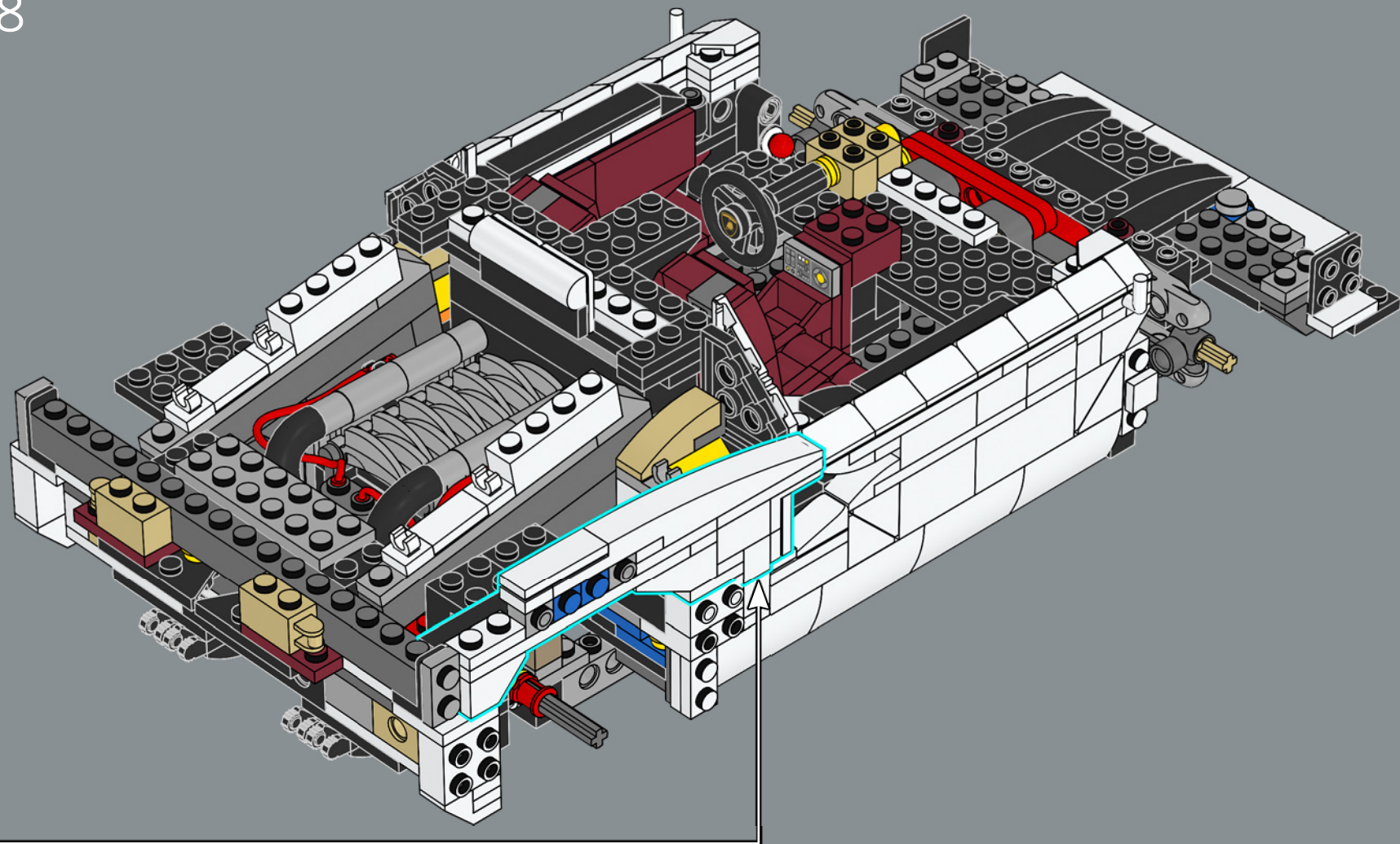



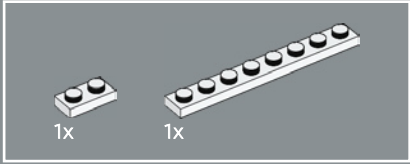
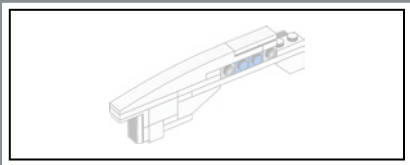

209

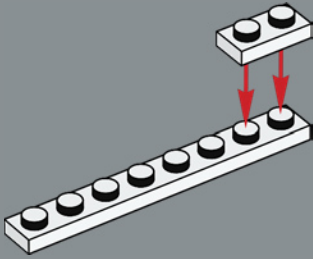

210

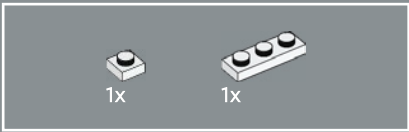
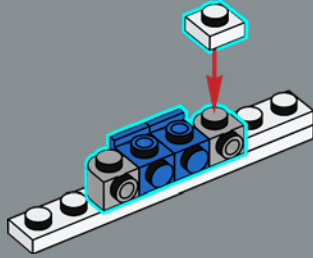

211

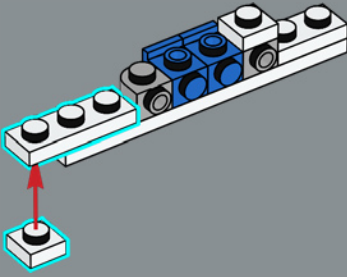

212

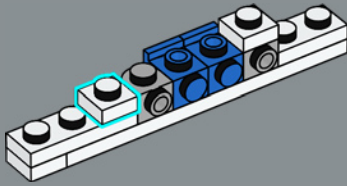

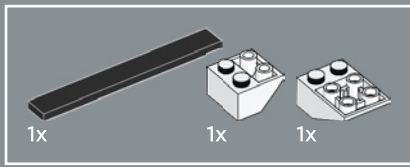

213

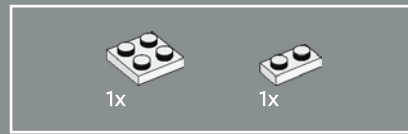
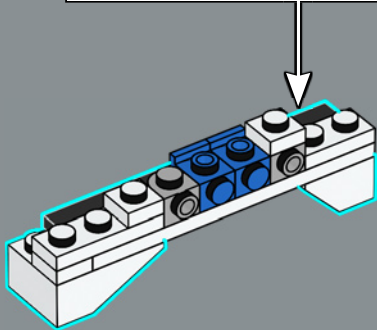
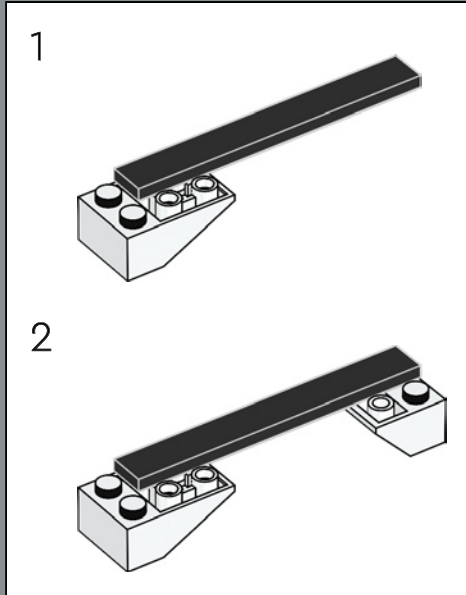

214

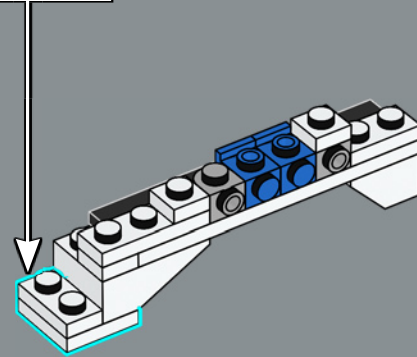
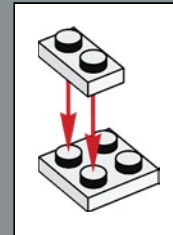

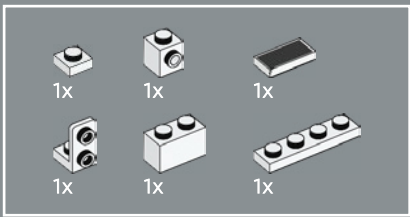

# 215

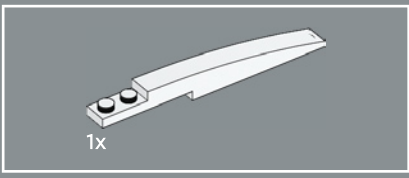
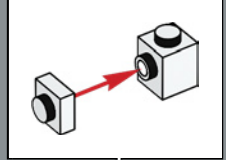
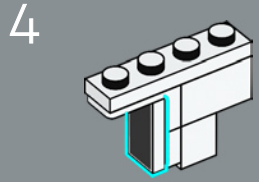
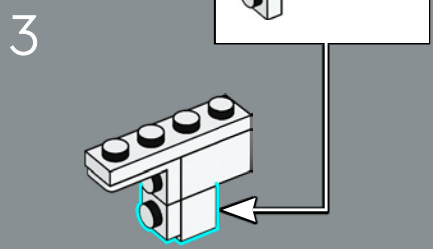
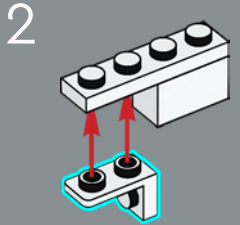
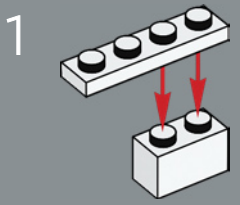

# 216

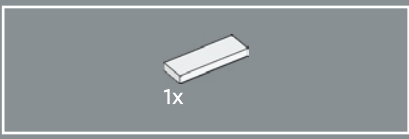
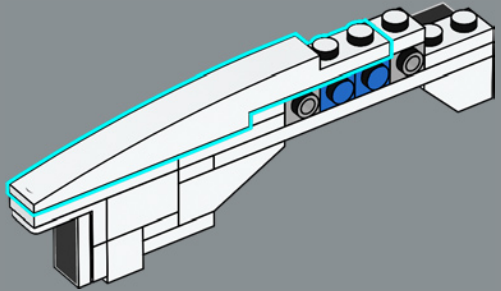

# 217

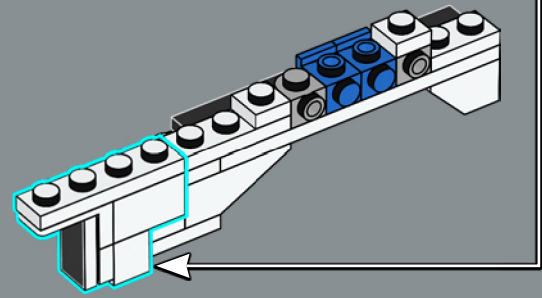
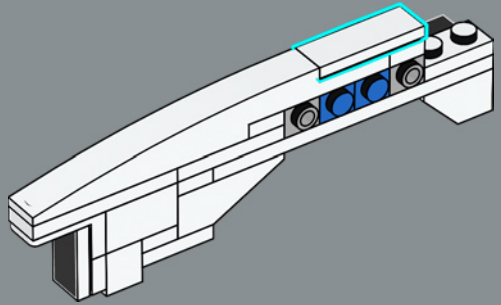

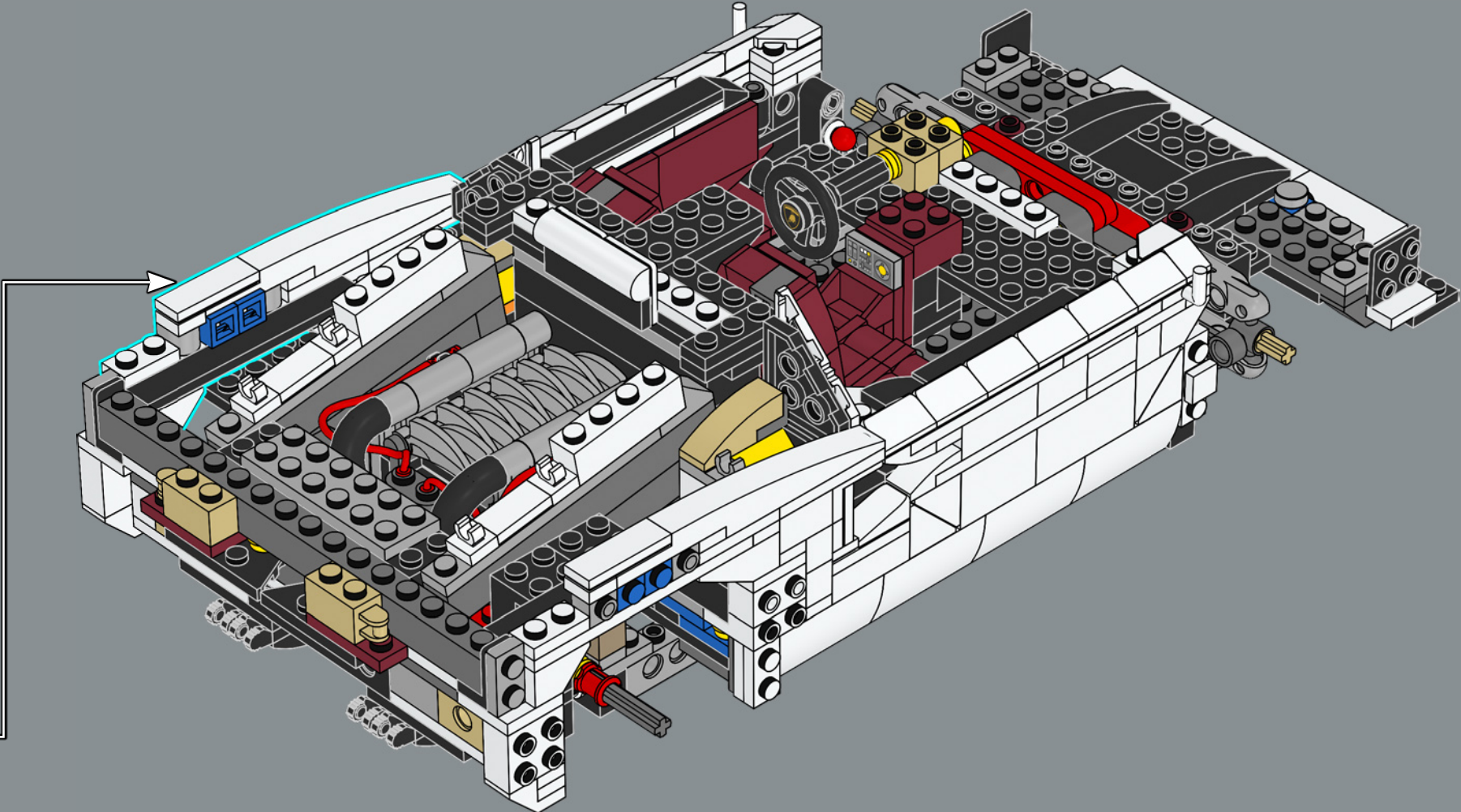



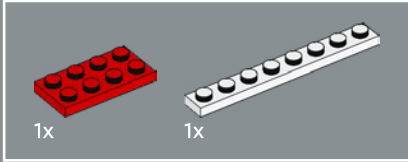
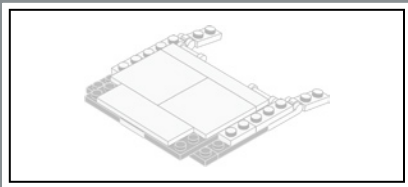

219

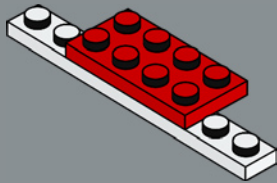

220

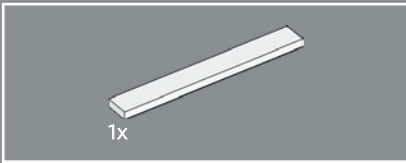
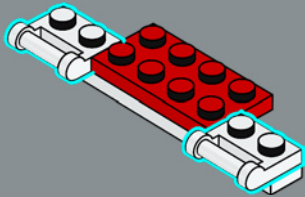

221

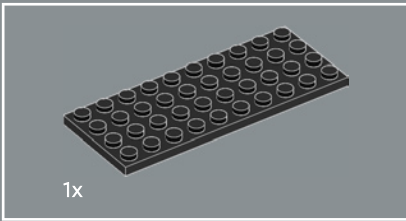
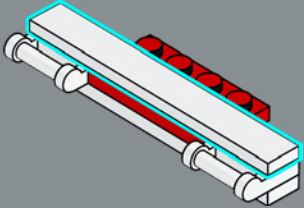

222

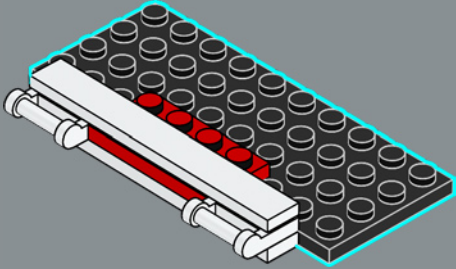

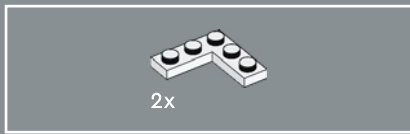

223

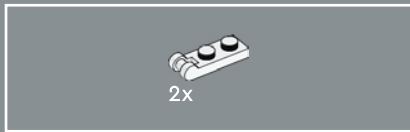
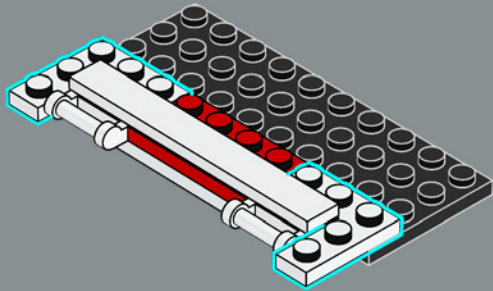

224

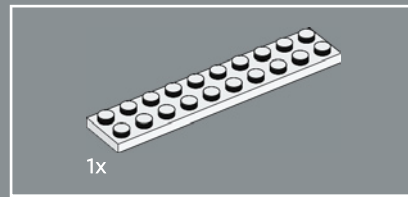
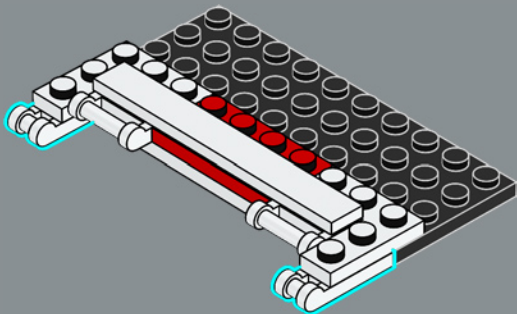

225

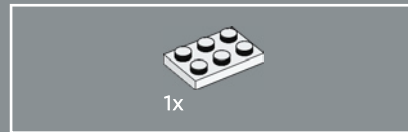
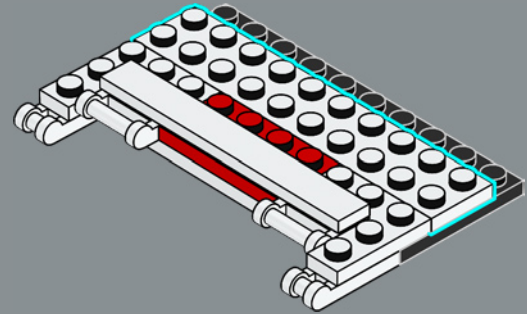

226

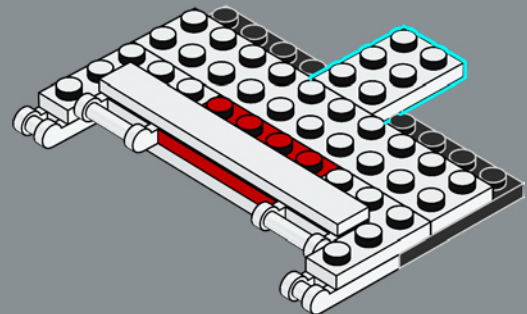

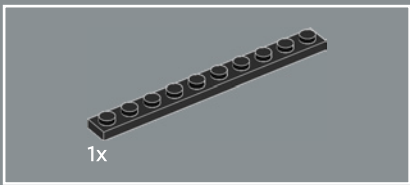

227

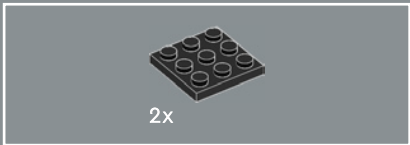
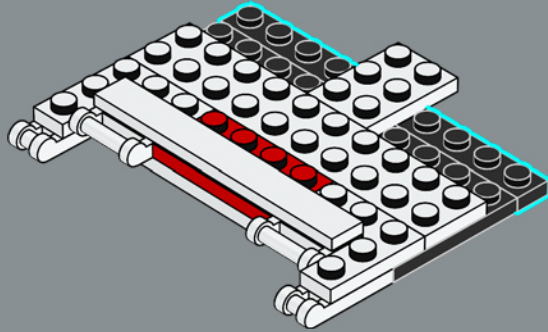

228

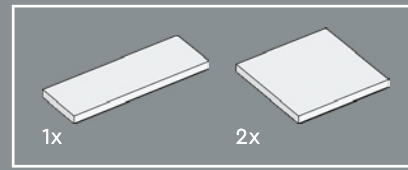
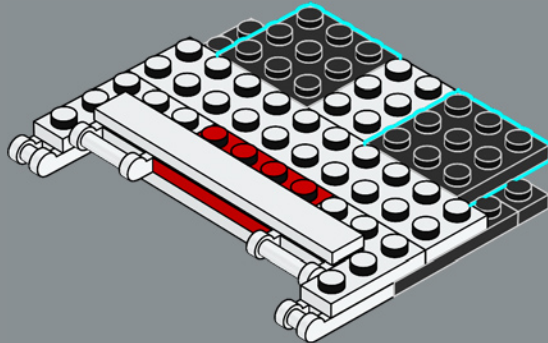

229

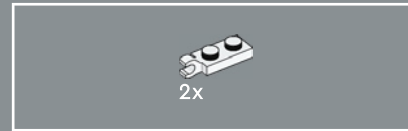
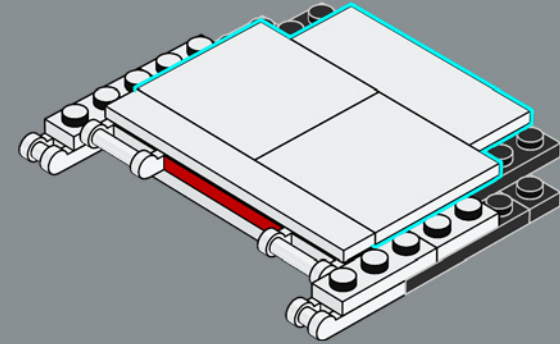

230

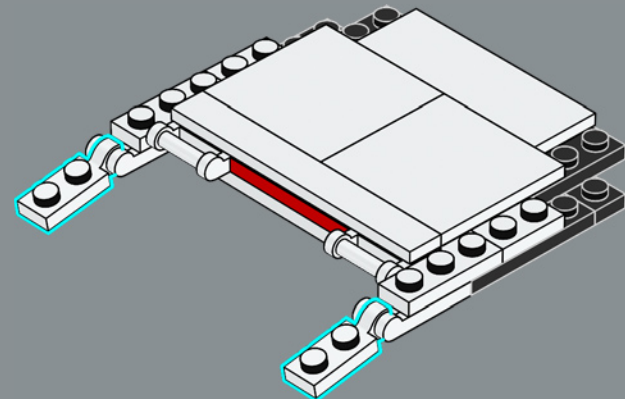

231

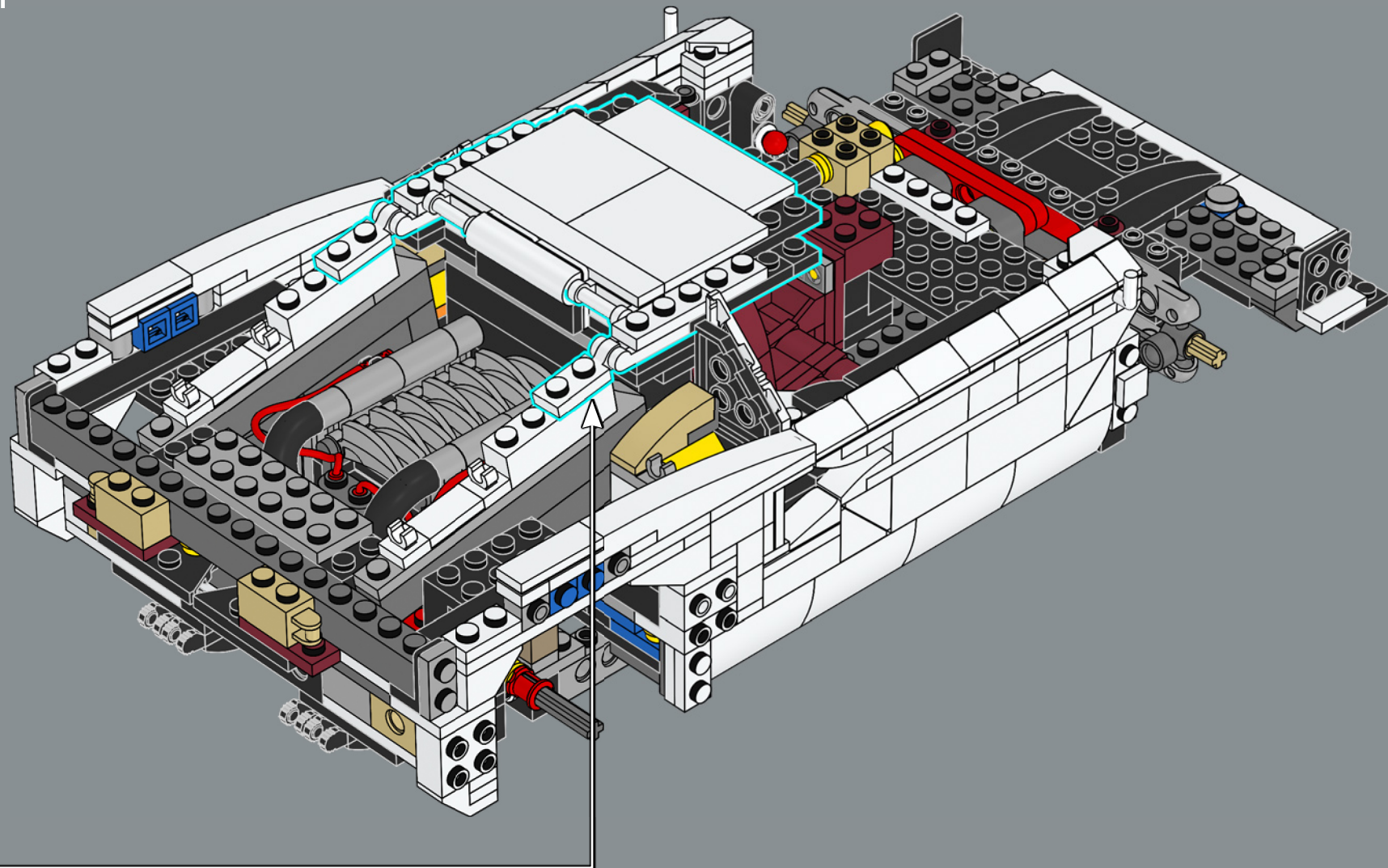



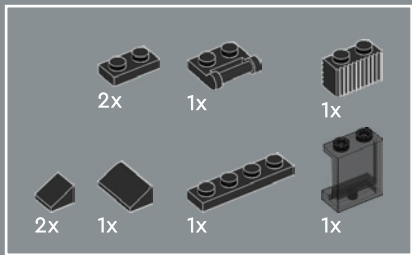

232

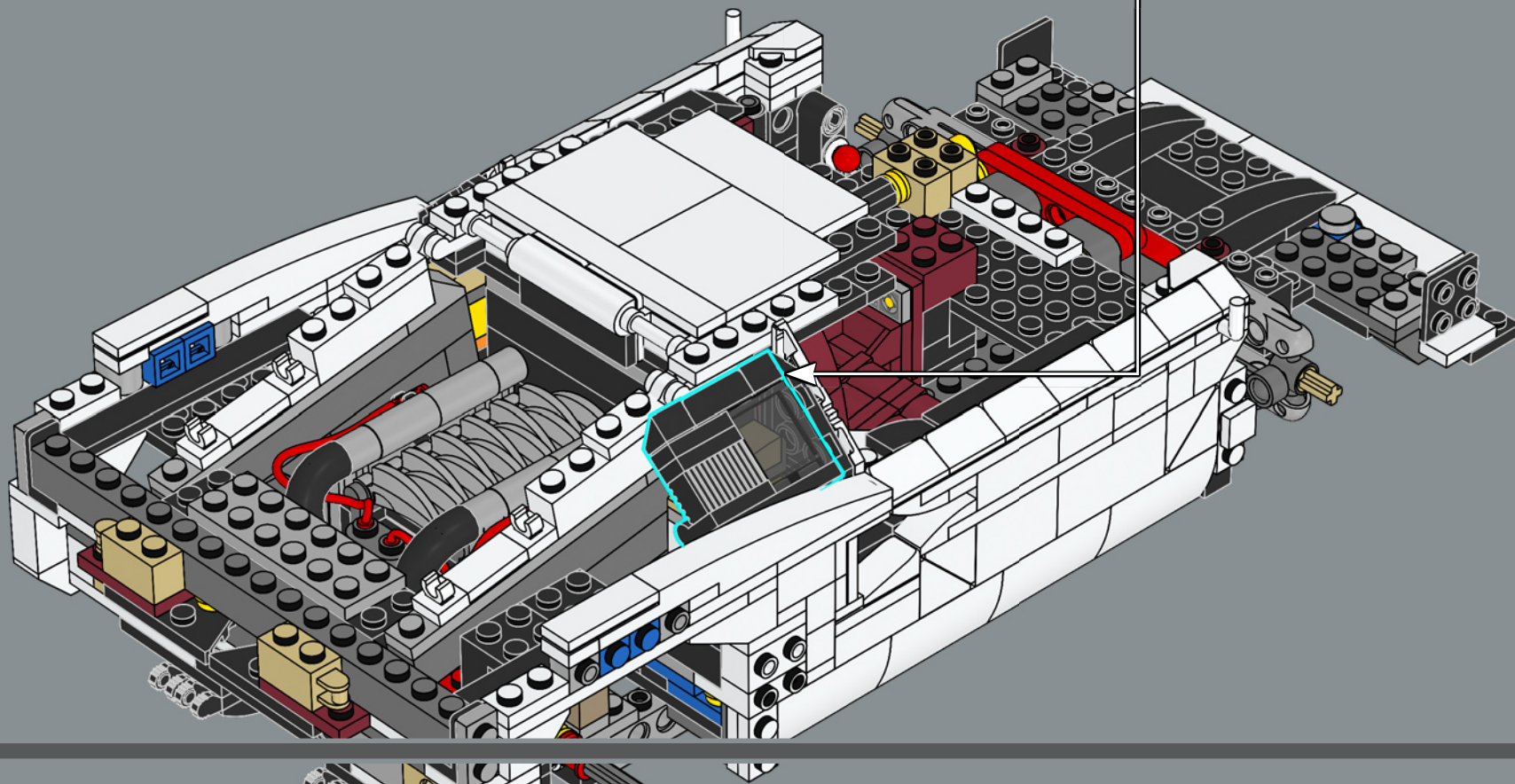
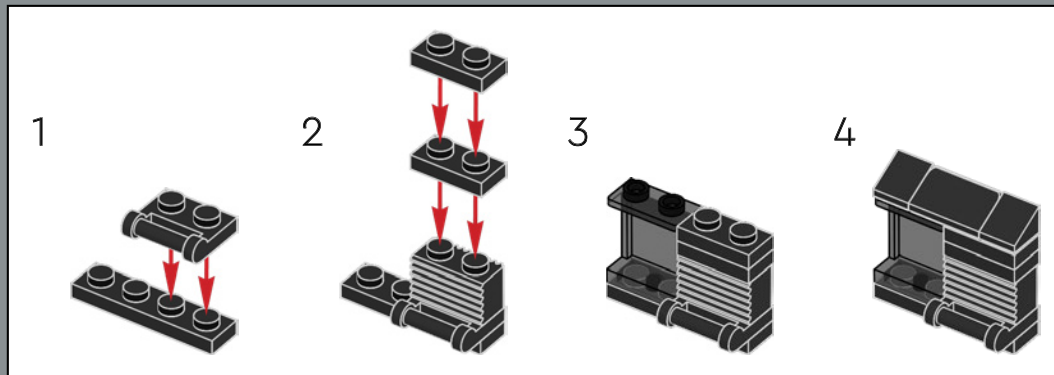

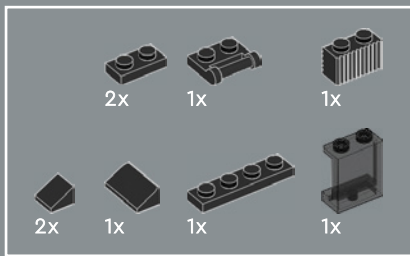

233

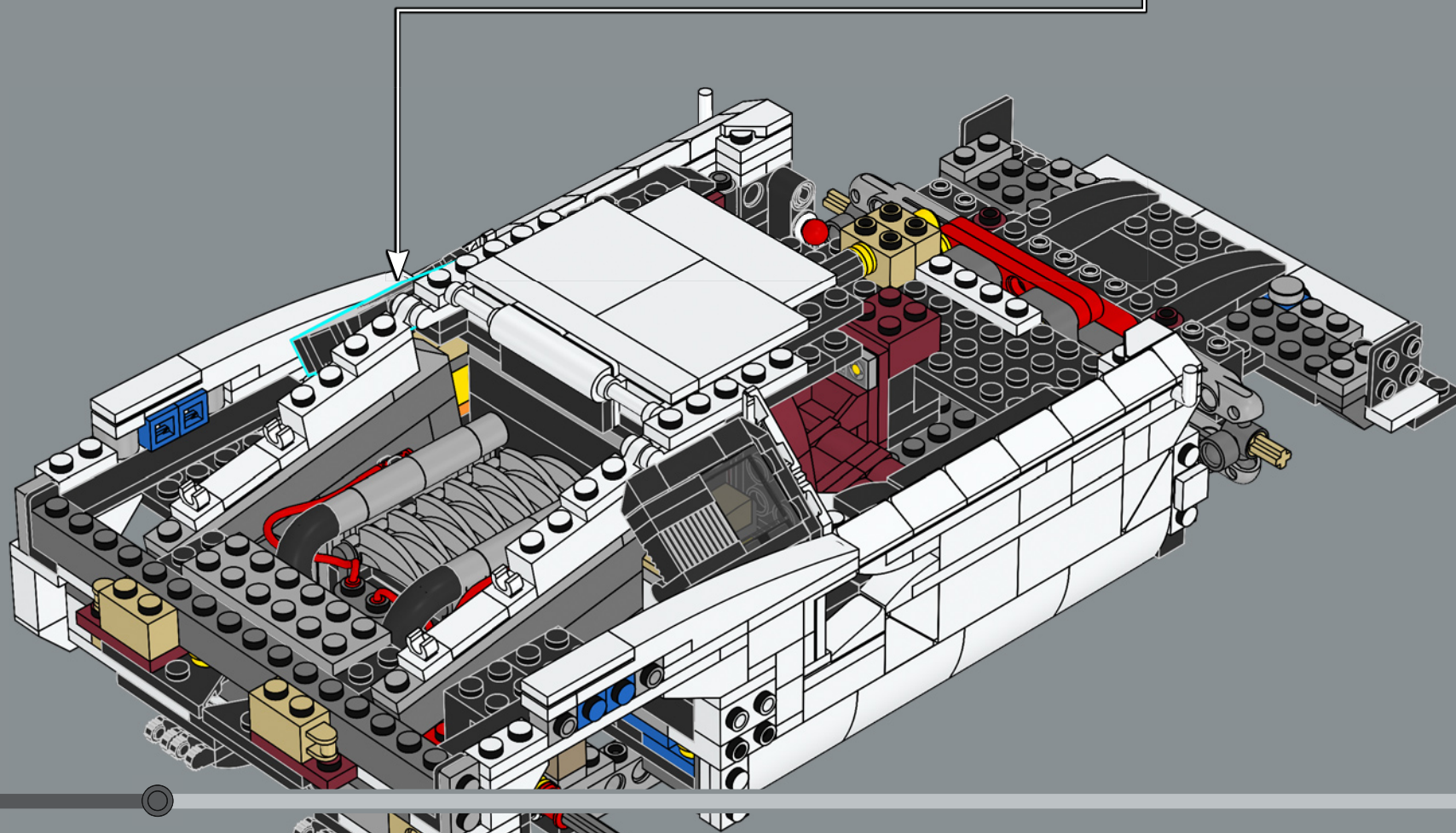
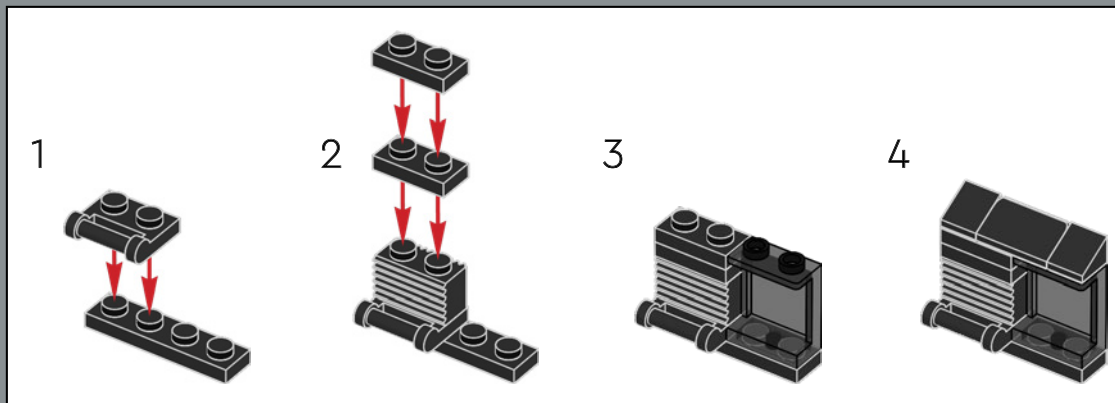



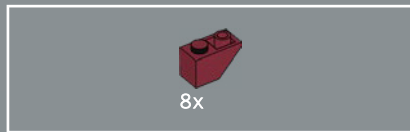

234

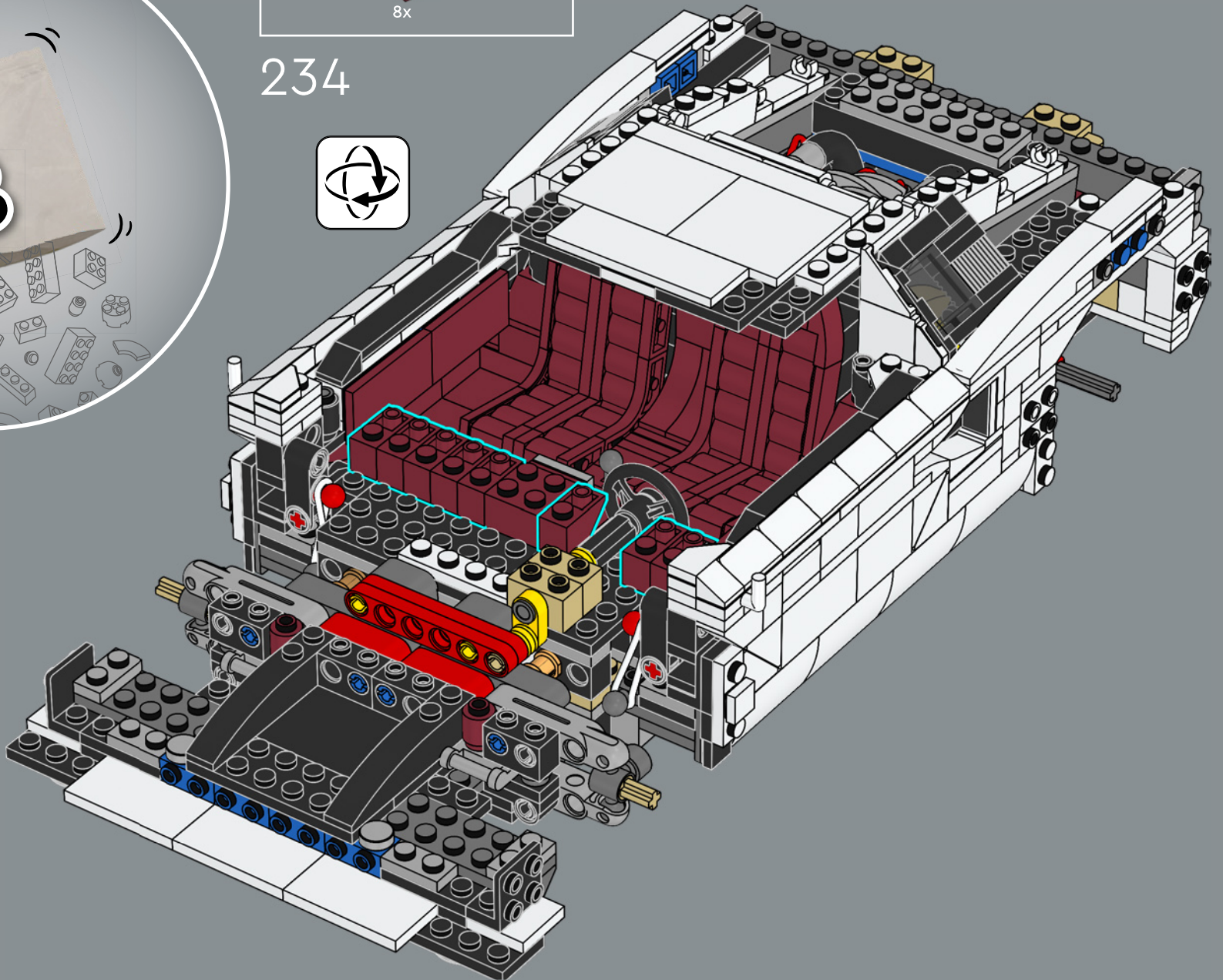

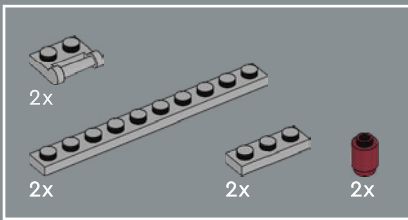

235

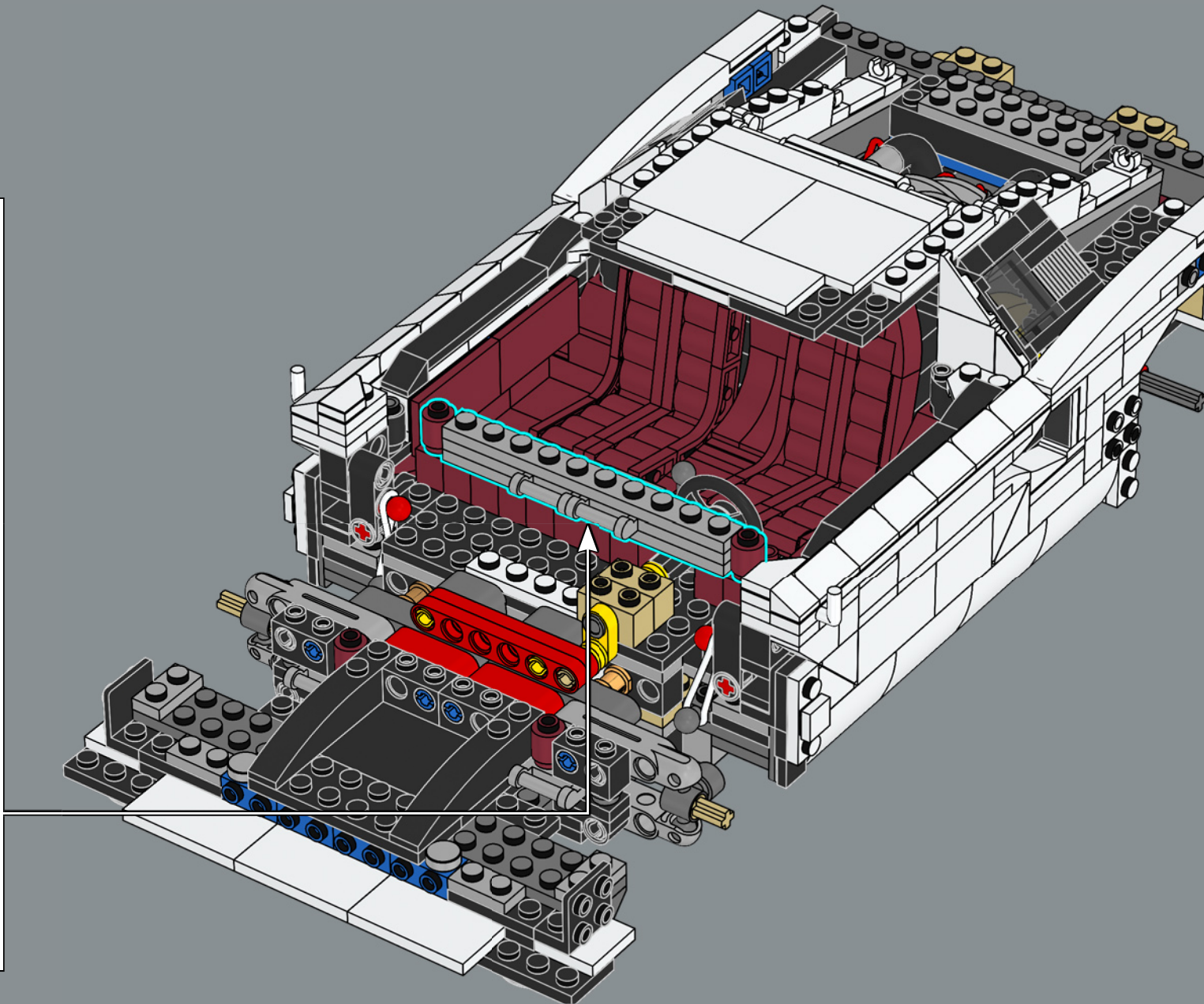
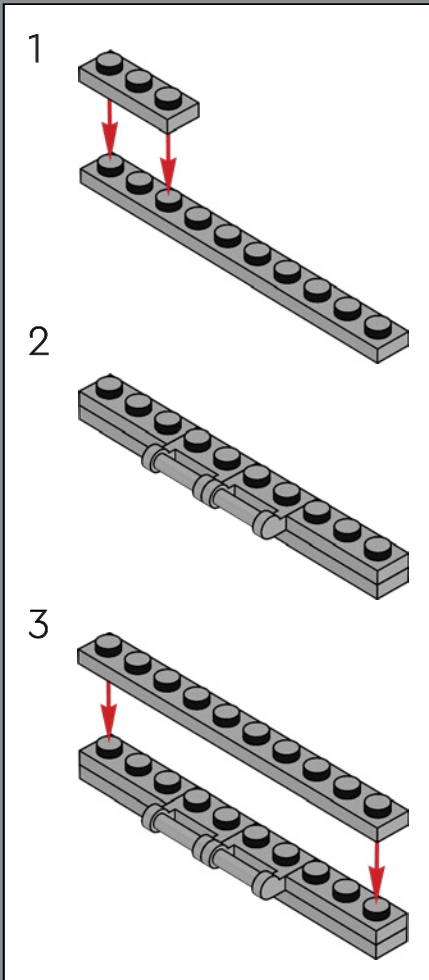



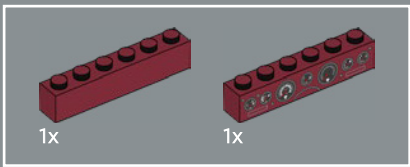

236

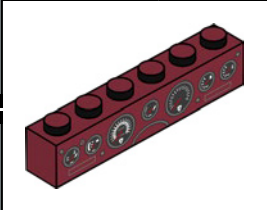
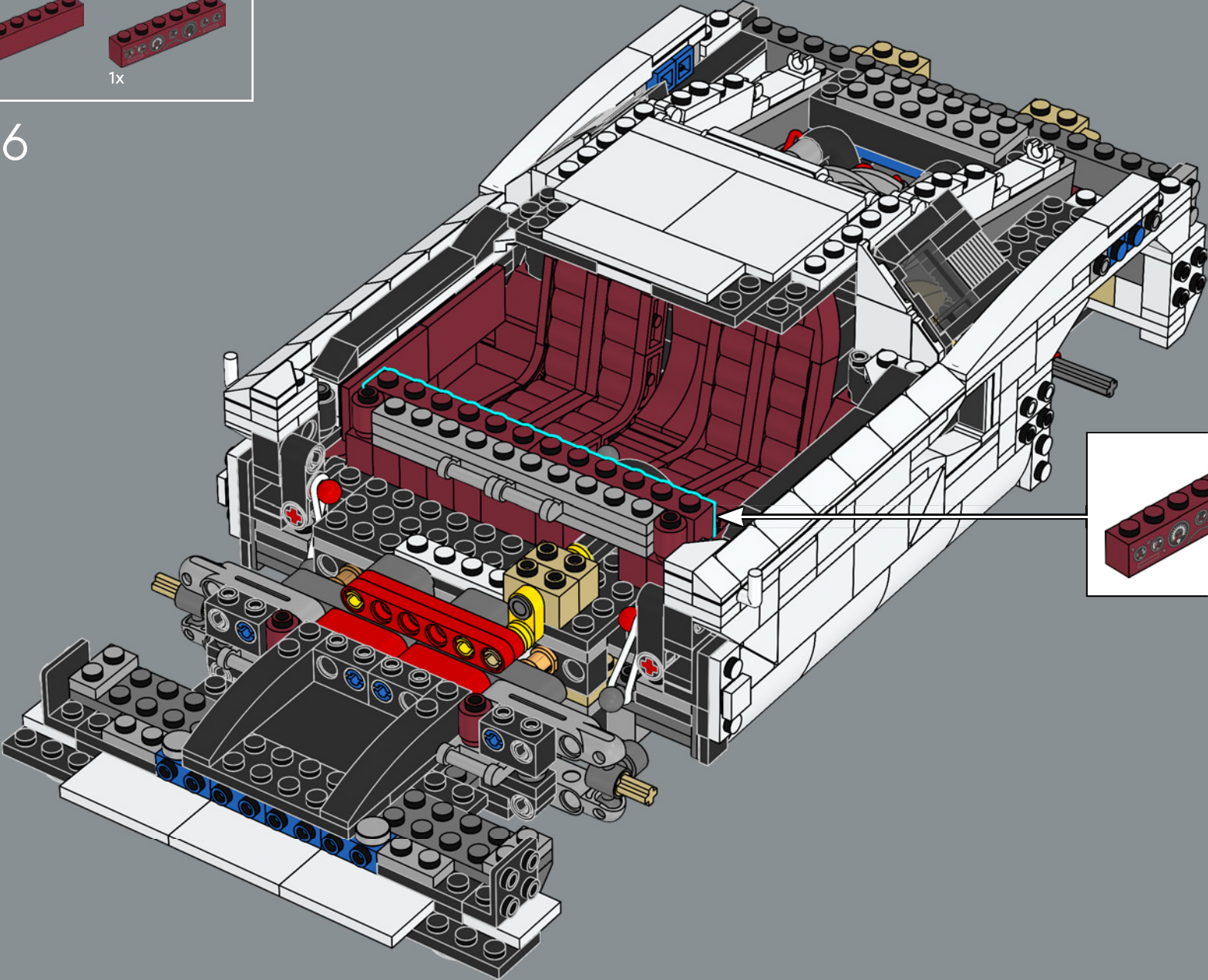

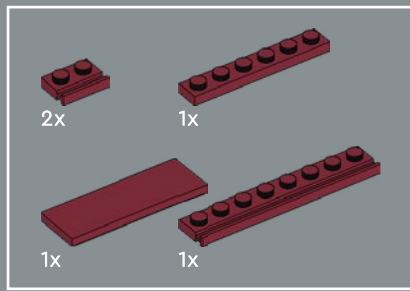

237

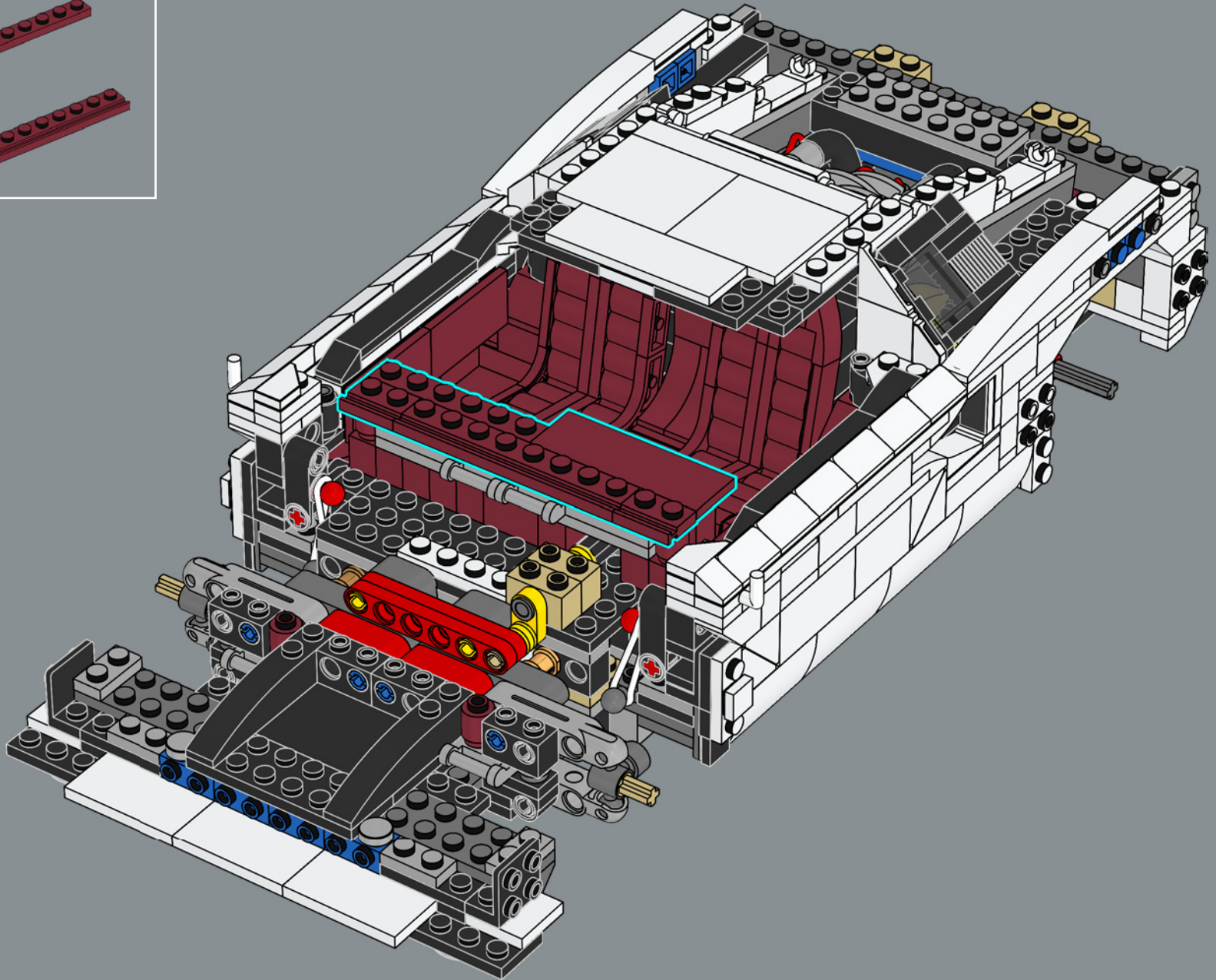





238

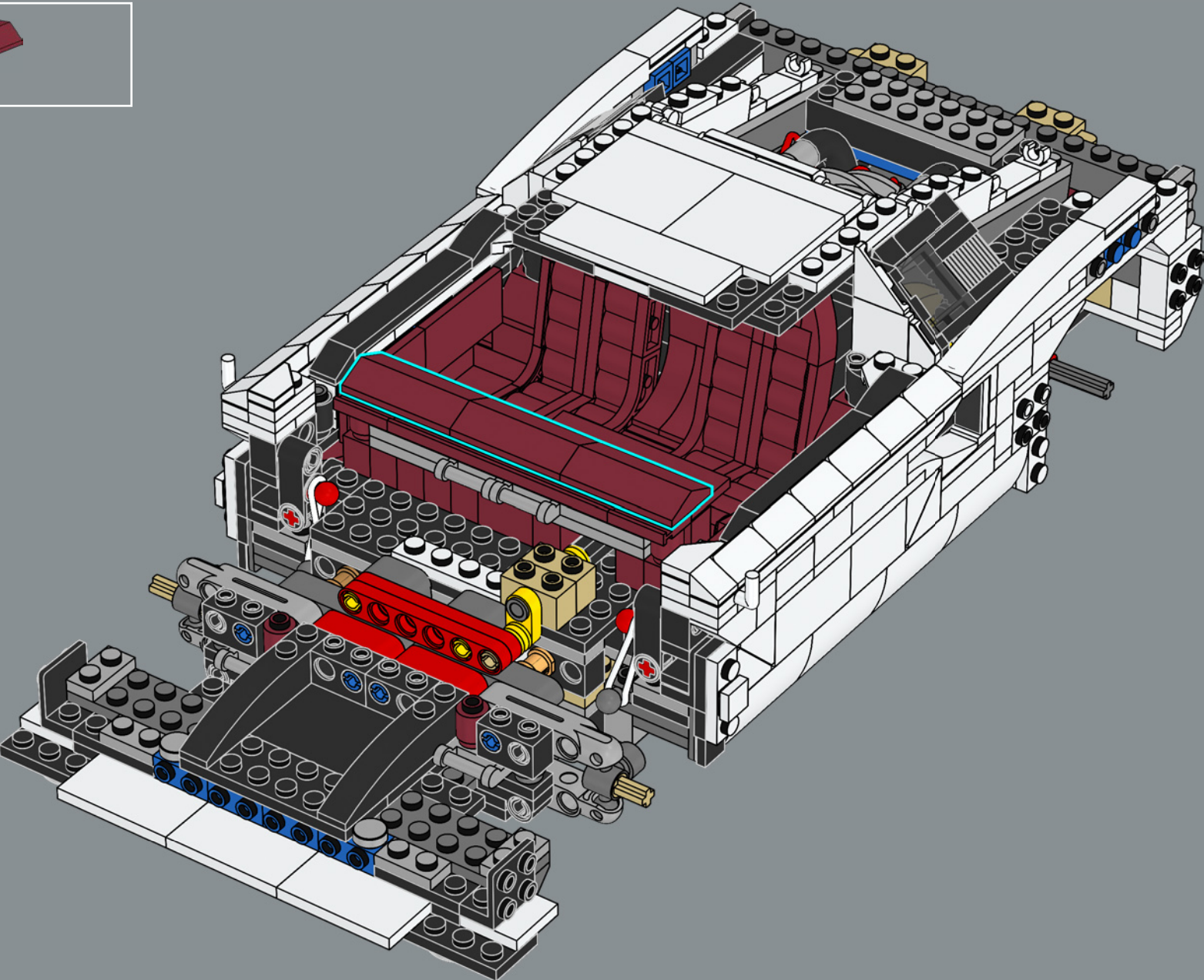

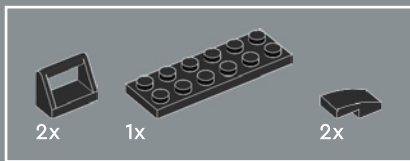

239

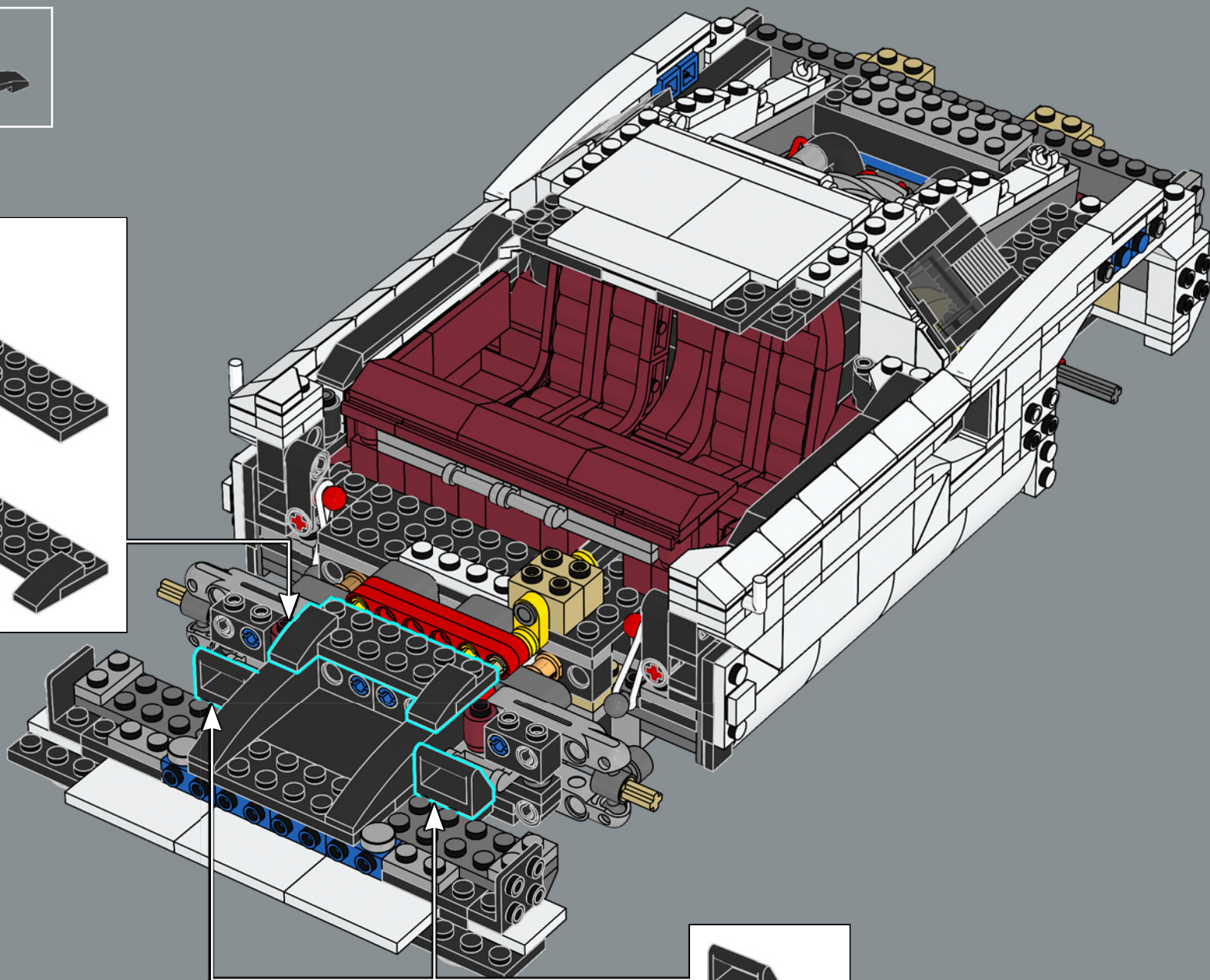
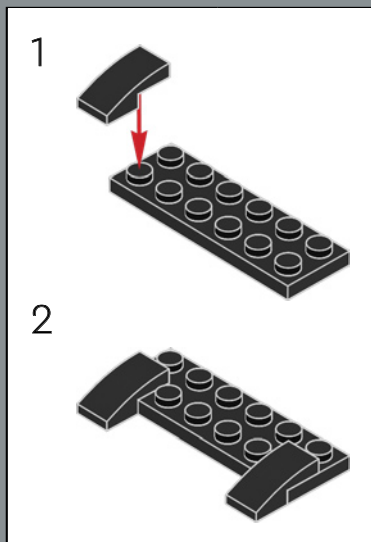



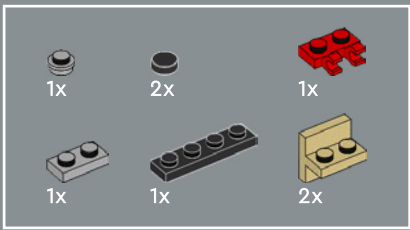

240

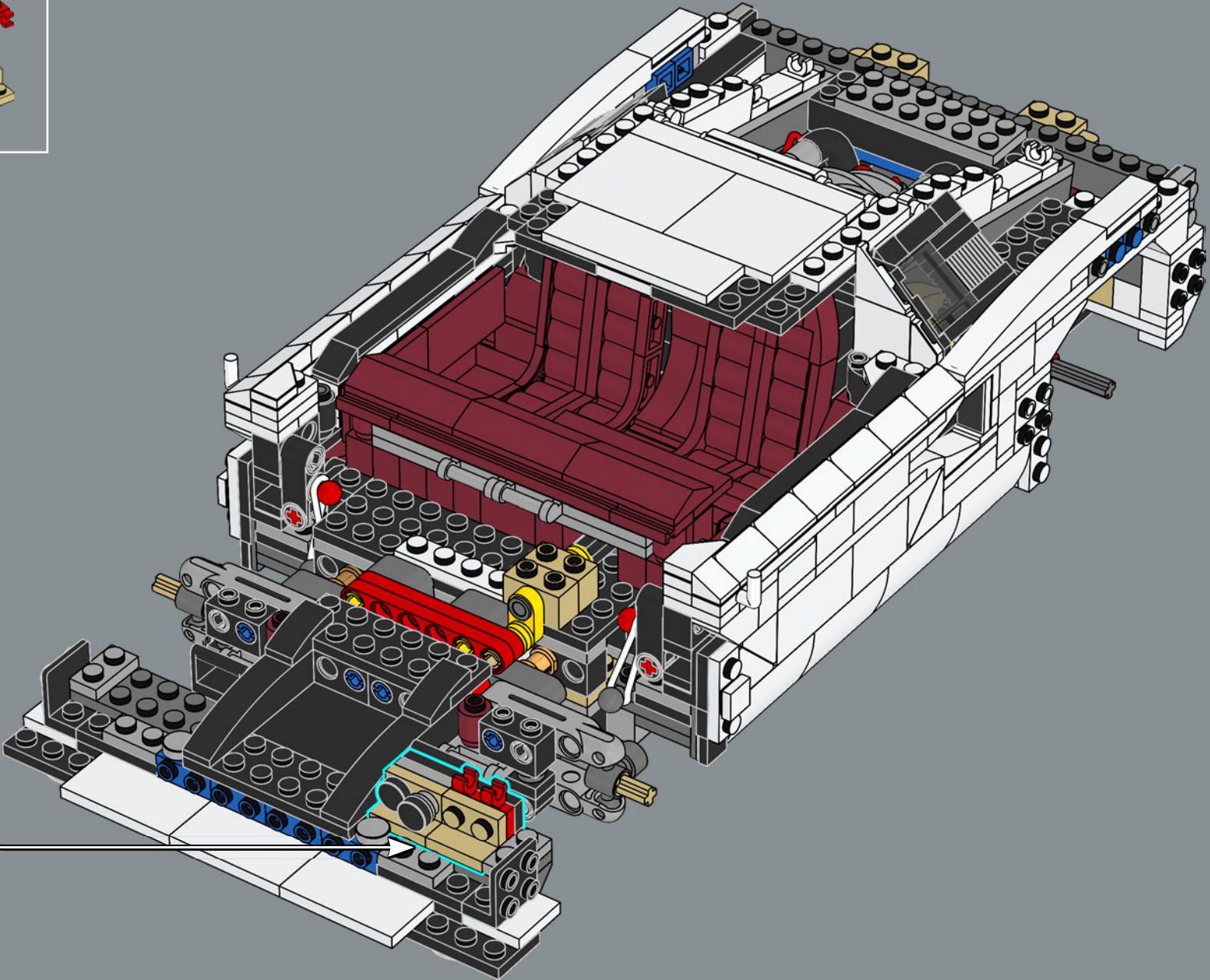
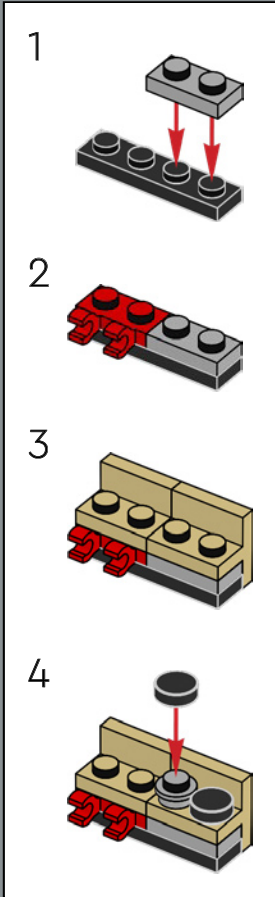

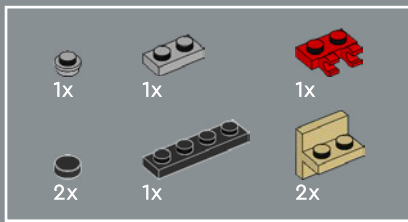

241

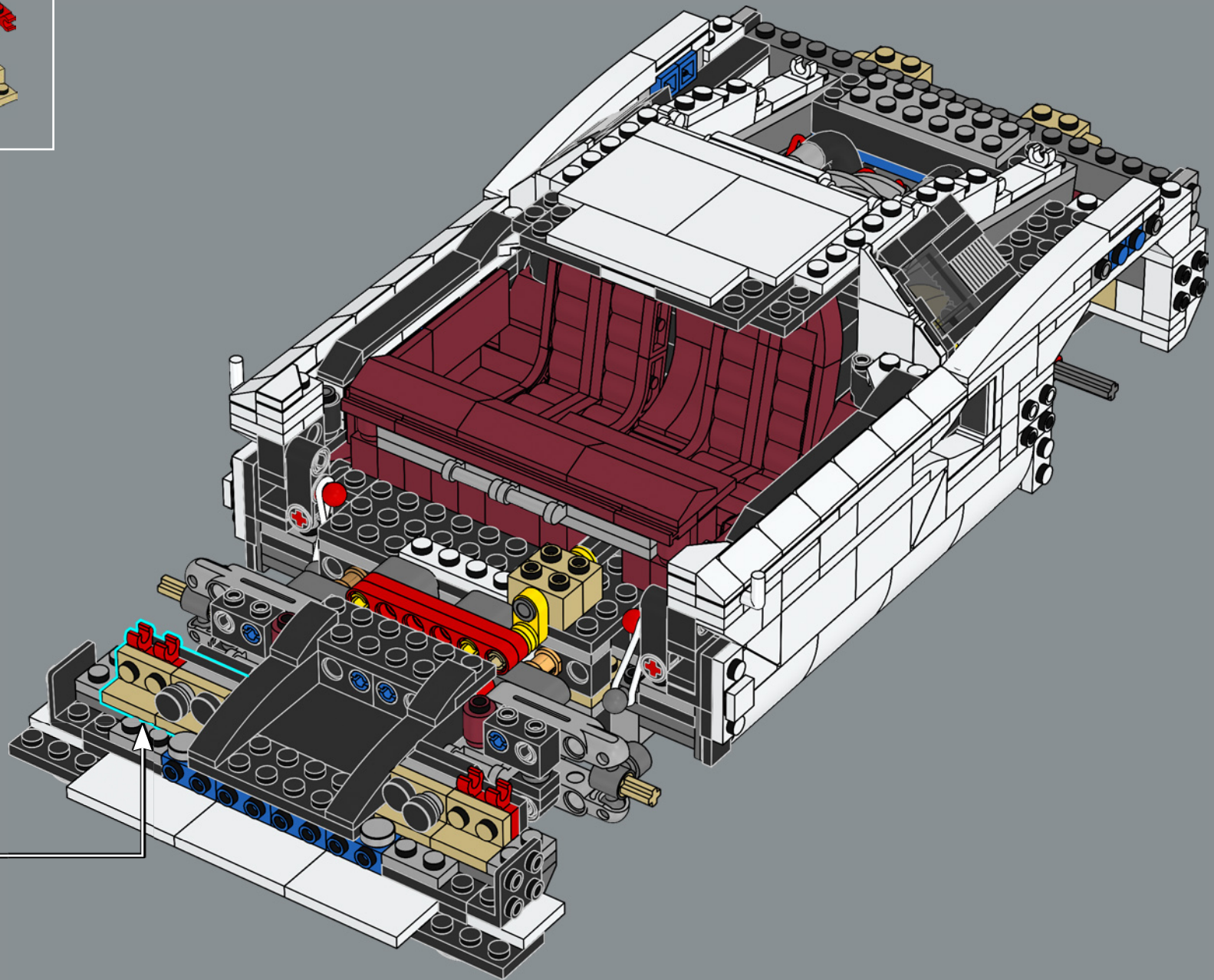
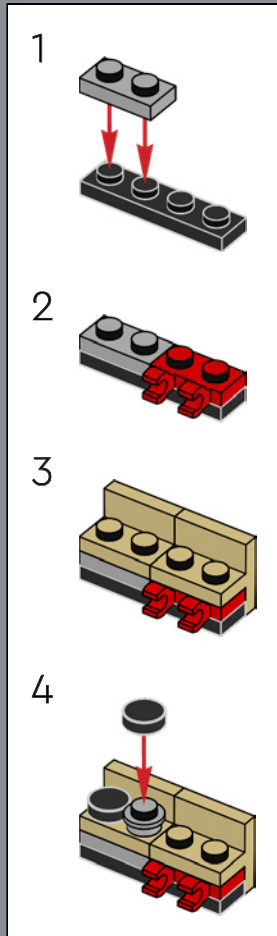





2x

242

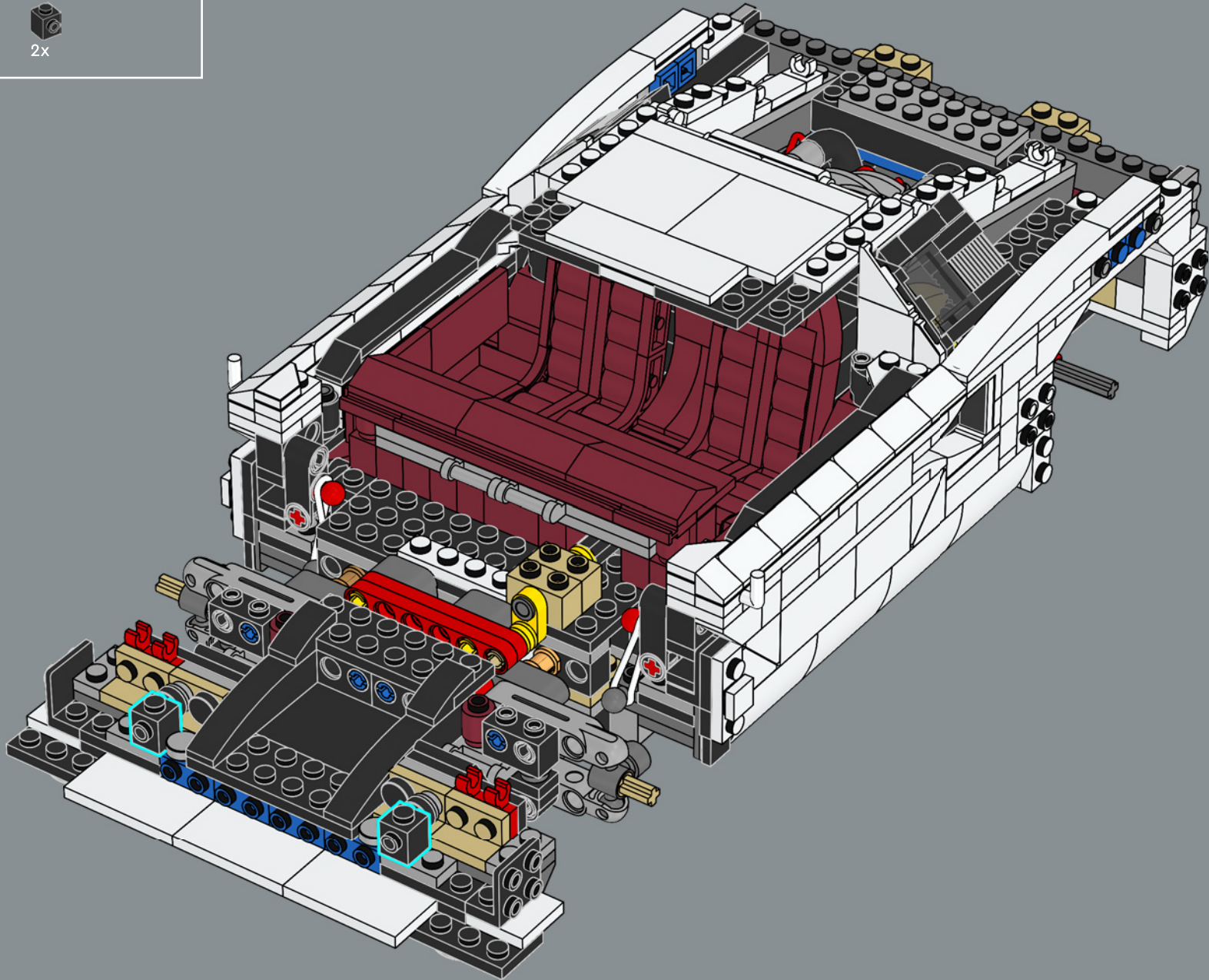

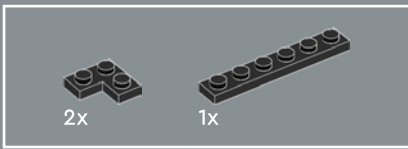

243

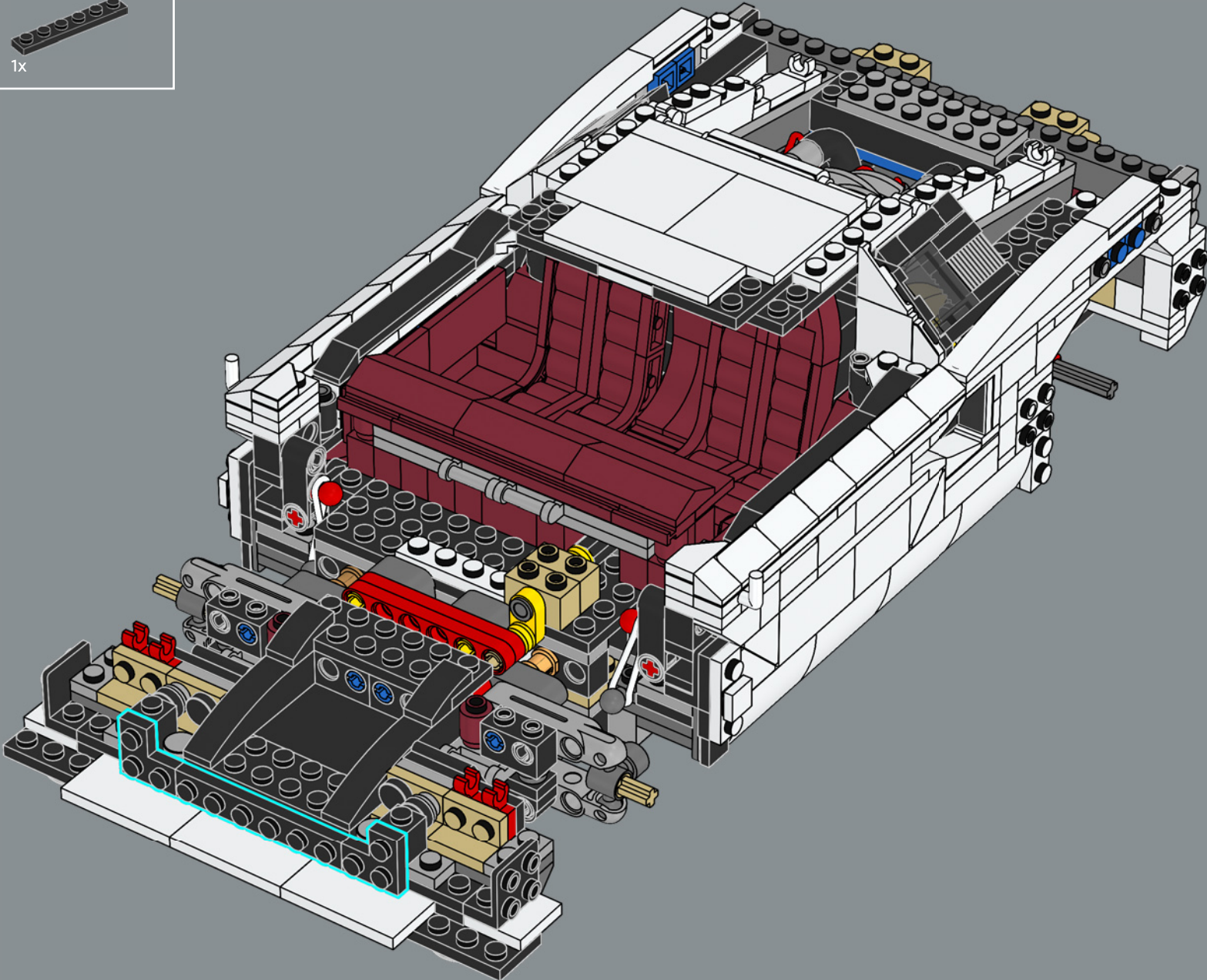





244

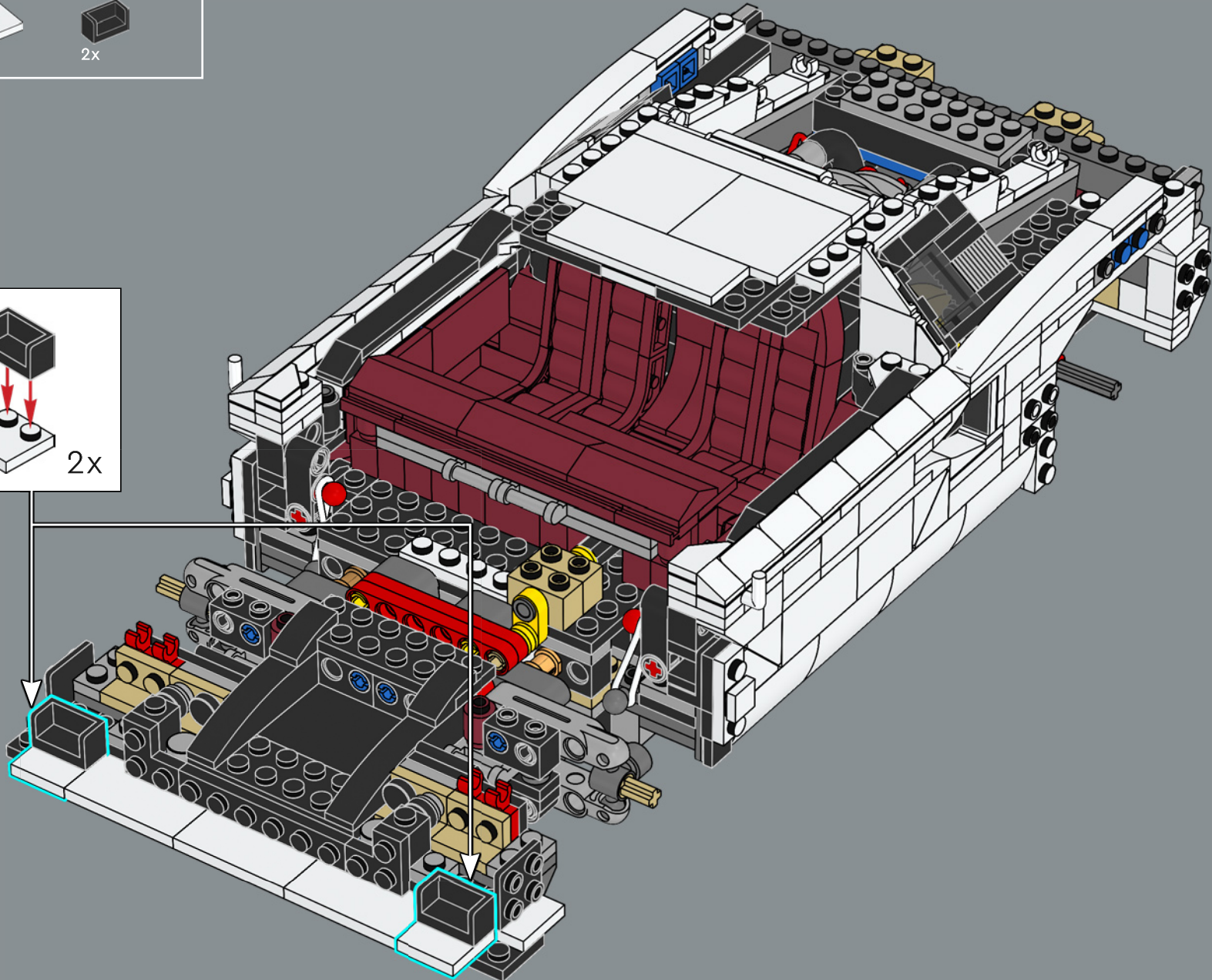
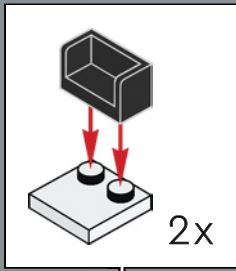

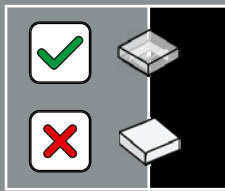
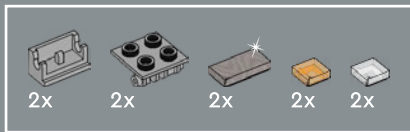

245

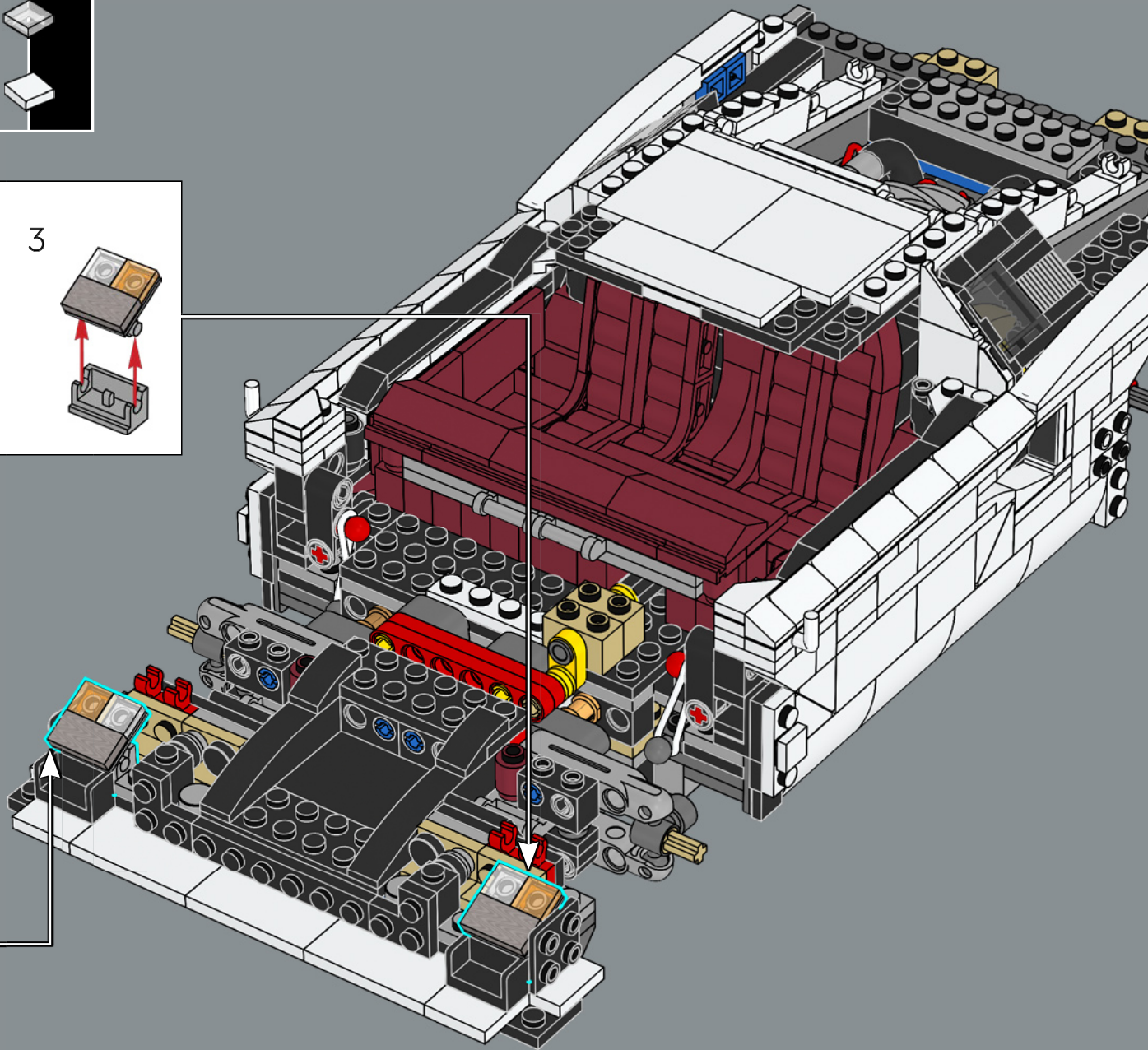
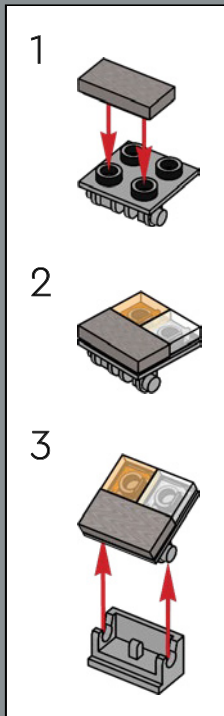
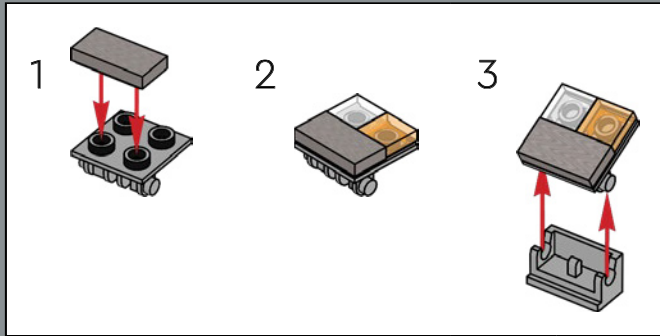

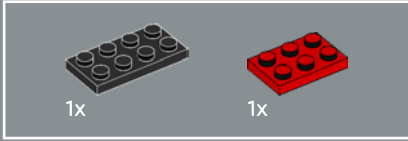
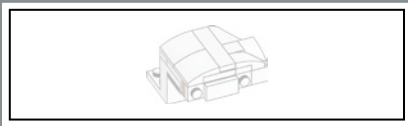

246

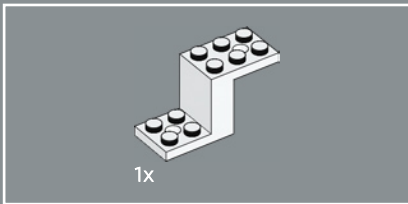
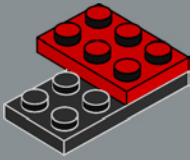

247

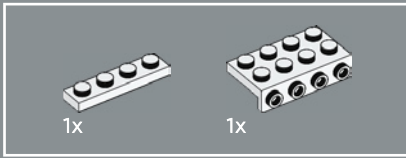
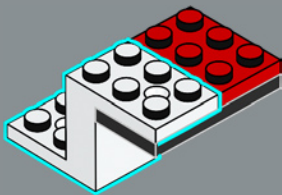

248

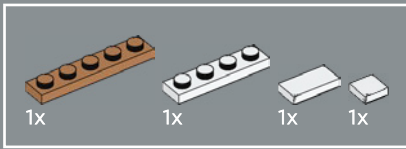
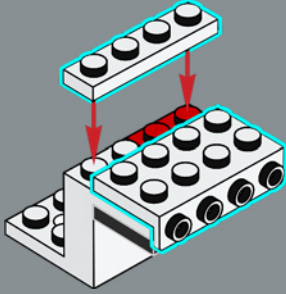

249

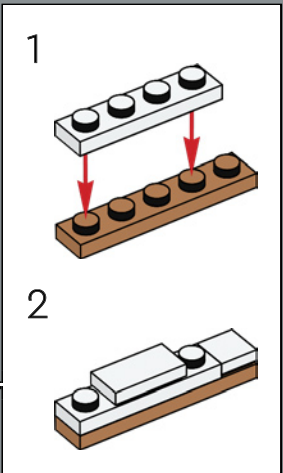
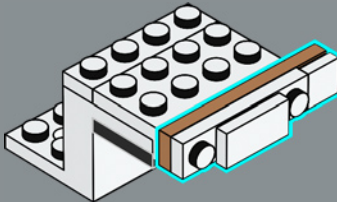



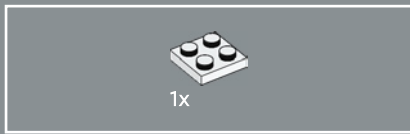

250

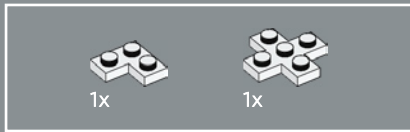
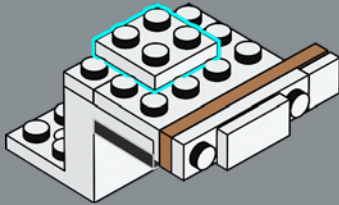

251

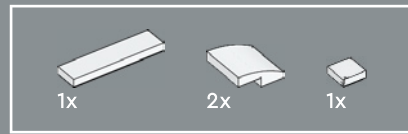
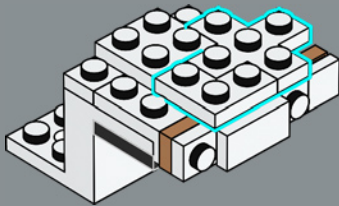

252

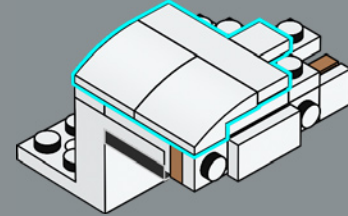

253

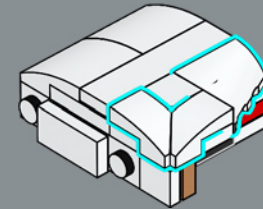



254

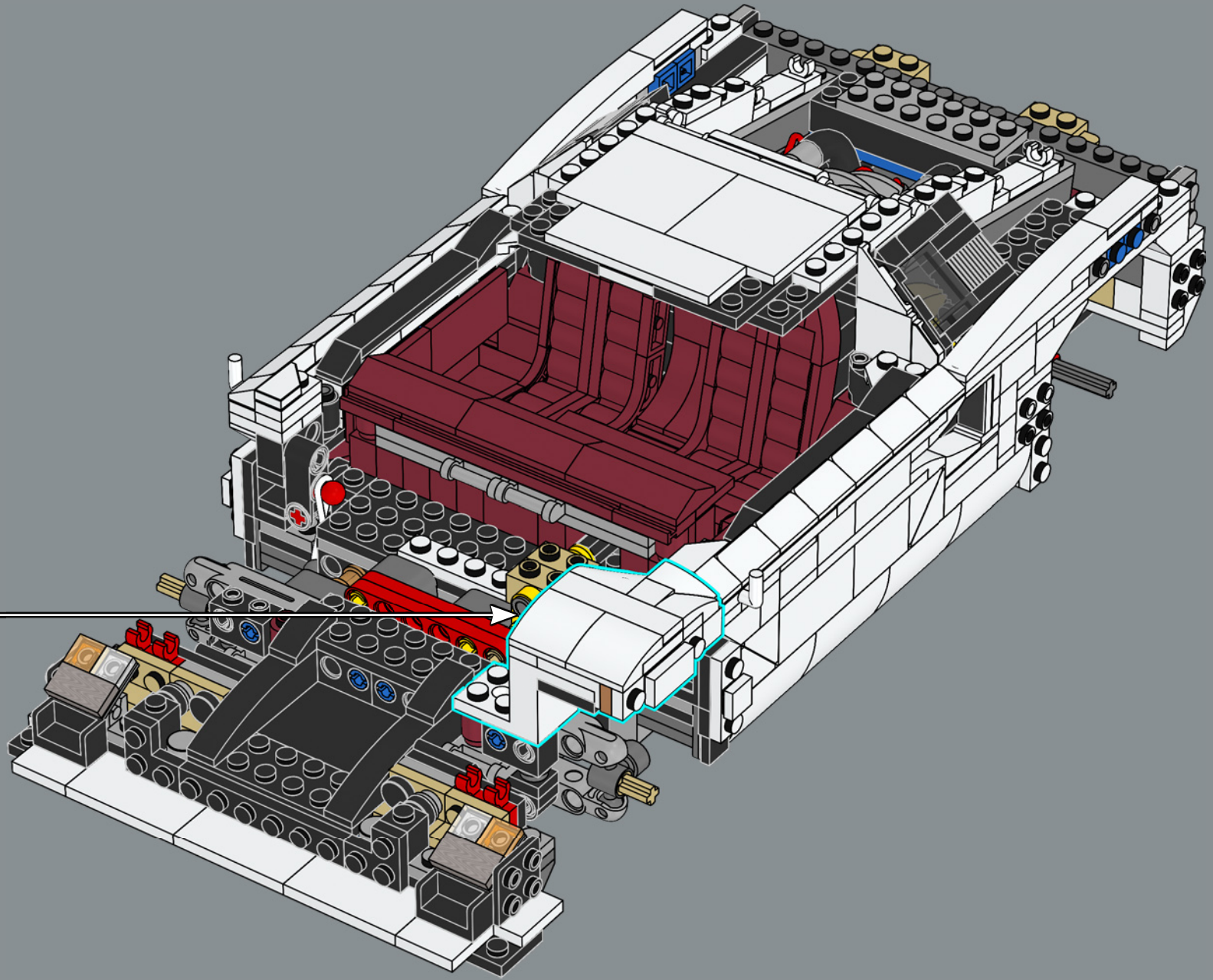

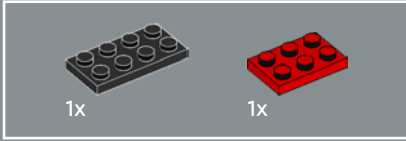
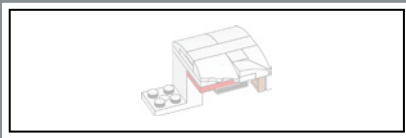

255

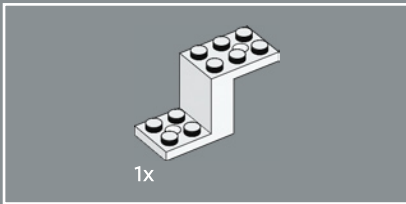
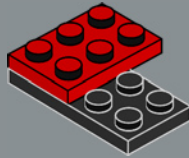

256

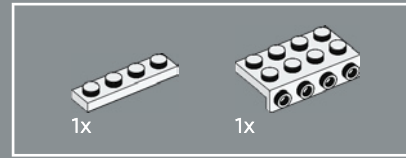
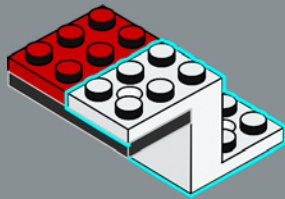

257

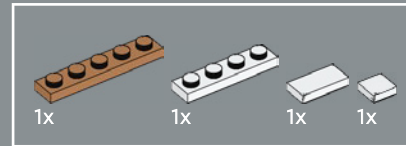
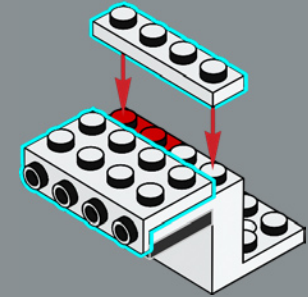

258

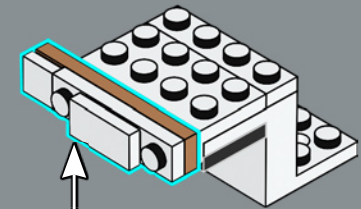
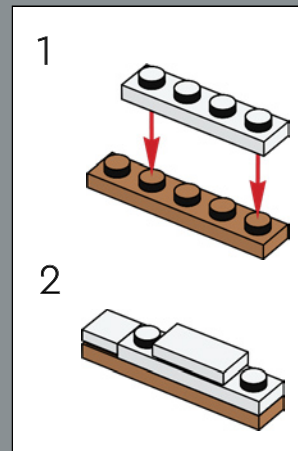



259

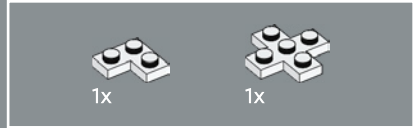
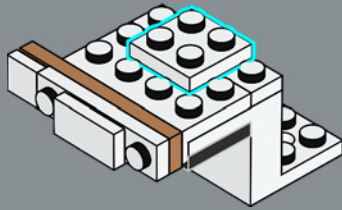

260

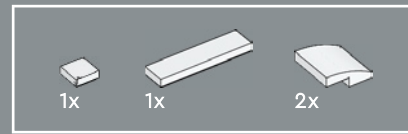
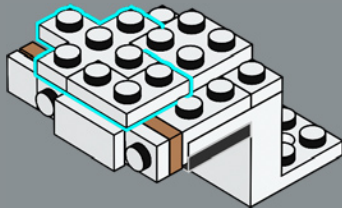

261

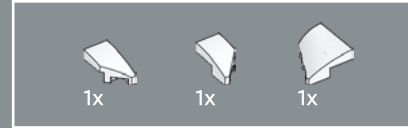
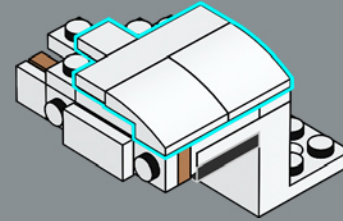

262

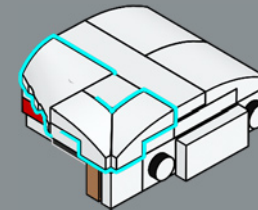



263

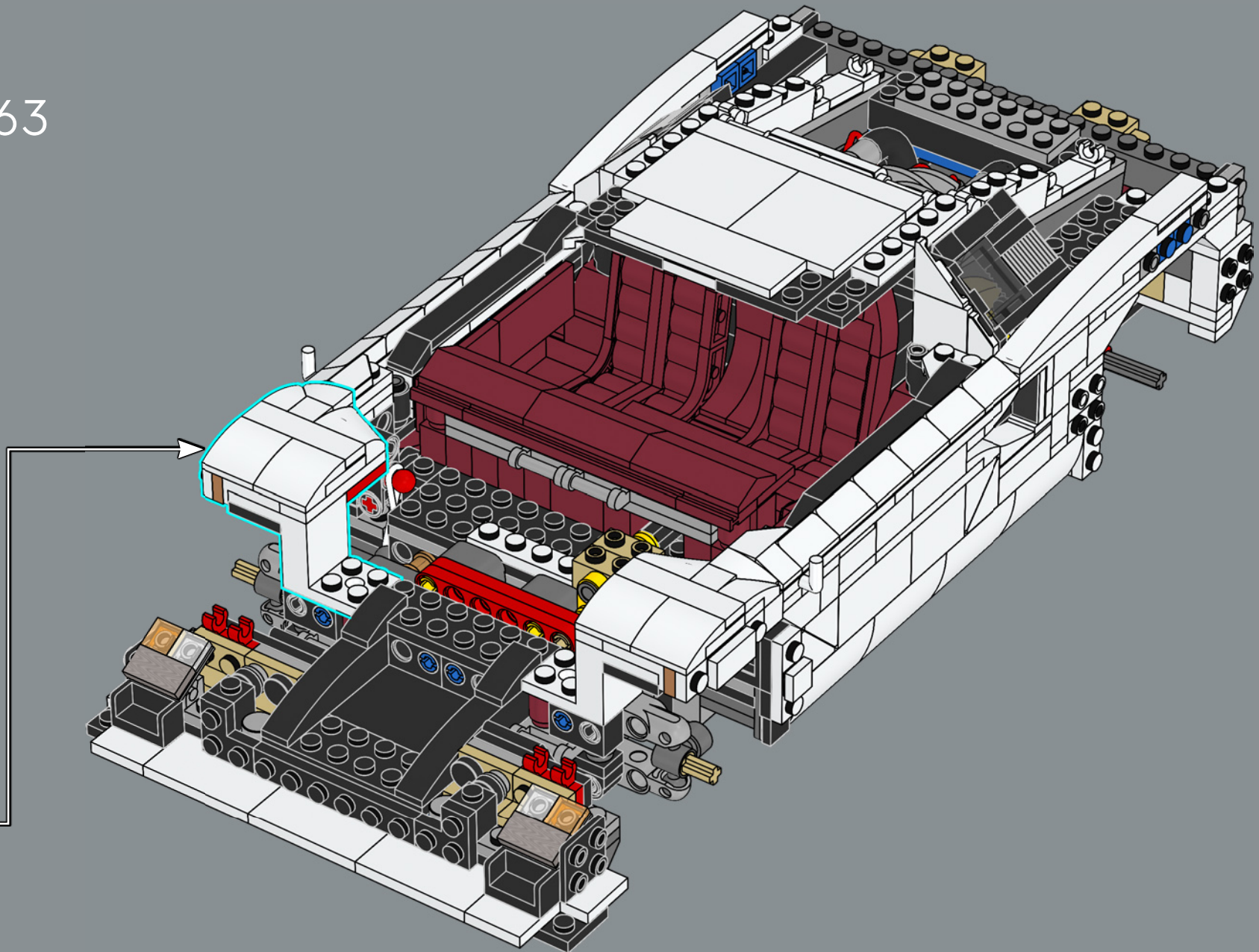

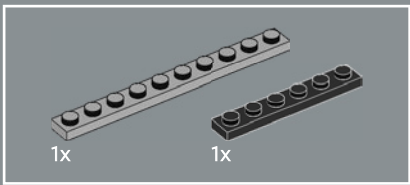

264

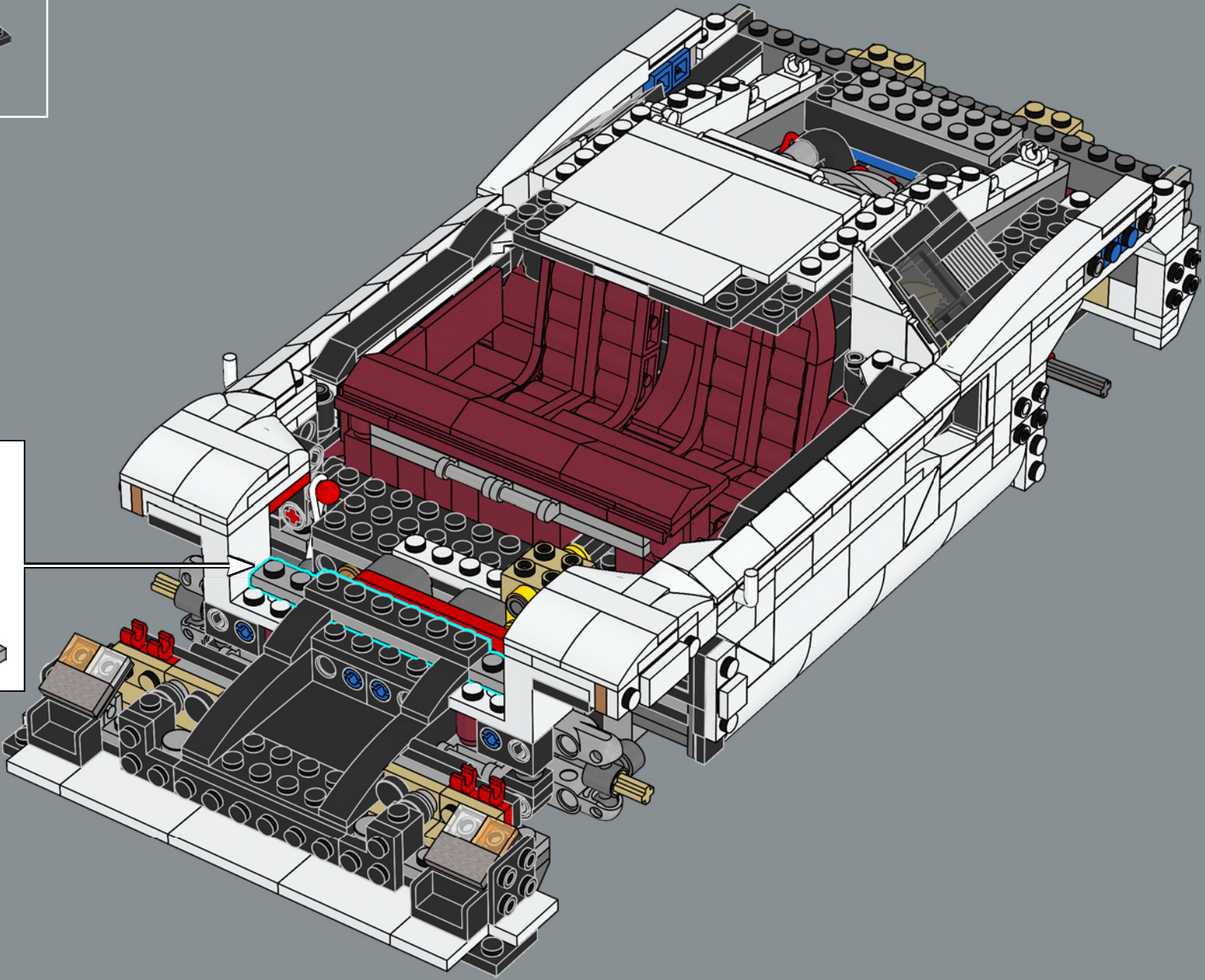
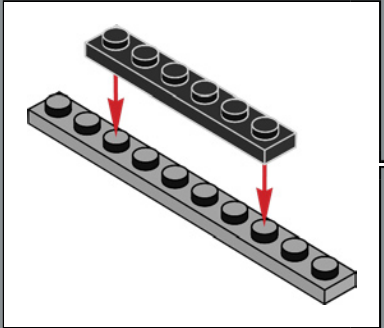



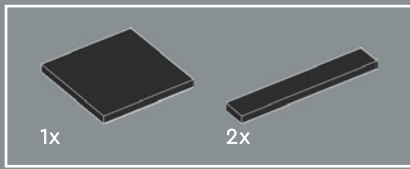

265

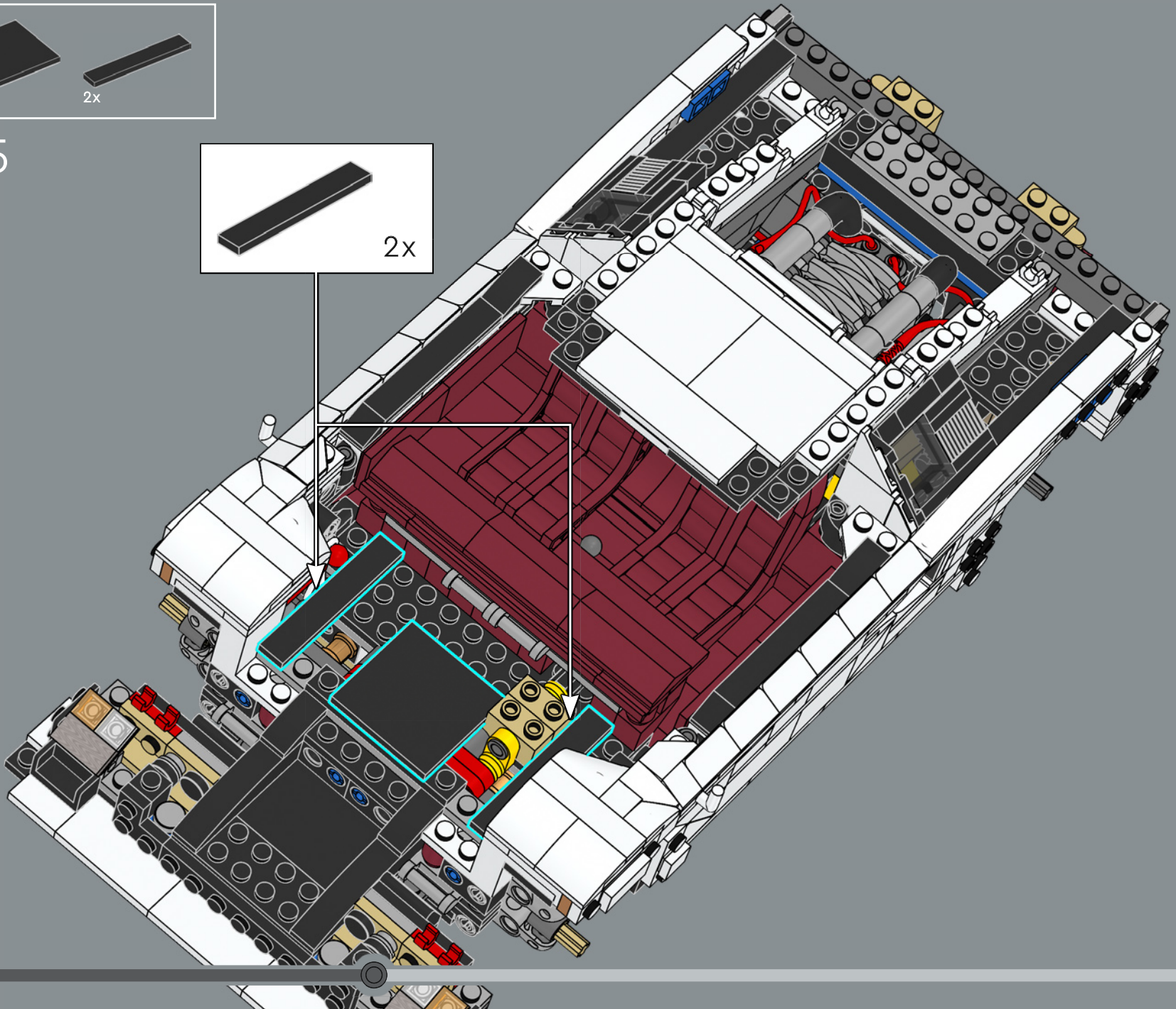
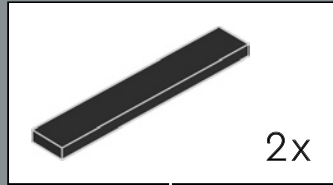



-  2x
-  2x
-  6x
-  2x

266

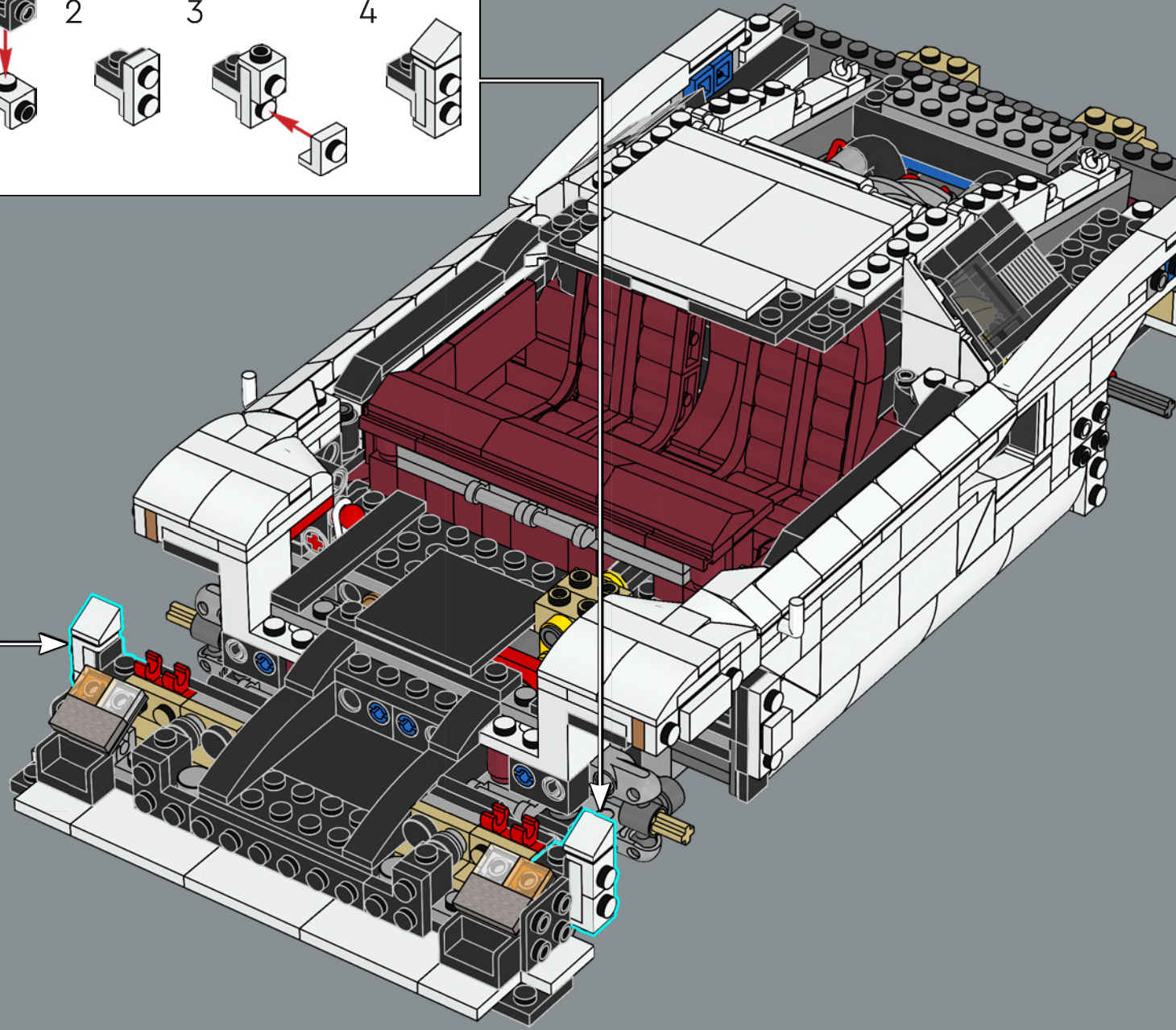
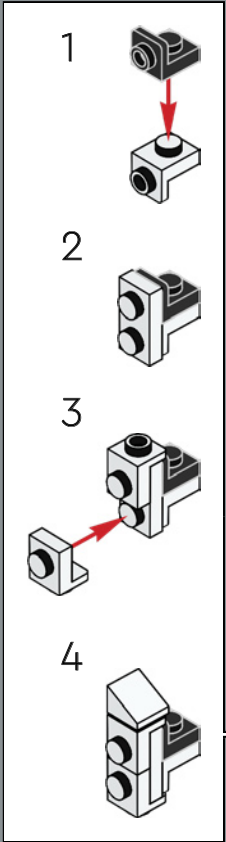
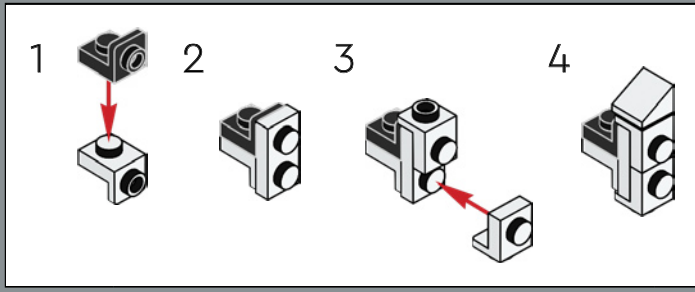



2x

267



2x

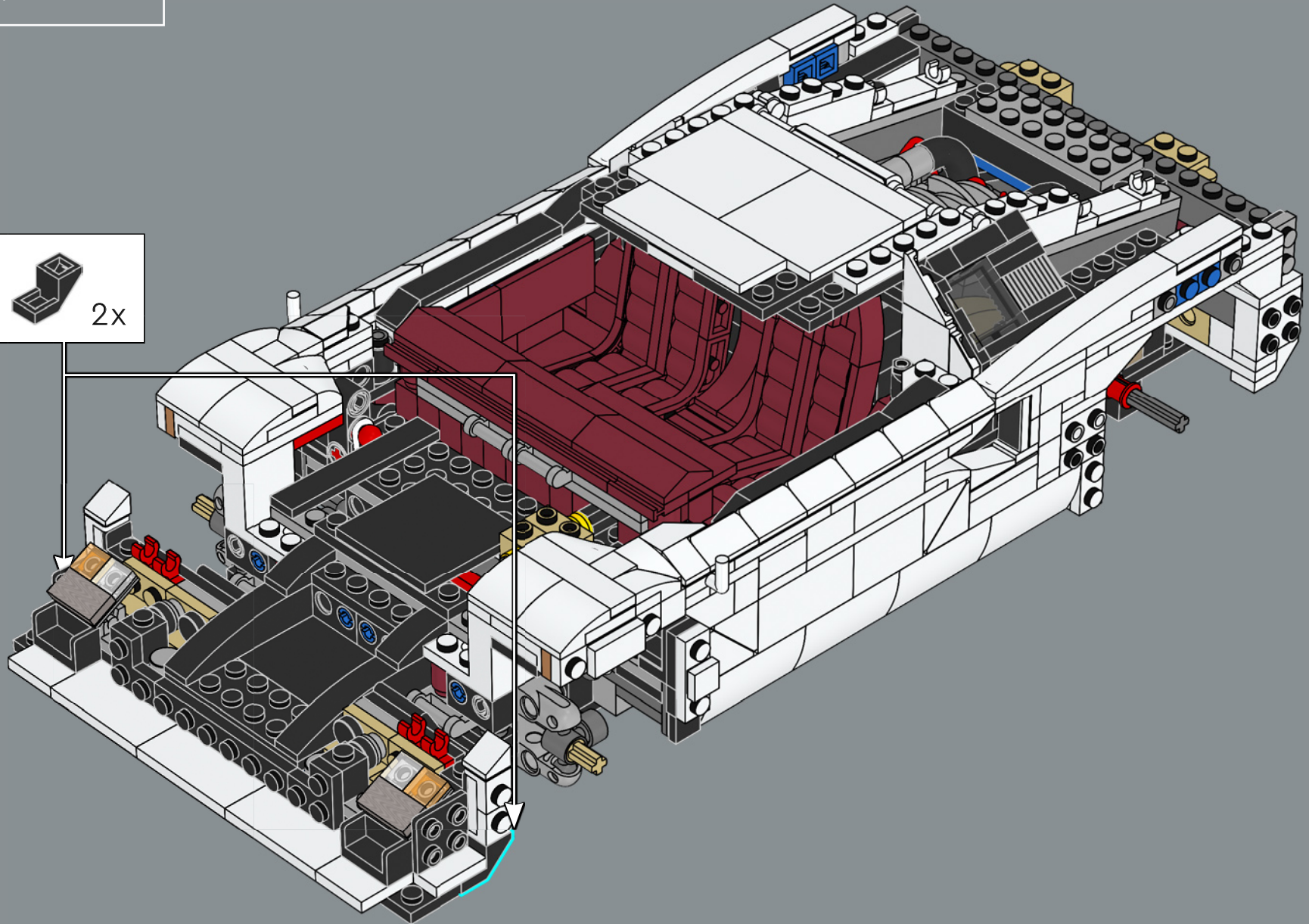



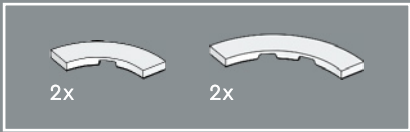

268

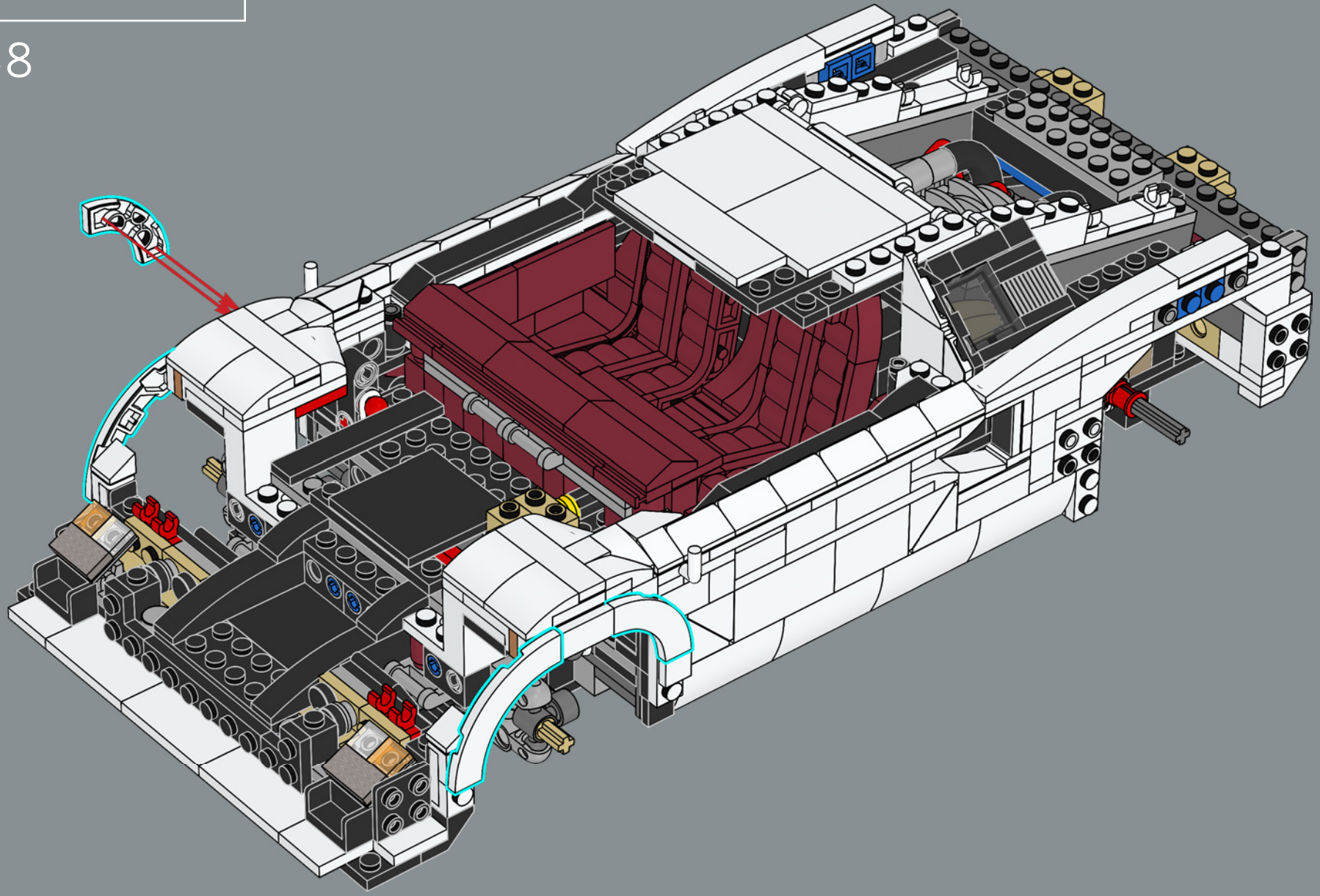



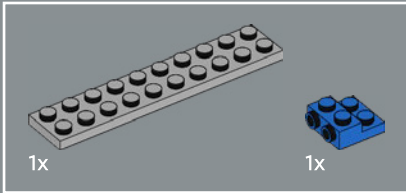
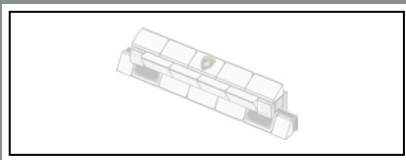

269

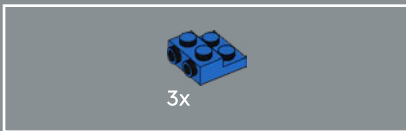
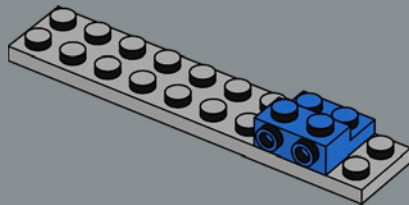

270

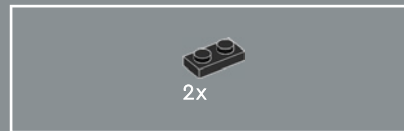
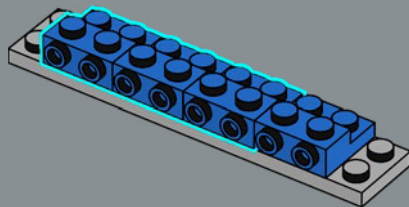

271

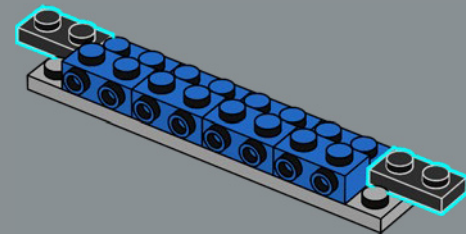

272

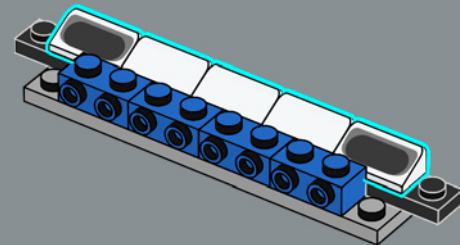



2x

273

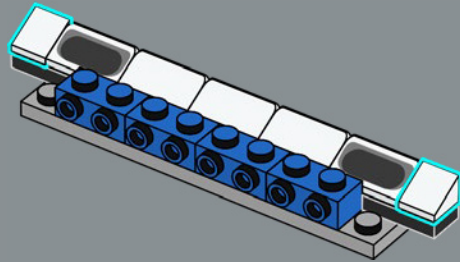

4x

274

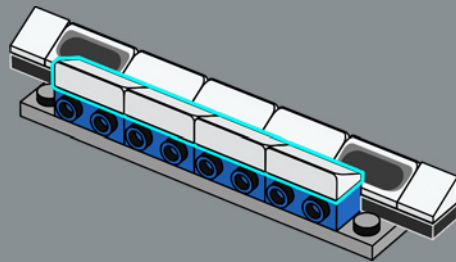

2x



2x

275

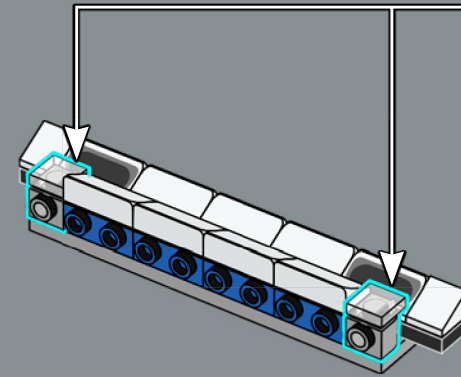

2x



4x



1x

276

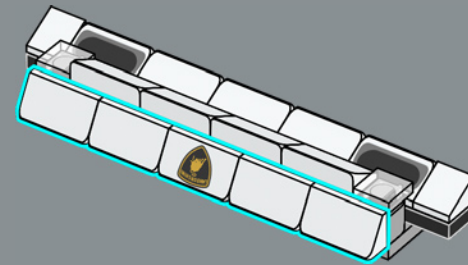

277

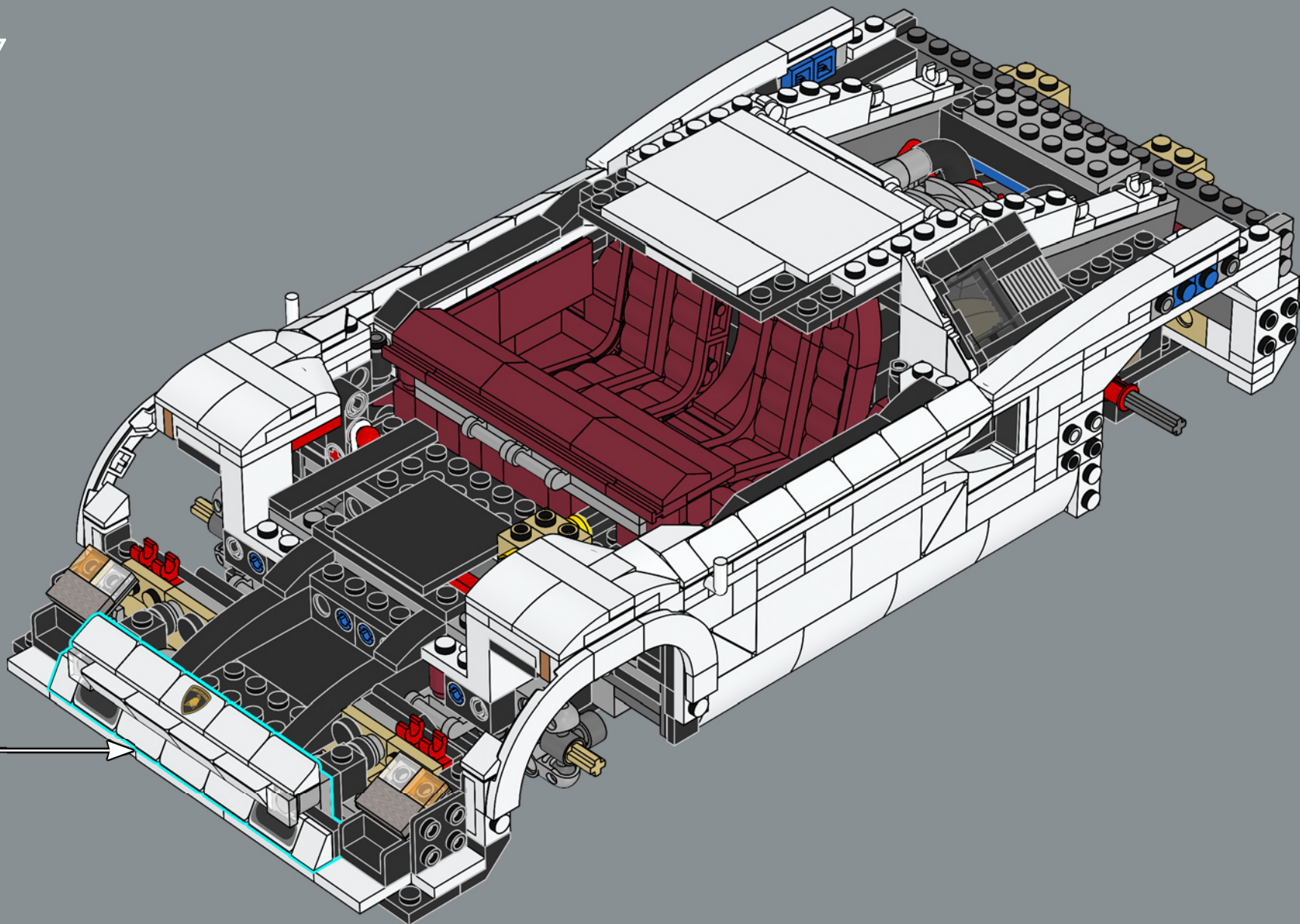



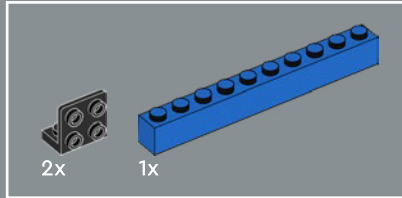
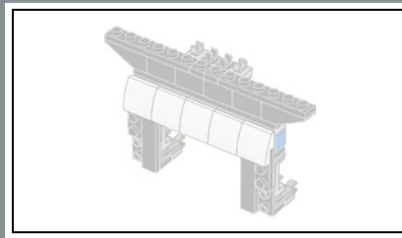
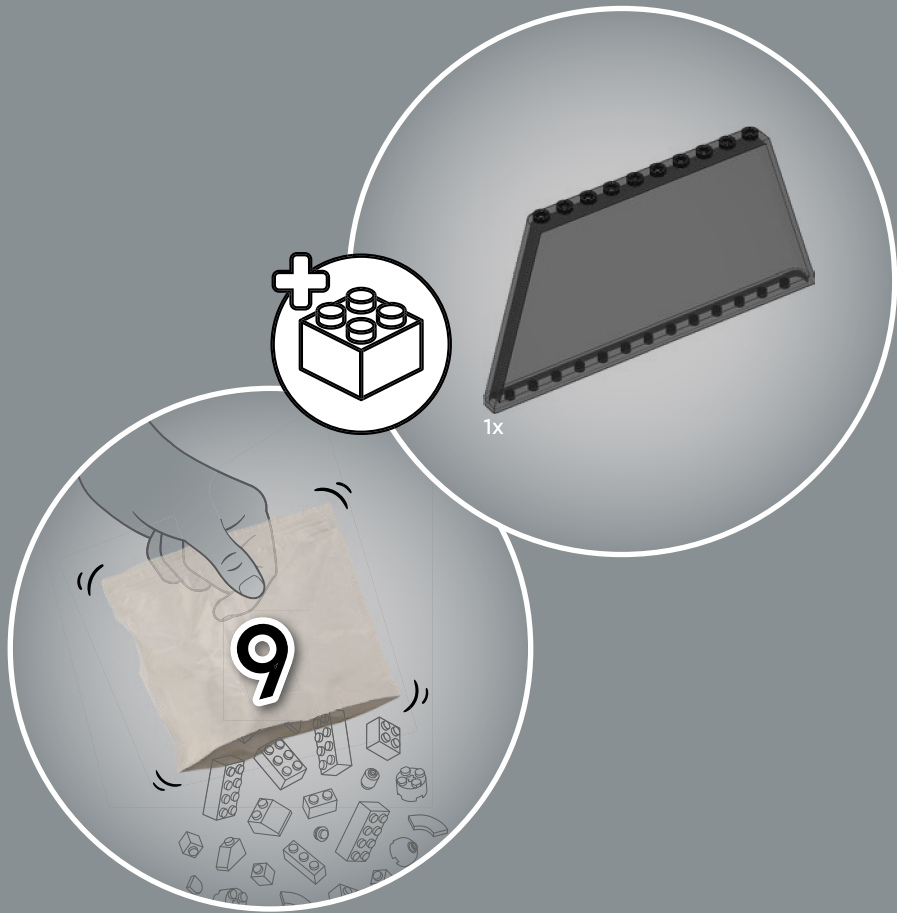

278

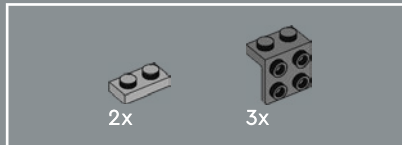
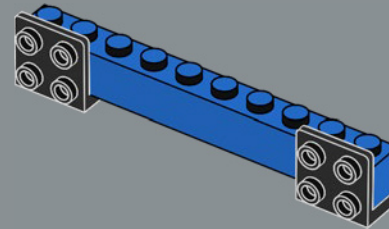

279

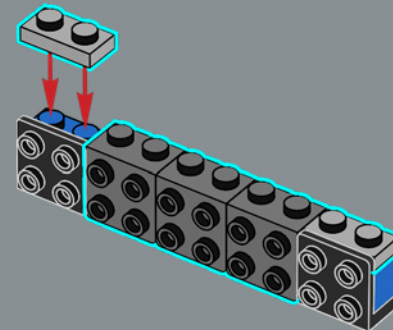

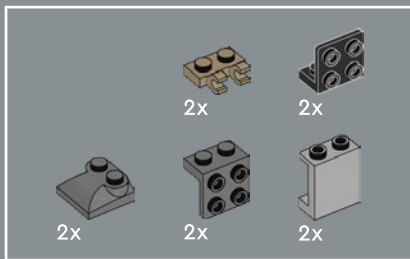

280

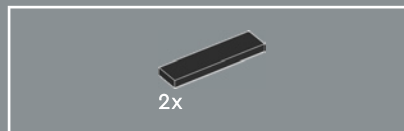
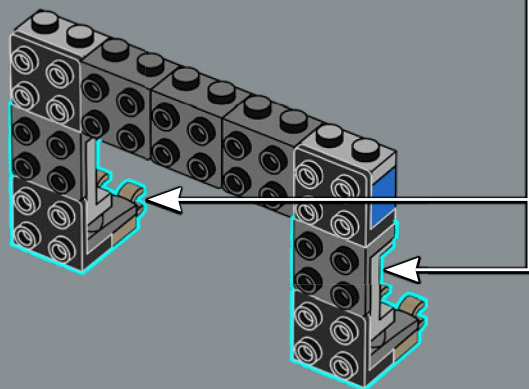
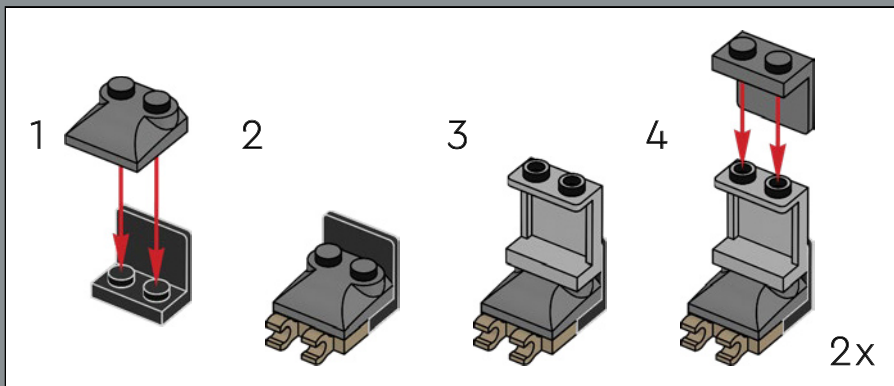

281

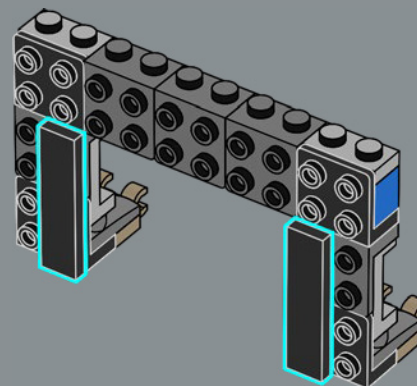

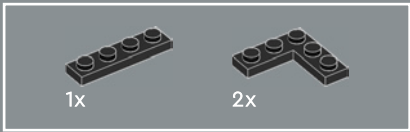

282

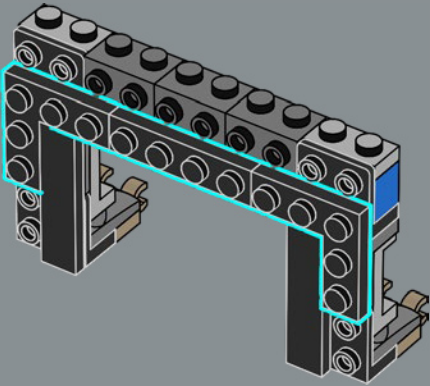

283

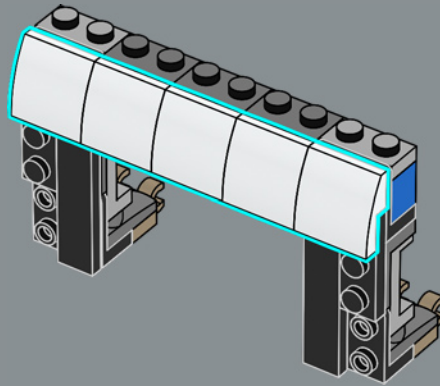



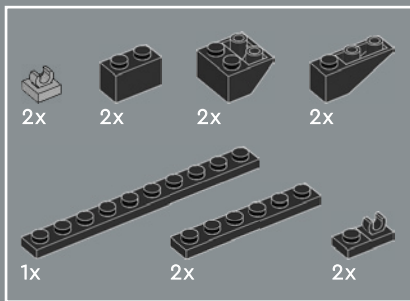

284

1

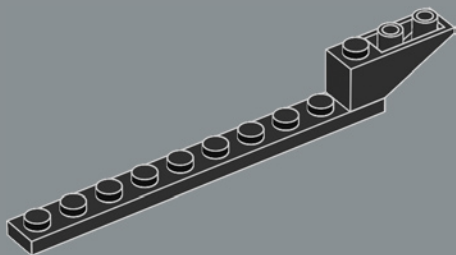

2

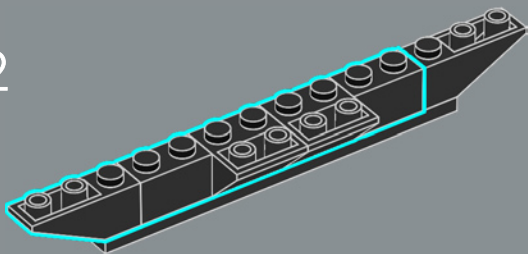

3

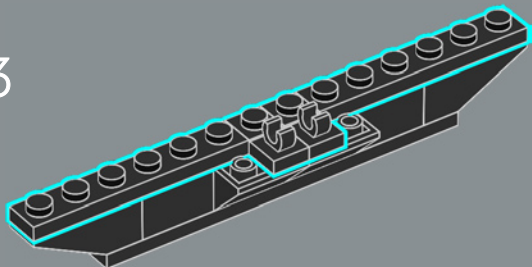

4

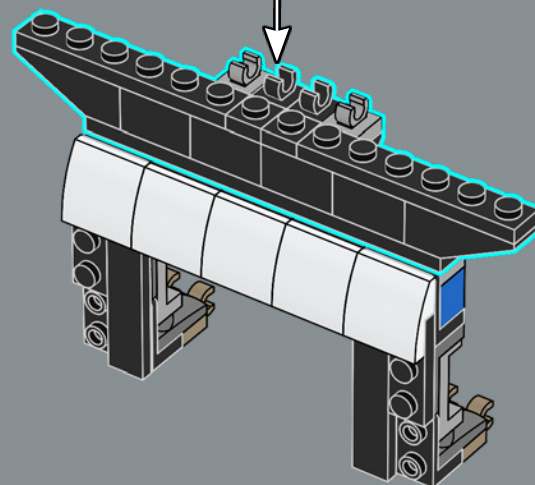
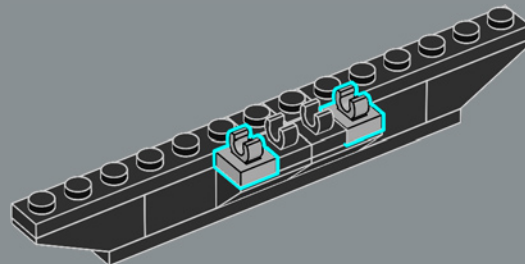

285

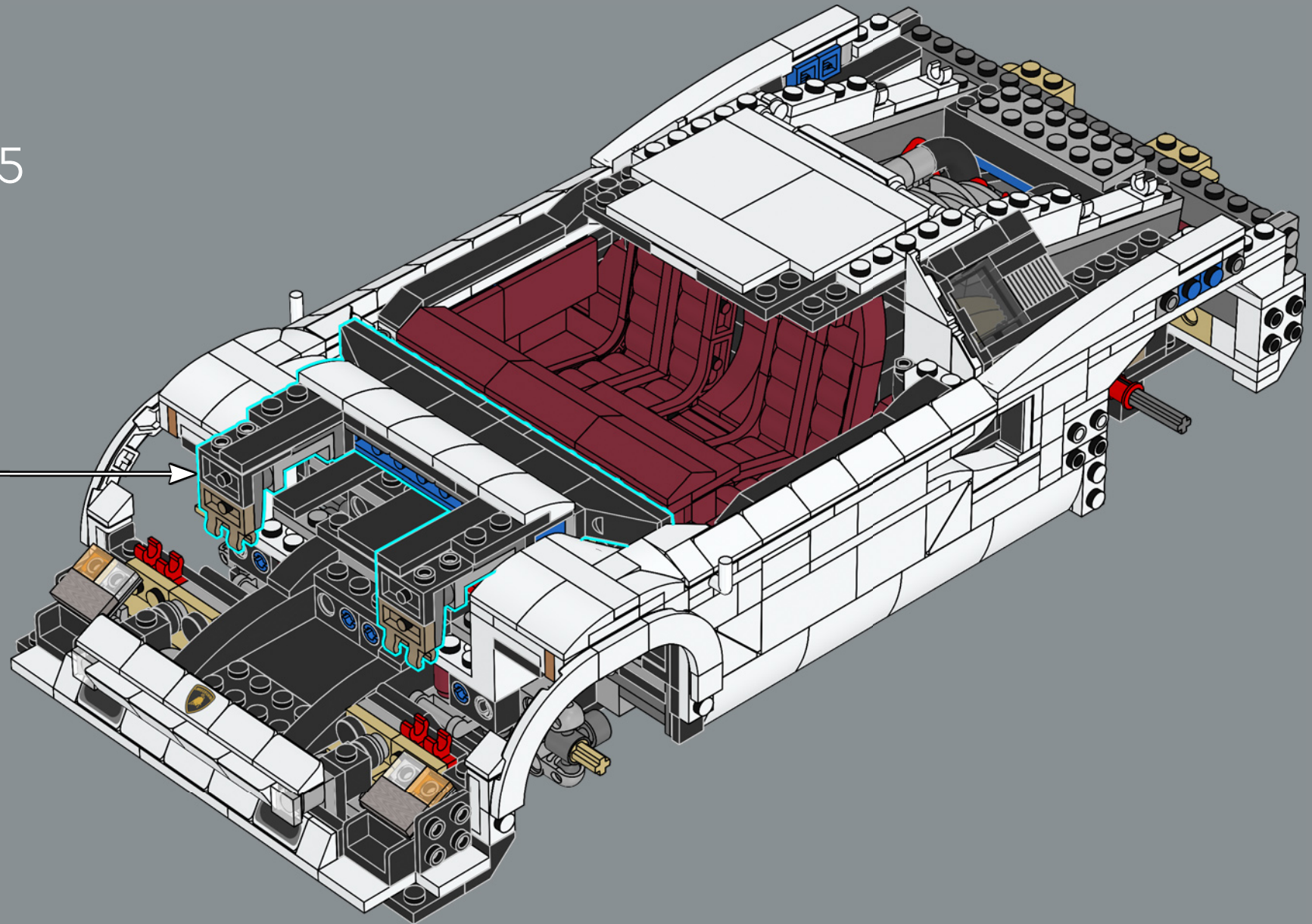

286

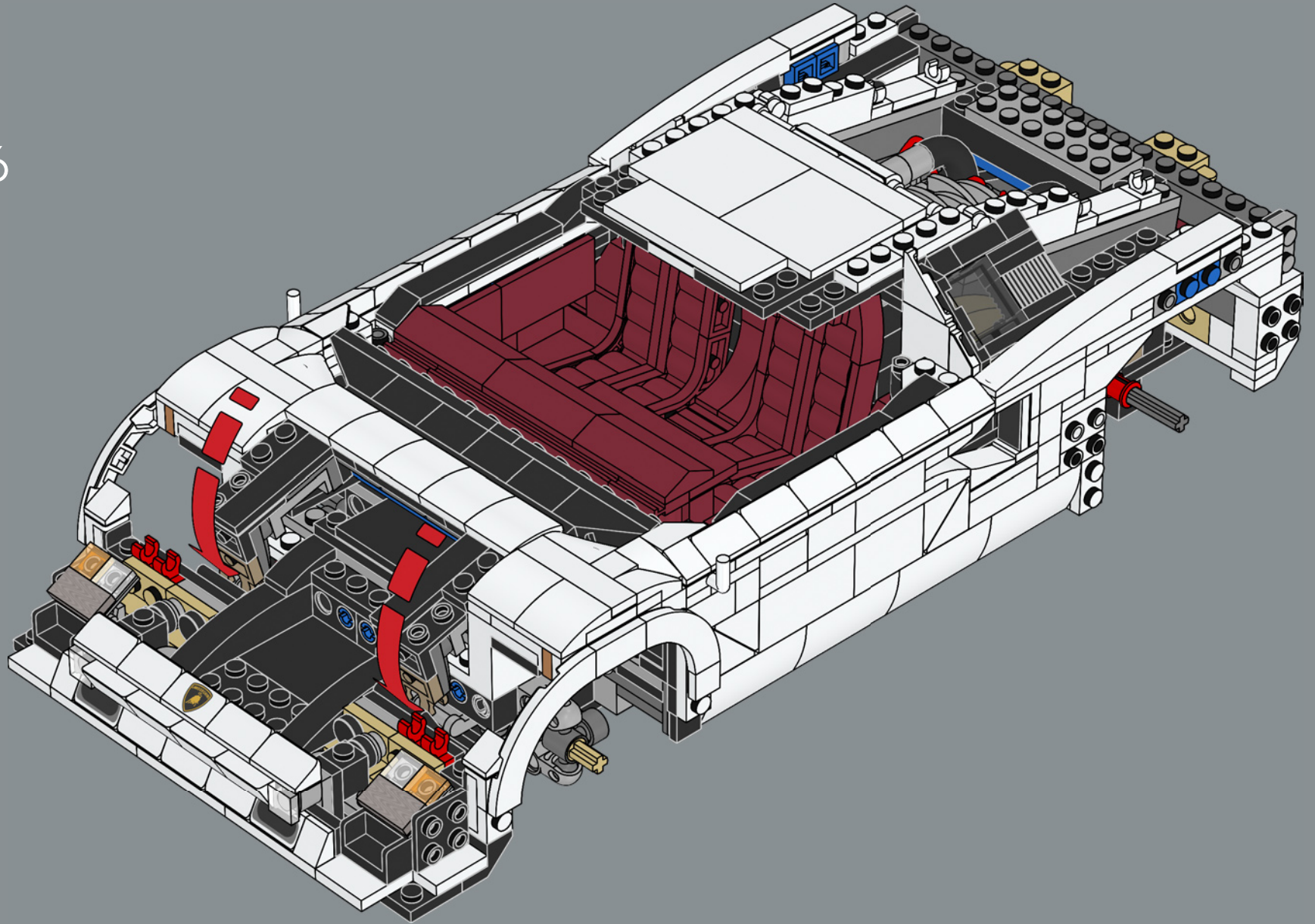





287

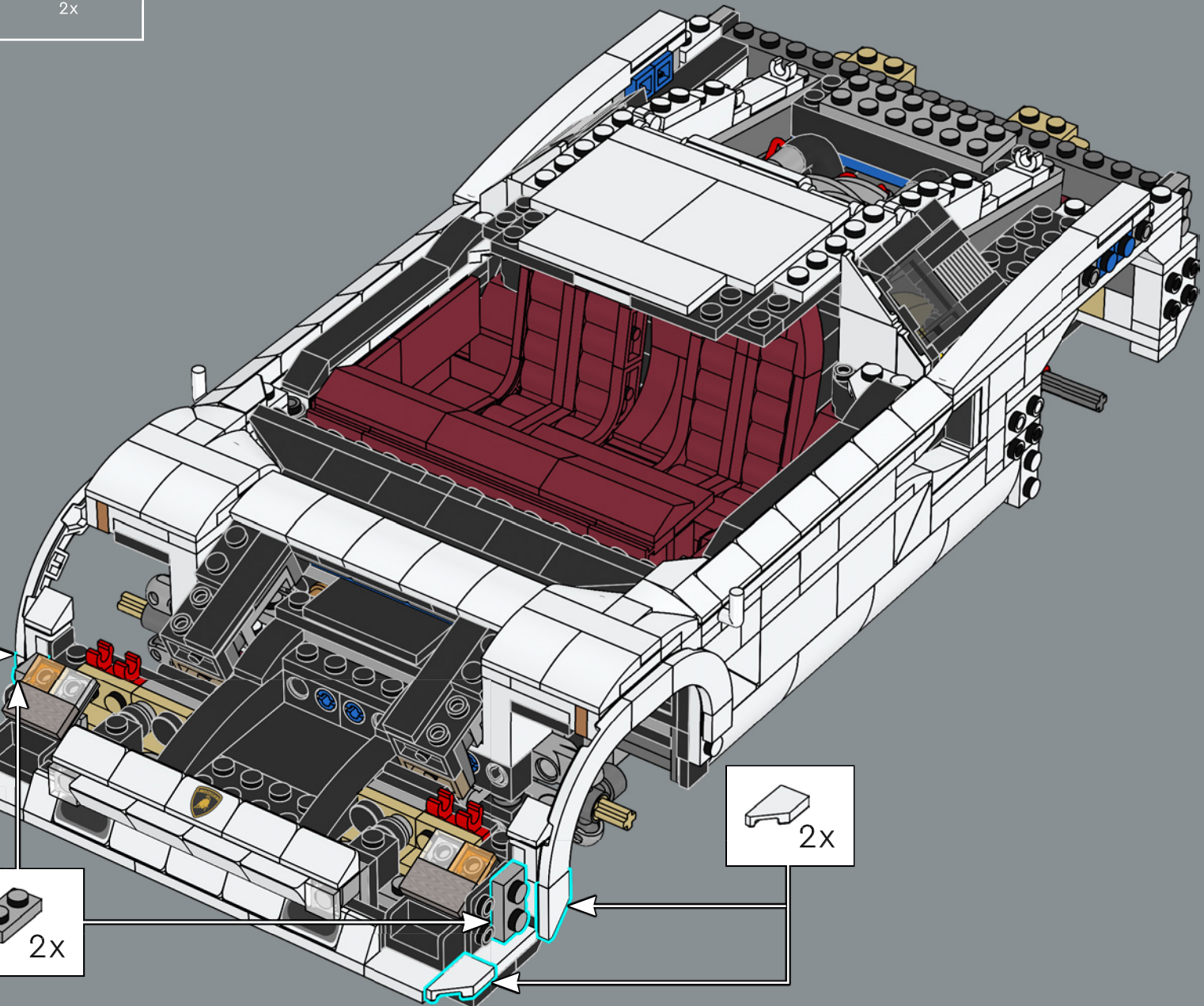
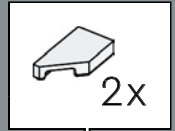
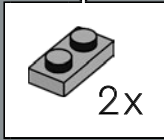
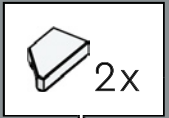



2x

288

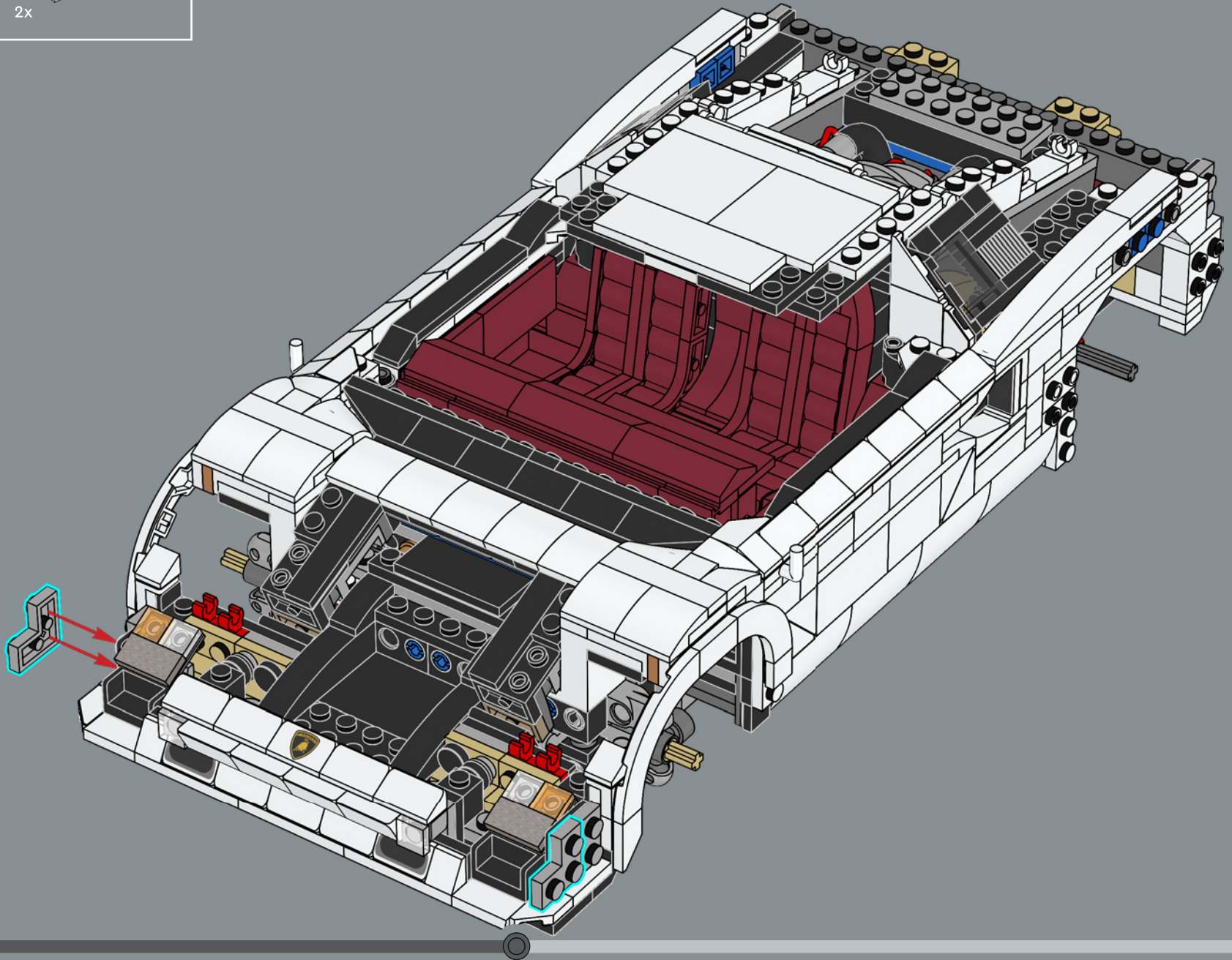



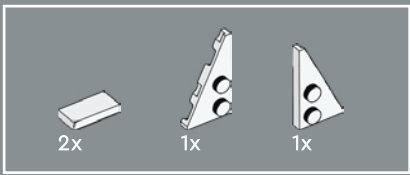

289

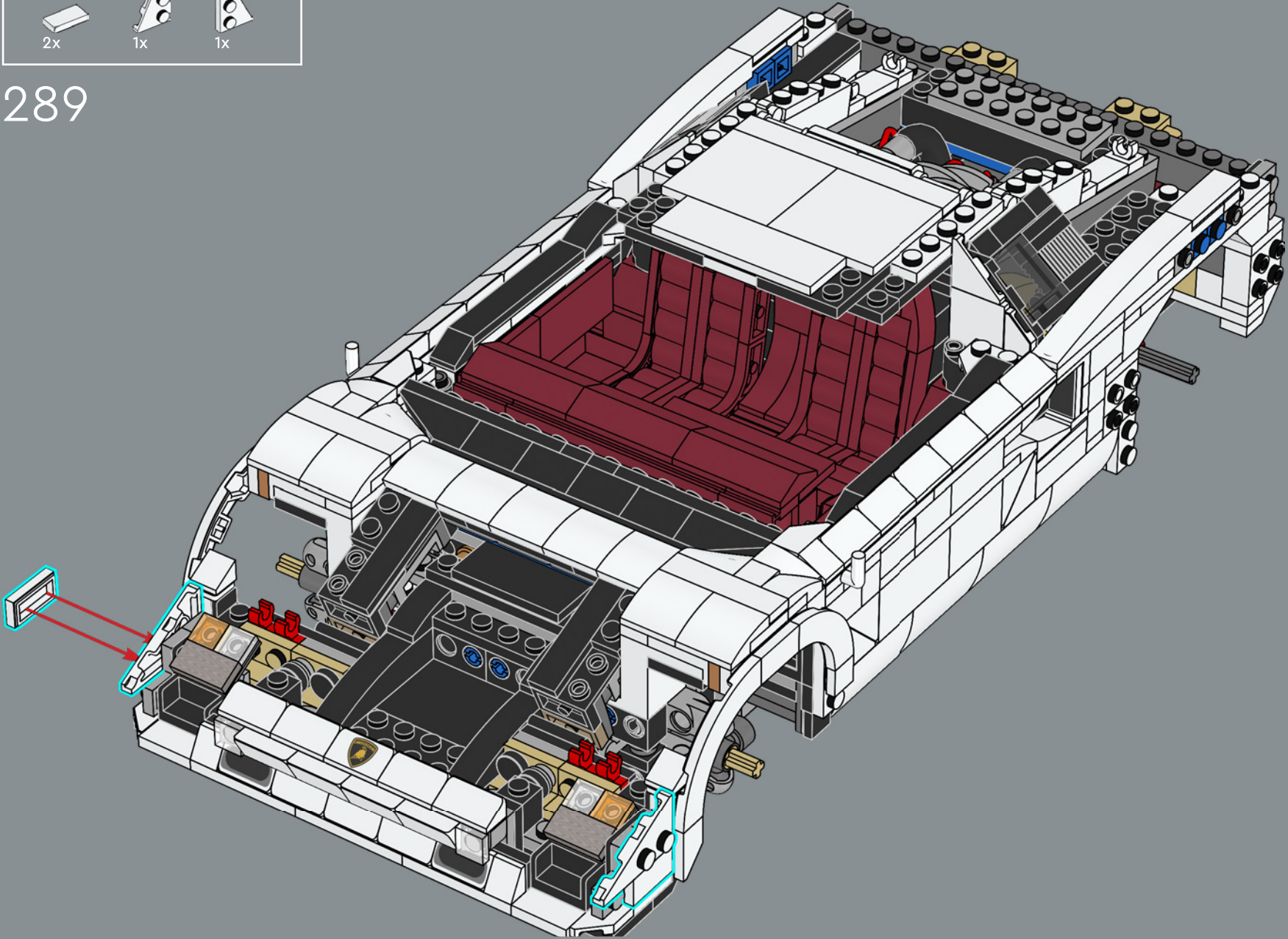





290

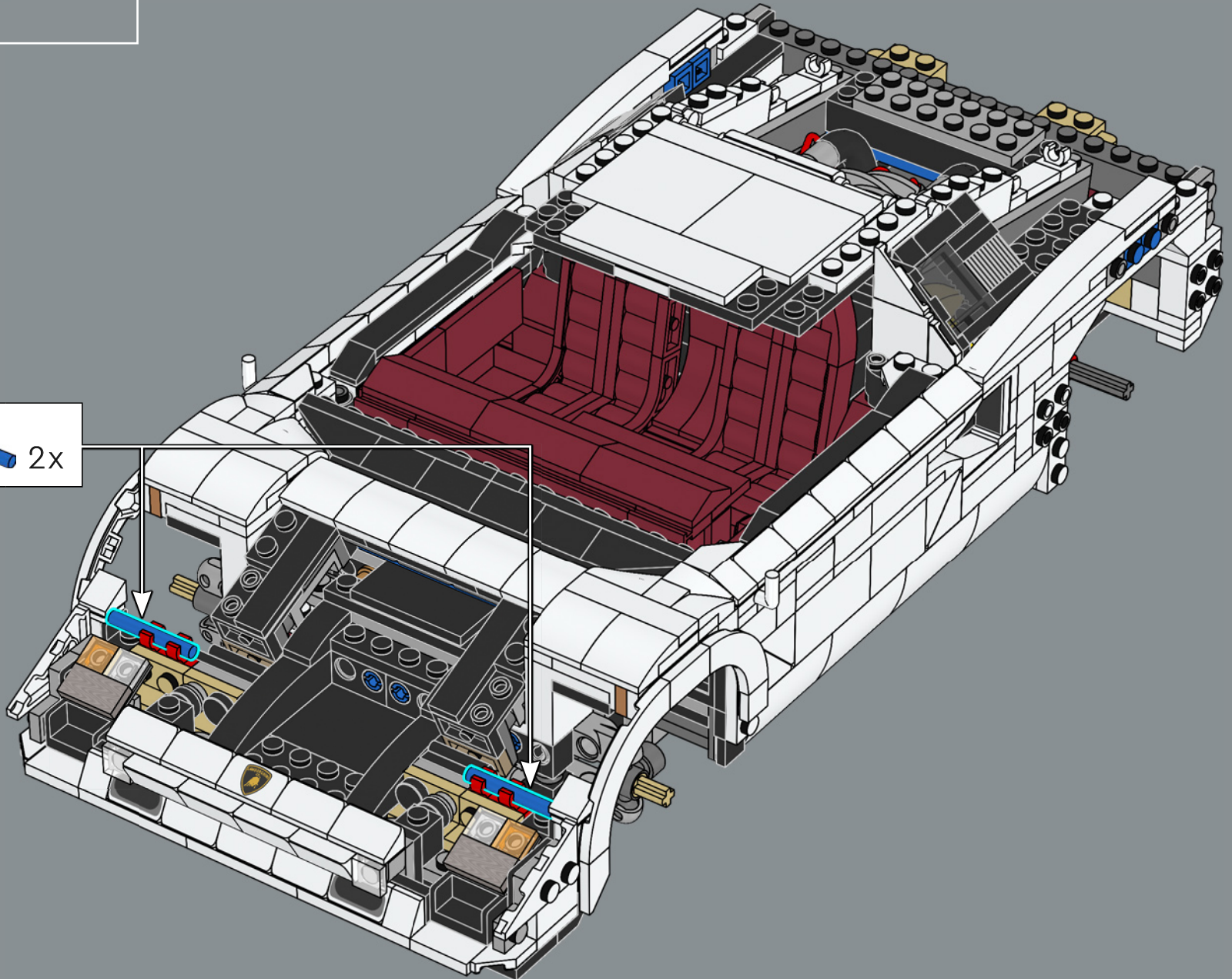
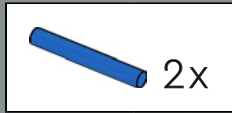

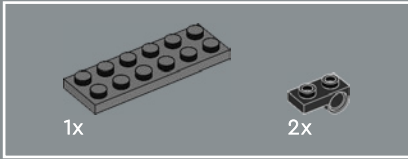
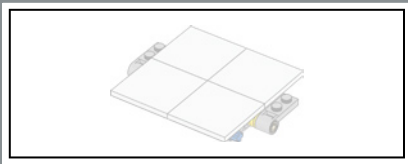

291

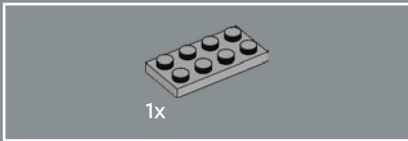
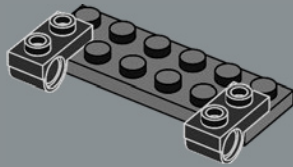

292

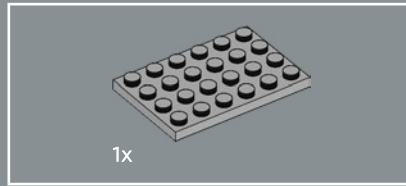
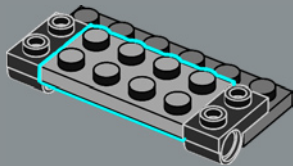

293

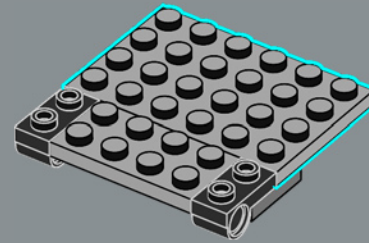

294

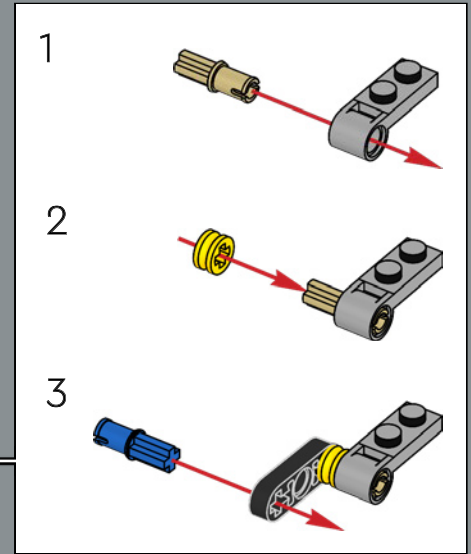
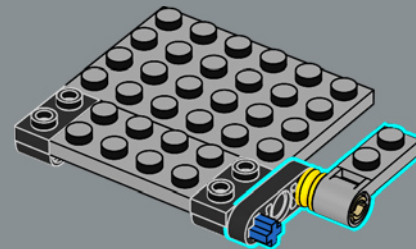



295

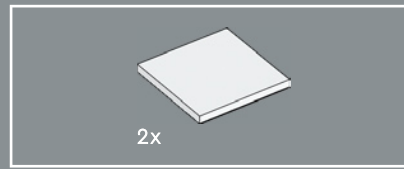
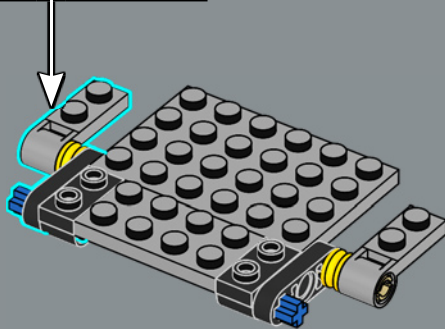
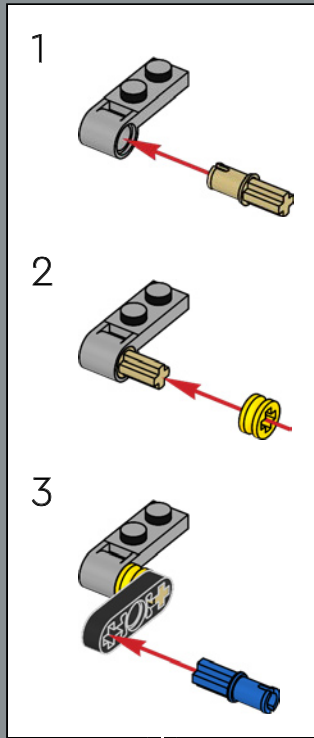

296

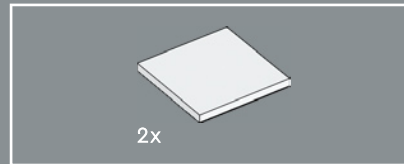
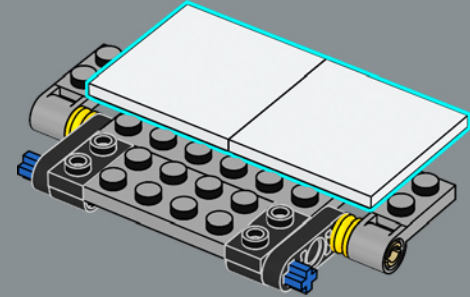

297

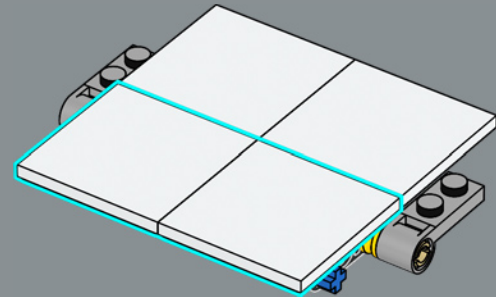



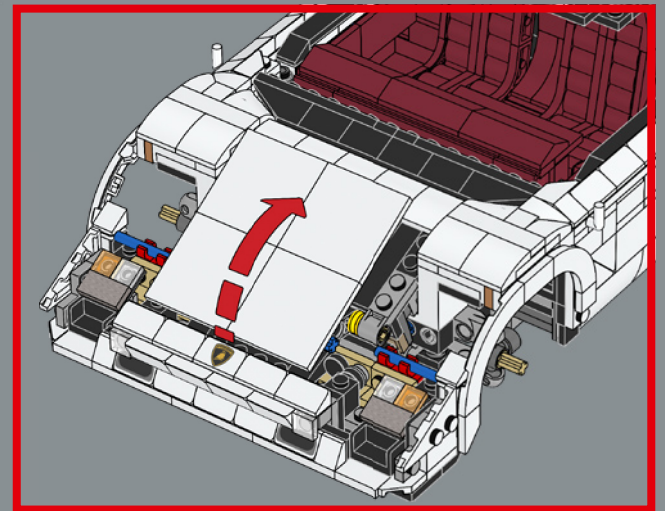
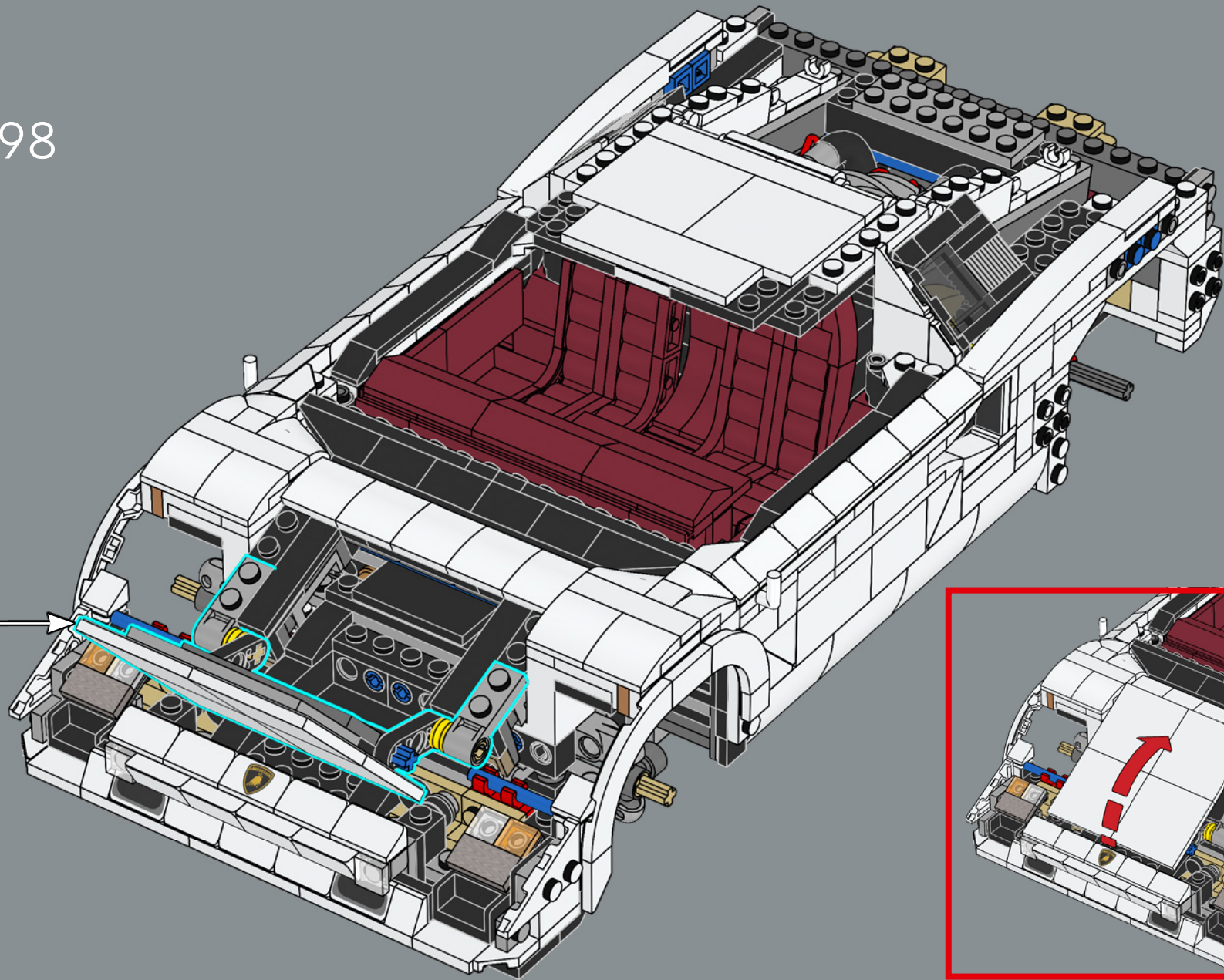

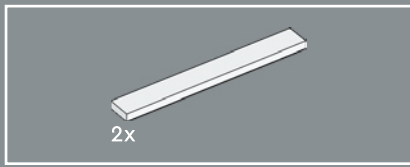

299

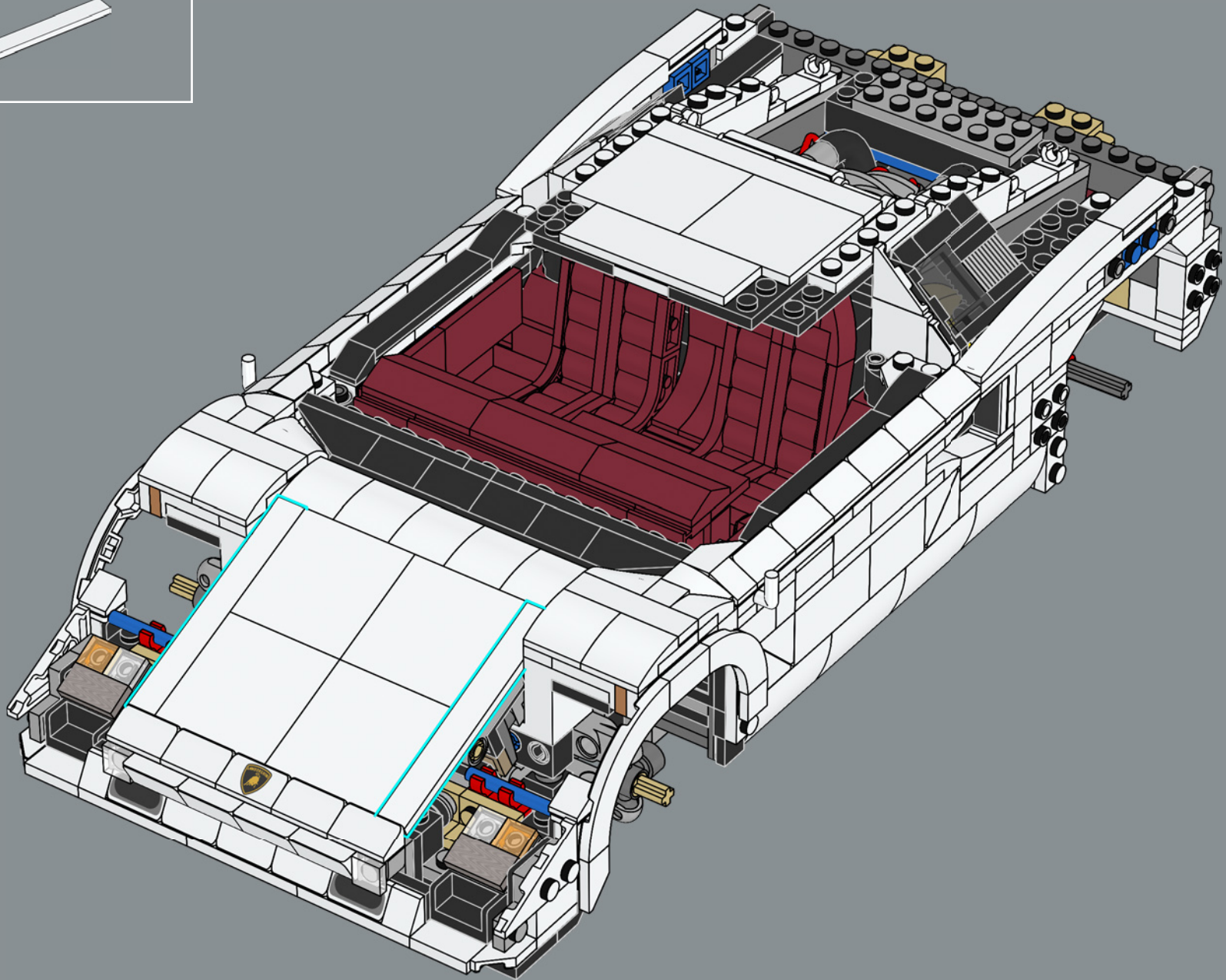

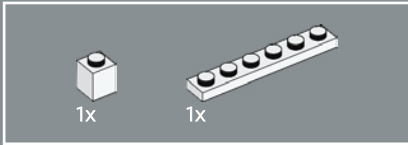
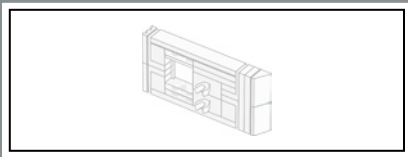

300

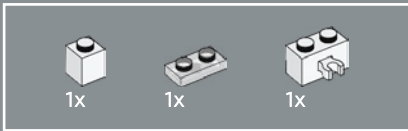
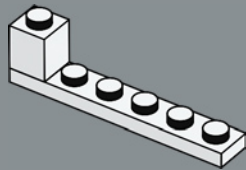

301

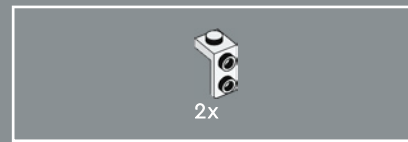
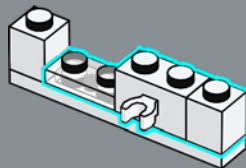

302

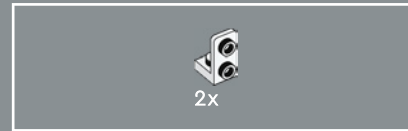
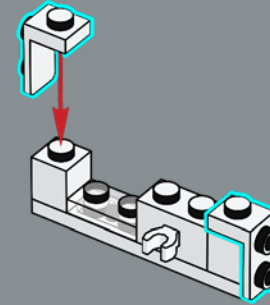

303

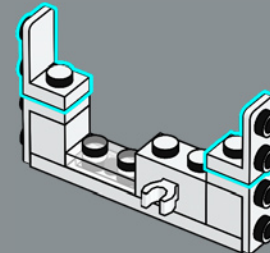



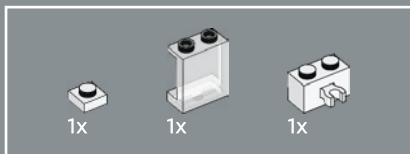

304

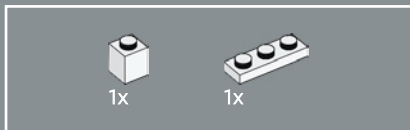
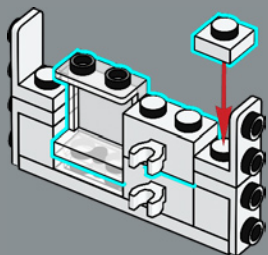

305

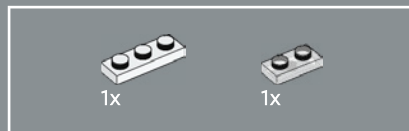
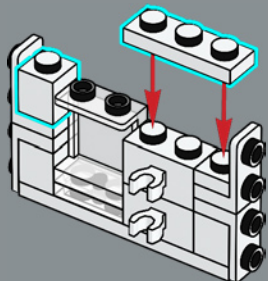

306

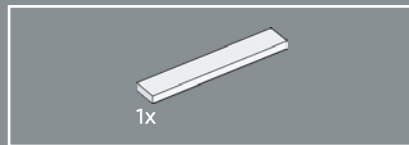
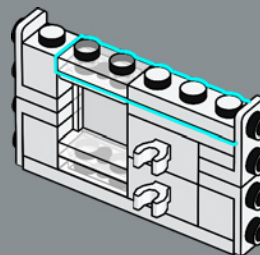

307

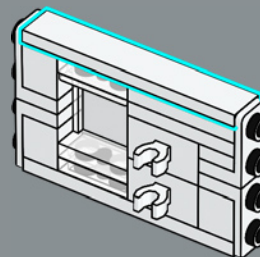



2x

308

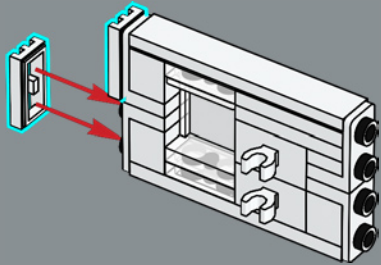

2x



2x

309

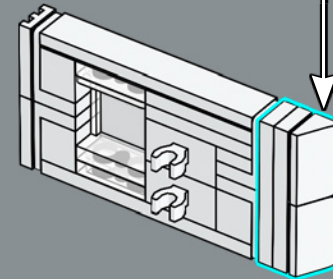
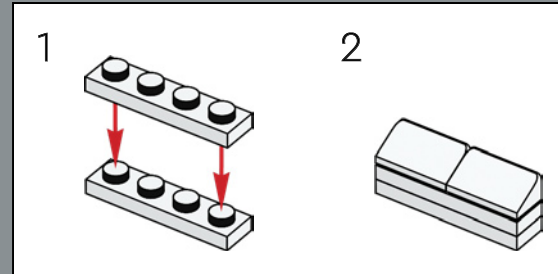

310

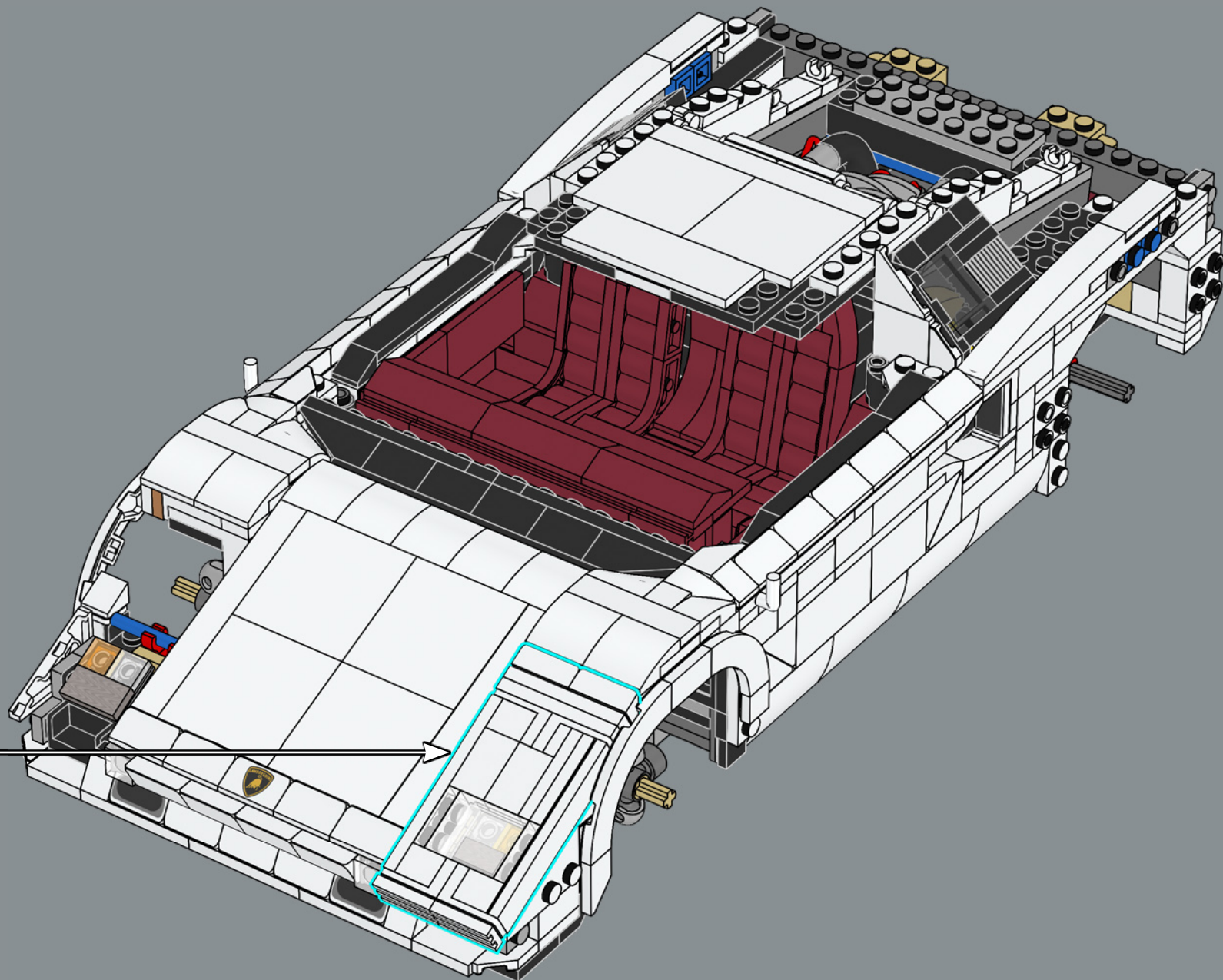



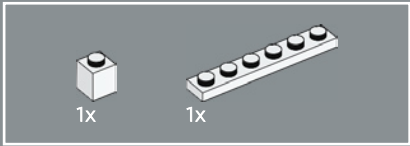
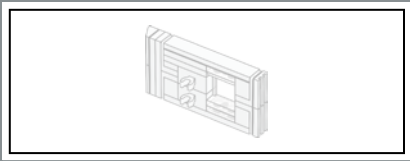

311

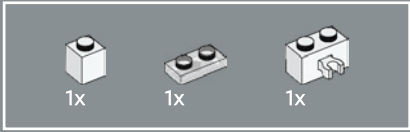
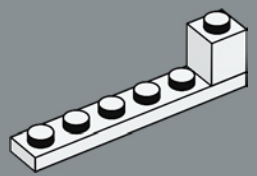

312

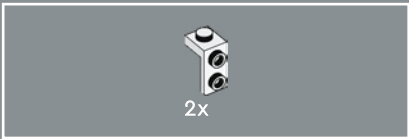
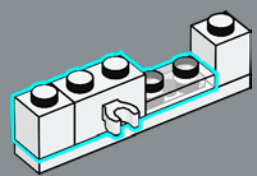

2x

313

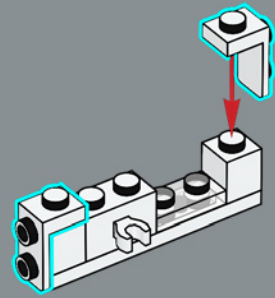

2x

314

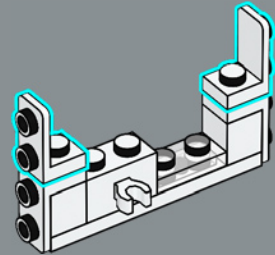

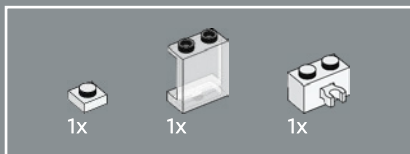

315

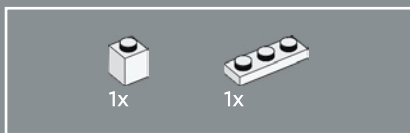
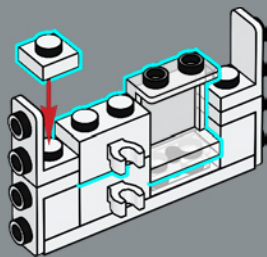

316

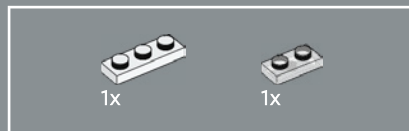
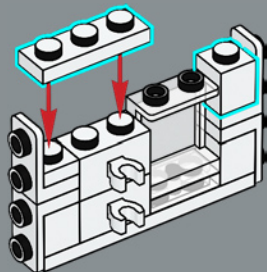

317

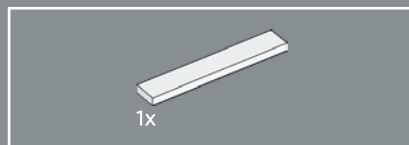
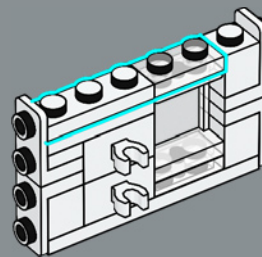

318

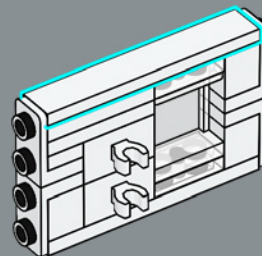



2x

319

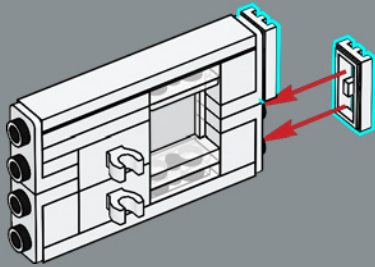

2x



2x

320

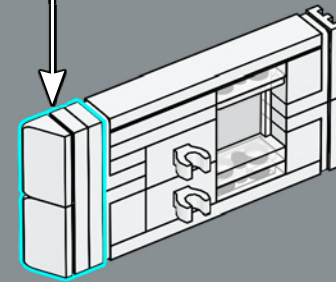
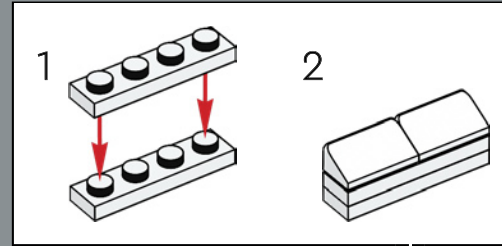



321

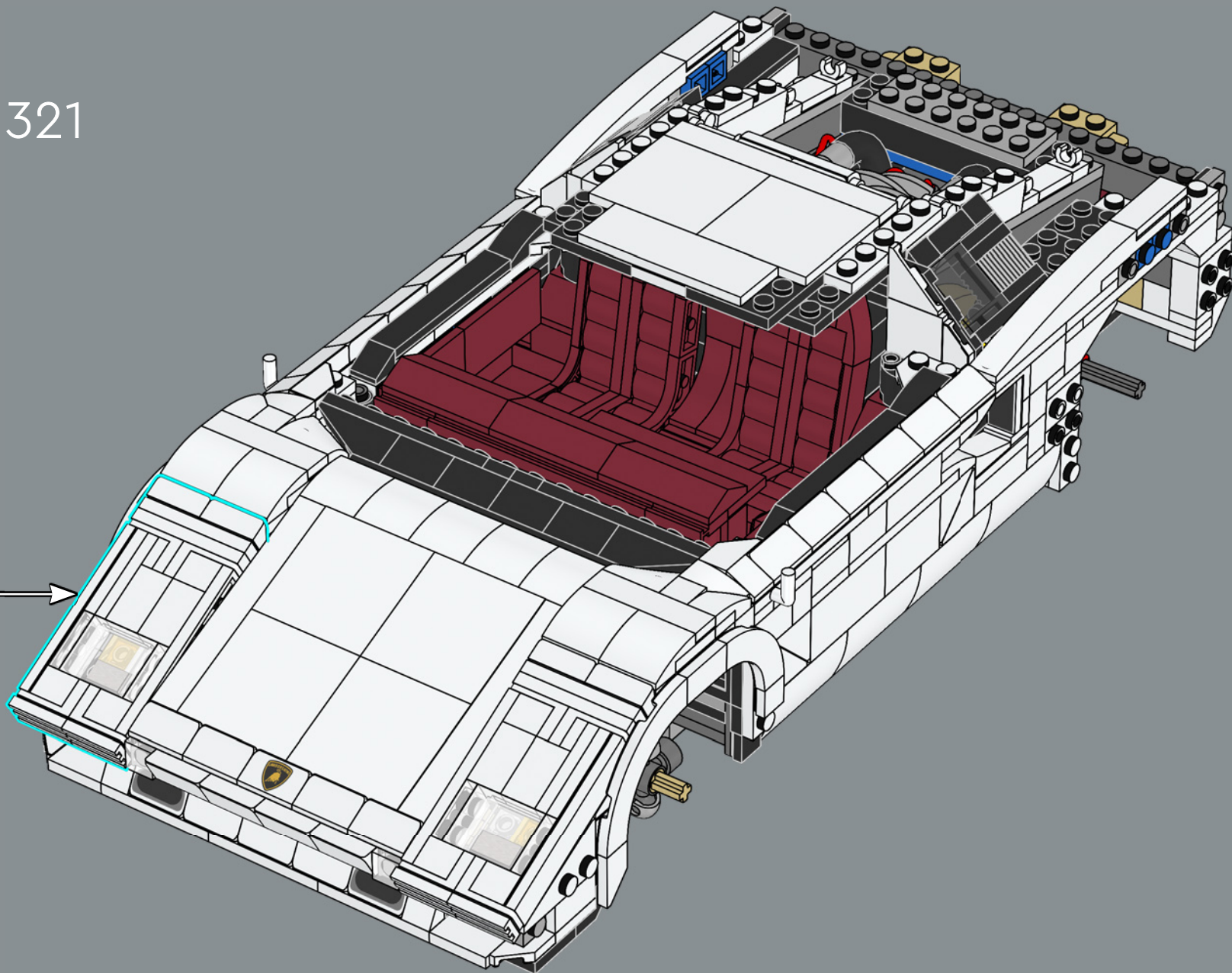

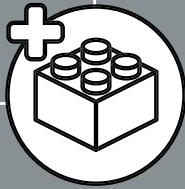
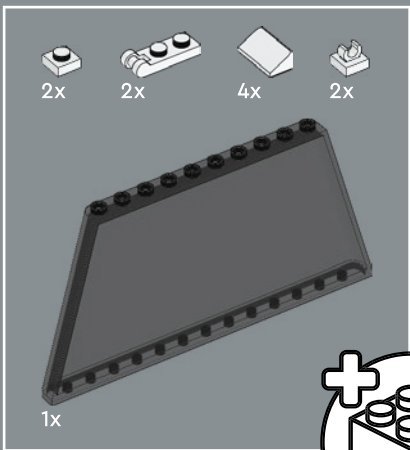

322

1

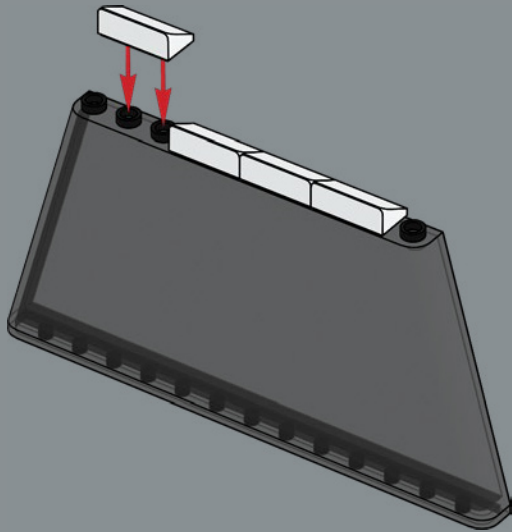

2

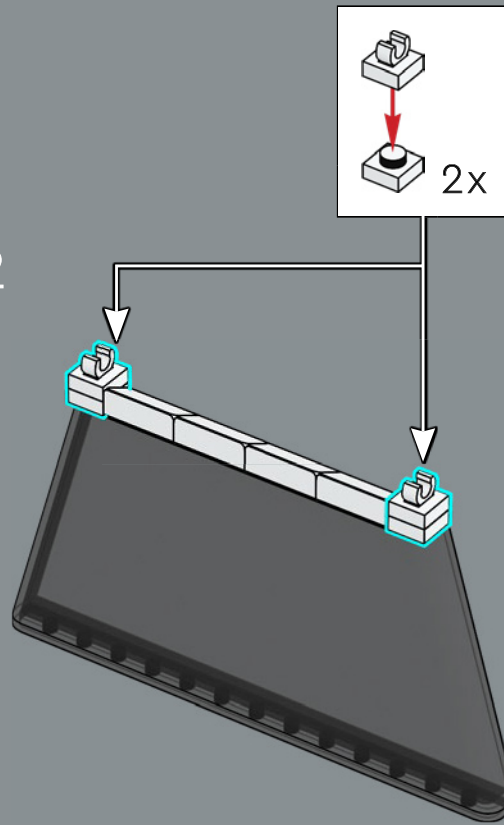

3

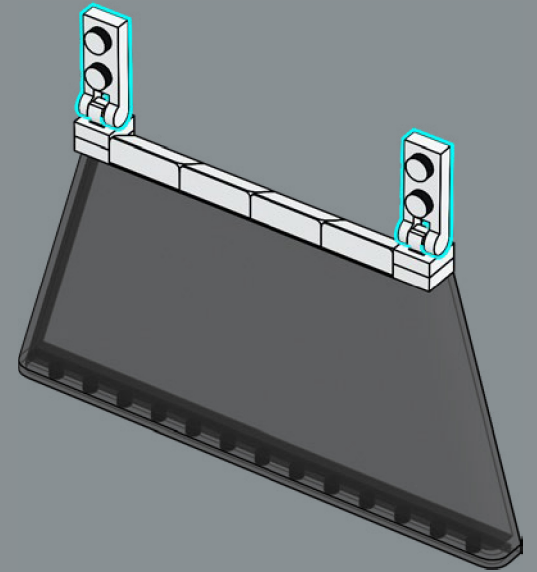

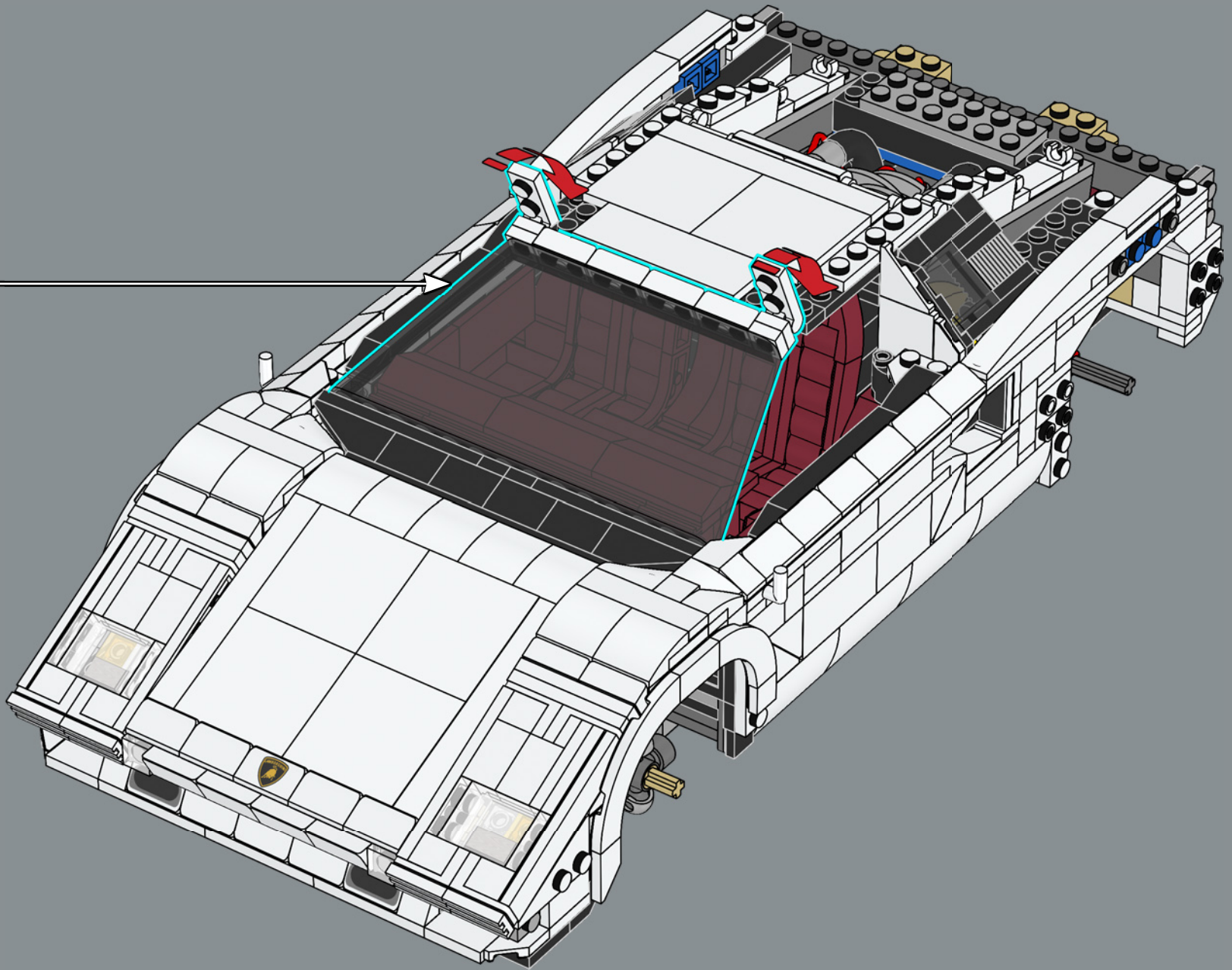



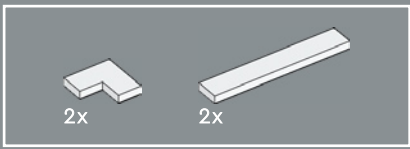

323

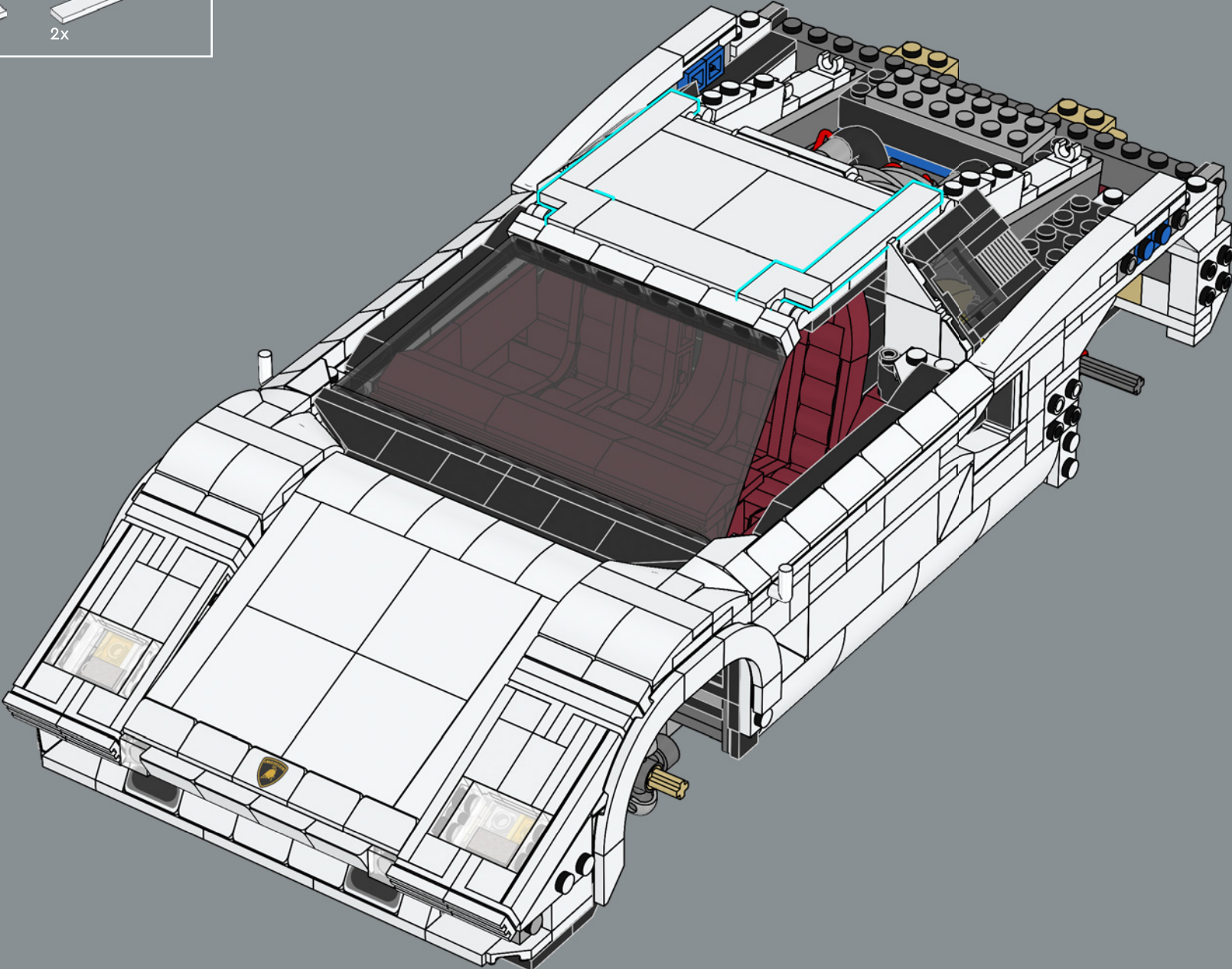

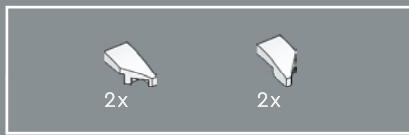

324

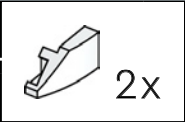
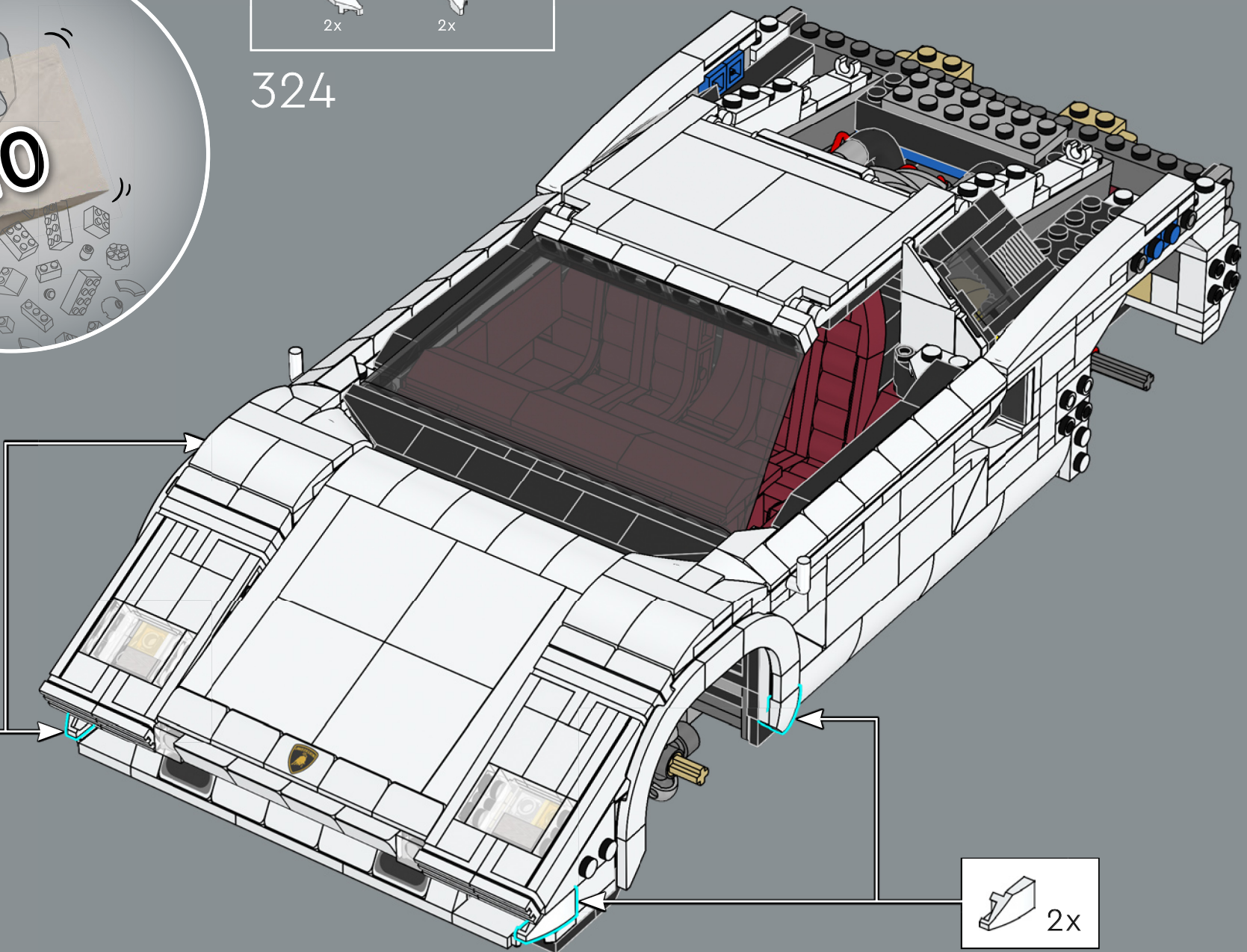



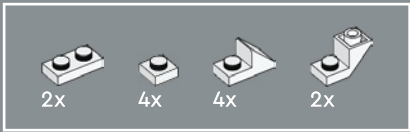

325

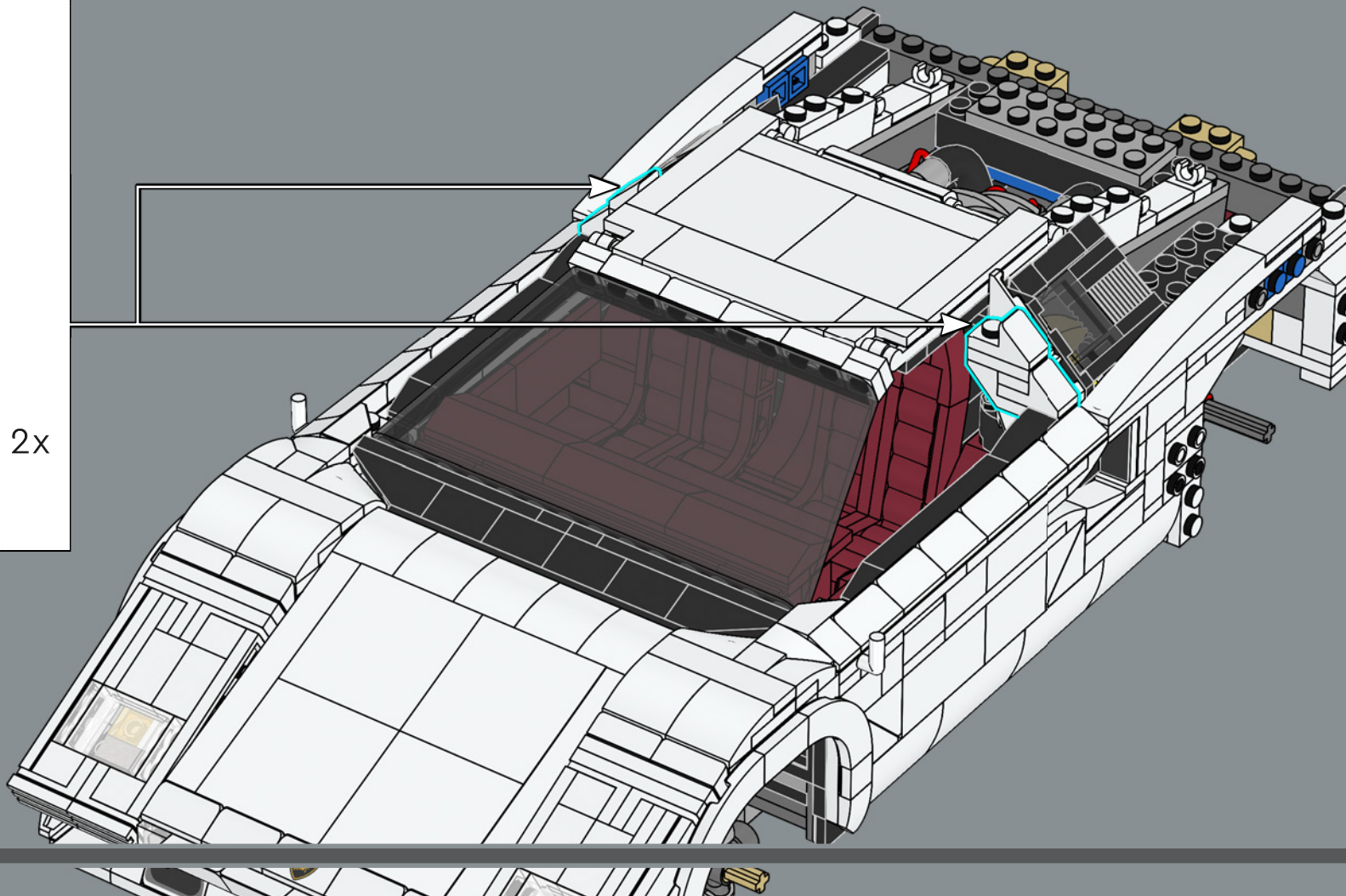
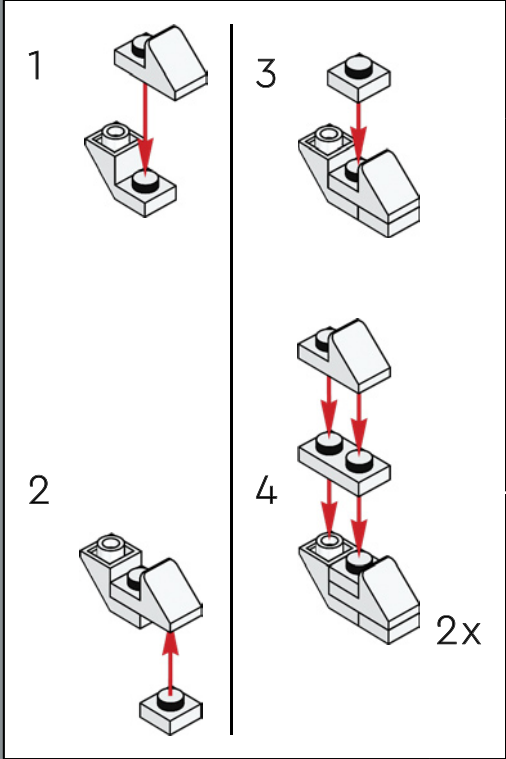



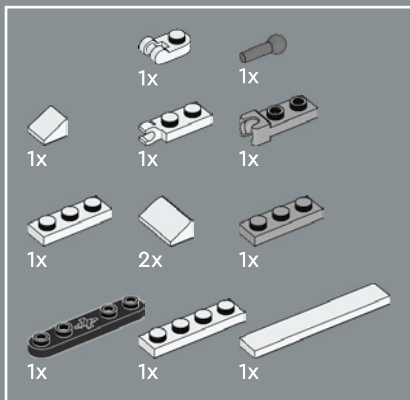

326

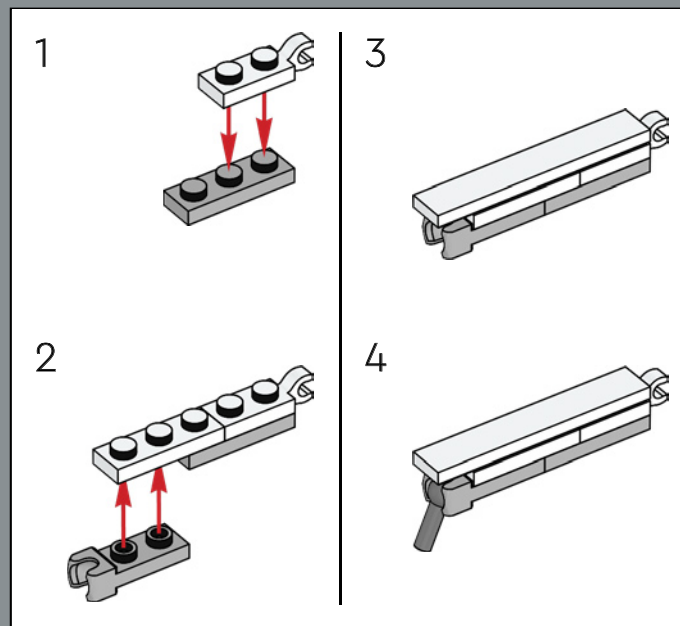
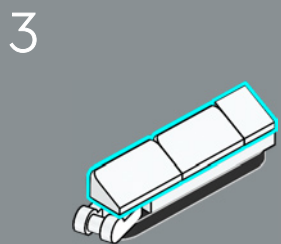
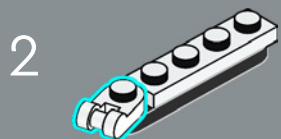
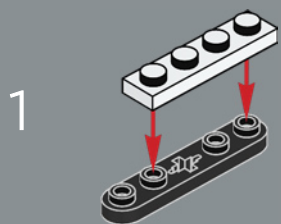

4

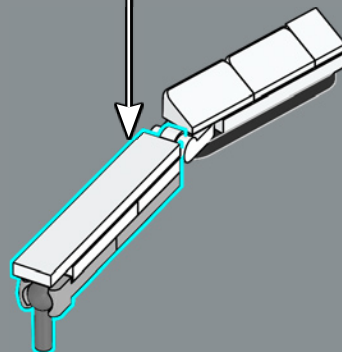

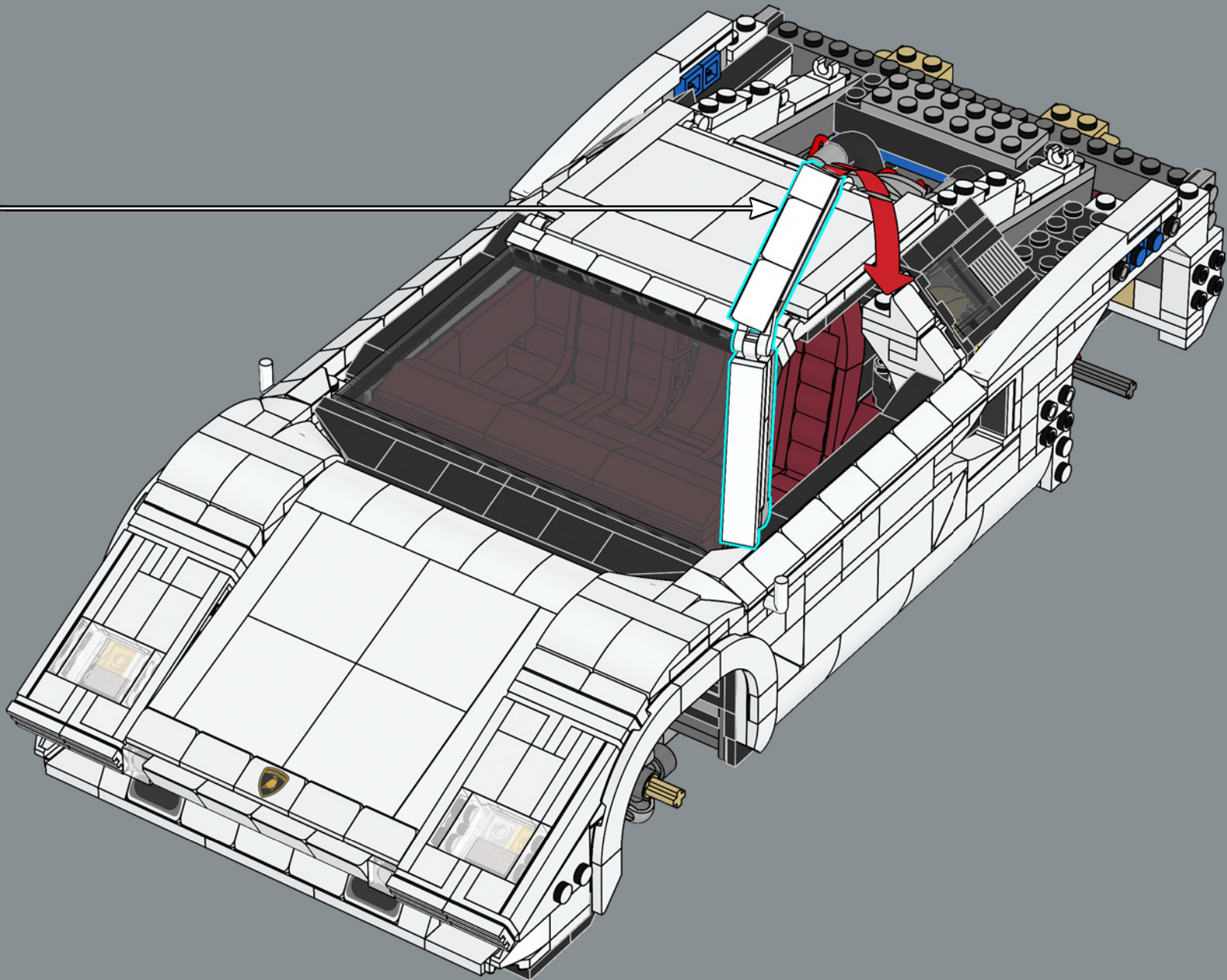

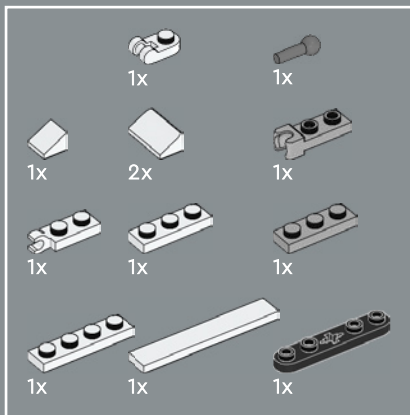

327

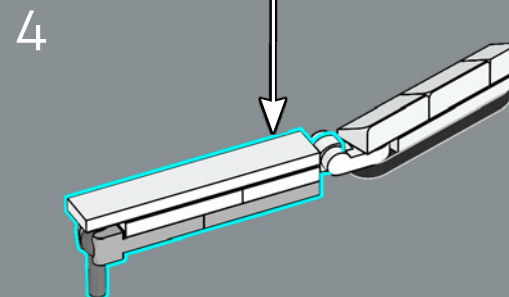
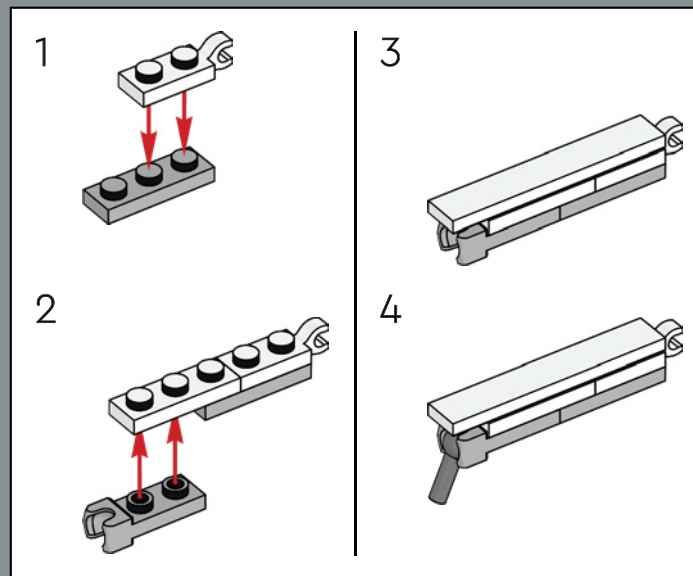
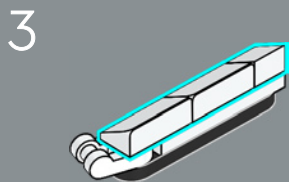
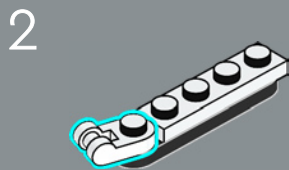
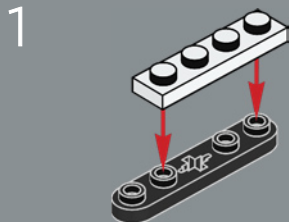



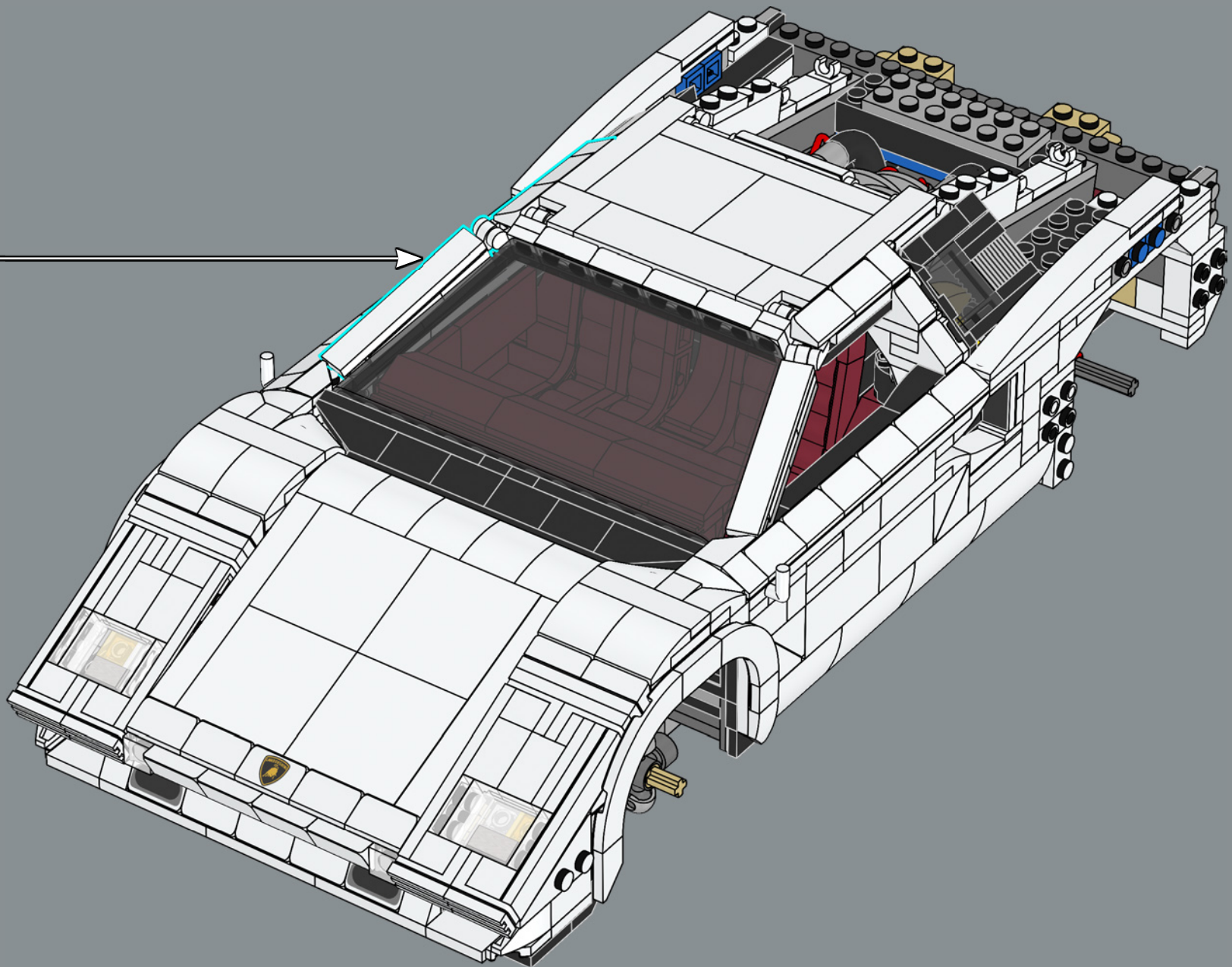

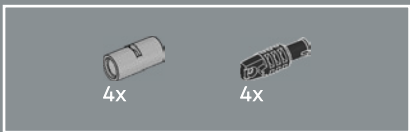

328

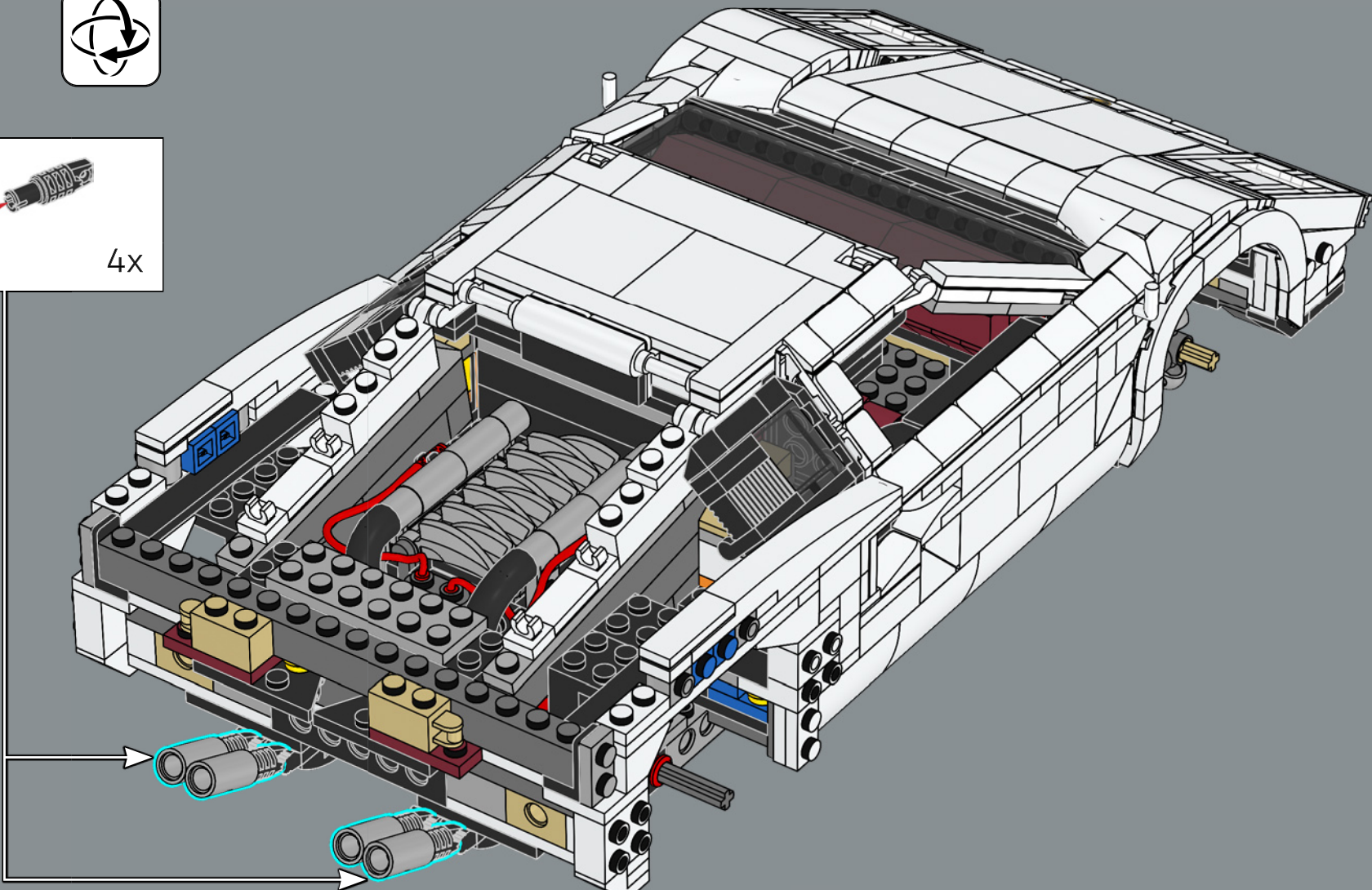
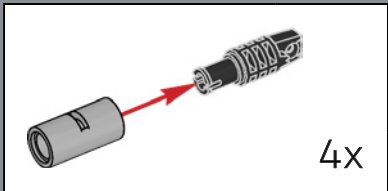

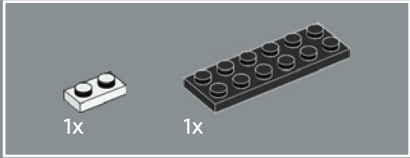
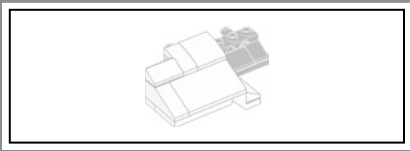

329

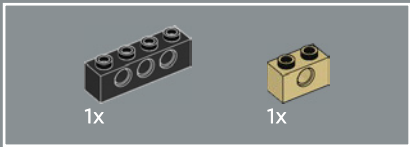
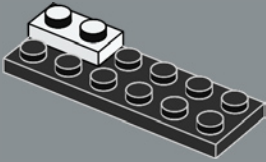

330

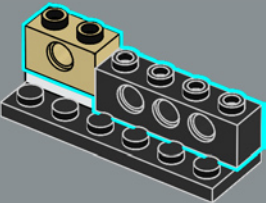

331

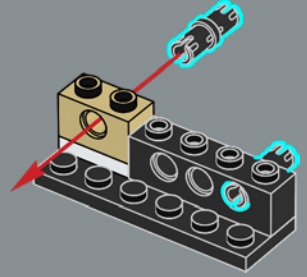

332

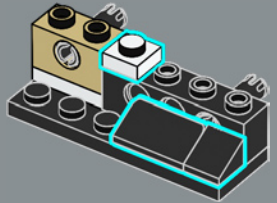



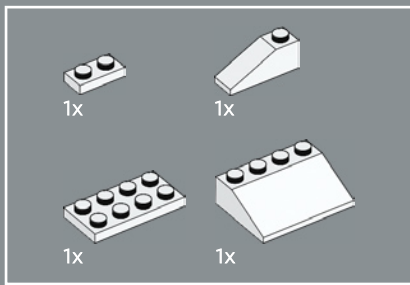

333

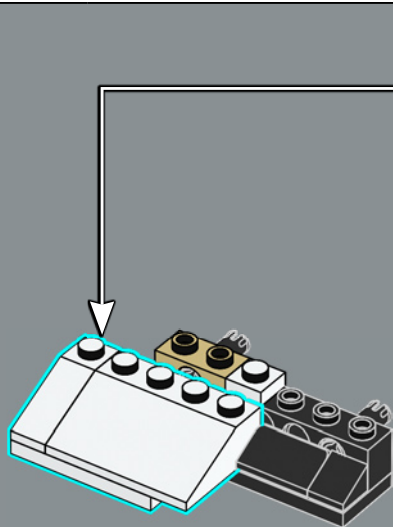
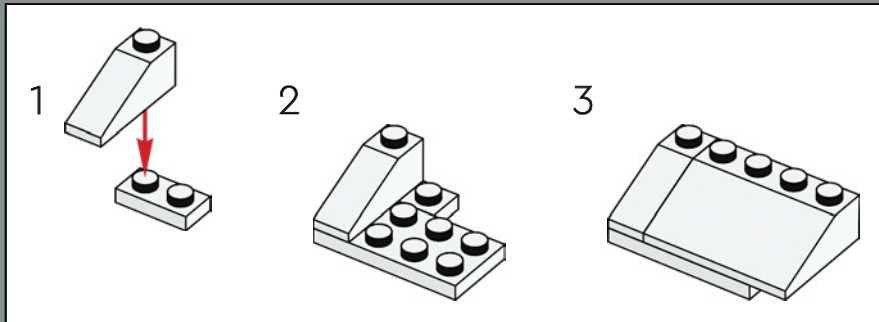

334

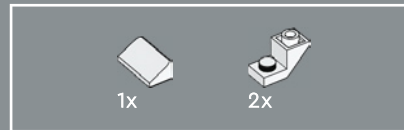
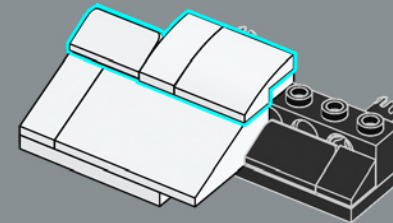

335

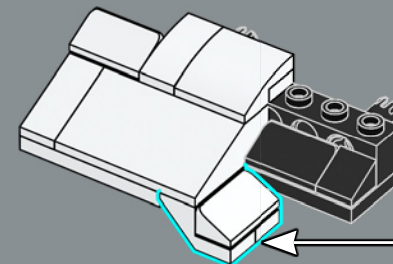
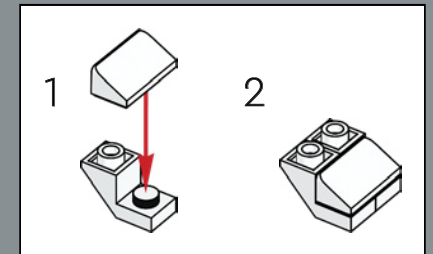

336

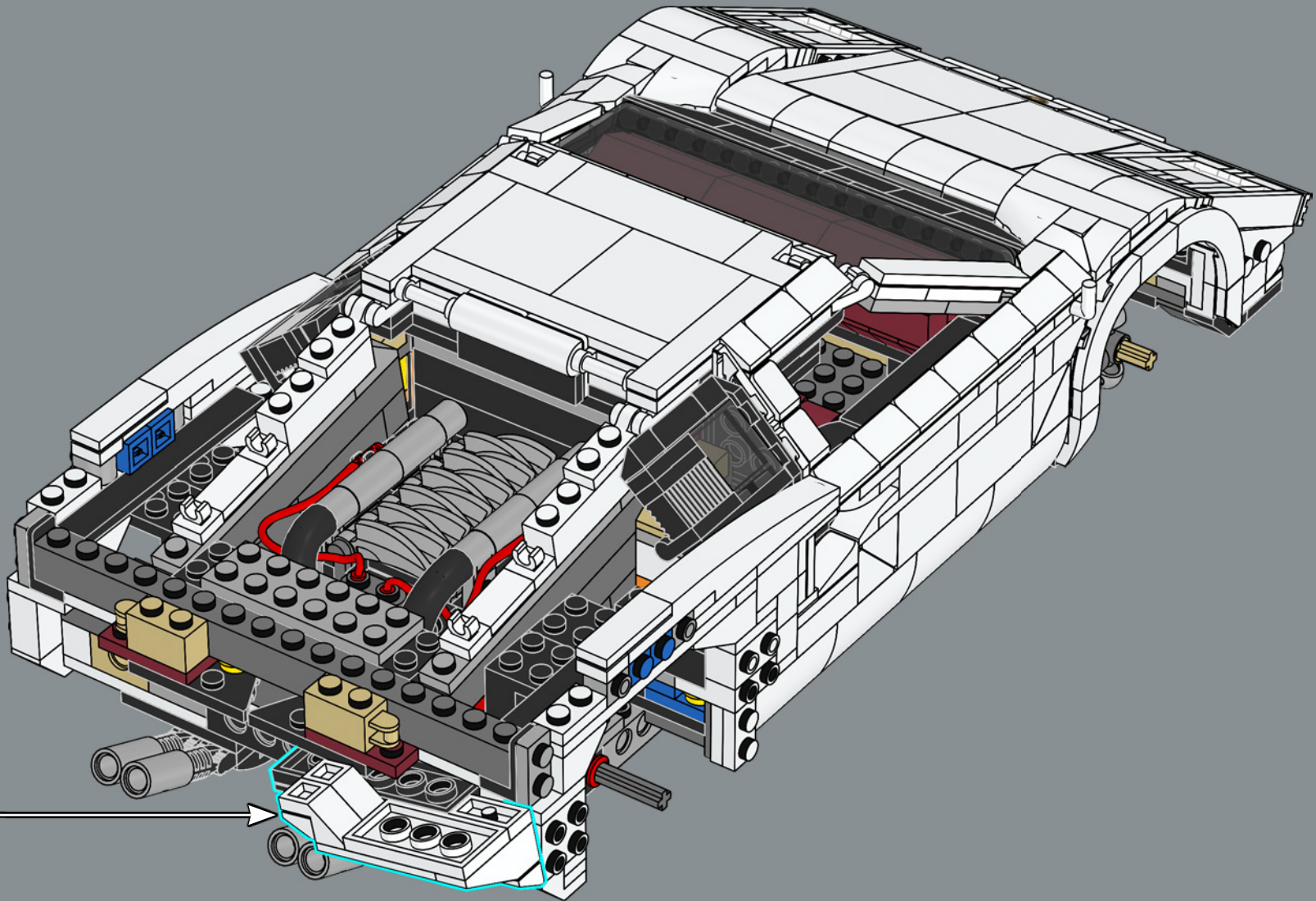

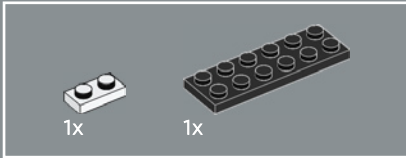
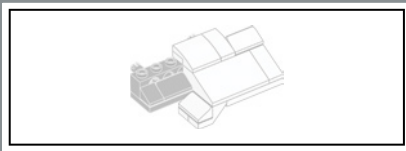

337

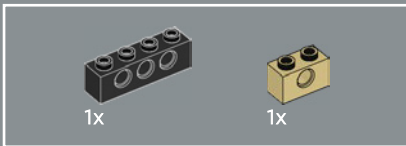
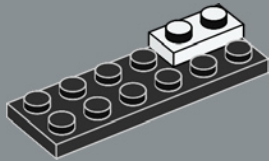

338

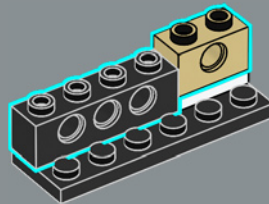

339

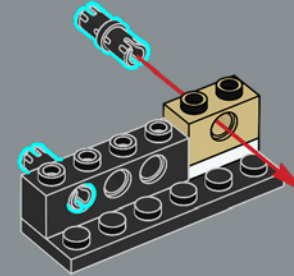

340

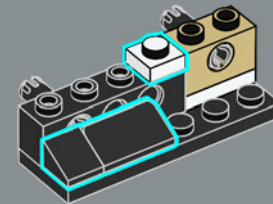



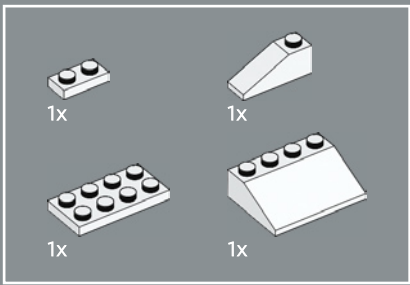

341

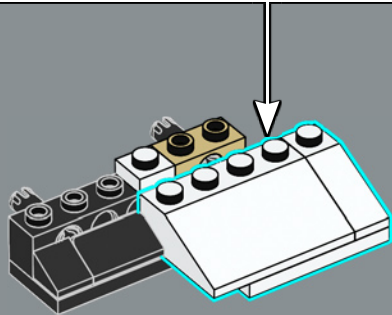
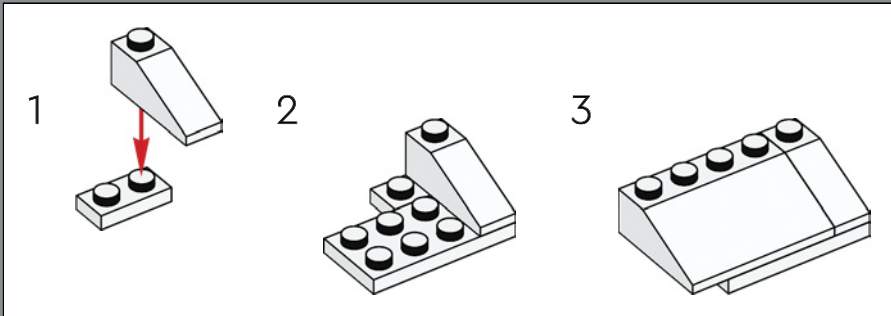

342

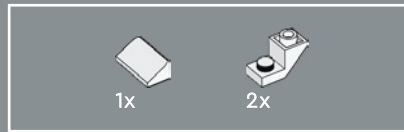
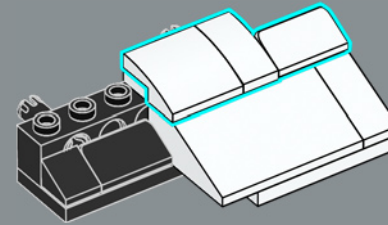

343

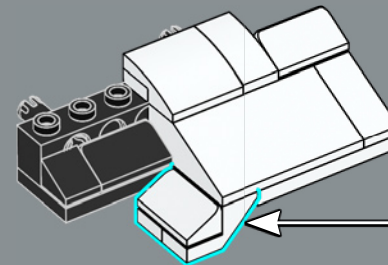
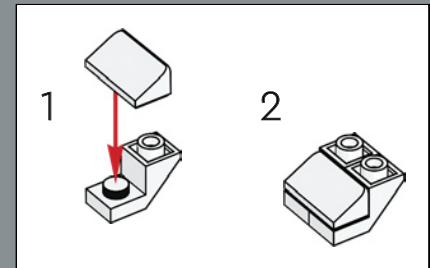

344

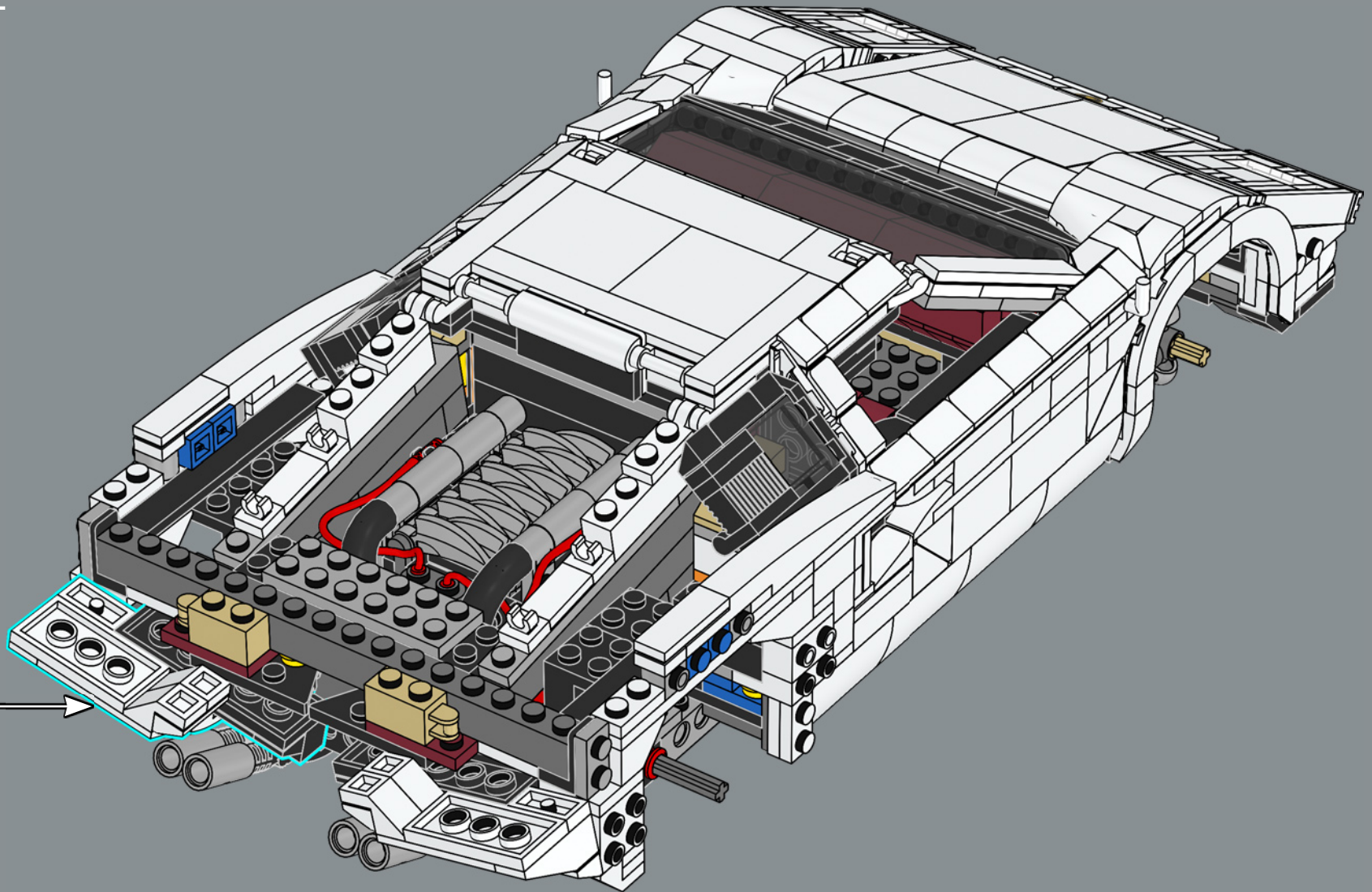

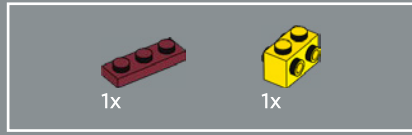
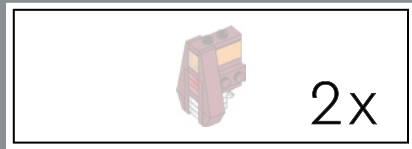

345

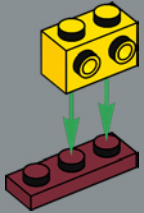

346

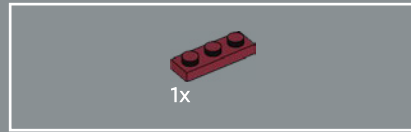
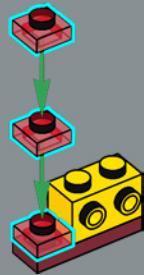

347

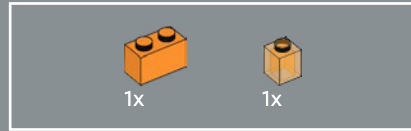
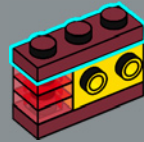

348

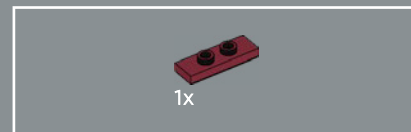

349

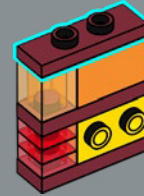

350

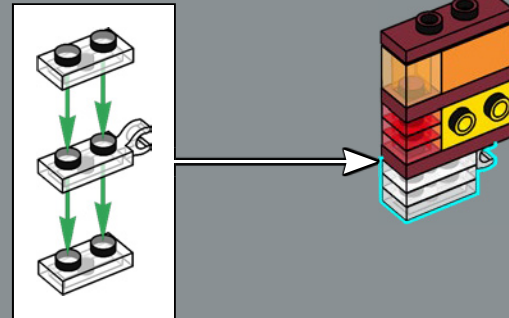
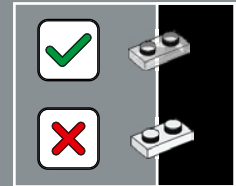



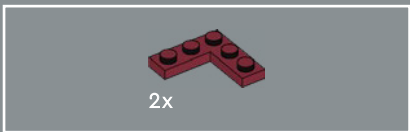

351

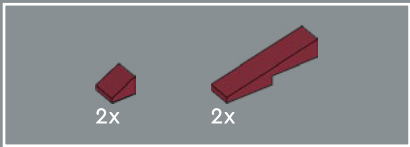
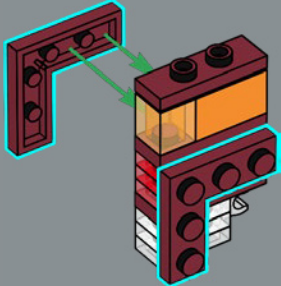

352

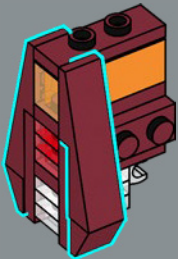

2x

353

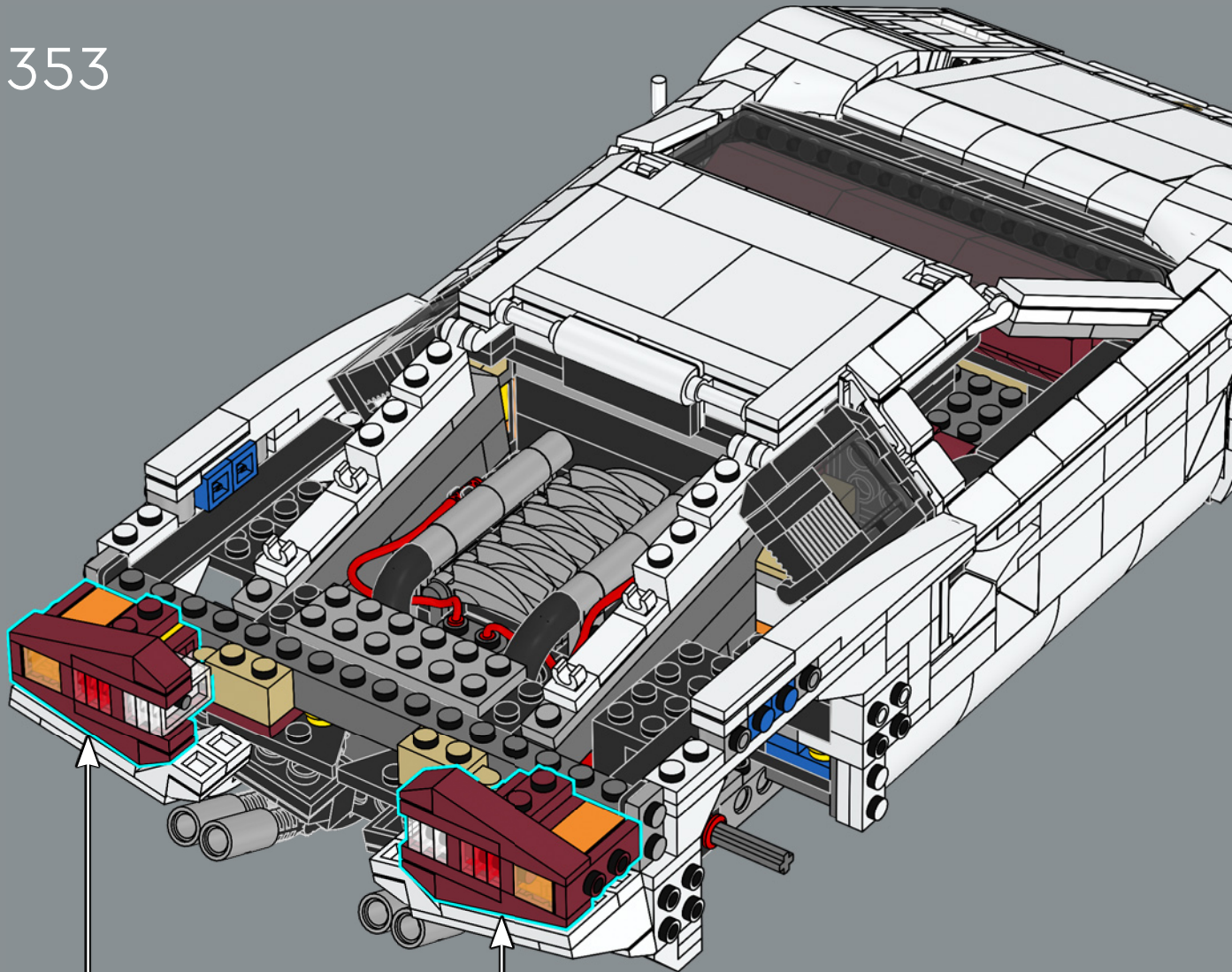

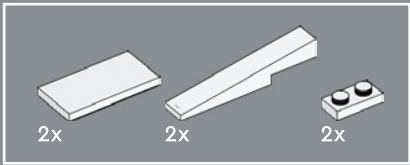

354

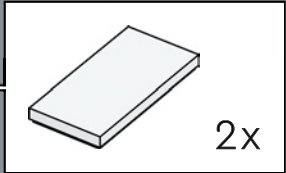
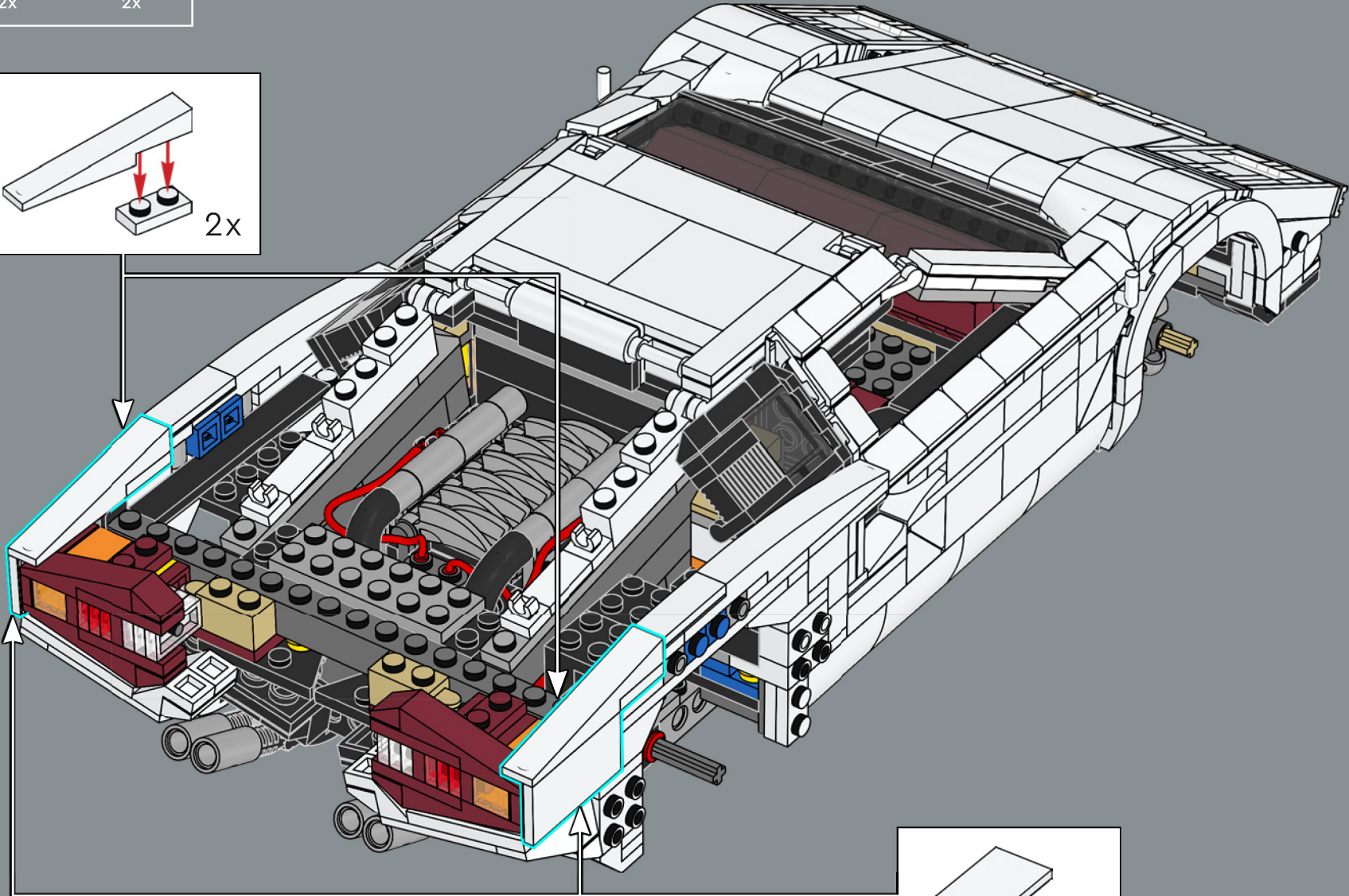
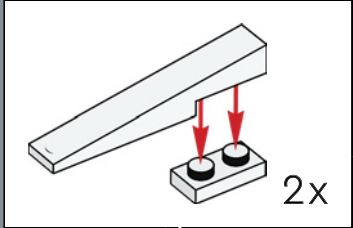



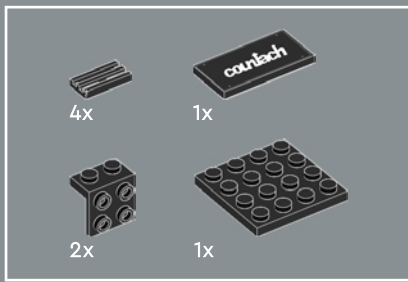

355

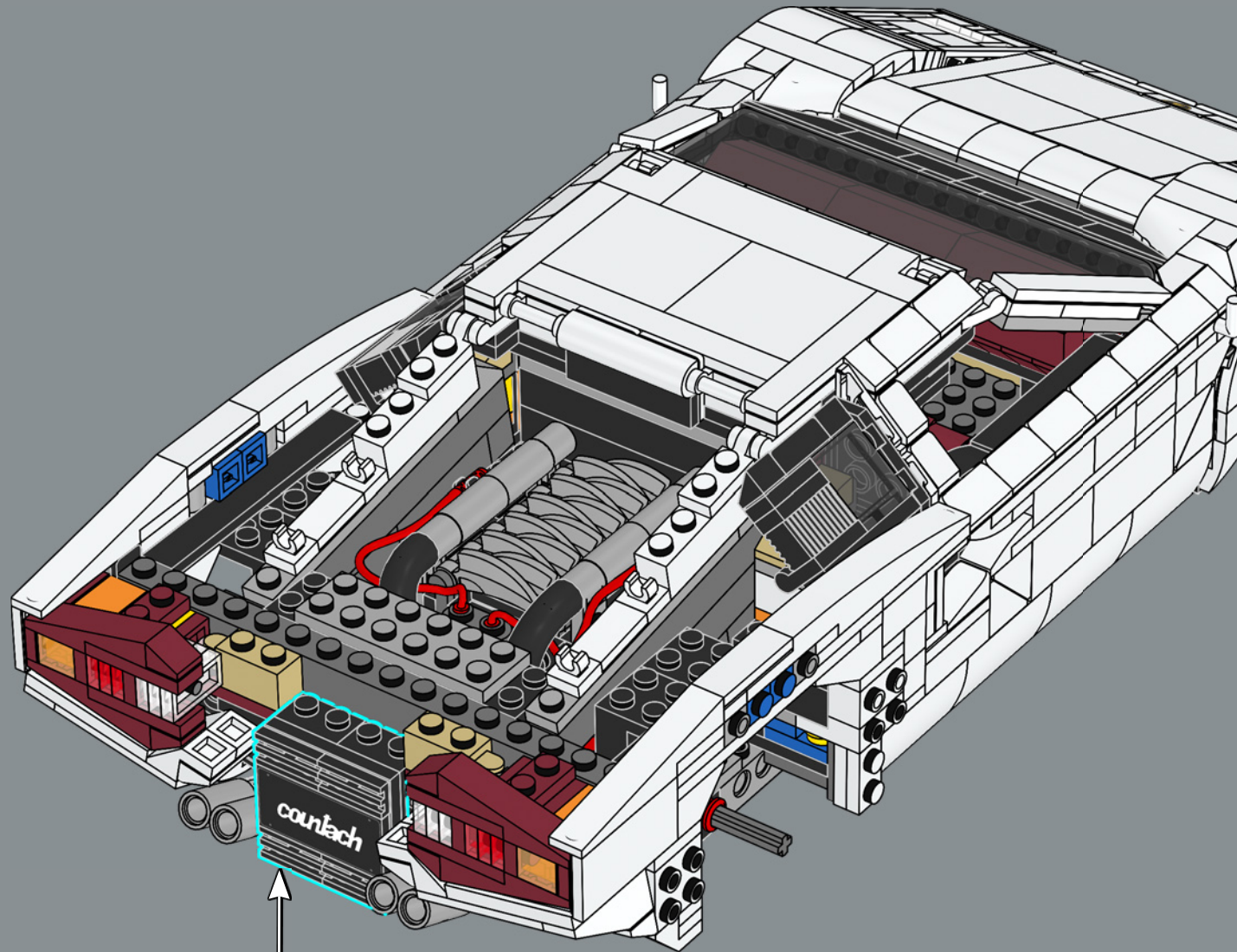
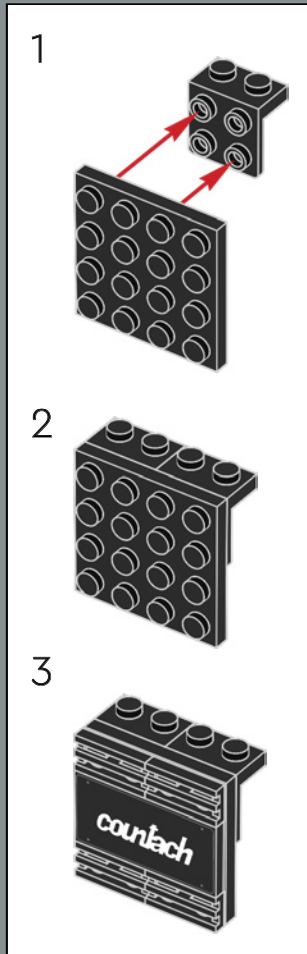



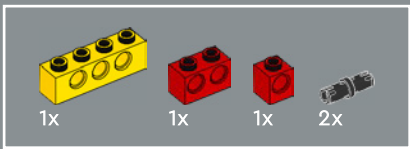

356

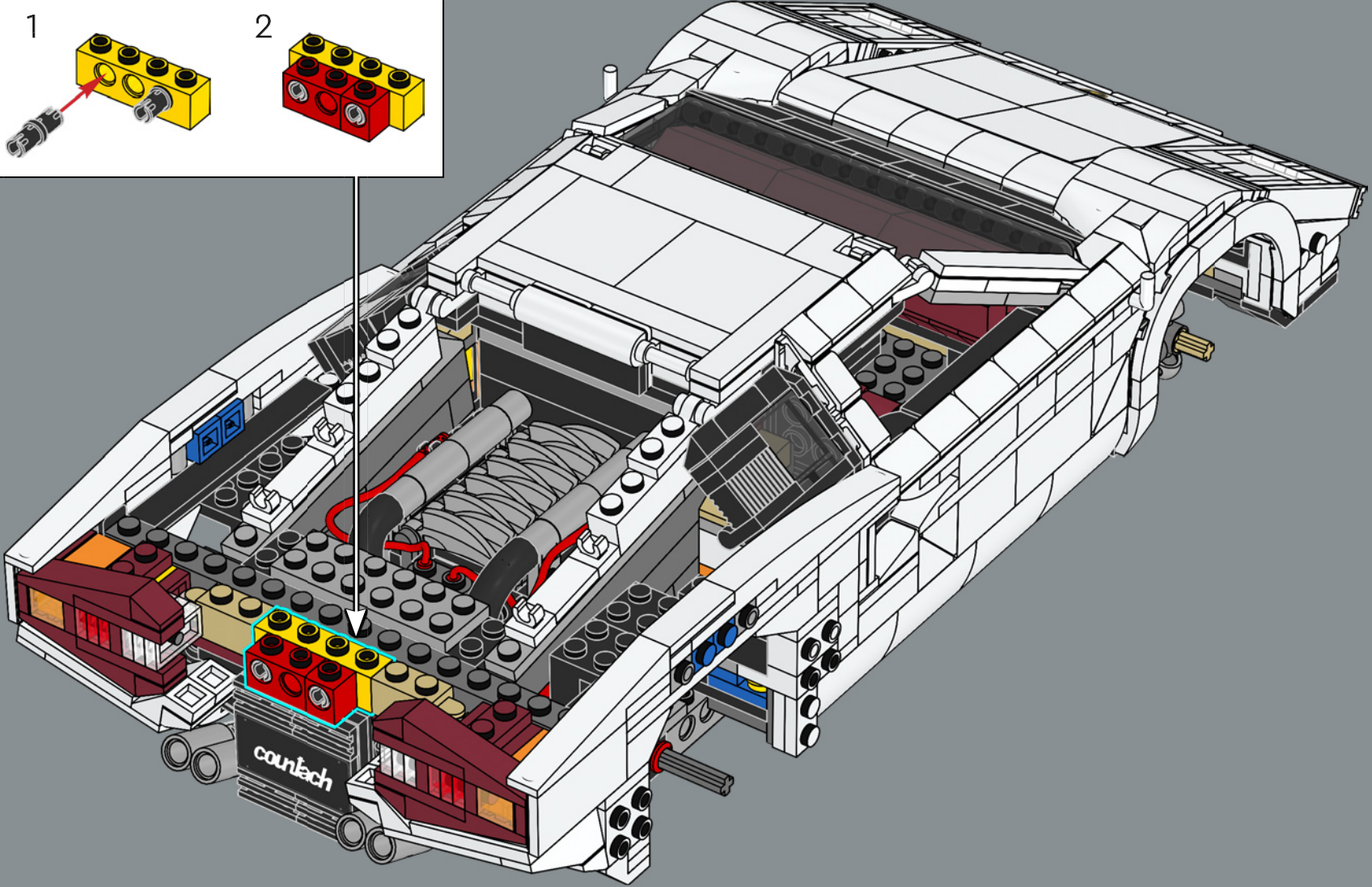
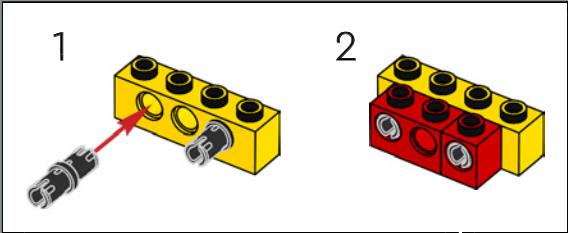

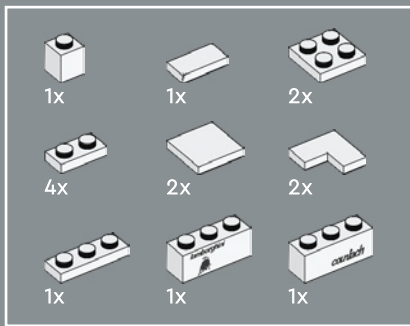

4

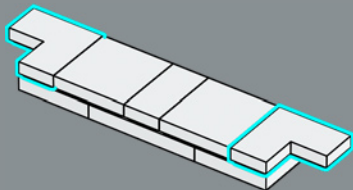

357

1

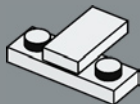

2

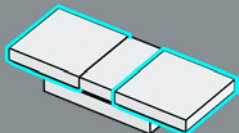

3

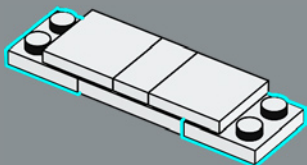

5

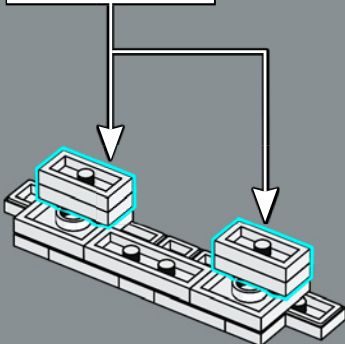
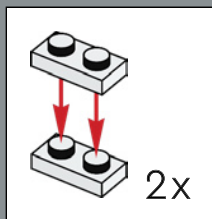

6

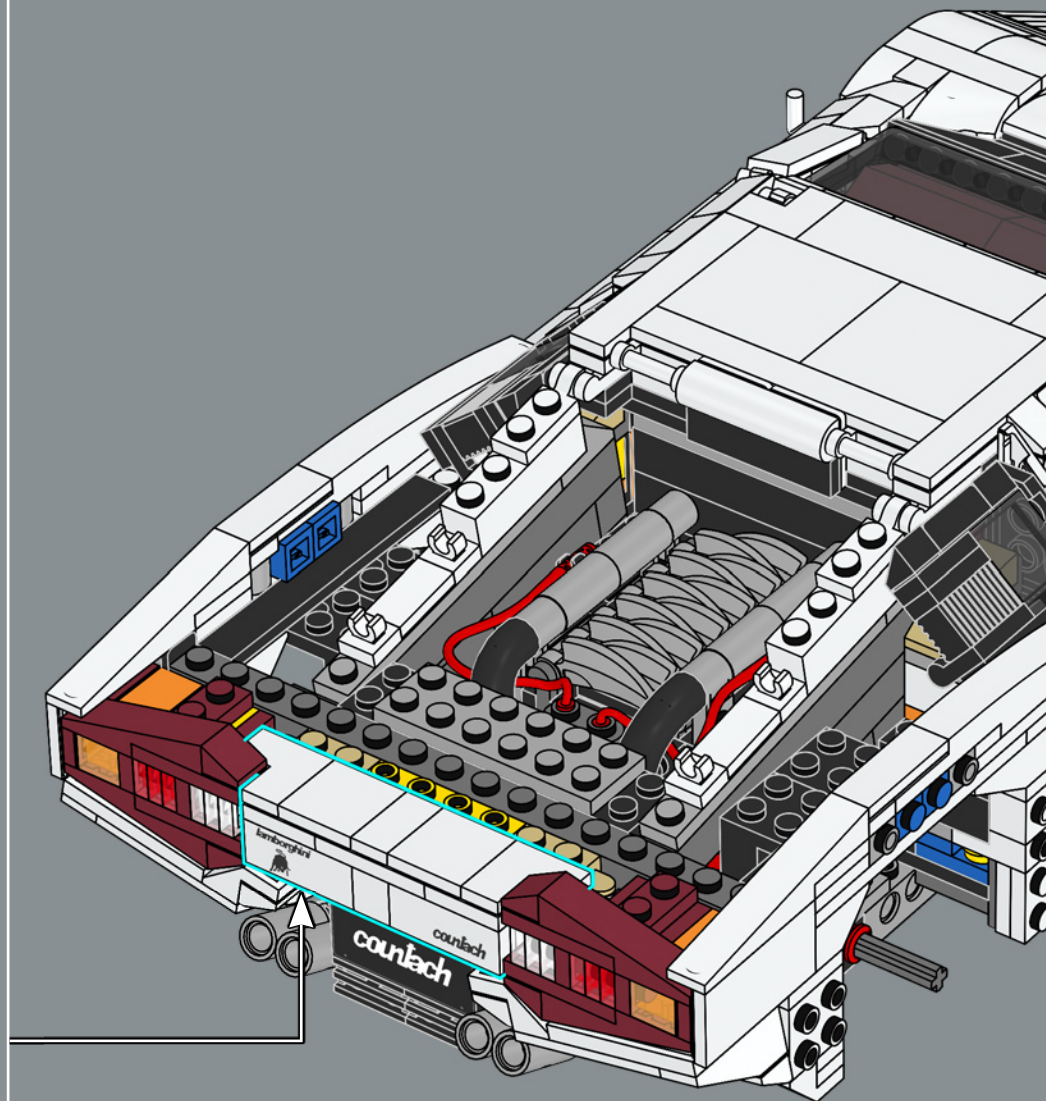
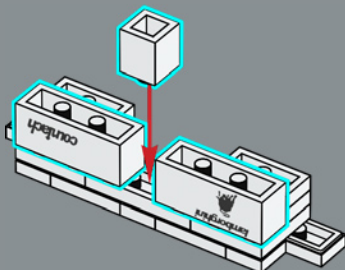



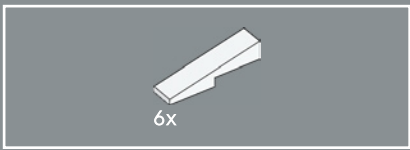

# 358



A new LEGO® slope element helps recreate short, shallow angles in the iconic design.

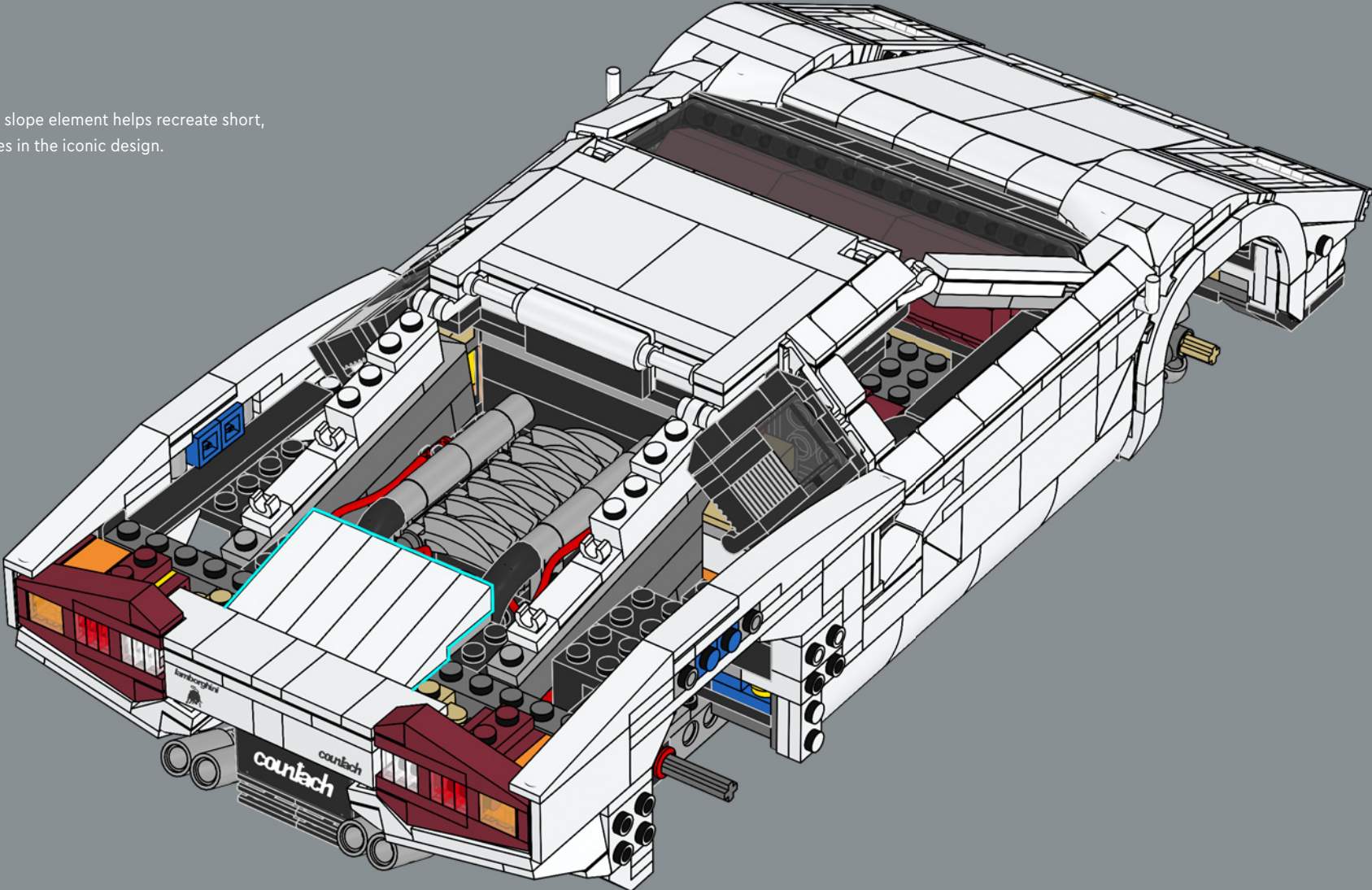



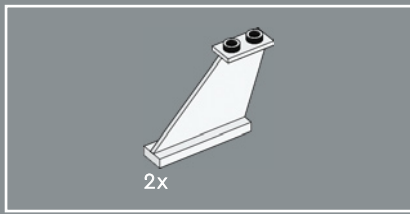

359

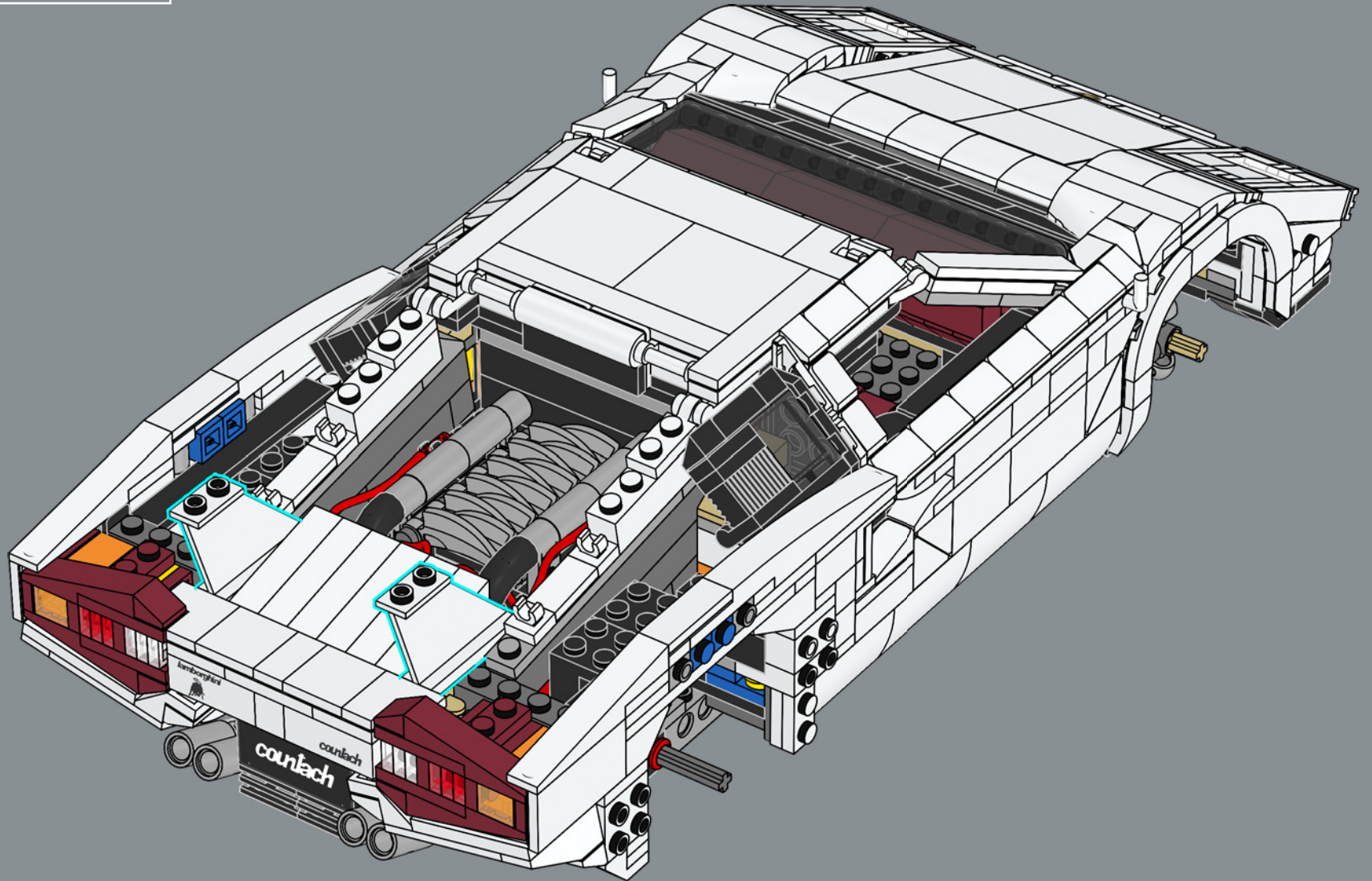





362

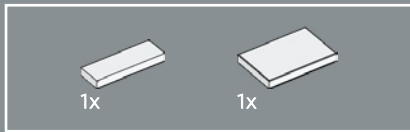
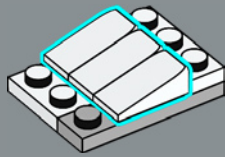

363

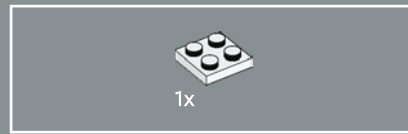
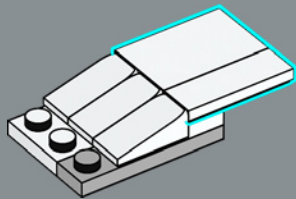
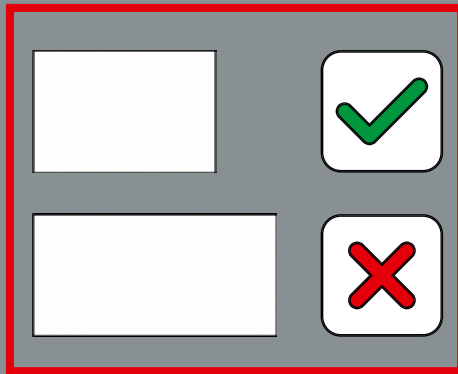

364

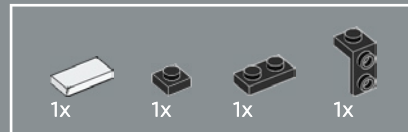
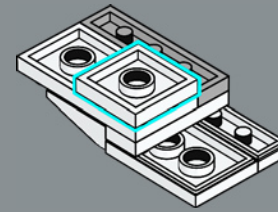

365

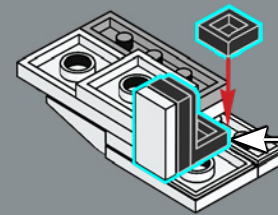
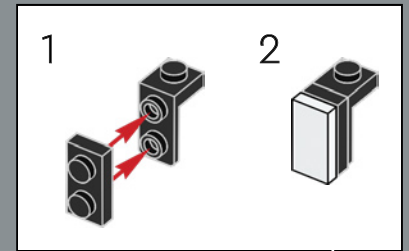





366

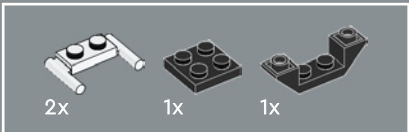
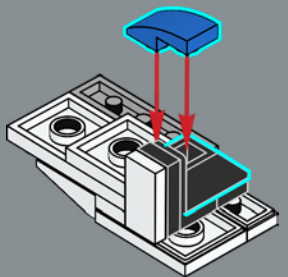

367

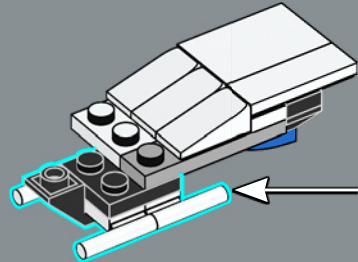
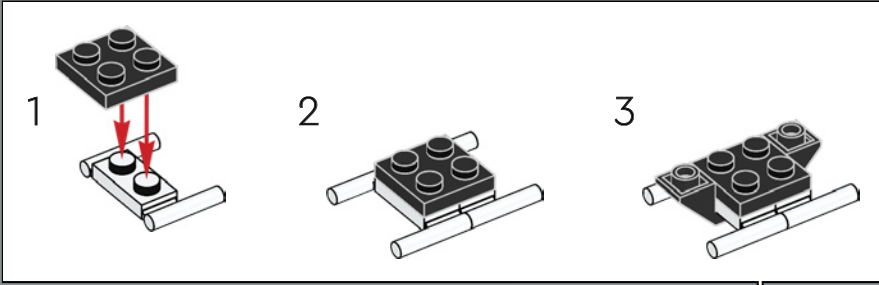



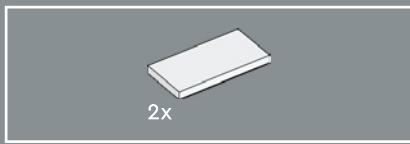

369

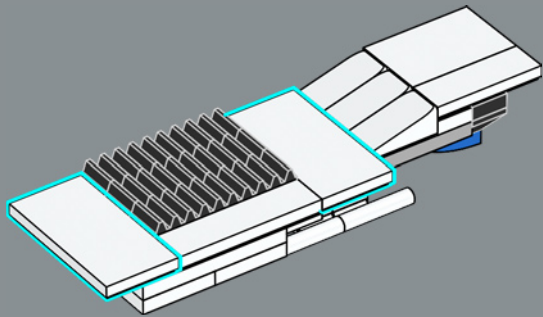
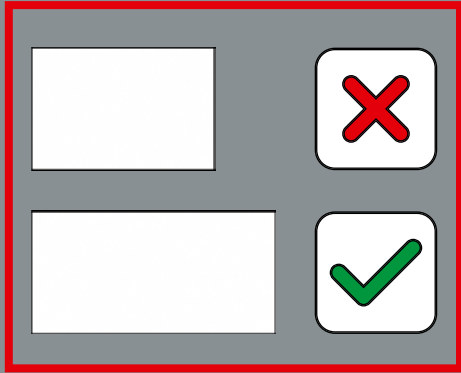

370

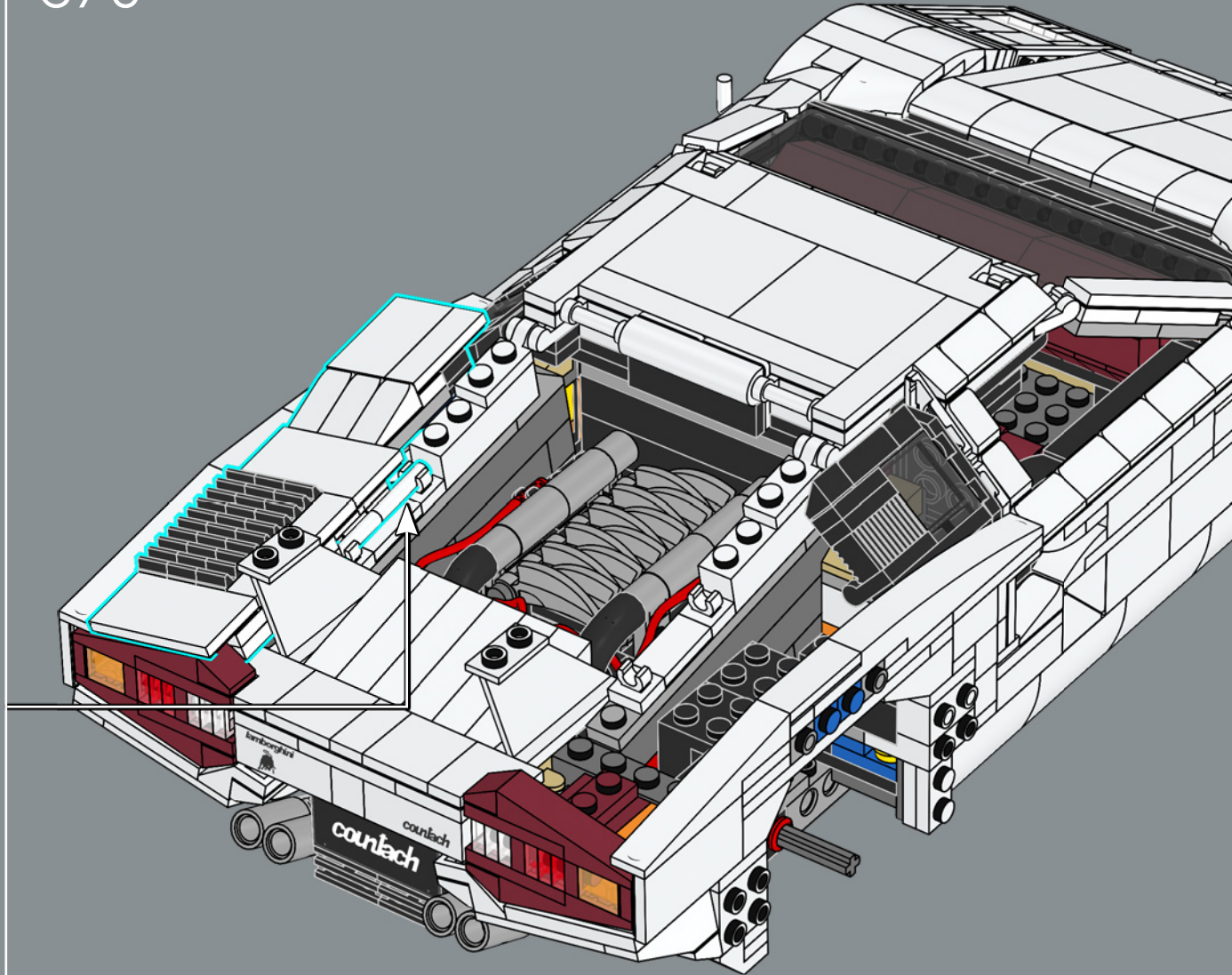



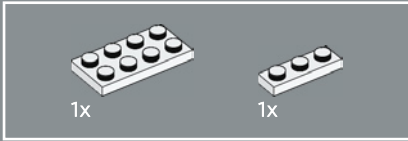
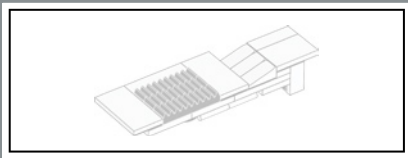

371

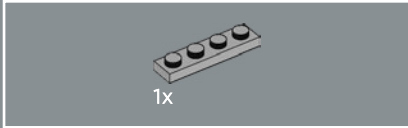
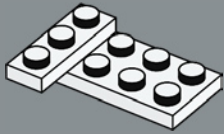

372

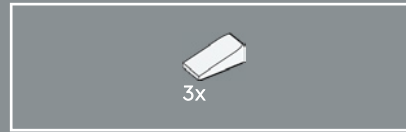
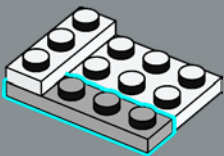

373

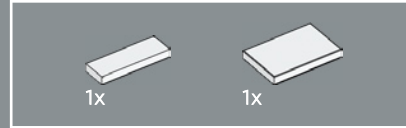
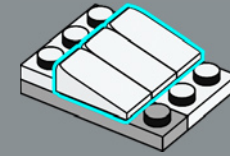

374

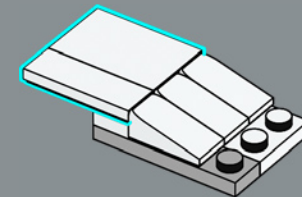
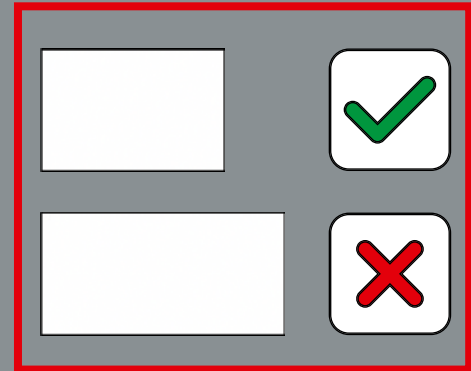

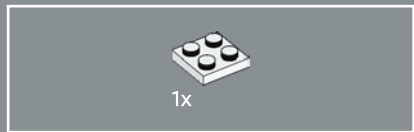

375

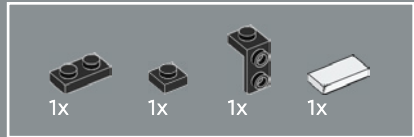
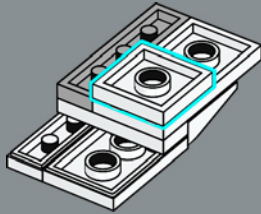

376

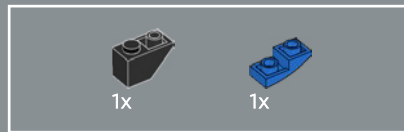
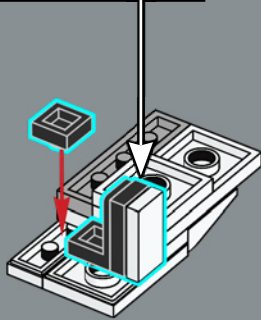
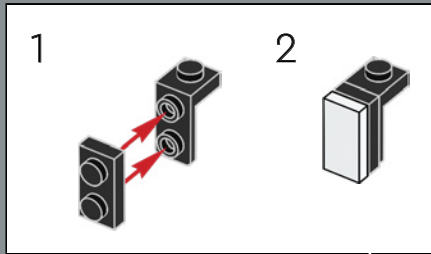

377

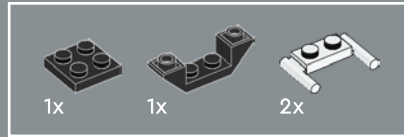
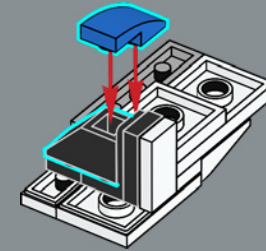

378

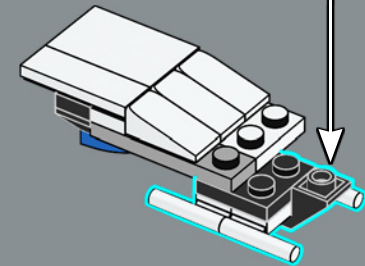
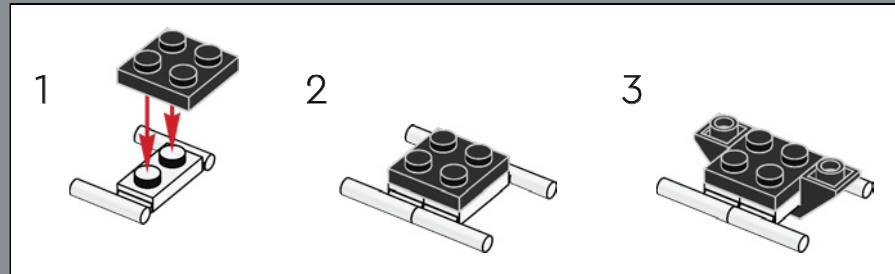

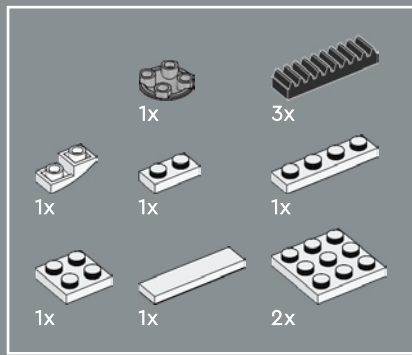

379

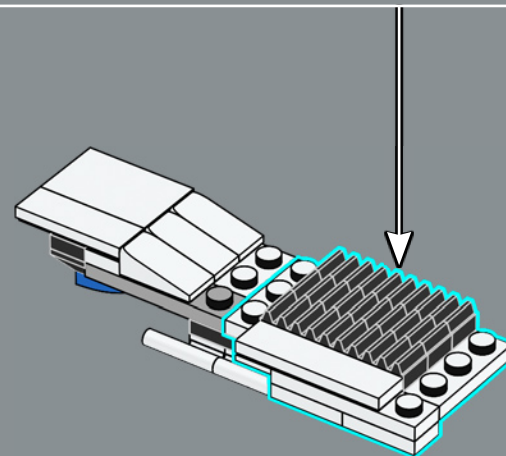
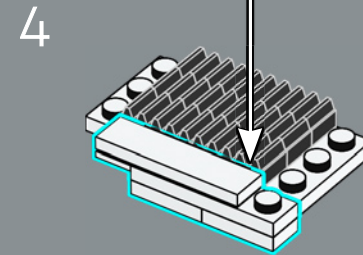
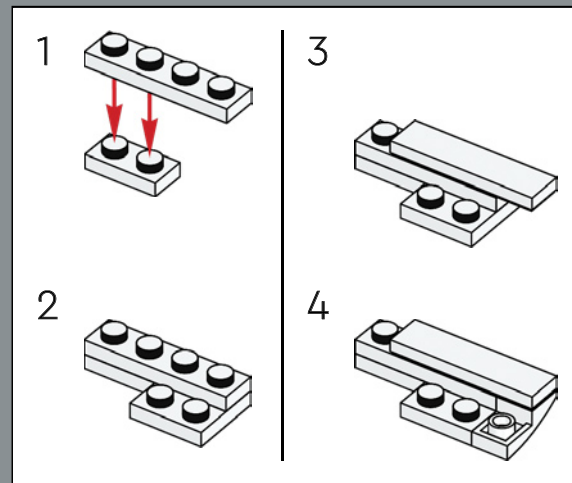
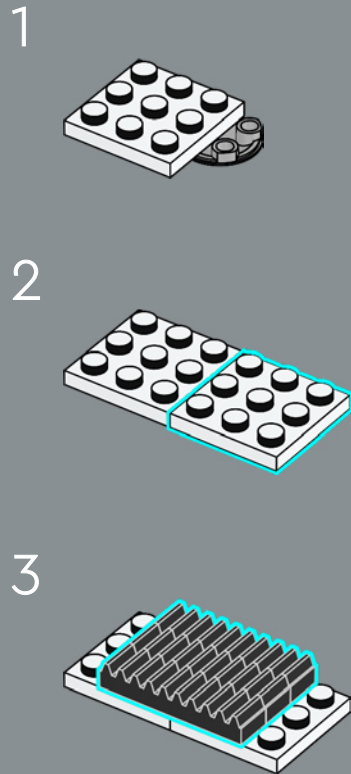



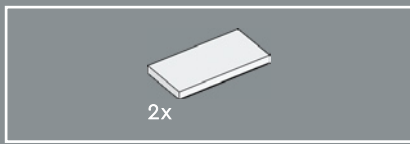

380

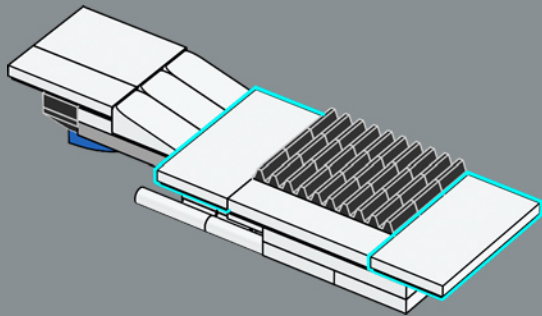
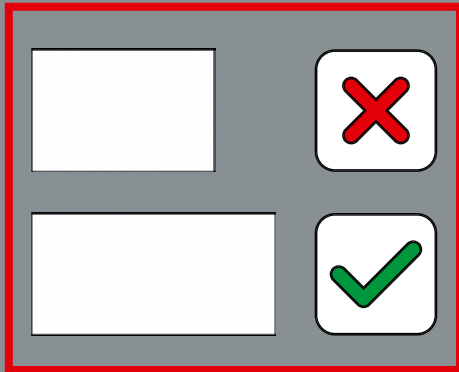

381

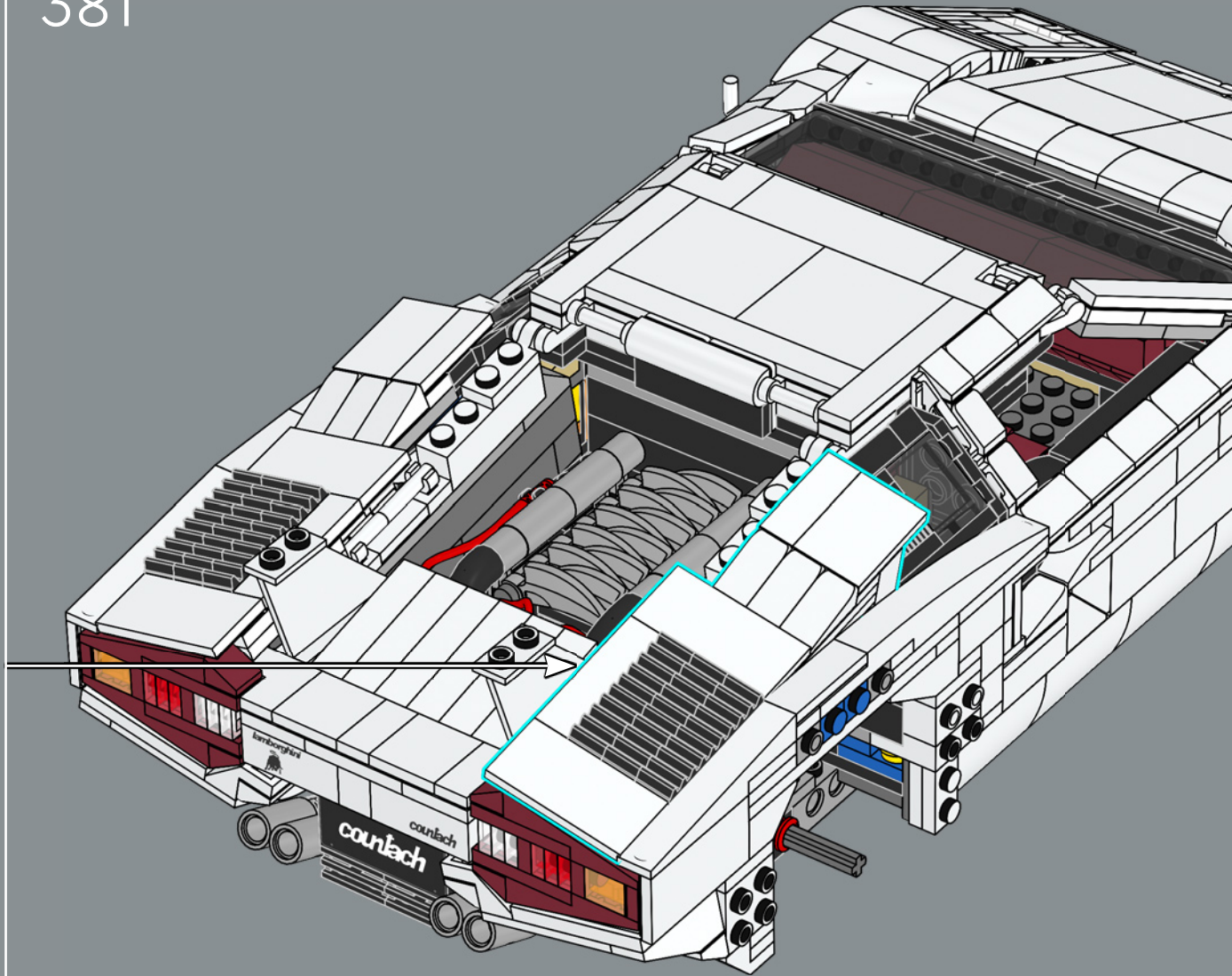

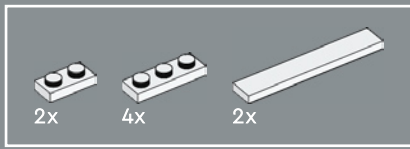

382

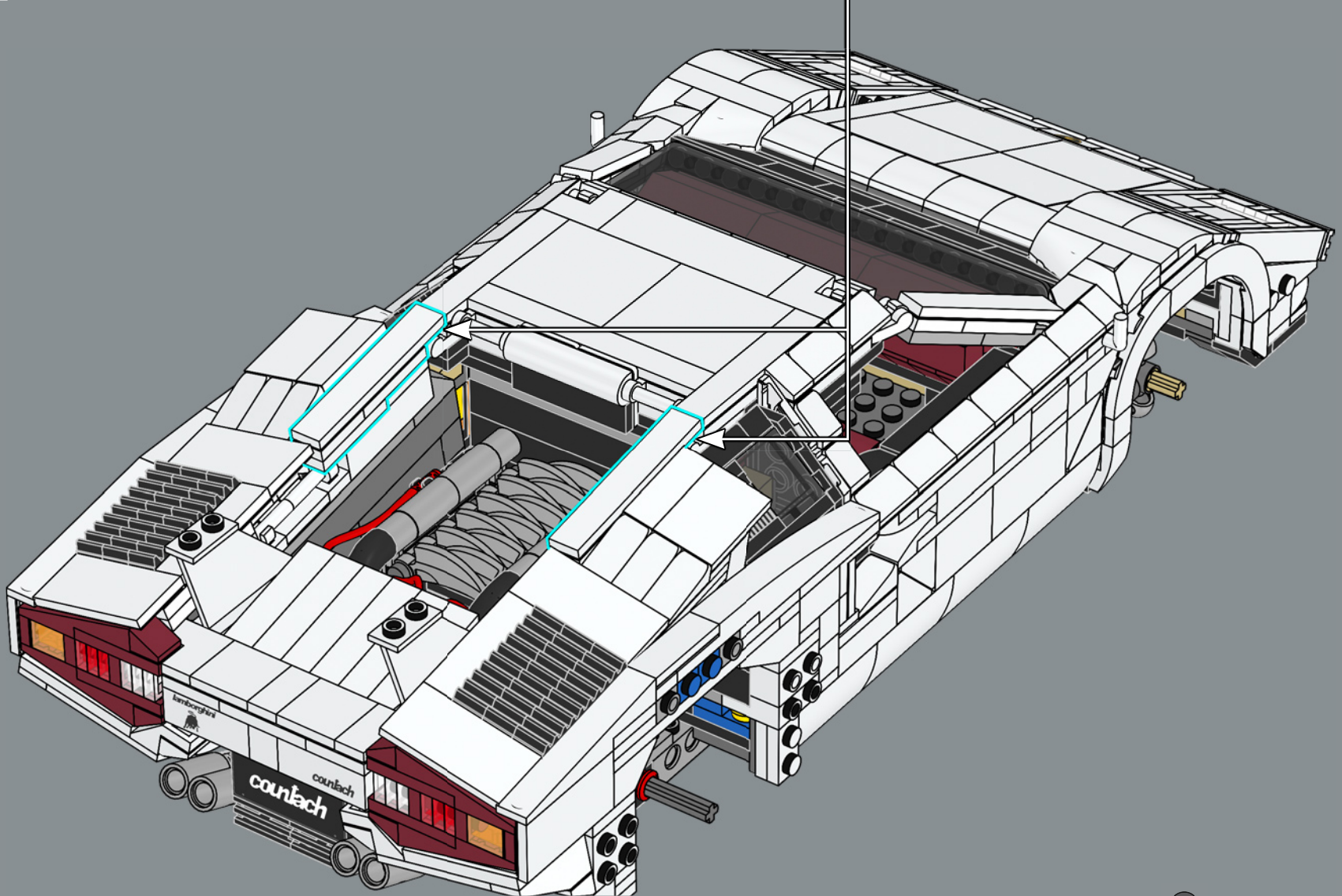
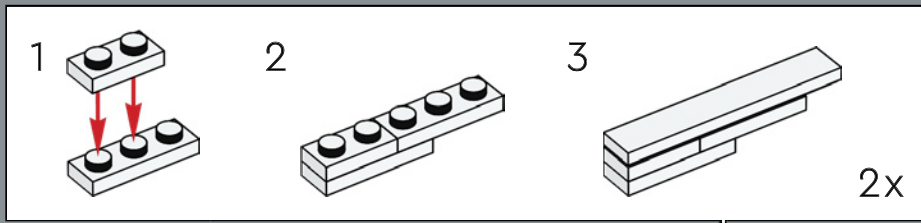

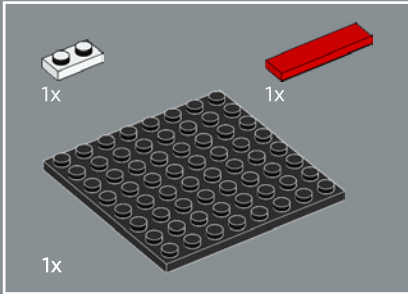
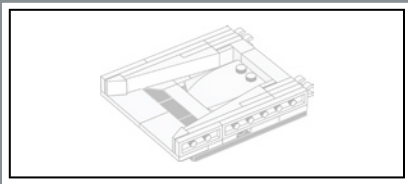

383

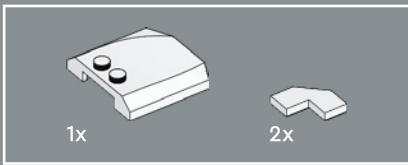
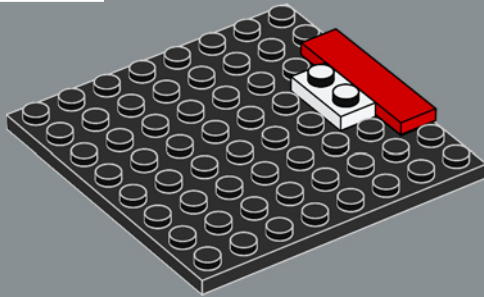

384

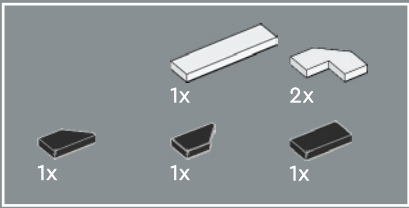
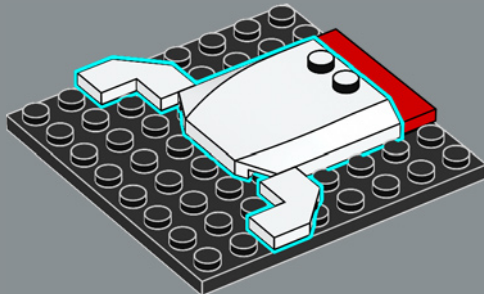

385

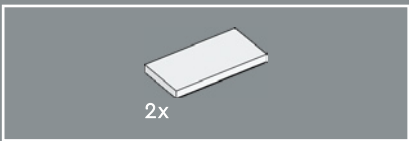
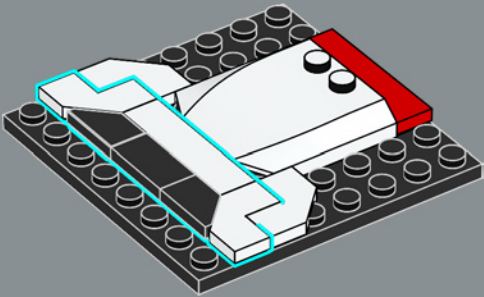

386

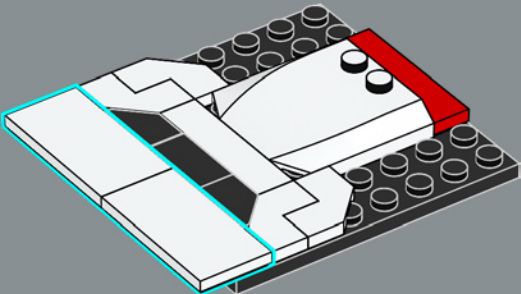



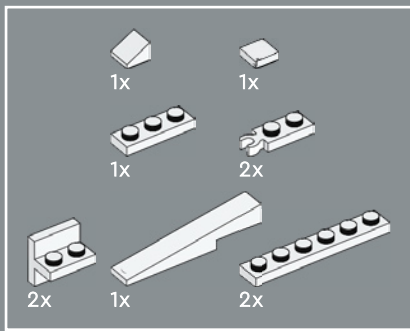

387

1

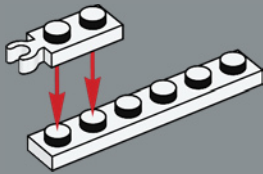

2

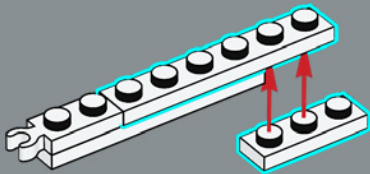

3

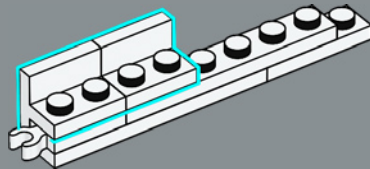

4

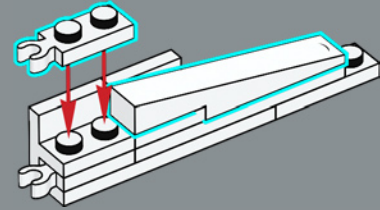

5

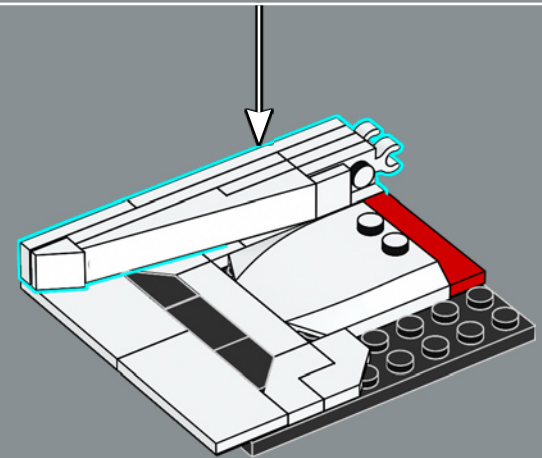
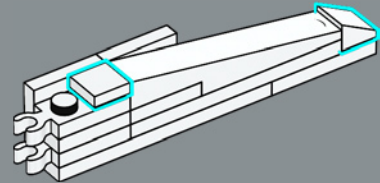

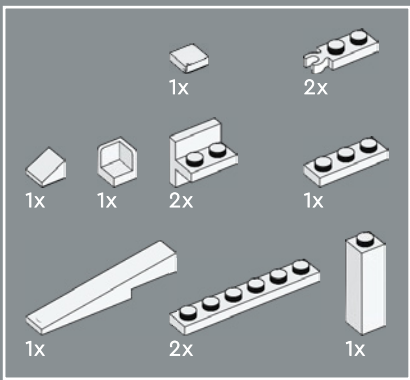

388

1

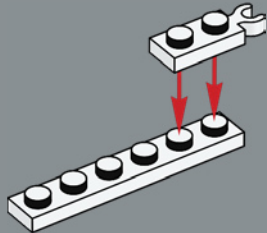

2

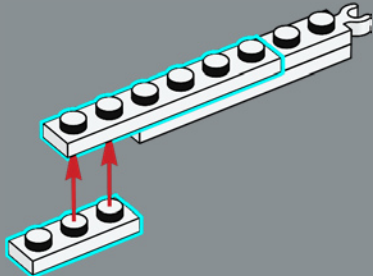

3

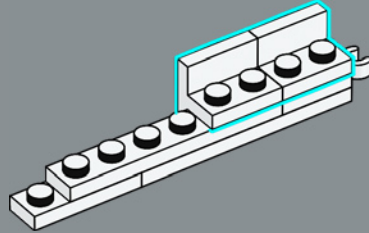

4

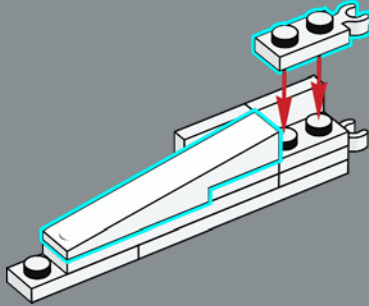

5

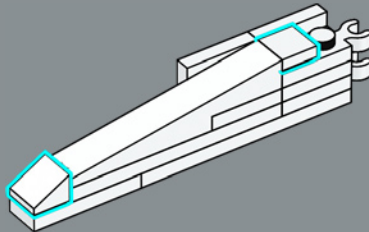

6

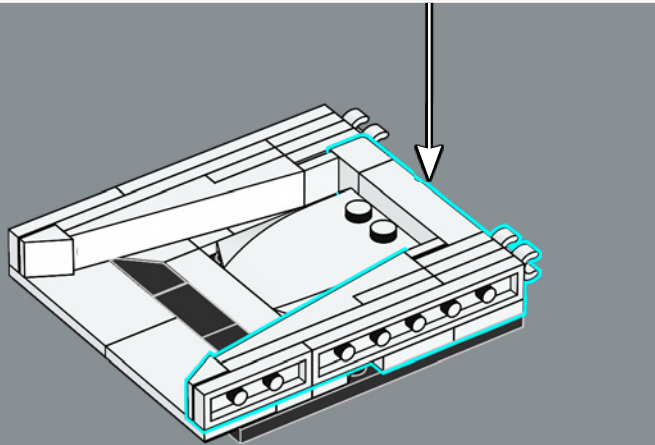
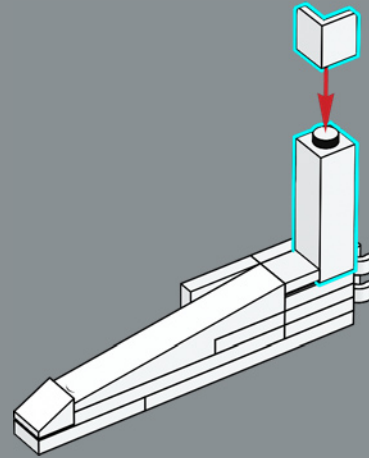

389

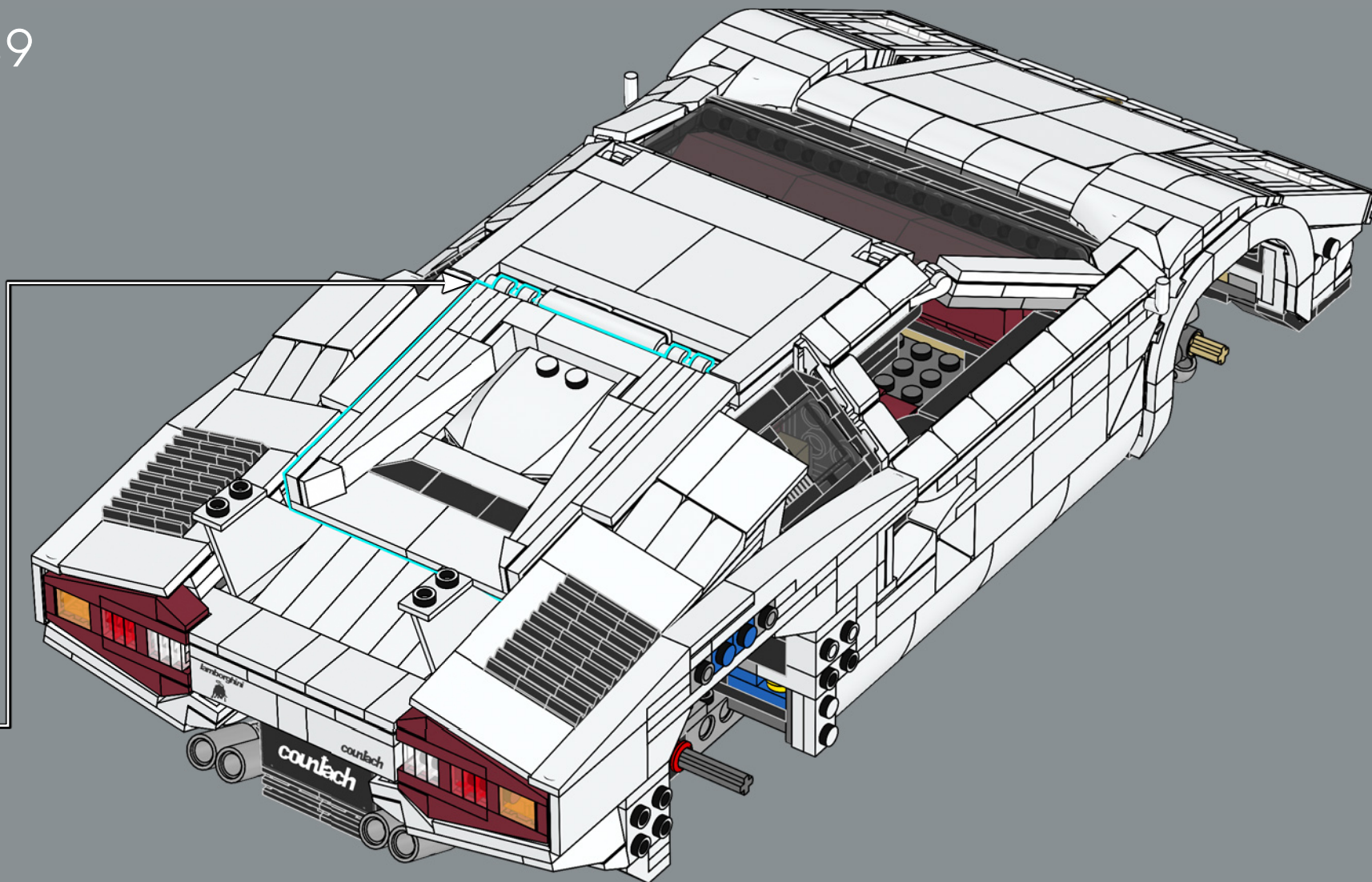



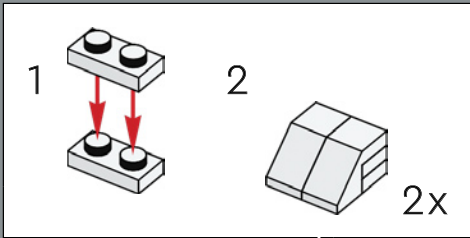
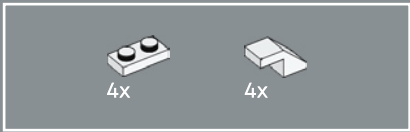

390

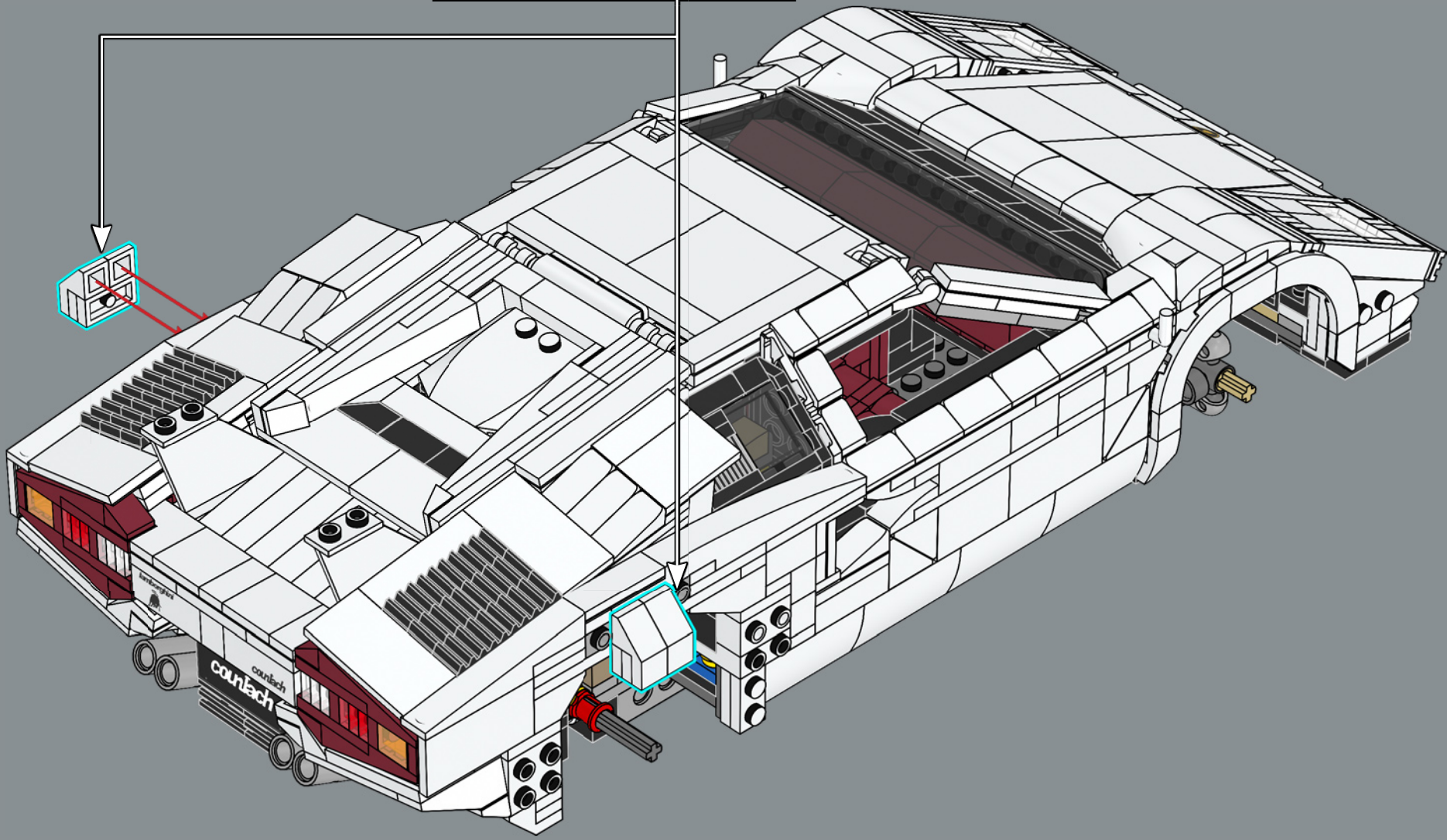



A new cone-shaped LEGO® element helps recreate the characteristic wing.

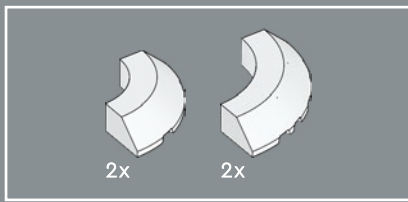

391

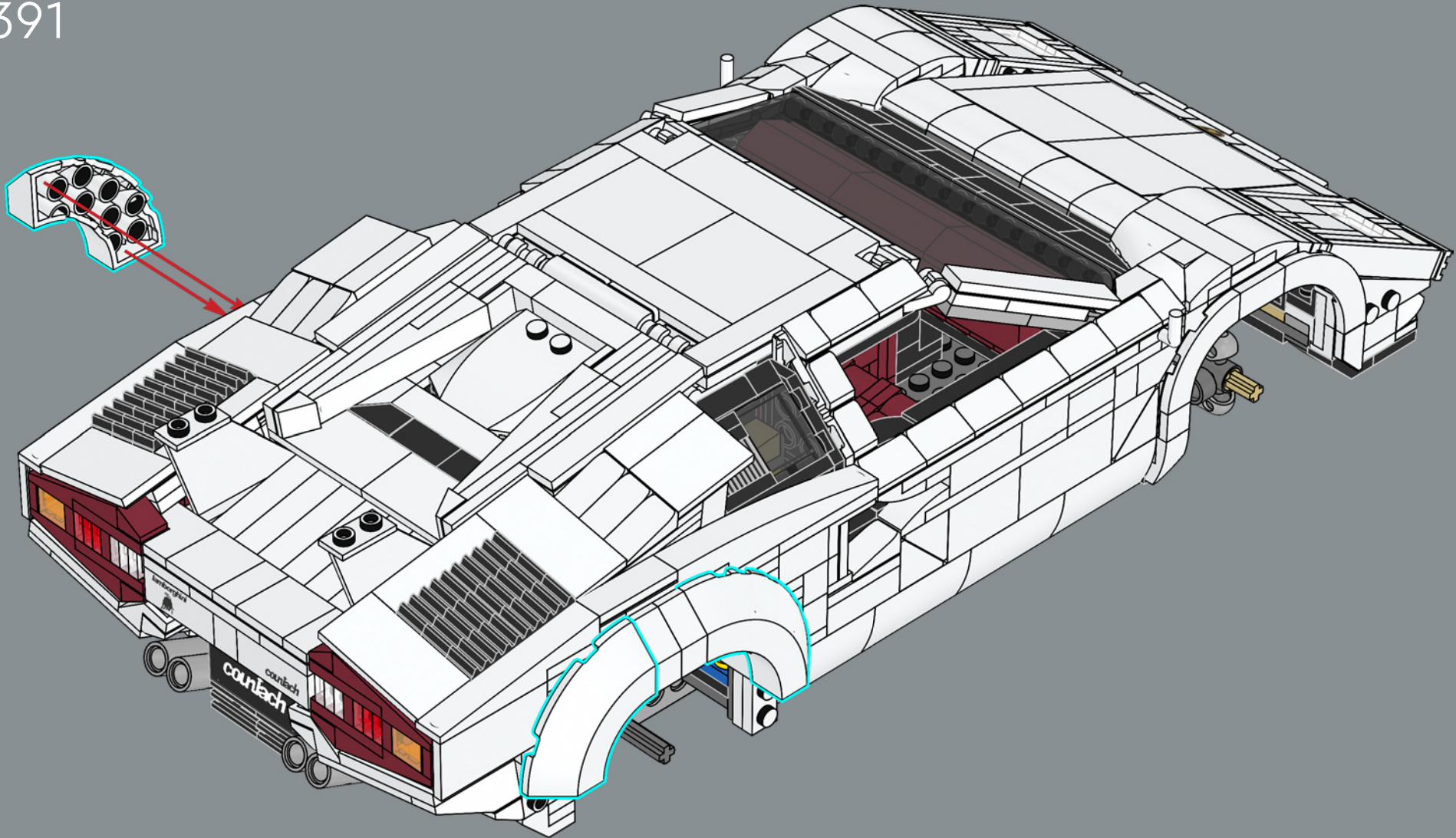





392

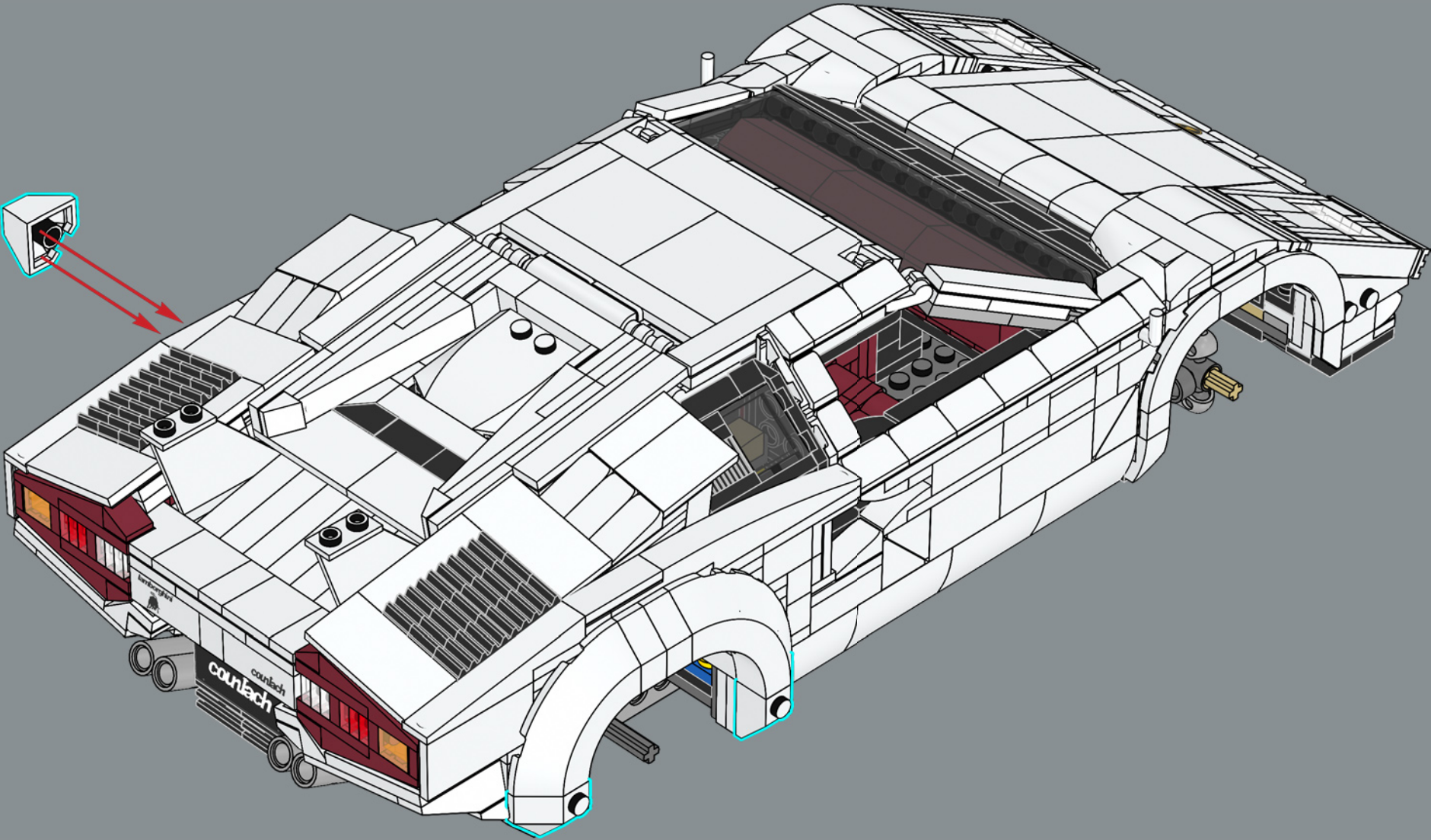



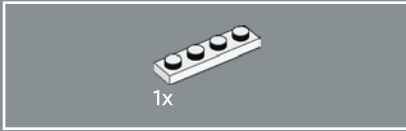
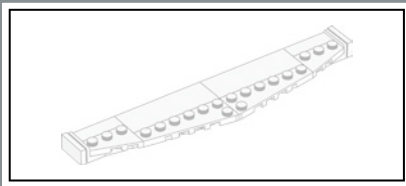

1x

393

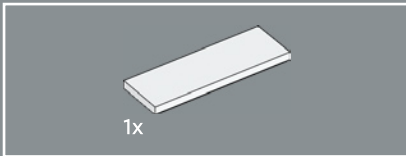

1x

394

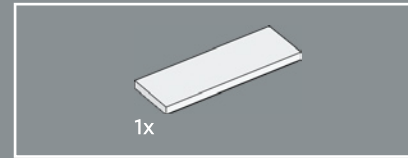
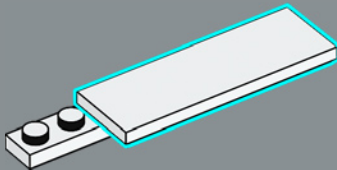

1x

395

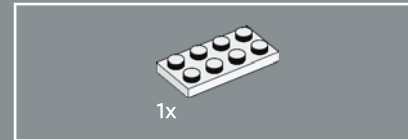
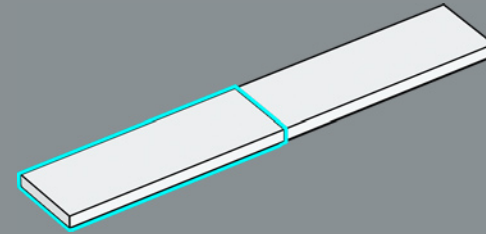

1x

396

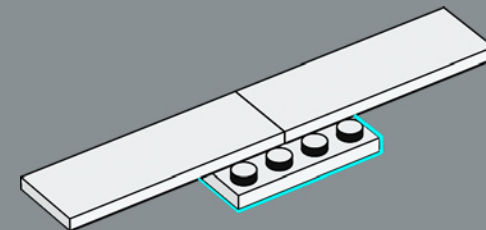

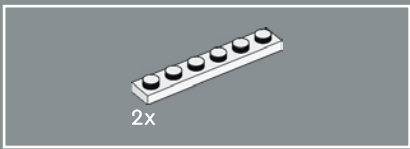

397

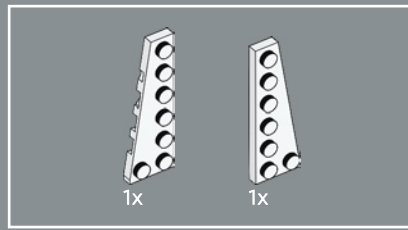
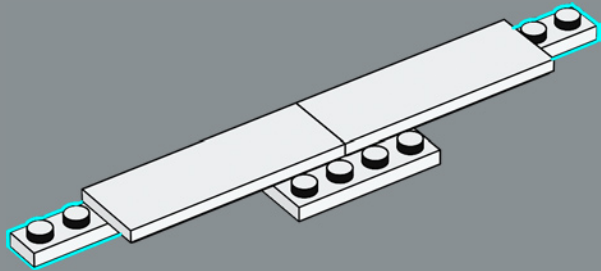

398

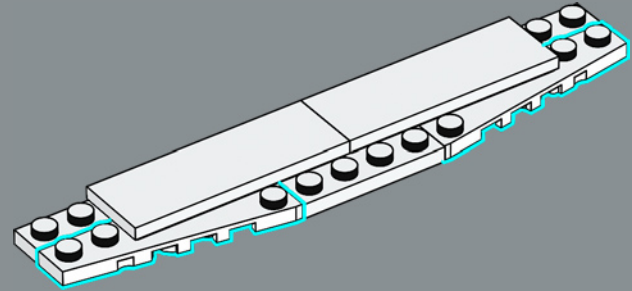

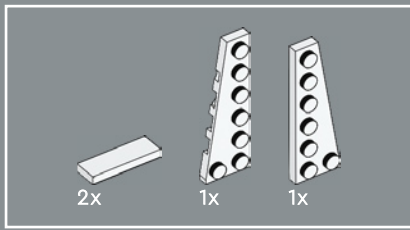

399

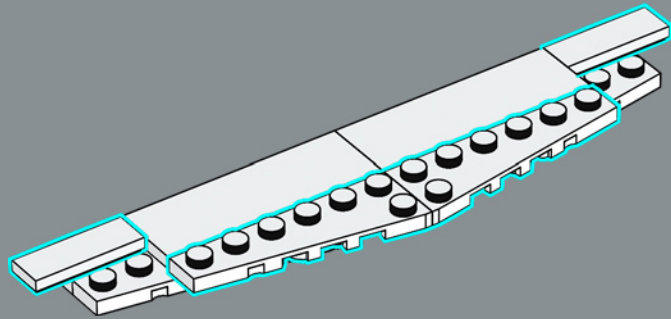

400

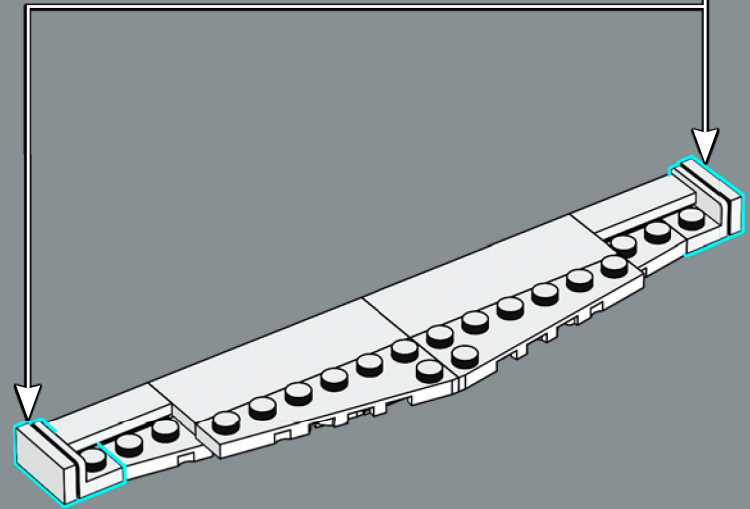
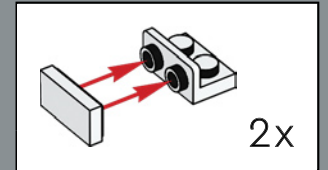



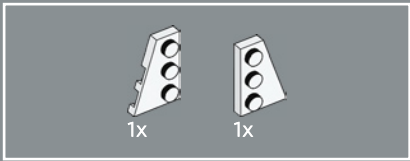

401

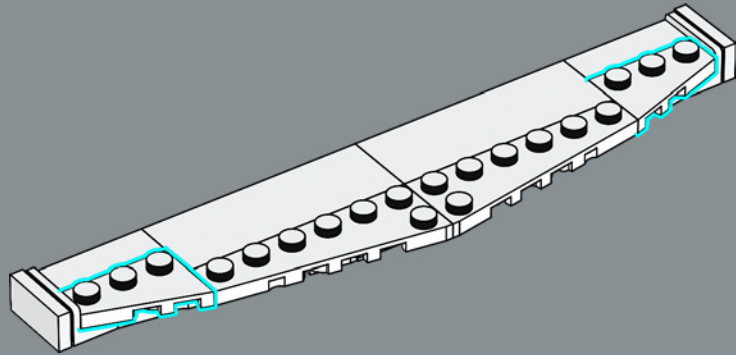

402

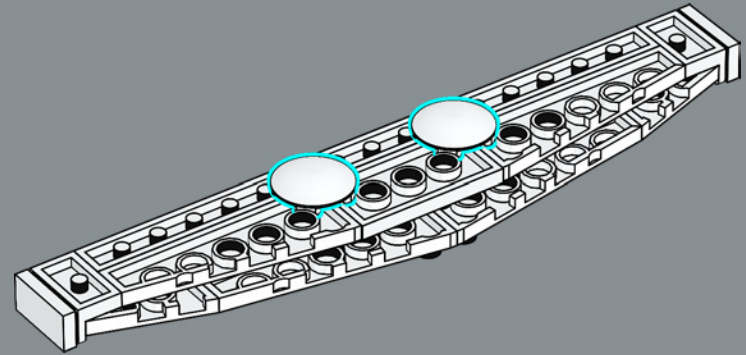

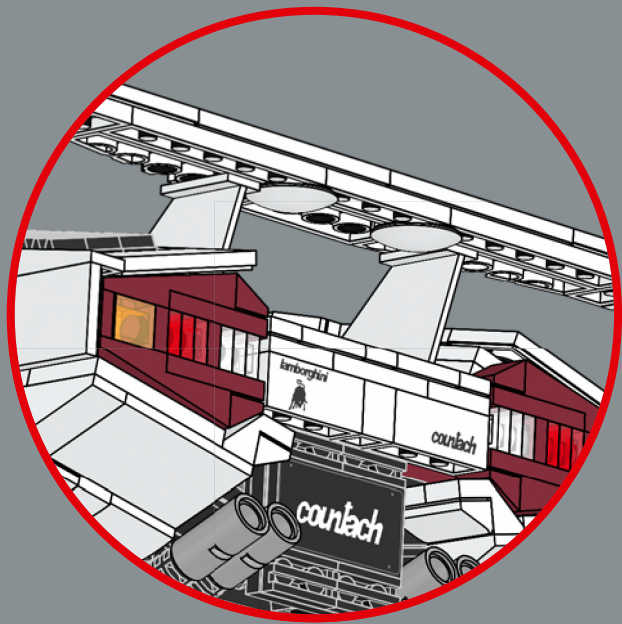

403

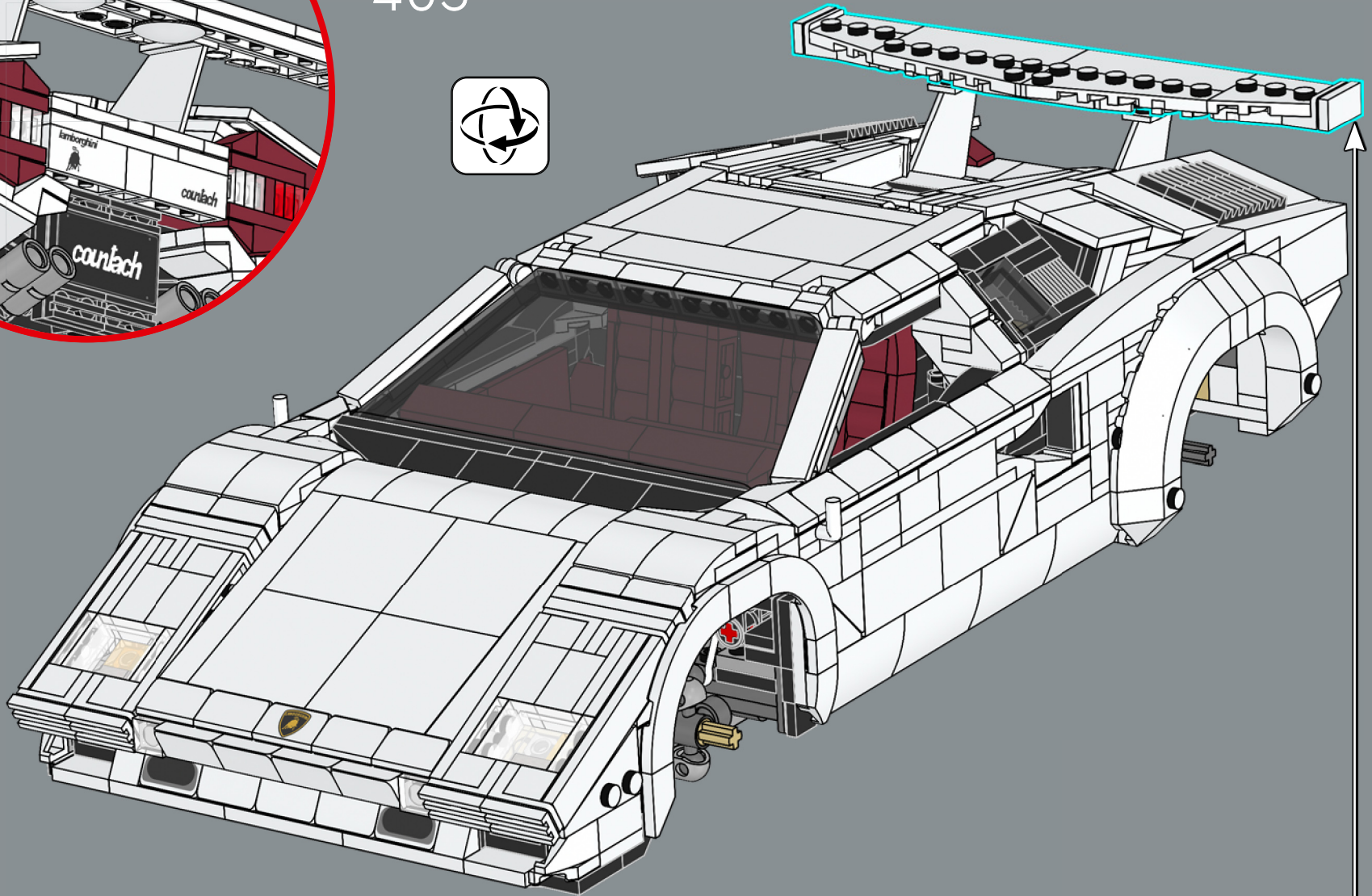

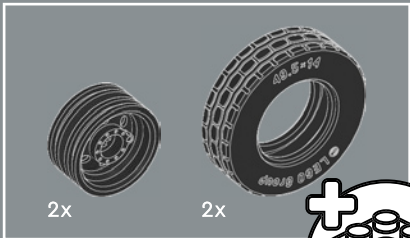

404

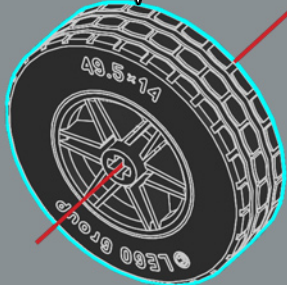
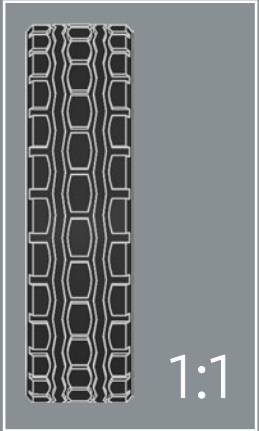
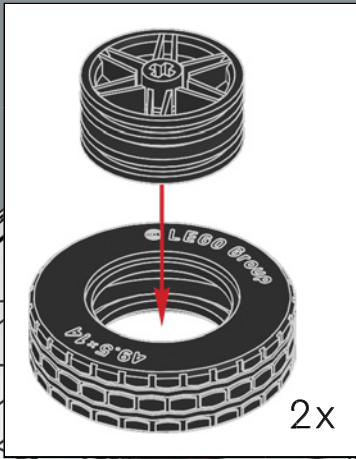
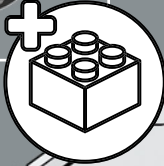



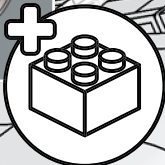
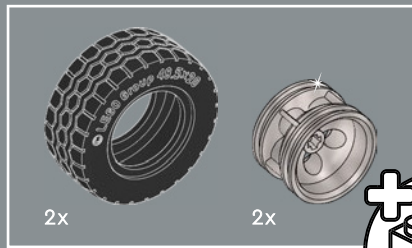

405

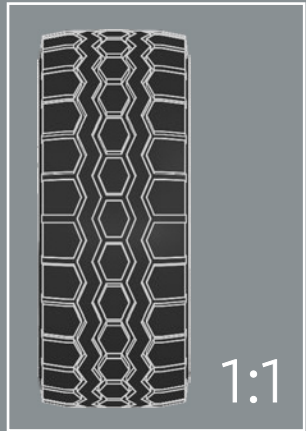
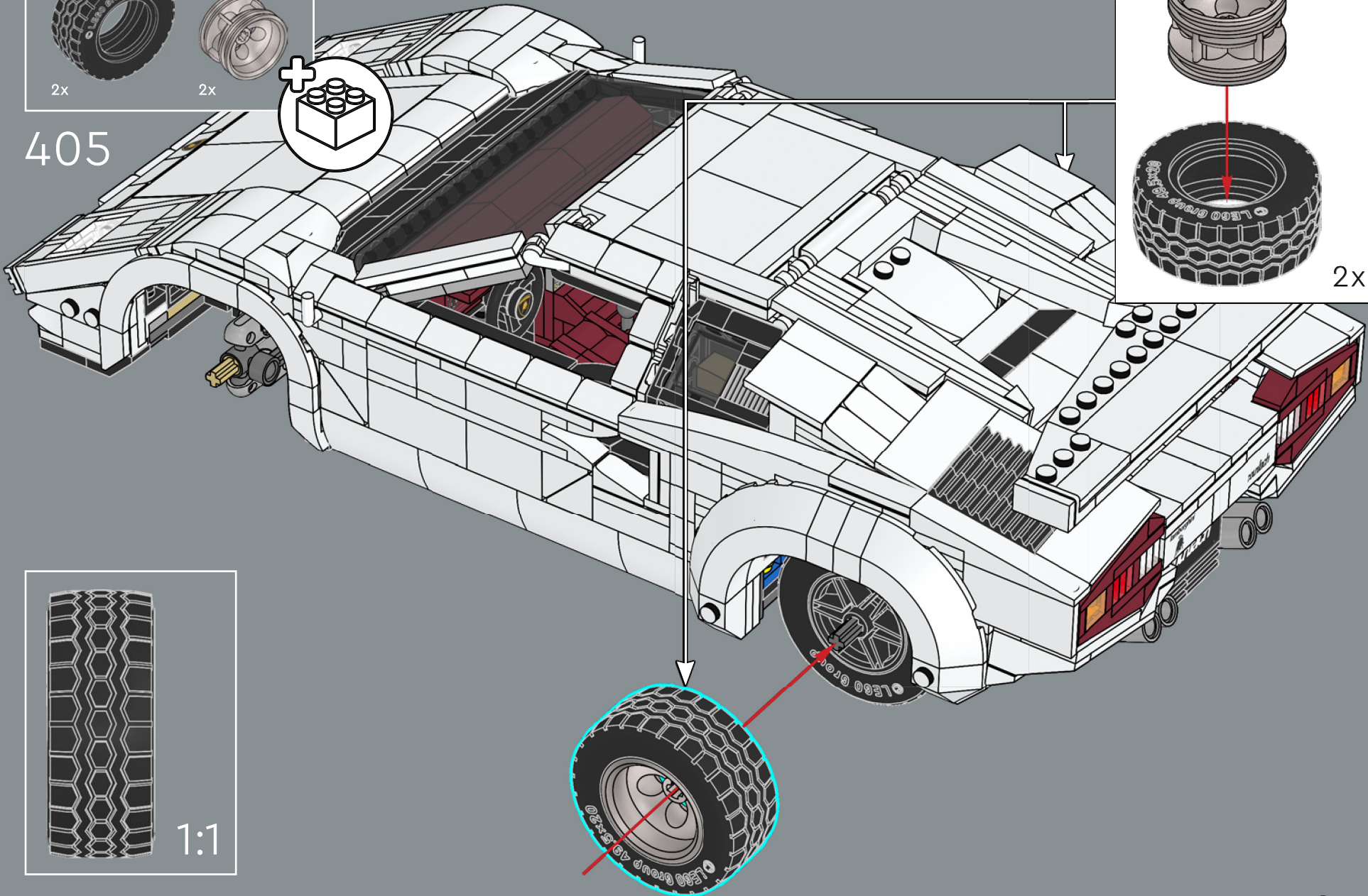
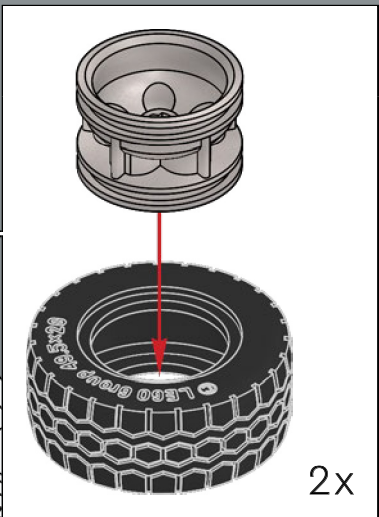



A new rim accommodates steering and a deep contour in the back wheels.



2x



2x

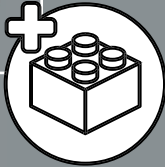

406

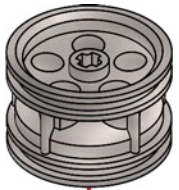

2x

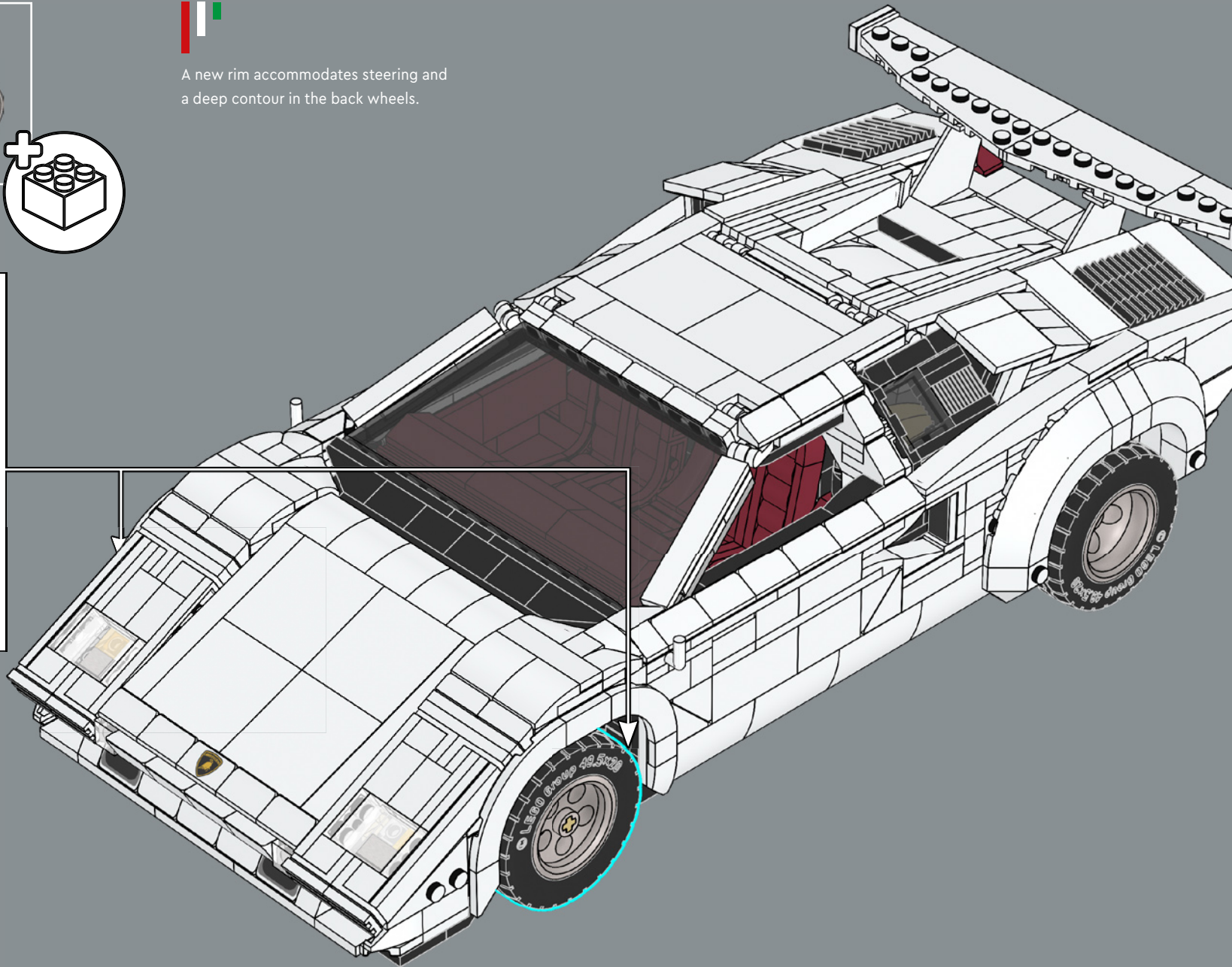





407

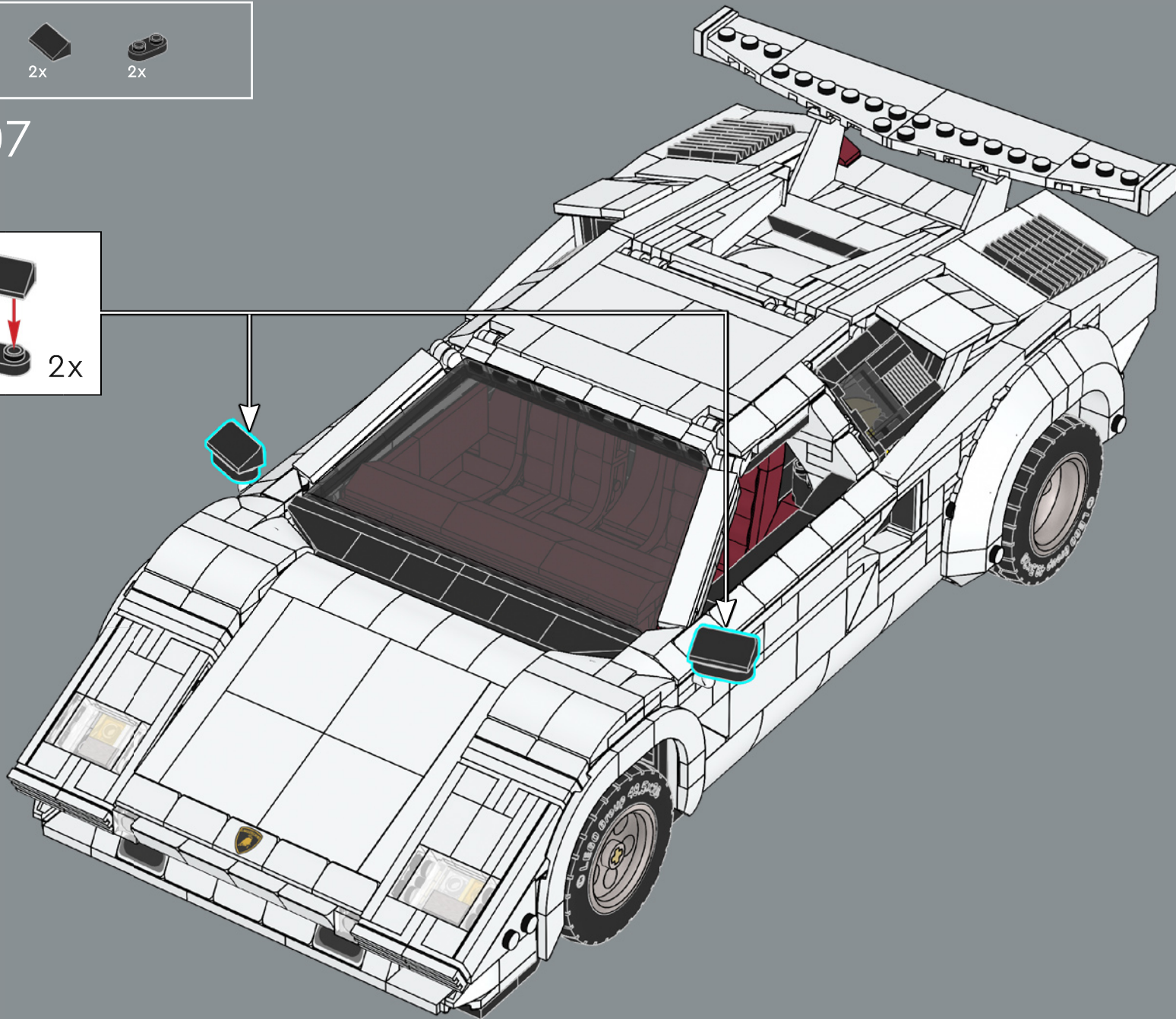
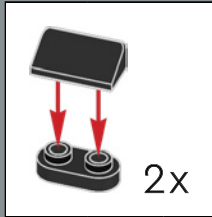



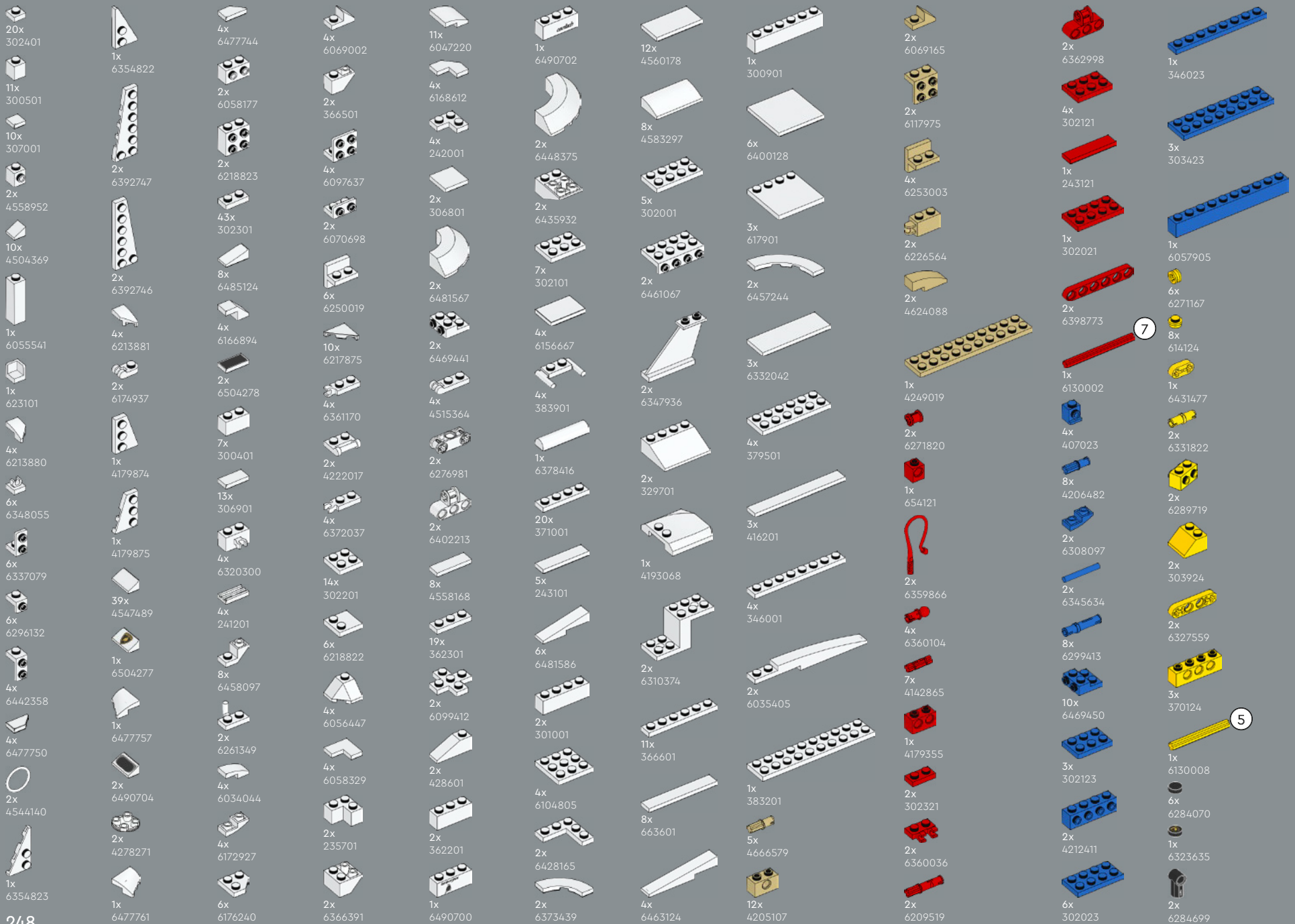



6x  
6448793

2x  
6284071

2x  
6308012

2x  
4211525

2x  
4278273

8x  
6173127

18x  
4211398

2x  
4211388

2x  
6326078

1x  
6329662

2x  
4593679

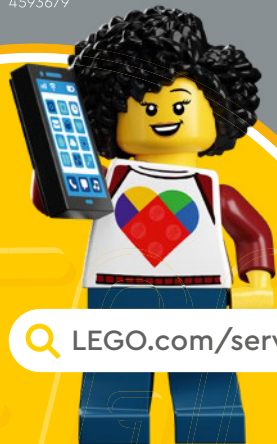

LEGO.com/service

2x  
4211469

2x  
6093859

2x  
6301870

4x  
4244627

12x  
6359723

4x  
6326478

3x  
4211397

2x  
4211353

2x  
4211815

2x  
4211881

3

2x  
6043639

6x  
6438836

4x  
4211429

8x  
4211396

4x  
4211445

4x  
6247352

1x  
4211395

2x  
4211549

1x  
4211452

2x  
4211425

1x  
4211404

1x  
4211406

5x  
4251149

1x  
4211462

4x  
6421513

2x  
4211360

1x  
6335319

1x  
6376639

2x  
6240550

2x  
6254252

1x  
4490599

8x  
6287672

2x  
6343854

4x  
6481570

2x  
6217492

2x  
6469858

2x  
4210633

2x  
6395635

2x  
4211044

2x  
4211098

6x  
6225494

1x  
6221607

4x  
6261374

2x  
6349479

2x  
6168776

2x  
6435267

5x  
6117972

2x  
6359227

6x  
6146321

2x  
6123814

2x  
4218696

4x  
6047417

3x  
6364352

2x  
6015356

4x  
4652259

4x  
4211068

2x  
4211104

8x  
6118832

1x  
6083620

2x  
4211103

4x  
4210686

2x  
4629920

4

2x  
4508553

1x  
4211002

2x  
4211107

1x  
4211061

4x  
4210794

2x  
4210783

1x  
4210796

1x  
6490496





# YOU COULD WIN



## YOU COULD WIN

Your feedback will help shape the future development of this product series.

Visit:

## DU KÖNNTEST GEWINNEN

Dein Feedback trägt zur Weiterentwicklung dieser Produktreihe bei.

Geh auf:

## VOUS POURRIEZ GAGNER

Vos commentaires nous aideront à concevoir les futurs produits de cette gamme.

Visitez :

## POTRESTI VINCERE TU

La tua opinione ci aiuterà a migliorare la creazione futura di questa linea di prodotti.

Visita:

## PUEDES GANAR

Tu opinión contribuirá al futuro de esta serie de productos.

Visita:

## 轻松获奖

您的反馈将有助于我们在今后改进本产品系列。

请访问:

---

[LEGO.com/productfeedback](https://LEGO.com/productfeedback)

---

You also have the chance to win a LEGO® set.

Terms and conditions apply.\*

Außerdem hast du die Chance, ein LEGO® Set zu gewinnen.

Es gelten die Teilnahmebedingungen.\*

Vous pourriez également gagner un ensemble LEGO®.

Des conditions s'appliquent.\*

Hai anche la possibilità di vincere un set LEGO®.

Termini e condizioni sono applicabili.\*

También tienes la oportunidad de ganar un set LEGO®.

Aplican términos y condiciones.\*

您还有机会赢取乐高®套装。

条款和条件适用。\*

\*[LEGO.com/productfeedback-terms](https://LEGO.com/productfeedback-terms)



LEGO and the LEGO logo are trademarks of the LEGO Group. ©2024 The LEGO Group. 6546408  
The "Lamborghini" and "Lamborghini Bull and Shield" trademarks, copyrights, designs and models are used under license from Automobili Lamborghini S.p.A, Italy.