

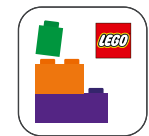

21352



Booklet available in English
Heft in deutscher Sprache erhältlich
Livret disponible en français
Libretto disponibile in italiano
Folleto disponible en español
如需中文版手册



LEGO® Builder

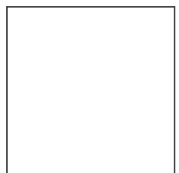



LEGO.com/sustainable-packaging



FR
**DONNEZ
OU
RECYCLEZ**



ASSOCIATION

OU



MAGASIN

OU



DÉCHÈTERIE

Adresses sur quefairedemesdechets.fr



BUILDER



Apple and the Apple logo are trademarks of Apple Inc., registered in the U.S. and other countries and regions. App Store is a service mark of Apple Inc. Google Play and the Google Play logo are trademarks of Google LLC. Tencent and the Tencent logo are trademarks of Tencent Inc.

LEGO.com/devicecheck



LEGO® Builder

MEET THE FAN DESIGNER

As if in a fairytale of her own, fan designer Anna Chen (LEGO® Ideas name 2A2A) won the hearts and votes of thousands of LEGO and Disney™ fans in the 2023 LEGO Ideas *100 Years of Fairytales!* challenge. The service engineer from Hong Kong cast a passionate and creative spell on her favourite Disney characters and movie moments in her challenge entry, and in addition to providing services to hospitals and healthcare professionals, she can now add LEGO Fan Designer to her resumé.

*Anna and her original
challenge submission*





"I have loved playing with LEGO bricks since early childhood, and I love the Disney animated movies, so I was thrilled to seize the opportunity to enter in the challenge and let my Disney and LEGO fuelled imagination run wild! It took maybe two or three weeks to design the model. I knew I wanted to include a big brick-built Mickey Mouse, and around Mickey I added mini-models representing some of my favourite Disney movies. Of course, I used the contest as an excuse to rewatch some of the movies I remember so fondly from my childhood! This also helped me select some of the most iconic symbols, accessories and characters to include in the model. When the voting began, I was so happy that the model resonated with other LEGO and Disney fans, and I am really thankful for all the fans who voted for this design. I hope they will be just as excited about the official, final design as I am. I am also thankful to the LEGO Ideas team for creating this special challenge – it allowed so many fans to express our love for classic Disney films and their beloved themes and characters."

AN IRRESISTIBLE MAGIC FORMULA



Through generations, our favourite Disney films have made us laugh, cry, dance and hum along to their captivating soundtracks - or bellow them from the top of our lungs. For some, they evoke fun memories of cosy movie nights, snuggled up with our family and friends, watching, rewinding and re-watching our cherished VHS cassettes until they literally frayed! From the big screen to streaming, from *Fantasia* to *Encanto* and beyond, an enchanted red thread has carried Disney's magic storytelling formula through ever-expanding realms. The engaging stories about endearing, relatable characters rooted in rich, diverse cultures from around the world - even the mythical Atlantica - inspire us to embrace the magical connections we share and follow our hearts, dreams and imaginations.

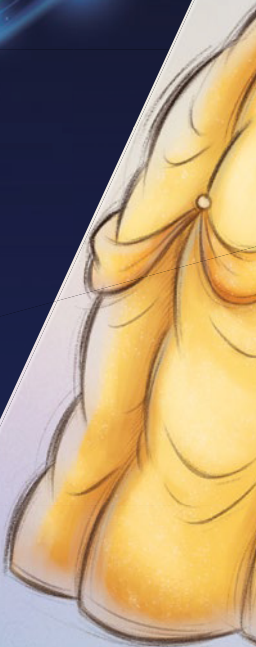



100 YEARS OF FAIRYTALES!

In celebration of Disney's 100th anniversary in 2023, we had the unique opportunity to invite fans from all over the world to join our virtual LEGO® | Disney designers' ball. We launched the exclusive LEGO Ideas *100 Years of Fairytales!* challenge on the LEGO Ideas website, hoping it would inspire fans to show their love of classic and new Disney animated films with LEGO bricks. With hundreds of enchanting, moving and funny interpretations of memorable film scenes, heroes and villains, the LEGO Ideas fan community and a panel of judges cast their votes. Now, for the first time since we released the first LEGO | Disney set in 1999, we can share a set created not only for fans but also by a fan, and usher in the next century of creative magic.



FROM THE LEGO® IDEAS DESIGN TEAM

"Anna did such a wonderful job of showcasing the history of Disney animation in an exciting model! Mickey Mouse, as the Sorcerer's Apprentice from *Fantasia*, commands the waves, surrounded by a series of tributes to iconic Disney movies. In collaboration with Disney Studios, we modified some of Anna's scenes to represent different decades and eras. From Belle's enchanted rose to Bruno's emerald tablet, the set weaves together a series of memorable, magical Disney moments, beloved characters and iconic elements. Mickey's iconic brooms from *Fantasia* even seem to come alive on top of the flooded stairs! On the inside of Mickey's body and head, we hid an Easter egg for the fan designer, using the colours of characters from her favourite movie. (Can you guess which movie it is?)"





BRINGING A LEGO® MODEL TO LIFE

Much like the brooms in *Fantasia*, ideas just seem to multiply when you start building with LEGO® bricks! Collaborating with the fan designer and Disney Studios, the LEGO Ideas design team waved their brick wands to bring the model to life.

PINOCCHIO (1940)

Geppetto is fighting the waves on his posable raft, inside the whale Monstro.

LILO & STITCH (2002)

A posable Lilo is having fun surfing the waves.

THE LION KING (1994)

Simba is admiring his kingdom from the top of Pride Rock, surrounded by savannah flora.





FANTASIA (1940)

Mickey Mouse, as the Sorcerer's Apprentice, takes centre stage, representing one of the most iconic animated films of all time, *Fantasia*. With just a few flicks of his hands, the magic brooms may wake up, rush down the stairs and pour more water from their buckets!

THE LITTLE MERMAID (1989)

Sebastian and Flounder playfully pop out of the waves.

ENCANTO (2021)

Bruno is standing outside the Casita, the Madrigal family's magic house, troubled by his visions.

BEAUTY AND THE BEAST (1991)

Belle is in the luxurious ballroom in Beast's castle, gazing at the enchanted rose.

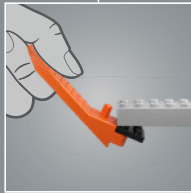
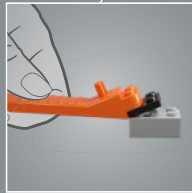
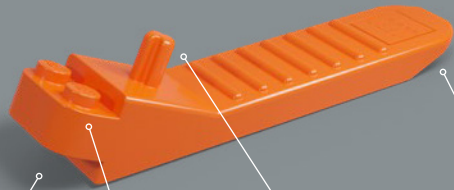

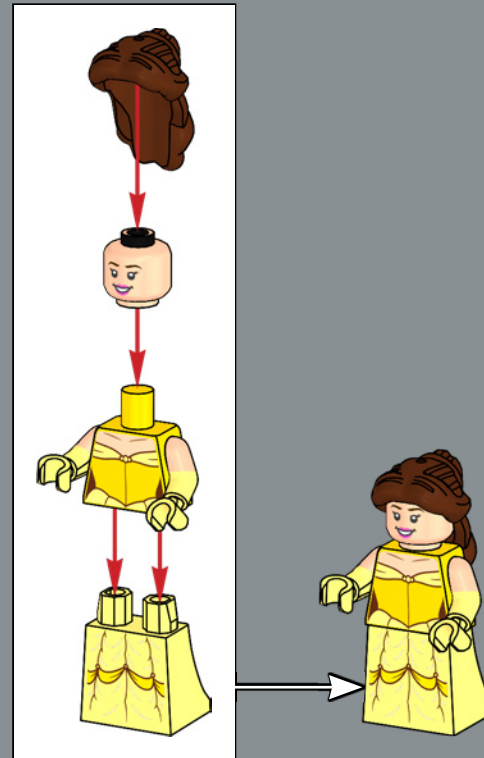

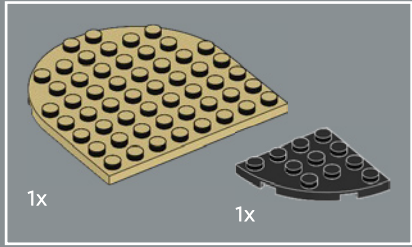

1

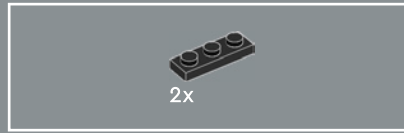
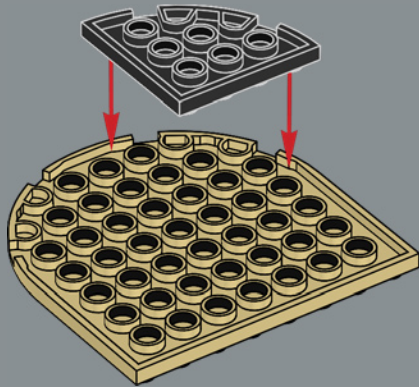

2

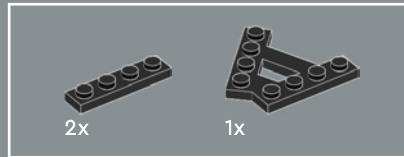
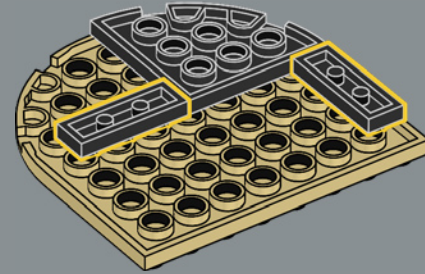

3

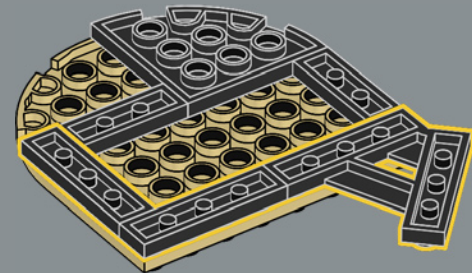

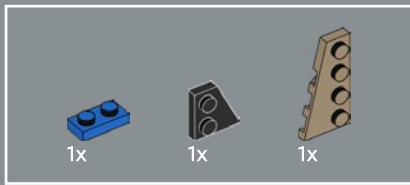

4

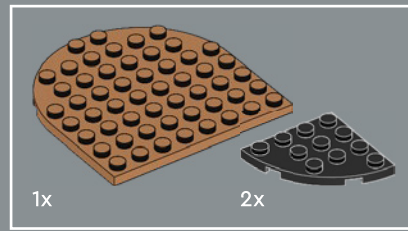
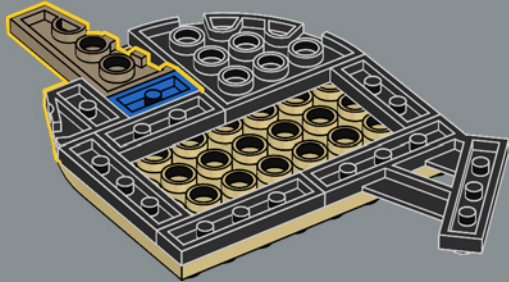

5

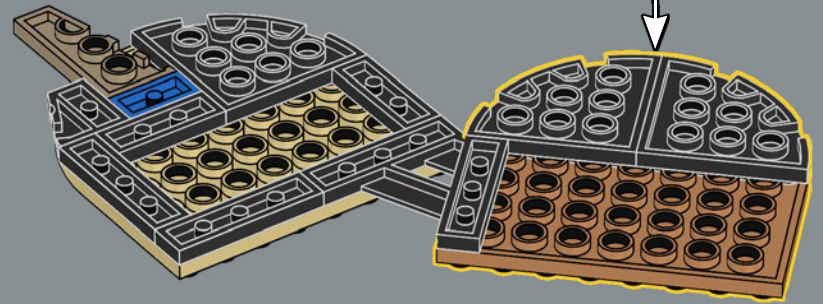
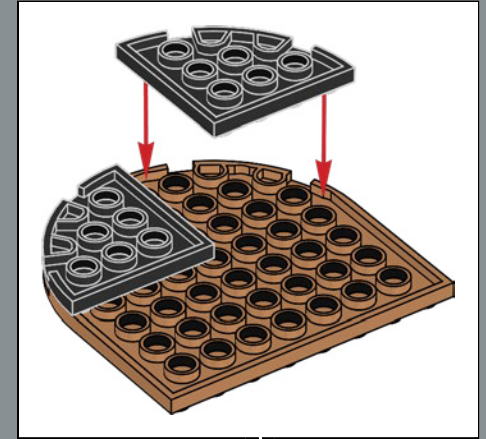

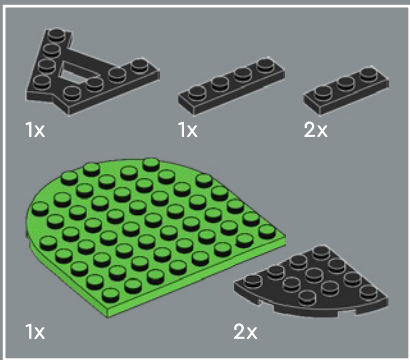

6

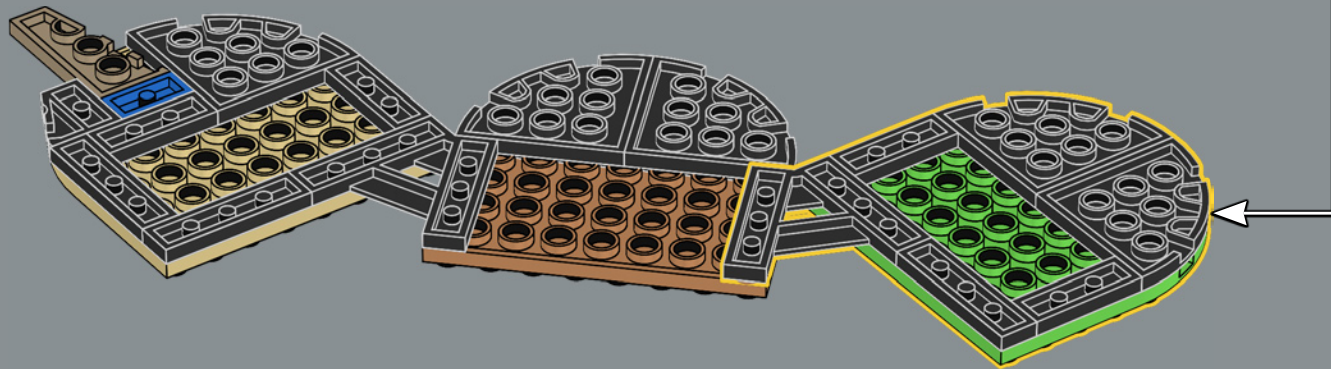
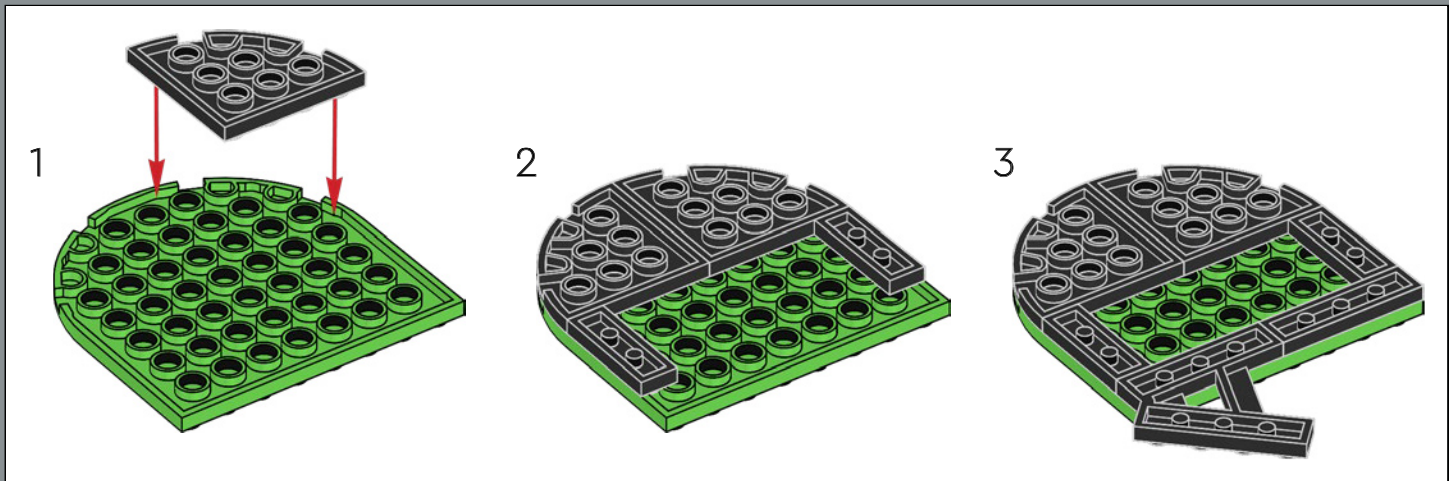

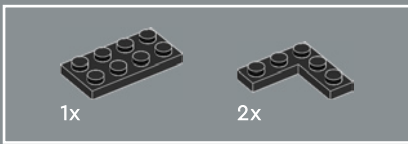

7

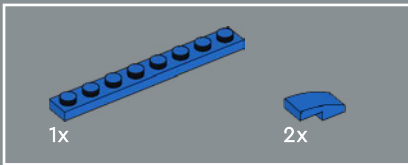
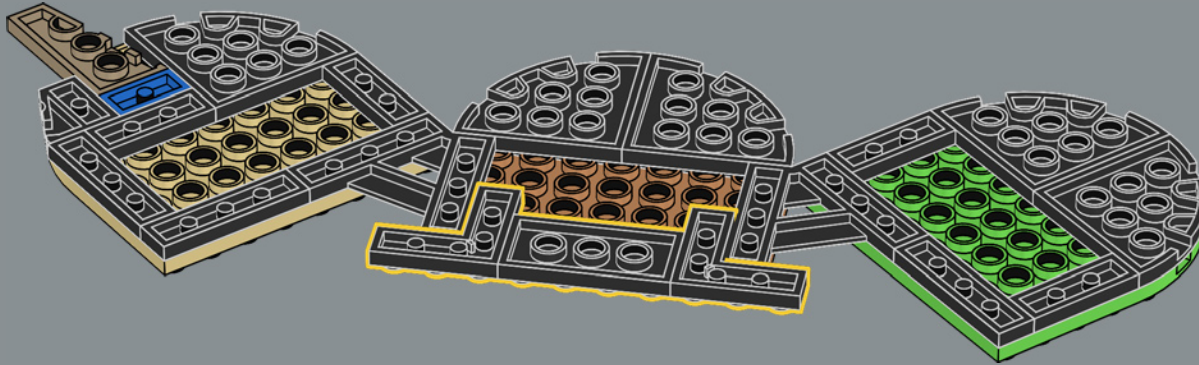

8

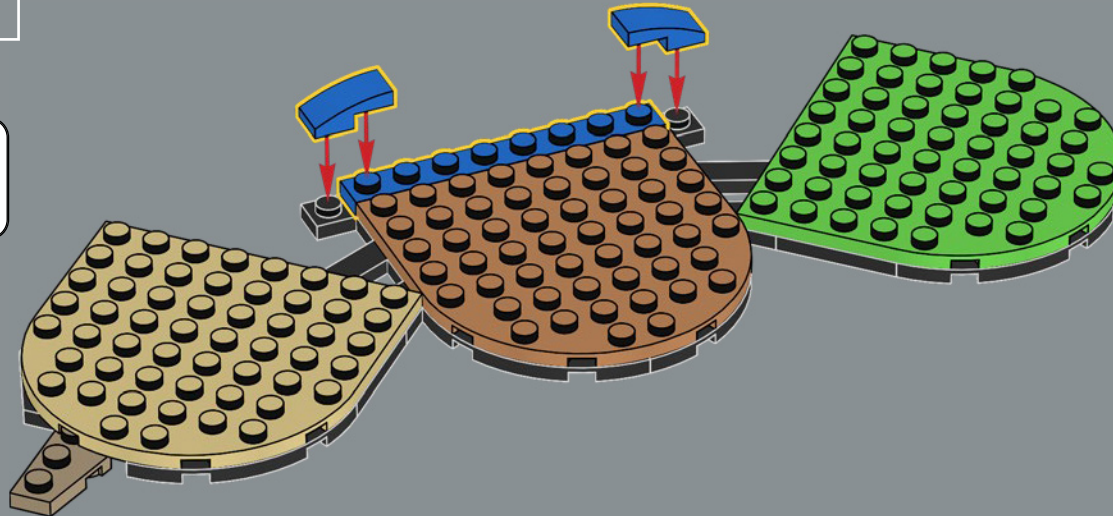

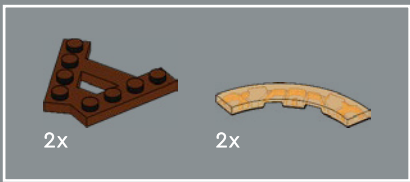

9

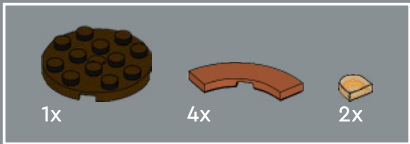
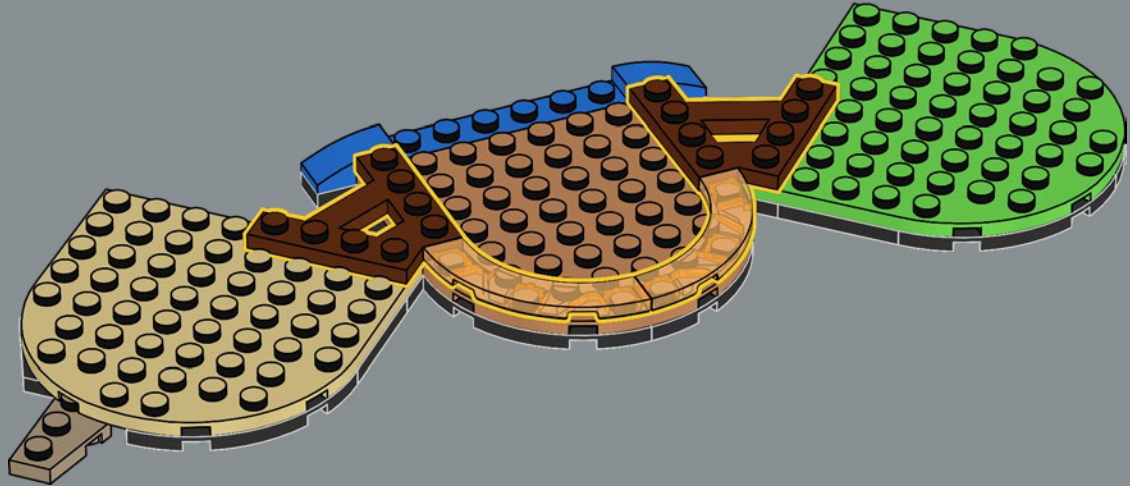

10

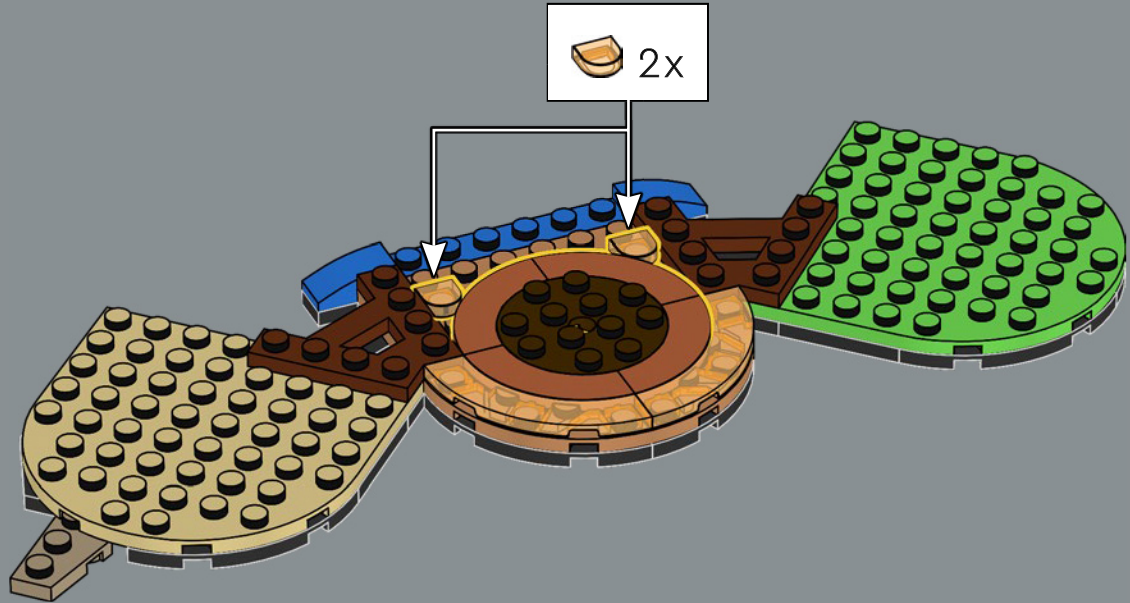

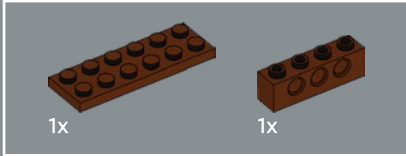

11

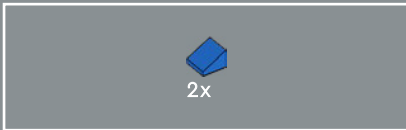
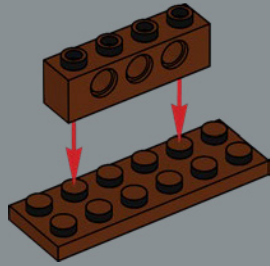

12

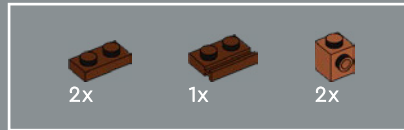
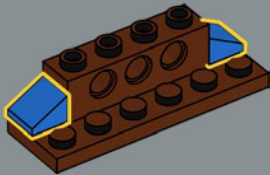

13

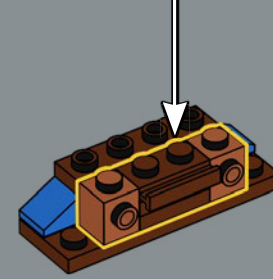
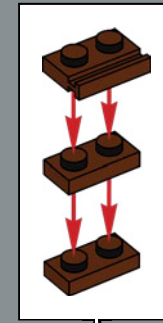

14

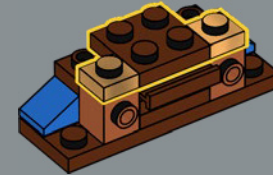

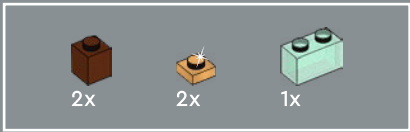

15

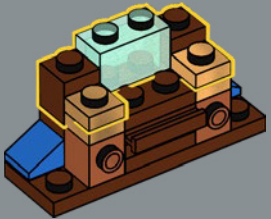

16

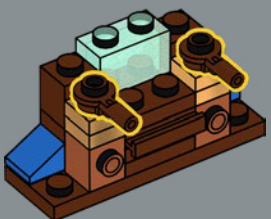

17

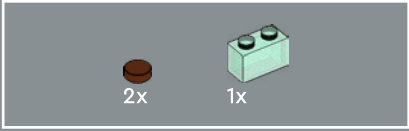
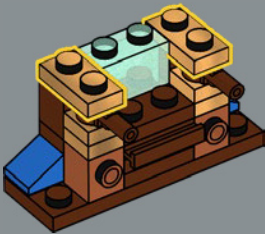

18

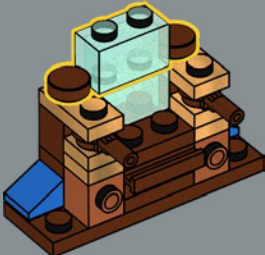

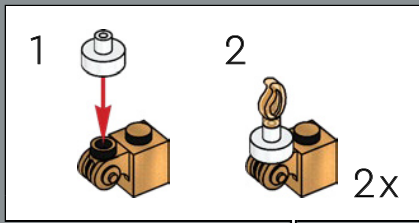
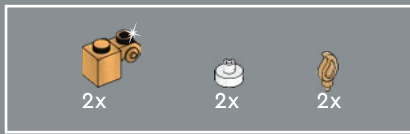

19

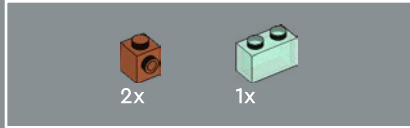
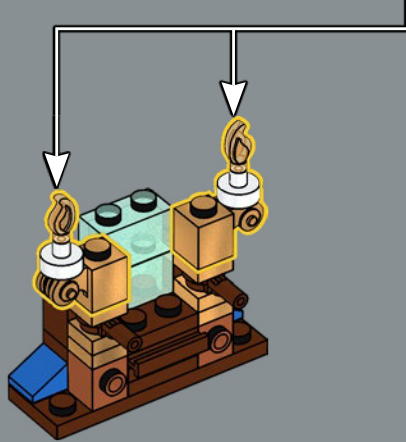

20

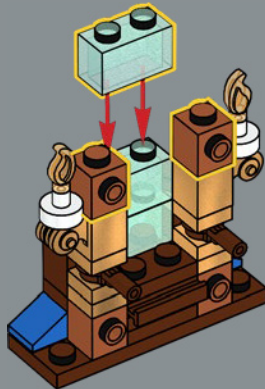

21

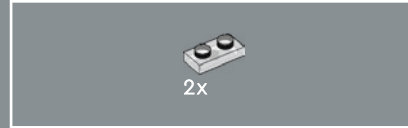

22



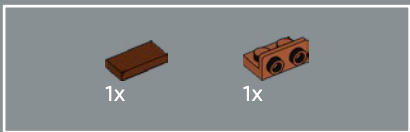

23

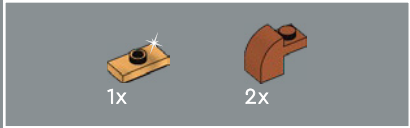

24



25

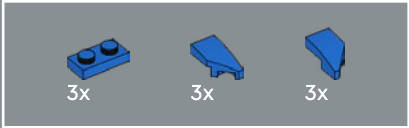

26

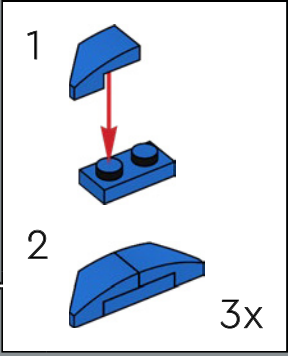

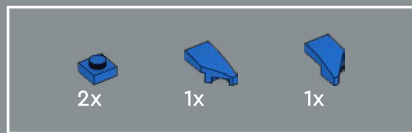

27

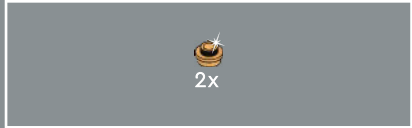
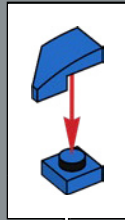
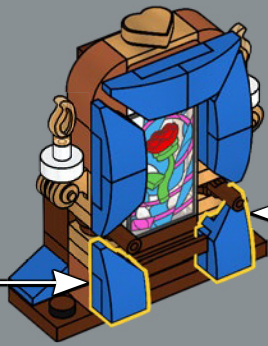
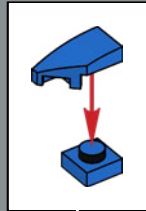

28

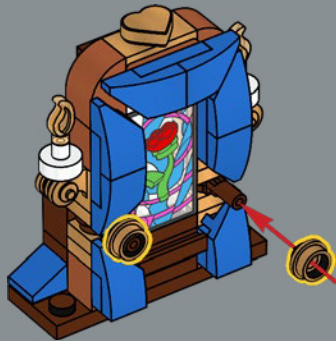

29

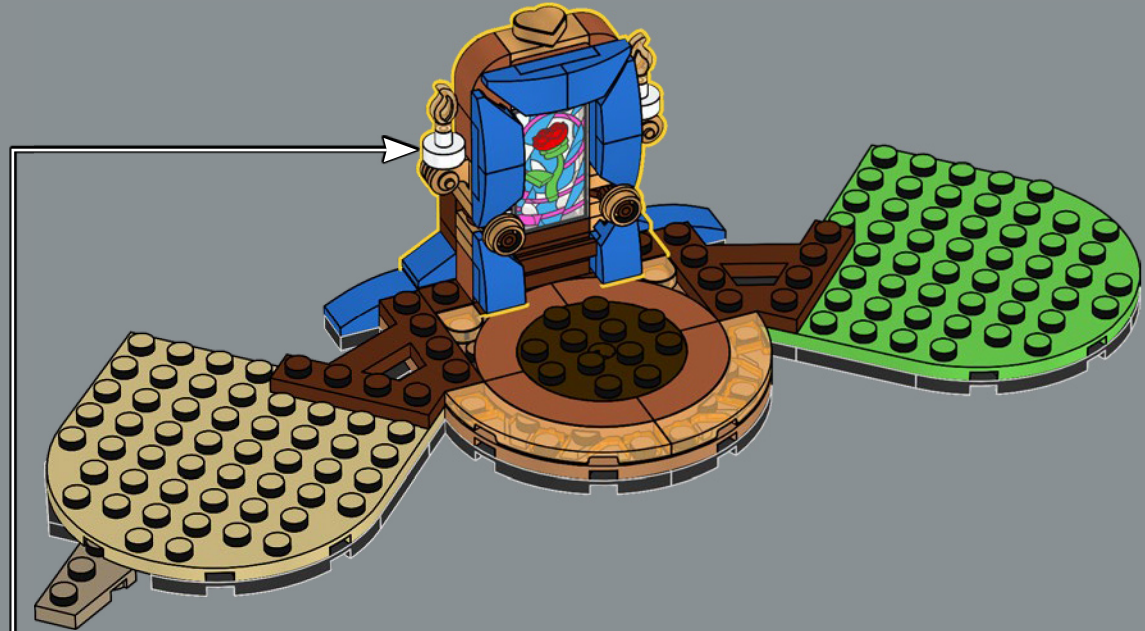

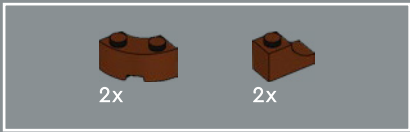

30

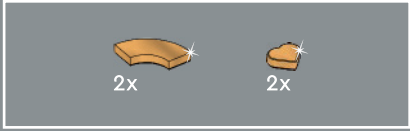

31





32

1



2

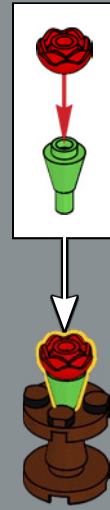

3

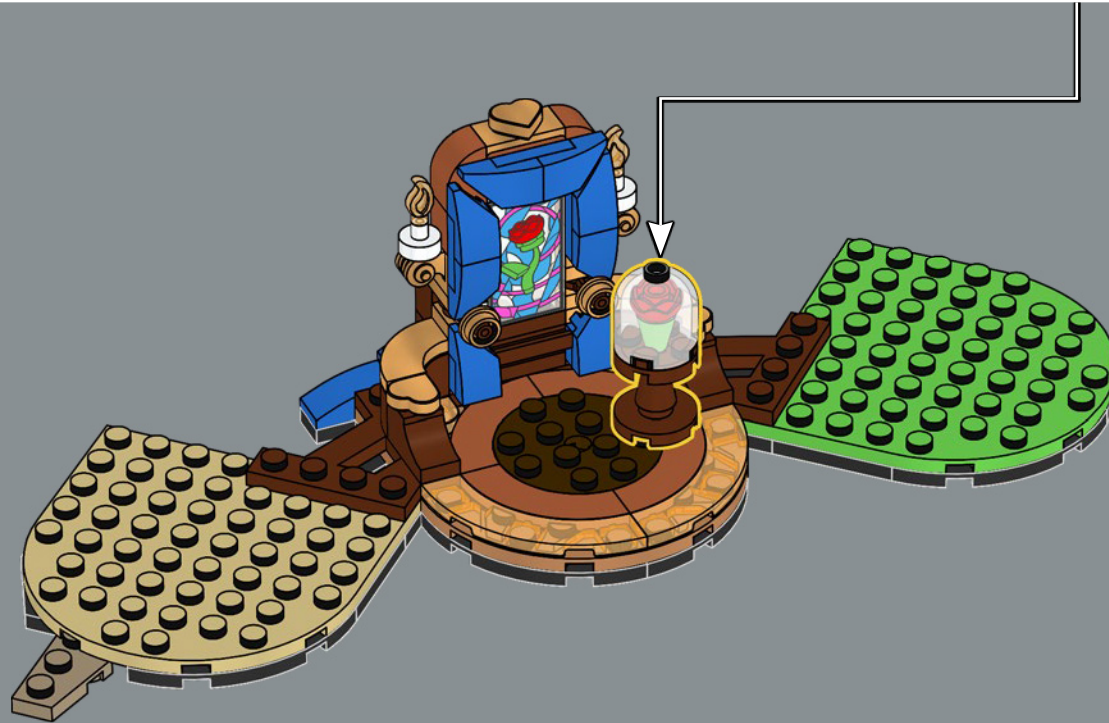
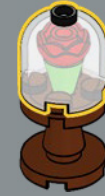

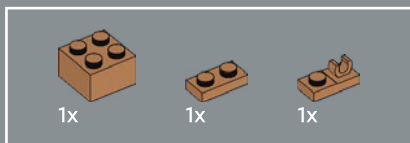

33

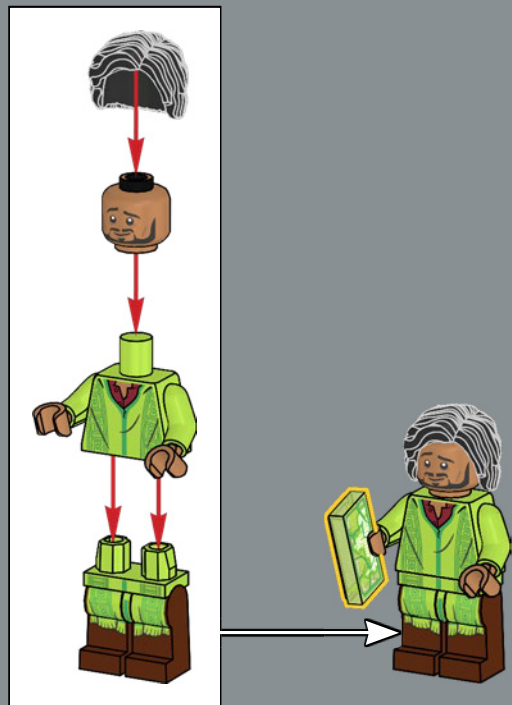

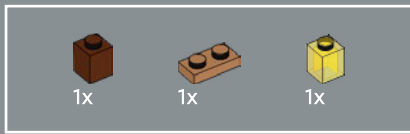

34

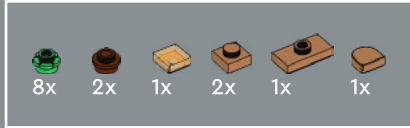

35





3x



1x



3x

36



5x



2x

37



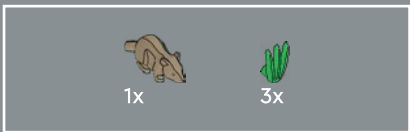

38

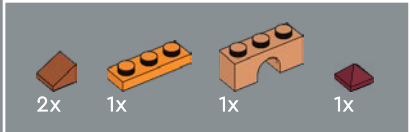

39

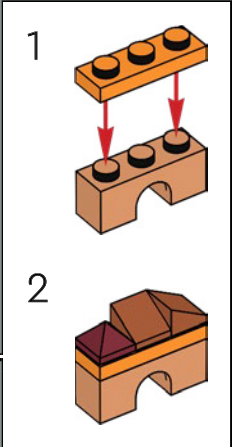

-  2x
-  1x
-  1x
-  1x
-  1x
-  2x

40

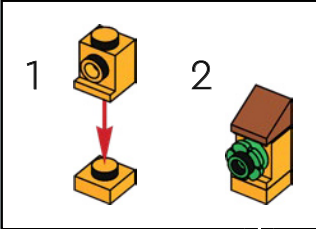

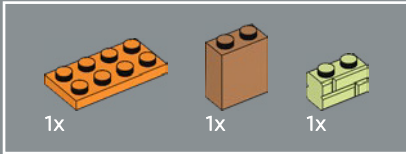

41

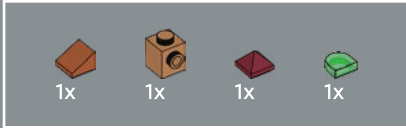
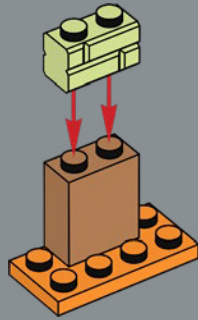

42

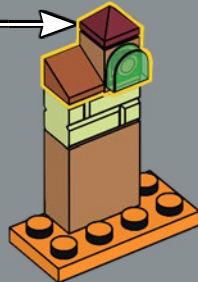
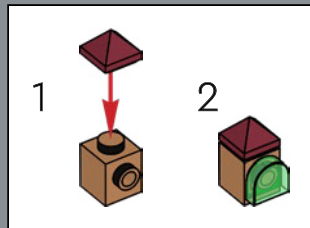

43

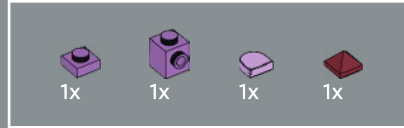
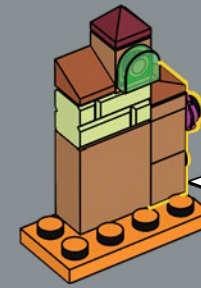
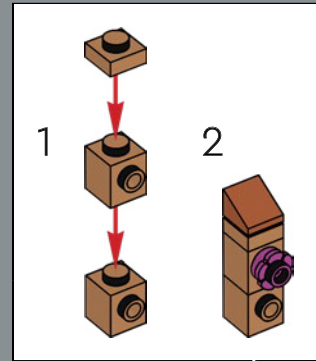

44

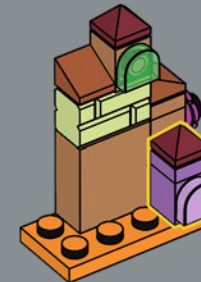
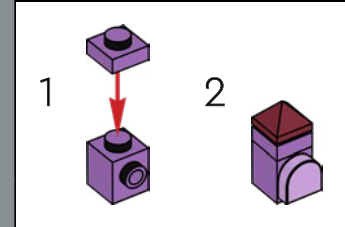

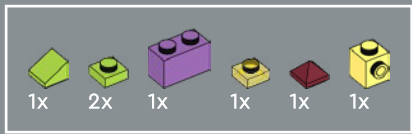

45

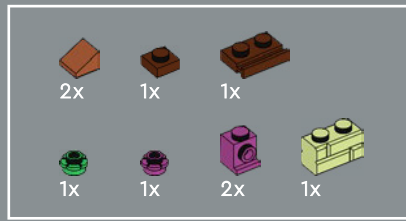
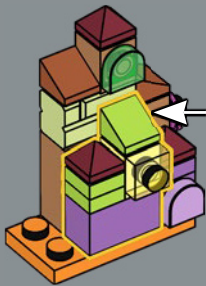
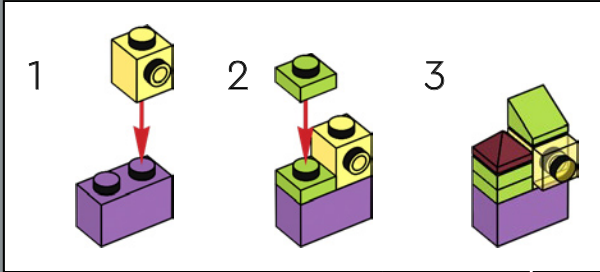

46

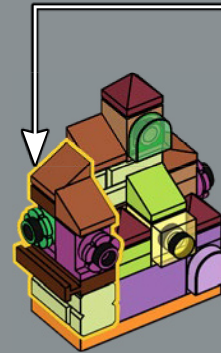
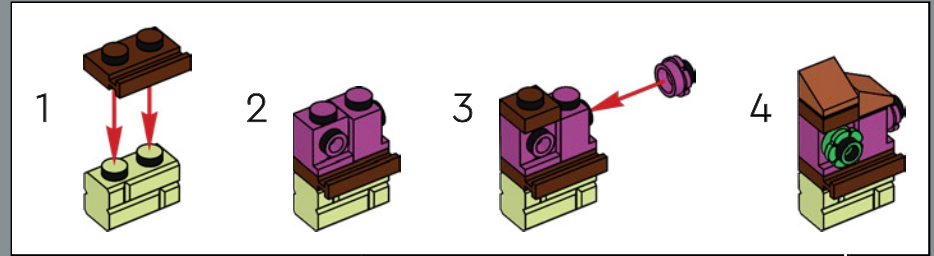

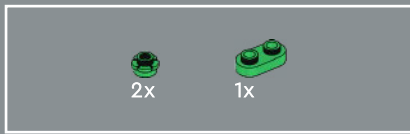

47

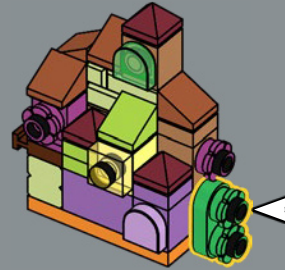
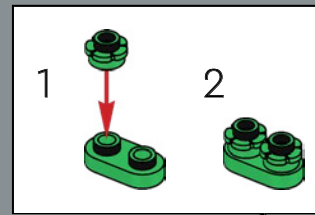

48





49

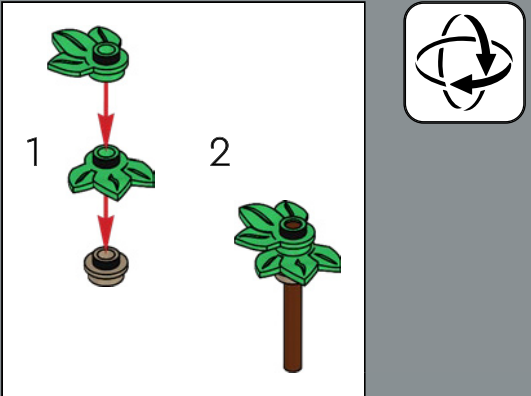

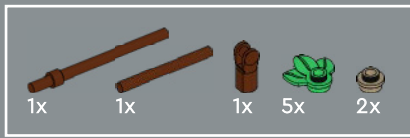

50

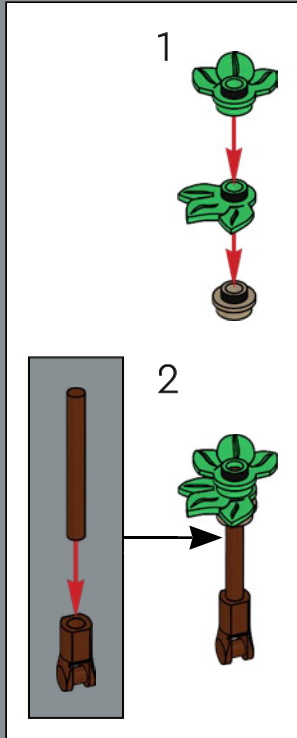
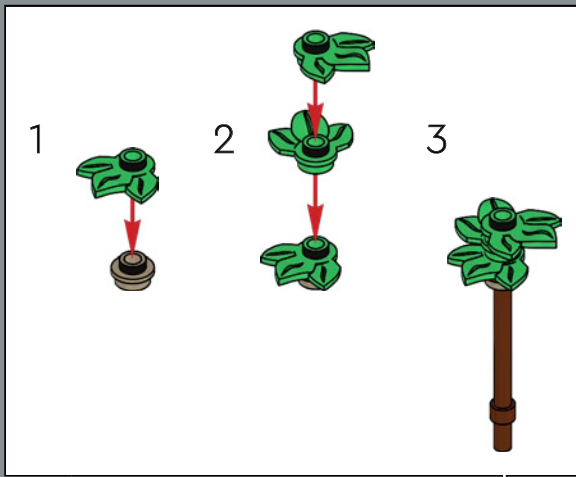

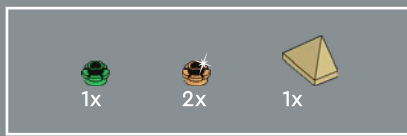

51

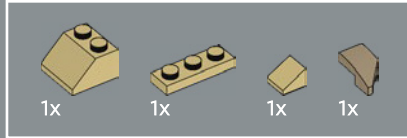
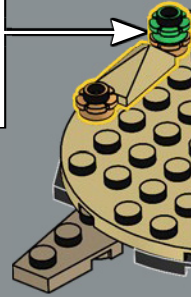
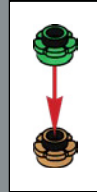

52

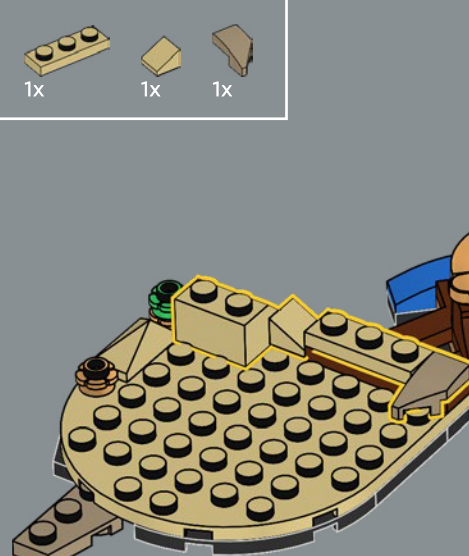

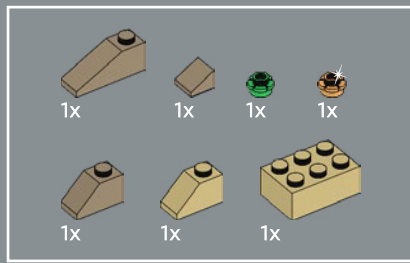

53

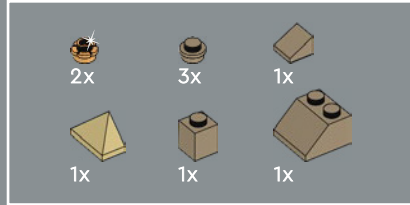

54





55

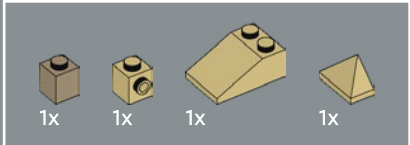
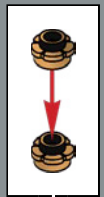

56



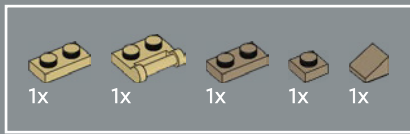

57

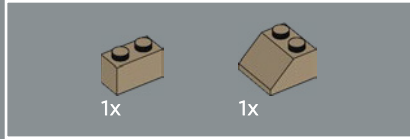
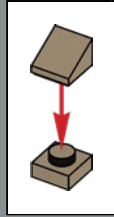
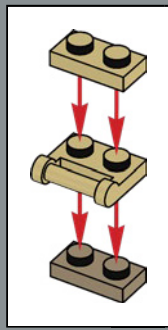

58



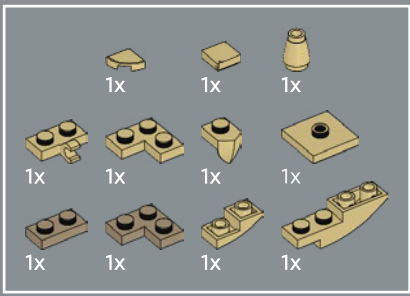

59

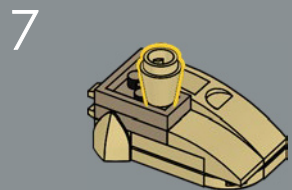
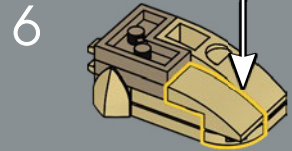
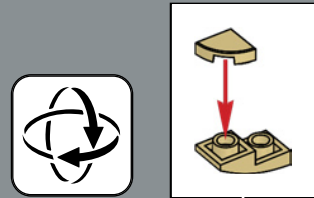
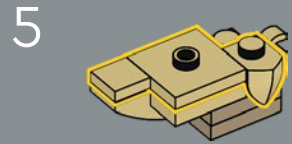
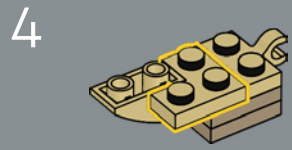
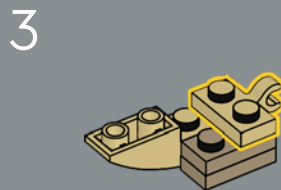
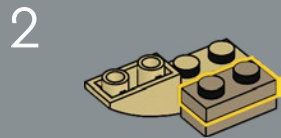
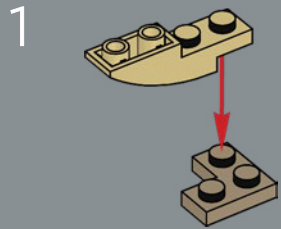

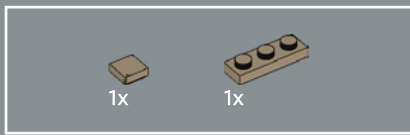

60

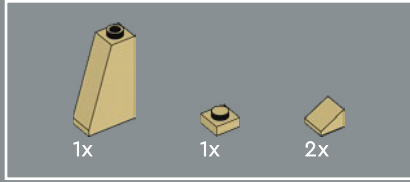

61

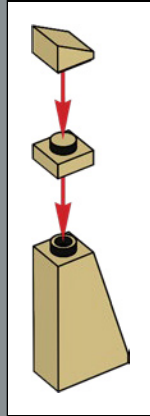

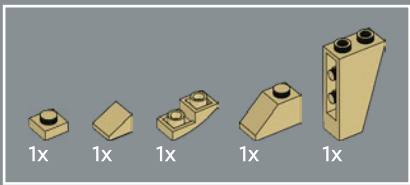

62

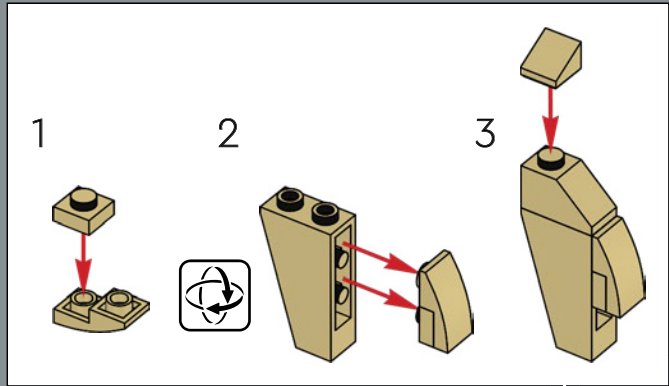

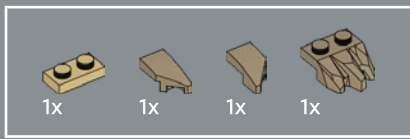

63

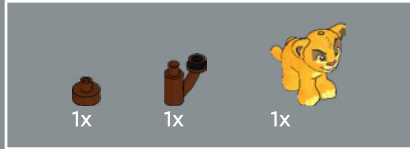
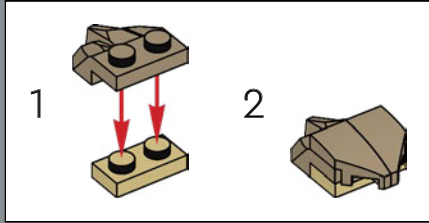

64

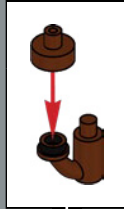



65



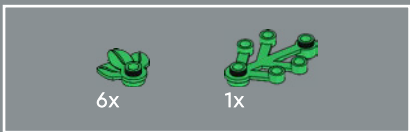

66

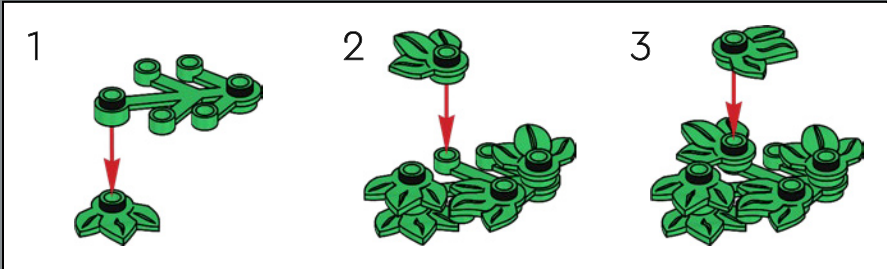

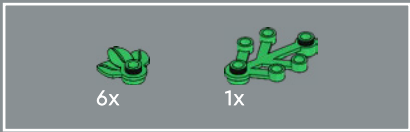

67

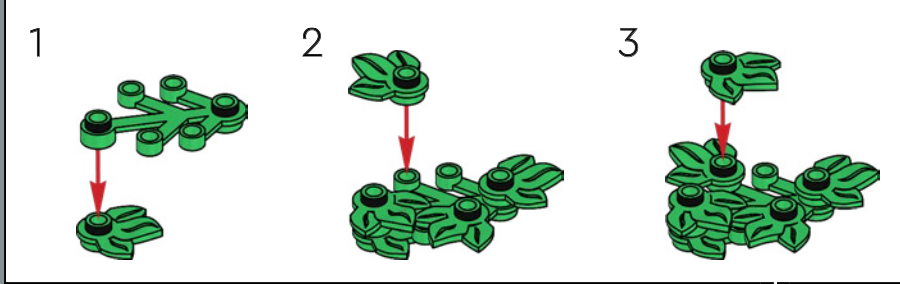

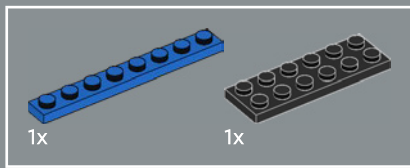

68

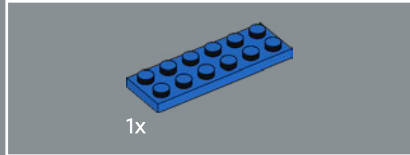
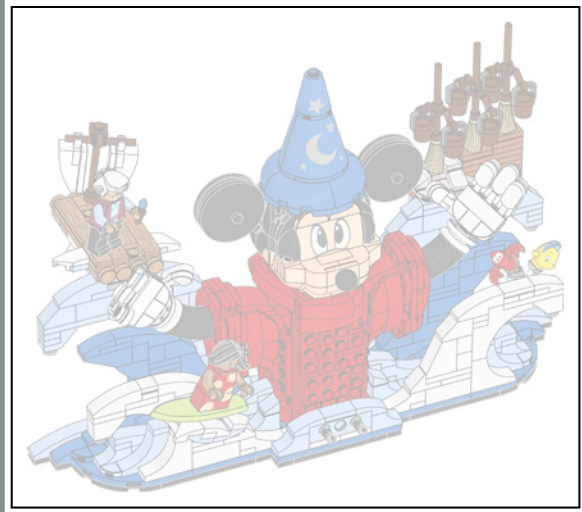
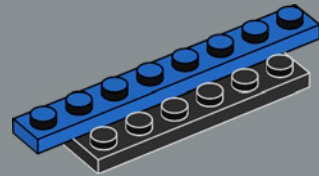

69

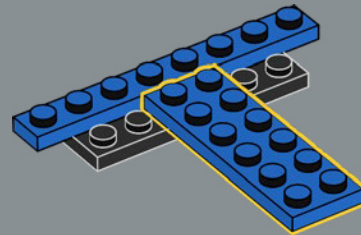

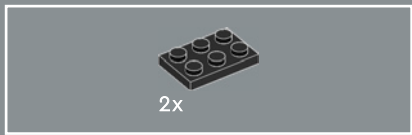

70

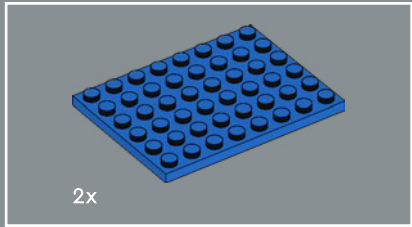
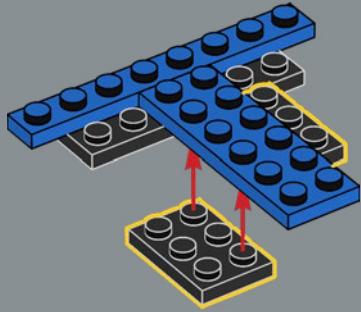

71

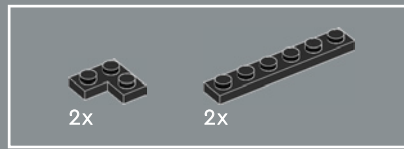
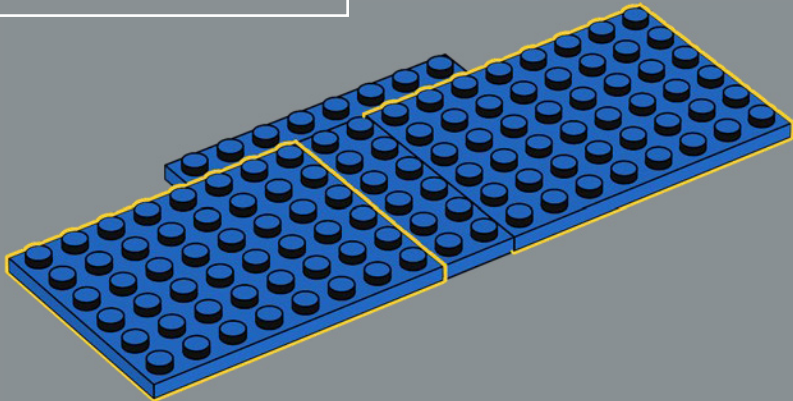

72

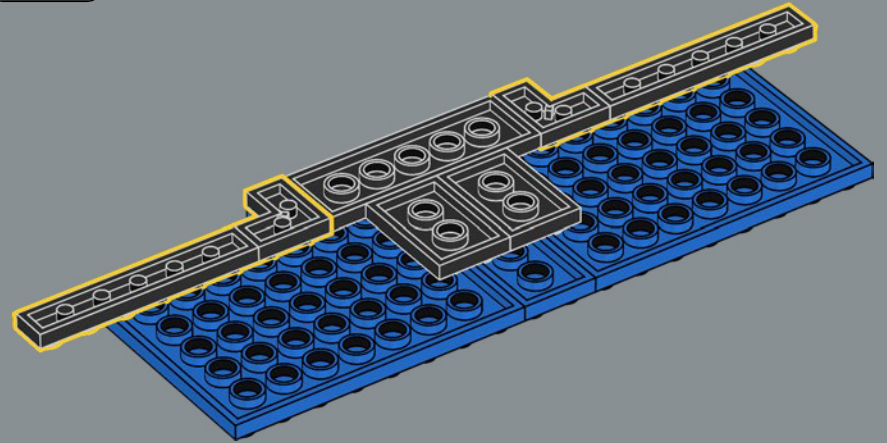

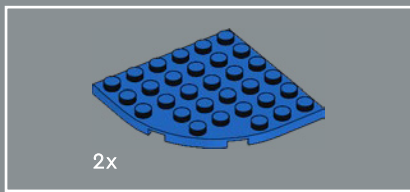

73

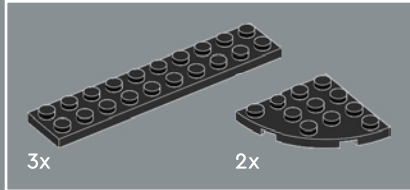
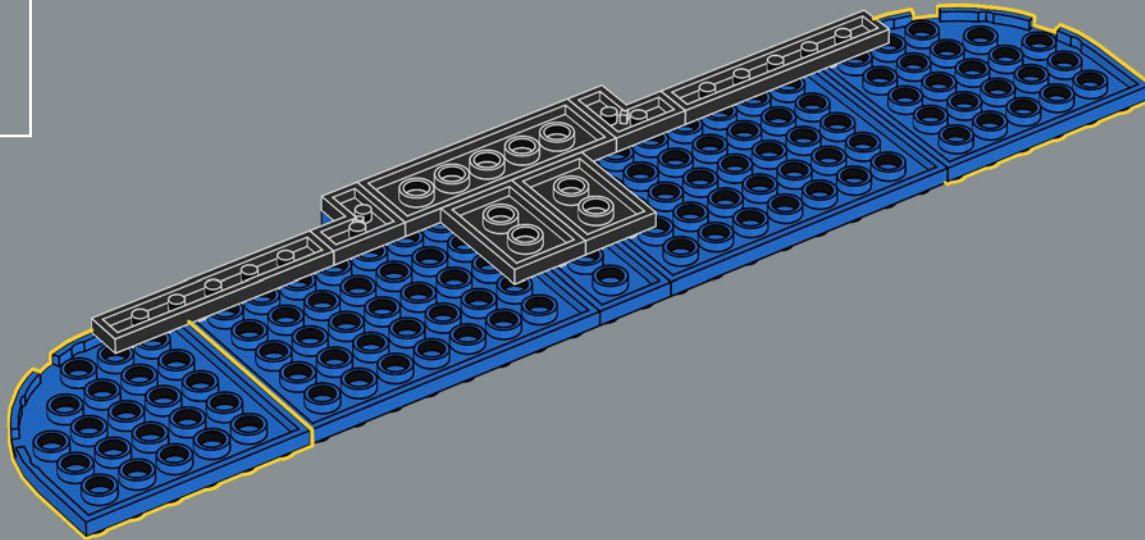

74

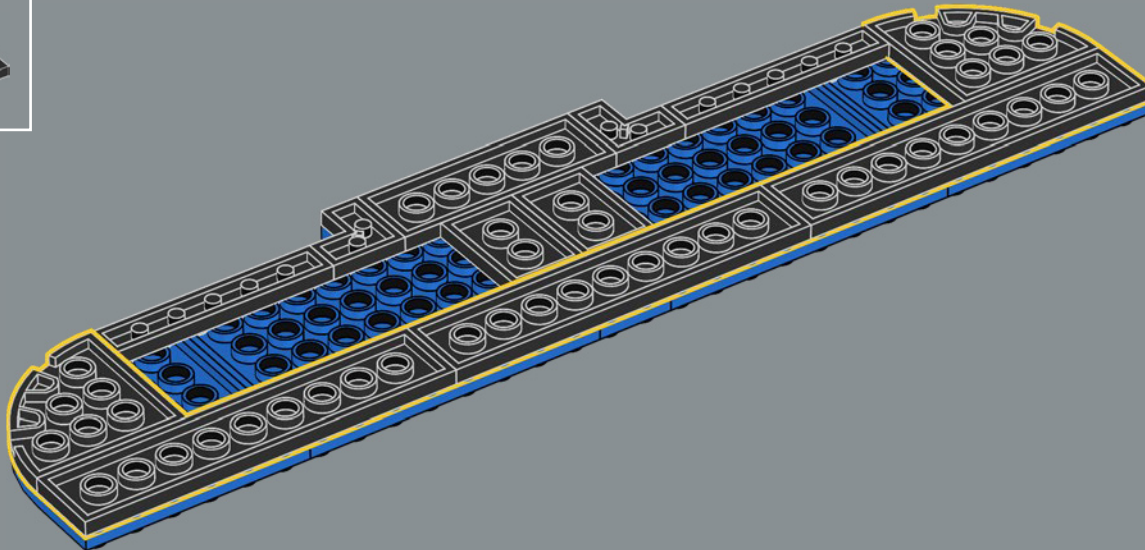



75

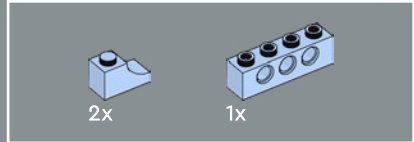
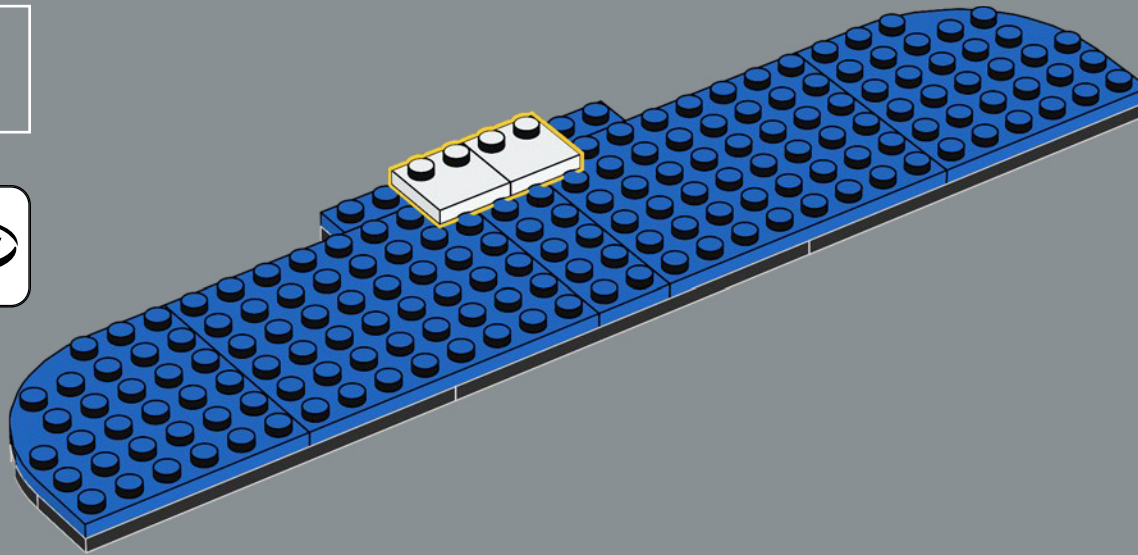

76

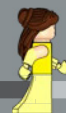
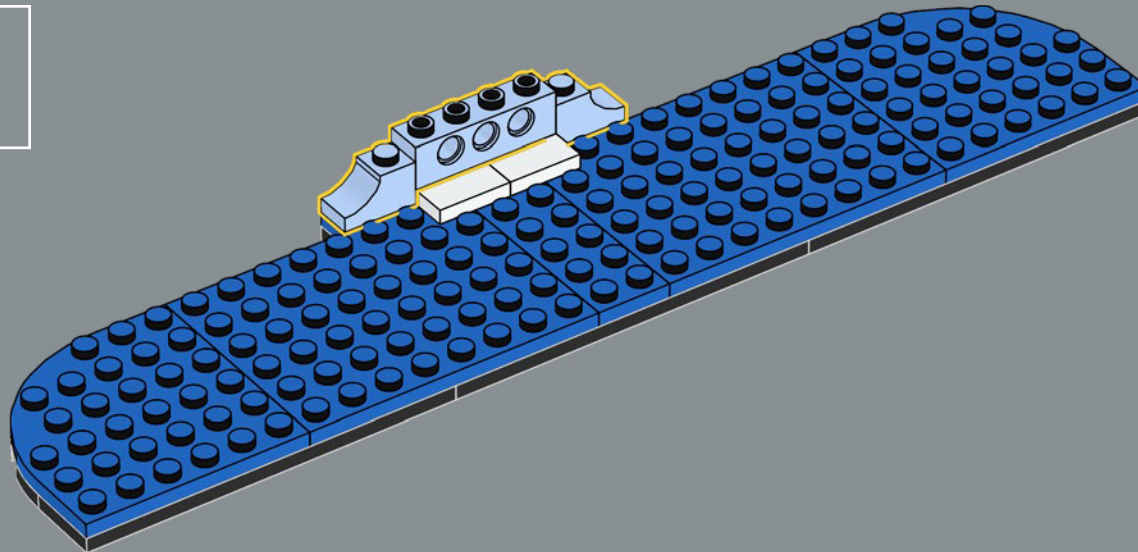

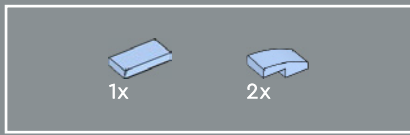

77

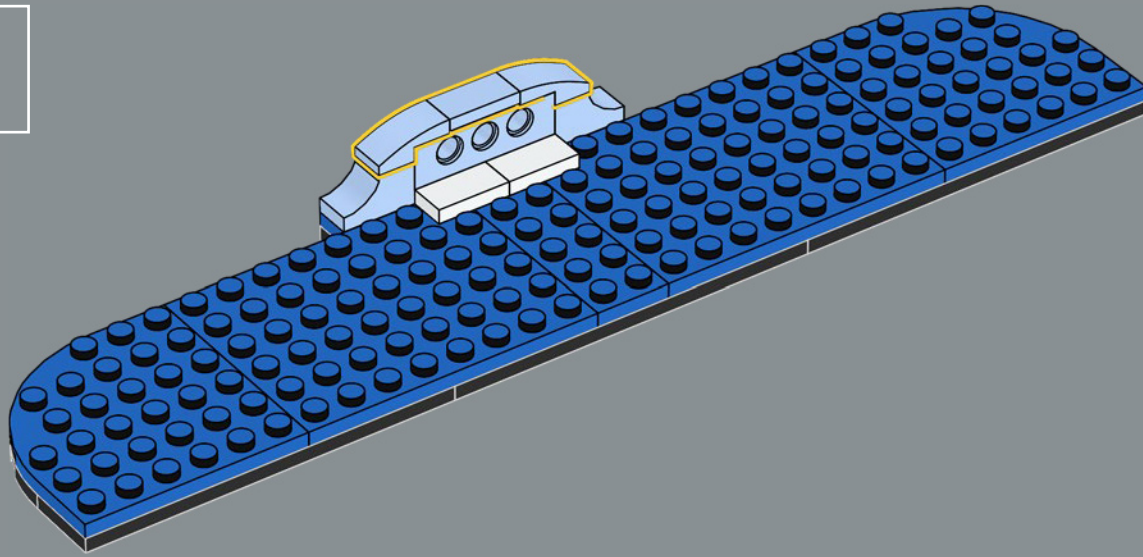

78

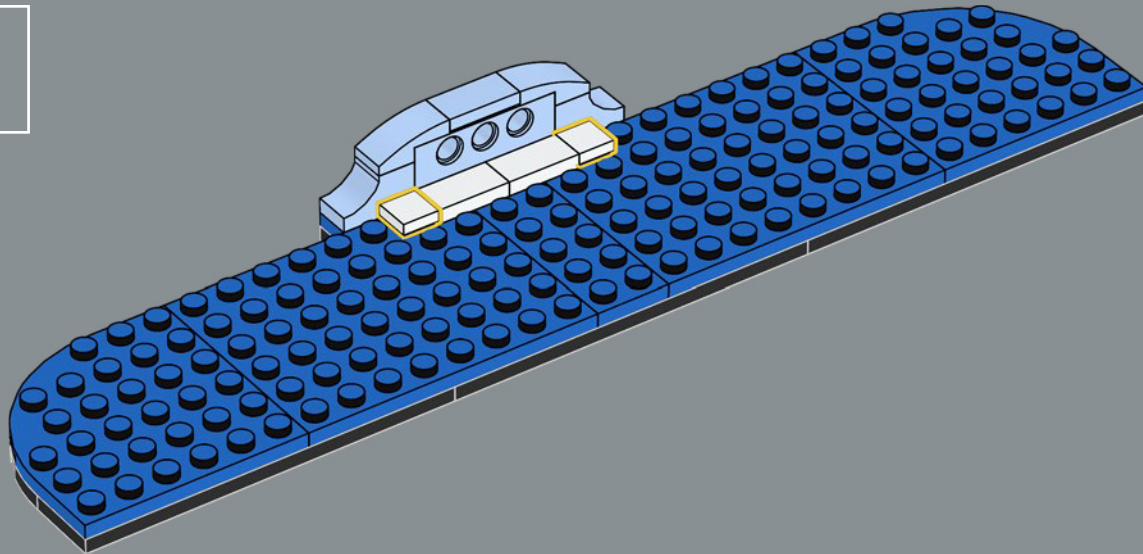

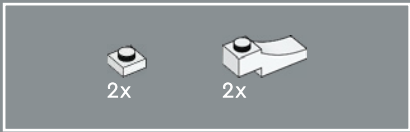

79

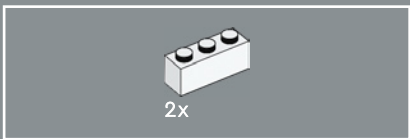
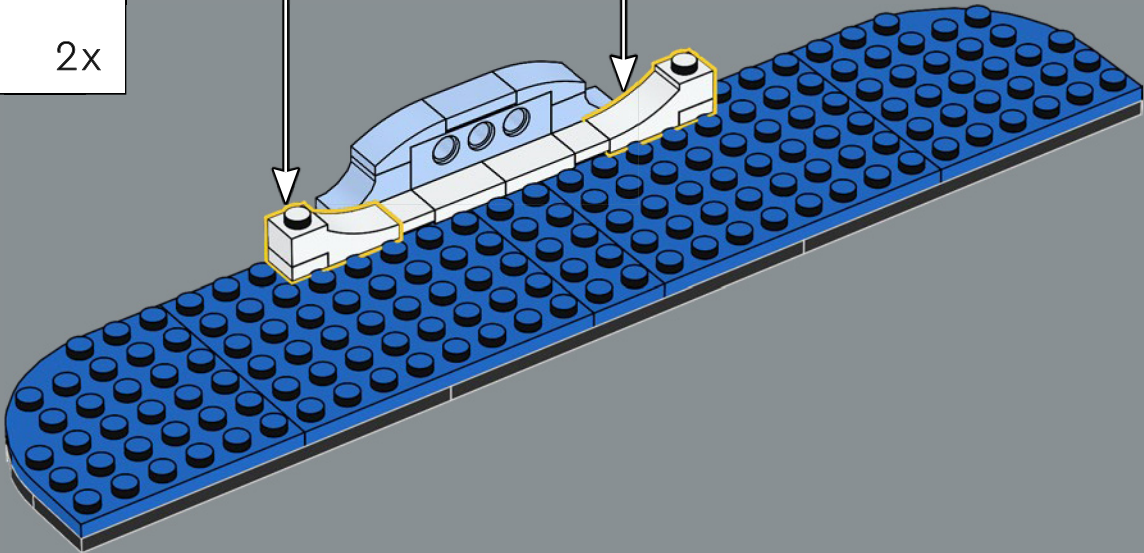
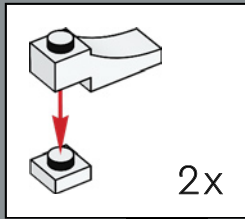

80

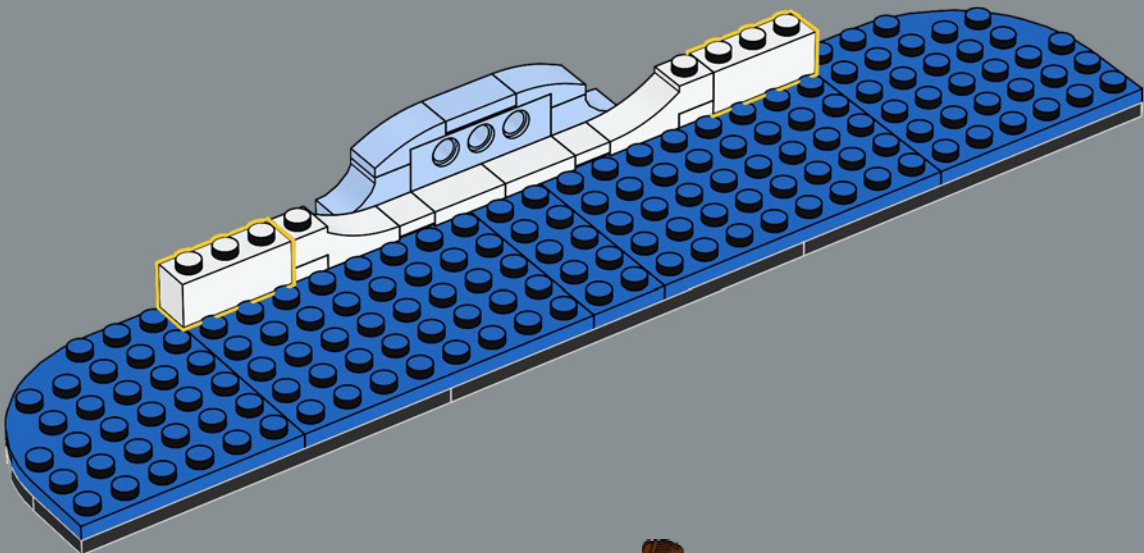

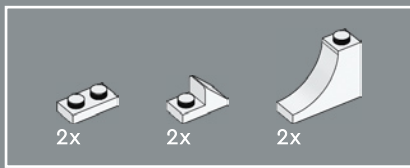

81

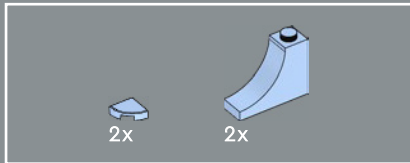
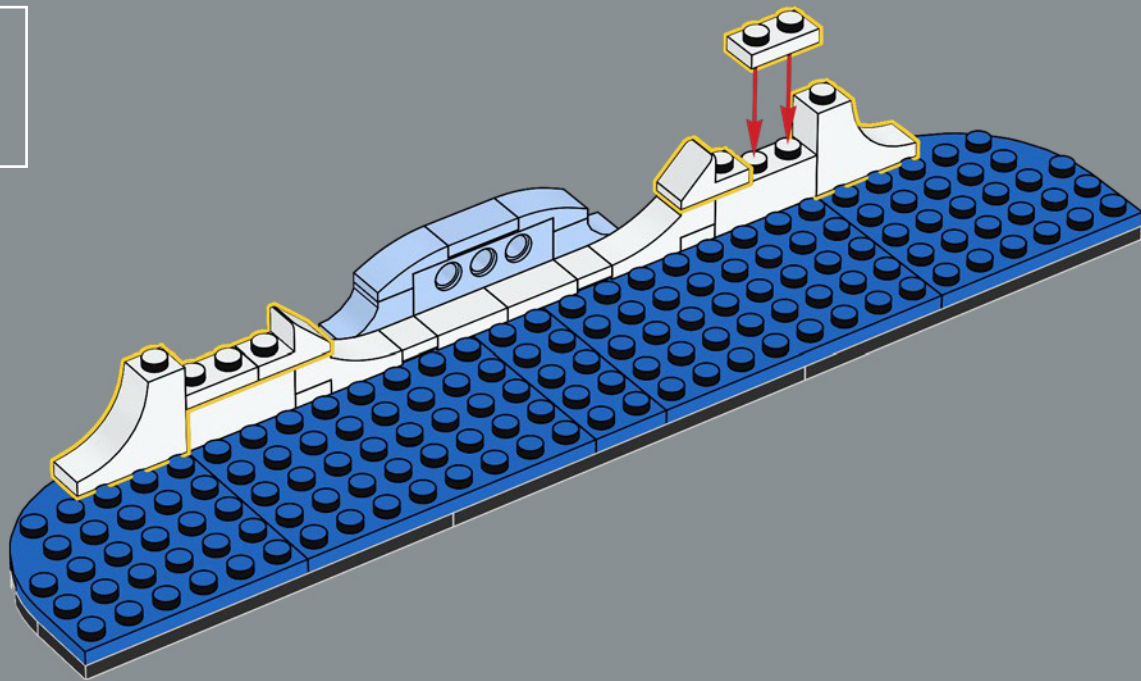

82

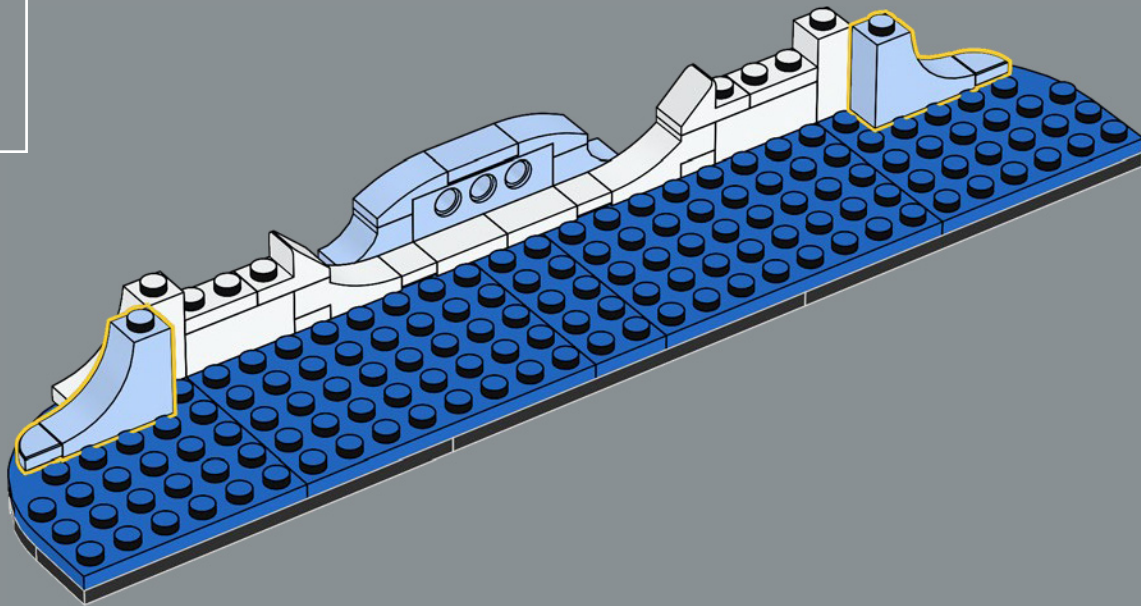

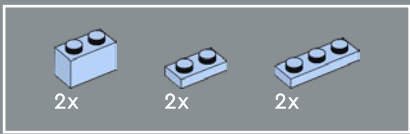

83

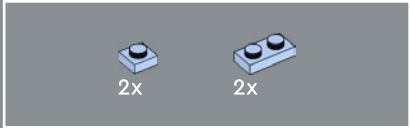
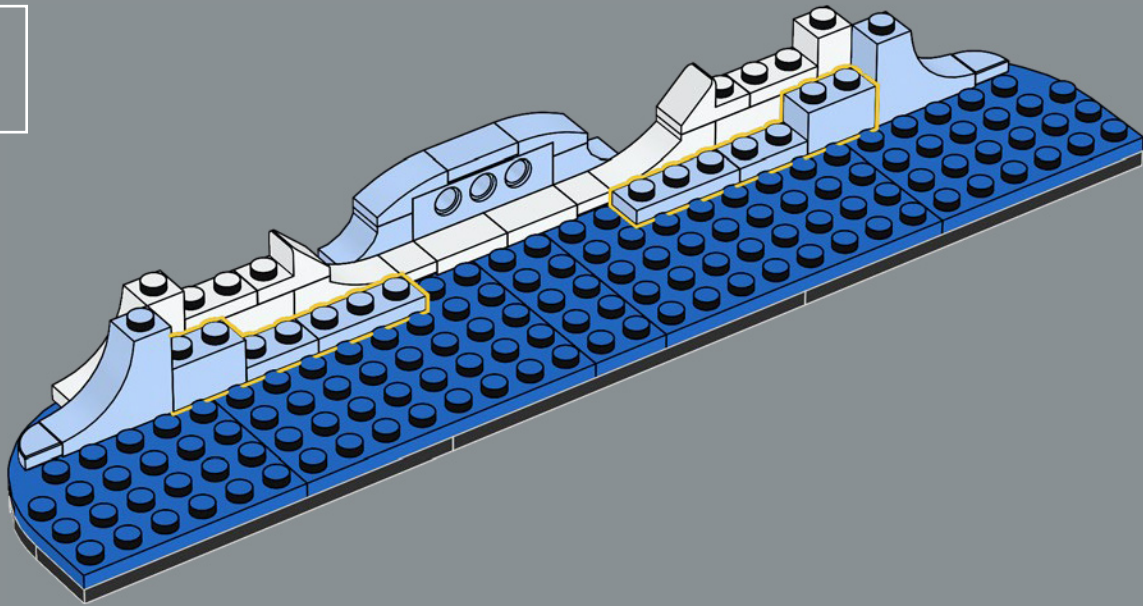

84

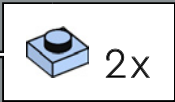
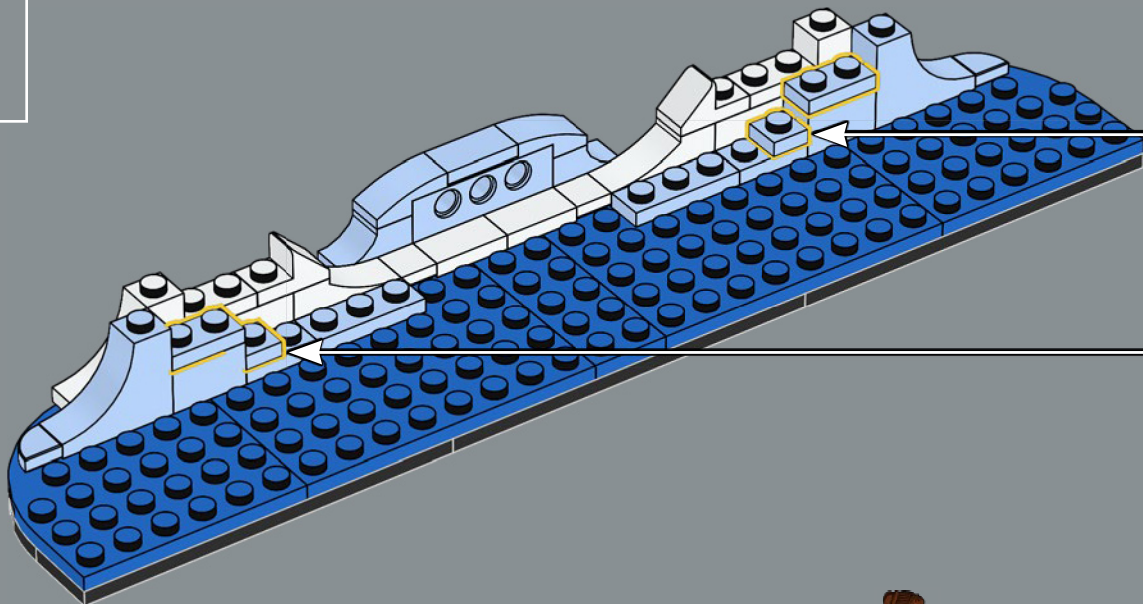

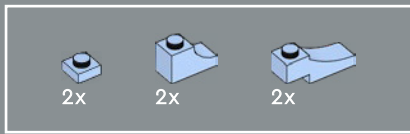

85

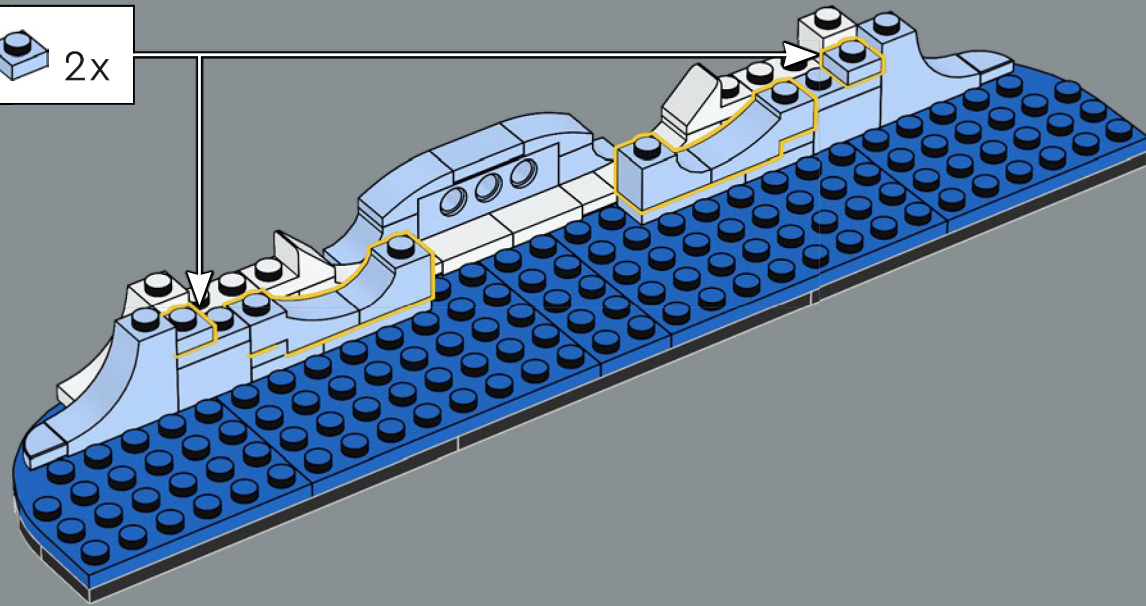
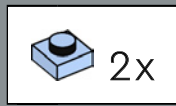

86

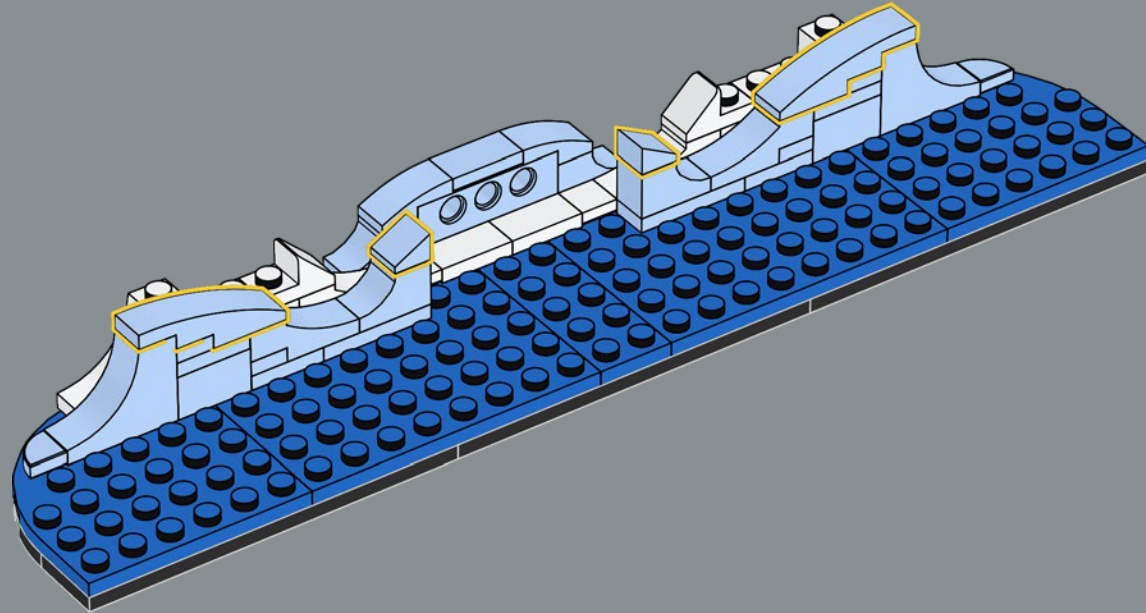

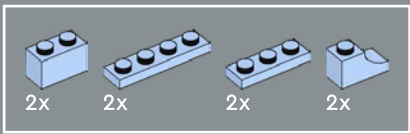

87

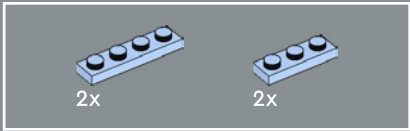
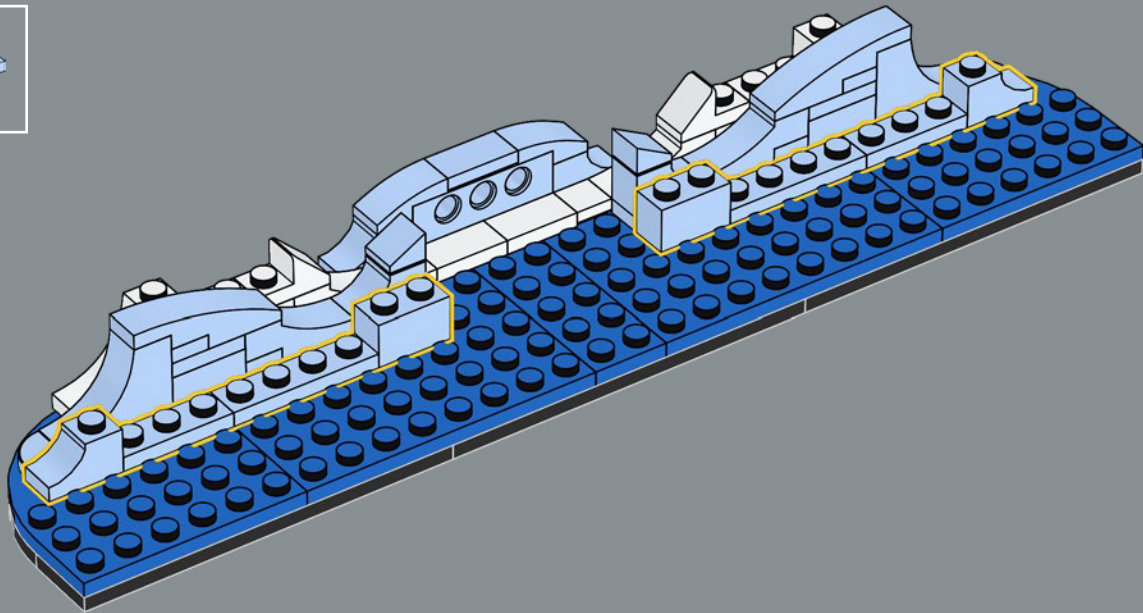

88

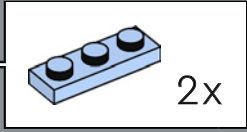
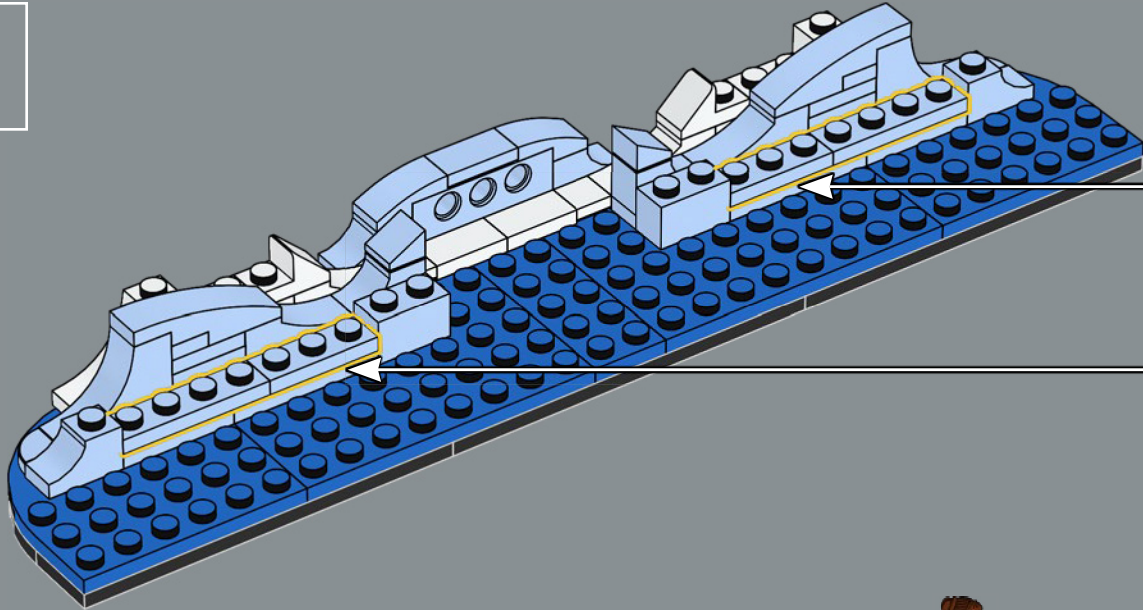

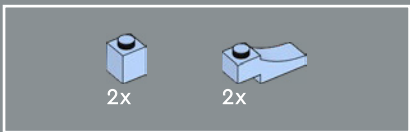

89

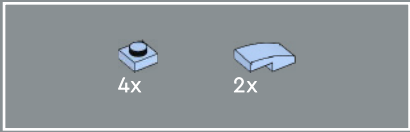
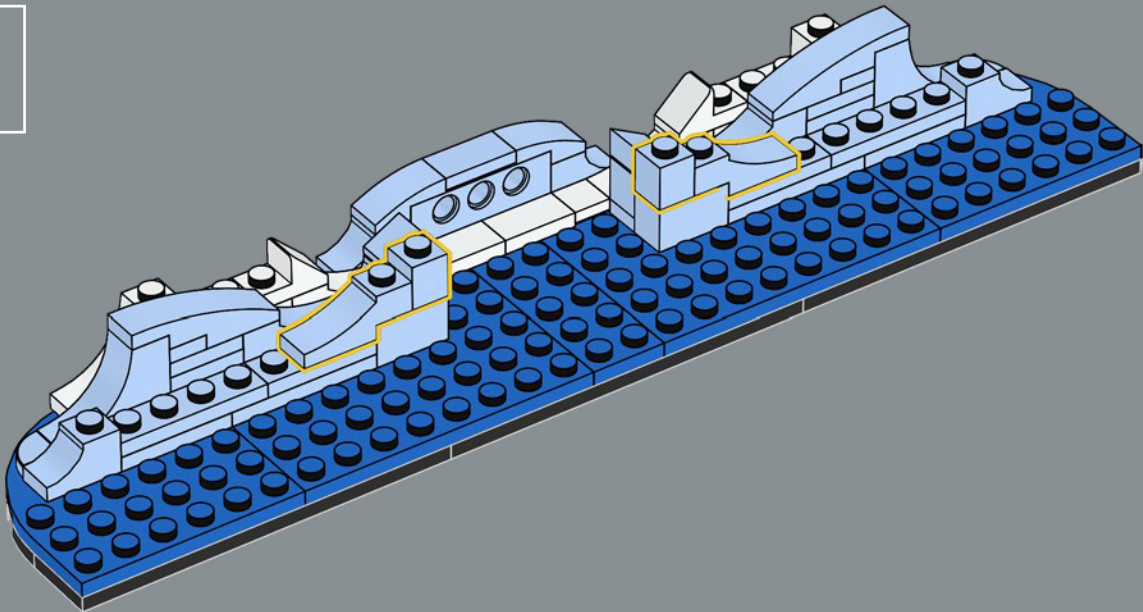

90

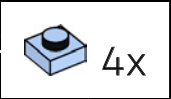
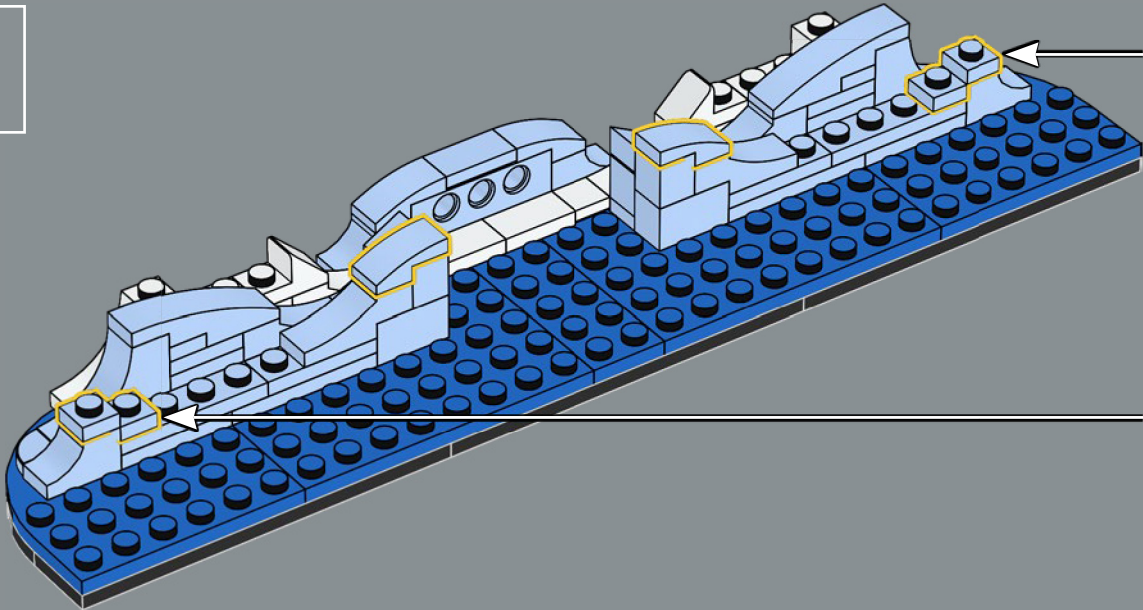

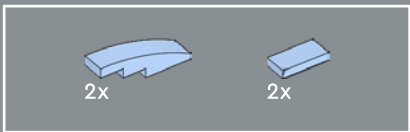

91

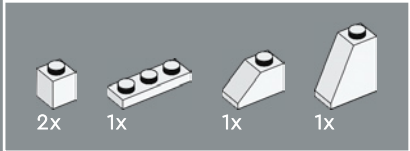
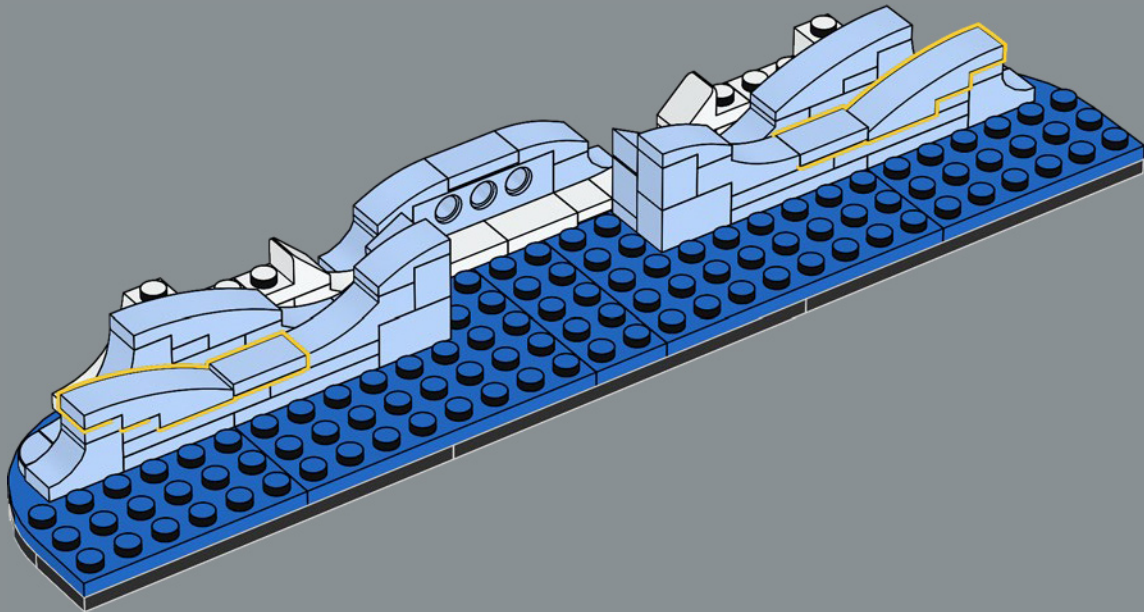

92

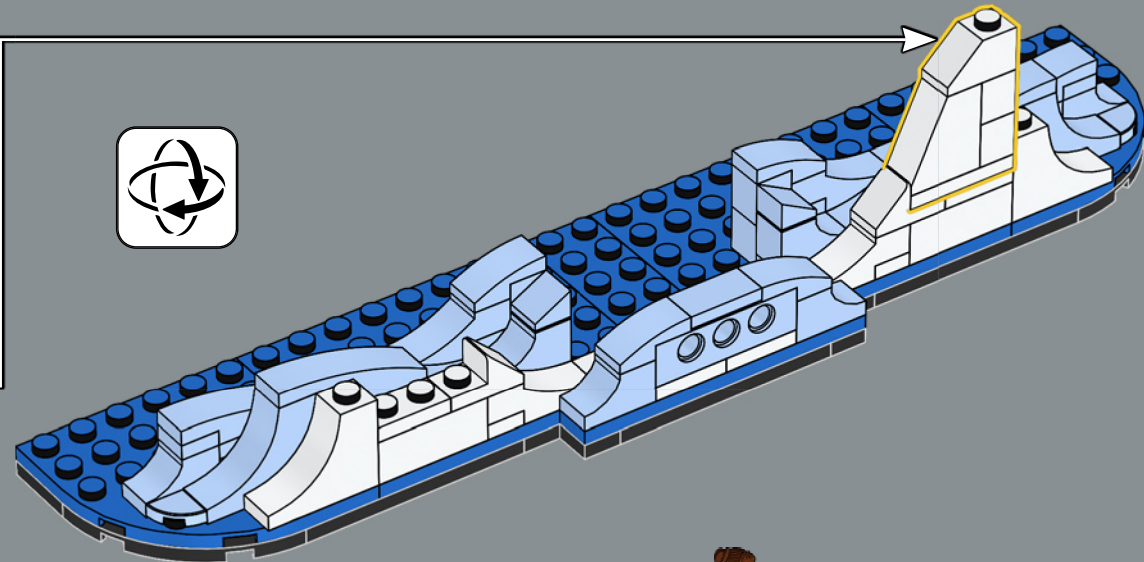
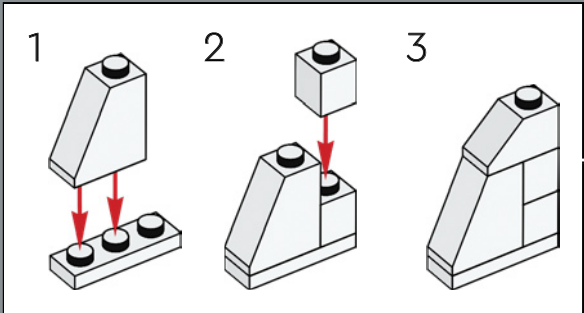

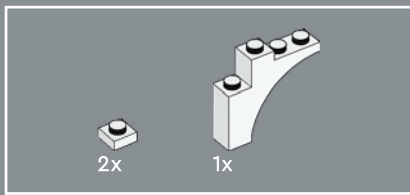

93

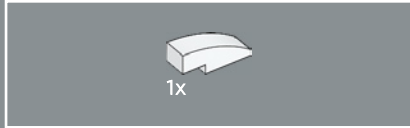
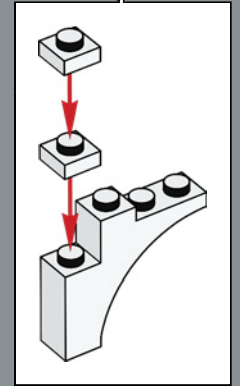
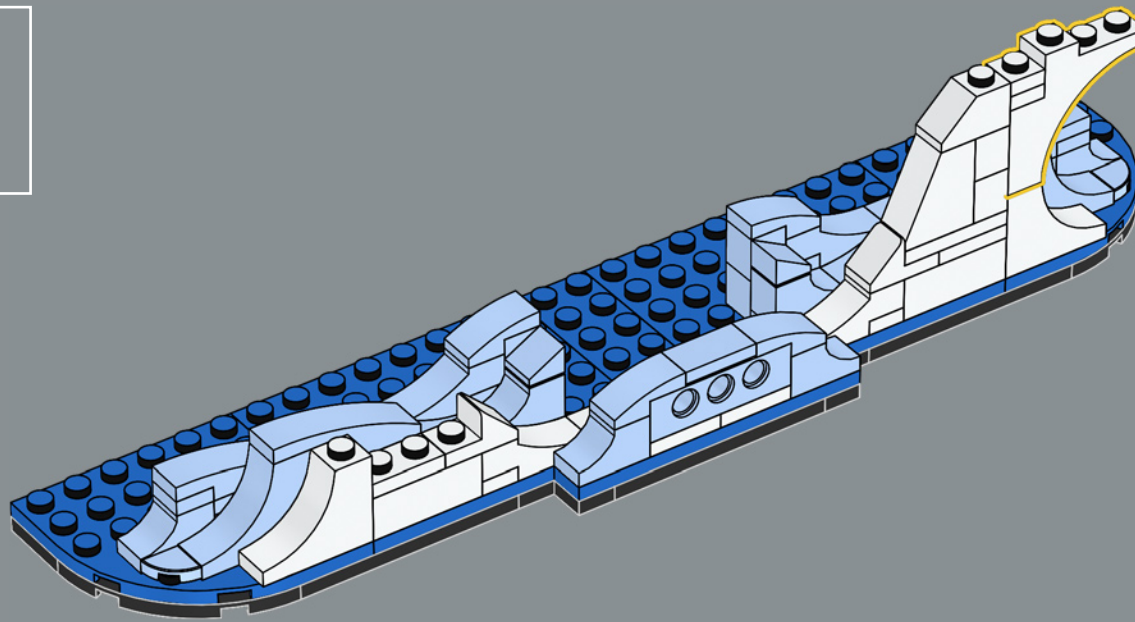

94

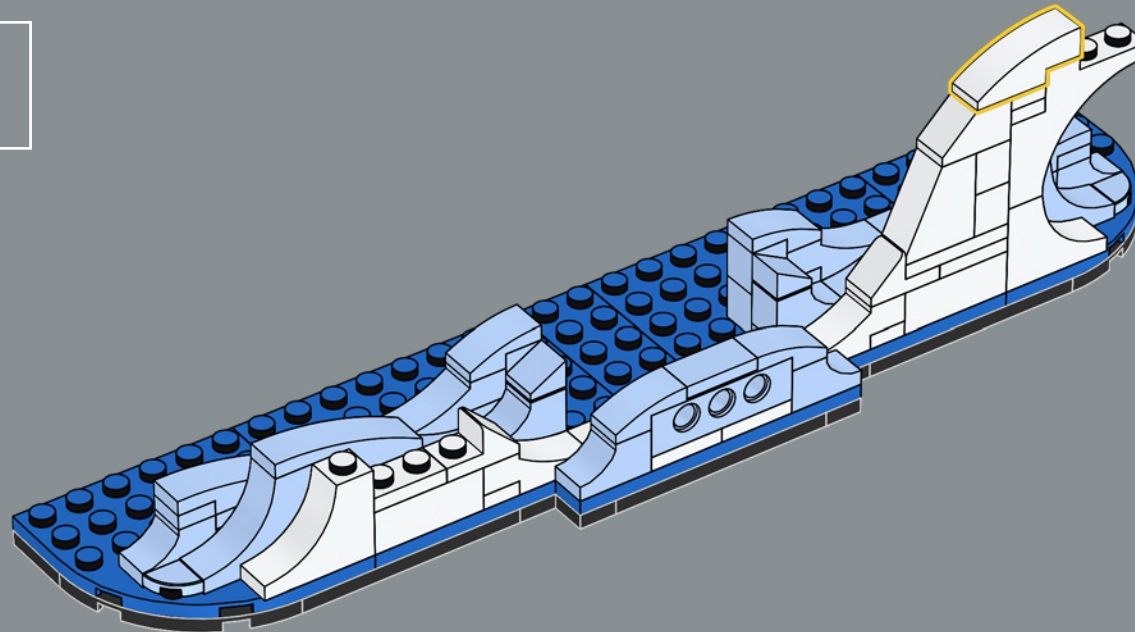

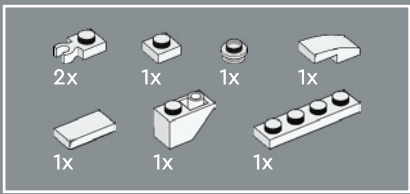

95

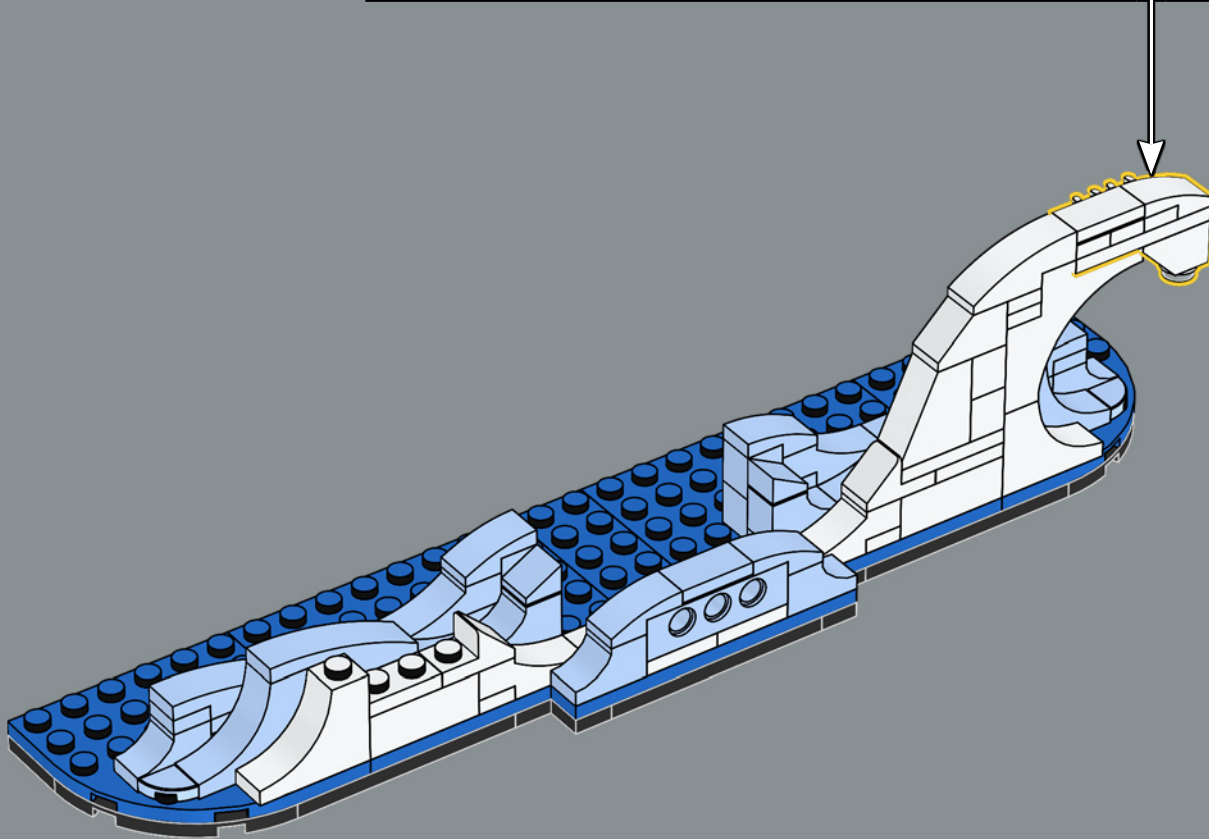
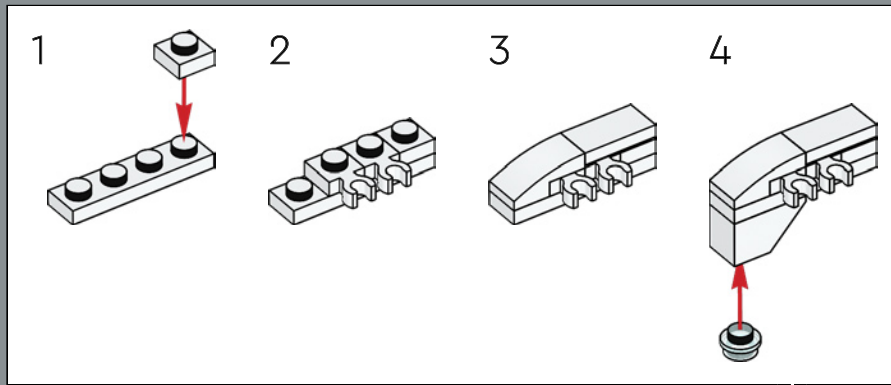

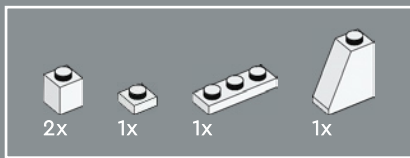

96

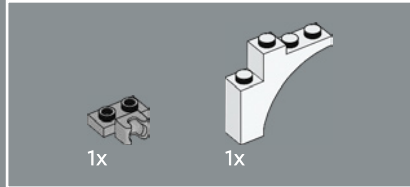
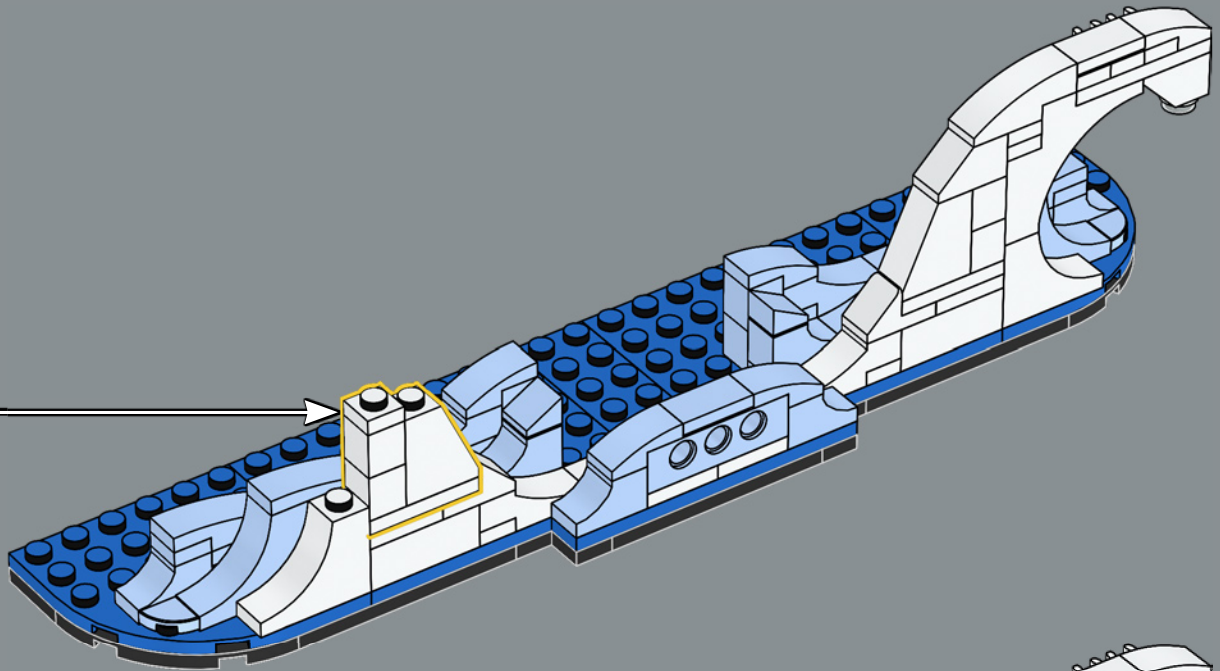
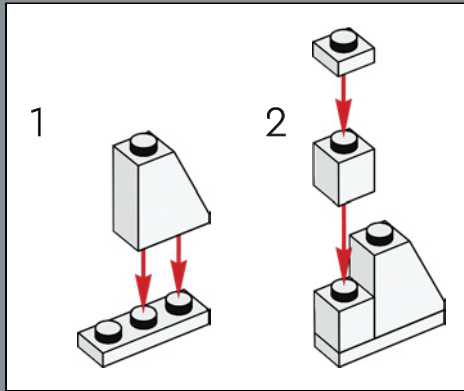

97

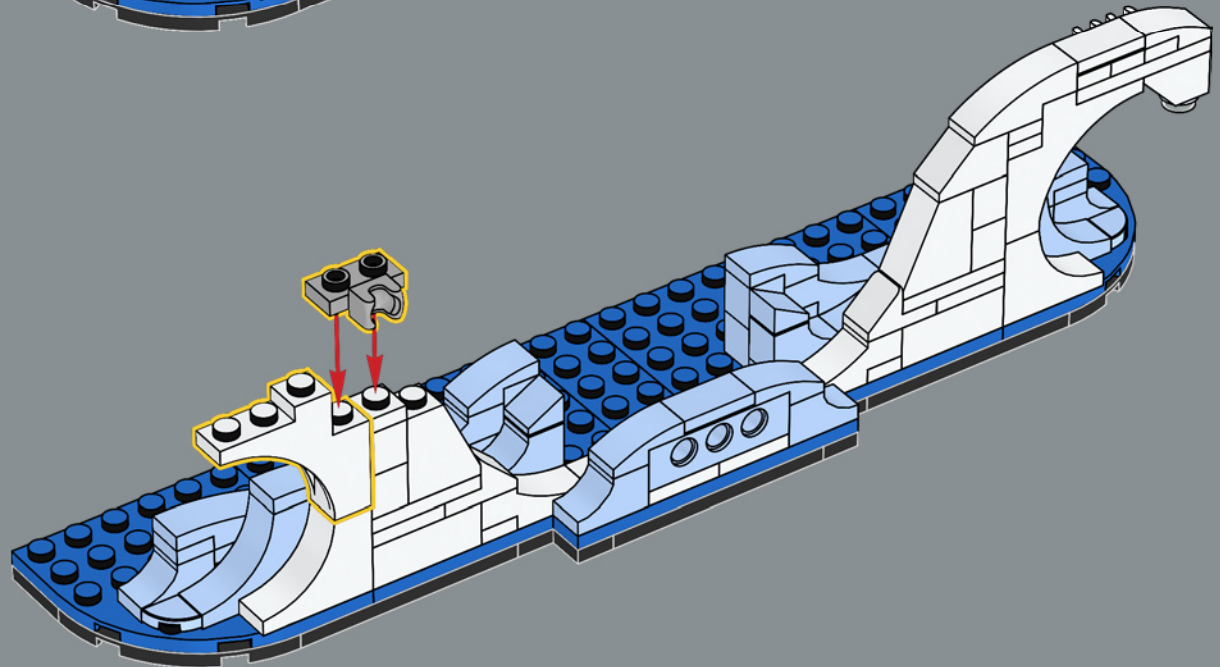

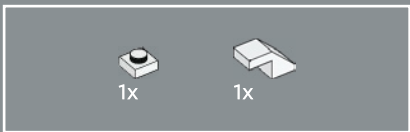

98

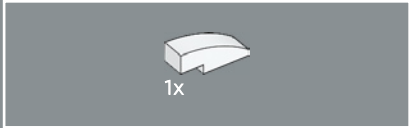
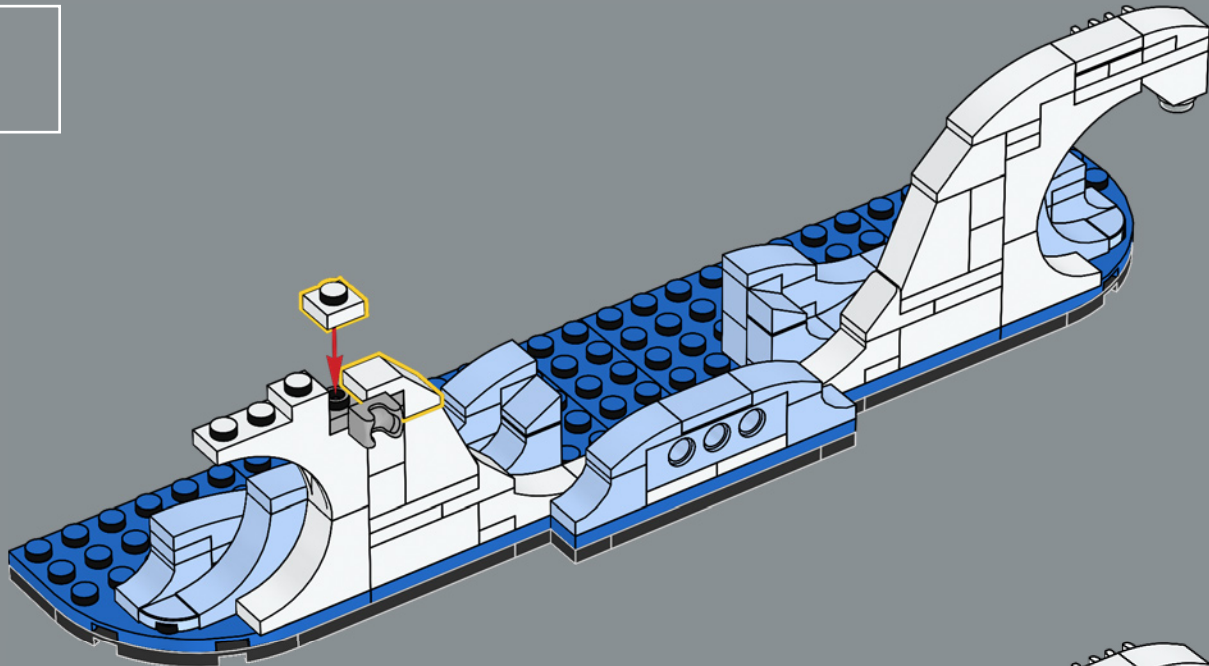

99

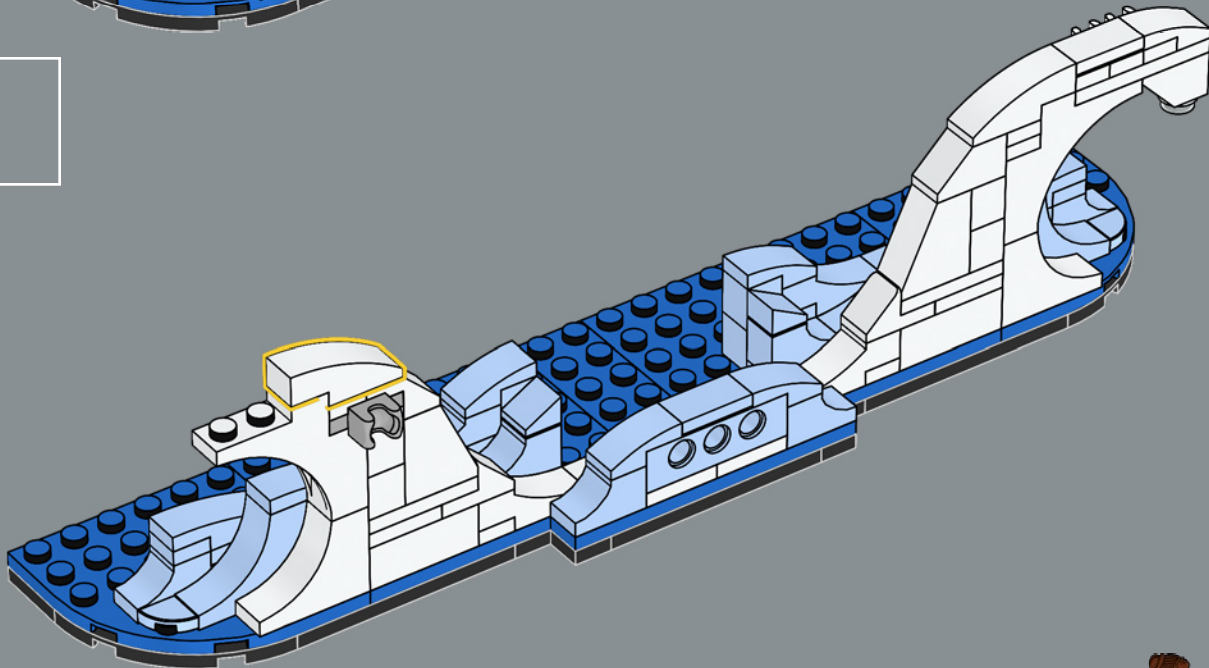

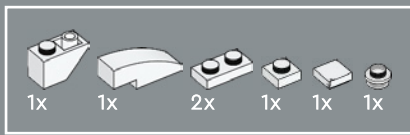

100

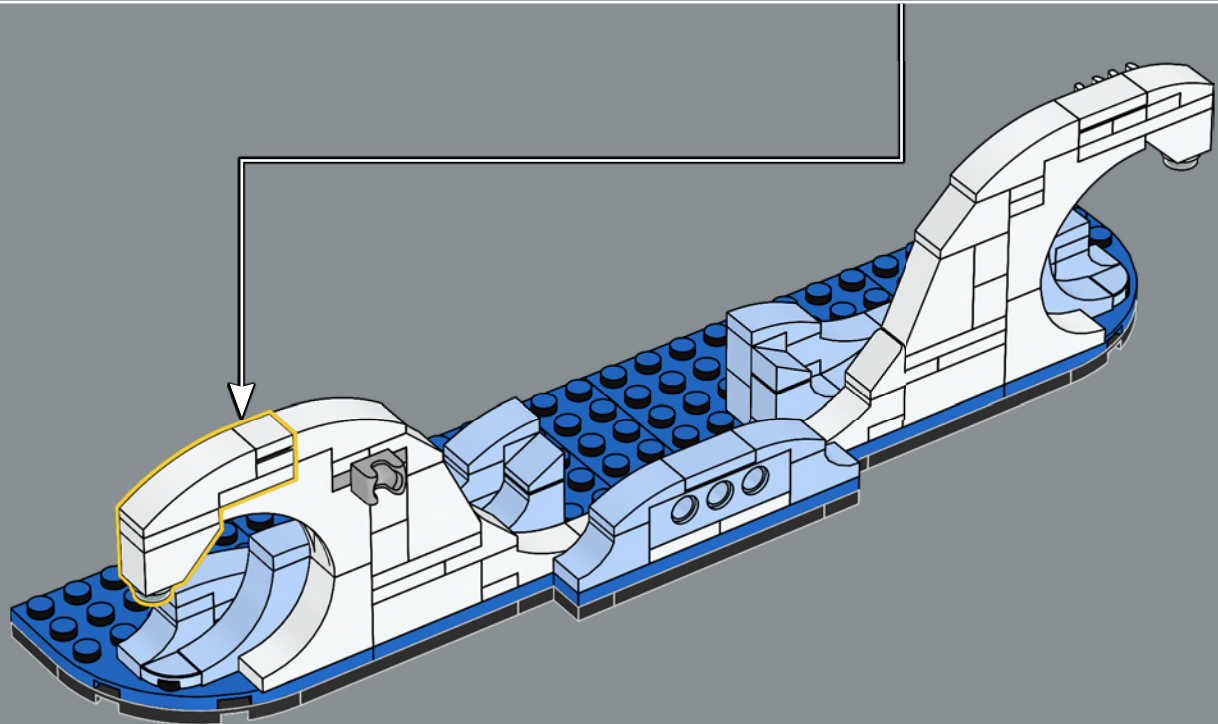
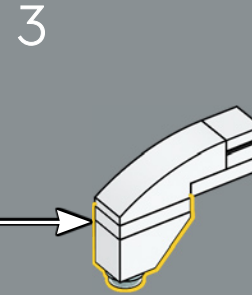
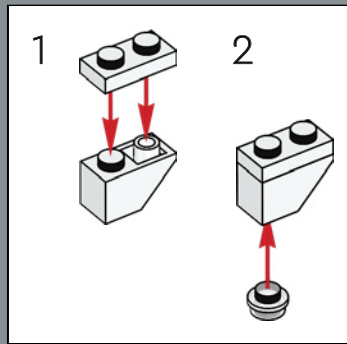
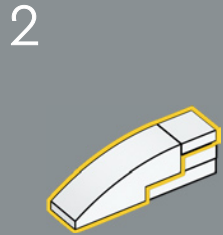
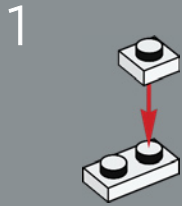

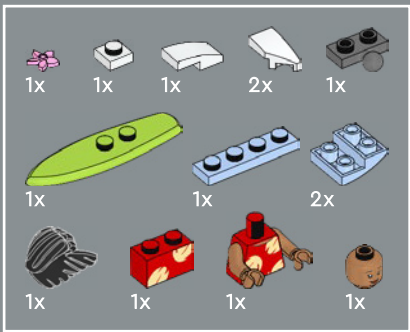

101

1

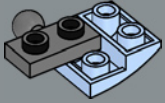

2

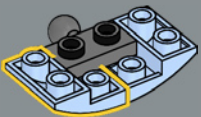

3

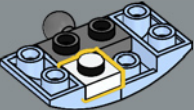

4

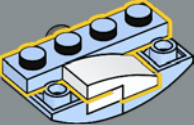

5

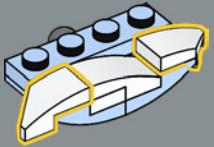

1

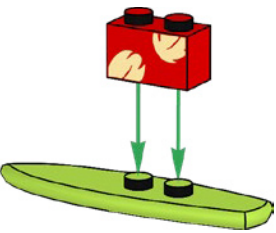

2

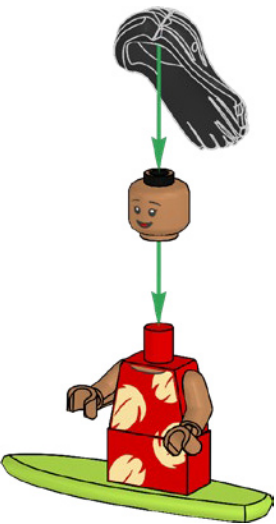





3

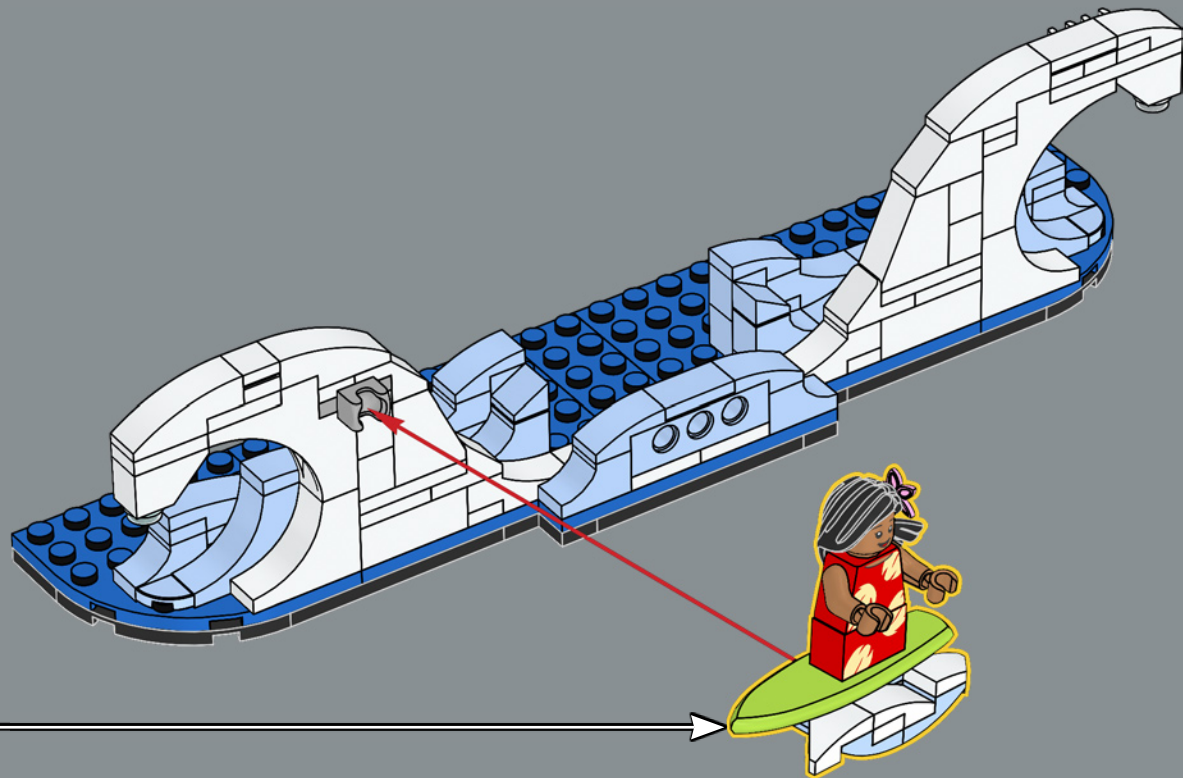

6





-  1x
-  1x
-  2x
-  1x
-  1x

102

	<input checked="" type="checkbox"/>
	<input type="checkbox"/>

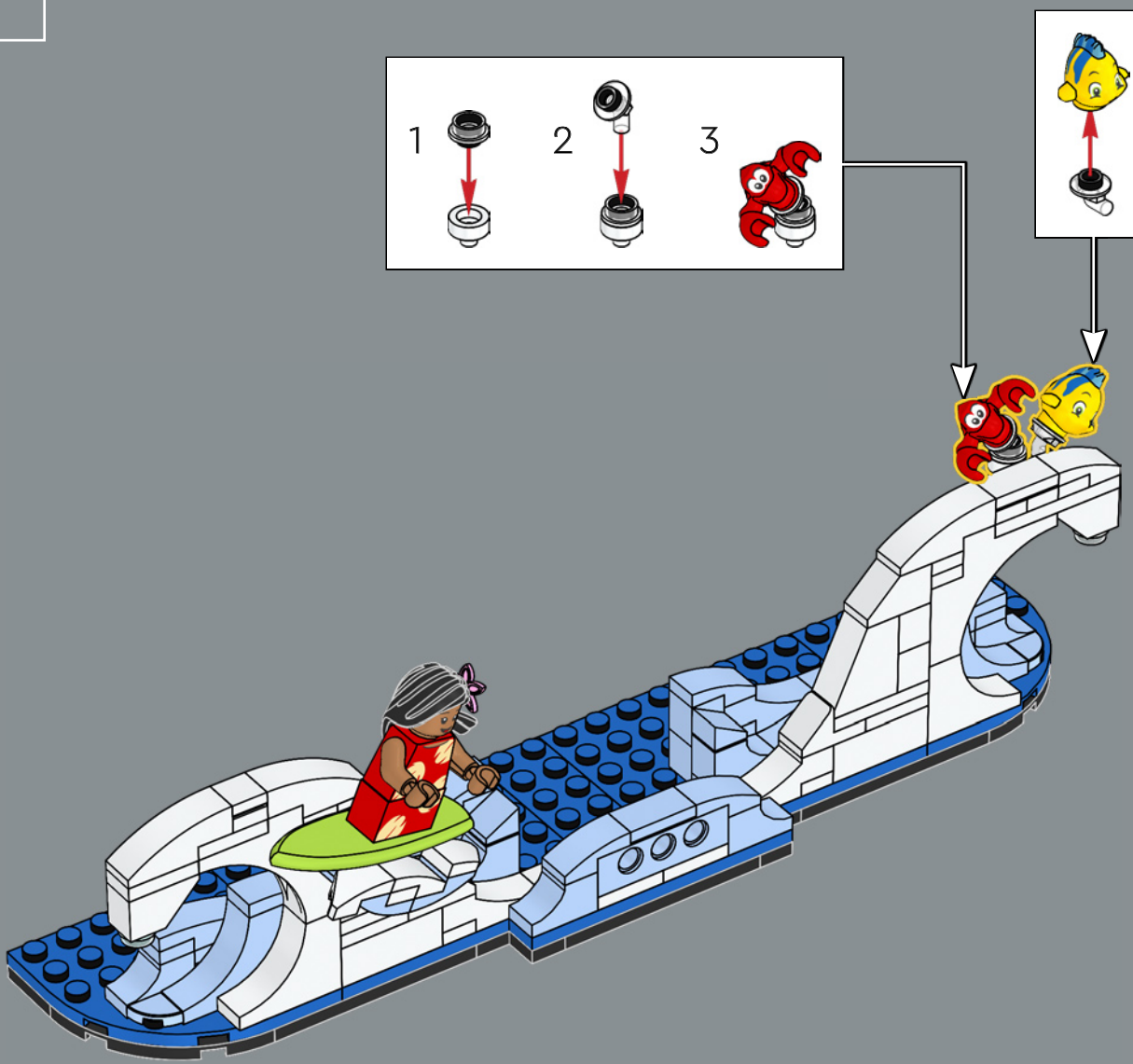
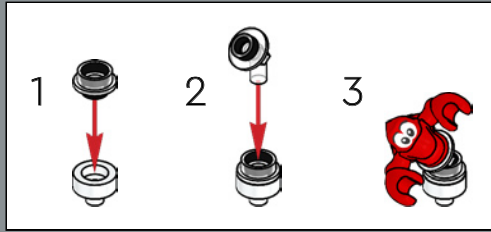

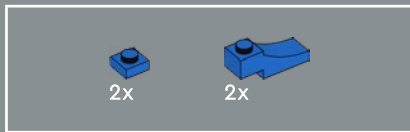

103

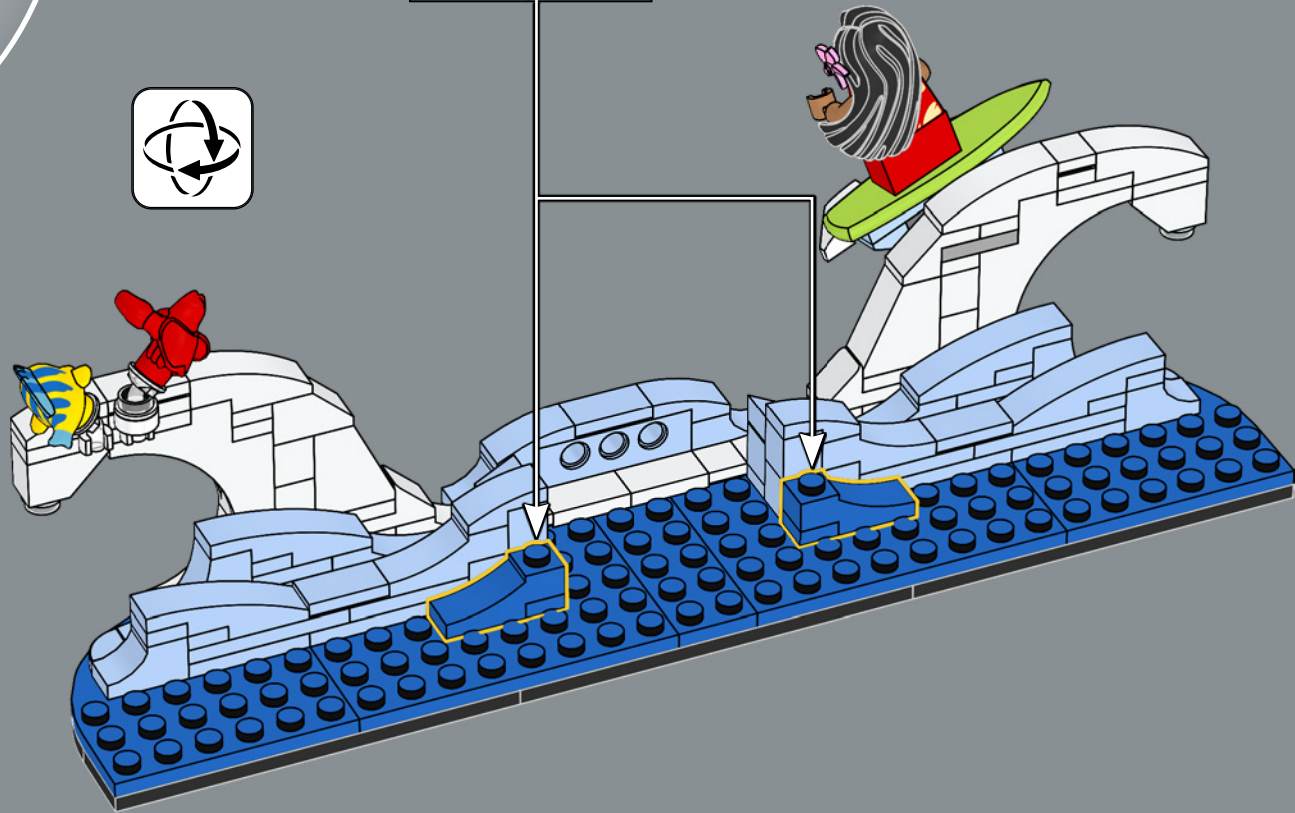
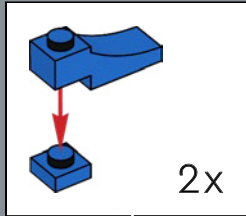

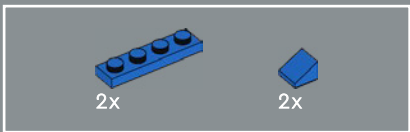

104

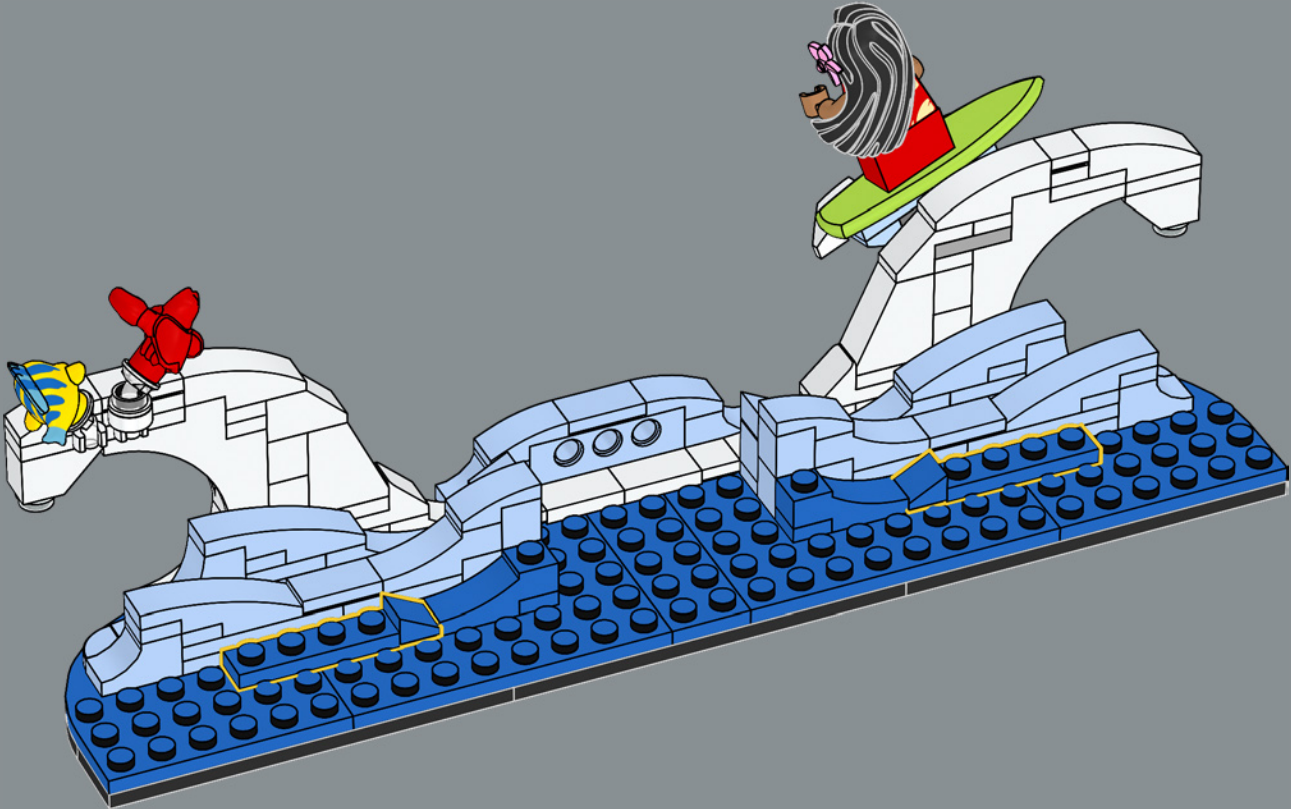

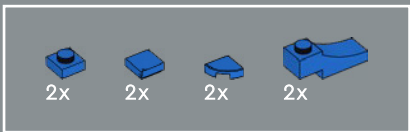

105

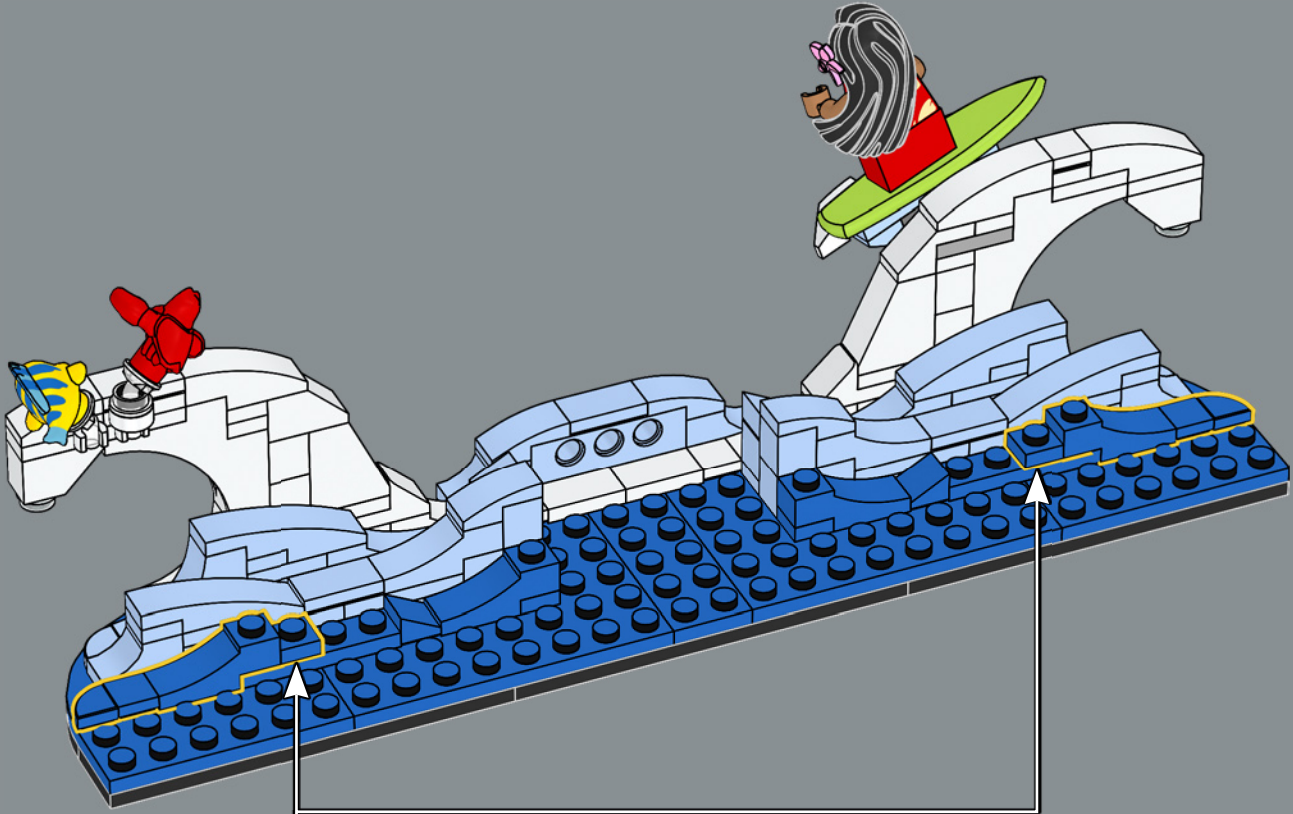

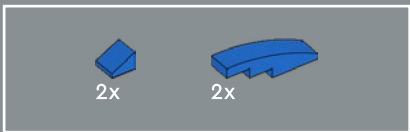

106

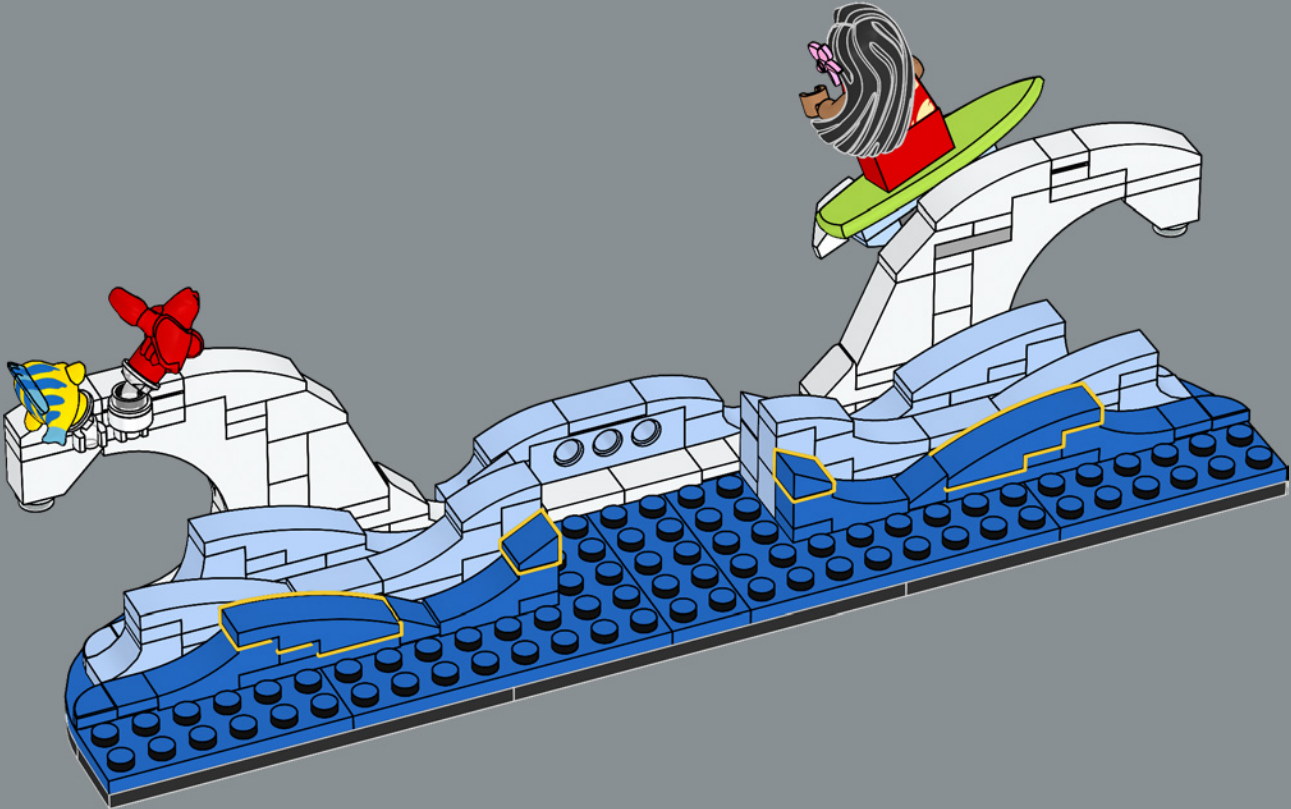

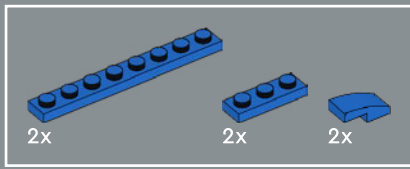

107

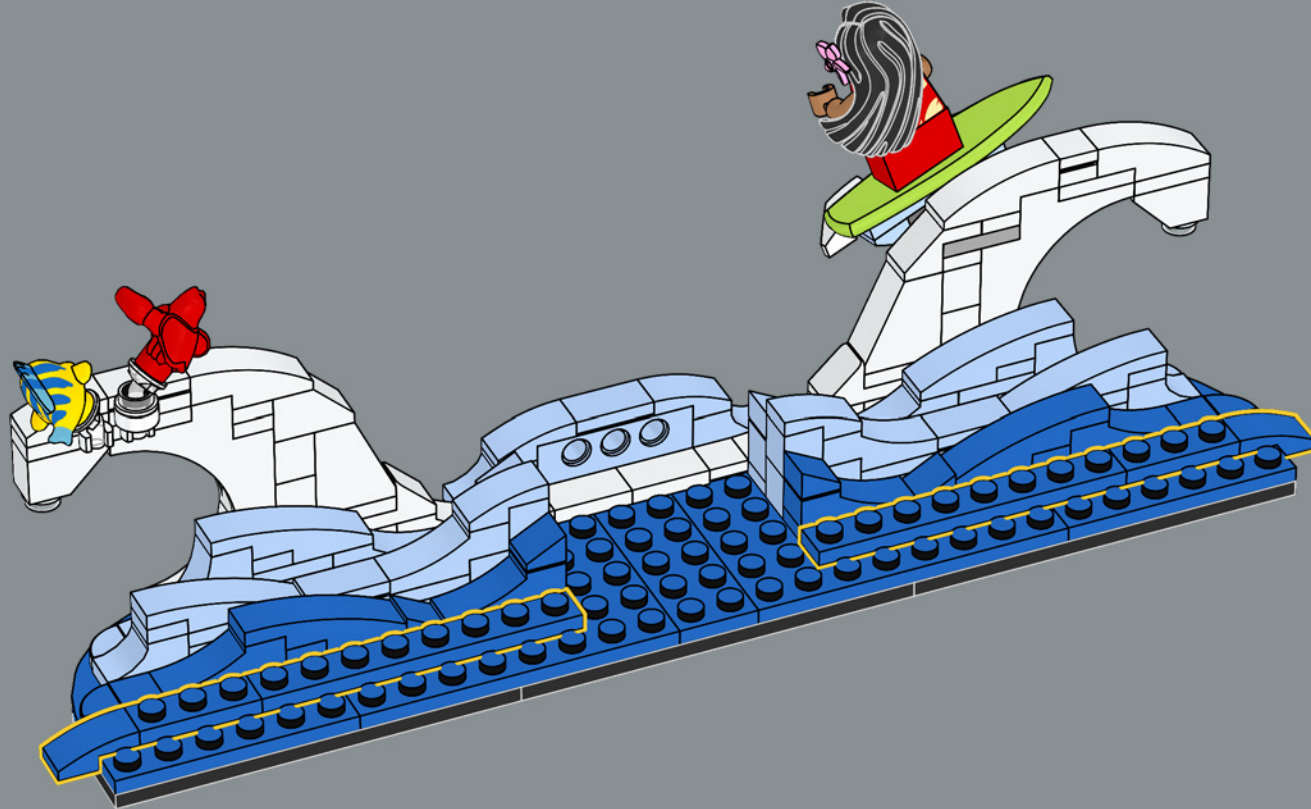

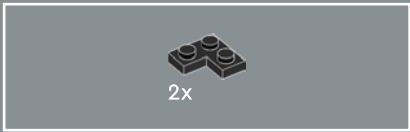

108

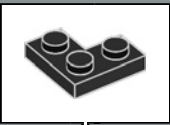
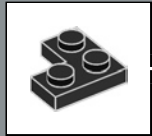
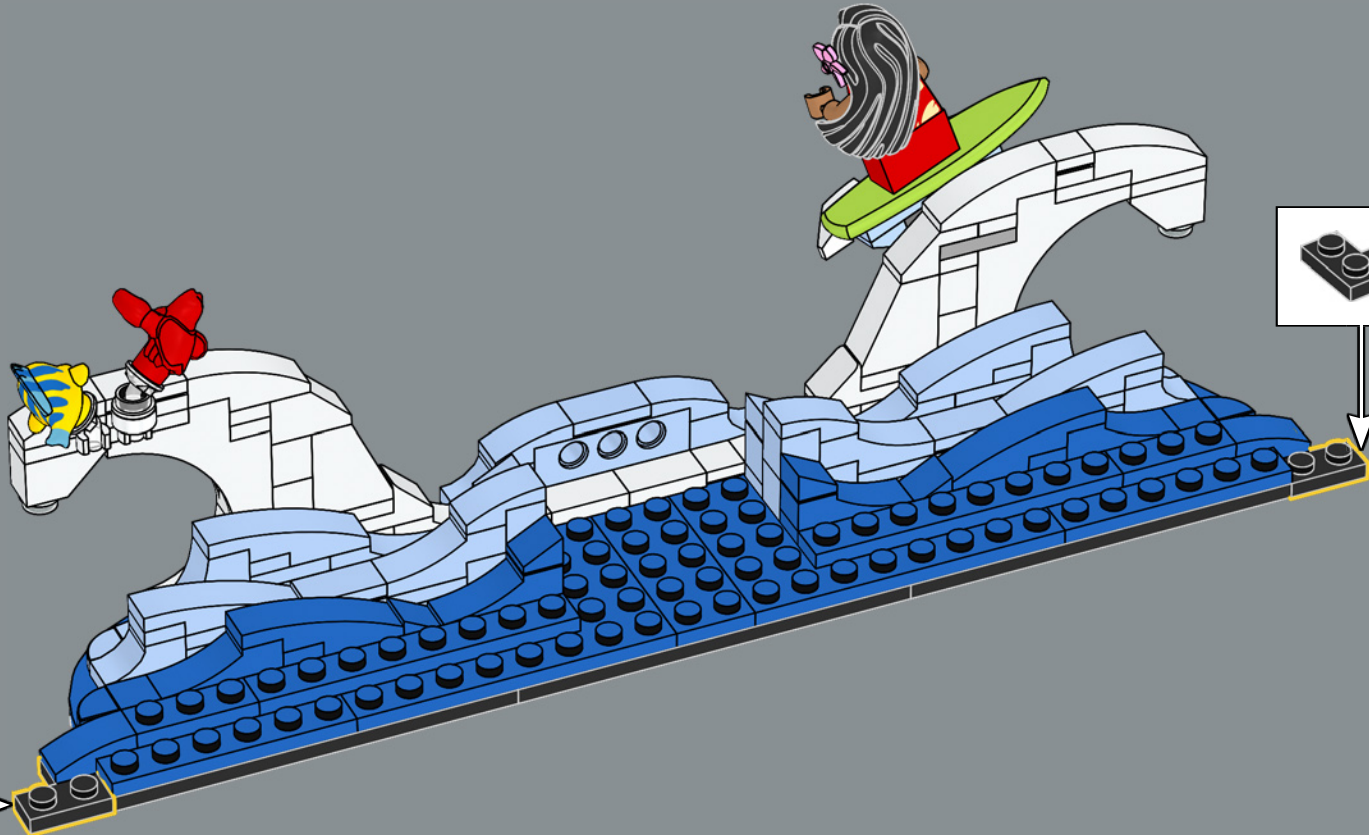

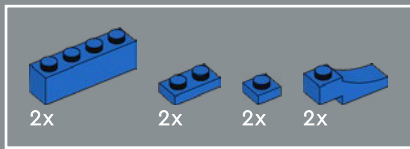

109

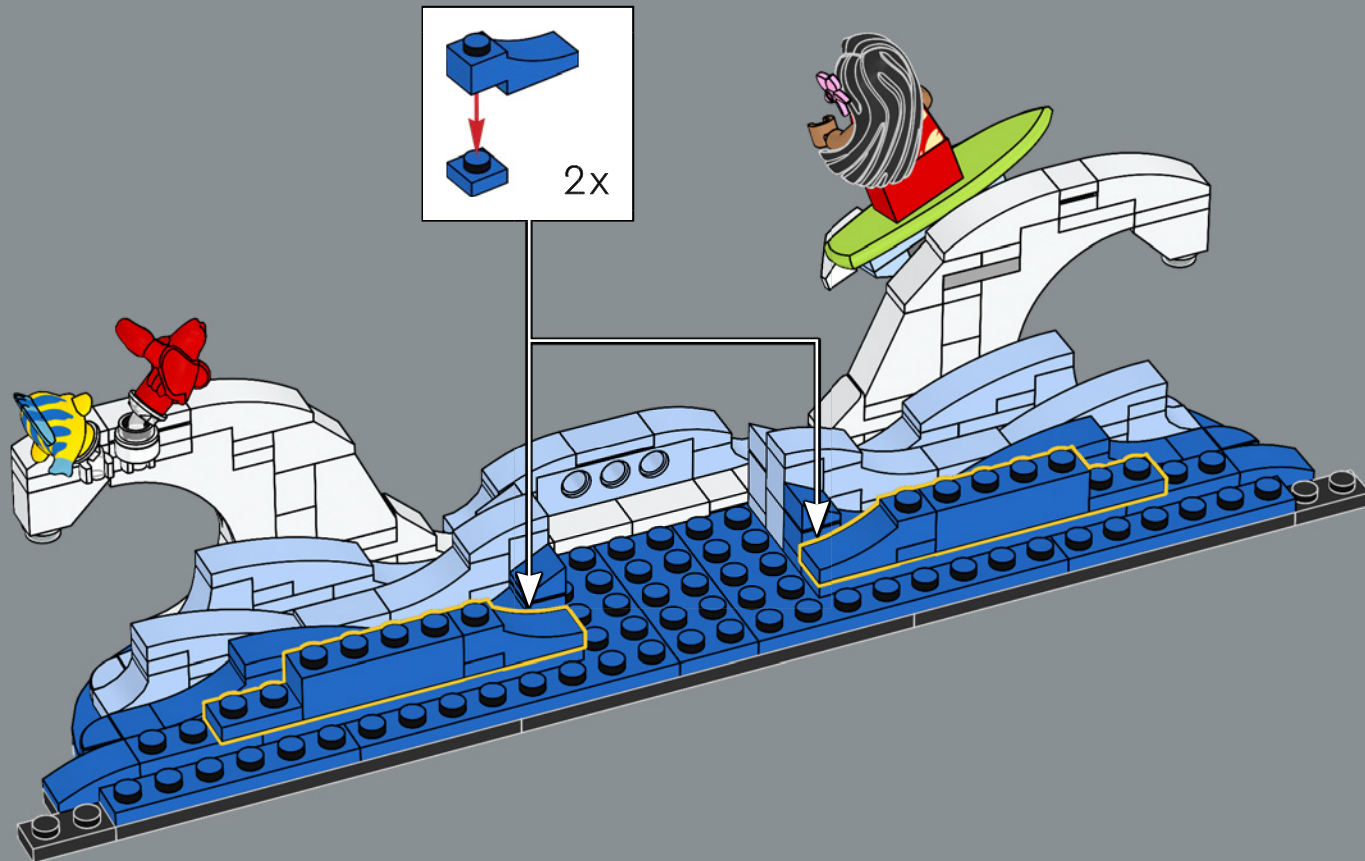

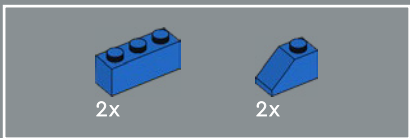

110

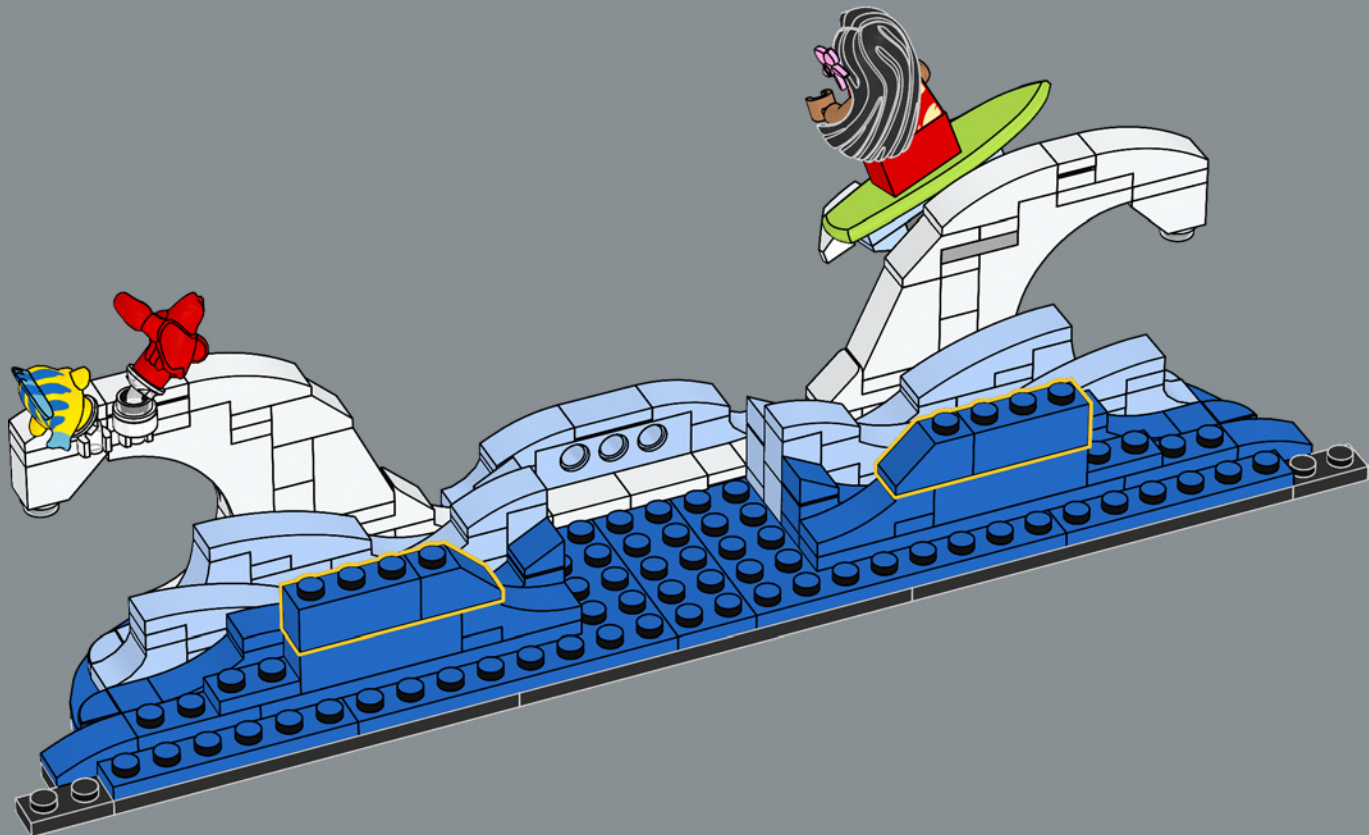



111

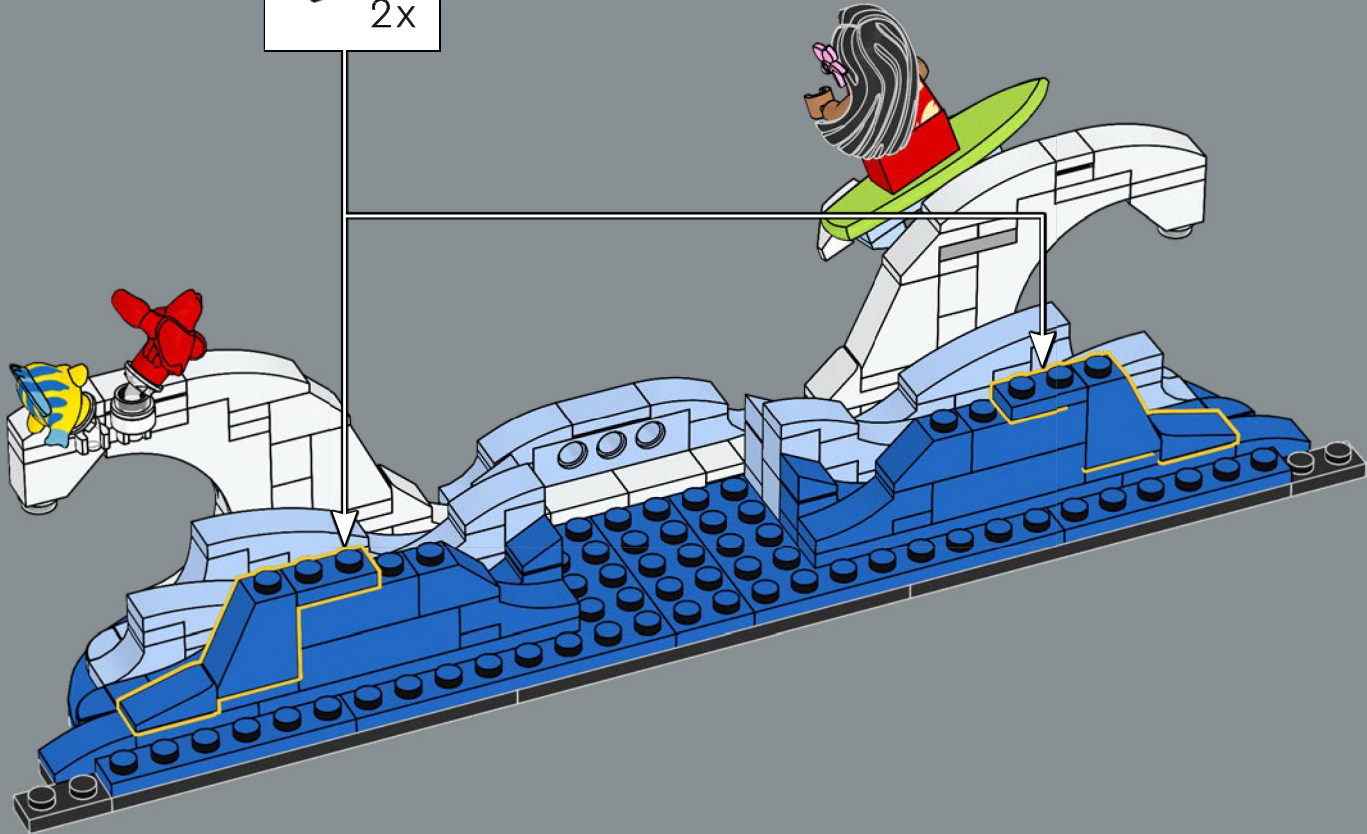
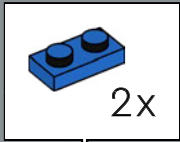

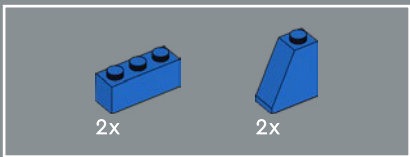

112

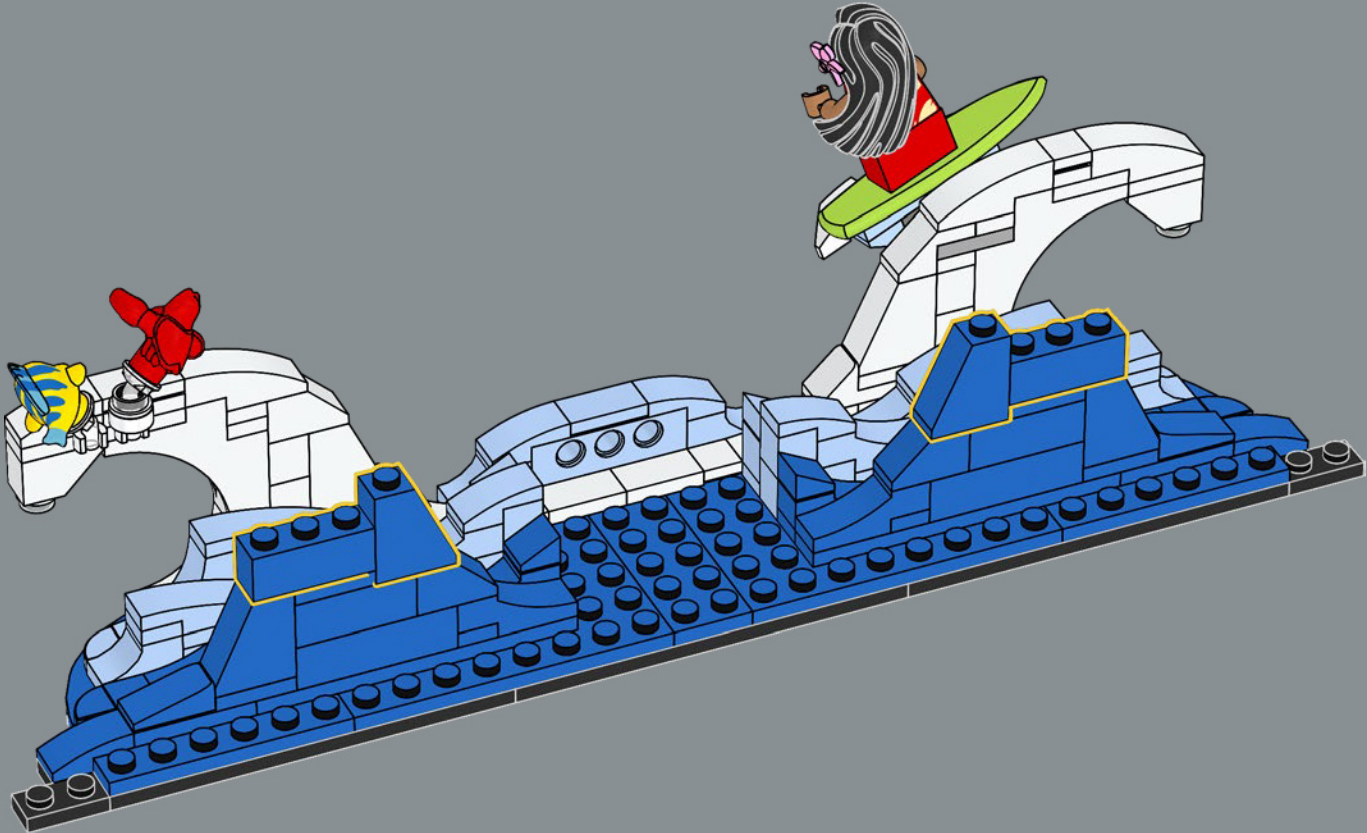

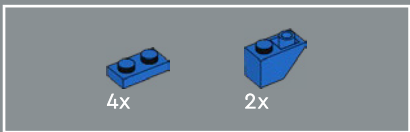

113

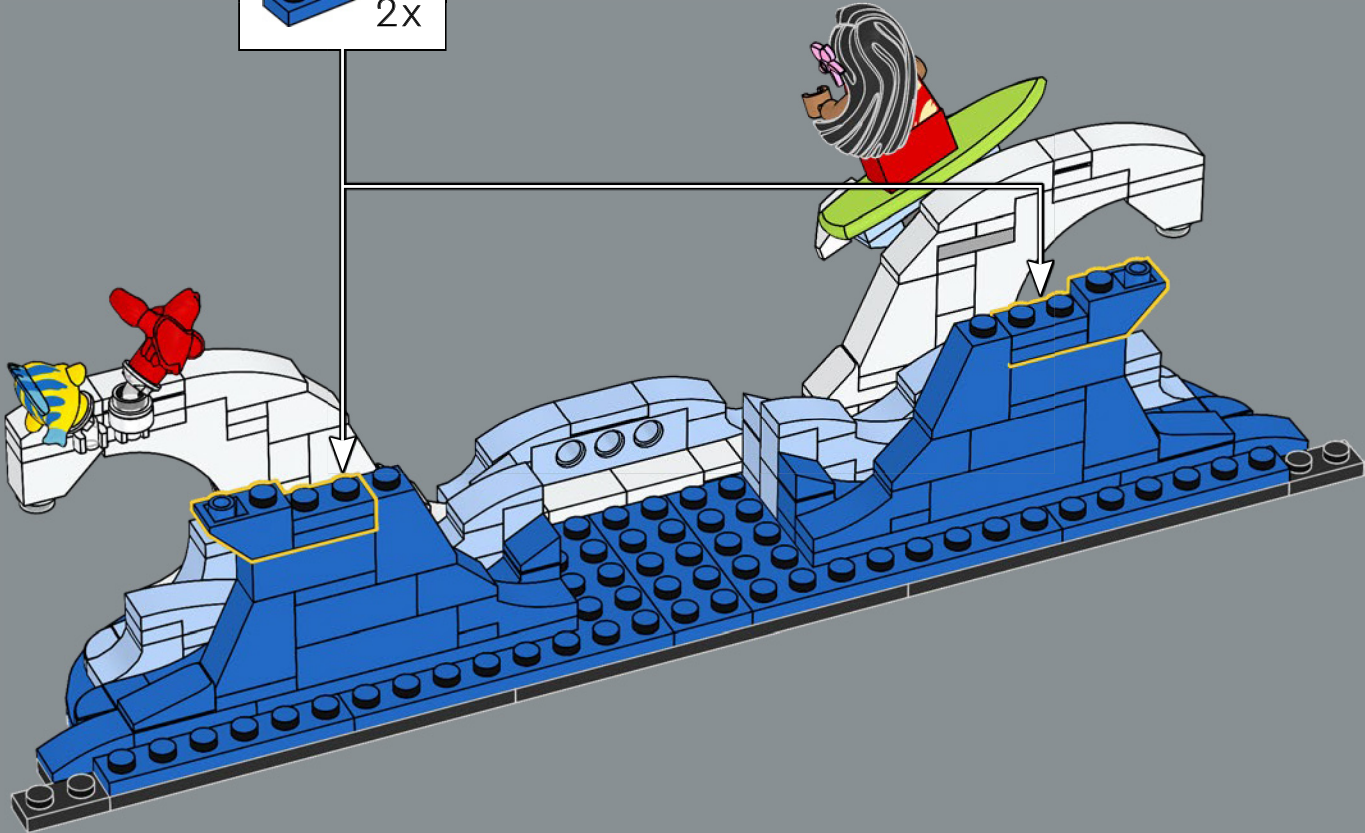
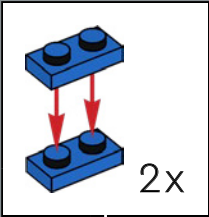

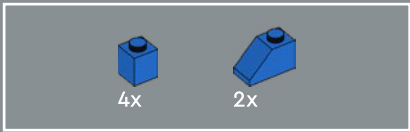

114

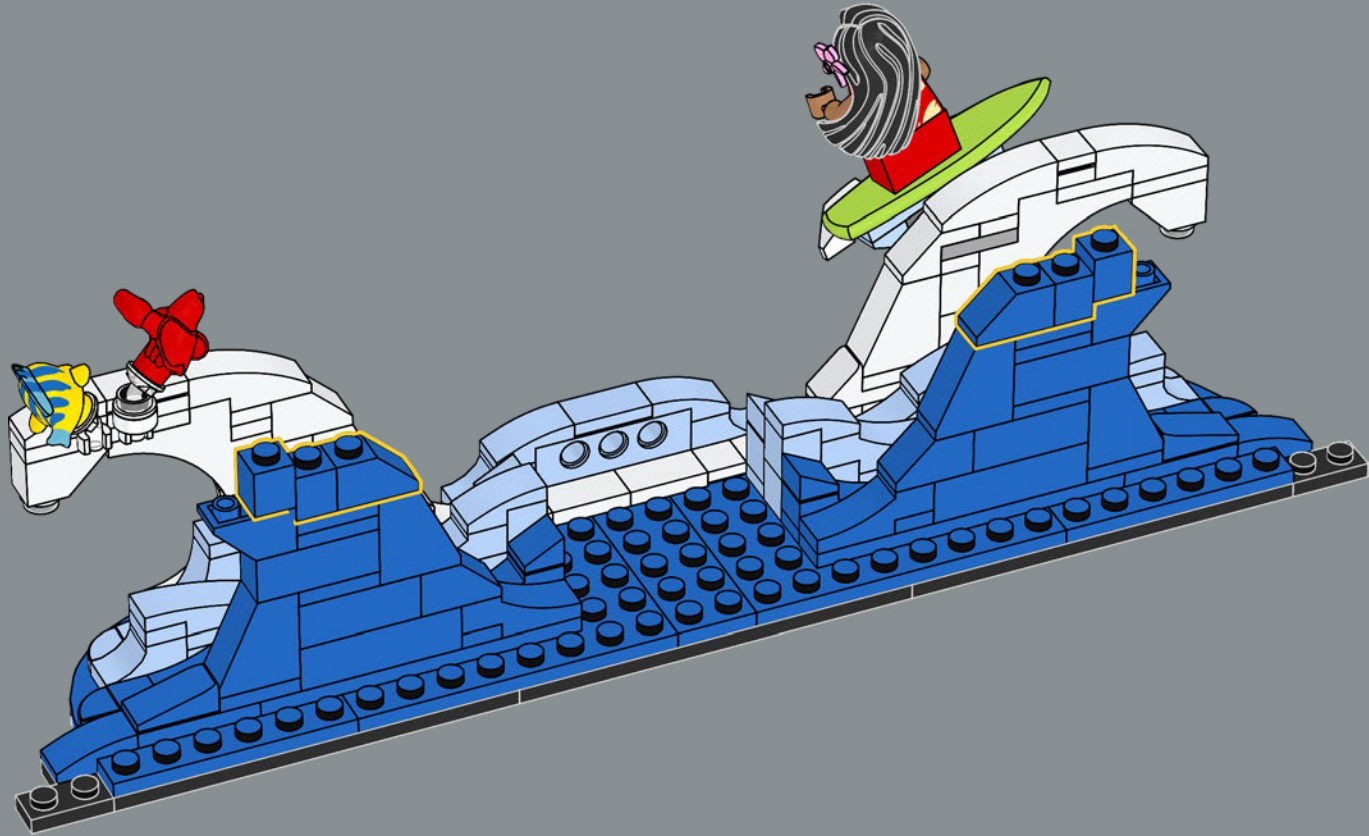

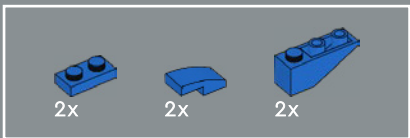

115

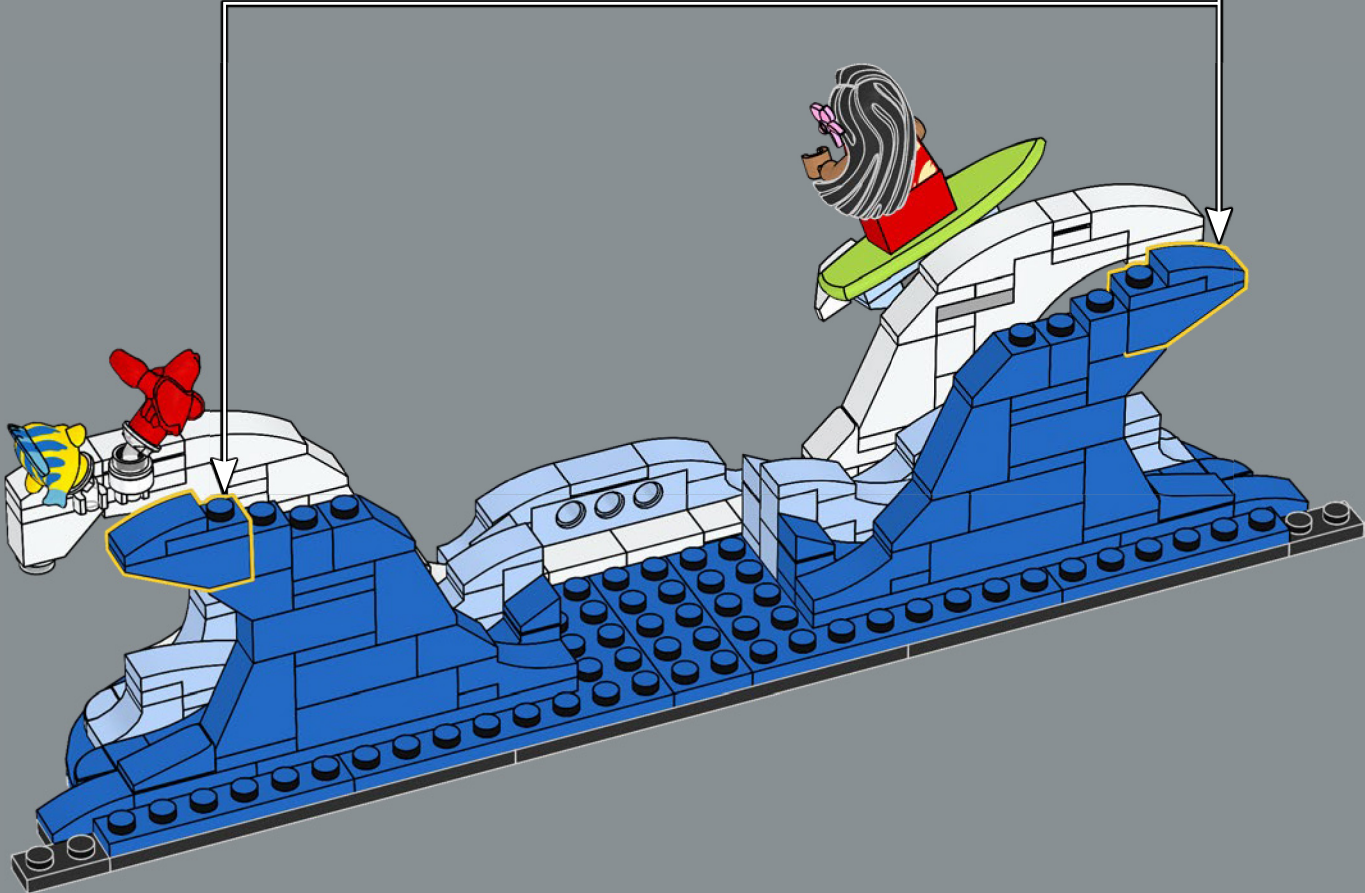
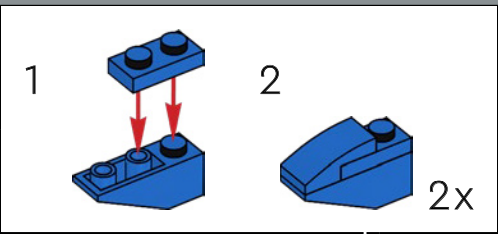

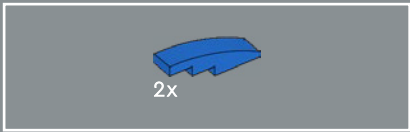

116

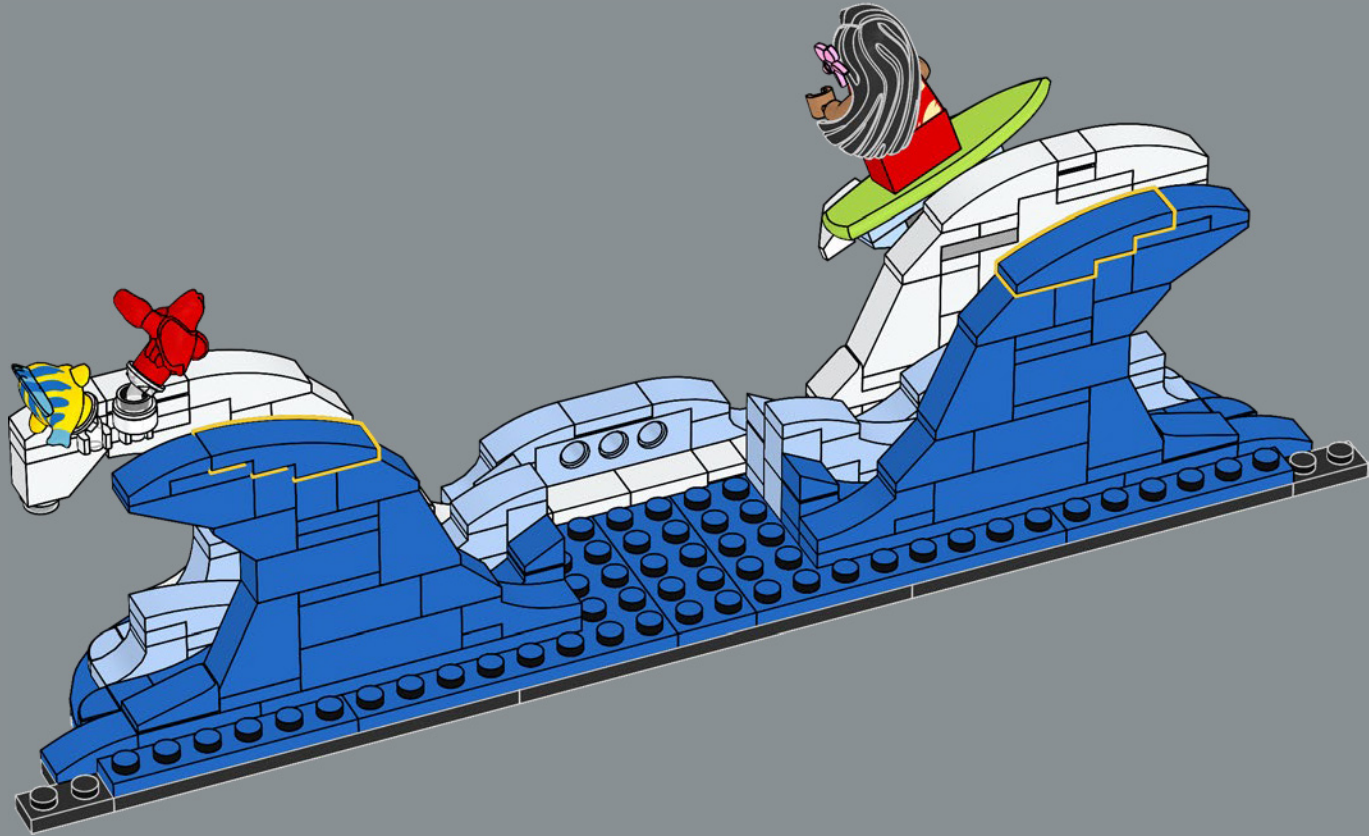

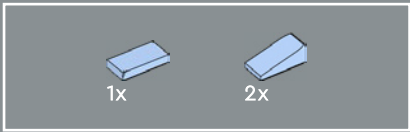

117

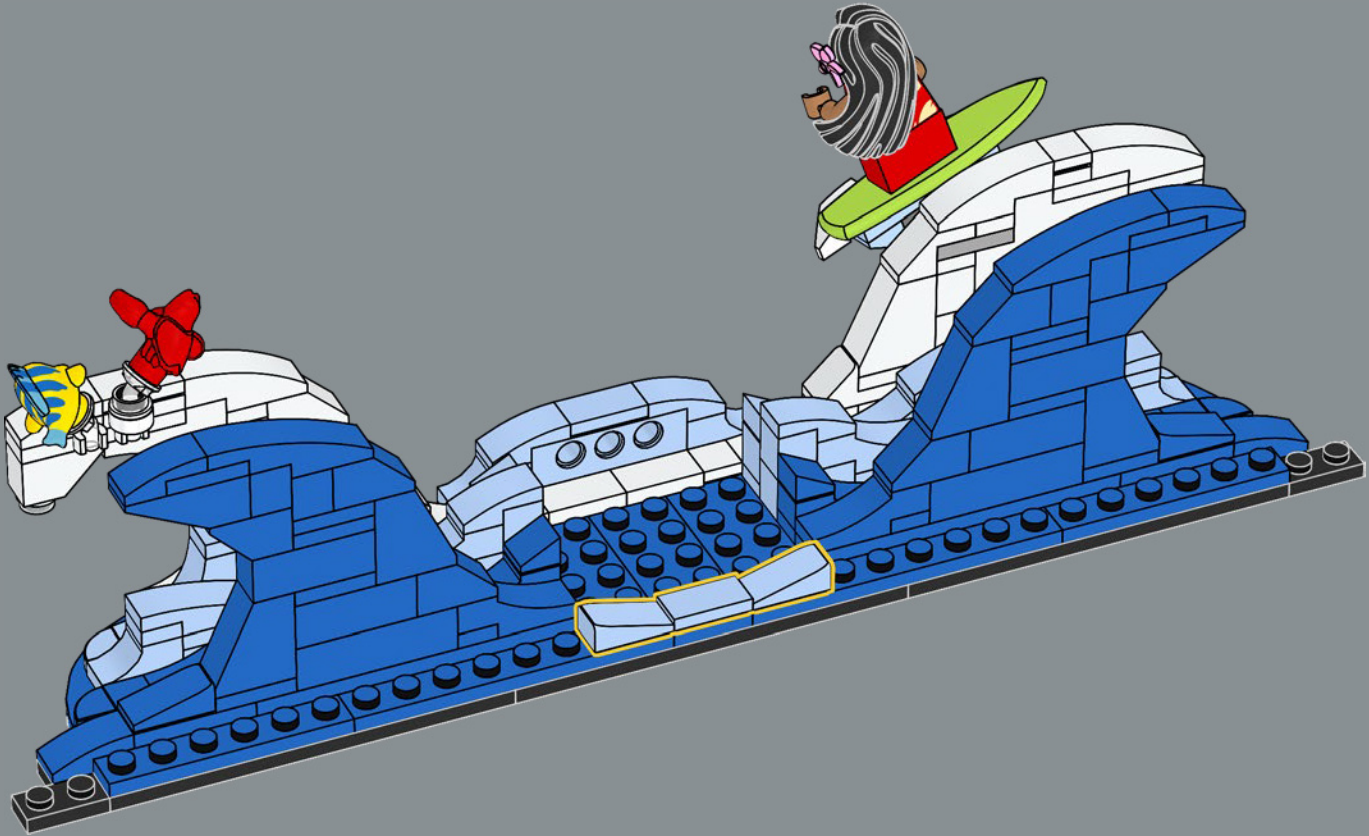

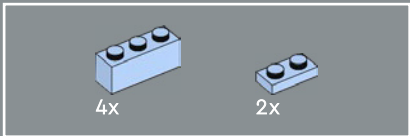

118

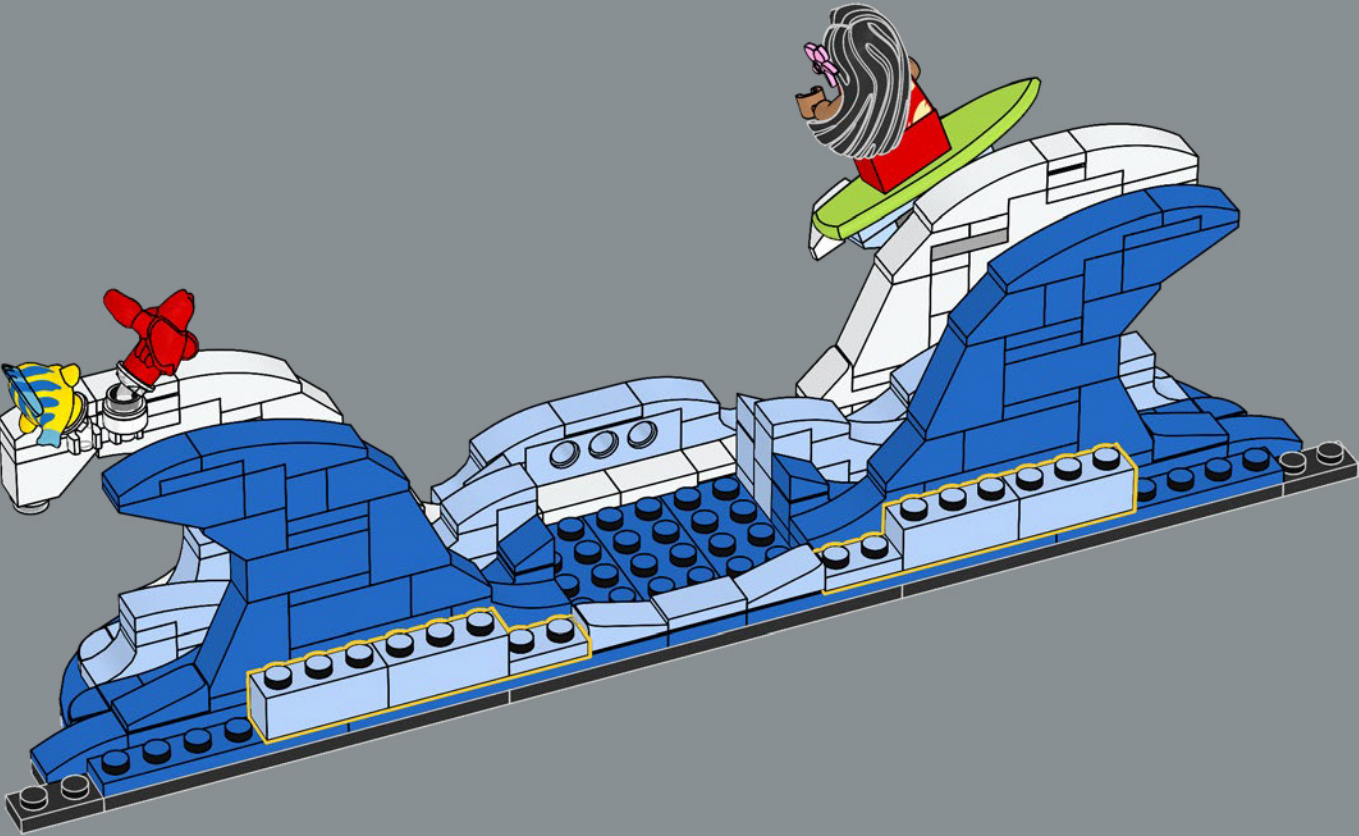

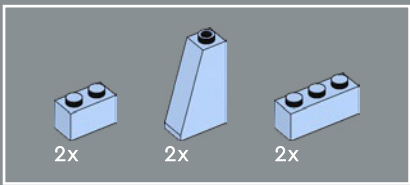

119

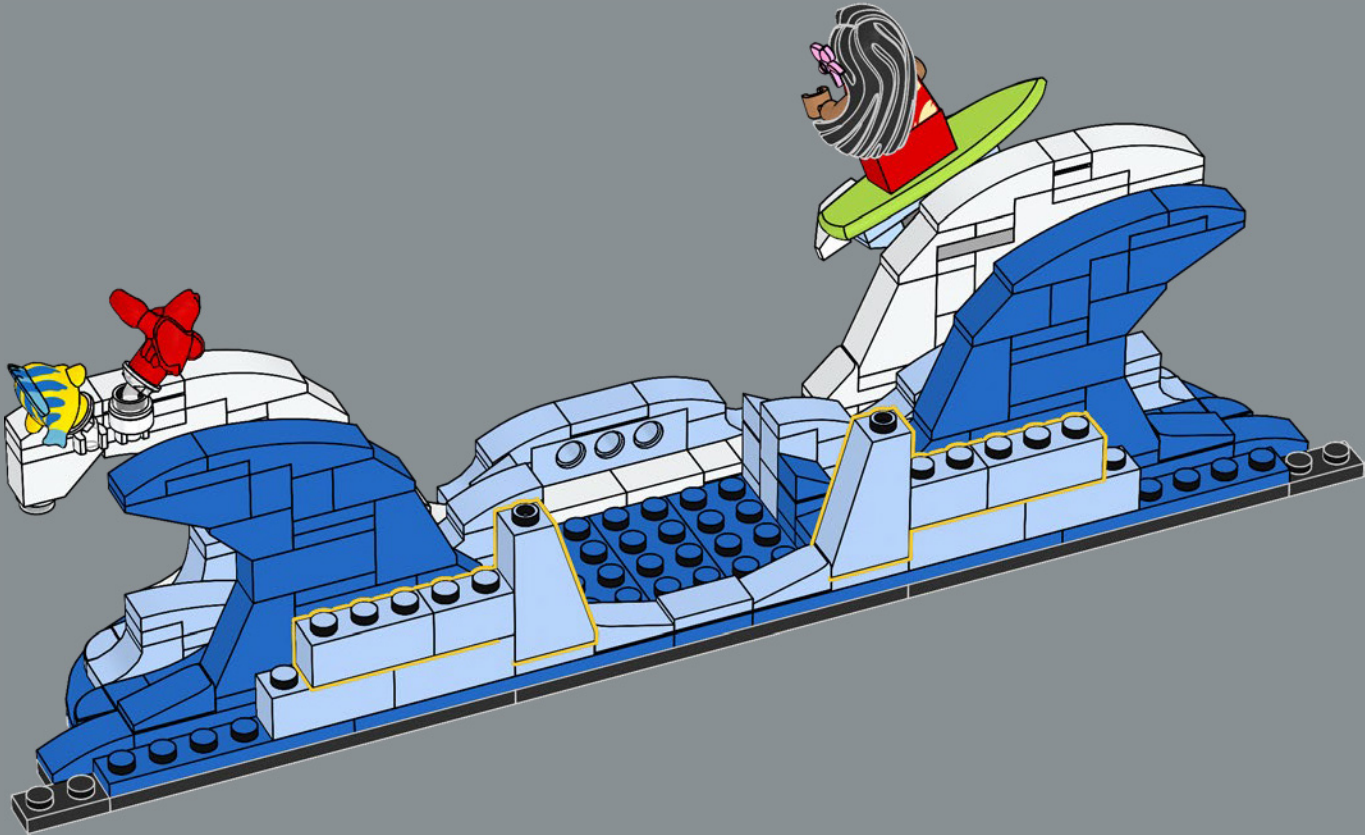

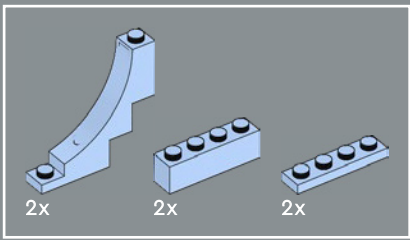

120

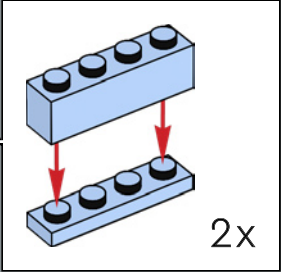
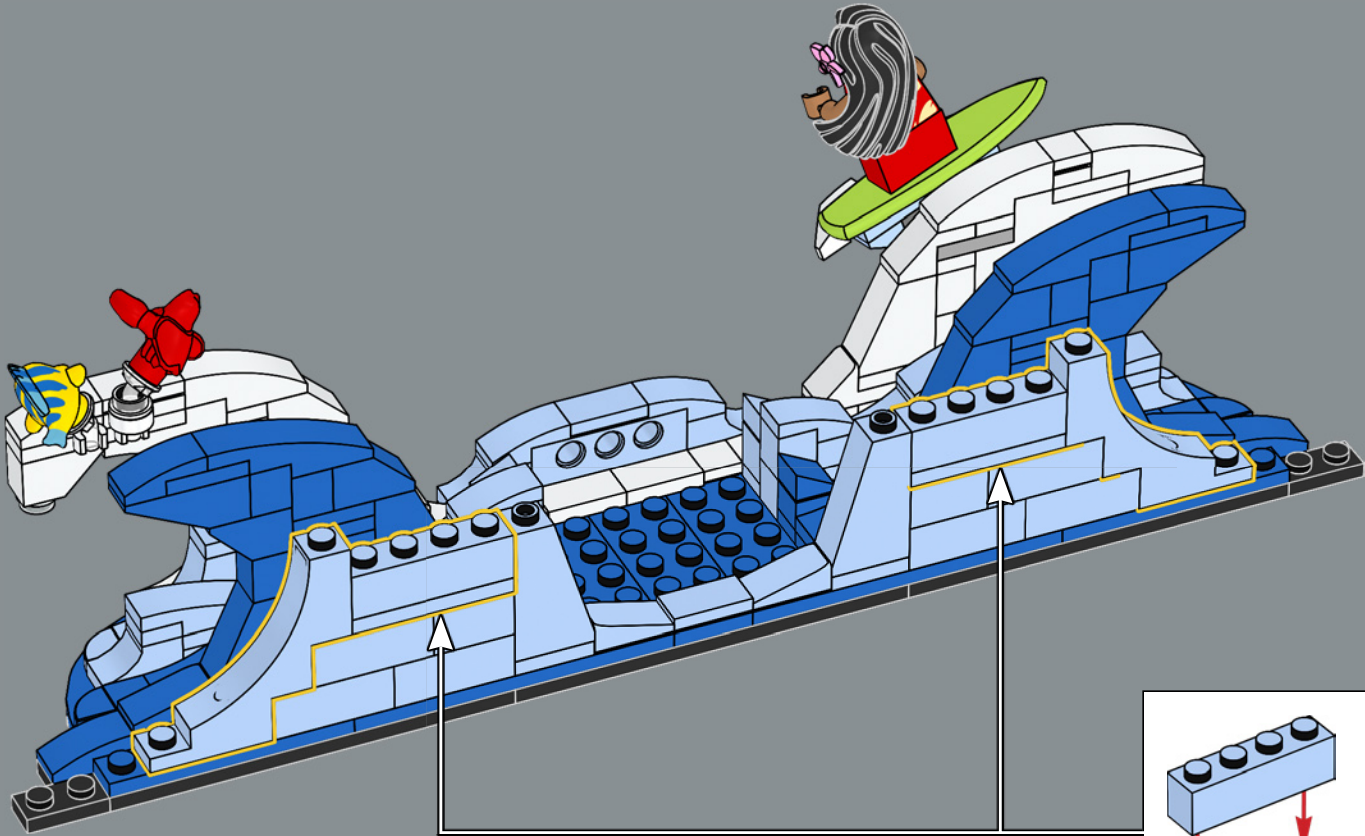

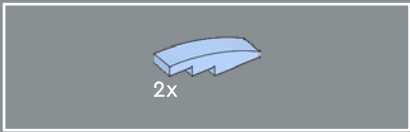

121

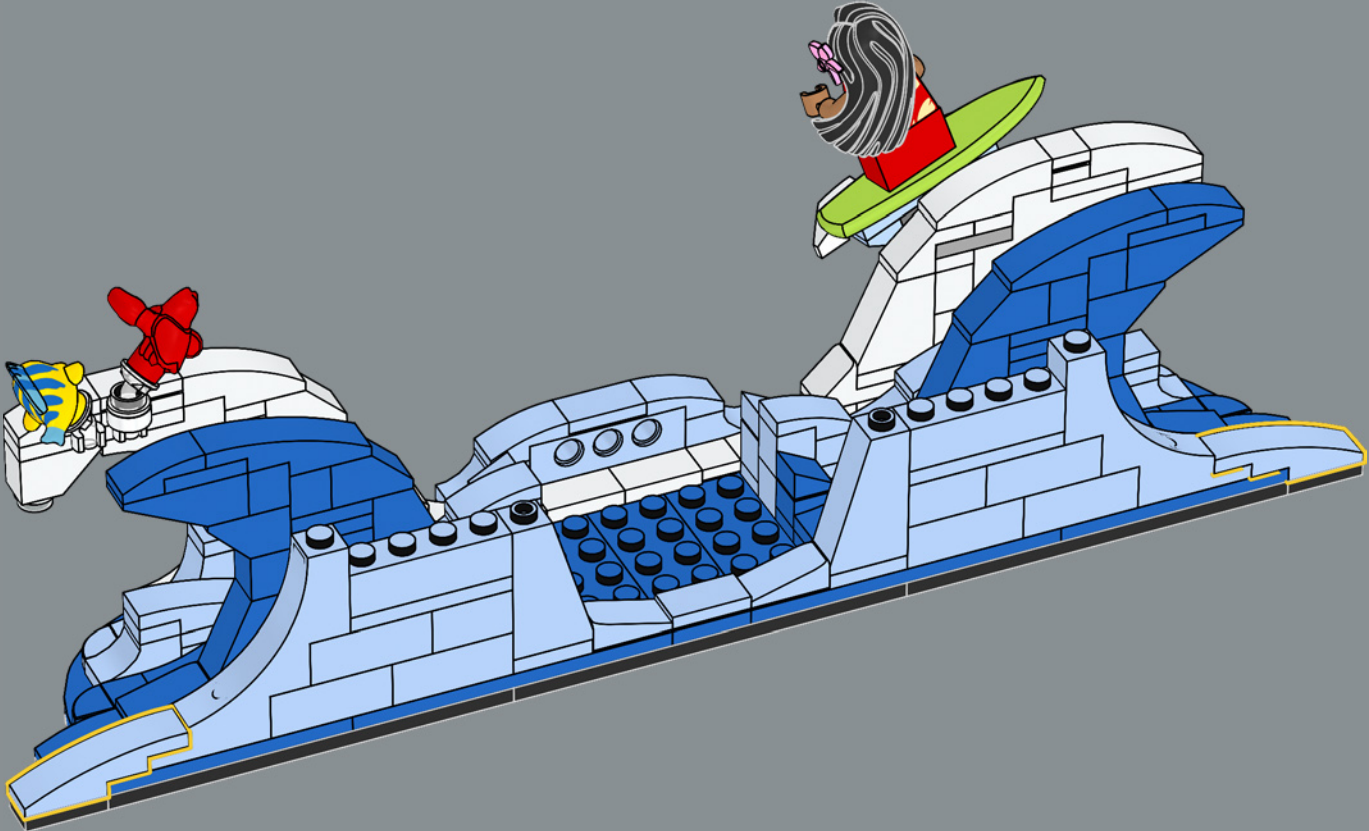

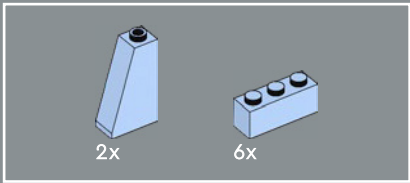

122

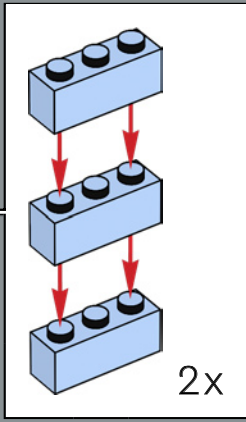
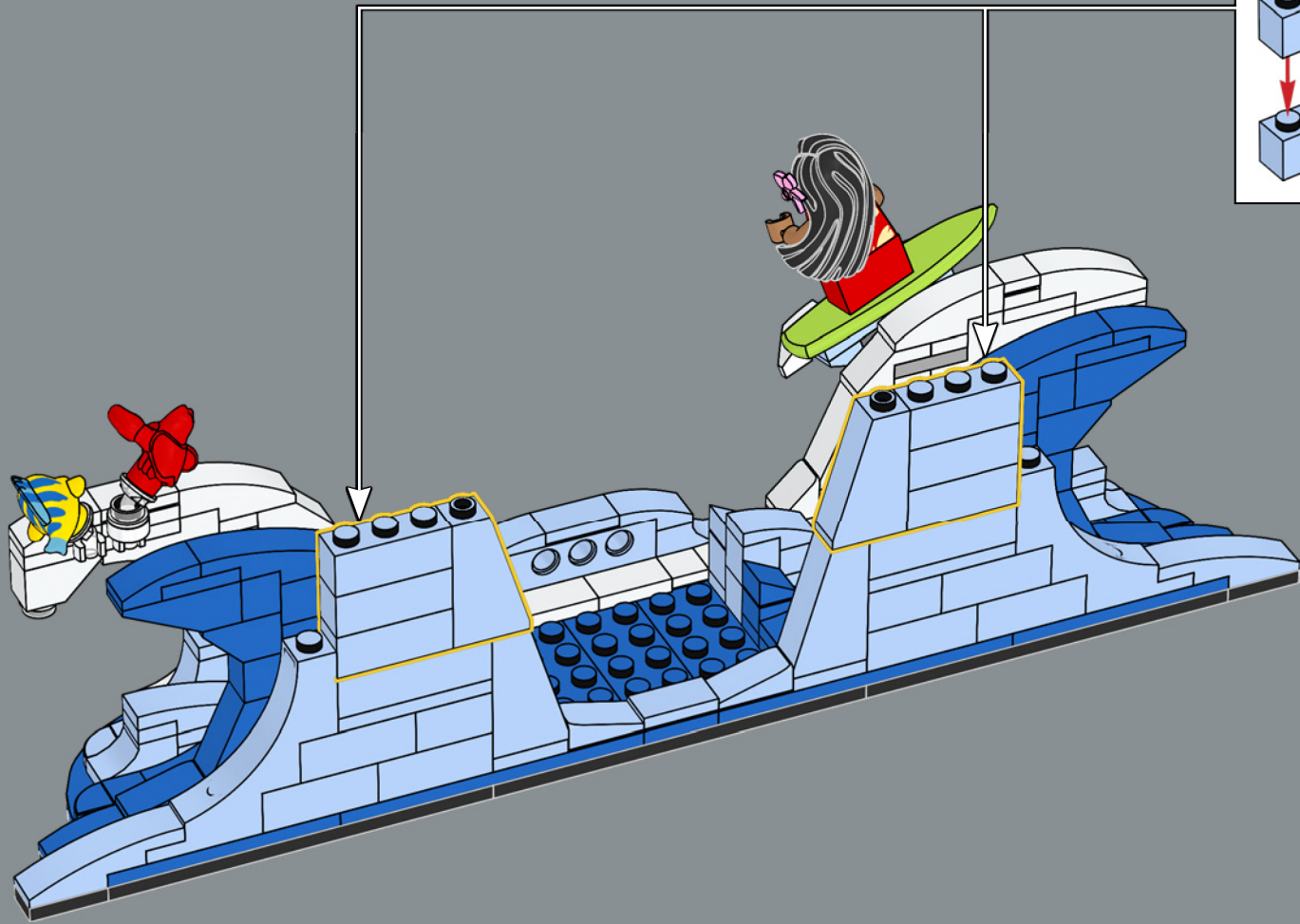

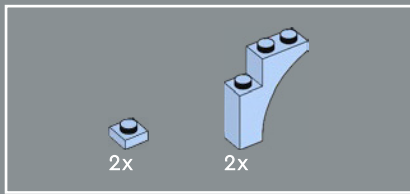

123

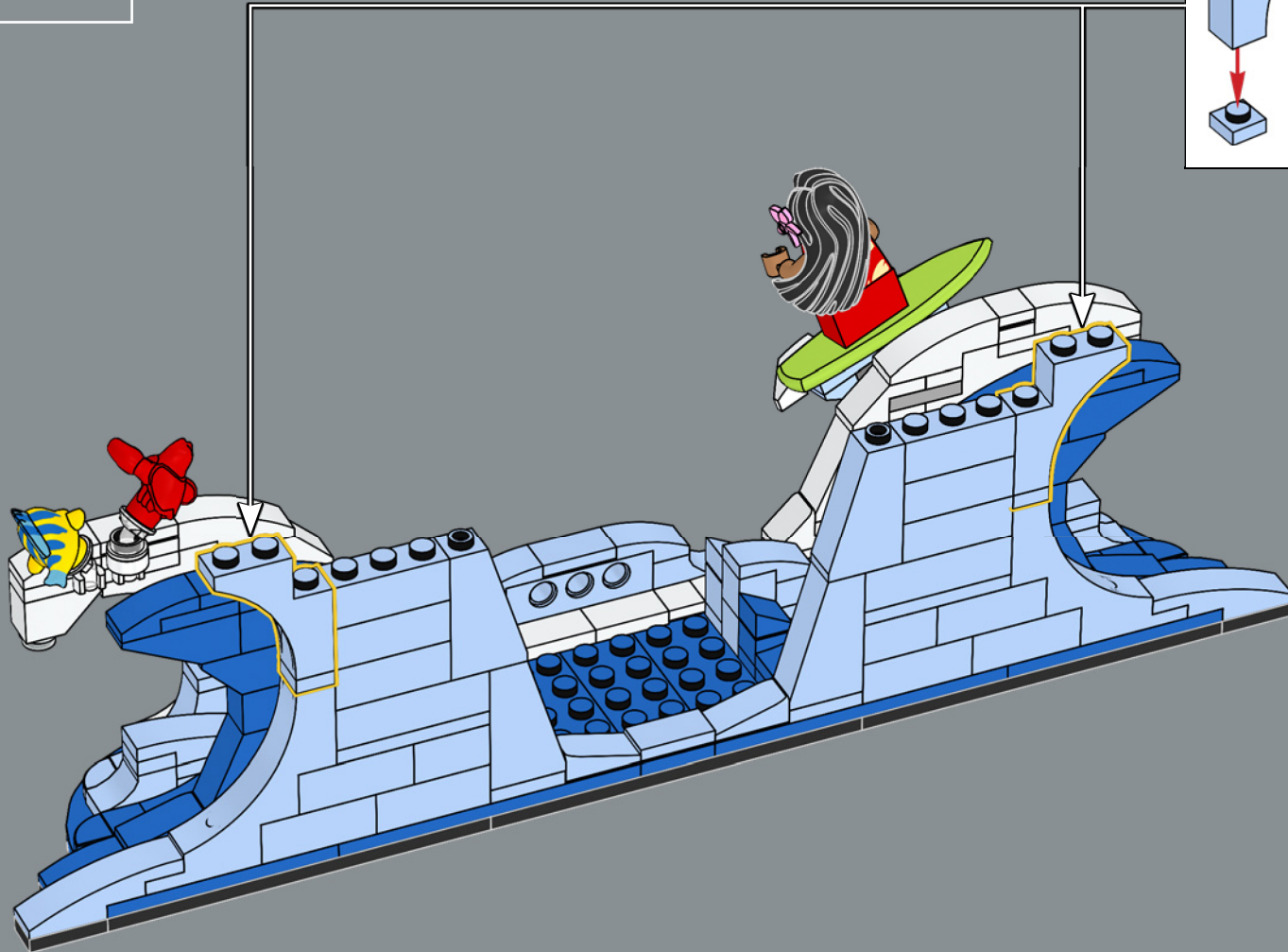
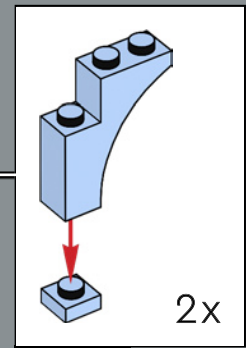

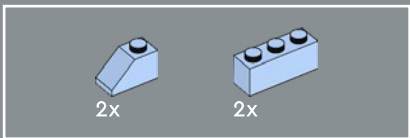

124

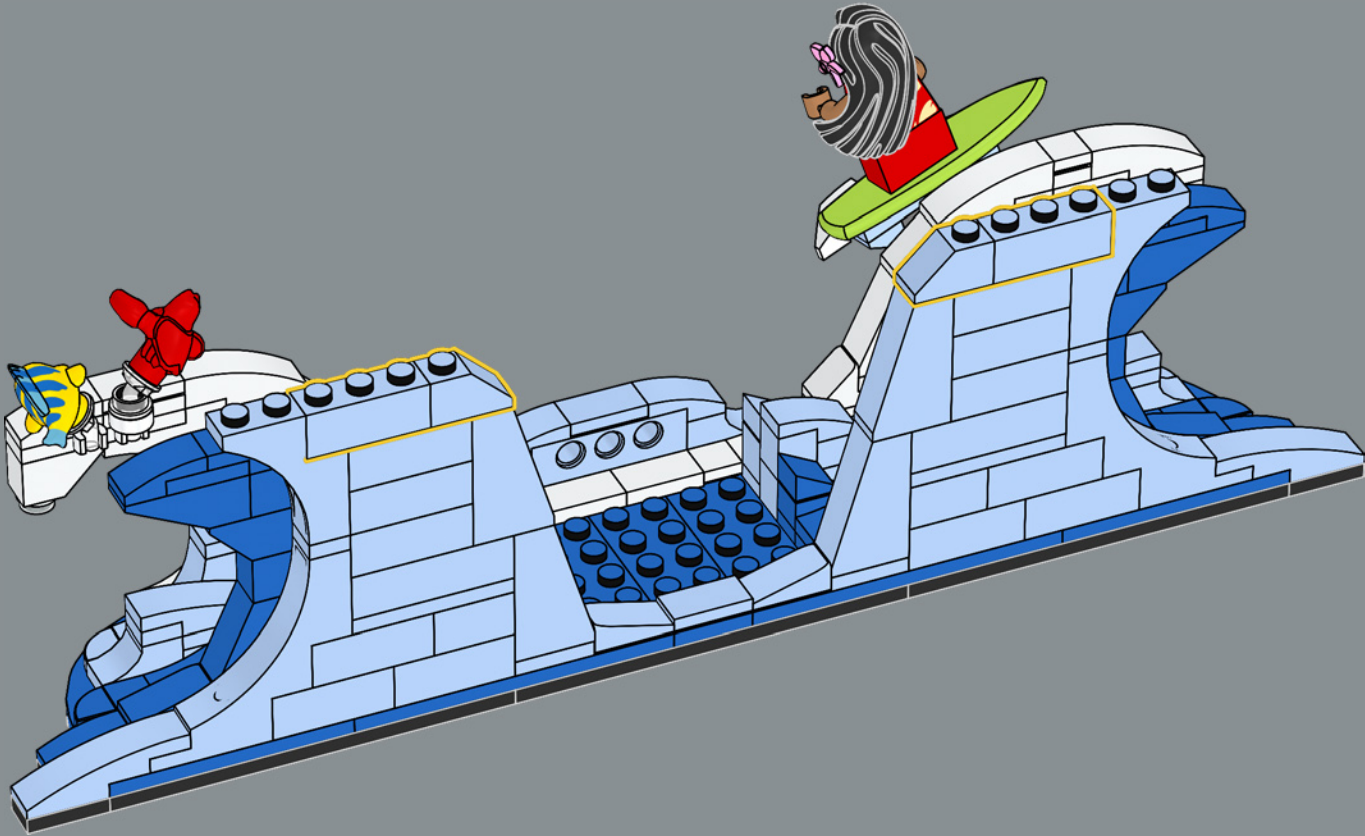

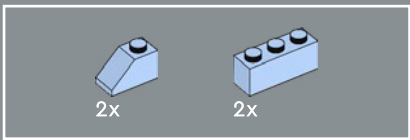

125

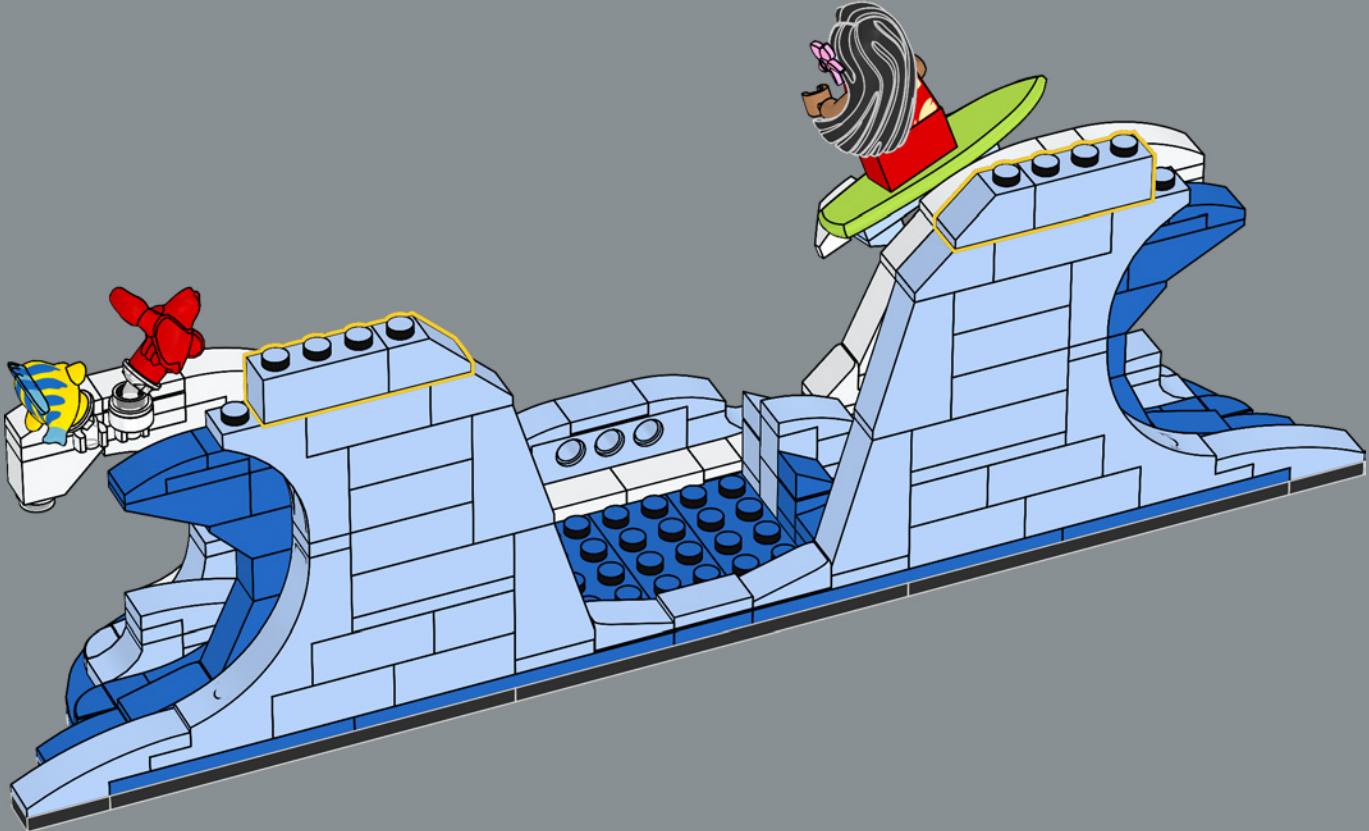

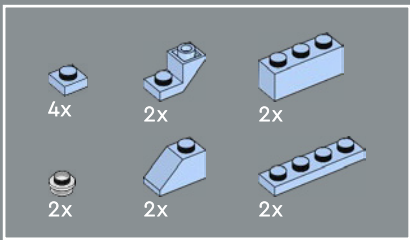

126

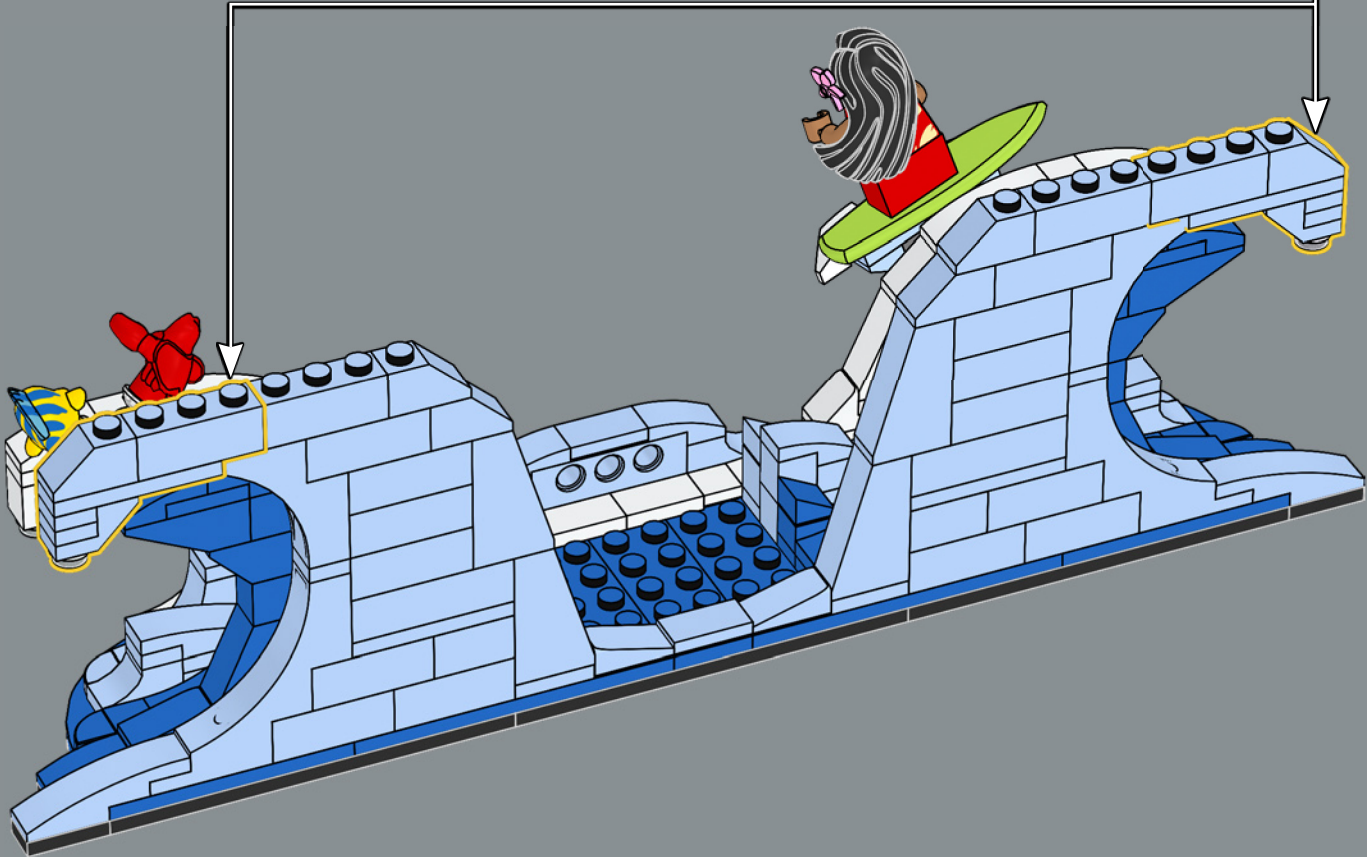
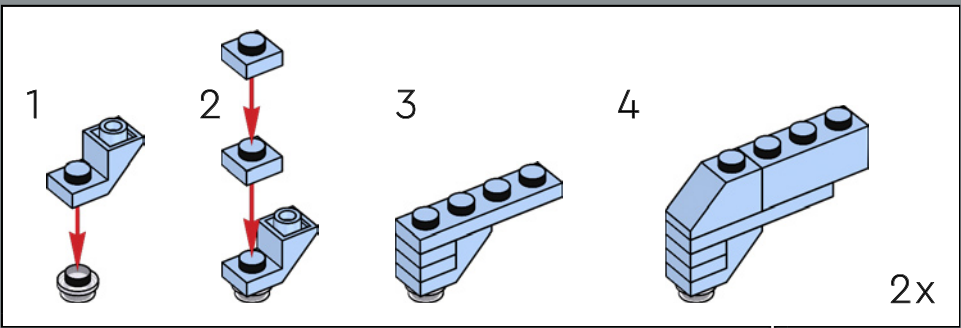

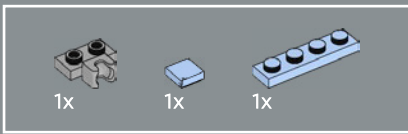

127

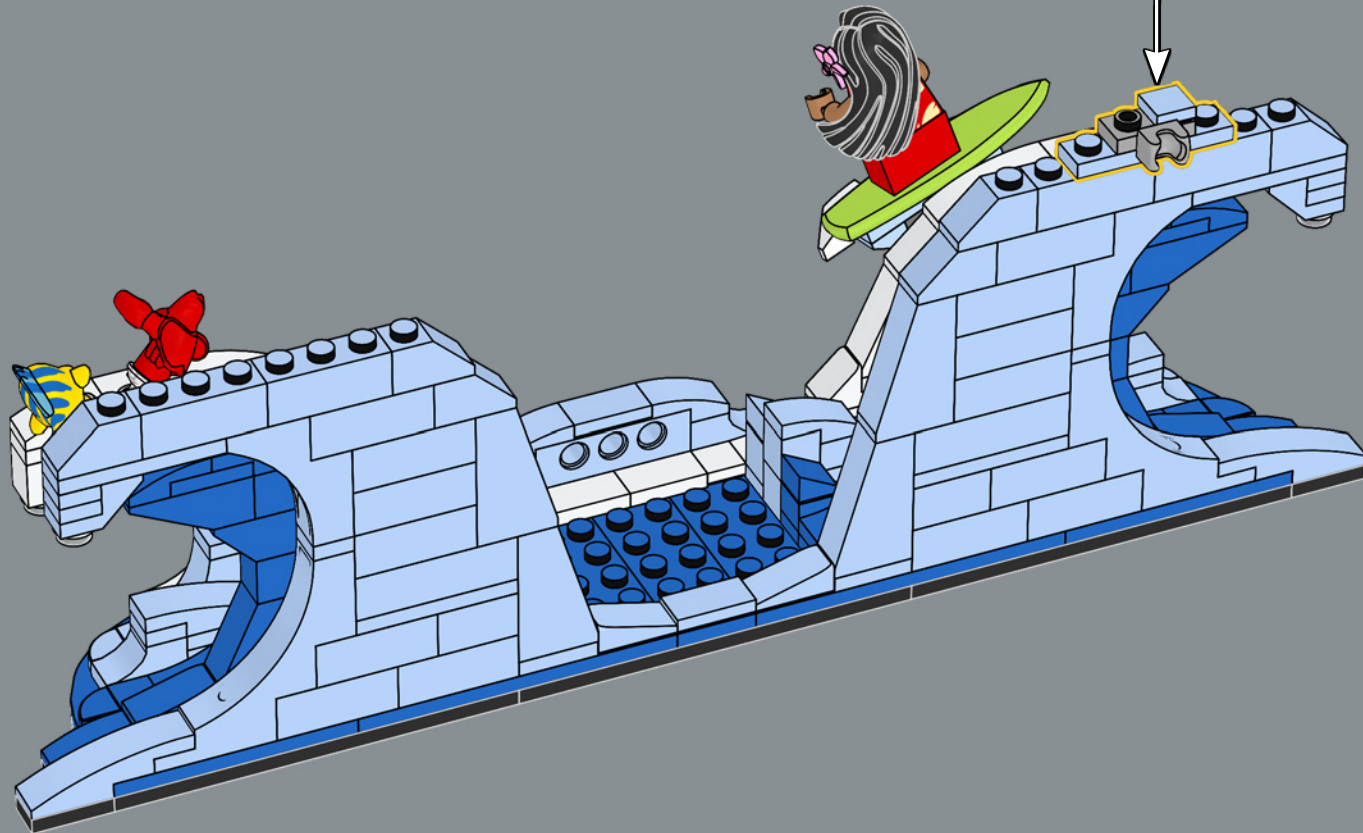
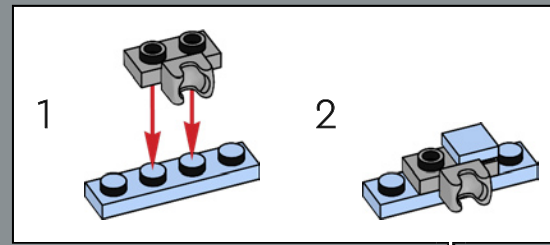

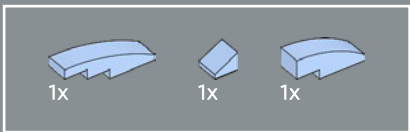

128

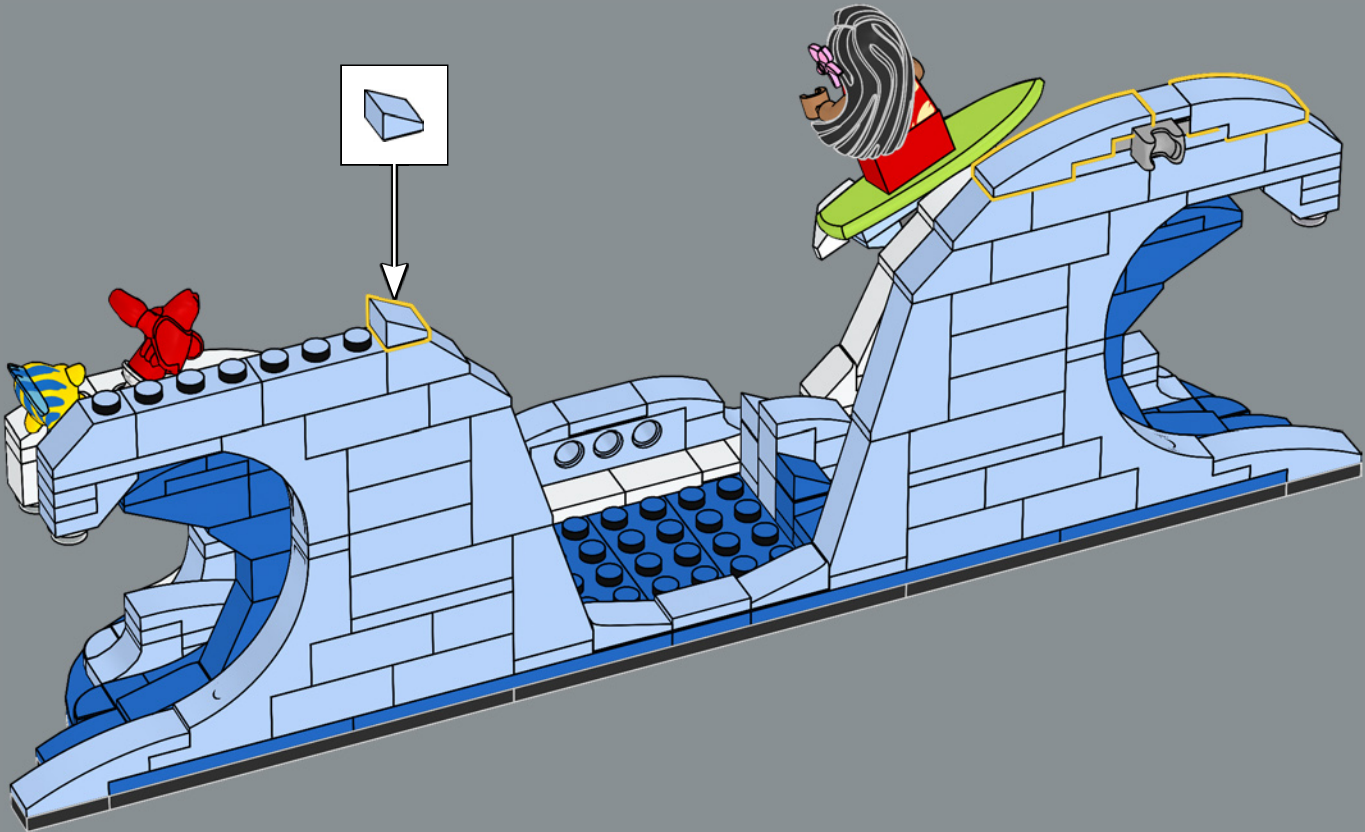

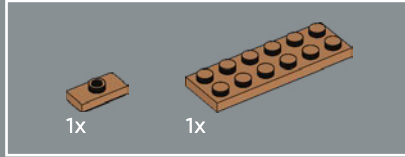
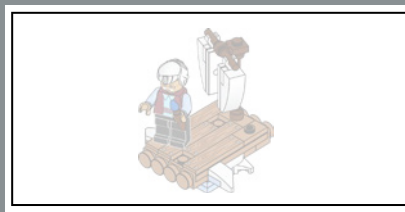

129

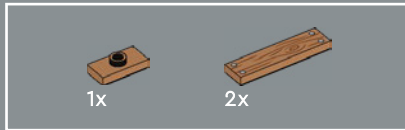
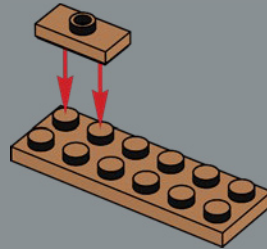

130

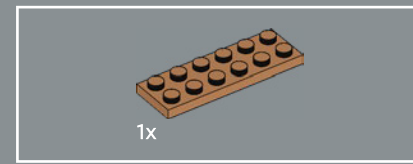
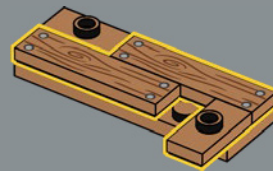

131

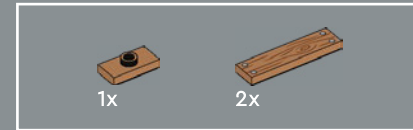
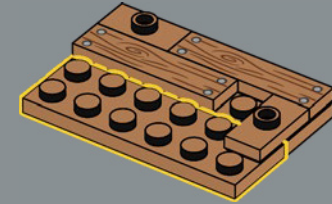

132

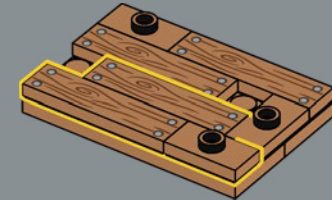

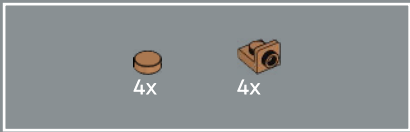

133

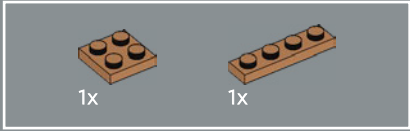
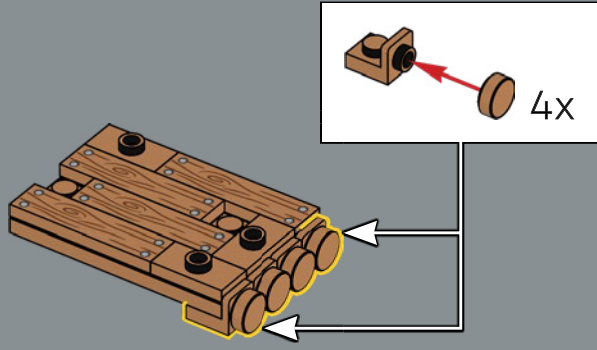

134

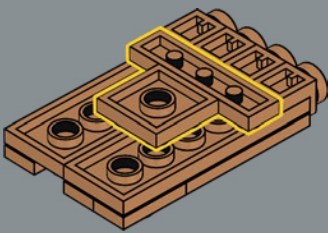

135

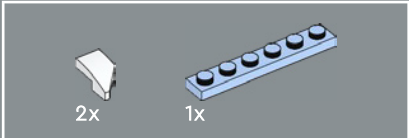
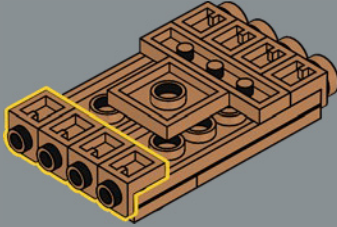

136

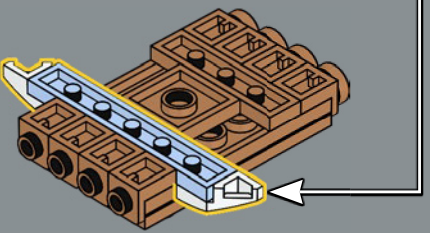
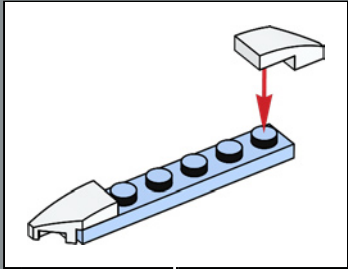

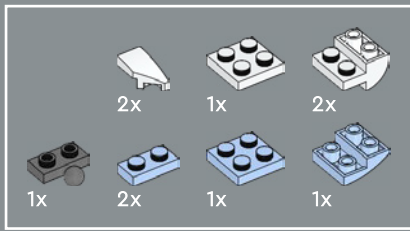

137

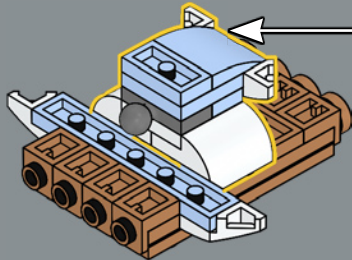
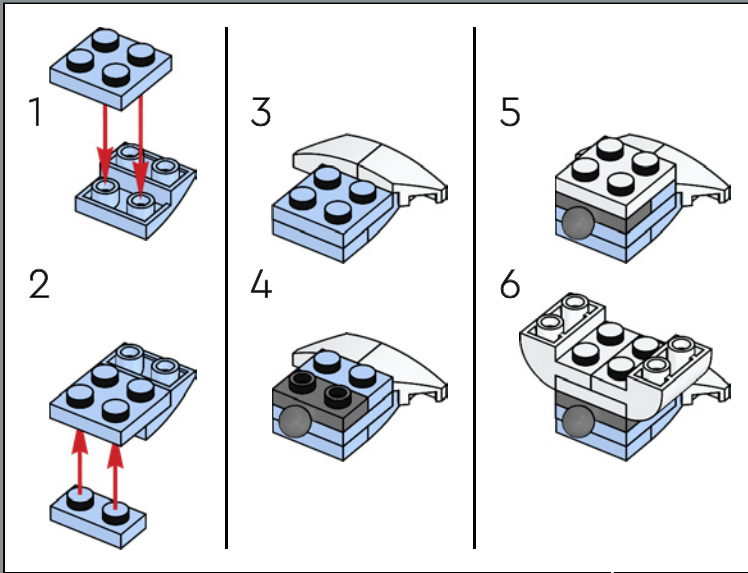

138

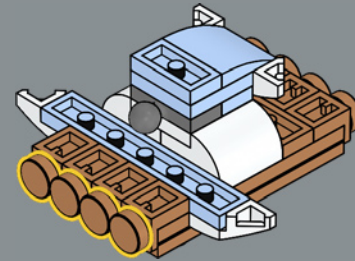

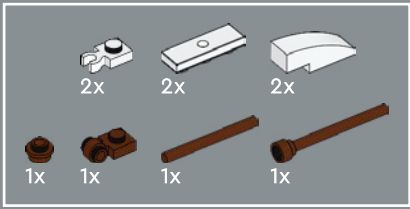

139

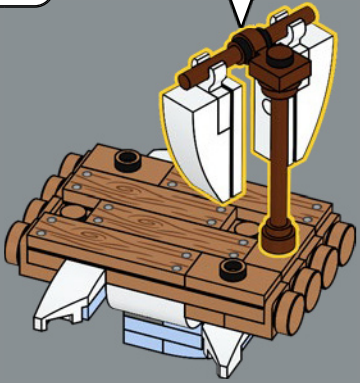
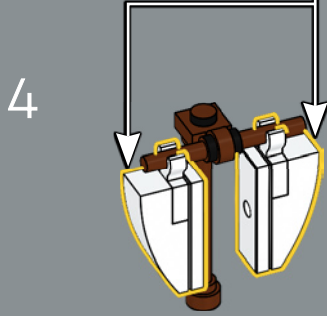
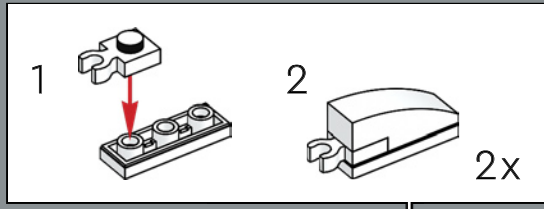
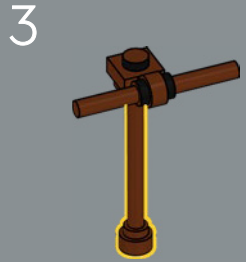
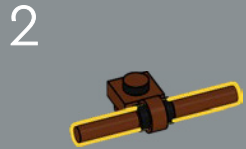
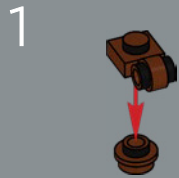

140

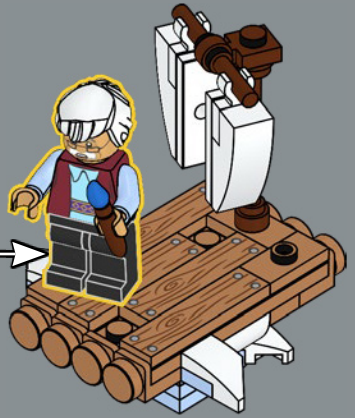
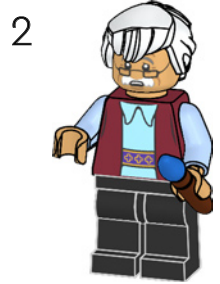
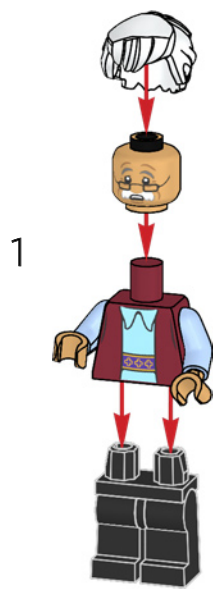

141

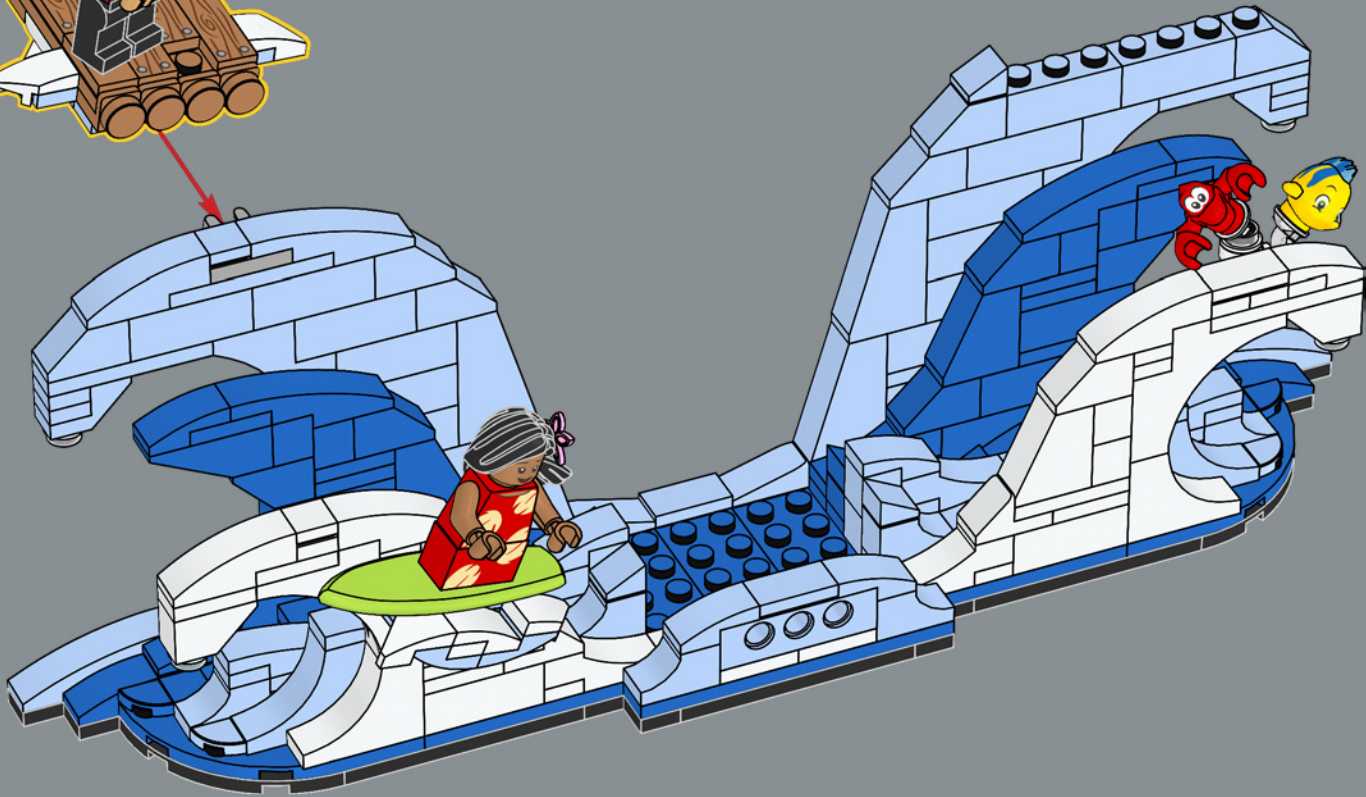

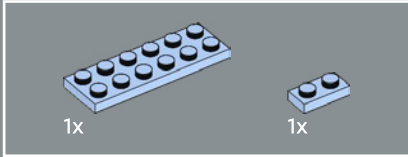
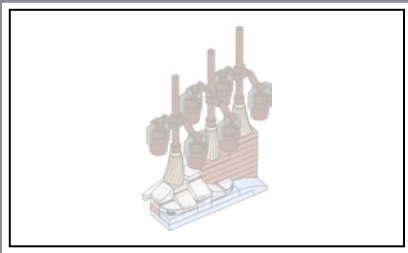

142

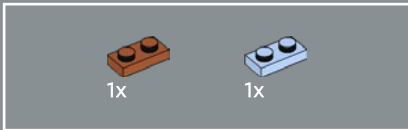
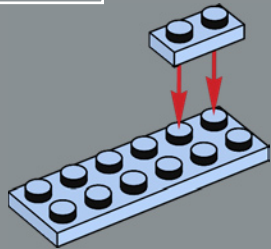

143

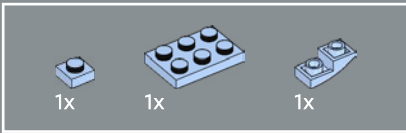
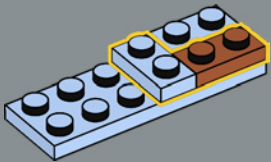

144

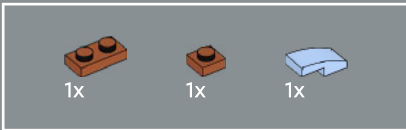
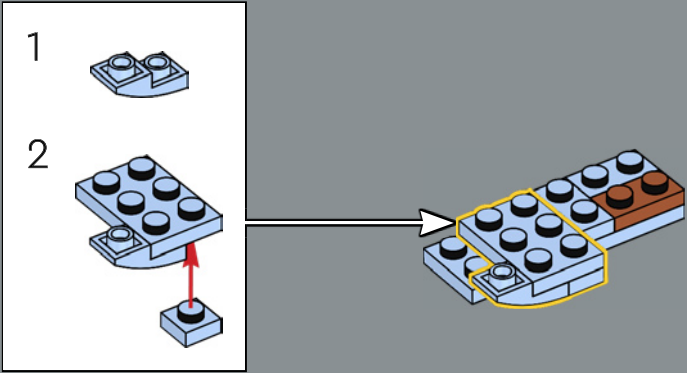

145

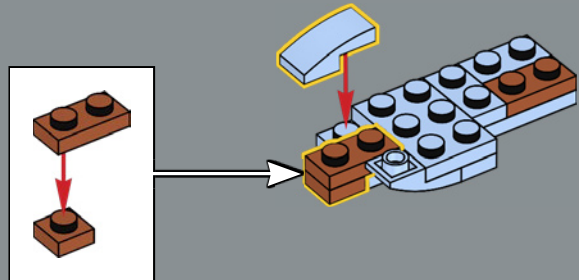

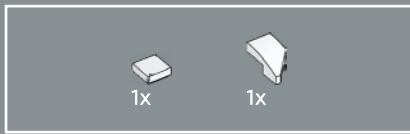

146

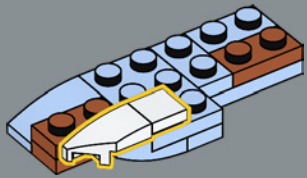

147

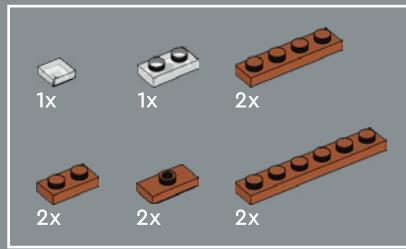
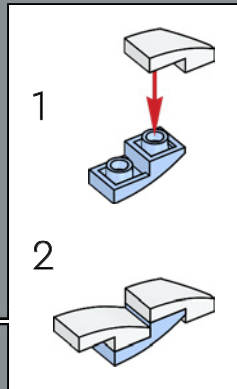
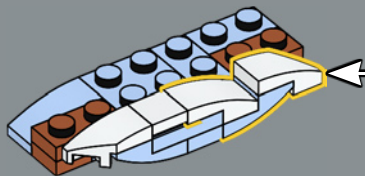

148

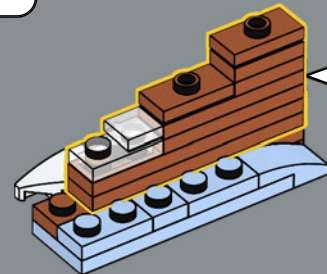
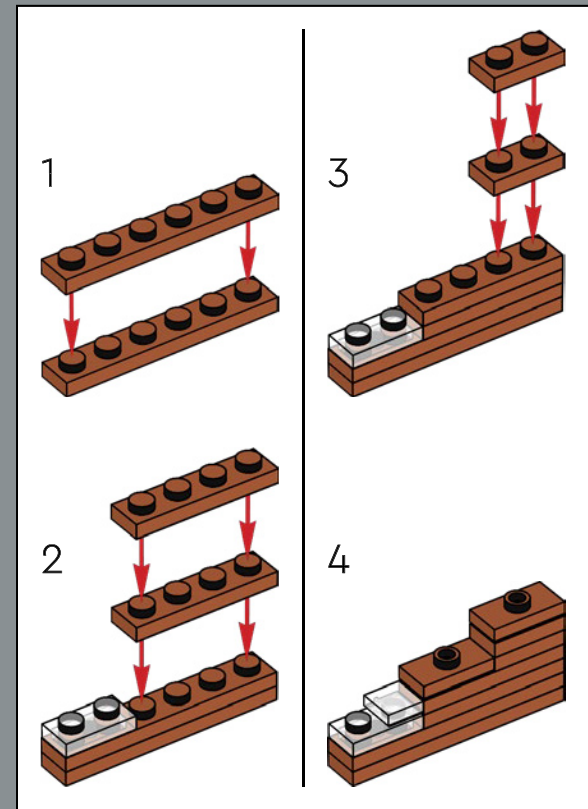



149

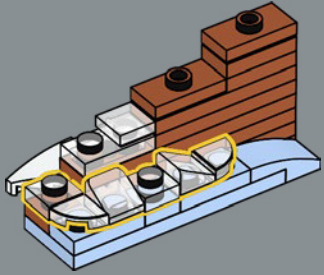

150

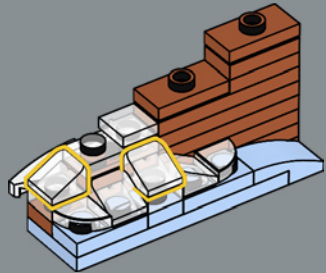

151

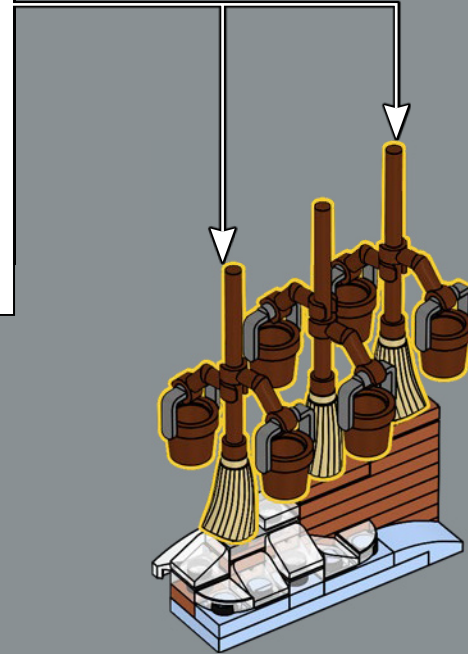
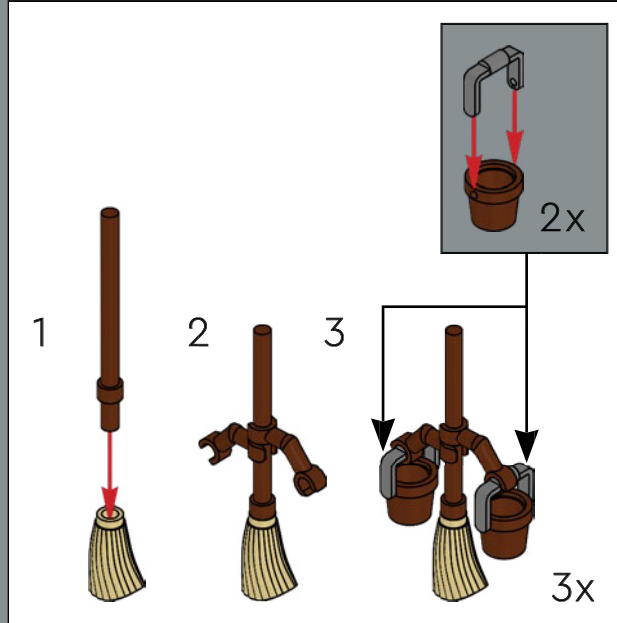

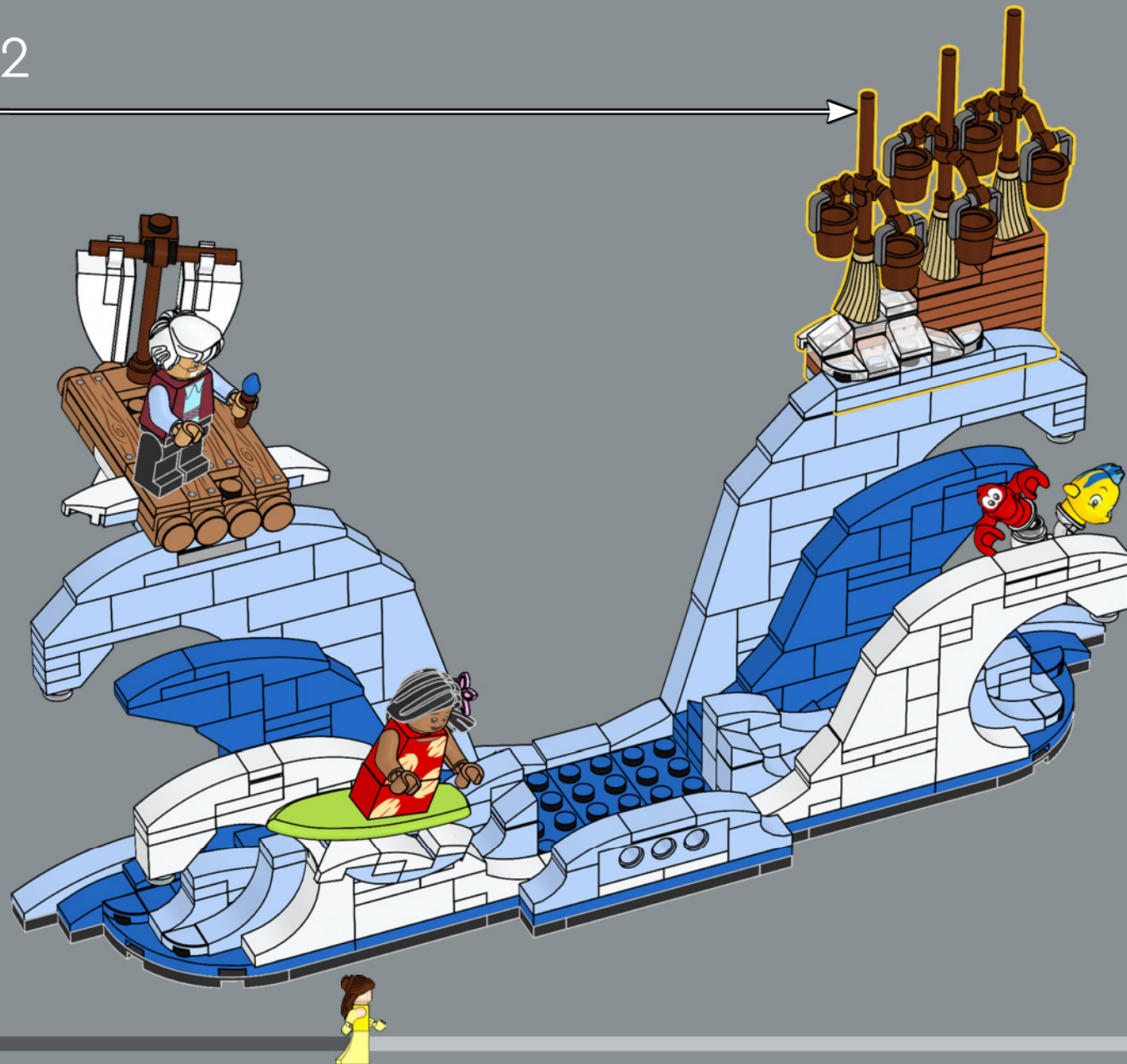

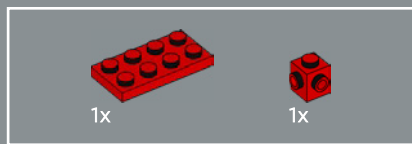
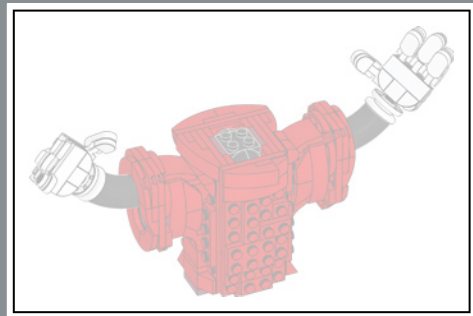

153

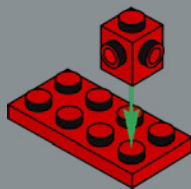

154

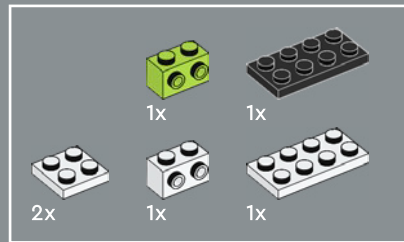

155

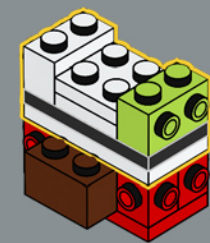
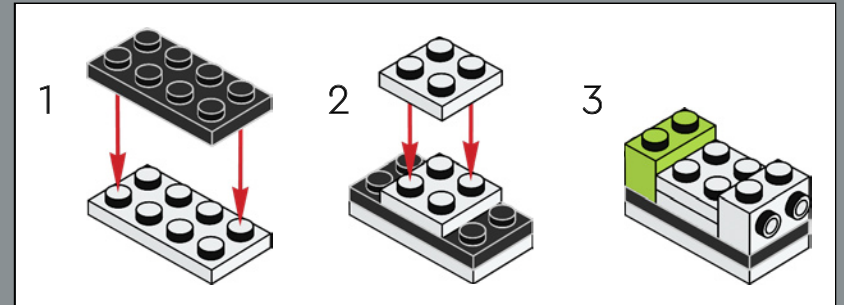

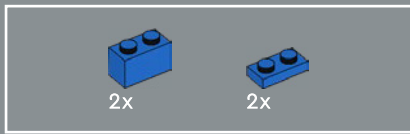

156

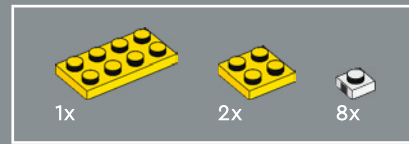
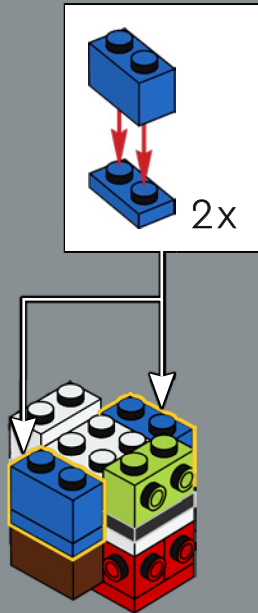

157

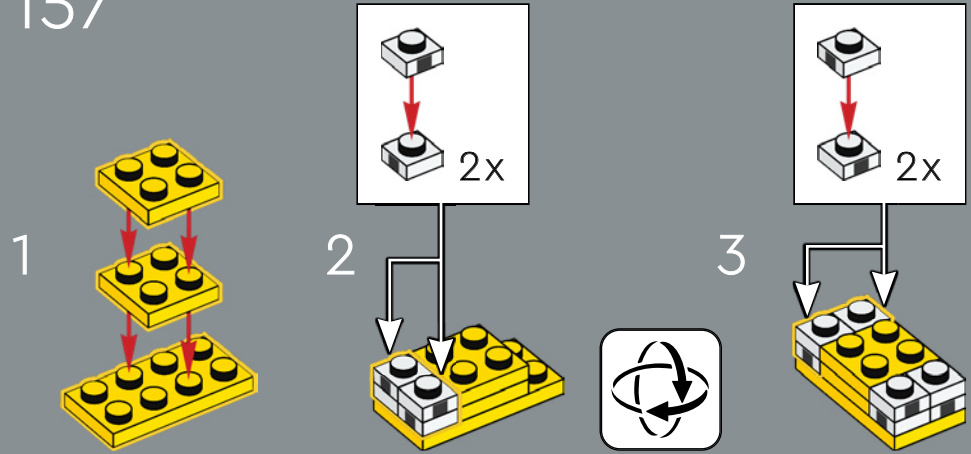

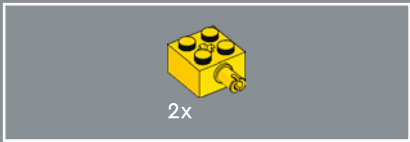

158

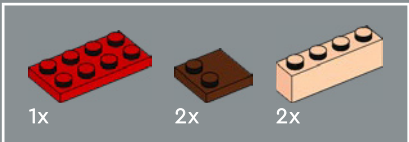
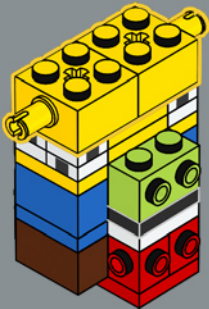

159

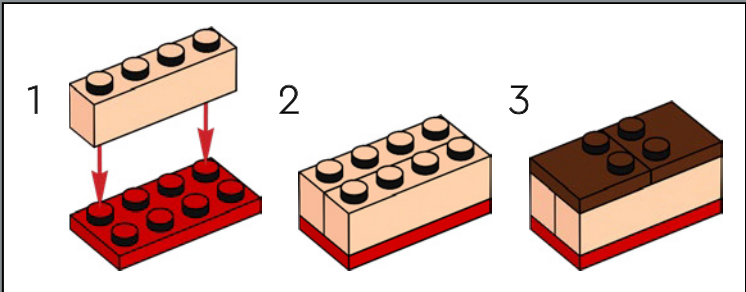



160

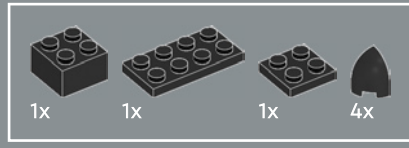
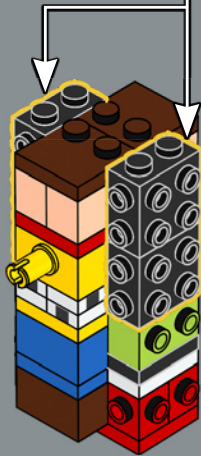
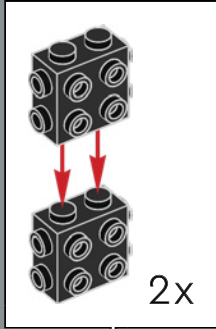

161

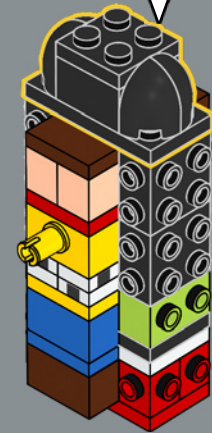
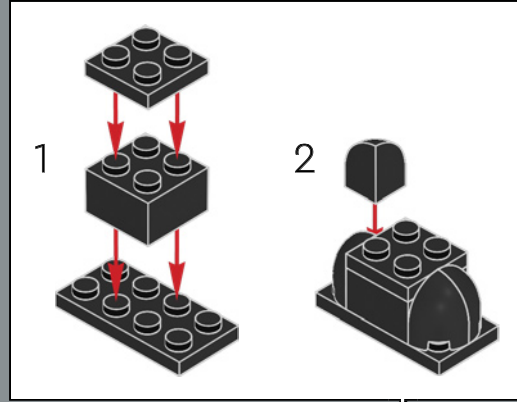

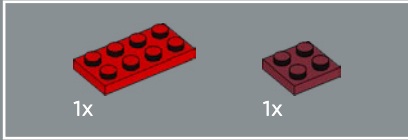
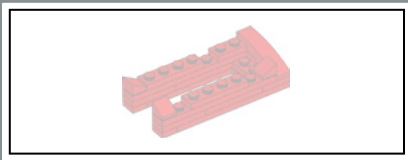

162

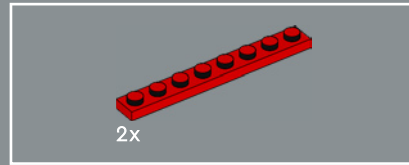
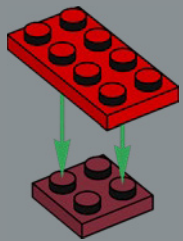

163

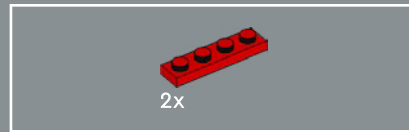
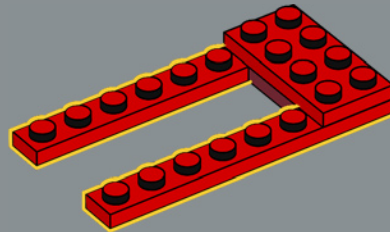

164

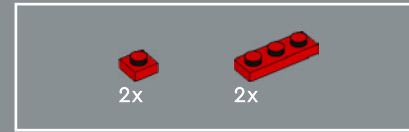
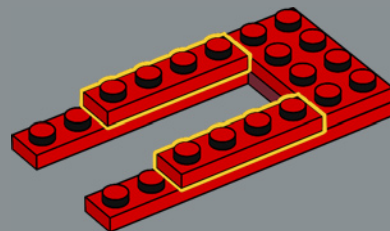

165

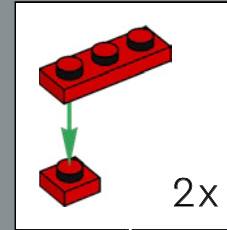

2x

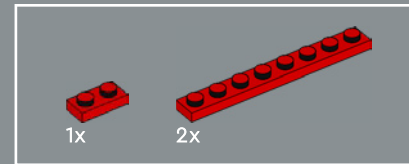
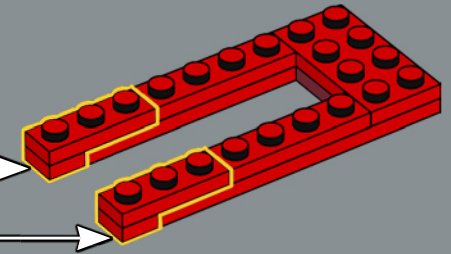

166

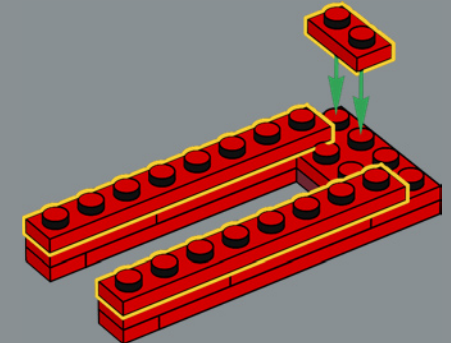

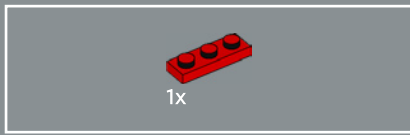

167

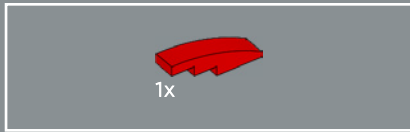
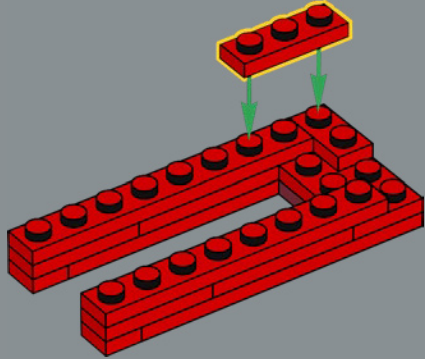

168

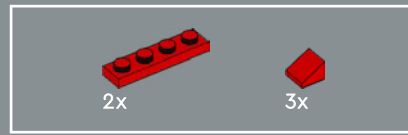
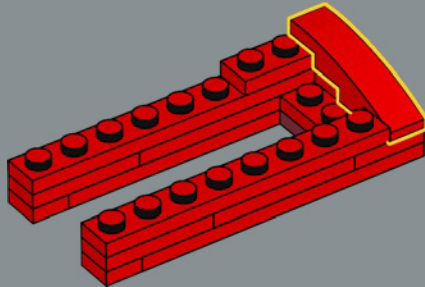

169

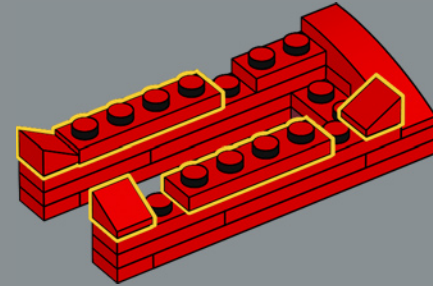

170

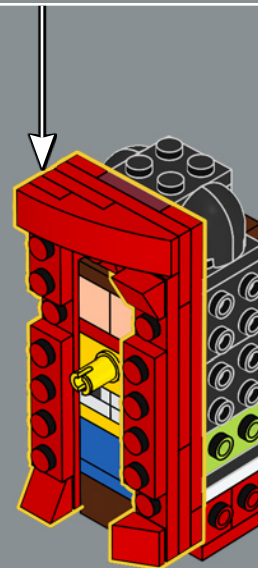

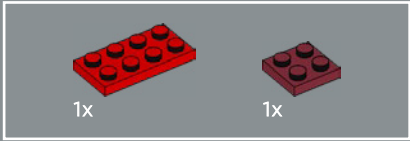
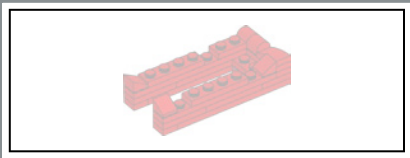

171

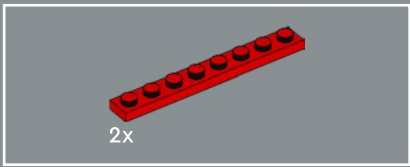
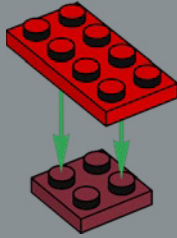

172

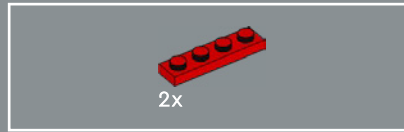
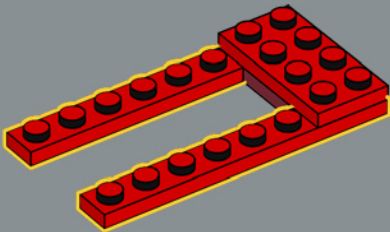

173

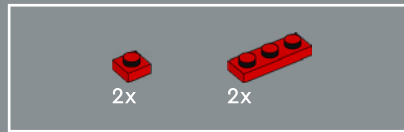
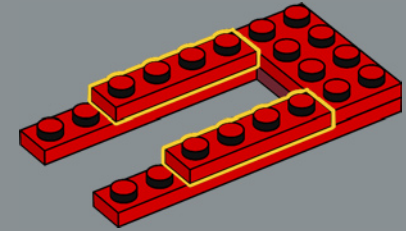

174

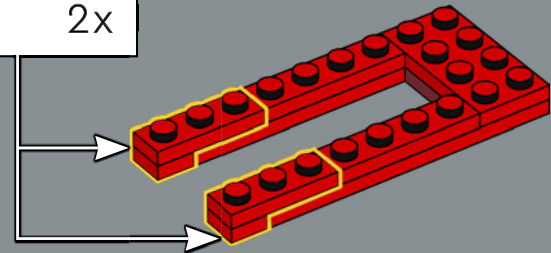
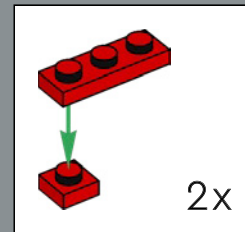

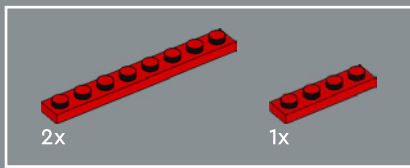

175

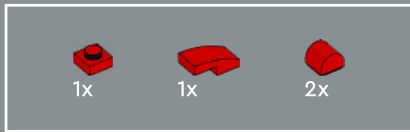
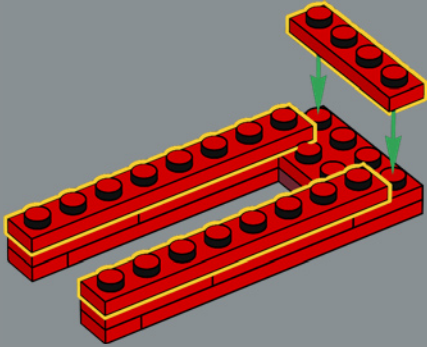

176

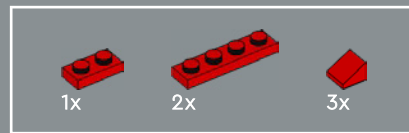
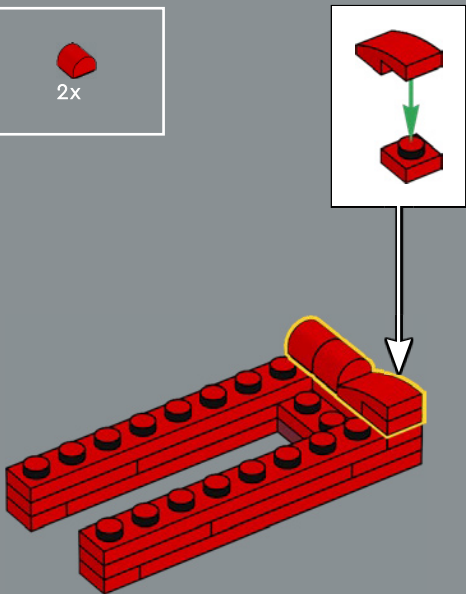

177

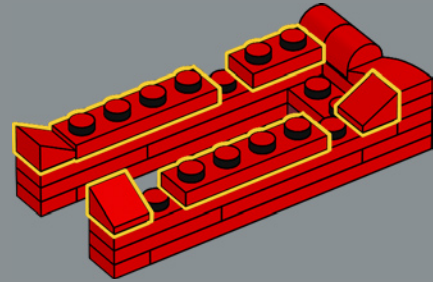

178



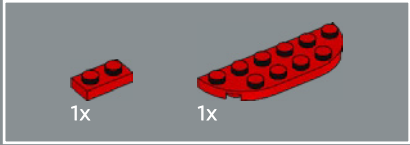

179

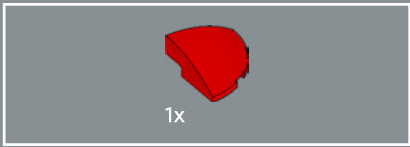
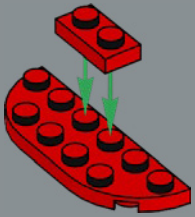

180

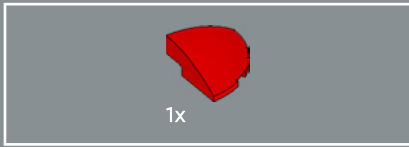
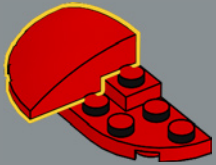

181

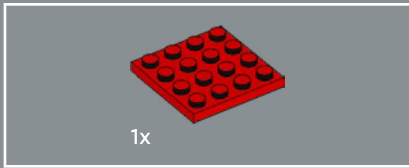
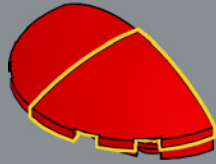

182

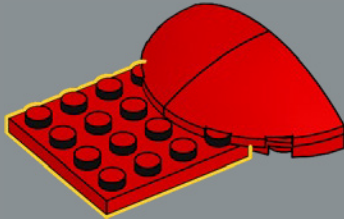

183

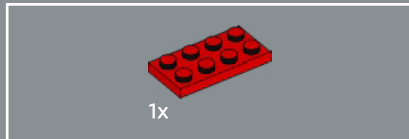
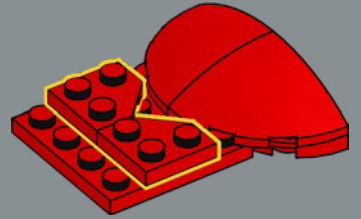

184

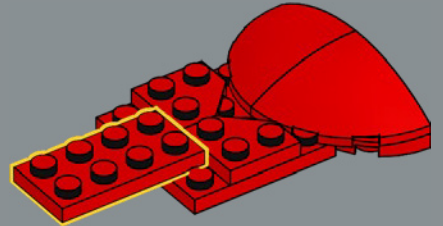

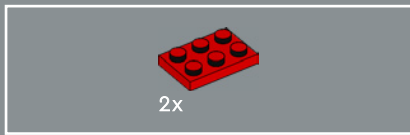

185

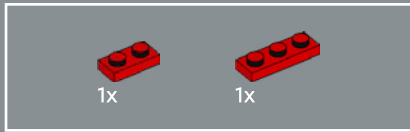
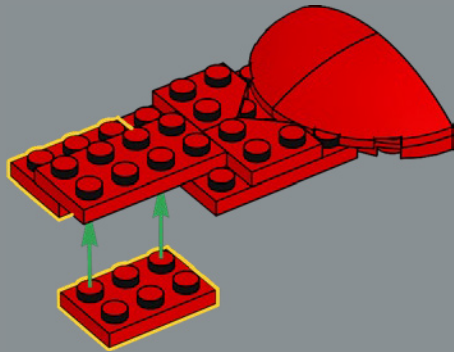

186

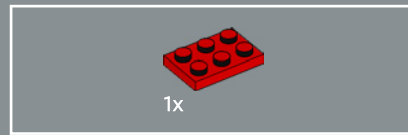
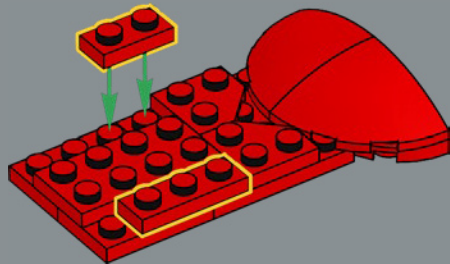

187

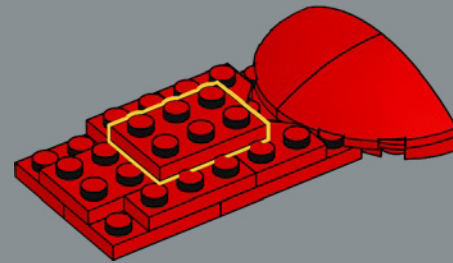

188

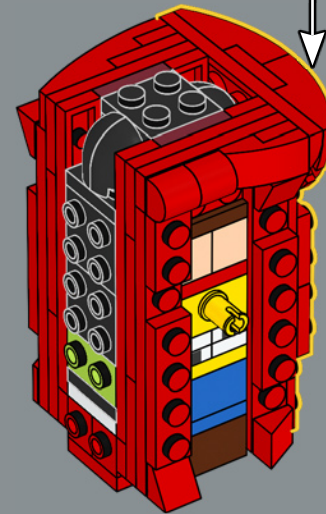

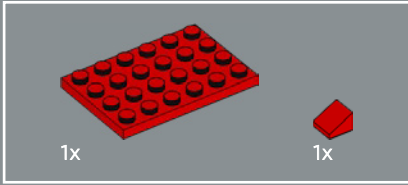

189

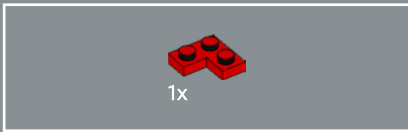
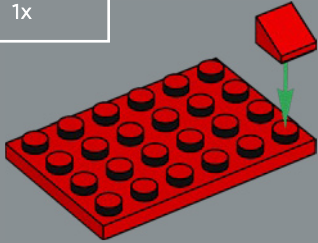

190

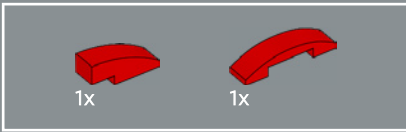
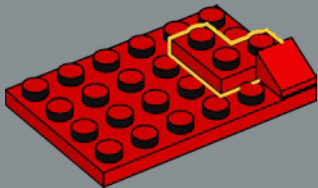

191

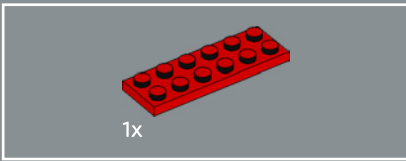
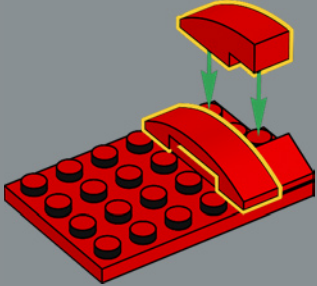

192

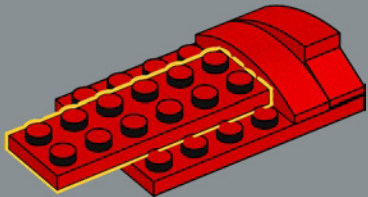

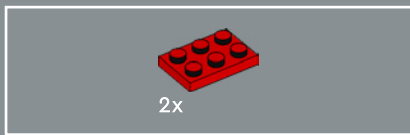

193

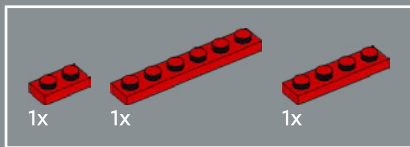
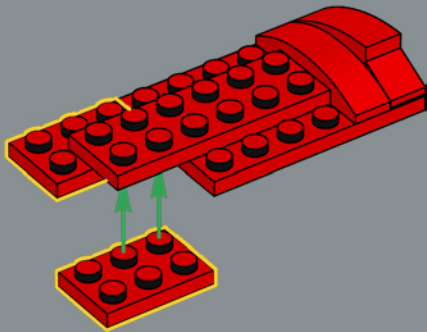

194

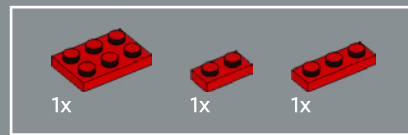
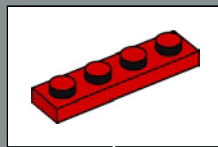
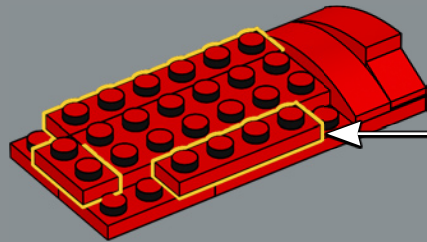

195

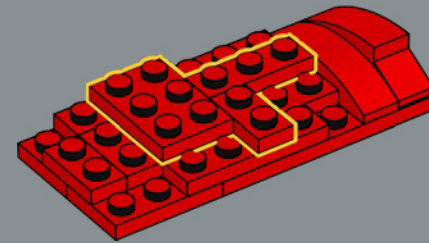

196

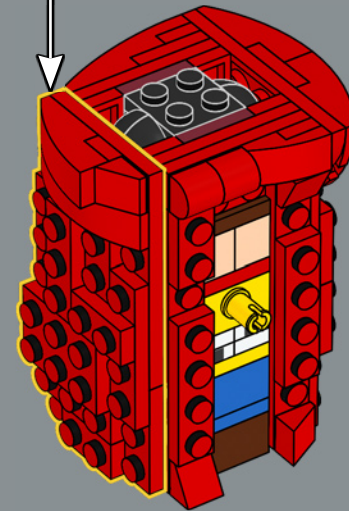

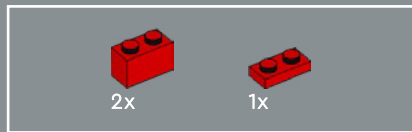
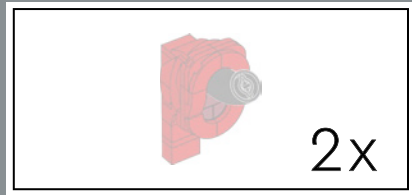

197

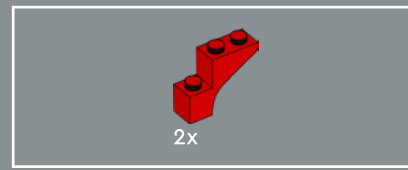
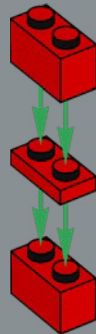

198

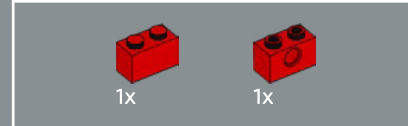
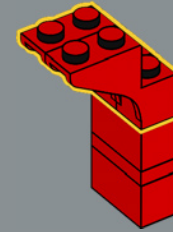

199

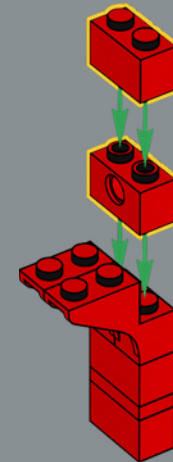

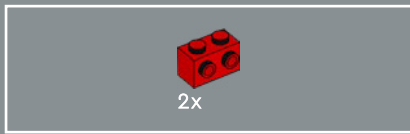

200

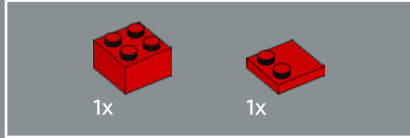
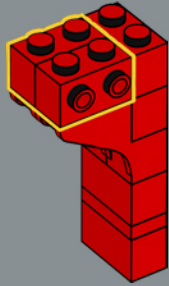

201

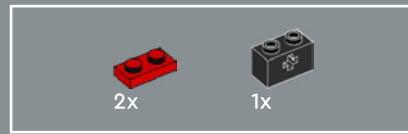
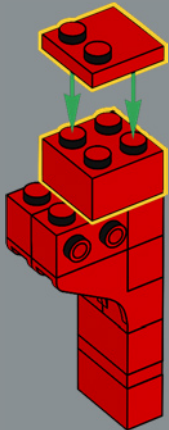

202

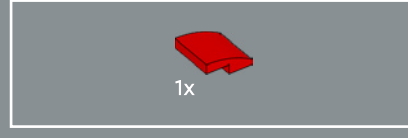
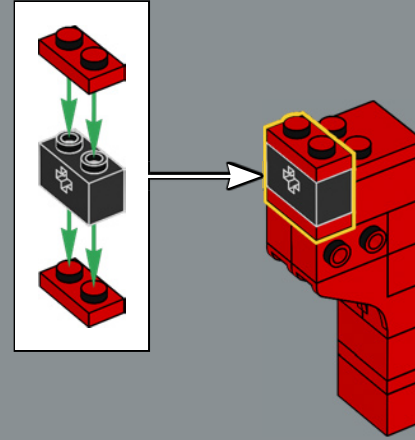

203

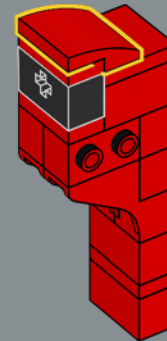



204

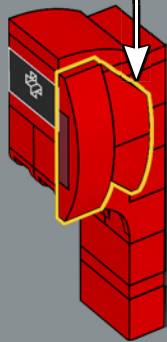
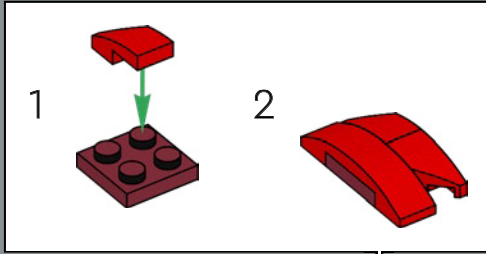

205

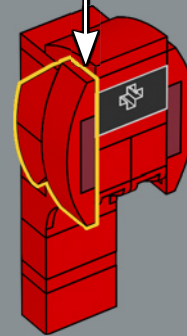
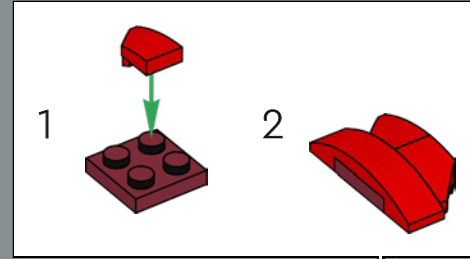

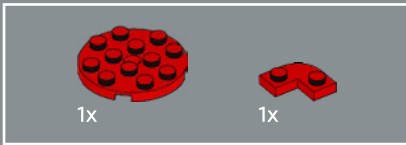
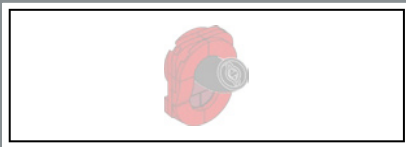

206

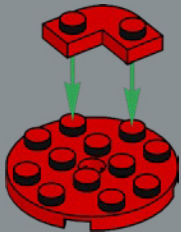

207



208

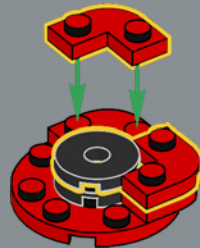

209

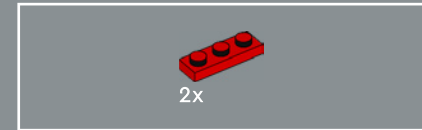
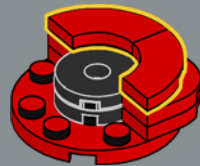

210

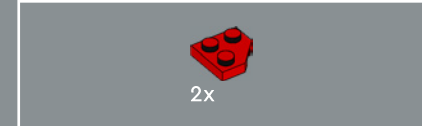
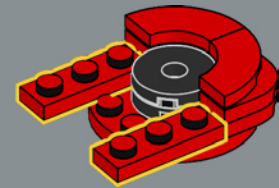

211

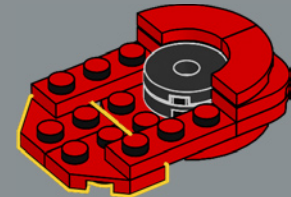



212

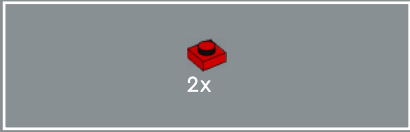
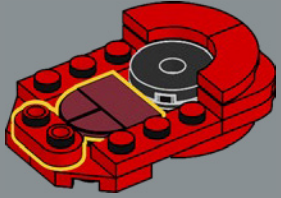

213

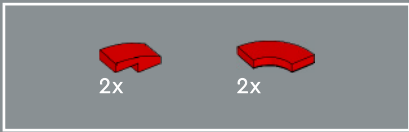
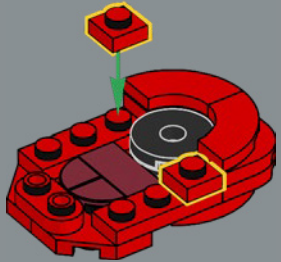

214

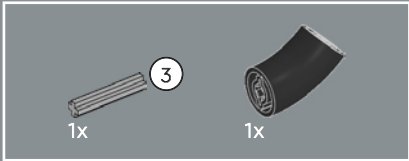
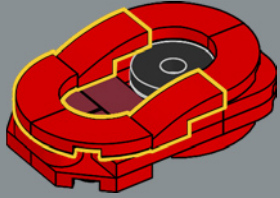

215

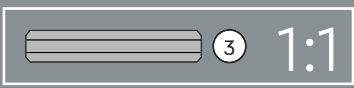
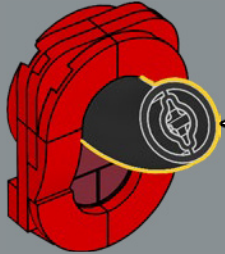
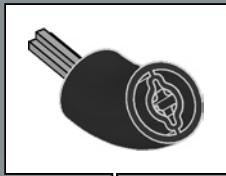

216

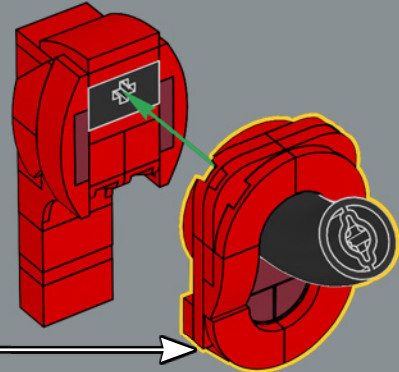

2x

217

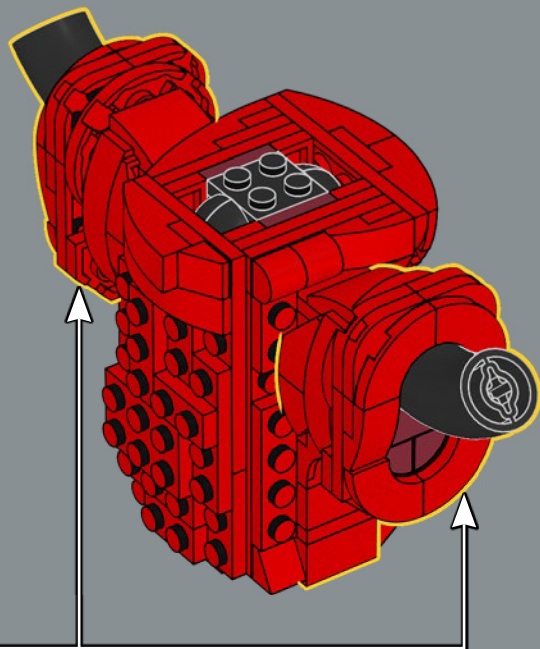

218

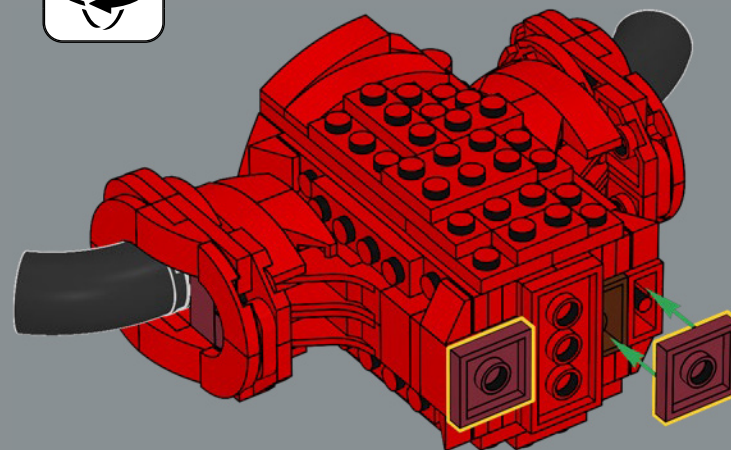
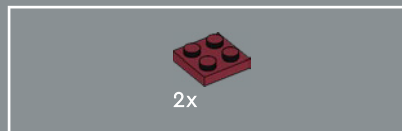



219

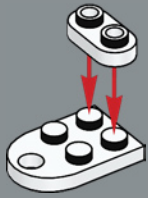

220

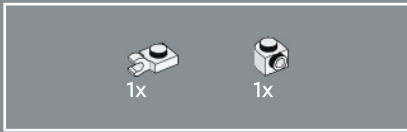

221

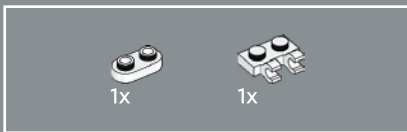

222

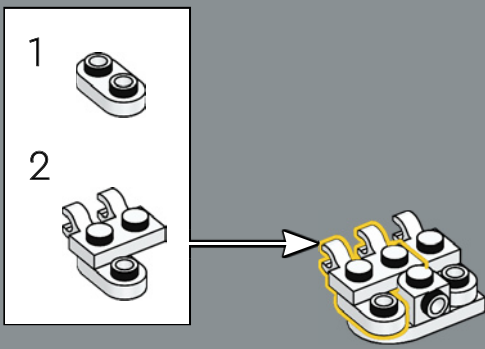

223

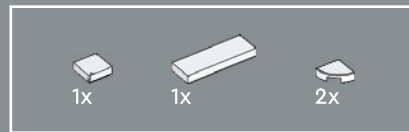
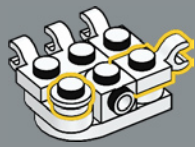

224

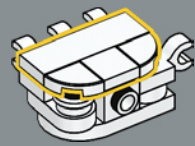



225

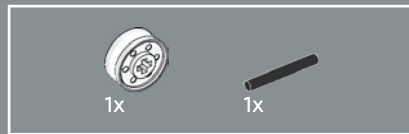
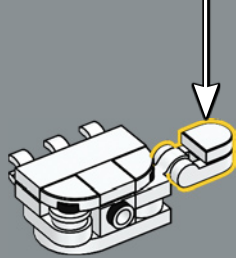
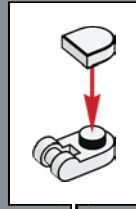

227

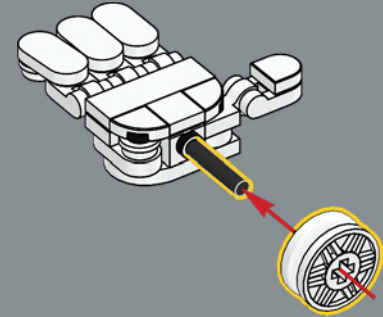

226

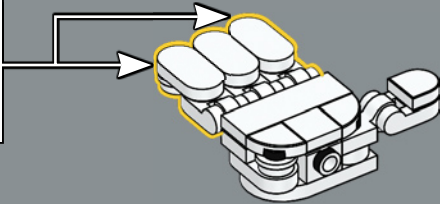
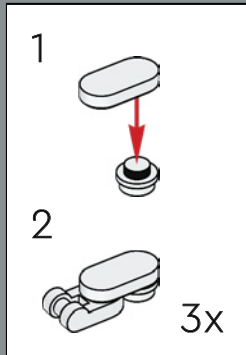

228

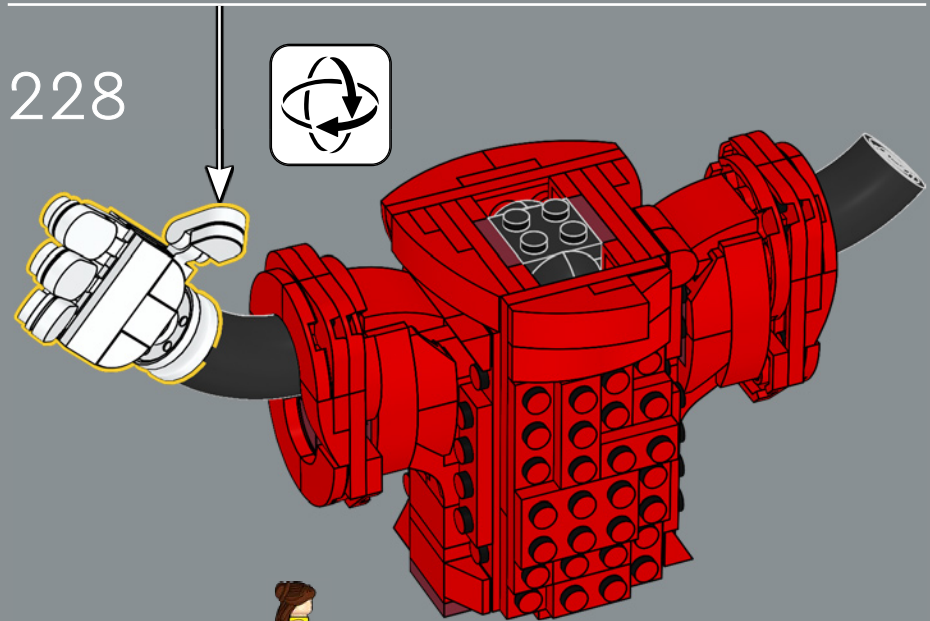

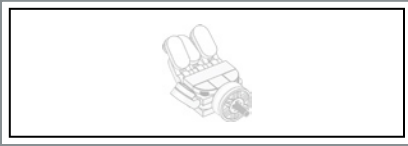

229



230

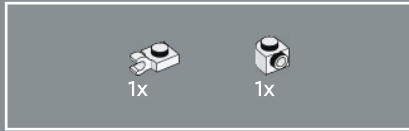

231

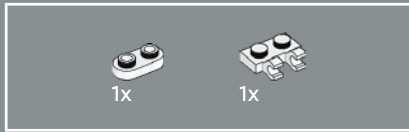

232

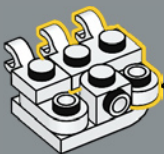
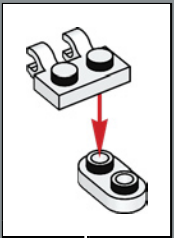

233

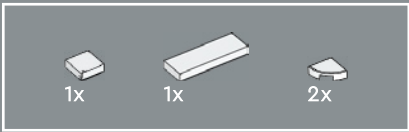
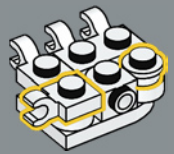

234

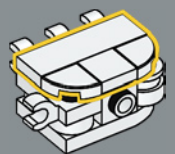

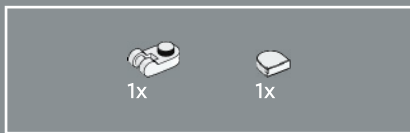

235

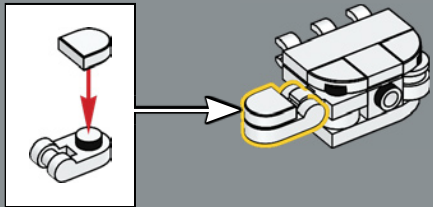

236

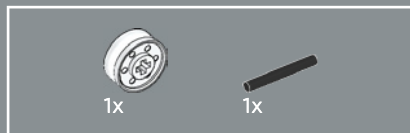
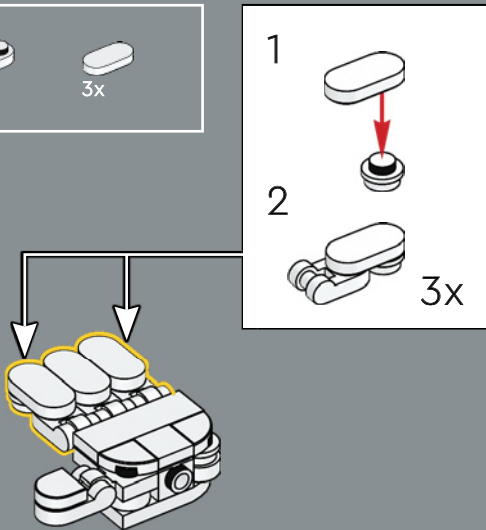

237

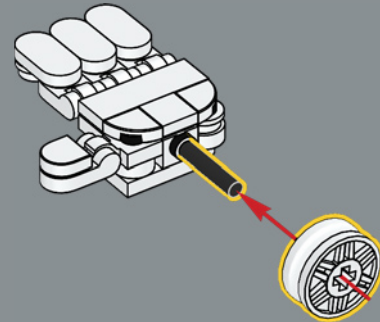

238

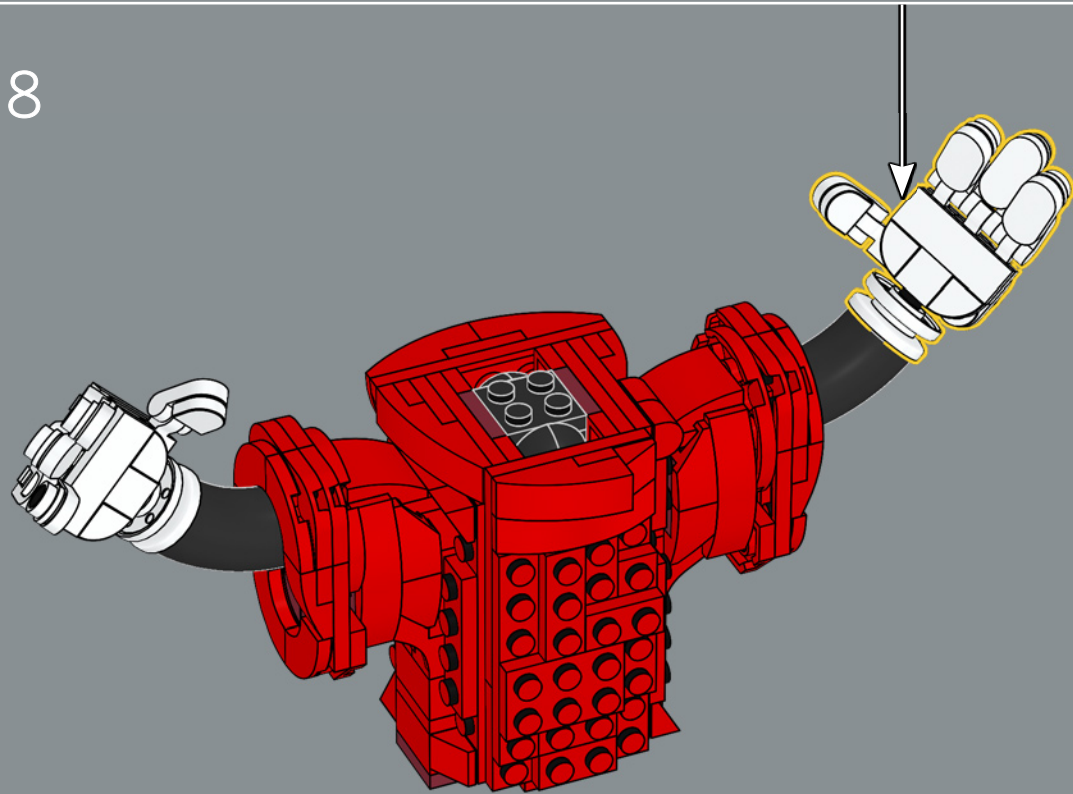

239

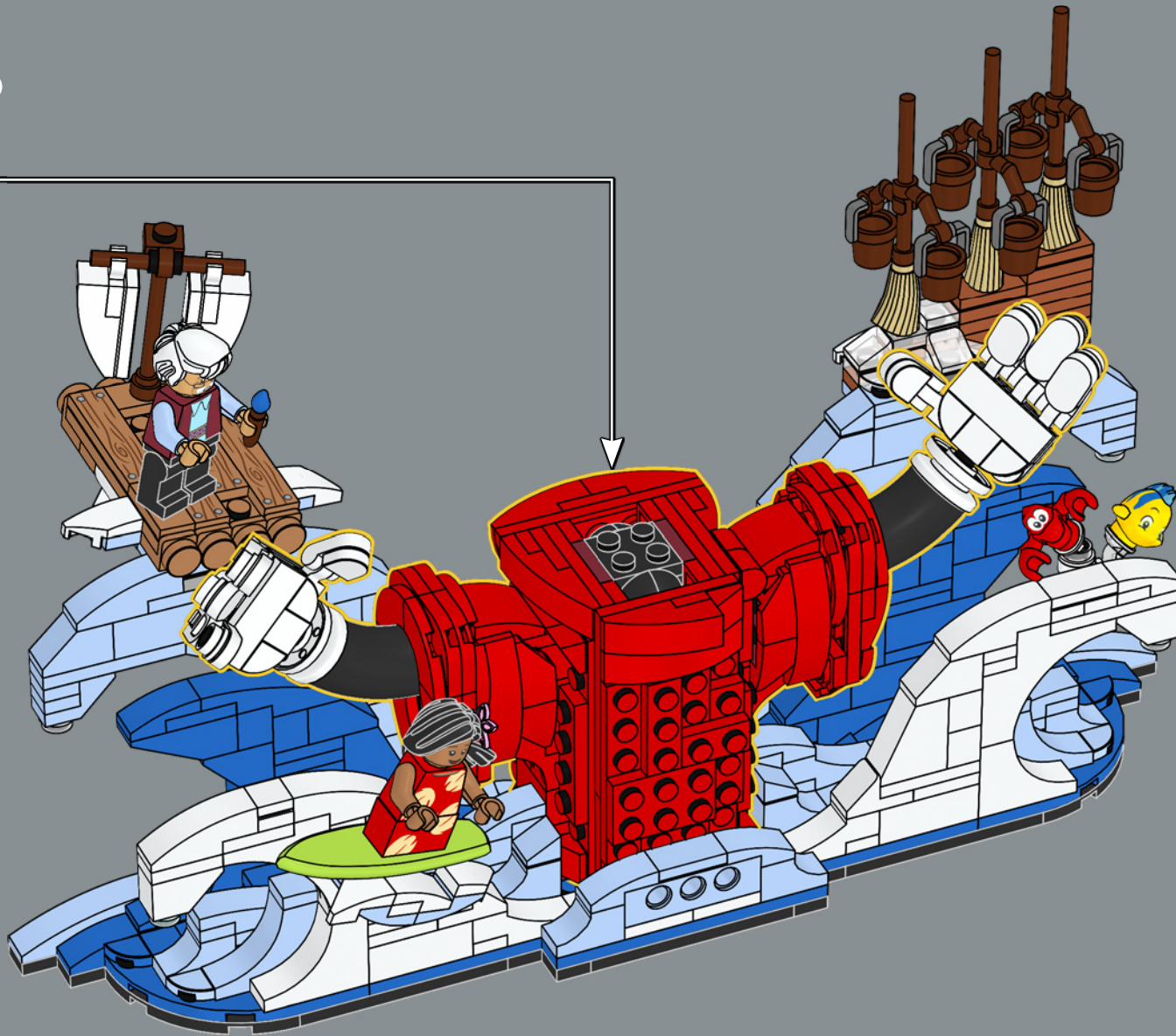



240

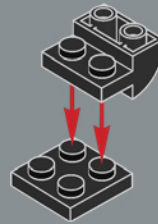

241

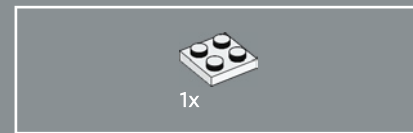
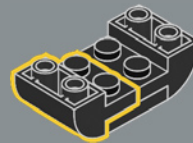

242

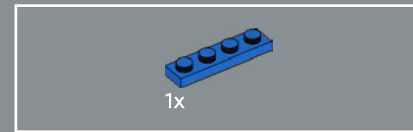
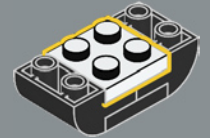

243

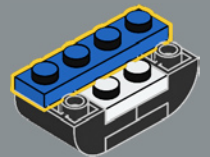

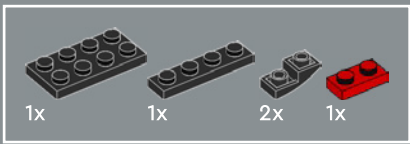

244

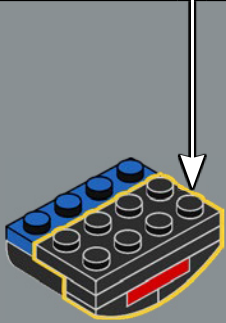
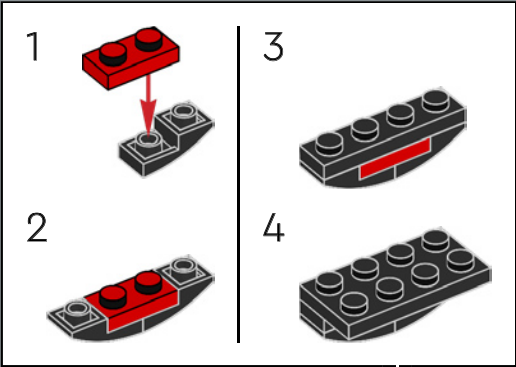

245

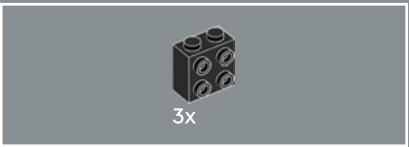

246

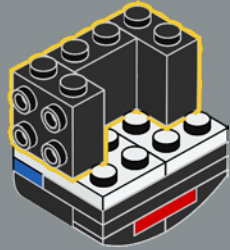

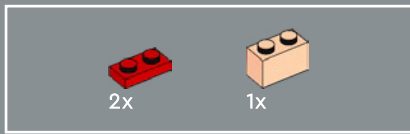

247

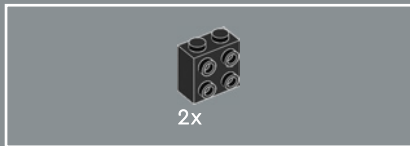
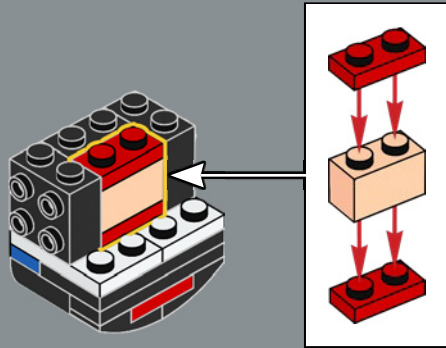

248

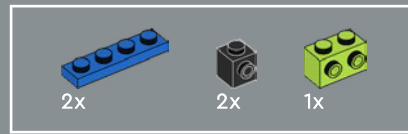
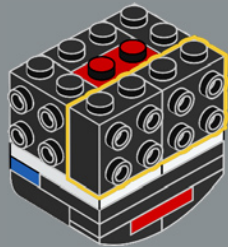

249

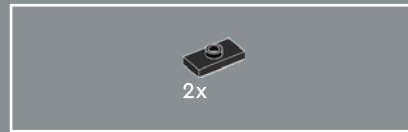
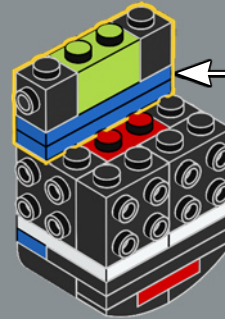

250

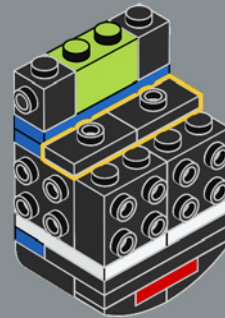

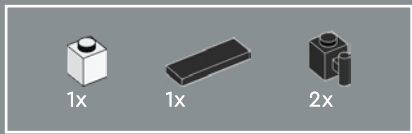

251

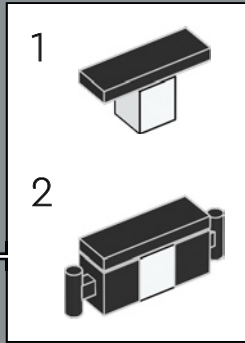
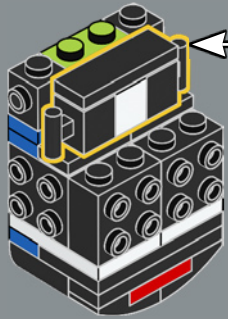

253

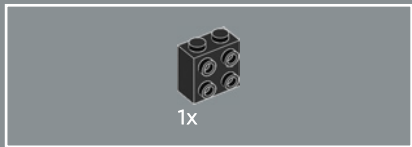
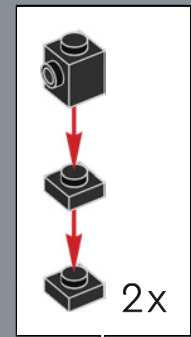
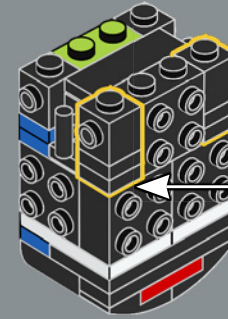

252

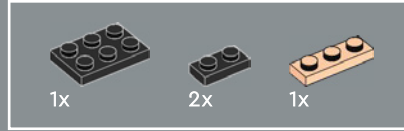
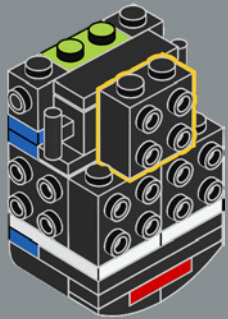

254

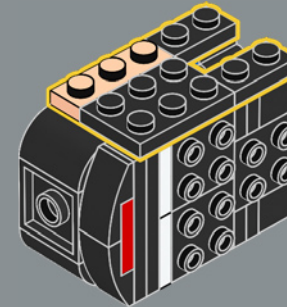



255

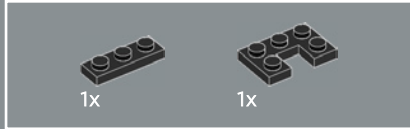
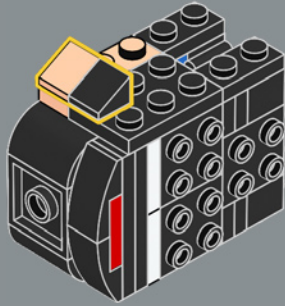

256

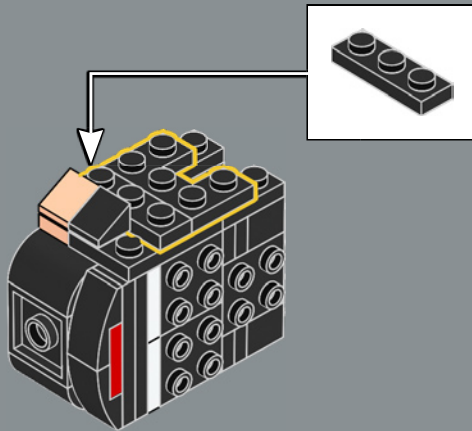

257

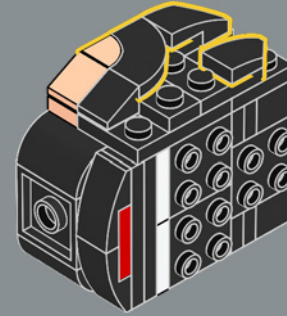

258

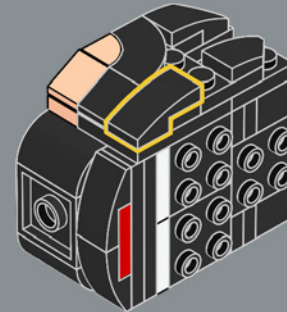

1x

259

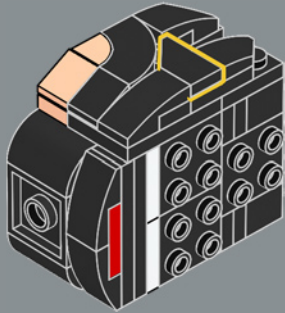

1x 2x 1x

260

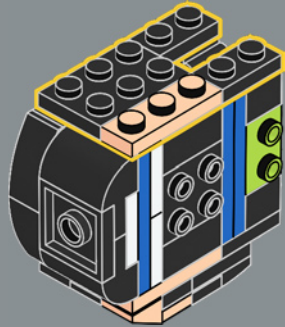

1x

1x

261

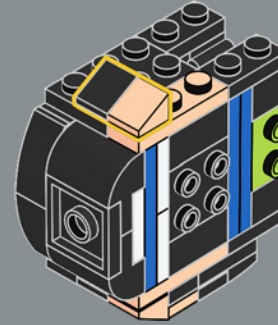

1x 1x

262

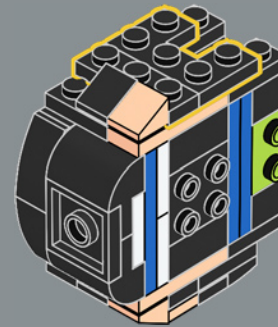

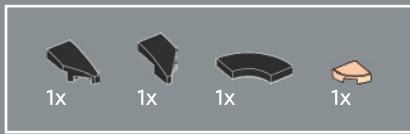

263

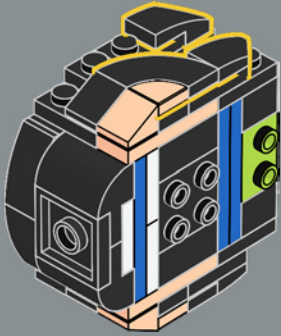

264

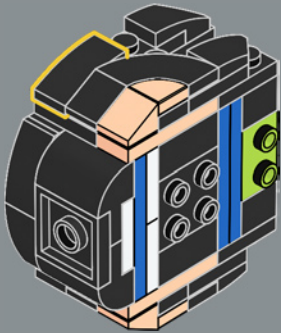

265

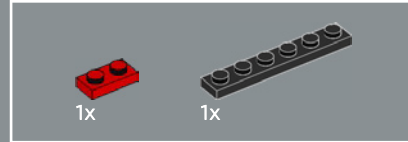
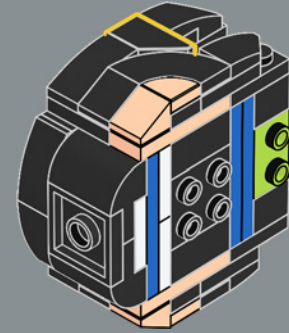

266

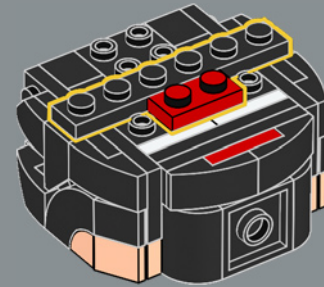

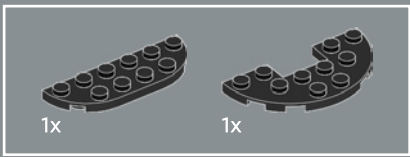

267

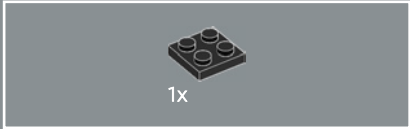
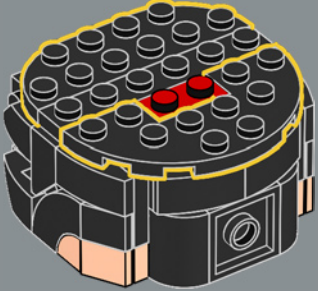

268

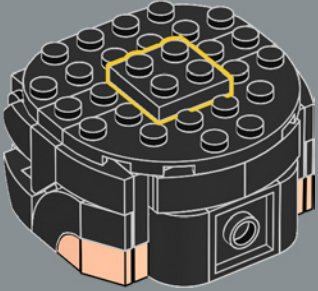

269

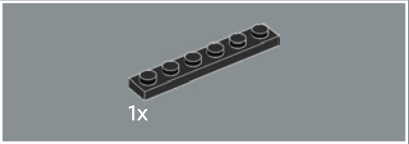
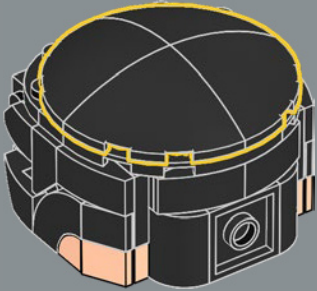

270

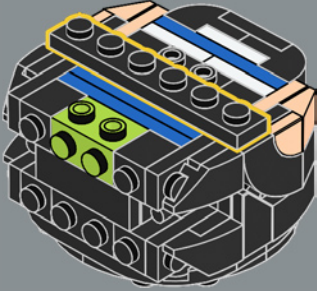

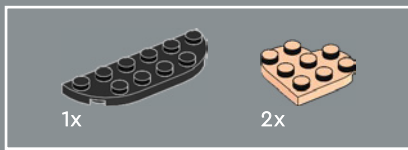

271

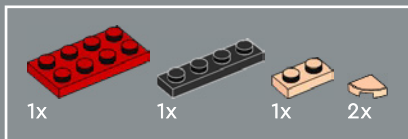
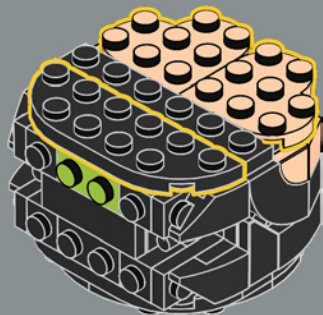

272

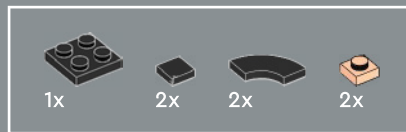
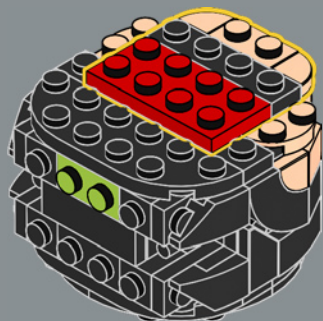

273

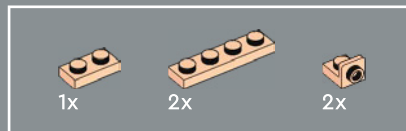
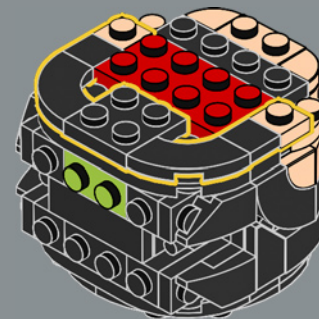

274

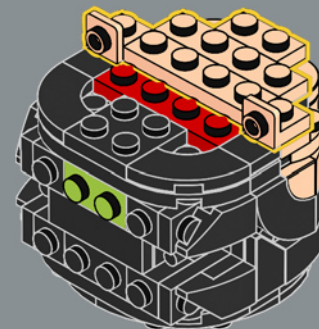

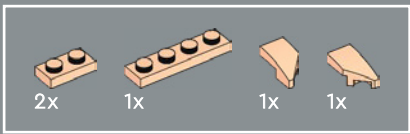

275

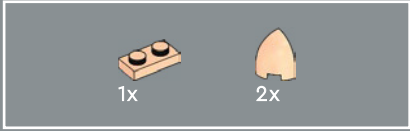
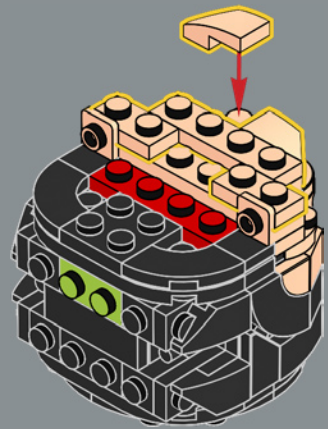

276

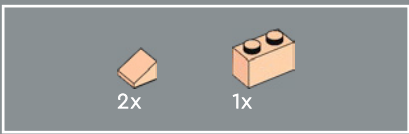
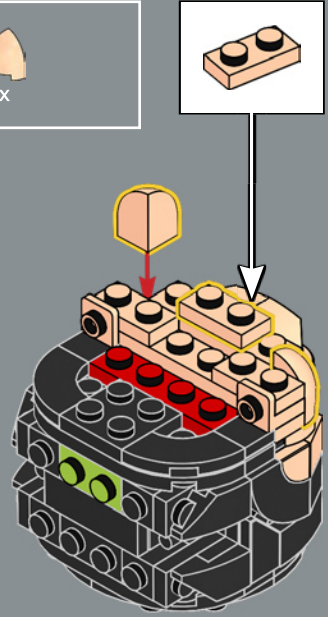

277

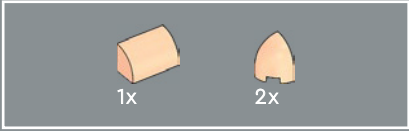
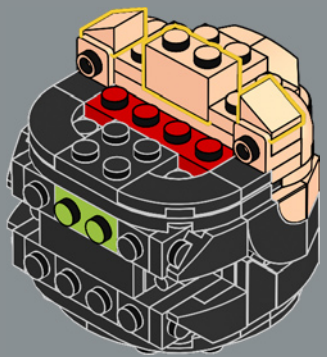

278

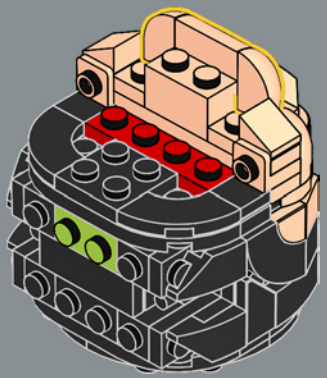



279

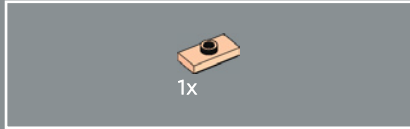
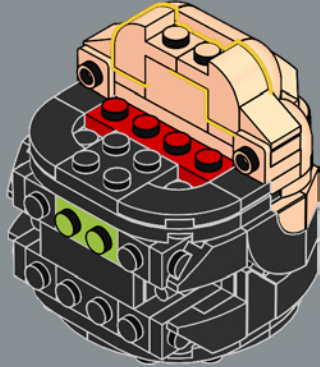

280

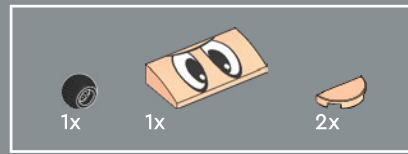
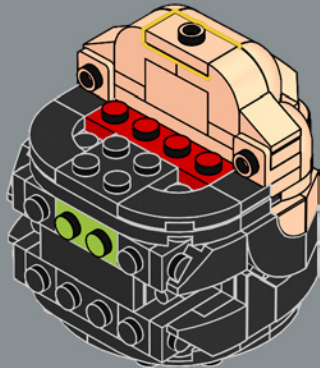

281

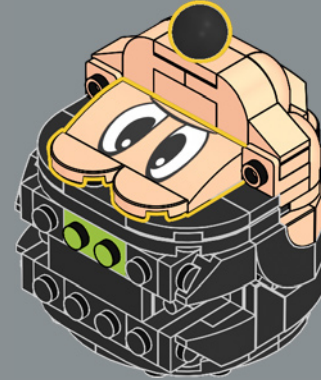

282

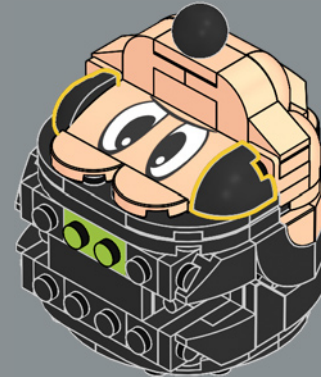

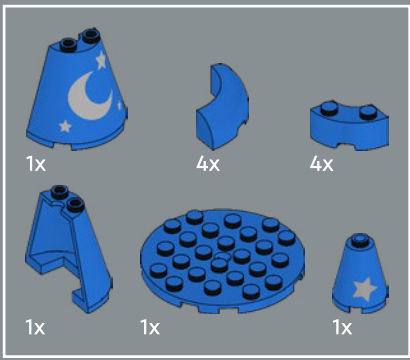

283

1

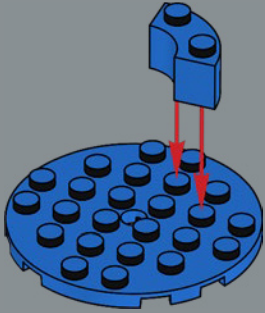

2

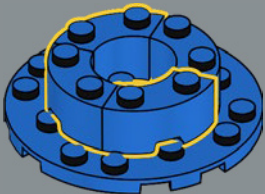

3

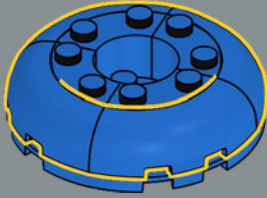

4

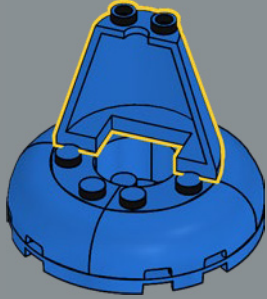

5



6

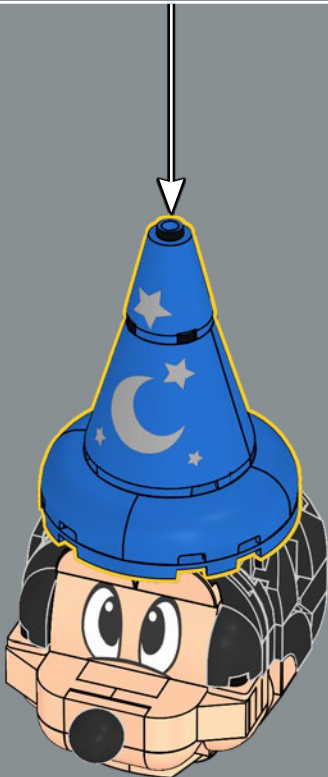

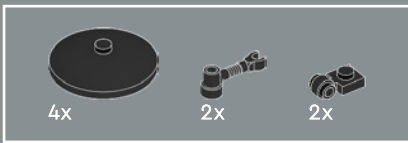

284

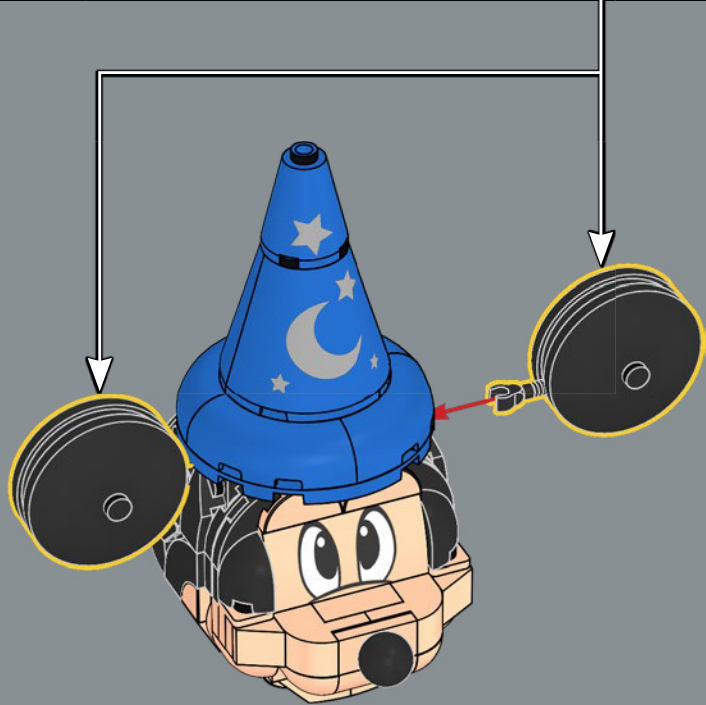
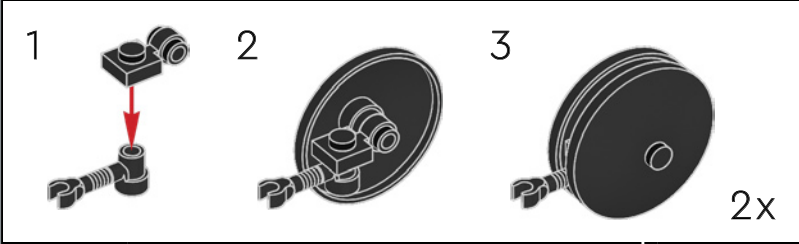

285





2x

286









IDEAS

GATHER SUPPORT
HOL DIR UNTERSTÜTZUNG
RECUEILLES DES VOTES
CHIEDI DI ESSERE SUPPORTATO
CONSIGUE APOYOS
OBTÉM APOIO
爭取支持
ZDOBĄDŹ GŁOSY

ZÍSKEJTE PODPORU
ZÍSKAJTE PODPORU
SZEREZZ TÁMOGATÁST!
CERE SPRIJIN
ПОЛУЧЕТЕ ПОДКРЕПА
IEGŪSTI ATBALSTU
KOGU TOETUST
RINK PALAIKYMĄ

SHARE YOUR IDEA
TEILE DEINE IDEE
PARTAGEZ VOTRE IDÉE
CONDIVIDI LA TUA IDEA
COMPARTE TU IDEA
PARTILHA A TUA IDEIA
分享创意
PODZIEL SIĘ POMYSŁEM

SDÍLEJTE SVÉ NÁPADY
ZDIEĽAJTE SVOJE NÁPADY
OSZD MEG AZ ÖTLETED!
ÎMPĂRȚĂȘEȘTE IDEEA TA
СПОДЕЛЕТЕ ИДЕИТЕ СИ
PARÁDI SAVU IDEJU
JAGA OMA IDEED
PASIDALINK SAVO IDĒJA

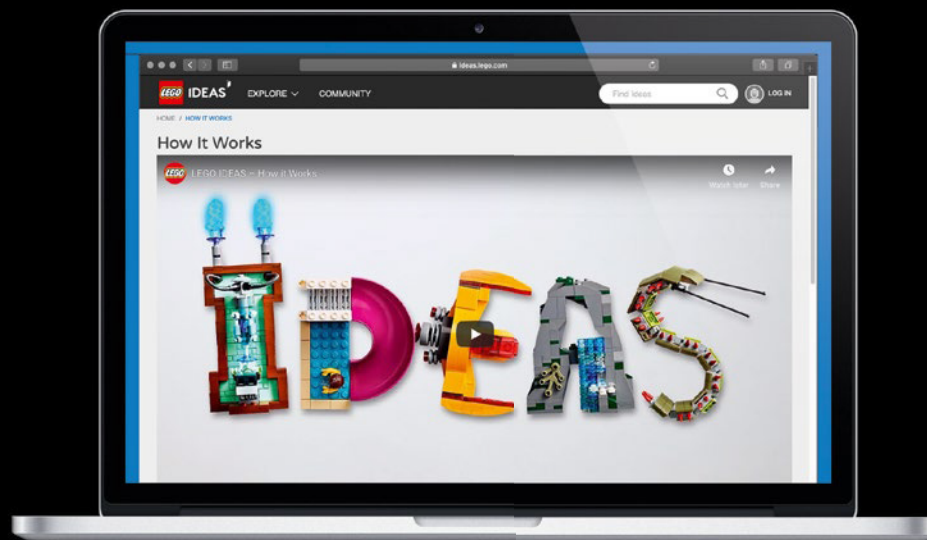
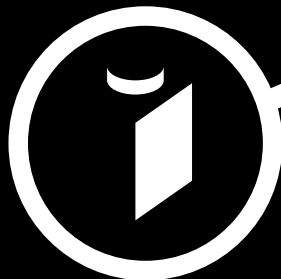
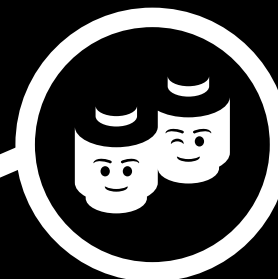

LEGO® REVIEW
LEGO® PRŮFUNG
EXAMEN PAR LEGO®
REVIEW LEGO®
REVISIÓN DE LEGO®
AVALIAÇÃO LEGO®
乐高®审核
OCENA LEGO®

POSOUZENÍ DESIGNÉRY LEGO®
POSÚDENÉ DIZAJNÉRMÍ LEGO®
LEGO® VÉLEMÉNYEZÉS
VERIFICARE LEGO®
ПРЕГЛЕД НА LEGO®
LEGO® RECENZJA
LEGO® ARVUSTUS
LEGO® APŽVALGA

NEW LEGO® PRODUCT
NEUES LEGO® PRODUKT
NOUVEAU PRODUIT LEGO®
NUOVO PRODOTTO LEGO®
NUEVO PRODUCTO LEGO®
全新乐高®产品
NOWY PRODUKT LEGO®

NOVÁ STAVEBNICE LEGO®
NOVÁ STAVEBNICA LEGO®
ÚJ LEGO® TERMÉK
PRODUS LEGO® NOU
НОВ ПРОДУКТ LEGO®
JAUNS LEGO® PRODUKTS
UUS LEGO® TOODE
NAUJAS LEGO® PRODUKTAS



ideas.LEGO.com

5x 300501	2x 6417970	8x 6174937
		4x 6330191
2x 362201	8x 6202501	
		2x 6347287
1x 6058177	6x 307001	
		2x 6223491
1x 4121932	11x 302401	
		2x 6089696
1x 6166894	1x 306901	
		8x 614101
2x 366501	4x 302301	
		2x 6250591
2x 4515370	4x 302201	
		4x 6172366
2x 6069002	2x 6218822	
		6x 6507793
4x 6213880	2x 362301	4x 6210272
4x 6213881	2x 4558168	1x 6515918
3x 6034044	2x 302101	
		2x 6013484
2x 6400127	1x 371001	2x 370021
2x 6110019	1x 302001	16x 302321
2x 6357598	3x 6186681	6x 300421
5x 4249112	2x 6446788	2x 300321
144		
	4x 6347293	2x 6435045

4x 6019155	4x 6473603
4x 6473603	7x 4504379
4x 6177505	
	9x 302421
2x 6278441	
	4x 6177507
4x 6177507	5x 6029946
	2x 6105976
5x 6029946	
	1x 4251162
2x 6105976	
	4x 6056816
1x 4251162	
	1x 6045937
4x 6056816	
	5x 4633914
1x 6045937	
	2x 6210269
5x 4633914	
	6x 6173961
2x 6210269	
	2x 6219819
6x 6173961	
	1x 242021
2x 6219819	

8x 6384910	8x 6310198
8x 6310198	2x 4515348
2x 4515348	11x 362321
11x 362321	6x 302121
6x 302121	10x 371021
10x 371021	6x 302021
6x 302021	1x 4243814
1x 4243814	1x 366621
1x 366621	1x 6108802
1x 6108802	1x 379521
1x 379521	8x 346021
8x 346021	1x 303221
1x 303221	
1x 6249092	

1x 6512571	1x 6380346
1x 6380346	1x 6503441
1x 6503441	1x 6517019
1x 6517019	1x 6469438
1x 6469438	2x 4121972
2x 4121972	1x 4129996
1x 4129996	1x 6030731
1x 6030731	1x 4114322
1x 4114322	1x 6020375
1x 6020375	1x 4159739
1x 4159739	1x 6313119
1x 6313119	1x 4217562
1x 4217562	1x 6273851
1x 6273851	

1x 4529237	4x 4516055
1x 6145570	
	3x 6312460
	2x 4159553
4x 4516055	1x 4125253
3x 6312460	
2x 4159553	
1x 4125253	
1x 4125253	
3x 6514488	
1x 6143058	
1x 6143058	
1x 4579260	
2x 4113917	
2x 4113917	
2x 6251252	
1x 4114077	
1x 4114077	
1x 4565387	
1x 4565387	
1x 4121921	
1x 4121921	
2x 366523	
2x 366523	
4x 6189189	
4x 6189189	
2x 6513920	
2x 6513920	

4x 300523	2x 6302961	1x 6382590	2x 6178922	2x 6281993	6x 6436425	1x 6396678	6x 6509268
2x 300423	8x 302423		2x 4504382	1x 6141556		3x 4211242	6x 4626196
	6x 4504380	1x 6517771	2x 6181720	2x 403226			
4x 362223	2x 4206330		2x 6181713	2x 6143850	1x 6421735	1x 4529242	1x 6476174
	4x 6172414	2x 302224	2x 6181713	4x 6191630		2x 6322211	2x 6186673
2x 301023	4x 6172414		2x 6147050	2x 6143850	2x 6279875		
	4x 6172411	2x 6347698	2x 4141580	4x 6191630		2x 6365885	3x 6433717
4x 6311259	6x 6055065		2x 6047276	2x 6093525	2x 4221744		2x 6306775
	16x 302323	1x 302024	1x 4290713	4x 302126	4x 4558954	1x 4211151	1x 6347749
1x 6517277	2x 362323		2x 307026	2x 6493691	2x 6170566	2x 4211150	2x 4645103
	1x 379523	1x 6147047	4x 302426	5x 371026	6x 6275806	1x 4216695	10x 6215659
4x 6307922			1x 6510139	2x 6439175		2x 6196221	2x 6284586
	1x 379523		1x 6510125	2x 6092585	4x 6308883	1x 4211159	1x 6102360
			2x 6092585	4x 302326	4x 6385597	1x 4267994	1x 6102360
1x 6503450	1x 6509261		4x 302326	4x 242026	1x 300326		
			4x 242026	4x 396026		1x 4211201	2x 6084573
1x 6440085	4x 346023		4x 302226	4x 302026			
	4x 346023		6x 362326	6x 362326	1x 9339	1x 4211247	3x 6116613
4x 4121936	2x 6093691		1x 4558170	2x 6054852		4x 6170468	1x 6400660
			2x 6458098	4x 366626	1x 6503445		
2x 6372038	2x 303623				1x 6420726	1x 4538252	1x 6503448
6x 6439891							
4x 6045938							
5x 371023							

- 2x 6252045
- 1x 6277483
- 4x 4666322
- 8x 6104342
- 2x 6186021
- 1x 6186012
- 2x 6092602
- 4x 4570877
- 1x 6440767
- 4x 6468066
- 2x 6074892
- 2x 6253418
- 4x 6430373
- 1x 6507961
- 1x 6491319
- 2x 6510188
- 1x 6510164
- 2x 6404363
- 4x 6245250
- 1x 6254254
- 2x 6252041
- 3x 6514001
- 1x 6286876
- 1x 6517500
- 8x 6209682
- 2x 6443851
- 1x 4504372
- 2x 4621557
- 2x 6208291
- 1x 6517017
- 1x 6102906
- 4x 6311890
- 4x 6398466
- 2x 4539090
- 8x 4585479
- 1x 6516984
- 8x 6209691
- 2x 6190252
- 3x 6301811
- 4x 6069887
- 1x 6092594
- 2x 6218047
- 2x 6173654
- 2x 6112307
- 3x 6300322
- 5x 6315781
- 1x 6055172
- 2x 4528604
- 1x 4550168
- 1x 6132768
- 1x 6338985
- 1x 6226594
- 1x 6401026
- 2x 6001824
- 1x 4521914
- 1x 4530678
- 2x 6184880
- 1x 6015454
- 2x 6258951
- 2x 6258949
- 1x 4549436
- 3x 6040126
- 2x 6514274
- 2x 6424623
- 1x 6065504
- 1x 6073040
- 1x 6503438
- 1x 6254252
- 2x 6507959
- 2x 6507986
- 2x 6316571
- 15x 6184484
- 3x 6372124
- 2x 6285271
- 6x 6100322
- 18x 6182777
- 2x 6287903
- 1x 6383136
- 2x 6486923
- 6x 6057389
- 4x 6097861
- 10x 6362254
- 1x 6099373
- 6x 6372138
- 1x 6361991
- 10x 6361988
- 1x 6316569
- 2x 6513917
- 4x 6136397
- 6x 6383091
- 2x 6372146
- 5x 6335524
- 3x 6336860
- 1x 6383112
- 4x 6392576
- 7x 6058766
- 2x 6383076
- 2x 6387467
- 2x 6383078
- 1x 6361985
- 1x 6132422
- 2x 6043656
- 2x 4211815
- 3x 6329651
- 1x 6331087
- 4x 6509875
- 4x 6357792
- 1x 6480356
- 1x 6480371
- 1x 6357793
- 2x 6509880
- 2x 6357797
- 1x 6440634
- 5x 6369188
- 1x 6329282
- 2x 6509879
- 4x 6275872
- 2x 6512570
- 2x 6369189
- 2x 6501239
- 2x 6509876
- 3x 6440965
- 2x 6378419
- 1x 6503449
- 8x 6284589
- 1x 6349124
- 1x 6503439
- 1x 6503446
- 3x 6215606
- 8x 6324205
- 3x 6314190
- 2x 6218360
- 1x 6347304
- 4x 6292154
- 1x 6096990
- 17x 6135287
- 1x 6210271
- 19x 6229130
- 2x 6268814
- 1x 6378799
- 1x 6401021
- 1x 6056383
- 1x 6058085
- 4x 6329605
- 1x 6167700
- 2x 6313600
- 1x 6301315
- 1x 6329119
- 1x 4619521
- 1x 6125776
- 1x 4623598
- 1x 6005030
- 3x 6514272
- 2x 6469891
- 1x 6503442
- 2x 6039479
- 6x 6245283

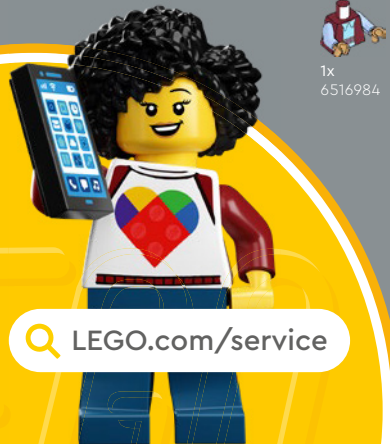

 [LEGO.com/service](https://www.LEGO.com/service)



YOU COULD WIN

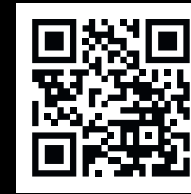

YOU COULD WIN

Your feedback will help shape the future development of this product series.

Visit:

DU KÖNNTEST GEWINNEN

Dein Feedback trägt zur Weiterentwicklung dieser Produktreihe bei.

Geh auf:

VOUS POURRIEZ GAGNER

Vos commentaires nous aideront à concevoir les futurs produits de cette gamme.

Visitez :

POTRESTI VINCERE TU

La tua opinione ci aiuterà a migliorare la creazione futura di questa linea di prodotti.

Visita:

PUEDES GANAR

Tu opinión contribuirá al futuro de esta serie de productos.

Visita:

轻松获奖

您的反馈将有助于我们在今后改进本产品系列。

请访问:

[LEGO.com/productfeedback](https://www.lego.com/productfeedback)

You also have the chance to win a LEGO® set.

Terms and conditions apply.*

Außerdem hast du die Chance, ein LEGO® Set zu gewinnen.

Es gelten die Teilnahmebedingungen.*

Vous pourriez également gagner un ensemble LEGO®.

Des conditions s'appliquent.*

Hai anche la possibilità di vincere un set LEGO®.

Termini e condizioni sono applicabili.*

También tienes la oportunidad de ganar un set LEGO®.

Aplican términos y condiciones.*

您还有机会赢取乐高®套装。

条款和条件适用。*

*[LEGO.com/productfeedback-terms](https://www.lego.com/productfeedback-terms)

