



77051



Q LEGO® Builder



### **Get excited about our new packaging!**

We're switching from plastic to paper-based packaging. That's why you might find a mix of paper and plastic in our boxes!

### **Nos nouveaux emballages vous emballeront !**

Nous passons des emballages en plastique aux emballages à base de papier. C'est pourquoi vous pourriez trouver un mélange de papier et de plastique dans nos boîtes !

### **¡Te presentamos nuestros nuevos empaques!**

Estamos sustituyendo las bolsas de plástico por bolsas con base de papel. ¡Por eso, puedes encontrar una mezcla de papel y de plástico en nuestras cajas!

**[LEGO.com/sustainable-packaging](https://www.lego.com/sustainable-packaging)**

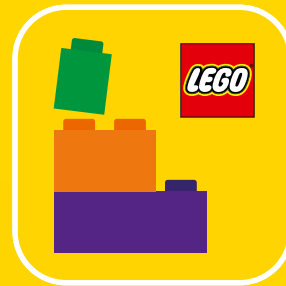

🔍 LEGO® Builder

# BUILDER

Download on the  
App Store

GET IT ON  
Google Play

腾讯应用宝  
安卓应用商店

Apple and the Apple logo are trademarks of Apple Inc., registered in the U.S. and other countries and regions. App Store is a service mark of Apple Inc. Google Play and the Google Play logo are trademarks of Google LLC. Tencent and the Tencent logo are trademarks of Tencent Inc.

🔍 [LEGO.com/devicecheck](https://LEGO.com/devicecheck)

EN Ask parents' permission before going online | DE Eltern um Erlaubnis bitten, bevor du online gehst | FR Demande l'autorisation d'un parent avant d'aller en ligne | IT Chiedi il permesso ai tuoi genitori prima di andare online | ES Pídeles permiso a tus papás antes de conectarte a Internet | PT Pede autorização aos pais antes de acederes online | ZH 上网前应先征得父母的同意 | PL Poproś rodziców o zgodę, zanim wejdiesz do Internetu | CS Než půjdeš na internet, požádej rodiče o svolení | SK Skôr než pôjdeš na internet, vypýtaj si povolenie od rodičov | HU Kérj szülői engedélyt, mielőtt online csatlakoznál! | RO Cere permisiunea părinților înainte de a te conecta online | BG Поискайте разрешение от родител, преди да влезете онлайн | LV Pirms došanās tiešsaistē palūdz atļauju vecākiem | ET Enne Interneti kasutamist küsi vanematelt luba | LT Prieš prisijungdami prie interneto, atsklauskite tėvų





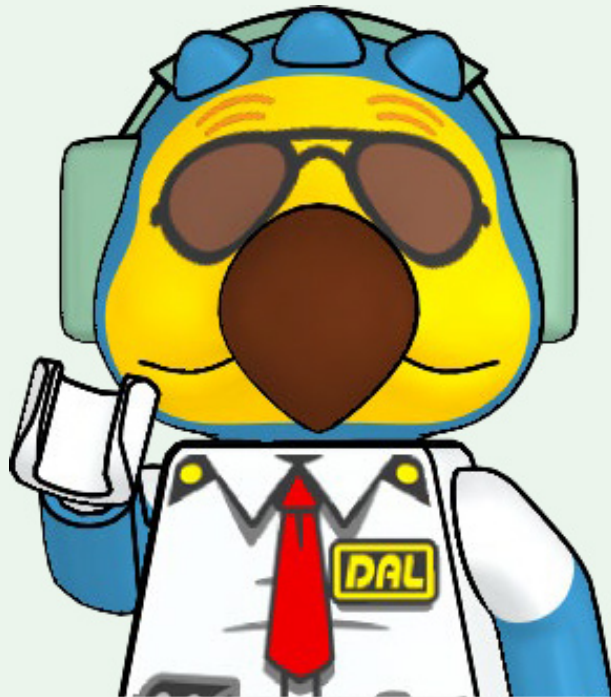
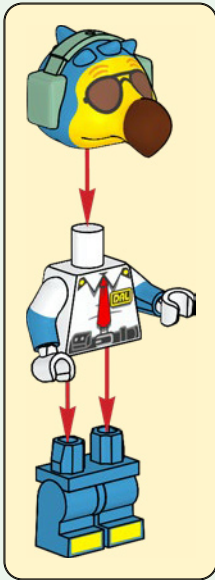

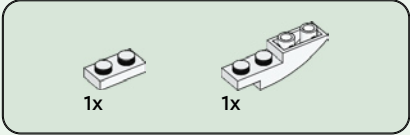
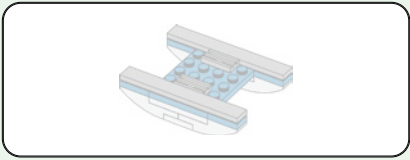

1

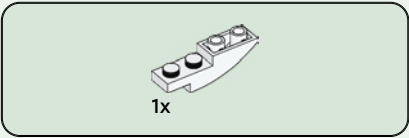
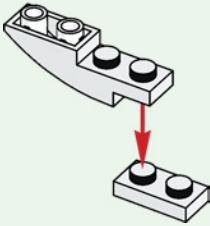

2

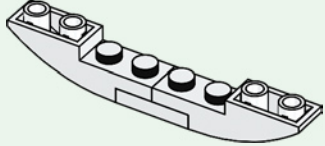

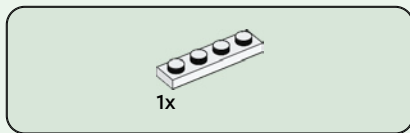

3

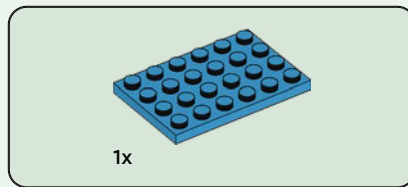
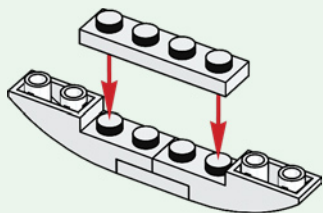

4

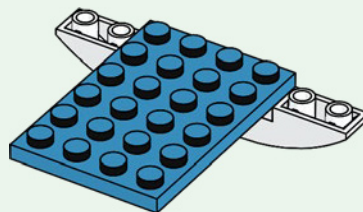

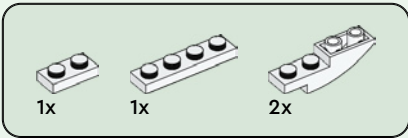

# 5

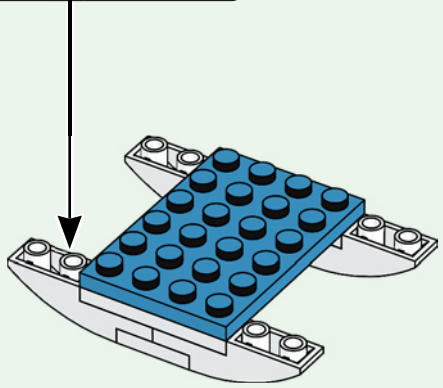
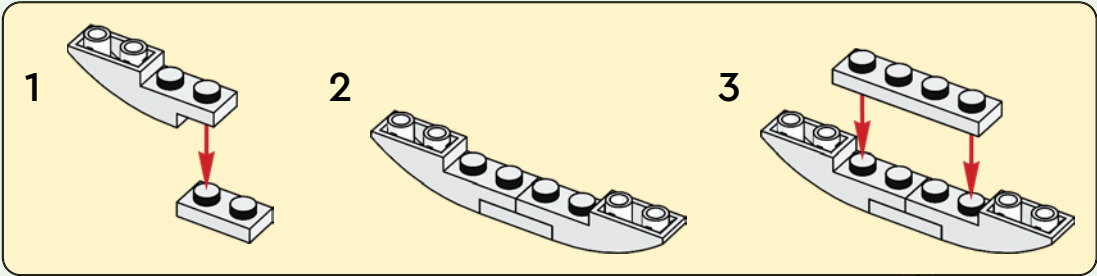



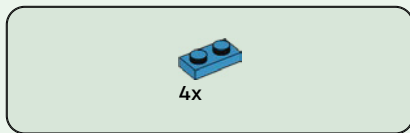

6

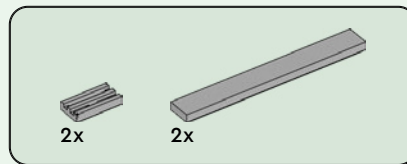
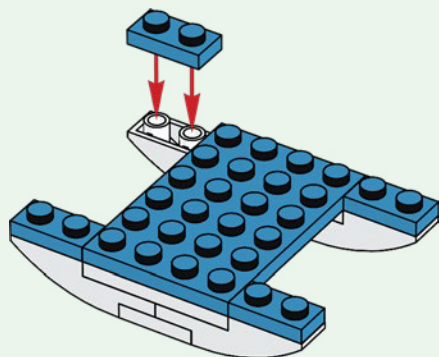

7

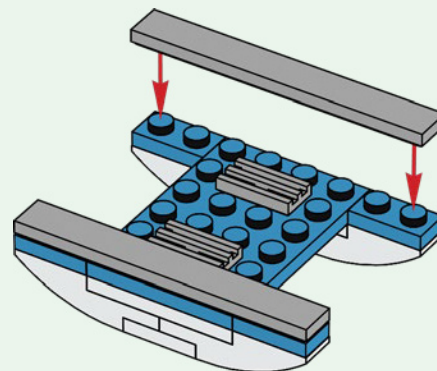

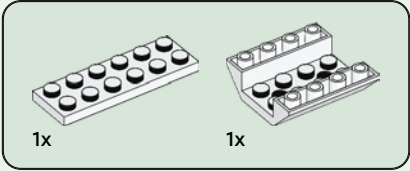
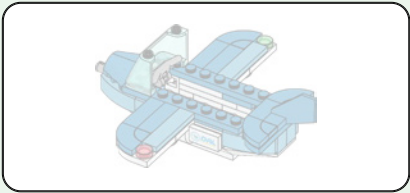

8

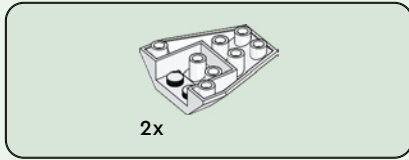
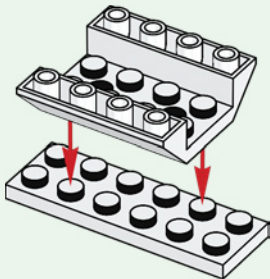

9

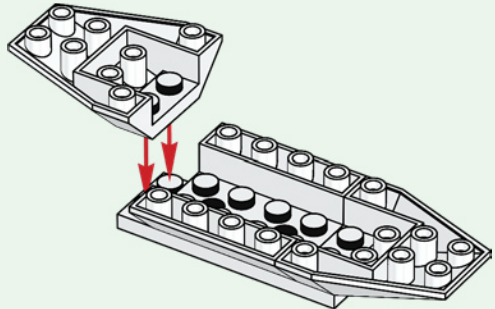

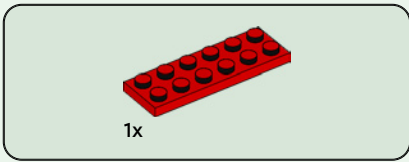

10

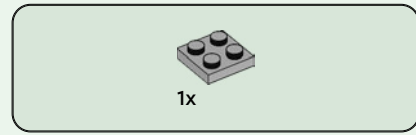
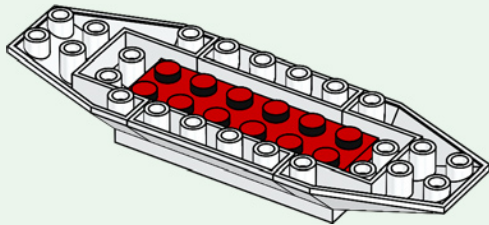

11

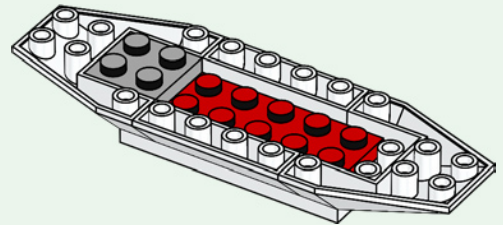



4x

12

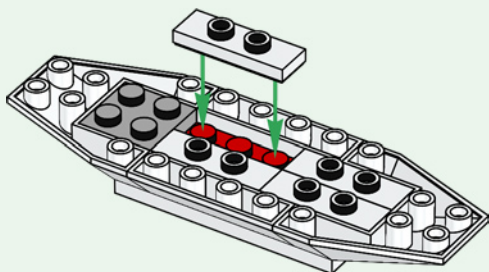

1x

13

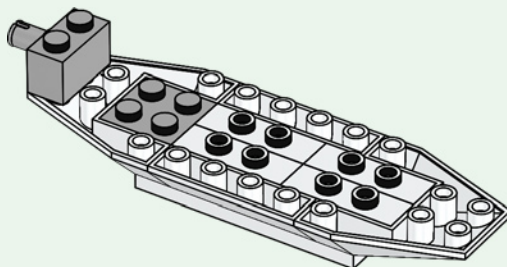





2x

14

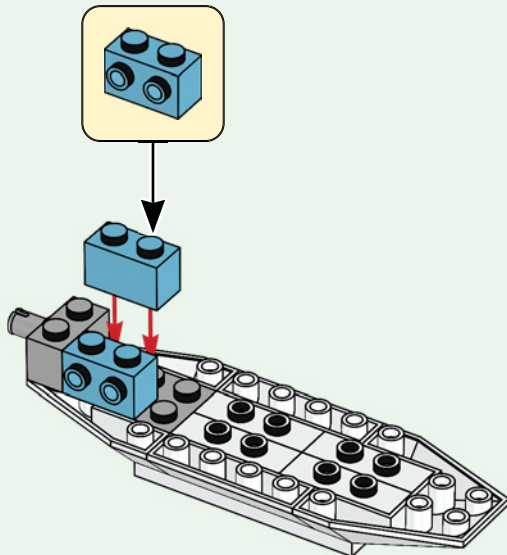

2x



2x

15

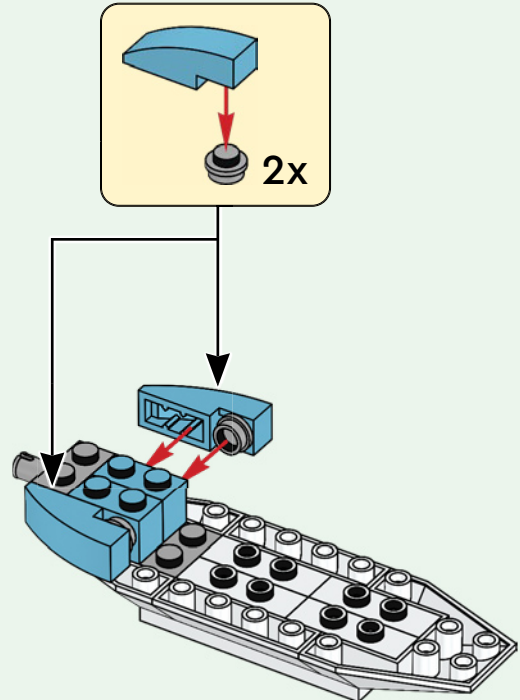



1x



1x

16

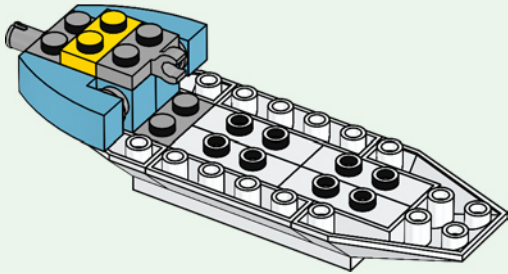

1x



1x

17

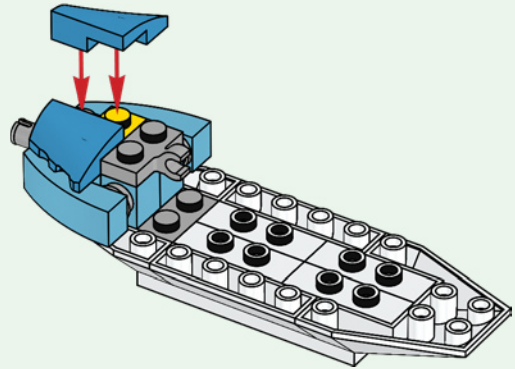



18

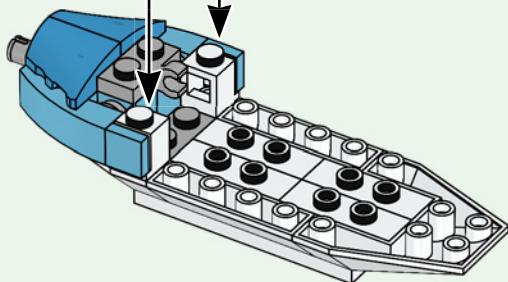
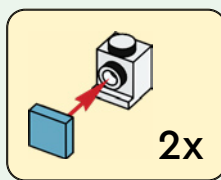



2x

19

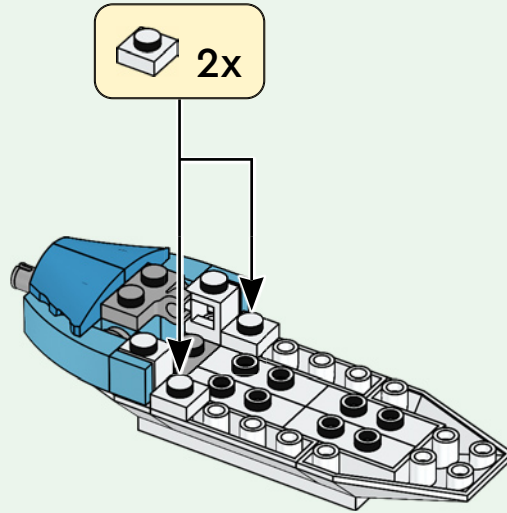





2x



2x

# 20

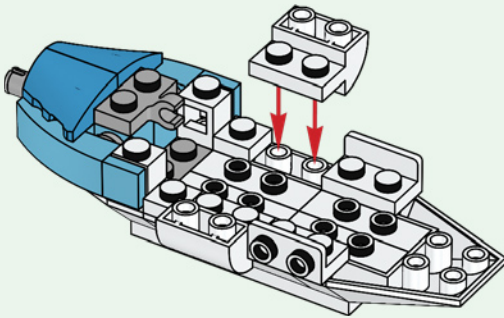

2x

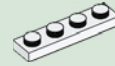

2x

# 21

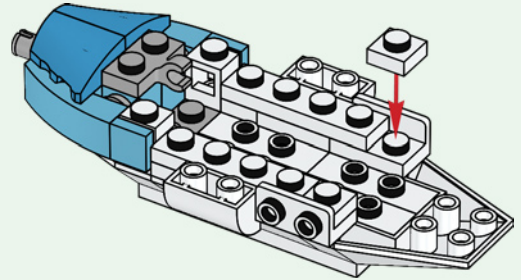



2x

22

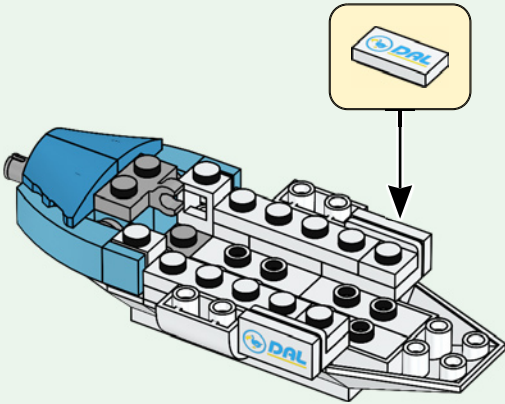

2x

23

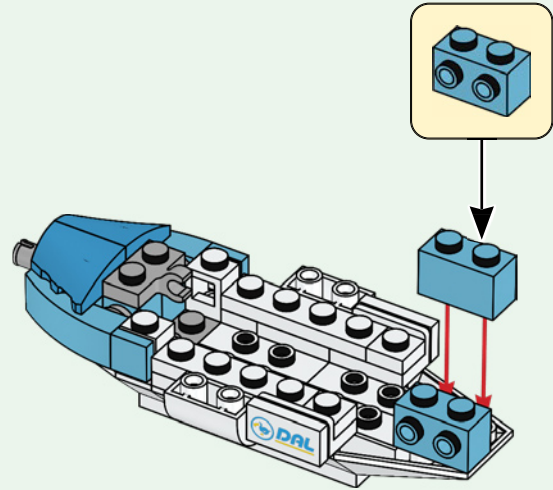



2x



2x

# 24

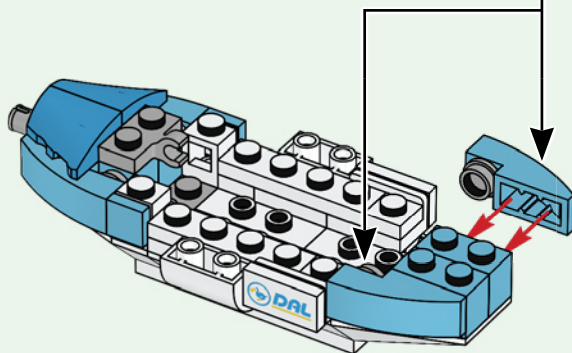
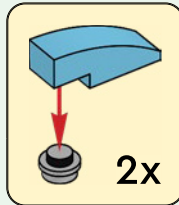

2x

# 25

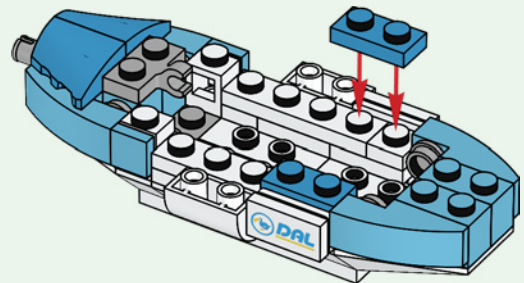

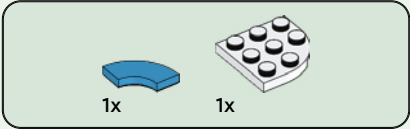
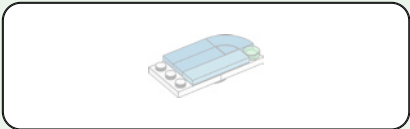

26

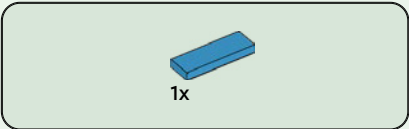
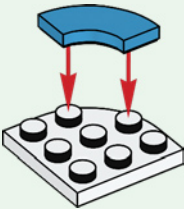

27

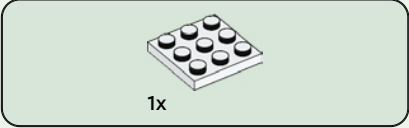
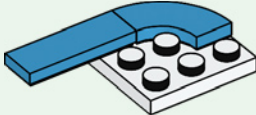

28

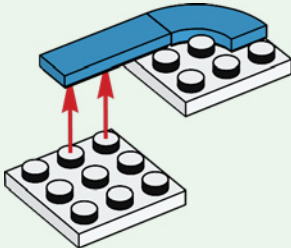

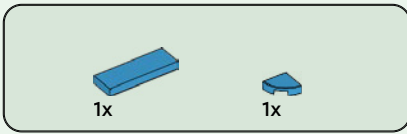

29

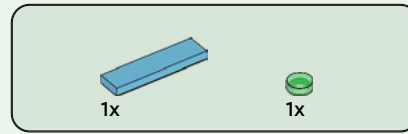
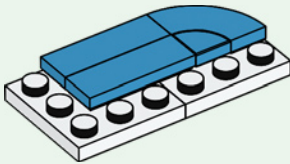

30

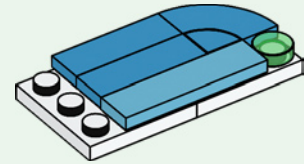

31

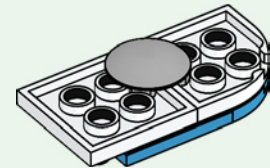
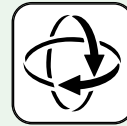

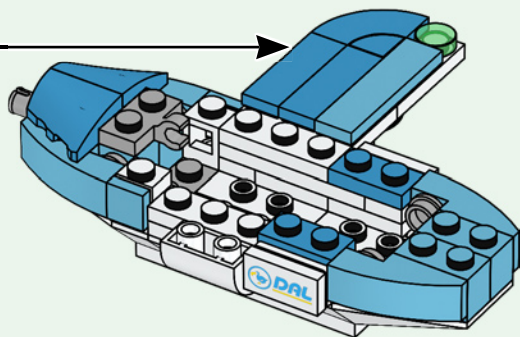

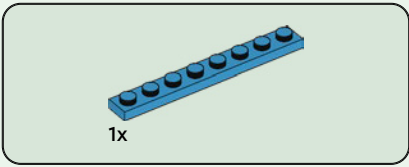

32

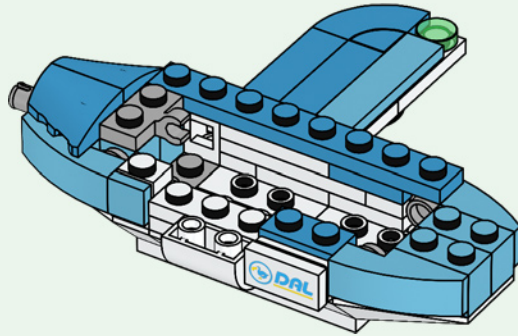

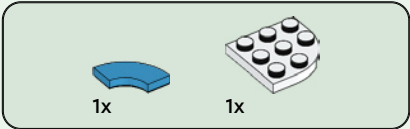
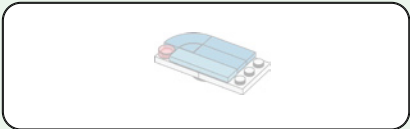

33

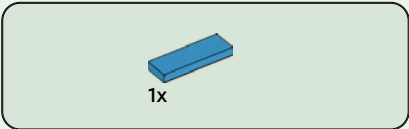
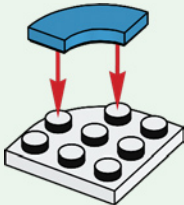

34

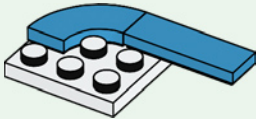

35

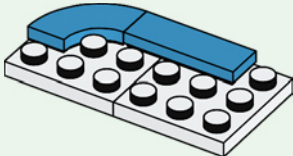



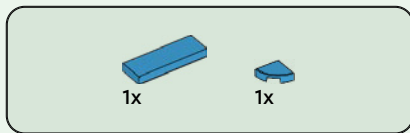

36

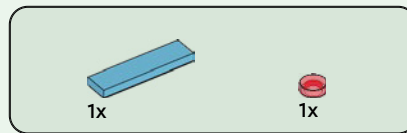
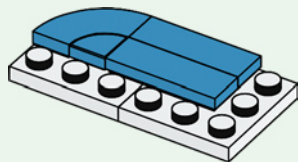

37

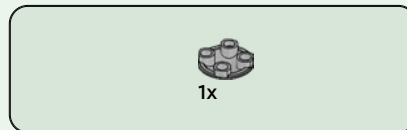
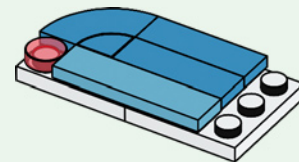

38

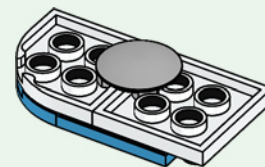

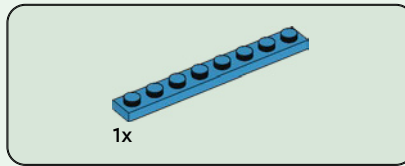

39

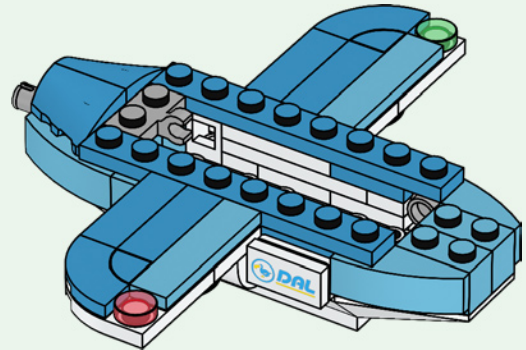
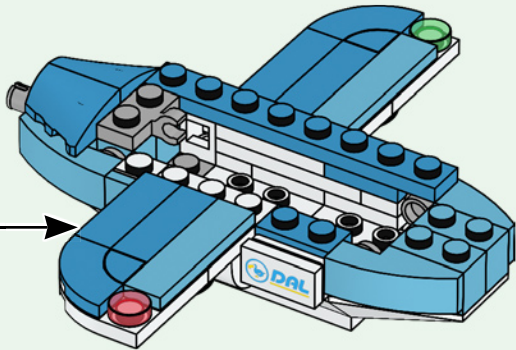

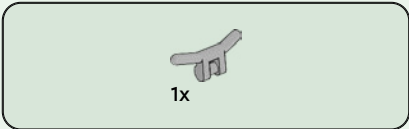

40

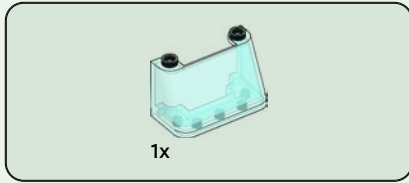
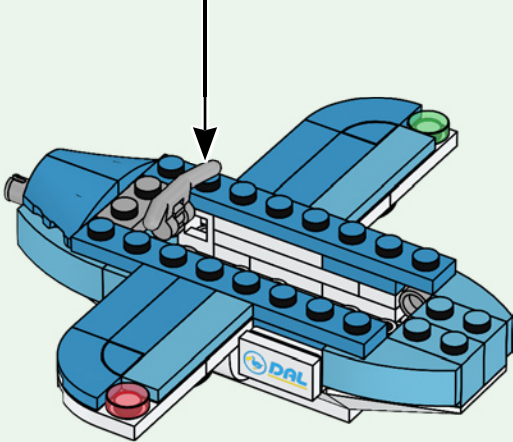

41

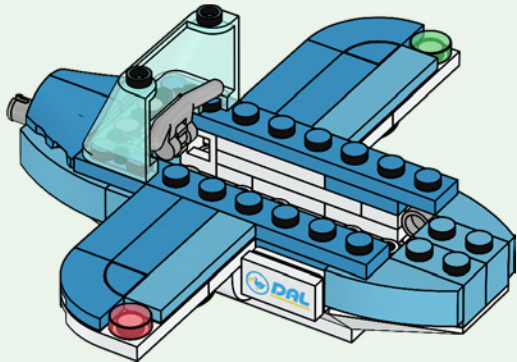

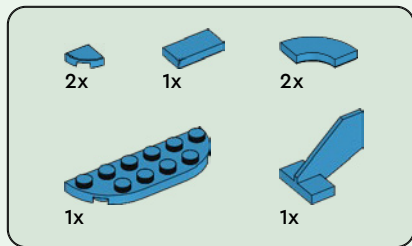

42

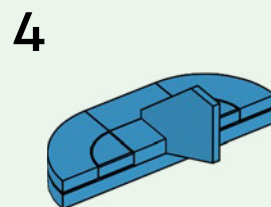
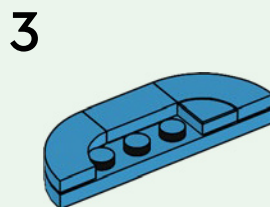
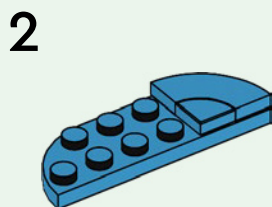
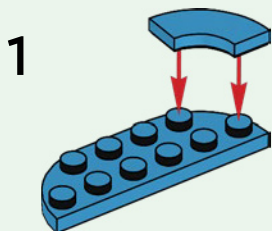

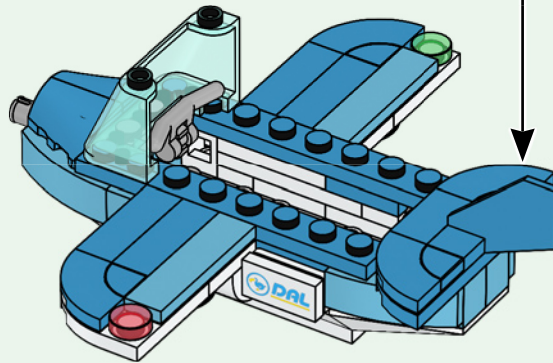

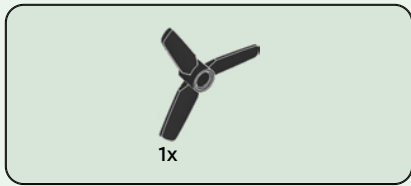

43

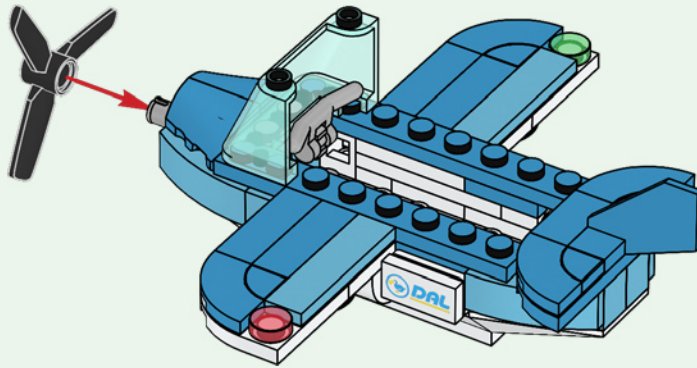

44

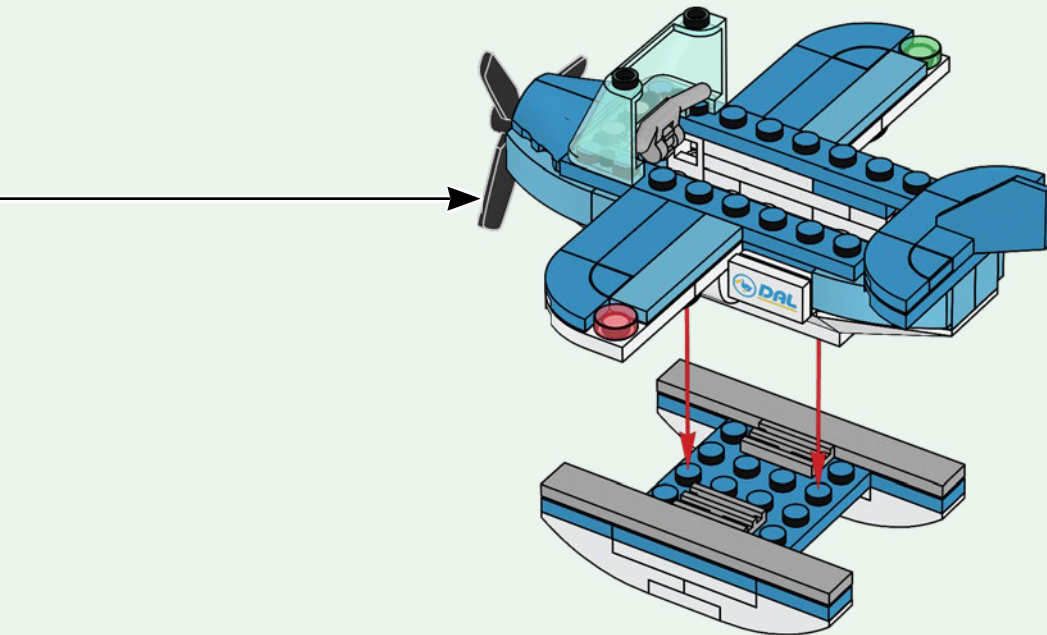

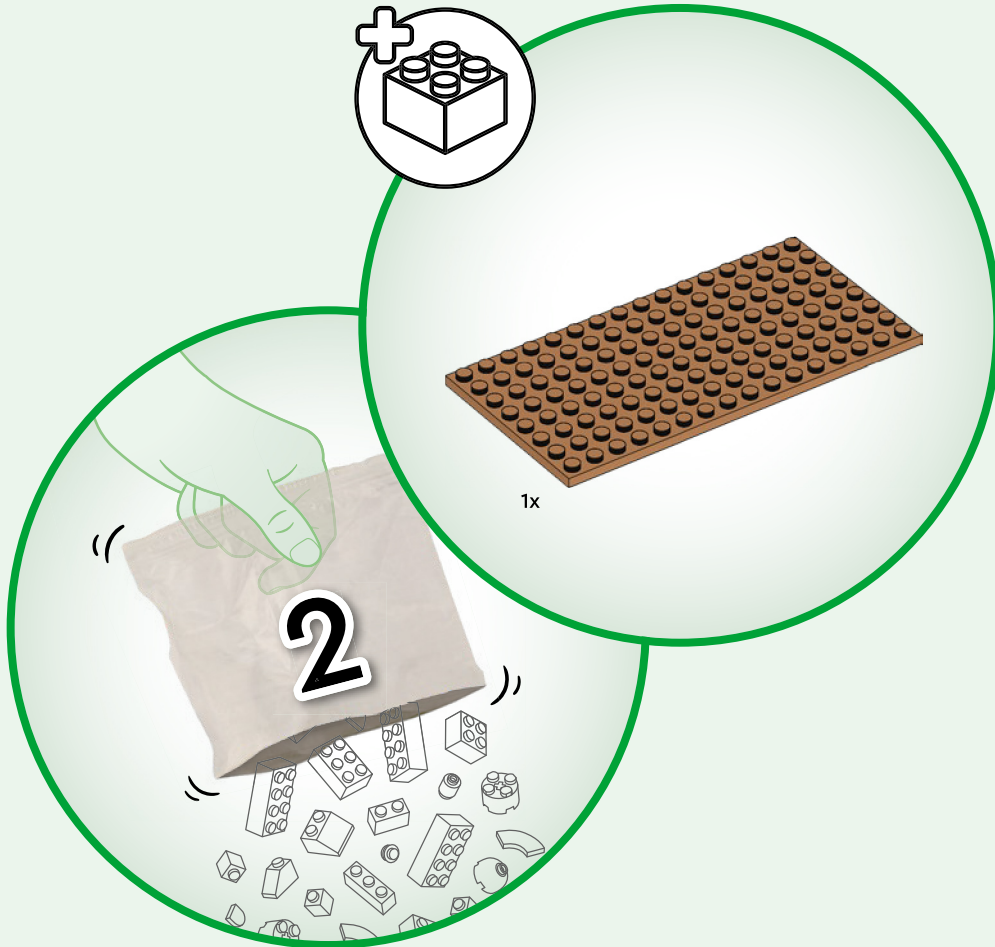



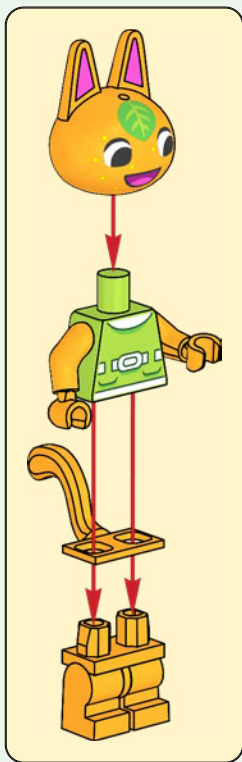

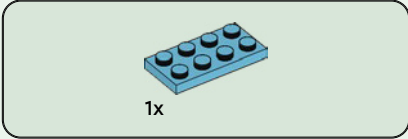
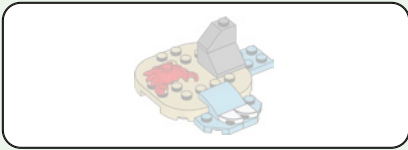

1x

45

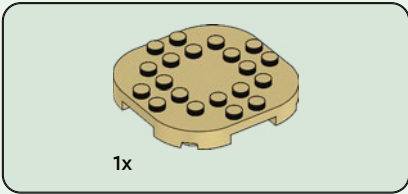
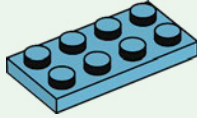

1x

46

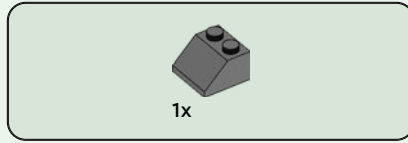
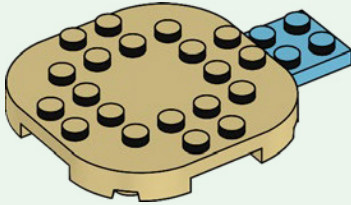

1x

47

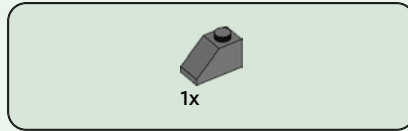
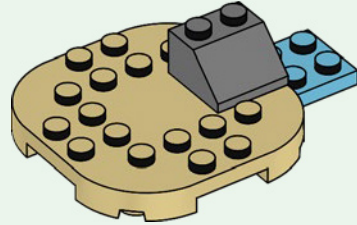

1x

48

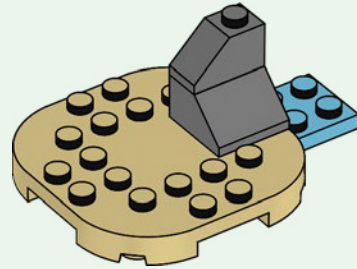



1x

49

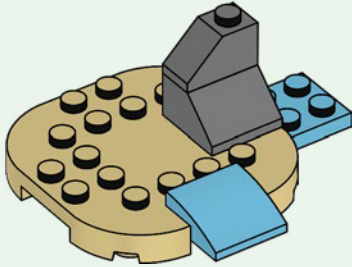

2x

50

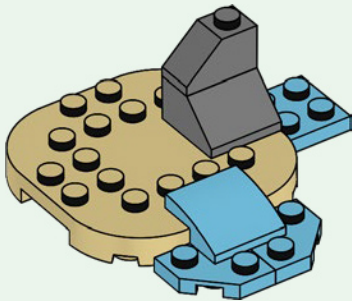

2x

51

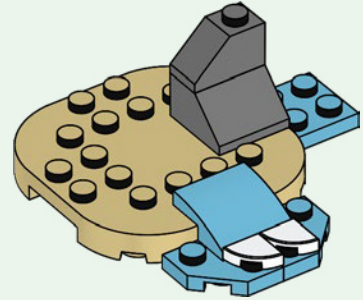

1x

52

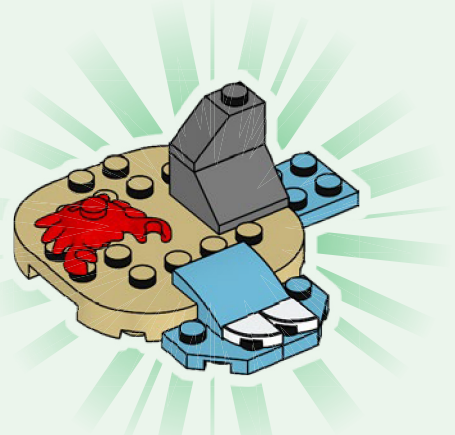

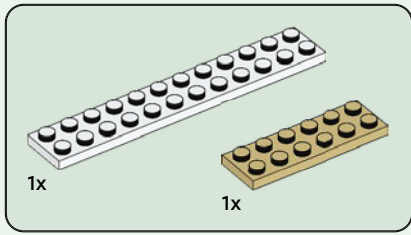

53

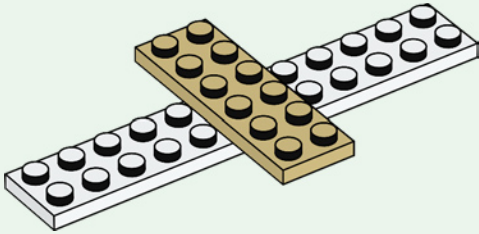

54

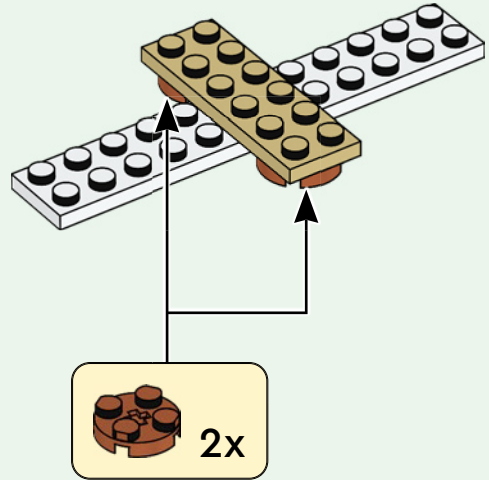

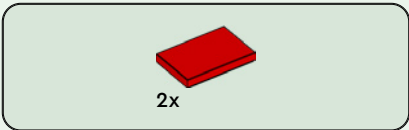

55

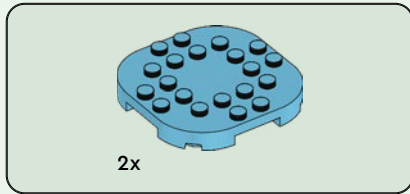
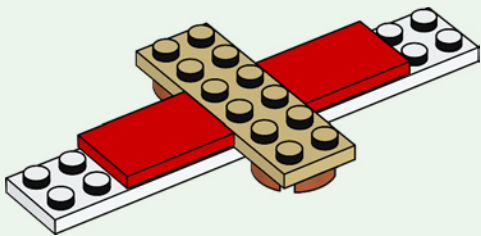

56

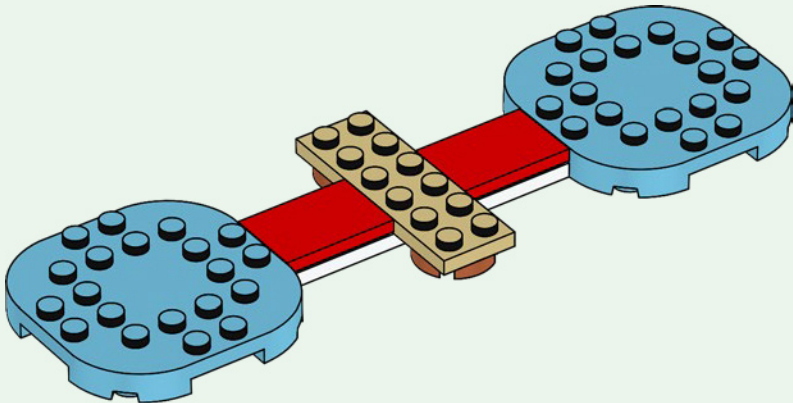

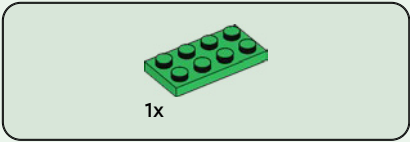

57

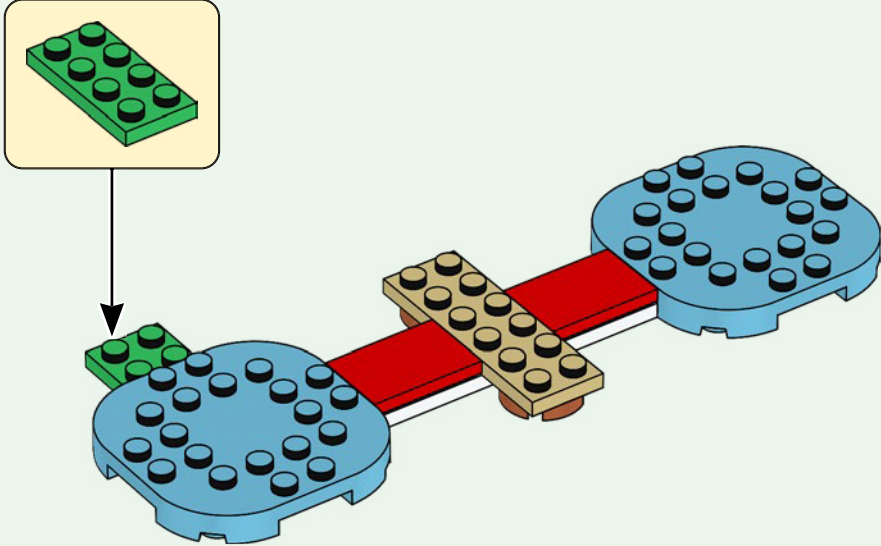



1x

58

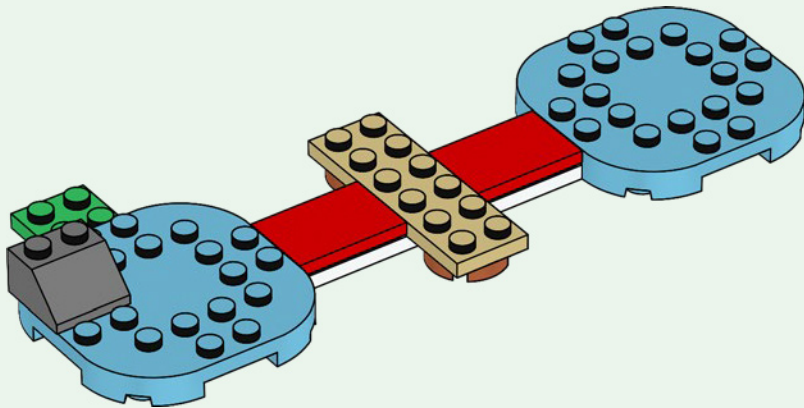



2x

59

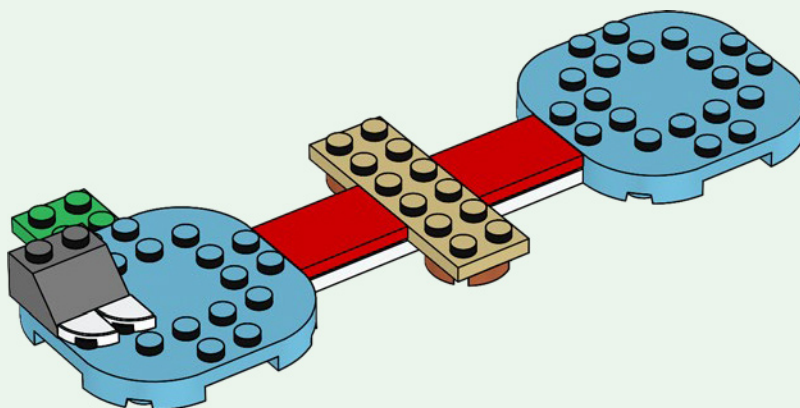



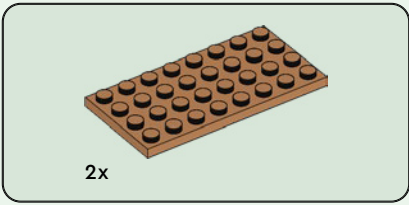

60

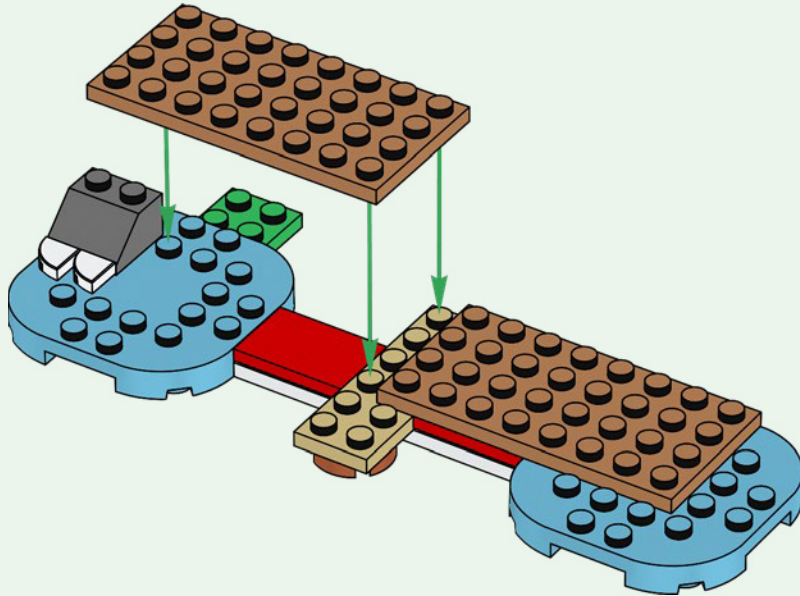



1x

61

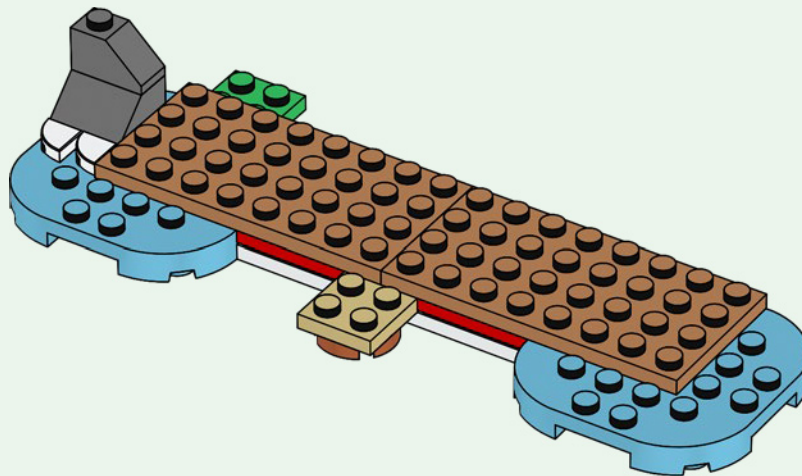

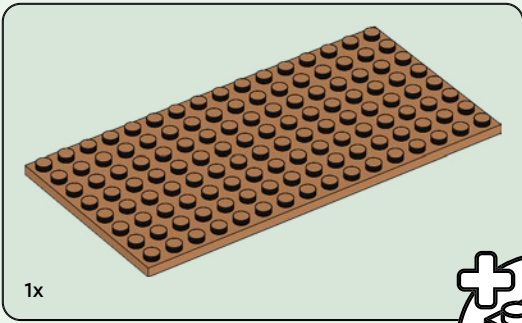

1x

62

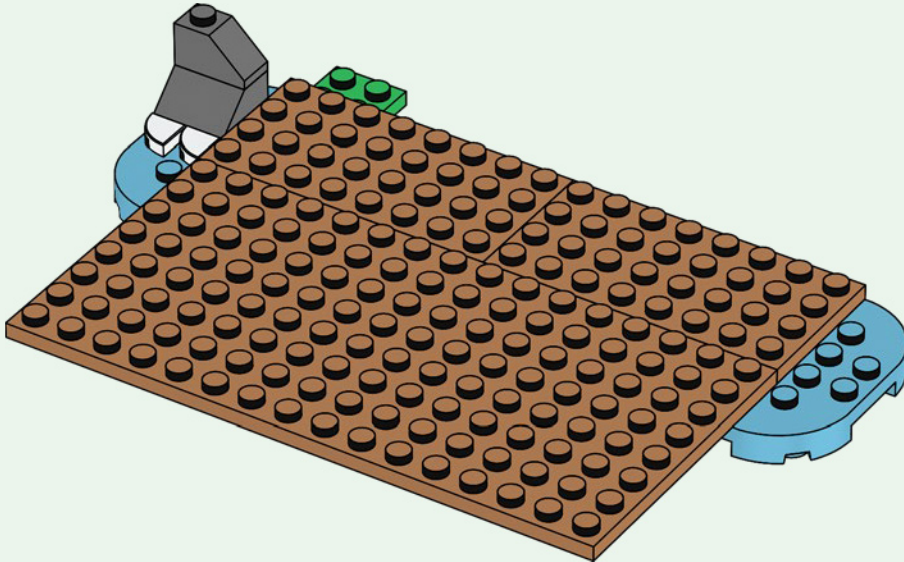
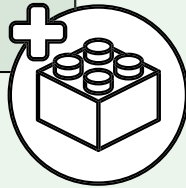



63

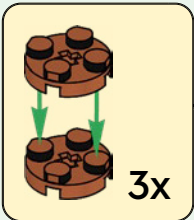
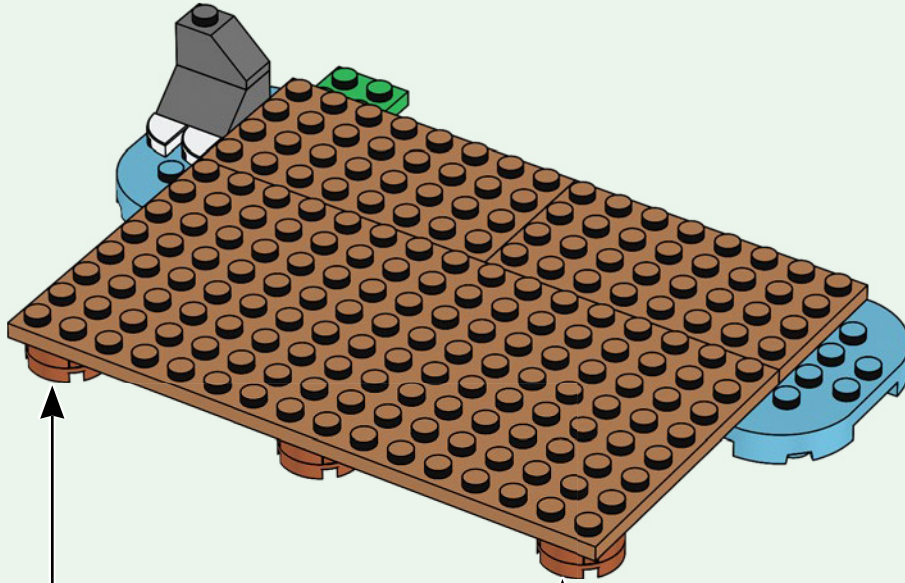

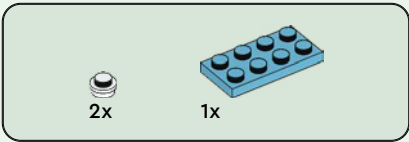

64

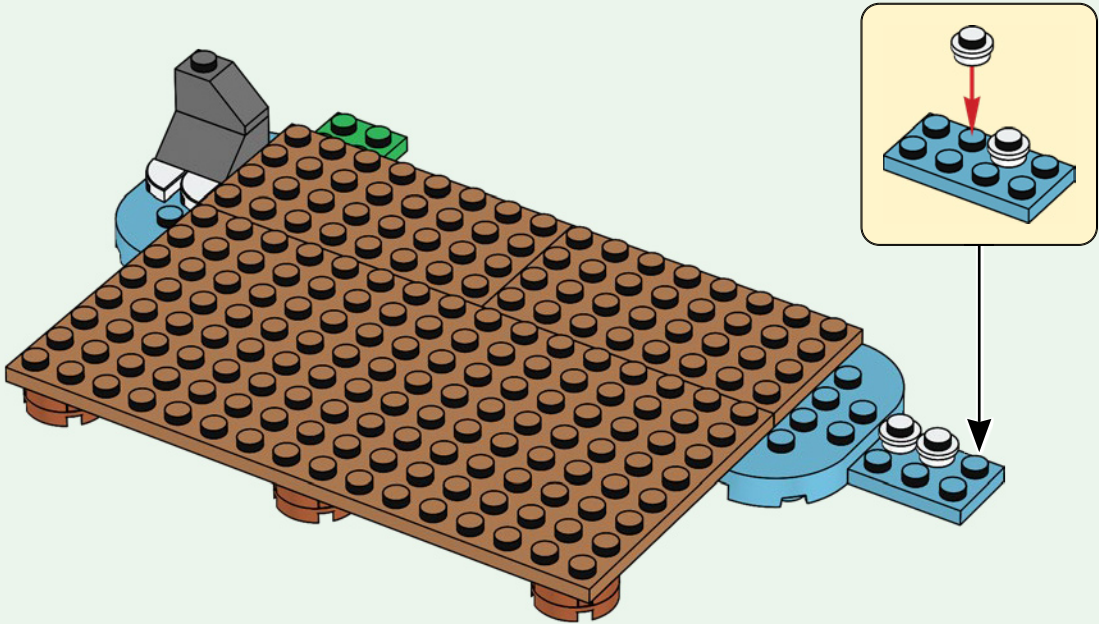

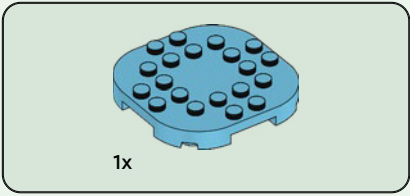

65

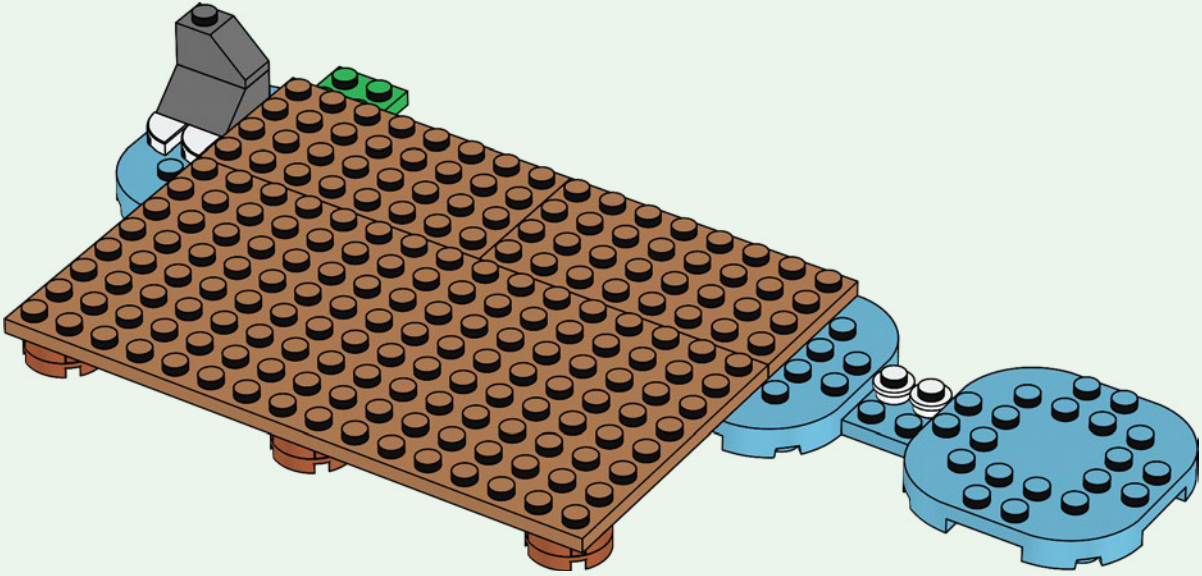



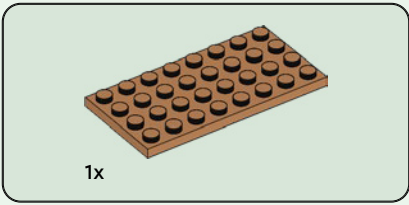

66

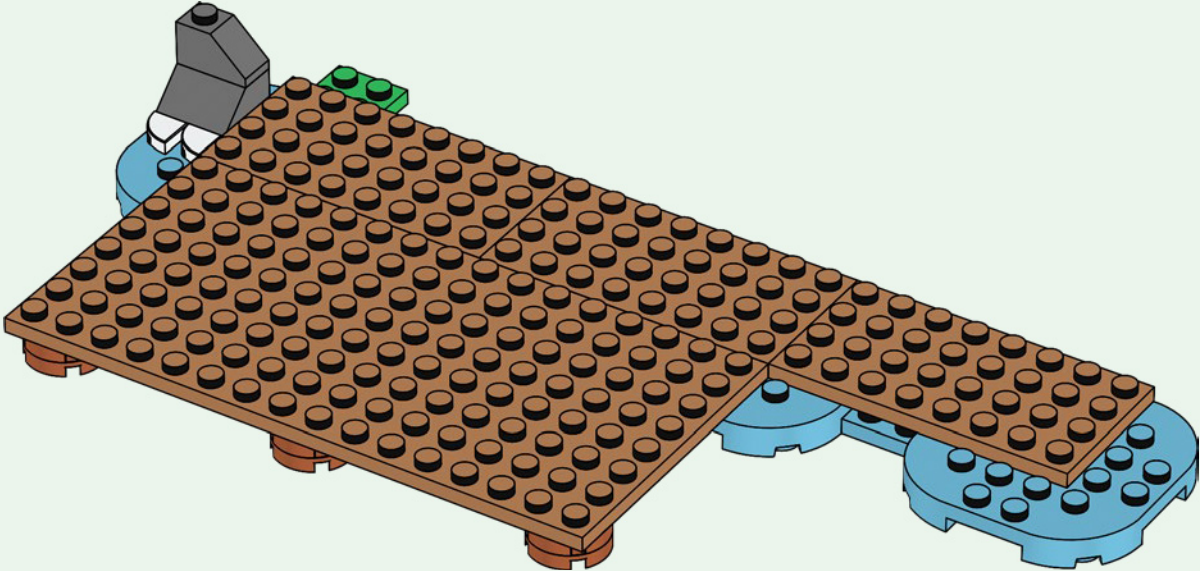



1x

67

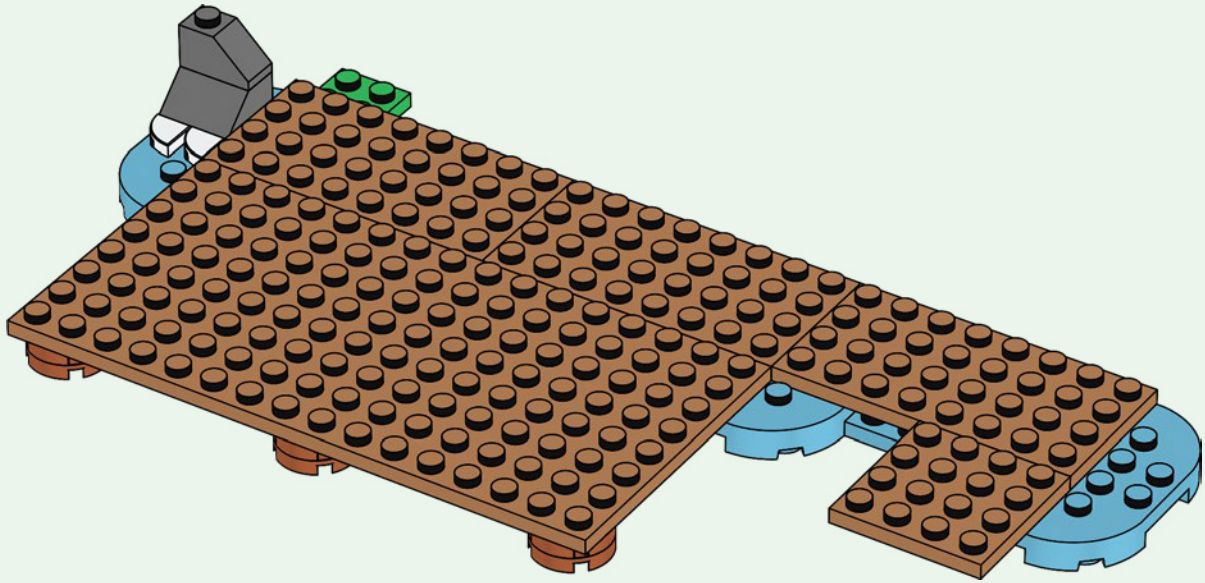





4x

68

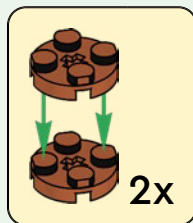
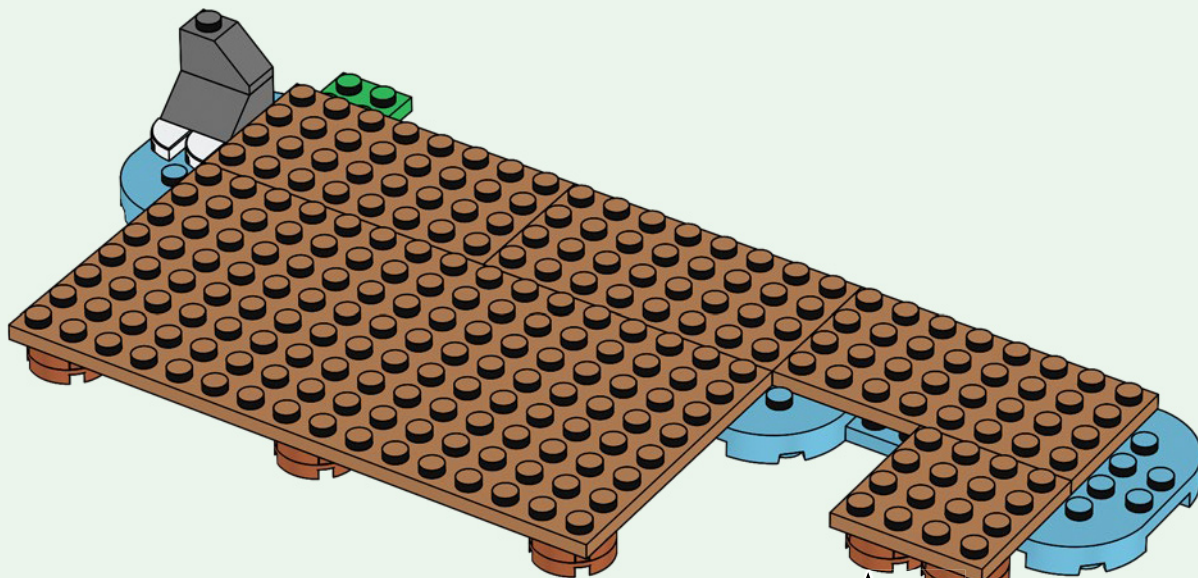



2x

69

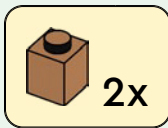
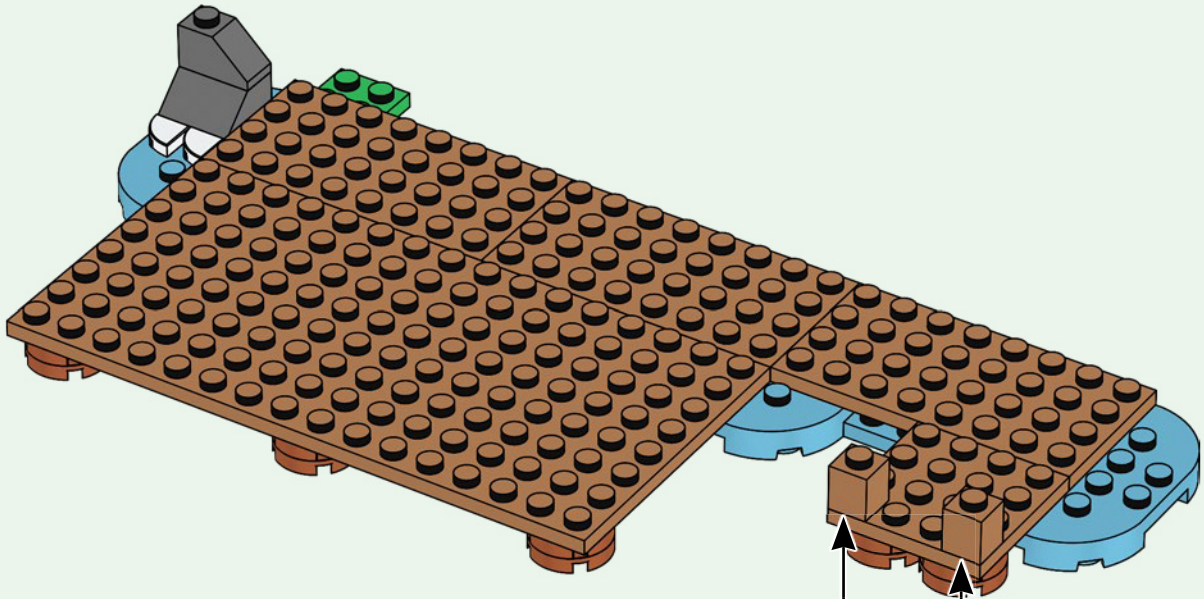

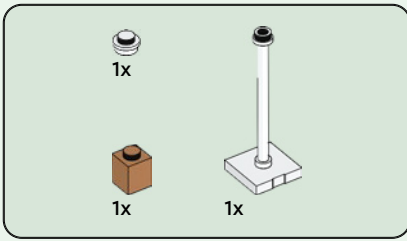

70

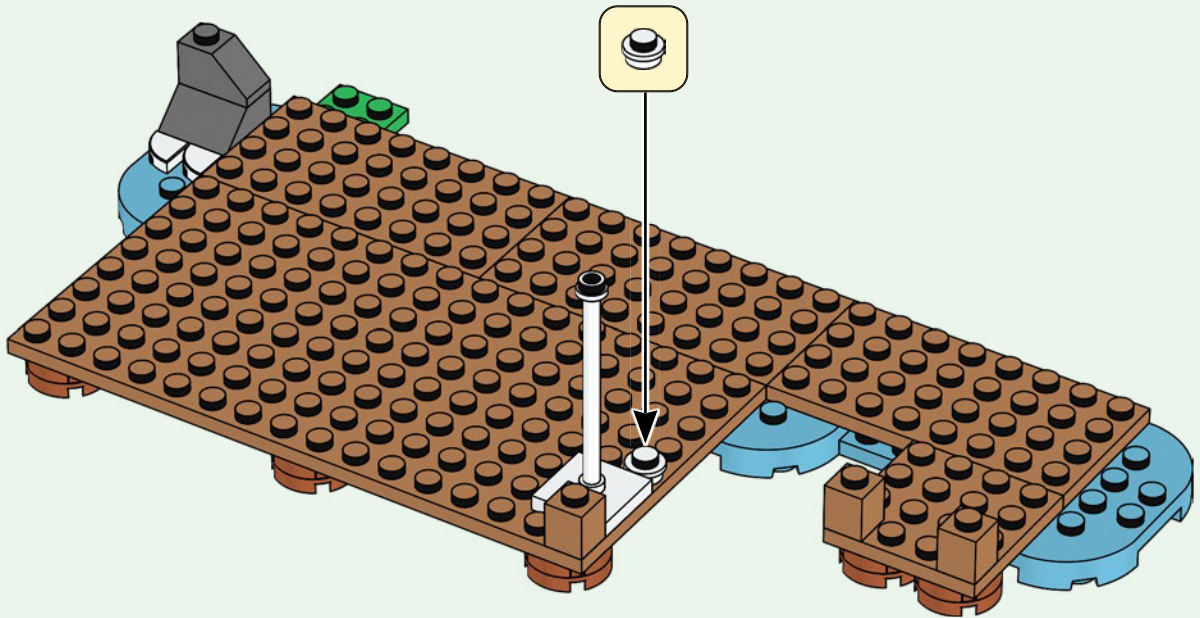

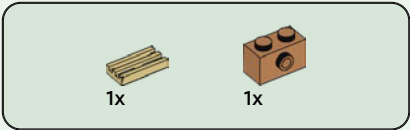

71

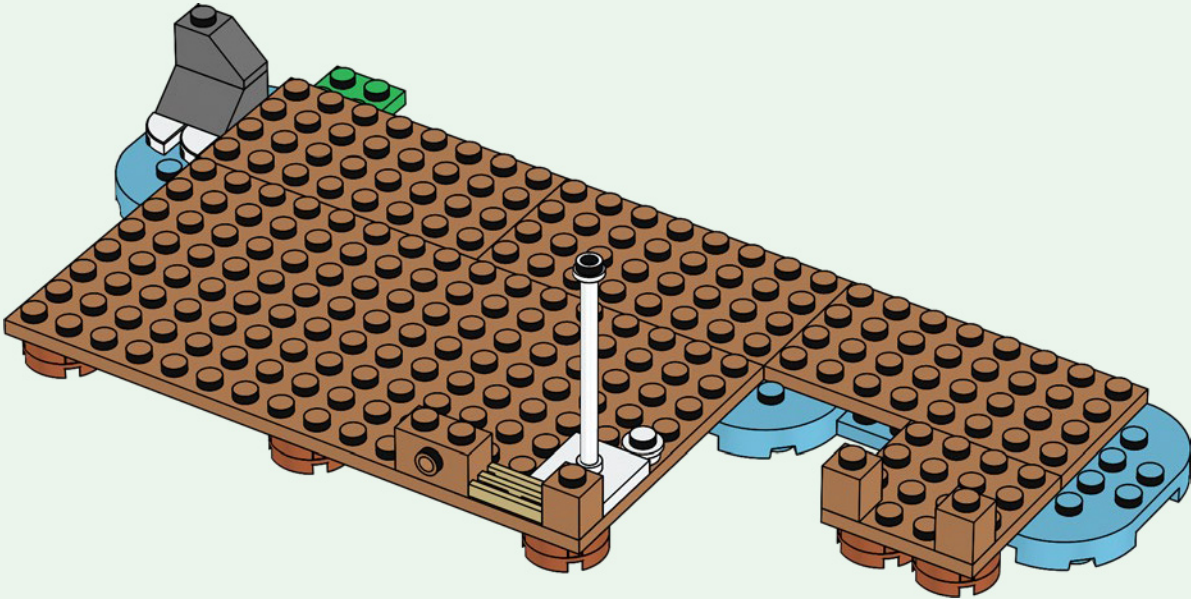



3x



2x

# 72

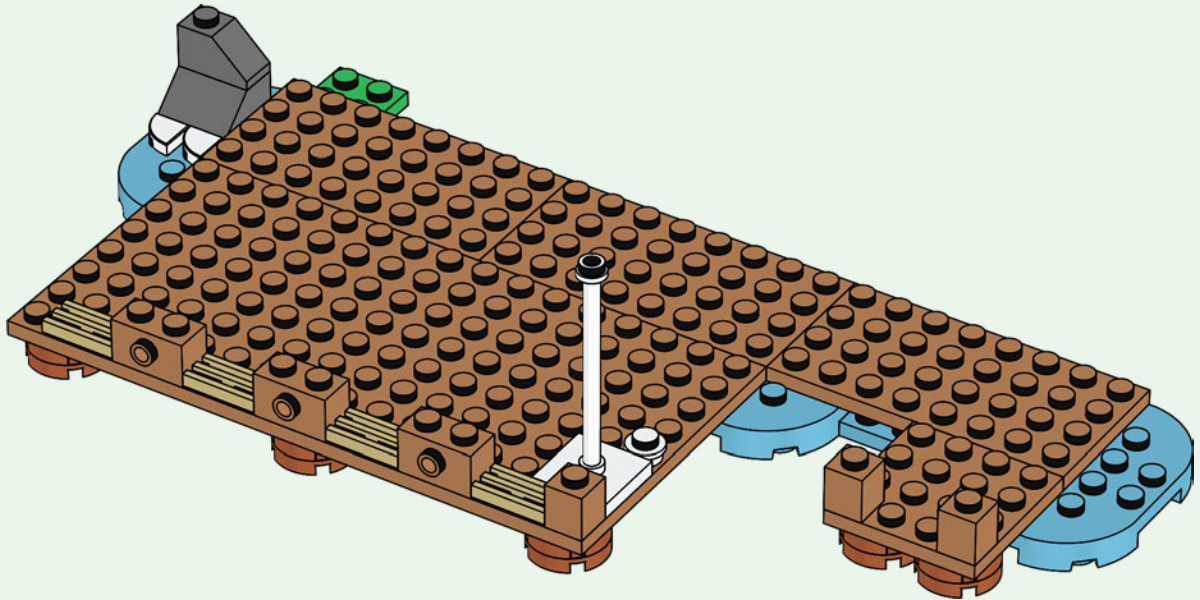



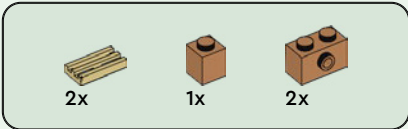

73

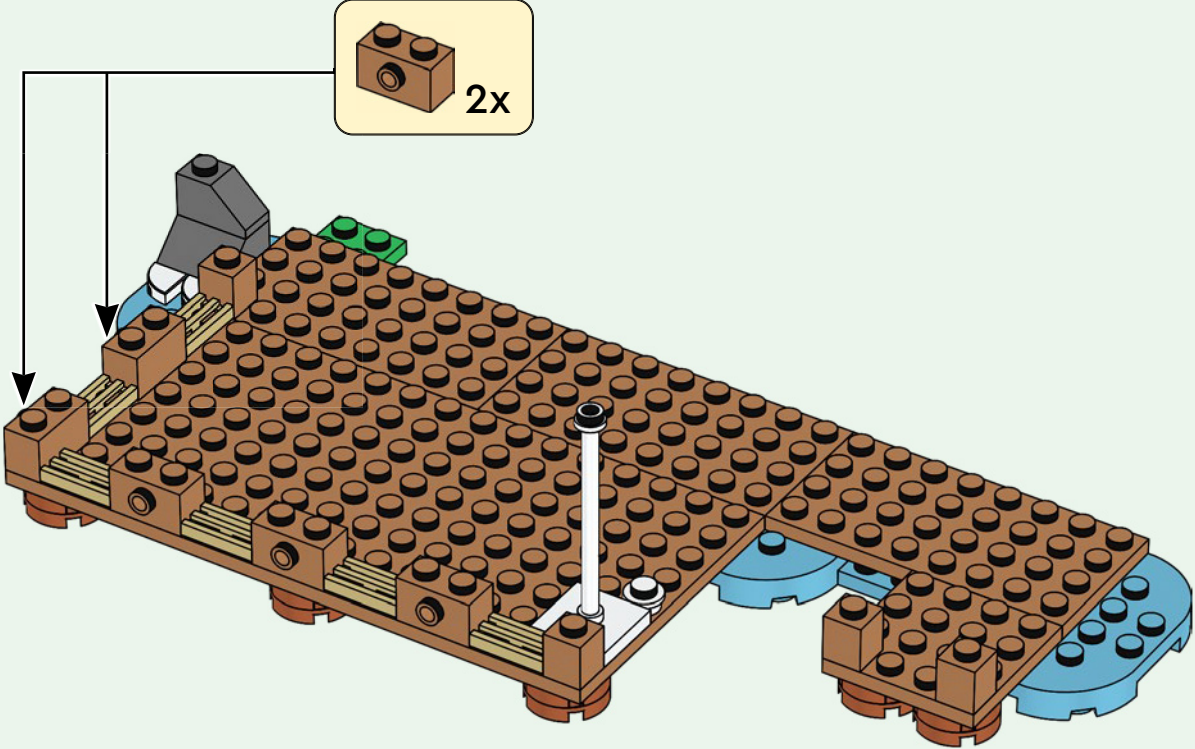
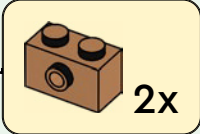



8x

74

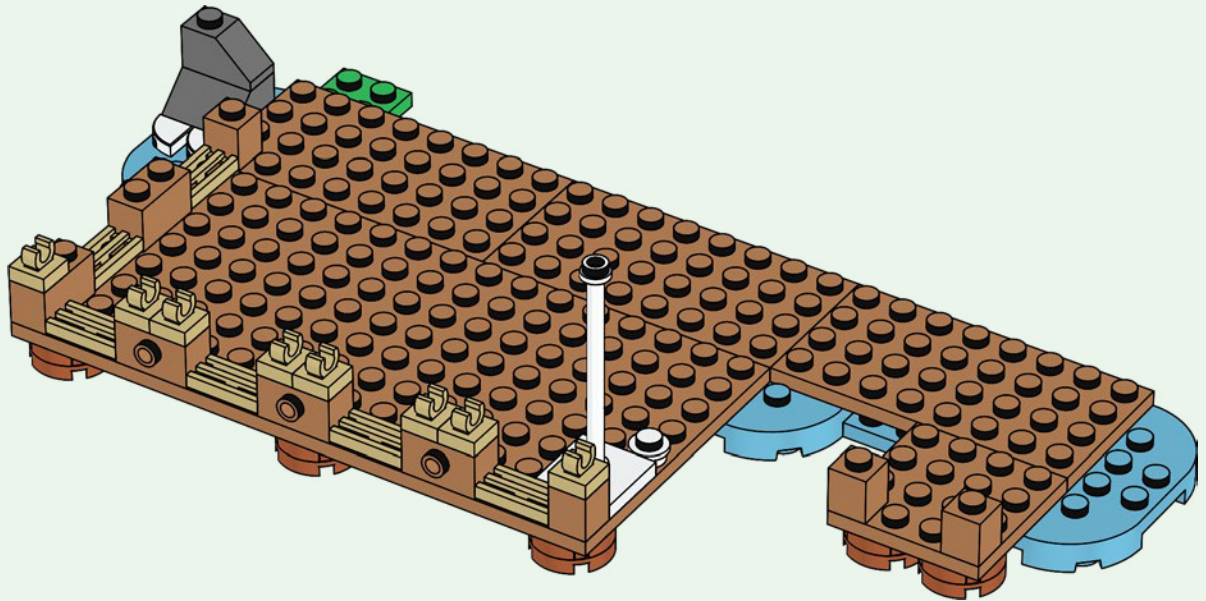

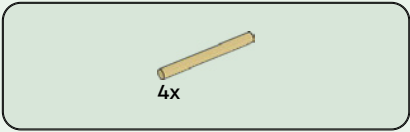

75

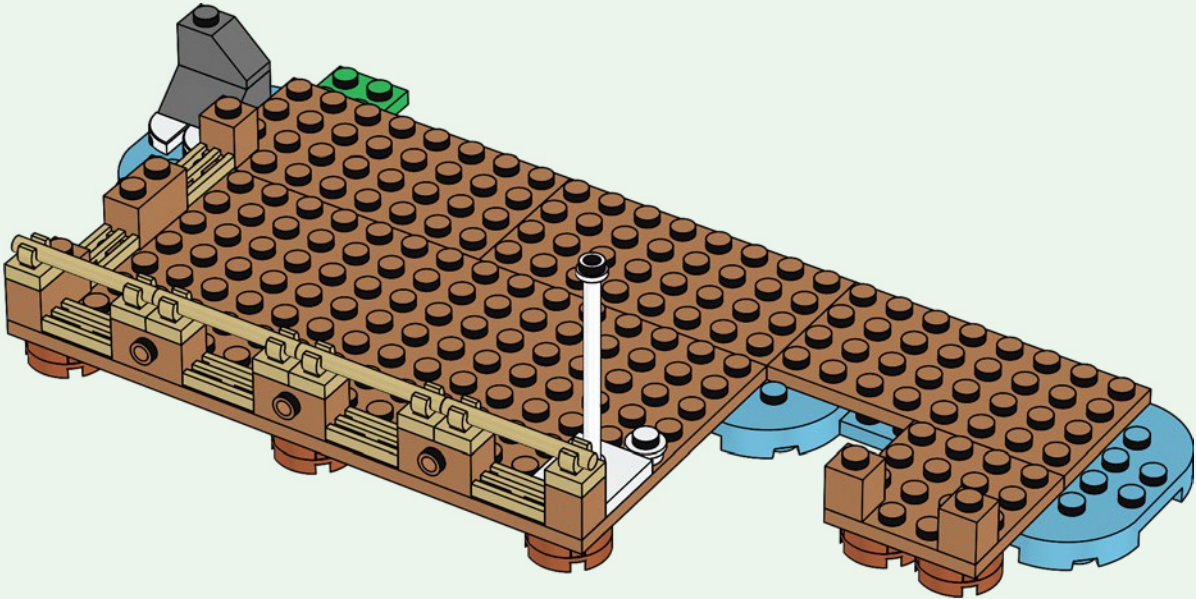





4x

76

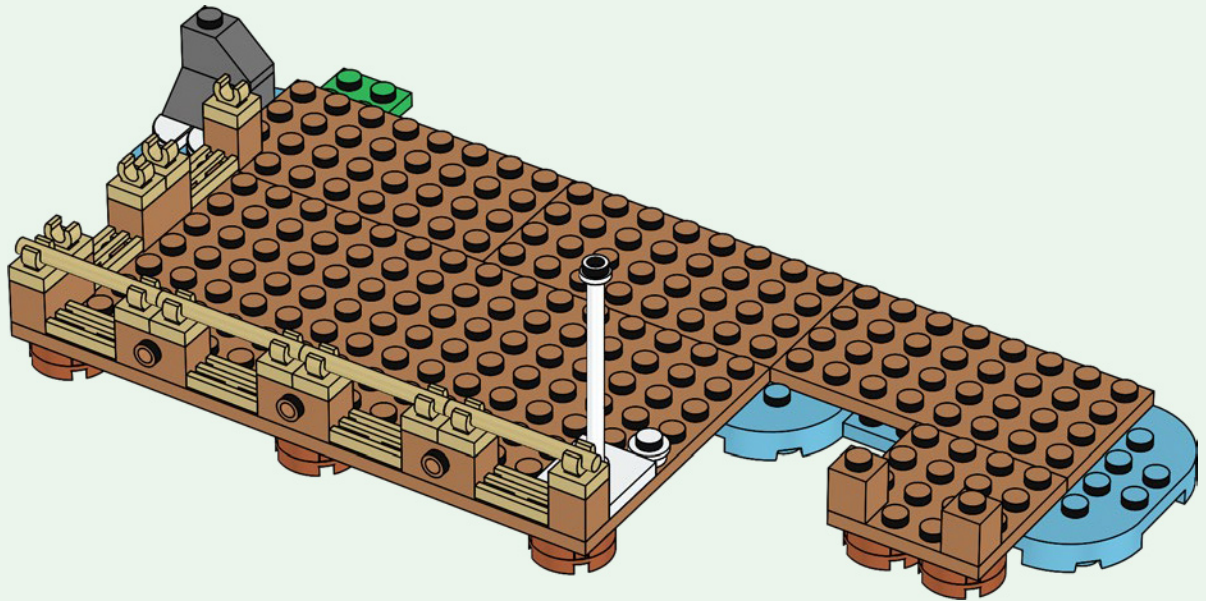

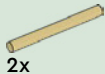

2x

77

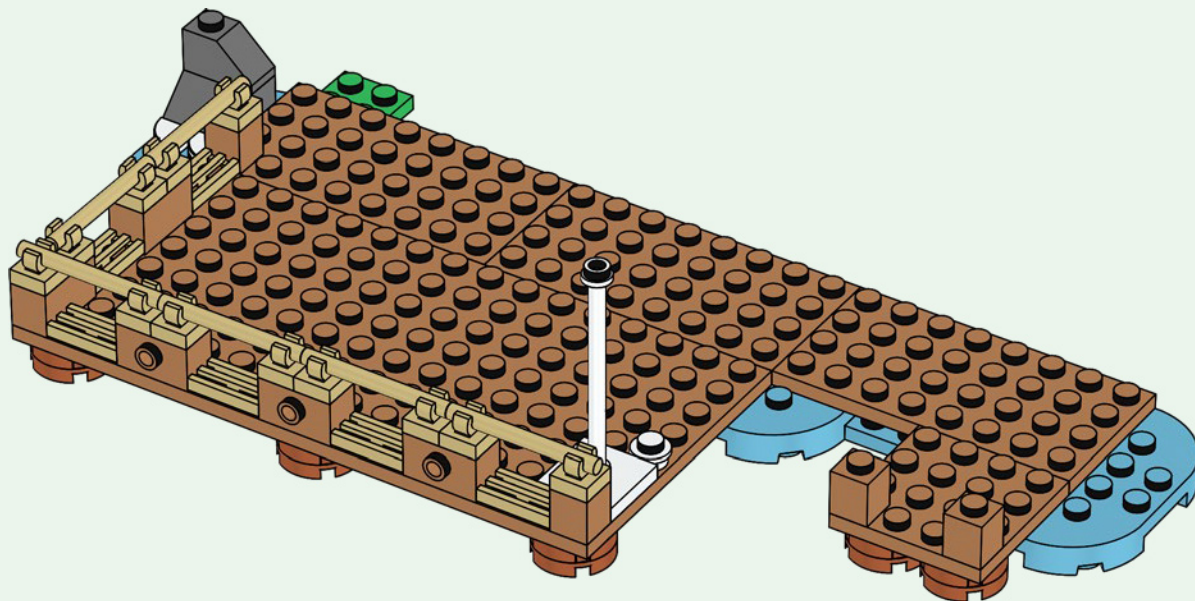



2x

78

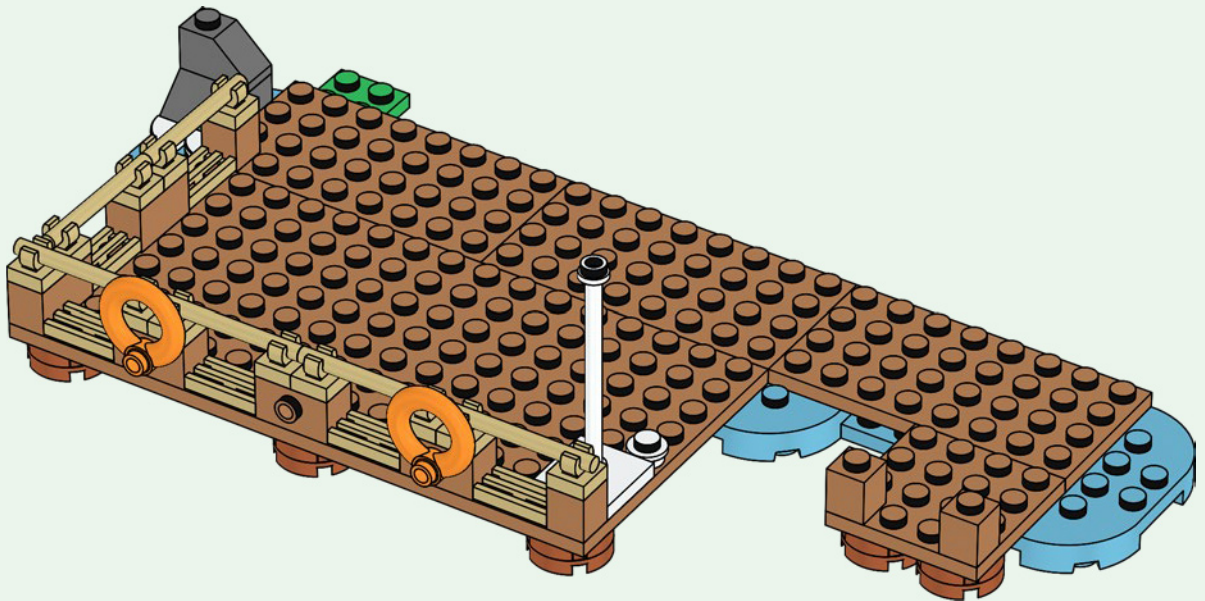



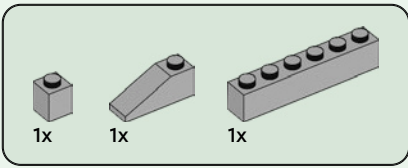

79

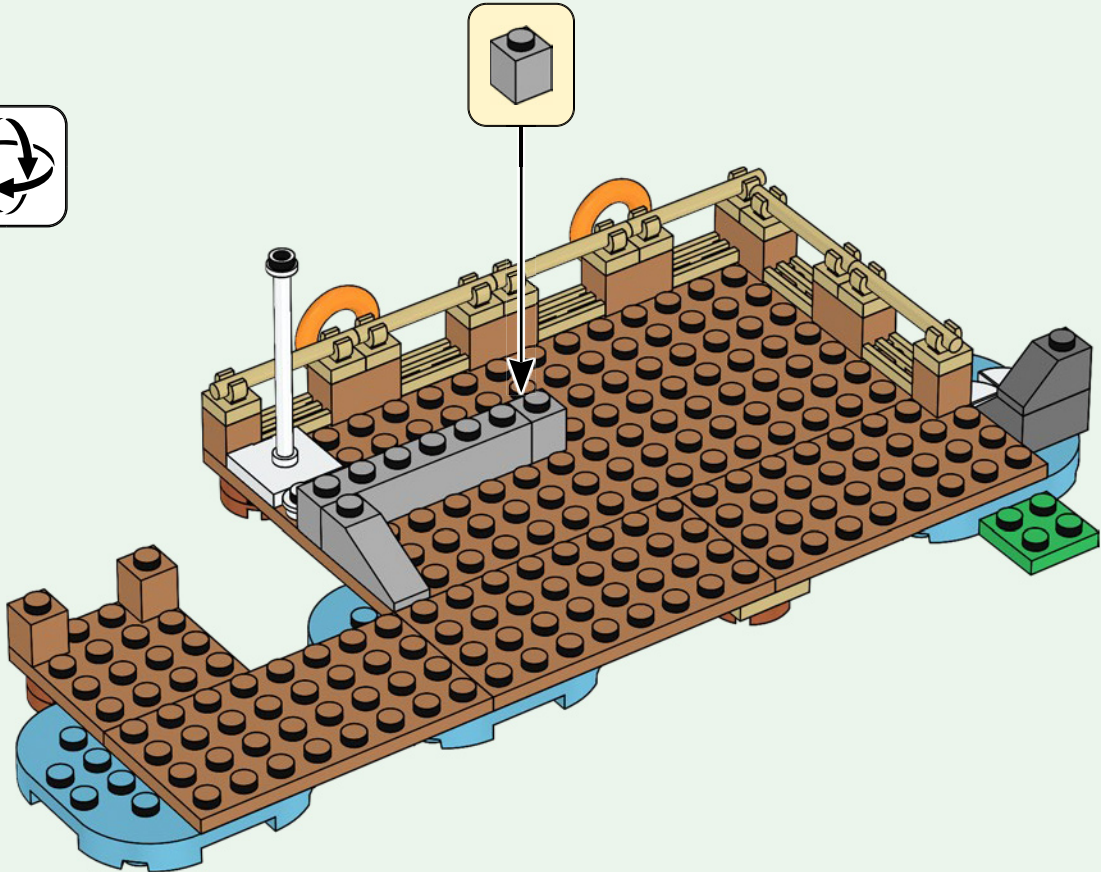



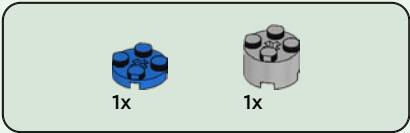

80

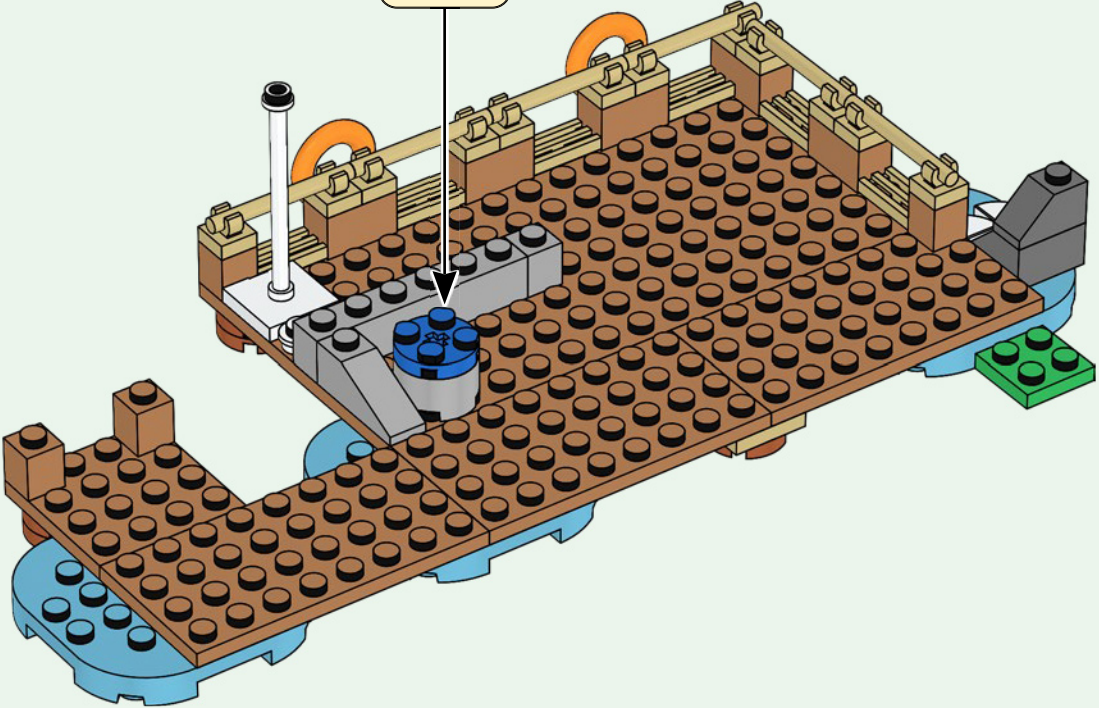
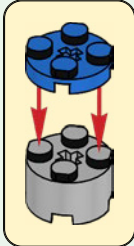



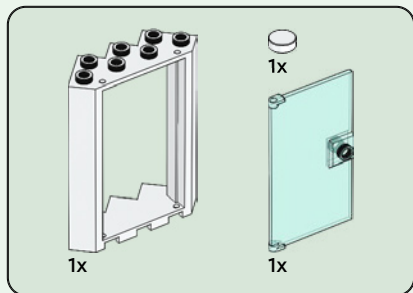

82

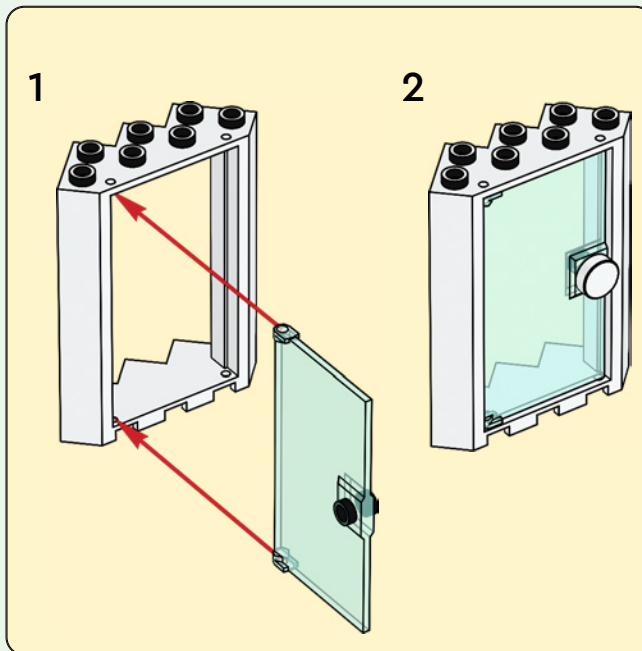



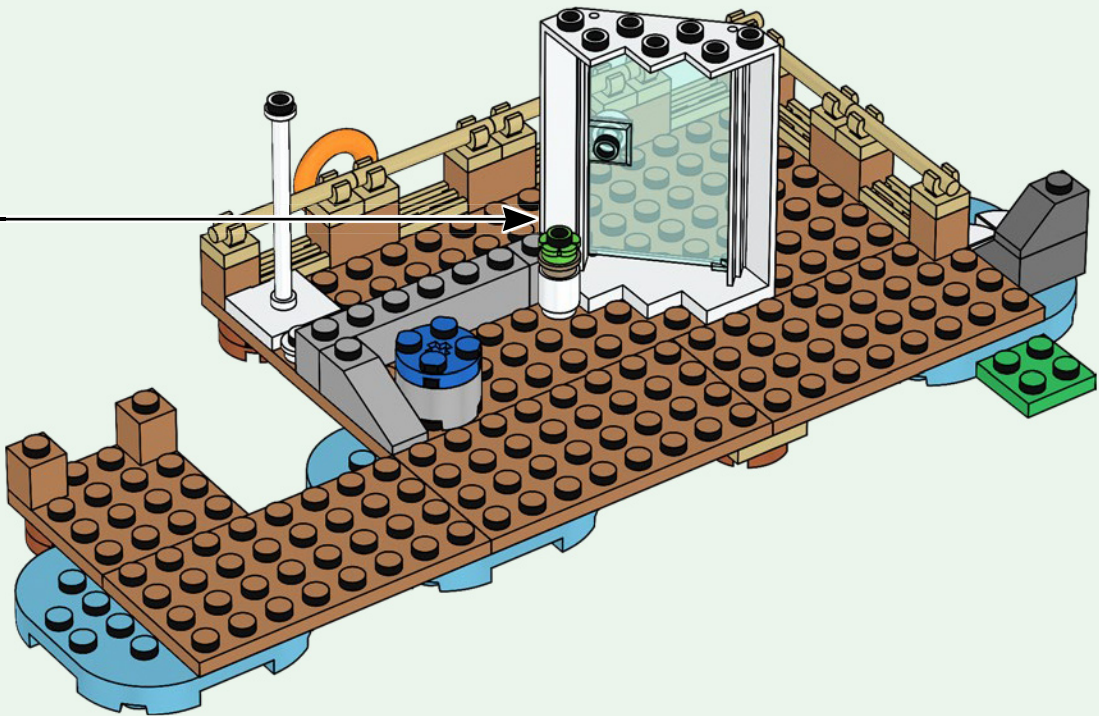

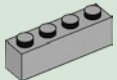

1x

83

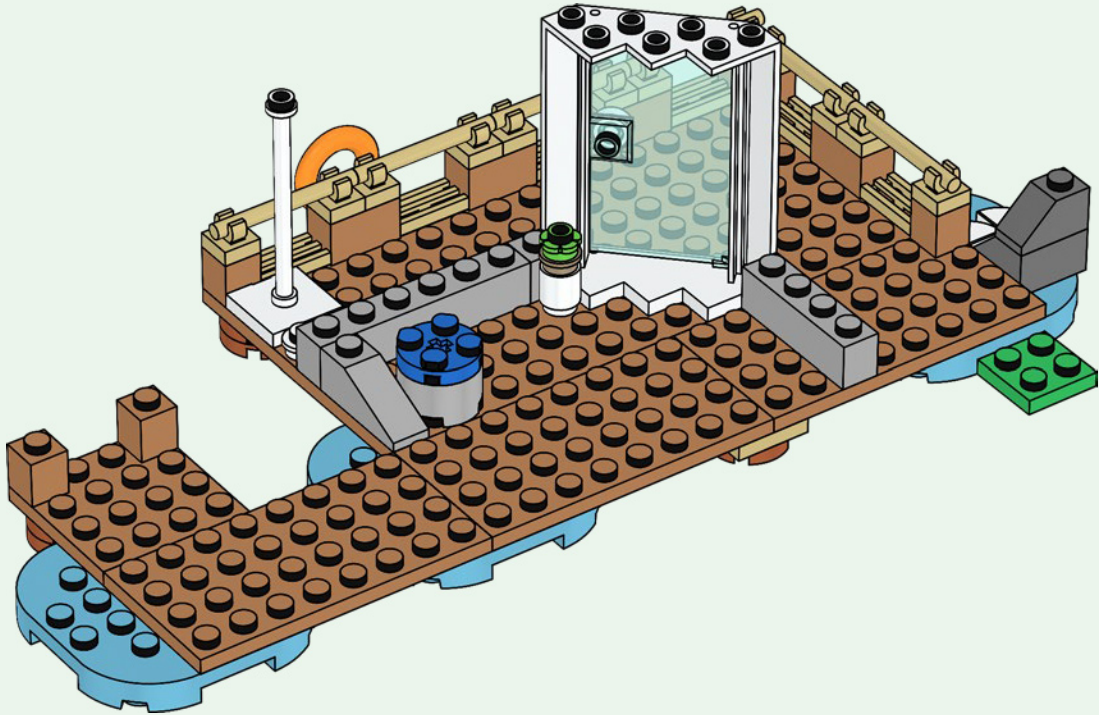



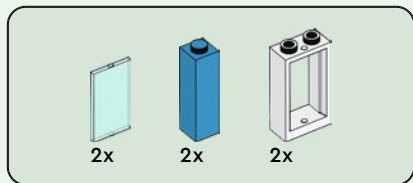

85

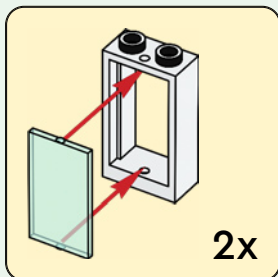





3x

# 86

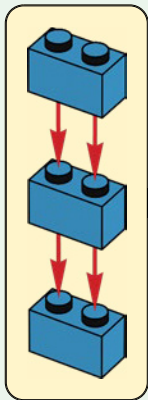

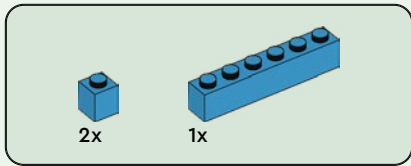

87

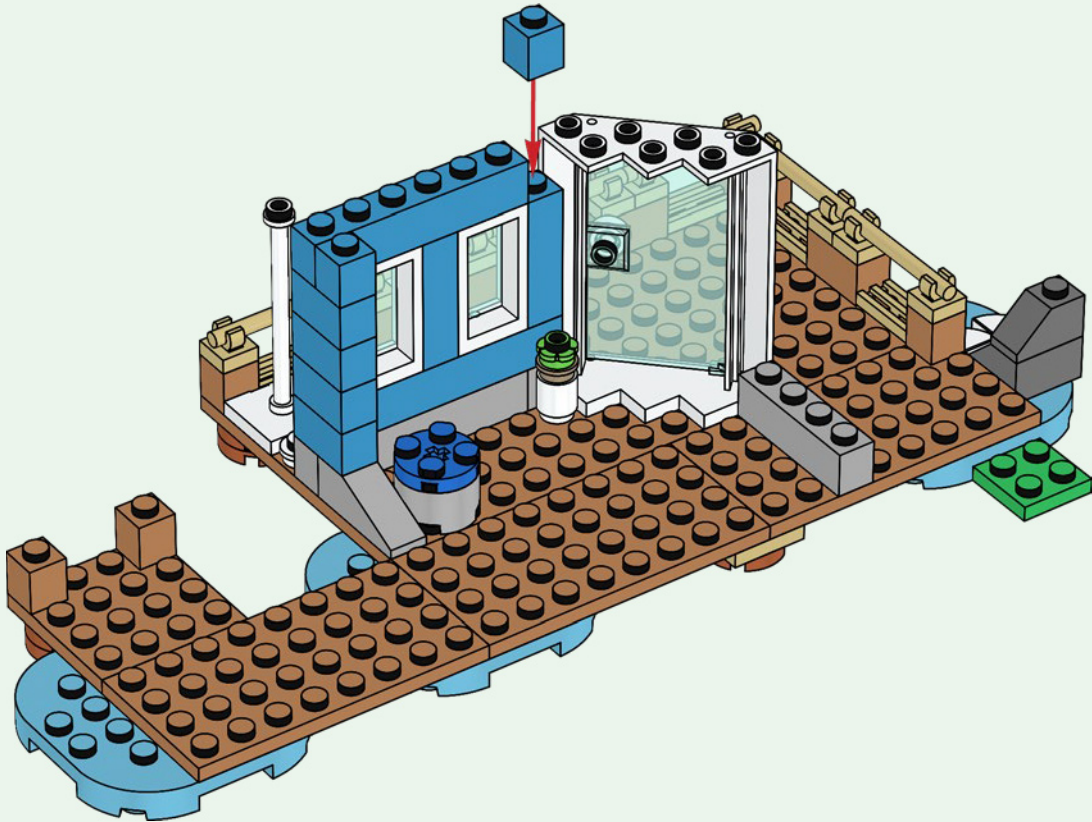

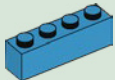

1x

88



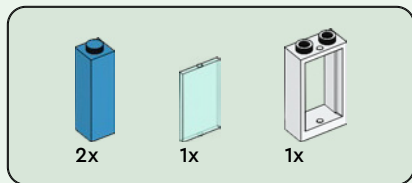

89

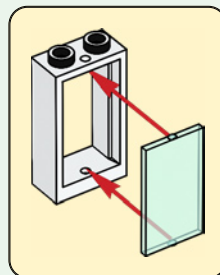



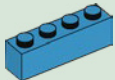

1x

90



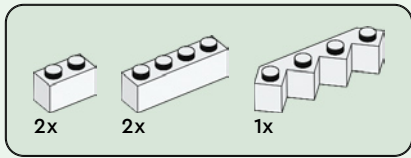

91





92

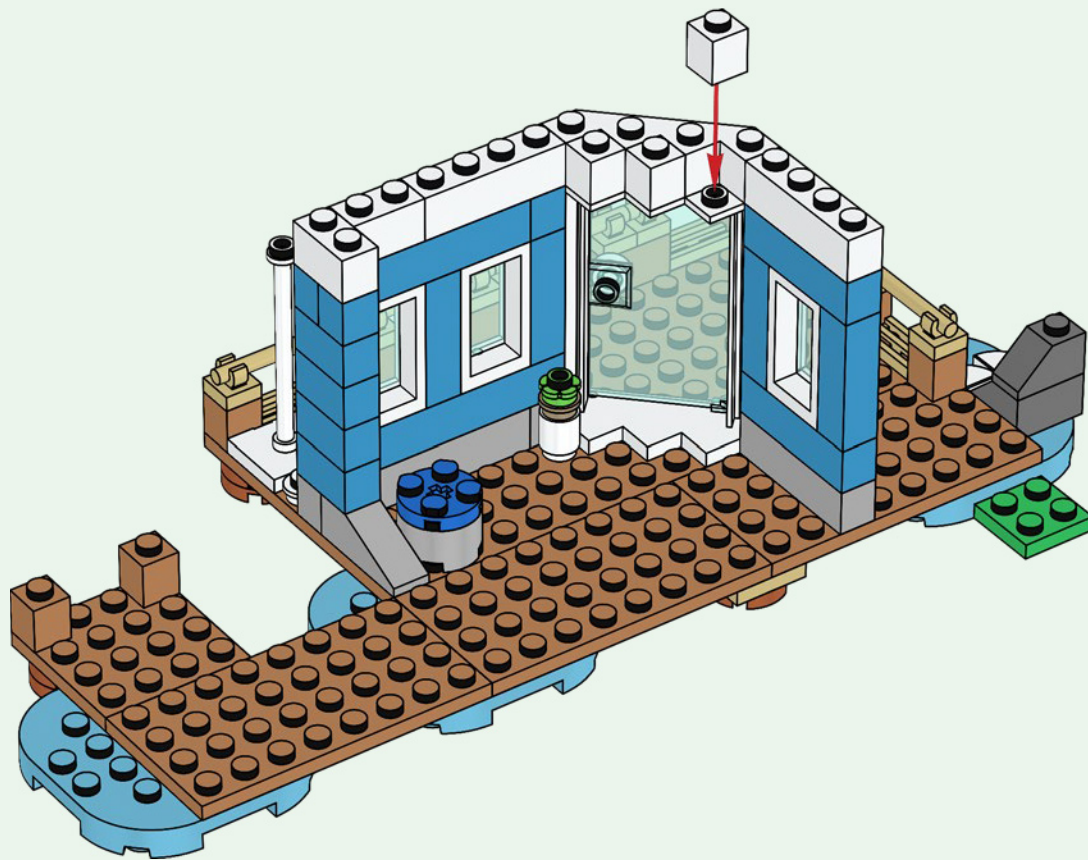

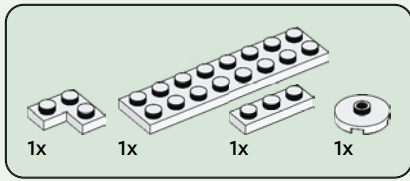

93





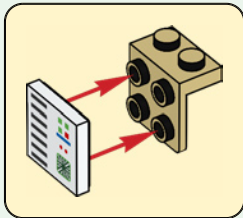
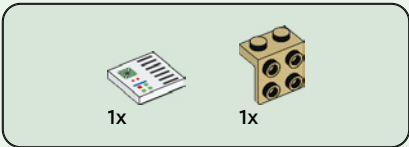

94





2x

95



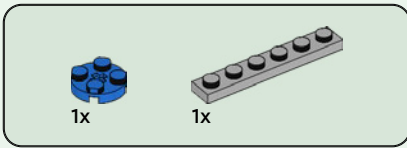

96







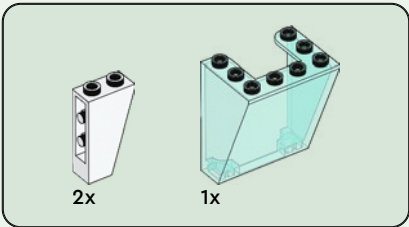

98

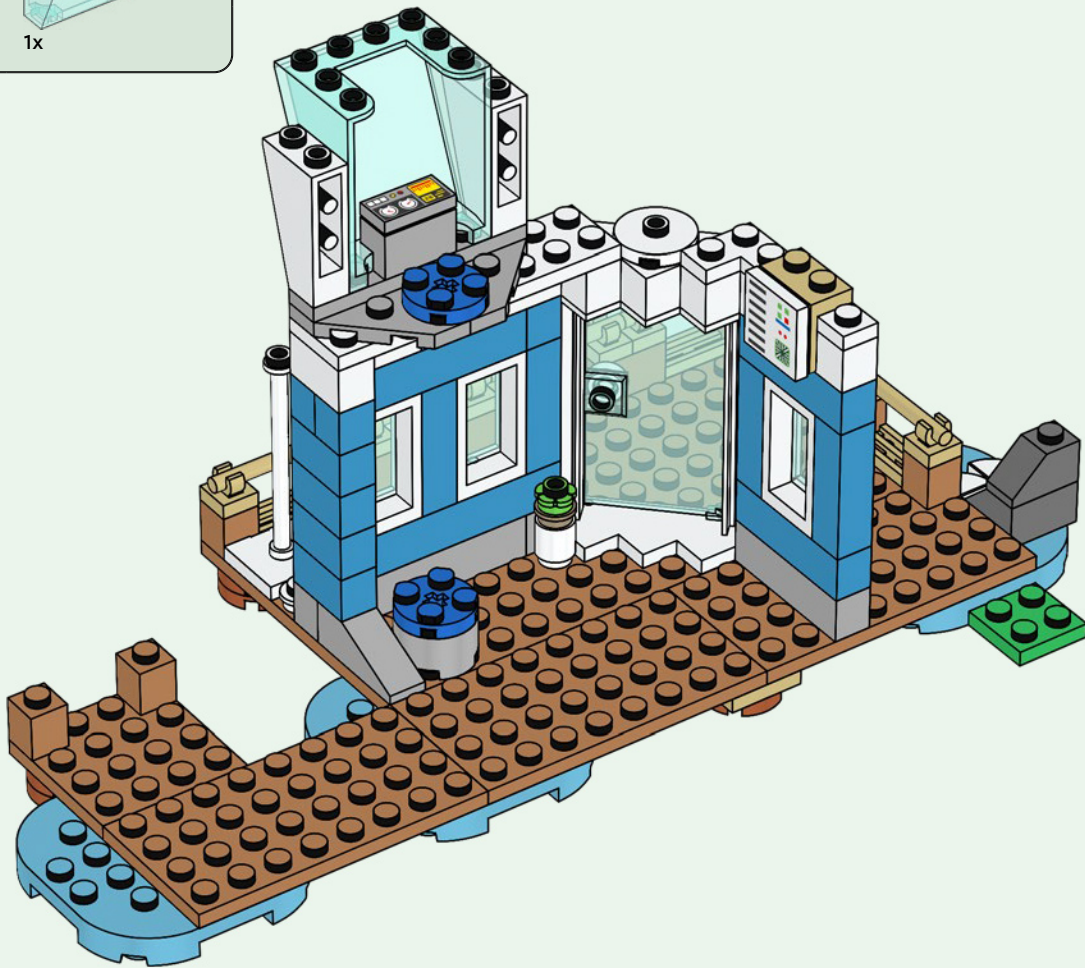



2x

99

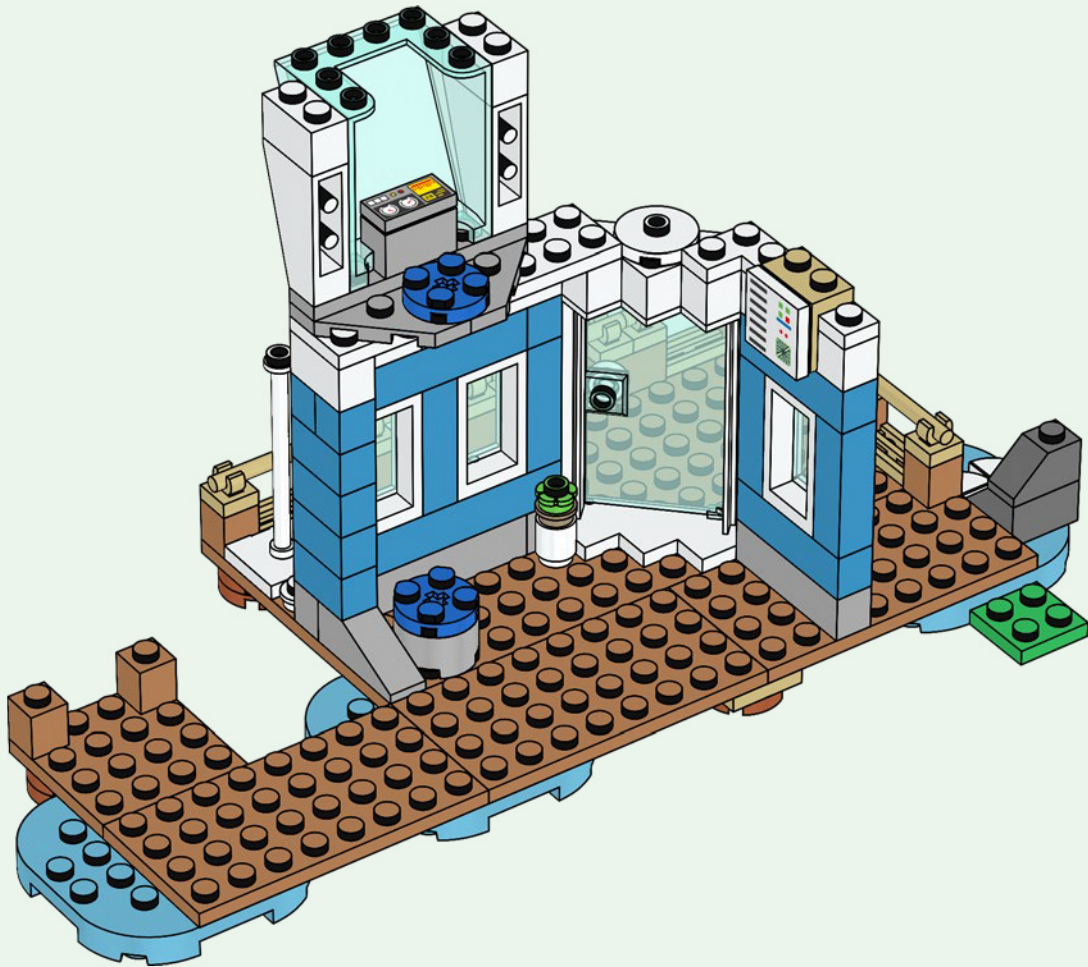

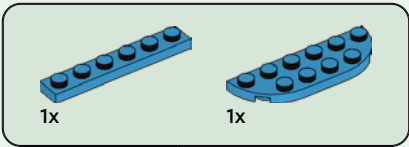

100

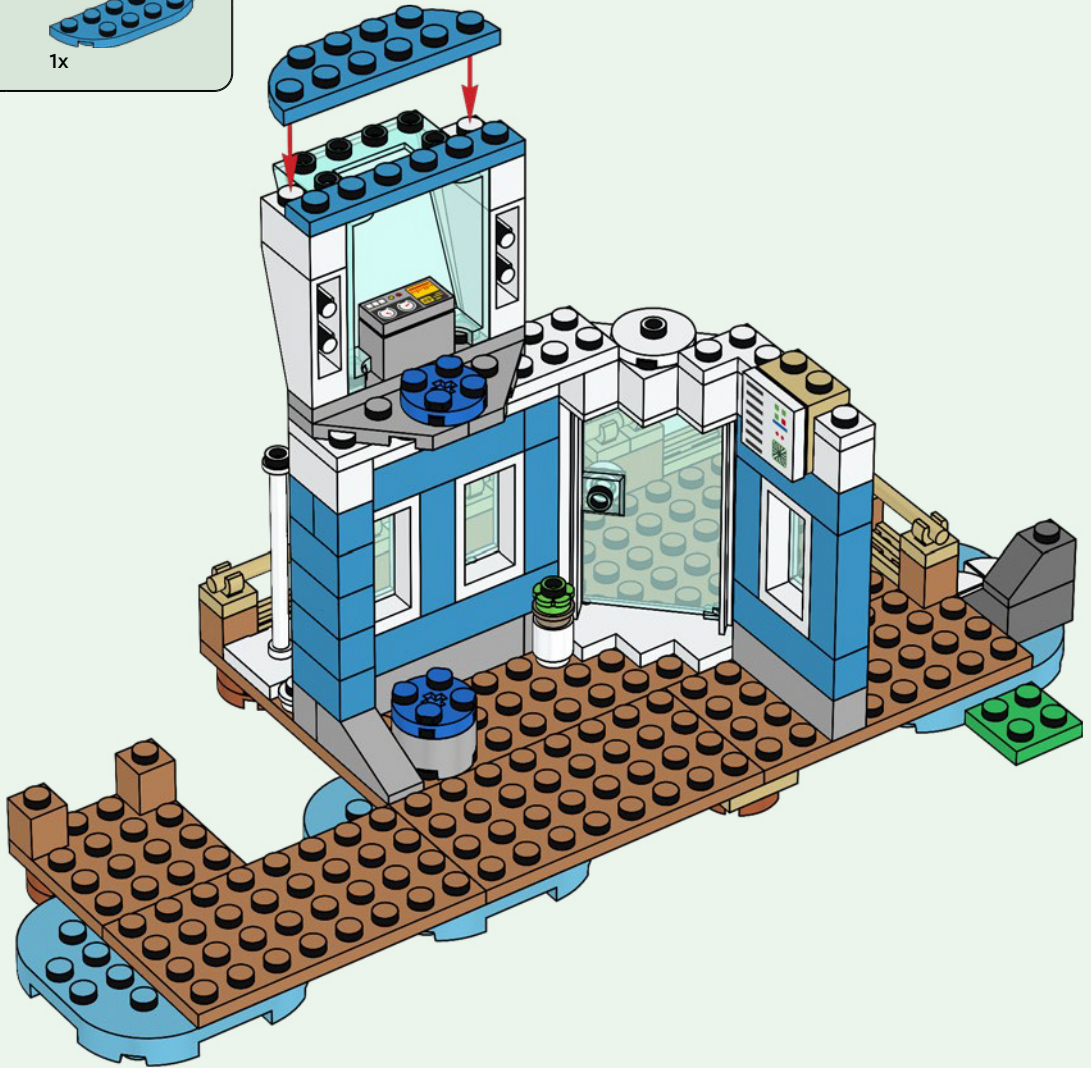



1x

101





1x



1x

102

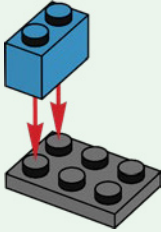

2x

103

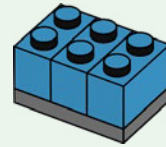





1x

104

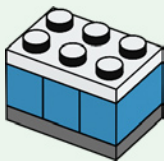

1x

105

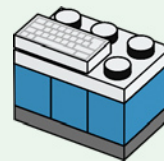

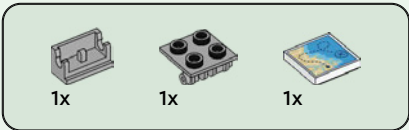

# 106

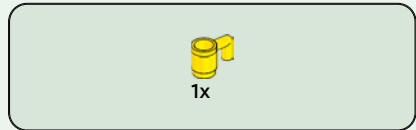
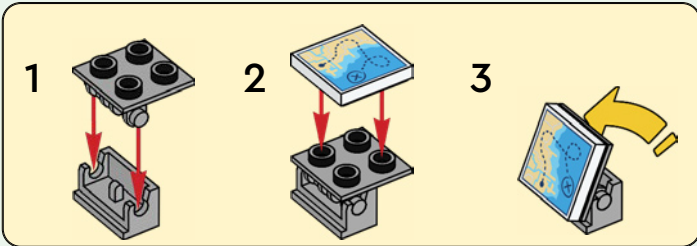

# 107





108

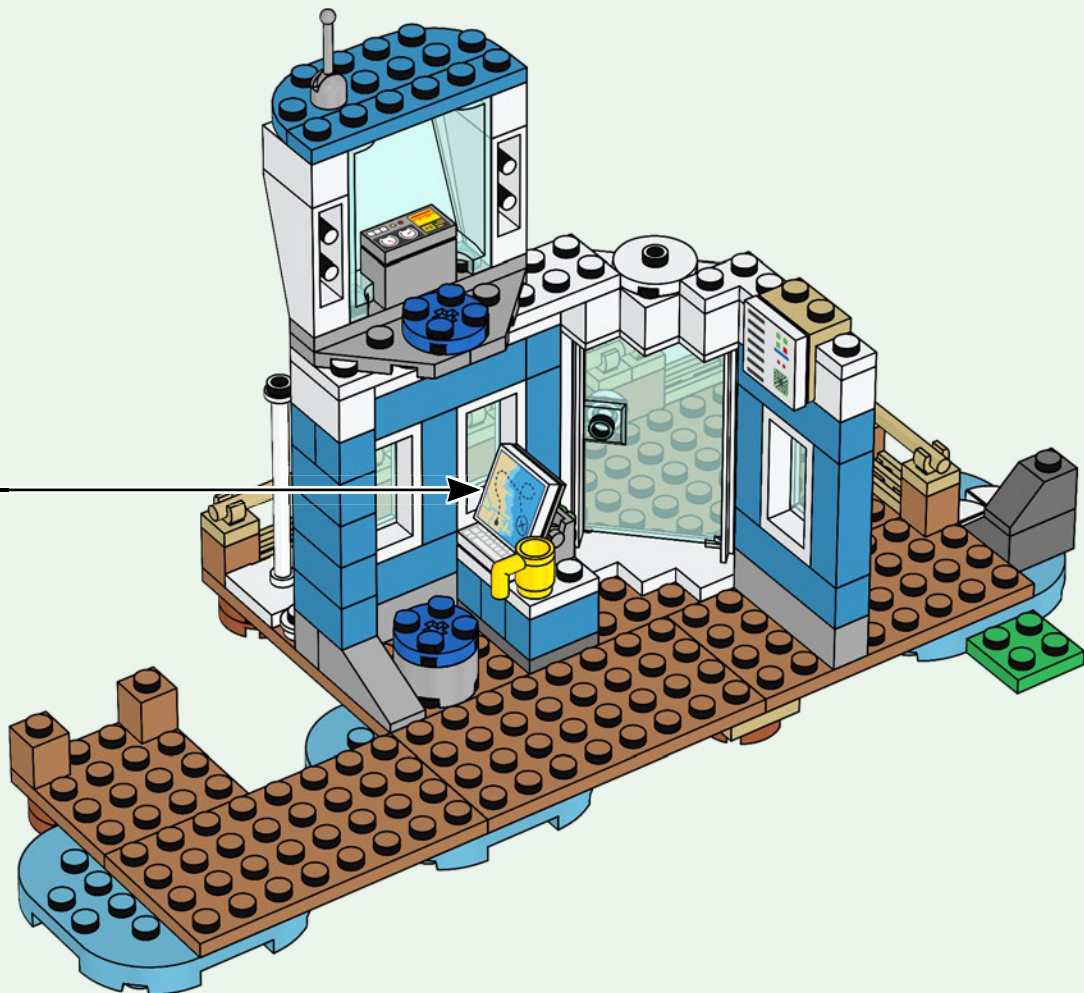

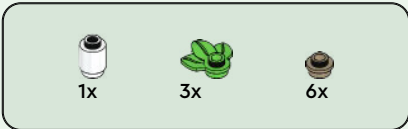

109

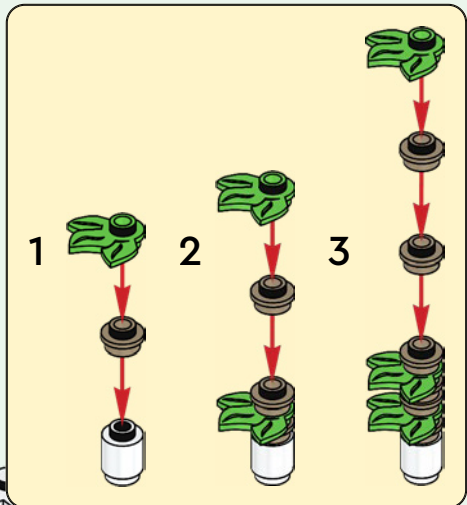
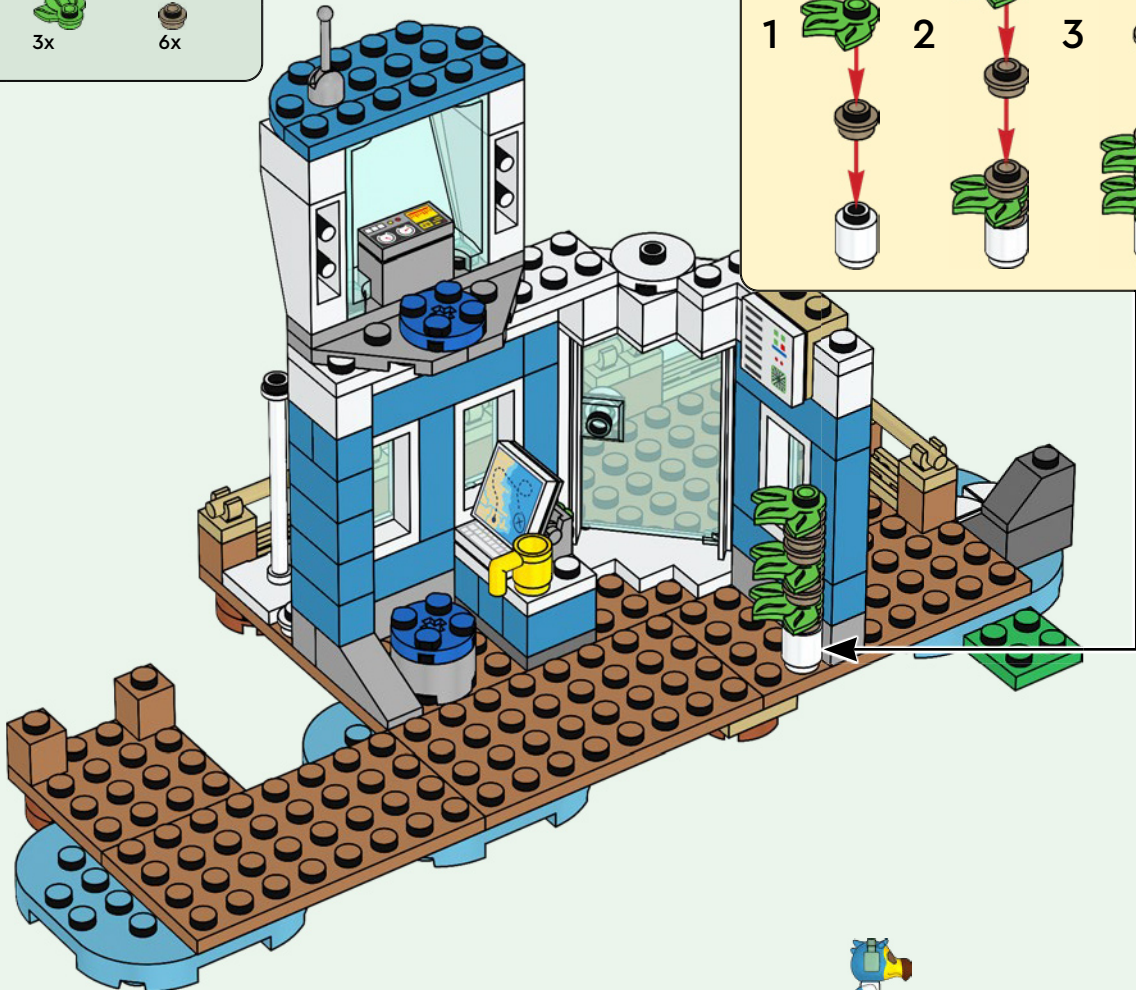

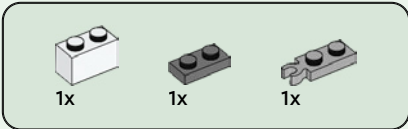

110

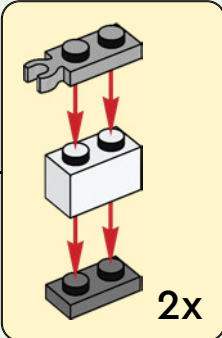



2x

111







1x

112





113

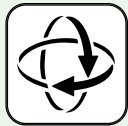
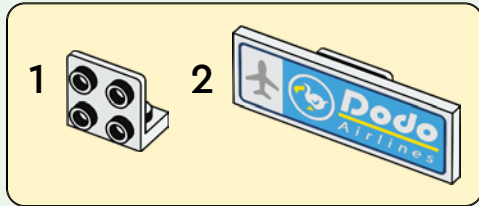

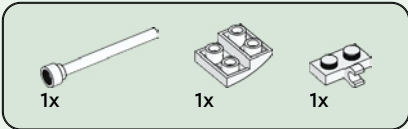

114

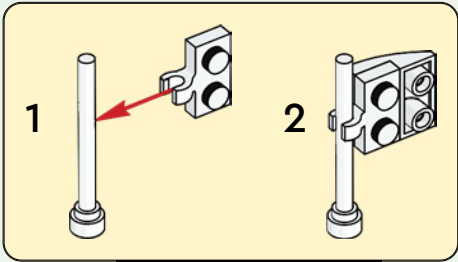



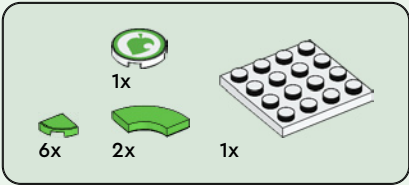

# 115

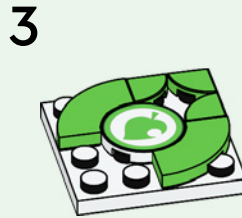
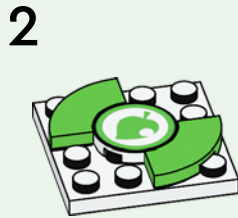
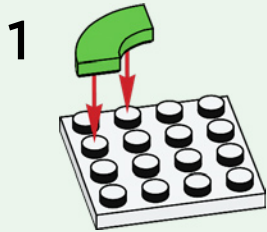

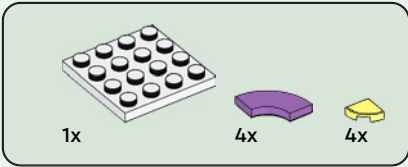

# 116

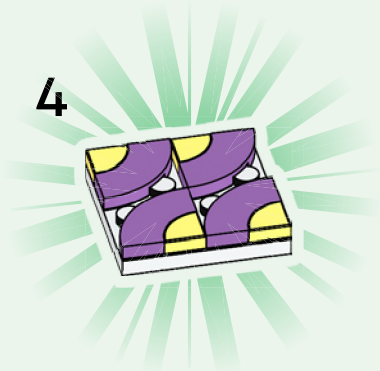
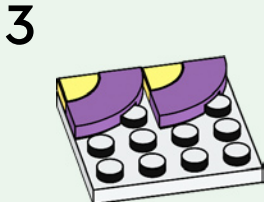
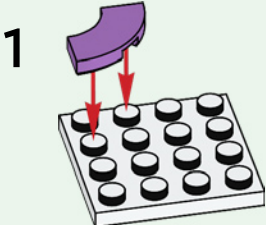

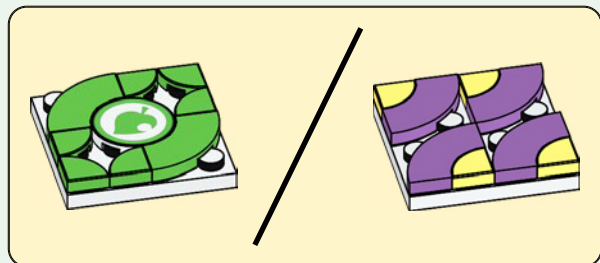

118

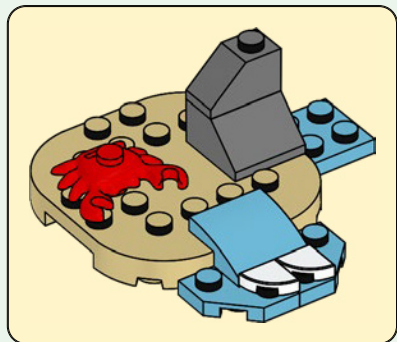

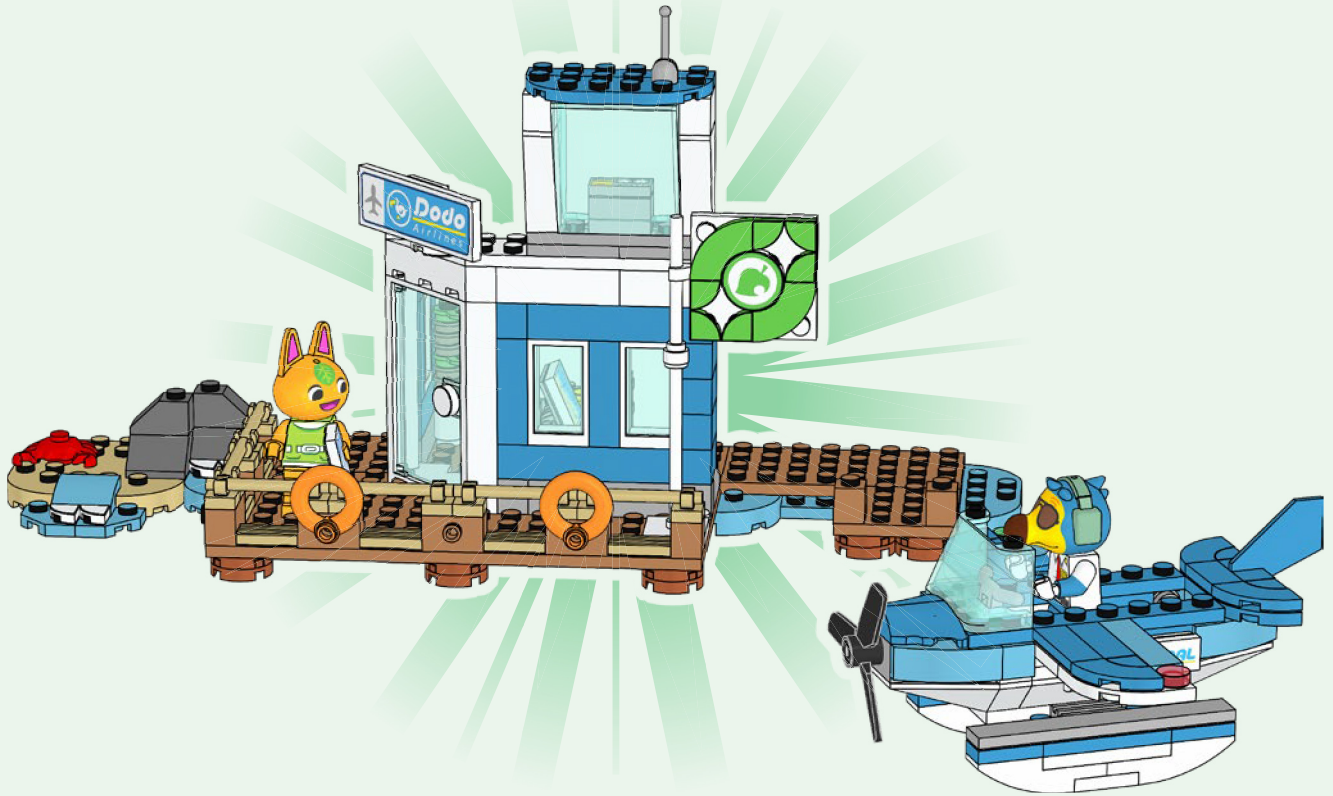





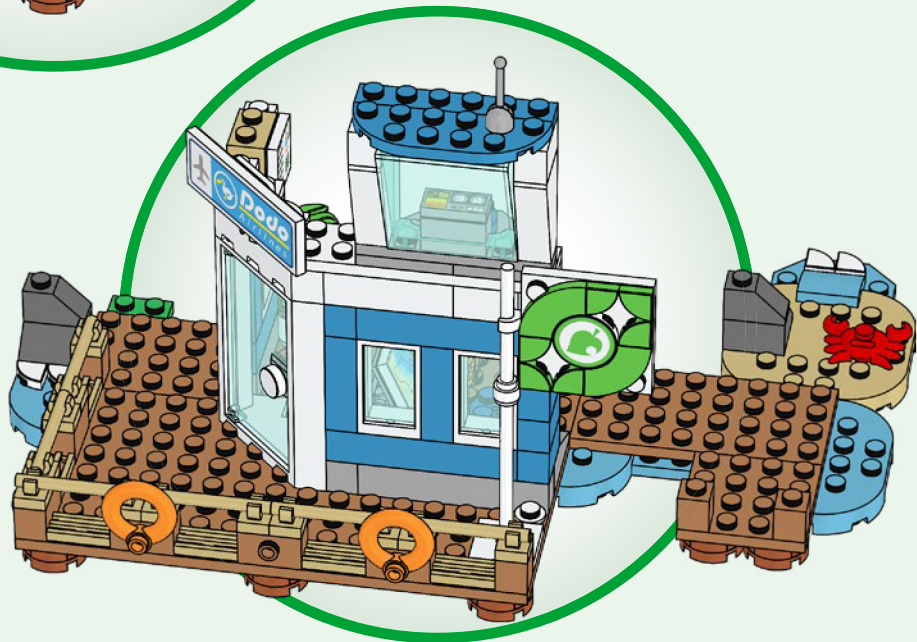
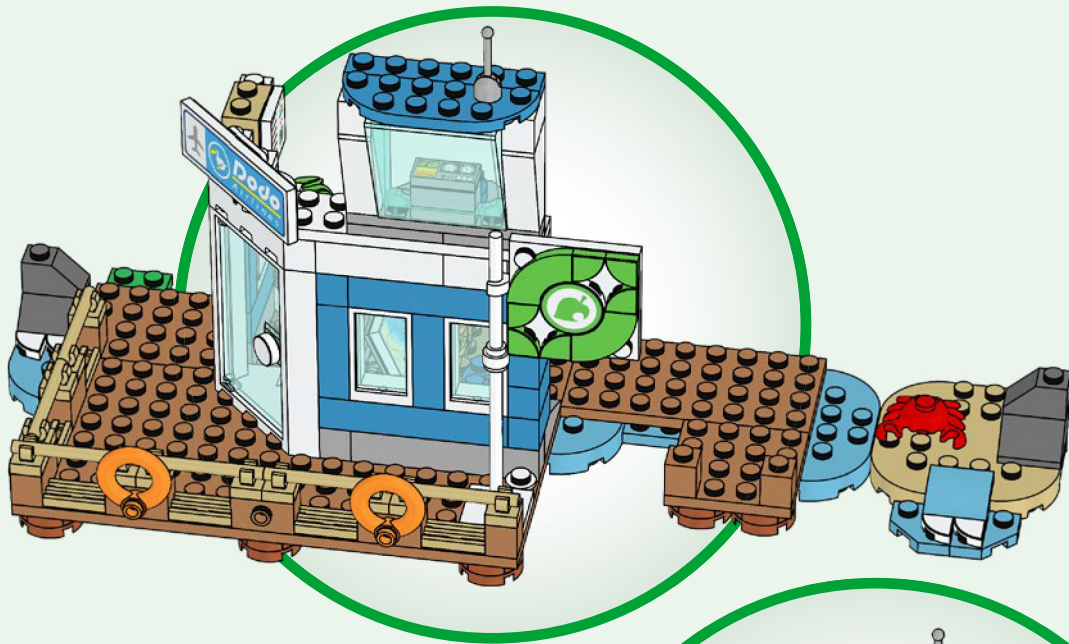



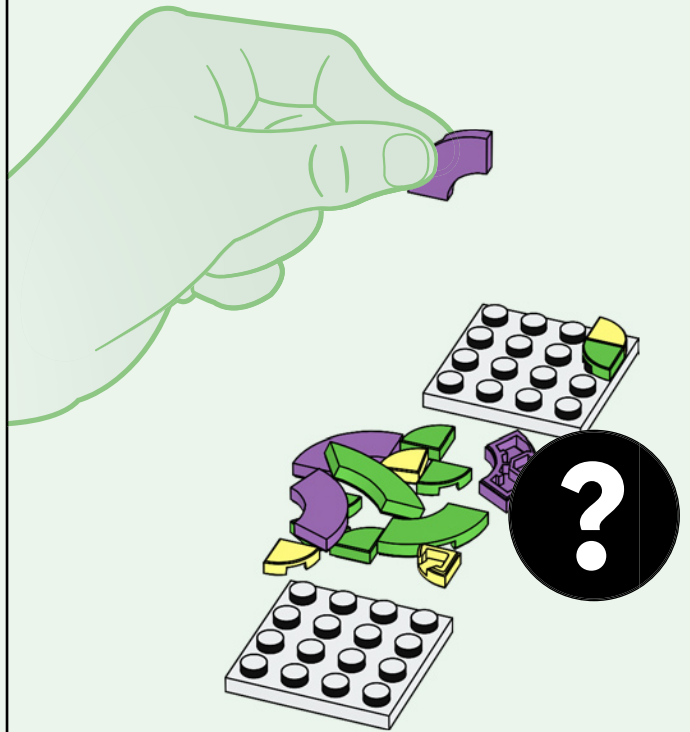
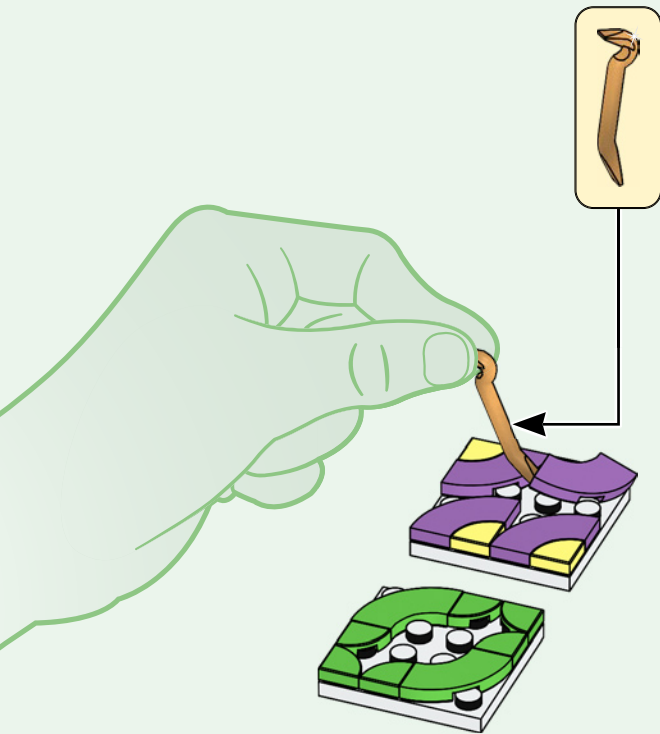

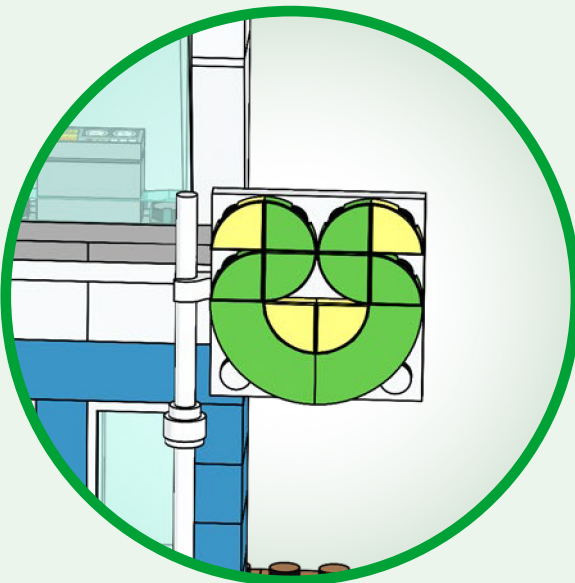
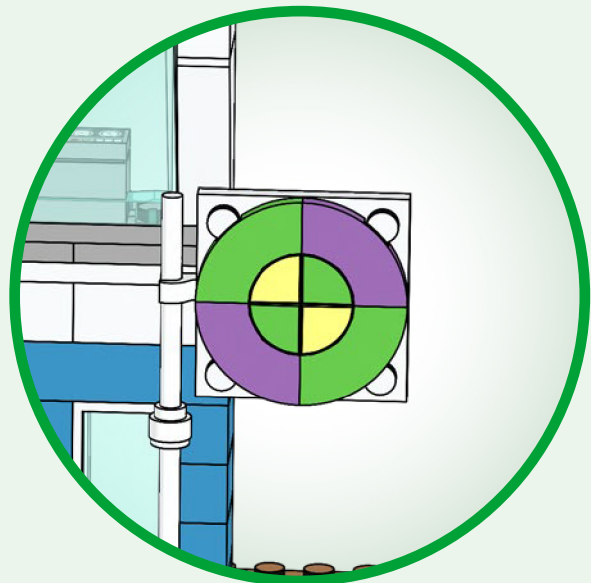
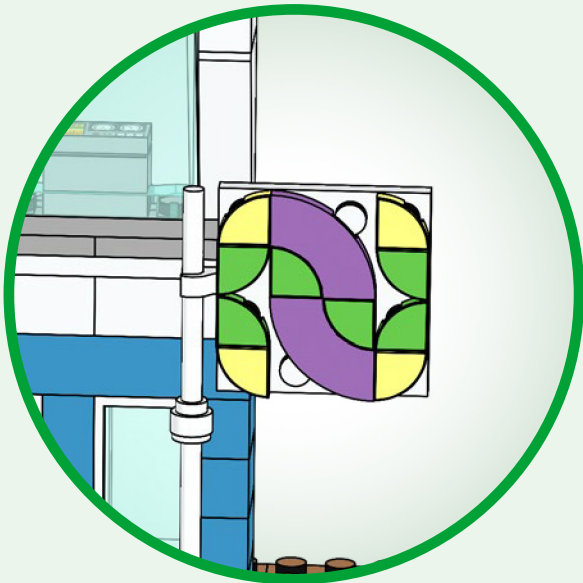



# Welcome to Animal Crossing







77052



77051



77047



77049



77050

2x 306201	1x 6313115	1x 6508577	2x 4243812	1x 6301627	12x 4616027	1x 6489711
3x 614101	2x 6489692	2x 4550745	1x 4658973	1x 6253363	1x 6258607	1x 6509366
1x 6284572	2x 302301	1x 302101	1x 6489691	2x 6189130	3x 6445336	1x 6267587
4x 6172366	1x 6097637	2x 301001	1x 379501	1x 379521	1x 6247361	1x 6267587
3x 300501	2x 6070698	4x 371001	1x 303401	2x 403223	1x 6253682	4x 4211525
2x 407001	1x 6428485	4x 6034675	1x 603401	1x 389924	1x 6253682	1x 4211389
4x 302401	1x 242001	2x 6104805	1x 244501	1x 302324	1x 6247801	2x 4278273
1x 6489694	1x 6093053	1x 395701	12x 6360078	1x 6360206	1x 6274742	1x 4211526
1x 6093053	1x 6170709	1x 6177157	6x 4124456	1x 302028	2x 6475432	1x 4211388
3x 6468341	1x 6413018	1x 6173055	1x 6117975	1x 6206150	2x 4190164	1x 6329585
6x 300401	2x 6400127	1x 6173055	6x 6116614	6x 6275873	1x 6508698	1x 4211469
1x 6329575	1x 6210385	1x 6173055	6x 6116614	3x 6182261	7x 6300322	1x 6321770
1x 6329575	1x 362301	2x 6092950	1x 4113993	3x 6182261	1x 6508669	1x 6313114
1x 6489693	4x 6195371			2x 6382958	1x 6508669	2x 4211350

2x  
6354568

1x  
4211397

1x  
4211881

2x  
4211361

1x  
4211488

1x  
4211394

1x  
4211393

1x  
4211438

2x  
4211481

4x  
6228969

1x  
6056774

4x  
6199900

1x  
4211043

2x  
4211135

2x  
4211063

2x  
4211054

1x  
6489710

4x  
6420725

2x  
6225538

4x  
6199887

1x  
6503570

1x  
6503571

1x  
6489712

4x  
6199897

1x  
6503573

4x  
6412744

2x  
6213272

2x  
6503567

2x  
6225539

1x  
6151657

2x  
6210227

1x  
6343649

7x  
6004943

6x  
4653988

1x  
6151659

4x  
6057986

5x  
6401015

1x  
6397823

3x  
6218145

1x  
6272111

2x  
4655243

2x  
6249415

4x  
6348142

1x  
6119126

4x  
6035598

2x  
4624705

2x  
4655256

3x  
6429297

 [LEGO.com/service](https://www.LEGO.com/service)

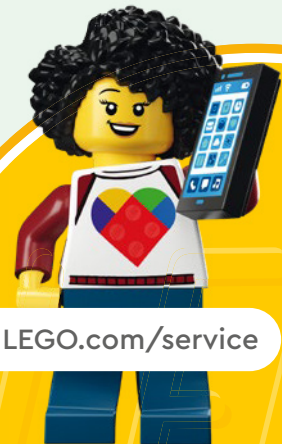



YOU COULD **WIN**

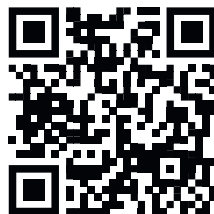

Scan this QR code or go to **LEGO.COM/PRODUCTFEEDBACK** and give us your short feedback about this LEGO® set for a chance to win a cool LEGO prize.

Terms and Conditions apply\*

**EN: YOU COULD WIN.** Terms and Conditions apply\* **DE: Du könntest GEWINNEN.** Es gelten die Teilnahmebedingungen\* **FR: Tu pourrais GAGNER.** Des conditions s'appliquent\* **IT: Potresti VINCERE tu.** Termini e condizioni sono applicabili\* **ES: Puedes GANAR.** Aplican términos y condiciones\* **PT: Poderá GANHAR.** Aplicam-se termos e condições\* **ZH: 轻松获奖. 条款和条件适用\*** **PL: Szansa na WYGRANĄ.** Obowiązują warunki korzystania\* **CS: Máte šanci VYHRÁT.** Platí všeobecné smluvní podmínky\* **SK: Máte šancu VYHRAŤ.** Platia všeobecné zmluvné podmienky\* **HU: TE IS NYERHETSZ.** Felhasználási feltételek érvényesek\* **RO: Ai putea CÂȘTIGA.** Se aplică termeni și condiții\* **BG: Можете да СПЕЧЕЛИТЕ.** Има определени правила и условия\* **LV: Tu vari LAIMĒT.** Ir spēkā noteikumi un nosacījumi.\* **ET: Sul on võimalus VÕITA.** Kehtivad tingimused\* **LT: Jūs galite LAIMĖTI.** Taikomos sąlygos\*

\*[LEGO.com/productfeedback-terms](https://www.lego.com/productfeedback-terms)

LEGO and the LEGO logo are trademarks and/or copyrights of the/son des marques de commerce et/ou copyrights du/son marcas registradas, algunas de ellas protegidas por derechos de autor, de LEGO Group. ©2024 The LEGO Group.

© Nintendo.