

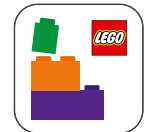

10335



Booklet available in English
Livret disponible en français
Folleto disponible en español



LEGO® Builder

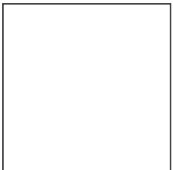



WE'RE MAKING OUR PACKAGING MORE SUSTAINABLE

We're transitioning from single-use plastic to paper-based packaging. As we progress, you may find a mix of paper and plastic in our boxes.

NOUS RENDONS NOS EMBALLAGES PLUS DURABLES

Nous passons des emballages en plastique à usage unique aux emballages à base de papier. Durant la transition, vous pourriez trouver un mélange de papier et de plastique dans nos boîtes.

QUEREMOS HACER MÁS SUSTENTABLES NUESTROS MATERIALES DE EMBALAJE

Estamos cambiando las bolsas de plástico desechables por bolsas con base de papel. Conforme avanzamos en este propósito, puedes encontrar una mezcla de papel y de plástico en nuestras cajas.

[LEGO.com/sustainable-packaging](https://www.lego.com/sustainable-packaging)



BUILDER



Apple and the Apple logo are trademarks of Apple Inc., registered in the U.S. and other countries and regions. App Store is a service mark of Apple Inc. Google Play and the Google Play logo are trademarks of Google LLC. Tencent and the Tencent logo are trademarks of Tencent Inc.

LEGO.com/devicecheck



LEGO® Builder

The *Endurance* rediscovered La redécouverte de l'*Endurance* Redescubrimiento del *Endurance*



★ In 2022, one hundred years after Sir Ernest Shackleton passed away, the wreckage of his most legendary ship, the *Endurance*, was rediscovered on the Weddell seafloor off the coast of Antarctica. First launched in 1912, the former luxury yacht was refurbished to withstand the most inhospitable environments and shield its crew from the elements on Shackleton's 1914 Imperial Trans-Atlantic Expedition. The daring mission to cross Antarctica failed as the *Endurance* was swallowed by the polar ice before reaching the shore. How its crew survived, however, became one of the most inspiring stories of human resilience, resourcefulness and camaraderie of the past century. While the *Endurance* will remain in its final resting place, the rediscovery of the remarkably well-preserved wreck once again brings its incredible story to the surface. Enjoy building, as we celebrate this epic survival story with a gorgeous LEGO® Icons model filled with the most minute of details.

★ En 2022, cent ans après la mort de Sir Ernest Shackleton, l'épave de son navire le plus légendaire, l'*Endurance*, est retrouvée sur le fond marin de Weddell, au large de l'Antarctique. Lancé pour la première fois en 1912, l'ancien yacht de luxe a été rénové pour résister aux environnements les plus inhospitaliers et protéger son équipage des éléments lors de l'expédition transatlantique impériale de Shackleton en 1914. L'audacieuse mission de traversée de l'Antarctique se solde par un échec, et l'*Endurance* est englouti par les glaces polaires avant d'atteindre le rivage. La façon dont son équipage a survécu est cependant devenue l'une des histoires les plus inspirantes de résilience, d'ingéniosité et de camaraderie humaines du siècle dernier. L'*Endurance* restera dans sa dernière demeure, mais la redécouverte de l'épave, remarquablement bien conservée, fait à nouveau remonter à la surface sa fabuleuse histoire. Profitez de la construction pour célébrer cette incroyable épopée de survie avec un magnifique modèle LEGO® Icons rempli de détails des plus minutieux.

★ En 2022, un siglo después del fallecimiento de Sir Ernest Shackleton, se redescubrieron los restos de la más legendaria de sus embarcaciones, el *Endurance*, en el lecho del mar de Weddell, frente a las costas de la Antártida. Botado por primera vez en 1912, el que fuera un yate de lujo fue sometido a una remodelación para hacerlo capaz de resistir los entornos más inhóspitos y proteger a su tripulación de los elementos en la expedición imperial transatlántica liderada por Shackleton en 1914. La temeraria misión de cruzar la Antártida fracasó, ya que el *Endurance* fue engullido por los hielos polares antes de llegar a la costa. No obstante, la supervivencia de su tripulación se convirtió en una de las crónicas de resistencia humana, ingenio y compañerismo más inspiradoras del siglo pasado. Si bien el *Endurance* permanecerá en su lugar de descanso final, el redescubrimiento de los restos del naufragio, extraordinariamente bien conservados, vuelve a sacar a la superficie su increíble historia. Esperamos que disfrutes construyendo mientras celebramos este épico episodio de supervivencia con un magnífico modelo LEGO® Icons repleto de los detalles más minuciosos.



The Antarctica Treaty

★ On December 1, 1959, twelve countries signed the Antarctica Treaty to preserve the continent as an independent center for scientific research. Under the treaty, with no indigenous people to claim sovereign rule, no country has the legal authority to claim or attempt to recover the Endurance.

Le Traité sur l'Antarctique

★ Le 1^{er} décembre 1959, douze pays signent le Traité sur l'Antarctique afin de préserver le continent en tant que centre indépendant de recherche scientifique. En vertu de ce traité, aucun peuple autochtone ne peut revendiquer la souveraineté, et aucun pays n'a l'autorité légale pour revendiquer ou tenter de récupérer l'Endurance.

El Tratado Antártico

★ El 1 de diciembre de 1959, doce países firmaron el Tratado Antártico para preservar el continente como centro independiente de investigación científica. Según el tratado, al no haber pueblos indígenas que reivindiquen su soberanía, ningún país tiene la autoridad legal para reclamar o intentar recuperar el Endurance.

Built to last

/// The three-masted barquentine was also fitted with a triple-expansion steam engine to navigate through harsh winds and ice.

/// A combination of oak, pine and greenheart wood timber made the hull sturdy enough to withstand the most extreme conditions.

/// Upon the wreck's discovery in 2022, the name *Endurance* in golden letters and the golden star were still intact.

Hecho para durar

/// El velero de tres mástiles también estaba equipado con una máquina de vapor de triple expansión para navegar entre el hielo y mantener el rumbo ante el azote de vientos intensos.

/// Una combinación de maderas de roble, pino y palo verde le dieron al casco la resistencia suficiente para soportar las condiciones más extremas.

/// Cuando se descubrieron los restos del naufragio en 2022, la estrella y las letras doradas del nombre *Endurance* seguían intactas.

Construit pour durer

/// Le trois-mâts goélette est également équipé d'un moteur à vapeur à triple expansion pour naviguer dans les vents violents et les glaces.

/// Une combinaison de bois de chêne, de pin et de cœur vert rend la coque suffisamment solide pour résister aux conditions les plus extrêmes.

/// Lors de la découverte de l'épave en 2022, le nom *Endurance* en lettres dorées et l'étoile dorée étaient encore intacts.



No man left behind

On December 5, 1914, Shackleton and his crew set sail from Grytviken in South Georgia on a year-long mission to reach the South Pole. By late February 1915, the *Endurance* became relentlessly stuck in ice that would shift and drift around the Weddell Sea. Undeterred, the crew remained onboard until October 27, 1915, when cracks threatened to sink the ship. It remained afloat until finally sinking on November 21st.

The 28 men used the preserved lifeboats to set up *Patience Camp* on the ice until April 1916 when they departed in a lifeboat for Elephant Island. Each crew member could pack two pounds of personal belongings – plus a banjo, which Shackleton declared vital mental medicine! From Elephant Island, Shackleton and a few of his men completed a final two-week leg back to South Georgia, only to reach the Stromness whaling station on the ‘wrong’ end of the island in a terrible storm. A day and a half-long march across the island later, the exhausted expedition returned to Grytviken. From there, it took Shackleton nearly four and a half months and several attempts to finally rescue his last men from Elephant Island.

History credits the survival of the crew of the *Endurance* to the extraordinary leadership of Sir Ernest Shackleton, emphasizing his heroic actions of self-sacrifice and morale-boosting optimism. From sharing his gloves and ordering his men to sleep to keep them energized to defying all odds to bring everyone home alive, it seems his crew's trust was well-earned.

Aucun laissé-pour-compte

Le 5 décembre 1914, Shackleton et son équipage quittent Grytviken, en Géorgie du Sud, pour une mission d'un an visant à atteindre le pôle Sud. À la fin du mois de février 1915, l'*Endurance* se retrouve bloqué dans les glaces qui se déplacent et dérivent autour de la mer de Weddell. Ne se laissant pas décourager, l'équipage reste à bord jusqu'au 27 octobre 1915, date à laquelle des fissures menacent de faire couler le navire. Il reste à flot jusqu'à ce qu'il coule finalement le 21 novembre.

Les 28 hommes utilisent les canots de sauvetage pour installer un camp, *Patience Camp*, sur la glace jusqu'en avril 1916, où ils repartent à bord d'un canot de sauvetage pour l'île de l'Éléphant. Chaque membre de l'équipage peut emporter deux livres d'effets personnels, ainsi qu'un banjo, que Shackleton déclare être un remède vital pour l'esprit ! Depuis l'île de l'Éléphant, Shackleton et quelques-uns de ses hommes effectuent une dernière étape de deux semaines vers la Géorgie du Sud, avant d'atteindre la station baleinière de Stromness, située à la « mauvaise » extrémité de l'île, au cours d'une terrible tempête. Après un jour et demi de marche à travers l'île, le groupe épuisé retourne à Grytviken. De là, il faut près de quatre mois et demi et plusieurs tentatives à Shackleton pour sauver ses derniers hommes de l'île de l'Éléphant.

L'histoire attribue la survie de l'équipage de l'*Endurance* à l'extraordinaire leadership de Sir Ernest Shackleton, soulignant ses actes héroïques d'abnégation et d'optimisme. Il partage ses gants, ordonne à ses hommes de dormir pour conserver leur énergie et défie tous les obstacles pour ramener tout le monde vivant, prouvant que la confiance de son équipage est bien méritée.



“By Endurance We Conquer.”

– The Shackleton family motto

« Nous vainquons par l'endurance. »

– La devise de la famille Shackleton

“Resistiendo, venceremos”.

– Lema de la familia Shackleton





Elephant Island

★ On April 15, 1916, Shackleton and his crew reached land for the first time in 497 days, on Elephant Island, where the last of the crew were rescued on August 30, 1916.

Île de l'Éléphant

★ Le 15 avril 1916, Shackleton et son équipage atteignent la terre pour la première fois en 497 jours, sur l'île de l'Éléphant, où les derniers membres de l'équipage sont secourus le 30 août 1916.

Isla Elefante

★ El 15 de abril de 1916, Shackleton y su tripulación pisaron tierra firme por primera vez en 497 días en la isla Elefante, donde se rescató a los últimos tripulantes el 30 de agosto de 1916.

Nadie se queda atrás

El 5 de diciembre de 1914, Shackleton y su tripulación zarparon de la estación Grytviken, en la isla Georgia del Sur, en una misión de un año cuyo objetivo era atravesar el Polo Sur. A finales de febrero de 1915, el *Endurance* quedó irremediadamente atrapado entre los hielos que avanzaban a la deriva por el mar de Weddell. Sin perder el ánimo, la tripulación permaneció a bordo hasta el 27 de octubre de 1915, cuando las grietas amenazaron con hundir el barco. Este permaneció a flote hasta que, finalmente, se hundió el 21 de noviembre.

Los 28 tripulantes usaron algunos botes salvavidas recuperados para establecer el campamento Patience en el hielo hasta abril de 1916, cuando partieron hacia la isla Elefante a bordo de uno más de ellos. A cada miembro de la tripulación se le permitió llevar un kilogramo de efectos personales, además de un banjo, ¡al que Shackleton declaró medicina mental vital! Desde la isla Elefante, Shackleton y algunos de sus hombres completaron una última etapa de dos semanas hasta la isla Georgia del Sur, solo para llegar a la estación ballenera Stromness por el extremo "equivocado" de la isla en medio de una impetuosa tormenta. Después de un día y medio de caminata a través de la isla, la agotada expedición regresó a la estación Grytviken. Desde allí, a Shackleton le tomó casi cuatro meses y medio y numerosos intentos rescatar a los últimos de sus hombres de la isla Elefante.

La historia atribuye la supervivencia de la tripulación del *Endurance* al extraordinario liderazgo de Sir Ernest Shackleton, destacando la abnegación y el alentador optimismo de sus heroicas acciones. Desde compartir sus guantes y ordenar a sus hombres que durmieran para mantenerlos con energía hasta desafiar todas las probabilidades para traer a todos a casa con vida, parece evidente que a su tripulación no le faltaban razones para depositar en él su confianza.

The Journey

Le périple

El viaje

- 1 Dec. 5, 1914 – The *Endurance* departs from Grytviken, South Georgia.
5 décembre 1914 – L'*Endurance* quitte Grytviken, en Géorgie du Sud.
5 de diciembre de 1914 – El *Endurance* parte de la estación Grytviken, en la isla Georgia del Sur.
- 2 Jan. 18, 1915 – After navigating the icy Weddell Sea for weeks, the *Endurance* becomes trapped in the ice.
18 janvier 1915 – Après avoir navigué pendant des semaines dans les eaux glacées de la mer de Weddell, l'*Endurance* se retrouve prisonnier des glaces.
18 de enero de 1915 – Luego de navegar durante semanas por el helado mar de Weddell, el *Endurance* queda atrapado en el hielo.
- 3 Nov. 21, 1915 – Weeks after the ship's hull begins to crack, it sinks off the Antarctic coast.
21 novembre 1915 – Des semaines après que sa coque ait commencé à se fissurer, le navire coule au large des côtes de l'Antarctique.
21 de noviembre de 1915 – Semanas después de que el casco de la embarcación empezara a resquebrajarse, esta se hunde frente a las costas de la Antártida.
- 4 Apr. 15, 1916 – Two weeks after leaving *Patience Camp* in one of the lifeboats, the crew arrives at Elephant Island.
15 avril 1916 – Deux semaines après avoir quitté *Patience Camp* à bord d'un des canots de sauvetage, l'équipage arrive à l'île de l'Éléphant.
15 de abril de 1916 – Dos semanas después de abandonar el campamento *Patience* en uno de los botes salvavidas, la tripulación llega a la isla Elefante.
- 5 May 21, 1916 – Shackleton and the first few crew members reach South Georgia.
21 mai 1916 – Shackleton et les premiers membres de l'équipage atteignent la Géorgie du Sud.
21 de mayo de 1916 – Shackleton y los primeros miembros de la tripulación llegan a la isla Georgia del Sur.
- 6 Aug. 30, 1916 – The last of the crew are finally rescued from Elephant Island.
30 août 1916 – Les derniers membres de l'équipage sont finalement sauvés de l'île de l'Éléphant.
30 de agosto de 1916 – Los últimos tripulantes son rescatados de la isla Elefante.

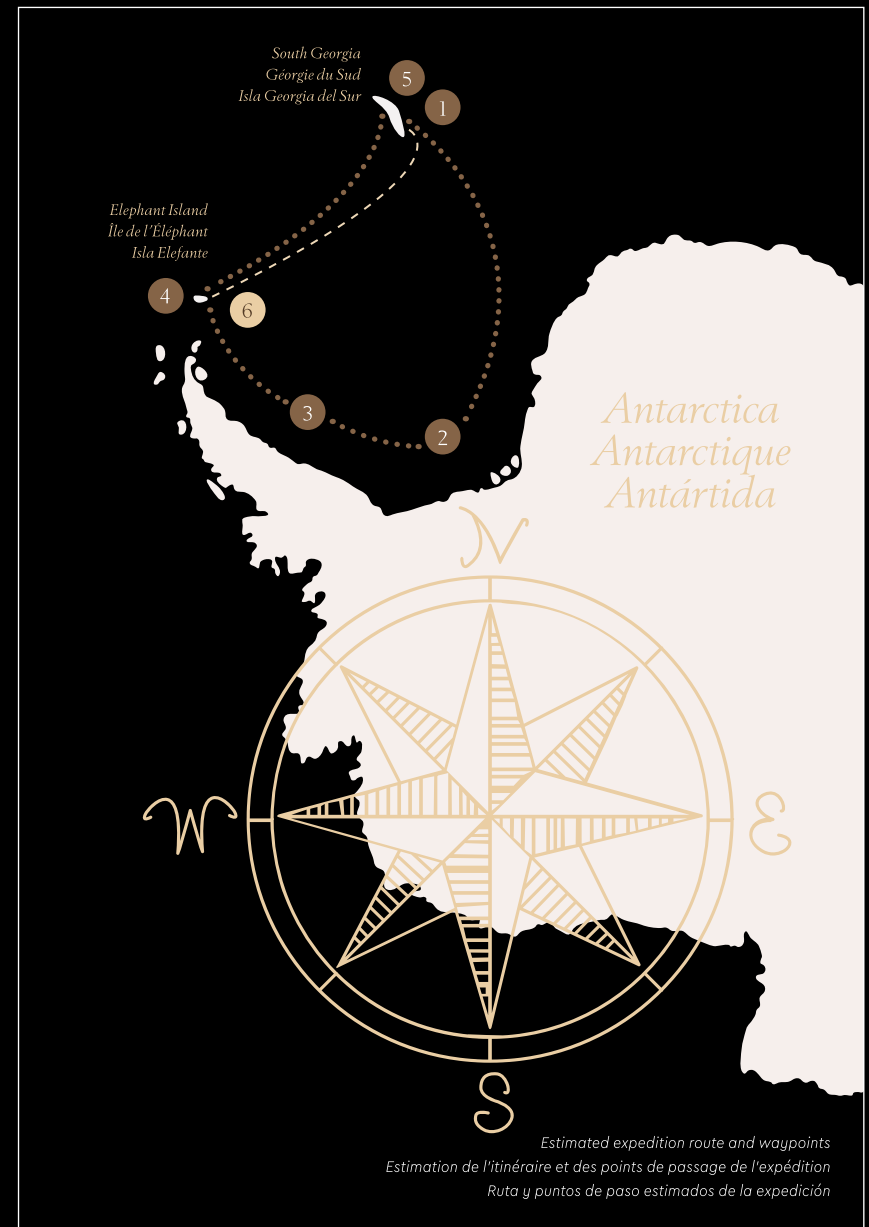



From the LEGO® Design Team

"To determine the scale of the model, we first picked a significant detail, the lifeboats (which came in two different sizes) and built them as small and detailed as we could. From there, we calculated what the ship's dimensions would be. Whereas the real-life *Endurance* had room for 28 men, we scaled it down a little to include cabins for Sir Ernest Shackleton and an expedition scientist. The interior also reveals the ship's steam engine which can be taken out. In real life, the steam engine was about as big as a two-story house! LEGO® Icons display models usually feature cool functions, and we wanted a working rudder connected to the steering wheel. For this function we created a tiny gearbox based on an angle plate that now comes in dark brown for the first time. It's one of numerous element color changes we made to give the ship its authentic look. After all, the *Endurance* was one of the strongest wooden ships ever built and deserves a proper tribute!"

*Hans Burkhard Schlömer,
LEGO® Model Designer*

Un mot de l'équipe de conception LEGO®

« Pour déterminer l'échelle du modèle, nous avons d'abord choisi un détail important, soit les canots de sauvetage (qui existaient en deux tailles différentes), et nous les avons construits aussi petits et détaillés que possible. À partir de là, nous avons calculé les dimensions du navire. Bien que l'*Endurance* réel pouvait accueillir 28 hommes, nous l'avons réduit un peu pour inclure des cabines pour Sir Ernest Shackleton et un scientifique de l'expédition. L'intérieur révèle également le moteur à vapeur du navire, qui peut être retiré. Dans la réalité, le moteur à vapeur était aussi grand qu'une maison de deux étages ! Les modèles à exposer LEGO® Icons proposent généralement des fonctions intéressantes, et nous voulions un gouvernail fonctionnel relié à la barre de pilotage. Pour cette fonction, nous avons créé une minuscule boîte de vitesses basée sur une plaque en angle qui, pour la première fois, est offerte en marron foncé. C'est l'un des nombreux changements de couleur que nous avons apportés à des éléments pour donner au navire son aspect authentique. Après tout, l'*Endurance* était l'un des navires en bois les plus solides jamais construits, et il mérite un hommage digne de ce nom ! »

*Hans Burkhard Schlömer,
concepteur de modèles LEGO®*

Impresiones del equipo de diseño de LEGO®

"Para determinar la escala del modelo, primero elegimos un detalle importante, los botes salvavidas (que los había en dos tamaños diferentes), y los recreamos en modelos tan pequeños y detallados como pudimos. A partir de ahí, calculamos cuáles serían las dimensiones de la embarcación. Mientras que el *Endurance* de la vida real tenía espacio para 28 personas, limitar un poco la capacidad del modelo nos permitió incluir camarotes para Sir Ernest Shackleton y un científico de la expedición. El interior también muestra la máquina de vapor del barco, que puede quitarse. En la vida real, la máquina de vapor era tan grande como una casa de dos pisos! Los modelos de exhibición LEGO® Icons suelen tener funciones interesantes, por lo que quisimos darle un timón funcional conectado a la rueda de gobierno. Para esta función, creamos un pequeño mecanismo basado en una placa en ángulo que ahora viene en café oscuro por primera vez. Este es uno de los numerosos cambios de color de elementos que hicimos para recrear con autenticidad el aspecto del barco. Al fin y al cabo, el *Endurance* fue uno de los barcos de madera más fuertes jamás construidos, y merece un homenaje a la altura".

*Hans Burkhard Schlömer,
modelista de LEGO®*

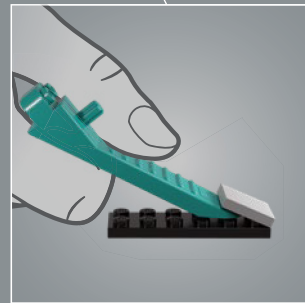
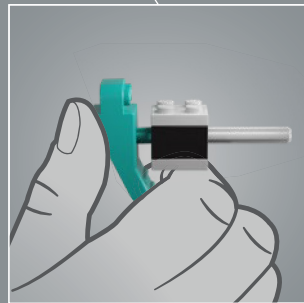
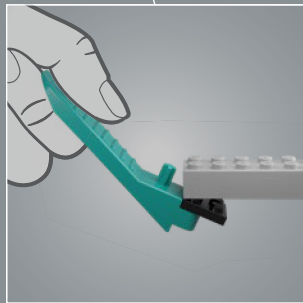
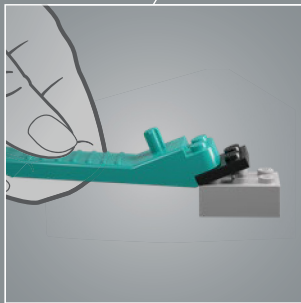
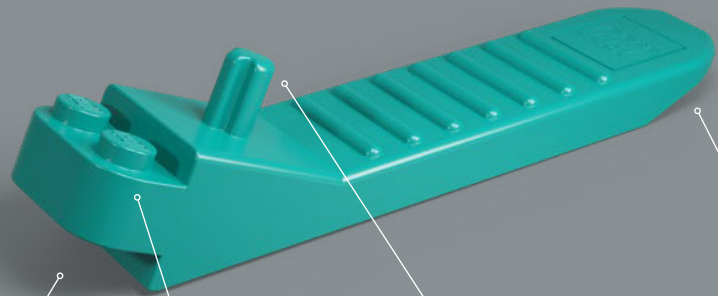

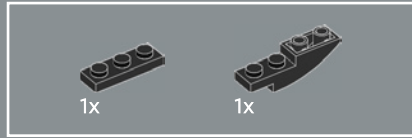

1

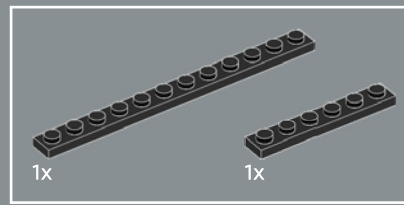
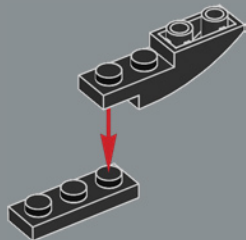

2

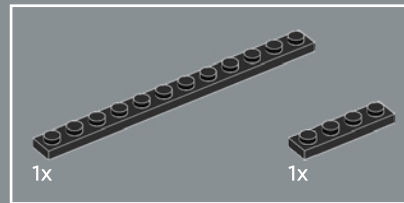
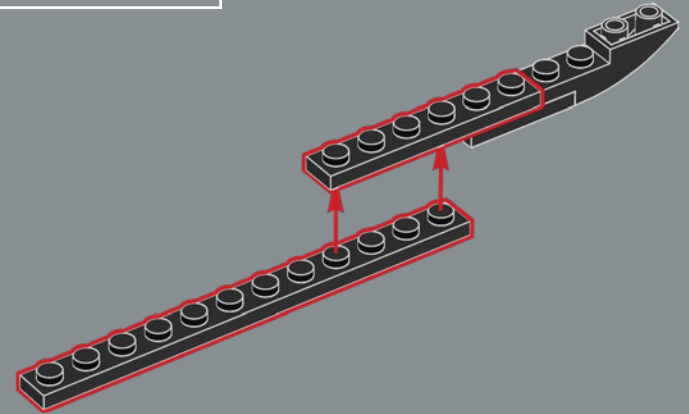

3

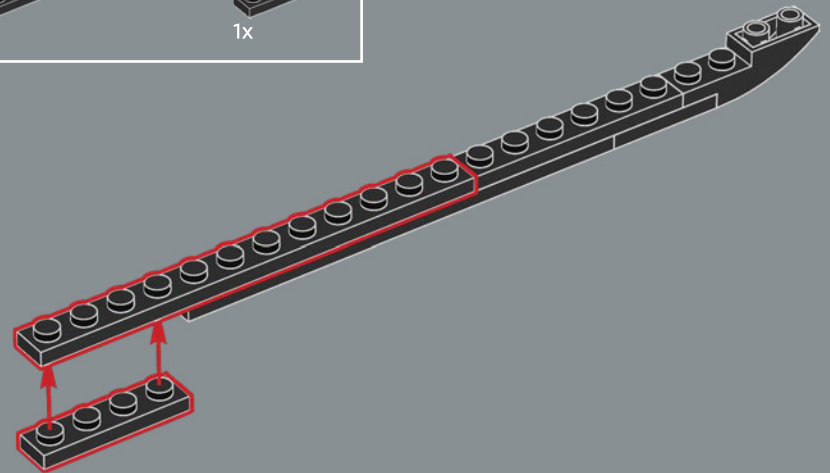

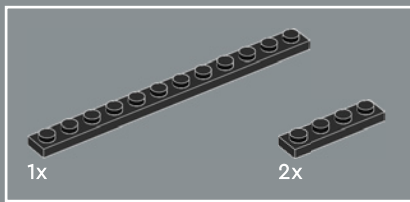

4

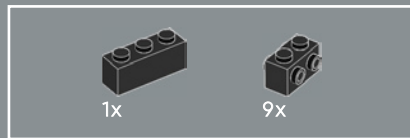
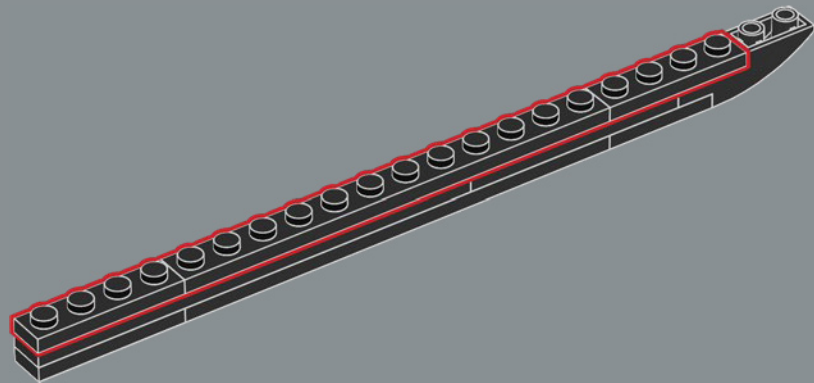

5

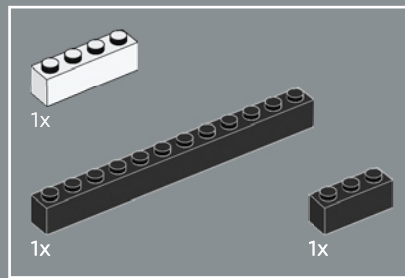
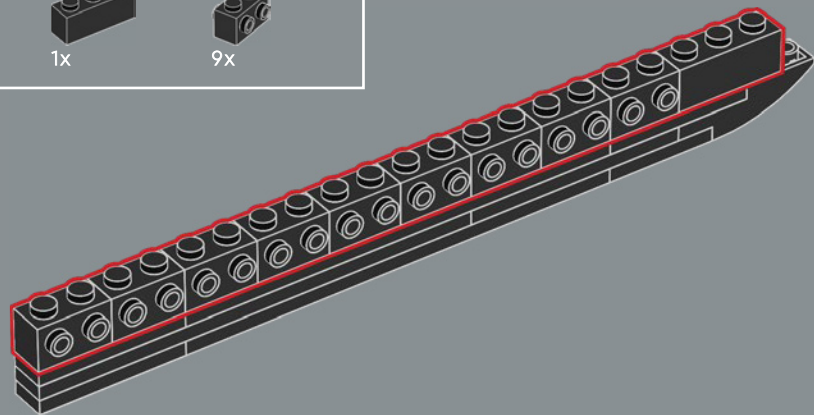

6

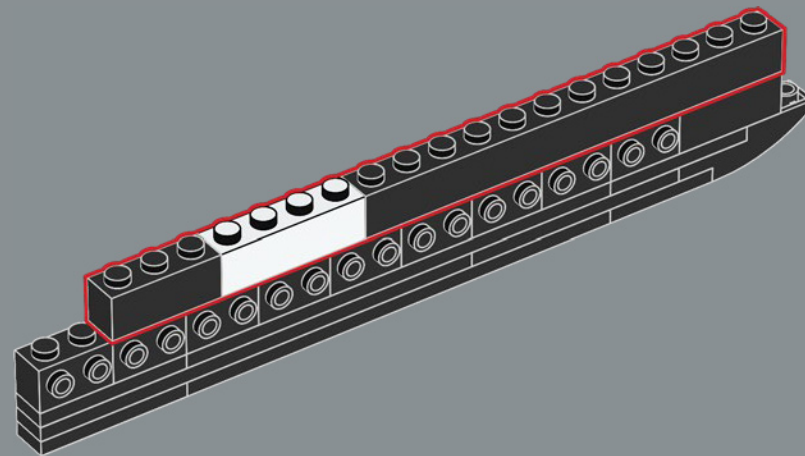

The keel is only one brick wide to keep the ship's sleek appearance, forming a wall in the front section with studs facing sideways. This technique creates a nice shape for the hull.

La quille ne fait qu'une seule brique de large afin de conserver l'aspect épuré du navire, formant un mur dans la section avant avec des tenons orientés latéralement. Cette technique permet de donner une belle forme à la coque.

La quilla tiene solo un brick de espesor para mantener el aspecto esbelto del barco, y los bricks de la sección delantera llevan las espigas hacia afuera. Esta técnica da al casco una silueta muy agradable a la vista.



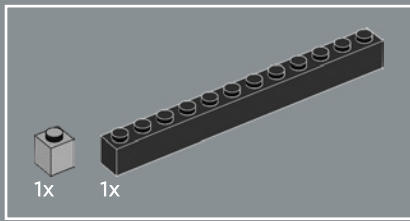

7

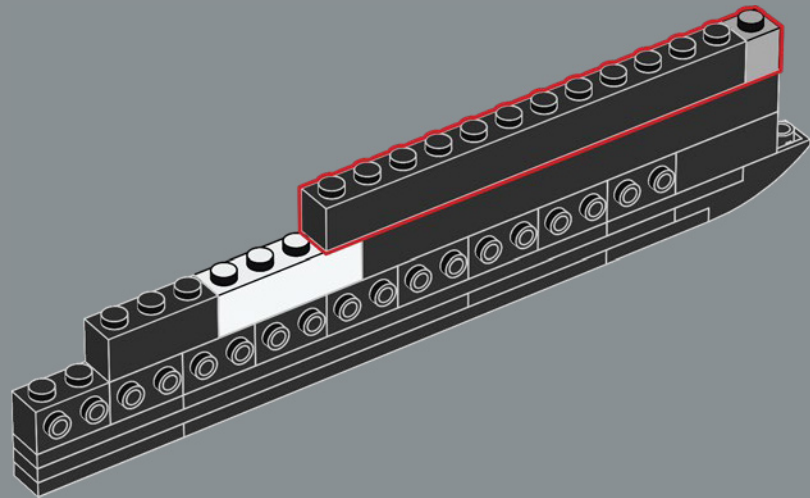

8

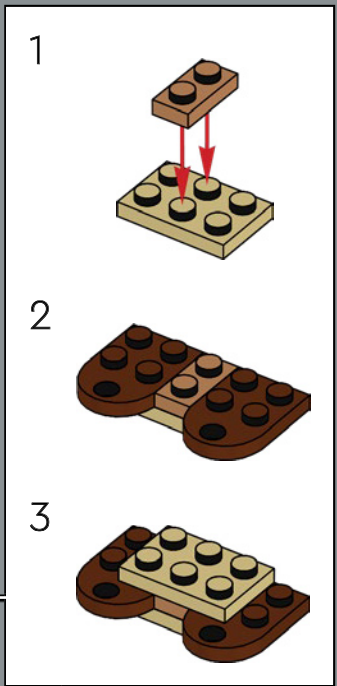
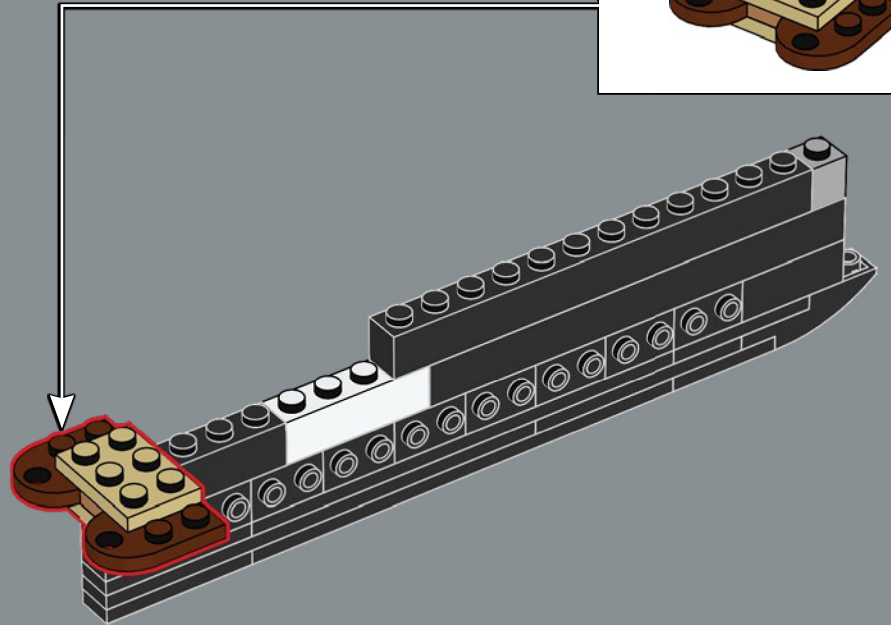

9

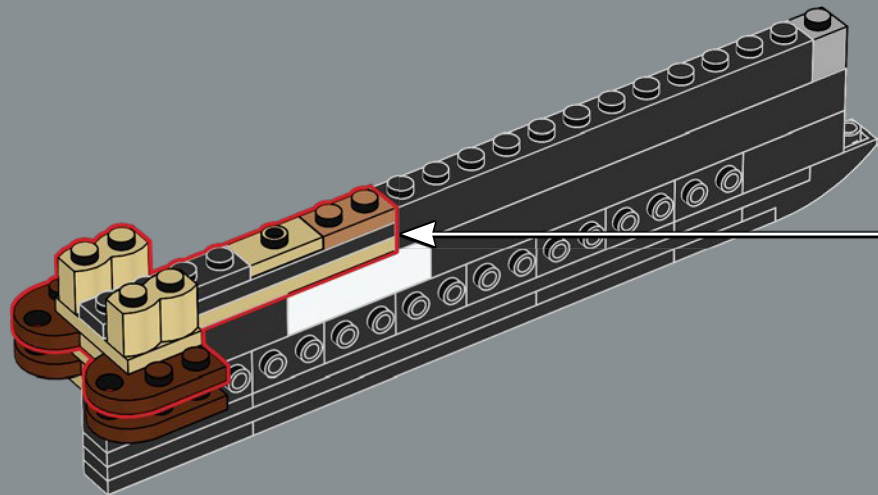
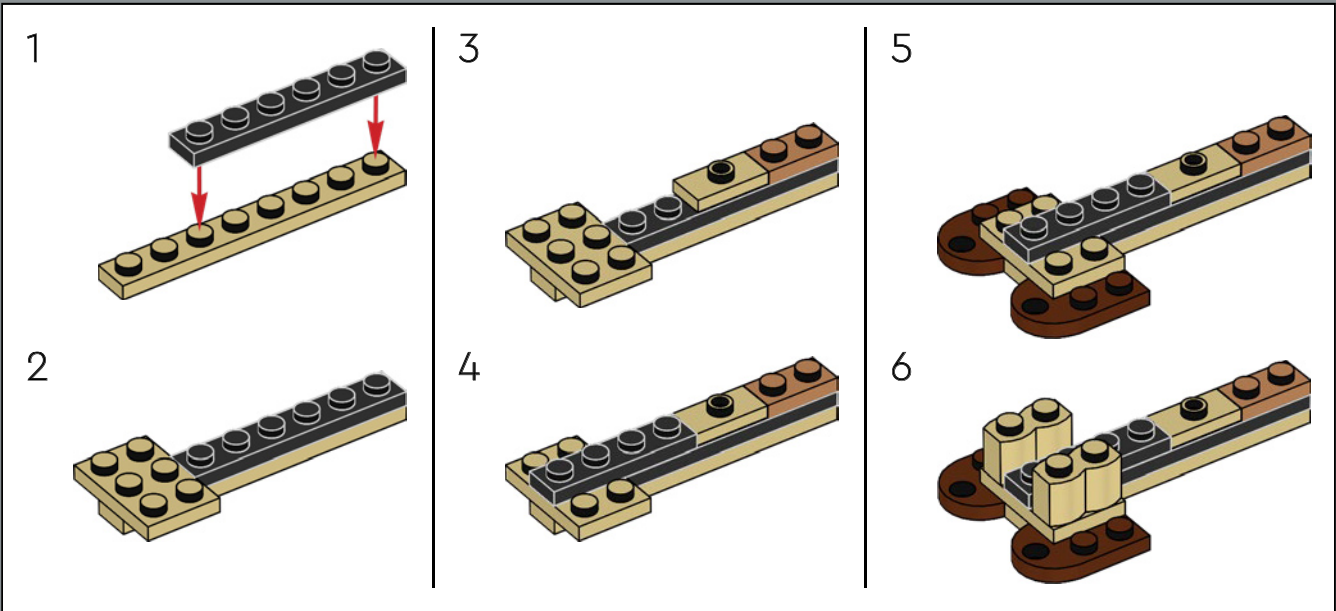
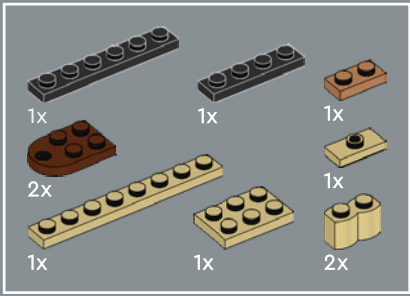

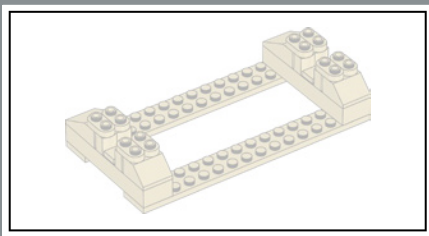

Because the keel is quite narrow, you can use the tan 'helper stand' to keep the model stable during construction.

Comme la quille est assez étroite, vous pouvez utiliser le « support d'aide » pour maintenir le modèle stable pendant la construction.

Como la quilla es muy estrecha, puedes usar el "soporte auxiliar" de color más claro para mantener estable el modelo durante la construcción.

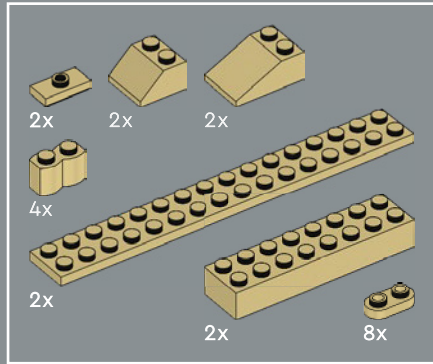

10

1

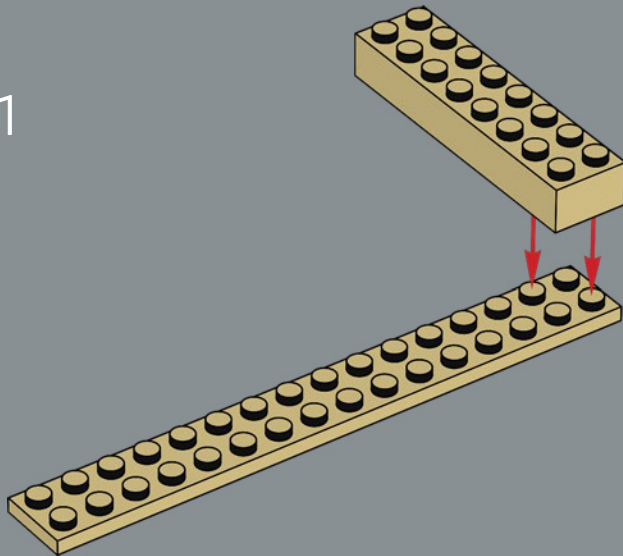

2

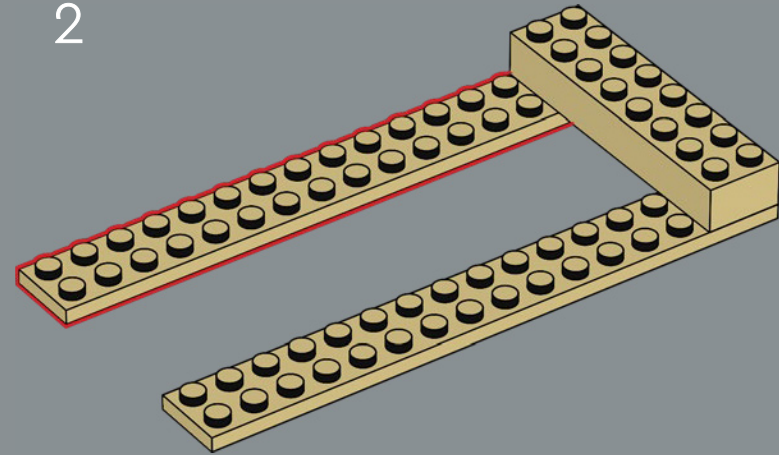

3

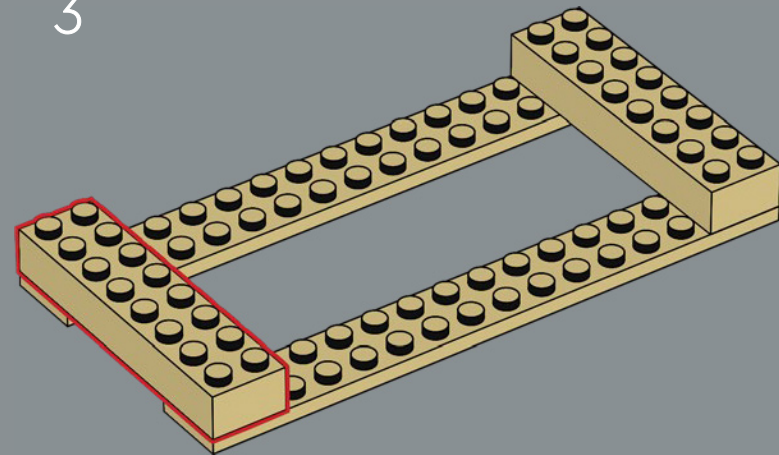

4

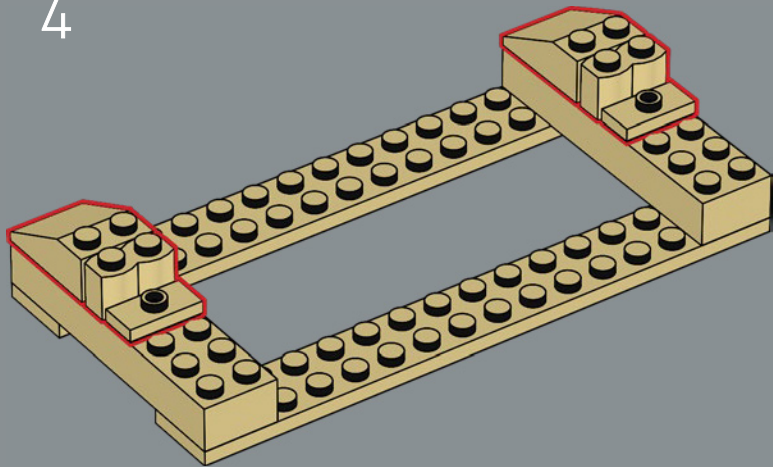

6

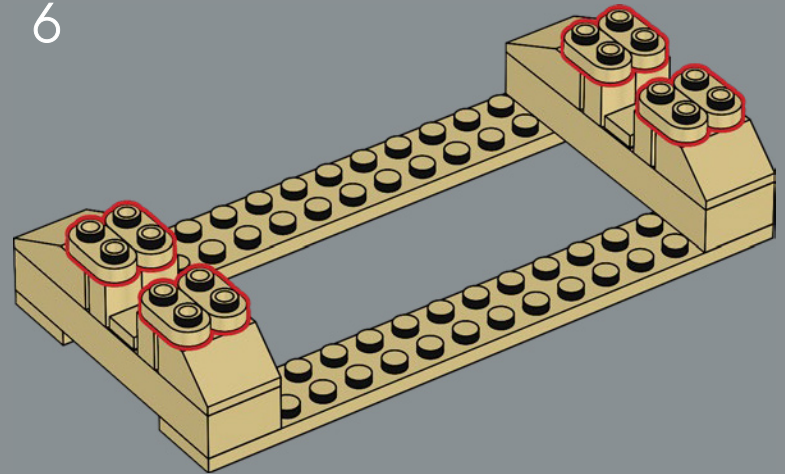

5

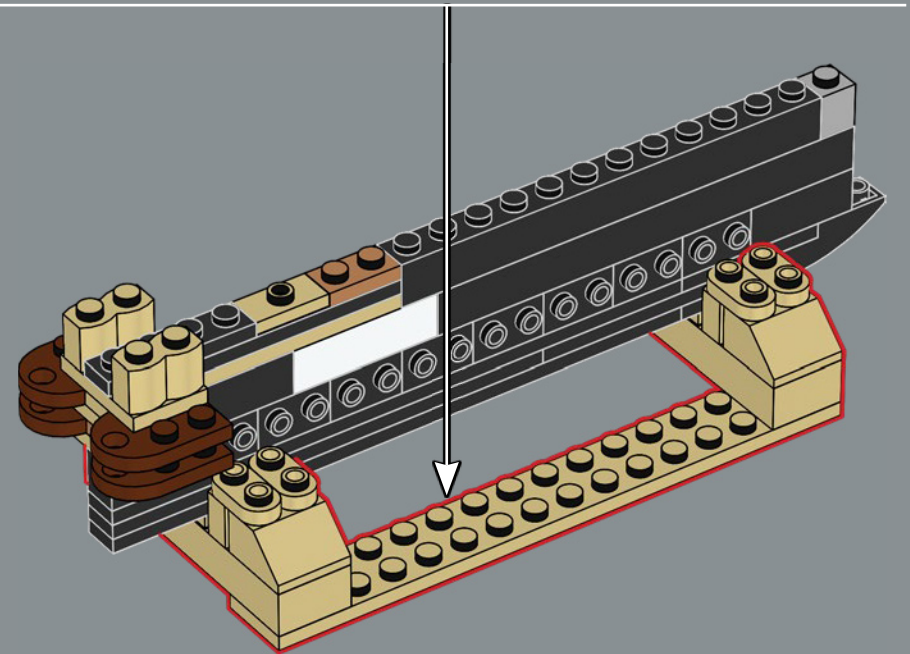
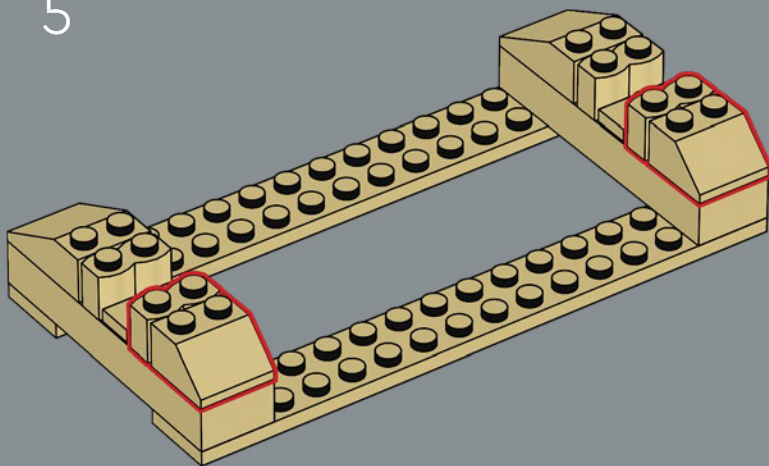

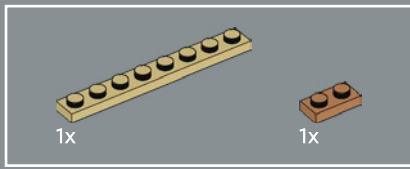

11

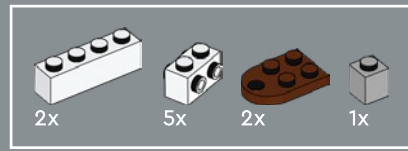
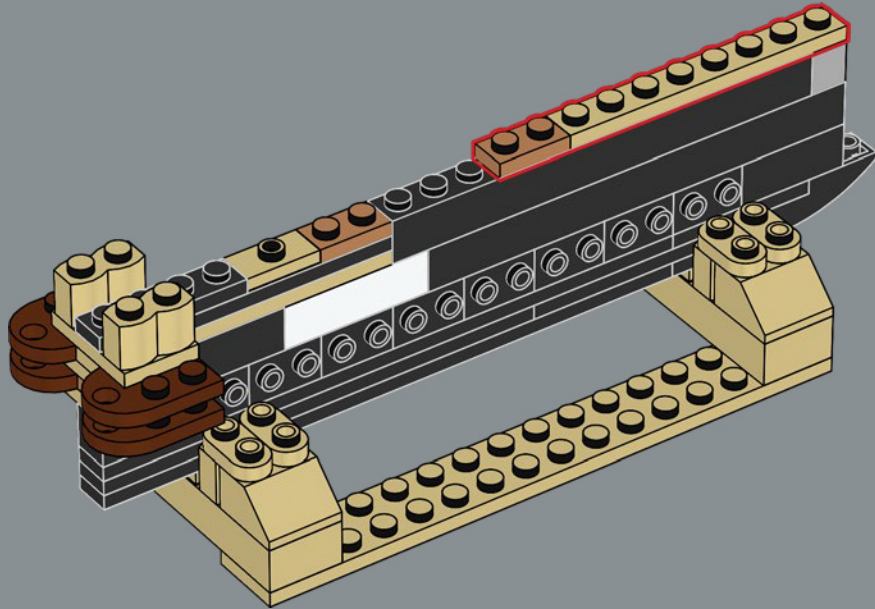

12

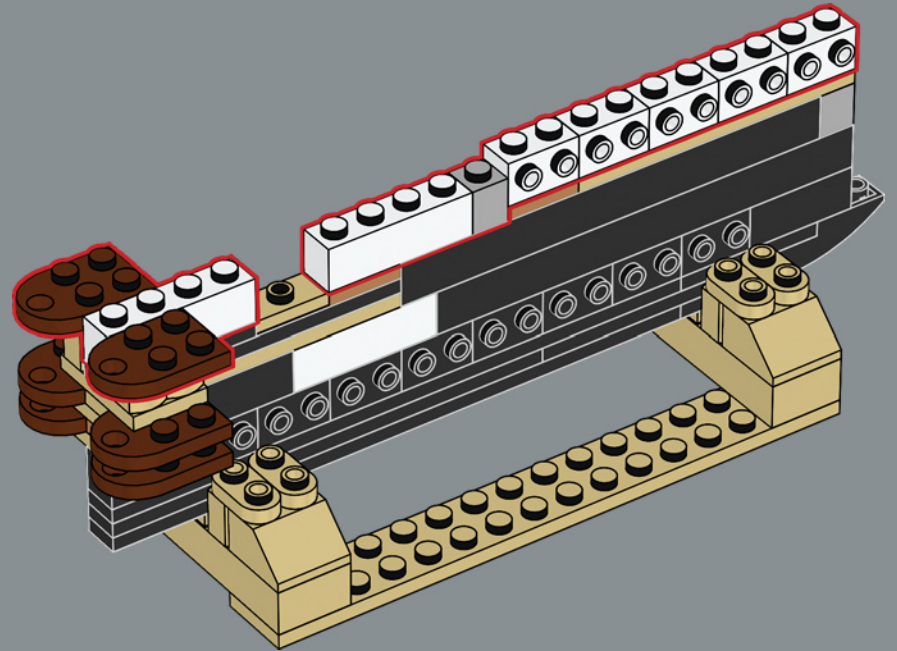



13

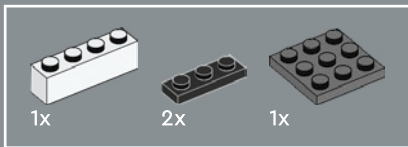
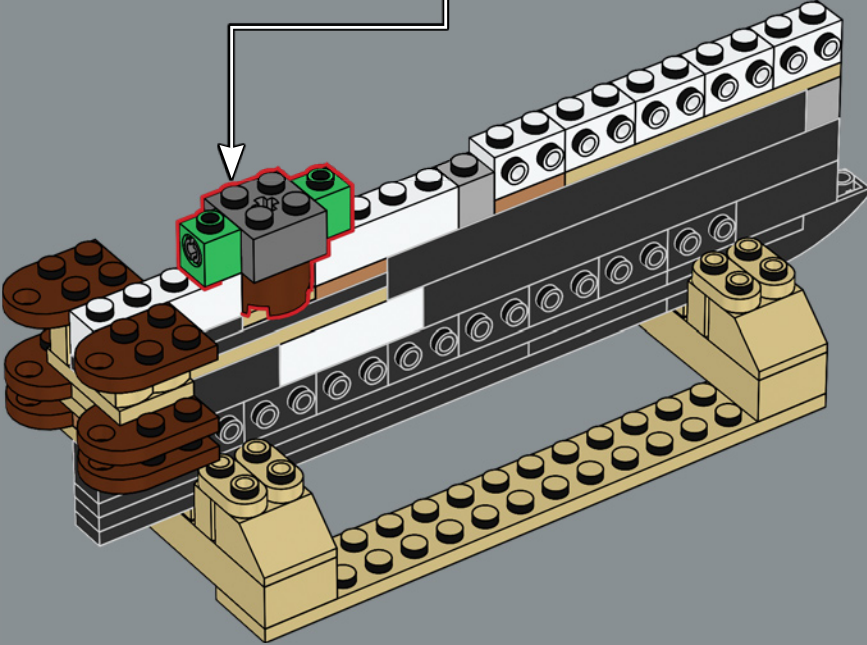
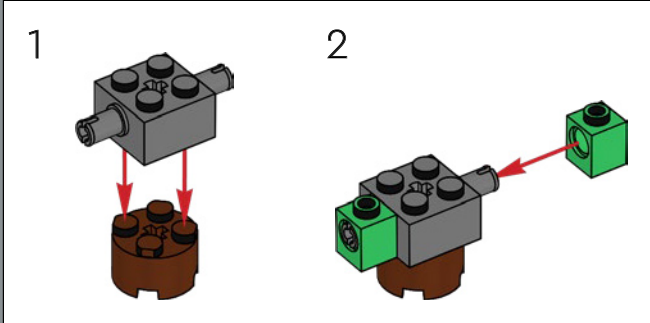

14

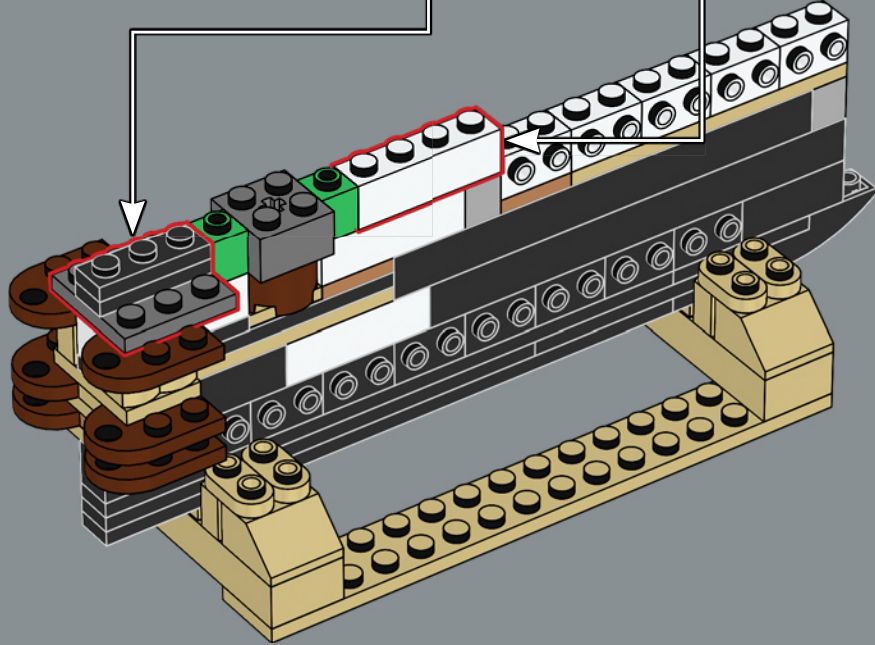
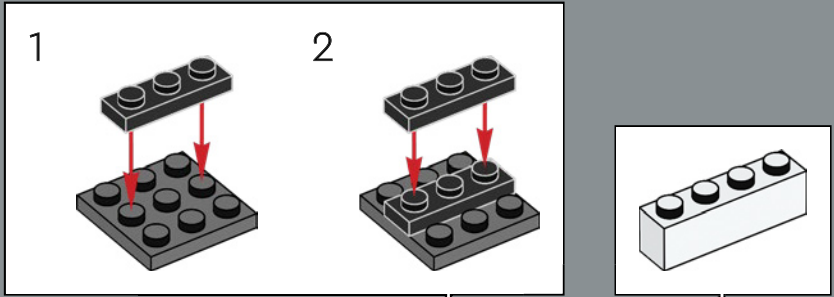

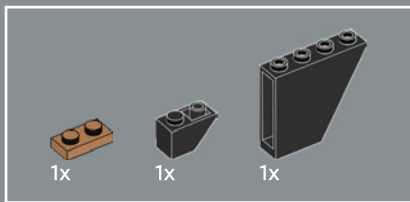

15

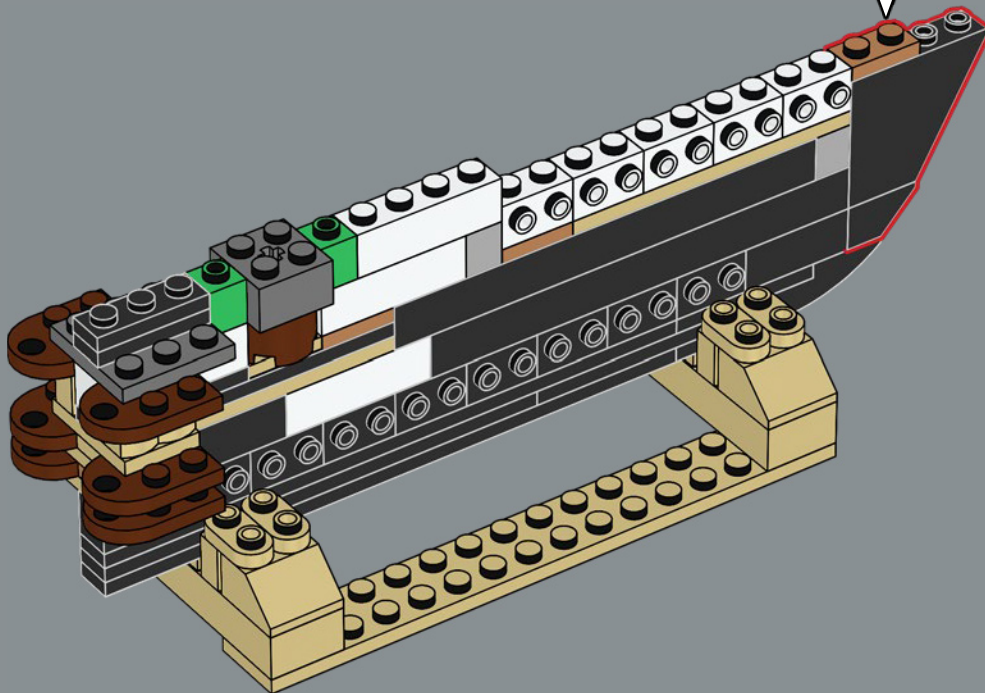
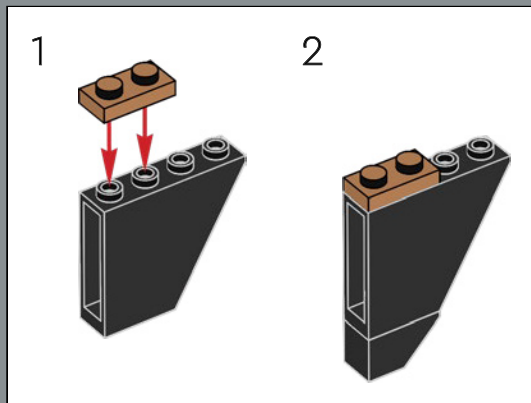

The ship hull's front was clad with metal sheets to protect the wooden keel from the polar ice. On the model, this section was recreated with a rarely used 1×4×3 inverted slope brick.

L'avant de la coque du navire était recouvert de tôles pour protéger la quille en bois de la glace polaire. Sur le modèle, cette section a été recréée à l'aide d'une brique à pente inversée 1×4×3, rarement utilisée.

El frente del casco del barco estaba revestido de láminas metálicas para proteger la quilla de madera de los hielos polares. En el modelo, esta sección se recreó con un inusual brick con pendiente invertida 1×4×3.

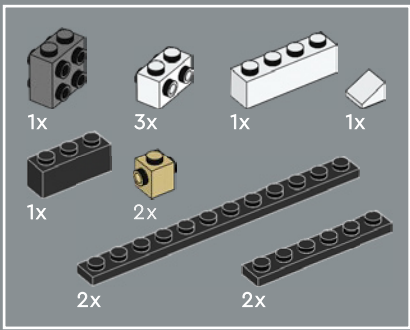

16

1

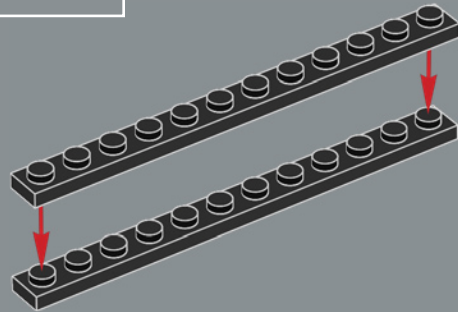

2

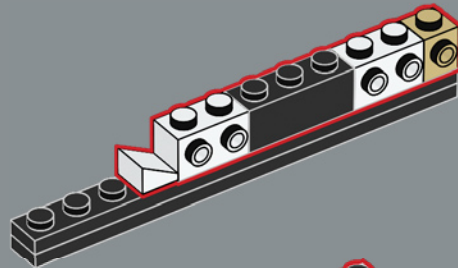

3

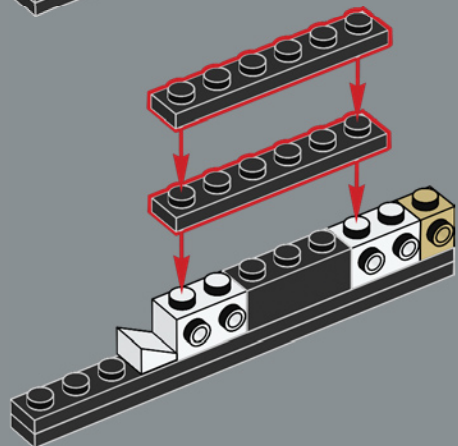

4

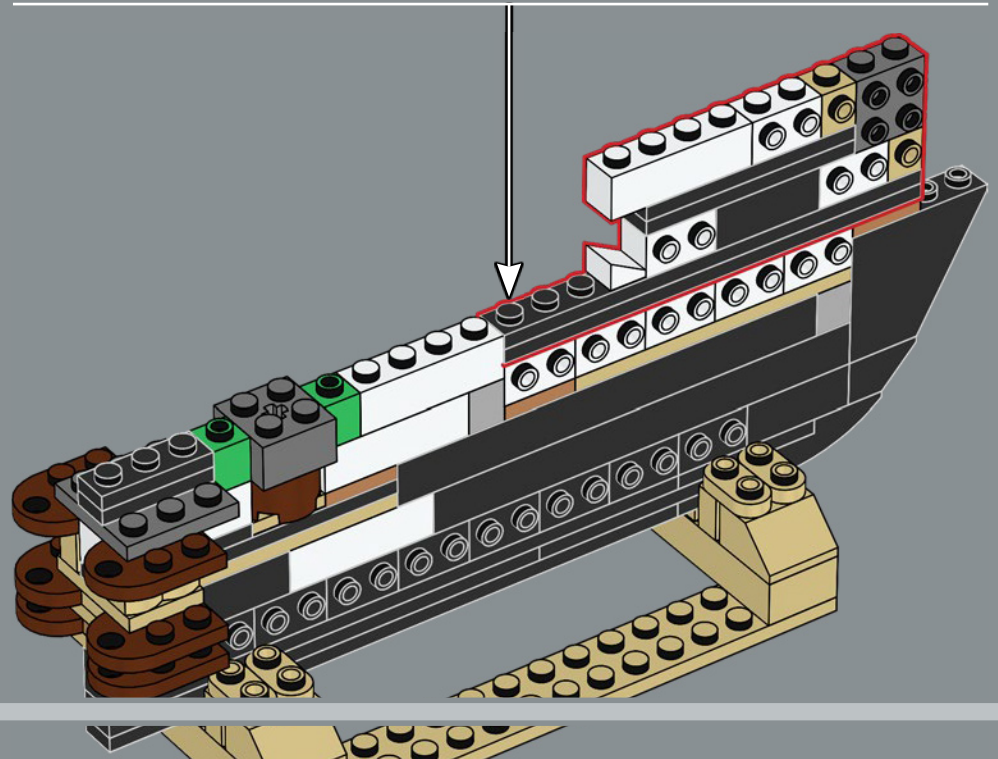
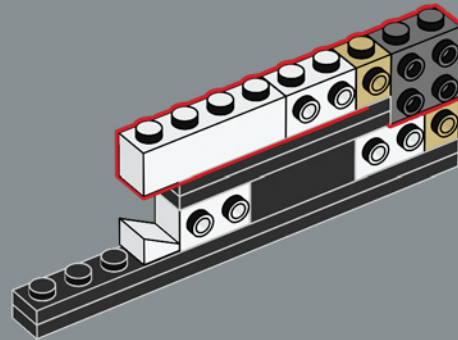

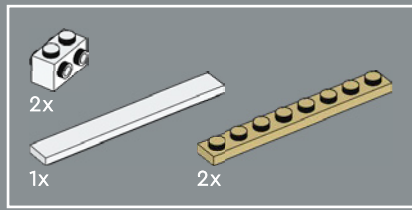

17

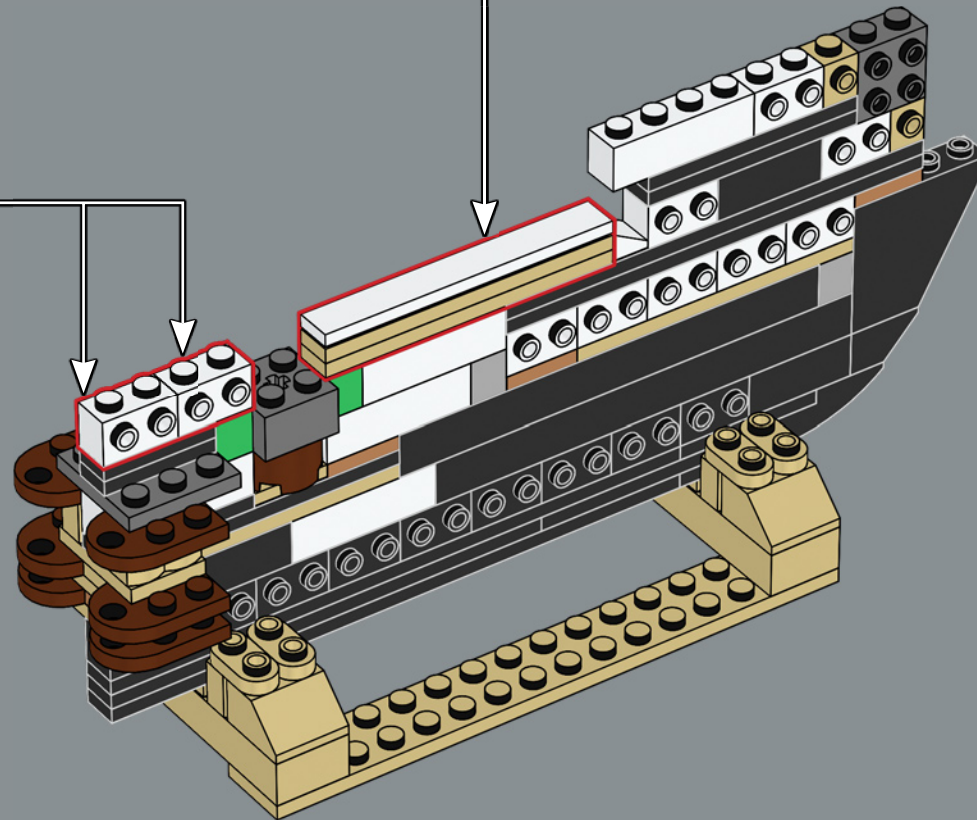
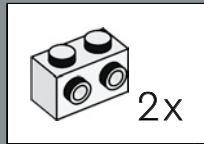
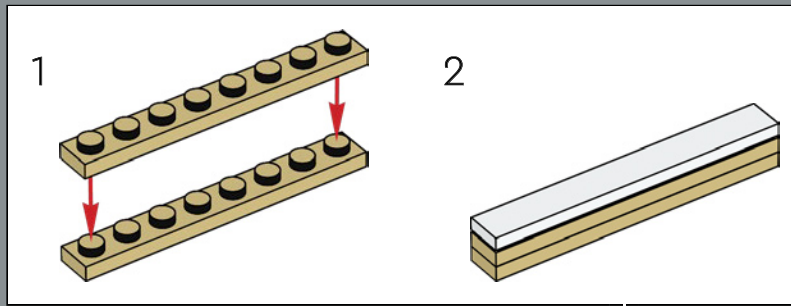

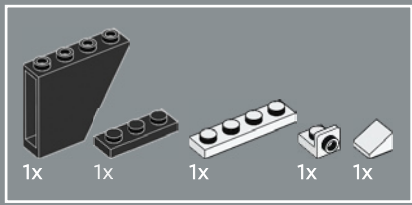

18

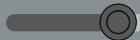
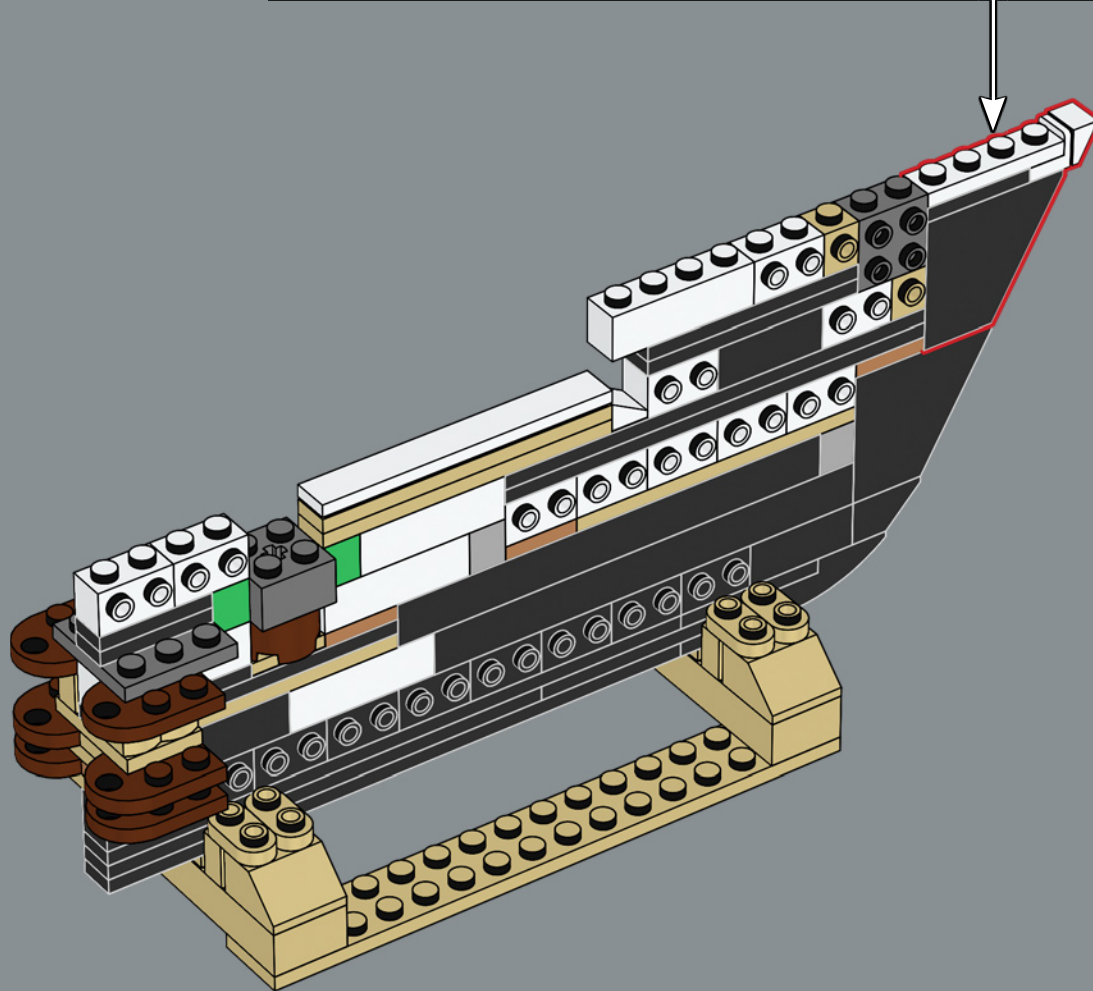
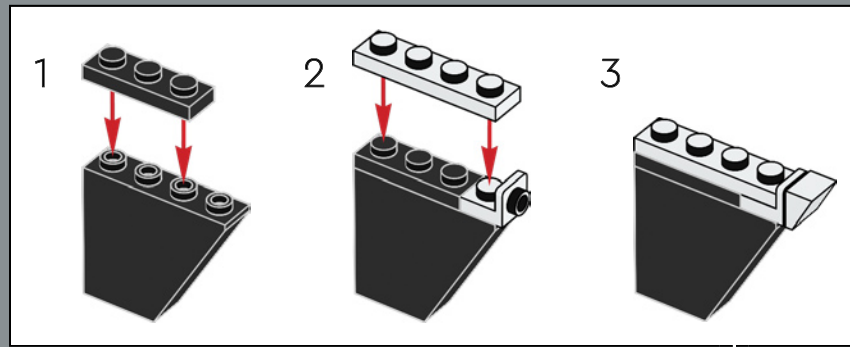

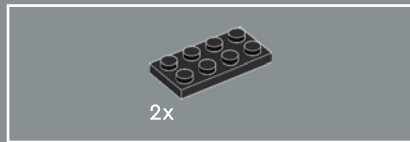
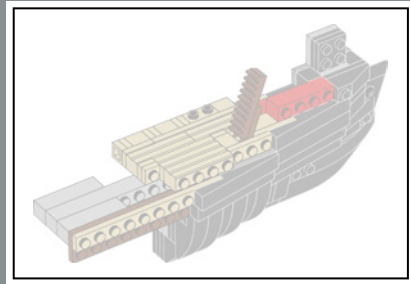

19

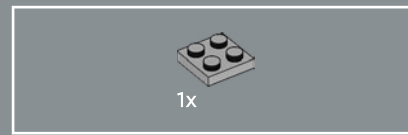
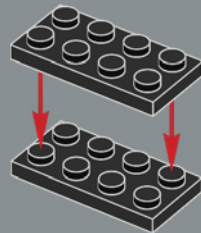

20

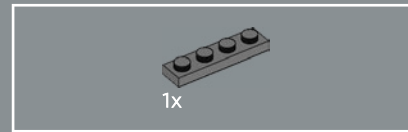
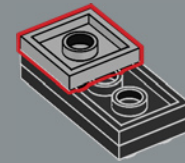

21

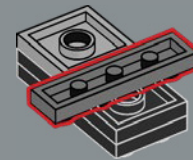

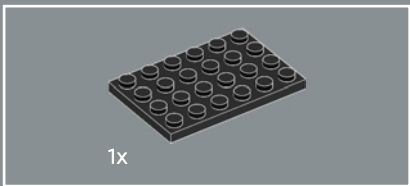

22

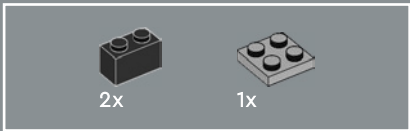
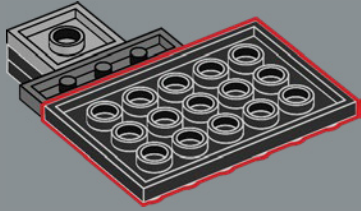

23

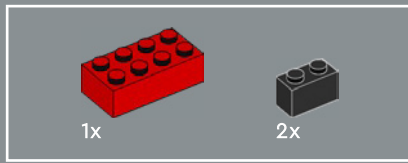
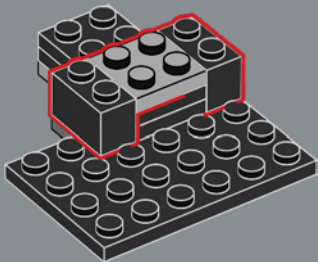

24

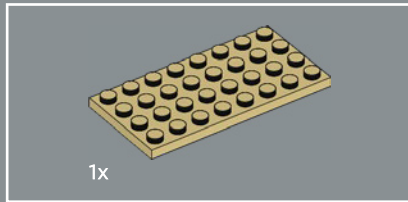
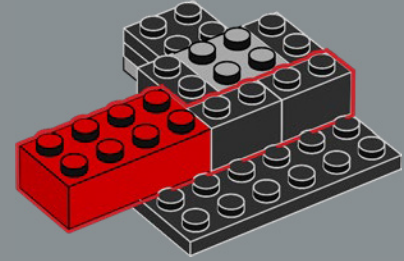

25

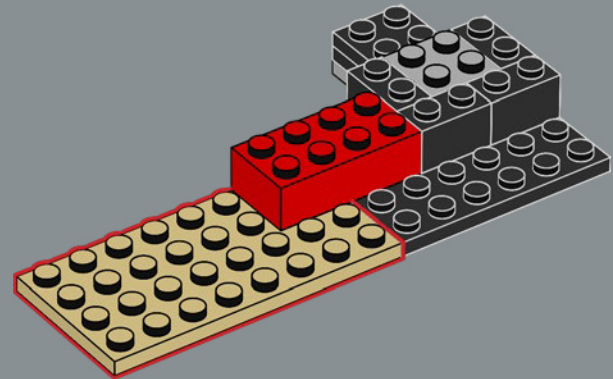

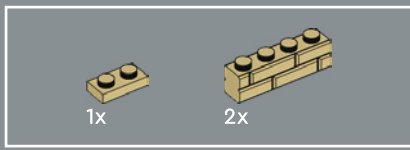

26

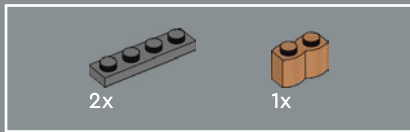
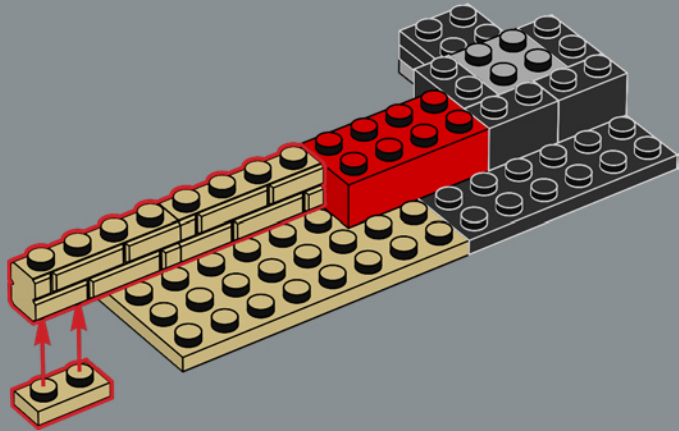

27

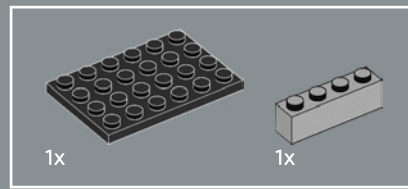
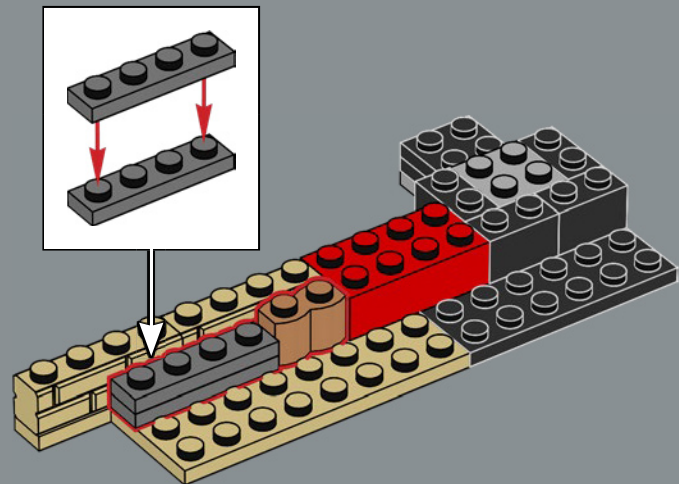

28

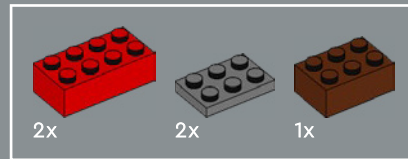
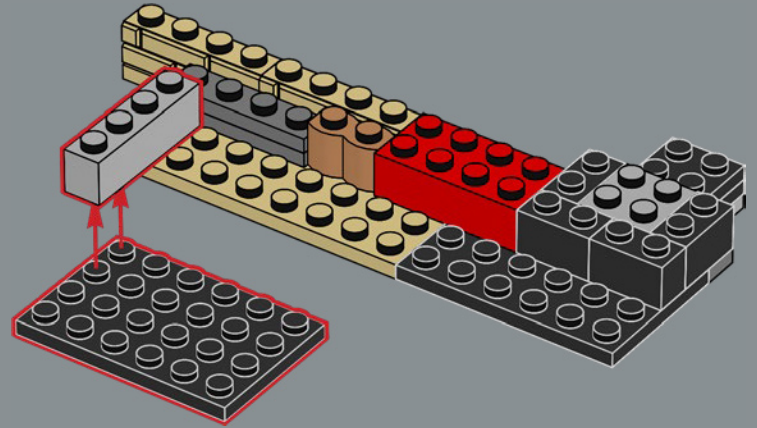

29

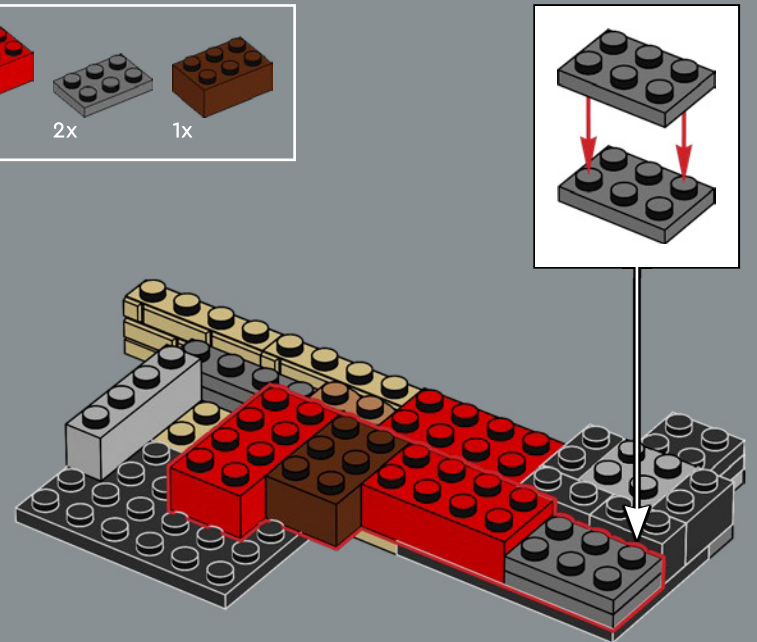

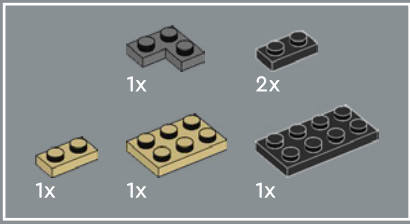

30

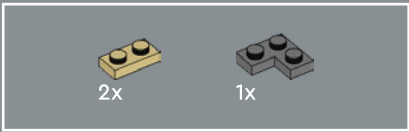
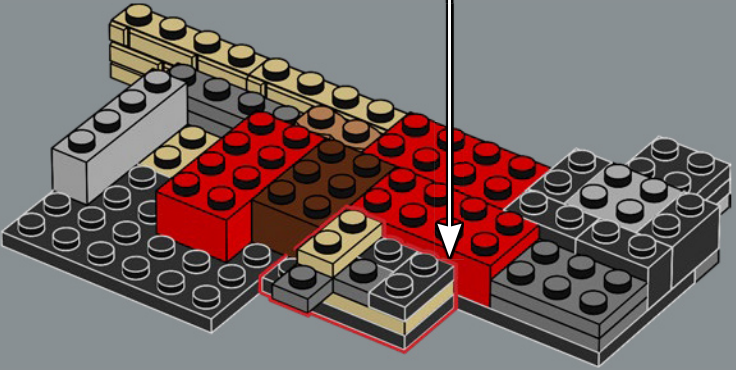
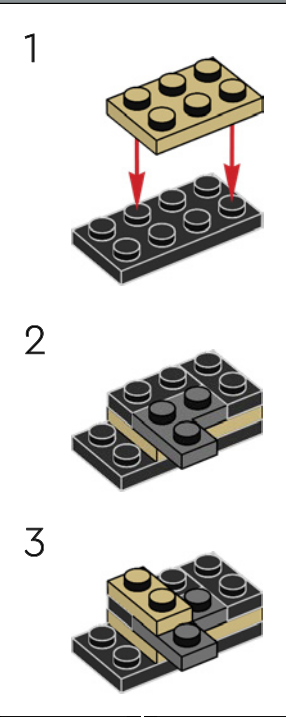

31

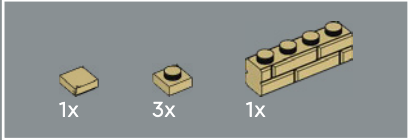
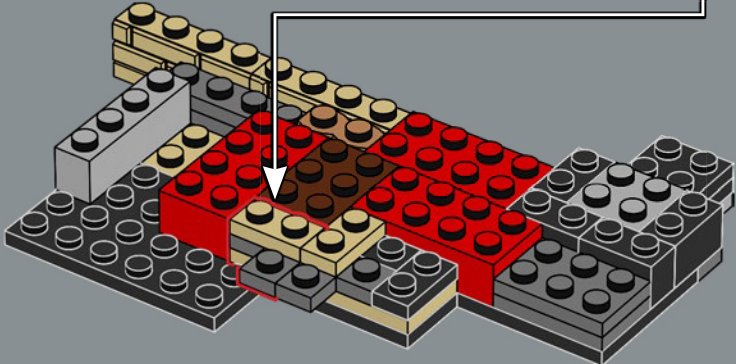
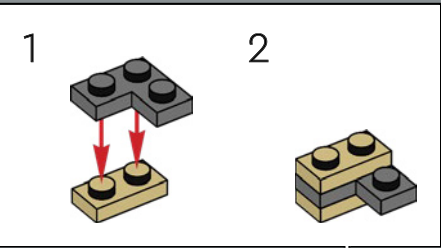

32

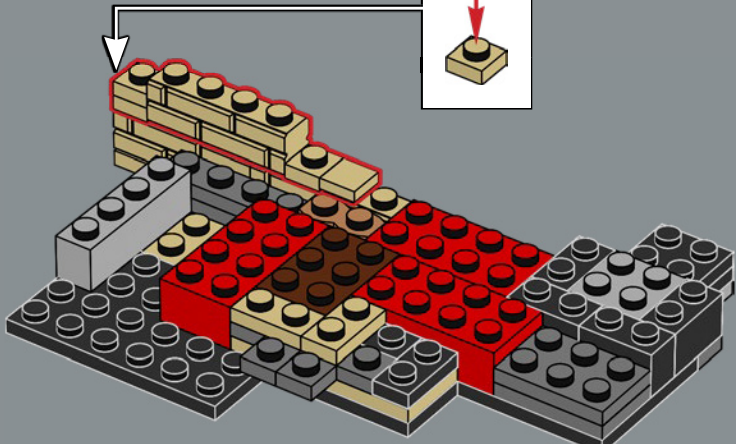
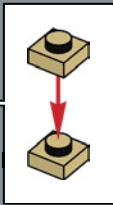

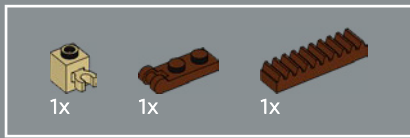

33

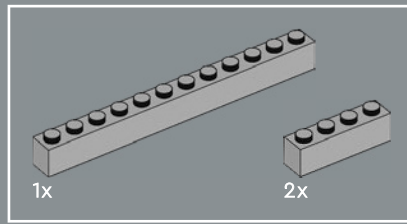
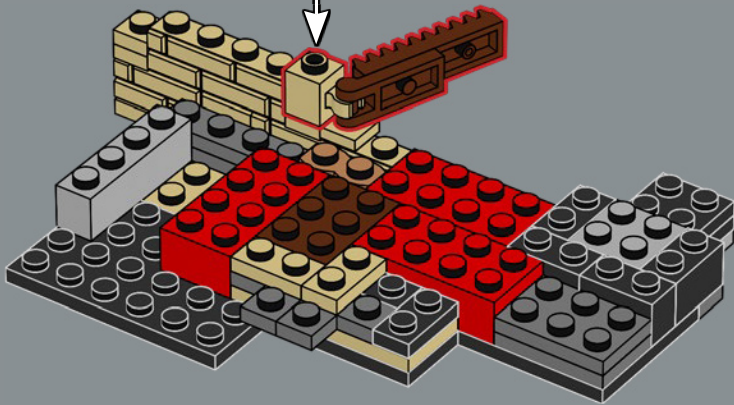
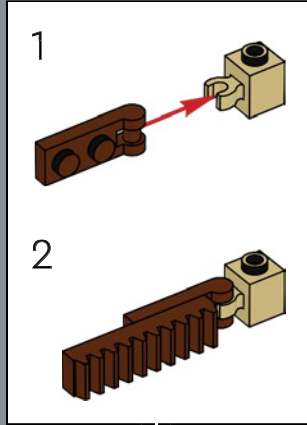

34

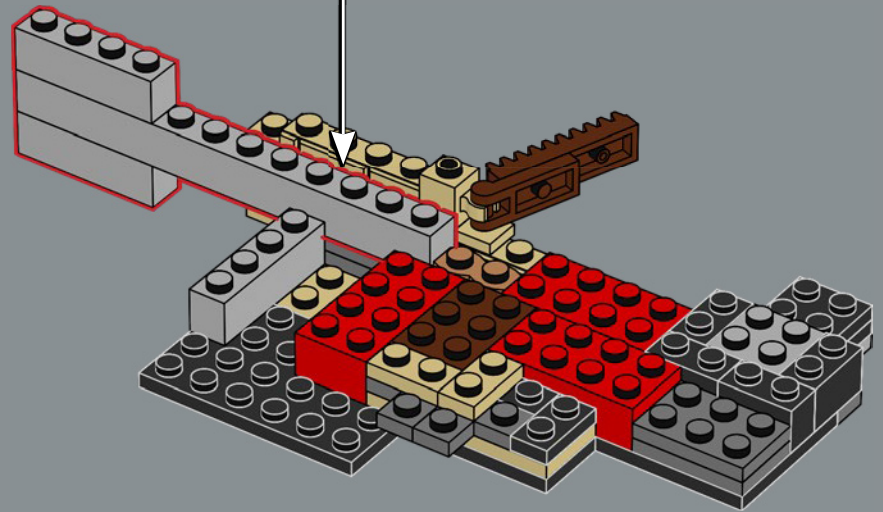
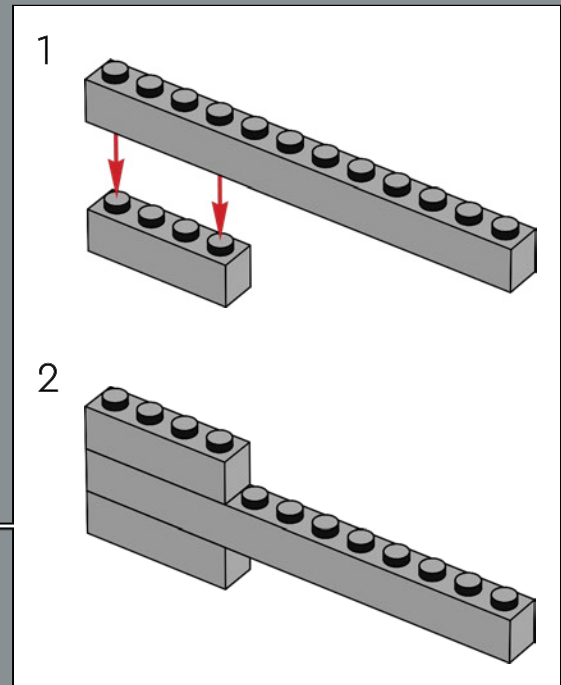

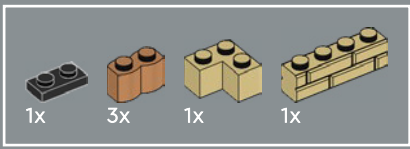

35

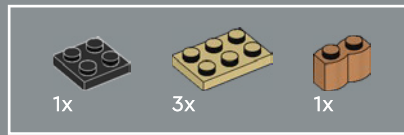
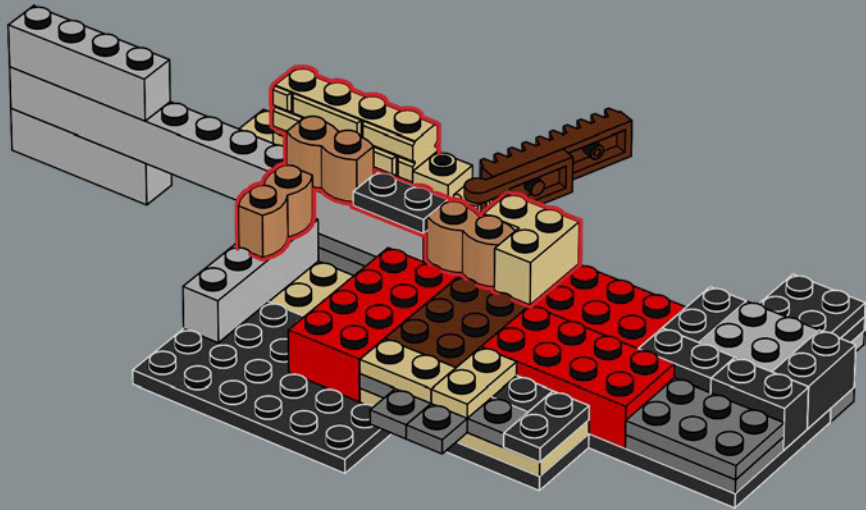

36

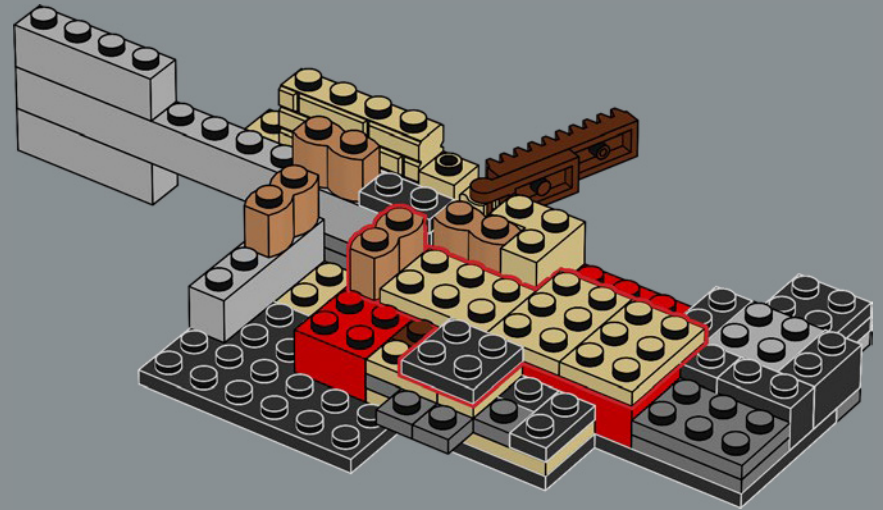

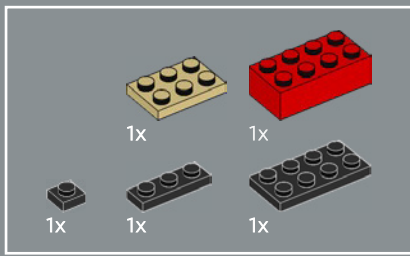

37

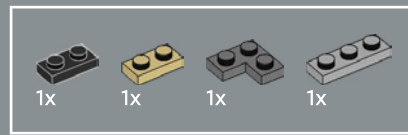
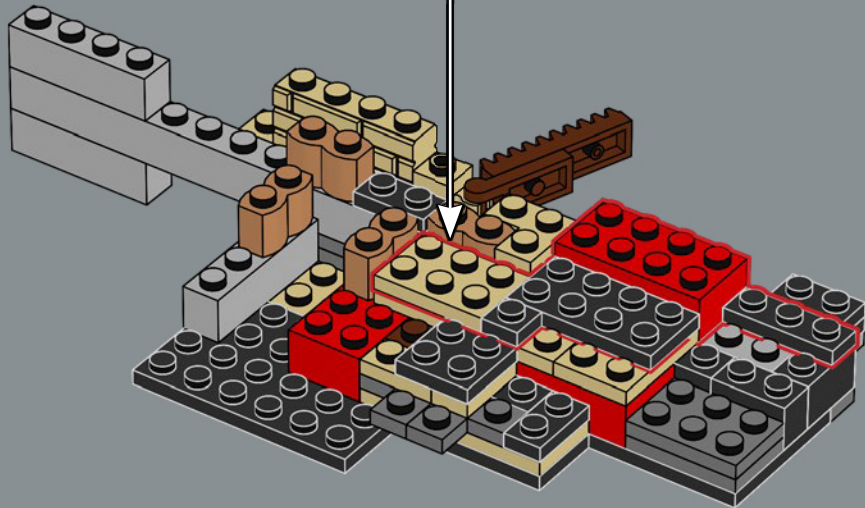
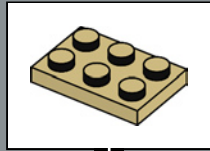

38

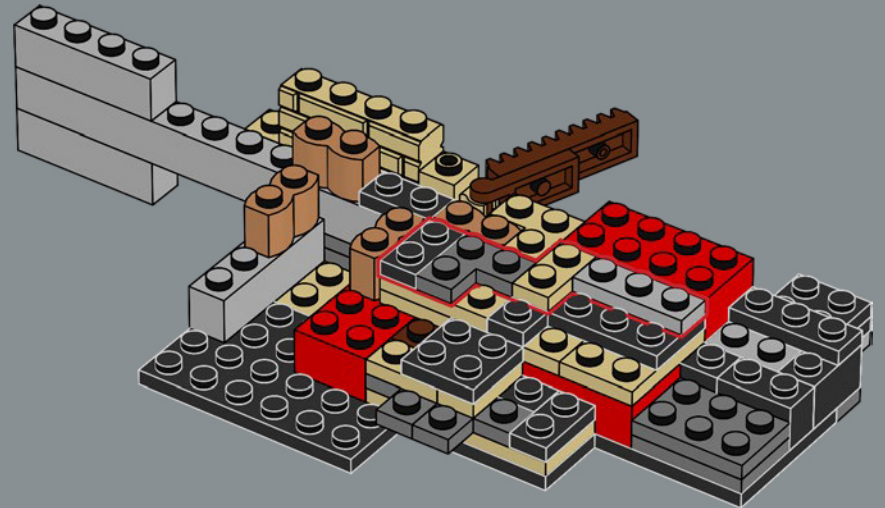

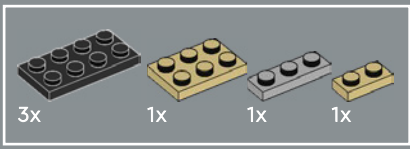

39

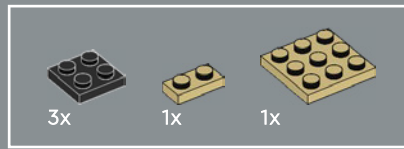
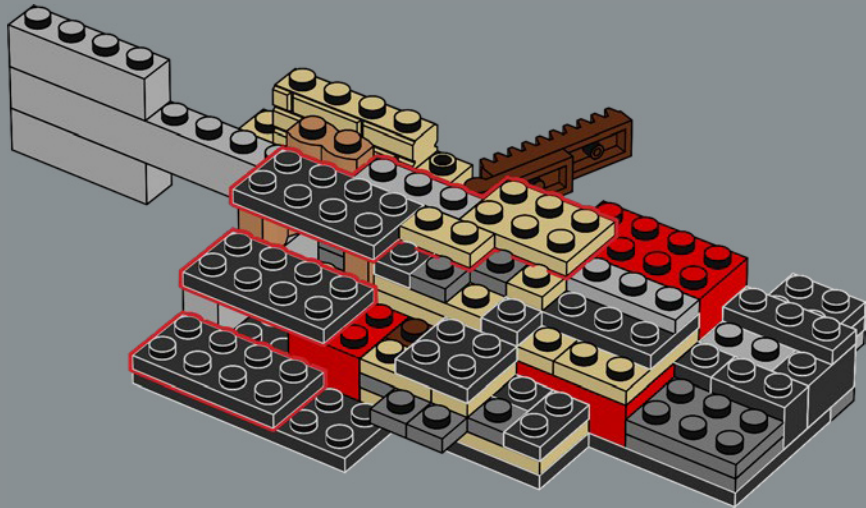

40

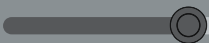
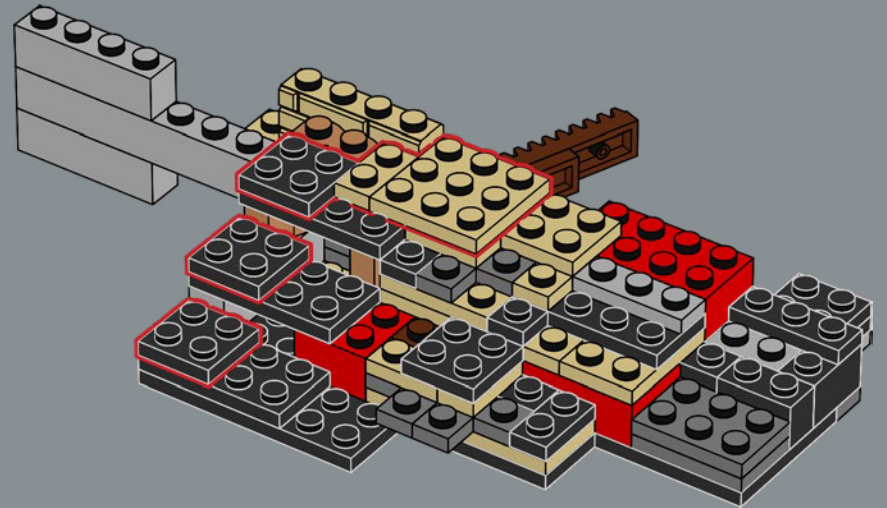

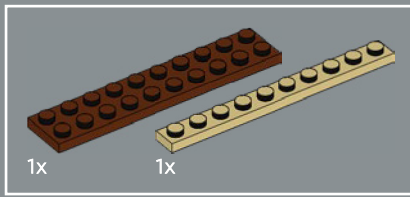

41

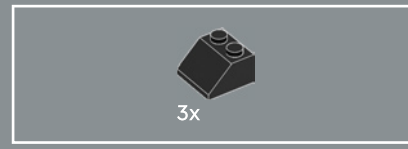
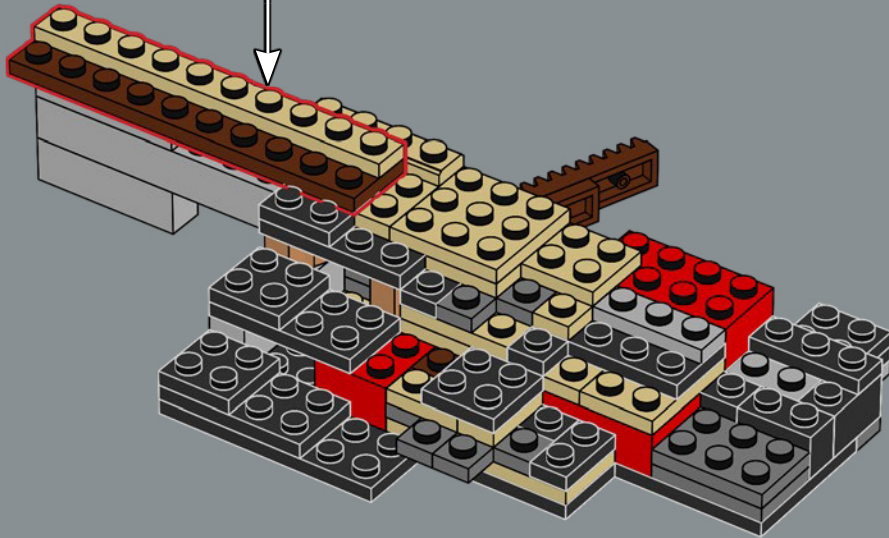
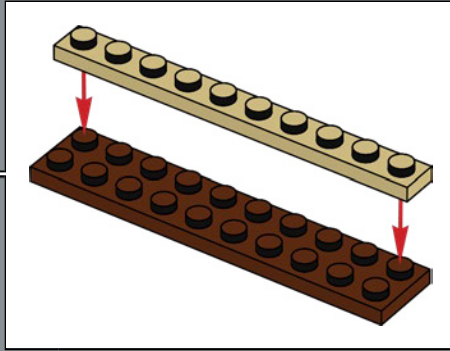

42

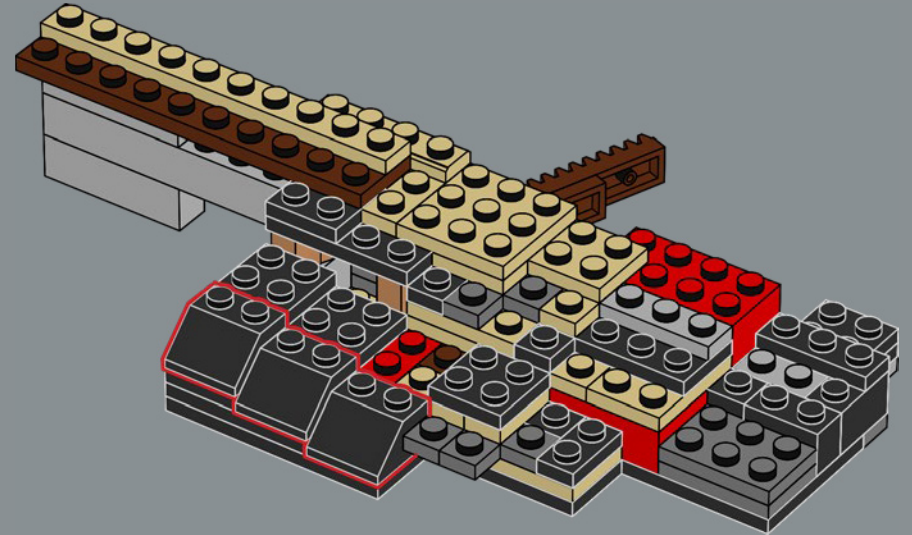



43

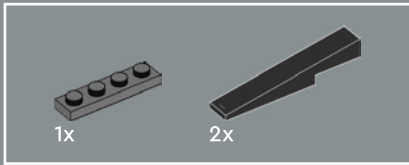
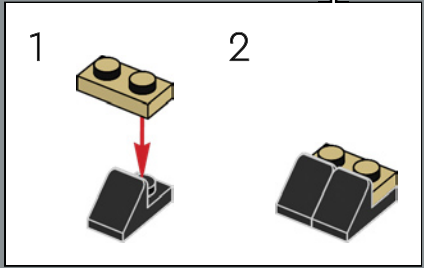
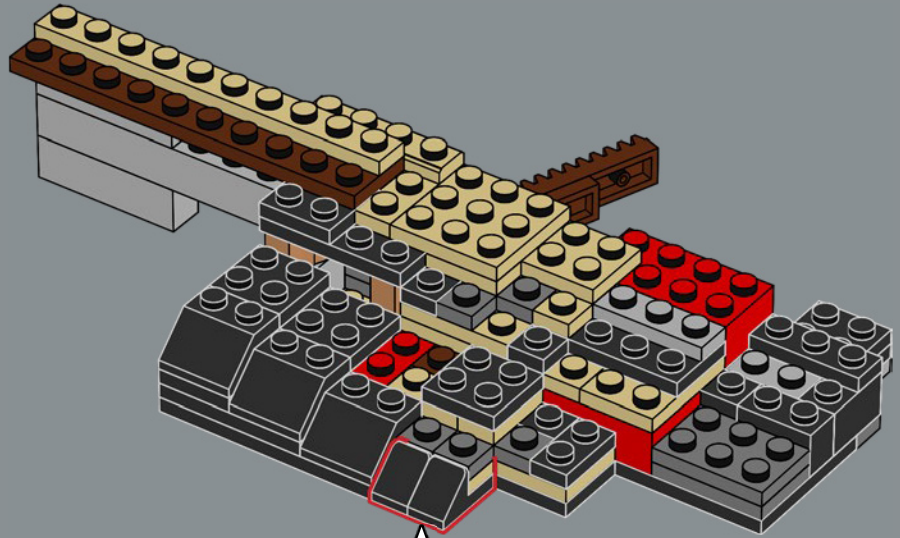

44

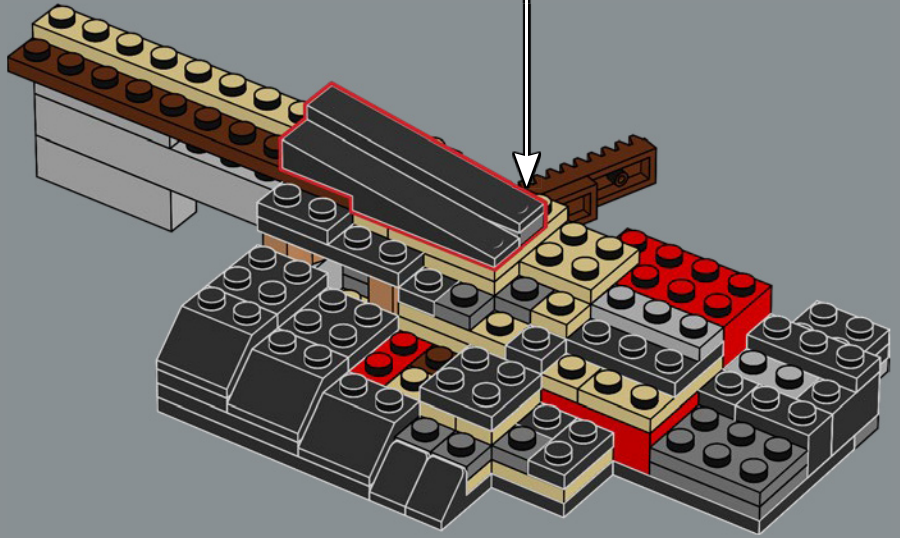
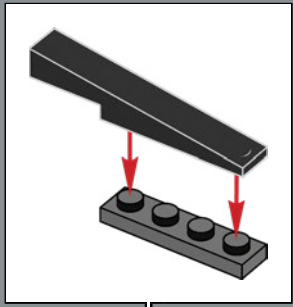



45

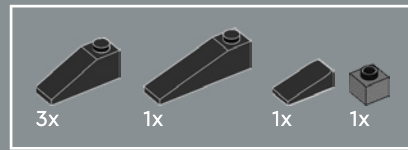
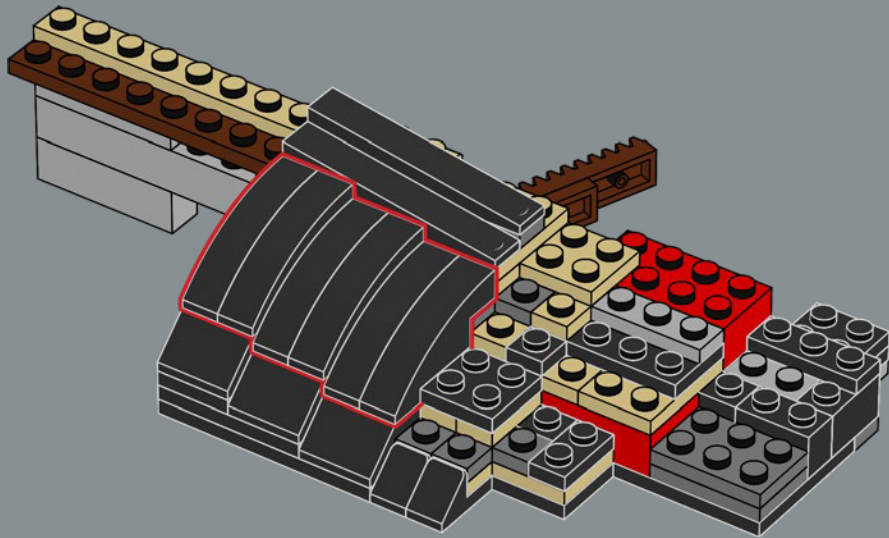

46

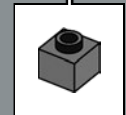
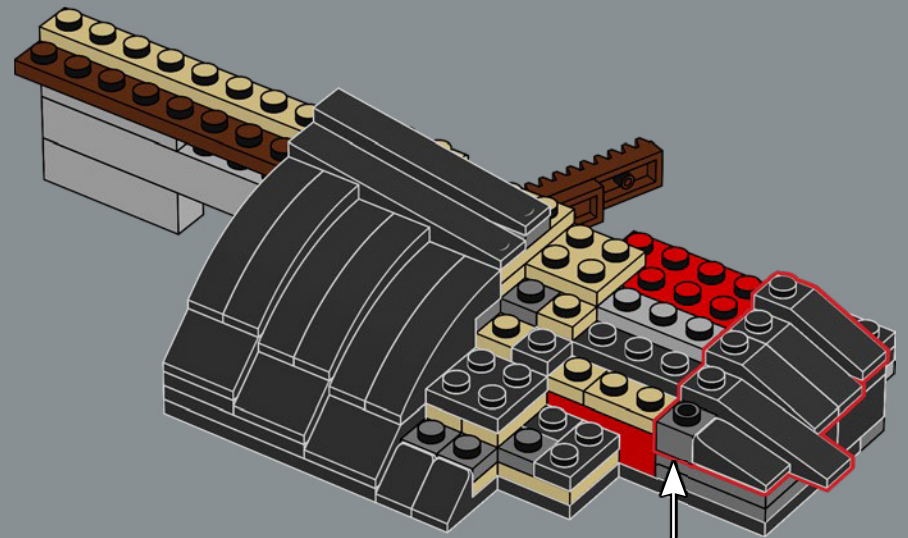

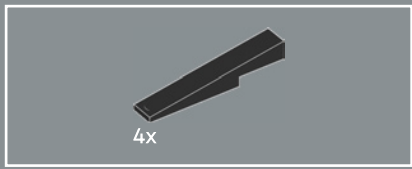

47

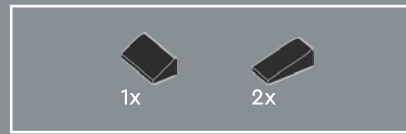
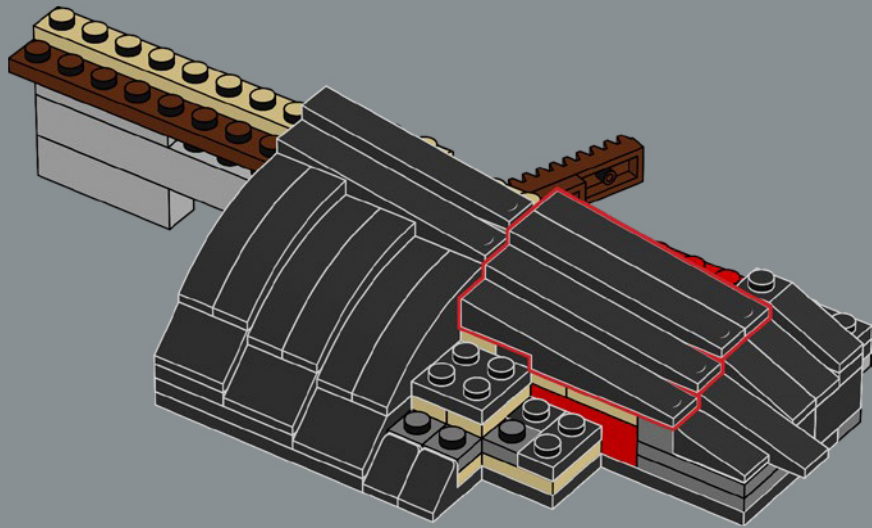

48

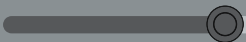
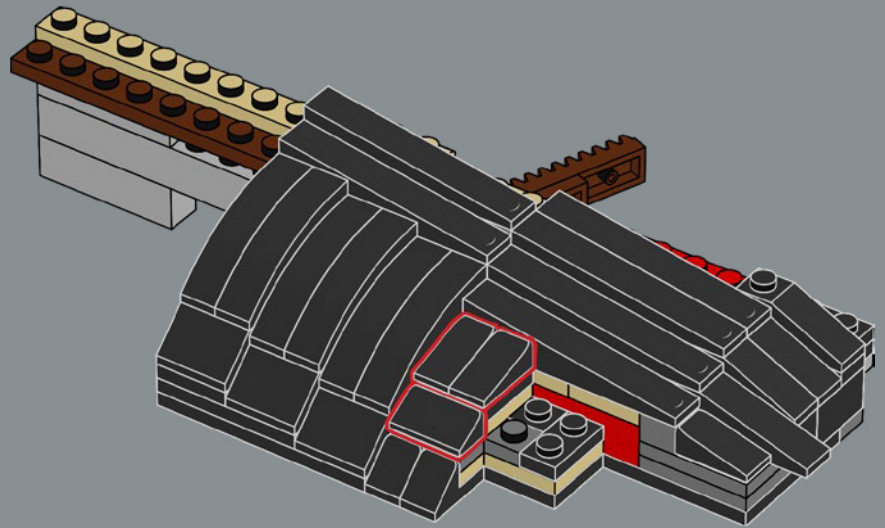

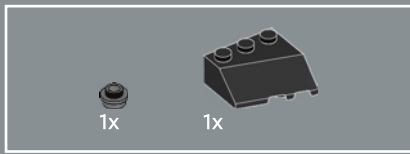

49

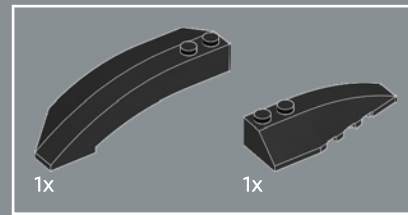
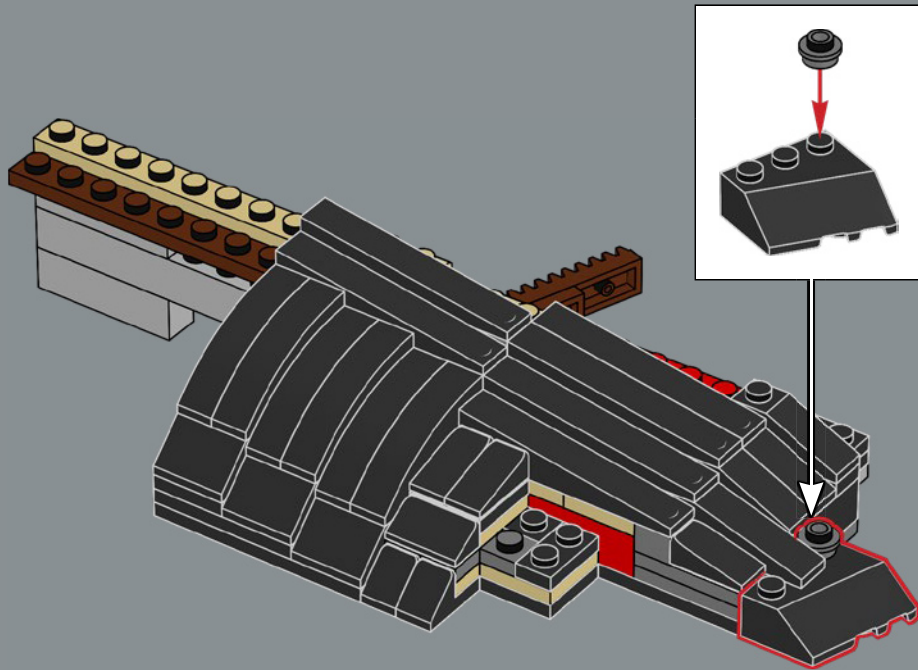

50

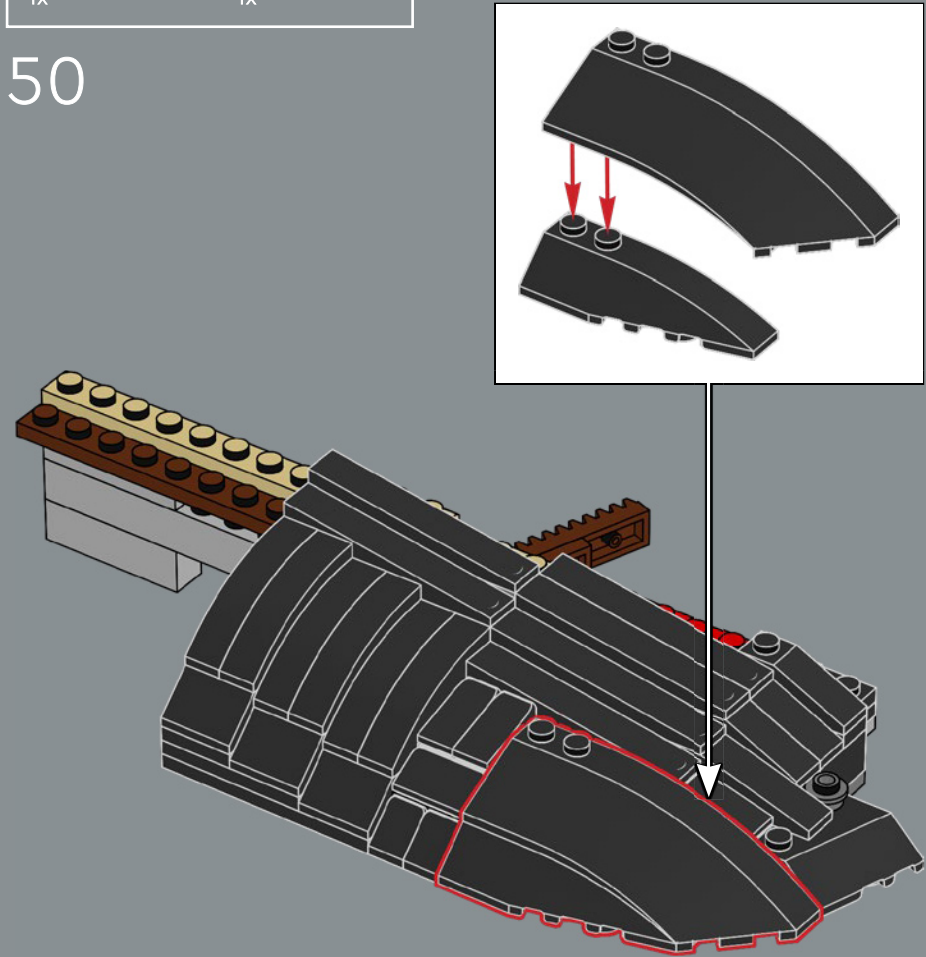



51

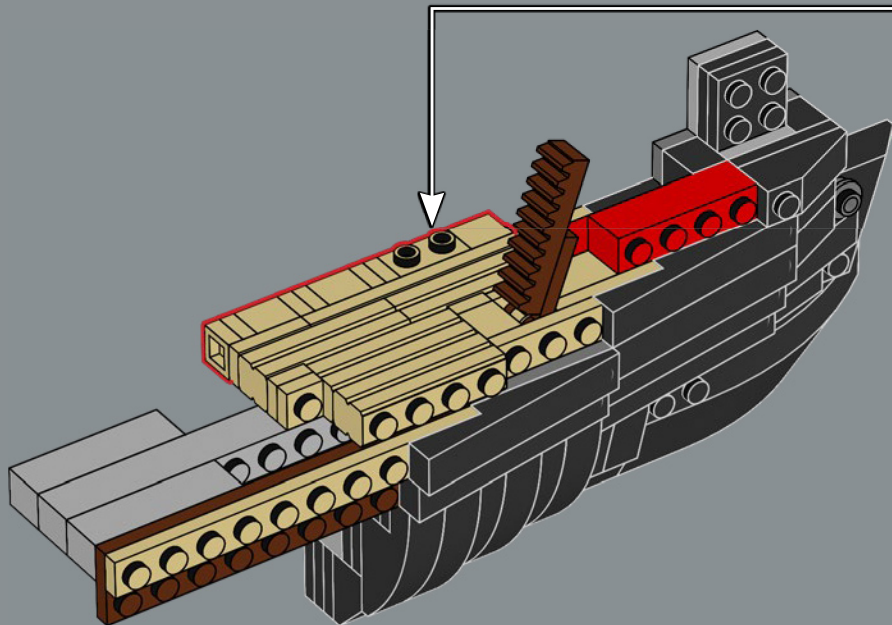
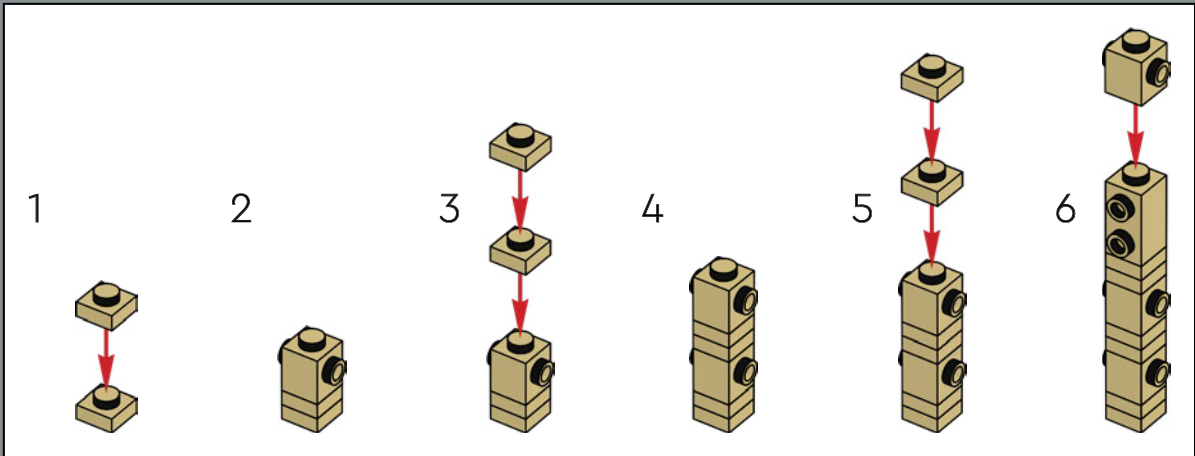

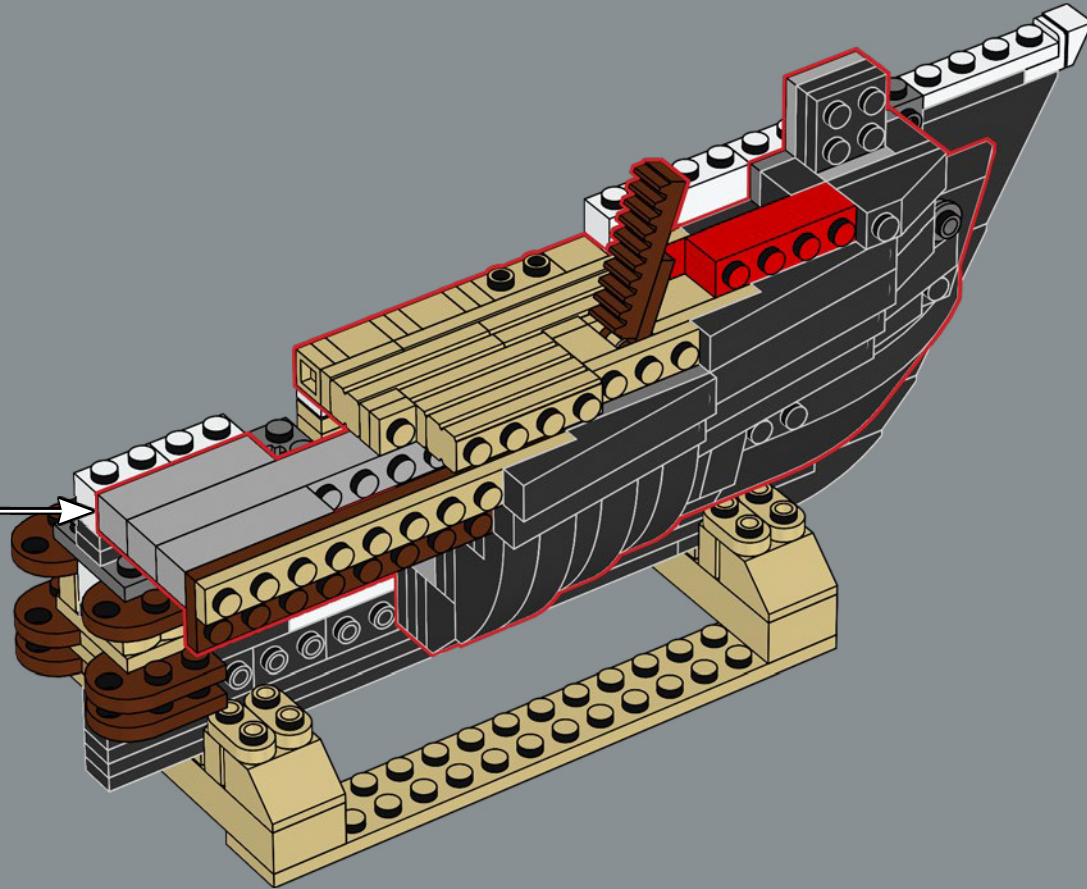

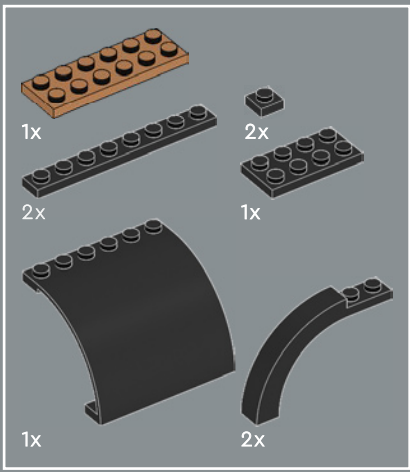

53

1

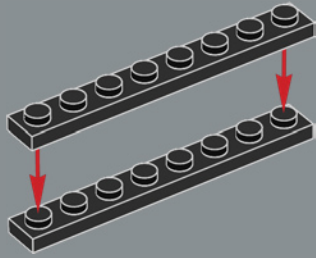

2

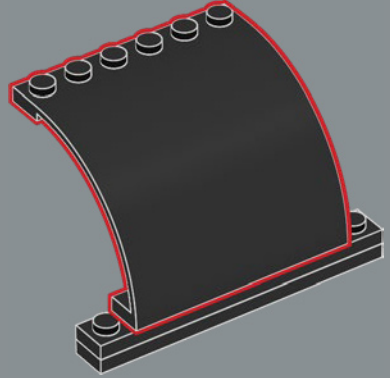

3

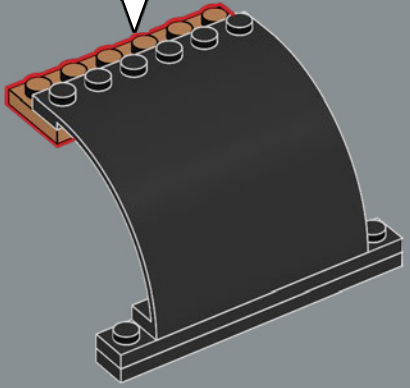
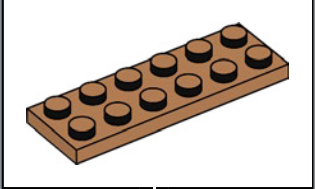

4

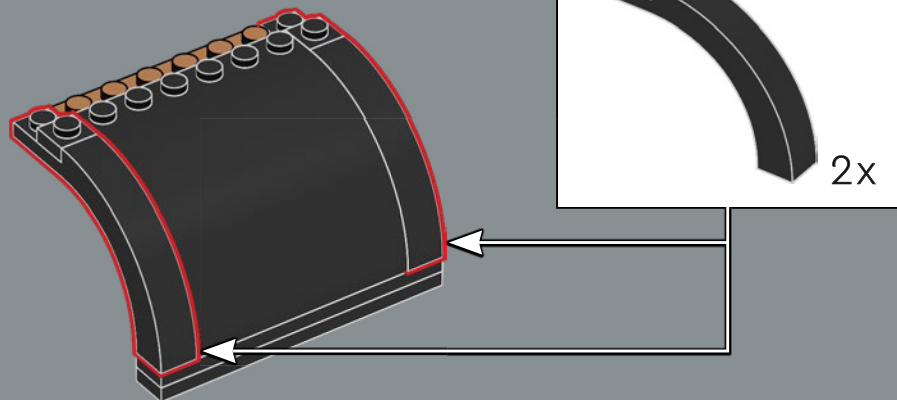

5

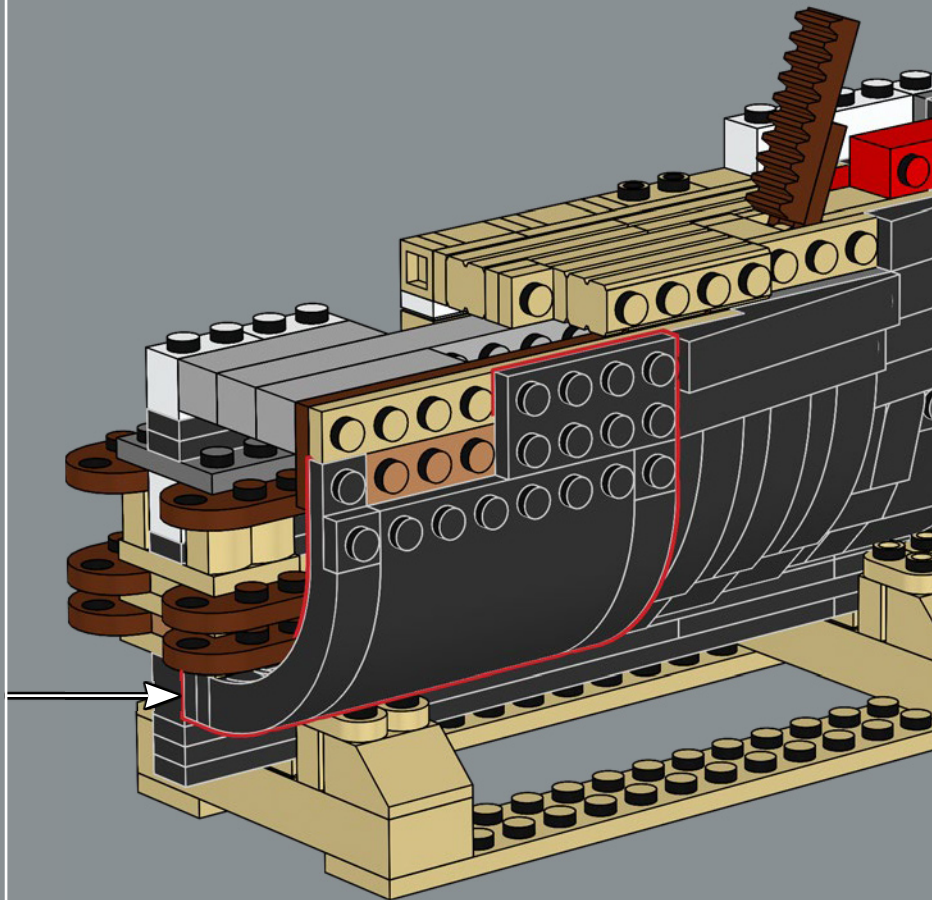
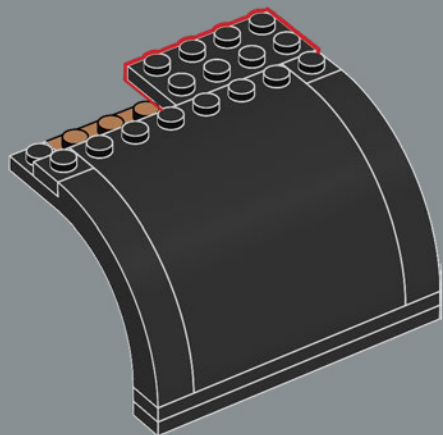

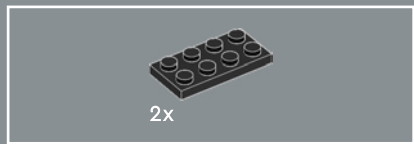
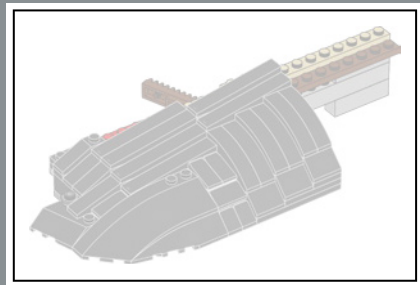

2x

54

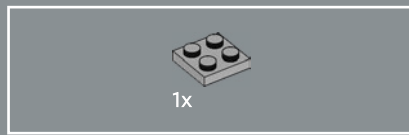
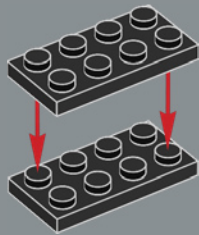

1x

55

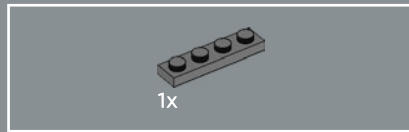
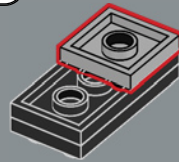

1x

56

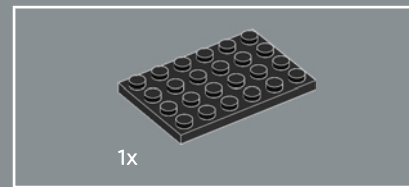
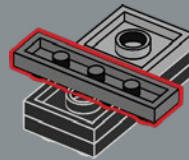

1x

57

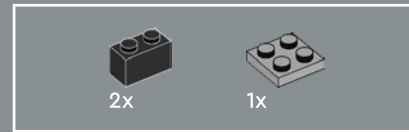
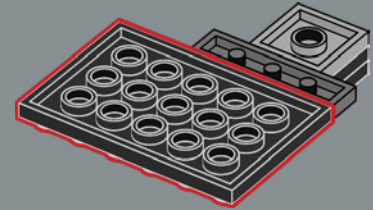

2x

1x

58

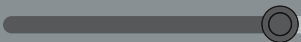
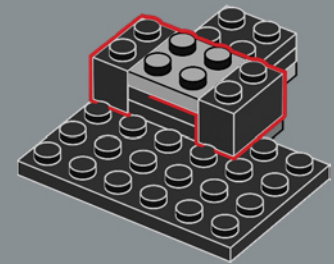

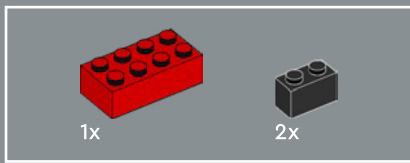

59

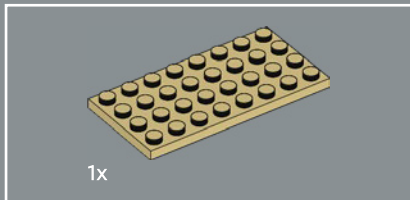
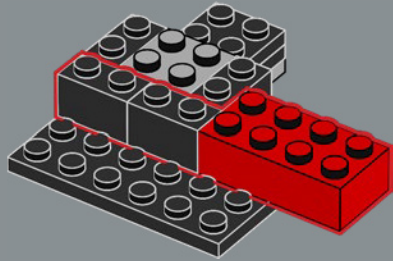

60

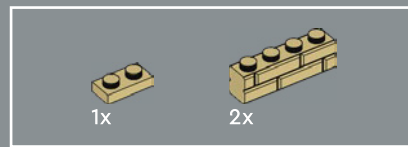
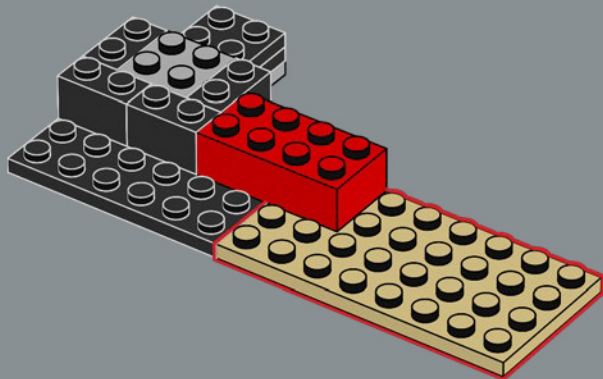

61

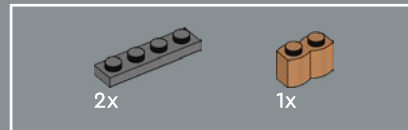
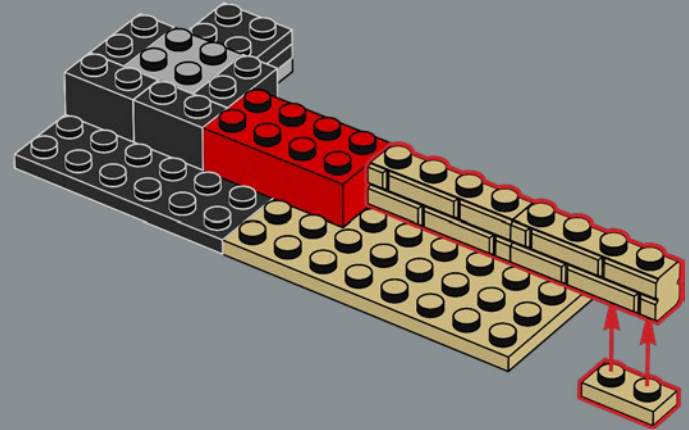

62

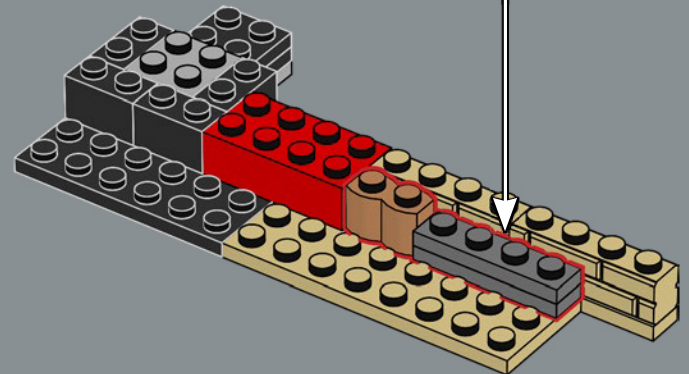
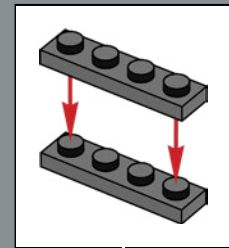

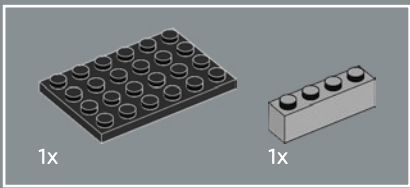

63

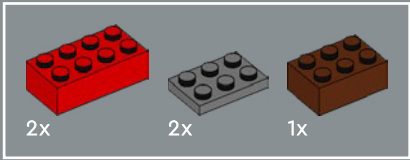
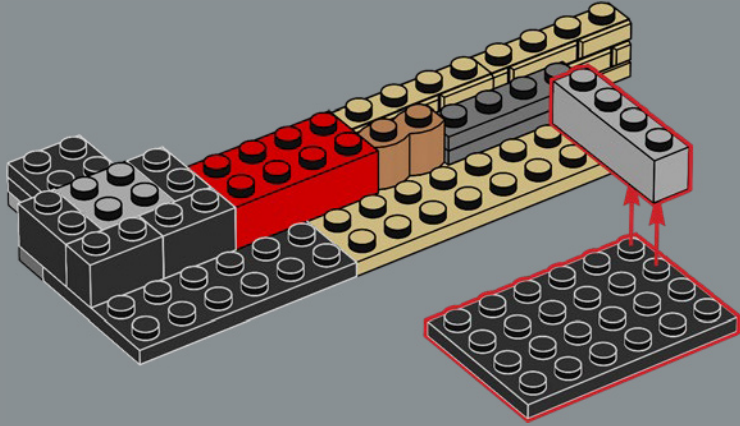

64

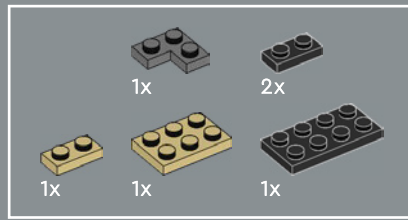
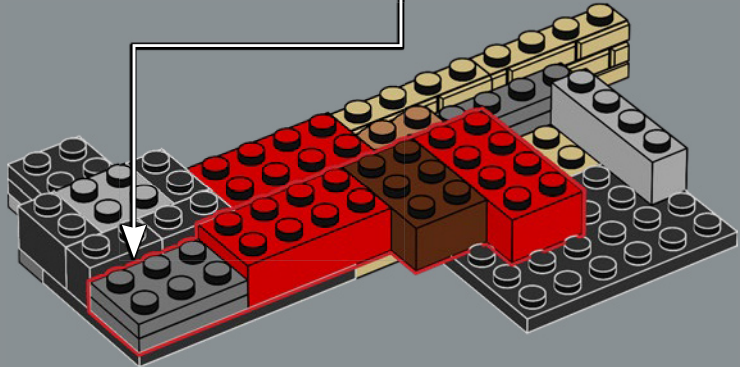
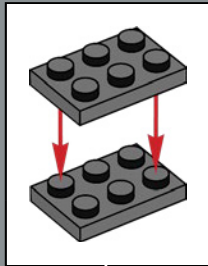

65

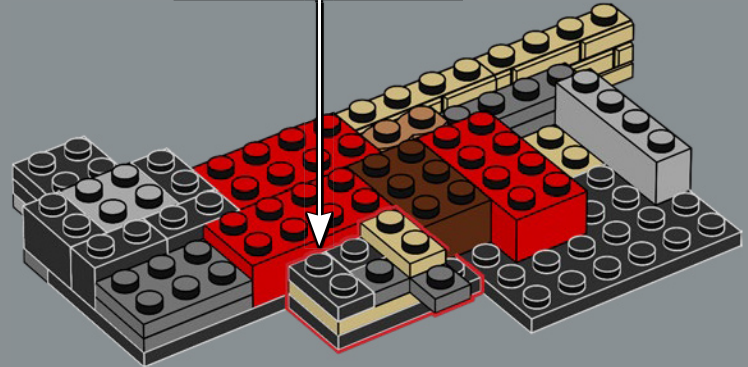
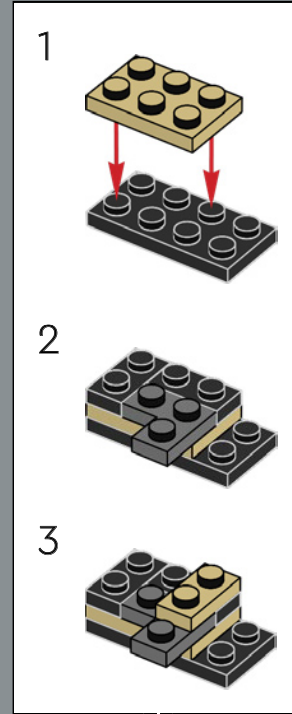



66

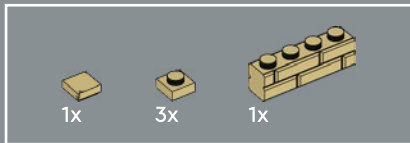
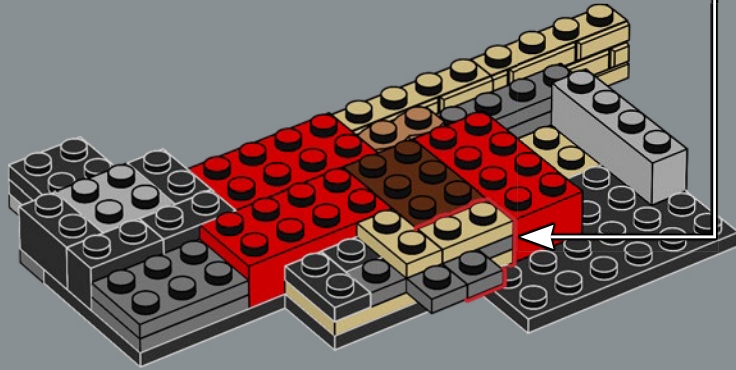
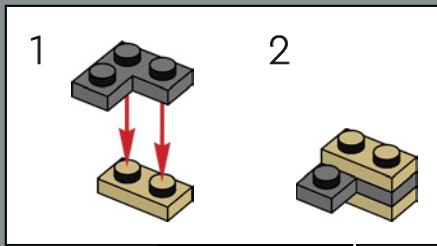

67

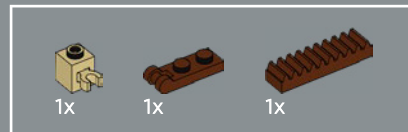
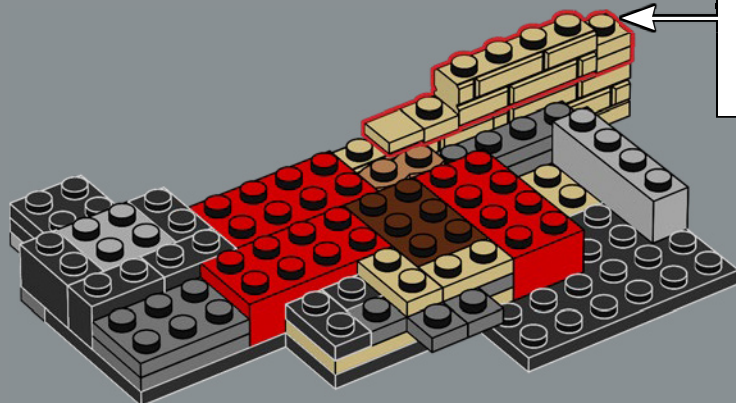
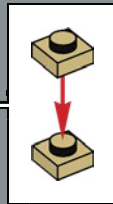

68

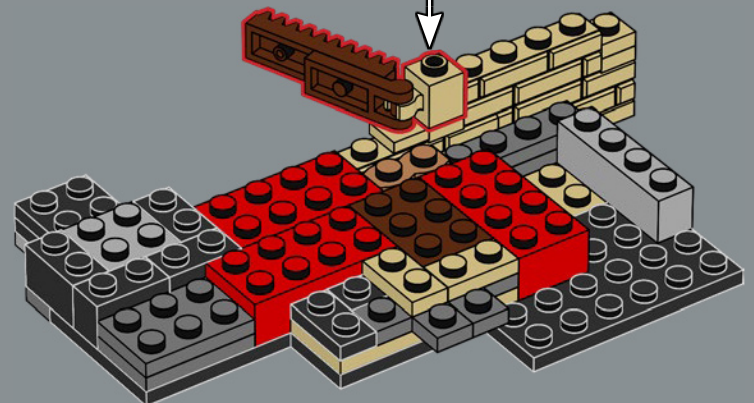
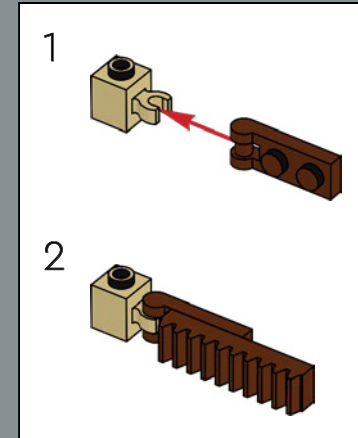

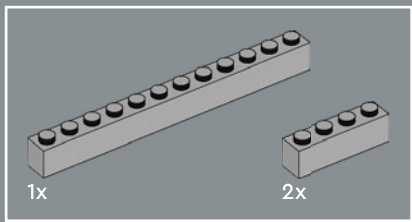

69

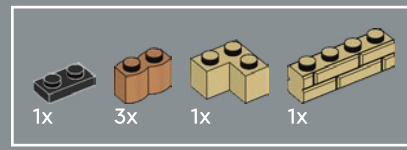
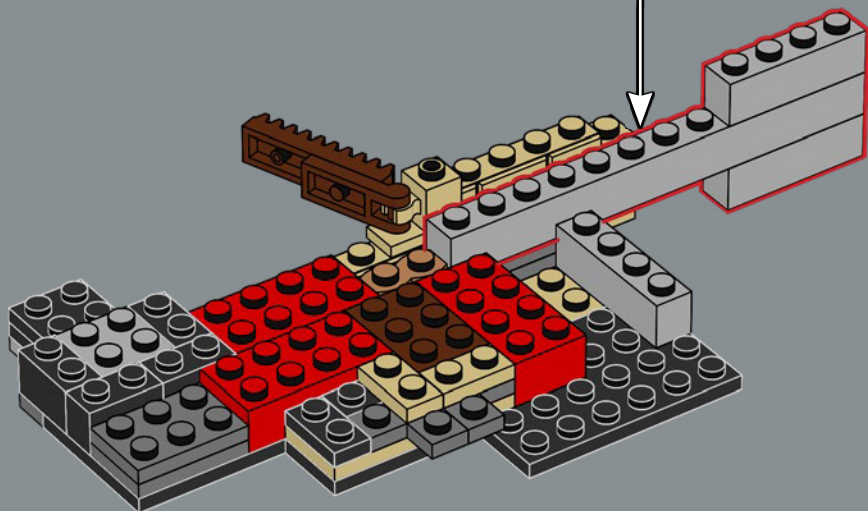
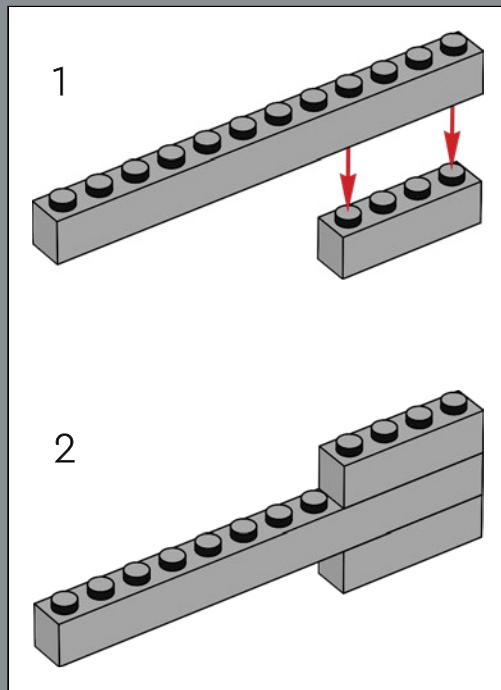

70

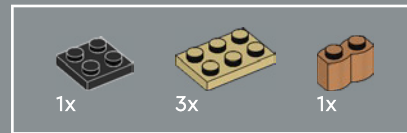
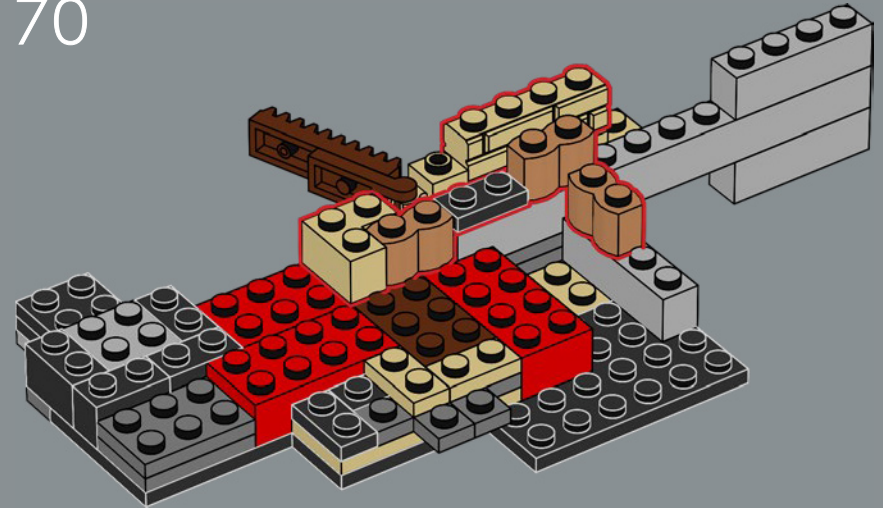

71

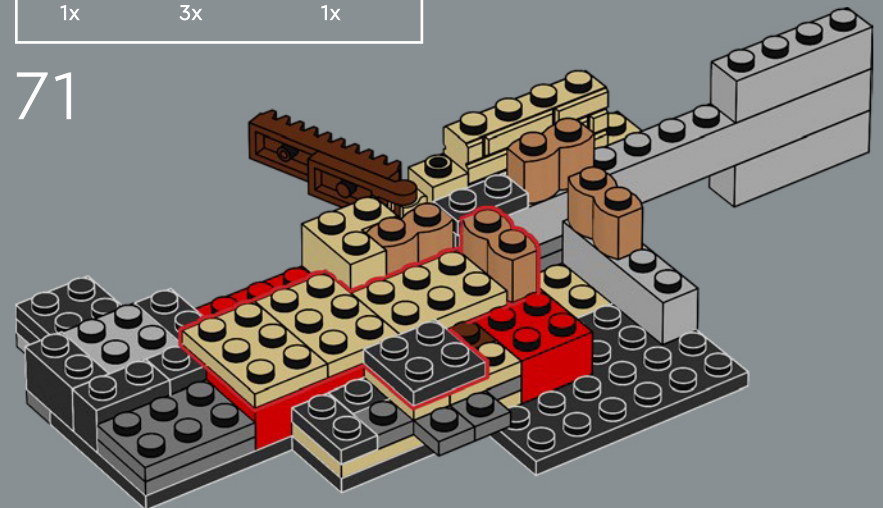

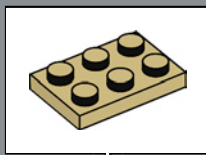
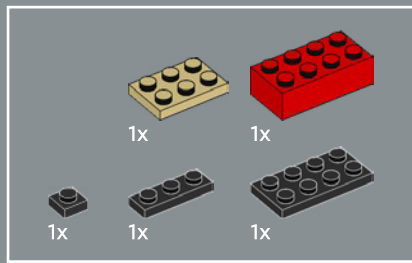

72

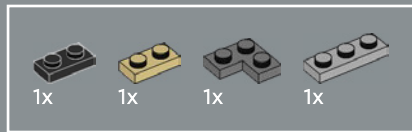
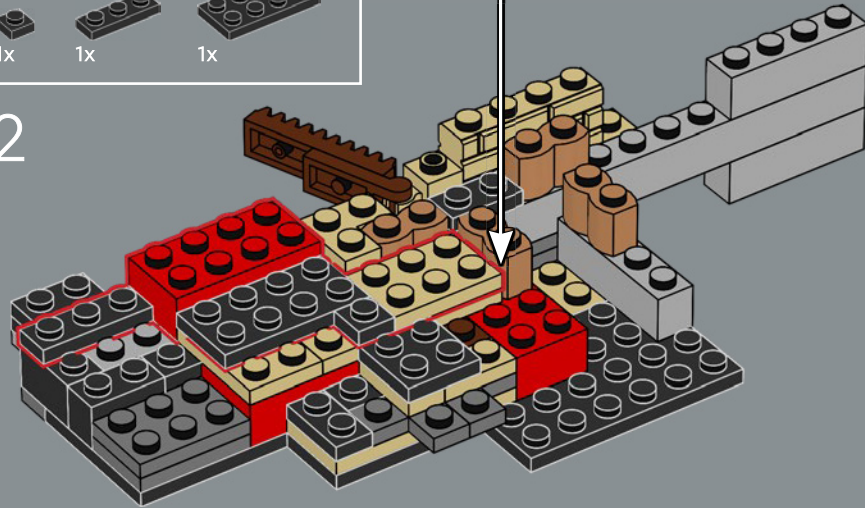

73

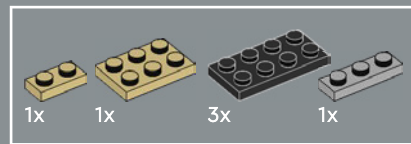
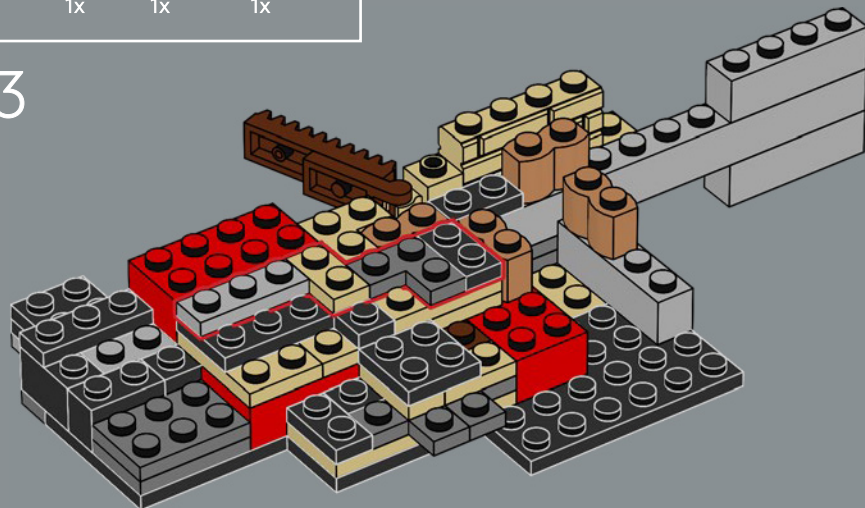

74

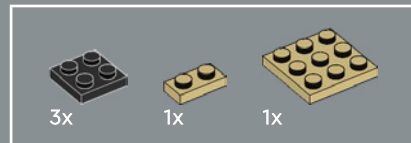
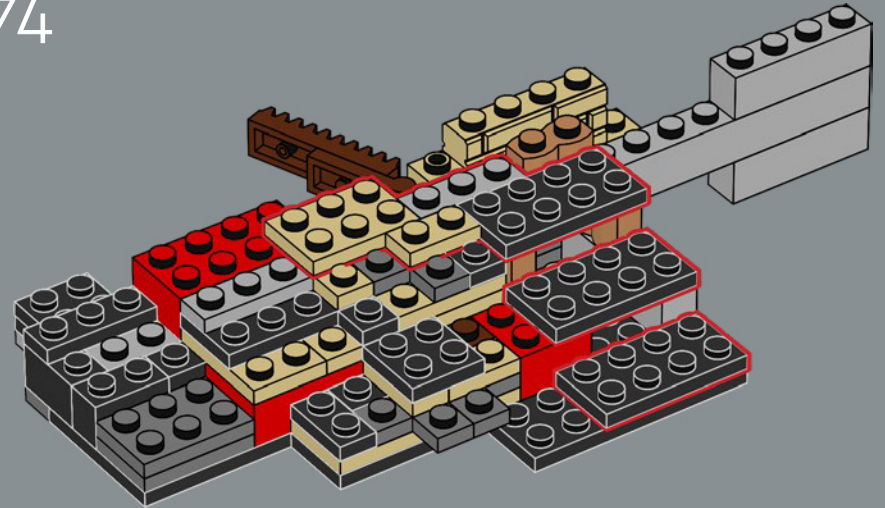

75

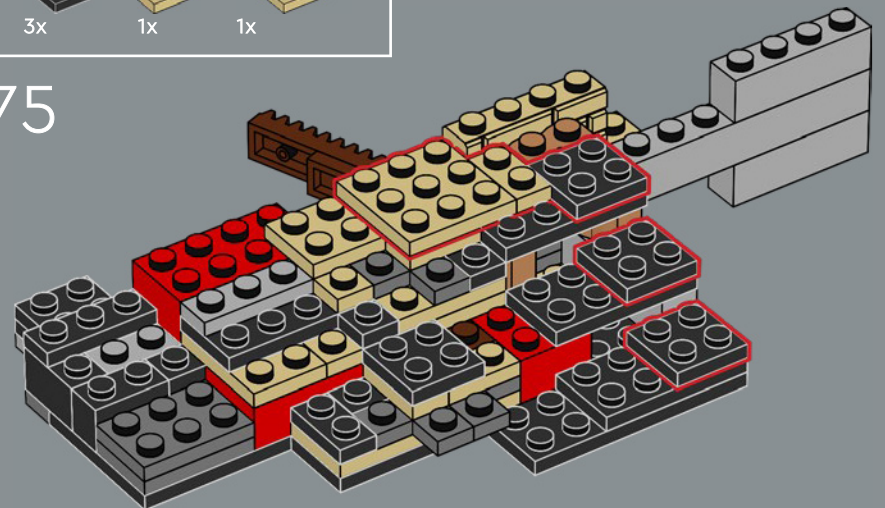

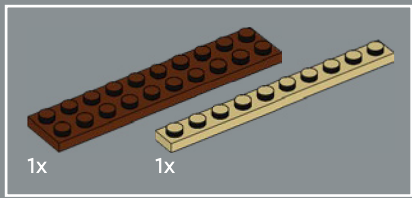

76

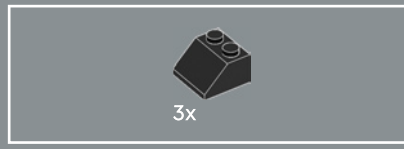
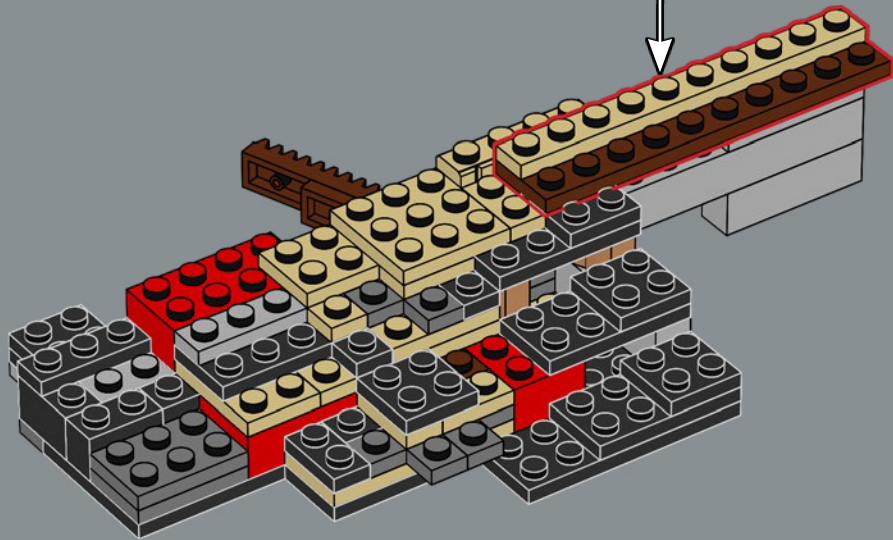
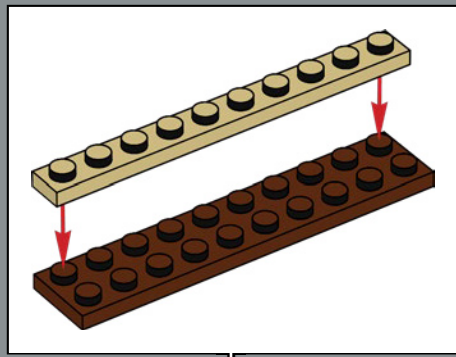

77

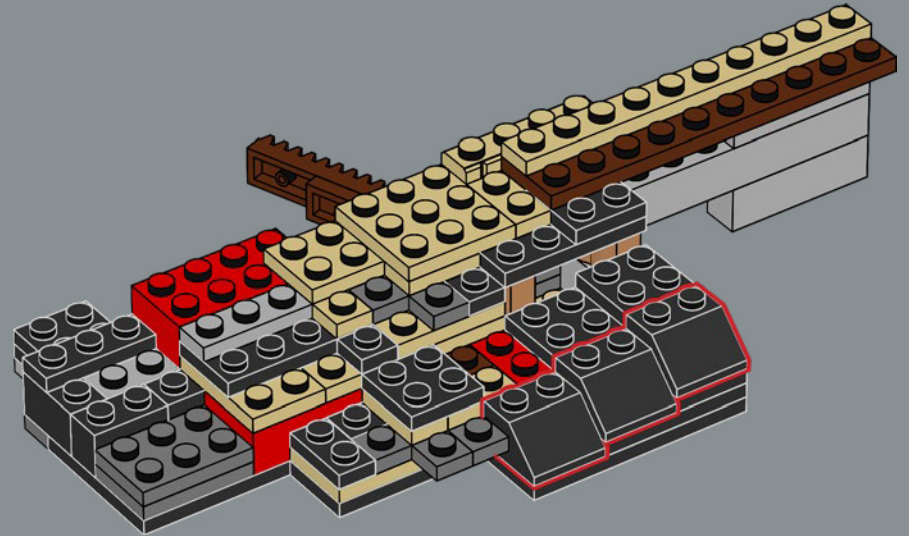



78

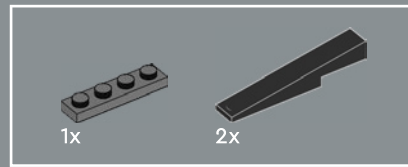
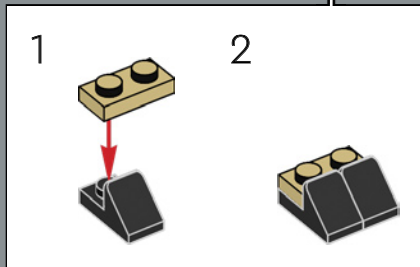
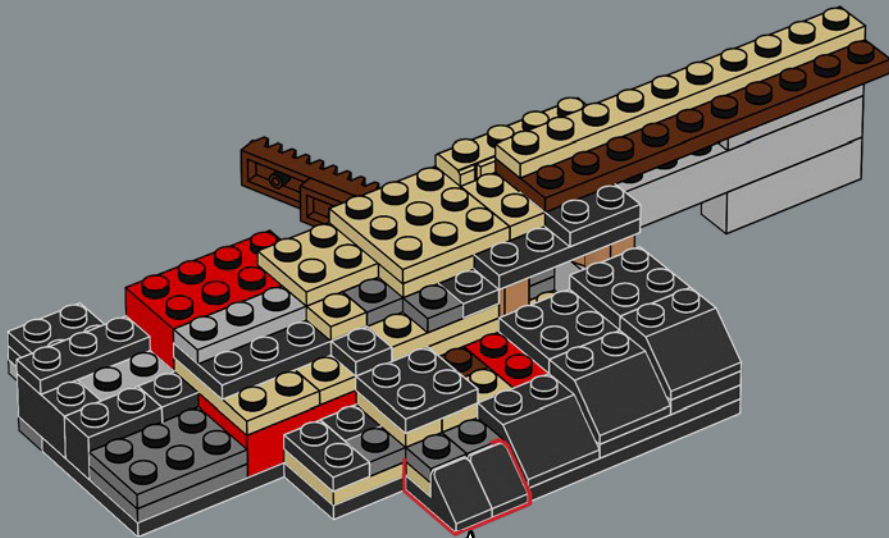

79

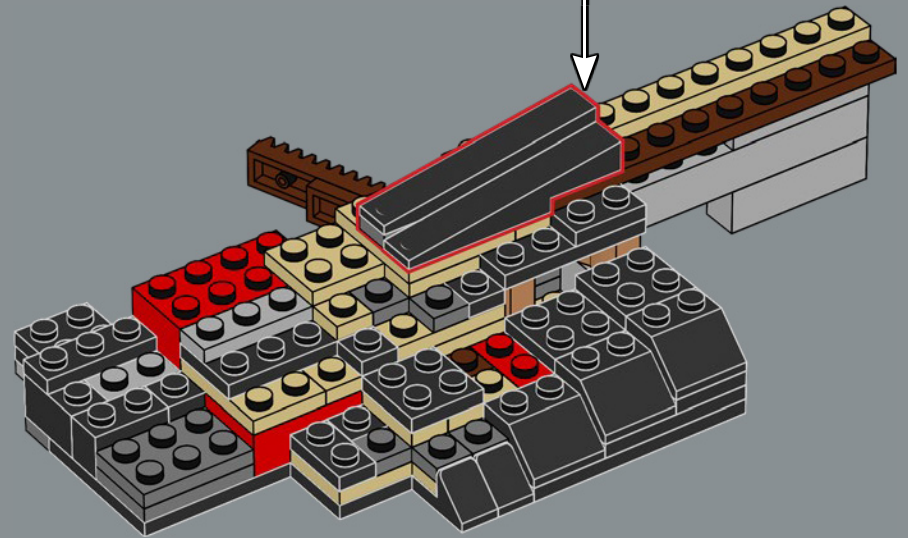
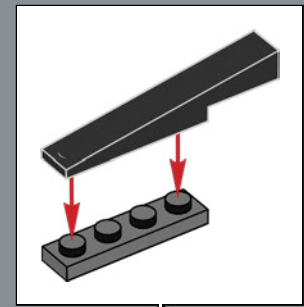



80

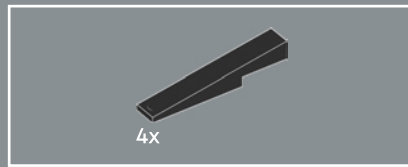
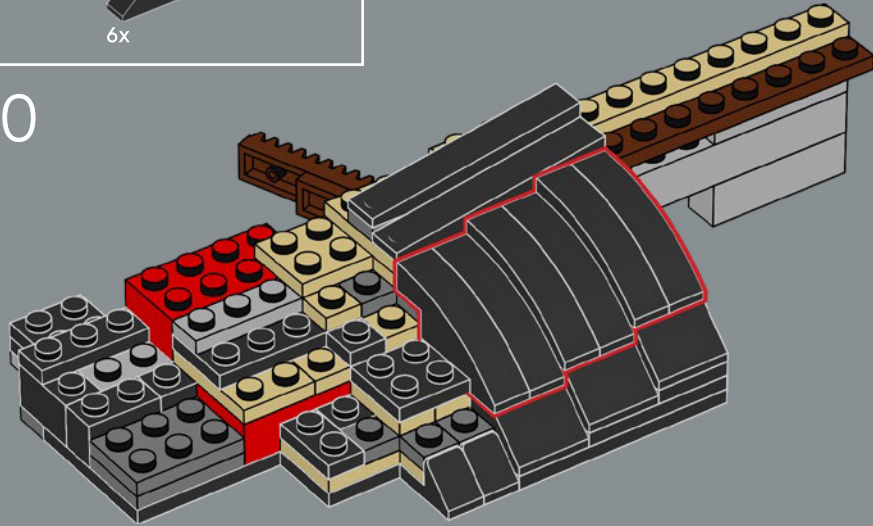

82

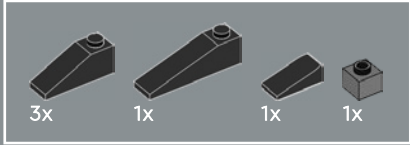
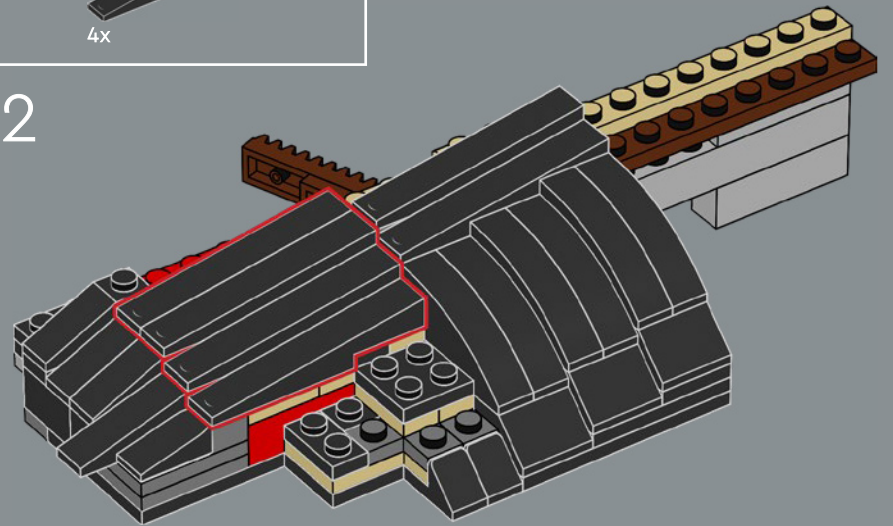

81

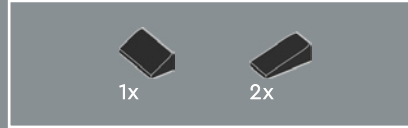
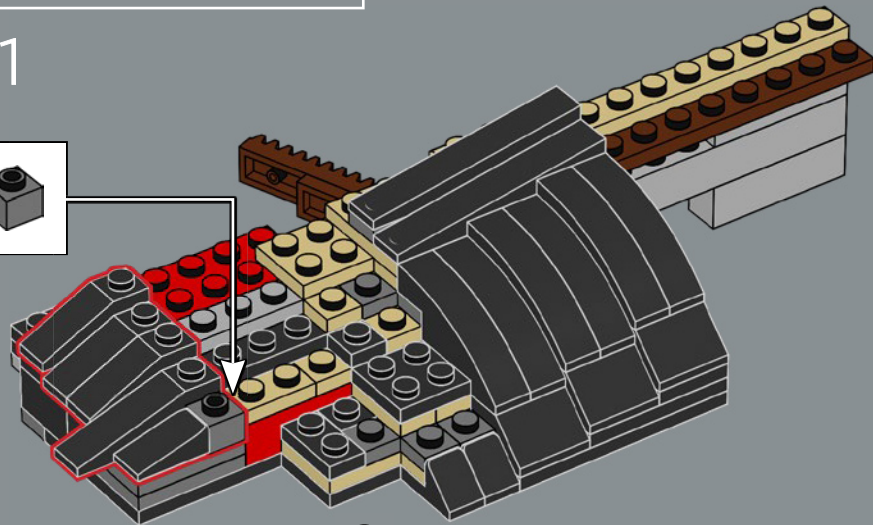
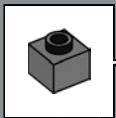

83

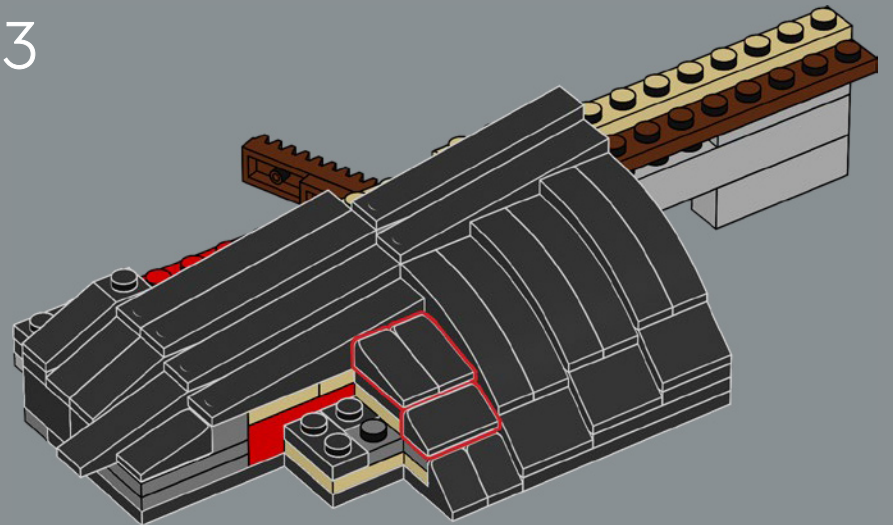

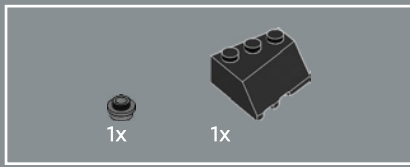

84

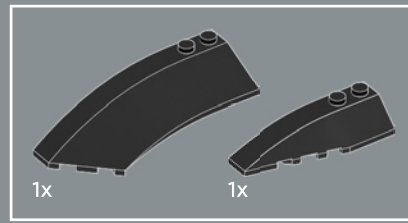
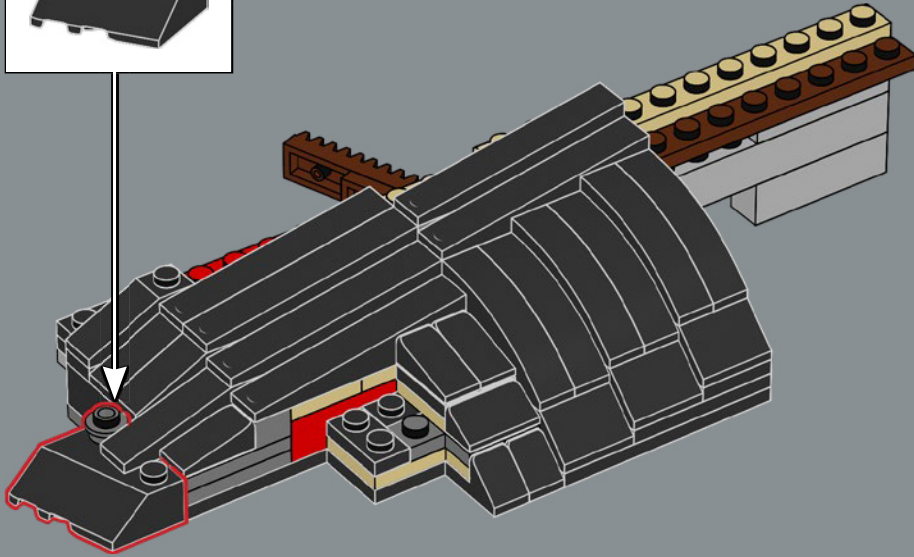
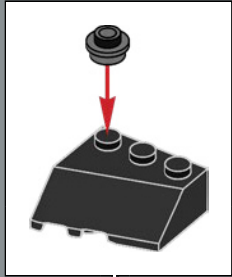

85

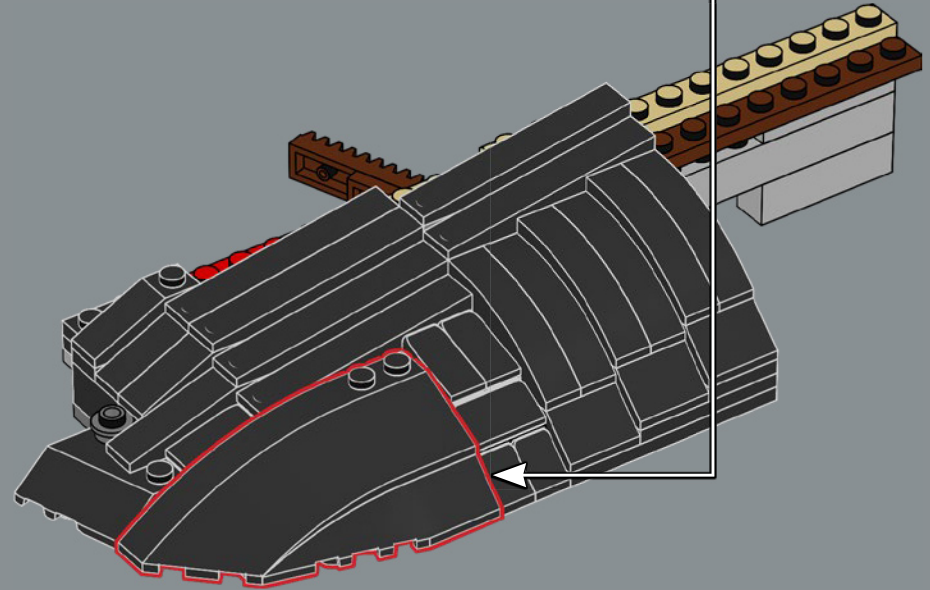
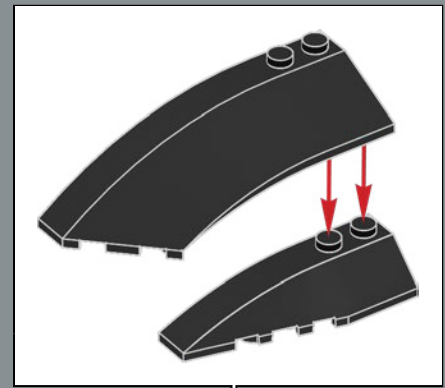



Brown LEGO® Technic™ 1×4 toothed bar gear rack elements make for nice little wooden ladders.

Les éléments de rampe dentée 1×4 LEGO® Technic™ en brun constituent de jolies petites échelles en bois.

Los elementos LEGO® Technic™ de barras dentadas café 1×4 recrean a la perfección las escaleras de madera.

86

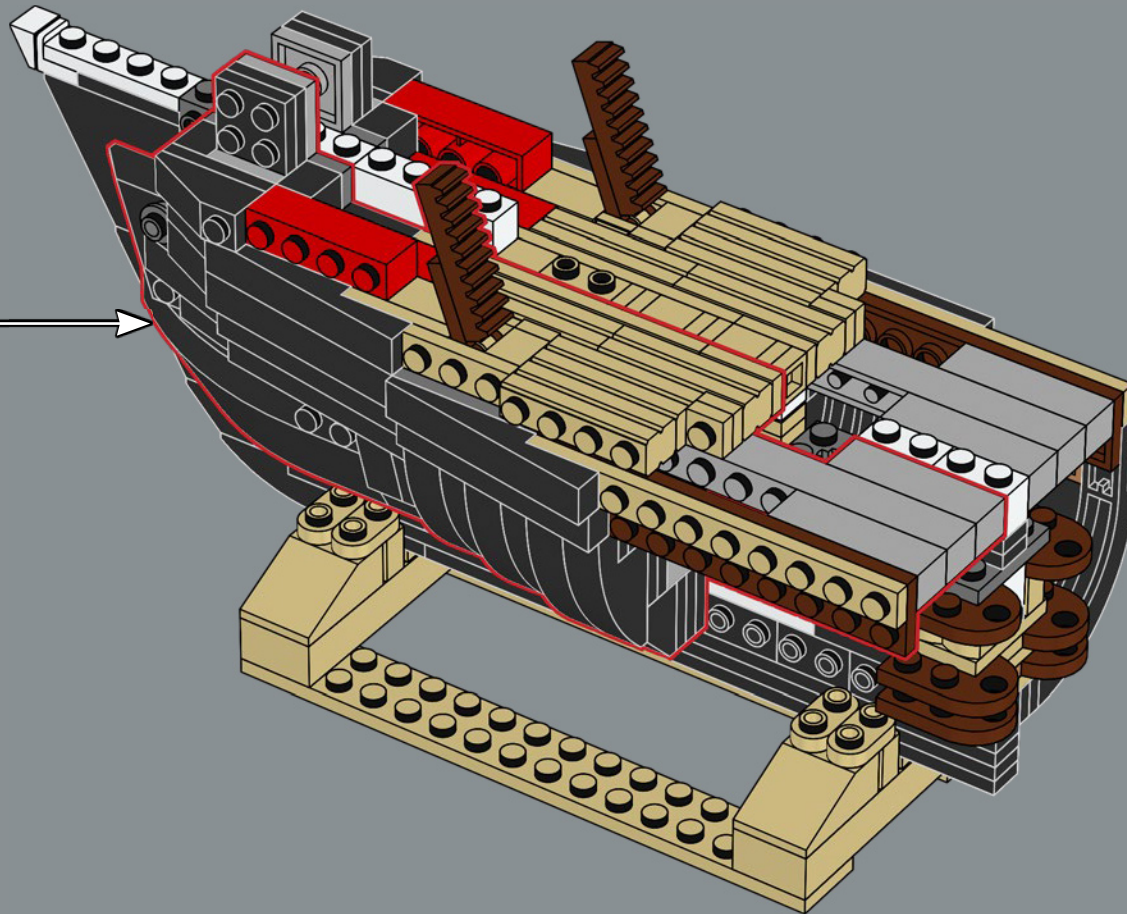

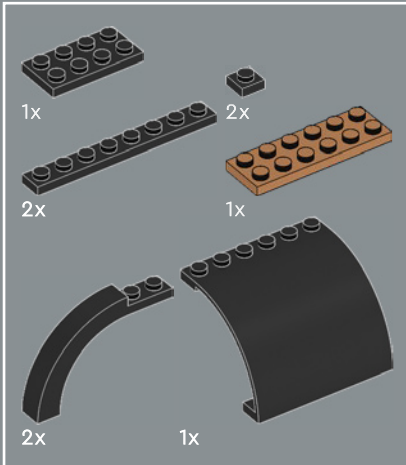
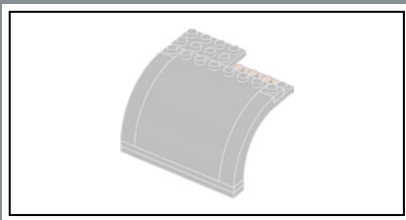

87

1

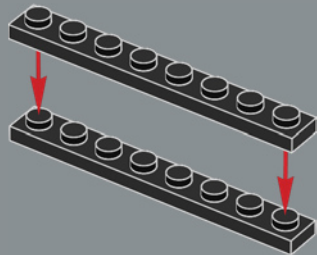

2

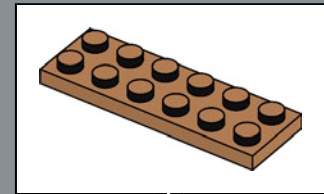
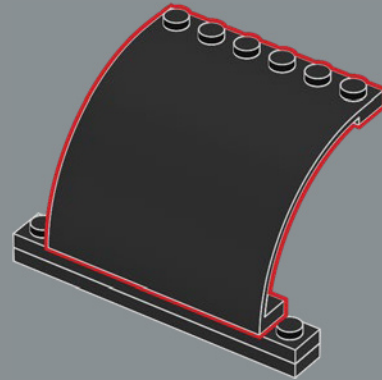

3

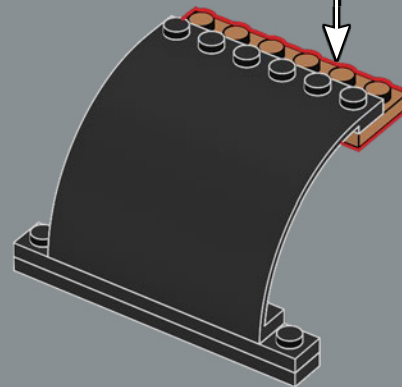

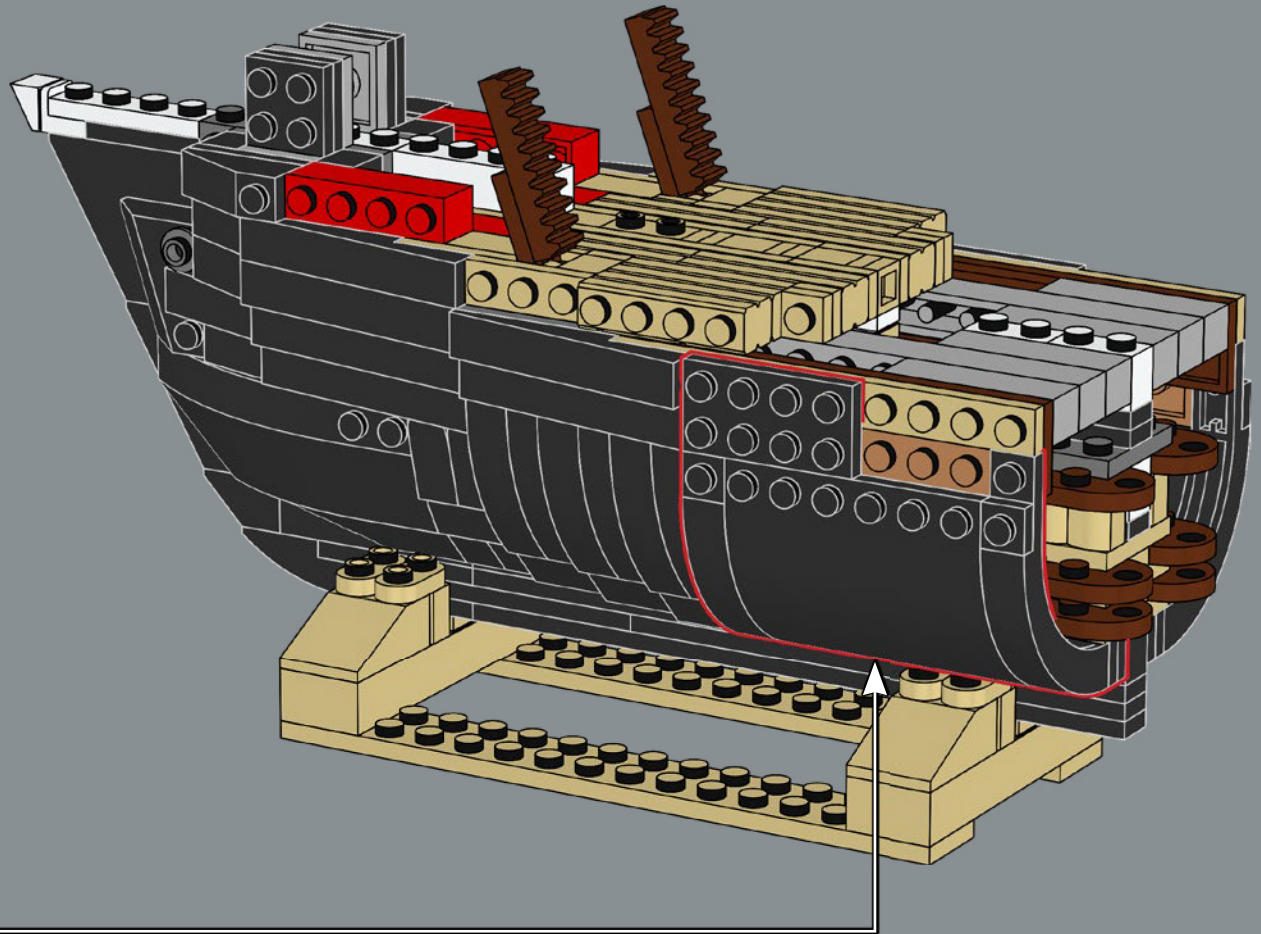
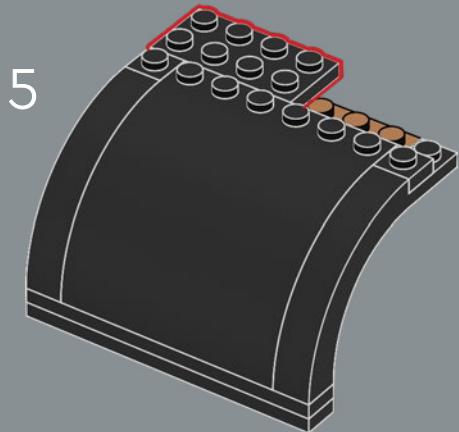
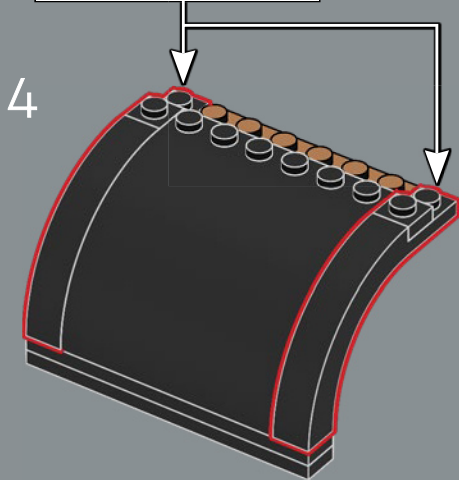
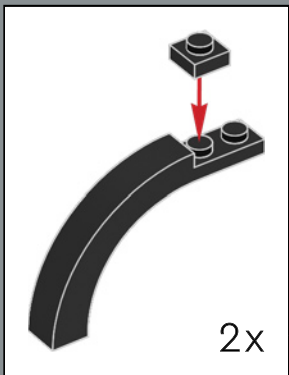

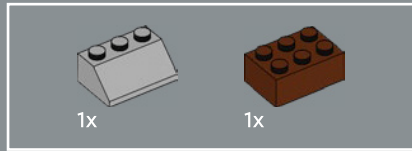

88

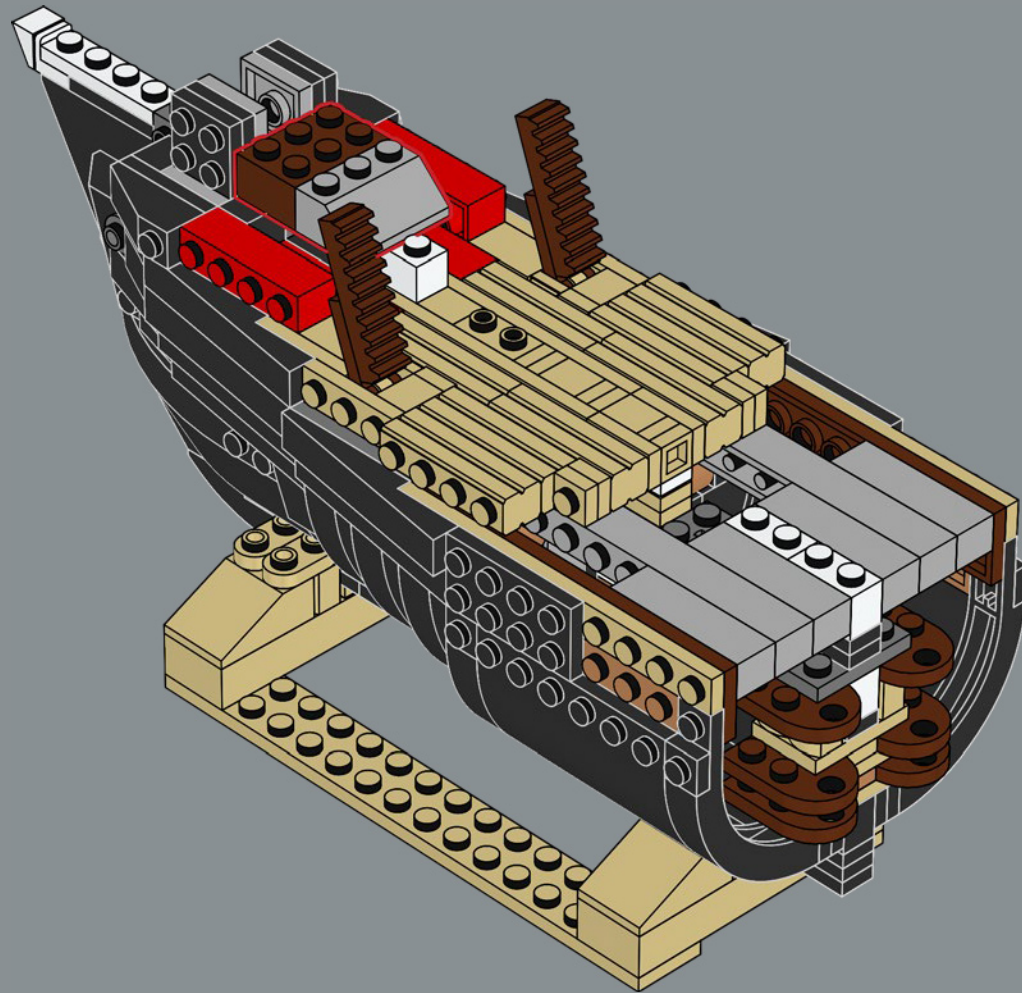



2x

89

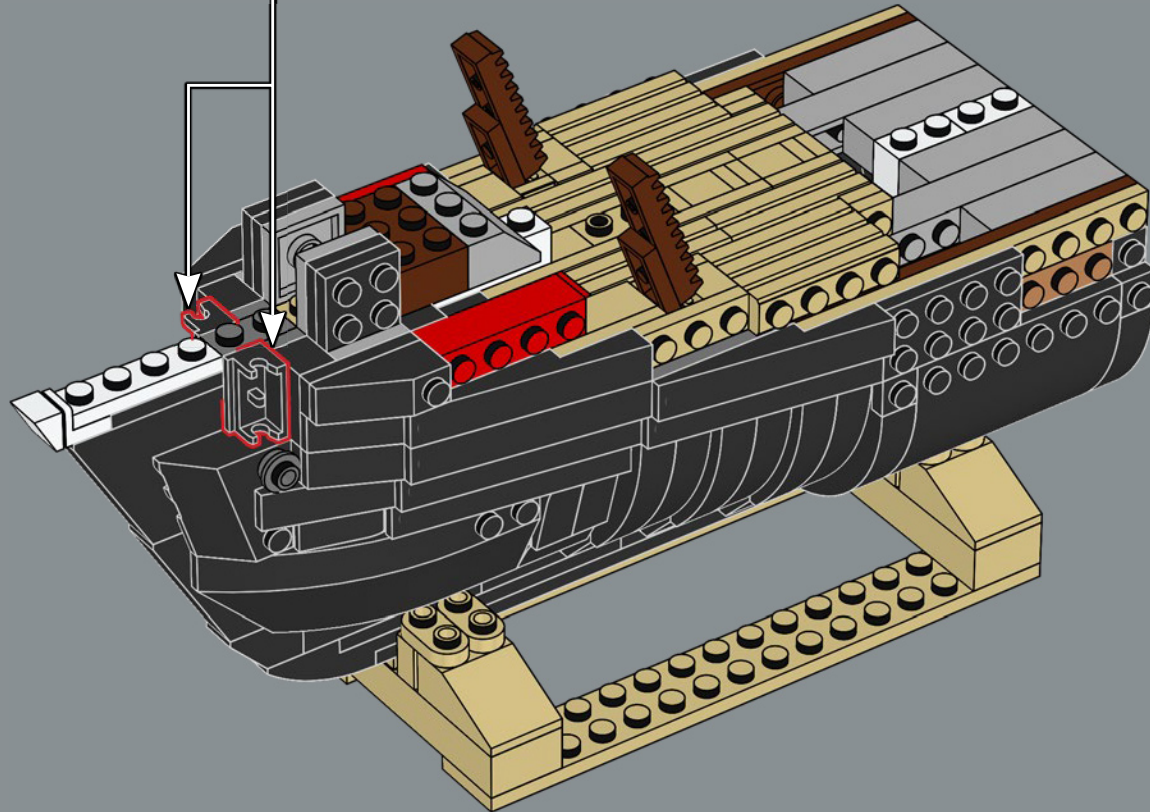
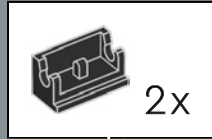

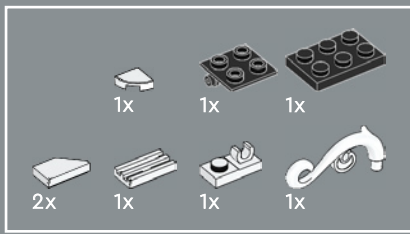

90

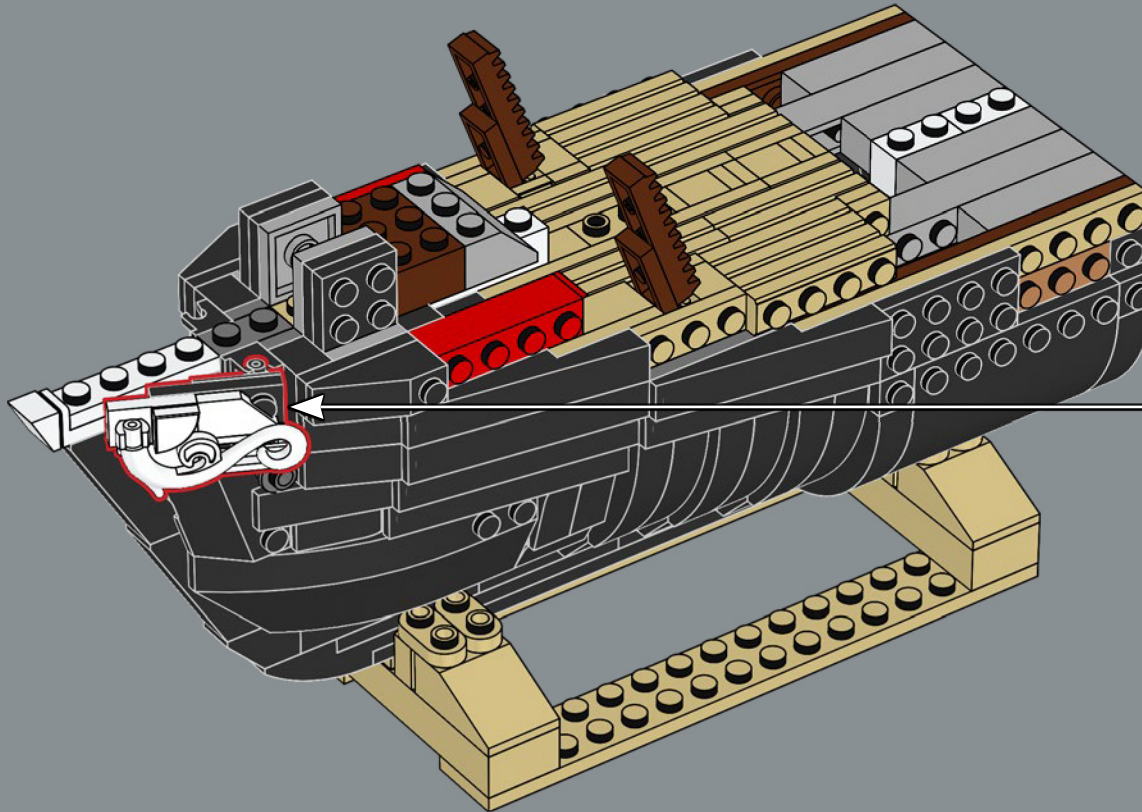
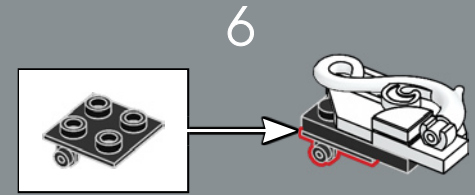
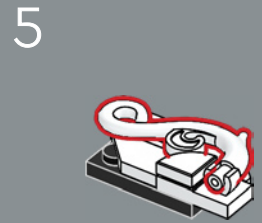
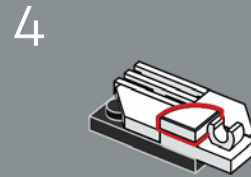
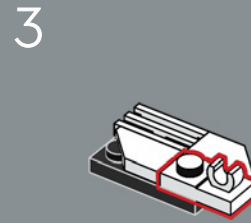
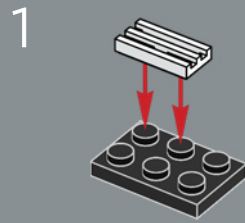

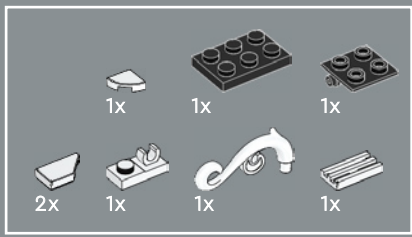

91

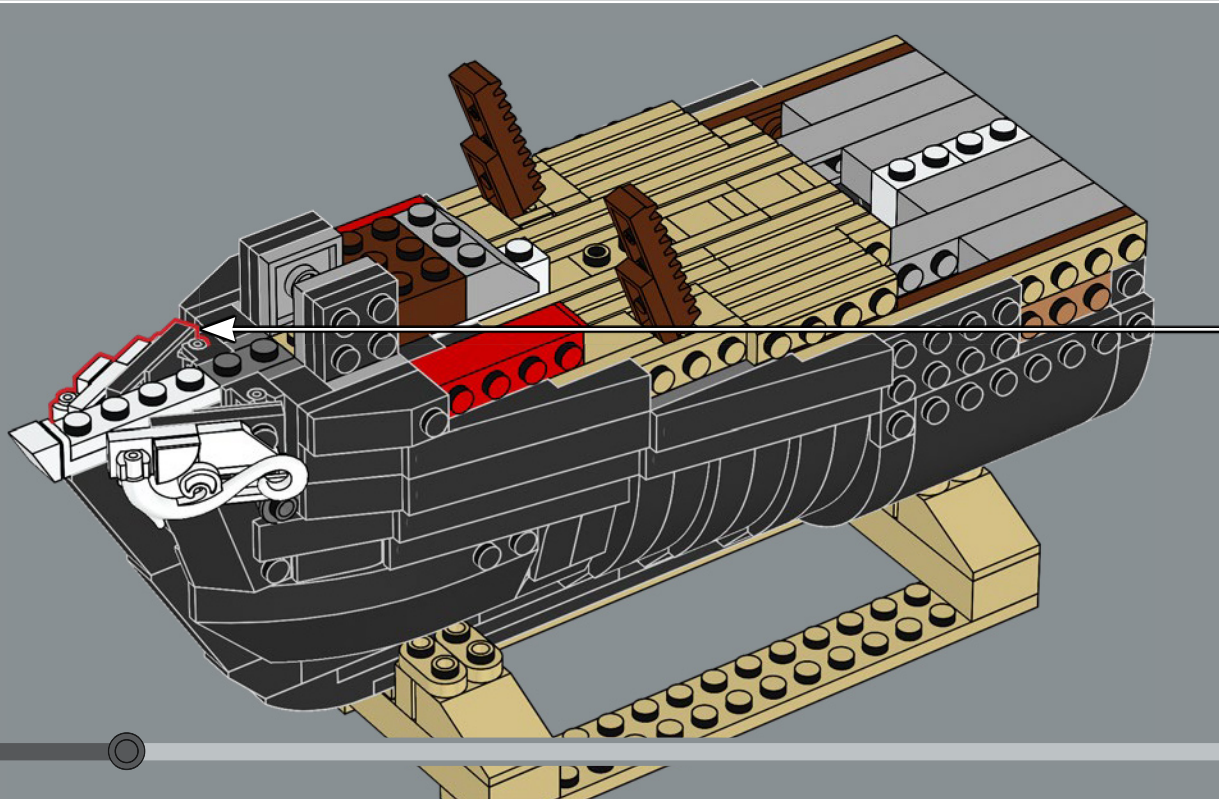
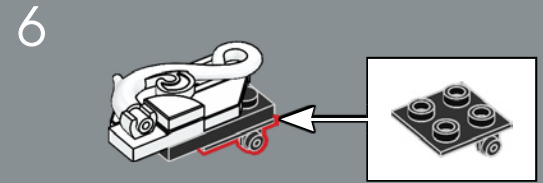
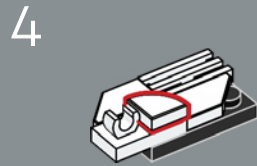
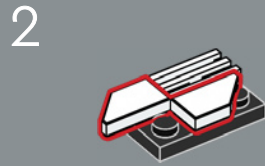
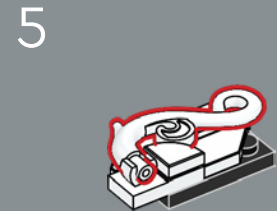
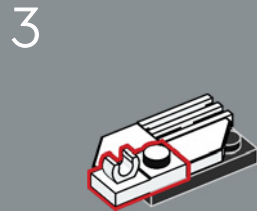
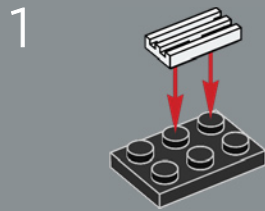

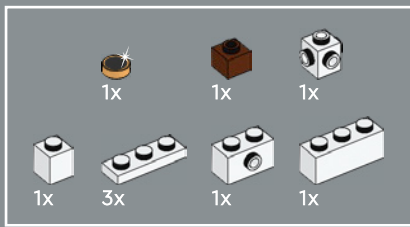

92

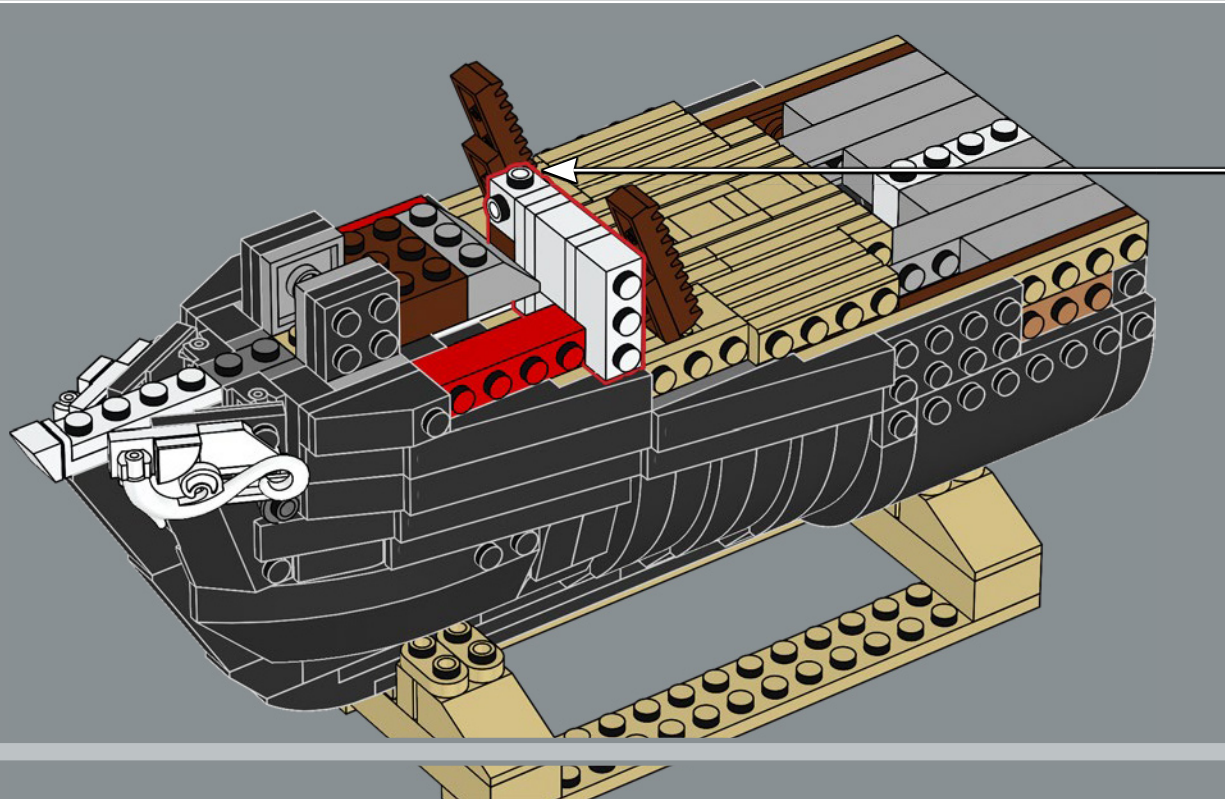
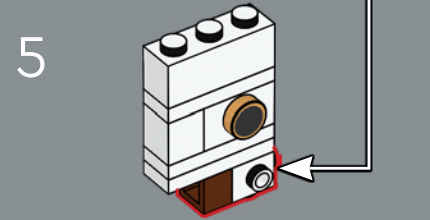
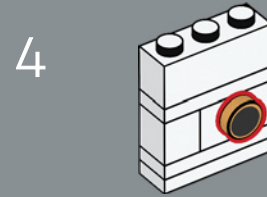
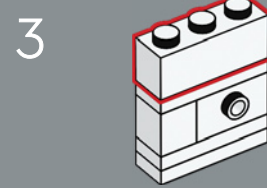
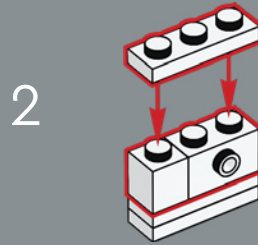
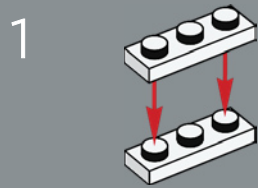

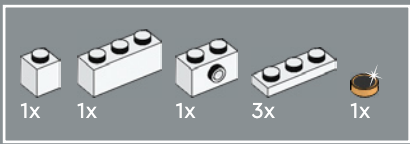

93

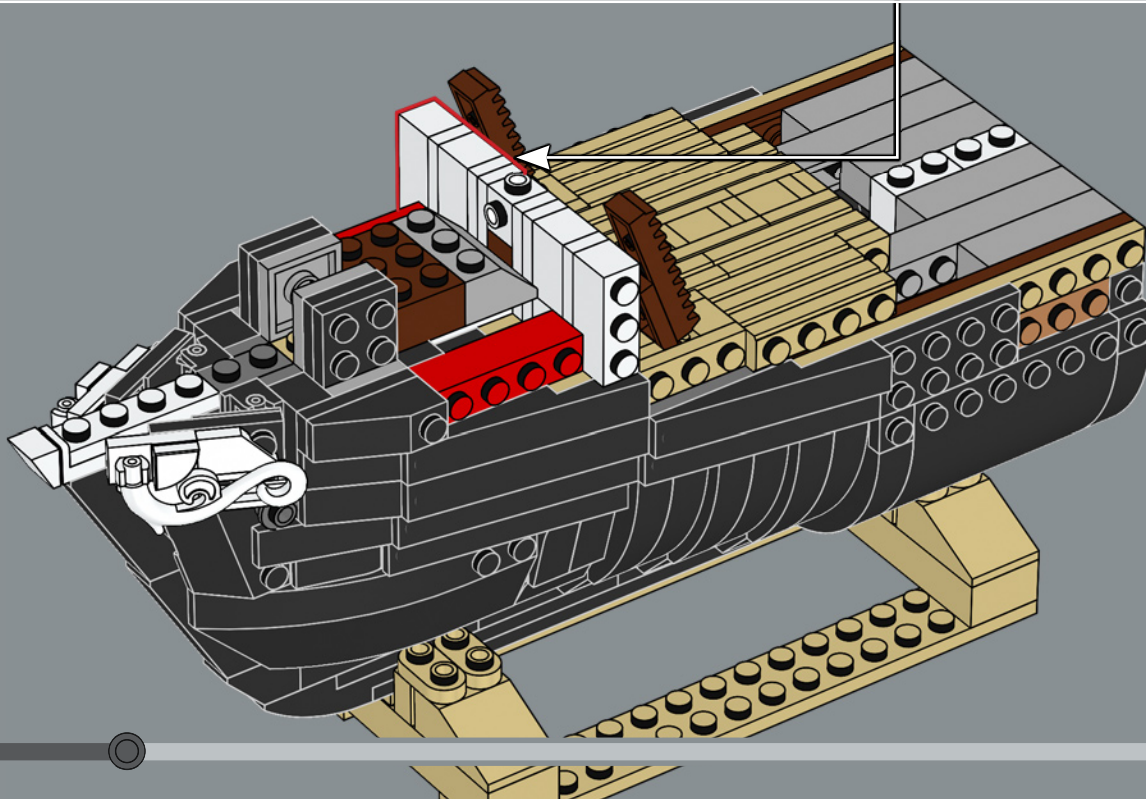
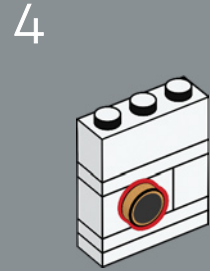
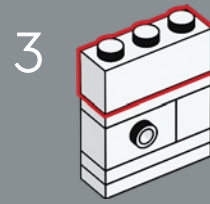
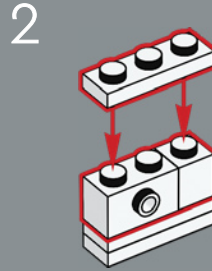
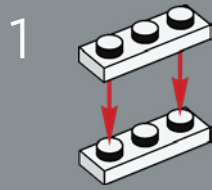

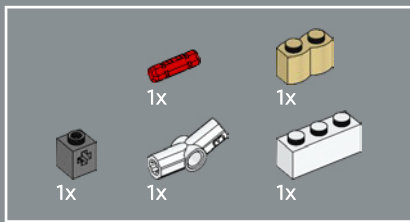

94

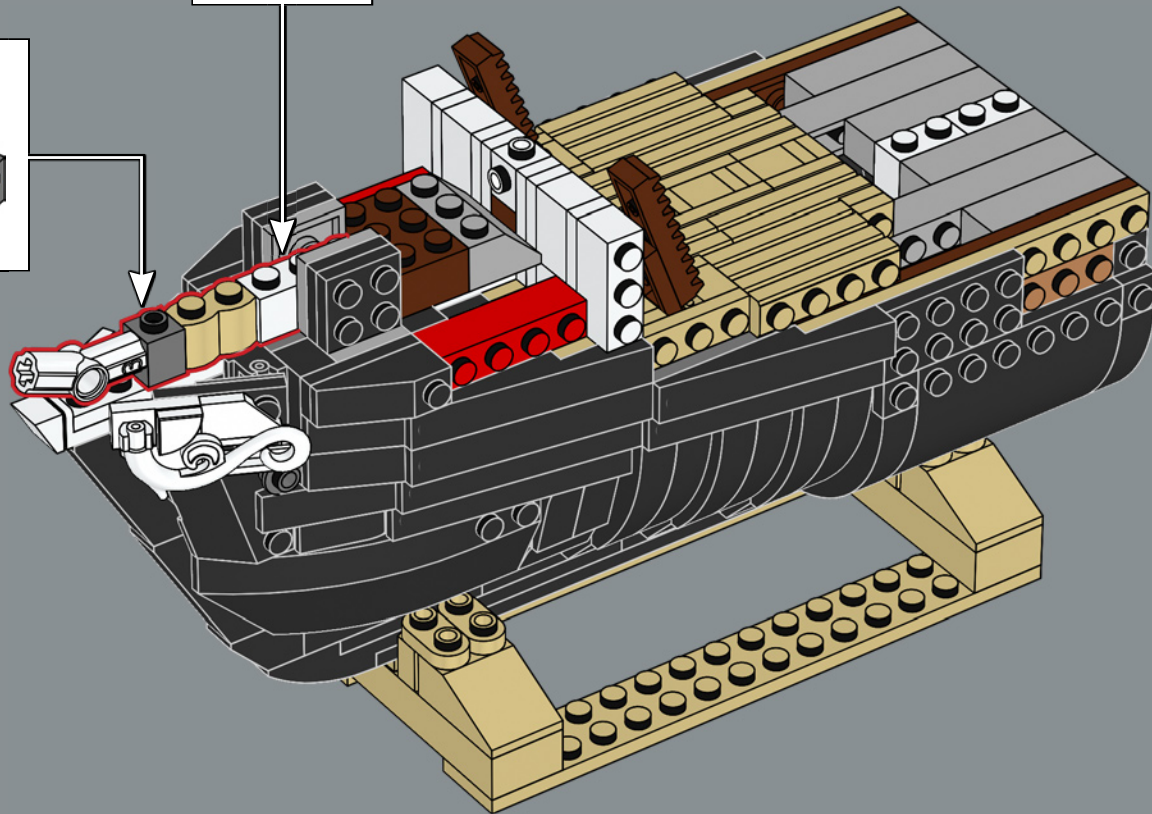
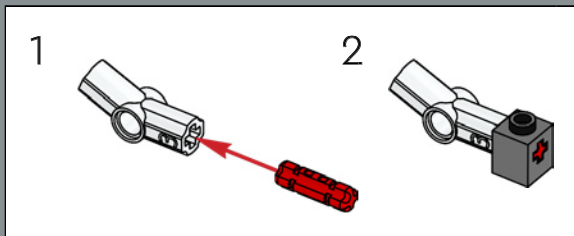
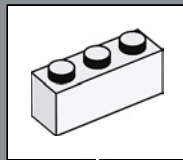

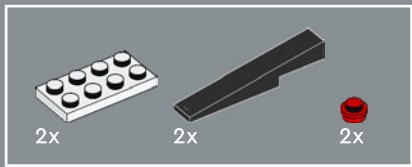

95

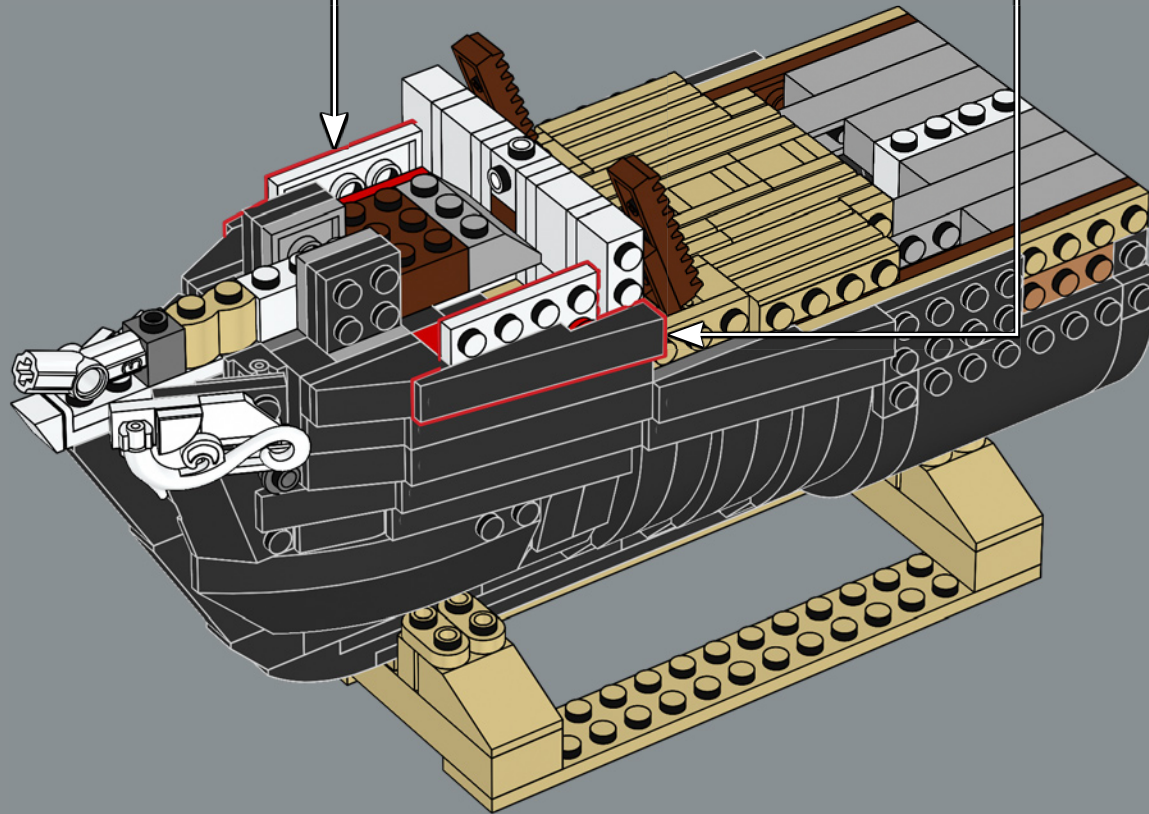
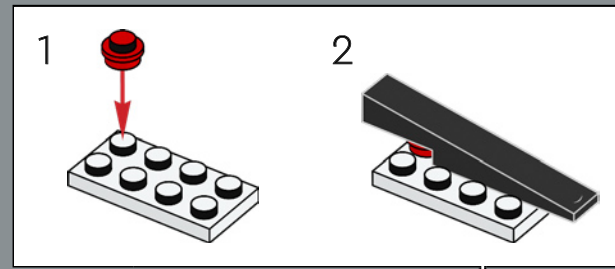
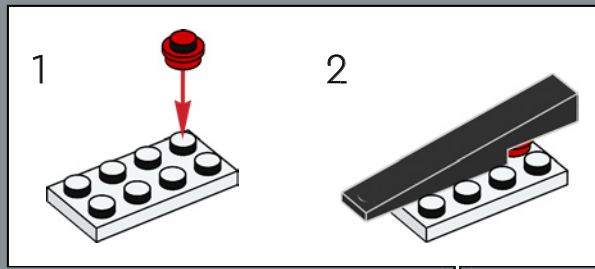

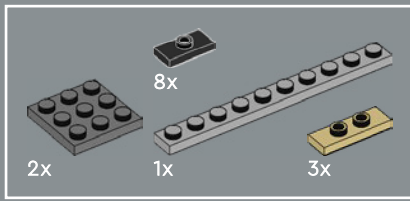

96

1

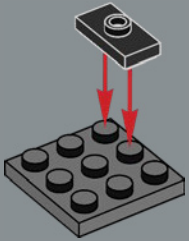

2

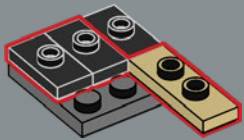

3

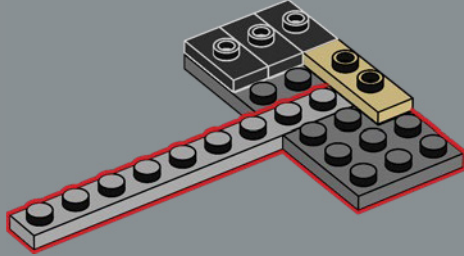

4

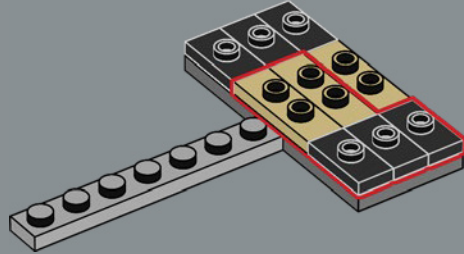

5

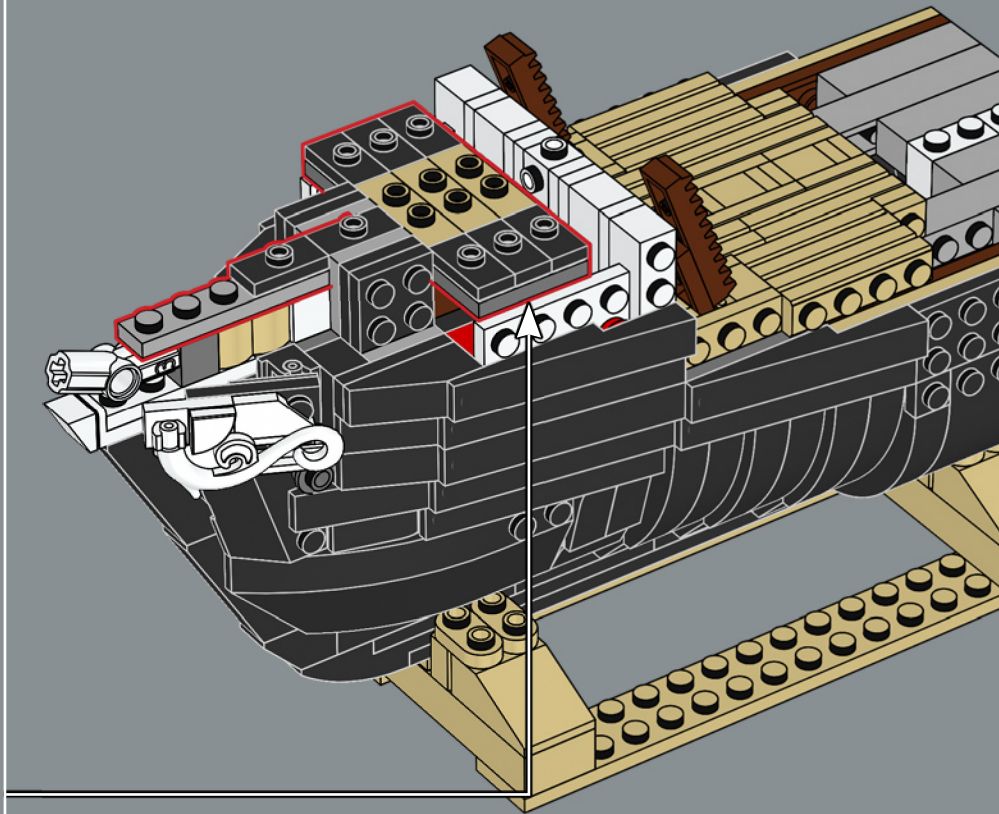
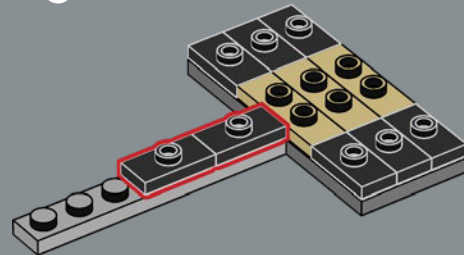

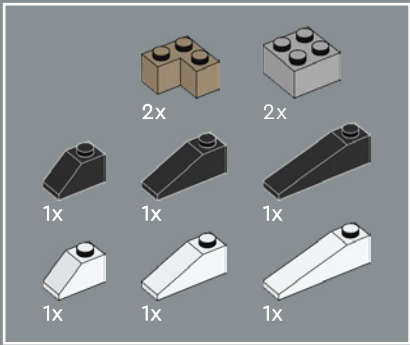

97

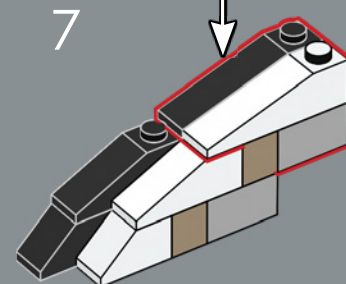
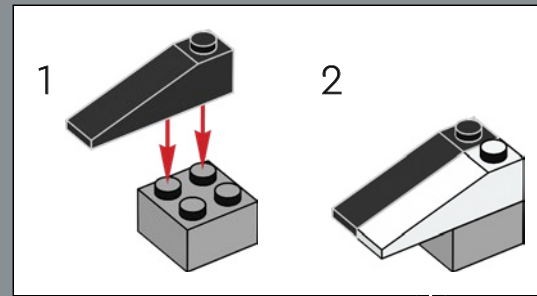
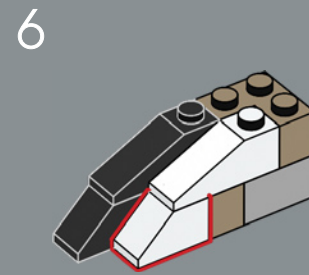
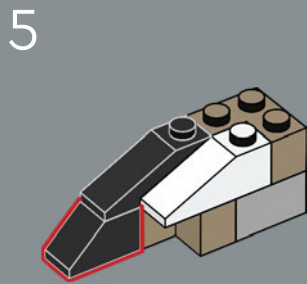
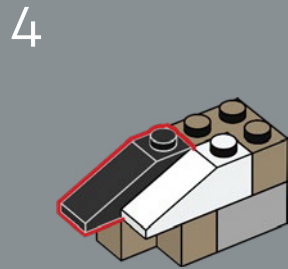
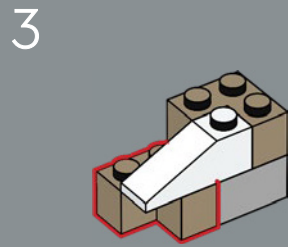
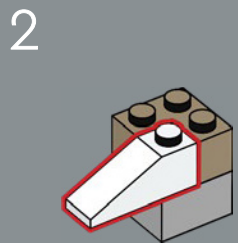
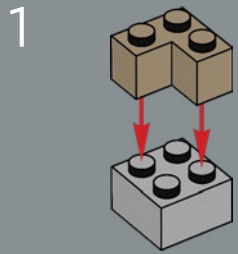

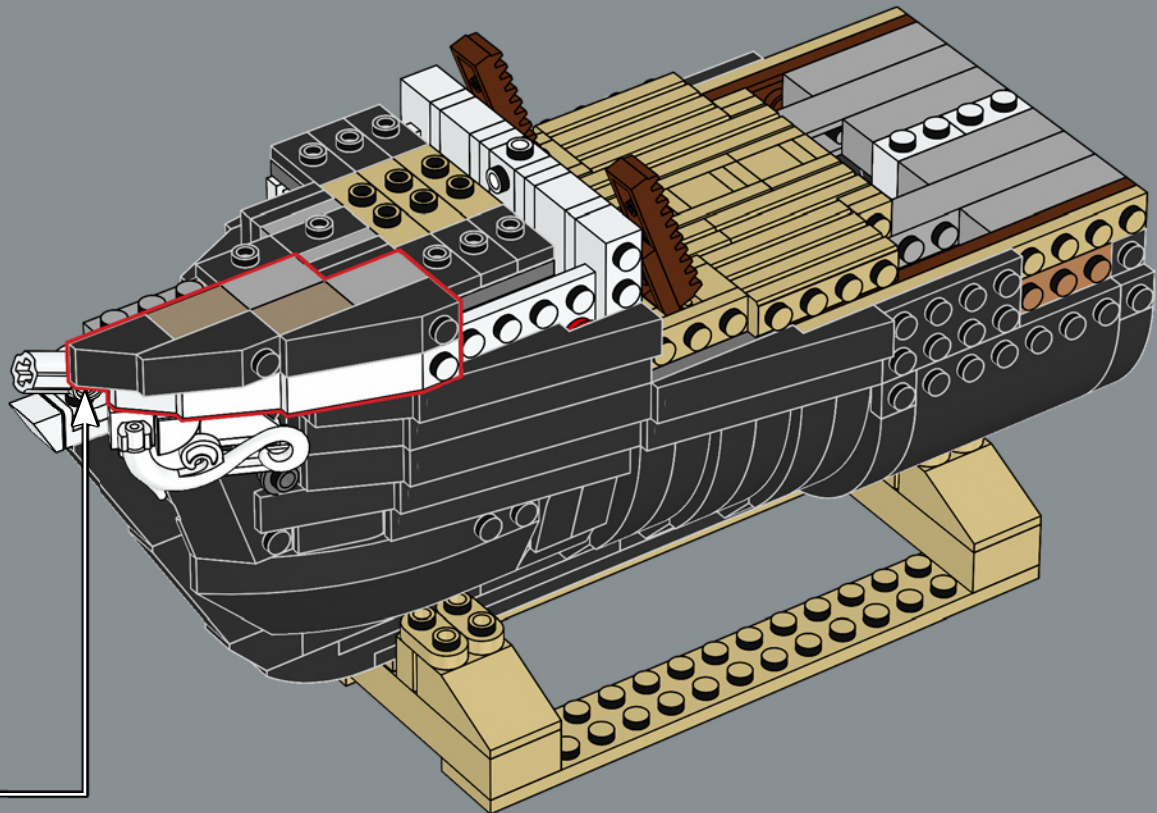

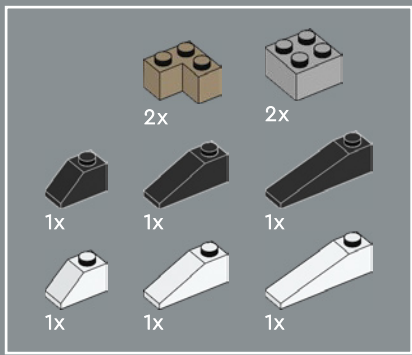

98

1

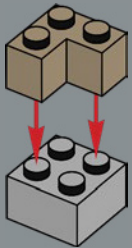

2

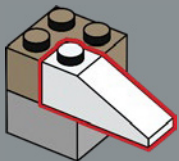

3

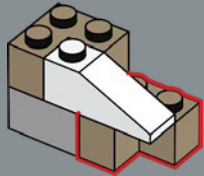

4

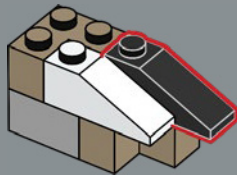

5

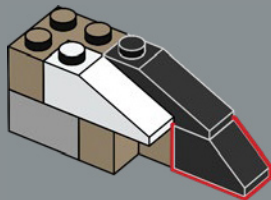

6

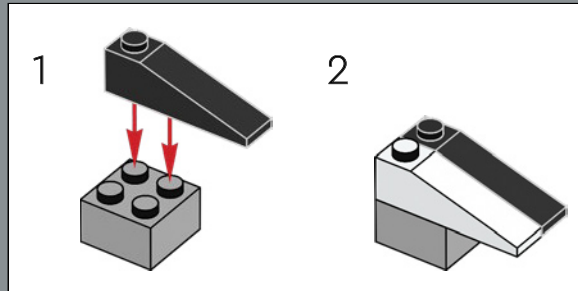
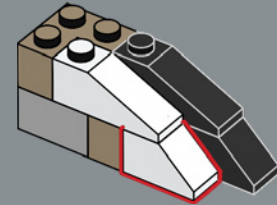

7

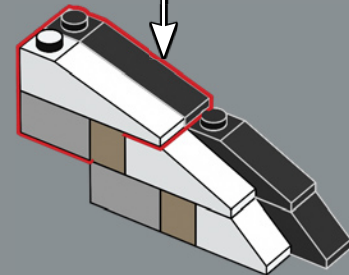

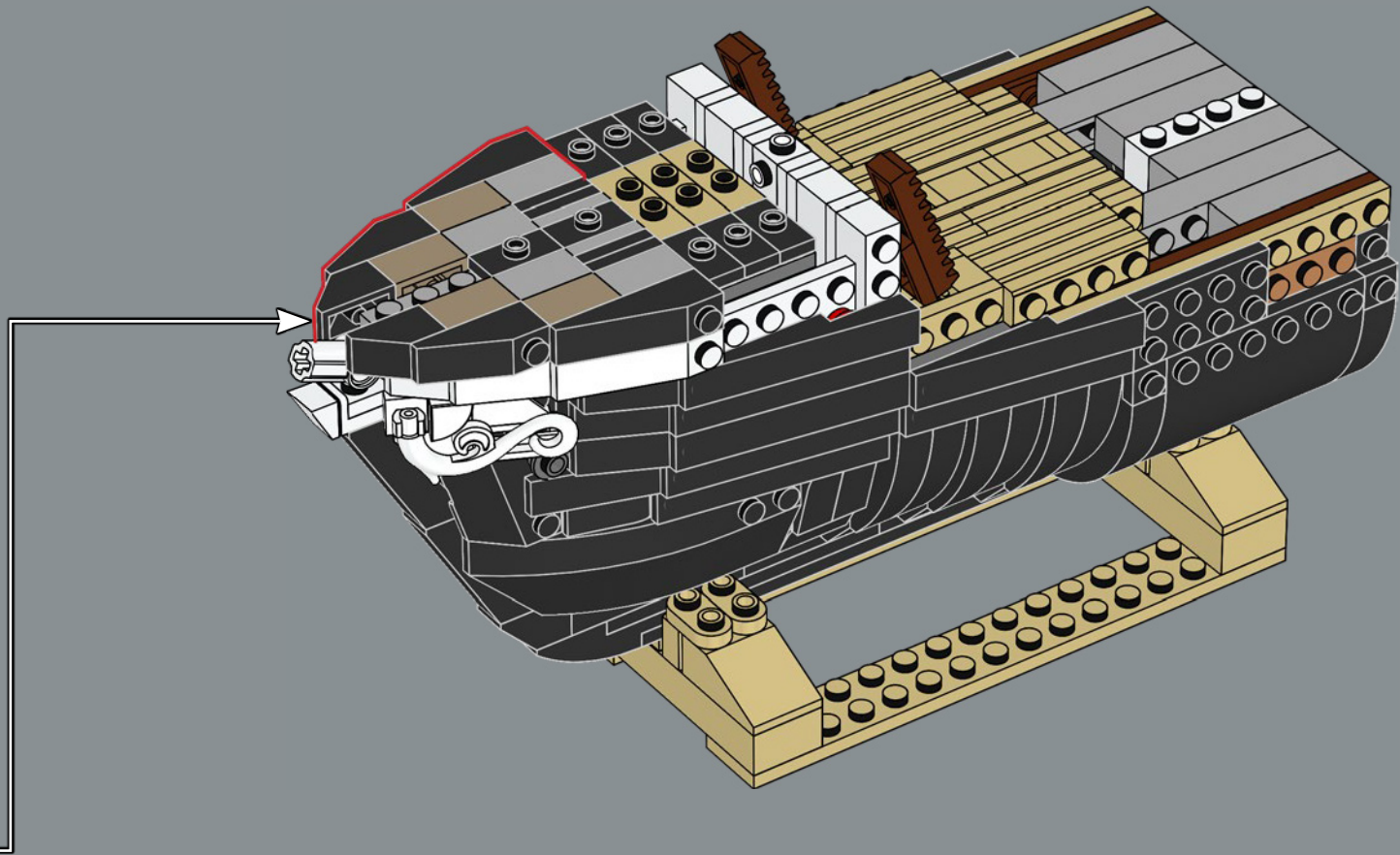



1x

99

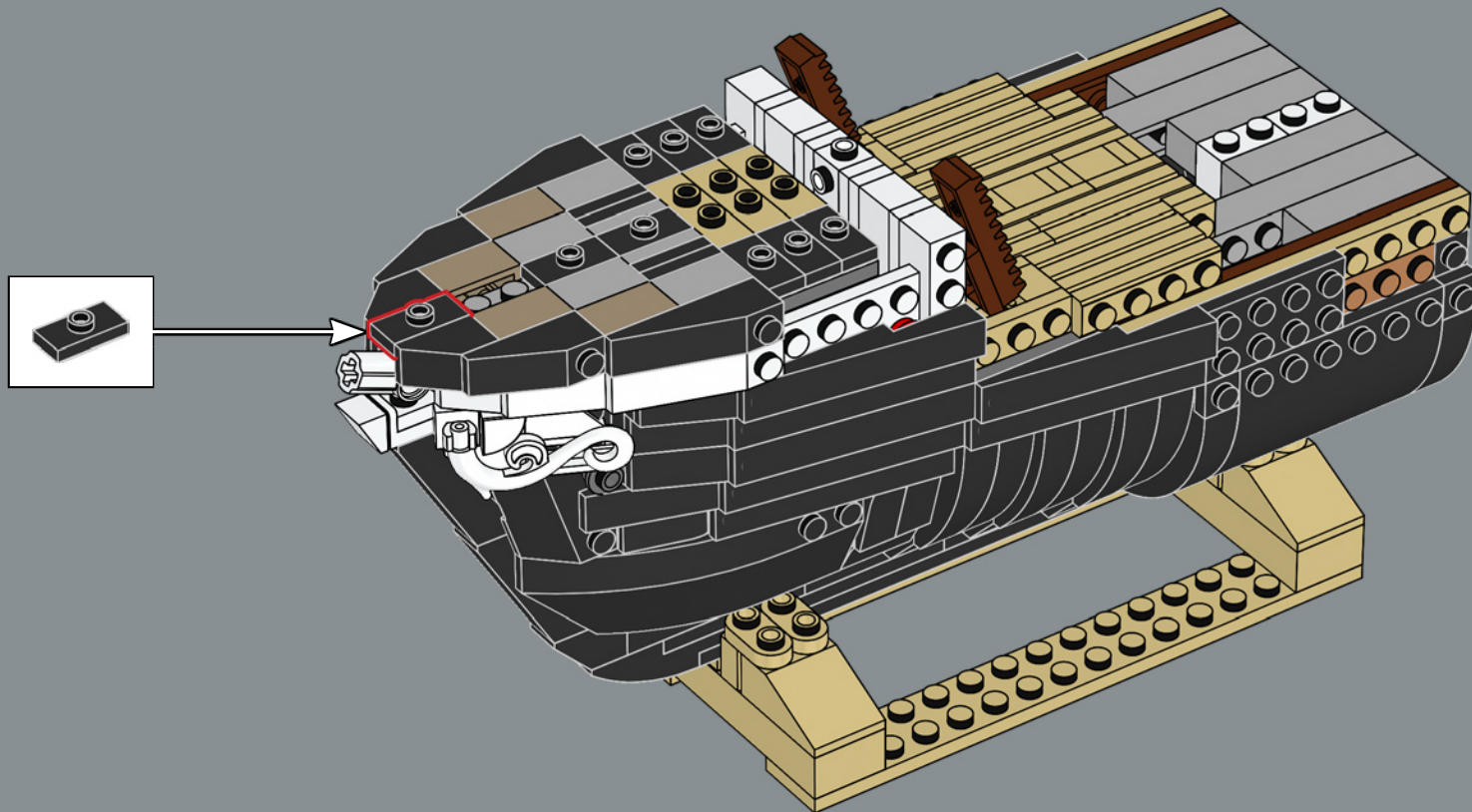

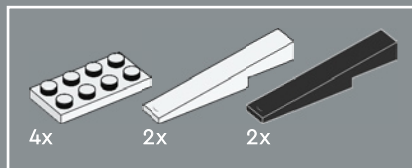

100

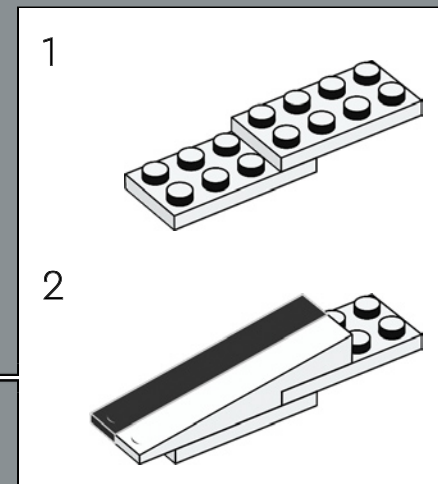
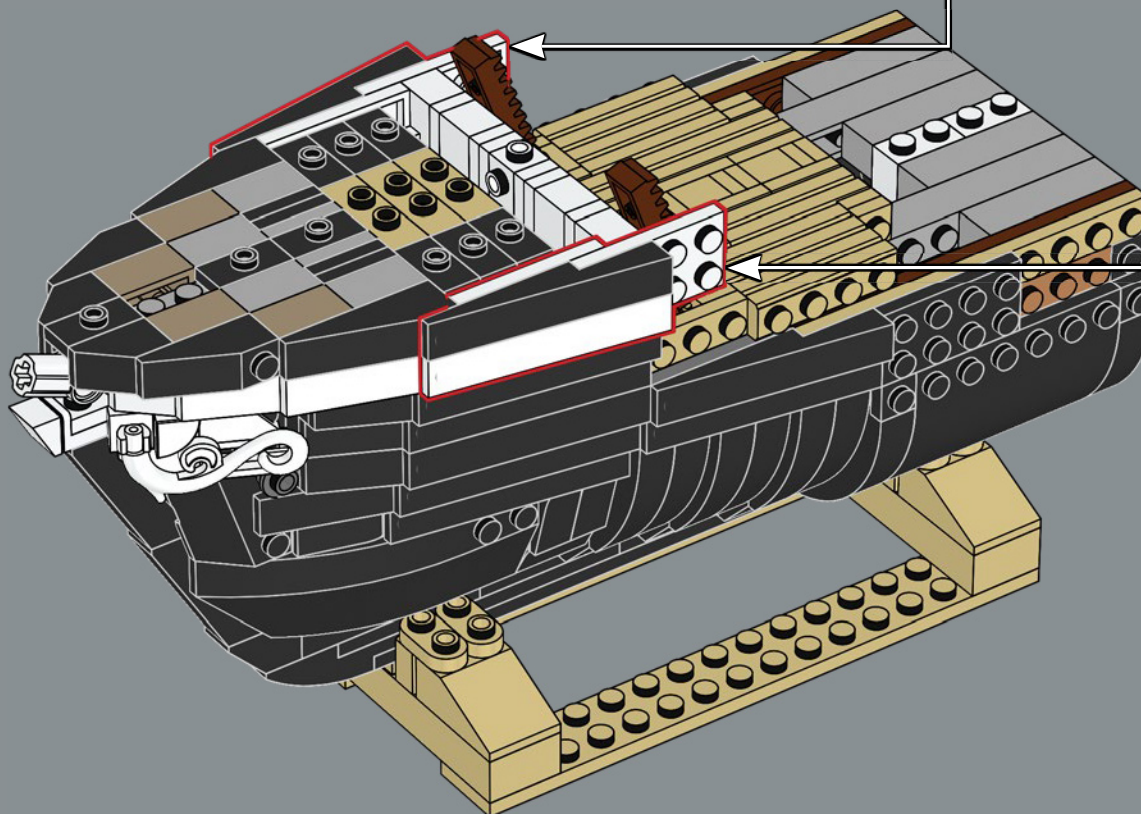
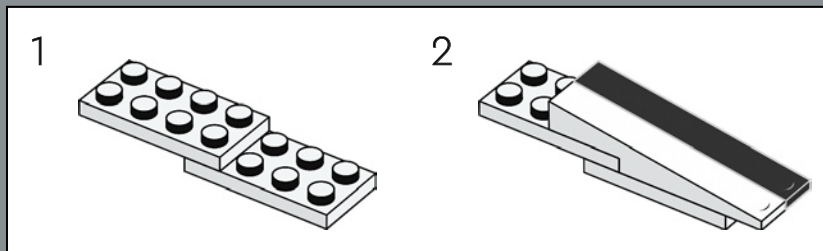

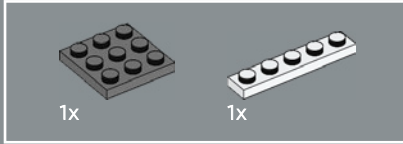
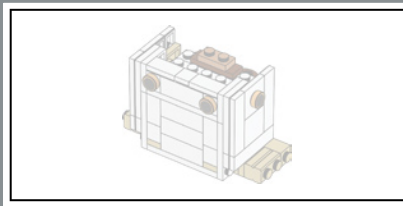

101

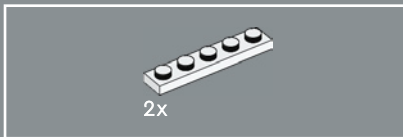
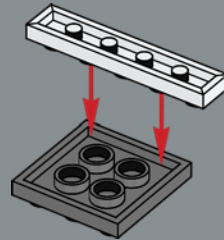

102

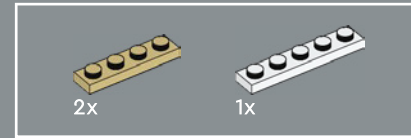
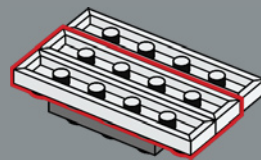

103

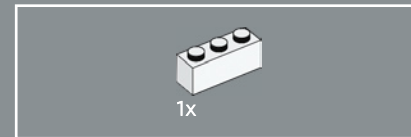
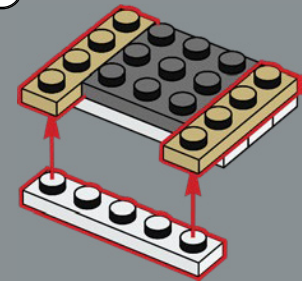

104

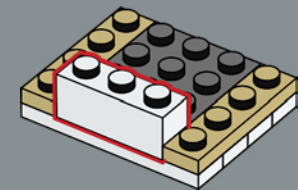

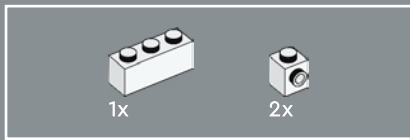

105

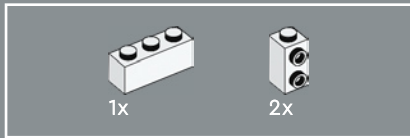
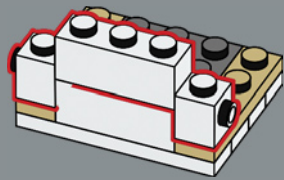

106

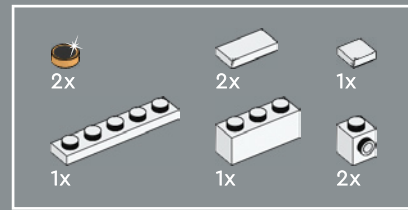
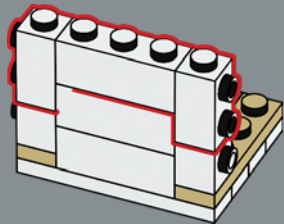

107

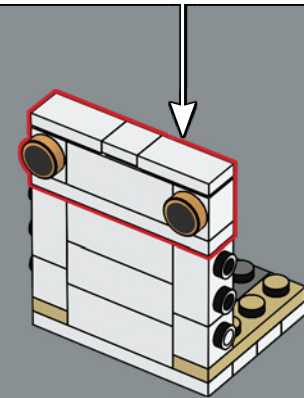
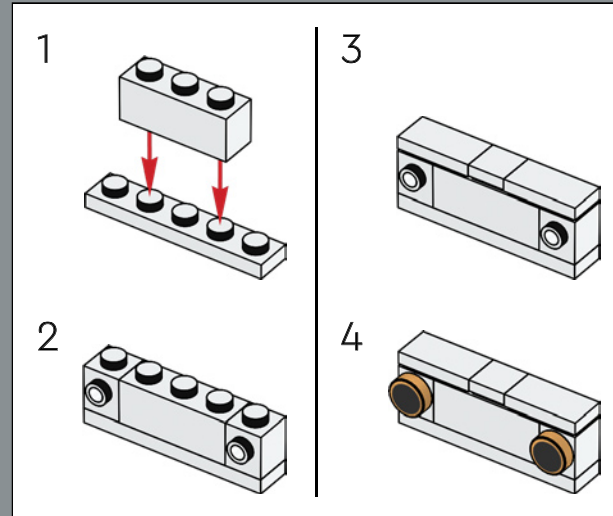



2x

108

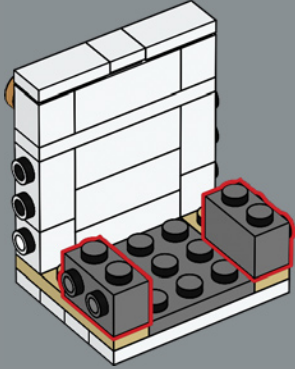

2x

109

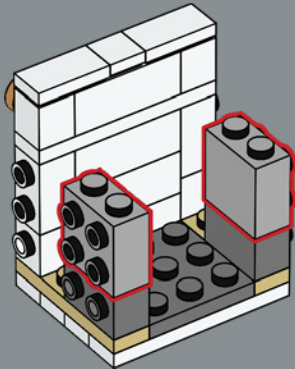

1x

2x

2x

1x

110

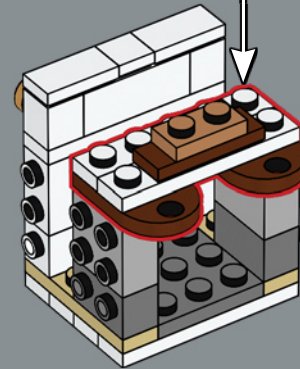
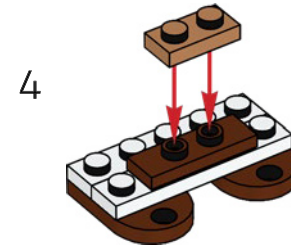
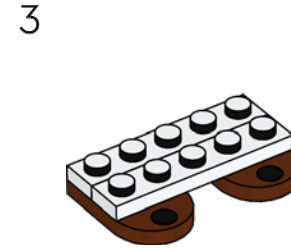
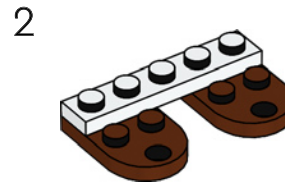
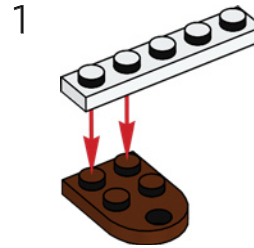

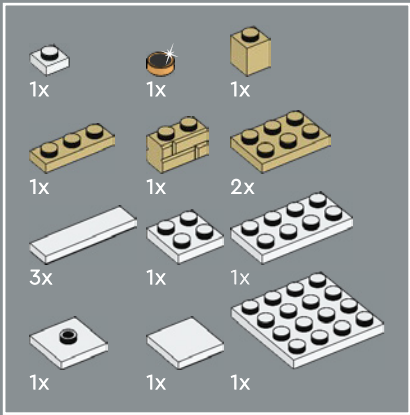

112

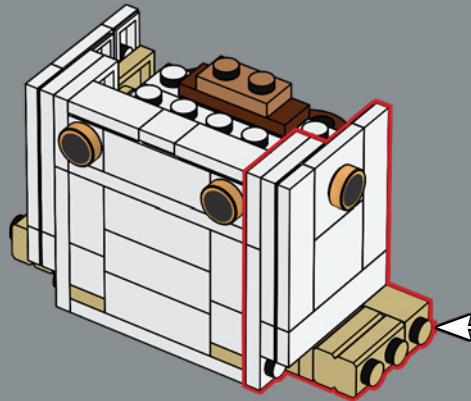
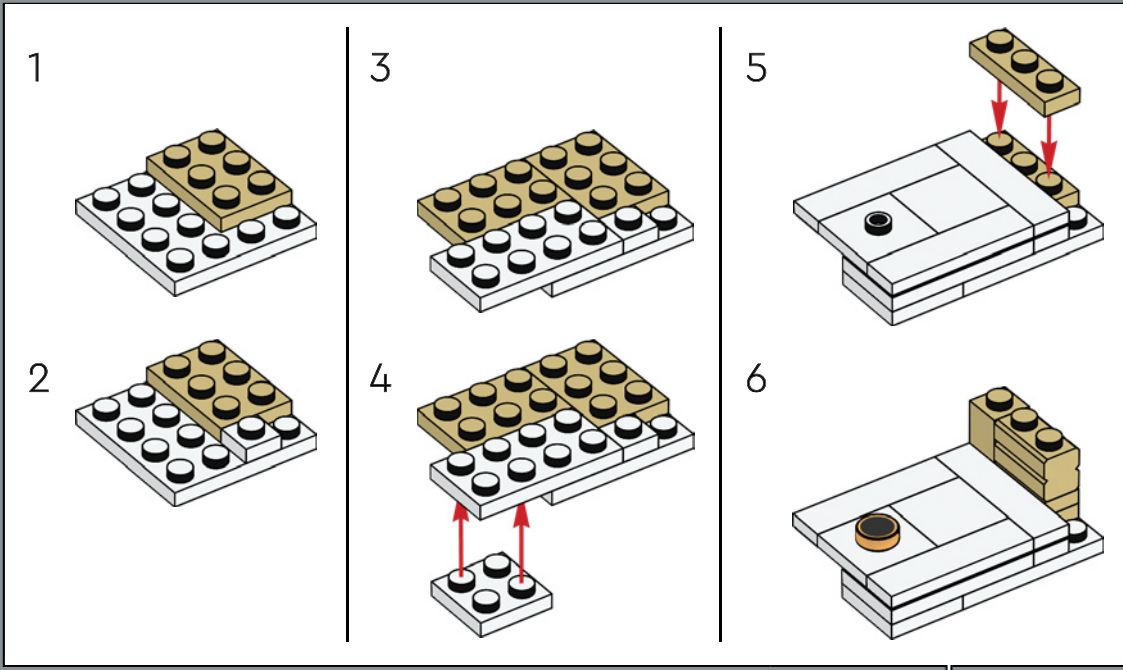

113

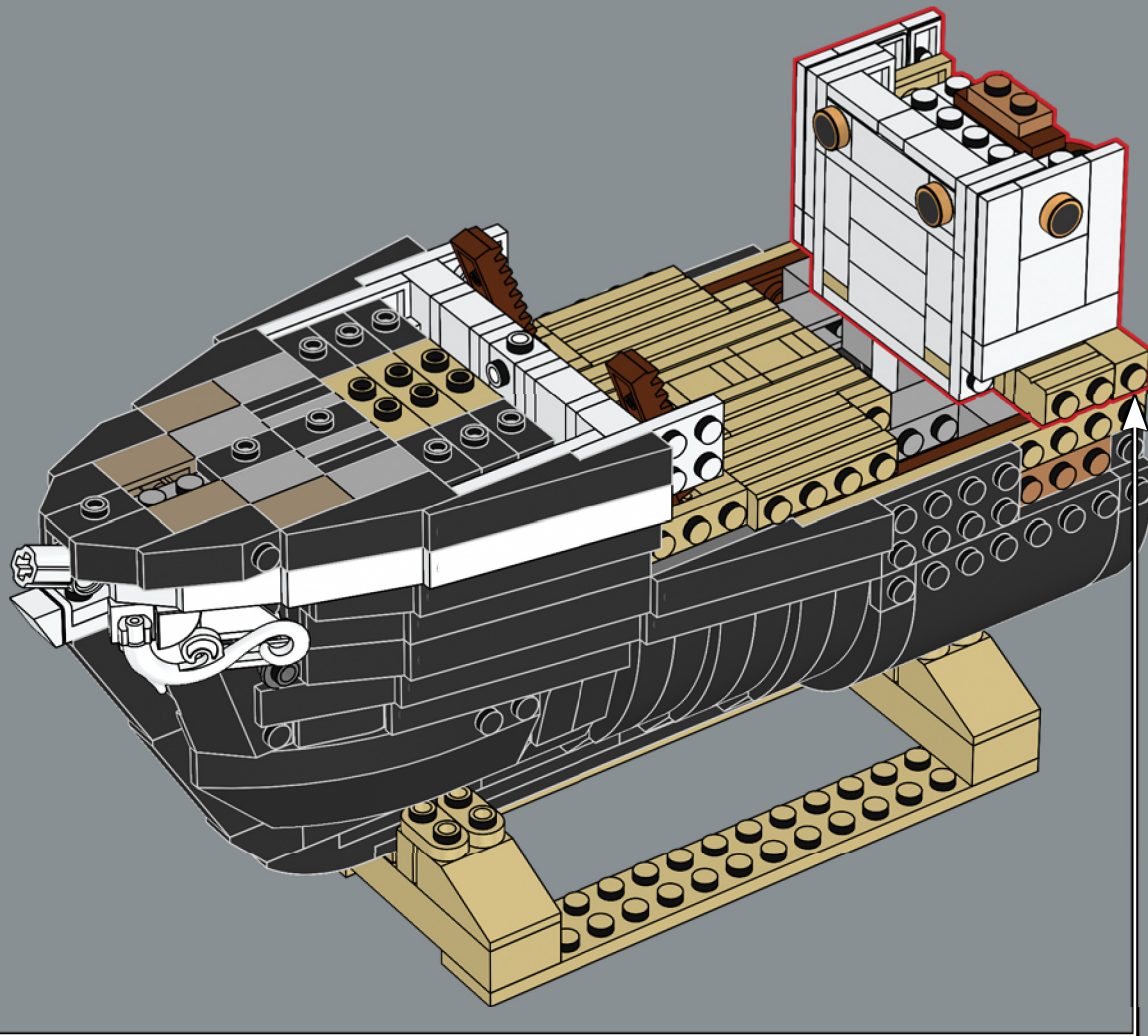

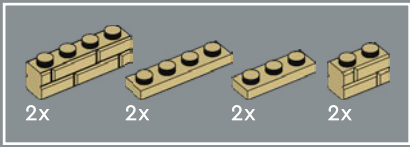

114

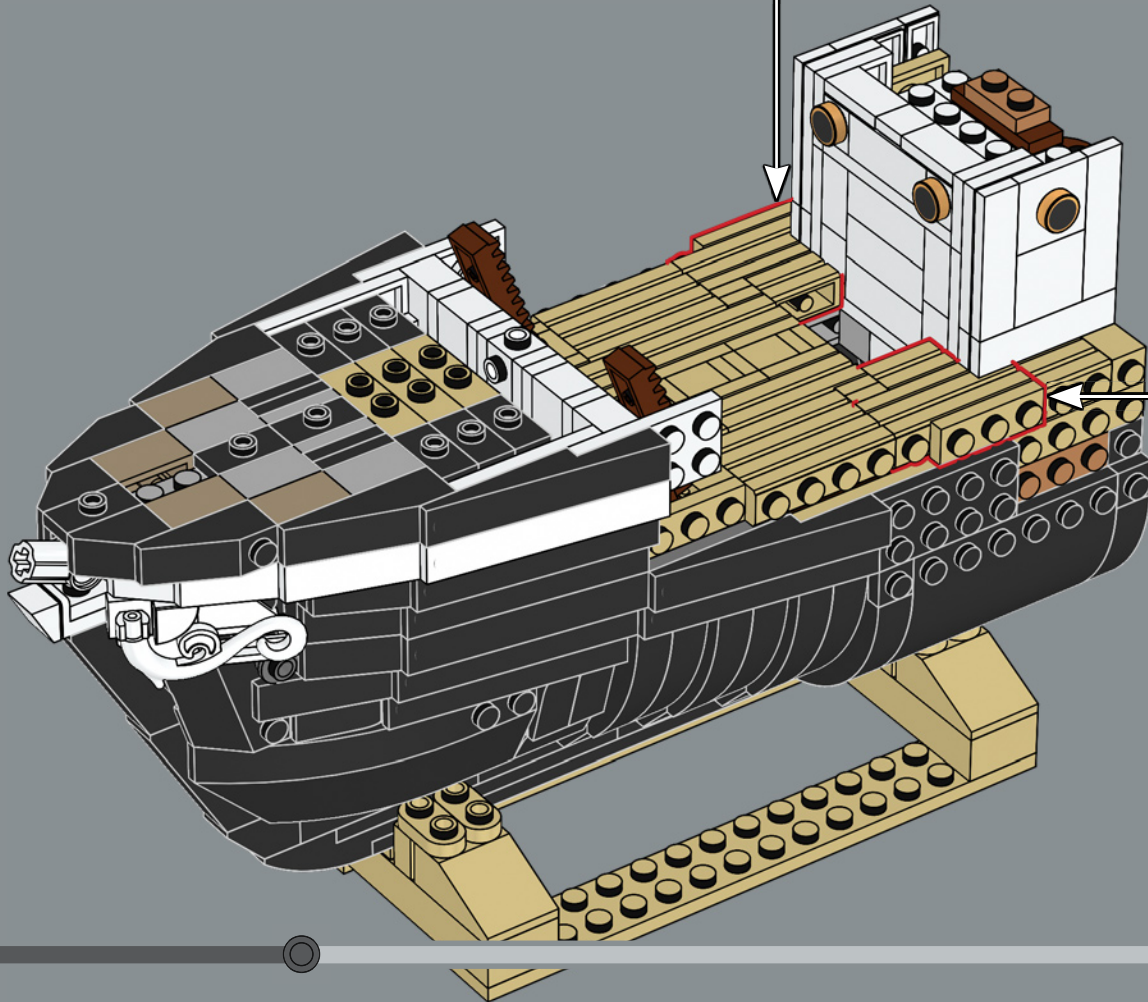
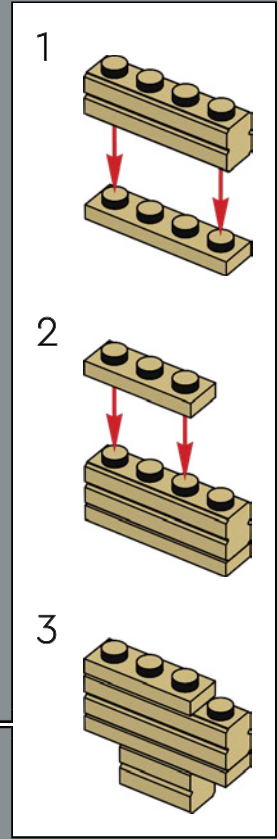
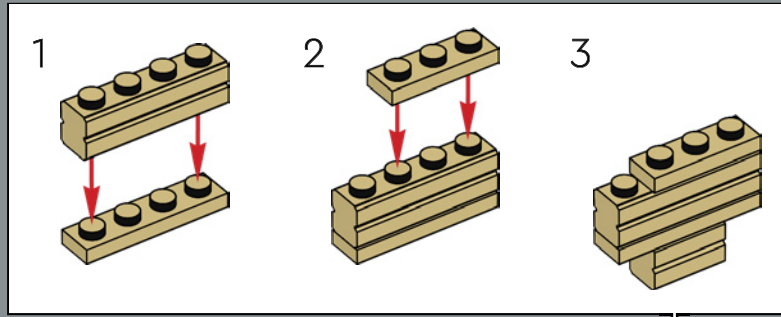

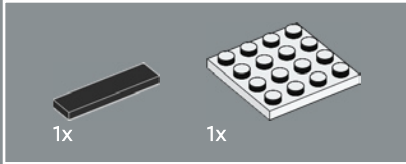
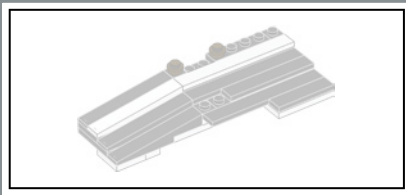

115

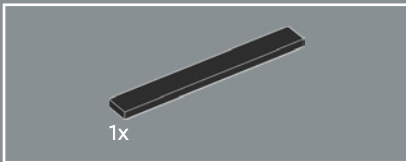
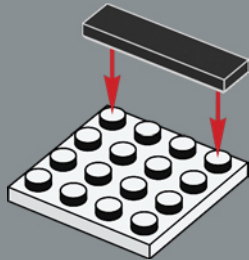

116

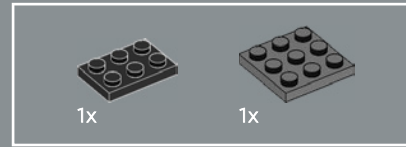
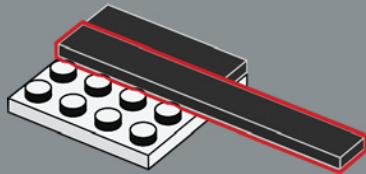

117

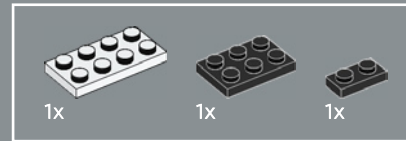
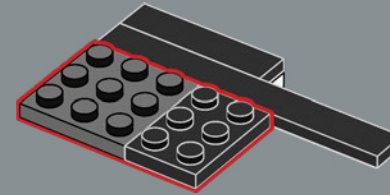

118

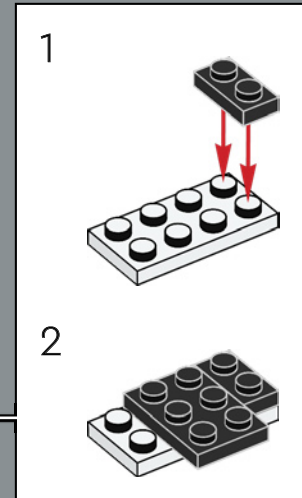
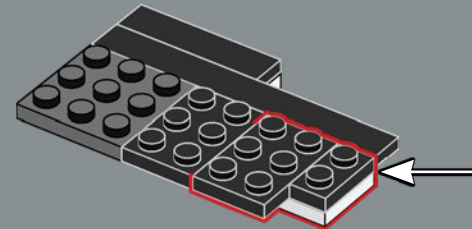

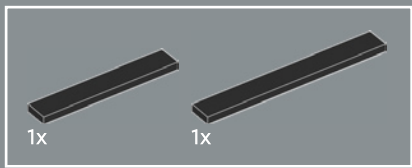

119

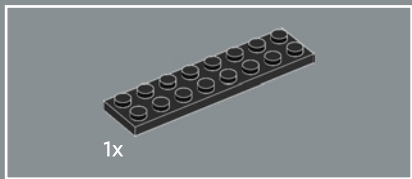
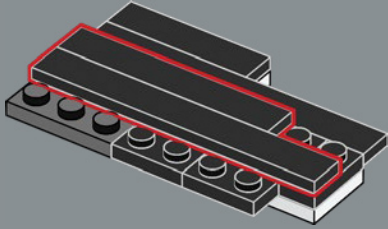

120

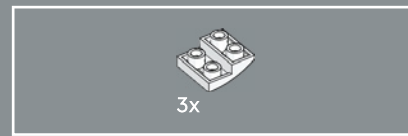
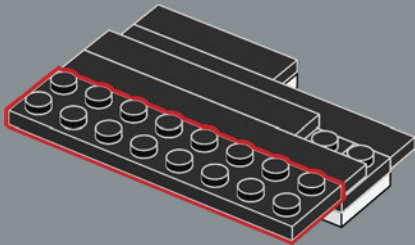

121

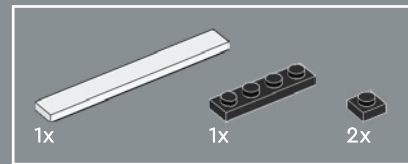
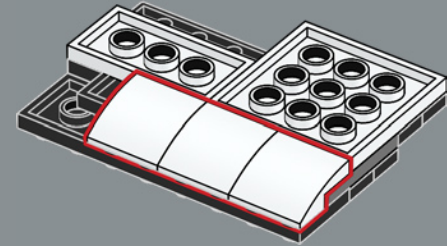

122

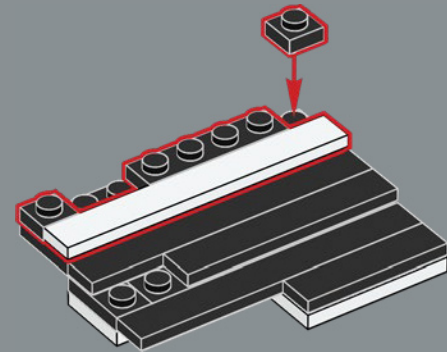



123

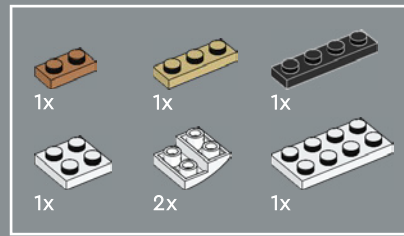
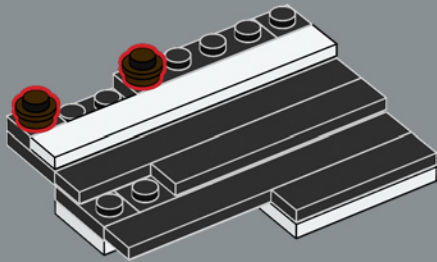

124

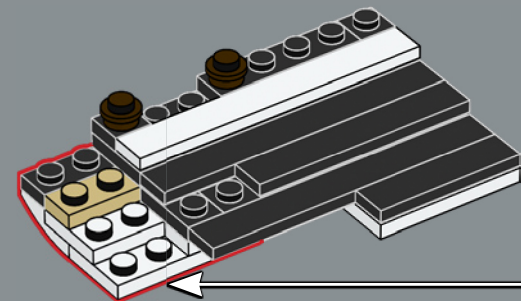
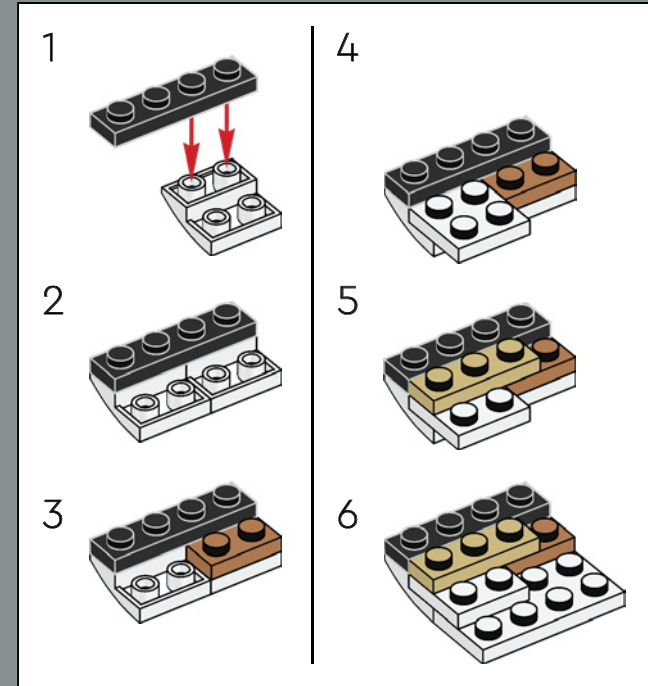

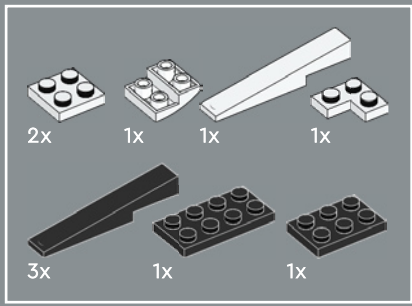

125

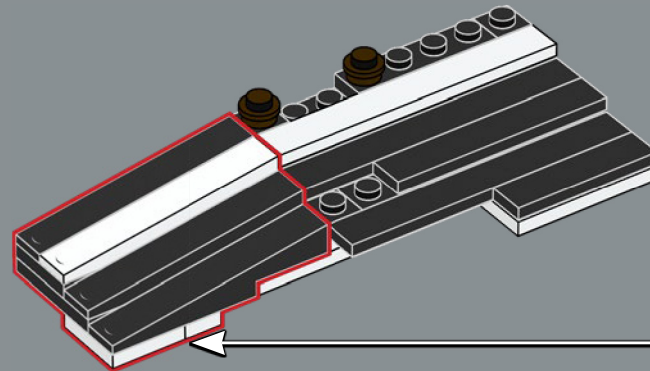
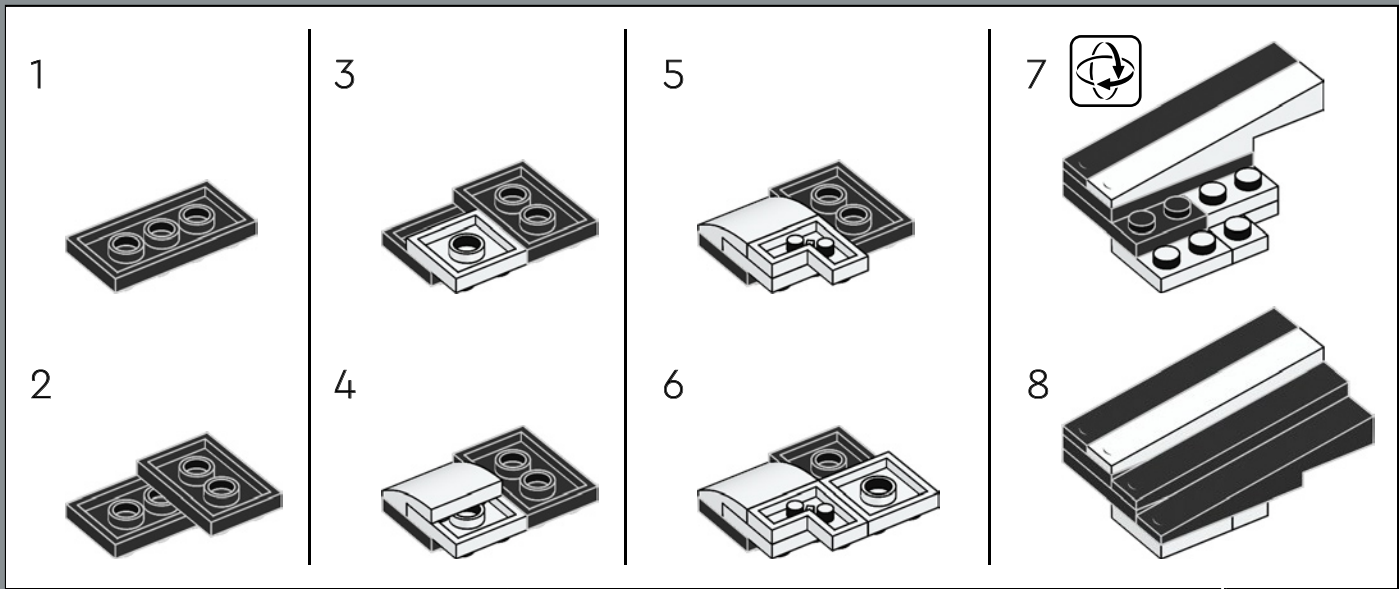

126

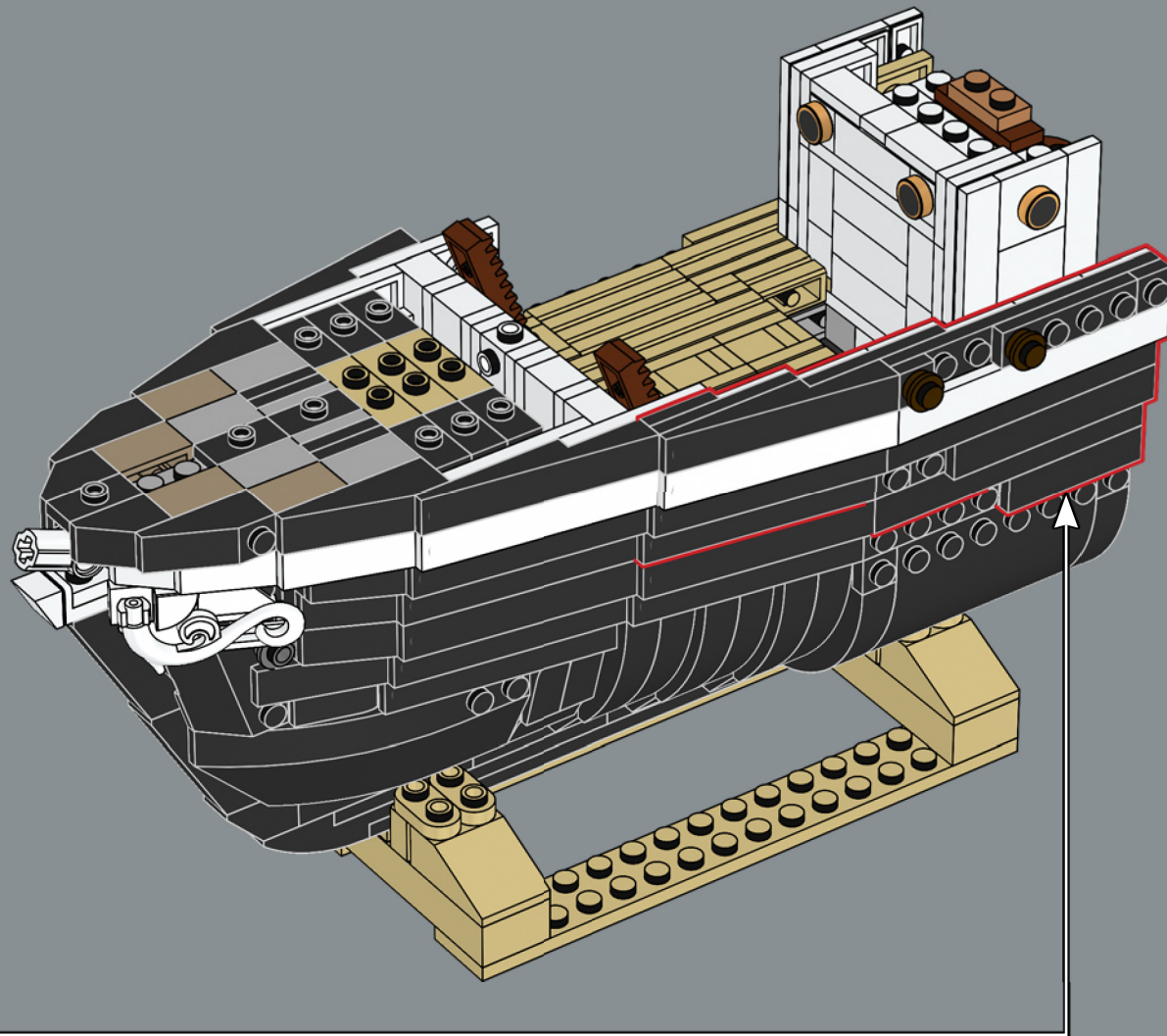

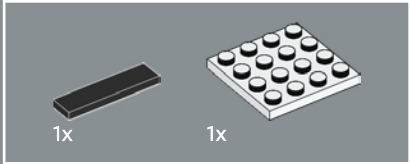
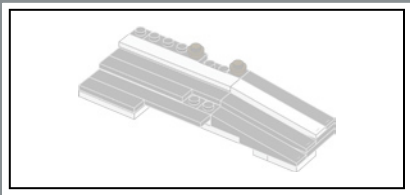

127

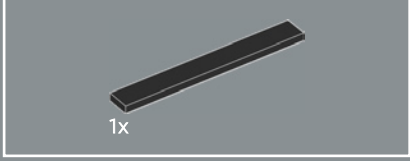
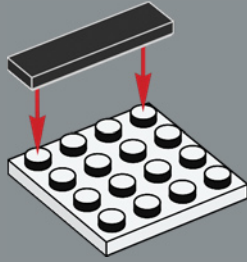

128

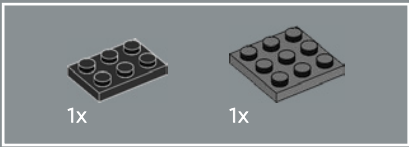
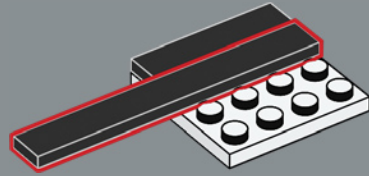

129

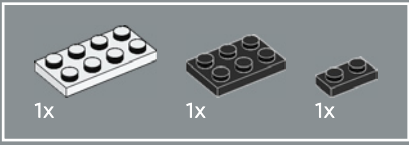
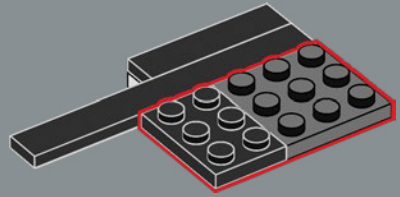

130

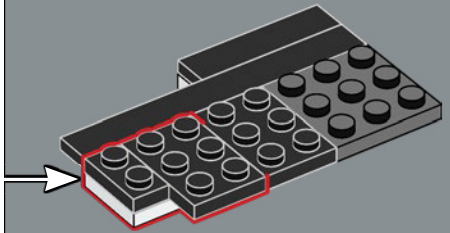
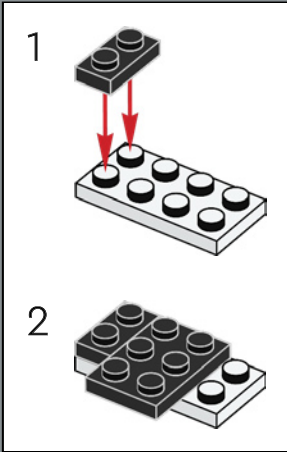

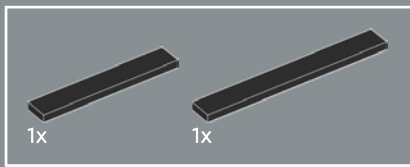

131

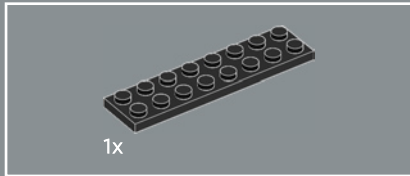
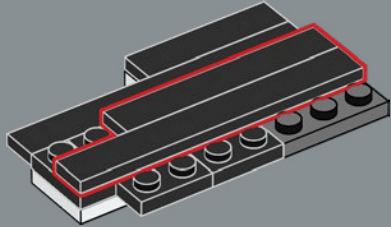

132

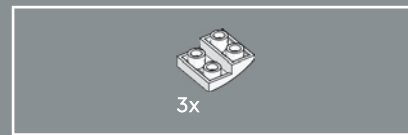
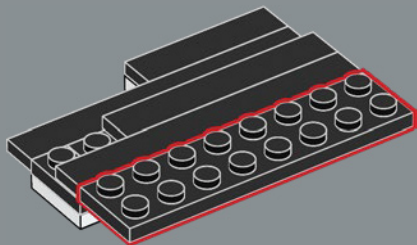

133

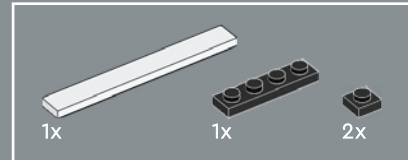
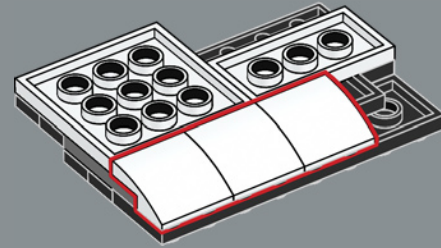

134

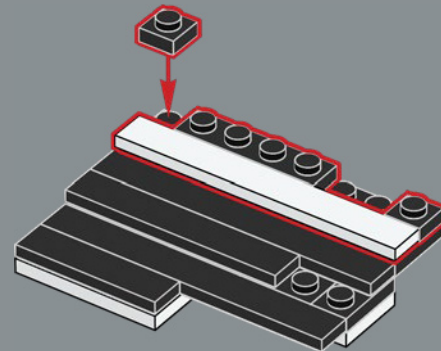

2x

135

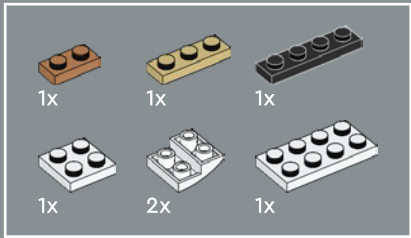
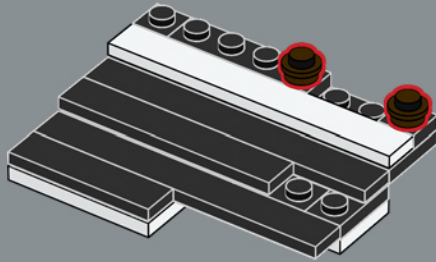

136

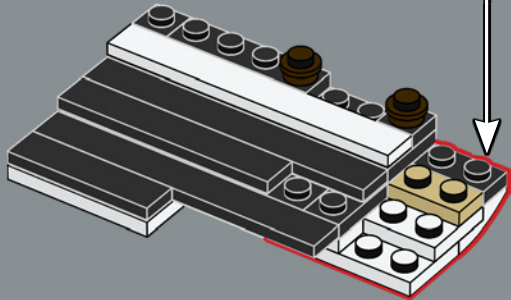
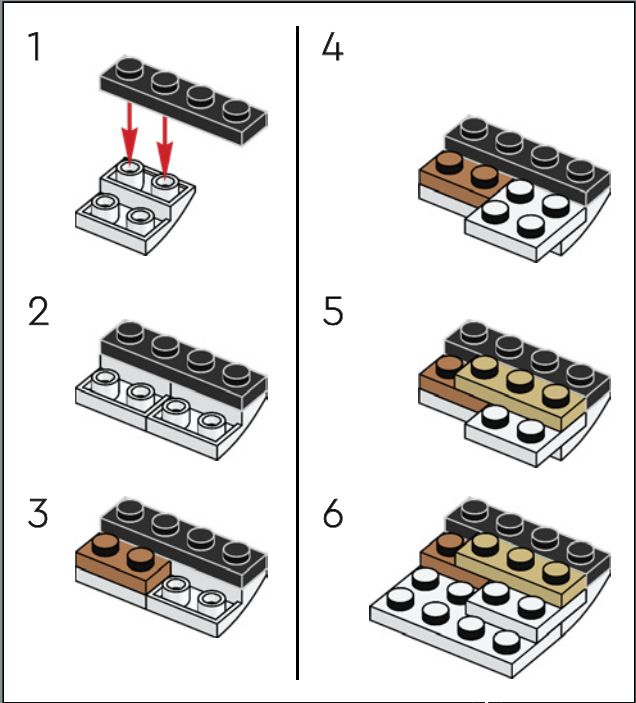

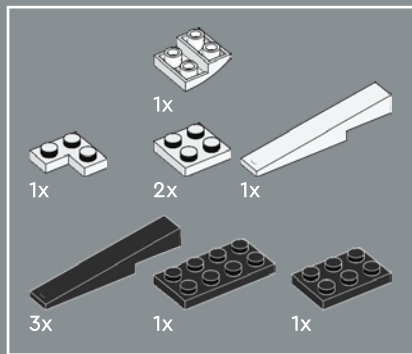

137

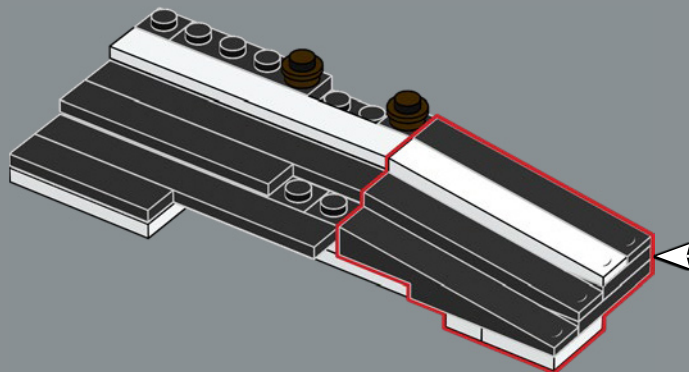
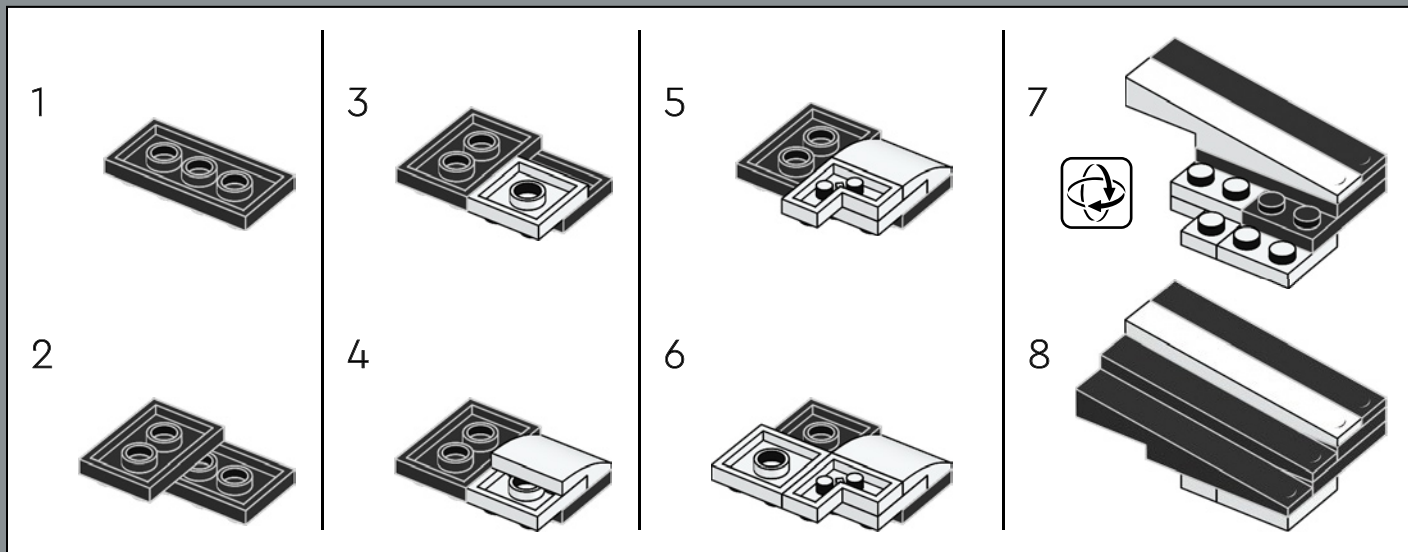

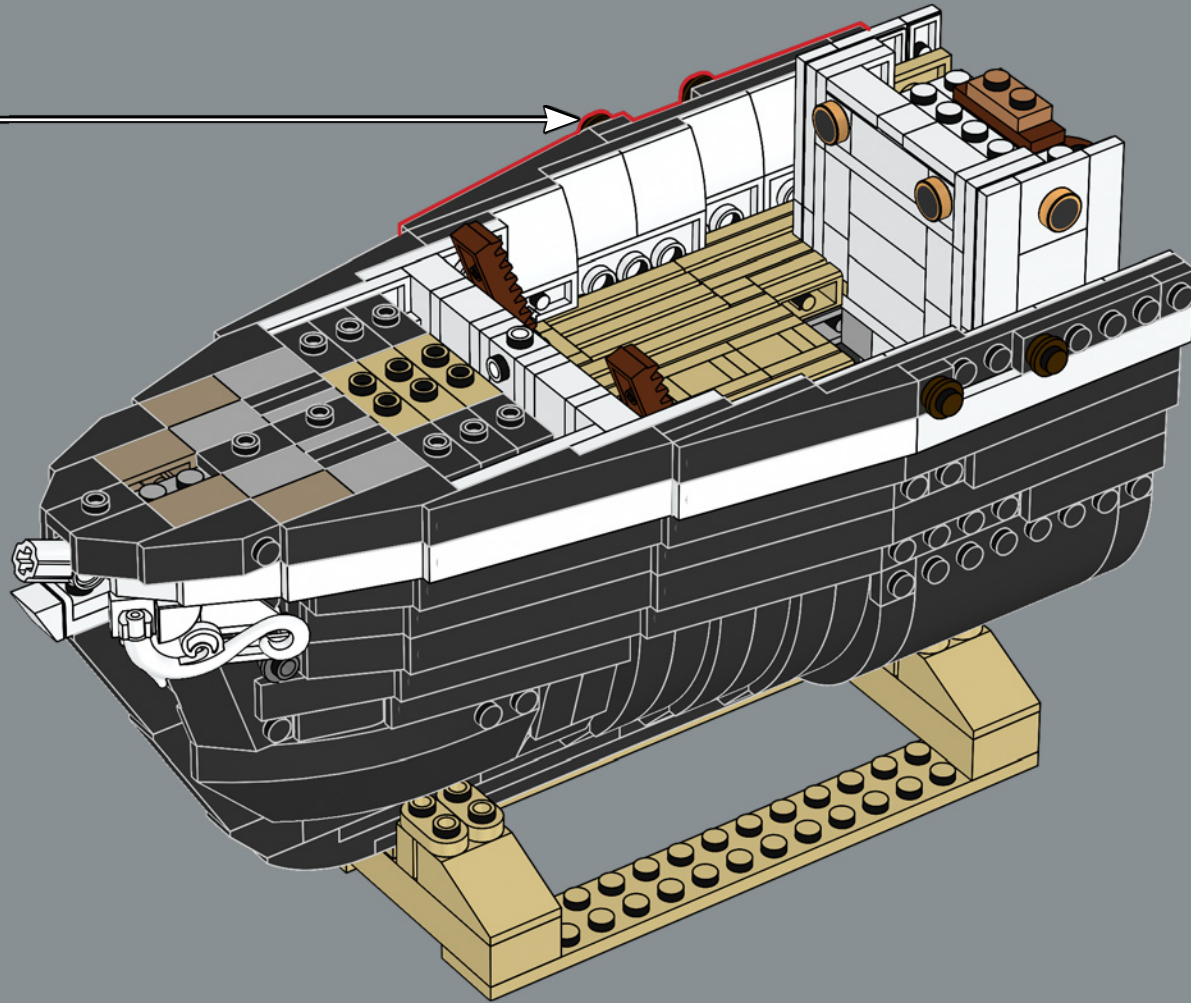

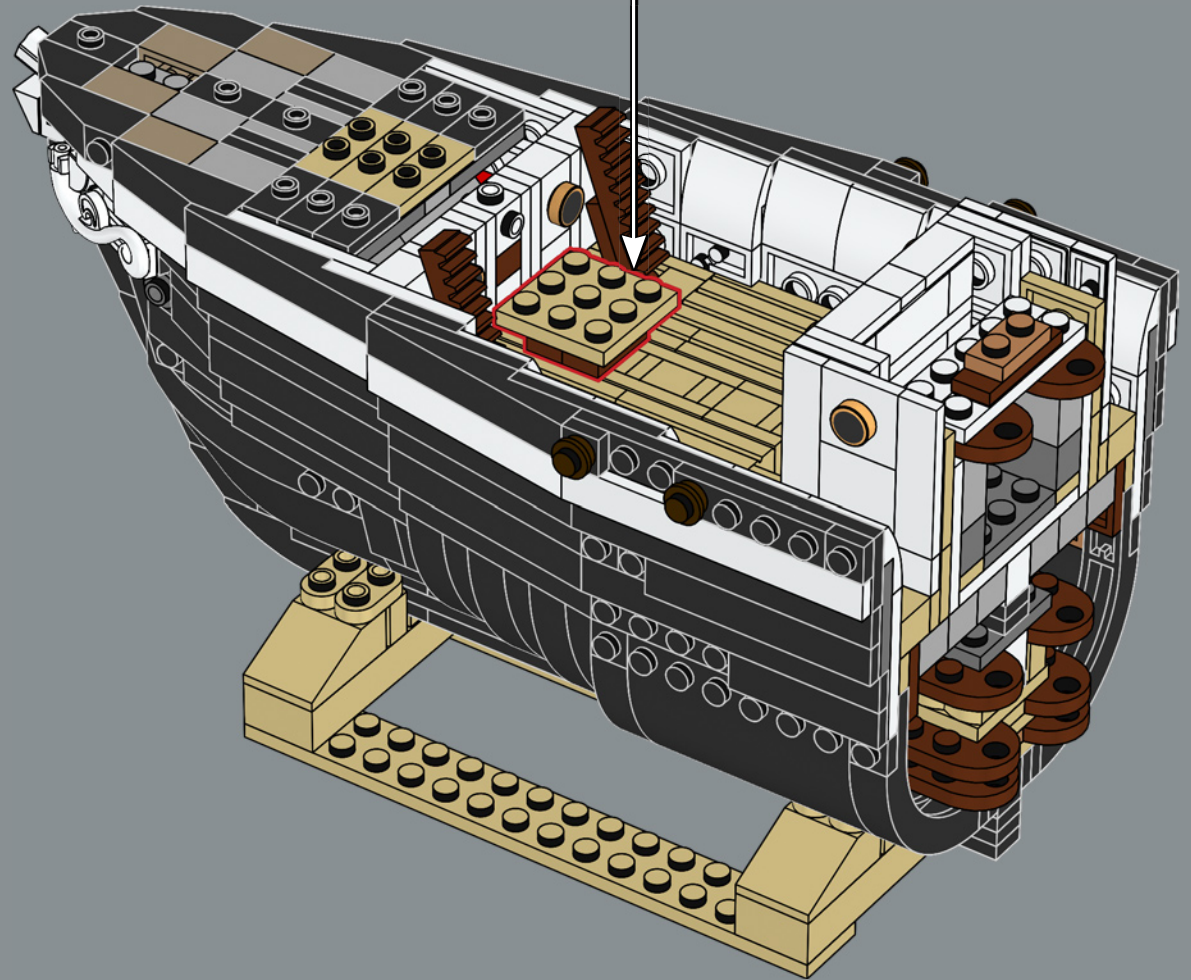
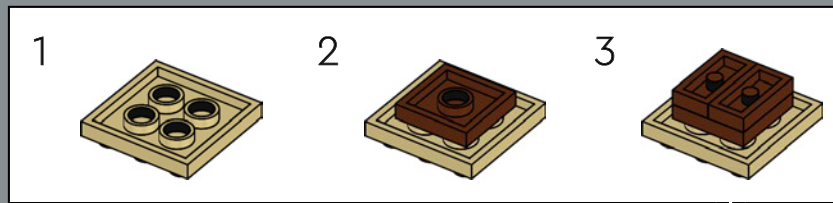
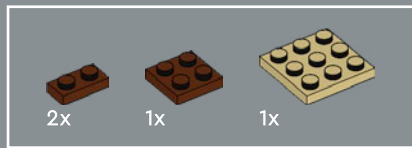

139

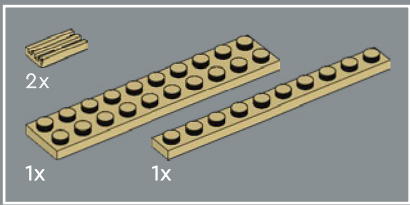

140

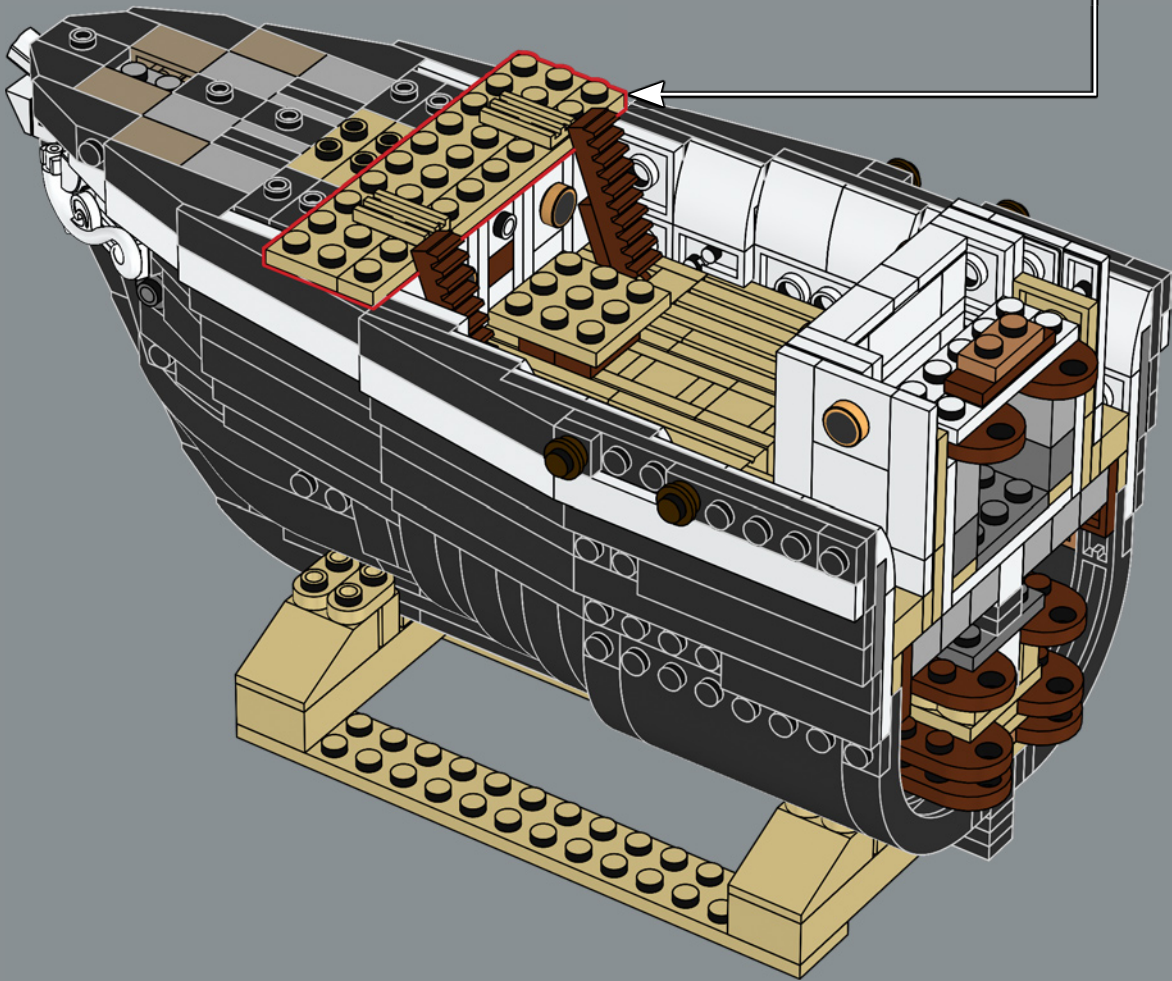
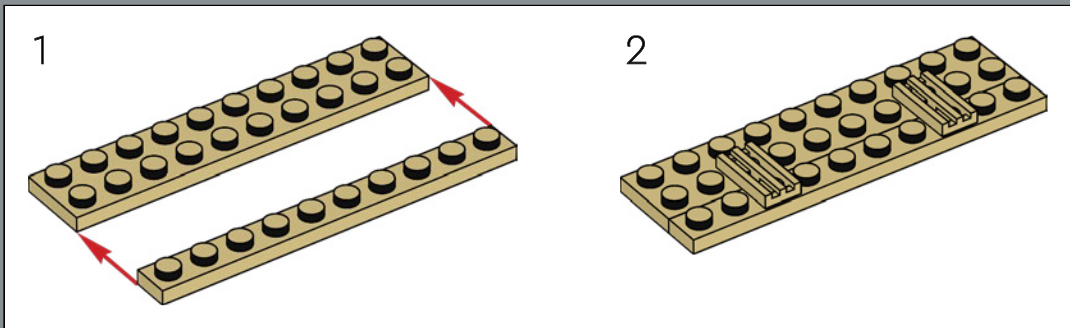

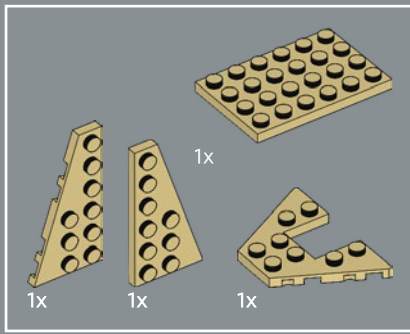

141

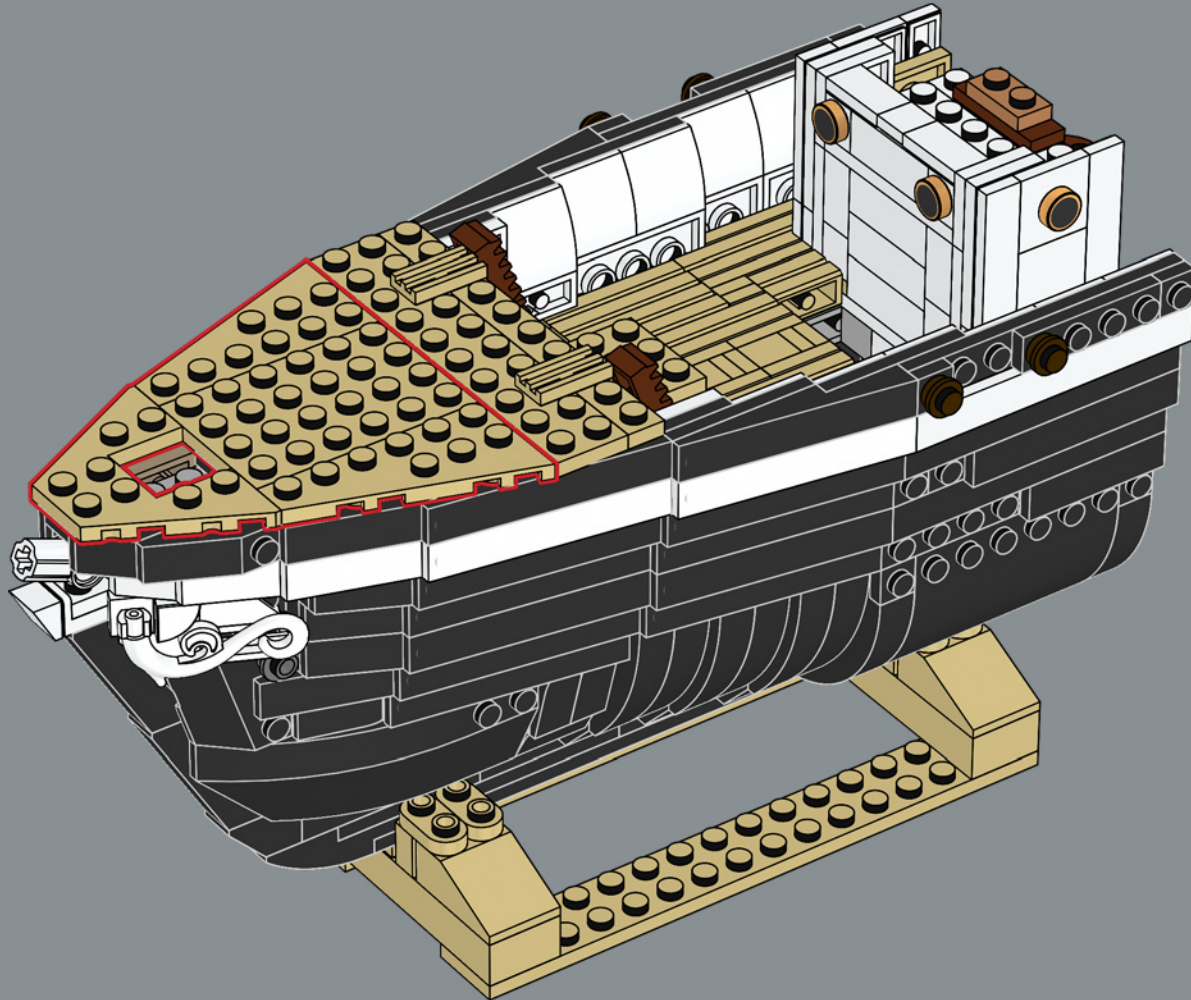

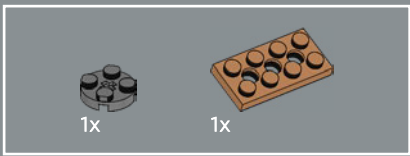

142

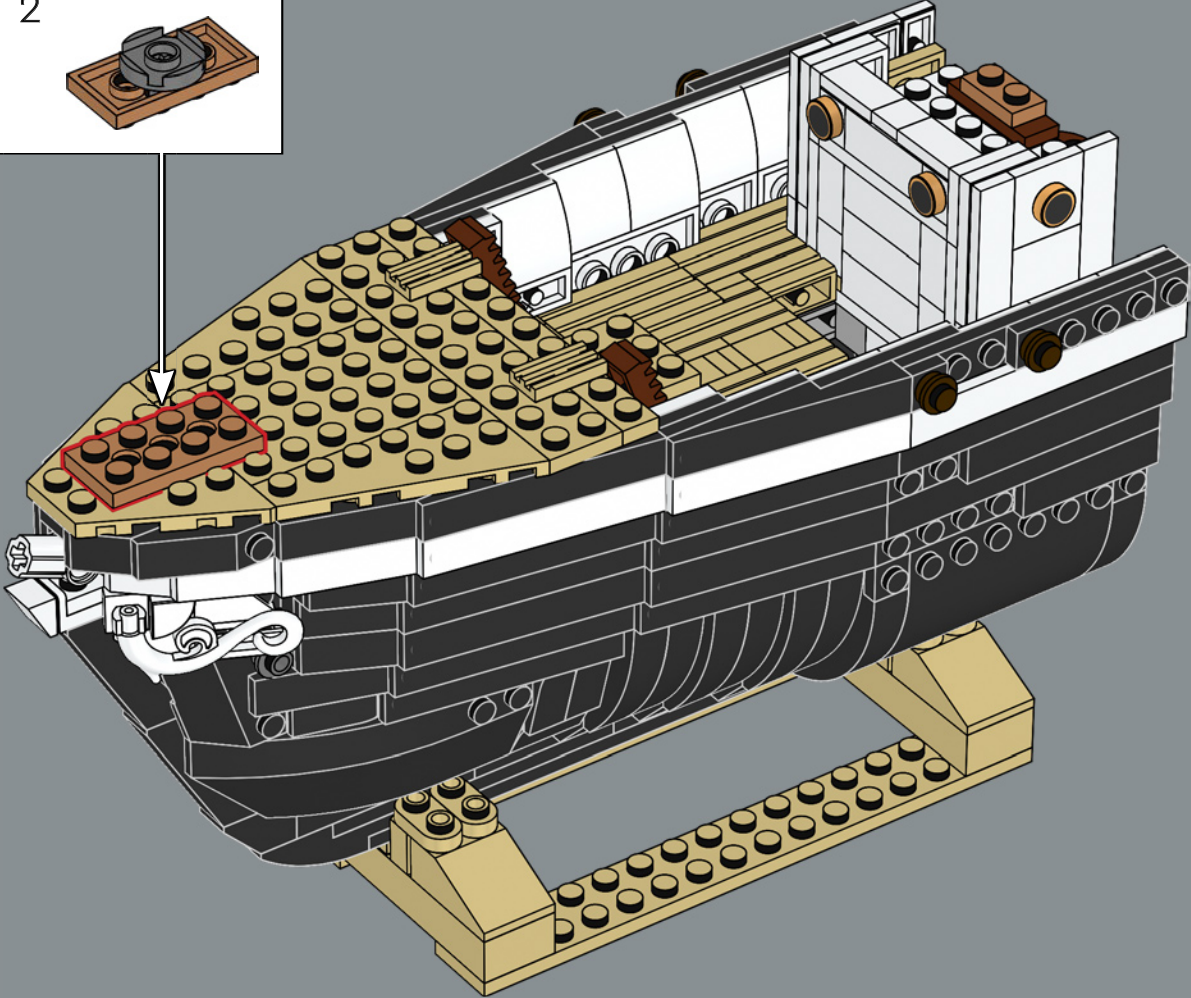
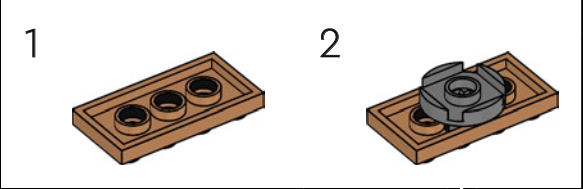

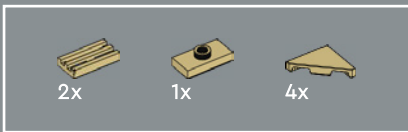

143

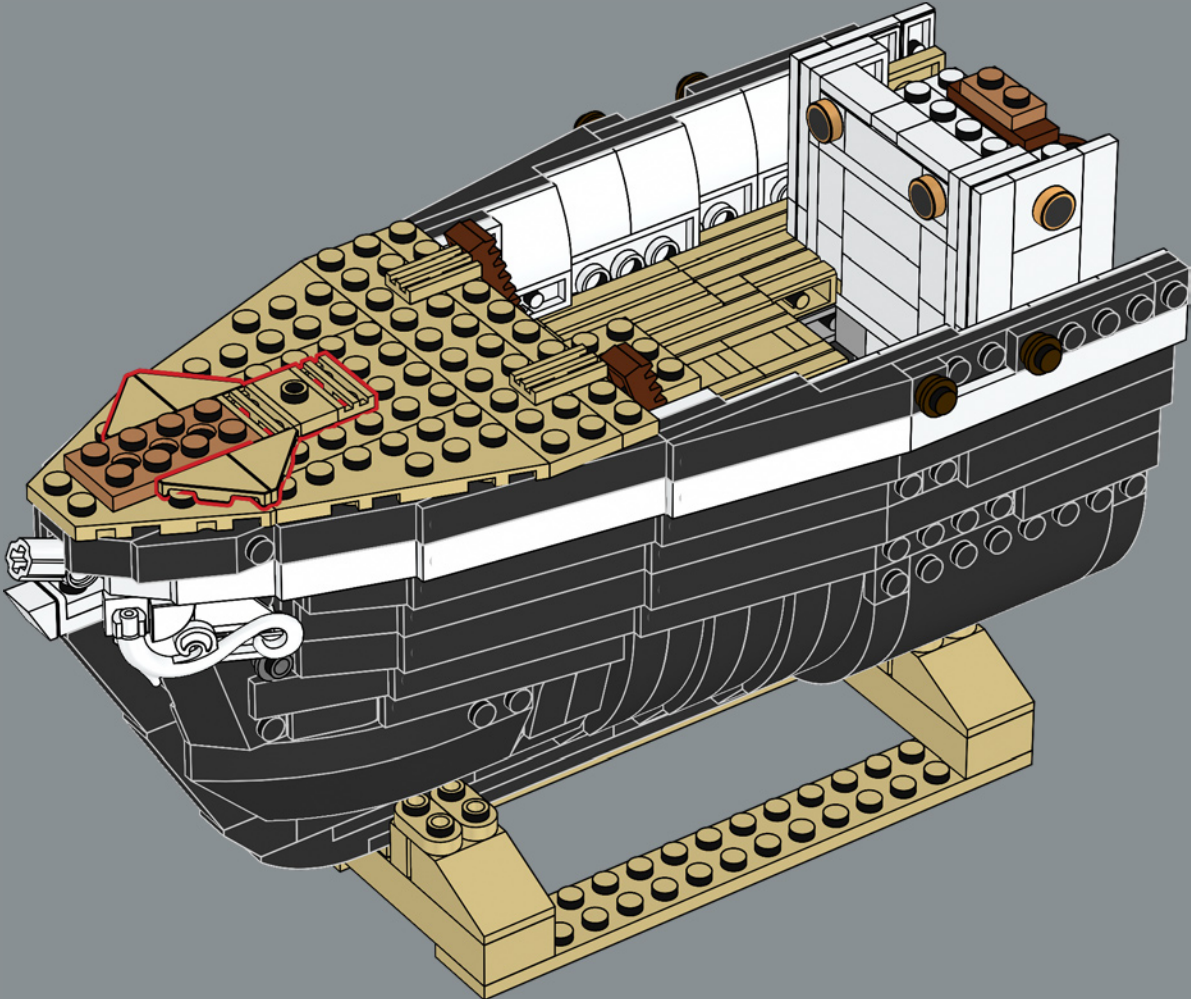



144

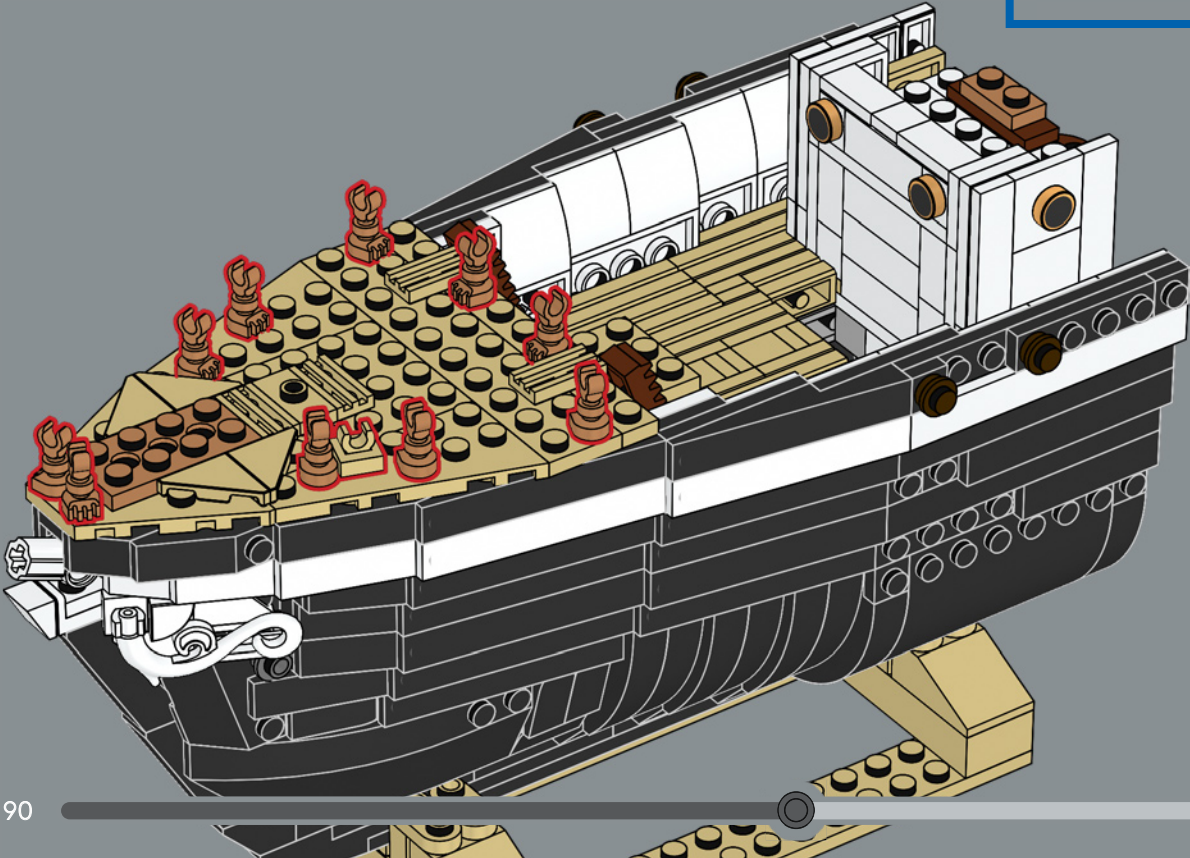
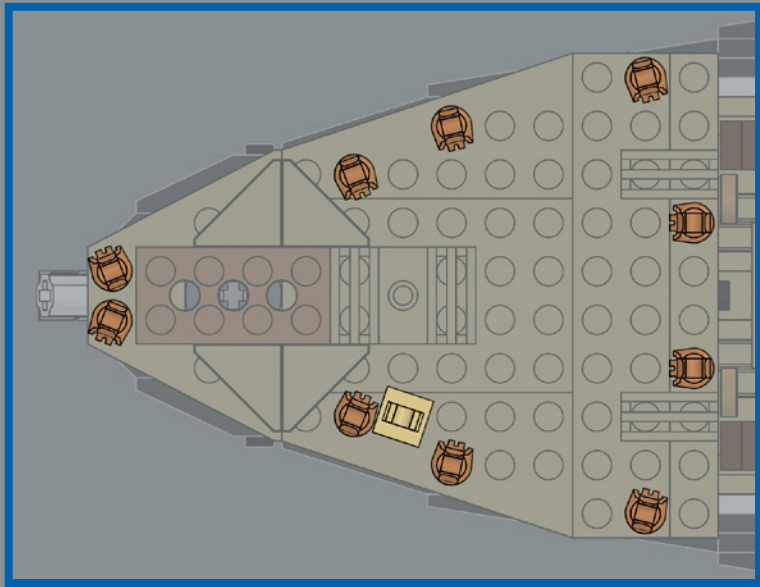



145

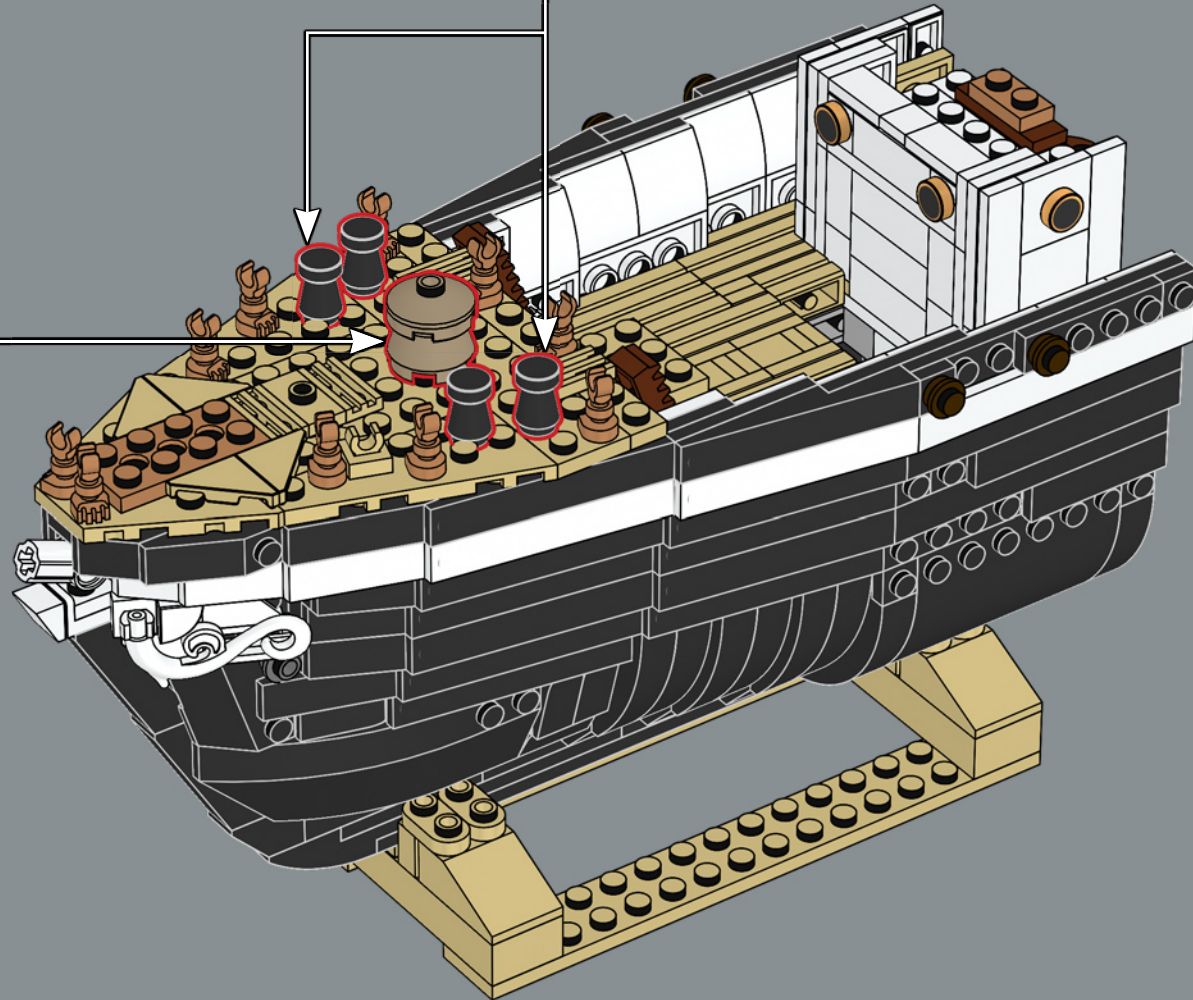
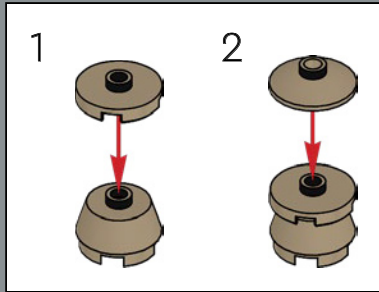
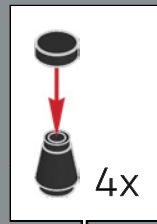

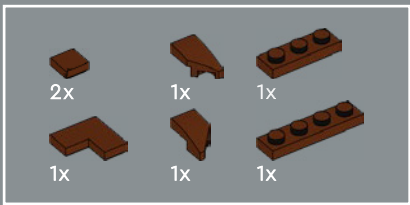

146

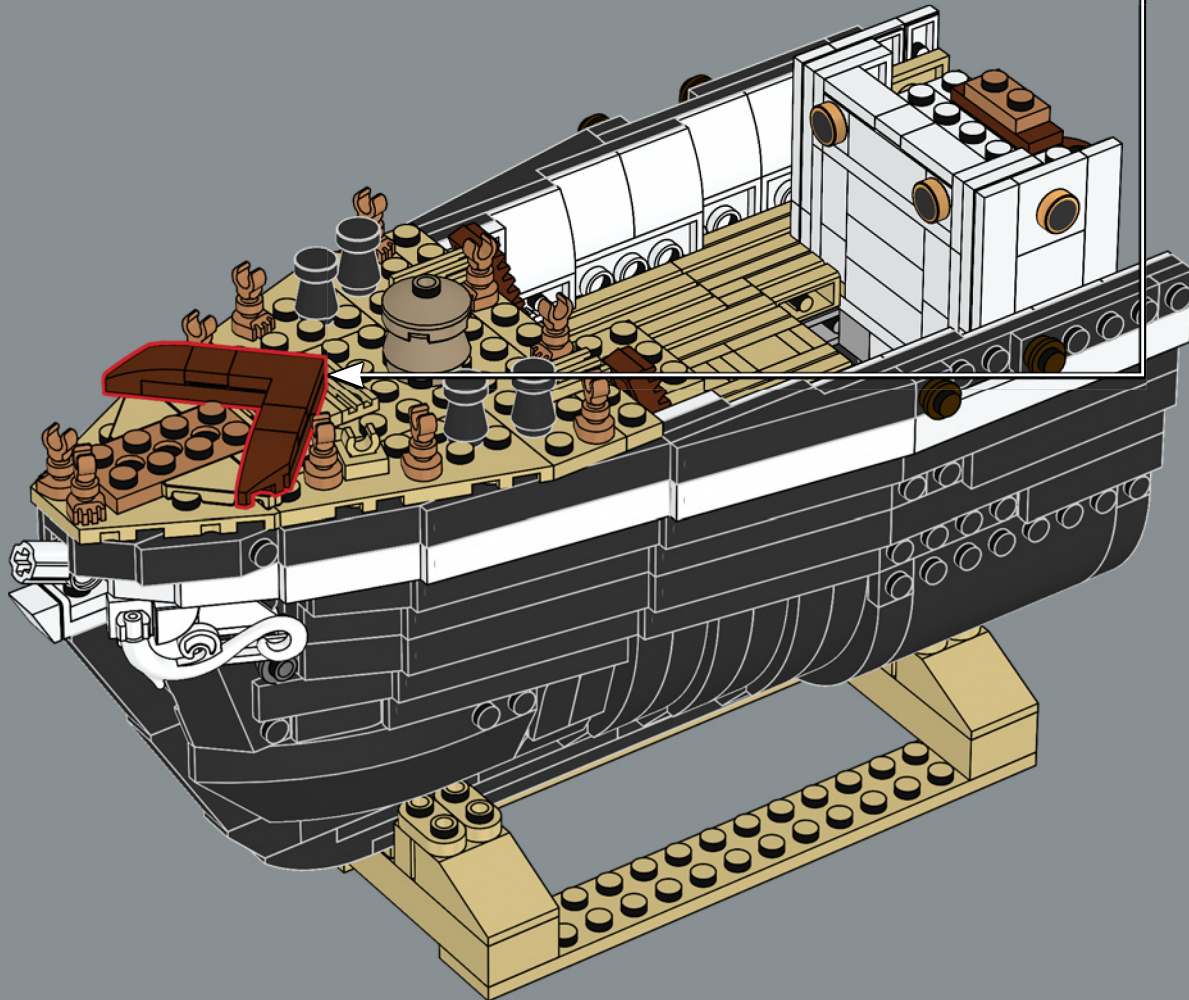
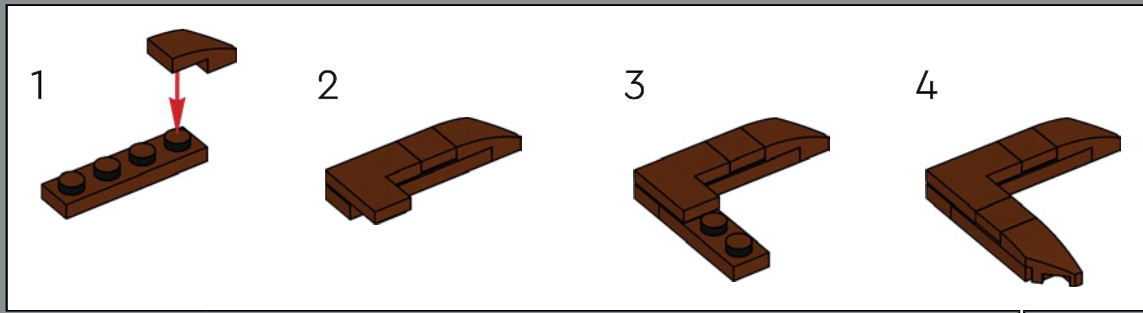

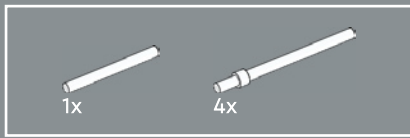

147

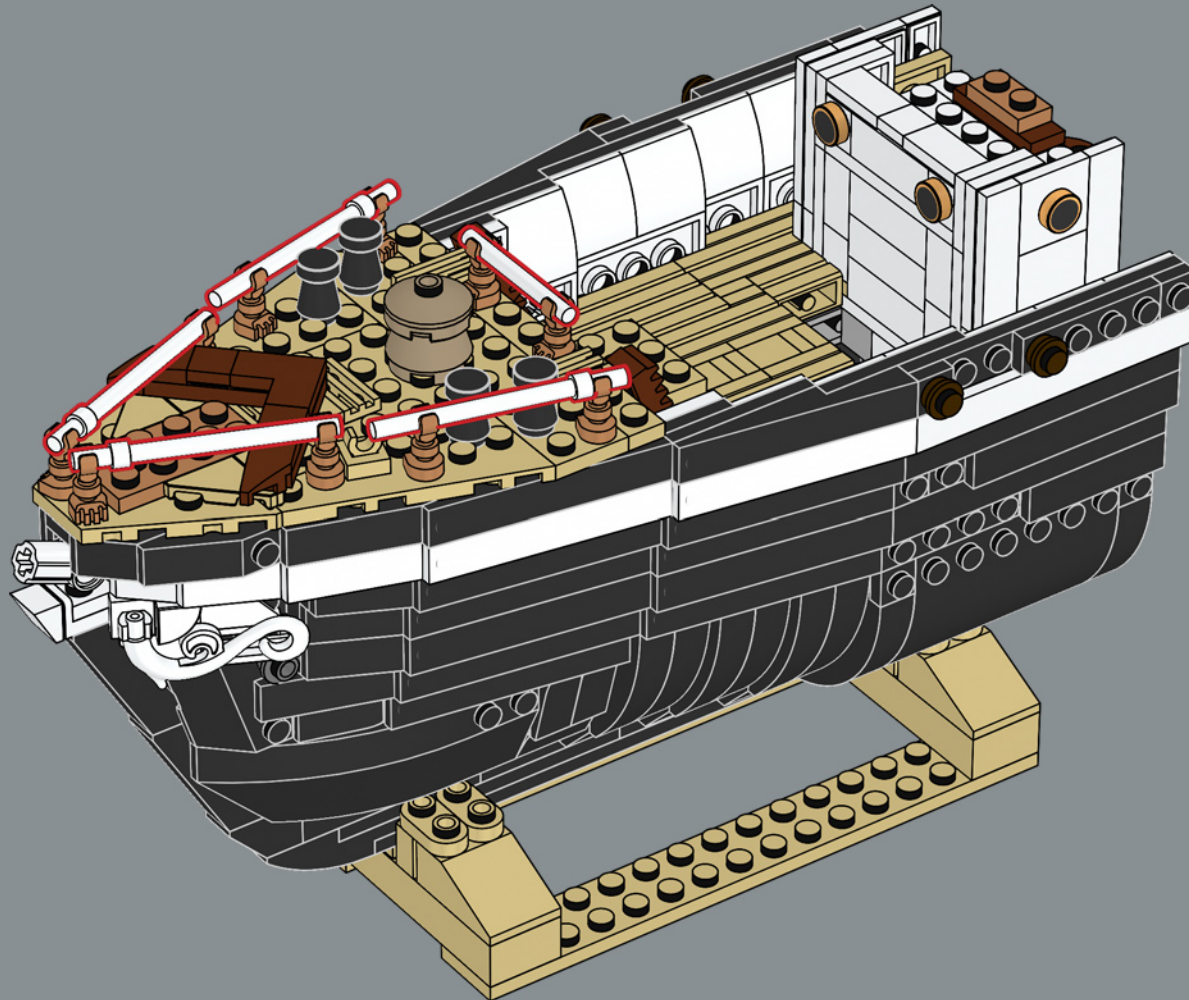



148

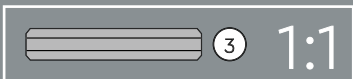
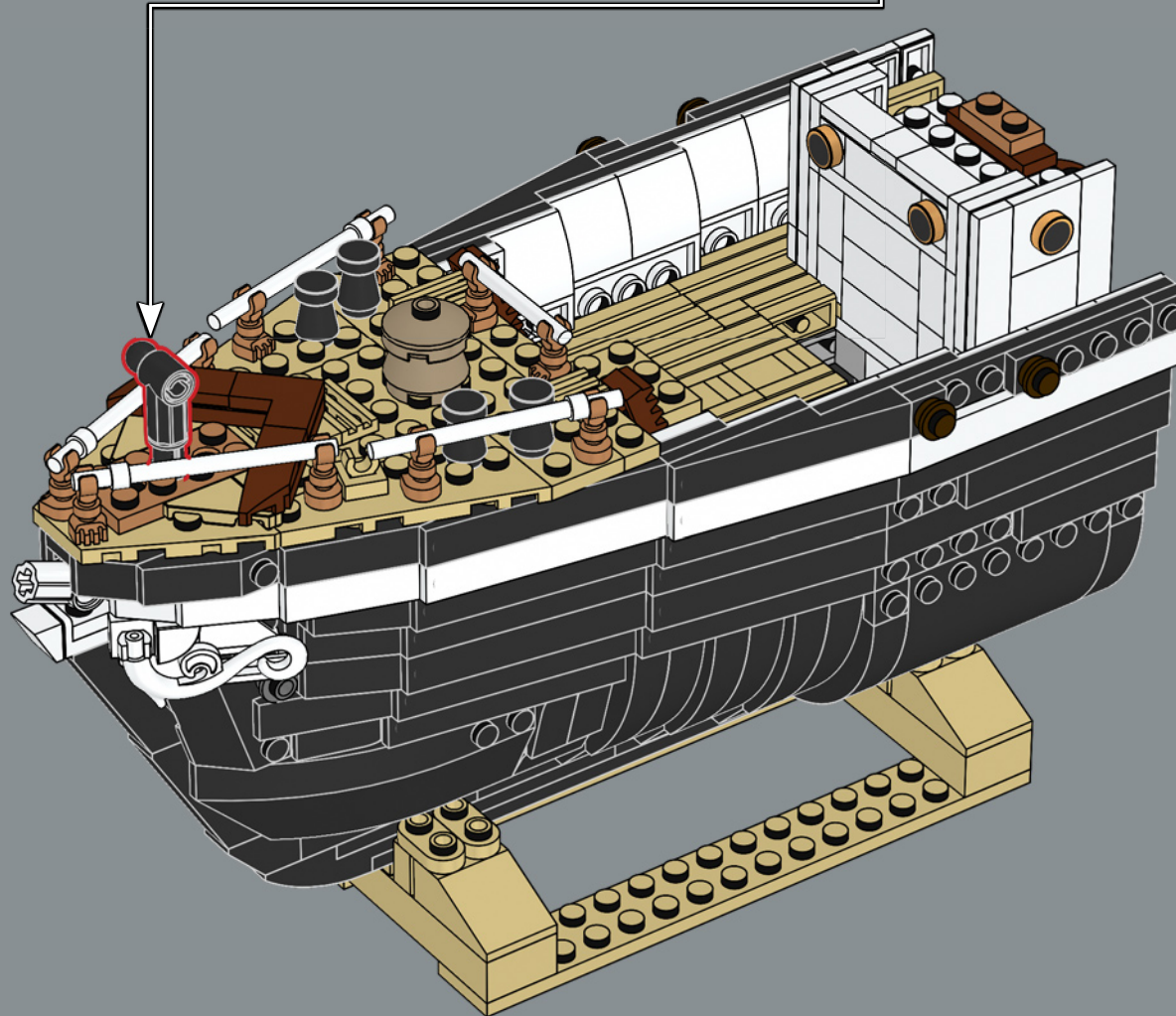
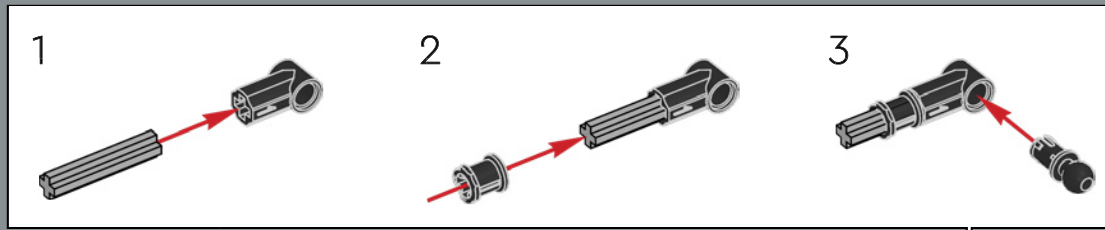

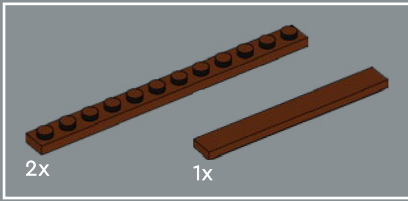
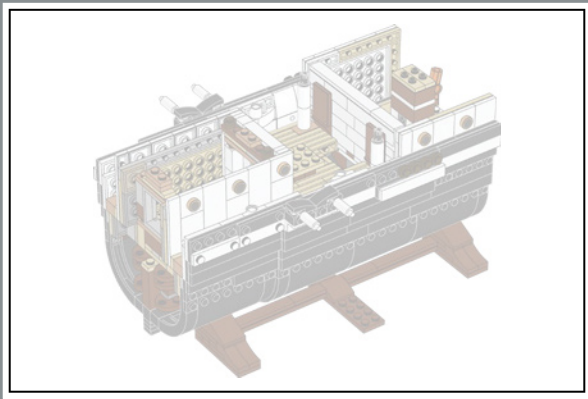

149

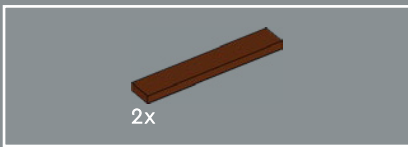
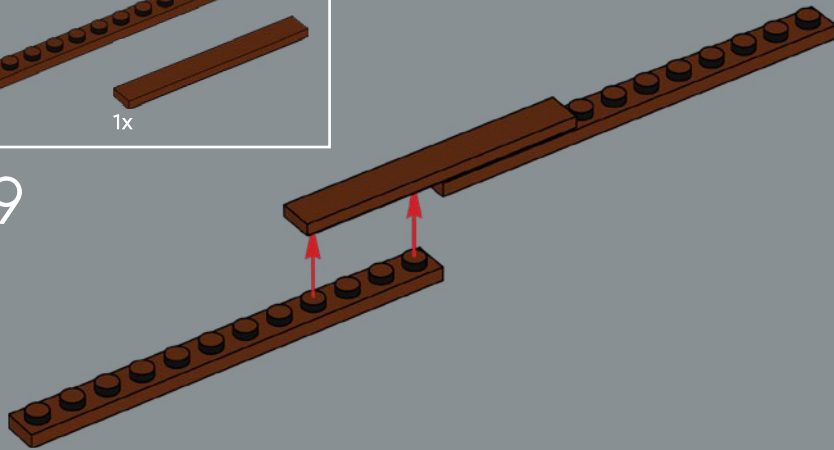

150

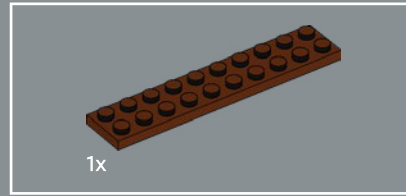
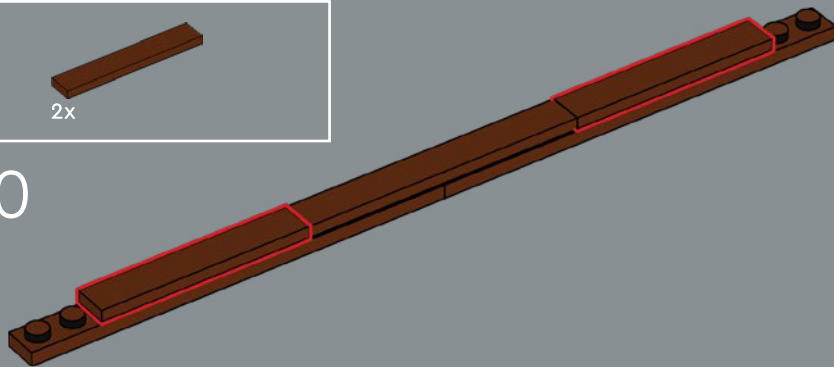

151

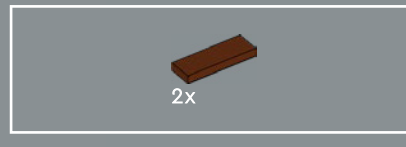
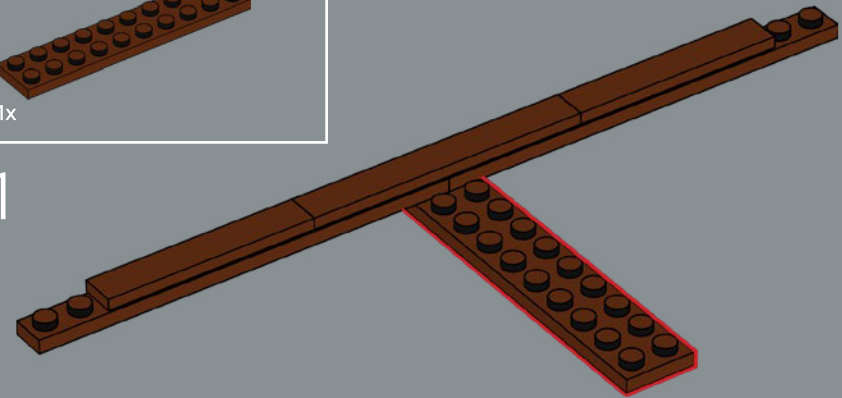

152

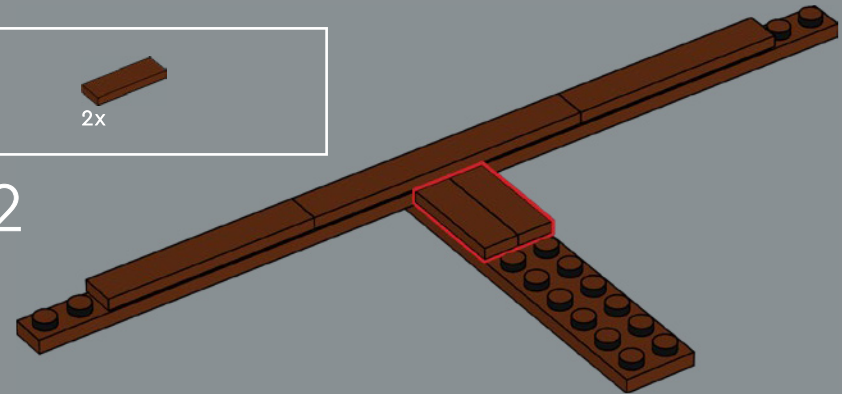

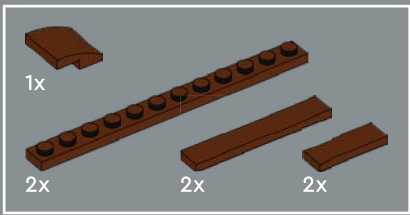

153

1

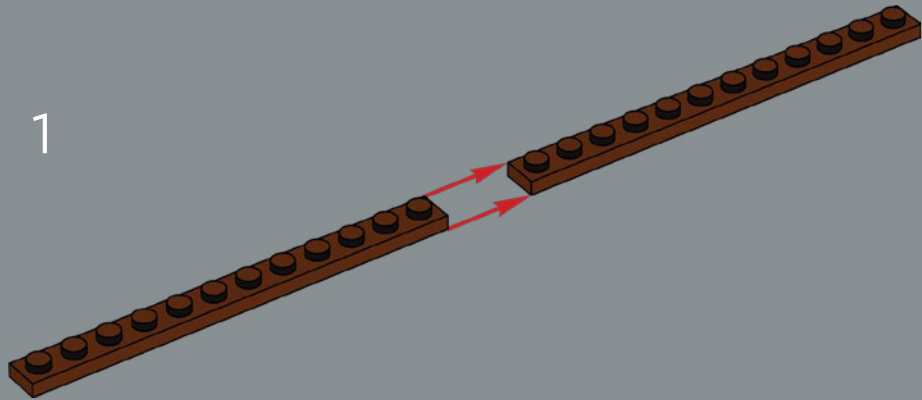

2

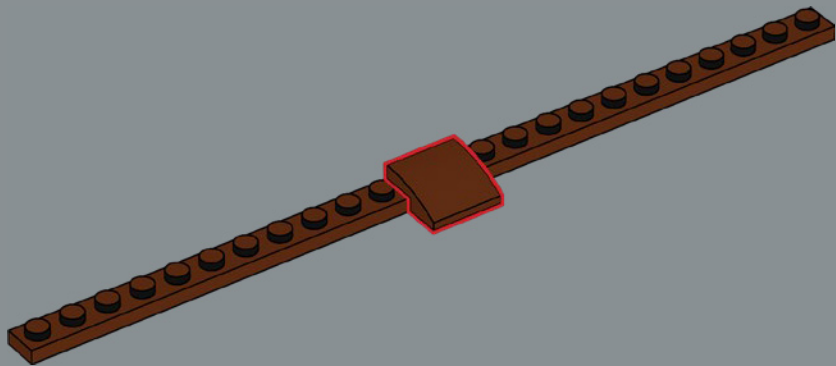

3

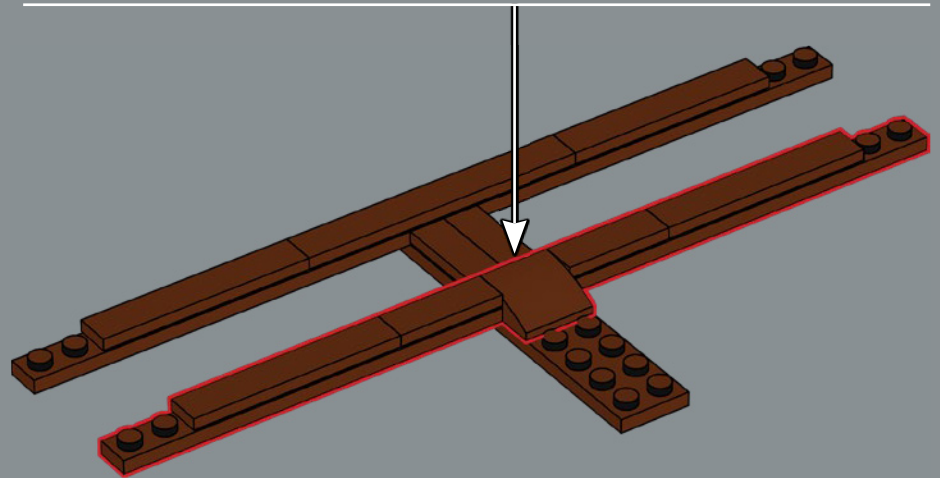
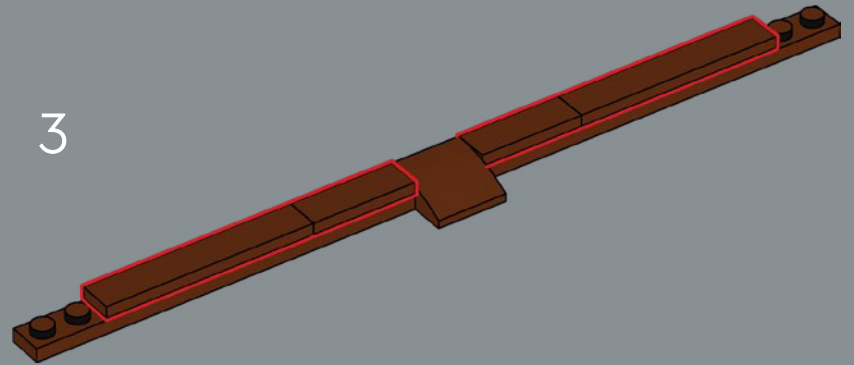

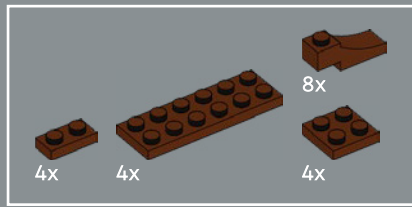

154

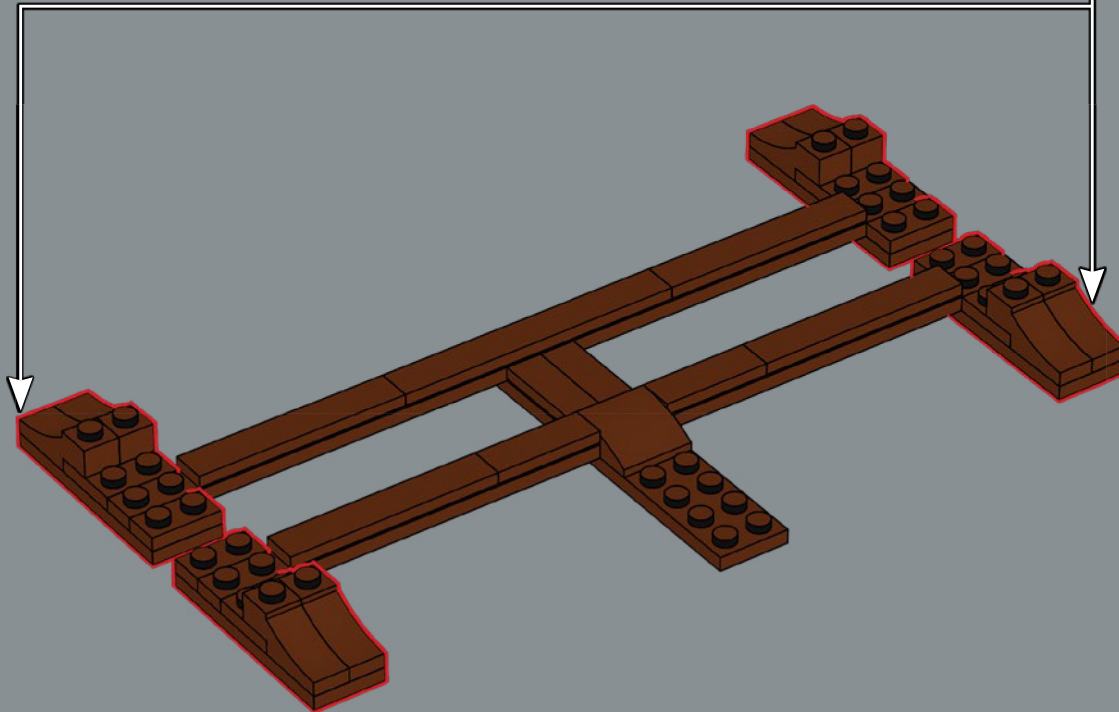
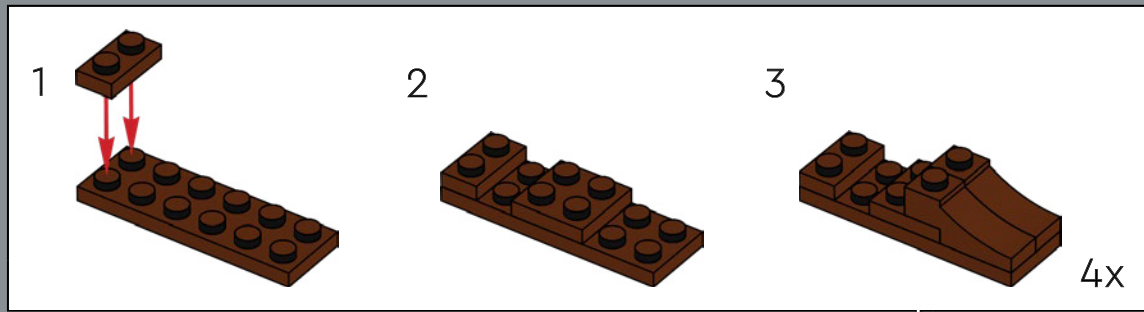

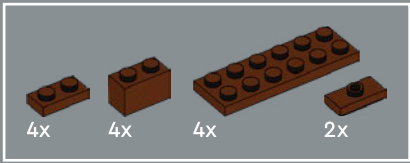

155

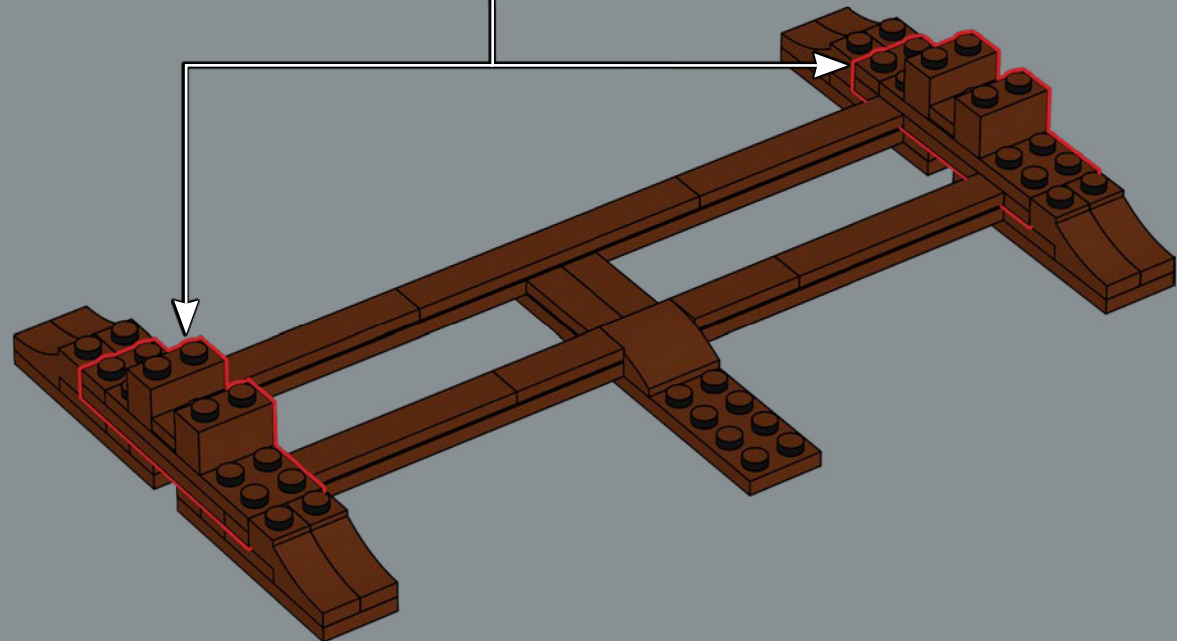
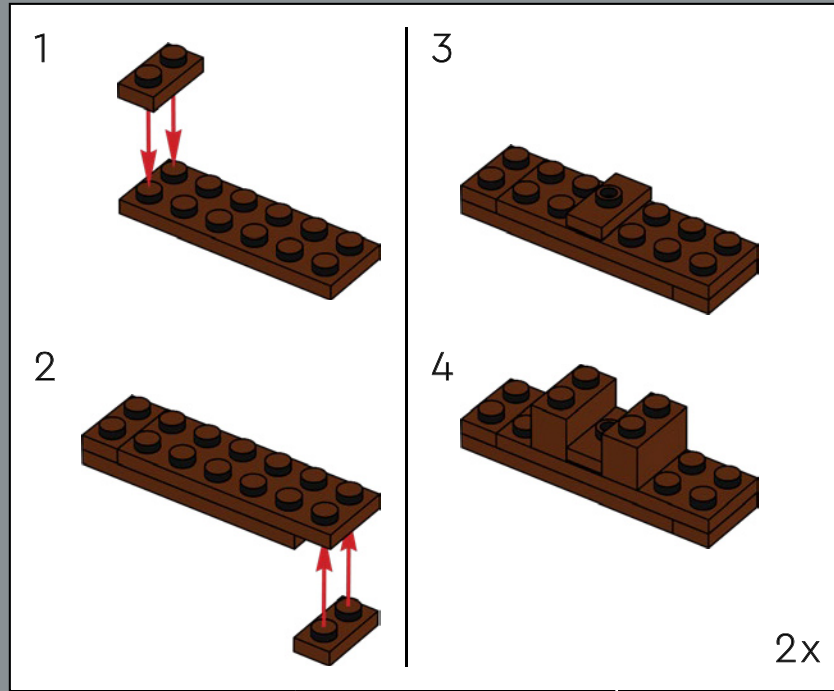



156

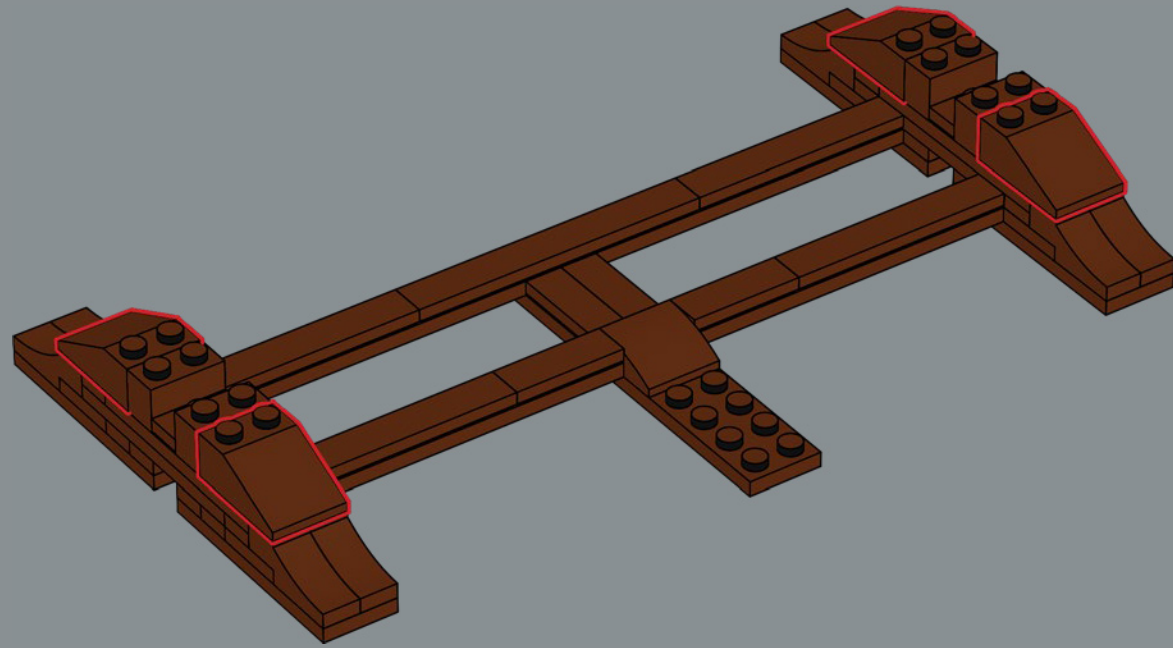

157

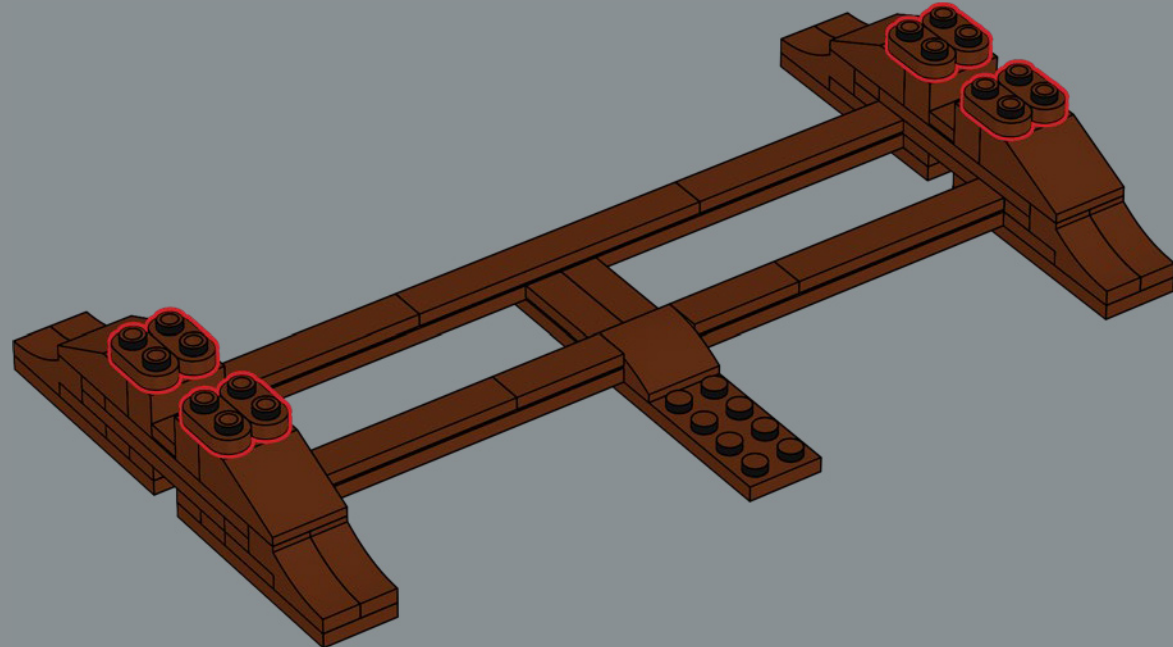

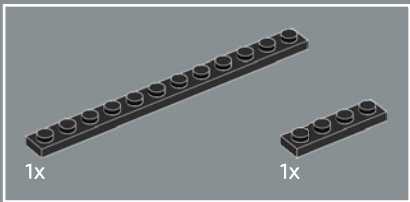
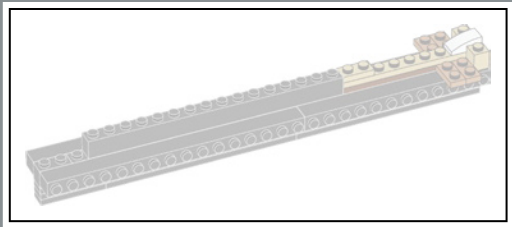

158

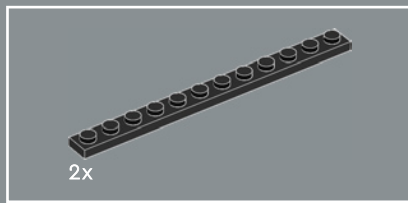
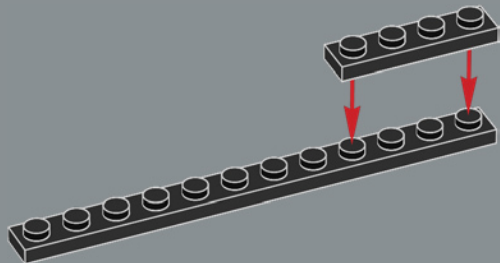

159

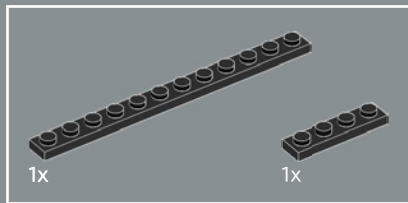
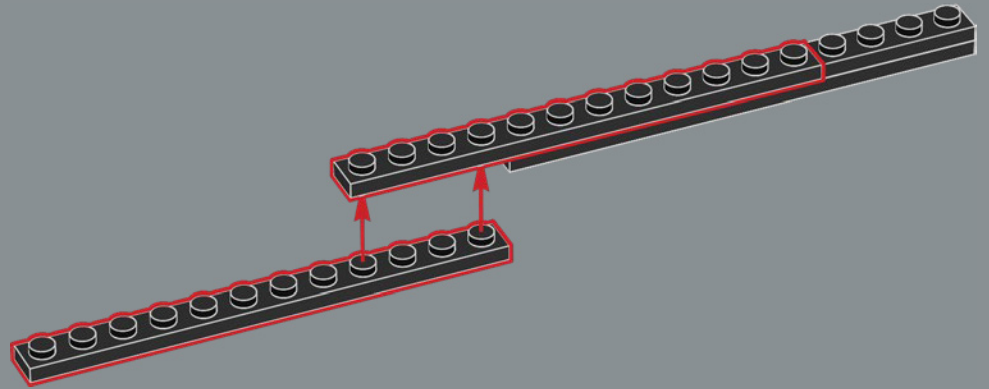

160

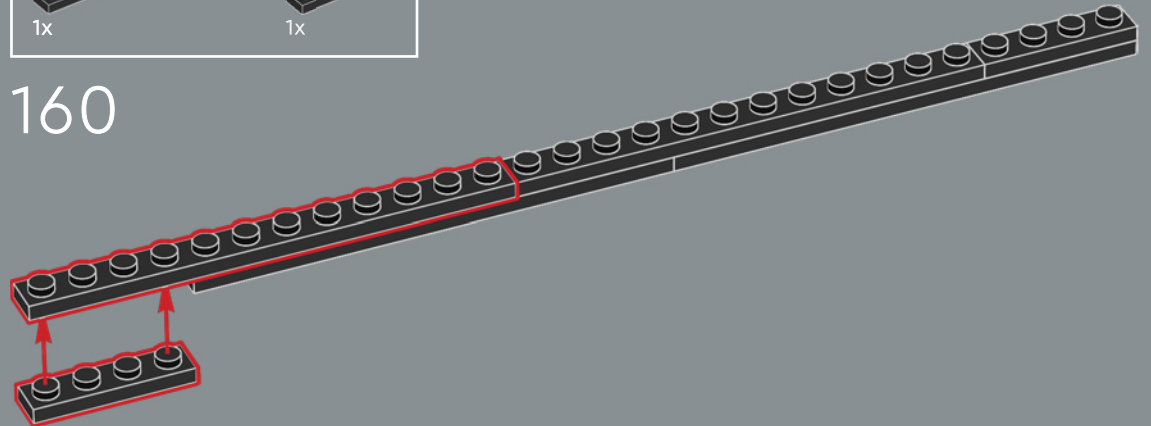

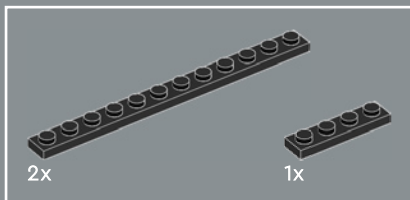

161

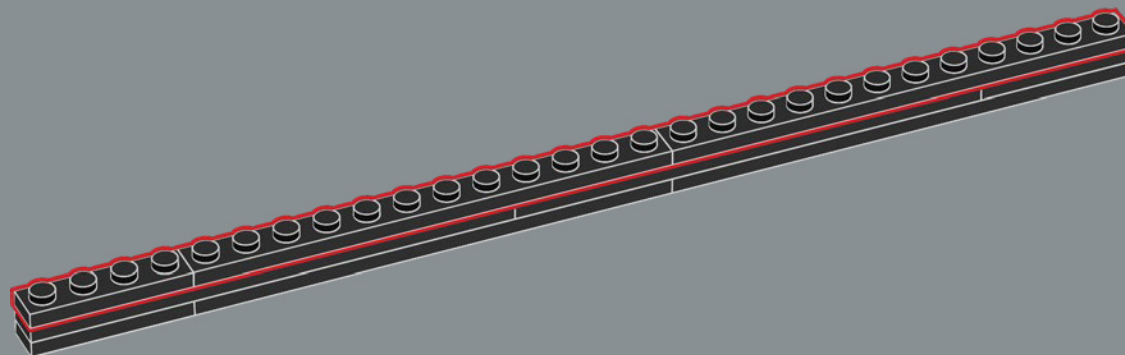

162

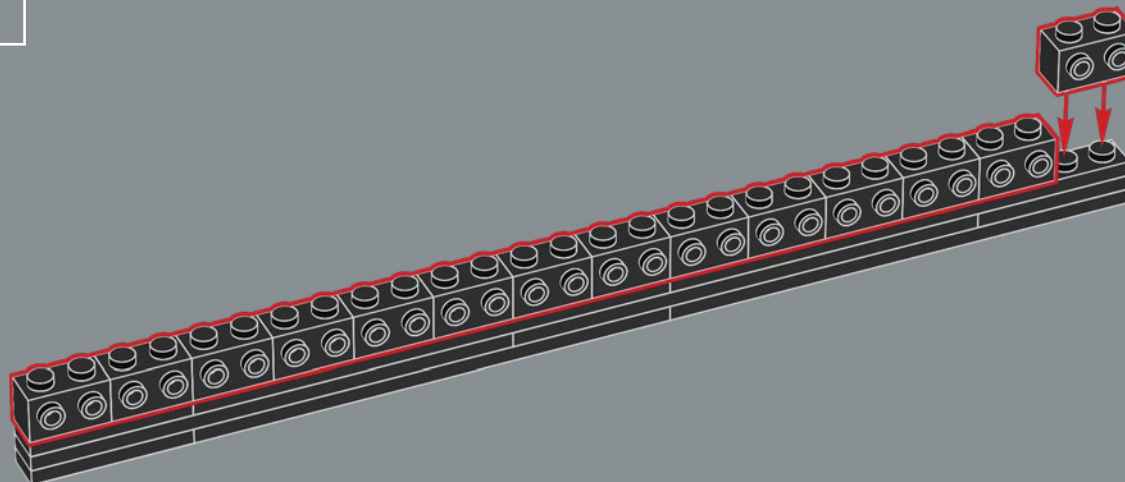

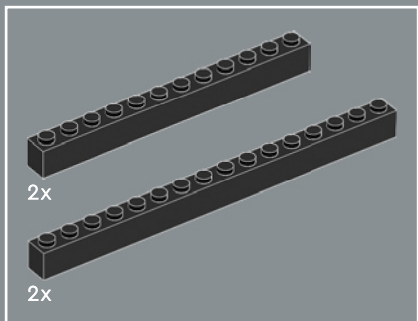

163

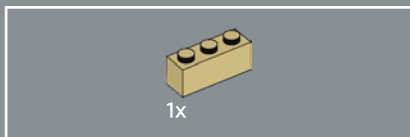
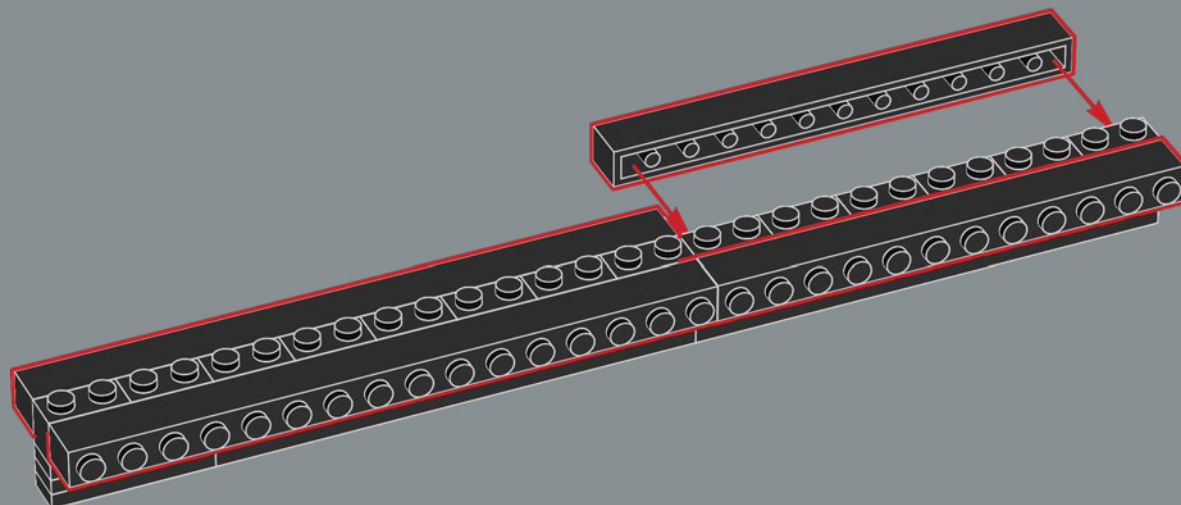

164

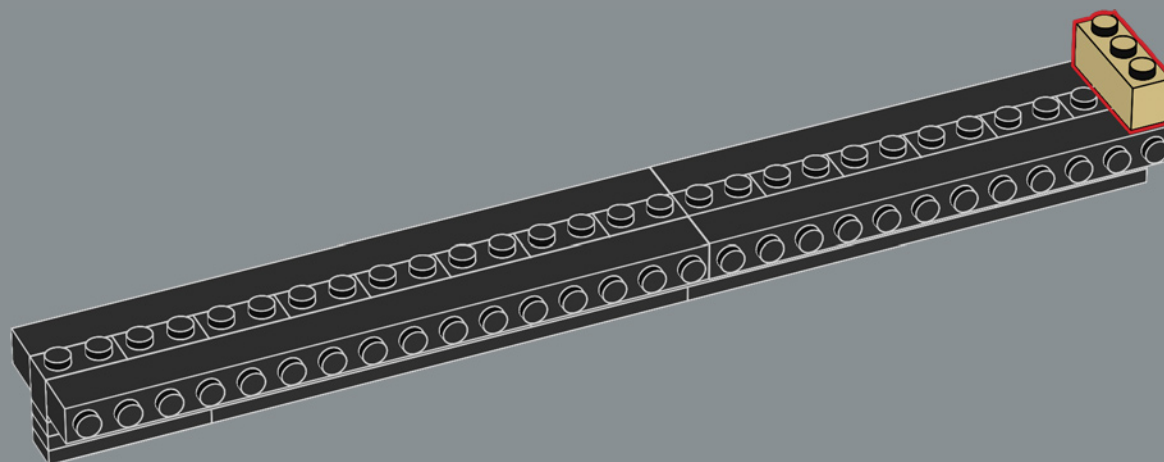

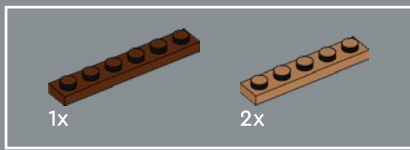

165

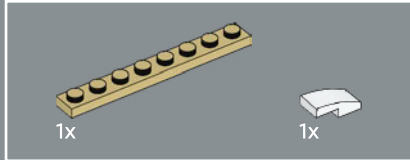
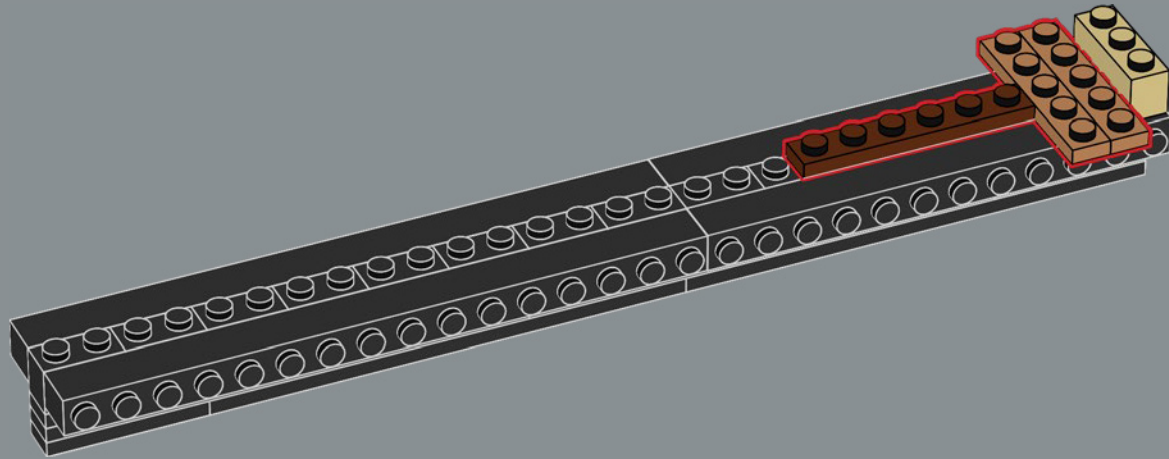

166

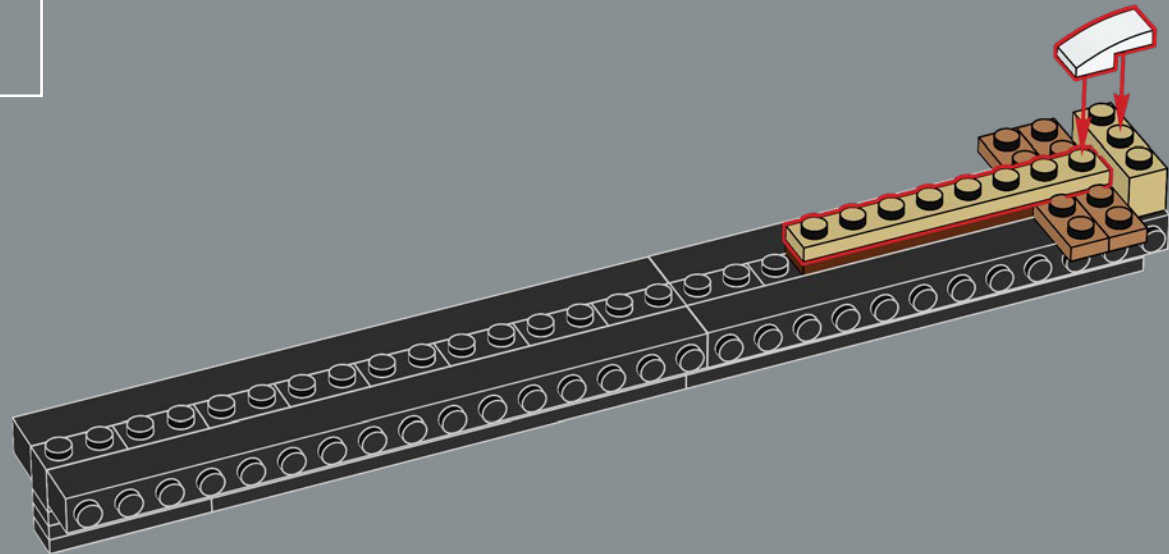

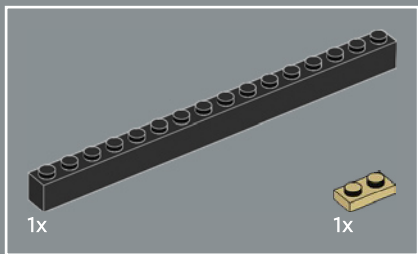

167

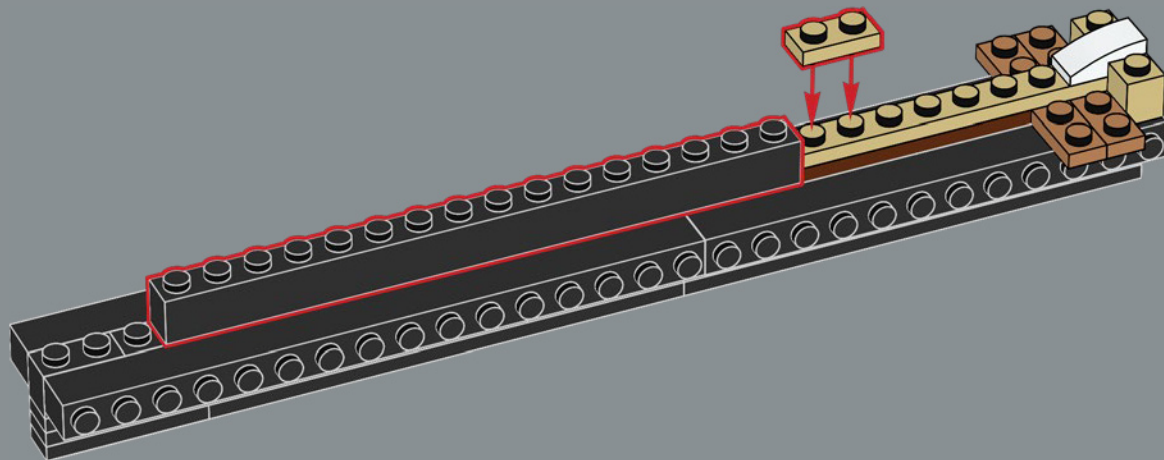

168

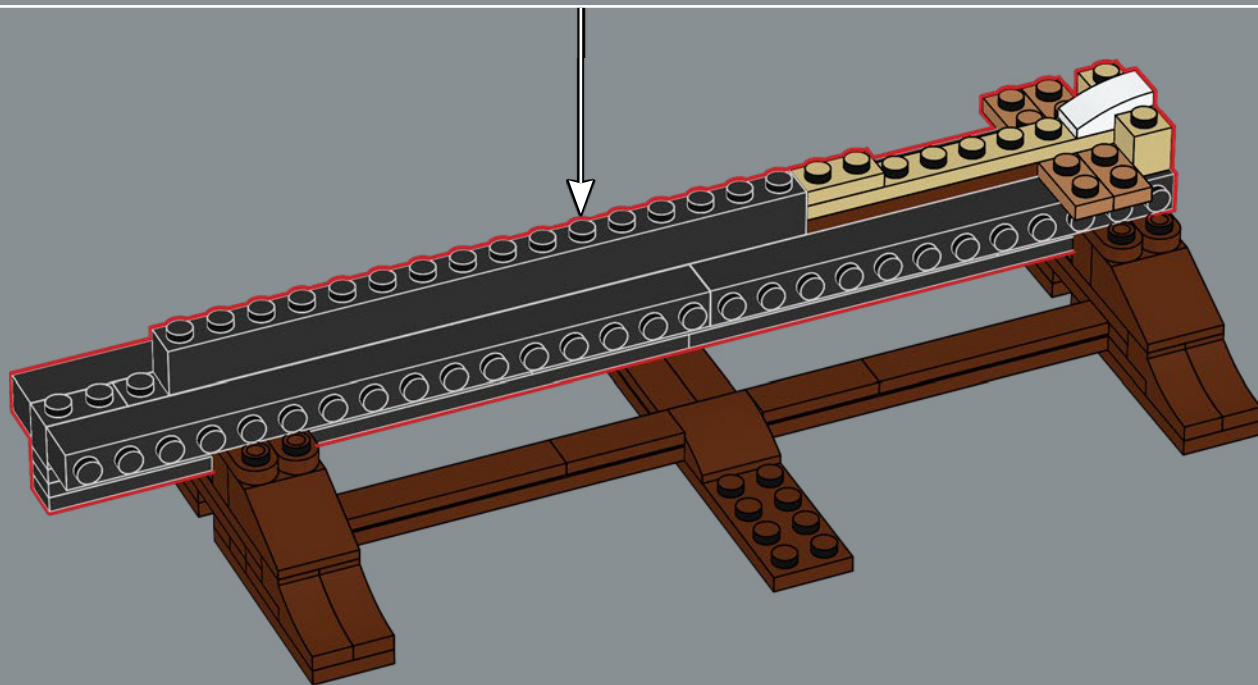



169

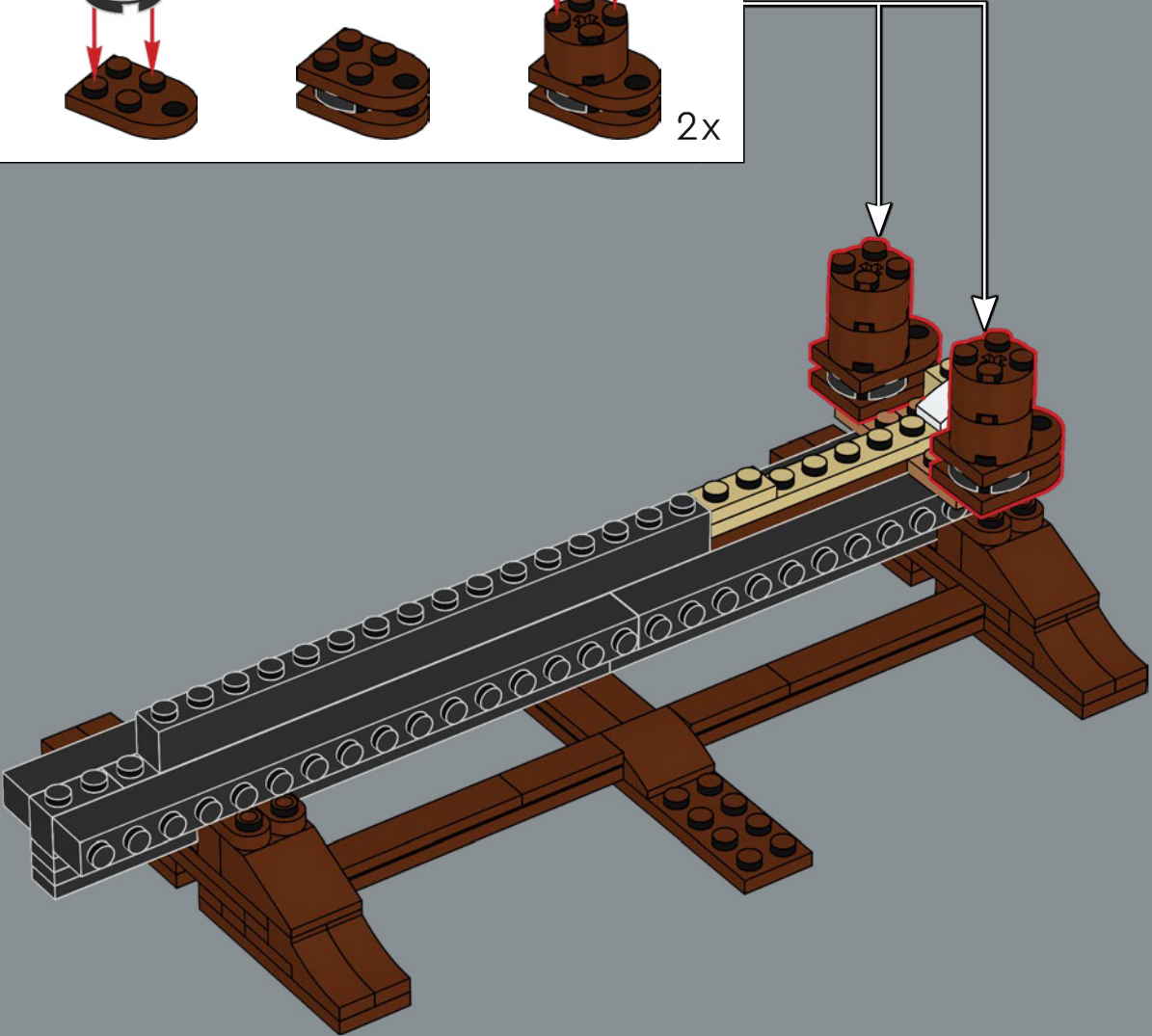

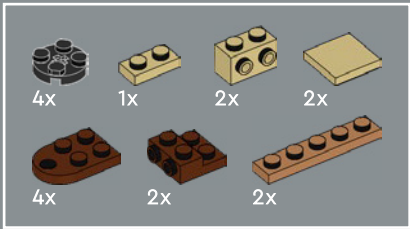

170

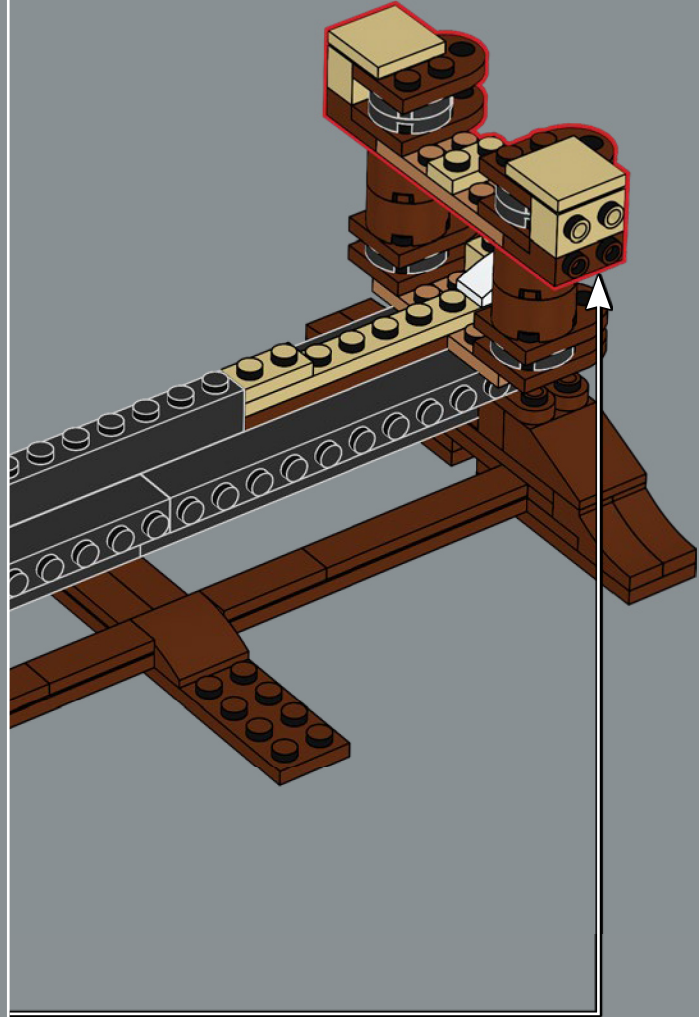
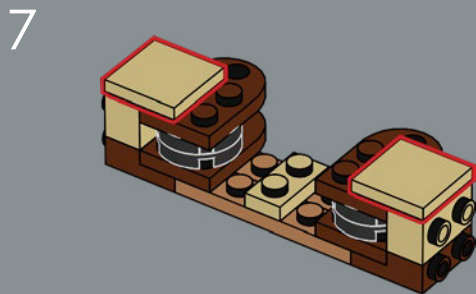
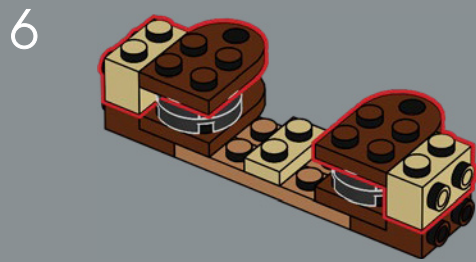
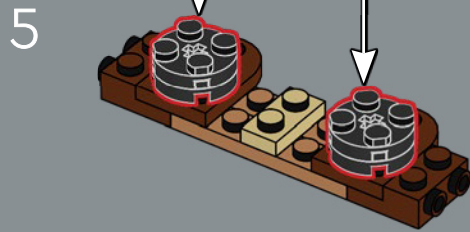
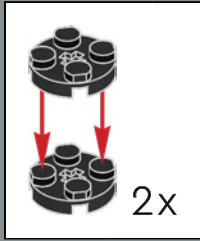
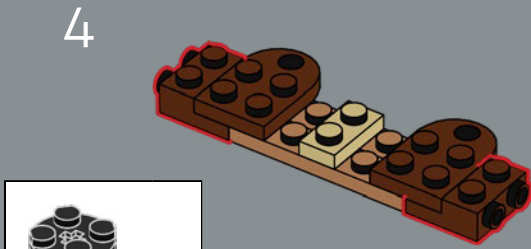
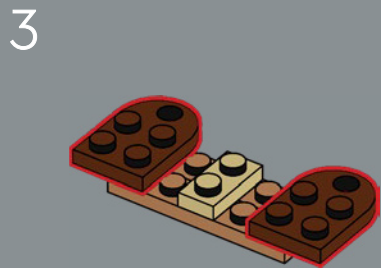
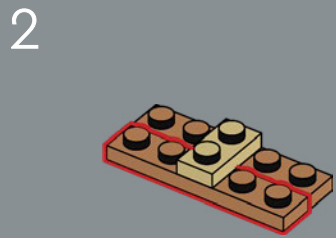
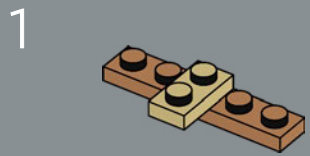

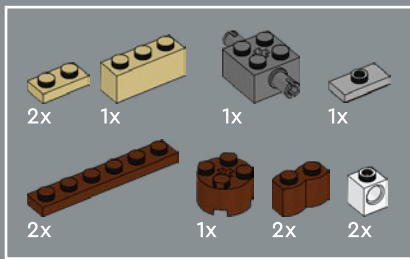

171

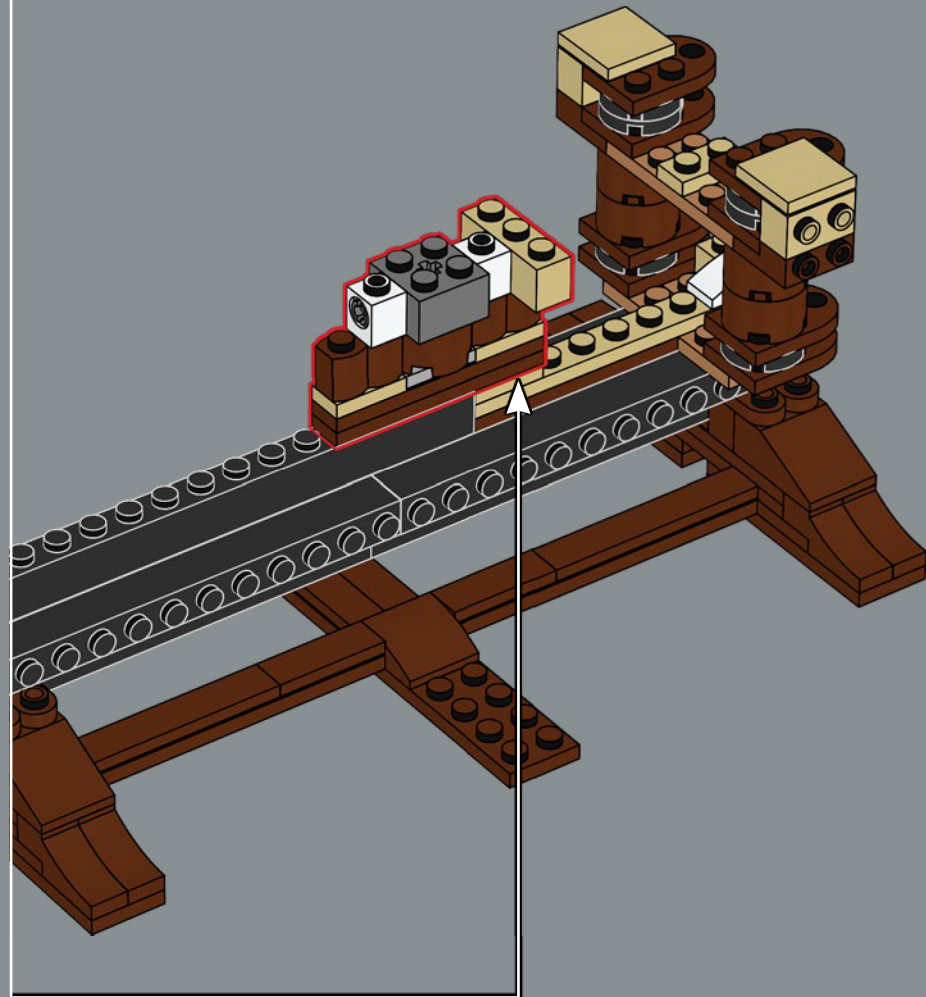
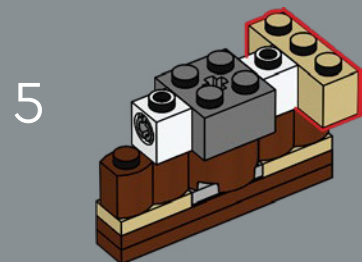
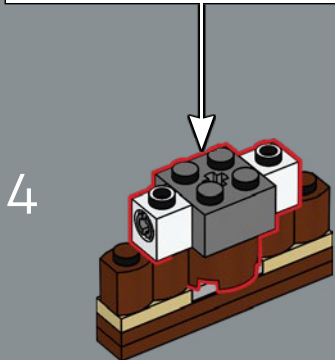
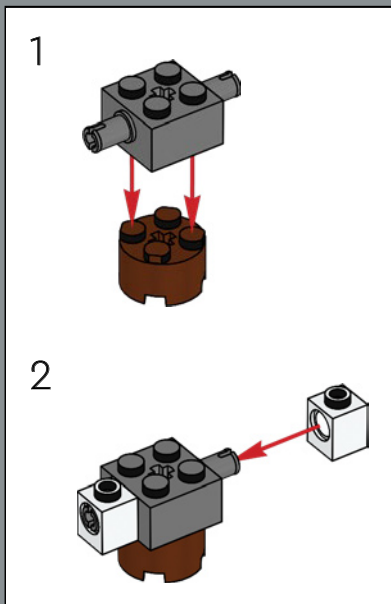
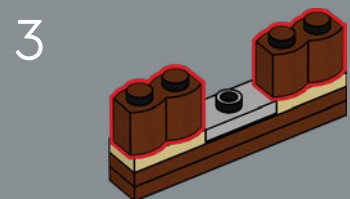
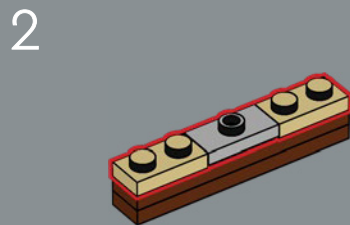
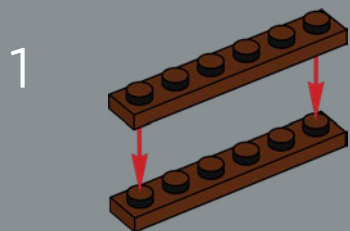

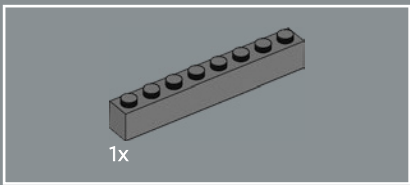

172

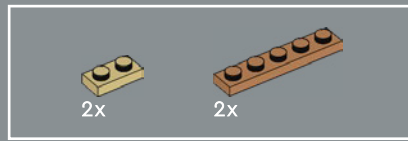
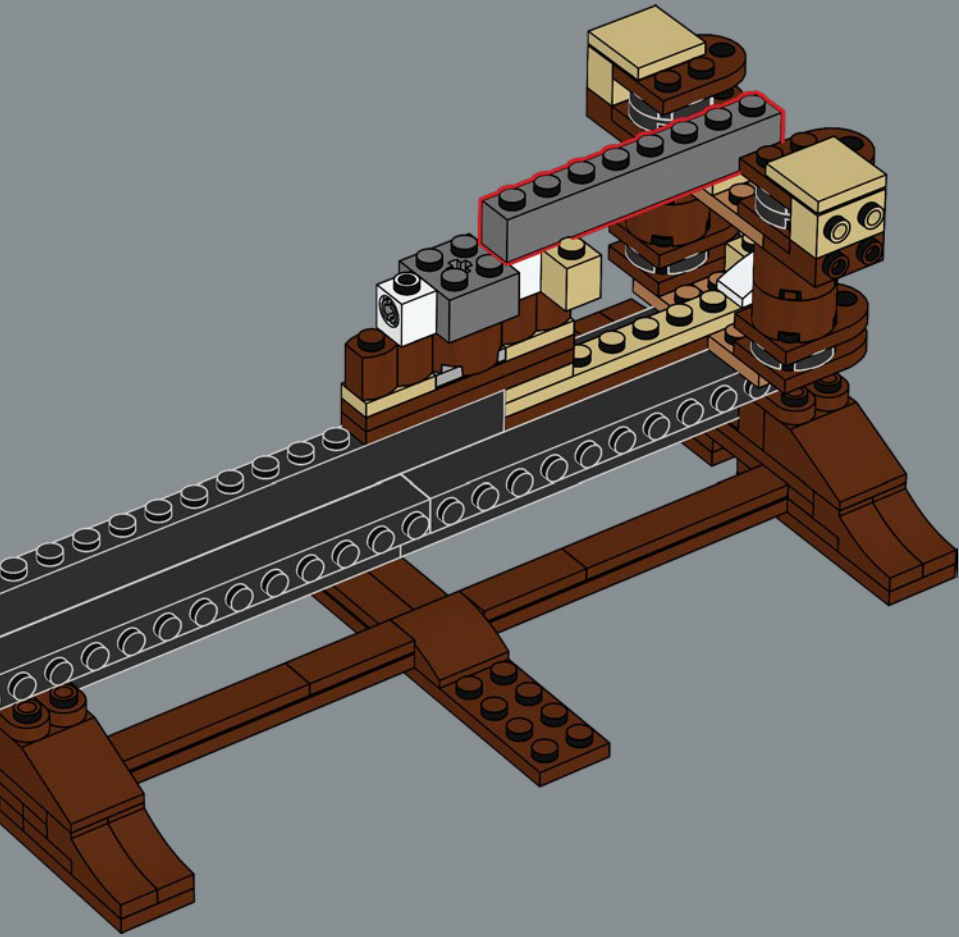

173

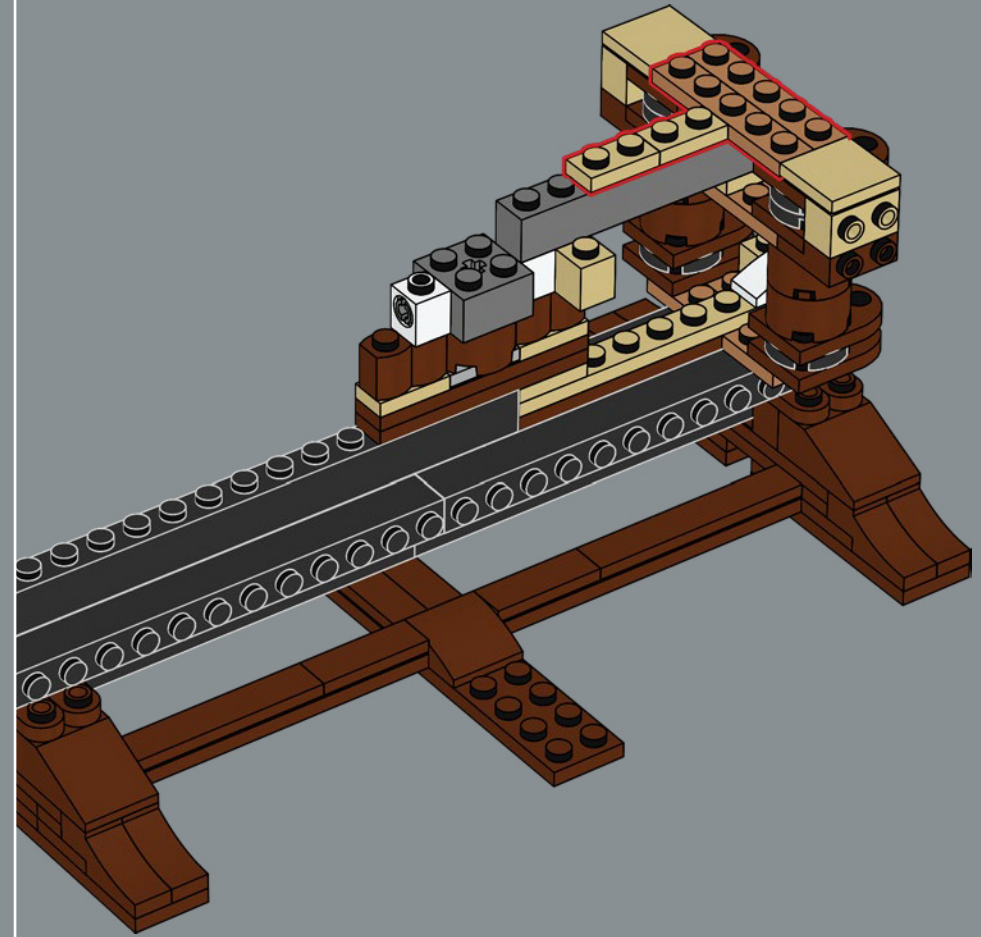

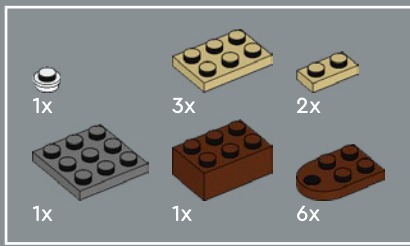

174

1

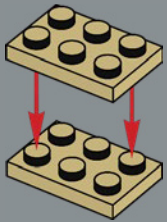

2

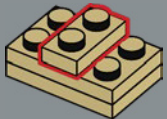

3

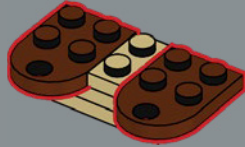

4



5

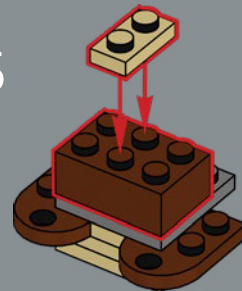

6

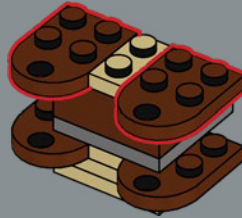

7

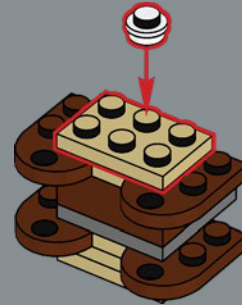

8

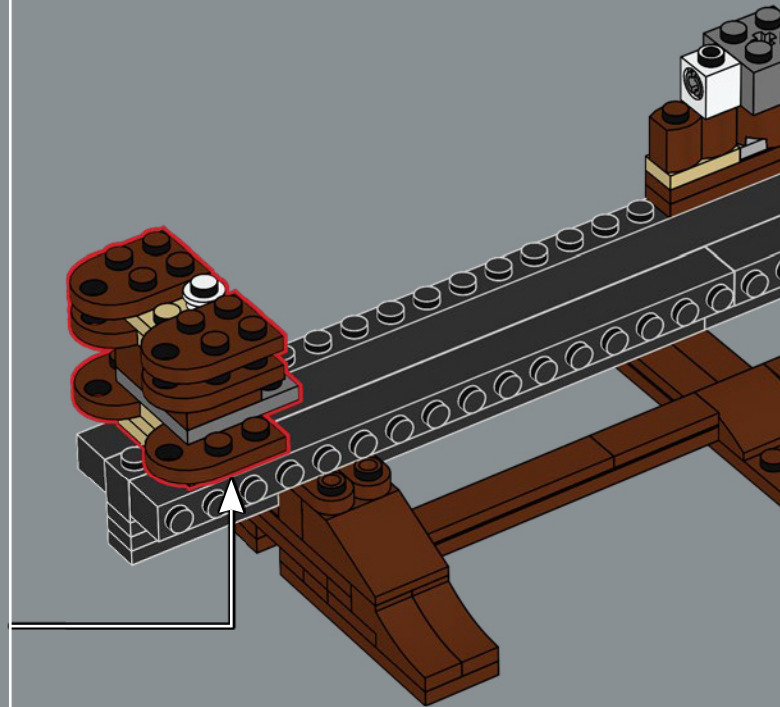
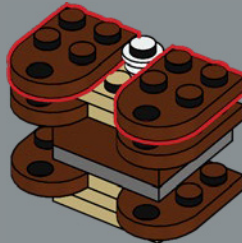

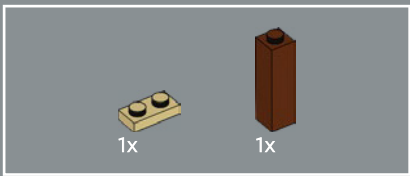

175

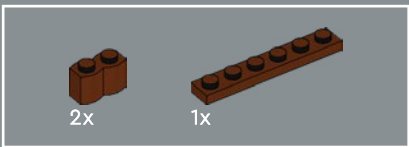
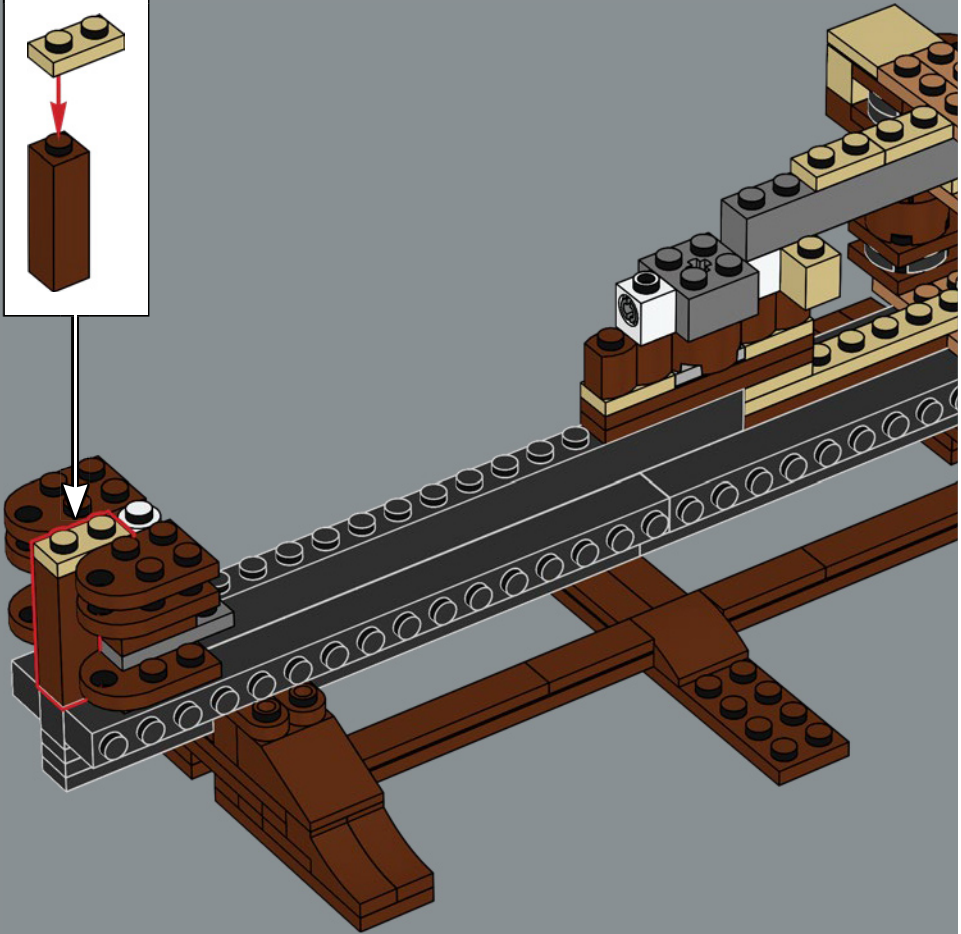
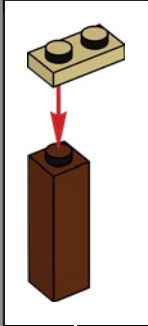

176

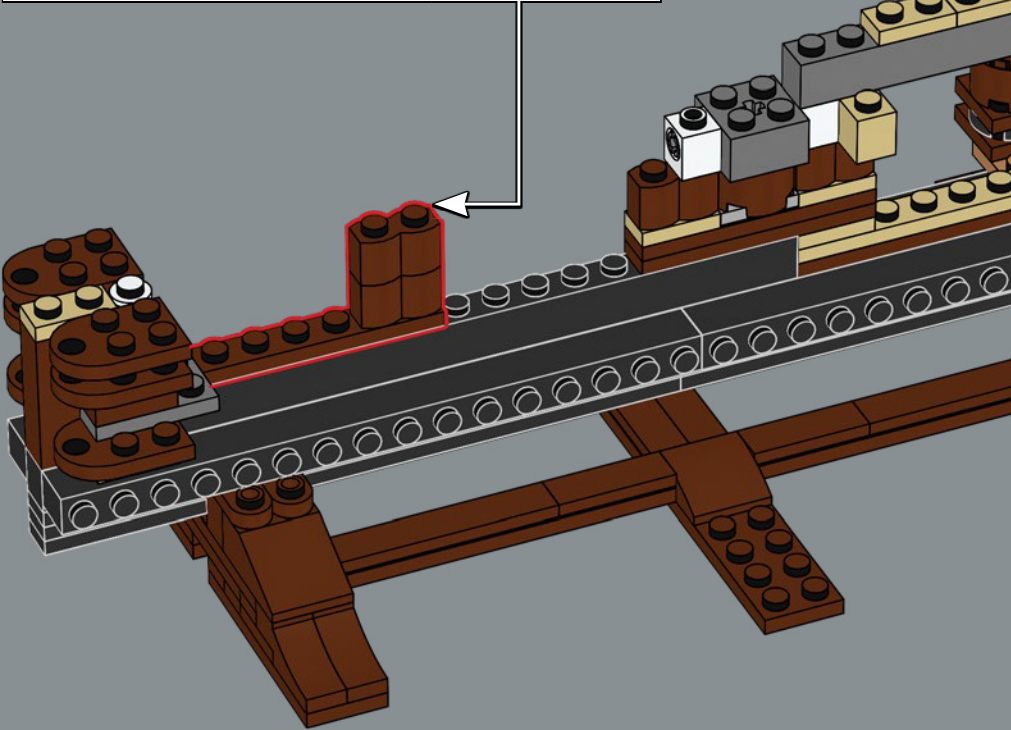
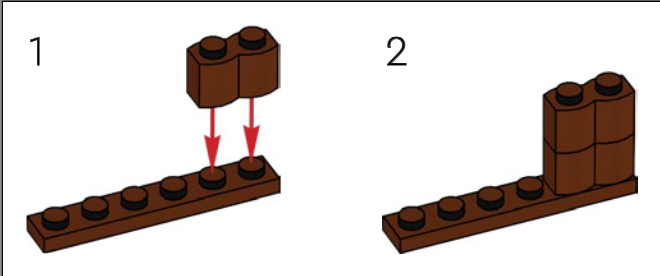

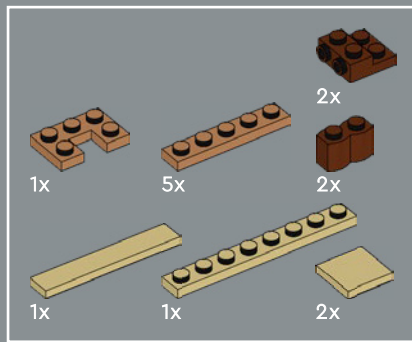

177

1

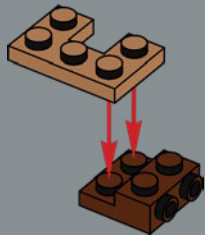

2

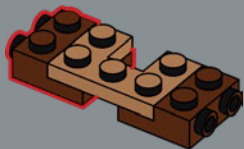

3

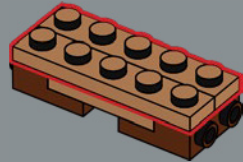

4

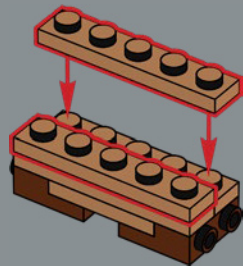

5

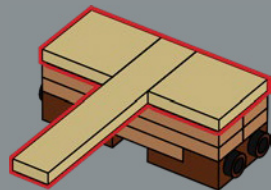

6

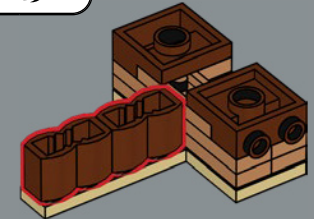

7

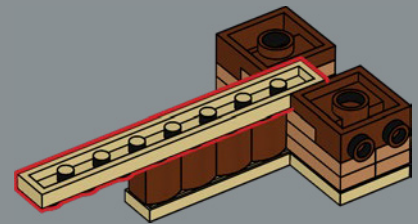

8

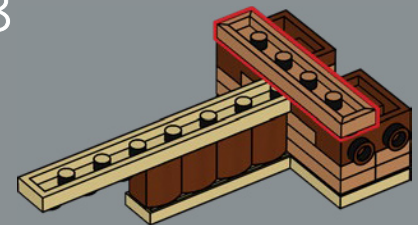

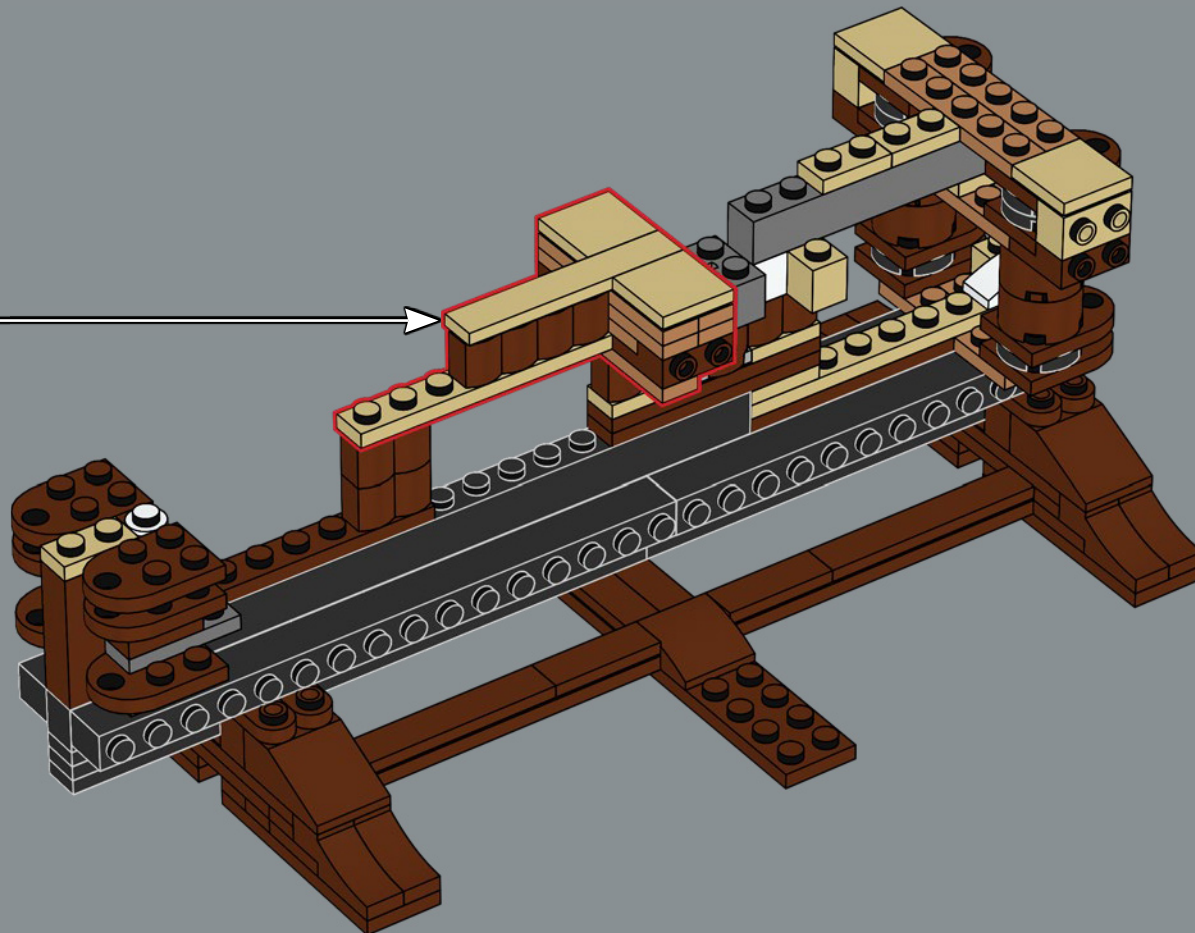

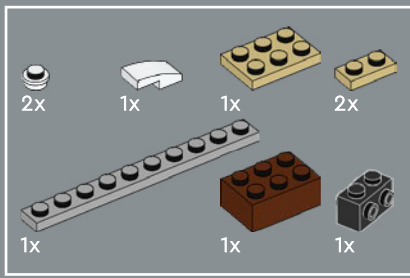

178

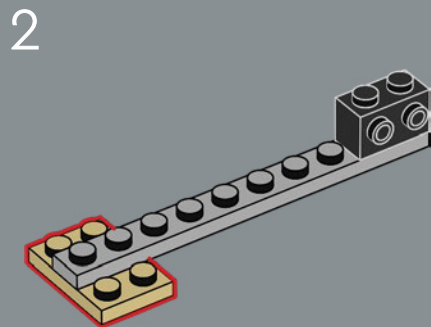
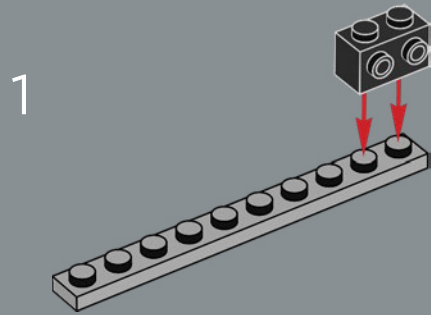

3

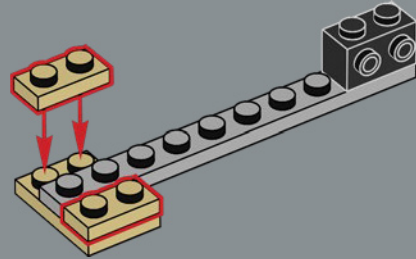

4

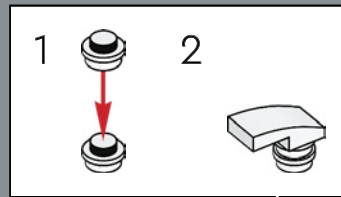
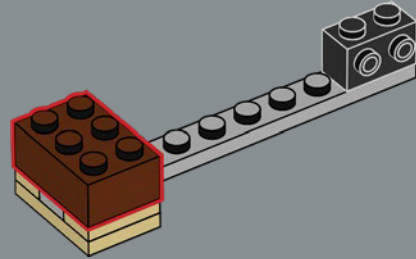

5

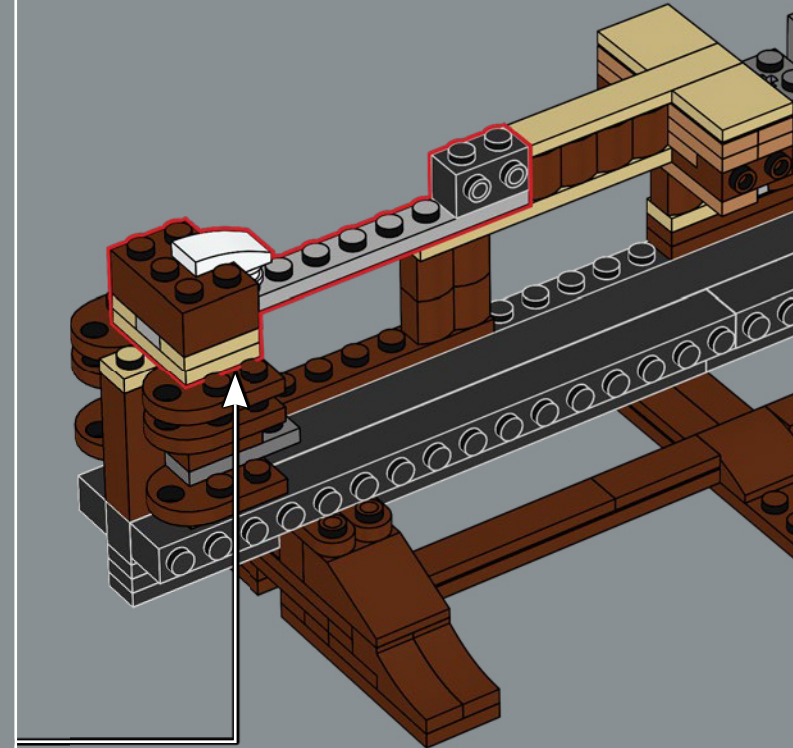
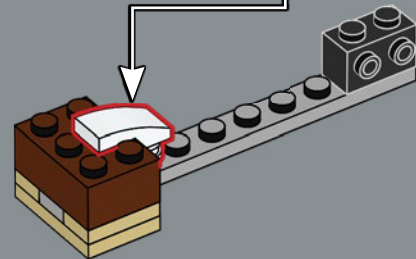

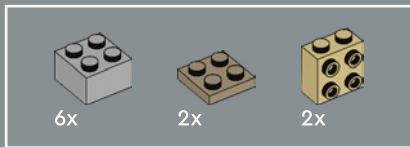

179

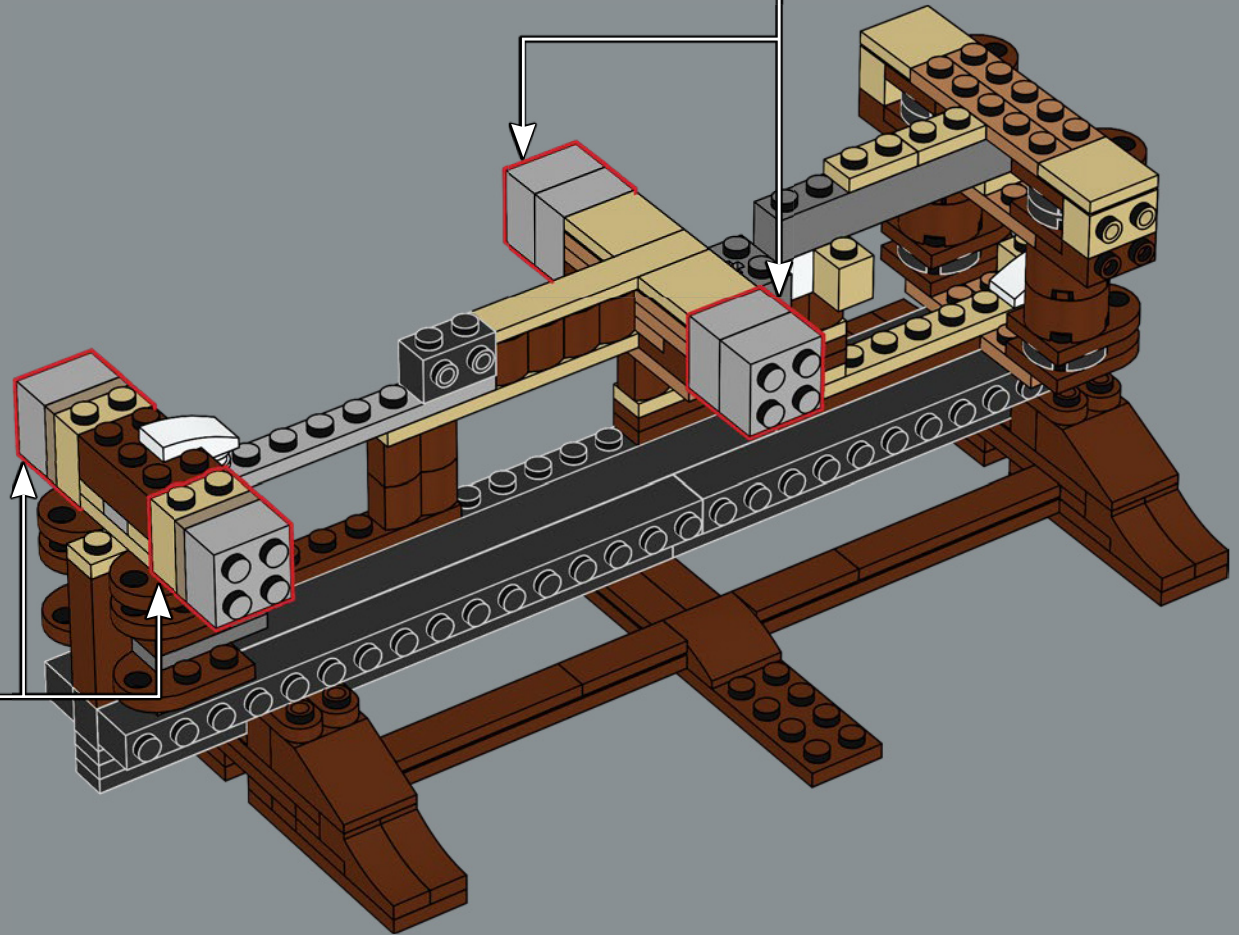
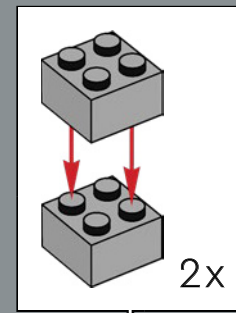
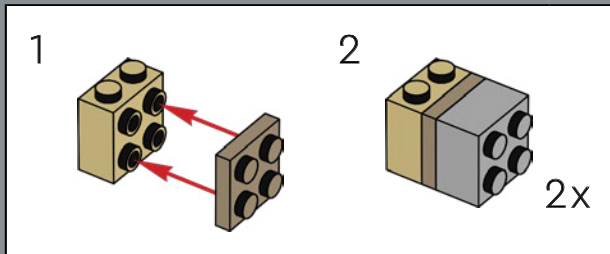

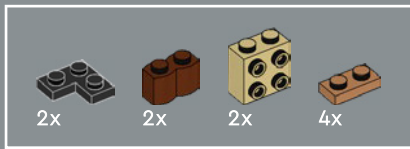

180

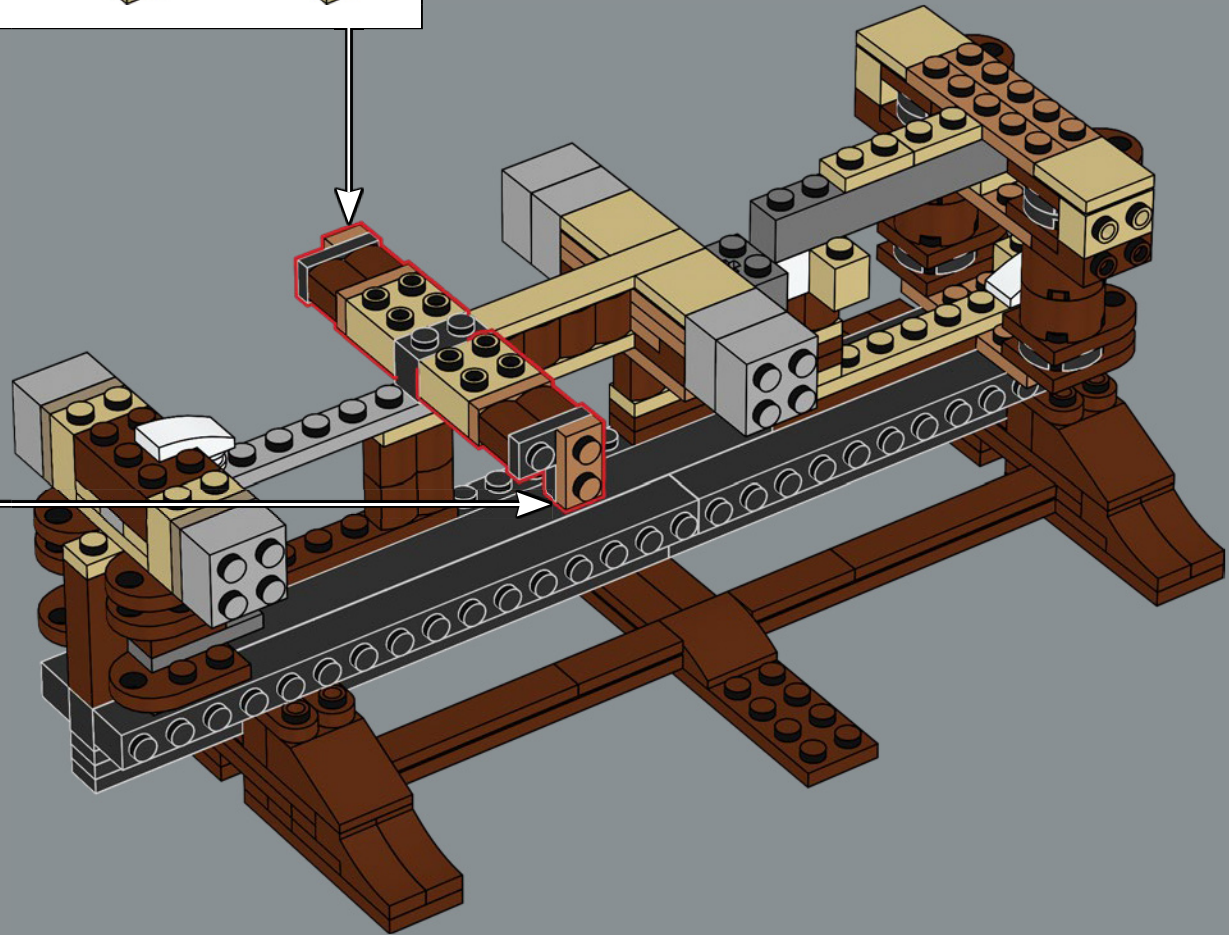
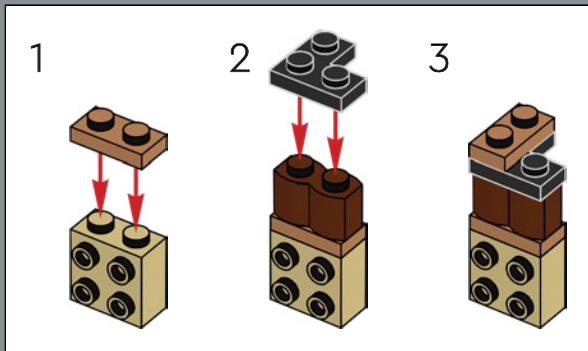
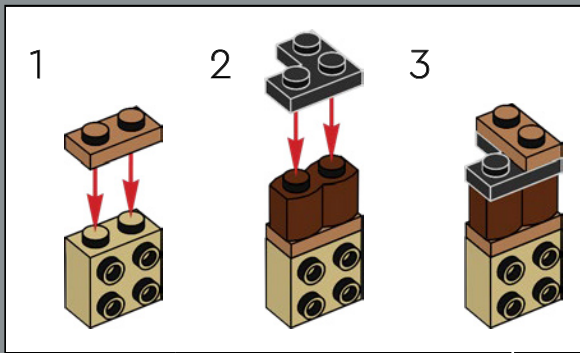

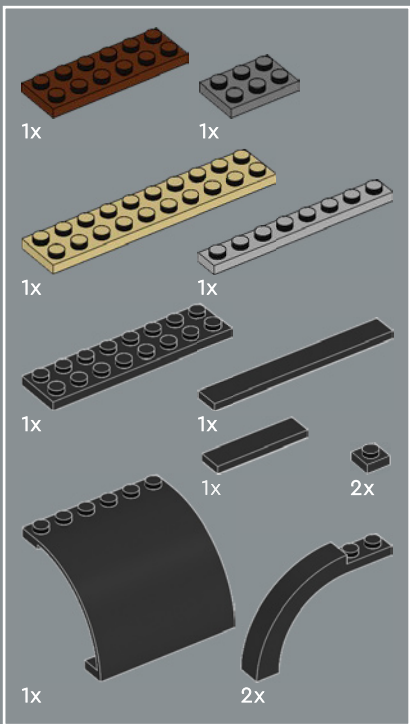

181

1

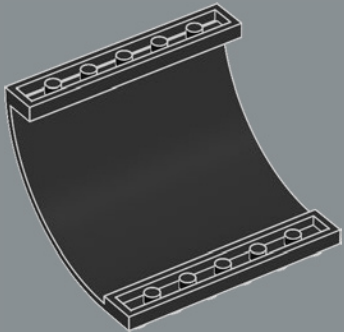

2

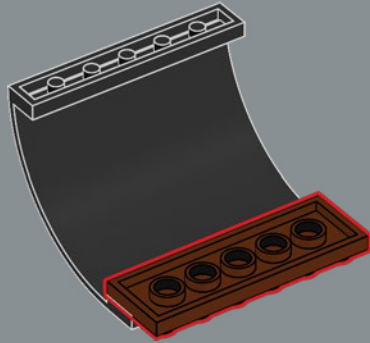

3

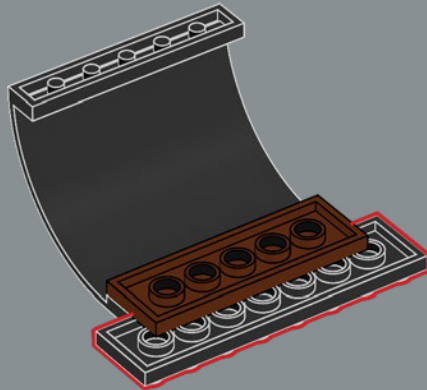

4

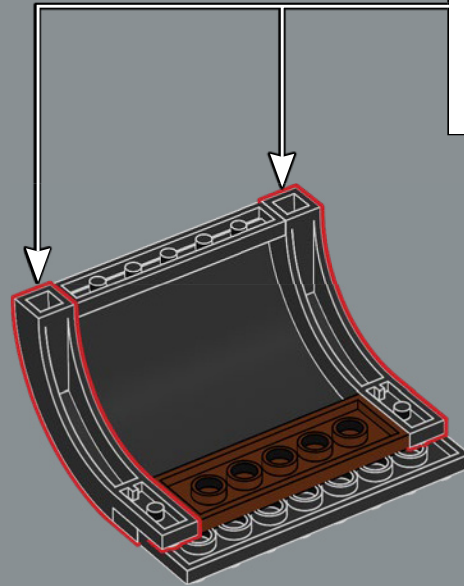

5

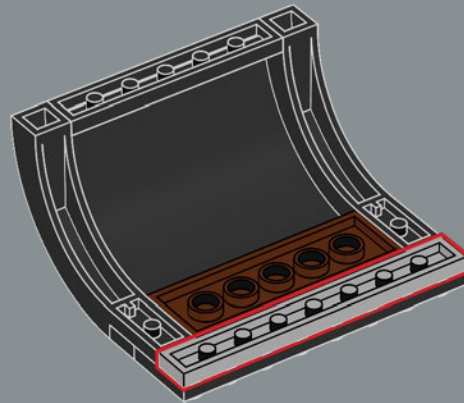

6

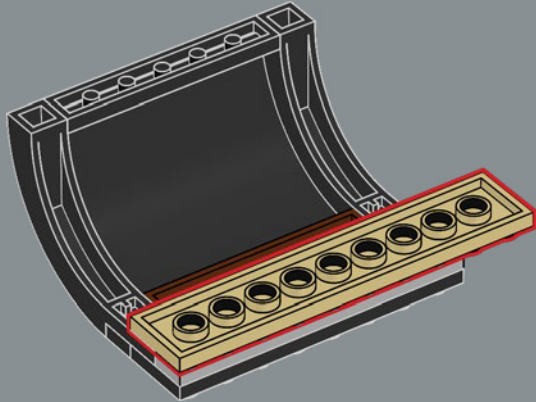

7

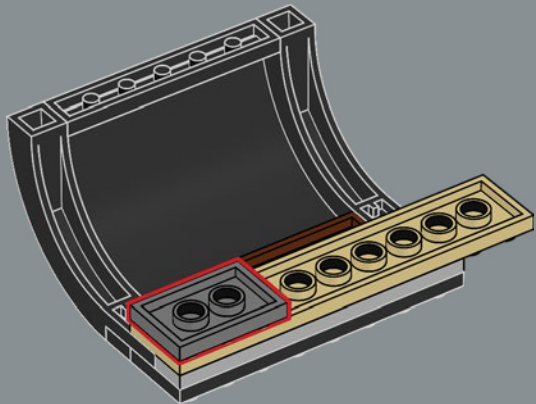

8

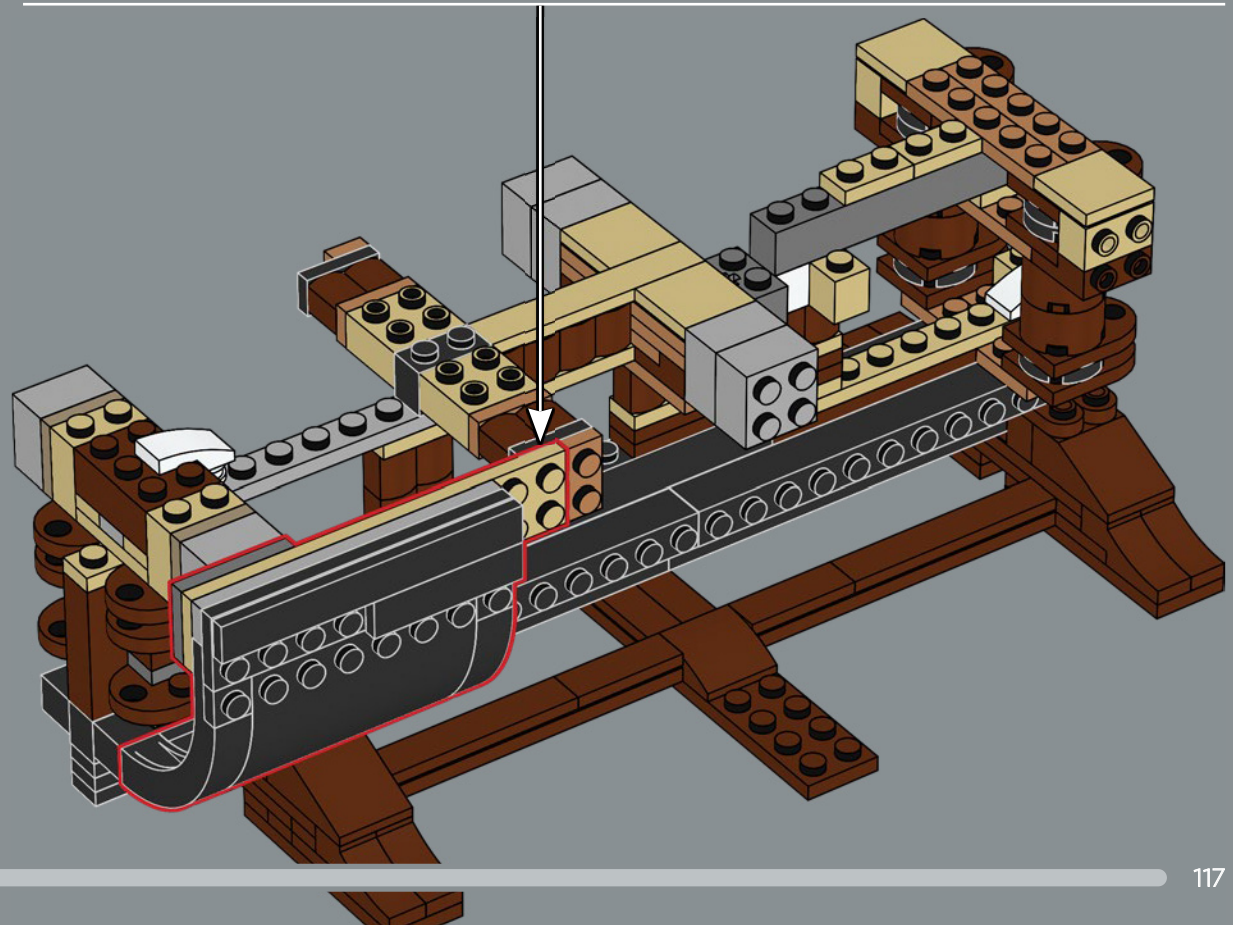
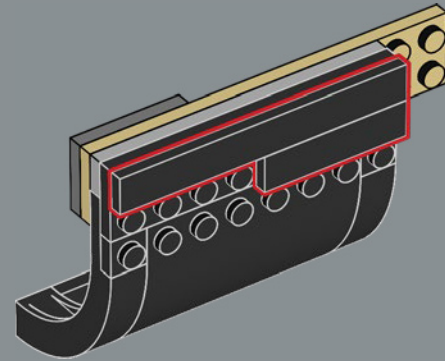

6

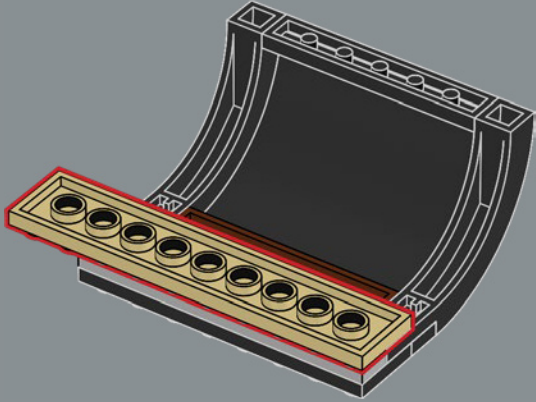

7

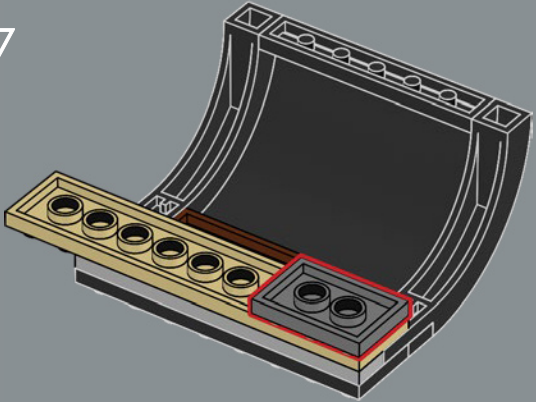

8

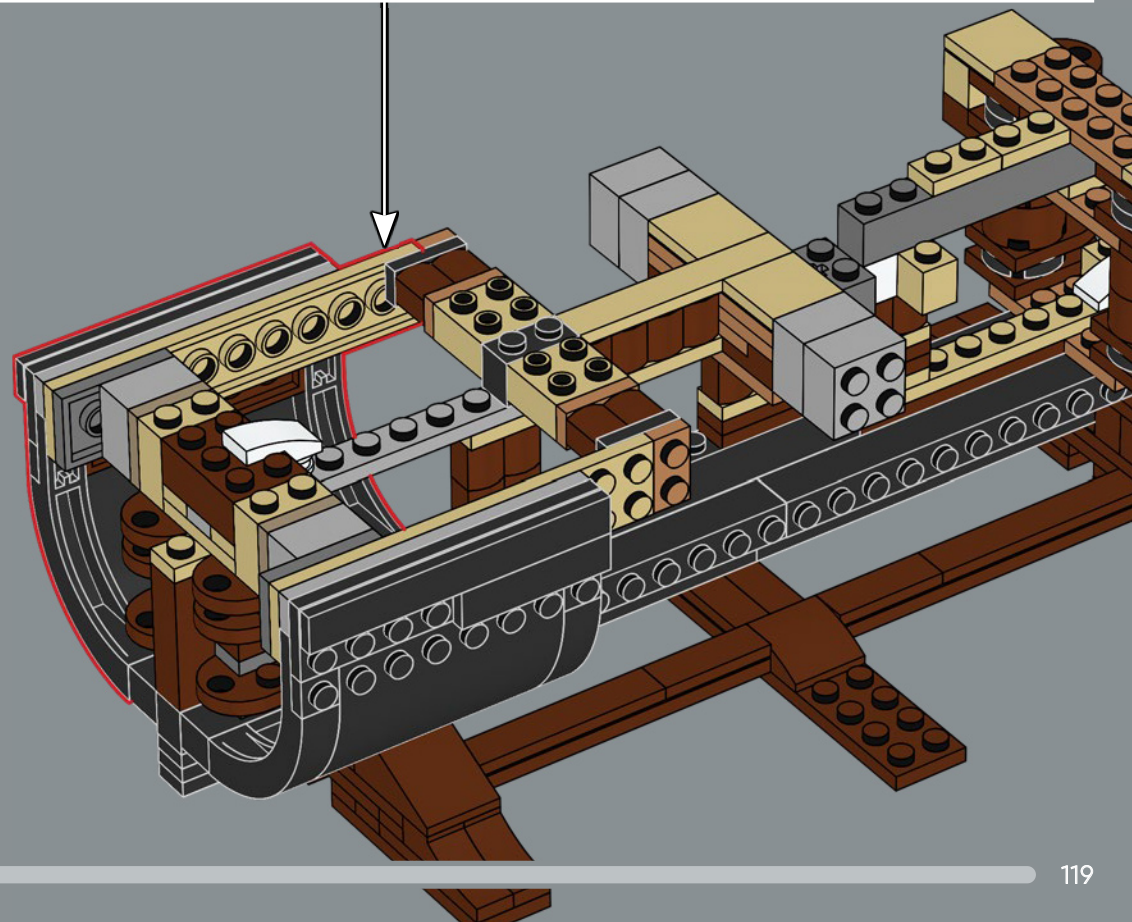
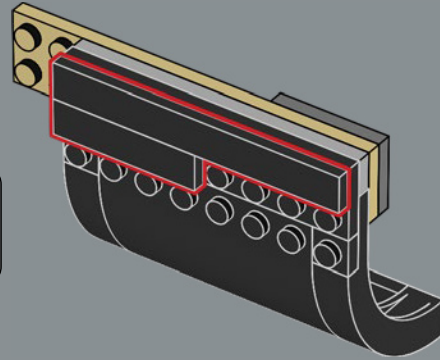

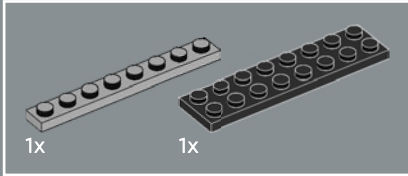
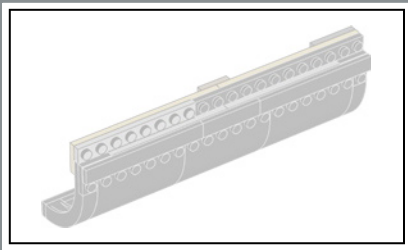

183

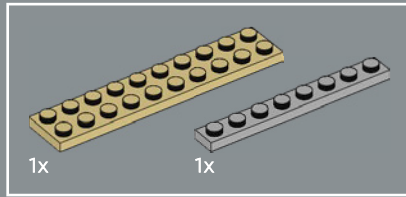
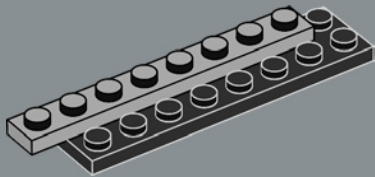

184

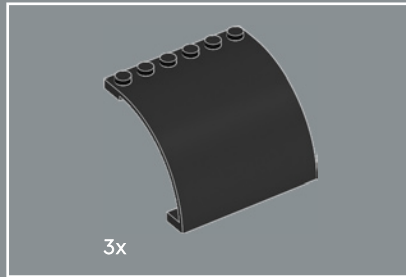
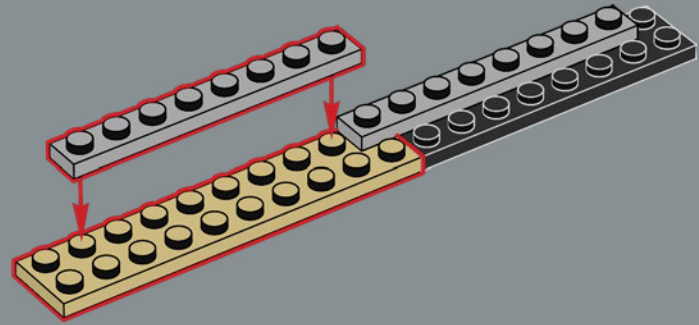

185

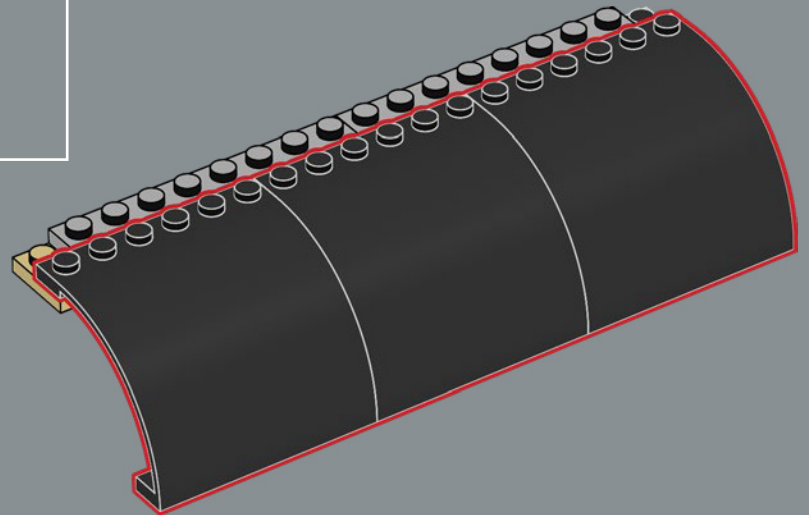

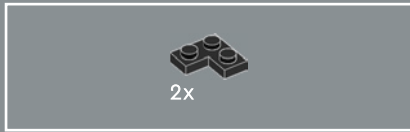

186

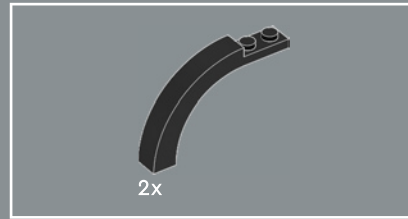
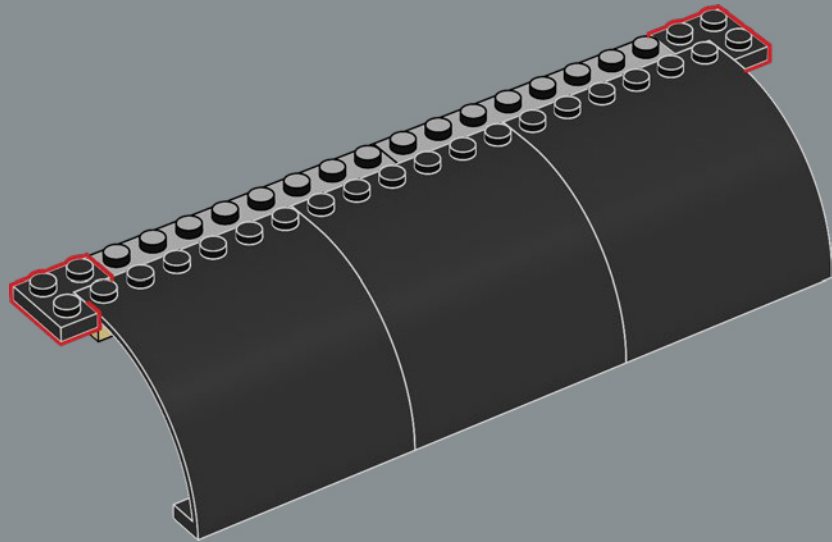

187

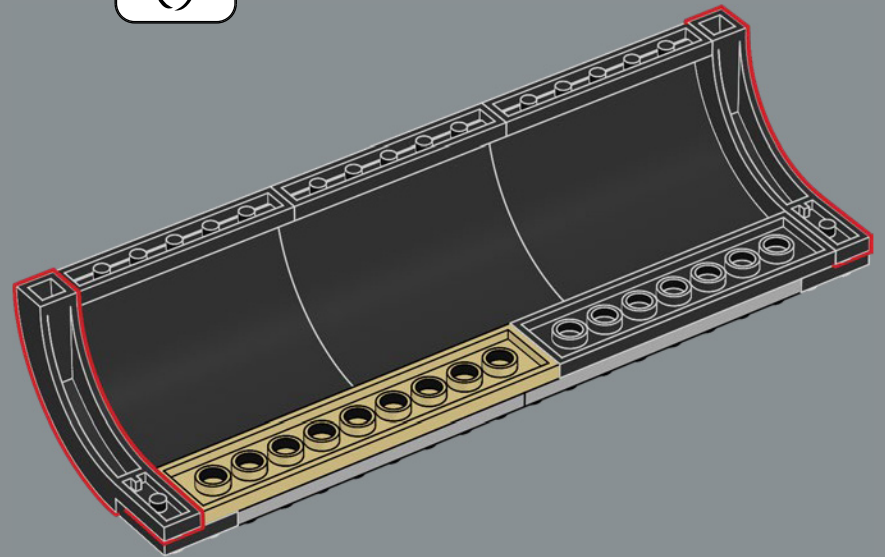

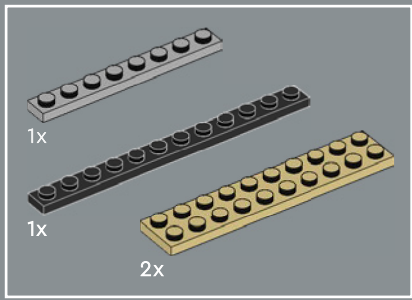

188

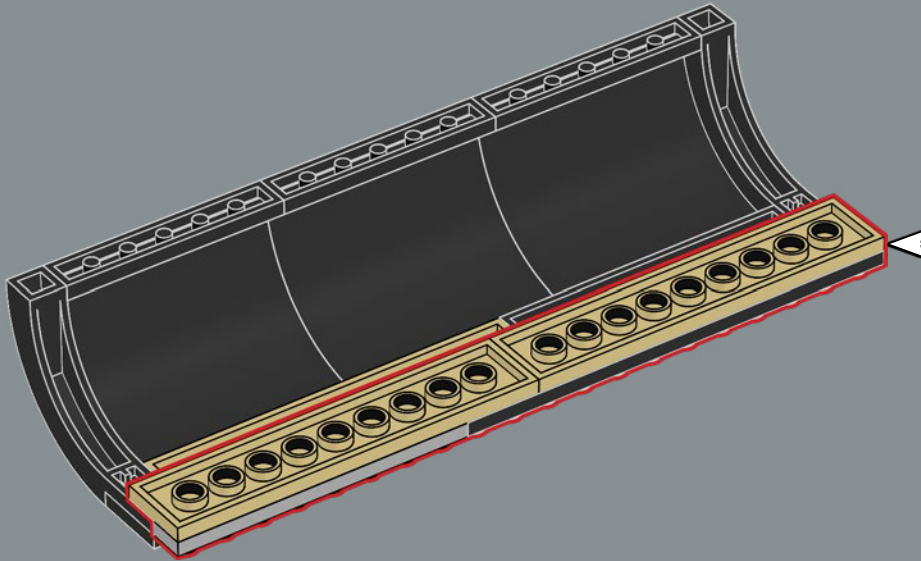
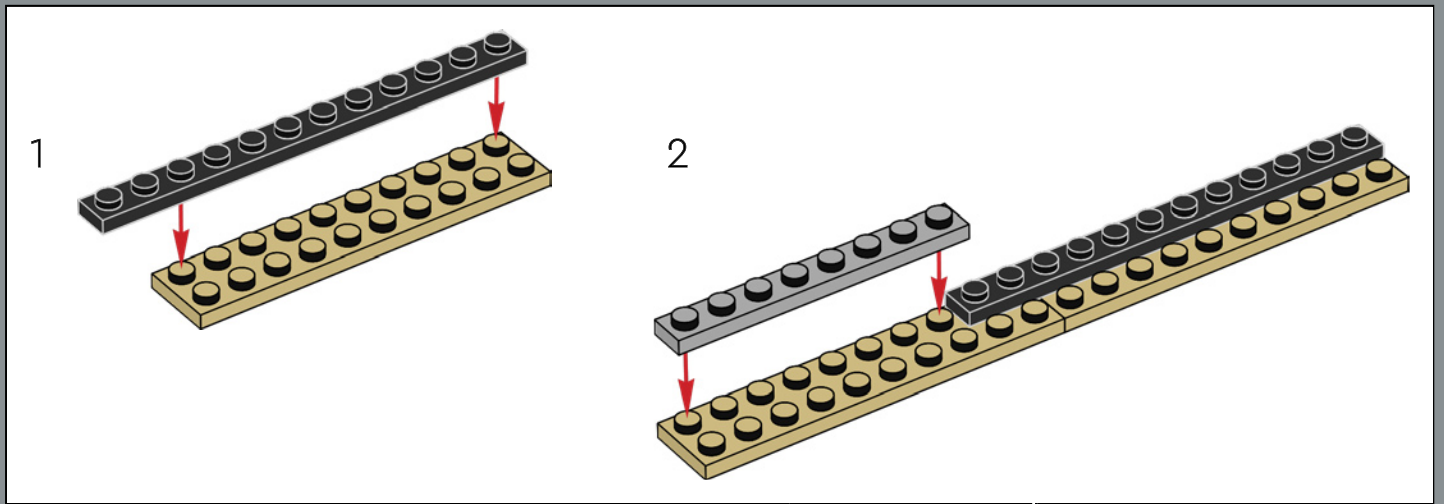



189

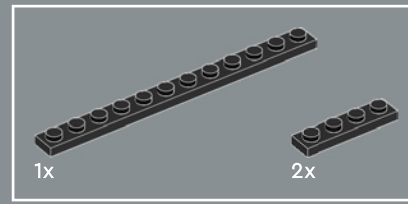
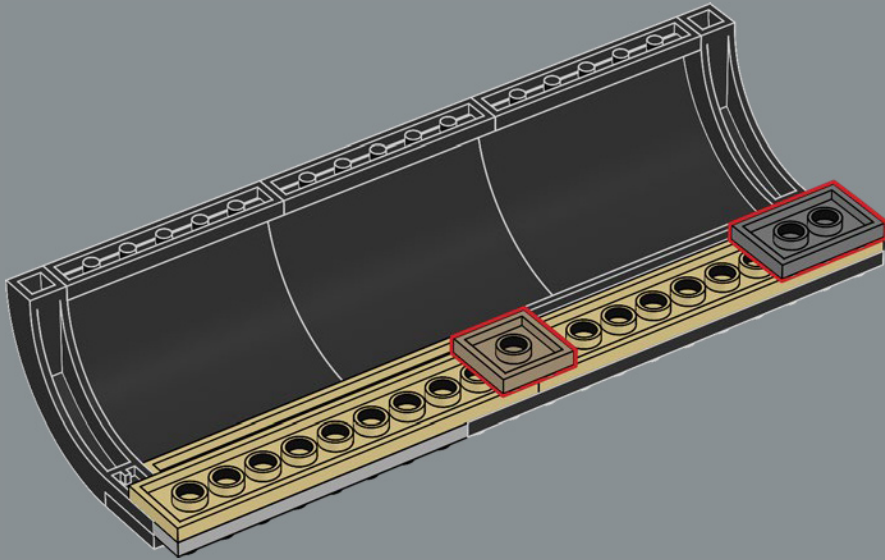

190

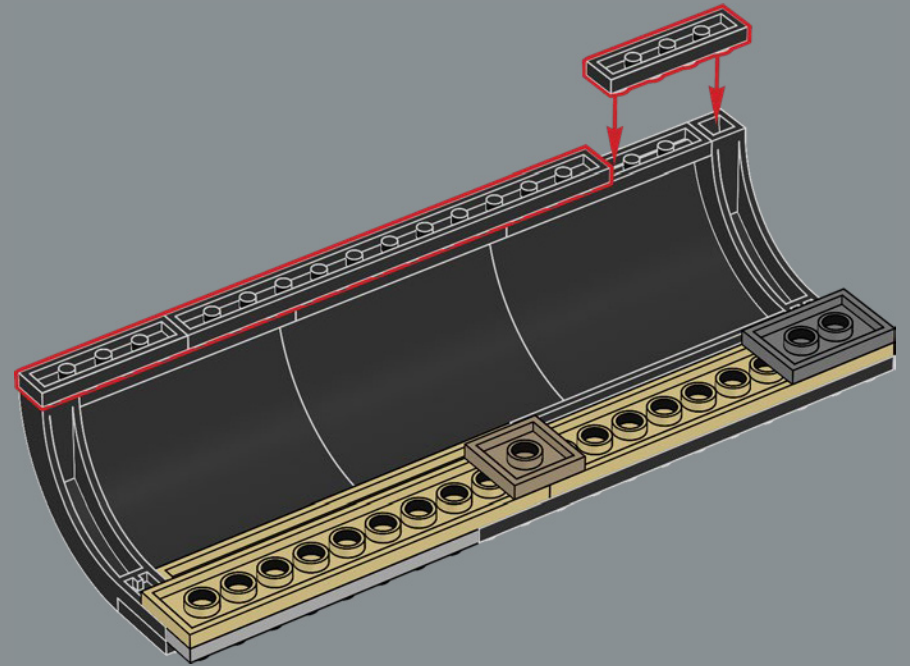

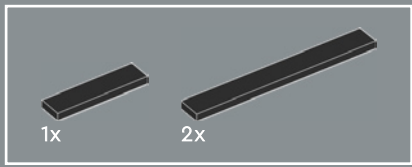

191

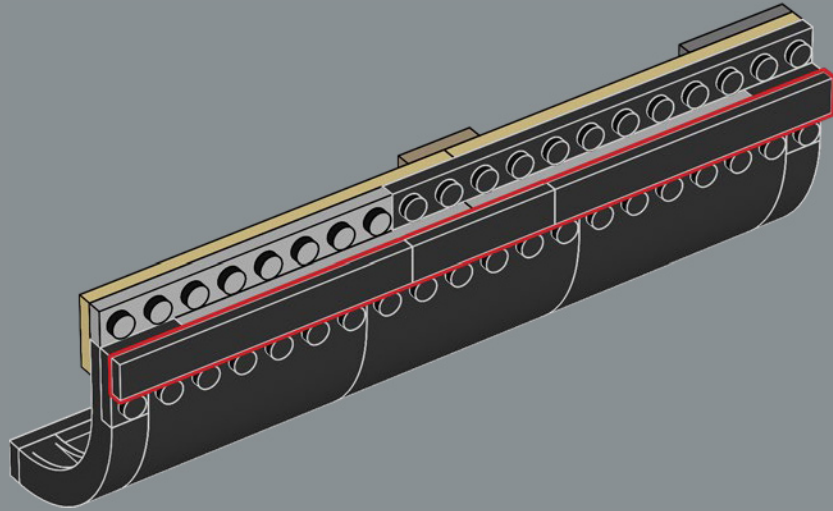

192

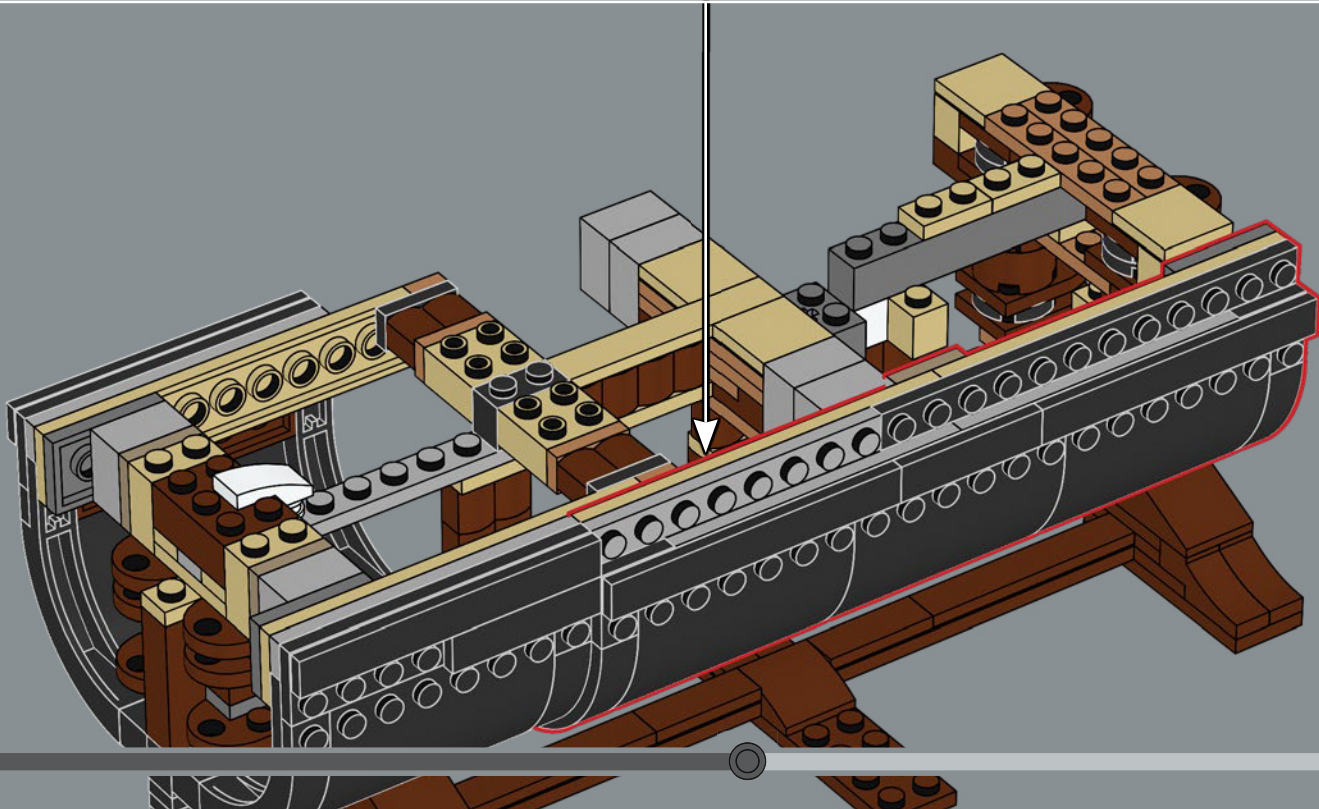

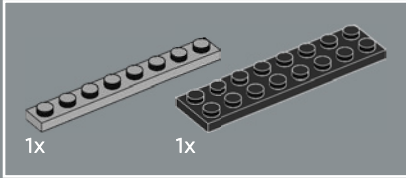
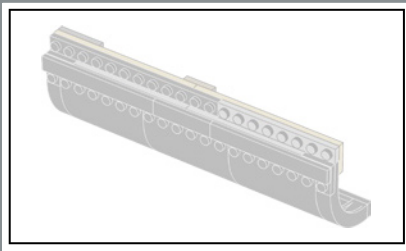

193

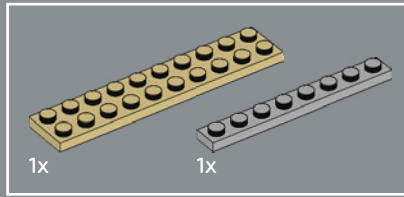
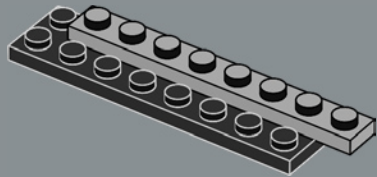

194

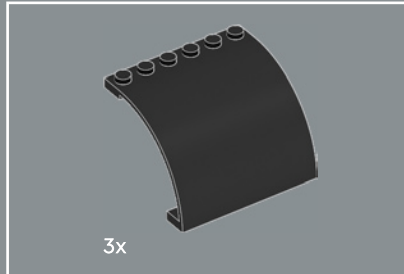

195



The black panels that make up most of the lower part of the ship's hull are considered 'wall' elements in LEGO® design terms. Made in black, their size and shape were just perfect for the ship's hull.

Les panneaux noirs qui constituent la majeure partie de la partie inférieure de la coque du navire sont considérés comme des éléments de « mur » en termes de conception LEGO®. Fabriqués en noir, ils ont la taille et la forme parfaites pour la coque du navire.

En términos de diseño LEGO®, los paneles negros que componen la mayor parte de la parte inferior del casco se consideran como elementos de pared. En color negro y con su tamaño y forma particulares resultaron perfectos para el casco del barco.

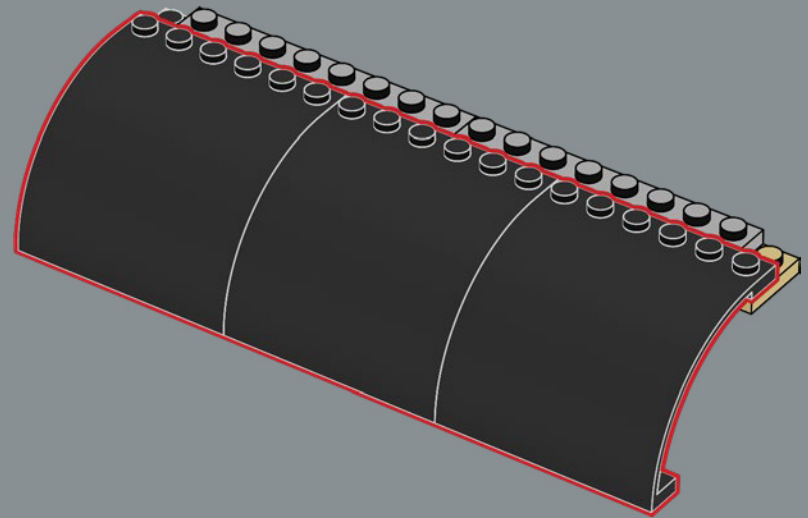
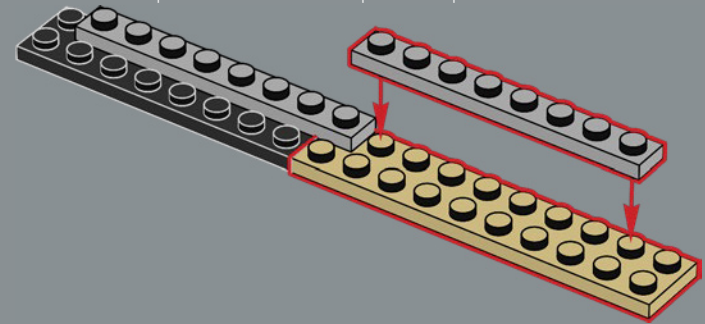

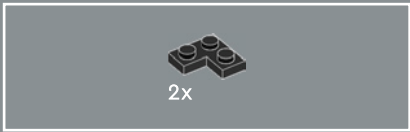

196

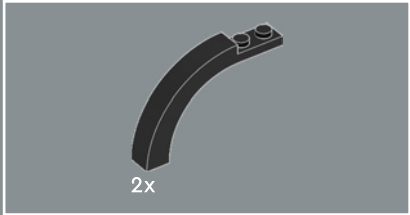
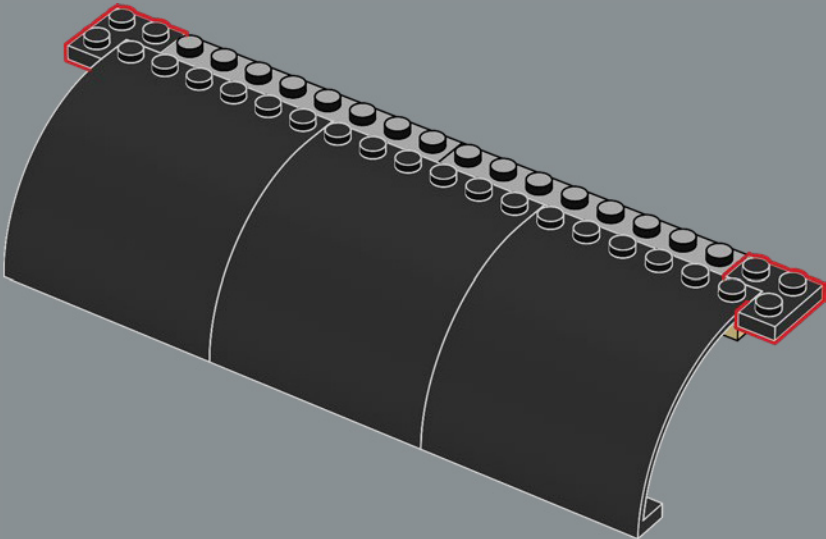

197

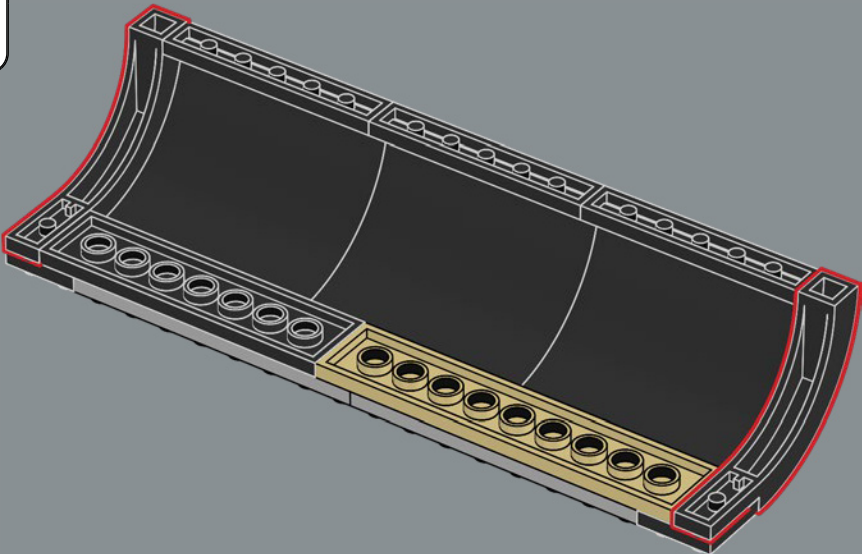

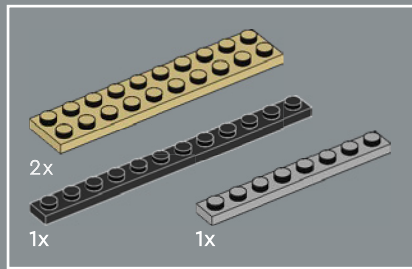

198

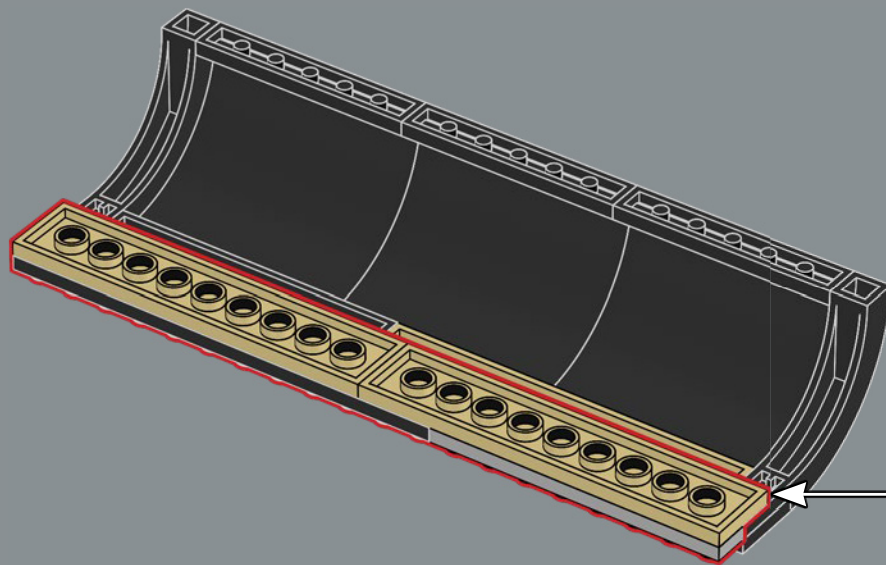
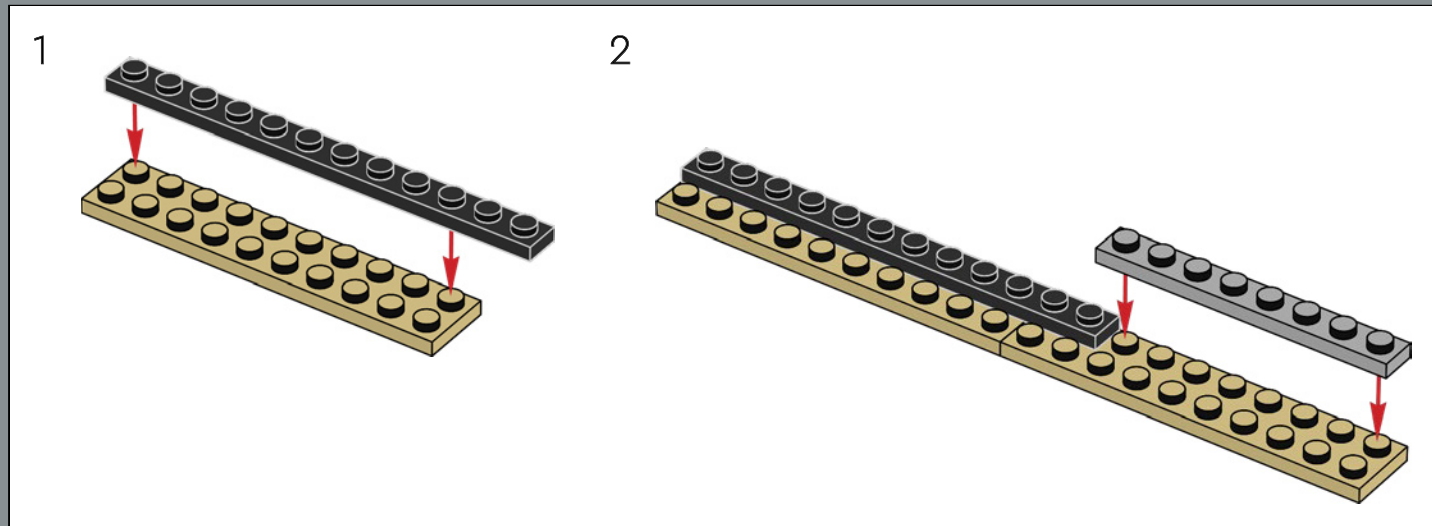



199

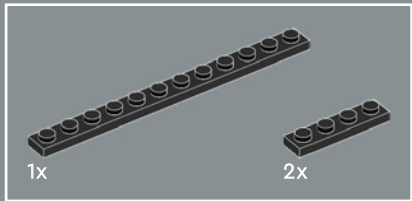
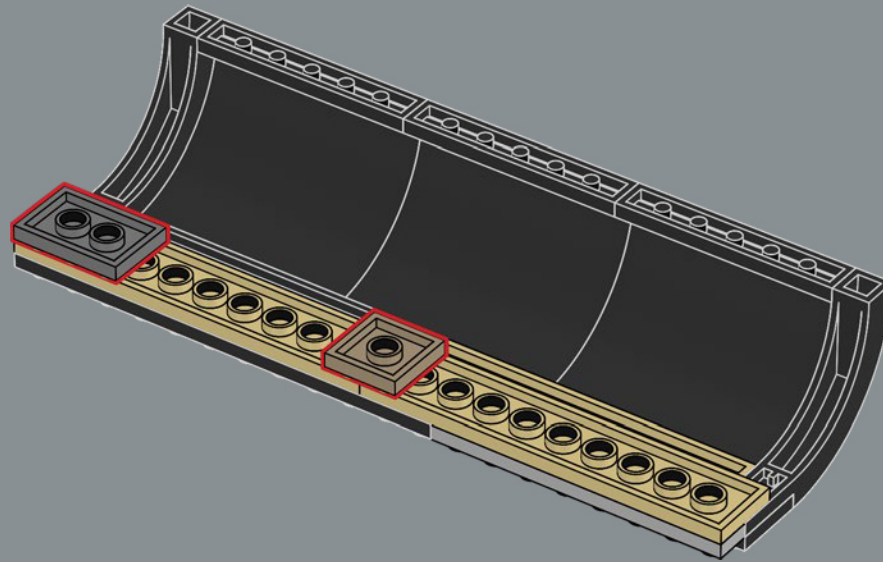

200

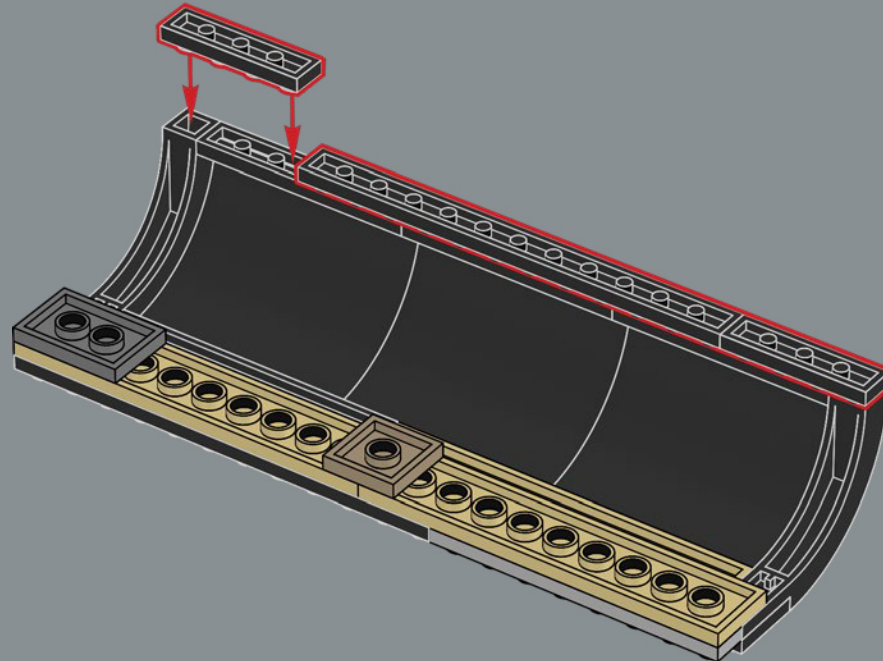

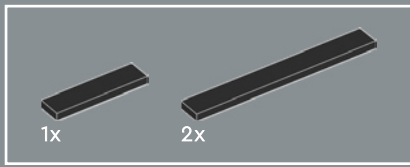

201

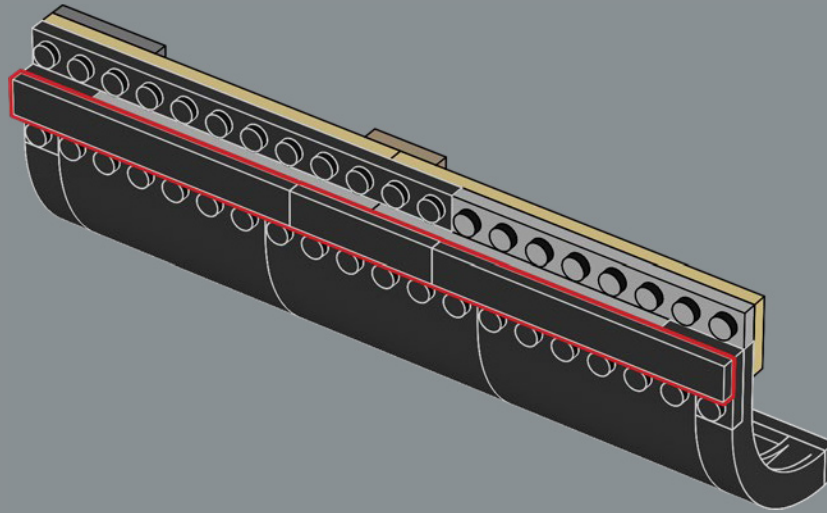

202

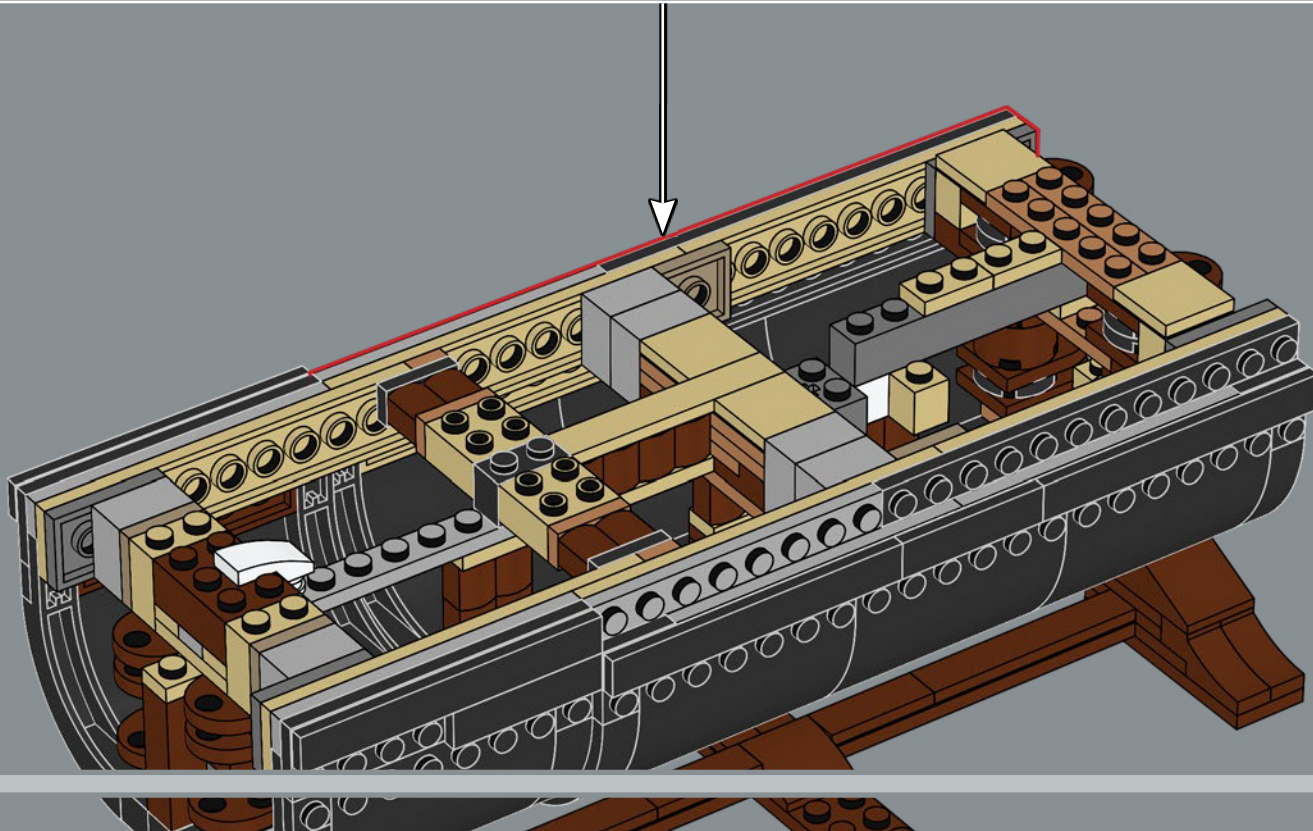

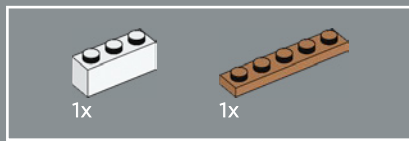
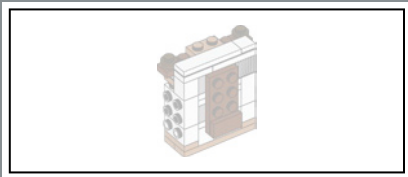

203

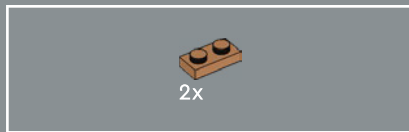
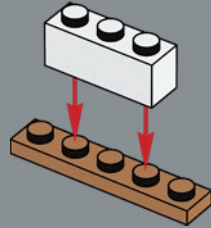

204

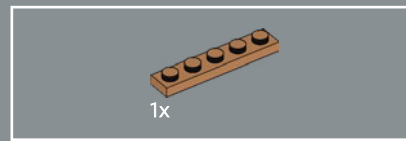
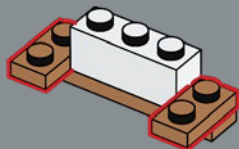

205

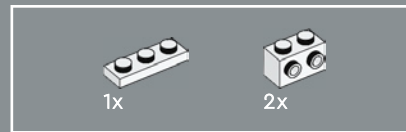
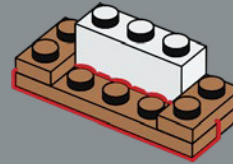

206

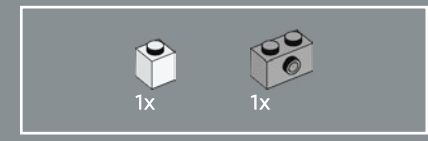
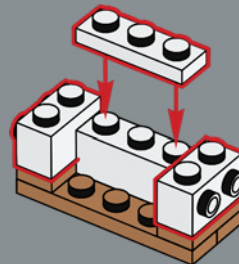

207

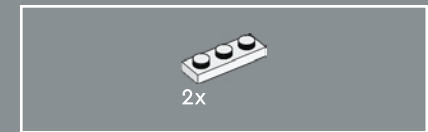
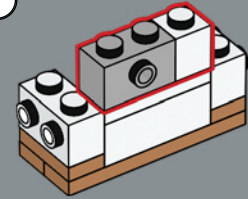

208

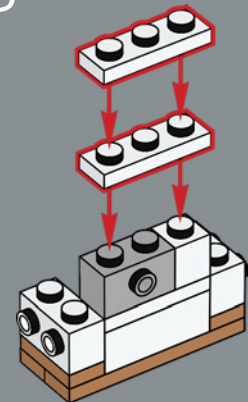

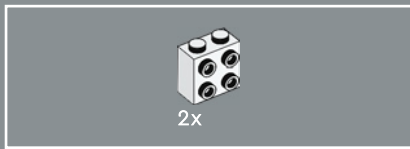

209

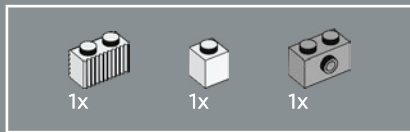
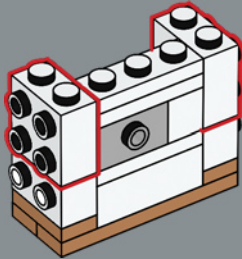

211

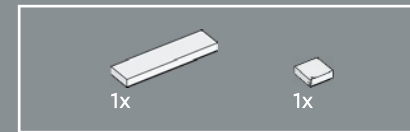
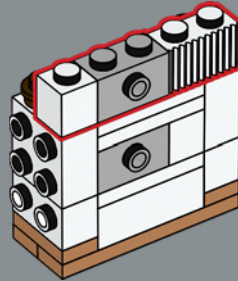

213

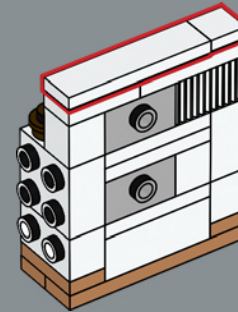

210

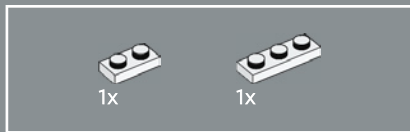
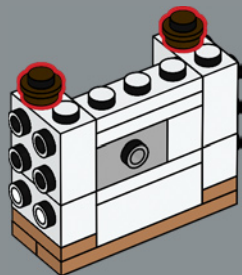

212

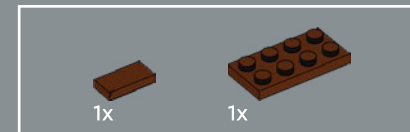
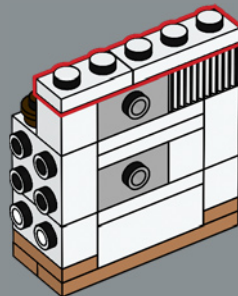

214

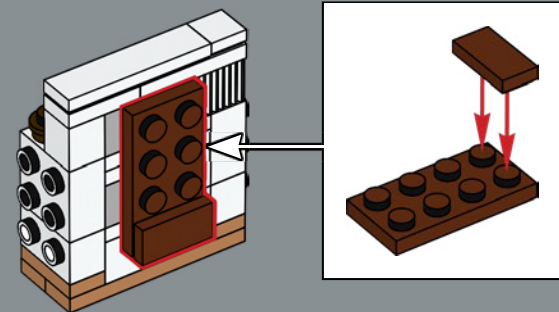

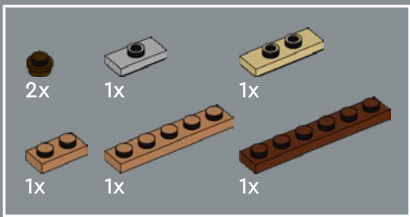

215

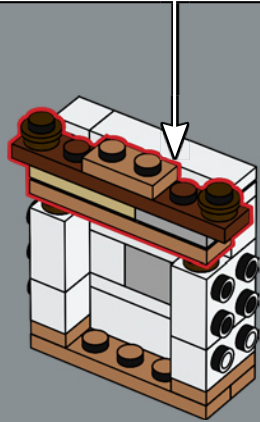
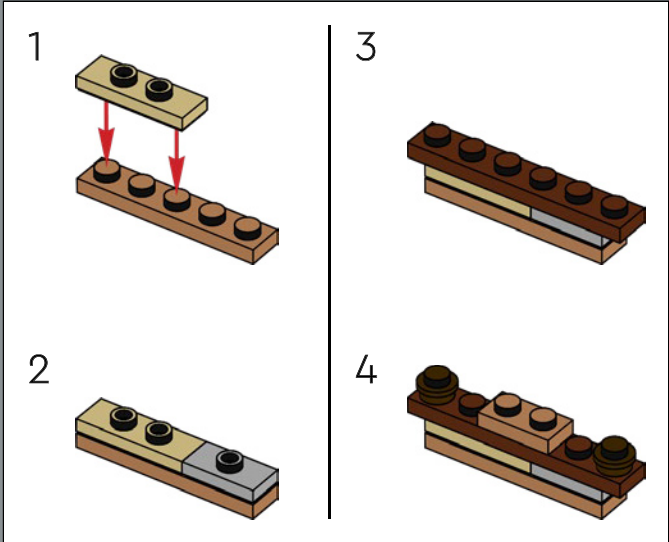

216

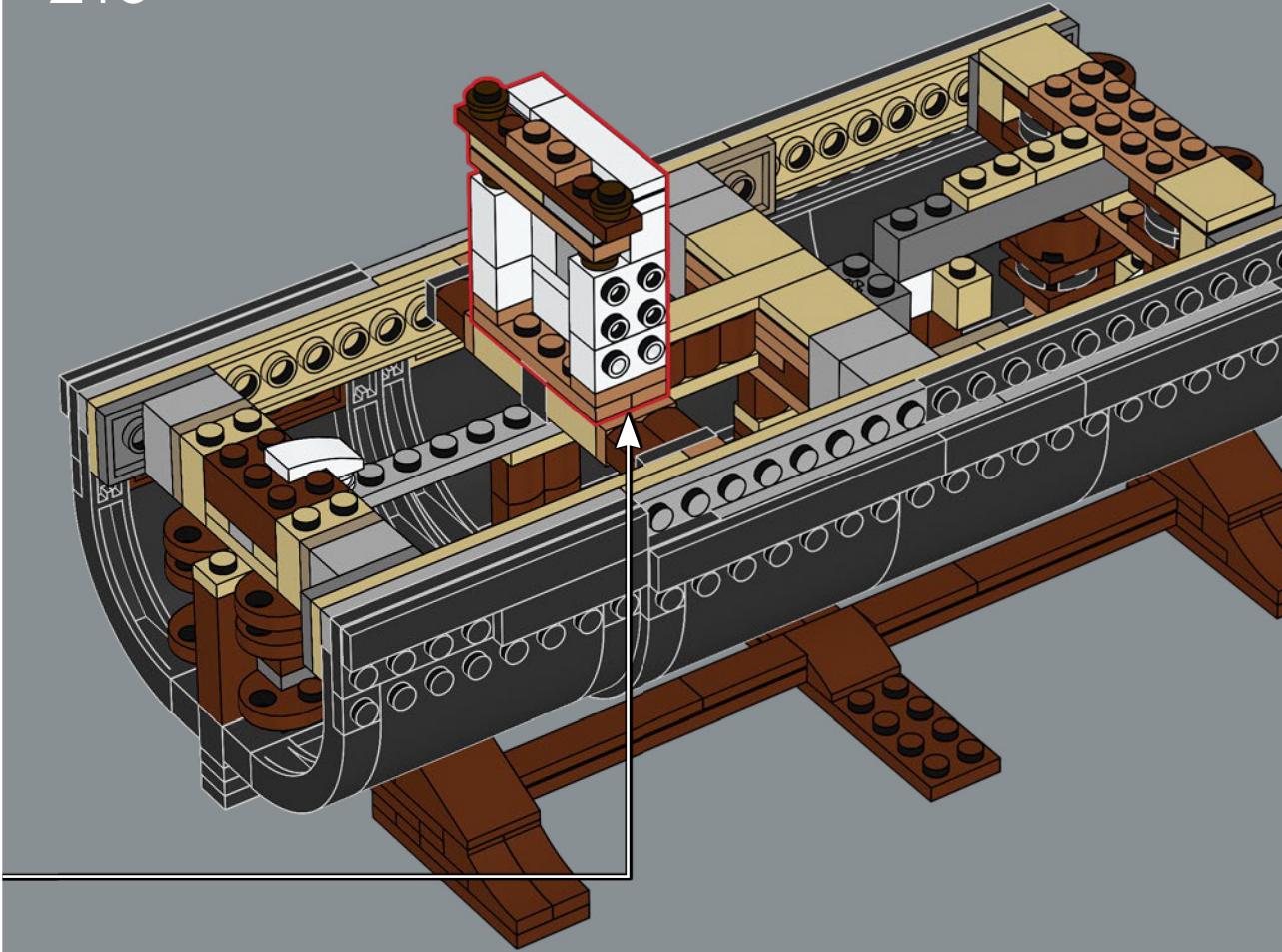

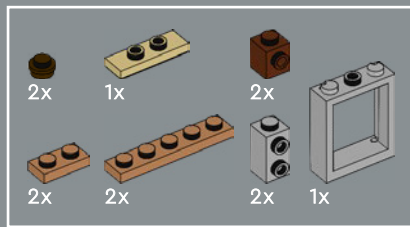

217

1

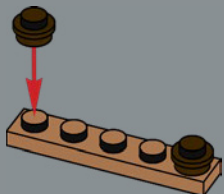

2

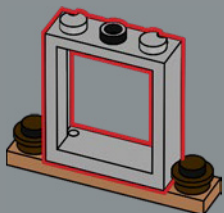

3

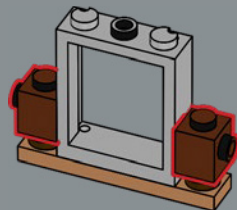

4

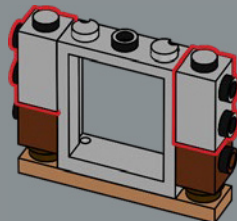

5

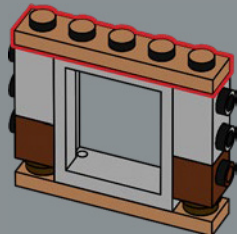

6

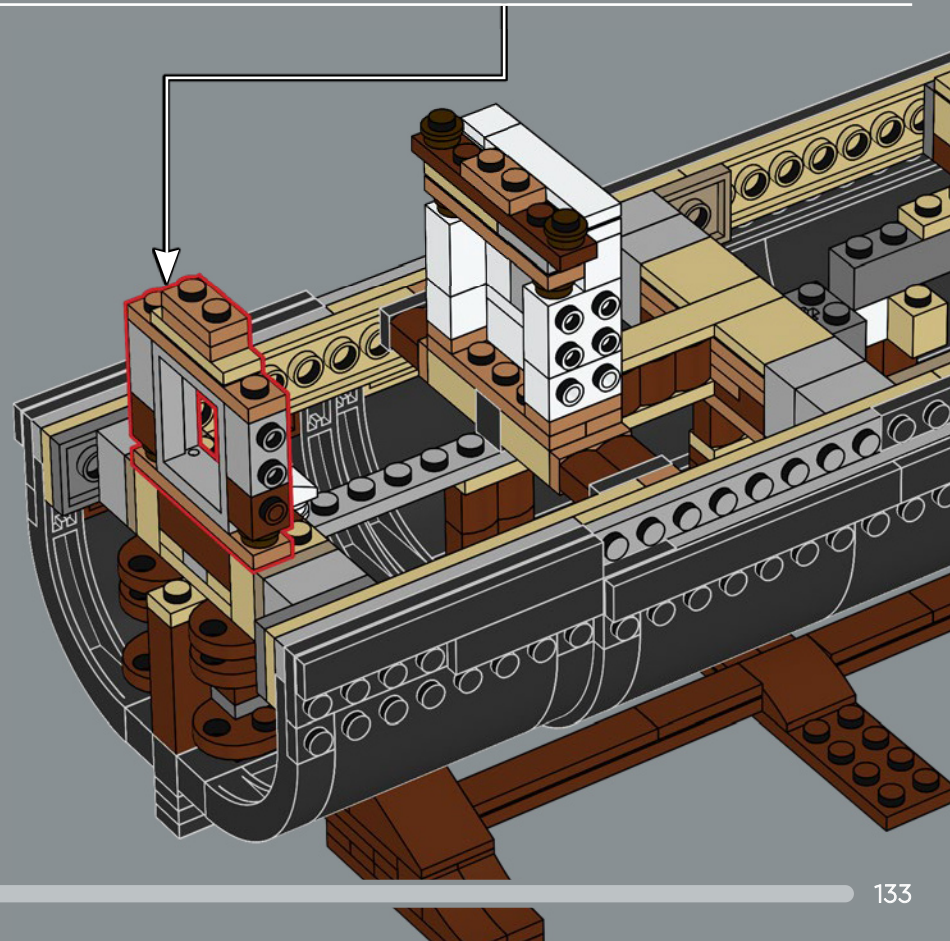
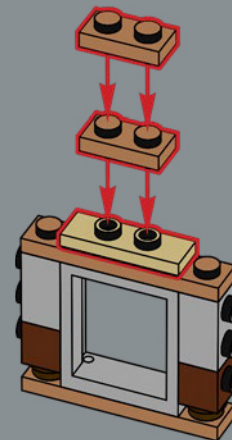

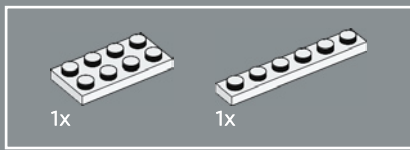

218

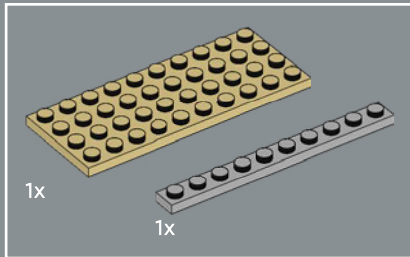
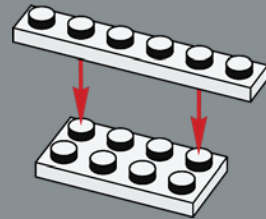

219

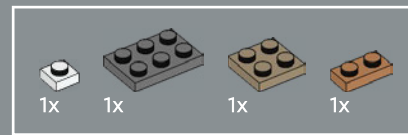
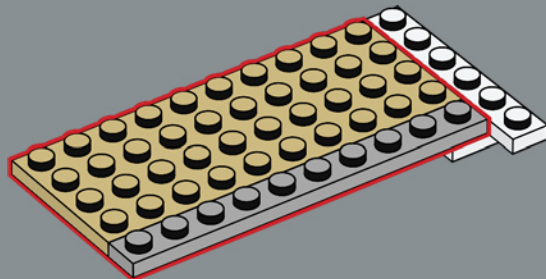

220

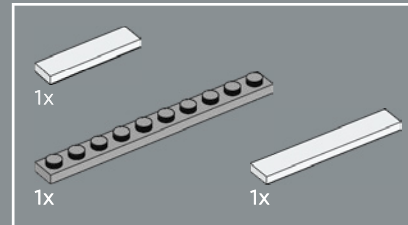
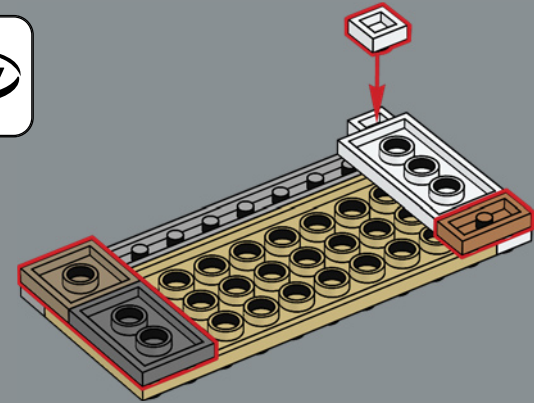

221

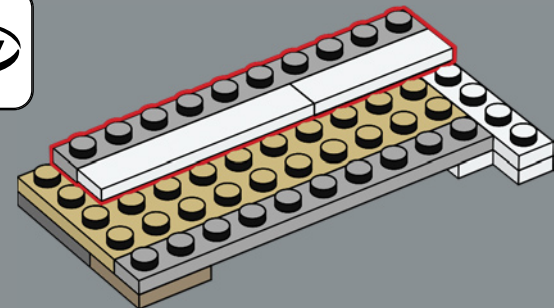

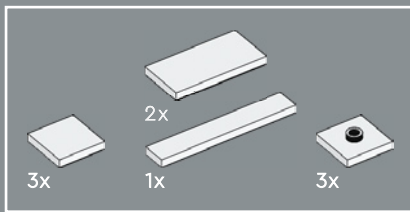

222

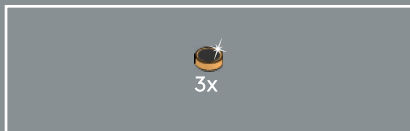
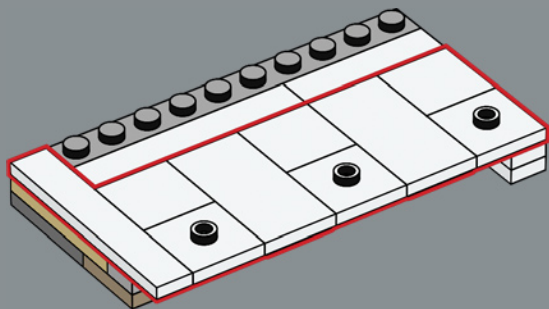

223

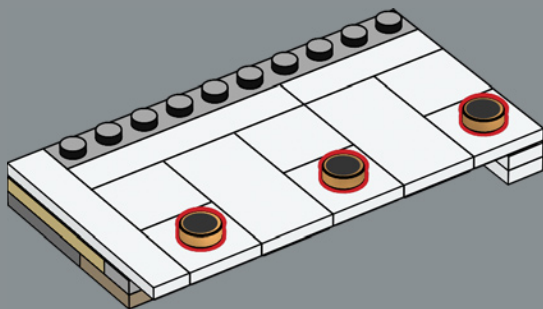

224

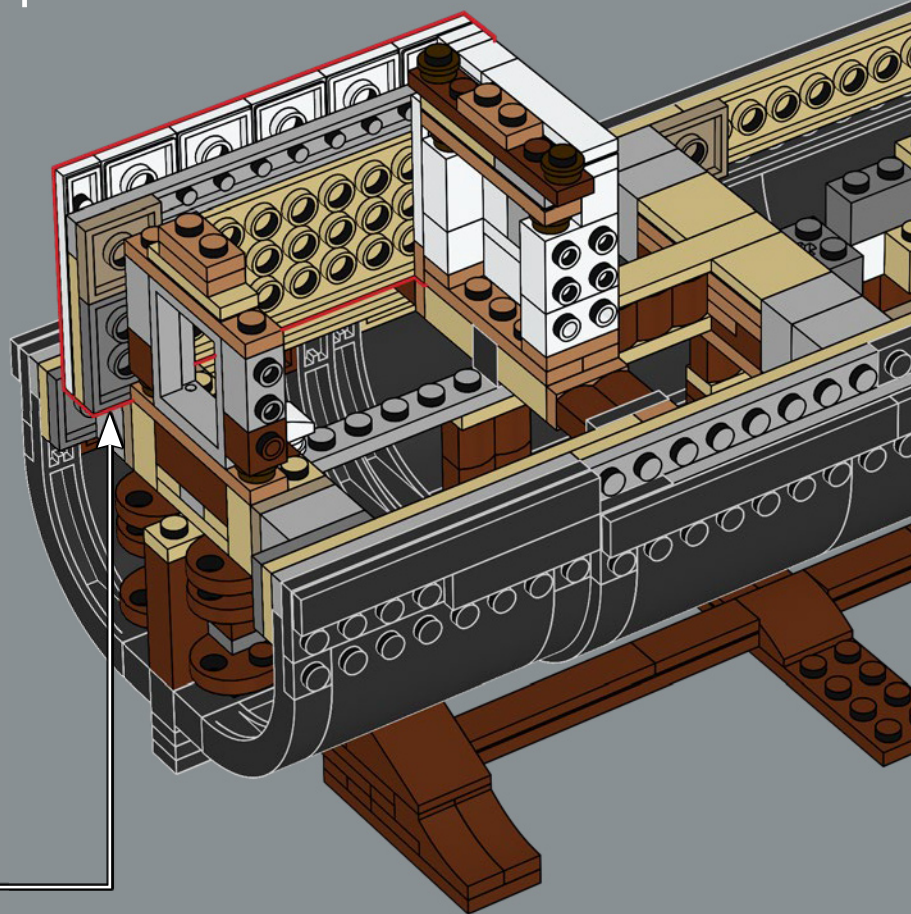

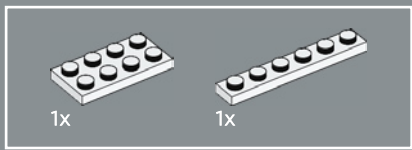

225

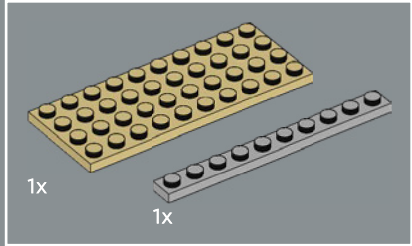
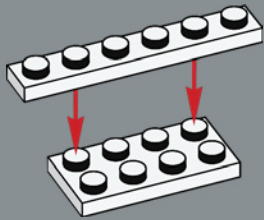

226

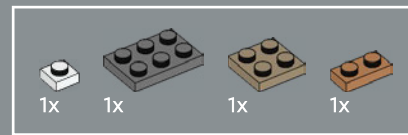
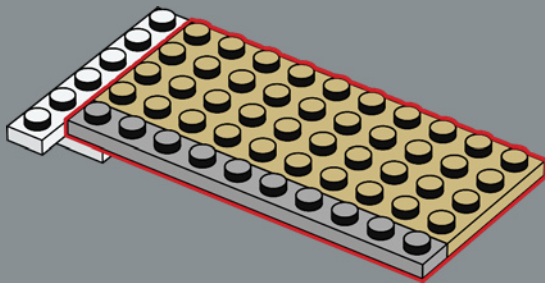

227

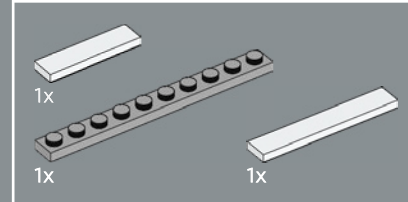
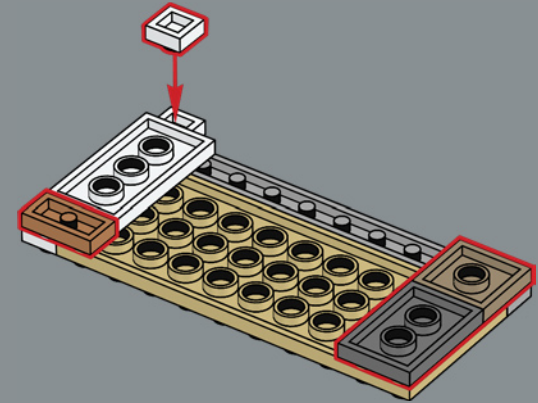

228

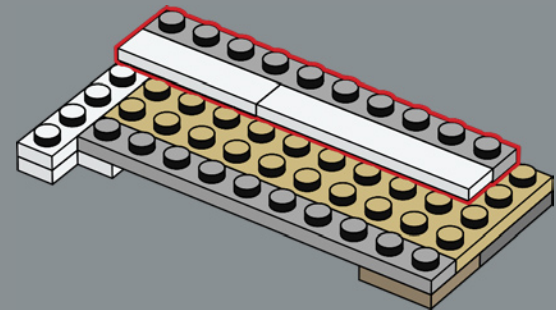
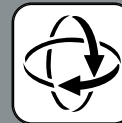

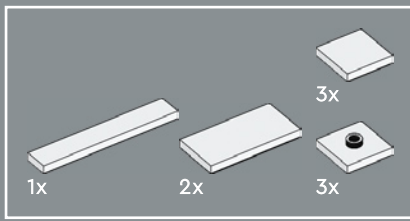

229

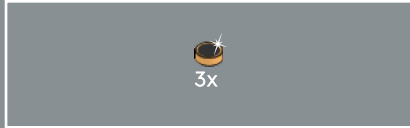
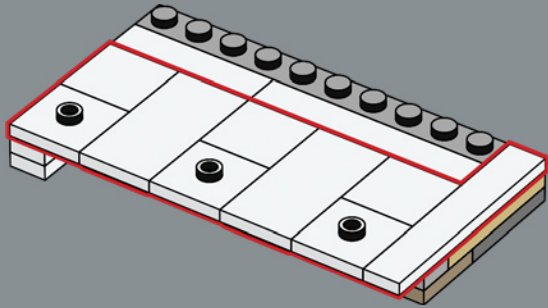

230

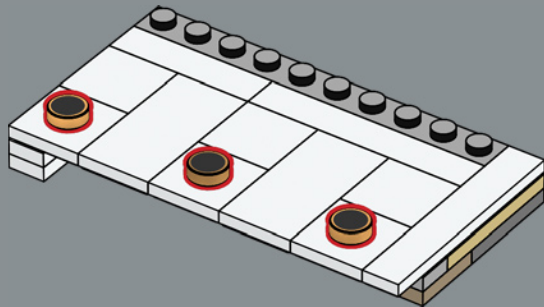

231

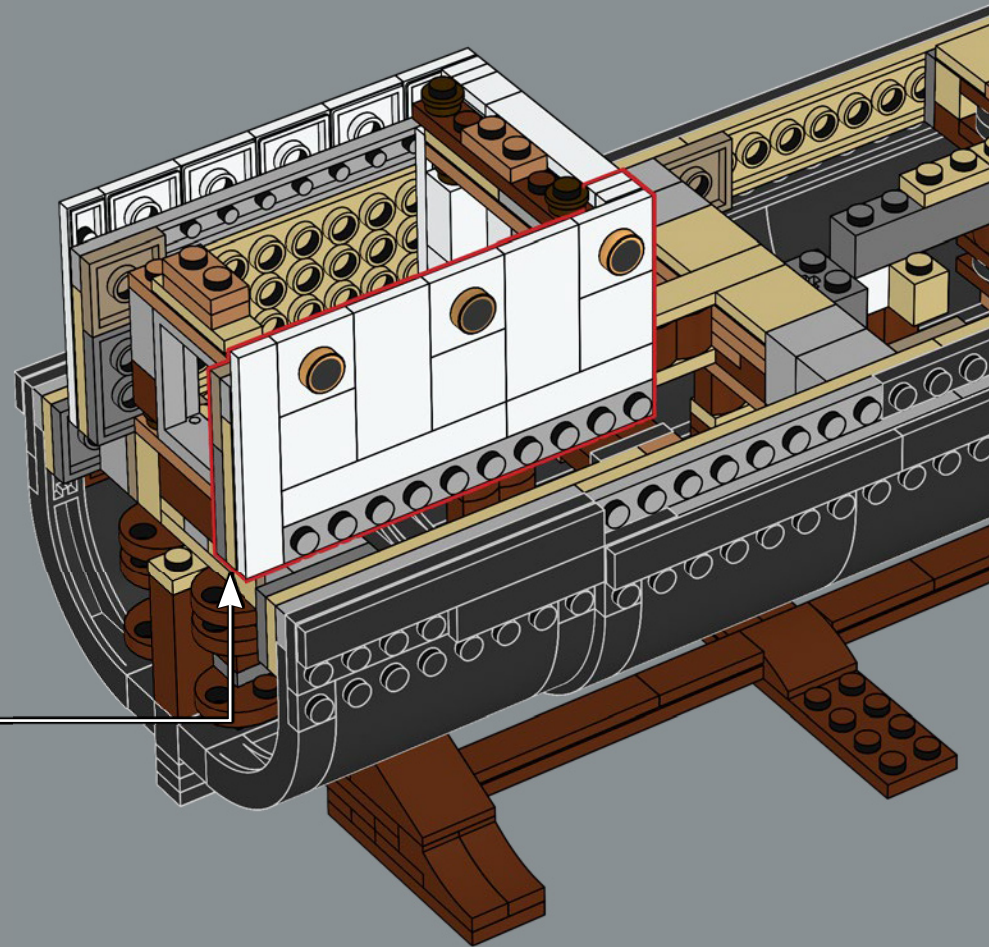



1

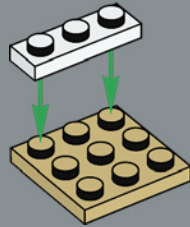

2



3

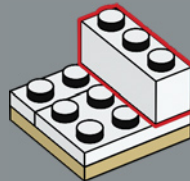

4

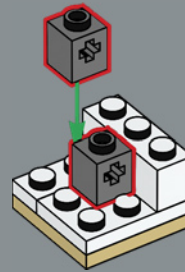

5

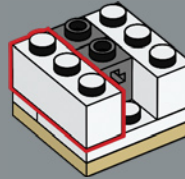

6

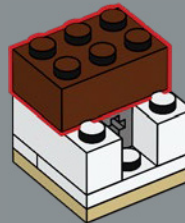

7

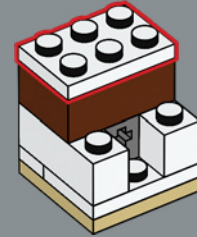

8

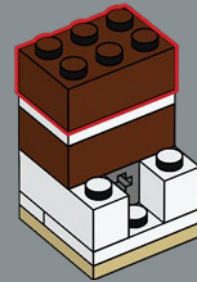

9

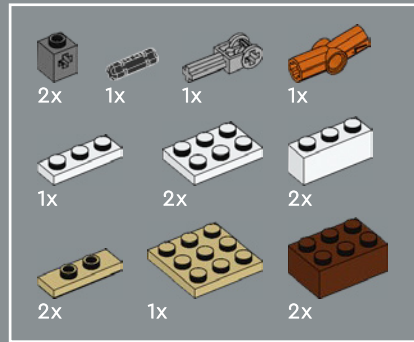
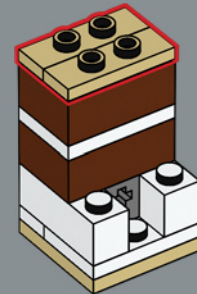

232

10

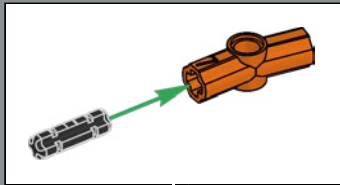
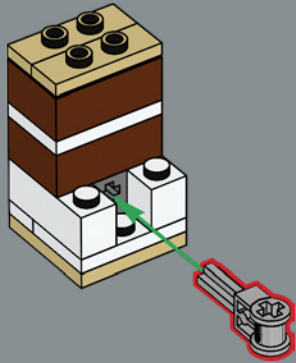

11

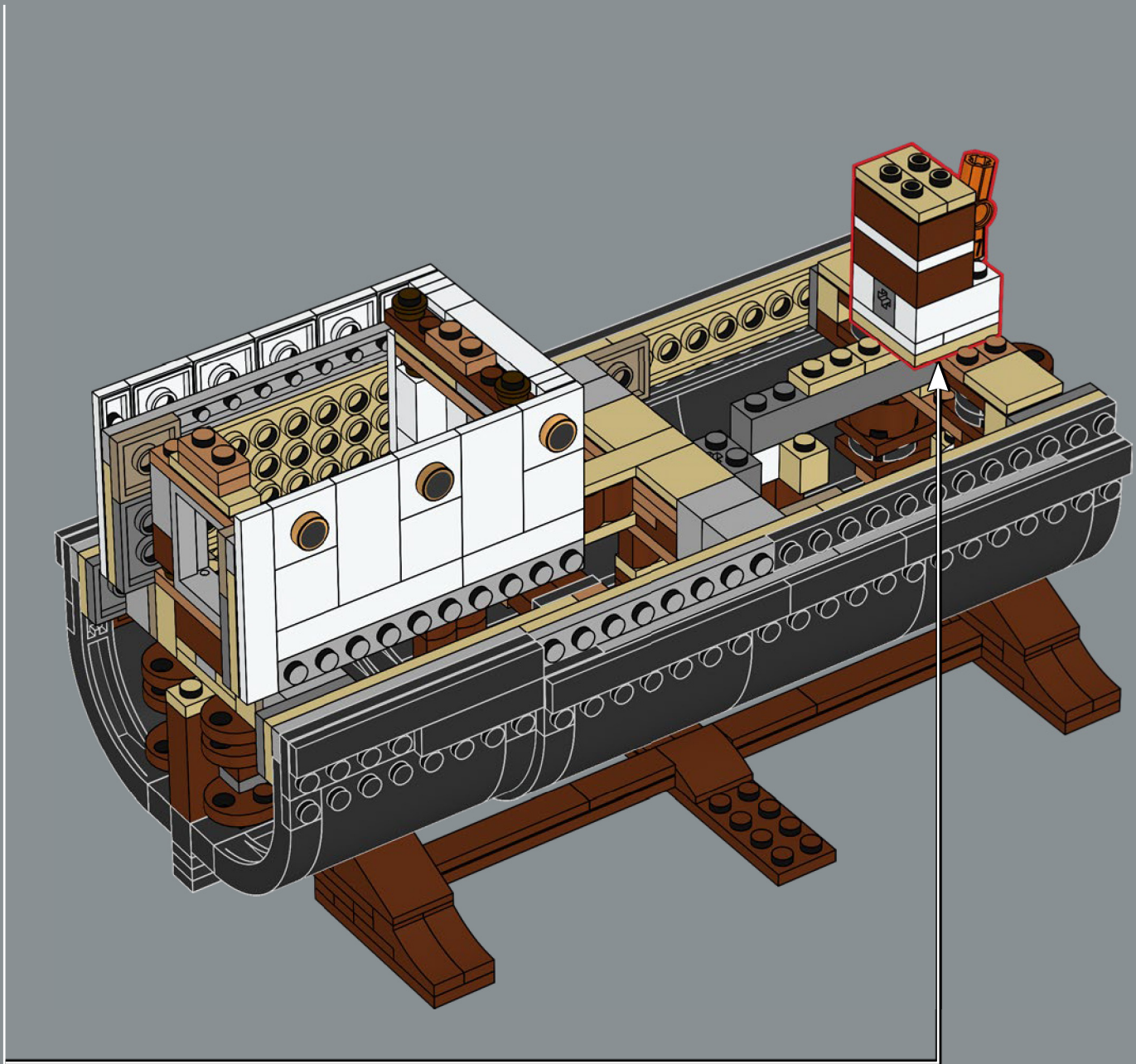
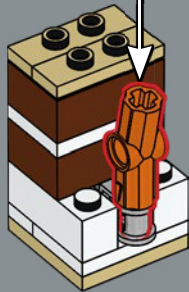

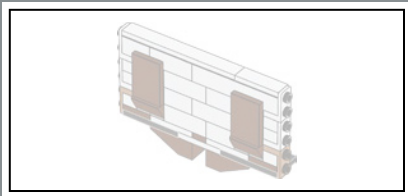

233

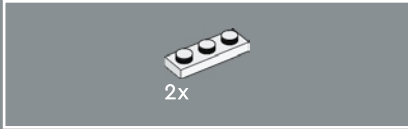
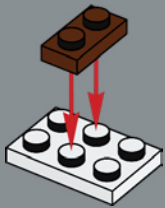

234

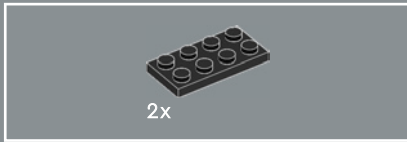
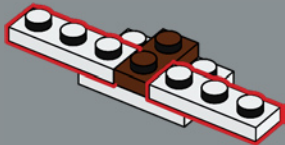

235

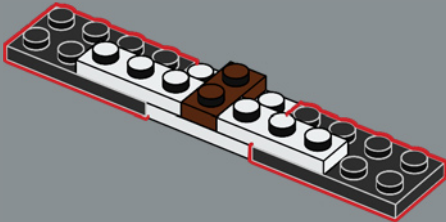

236

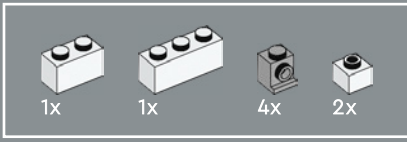
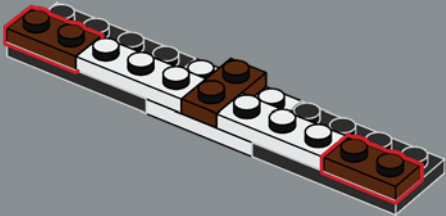

237

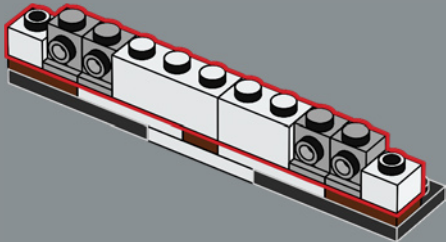

238

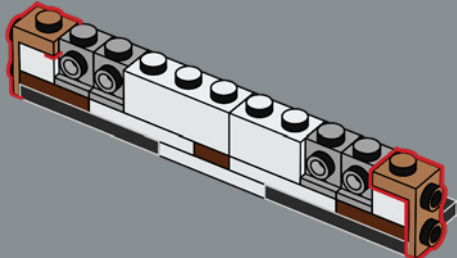

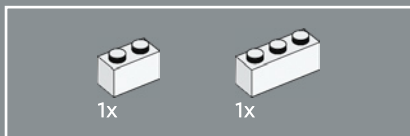

239

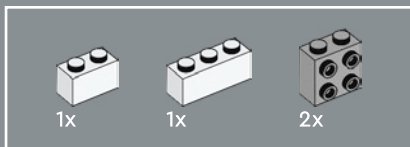
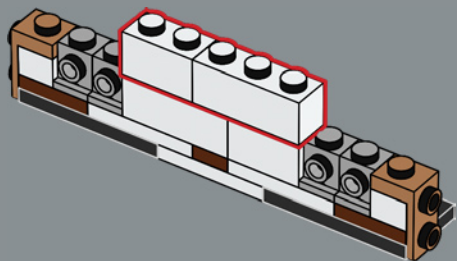

240

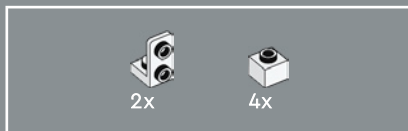
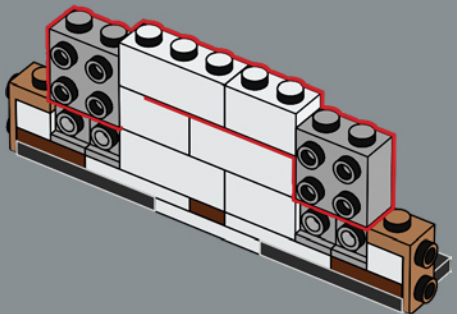

241

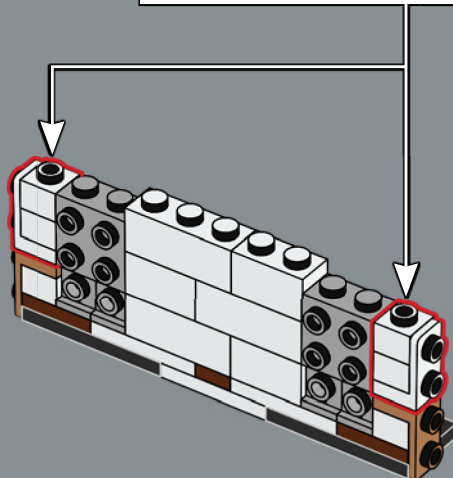
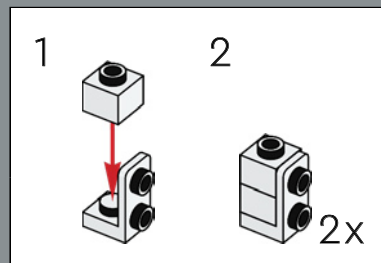

242

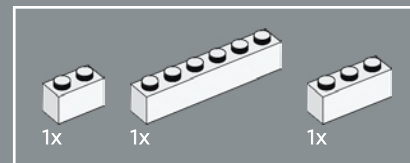
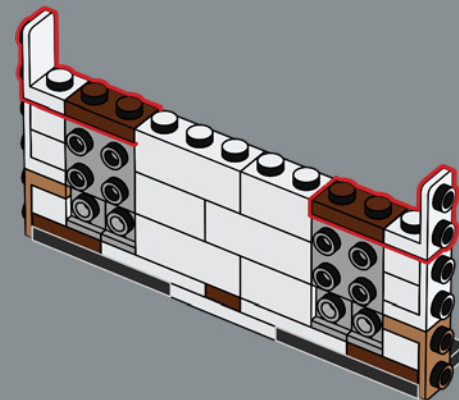

243

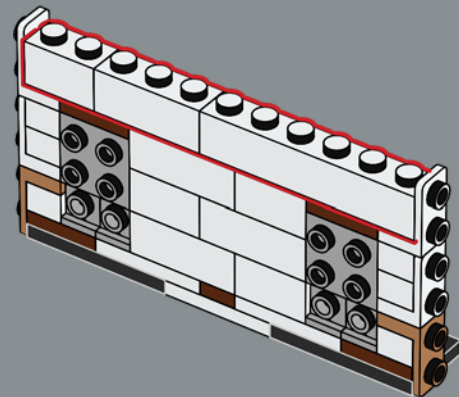

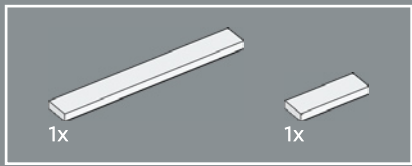

244

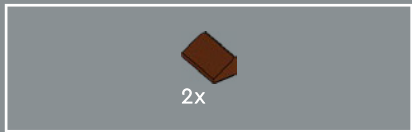
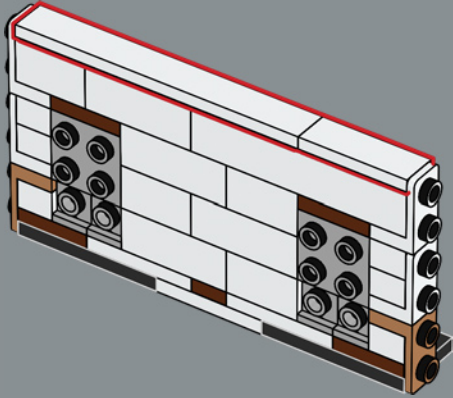

245

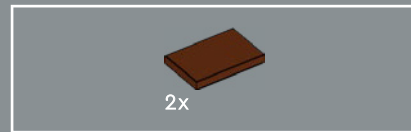
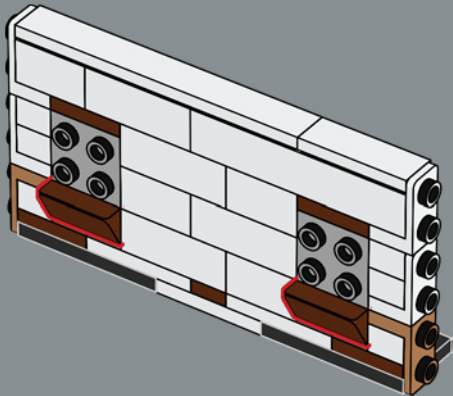

246

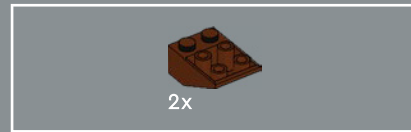
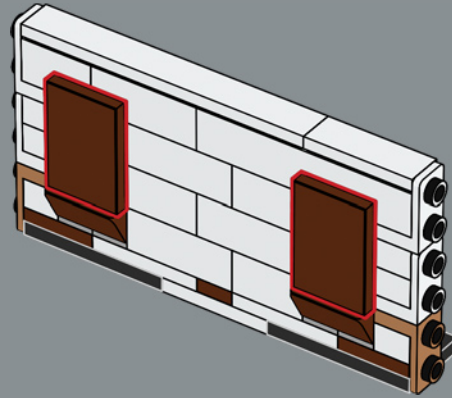

247

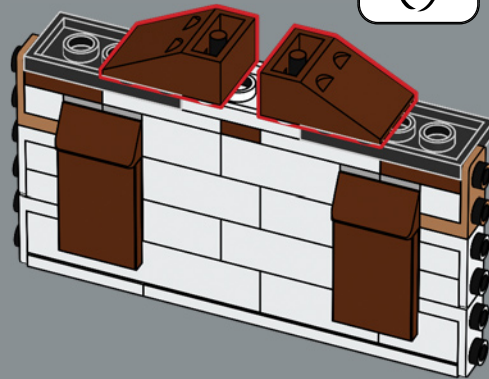

248

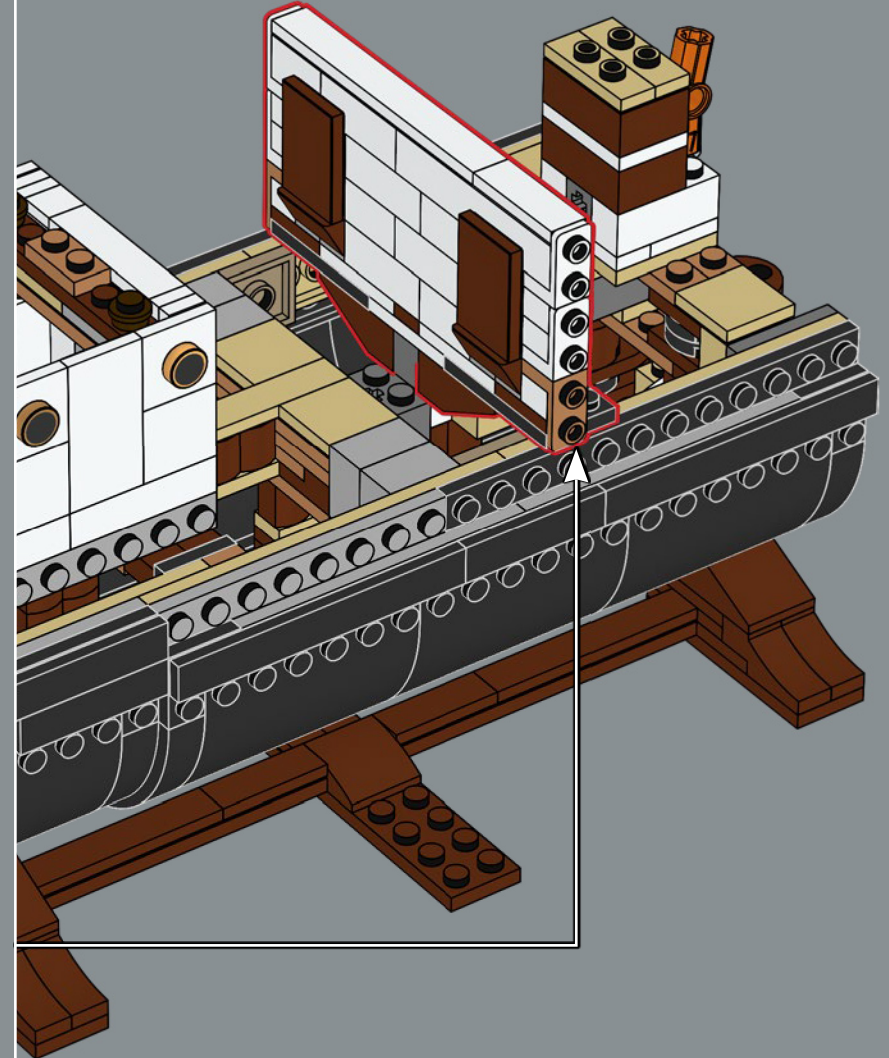

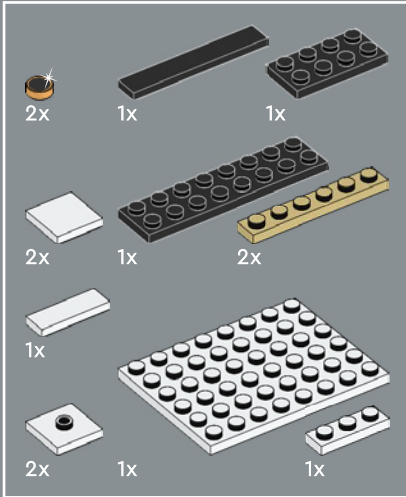
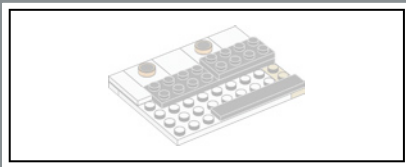

249

1

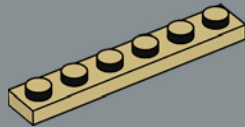

2

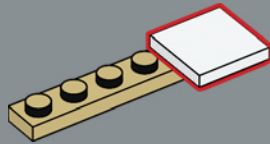

3

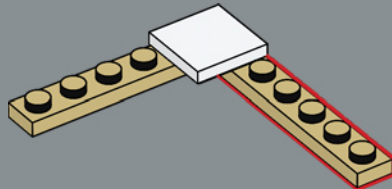

4

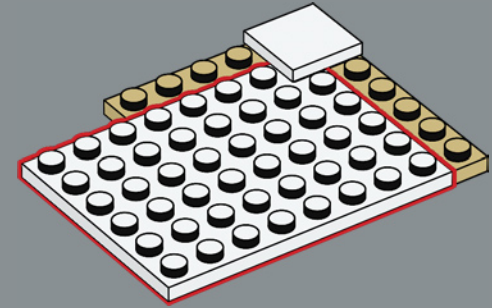

5

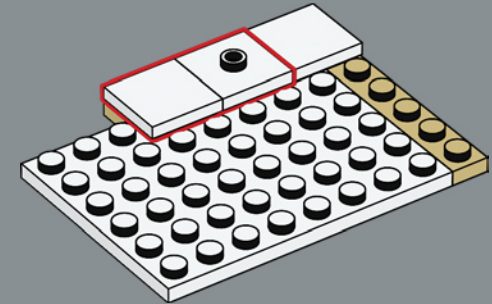

6

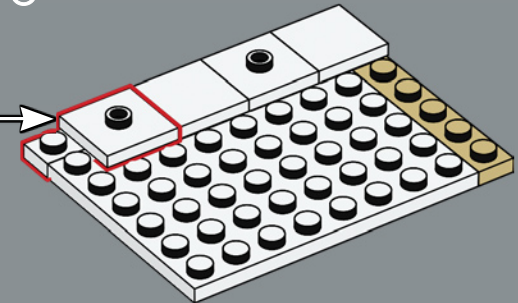
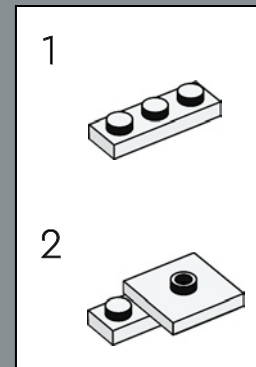

7

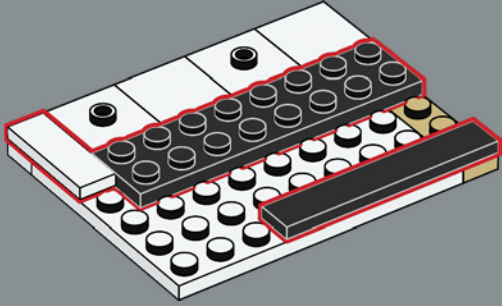

8

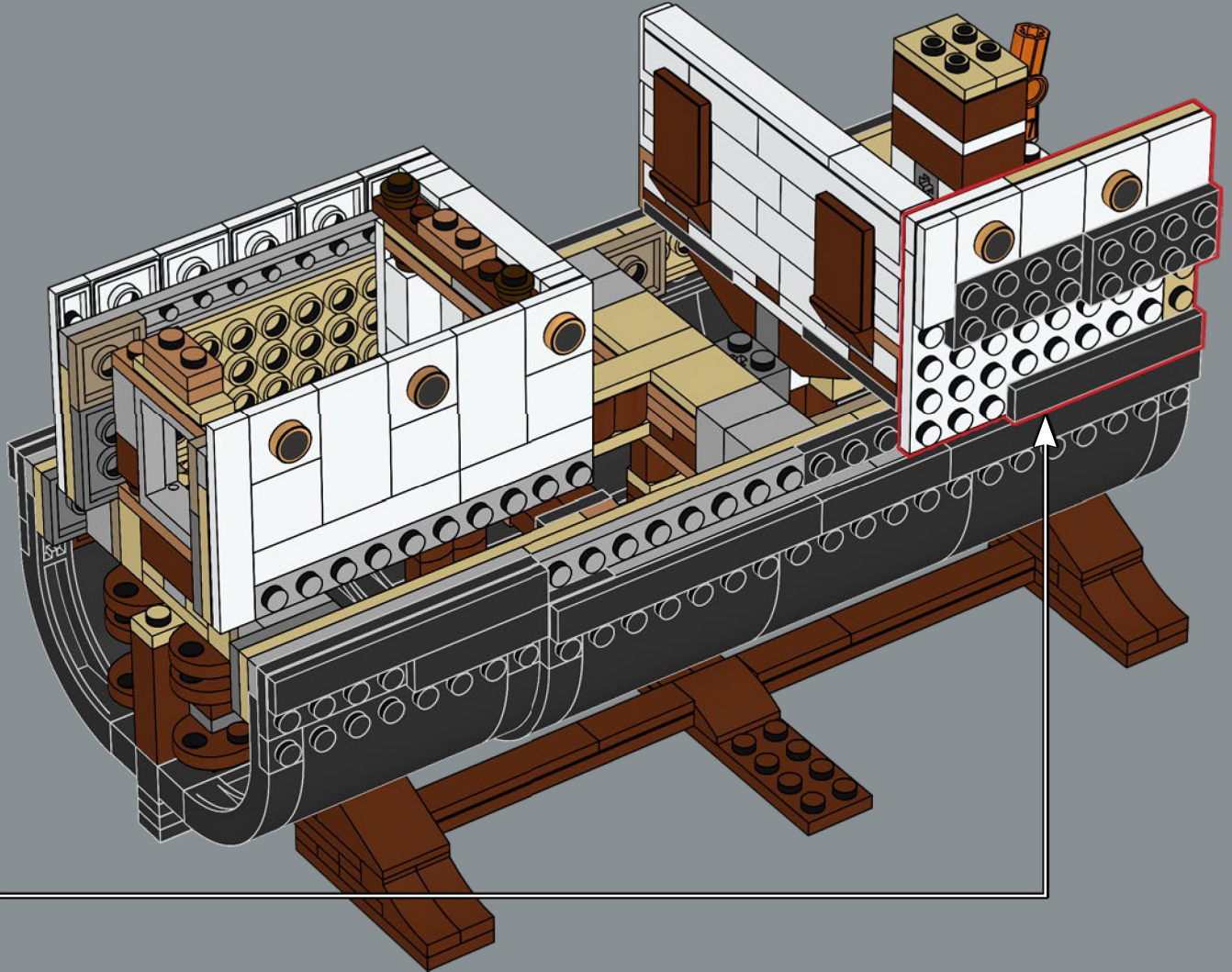
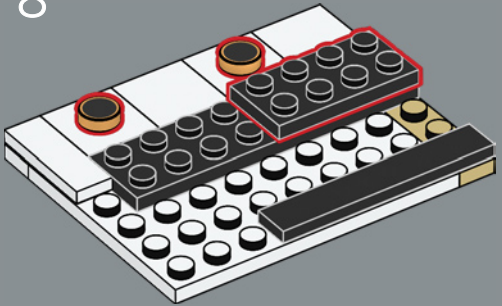

7

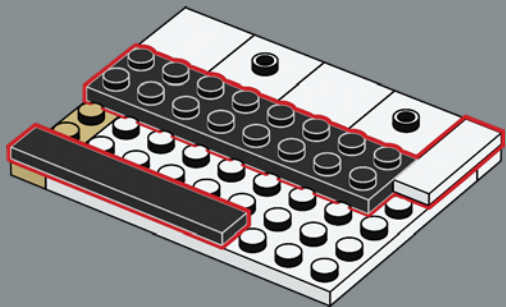

8

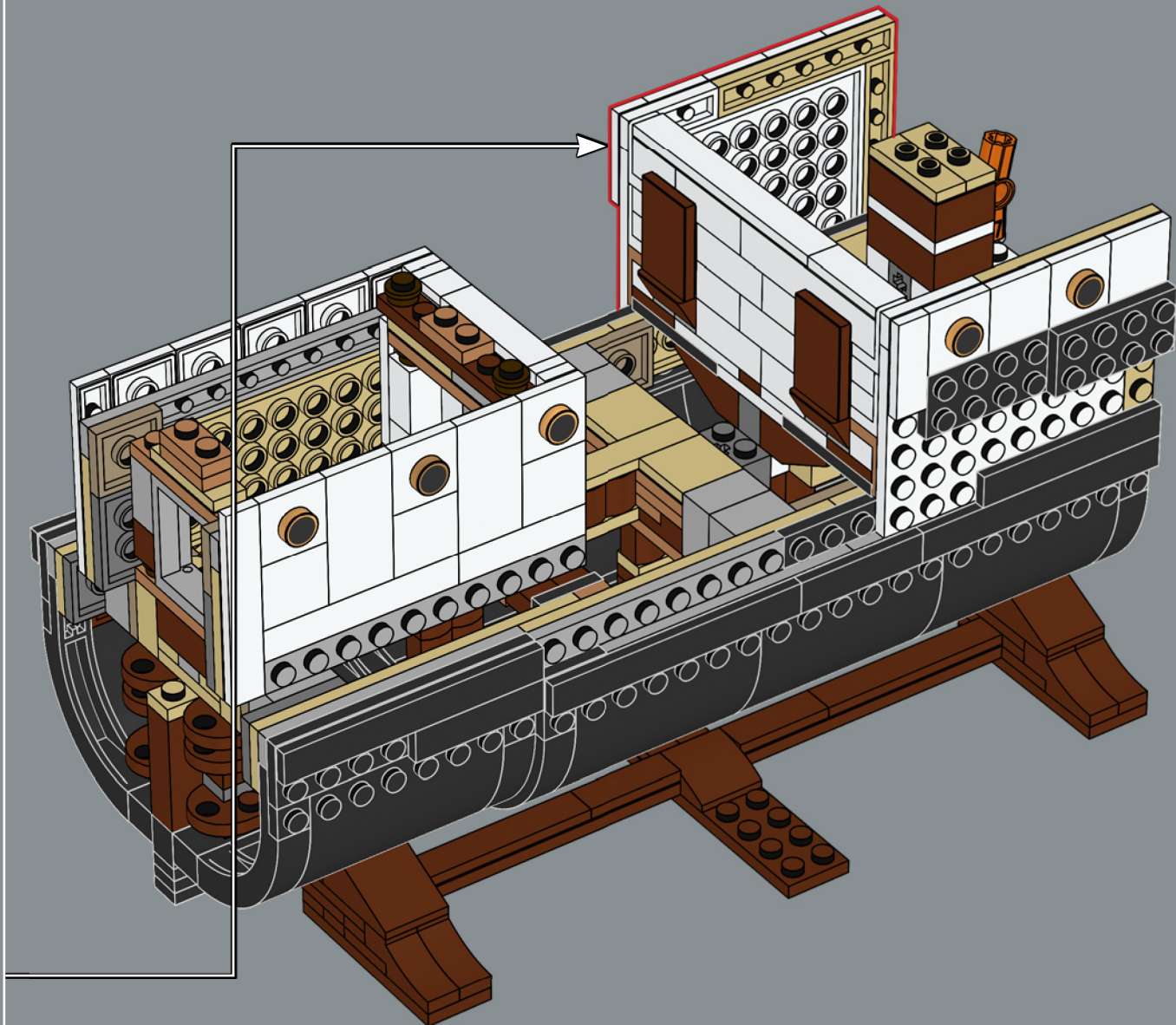
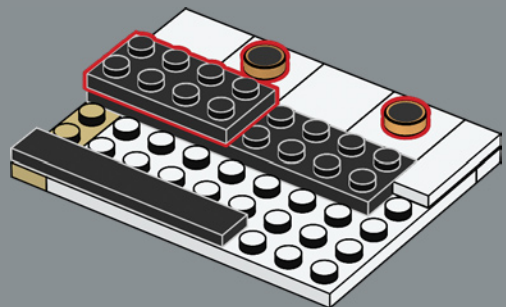

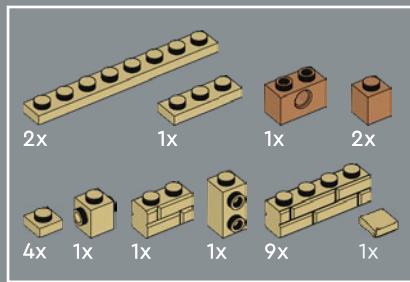
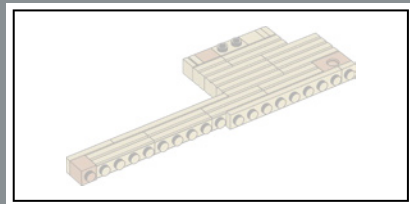

251

1

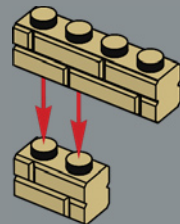

2

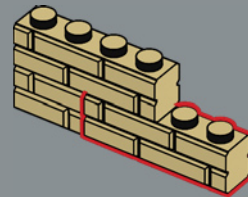

3

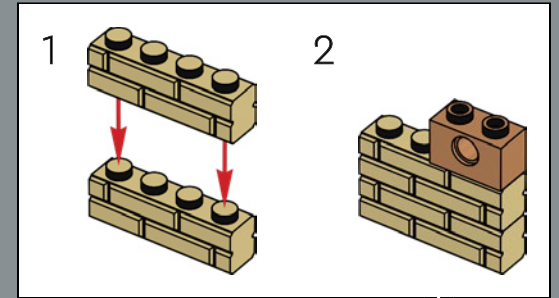
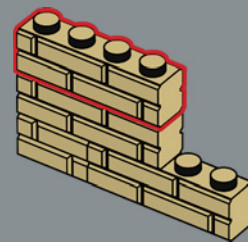

4

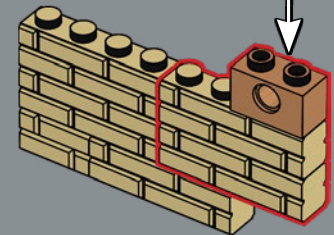

5

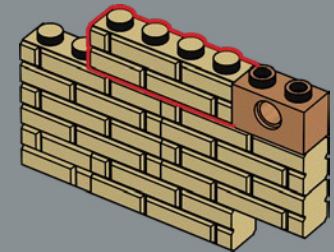

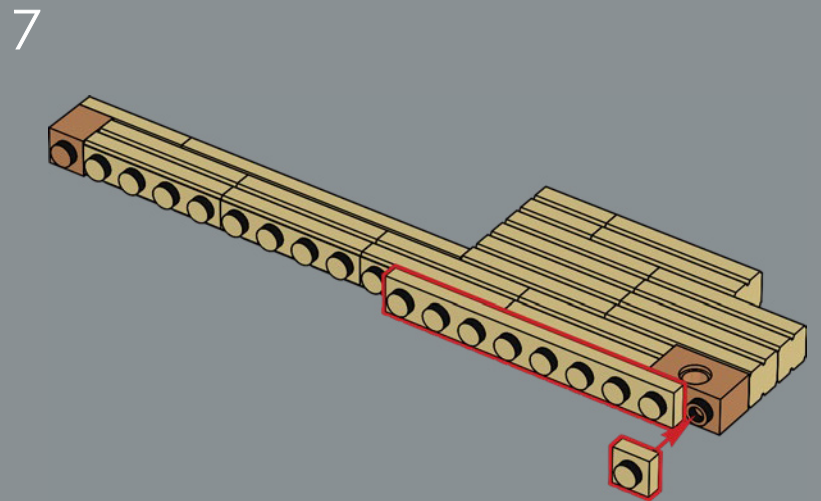
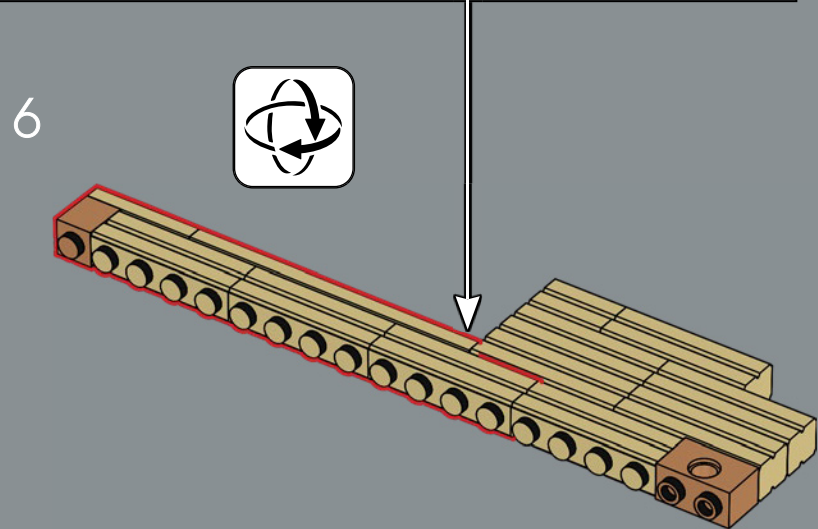
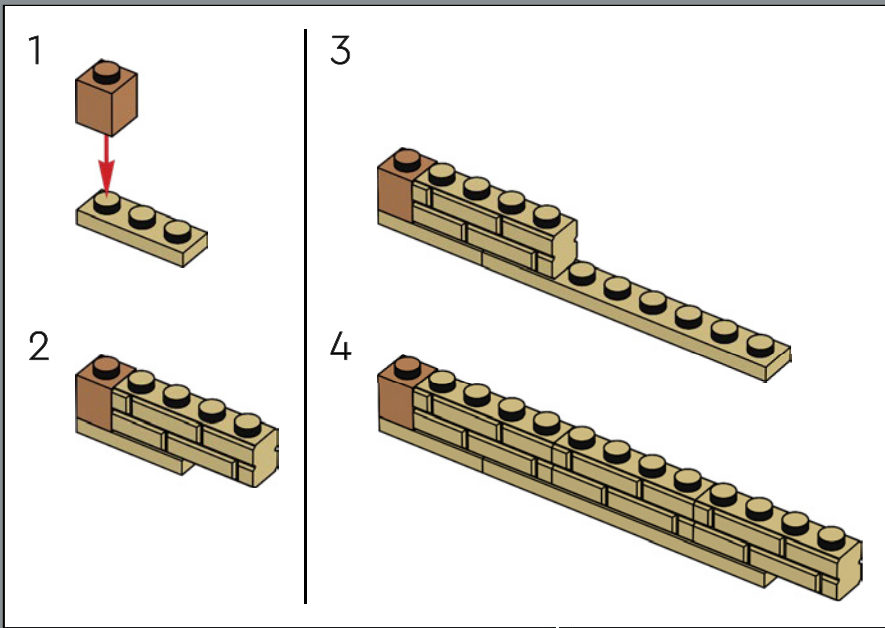

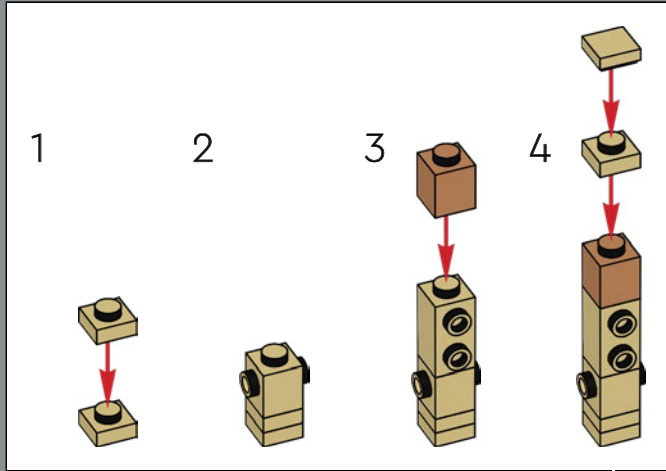

8

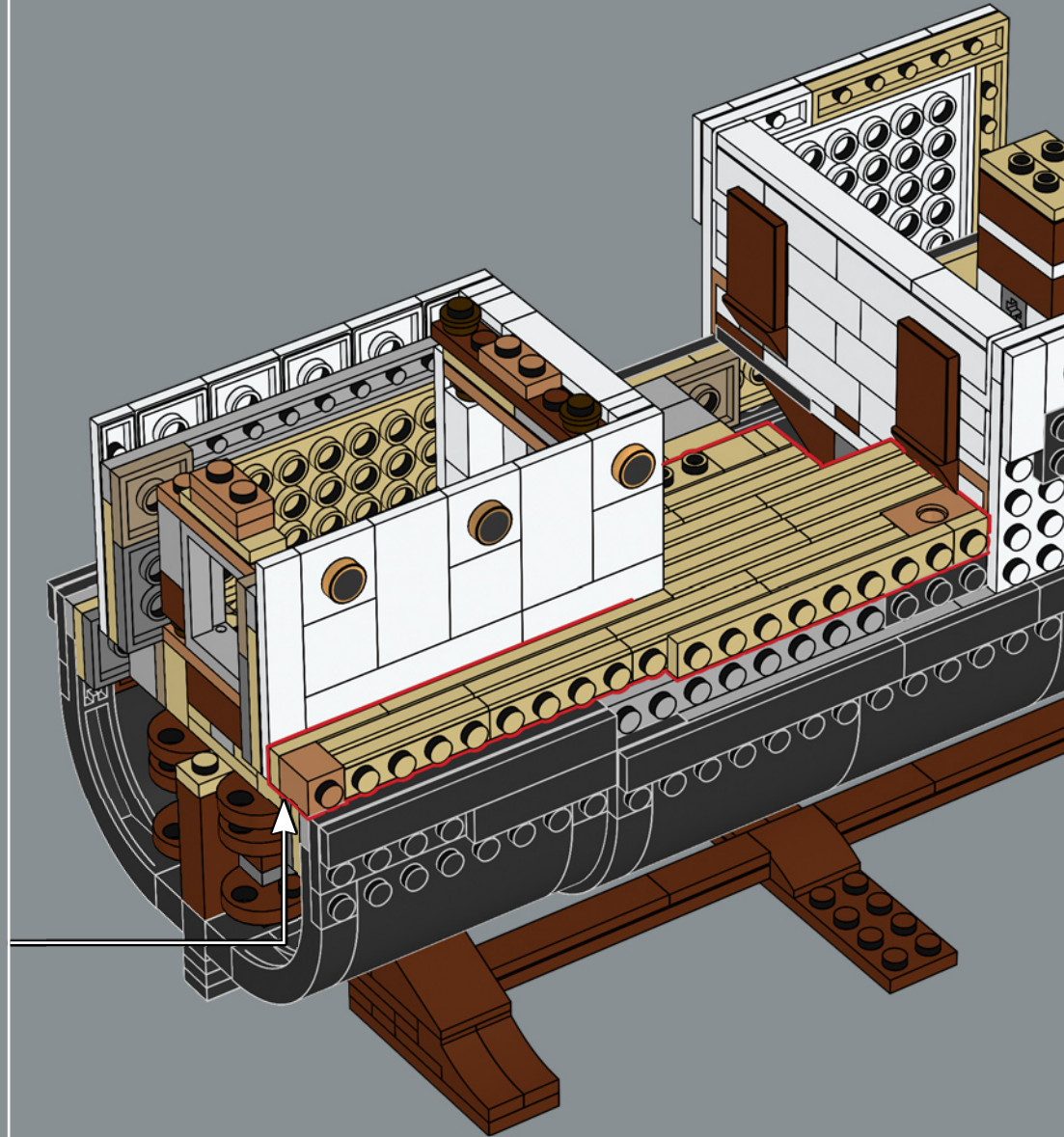
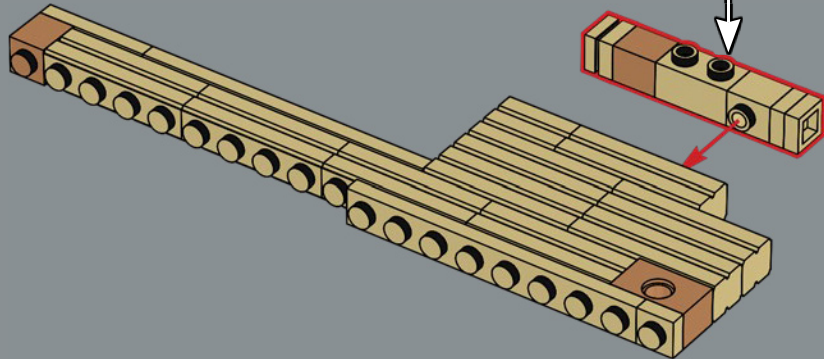

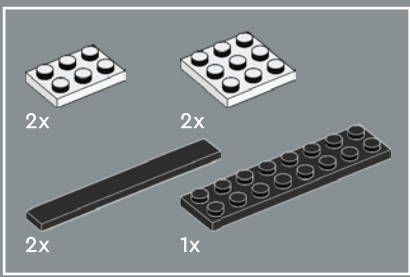

252

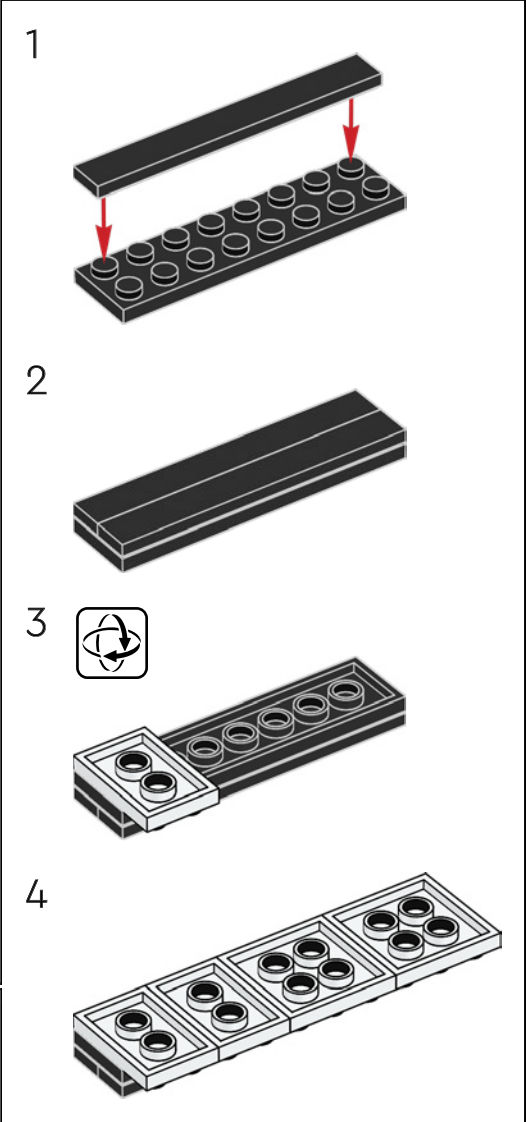
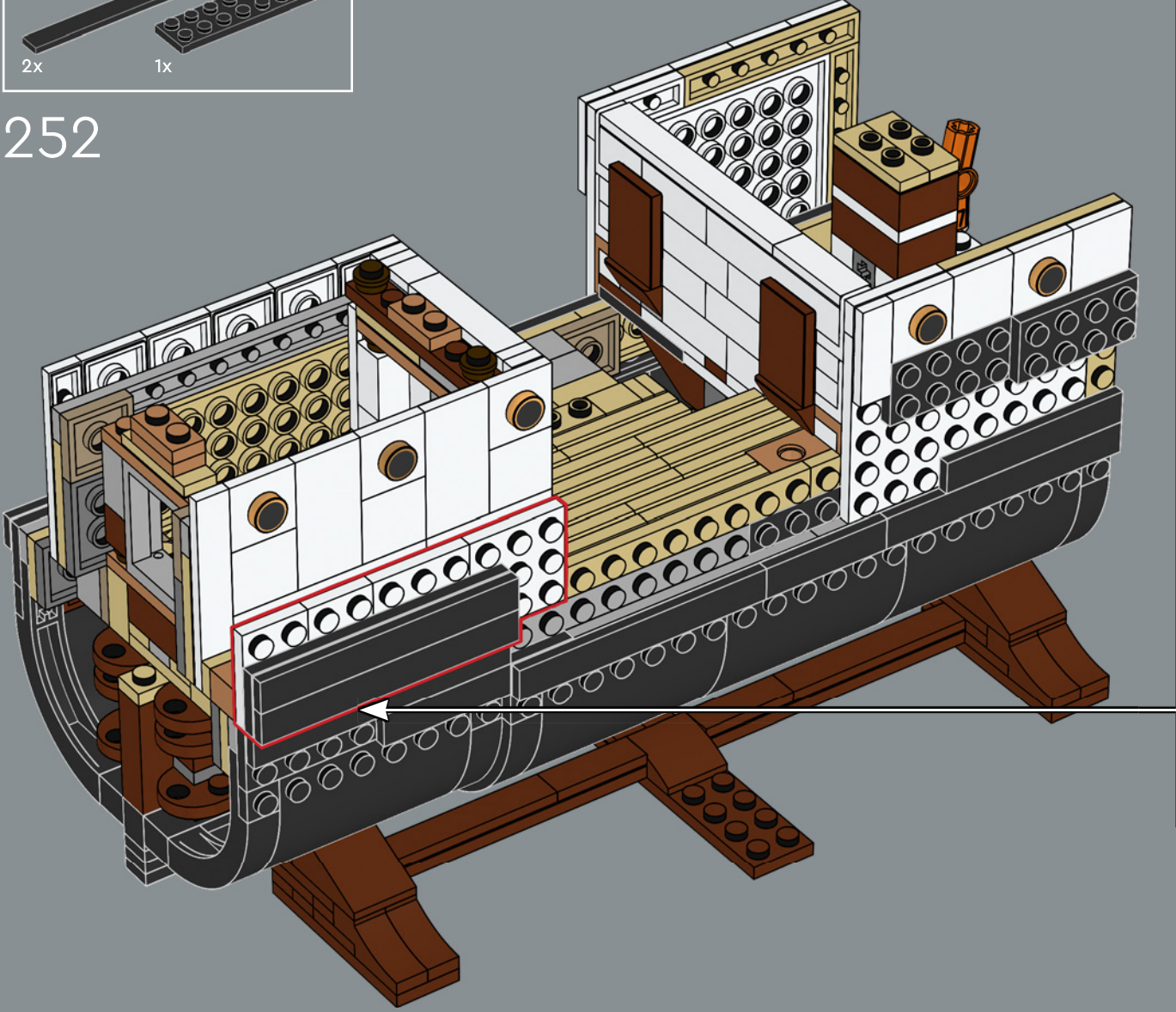

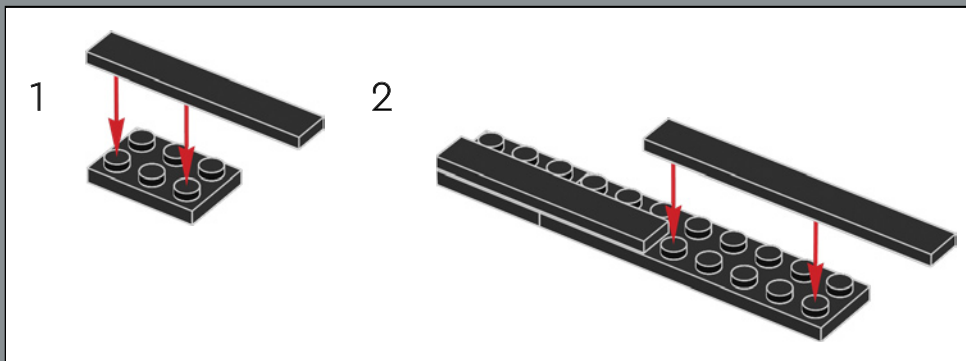
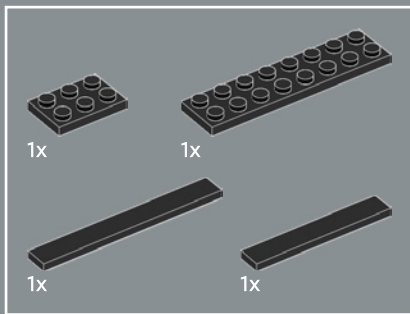

253

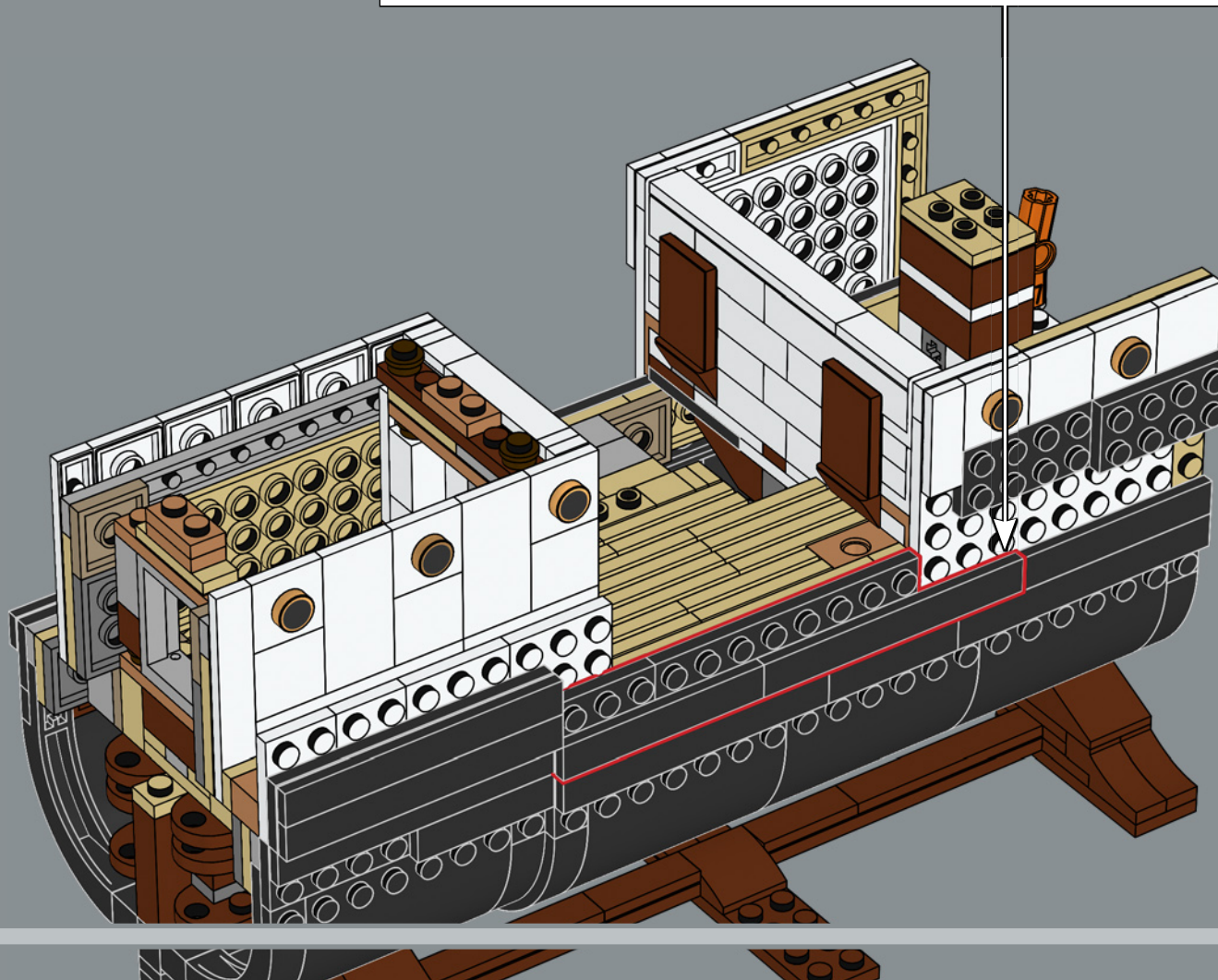

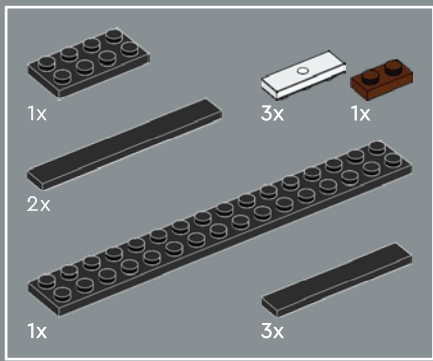

254

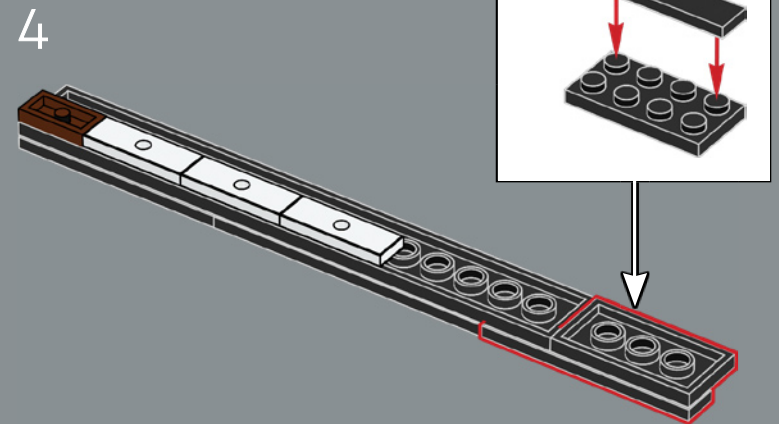
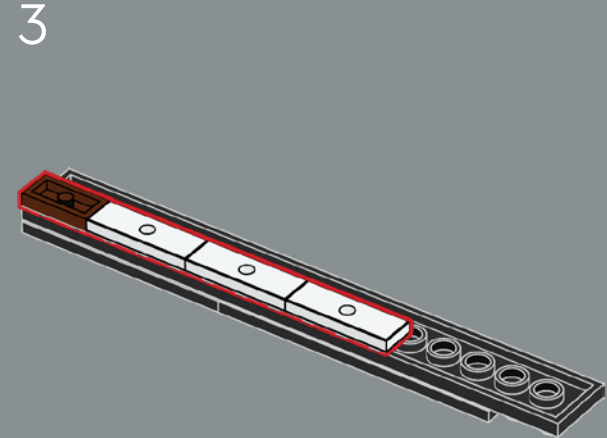
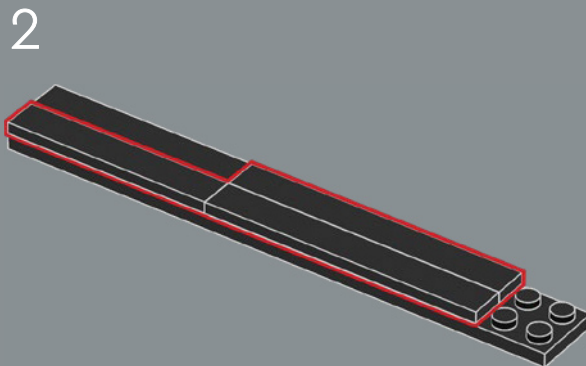
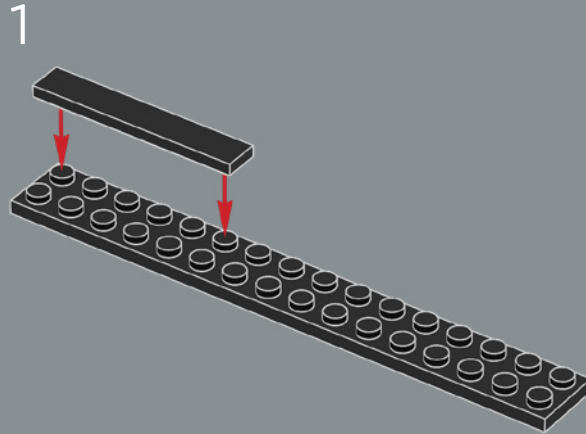

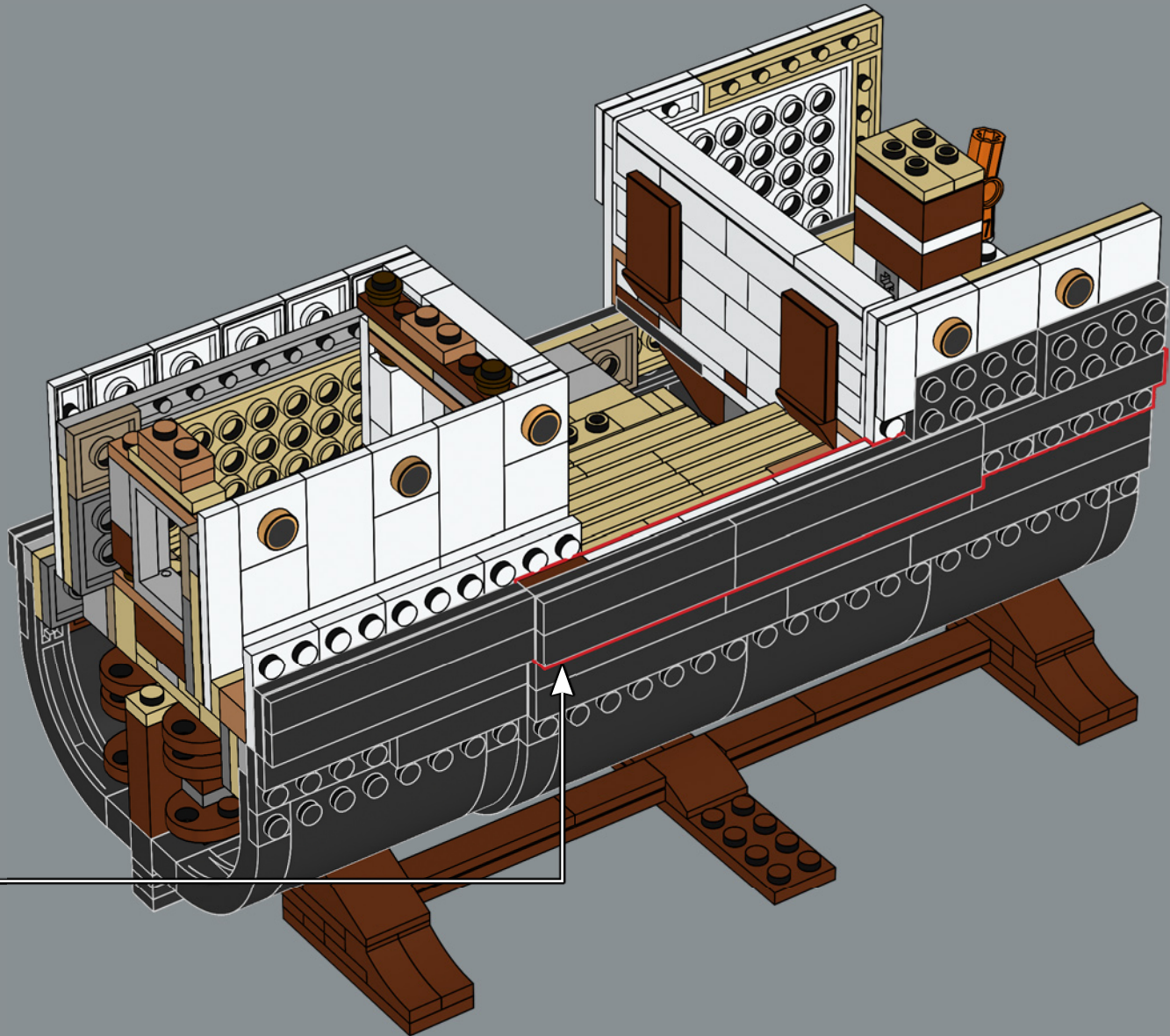

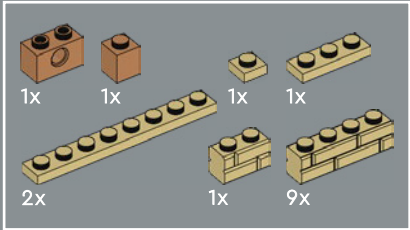
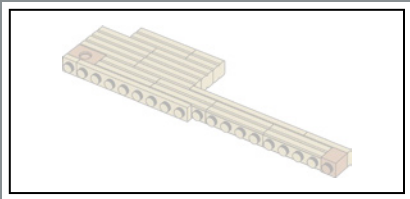

255

1

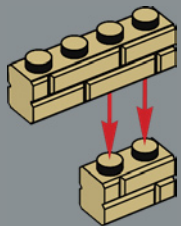

2

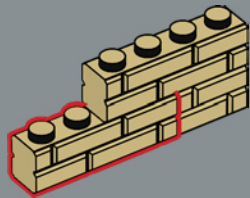

3

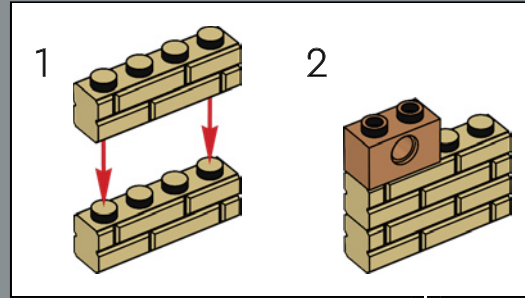
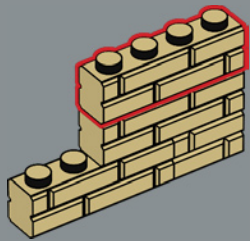

4

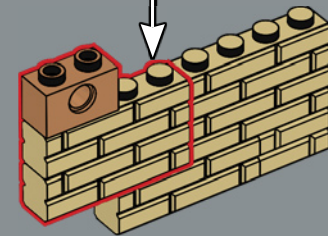

5

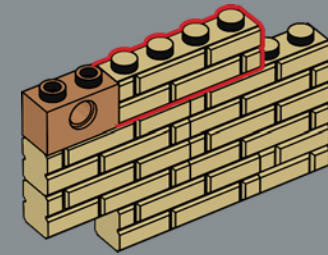

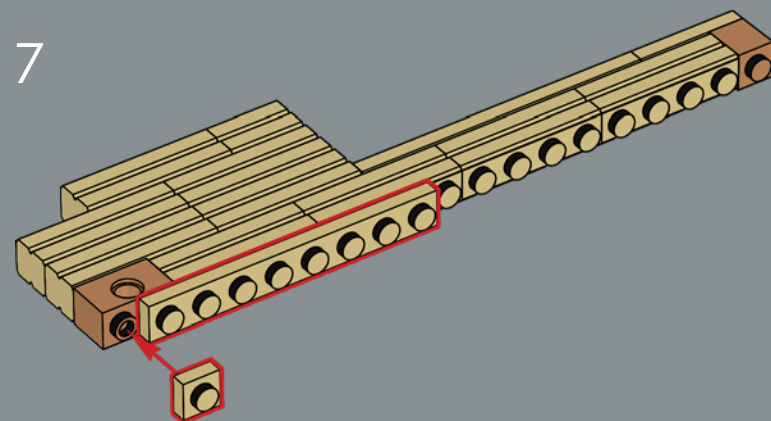
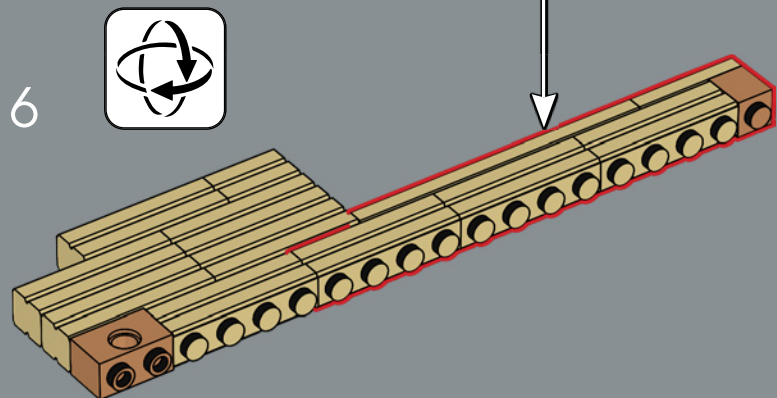
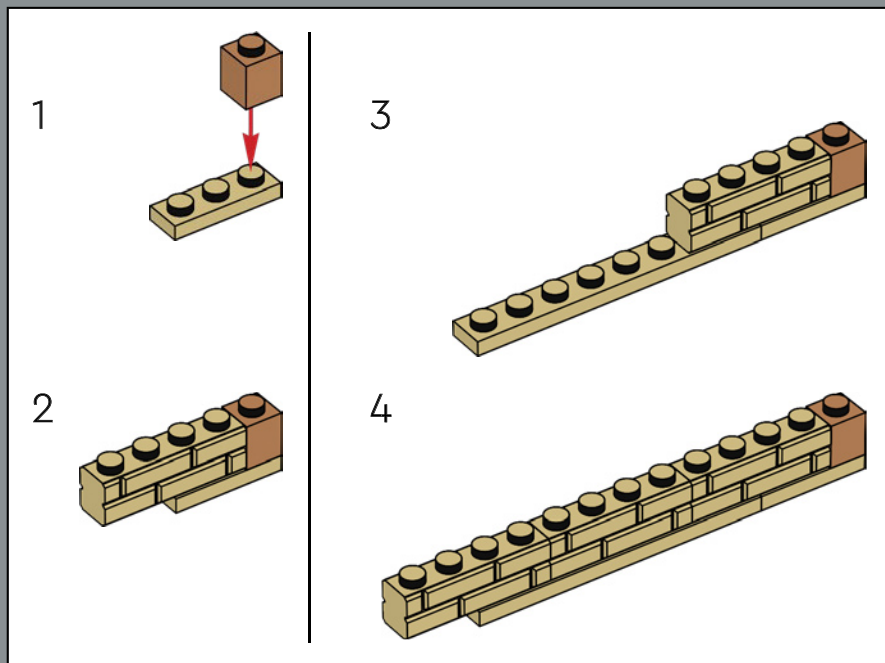

To give the lower deck the appearance of being made from wooden planks, the back side of LEGO® 'brick wall' profile bricks are used here.

Pour donner au pont inférieur l'apparence d'être fait de planches de bois, l'arrière des briques profilées « mur de briques » LEGO® est utilisé ici.

Para dar a la cubierta inferior la apariencia de estar hecha de tabloncillos de madera, se utilizaron bricks LEGO® comúnmente usados para representar paredes de ladrillo con la cara posterior visible.

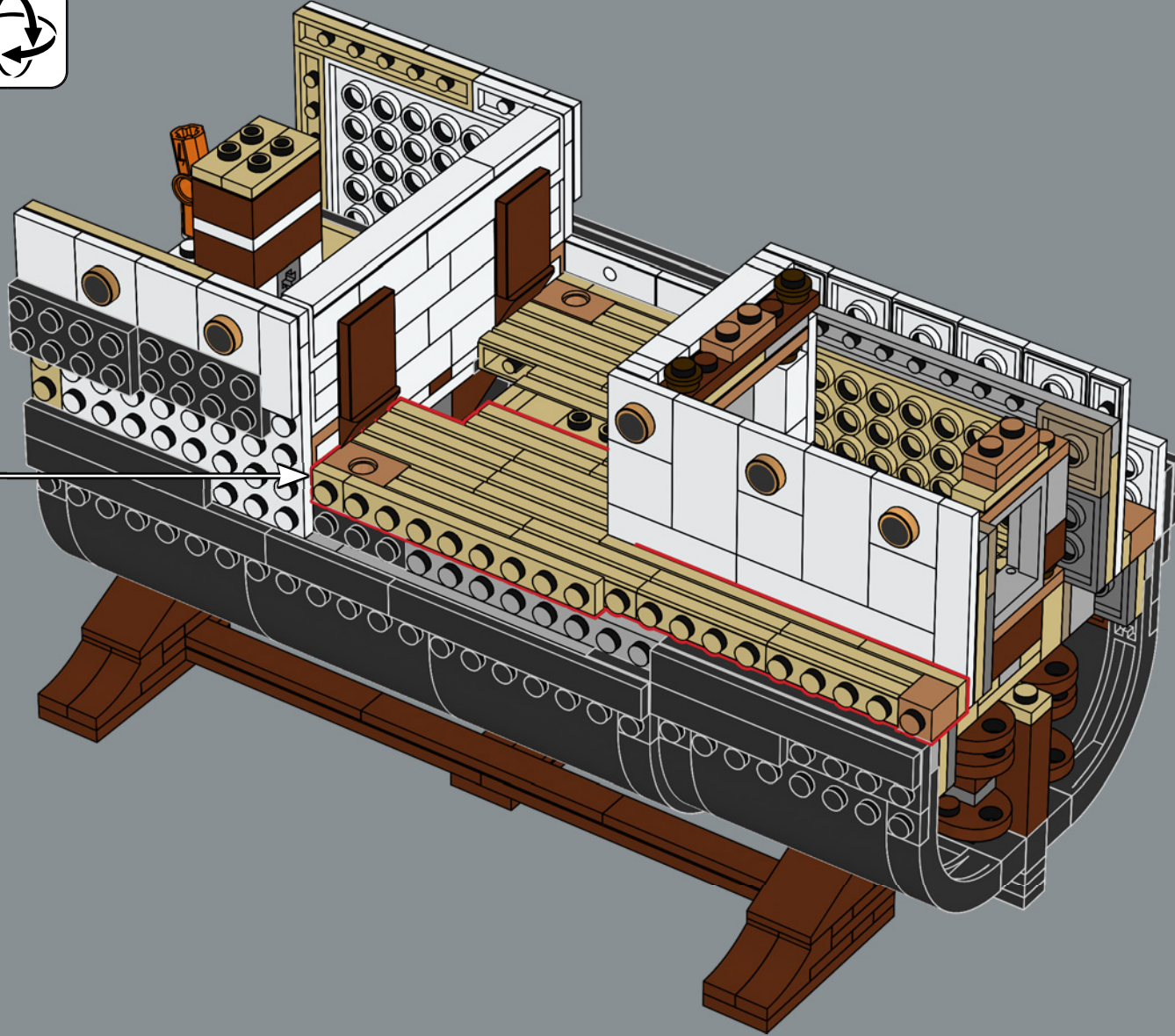

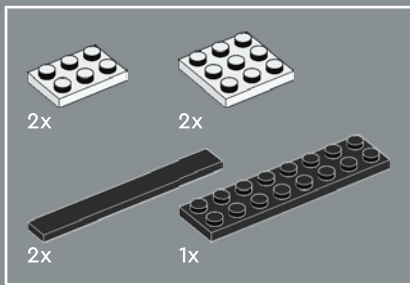

256

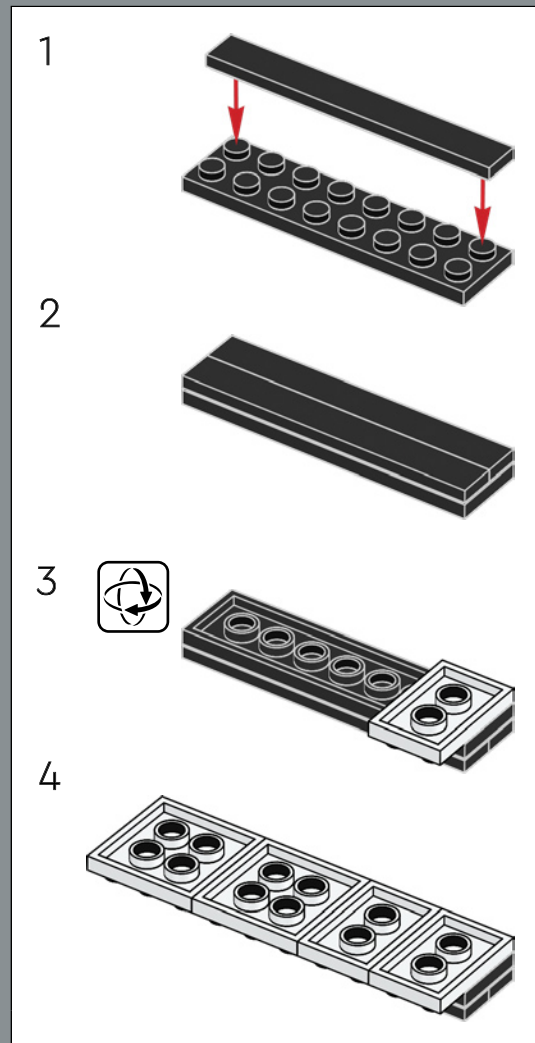
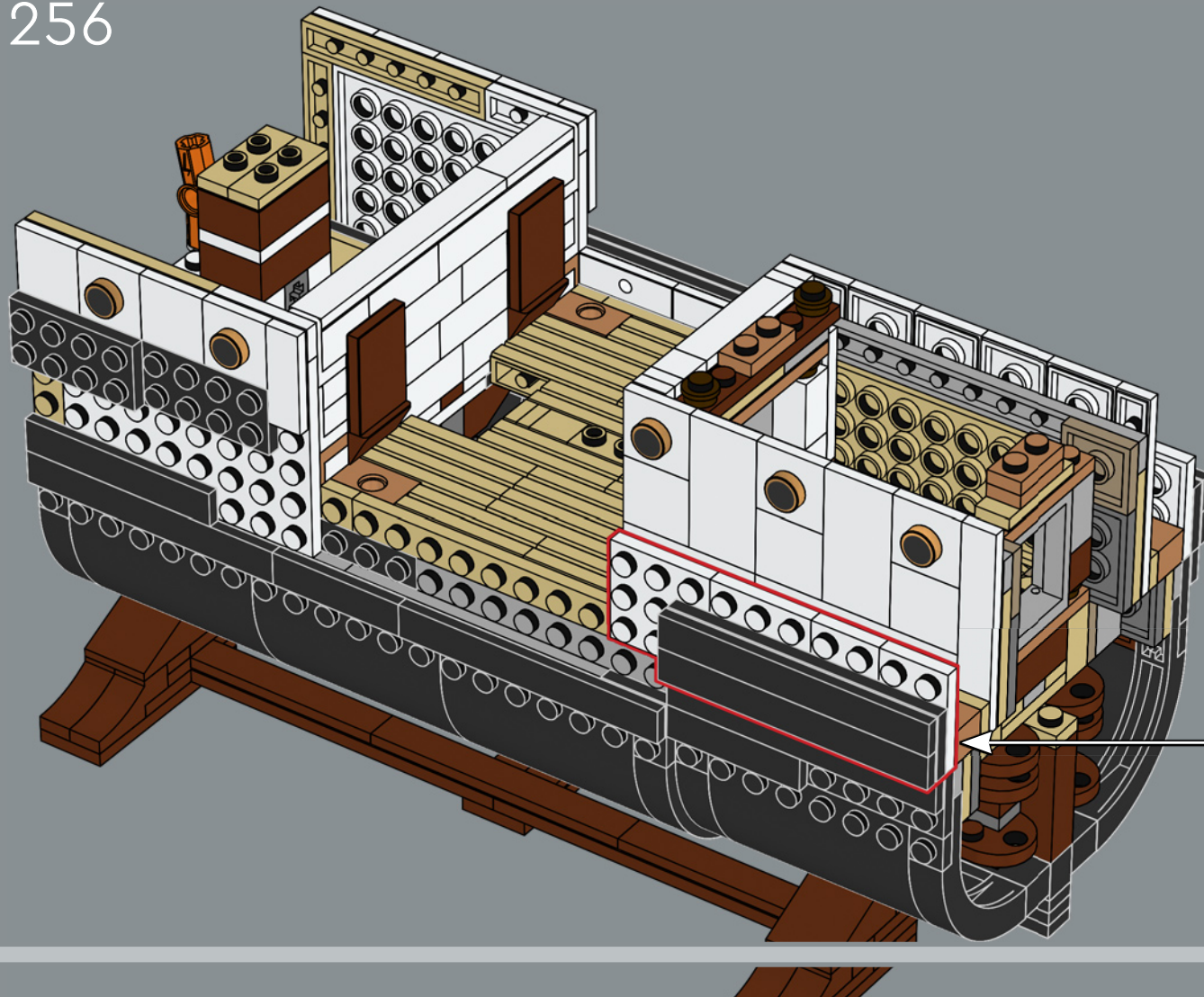

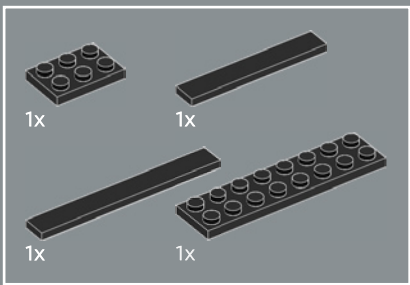

257

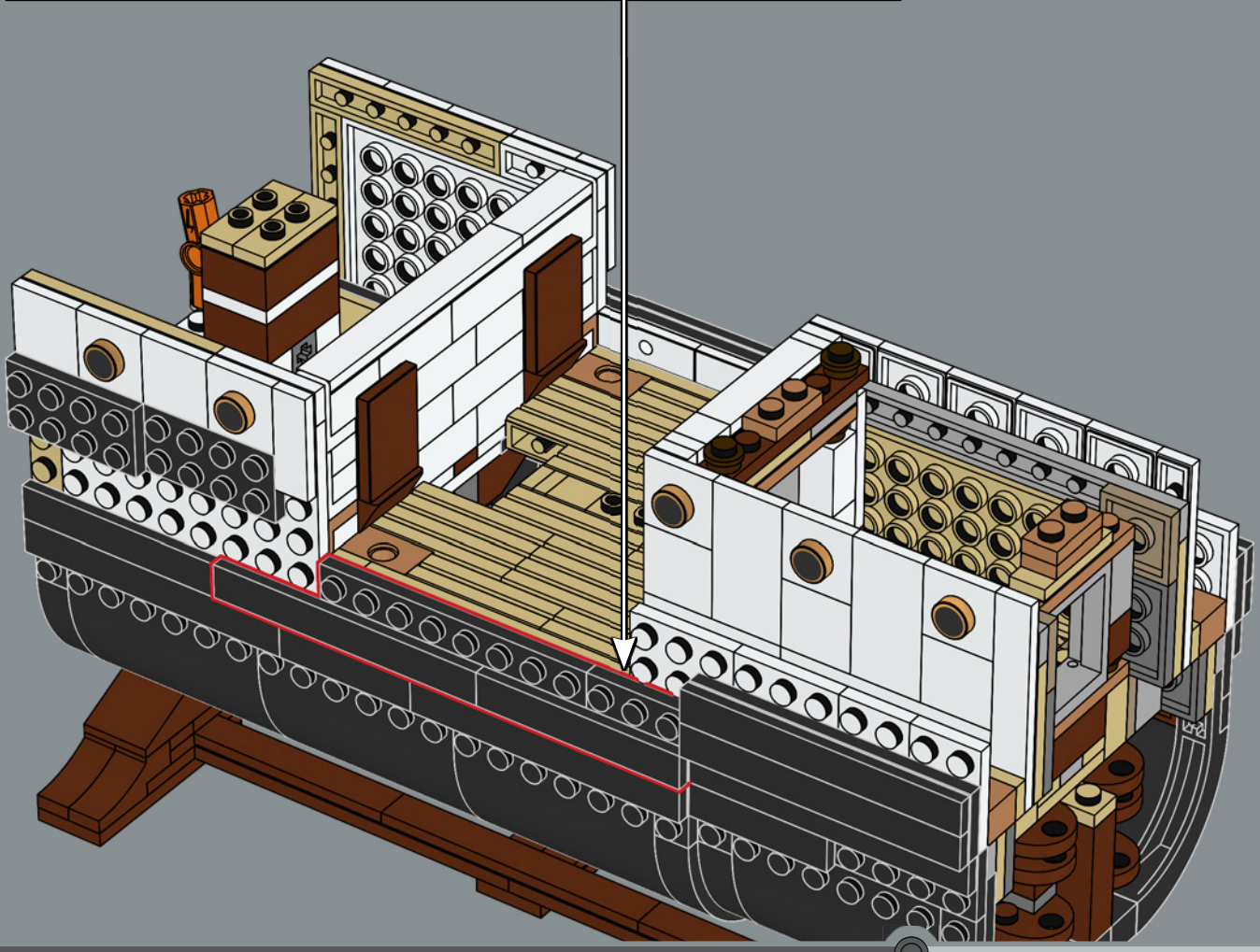
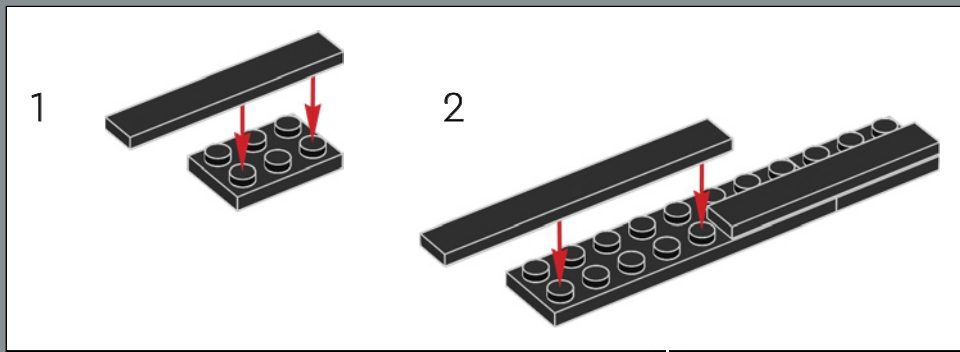

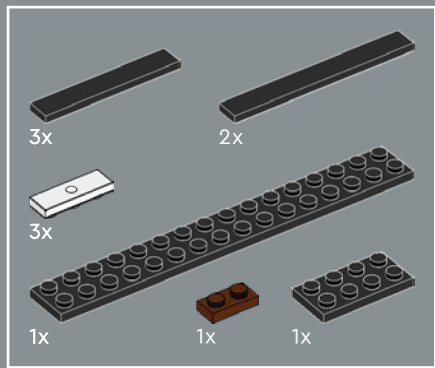

258

1

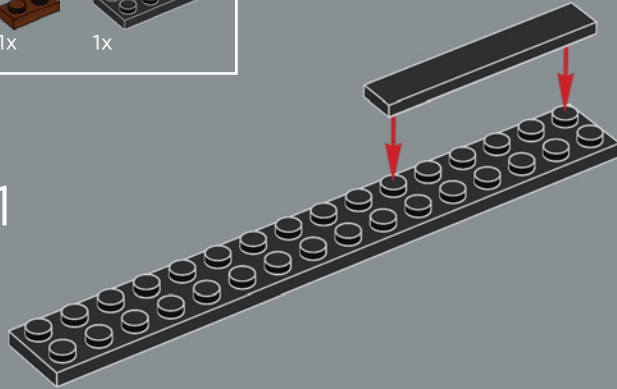

2

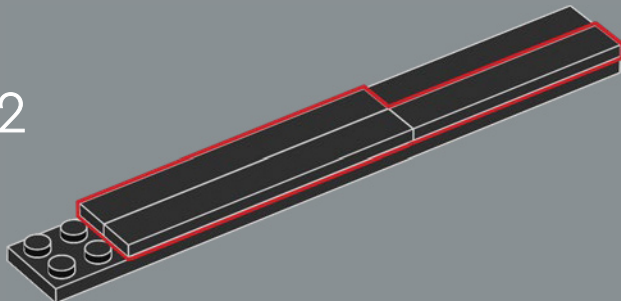

3

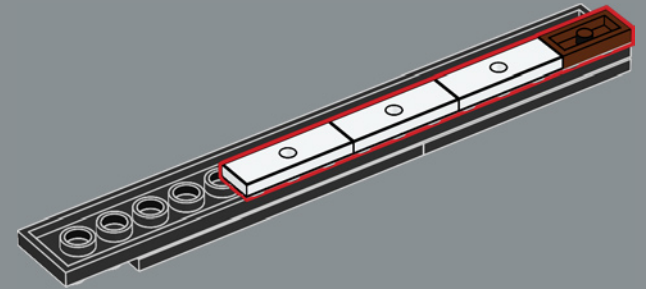

4

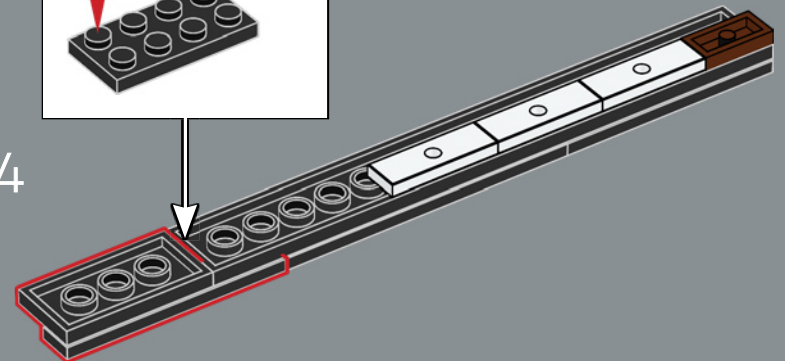
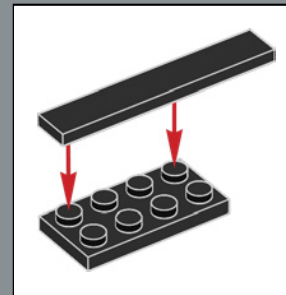

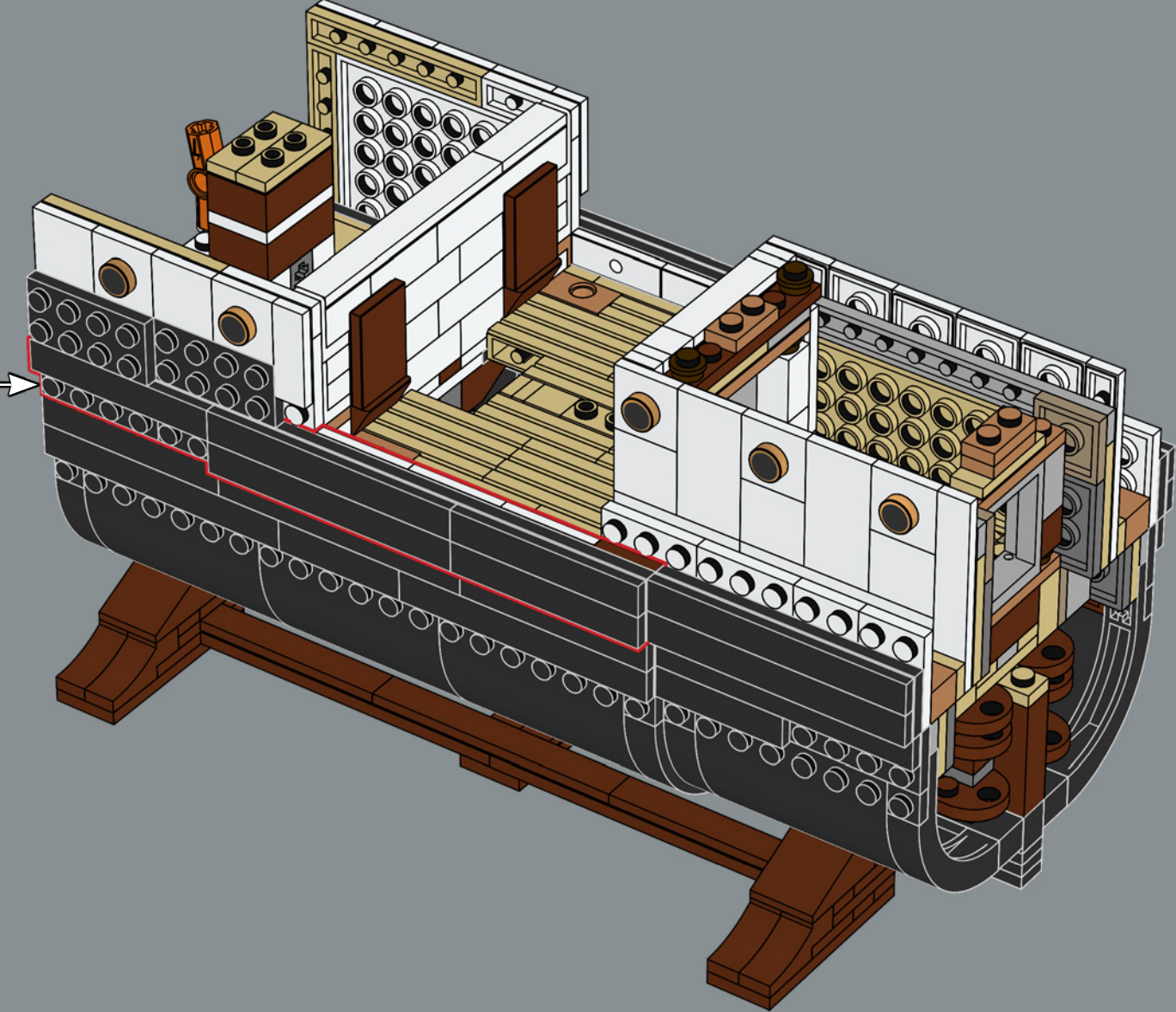

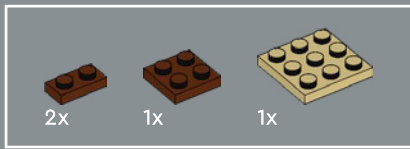

259

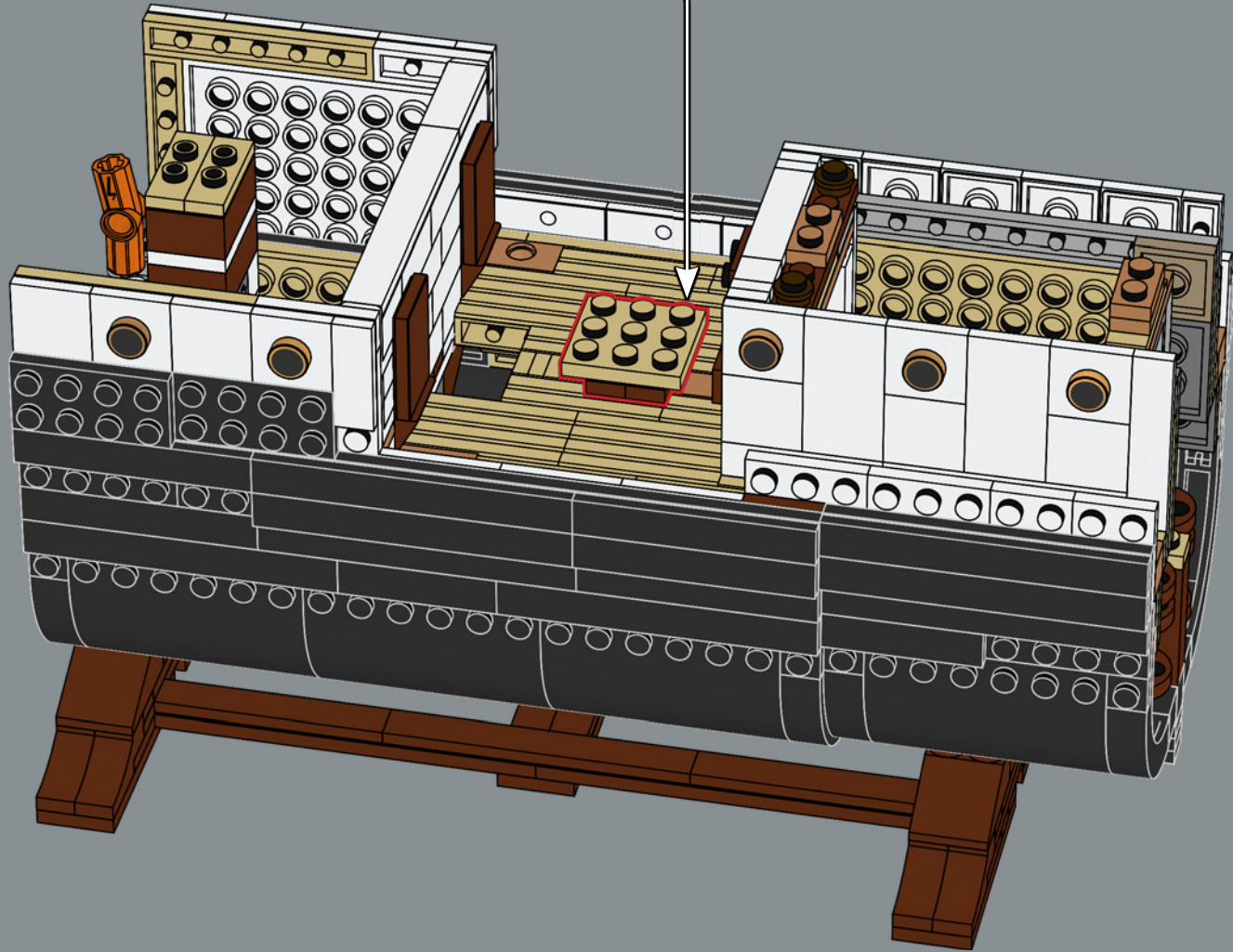
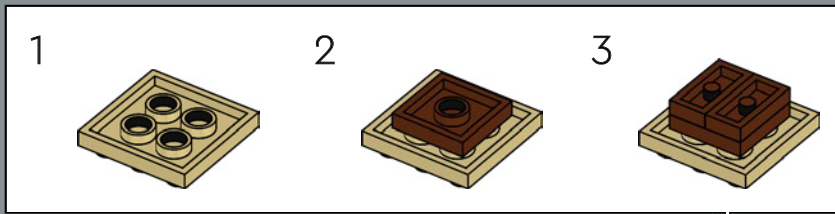

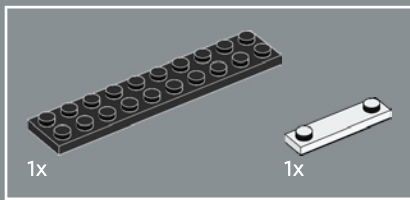
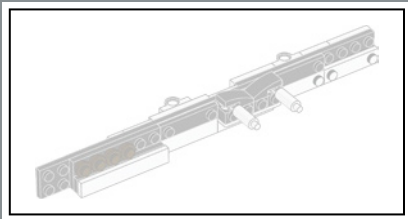

260

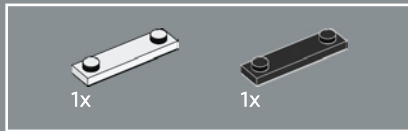
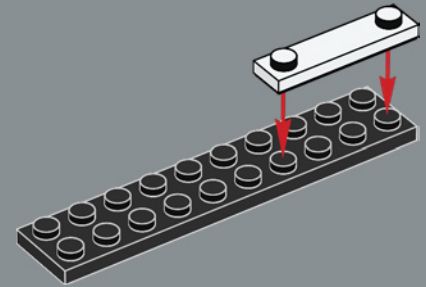

261

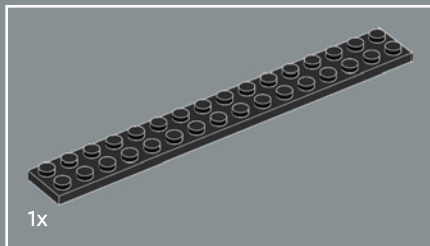
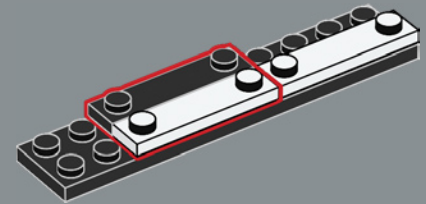

262

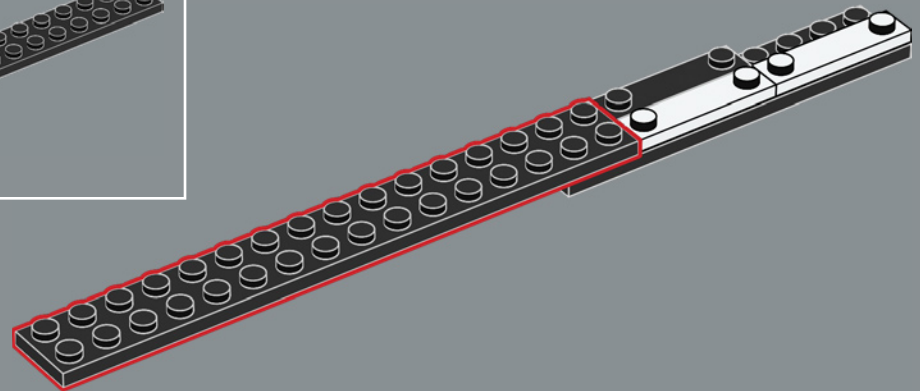

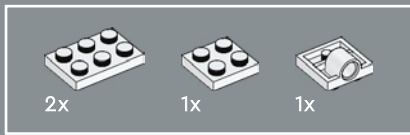

263

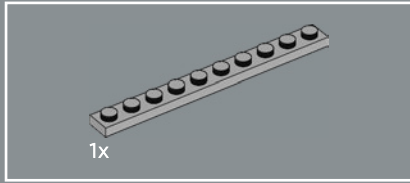
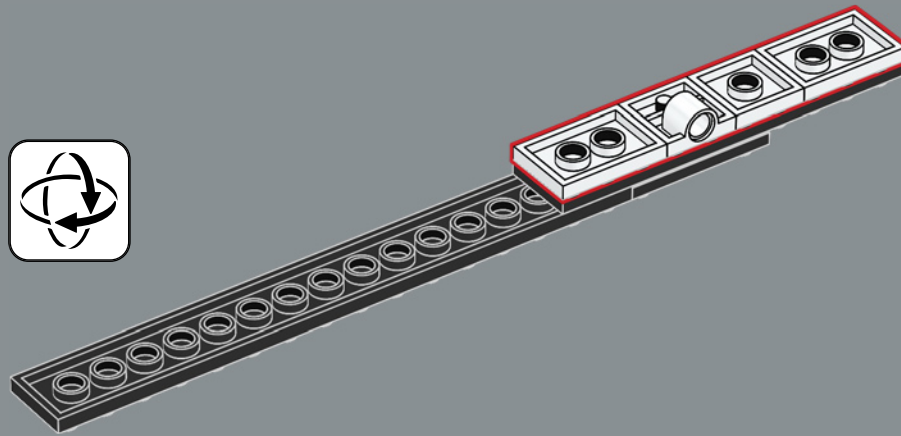

264

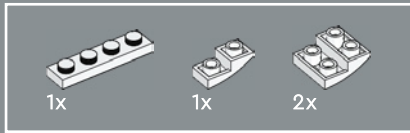
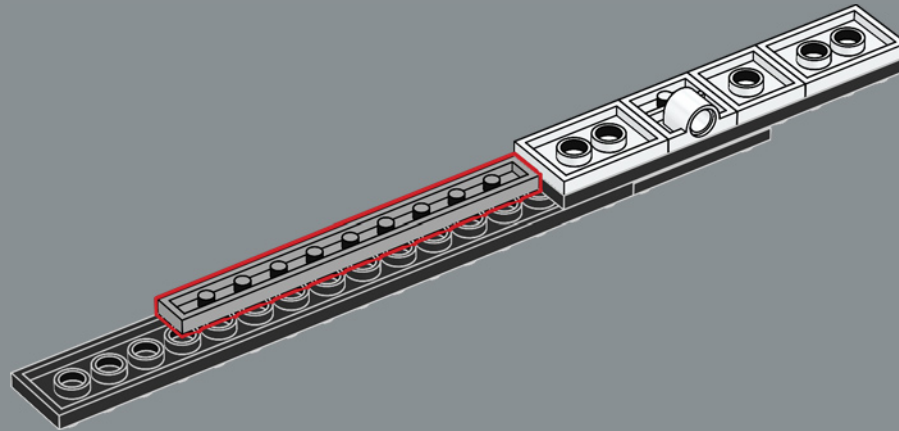

265

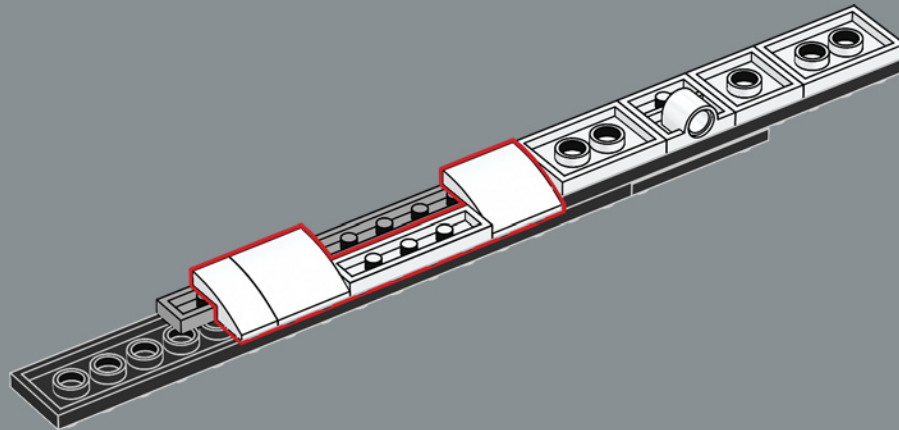



266

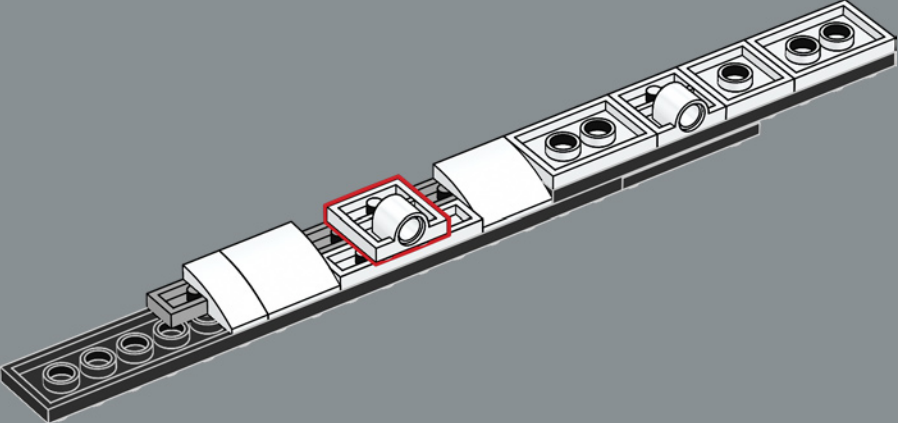

267

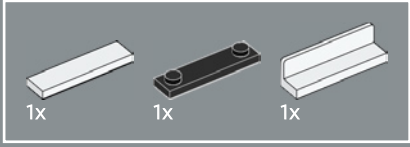
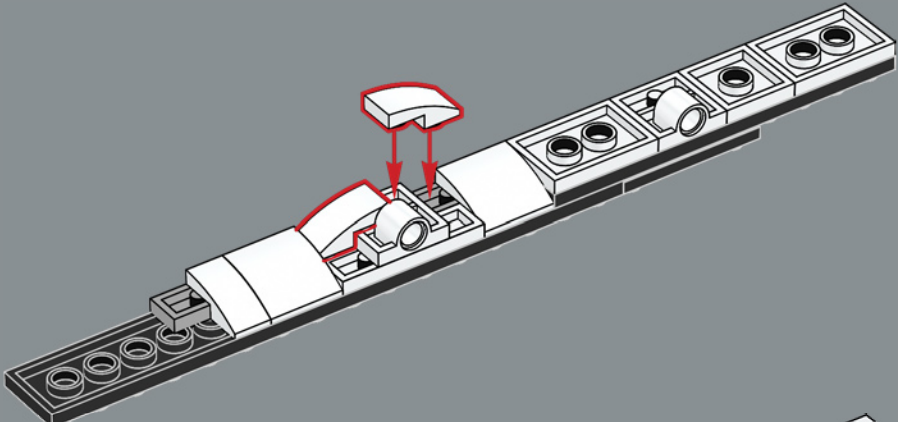

268

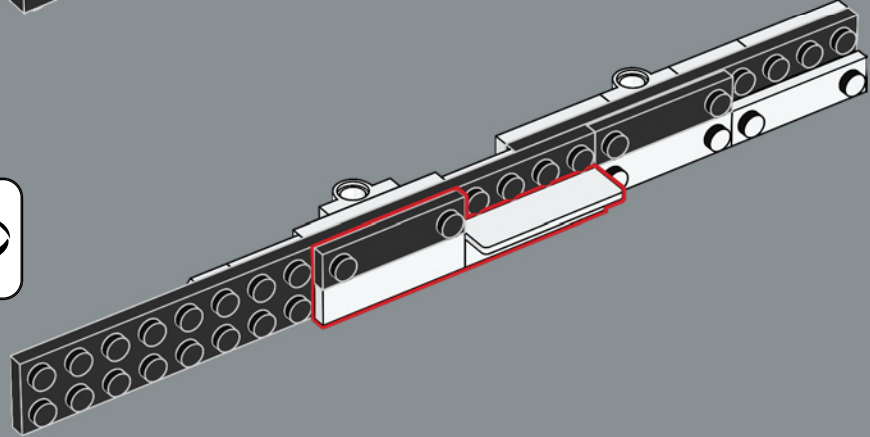

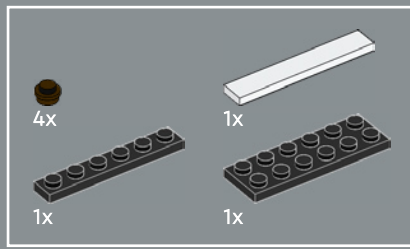

269

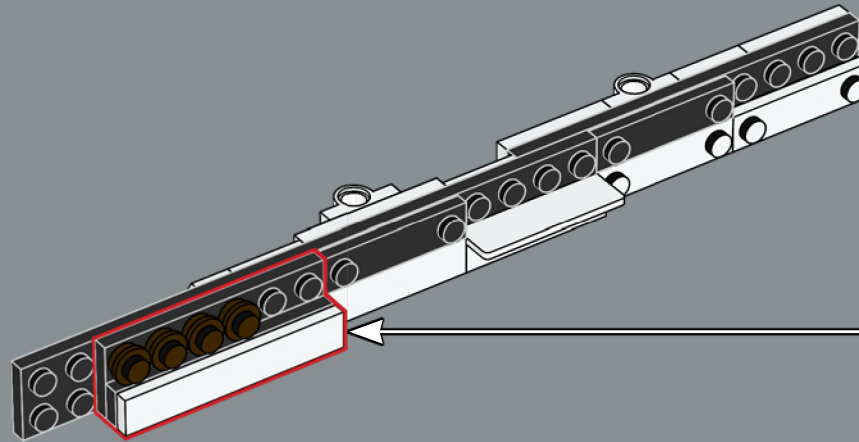
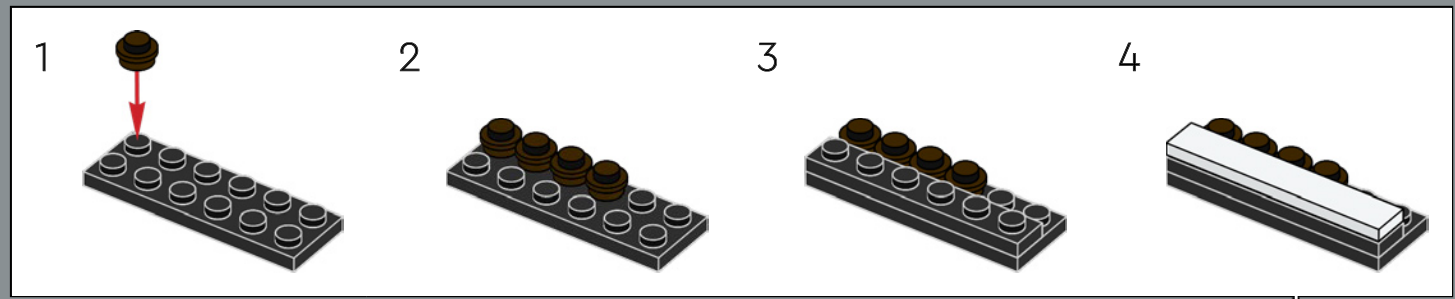



4x

270

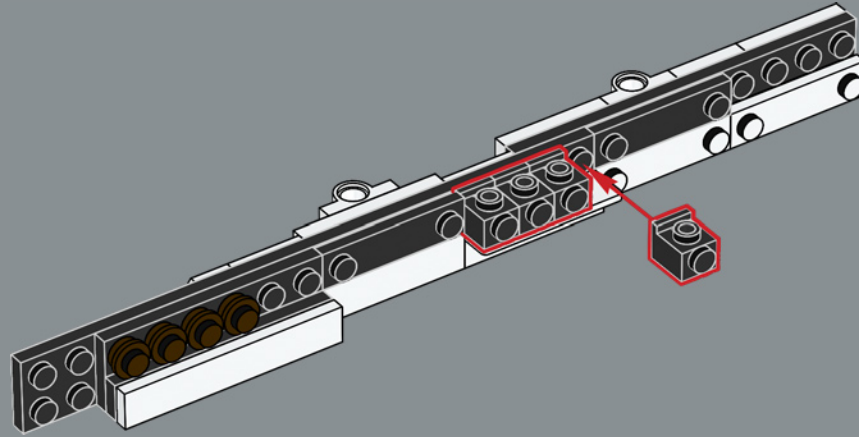

2x



2x



2x

271

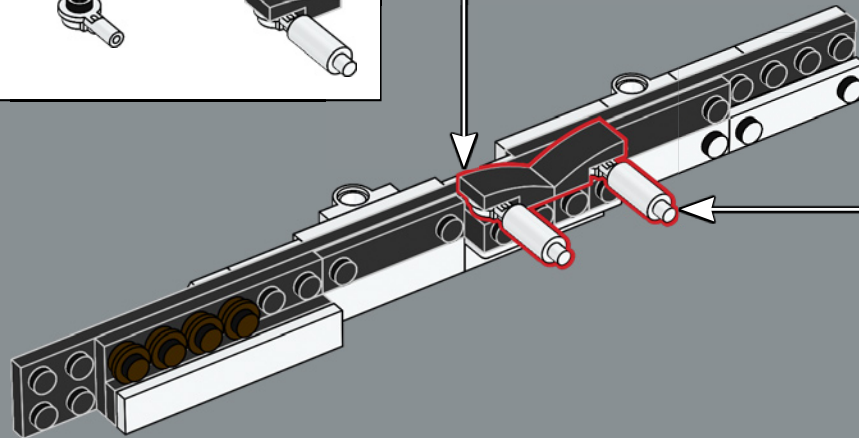
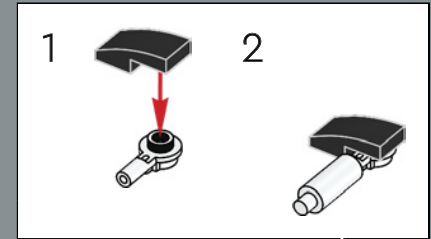
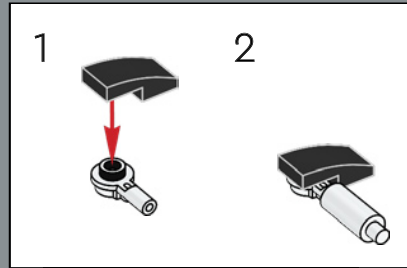

272

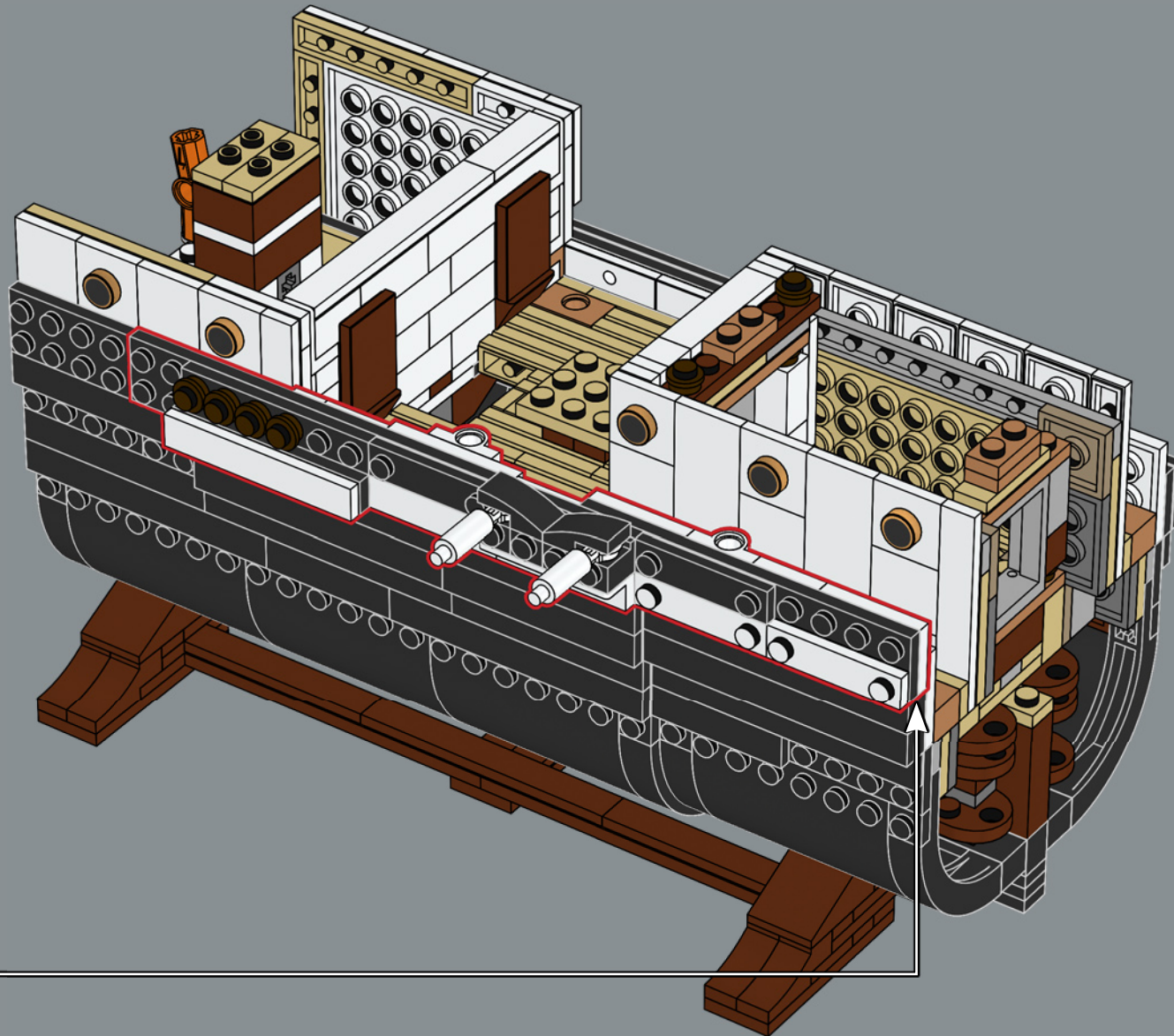

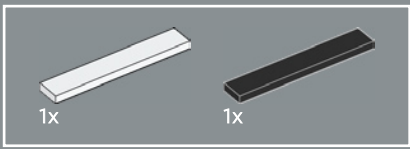

273

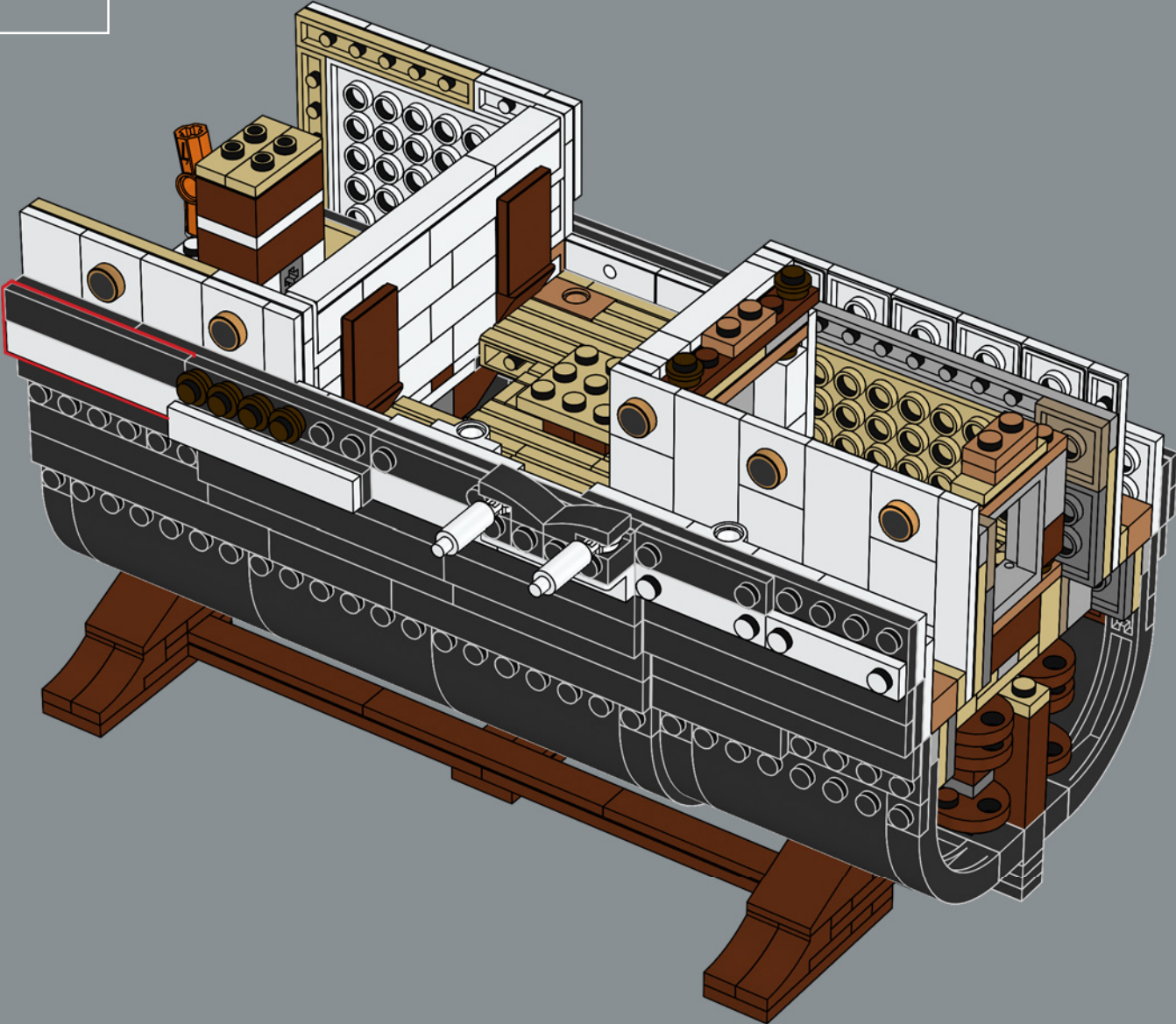

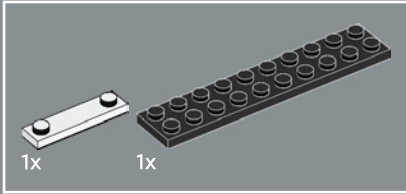
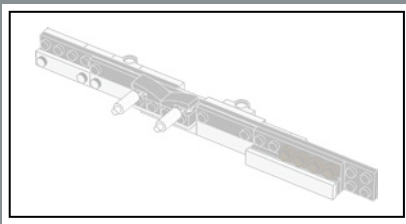

274

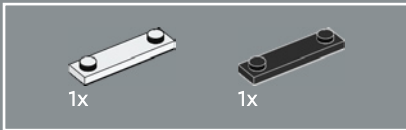
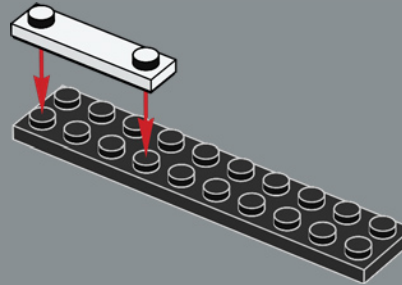

275

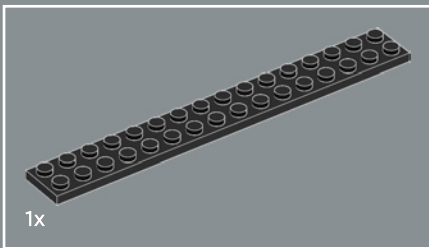
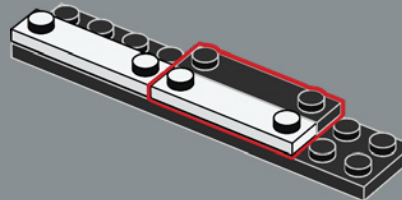

276

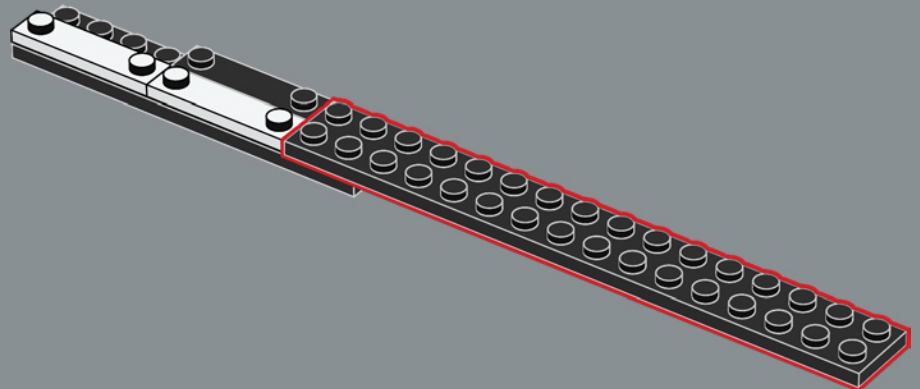

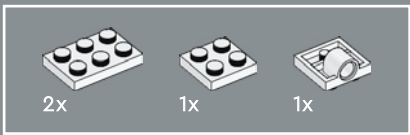

277

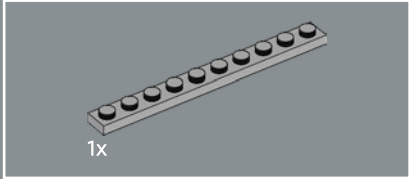
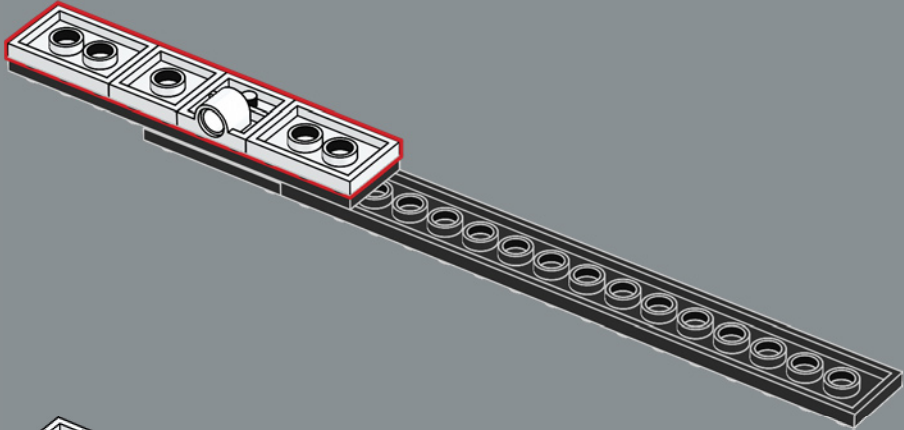

278

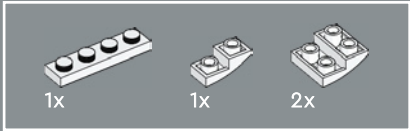
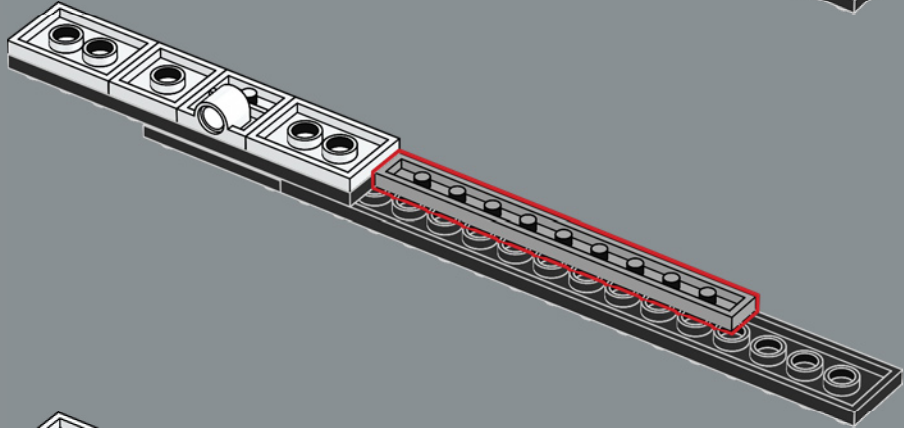

279

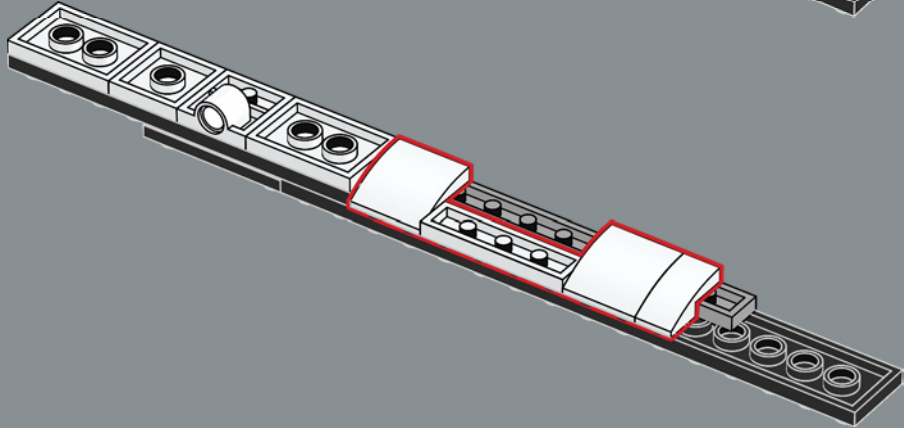



280



281

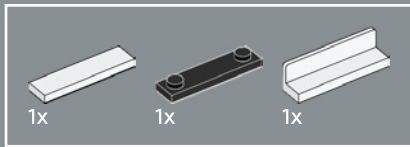

282

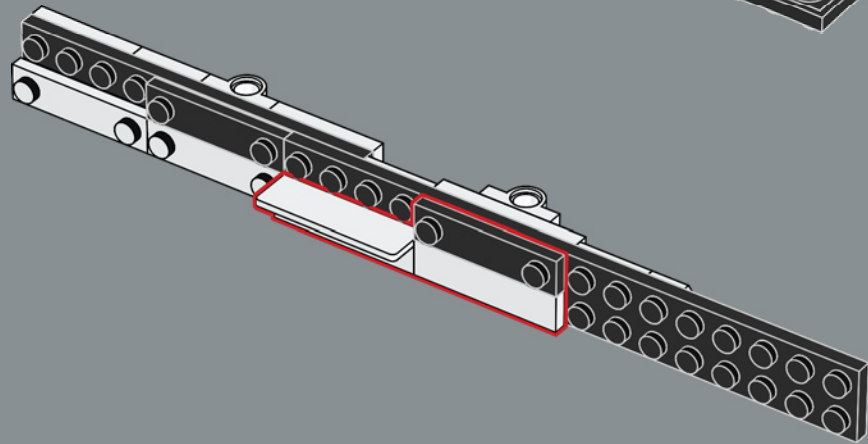
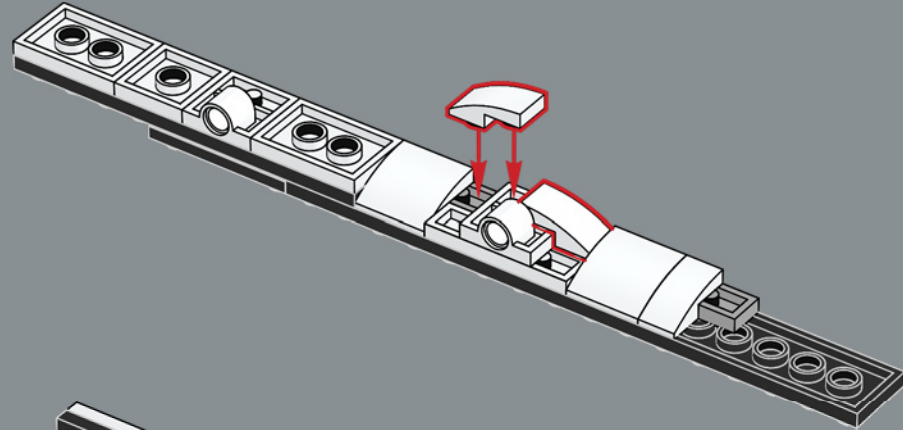
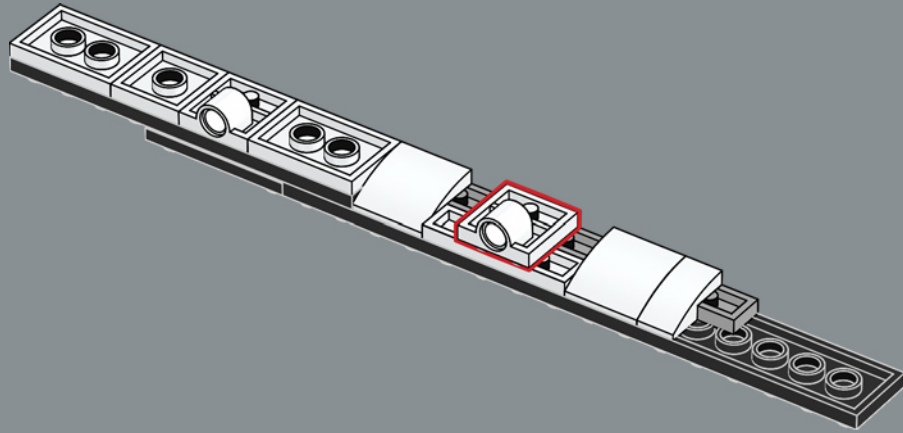

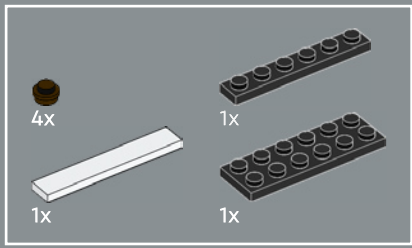

283

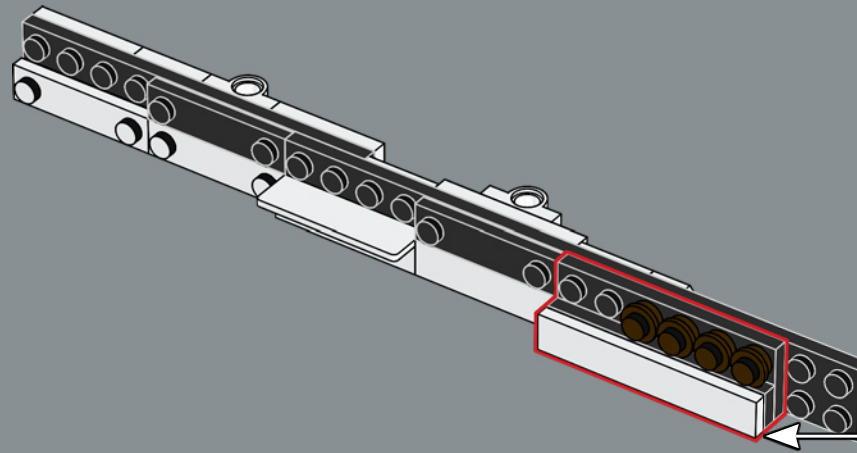
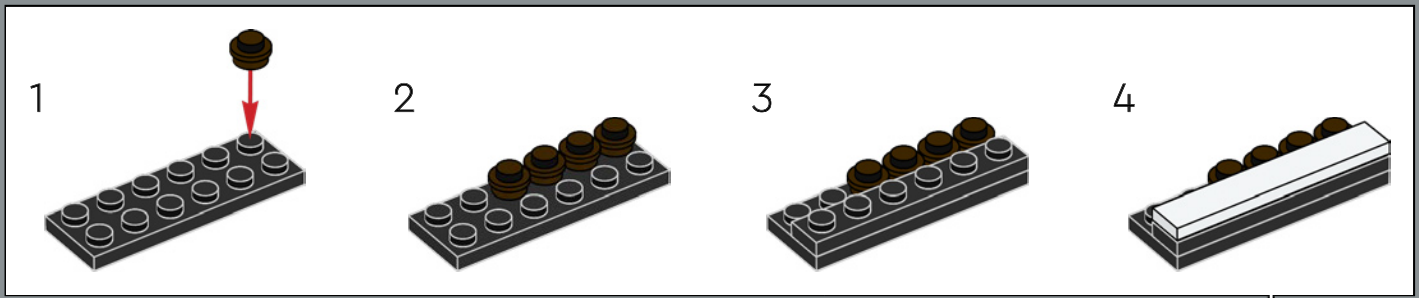



284

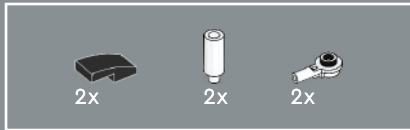
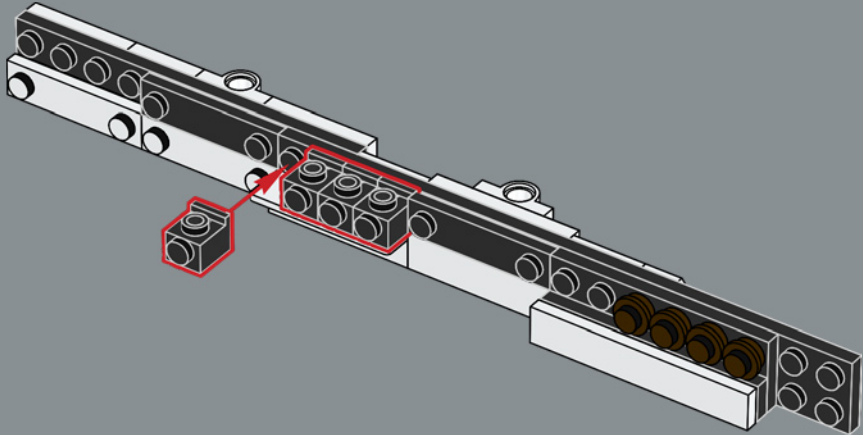

285

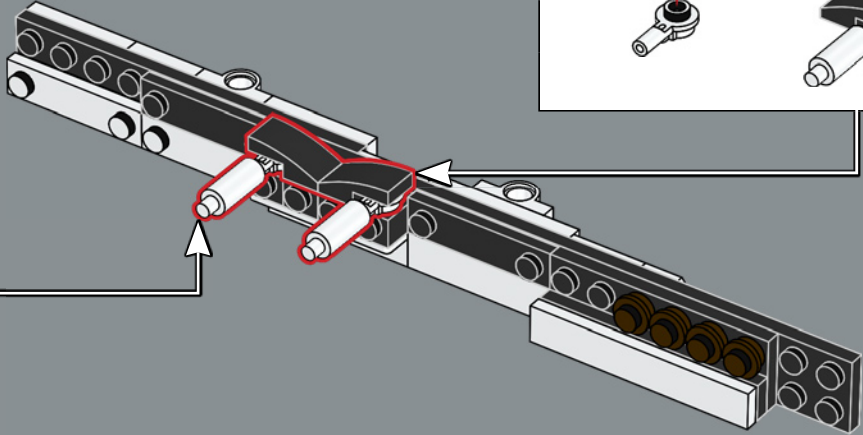
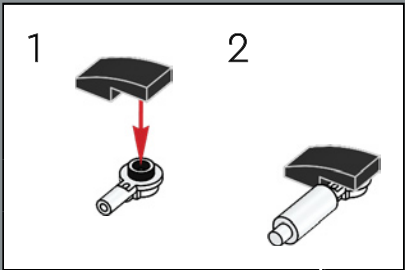
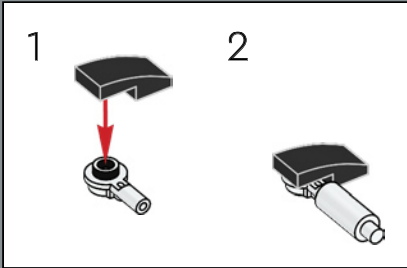

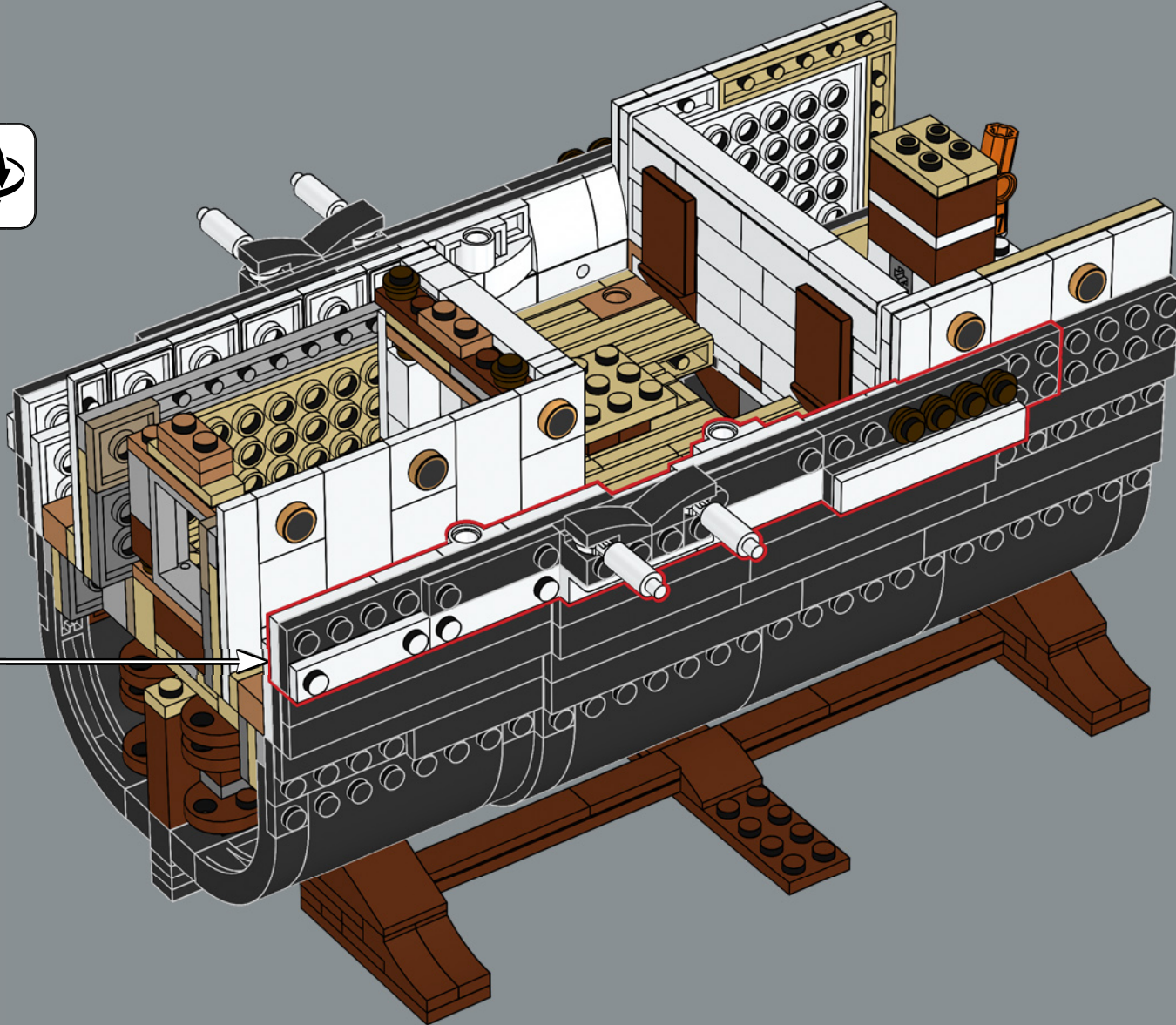

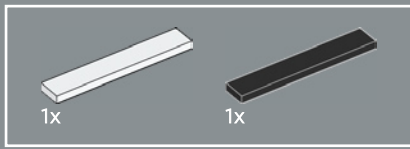

287

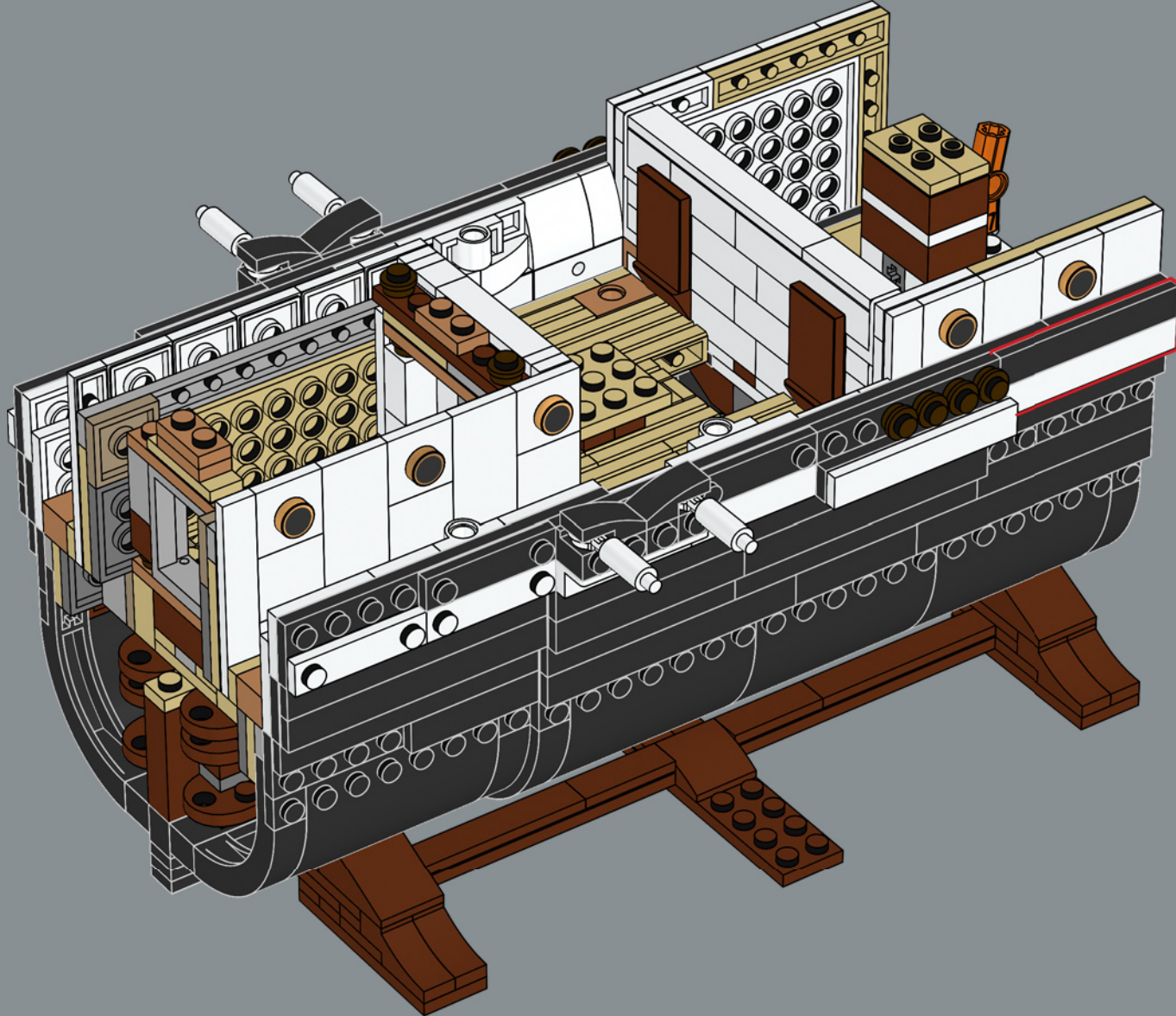

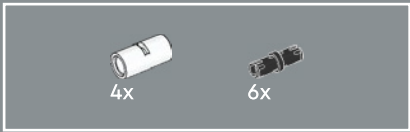

288

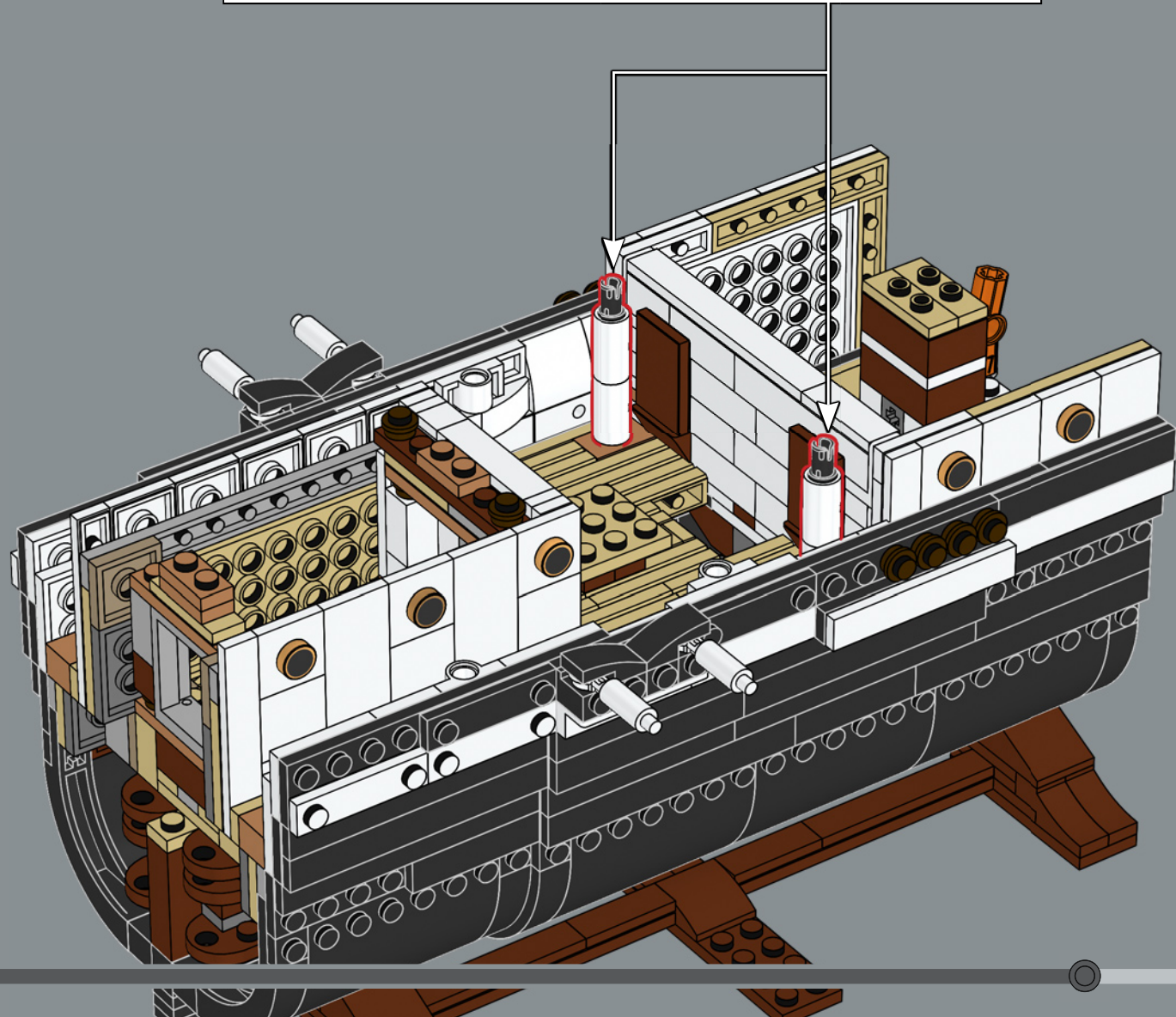
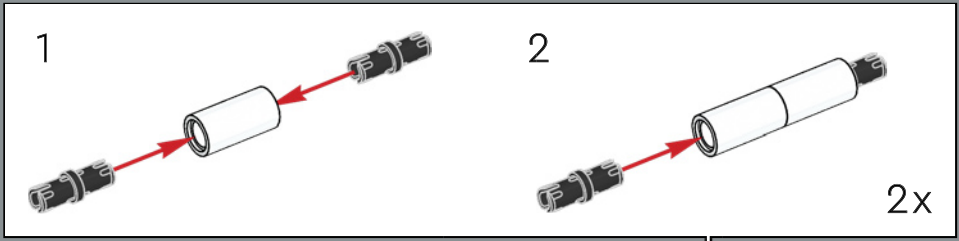

289

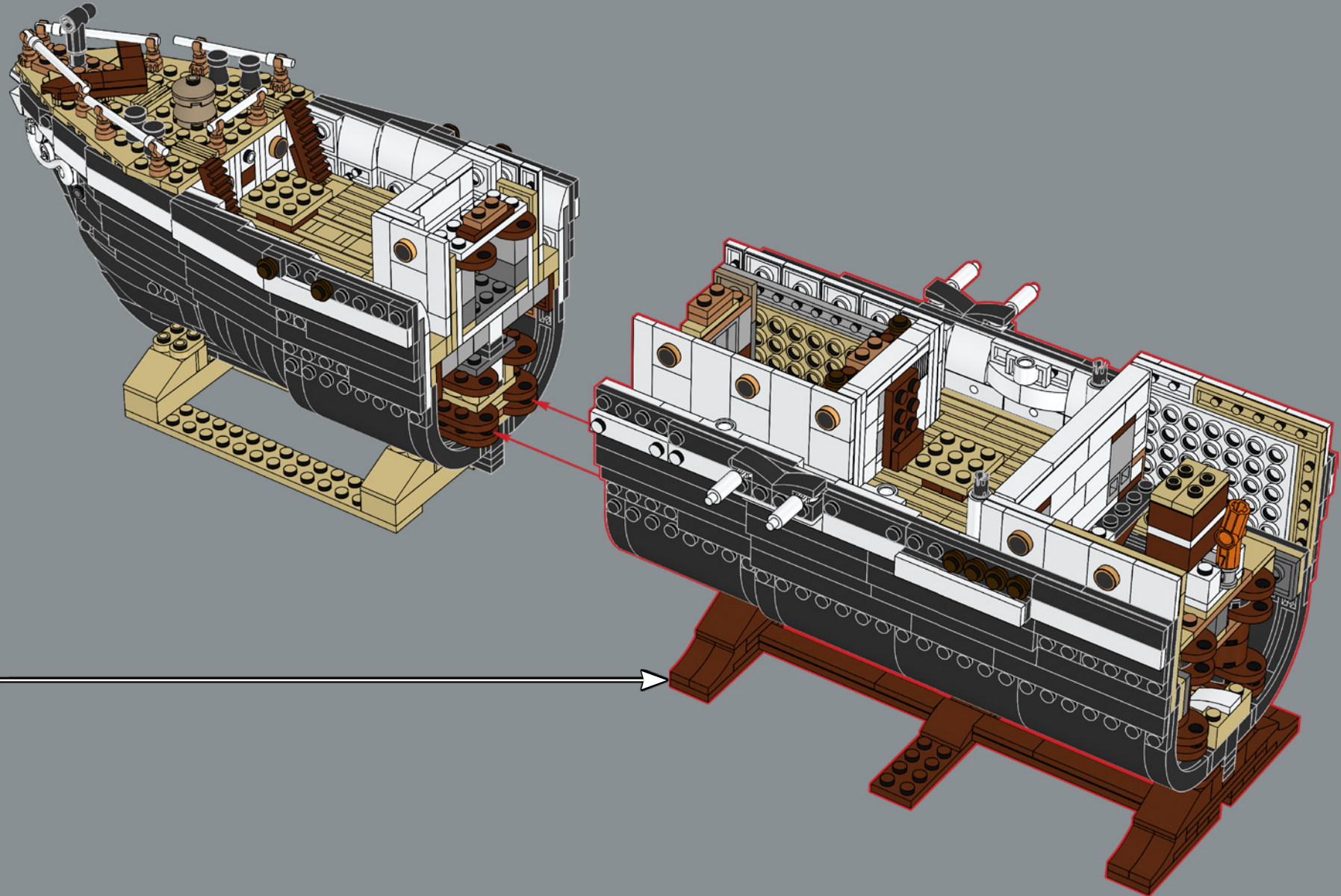

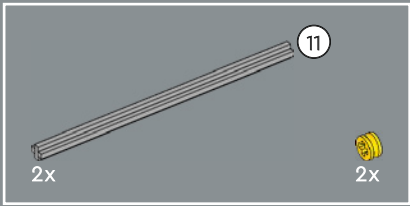

290

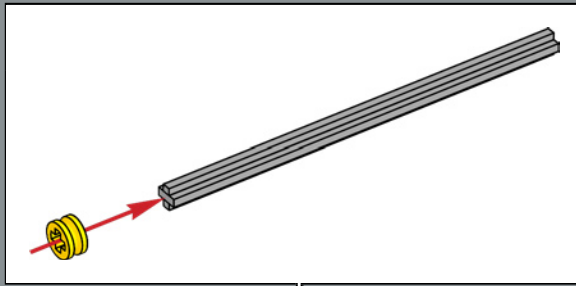

Master craftsmen made the *Endurance* one of the strongest wooden ships ever built, reinforcing the hull's strength wherever possible. On the LEGO® model, the three hull sections are connected by LEGO Technic™ axles, holding them securely in place.

Les maîtres artisans ont fait de l'*Endurance* l'un des navires en bois les plus solides jamais construits, en renforçant la solidité de la coque partout où cela était possible. Sur le modèle LEGO®, les trois sections de la coque sont reliées par des essieux LEGO Technic™, qui les maintiennent solidement en place.

Los maestros artesanos lograron hacer del *Endurance* uno de los barcos de madera más resistentes jamás construidos reforzando el casco de todas las maneras posibles. En el modelo LEGO®, las tres secciones del casco están unidas por ejes LEGO Technic™ que las mantienen en su lugar con gran firmeza.

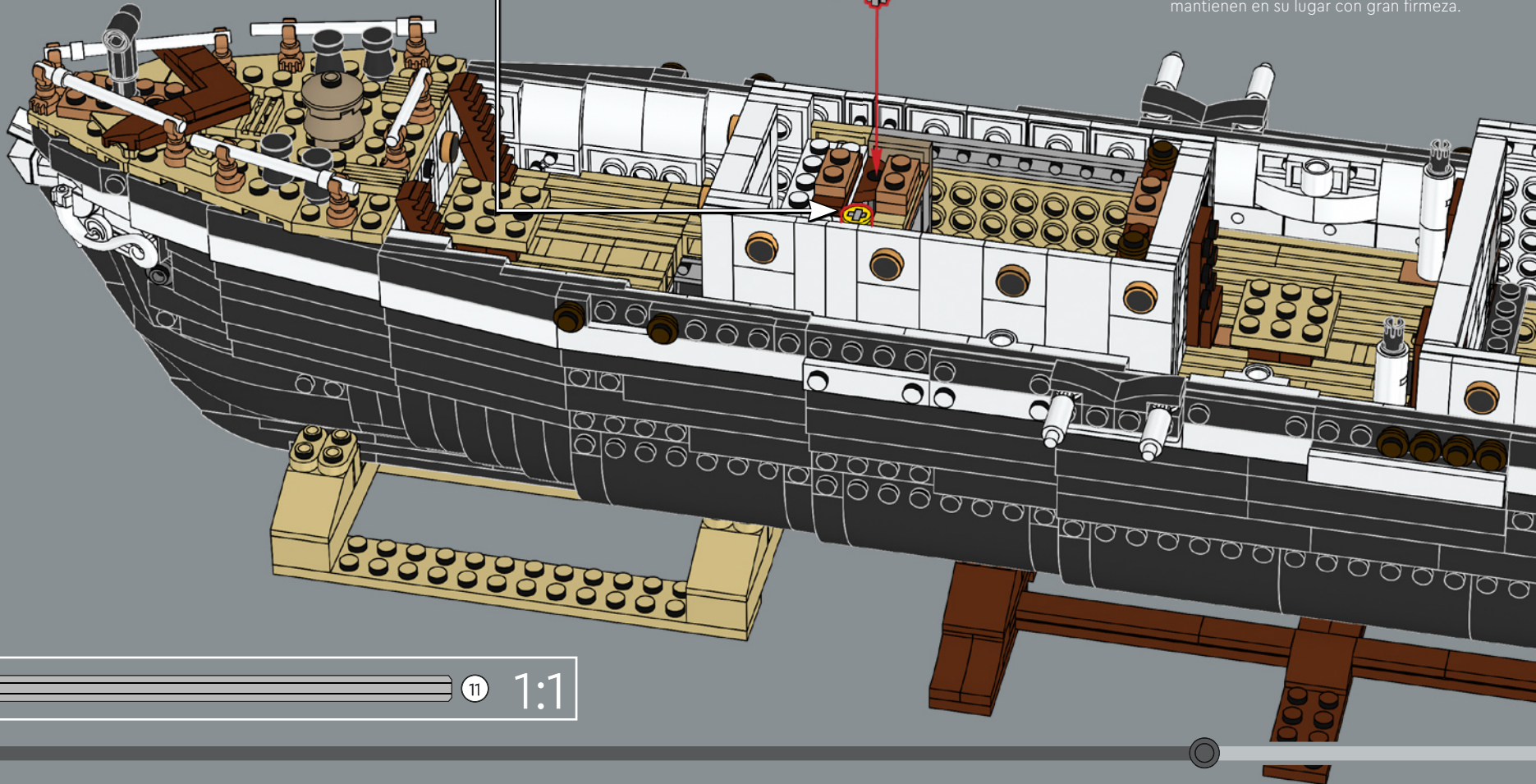

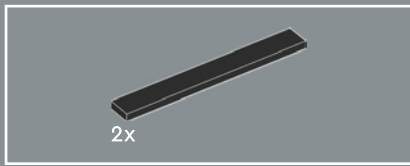

291

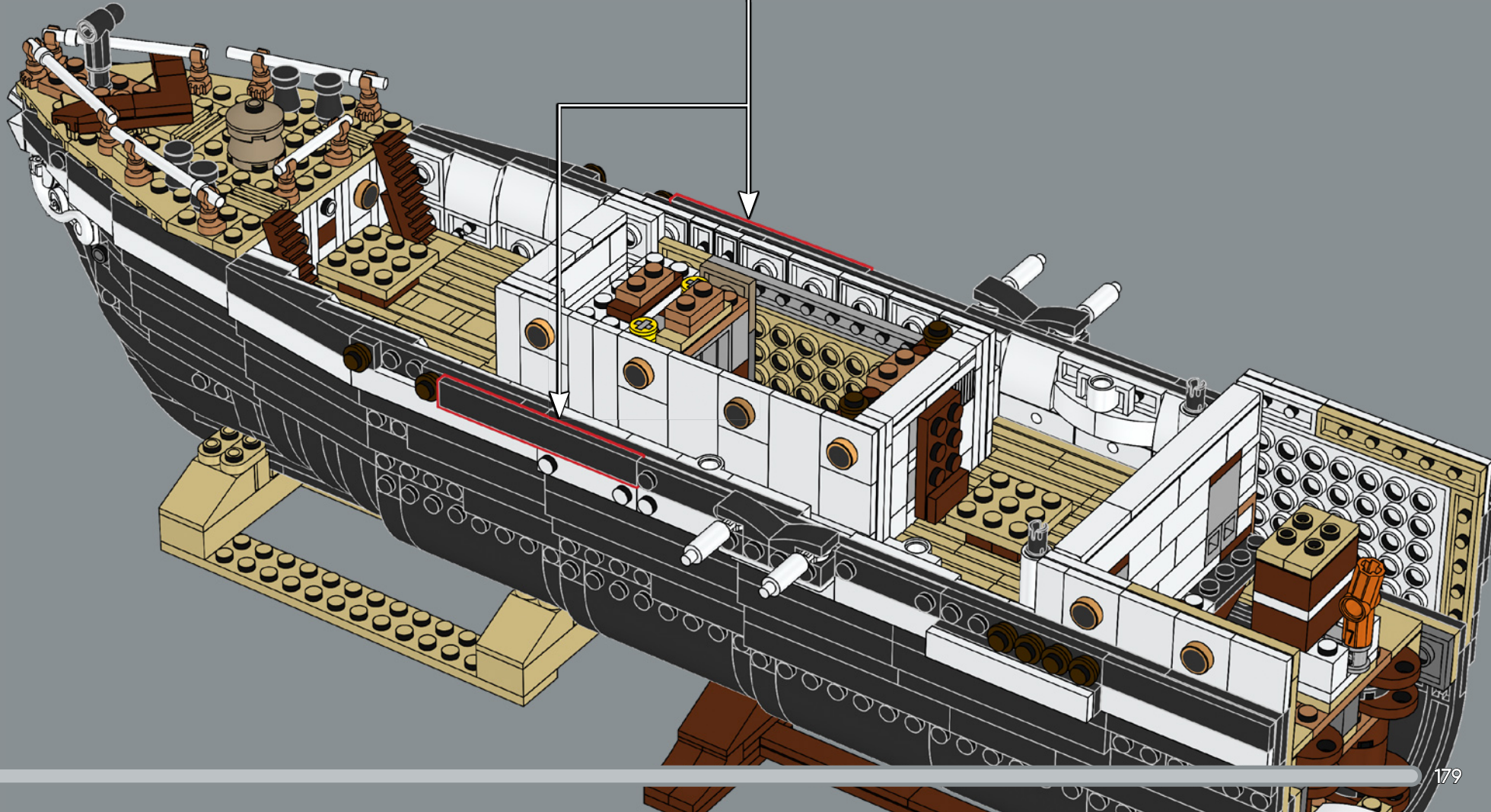
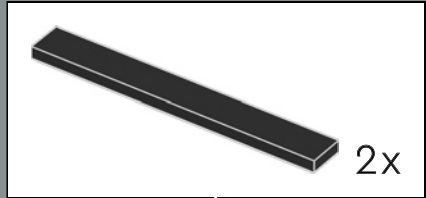

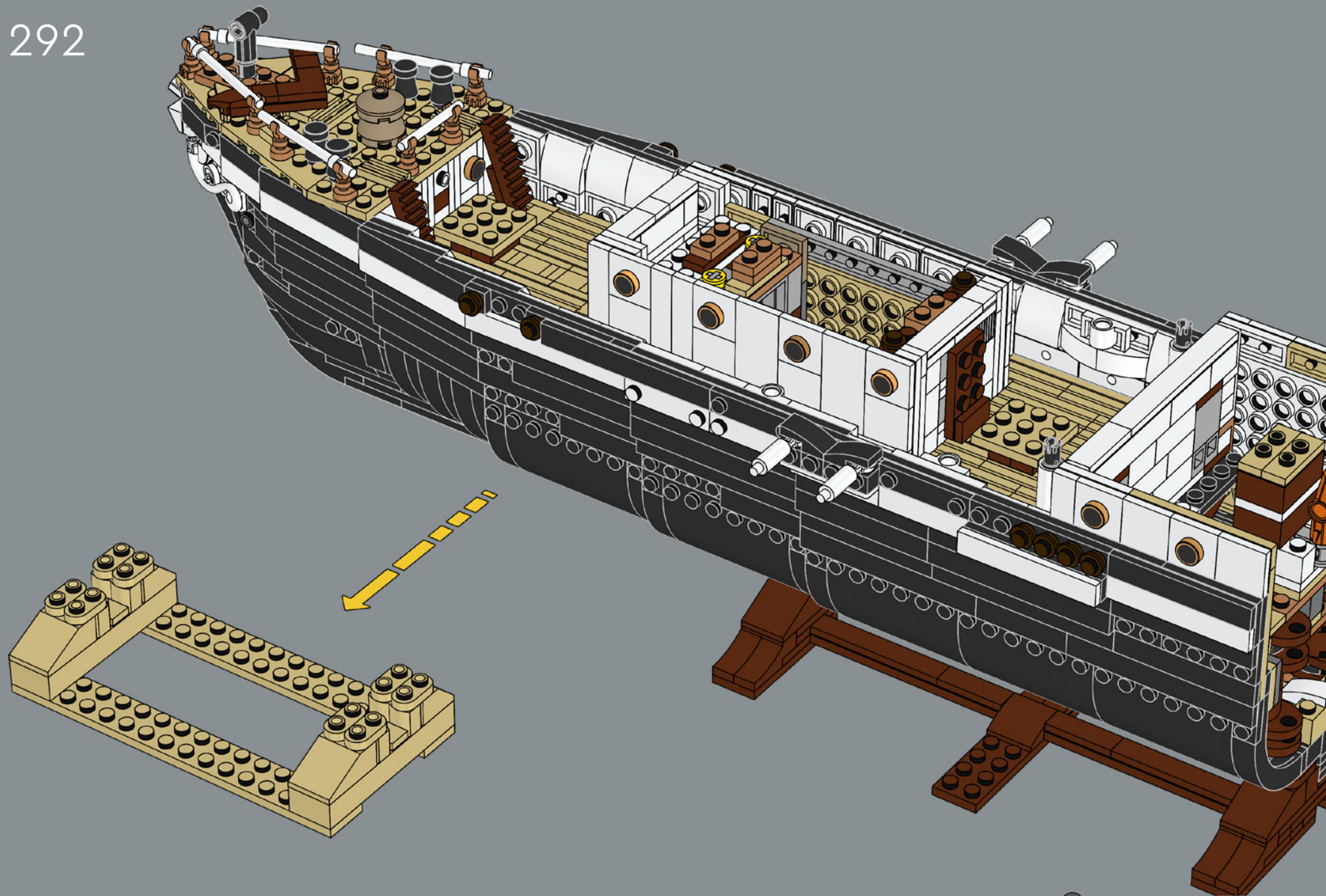

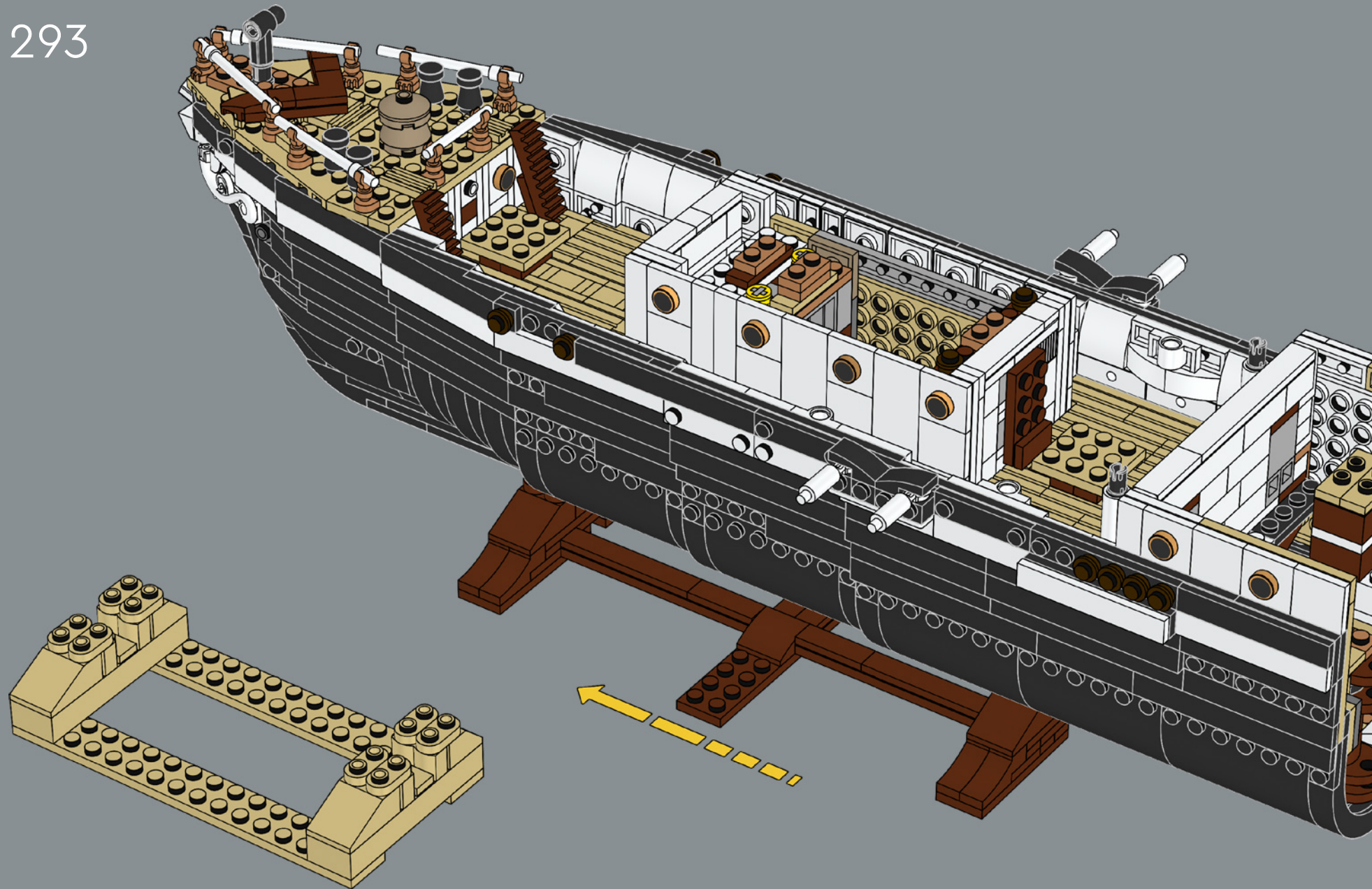

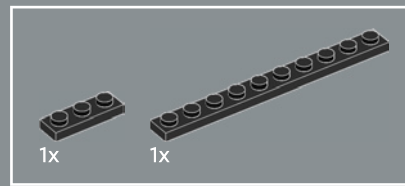
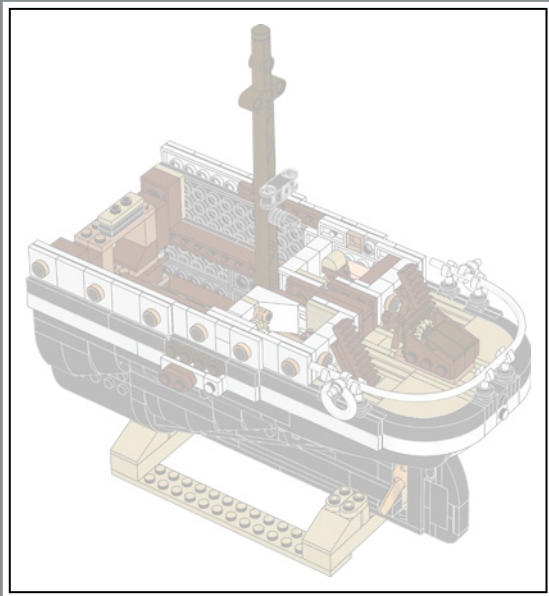
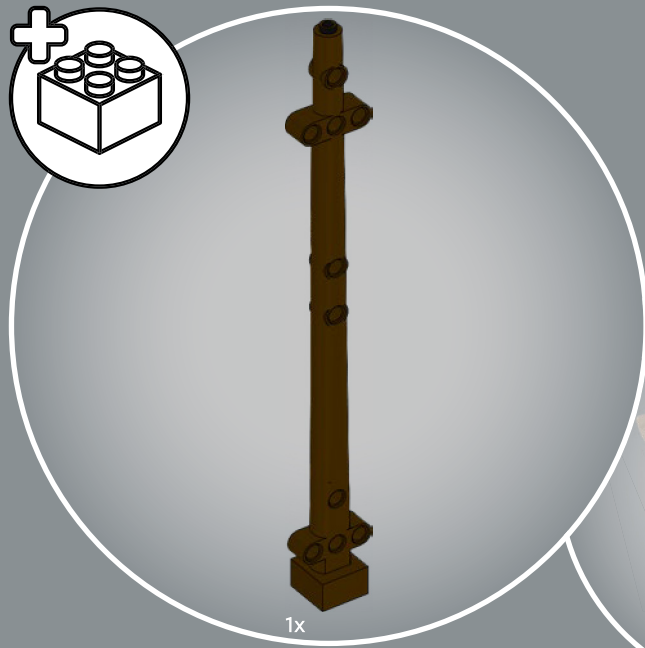
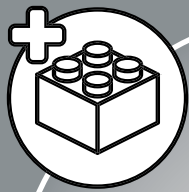

294

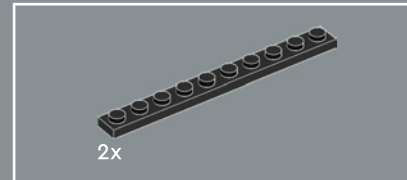
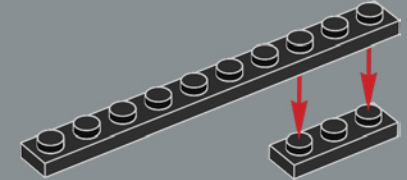

295

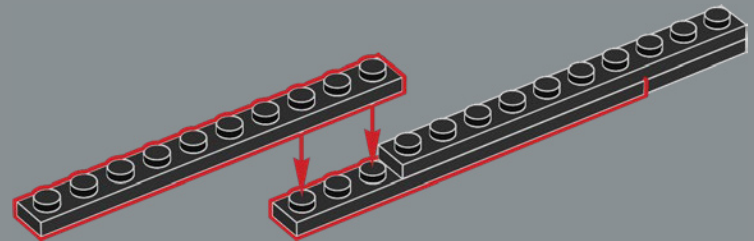

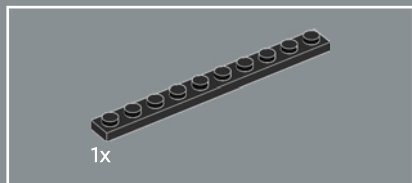

1x

296

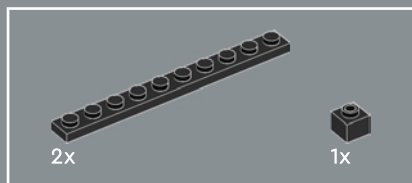
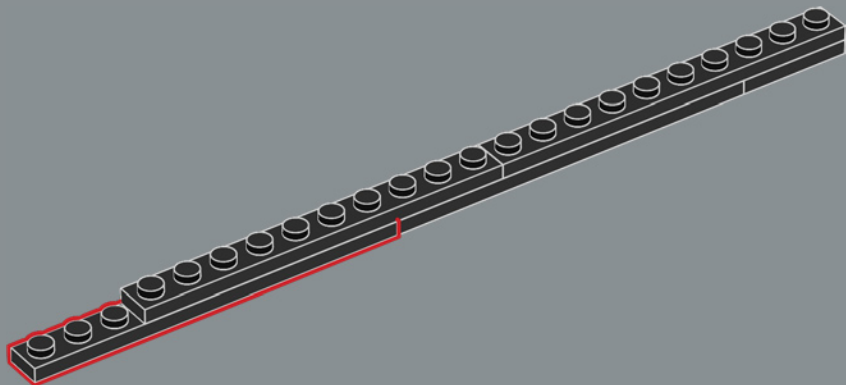

2x

1x

297

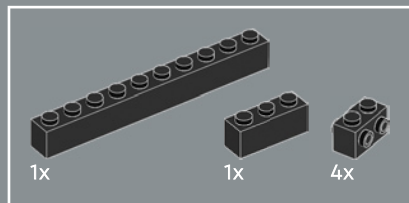
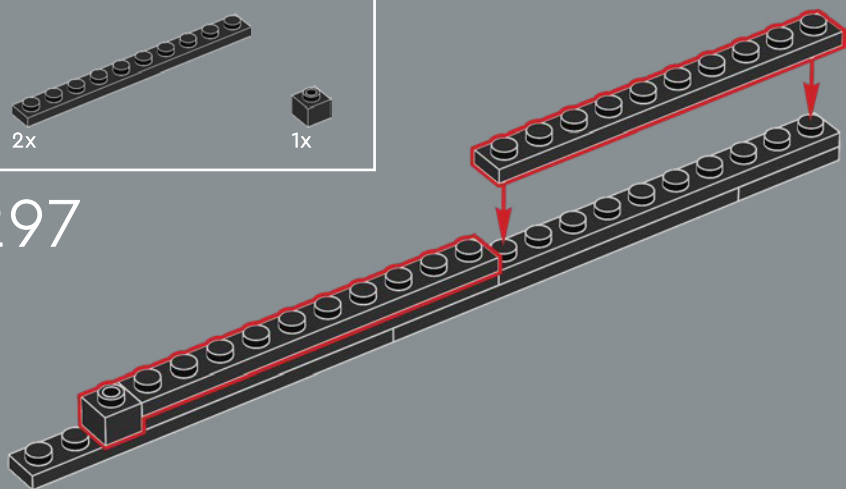

1x

1x

4x

298

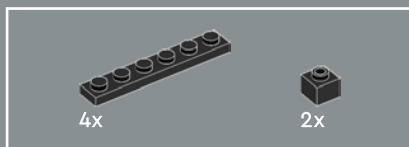
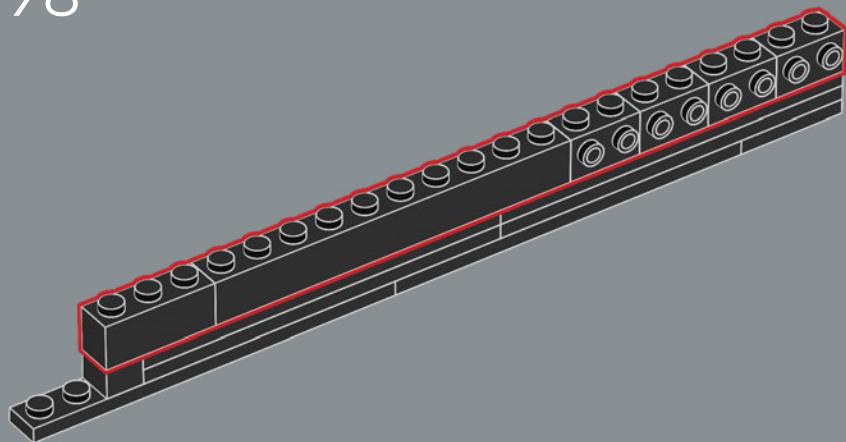

4x

2x

299

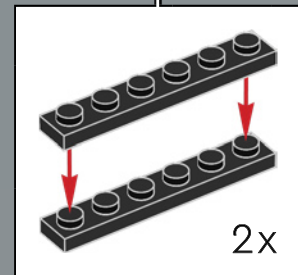
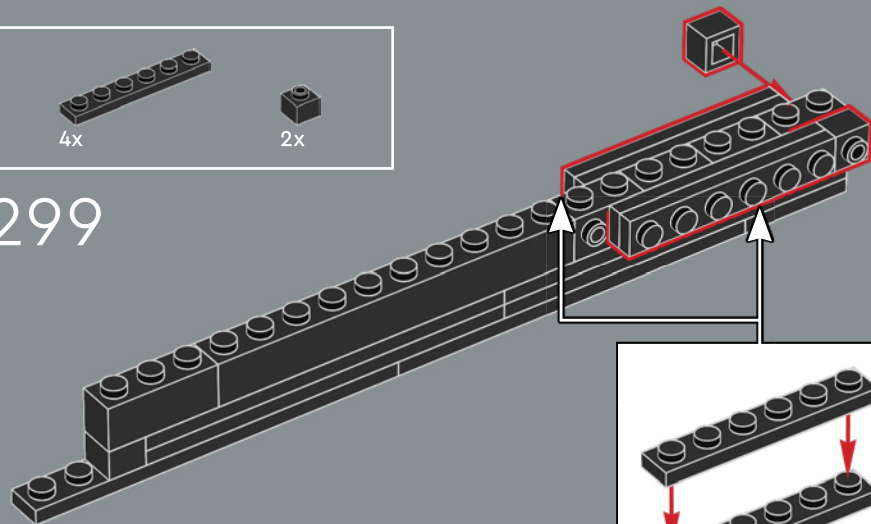

2x

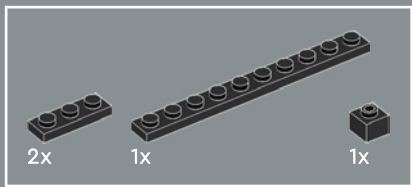

300

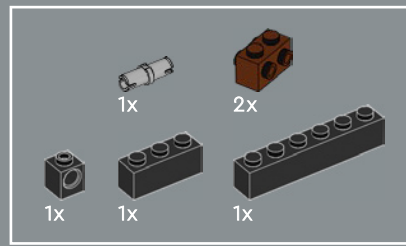
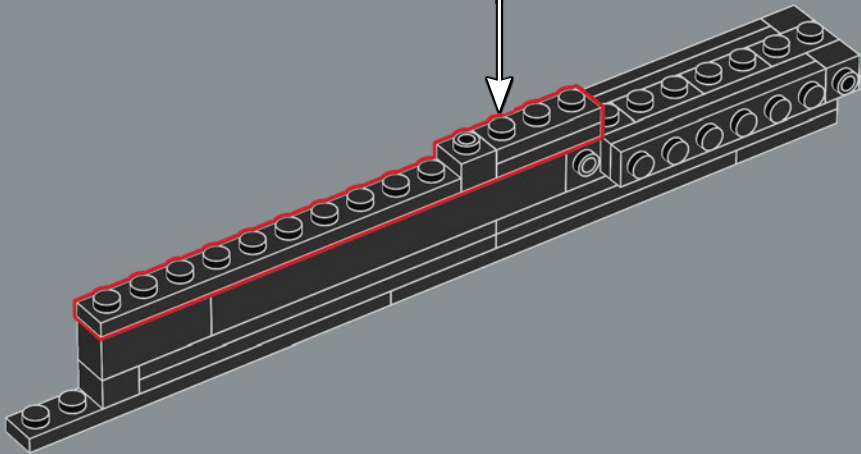
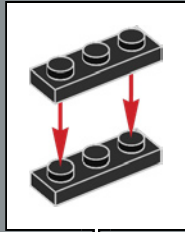

301

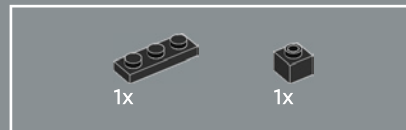
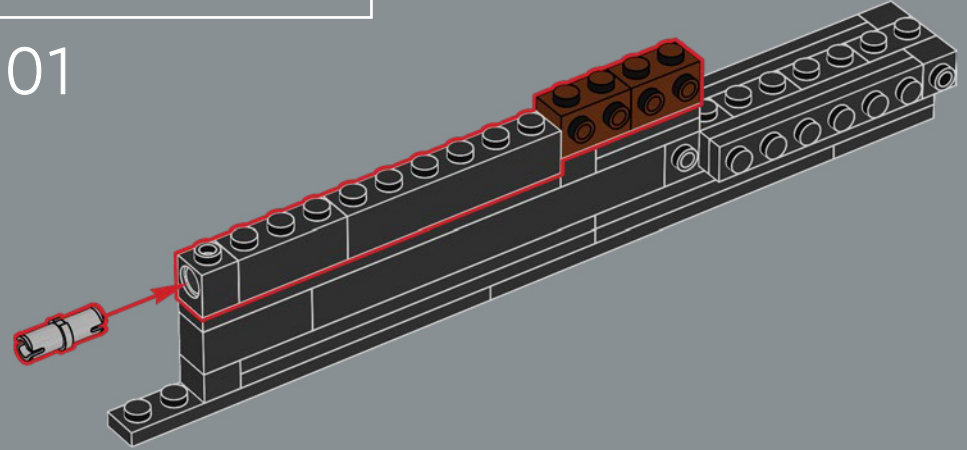

302

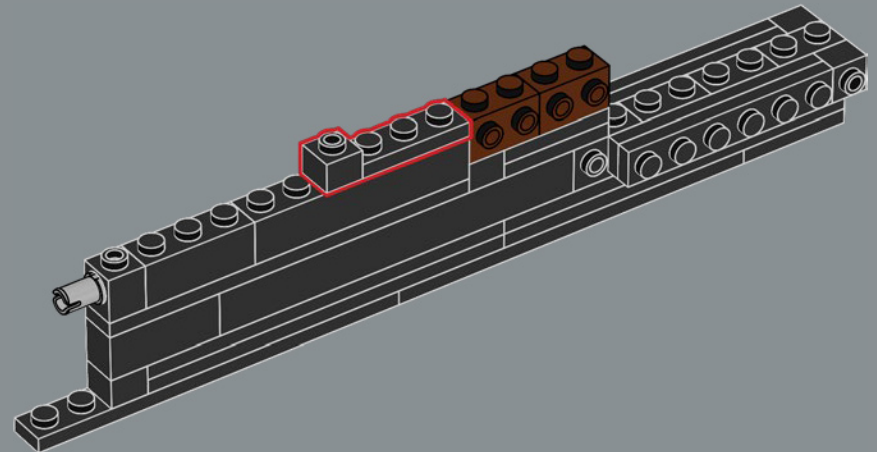

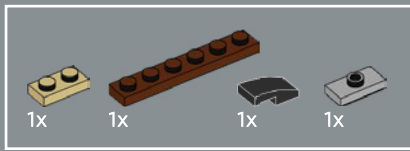

303

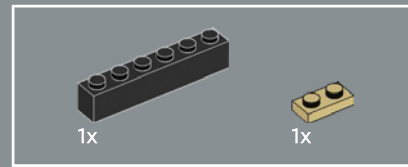
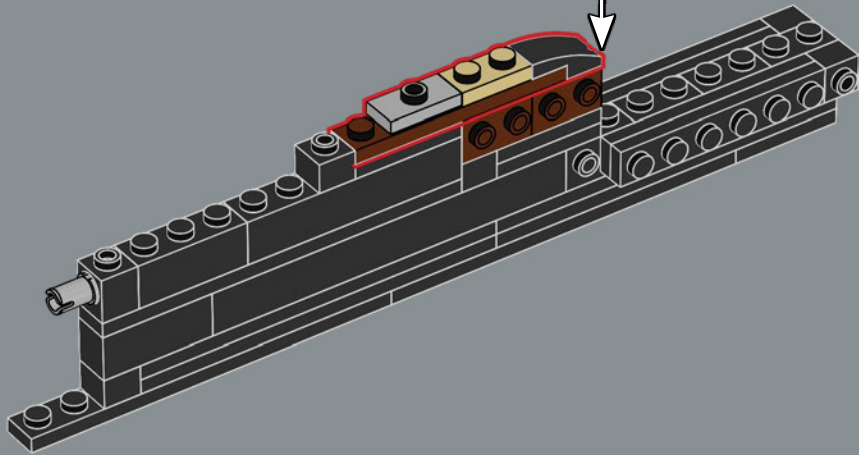
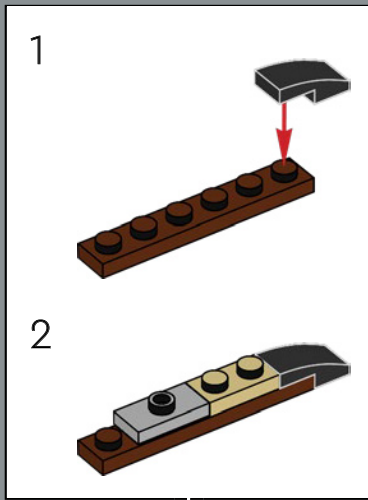

304

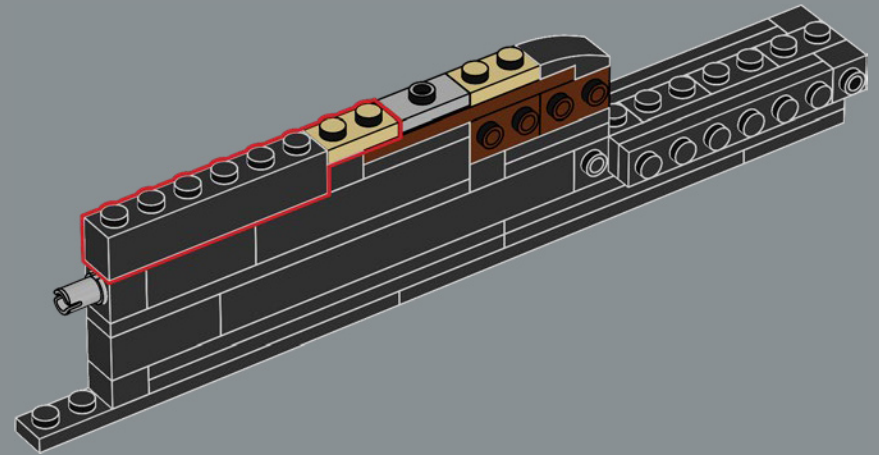

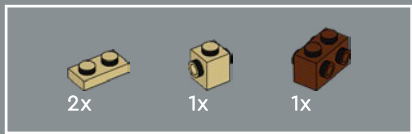

305

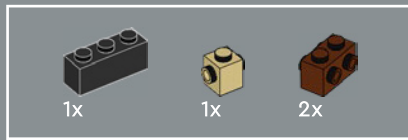
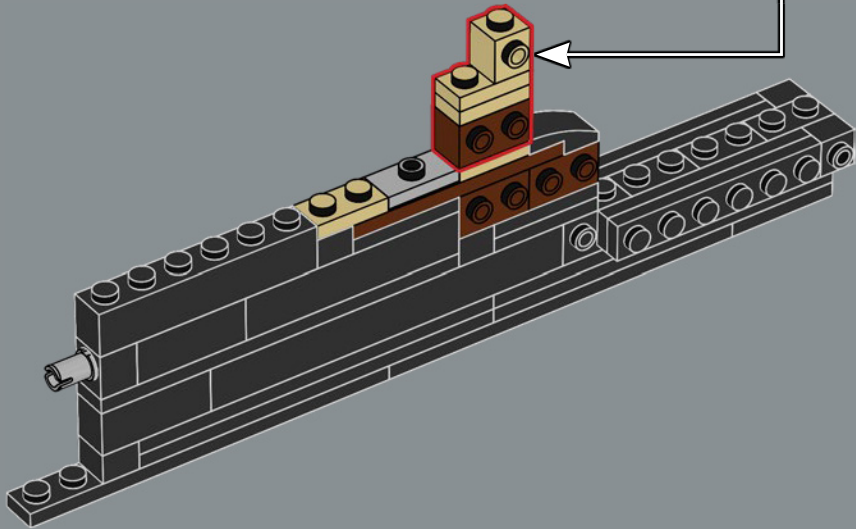
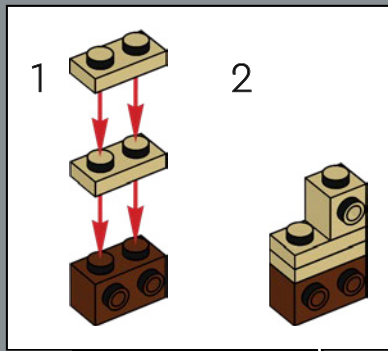

306

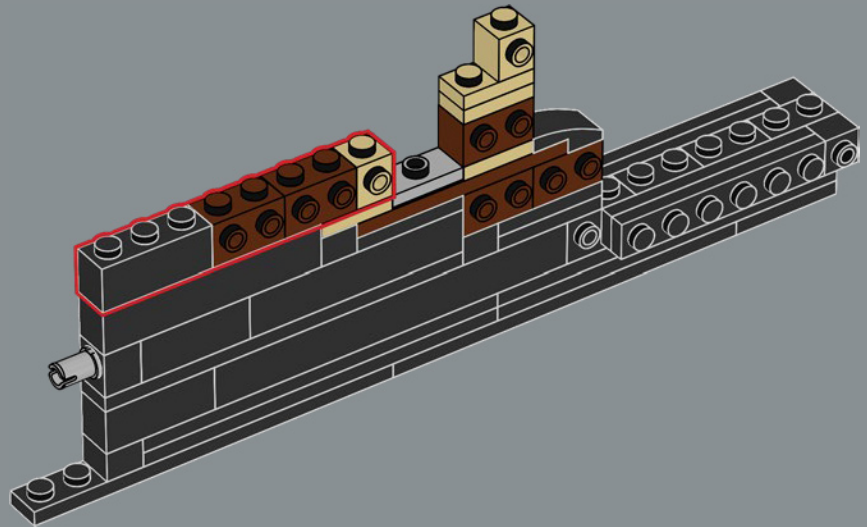

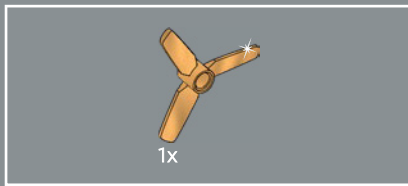

On the real-life *Endurance*, the propeller was black, but the LEGO® element was made in molded gold to make it stand out against the ship's black hull.

L'hélice de l'*Endurance* réel était noire, mais l'élément LEGO® a été moulé en couleur or pour le faire ressortir de la coque noire du navire.

La hélice del *Endurance* de la vida real era negra, pero el elemento LEGO® que la recrea se fabricó en dorado para hacerla más visible y distinguirla del casco.

307

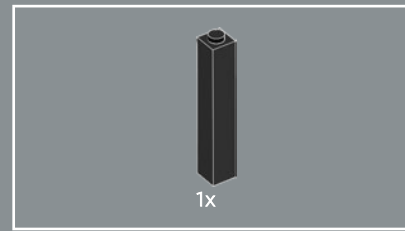
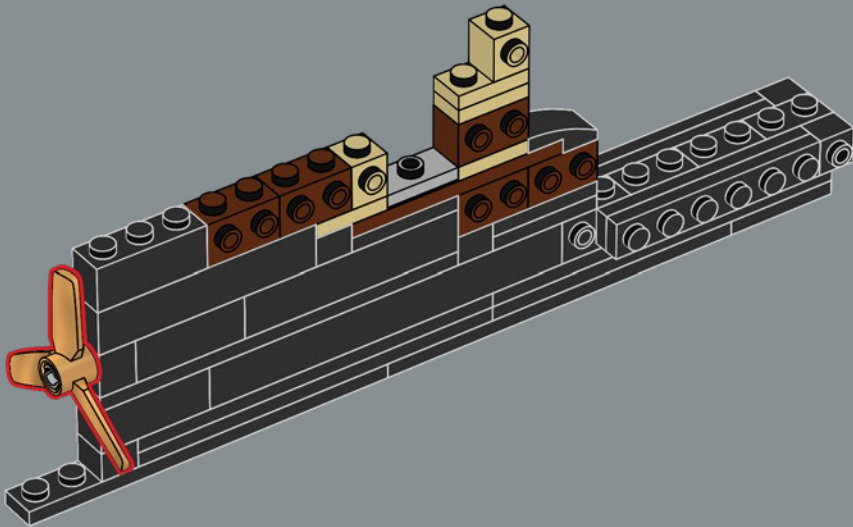

308

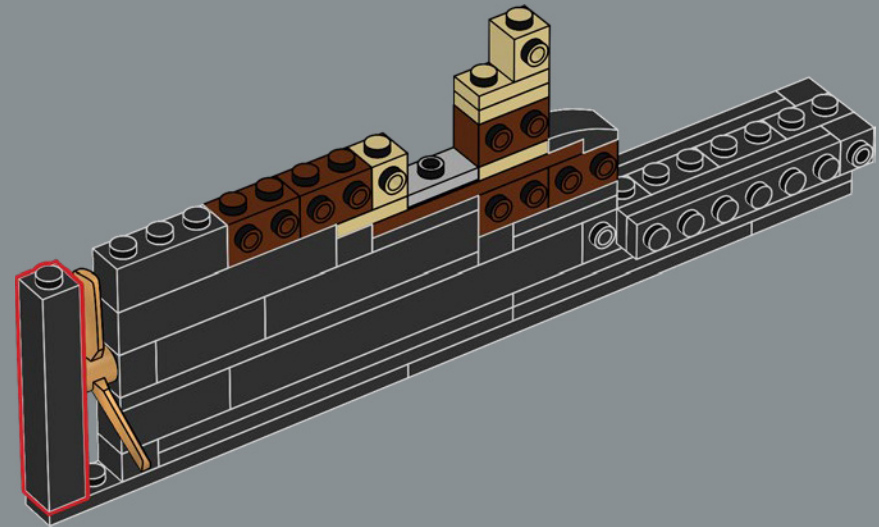

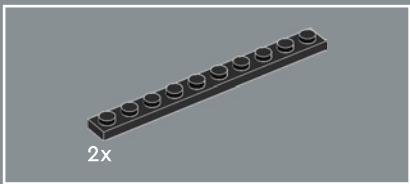

309

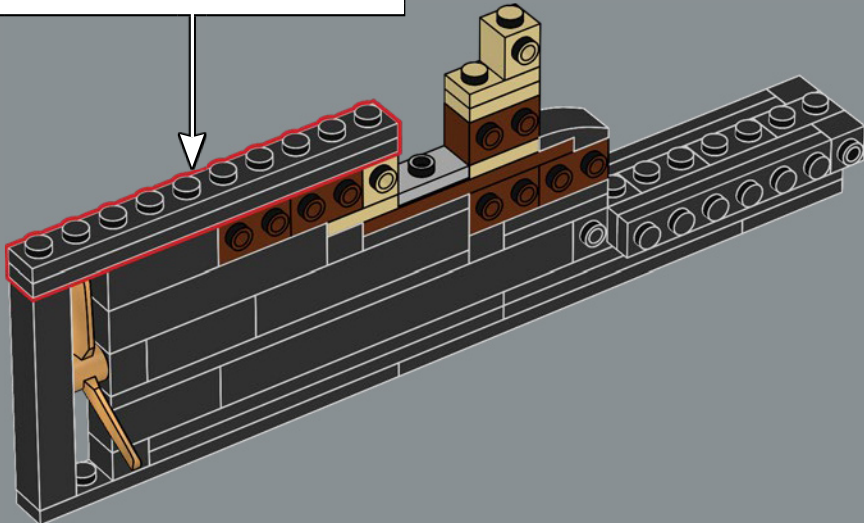
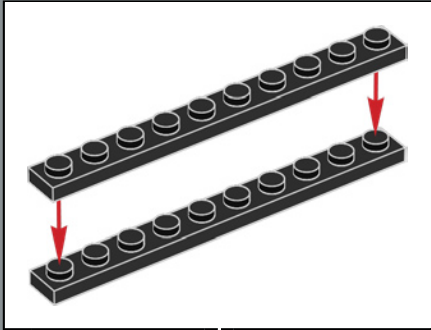

310

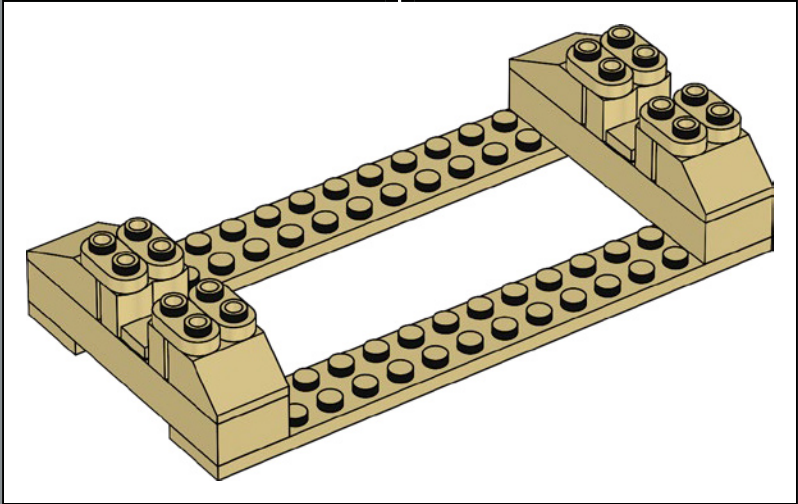
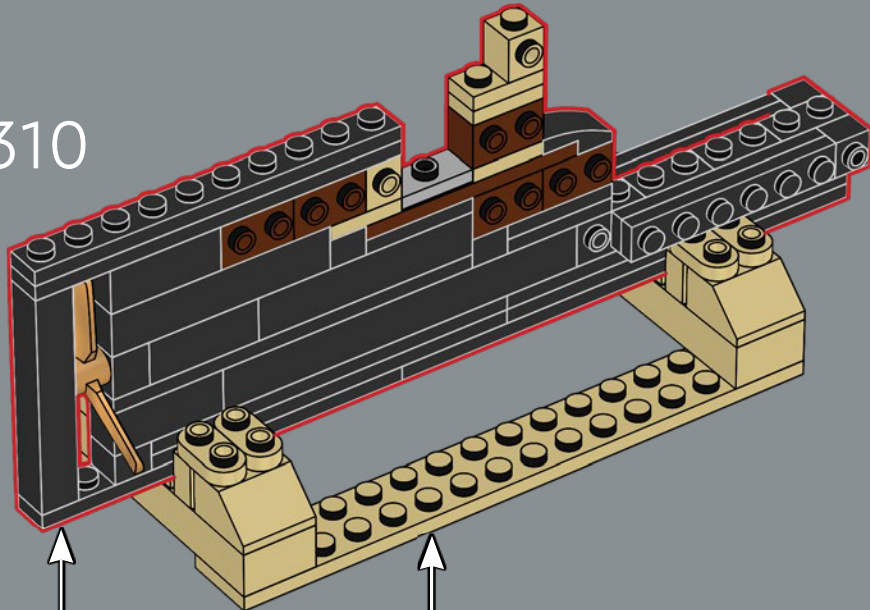

4

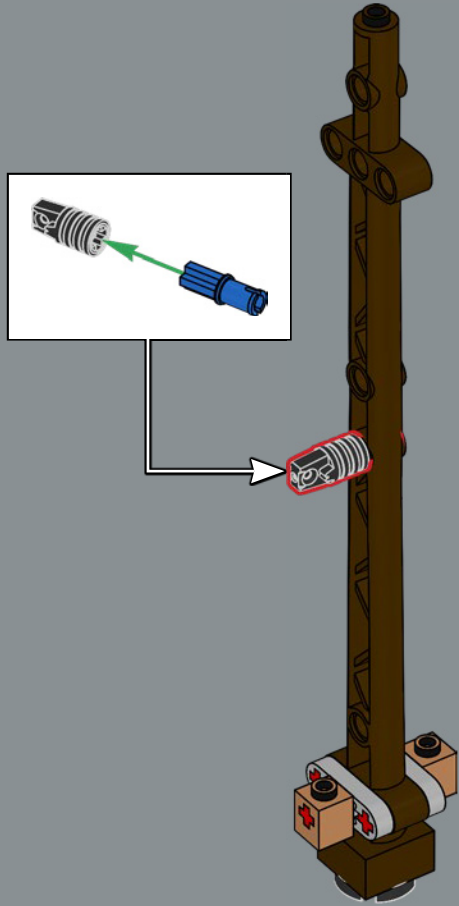

5

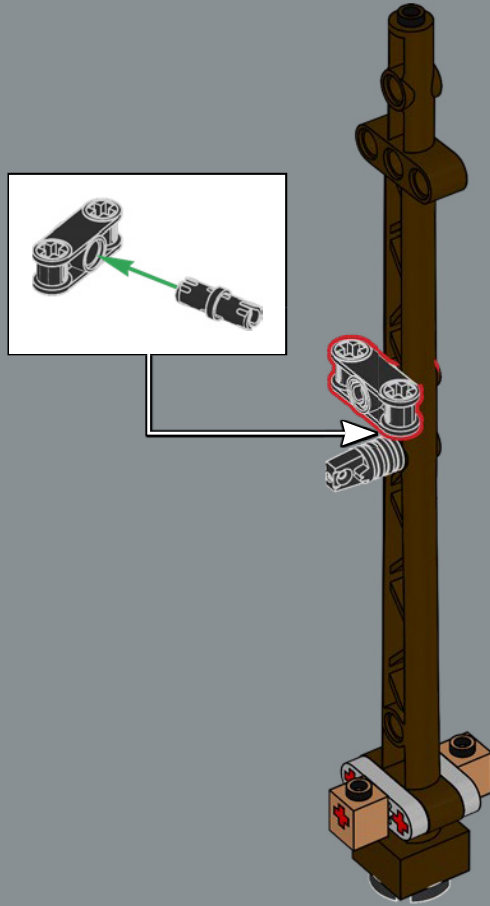

6

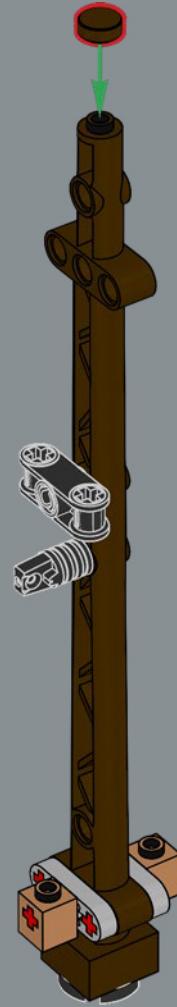

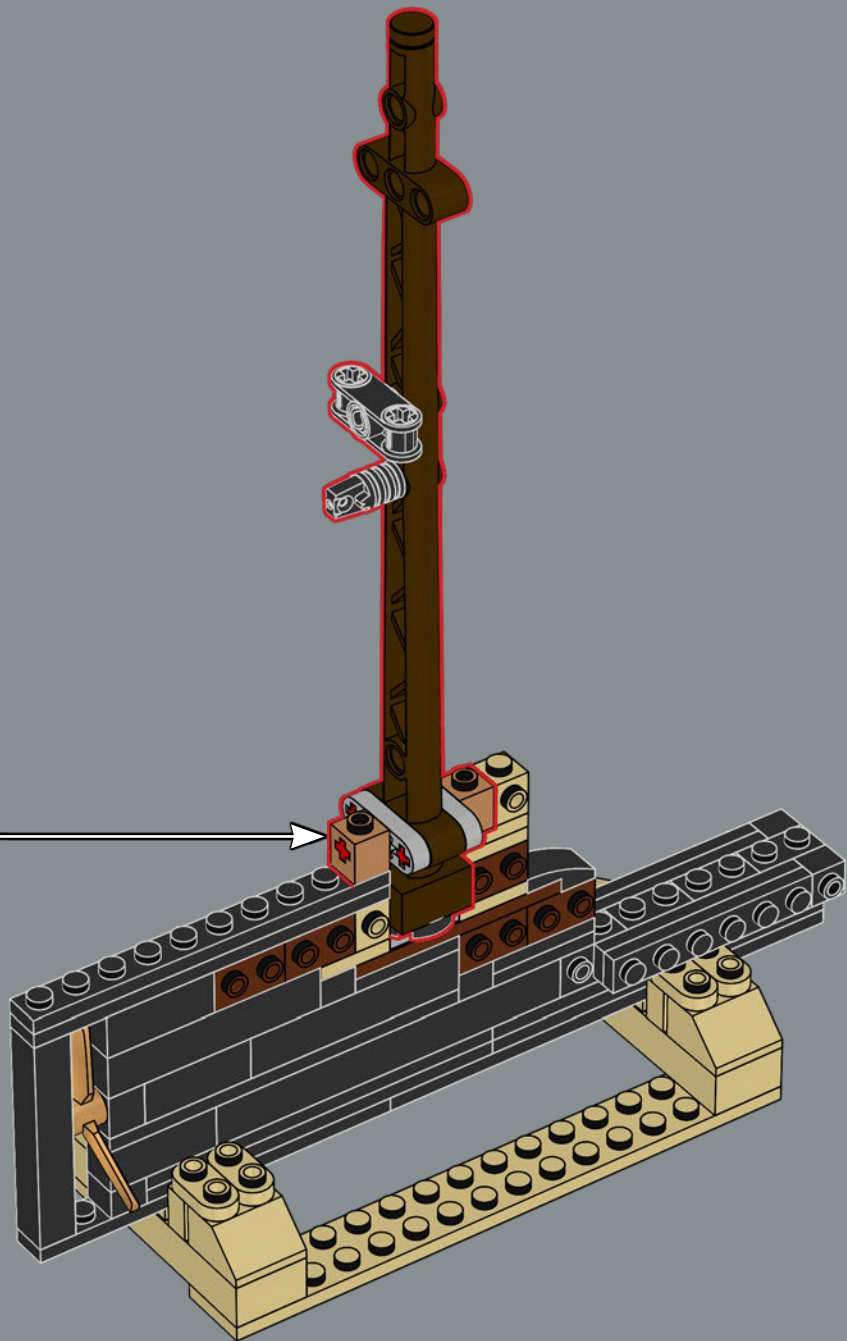

312

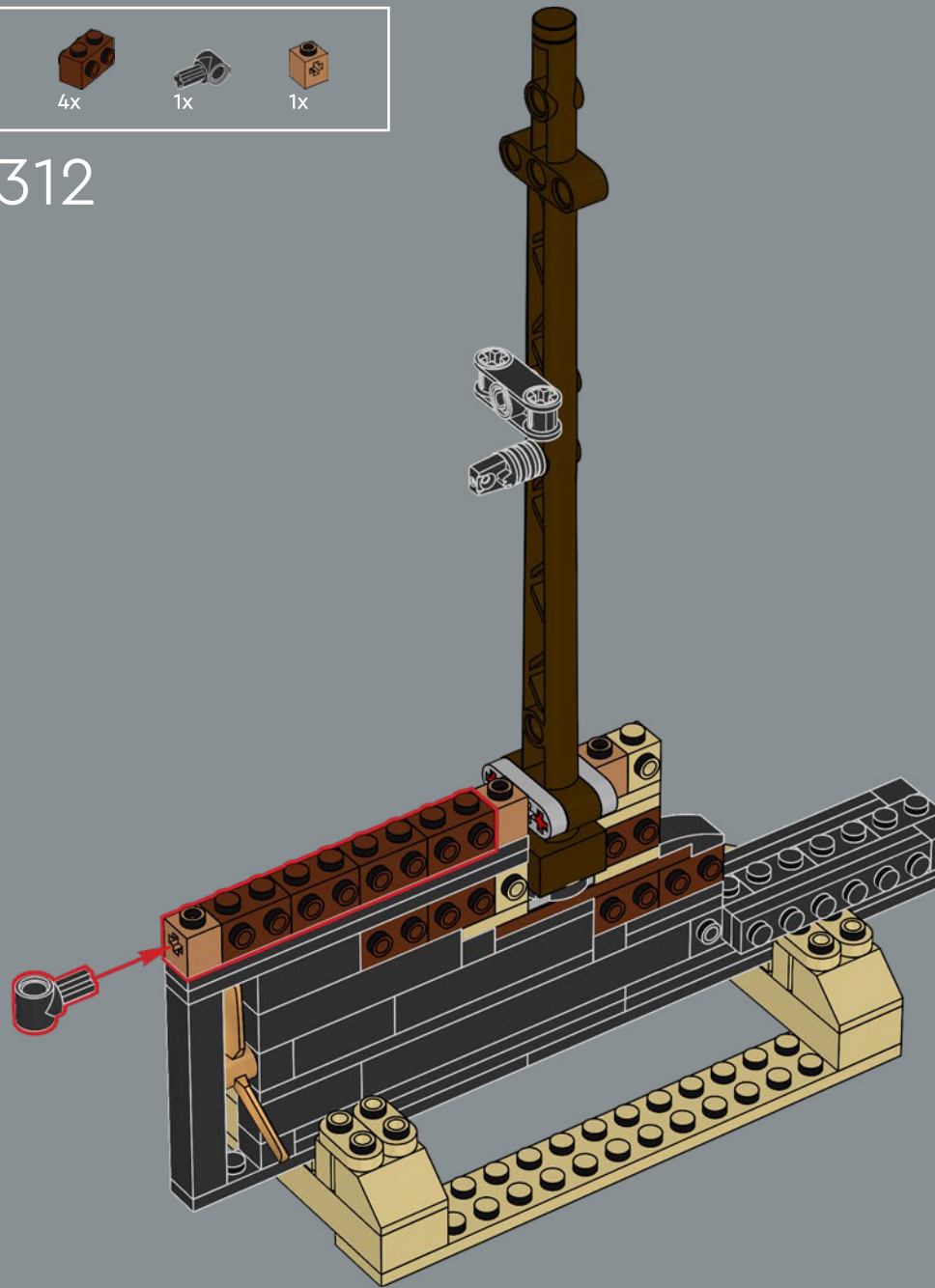

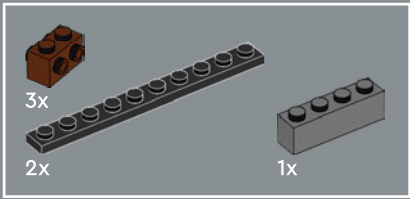

313

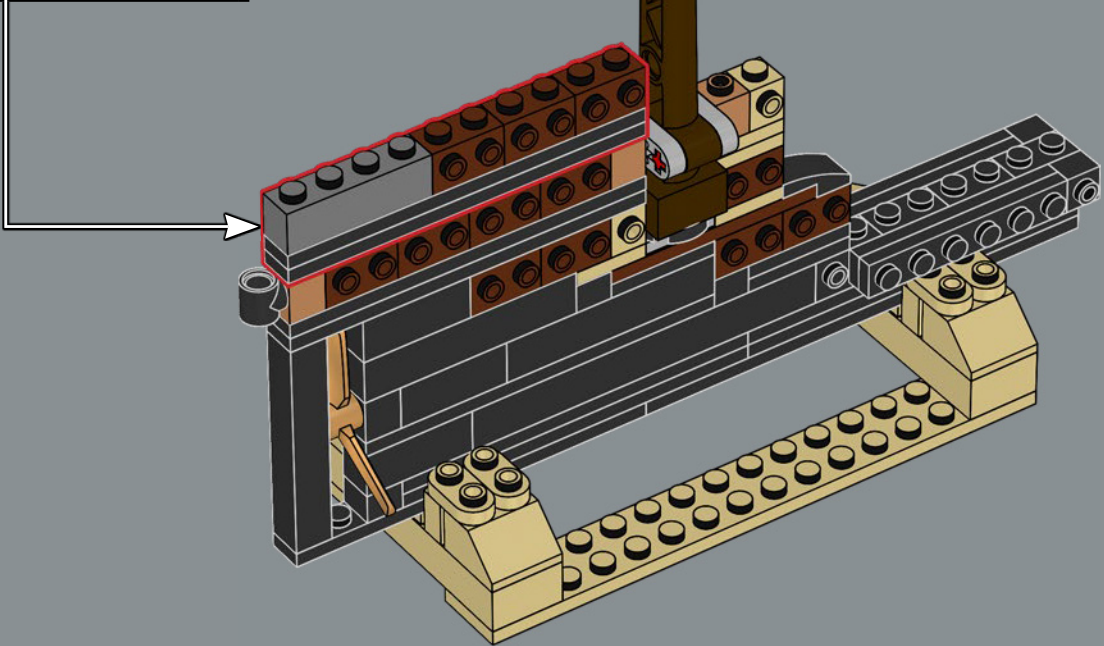
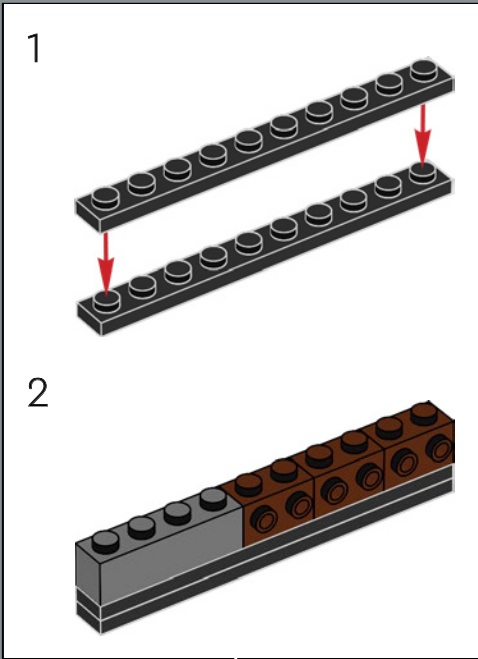

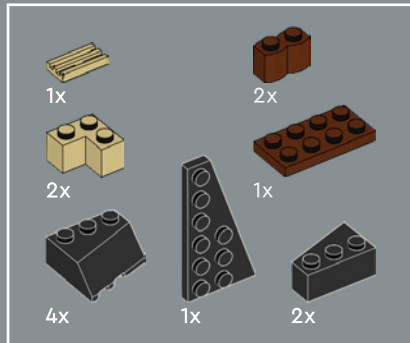
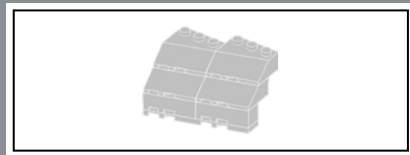

314

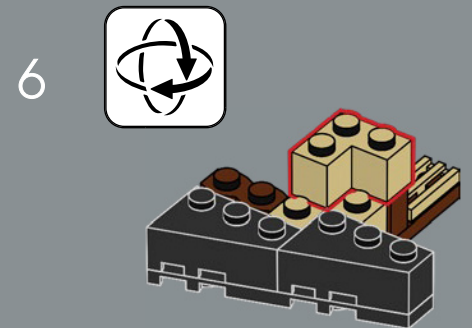
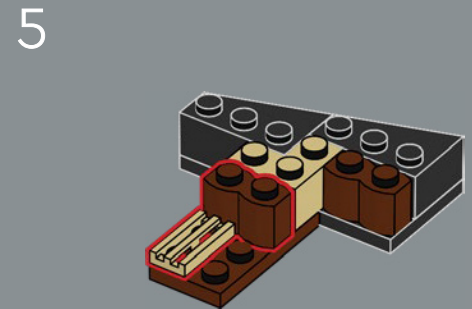
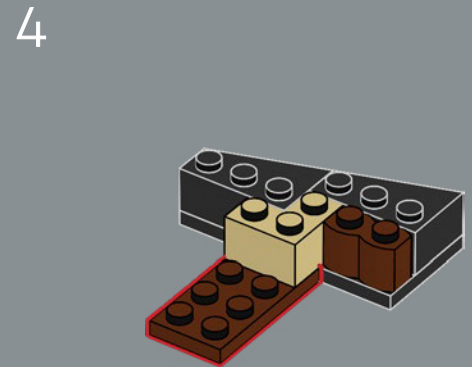
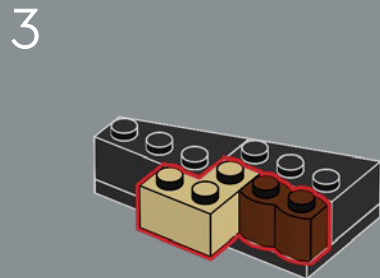
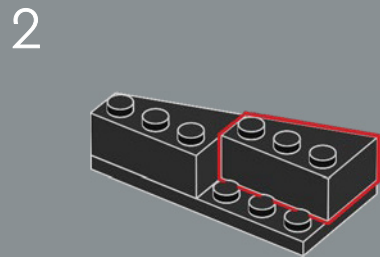
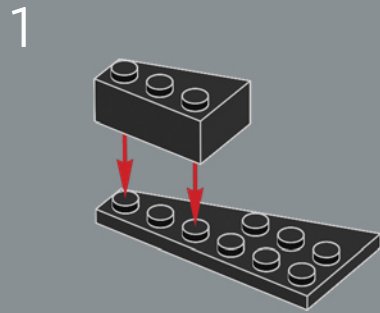

7

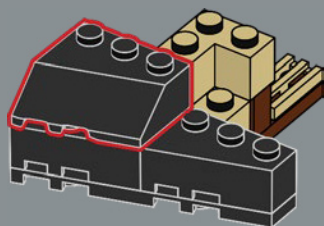

8

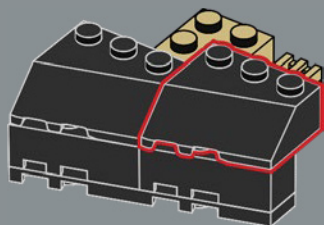

9

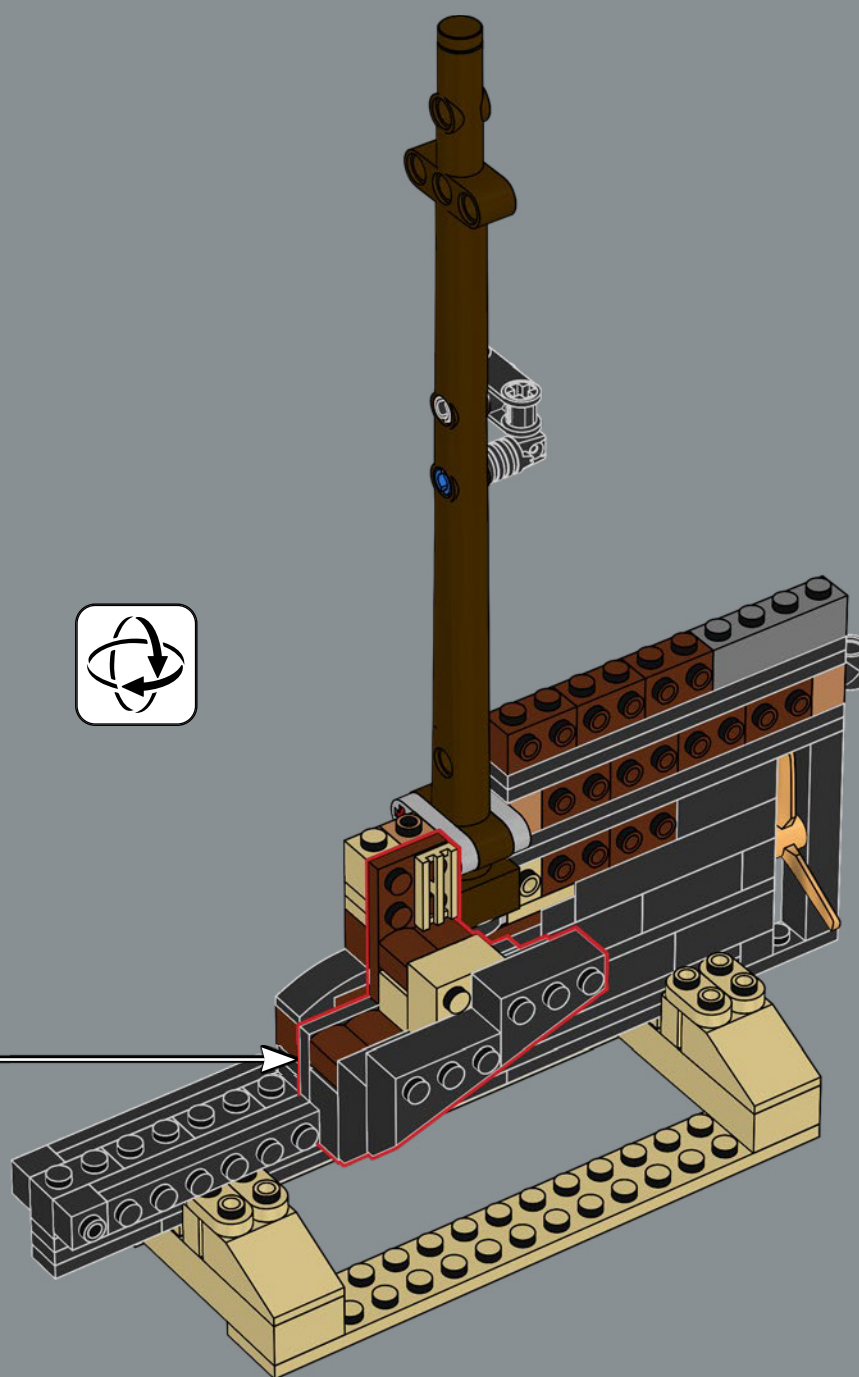
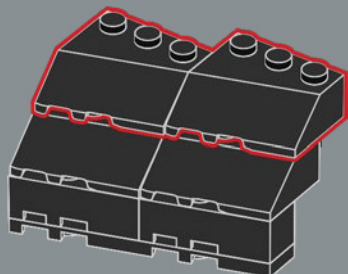

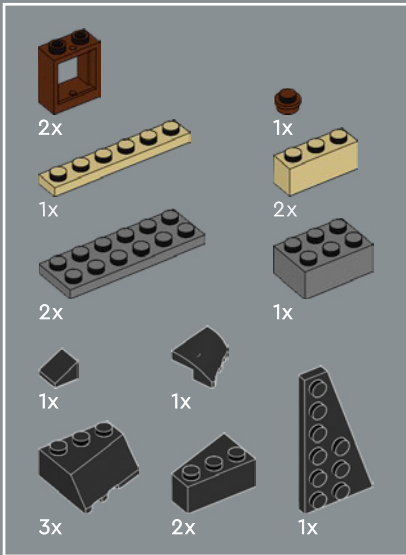
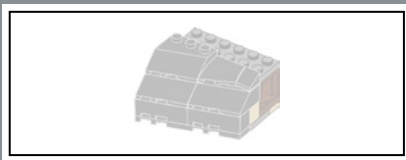

315

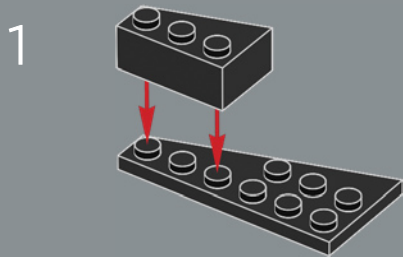

2

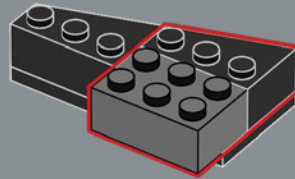

3

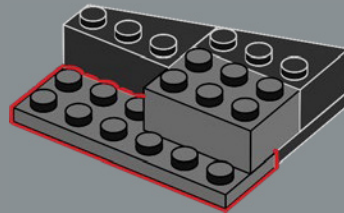

4

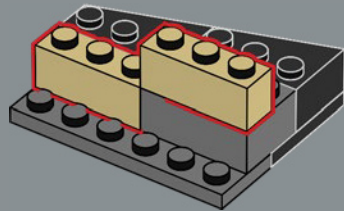

5

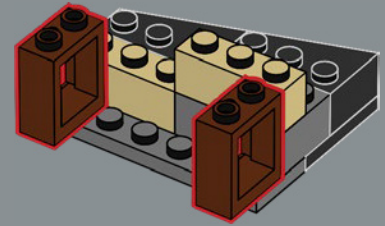

6

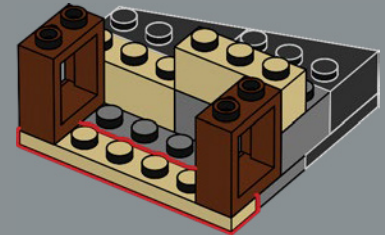

7

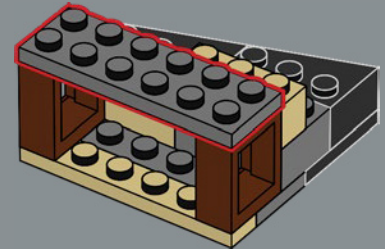

8

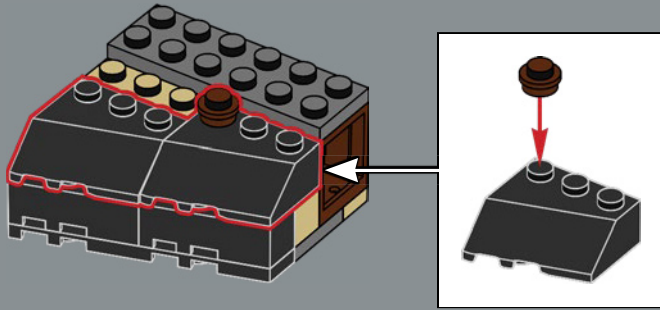

9

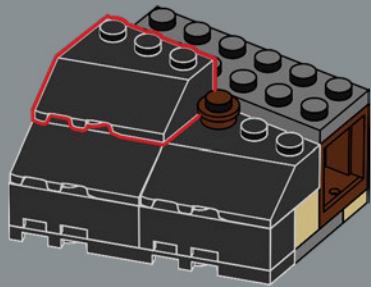

10

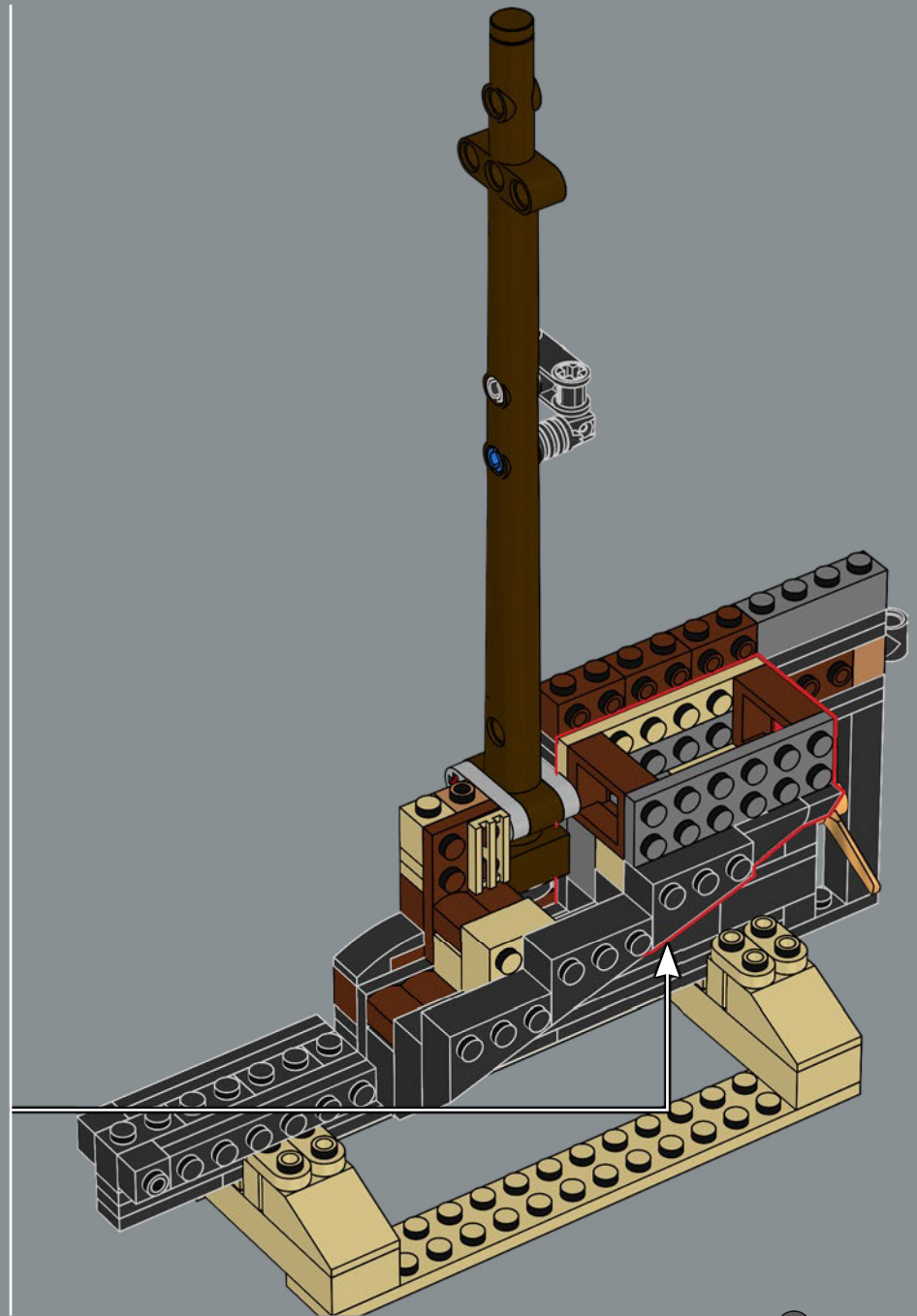
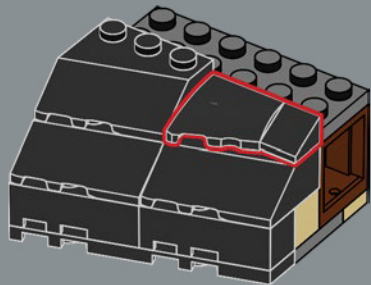

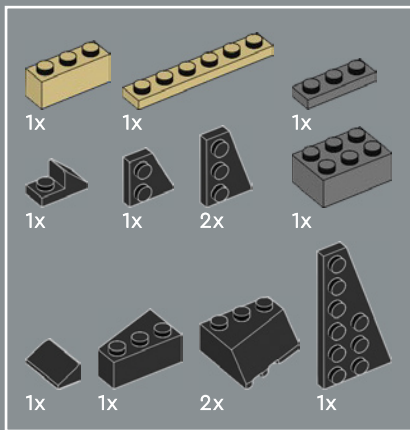

316

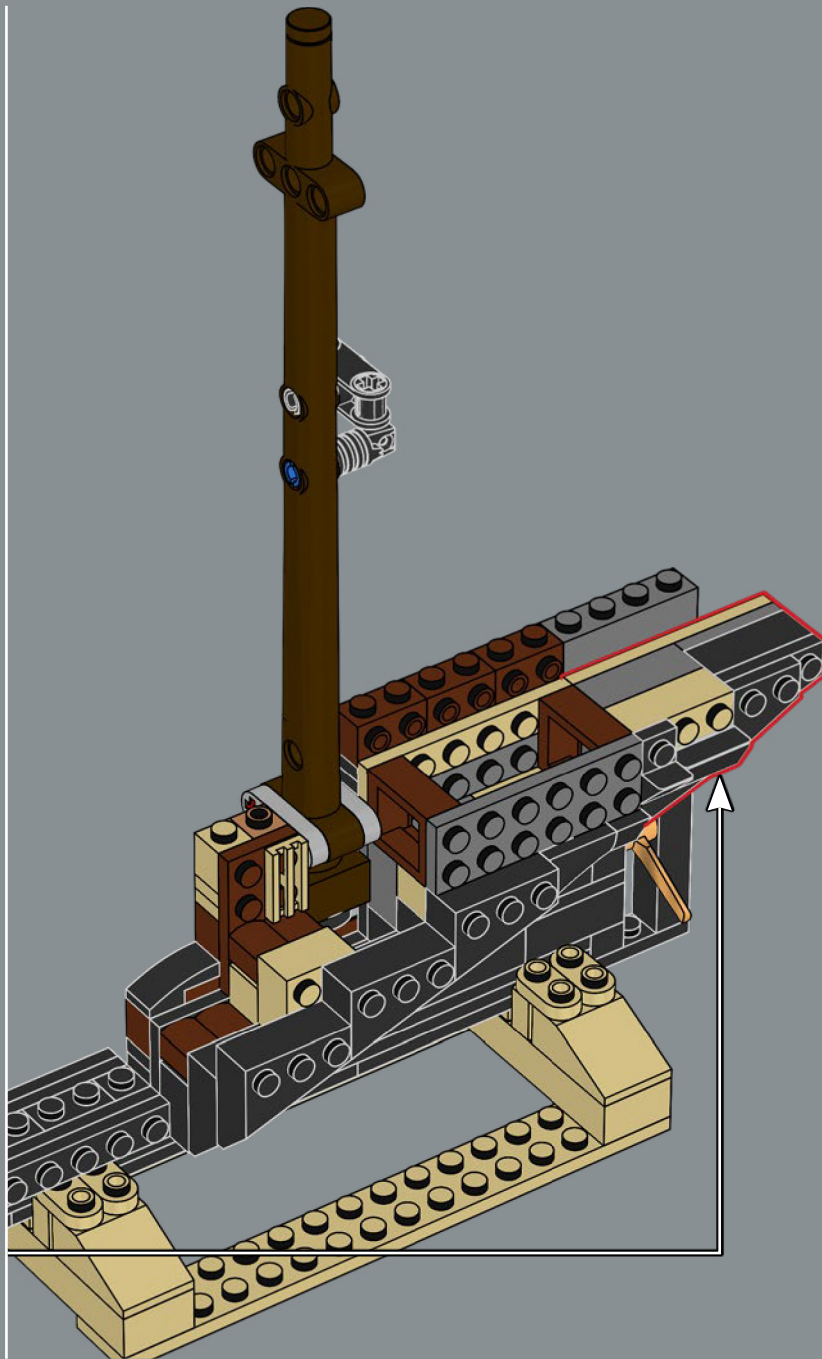
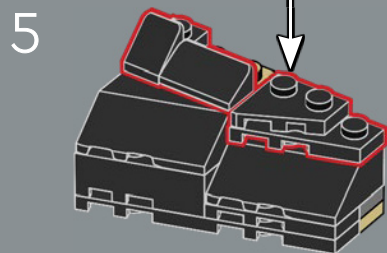
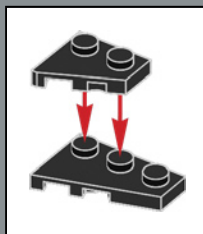
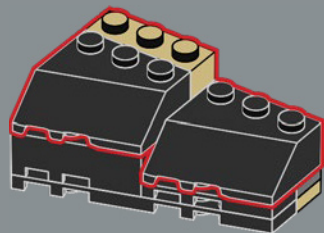
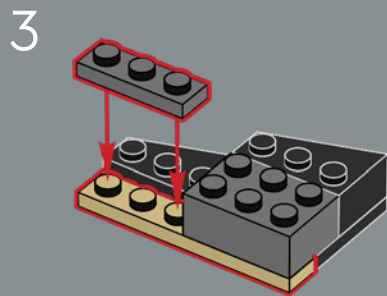
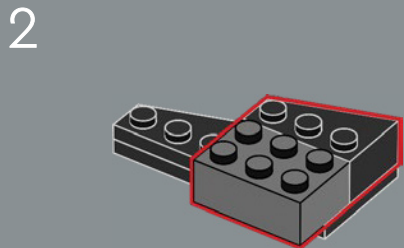
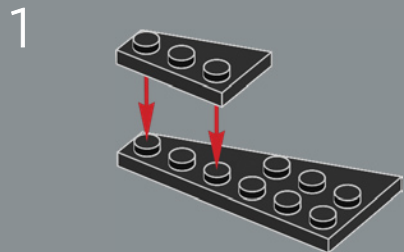

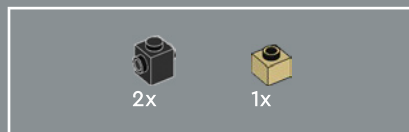

317

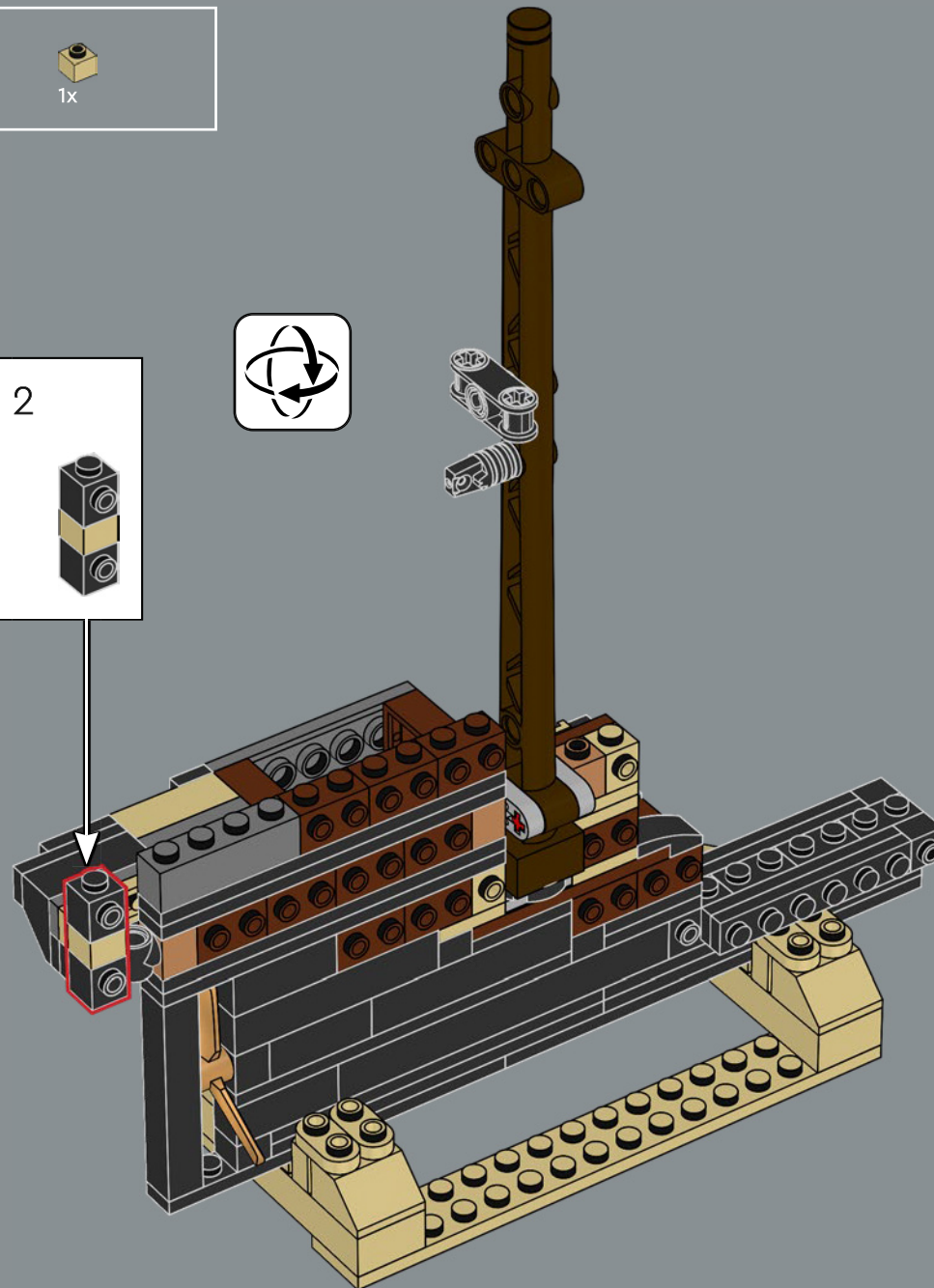
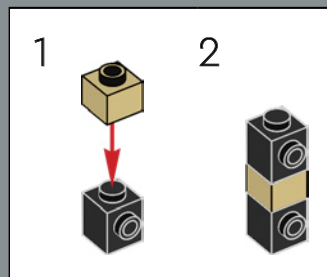

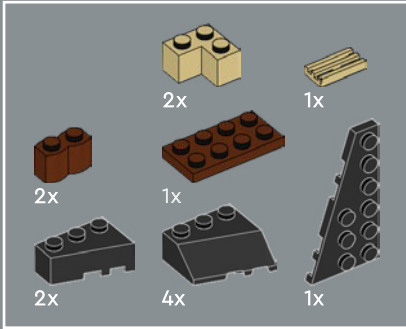
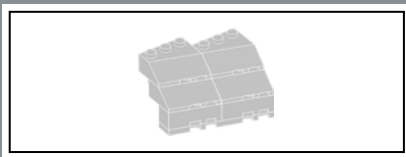

318

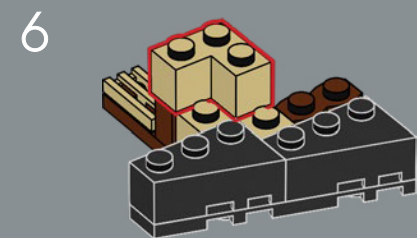
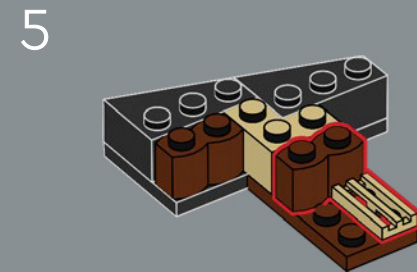
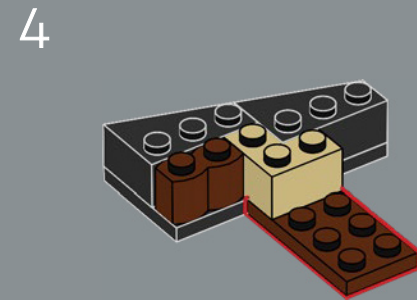
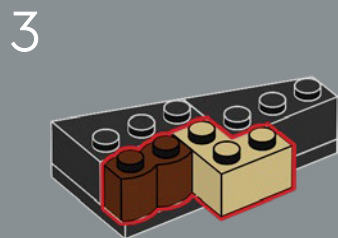
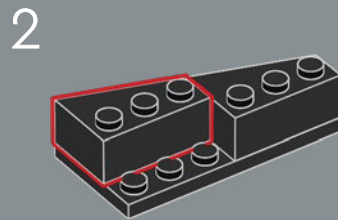
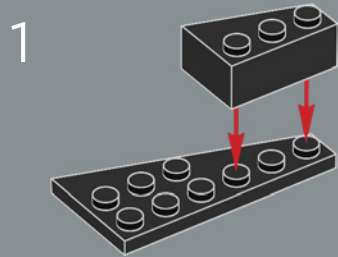

7

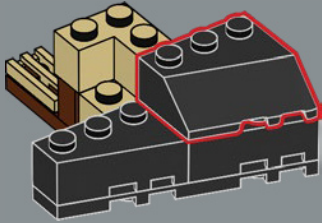

8

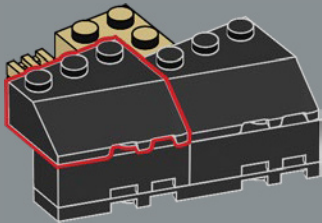

9

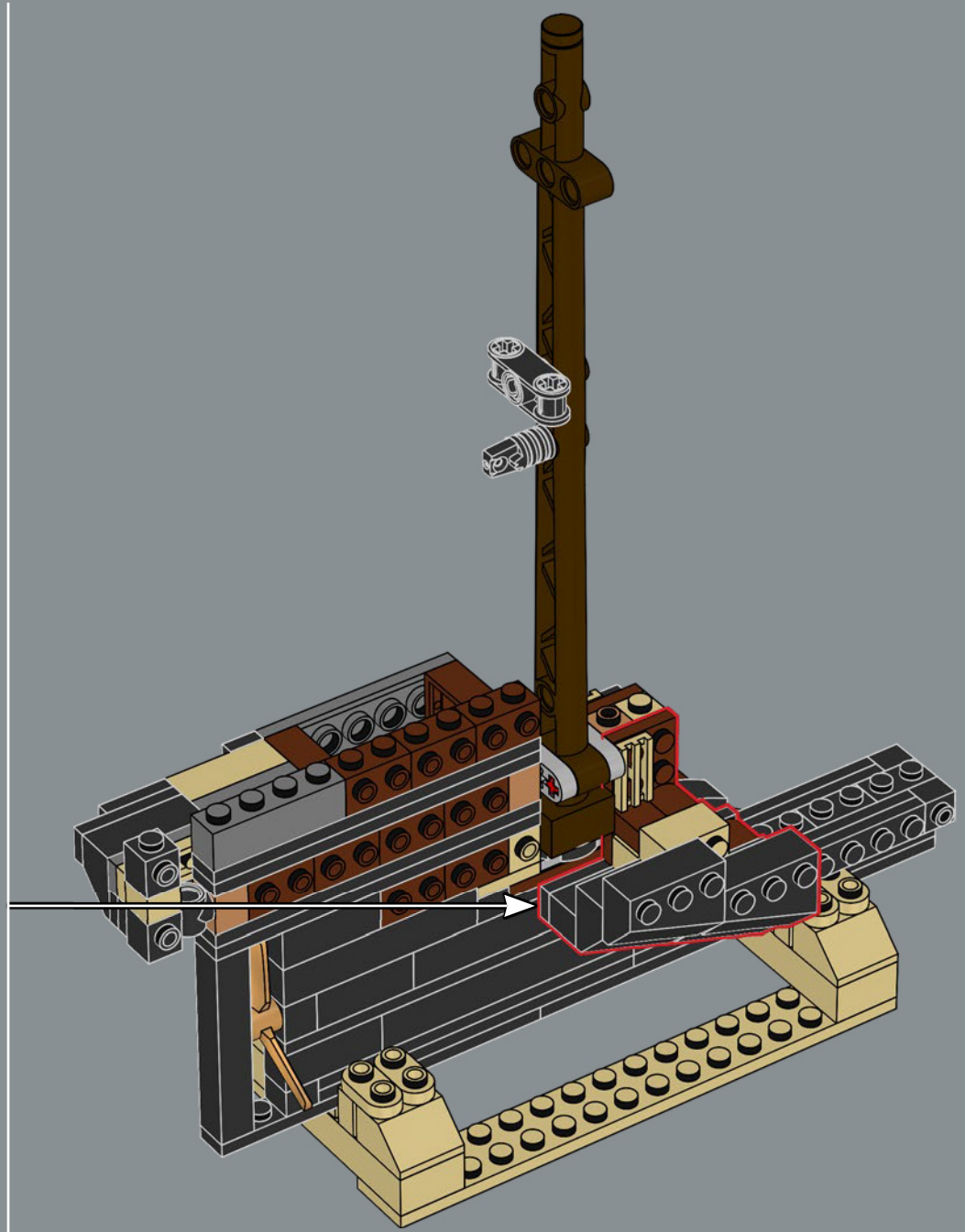
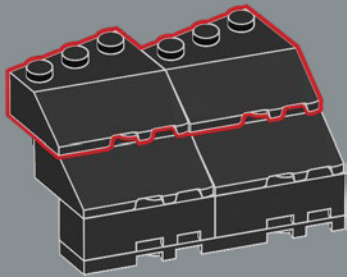

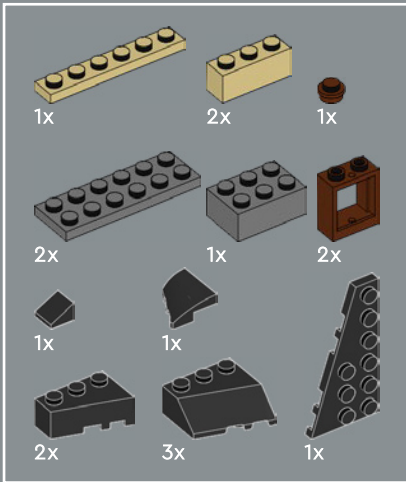
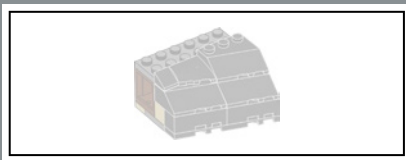

319

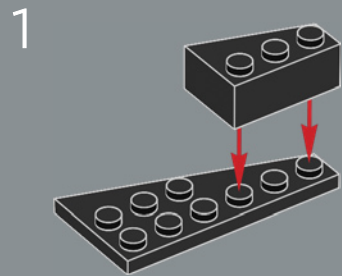

2

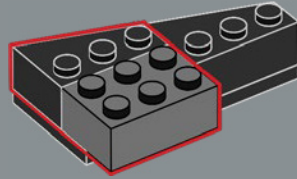

3

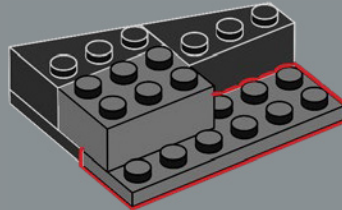

4

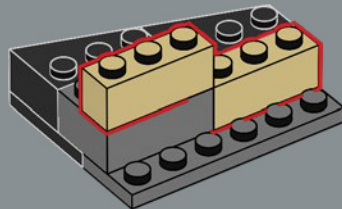

5

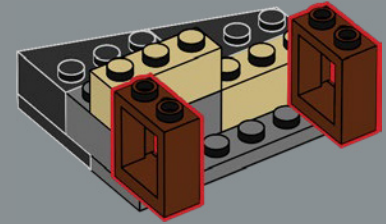

6

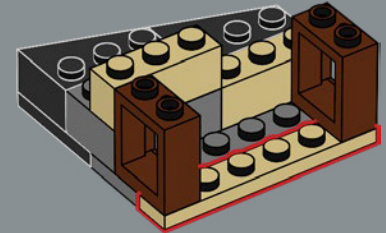

7

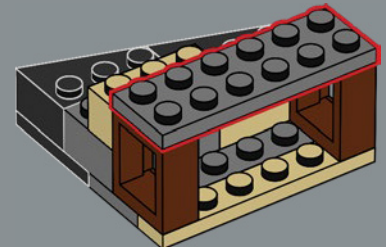

8

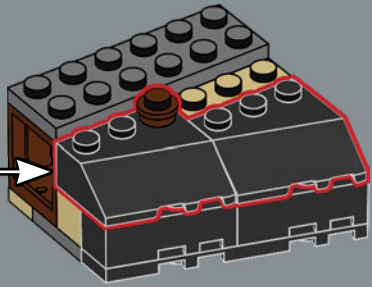
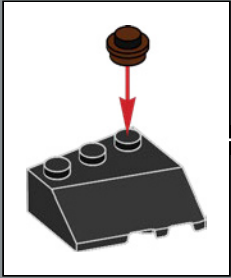

9

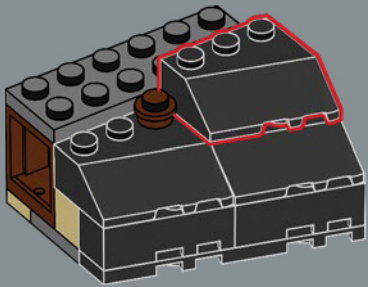

10

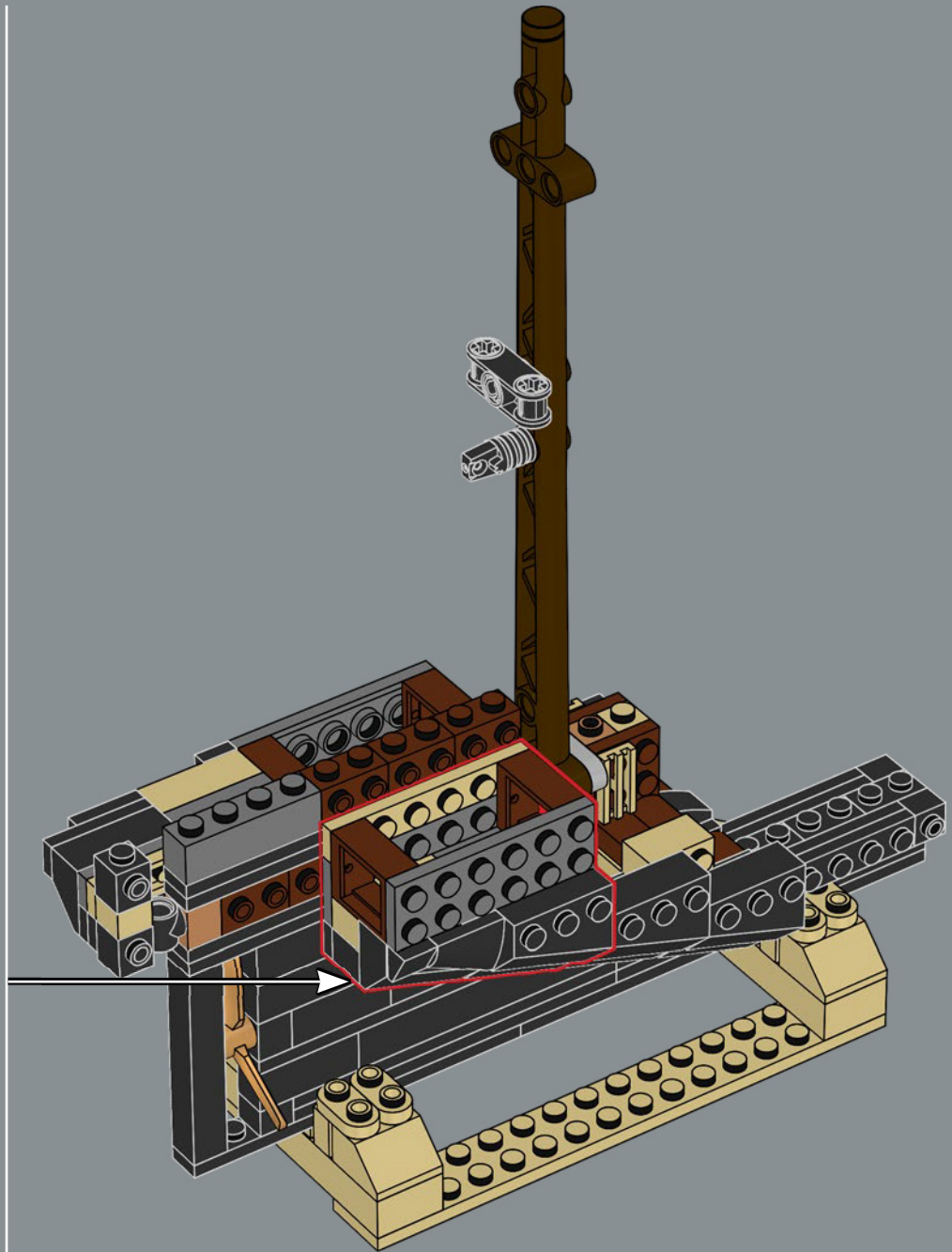
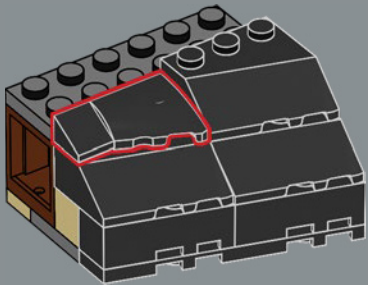



321

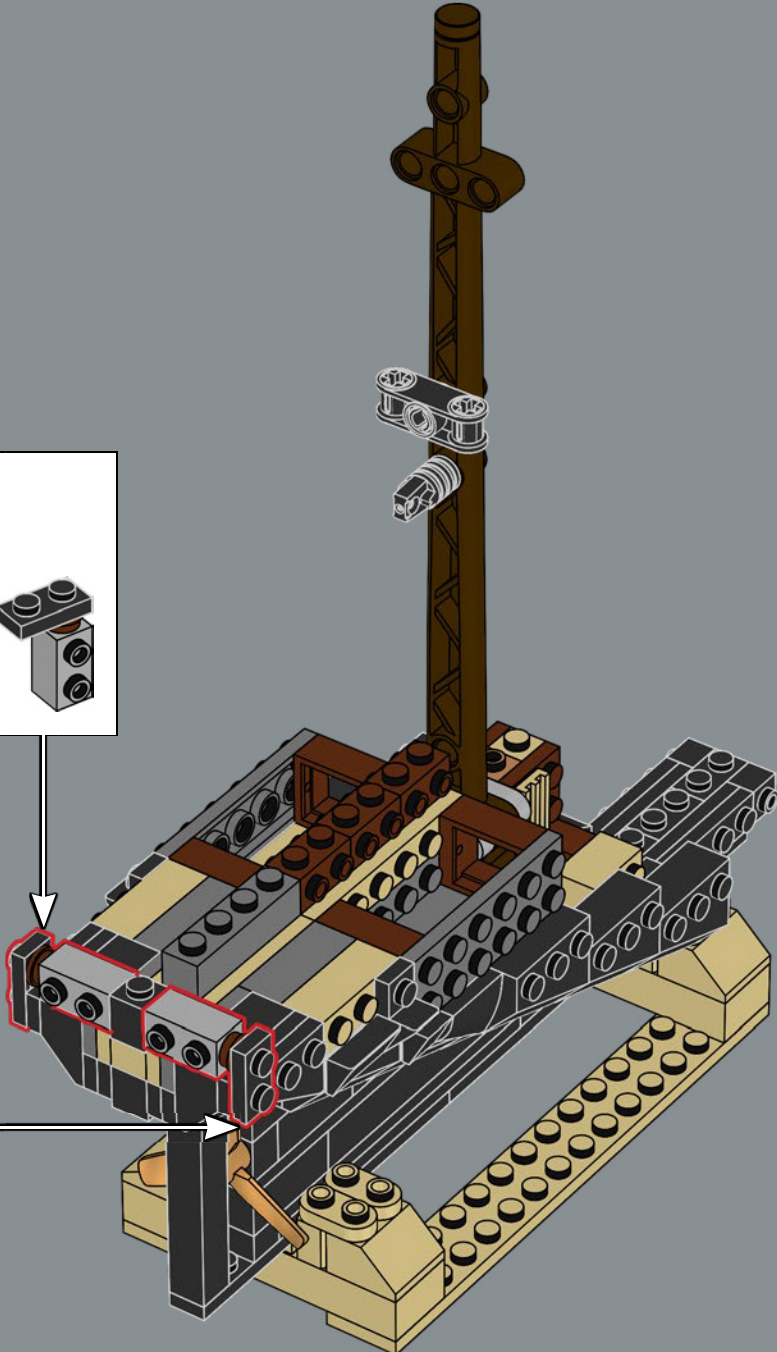
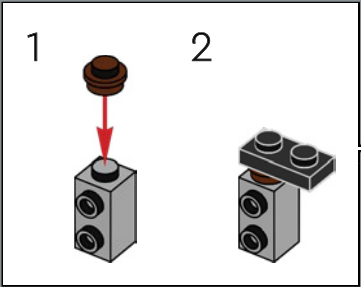
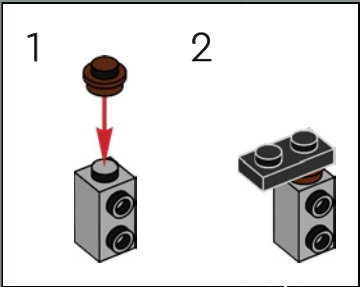

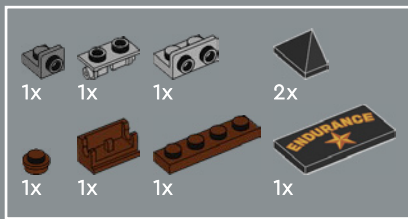

322

1

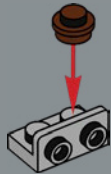

2

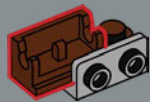

3

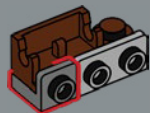

4

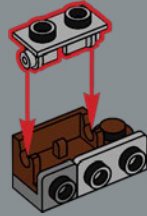

5

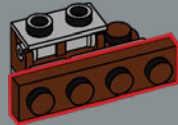

6

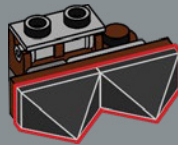

7



The *Endurance* was originally named *Polaris*. Whether Shackleton considered the name of the North Star unfit for an expedition to the South Pole, or he was inspired by his family motto, "By Endurance We Conquer," is unknown. Either way, the star stayed on!

L'*Endurance* s'appelaît à l'origine *Polaris*. On ne sait pas si Shackleton considérait que le nom de l'étoile du Nord ne convenait pas à une expédition au pôle Sud, ou s'il a été inspiré par la devise de sa famille, « By Endurance We Conquer » (« Nous vainquons par l'endurance »). Quoi qu'il en soit, l'étoile a été gardée !

El nombre original del *Endurance* era *Polaris*. Se desconoce si Shackleton consideró que el nombre de la estrella que señala el norte era inapropiado para una expedición al Polo Sur o si se inspiró en el lema de su familia, "Resistiendo, venceremos" (cuya versión original en inglés contiene la palabra *endurance*). Como haya sido, ¡la estrella se mantuvo allí!

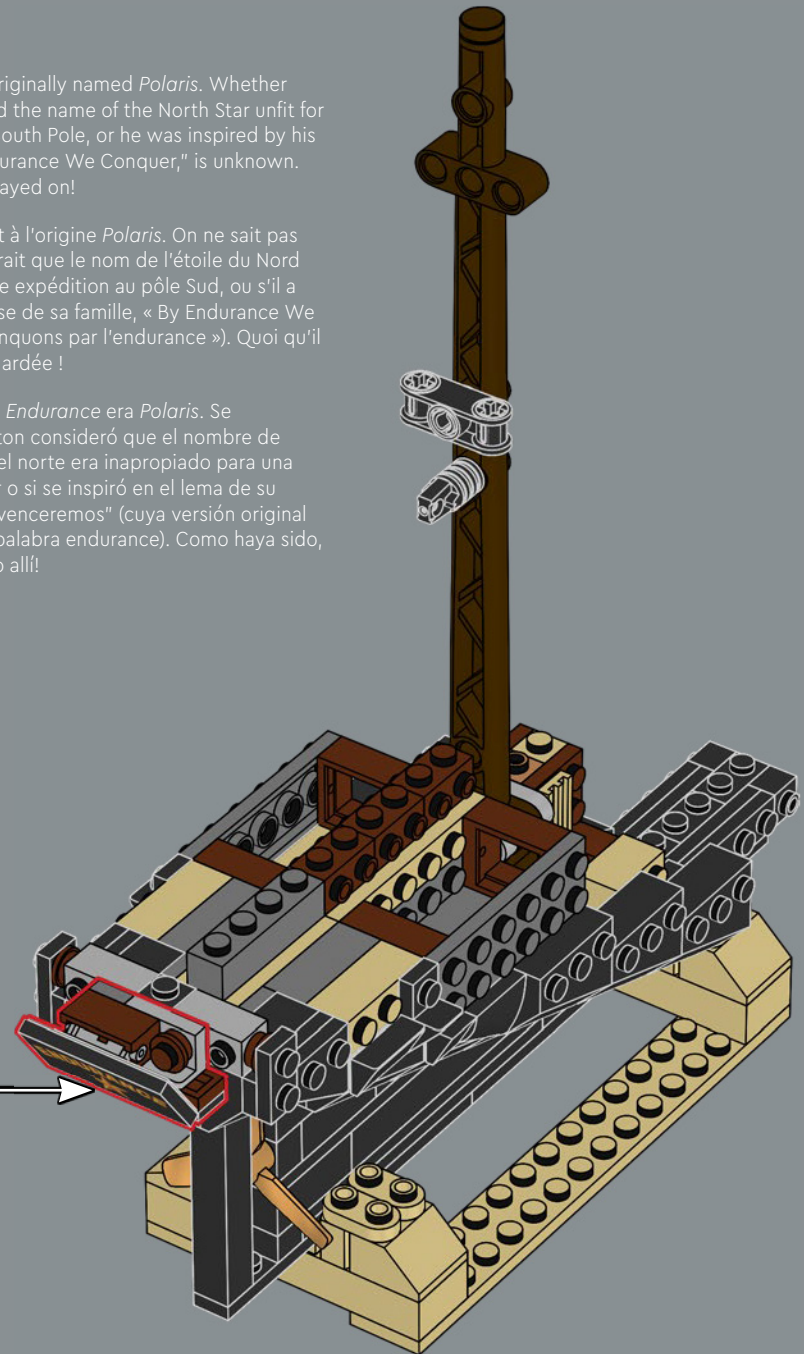

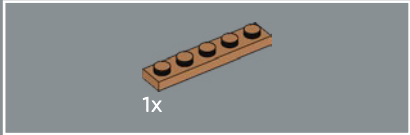
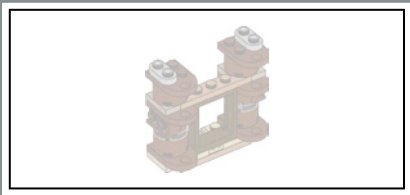

323

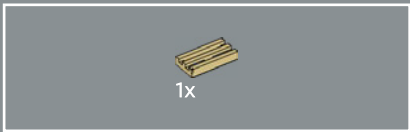
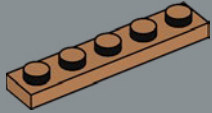

324

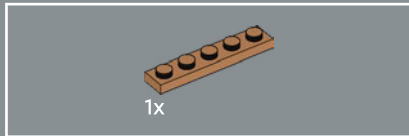
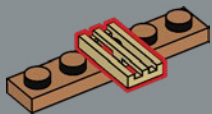

325

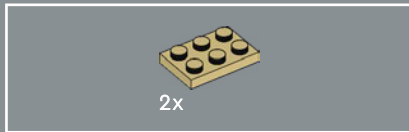
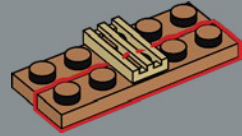

326

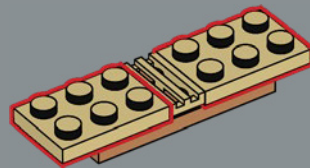

327

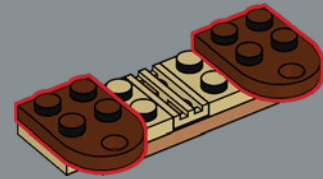

328

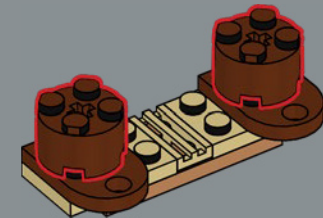



329

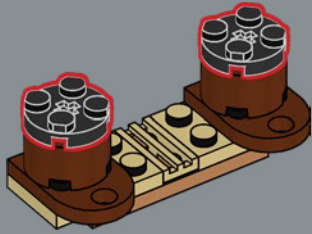

330

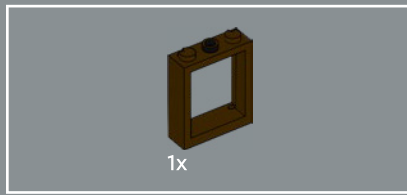
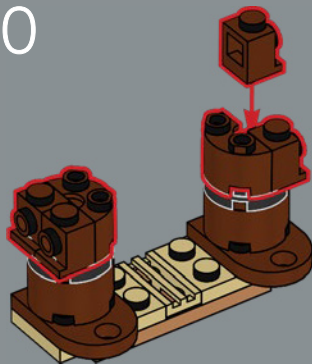

331

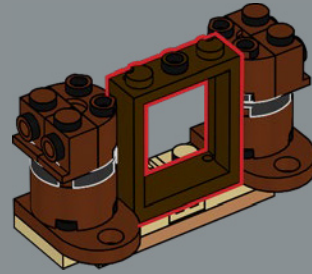

332

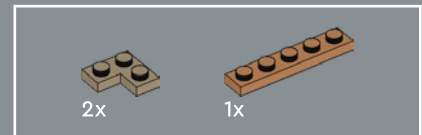
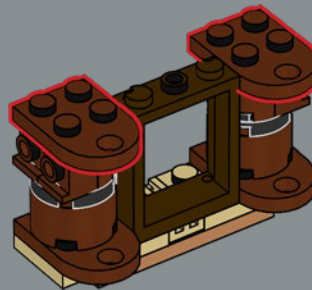

333

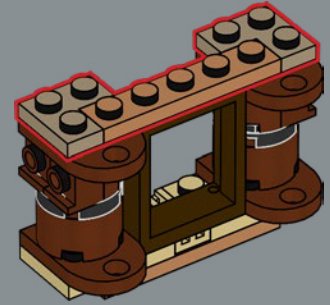

334

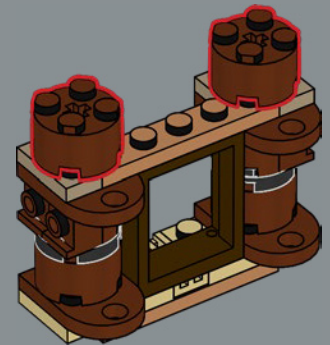



335

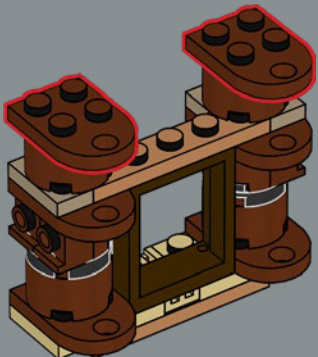

336

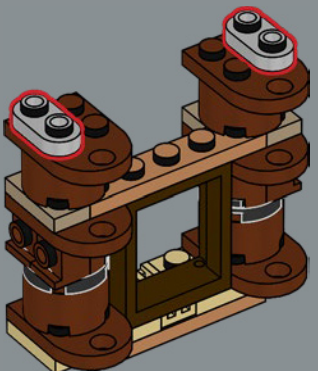

337

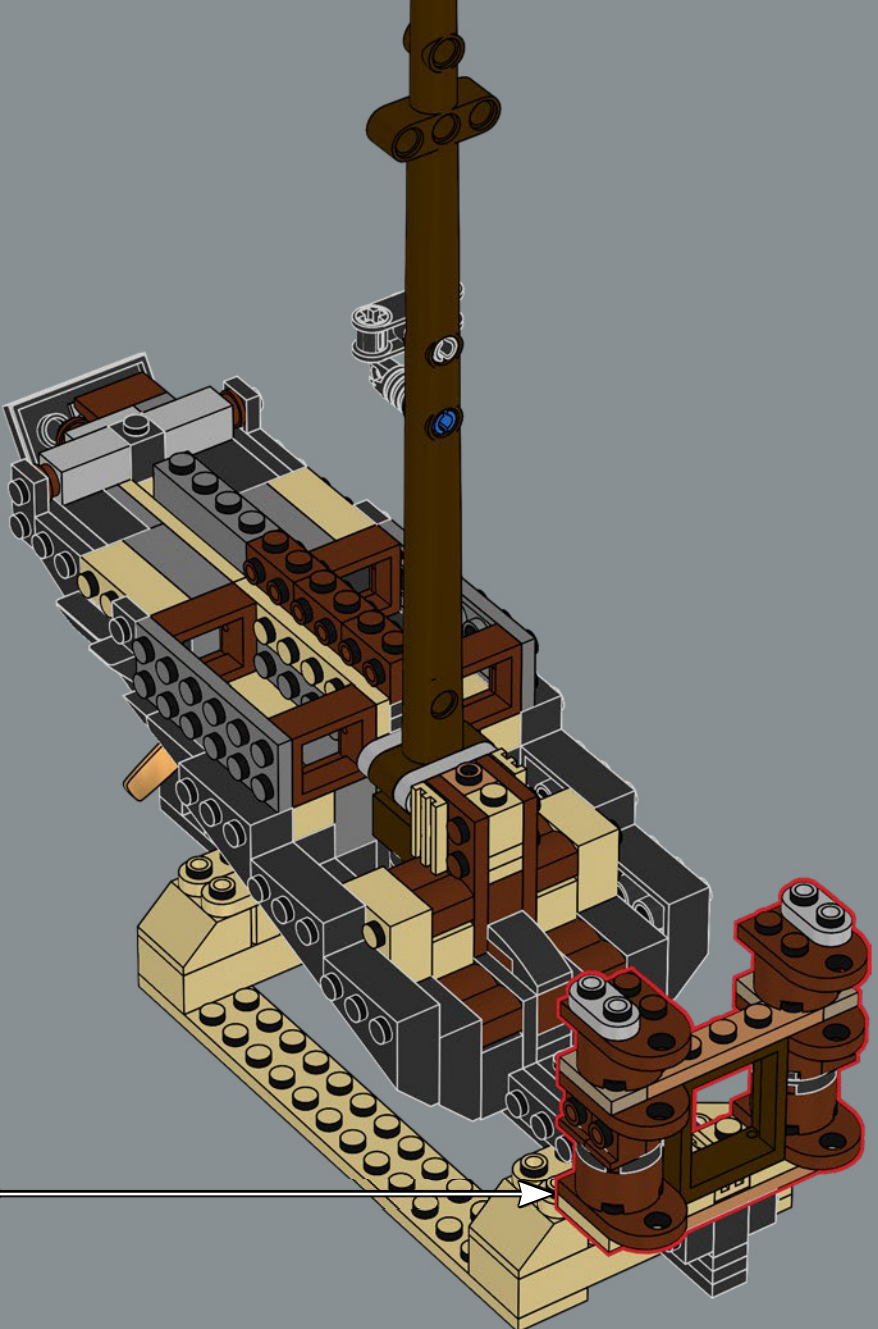

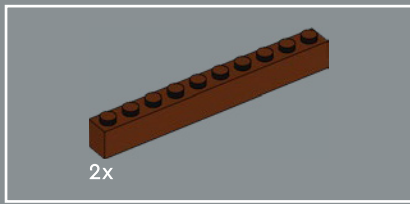

338

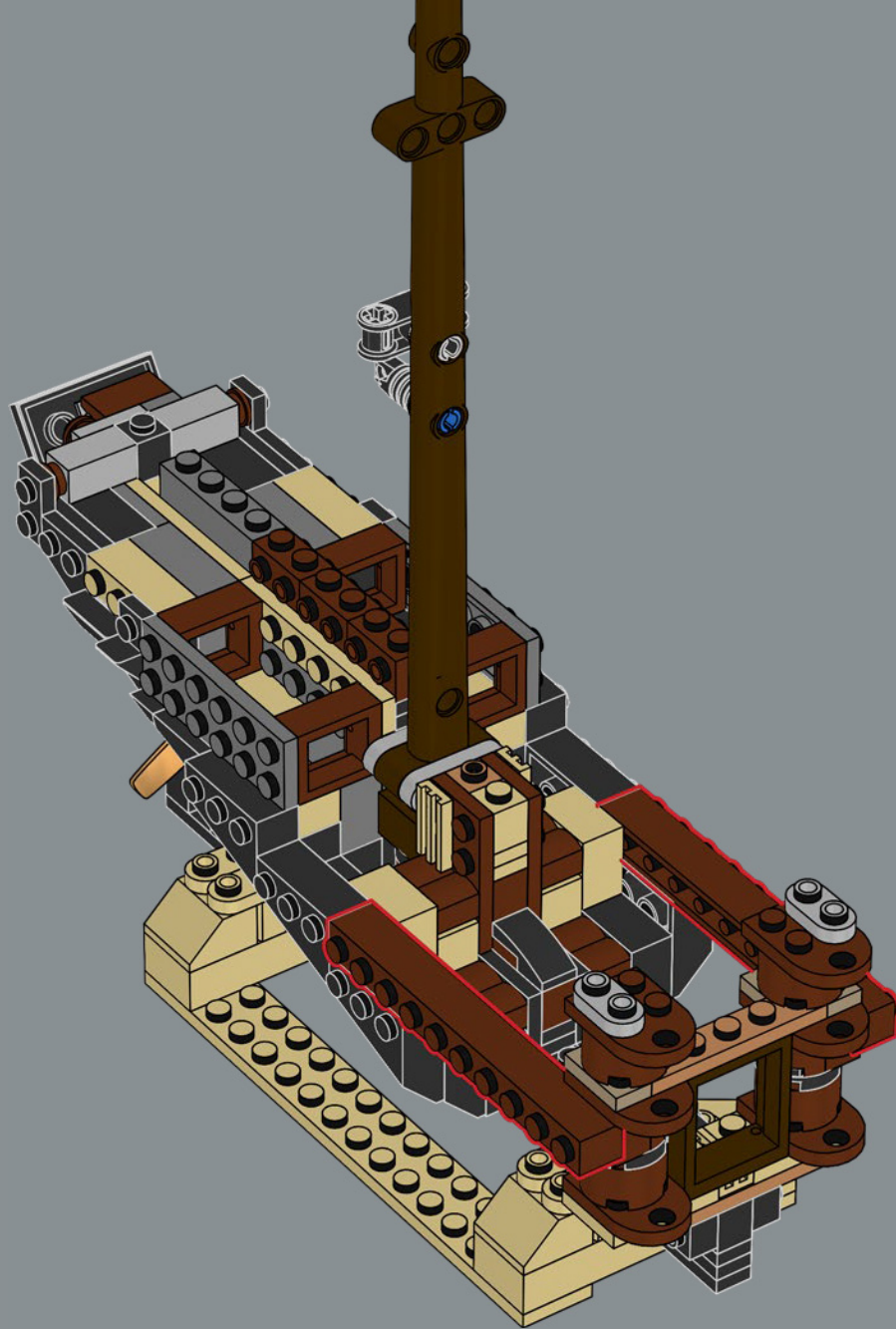

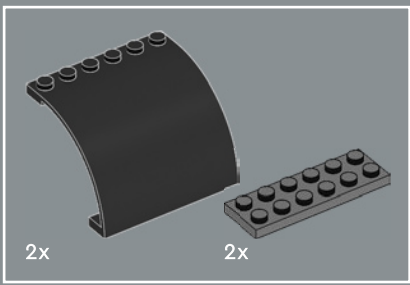

339

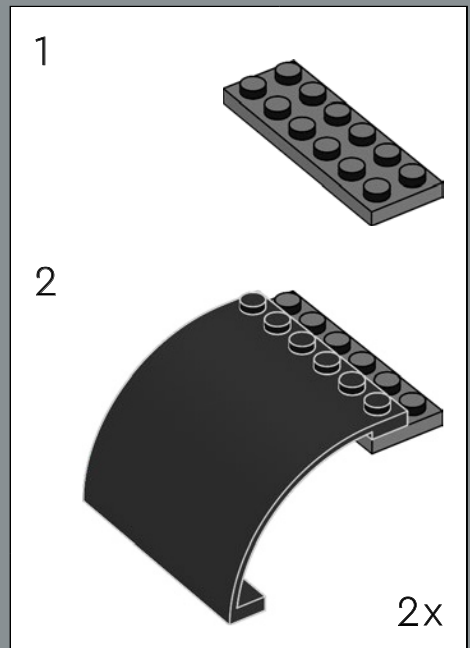
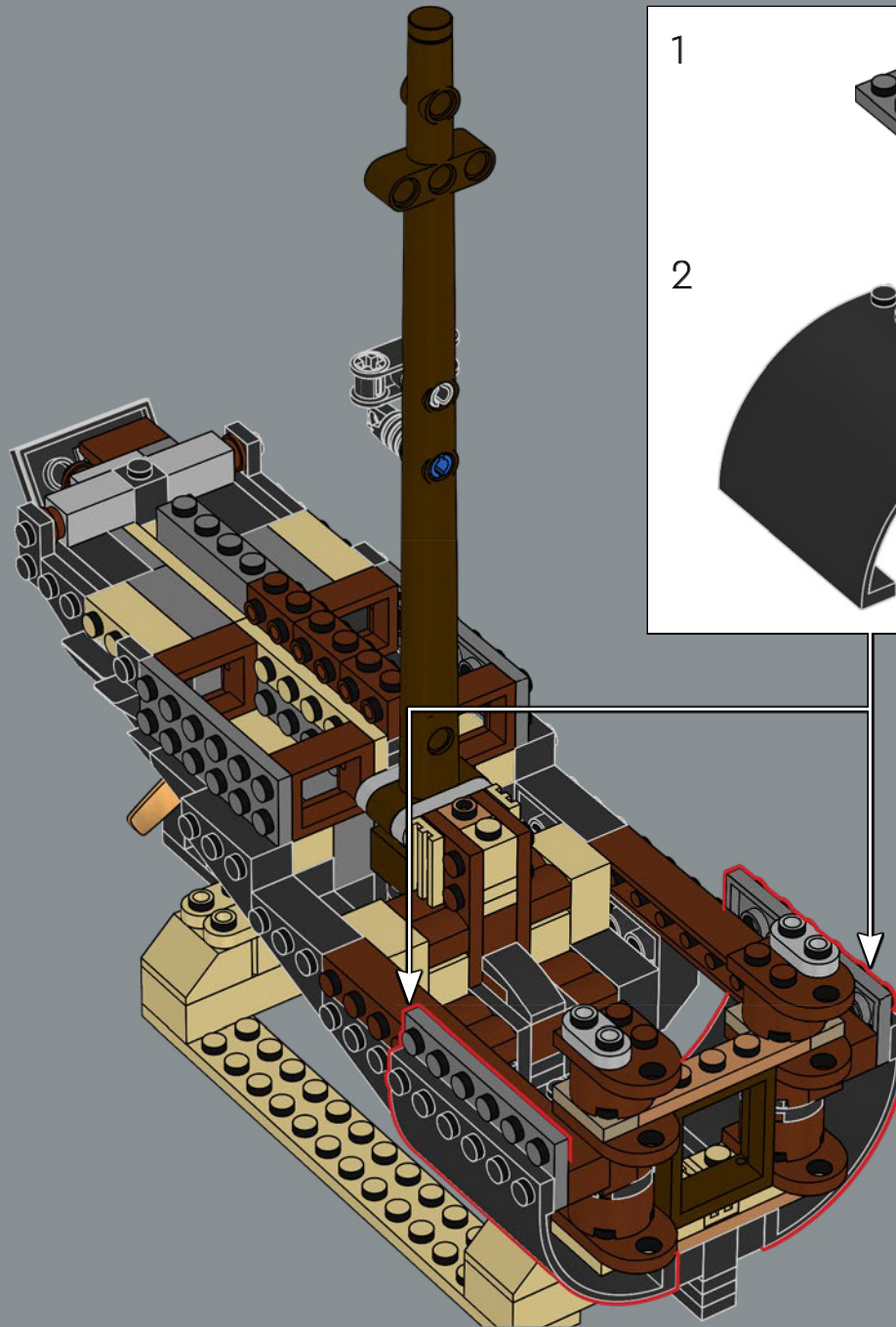

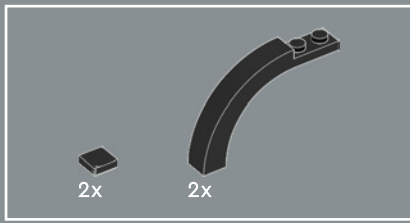

340

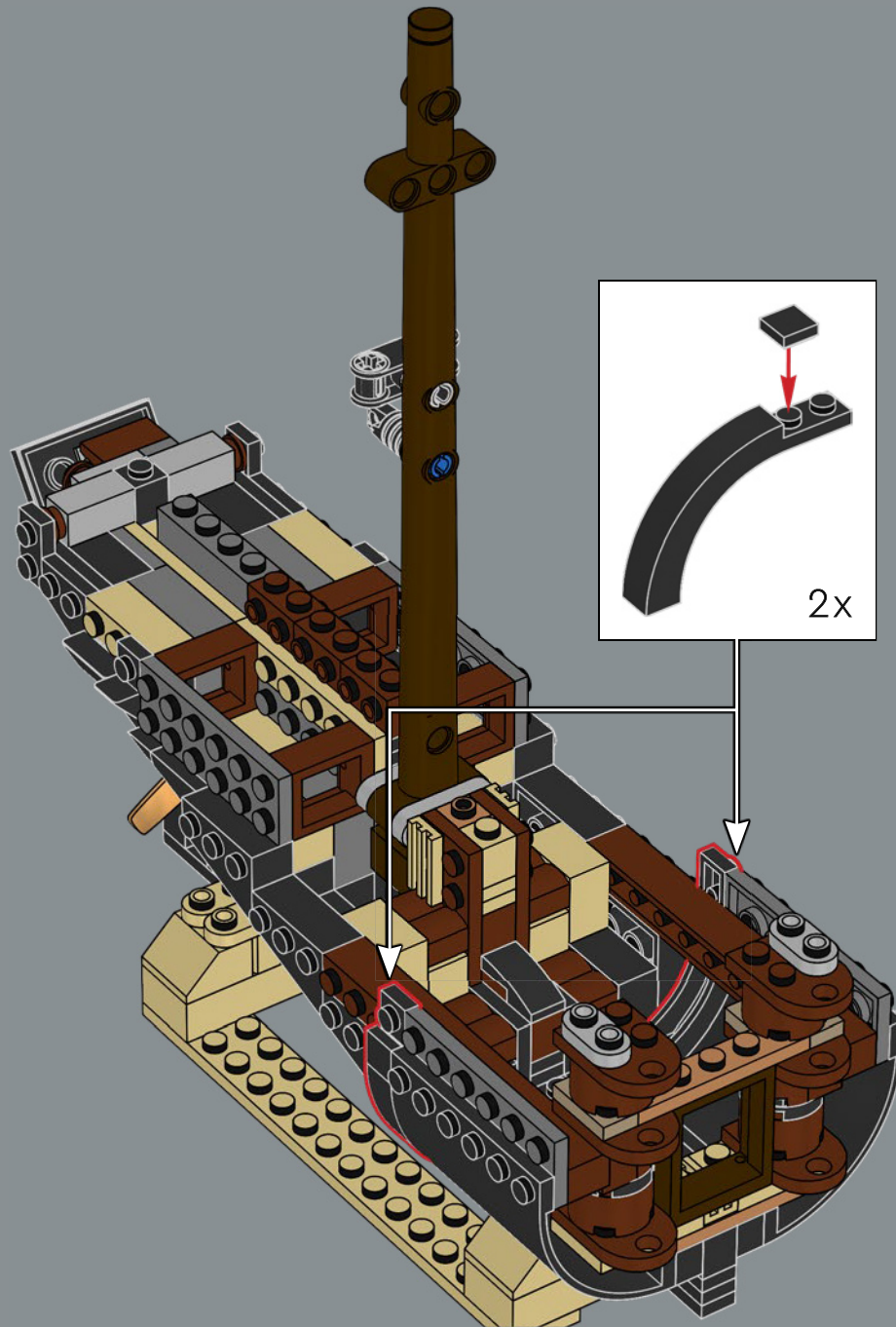

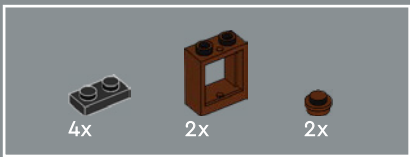

341

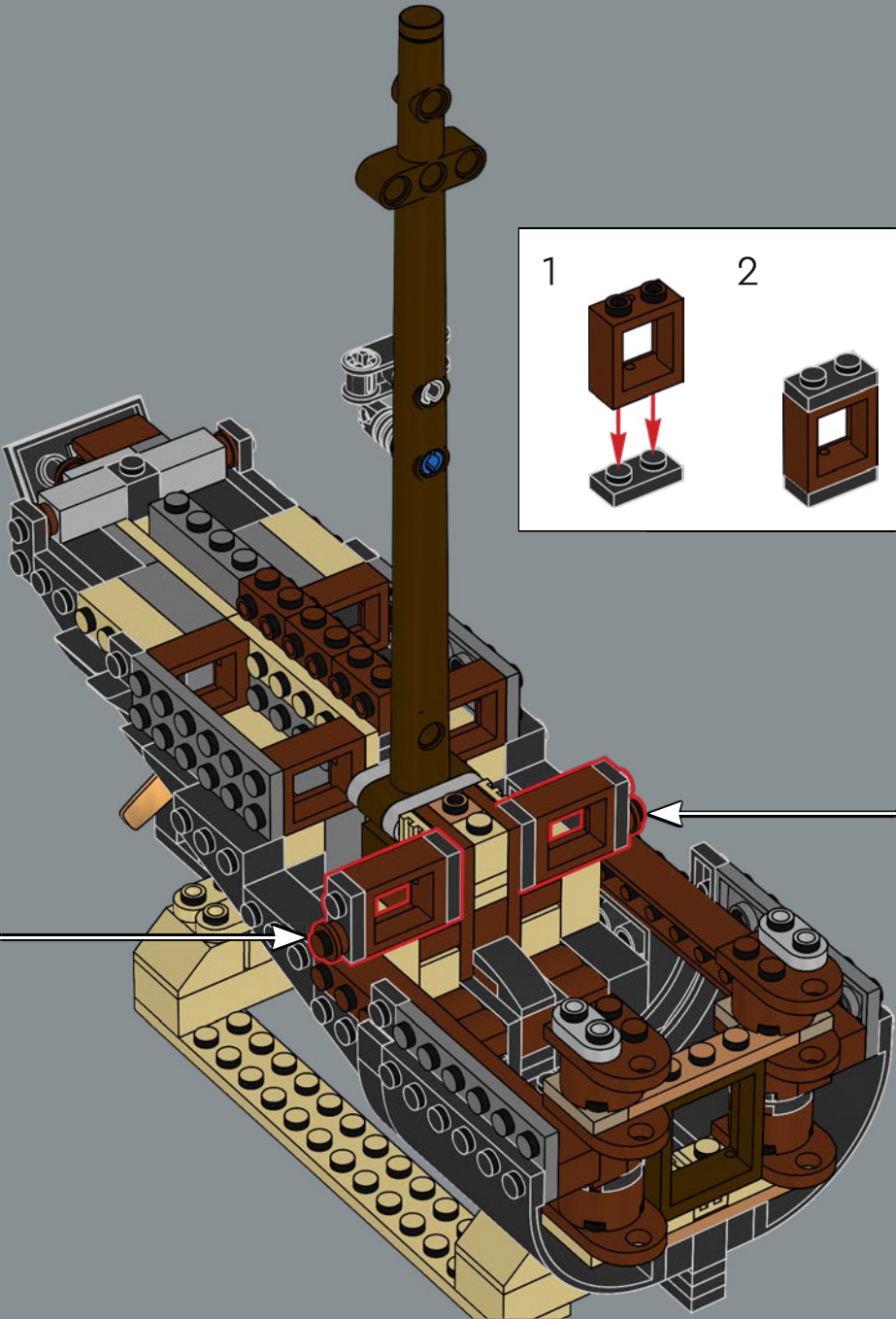
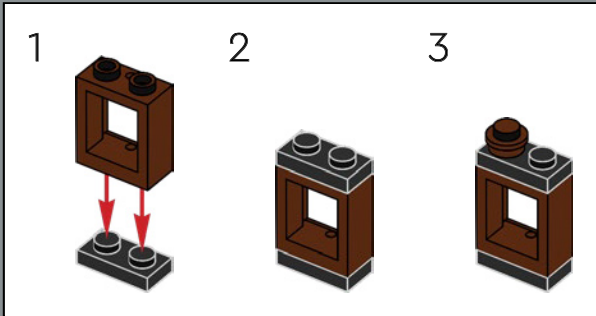
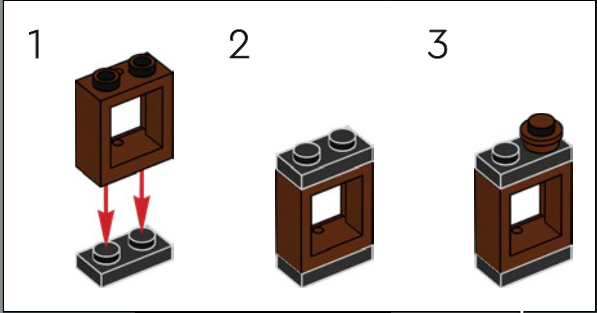

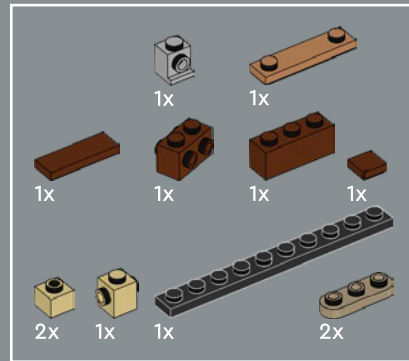
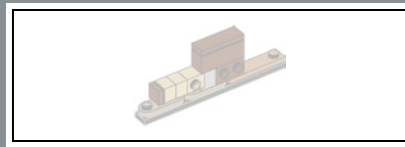

342

1

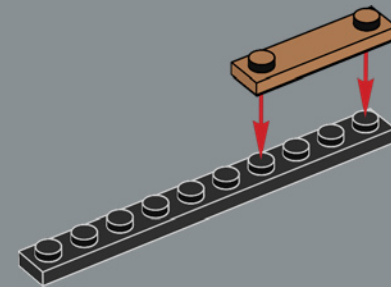

2

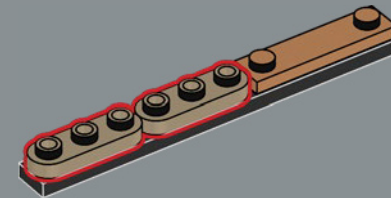

3

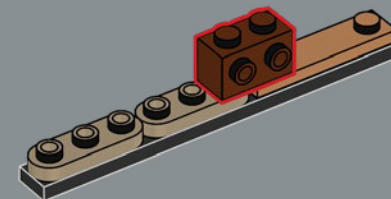

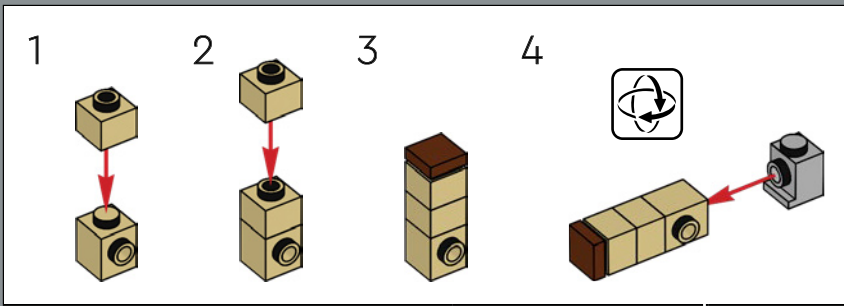

4

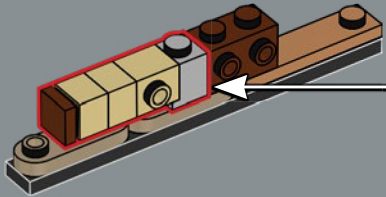

5

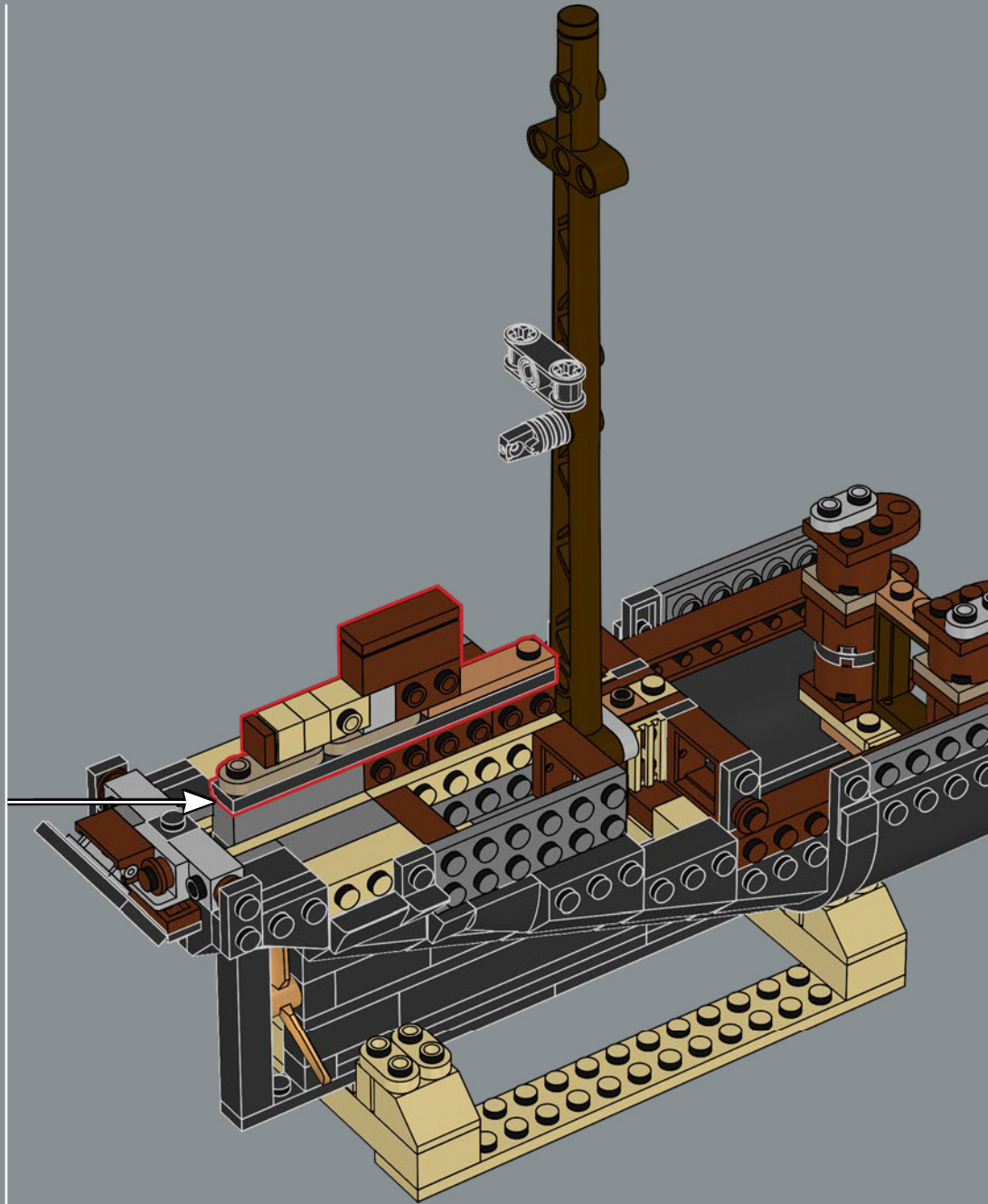
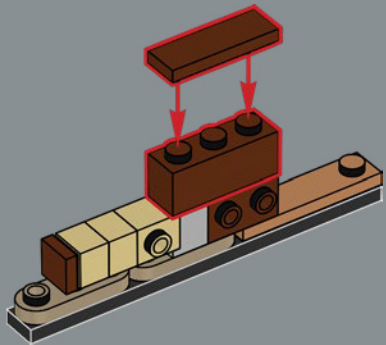

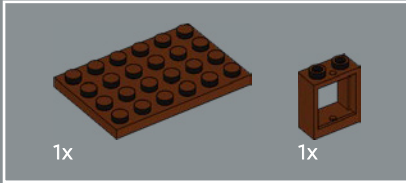
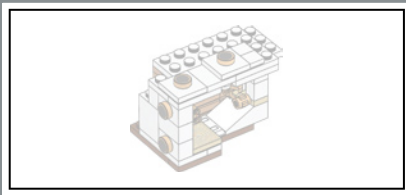

343

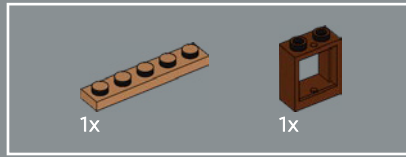
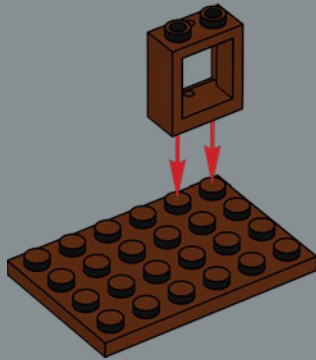

344

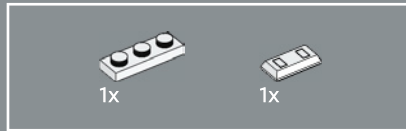
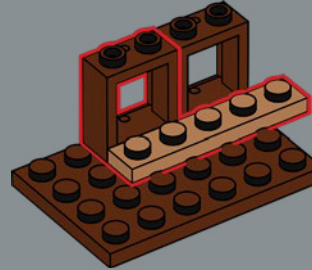

345

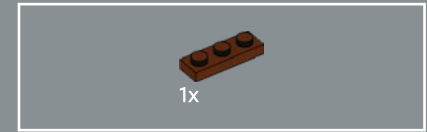
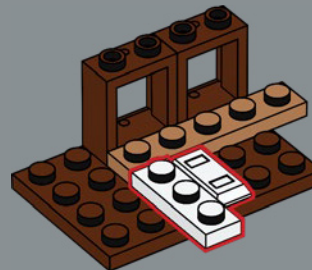

346

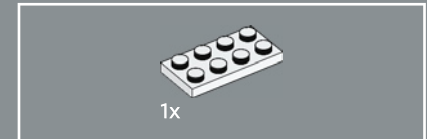
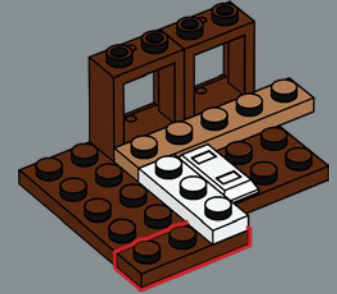

347

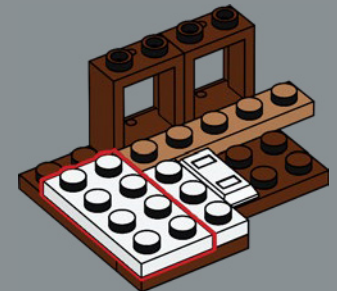

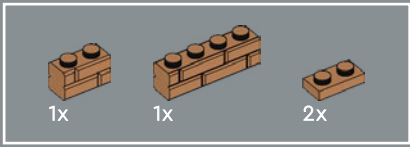

348

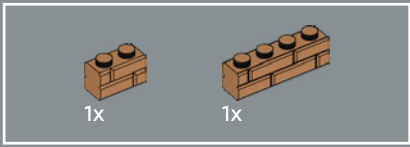
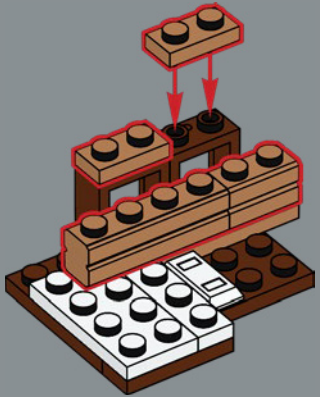

349

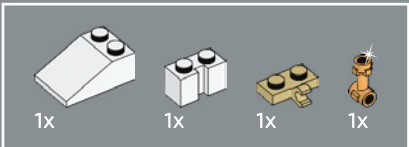
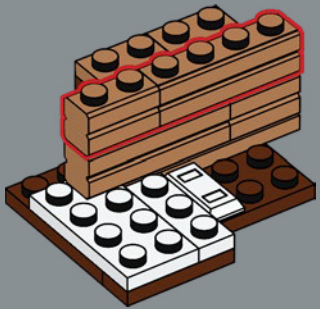

350

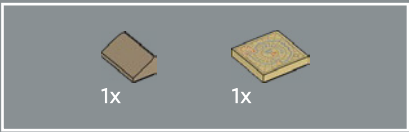
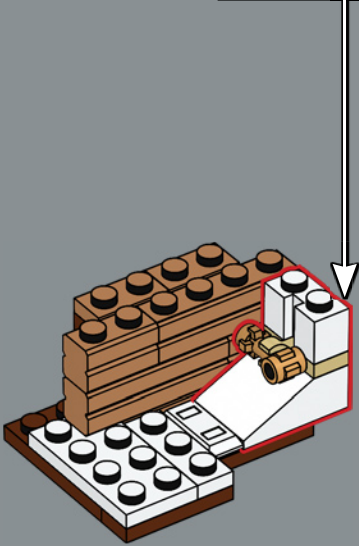
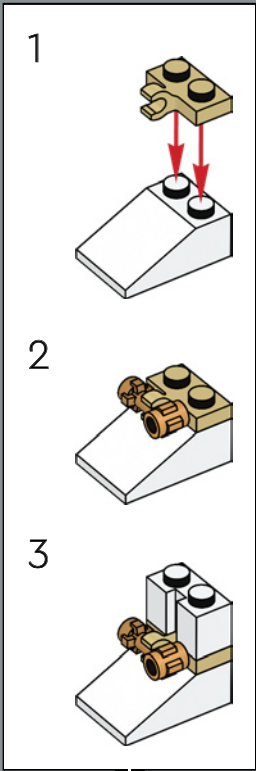

351

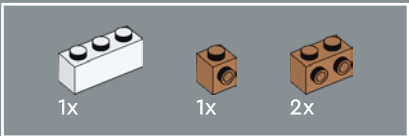
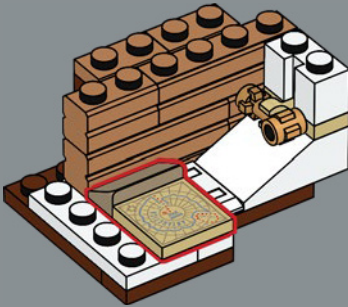

352

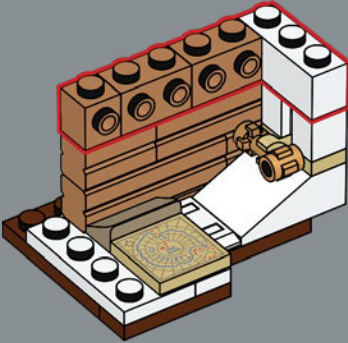

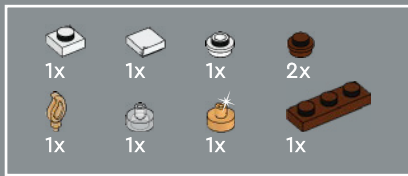

353

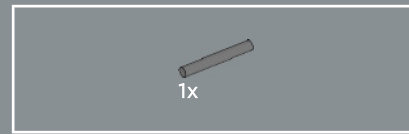
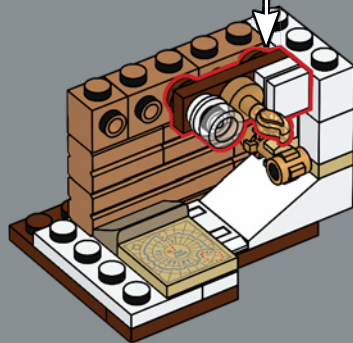
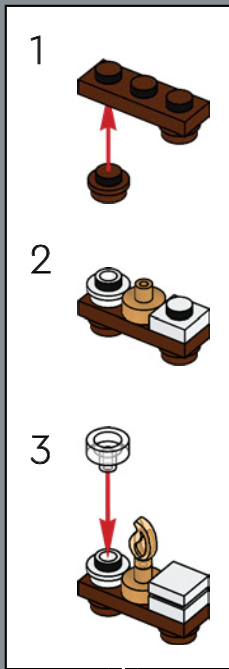

354

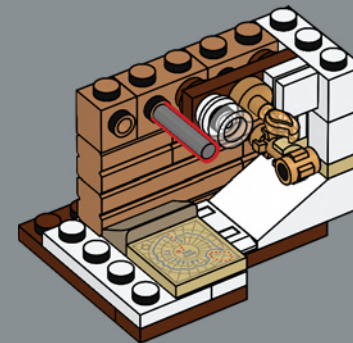

The dark gray vertical sticks inside the cabins are steam heating pipes. The scientists' cabin features an exclusive LEGO® map of Antarctica.

Les bâtons verticaux gris foncé à l'intérieur des cabines sont des tuyaux de chauffage à vapeur. La cabine des scientifiques présente une carte LEGO® exclusive de l'Antarctique.

Las pértigas en gris oscuro que atraviesan verticalmente los camarotes representan tuberías de vapor para calefacción. El camarote de los científicos incluye un exclusivo mapa LEGO® de la Antártida.

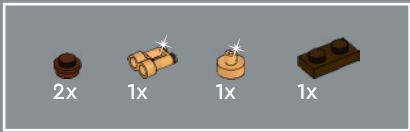

355

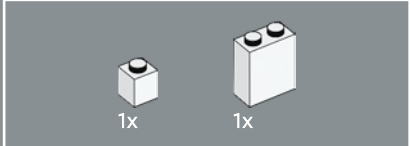
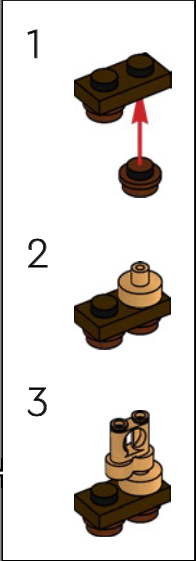
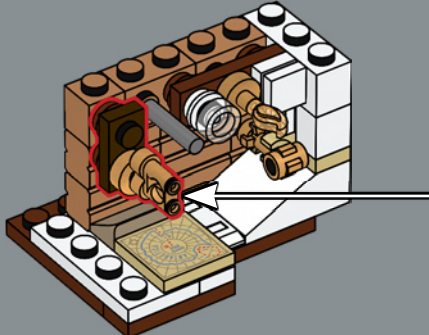

356

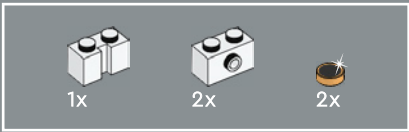
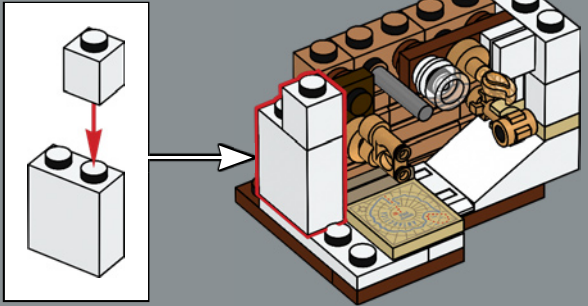

357

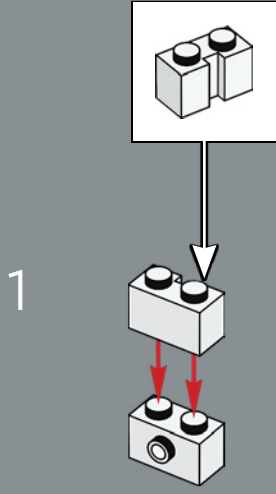

2

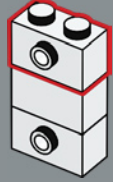

3

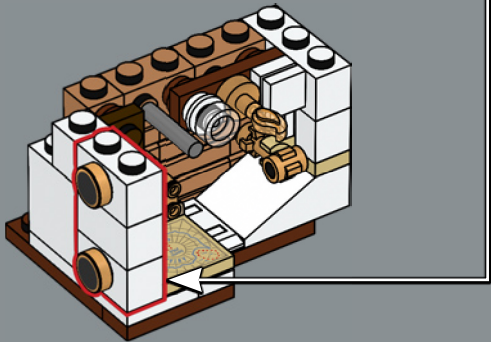
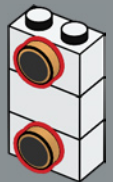

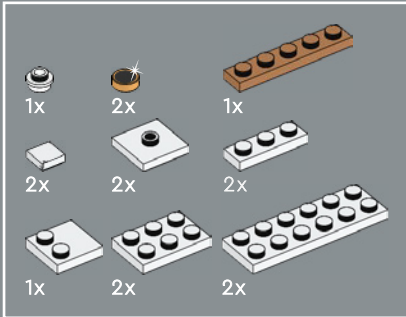
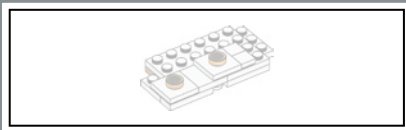

358

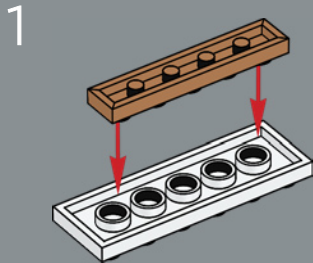

2

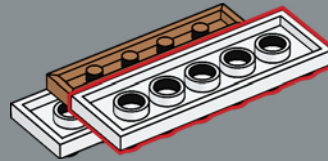

3

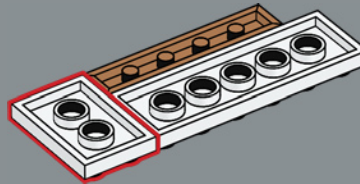

4

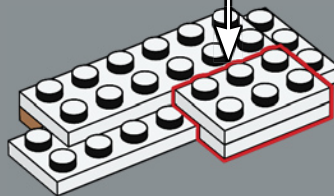
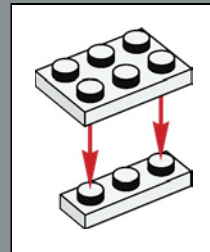

5

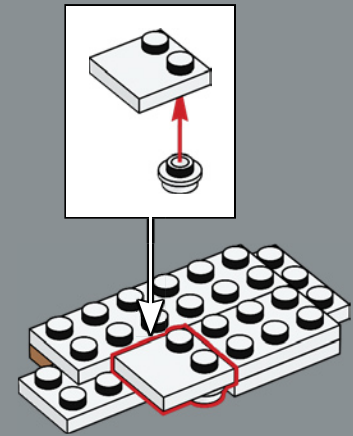

6

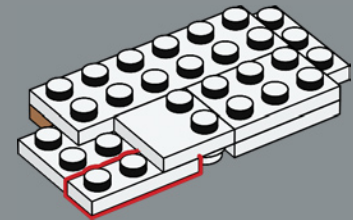

7

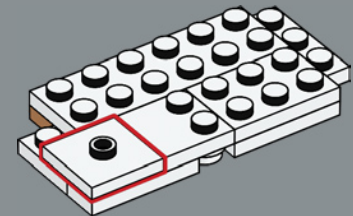

8

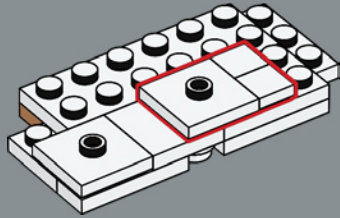

9

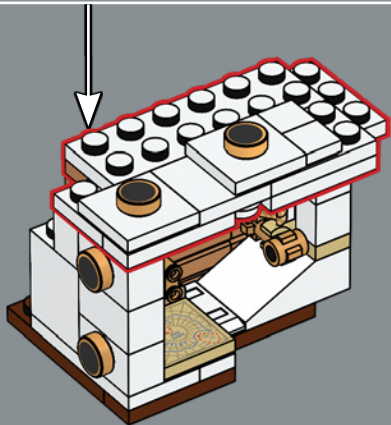
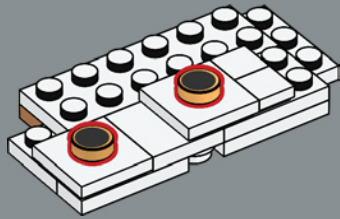

359

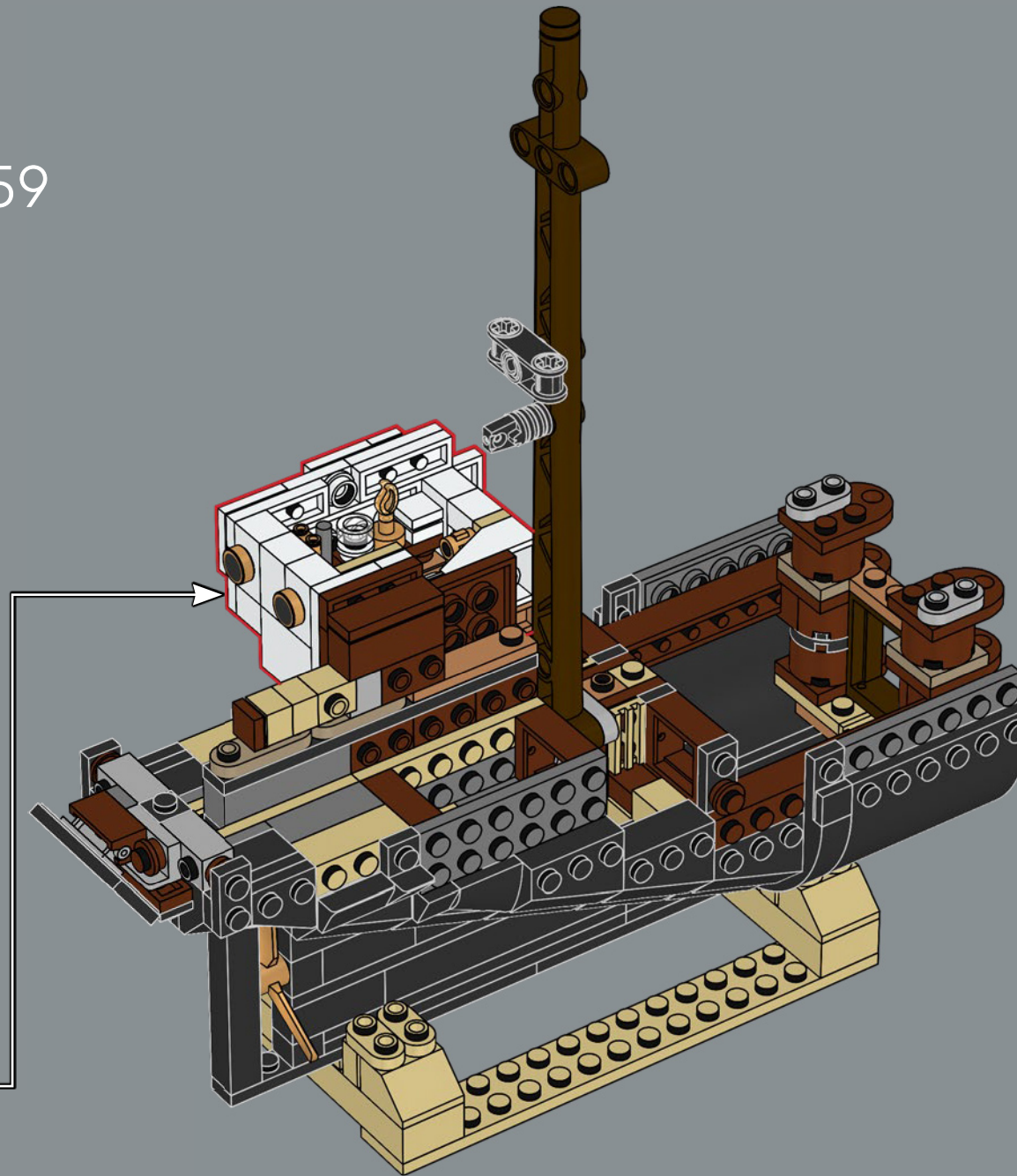

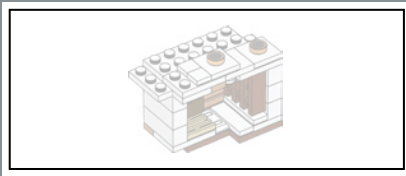

360

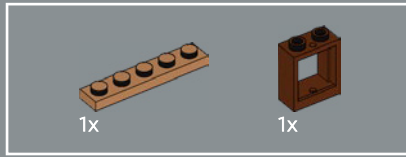
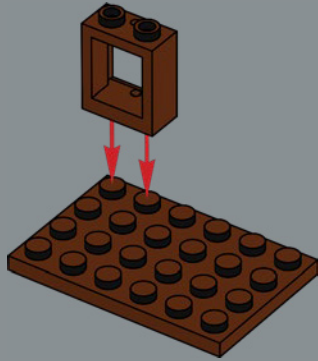

361

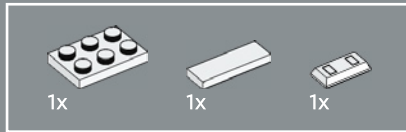
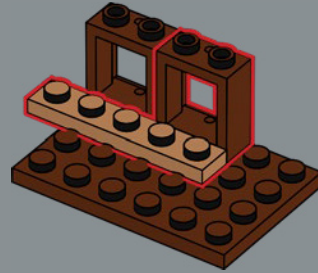

362



363

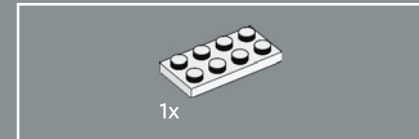
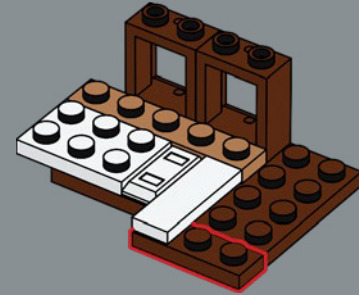

364

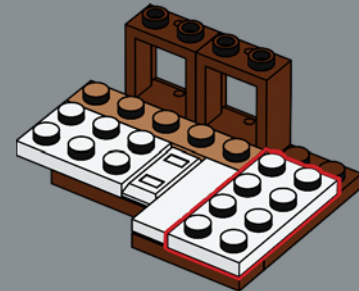

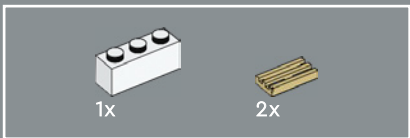

365

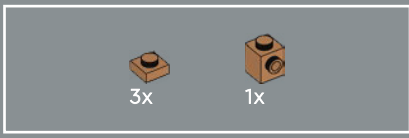
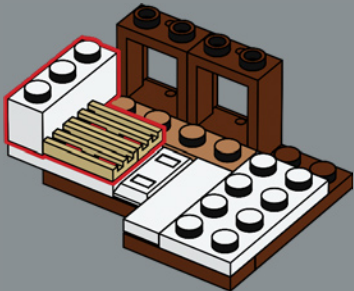

367

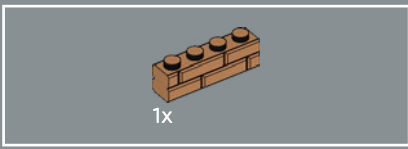
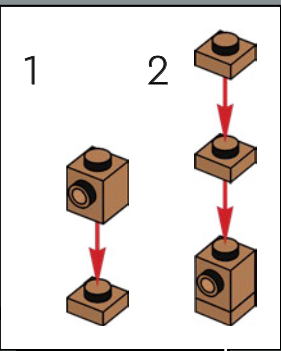
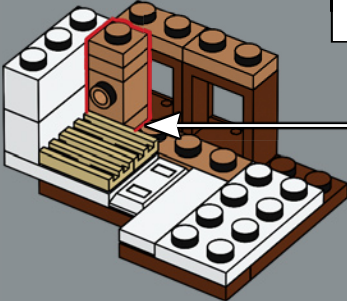

369

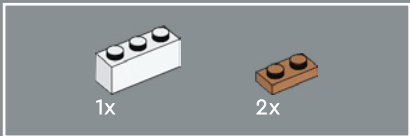
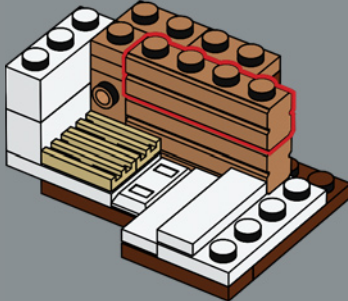

366

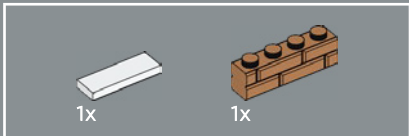
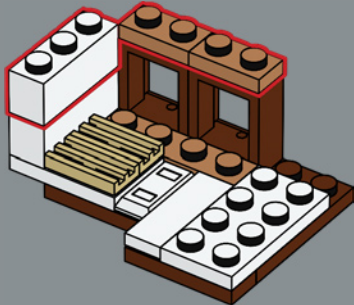

368

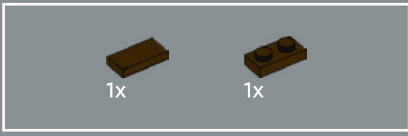
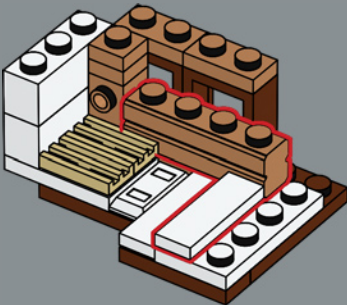

370

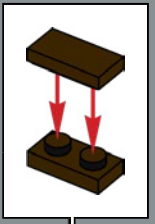
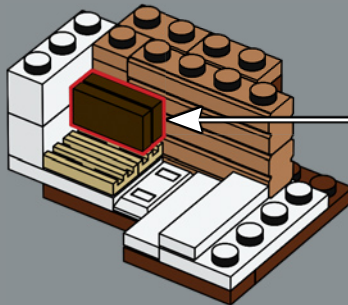

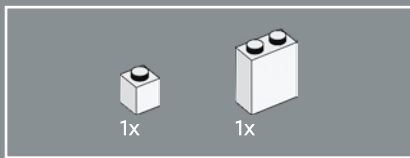

371

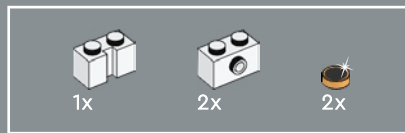
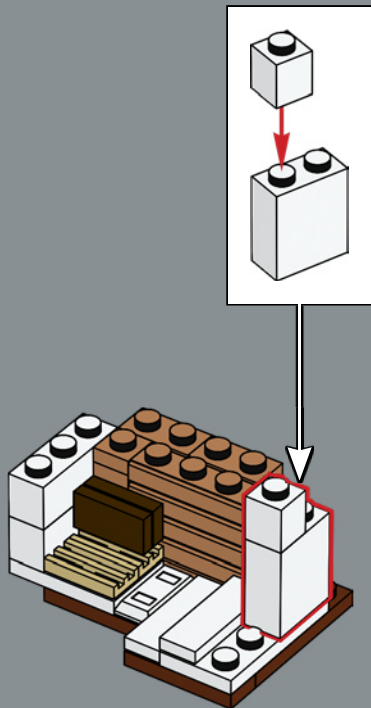

372

1

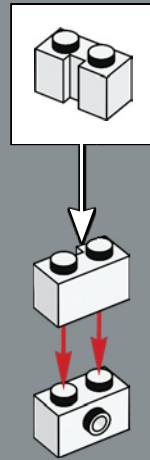

2

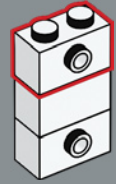

3

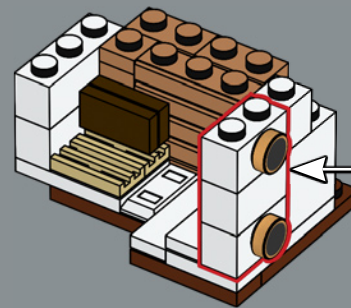
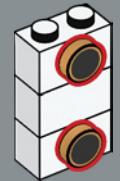

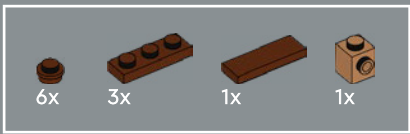

373

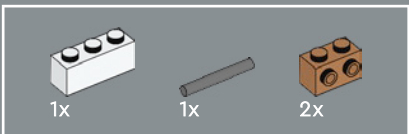
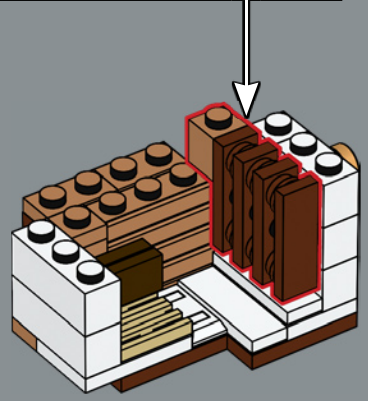
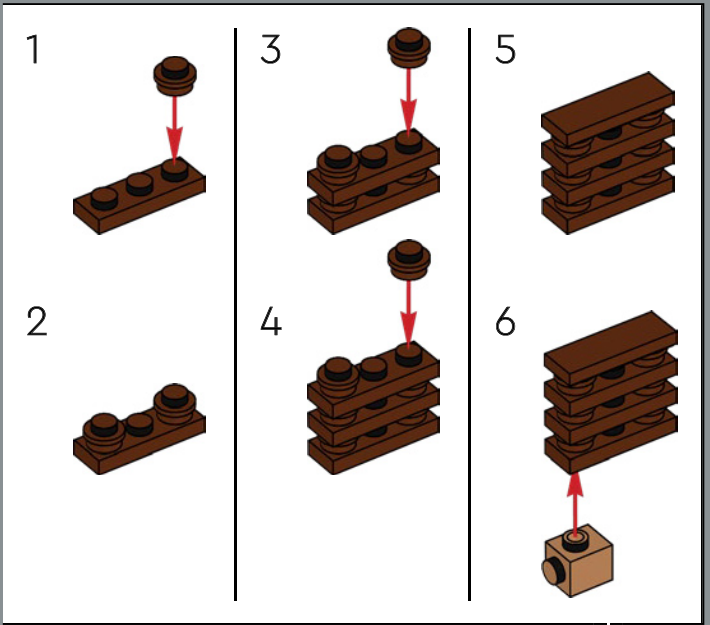

374

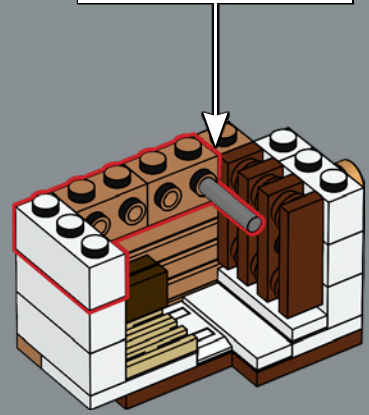
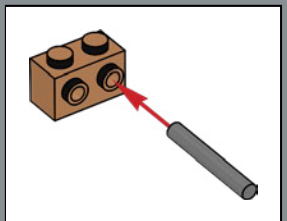

375

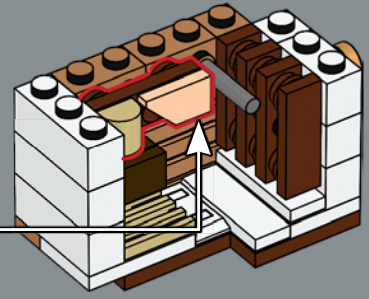
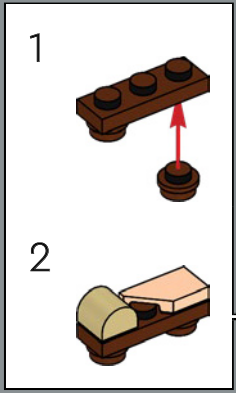

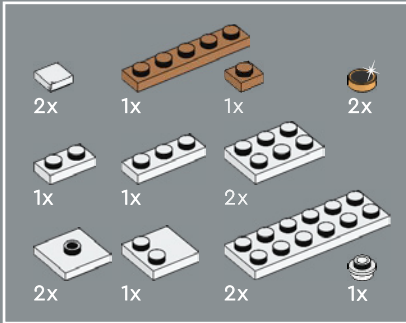
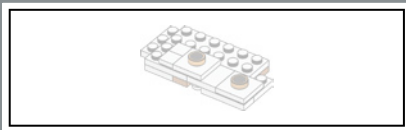

376

1

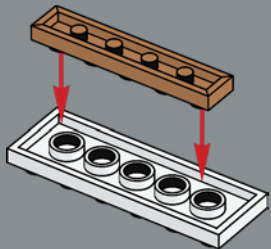

2

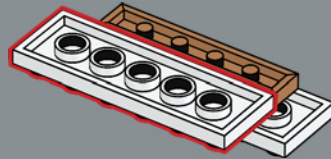

3

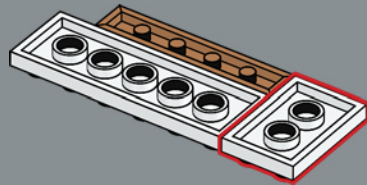

4

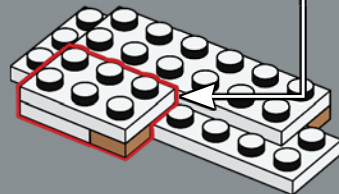
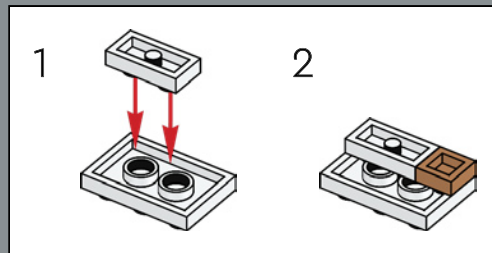

5

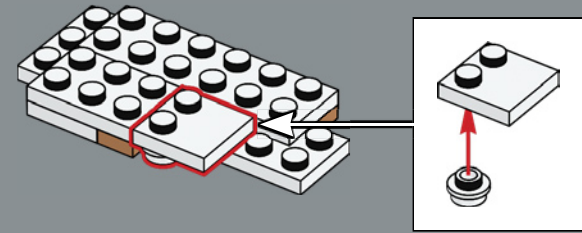

6

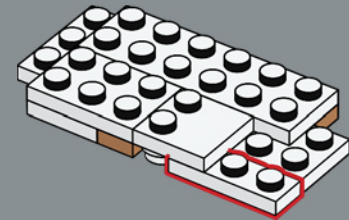

7



8

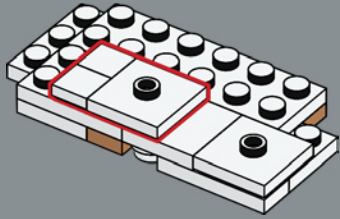

9

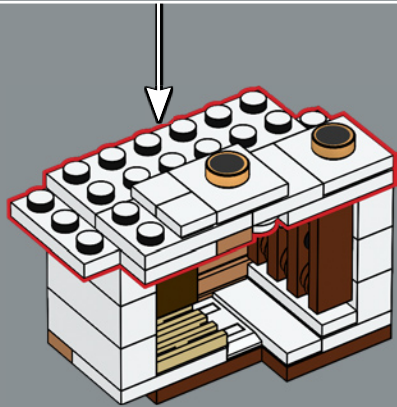
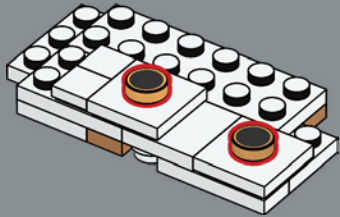

377

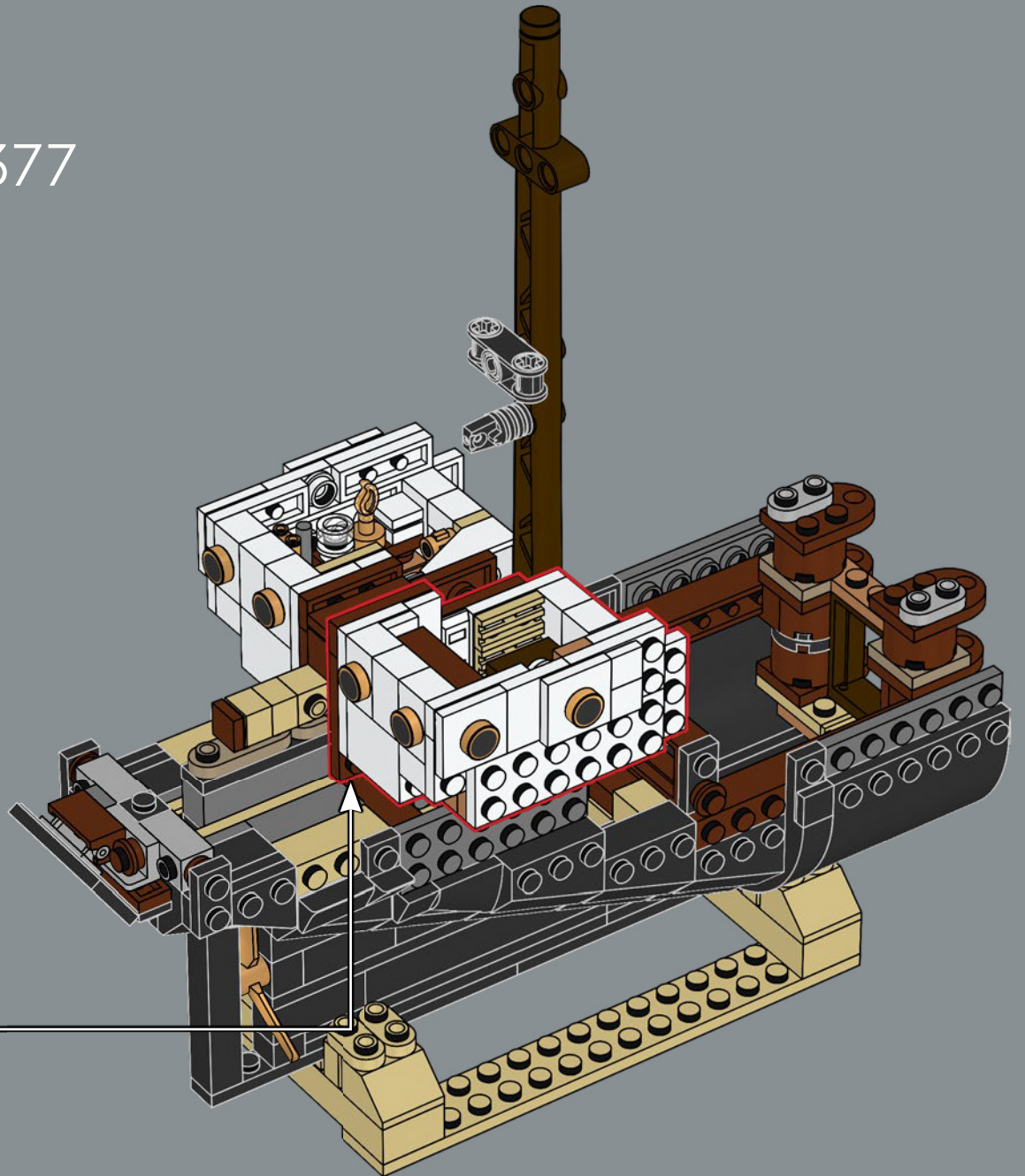

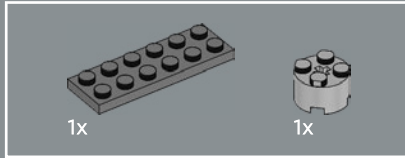
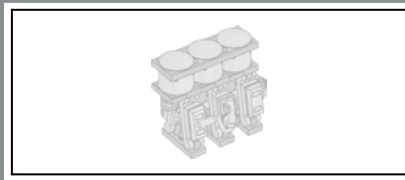

378

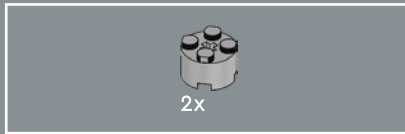
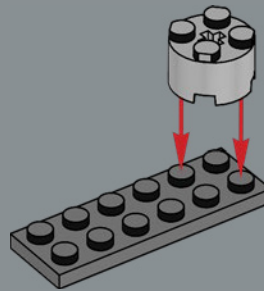

379

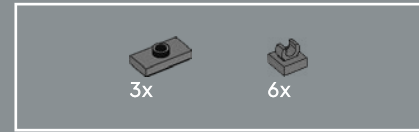
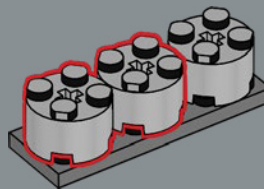

380

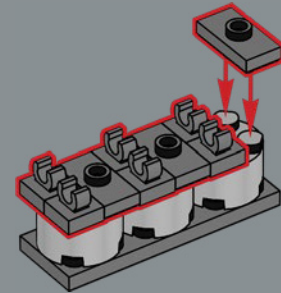

381

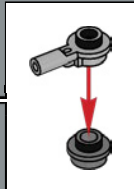
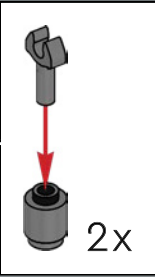
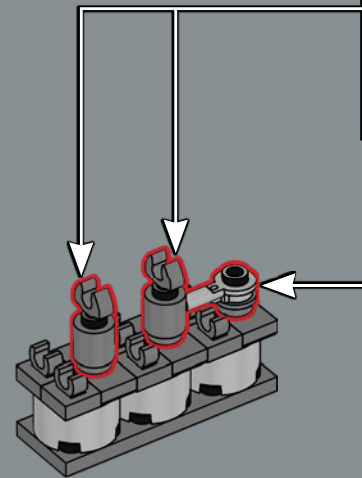

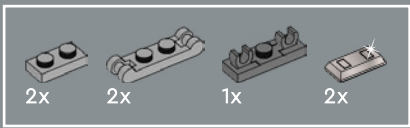

382

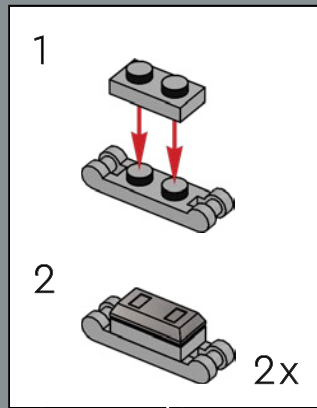

1

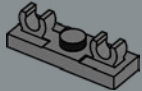

2

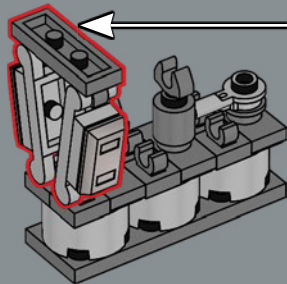
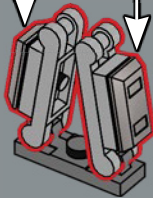

383

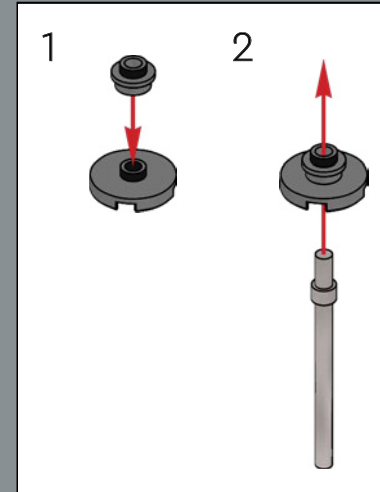

1

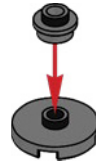

2

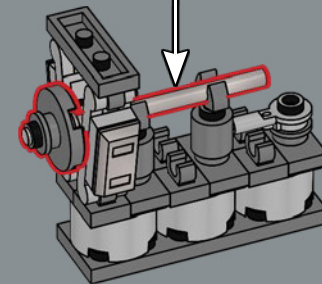
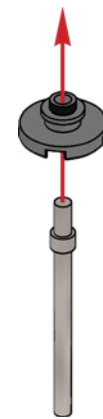

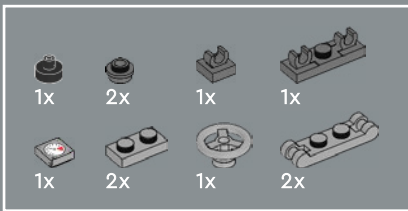

384

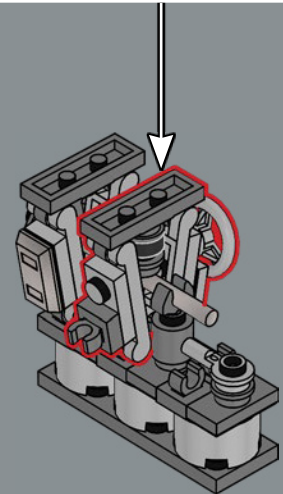
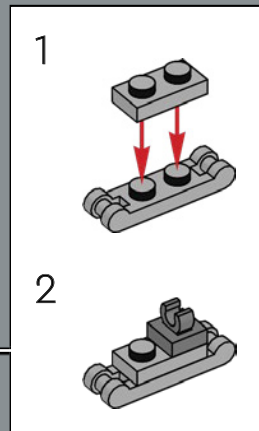
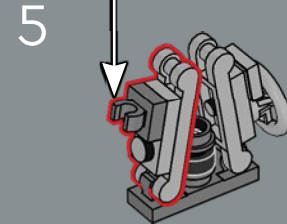
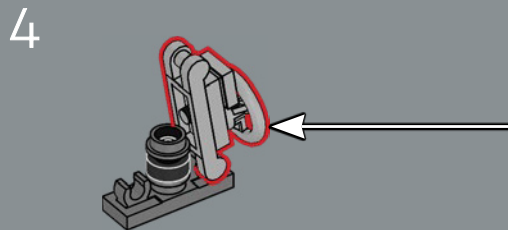
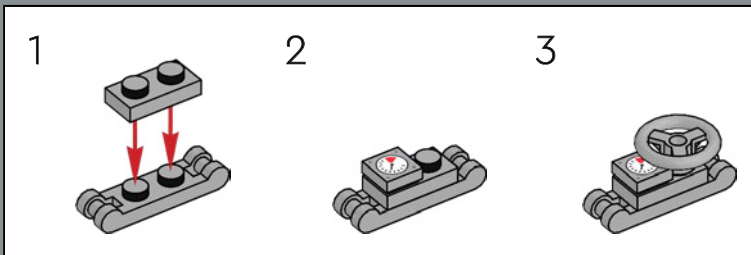
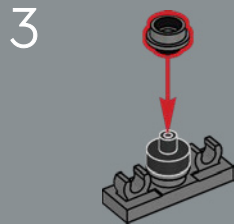
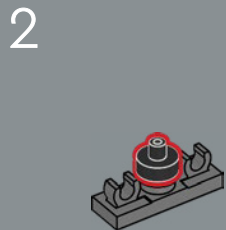
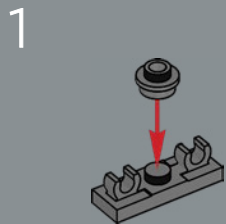

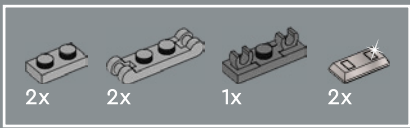

385

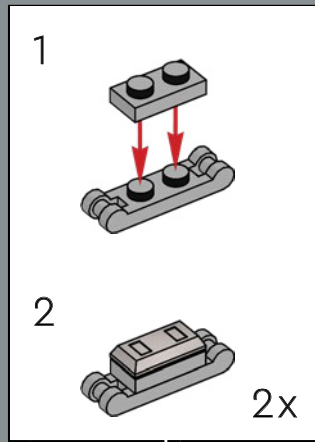

1

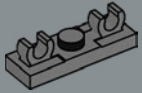

2

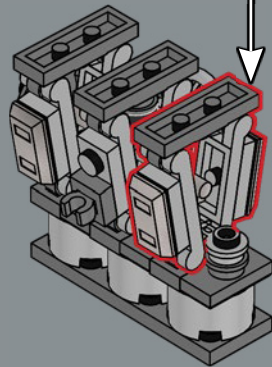
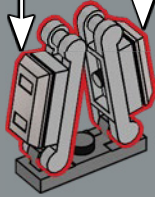

386

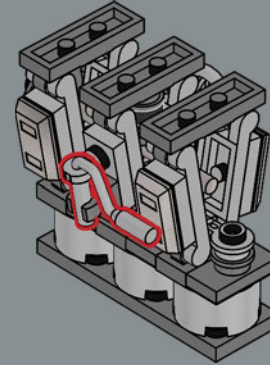

387

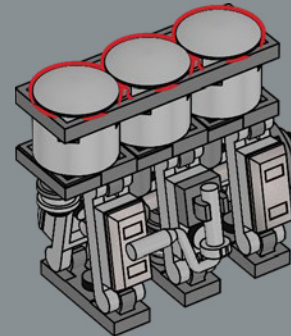



388

The 'triple-expansion steam engine' can be removed from the engine room and put on display.

Le « moteur à vapeur à triple expansion » peut être retiré du compartiment moteur et exposé.

Es posible extraer la máquina de vapor de triple expansión de la sala de máquinas para exhibirla aparte.

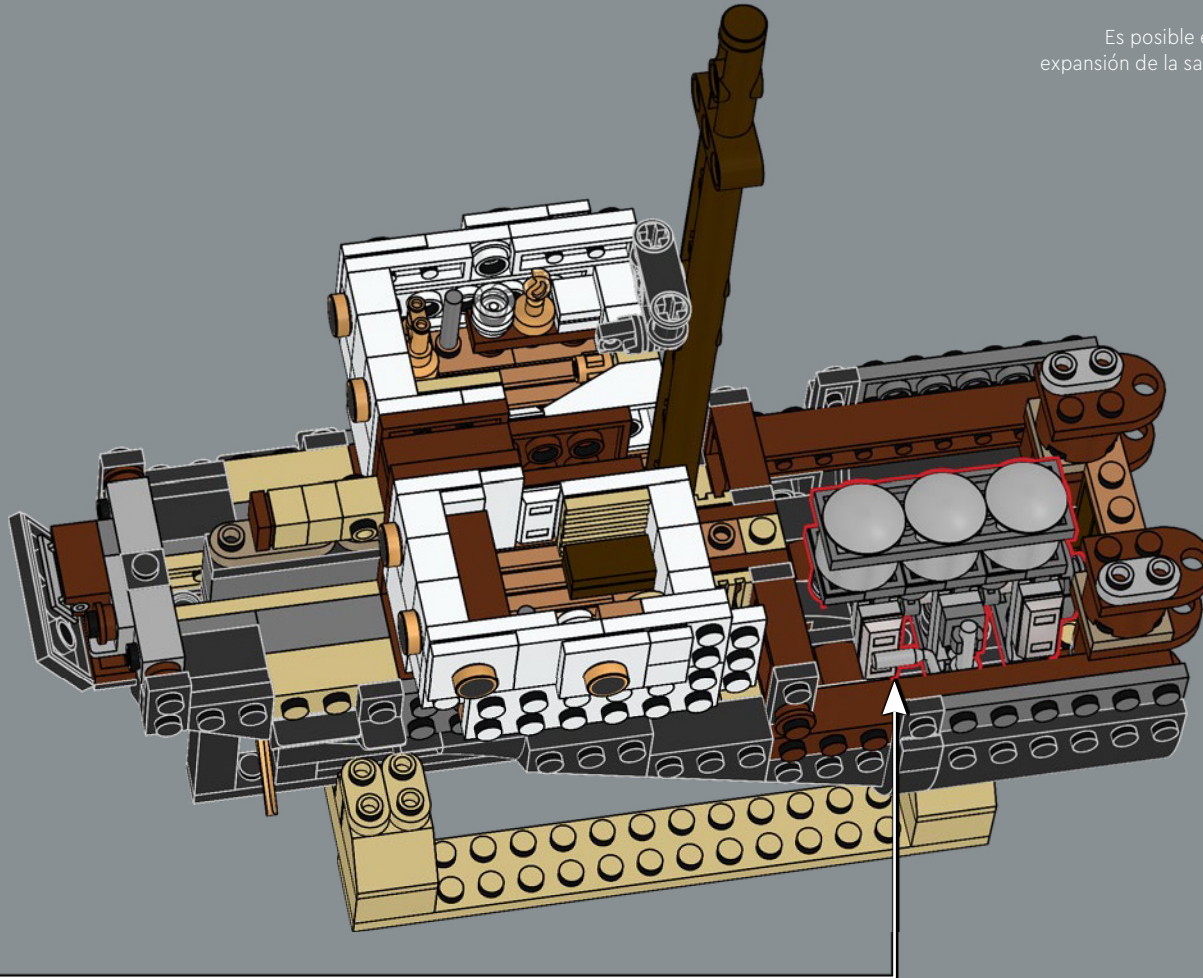

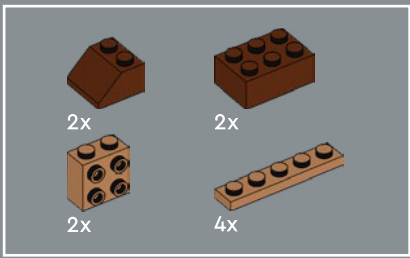

389

1

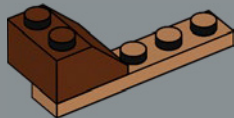

2

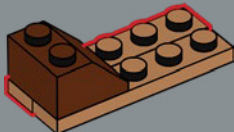

3

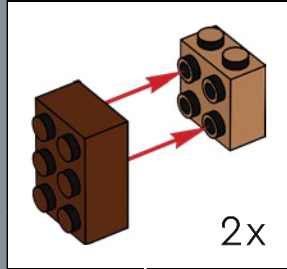
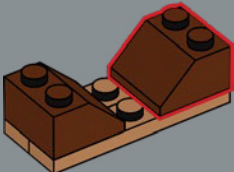

4

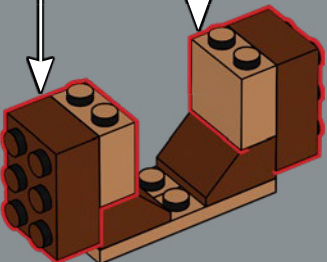

5

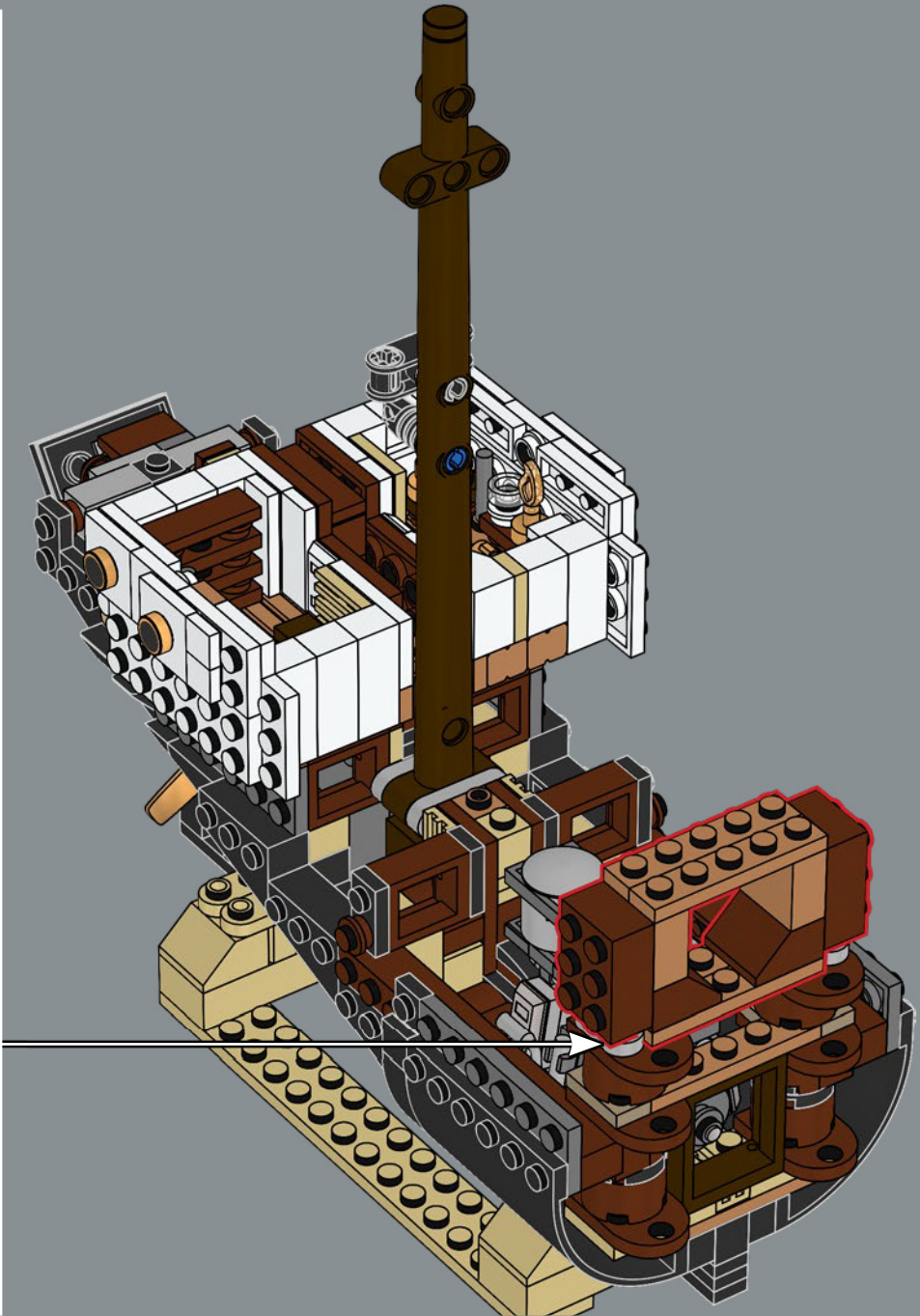
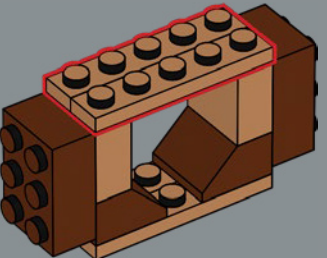

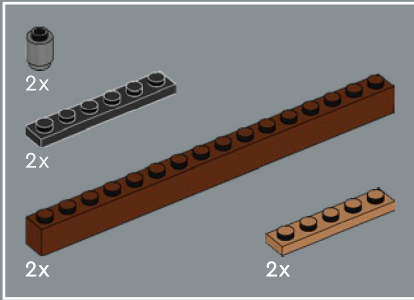
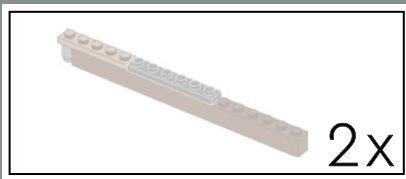

390

1

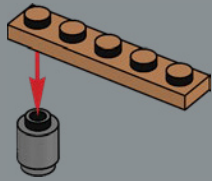

2

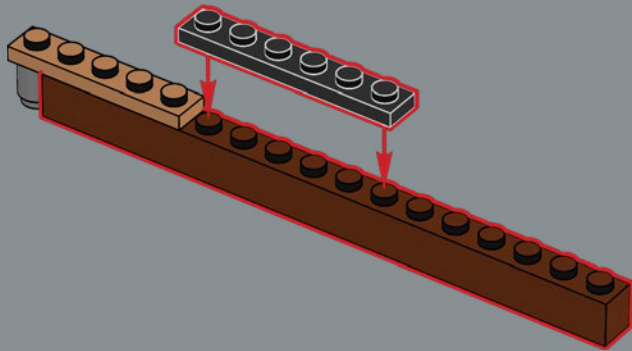

2x

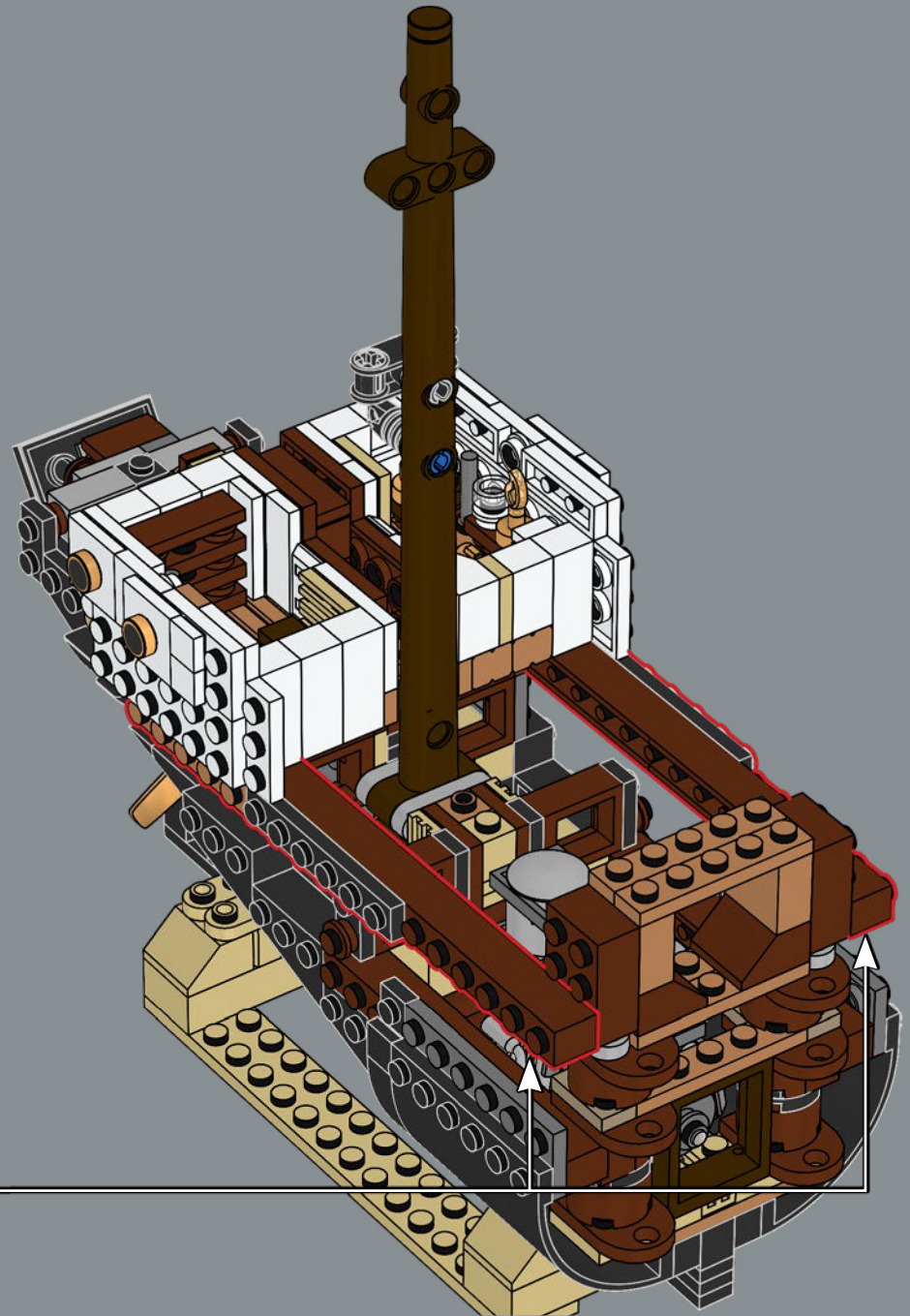

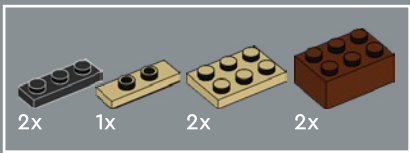

391

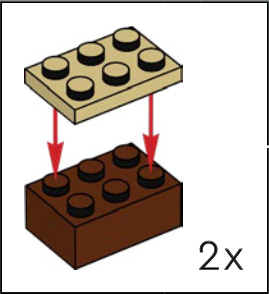
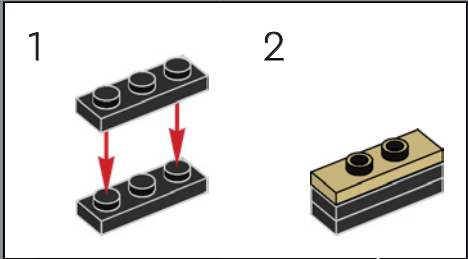
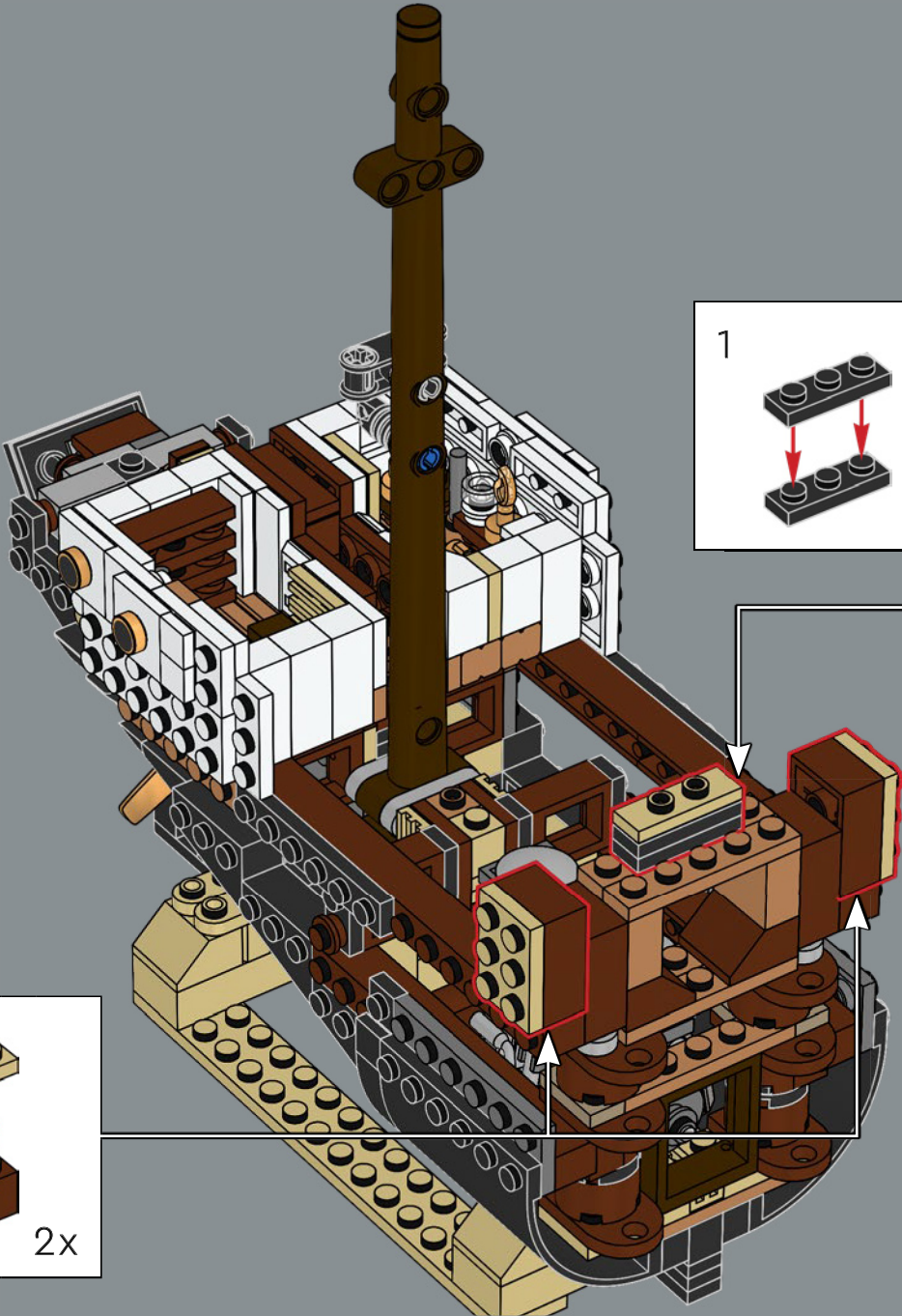

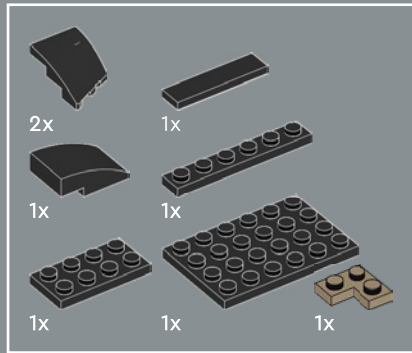

392

1

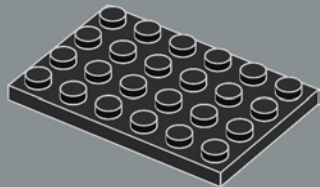

2

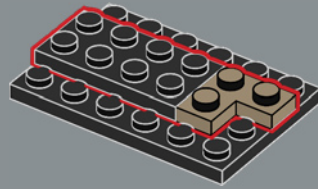

3

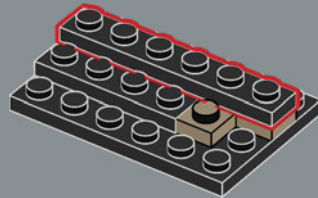

4

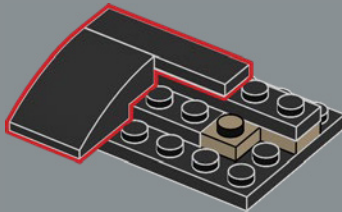

5

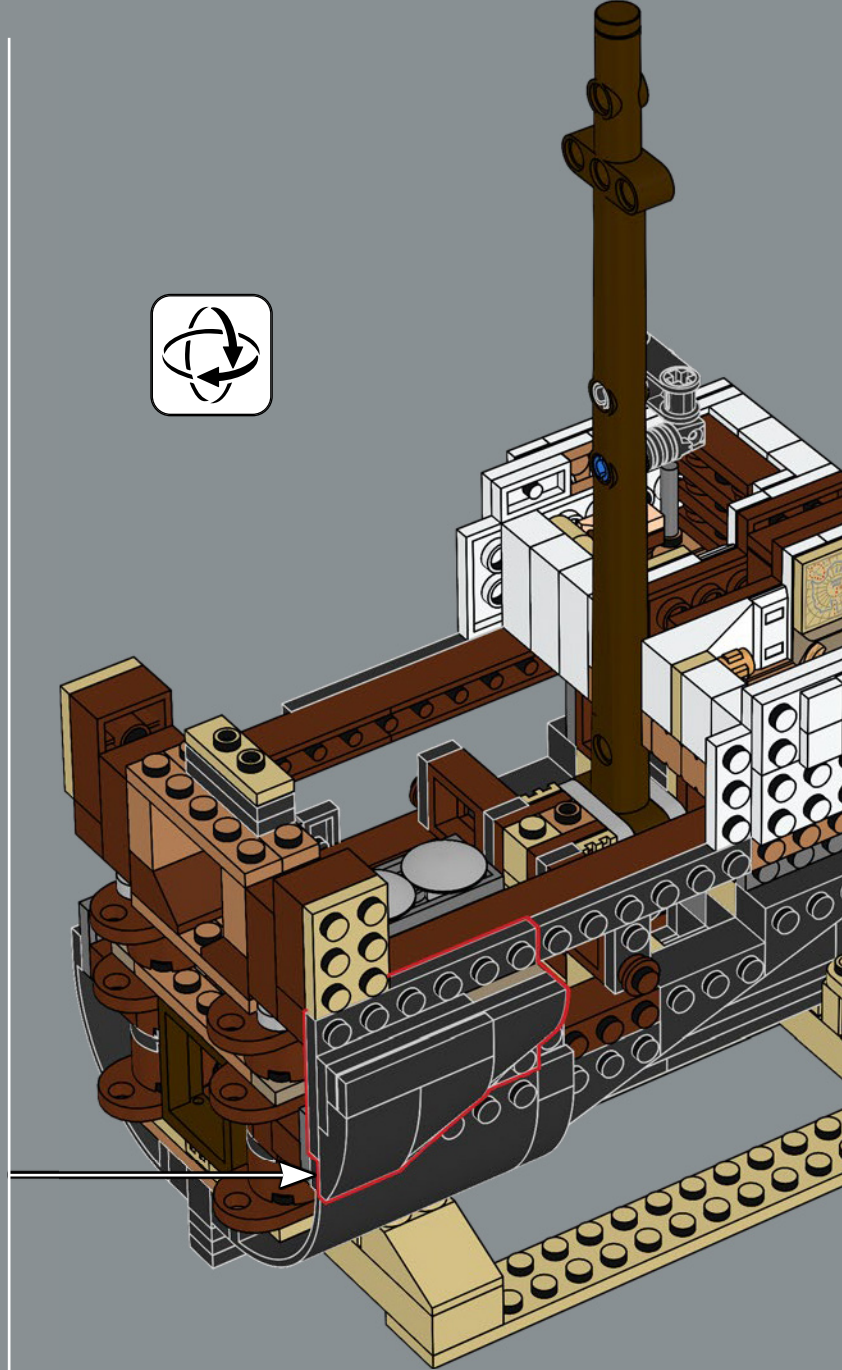
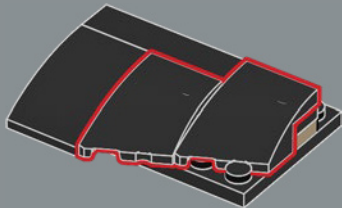

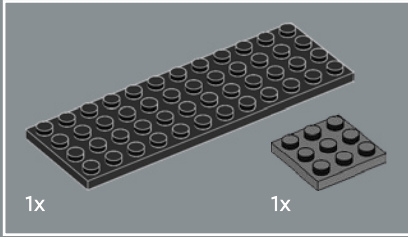
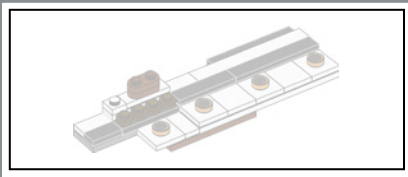

393

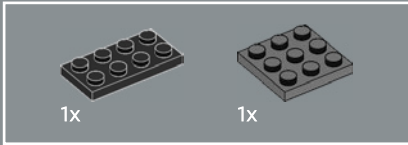
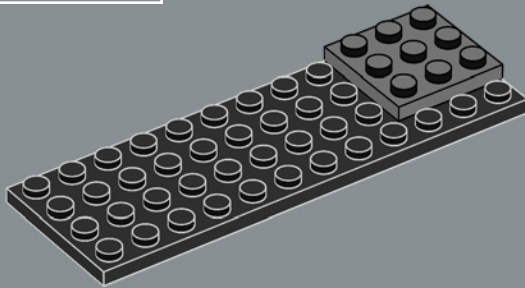

394

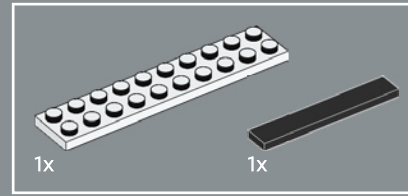
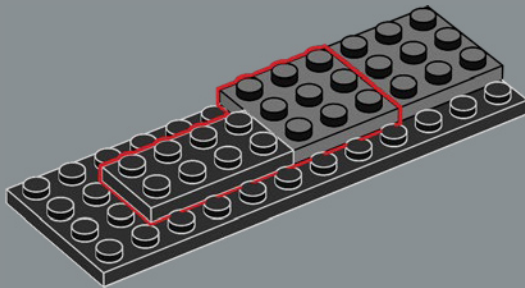

395

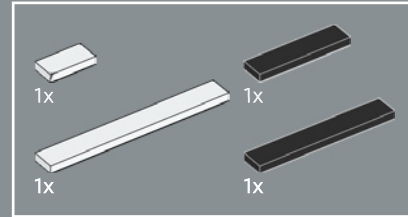
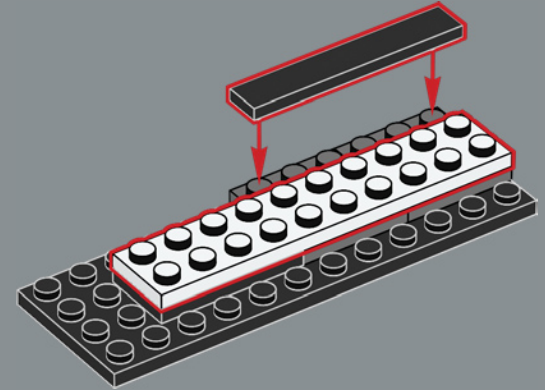

396

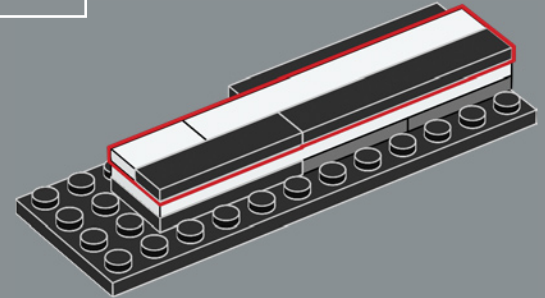

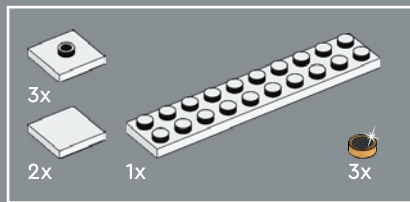

397

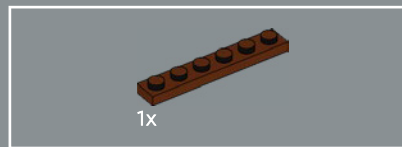
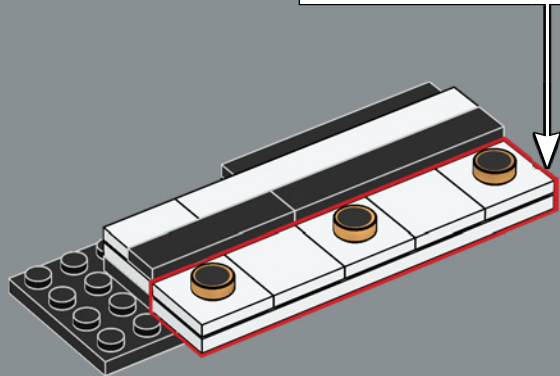
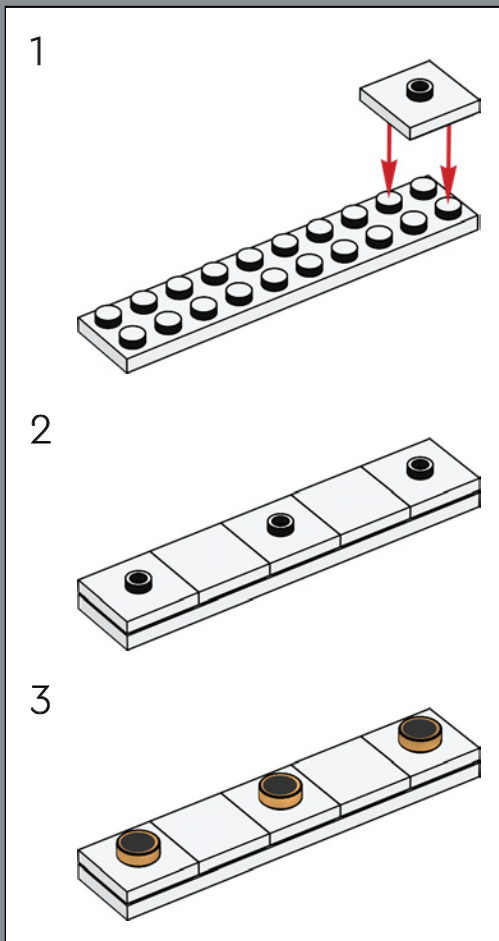

398

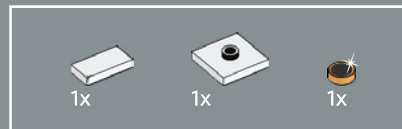
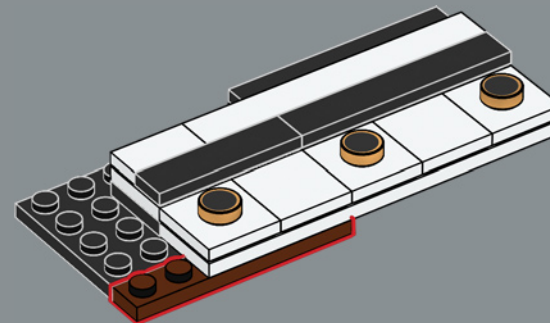

399

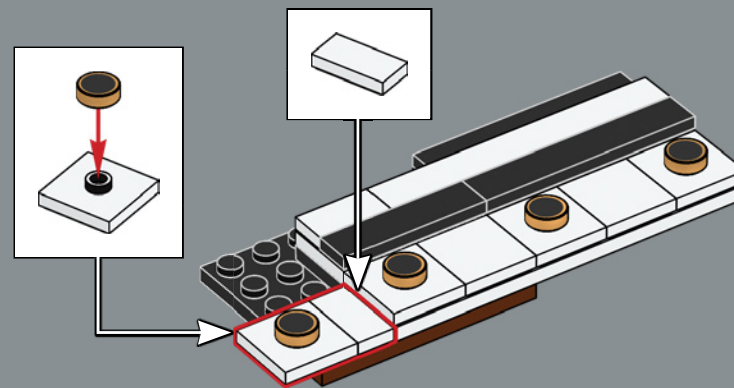

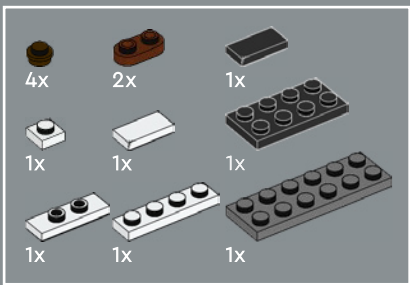

400

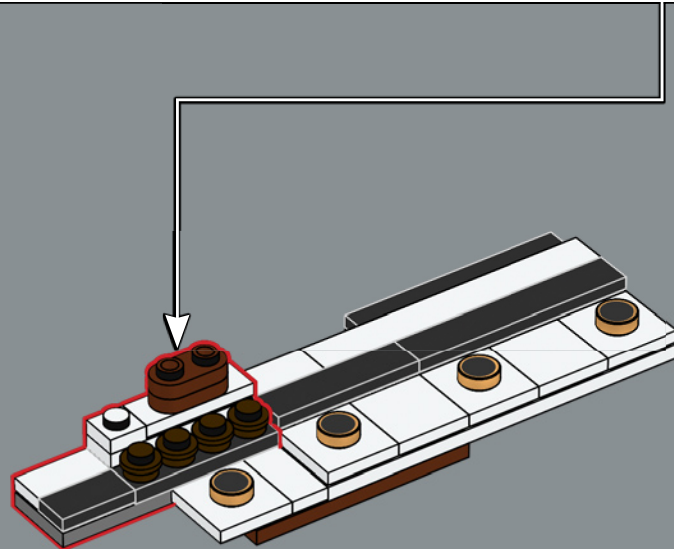
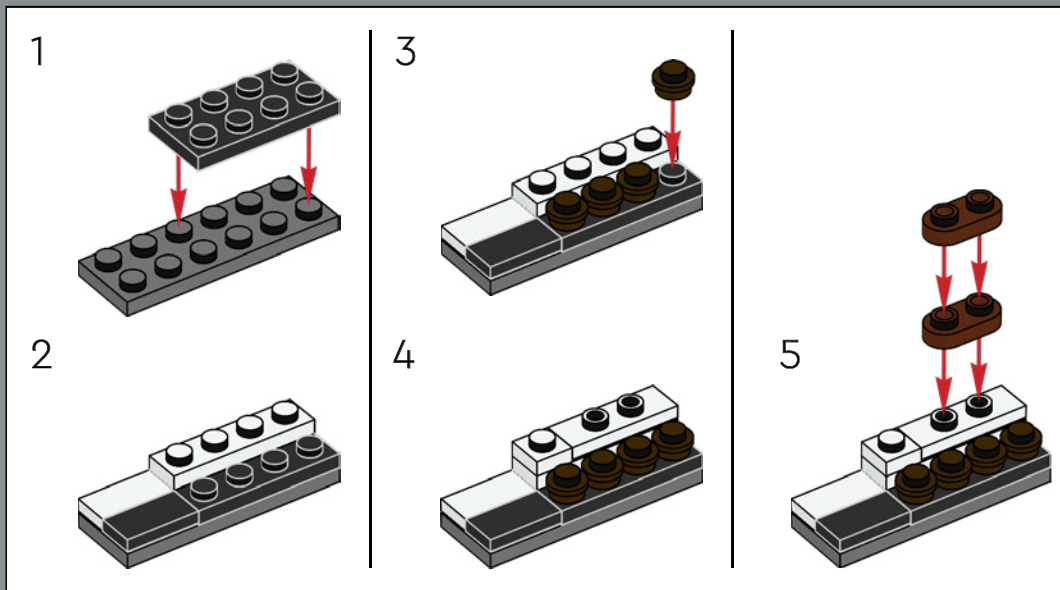

401

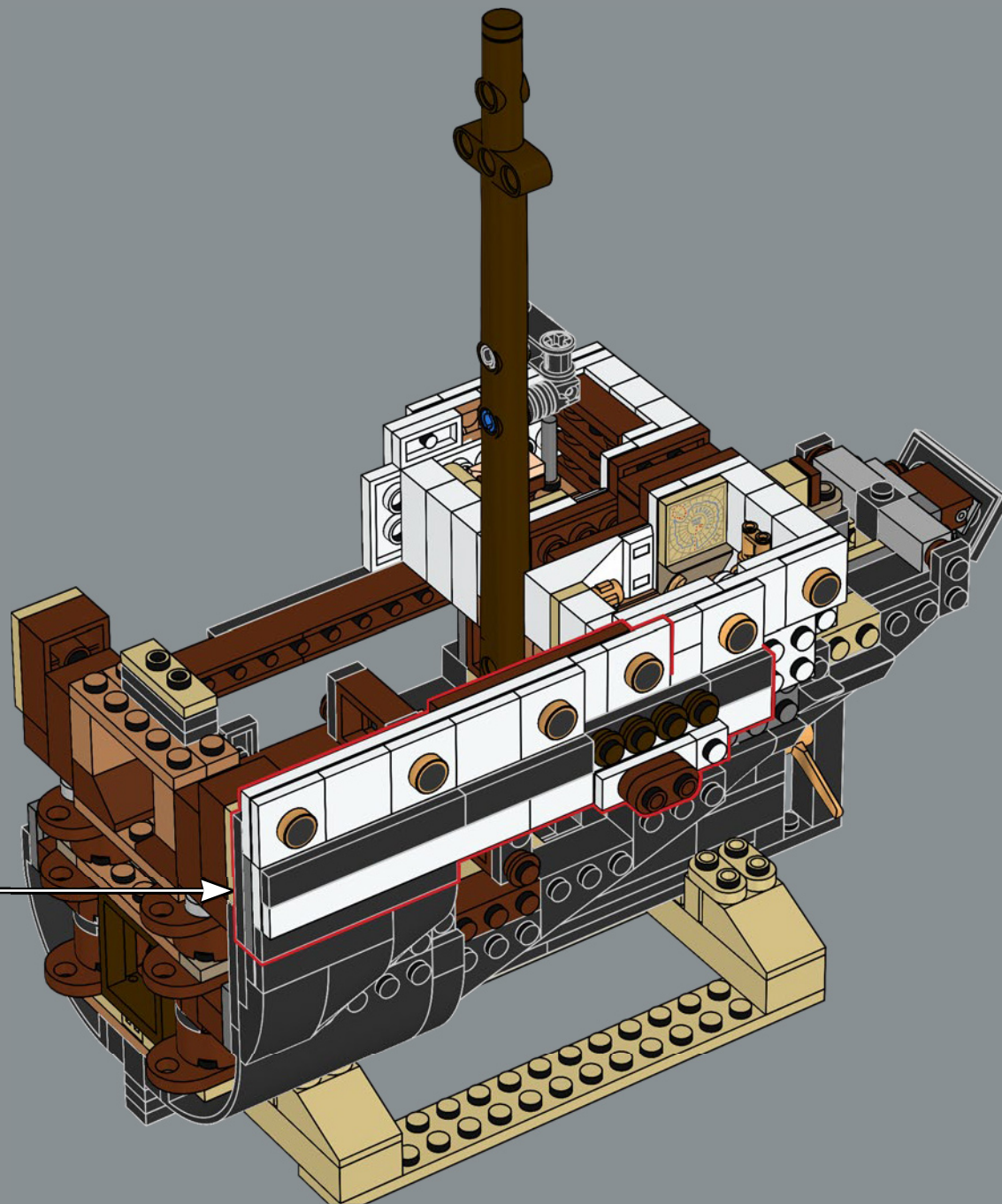

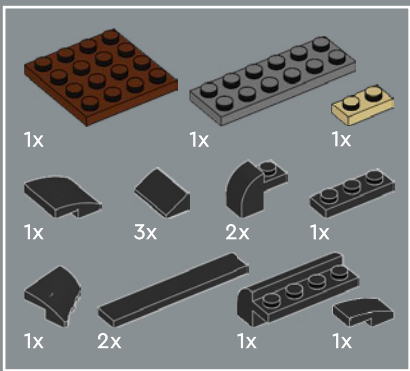

402

1

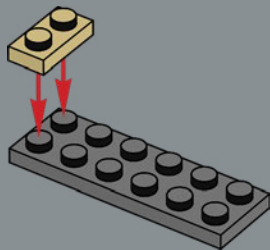

2

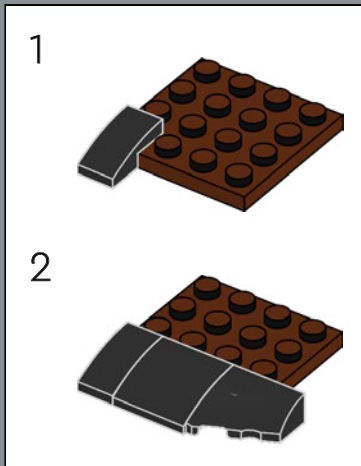
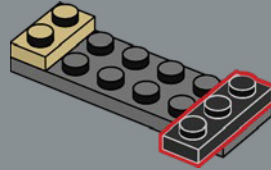

3

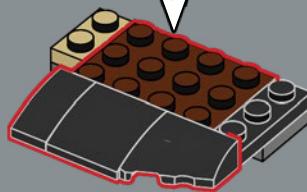

4

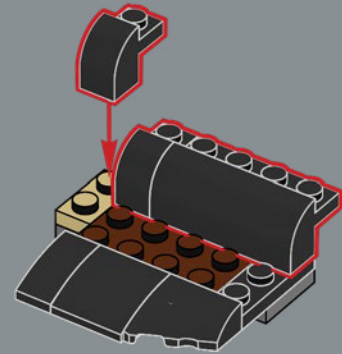

5

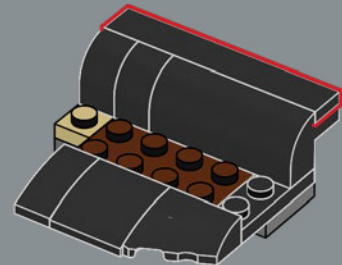

6

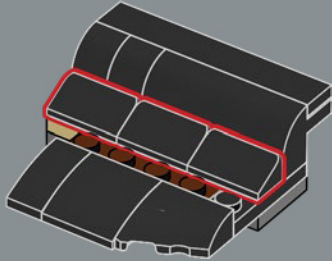

7

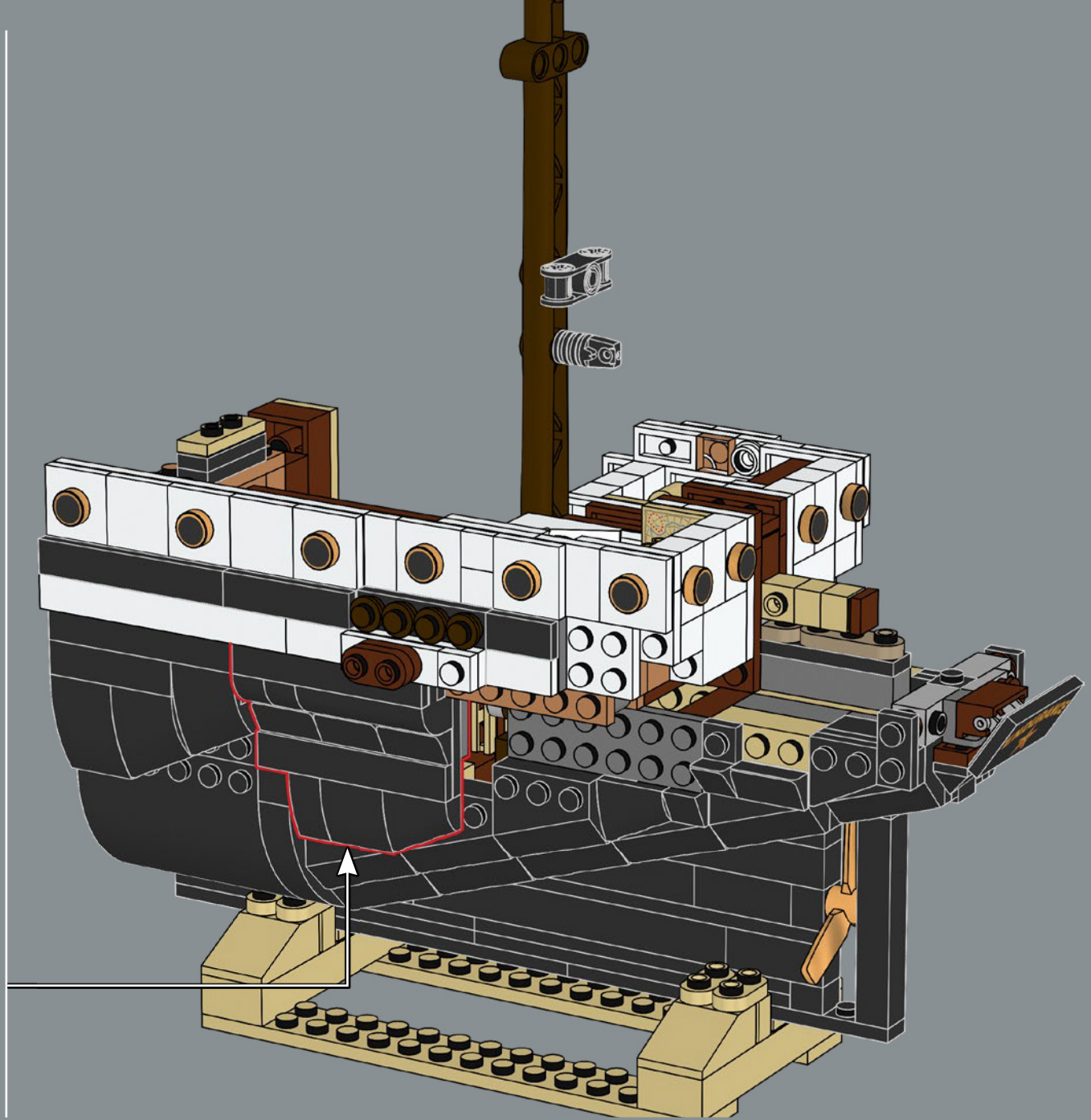
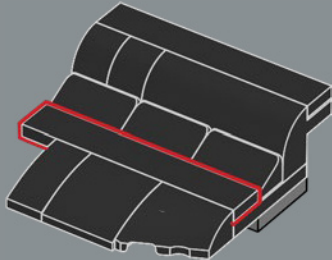

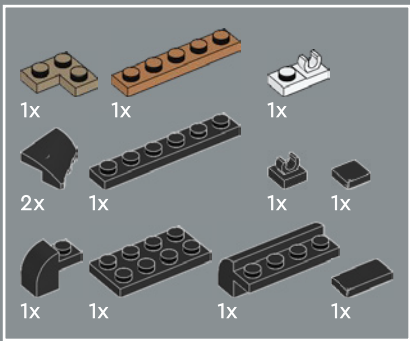

403

1

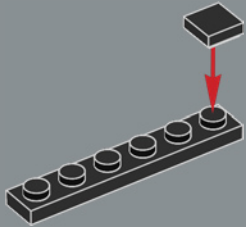

2

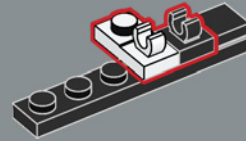

3

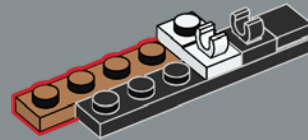

4

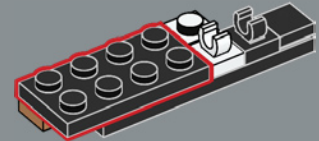

5

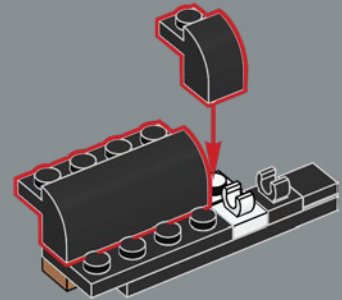

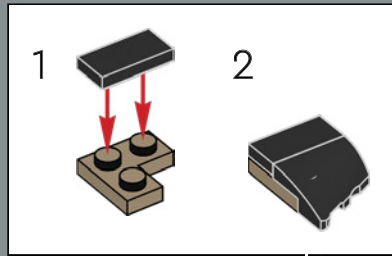

6

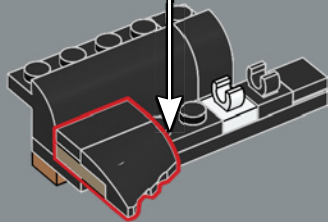

7

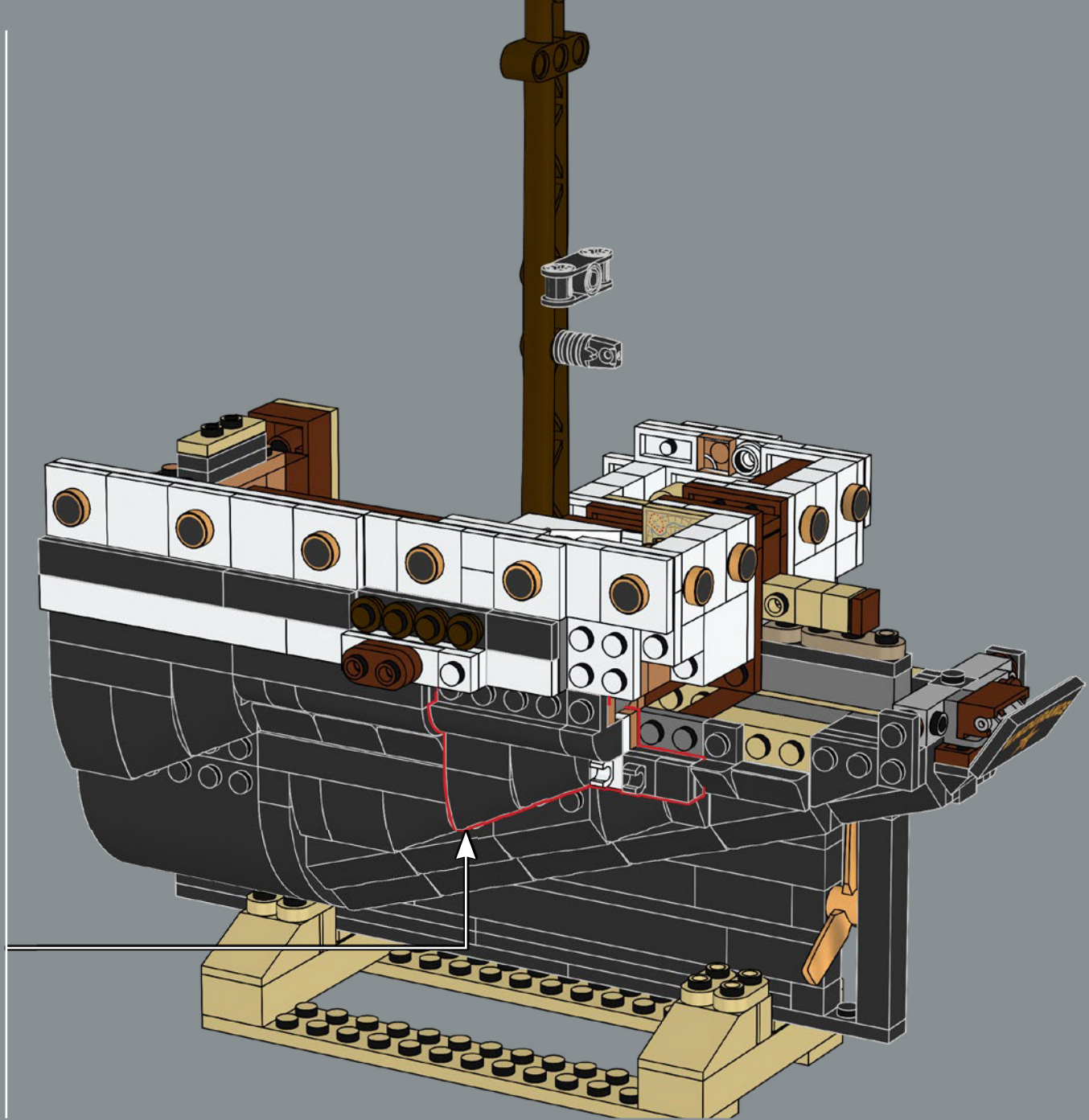
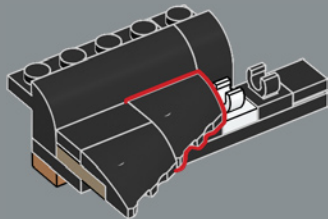

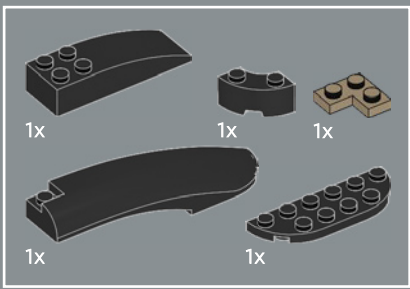

404

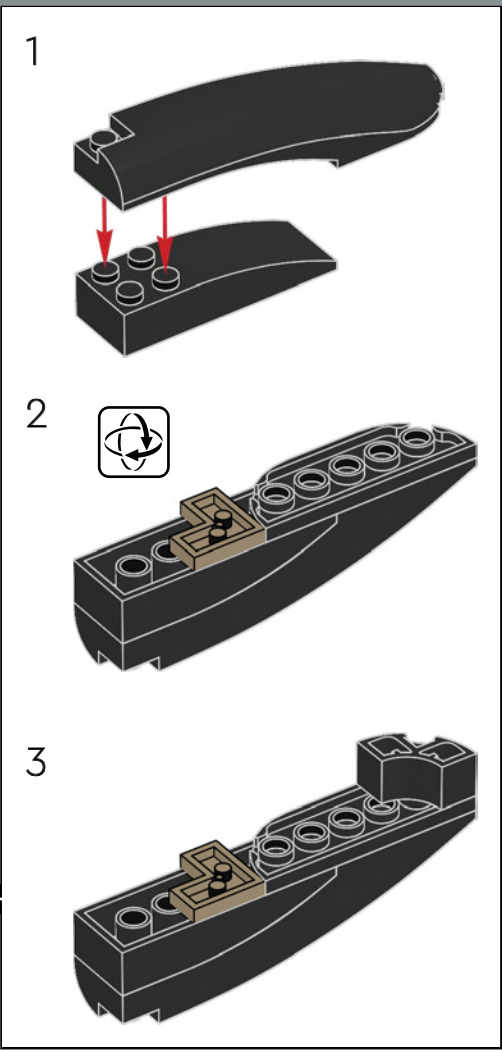
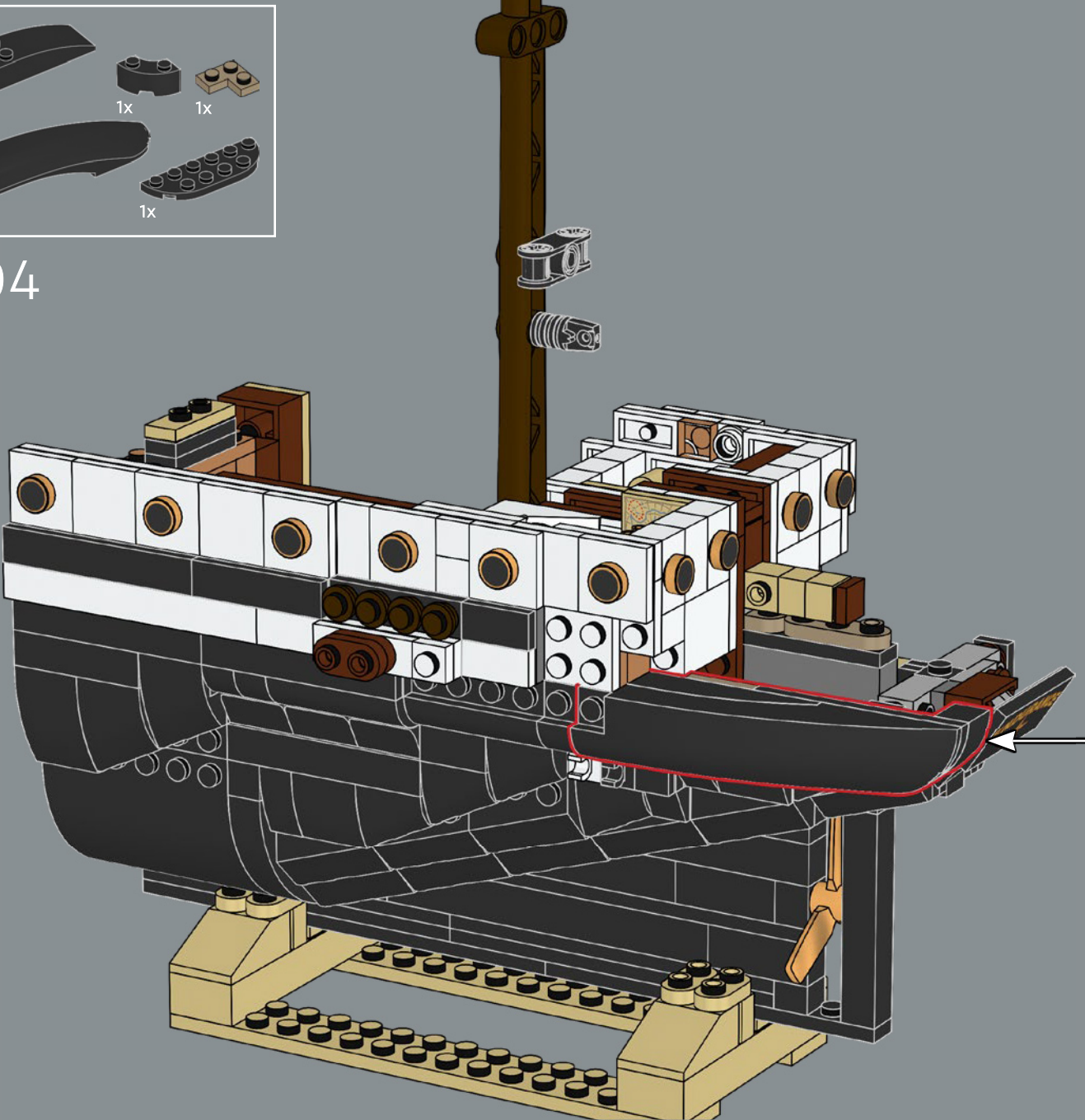

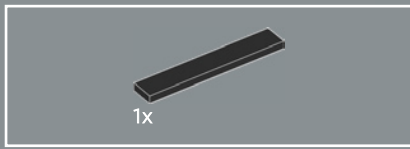

405

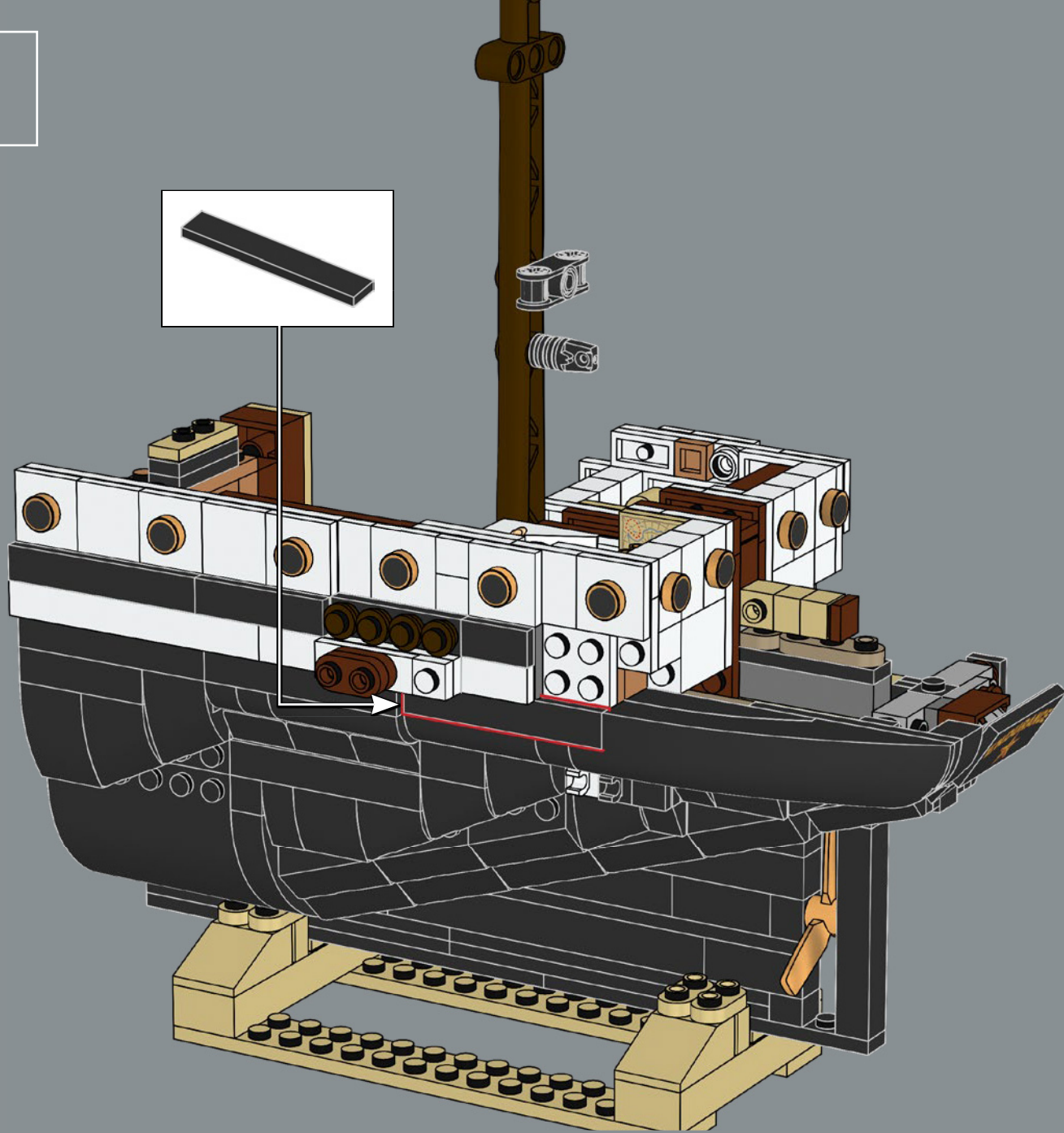
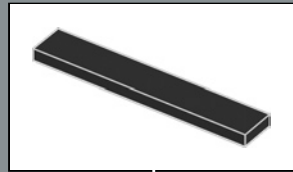

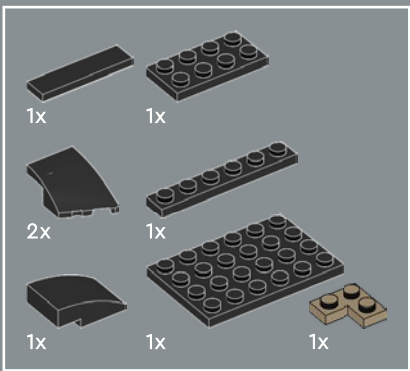
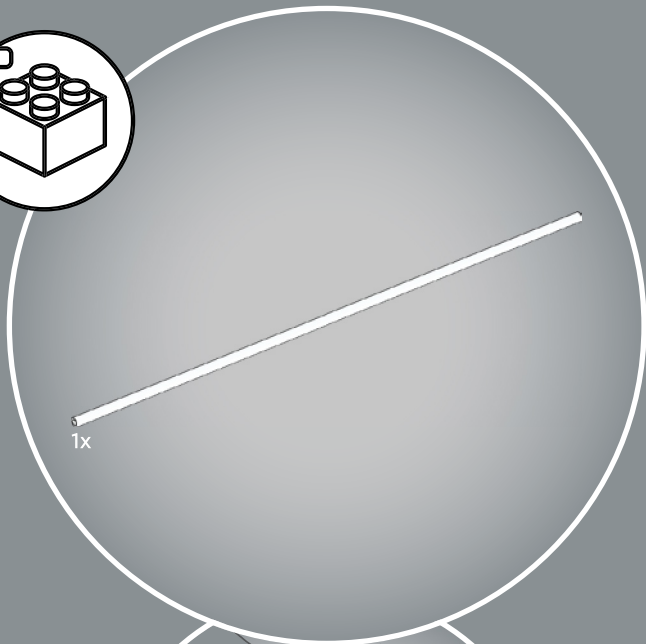
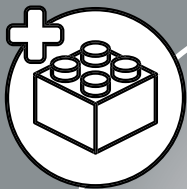

406



1

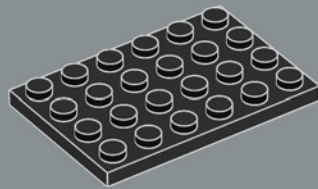

2

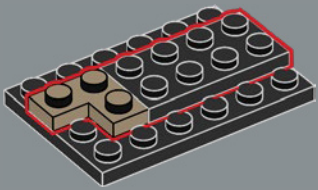

3

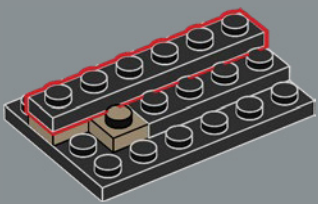

4

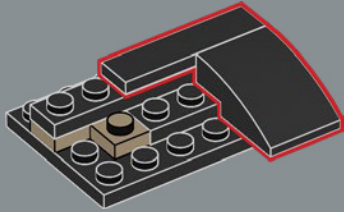

5

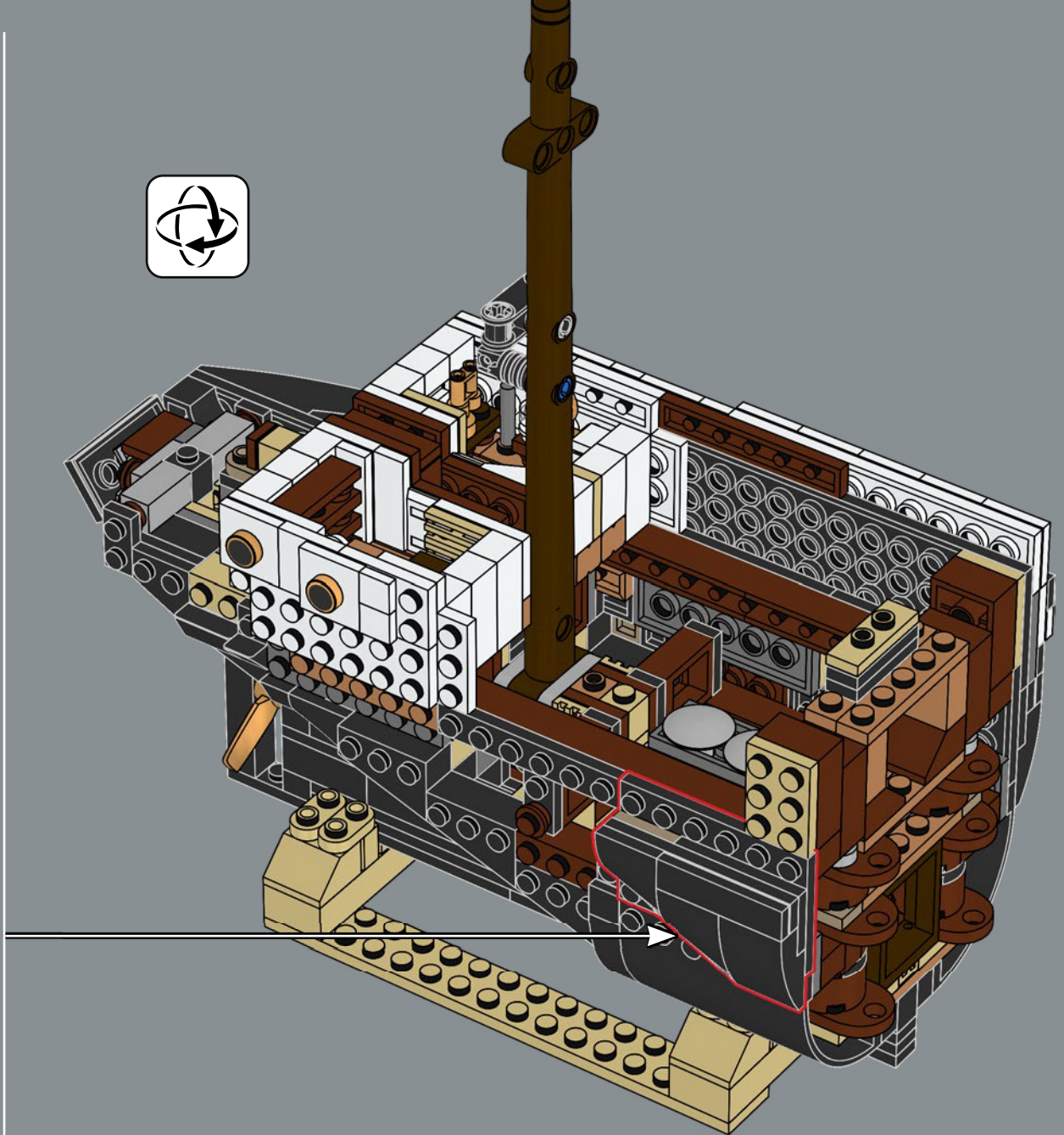
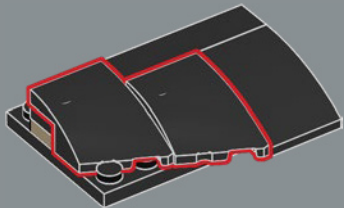

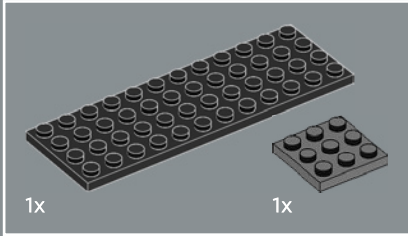
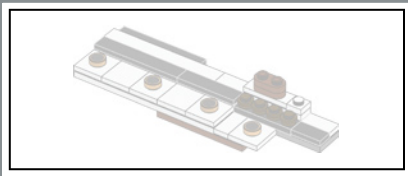

407

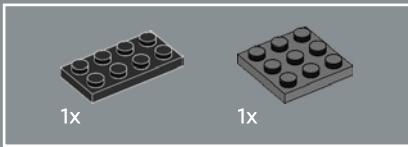
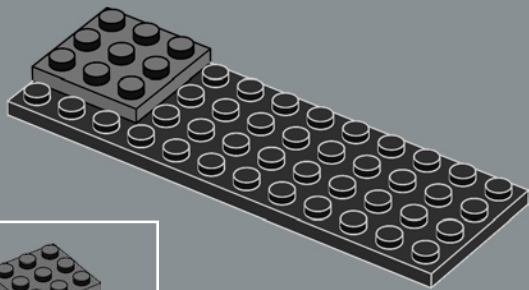

408

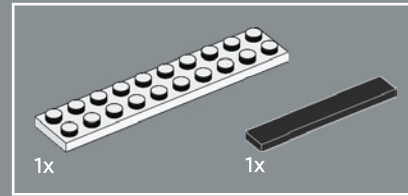
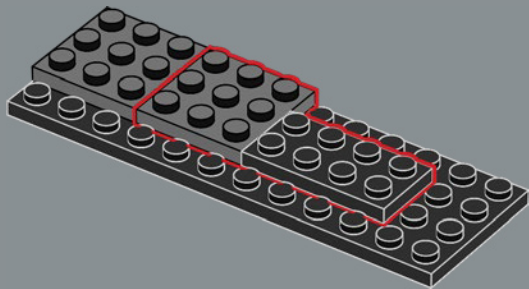

409

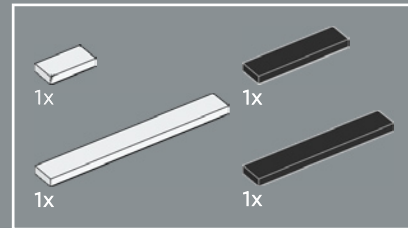
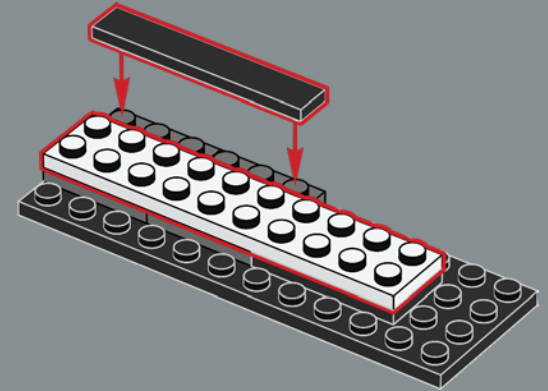

410

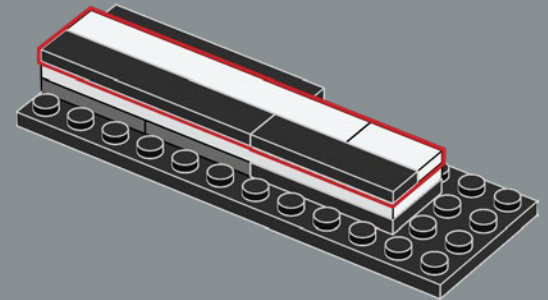

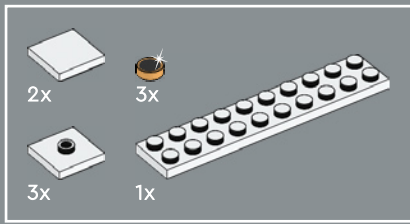

411

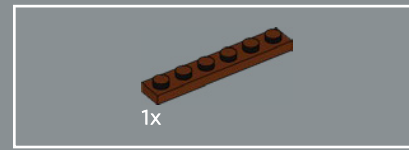
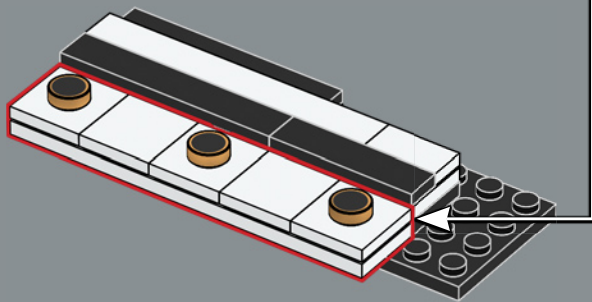
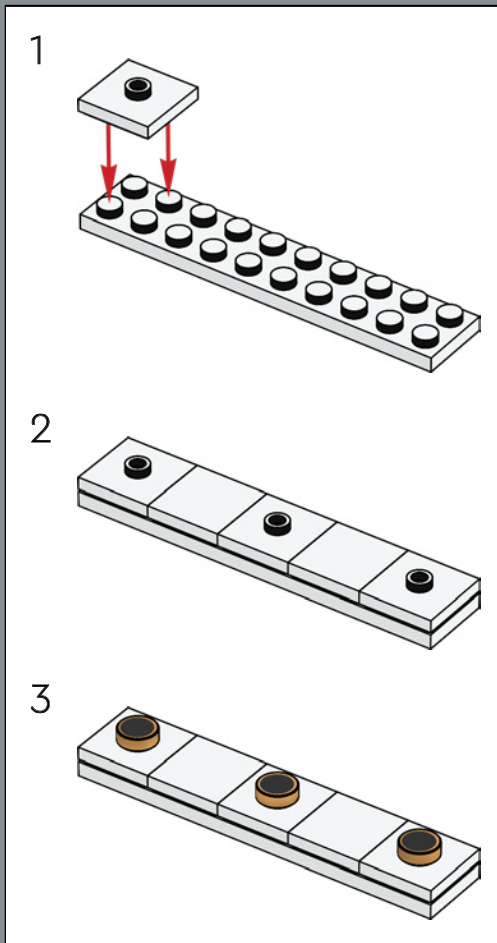

412

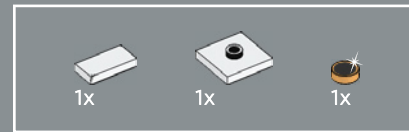
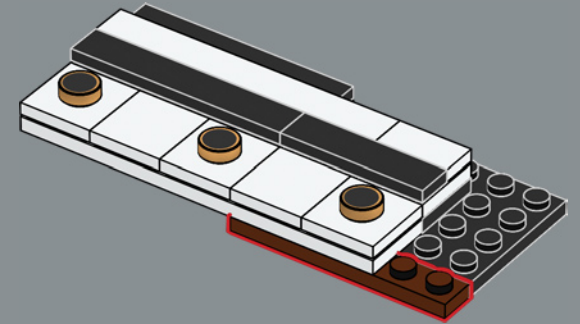

413

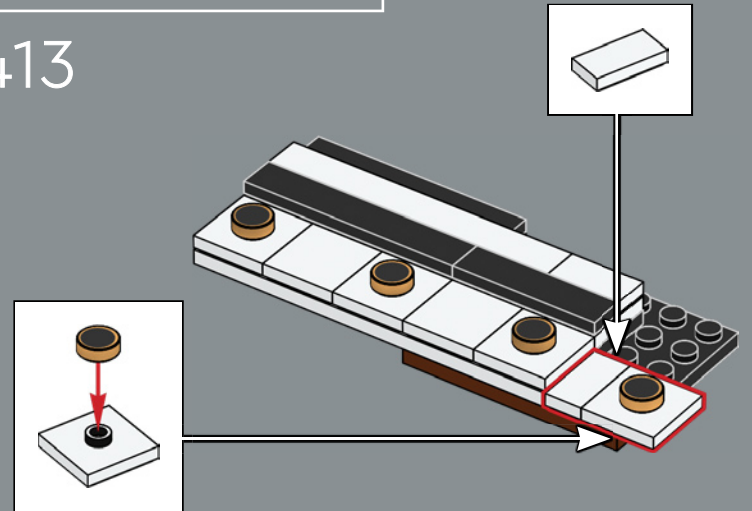

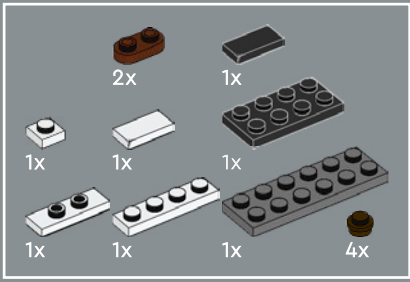

414

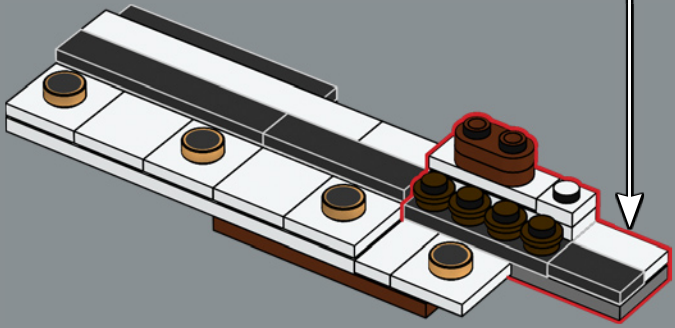
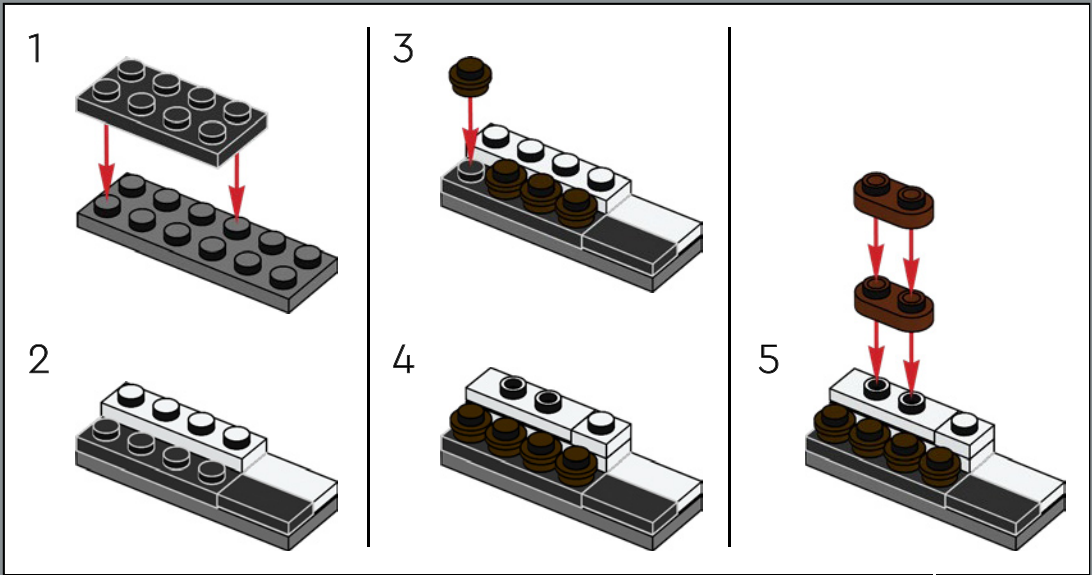

415

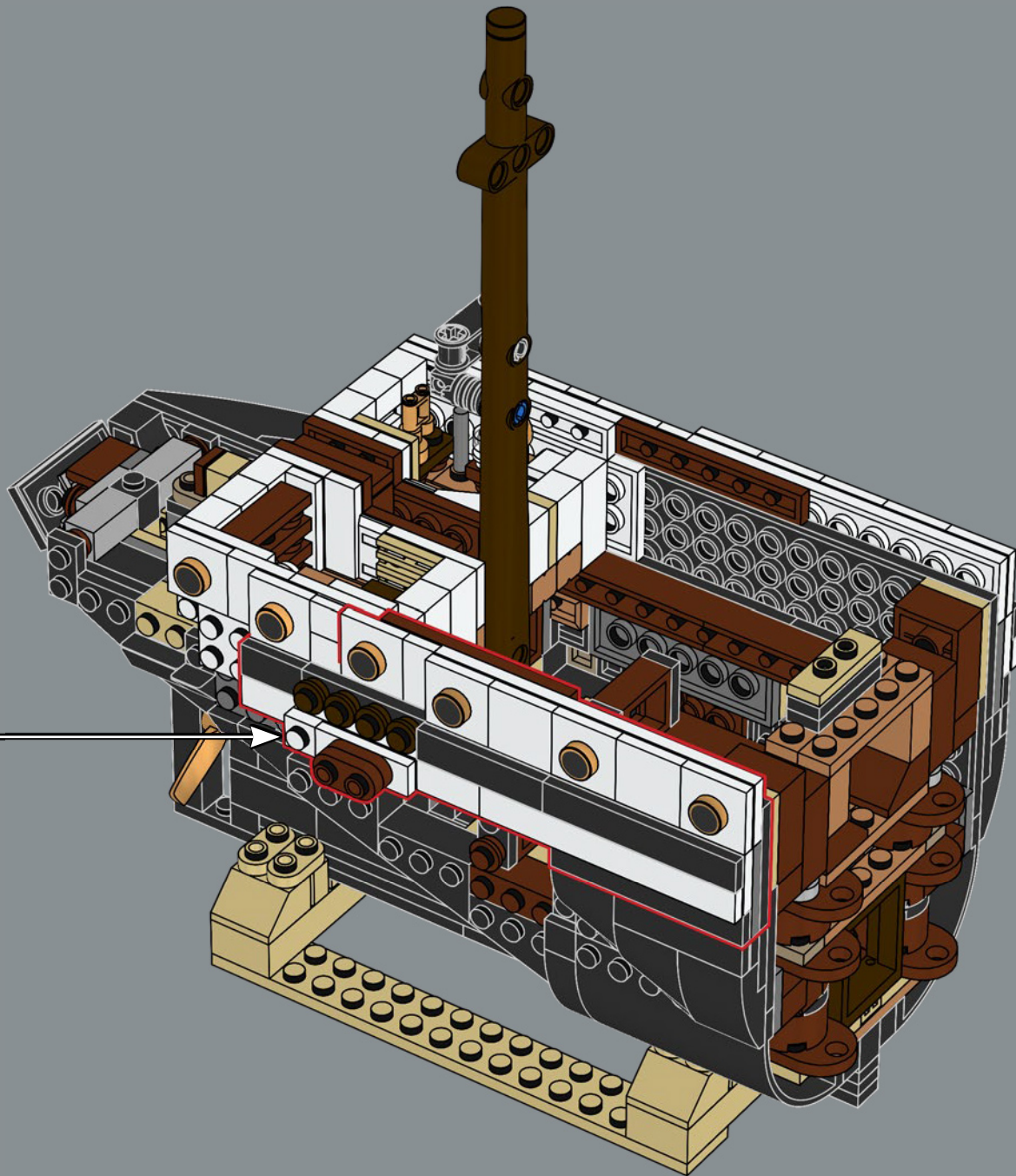

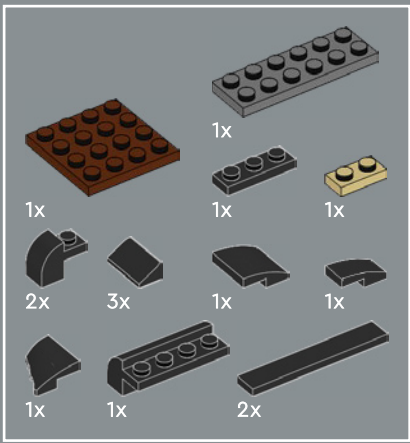

416

1

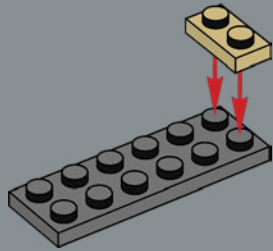

2

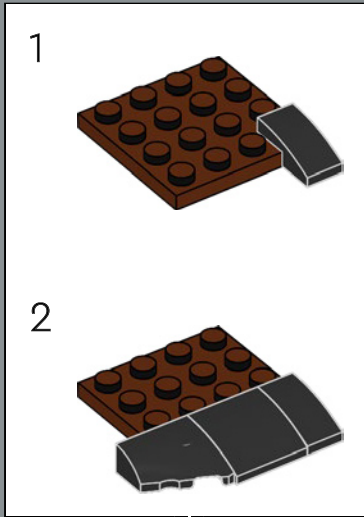
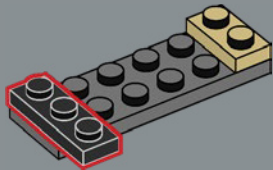

3

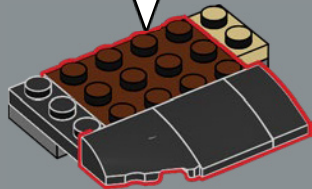

4

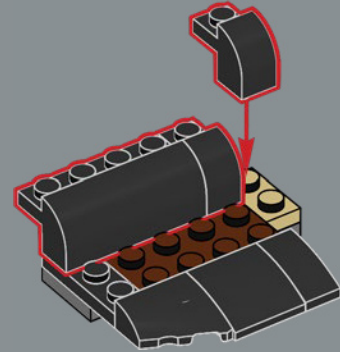

5

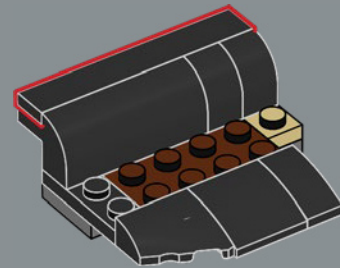

6

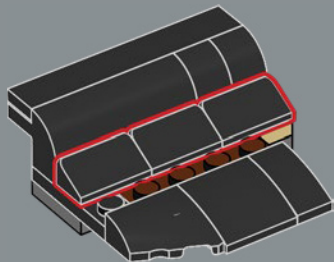

7

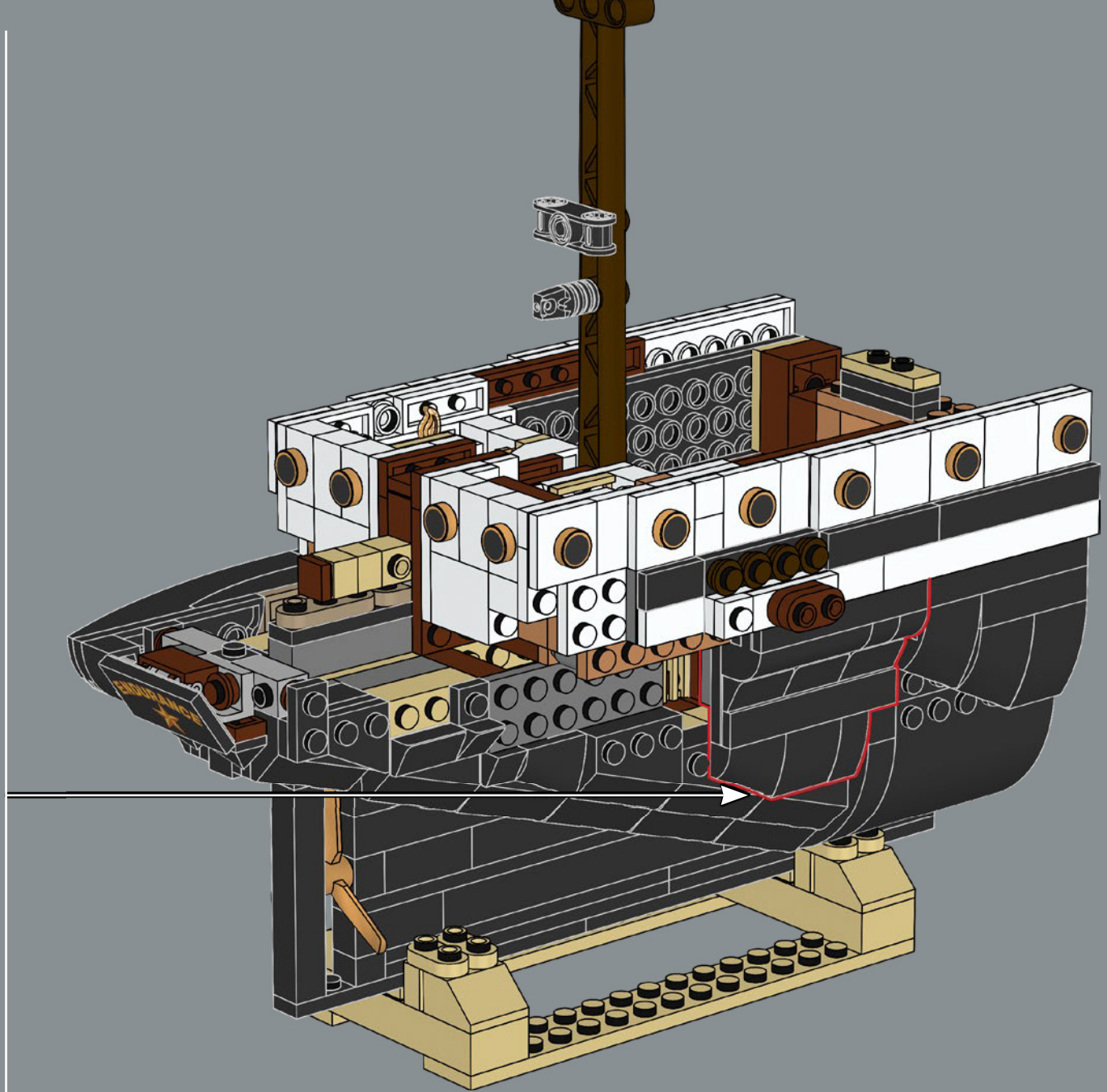
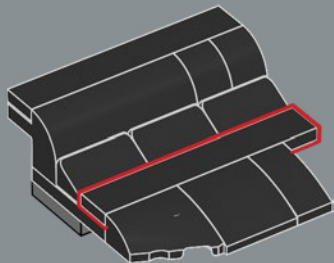

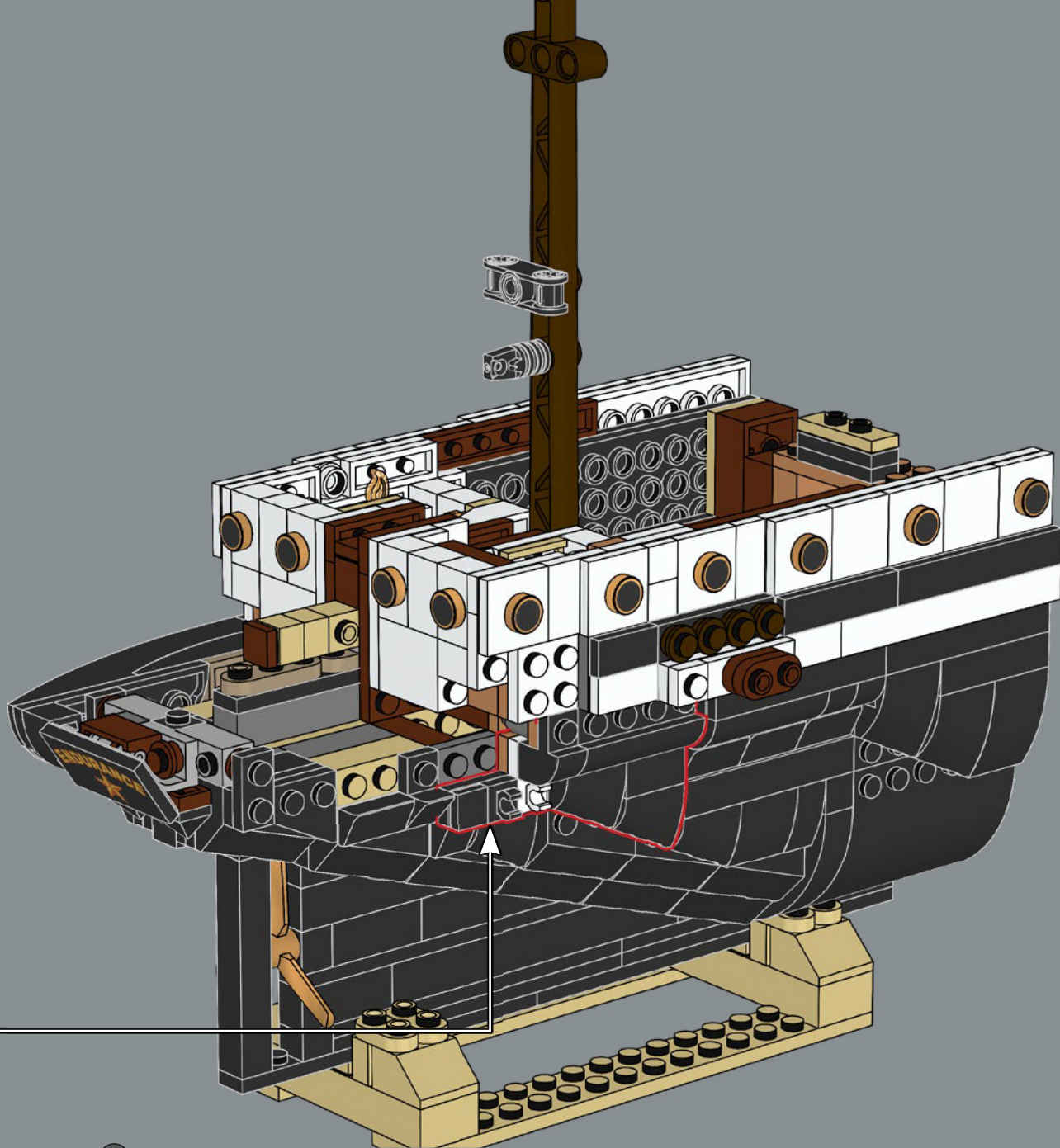

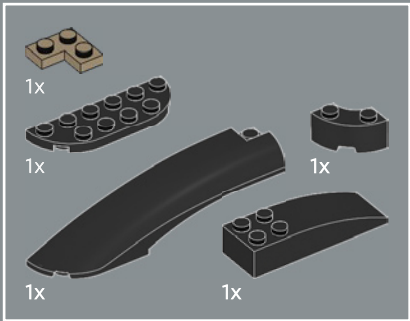

418

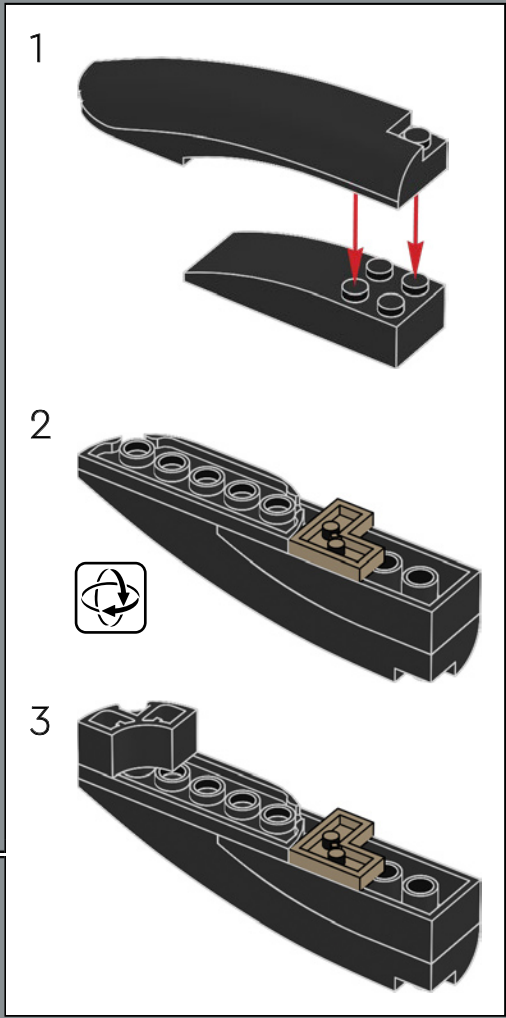
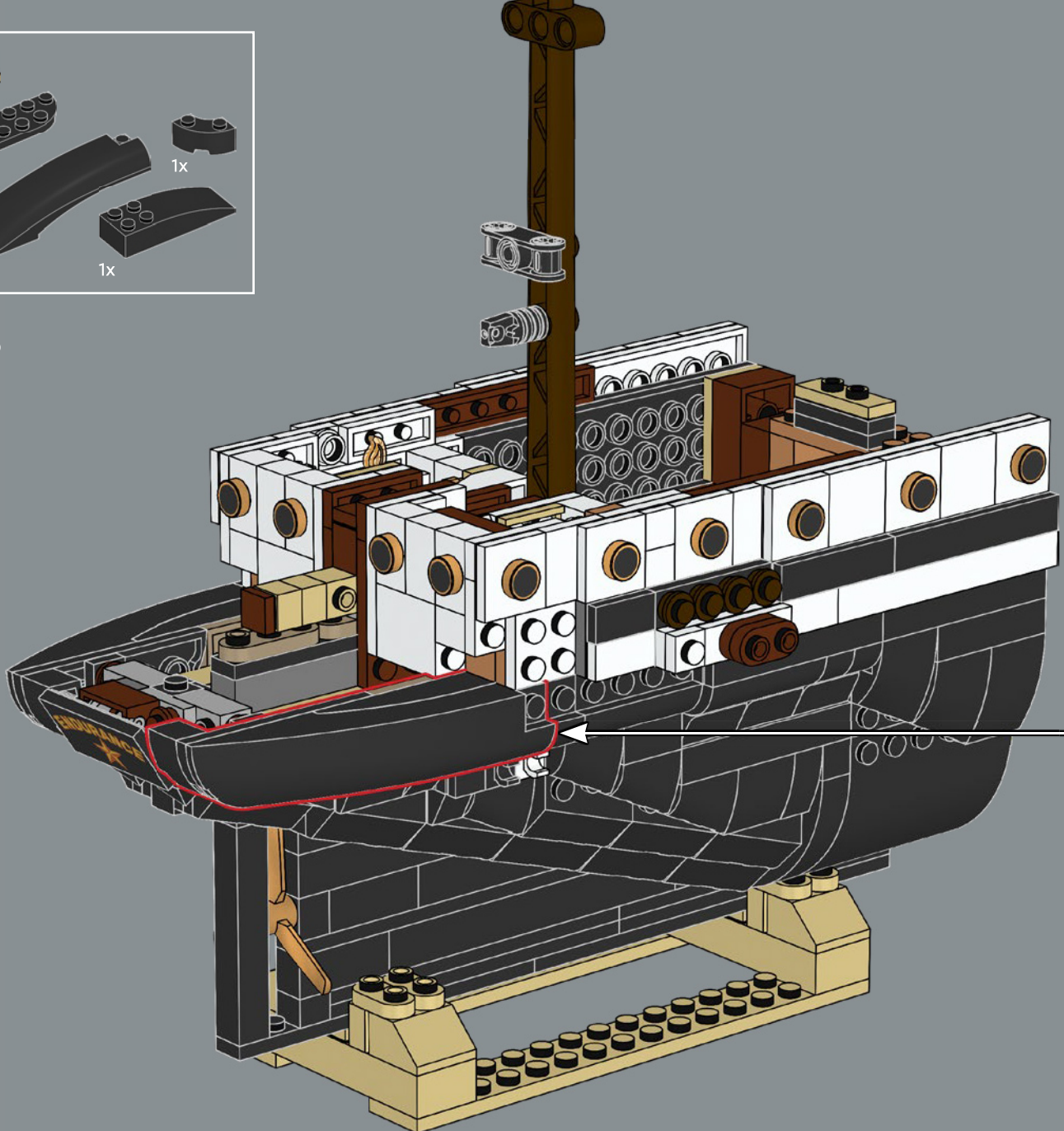

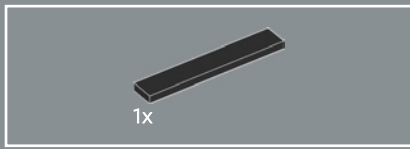

419

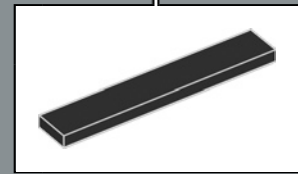
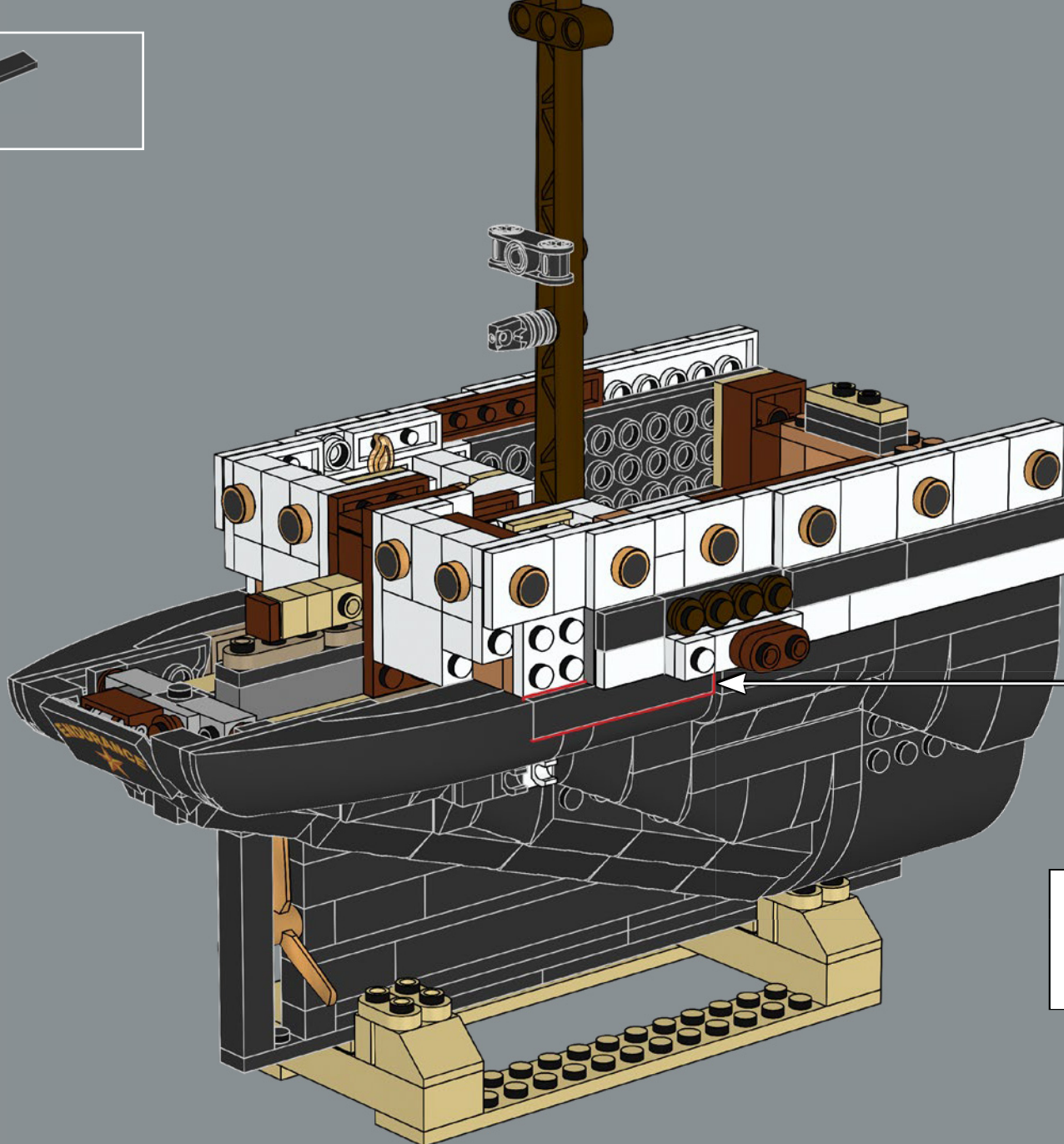

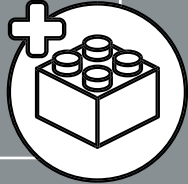
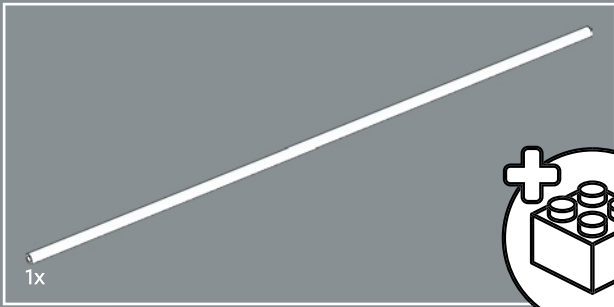

420

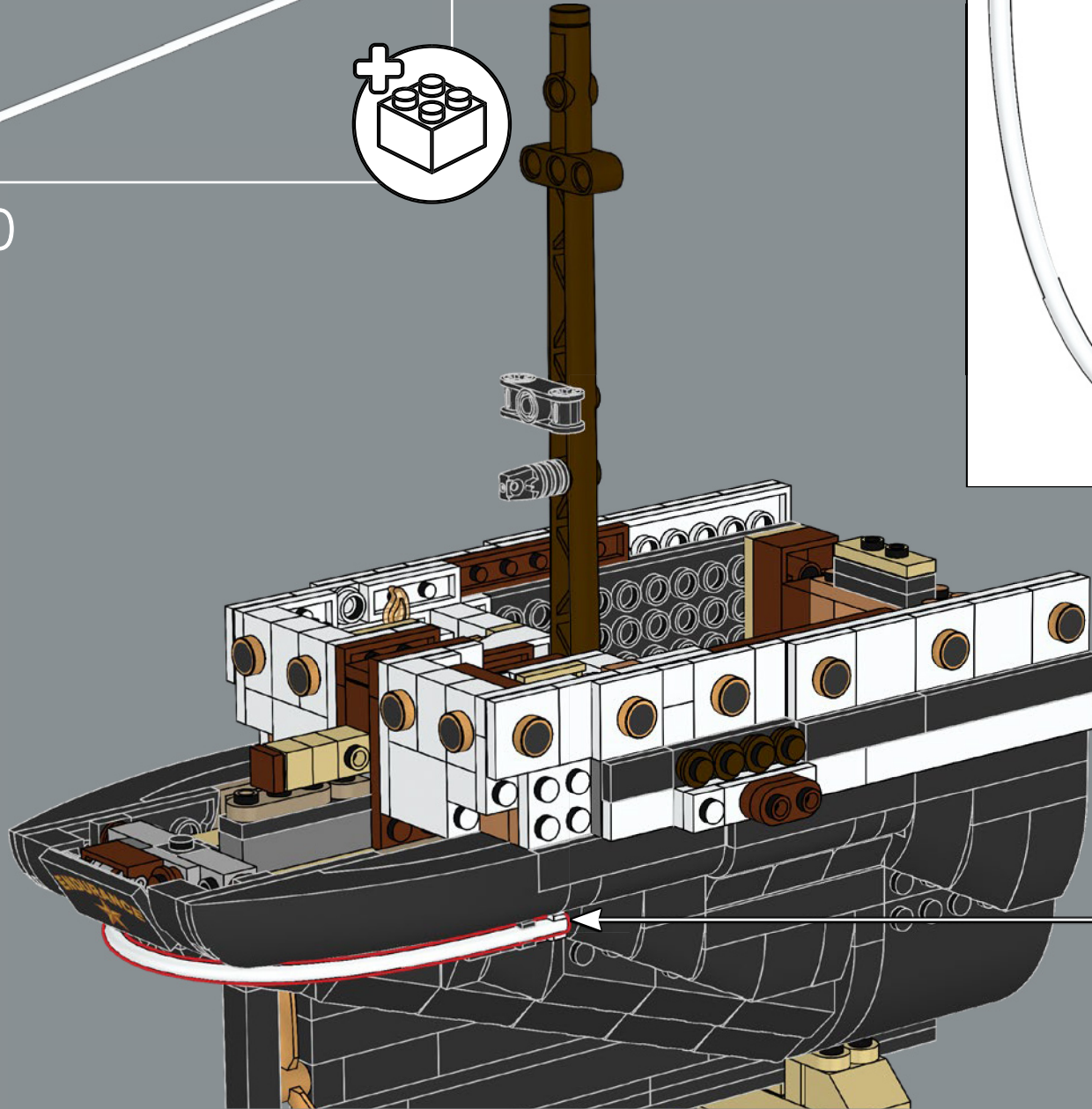
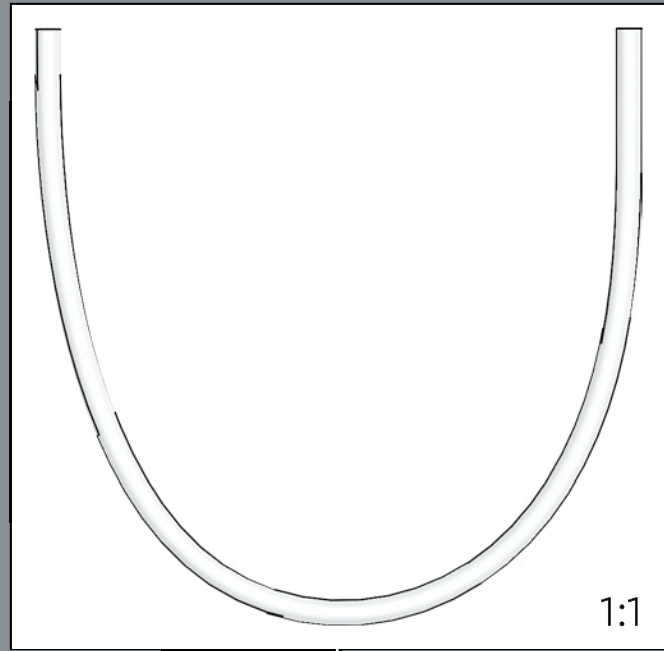

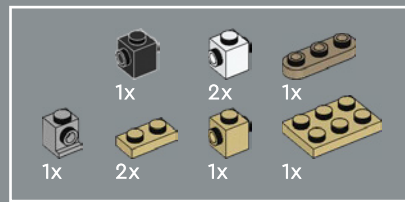
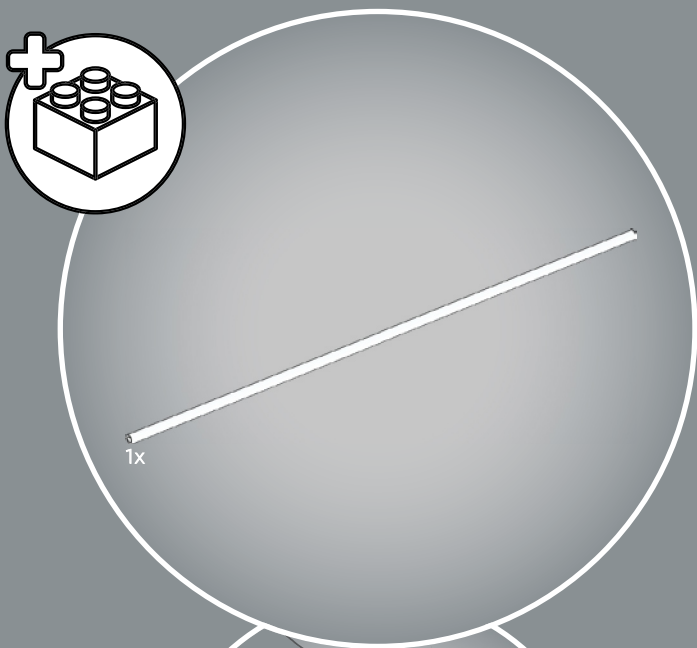
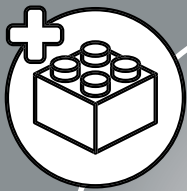

421

1

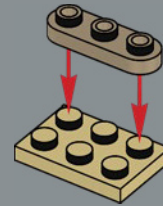

2

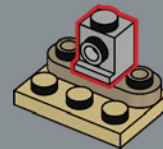

3

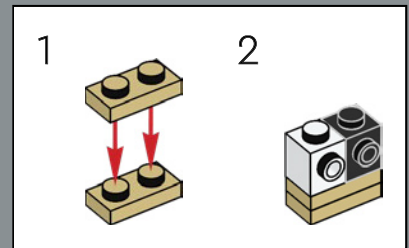
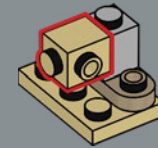

4

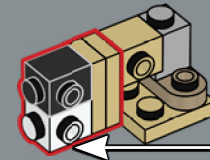

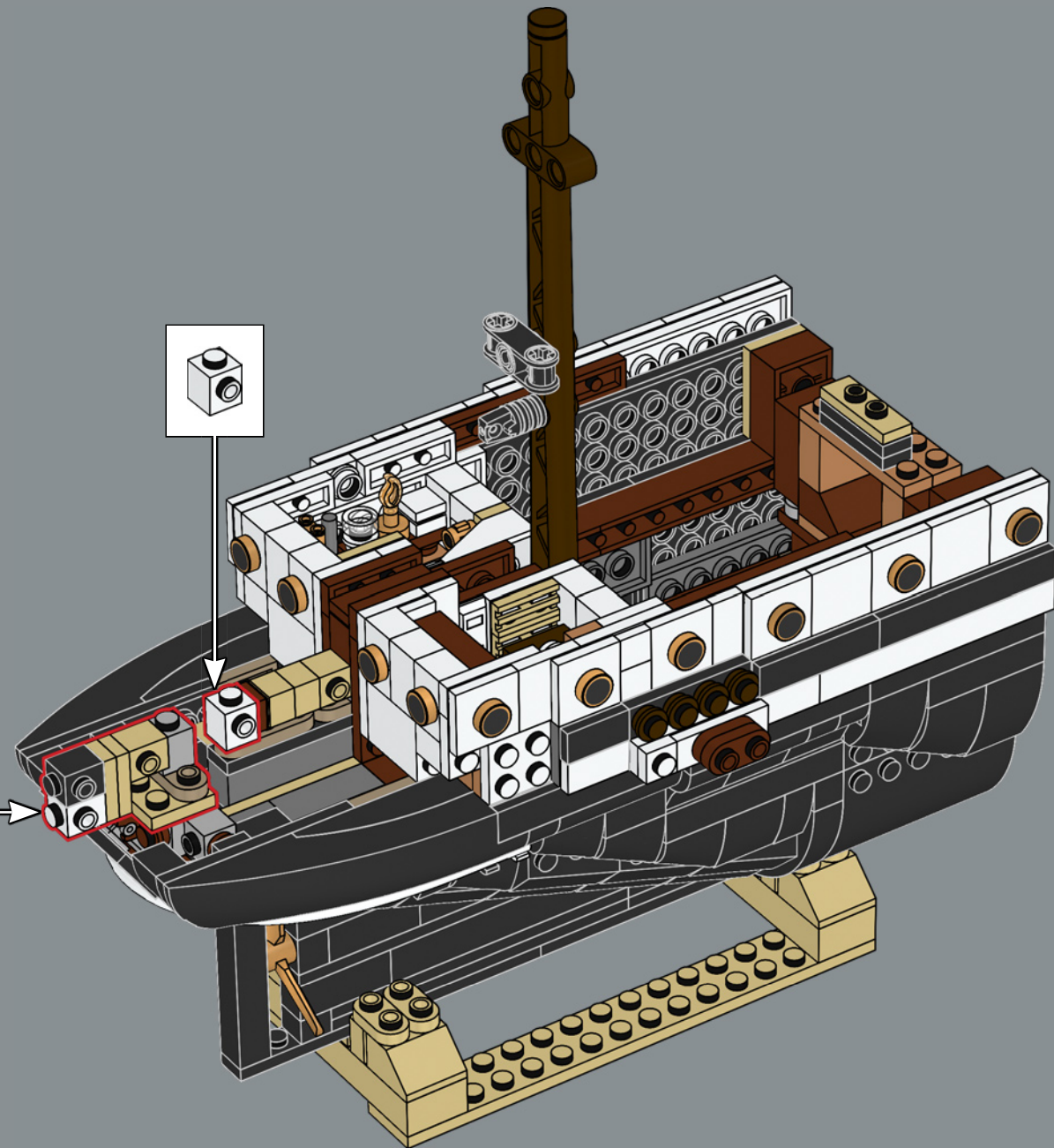

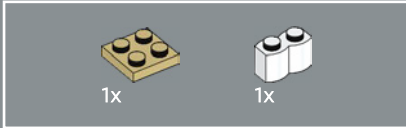
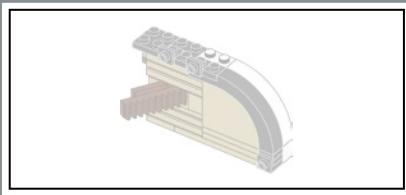

422

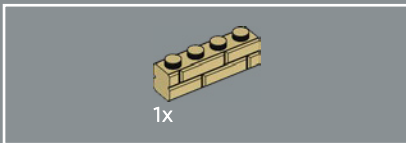
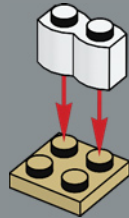

423

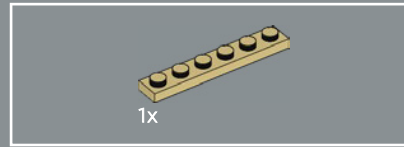
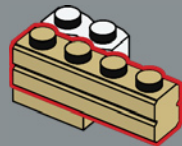

424

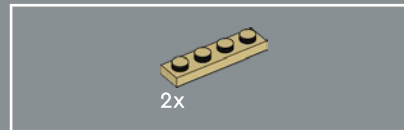
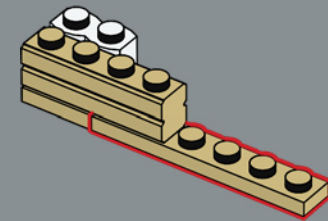

425

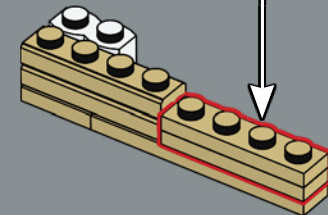
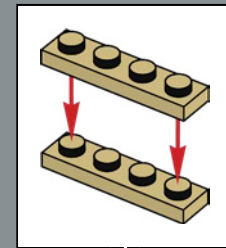

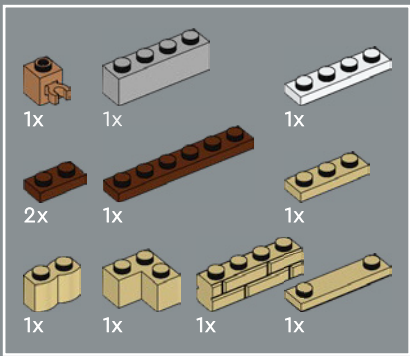

426 1

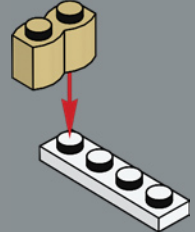

2

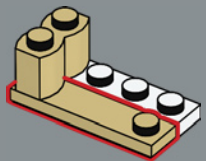

3

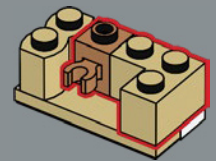

4

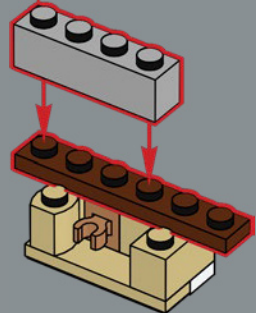

5

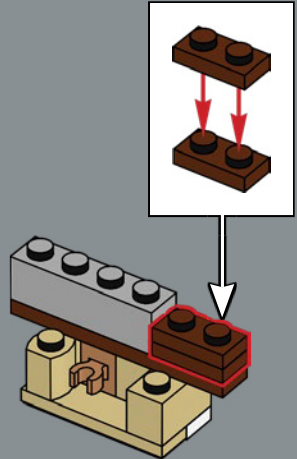

6

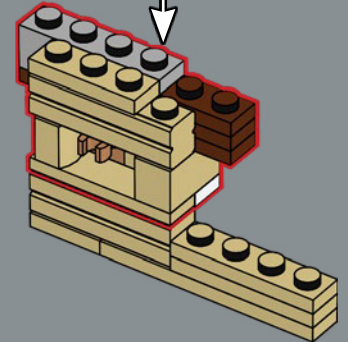
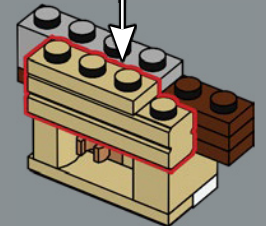
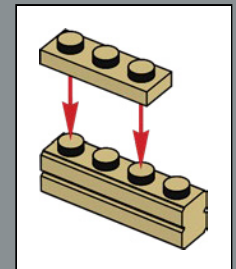

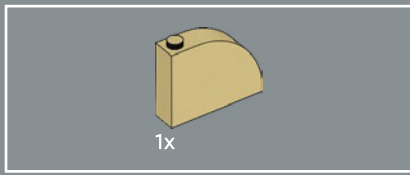

427

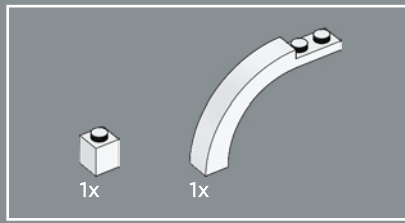
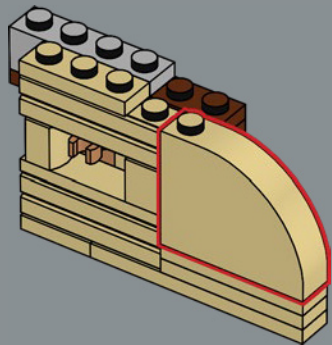

428

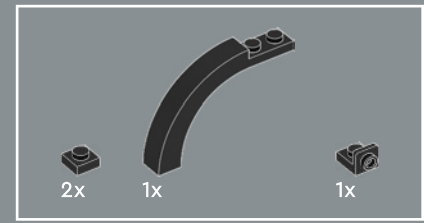
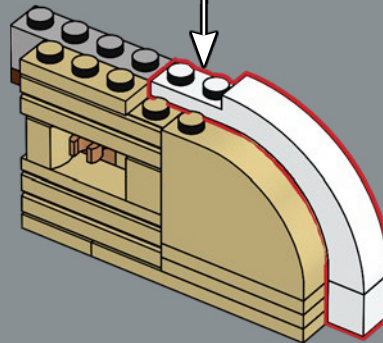
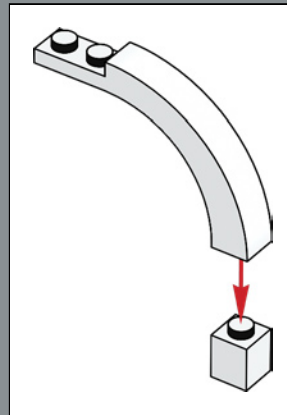

429

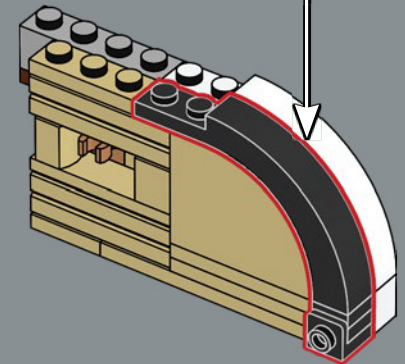
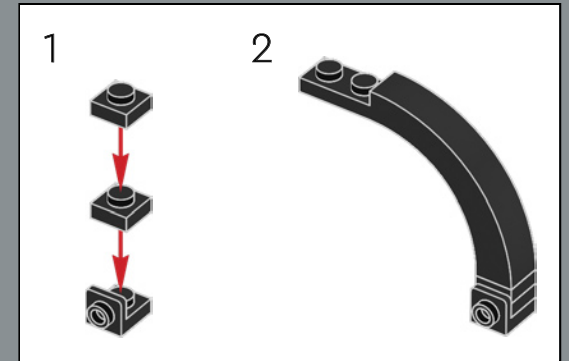

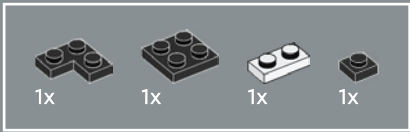

430

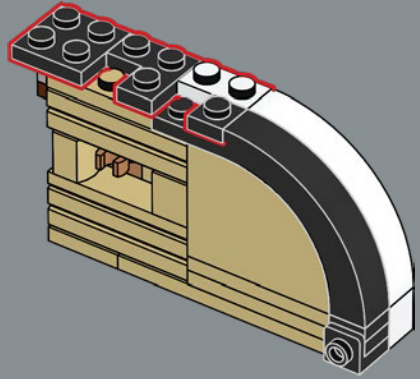

431

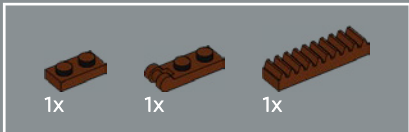
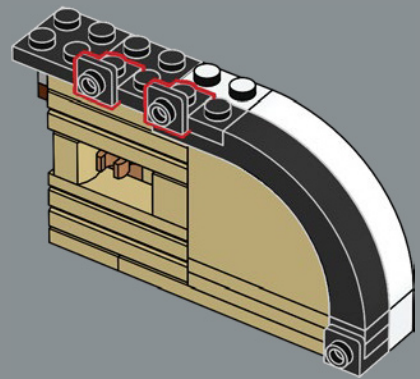

432

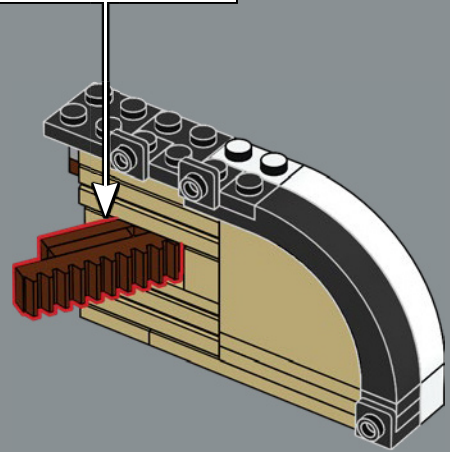
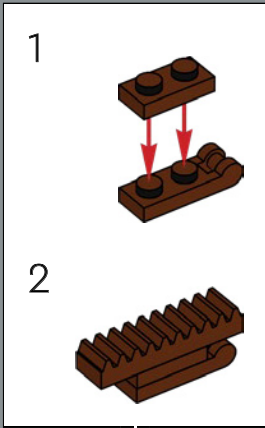

433

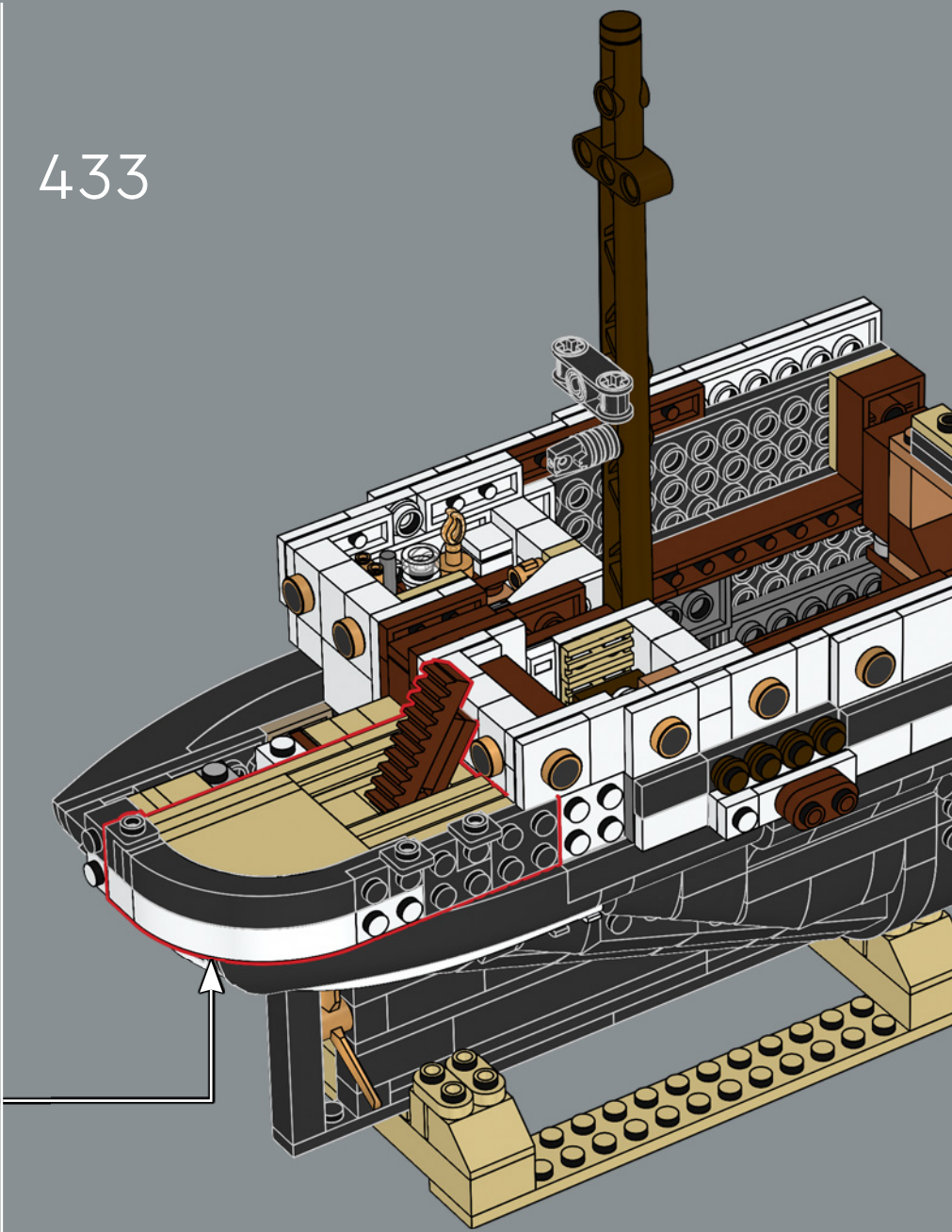

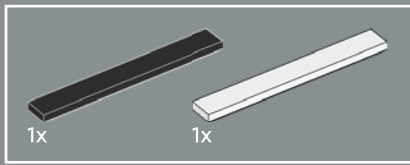

434

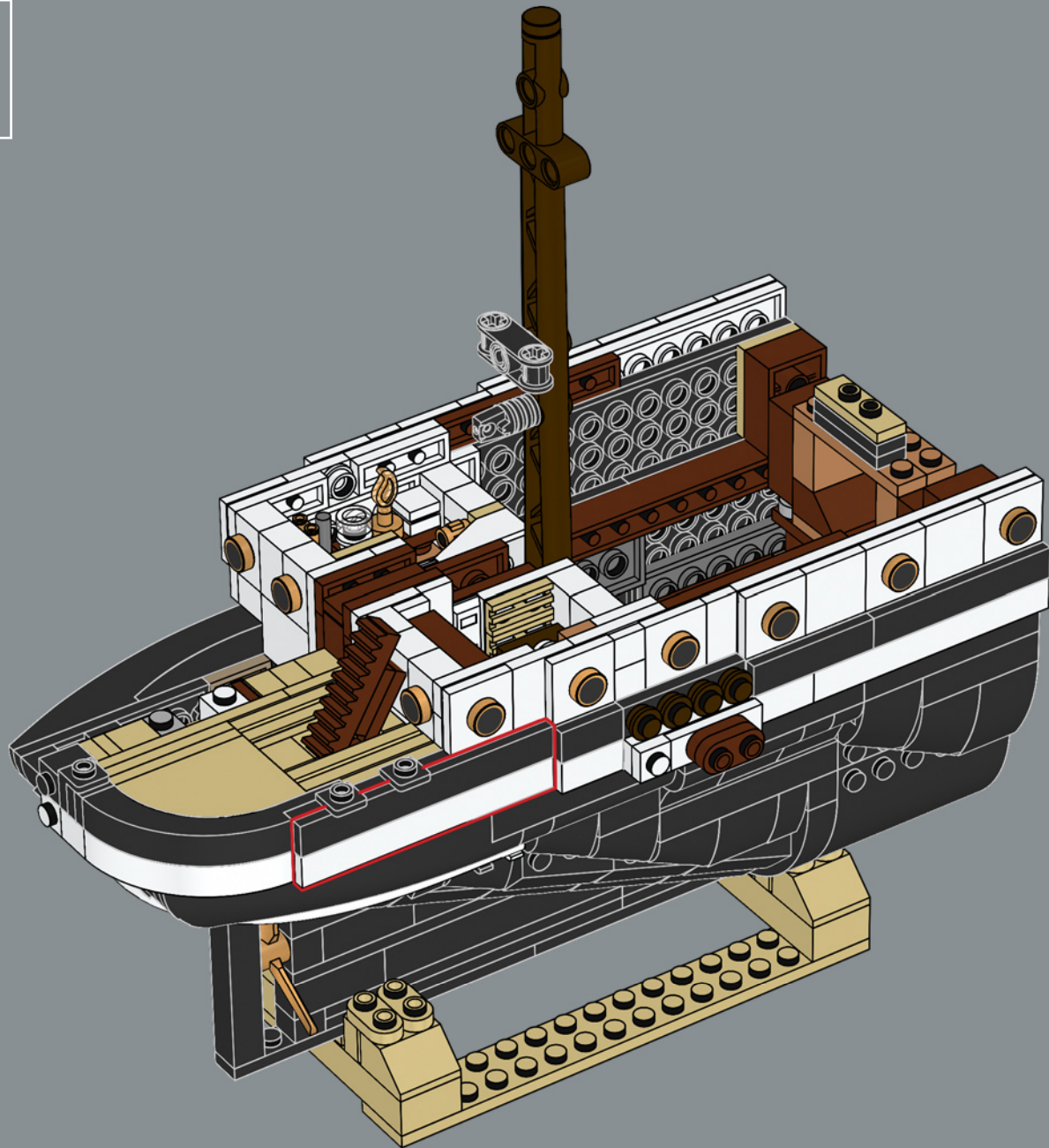

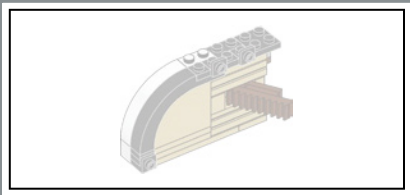

435

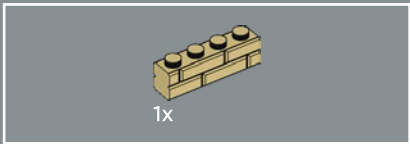
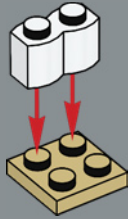

436

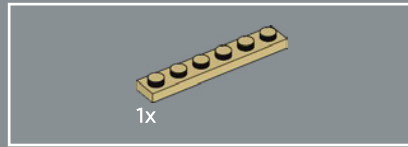
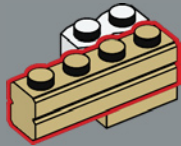

437

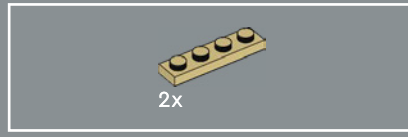
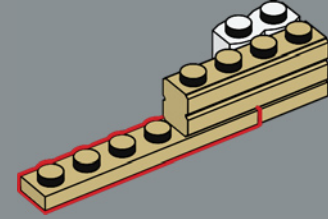

438

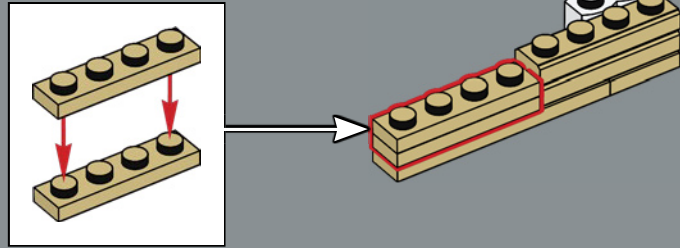

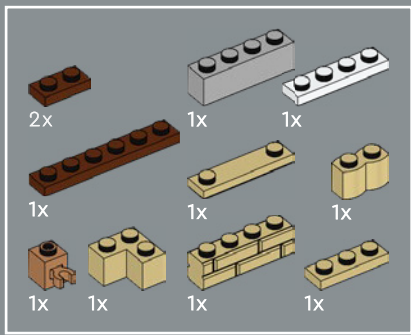

439

1

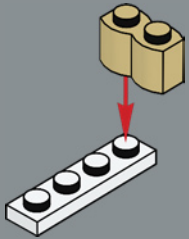

2

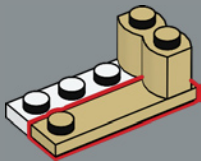

3

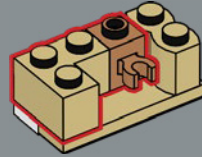

4

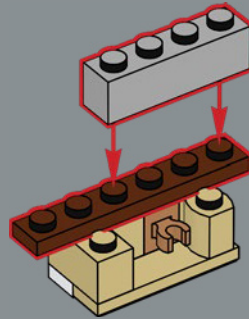

5

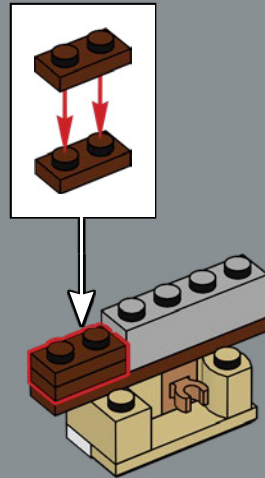

6

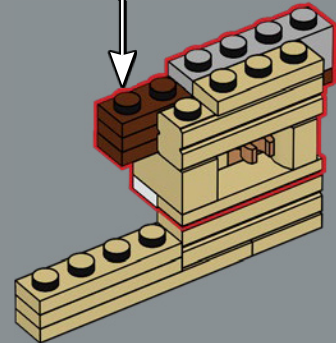
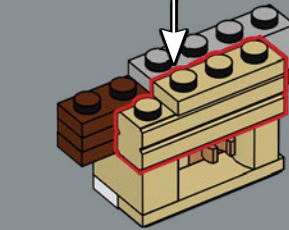
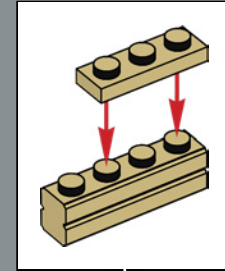

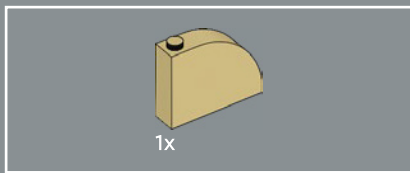

440

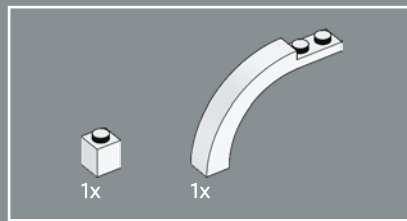
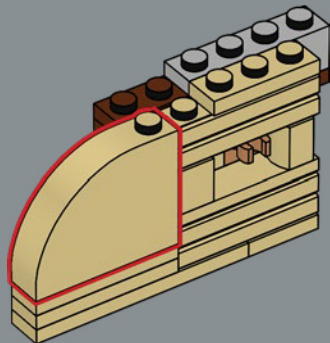

441

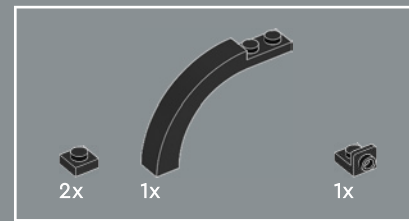
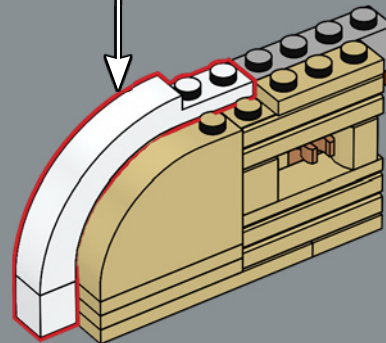
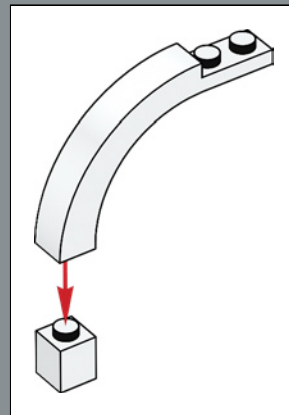

442

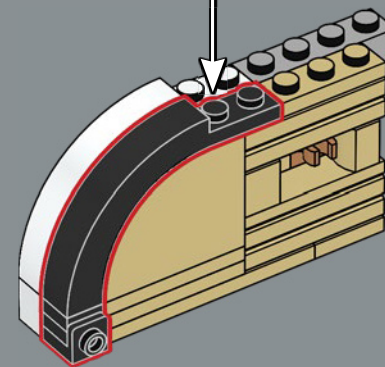
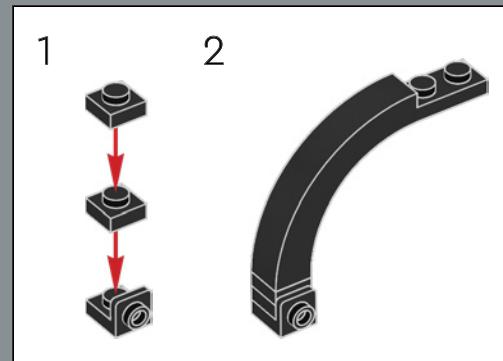

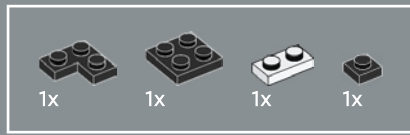

443

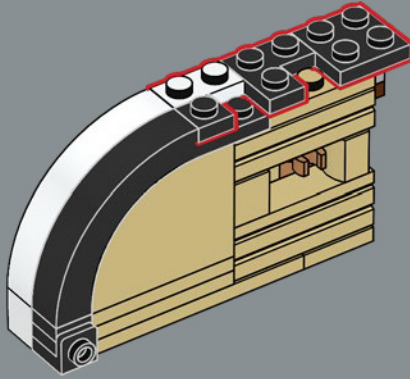

444

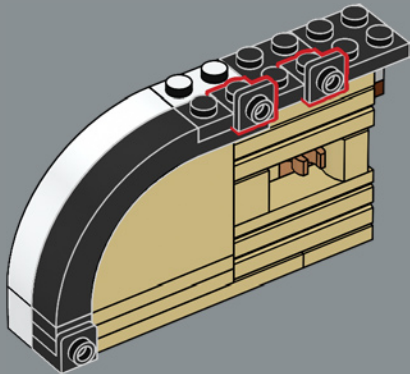

445

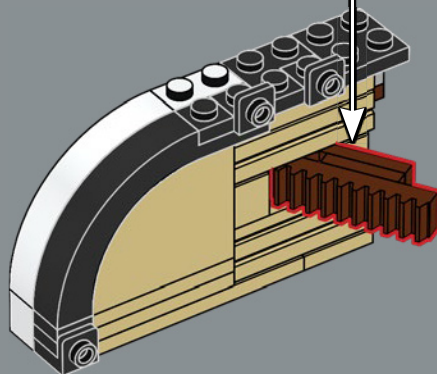
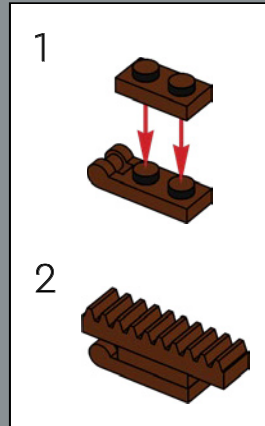

446

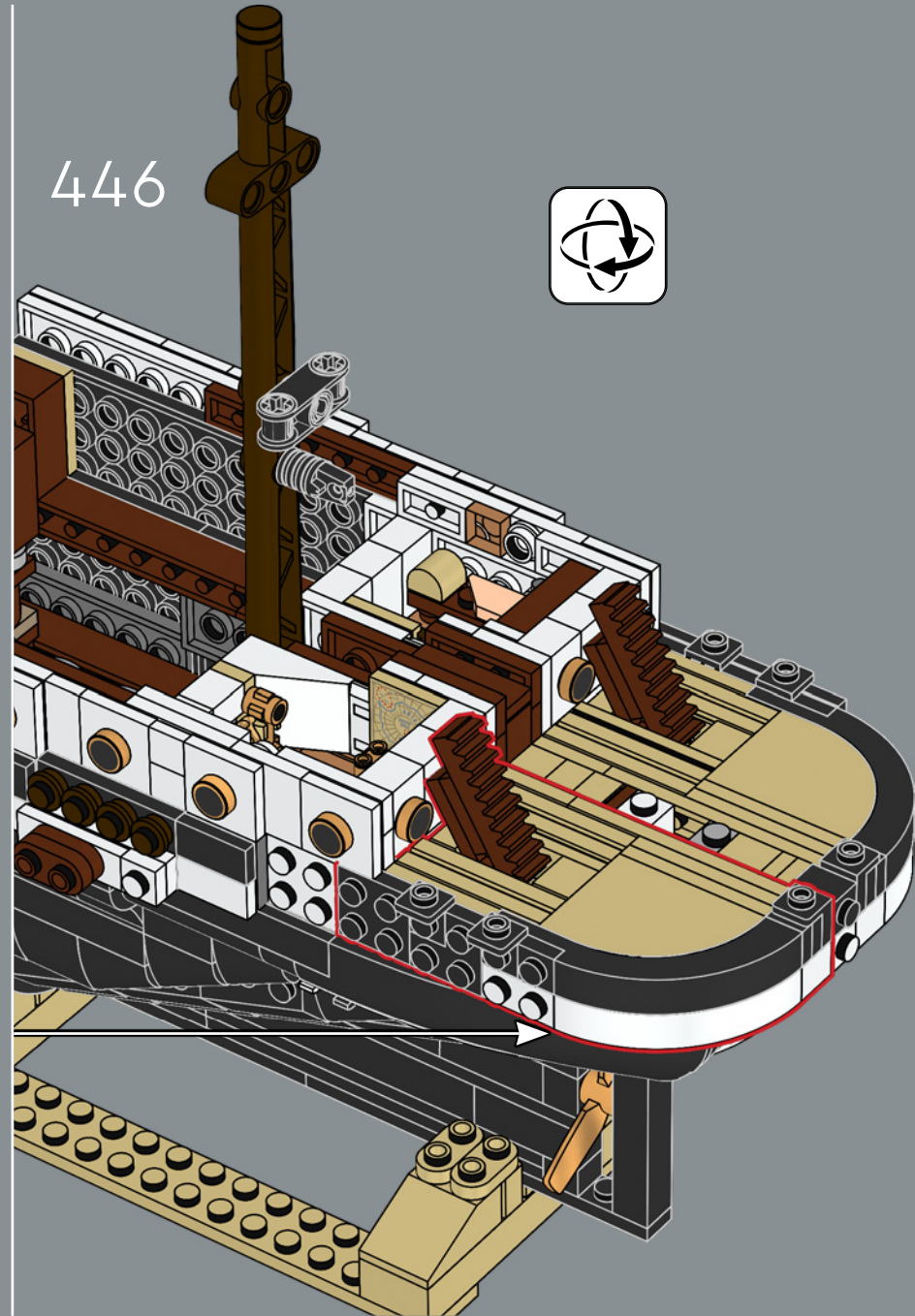

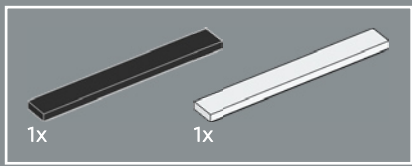

447

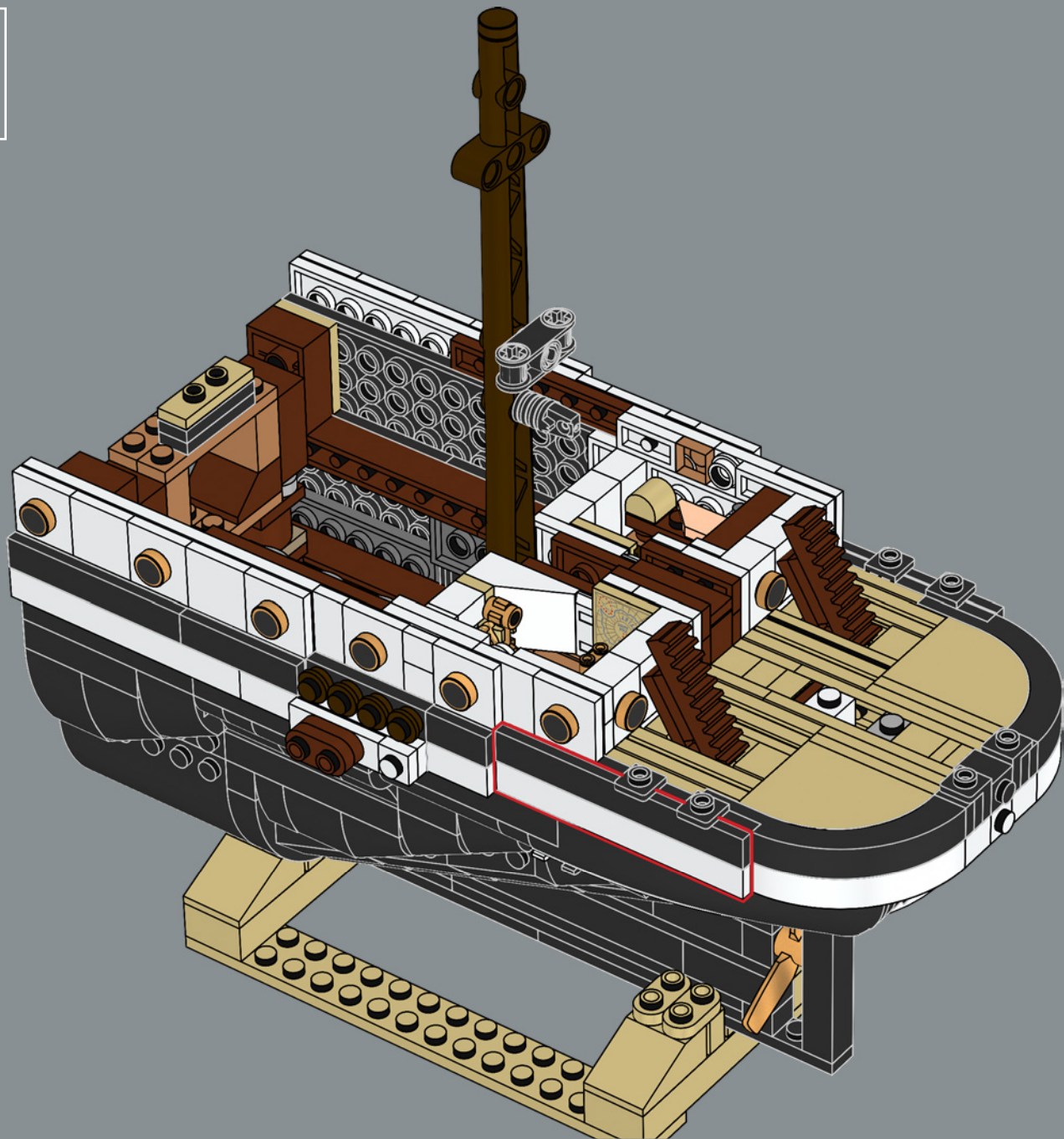

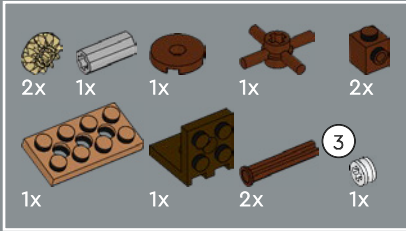
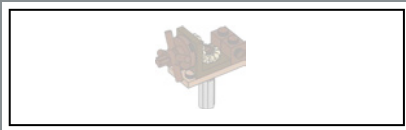

448

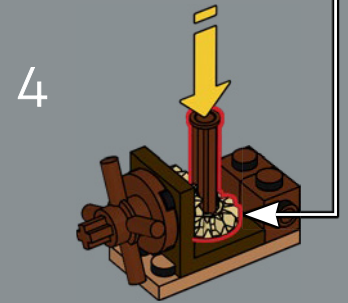
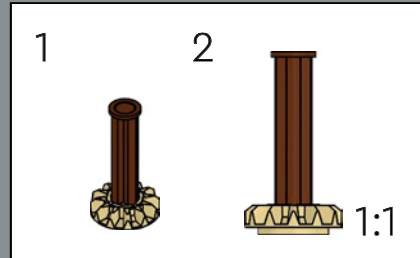
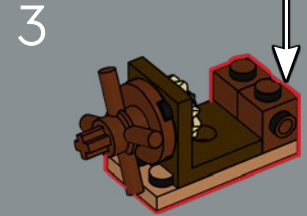
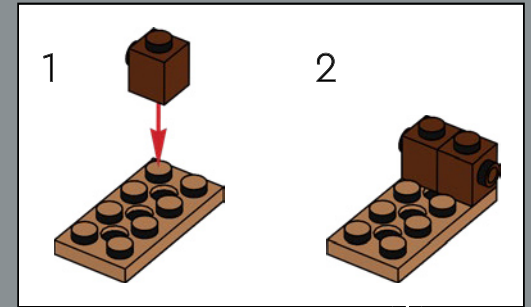
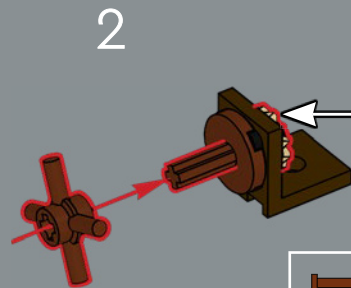
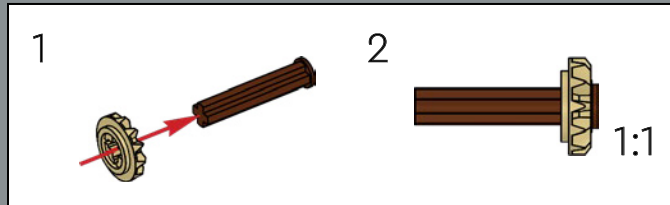
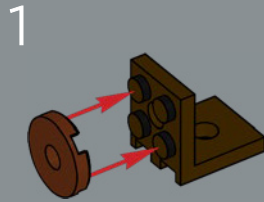

5

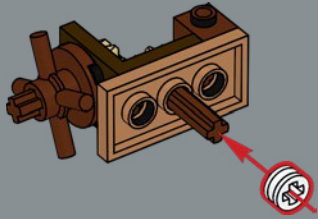

6

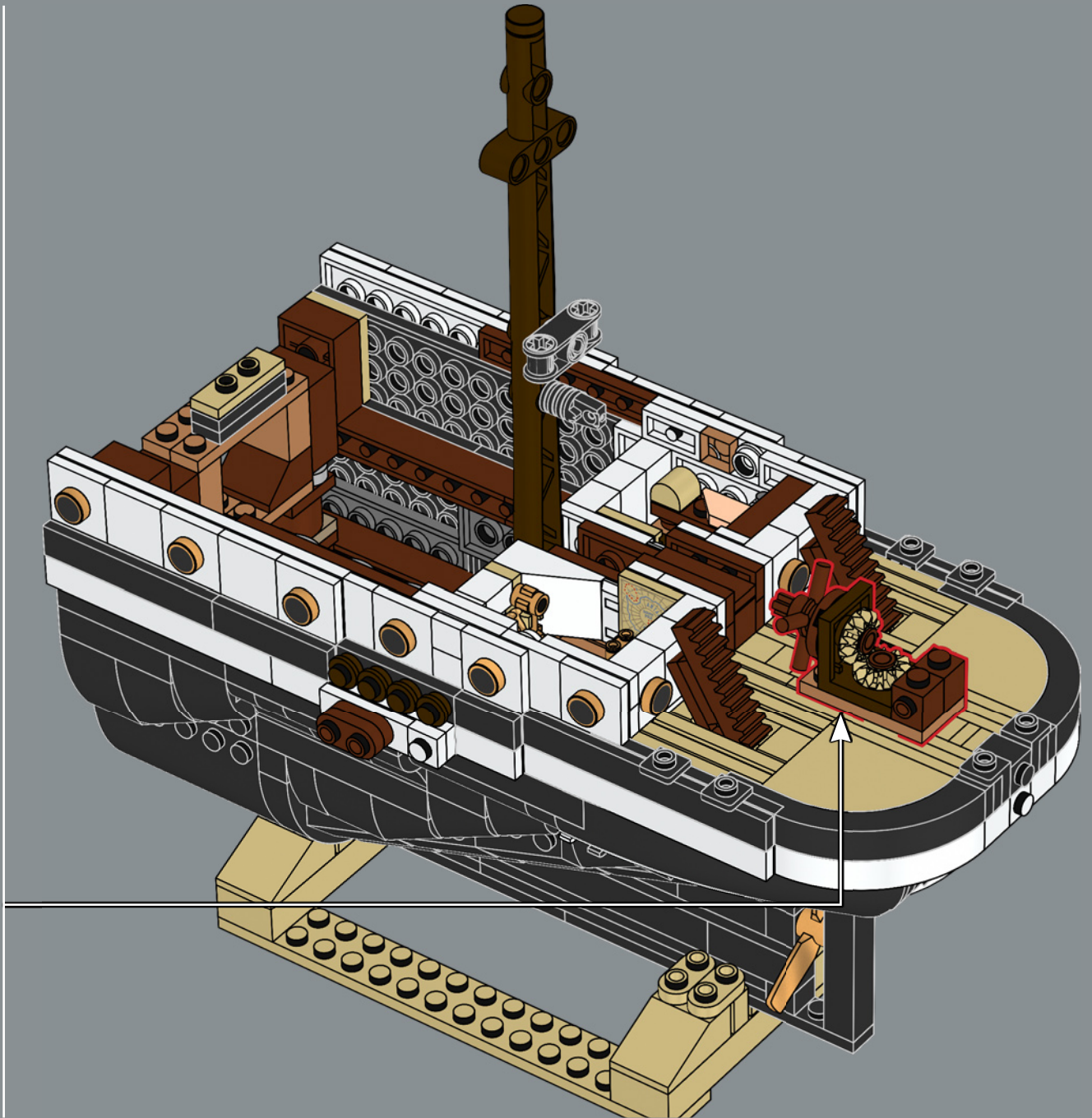
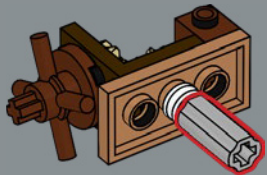

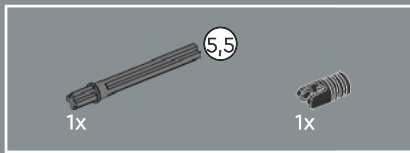

449

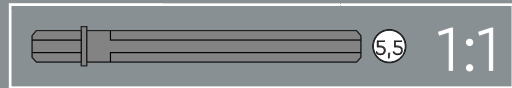
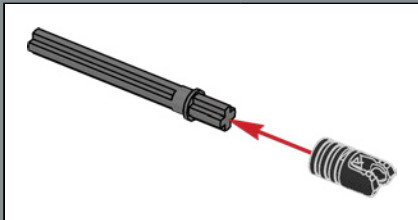
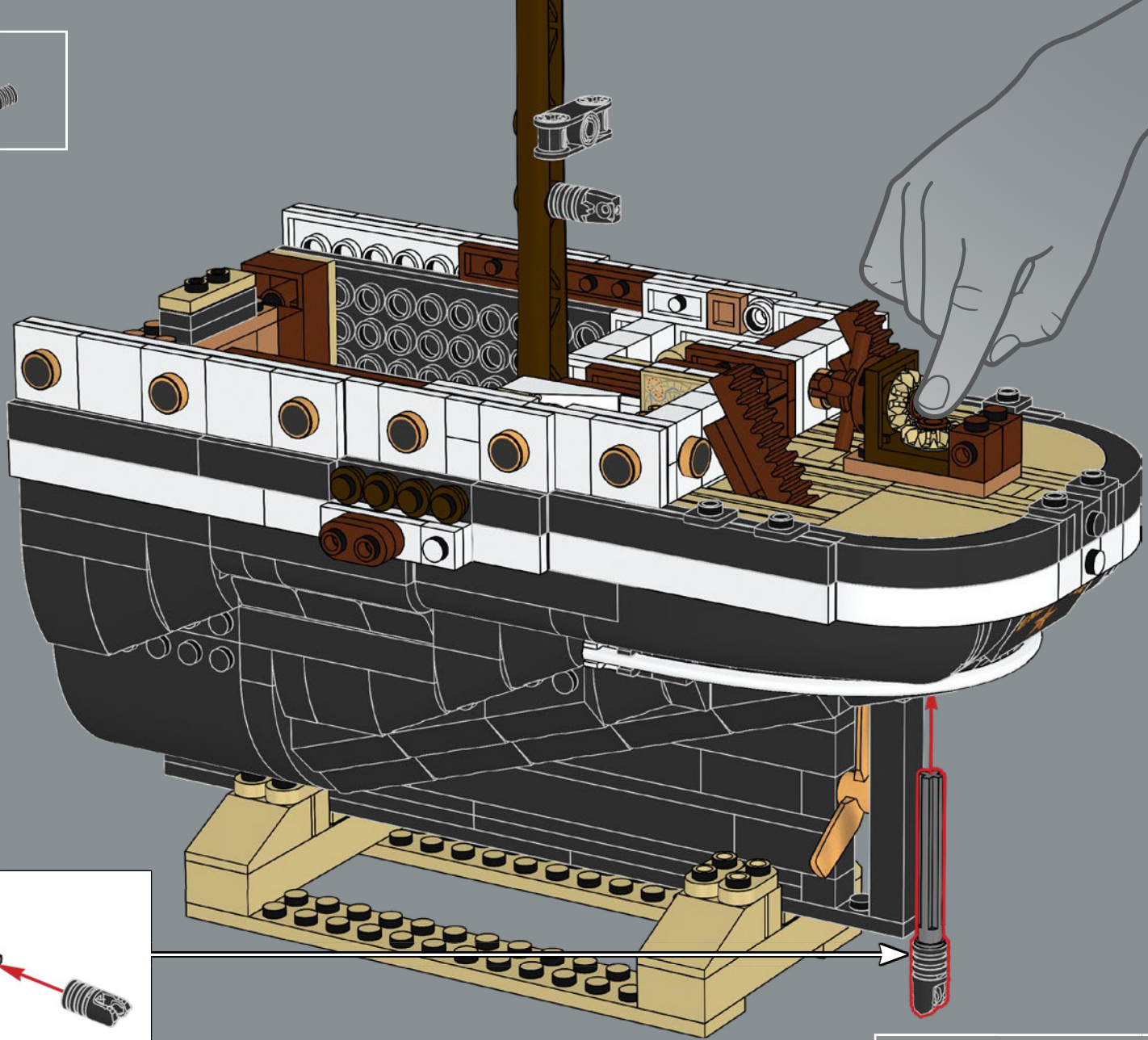

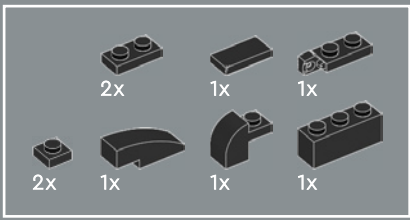

450

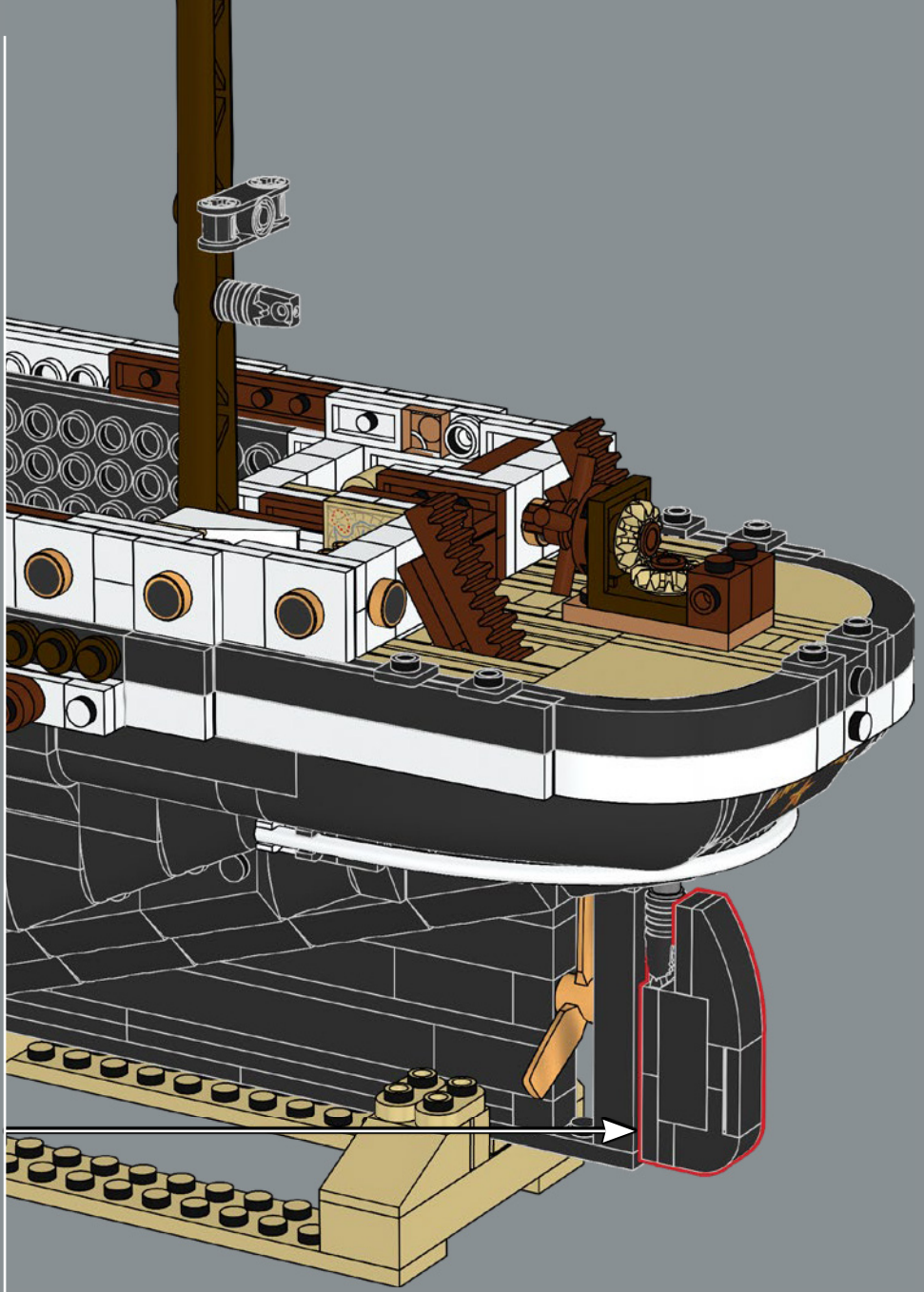
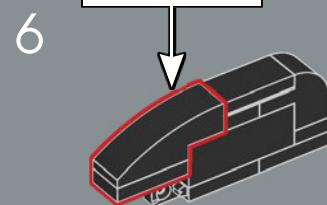
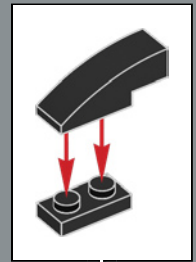
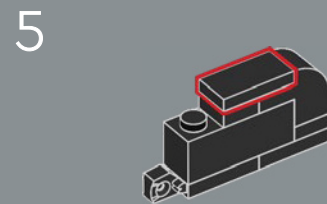
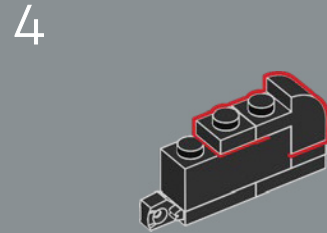
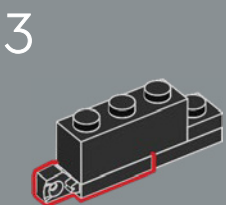
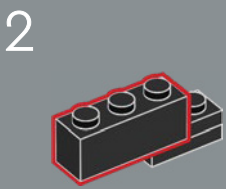
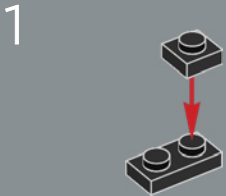

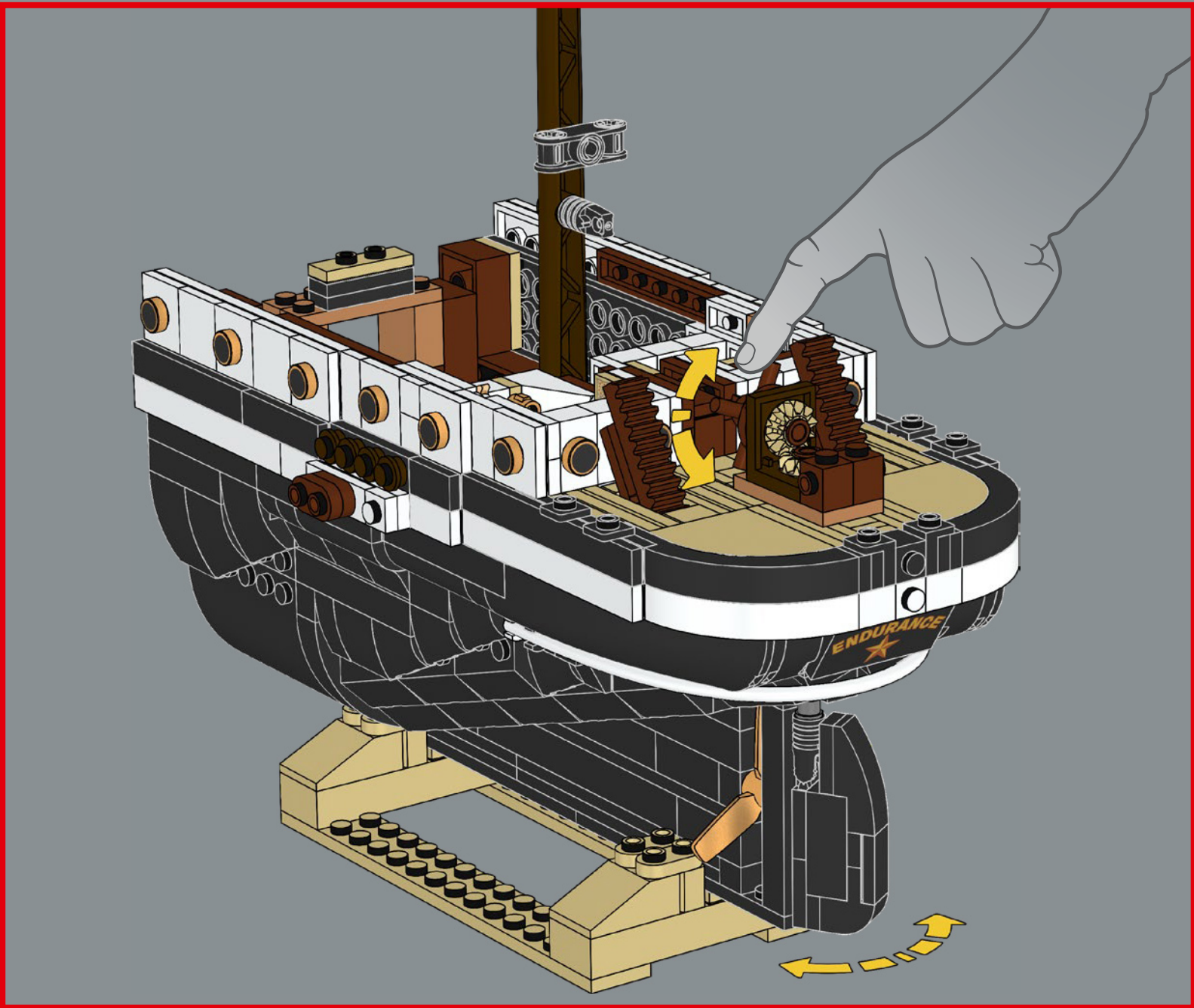

2x

451

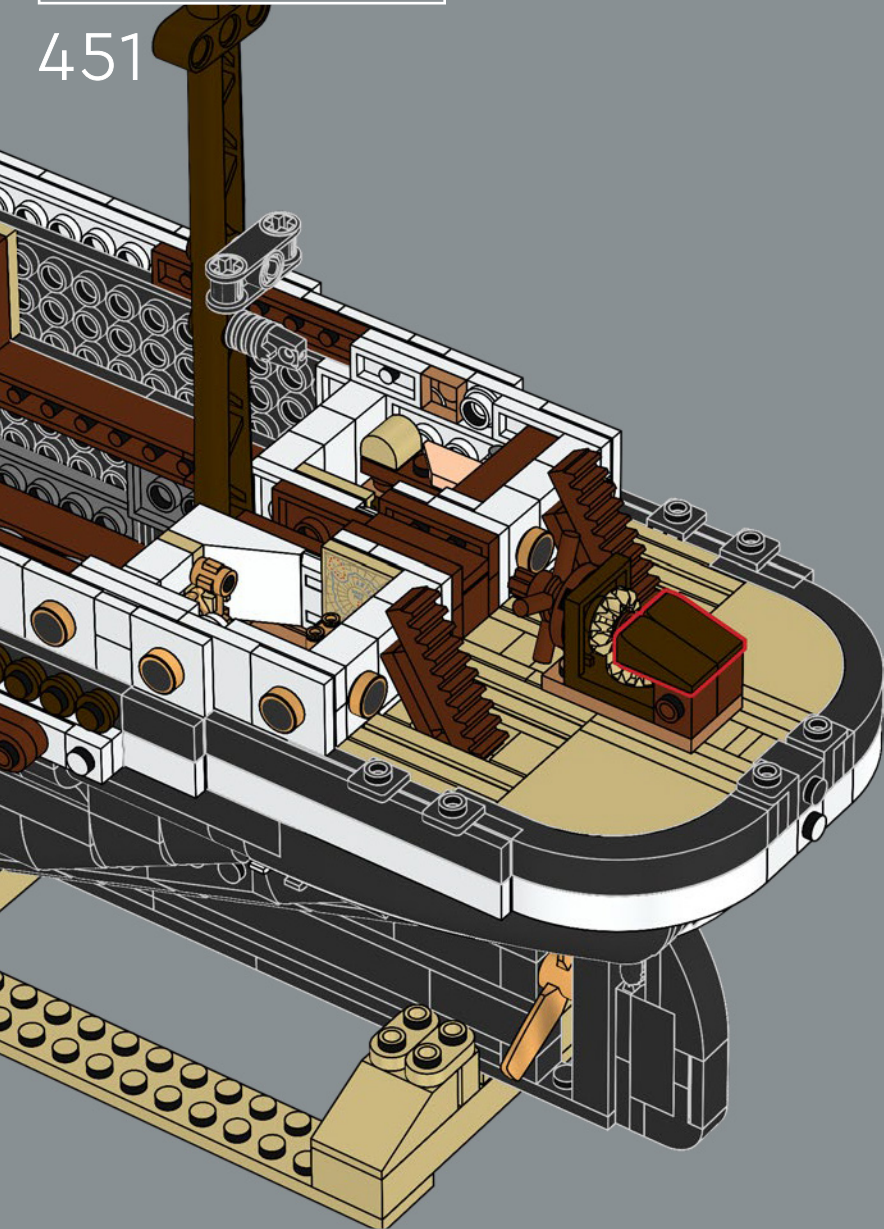

1x

1x

452

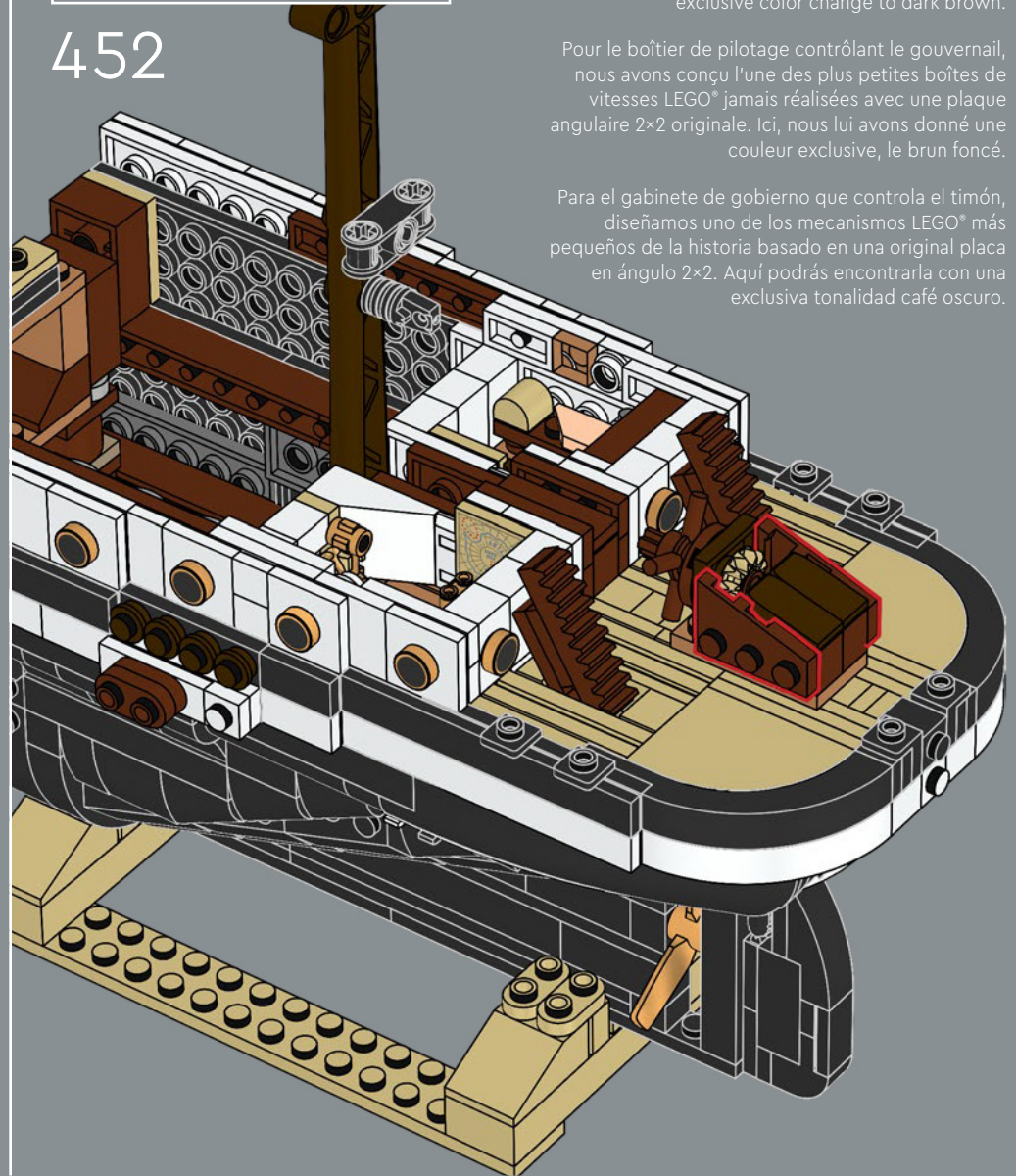

★
For the steering cabinet controlling the rudder, we designed one of the smallest ever LEGO® gearboxes with an original 2x2 angle plate. Here, we gave it an exclusive color change to dark brown.

Pour le boîtier de pilotage contrôlant le gouvernail, nous avons conçu l'une des plus petites boîtes de vitesses LEGO® jamais réalisées avec une plaque angulaire 2x2 originale. Ici, nous lui avons donné une couleur exclusive, le brun foncé.

Para el gabinete de gobierno que controla el timón, diseñamos uno de los mecanismos LEGO® más pequeños de la historia basado en una original placa en ángulo 2x2. Aquí podrás encontrarla con una exclusiva tonalidad café oscuro.



6x

453

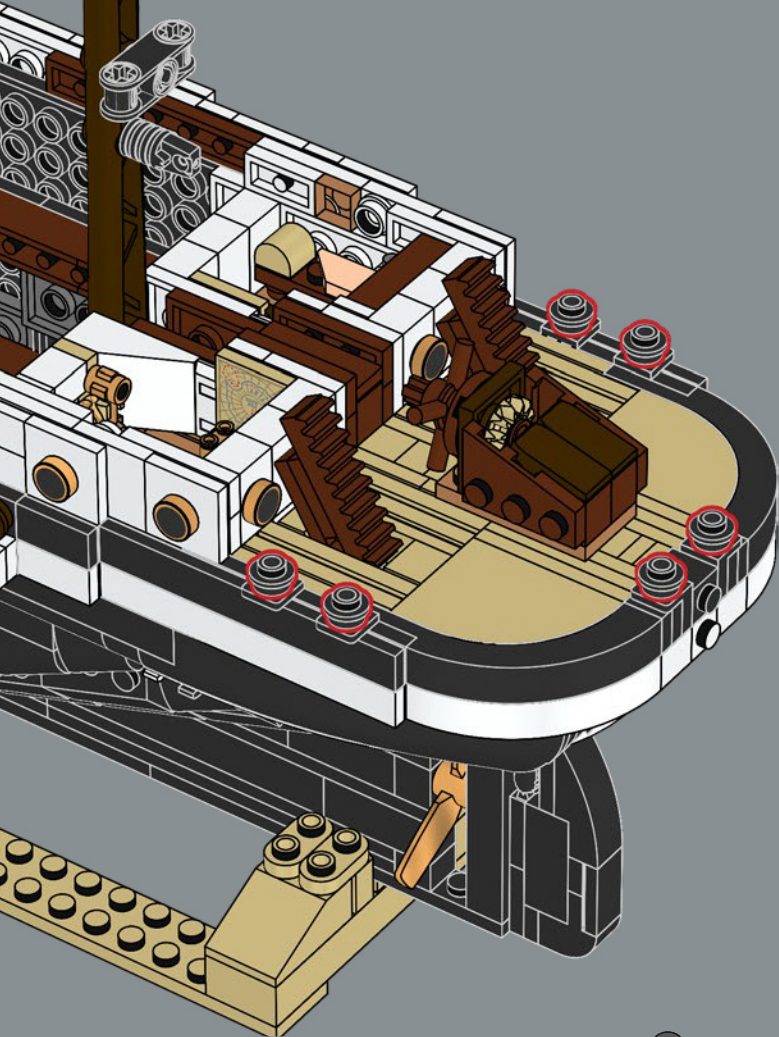

6x

454

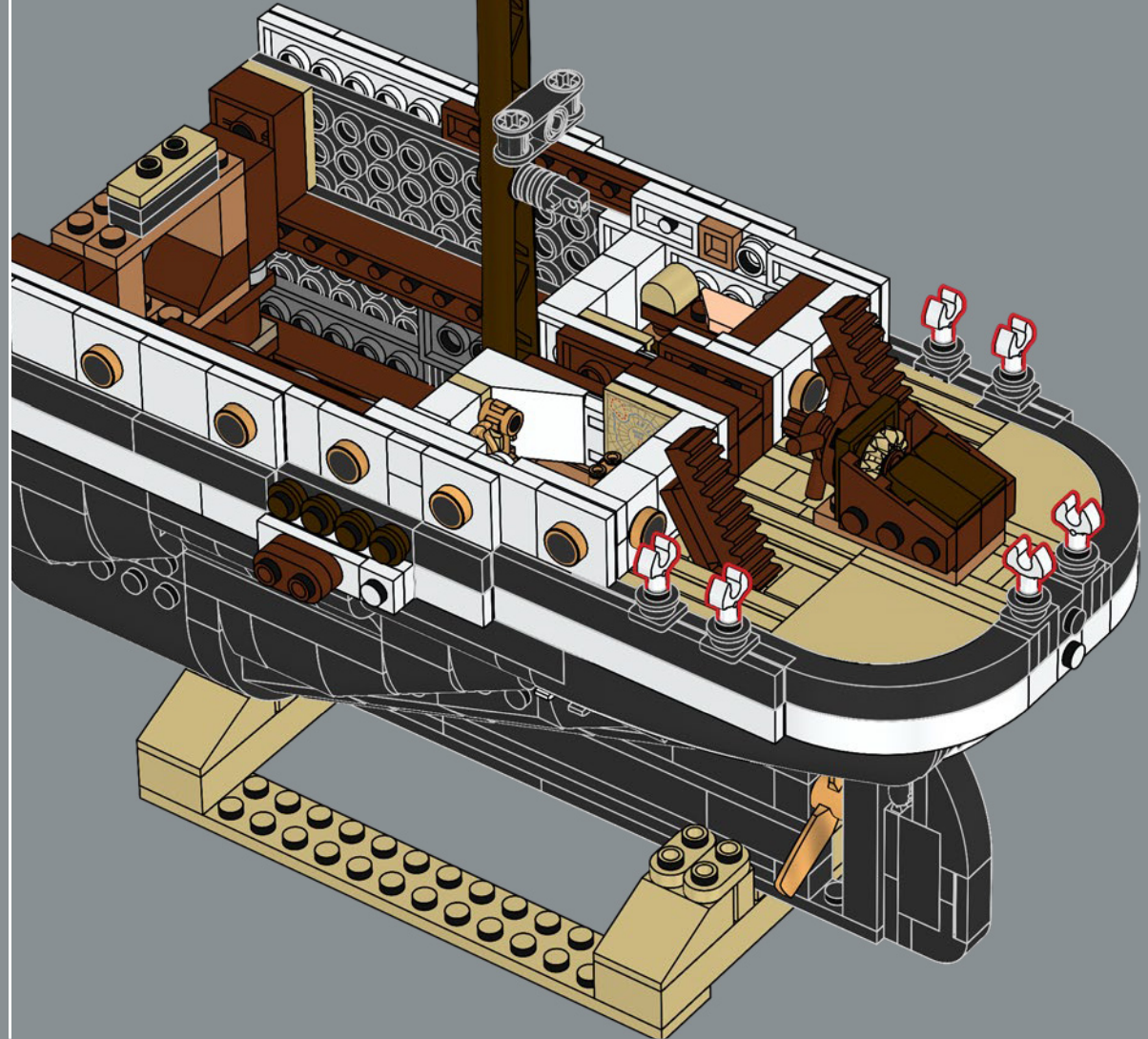

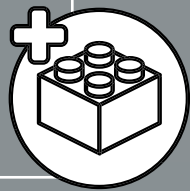
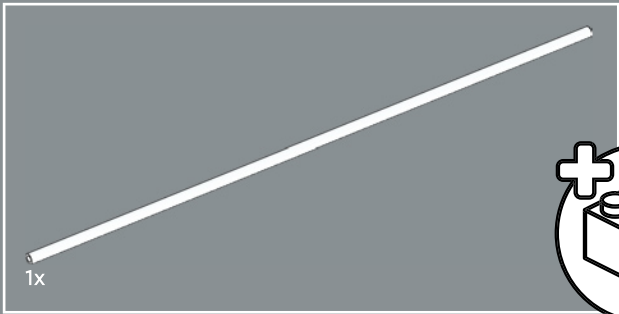

455

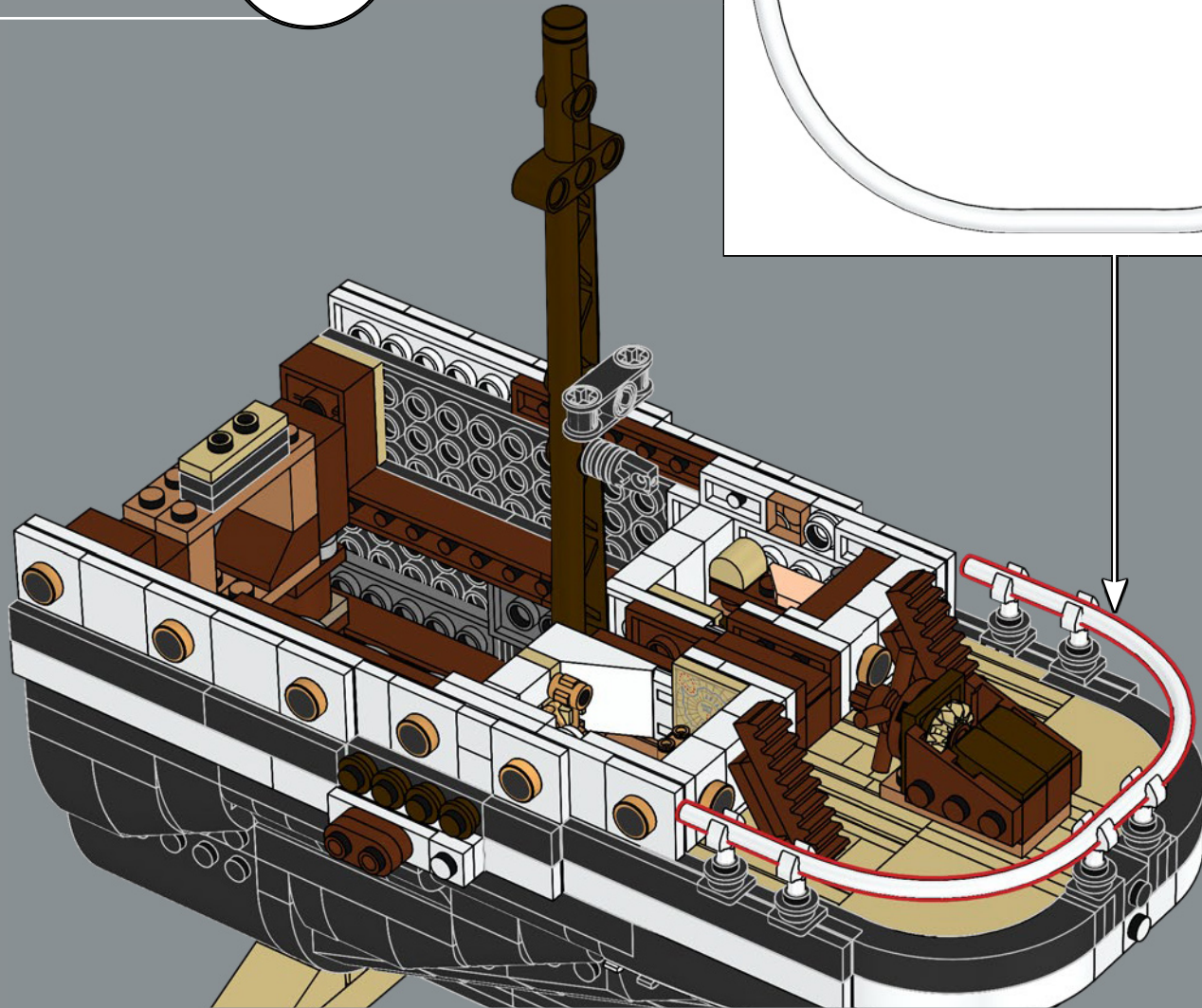
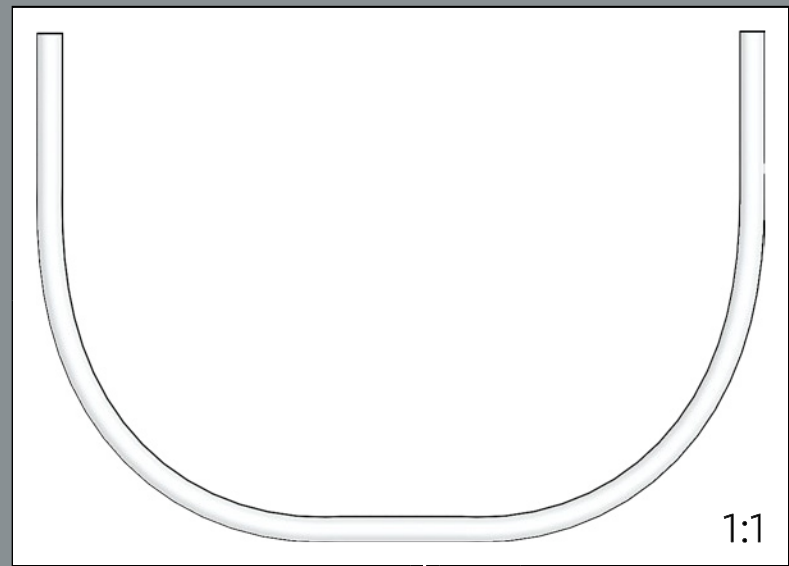



2x

456

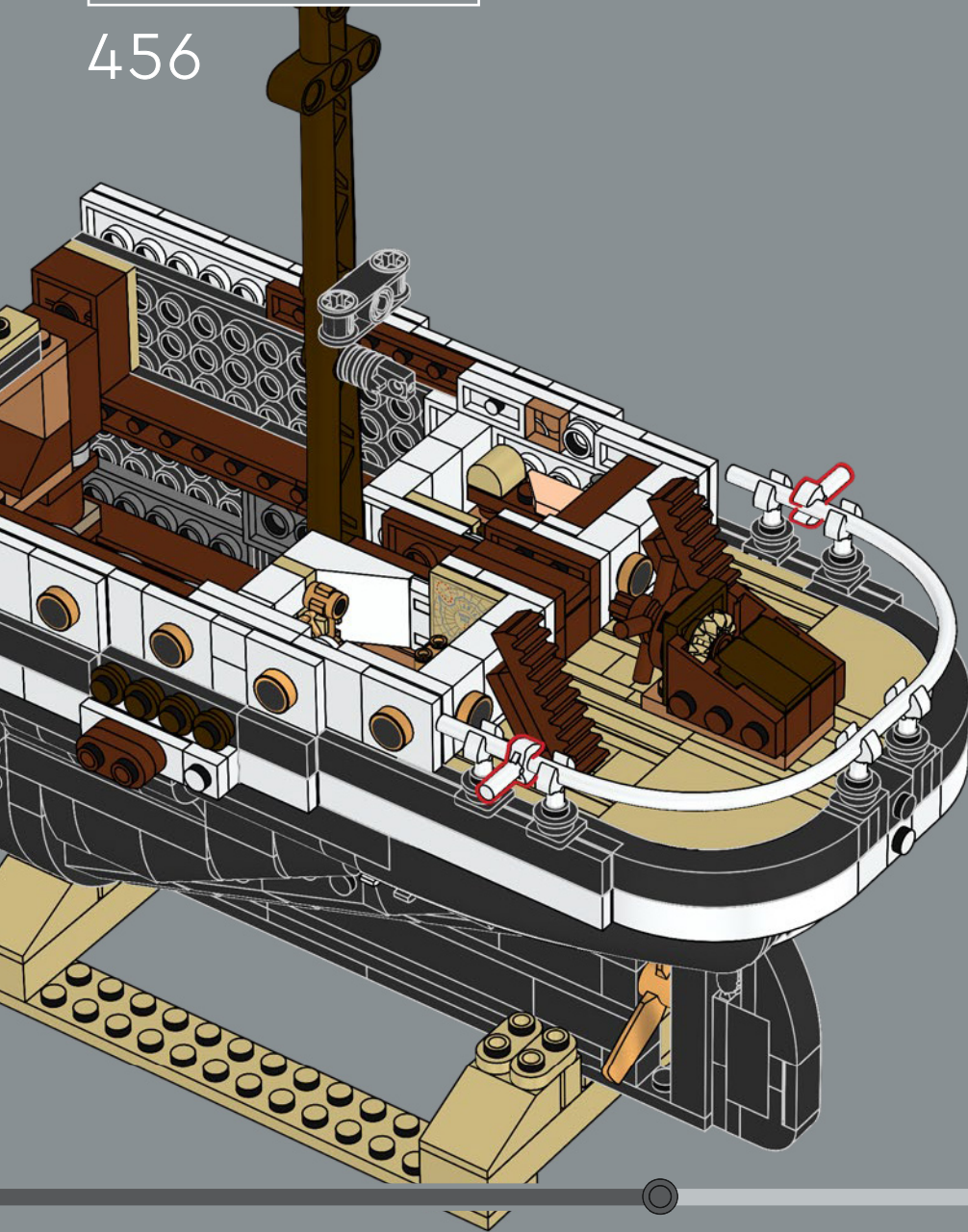

2x

457

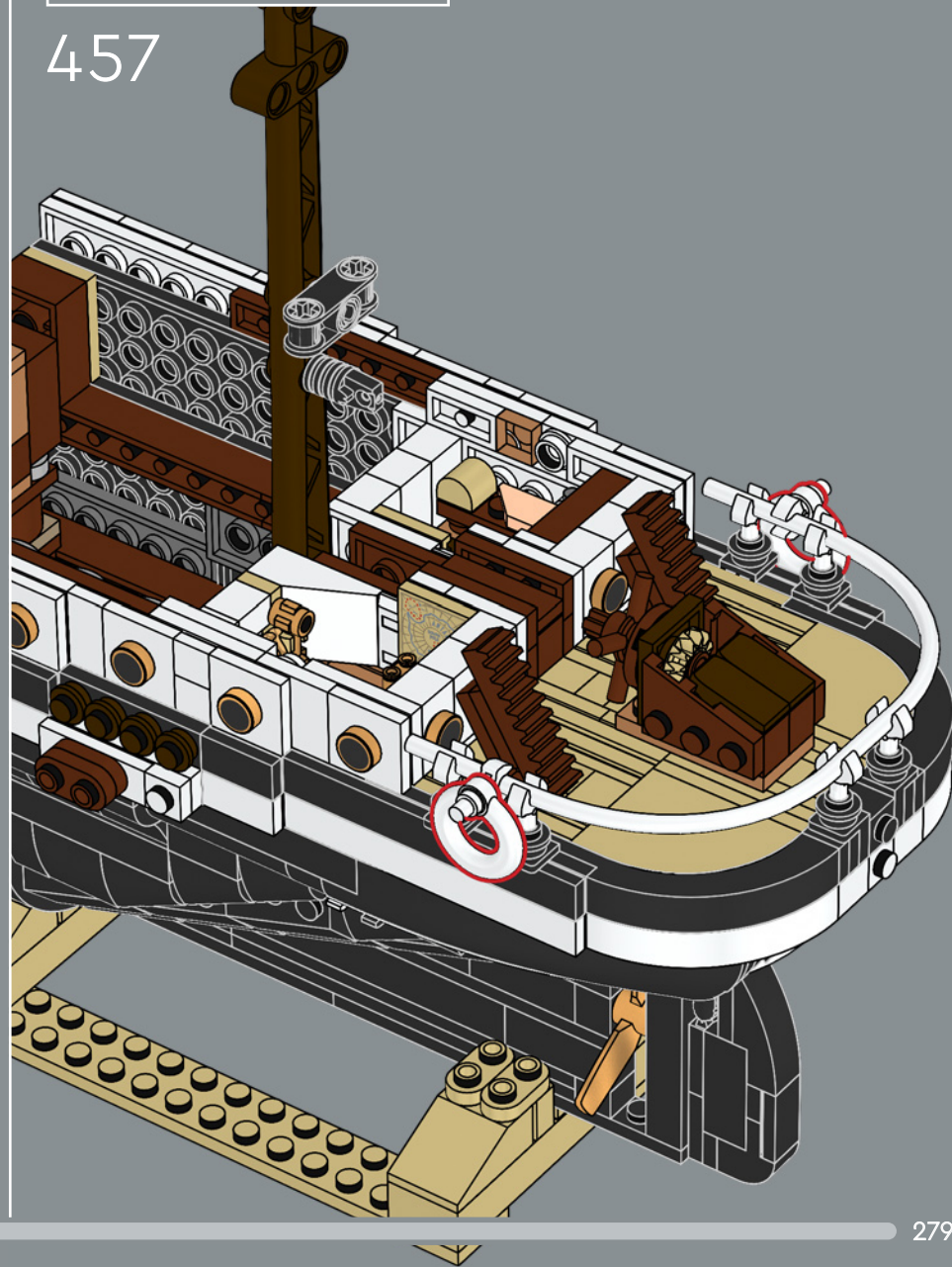

458

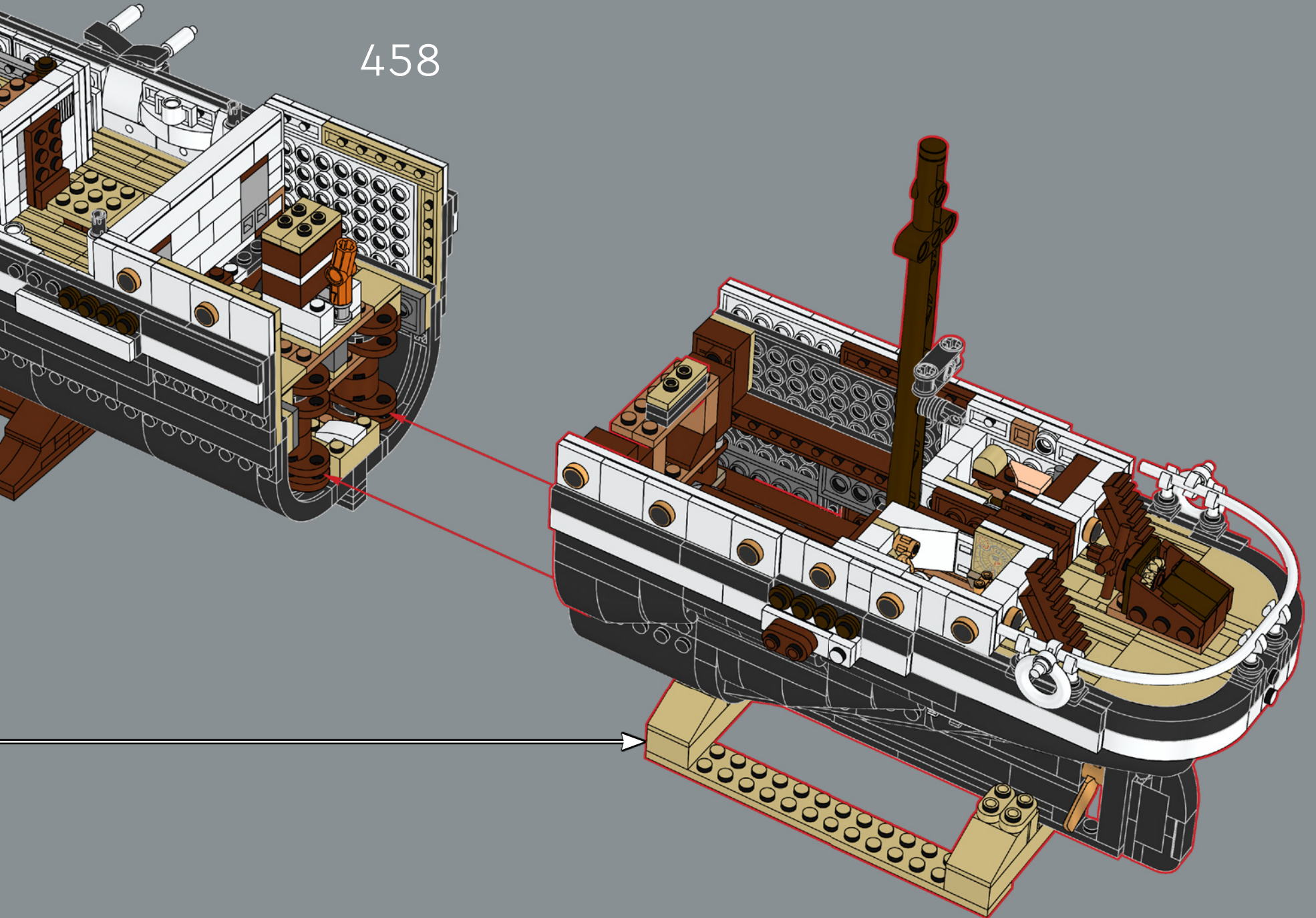

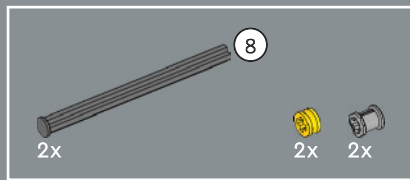

459

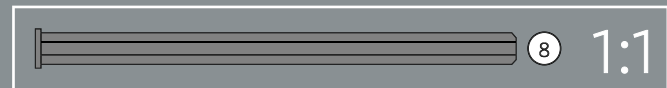
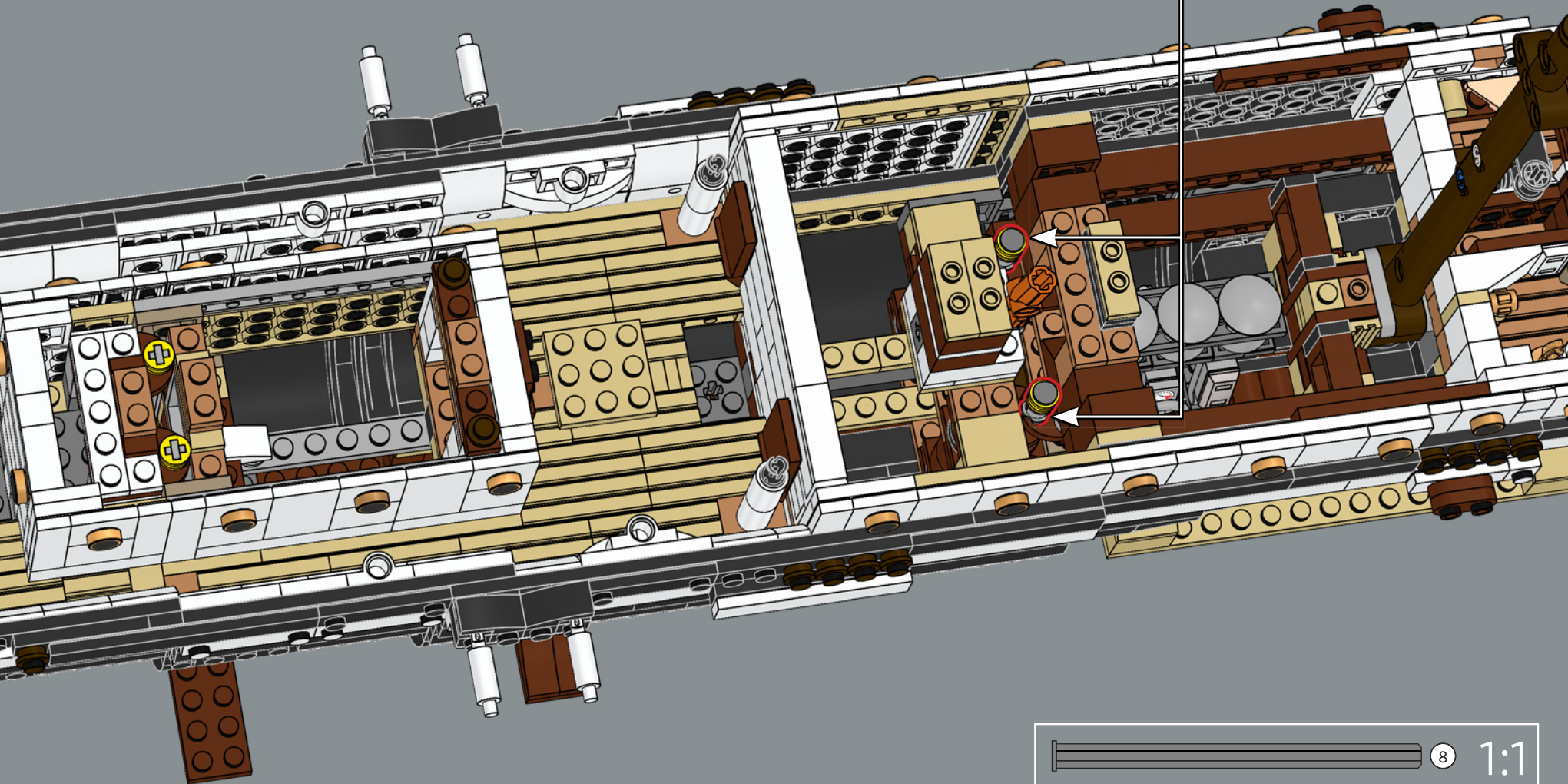
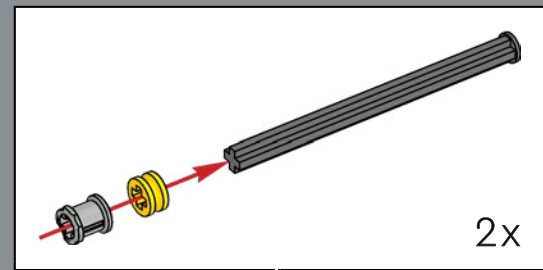

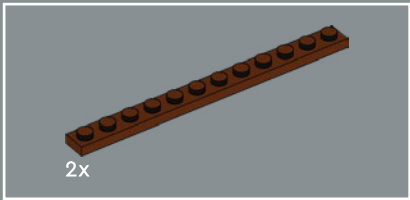

2x

460

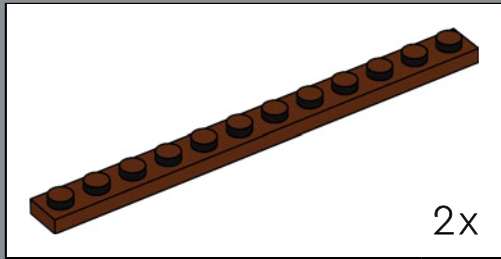

2x

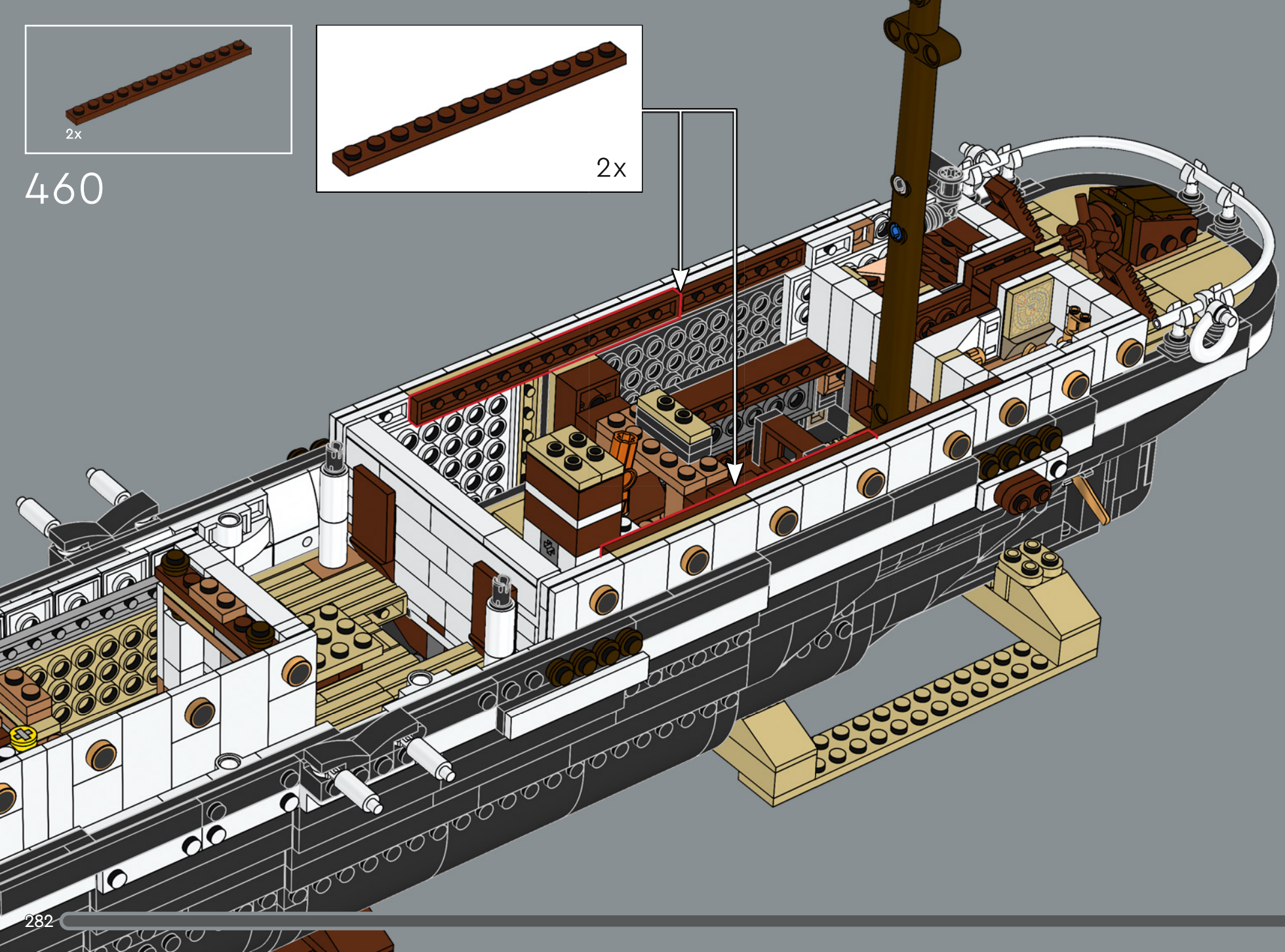

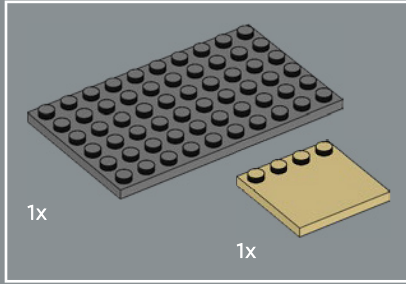
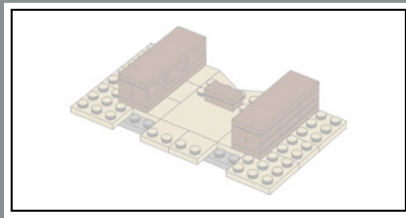

461

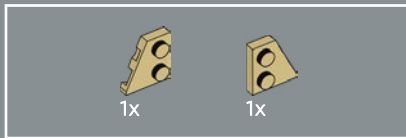
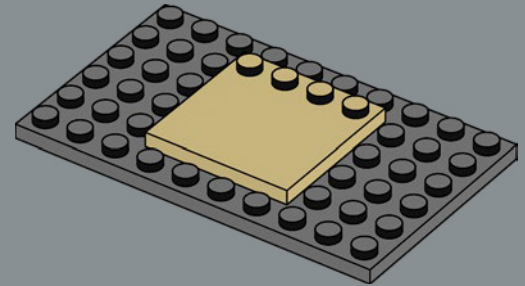

462

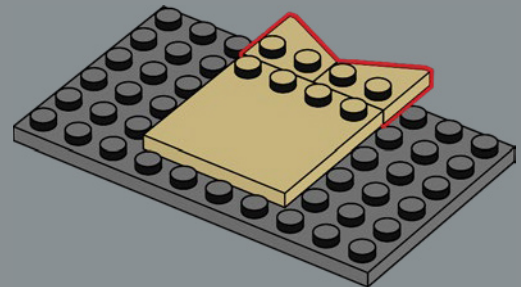

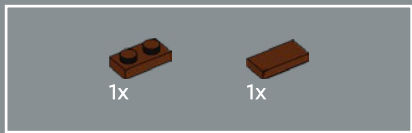

463

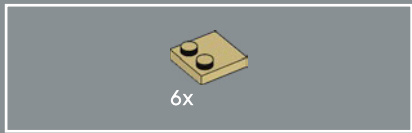
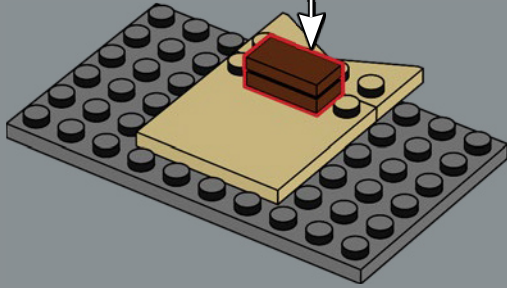
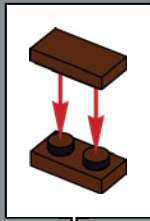

464

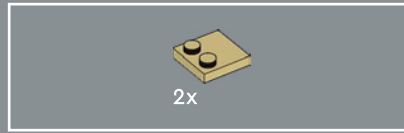
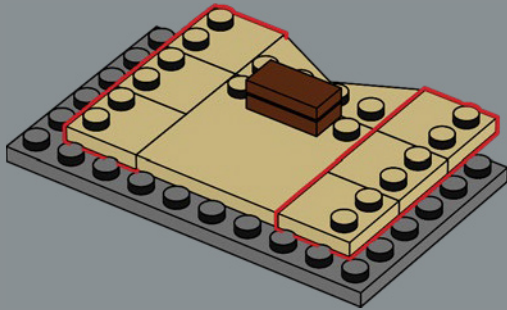

465

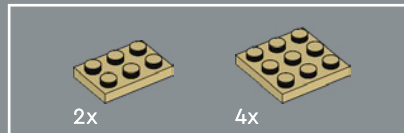
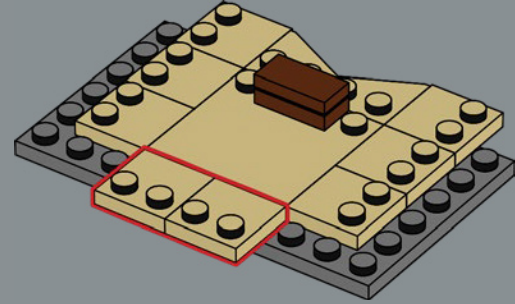

466

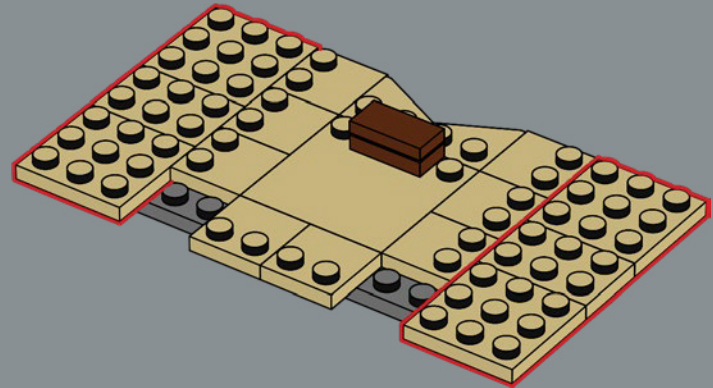

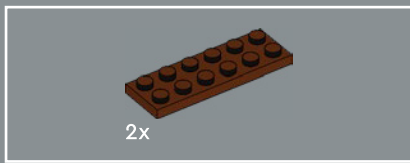

467

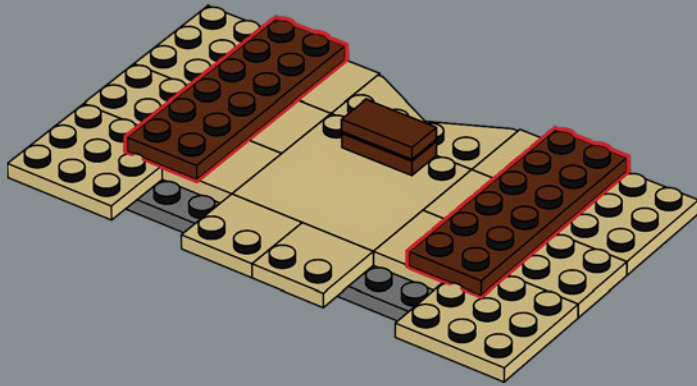

468

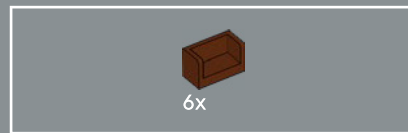
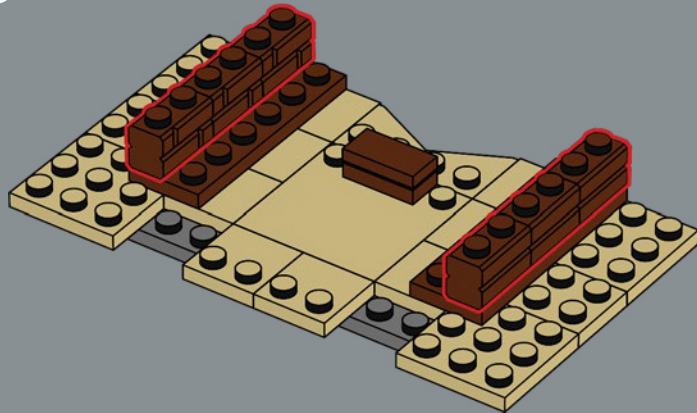

469

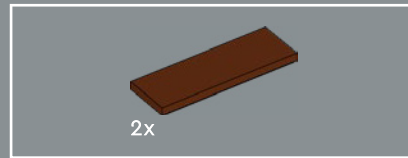
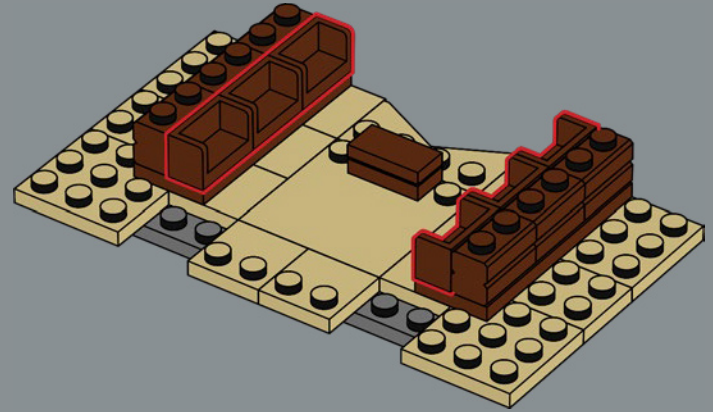

470

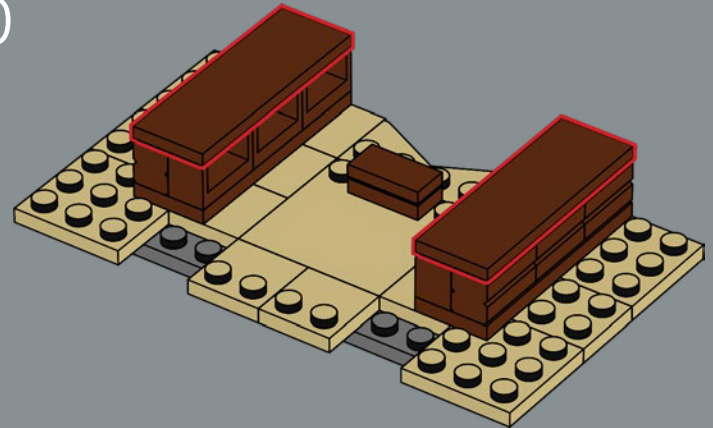

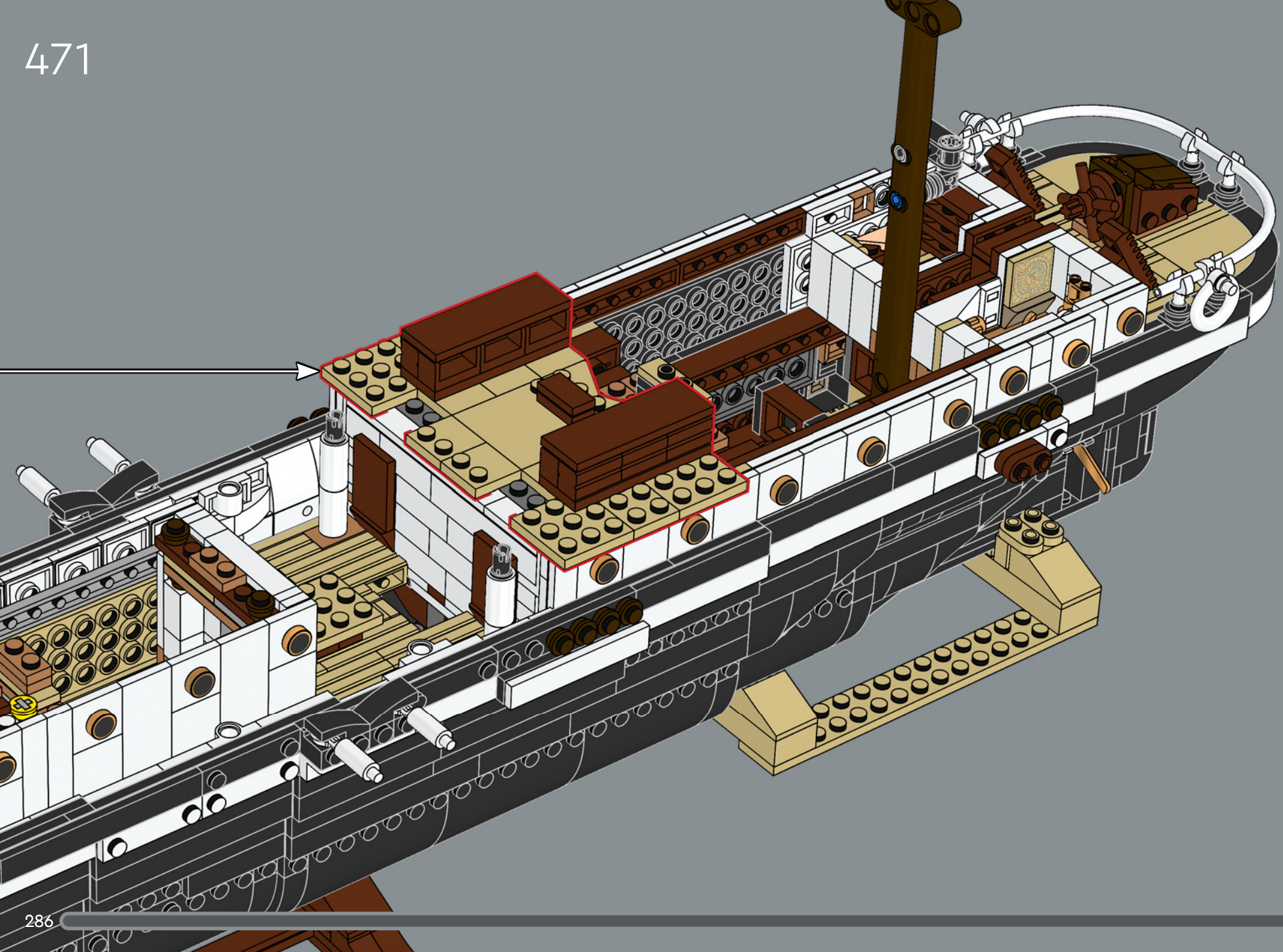

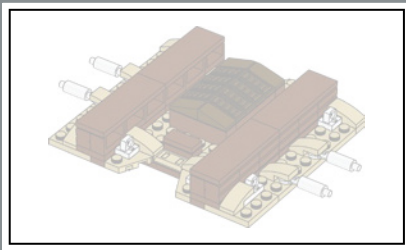

472

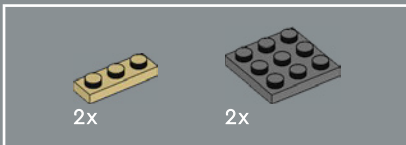
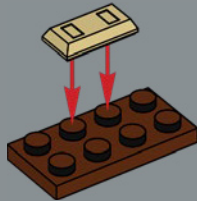

473

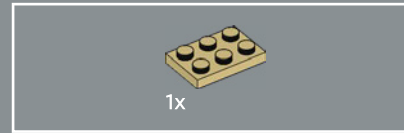
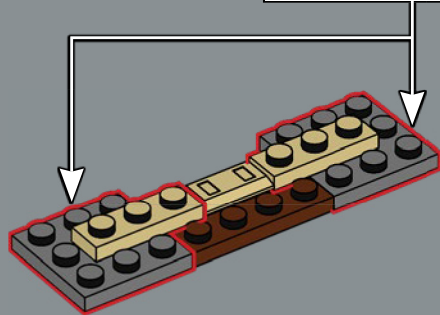
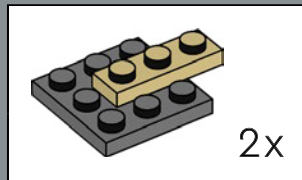

474

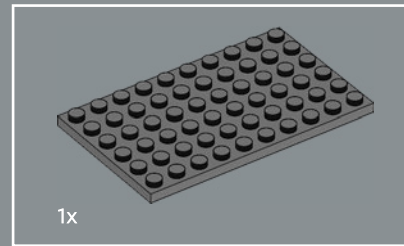
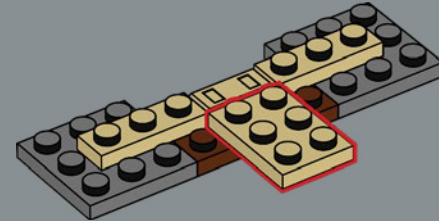

475

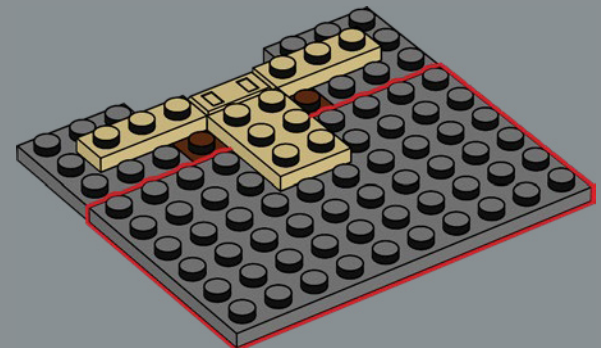

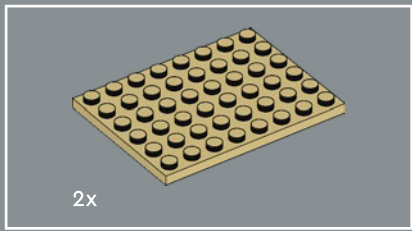

476

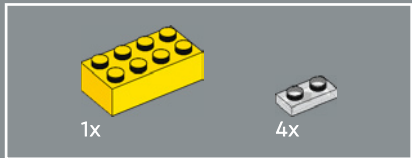
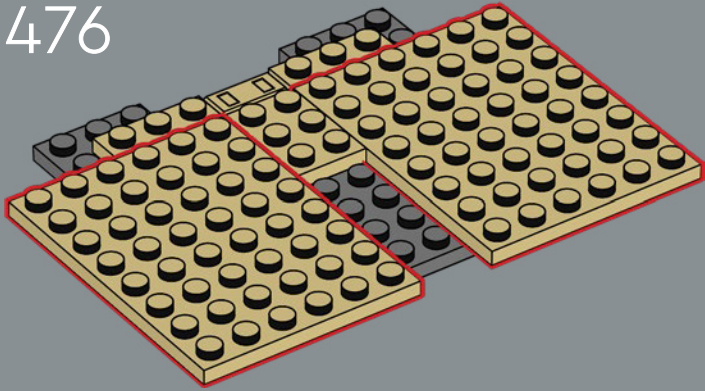

477

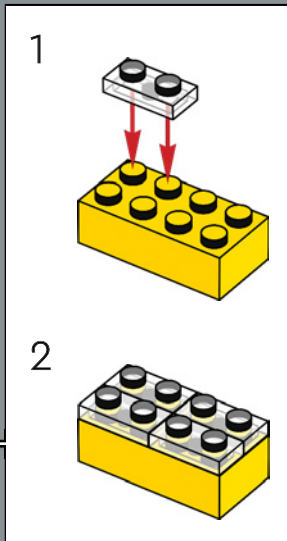
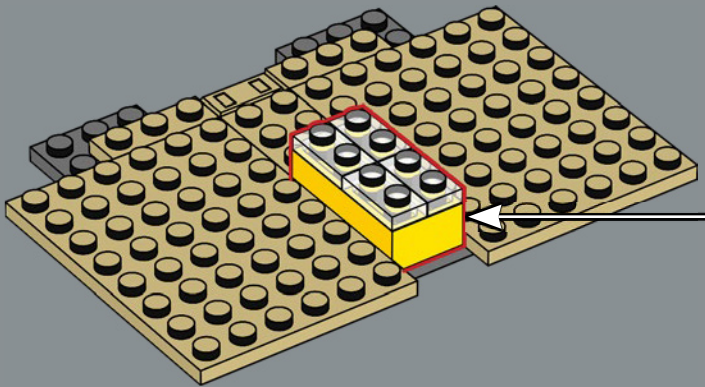

478

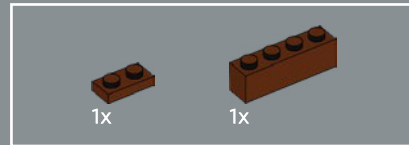
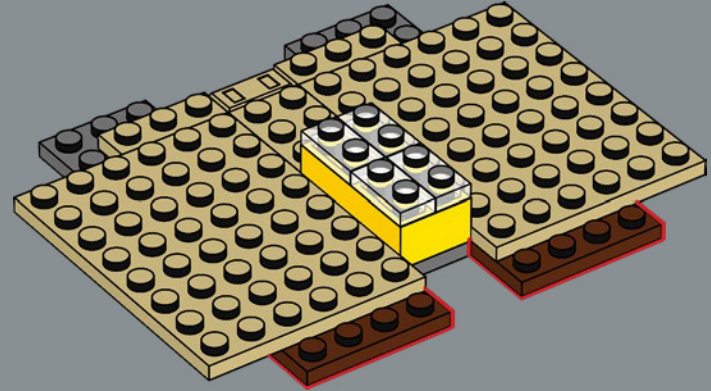

479

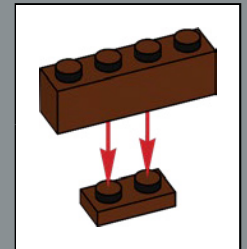
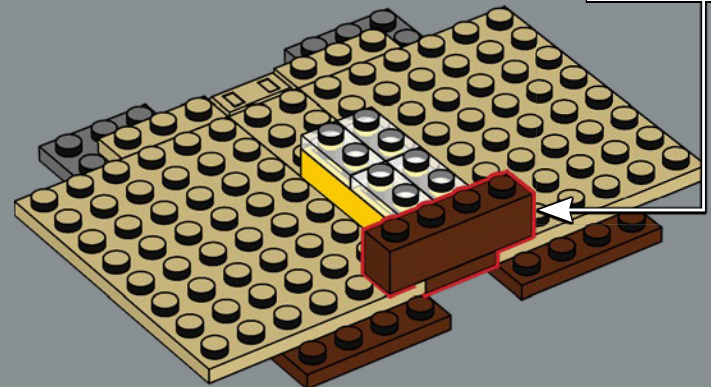

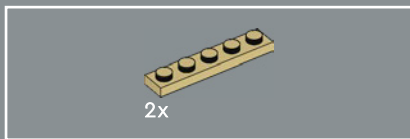

480

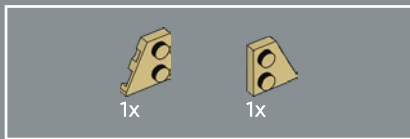
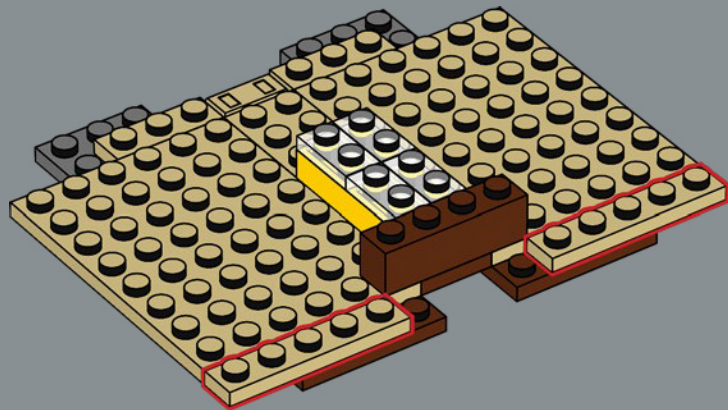

481

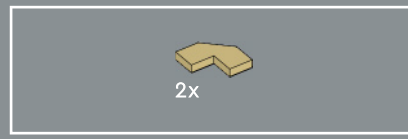
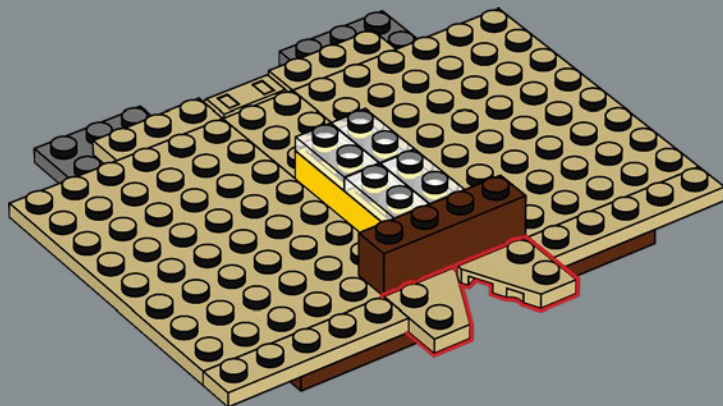

482

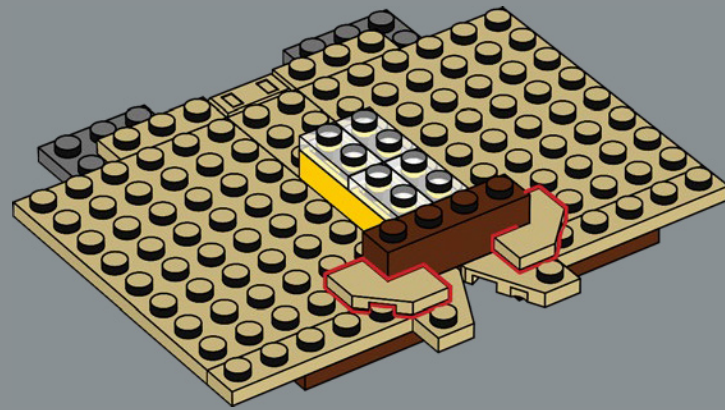

483

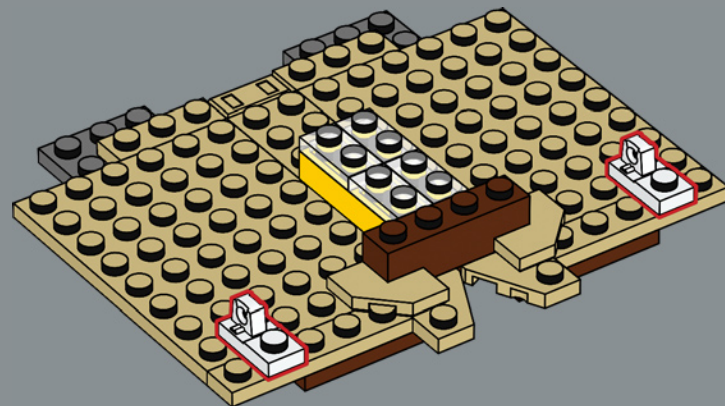



2x

484

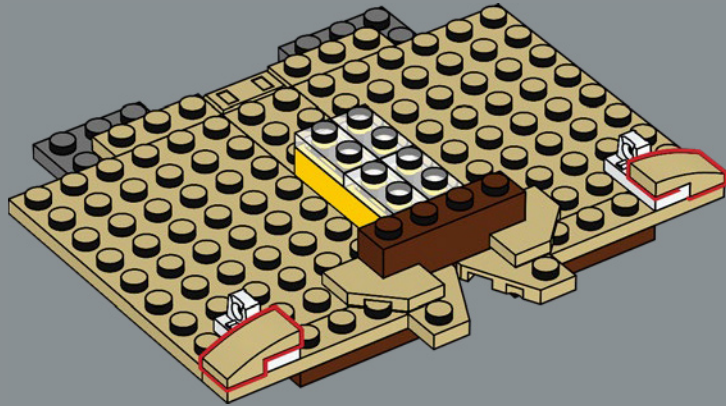

3x

485

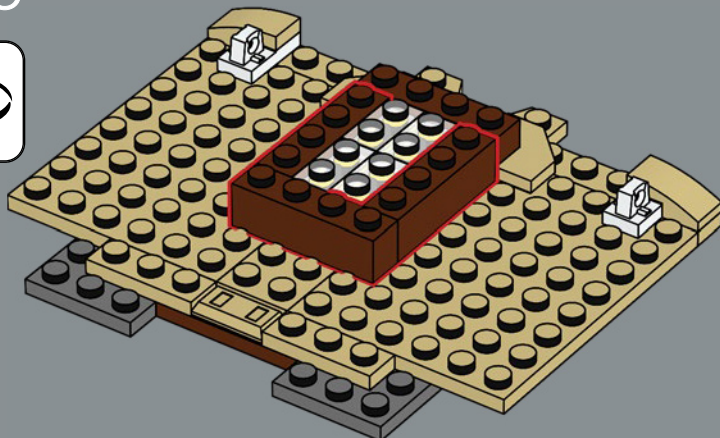

4x



8x

486

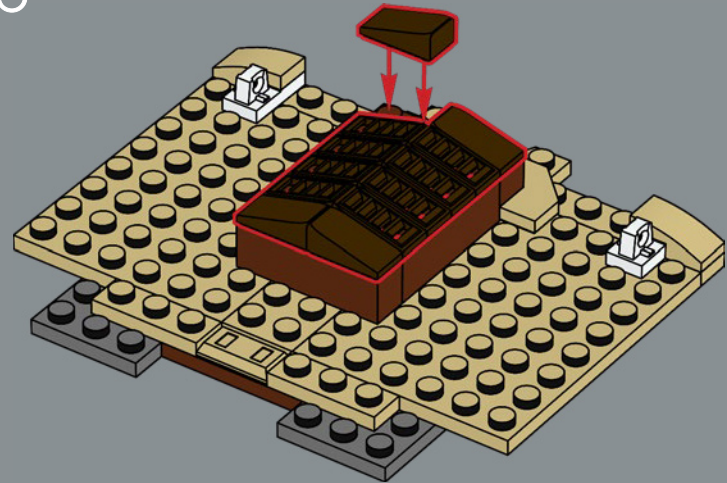

To give the top of the model's cabins a more rugged appearance, small 1x2 slope elements for the cabins' roofs were made in dark brown for the first time.

Pour donner au toit des cabines du modèle un aspect plus robuste, de petits éléments de pente 1x2 ont été créés pour la première fois en brun foncé.

A fin de dar a la parte superior de los camarotes del modelo un aspecto más robusto, se fabricaron por primera vez en café oscuro pequeños elementos con pendiente 1x2 para sus techos.

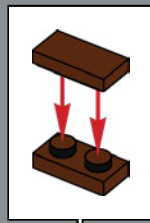
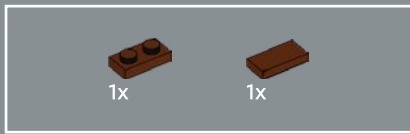

487

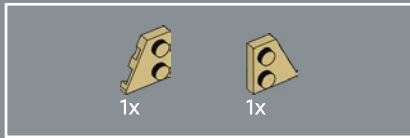
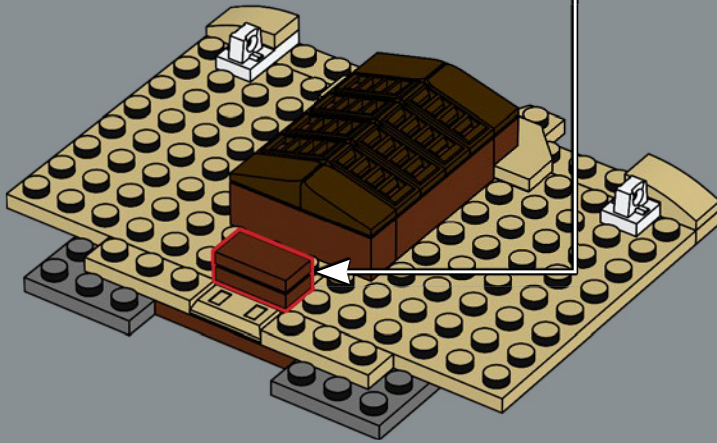

488

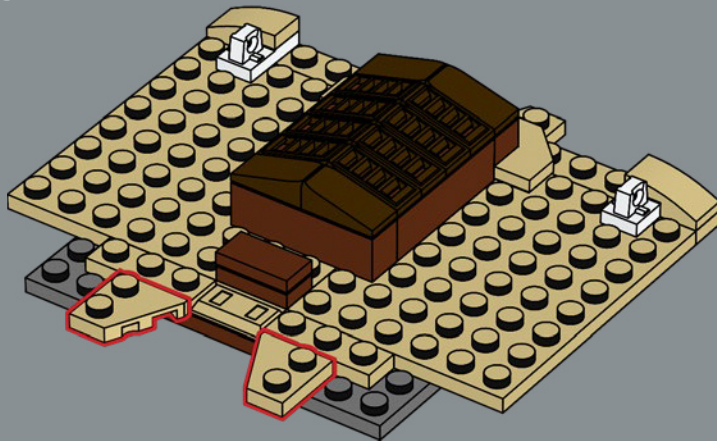

489

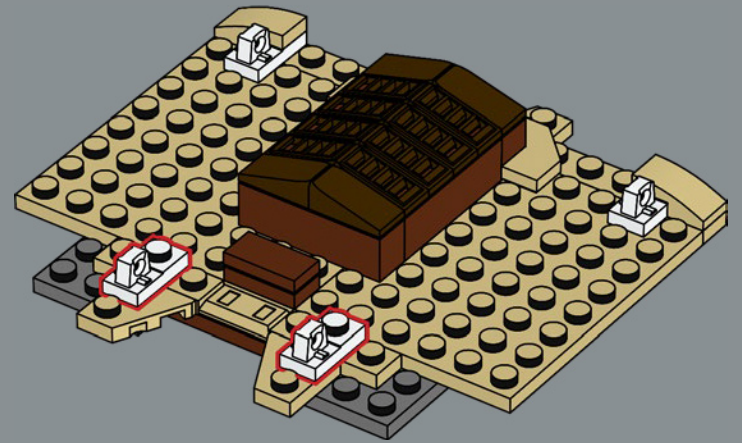

490

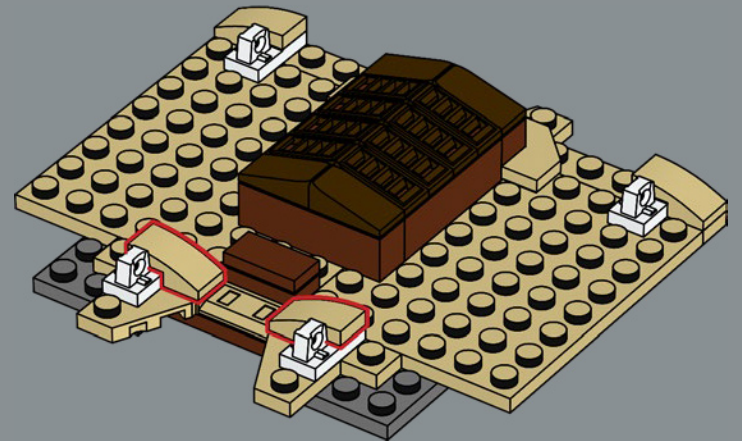

2x

491

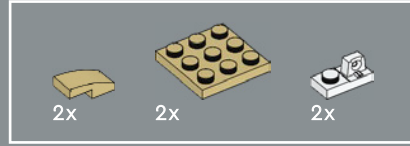
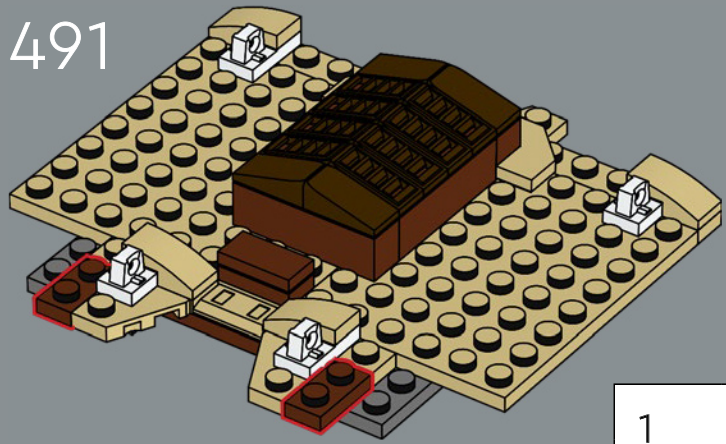

492

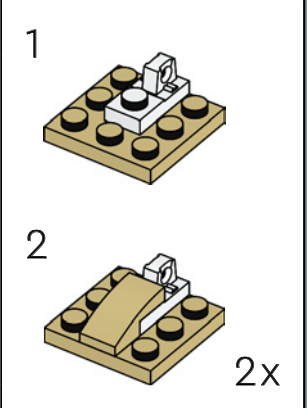
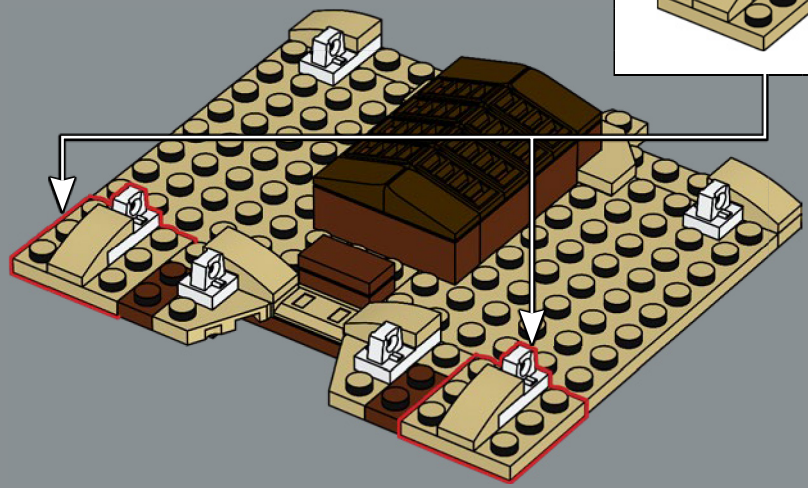

4x

493

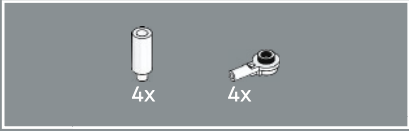
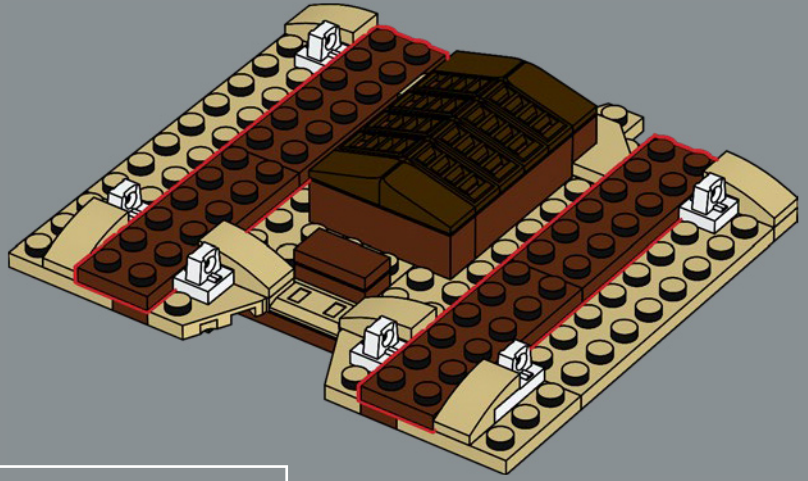

494

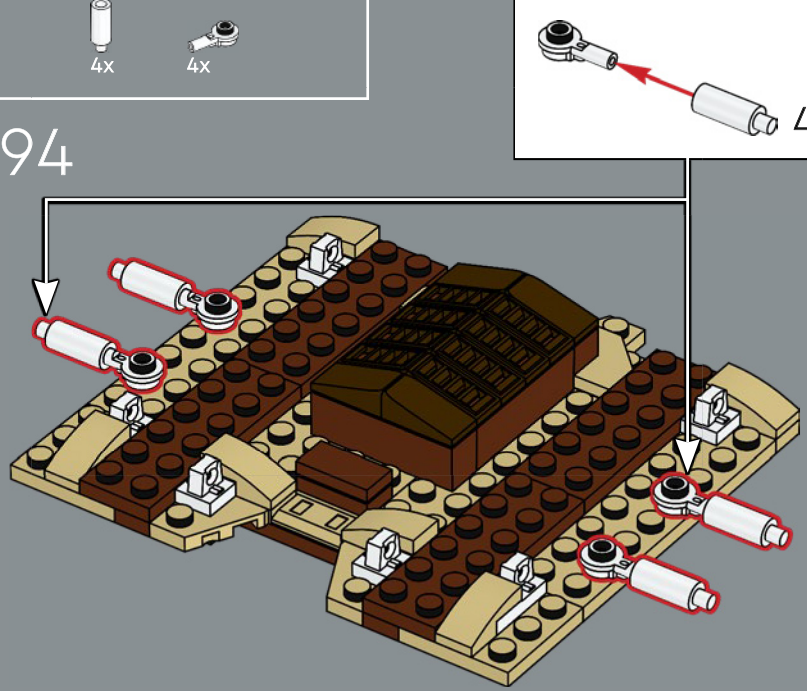



495

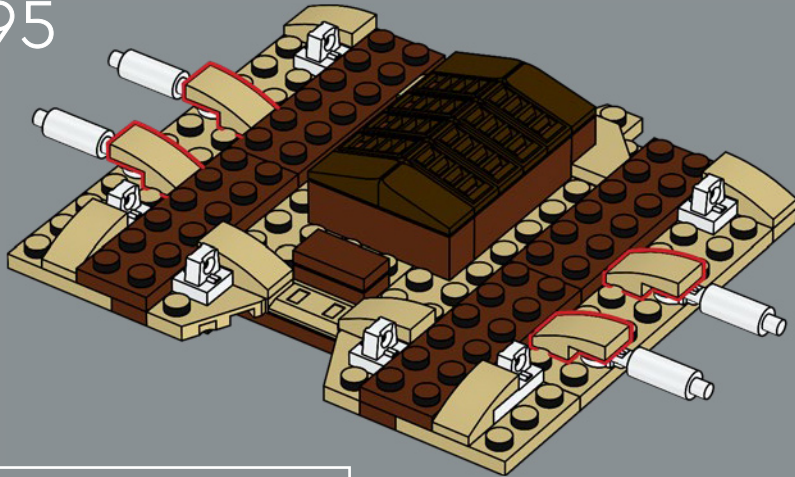

496

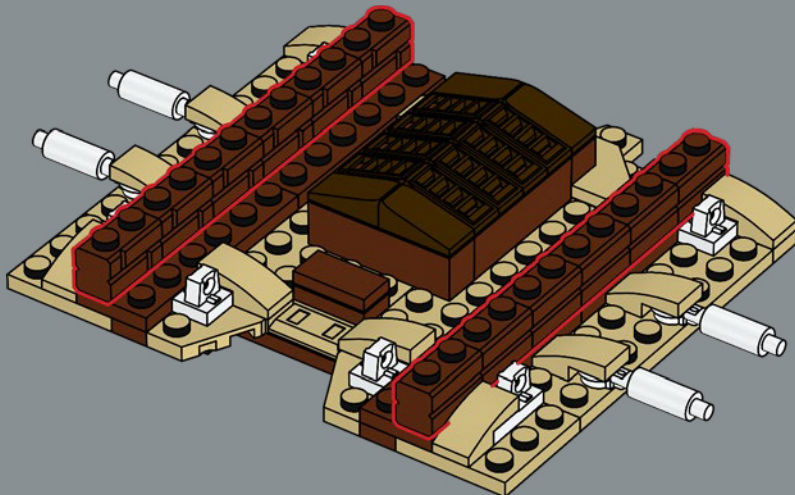

497

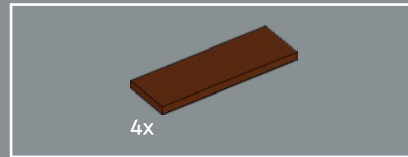
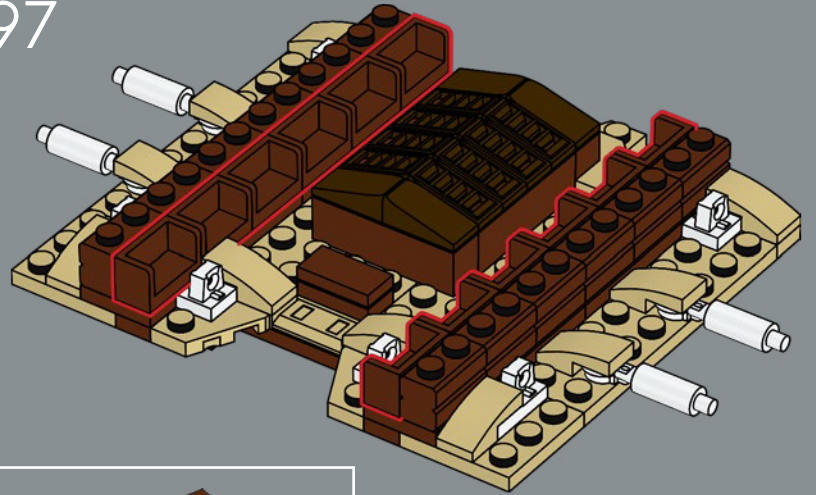

498

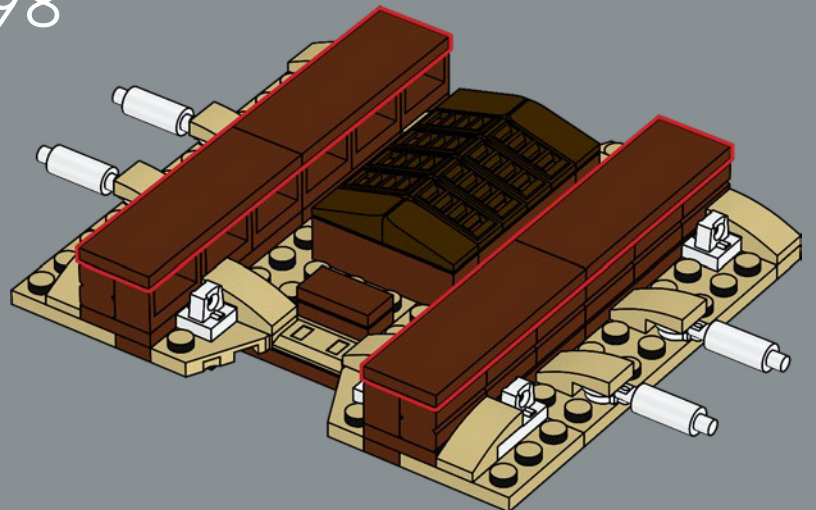

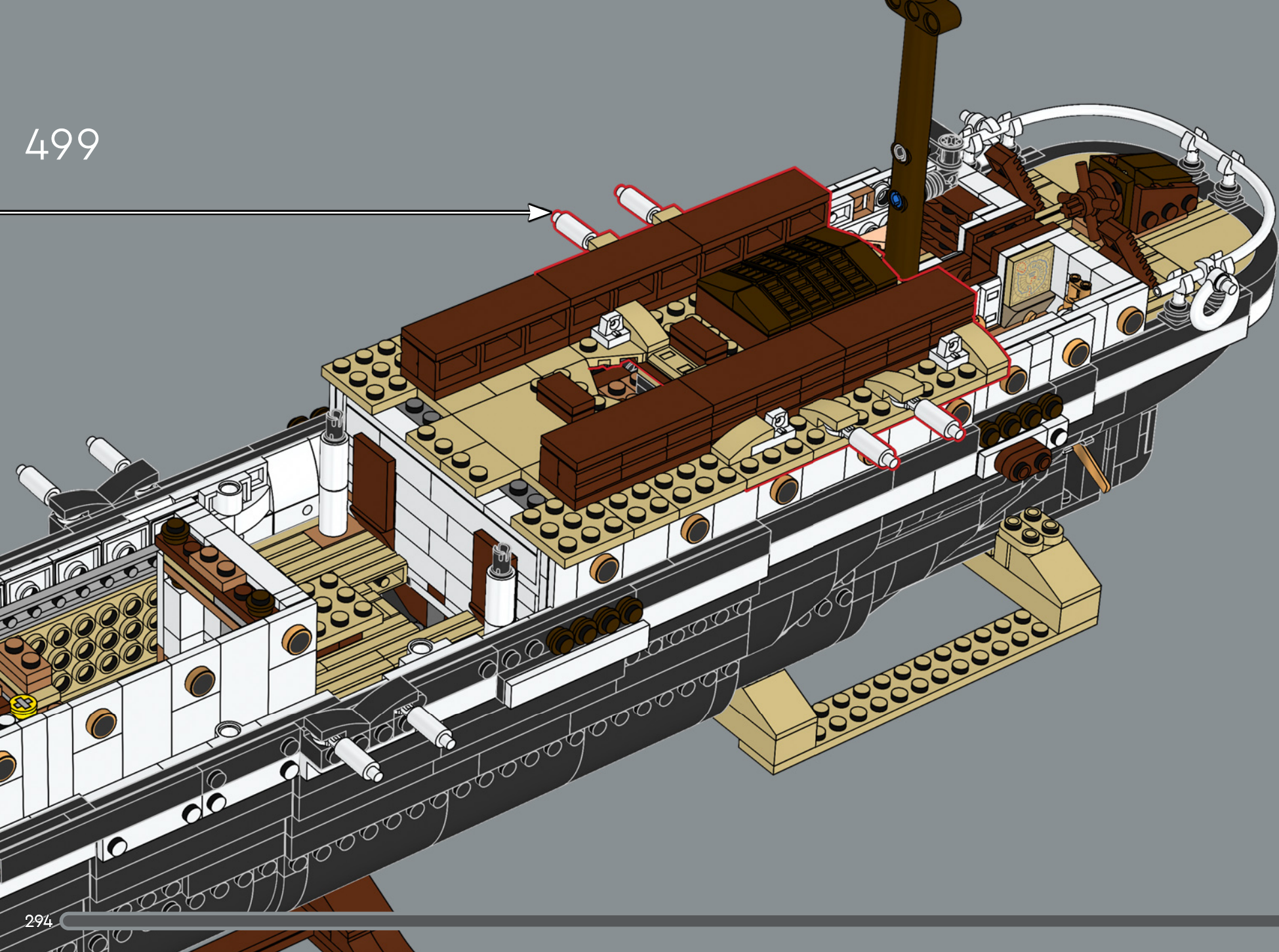

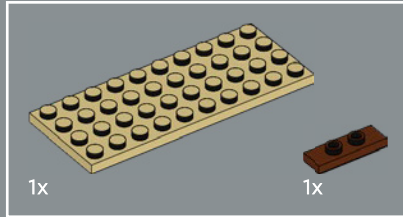
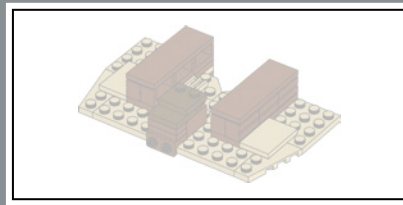

500

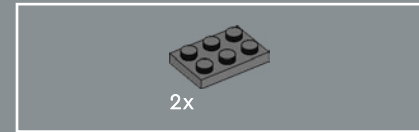
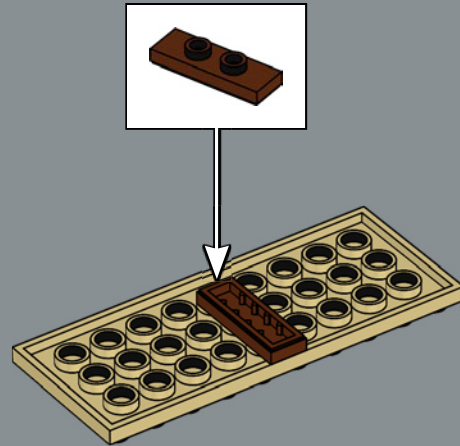

501

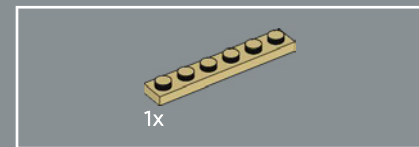
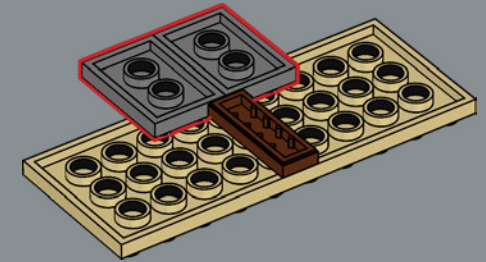

502

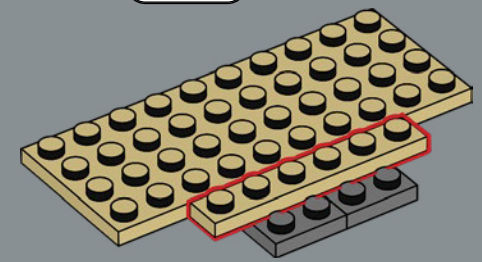

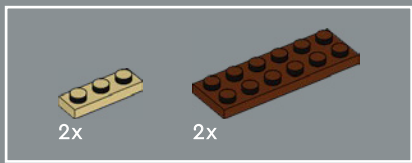

503

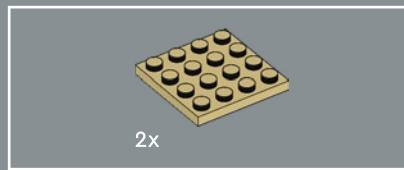
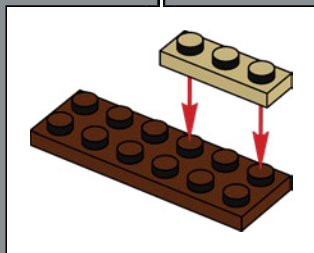
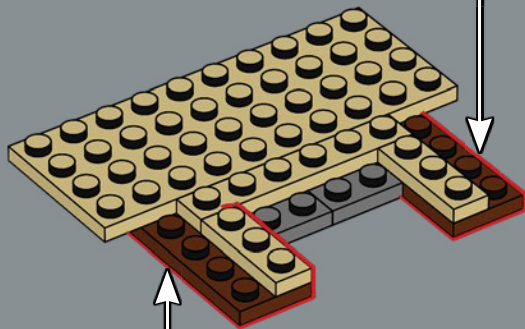
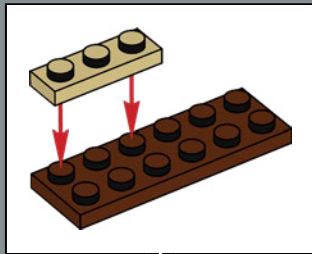

504

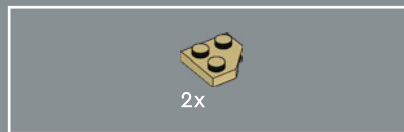
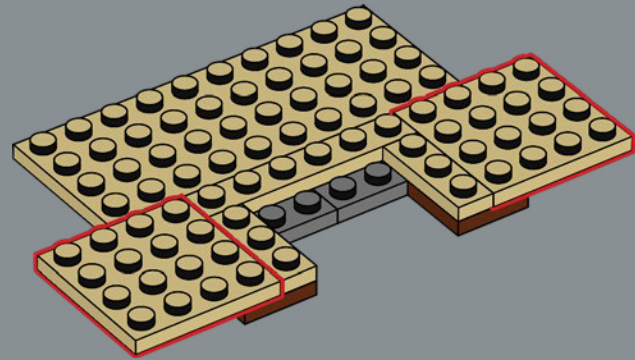

505

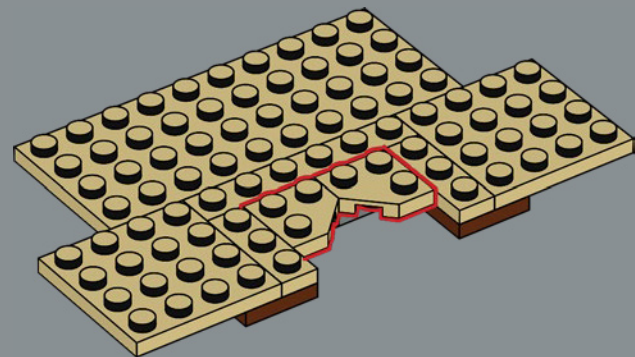

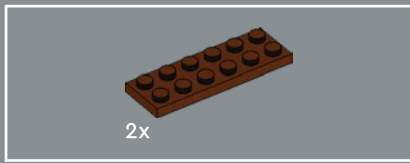

506

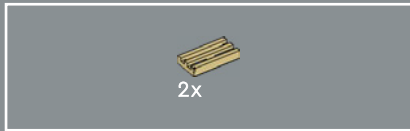
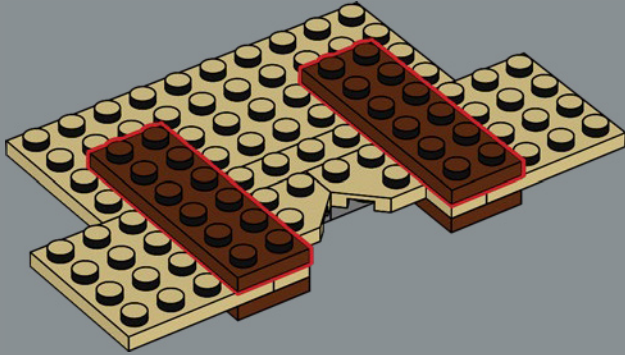

507

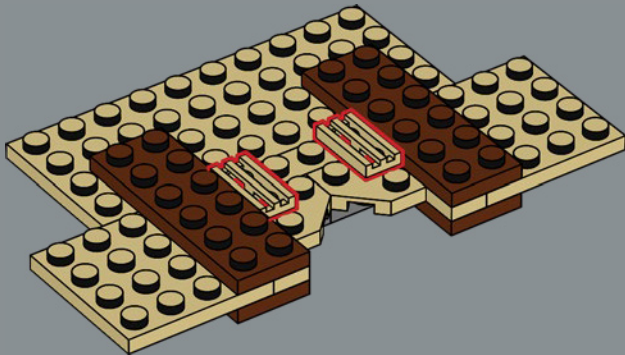

508

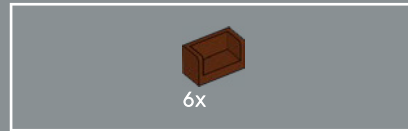
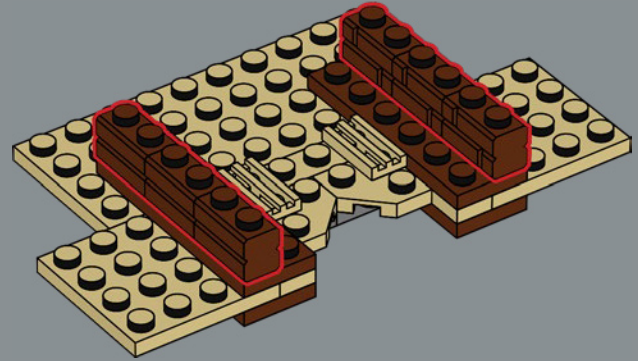

509

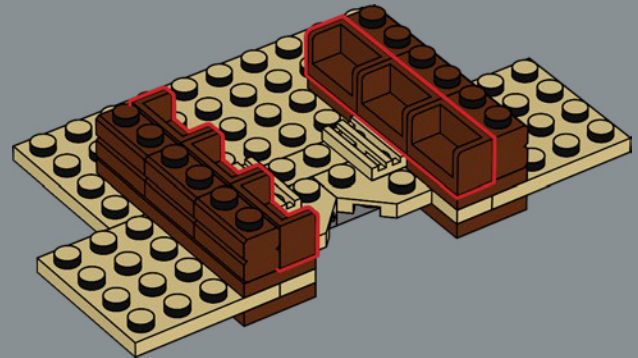

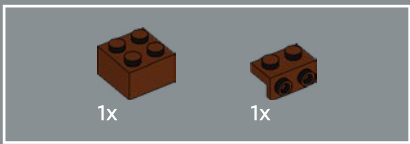

510

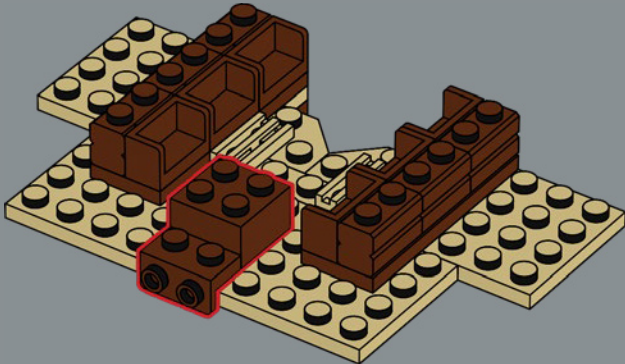

511

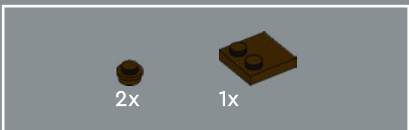
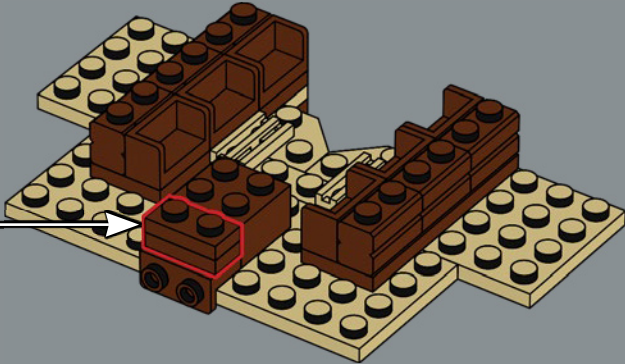
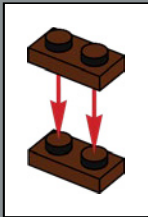

512

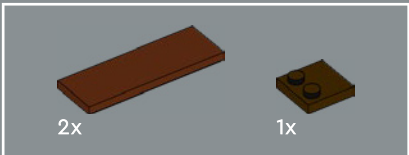
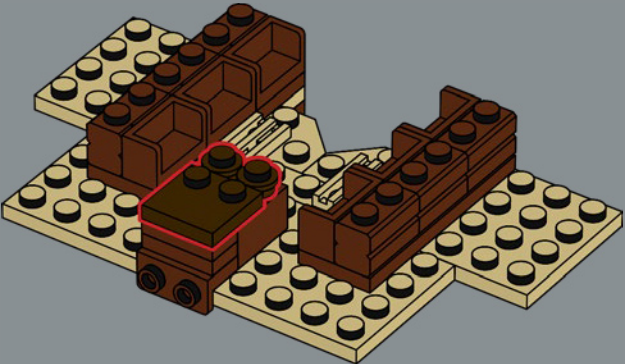

513

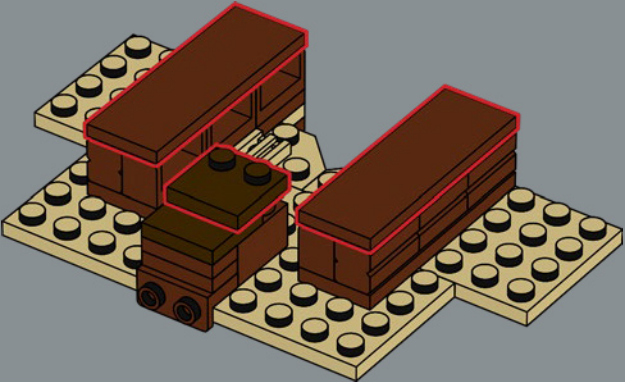

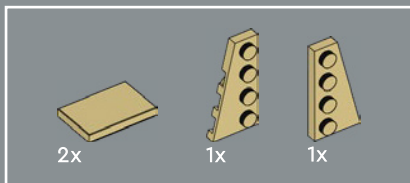

514

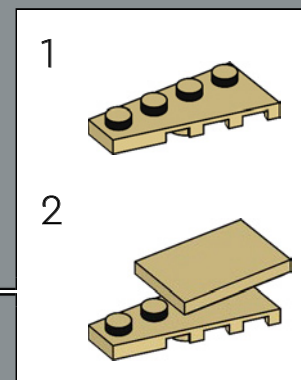
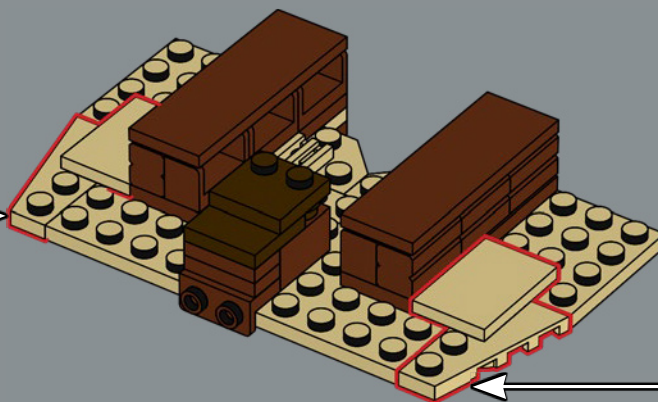
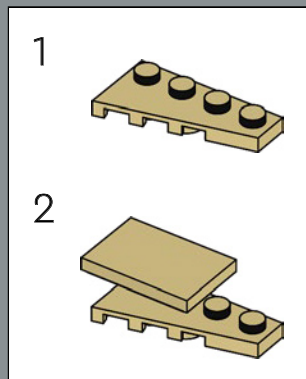

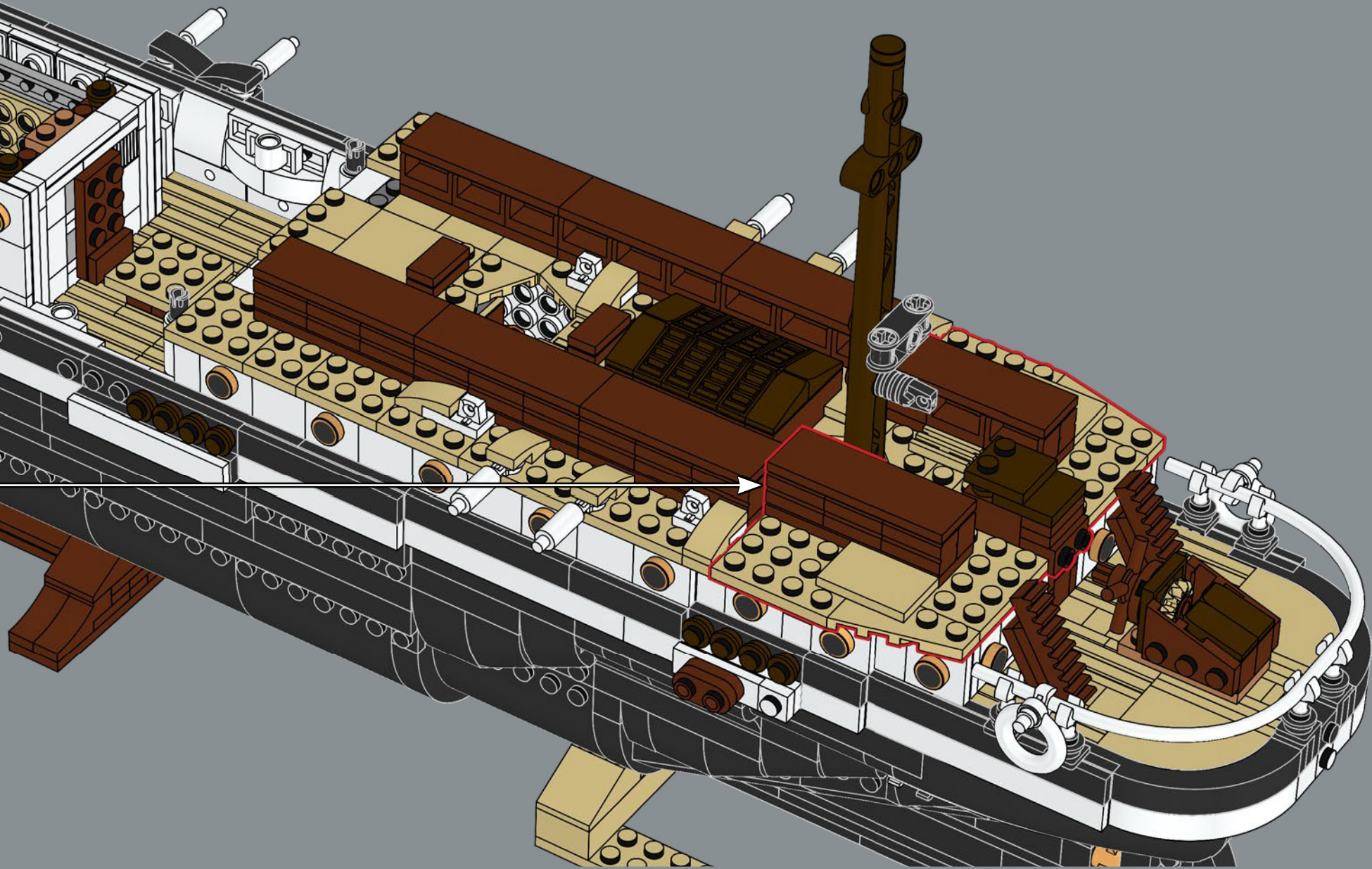

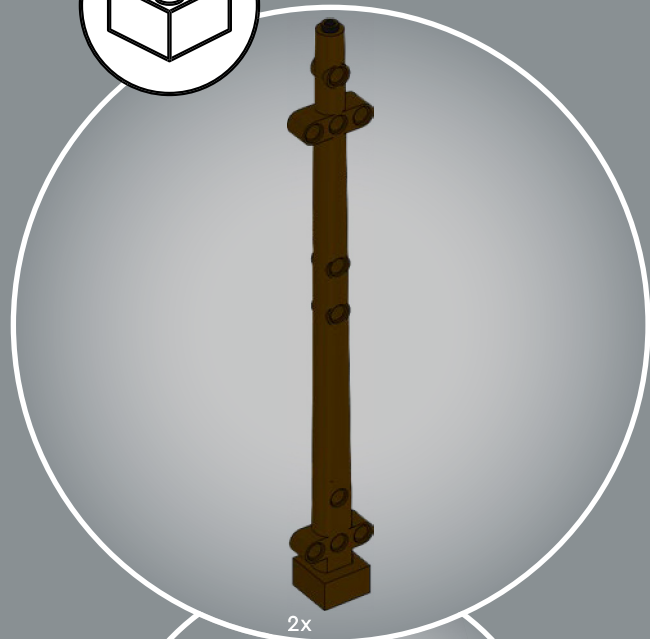
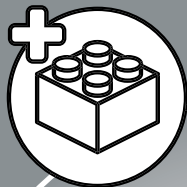

2x



516

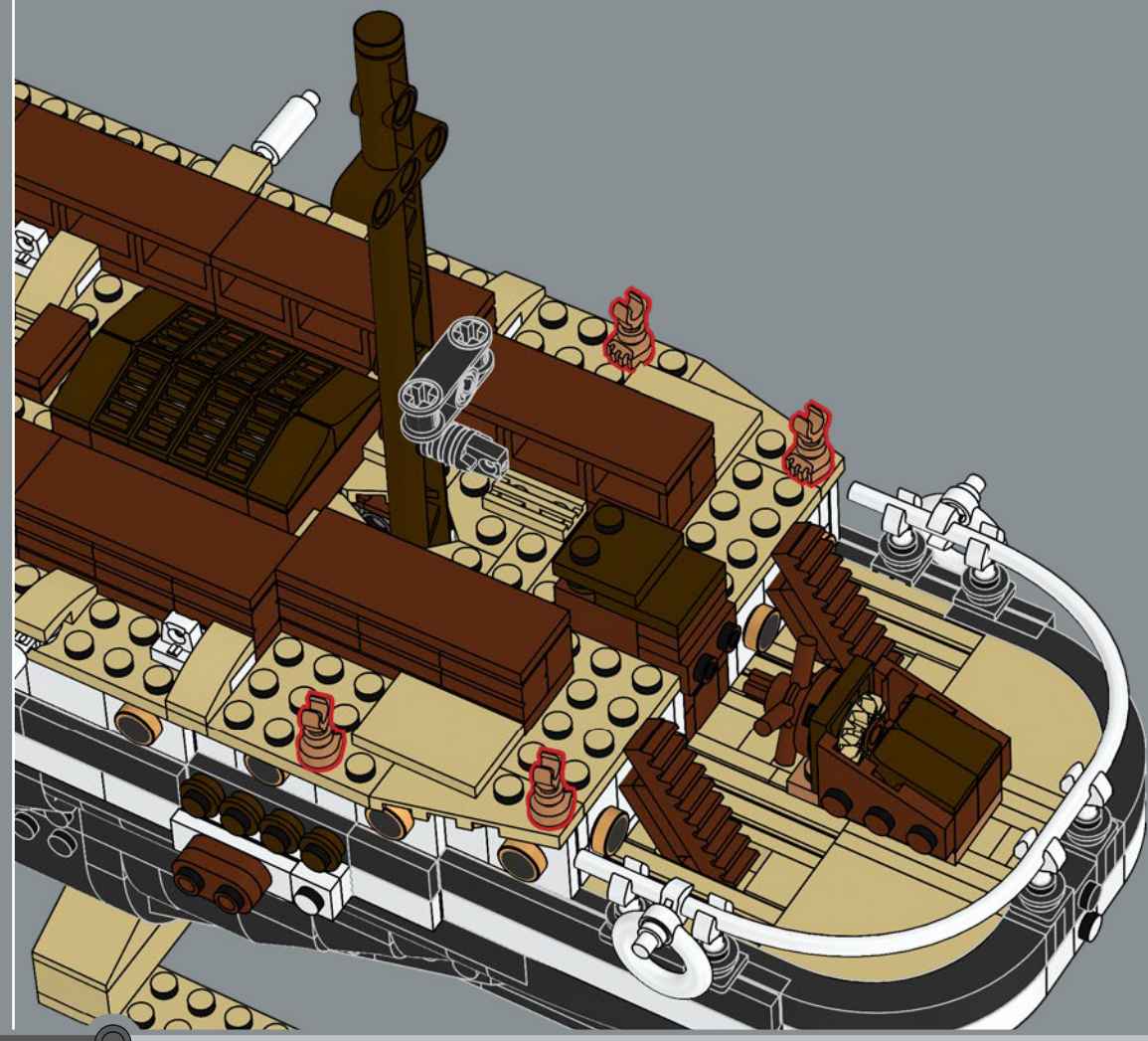



517

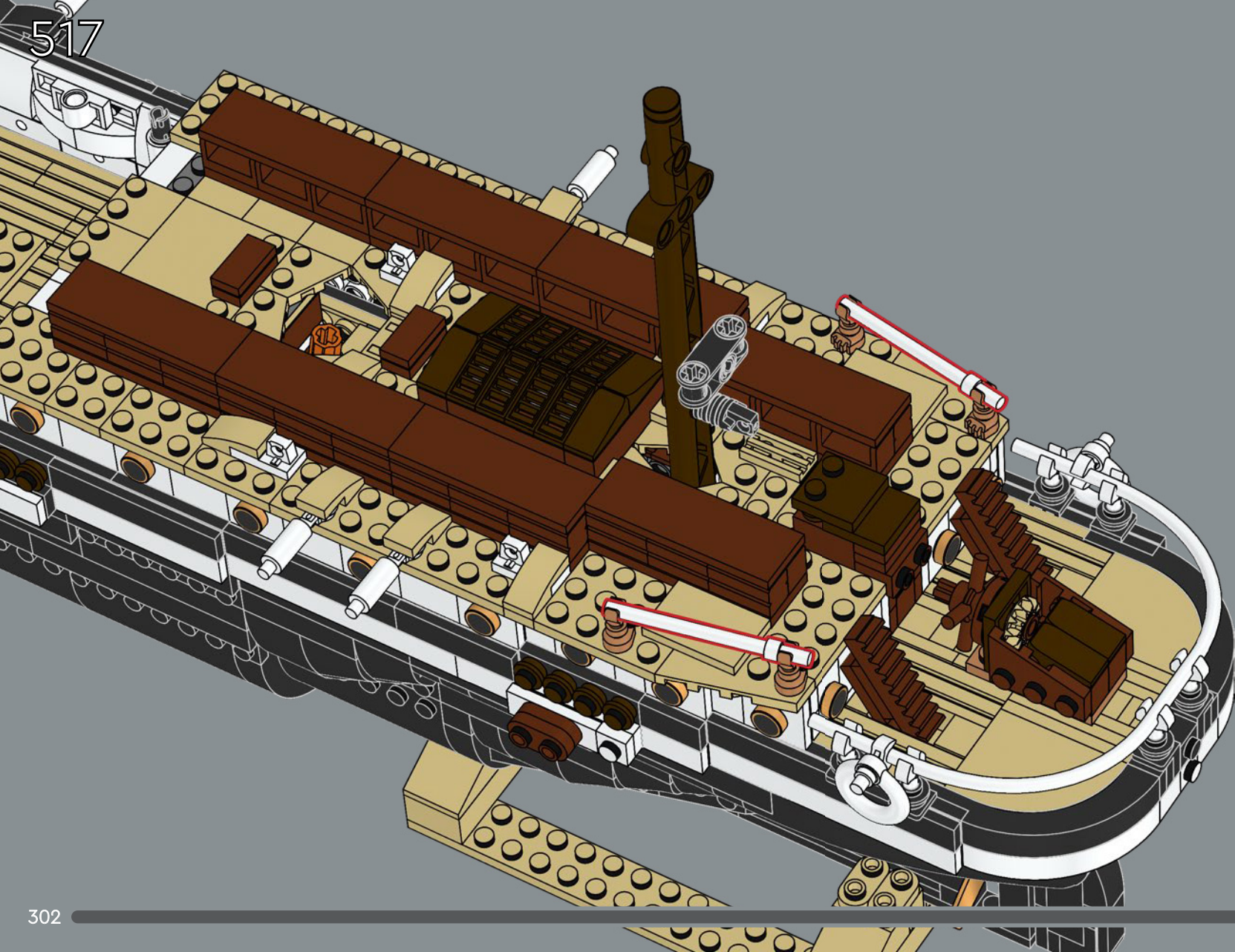

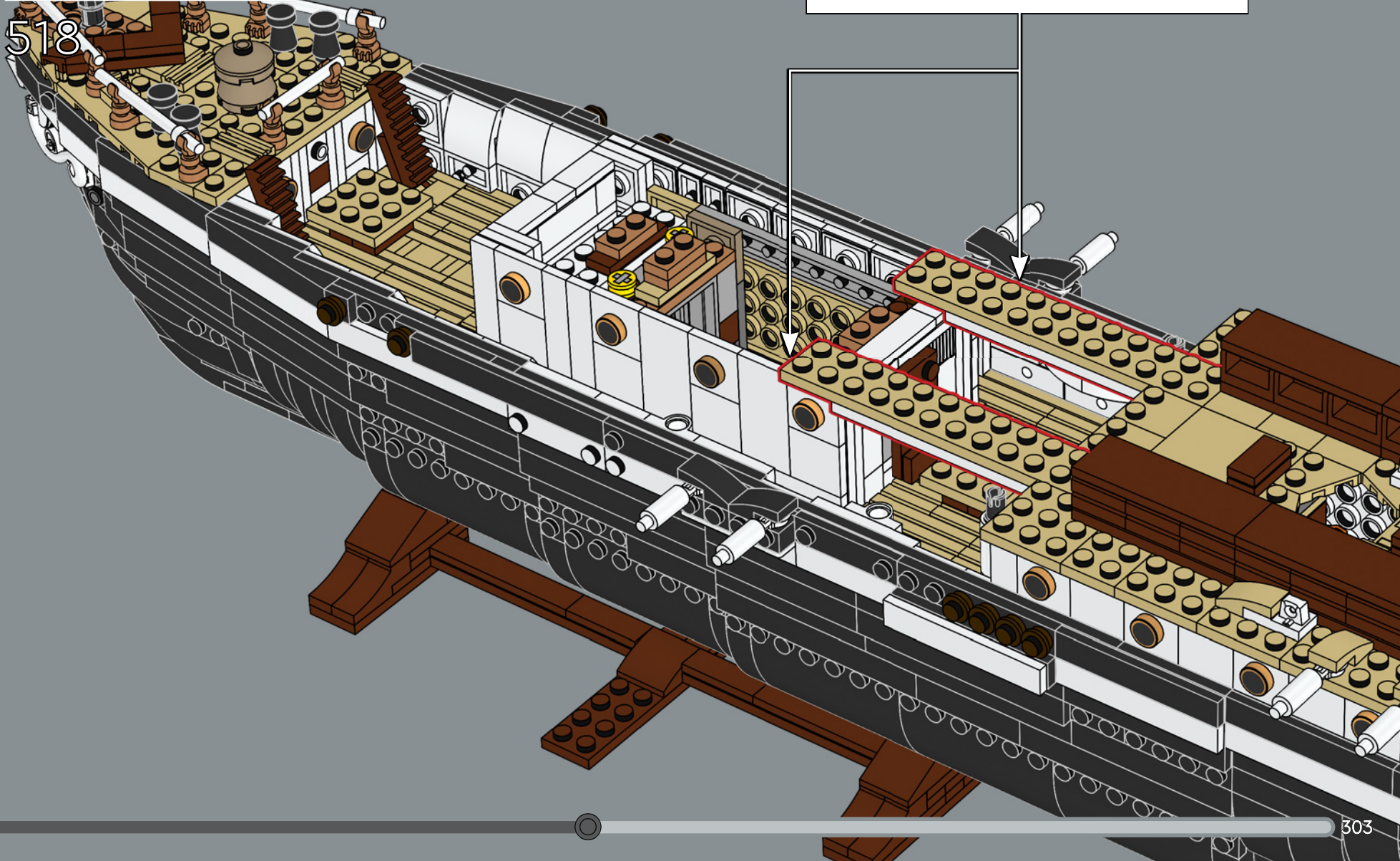
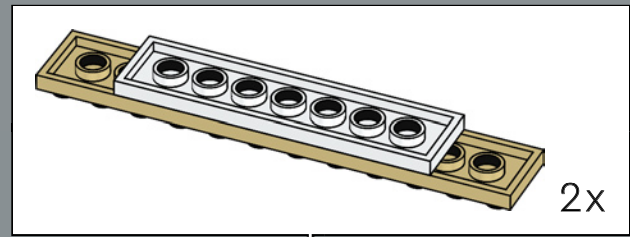
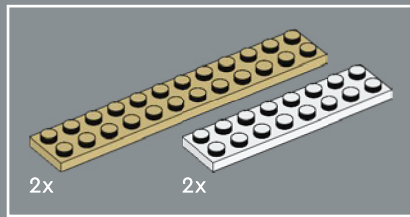

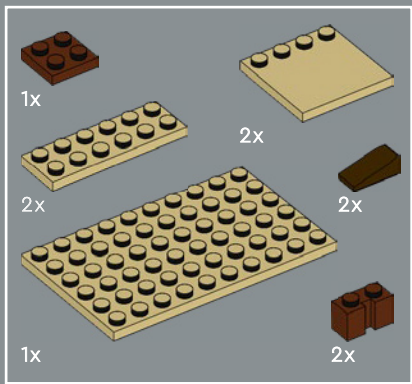

519

1

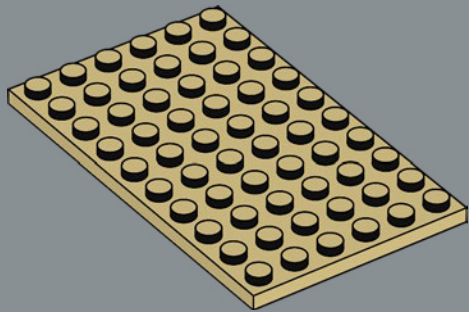

2

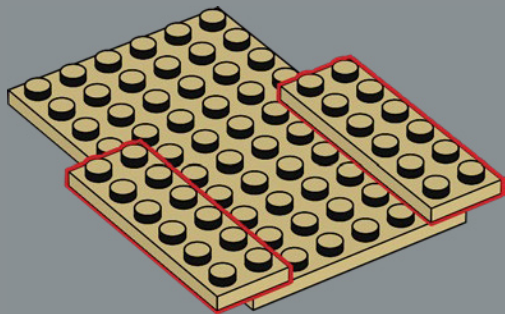

3

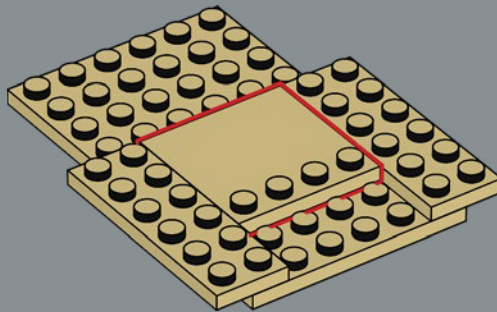

4

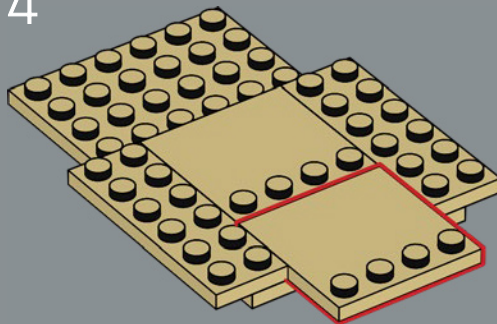

5

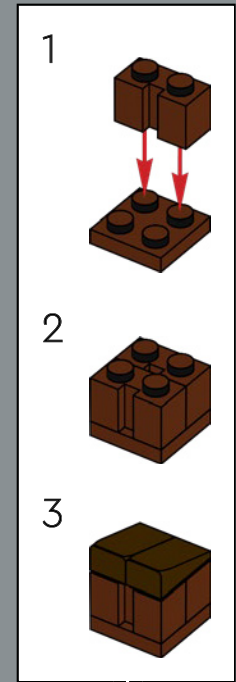
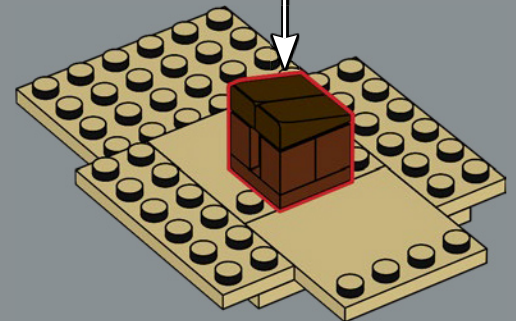

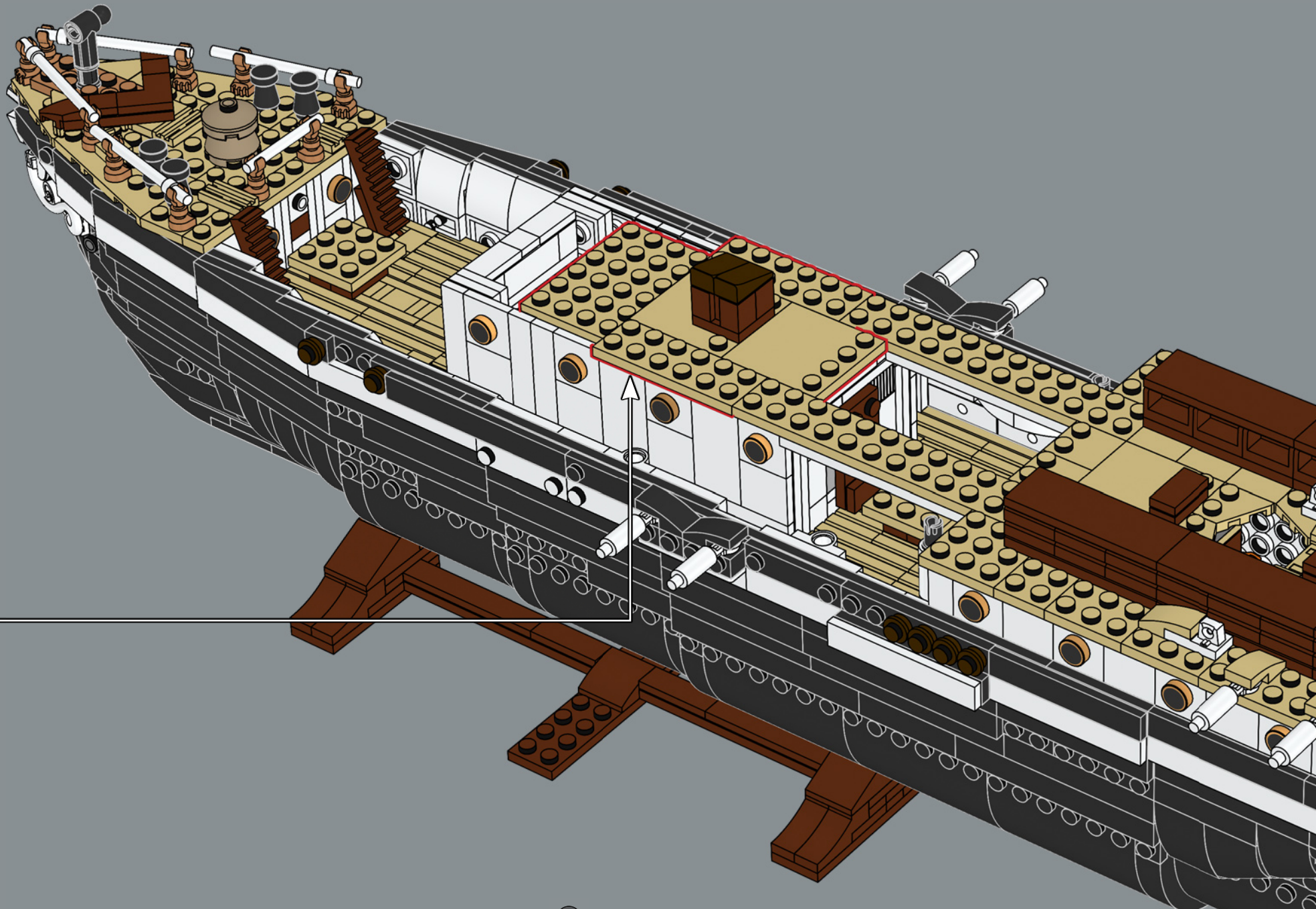

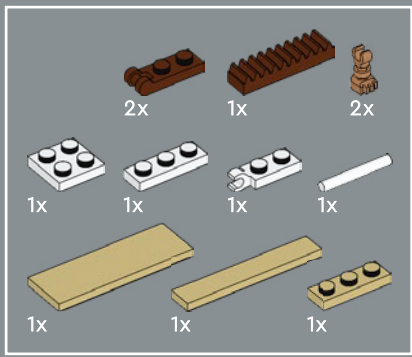

520

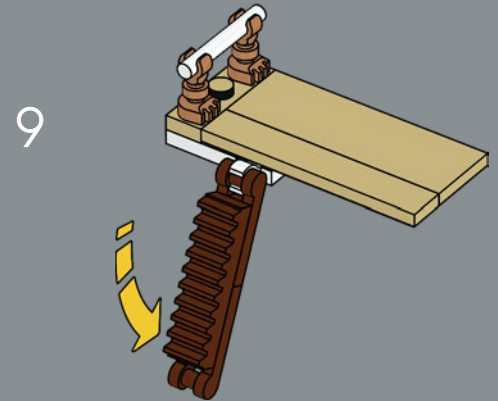
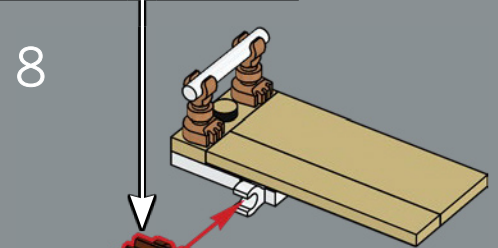
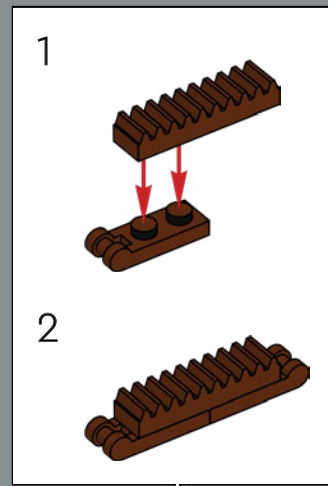
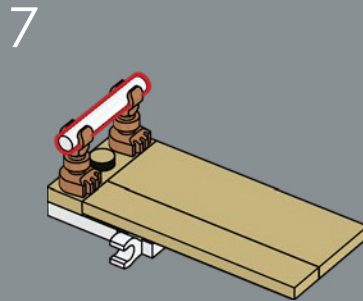
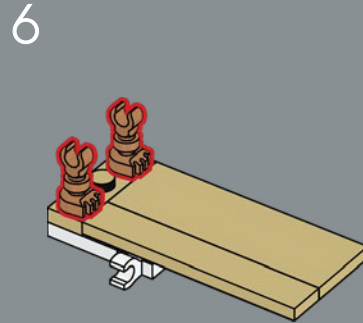
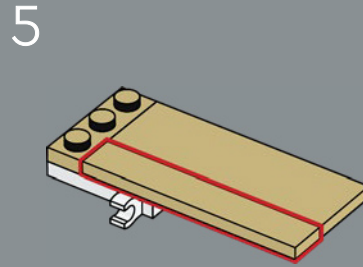
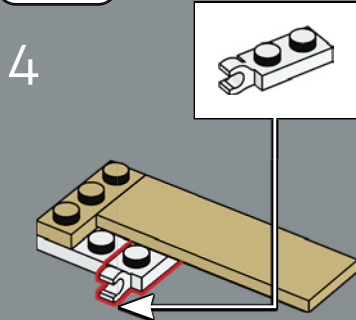
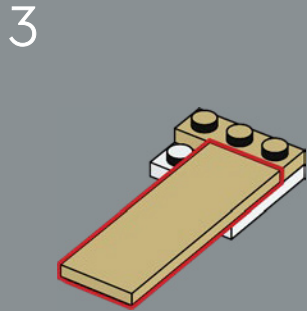
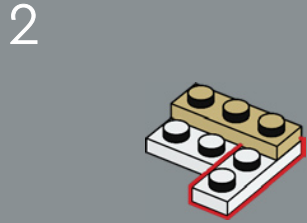
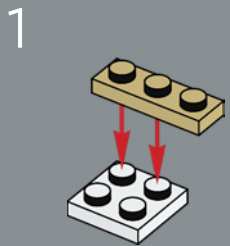

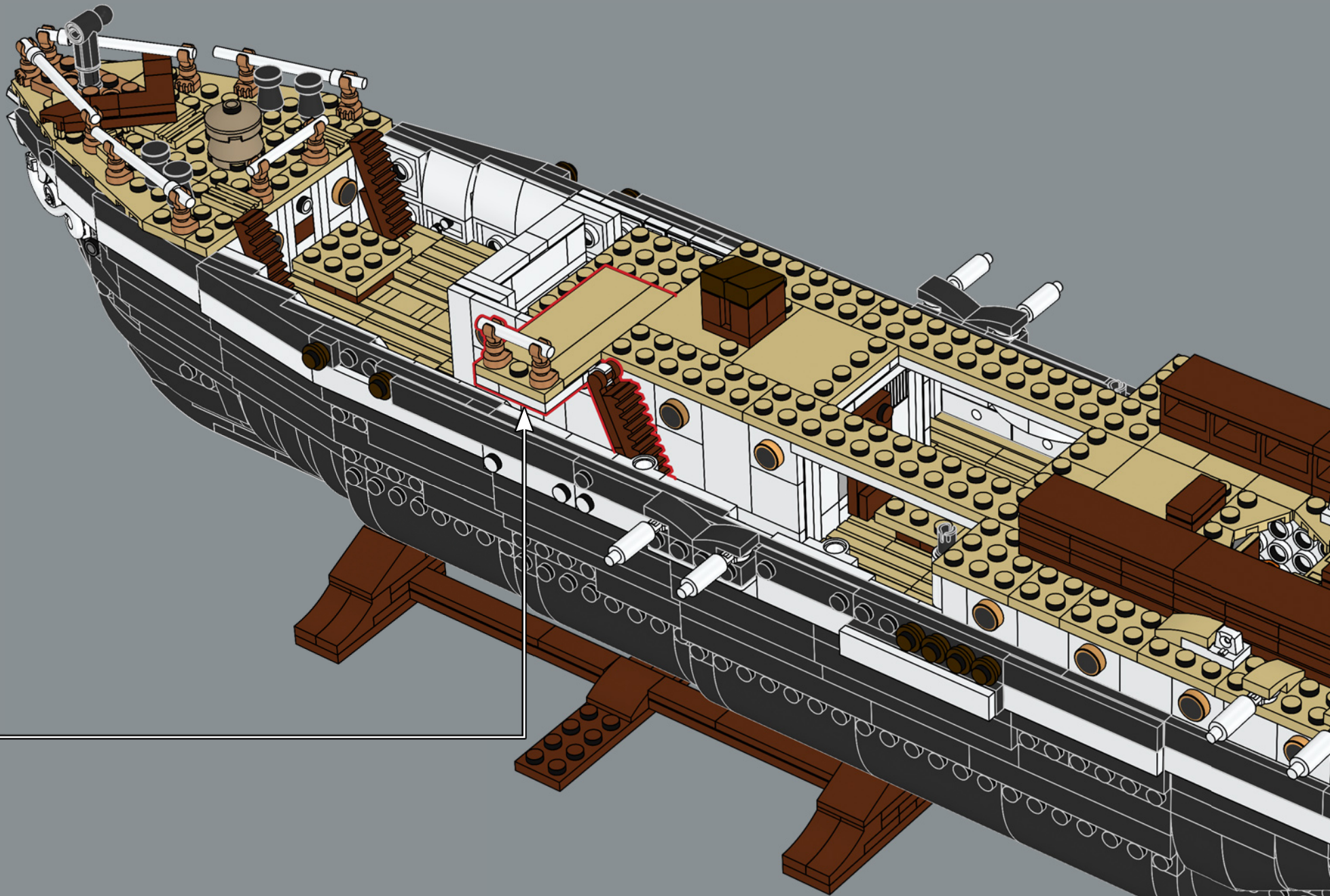

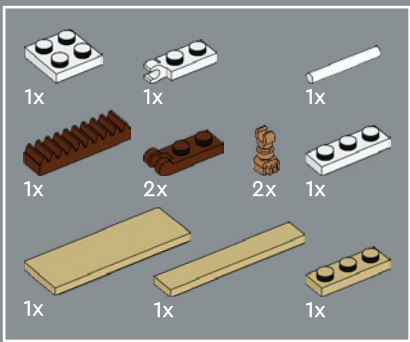

521

1

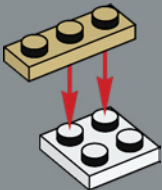

2

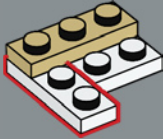

3

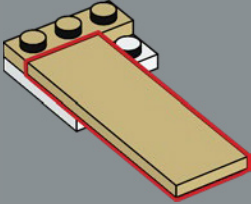

4

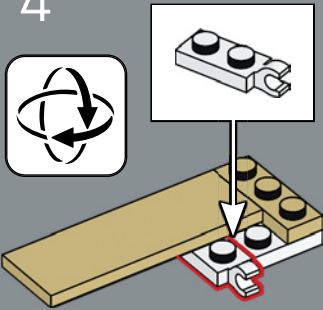

5

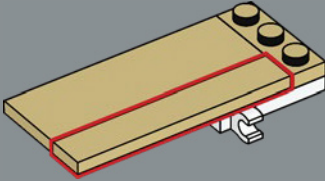

6

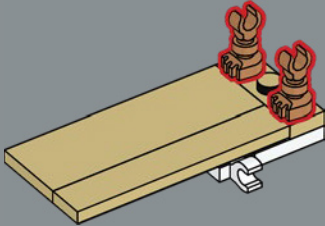

7

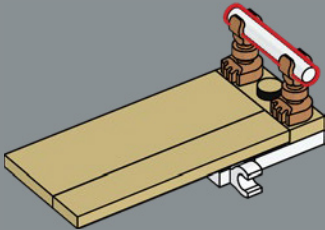

8

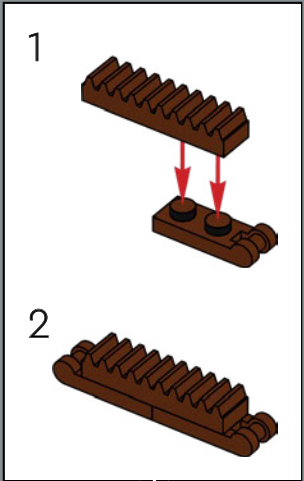

9

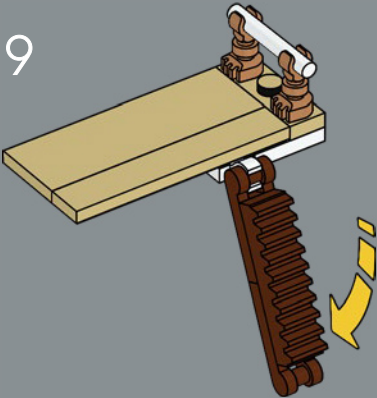

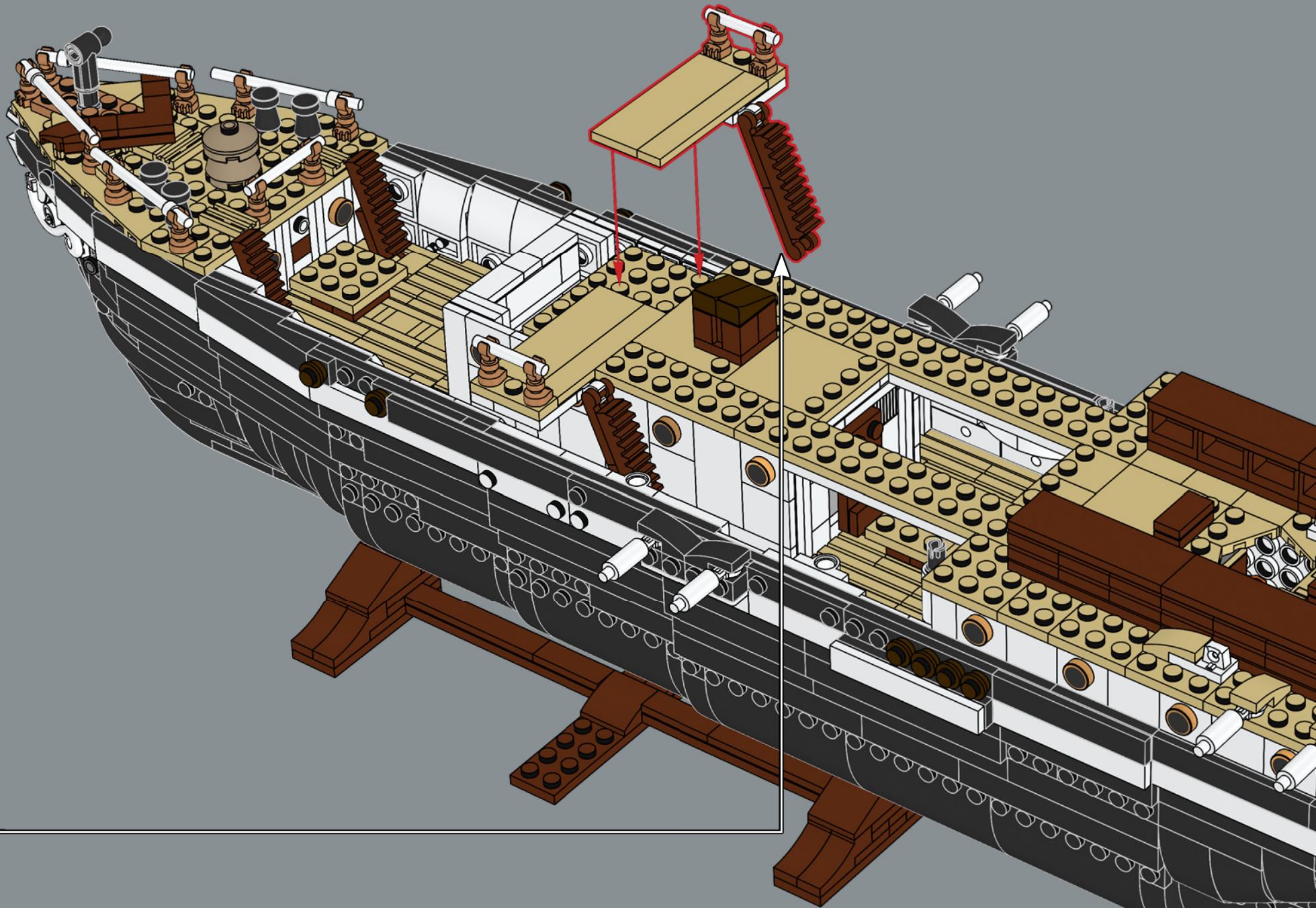

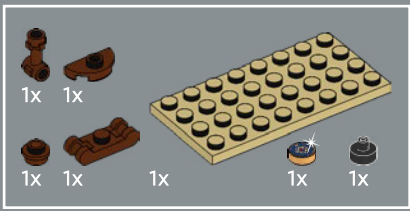

522

1

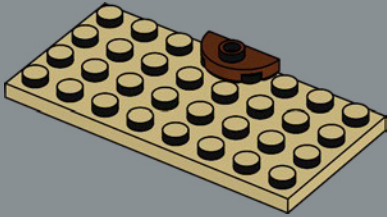

2

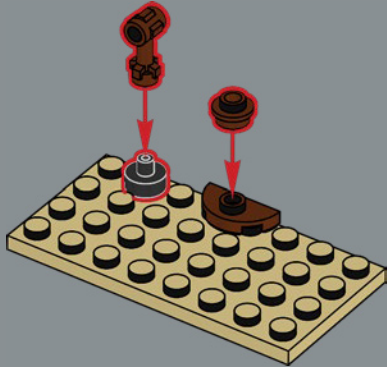

3

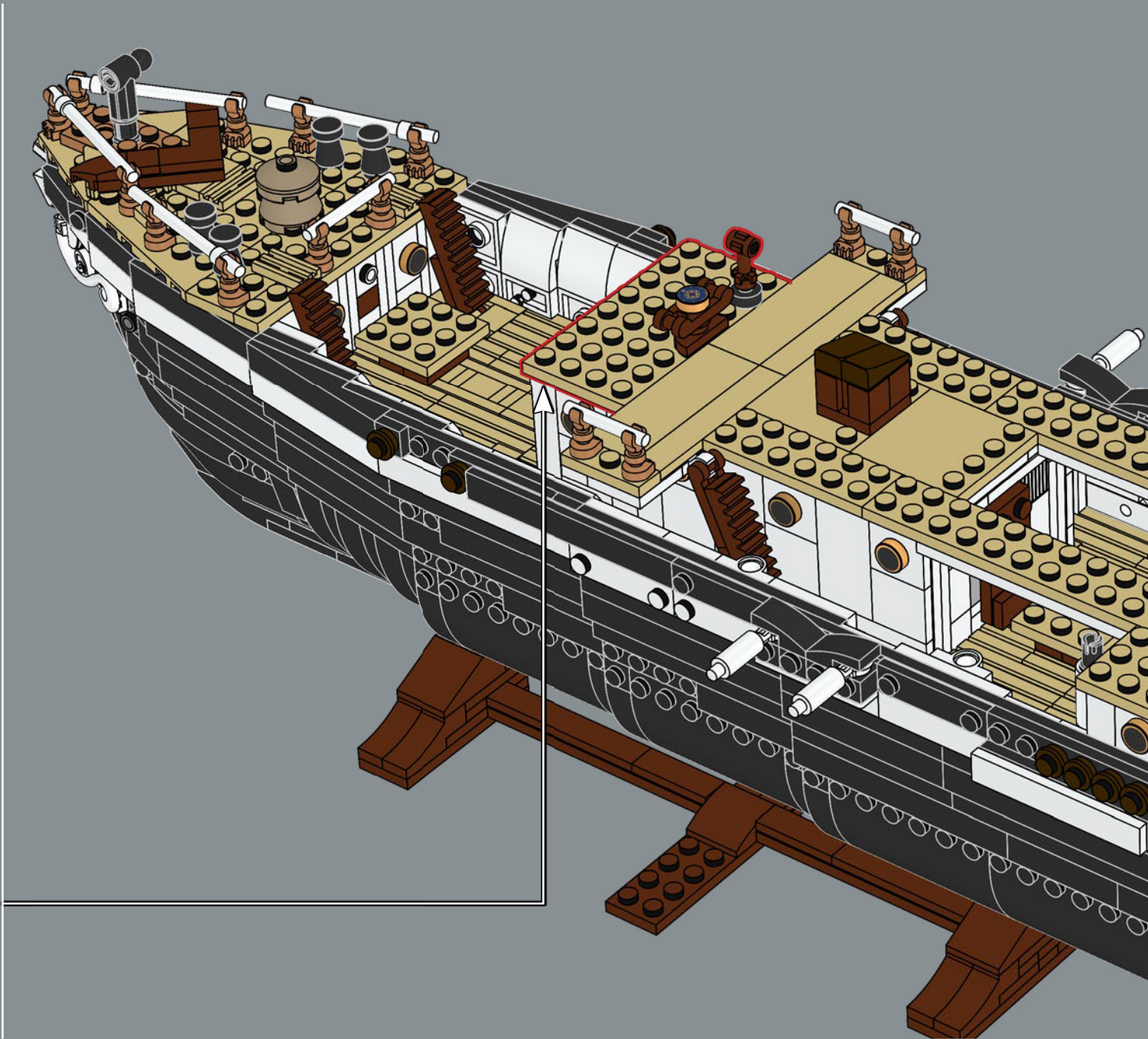

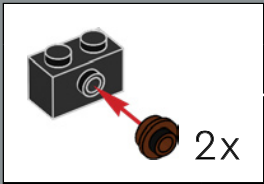

523

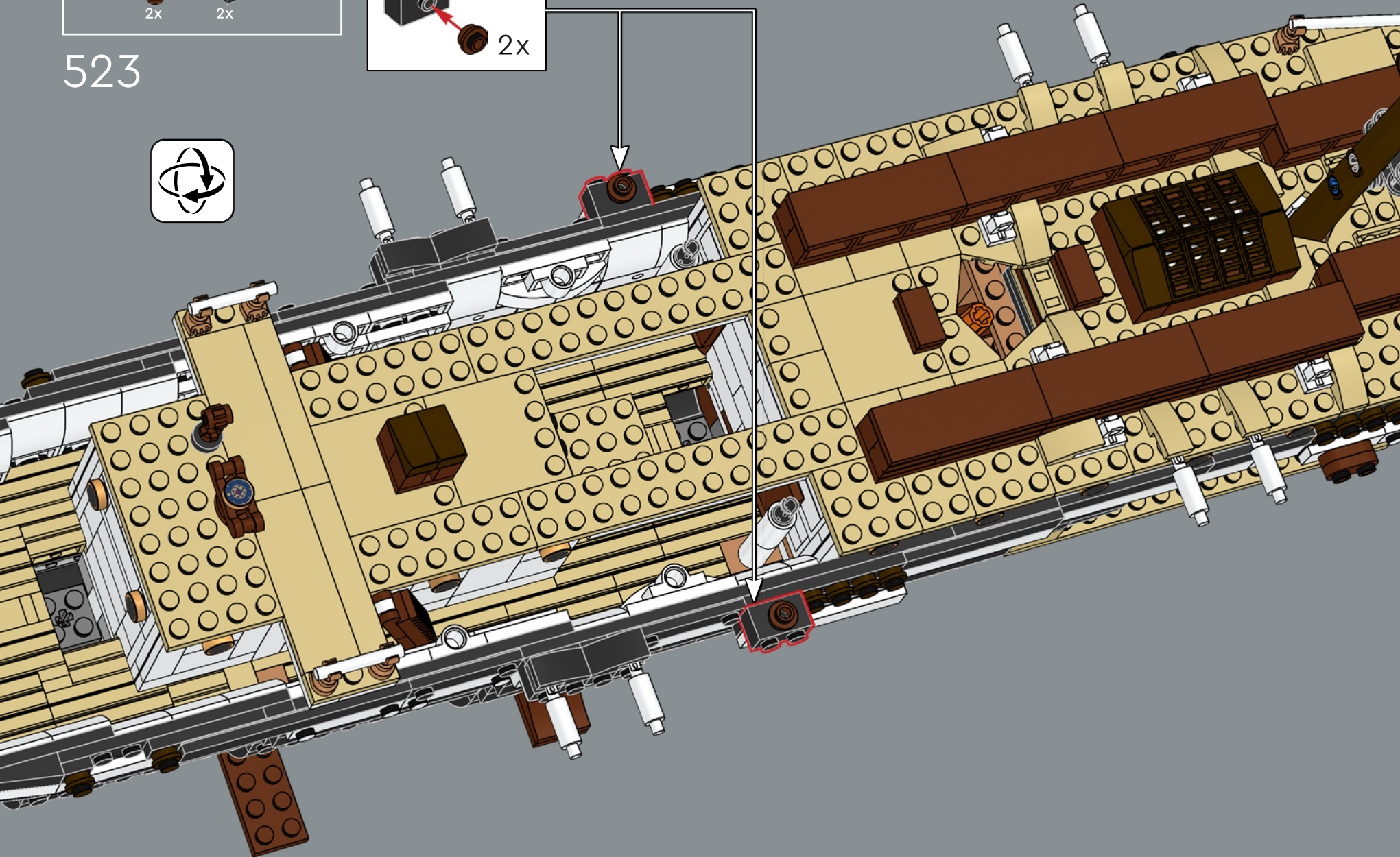



38x

524

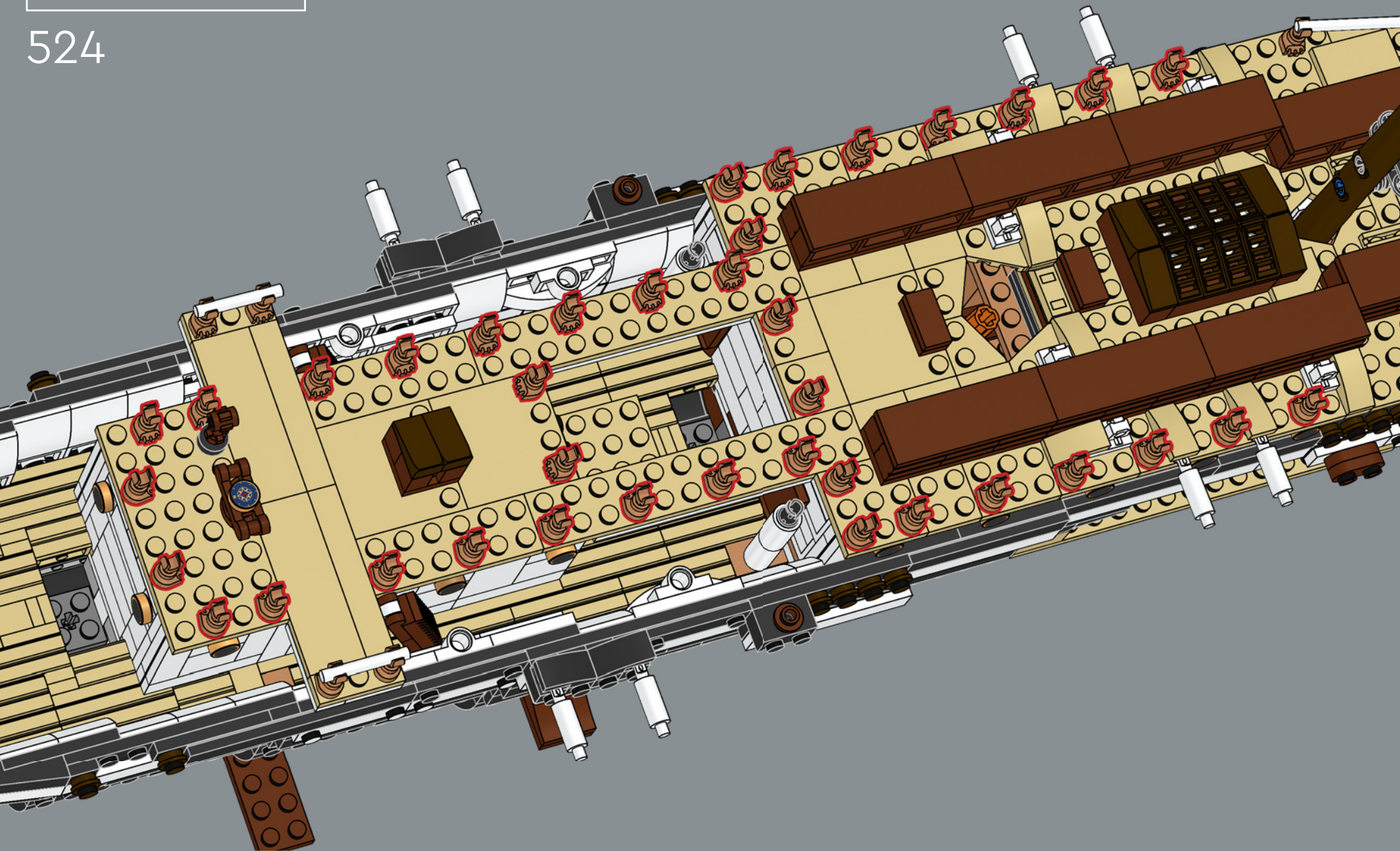

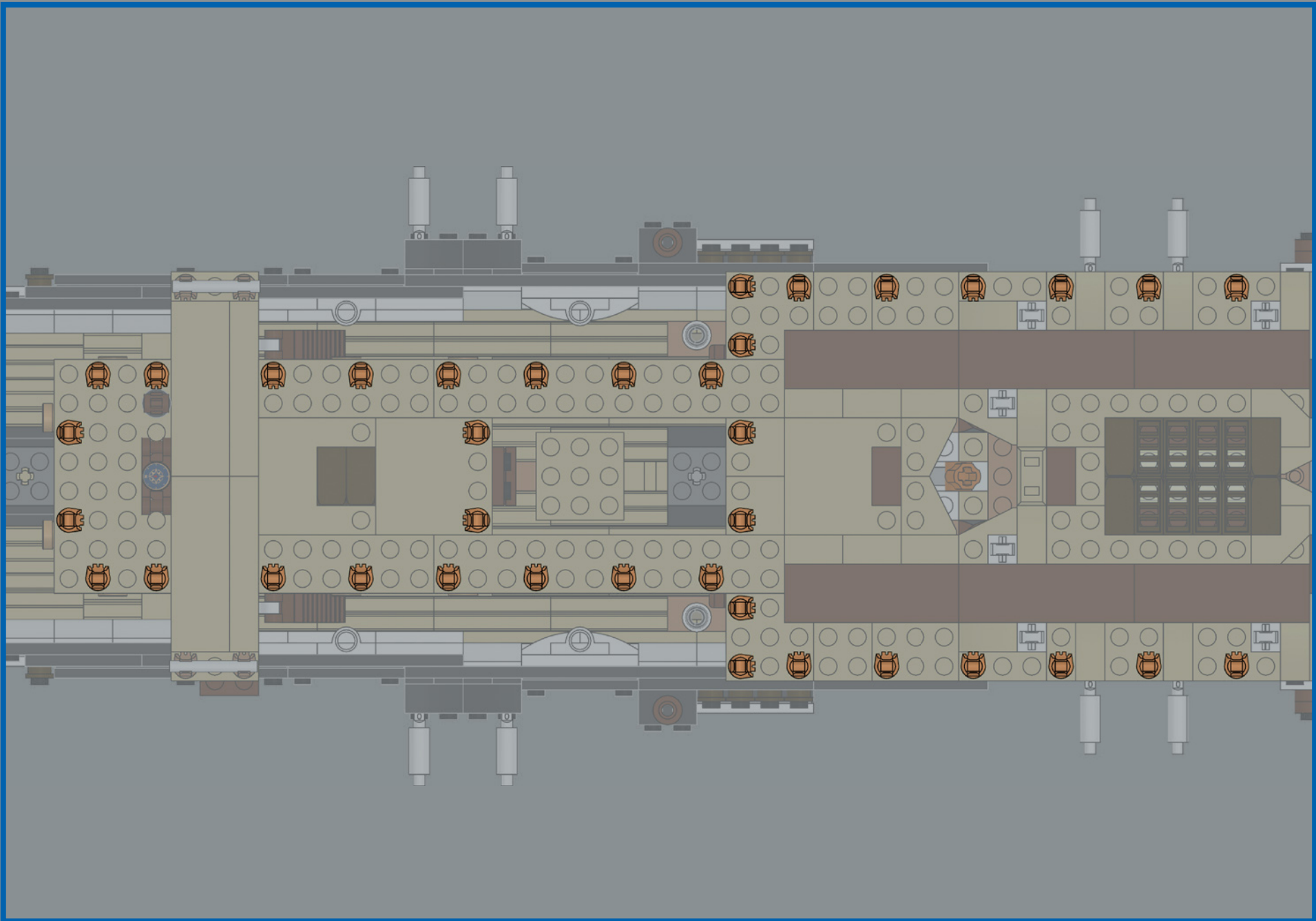

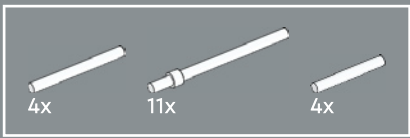

525

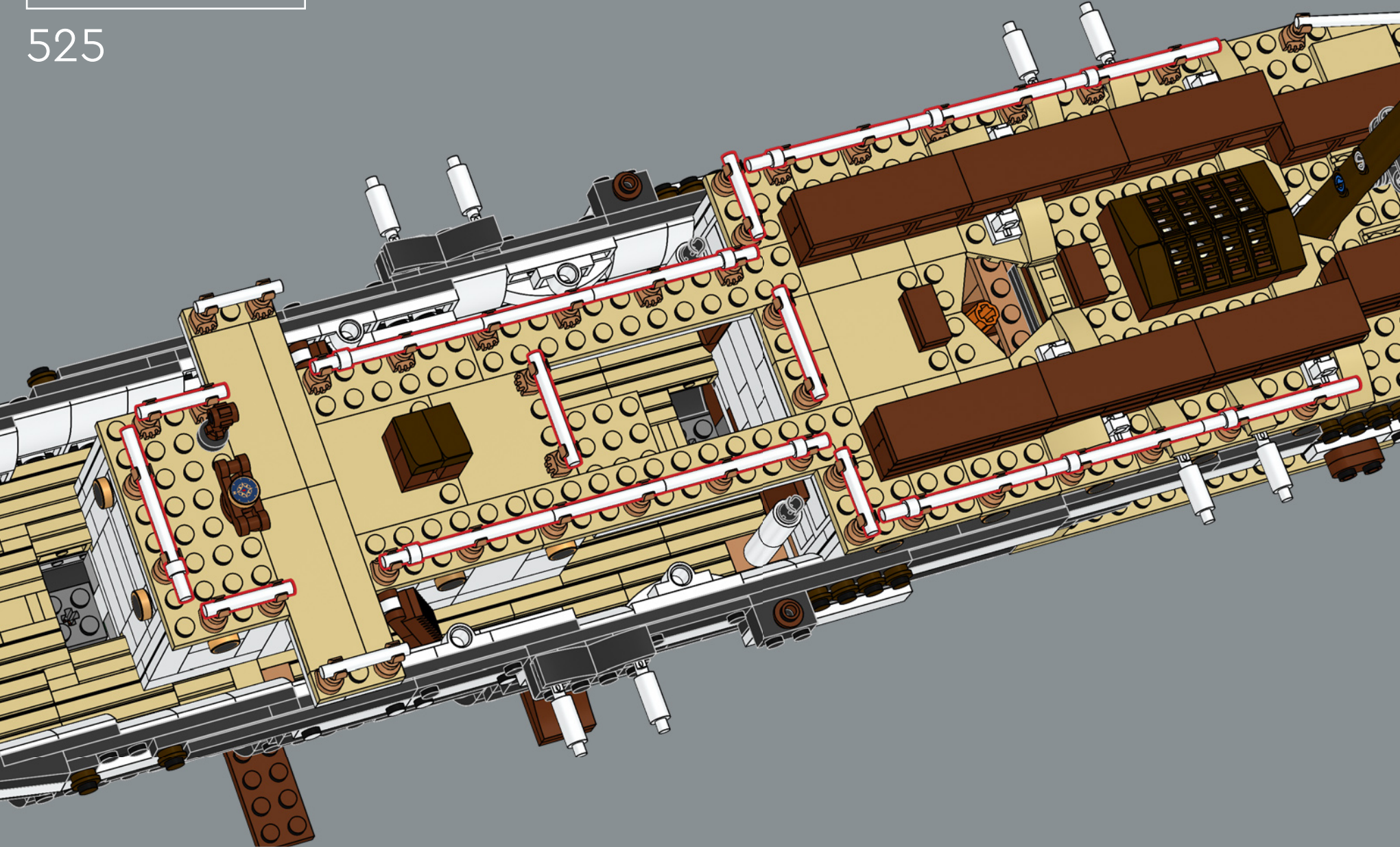

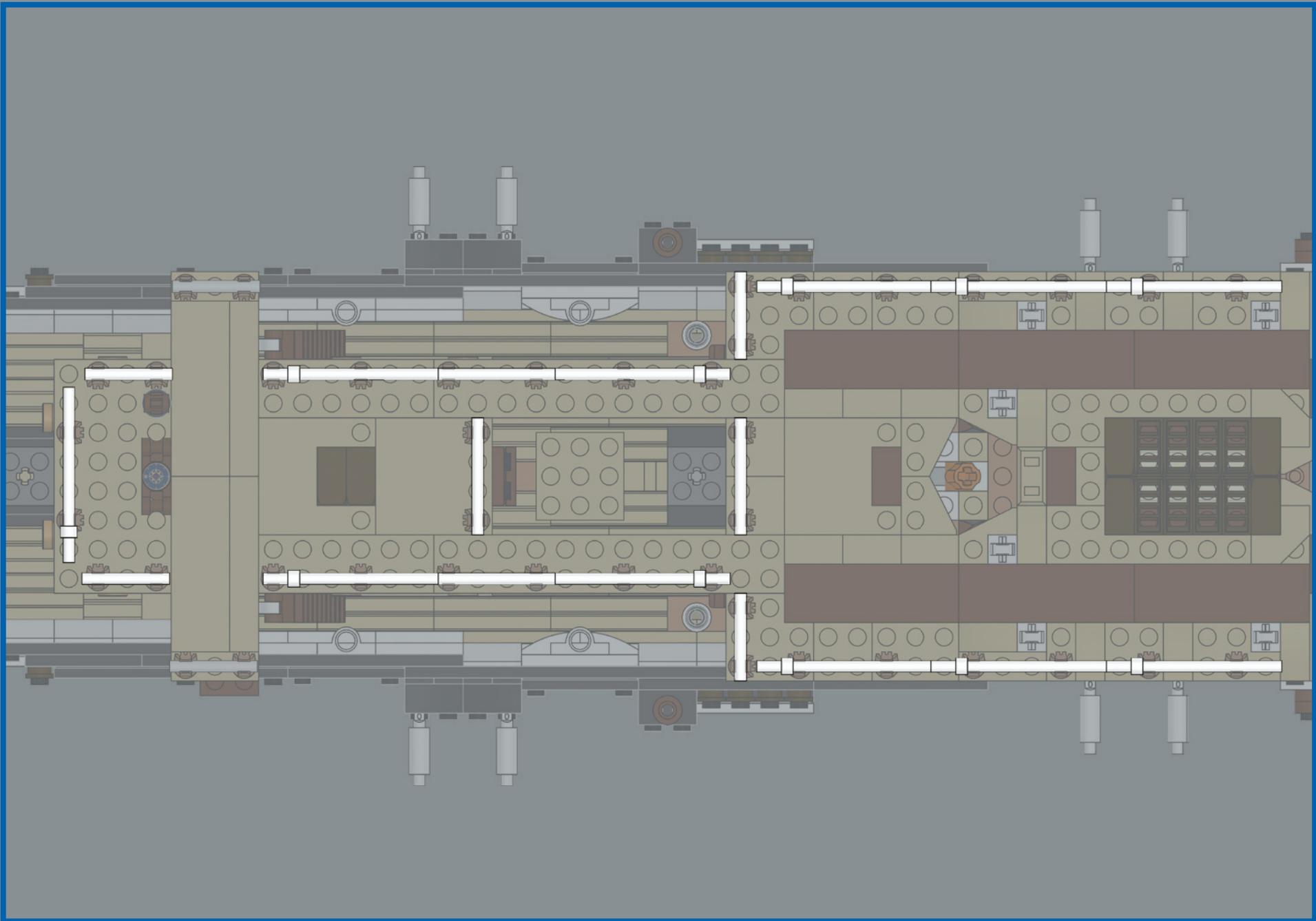

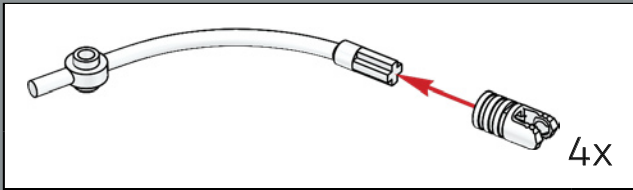
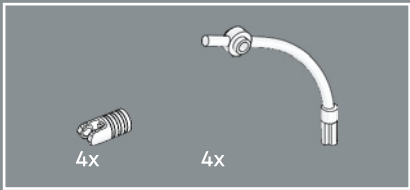

526

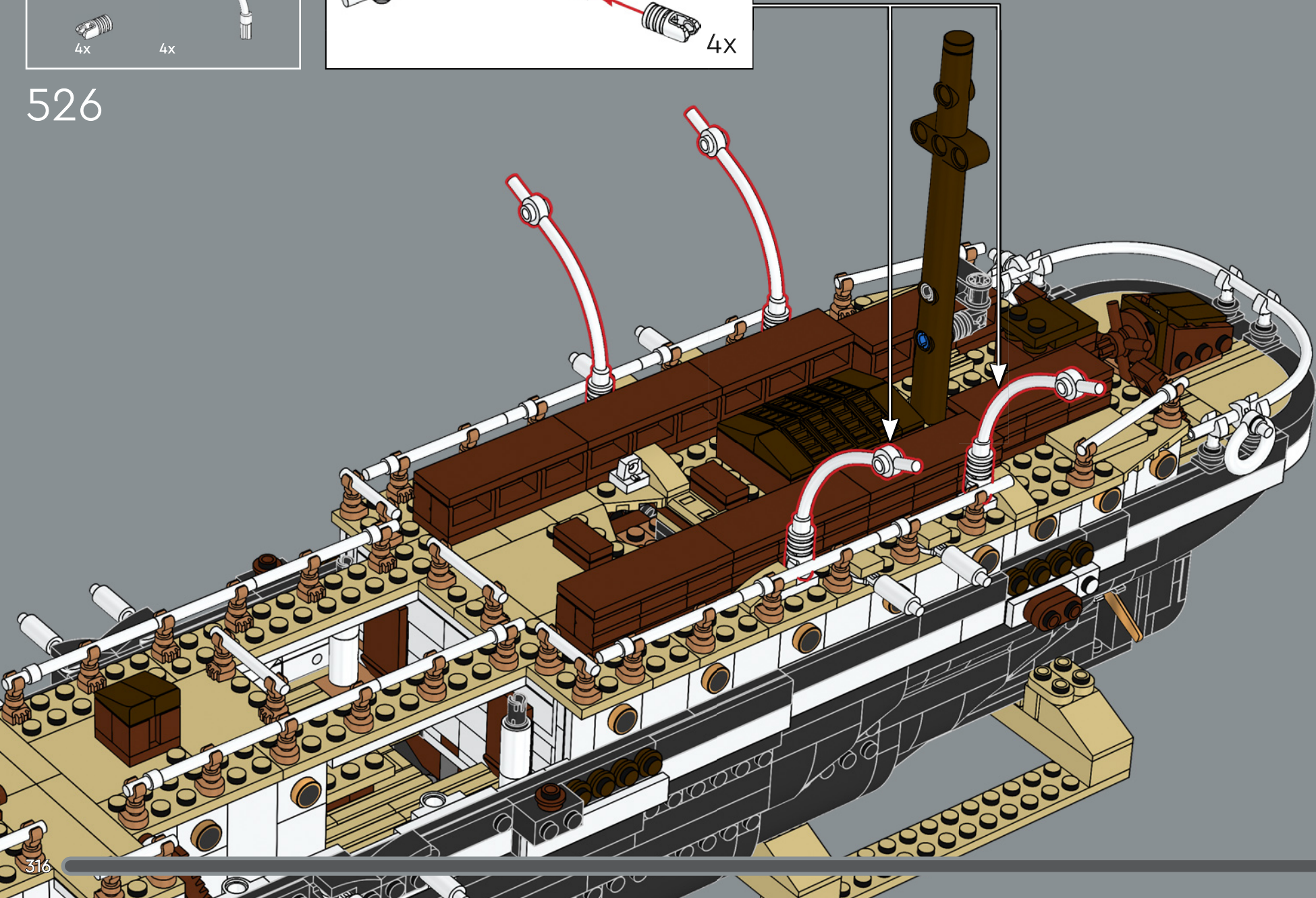

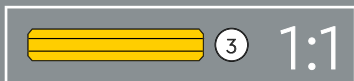
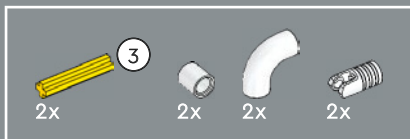

527

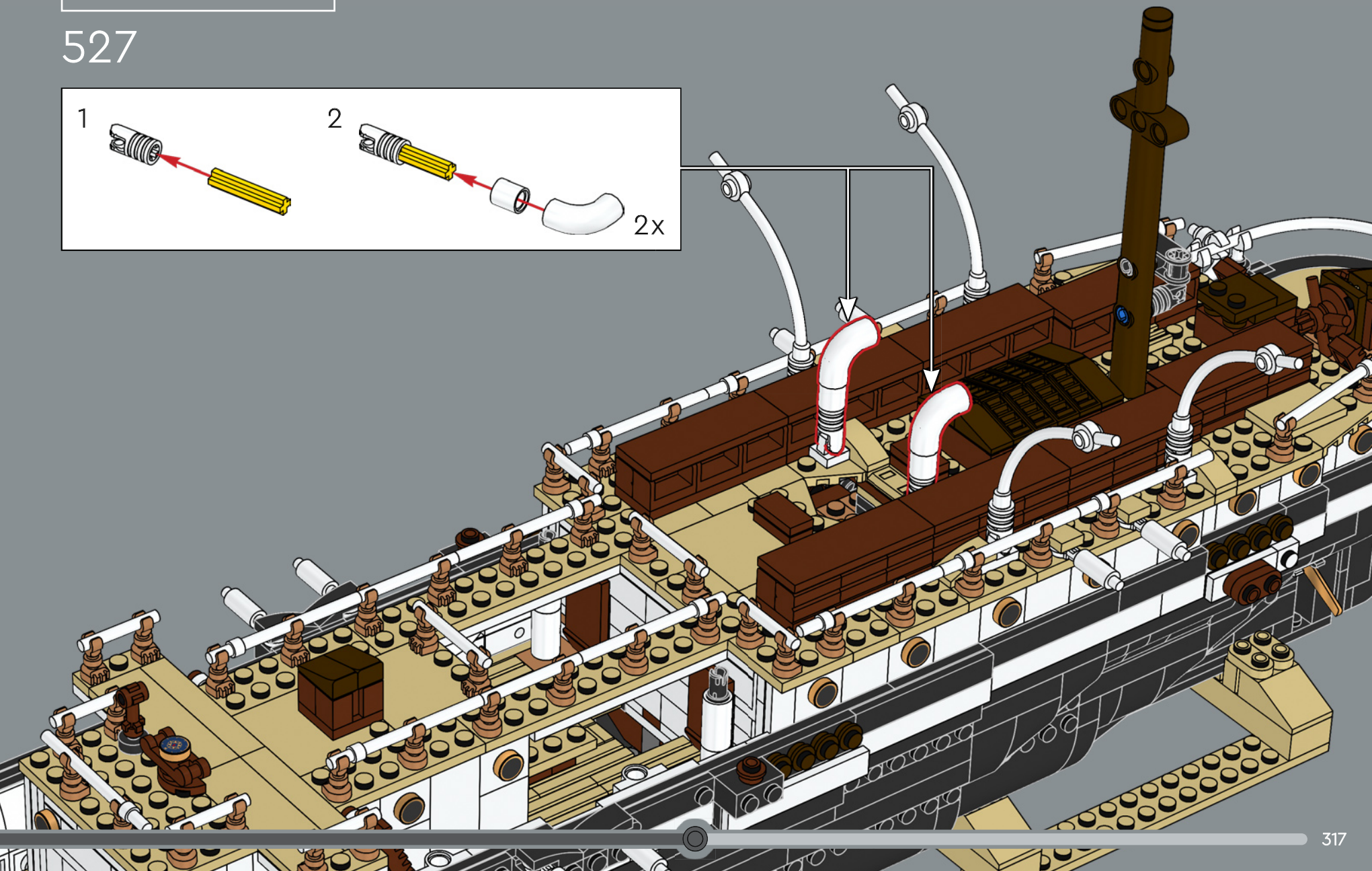
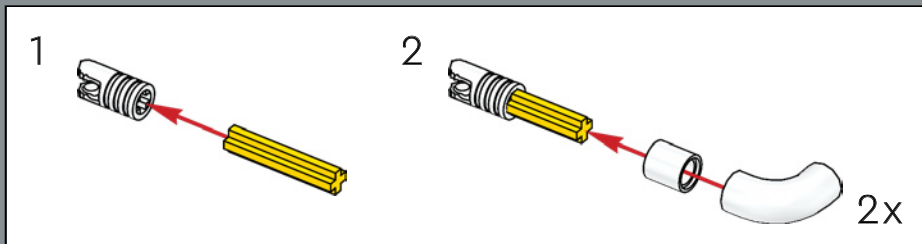

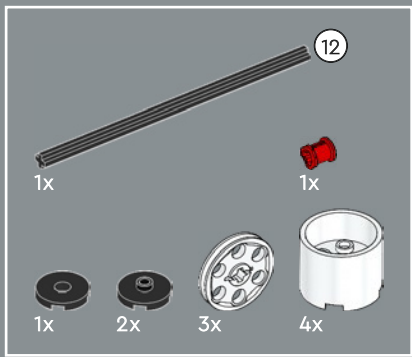

528

1

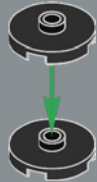

2

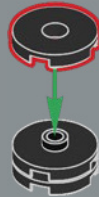

3



4

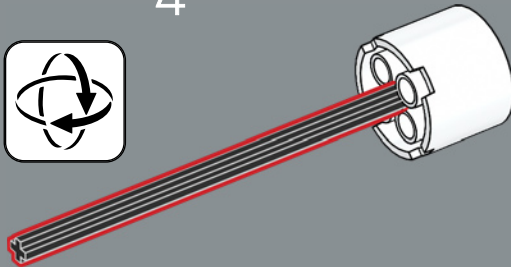

5



6

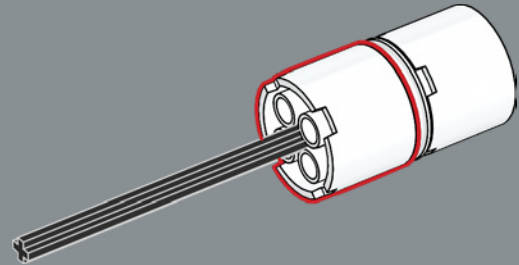

7

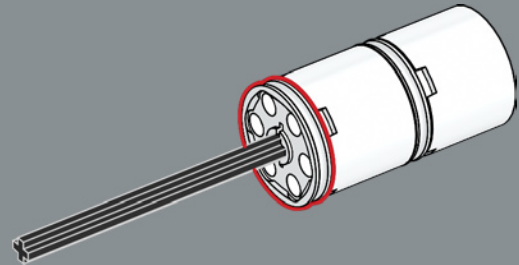

8

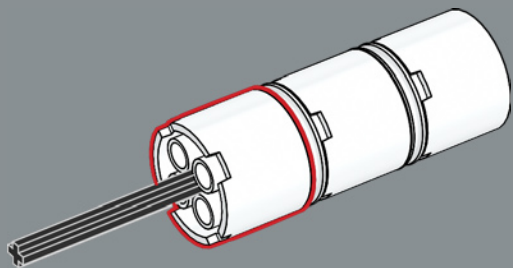

9

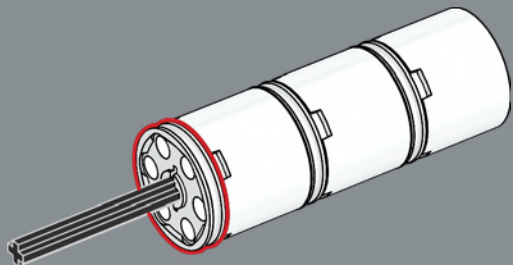

10

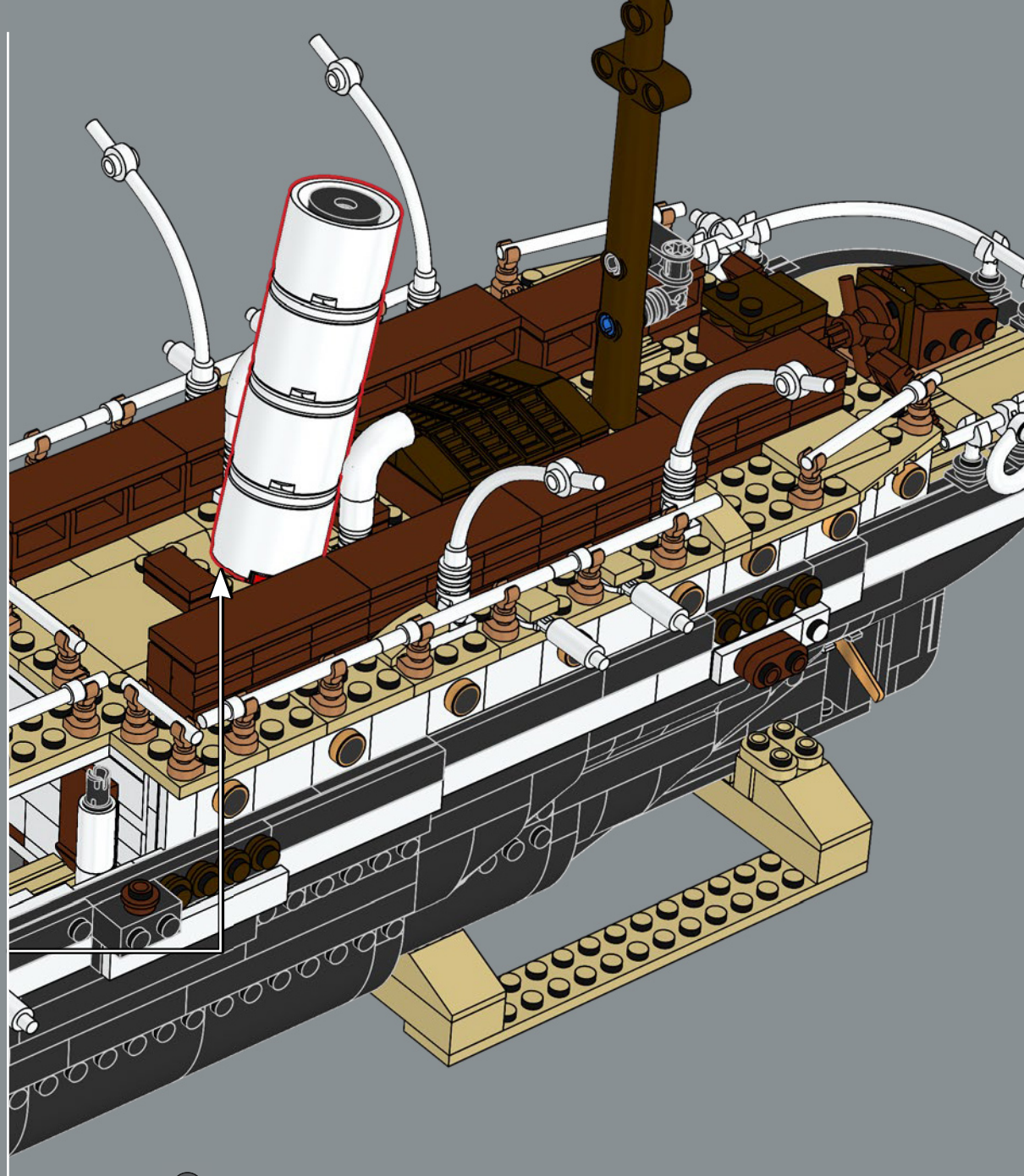
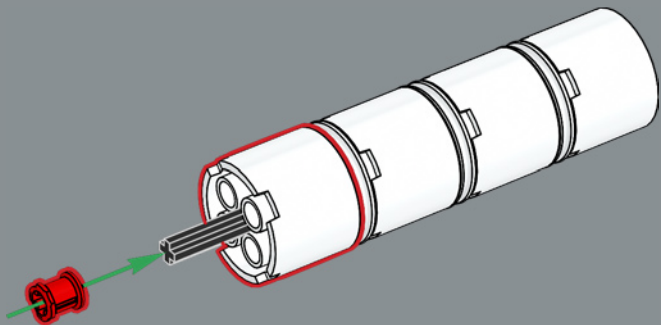



529

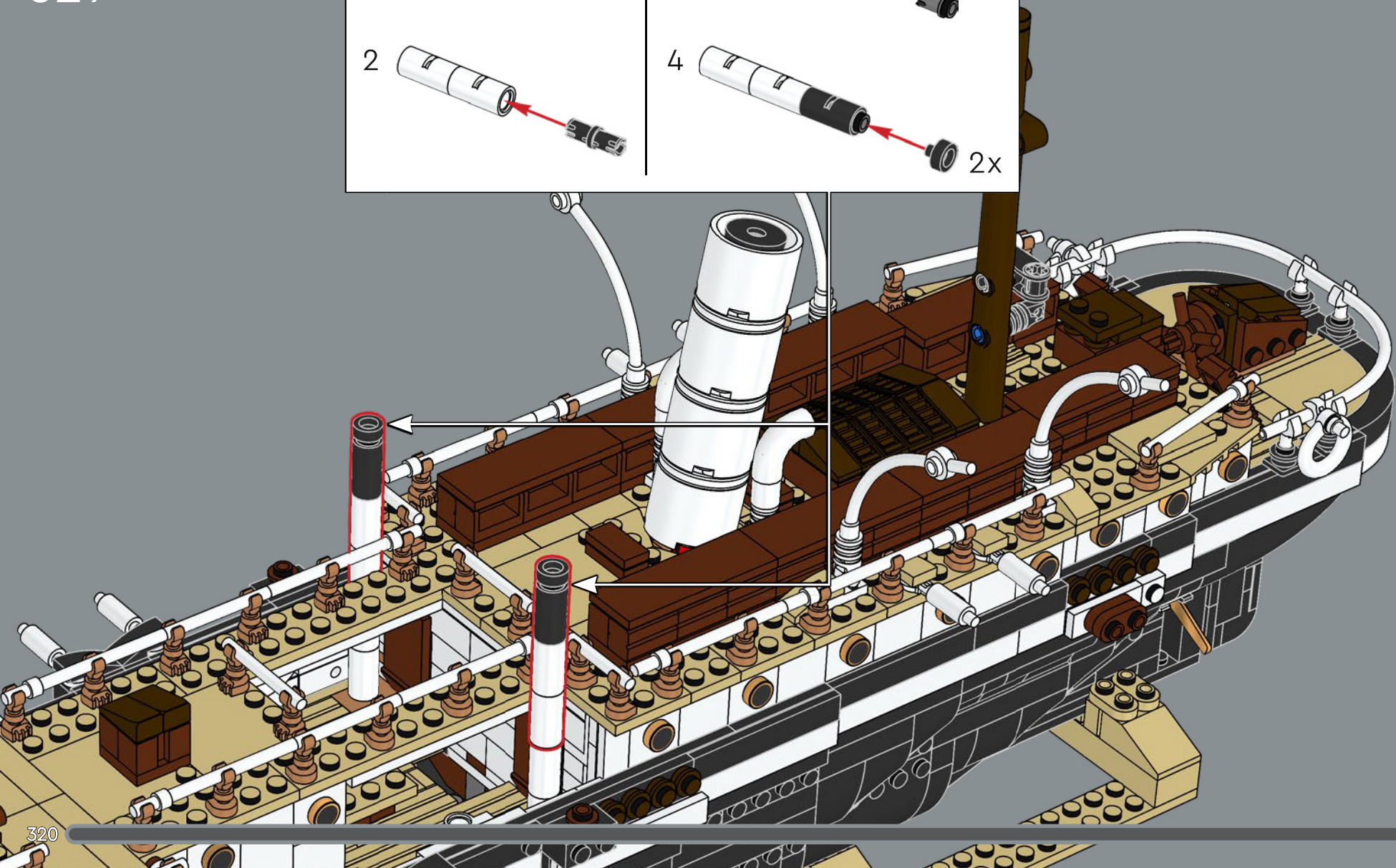
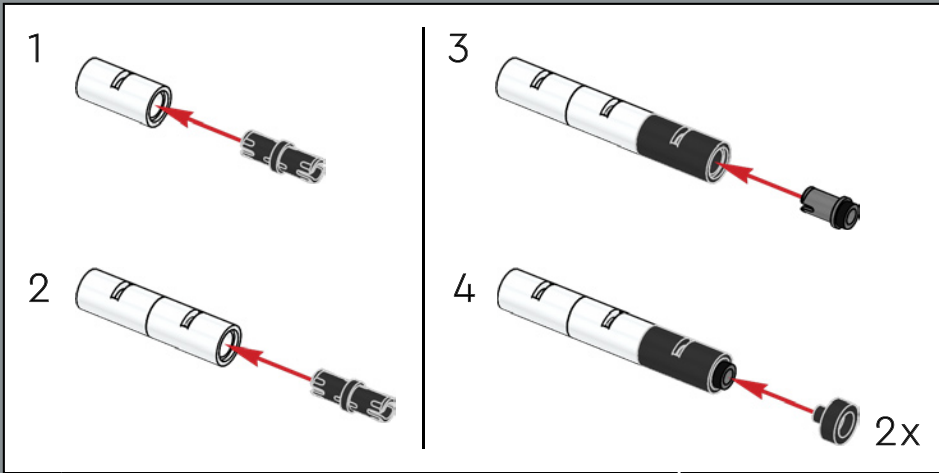

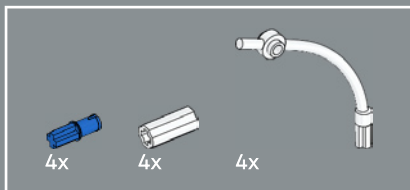

530

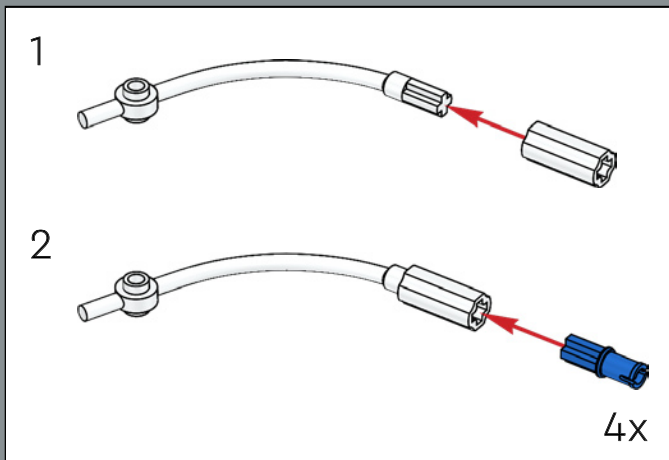

The curved arms holding the four lifeboats were originally designed as LEGO® minifigure holder elements.

Les bras courbés qui tiennent les quatre canots de sauvetage ont été initialement conçus comme des éléments de support de figurines LEGO®.

Los brazos curvos que sostienen los cuatro botes salvavidas se diseñaron originalmente como soportes para minifiguras LEGO®.

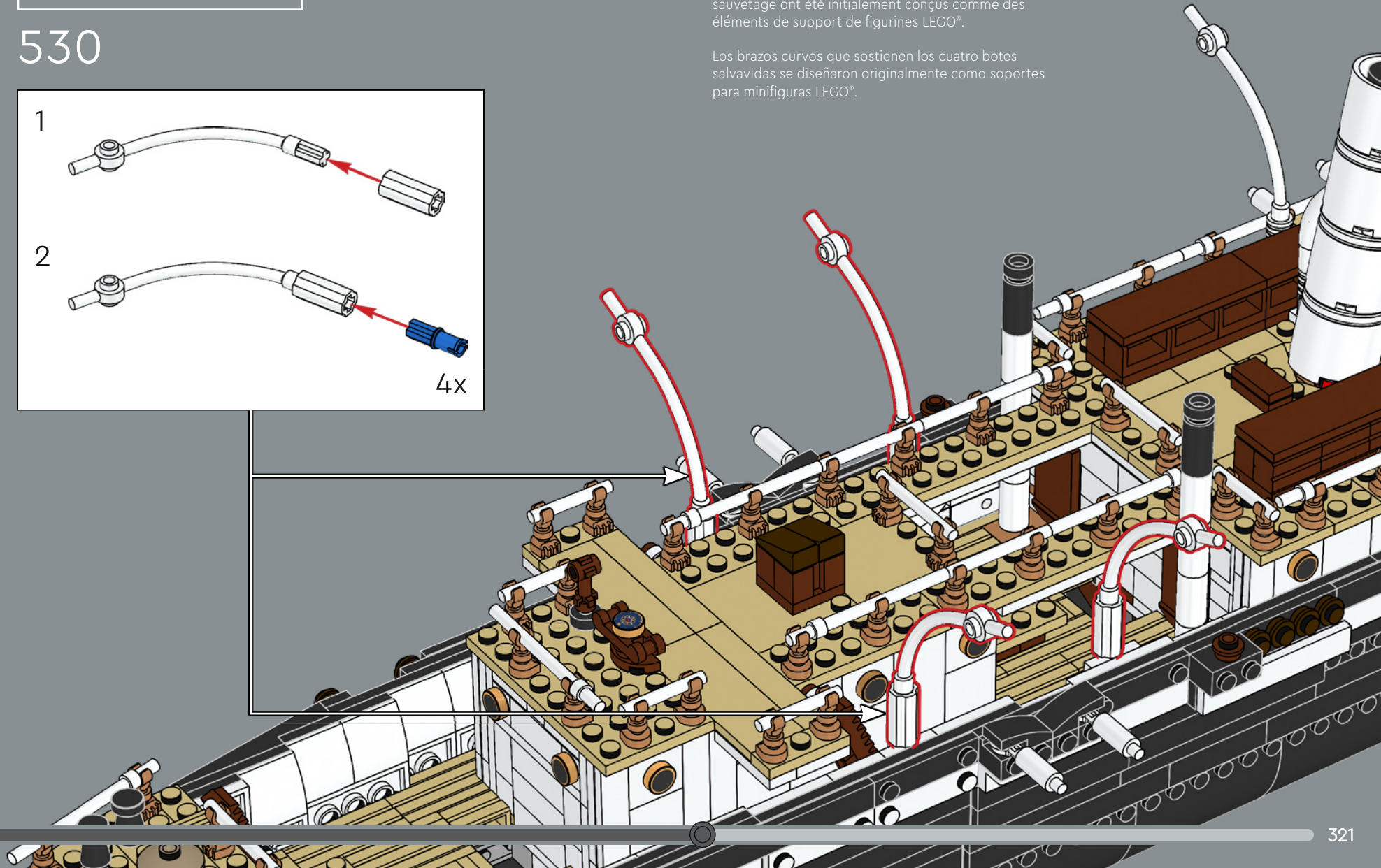

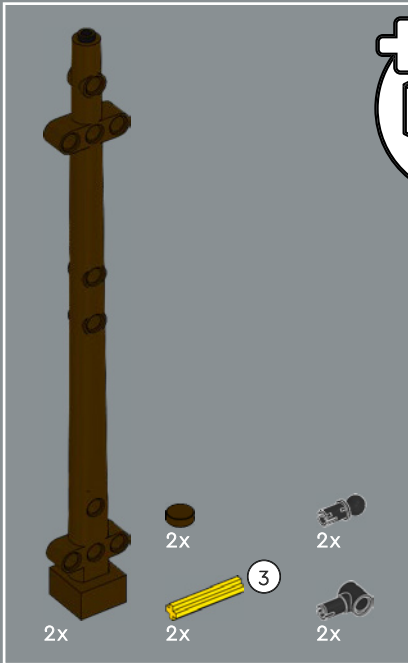
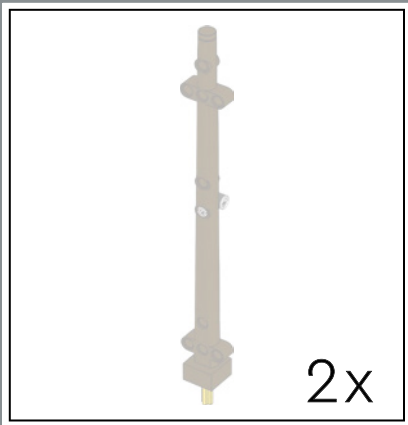

531

1



2



3



2x

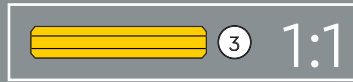

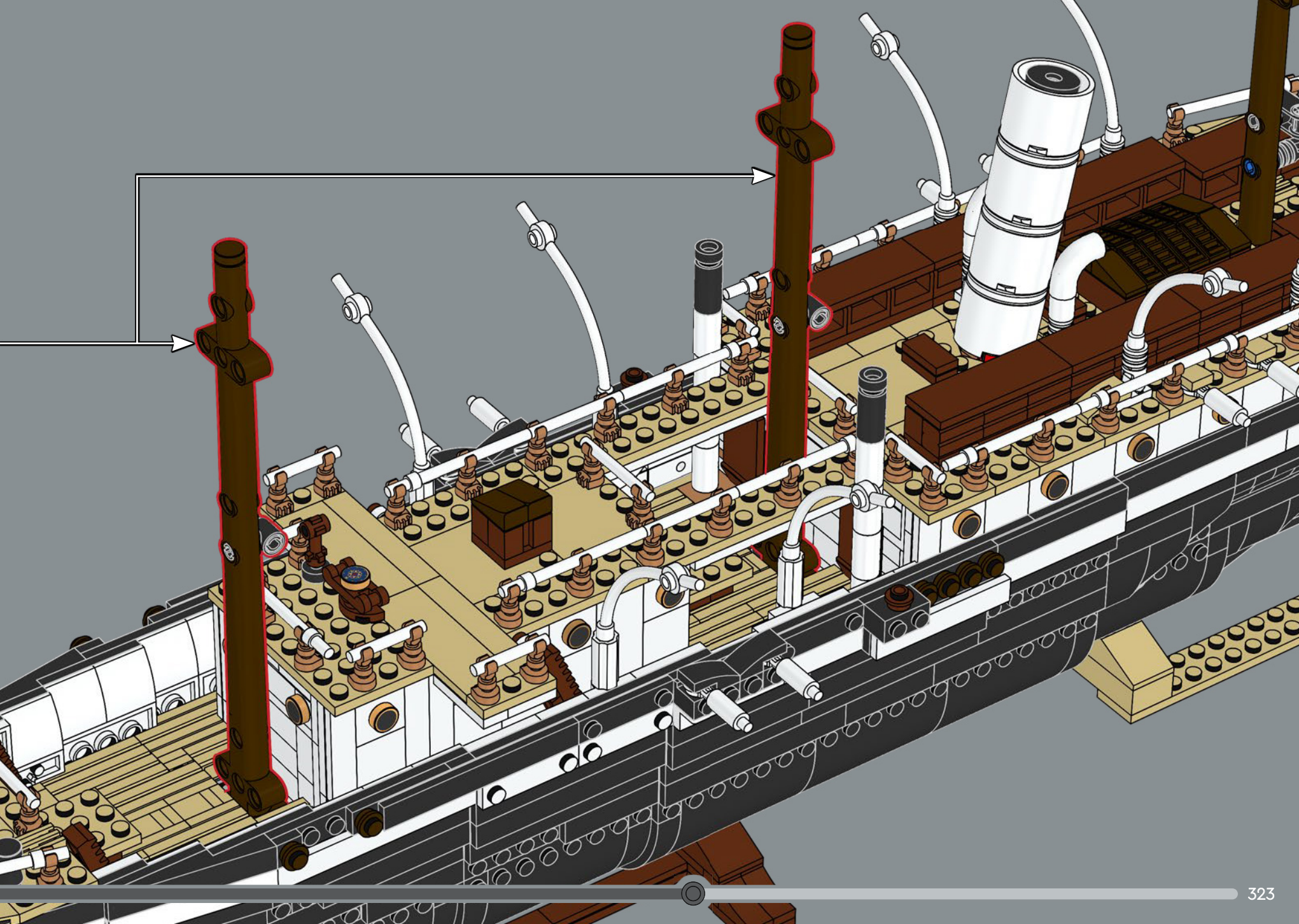

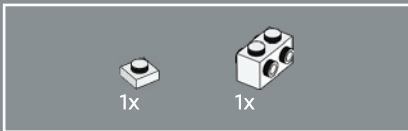
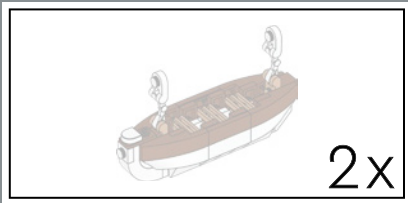

532

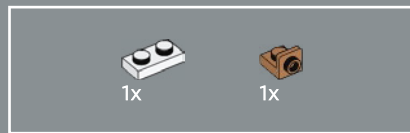
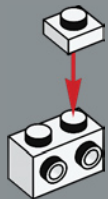

533

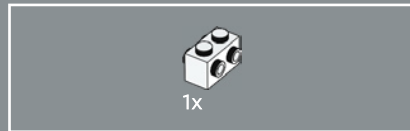
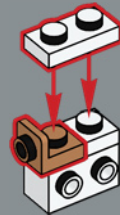

534

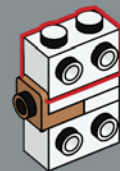

535

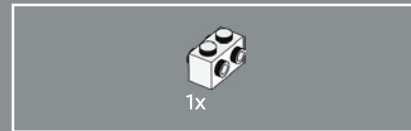
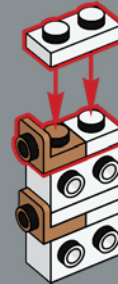

536

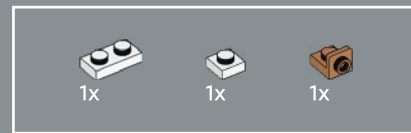
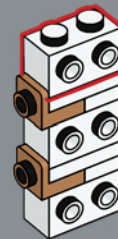

537

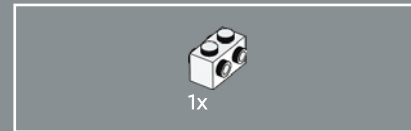
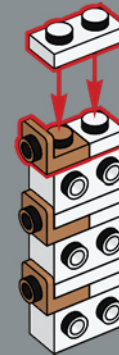

538



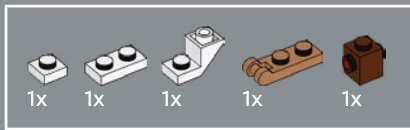

539

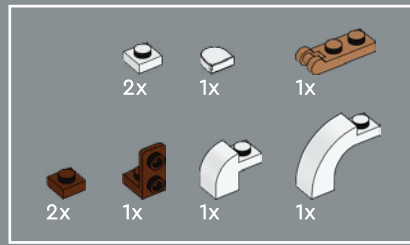
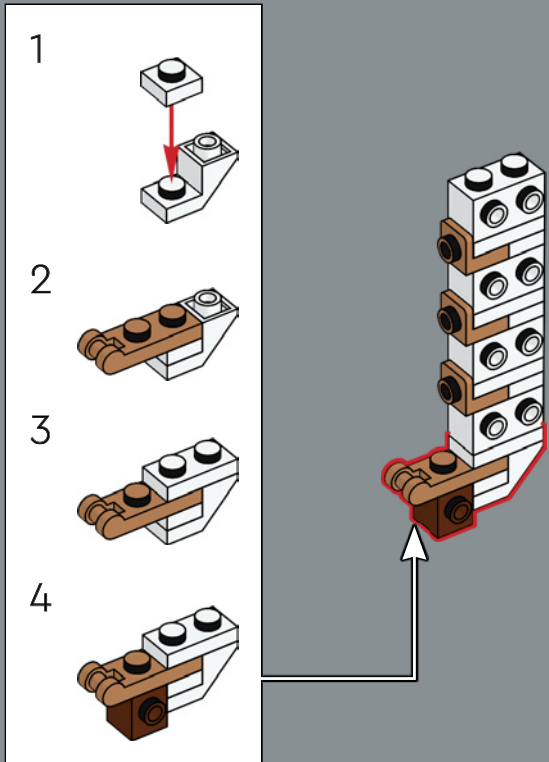

540

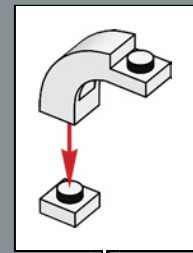
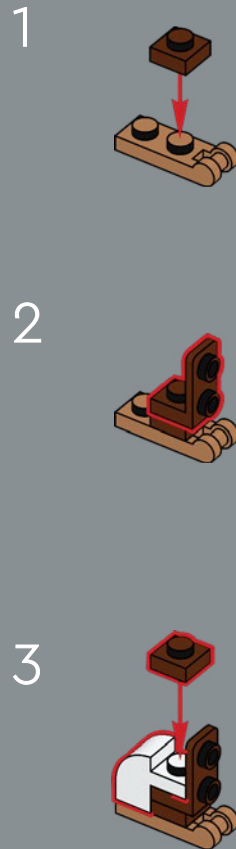

4

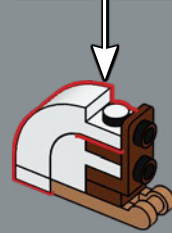

5

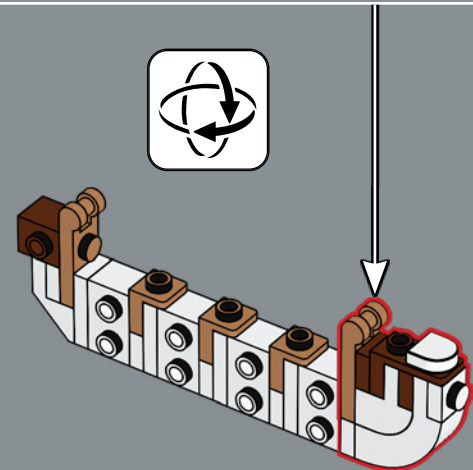
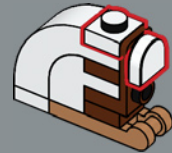

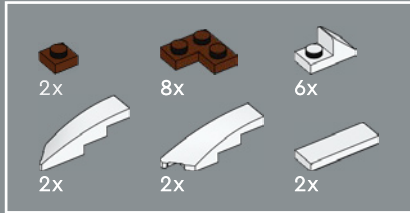
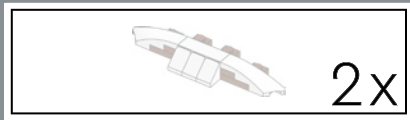

541

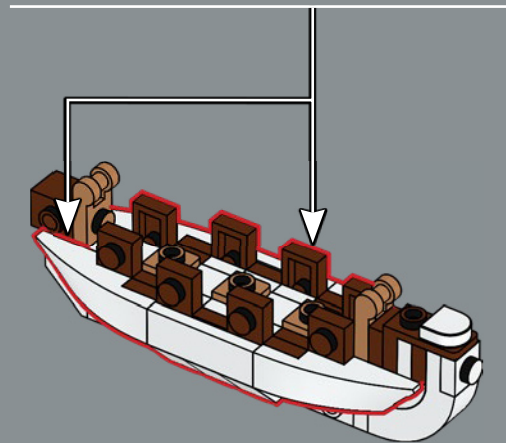
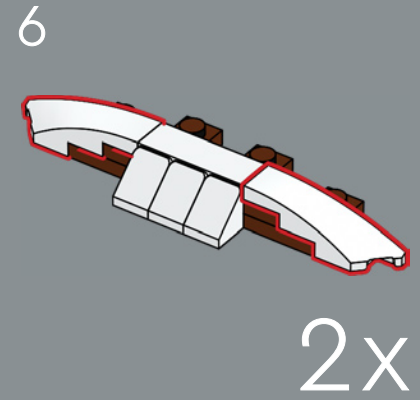
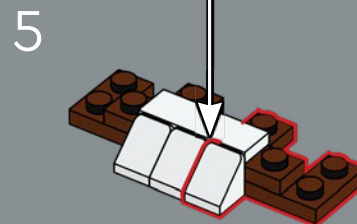
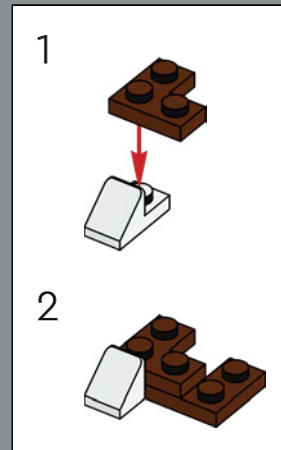
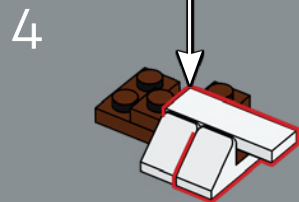
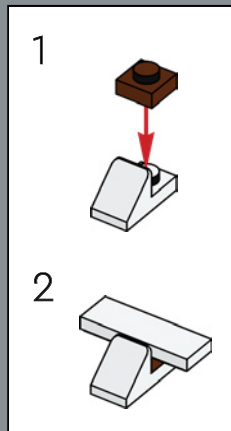
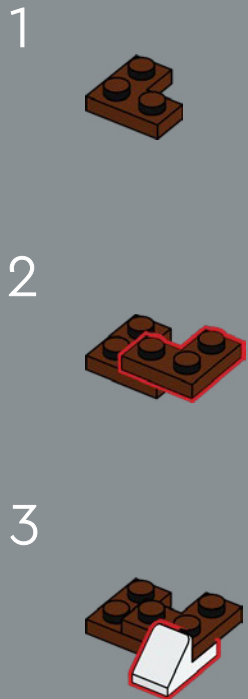



542

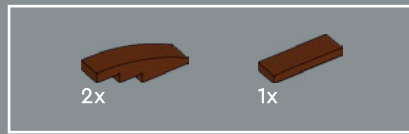
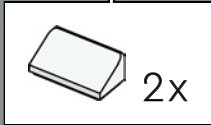
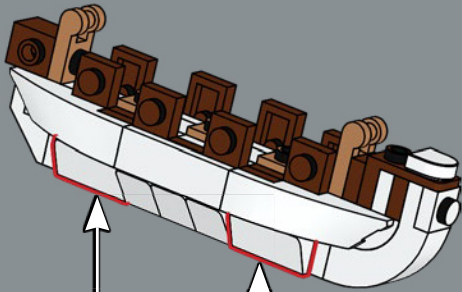

543

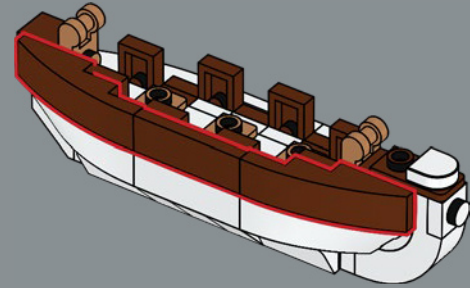

544

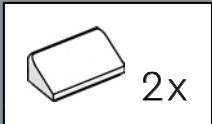
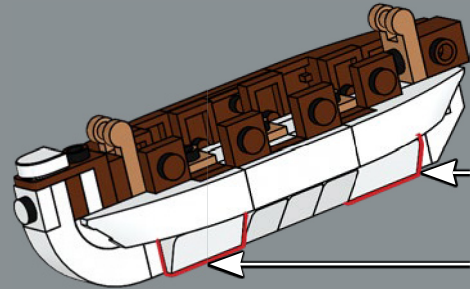



3x

545

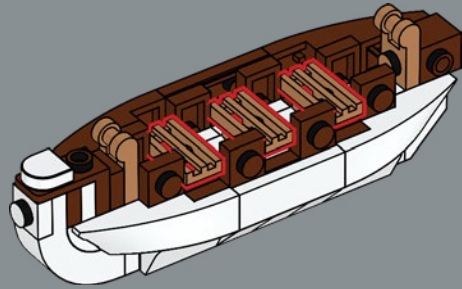

2x



1x

546

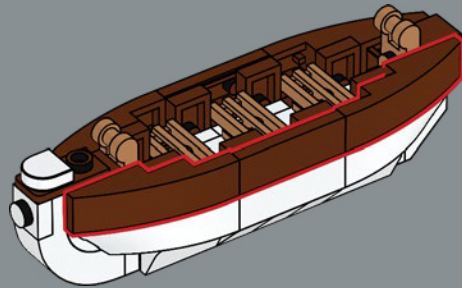

2x

547

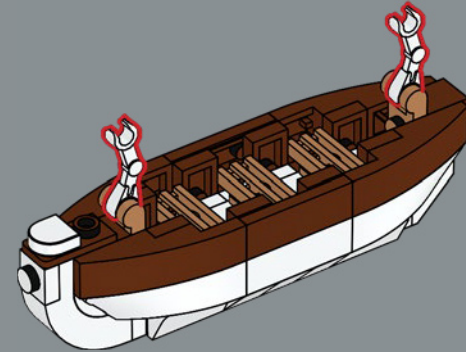

2x

548

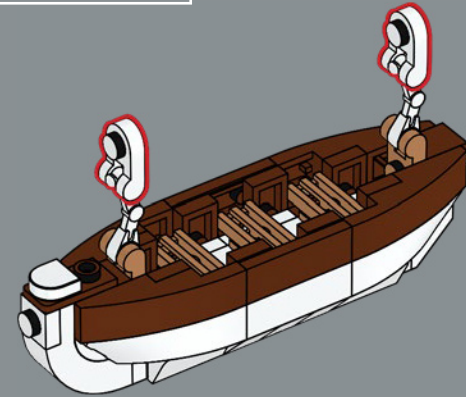

2x

549

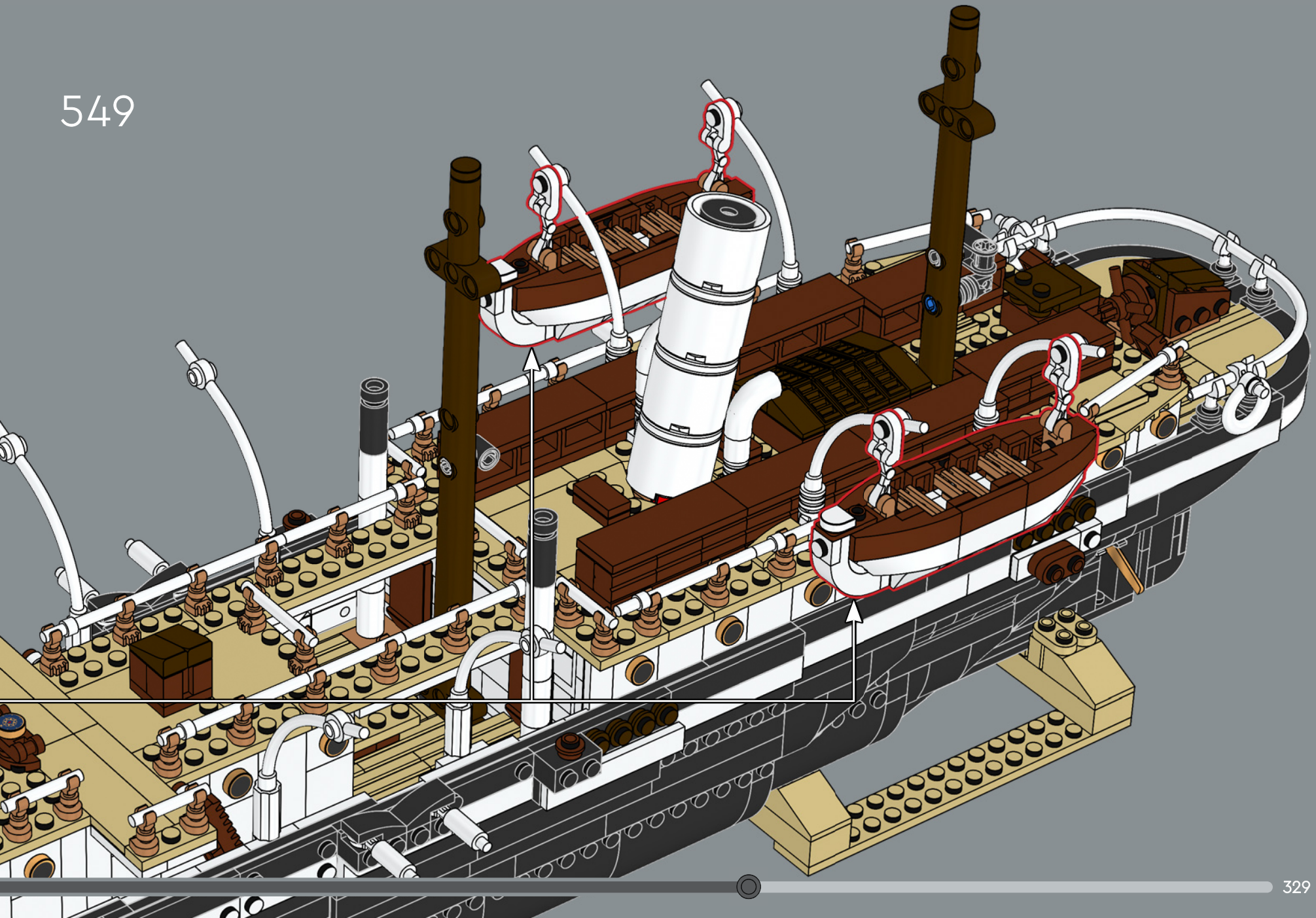

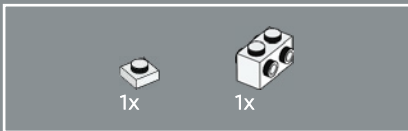
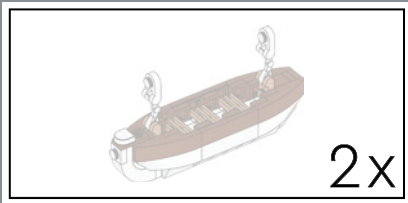

550

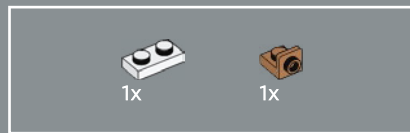
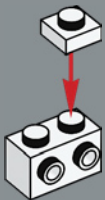

551

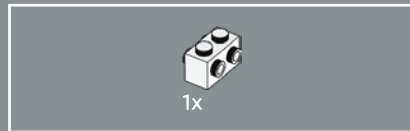
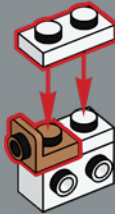

552

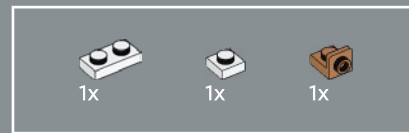

553

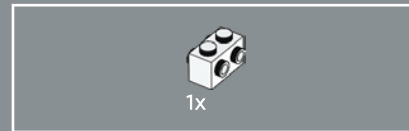
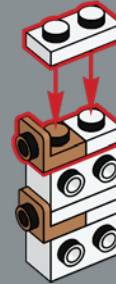

554

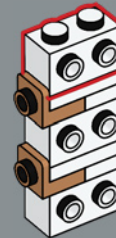

555

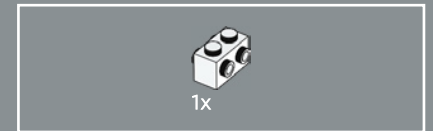

556

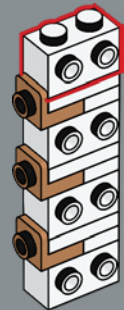

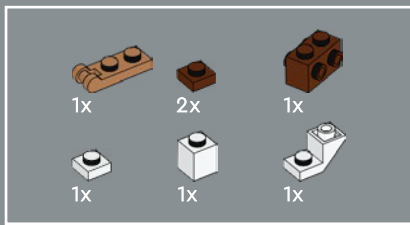

557

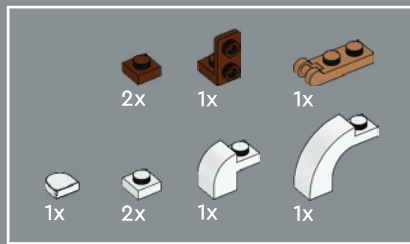
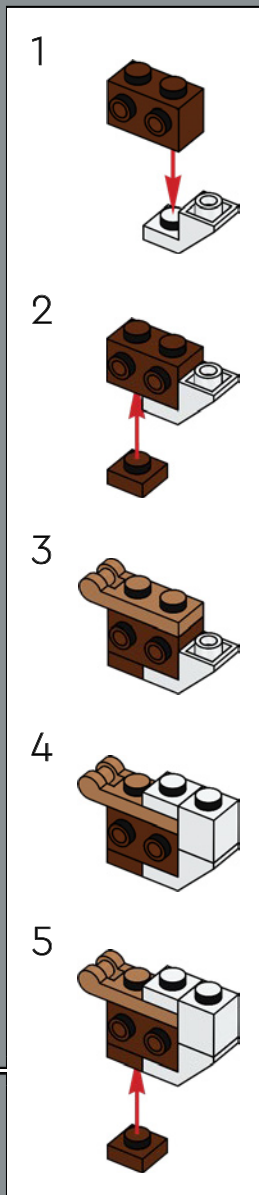
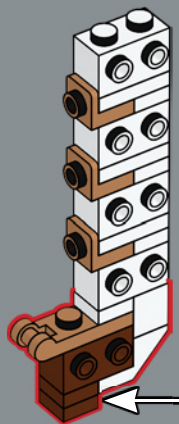

558

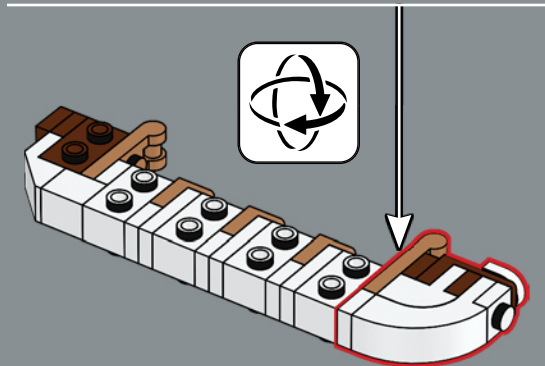
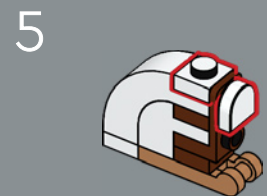
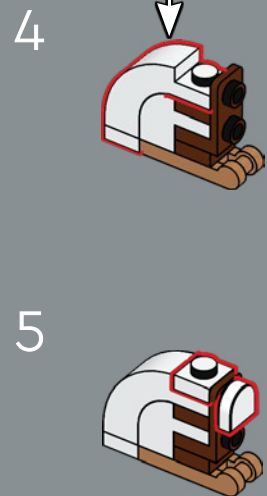
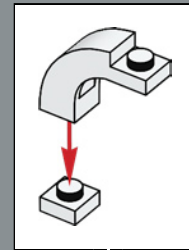
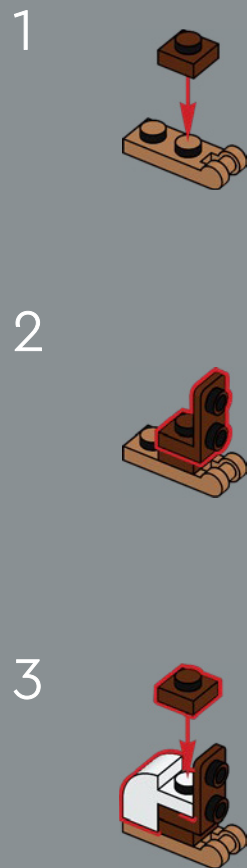

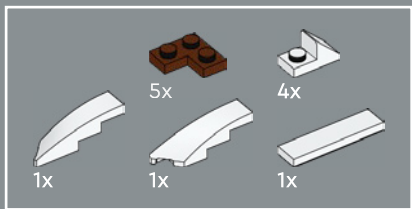

559

1



2



3

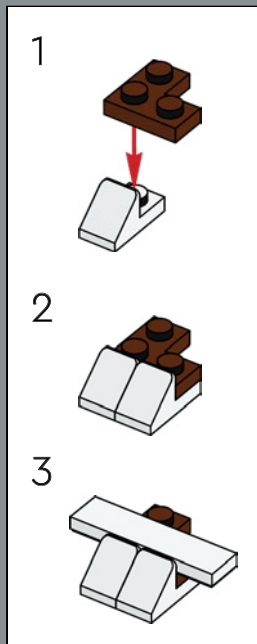

4

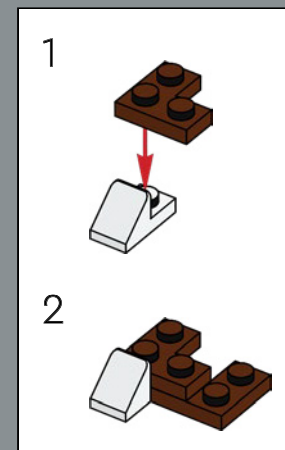
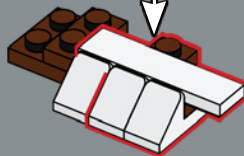

5

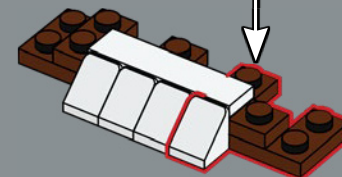

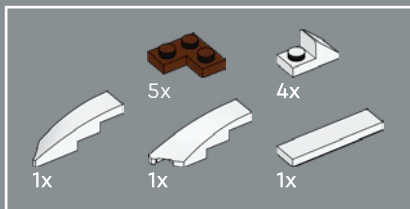

562

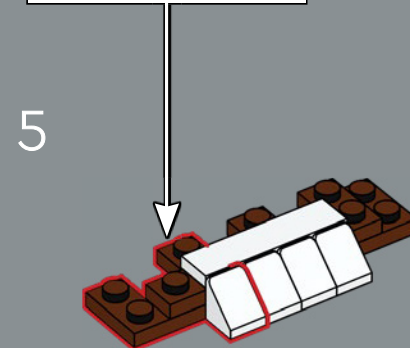
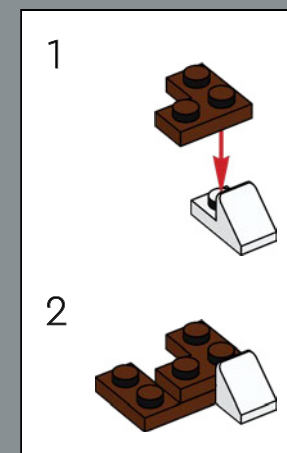
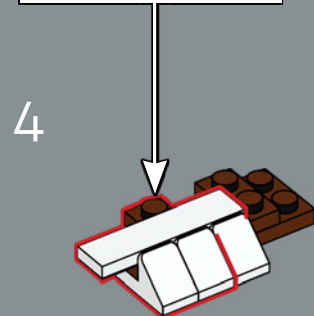
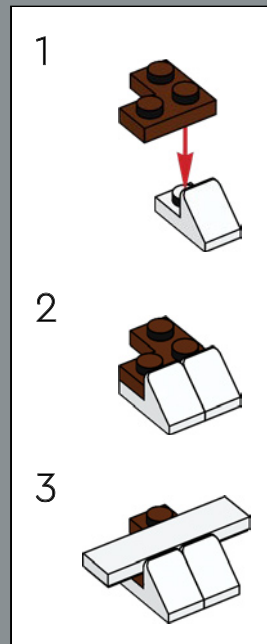
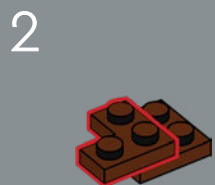

6

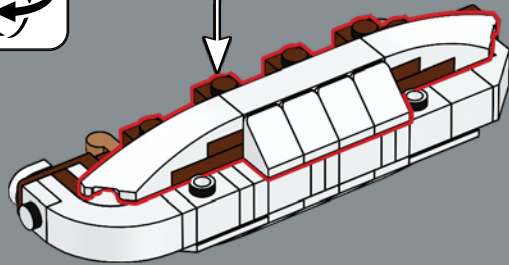
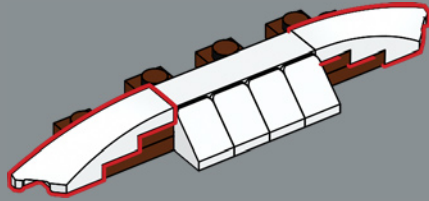

2x

563

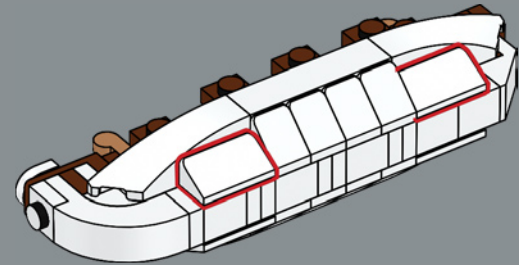

3x

564

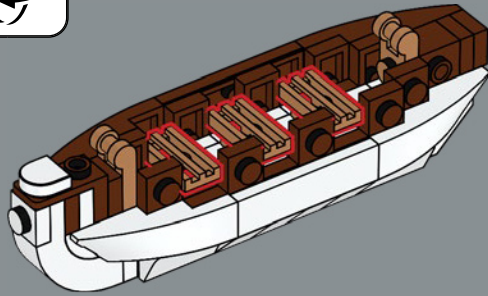

1x

2x

565

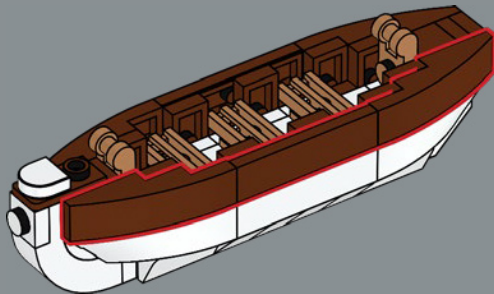

2x

566

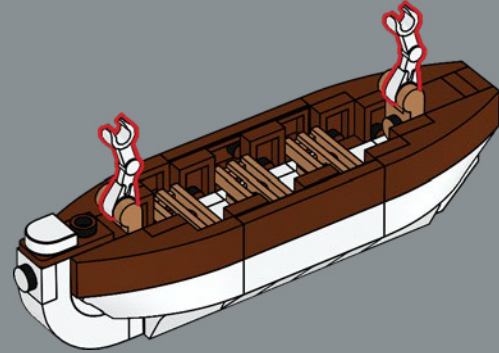

2x

567

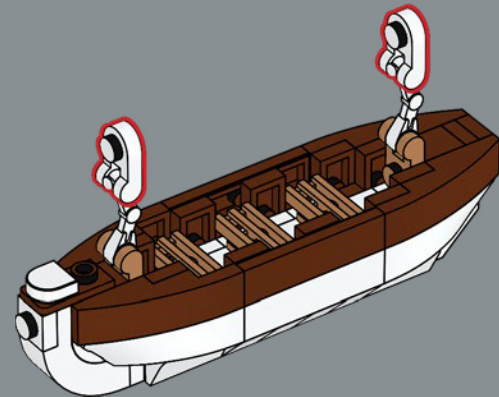

2x

568

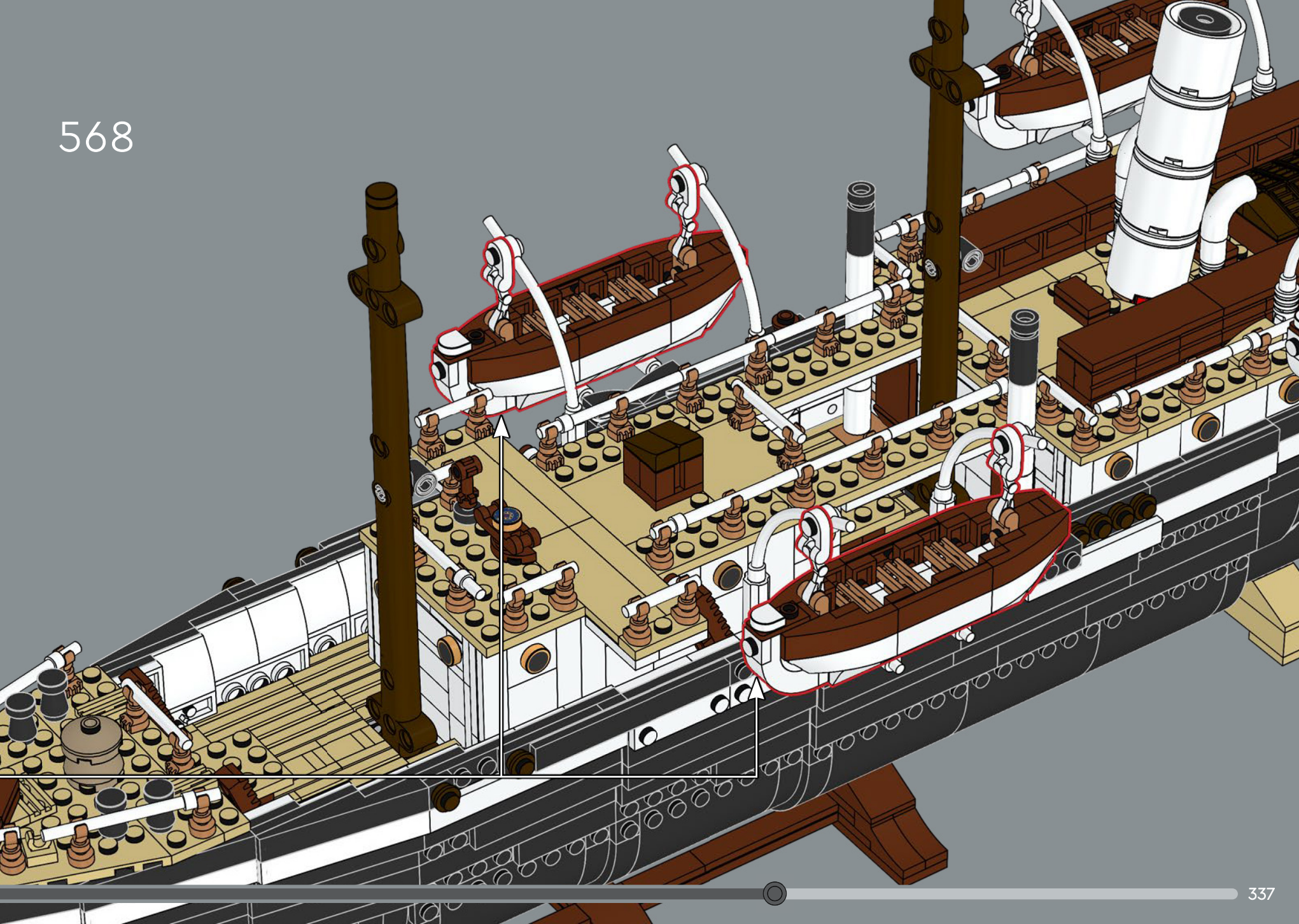

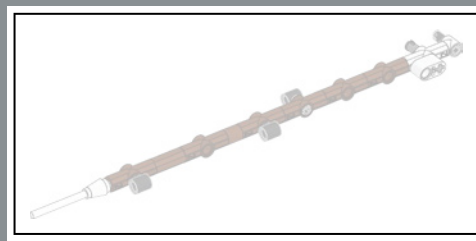

569

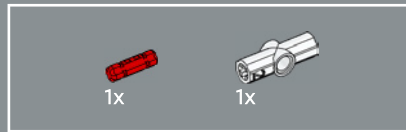
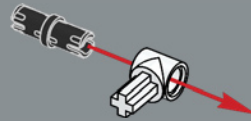

570

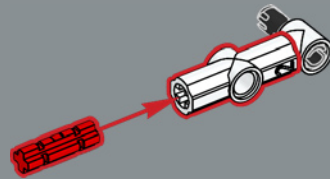

571

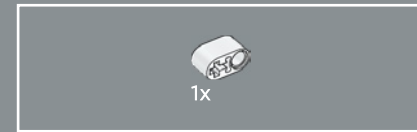
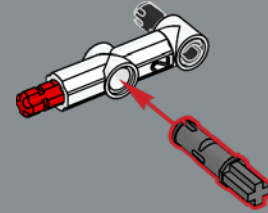

572

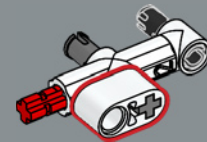

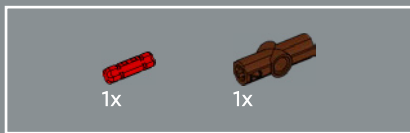

573

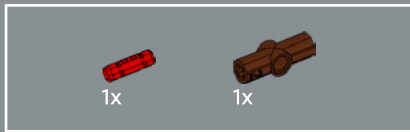
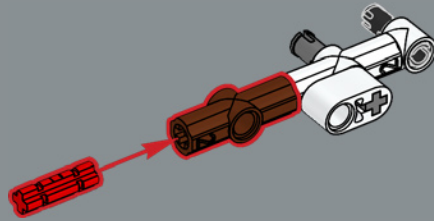

574

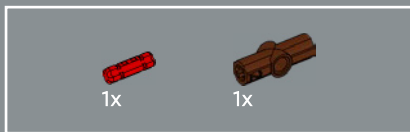
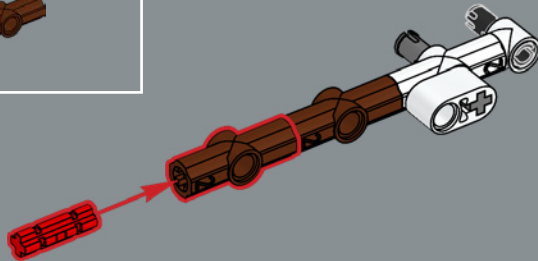

575

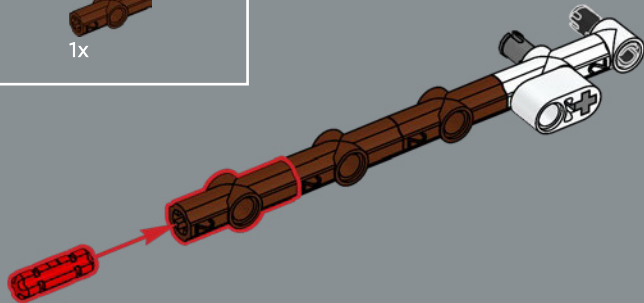

576

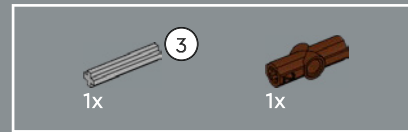
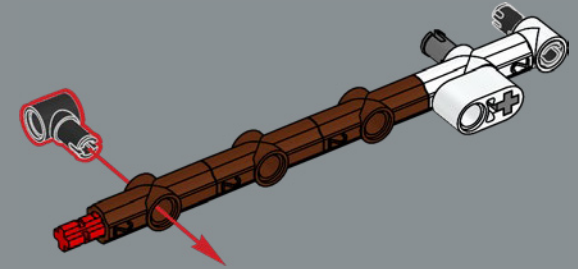

577

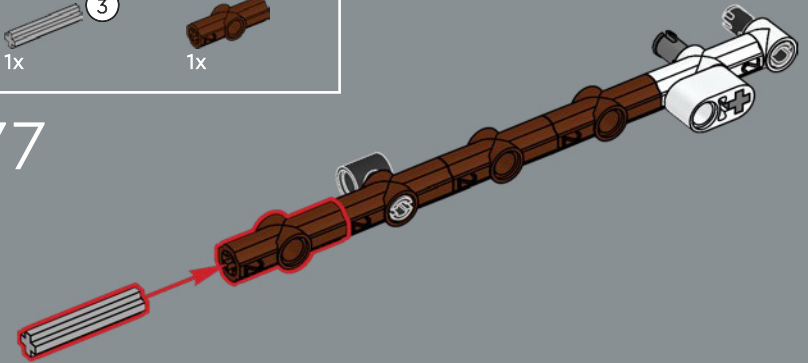

578

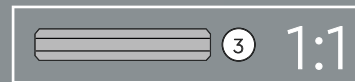
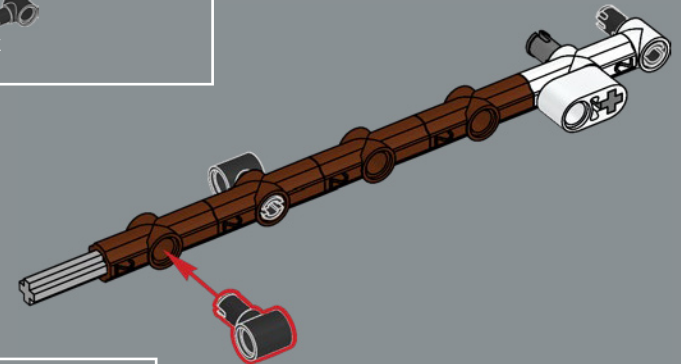



579

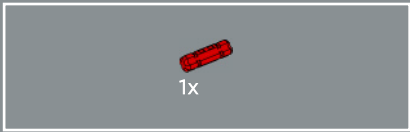
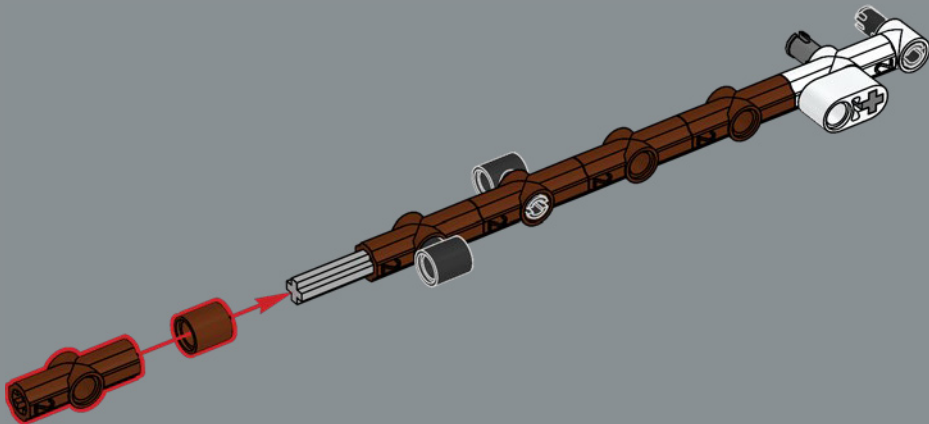

580

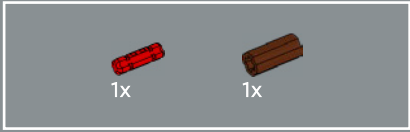
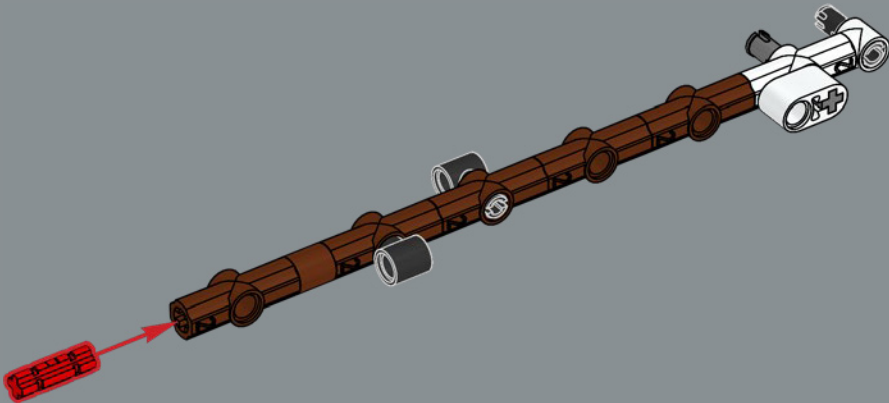

581

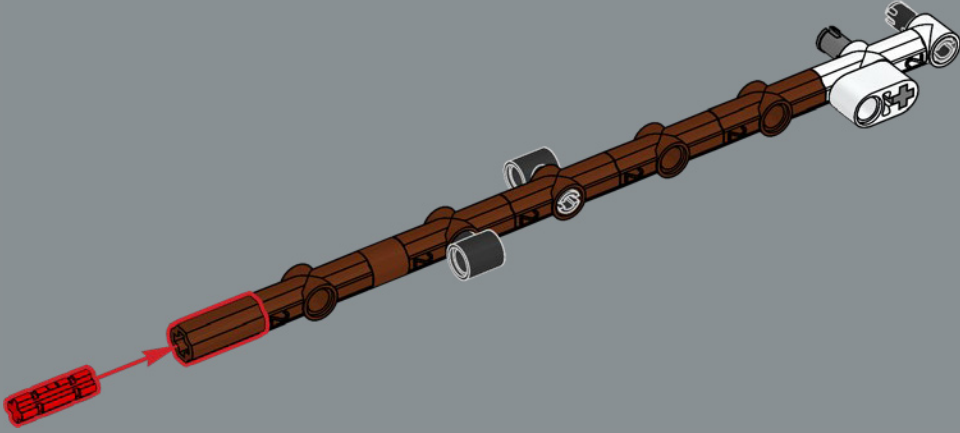



582

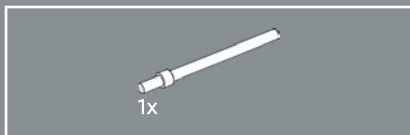
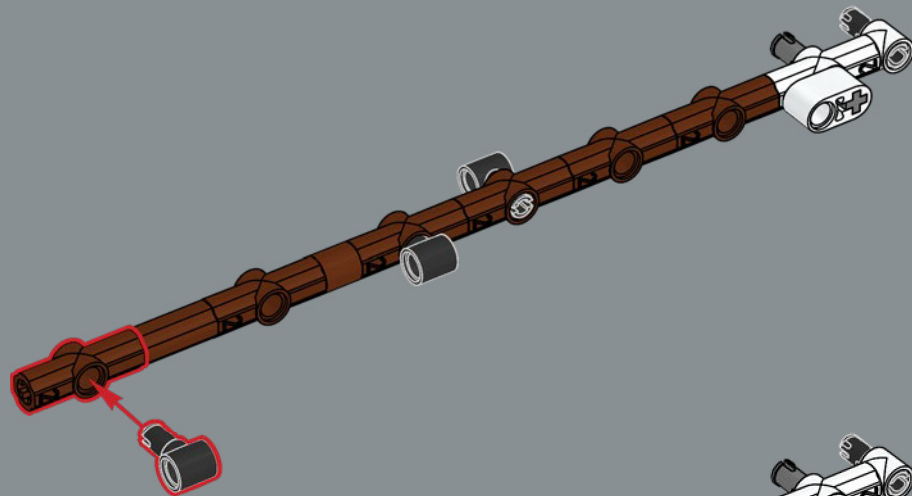

583

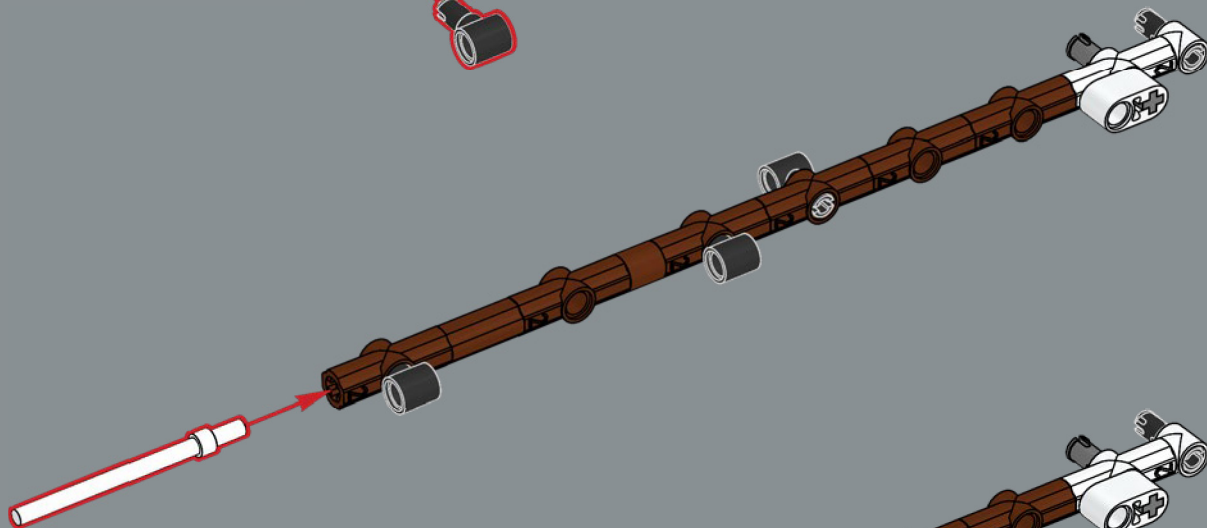

584

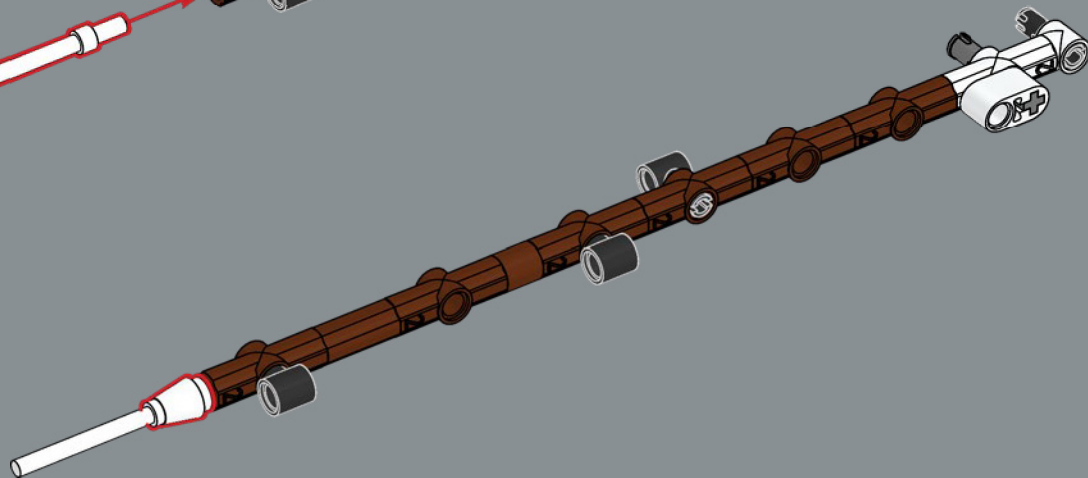

585

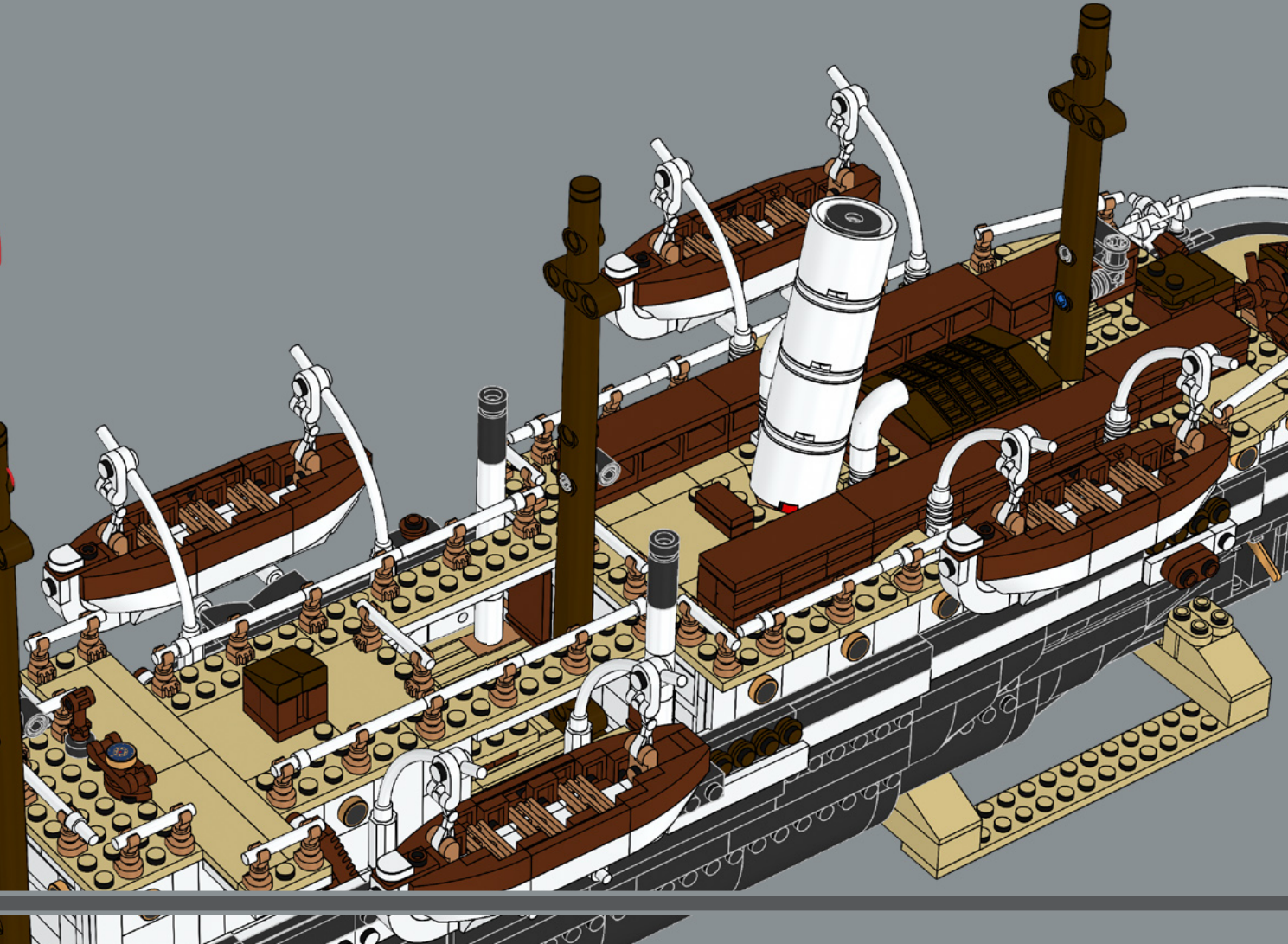
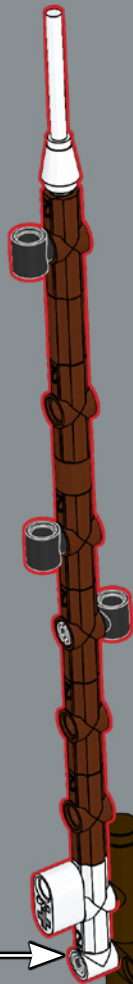

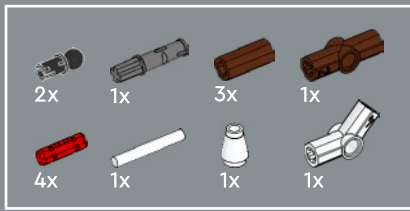

586

1

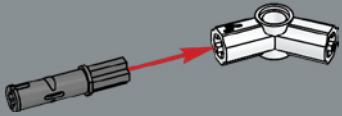

2

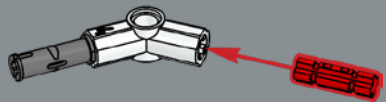

3

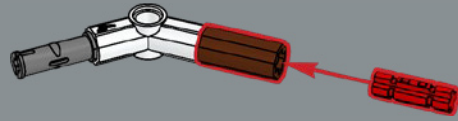

4



5

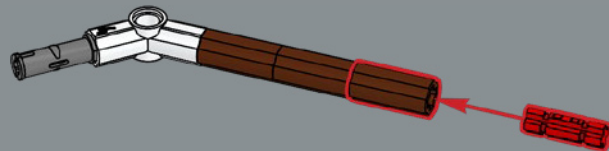

6

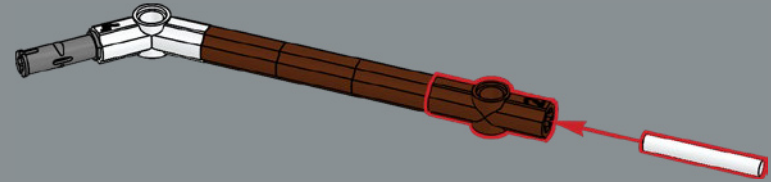

7

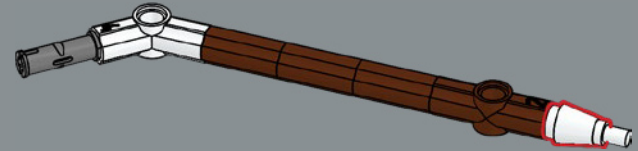

8

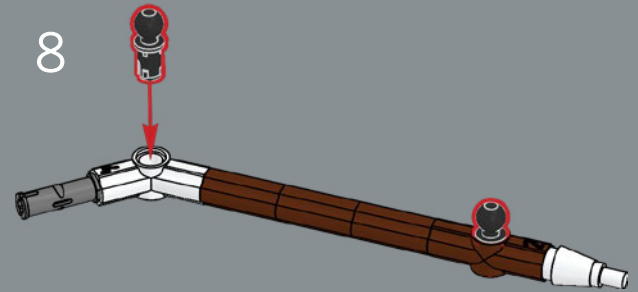

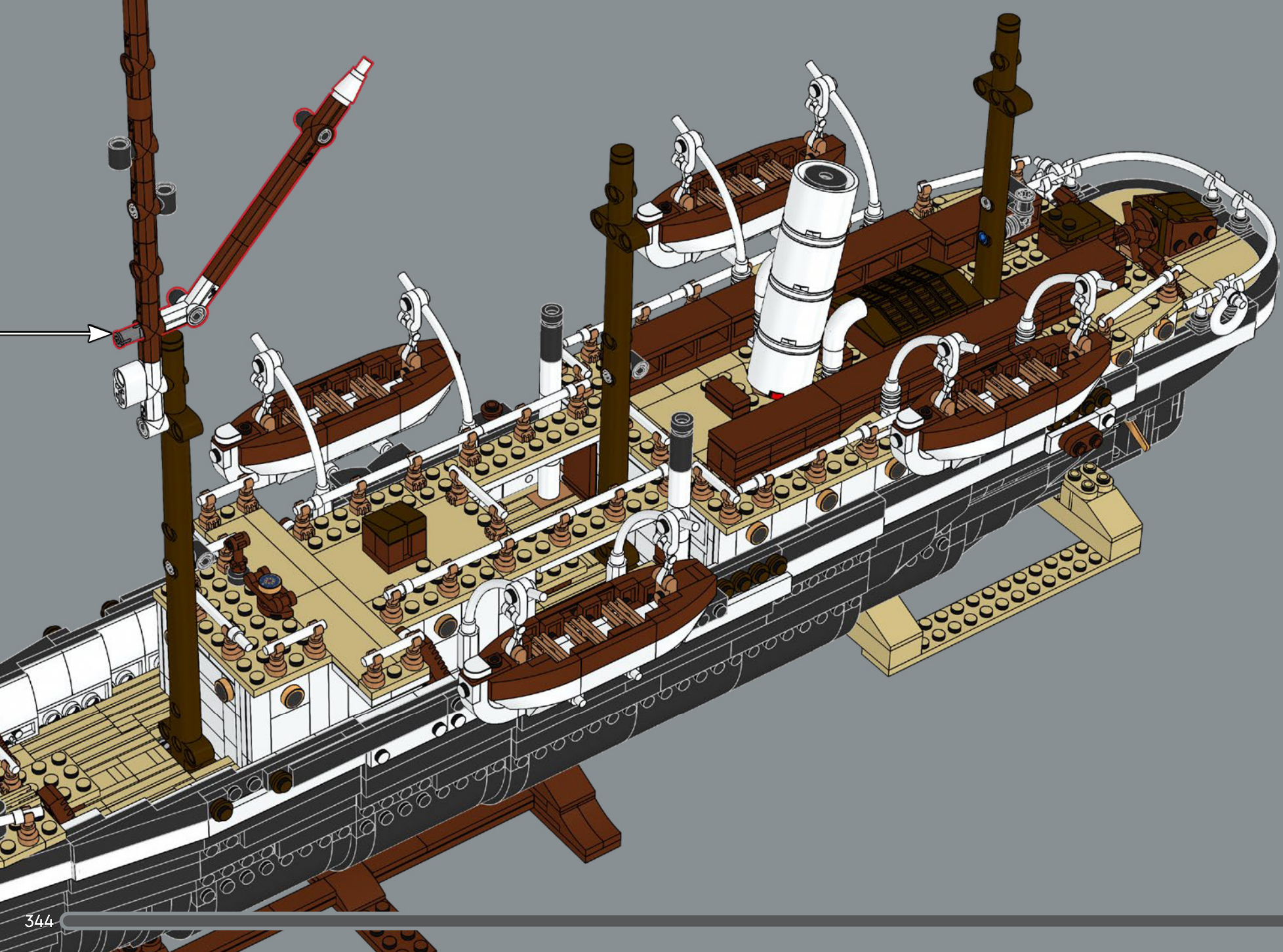

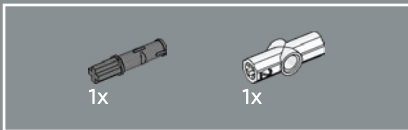
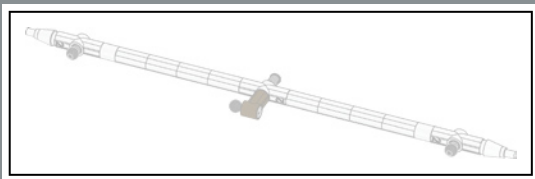

587

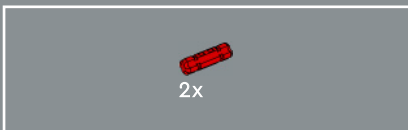
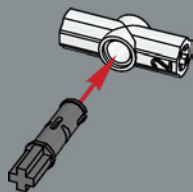

588

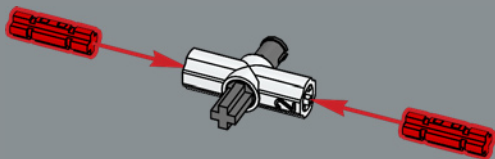

589

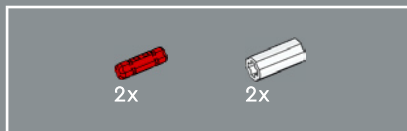
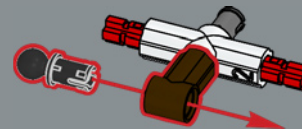

590

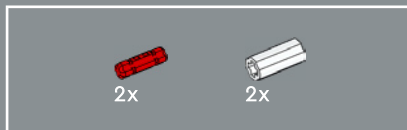
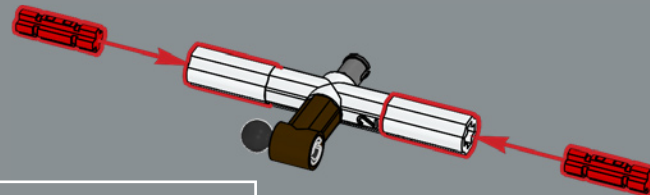

591

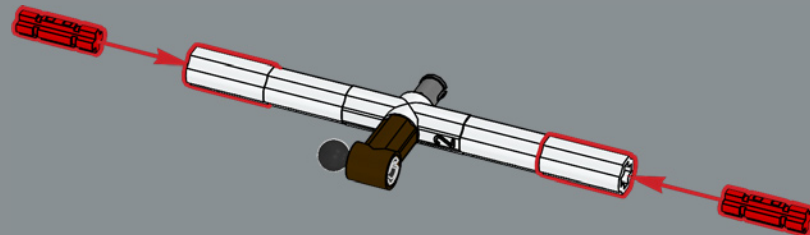

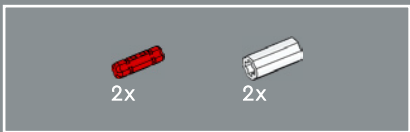

592

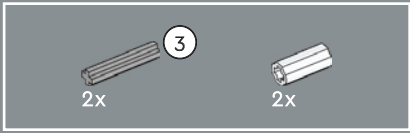
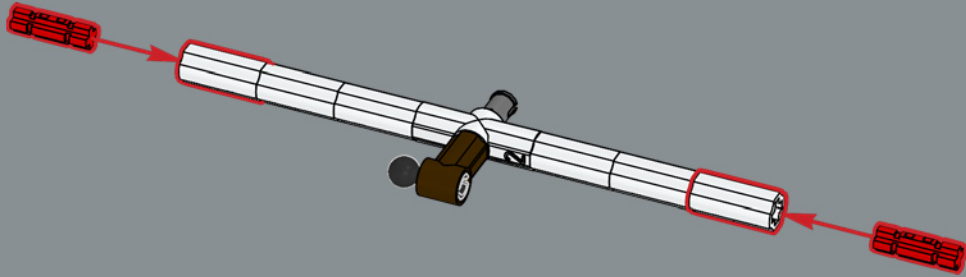

593

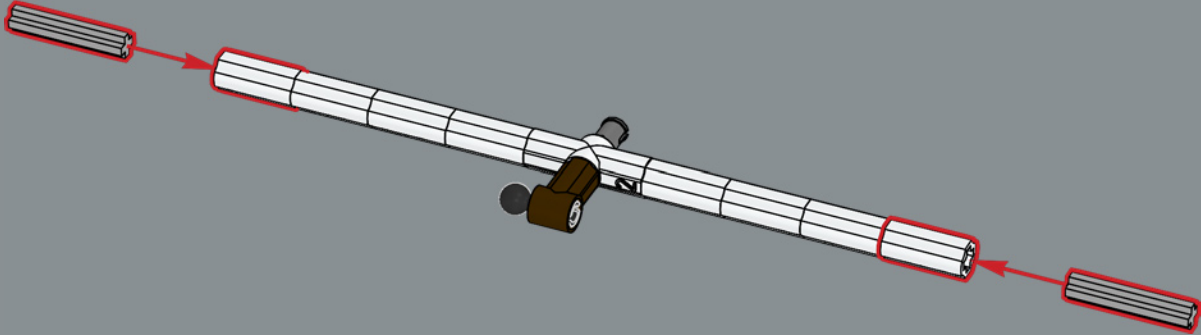

594

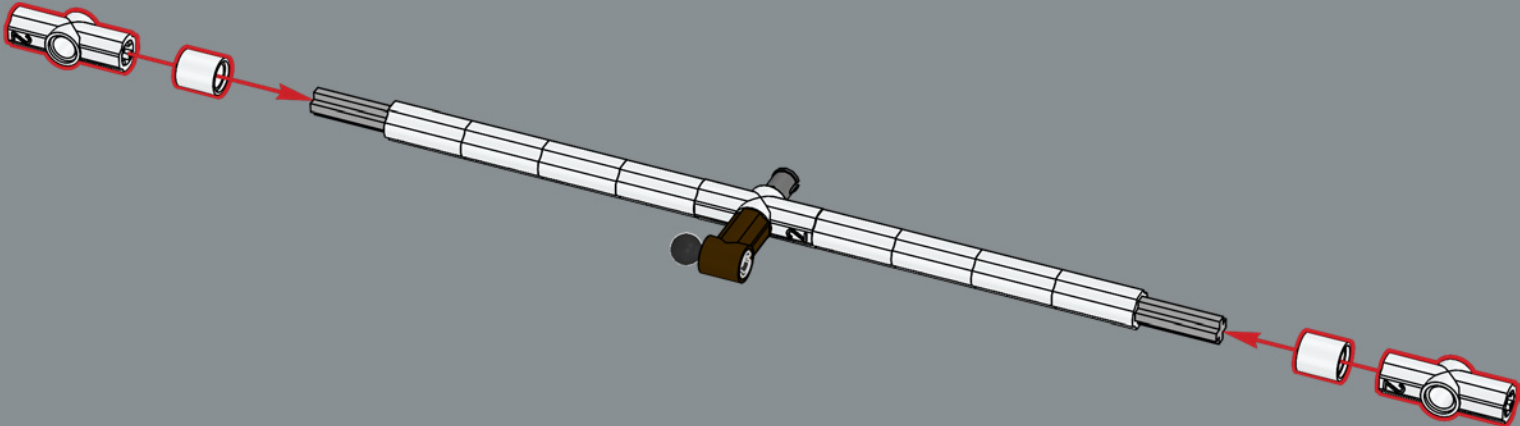



595

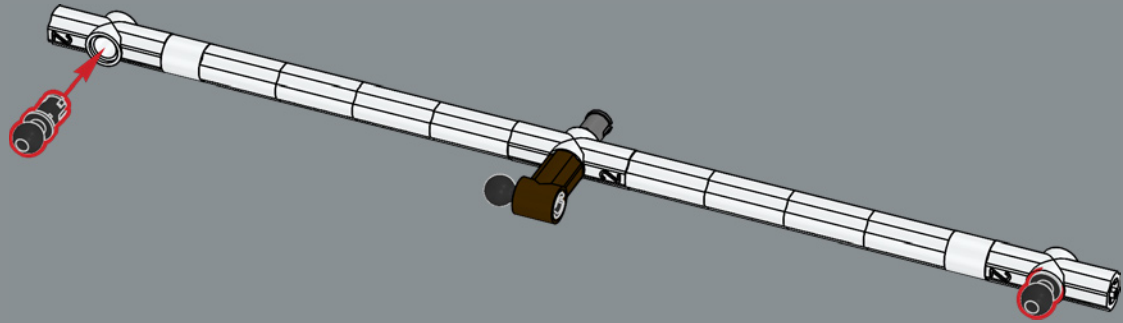

596

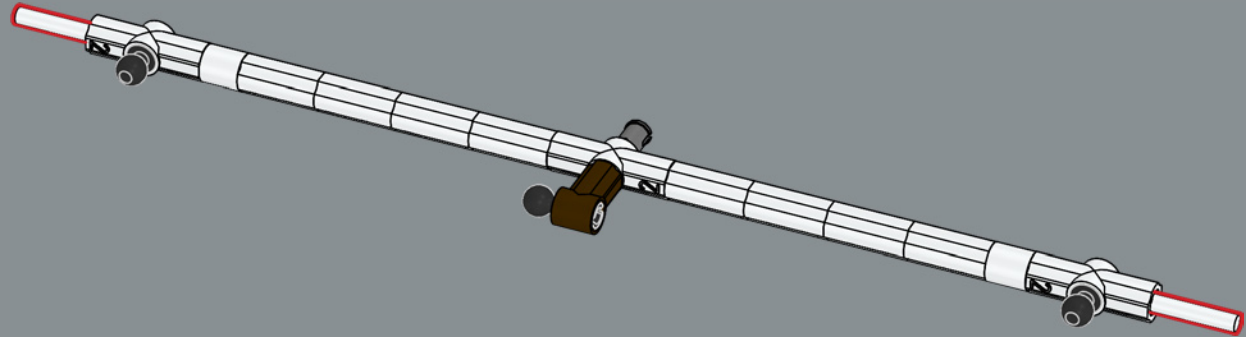

597

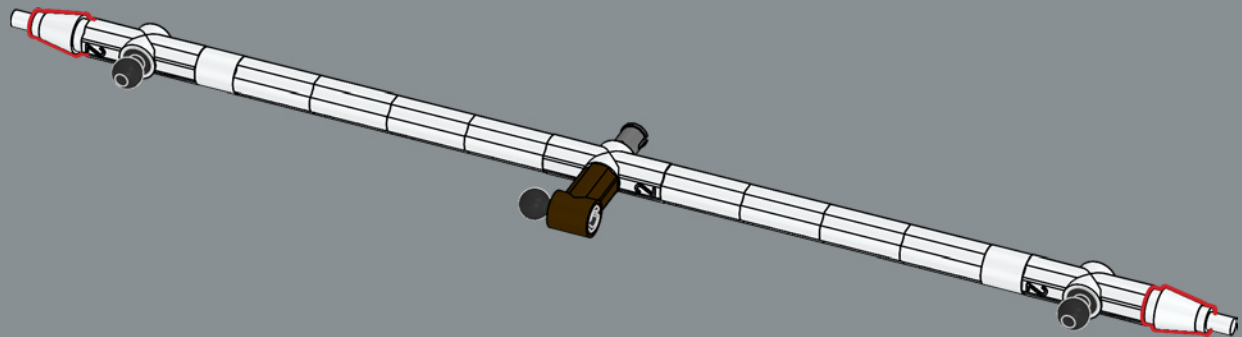

598

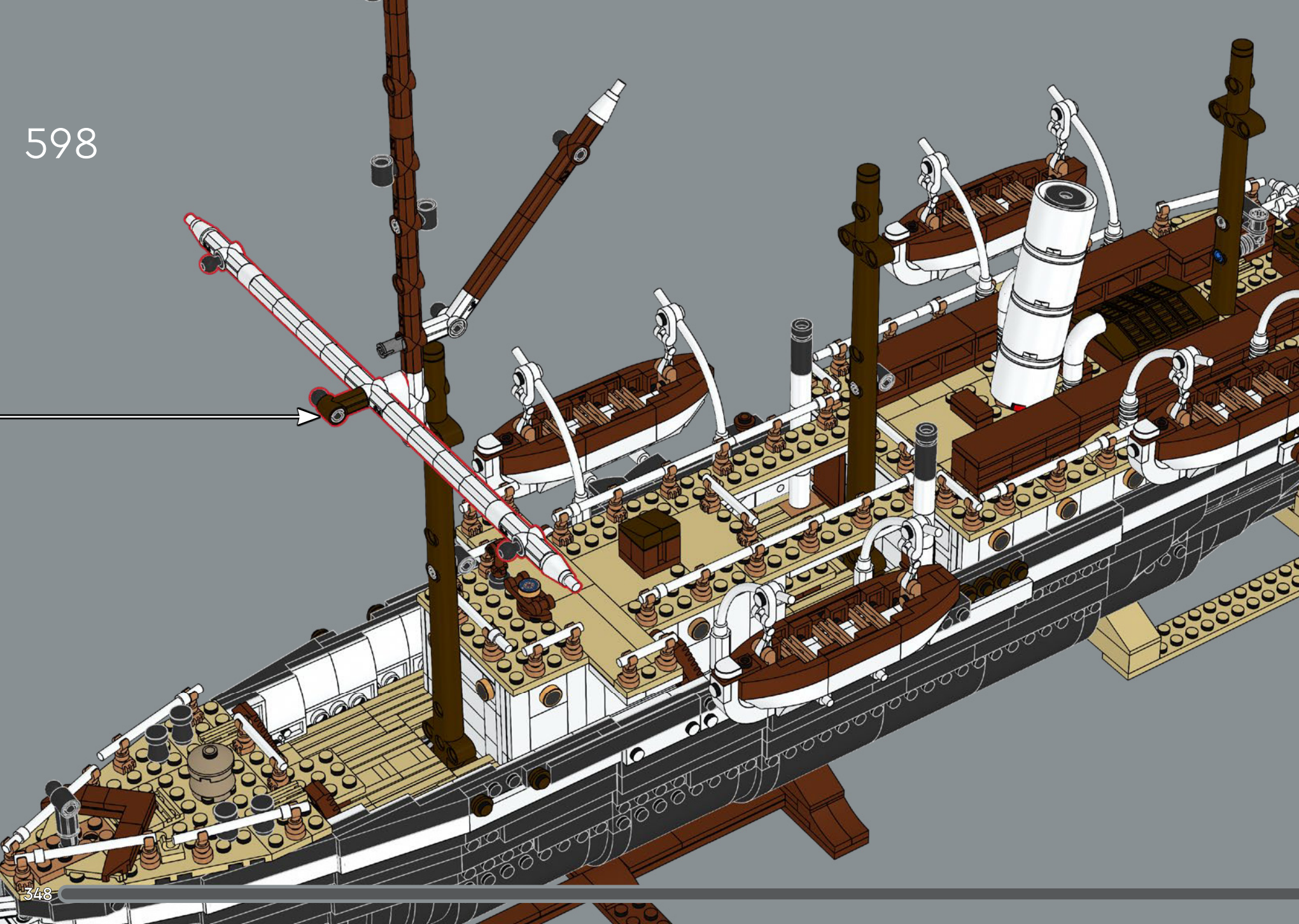



599

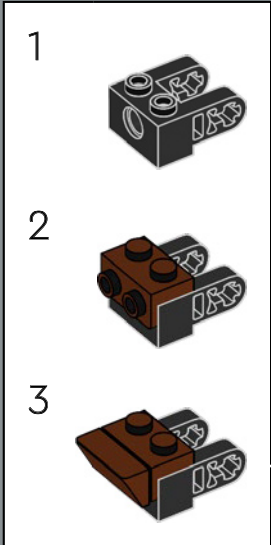

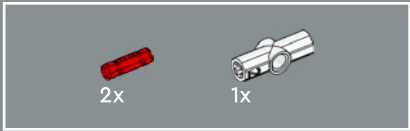
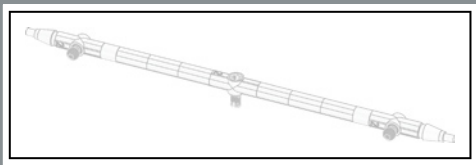

600

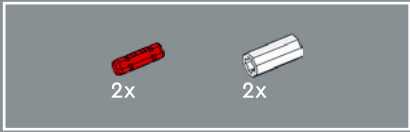
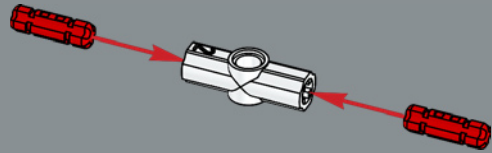

601

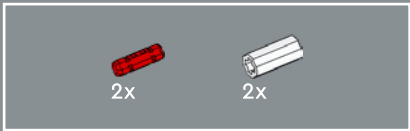
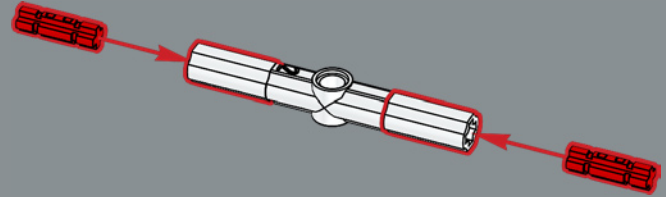

602

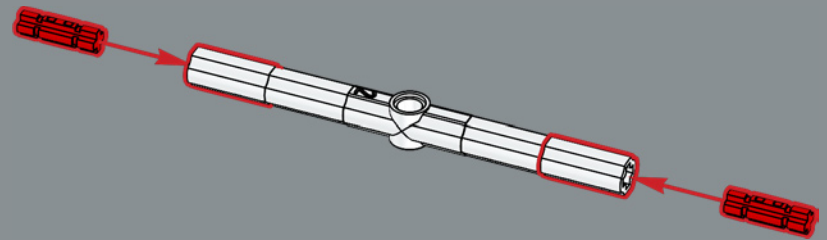

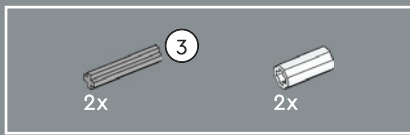

603

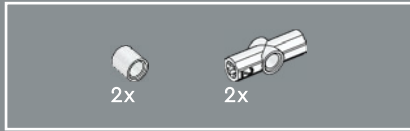
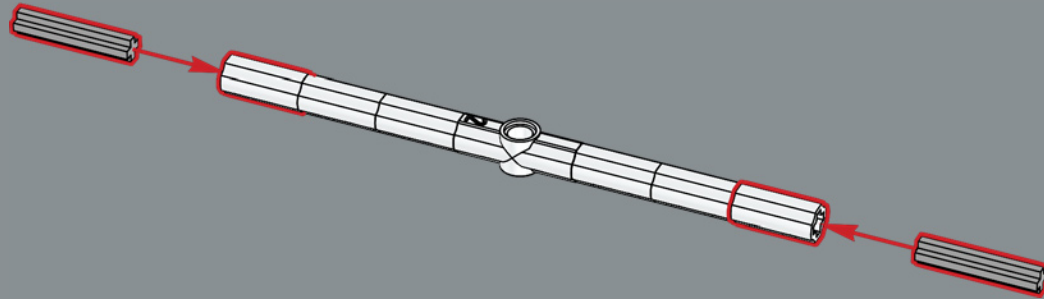

604

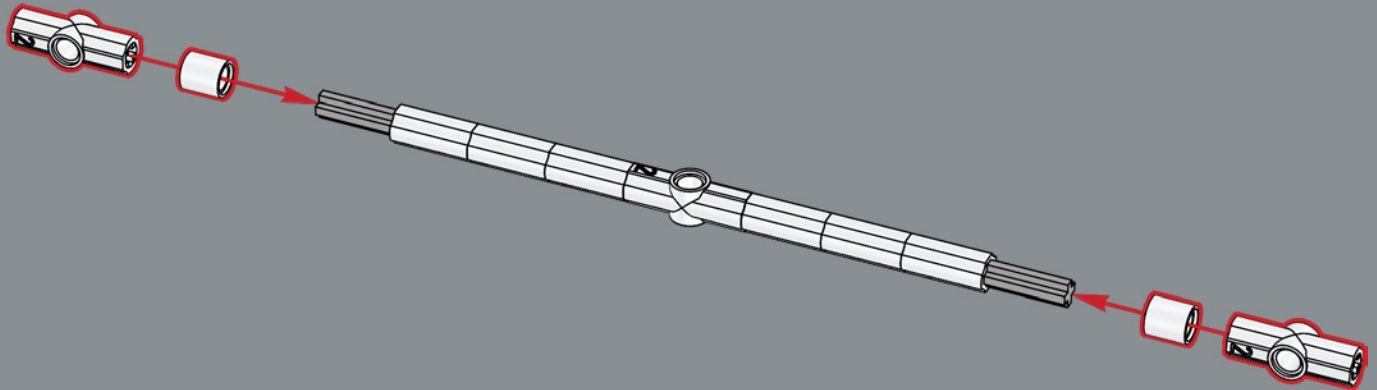

605

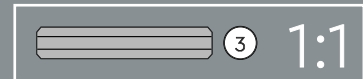
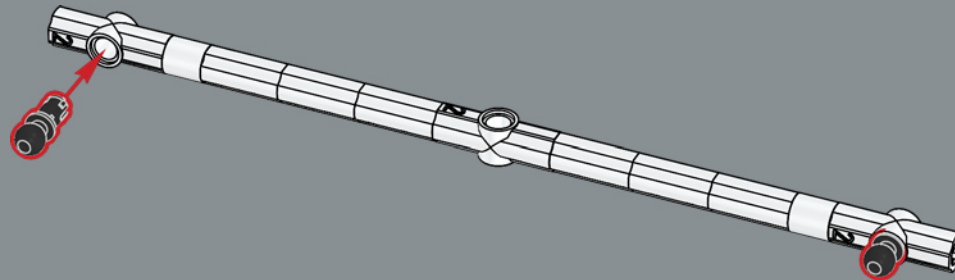



606

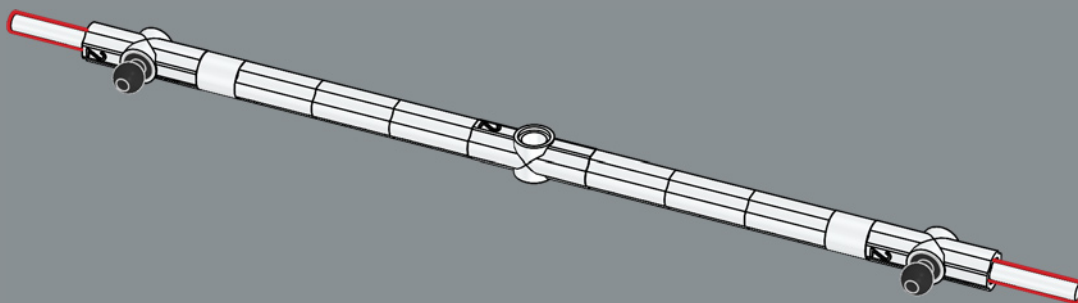

607

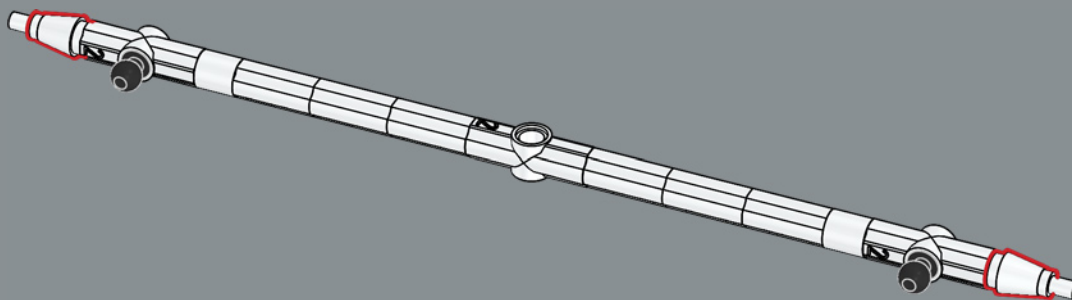

608

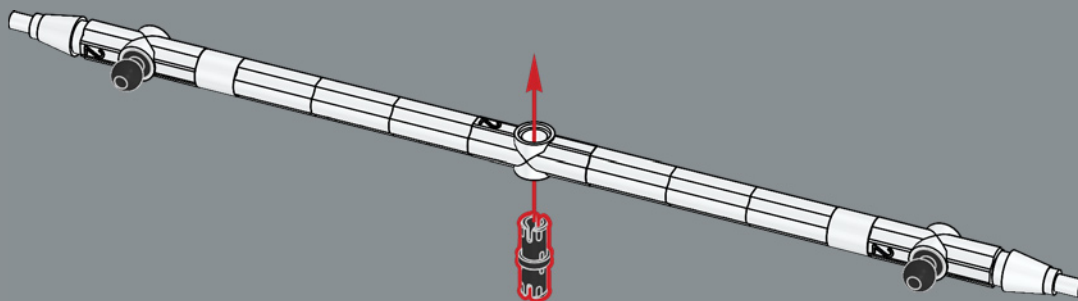

609



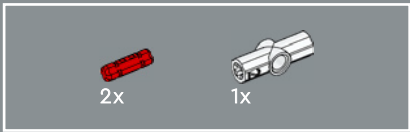
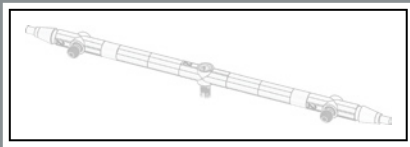

610

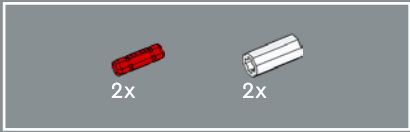
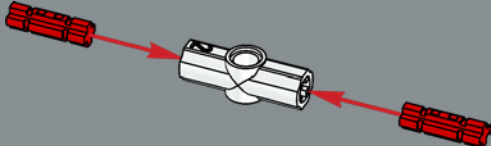

611

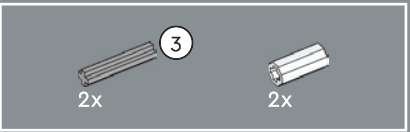
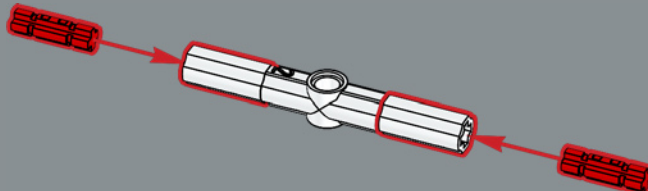

612

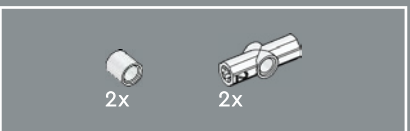
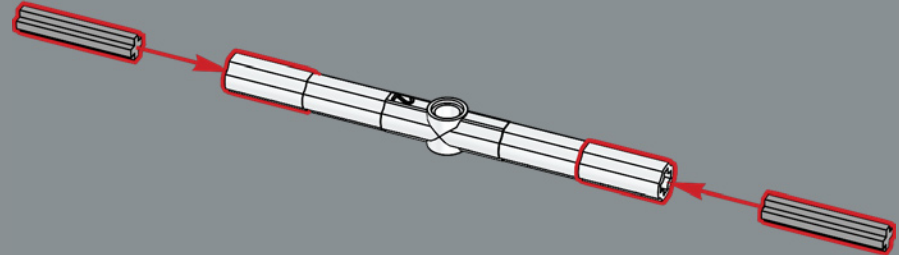

613

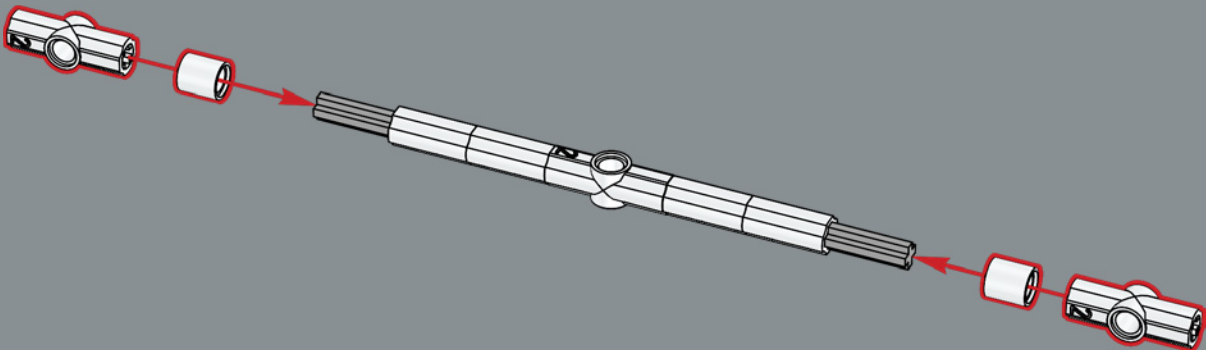



614

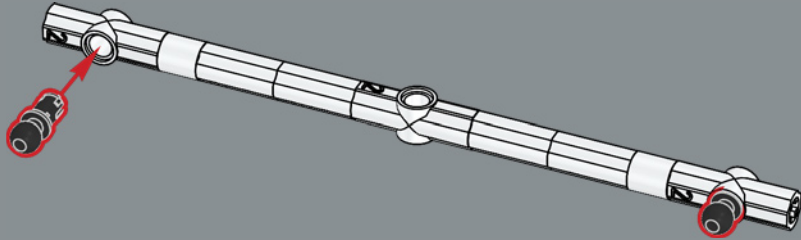

615

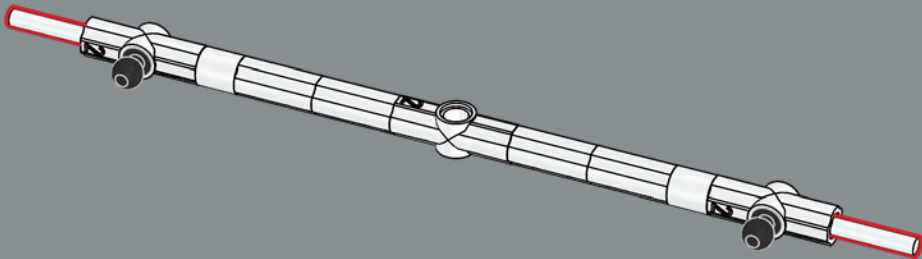

616

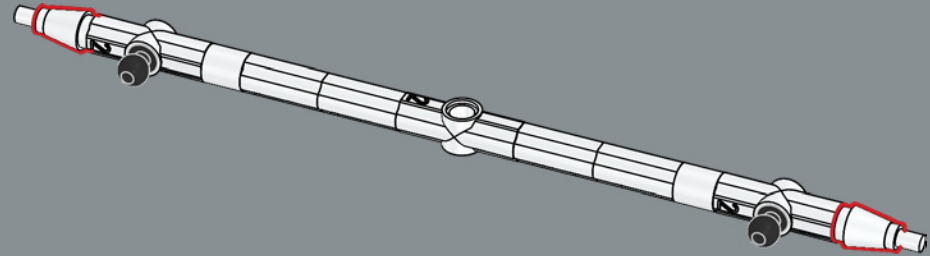

617

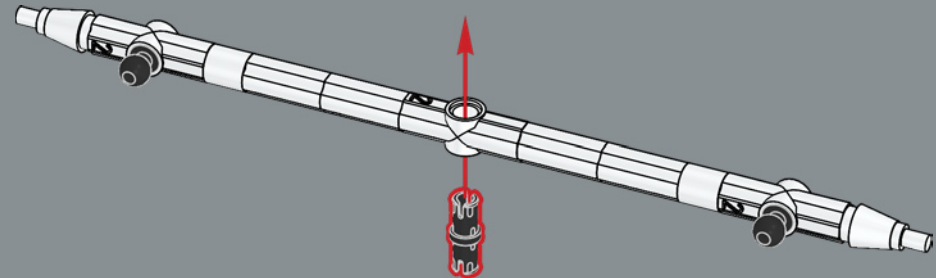

618



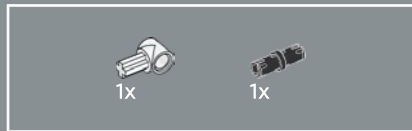
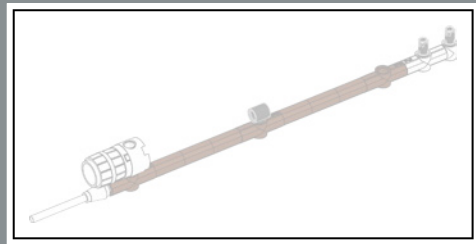

619

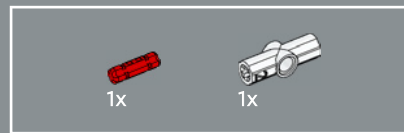

620

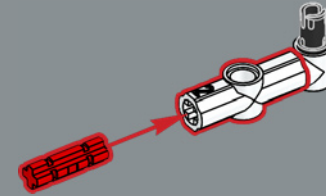

621

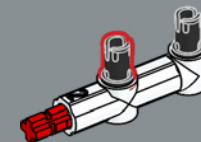

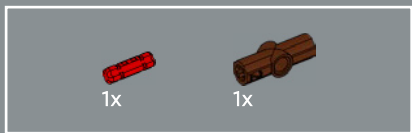

622

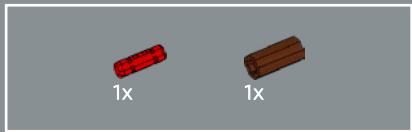
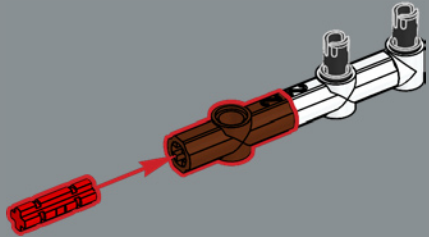

623

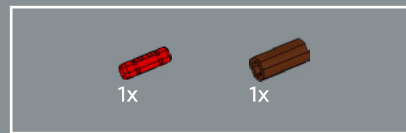
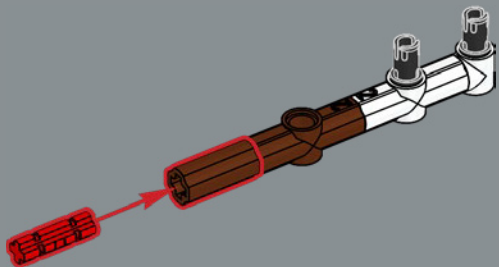

624

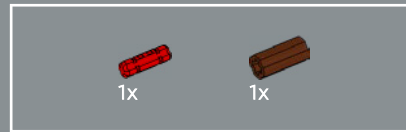
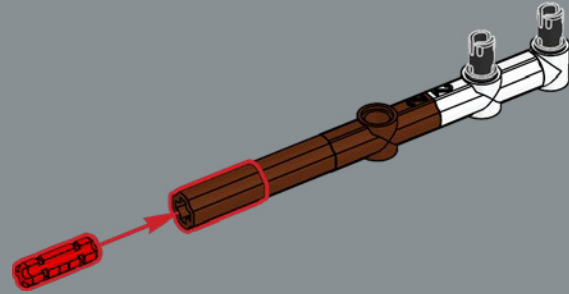

625

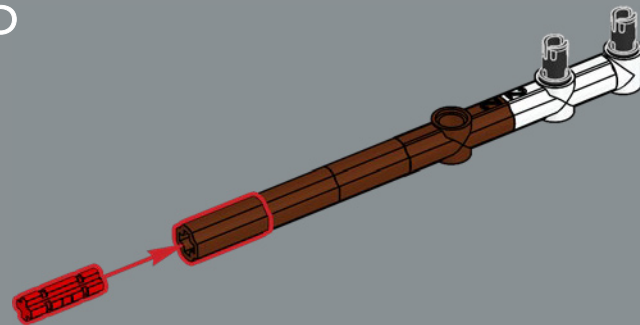

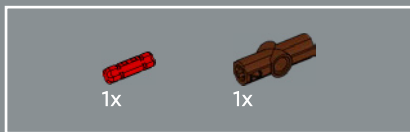

626

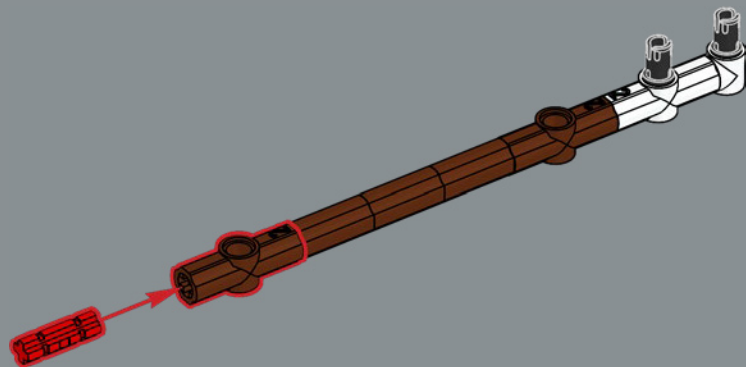

627

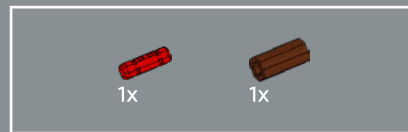
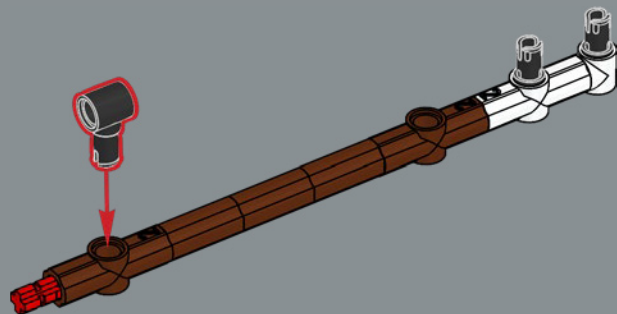

628

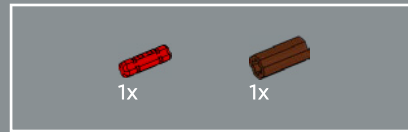
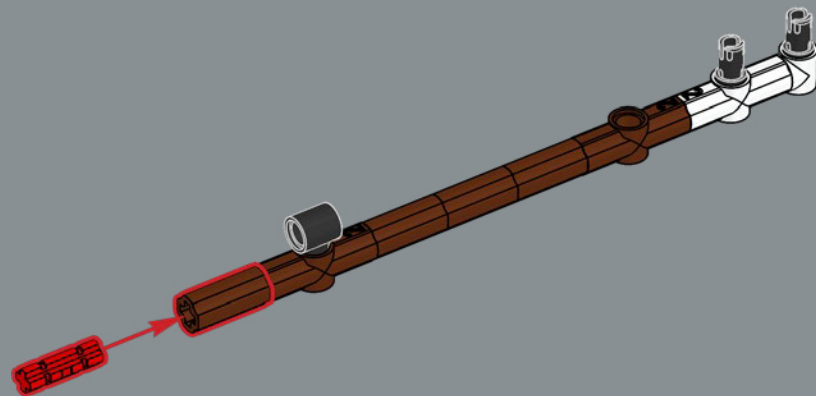

629

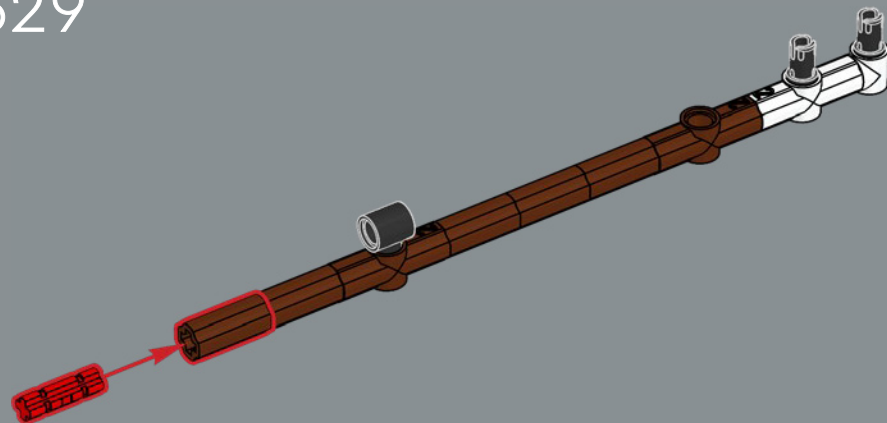

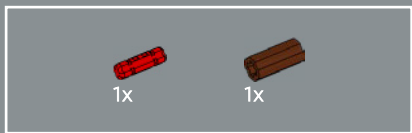

630

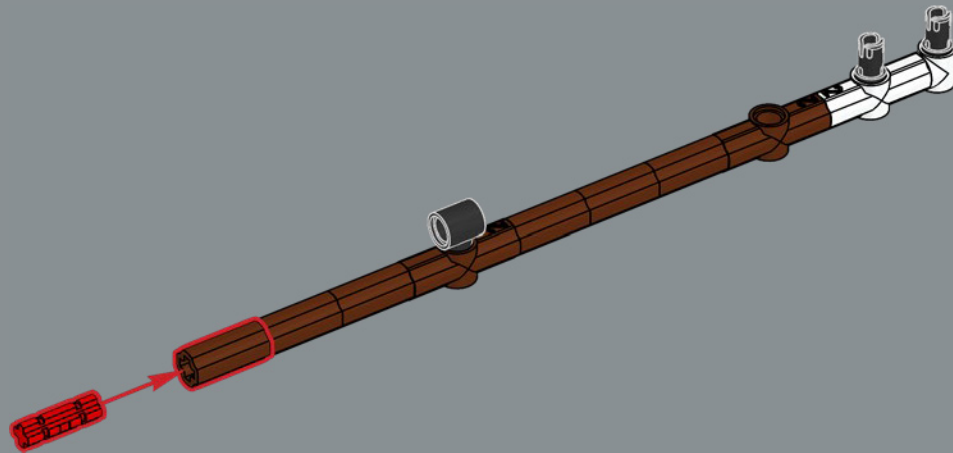

631

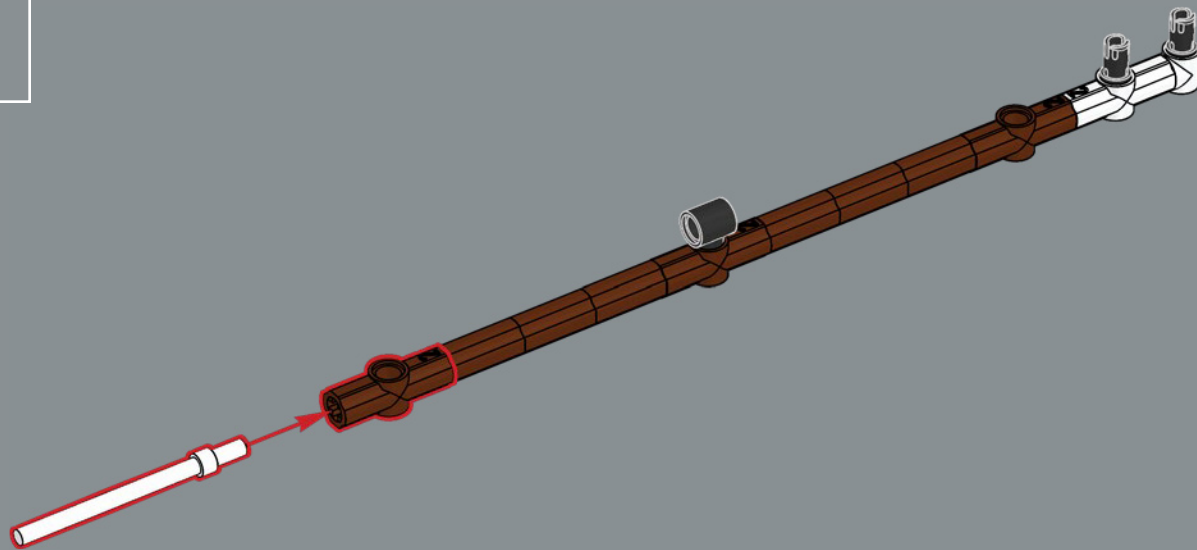



632

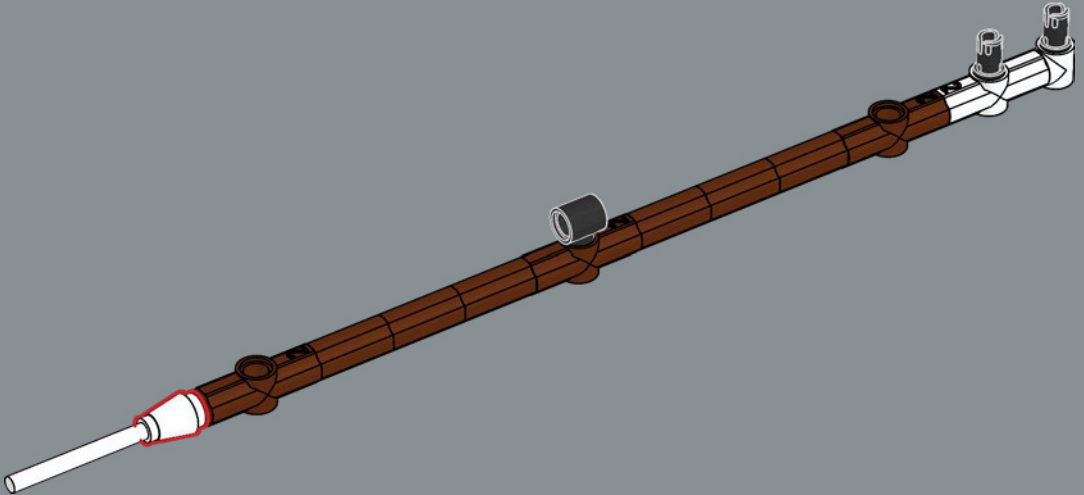

633

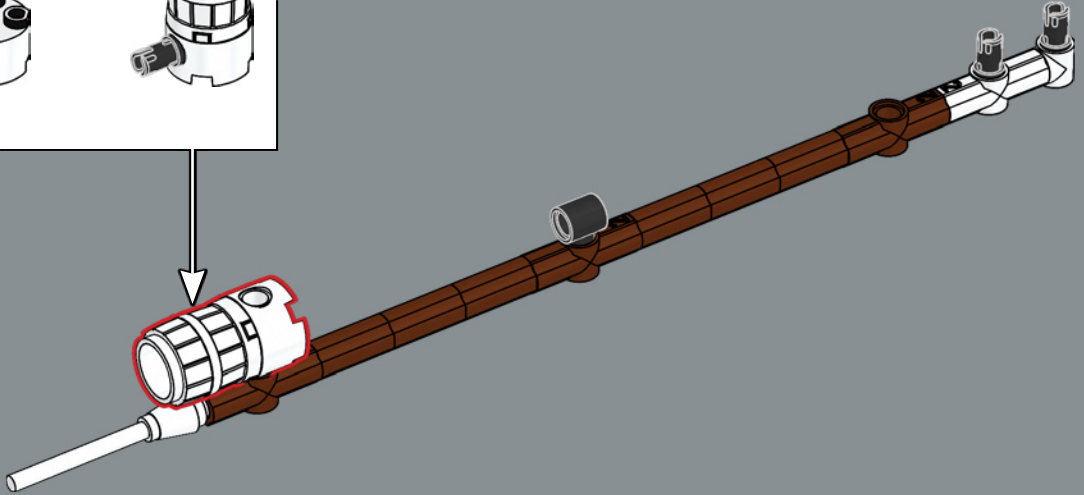
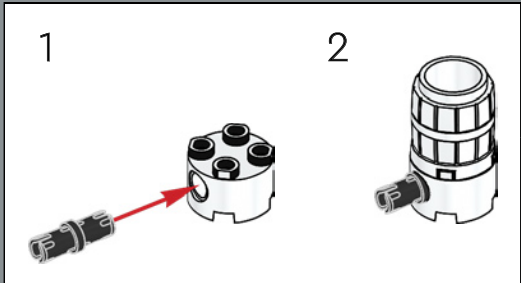

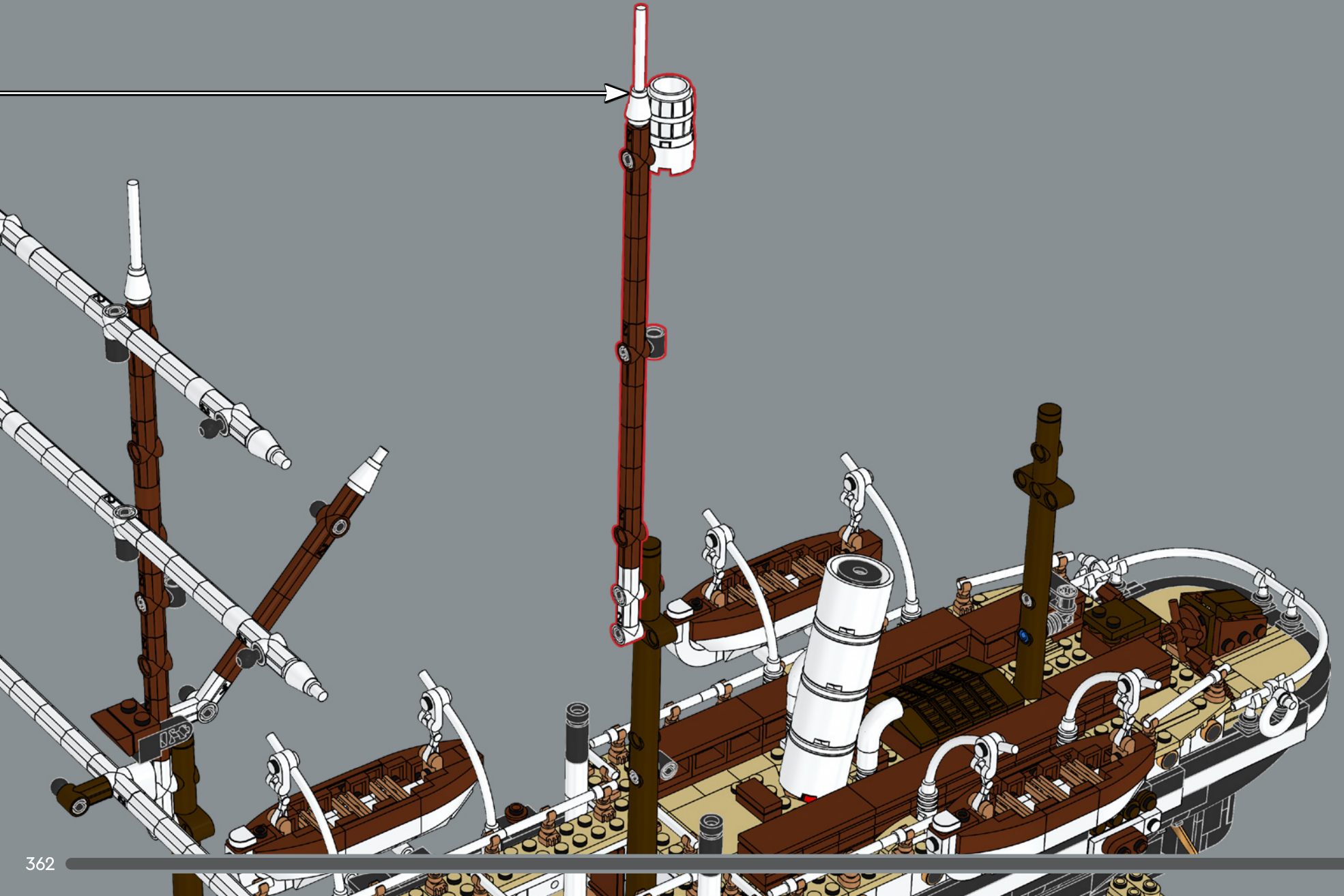

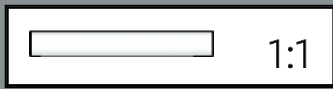
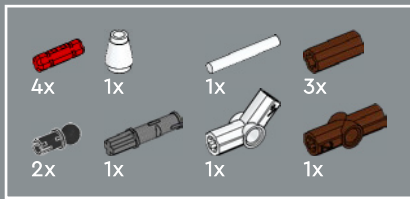

635

1

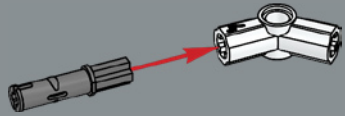

2

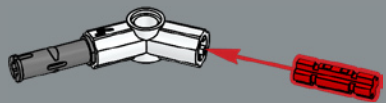

3

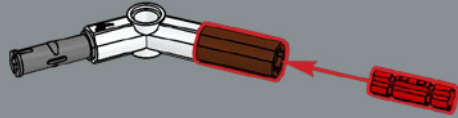

4



5

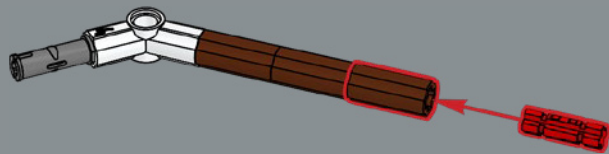

6

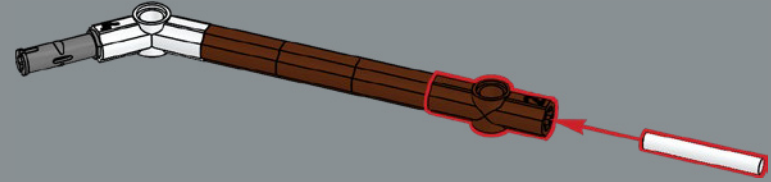

7

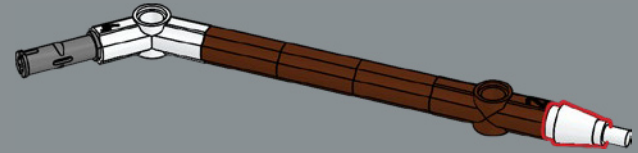

8

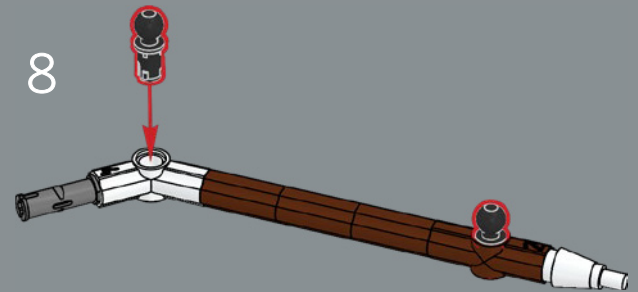





636

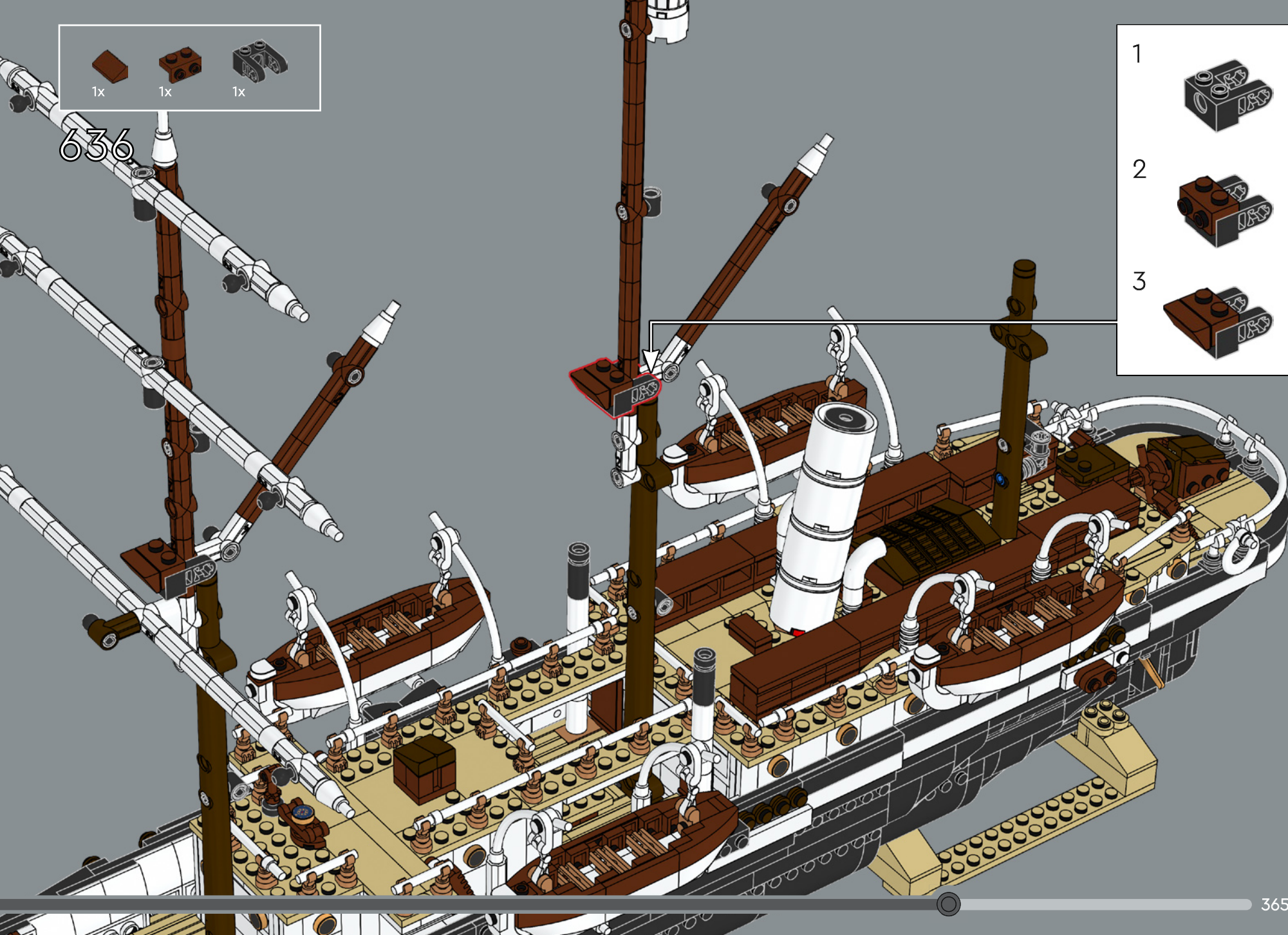
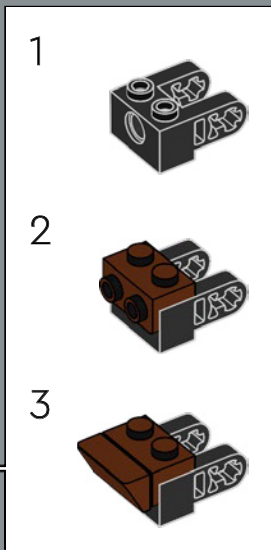

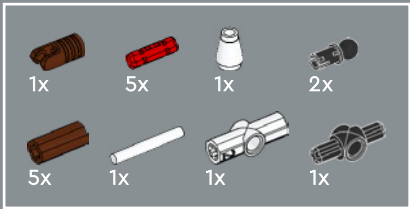

637

1

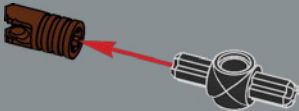

2

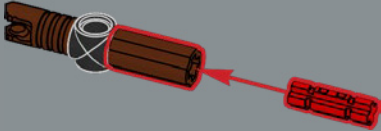

3

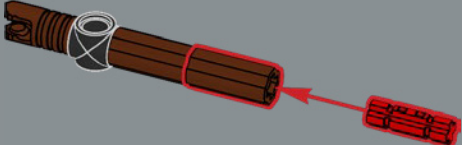

4

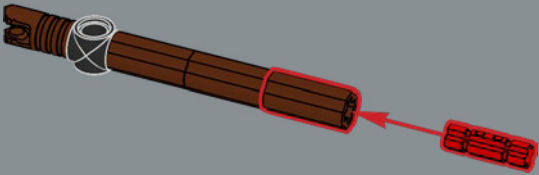

5

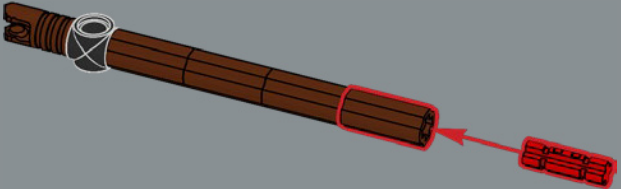

6

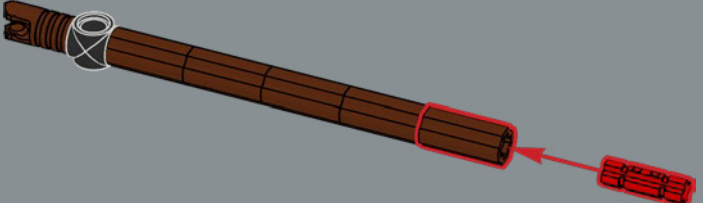

7

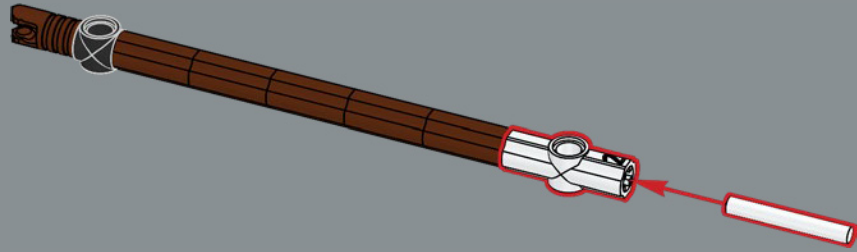

8

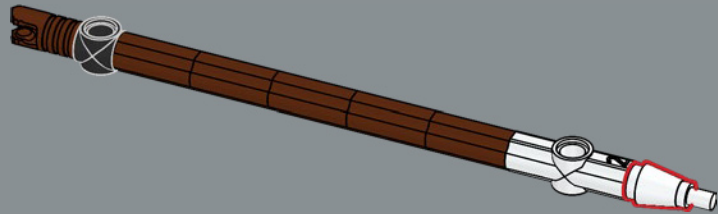

9

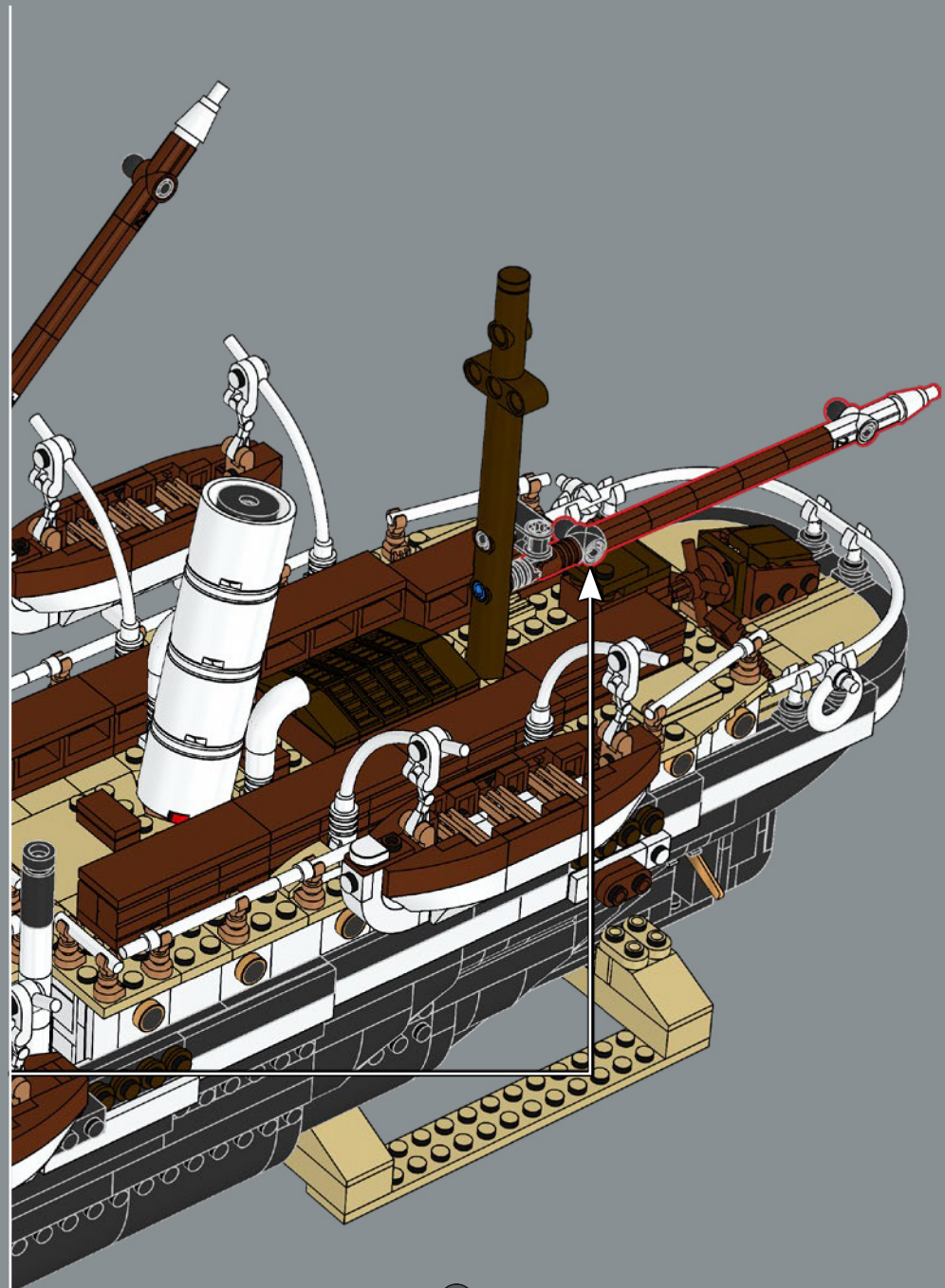
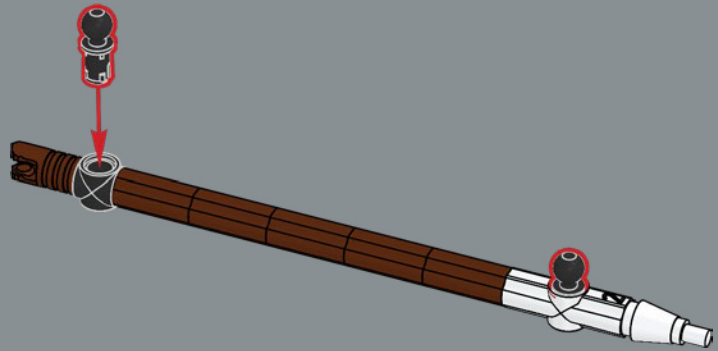

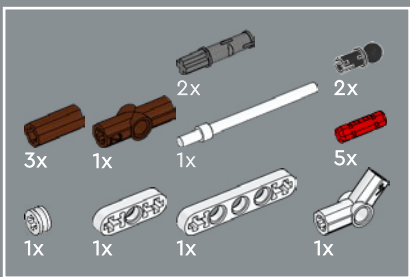

638

1

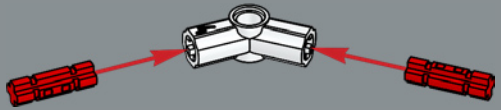

2

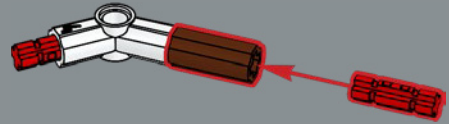

3

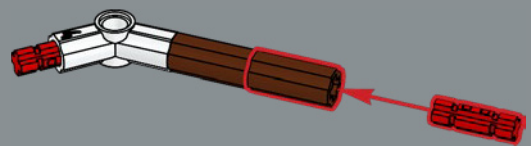

4

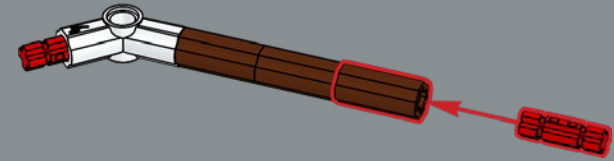

5

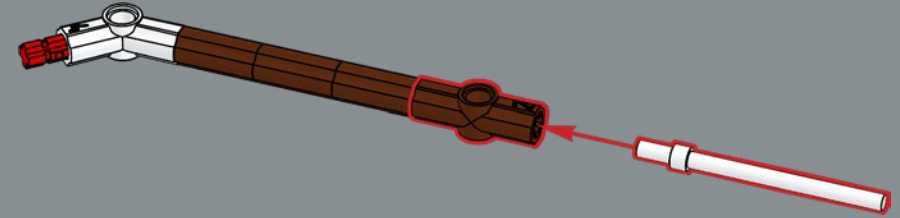

6

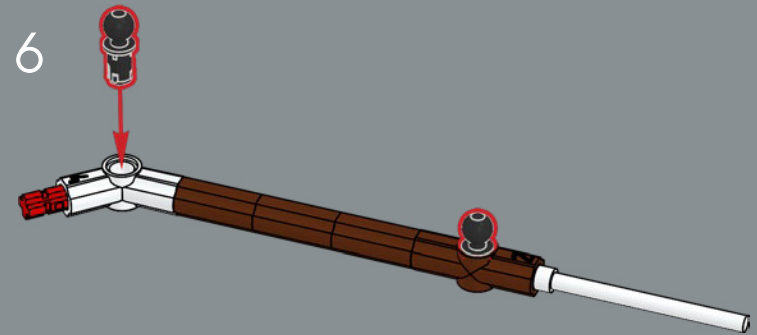

7

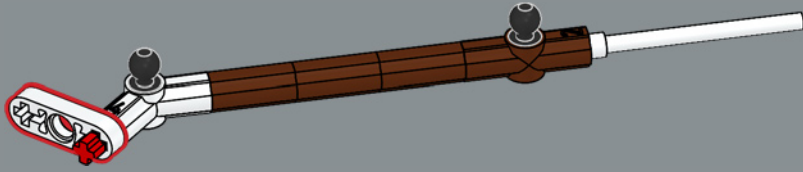

9

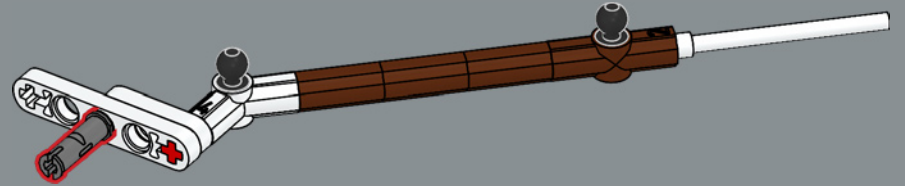

8

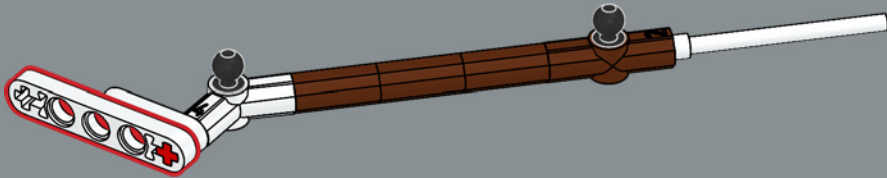

10

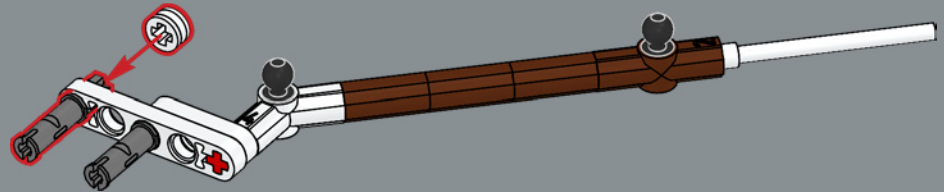

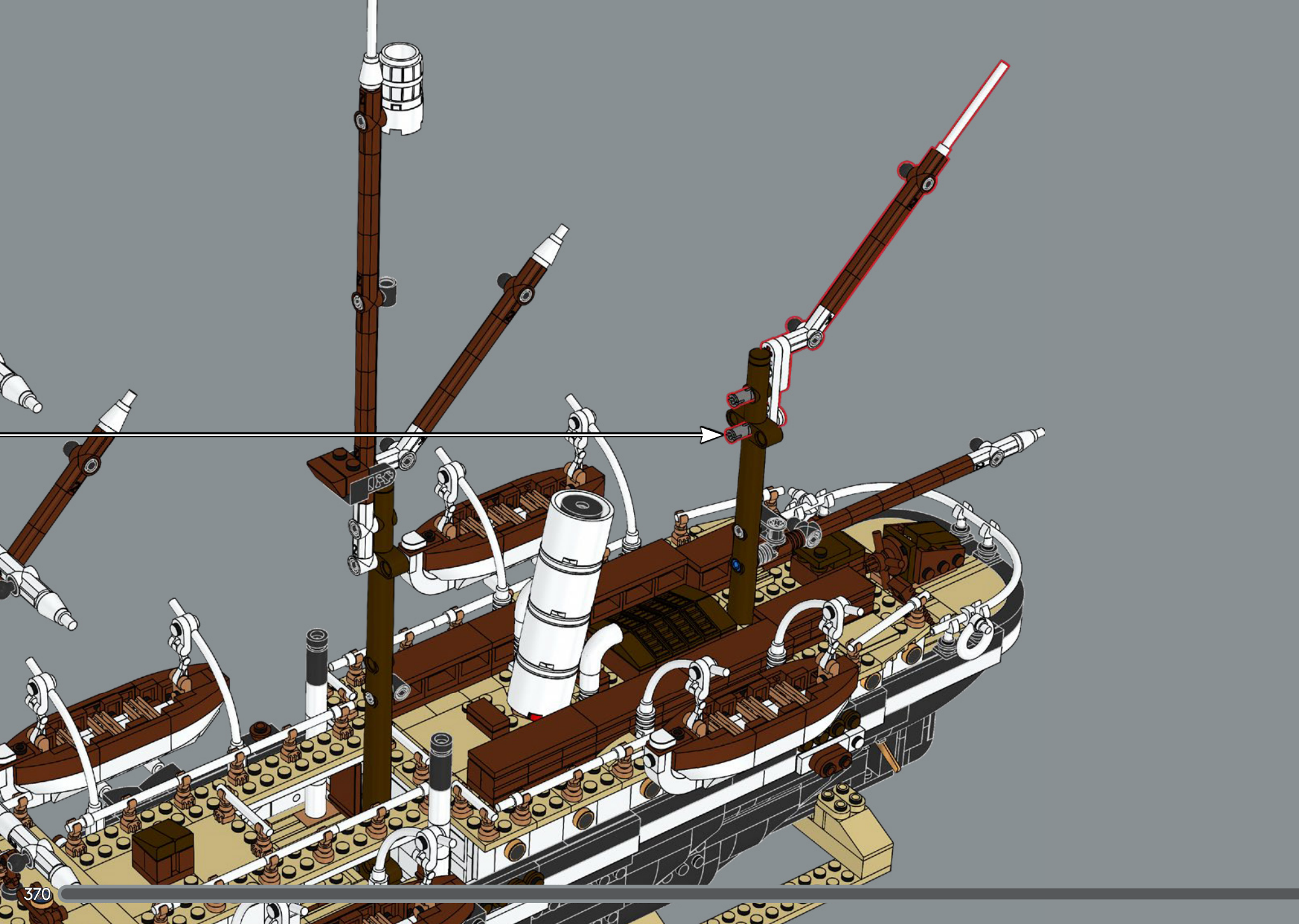

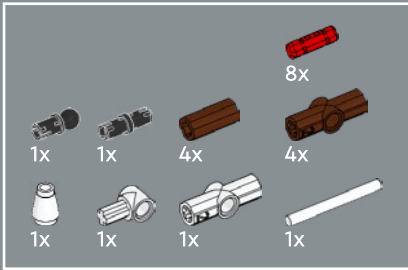
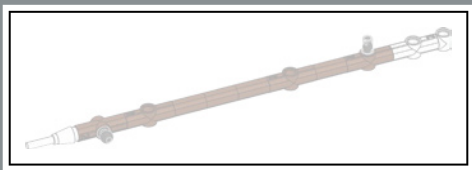

639

1

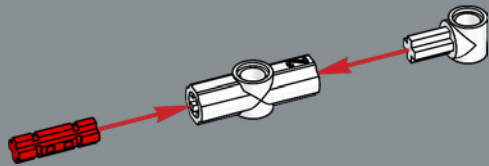

2

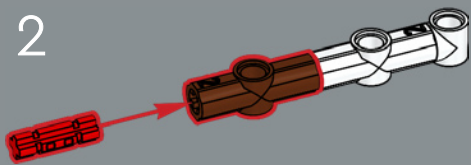

3

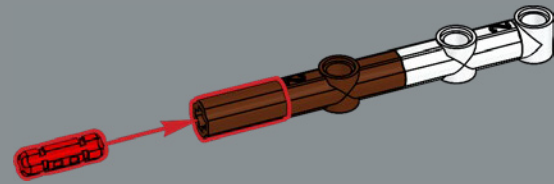

4

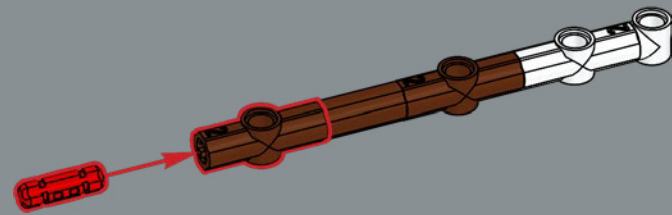

5

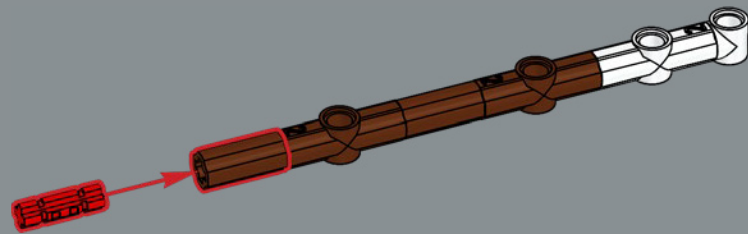

6

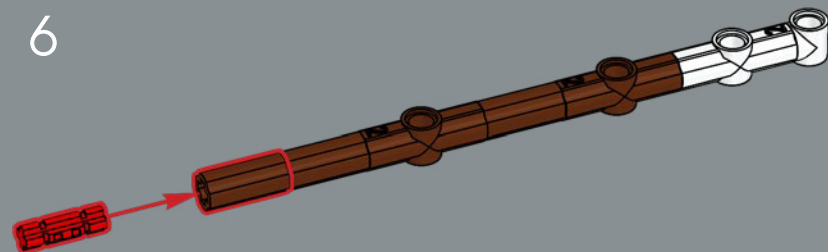

7

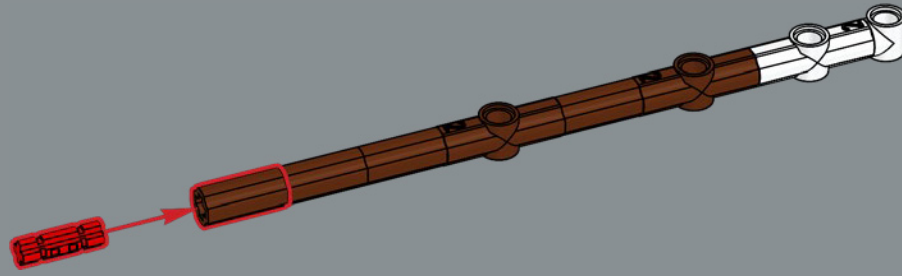

8

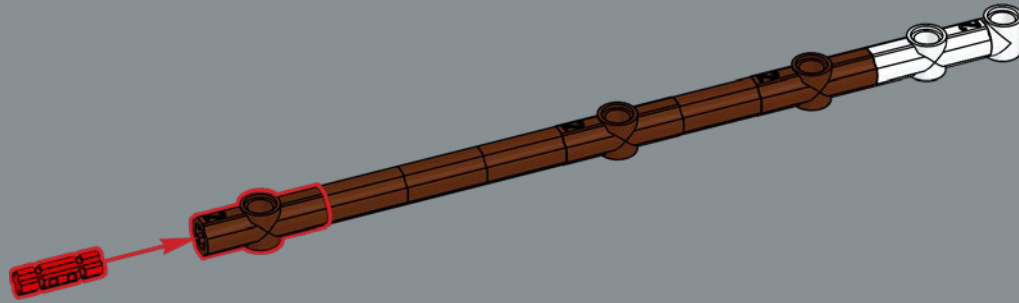

9

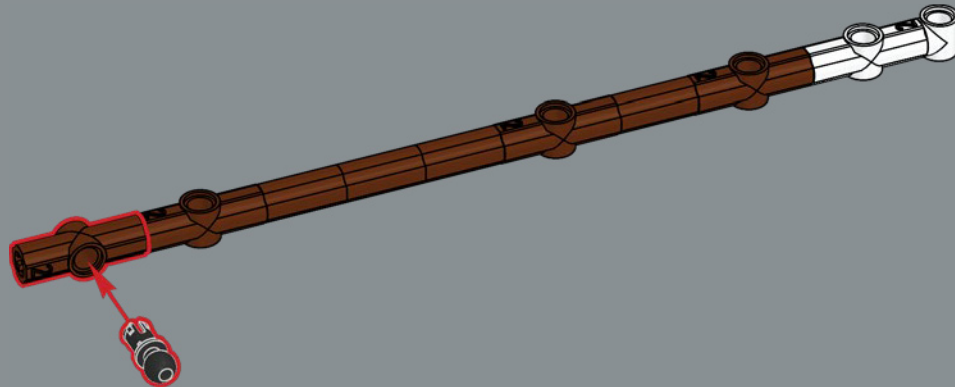

10

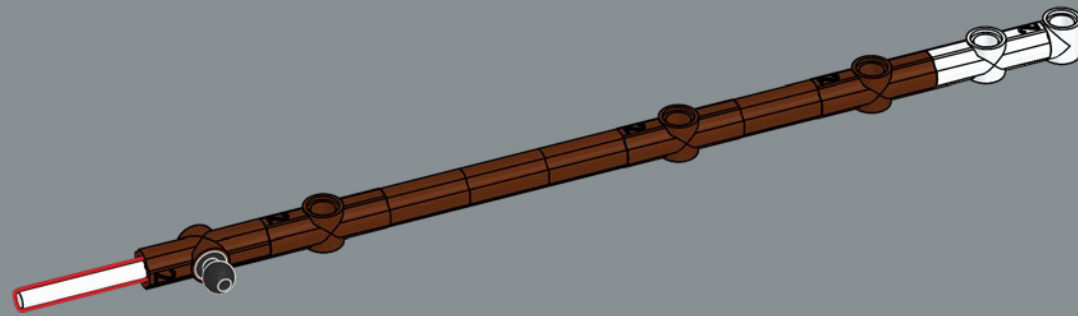

11

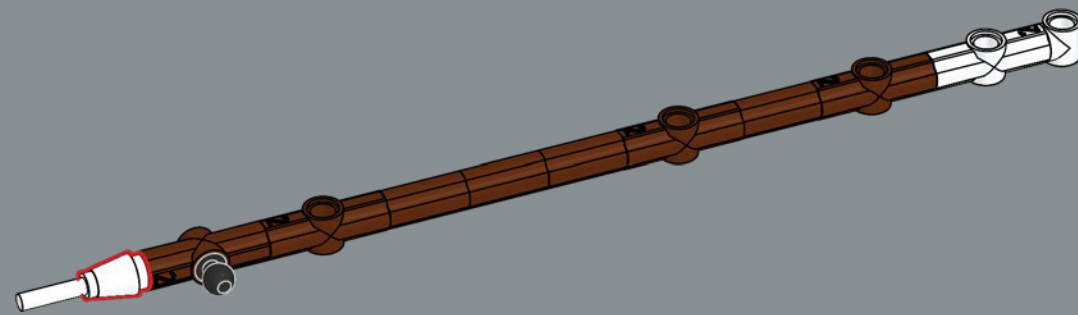

12

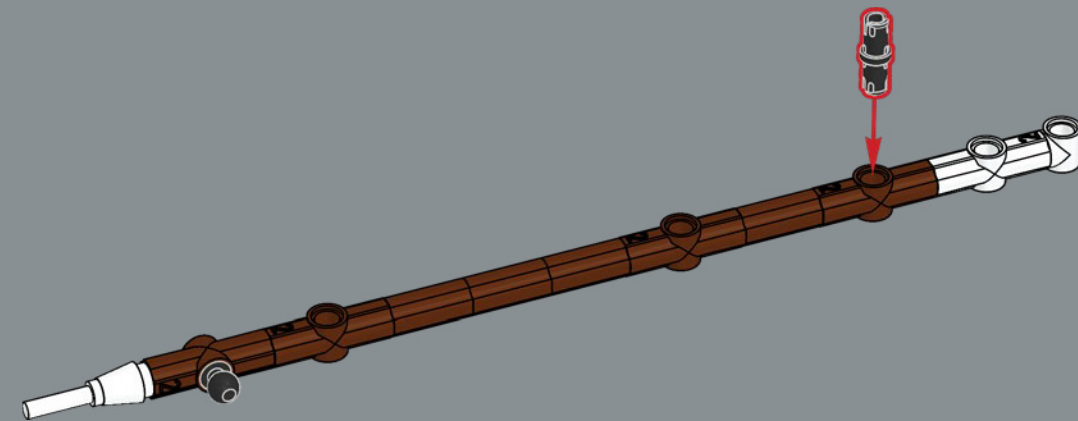





640

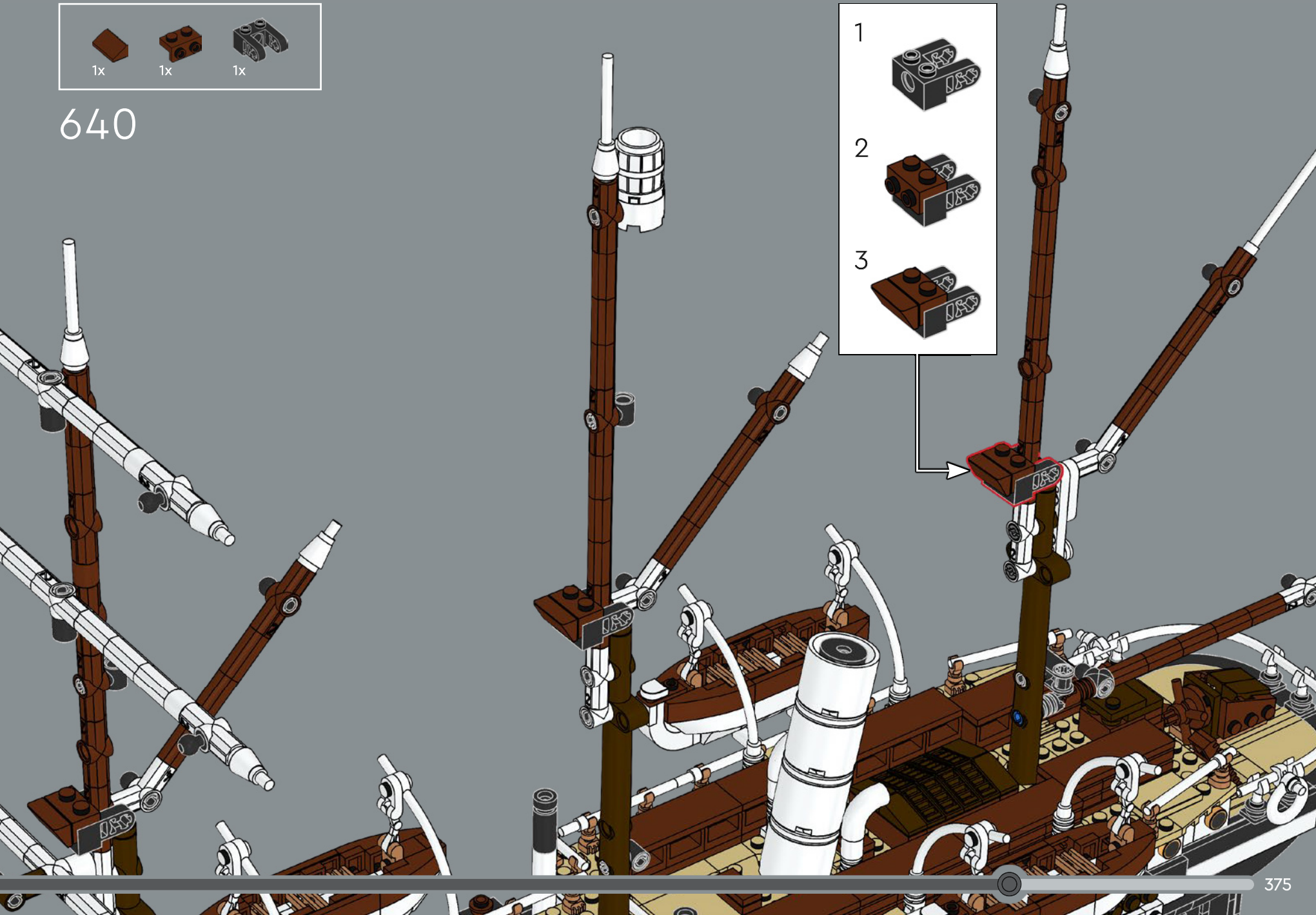
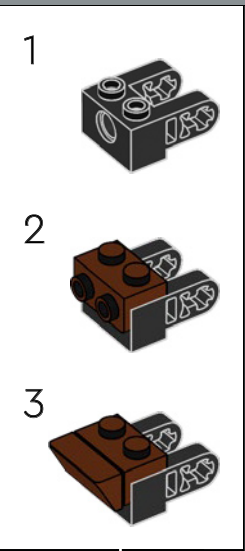

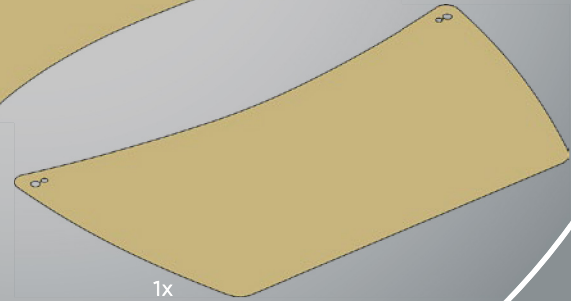
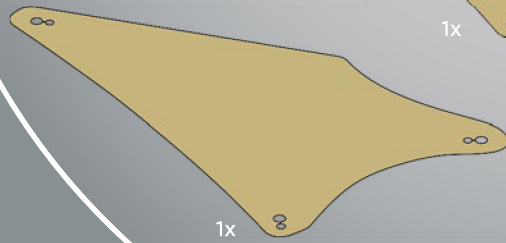
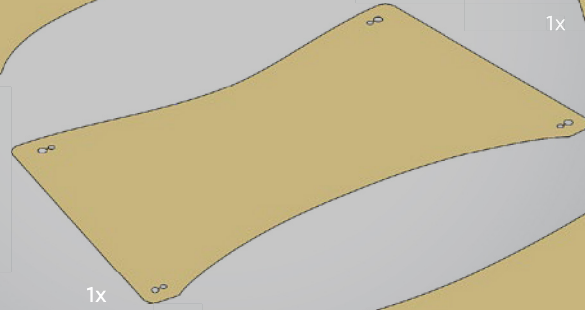
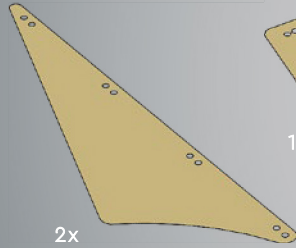
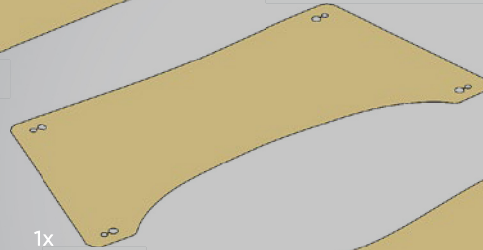
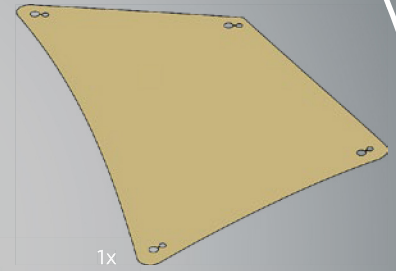
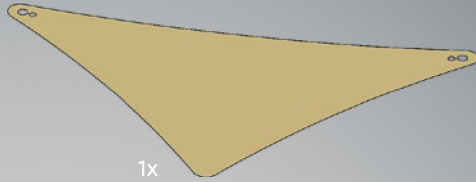
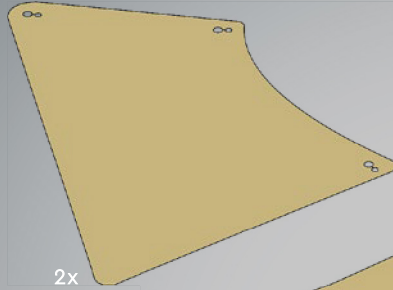
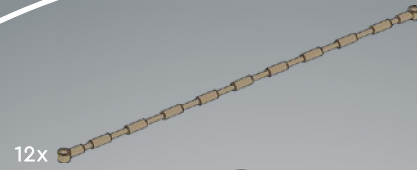
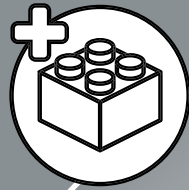



641

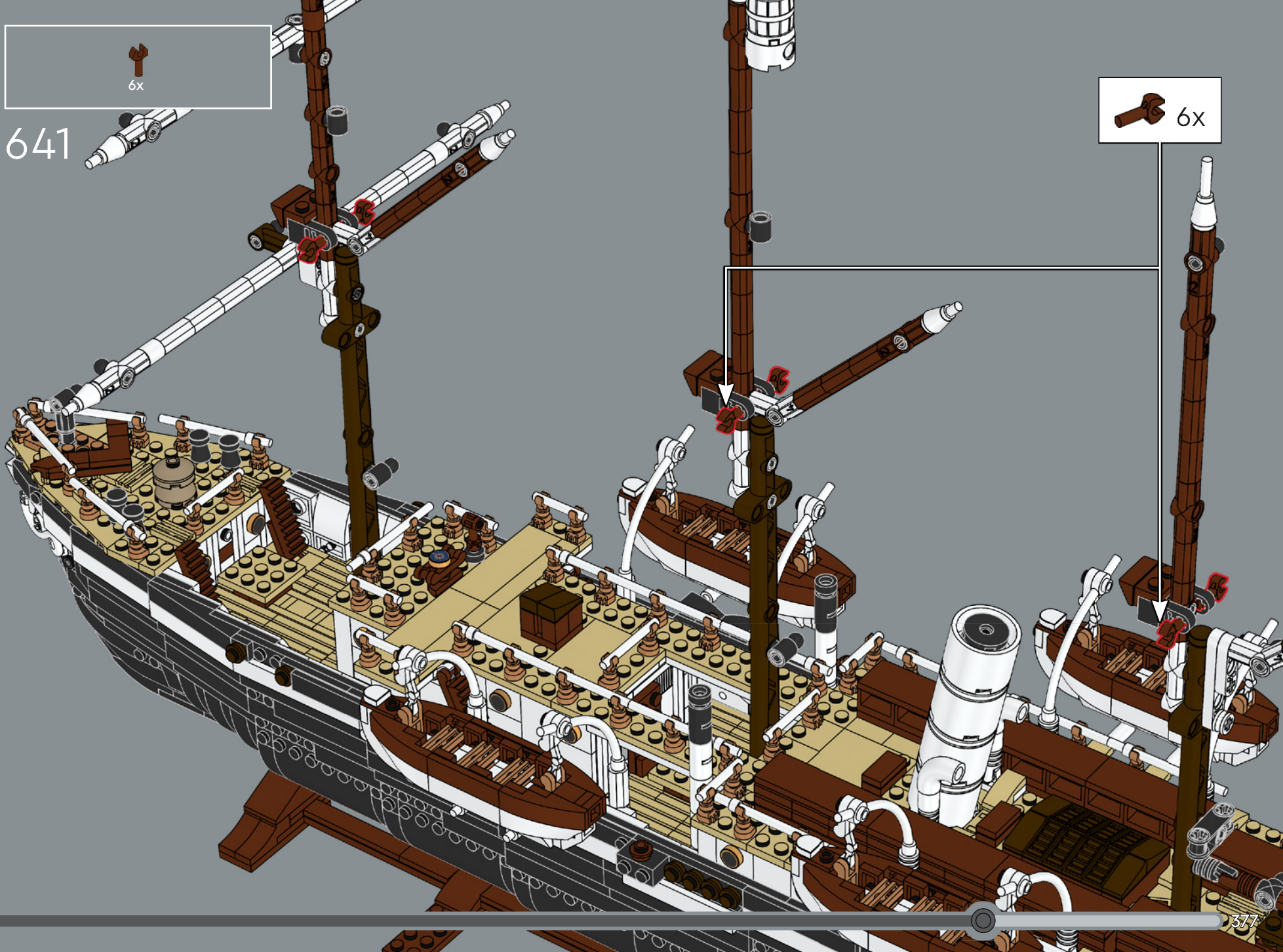
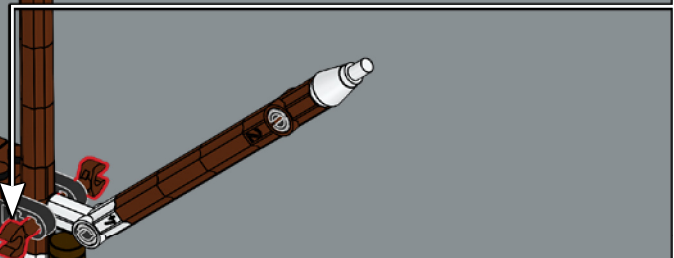
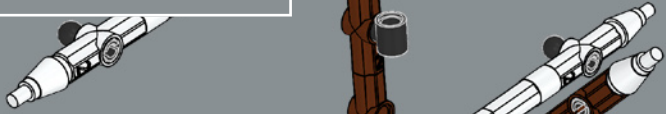

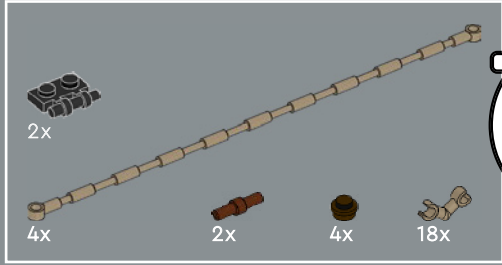
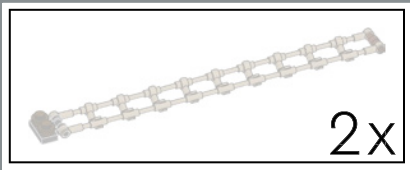

642

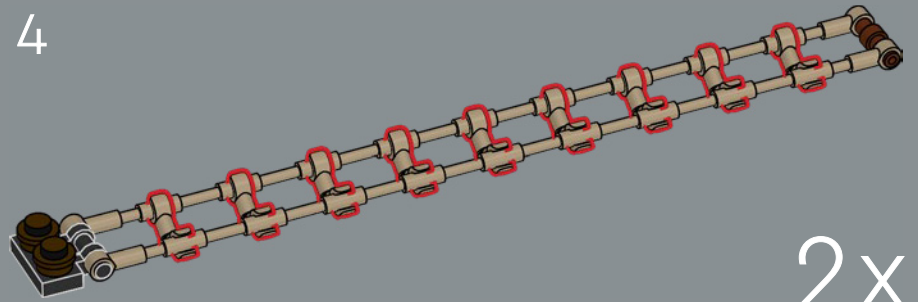
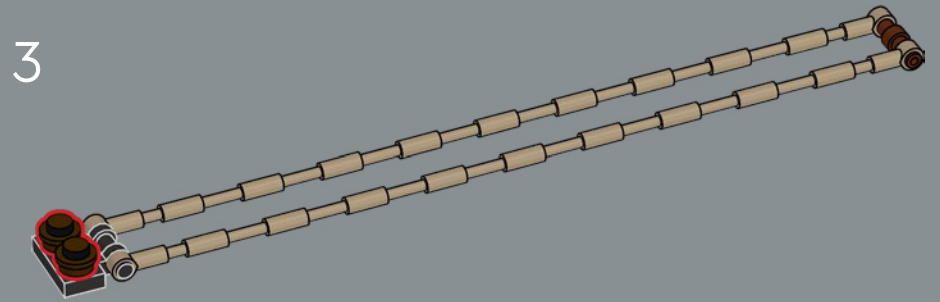
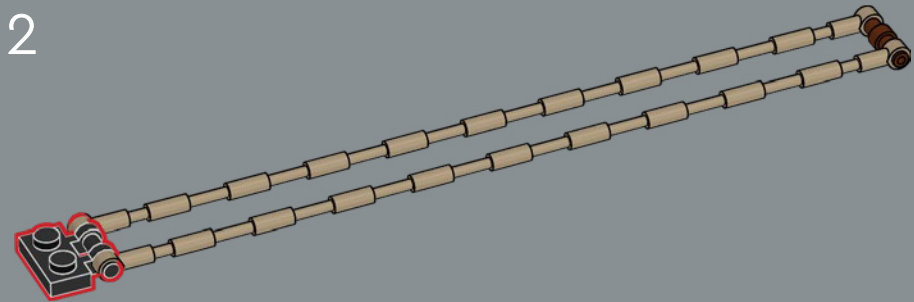
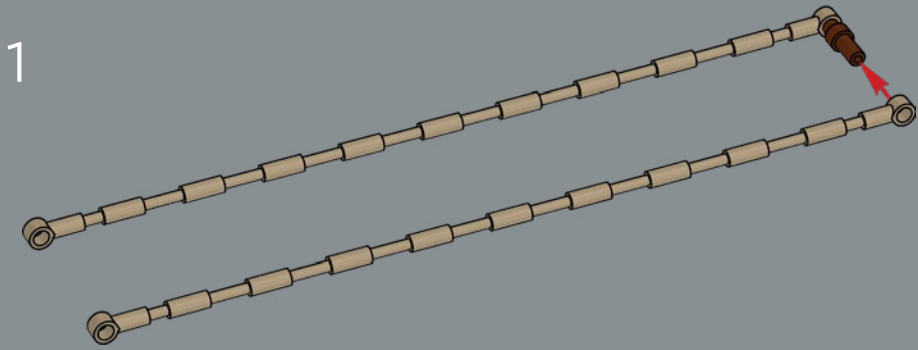



The rope ladders were made in dark tan to distinguish the material from most of the ship's wooden structure.

Les échelles de corde ont été créées en beige foncé pour les distinguer de la plupart des structures en bois du navire.

A las escalas de cabo se les dio una tonalidad café ligeramente más oscura para que su material se distinguiera de la mayor parte de la estructura del barco, de color similar a la madera.

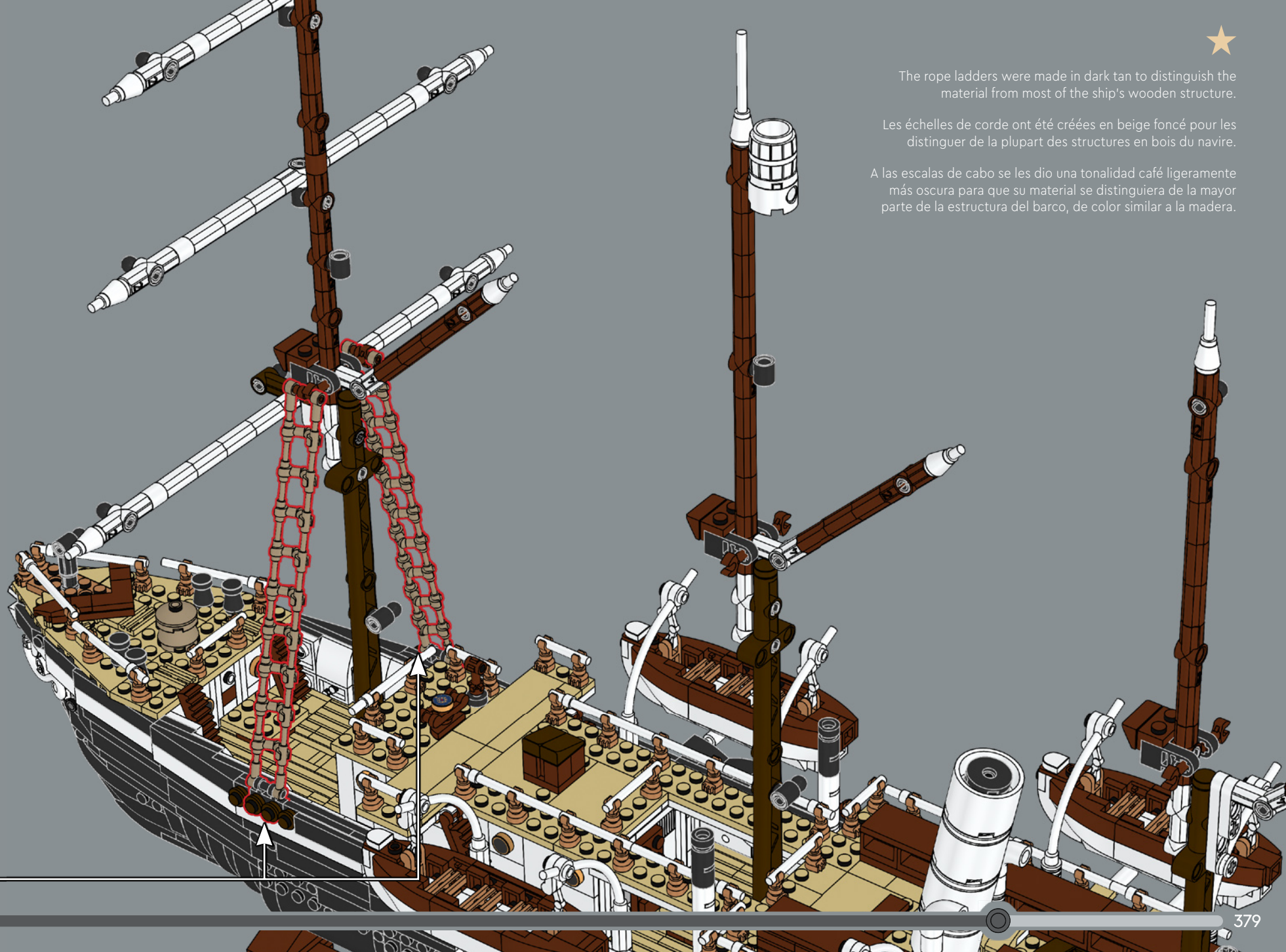

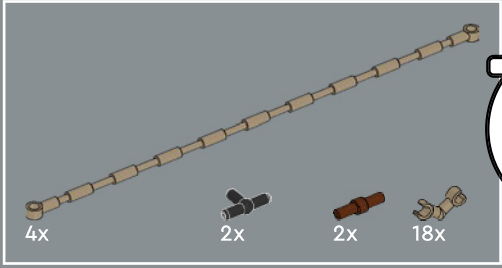
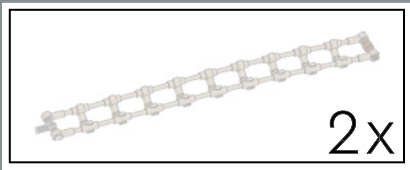

643

1

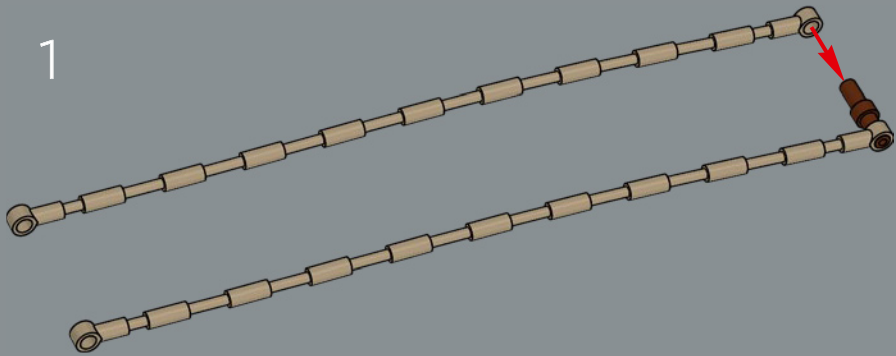

2

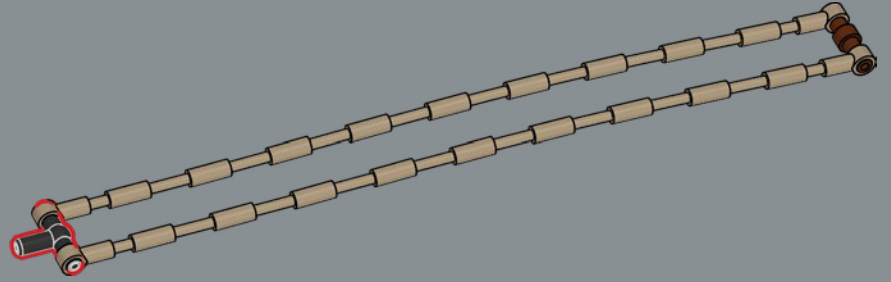

3

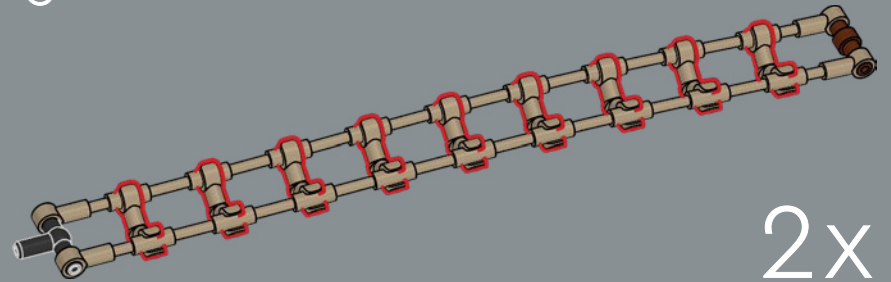

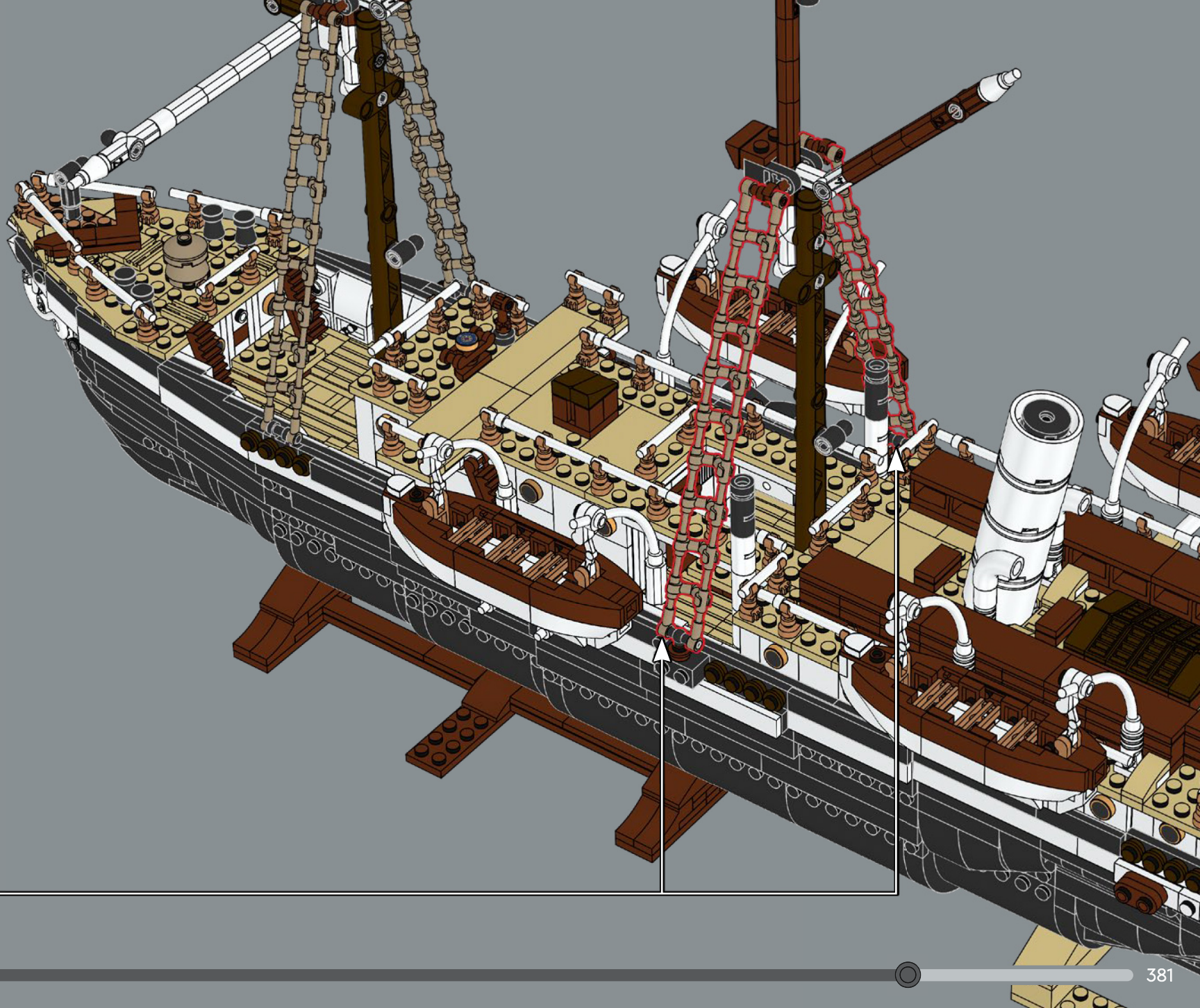

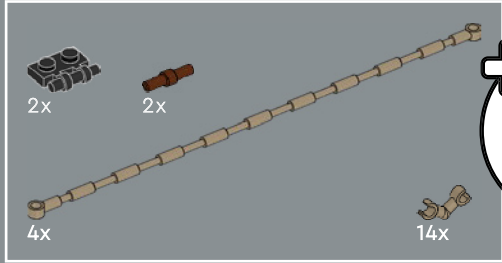
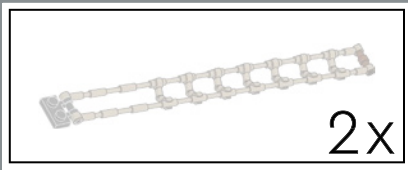

644

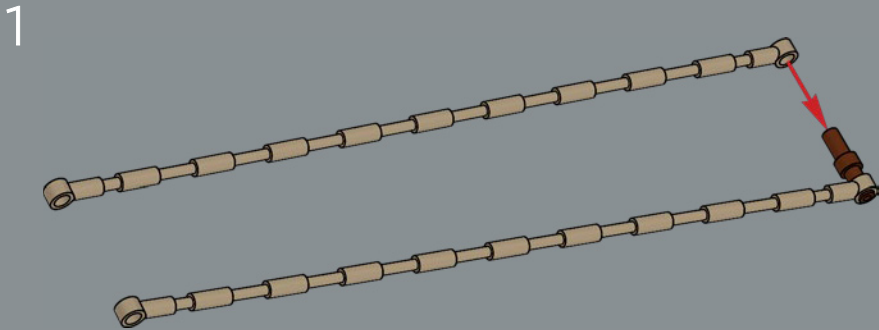

2

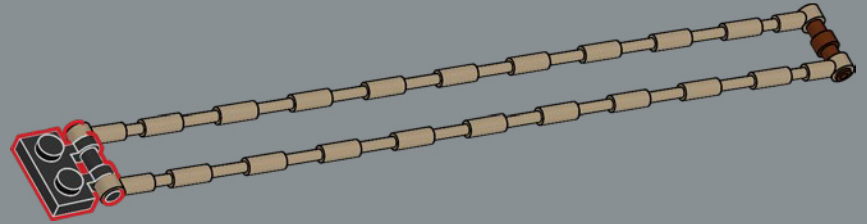

3

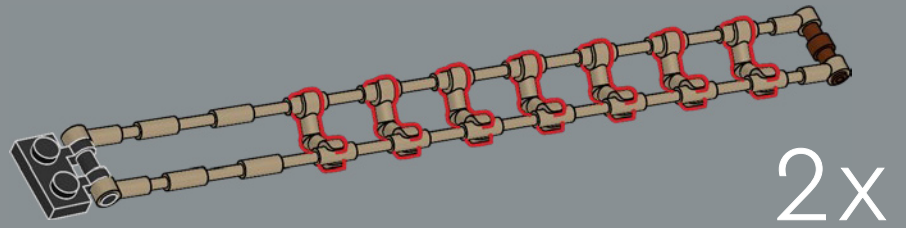

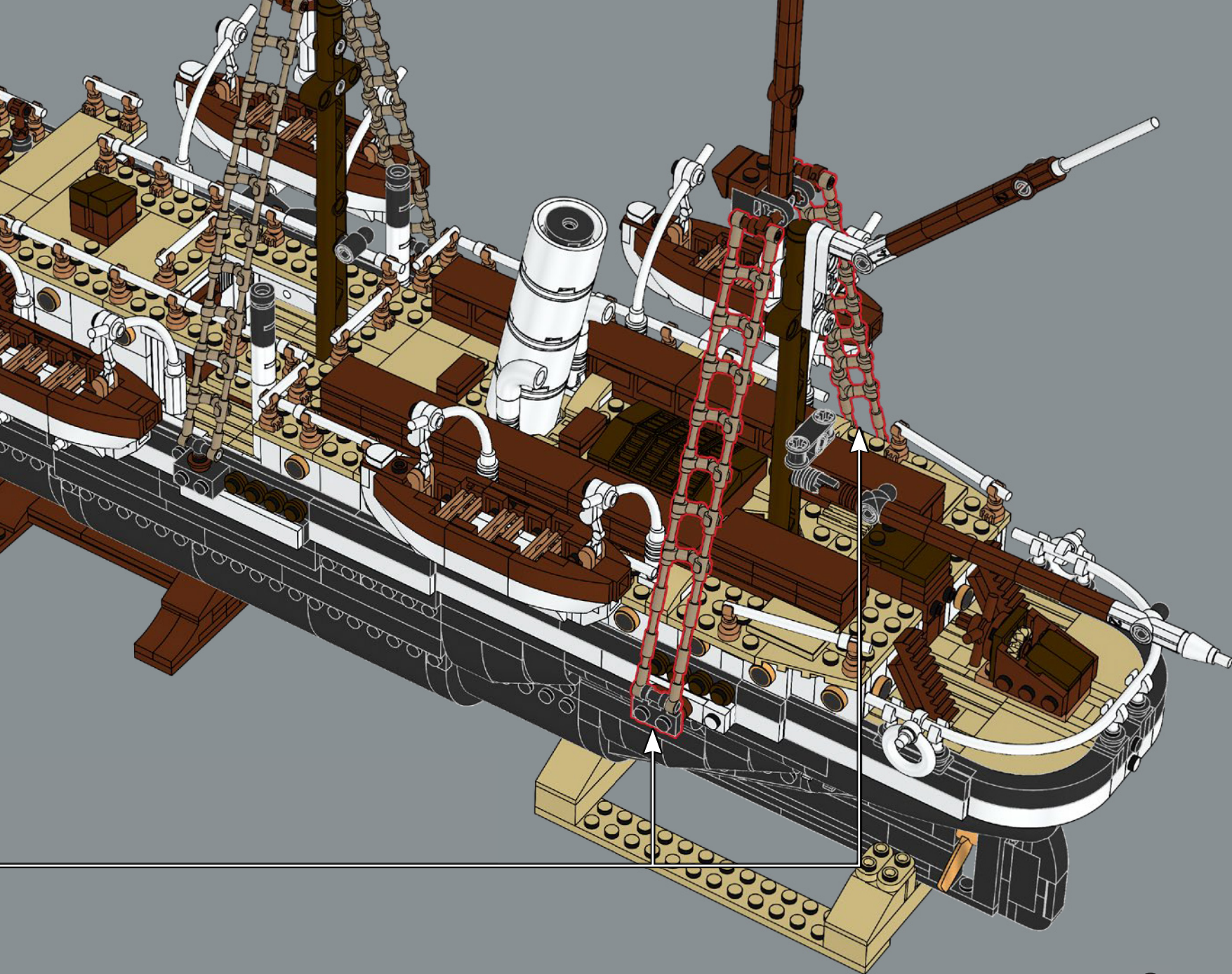

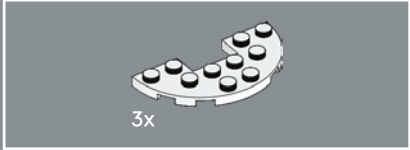

3x

645



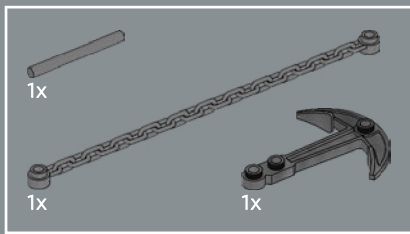

646

1

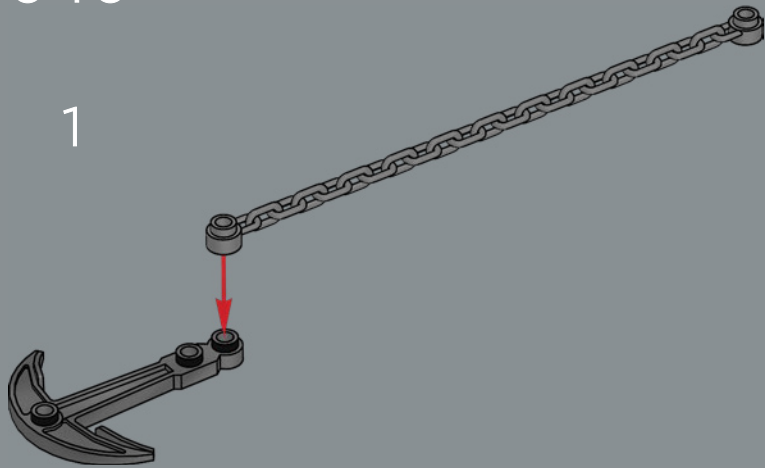

2

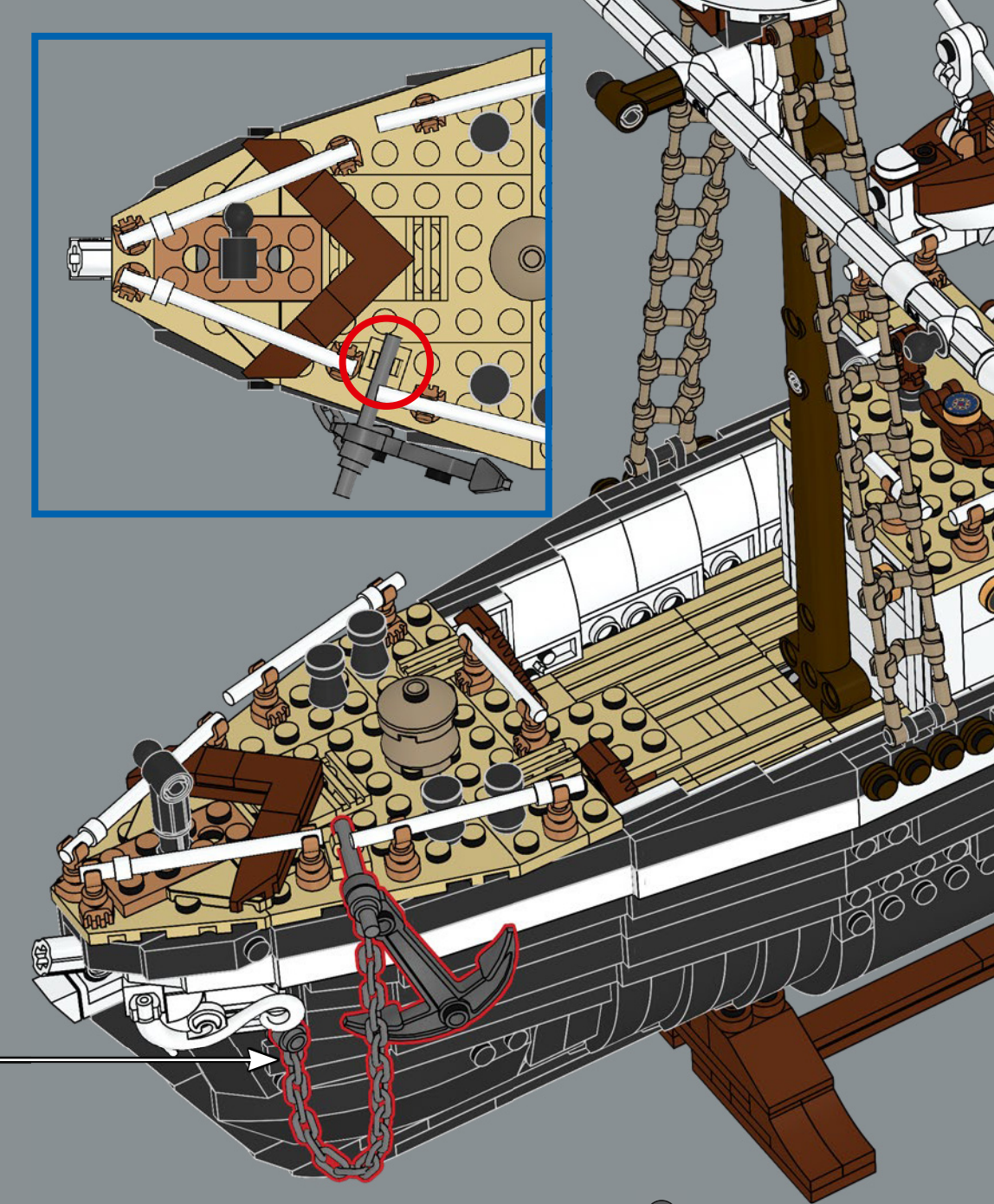
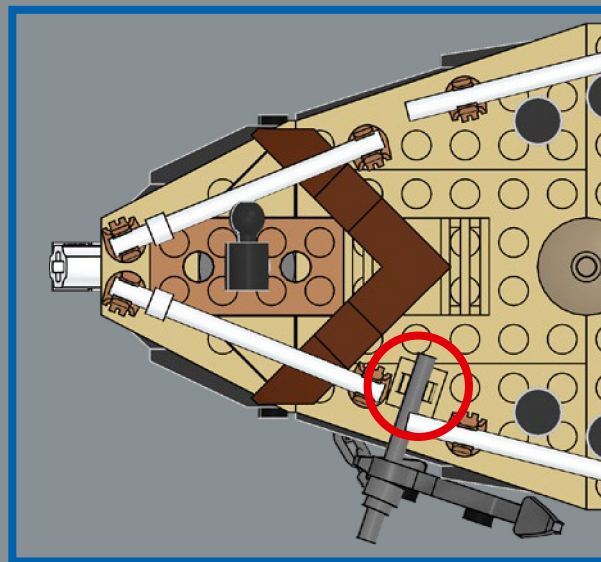
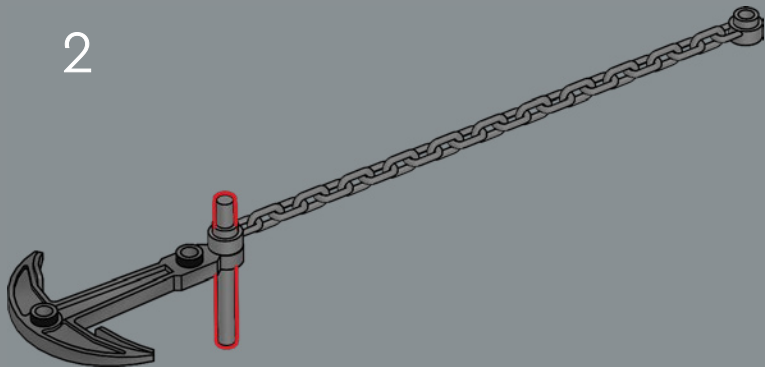

647

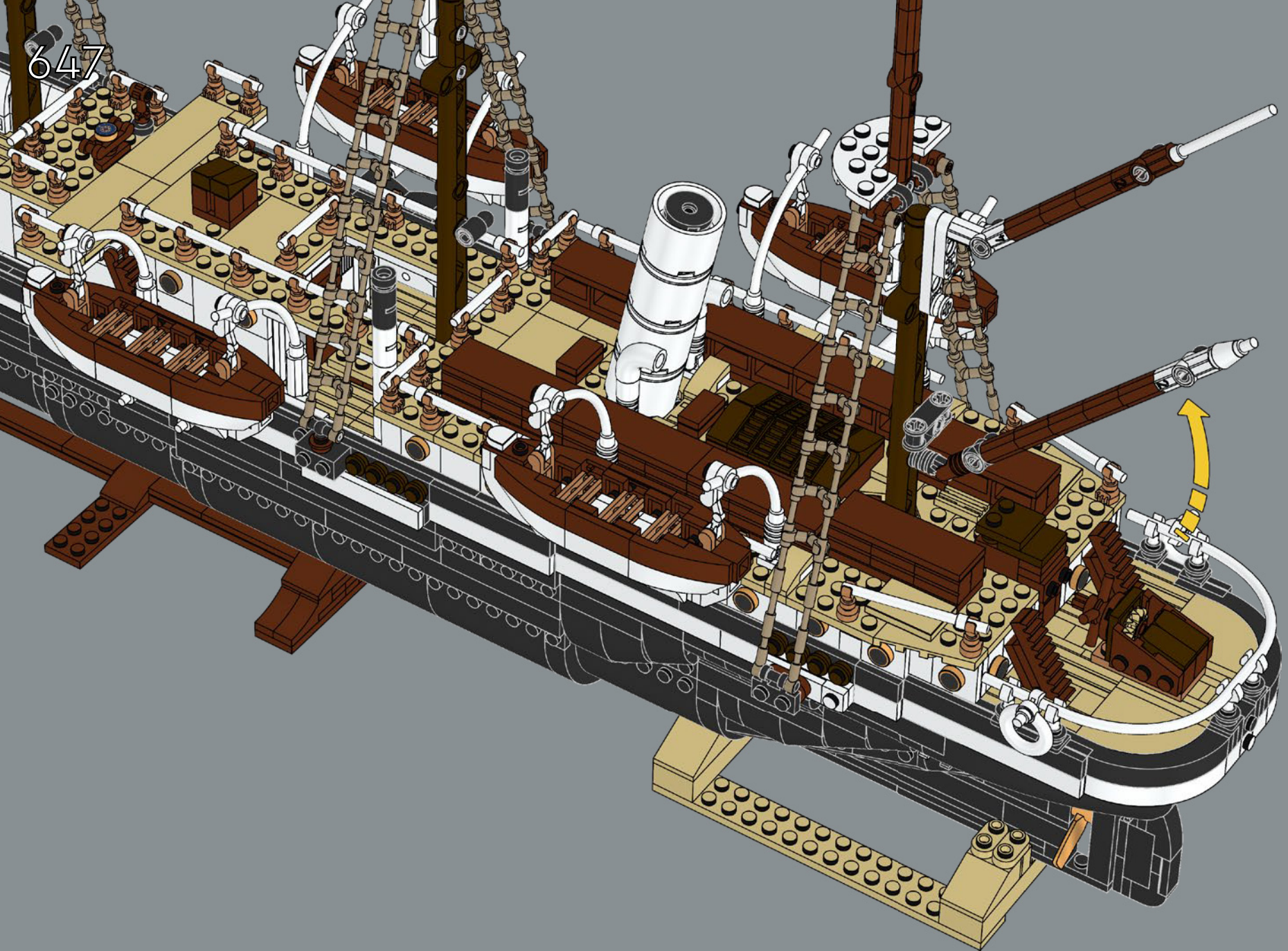

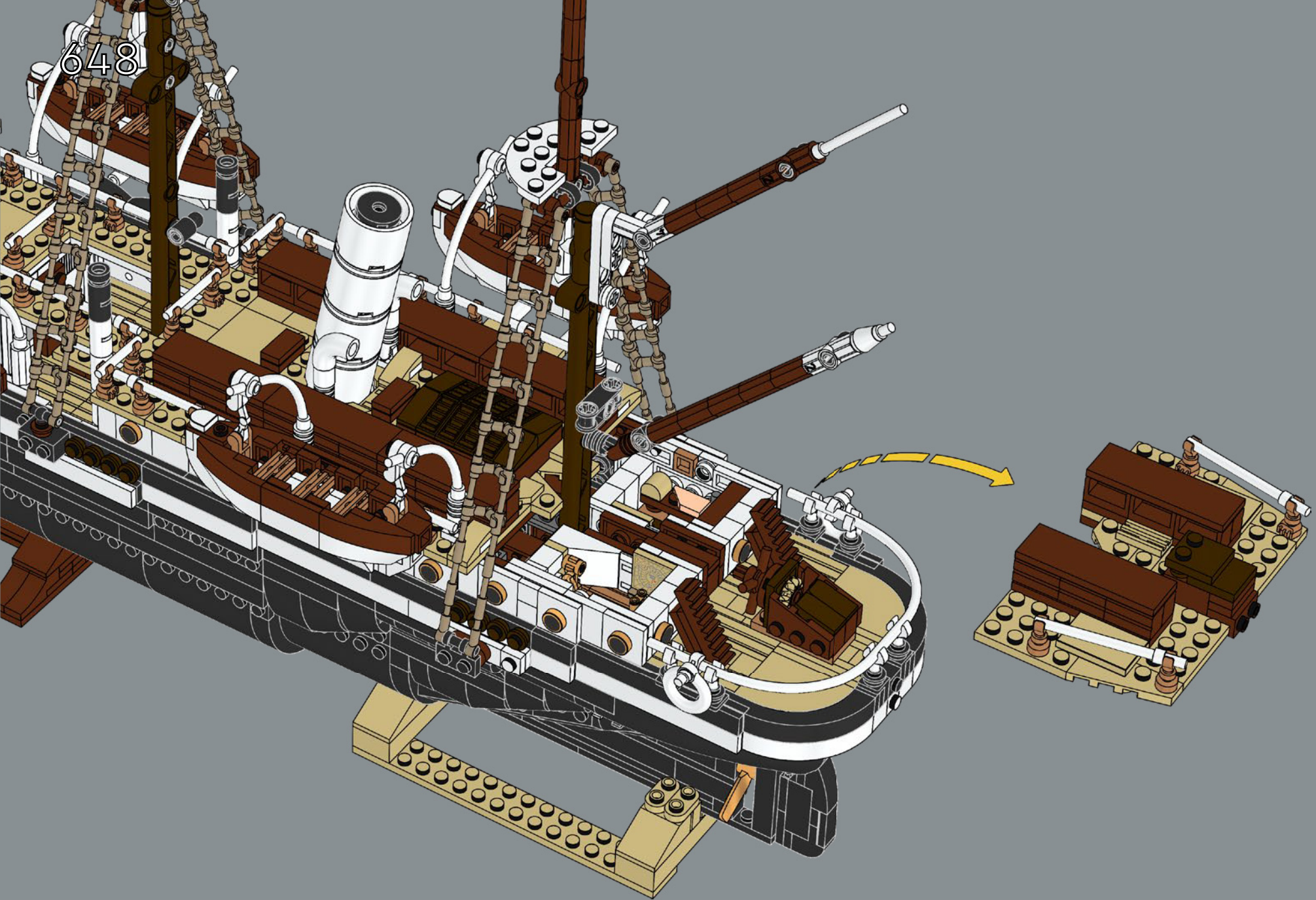

649

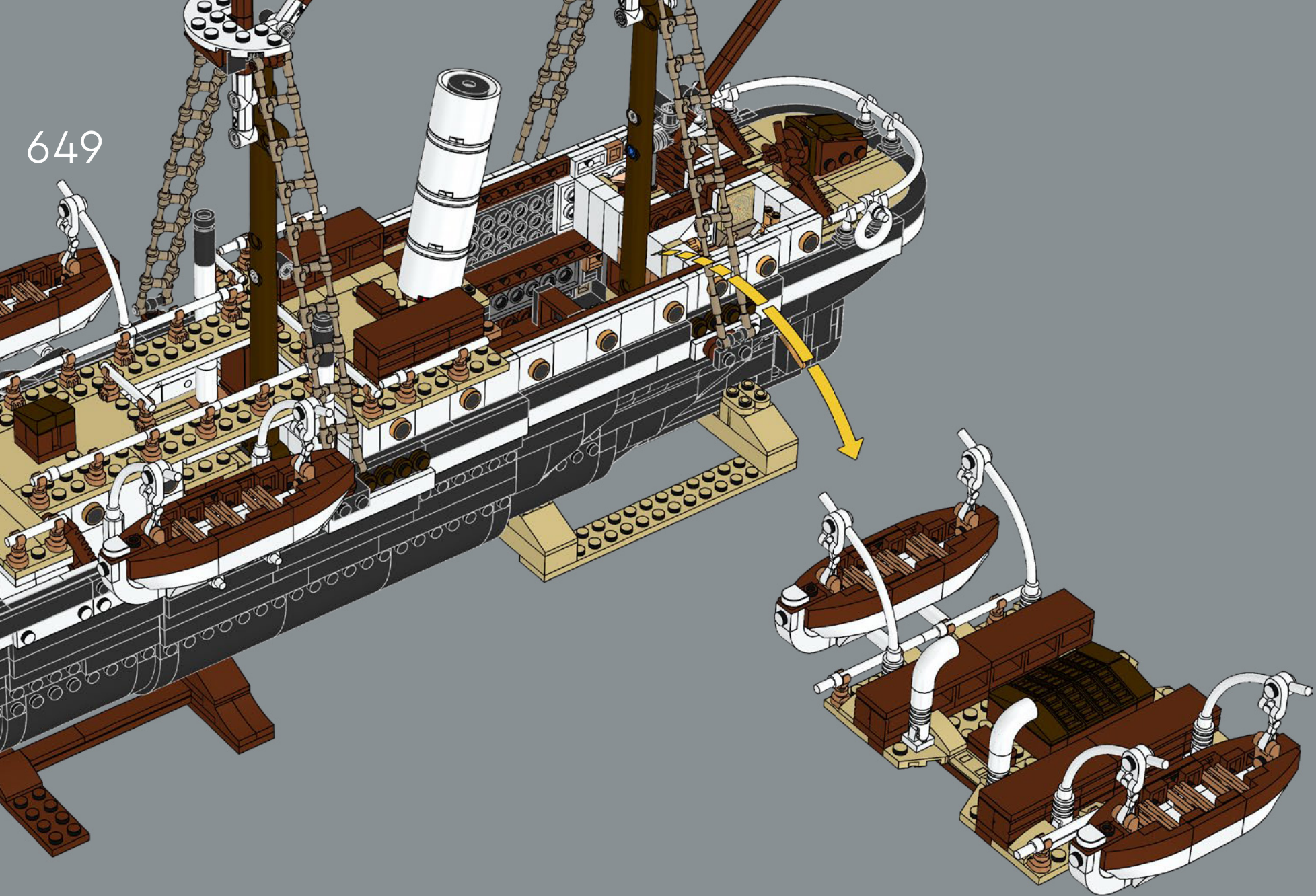

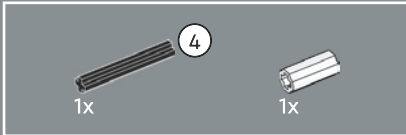
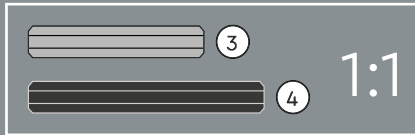
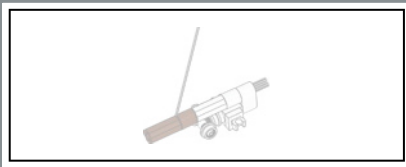

650

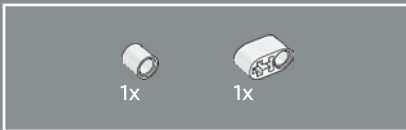
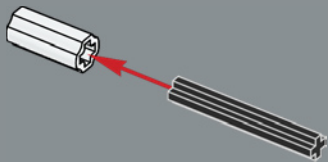

651

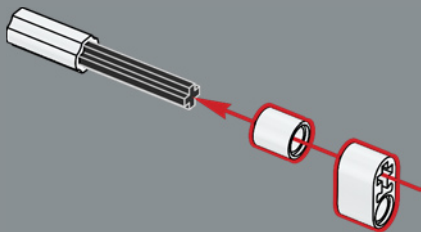

652

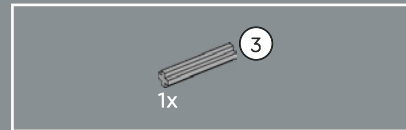
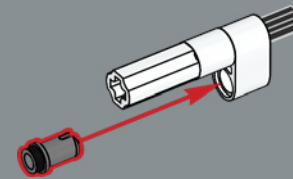

653

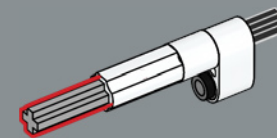

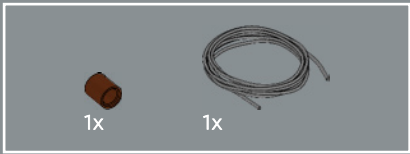

654

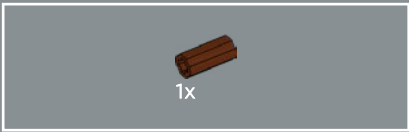
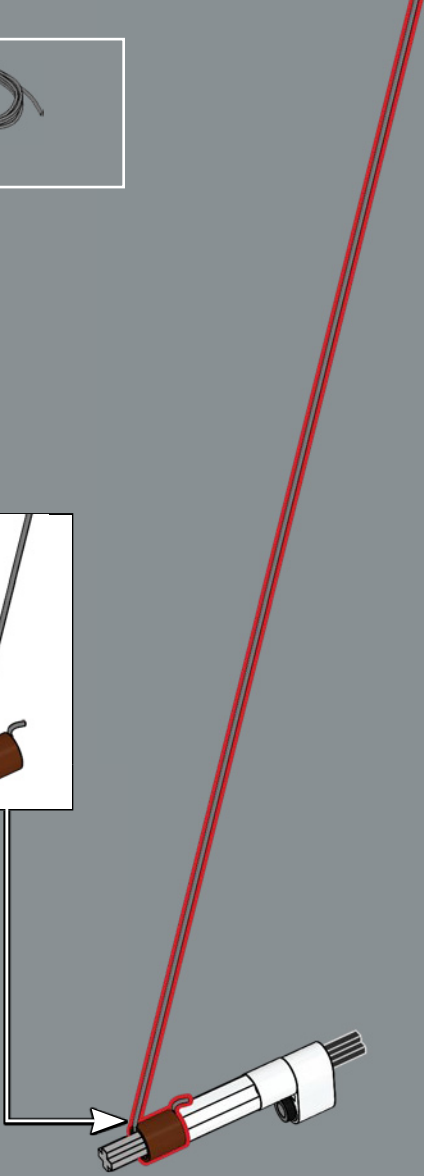
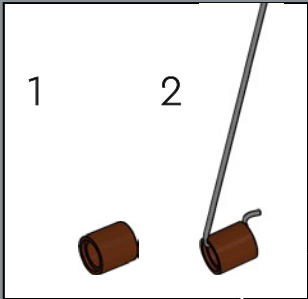

655

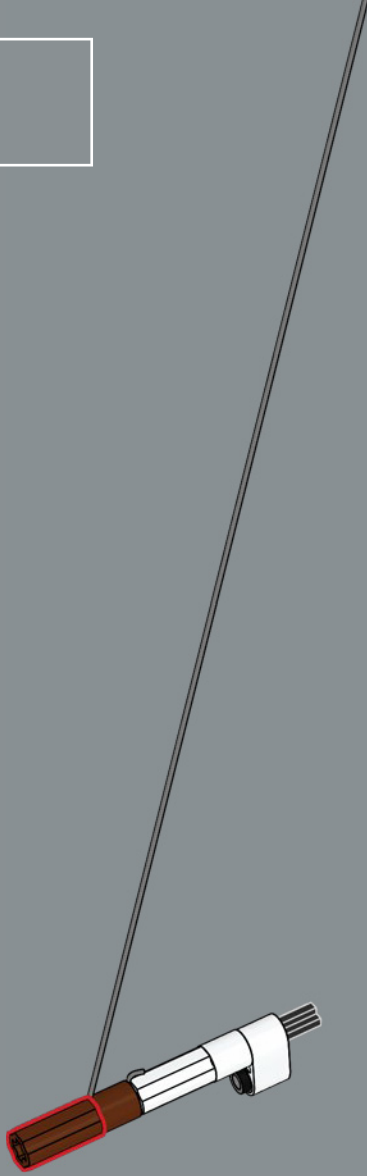

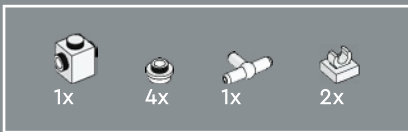

656

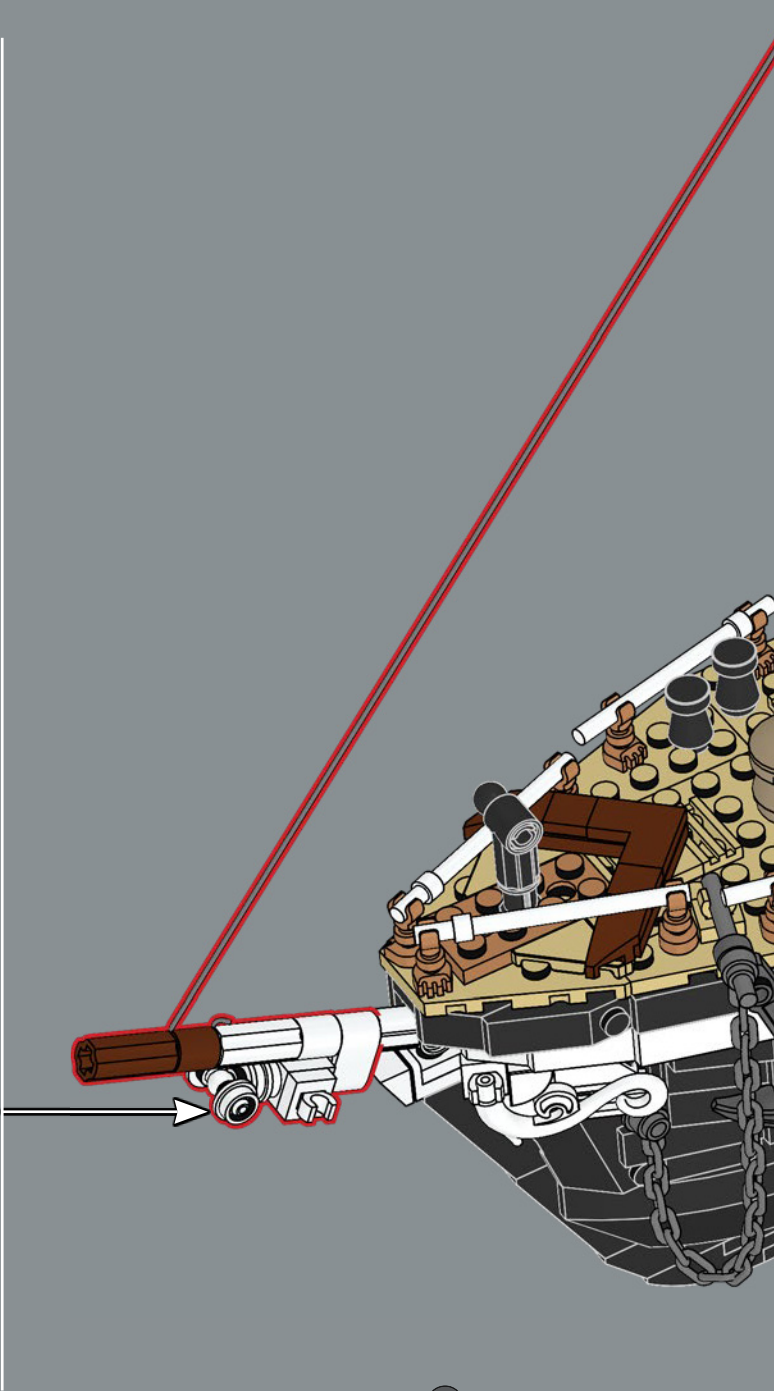
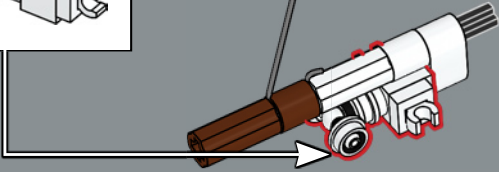
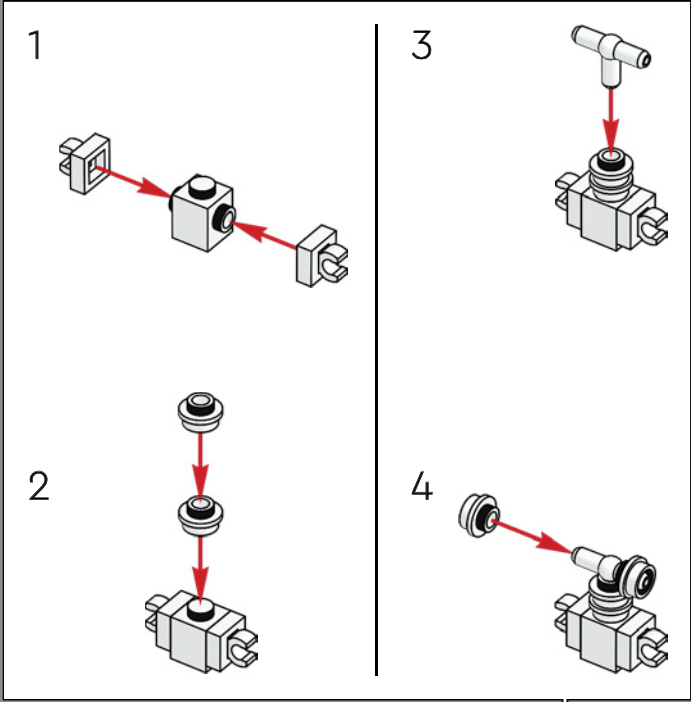



657

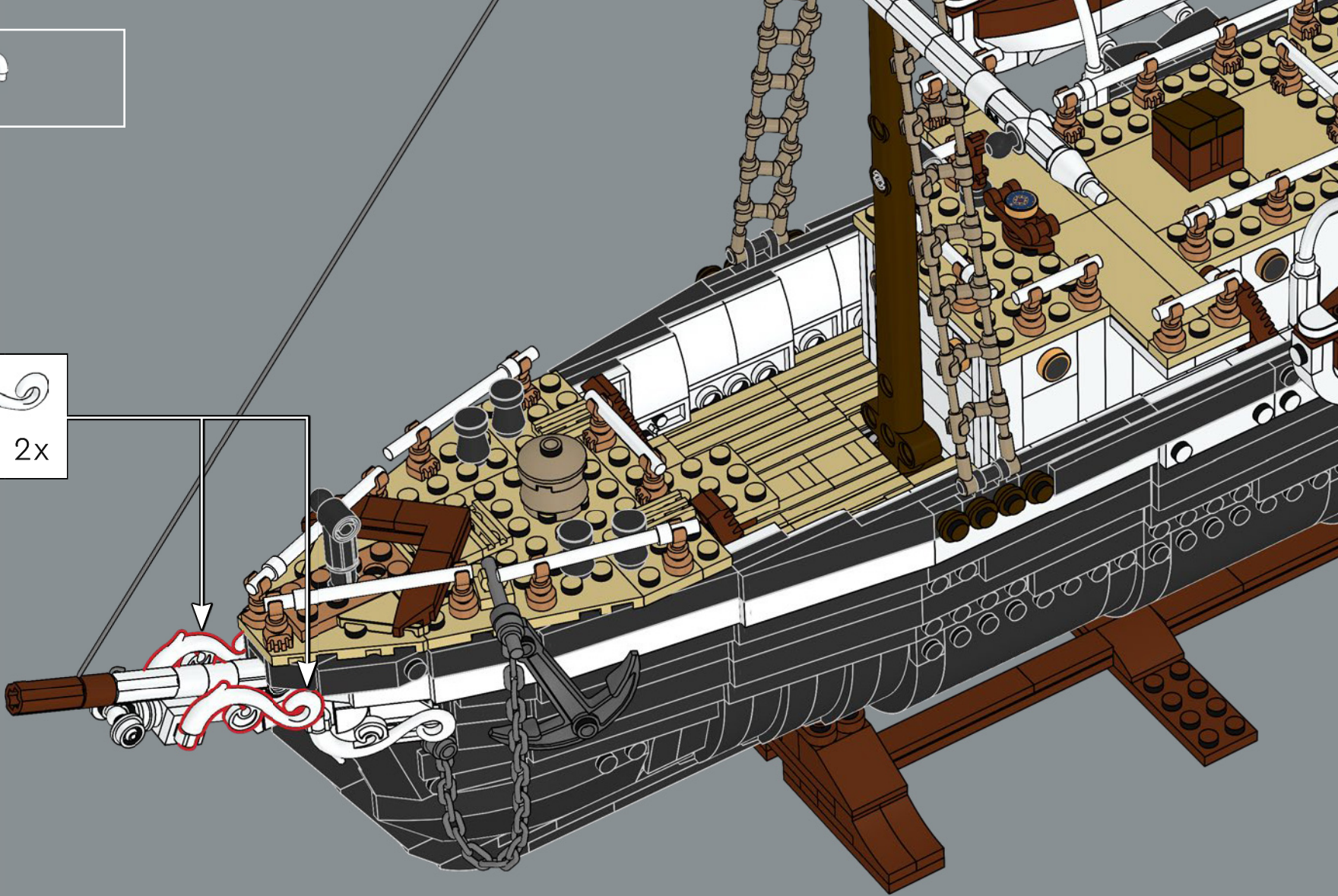
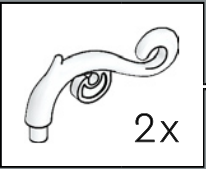

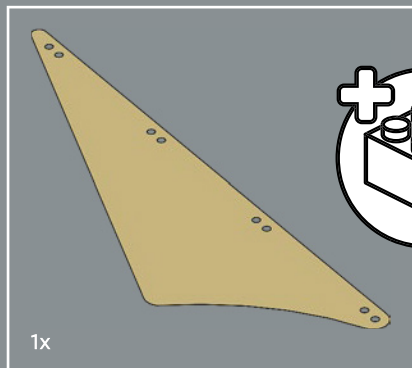

1x



LEGO® textiles use the same colors as LEGO bricks. For the sails, tan was considered the most attractive and appropriate color.

Les textiles LEGO® utilisent les mêmes couleurs que les briques LEGO. Pour les voiles, la couleur beige a été considérée comme la plus attrayante et la plus appropriée.

Los textiles LEGO® tienen los mismos colores que los bricks LEGO. Para las velas, se consideró que la opción más atractiva y apropiada era el café claro.

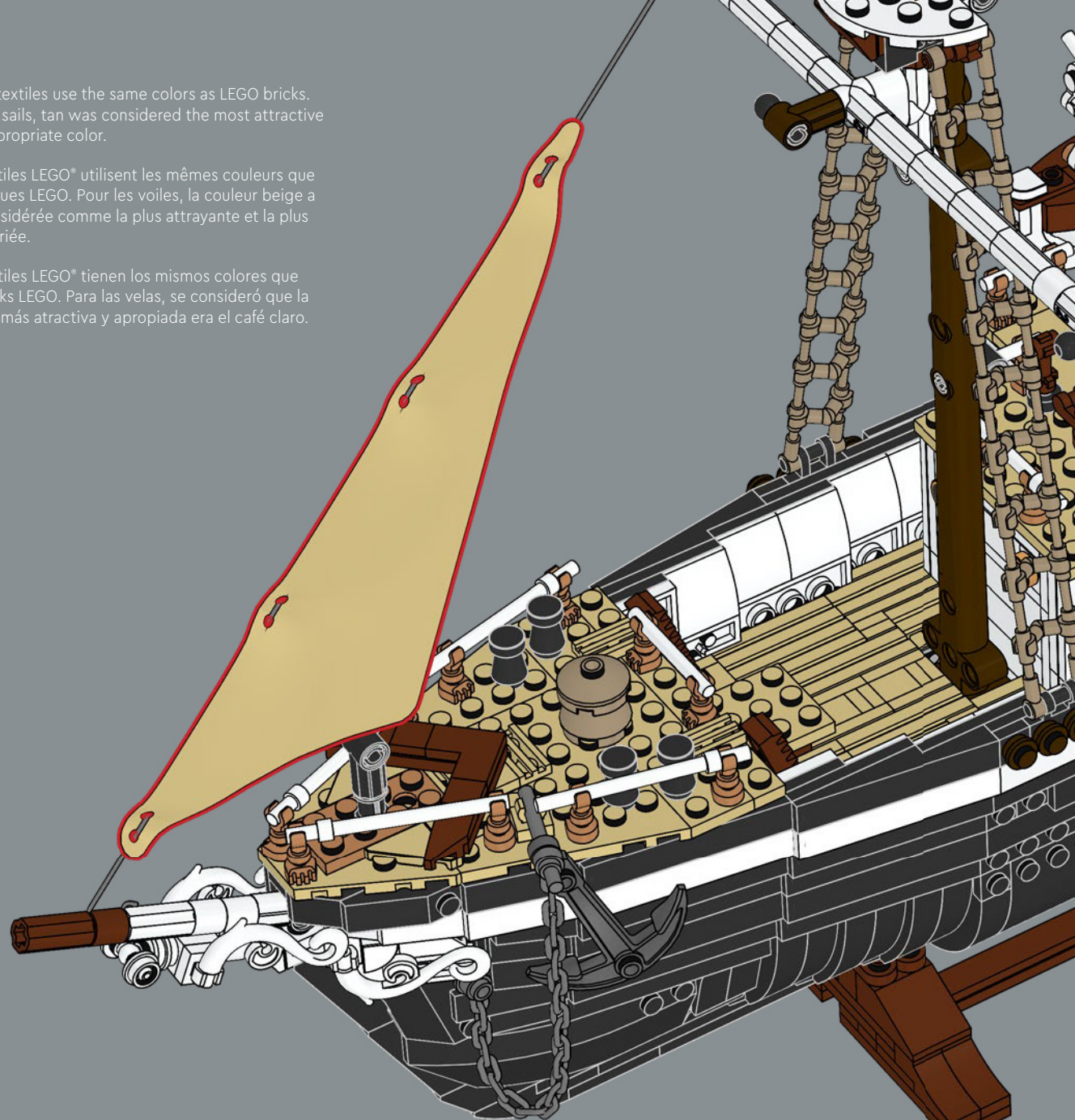

658

659

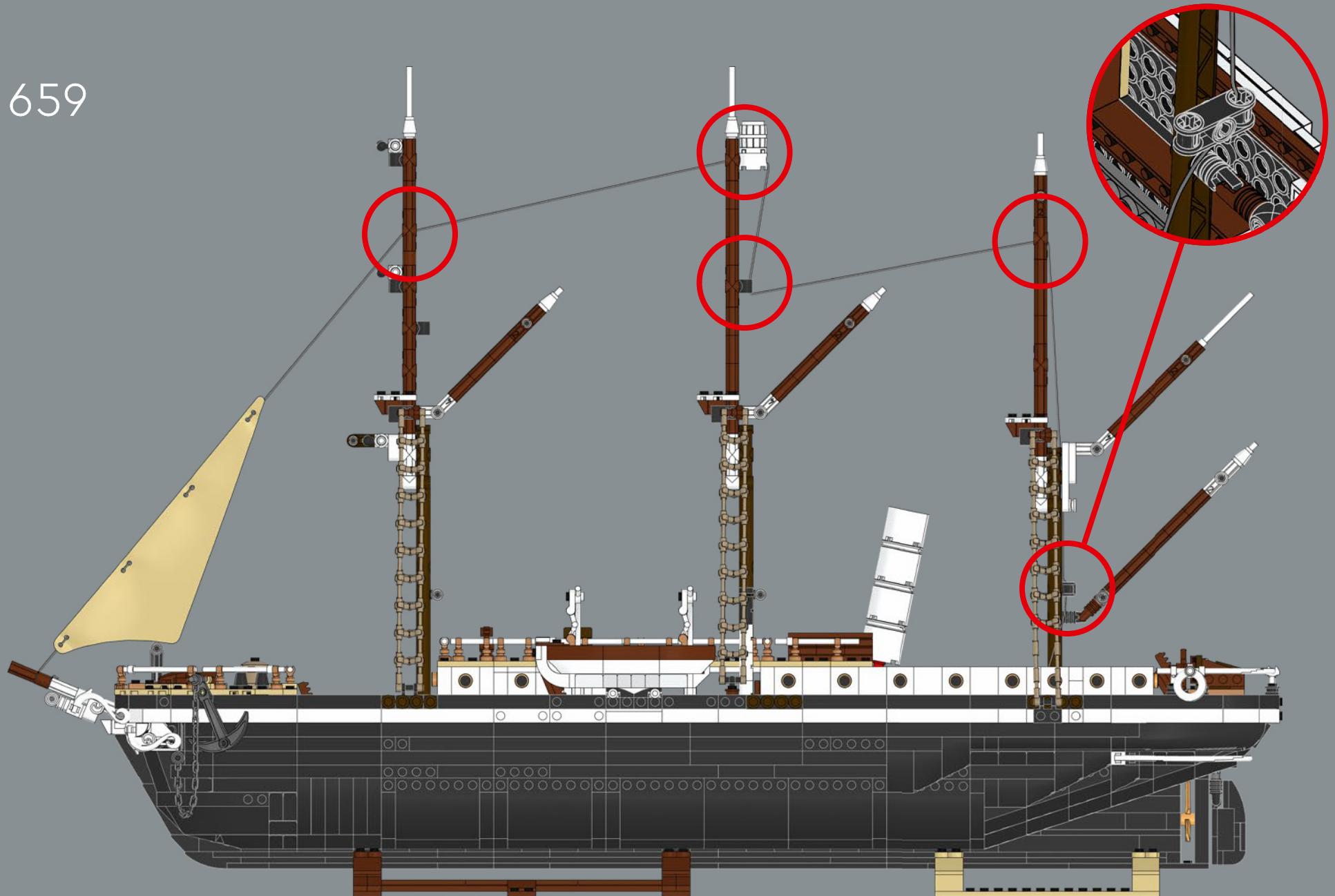

1x



660

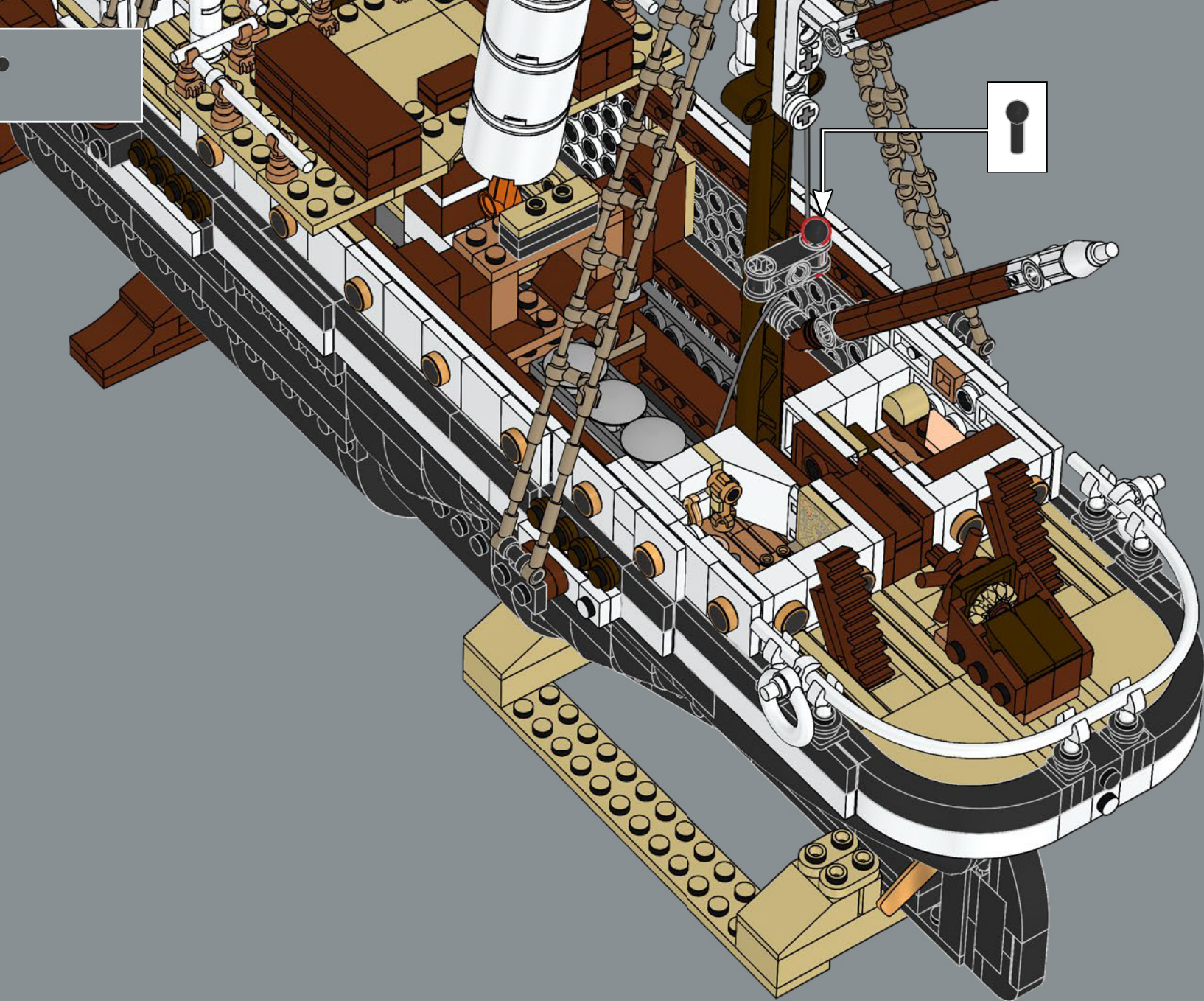

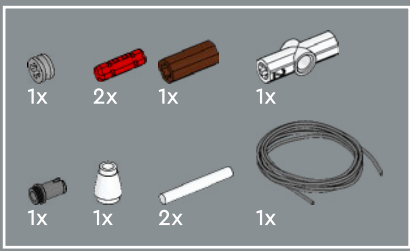

661

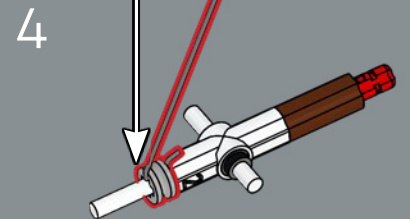
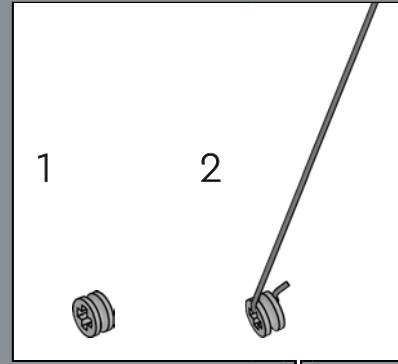
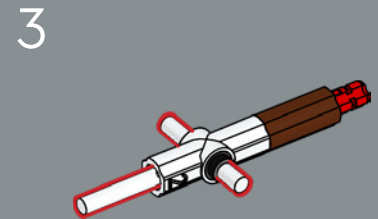
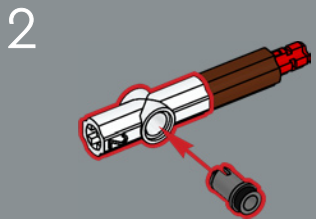
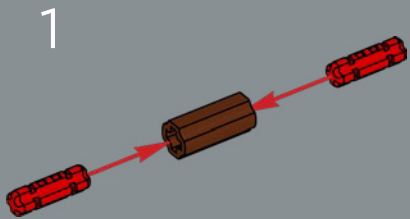

5

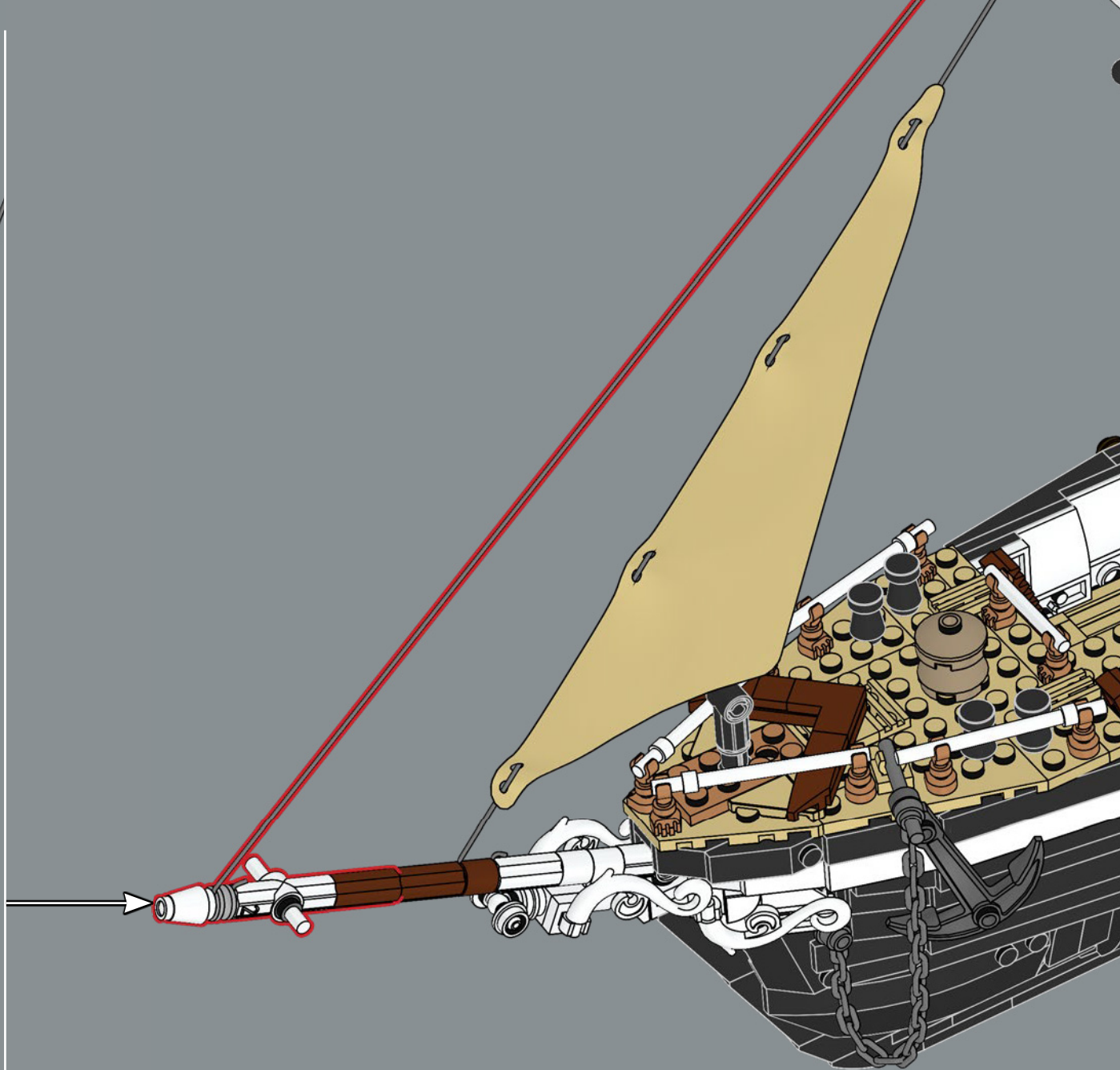
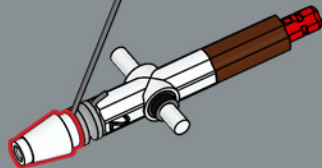

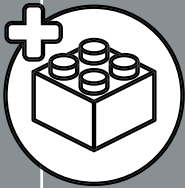
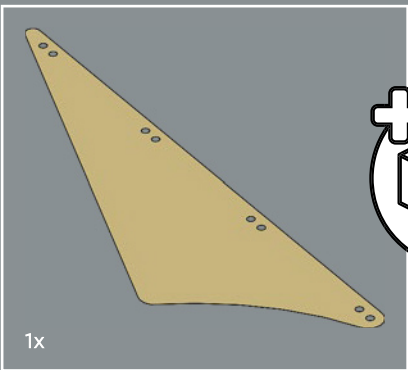

662

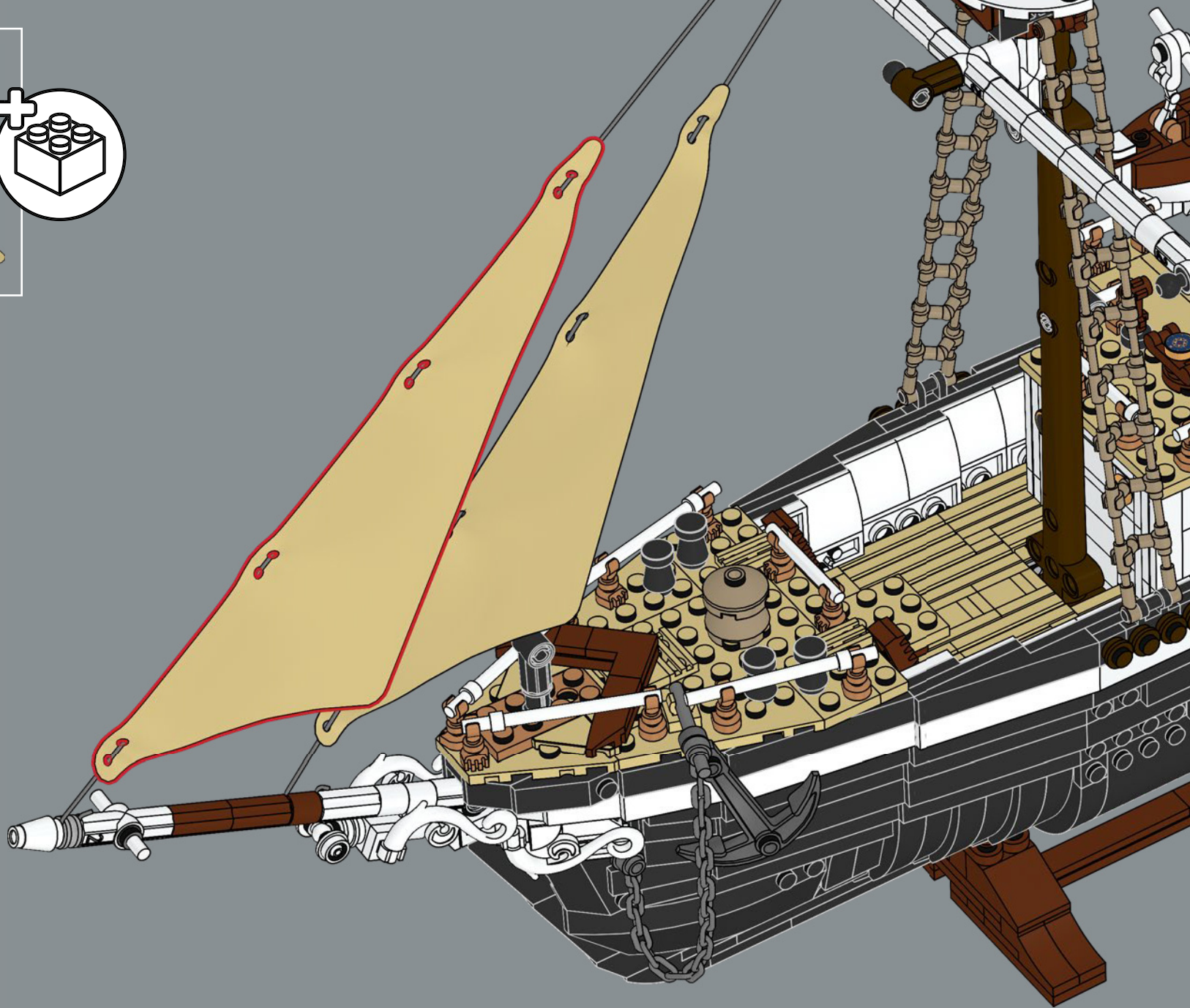

663

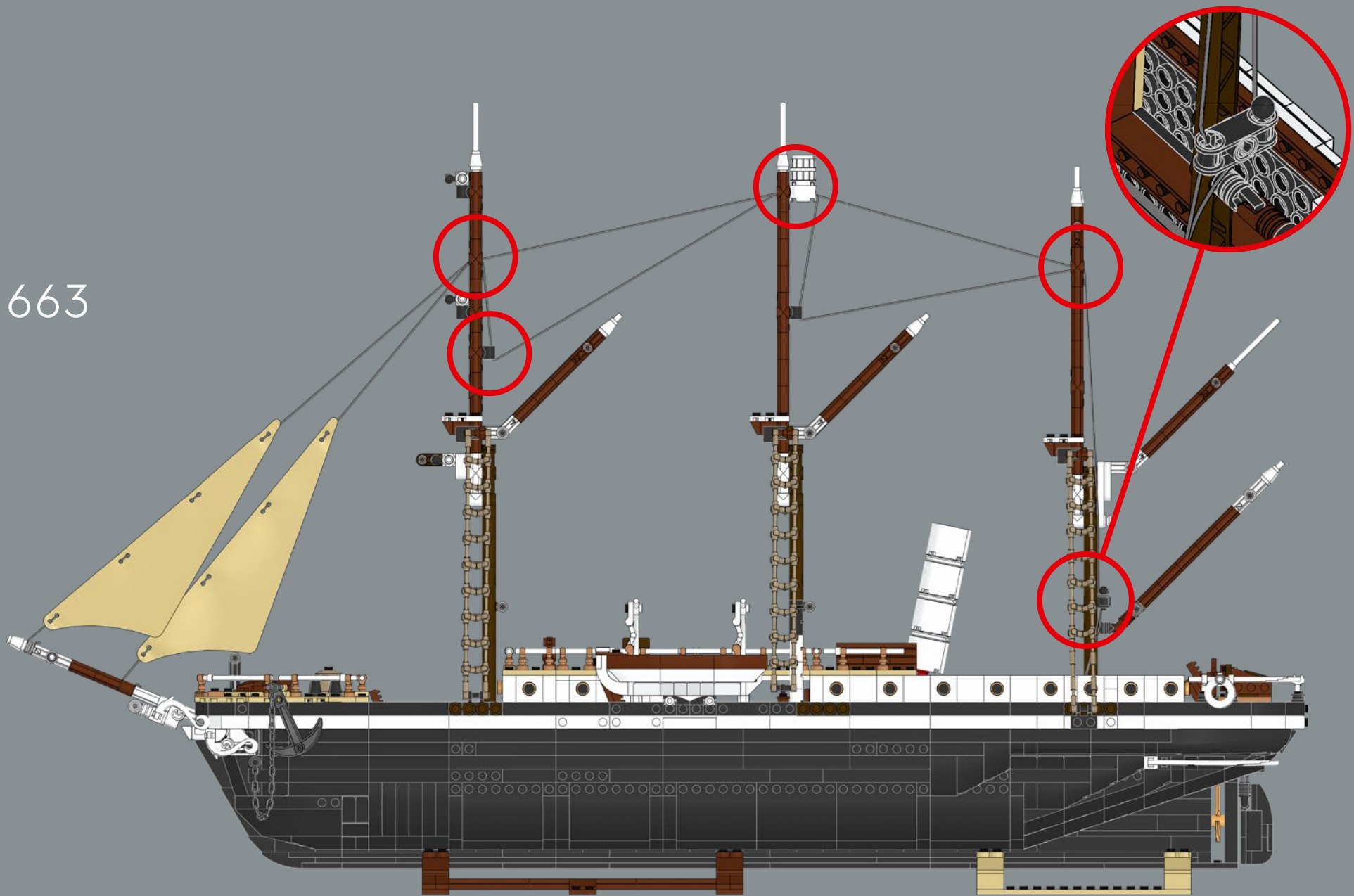



1x

664



LEGO® string elements are heat-cut to keep the ends from fraying. For this model, we found a no-knots and no-cutting solution, with excess string wrapped around a bobber and tucked away below deck.

Les éléments de ficelle LEGO® sont coupés à la chaleur pour éviter que les extrémités ne s'effilochent. Pour ce modèle, nous avons trouvé une solution sans nœud ni coupe : l'excédent de ficelle est enroulé autour d'un flotteur et rangé sous le pont.

Las cuerdas LEGO® se cortan con calor para evitar que los extremos se deshilachen. Para este modelo, encontramos una solución sin nudos ni cortes: enrollar la cuerda sobrante alrededor de un flotador que se guarda debajo de la cubierta.

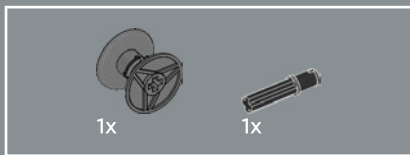

665

1

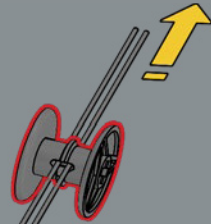

2

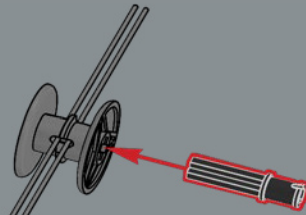

3

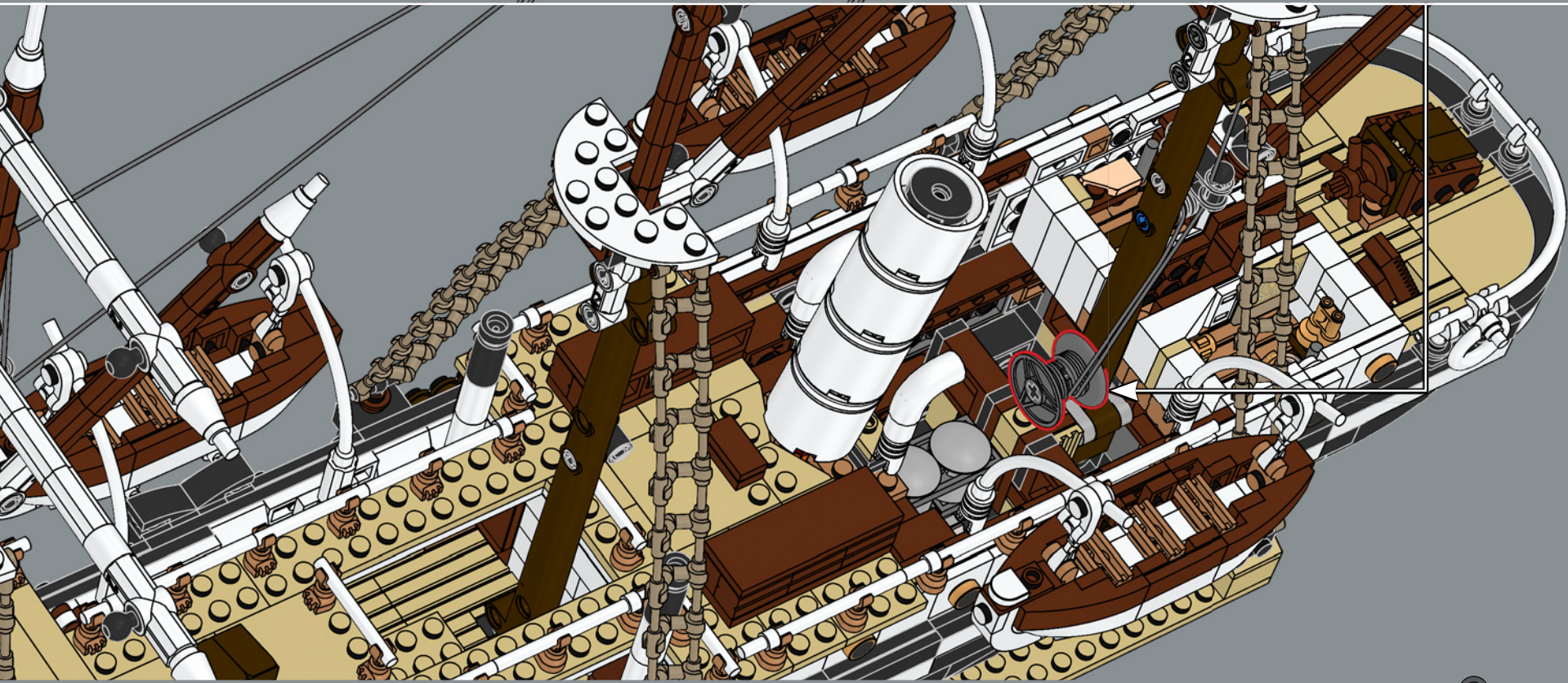
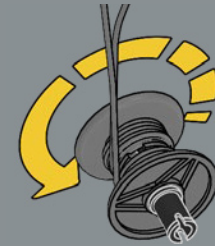

666

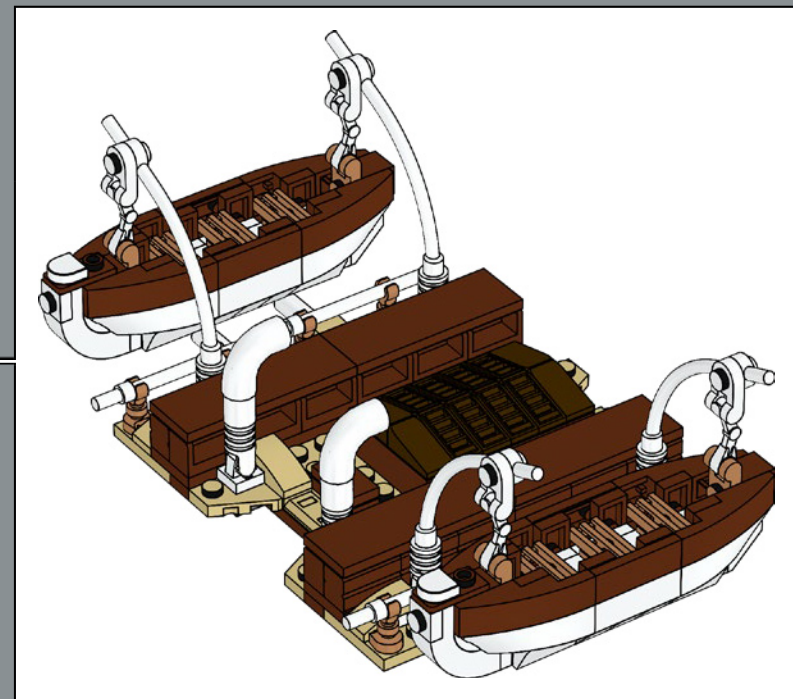
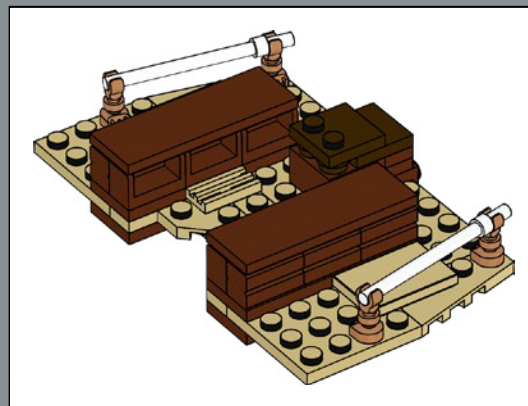
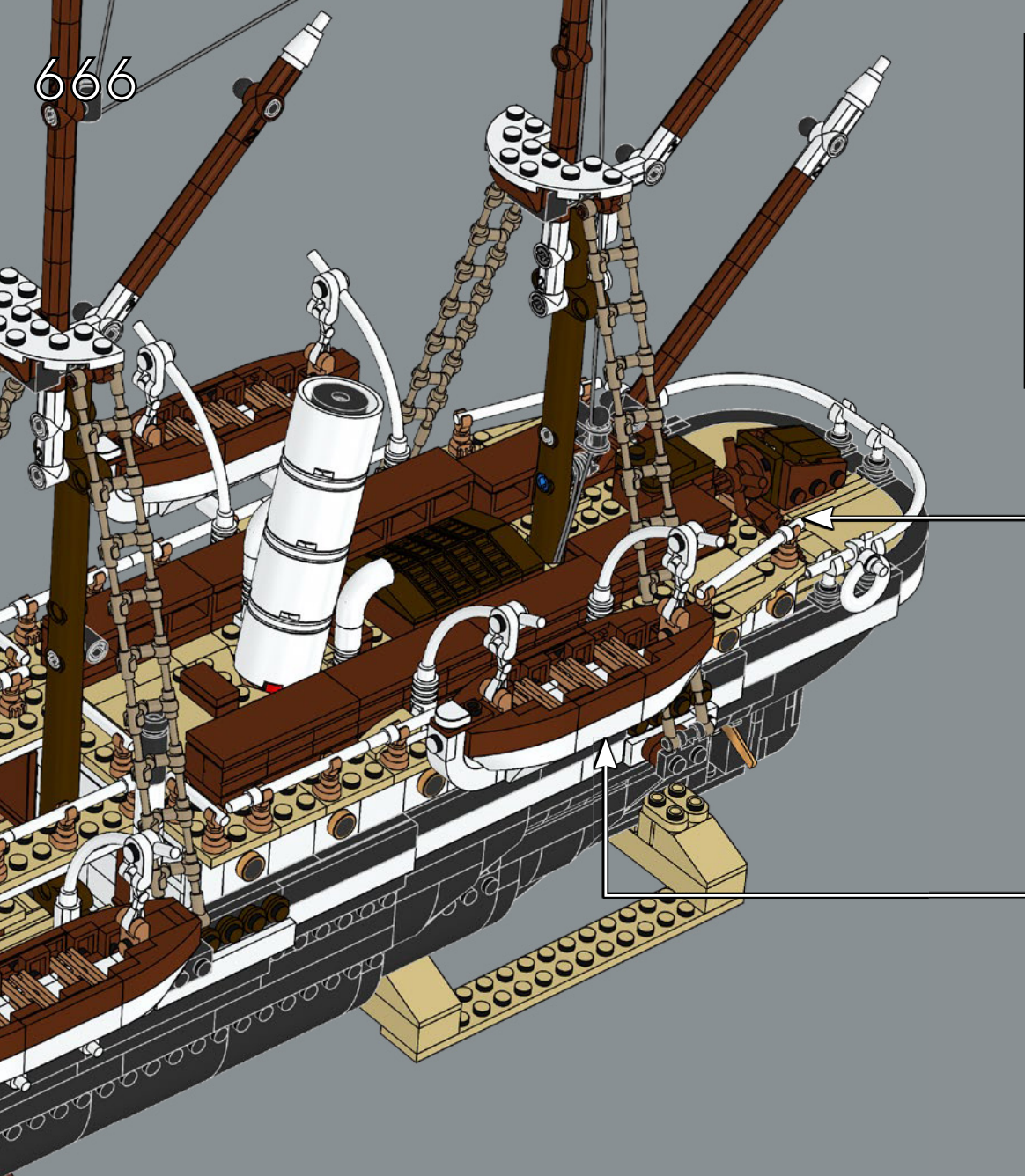

667

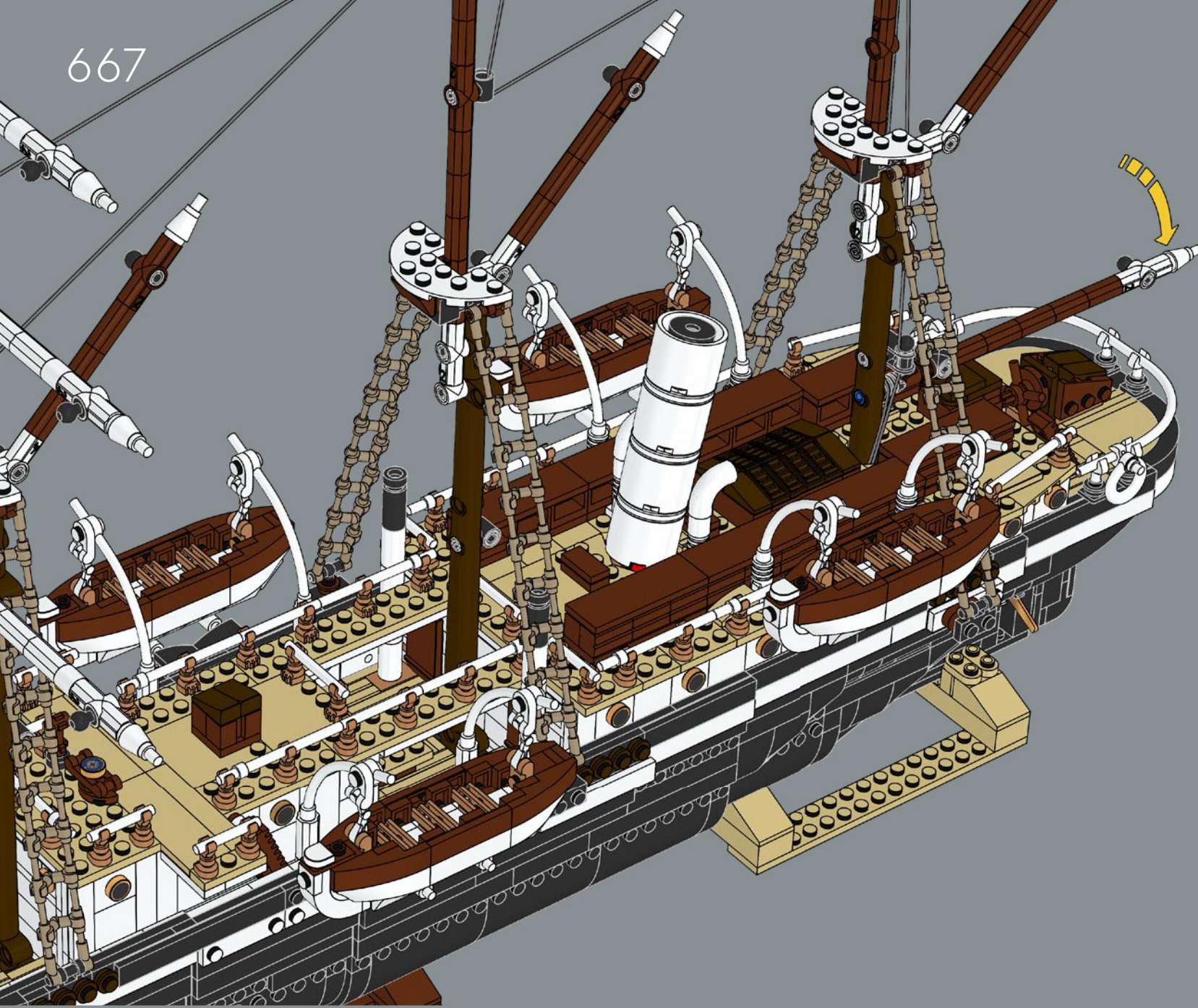

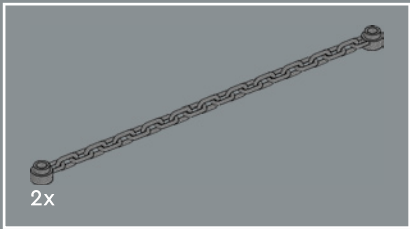

668

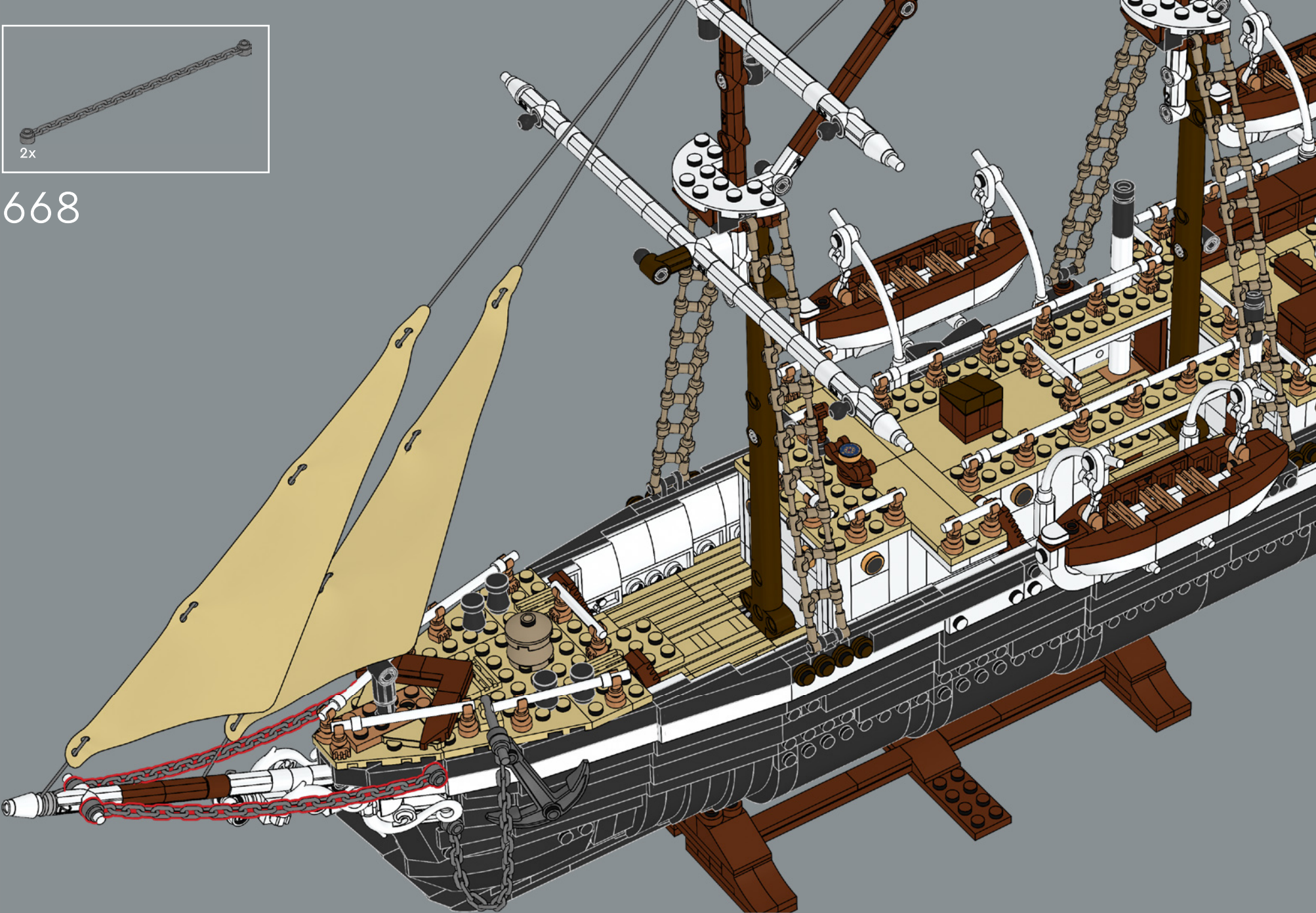

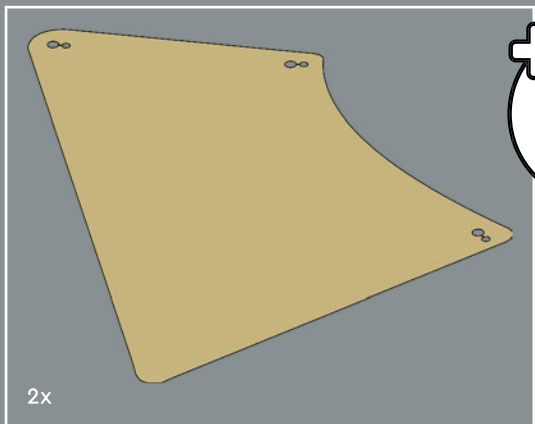

2x

669



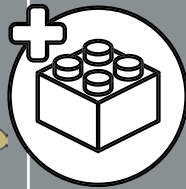
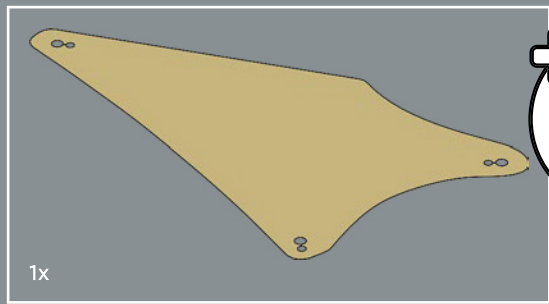

670

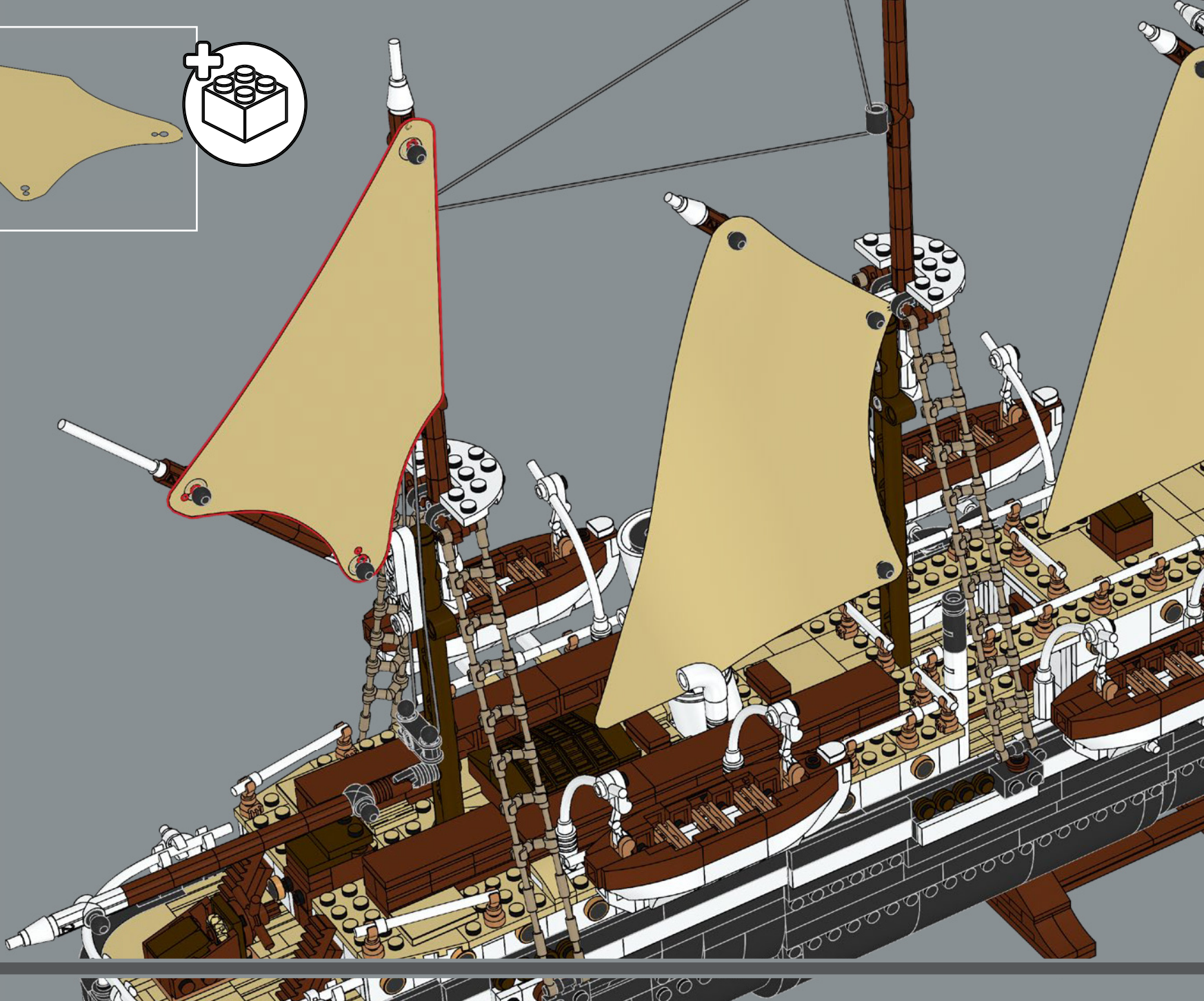



1x

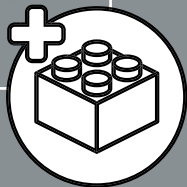

671



This British flag is called the 'Red Ensign' and was the appropriate flag for merchantmen and private ships to fly during that period.

Ce drapeau britannique, appelé « Red Ensign », était le drapeau officiel des navires marchands et des navires privés à cette époque.

Esta bandera británica denominada "pabellón rojo" era la que debían enarbolar las embarcaciones mercantes y privadas de aquella época.

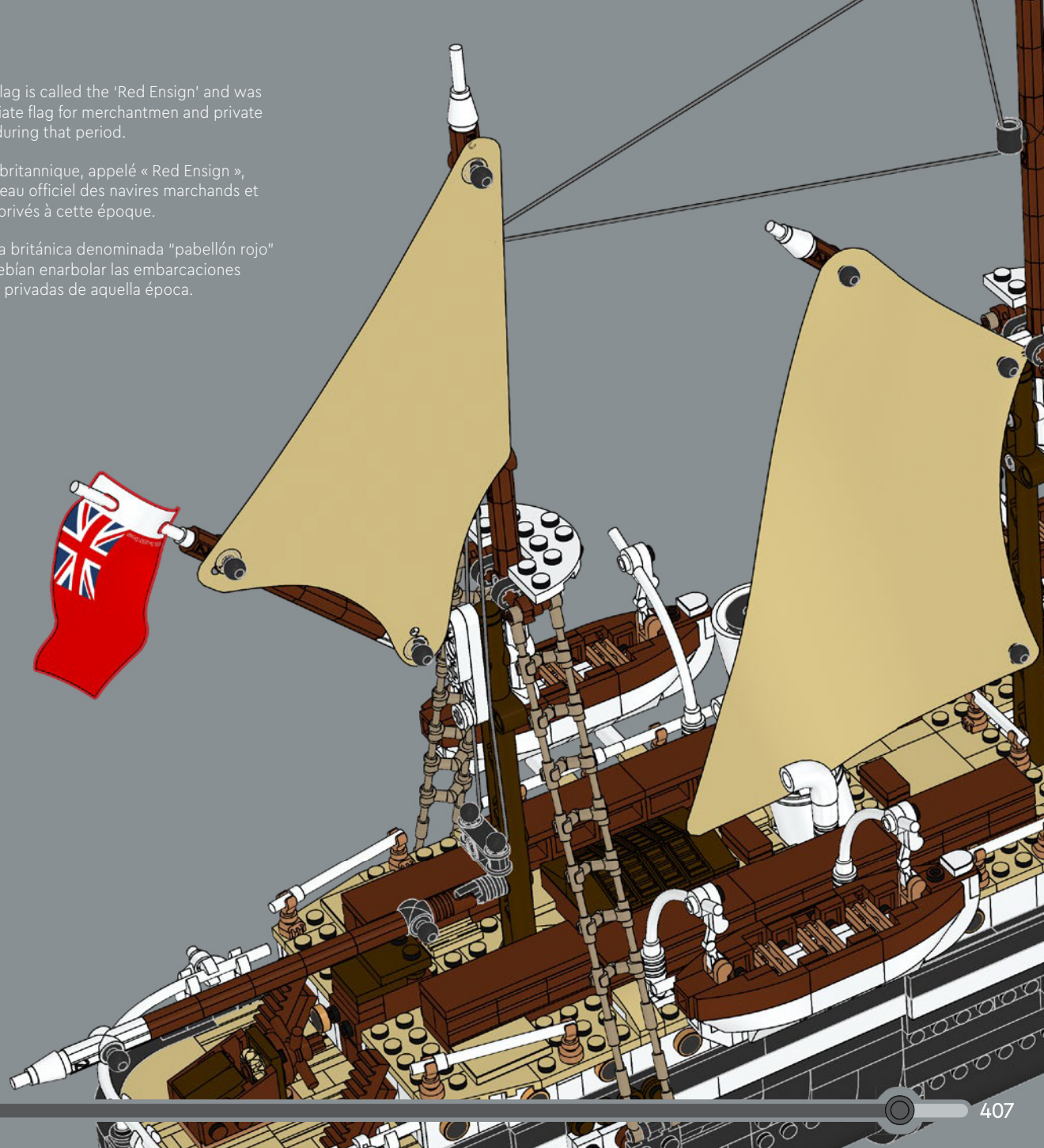

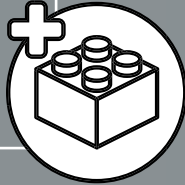
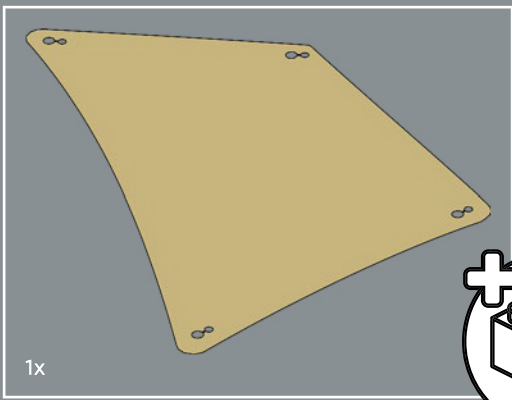

1x

672

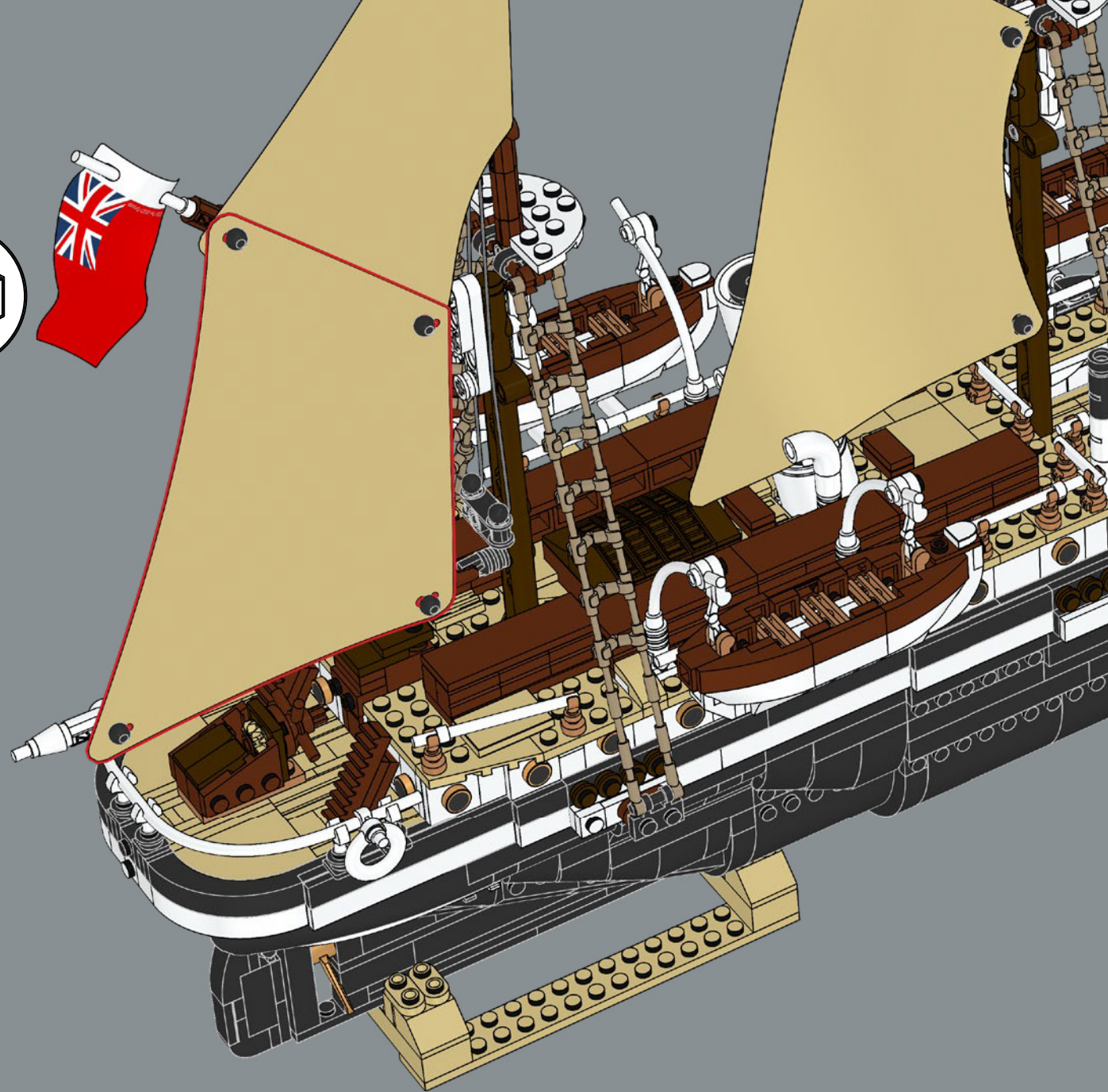

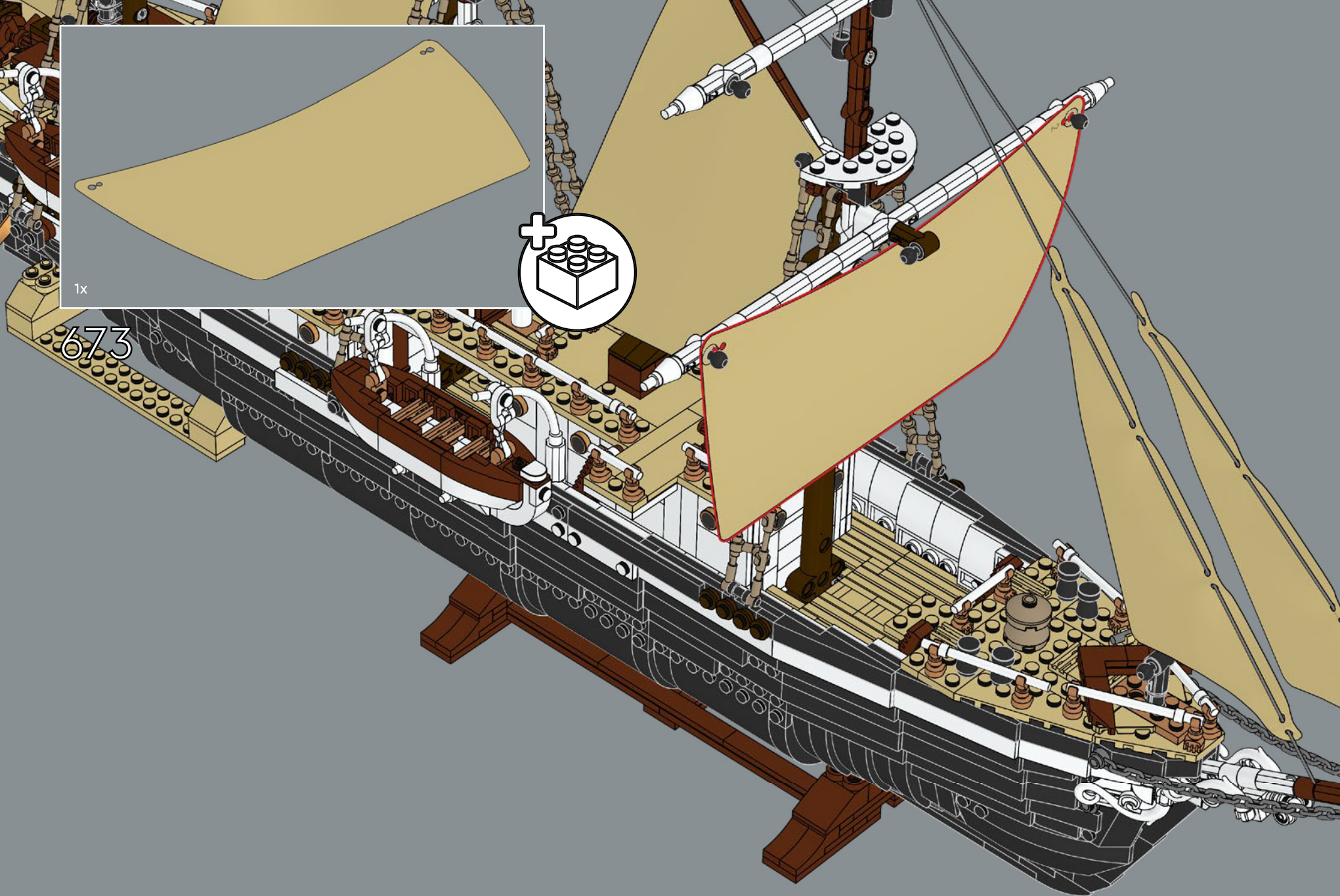

1x

673

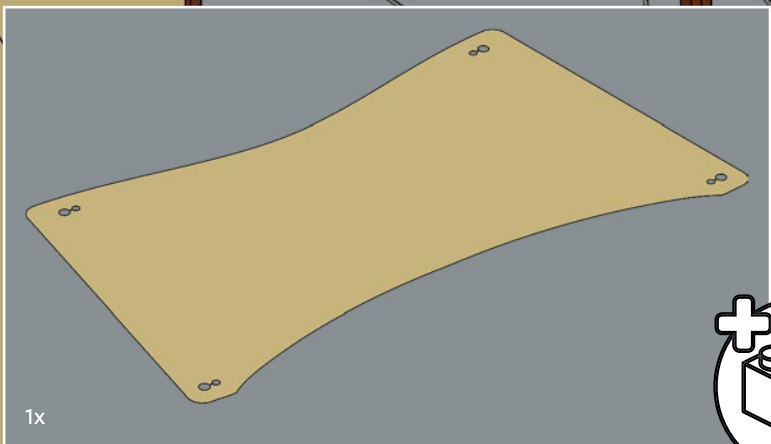

1x

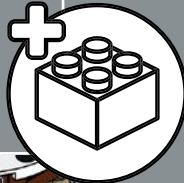

674

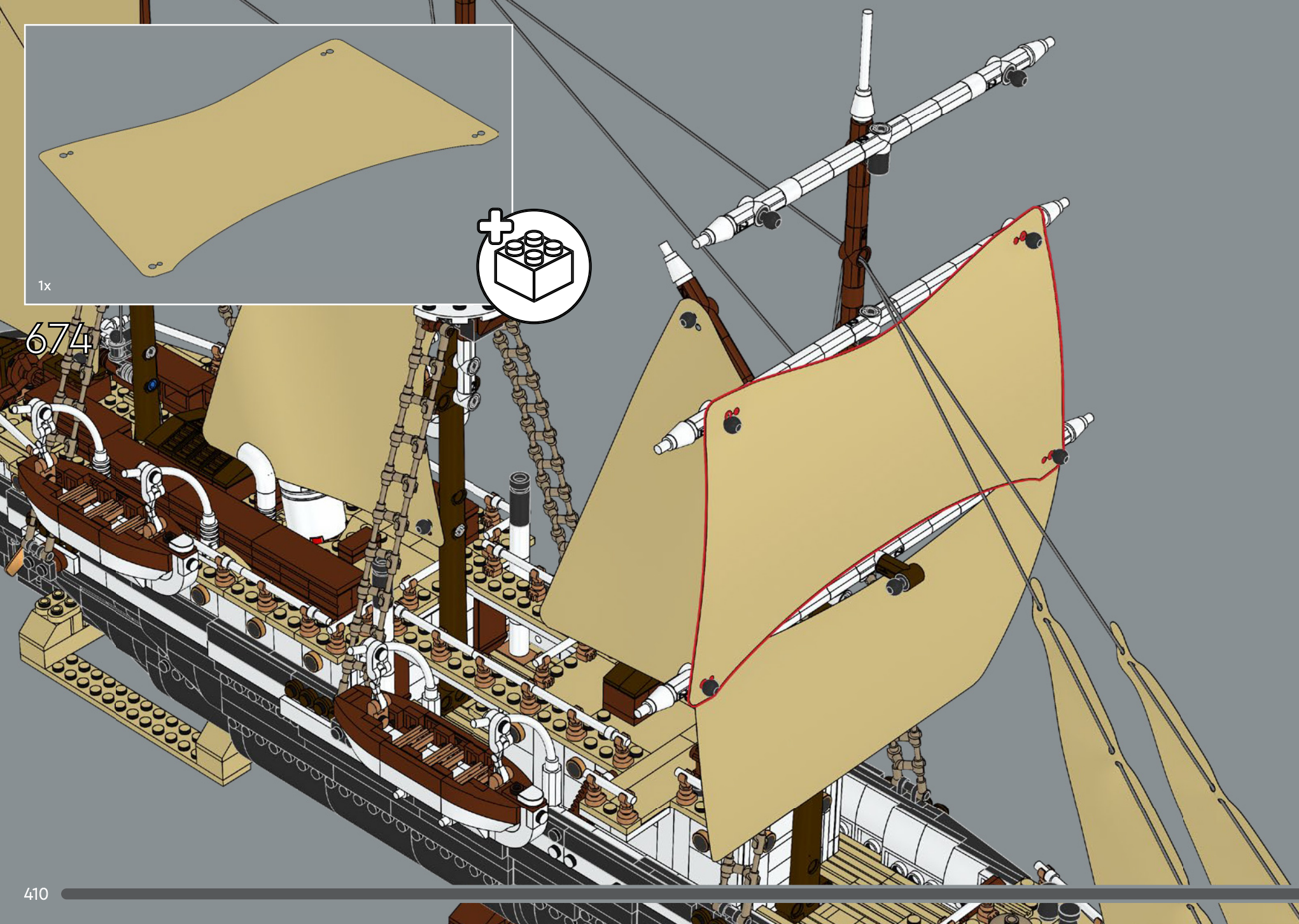

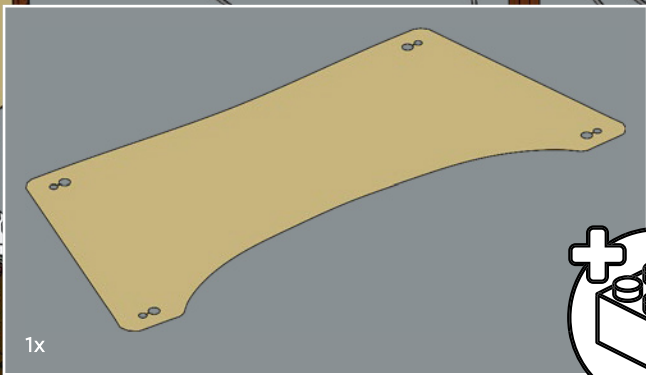

1x

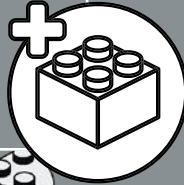

675

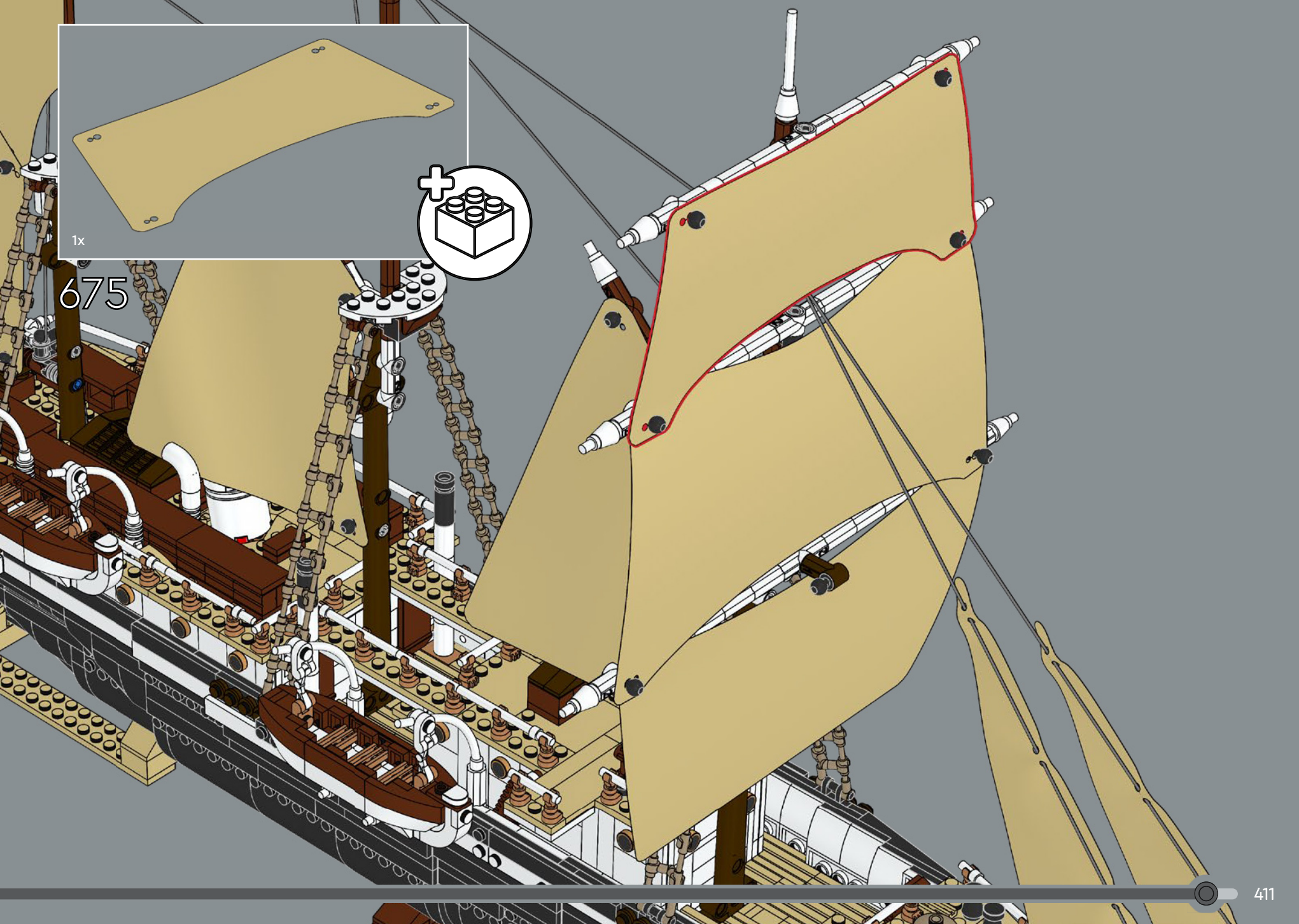

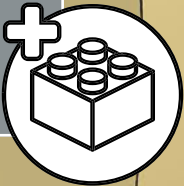
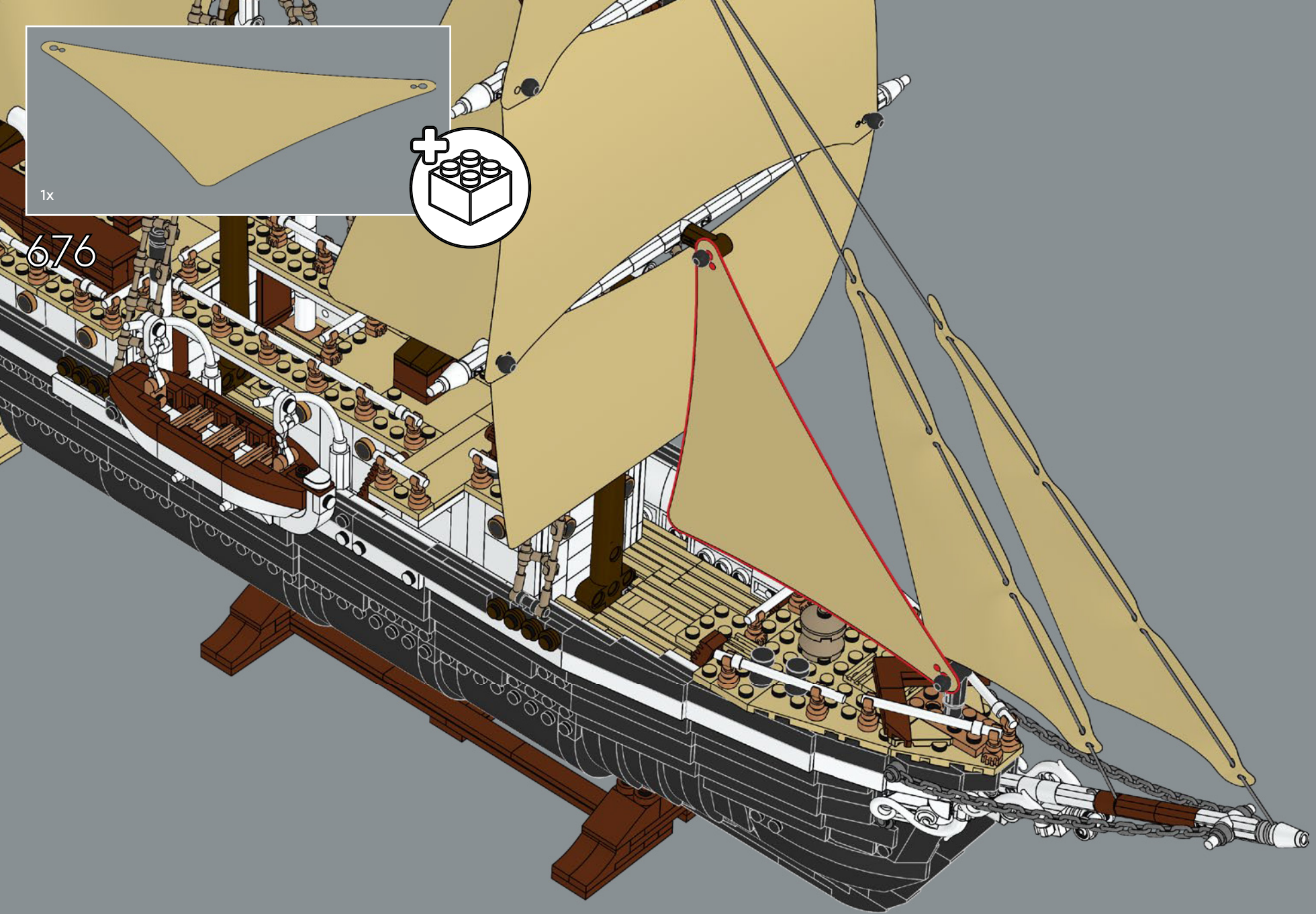

1x

676

677

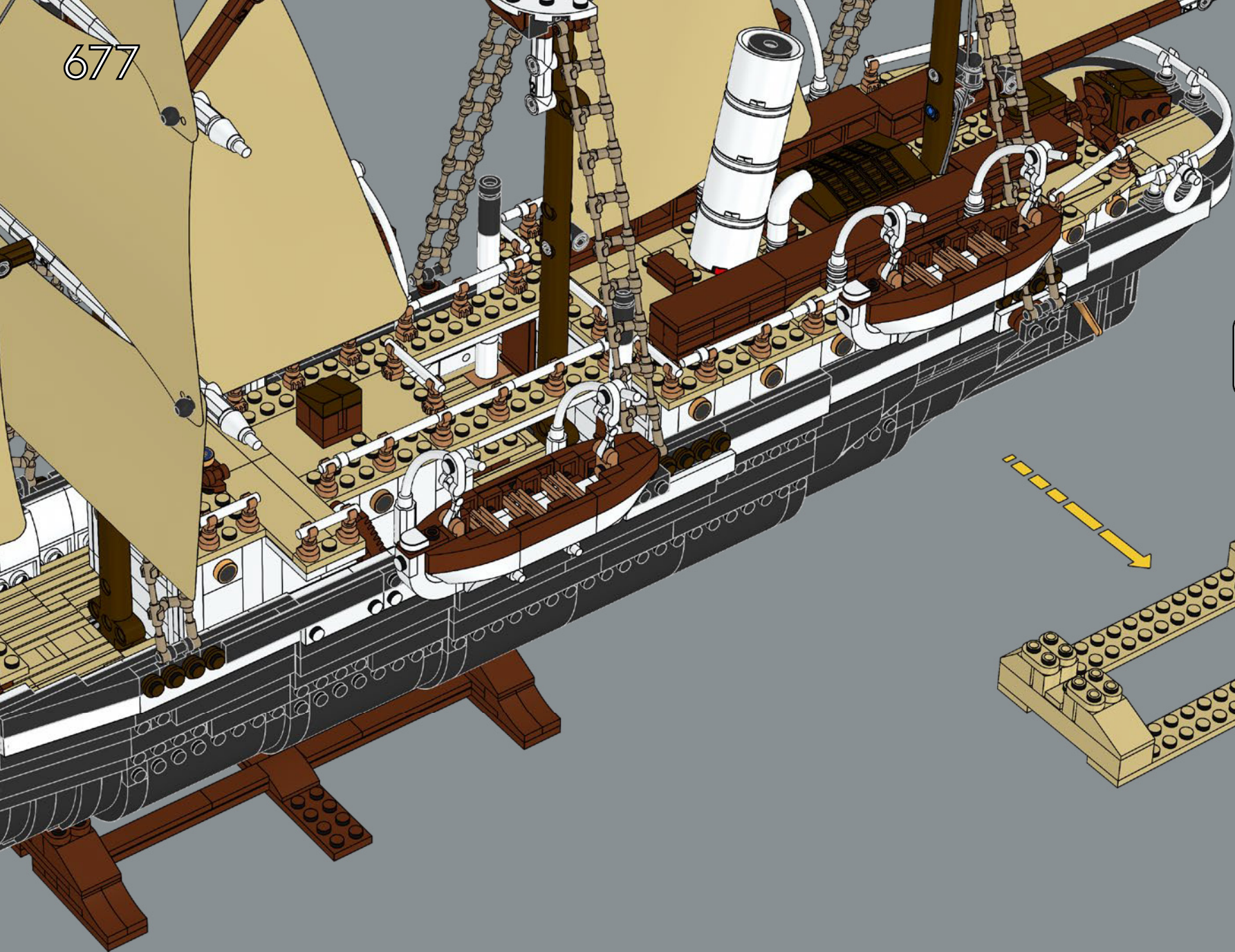

678

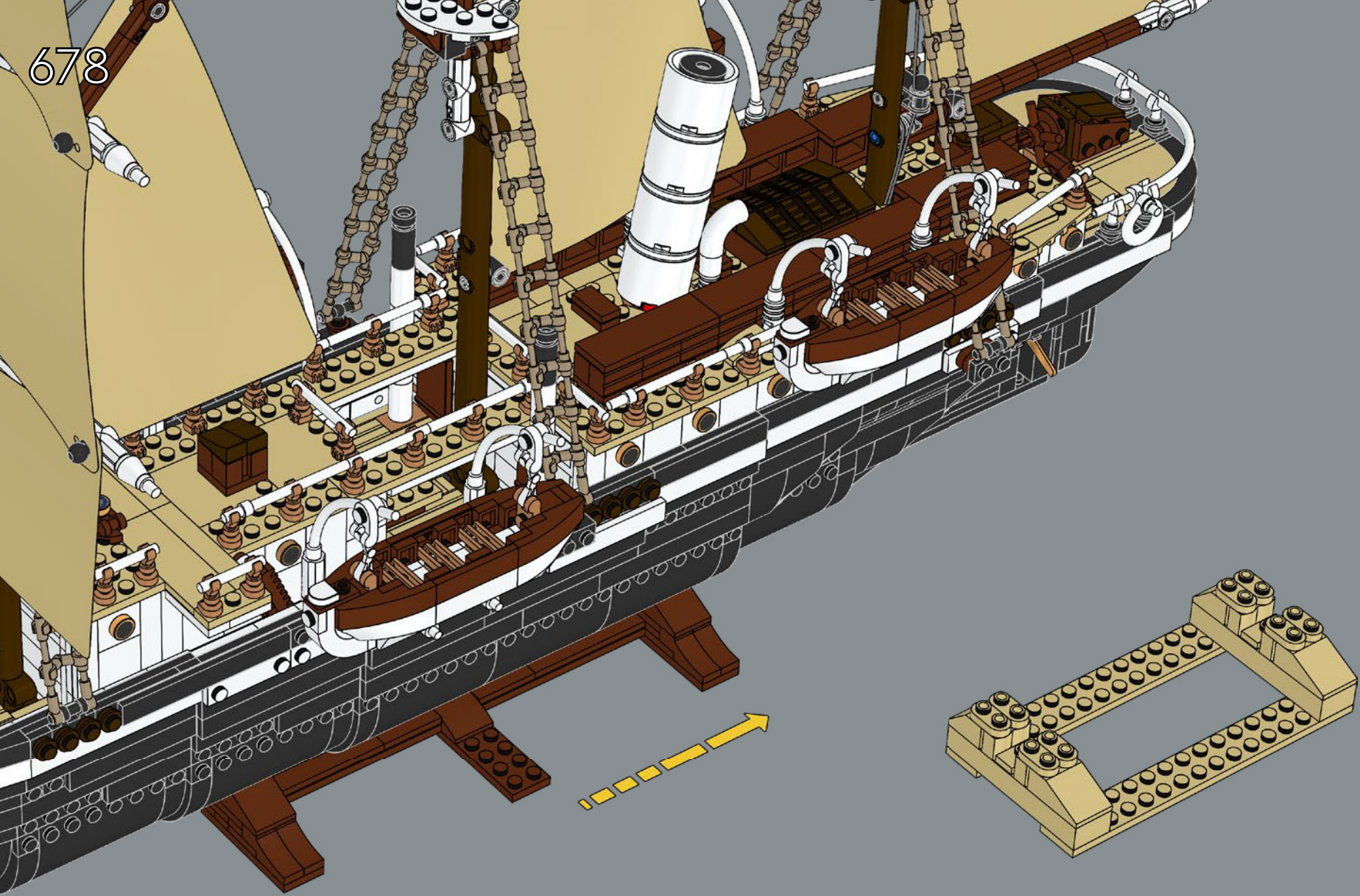

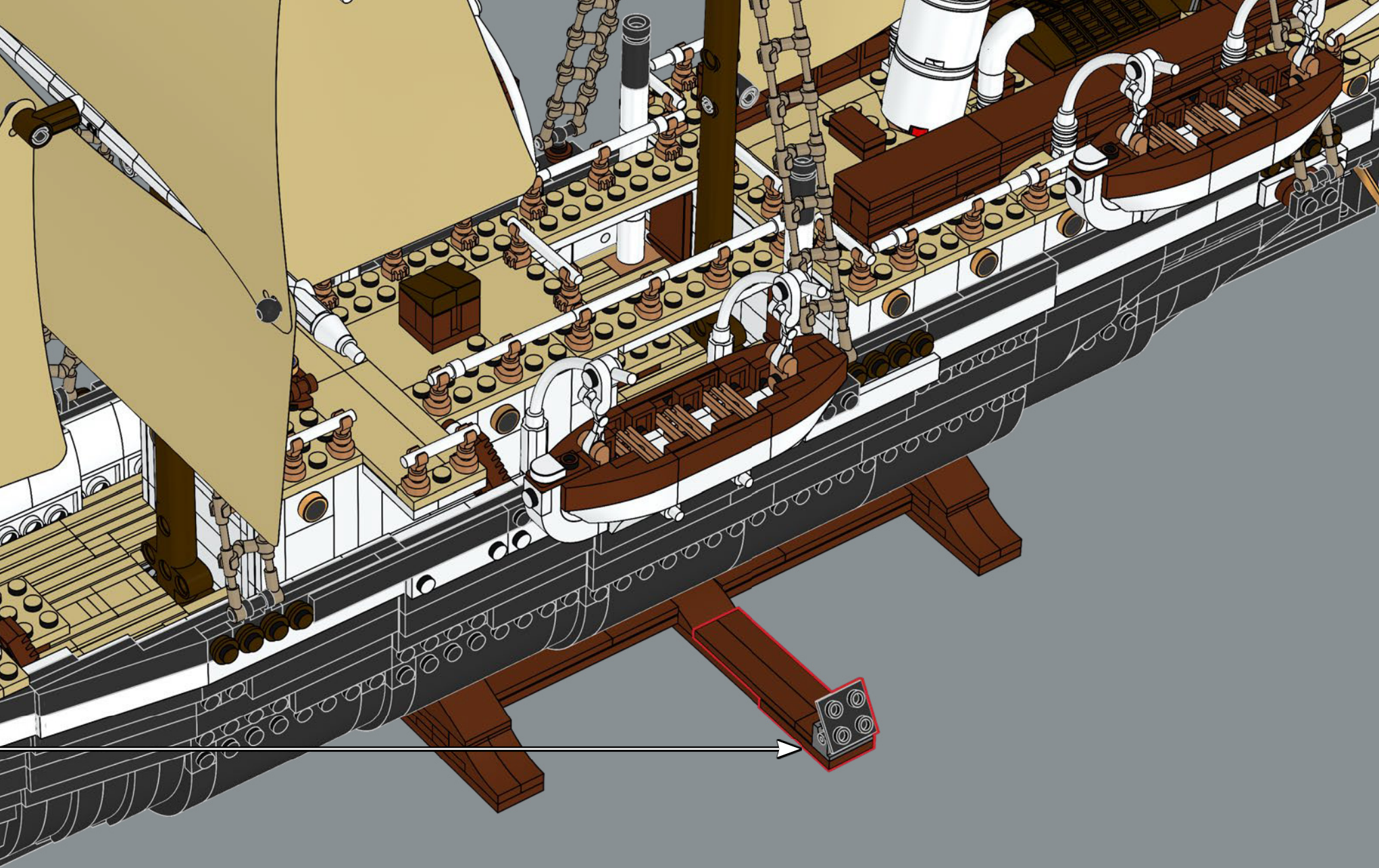

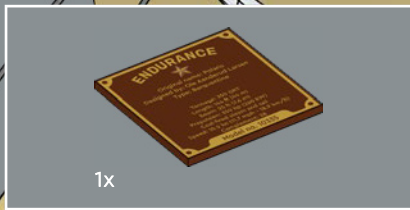

680



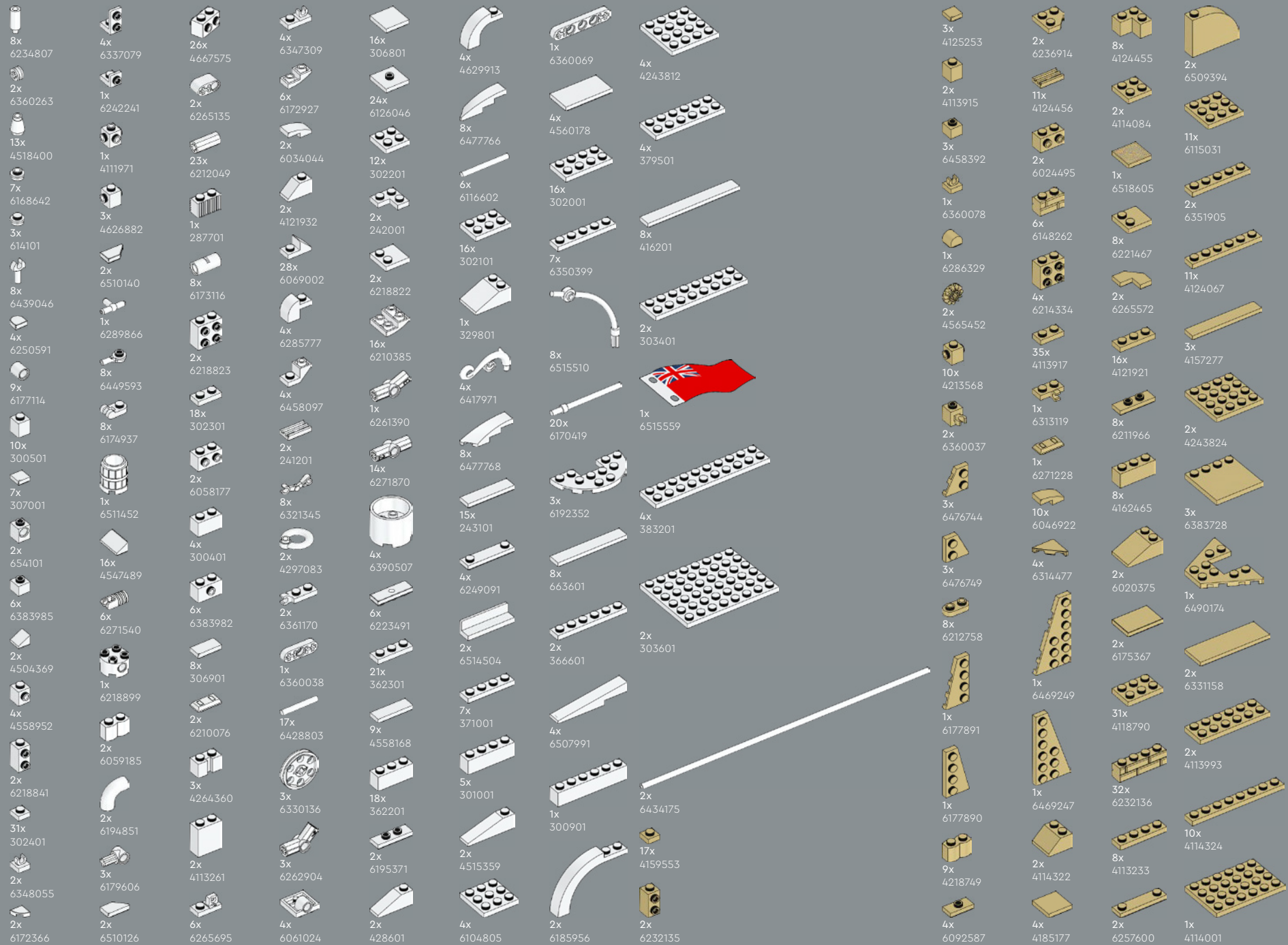

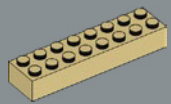

2x
6037398

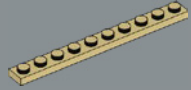

3x
4143409

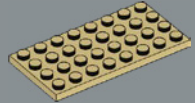

3x
4509897

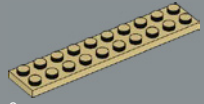

9x
4249019

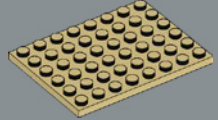

2x
6070501

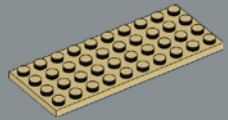

3x
6037834

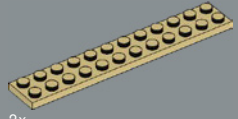

2x
6093864

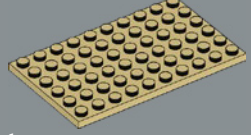

1x
4624185

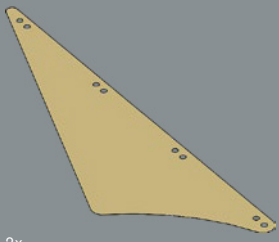

2x
6509959

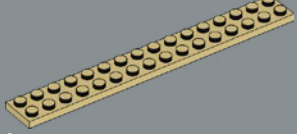

2x
6030980

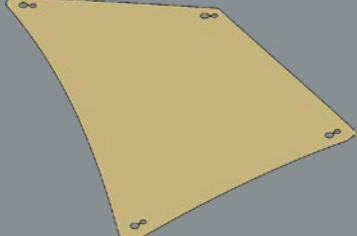

1x
6509952

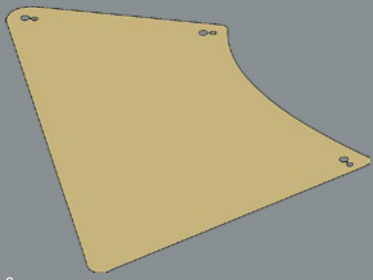

2x
6509954

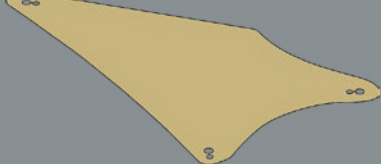

1x
6509953

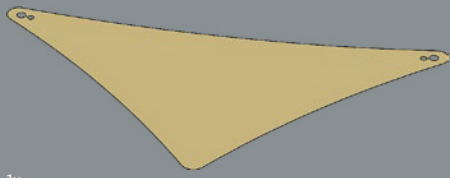

1x
6509958

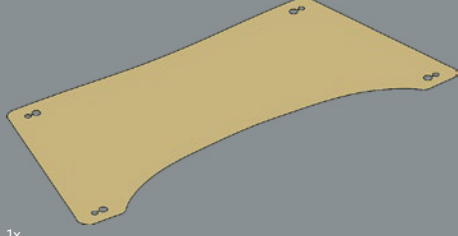

1x
6509955

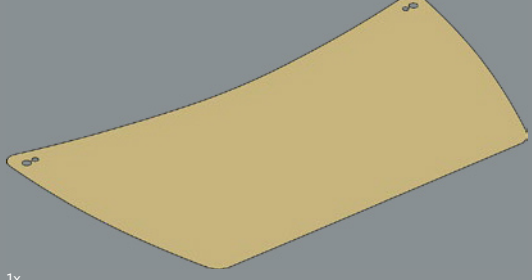

1x
6509957

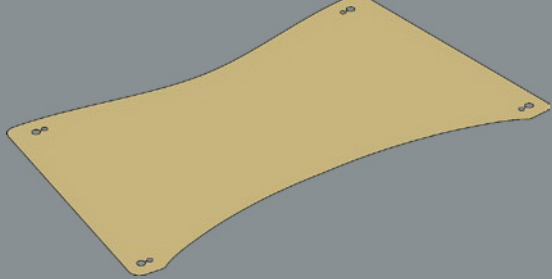

1x
6509956

- 2x 614121
- 1x 6271820
- 64x 4142865



1x
6129995



8x
300121



5x
4206482



4x
6271167



4x
6130007



1x
300124



4x
6186675



6x
6168646



4x
6284070



4x
4529236



1x
6332148



1x
6284699



8x
407026



4x
6141554



2x
6104209



1x
6265699



1x
6253260



1x
6141556



2x
4180536



2x
4180508



6x
6513918



10x
4548180



5x
6388352



2x
6335388



1x
4566308



6x
6234695



3x
4214559



1x
300124



3x
6130007



2x
6509664



19x
6344752



1x
6141554



2x
6104209



1x
6265699



1x
6253260



1x
6141556



2x
4180536



2x
4180508



6x
6513918



10x
4548180



5x
6388352



2x
6335388



1x
4566308



1x
6129995



8x
300121



5x
4206482



4x
6271167



4x
6130007



1x
300124



4x
6186675



6x
6168646



4x
6284070



4x
4529236



1x
6332148



1x
6284699



8x
407026



5x
6388352



2x
6335388



1x
4566308



6x
6234695



3x
4214559



1x
300124



2x
6509664



19x
6344752



1x
6141554



2x
6104209



1x
6265699



1x
6253260



1x
6141556



2x
4180536



2x
4180508



6x
6513918



10x
4548180



5x
6388352



2x
6335388



1x
4566308



6x
6234695



3x
4214559



1x
300124



2x
6509664



19x
6344752



1x
6141554



2x
6104209



1x
6265699



1x
6253260



1x
6141556



2x
4180536



2x
4180508



2x
6051508



4x
6477759



9x
403226



18x
6279875



1x
4109810



1x
6271535



2x
6195325



1x
6143850



4x
6507846



6x
6282140



1x
4283260



28x
4253815



2x
6173119



7x
6047276



2x
6475339



2x
6051508



4x
6477759



9x
403226



18x
6279875



1x
4109810



1x
6271535



2x
6195325



1x
6143850



4x
6507846



6x
6282140



1x
4283260



28x
4253815







2x
4271874



1x
6511449



2x
6469351



3x
4211214



6x
6055145

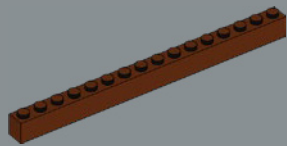

2x
6258989

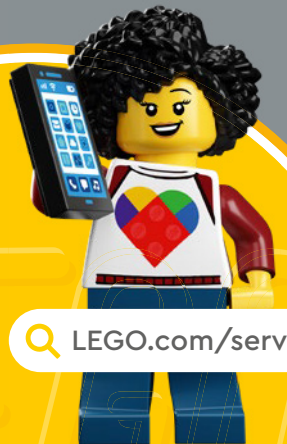

[LEGO.com/service](https://www.lego.com/service)



1x
6271165



2x
6275844



4x
6225242



6x
4211476



2x
4211389



1x
6329584



1x
6253856



2x
6248890



1x
6227897



1x
4211807



3x
4278273



3x
4211526



1x
6092956



1x
4512360



3x
6066097



4x
6123809



2x
6383177



6x
4211398



1x
4211470



1x
6004990



2x
6360043



10x
4211387



4x
4211397



9x
4211815



1x
4211536



4x
4211429

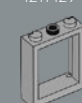

1x
6381253



6x
6093058



1x
4211773



8x
4211394



8x
4211425



8x
4251149



2x
6178172



2x
4211522



2x
4211522



6x
4210635



6x
4210635



6x
4210635

3



4x
4211090



6x
6231765



2x
6439040



4x
6395635



3x
6362259



7x
6344022



2x
6388133



1x
6225494



1x
4211042



1x
6115080



1x
6514456



2x
6230233



1x
4211066



3x
6092572



2x
6310596



6x
4210635



6x
4210635



6x
4210635

11



2x
6405646



6x
6015356



2x
4211133



3x
6365692



1x
4239891



1x
6378143



12x
4211043



4x
4211105



8x
4211001



1x
4211103



13x
6039176



2x
6431485



1x
4508553



11x
4211002



11x
4211002



11x
4211002



11x
4211002



11x
4211002

55



2x
4499858



1x
4211099



2x
4211114



3x
6258887



1x
6510133



32x
6511448



1x
6287847



2x
6186672



1x
6328909



1x
6034543



1x
6490722



32x
6315780



3x
6322813



1x
6332586



1x
6332586



1x
6332586

8



8x
6509391



8x
6509392



1x
4566688



2x
6058221



2x
6347604



1x
6515036



1x
6331950



3x
6258887



1x
6510133



32x
6511448



1x
6287847



2x
6186672



1x
6328909



1x
6034543



1x
6490722



32x
6315780



3x
6322813

1x
6332586



3x
6314190



3x
6457557



4x
6215606



2x
6474266



12x
6324205



2x
6360035



10x
4651231



2x
6192920



22x
6218360



2x
6431328



4x
6411587



2x
4656783



12x
6452541



8x
6167699



1x
6336665



1x
6452865



1x
6452865



4x
6055309



1x
6257605



2x
6489195



31x
6343854



2x
6313600



4x
6208446



1x
6474270



1x
647



YOU COULD WIN



YOU COULD WIN

Your feedback will help shape the future development of this product series.

Visit:

DU KÖNNTEST GEWINNEN

Dein Feedback trägt zur Weiterentwicklung dieser Produktreihe bei.

Geh auf:

VOUS POURRIEZ GAGNER

Vos commentaires nous aideront à concevoir les futurs produits de cette gamme.

Visitez :

POTRESTI VINCERE TU

La tua opinione ci aiuterà a migliorare la creazione futura di questa linea di prodotti.

Visita:

PUEDES GANAR

Tu opinión contribuirá al futuro de esta serie de productos.

Visita:

轻松获奖

您的反馈将有助于我们在今后改进本产品系列。

请访问:

[LEGO.com/productfeedback](https://www.lego.com/productfeedback)

You also have the chance to win a LEGO® set.

Terms and conditions apply.*

Außerdem hast du die Chance, ein LEGO® Set zu gewinnen.

Es gelten die Teilnahmebedingungen.*

Vous pourriez également gagner un ensemble LEGO®.

Des conditions s'appliquent.*

Hai anche la possibilità di vincere un set LEGO®.

Termini e condizioni sono applicabili.*

También tienes la oportunidad de ganar un set LEGO®.

Aplican términos y condiciones.*

您还有机会赢取乐高®套装。

条款和条件适用。*

*[LEGO.com/productfeedback-terms](https://www.lego.com/productfeedback-terms)



LEGO and the LEGO logo are trademarks of the/sont des marques de commerce du/son marcas registradas de LEGO Group.
©2024 The LEGO Group. 6541881