

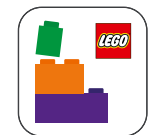

10335



Booklet available in English
Heft in deutscher Sprache erhältlich
Livret disponible en français
Libretto disponibile in italiano
Folleto disponible en español
如需中文版手册



LEGO® Builder

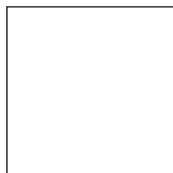



LEGO.com/sustainable-packaging



FR
**DONNEZ
OU
RECYCLEZ**



ASSOCIATION

OU



MAGASIN

OU



DÉCHÈTERIE

Adresses sur quefairedemesdechets.fr



BUILDER



Apple and the Apple logo are trademarks of Apple Inc., registered in the U.S. and other countries and regions. App Store is a service mark of Apple Inc. Google Play and the Google Play logo are trademarks of Google LLC. Tencent and the Tencent logo are trademarks of Tencent Inc.

LEGO.com/devicecheck



LEGO® Builder



The *Endurance* rediscovered

In 2022, one hundred years after Sir Ernest Shackleton passed away, the wreckage of his most legendary ship, the *Endurance*, was rediscovered on the Weddell seafloor off the coast of Antarctica. First launched in 1912, the former luxury yacht was refurbished to withstand the most inhospitable environments and shield its crew from the elements on Shackleton's 1914 Imperial Trans-Antarctic Expedition. The daring mission to cross Antarctica failed as the *Endurance* was swallowed by the polar ice before reaching the shore. How its crew survived, however, became one of the most inspiring stories of human resilience, resourcefulness and camaraderie of the past century. While the *Endurance* will remain in its final resting place, the rediscovery of the remarkably well-preserved wreck once again brings its incredible story to the surface. Enjoy building, as we celebrate this epic survival story with a gorgeous LEGO® Icons model filled with the most minute of details.



The Antarctica Treaty

On 1 December 1959, twelve countries signed the Antarctica Treaty to preserve the continent as an independent centre for scientific research. Under the treaty, with no indigenous people to claim sovereign rule, no country has the legal authority to claim or attempt to recover the Endurance.

Built to last

/// The three-masted barquentine was also fitted with a triple-expansion steam engine to navigate through harsh winds and ice.

/// A combination of oak, pine and greenheart timber made the hull sturdy enough to withstand the most extreme conditions.

/// Upon the wreck's discovery in 2022, the name *Endurance* in golden letters and the golden star were still intact.



No man left behind

On 5 December 1914, Shackleton and his crew set sail from Grytviken in South Georgia on a year-long mission to reach the South Pole. By late February 1915, the *Endurance* became relentlessly stuck in ice that would shift and drift around the Weddell Sea. Undeterred, the crew remained on board until 27 October 1915, when cracks threatened to sink the ship. It remained afloat until finally sinking on 21 November.

The 28 men used the preserved lifeboats to set up *Patience Camp* on the ice until April 1916 when they departed in a lifeboat for Elephant Island. Each crew member could pack two pounds of personal belongings – plus a banjo, which Shackleton declared vital mental medicine! From Elephant Island, Shackleton and a few of his men completed a final two-week leg back to South Georgia, only to reach the Stromness whaling station on the 'wrong' end of the island in a terrible storm. A day-and-a-half-long march across the island later, the exhausted expedition returned to Grytviken. From there, it took Shackleton nearly four and a half months and several attempts to finally rescue his last men from Elephant Island.

History credits the survival of the crew of the *Endurance* to the extraordinary leadership of Sir Ernest Shackleton, emphasising his heroic actions of self-sacrifice and morale-boosting optimism. From sharing his gloves and ordering his men to sleep to keep them energised, to defying all odds to bring everyone home alive, it seems his crew's trust was well-earned.



*“By Endurance
We Conquer.”*

– The Shackleton
family motto



Elephant Island

On 15 April 1916, Shackleton and his crew reached land for the first time in 497 days, on Elephant Island, where the last of the crew were rescued on 30 August 1916.



The Journey

- 1 5 Dec. 1914 – The *Endurance* departs from Grytviken, South Georgia.
- 2 18 Jan. 1915 – After navigating the icy Weddell Sea for weeks, the *Endurance* becomes trapped in the ice.
- 3 21 Nov. 1915 – Weeks after the ship's hull begins to crack, it sinks off the Antarctic coast.
- 4 15 Apr. 1916 – Two weeks after leaving *Patience Camp* in one of the lifeboats, the crew arrives at Elephant Island.
- 5 21 May 1916 – Shackleton and the first few crew members reach South Georgia
- 6 30 Aug. 1916 – The last of the crew are finally rescued from Elephant Island



From the LEGO® Design Team

"To determine the scale of the model, we first picked a significant detail, the lifeboats (which came in two different sizes) and built them as small and detailed as we could. From there, we calculated what the ship's dimensions would be. Whereas the real-life *Endurance* had room for 28 men, we scaled it down a little to include cabins for Sir Ernest Shackleton and an expedition scientist. The interior also reveals the ship's steam engine, which can be taken out. In real life, the steam engine was about as big as a two-storey house! LEGO® Icons display models usually feature cool functions, and we wanted a working rudder connected to the steering wheel. For this function we created a tiny gearbox based on an angle plate that now comes in dark brown for the first time. It's one of numerous element colour changes we made to give the ship its authentic look. After all, the *Endurance* was one of the strongest wooden ships ever built and deserves a proper tribute!"

*Hans Burkhard Schlömer,
LEGO® Model Designer*



*"After all, the
Endurance was one of
the strongest wooden
ships ever built and
deserves a proper
tribute!"*



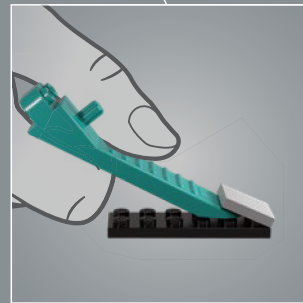
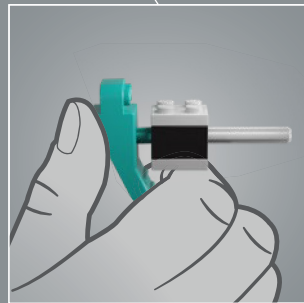
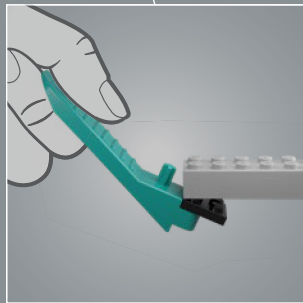
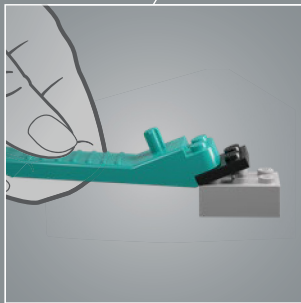
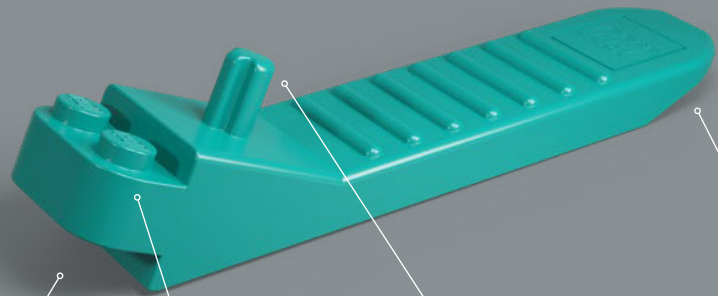

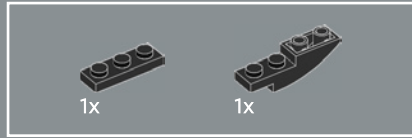

1

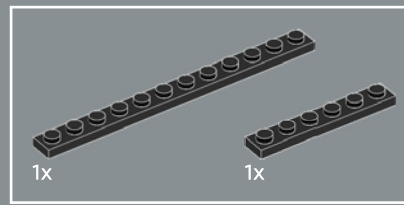
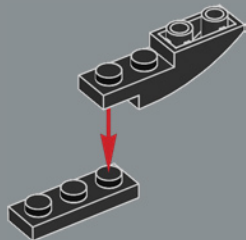

2

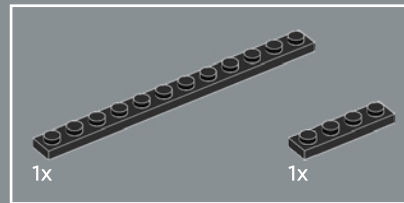
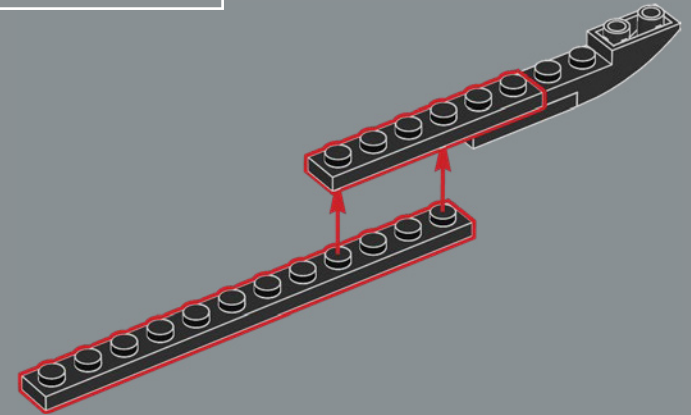

3

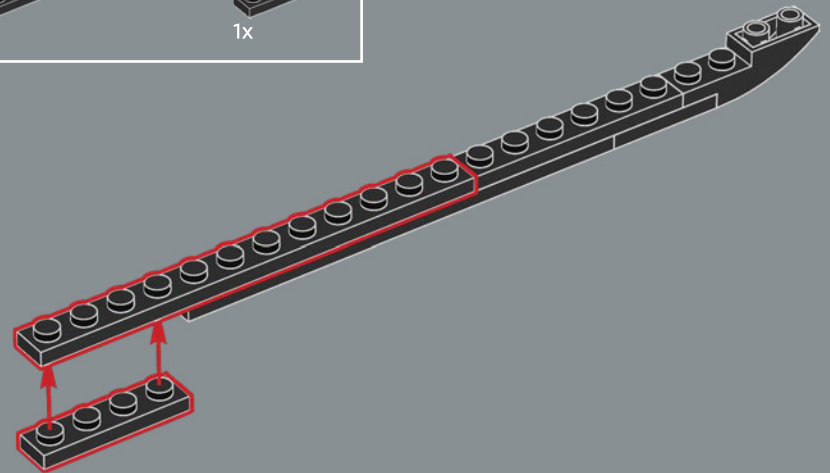

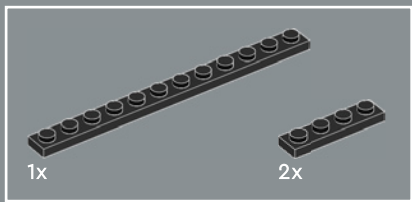

4

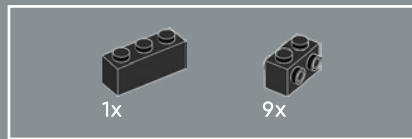
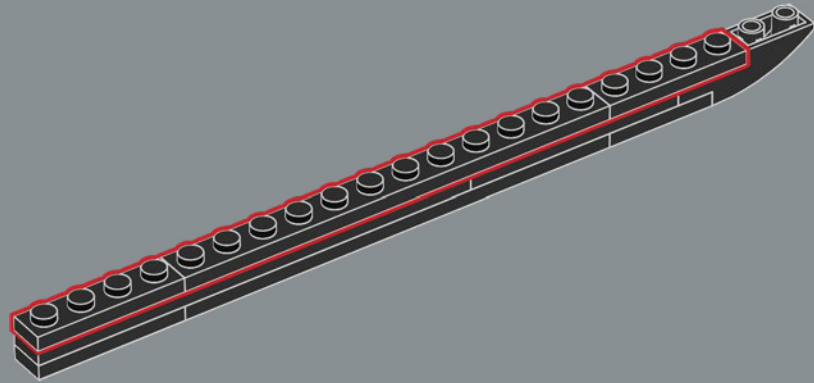

5

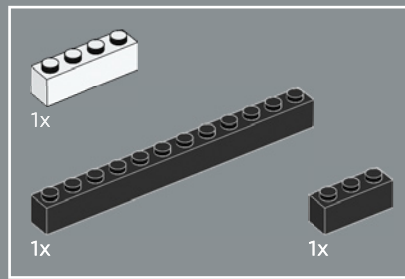
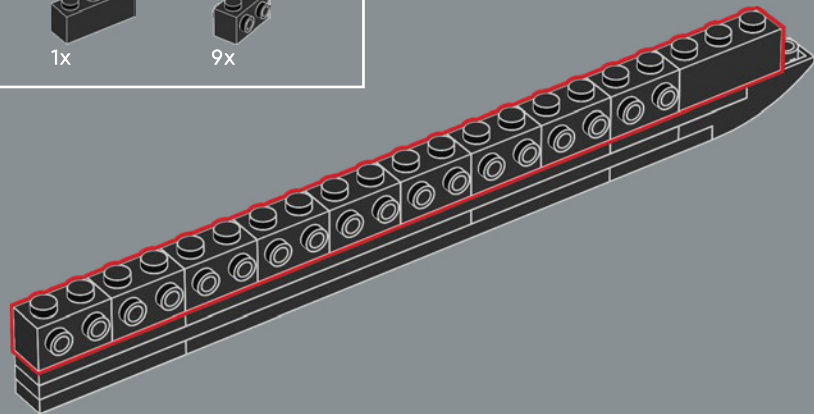

6

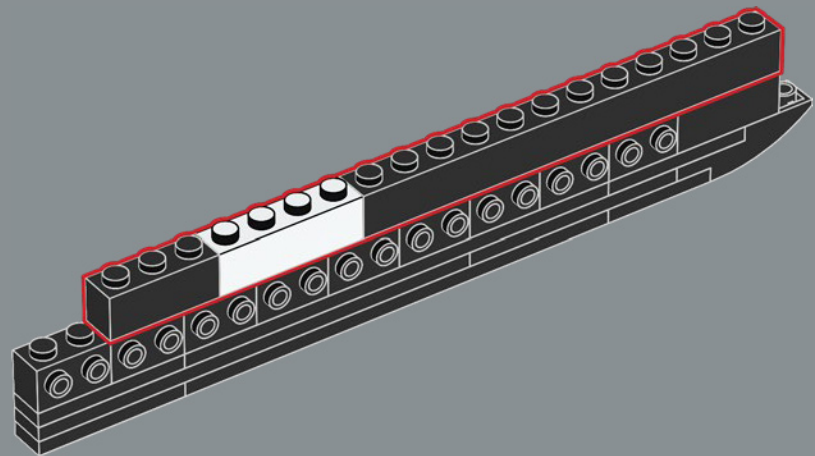

The keel is only one brick wide to keep the ship's sleek appearance, forming a wall in the front section with studs facing sideways. This technique creates a nice shape for the hull.



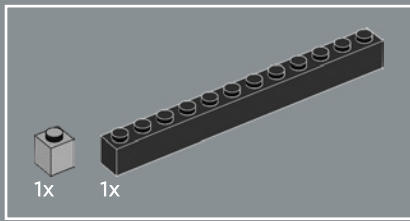

7

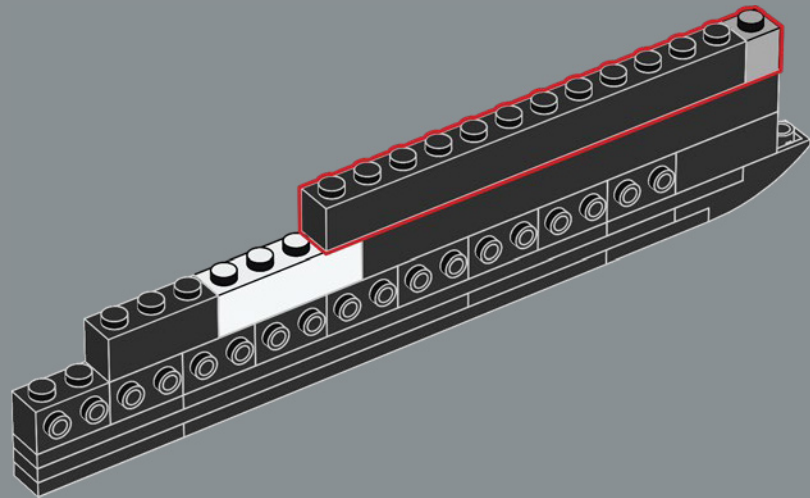

8

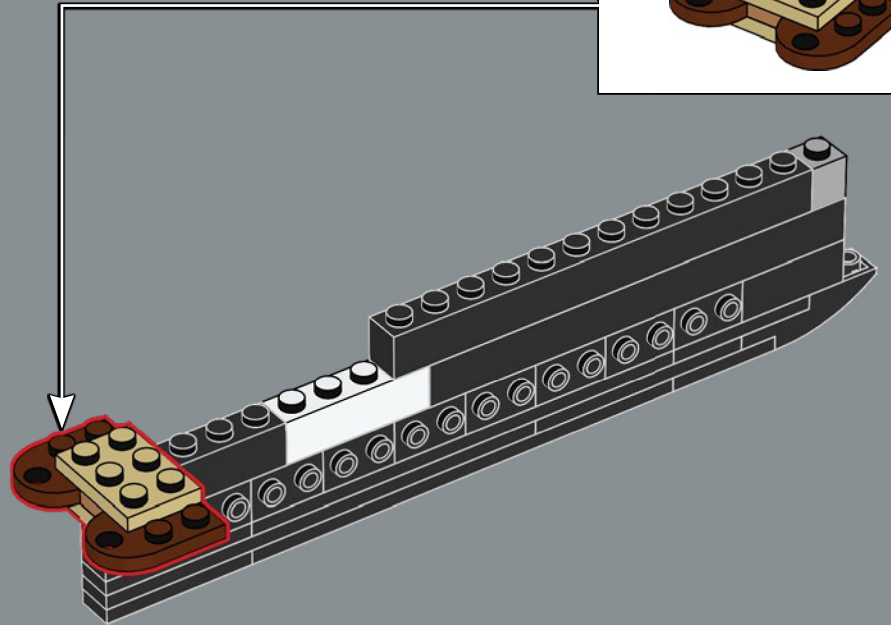

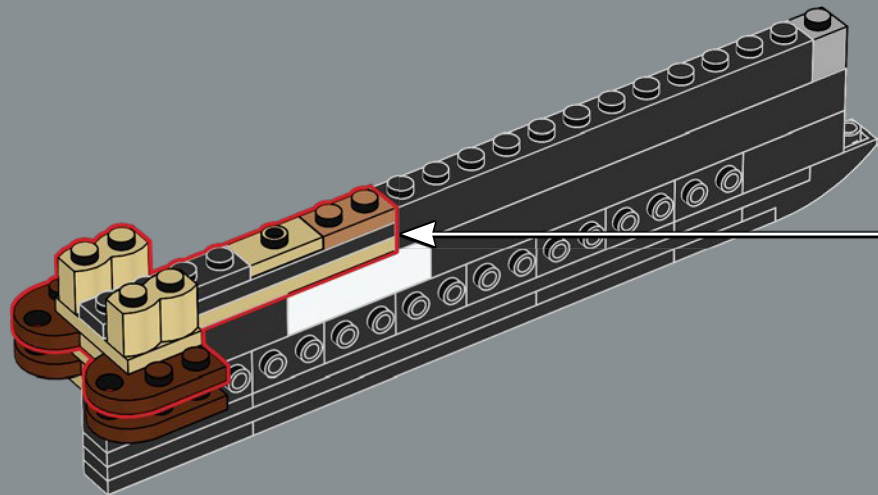
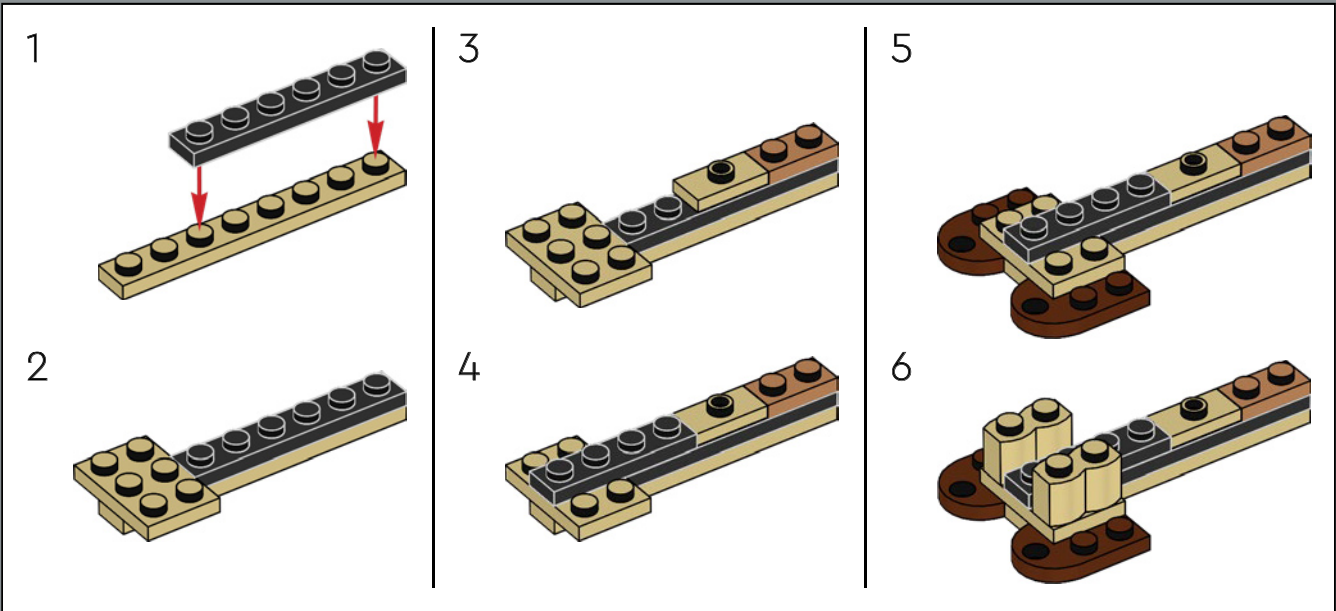
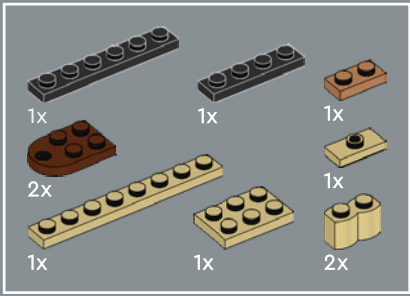

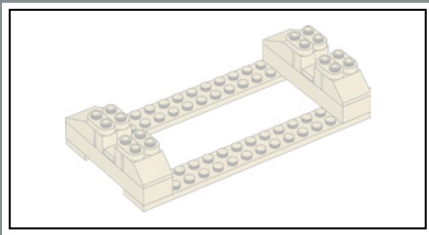

Because the keel is quite narrow, you can use the tan 'helper stand' to keep the model stable during construction.

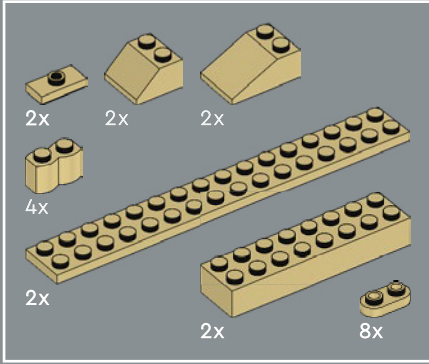

10

1

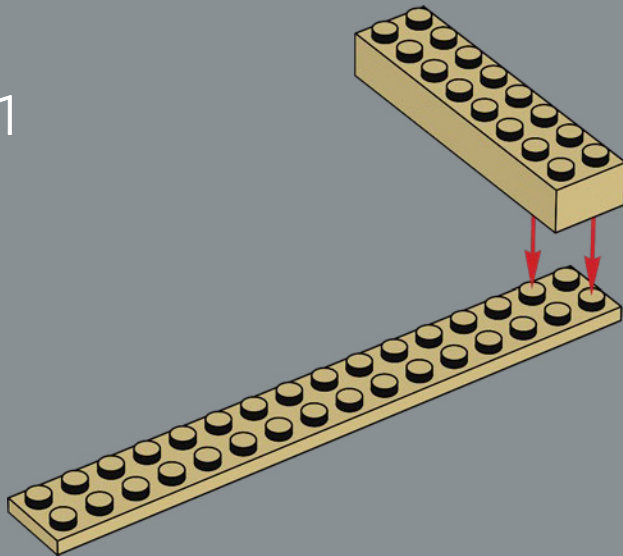

2

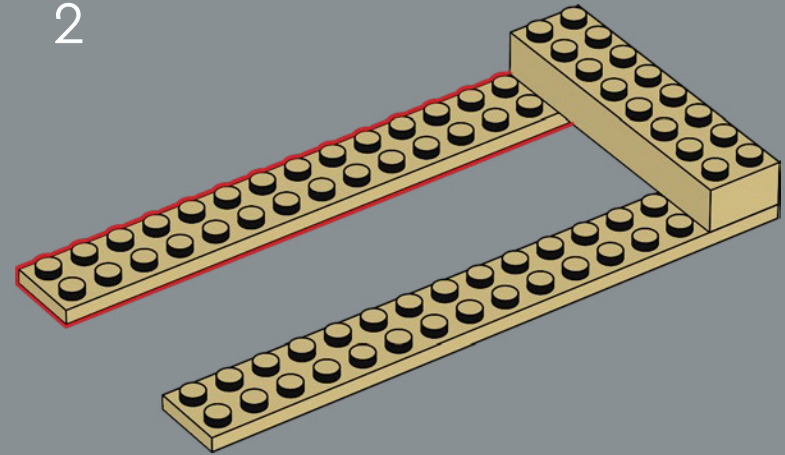

3

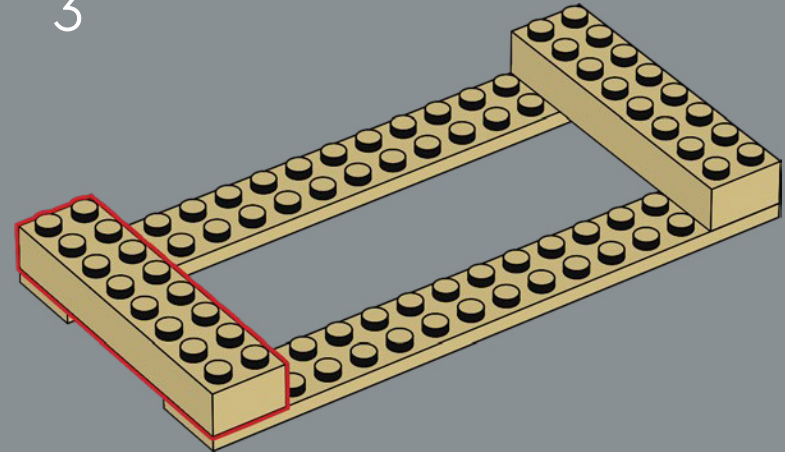

4

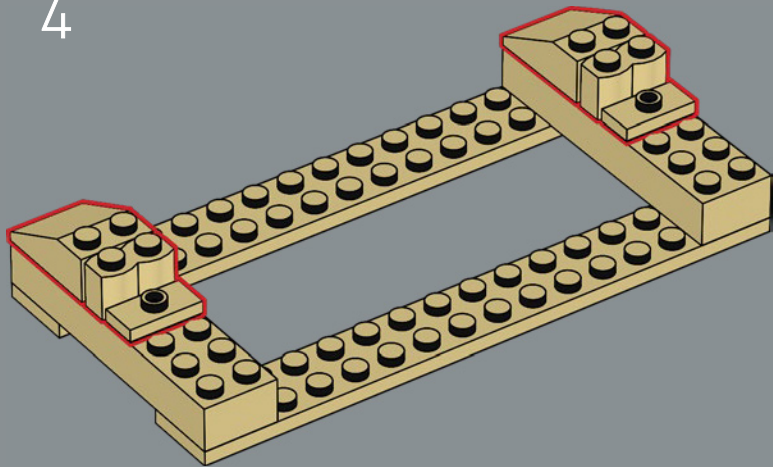

6

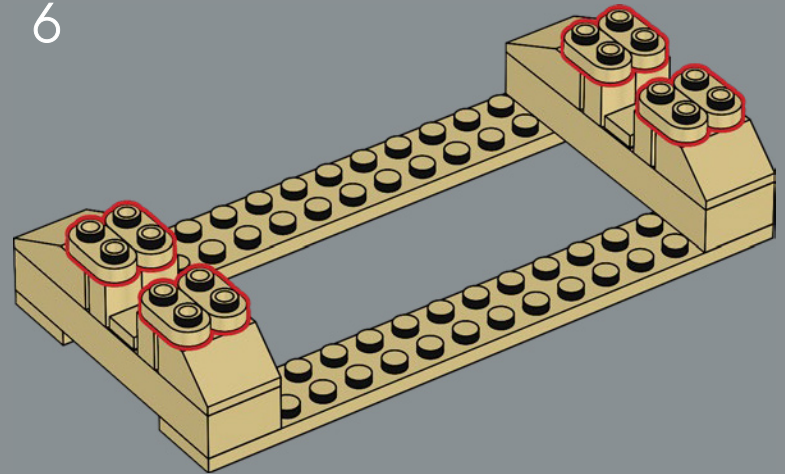

5

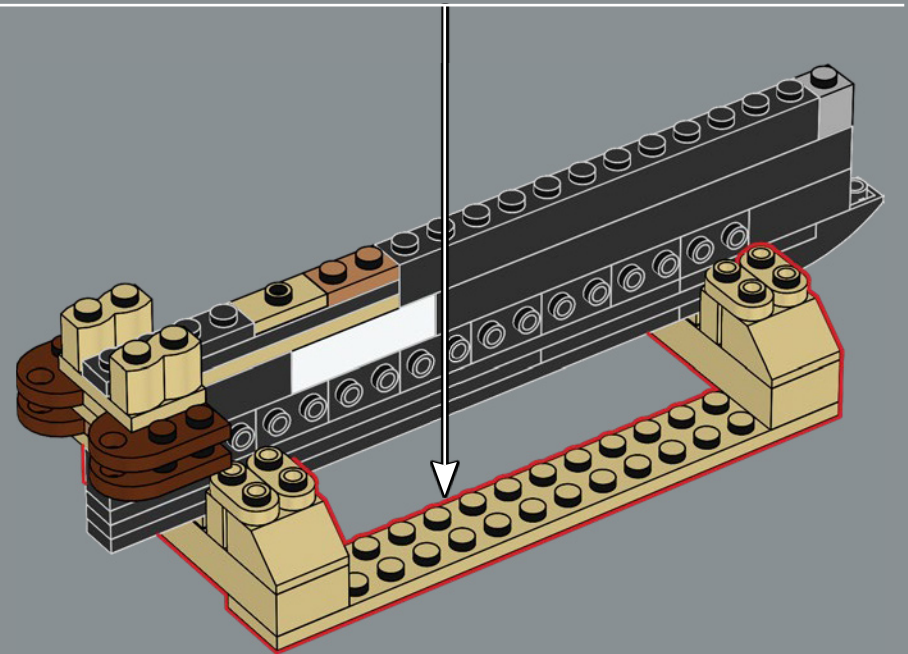
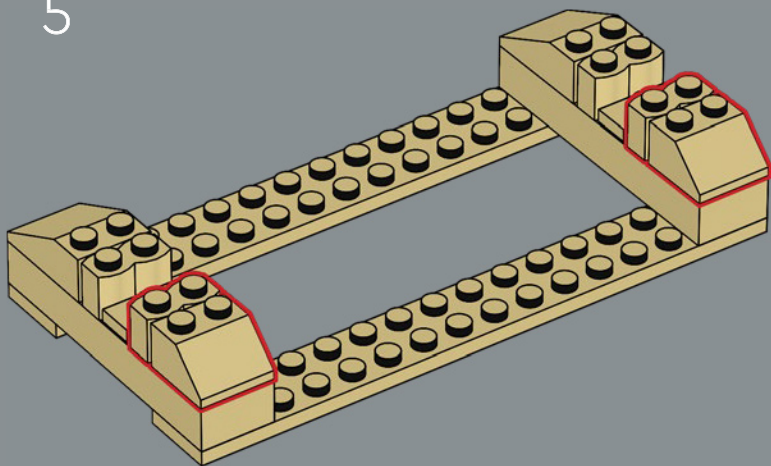

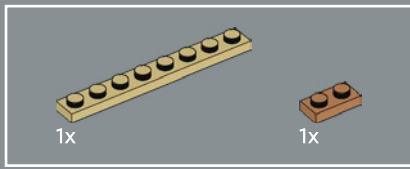

11

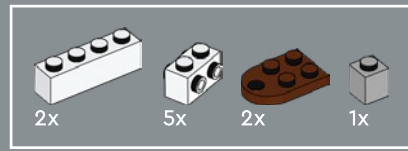
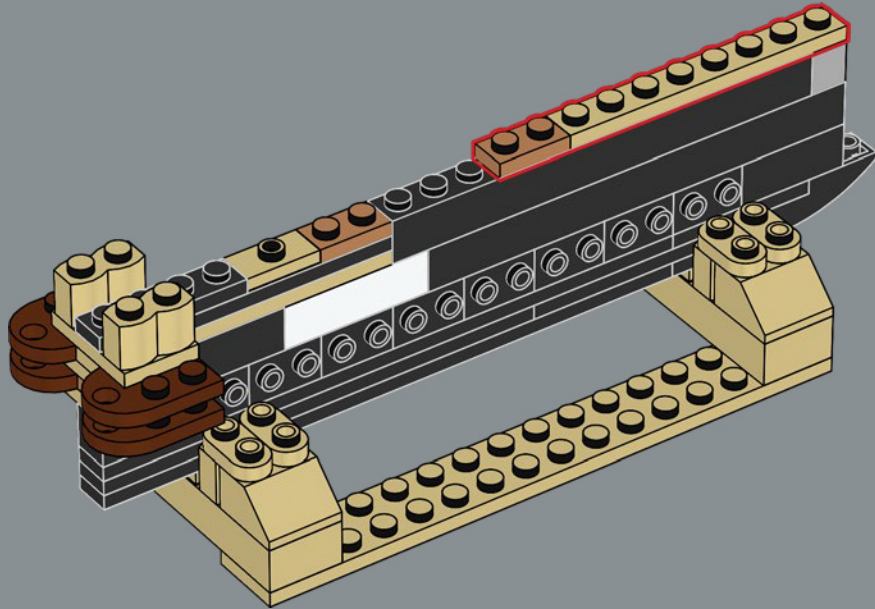

12

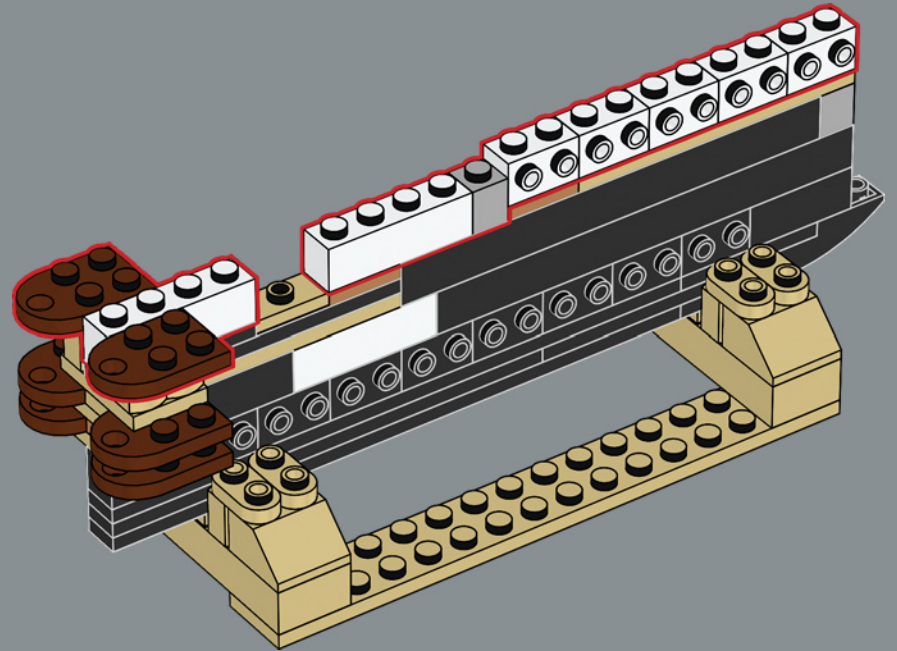

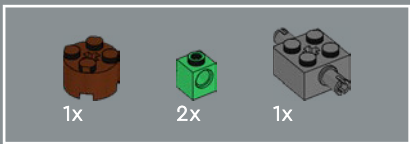

13

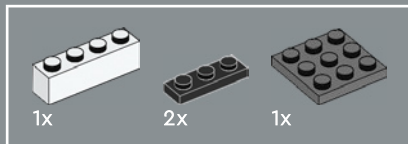
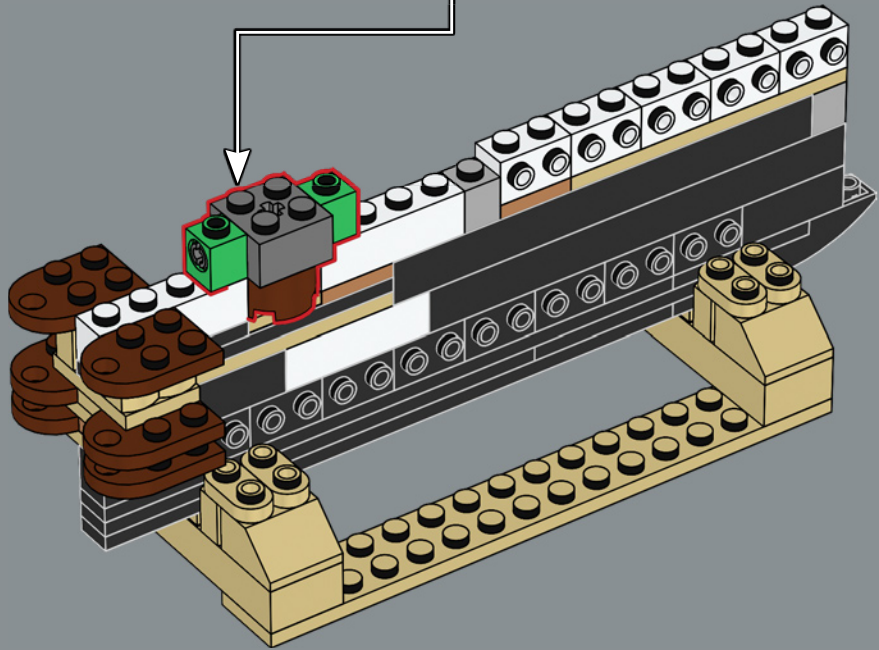
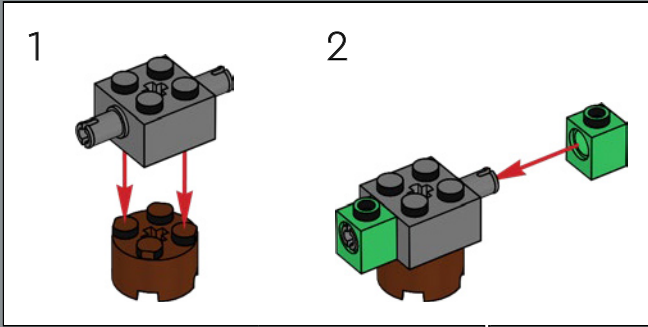

14

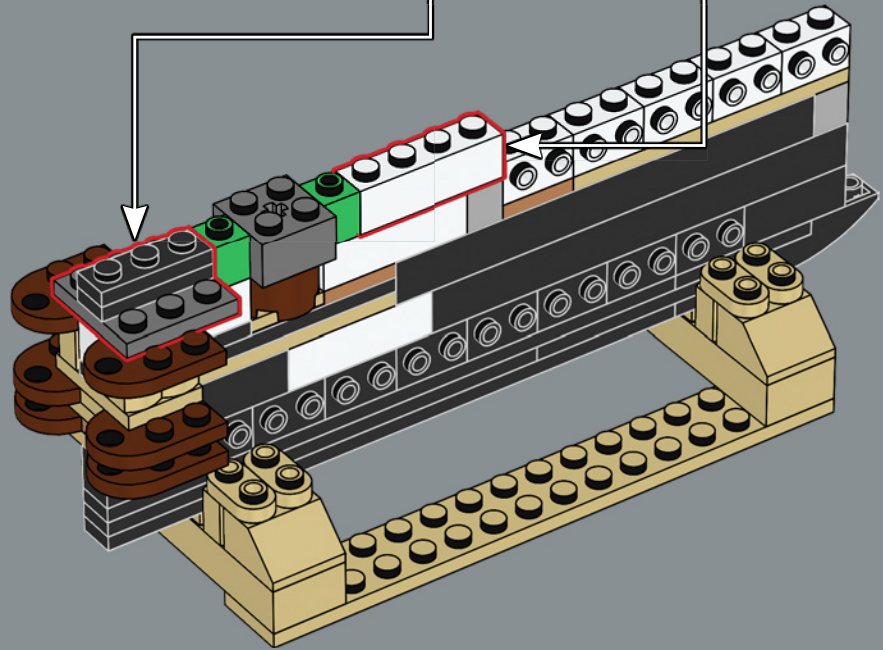
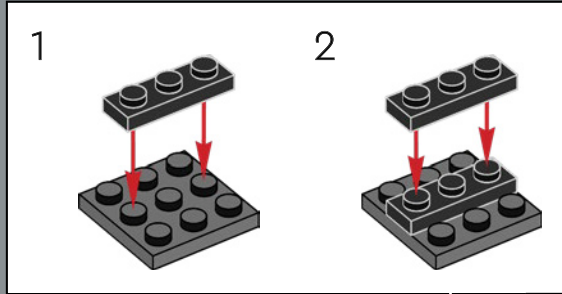

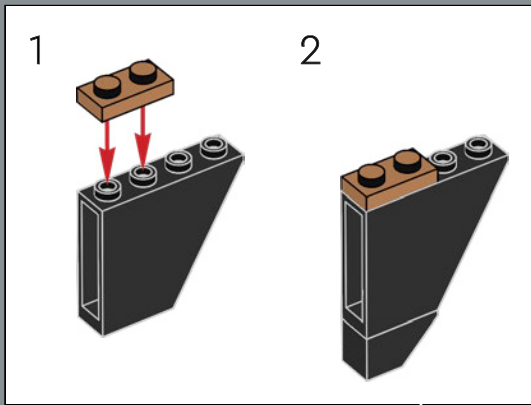
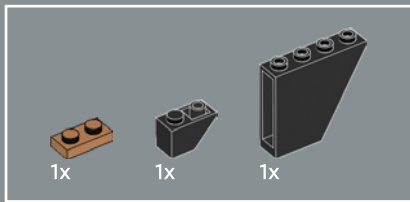

15

The ship hull's front was clad with metal sheets to protect the wooden keel from the polar ice. On the model, this section was recreated with a rarely used 1x4x3 inverted slope brick.

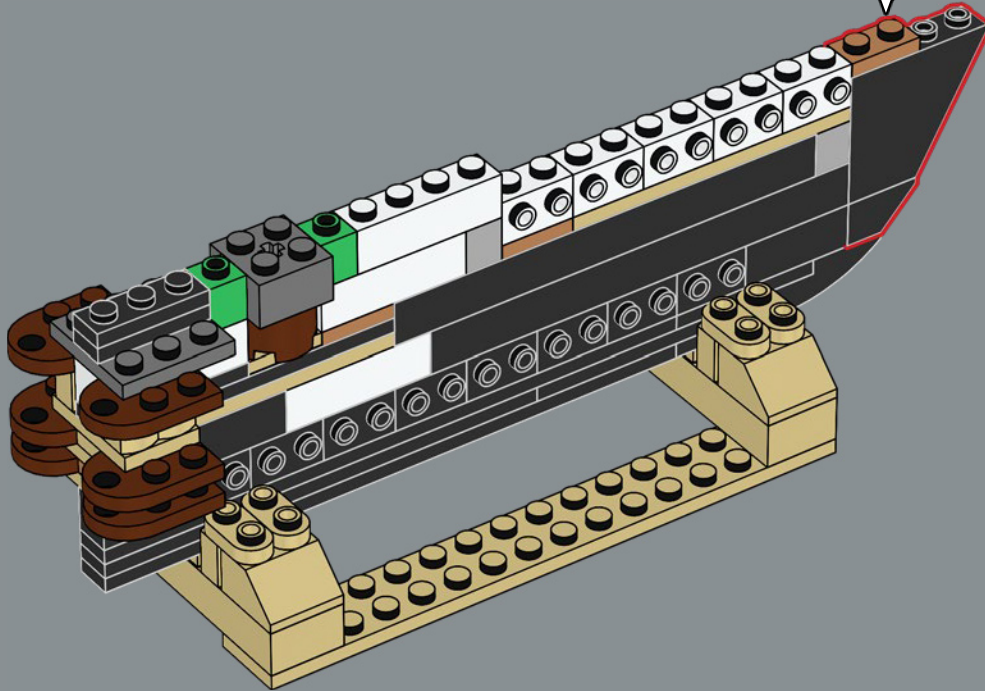

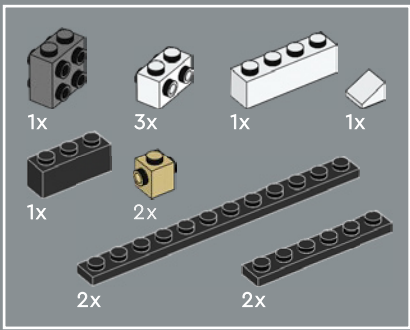

16

1

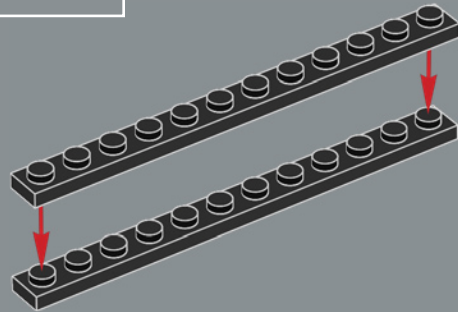

2

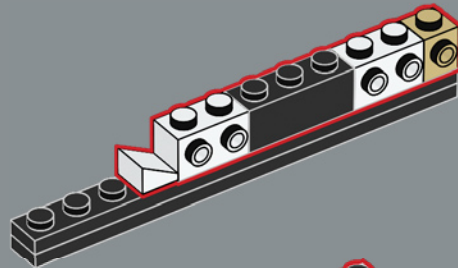

3

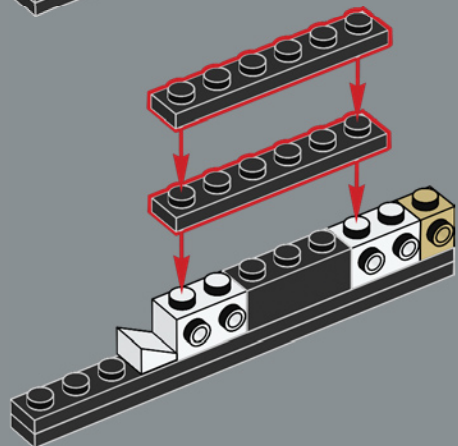

4

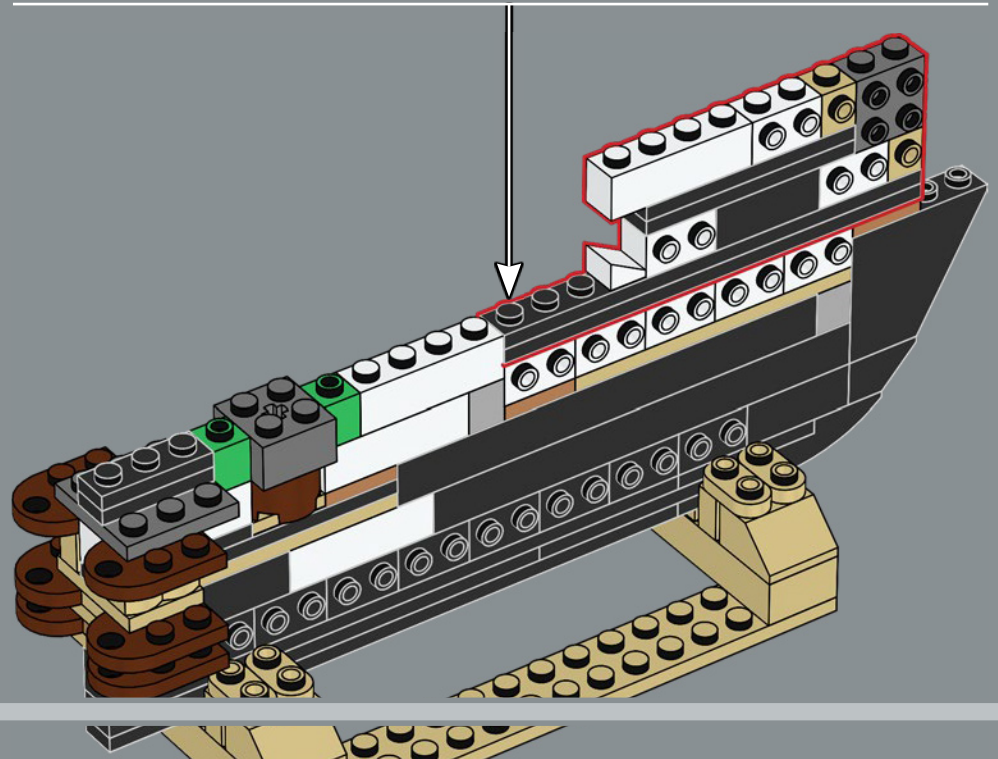
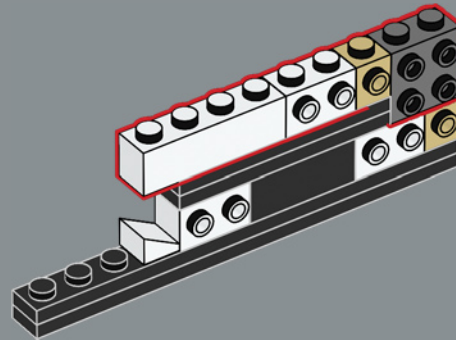

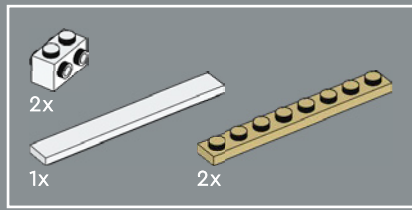

17

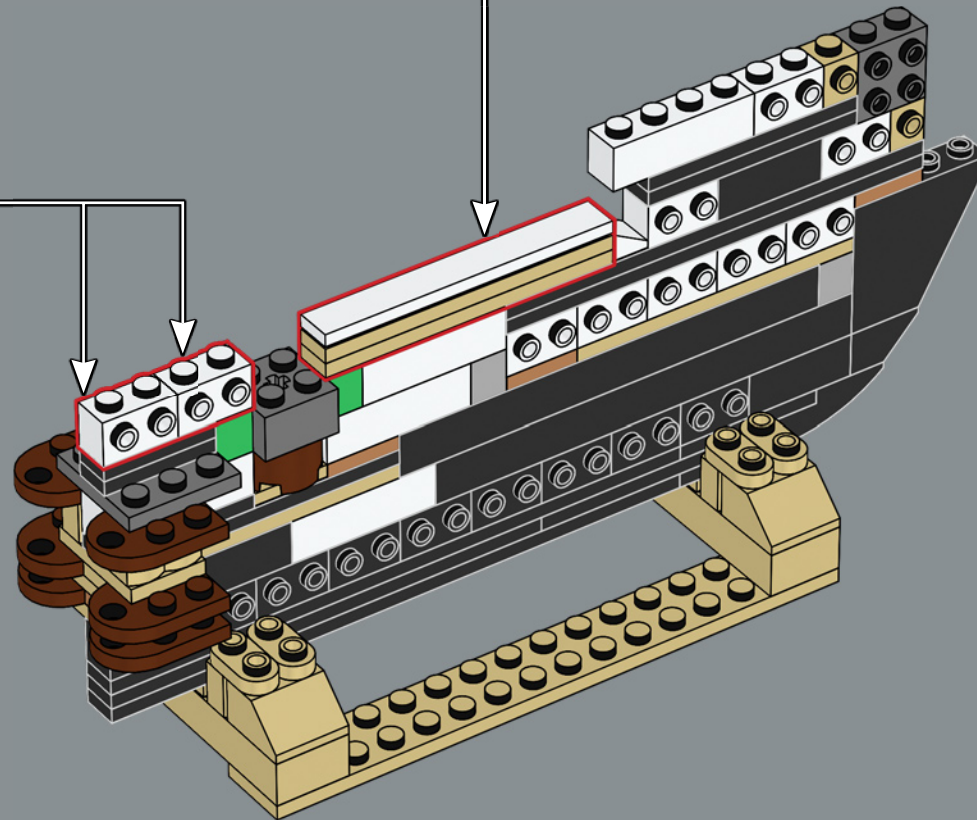
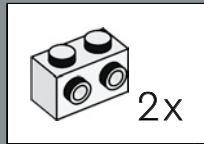
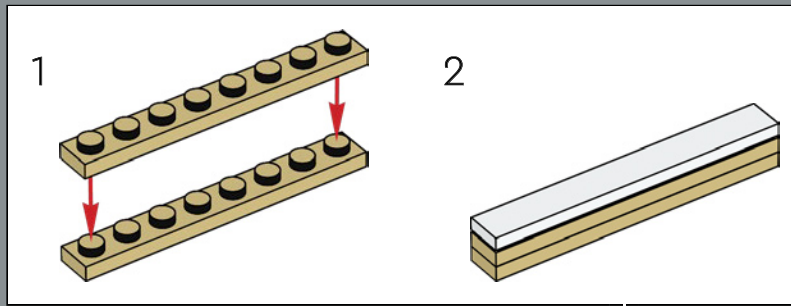

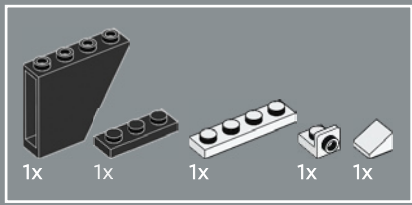

18

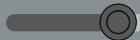
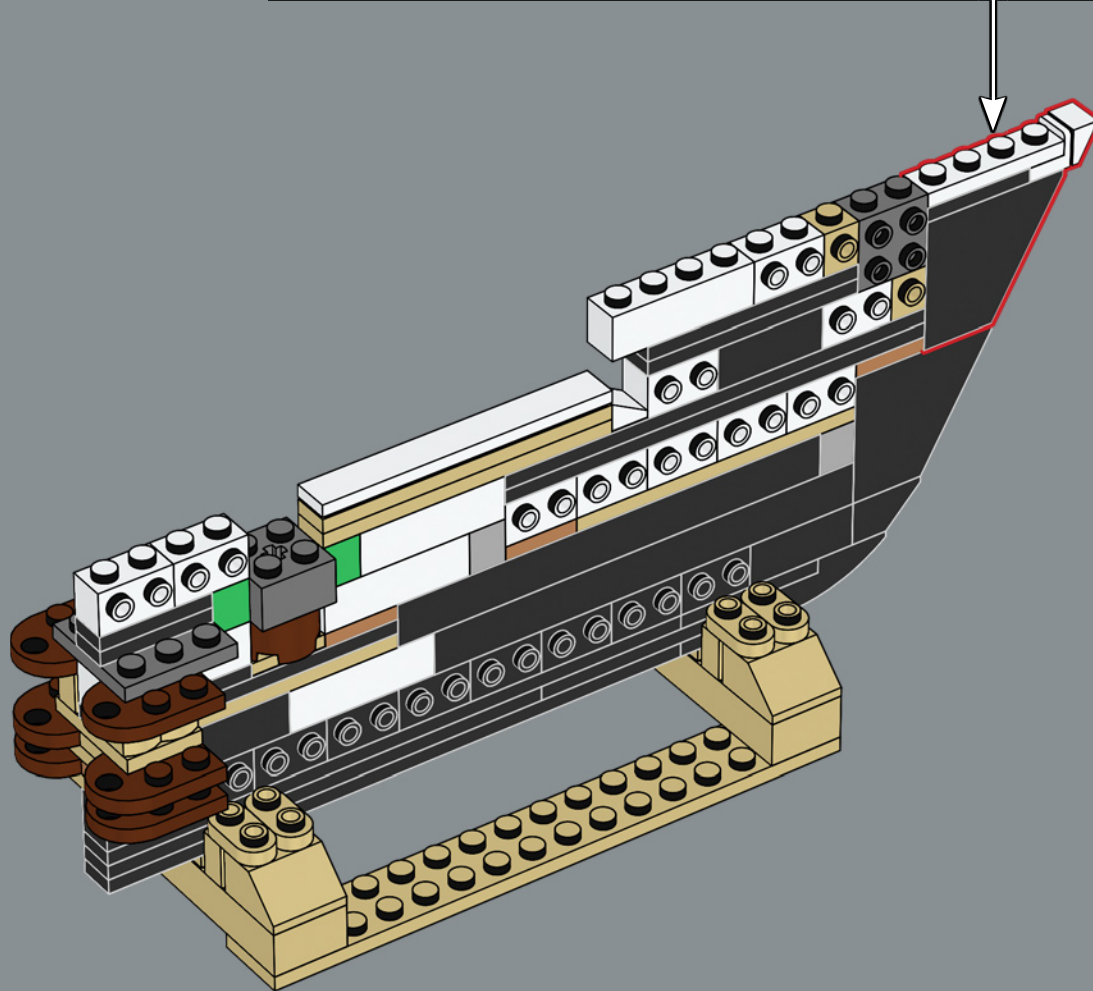
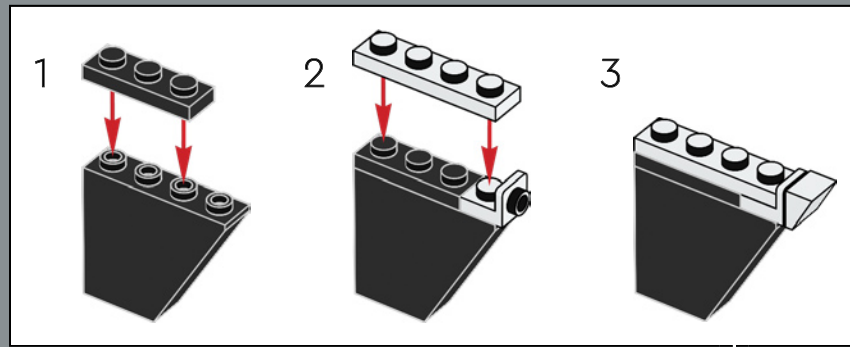

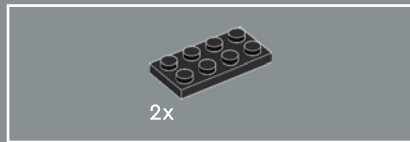
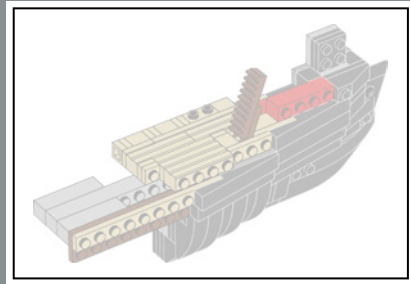

19

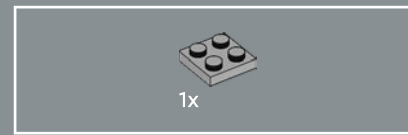
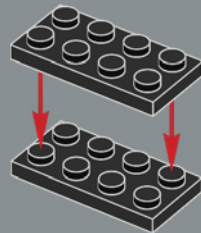

20

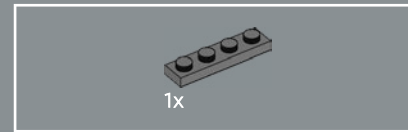
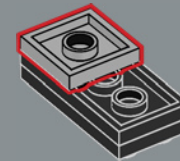

21

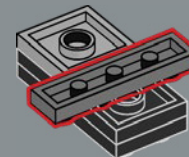

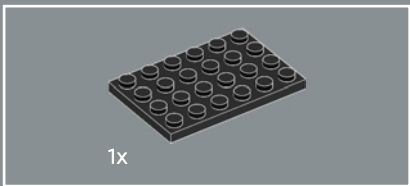

22

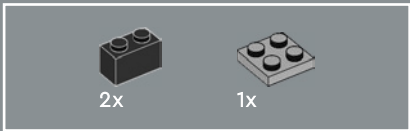
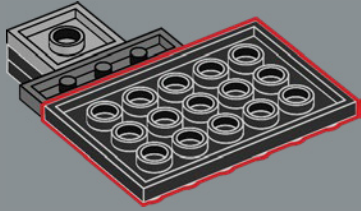

23

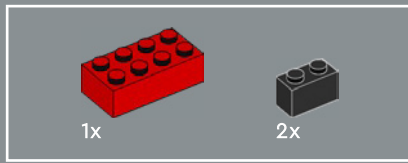
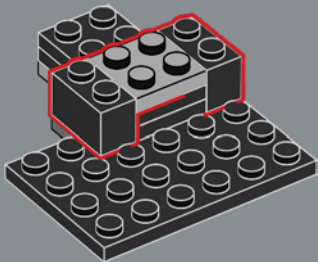

24

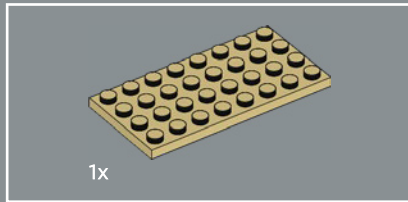
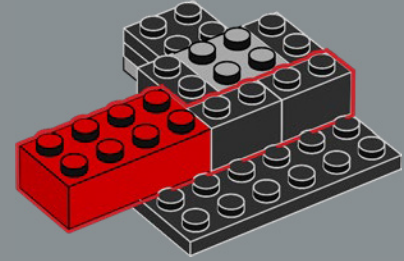

25

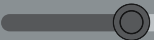
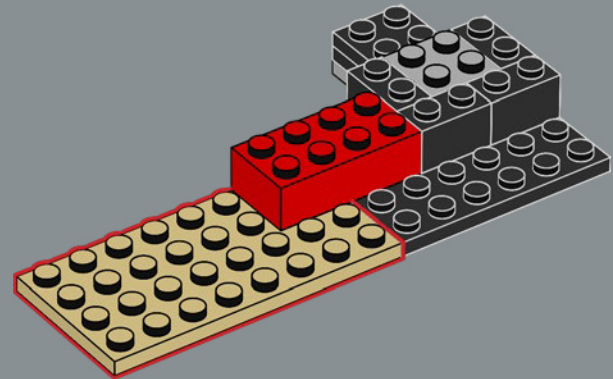

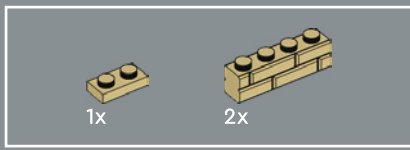

26

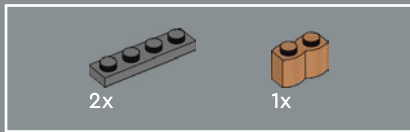
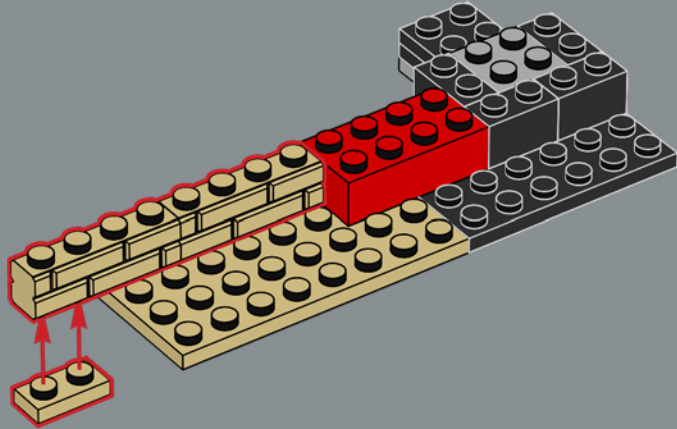

27

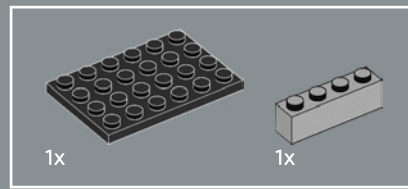
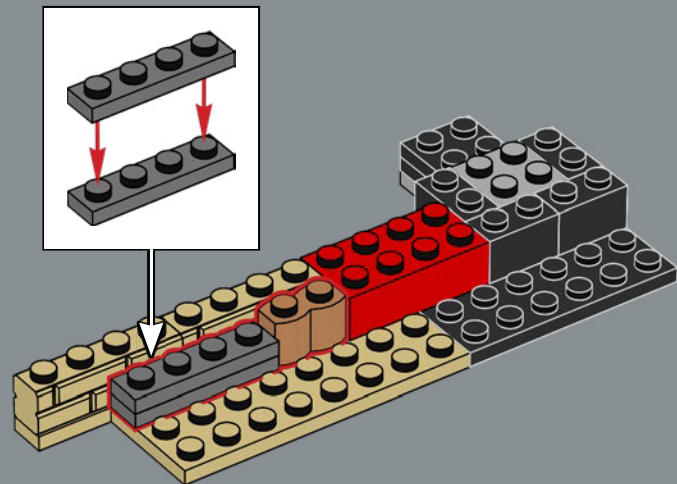

28

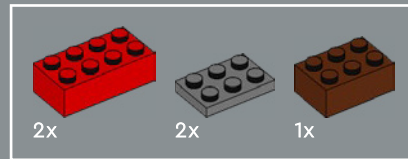
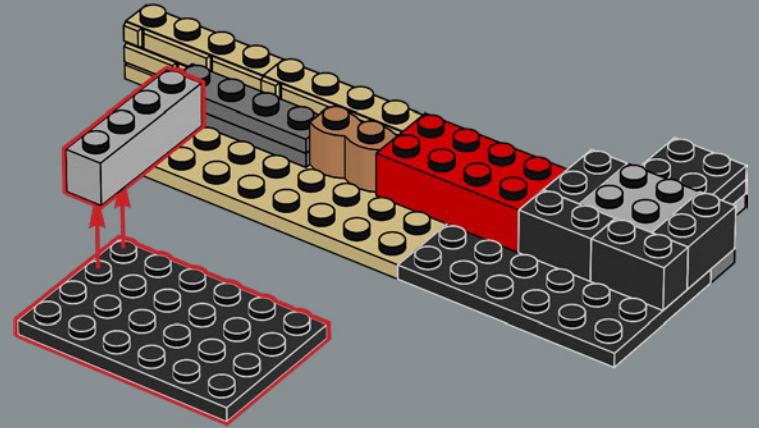

29

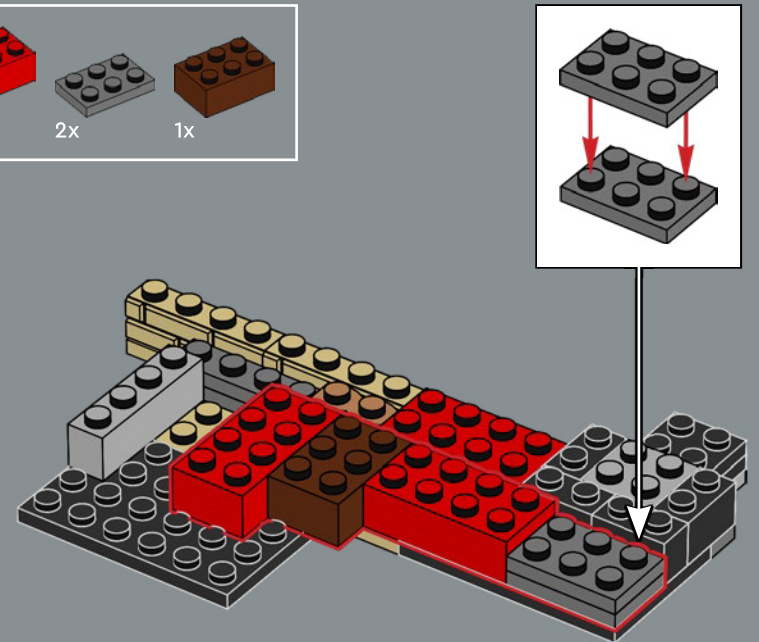

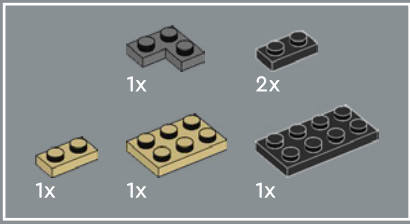

30

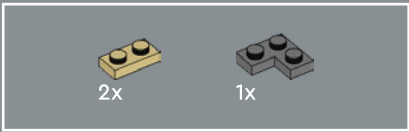
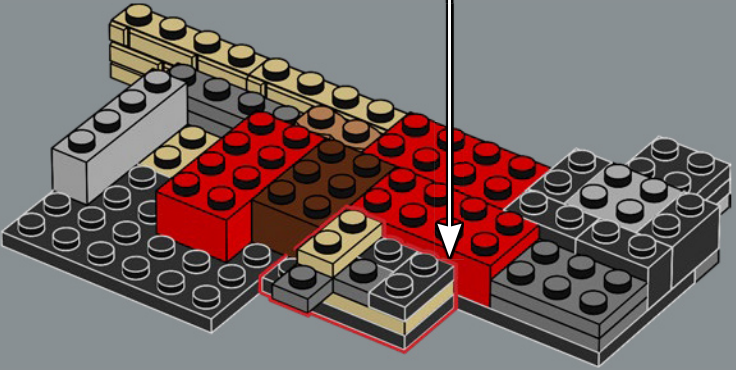
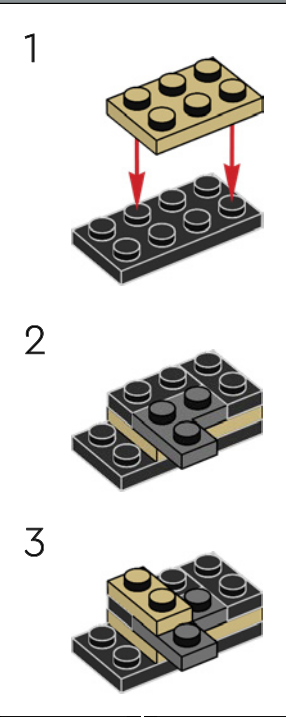

31

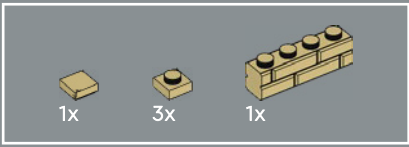
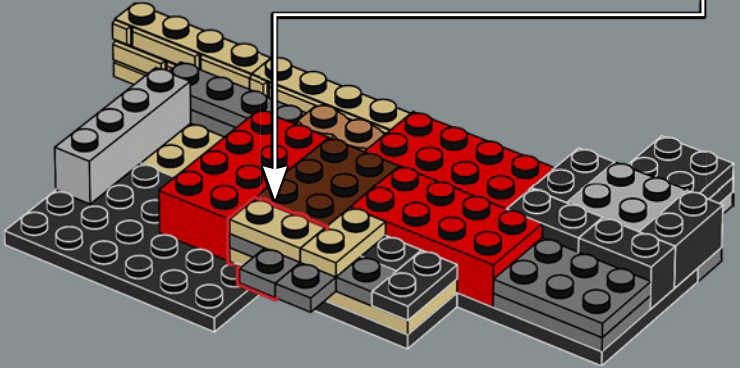
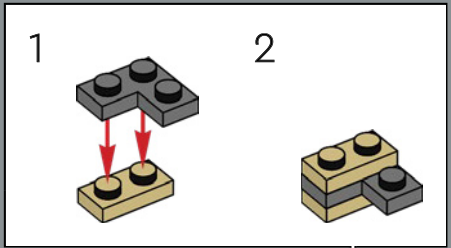

32

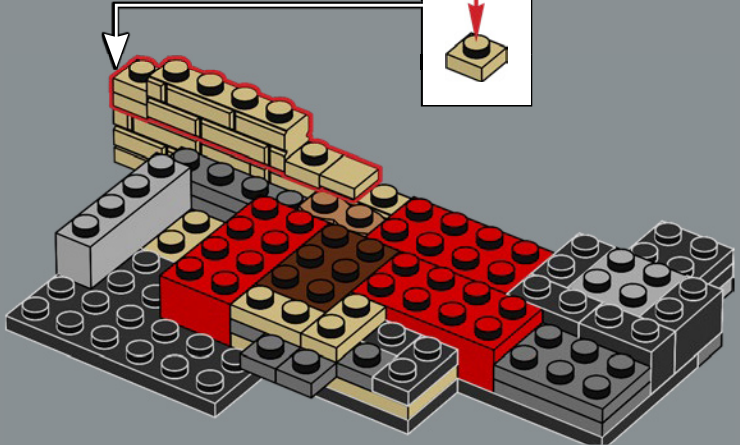
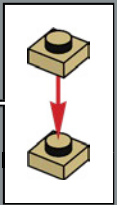

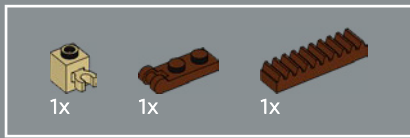

33

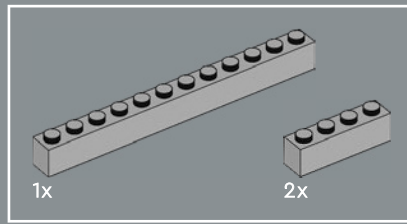
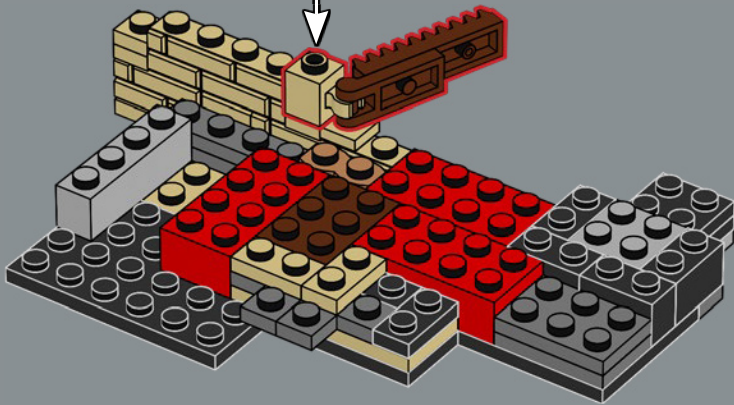
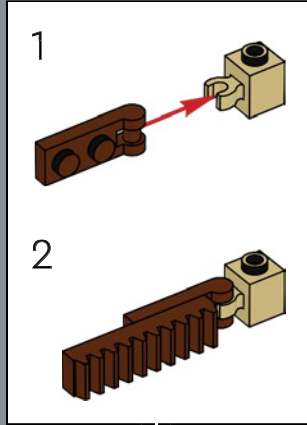

34

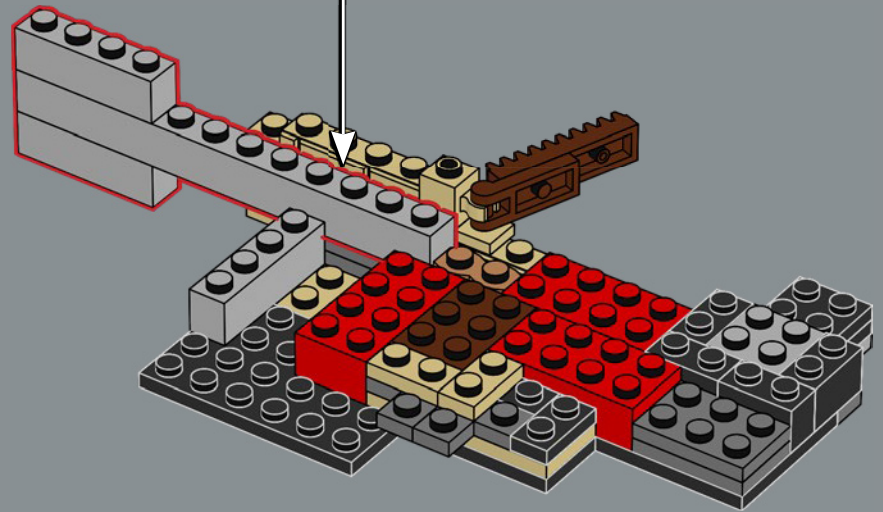
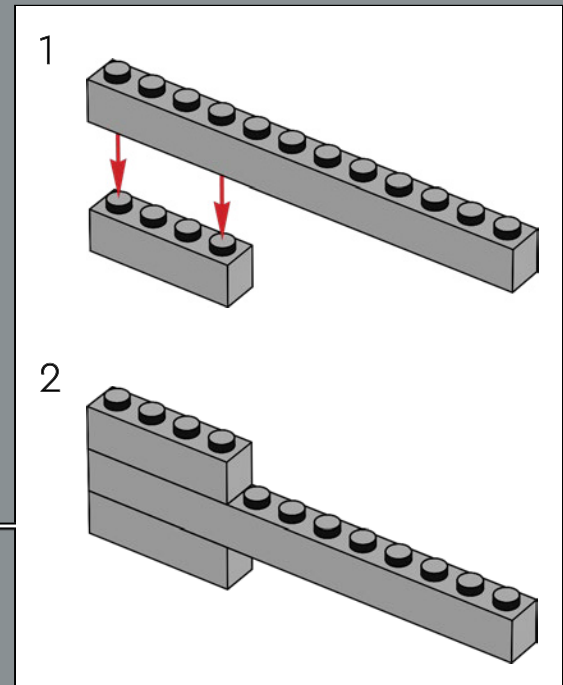

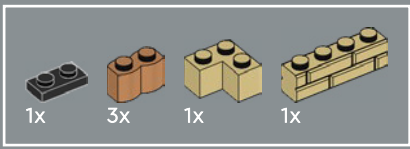

35

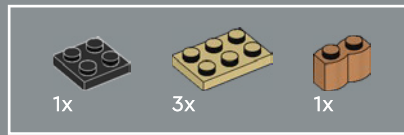
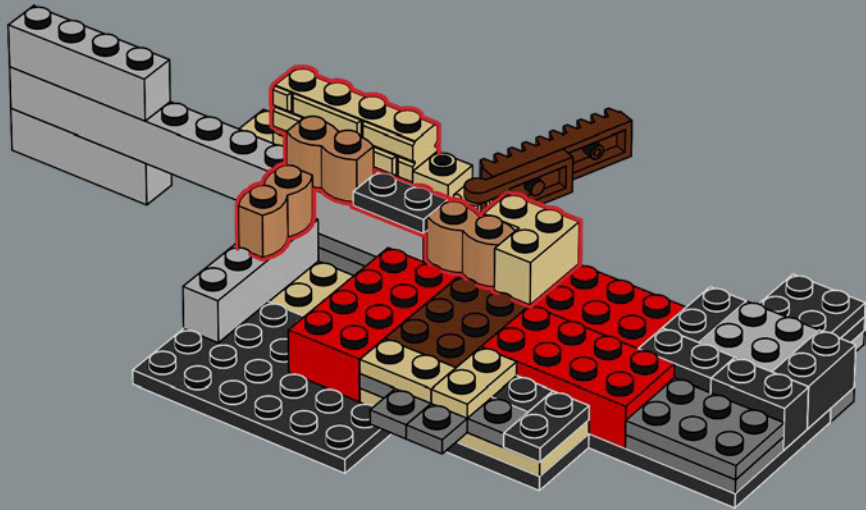

36

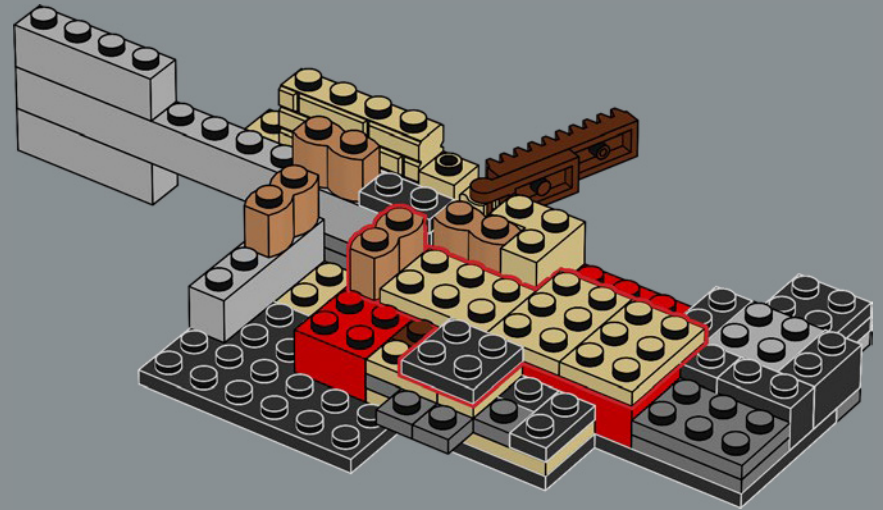

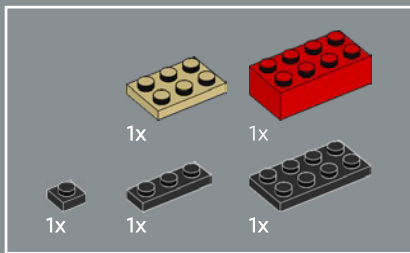

37

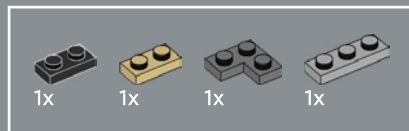
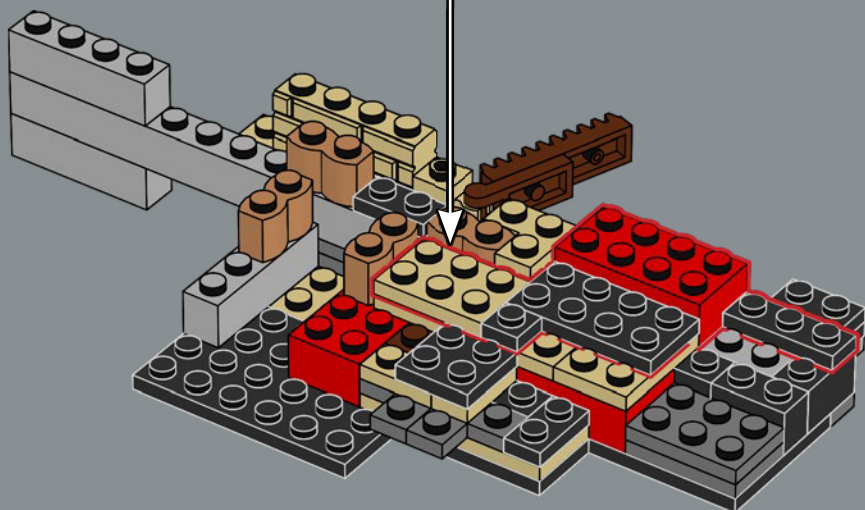
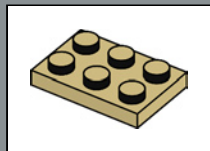

38

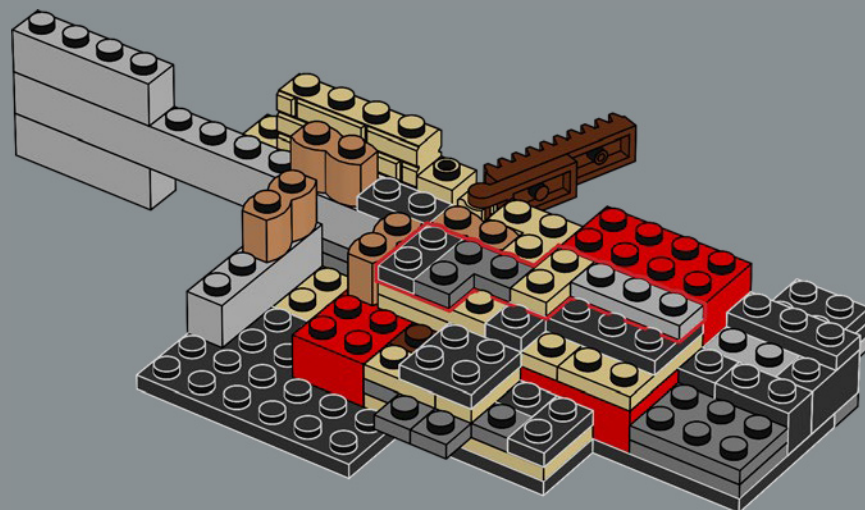

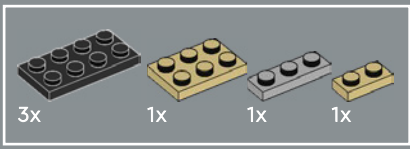

39

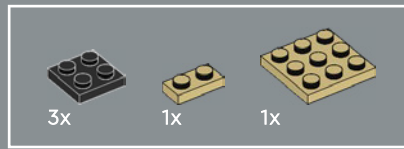
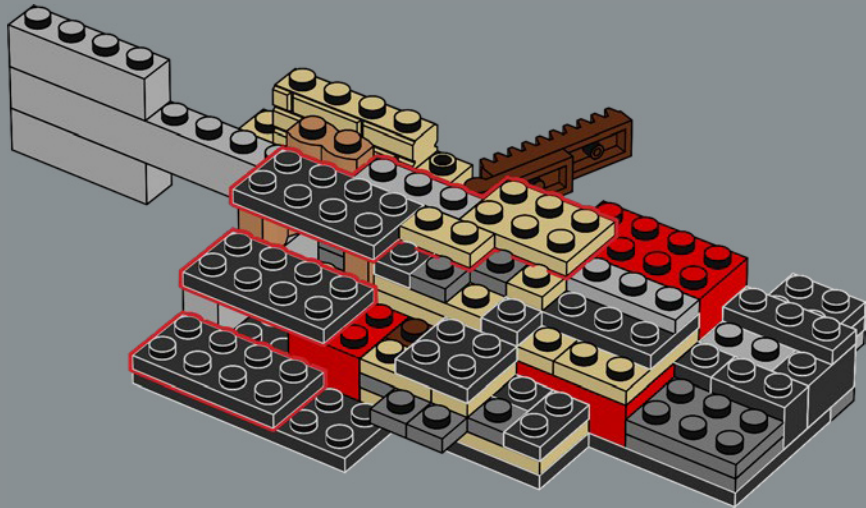

40

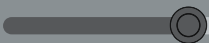
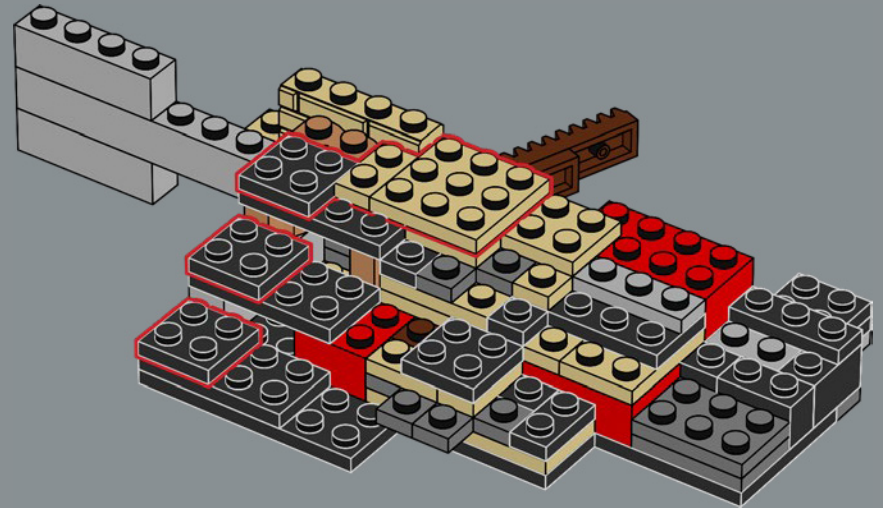

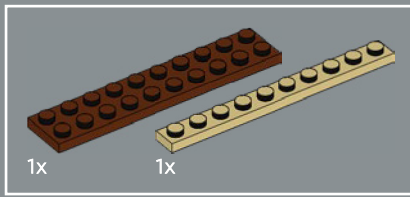

41

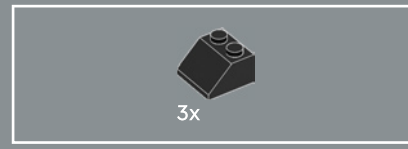
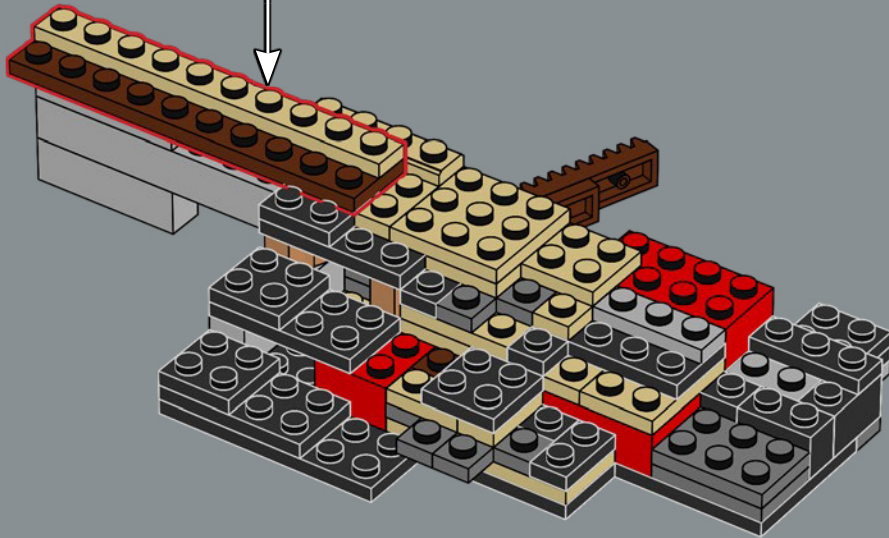
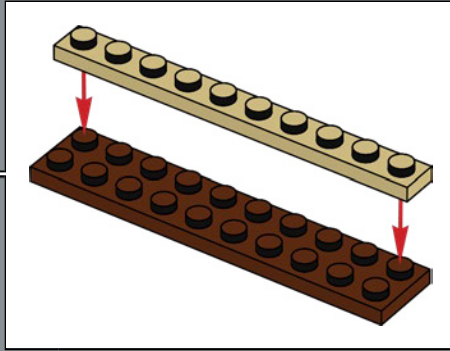

42

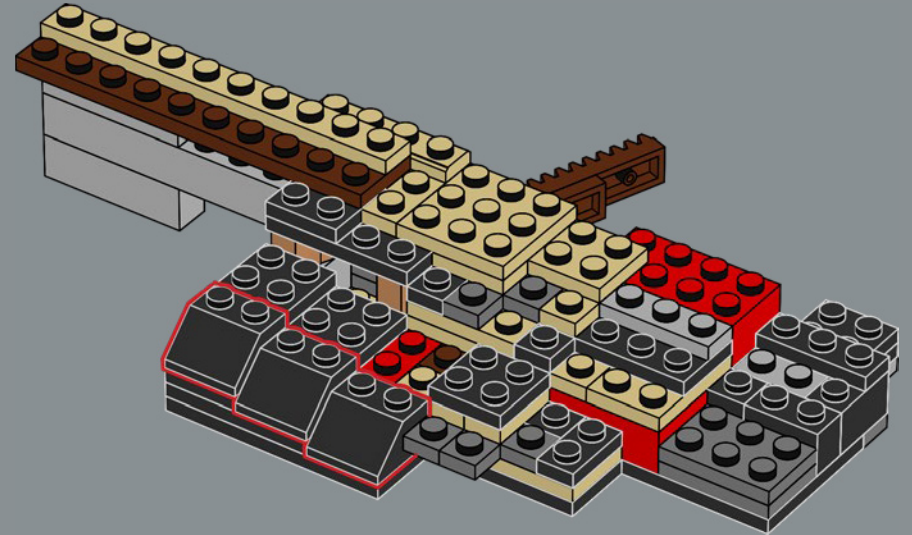



43

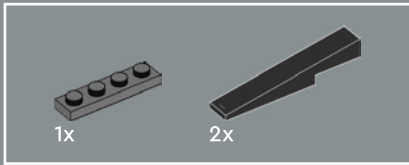
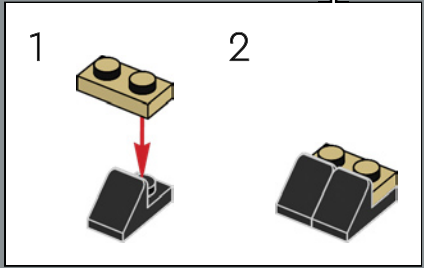
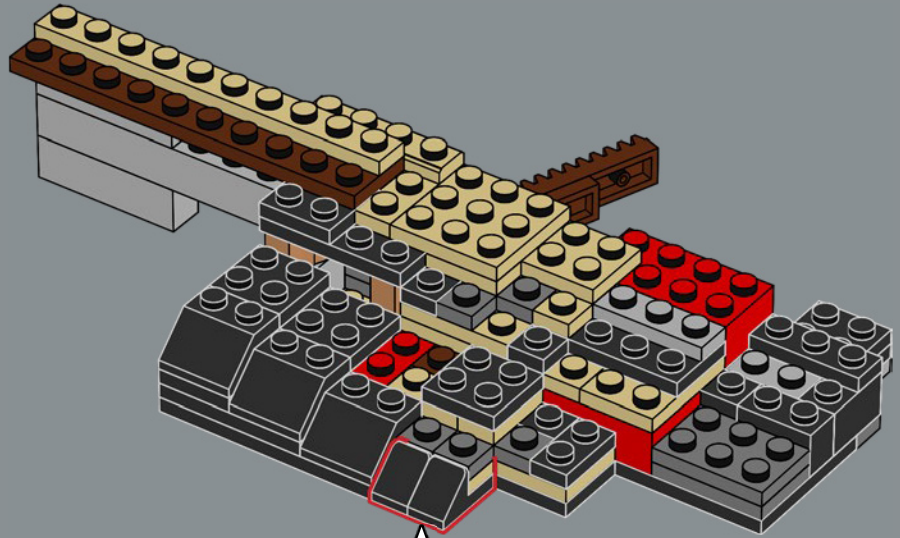

44

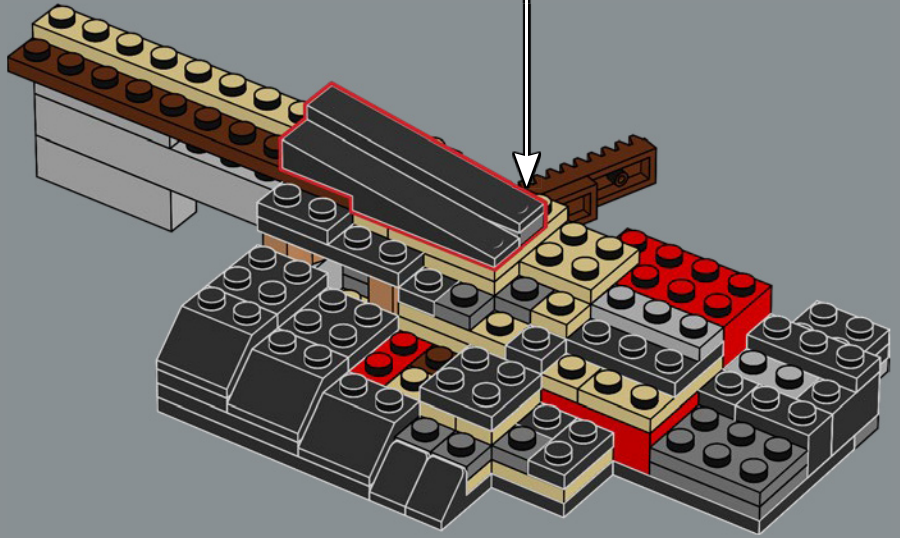
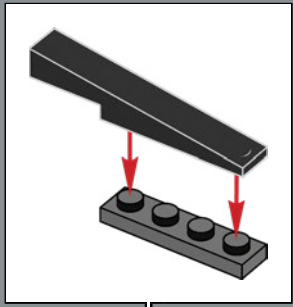



45

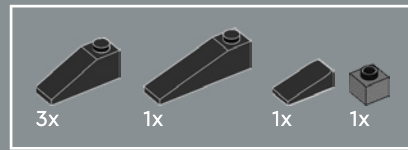
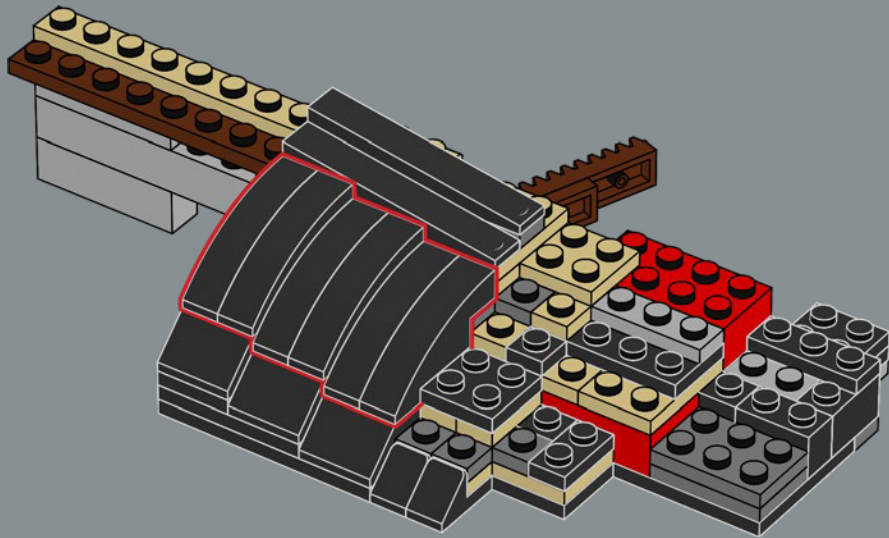

46

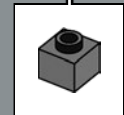
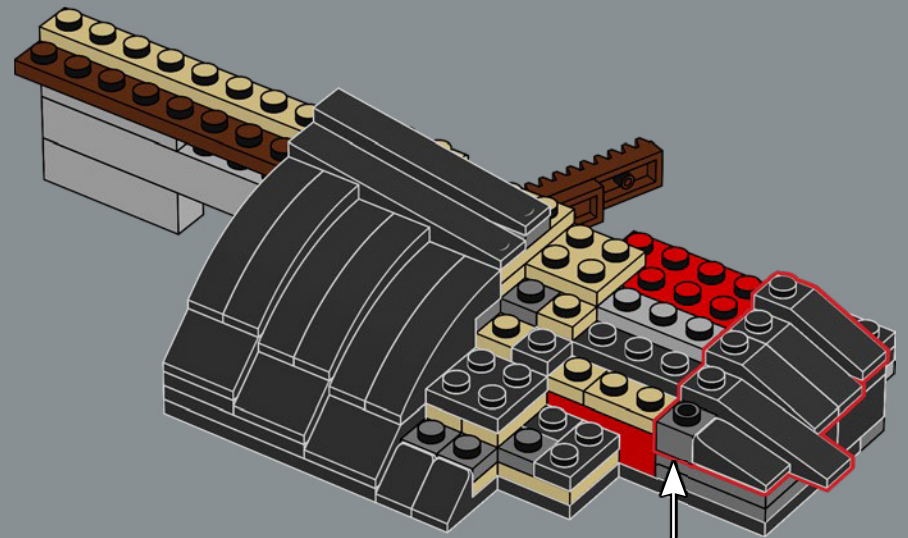

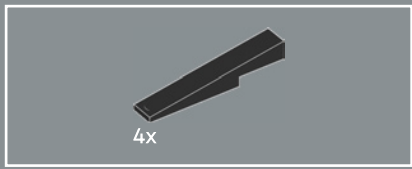

47

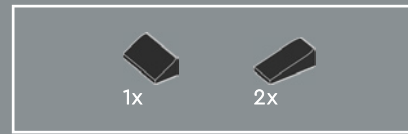
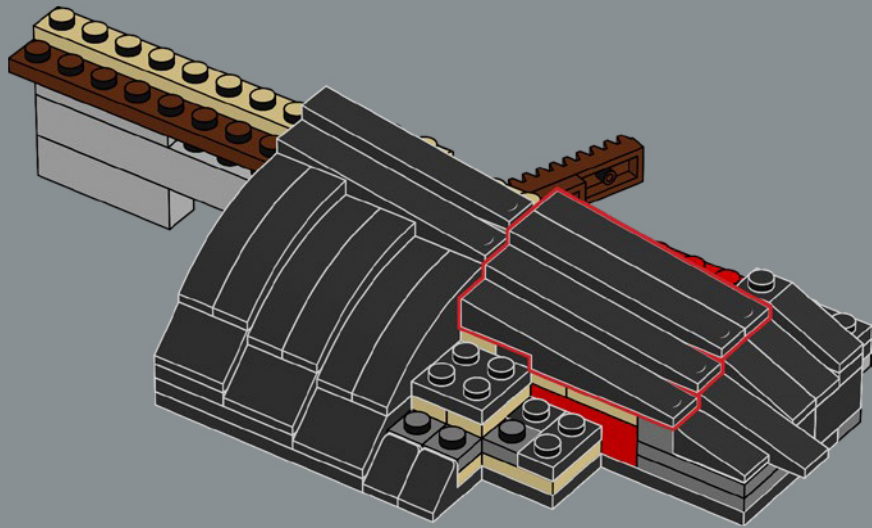

48

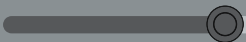
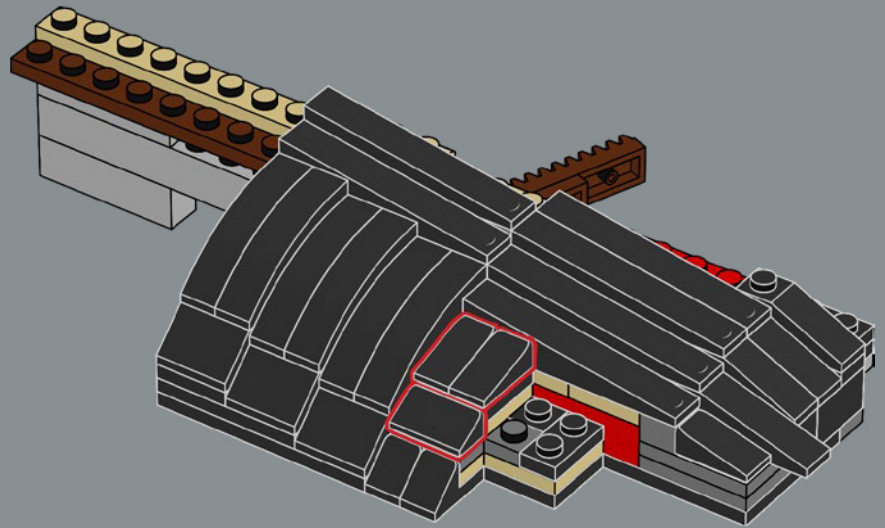

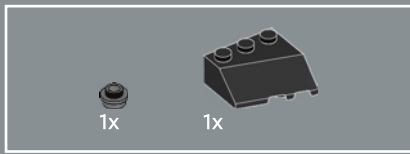

49

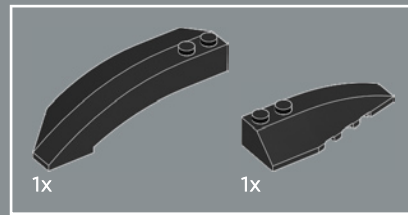
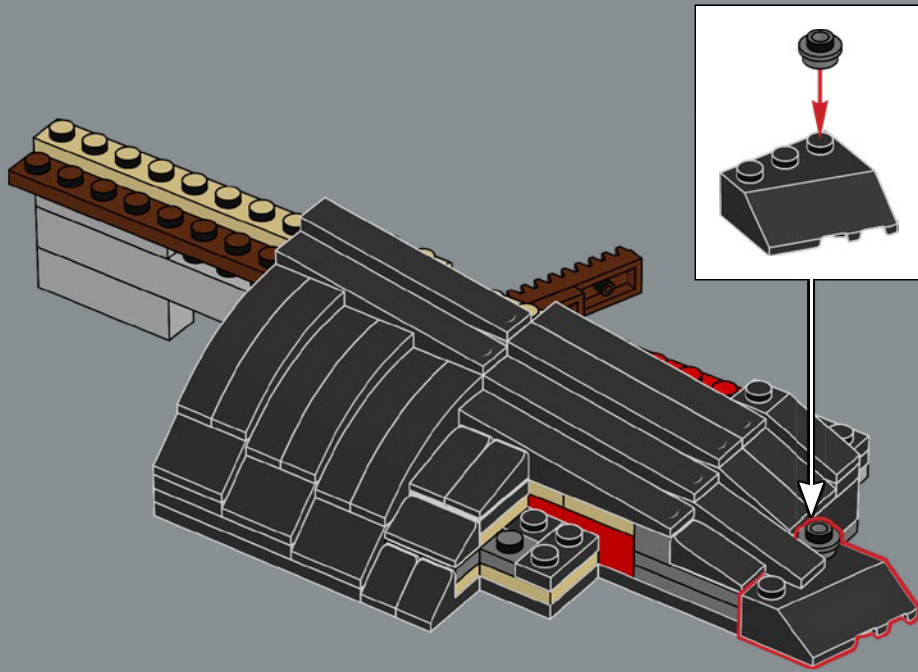

50

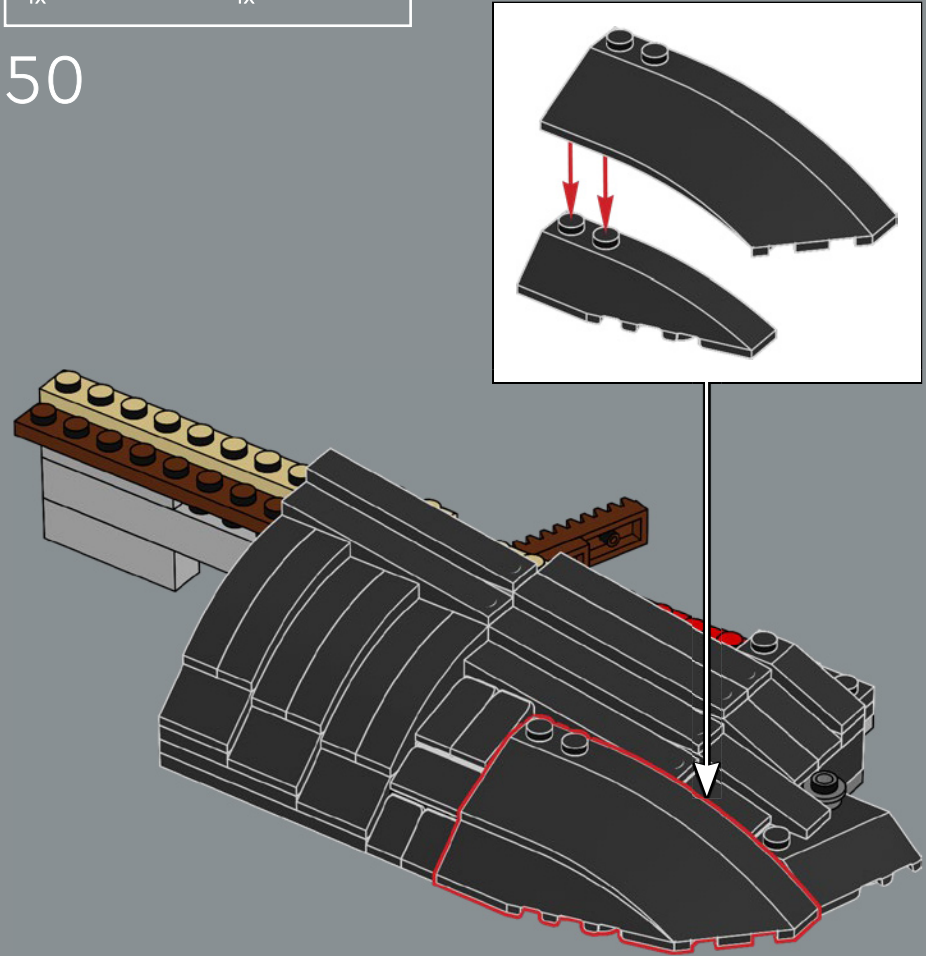



51

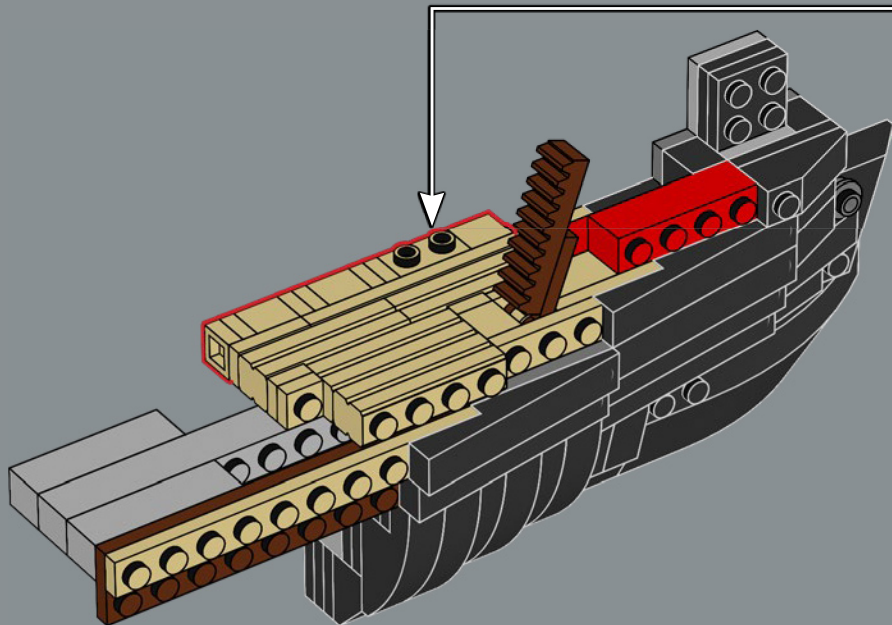
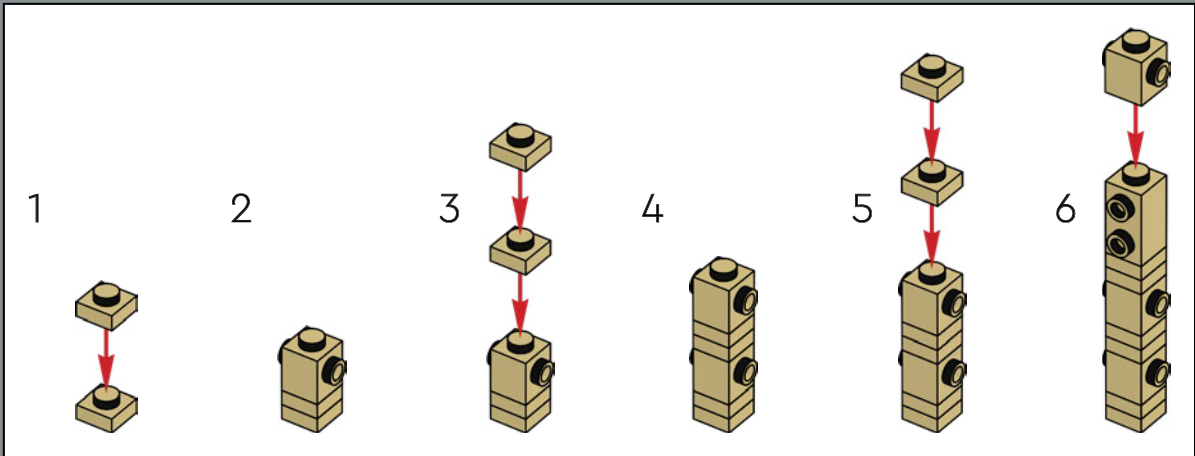

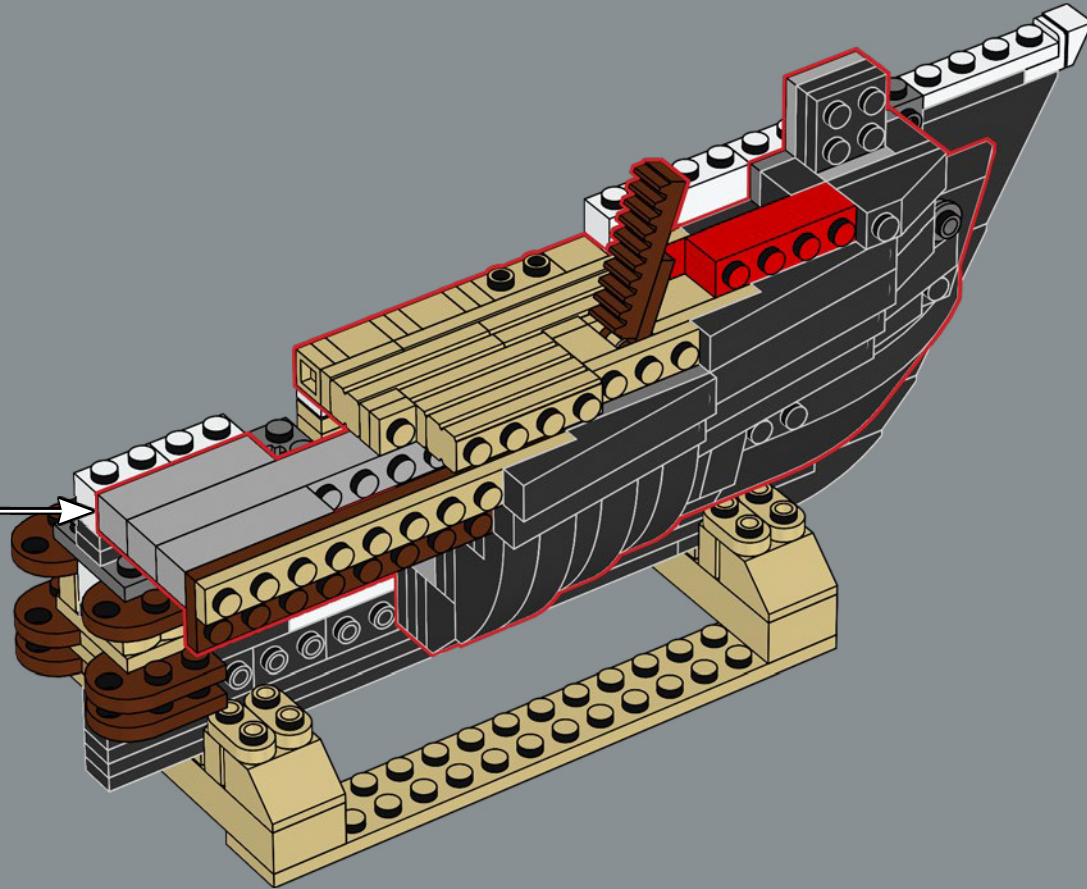

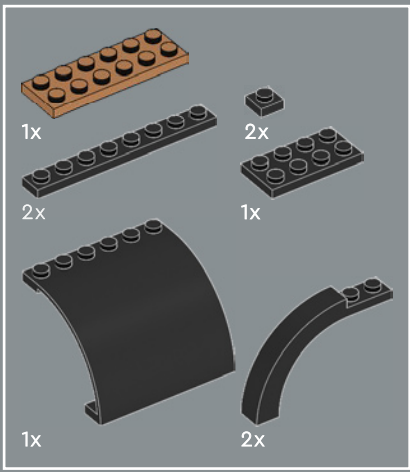

53

1

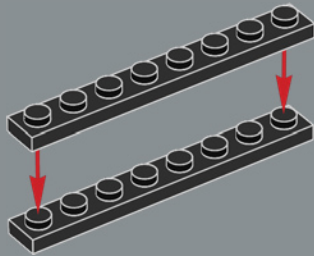

2

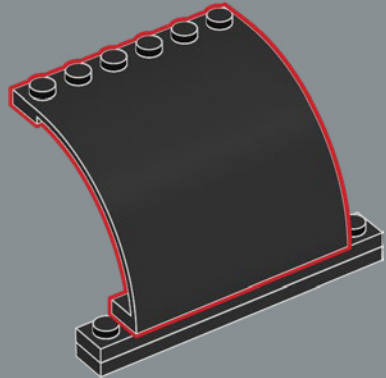

3

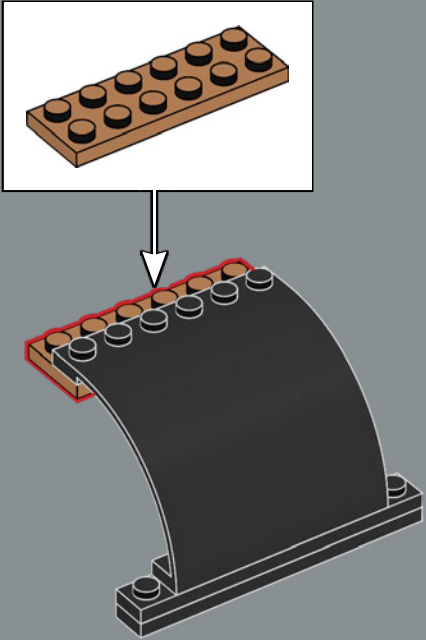

4

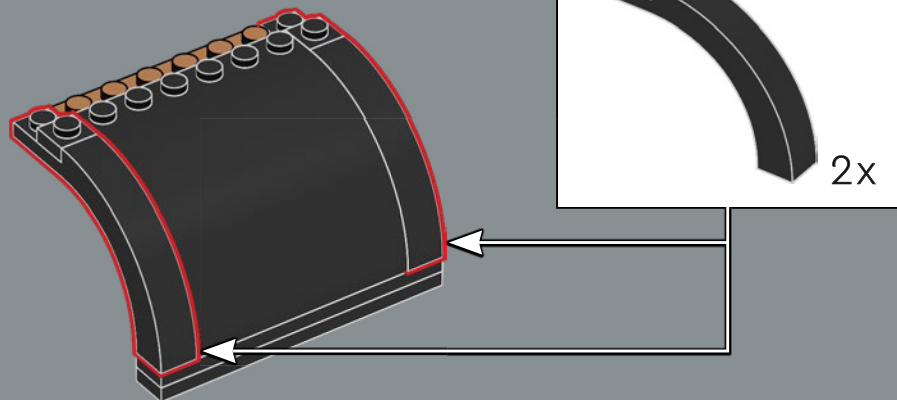

5

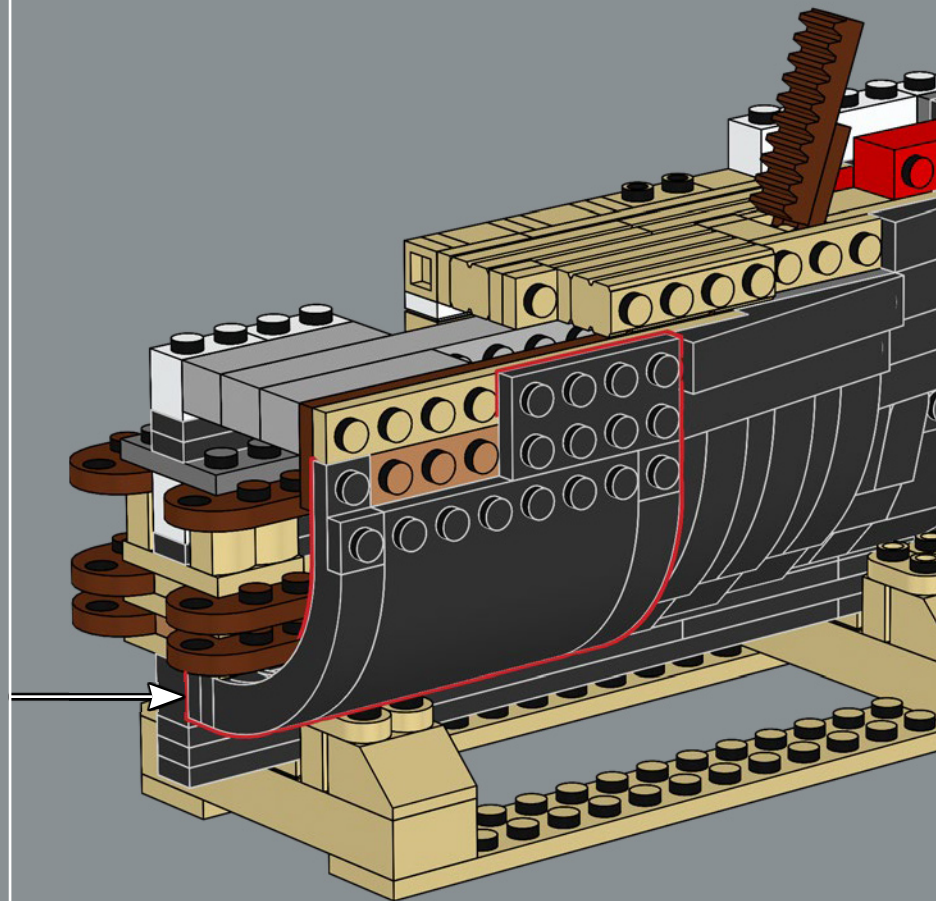
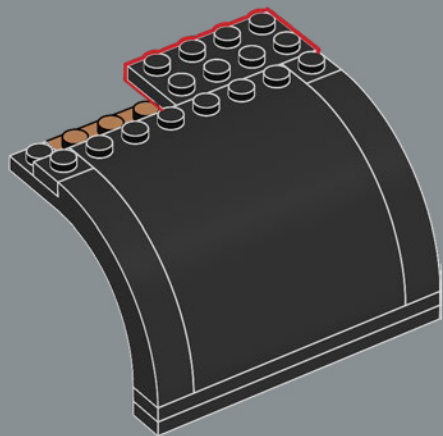

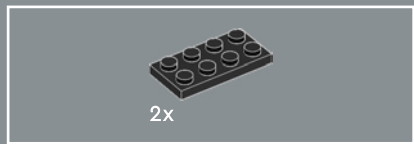
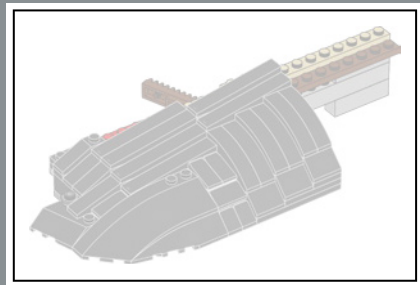

2x

54

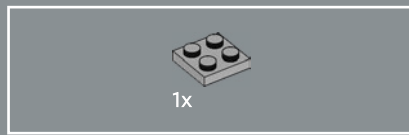
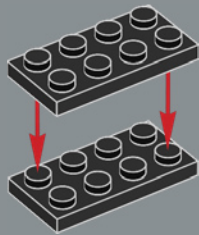

1x

55

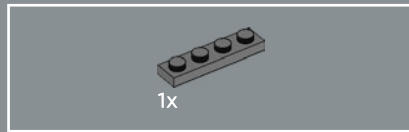
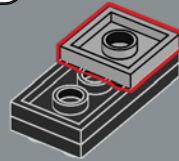

1x

56

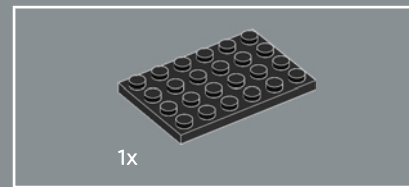
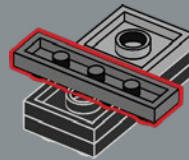

1x

57

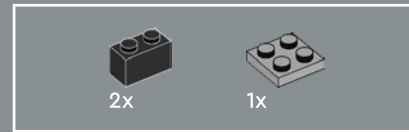
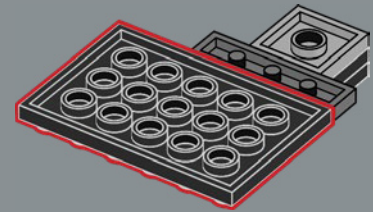

2x

1x

58

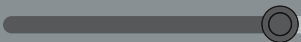
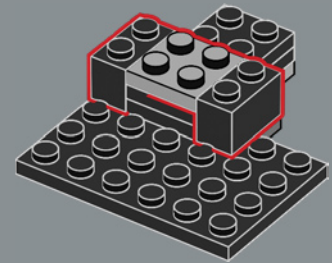

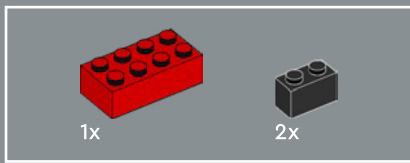

59

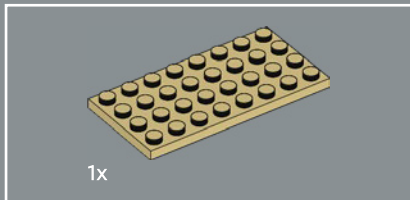
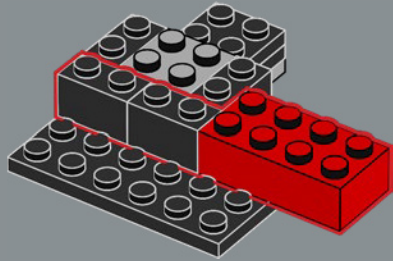

60

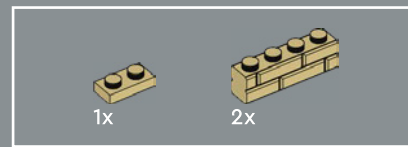
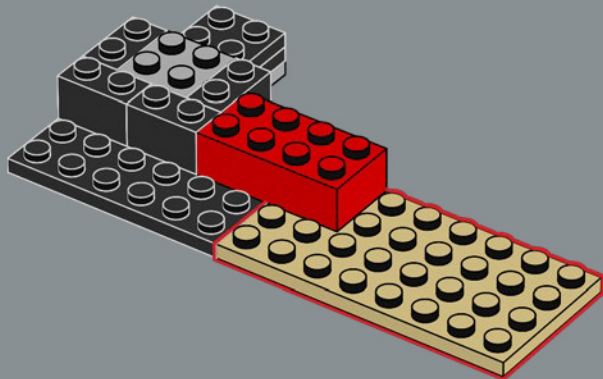

61

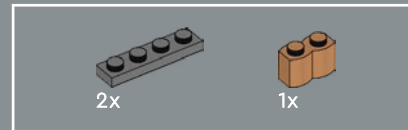
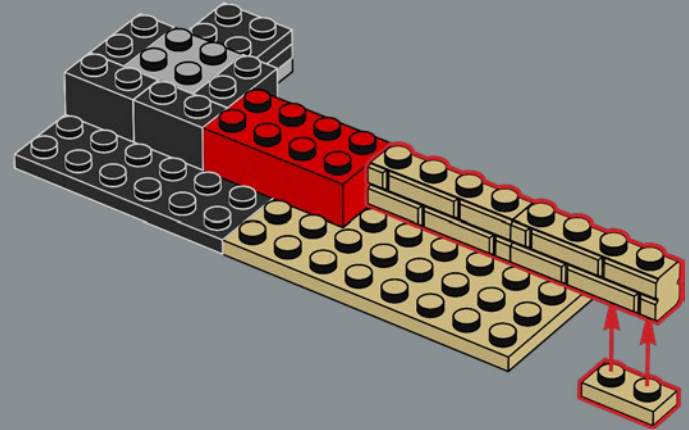

62

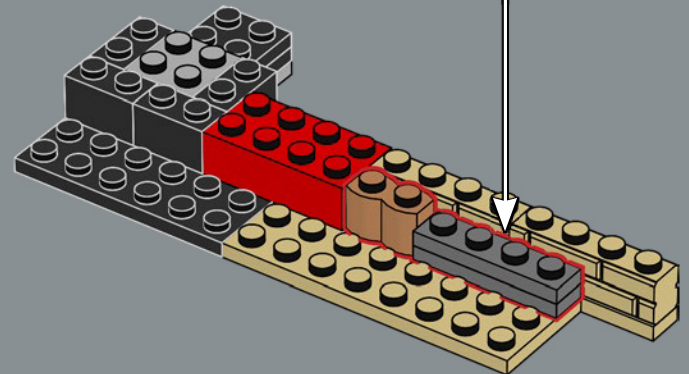
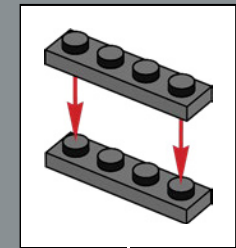

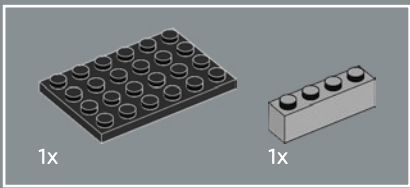

63

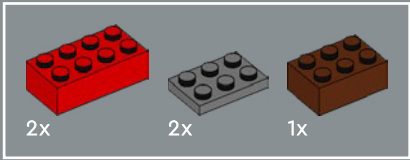
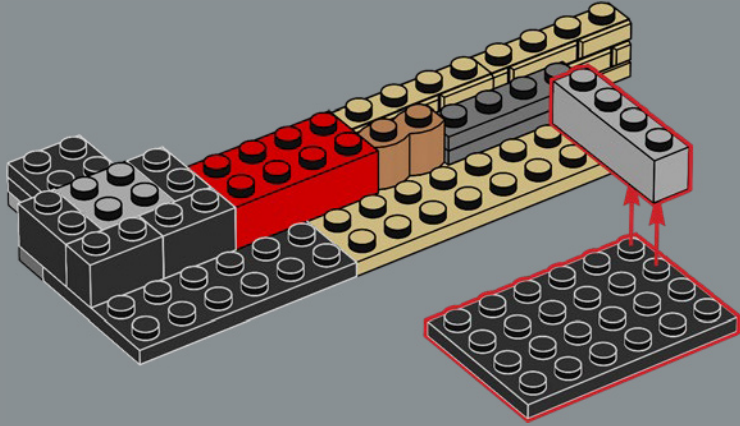

64

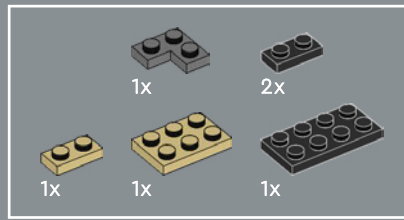
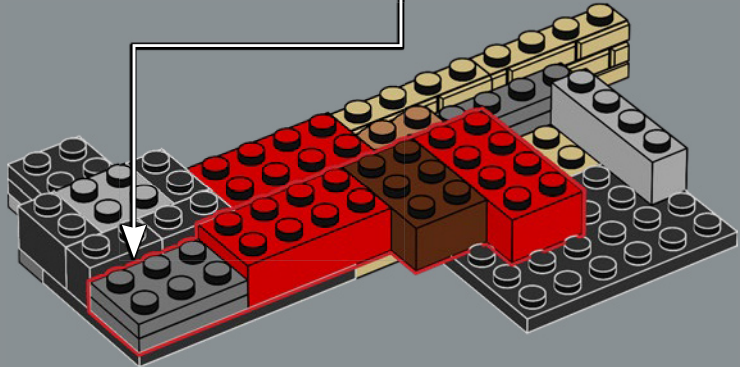
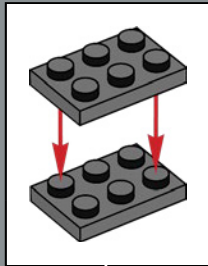

65

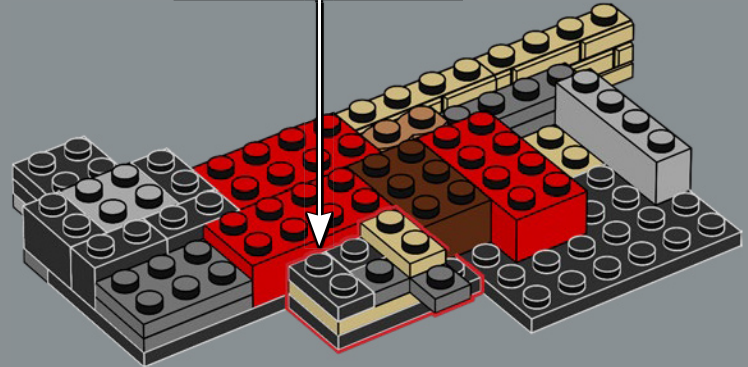
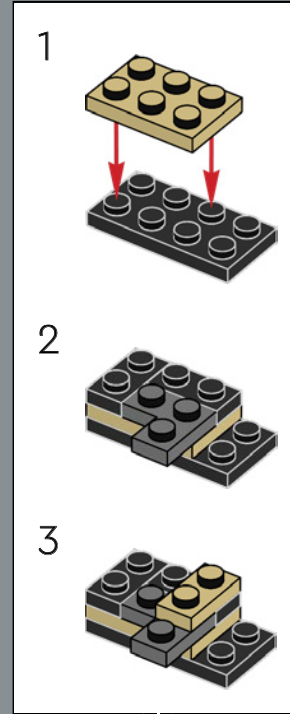



66

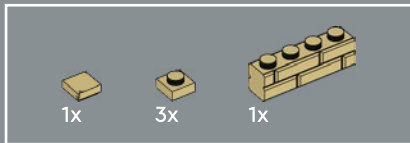
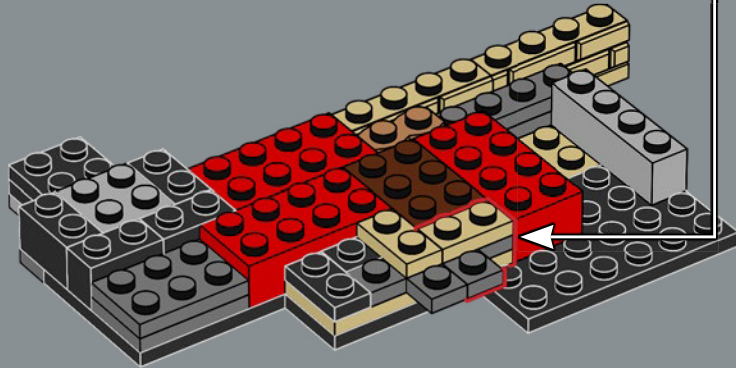
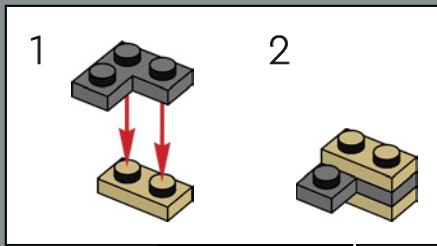

67

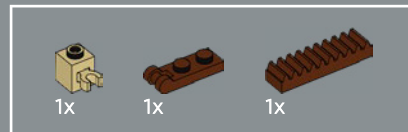
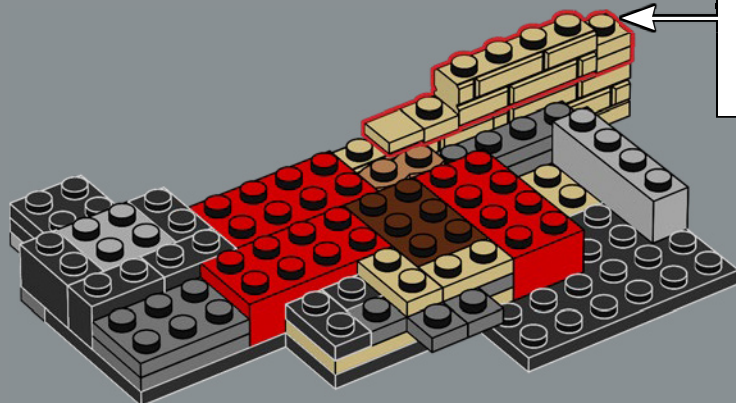
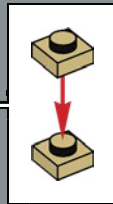

68

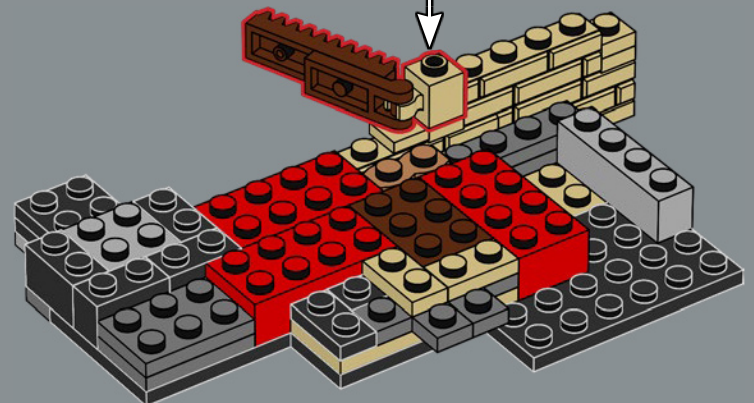
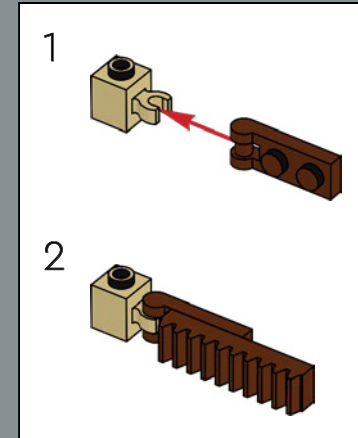

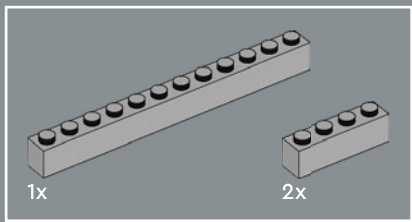

69

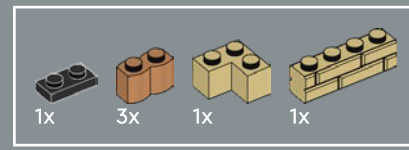
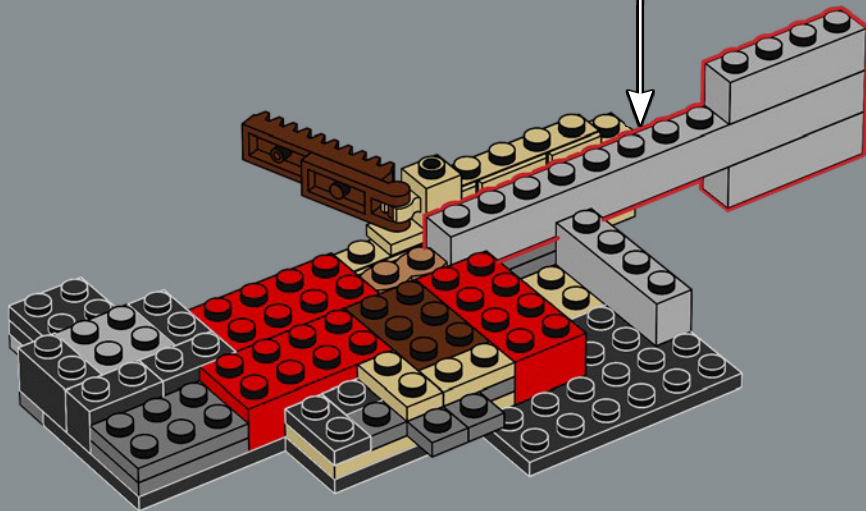
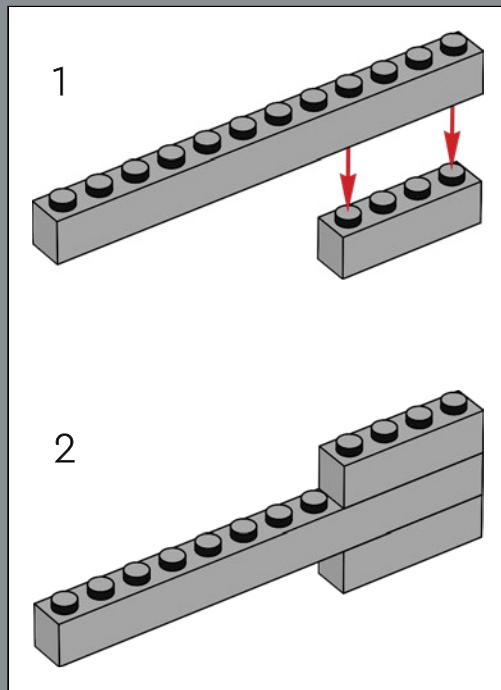

70

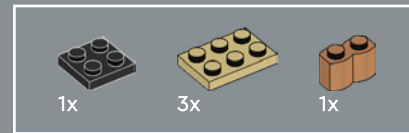
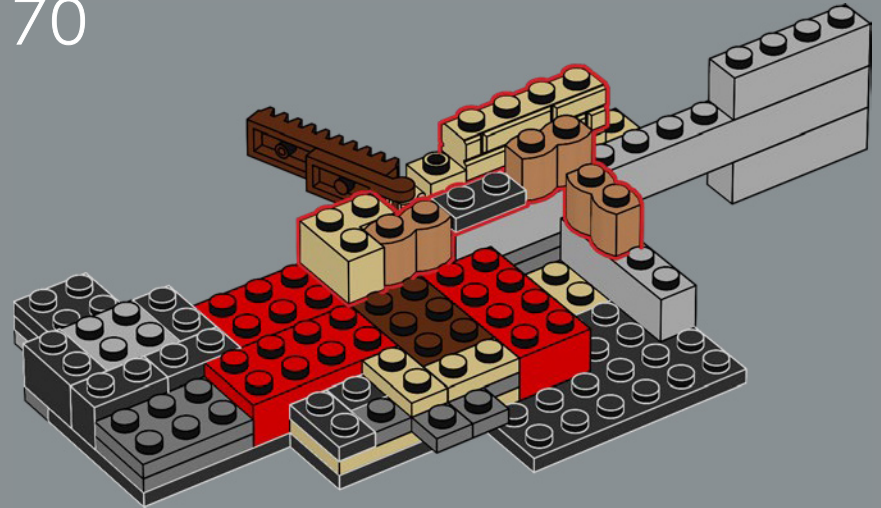

71

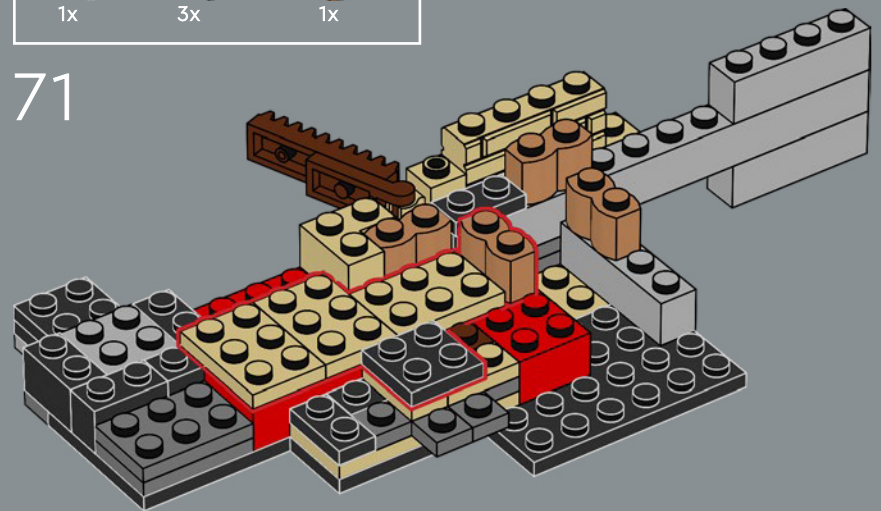

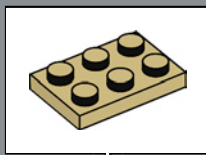
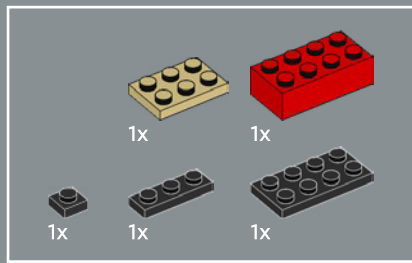

72

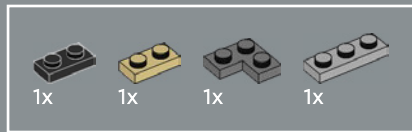
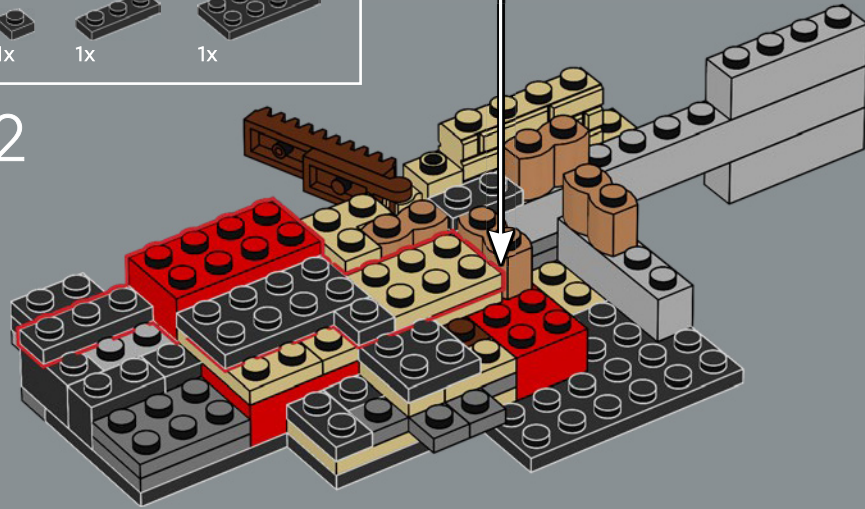

73

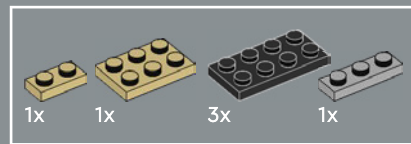
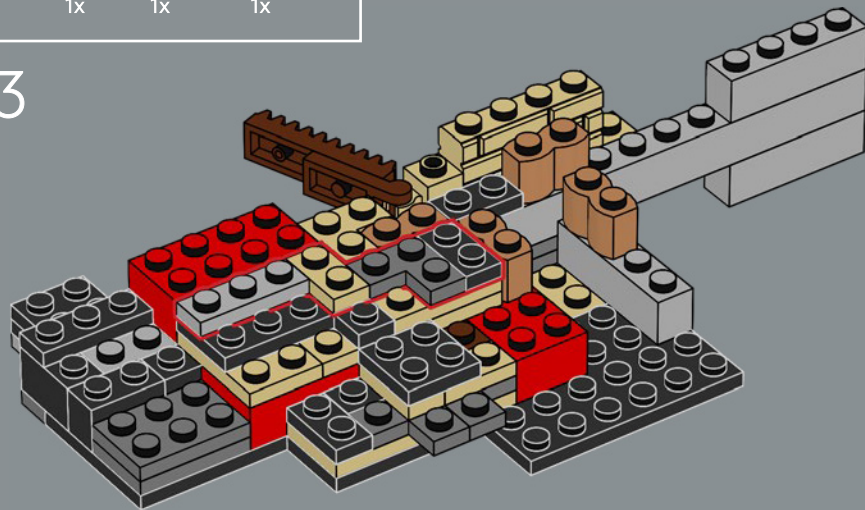

74

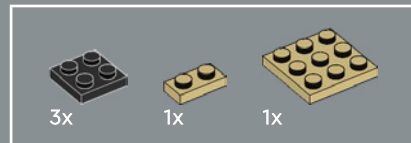
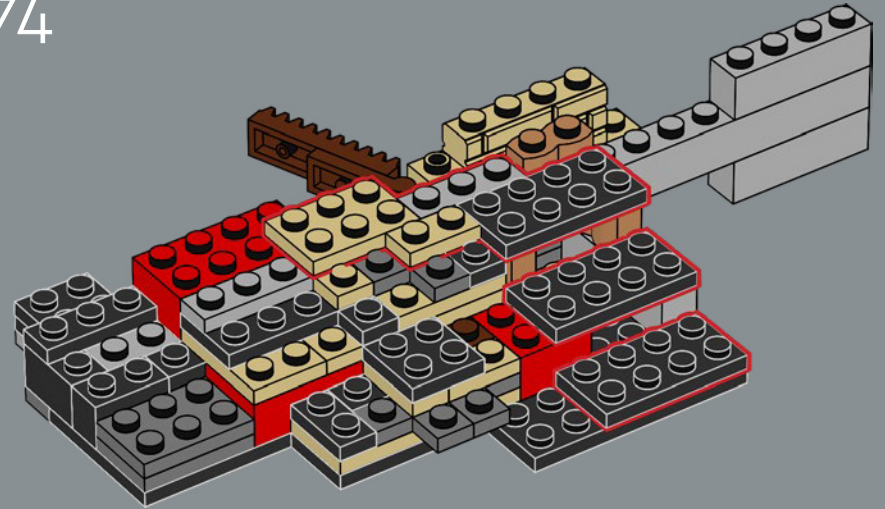

75

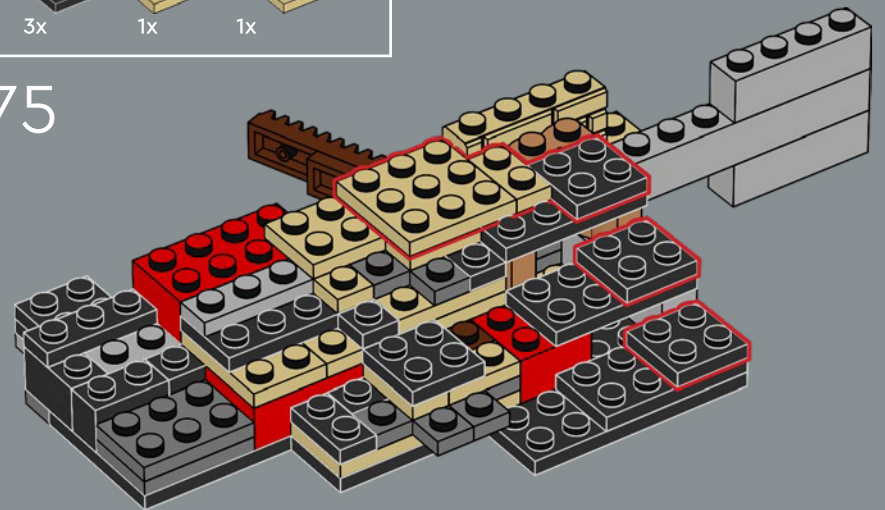

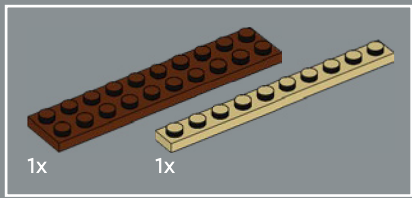

76

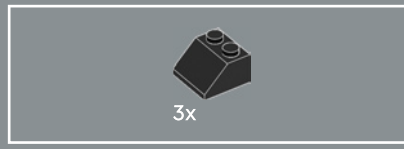
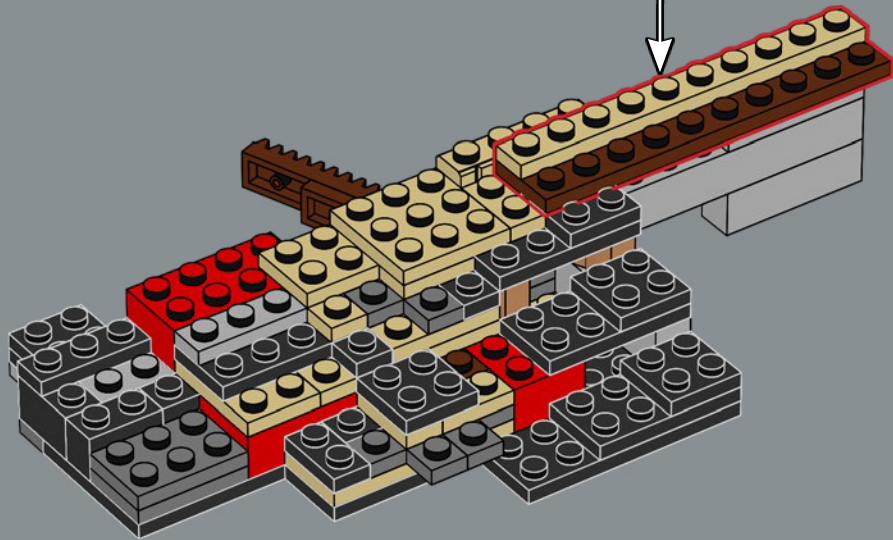
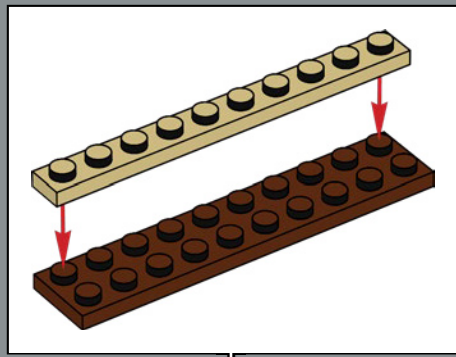

77

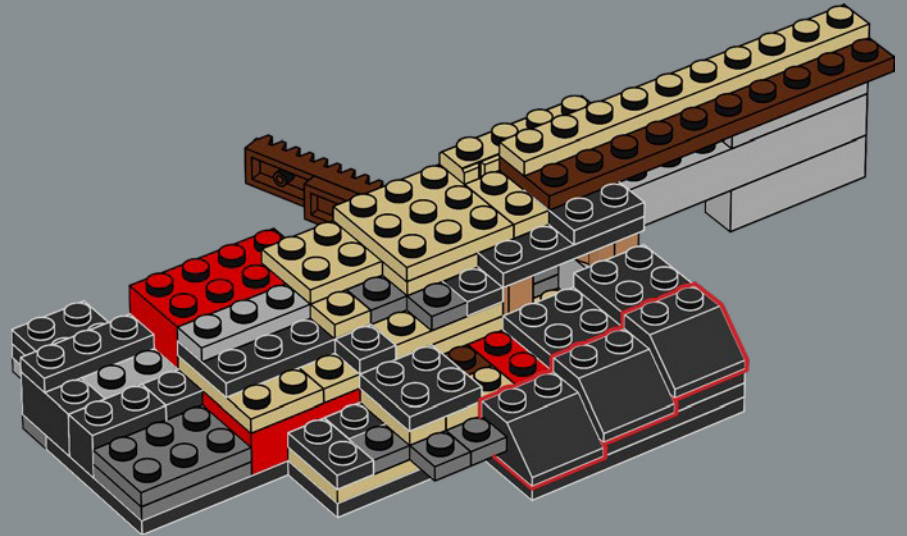



78

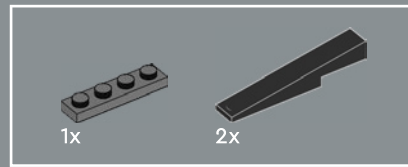
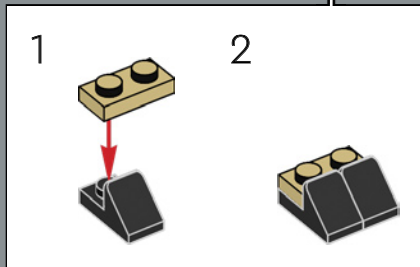
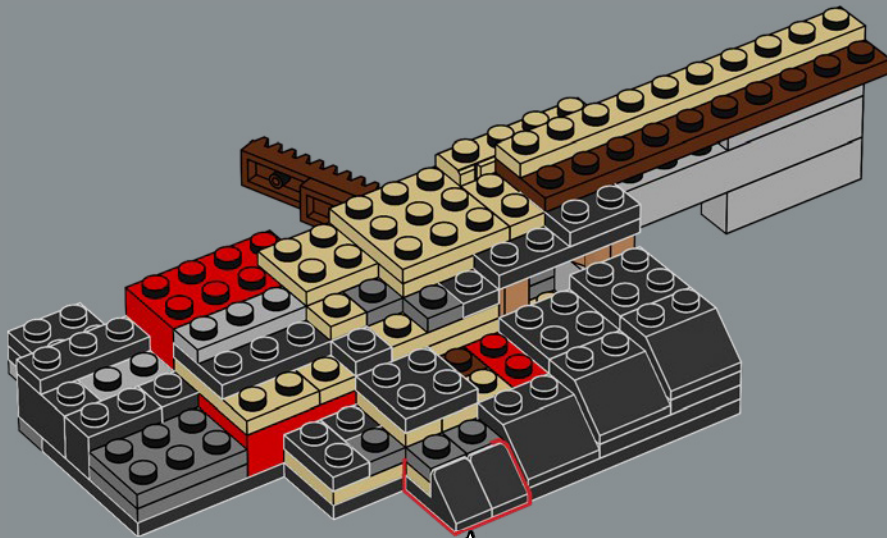

79

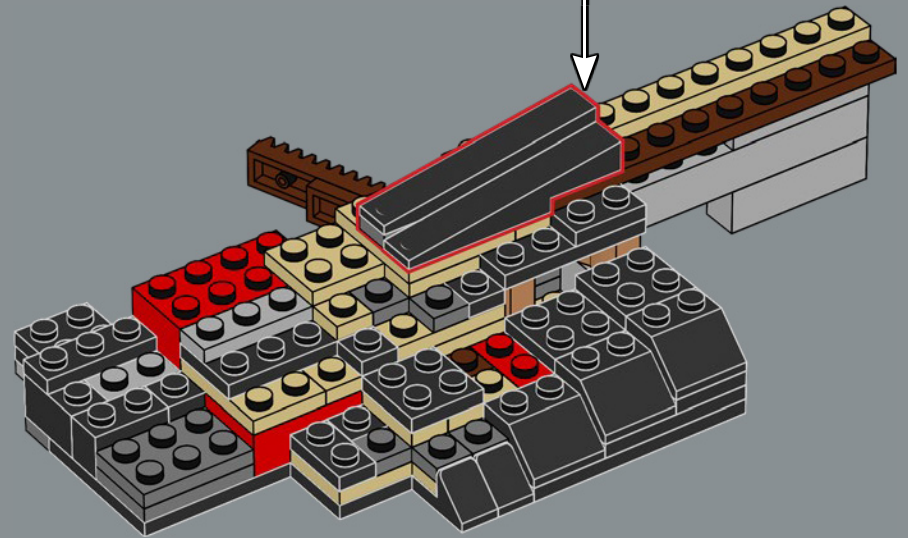
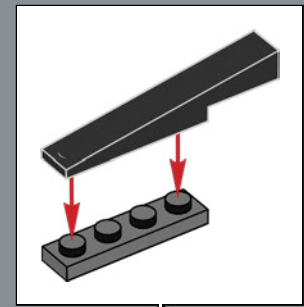



80

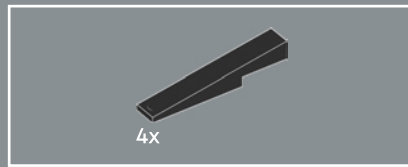
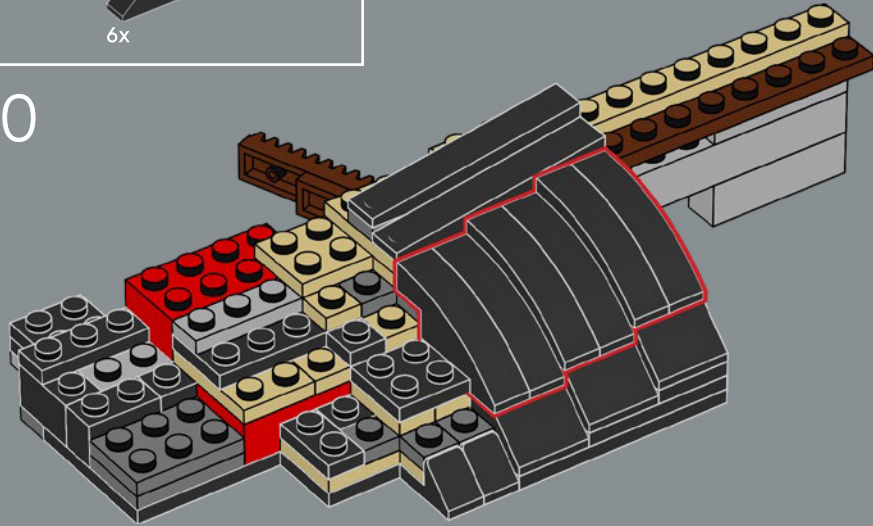

82

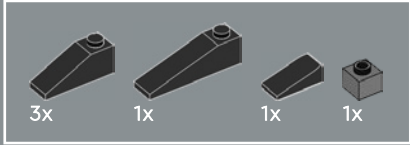
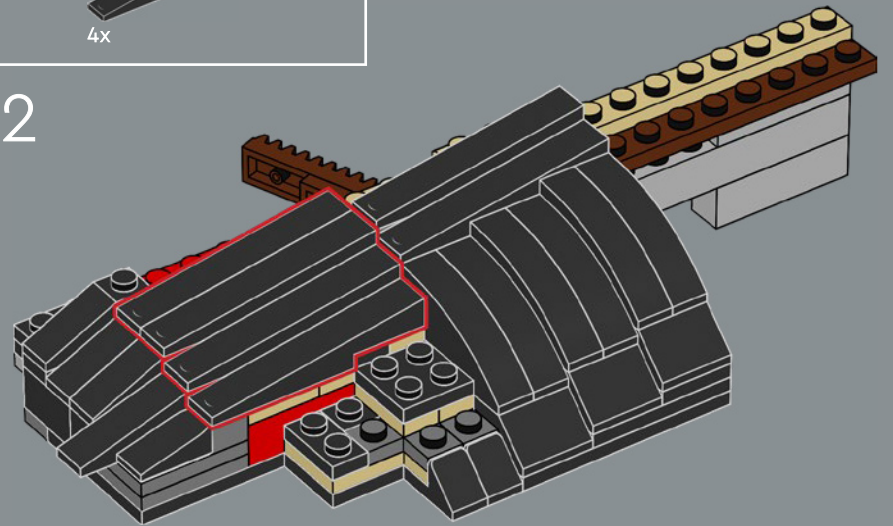

81

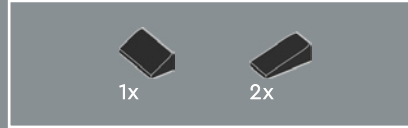
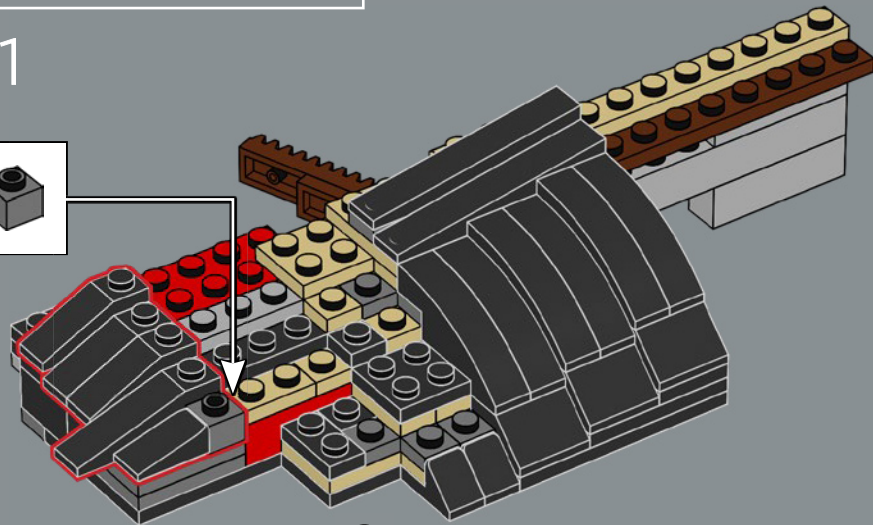
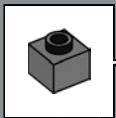

83

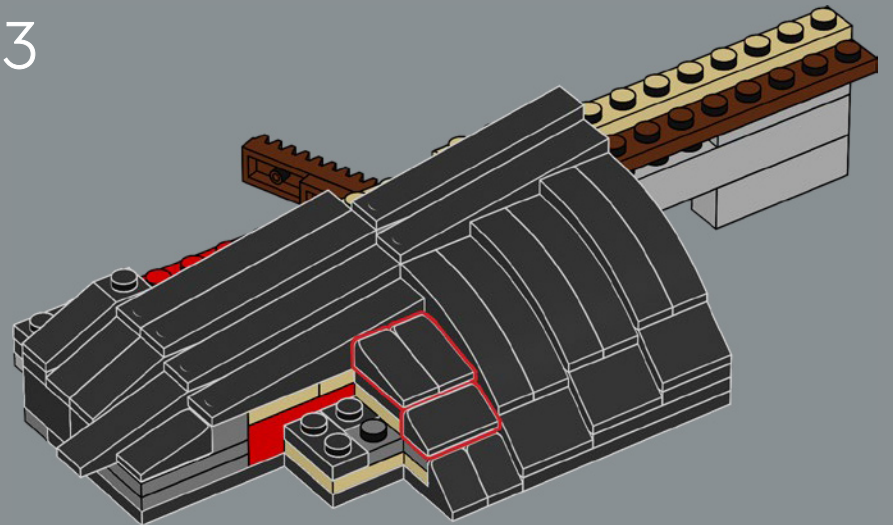

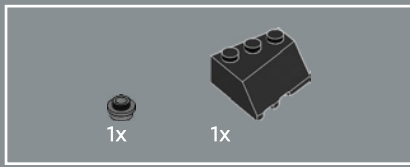

84

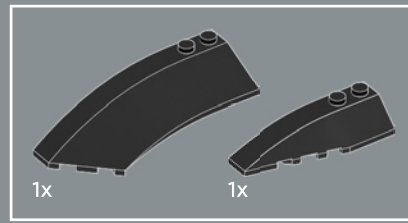
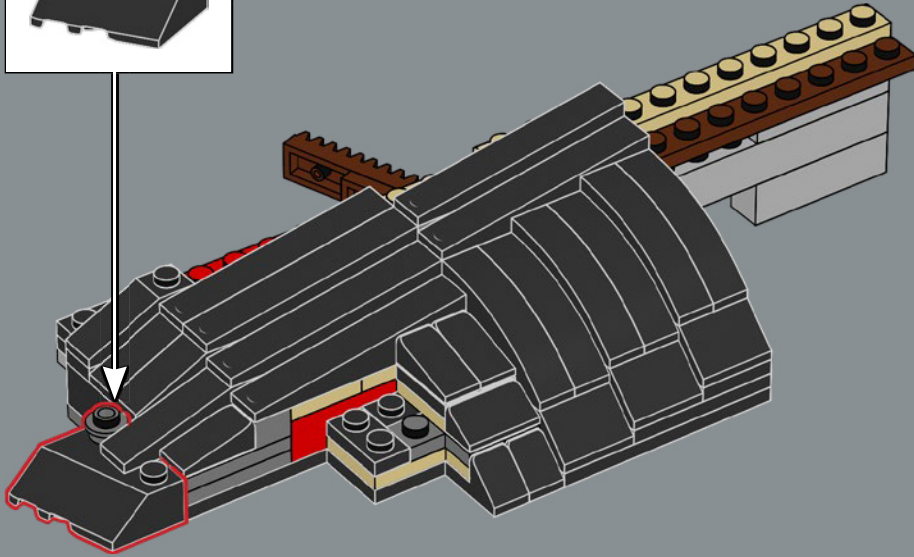
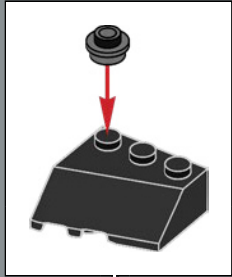

85

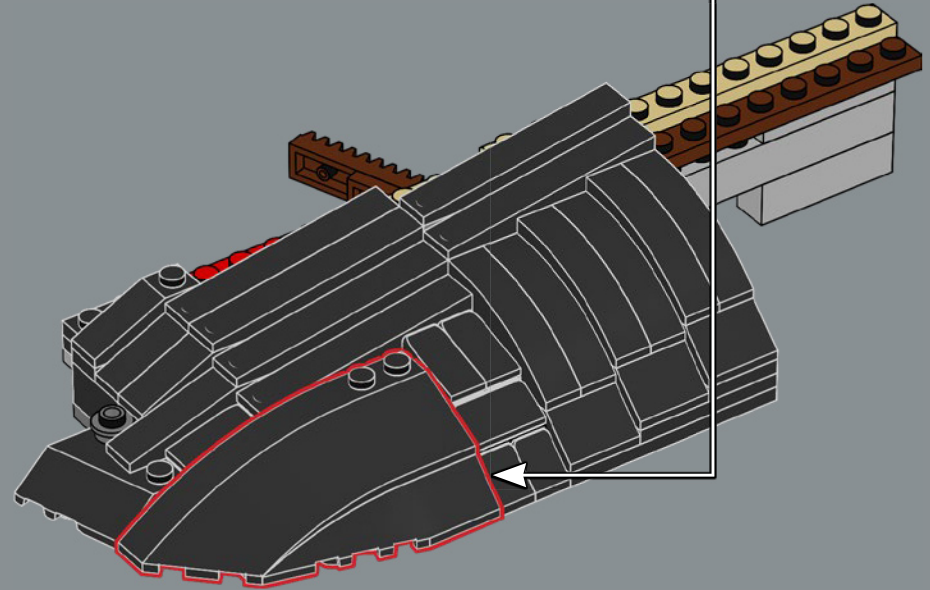
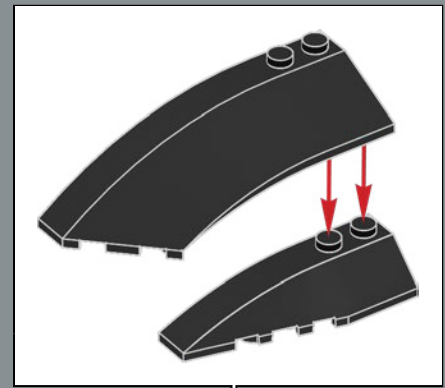



Brown LEGO® Technic 1x4 toothed bar gear rack elements make for nice little wooden ladders.

86

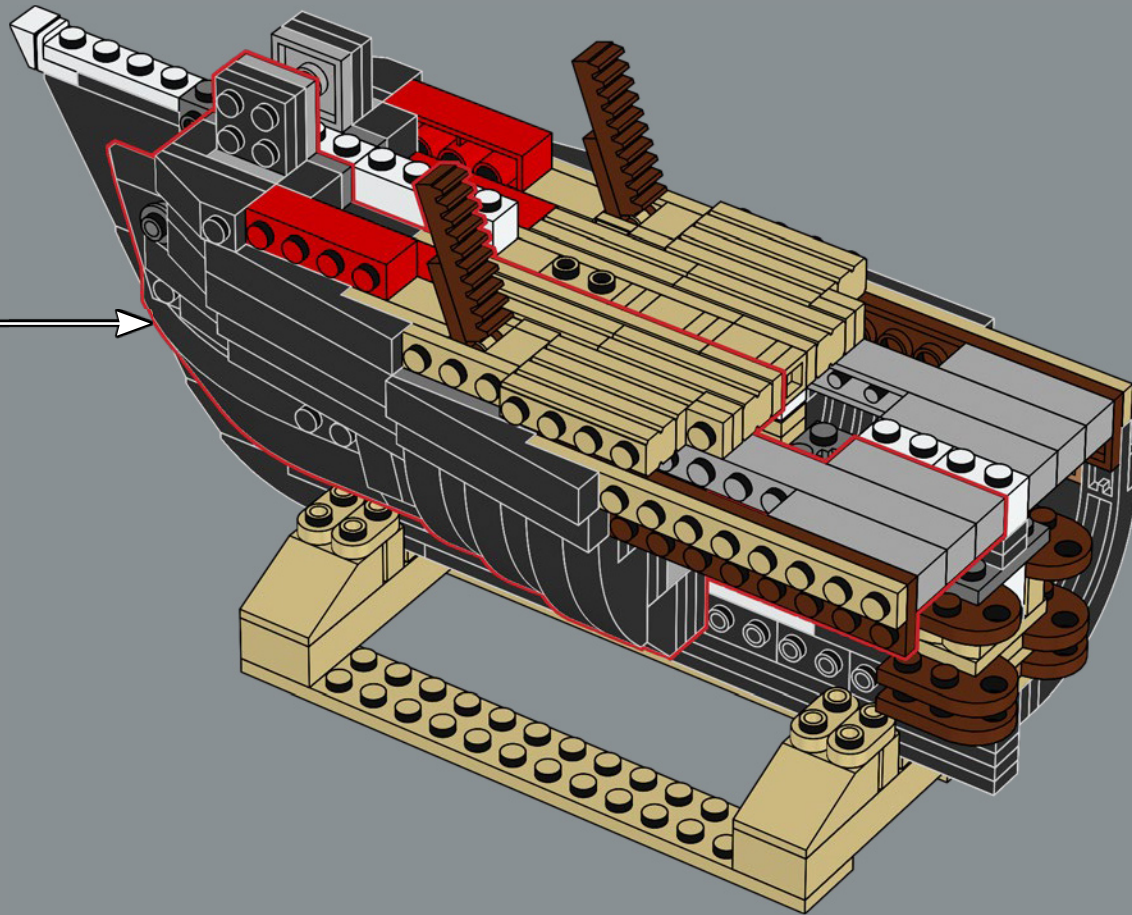

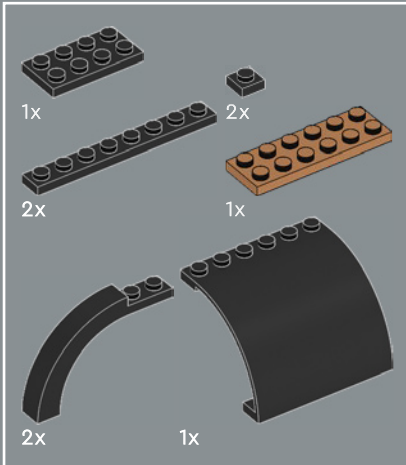
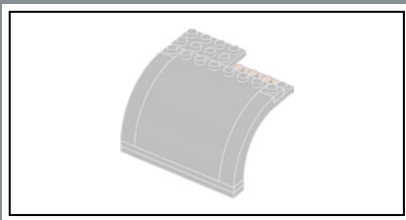

87

1

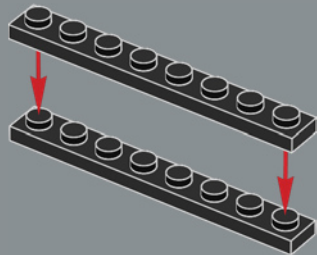

2

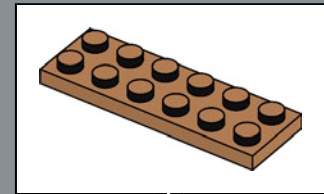
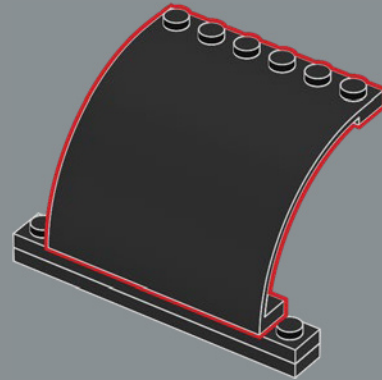

3

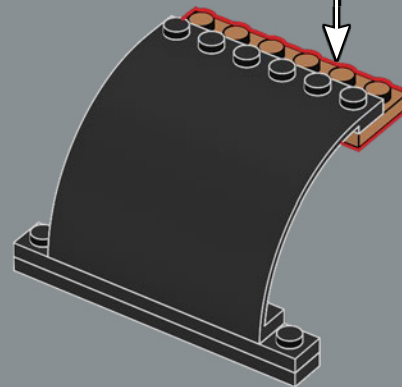

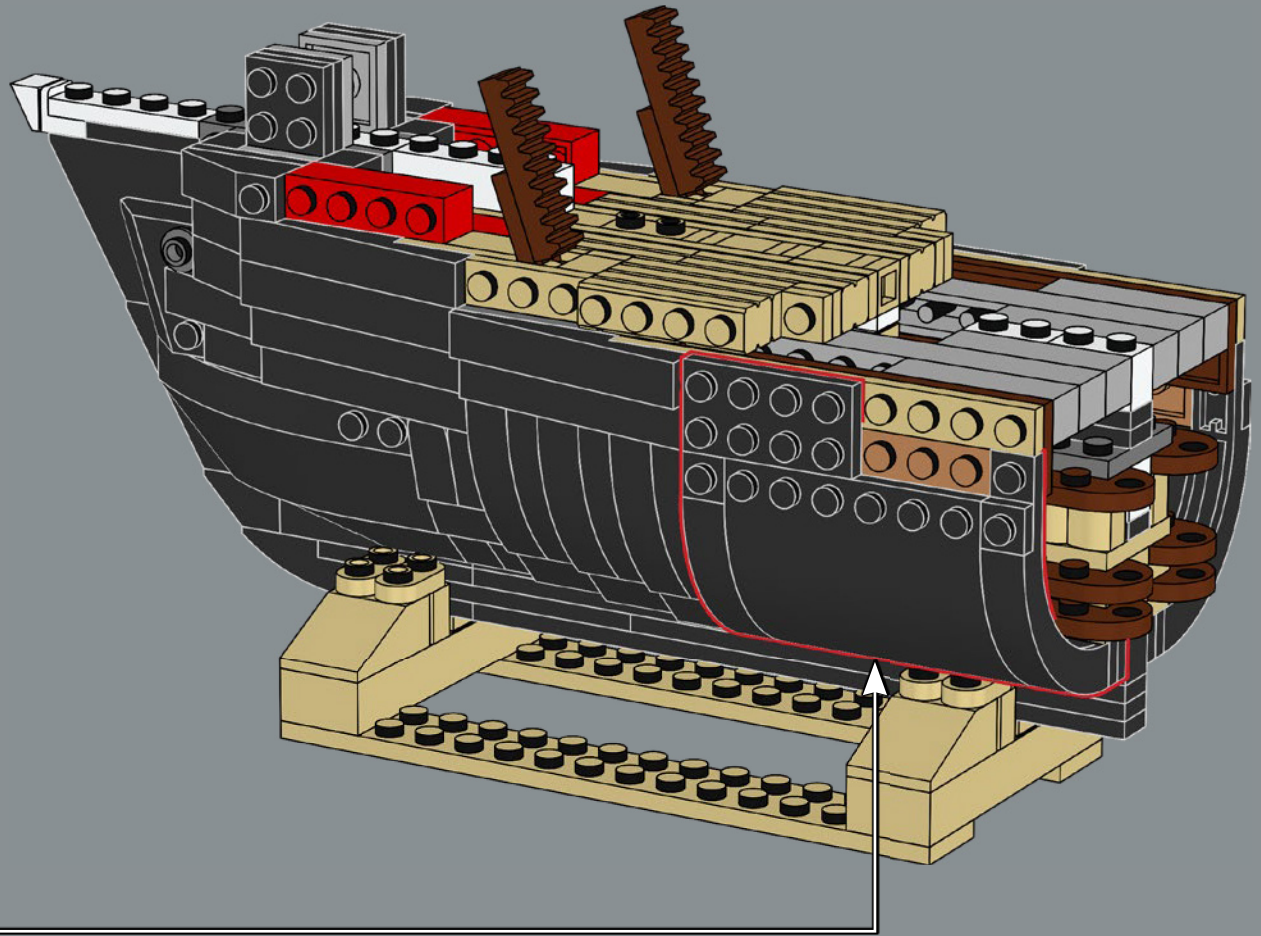
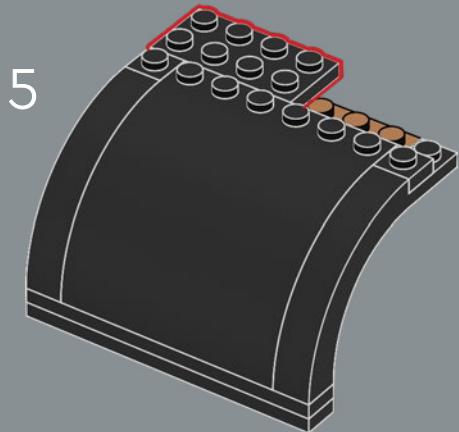
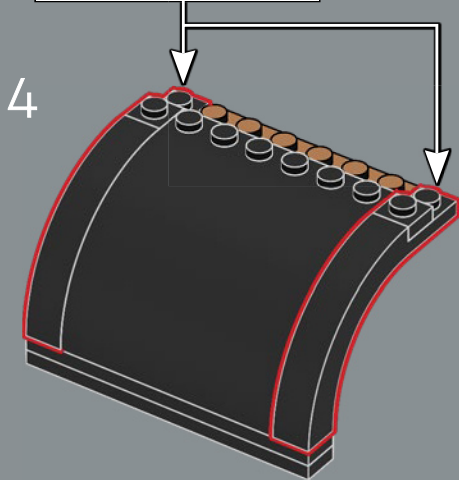
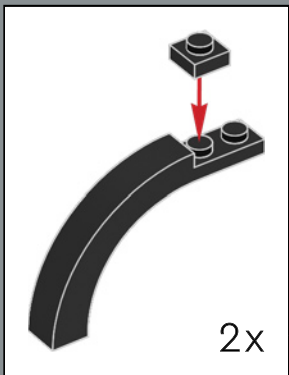

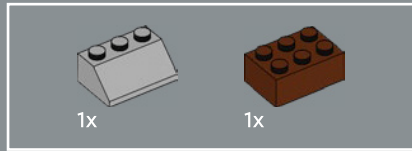

88

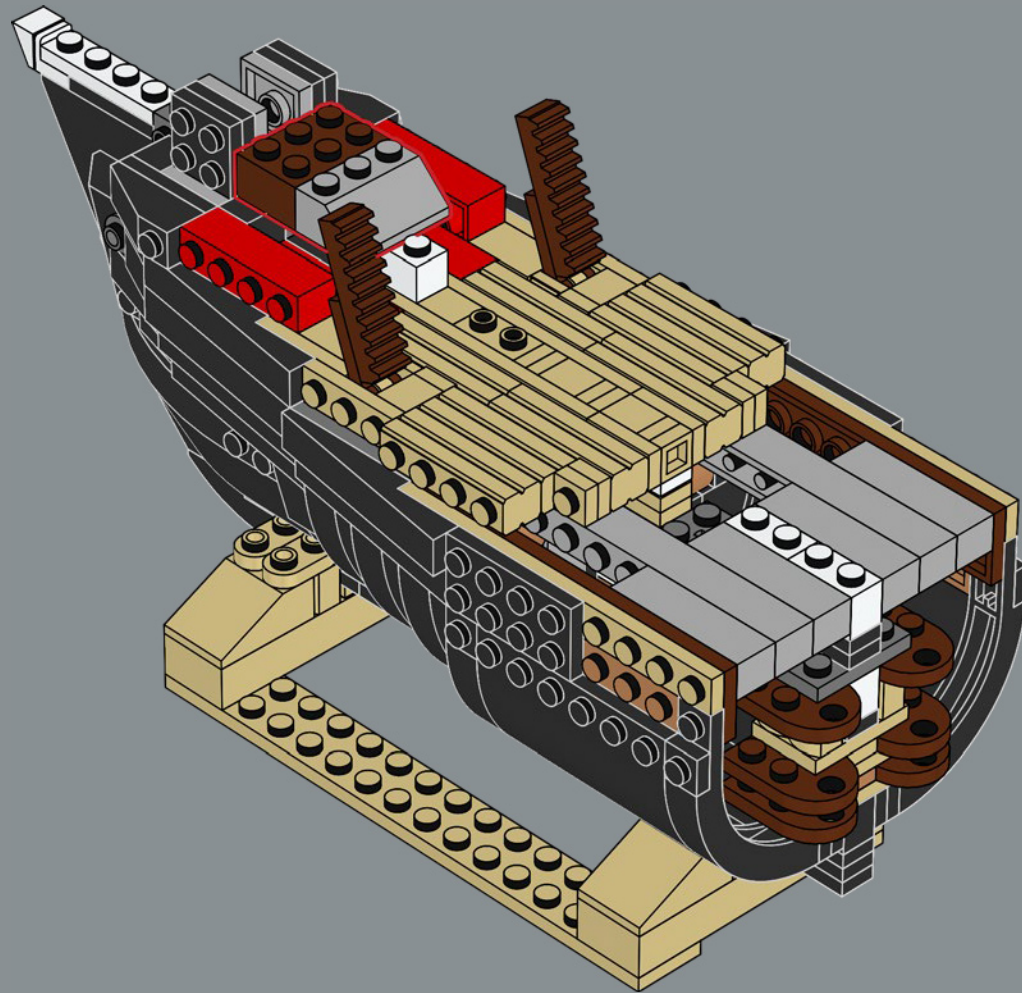



2x

89

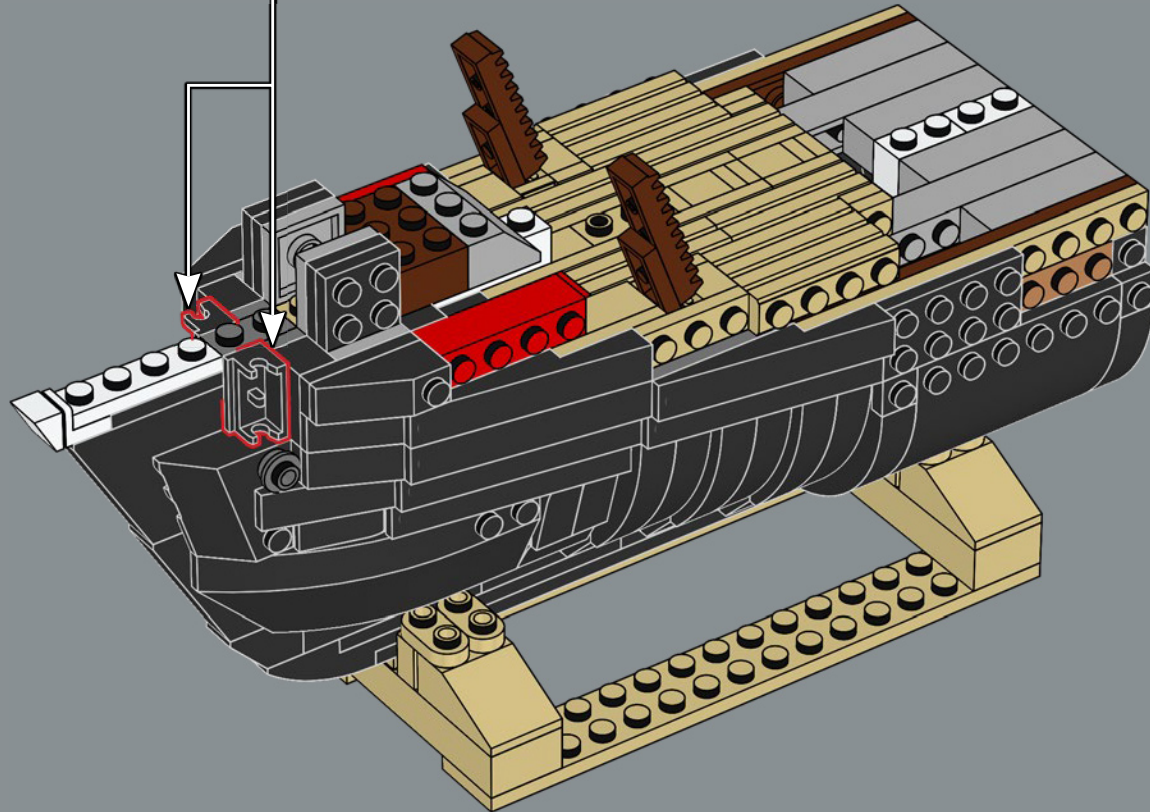
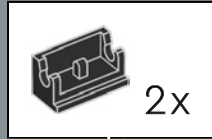

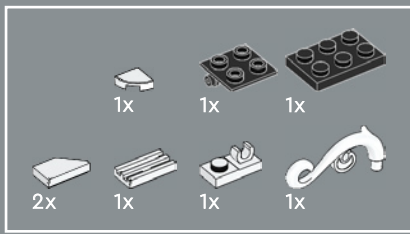

90

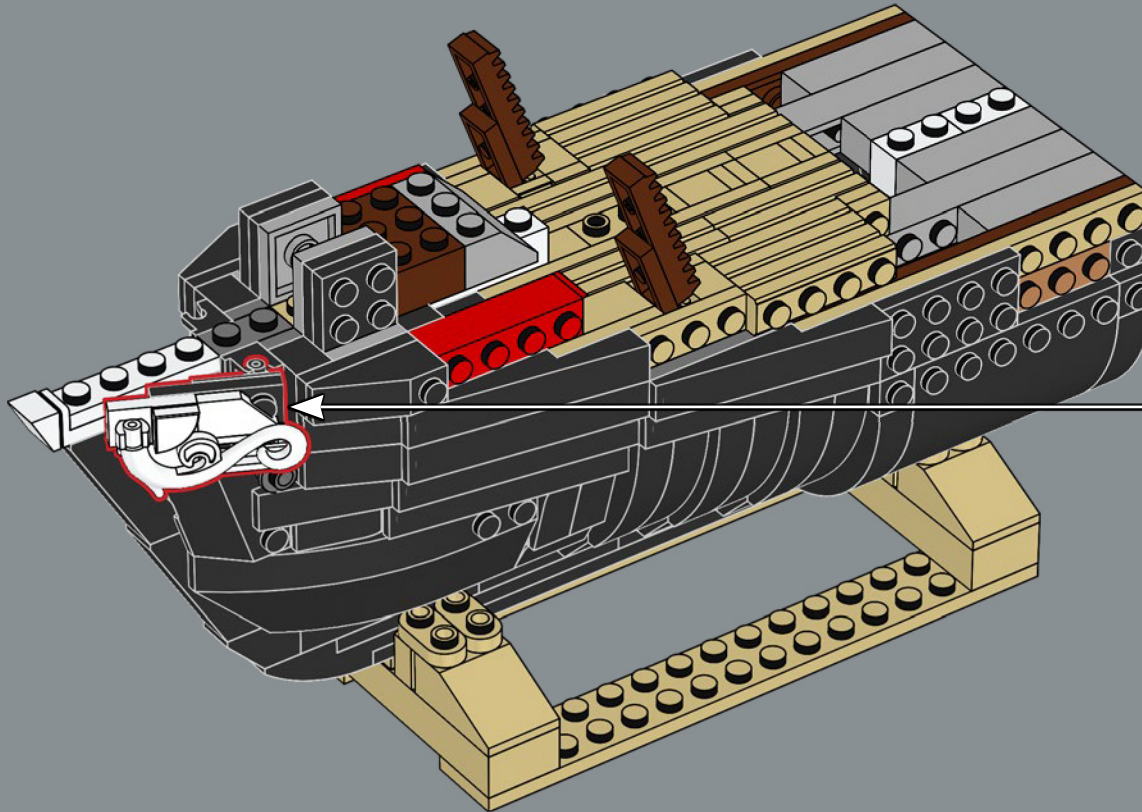
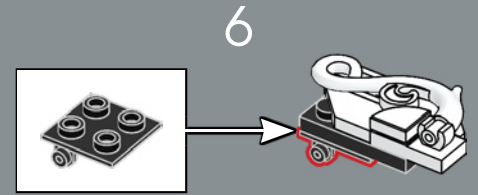
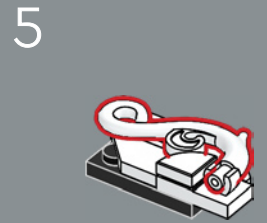
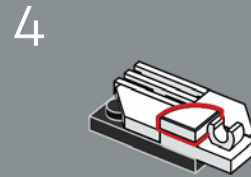
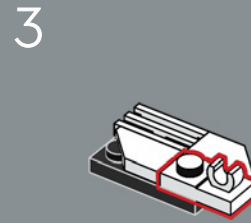
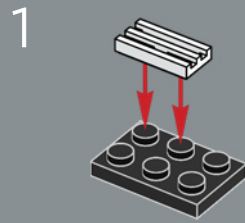

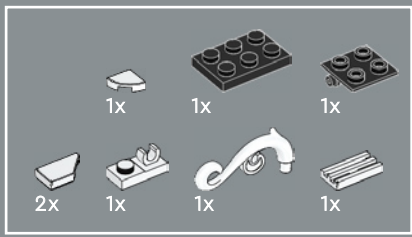

91

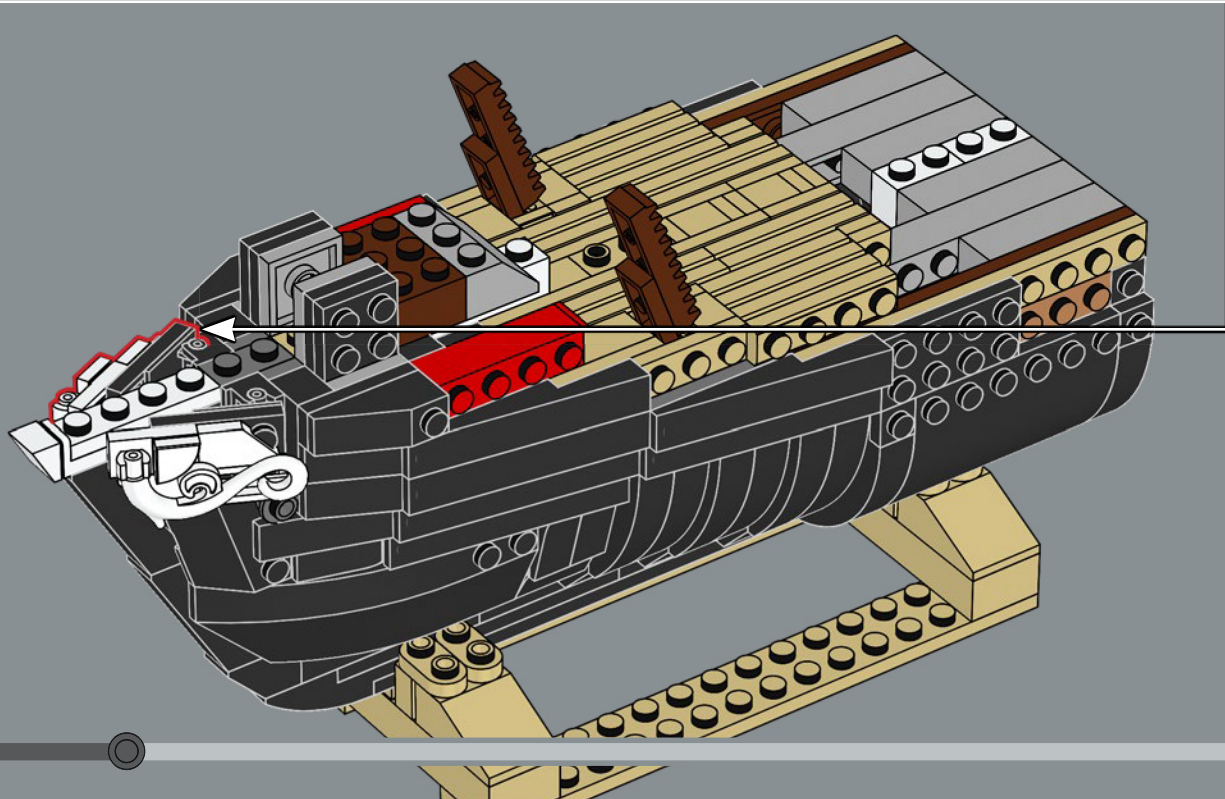
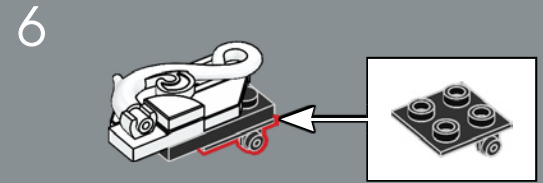
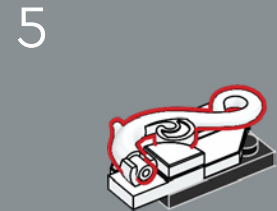
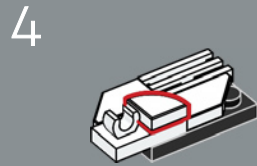
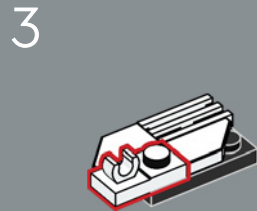
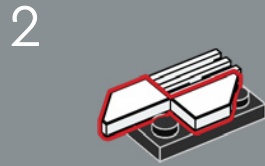
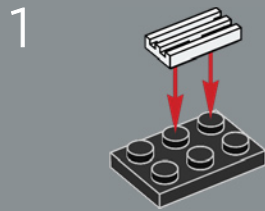

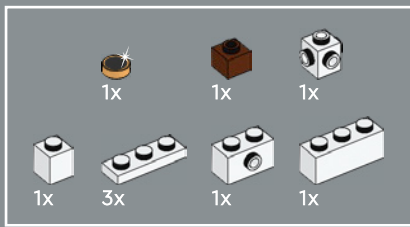

92

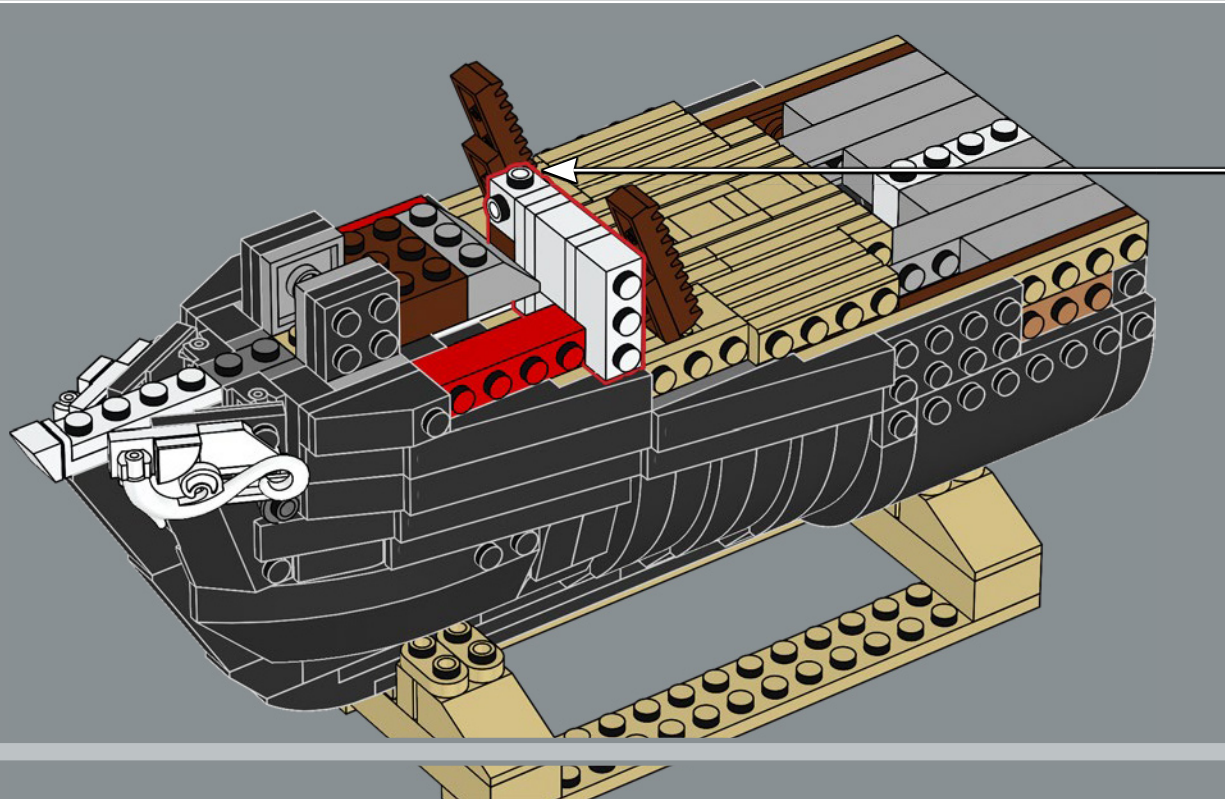
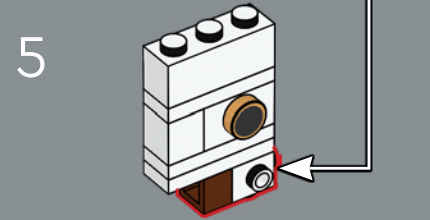
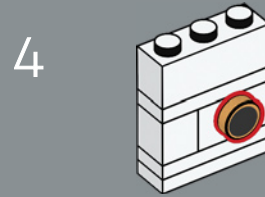
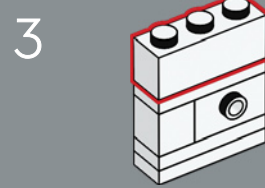
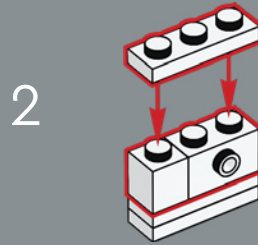
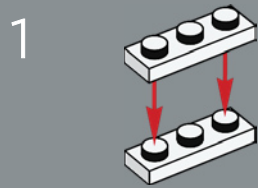

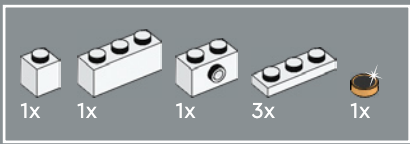

93

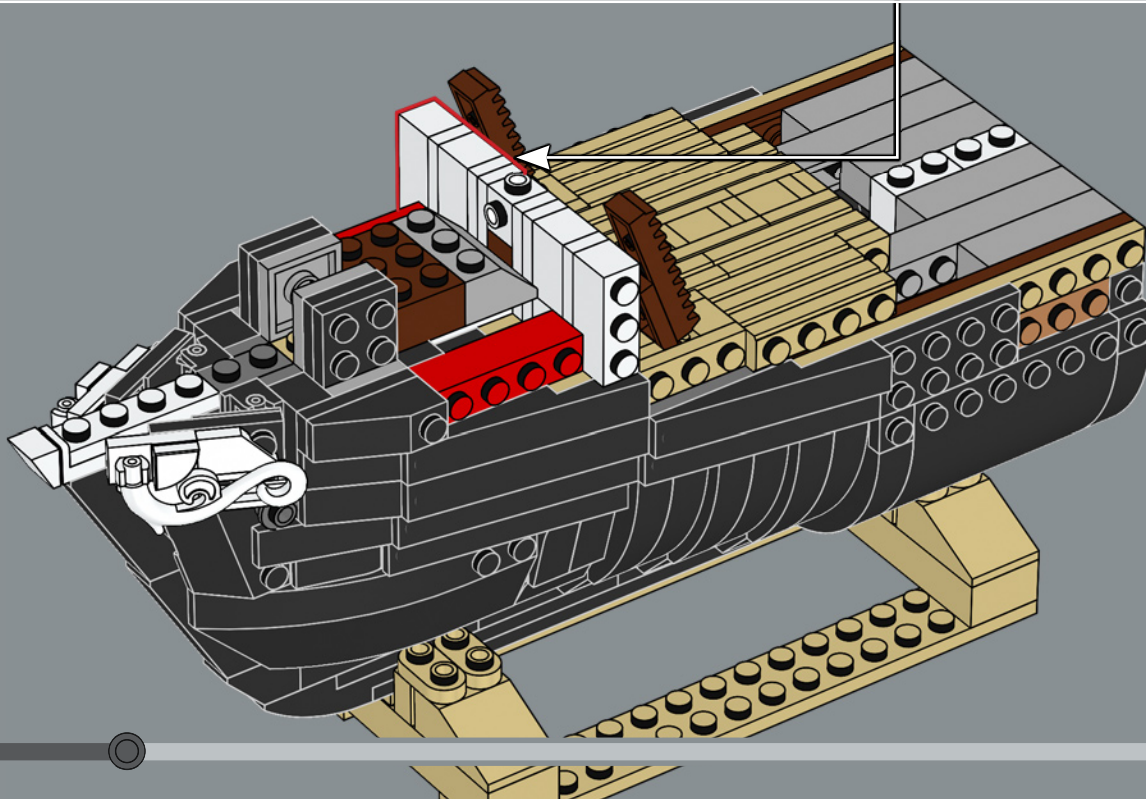
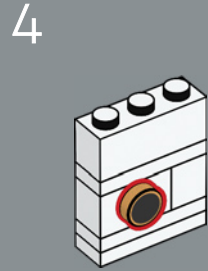
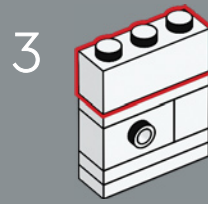
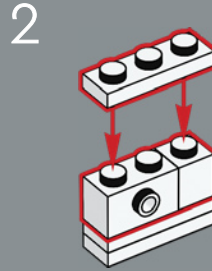
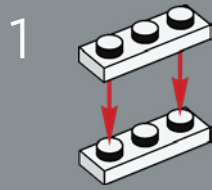

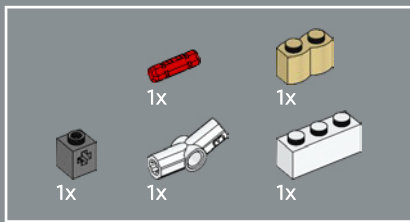

94

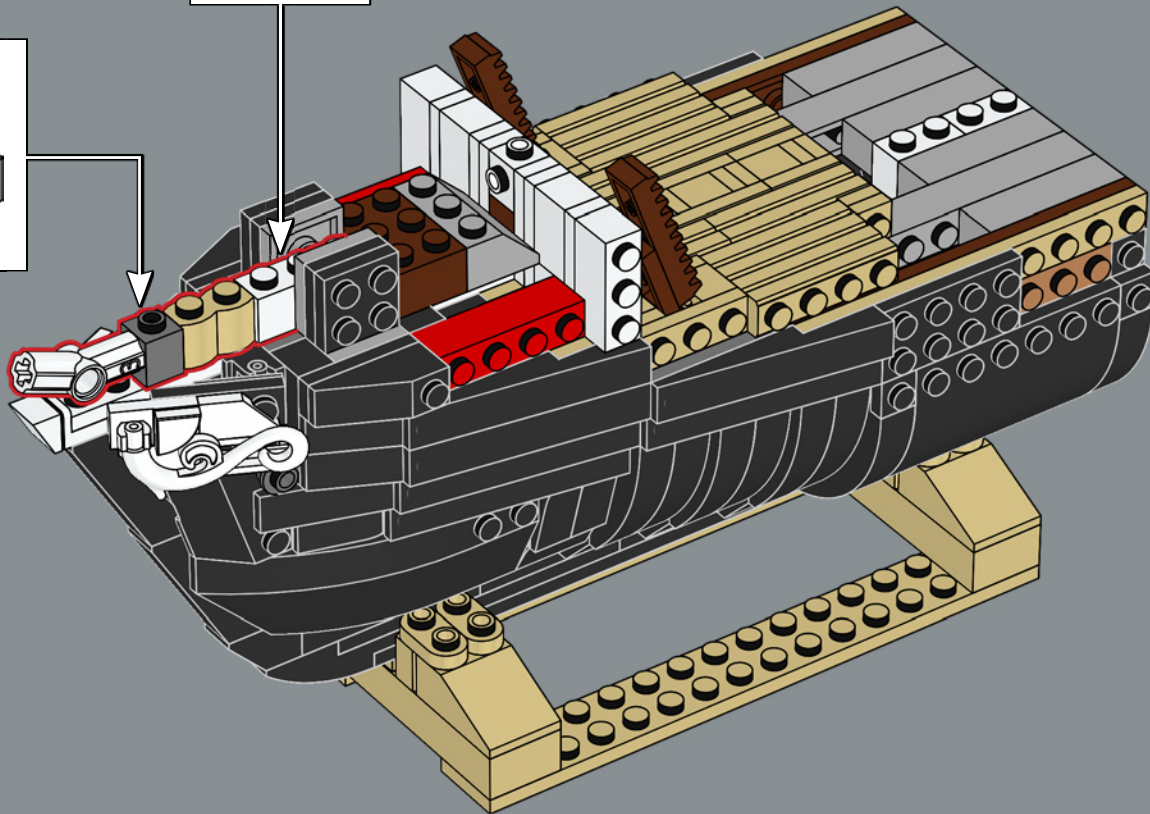
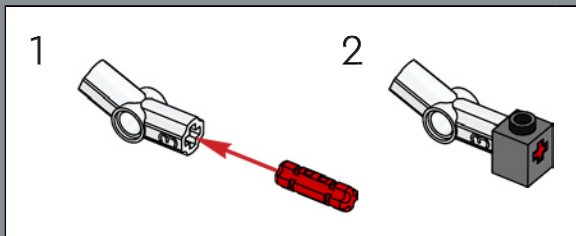
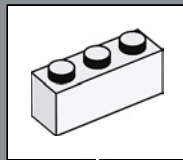

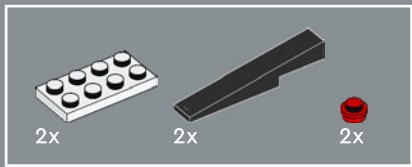

95

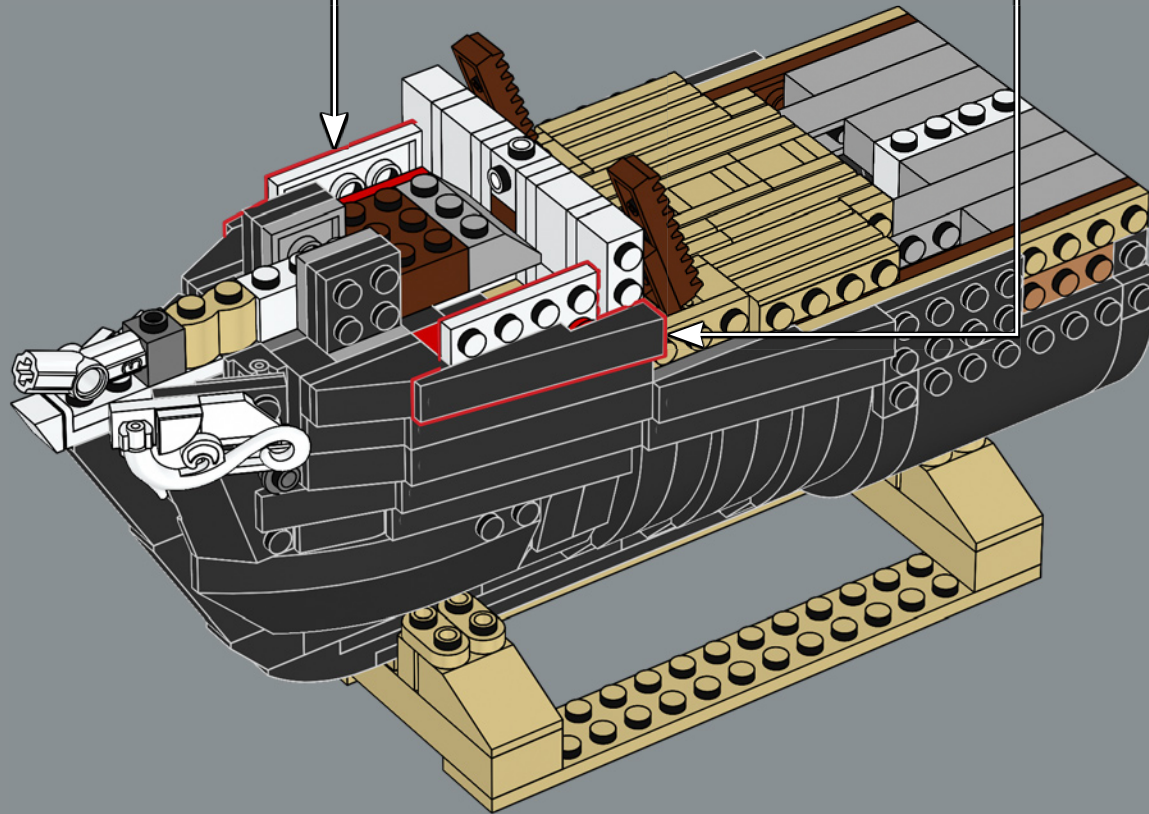
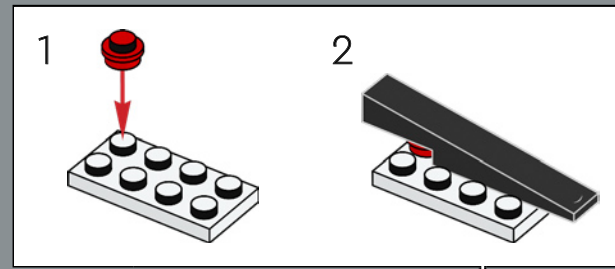
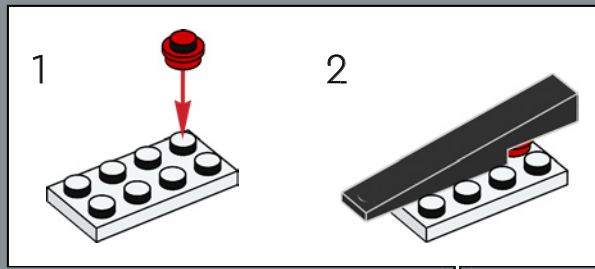

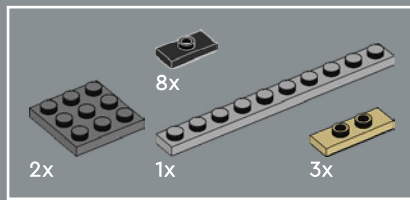

96

1

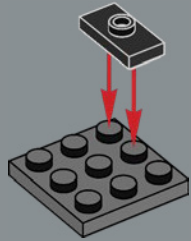

2

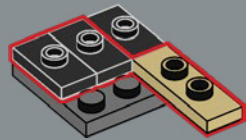

3

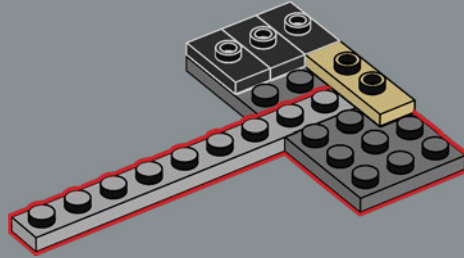

4

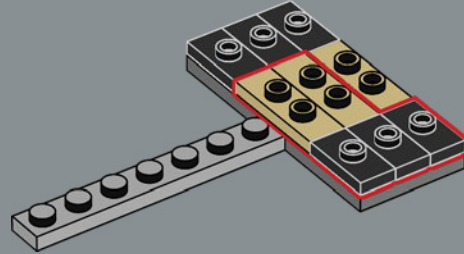

5

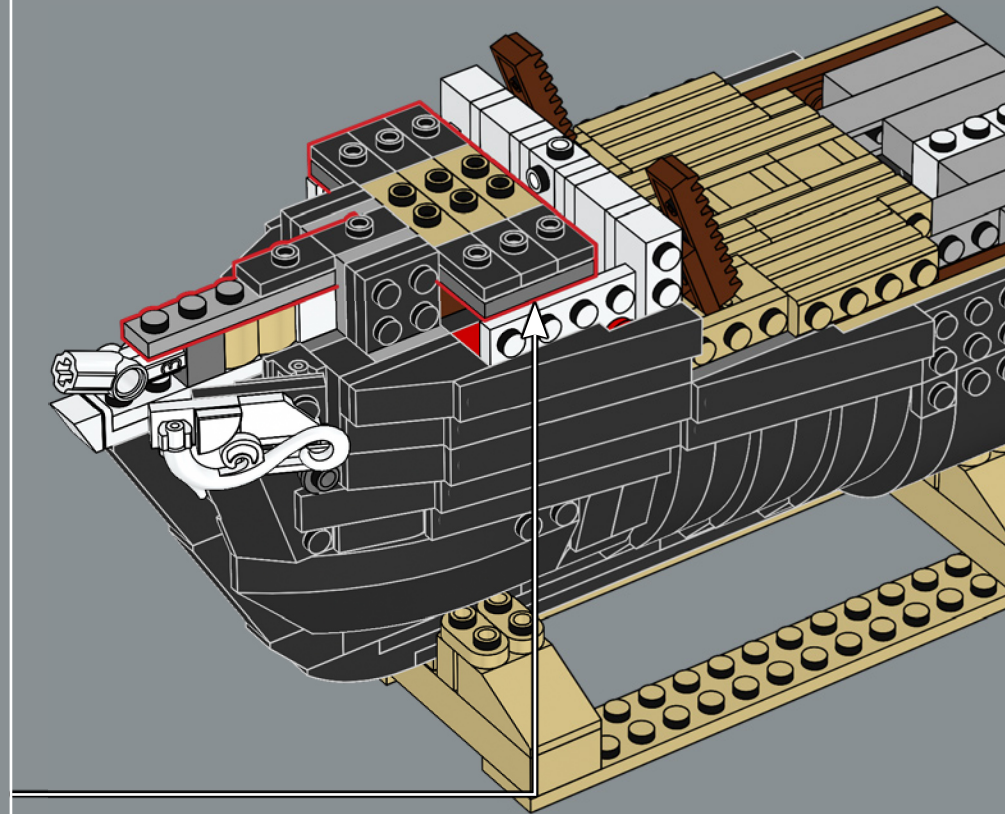
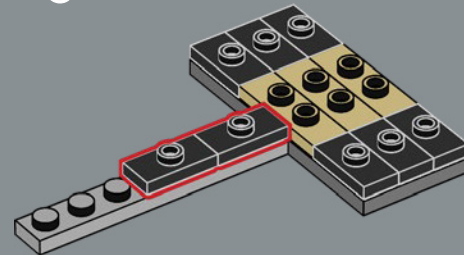

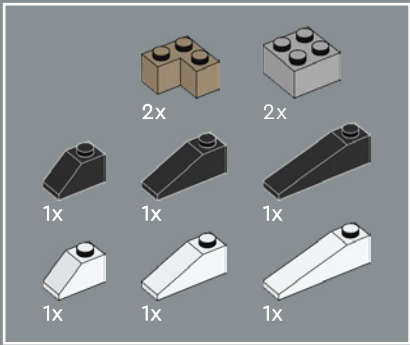

97

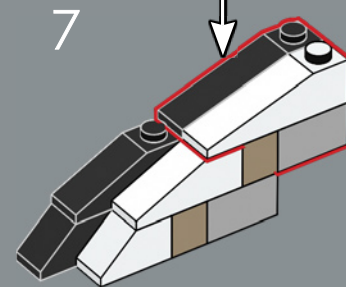
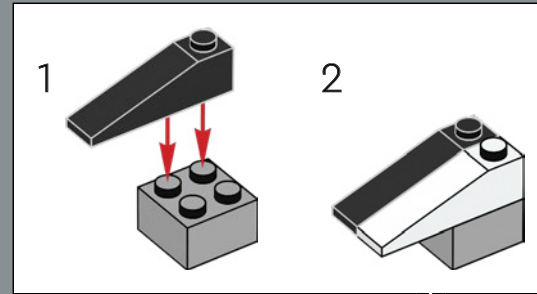
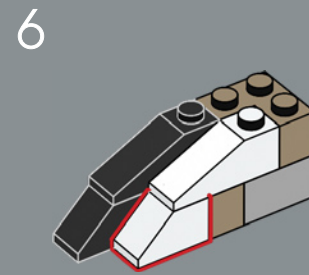
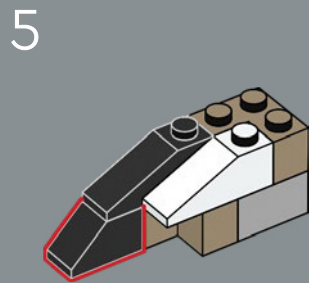
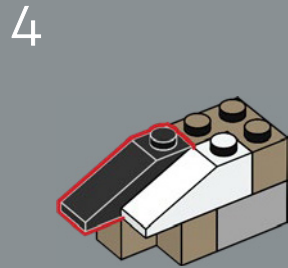
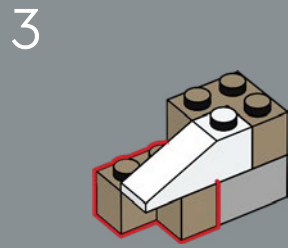
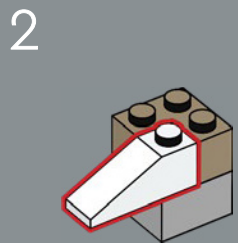
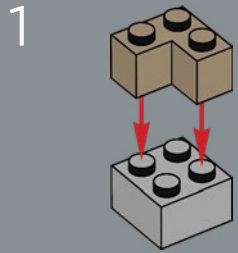

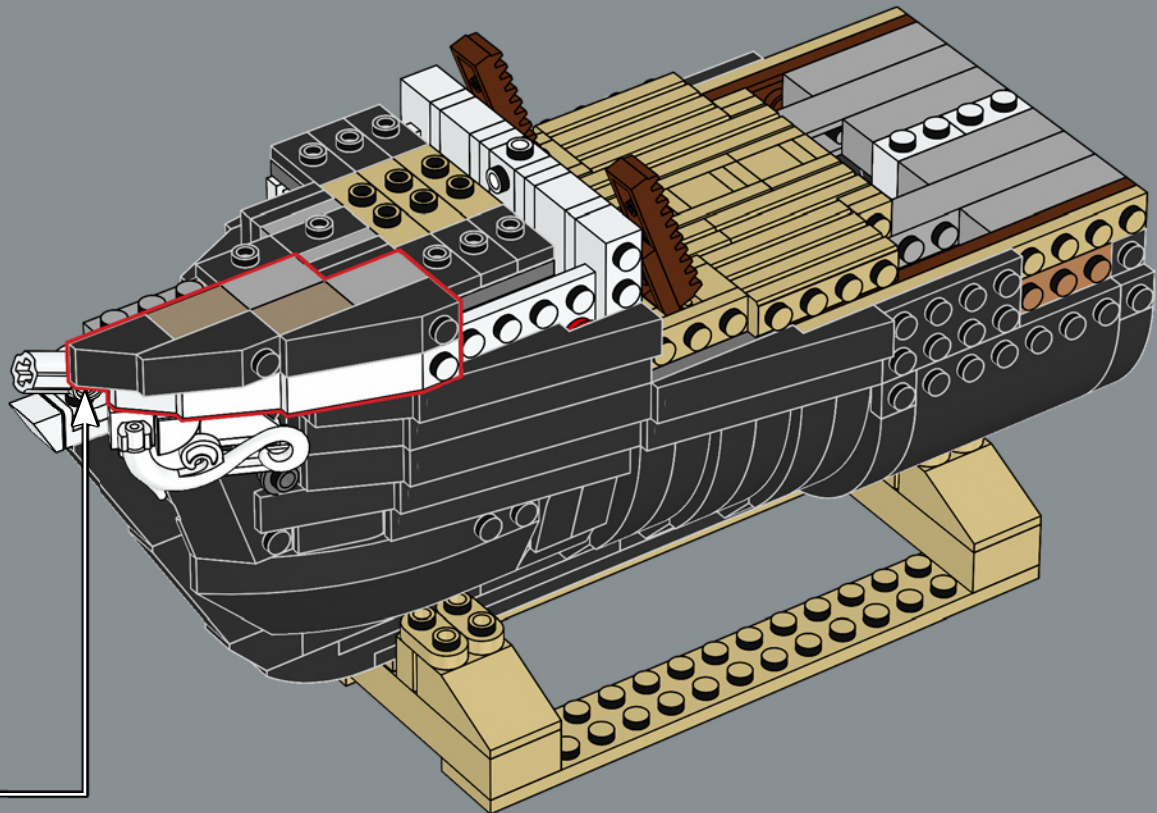

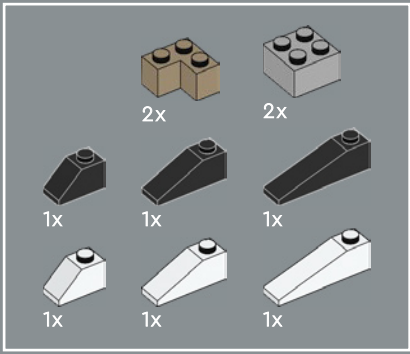

98

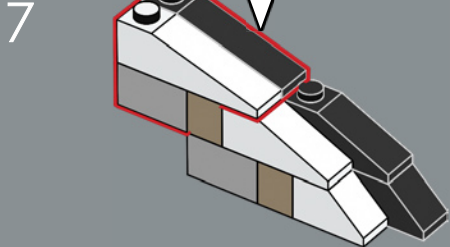
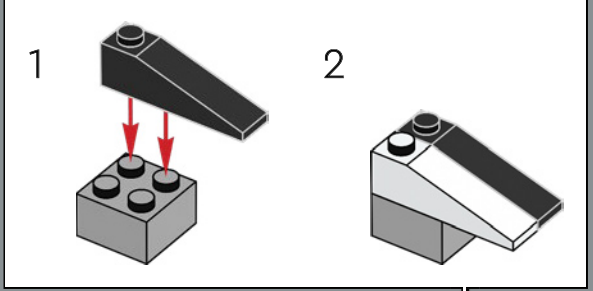
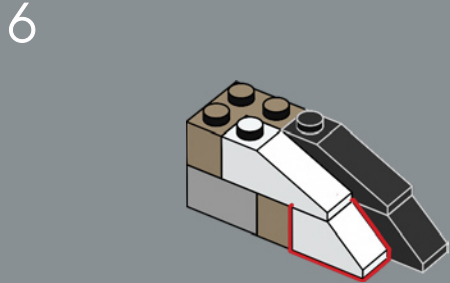
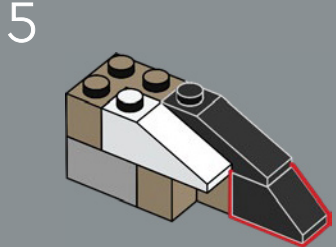
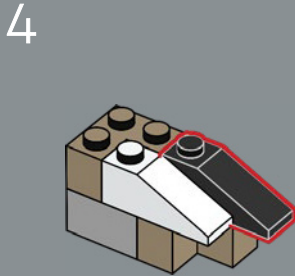
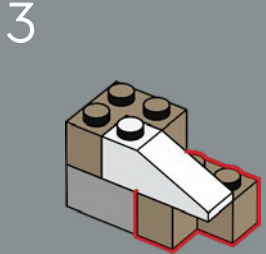
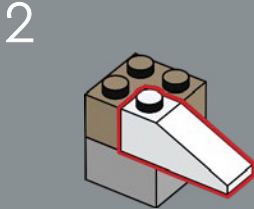
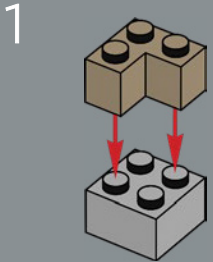

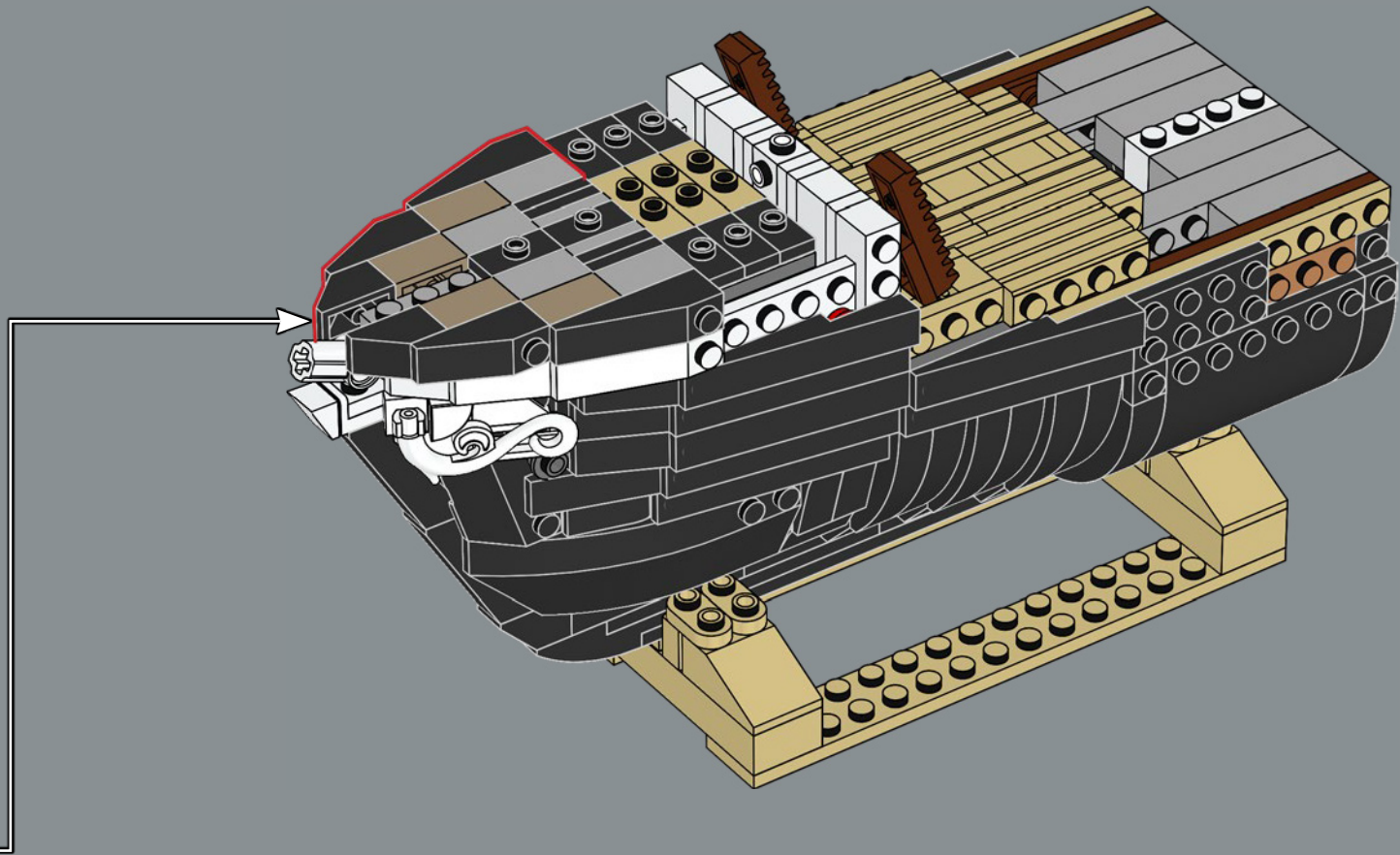



1x

99

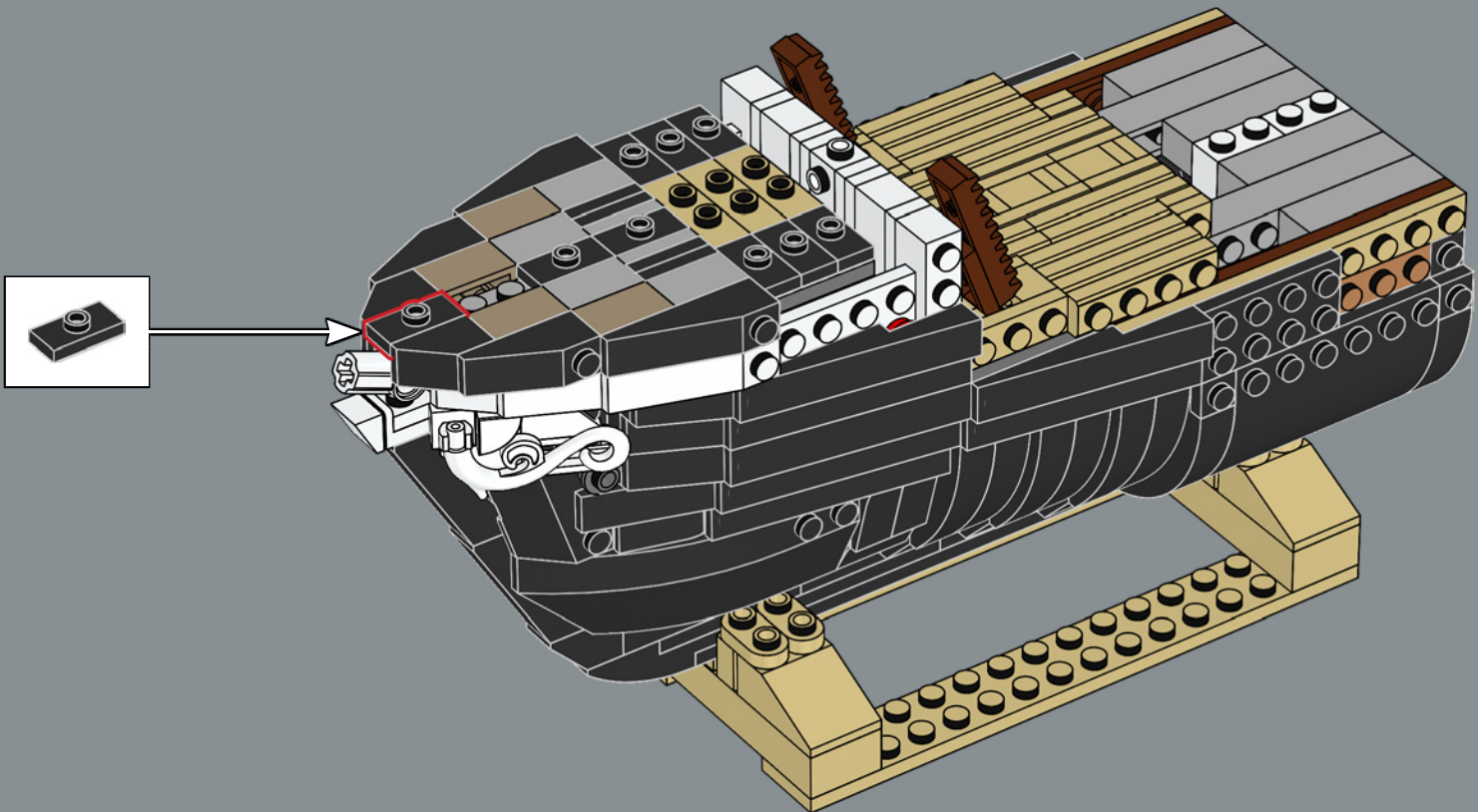

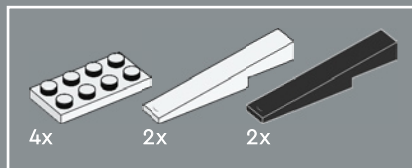

100

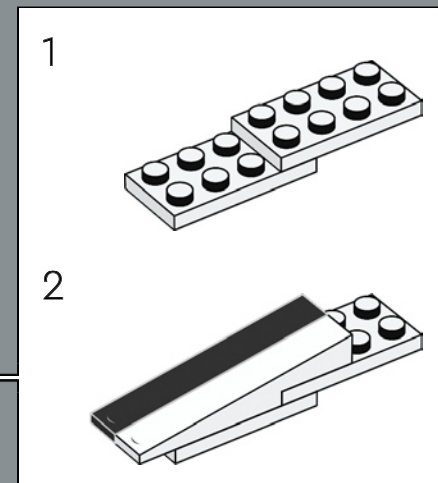
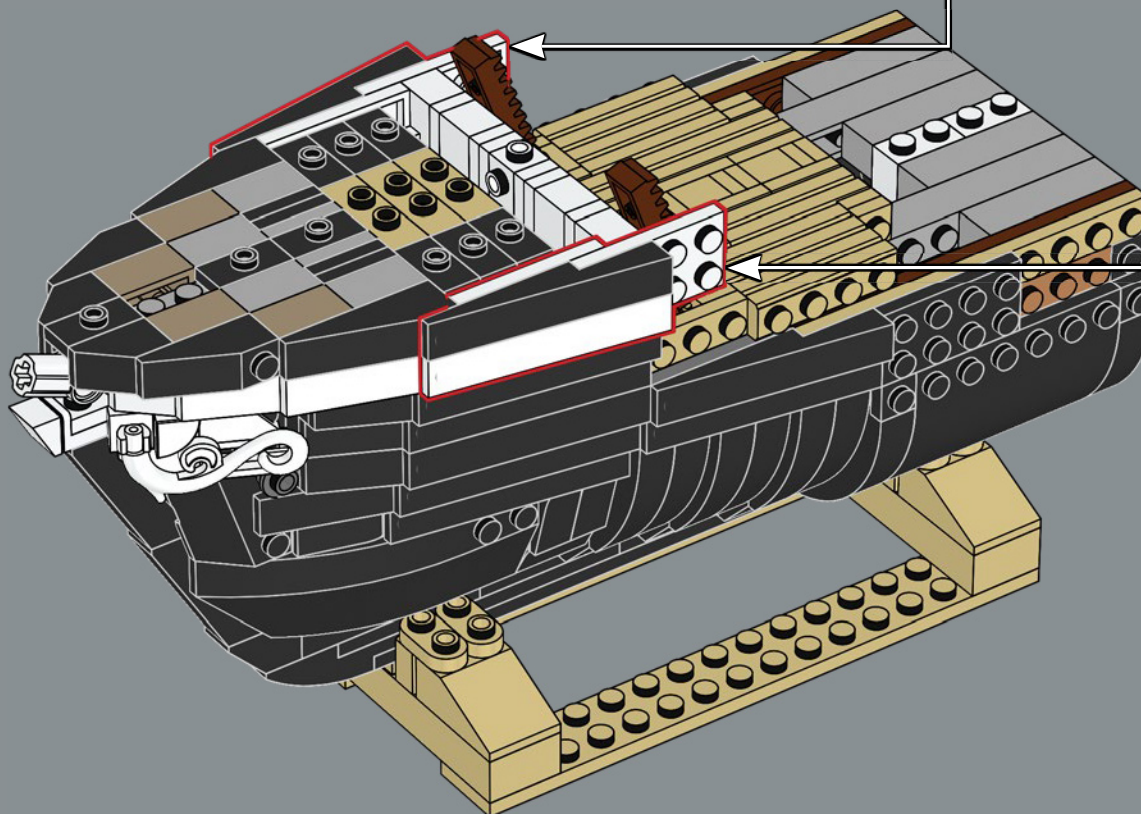
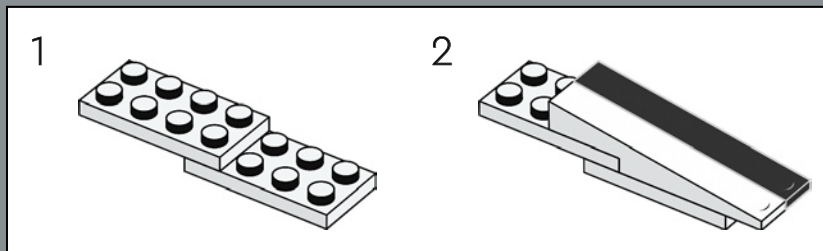

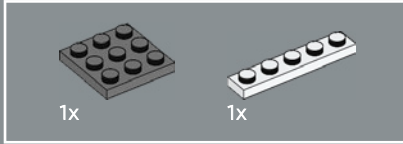
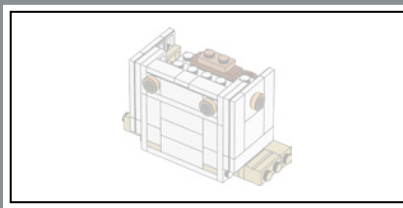

101

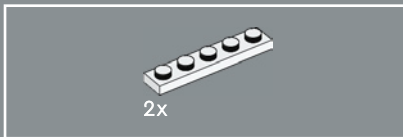
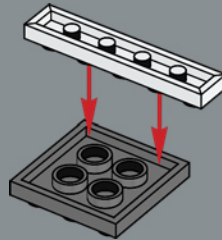

102

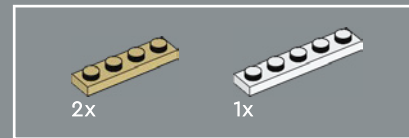
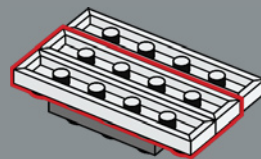

103

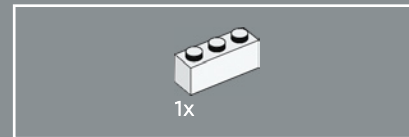
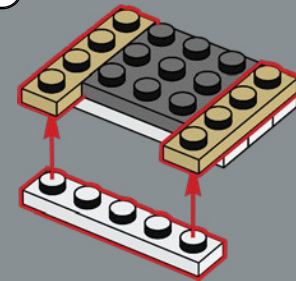

104

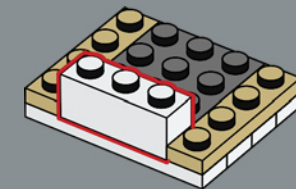

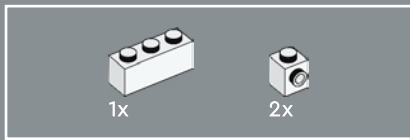

105

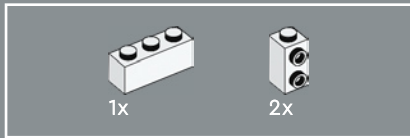
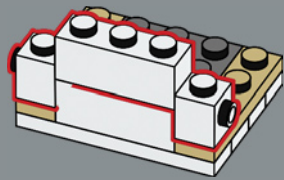

106

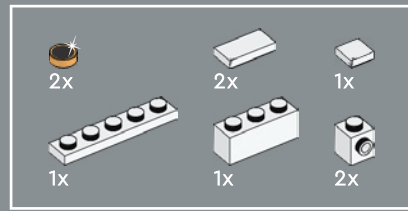
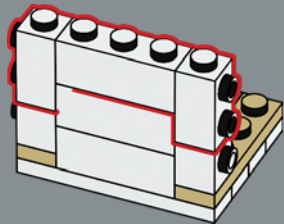

107

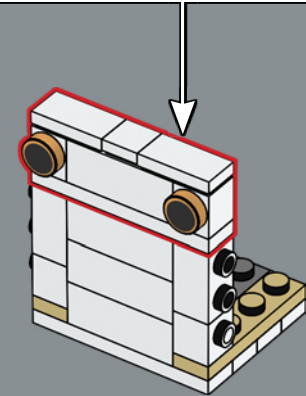
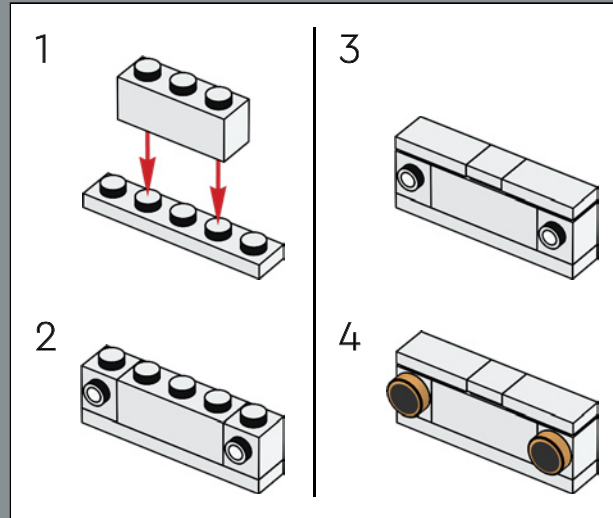



2x

108

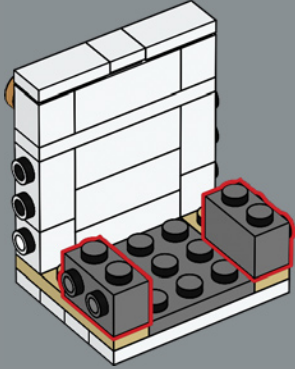

2x

109

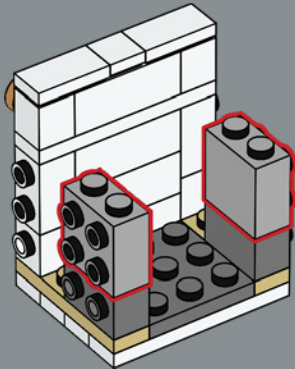

1x

2x

2x

1x

110

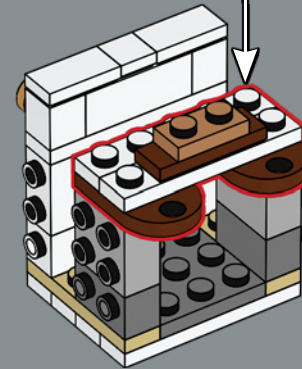
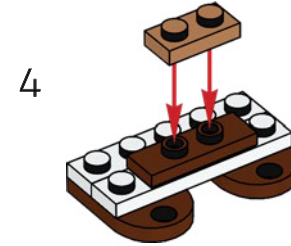
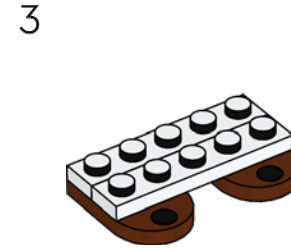
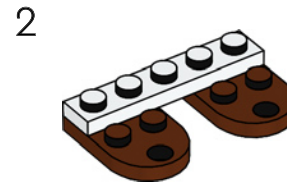
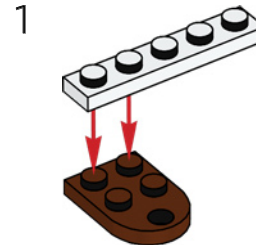

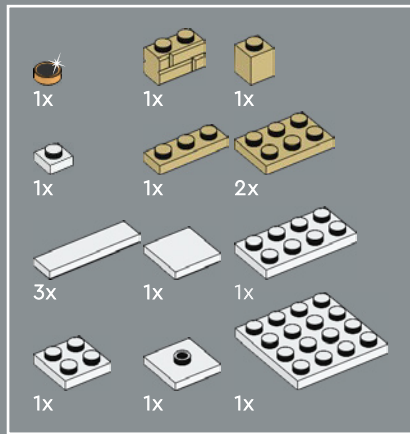

111

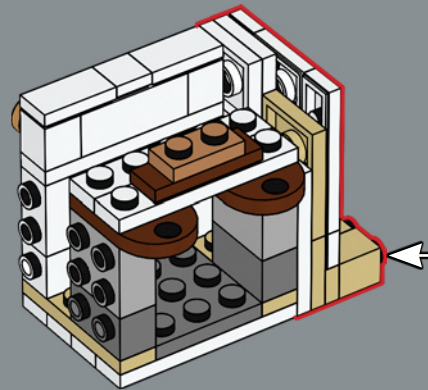
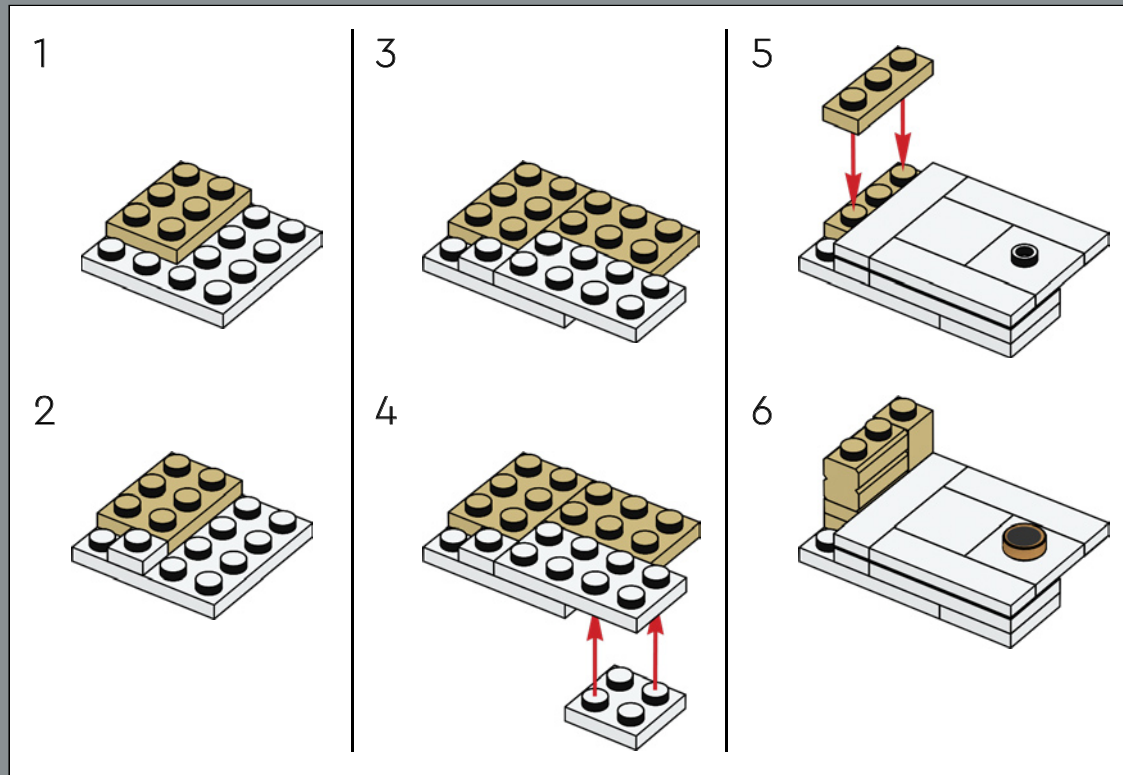

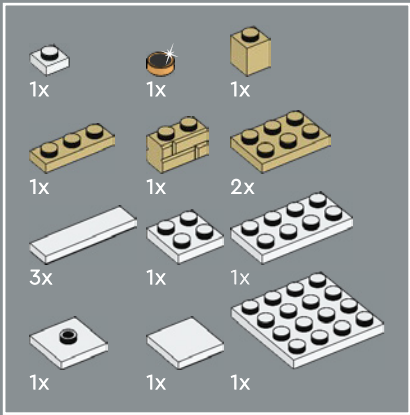

112

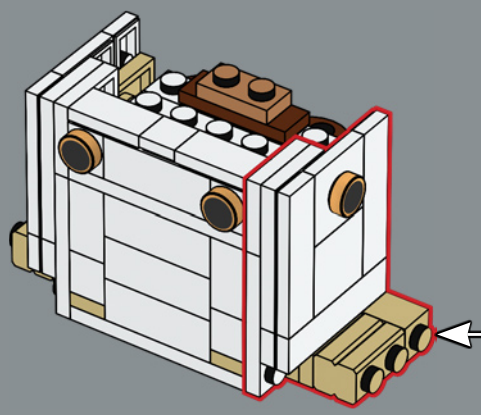
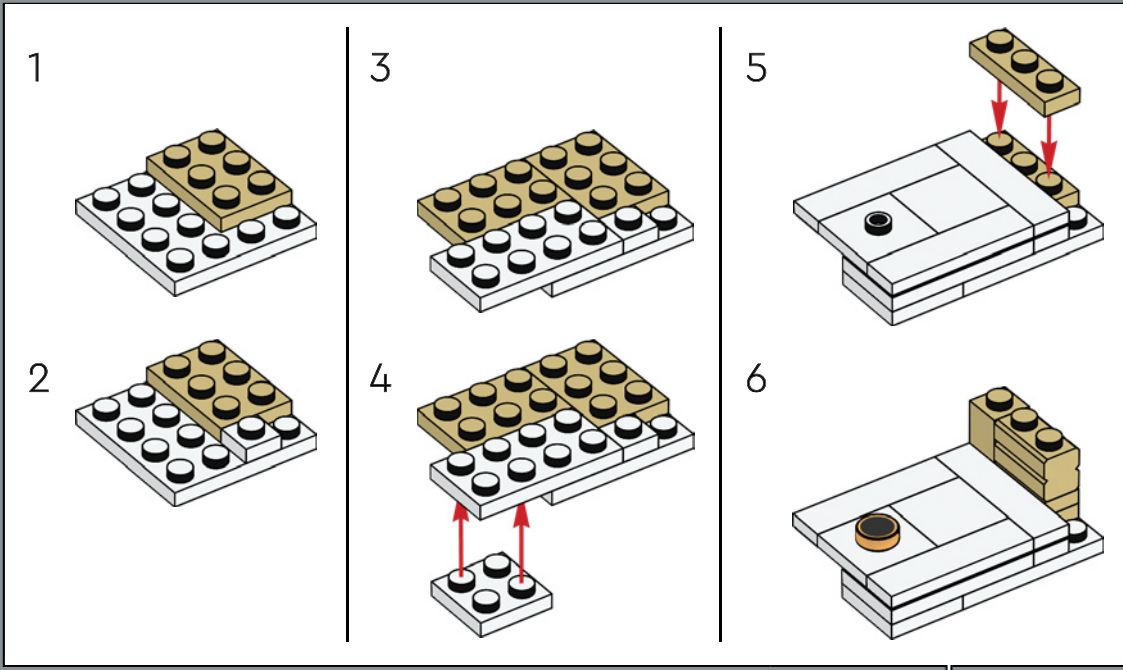

113

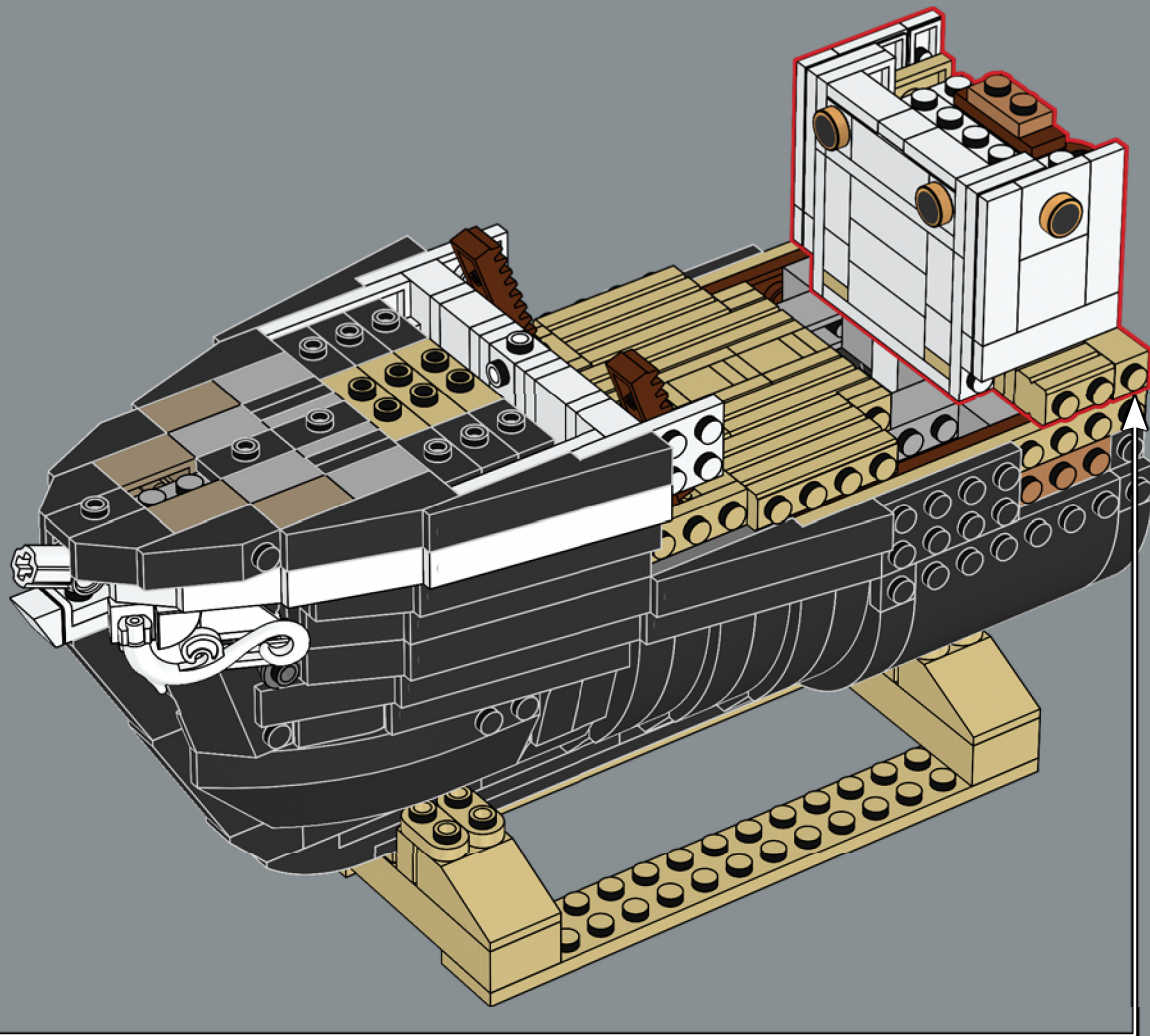

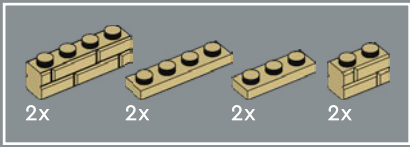

114

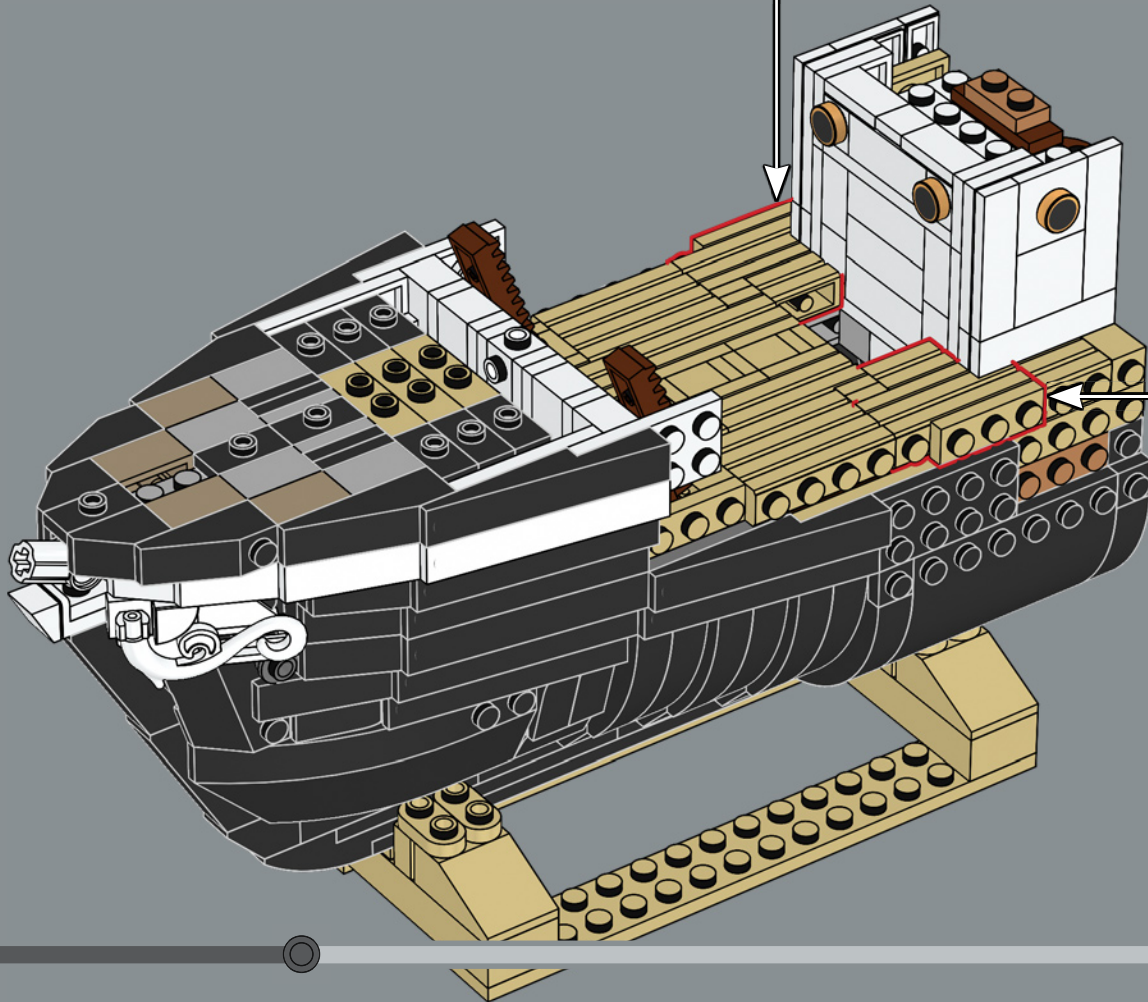
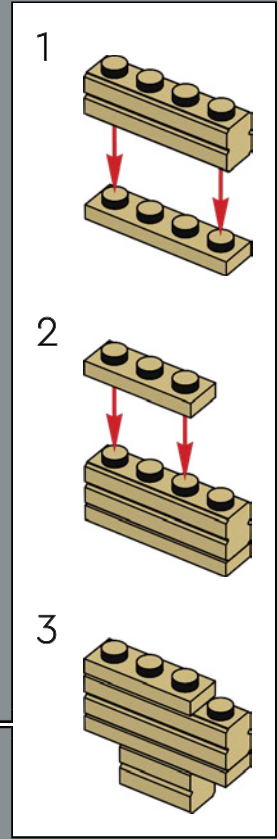
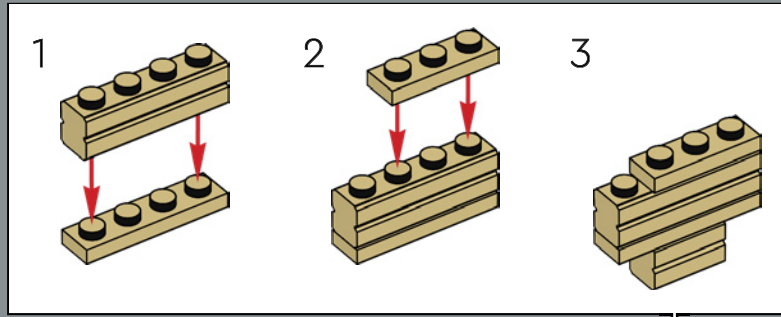

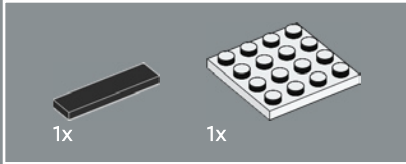
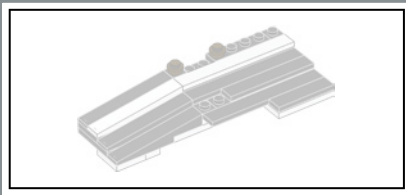

115

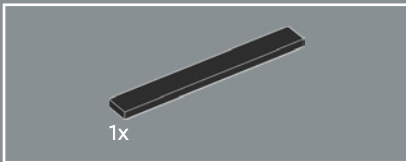
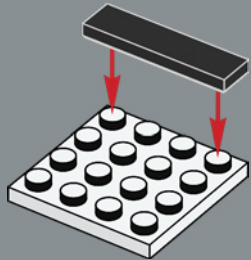

116

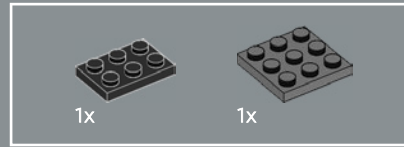
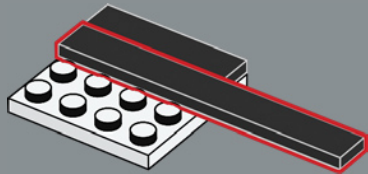

117

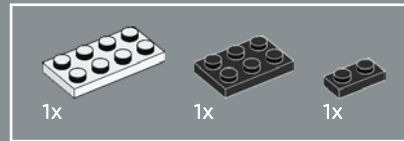
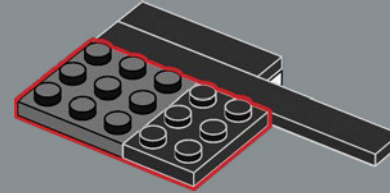

118

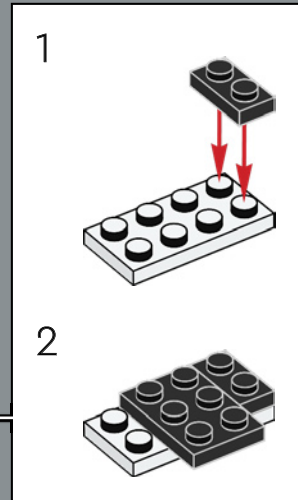
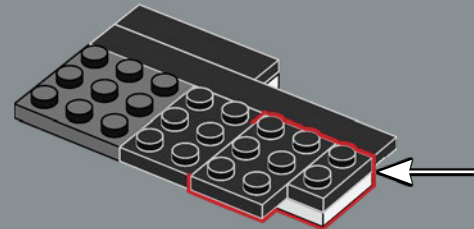

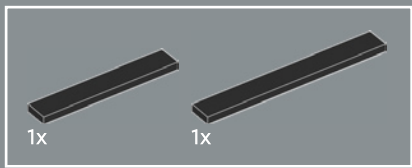

119

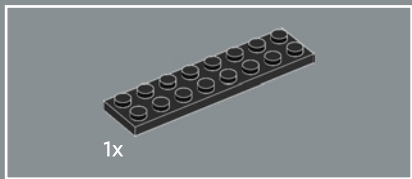
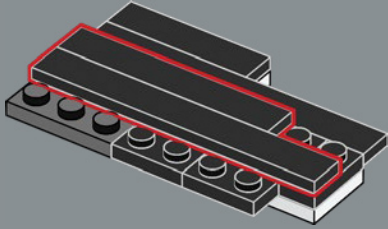

120

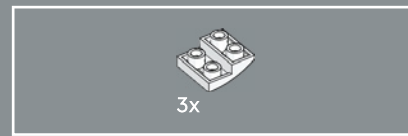
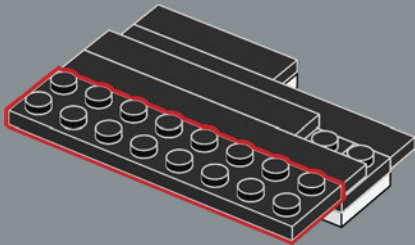

121

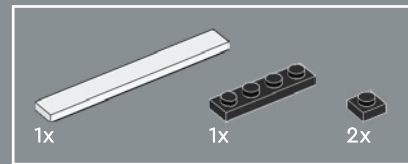
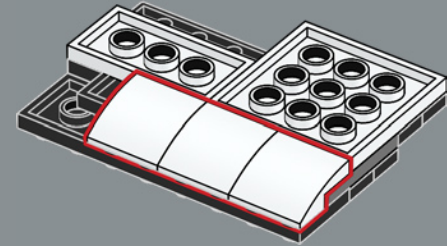

122

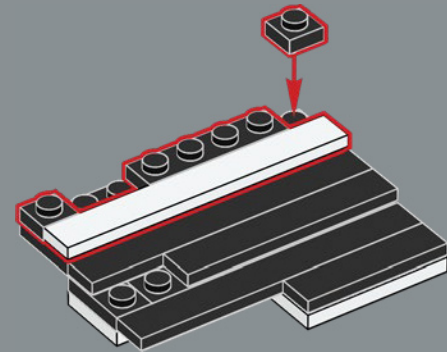



123

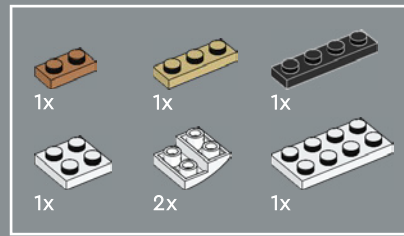
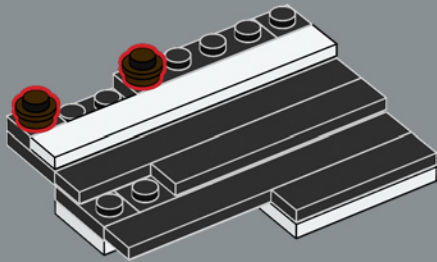

124

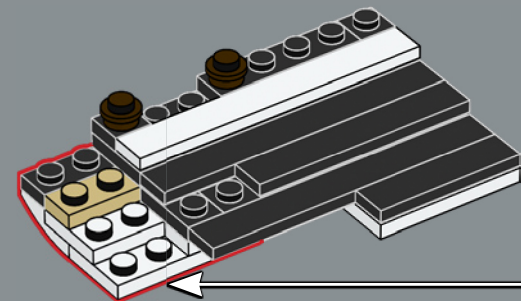
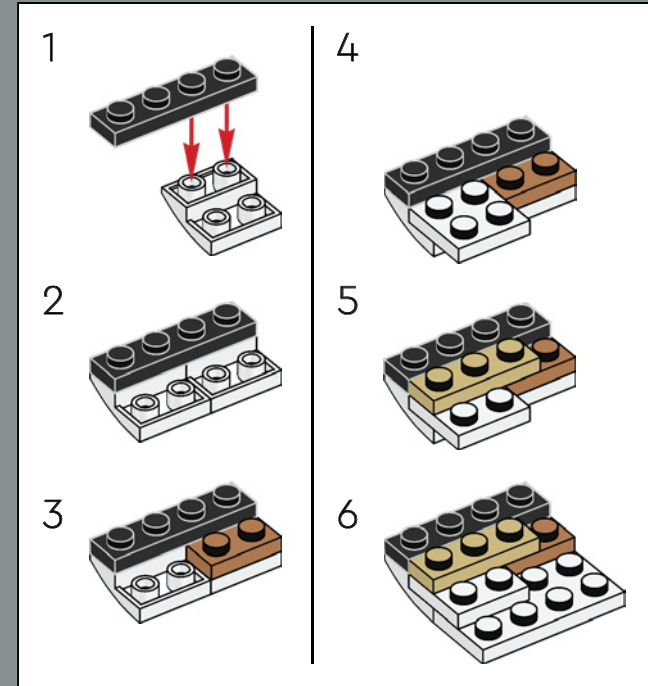

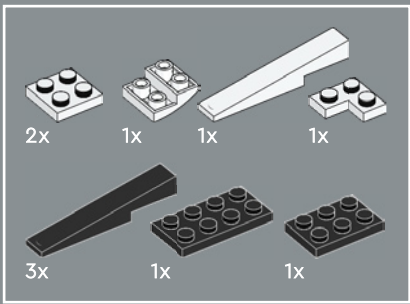

125

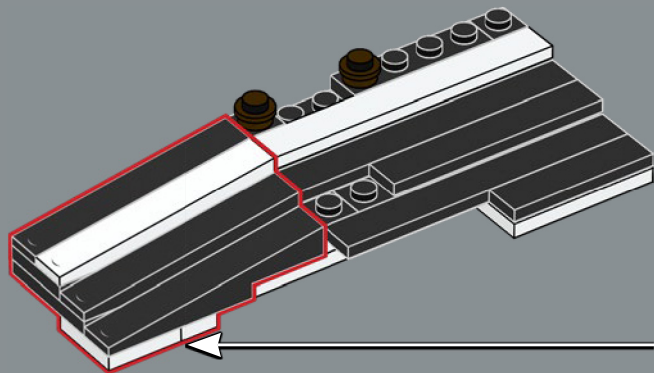
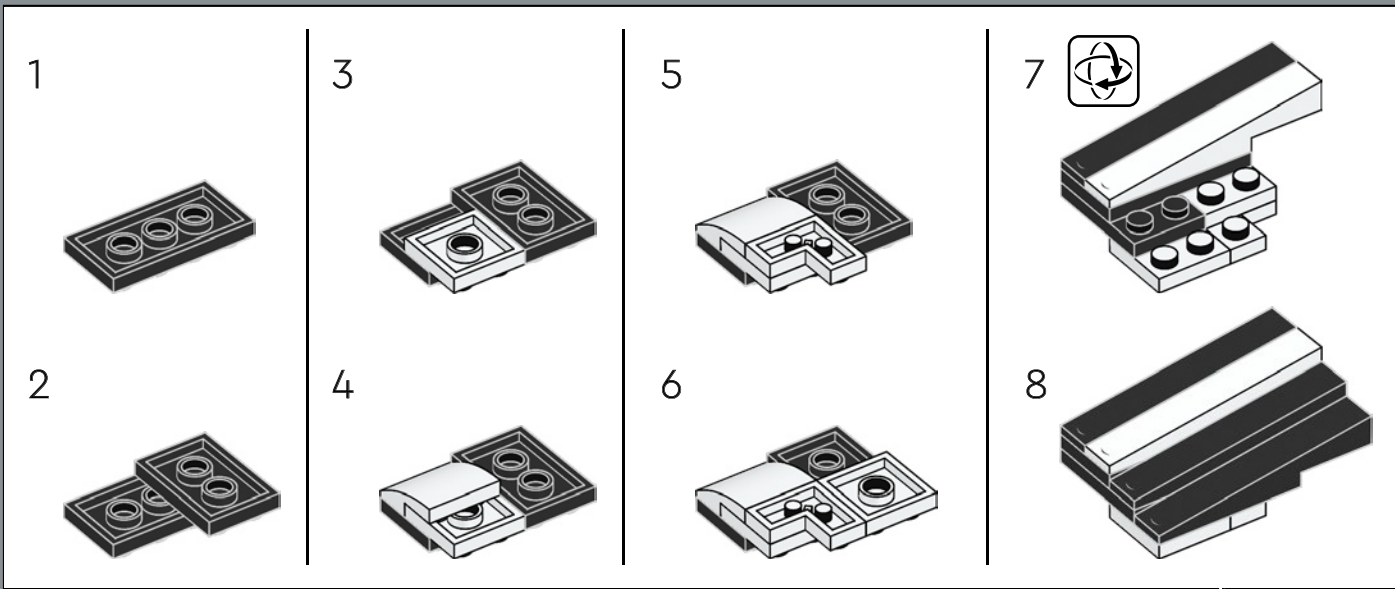

126

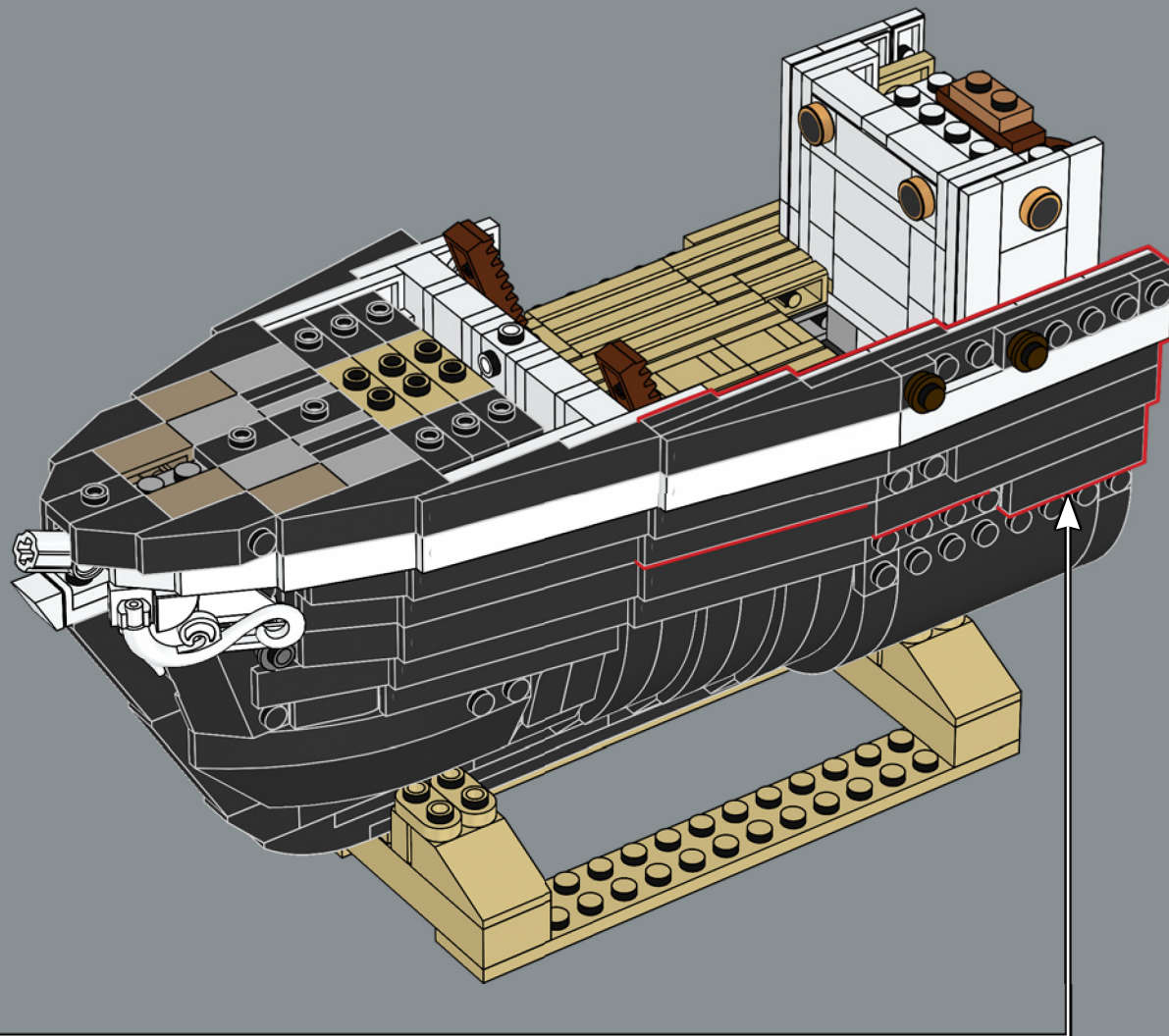

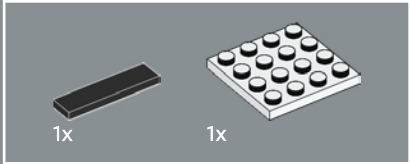
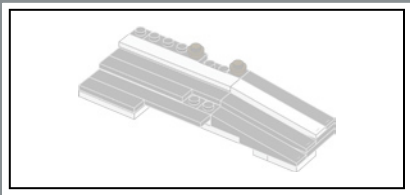

127

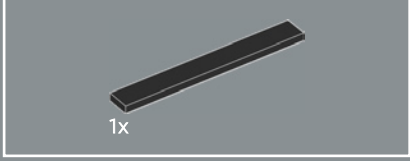
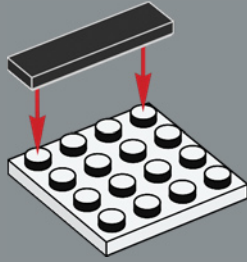

128

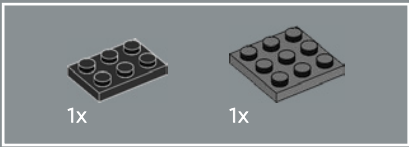
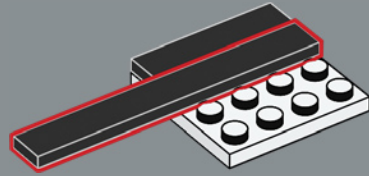

129

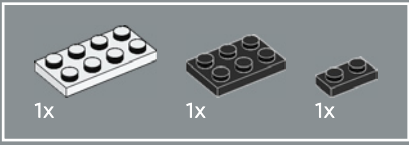
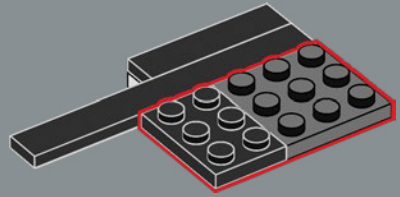

130

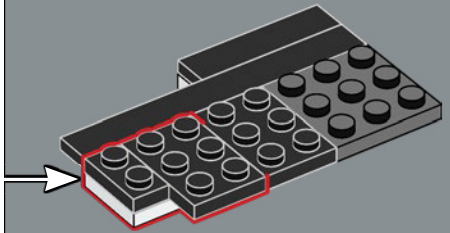
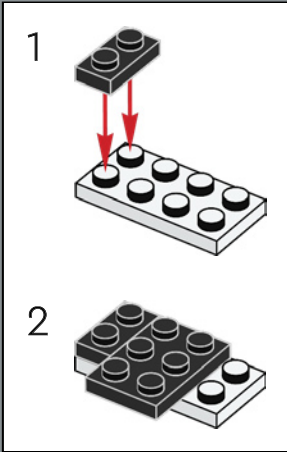

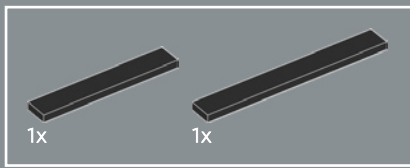

131

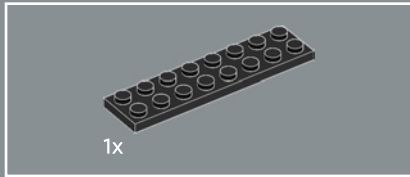
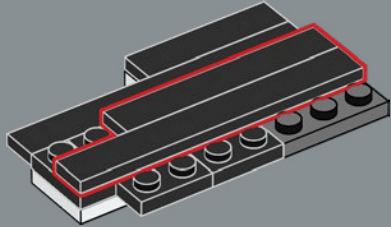

132

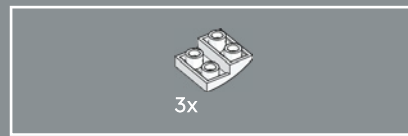
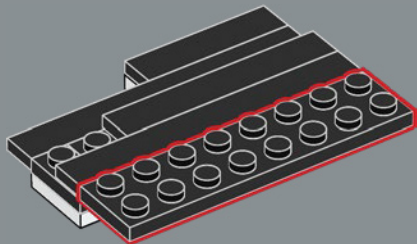

133

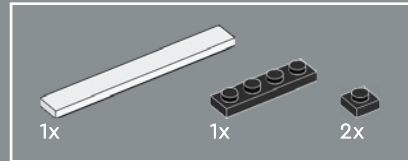
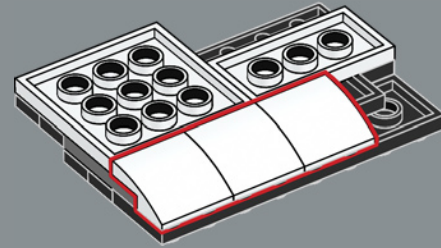

134

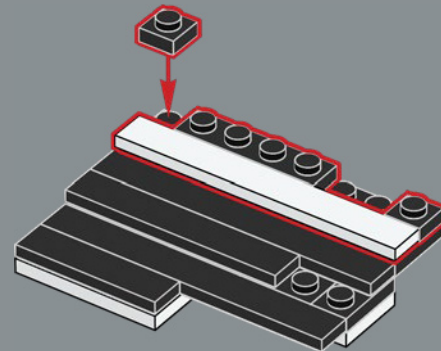

2x

135

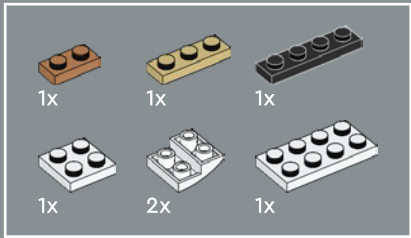
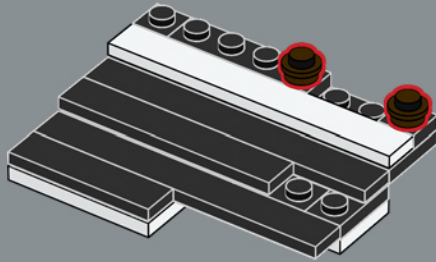

136

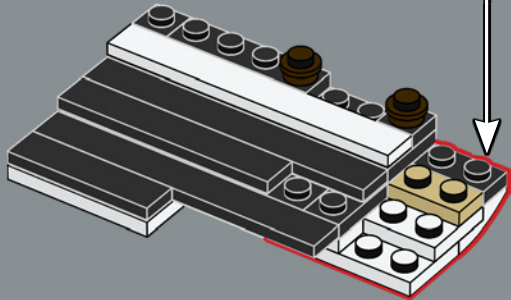
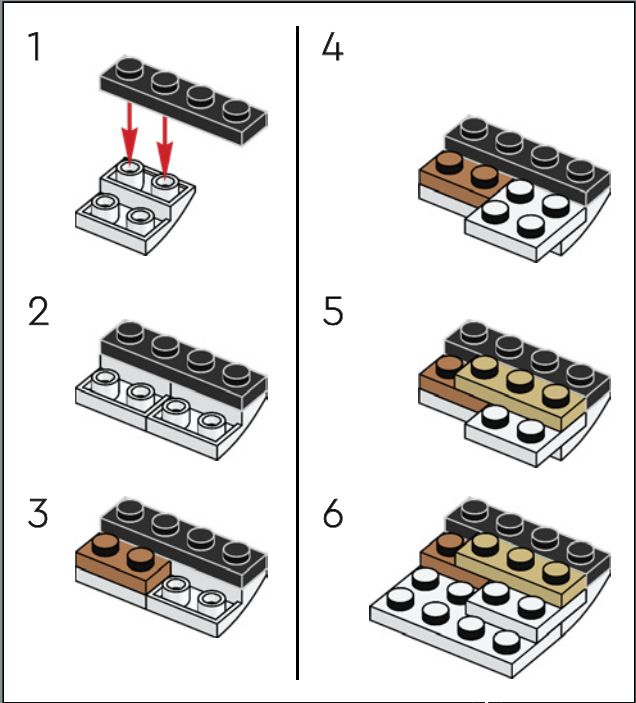

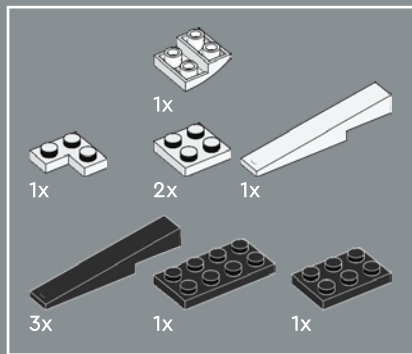

137

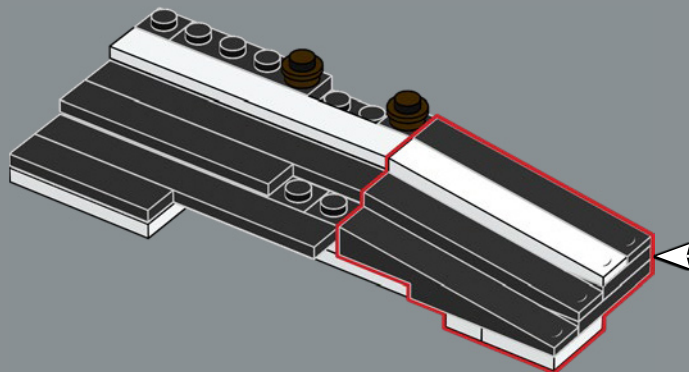
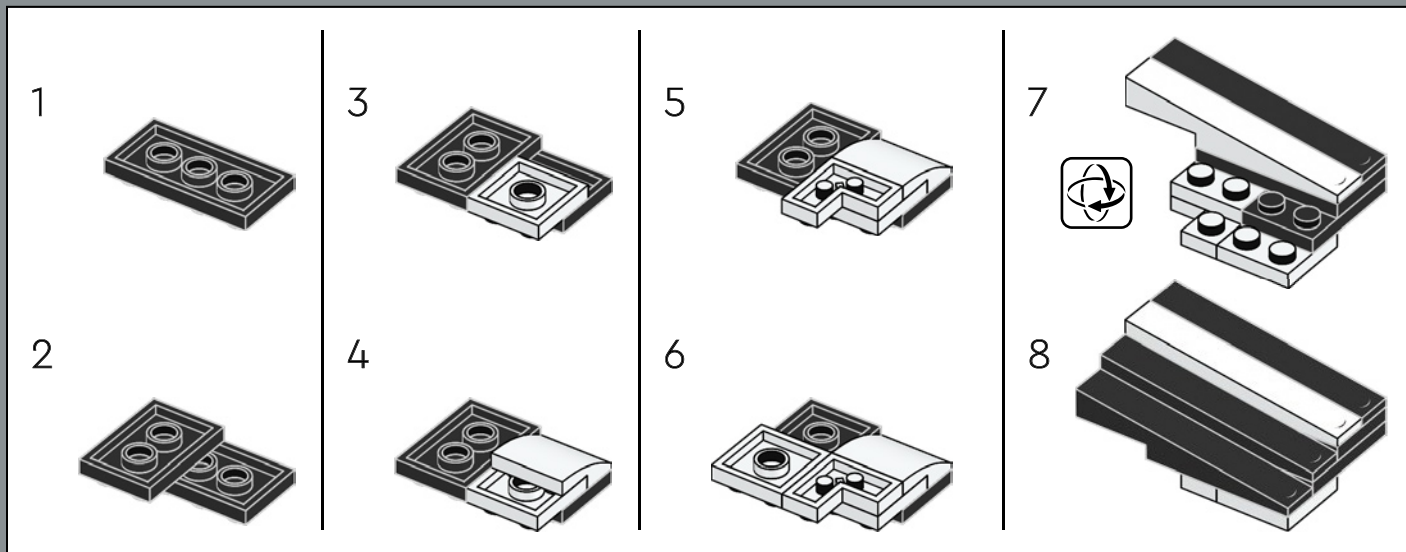

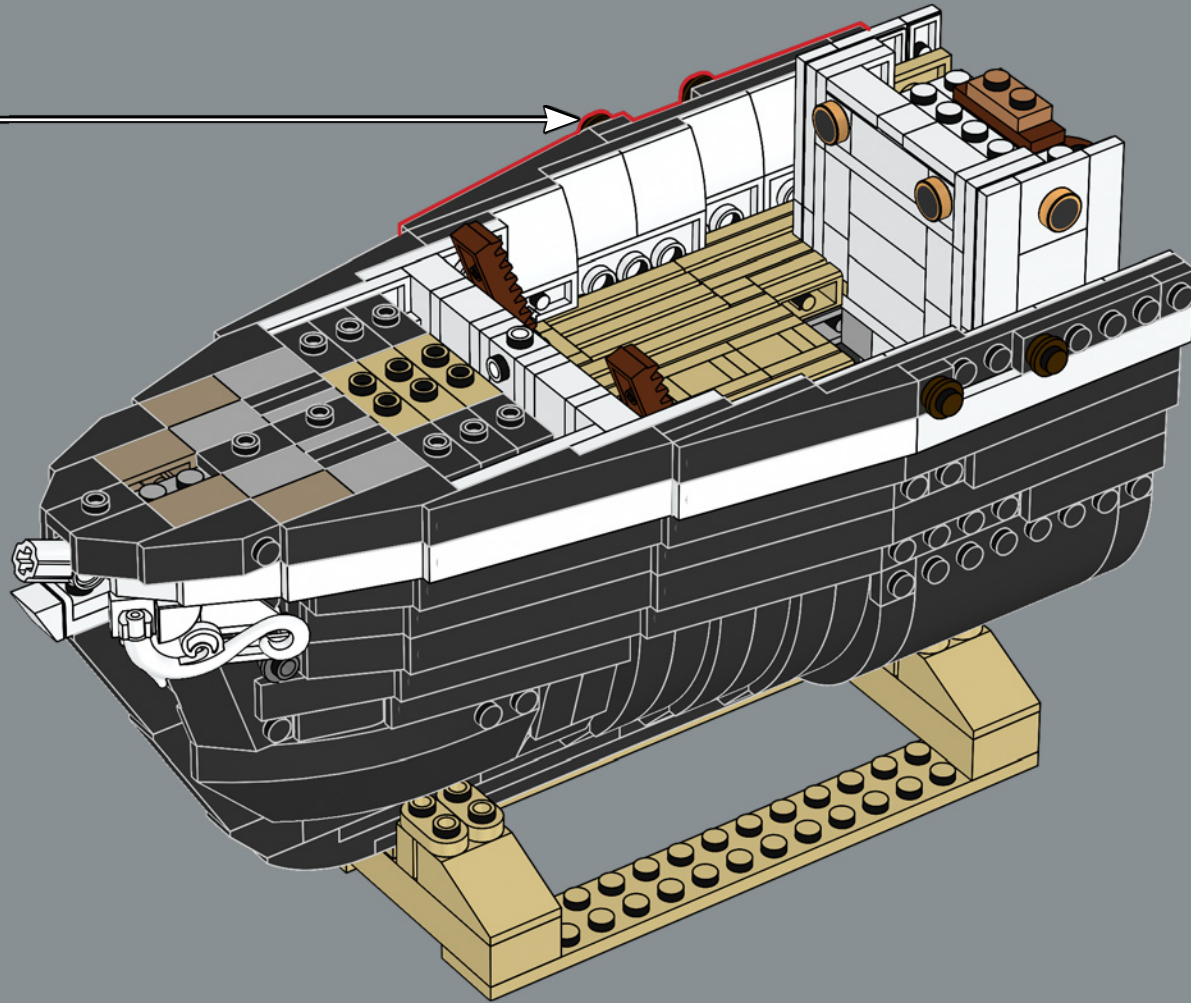

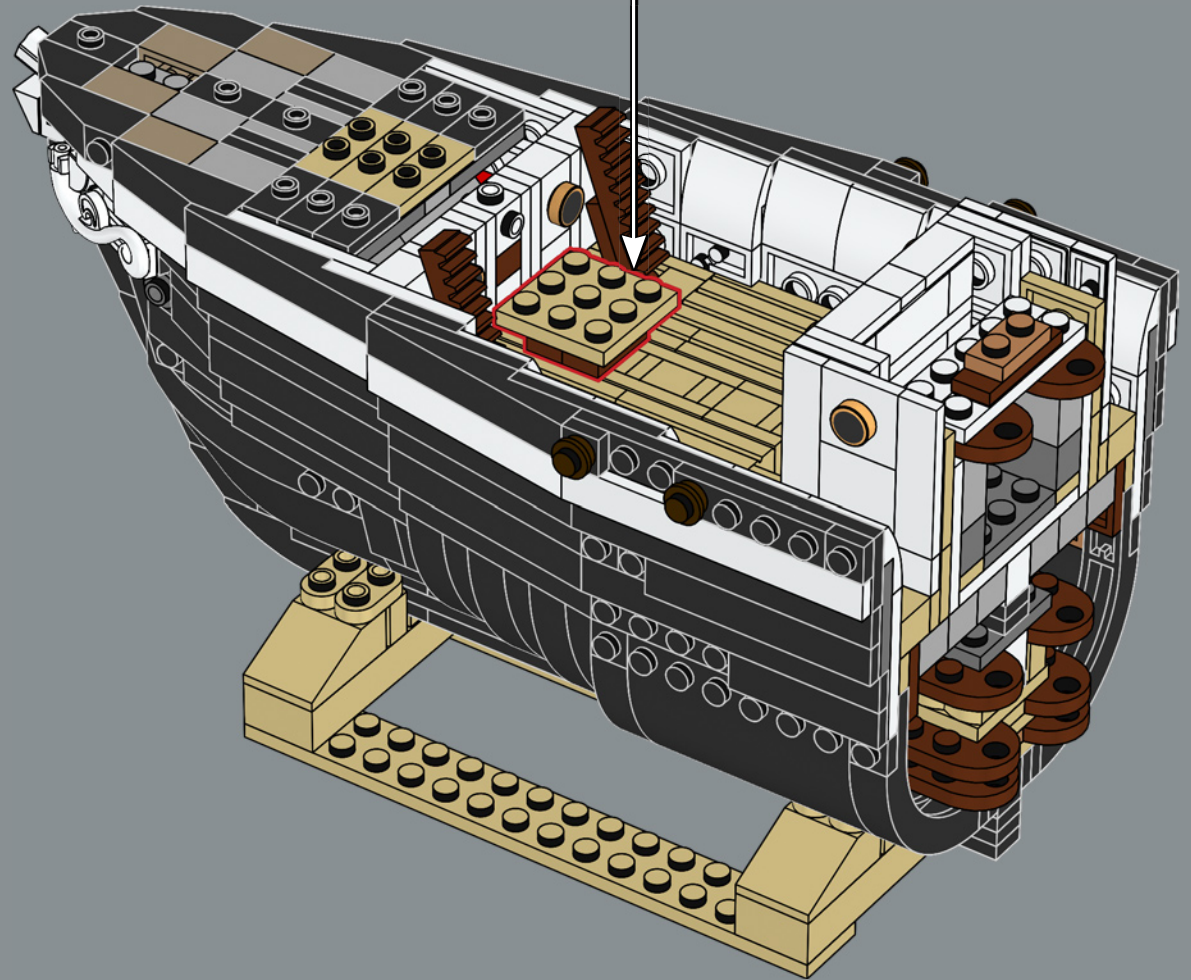
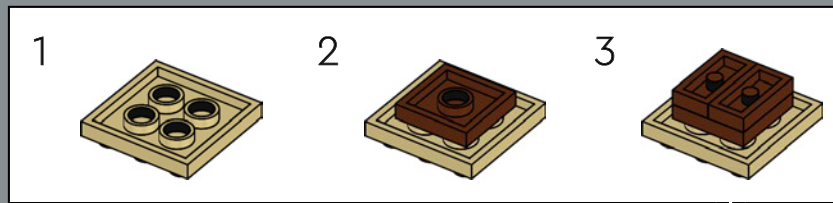
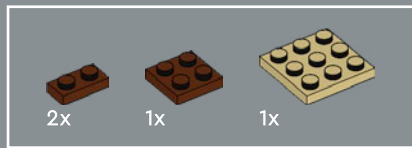

139

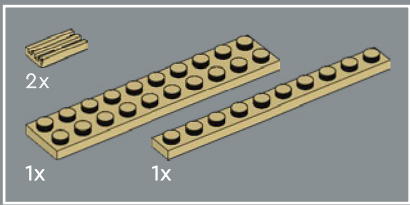

140

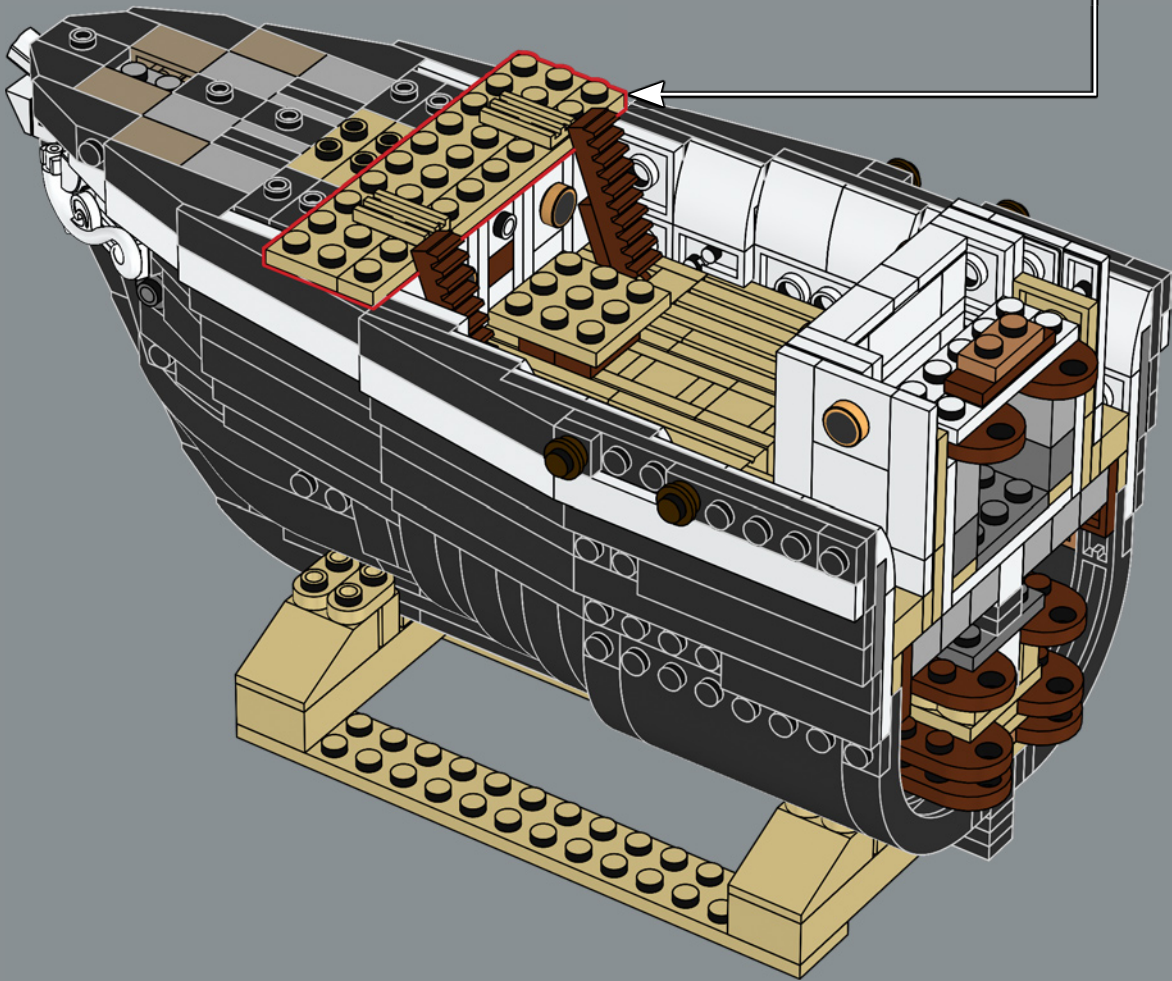
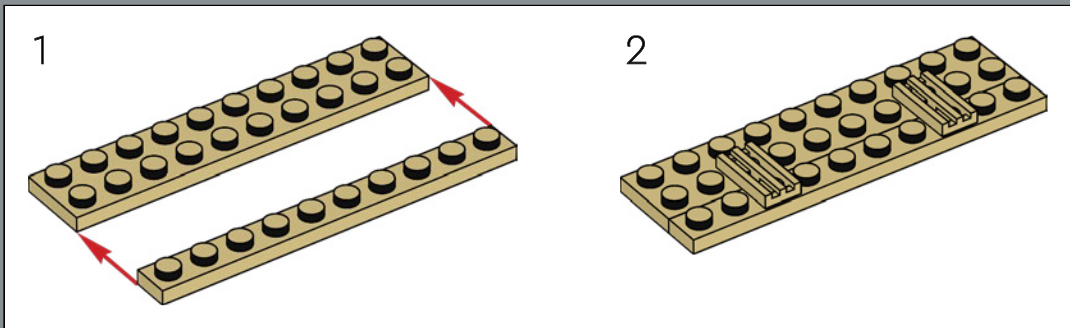

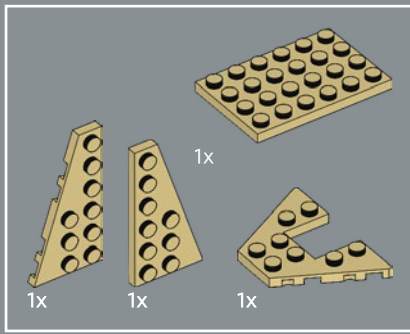

141

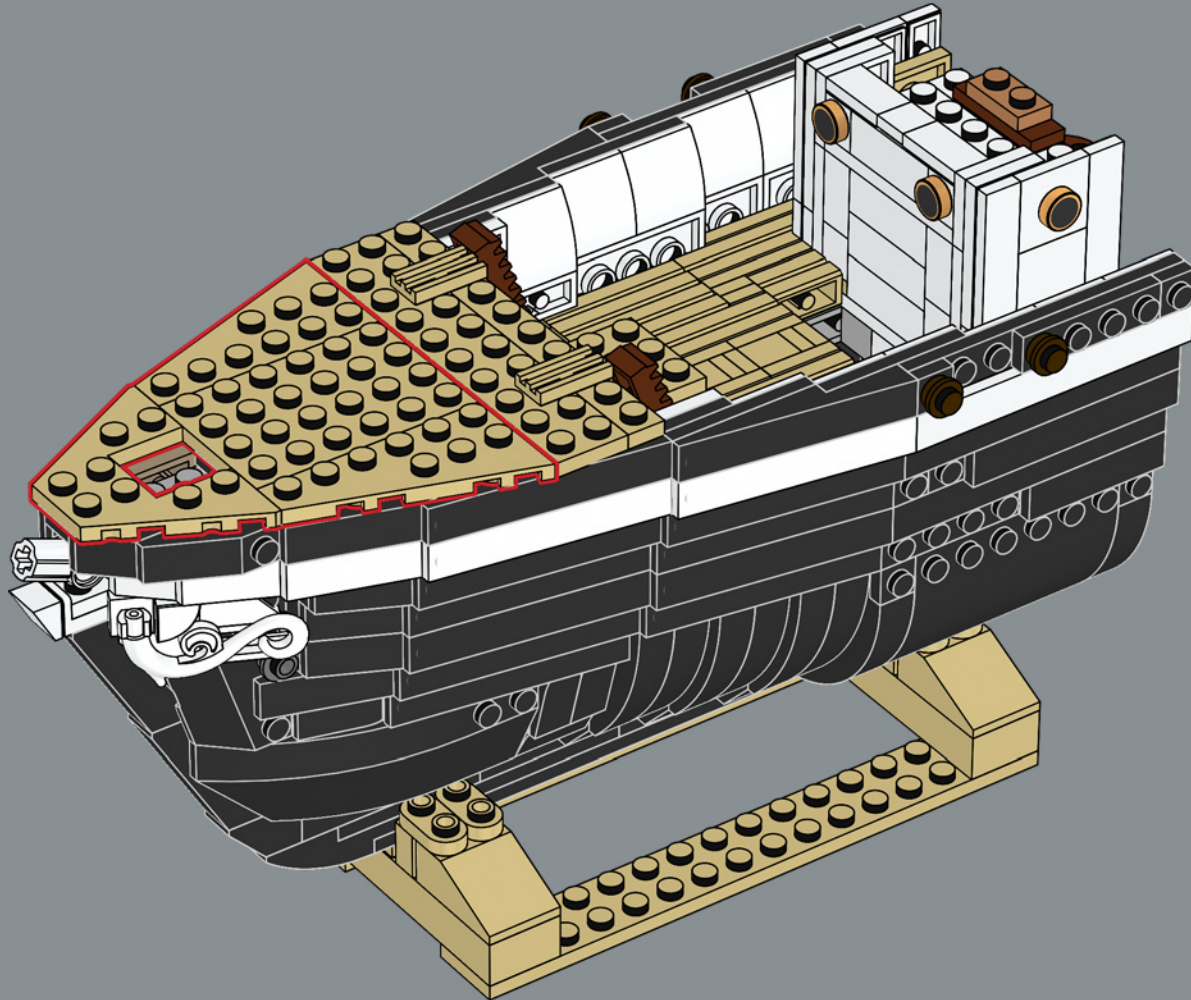

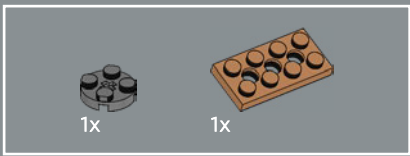

142

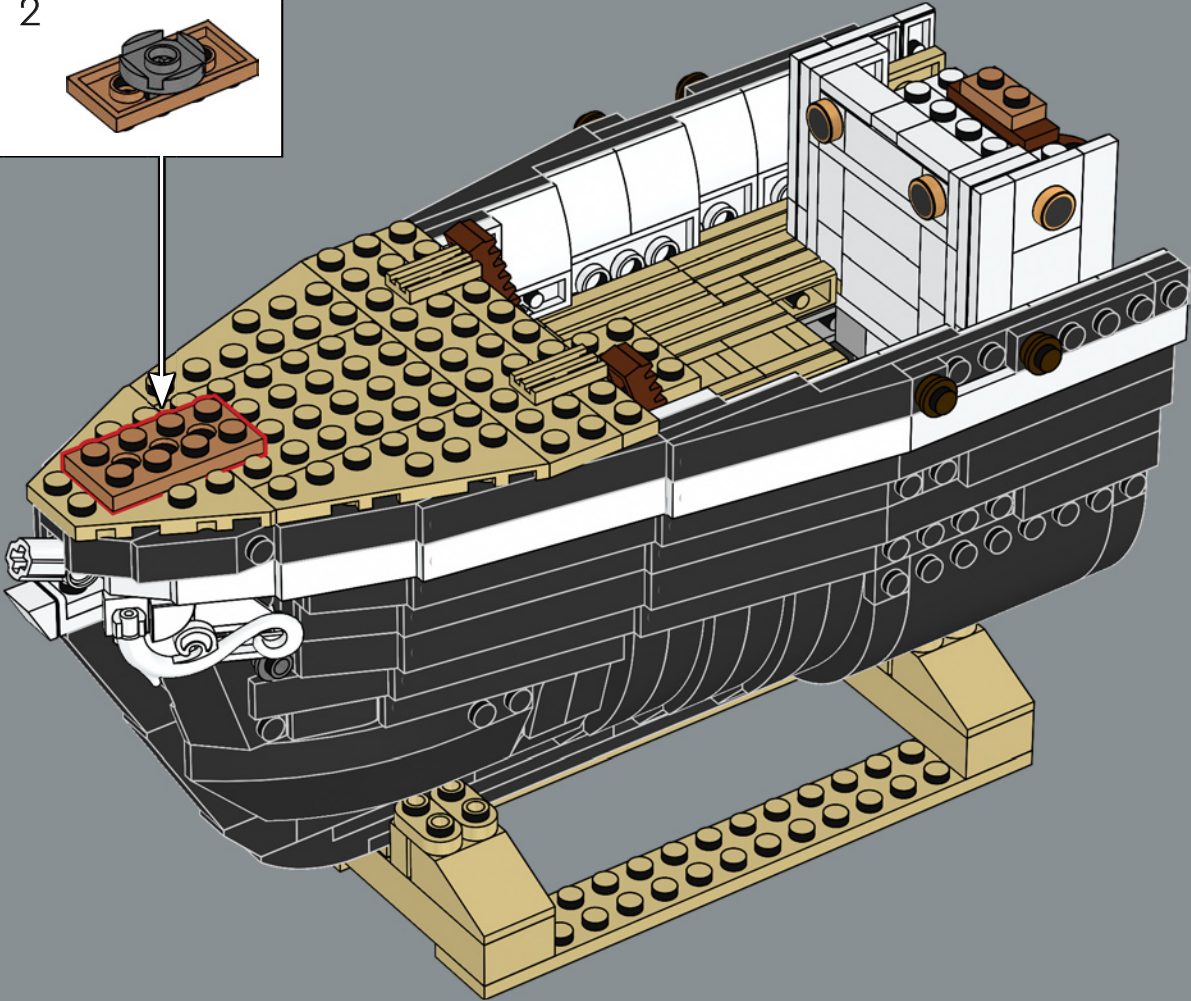
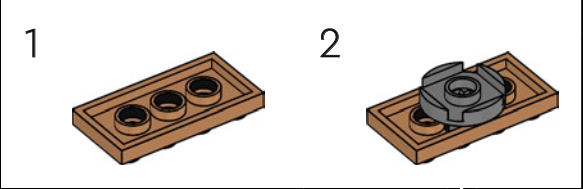

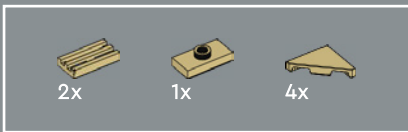

143

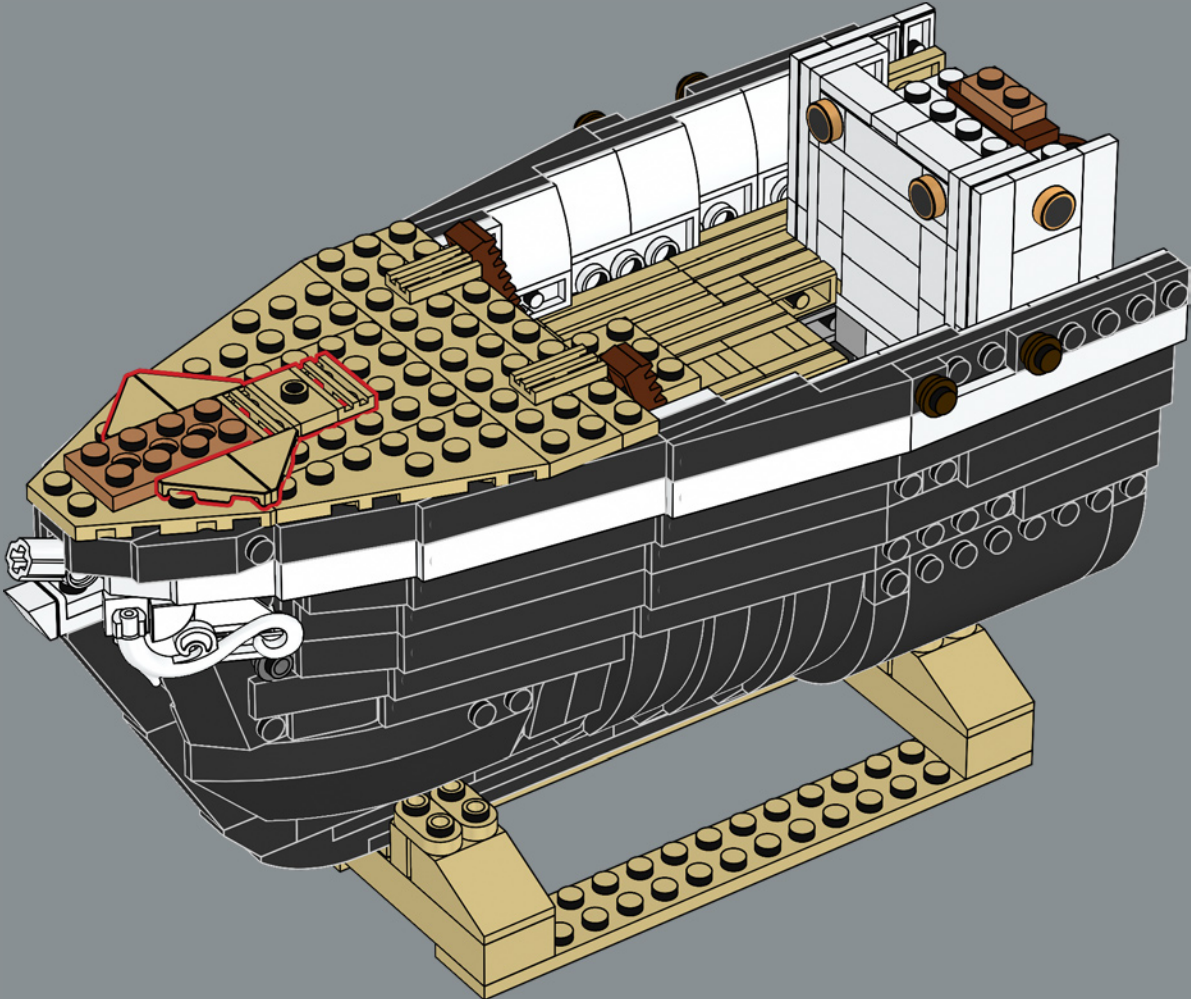



144

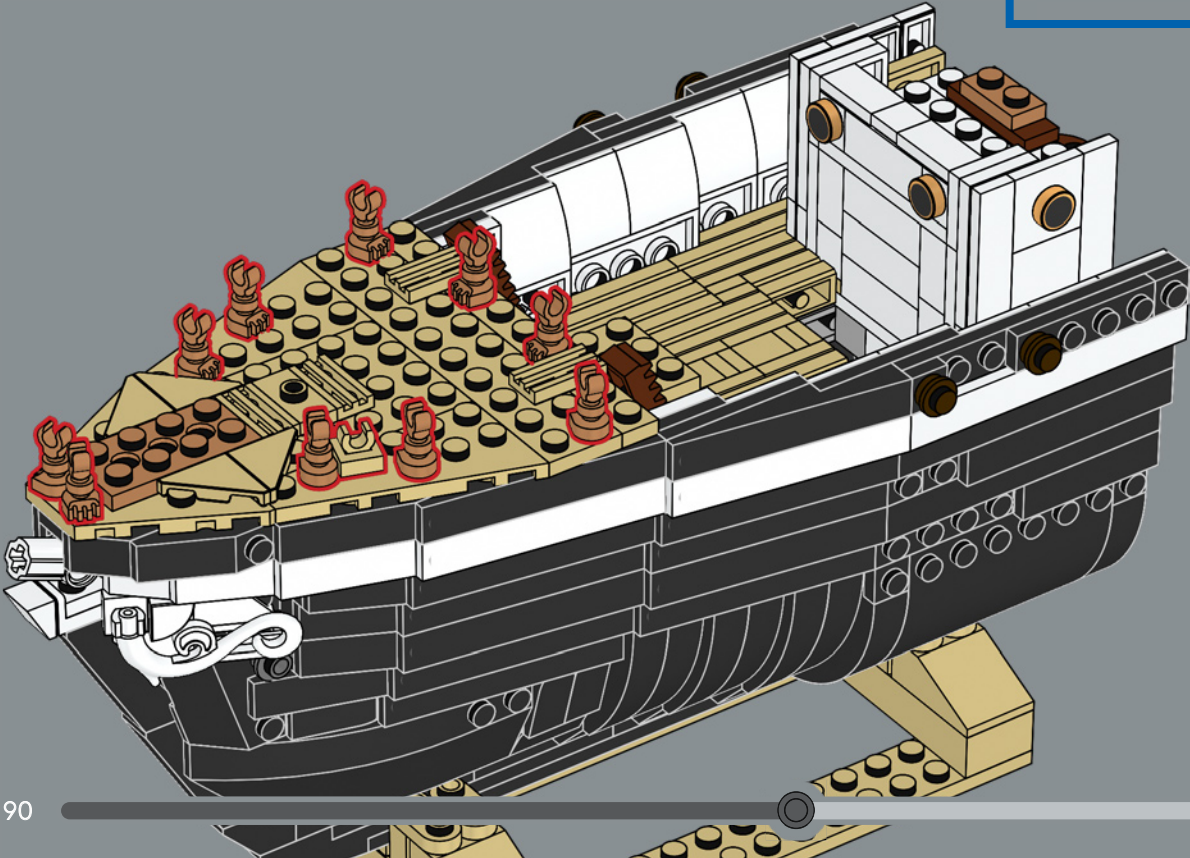
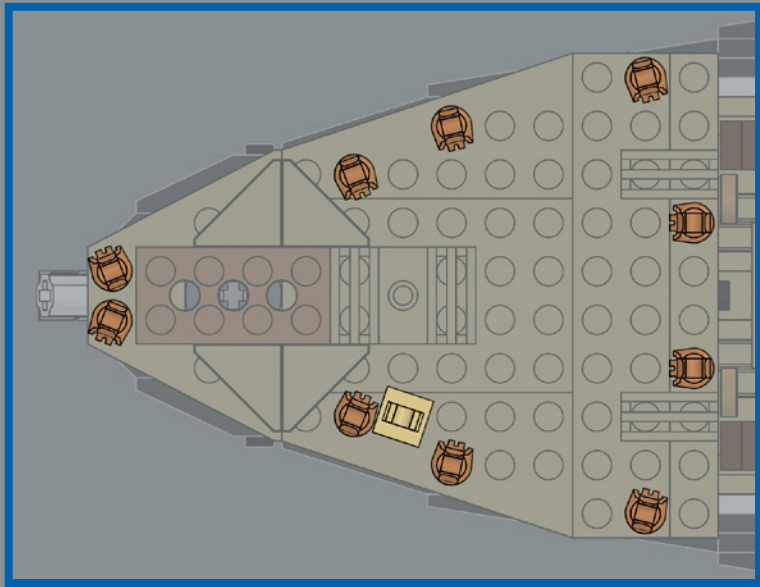



145

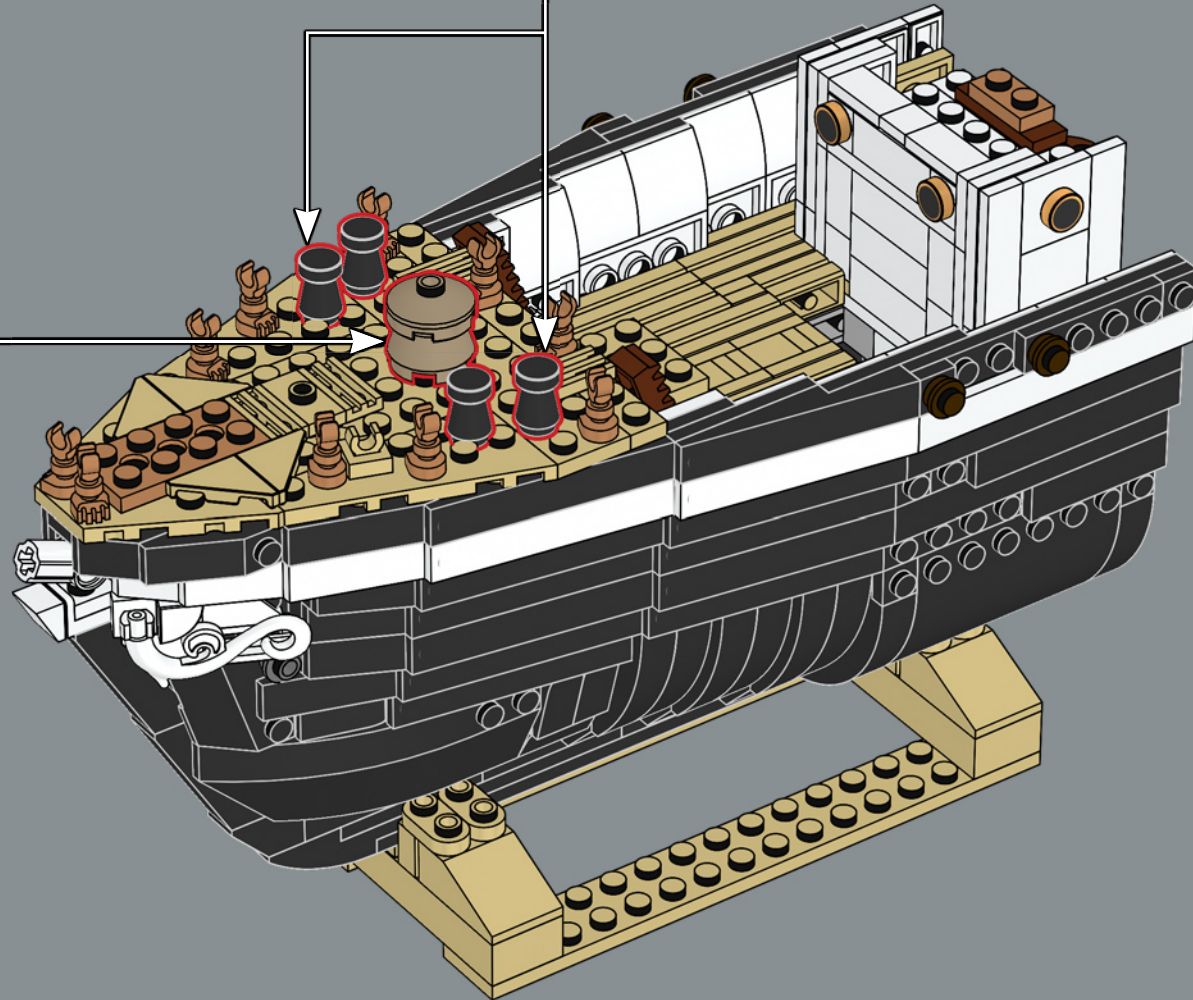
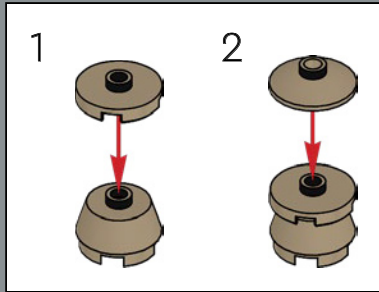
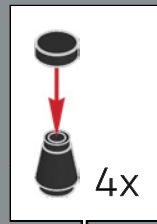

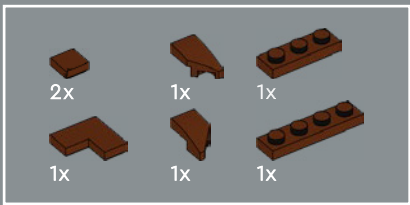

146

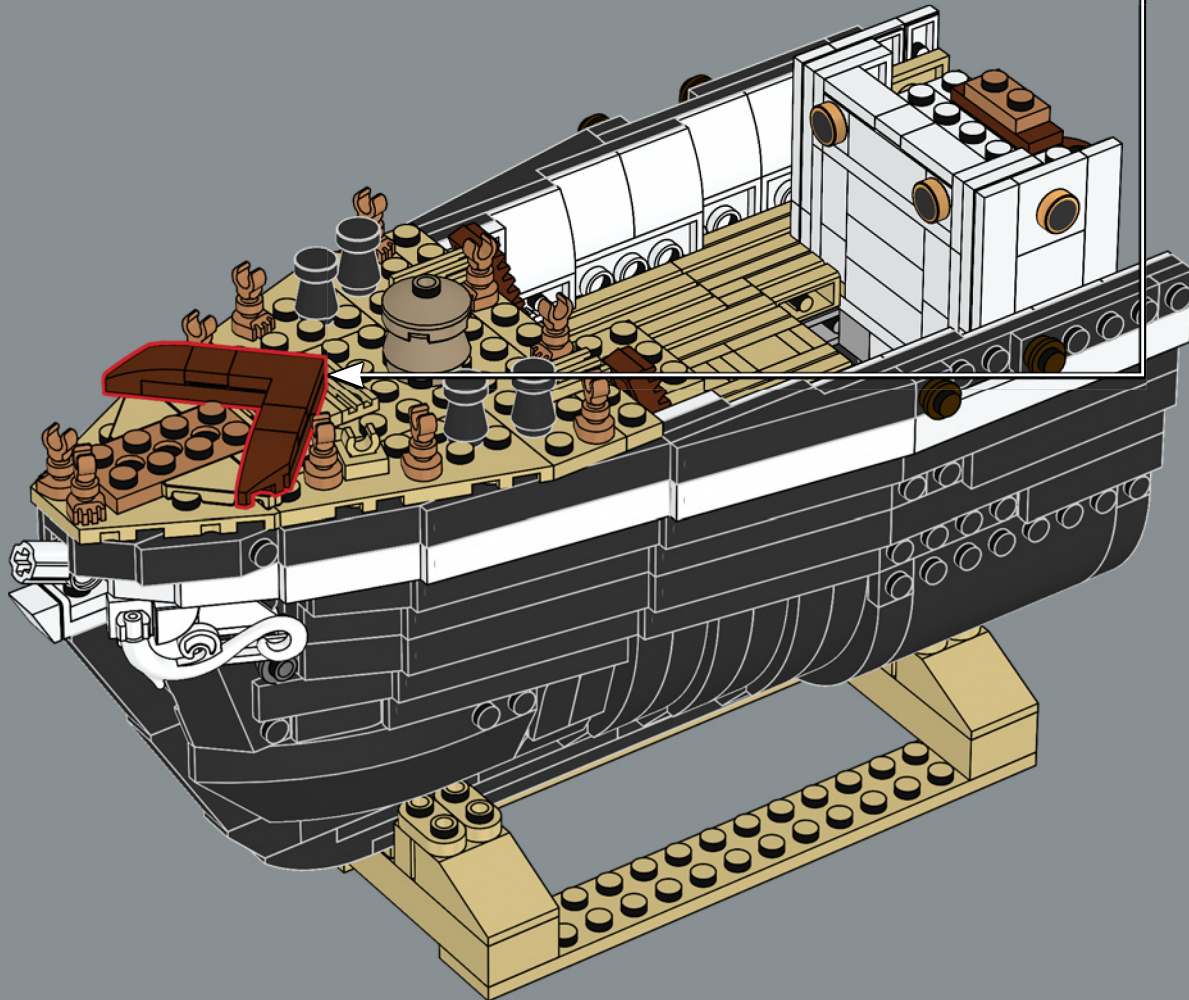
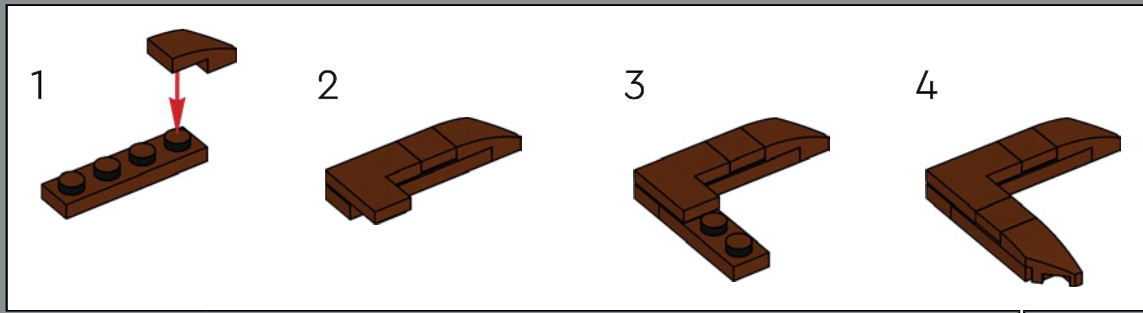

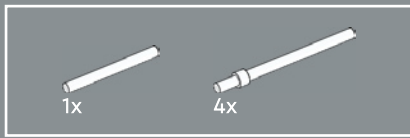

147

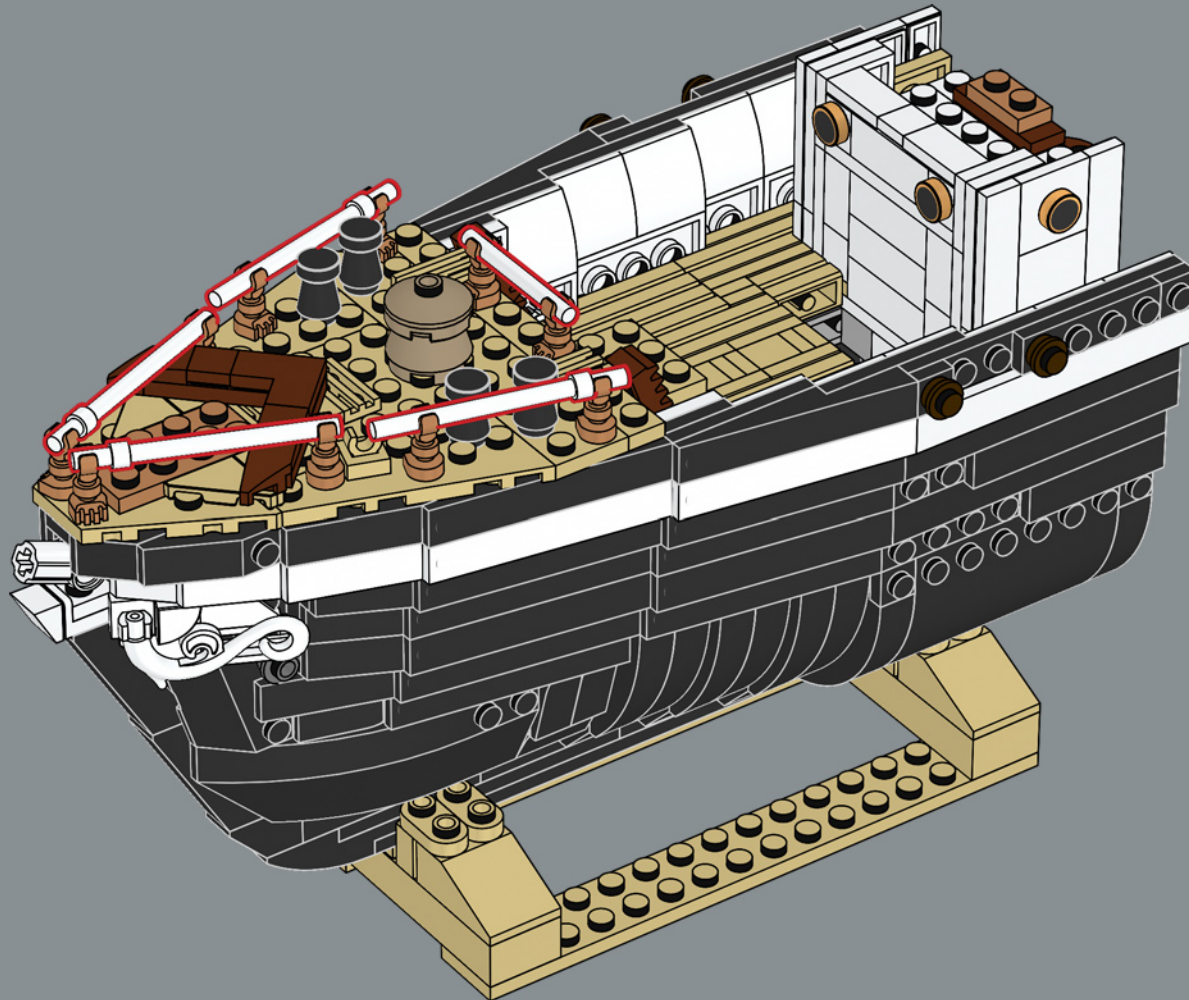



148

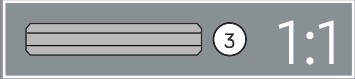
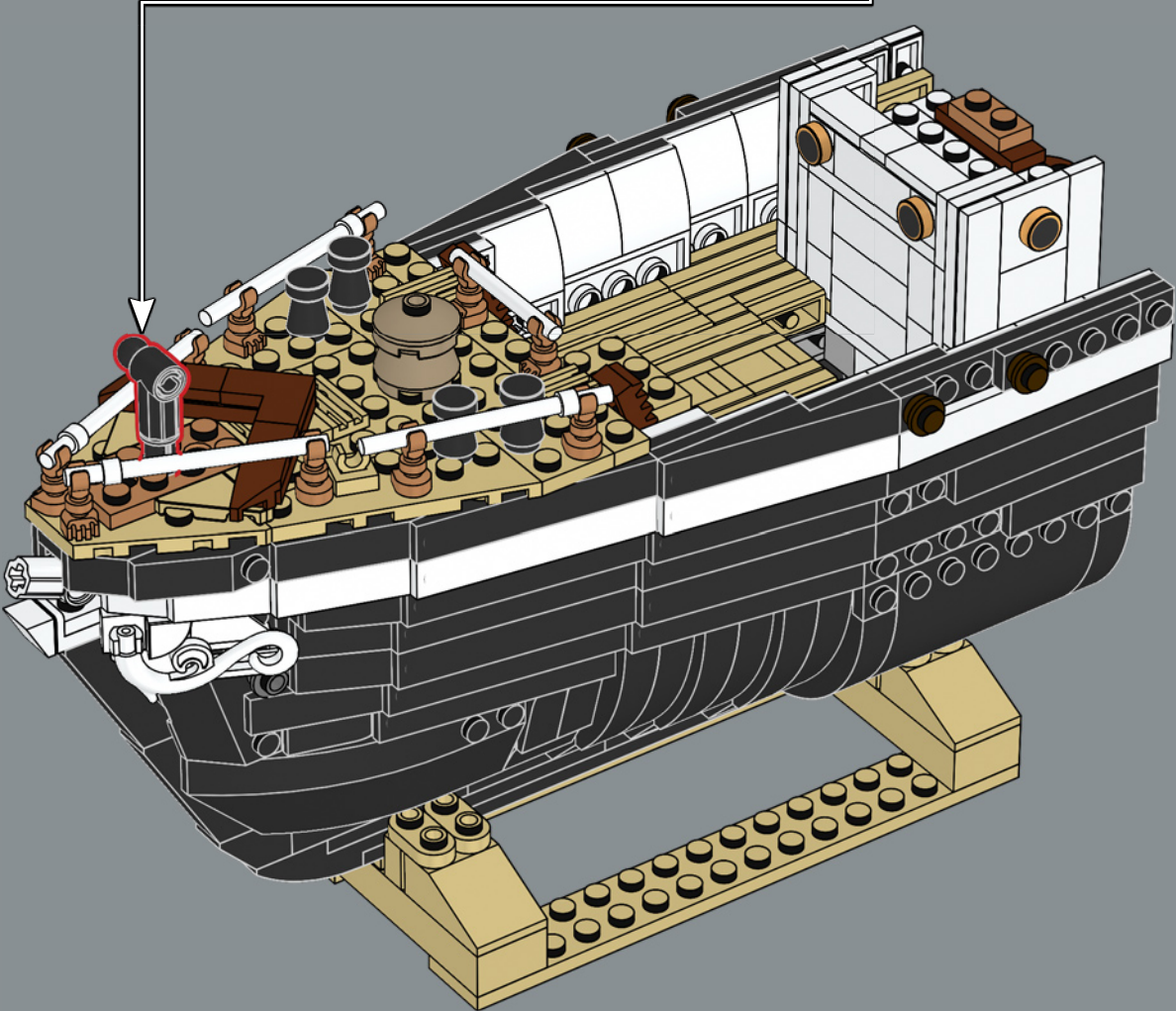
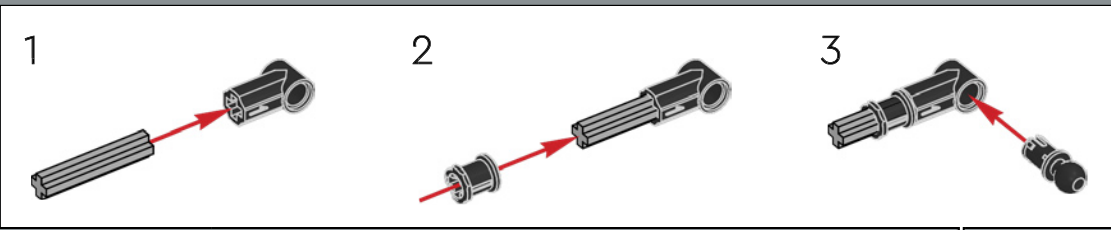

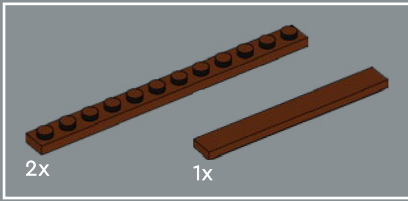
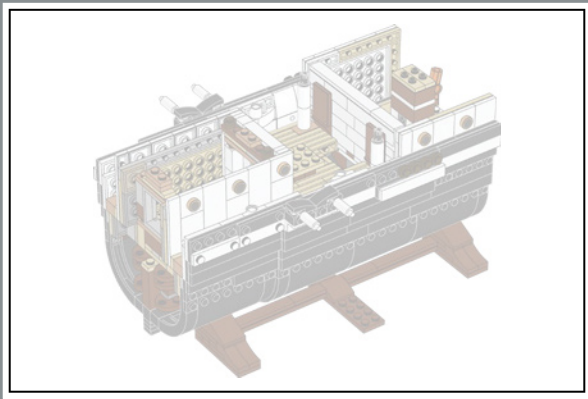

149

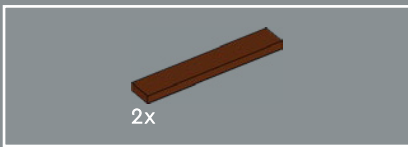
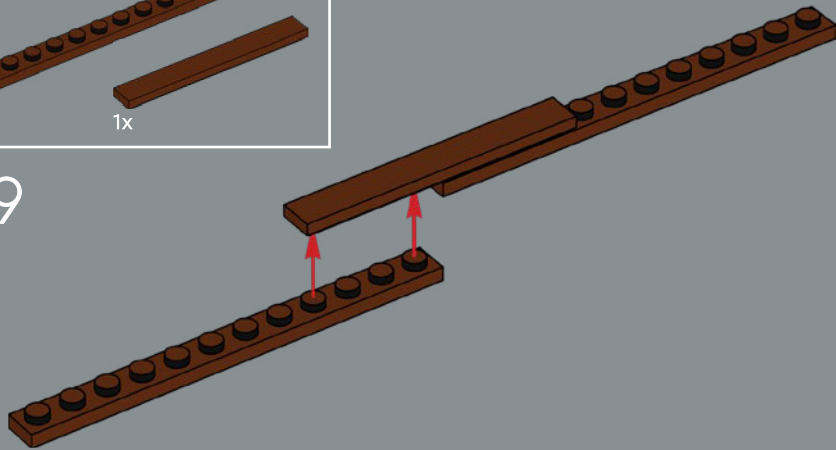

150

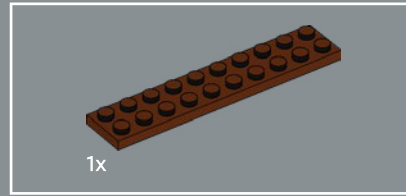
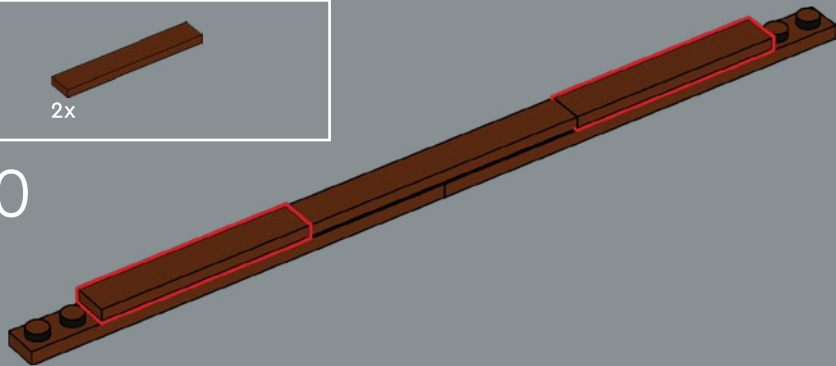

151

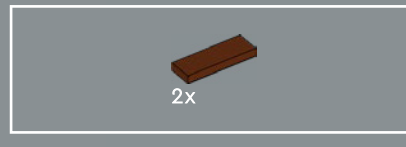
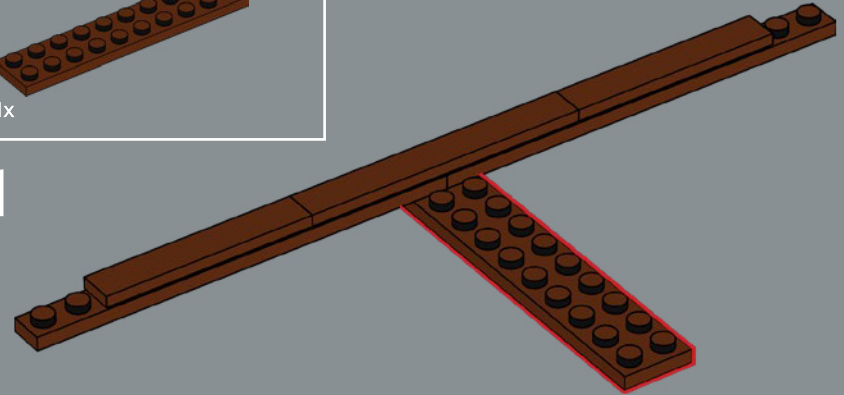

152

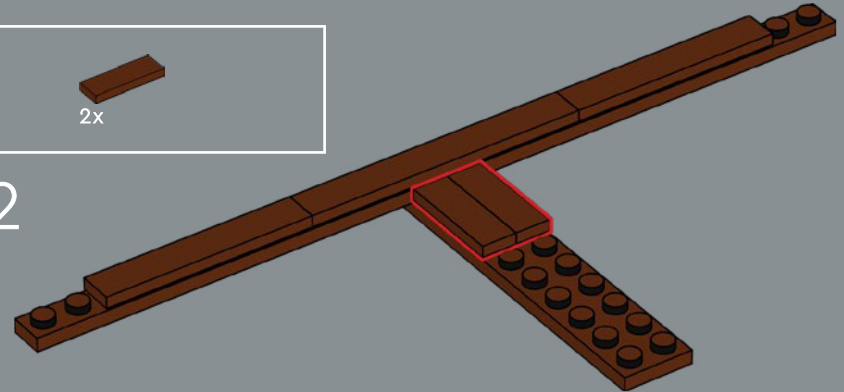

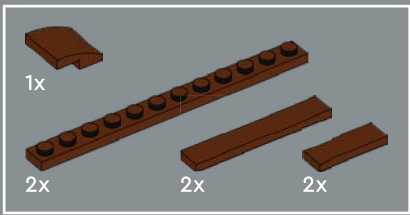

153

1

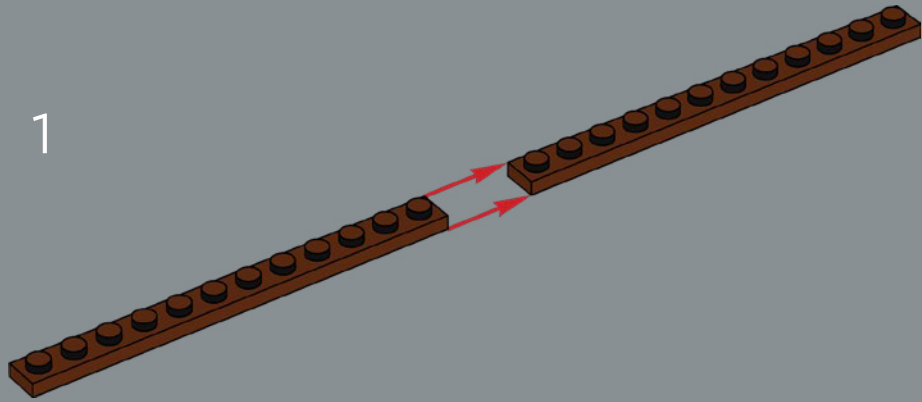

2

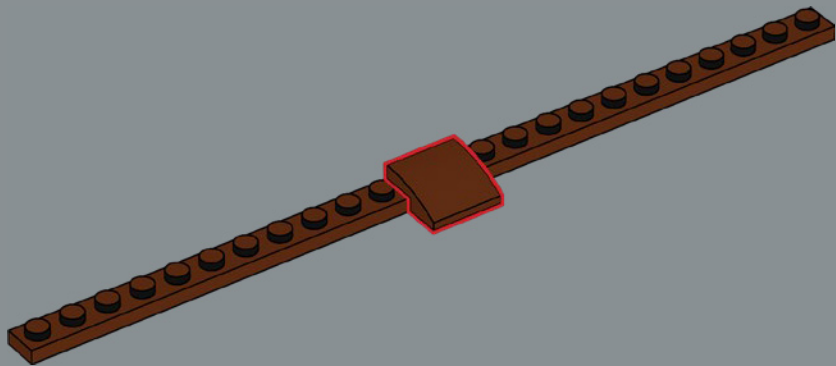

3

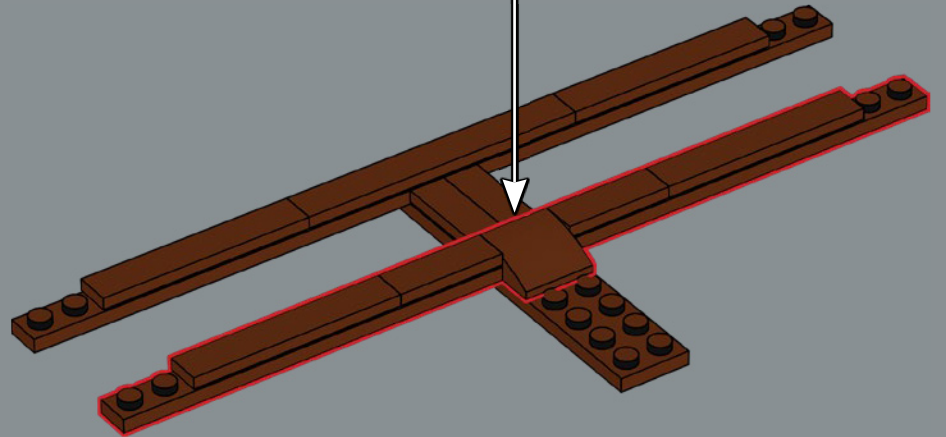
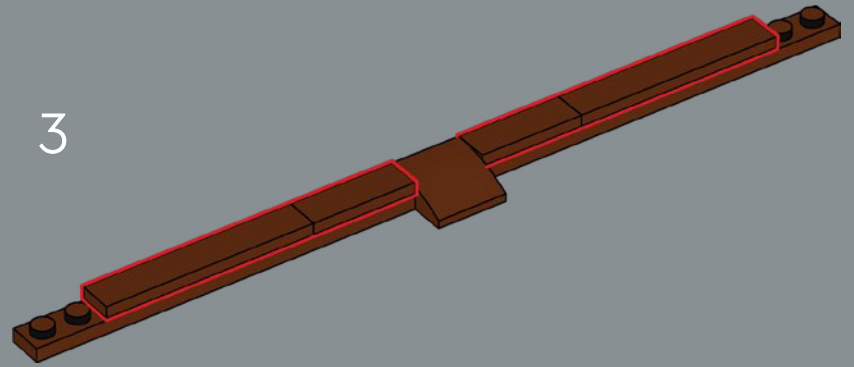

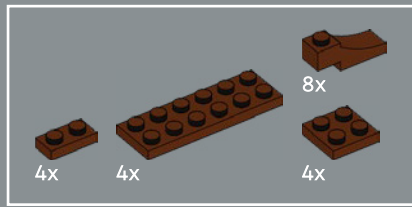

154

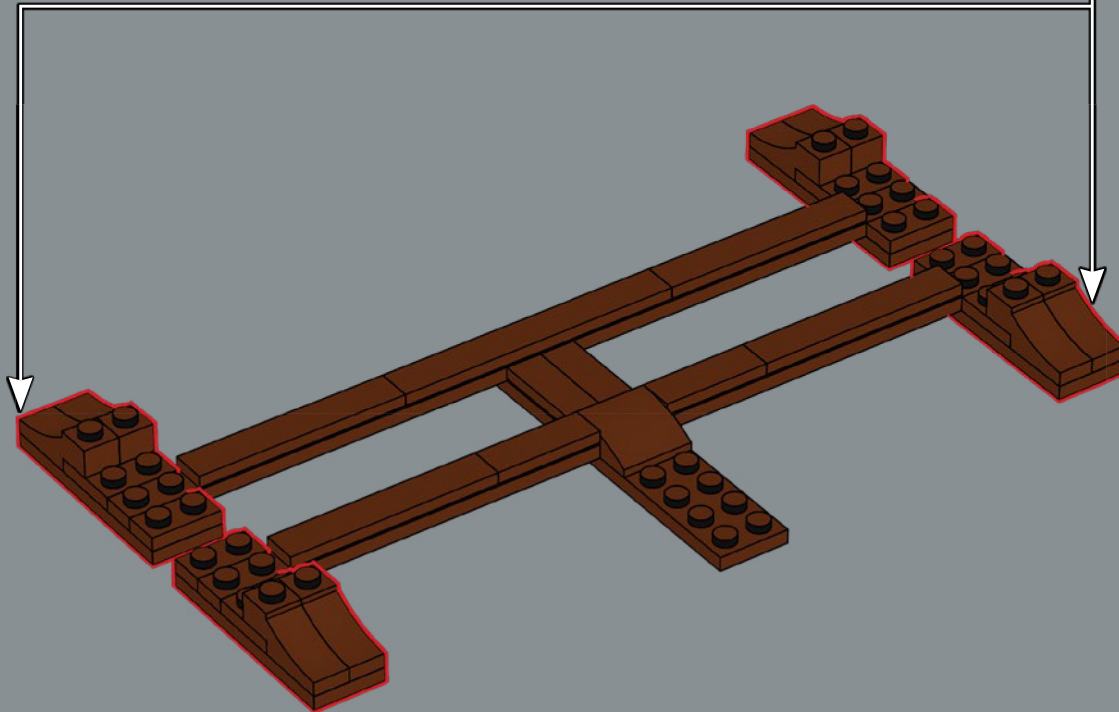
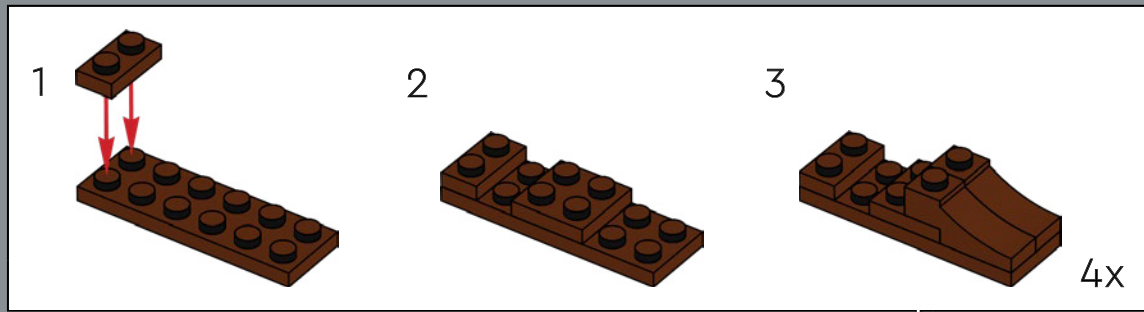

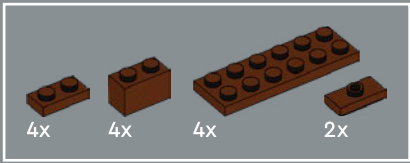

155

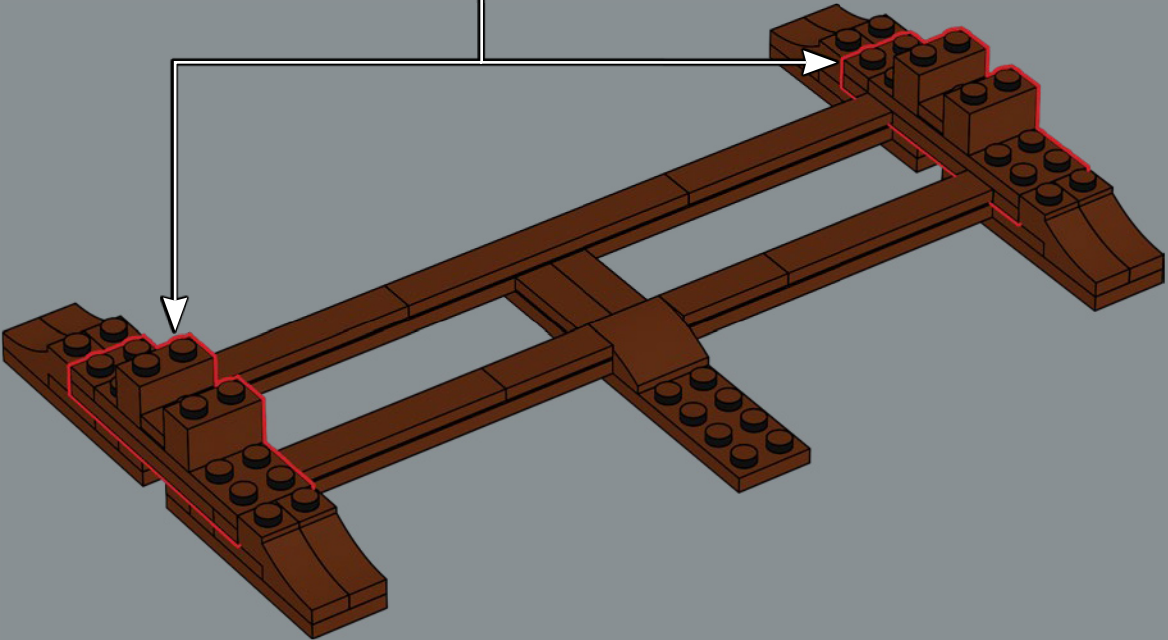
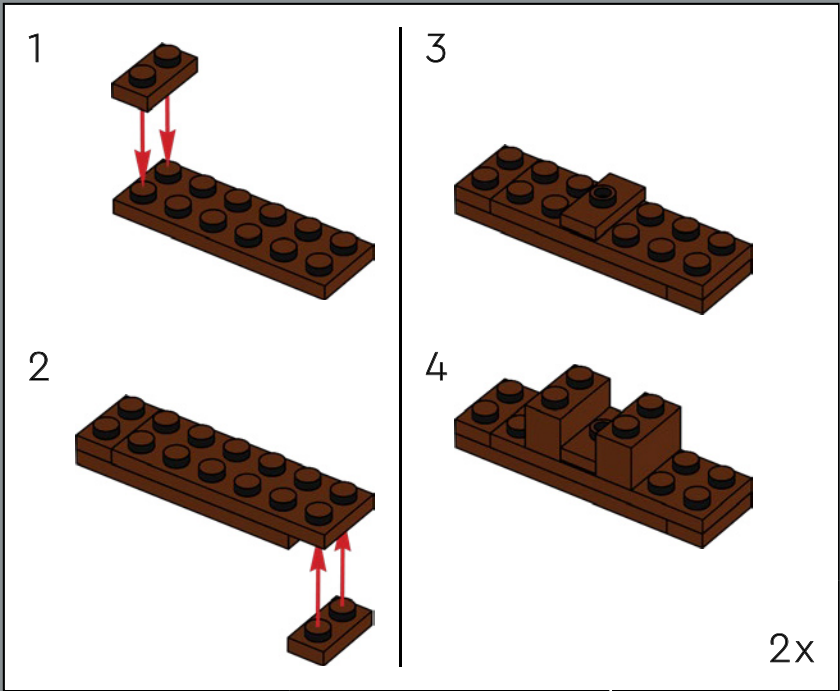



156

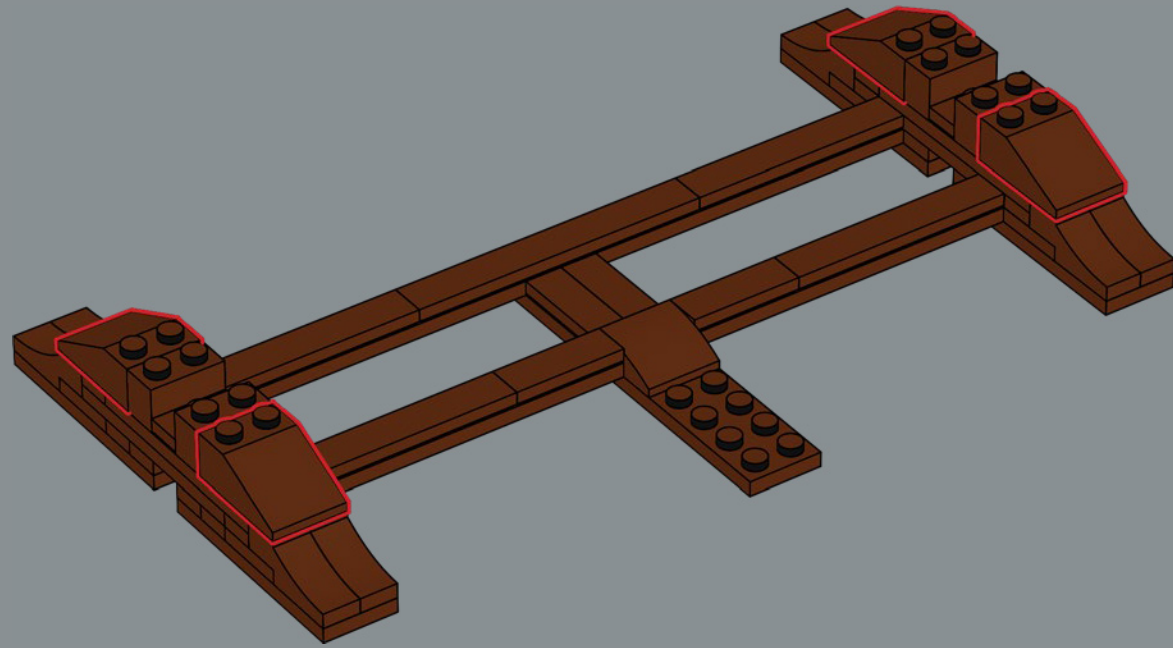

157

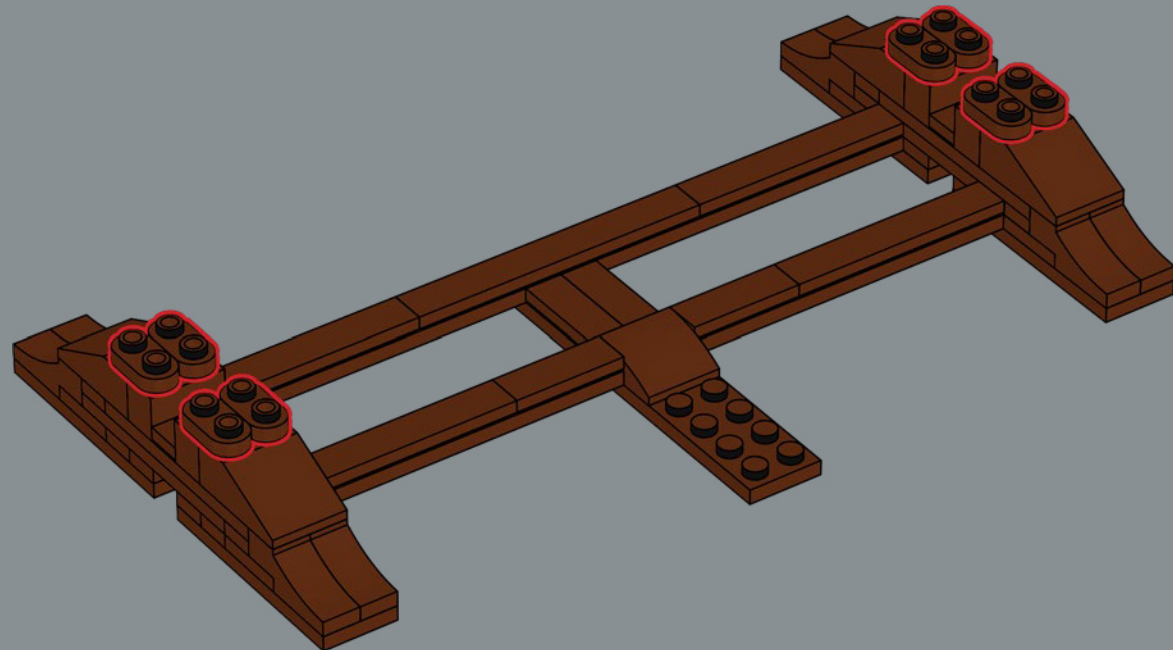

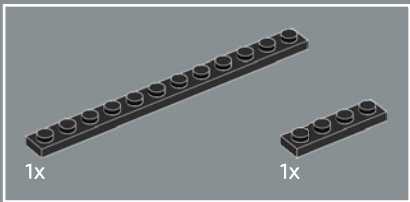
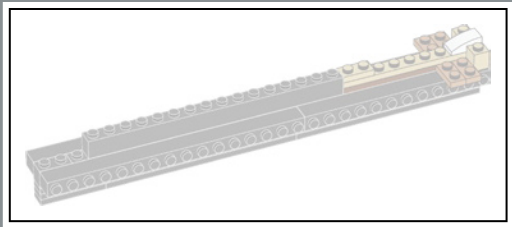

158

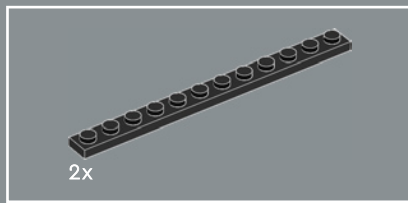
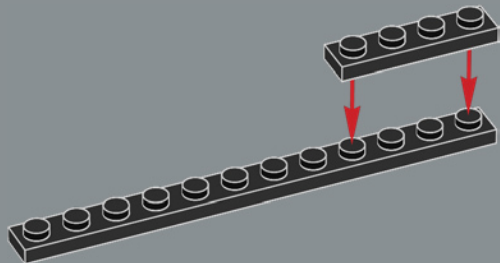

159

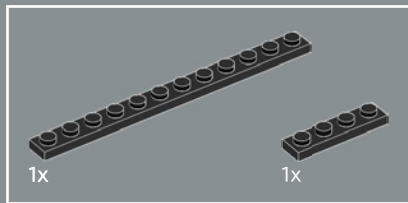
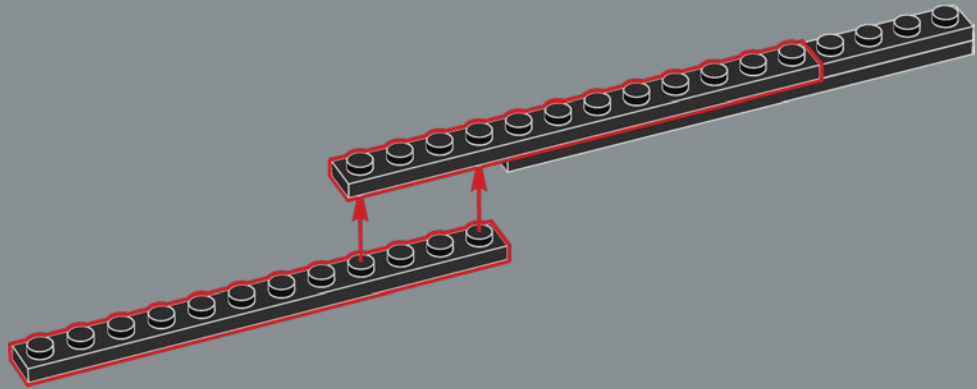

160

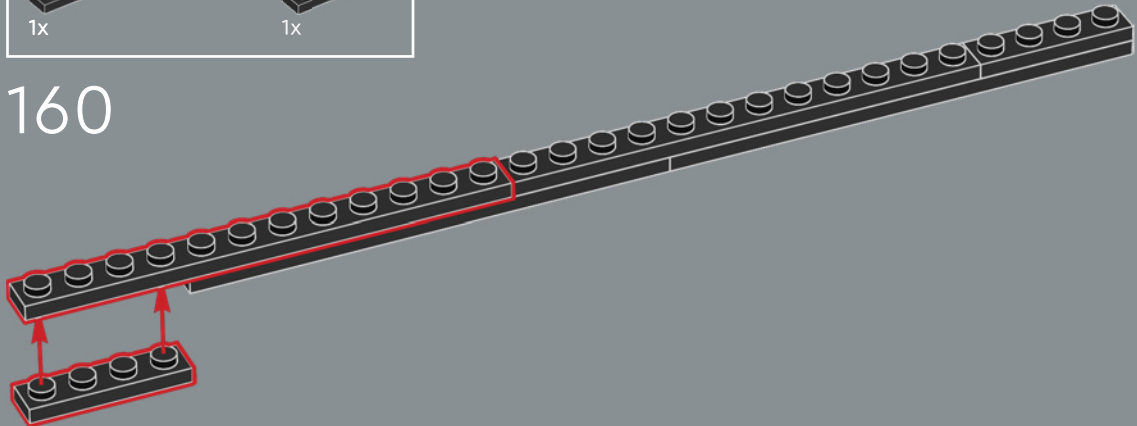

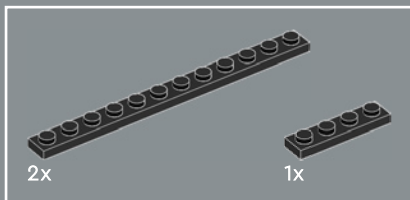

161

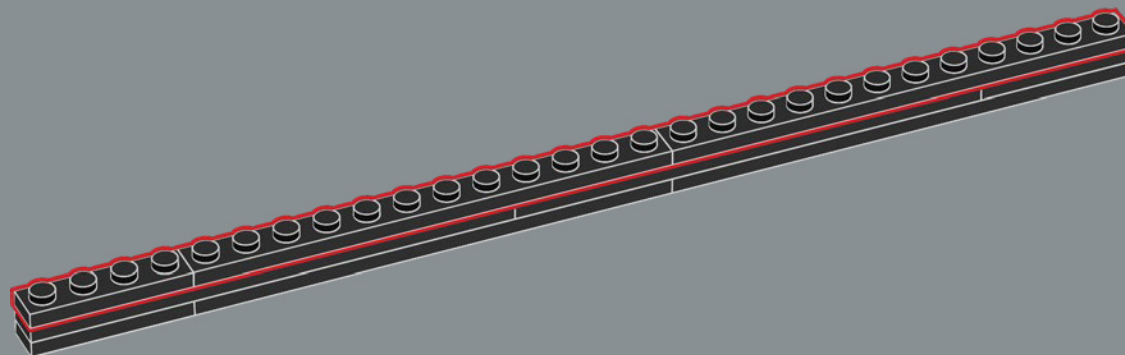

162

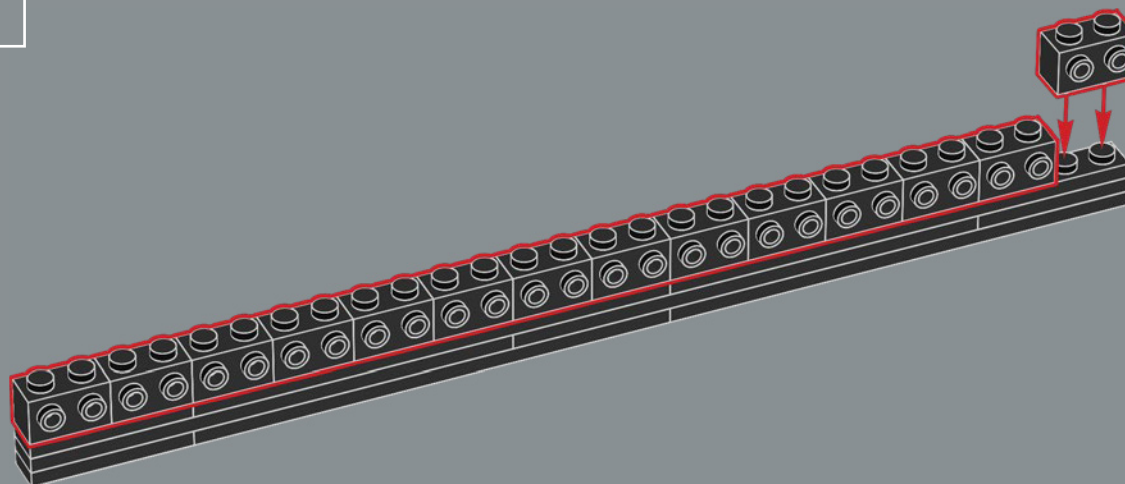

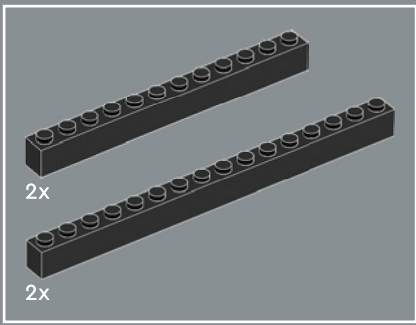

163

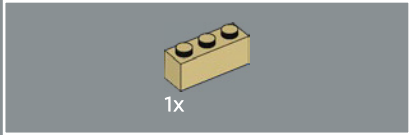
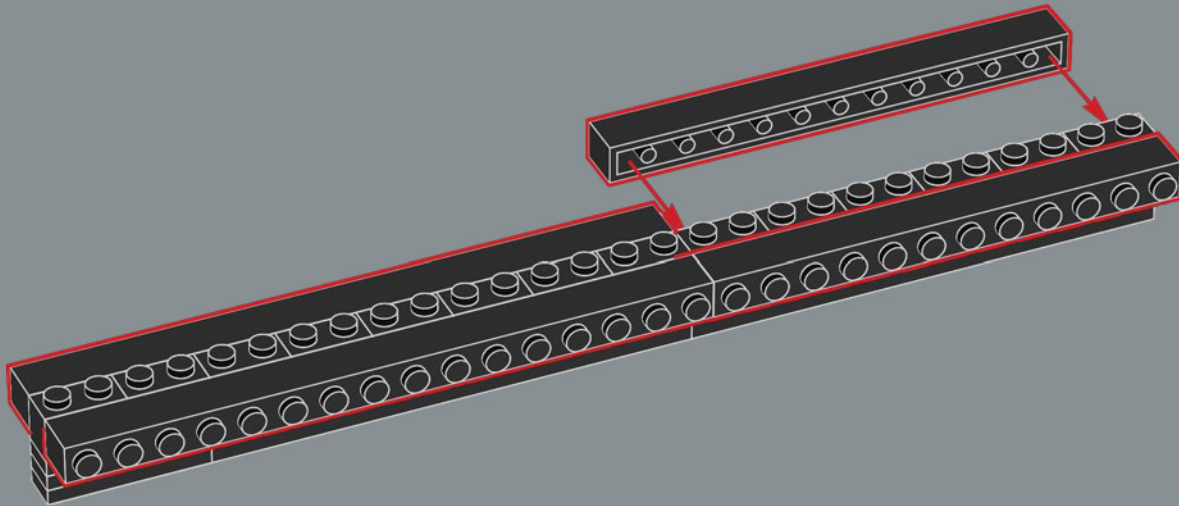

164

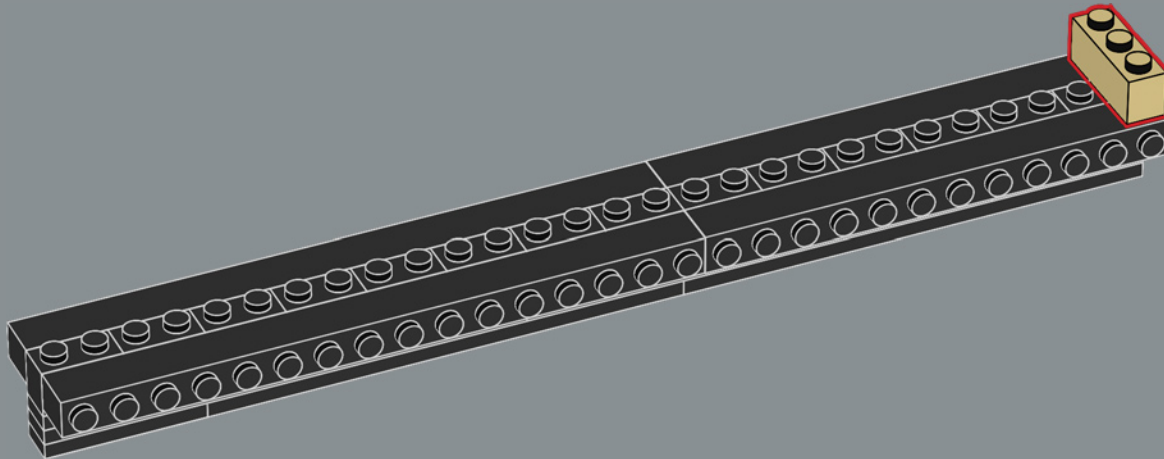

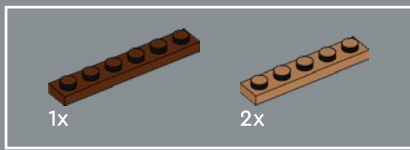

165

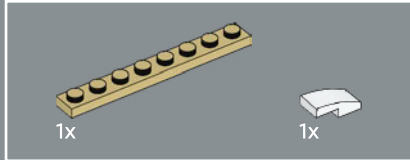
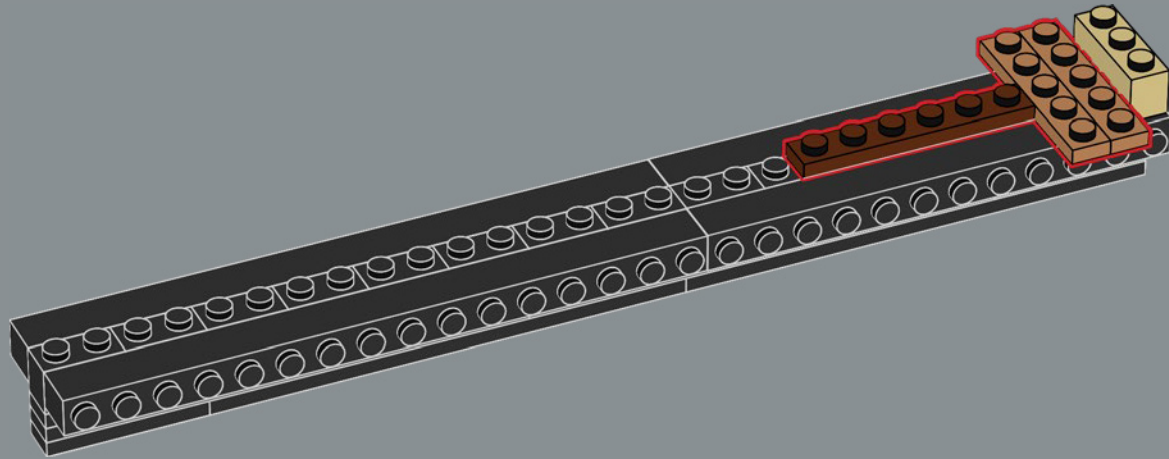

166

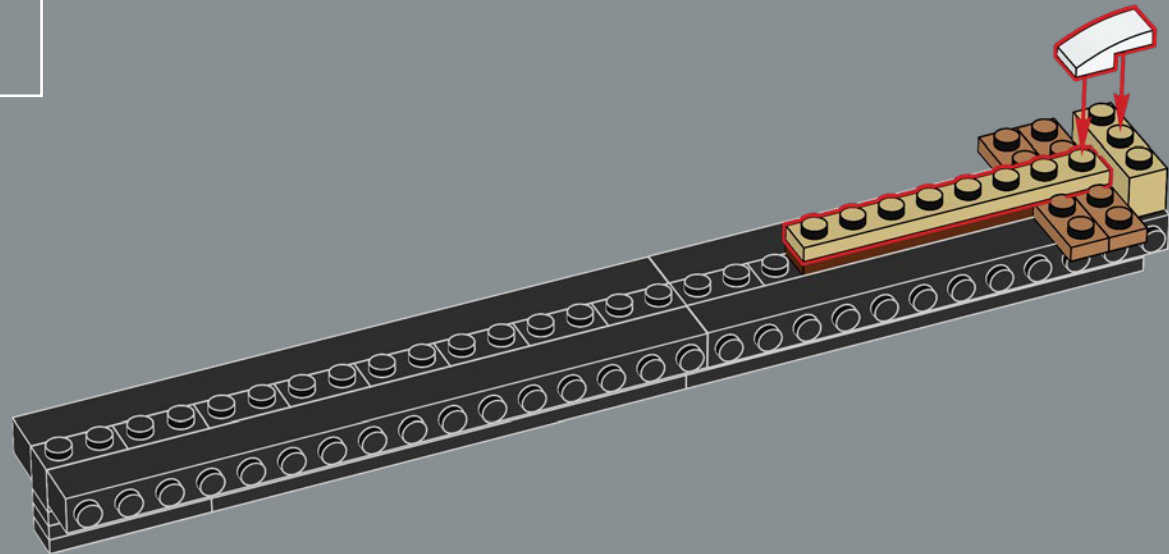

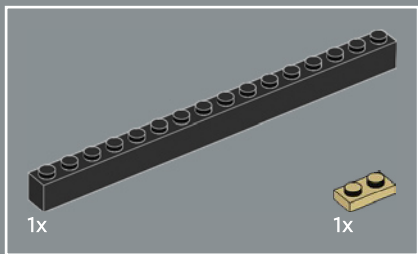

167

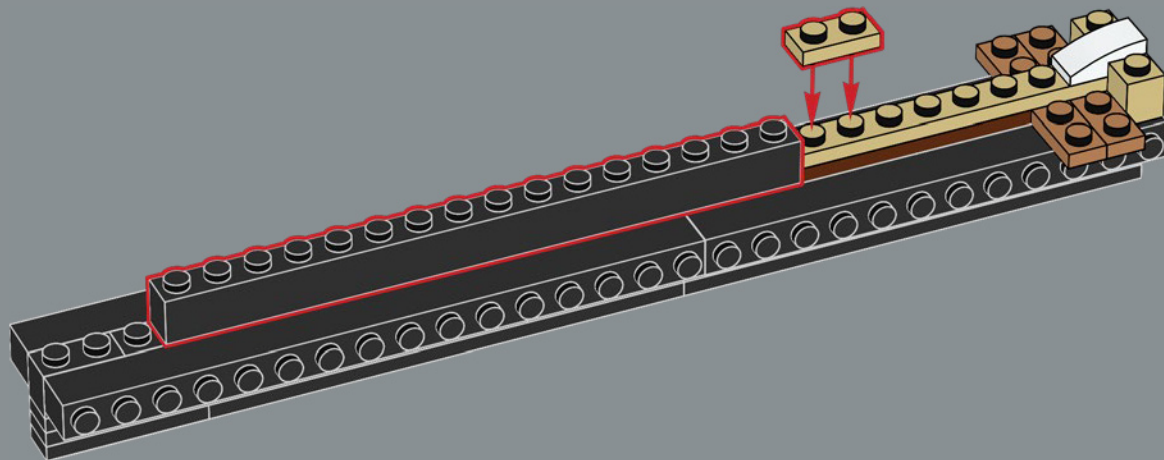

168

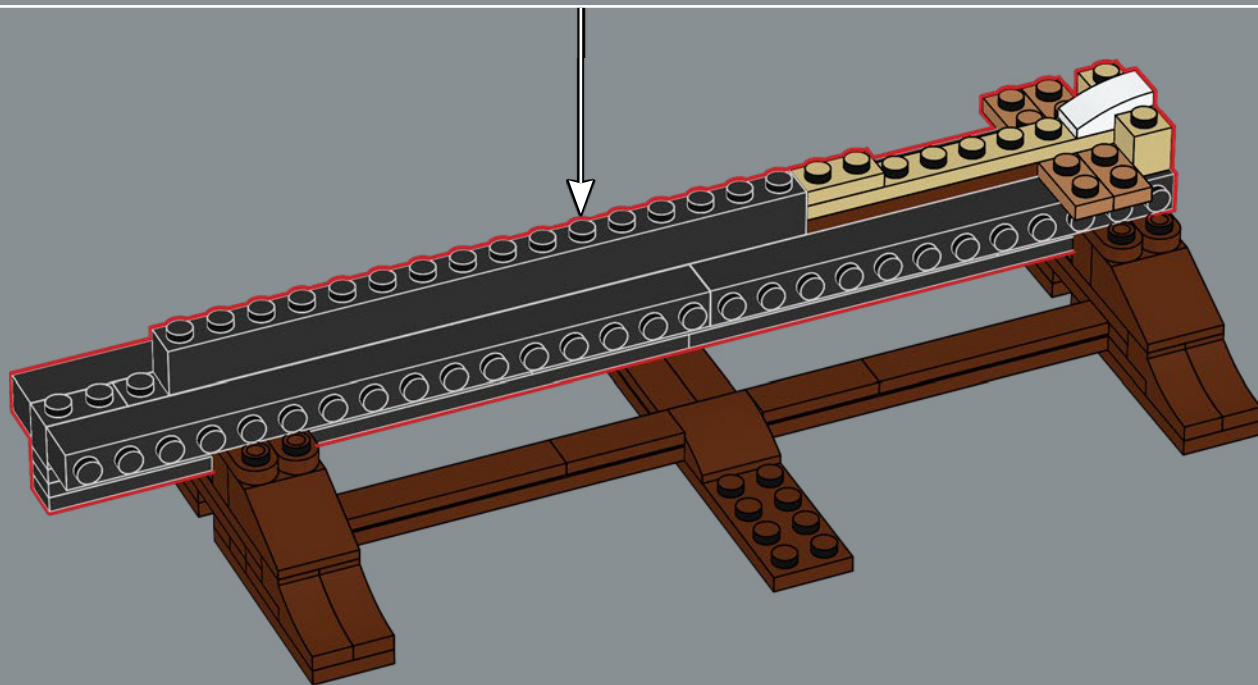



169

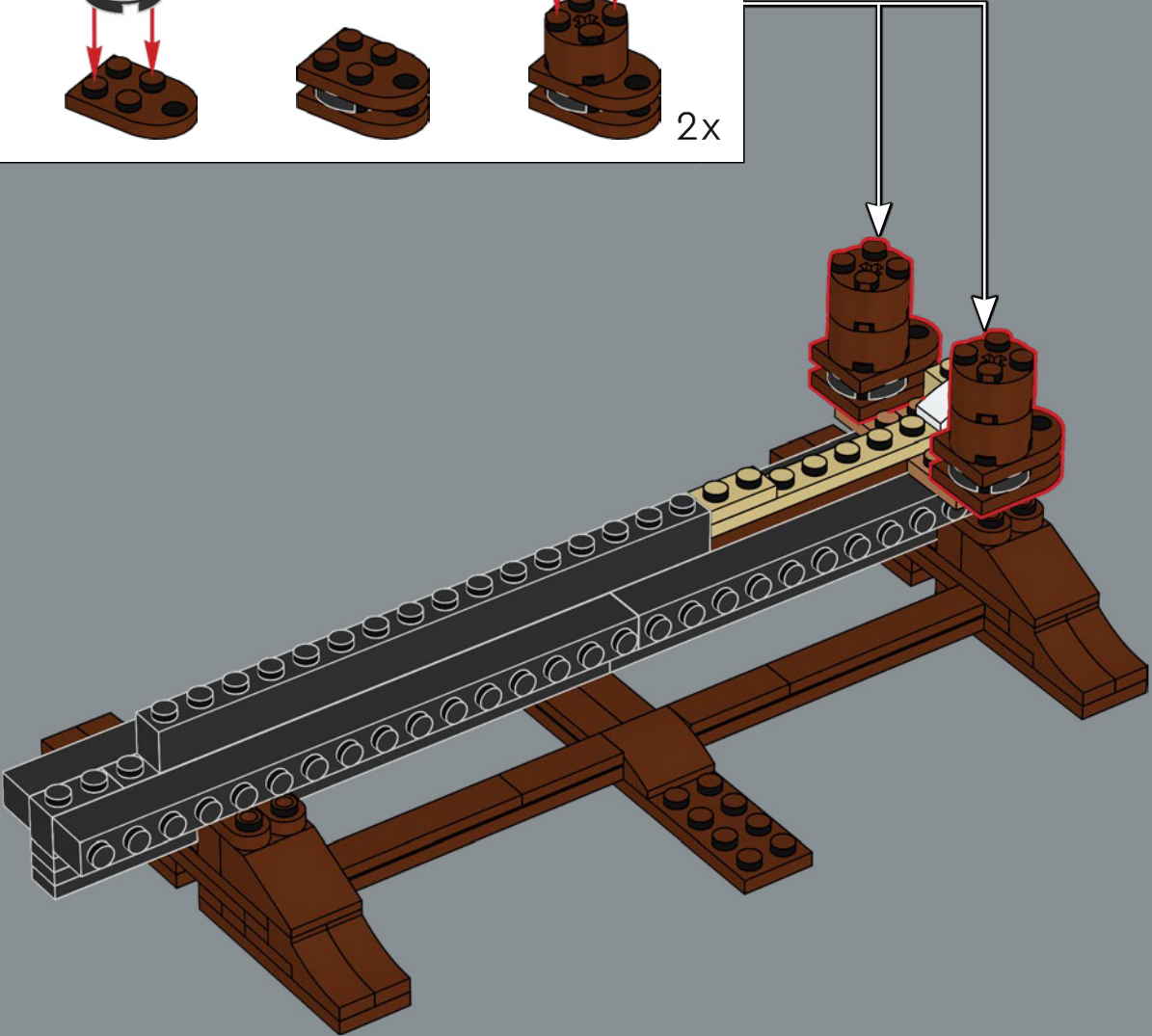

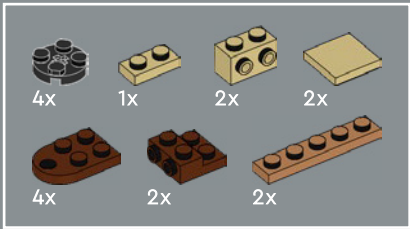

170

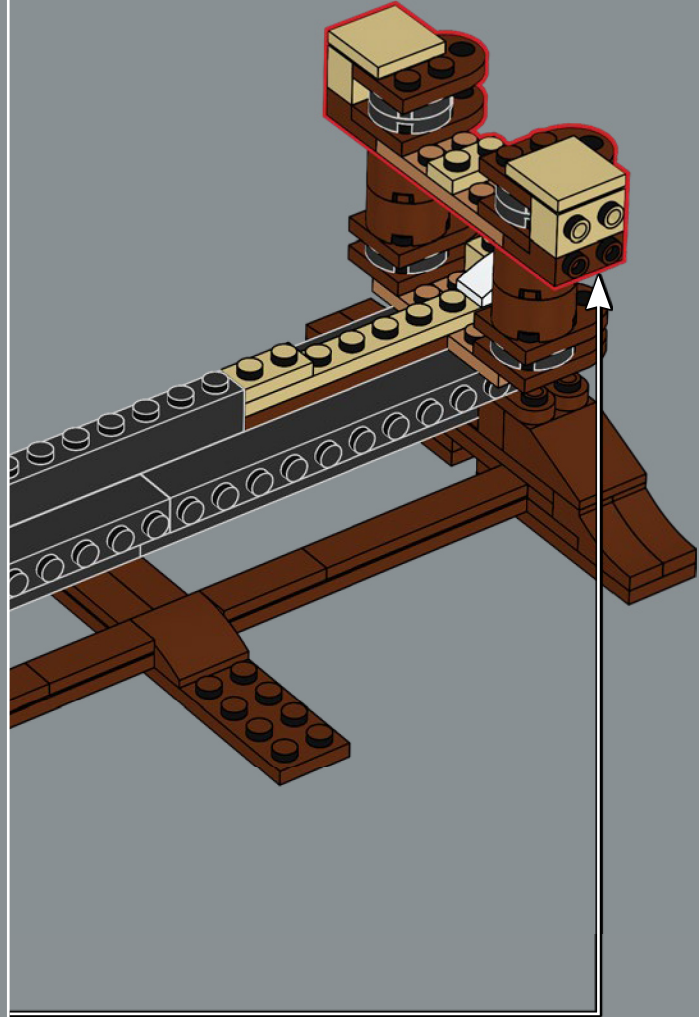
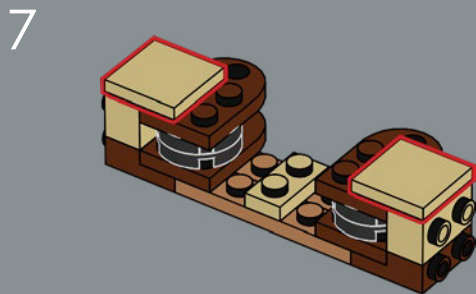
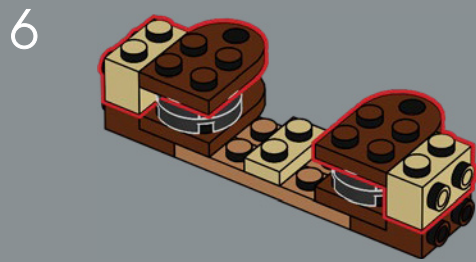
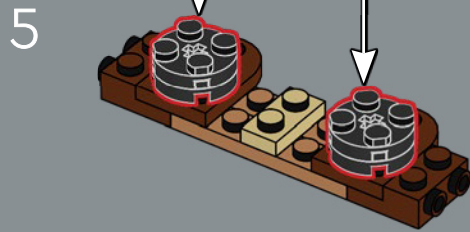
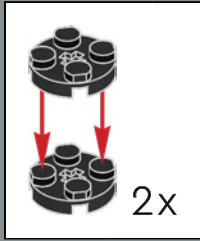
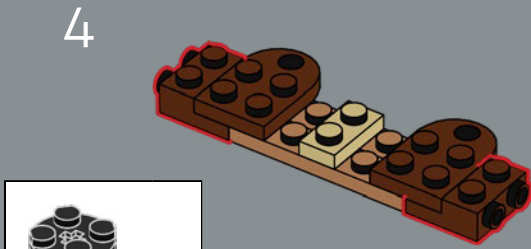
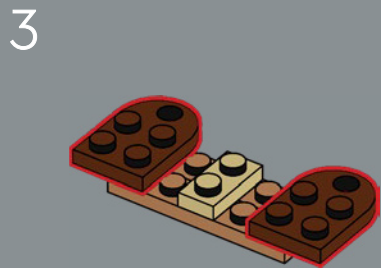
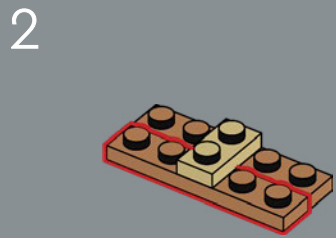
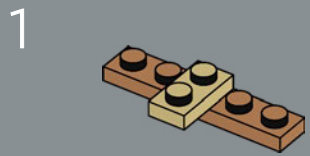

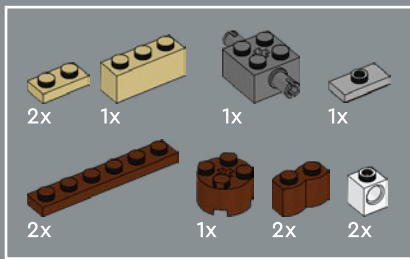

171

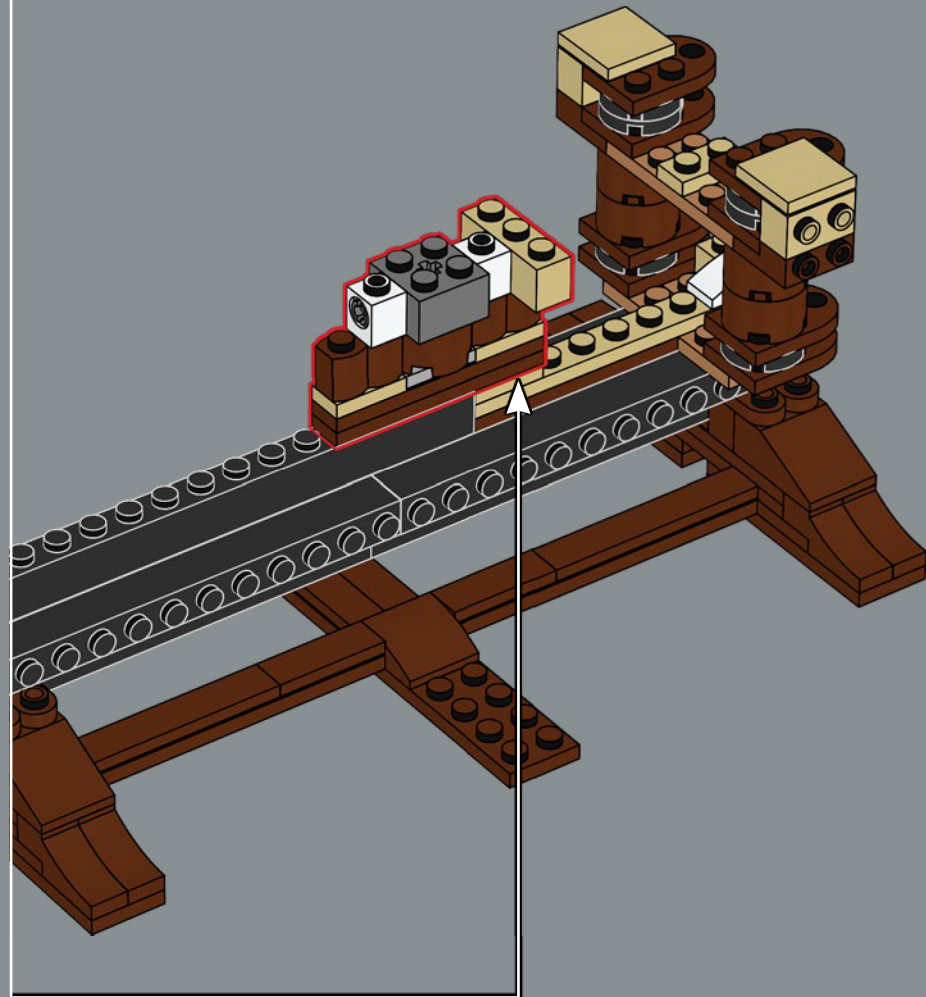
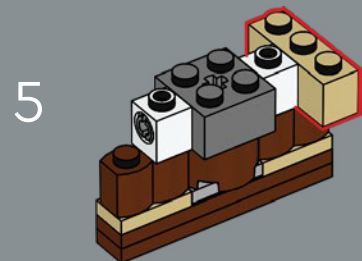
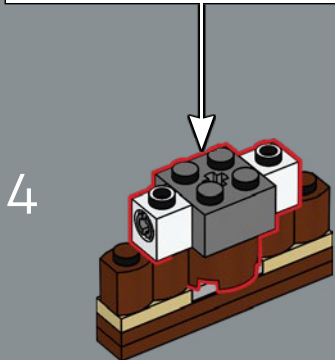
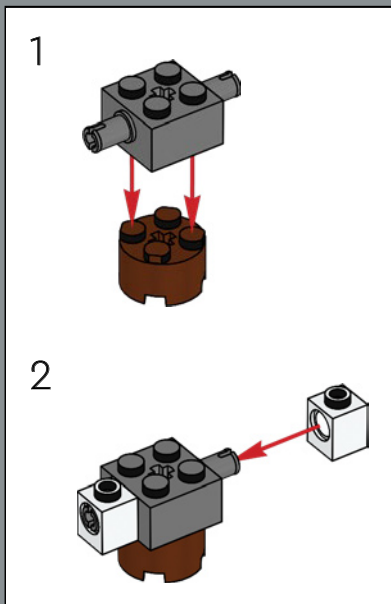
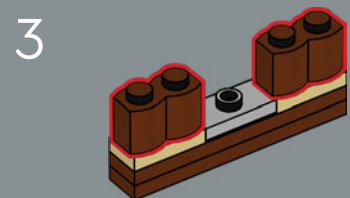
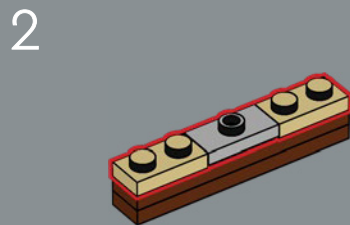
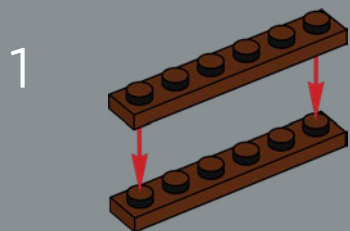

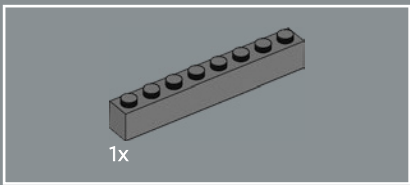

172

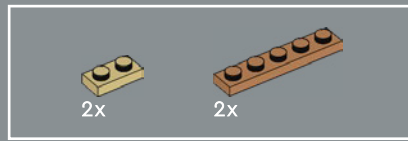
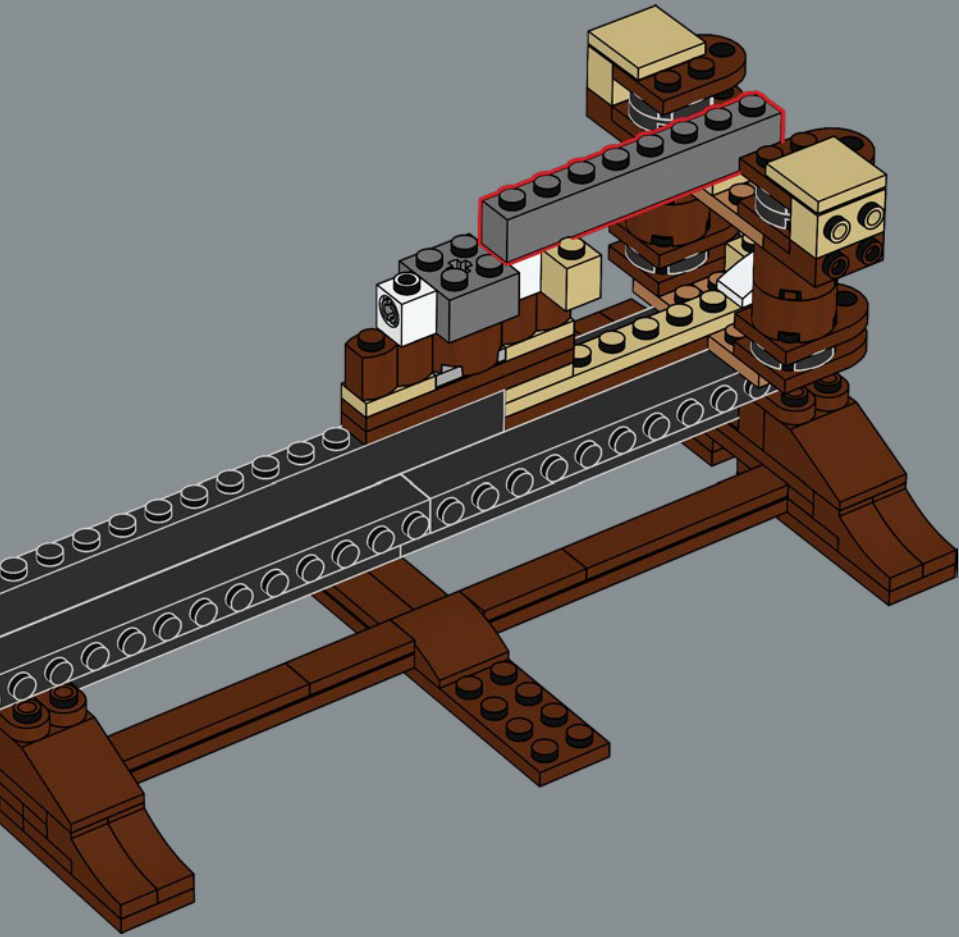

173

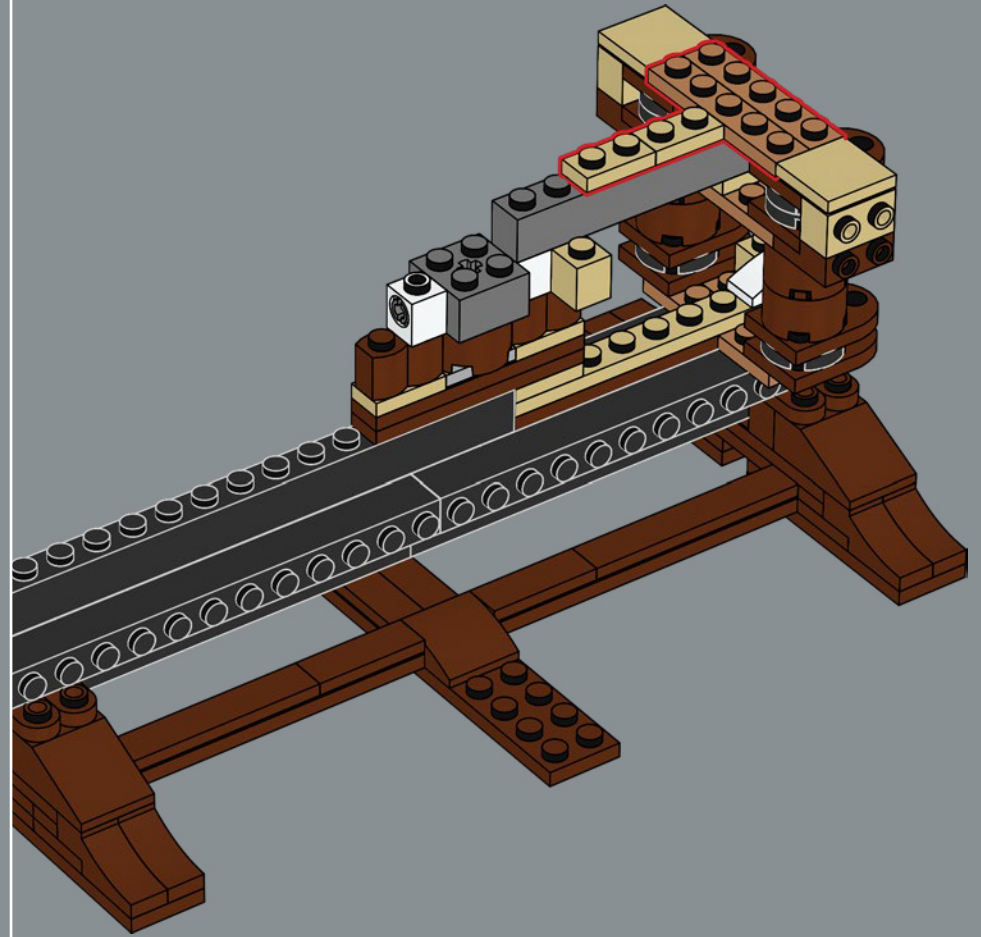

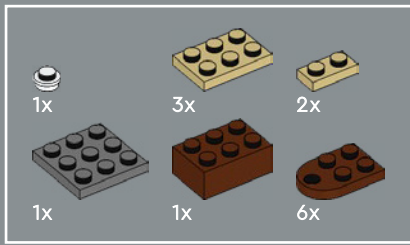

174

1

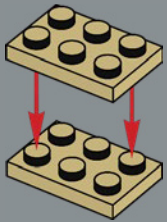

2

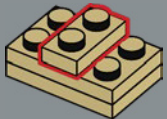

3

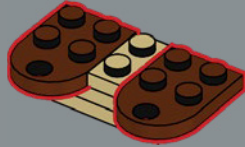

4



5

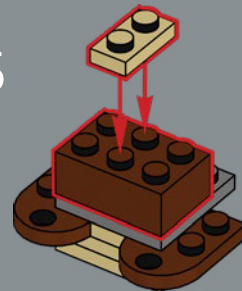

6

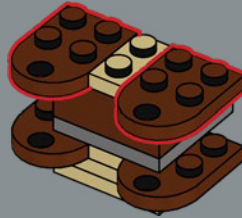

7

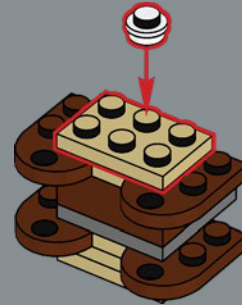

8

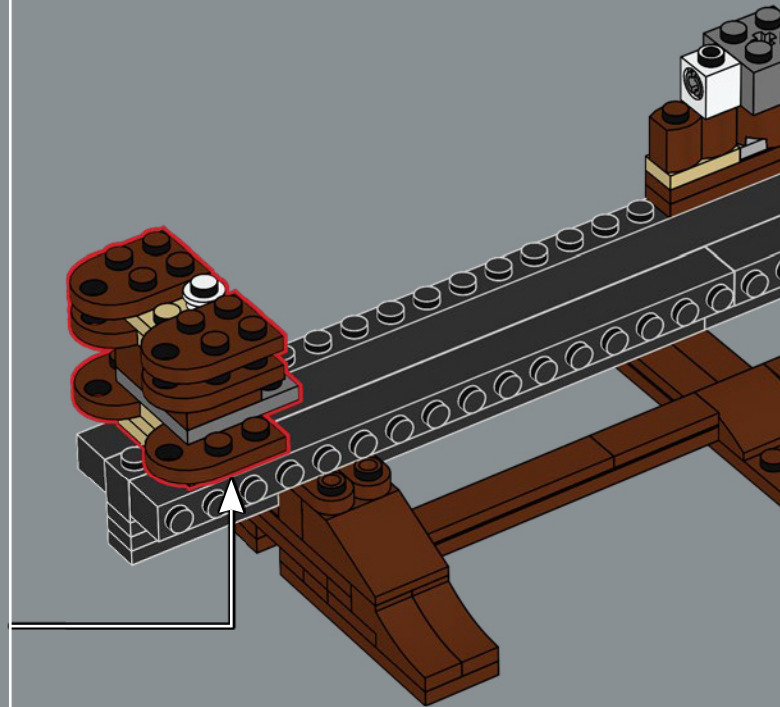
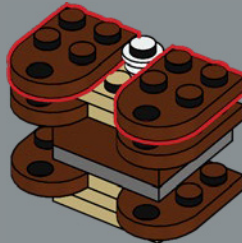

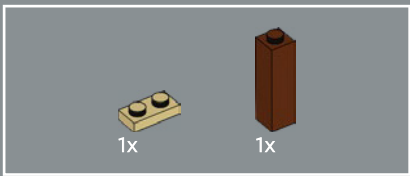

175

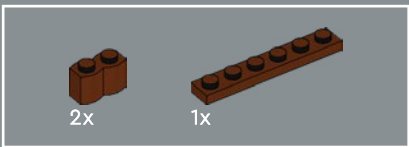
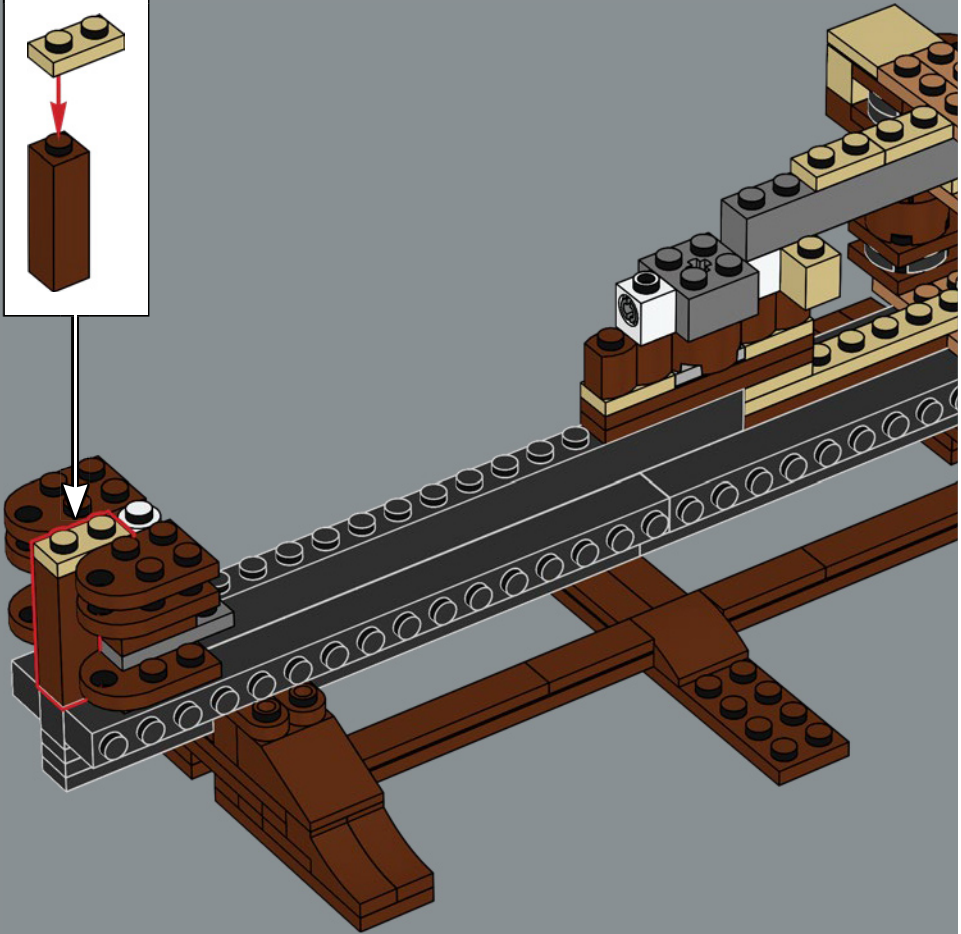
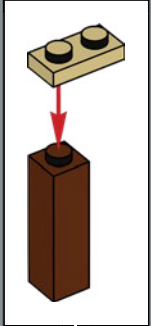

176

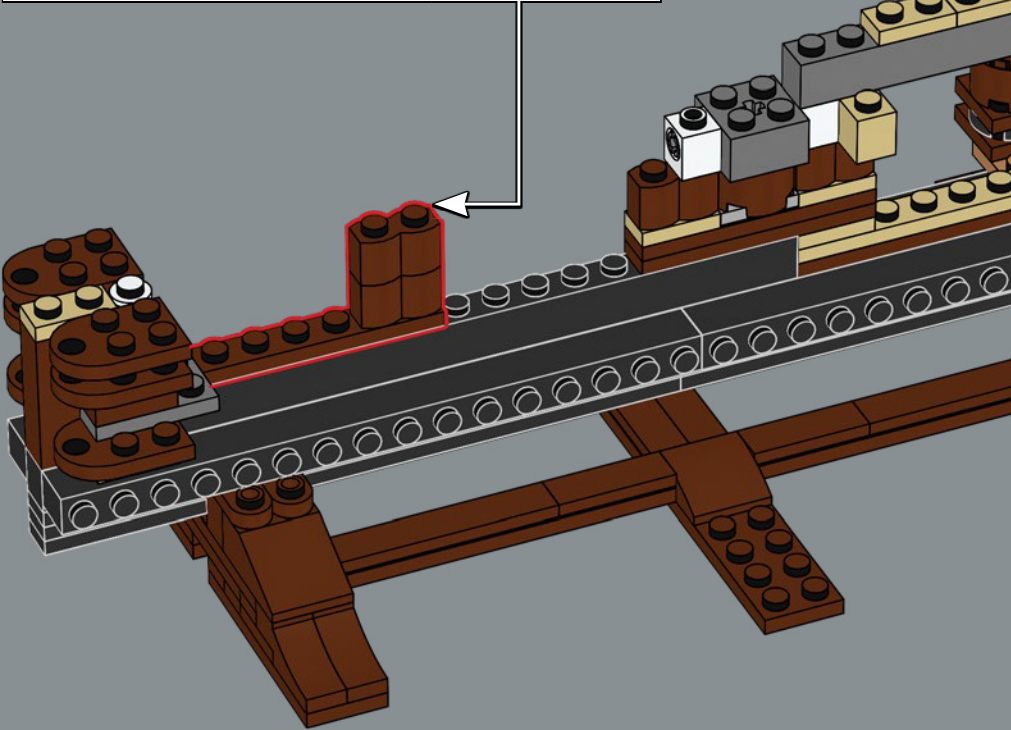
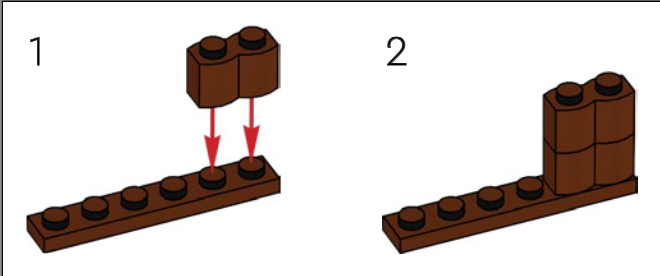

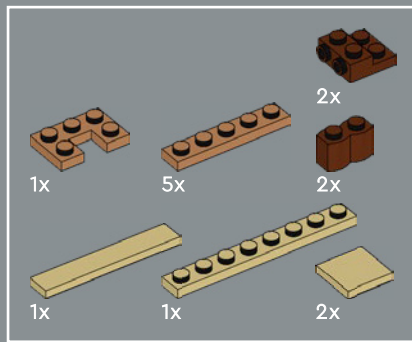

177

1

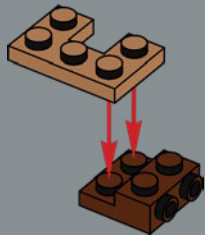

2

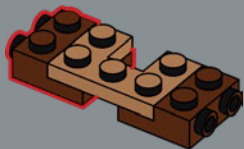

3

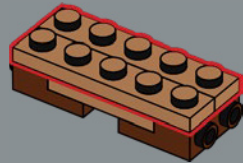

4

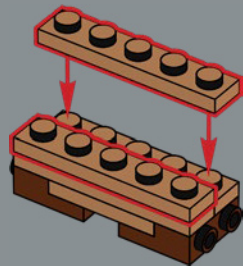

5

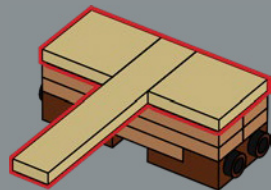

6

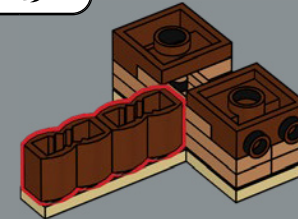

7

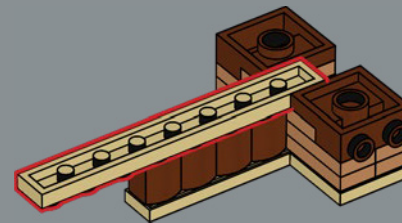

8

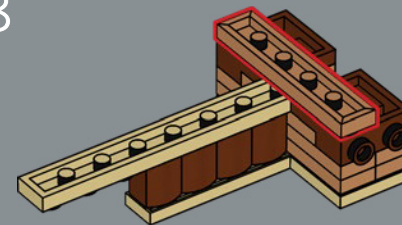

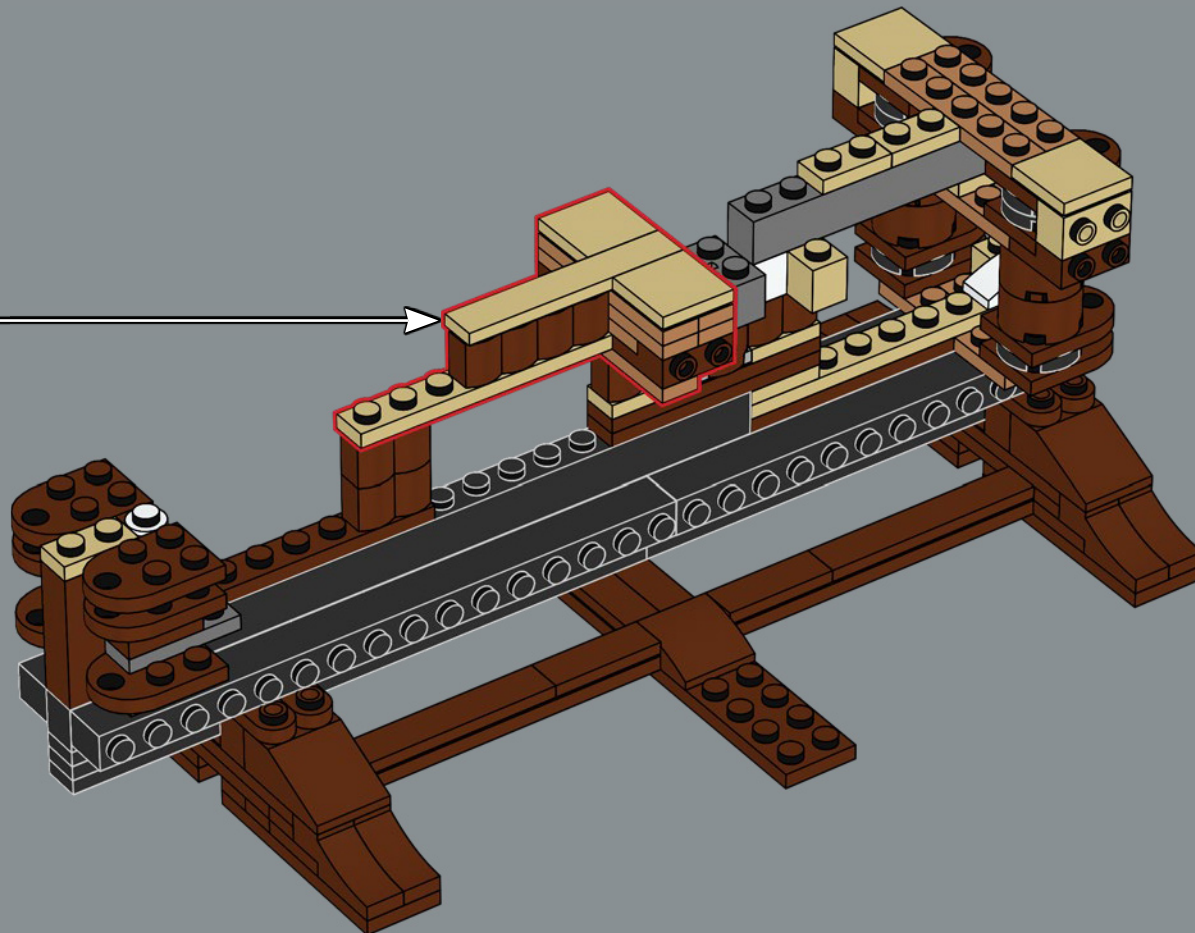

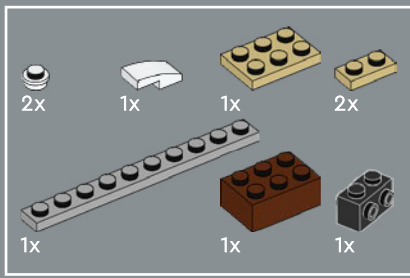

178

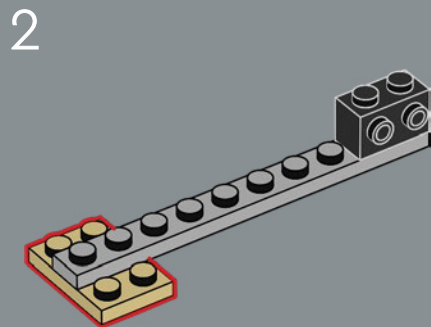
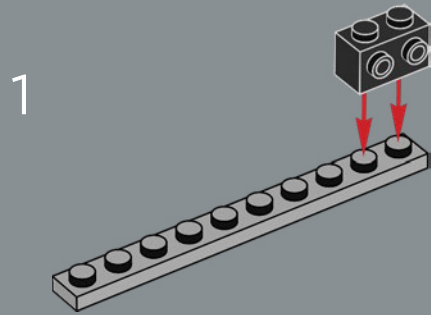

3

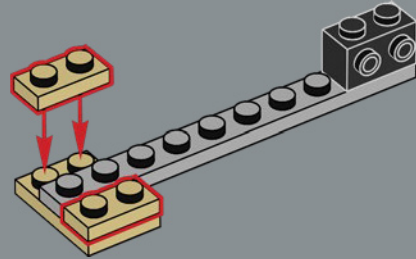

4

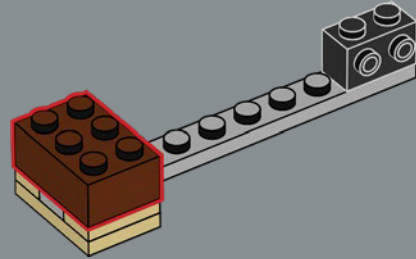

5

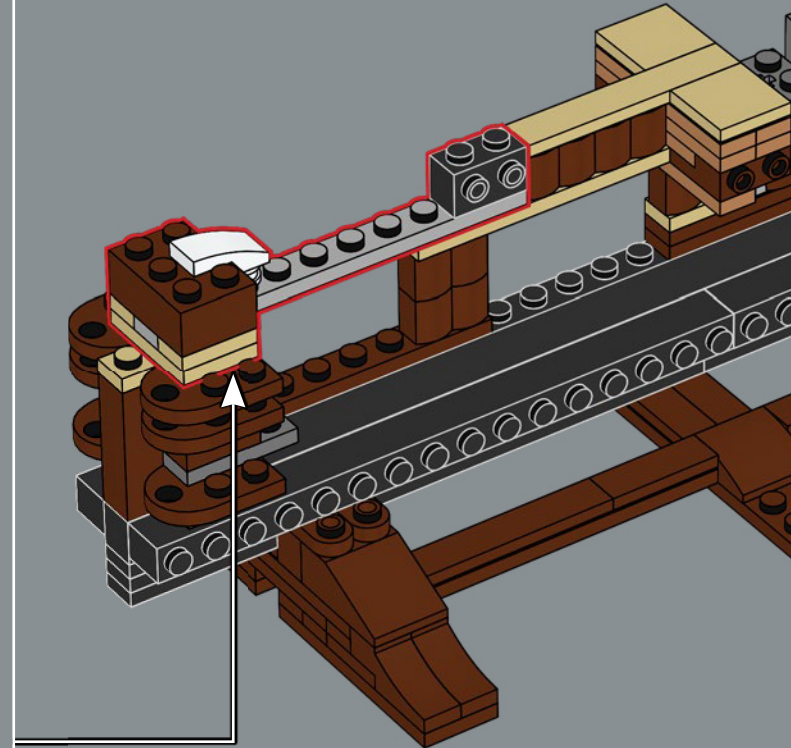
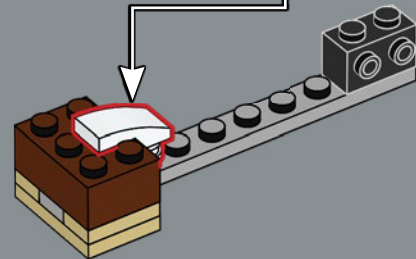
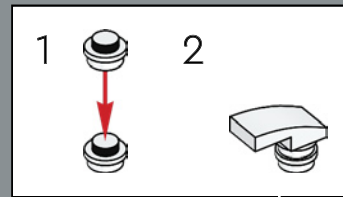

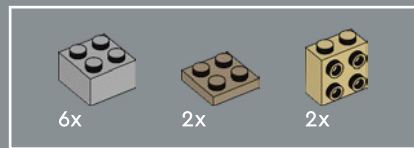

179

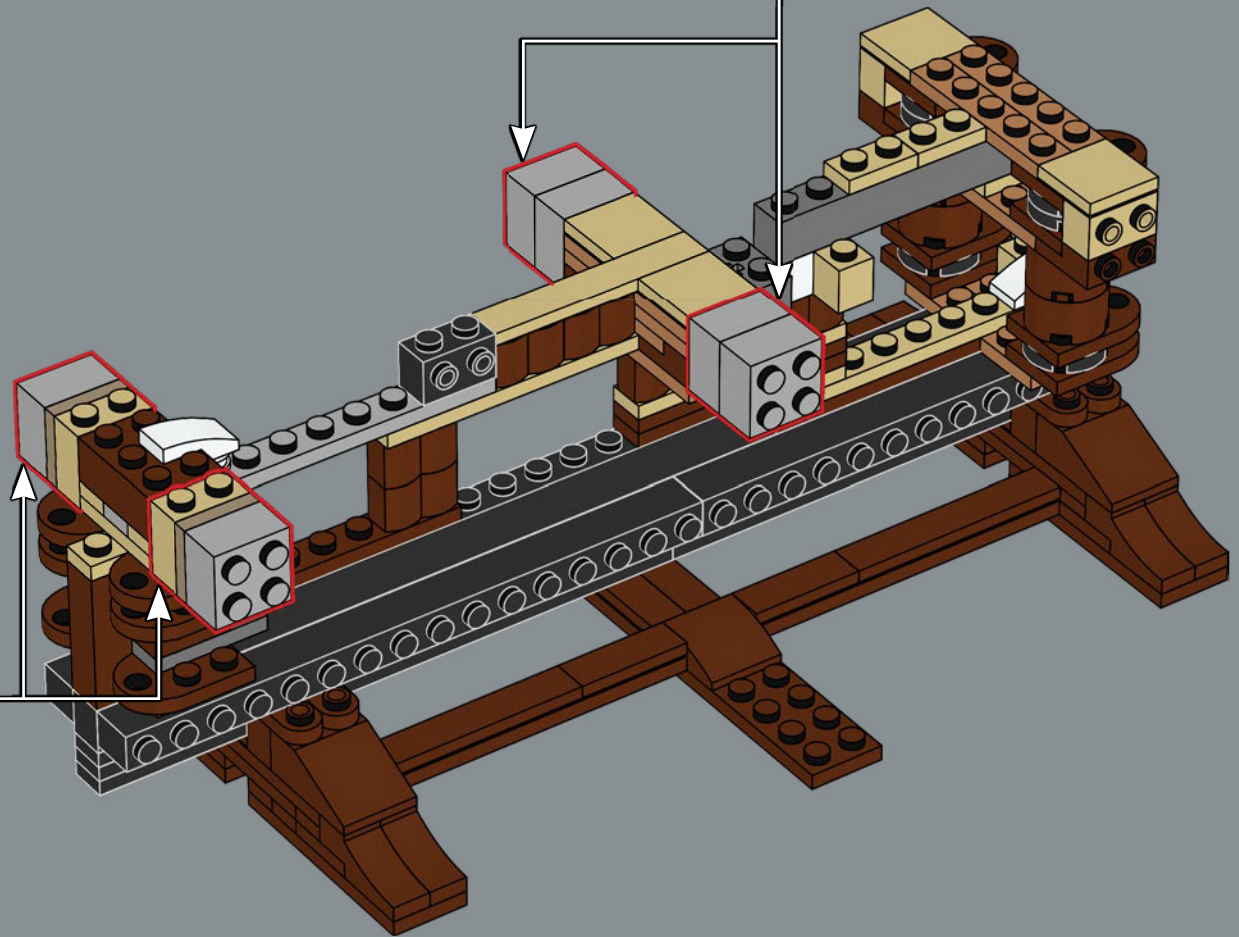
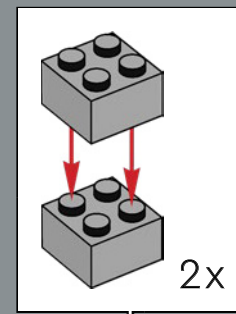
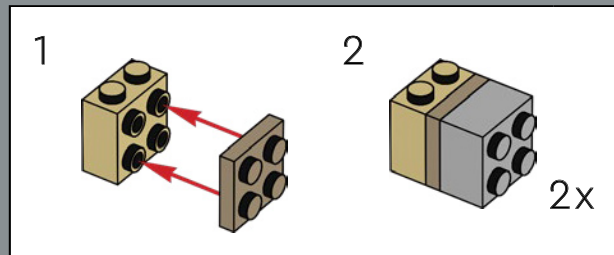

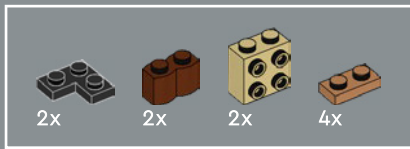

180

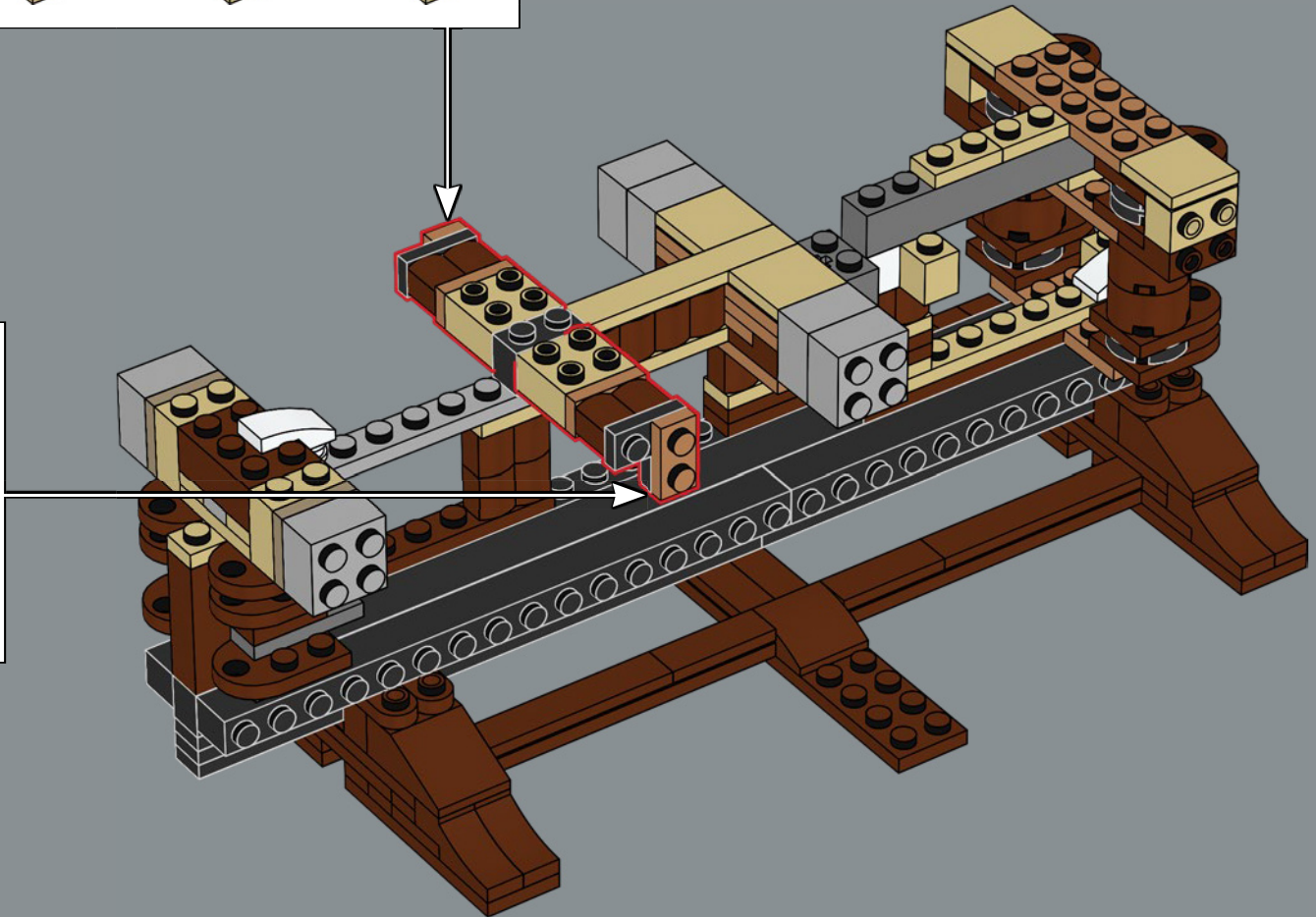
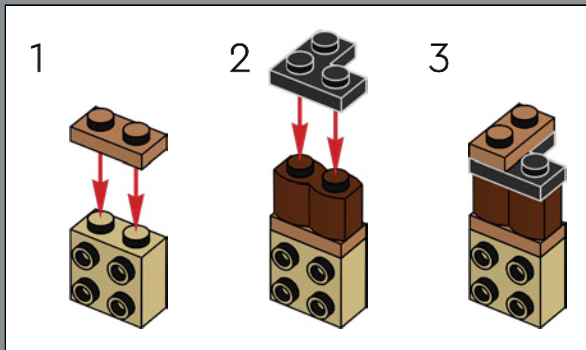
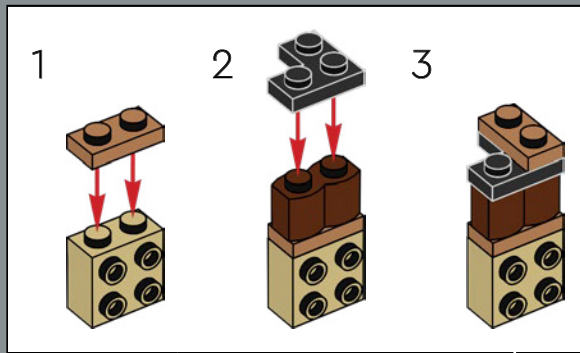

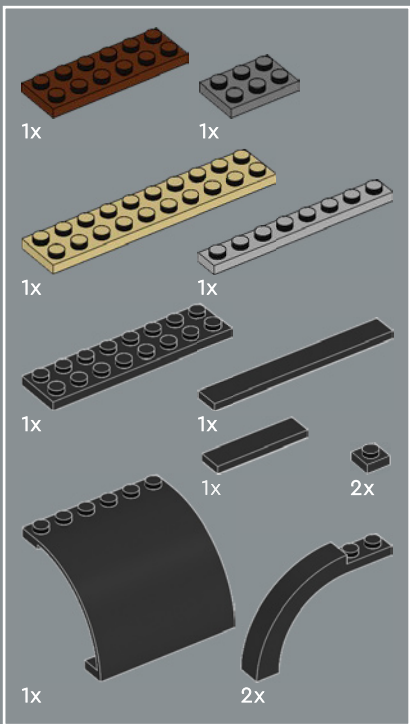

181

1

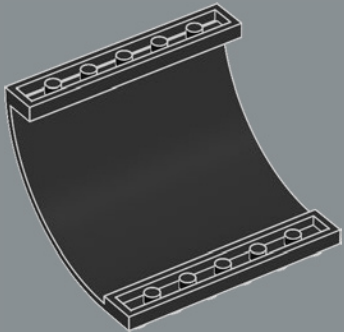

2

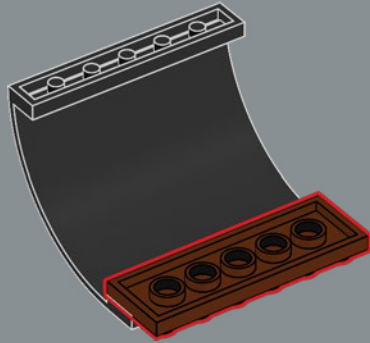

3

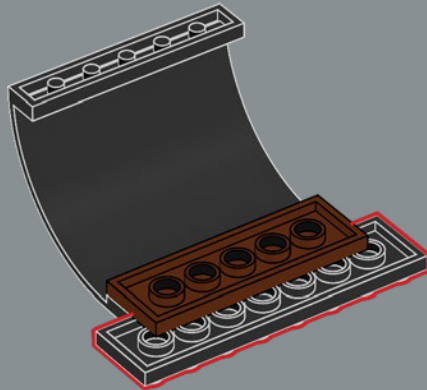

4

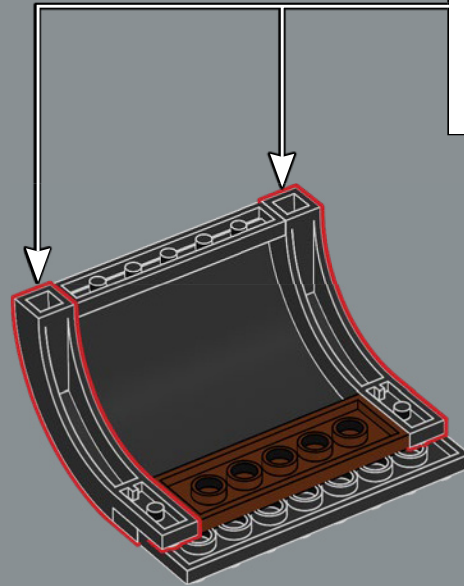

5

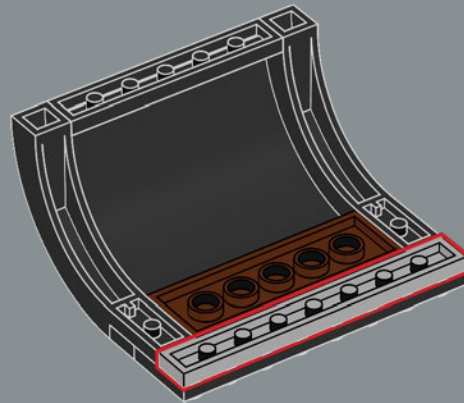

6

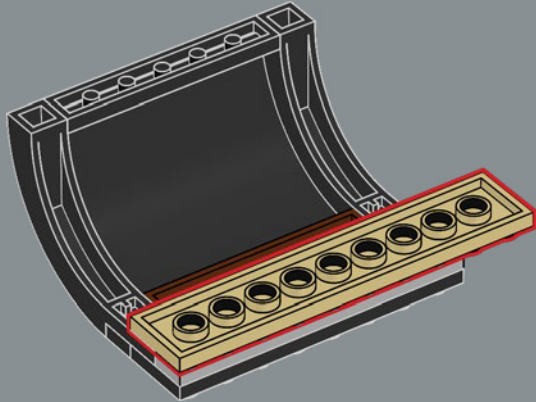

7

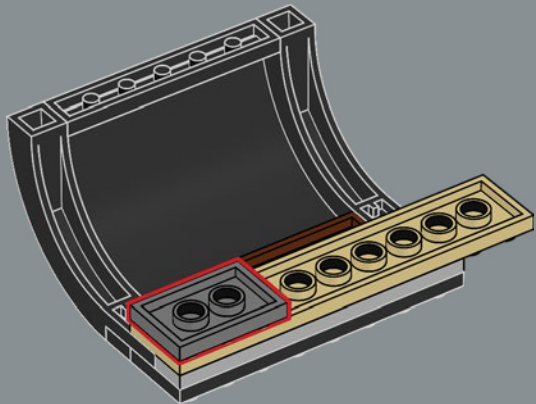

8

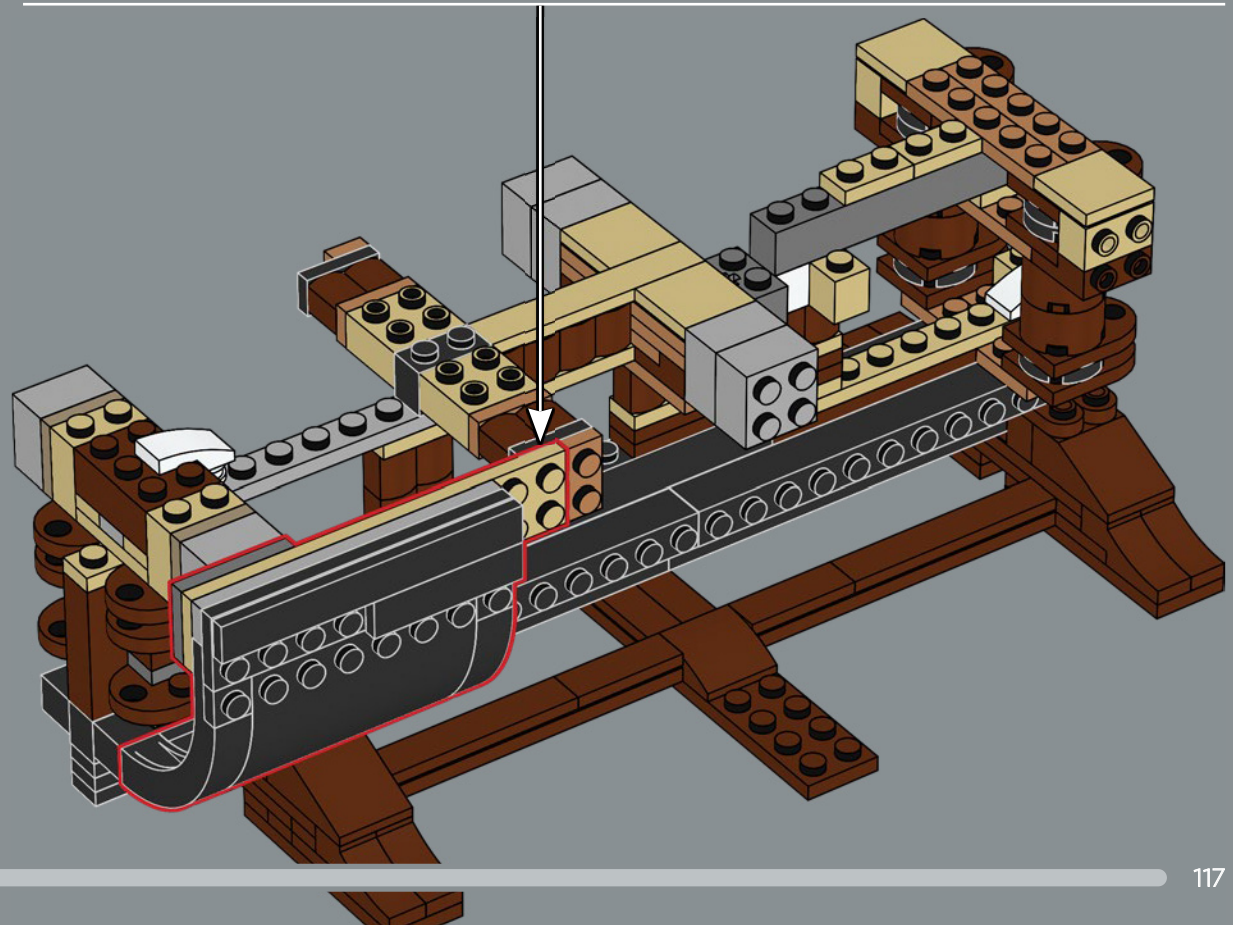
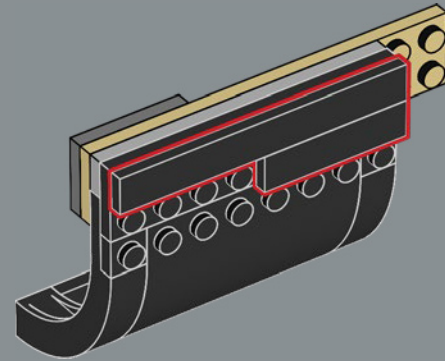

6

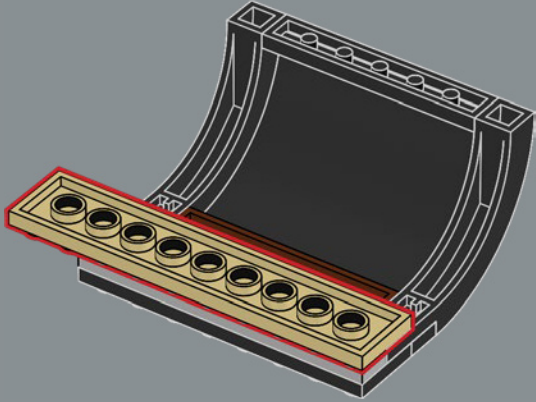

7

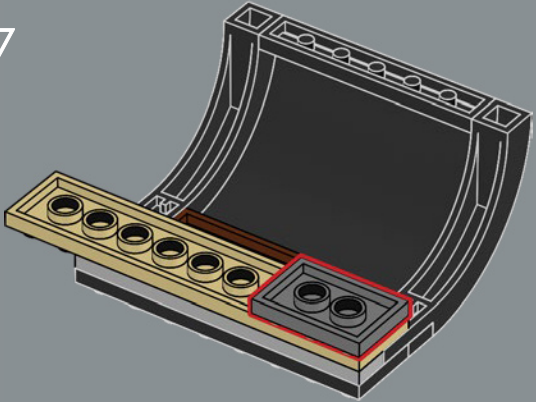

8

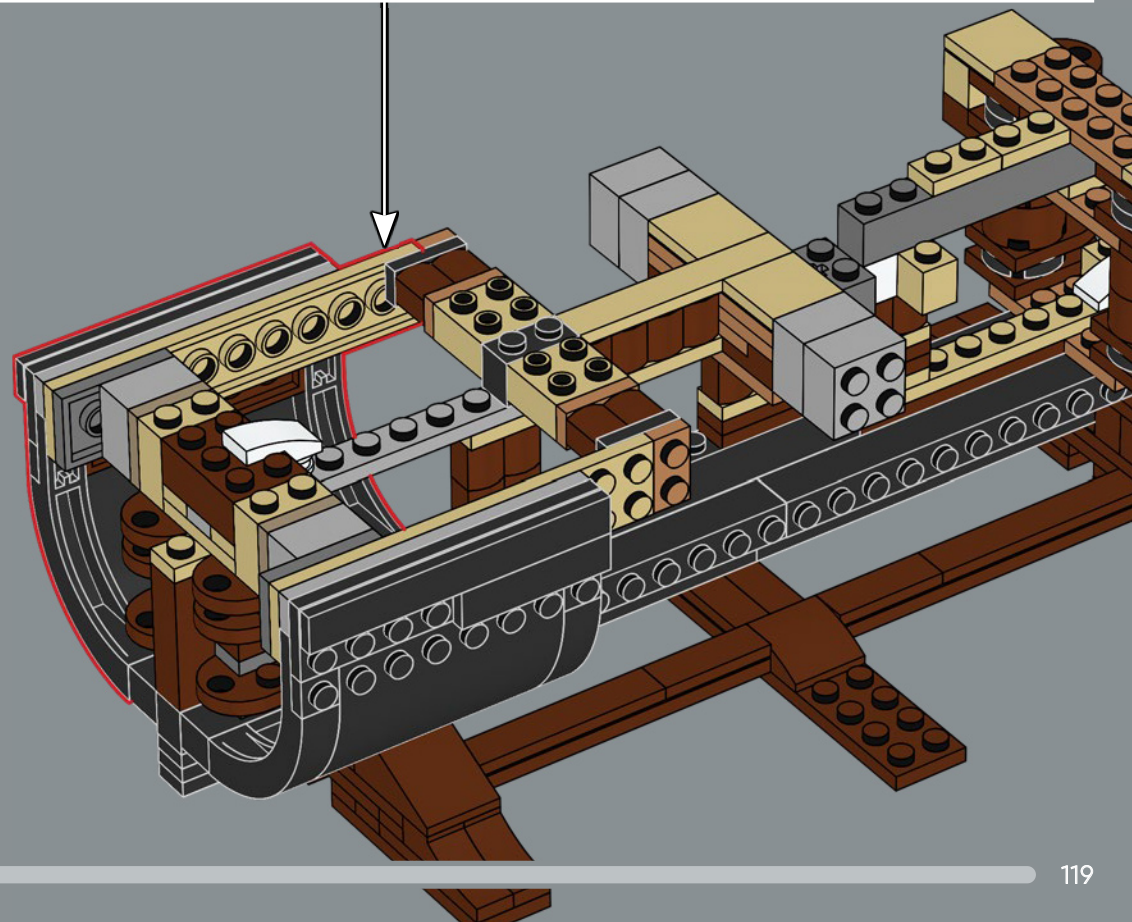
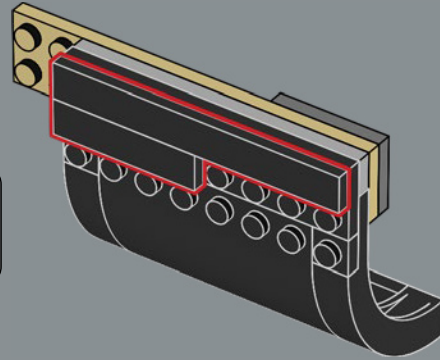

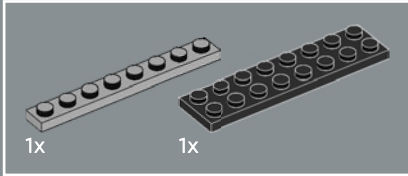
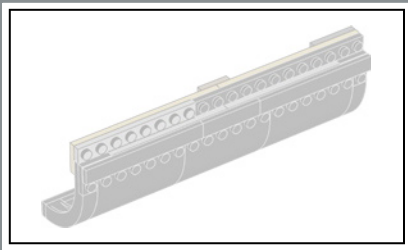

183

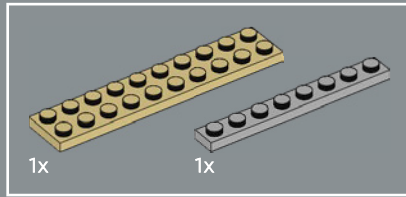
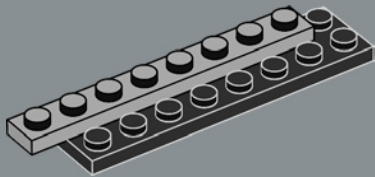

184

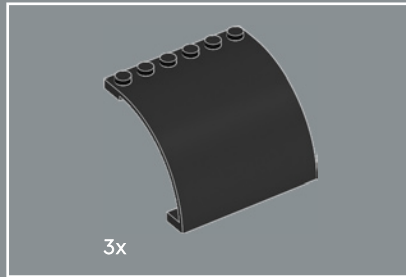
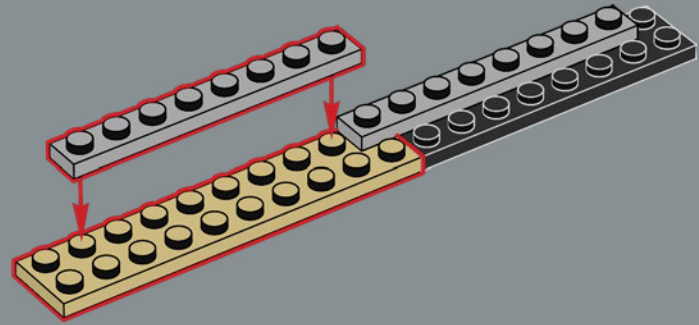

185

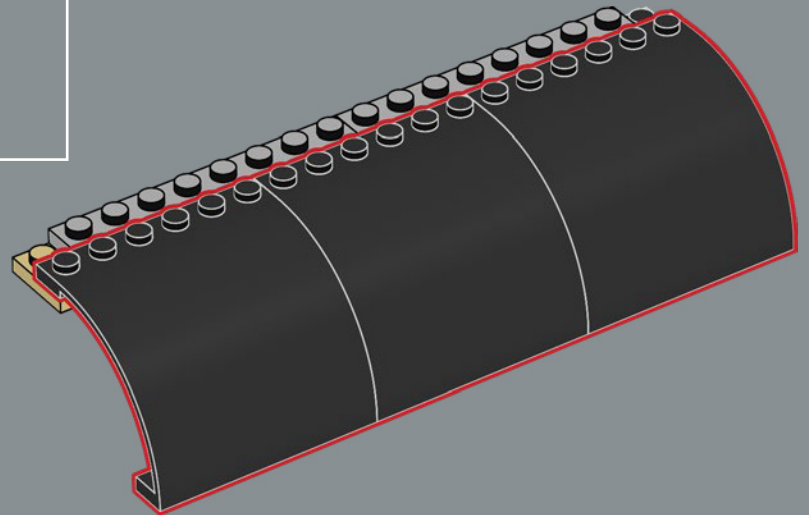



186

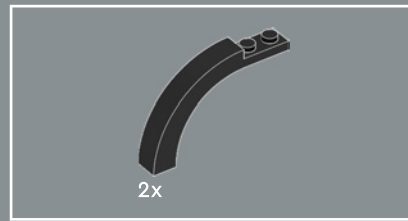
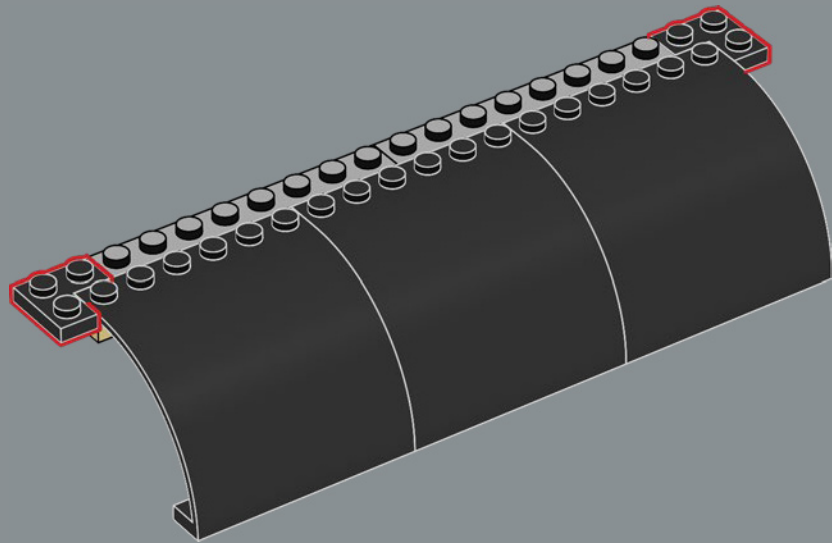

187

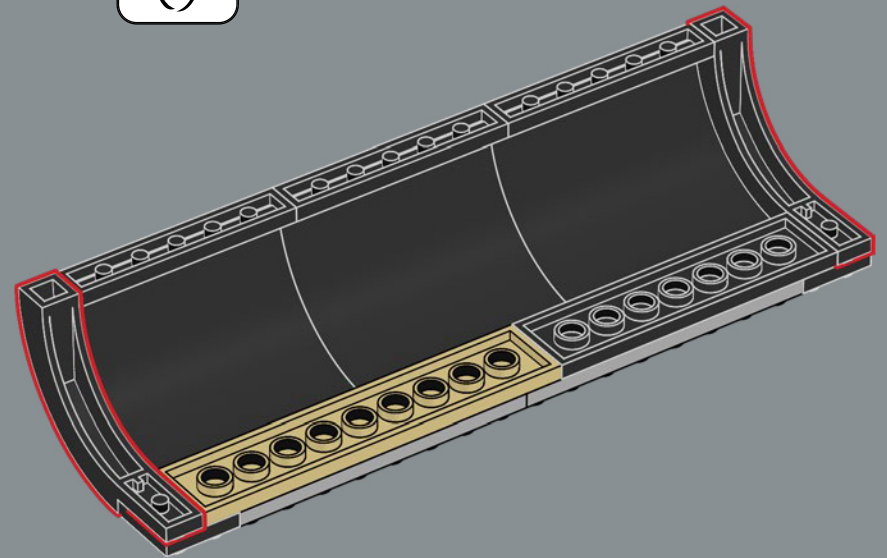

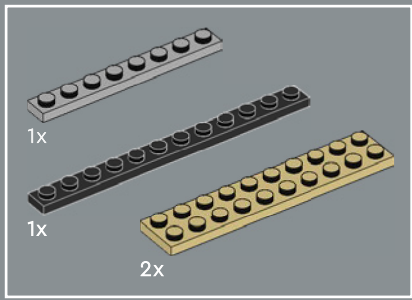

188

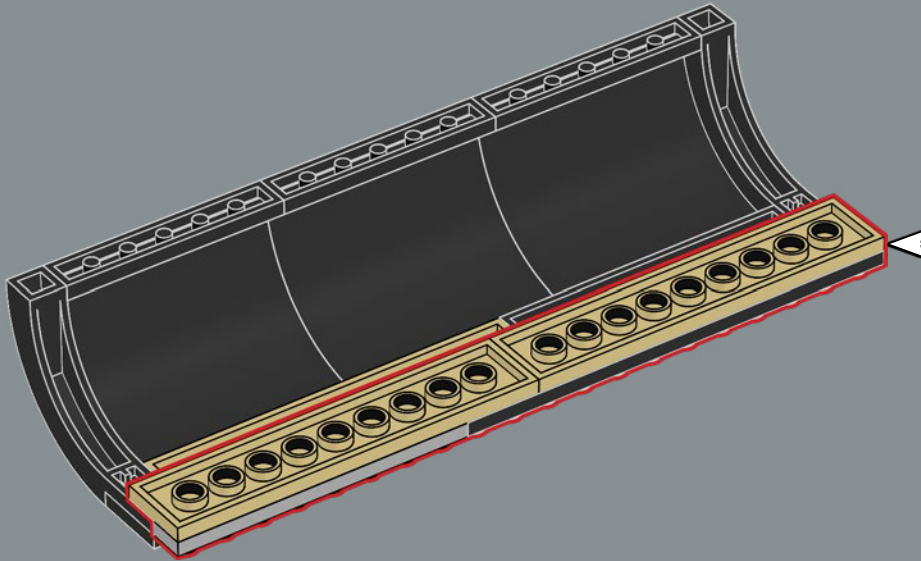
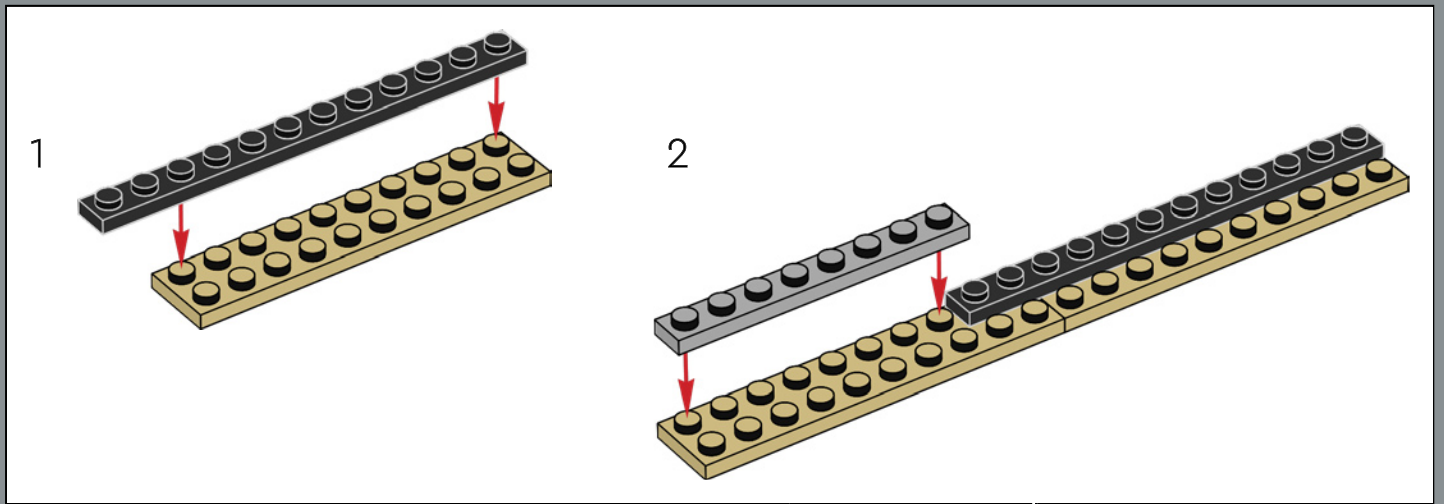



189

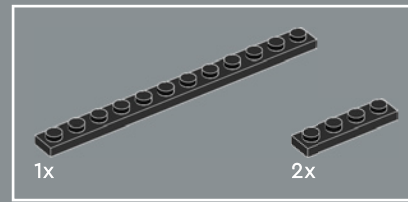
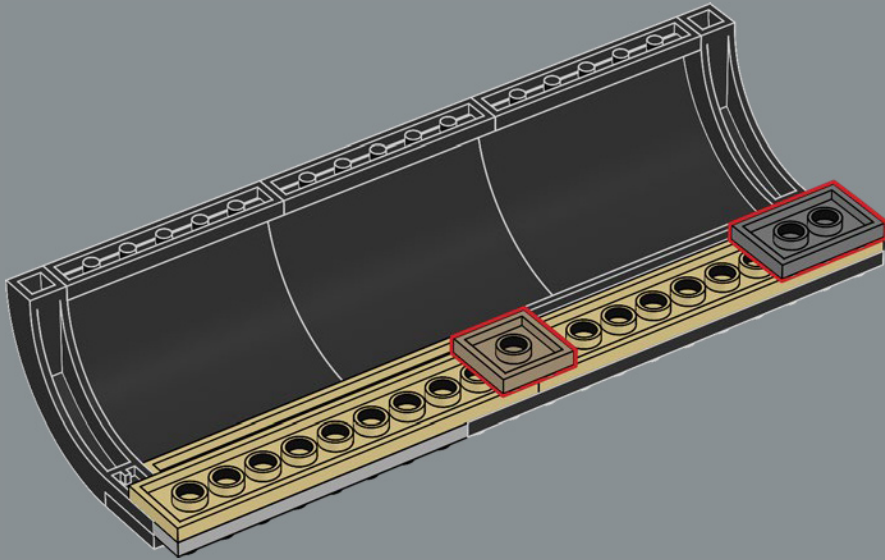

190

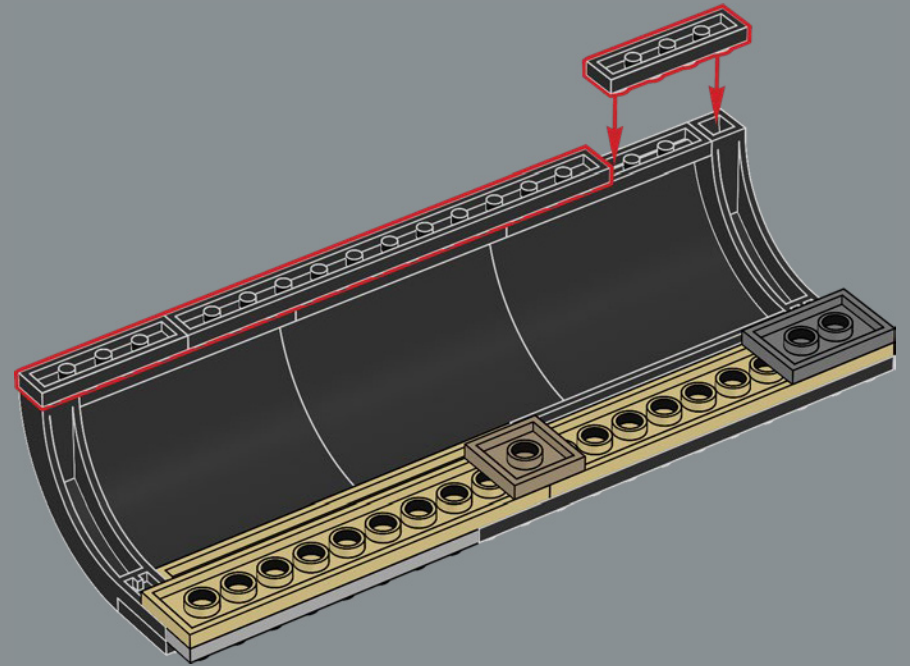

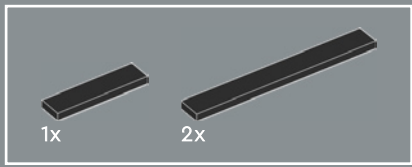

191

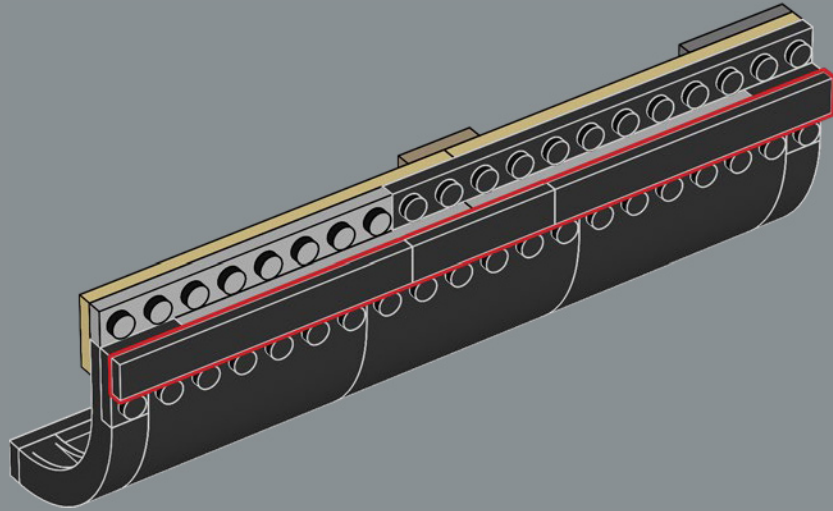

192

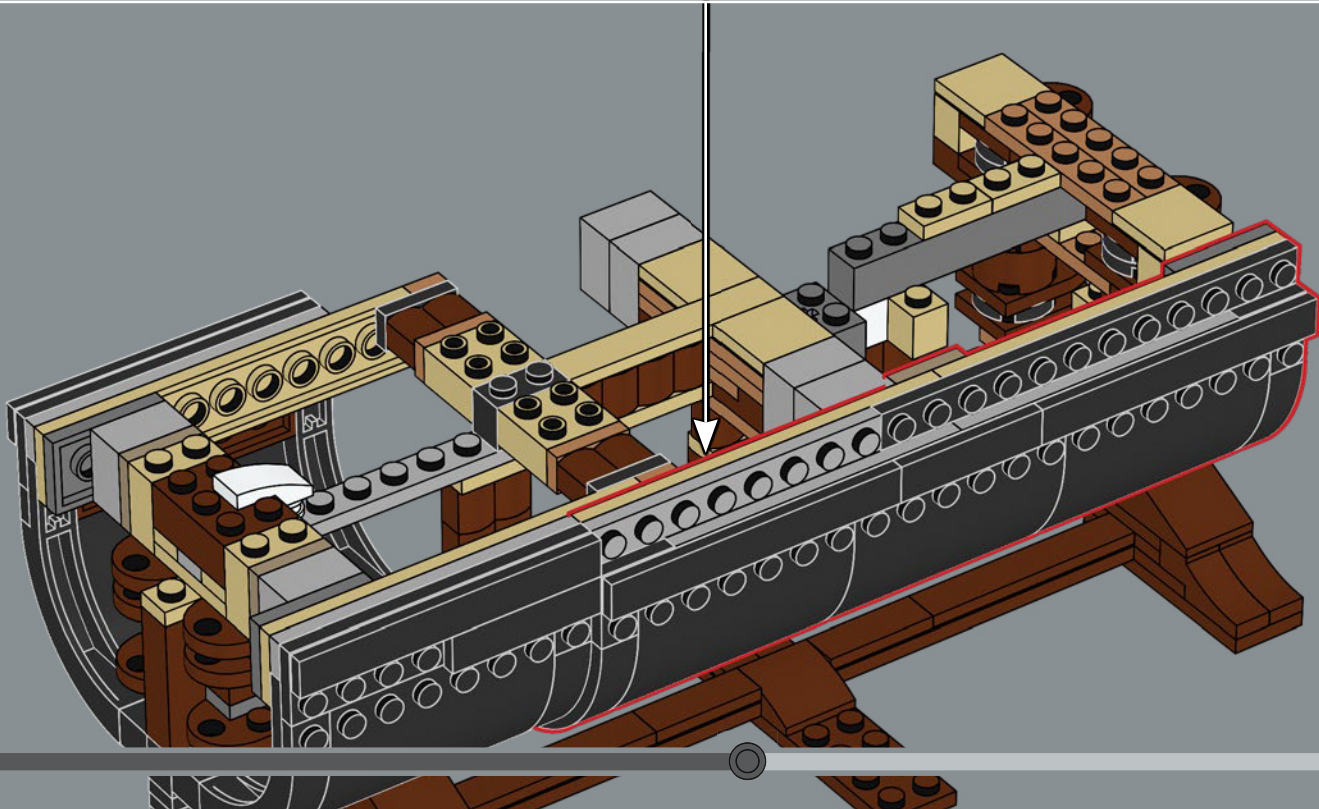

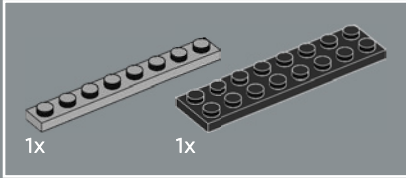
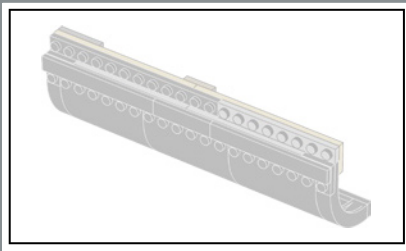

193

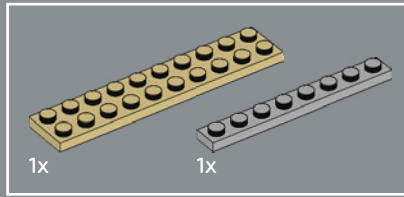
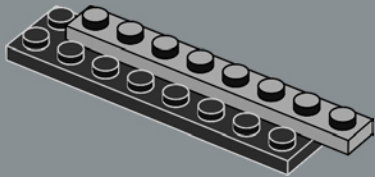

194

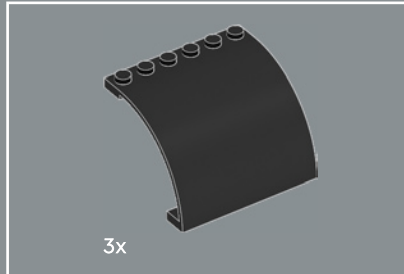

195



The black panels that make up most of the lower part of the ship's hull are considered 'wall' elements in LEGO® design terms. Made in black, their size and shape were just perfect for the ship's hull.

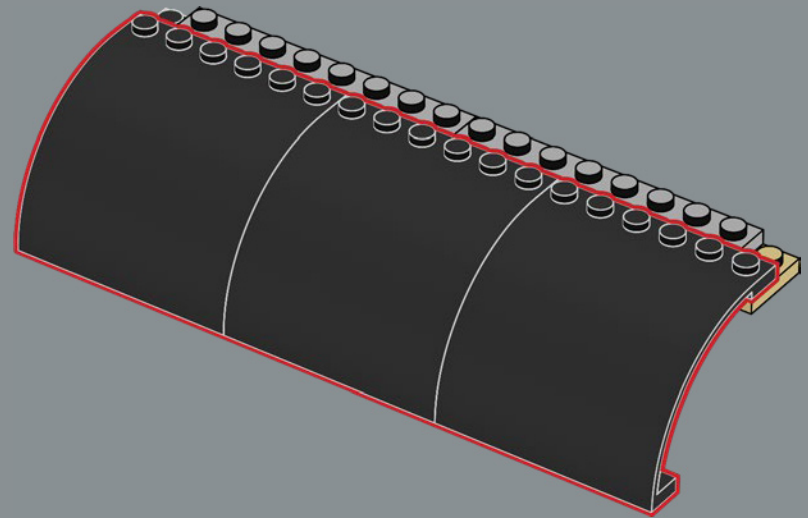
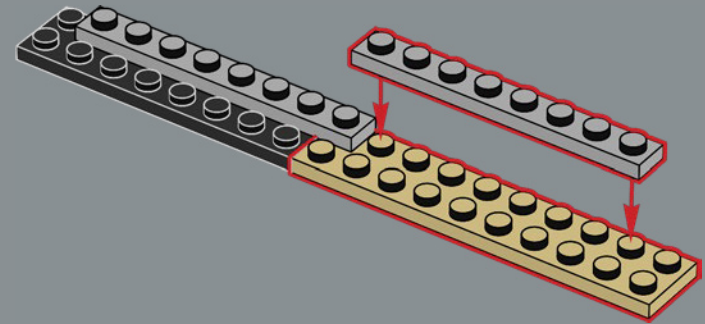

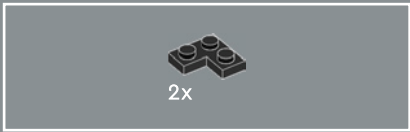

196

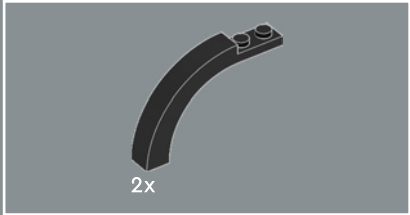
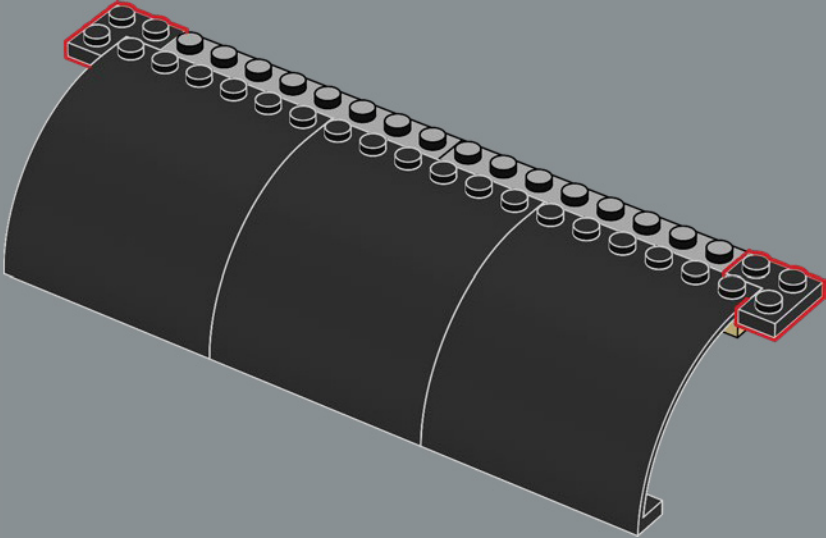

197

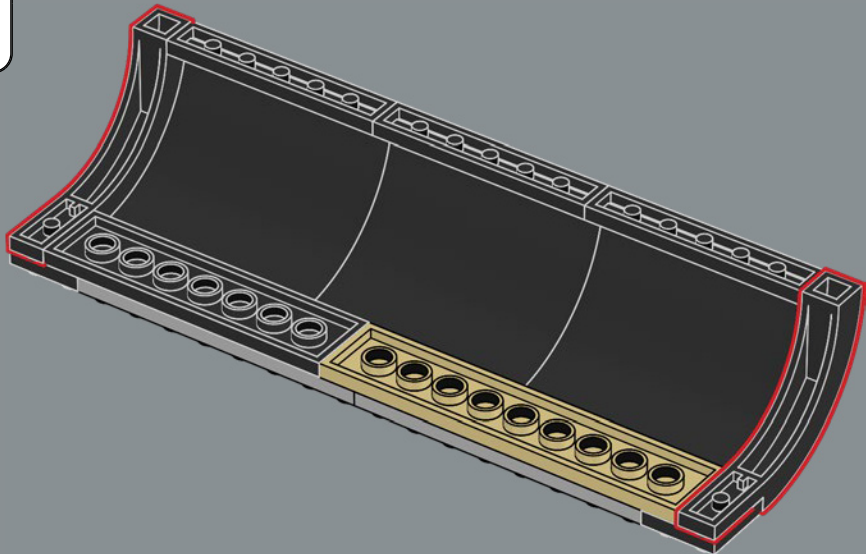

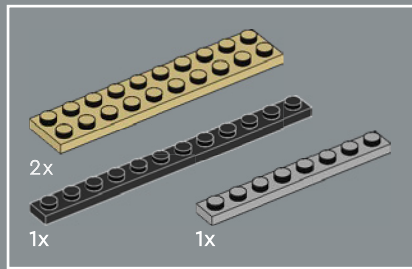

198

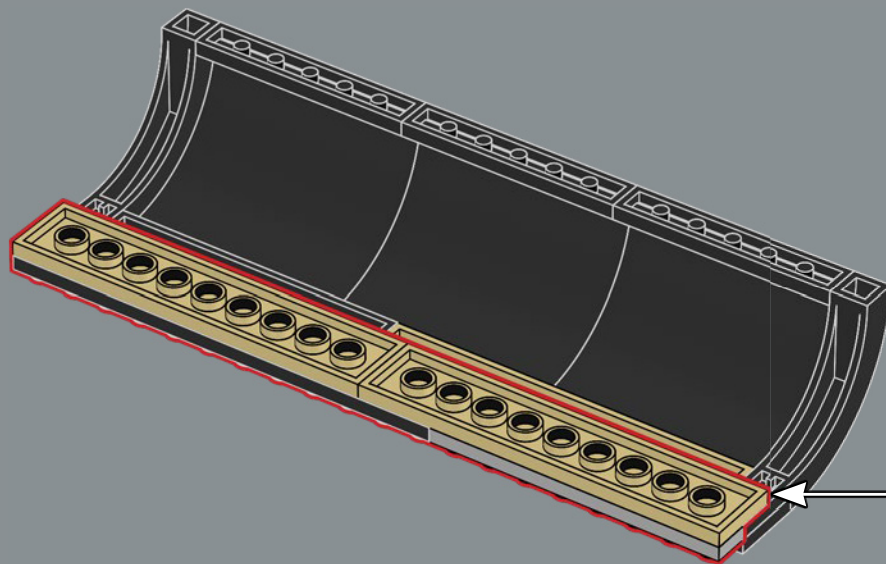
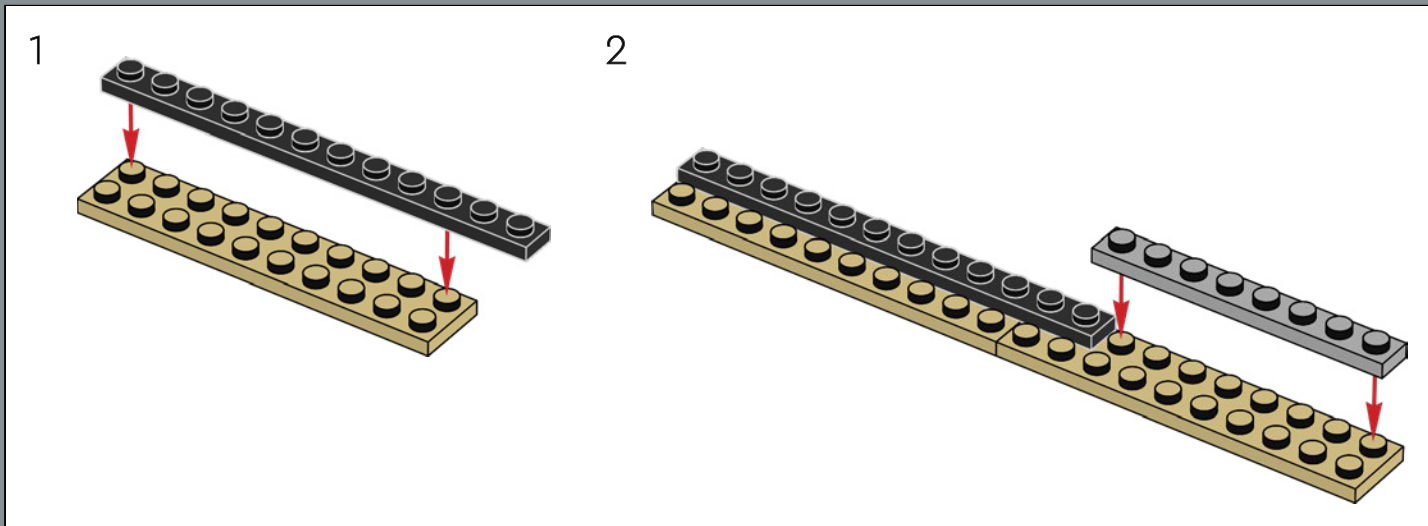



199

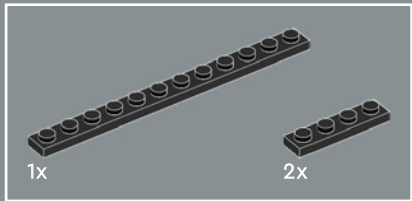
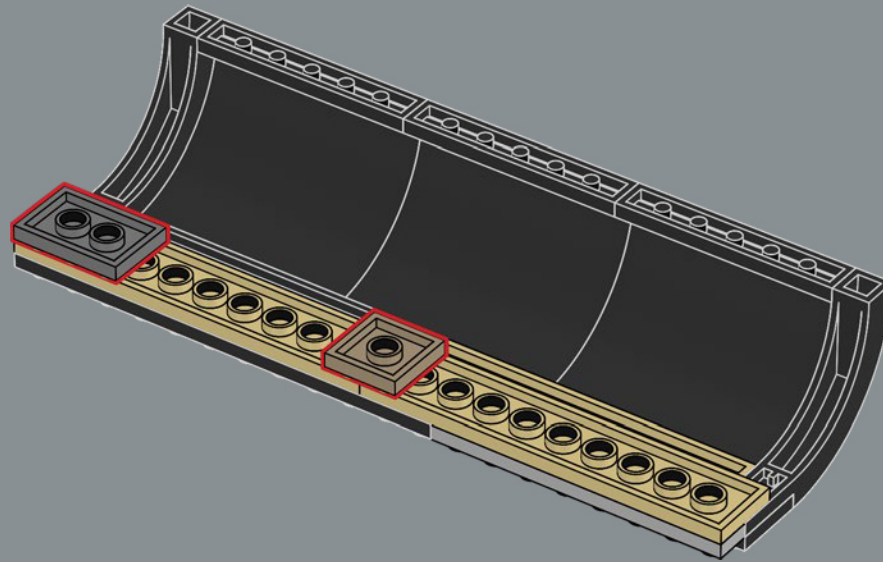

200

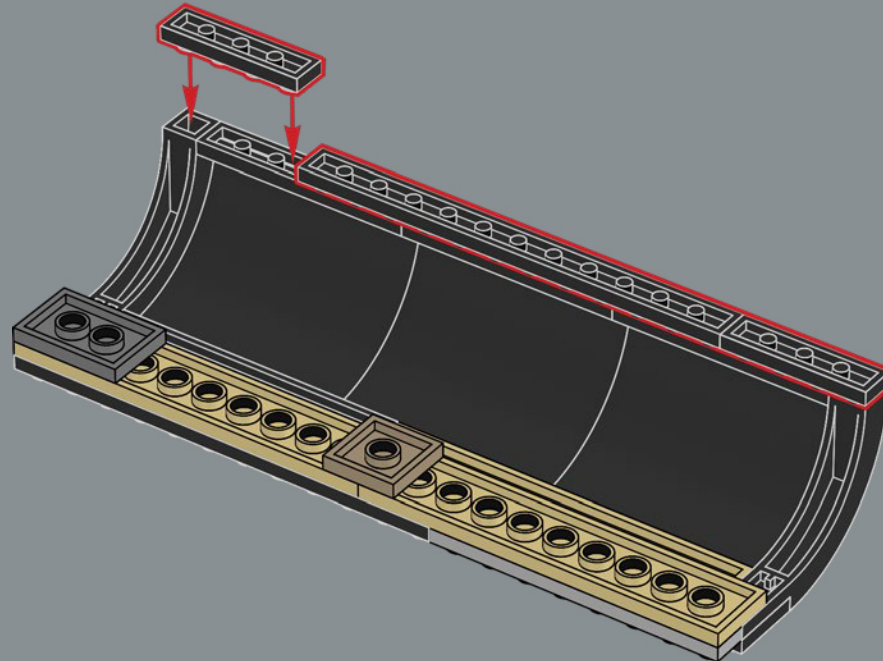

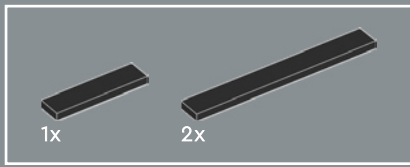

201

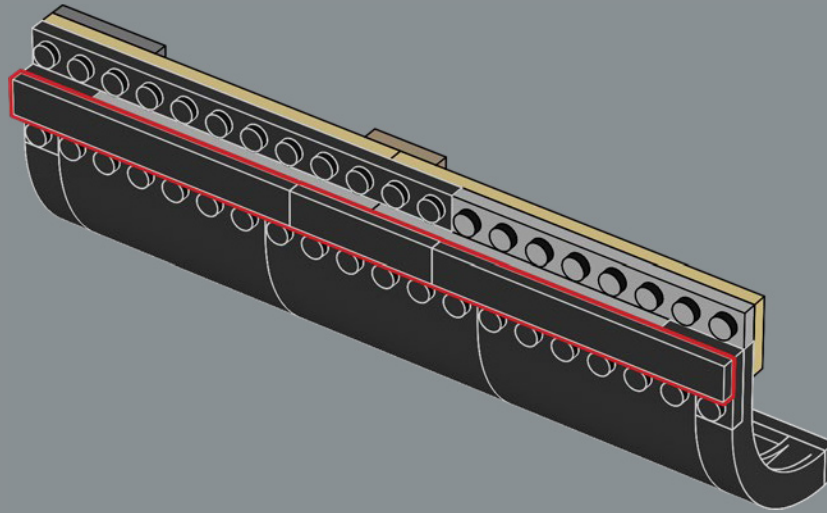

202

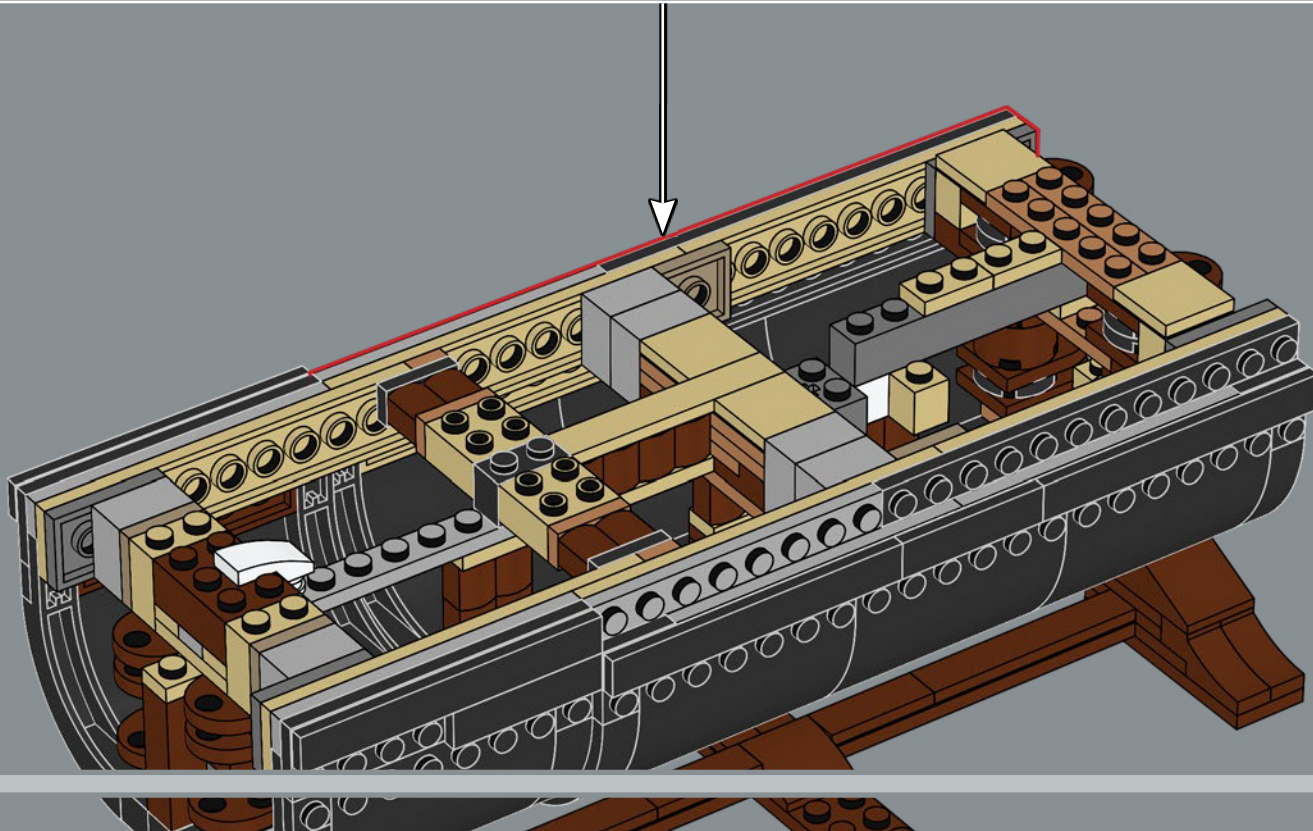

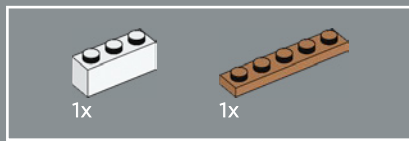
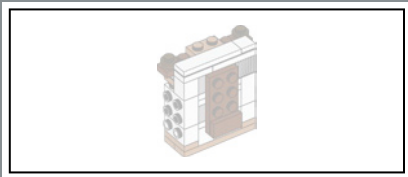

203

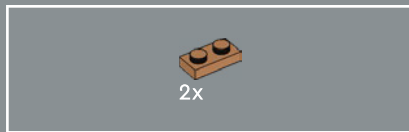
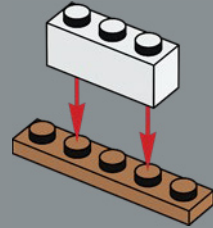

204

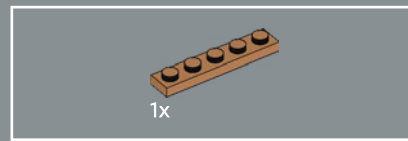
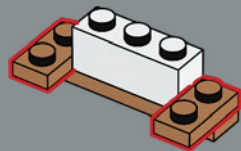

205

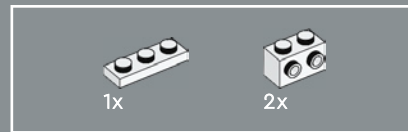
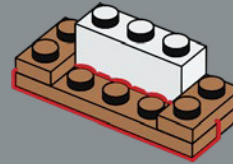

206

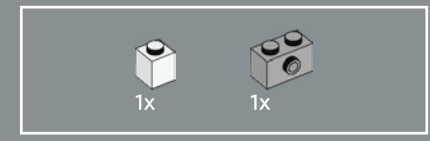
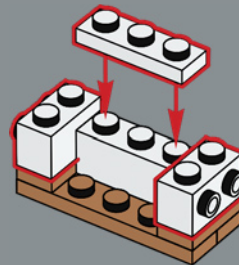

207

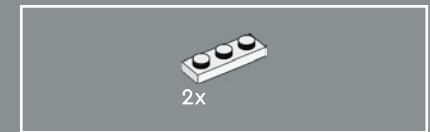
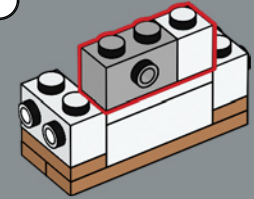

208

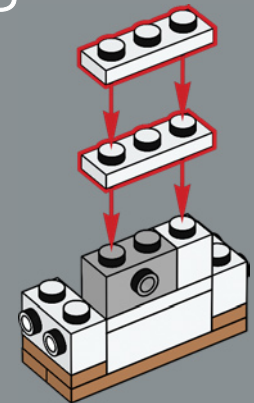

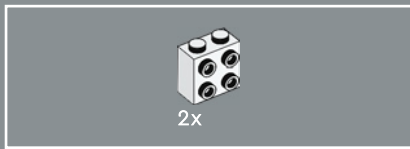

209

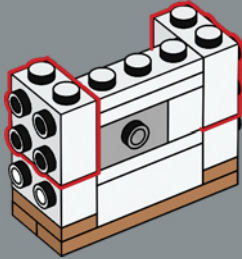

210

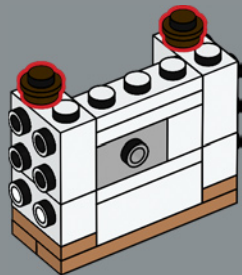

211

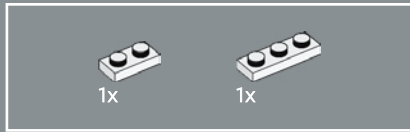
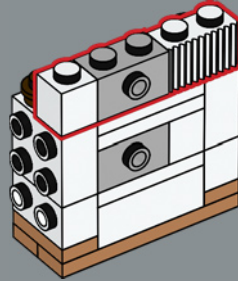

212

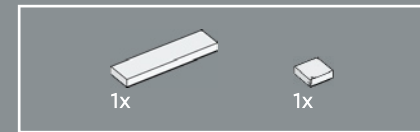
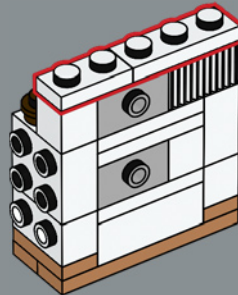

213

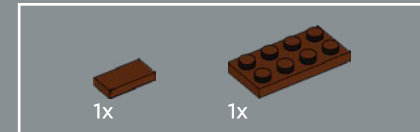
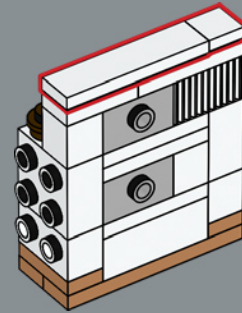

214

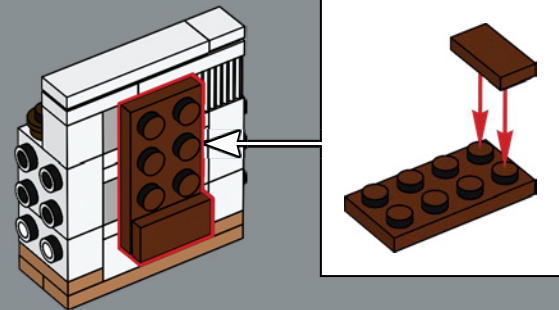

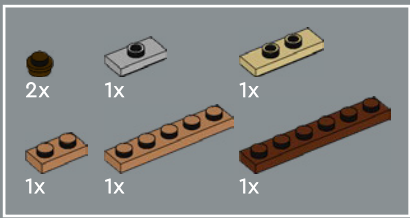

215

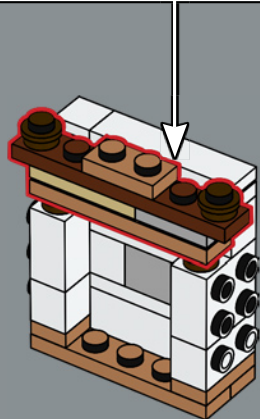
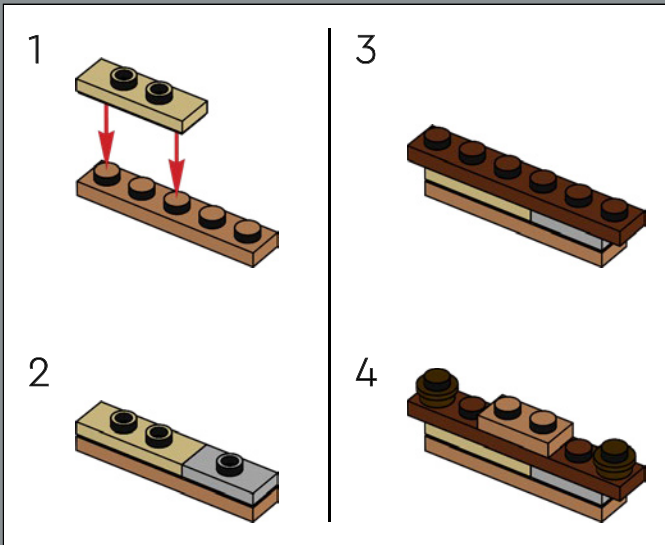

216

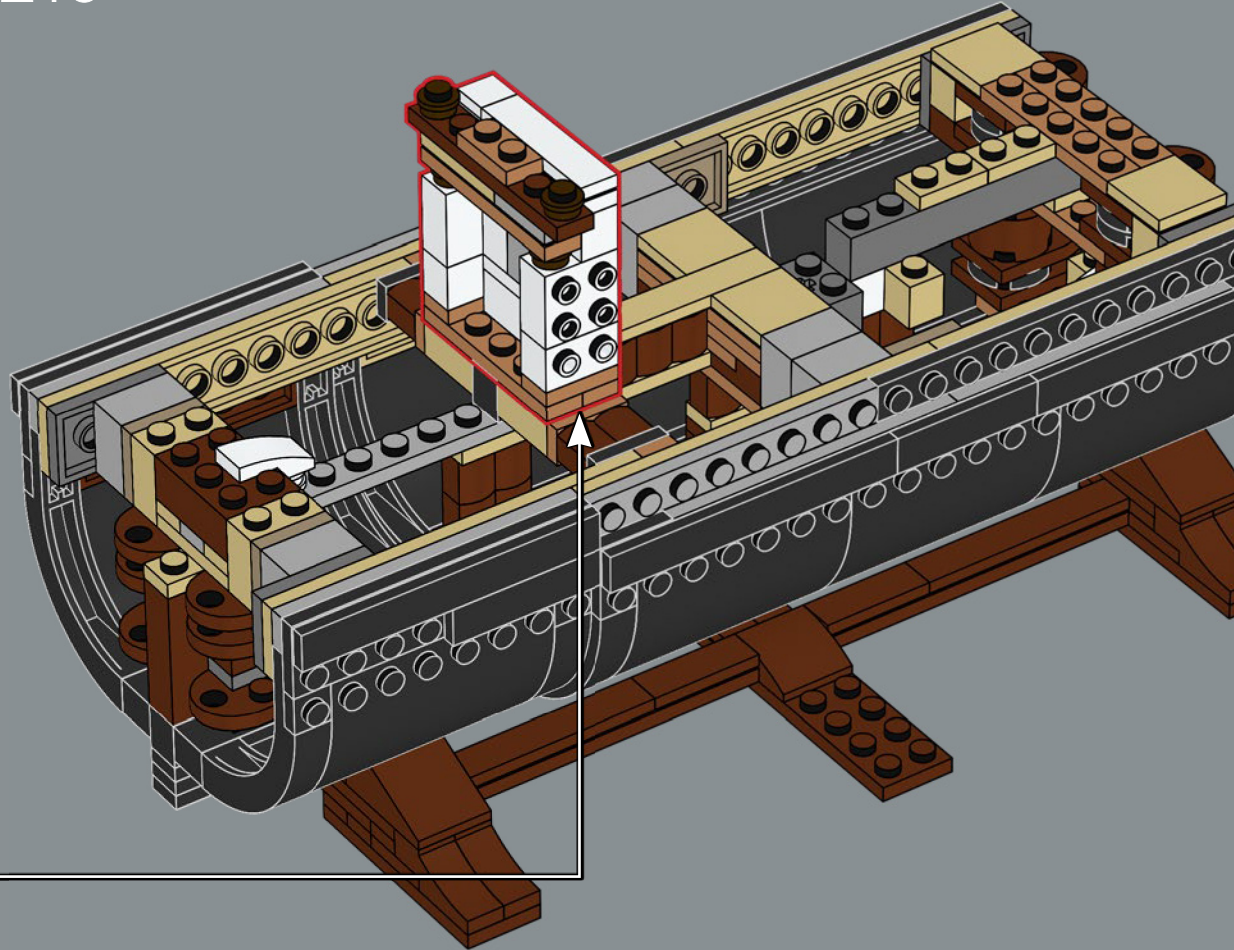

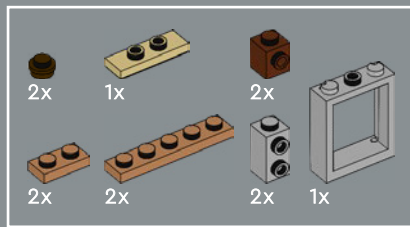

217

1

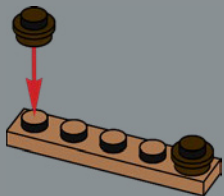

2

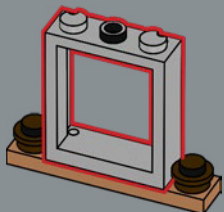

3

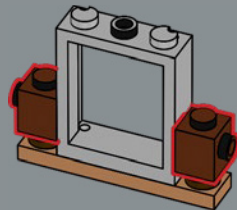

4

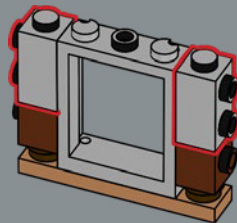

5

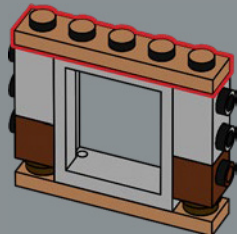

6

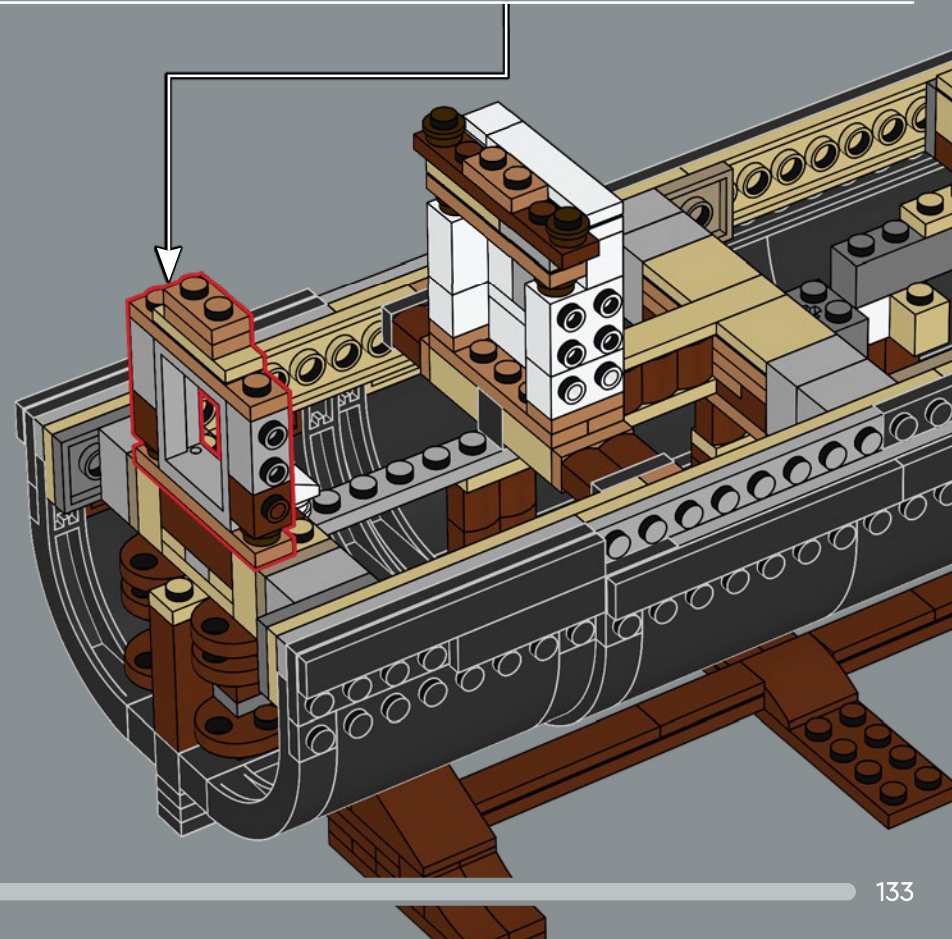
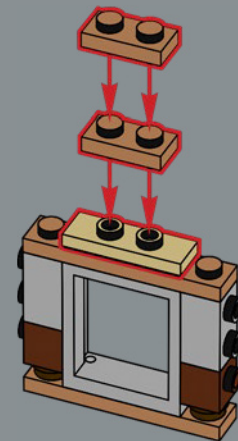

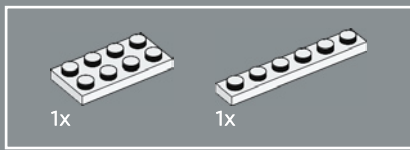

218

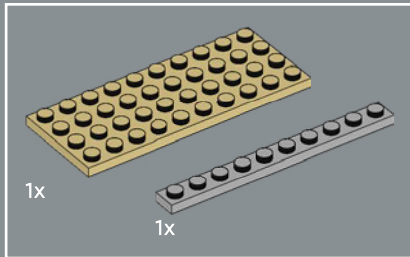
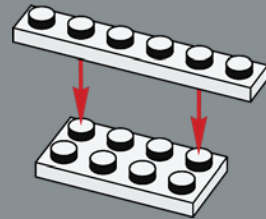

219

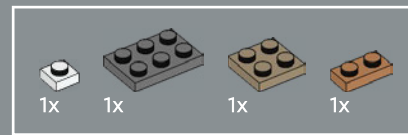
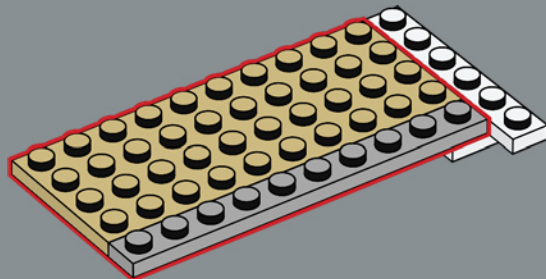

220

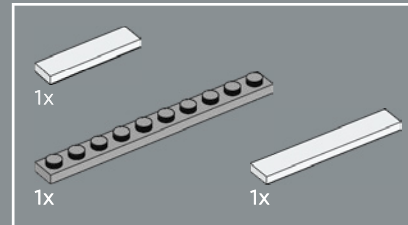
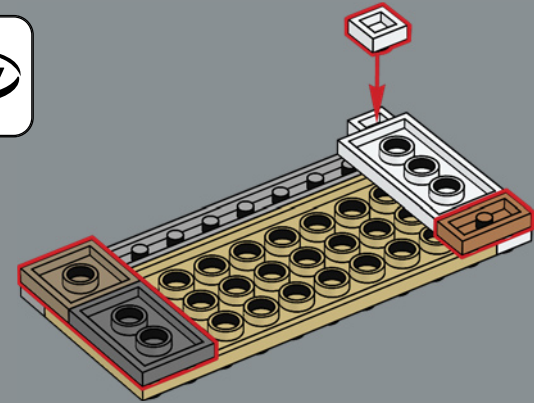

221

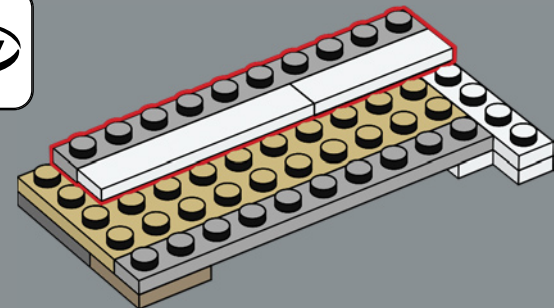

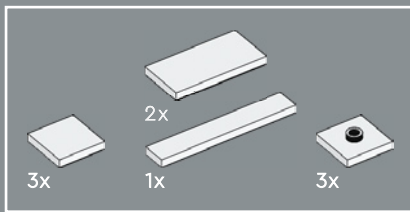

222

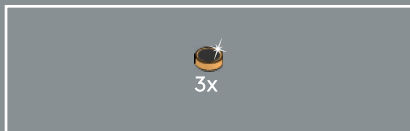
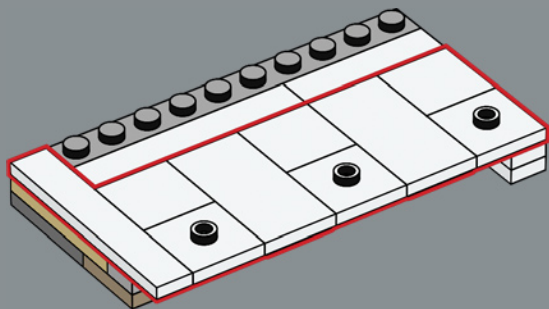

223

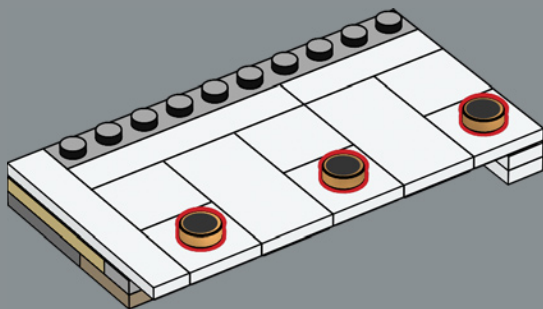

224

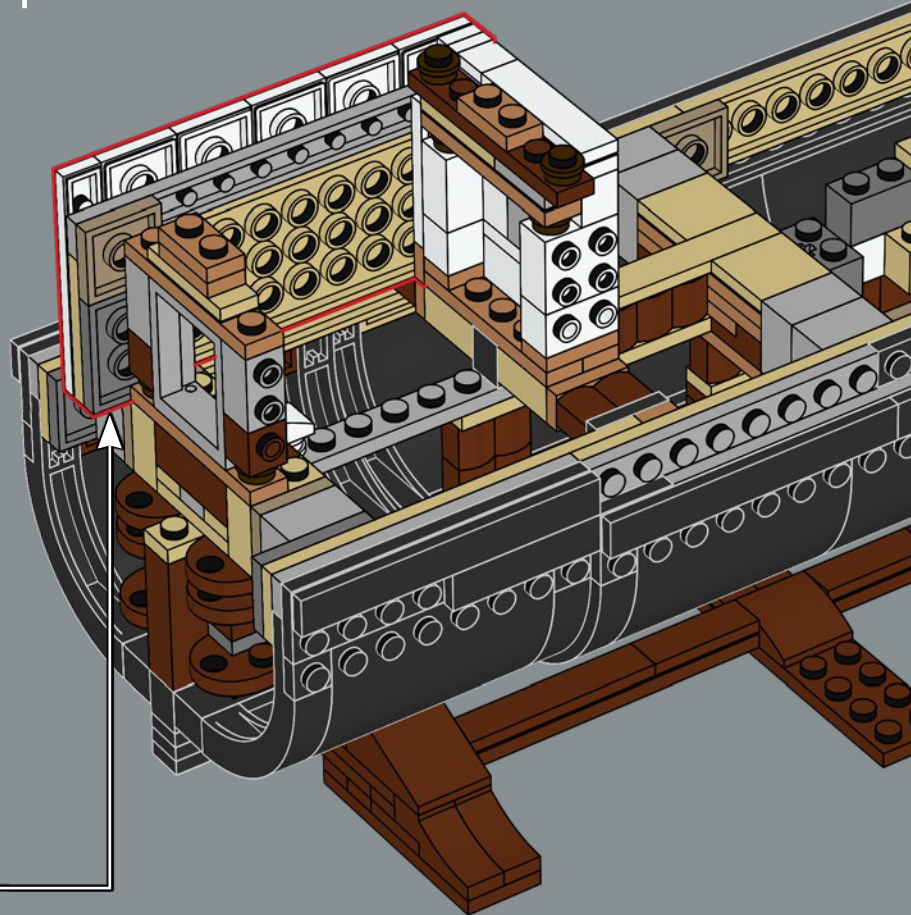

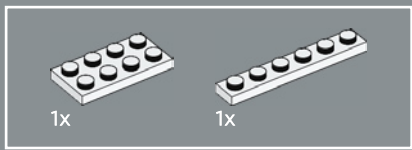

225

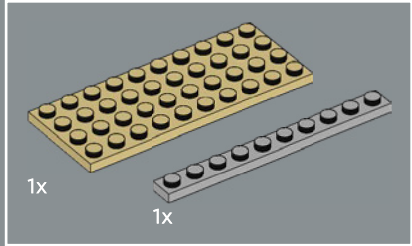
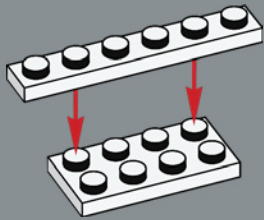

226

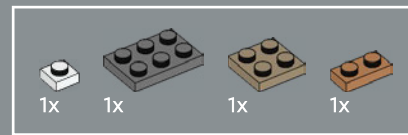
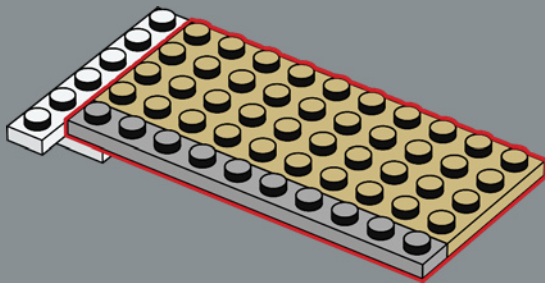

227

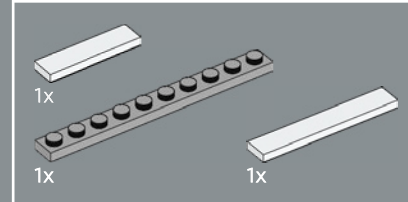
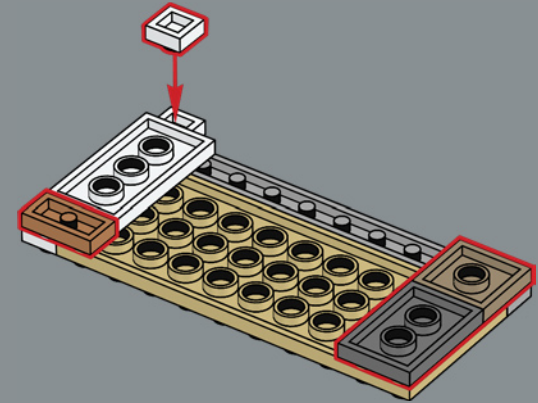

228

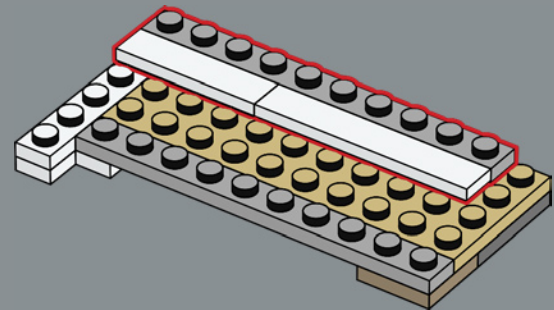
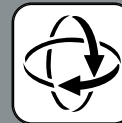

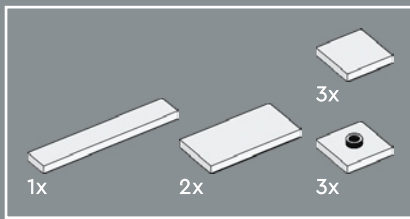

229

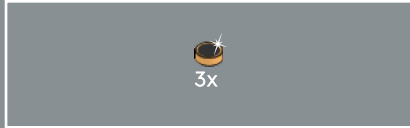
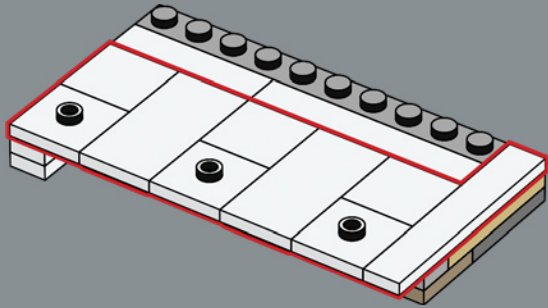

230

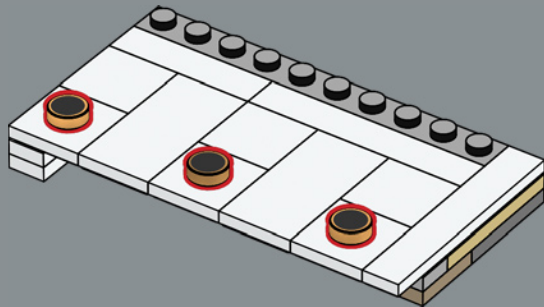

231

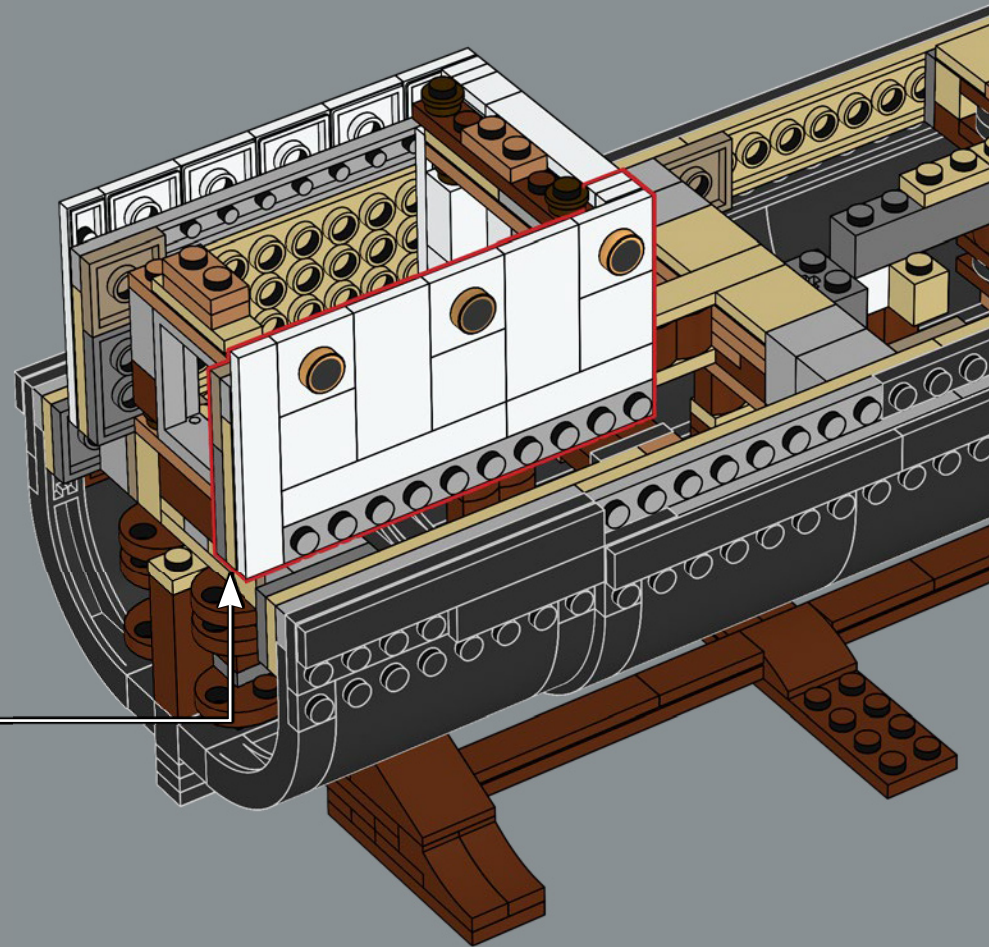



1

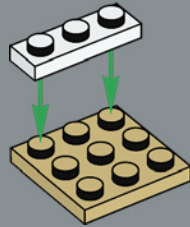

2



3

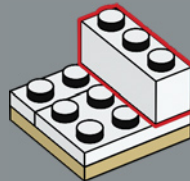

4

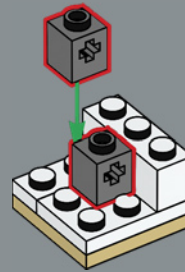

5

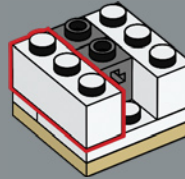

6

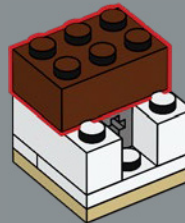

7

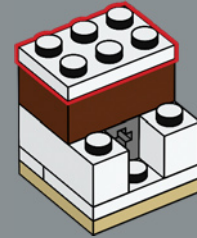

8

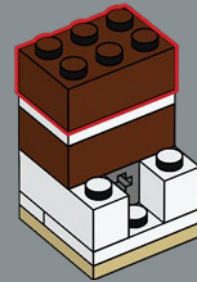

9

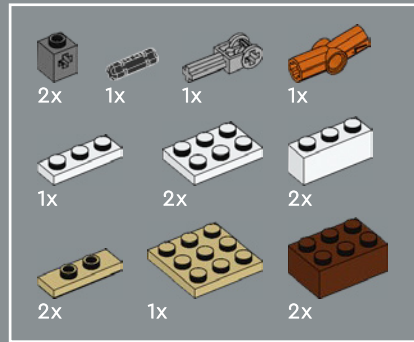
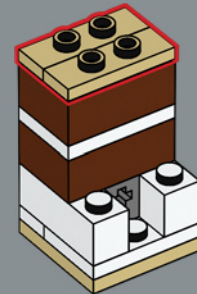

232

10

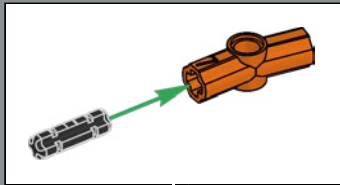
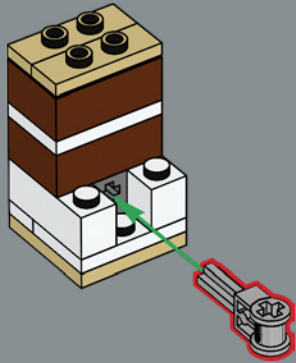

11

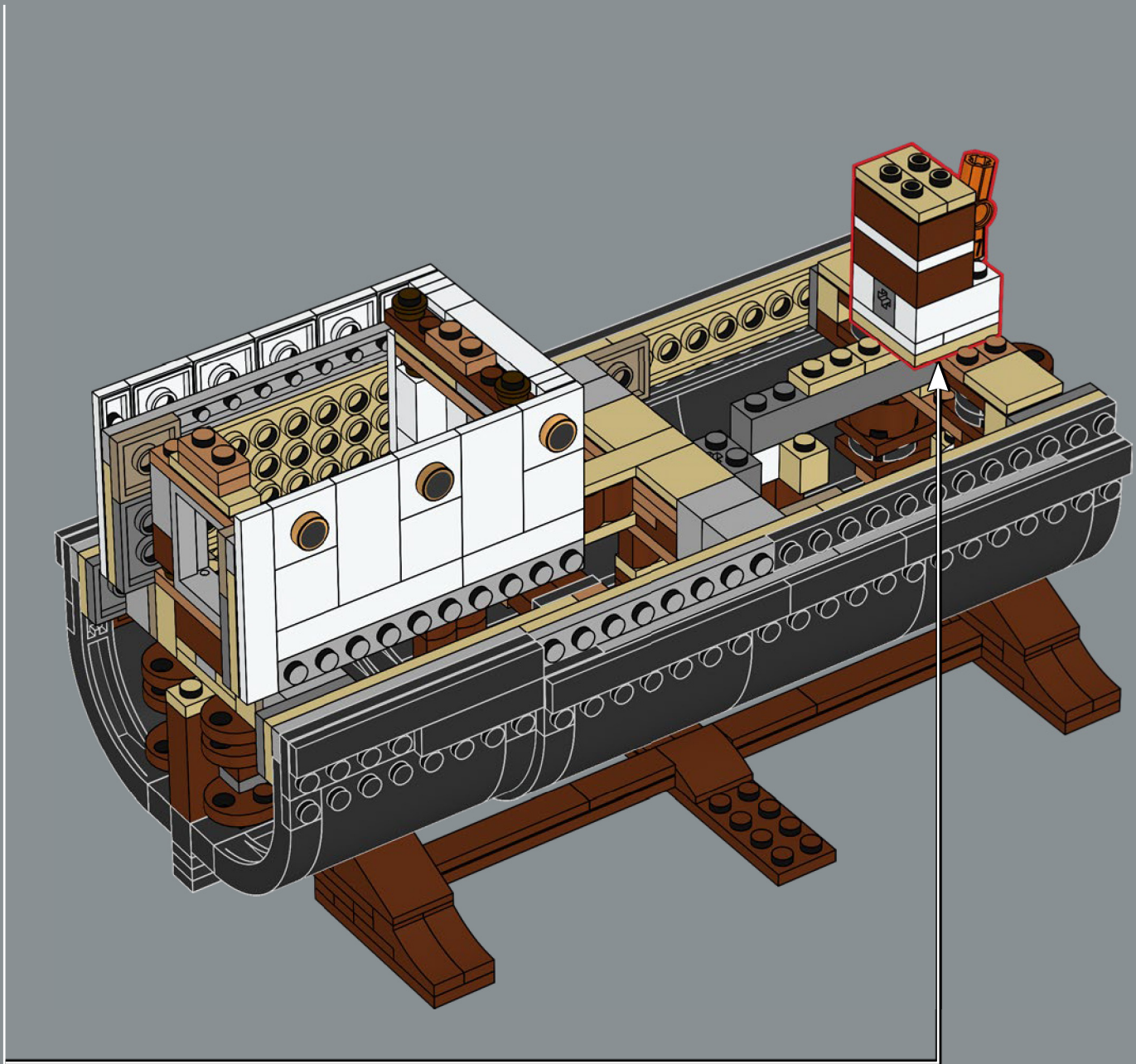
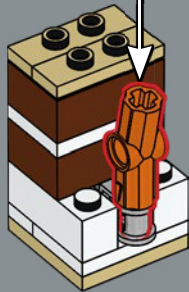

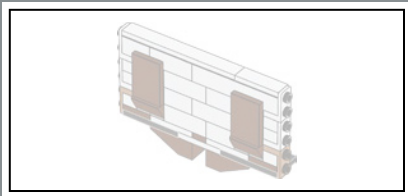

233

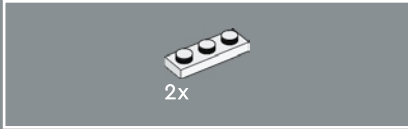
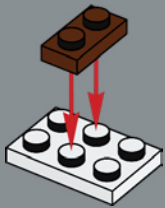

234

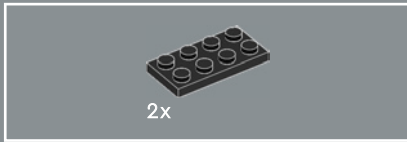
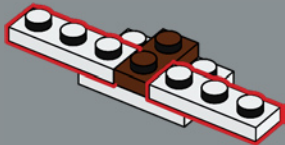

235

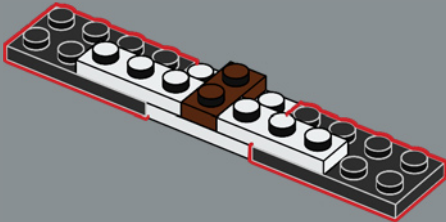

236

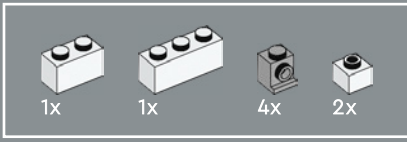
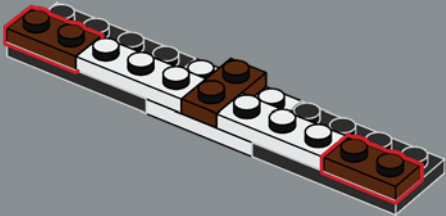

237

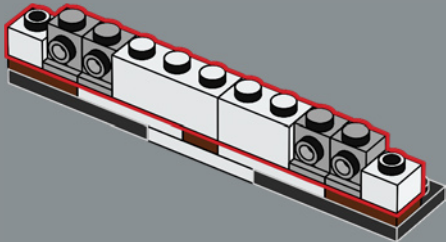

238

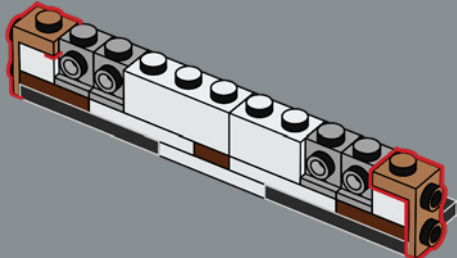

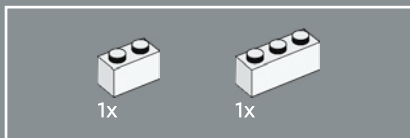

239

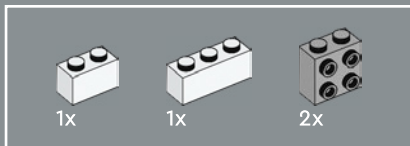
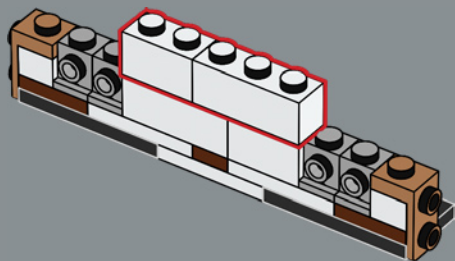

240

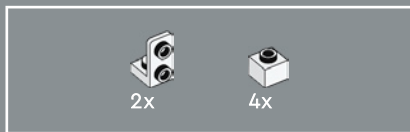
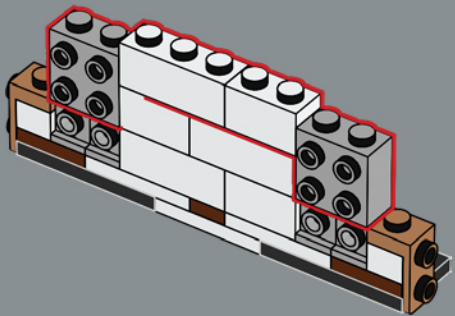

241

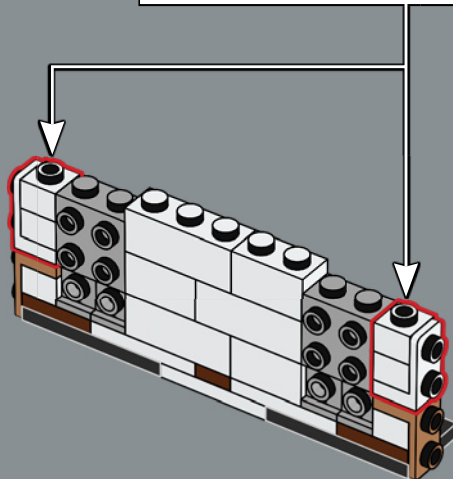
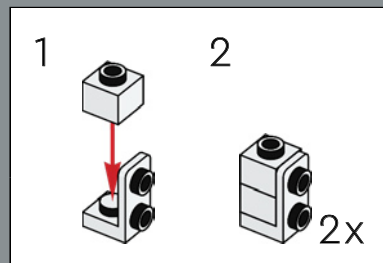

242

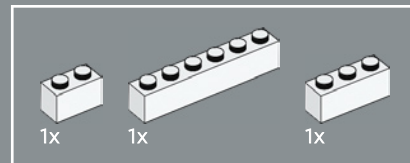
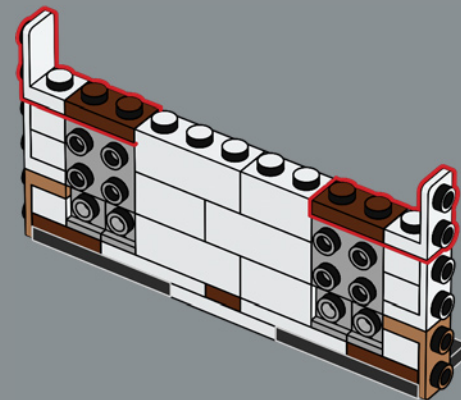

243

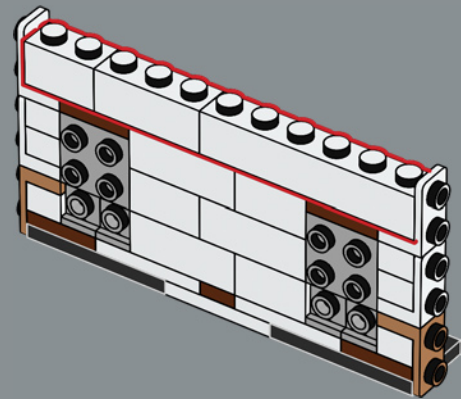

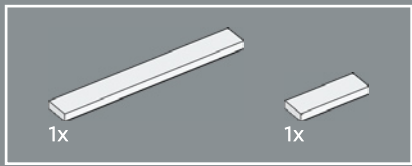

244

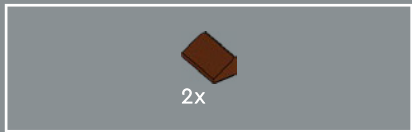
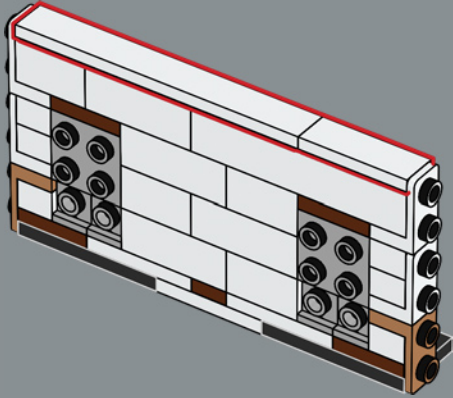

245

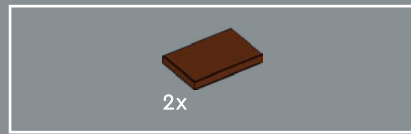
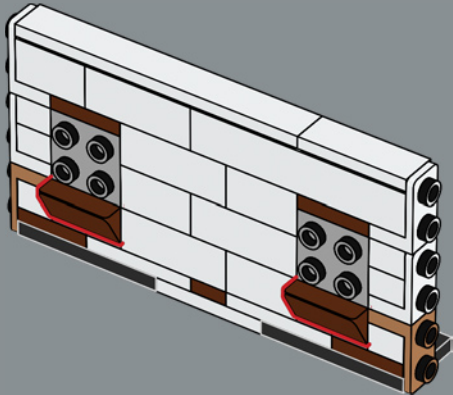

246

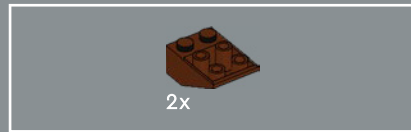
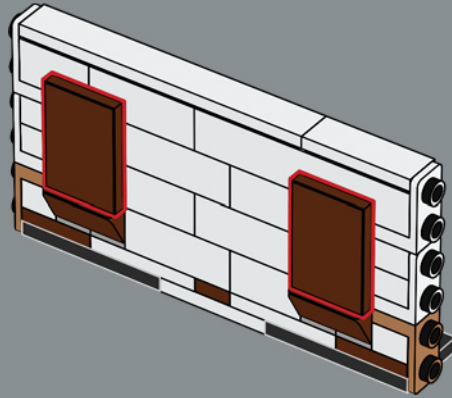

247

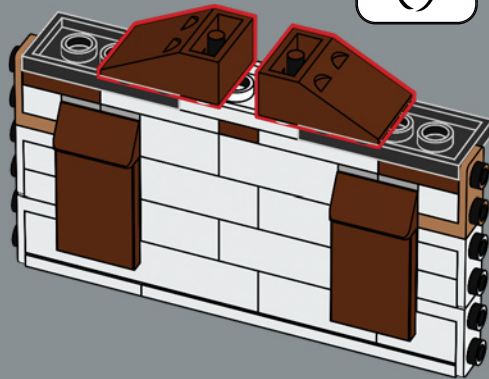

248

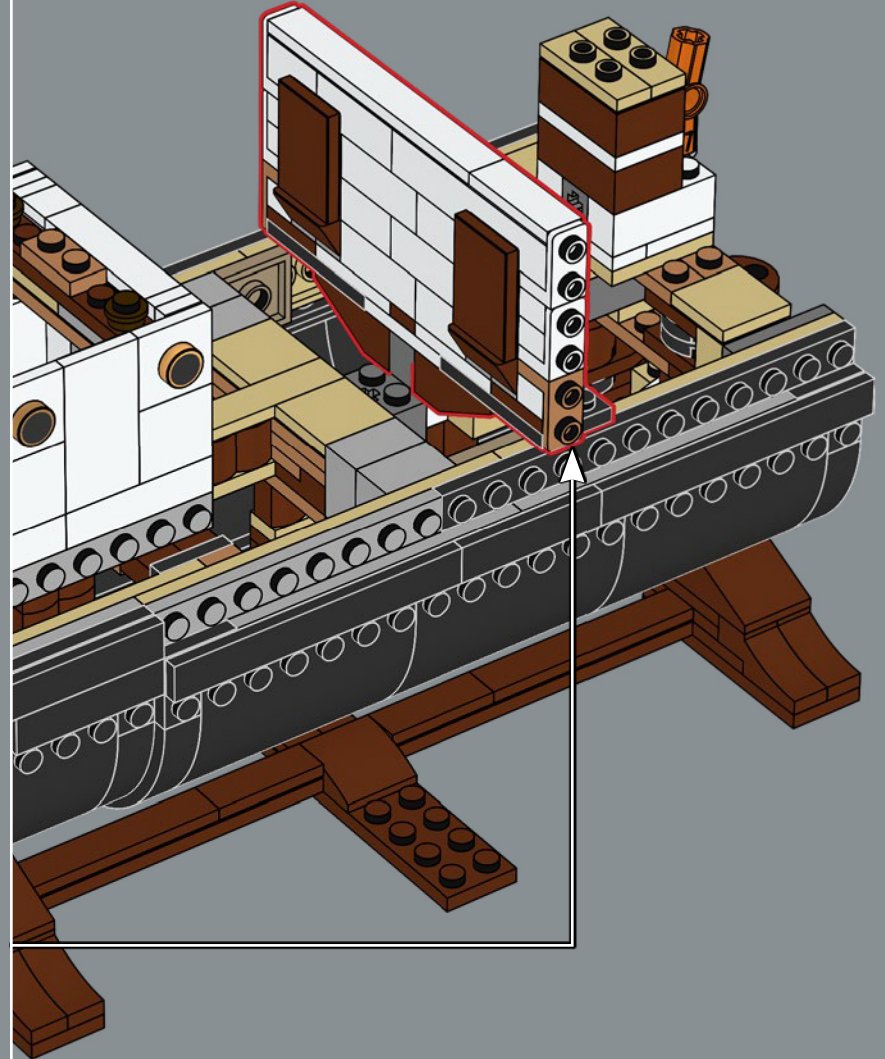

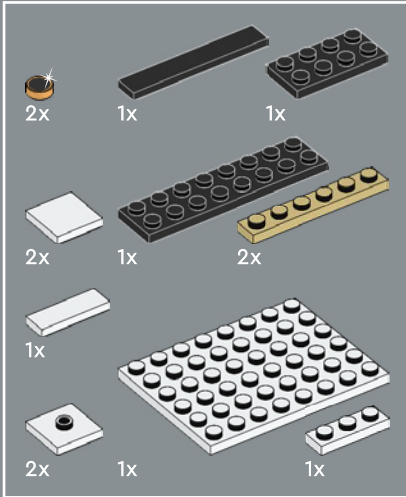
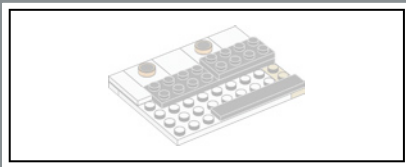

249

1

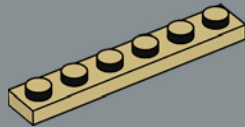

2

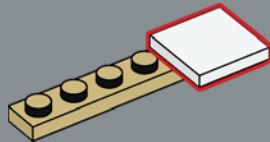

3

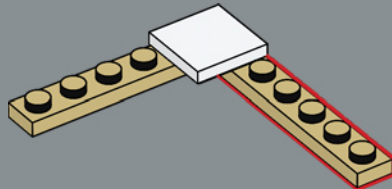

4

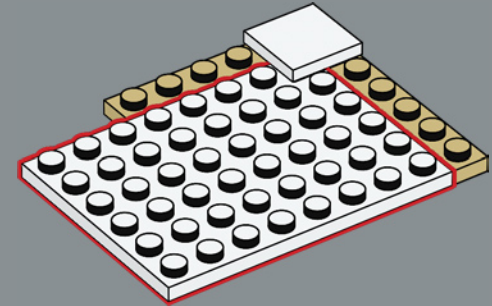

5

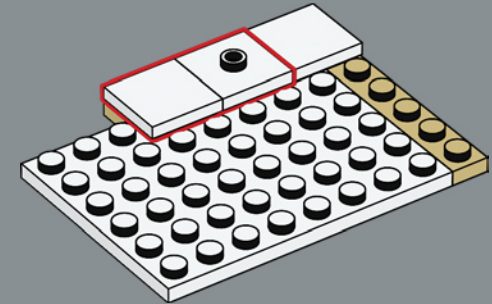

6

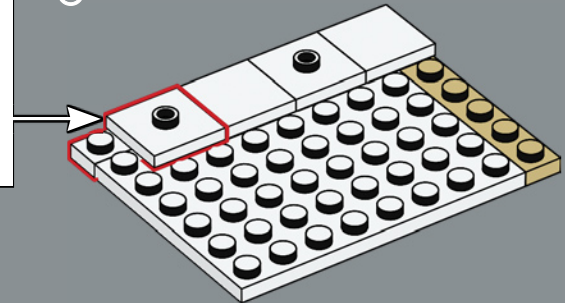
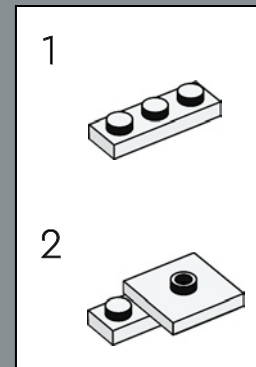

7

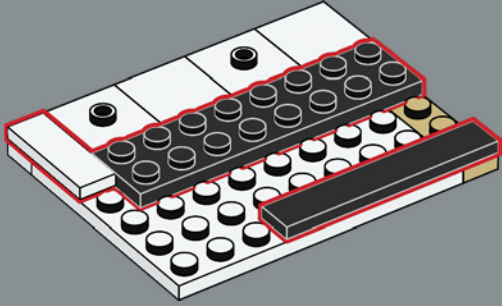

8

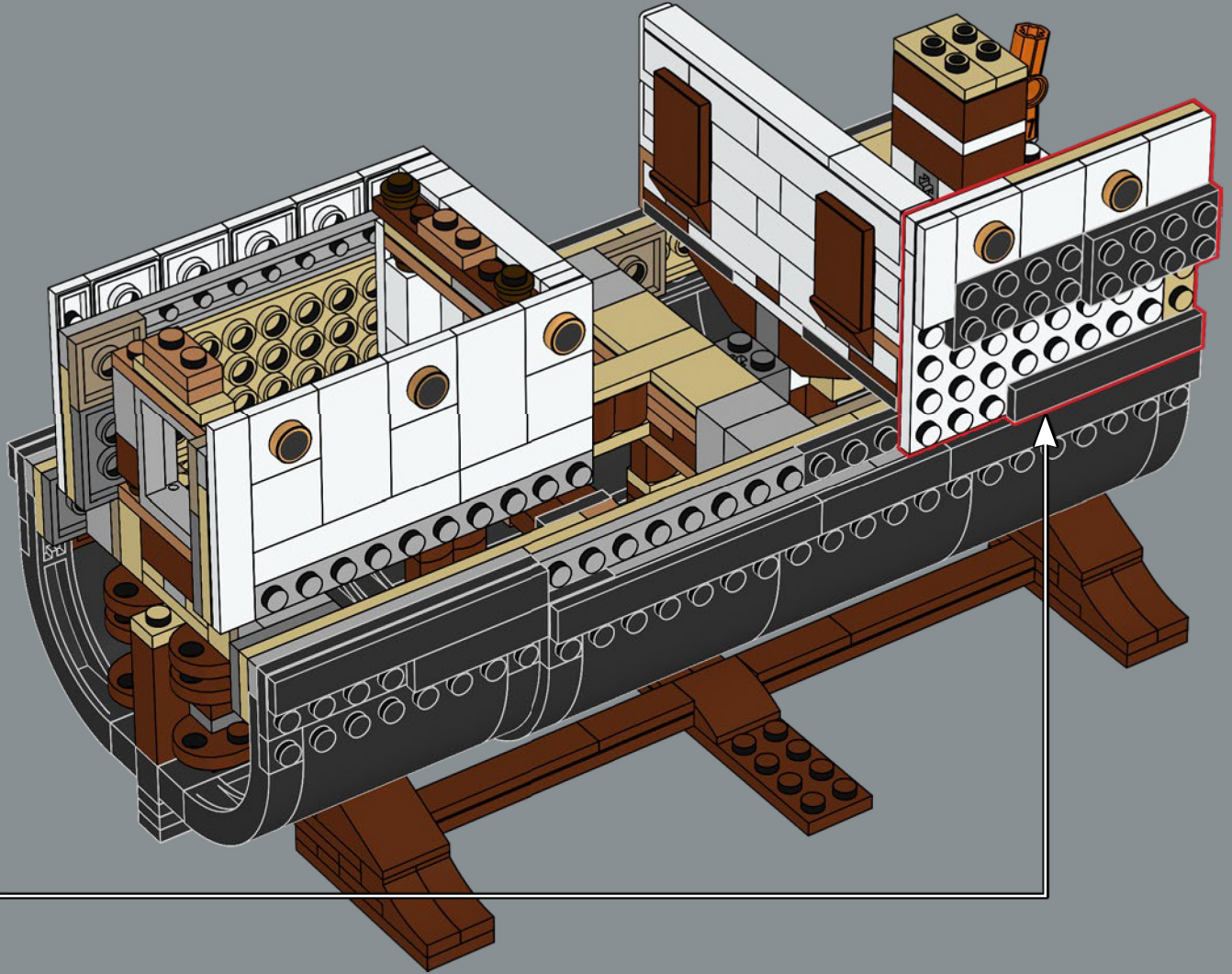
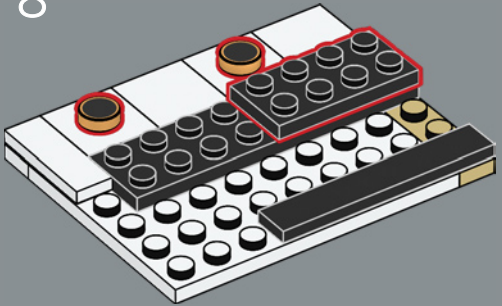

7

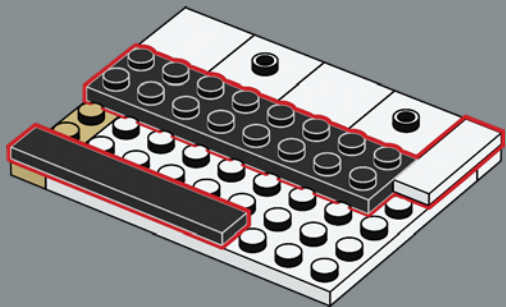

8

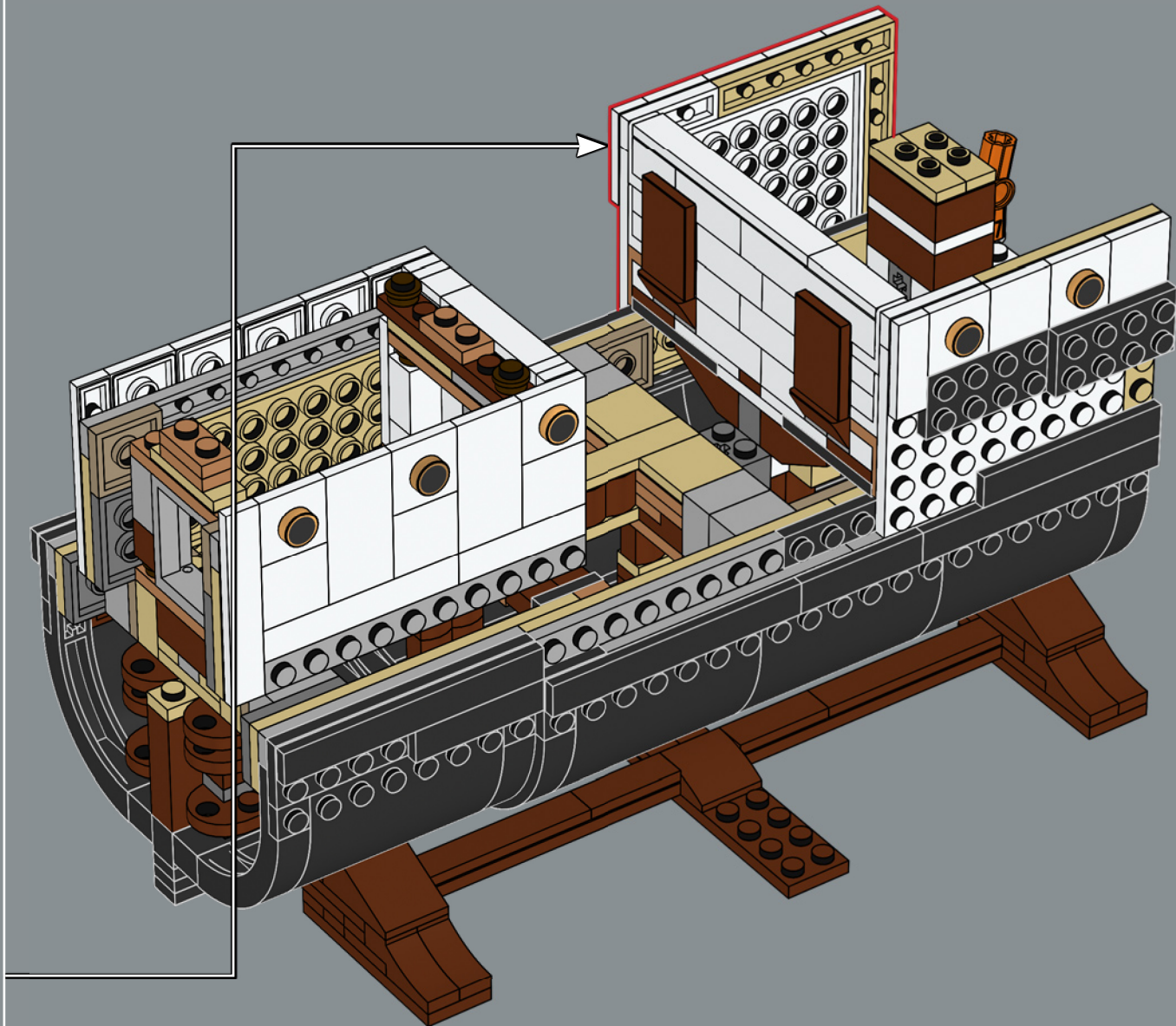
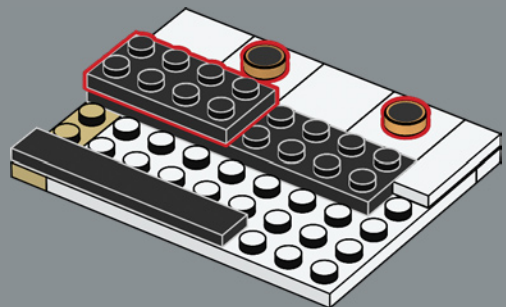

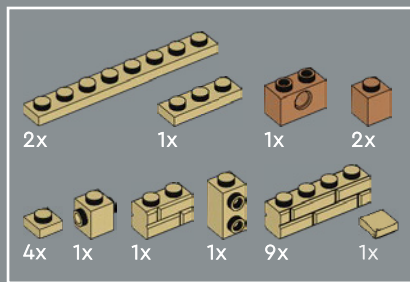
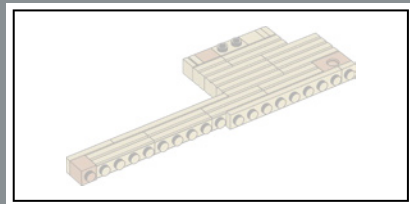

251

1

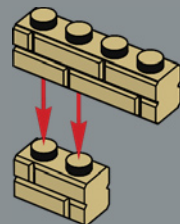

2

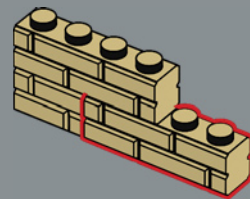

3

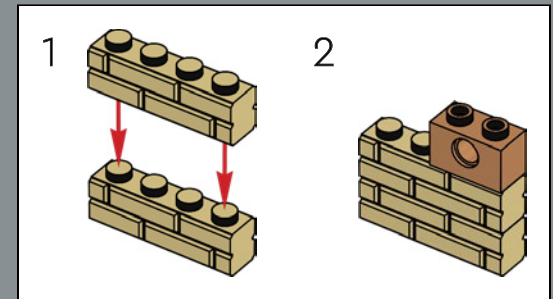
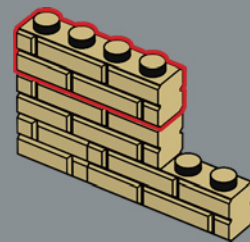

4

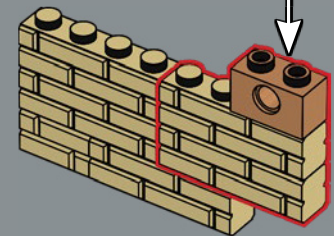

5

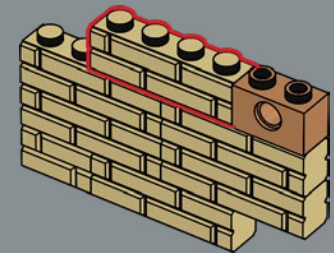

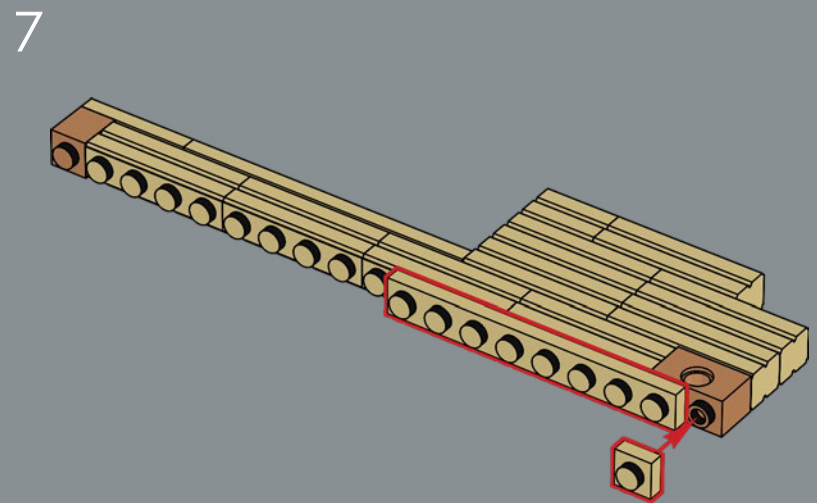
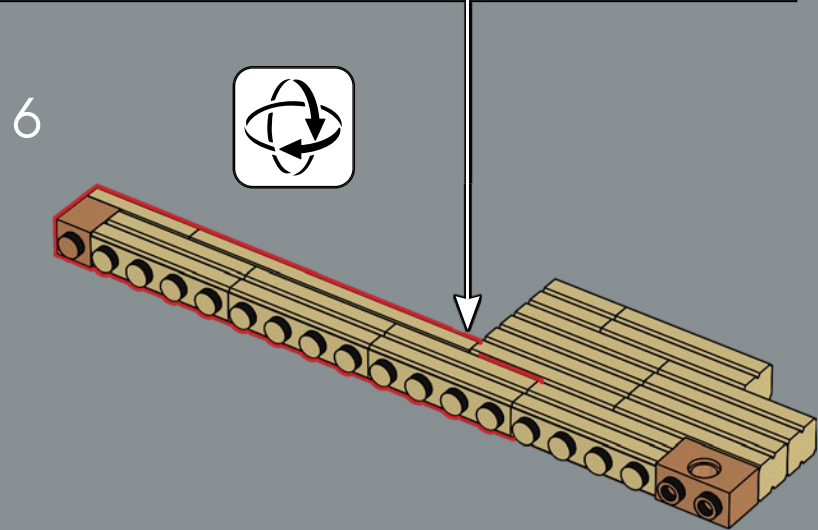
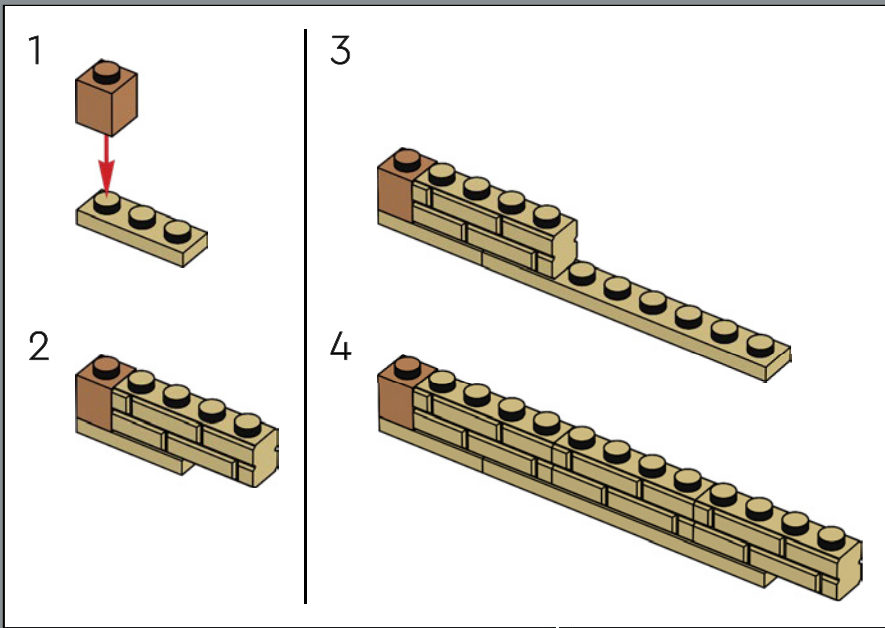

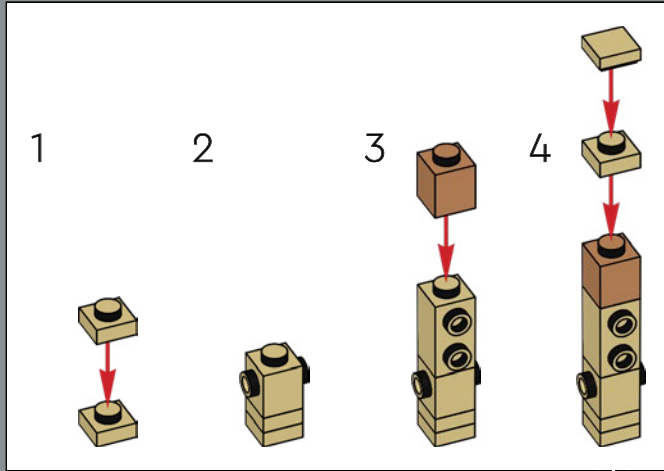

8

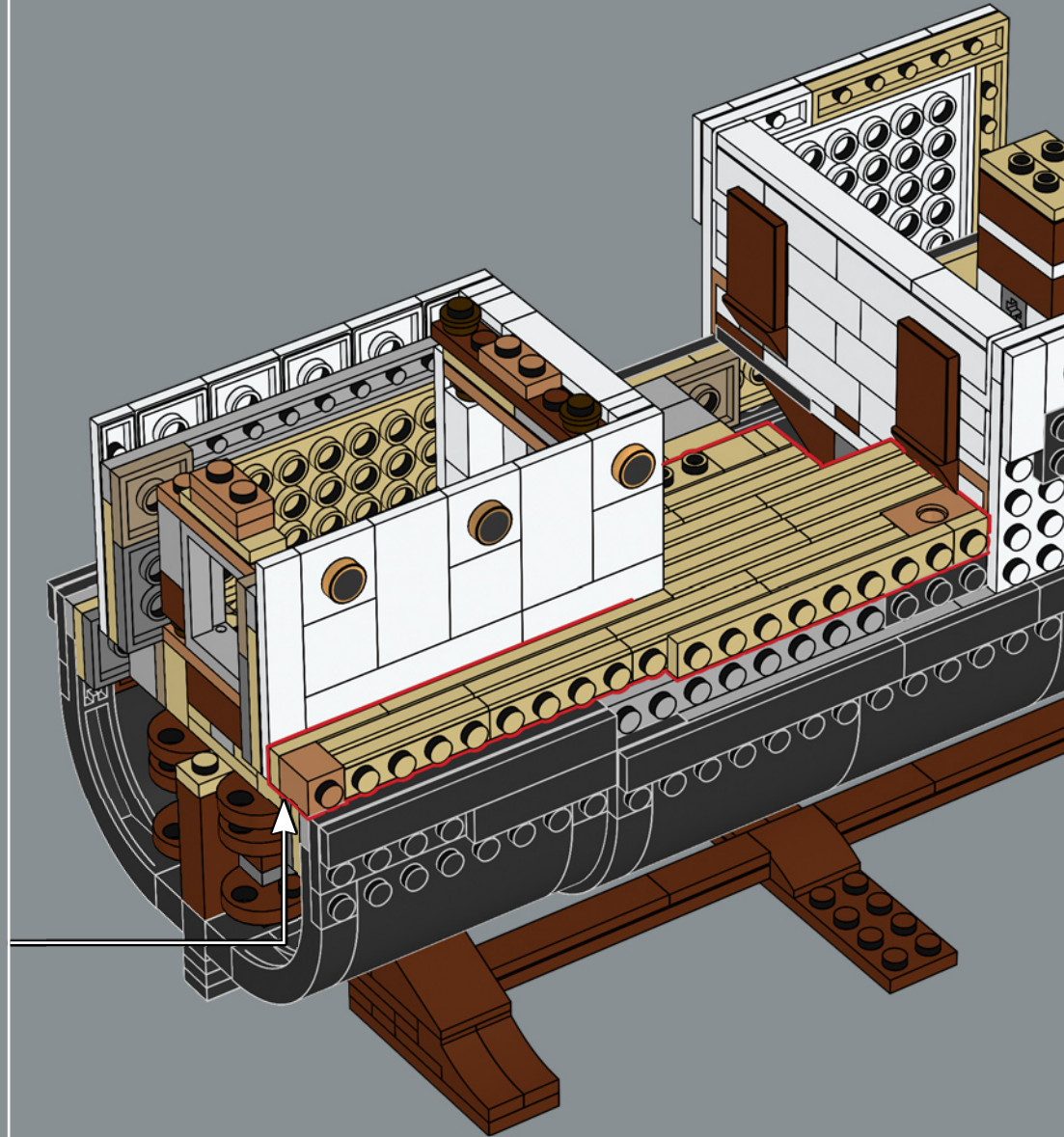
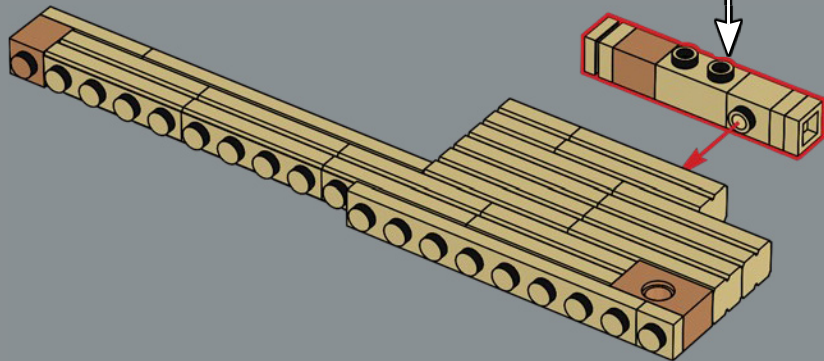

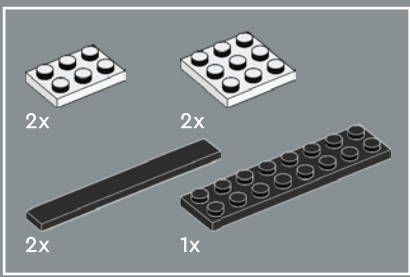

252

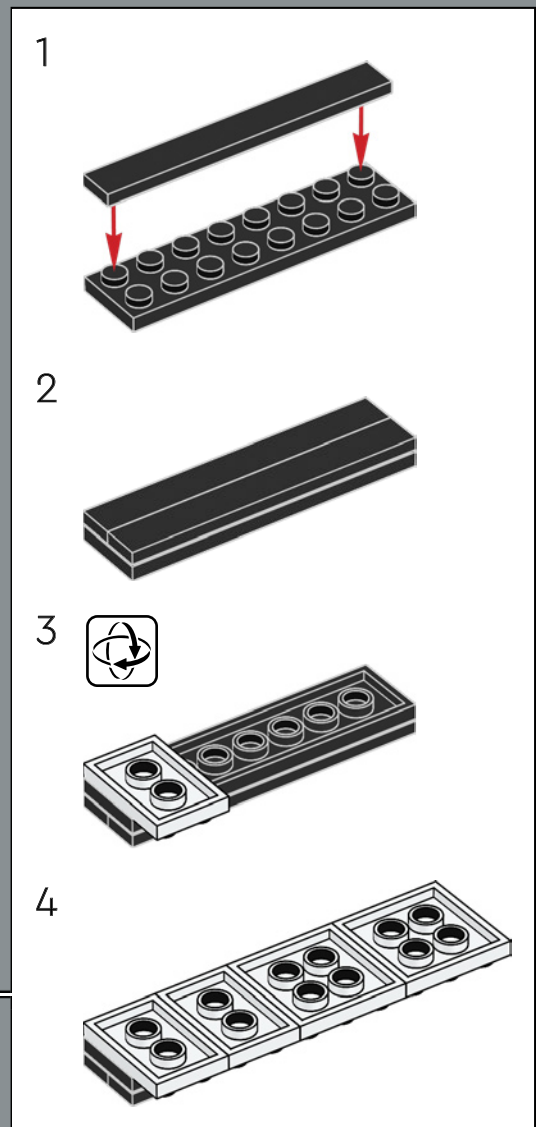
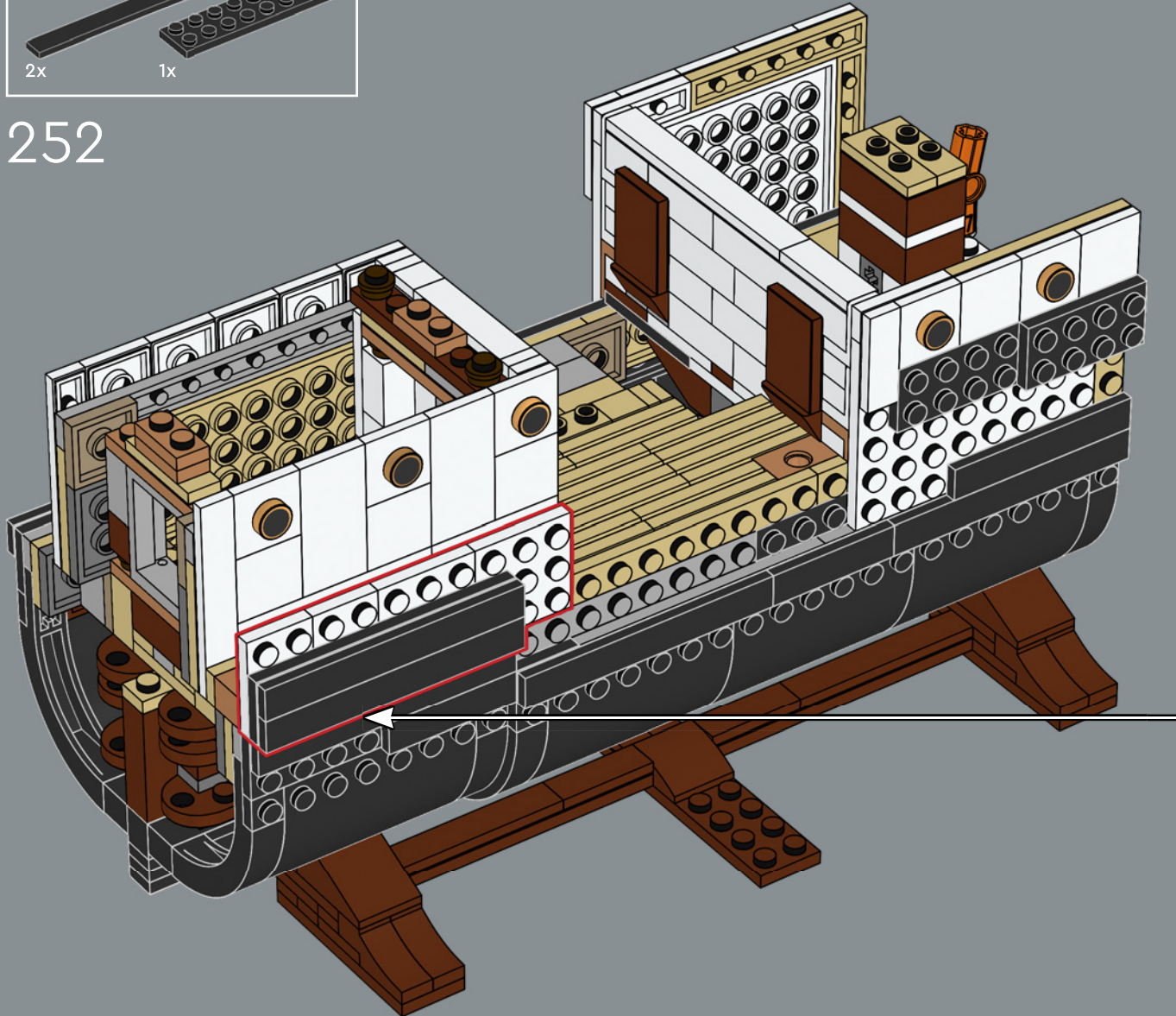

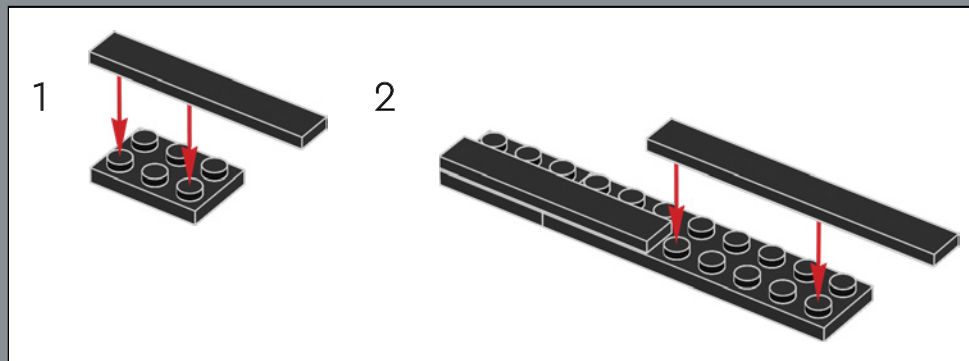
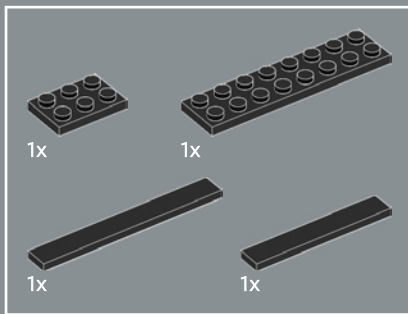

253

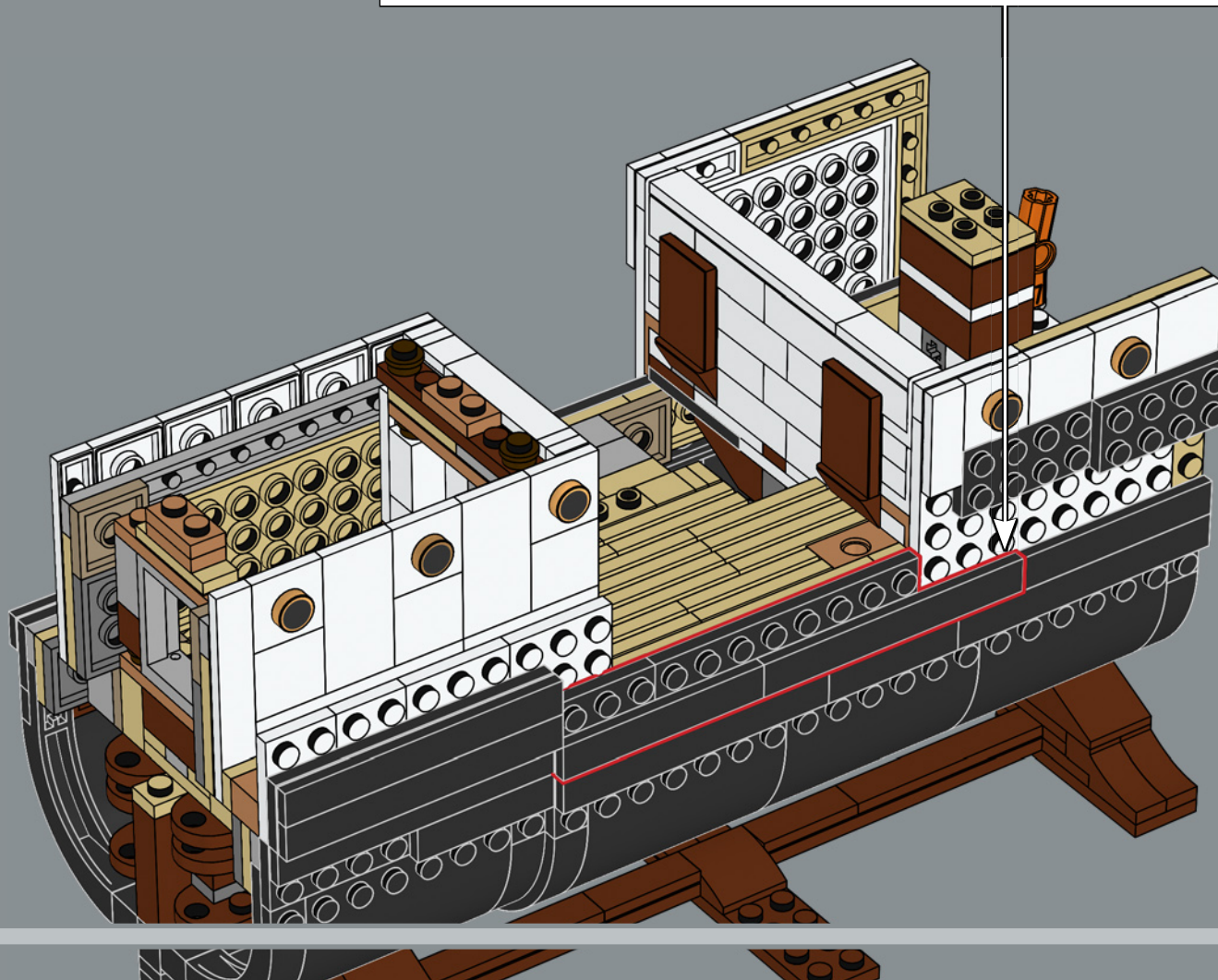

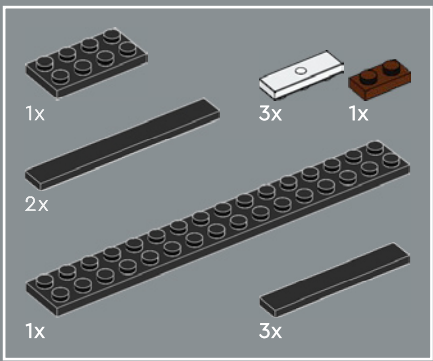

254

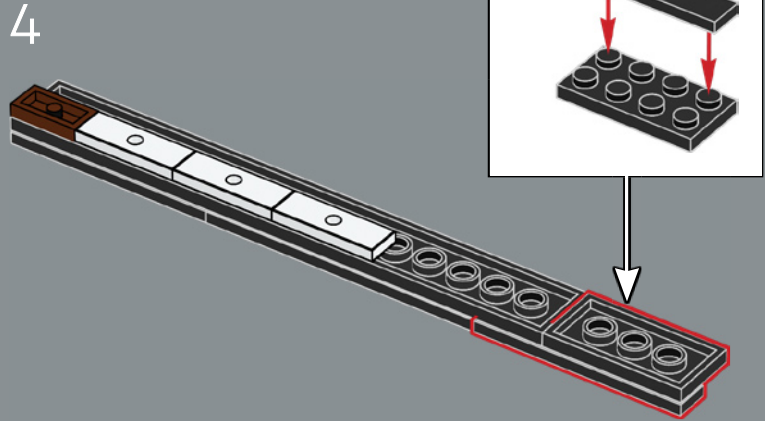
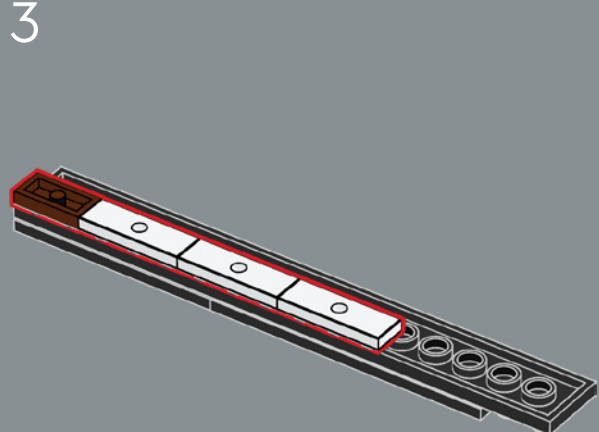
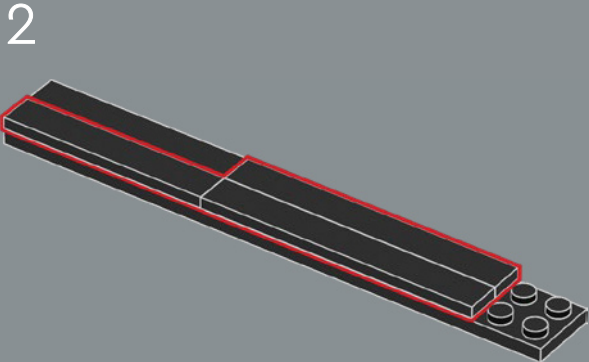
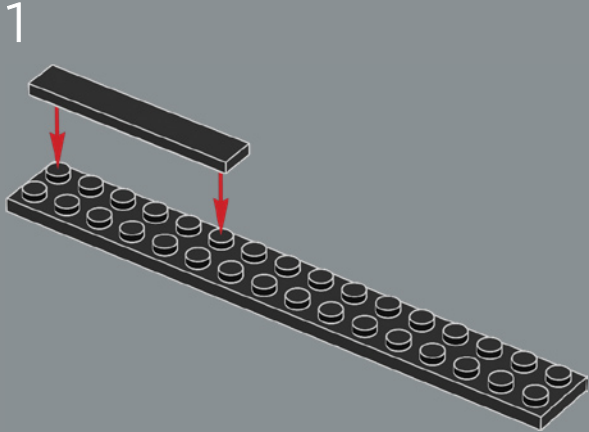

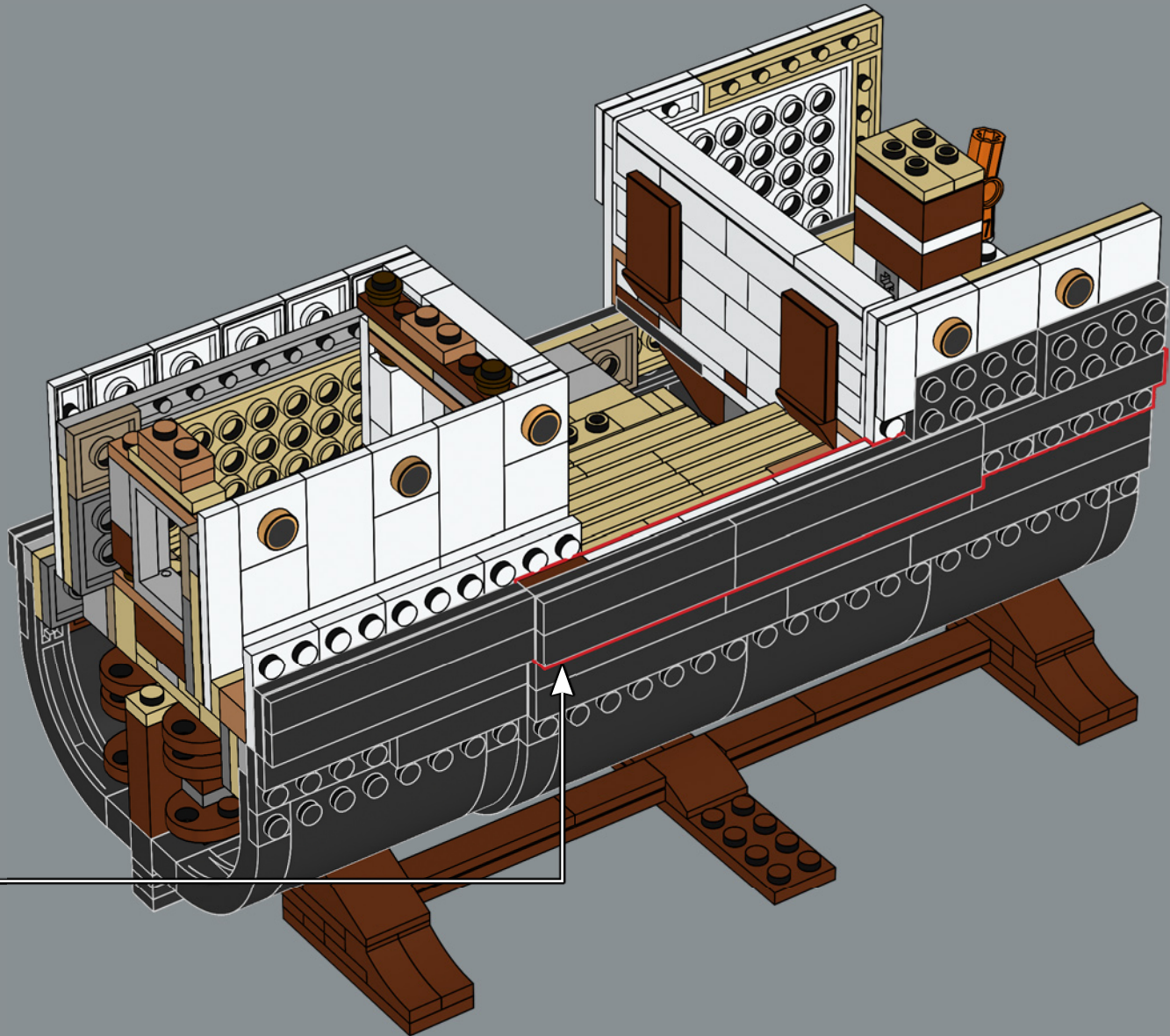

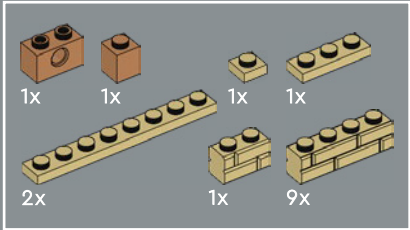
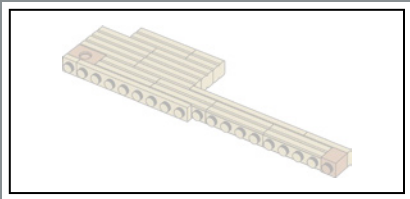

255

1

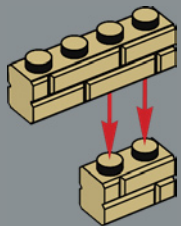

2

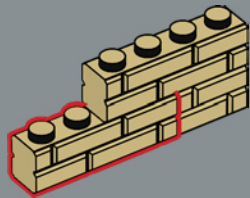

3

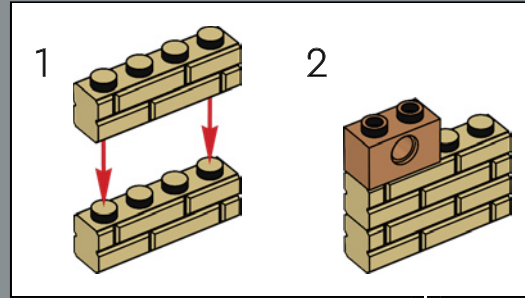
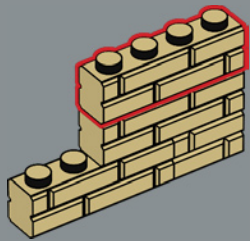

4

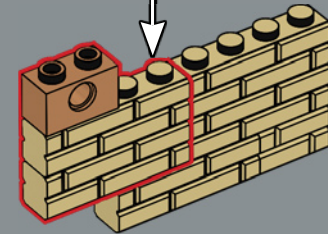

5

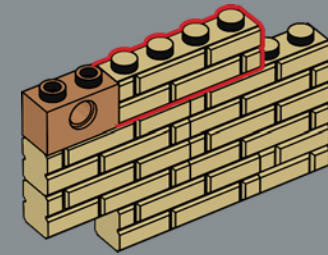

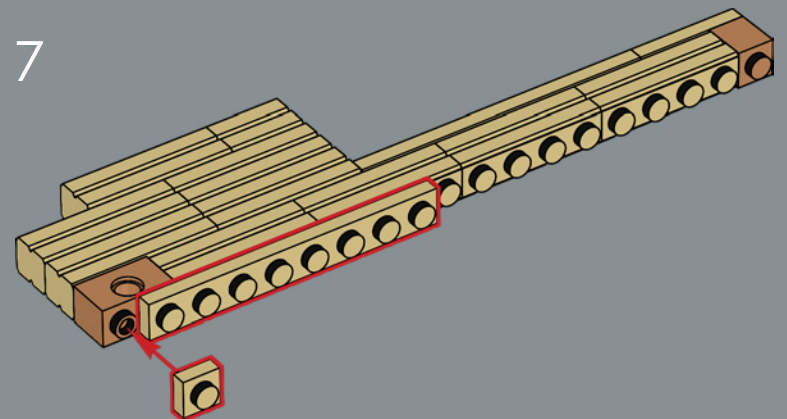
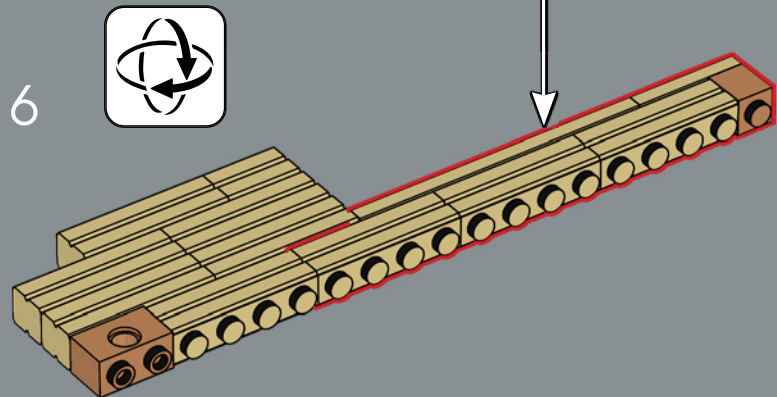
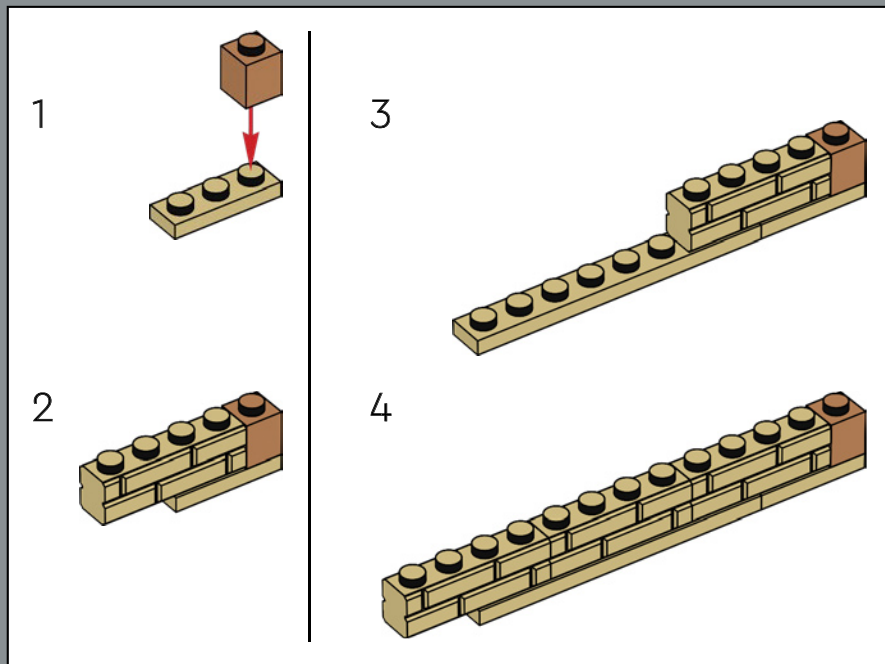

To give the lower deck the appearance of being made from wooden planks, the back side of LEGO® 'brick wall' profile bricks are used here.

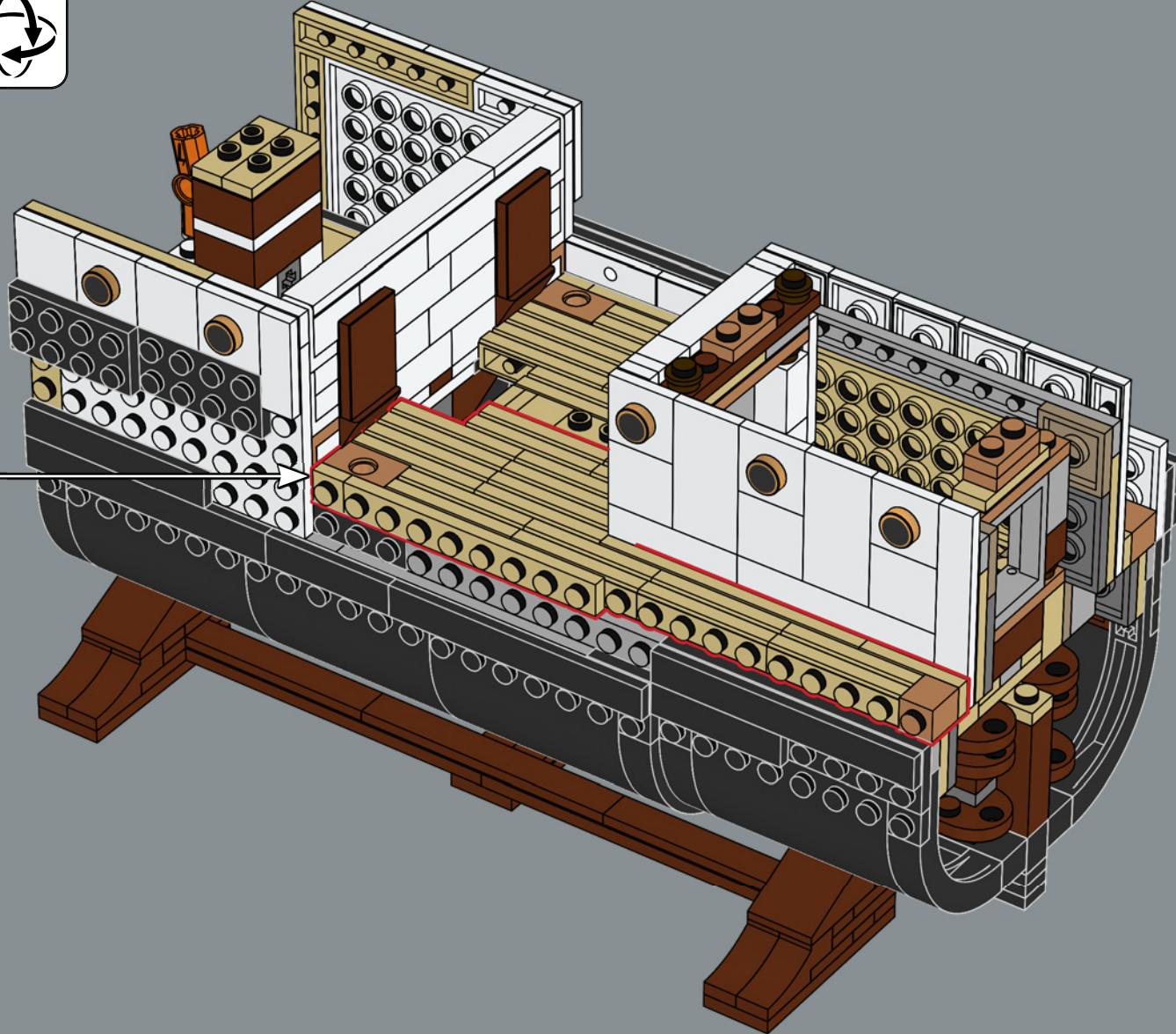

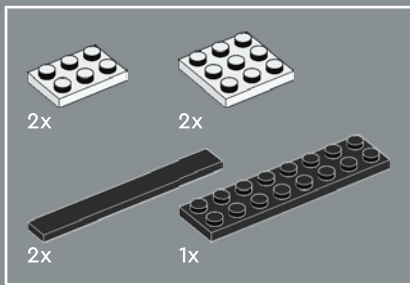

256

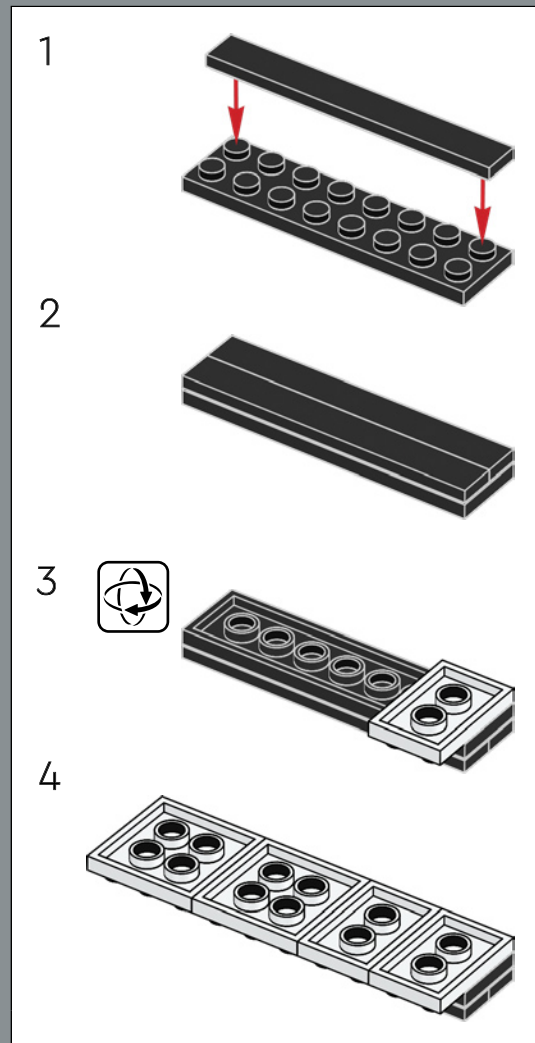
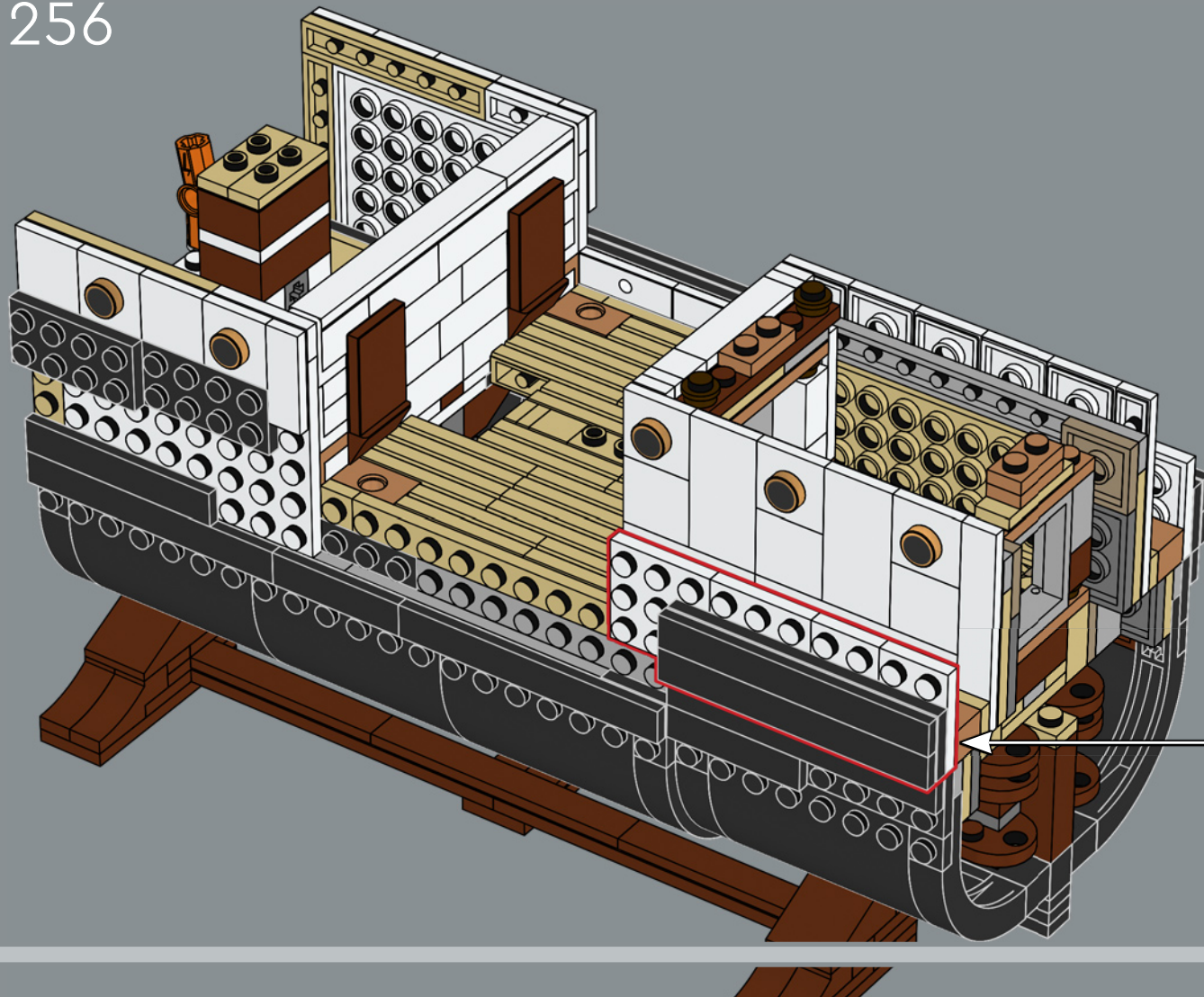

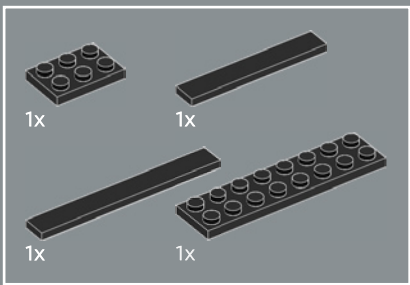

257

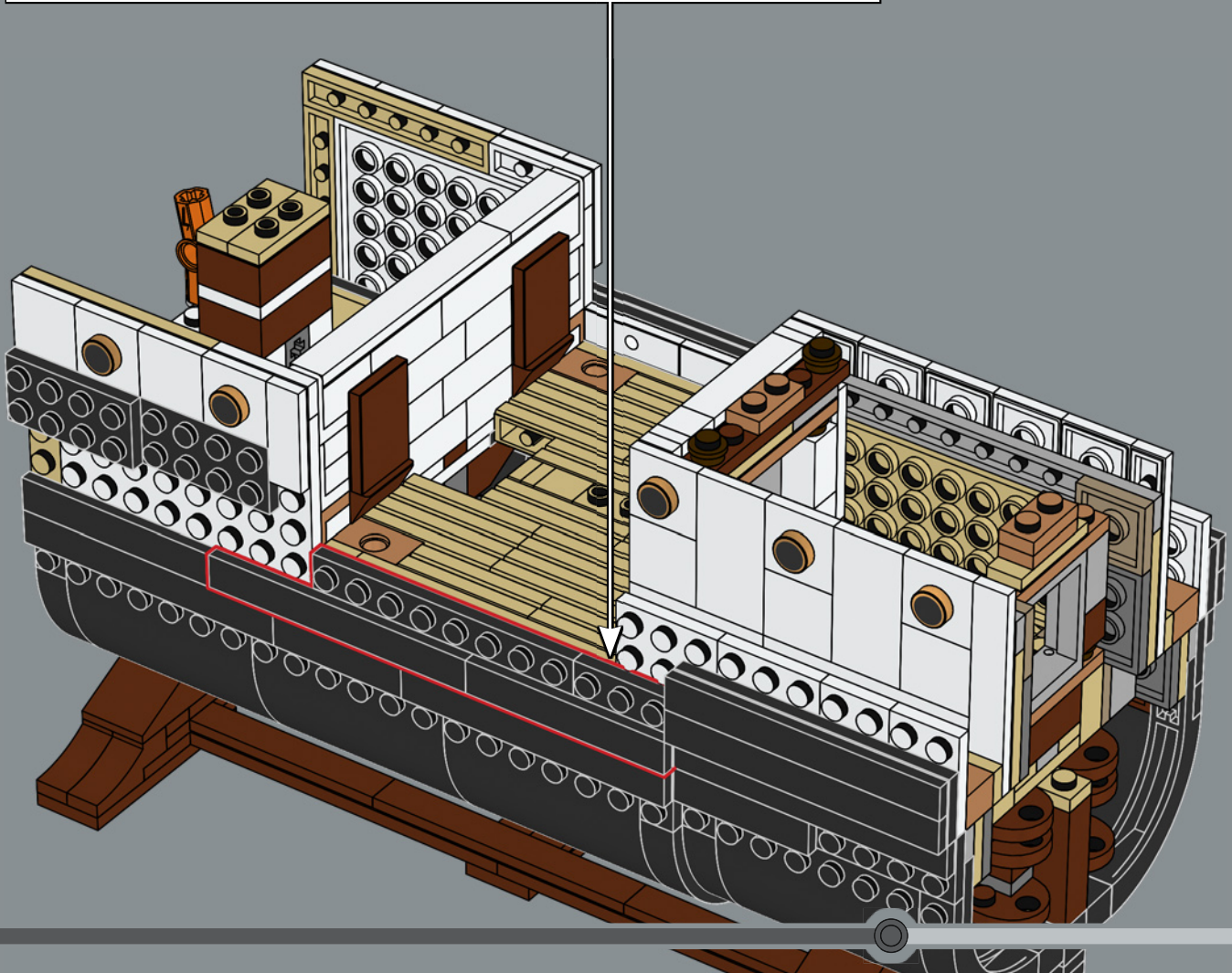
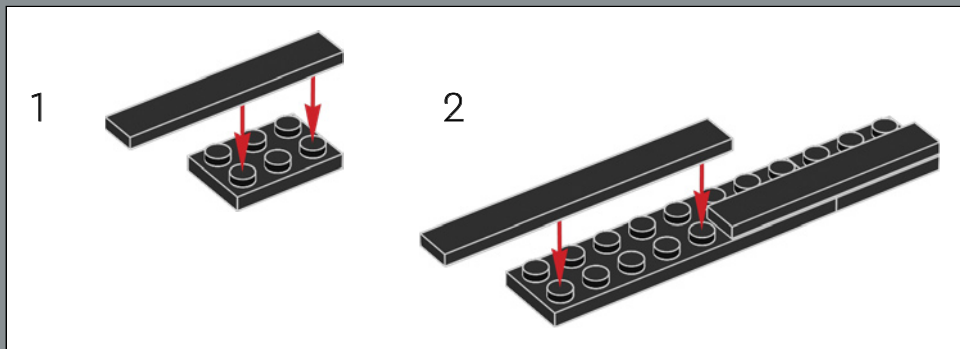

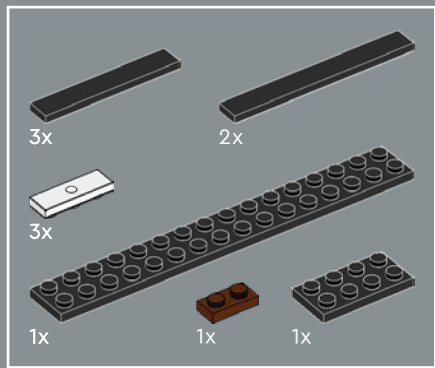

258

1

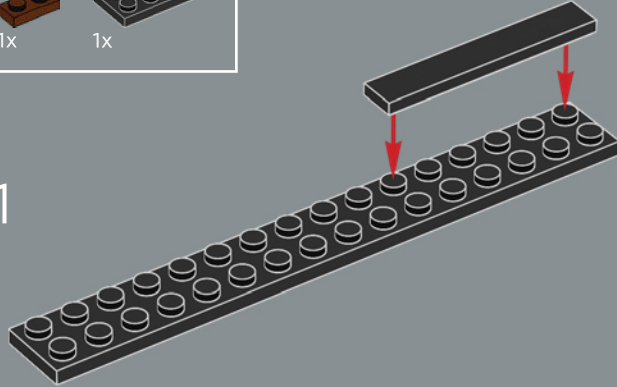

2

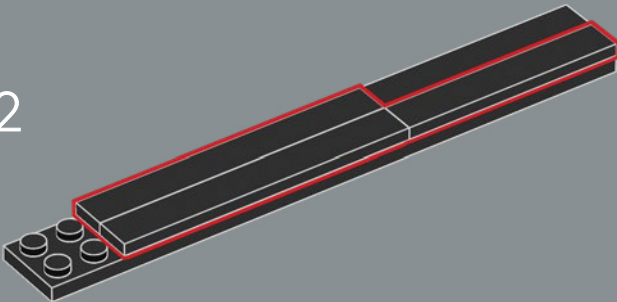

3

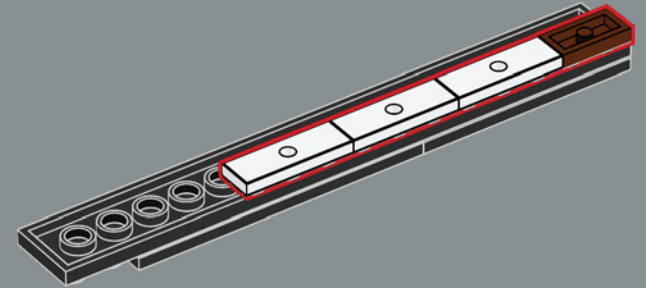

4

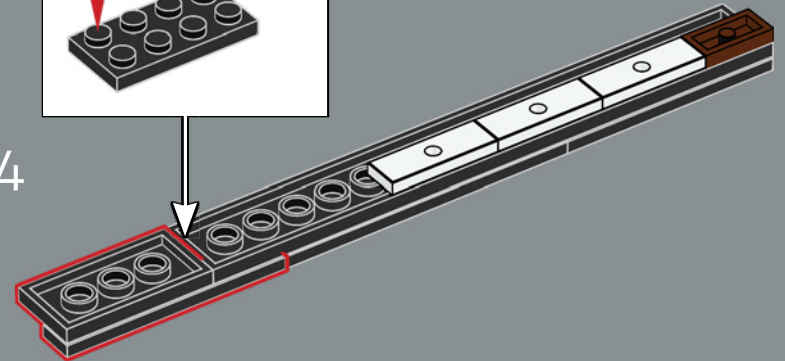
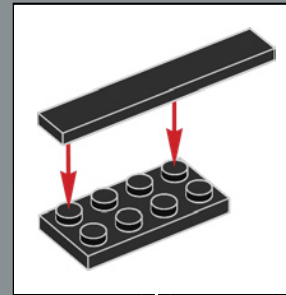

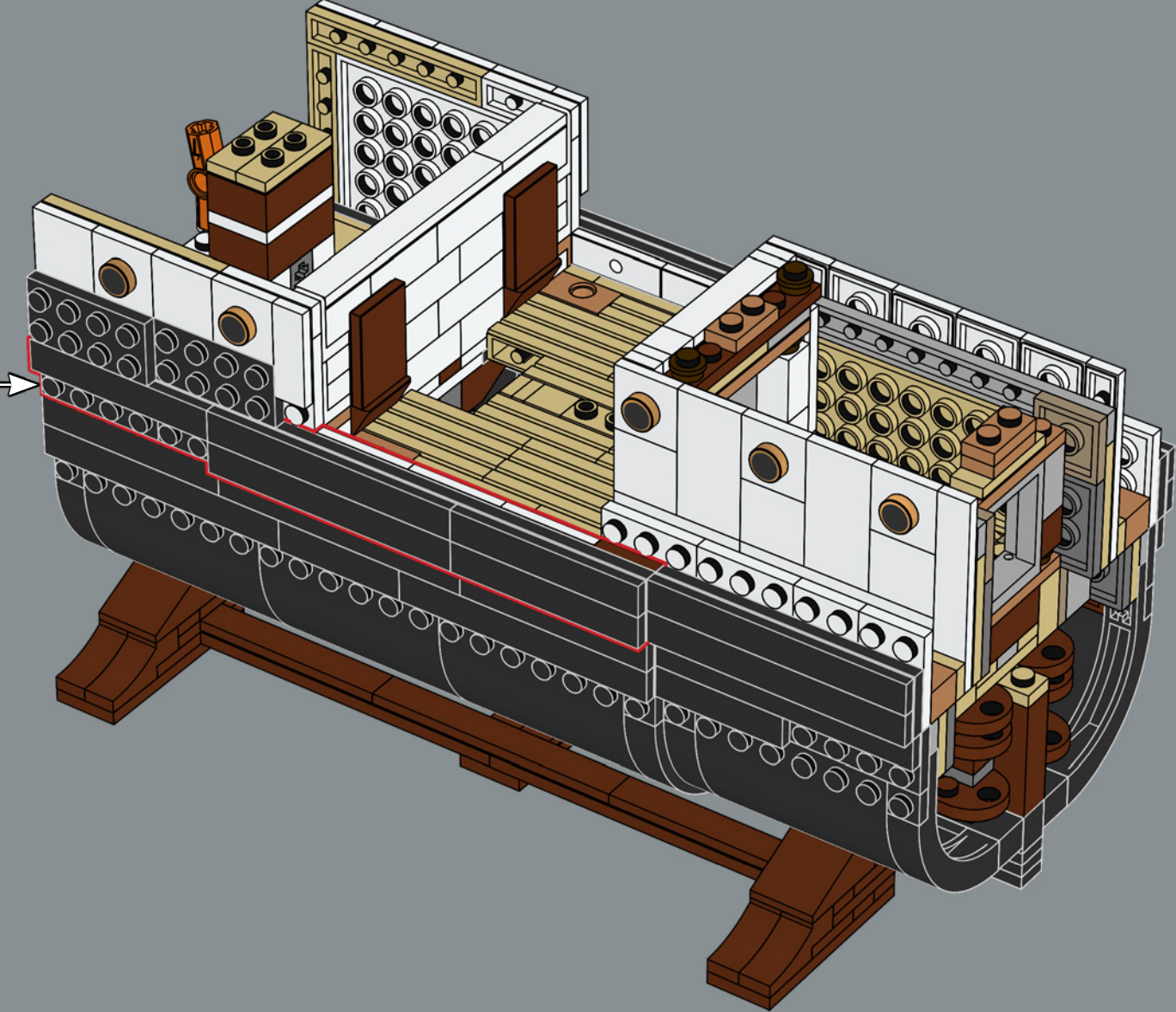

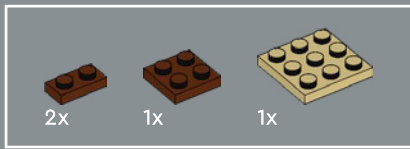

259

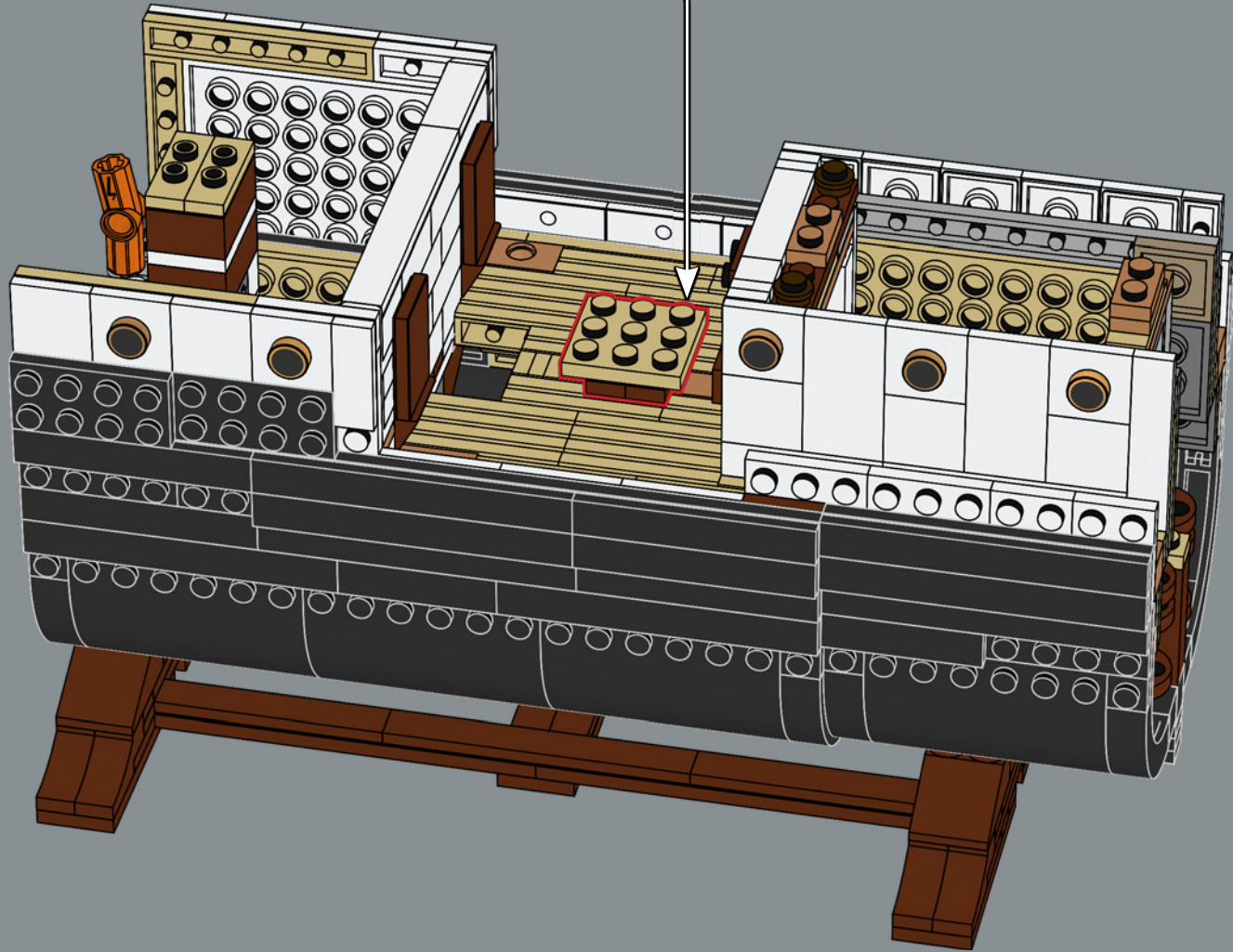
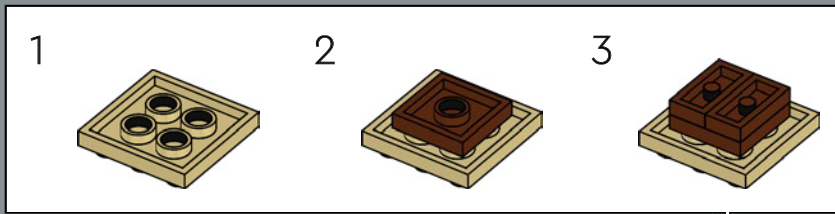

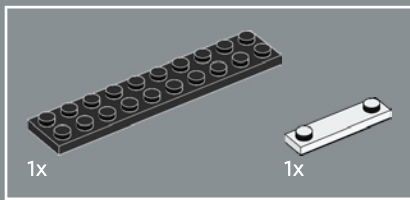
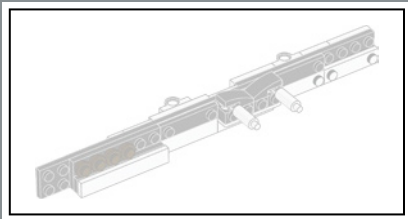

260

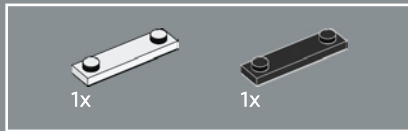
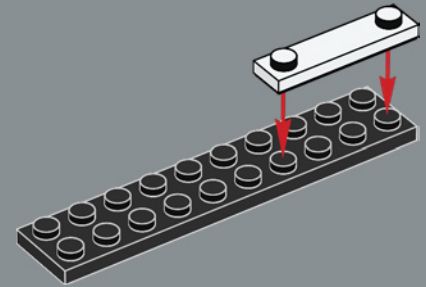

261

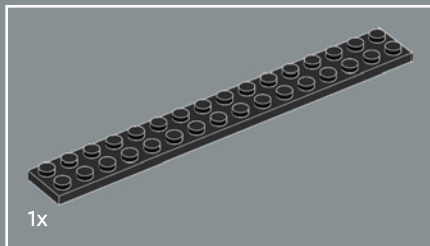
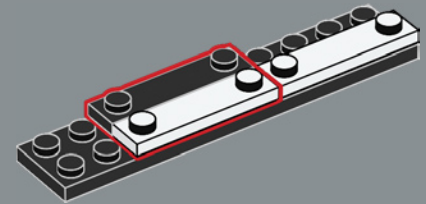

262

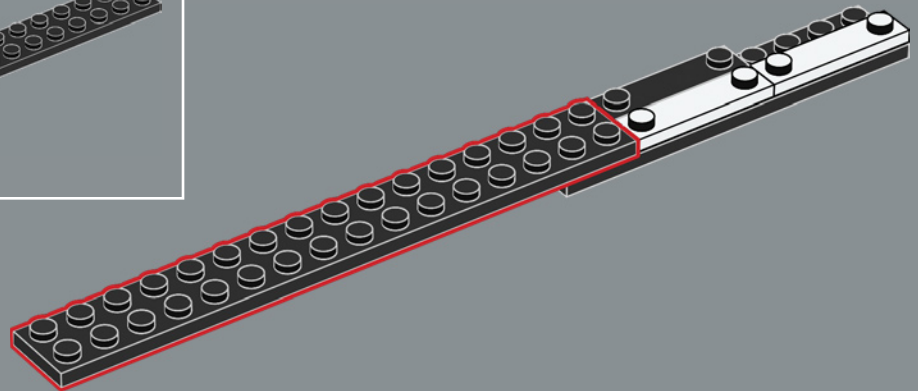

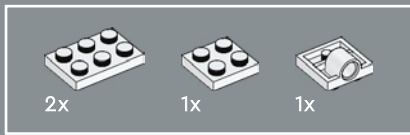

263

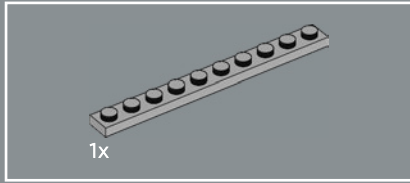
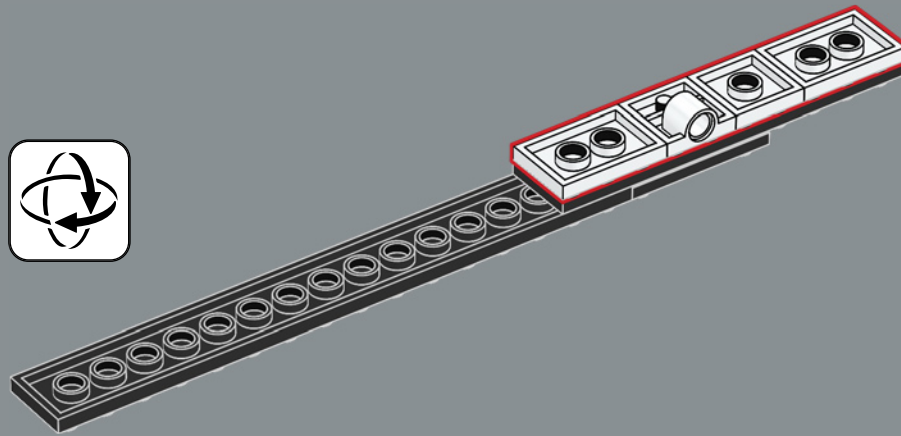

264

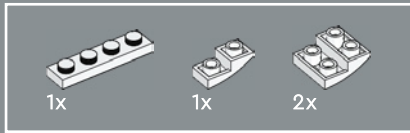
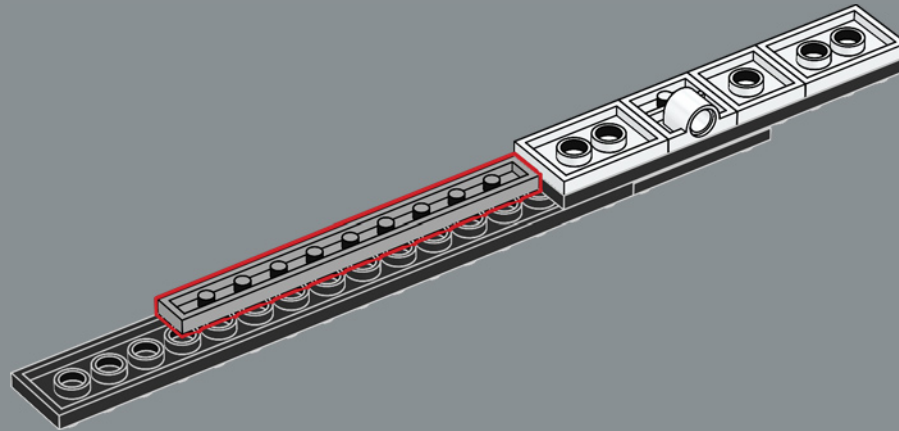

265

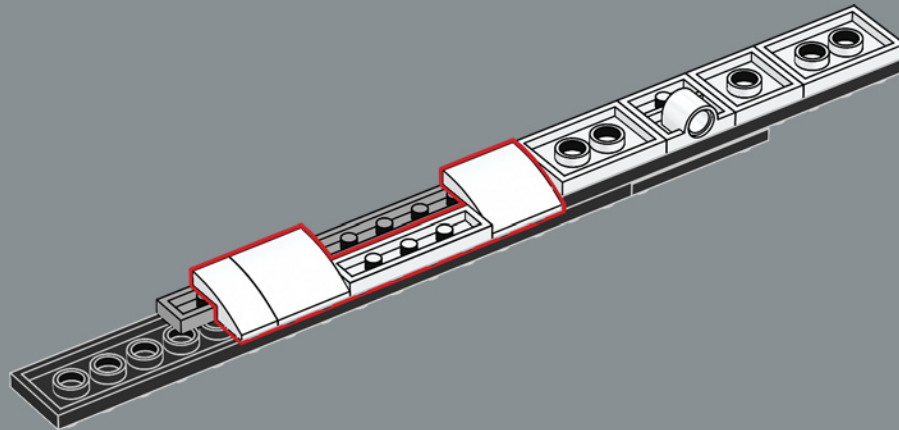



266

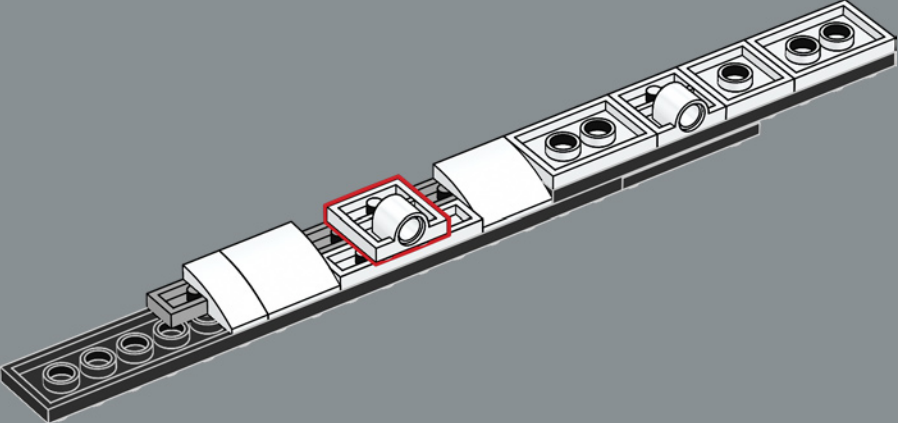

267

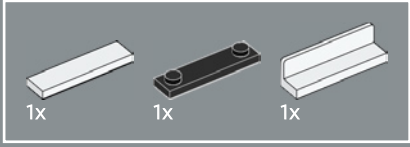
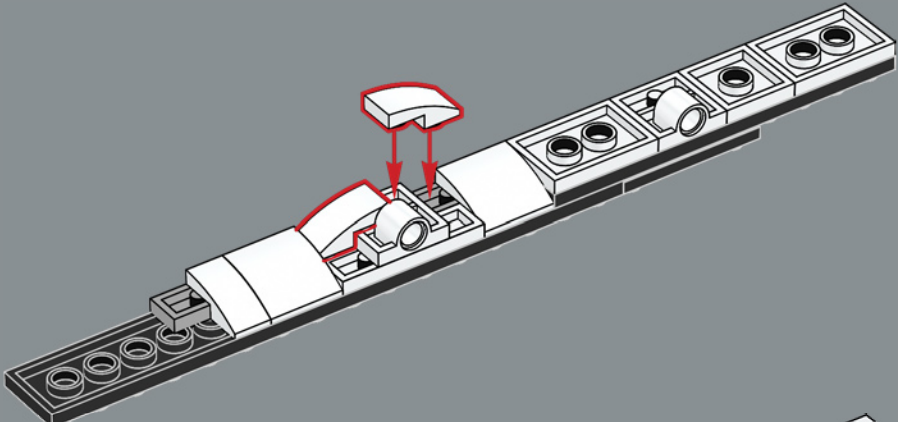

268

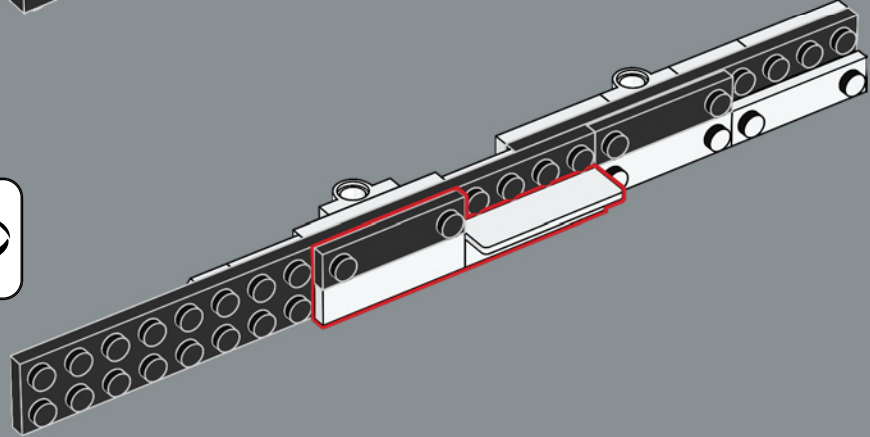

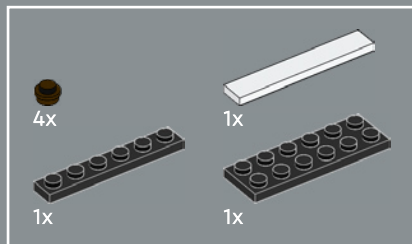

269

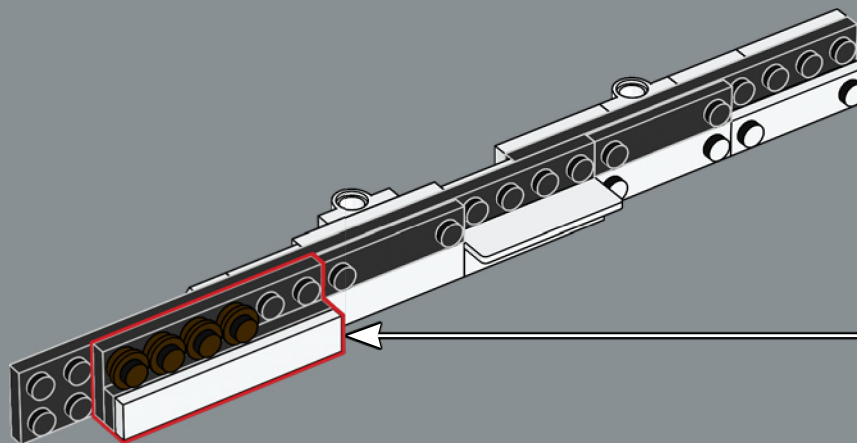
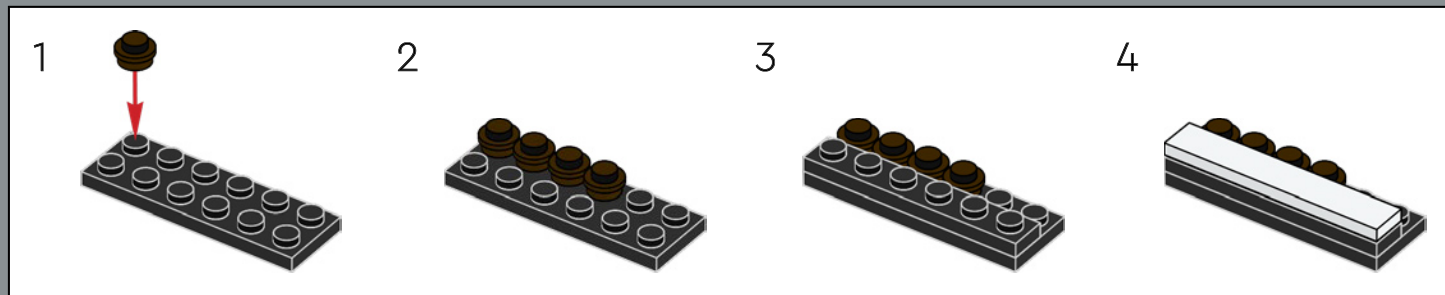



4x

270

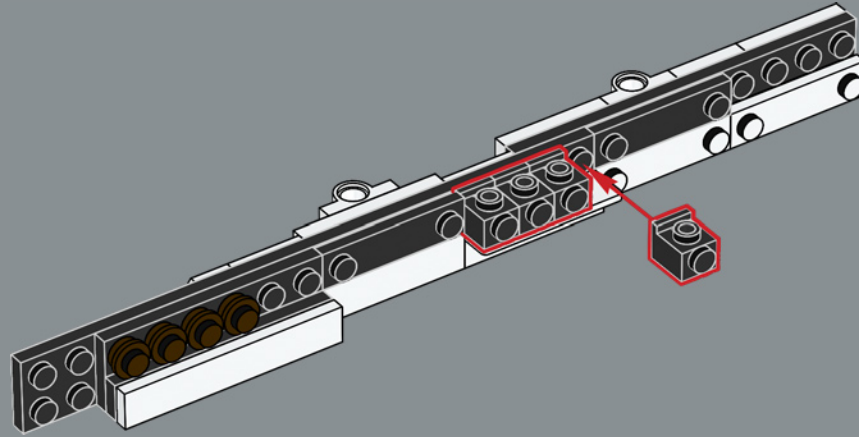

2x



2x



2x

271

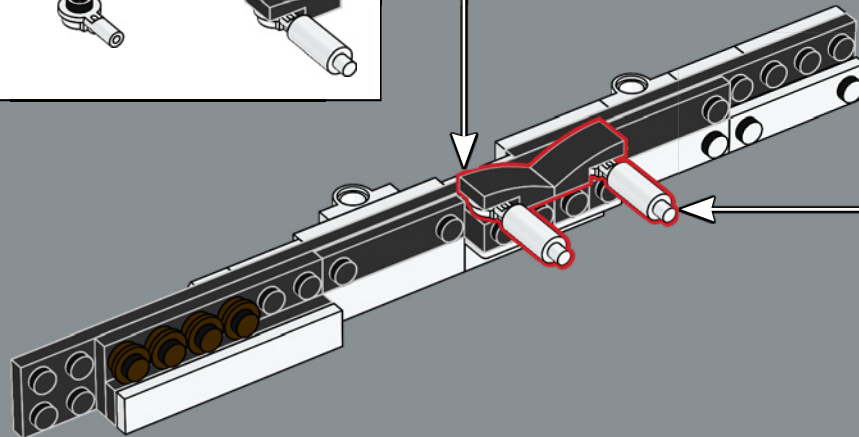
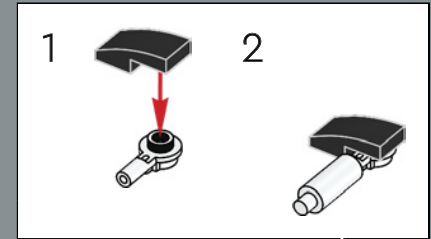
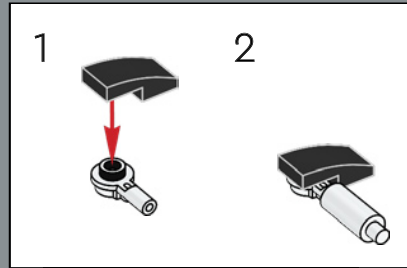

272

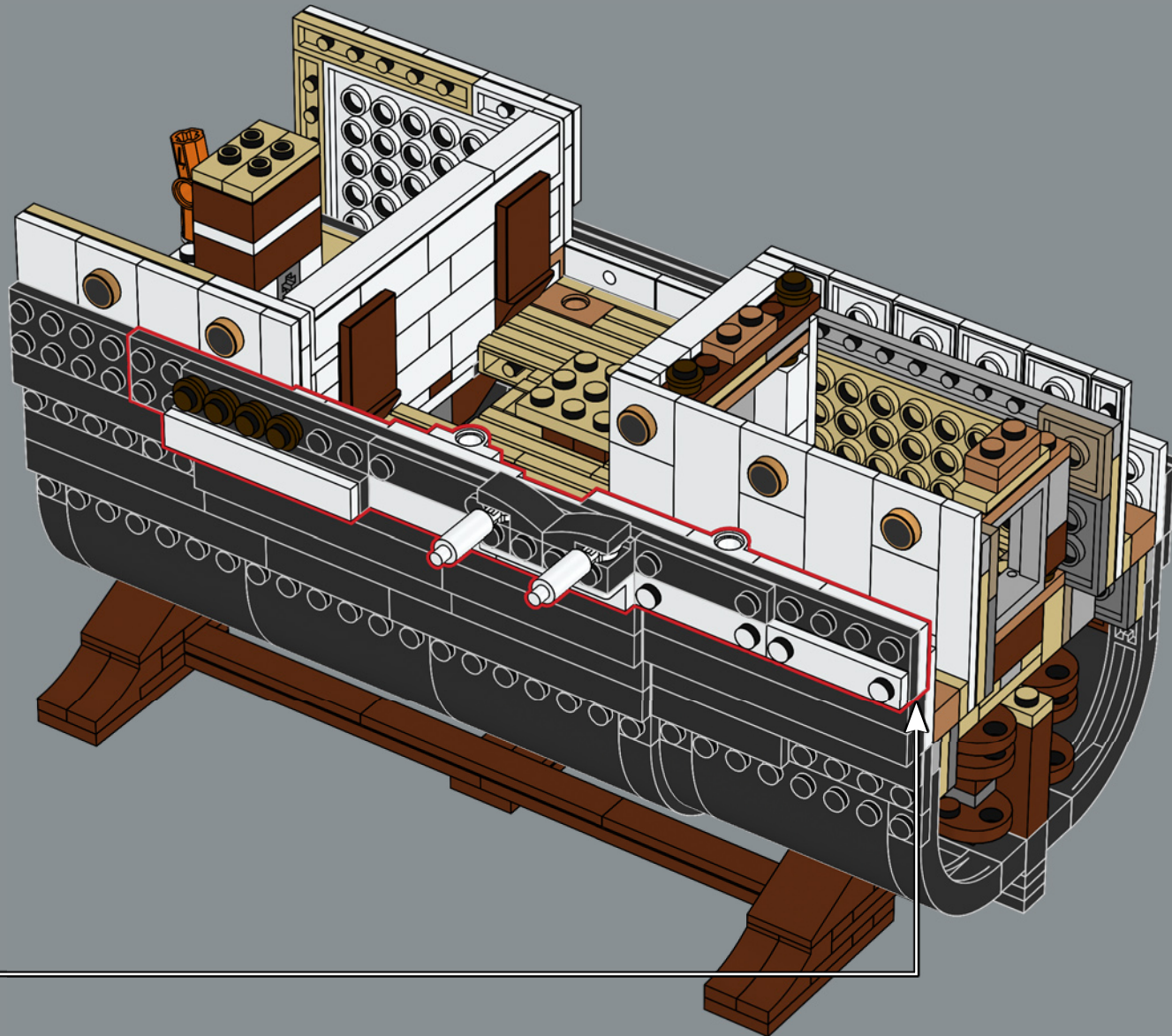

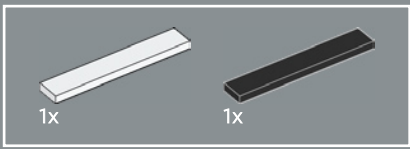

273

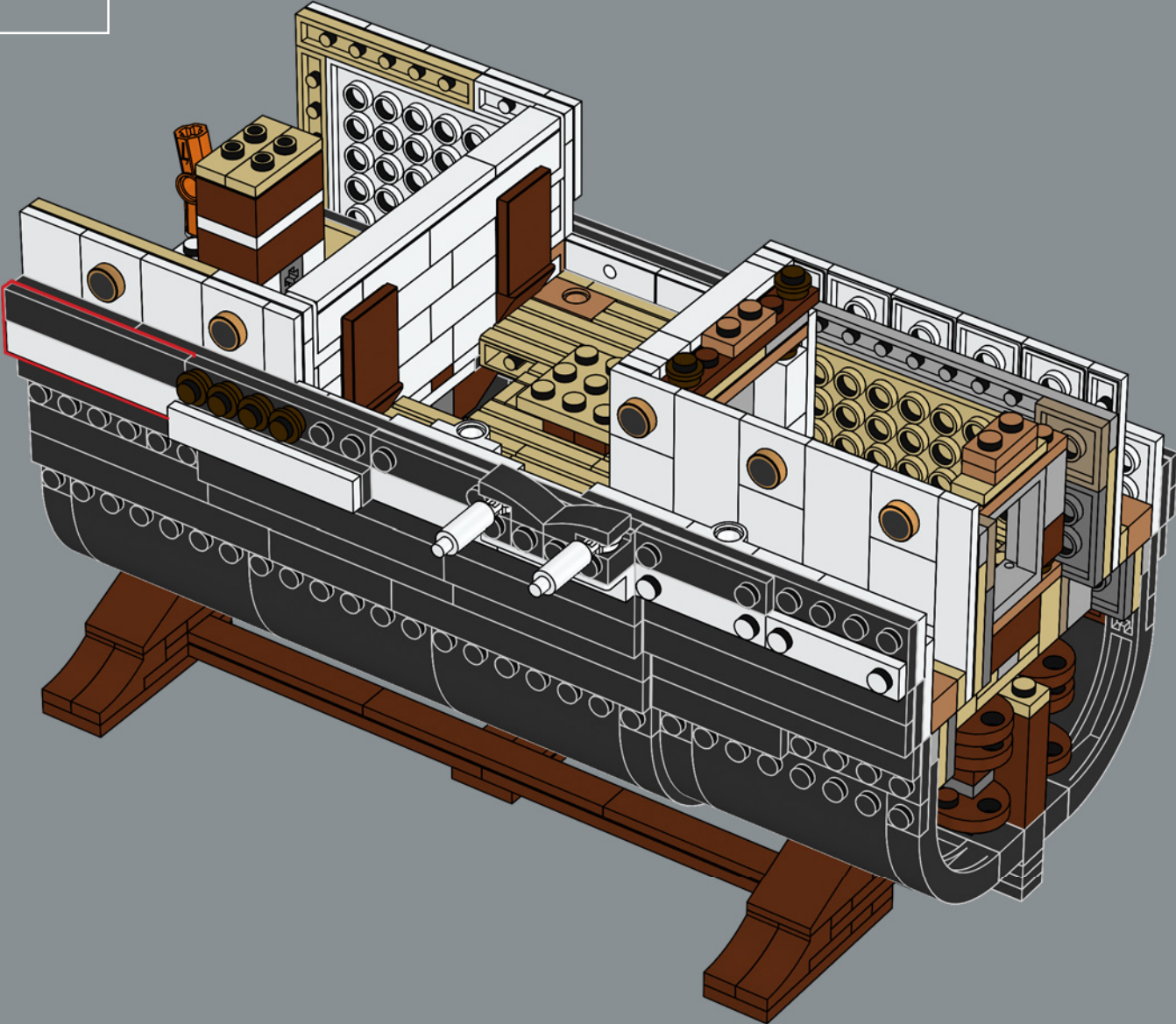

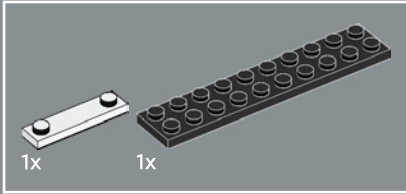
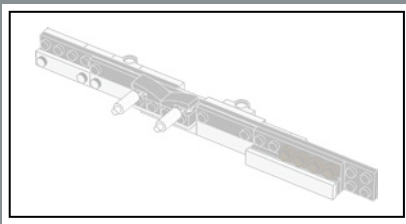

274

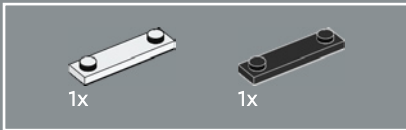
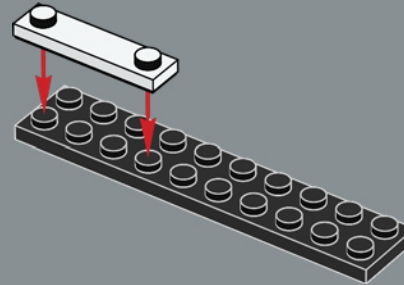

275

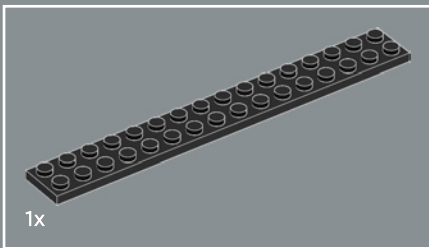
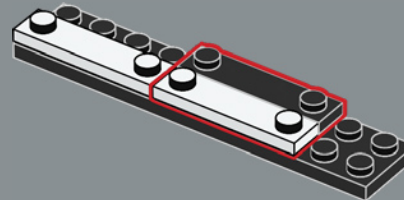

276

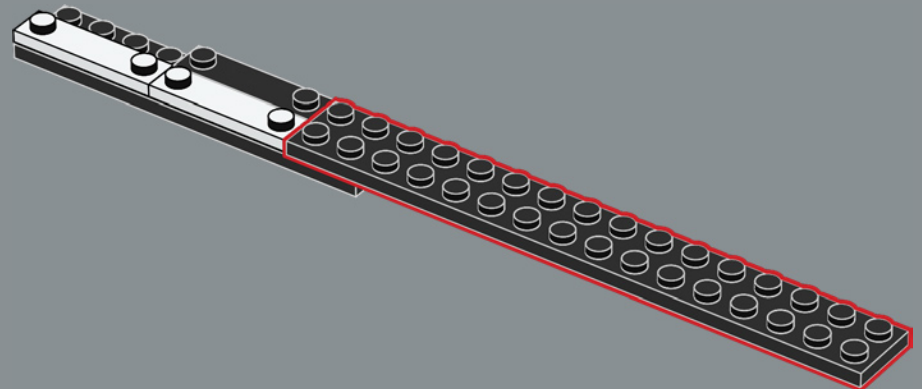

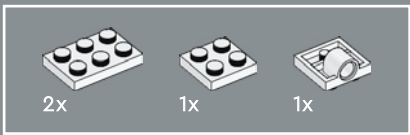

277

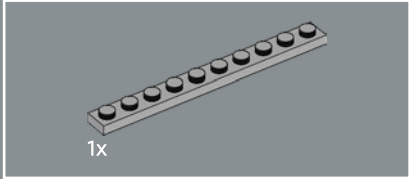
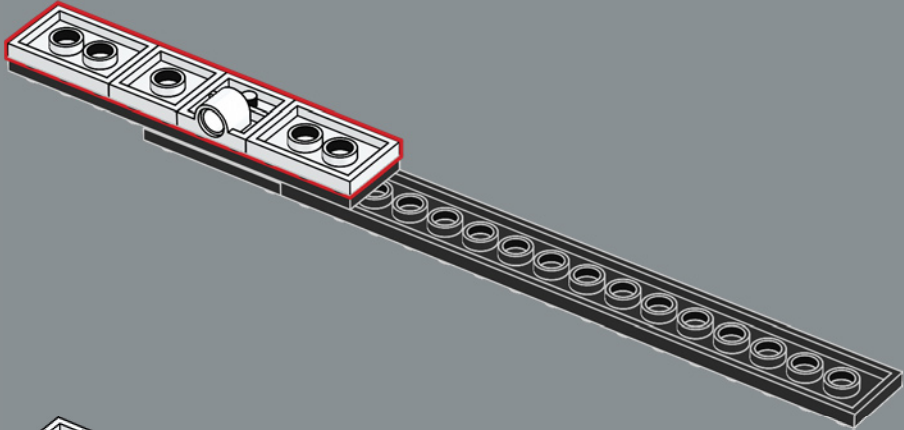

278

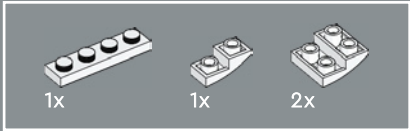
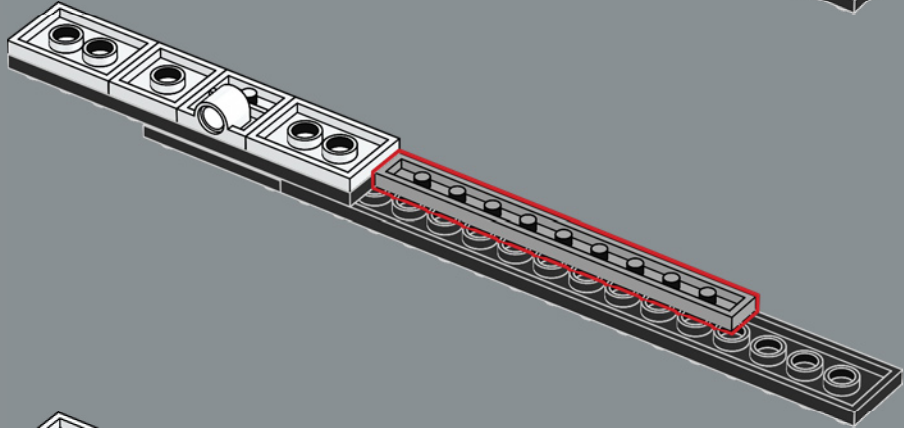

279

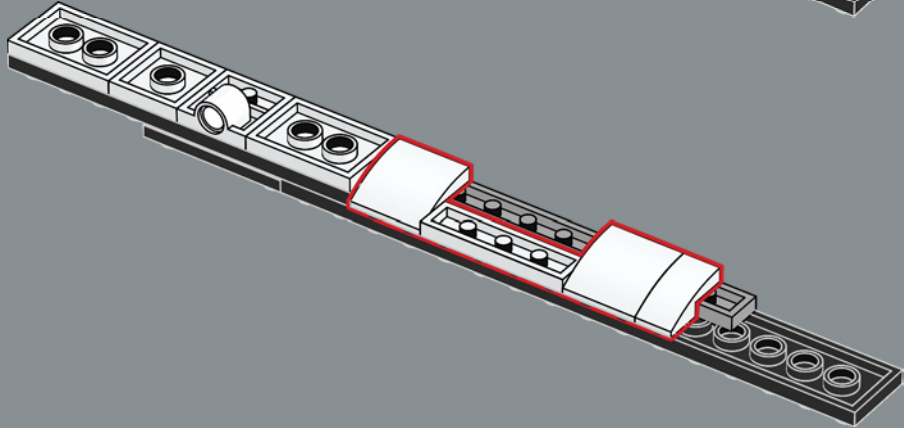



280



281

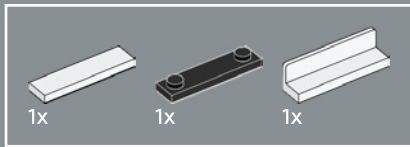

282

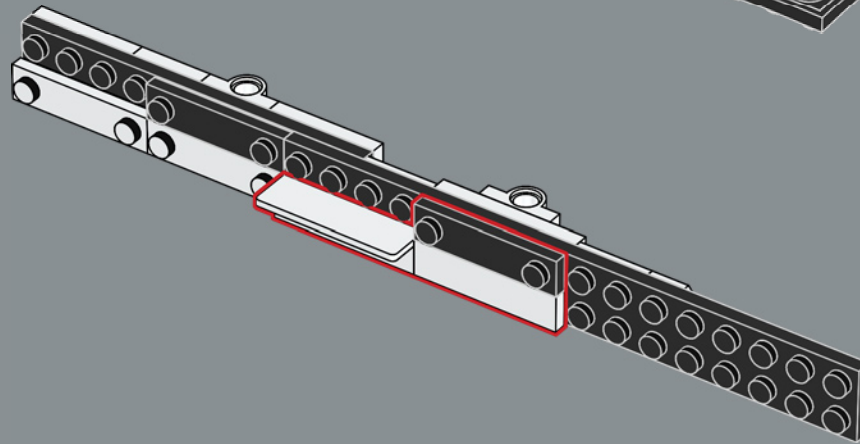
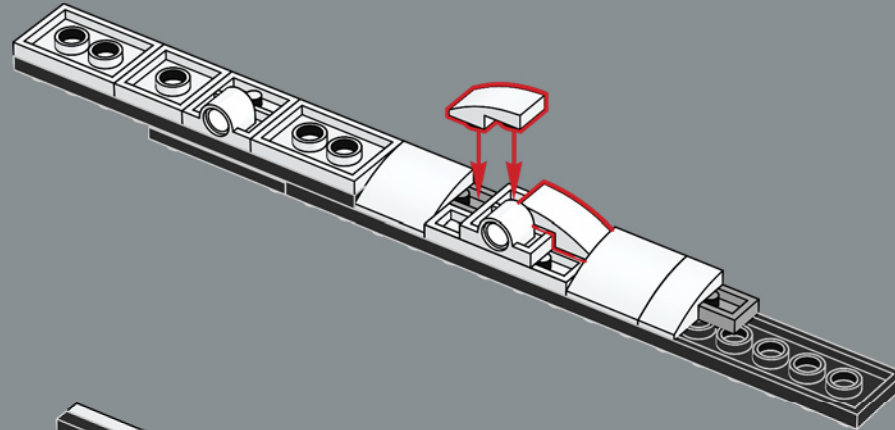
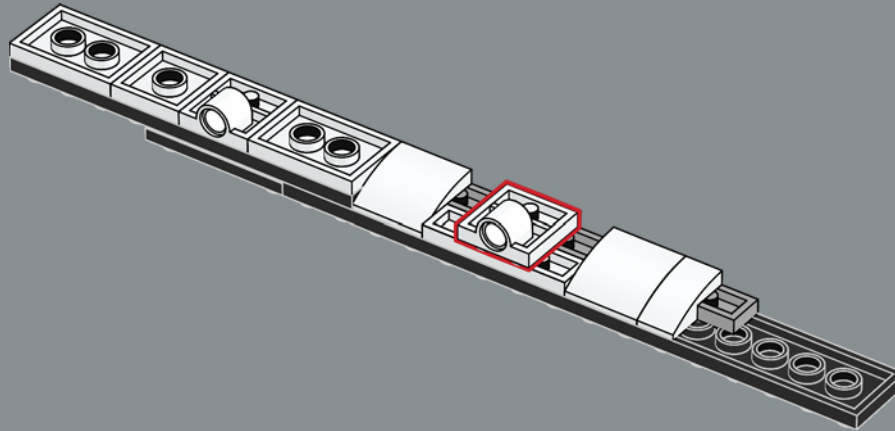

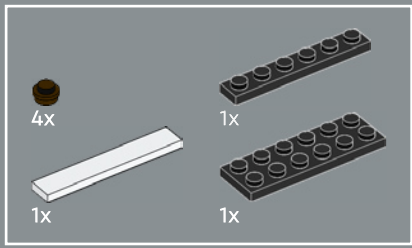

283

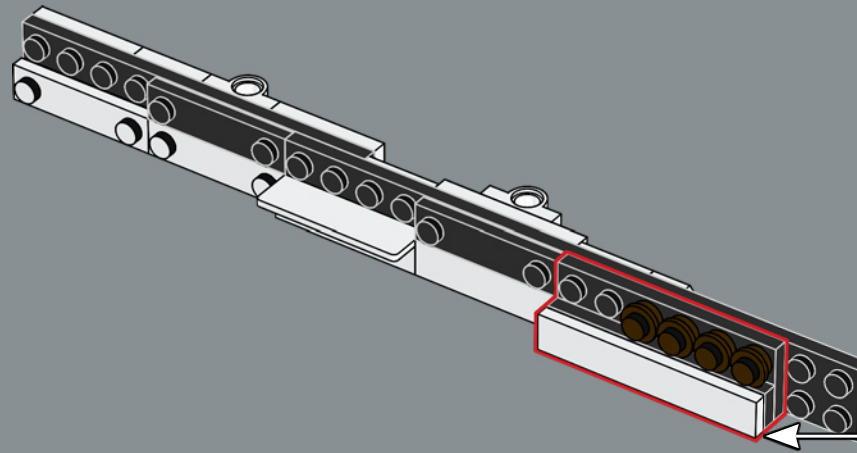
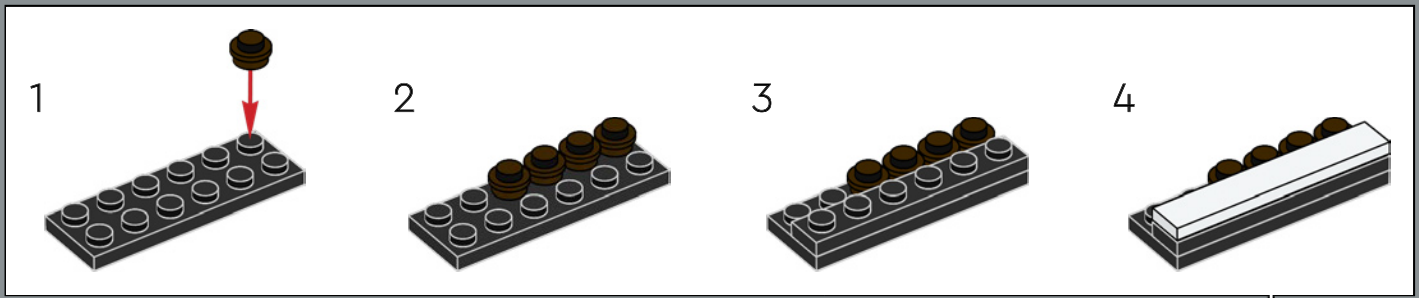



284

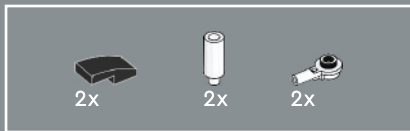
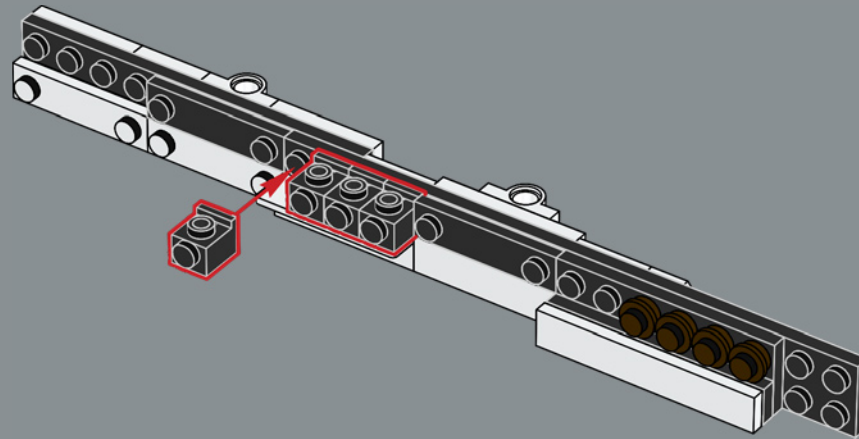

285

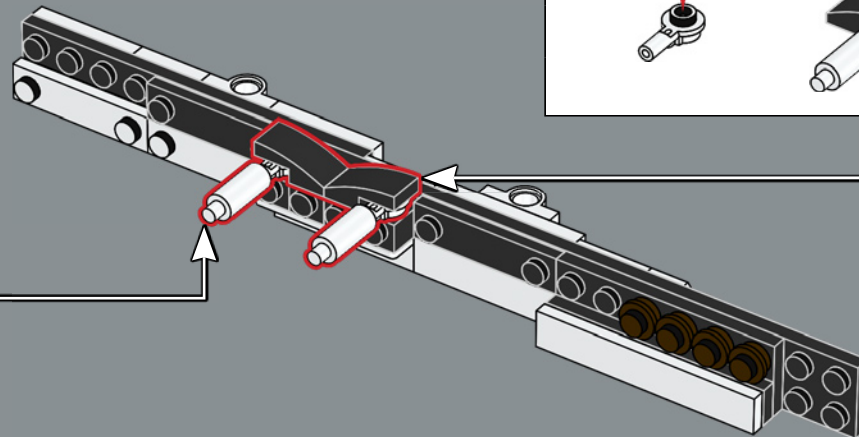
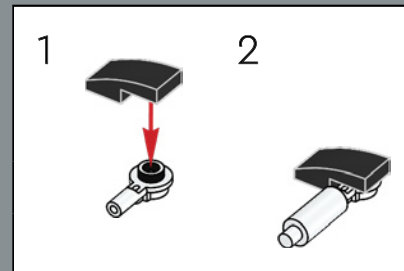
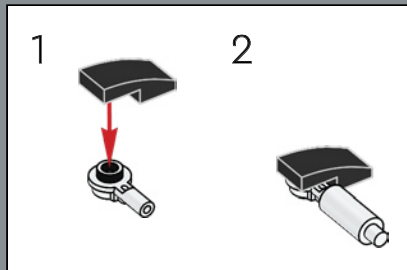

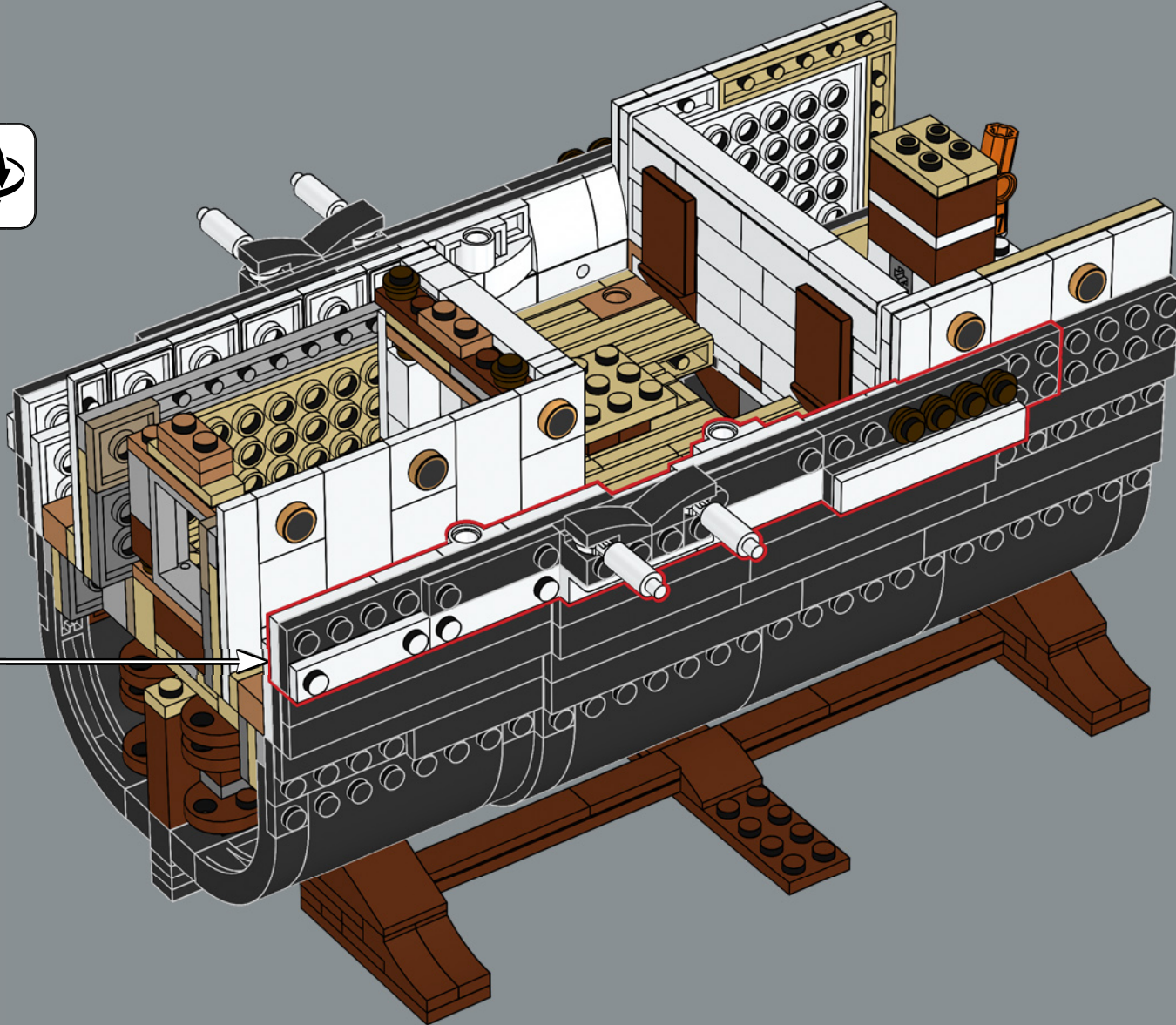

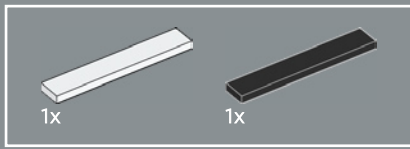

287

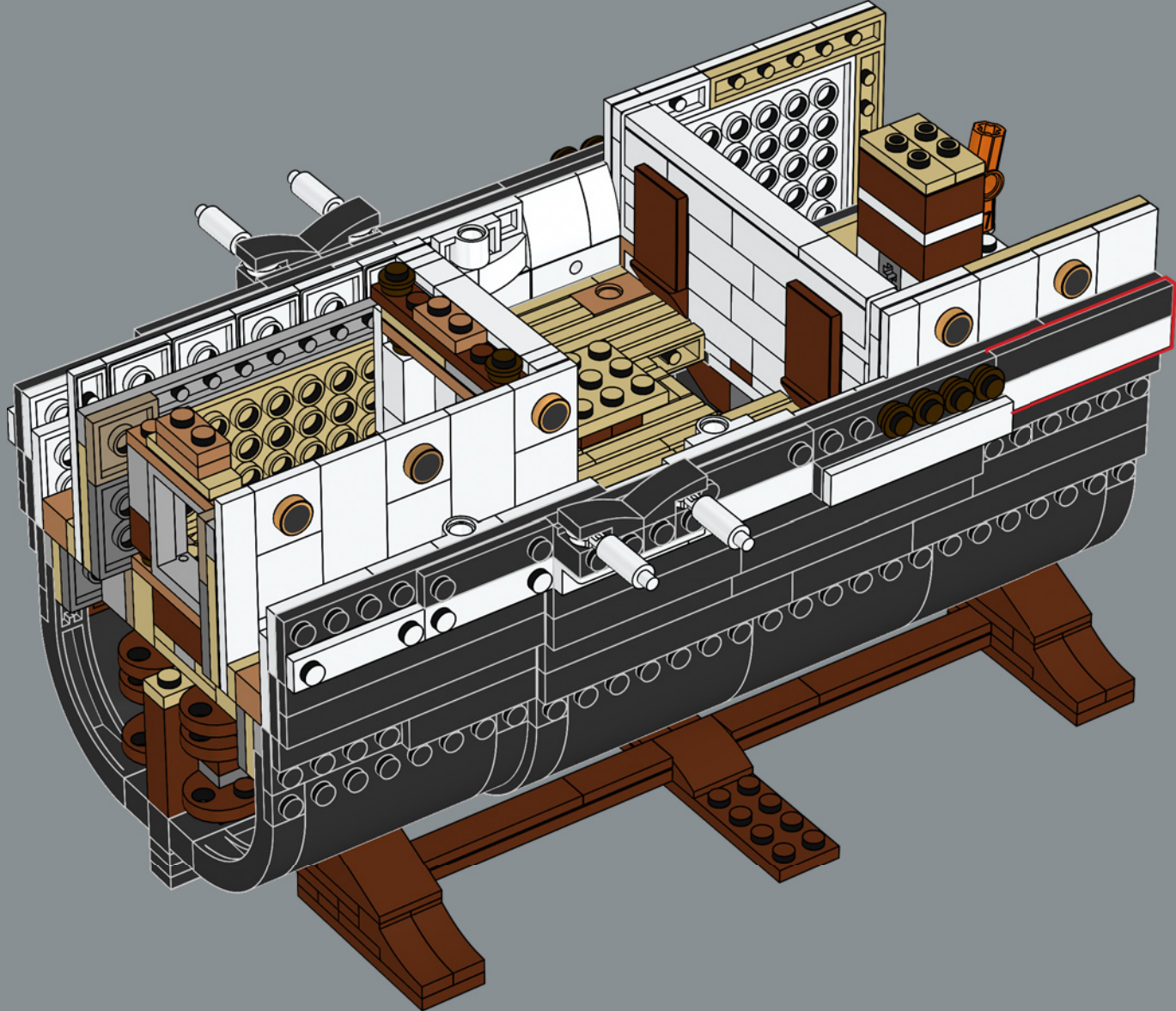

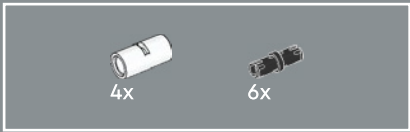

288

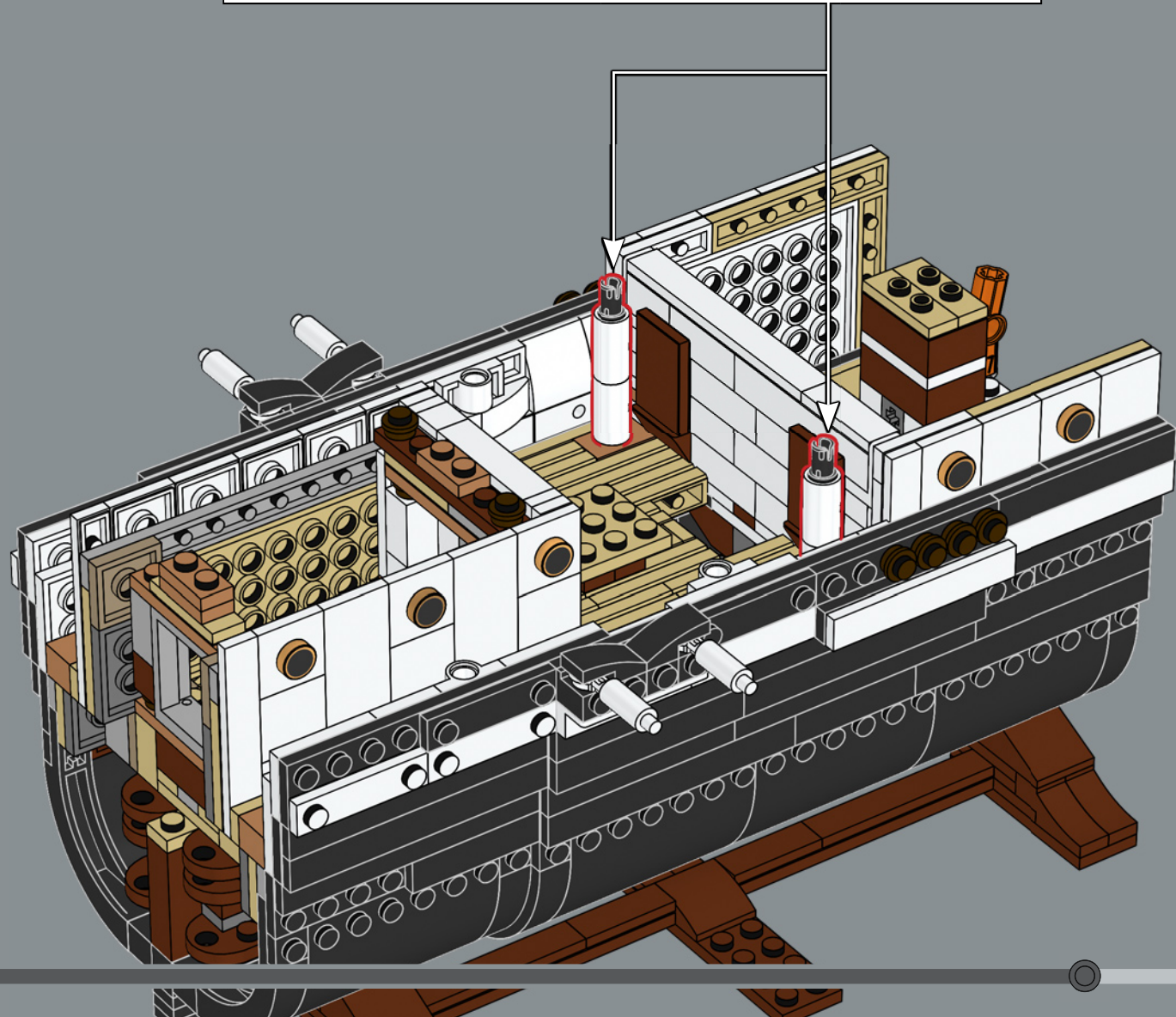
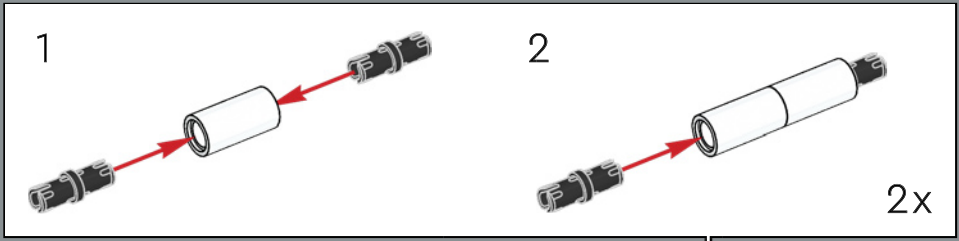

289

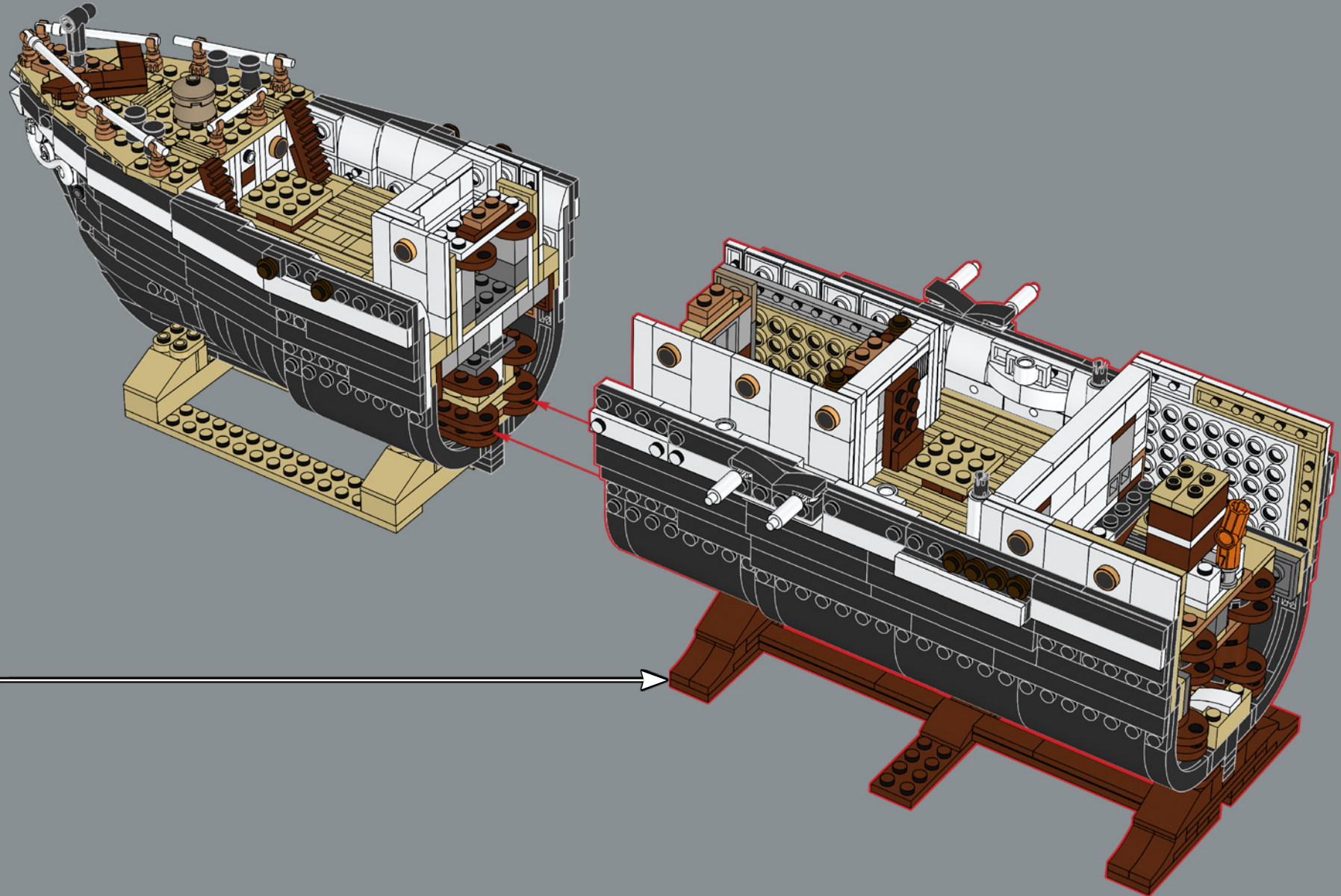



Master craftsmen made the *Endurance* one of the strongest wooden ships ever built, reinforcing the hull's strength wherever possible. On the LEGO® model, the three hull sections are connected by LEGO Technic axes, which hold them securely in place.

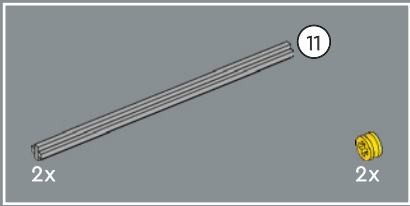

290

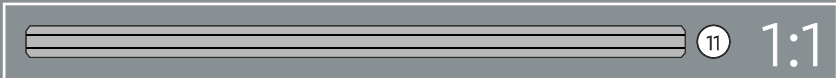
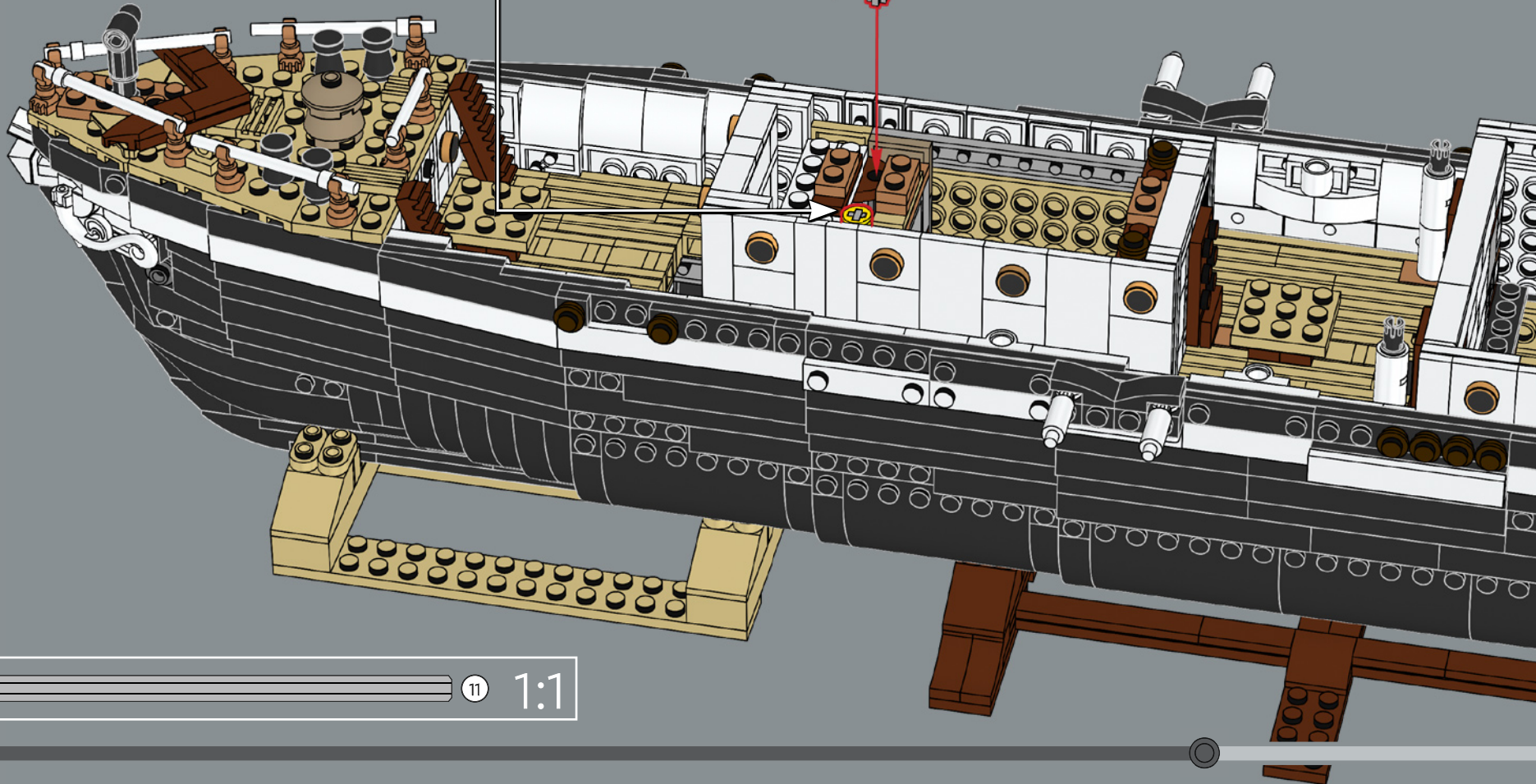
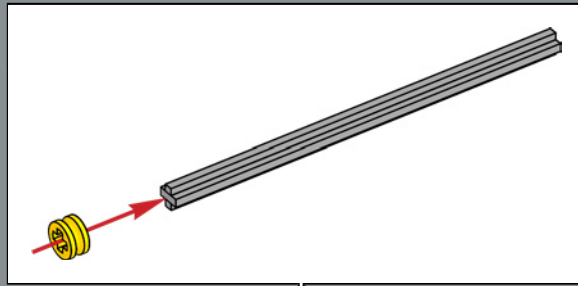

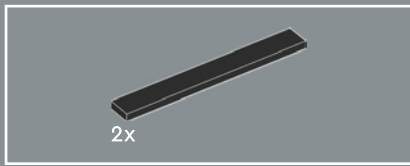

291

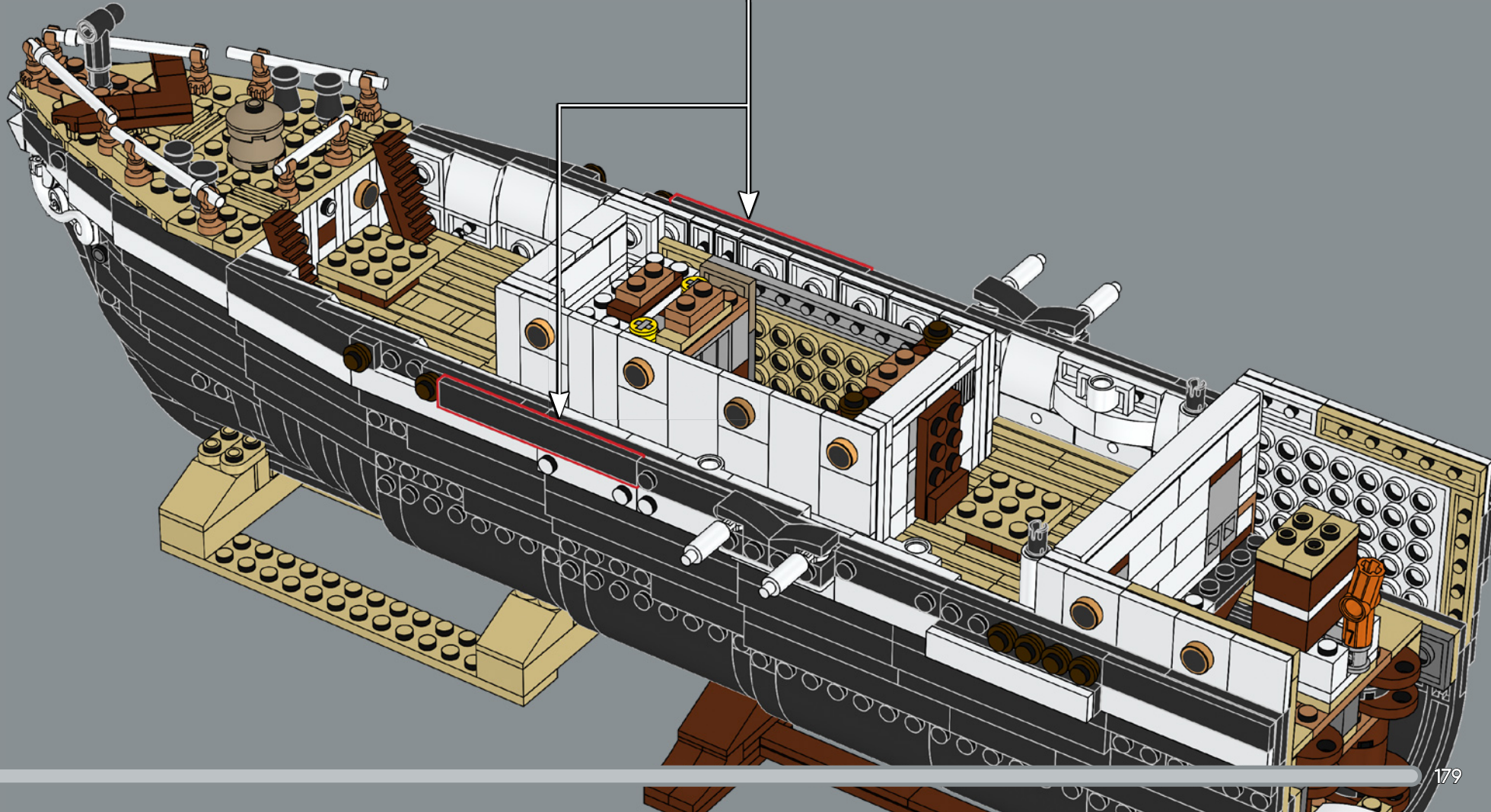
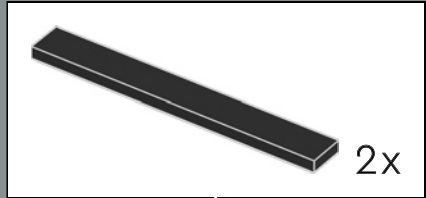

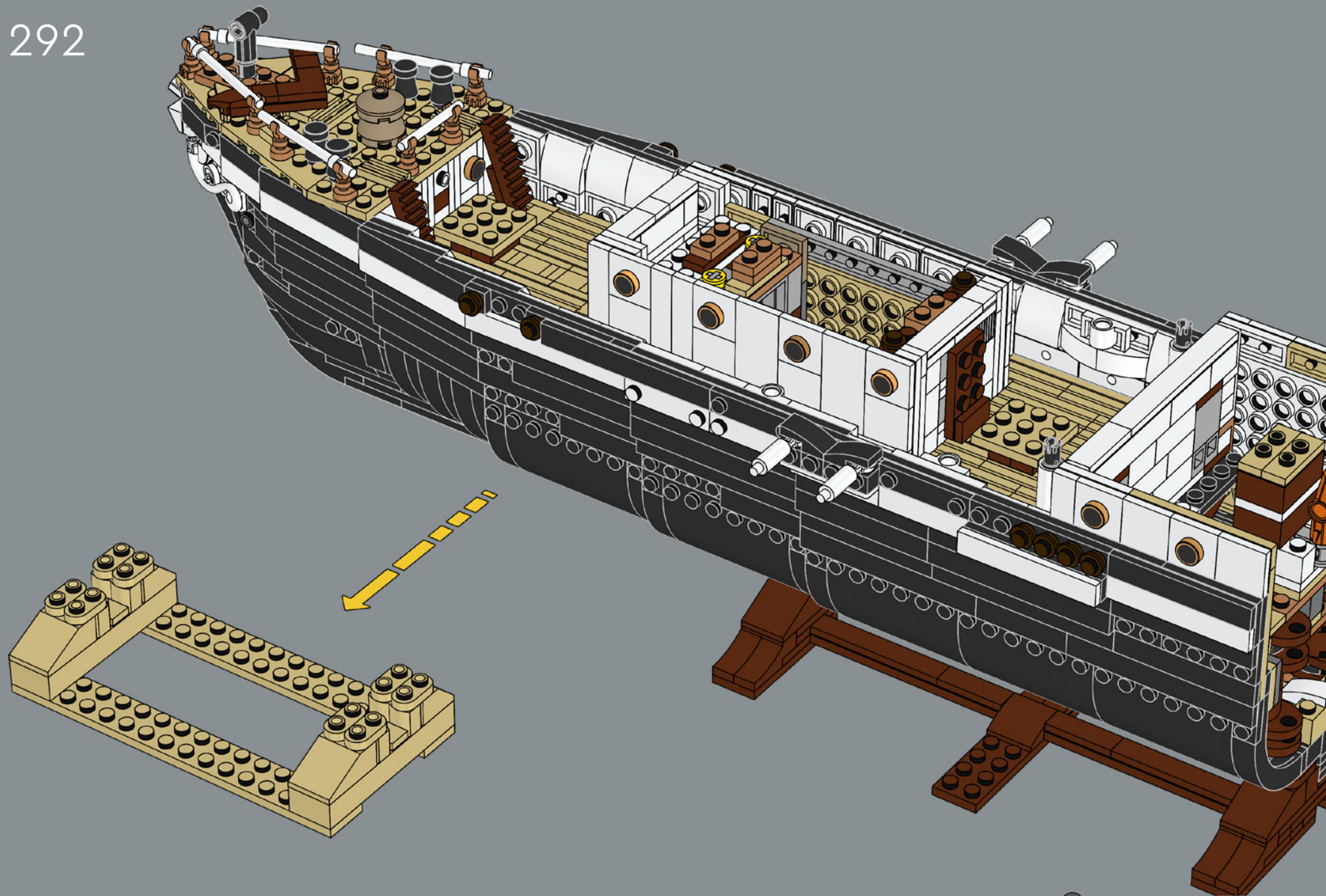

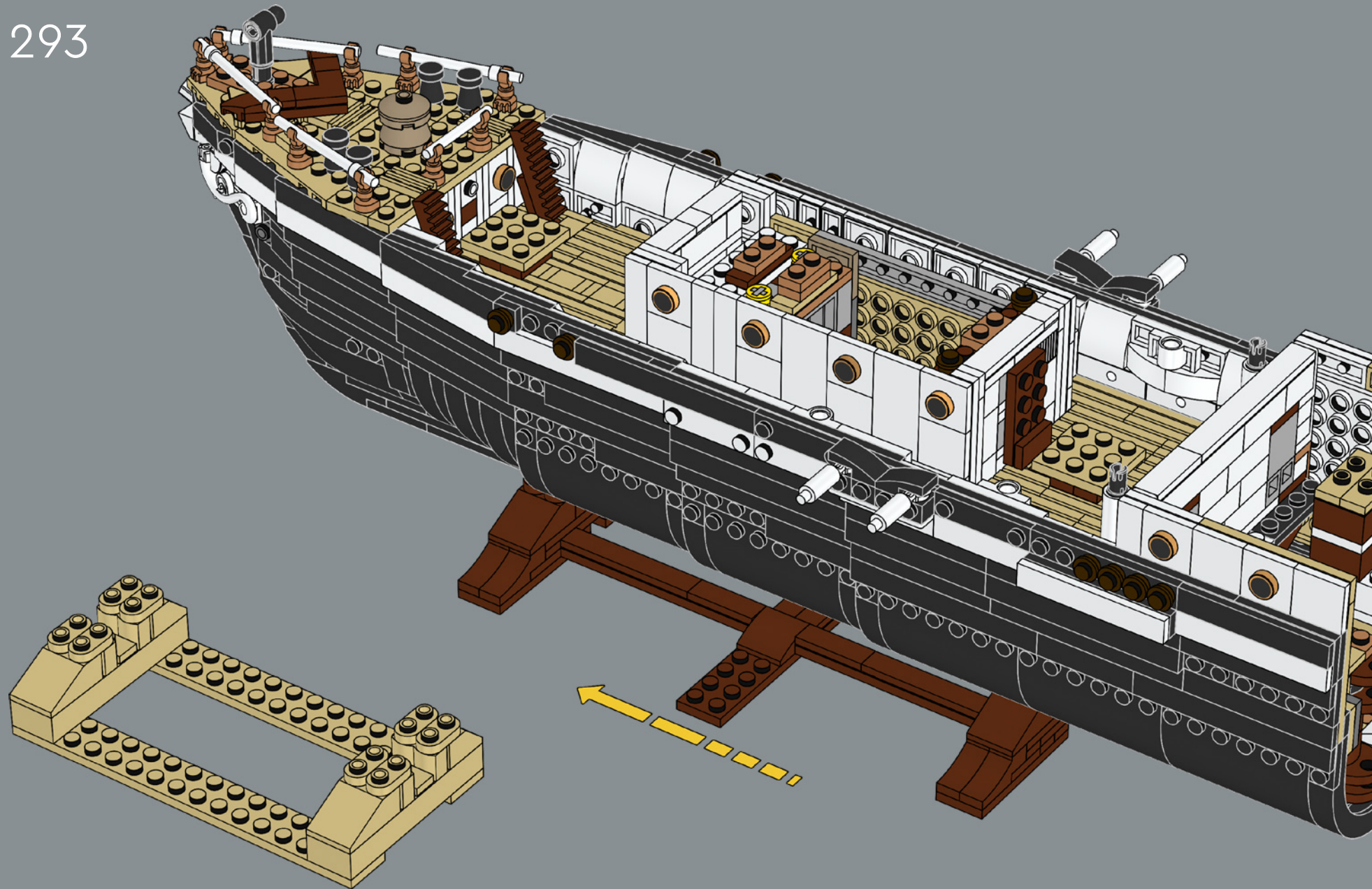

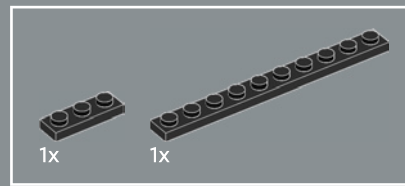
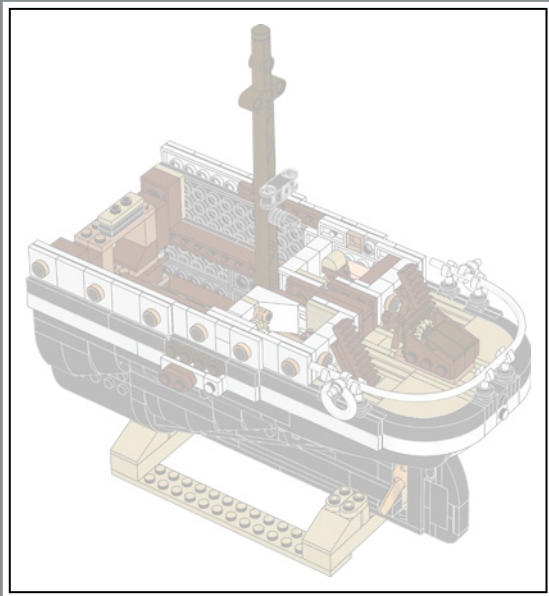
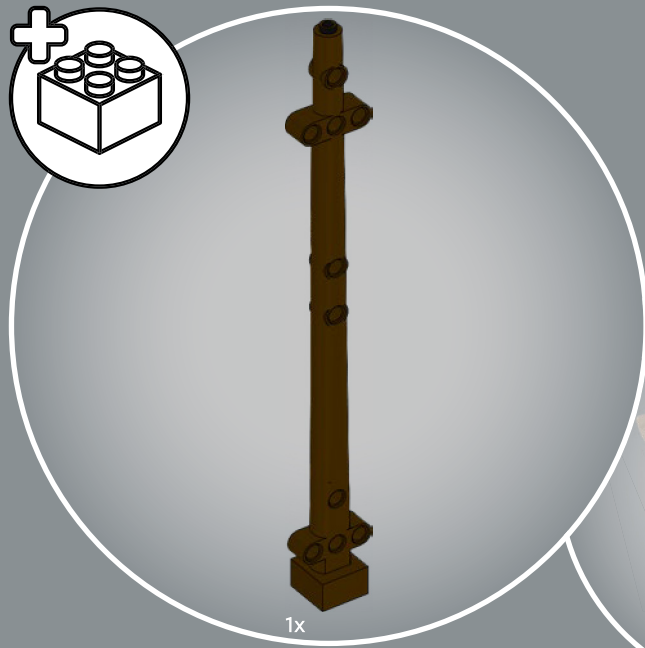
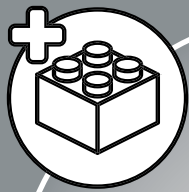

294

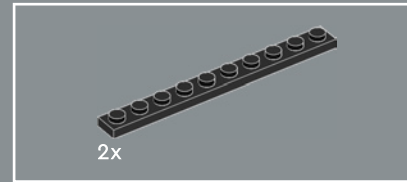
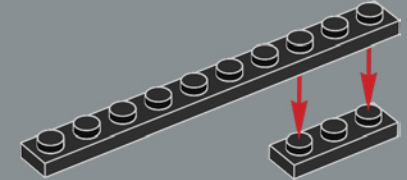

295

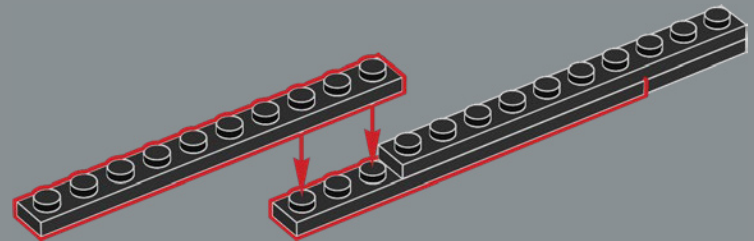

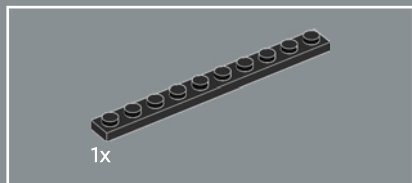

1x

296

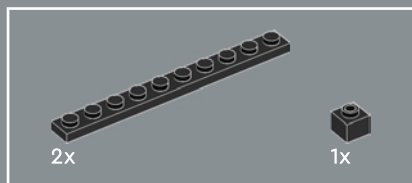
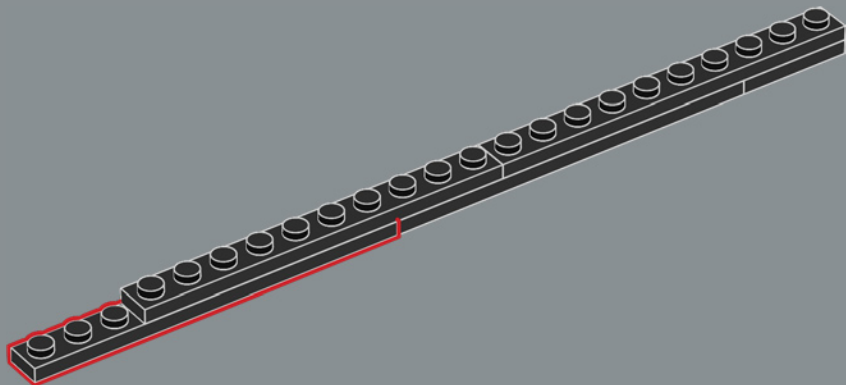

2x

1x

297

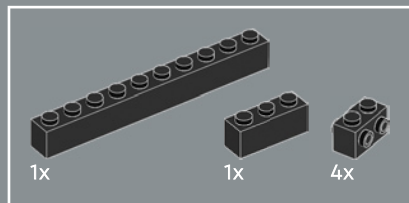
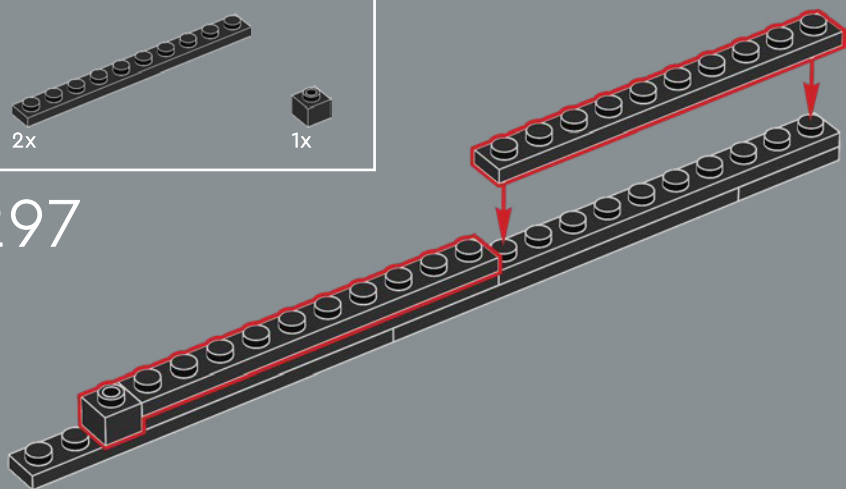

1x

1x

4x

298

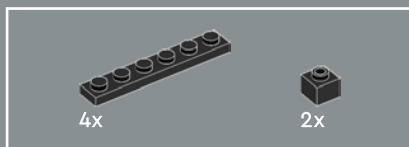
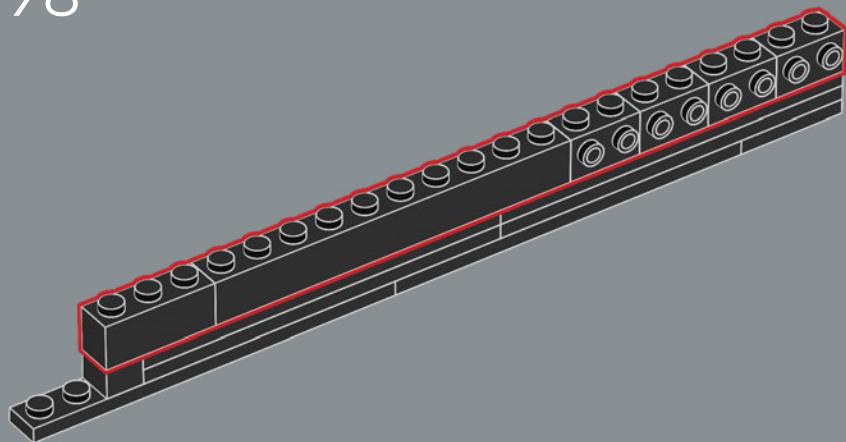

4x

2x

299

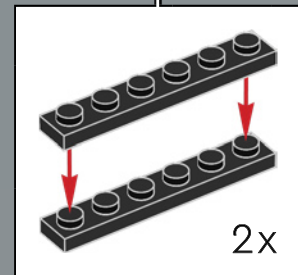
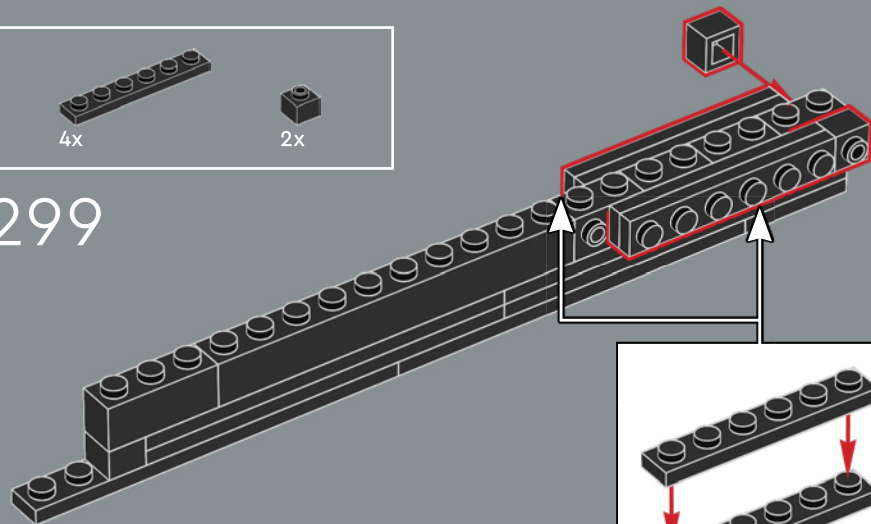

2x

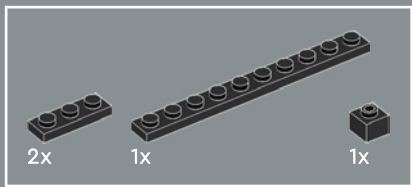

300

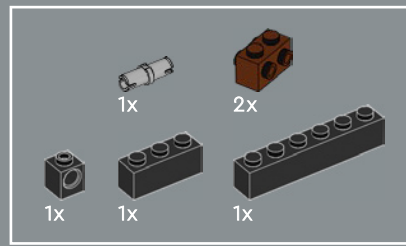
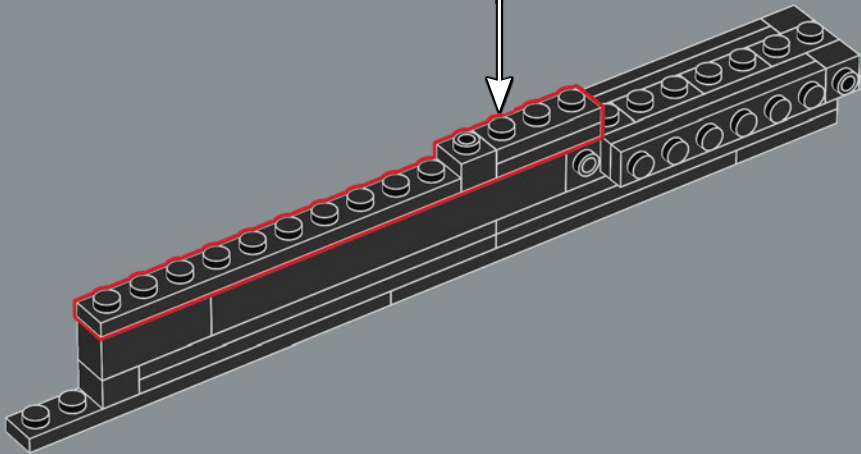
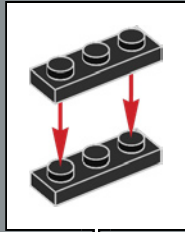

301

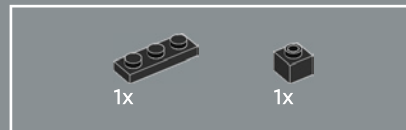
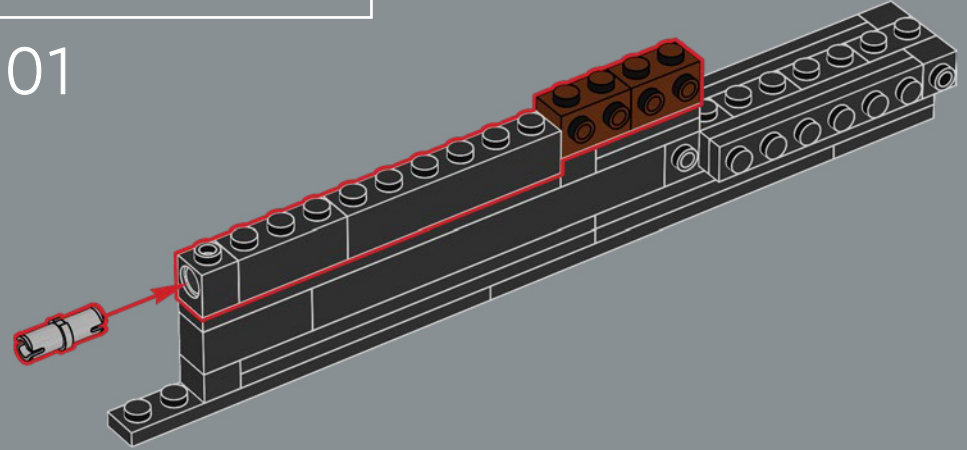

302

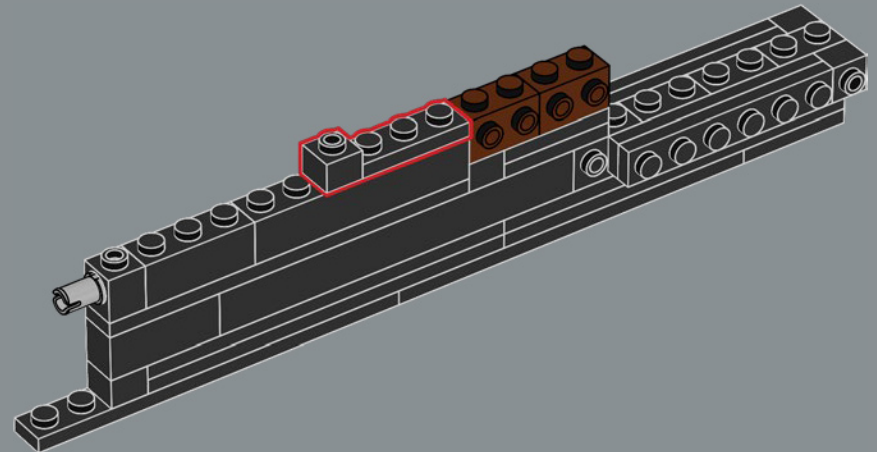

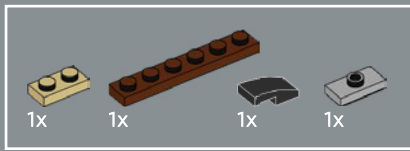

303

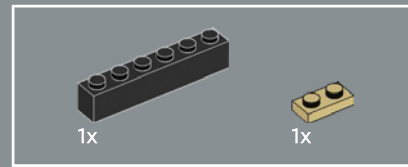
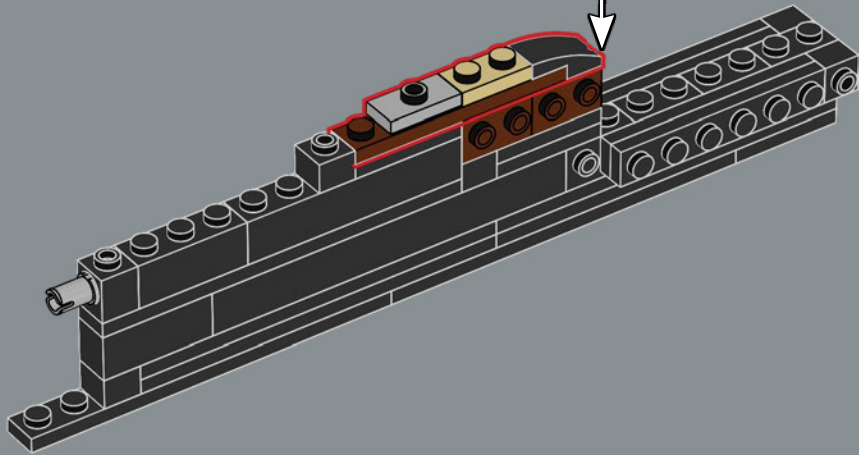
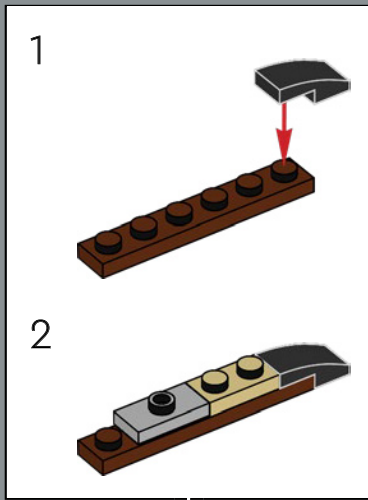

304

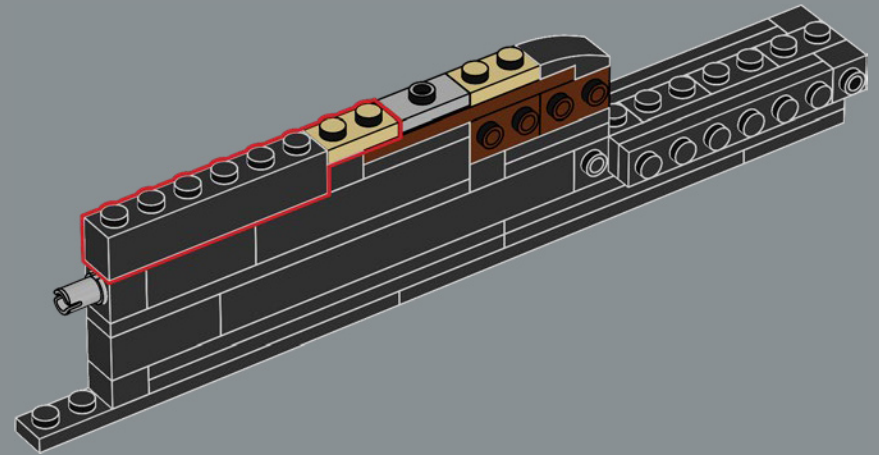

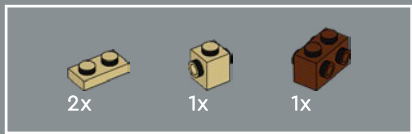

305

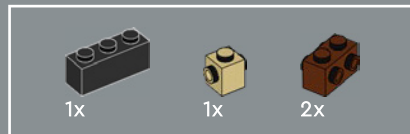
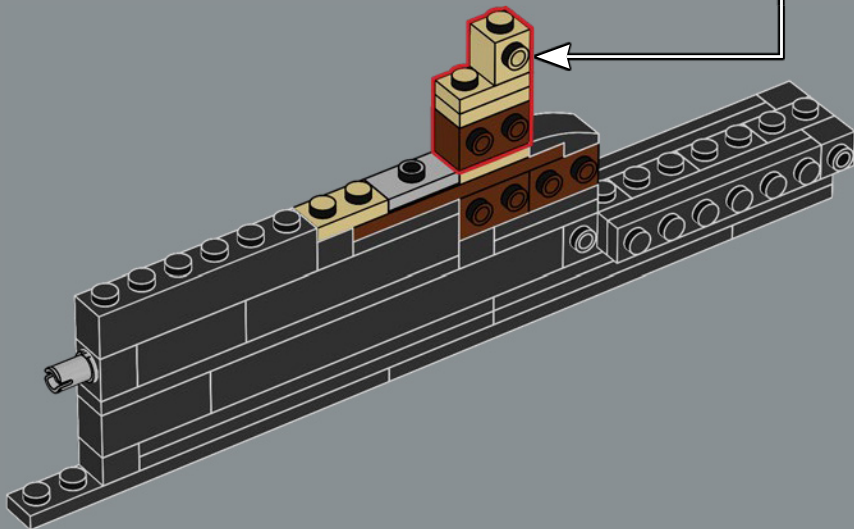
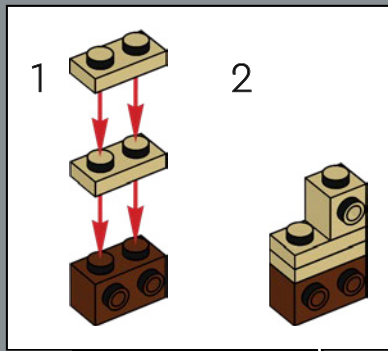

306

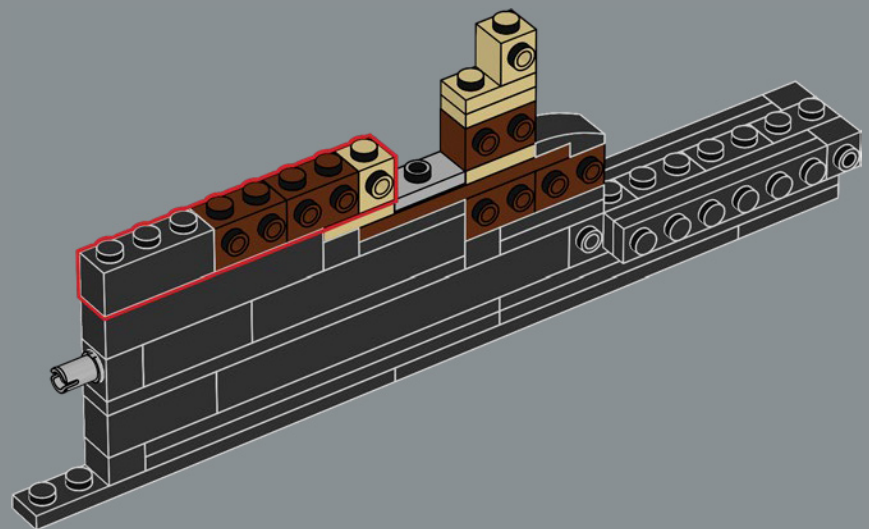

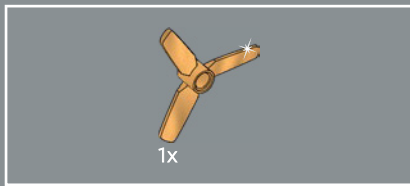

★
On the real-life *Endurance*, the propeller was black, but the LEGO® element was made in moulded gold to make it stand out against the ship's black hull.

307

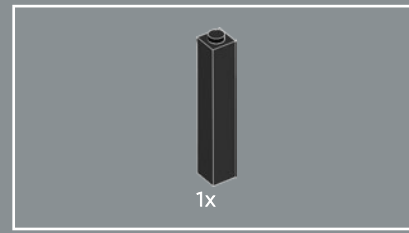
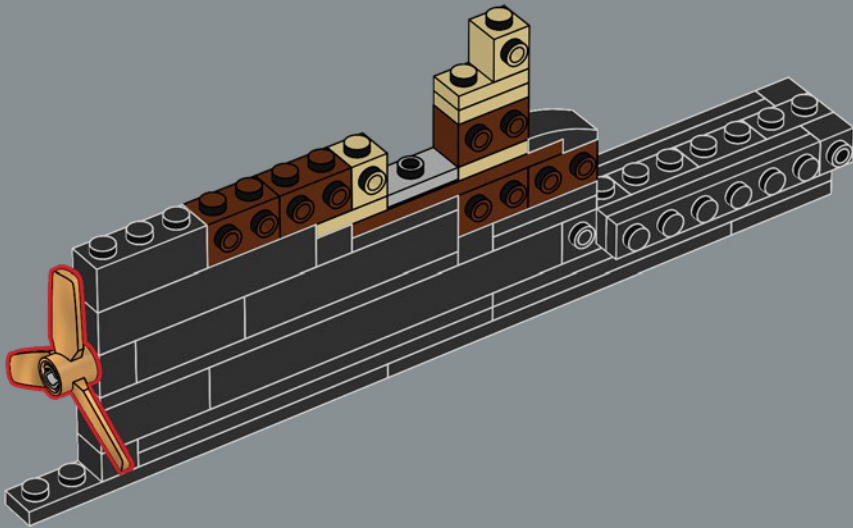

308

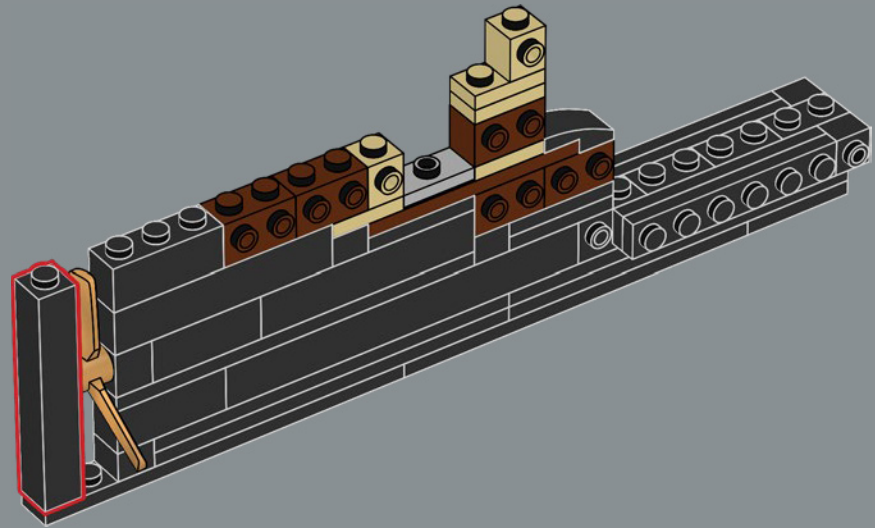

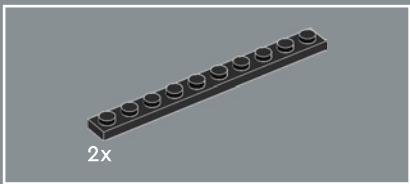

309

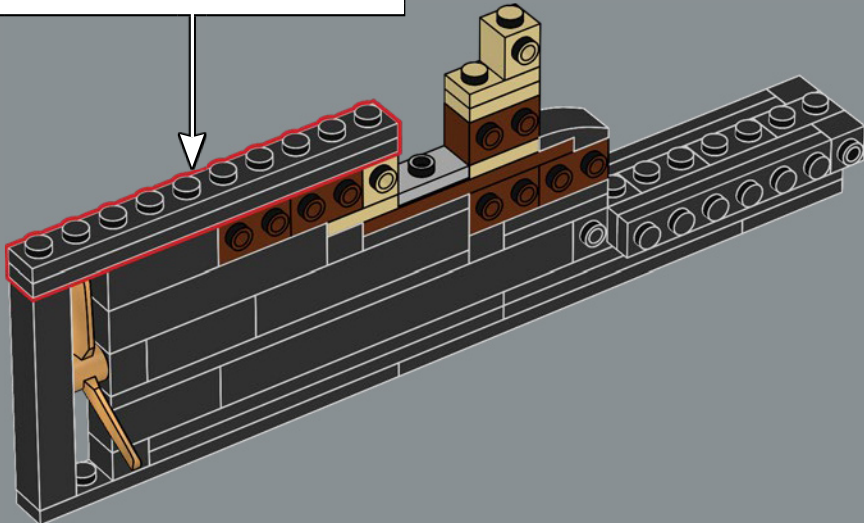
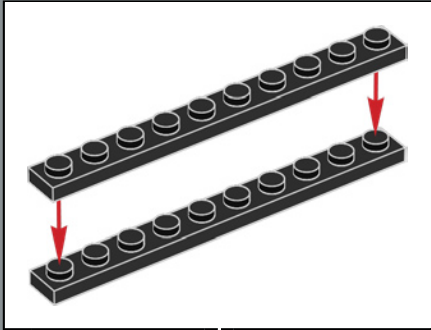

310

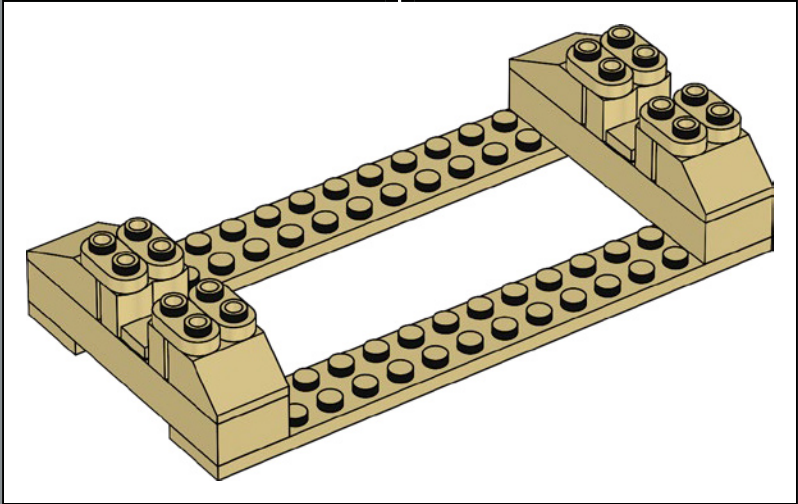
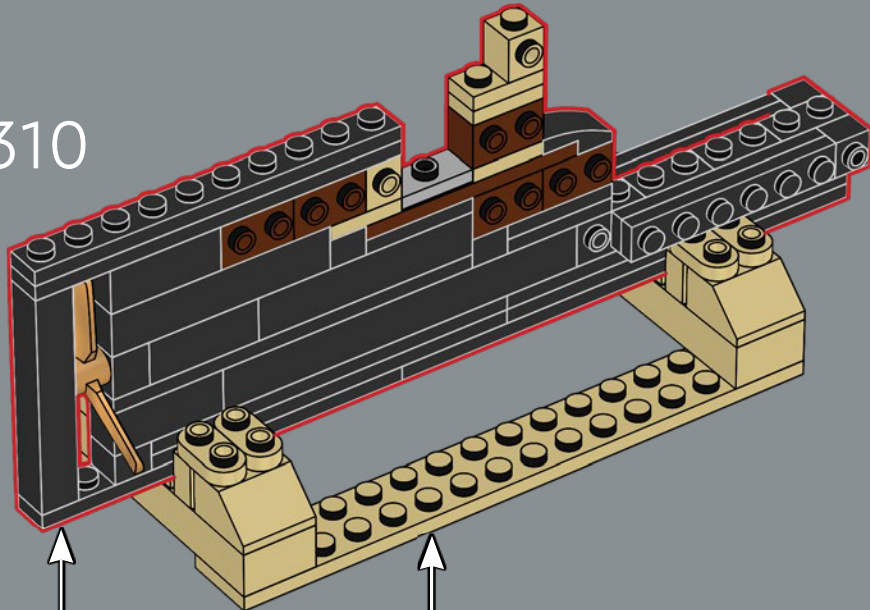

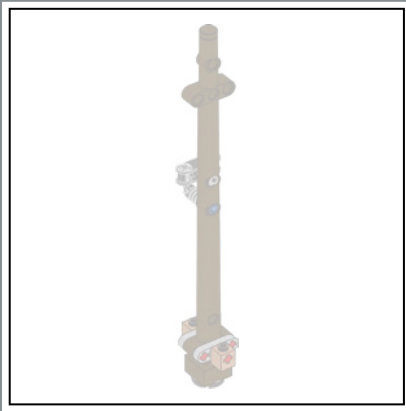

1



2

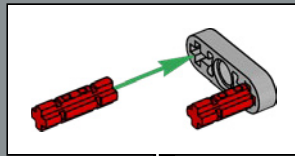

3

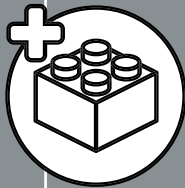
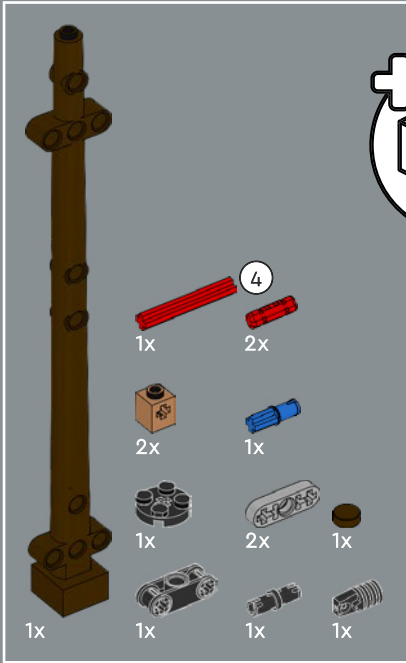
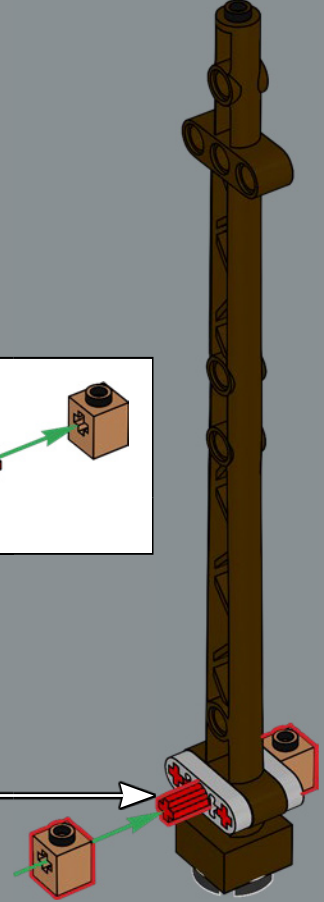
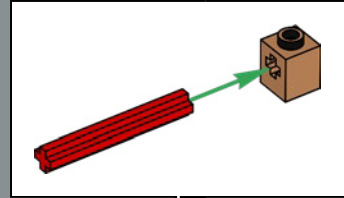

311

4

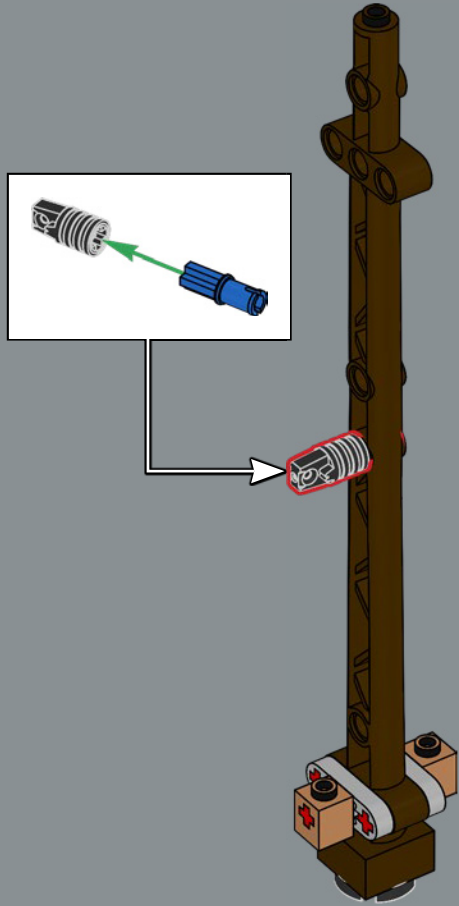

5

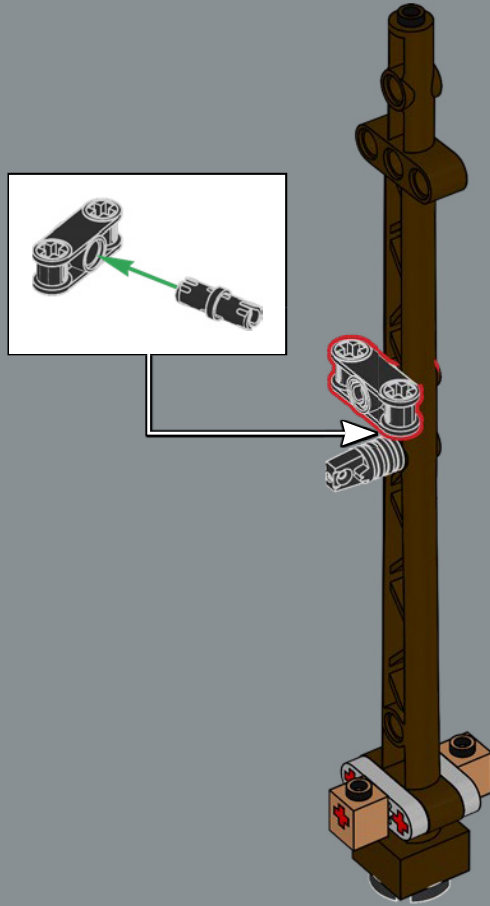

6

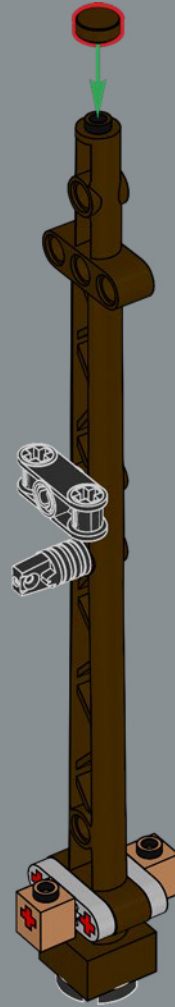

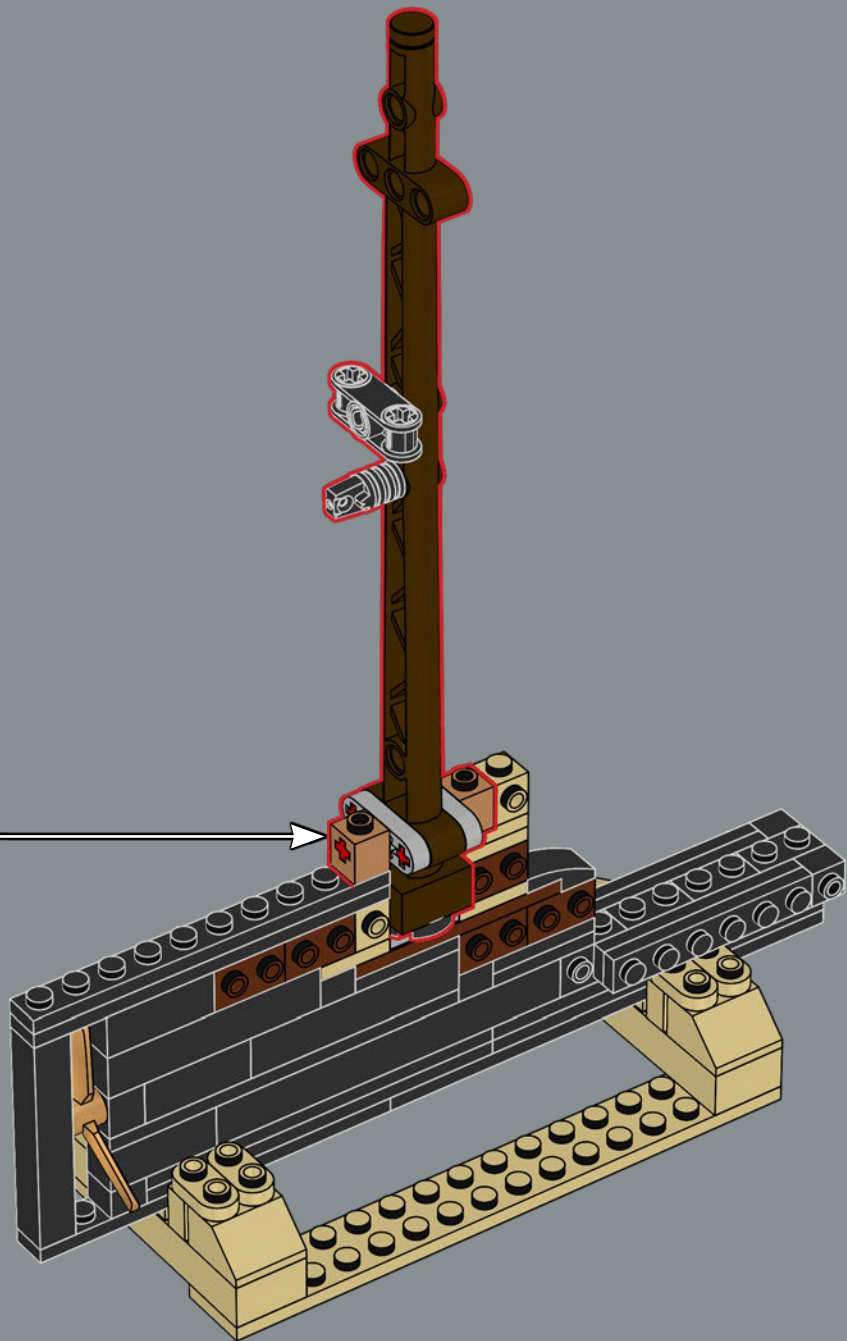

- 4x
- 1x
- 1x

312

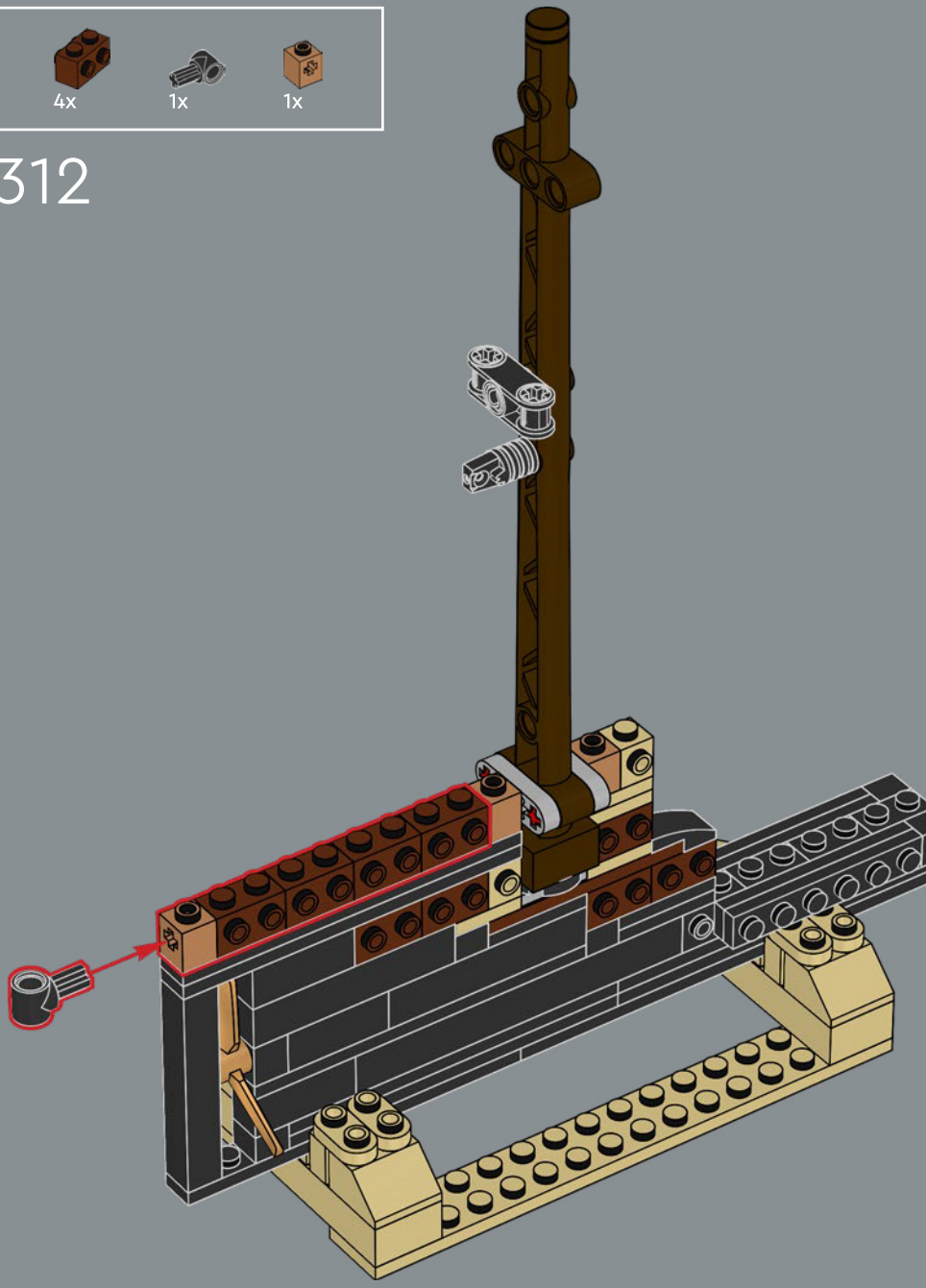

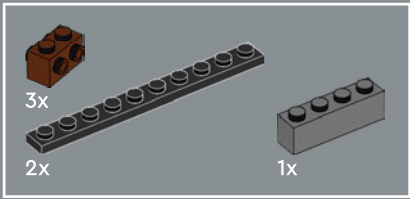

313

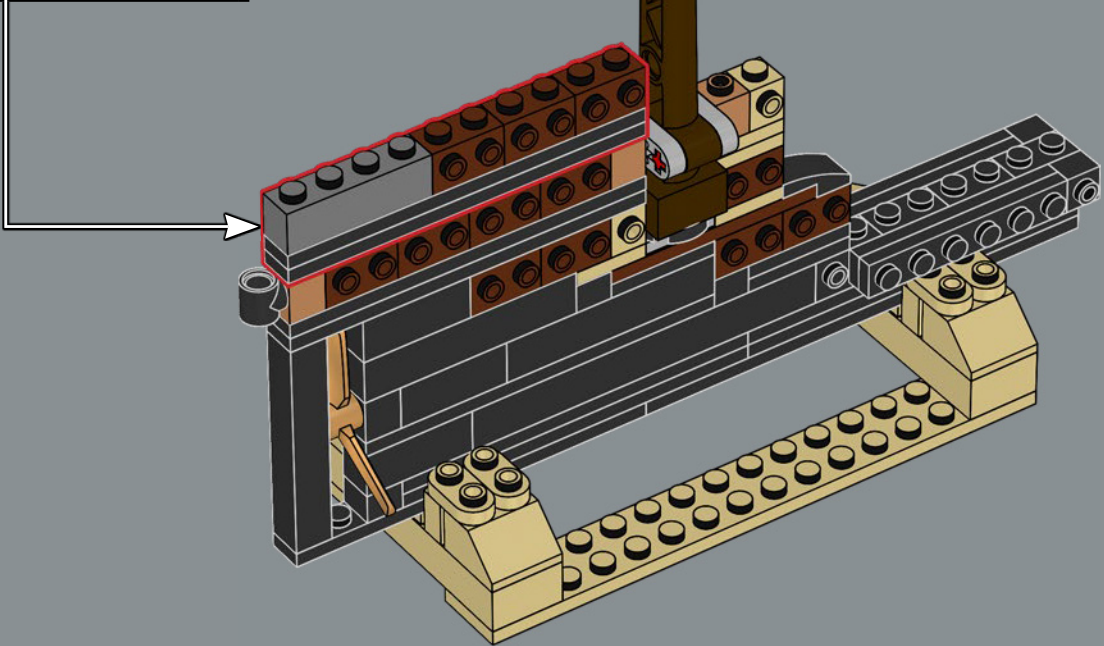
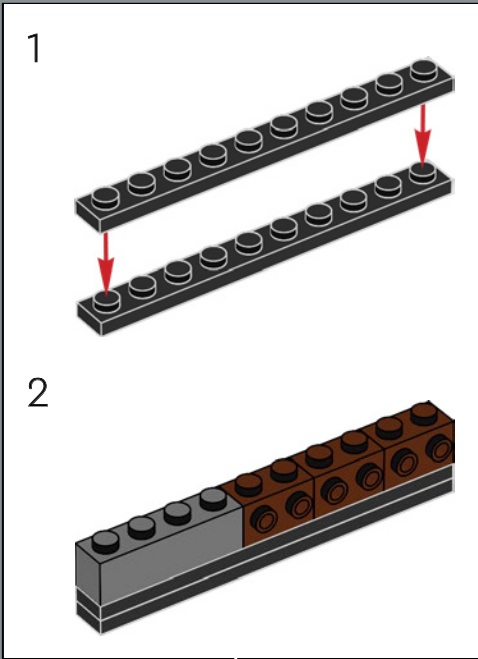

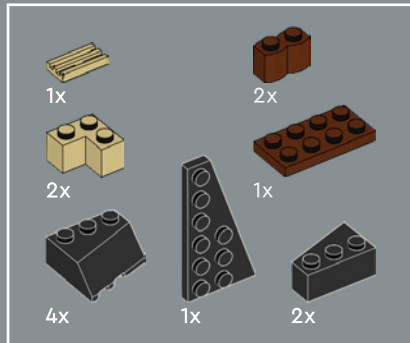
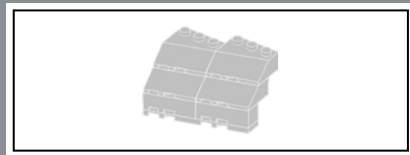

314

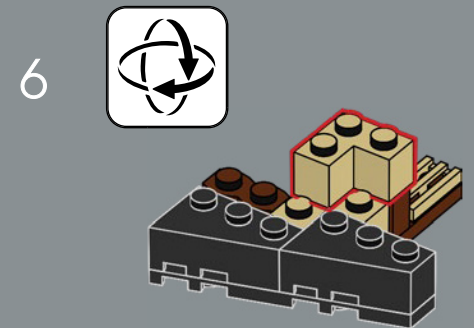
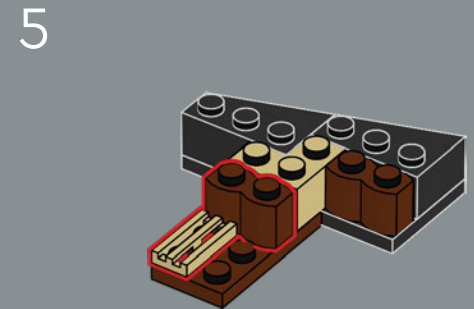
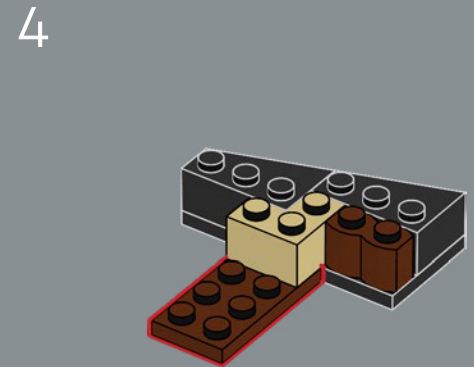
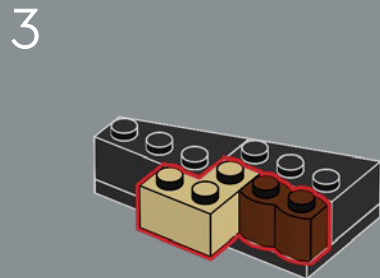
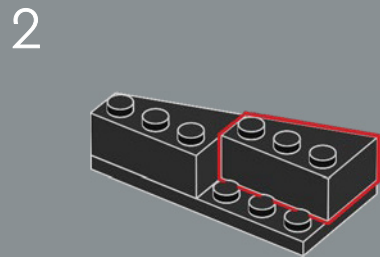
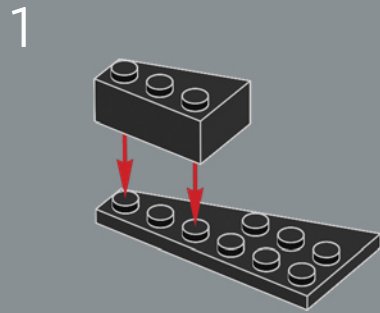

7

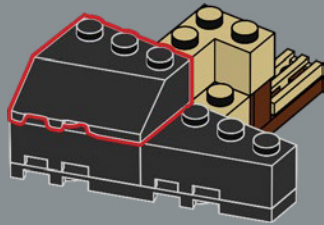

8

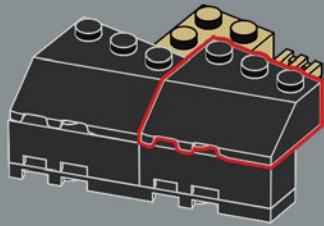

9

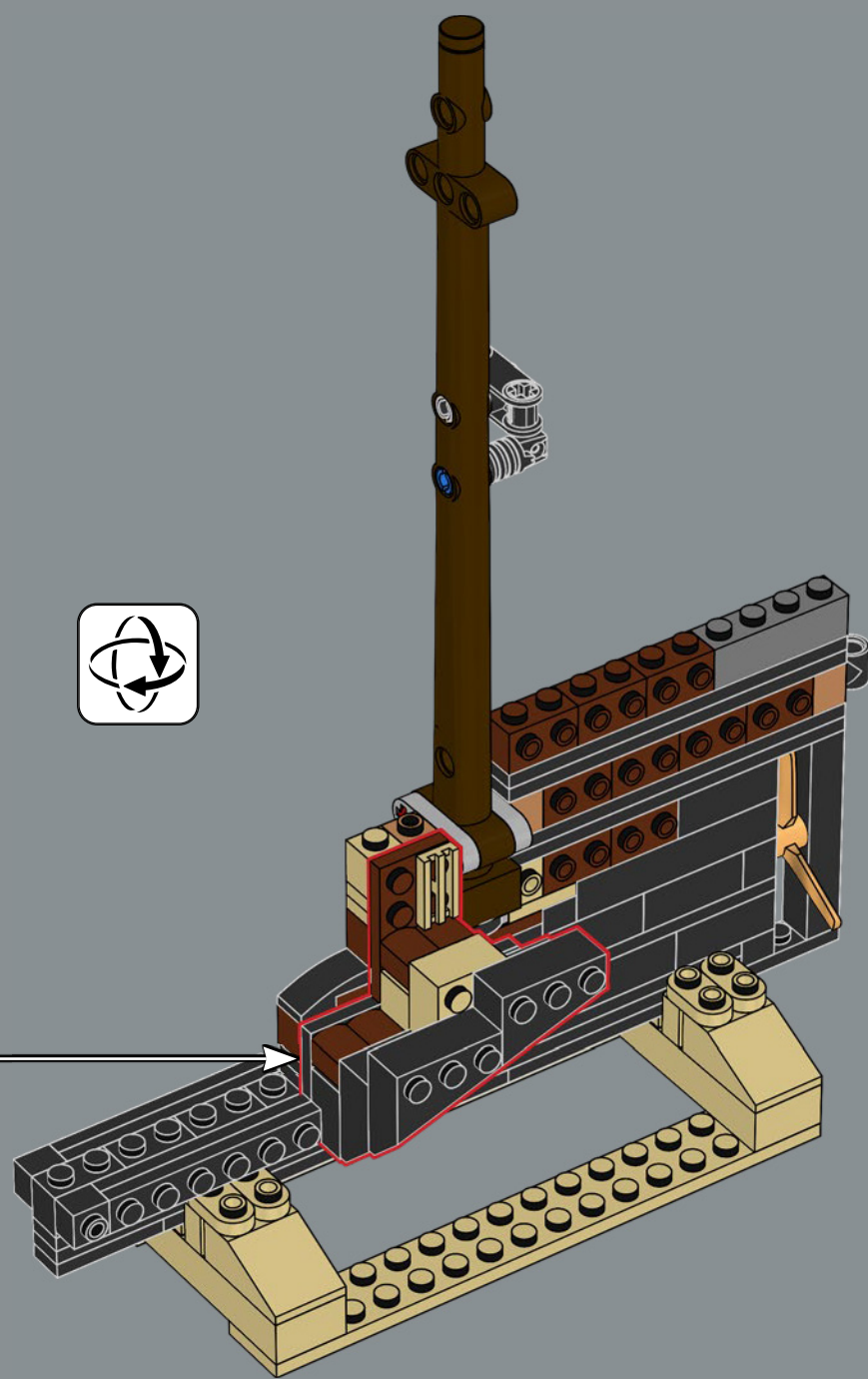
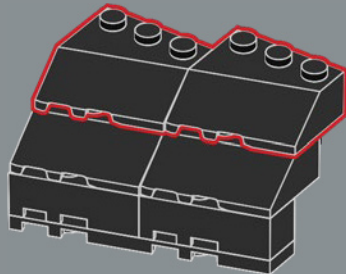

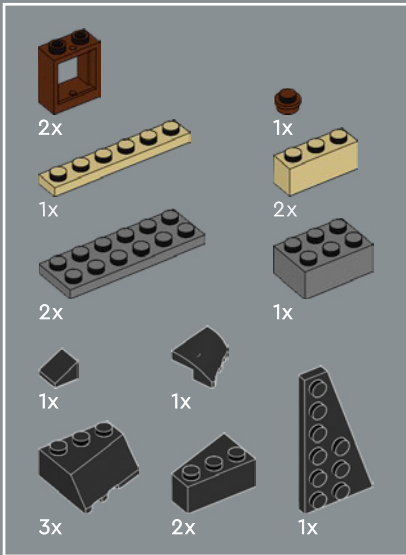
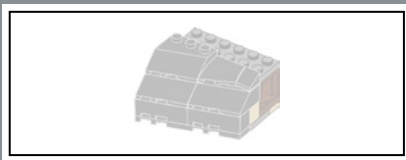

315

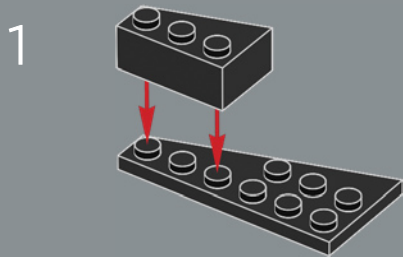

2

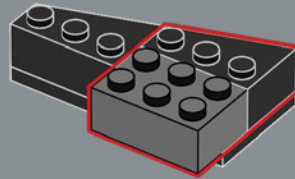

3

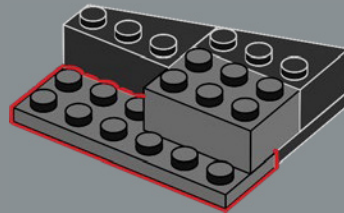

4

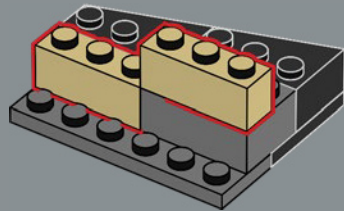

5

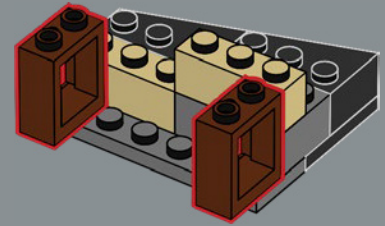

6

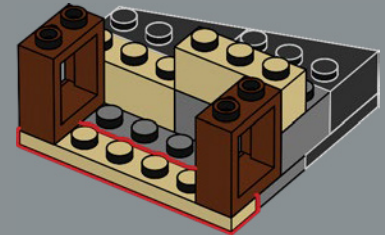

7

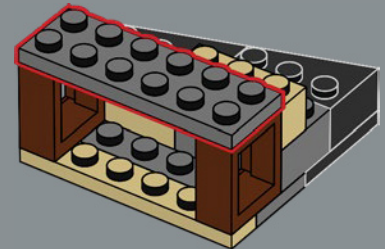

8

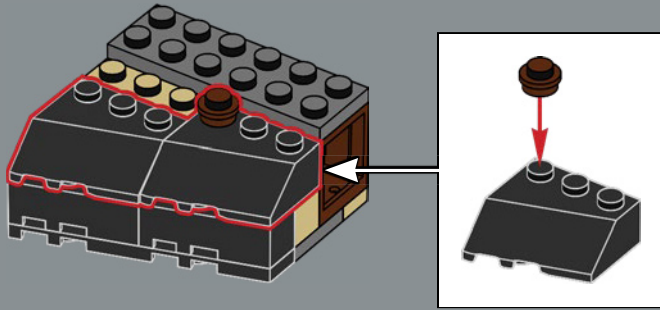

9

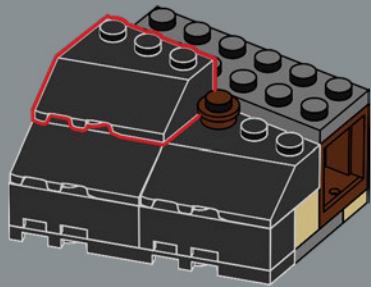

10

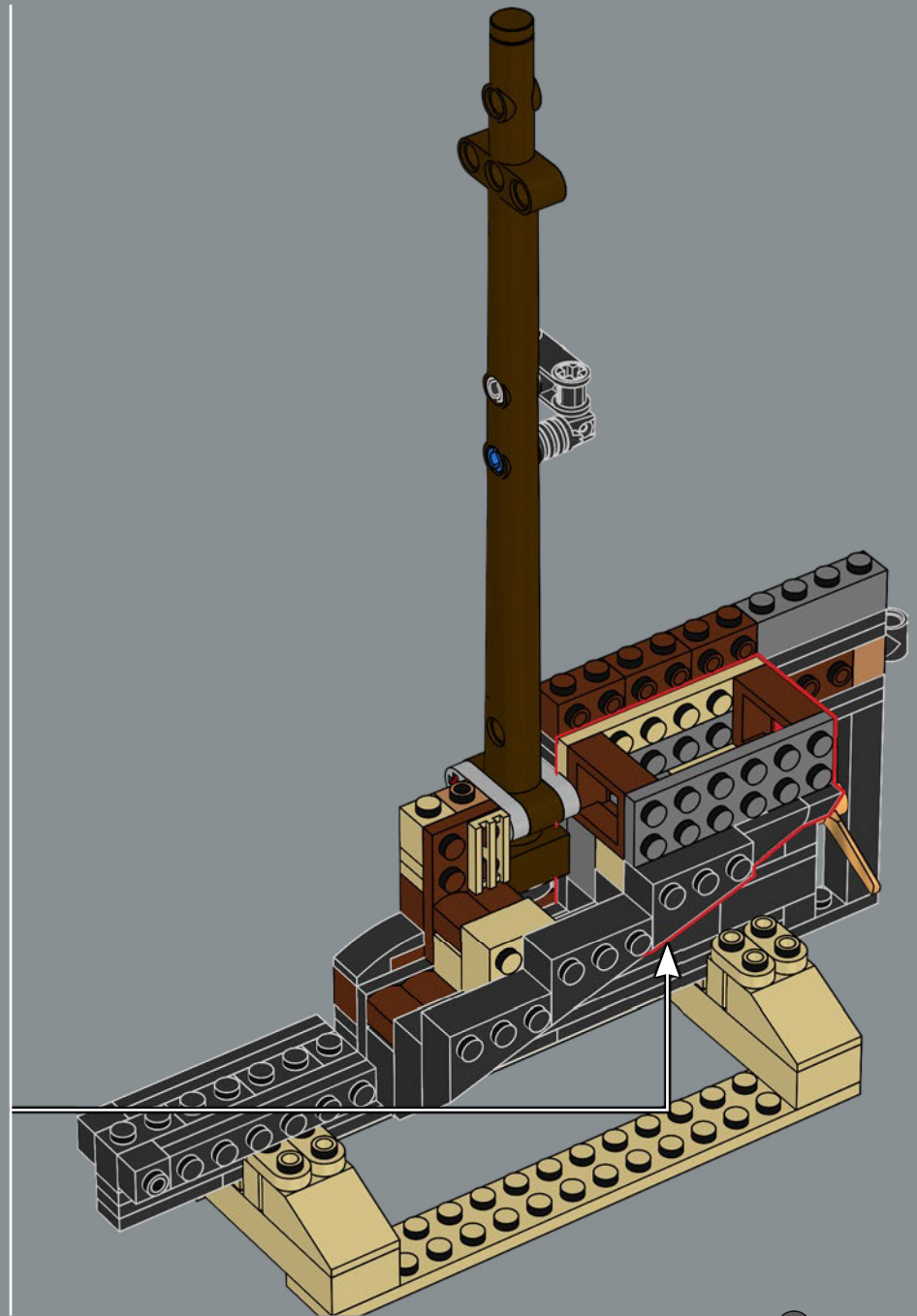
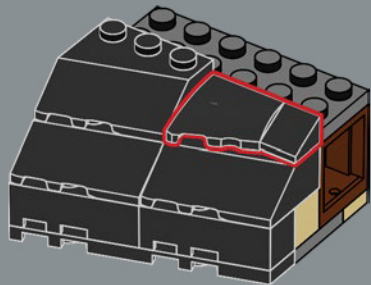

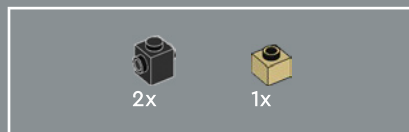

317

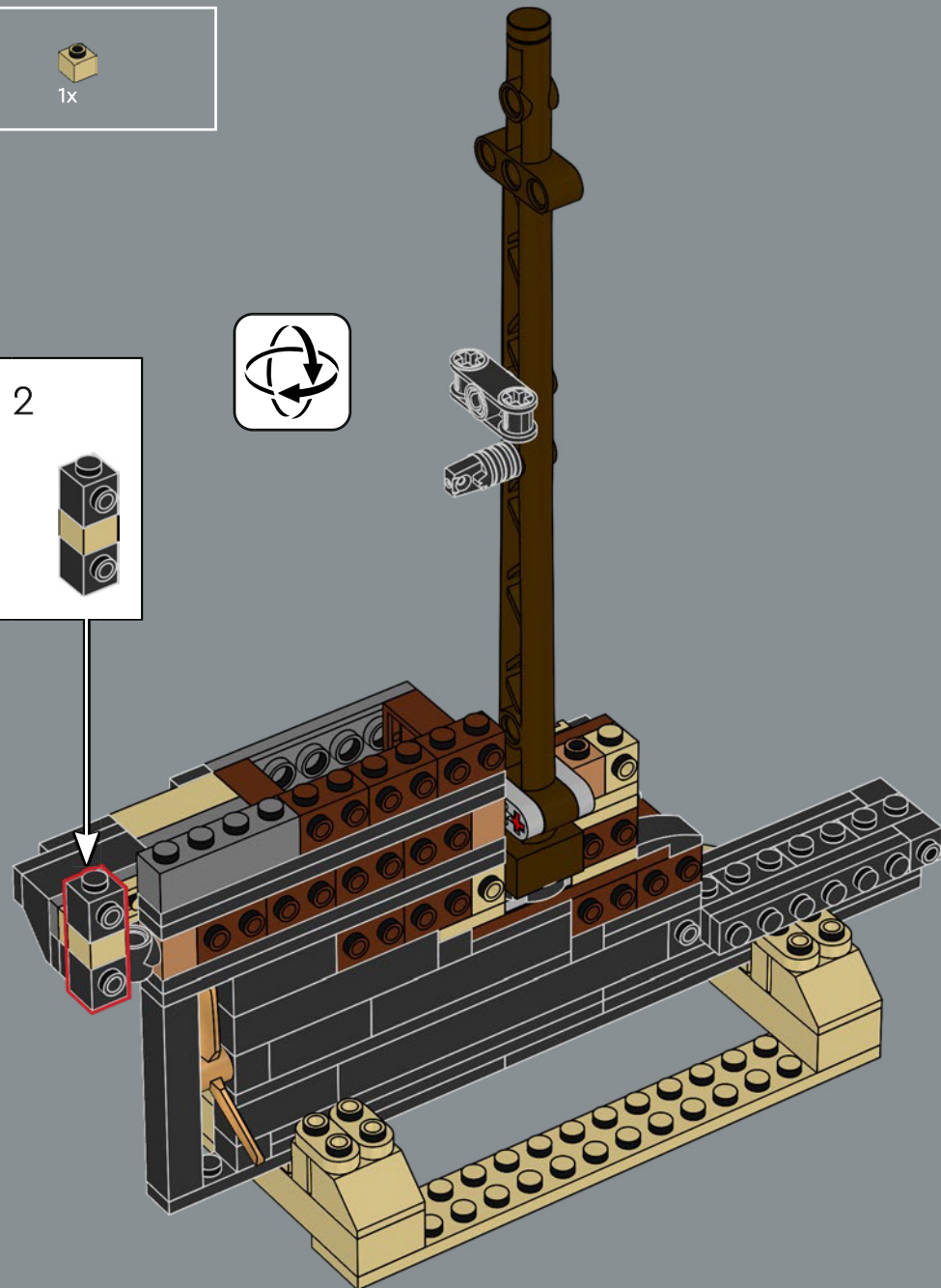
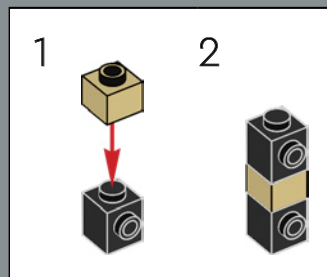

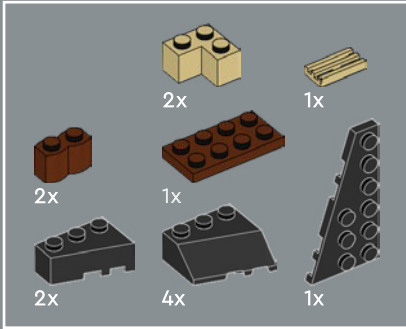
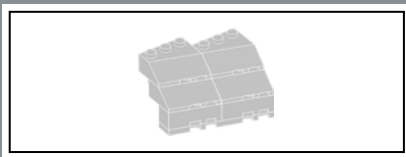

318

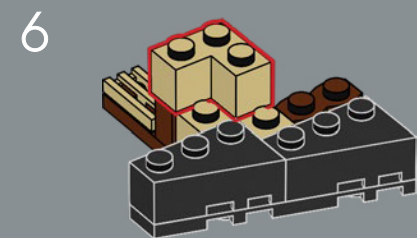
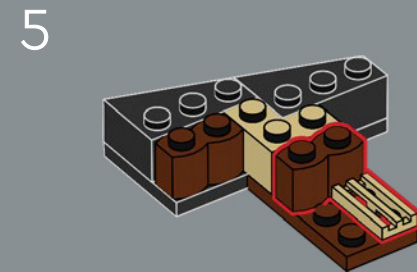
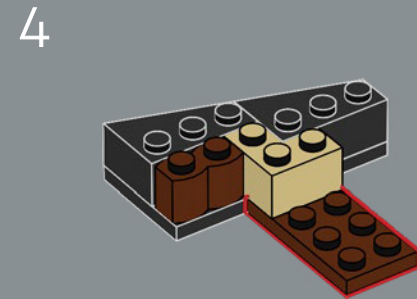
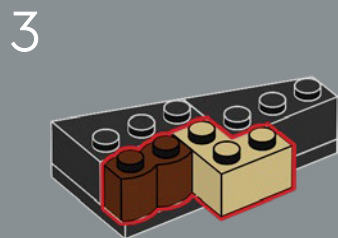
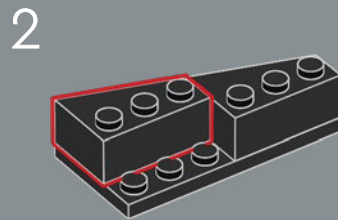
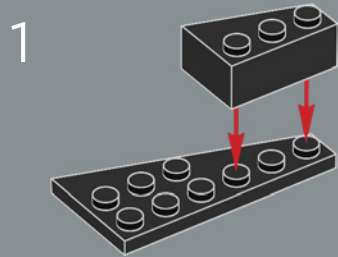

7

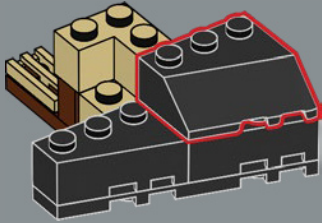

8

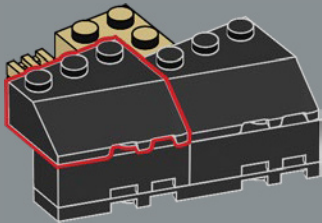

9

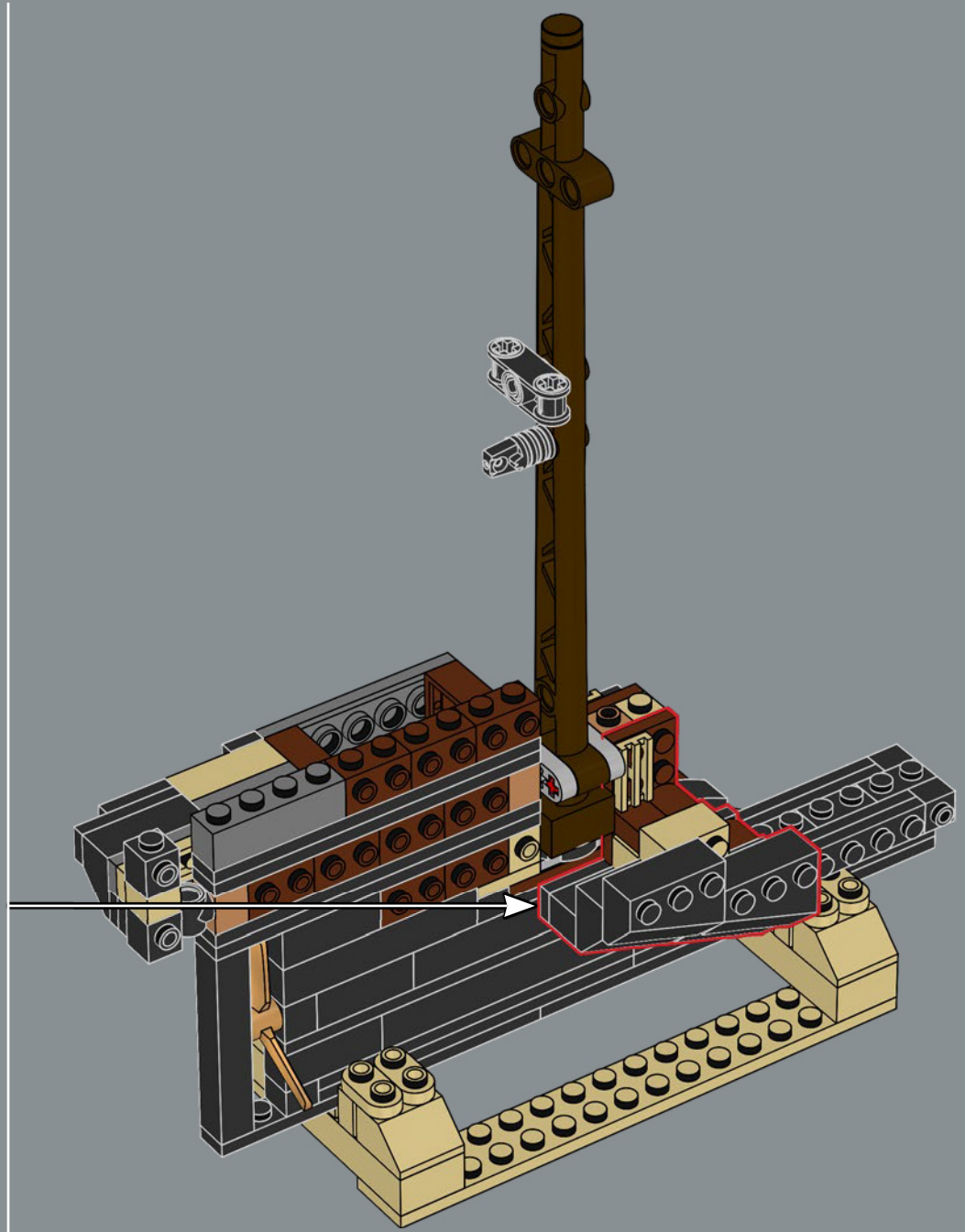
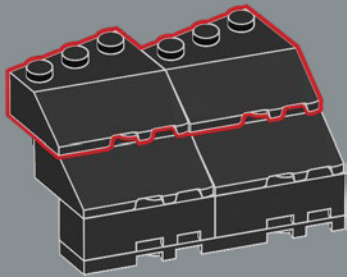

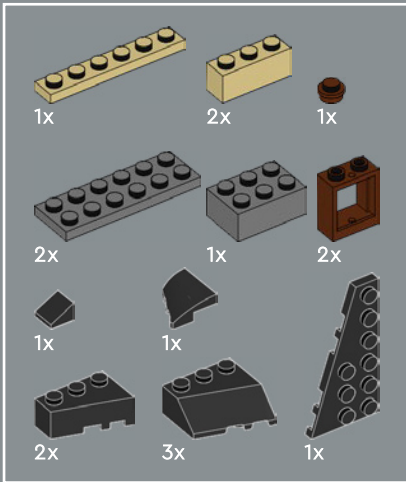
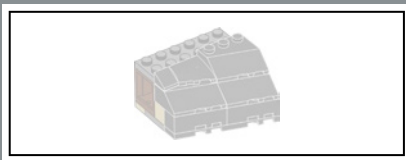

319

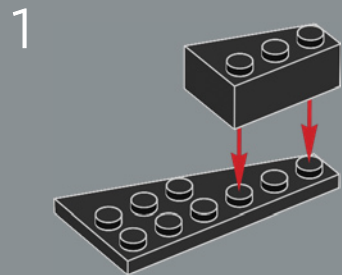

2

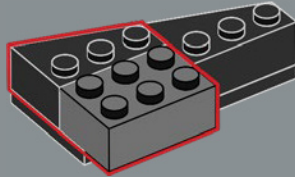

3

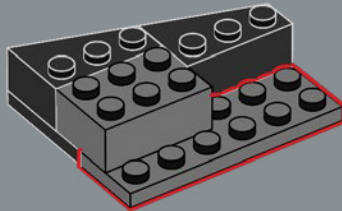

4

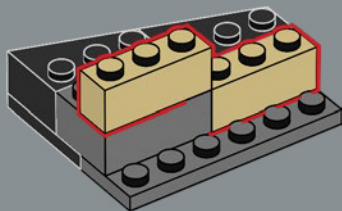

5

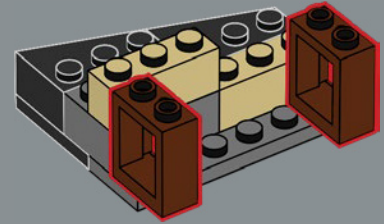

6

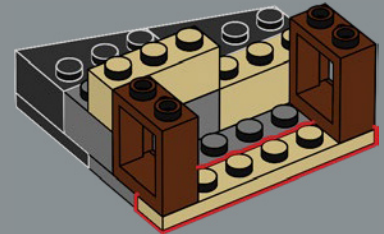

7

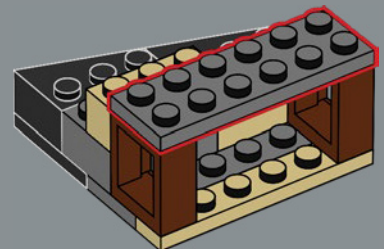

8

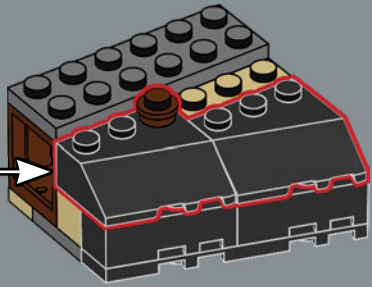
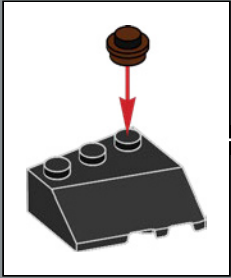

9

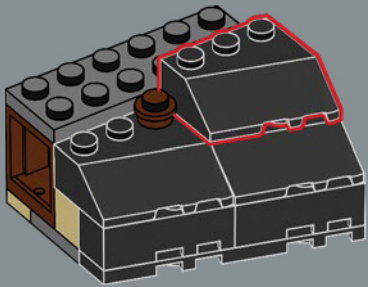

10

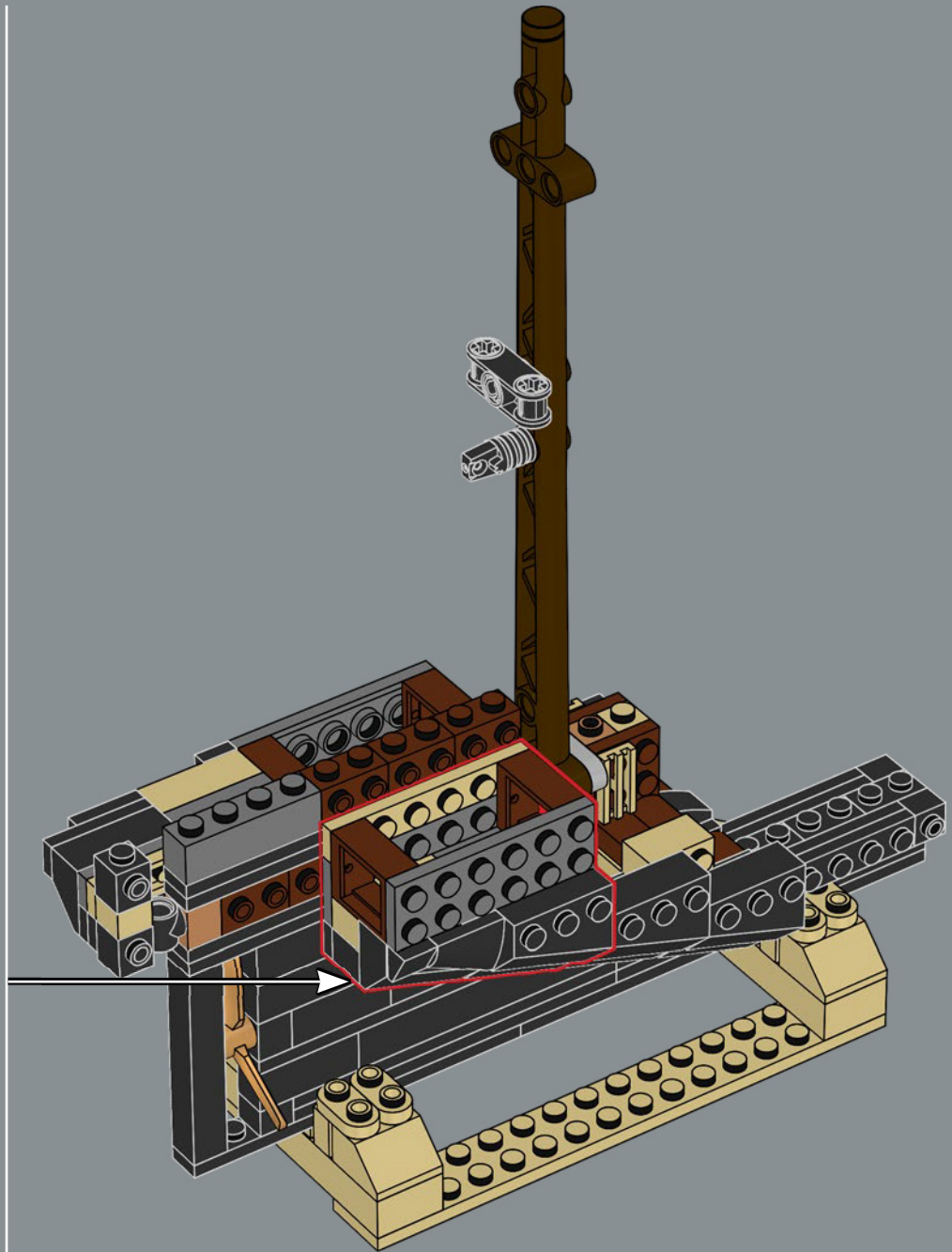
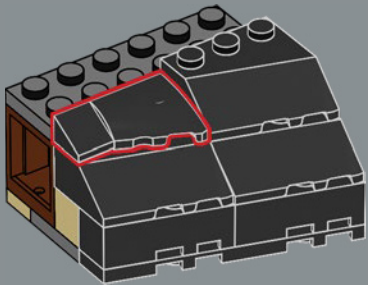

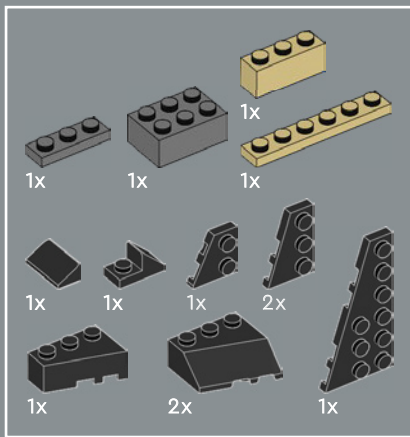

320

1

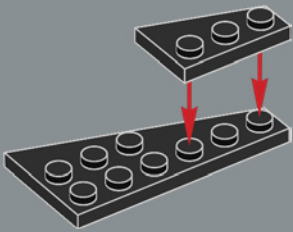

2

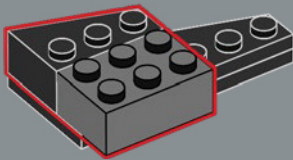

3

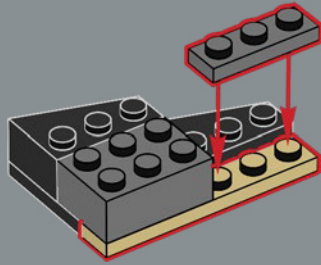

4

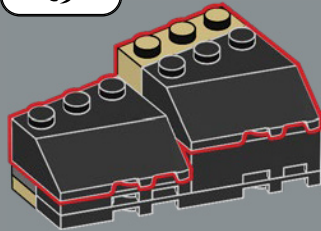

5

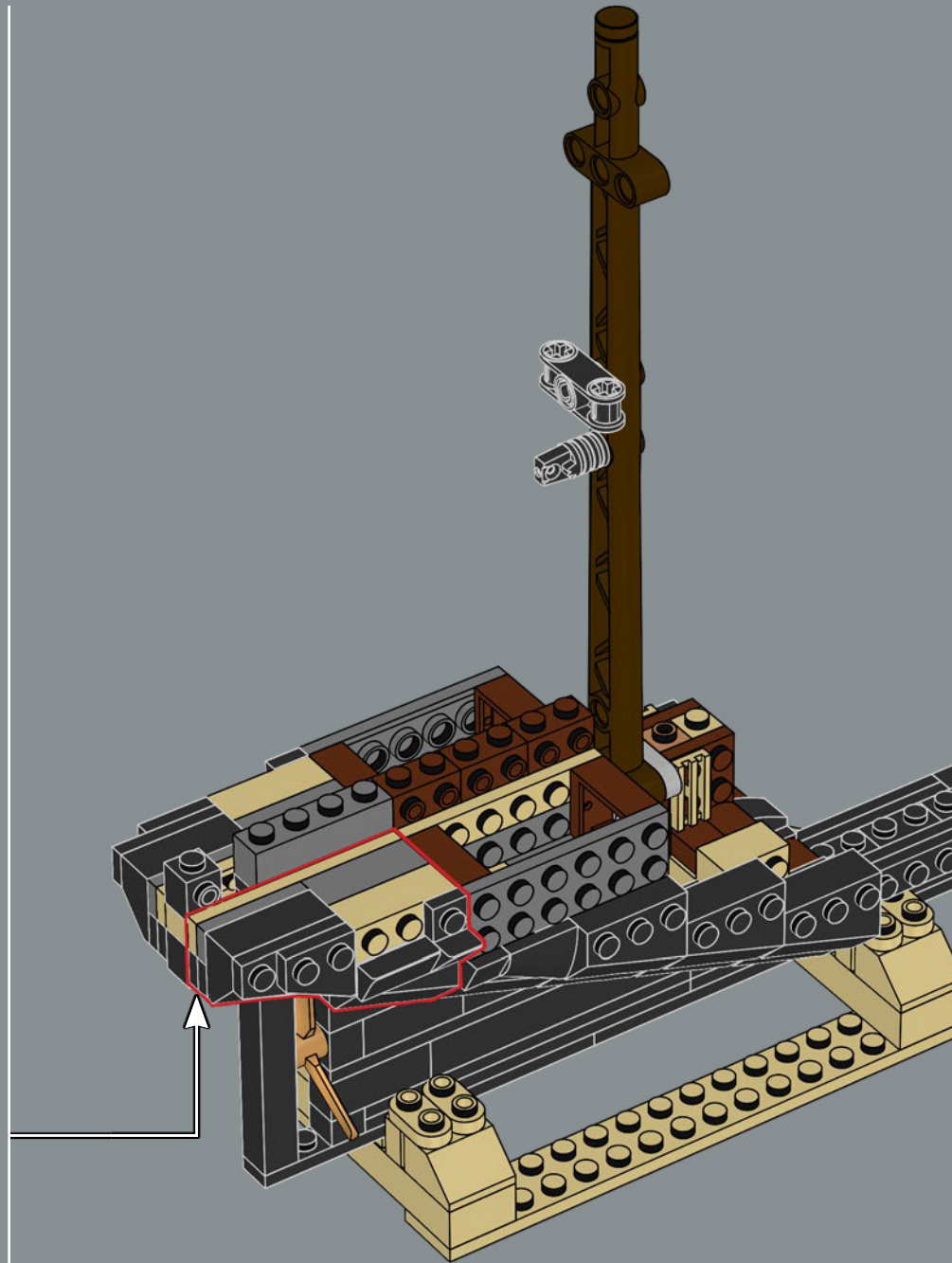
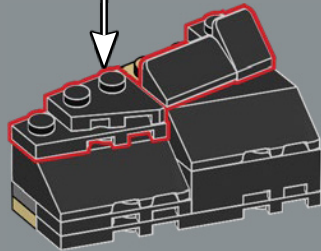
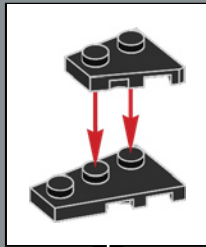

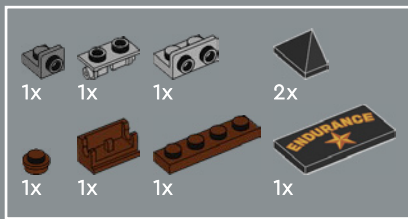

322

1

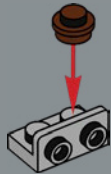

2

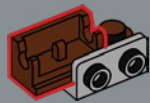

3

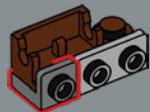

4

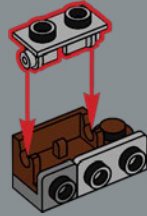

5

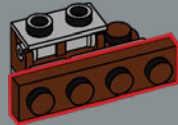

6

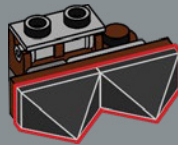

7



The *Endurance* was originally named *Polaris*. Whether Shackleton considered the name of the North Star unfit for an expedition to the South Pole, or whether he was inspired by his family motto, "By Endurance We Conquer", is unknown. Either way, the star stayed on!

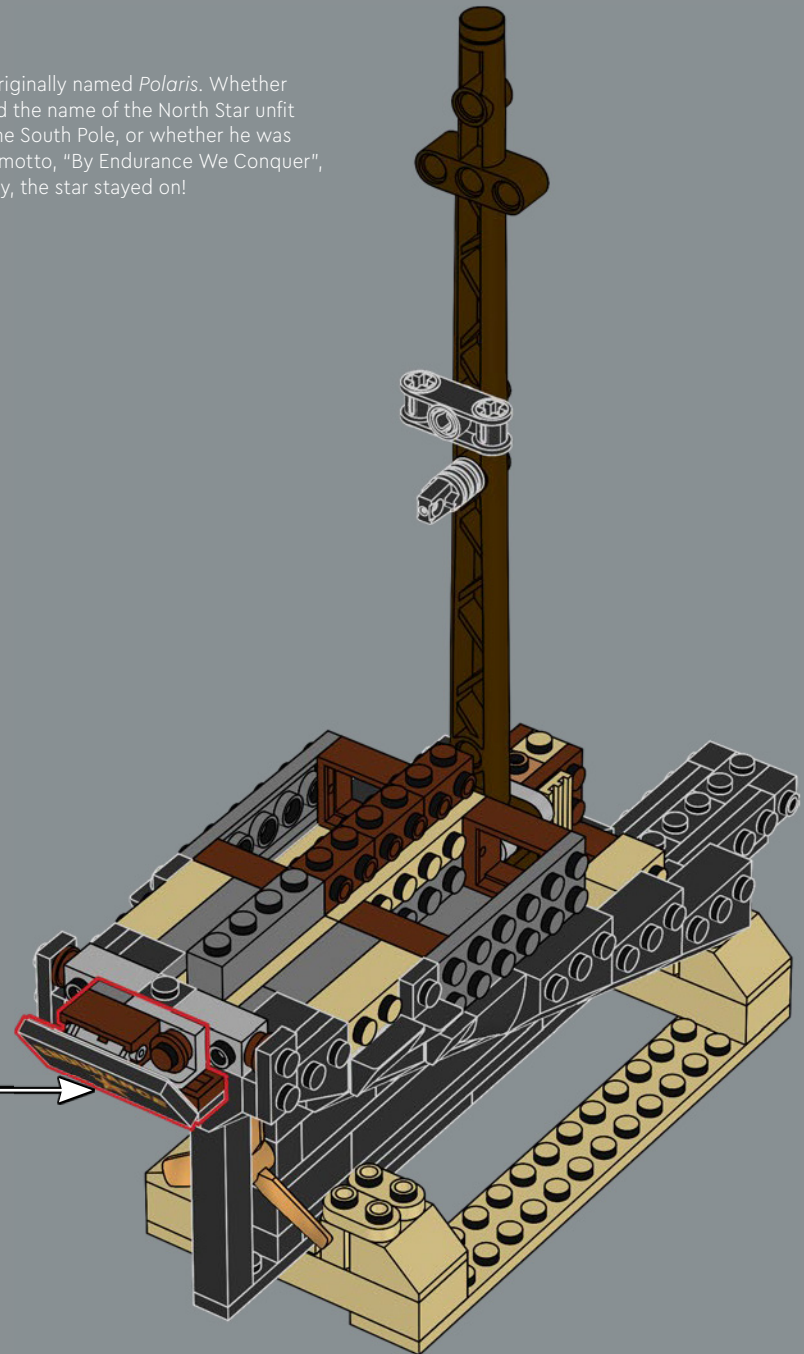

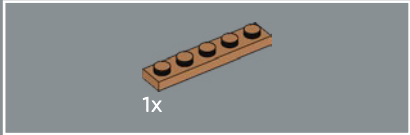
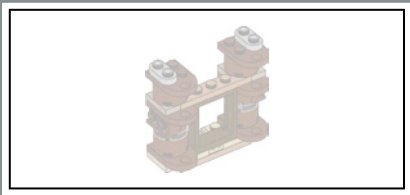

323

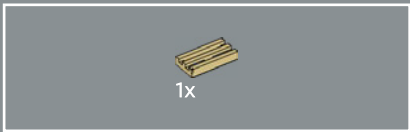
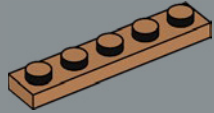

324

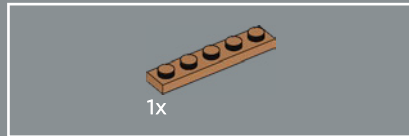
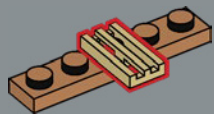

325

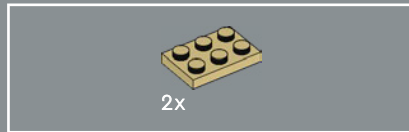
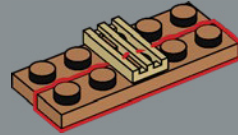

326

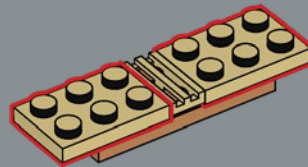

327

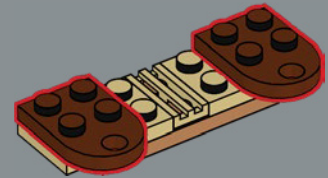

328

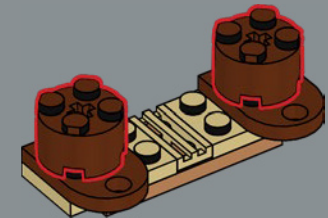



329

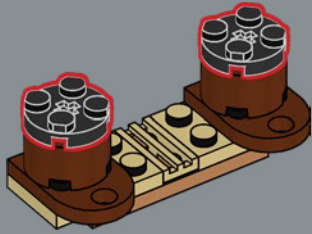

330

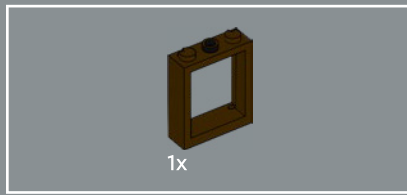
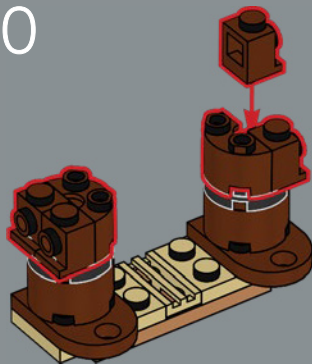

331

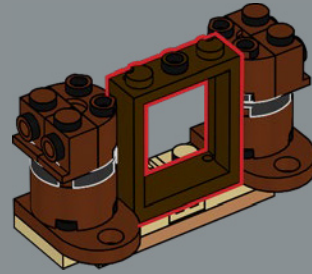

332

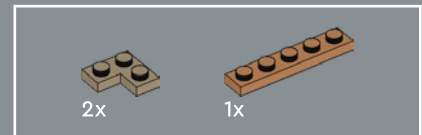
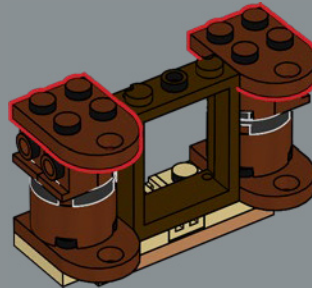

333

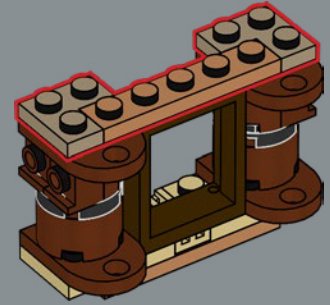

334

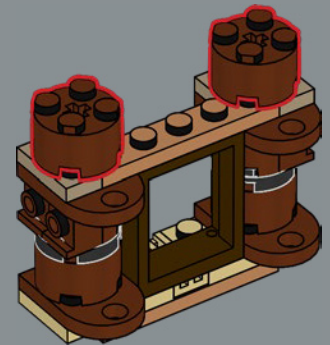



335

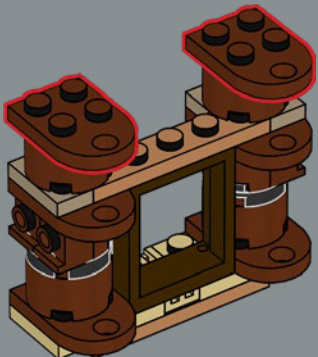

336

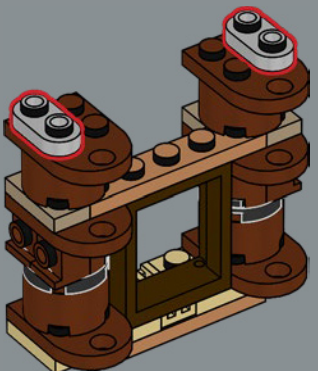

337

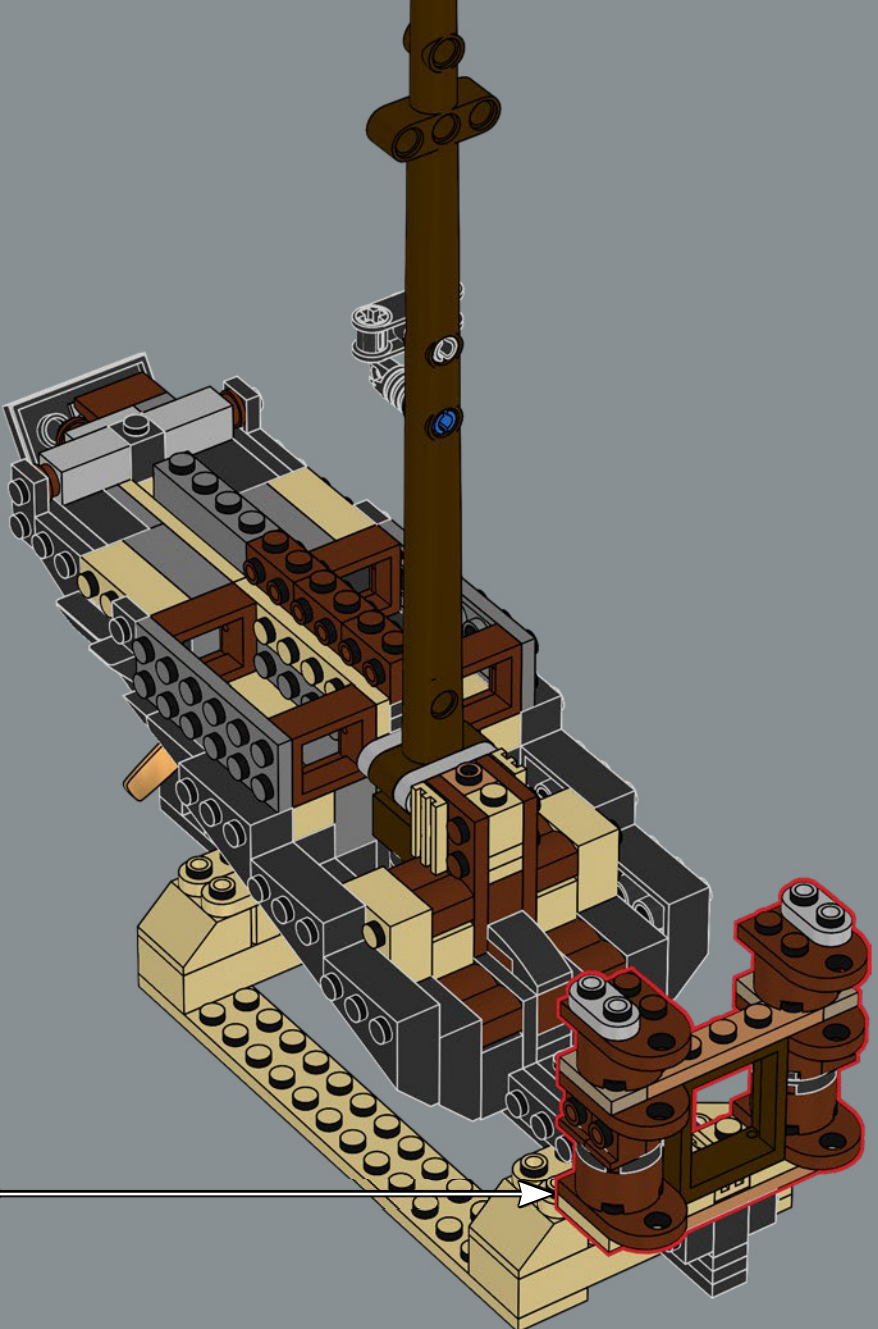

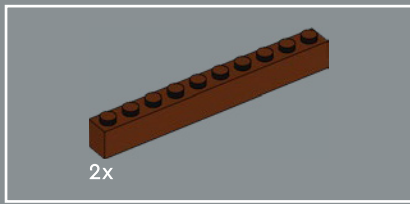

338

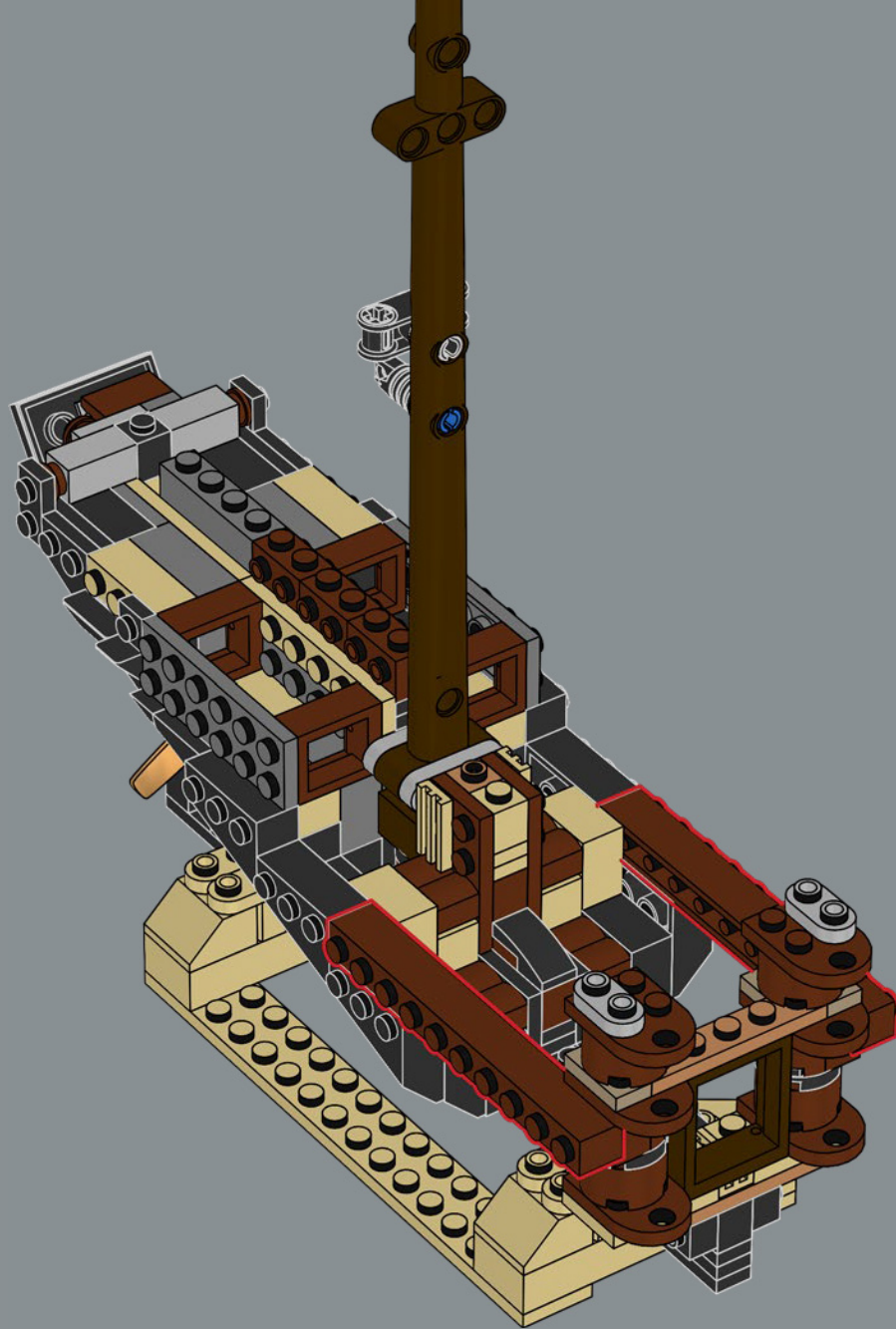

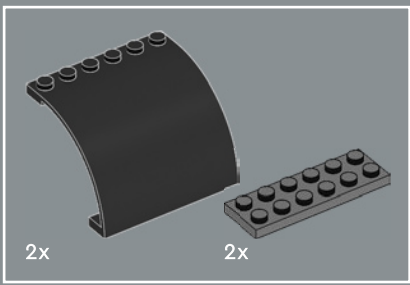

339

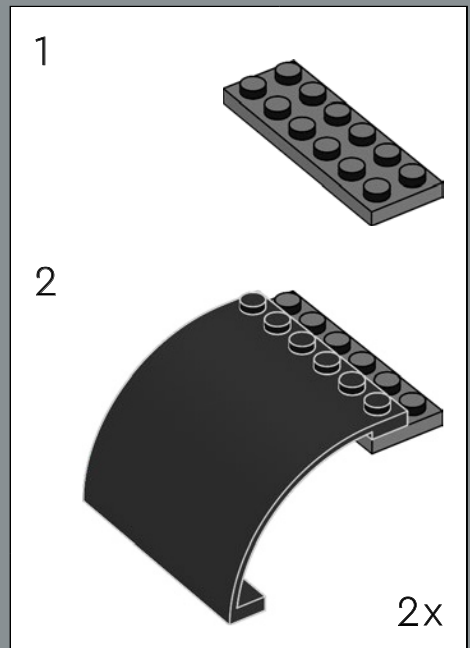
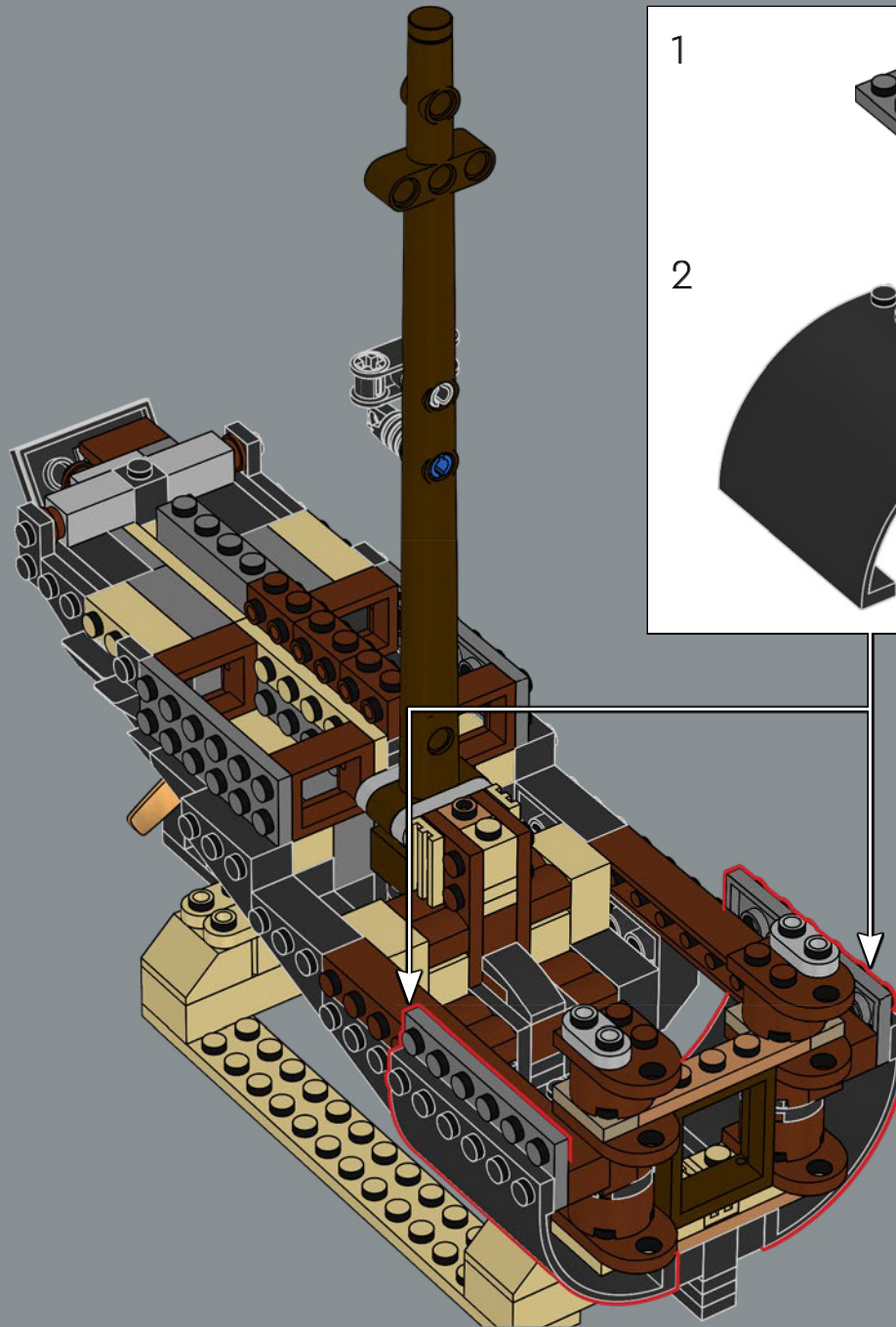

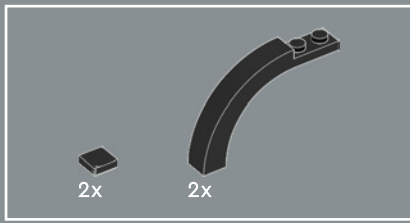

340

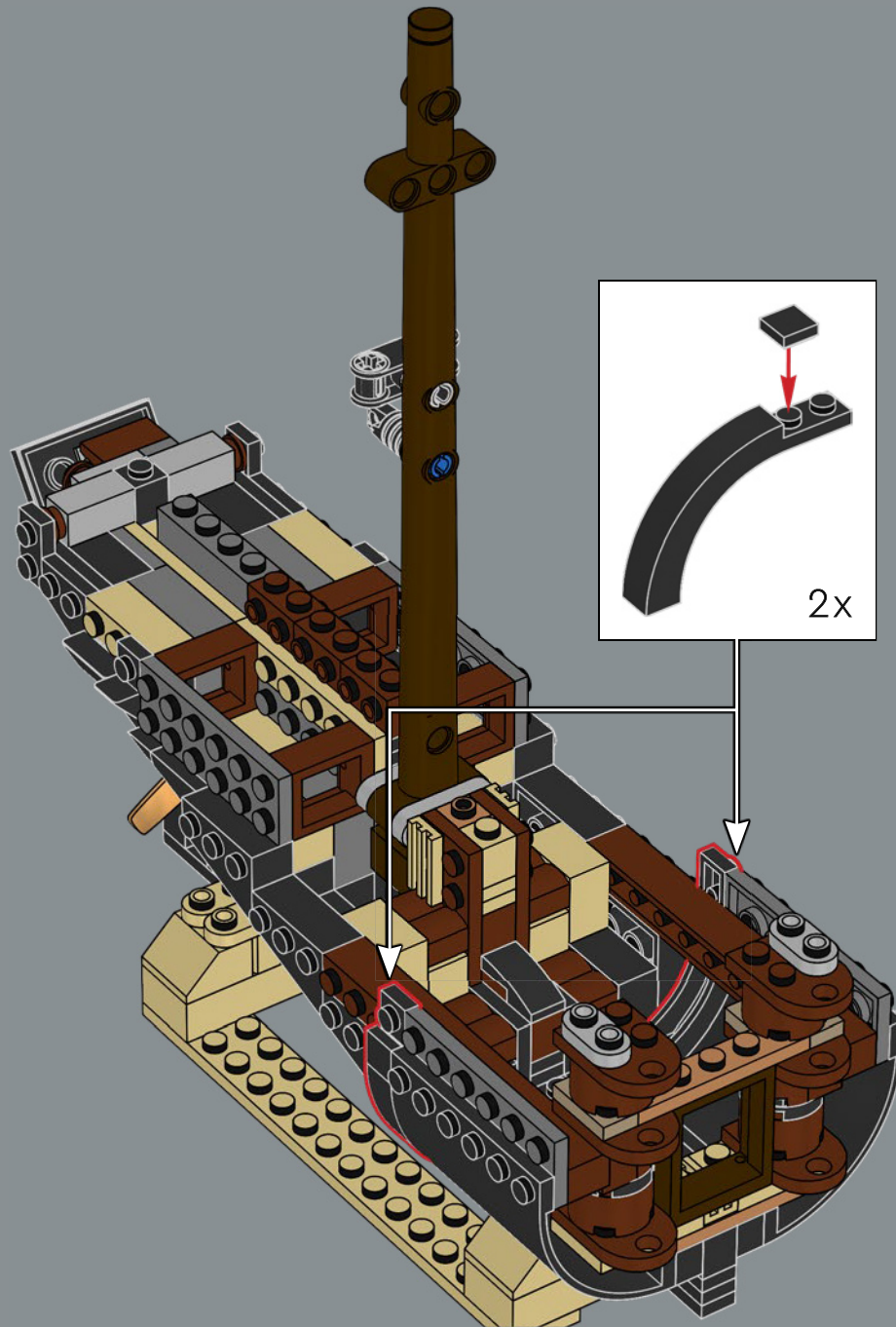

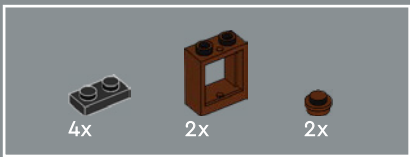

341

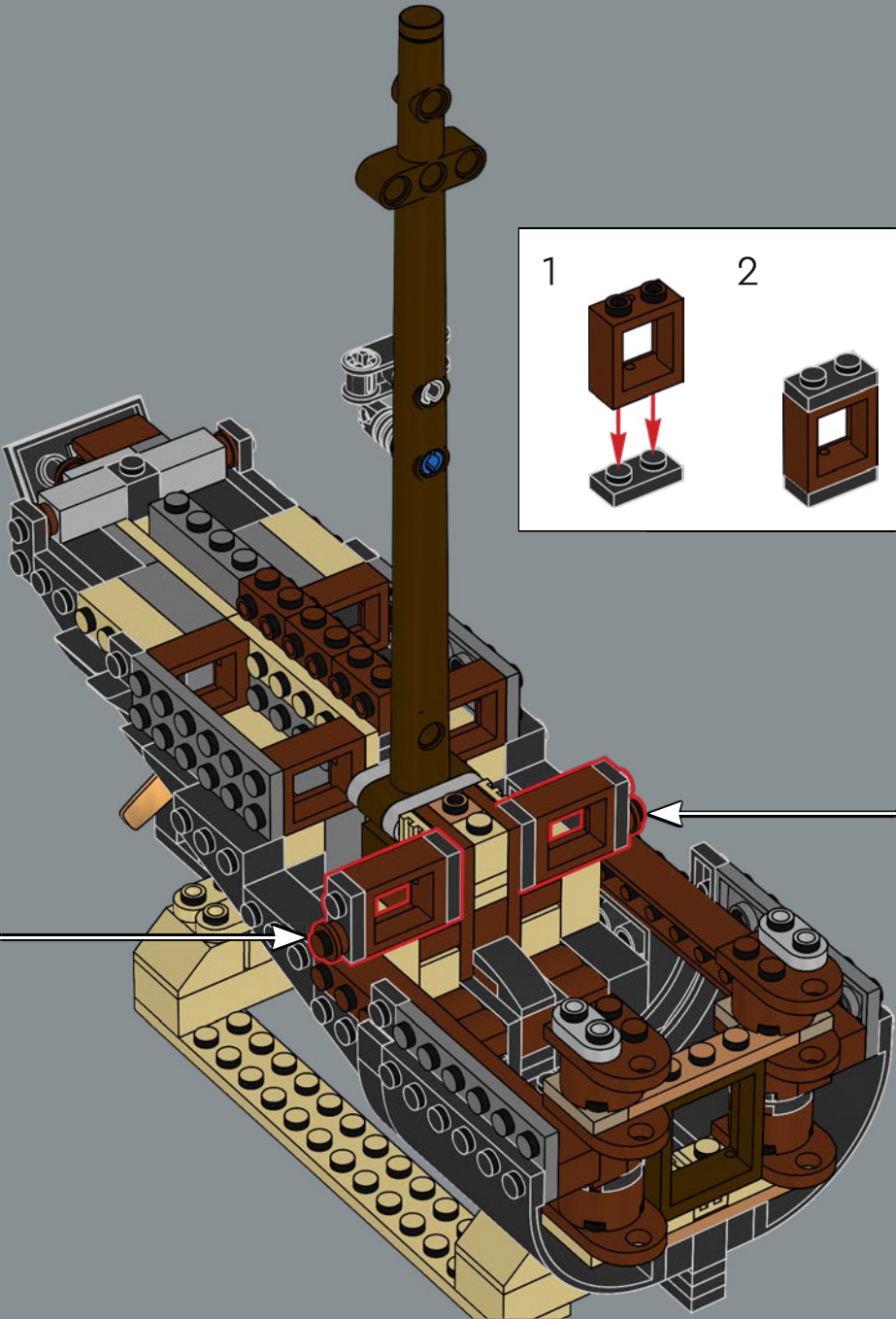
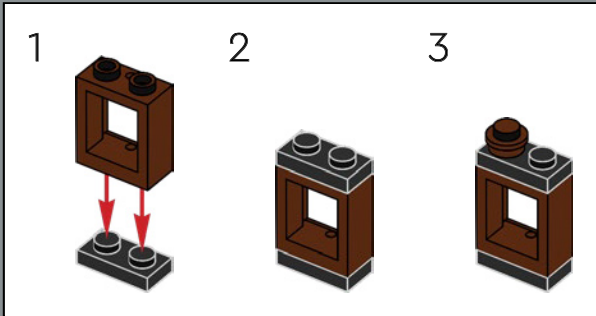
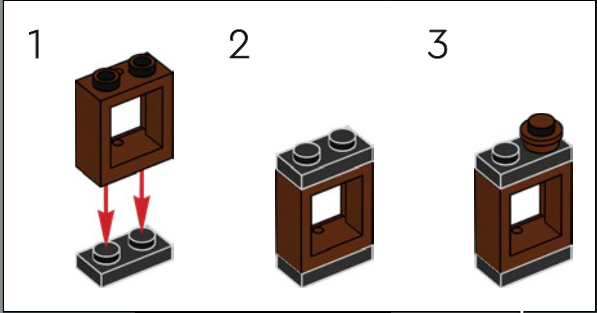

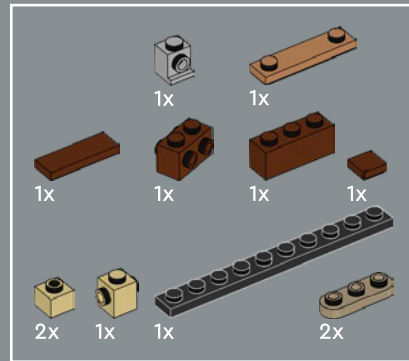
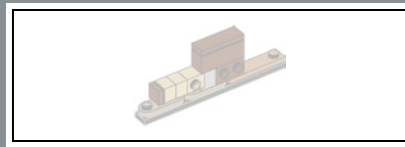

342

1

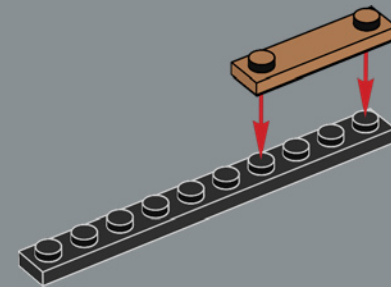

2

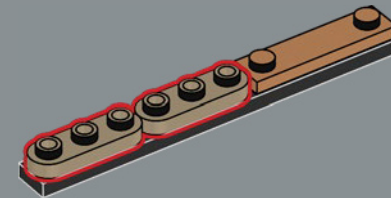

3

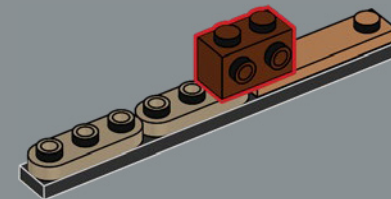

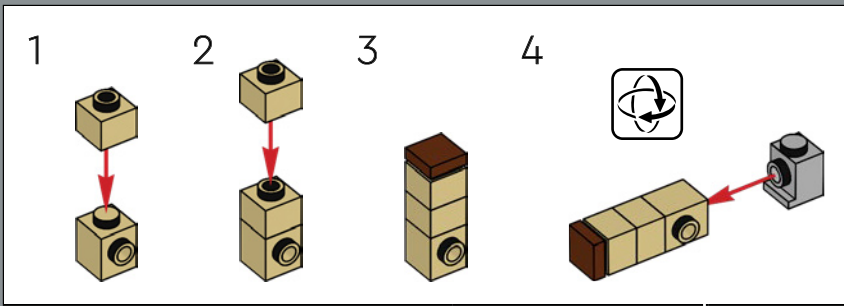

4

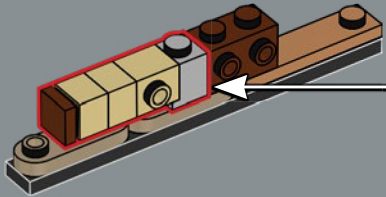

5

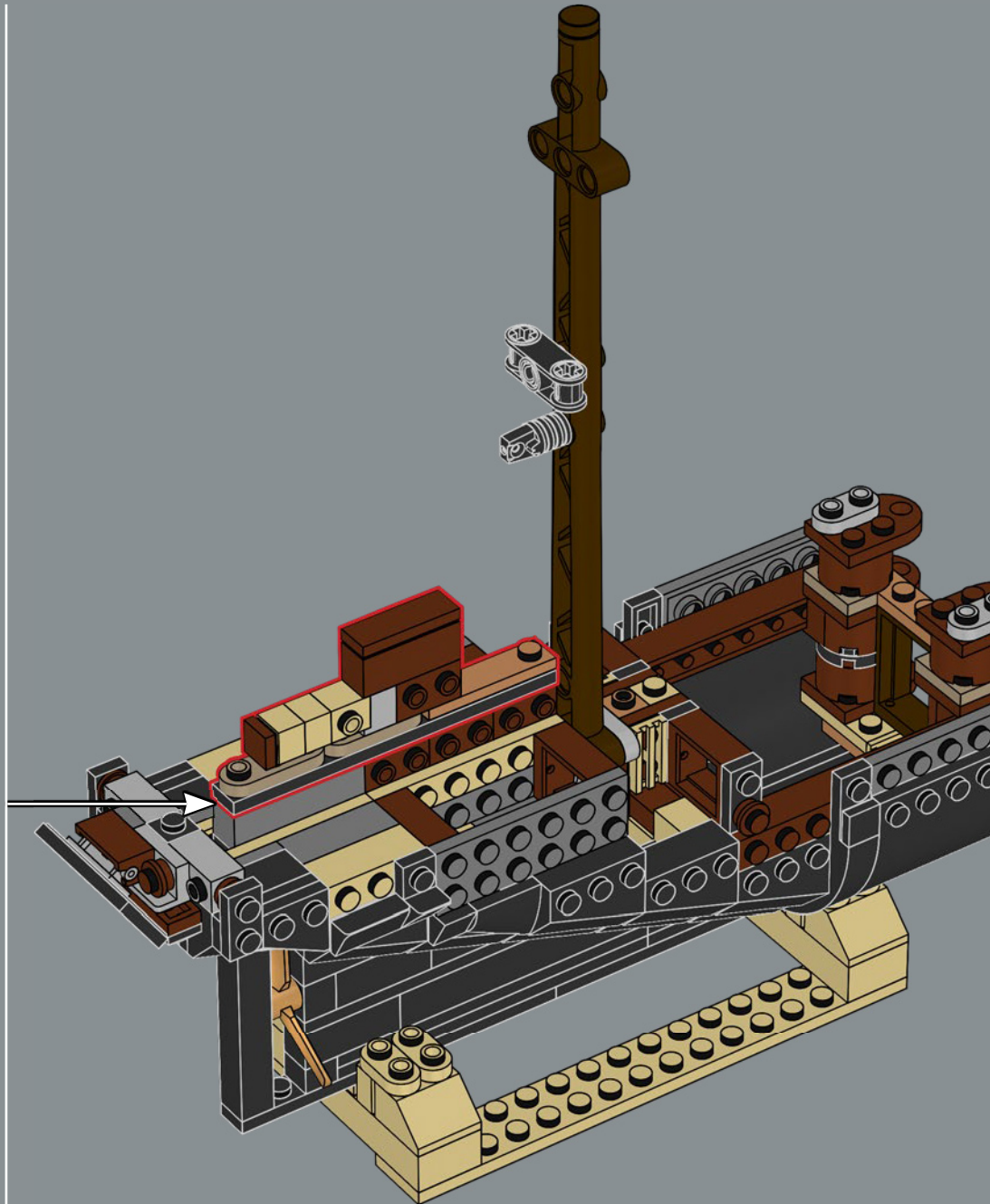
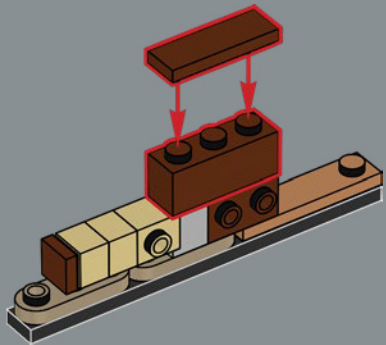

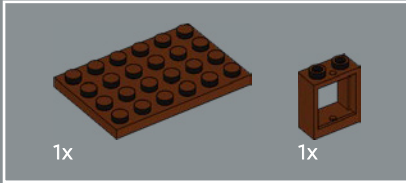
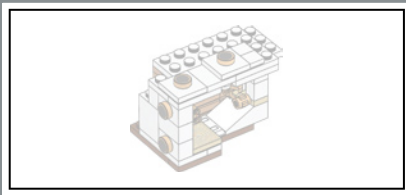

343

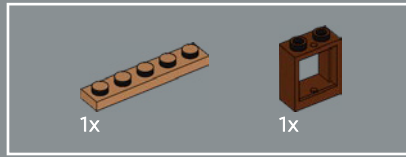
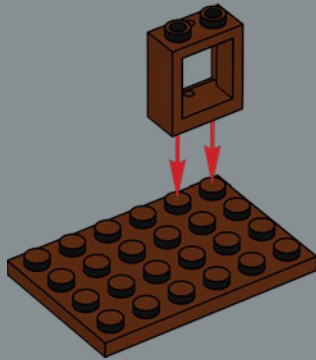

344

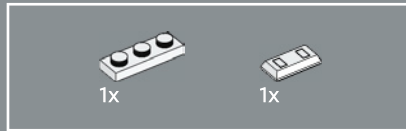
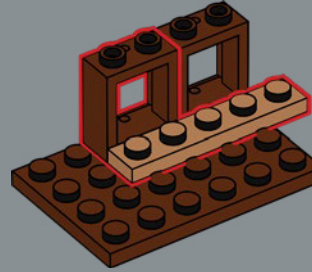

345

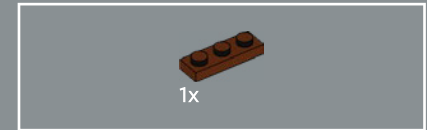
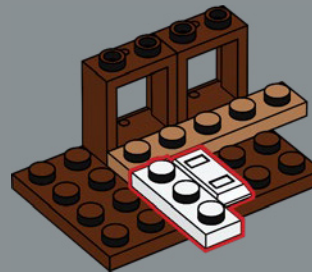

346

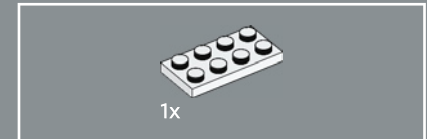
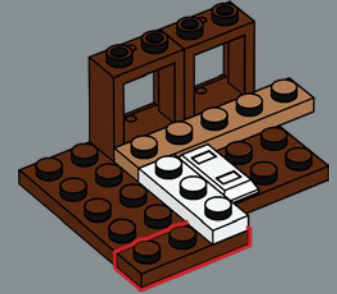

347

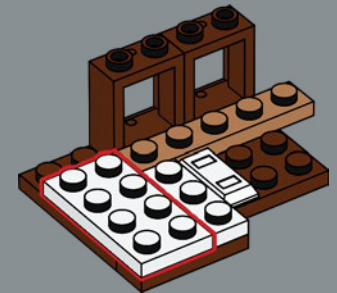

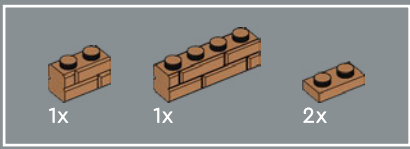

348

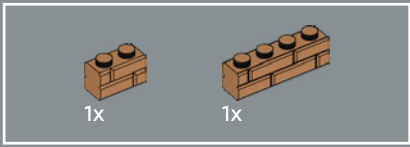
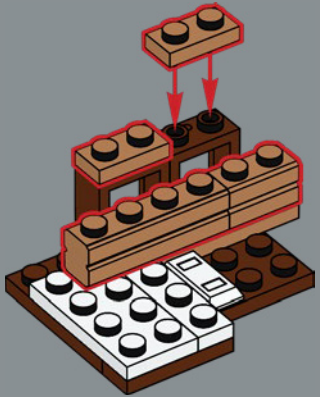

349

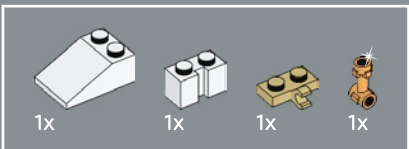
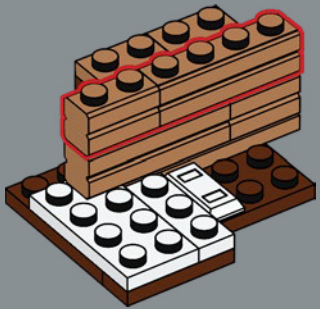

350

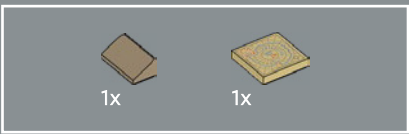
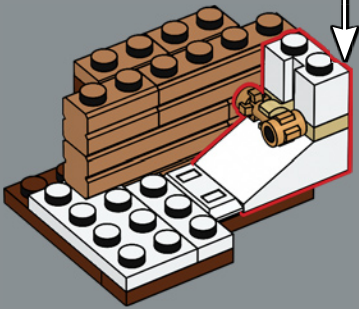
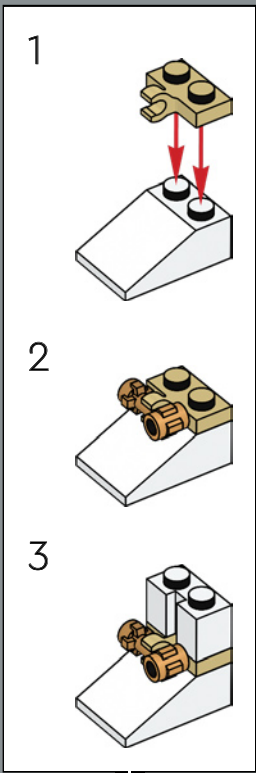

351

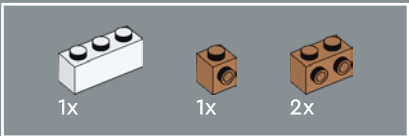
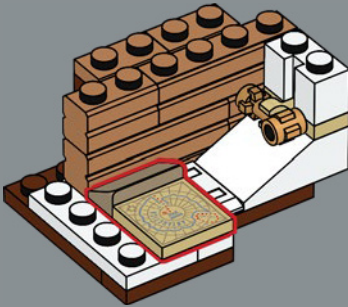

352

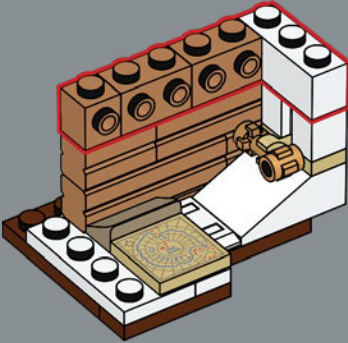

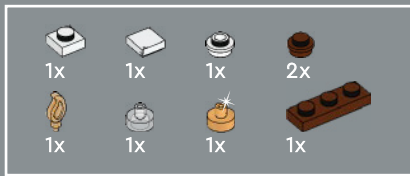

353

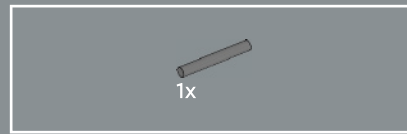
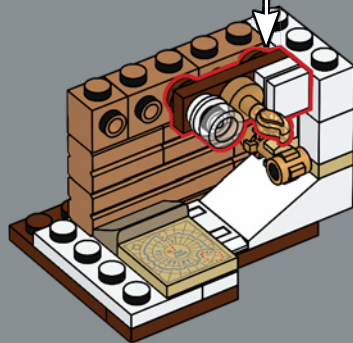
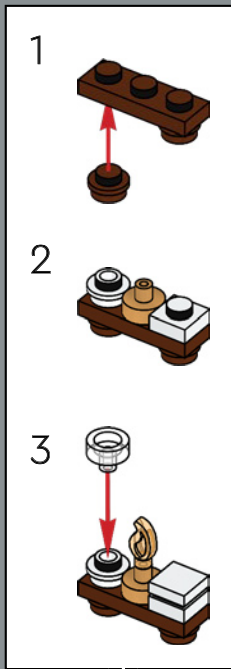

354

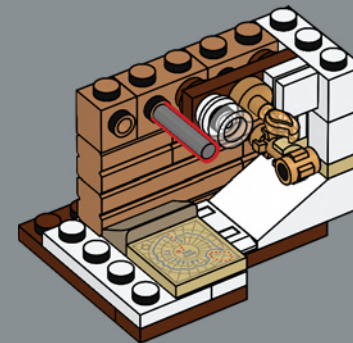

The dark-grey vertical sticks inside the cabins are steam heating pipes. The scientist's cabin features an exclusive LEGO® map of Antarctica.

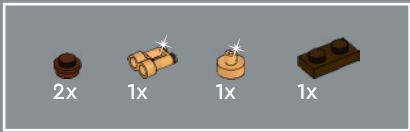

355

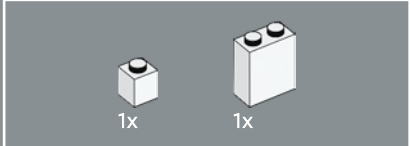
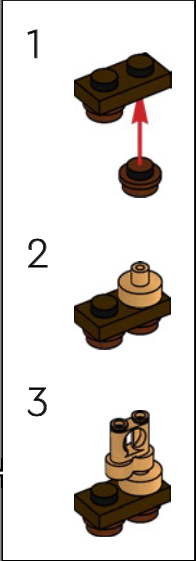
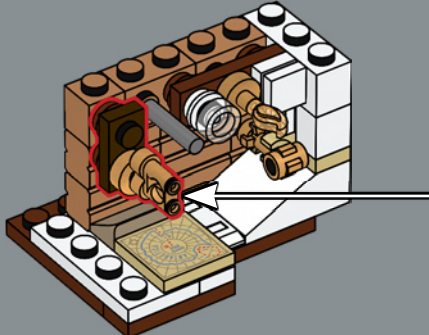

356

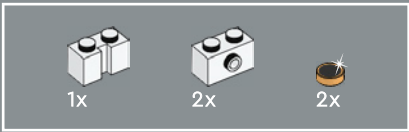
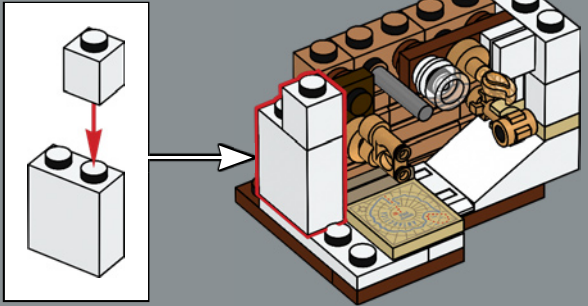

357

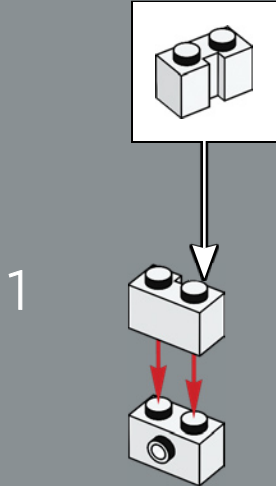

2

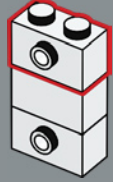

3

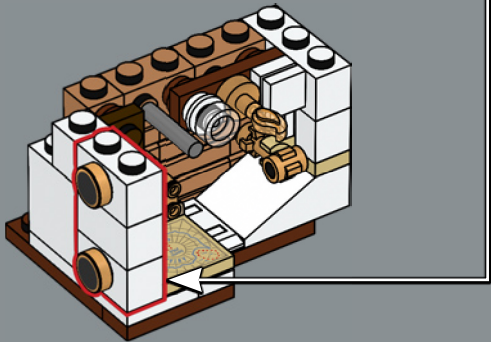
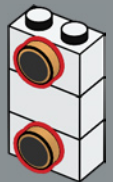

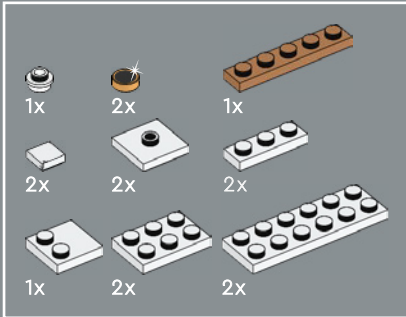
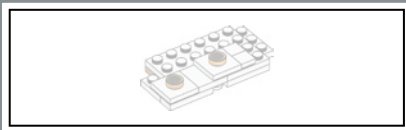

358

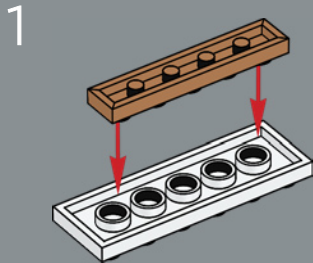

2

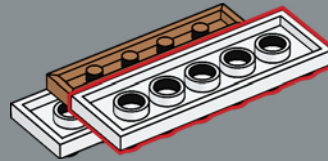

3

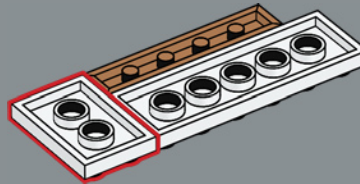

4

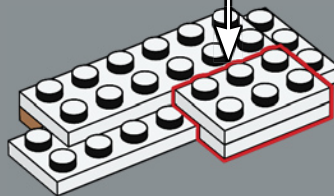
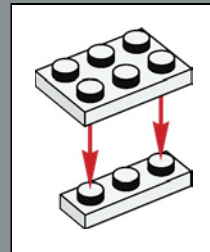

5

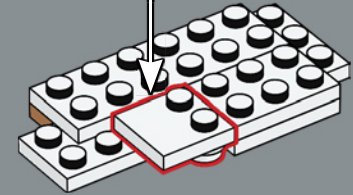
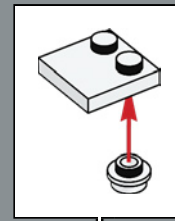

6

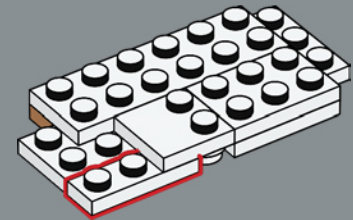

7

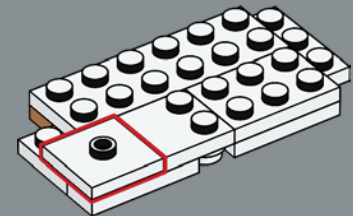

8

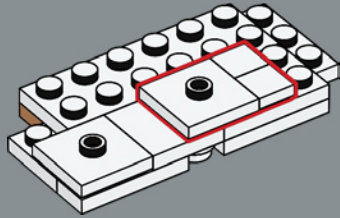

9

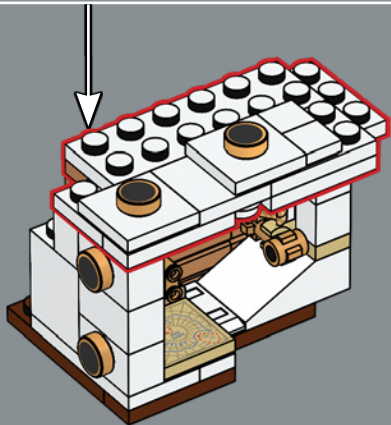
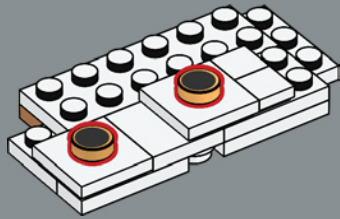

359

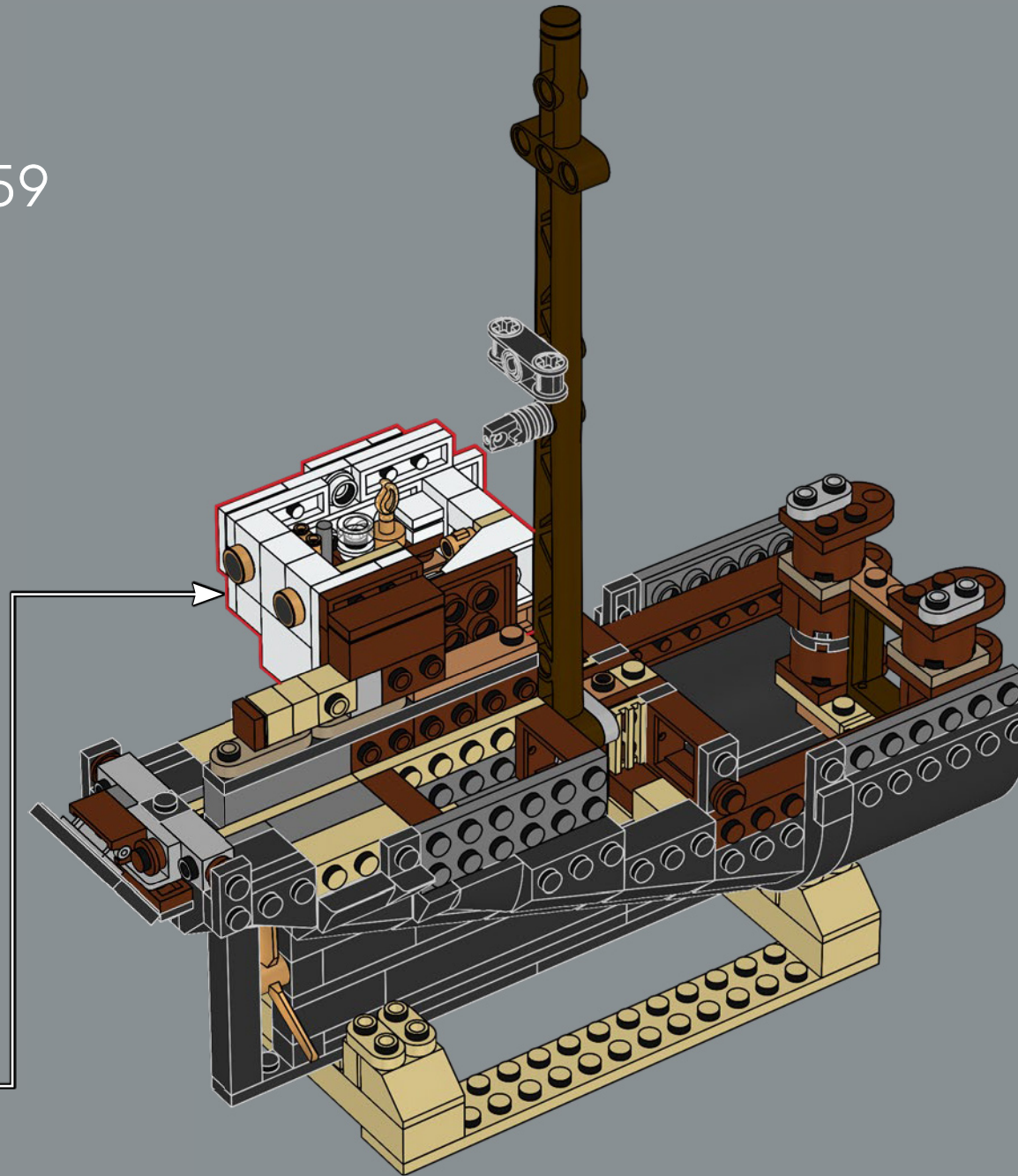

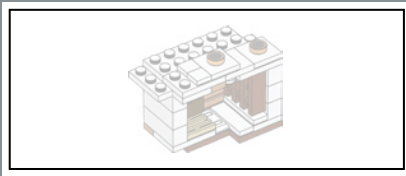

360

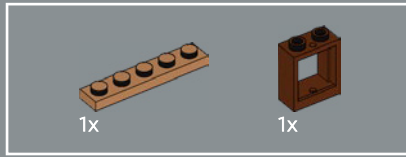
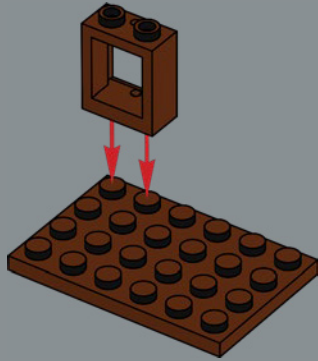

361

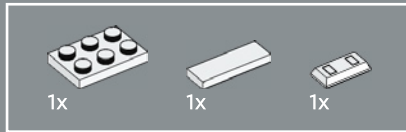
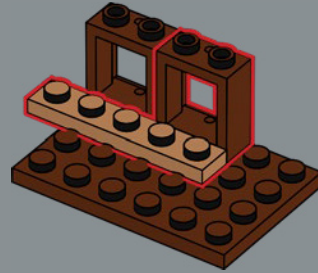

362



363

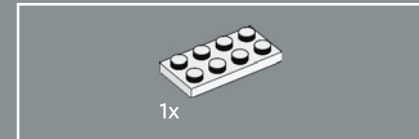
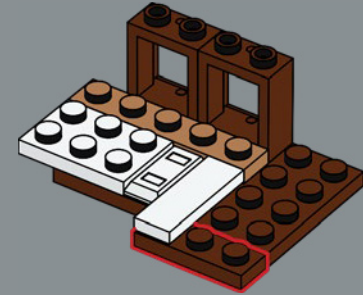

364



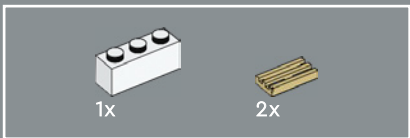

365

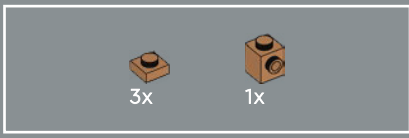
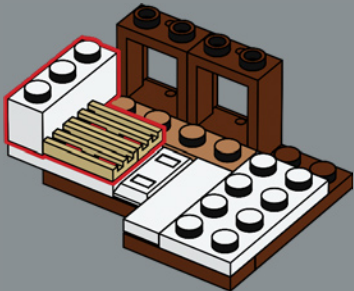

367

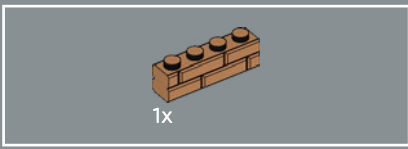
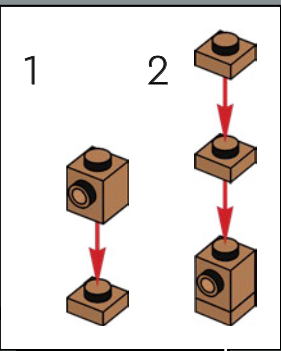
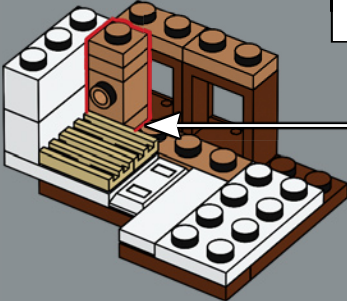

369

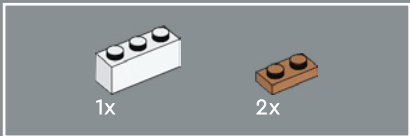
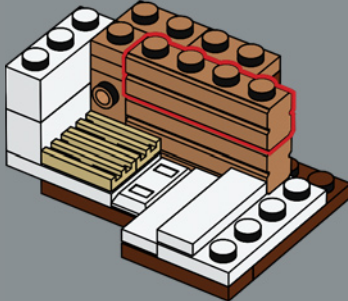

366

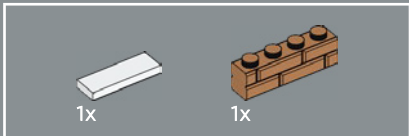
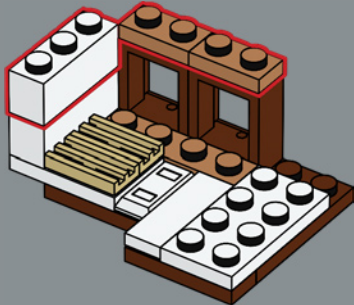

368

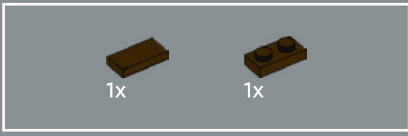
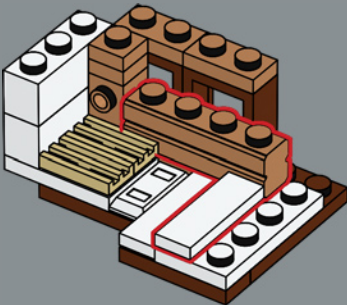

370

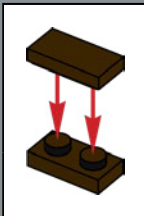
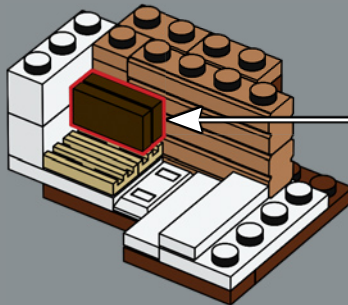

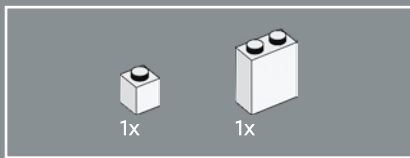

371

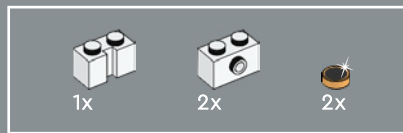
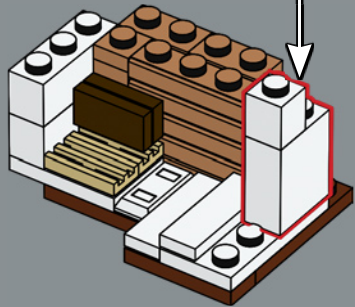
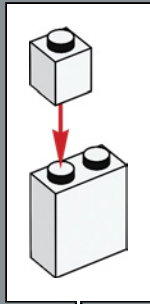

372

1

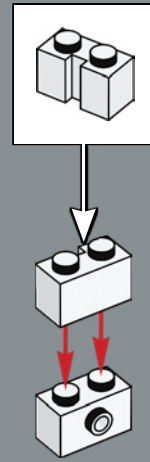

2

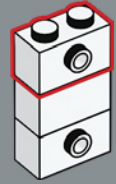

3

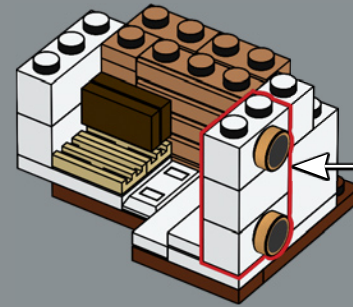
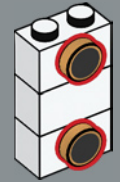

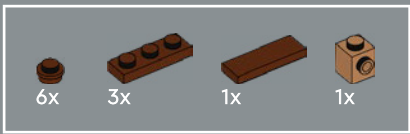

373

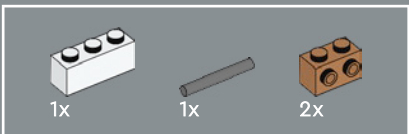
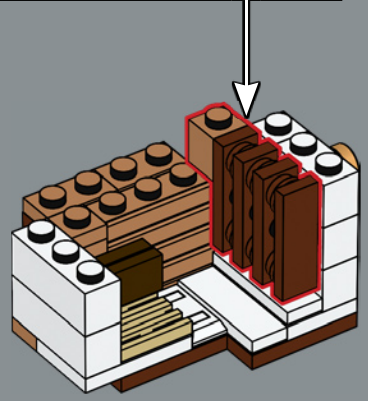
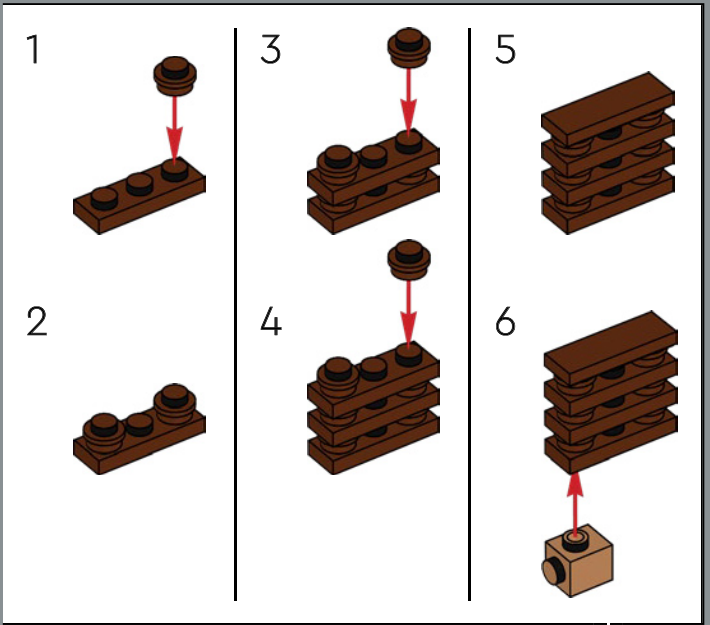

374

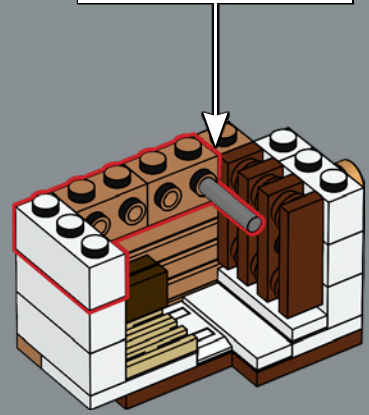
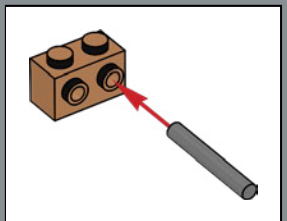

375

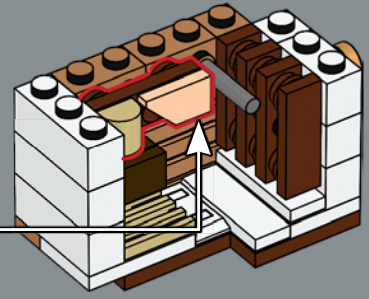
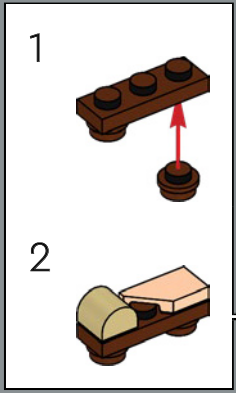

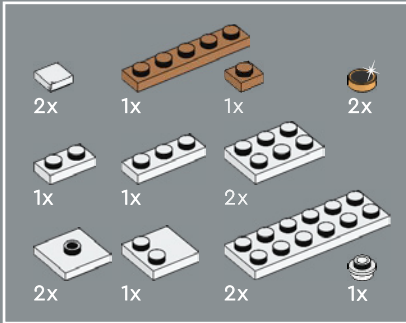
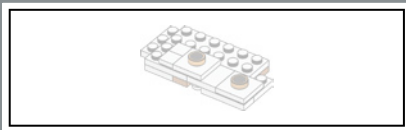

376

1

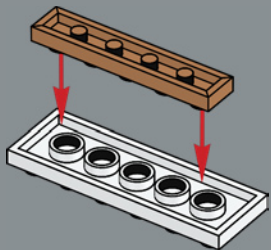

2

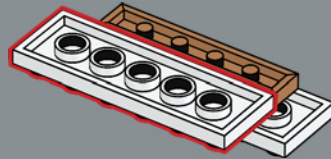

3

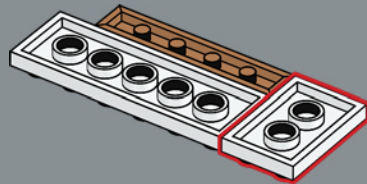

4

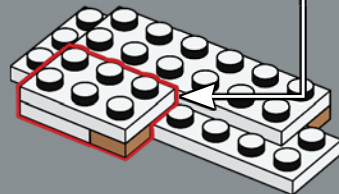
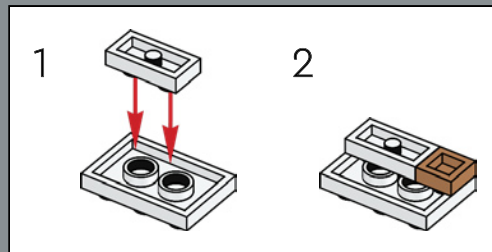

5

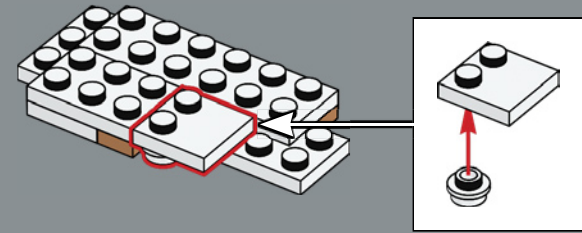

6

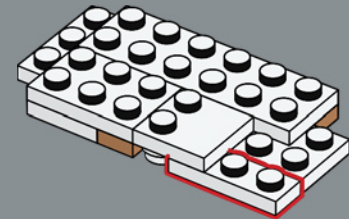

7



8

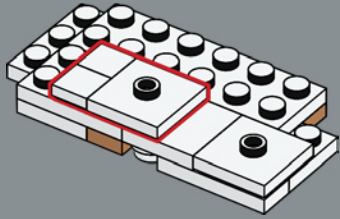

9

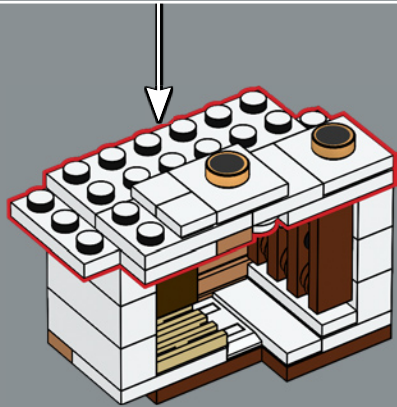
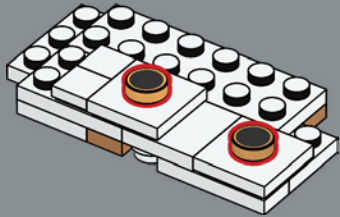

377

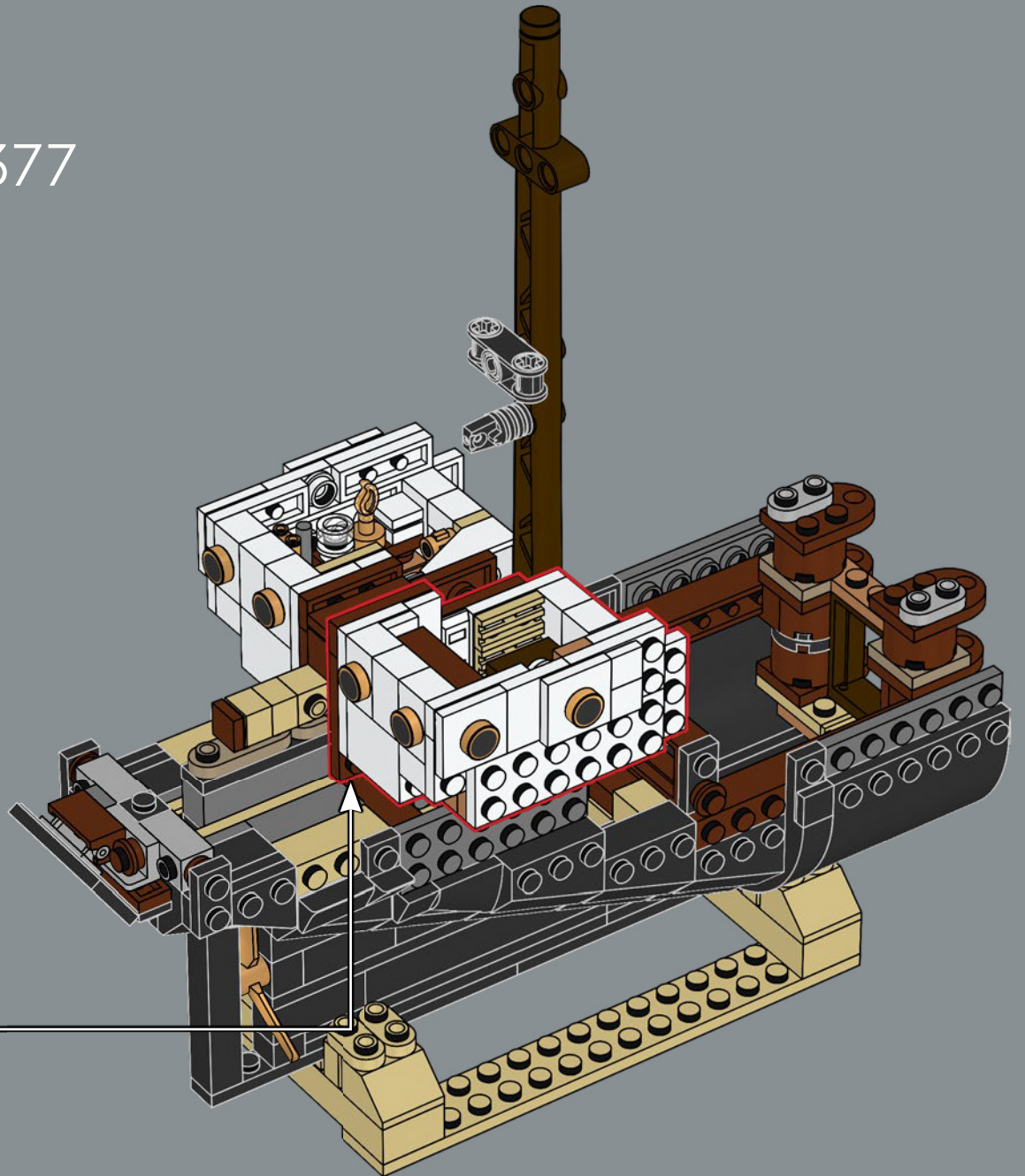

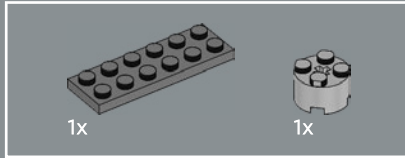
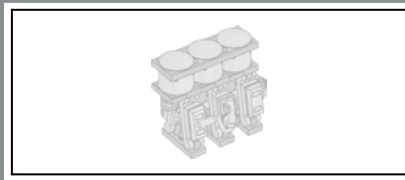

378

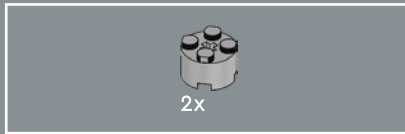
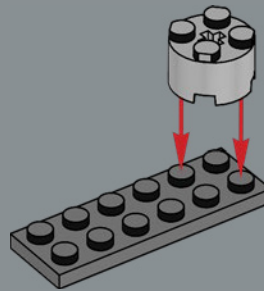

379

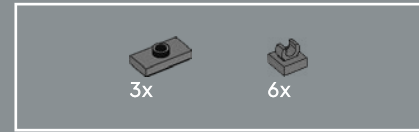
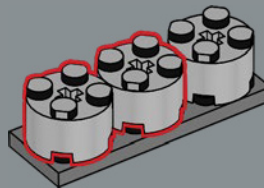

380

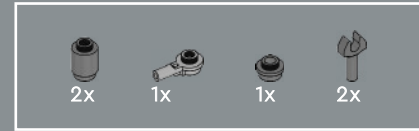
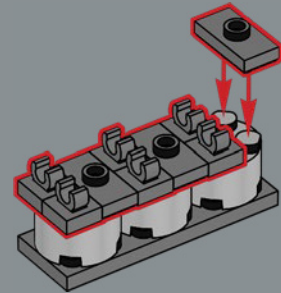

381

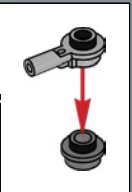
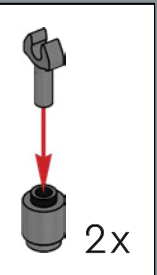
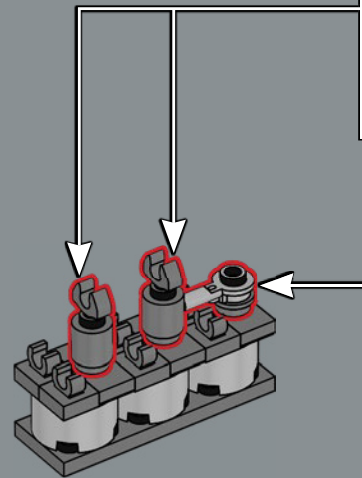

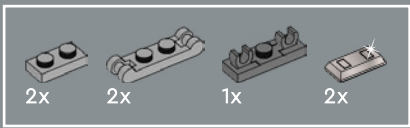

382

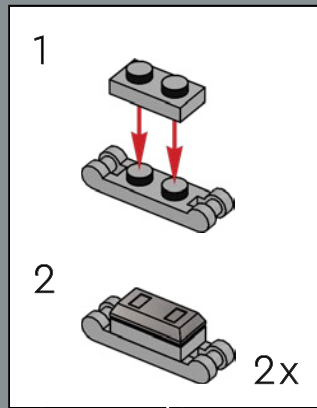

1

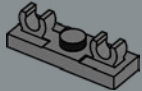

2

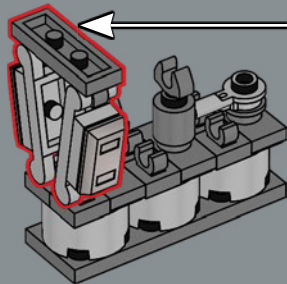
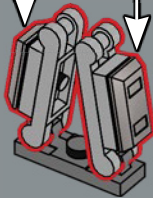

383

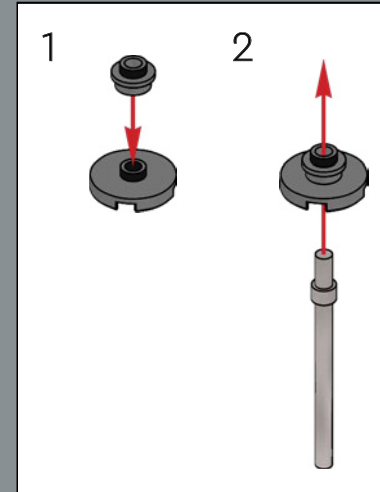

1

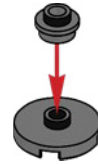

2

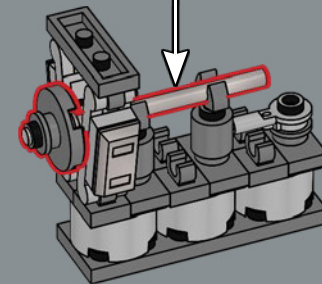
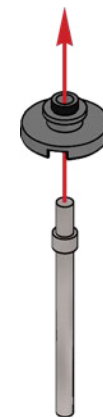

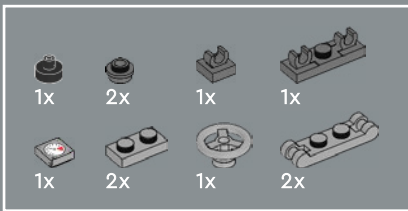

384

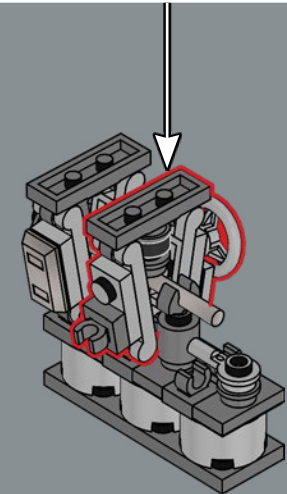
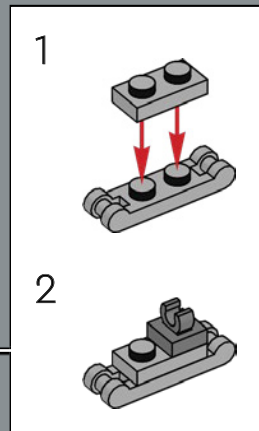
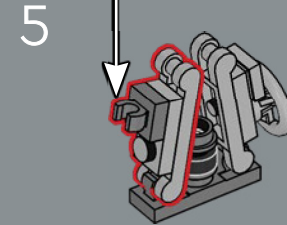
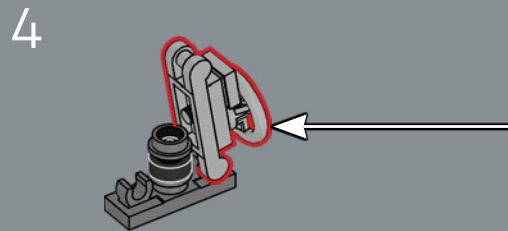
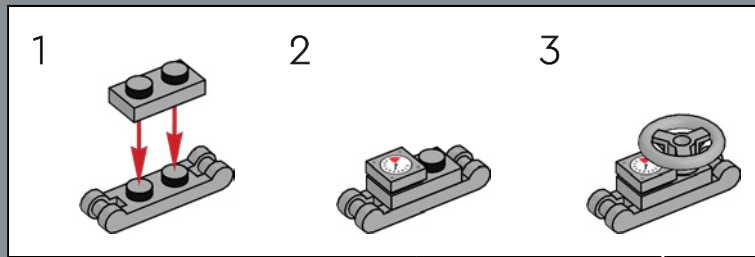
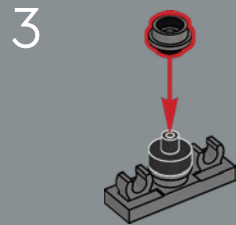
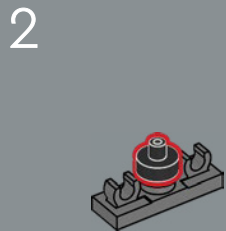
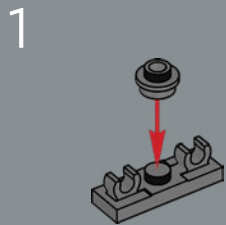

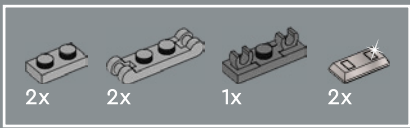

385

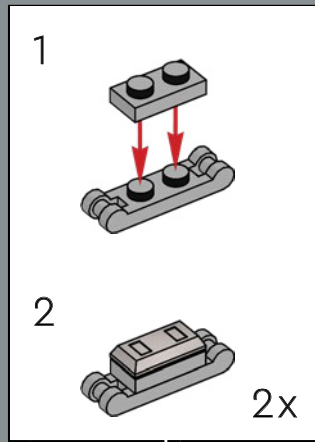

1

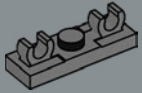

2

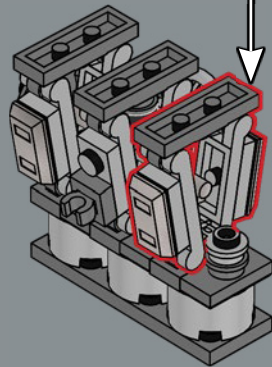
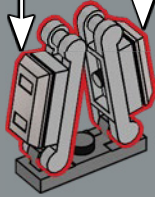

386

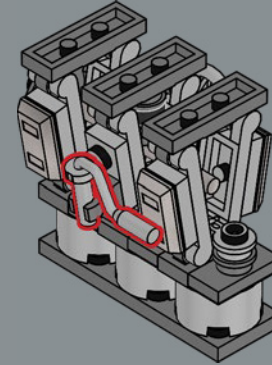

387

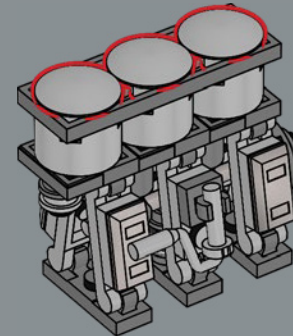



The 'triple-expansion steam engine' can be removed from the engine room and put on display.

388

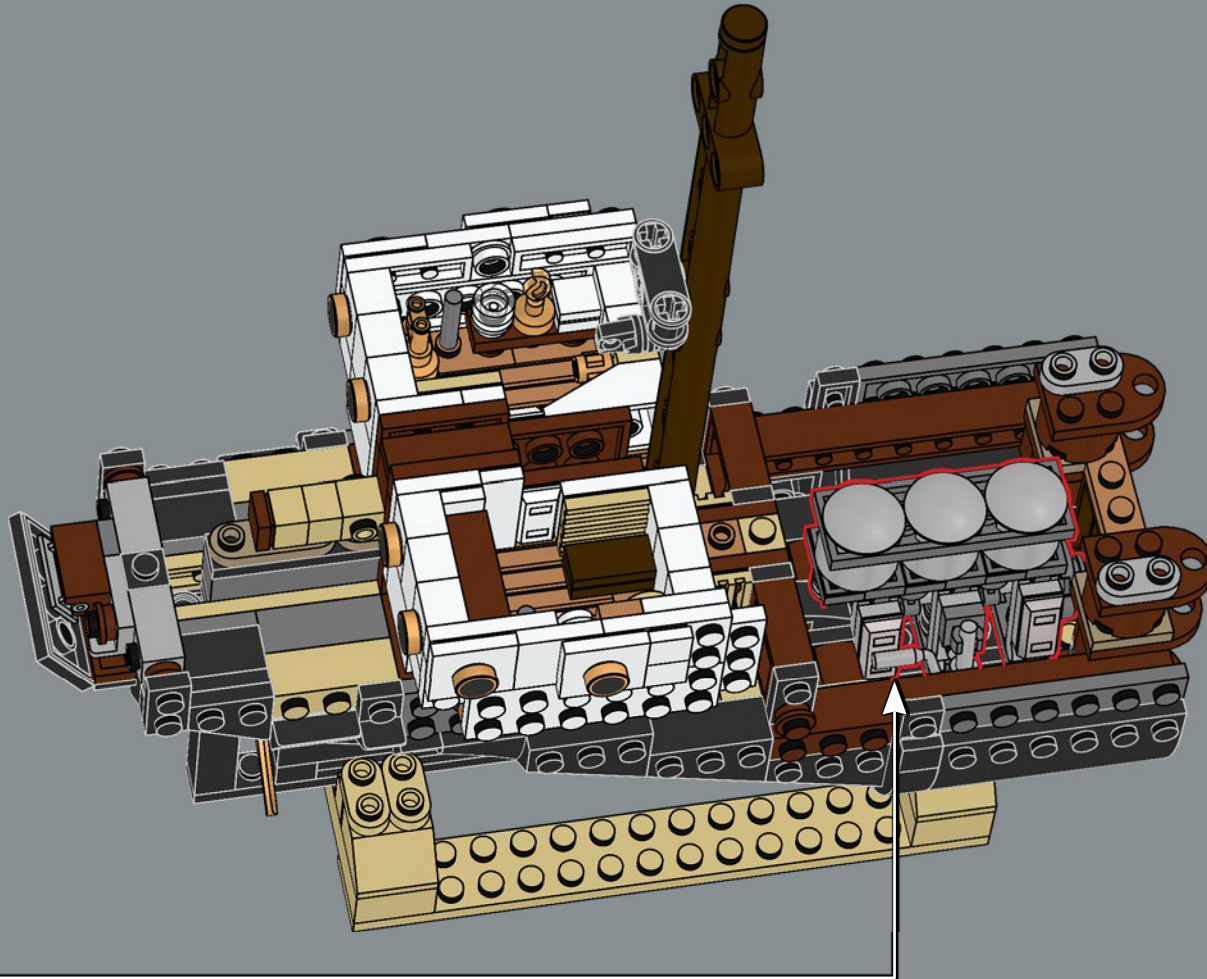

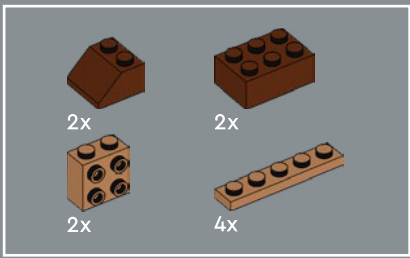

389

1

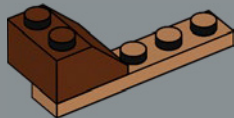

2

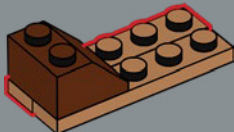

3

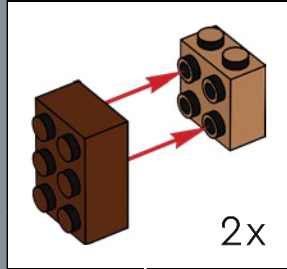
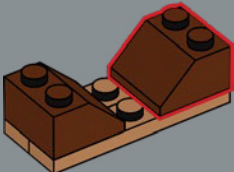

4

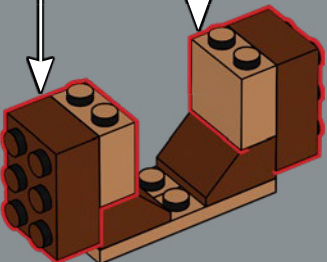

5

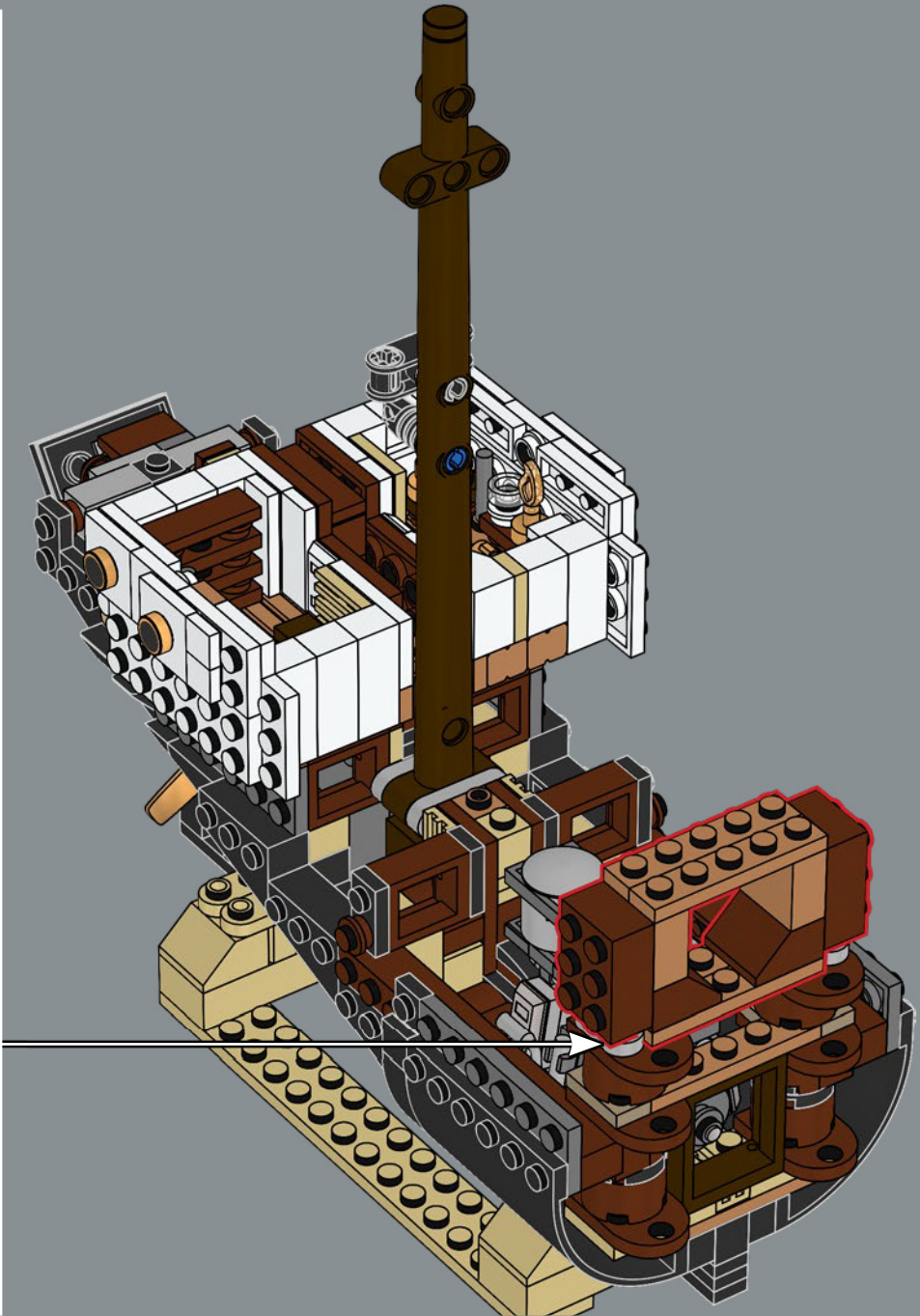
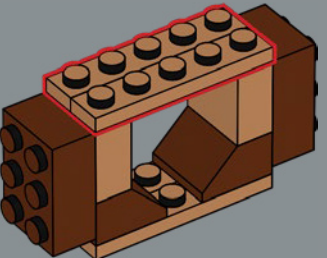

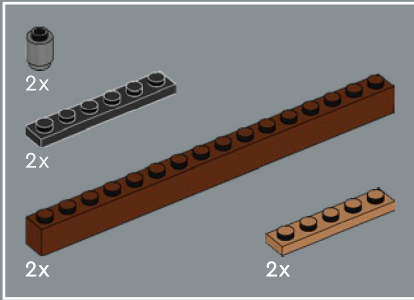
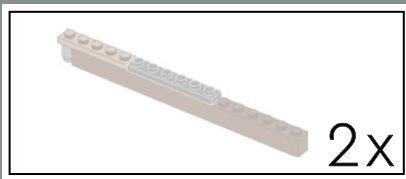

390

1

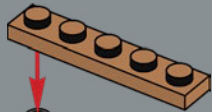

2

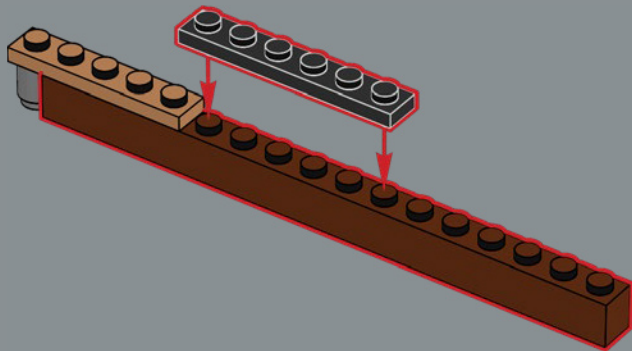

2x

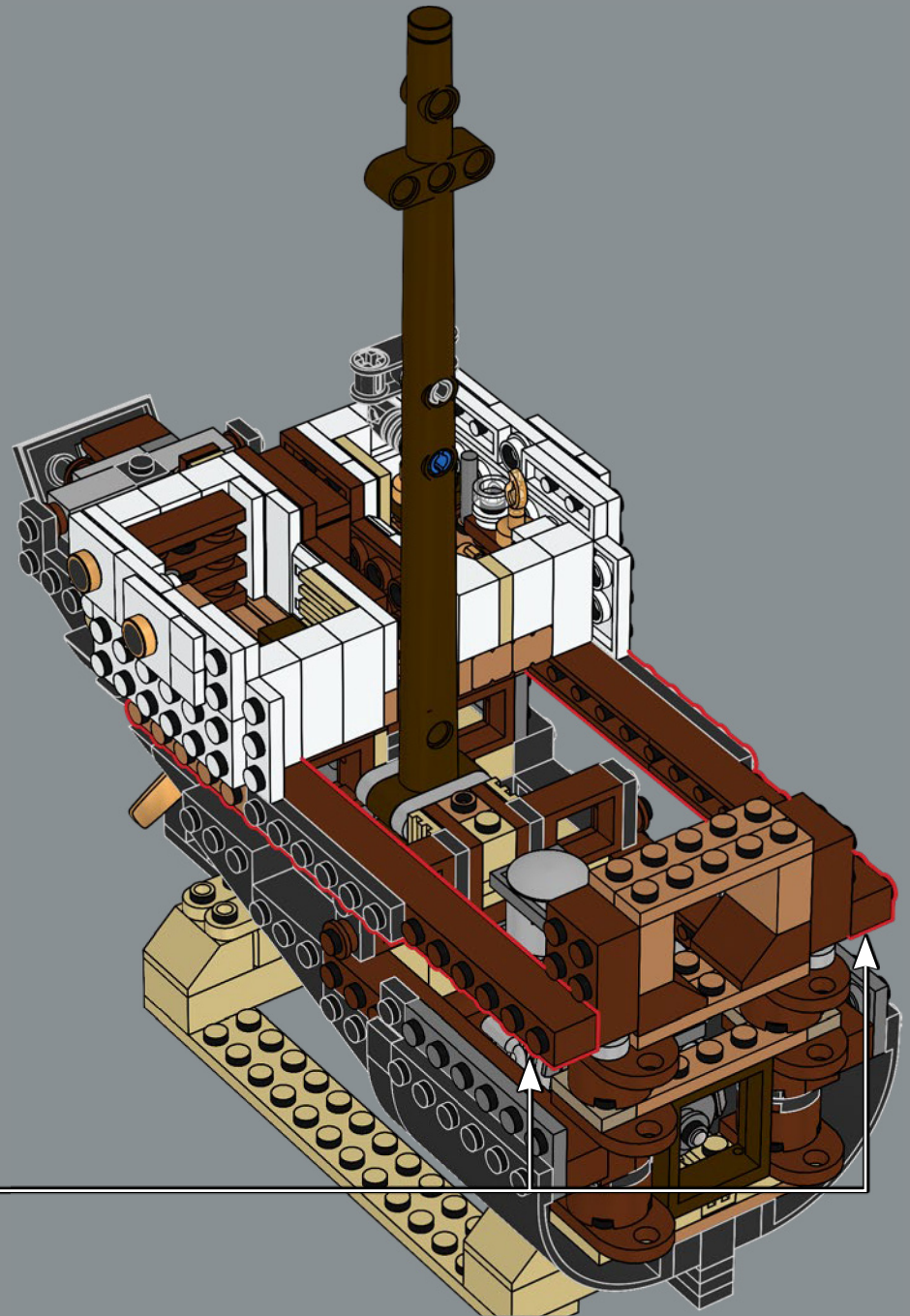

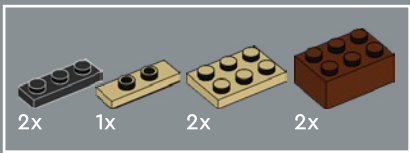

391

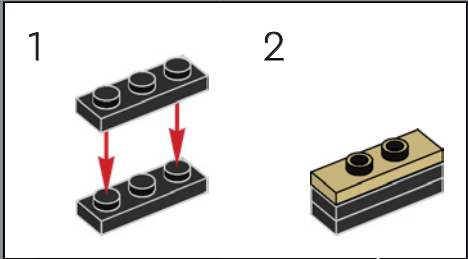
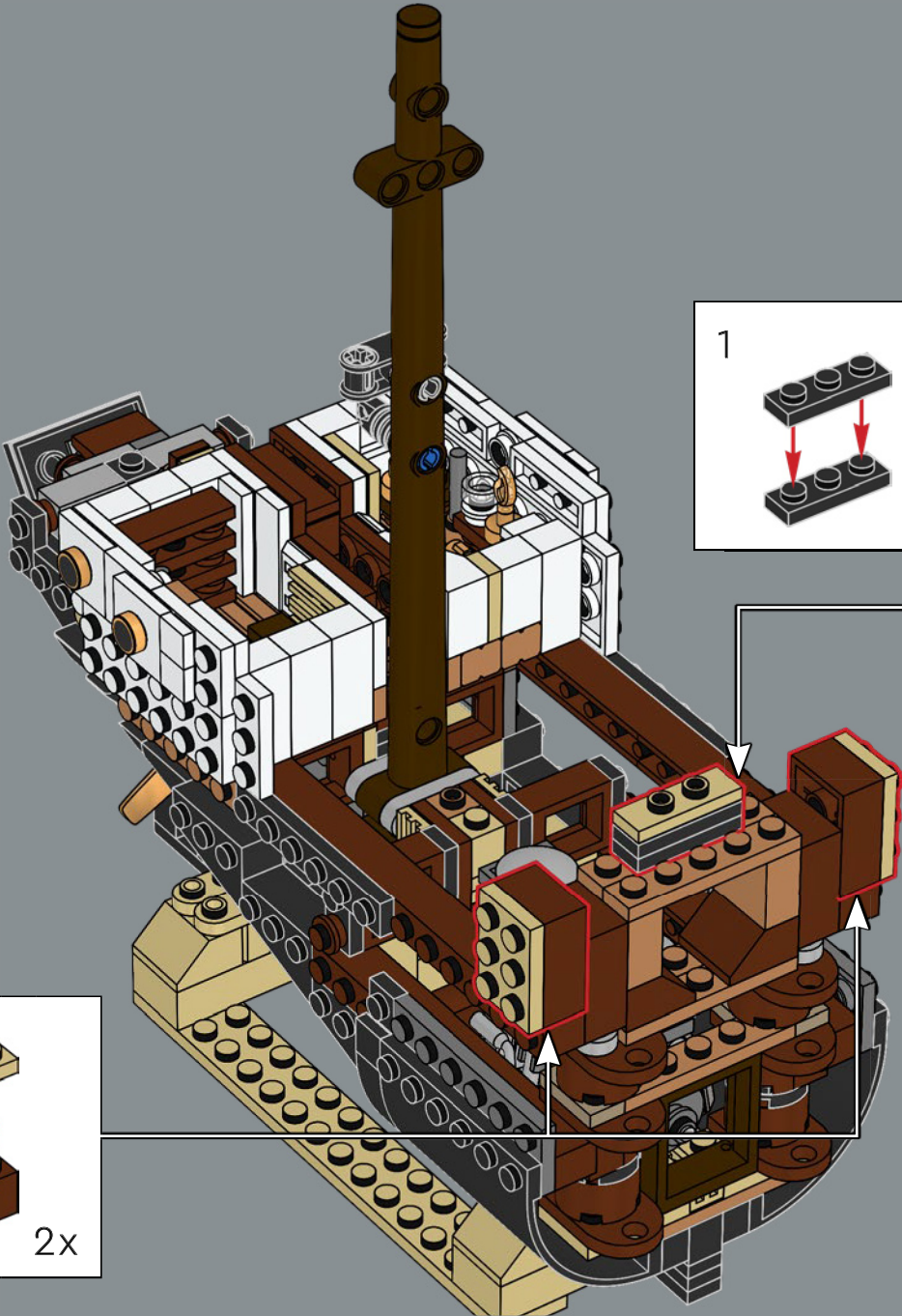

2

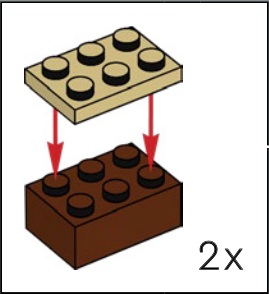
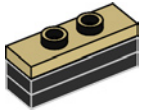

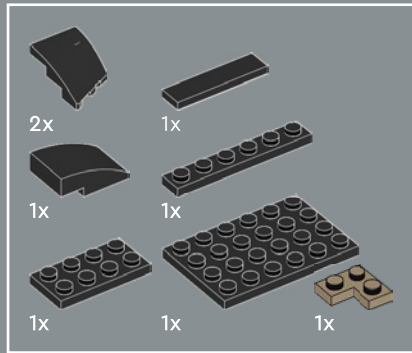

392

1

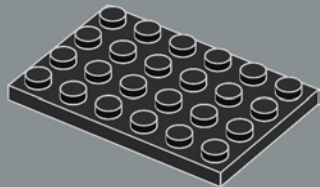

2

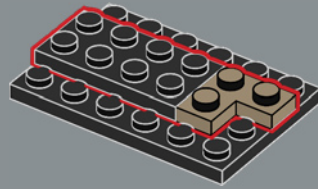

3

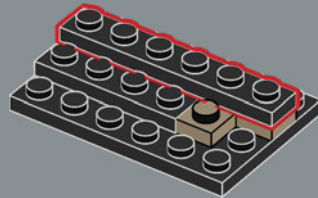

4

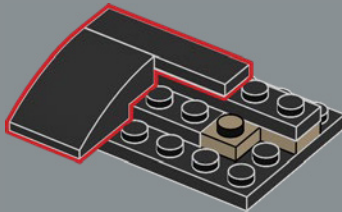

5

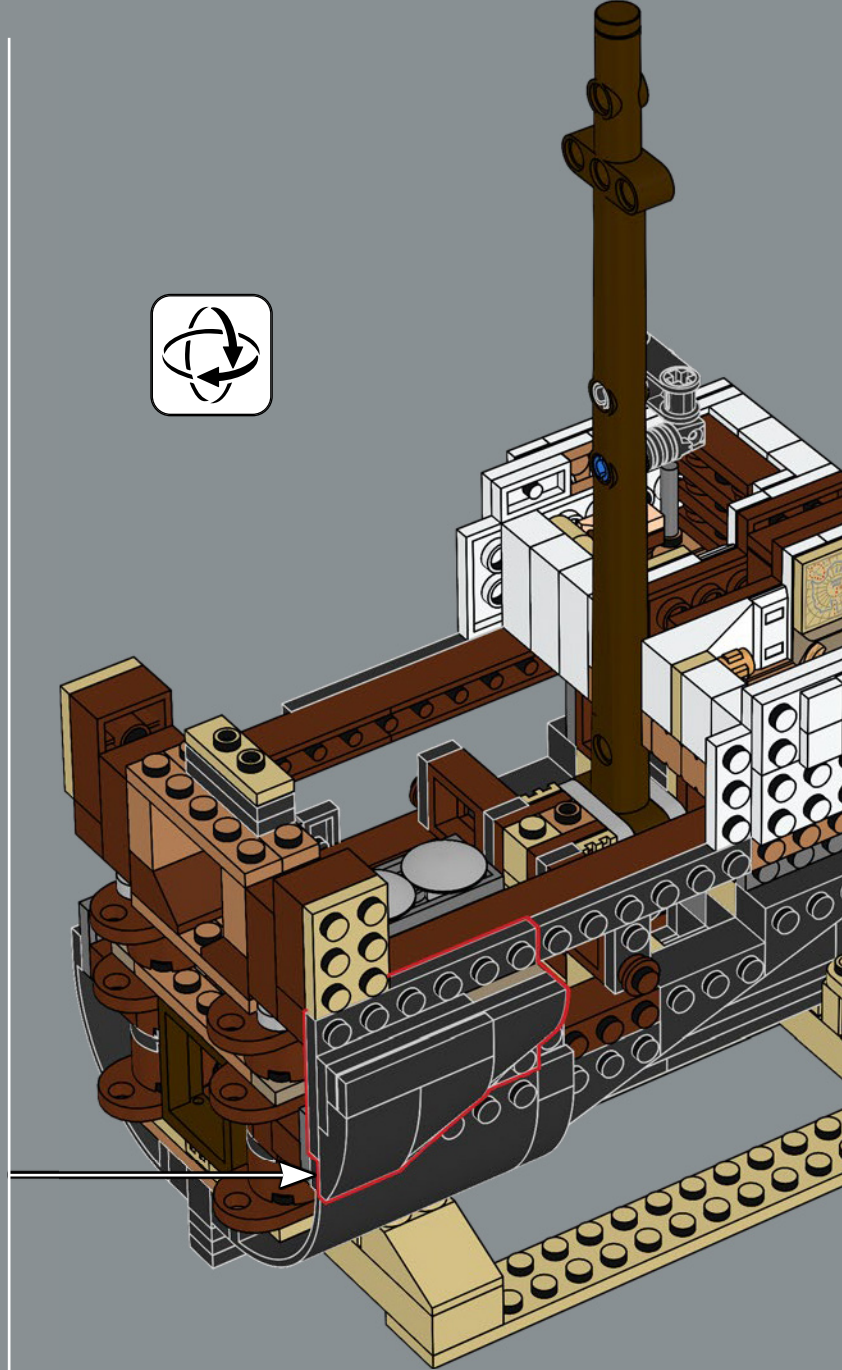
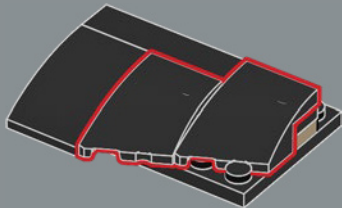

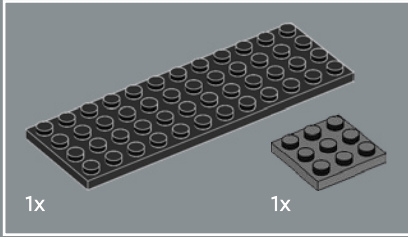
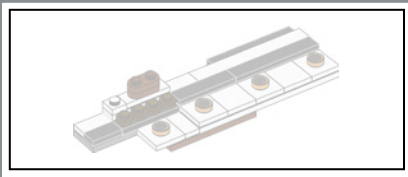

393

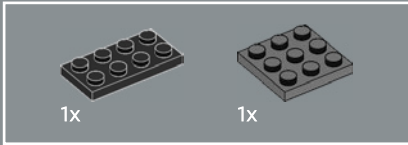
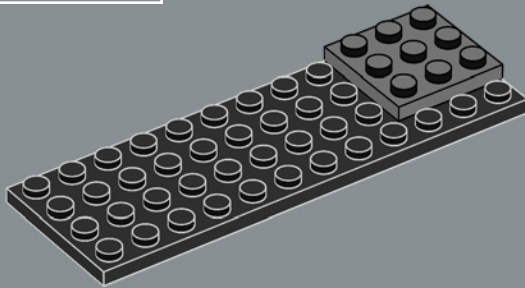

394

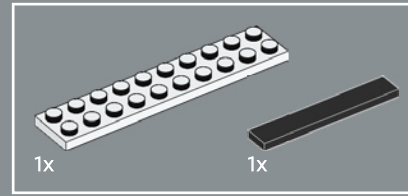
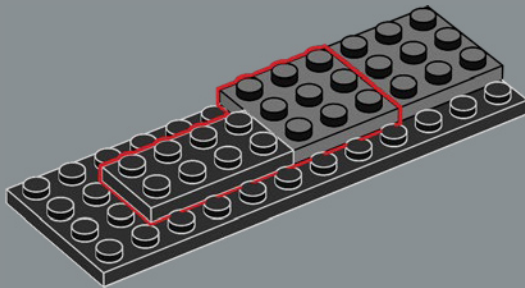

395

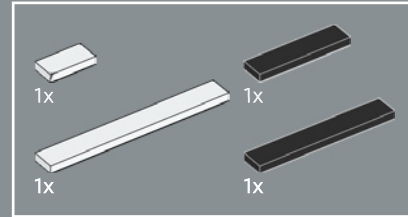
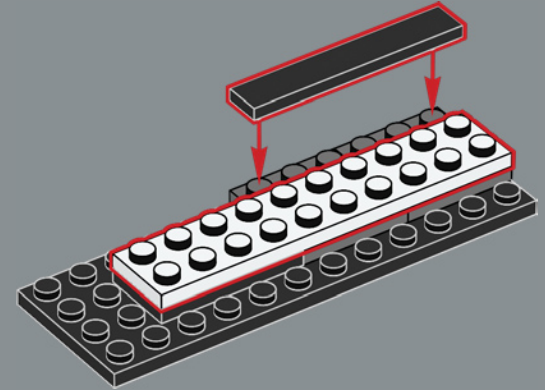

396

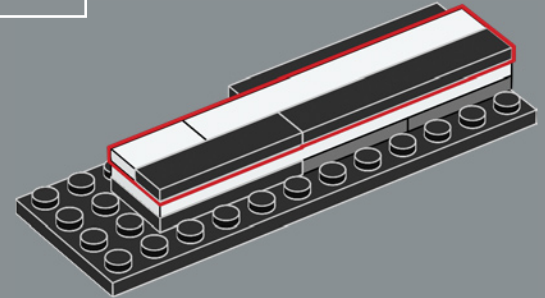

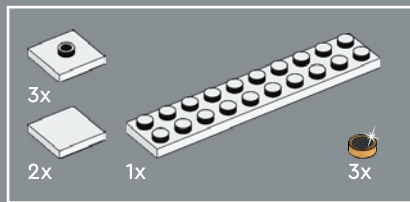

397

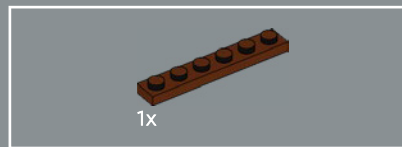
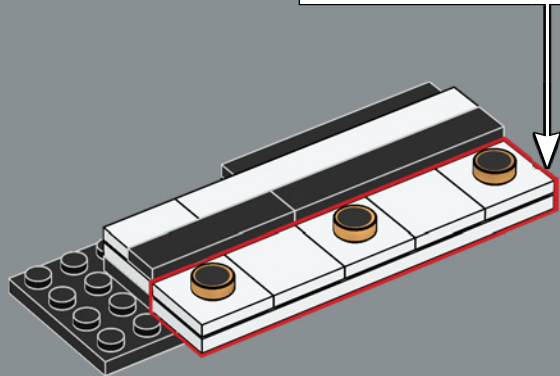
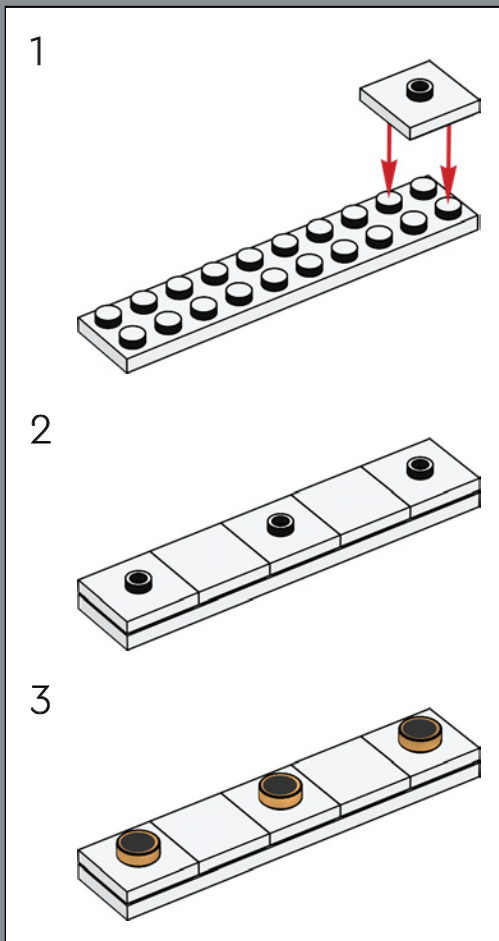

398

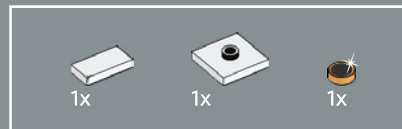
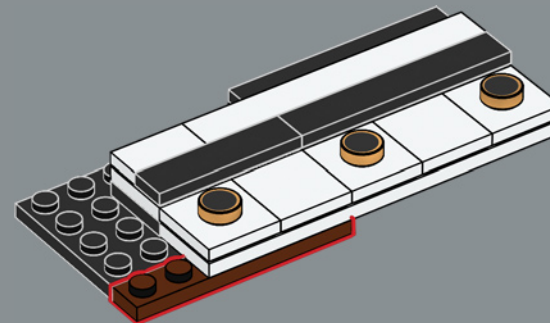

399

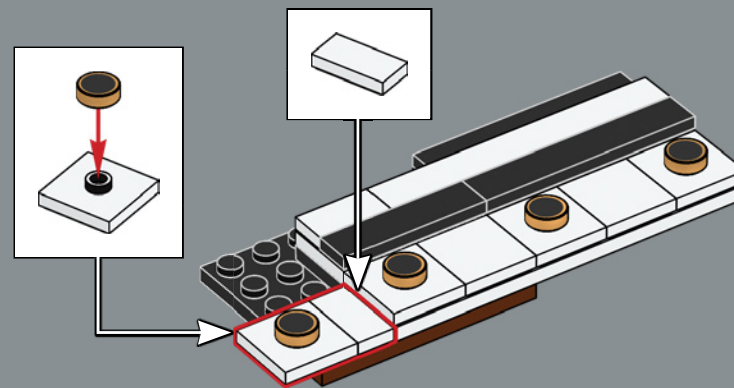

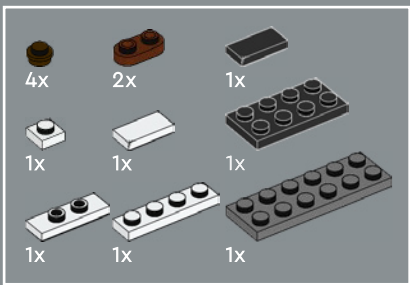

400

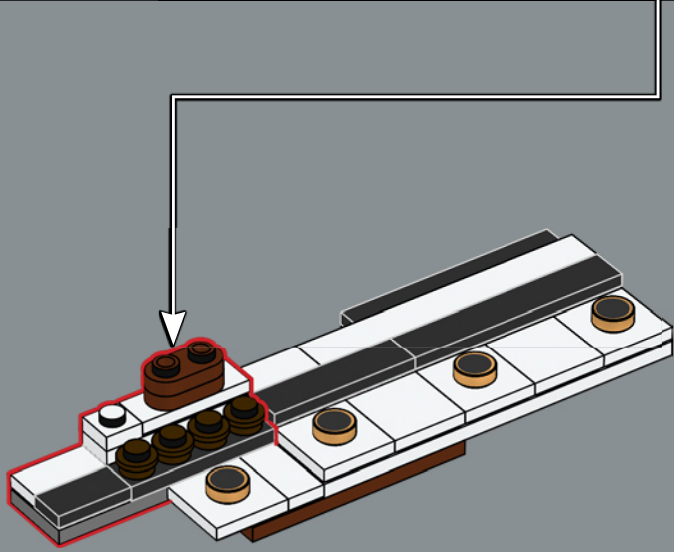
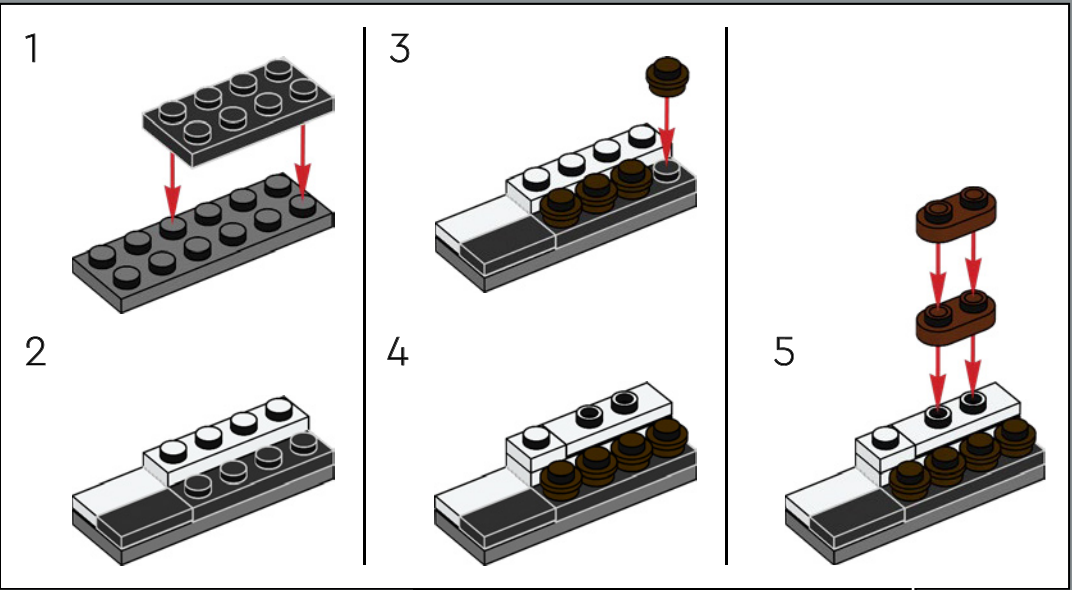

401

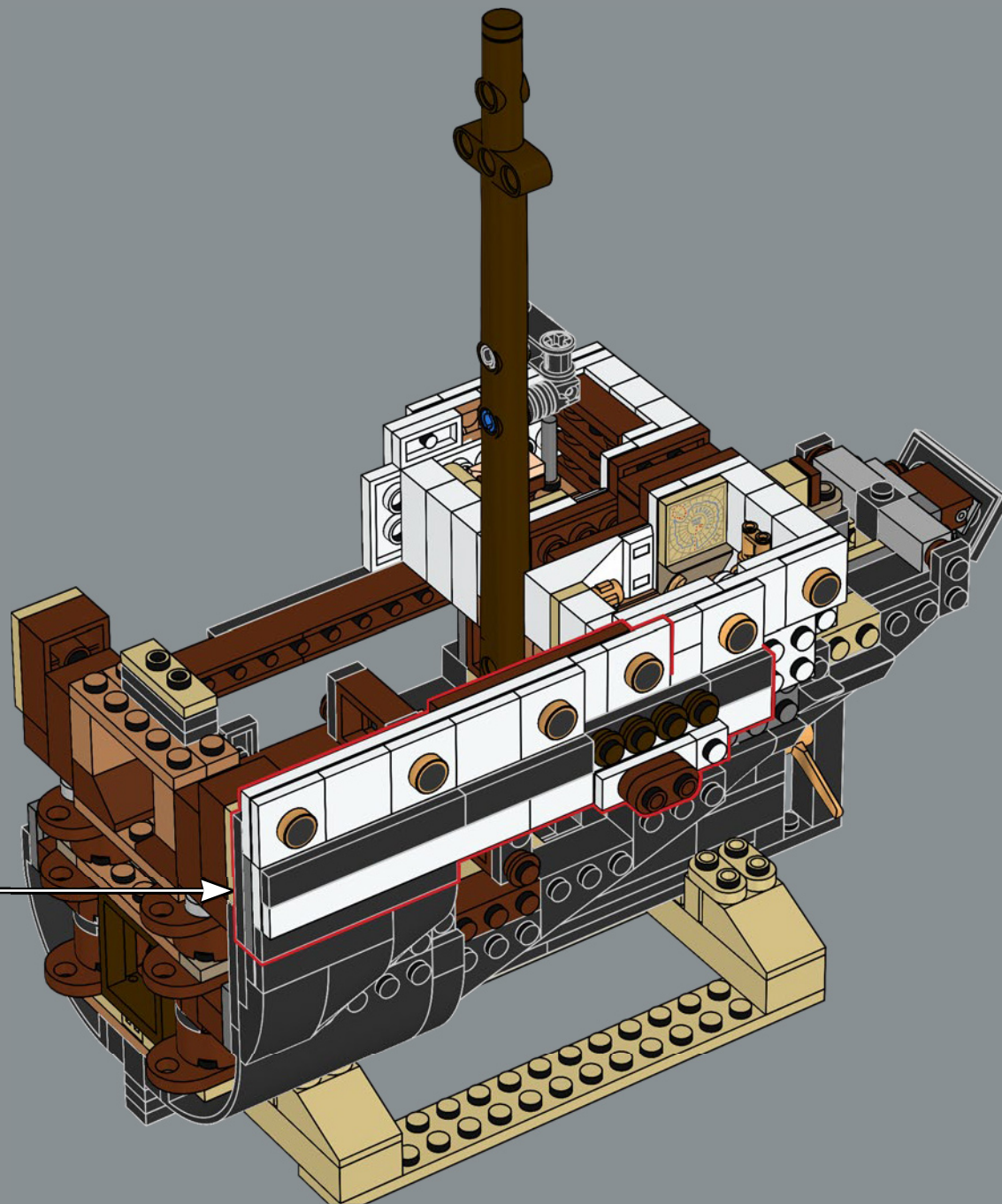

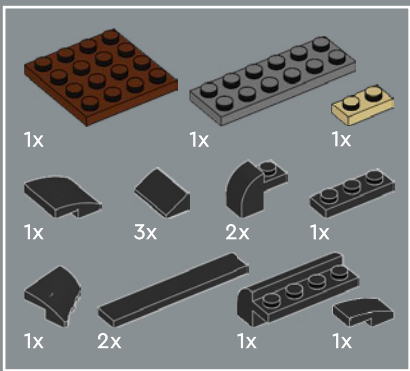

402

1

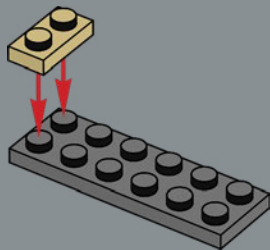

2

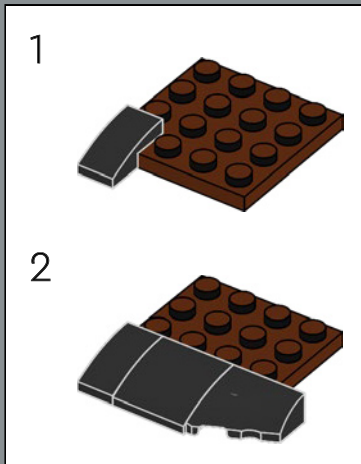
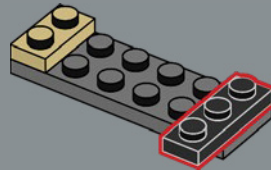

3

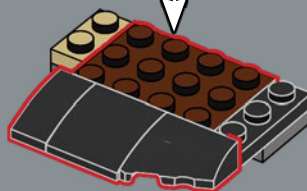

4

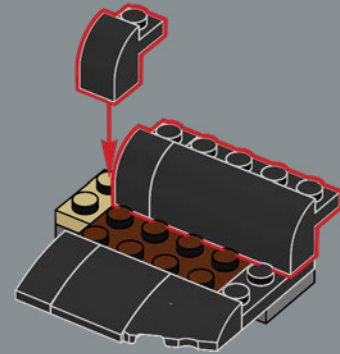

5

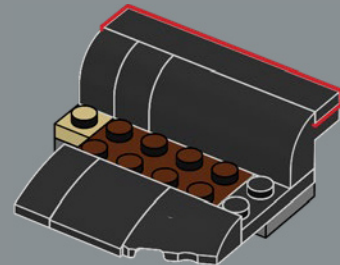

6

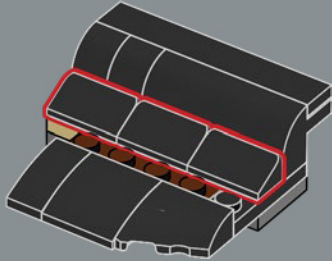

7

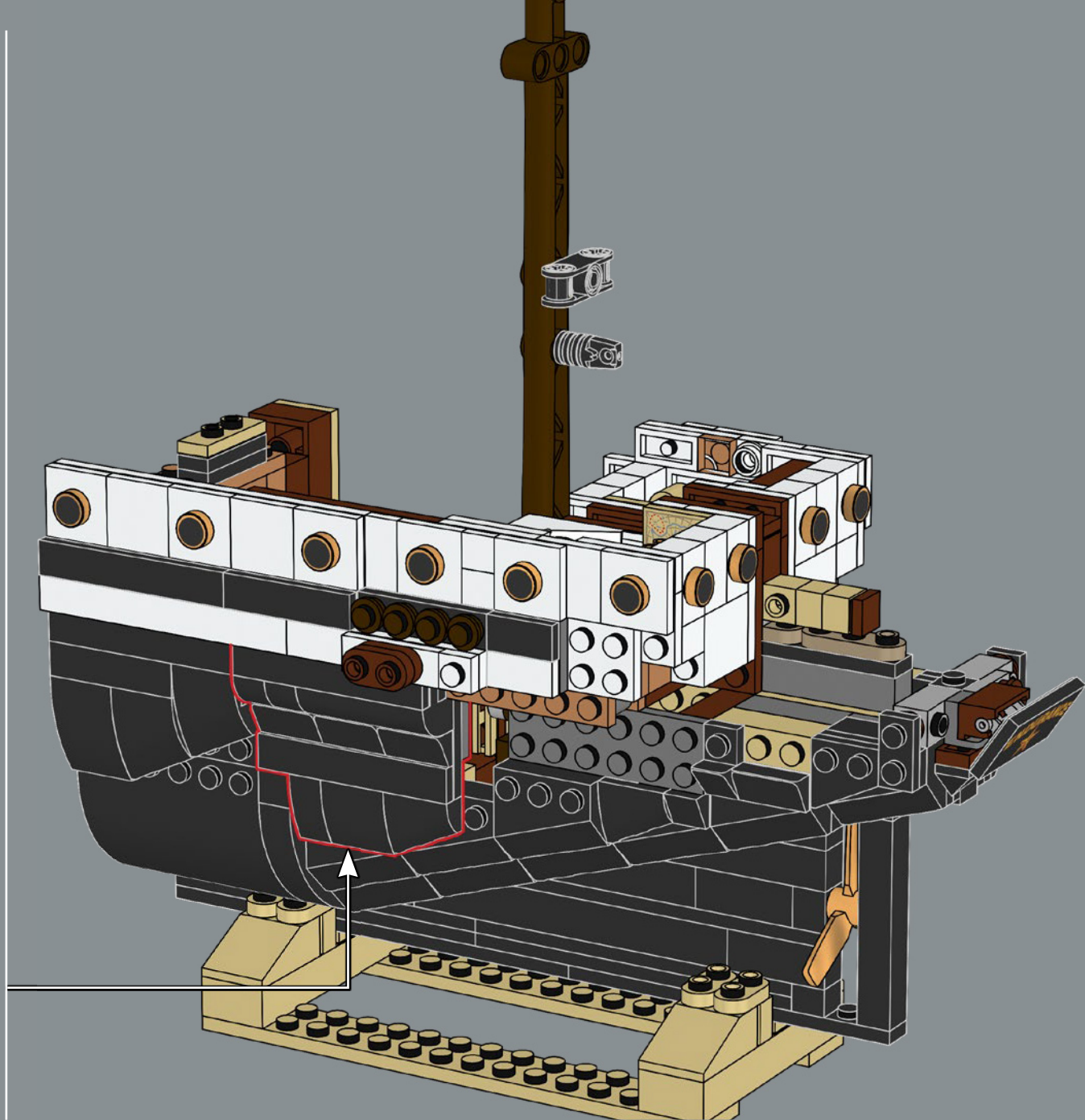
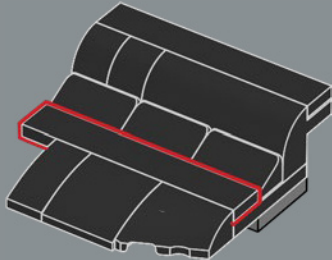

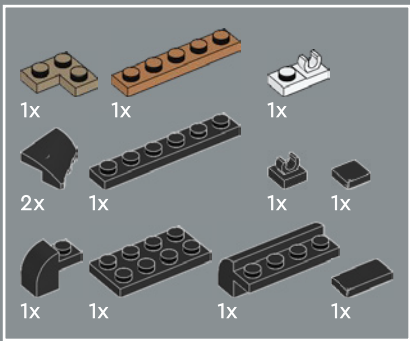

403

1

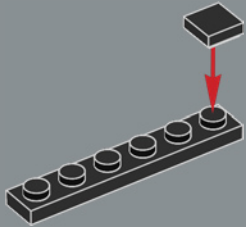

2

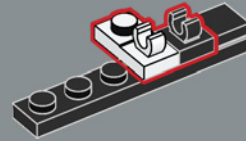

3

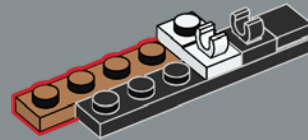

4

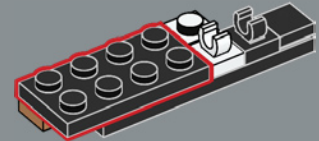

5

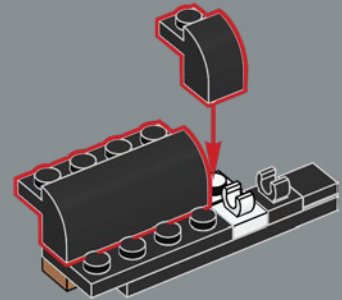

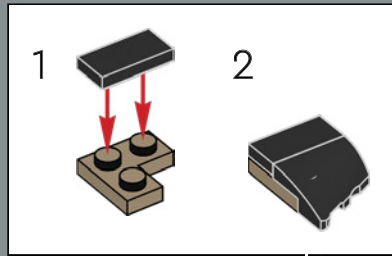

6

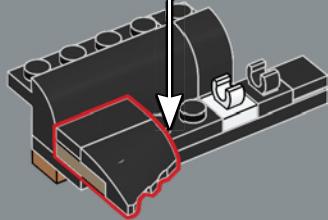

7

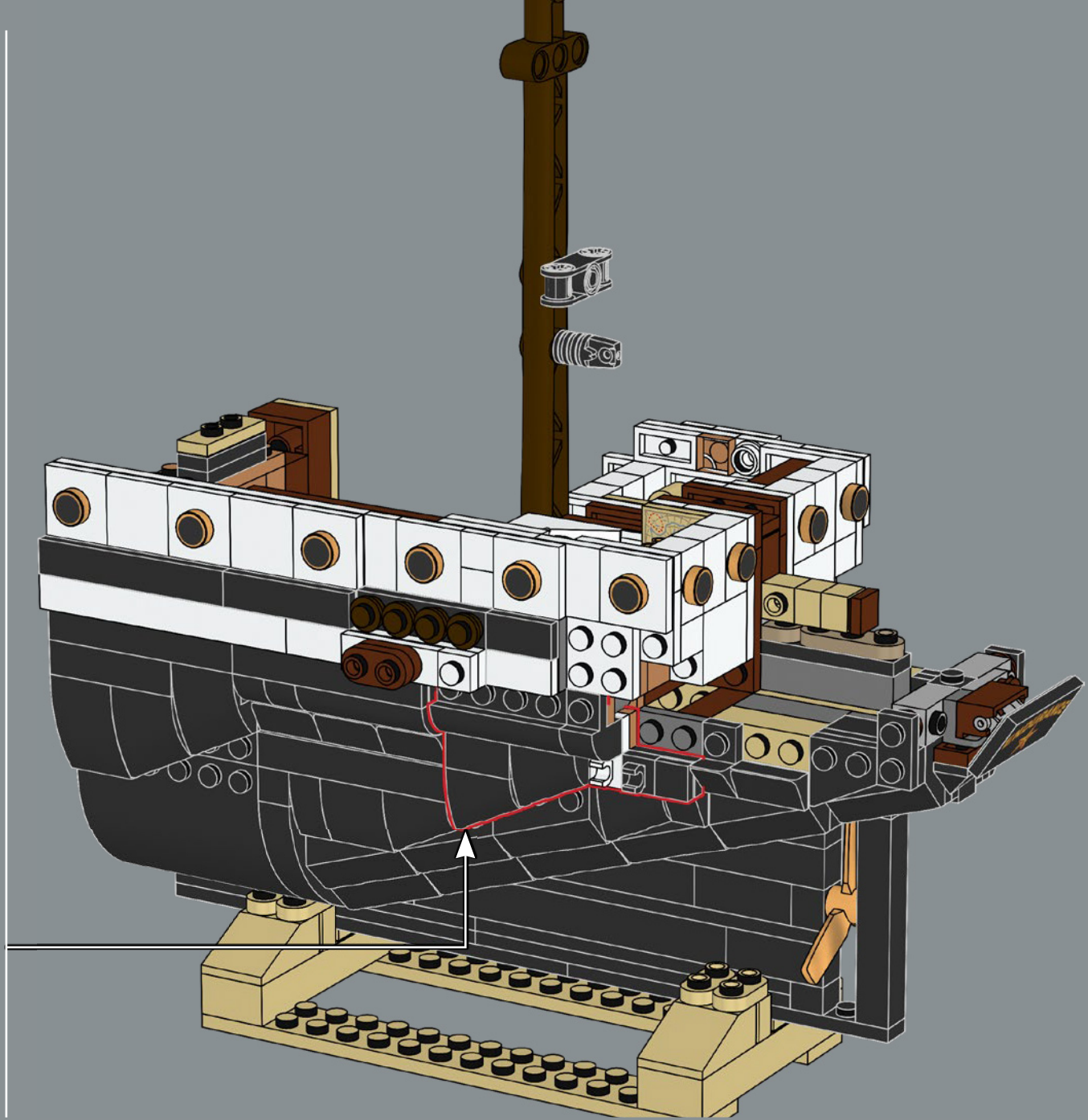
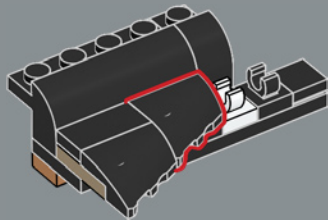

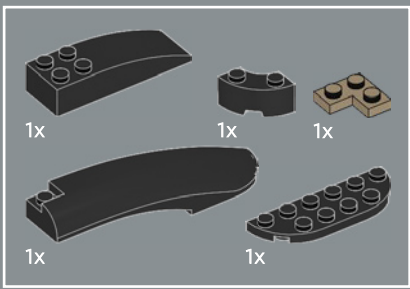

404

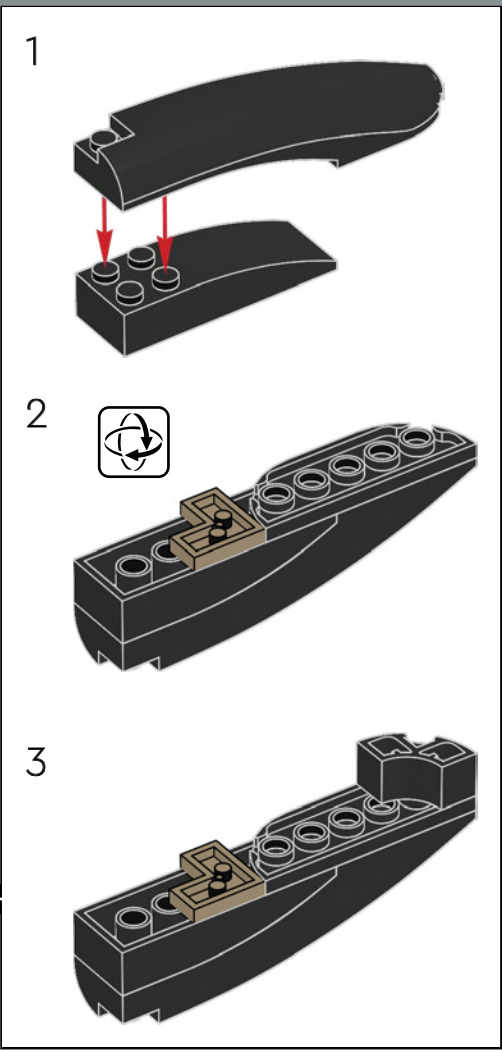
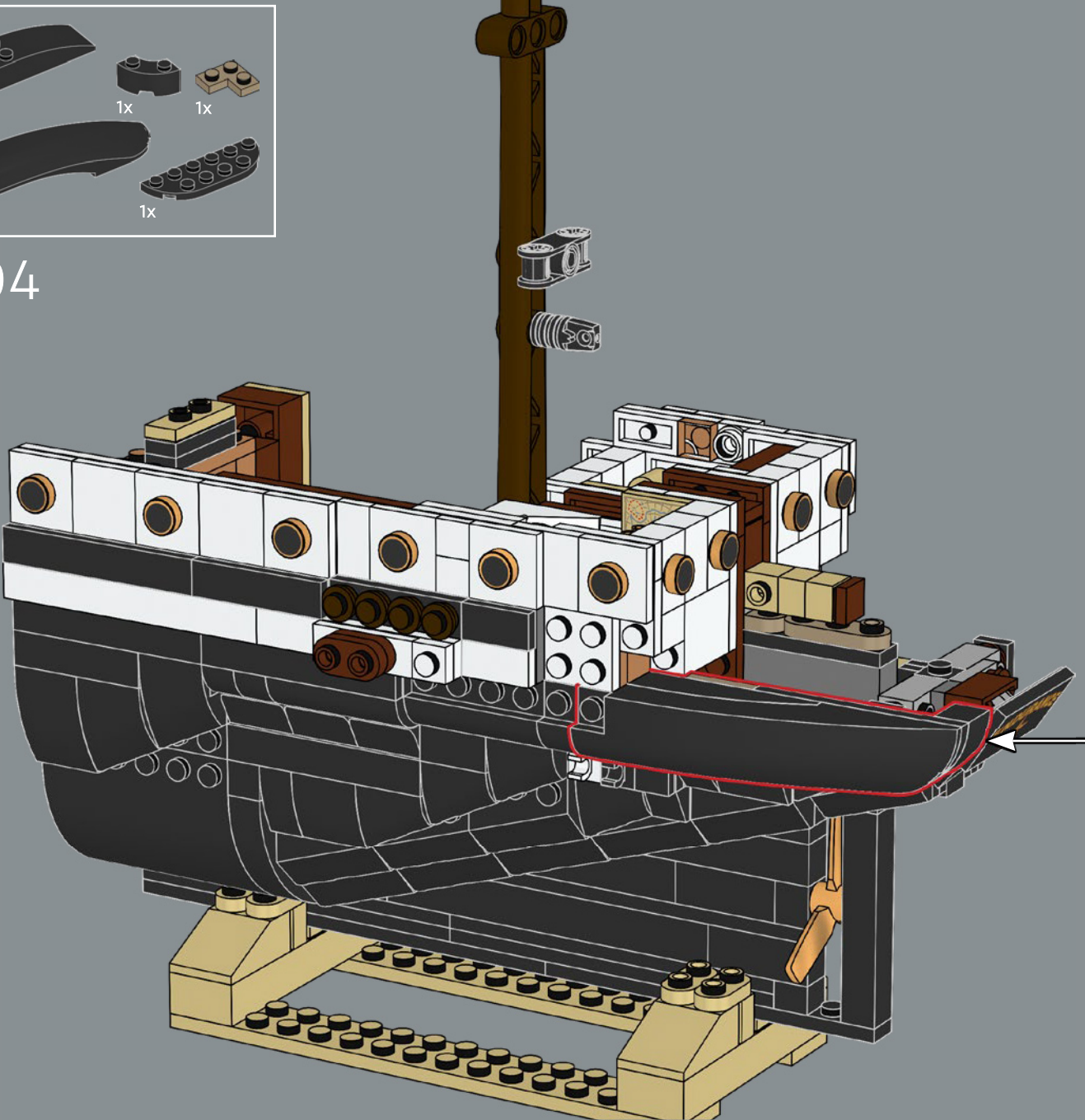

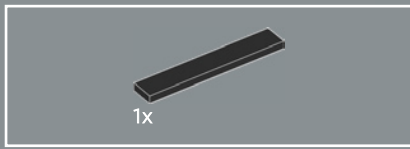

405

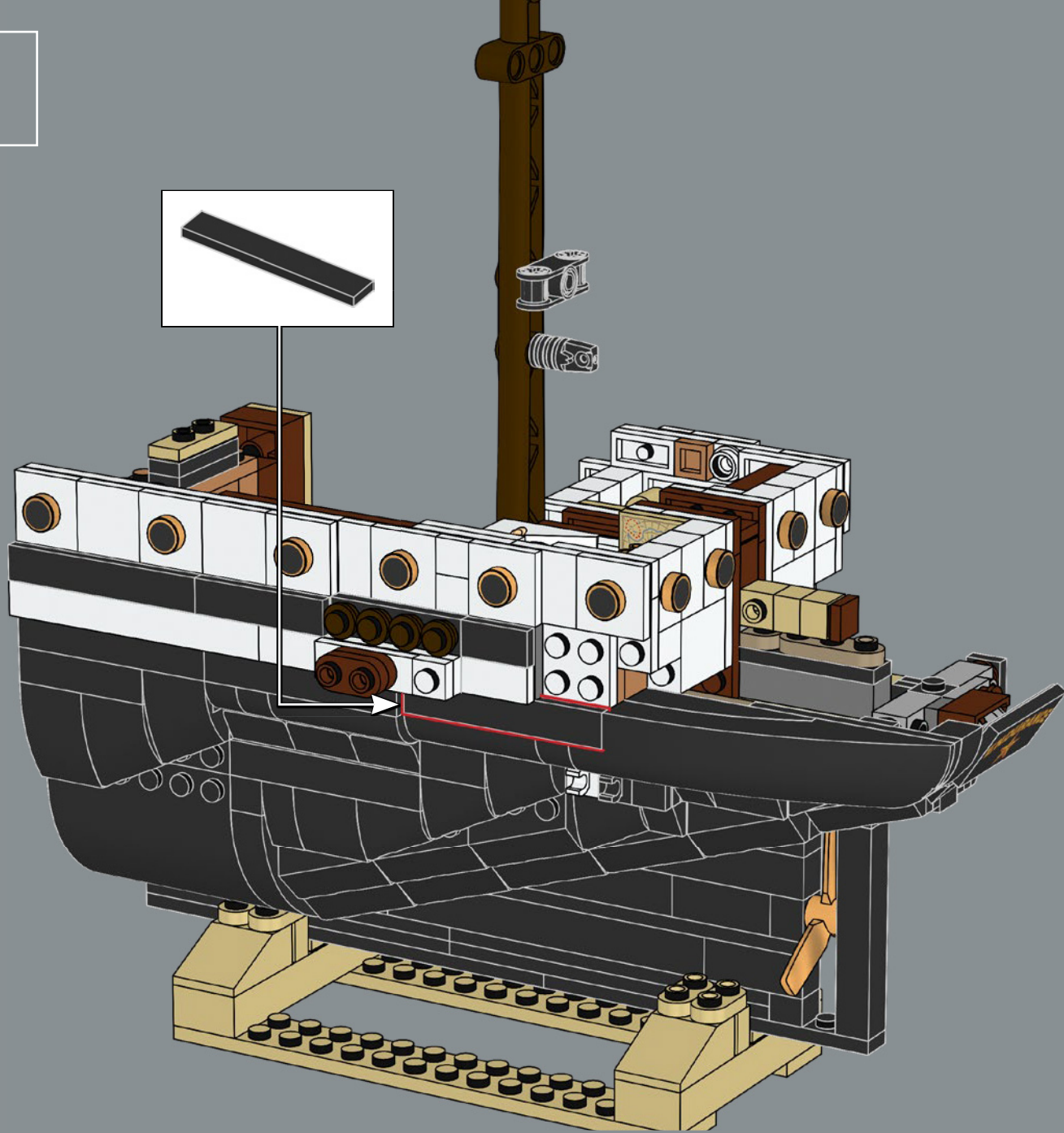
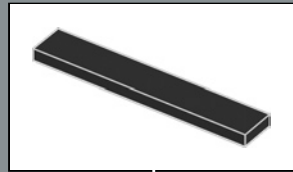

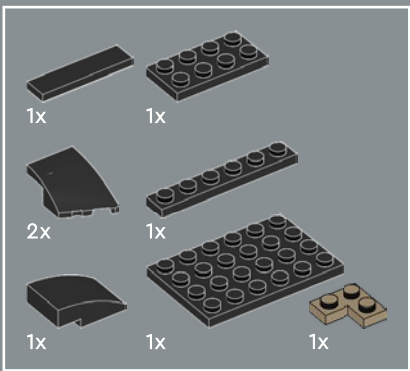
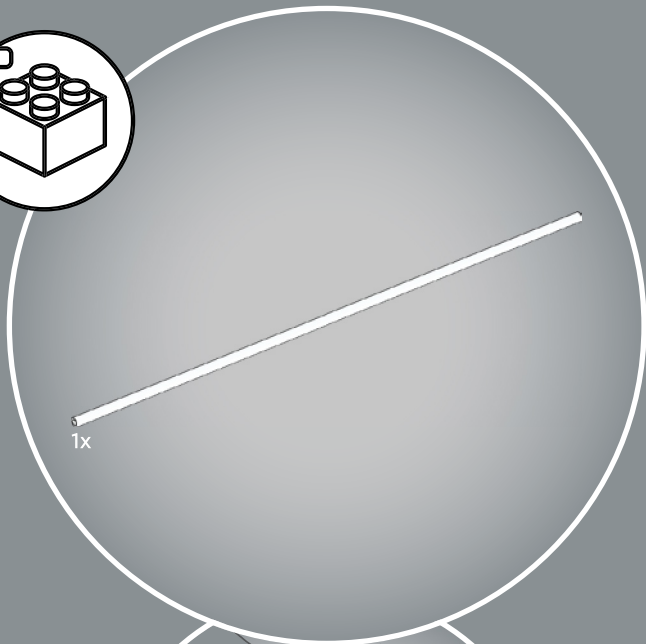
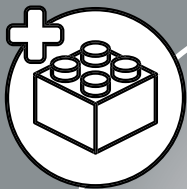

406



1

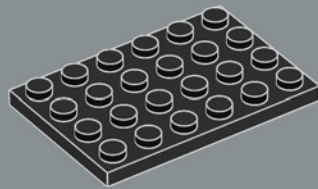

2

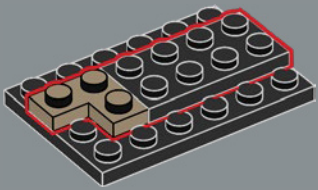

3

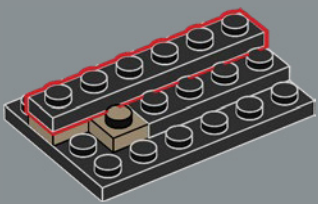

4

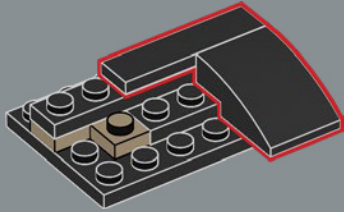

5

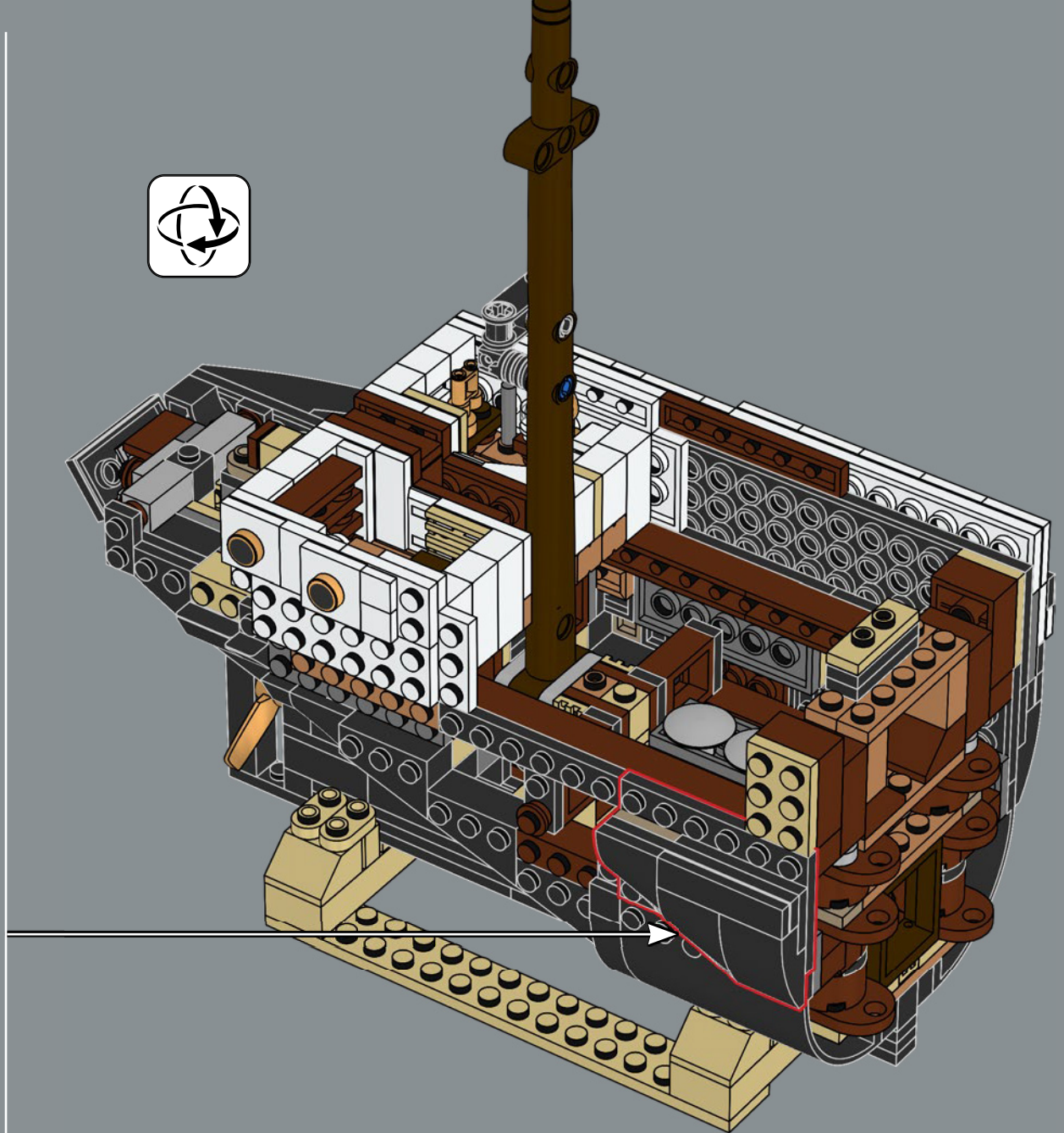
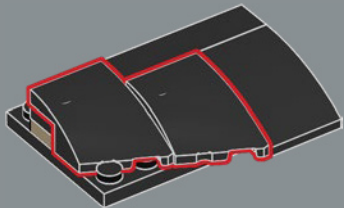

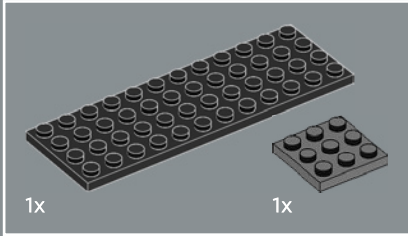
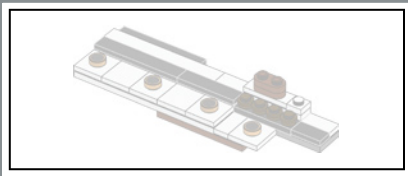

407

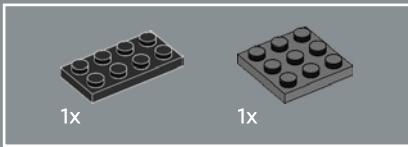
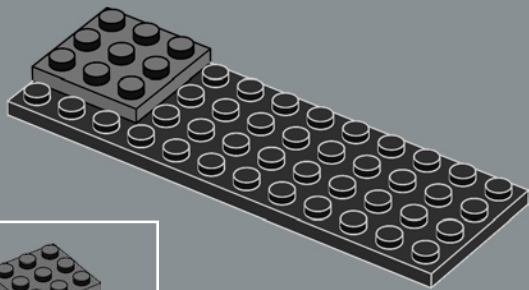

408

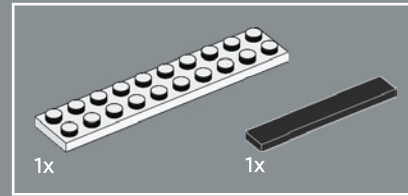
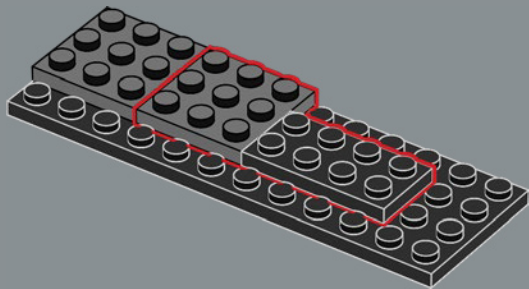

409

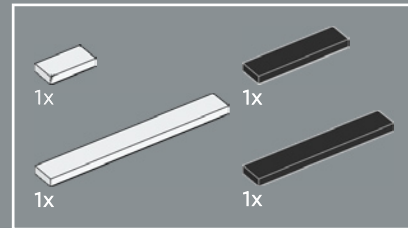
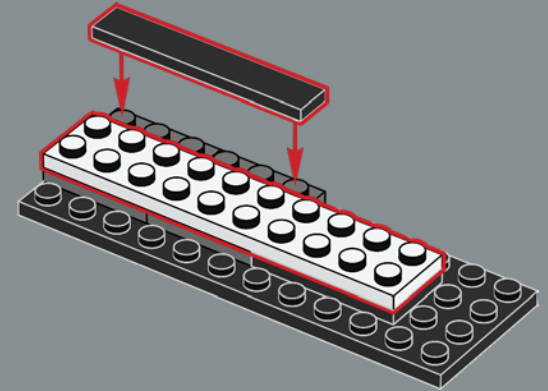

410

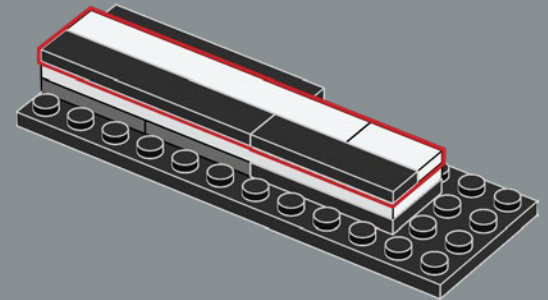

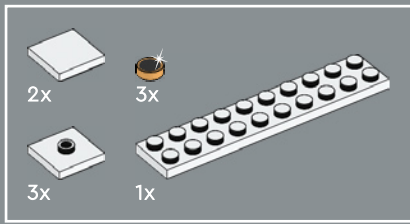

411

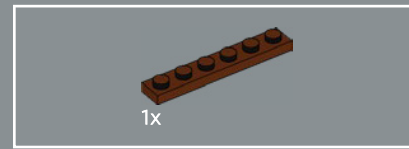
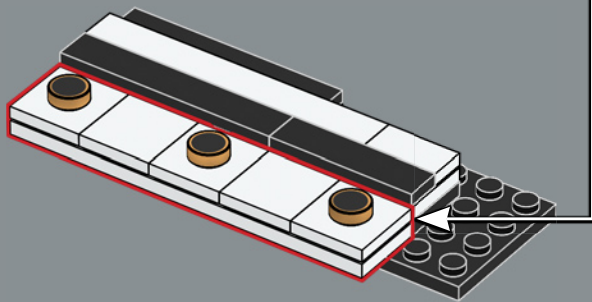
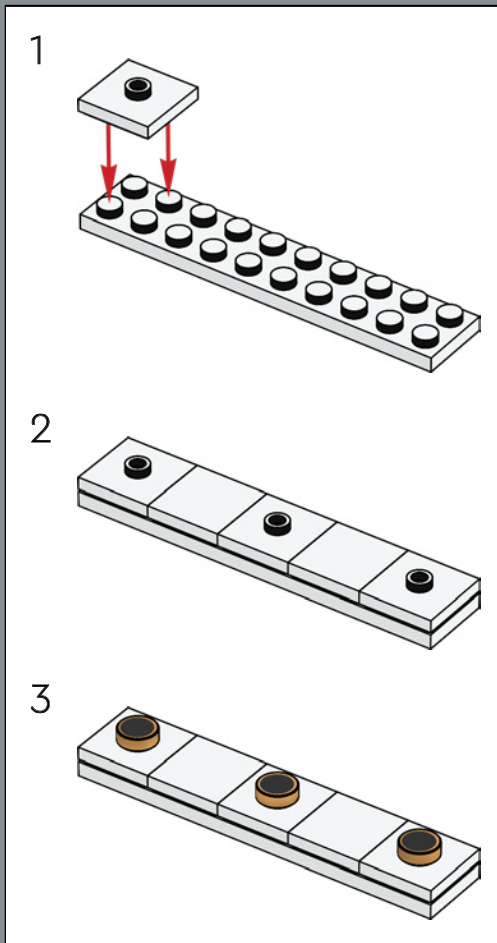

412

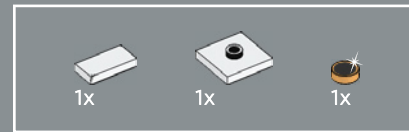
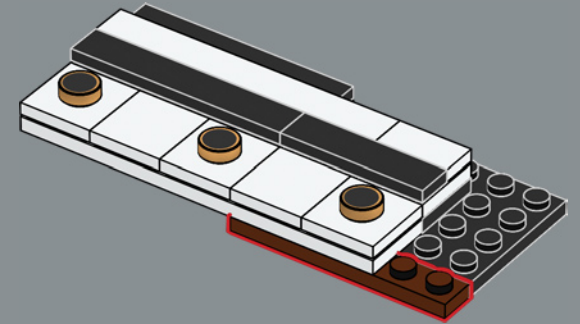

413

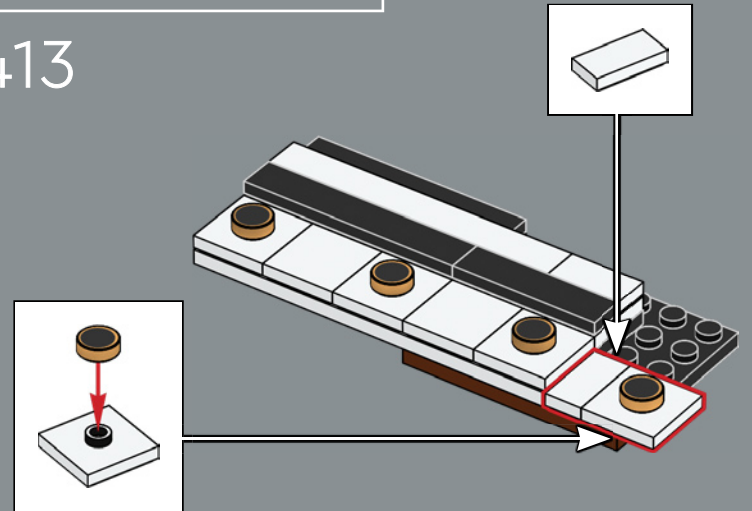

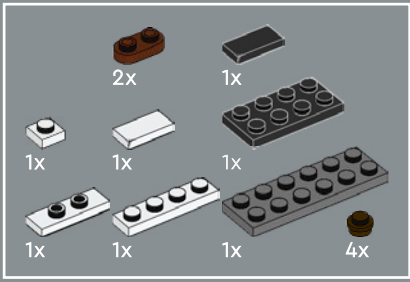

414

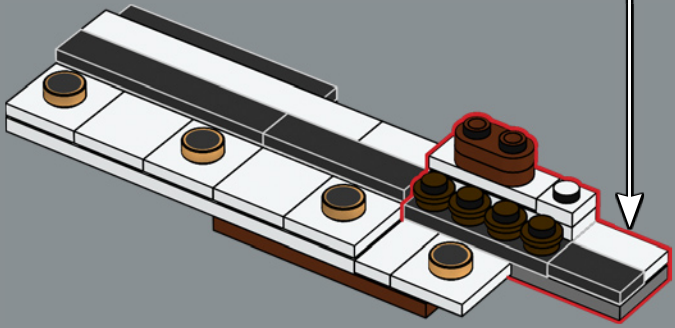
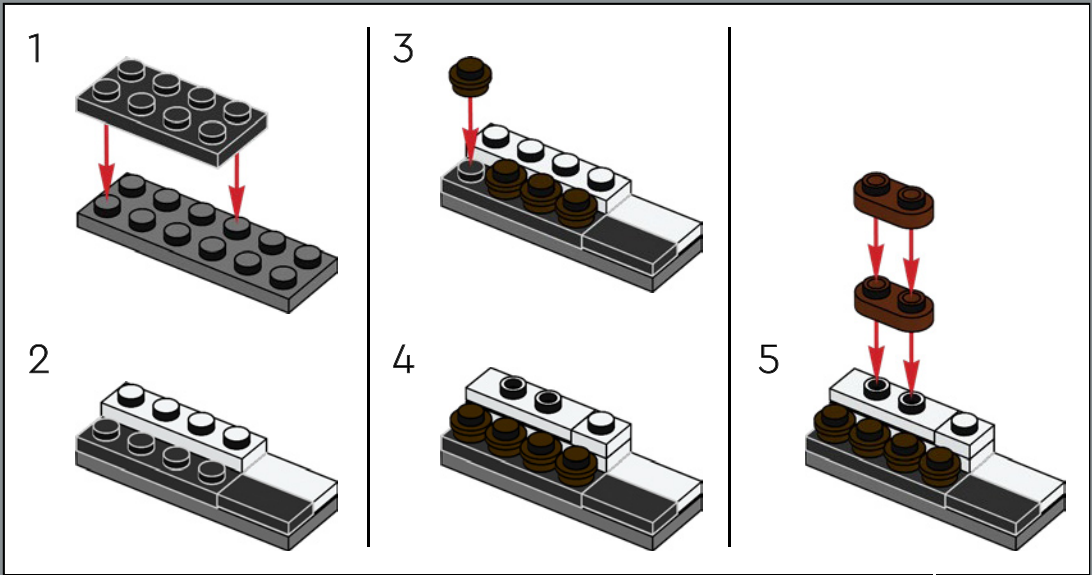

415

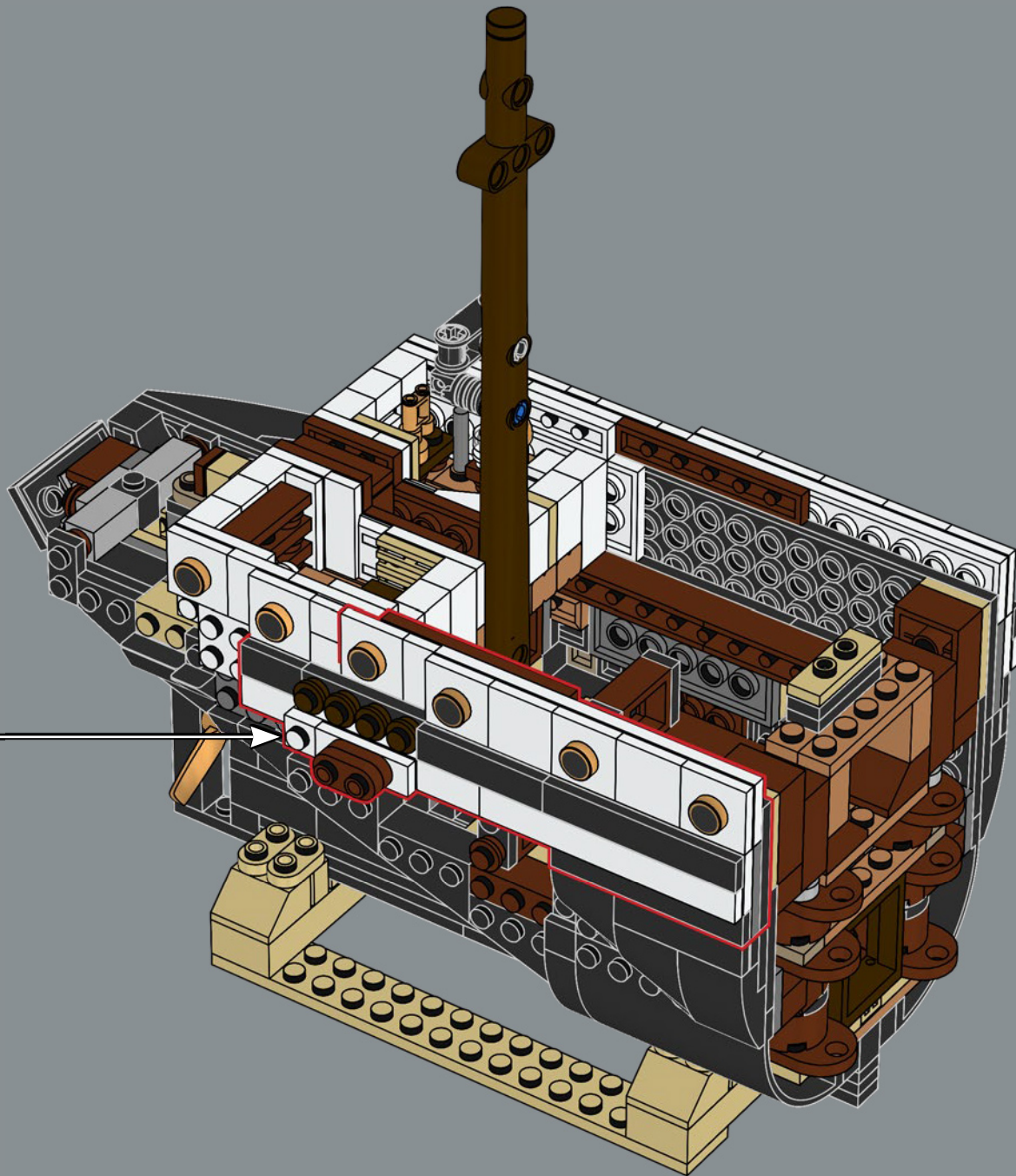

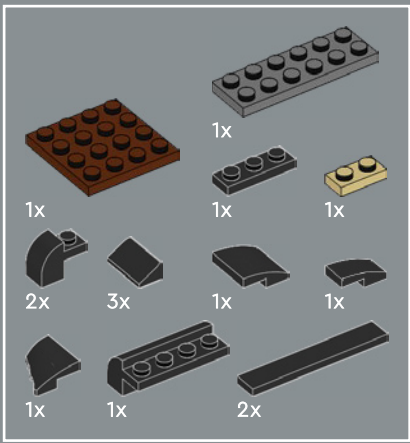

416

1

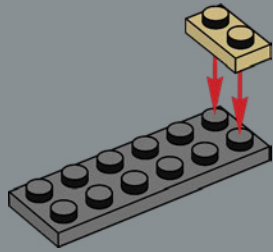

2

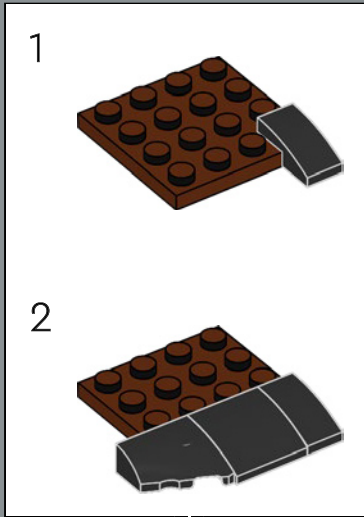
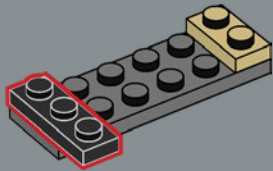

3

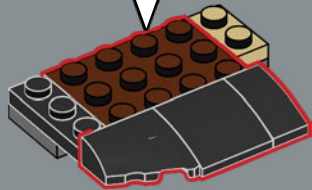

4

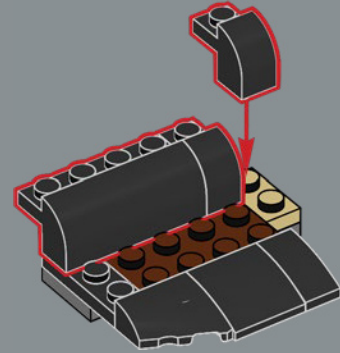

5

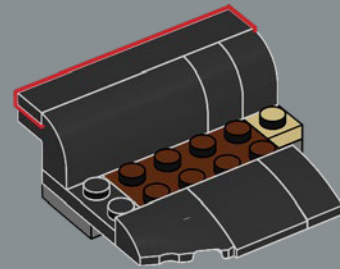

6

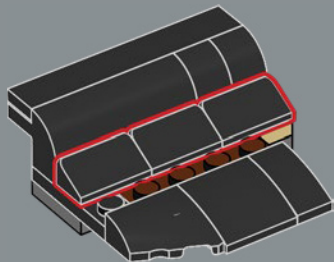

7

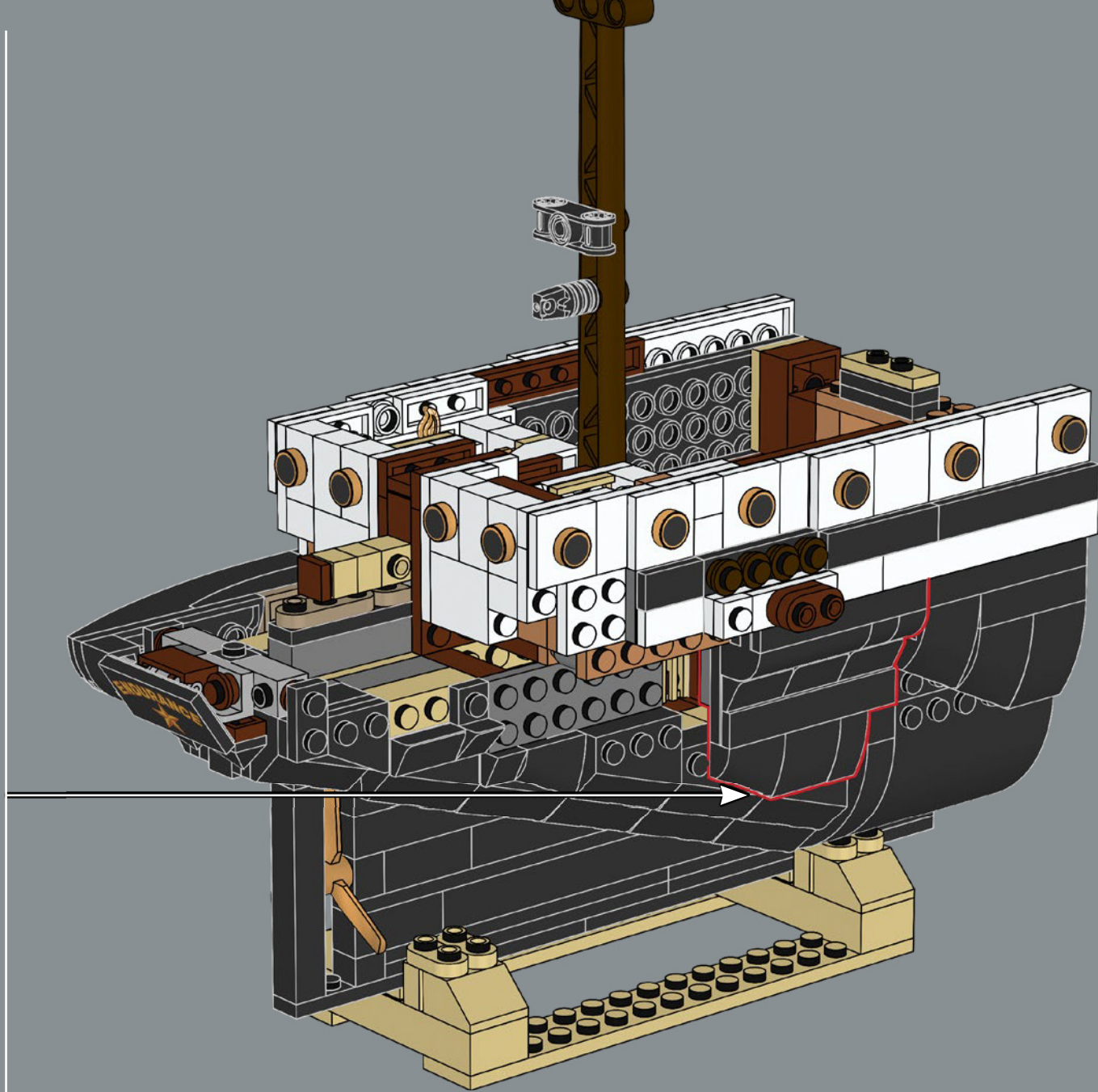
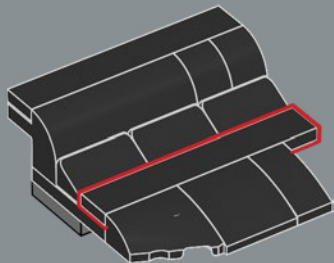

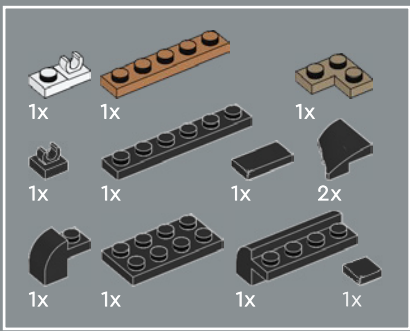

417

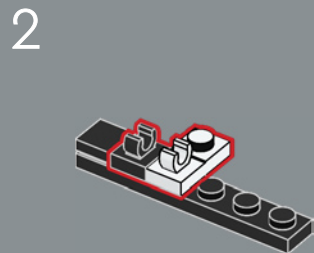
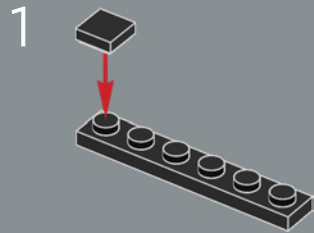

3

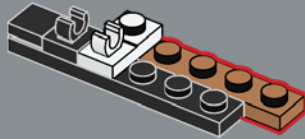

4

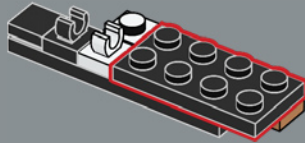

5

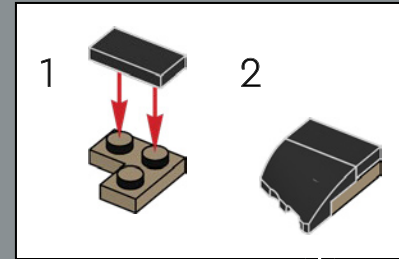
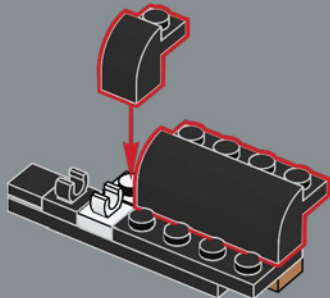

6

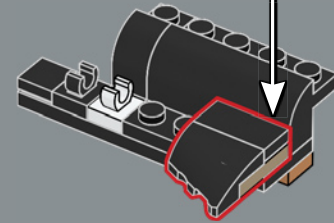

7

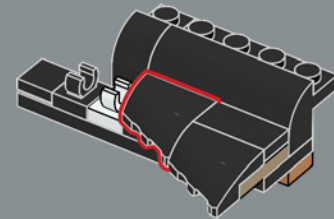

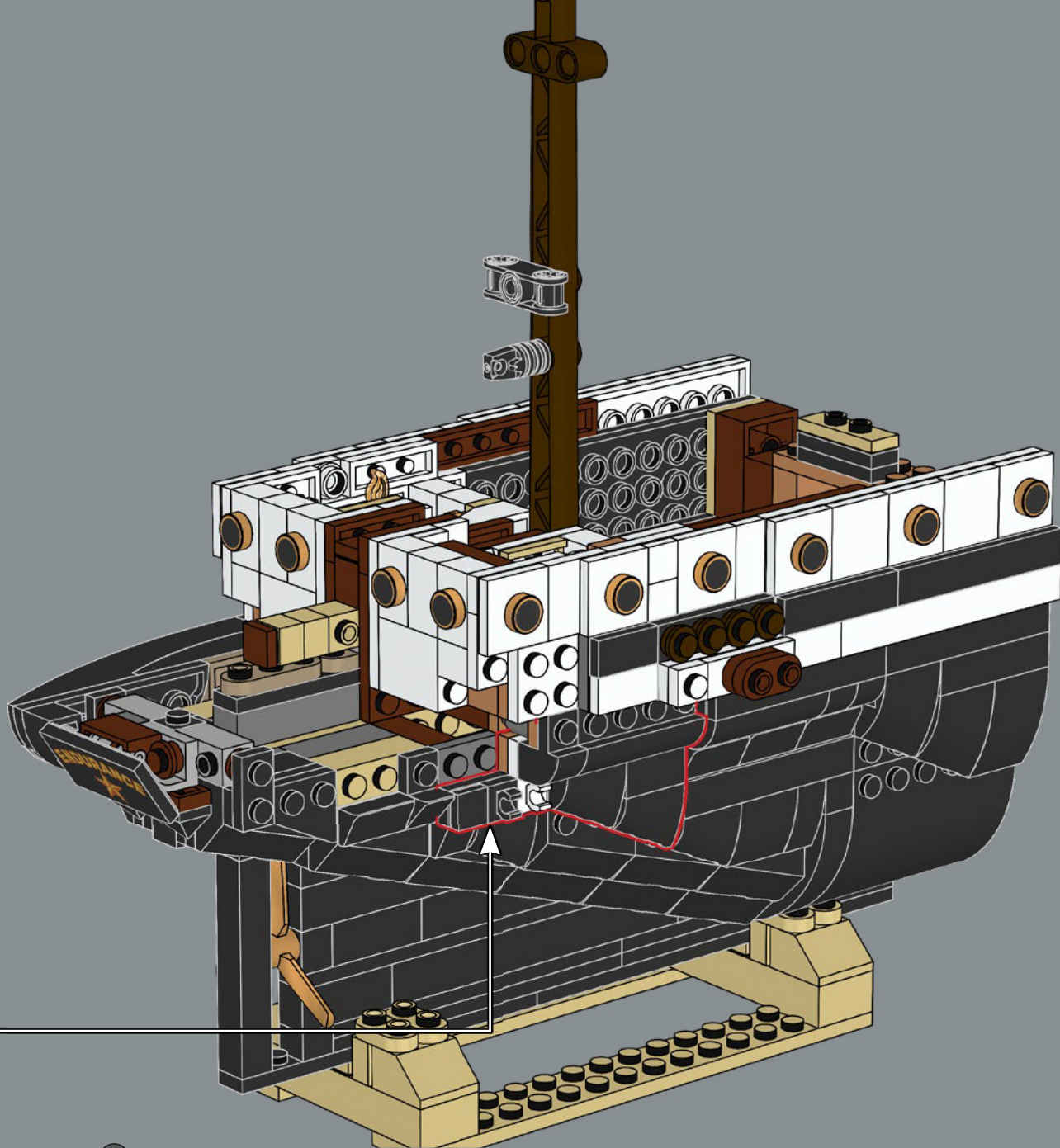

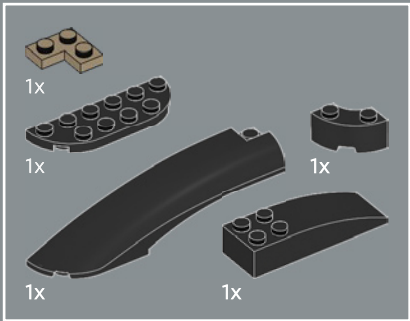

418

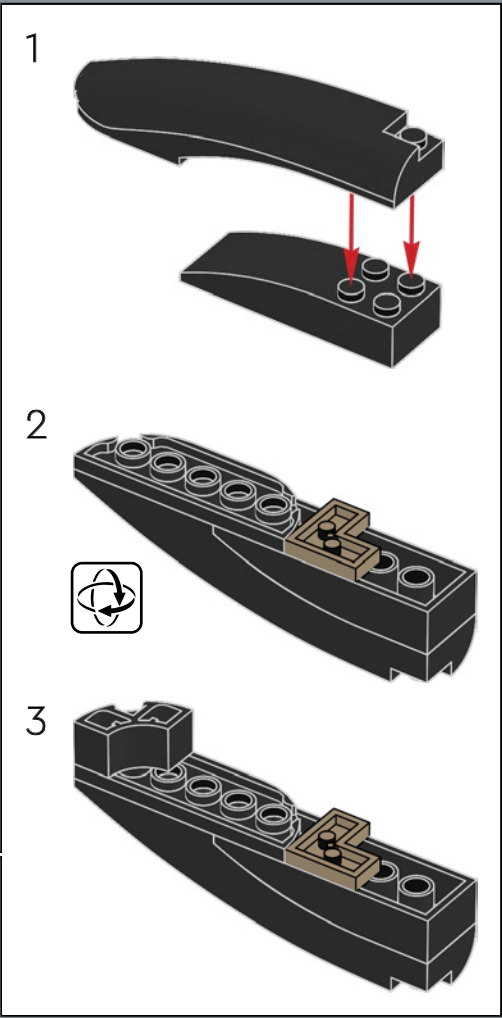
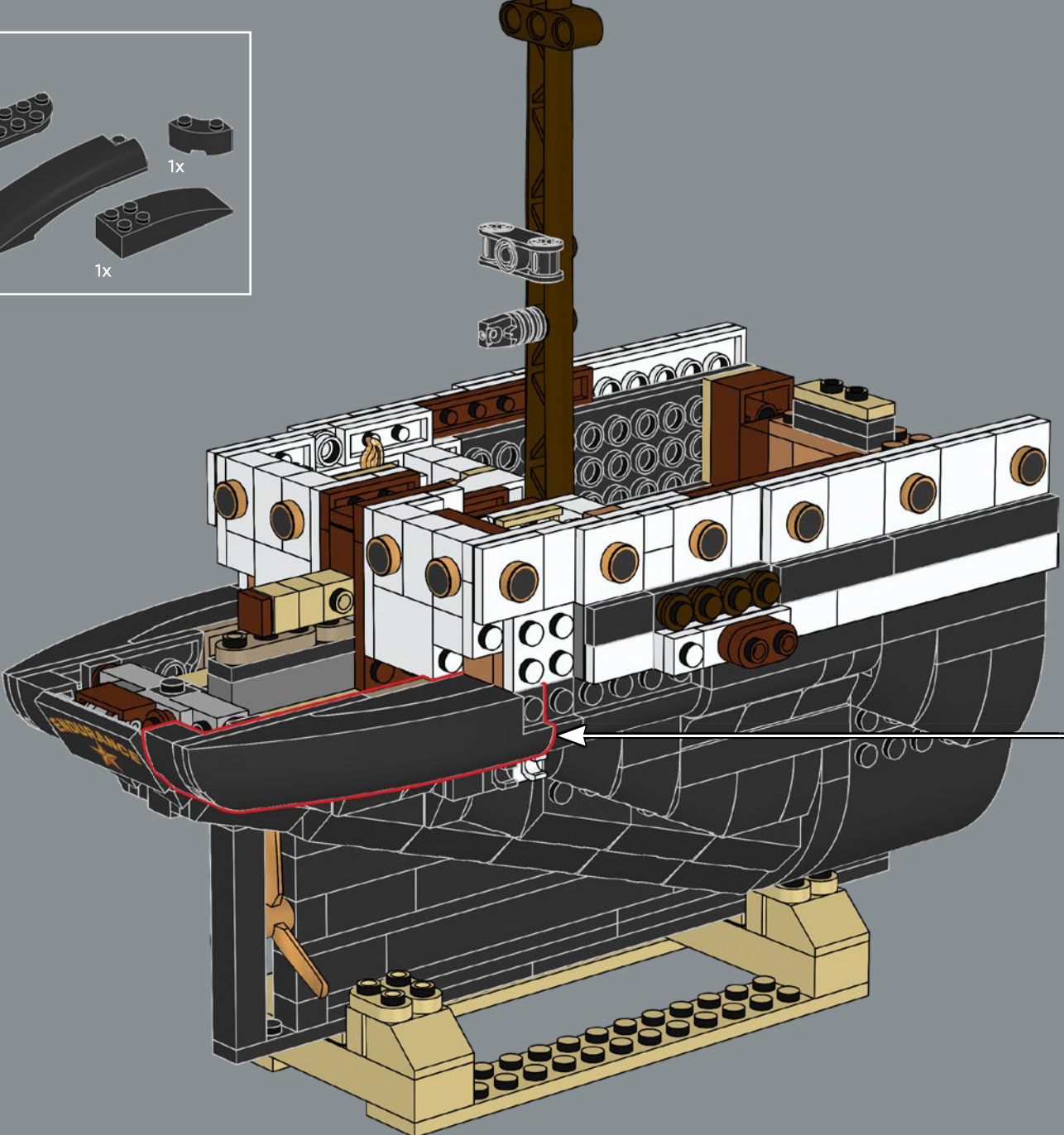

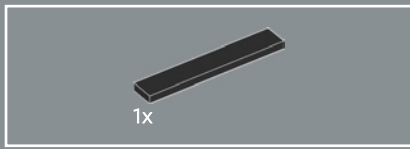

419

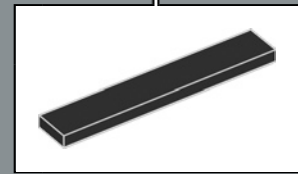
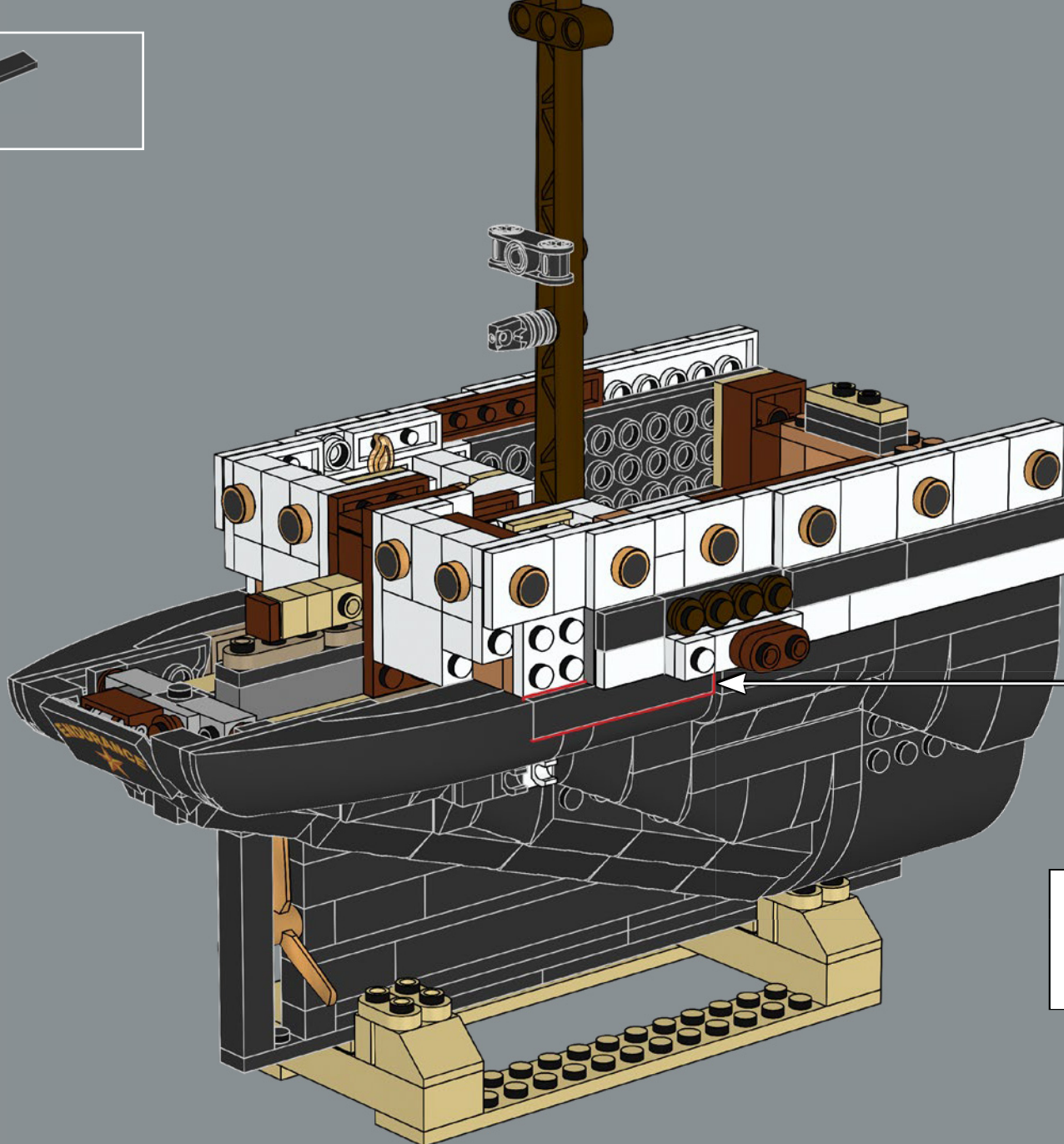

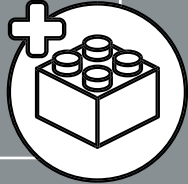
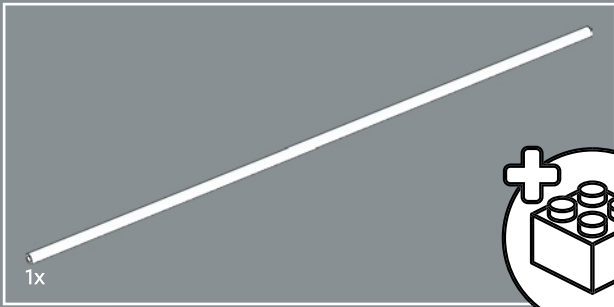

420

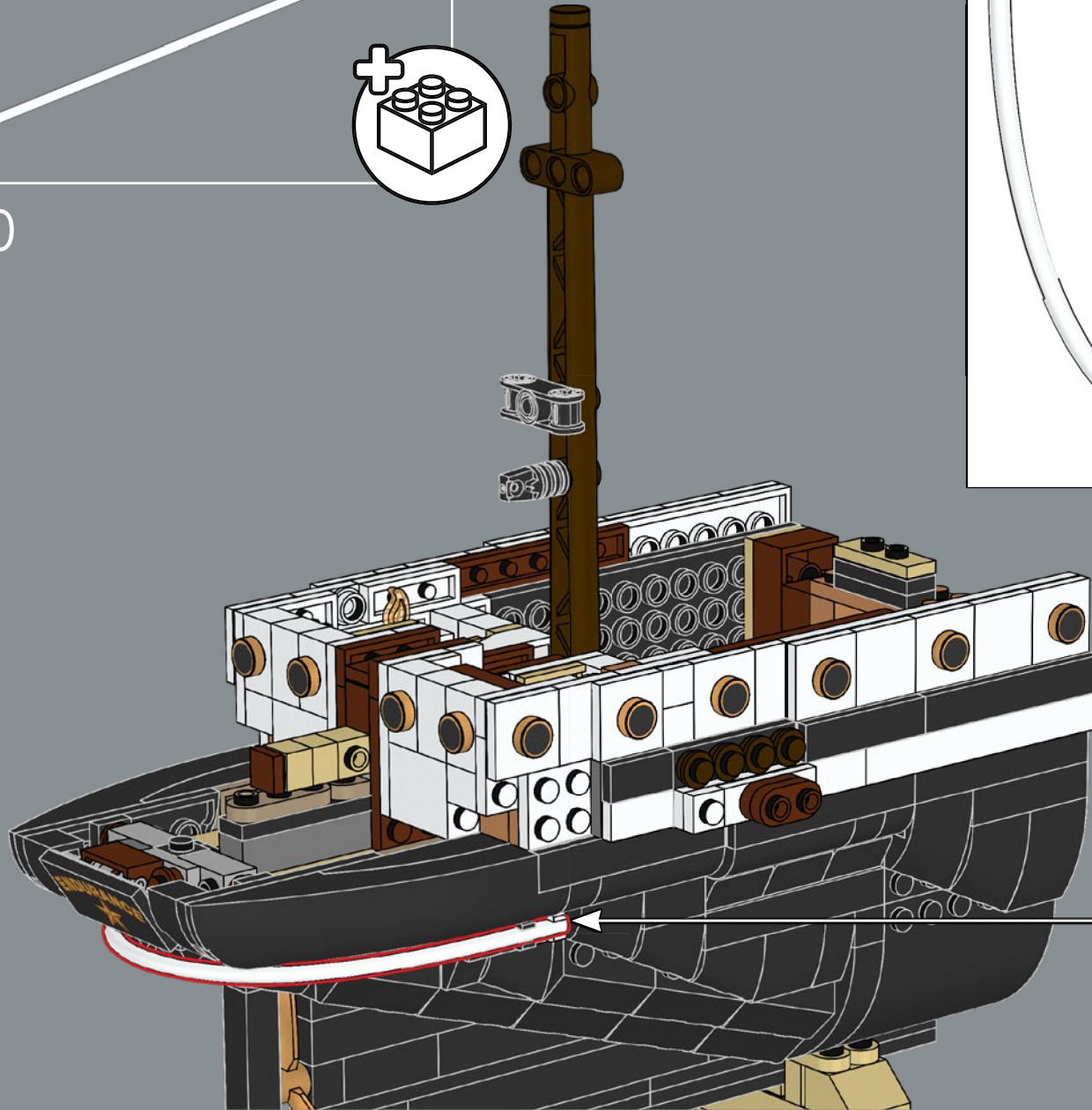
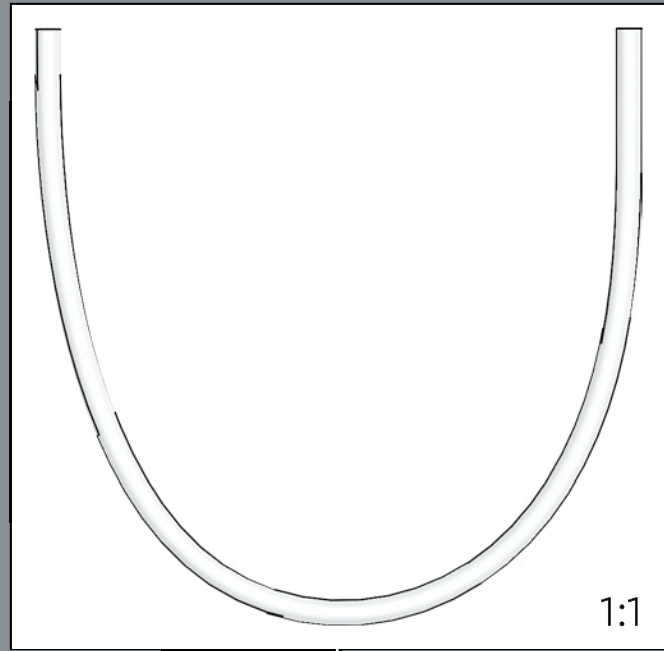

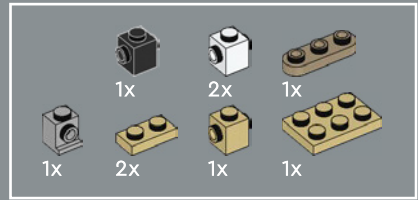
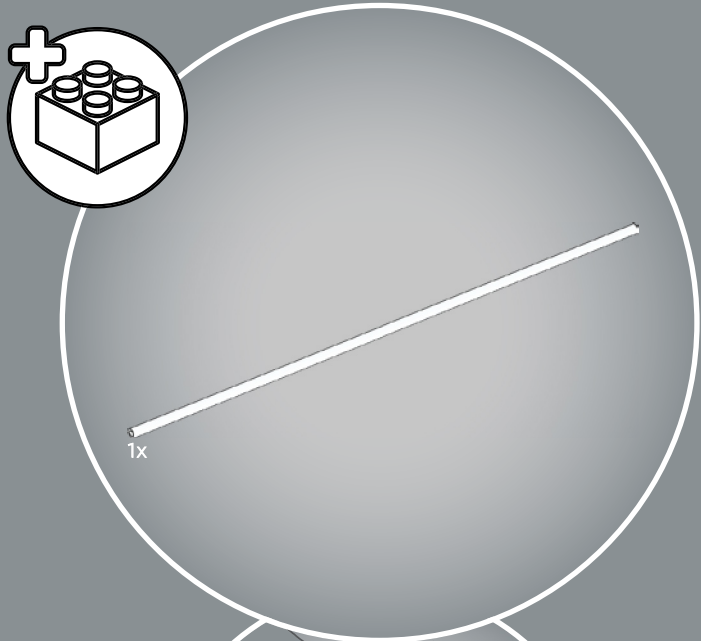

421

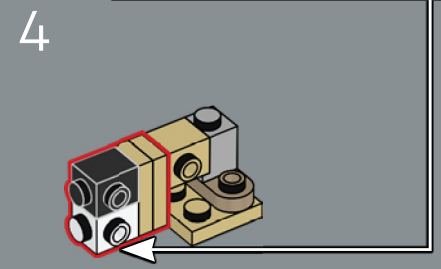
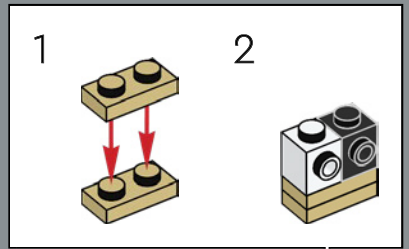
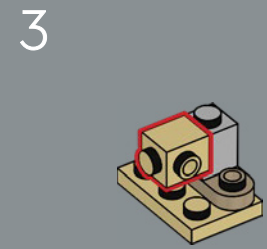
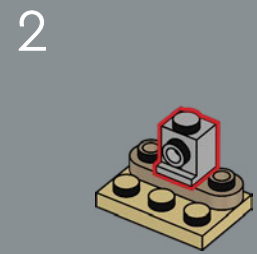
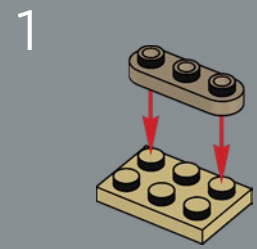

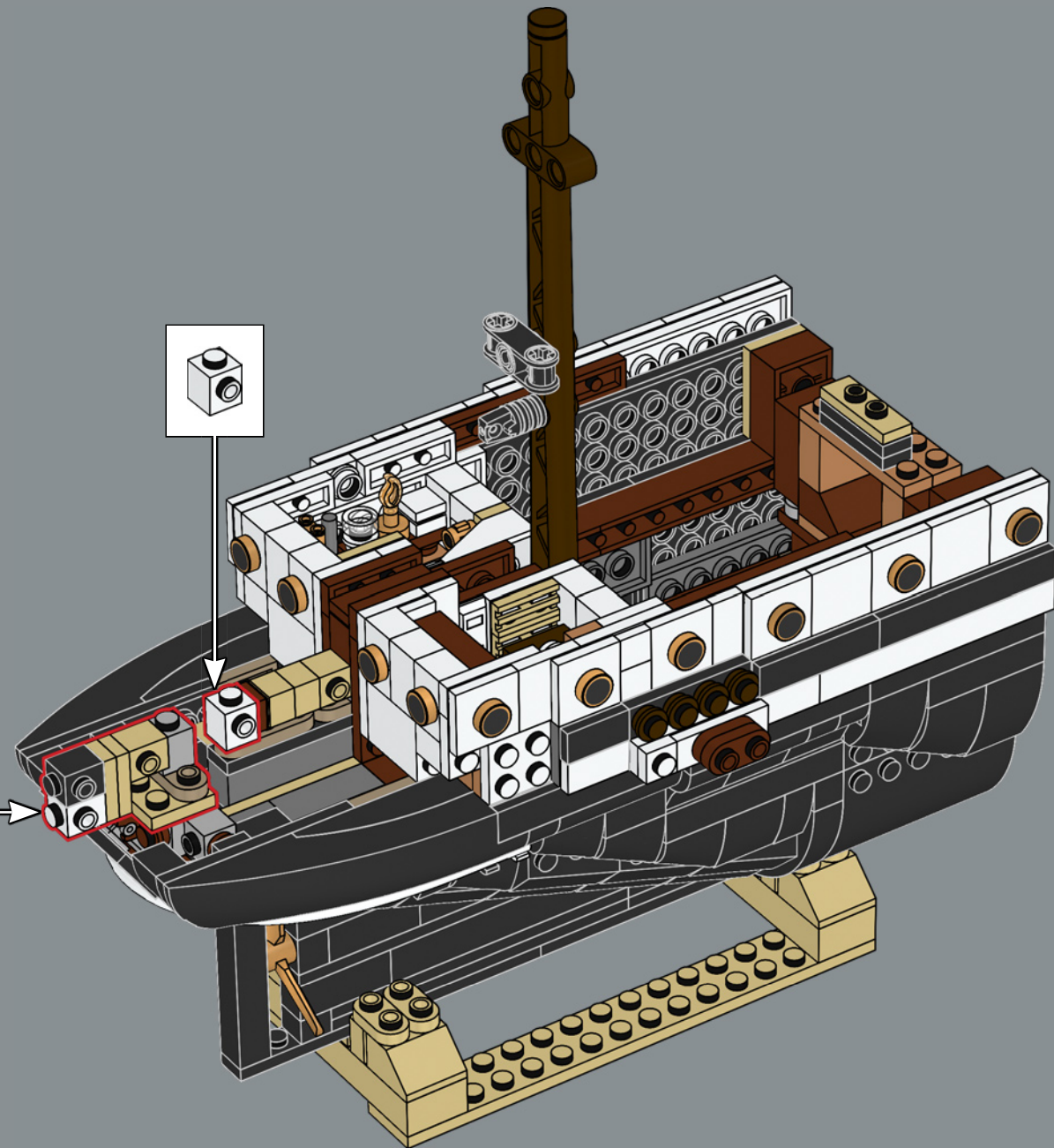

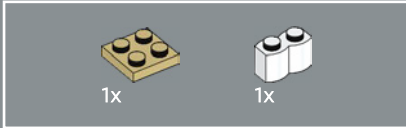
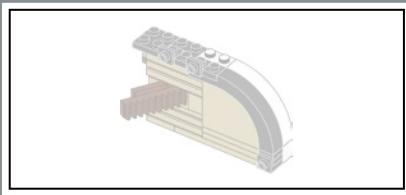

422

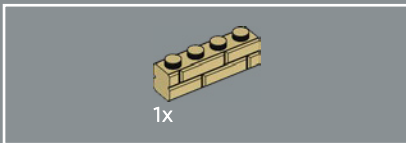
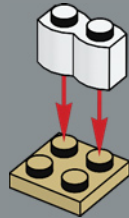

423

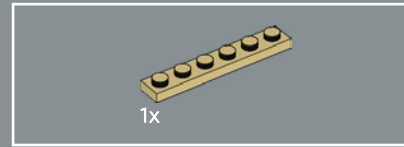
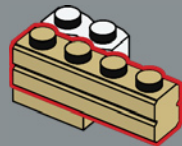

424

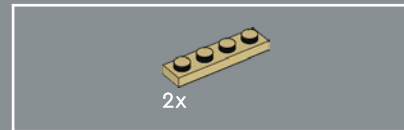
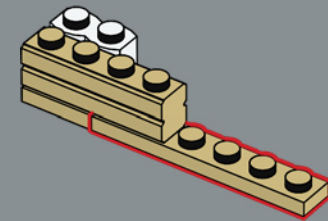

425

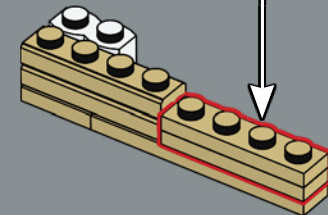
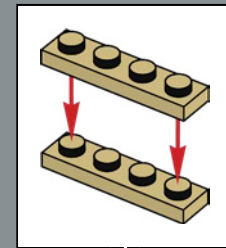

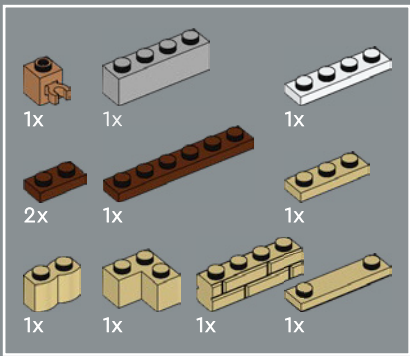

426 1

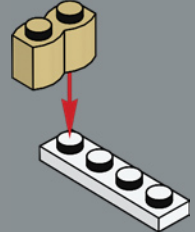

2

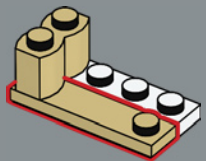

3

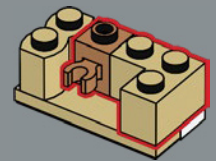

4

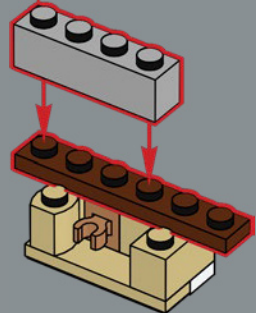

5

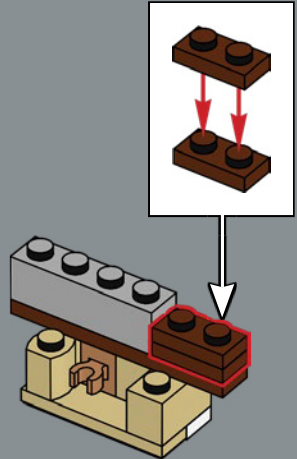

6

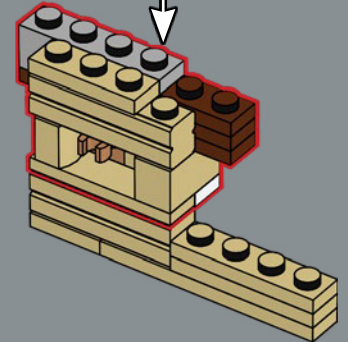
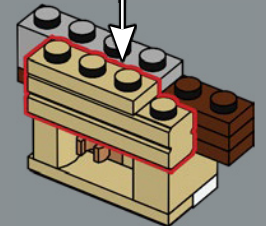
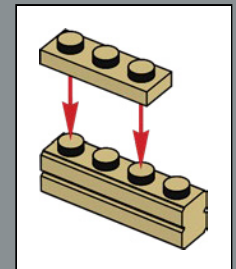

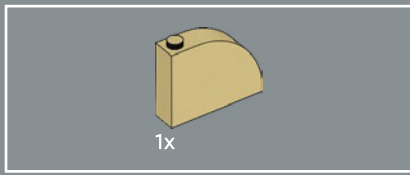

427

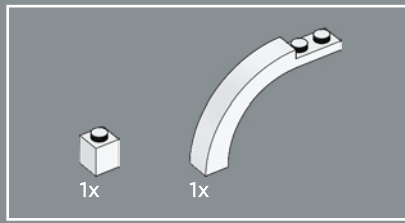
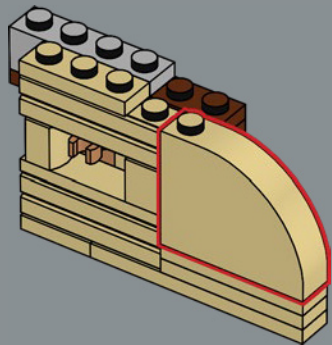

428

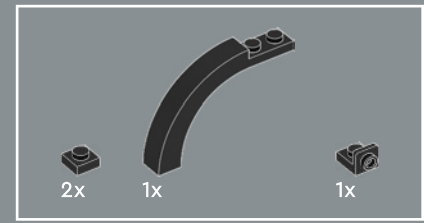
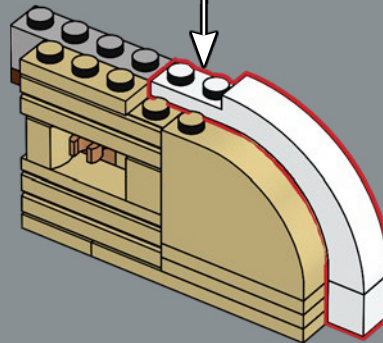
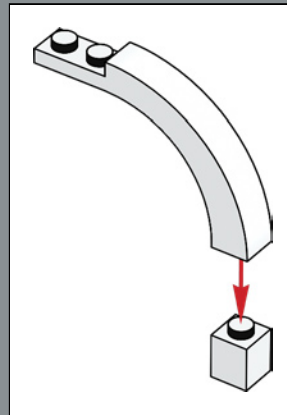

429

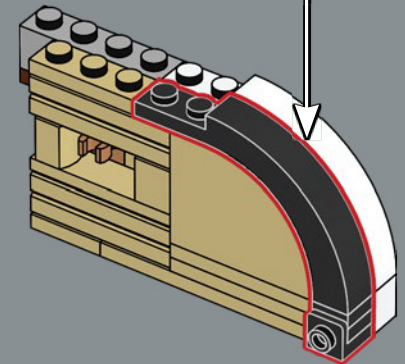
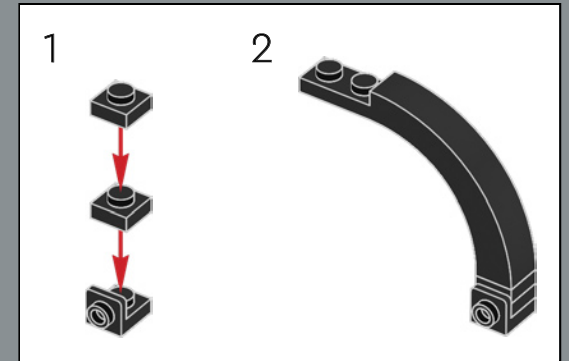

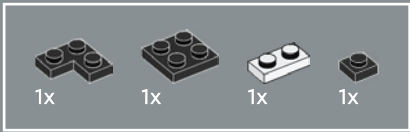

430

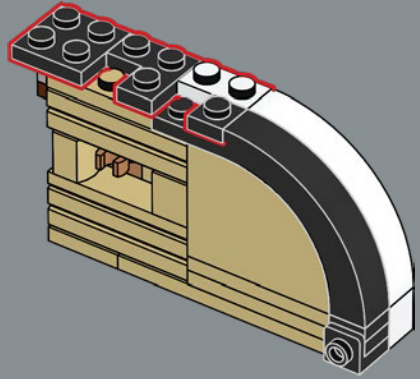

431

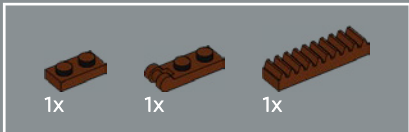
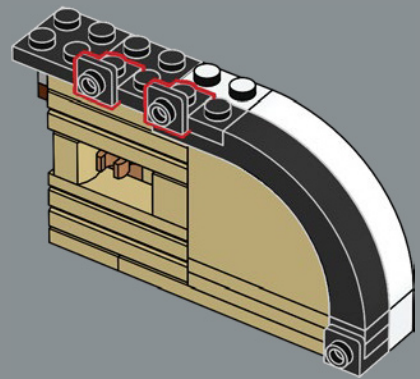

432

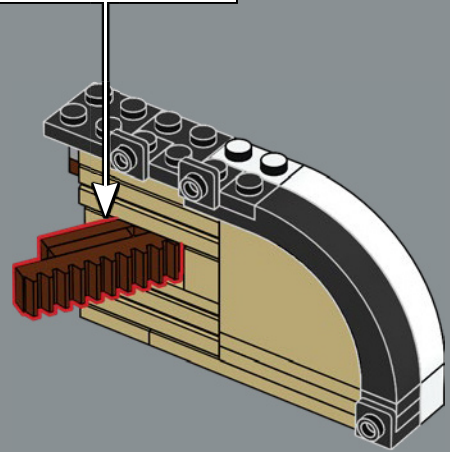
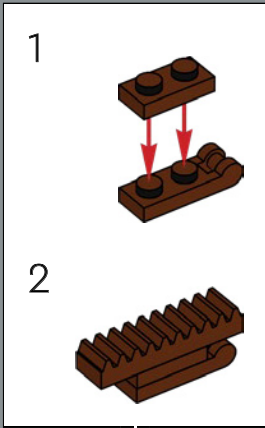

433

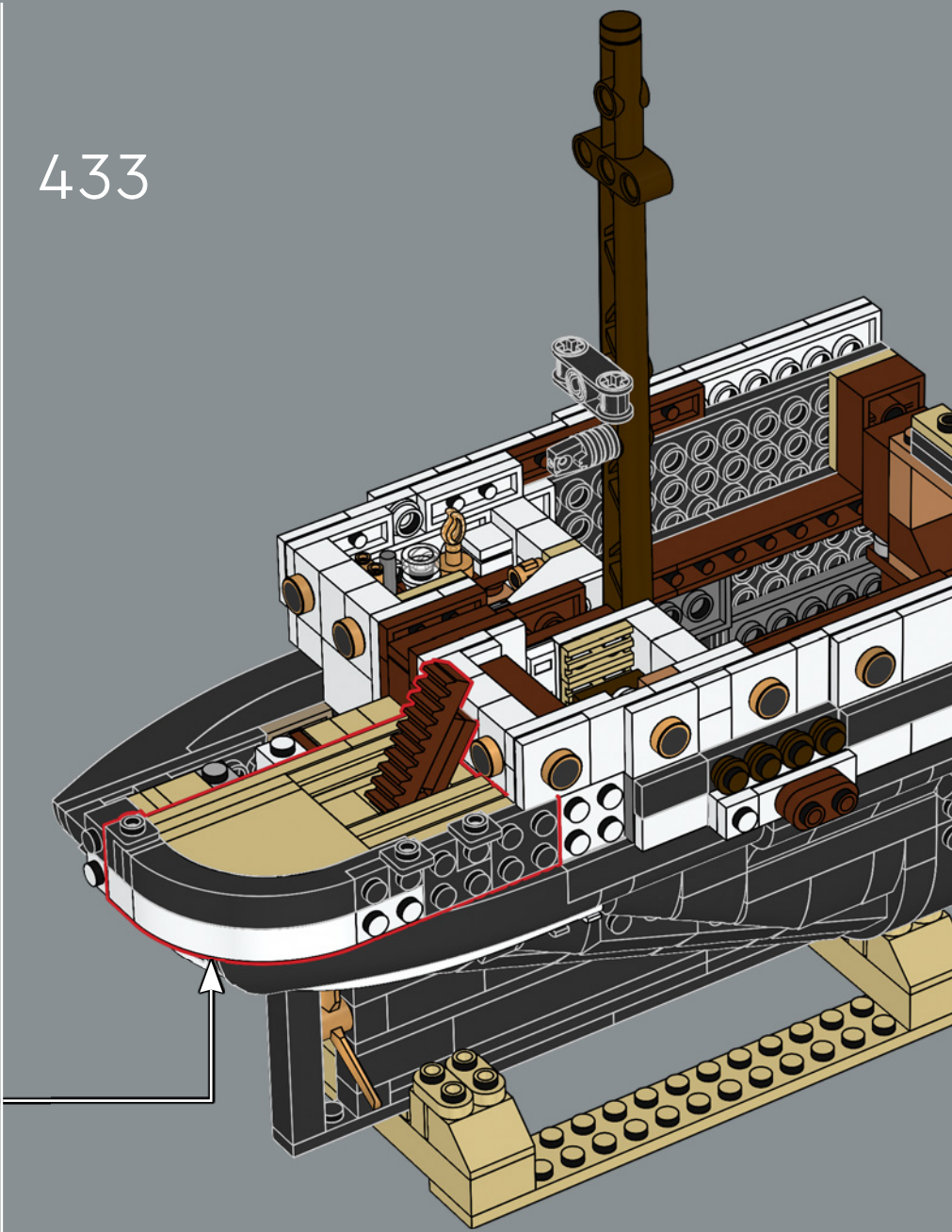

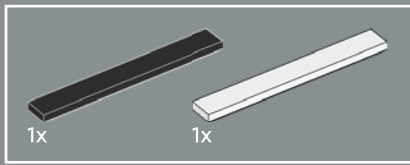

434

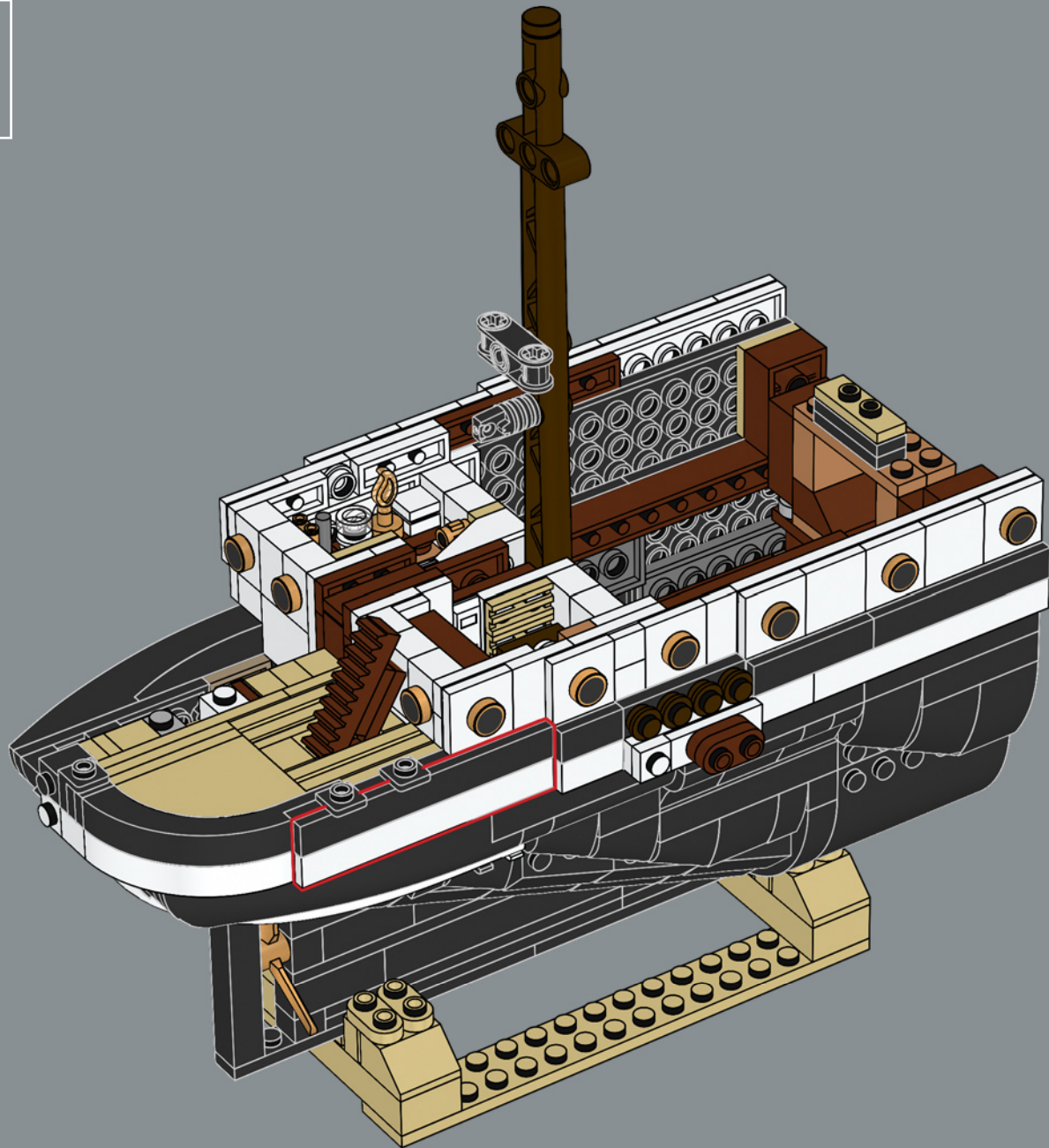

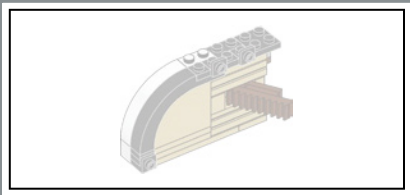

435

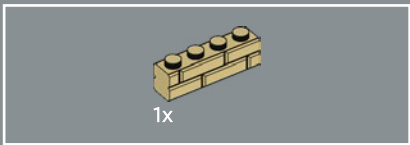
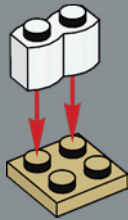

436

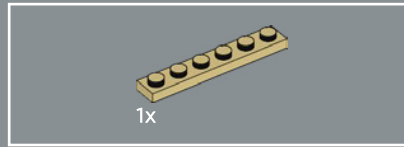
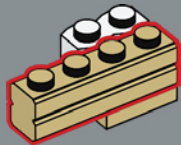

437

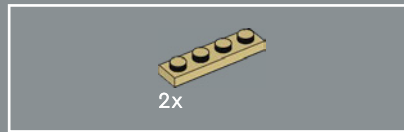
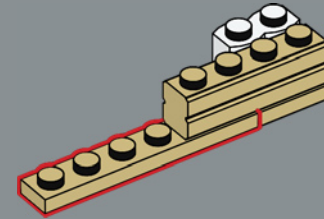

438

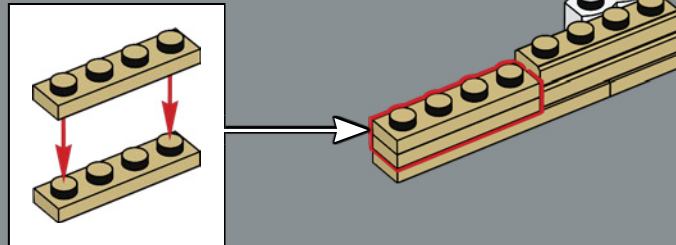

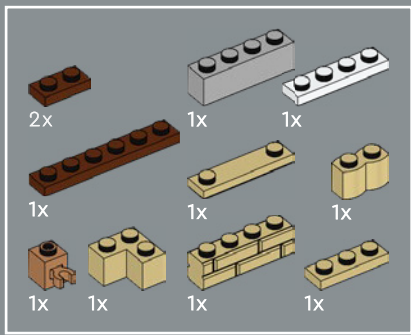

439

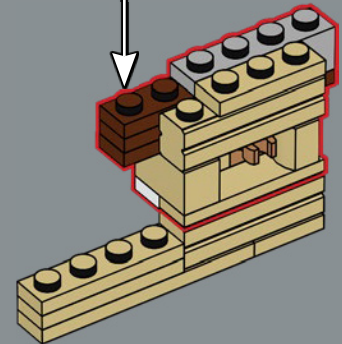
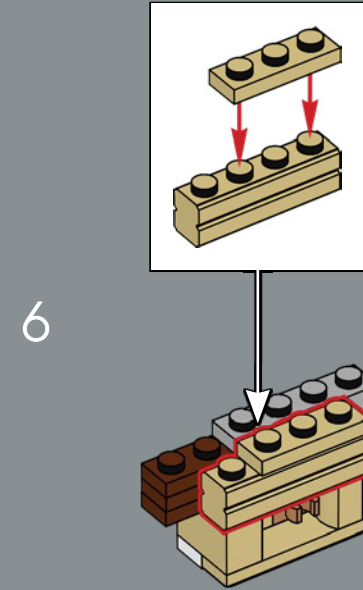
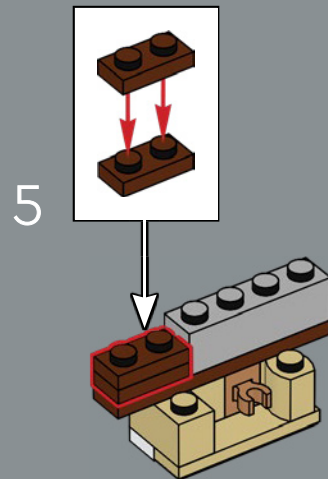
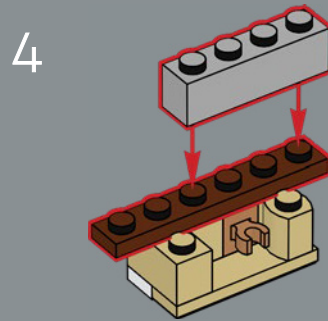
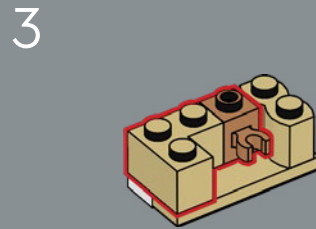
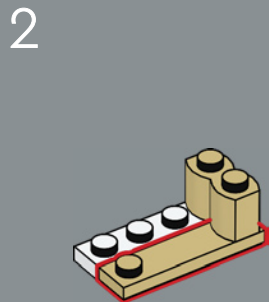
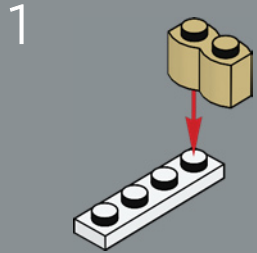

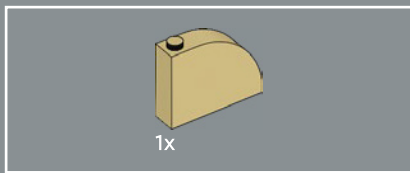

440

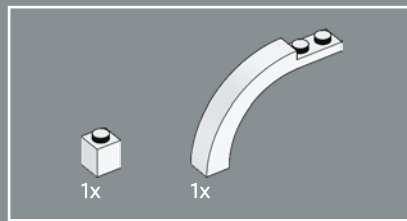
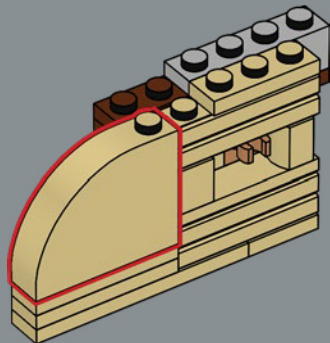

441

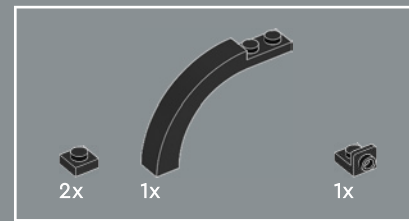
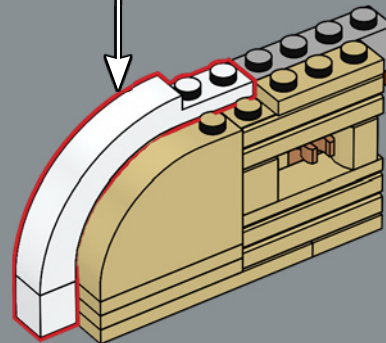
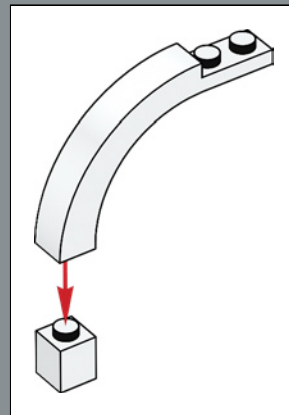

442

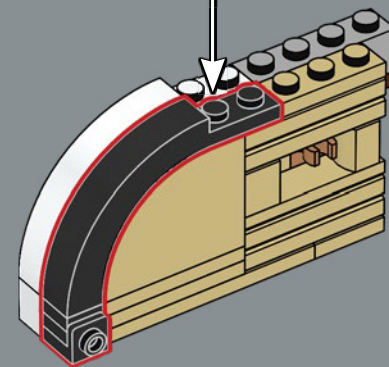
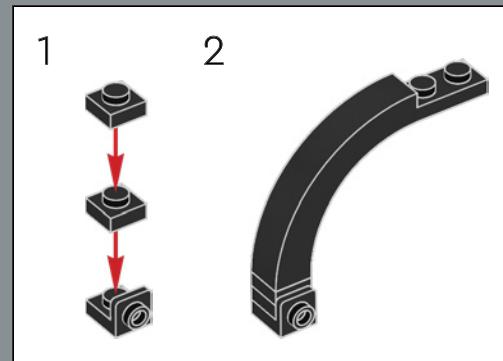

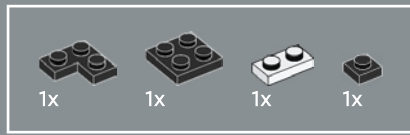

443

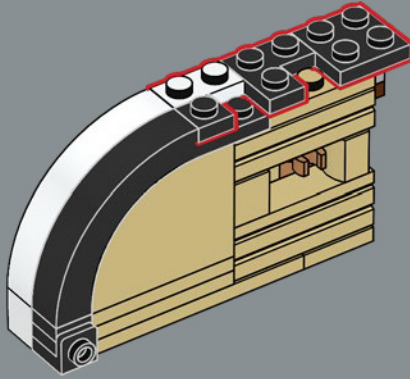

444

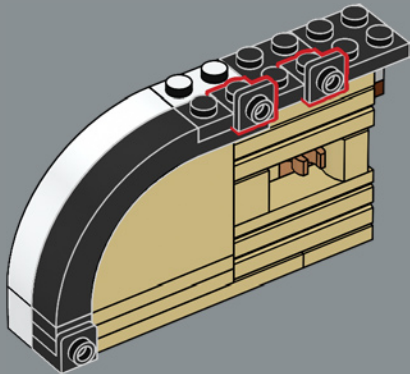

445

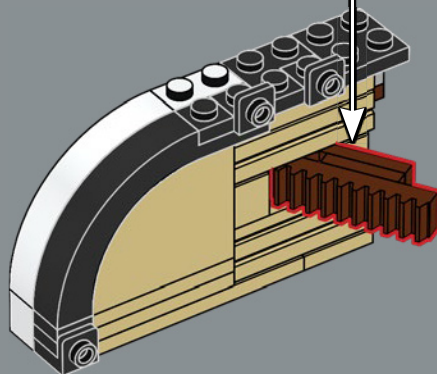
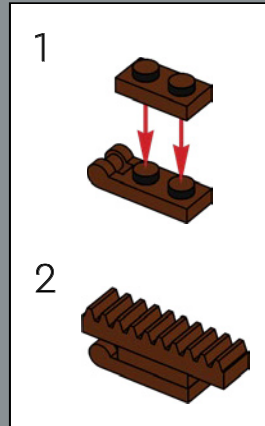

446

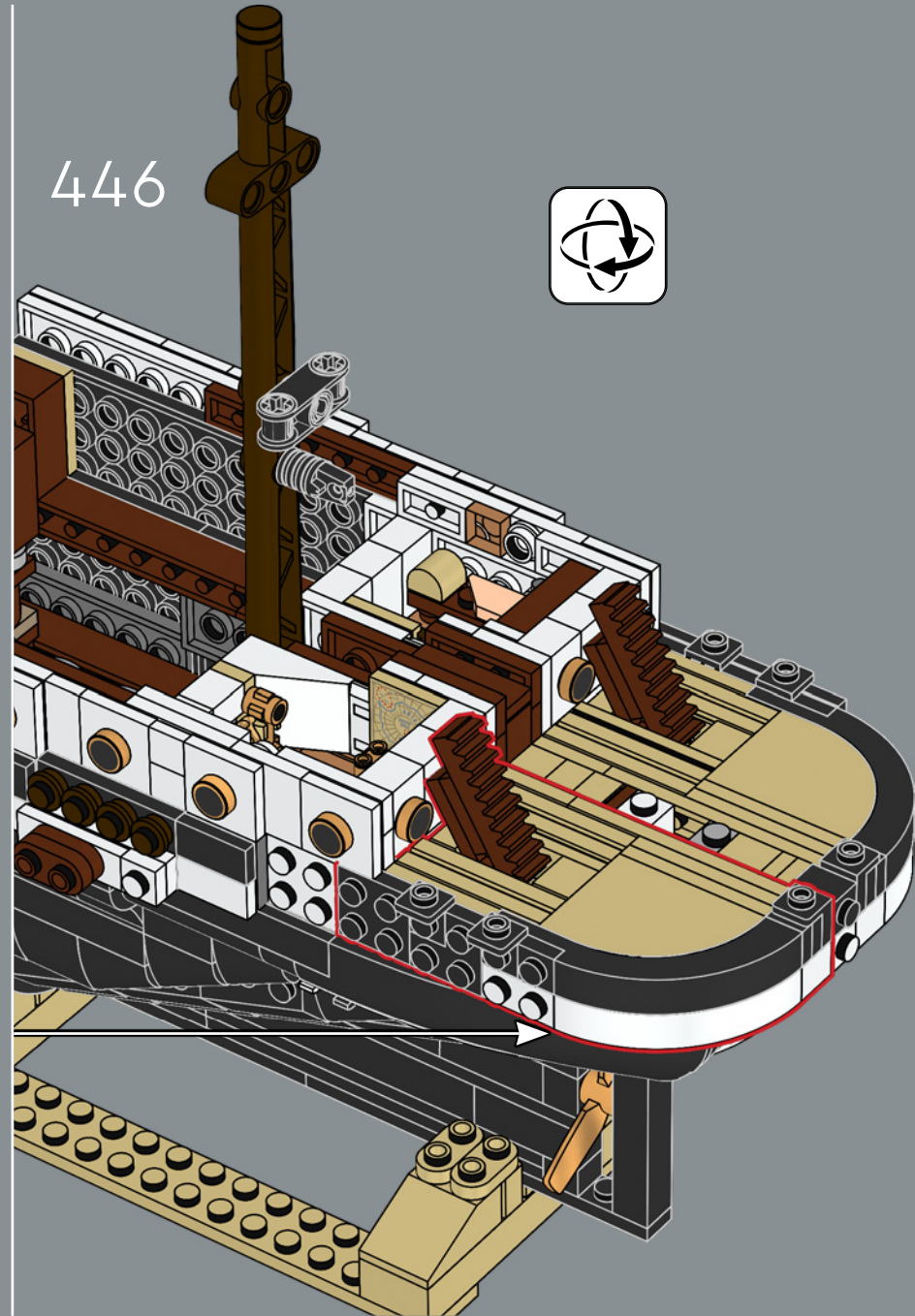

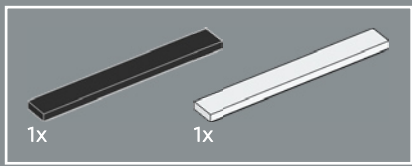

447

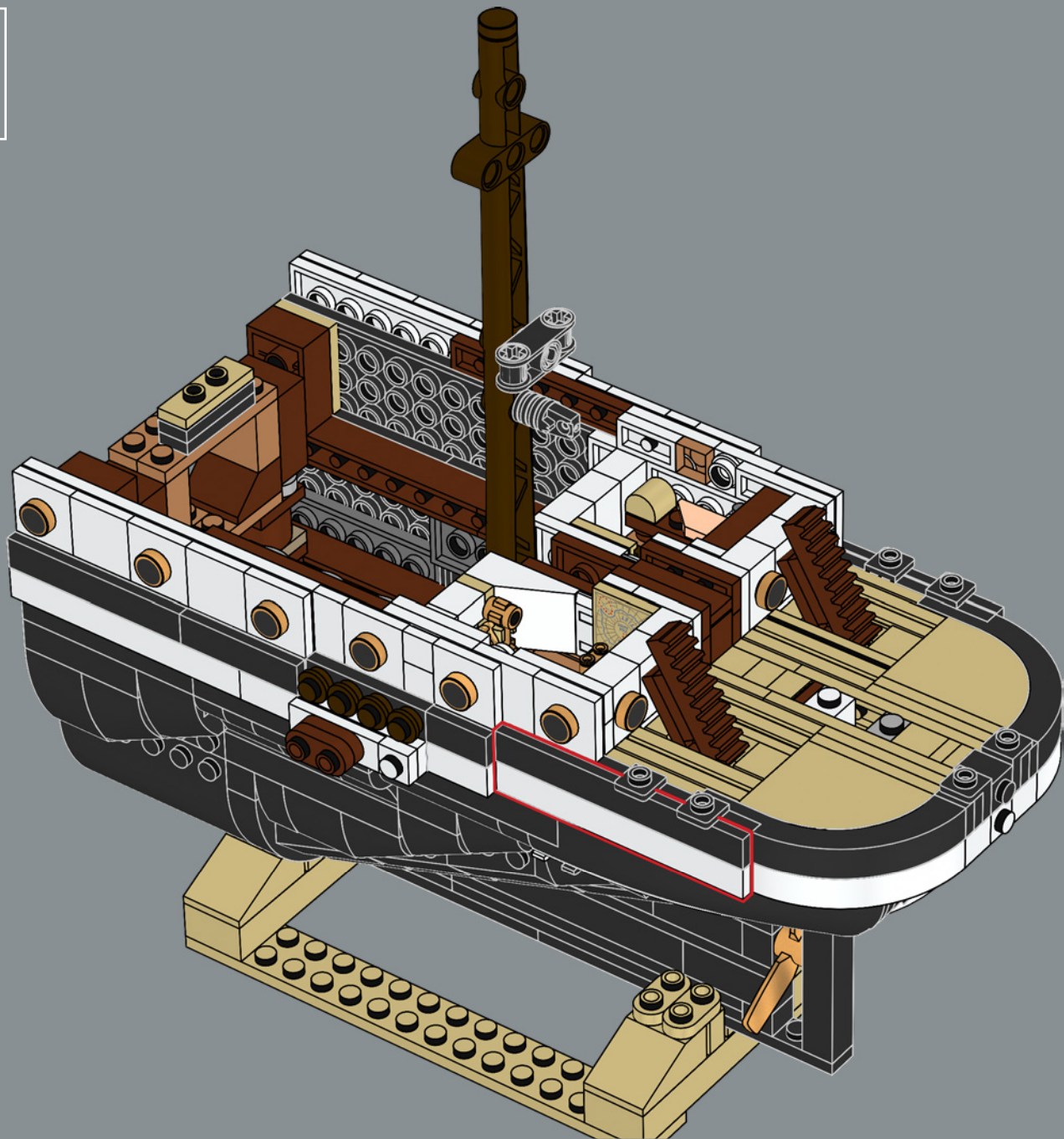

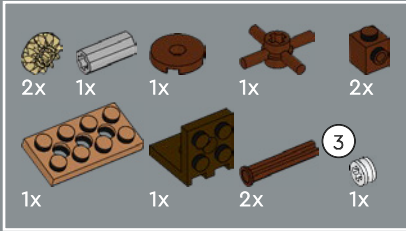
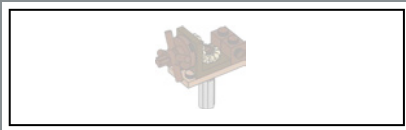

448

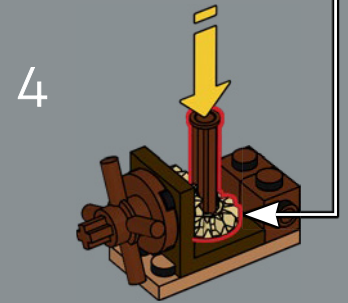
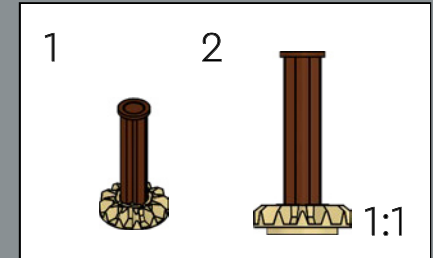
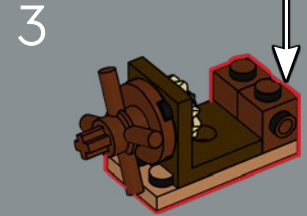
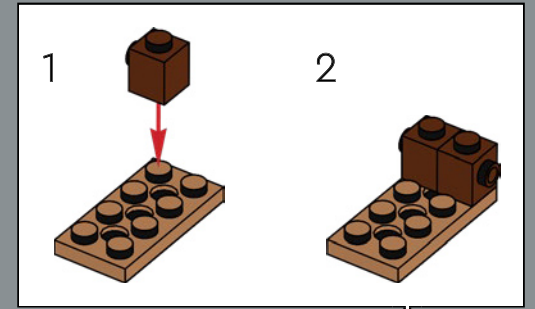
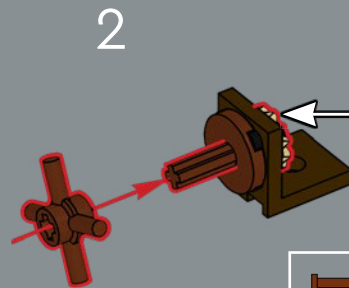
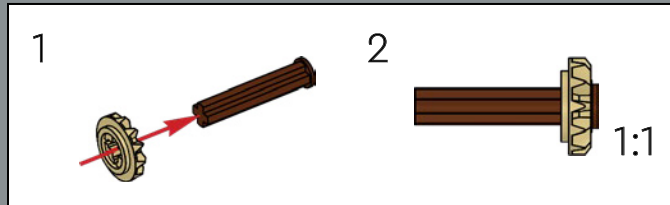
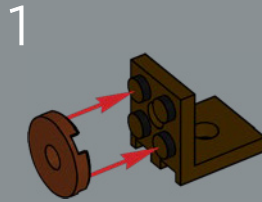

5

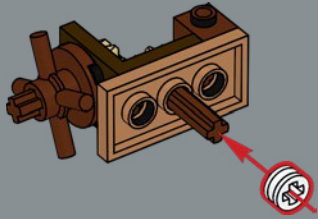

6

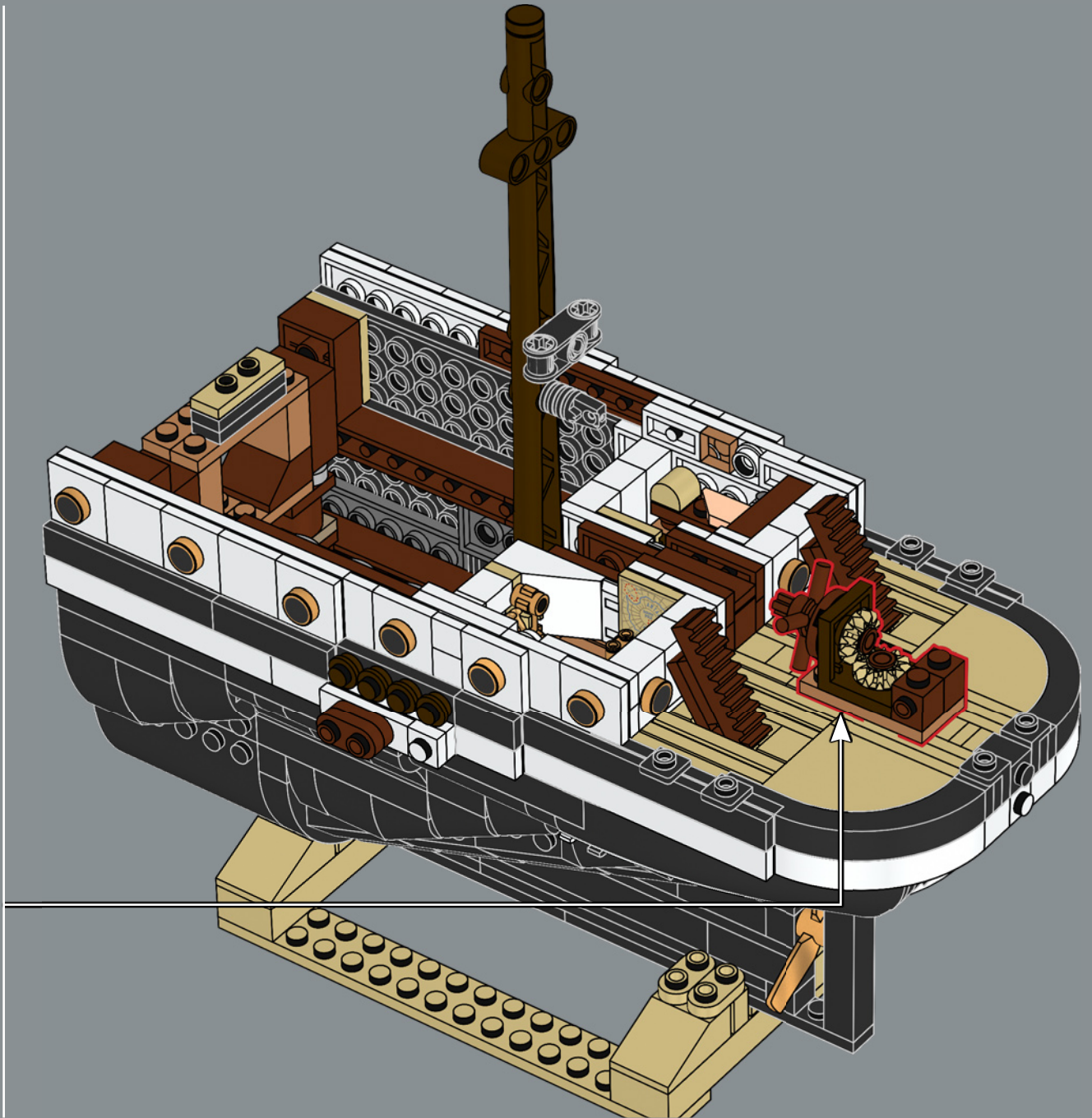
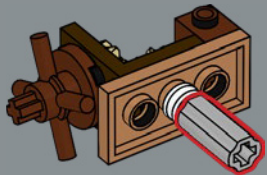

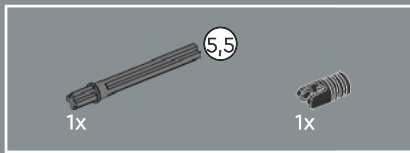

449

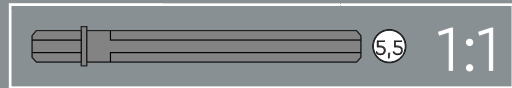
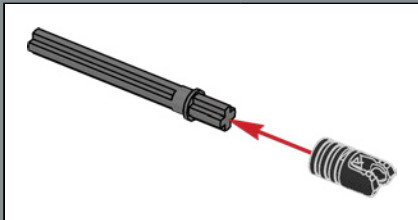
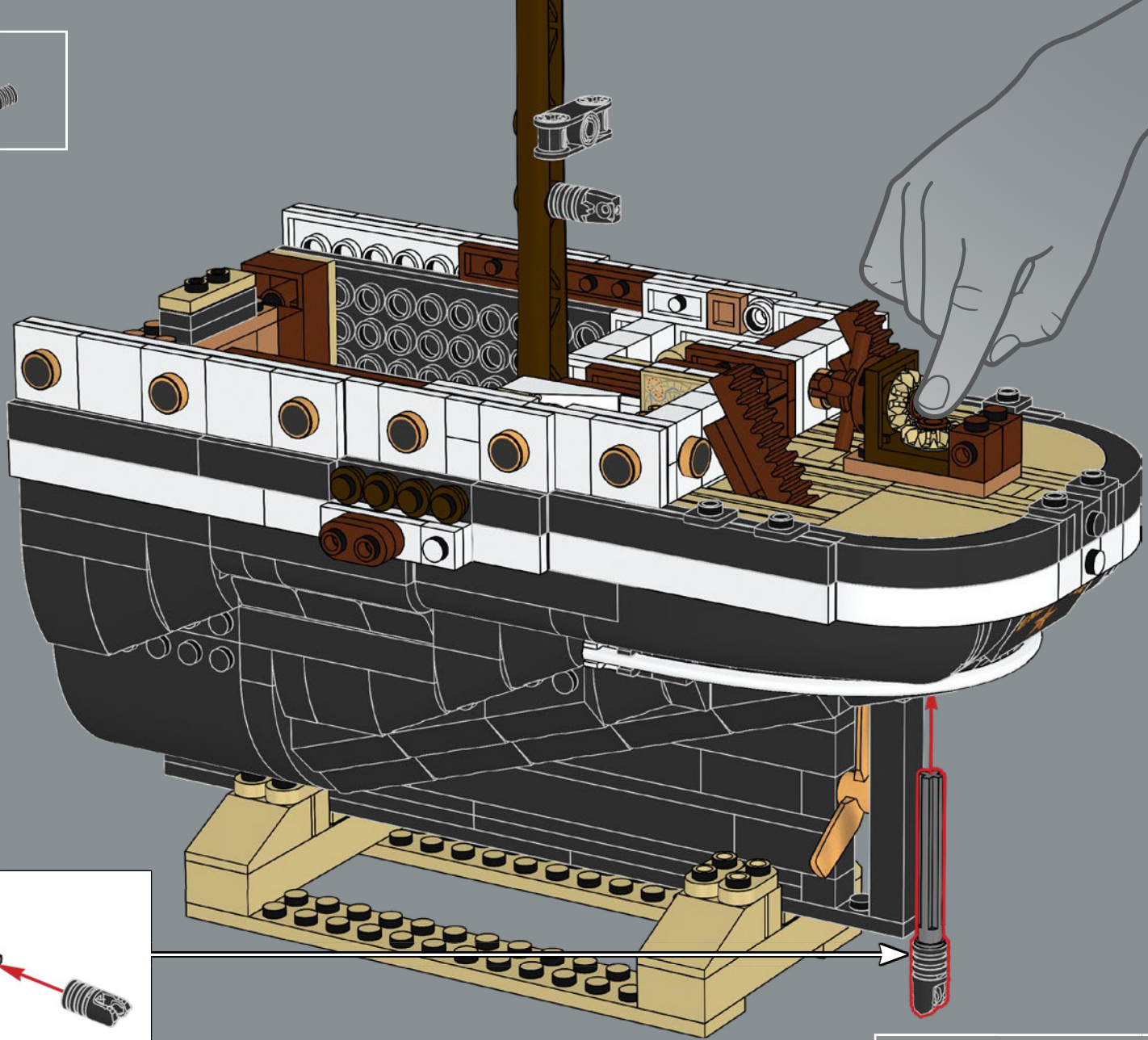

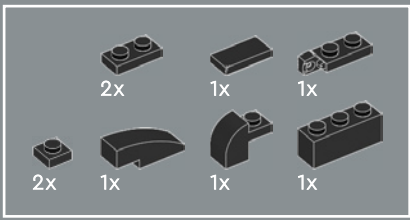

450

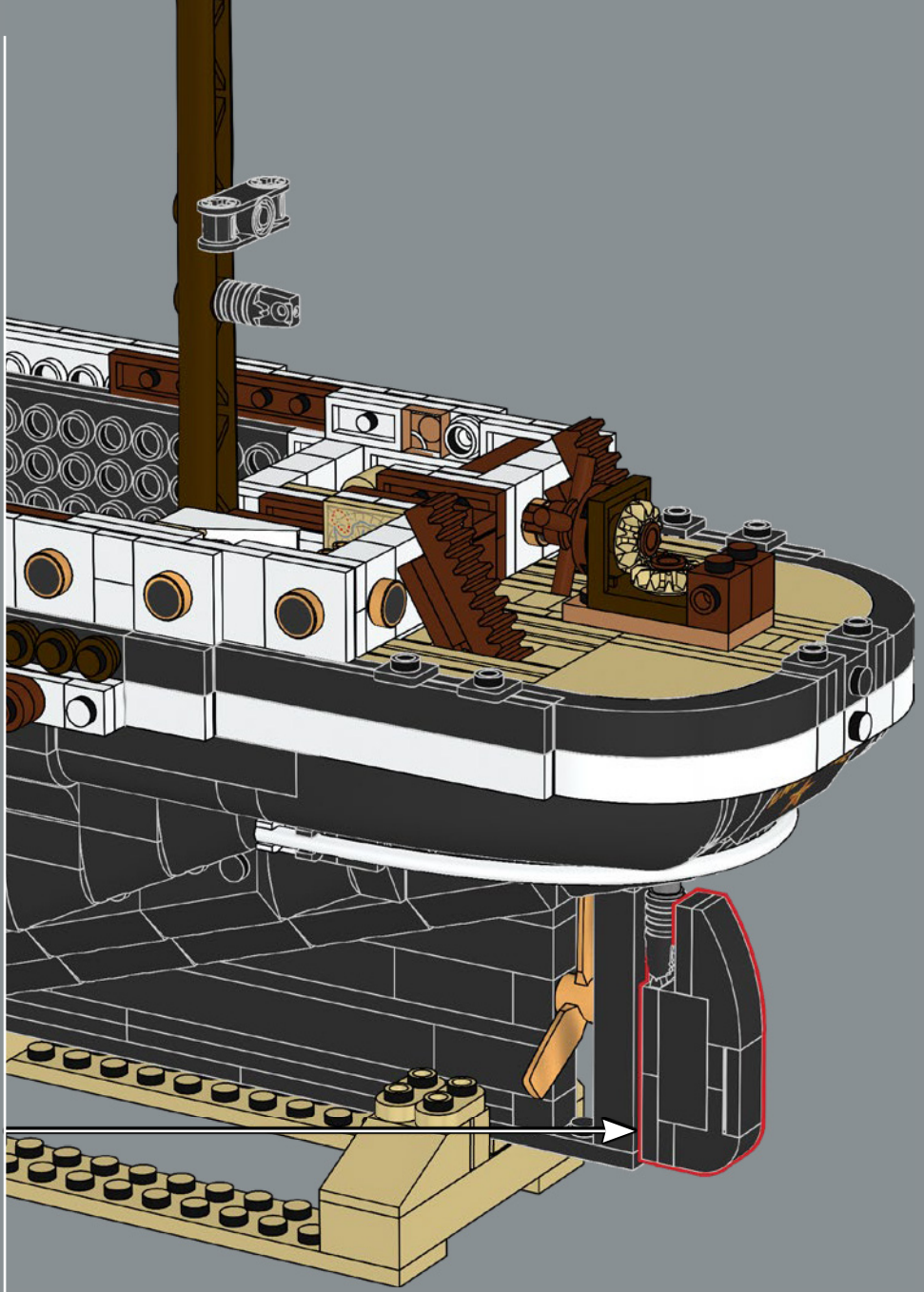
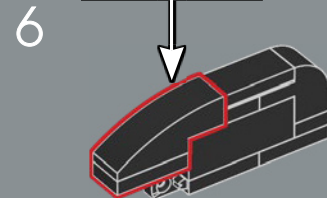
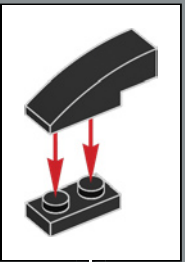
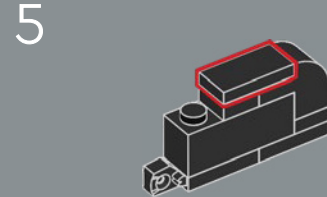
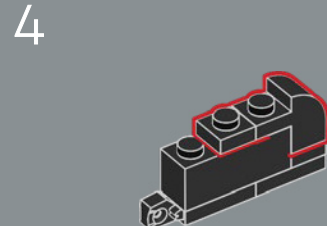
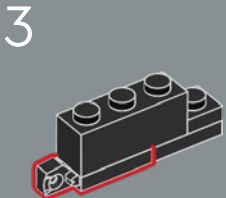
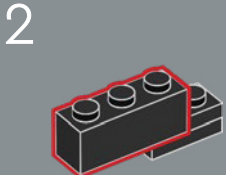
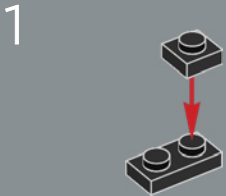

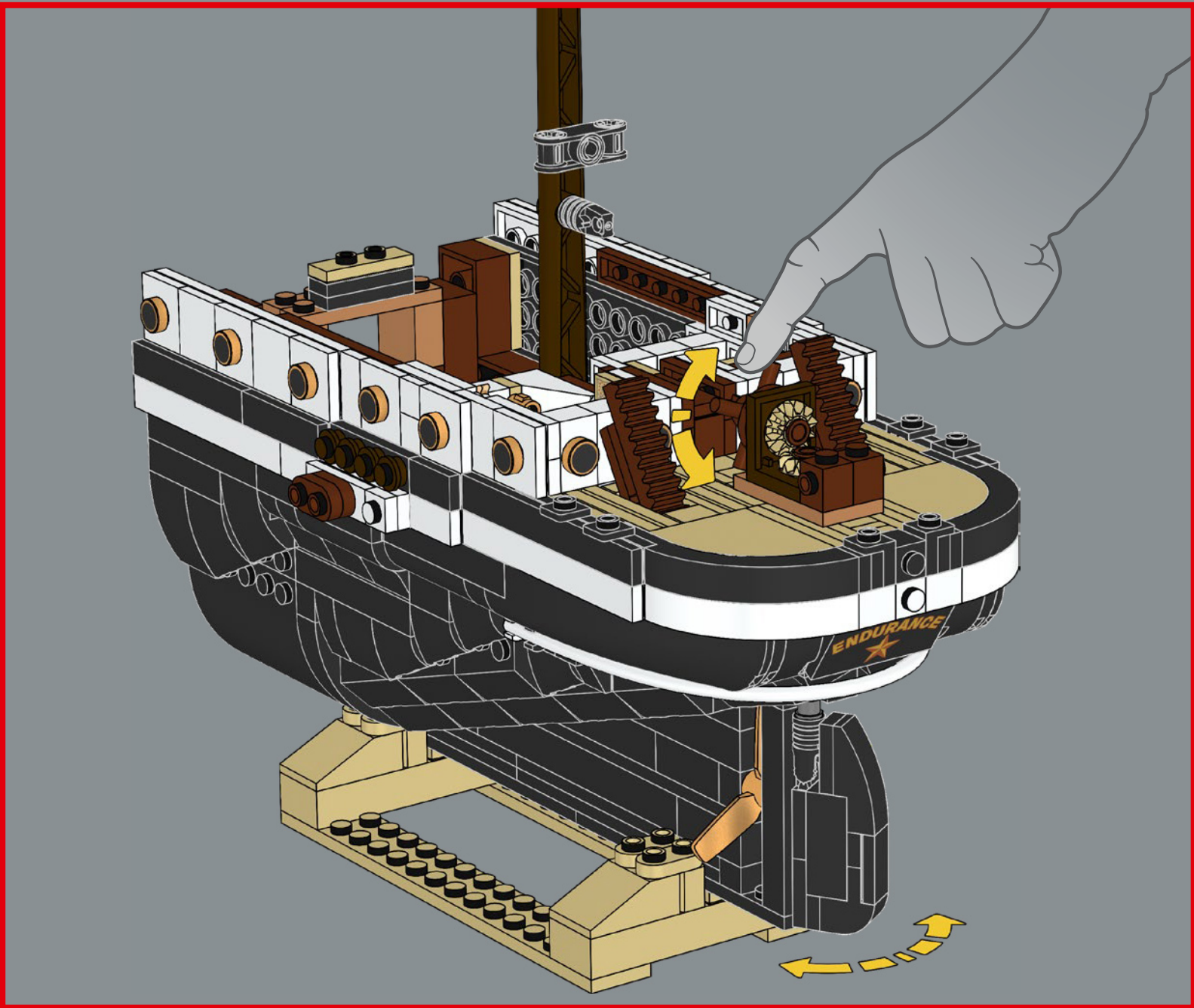

2x

451

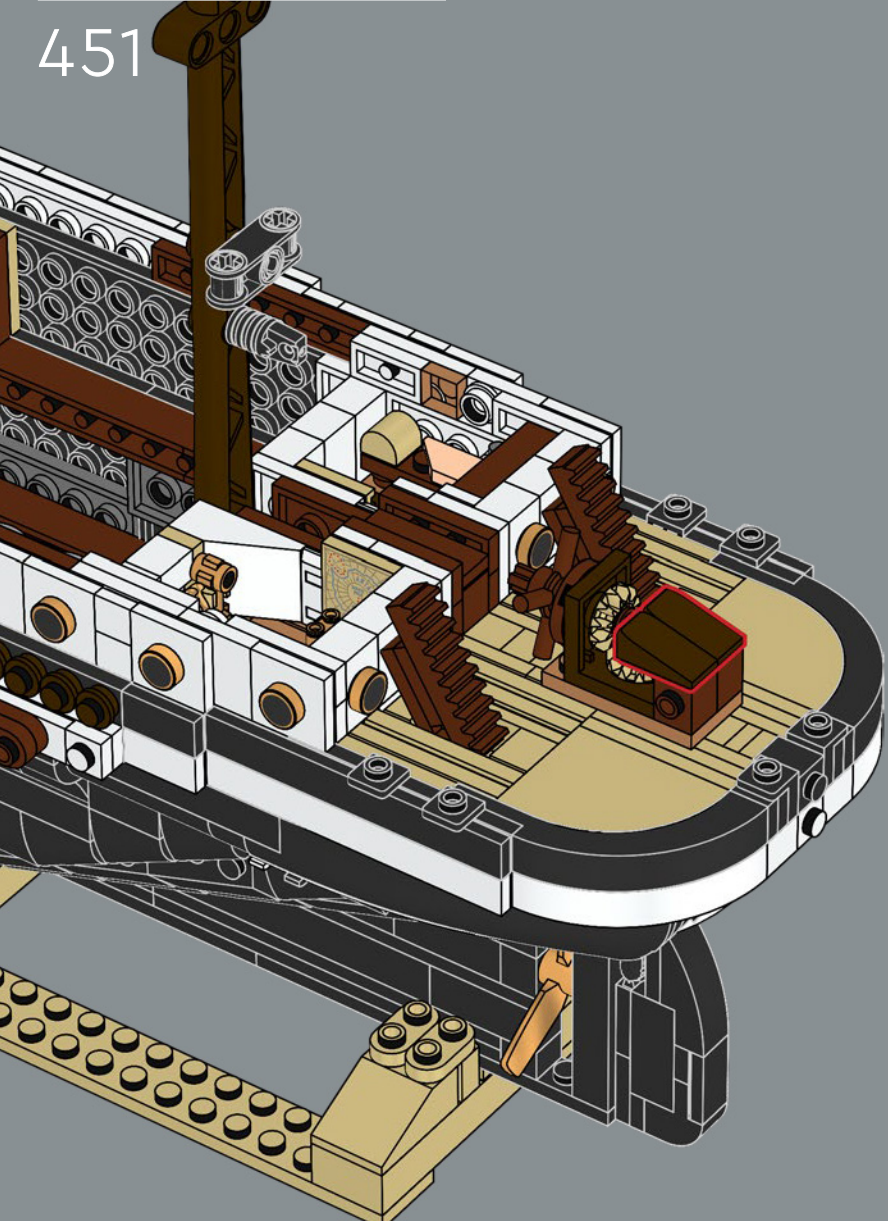

1x

1x

452

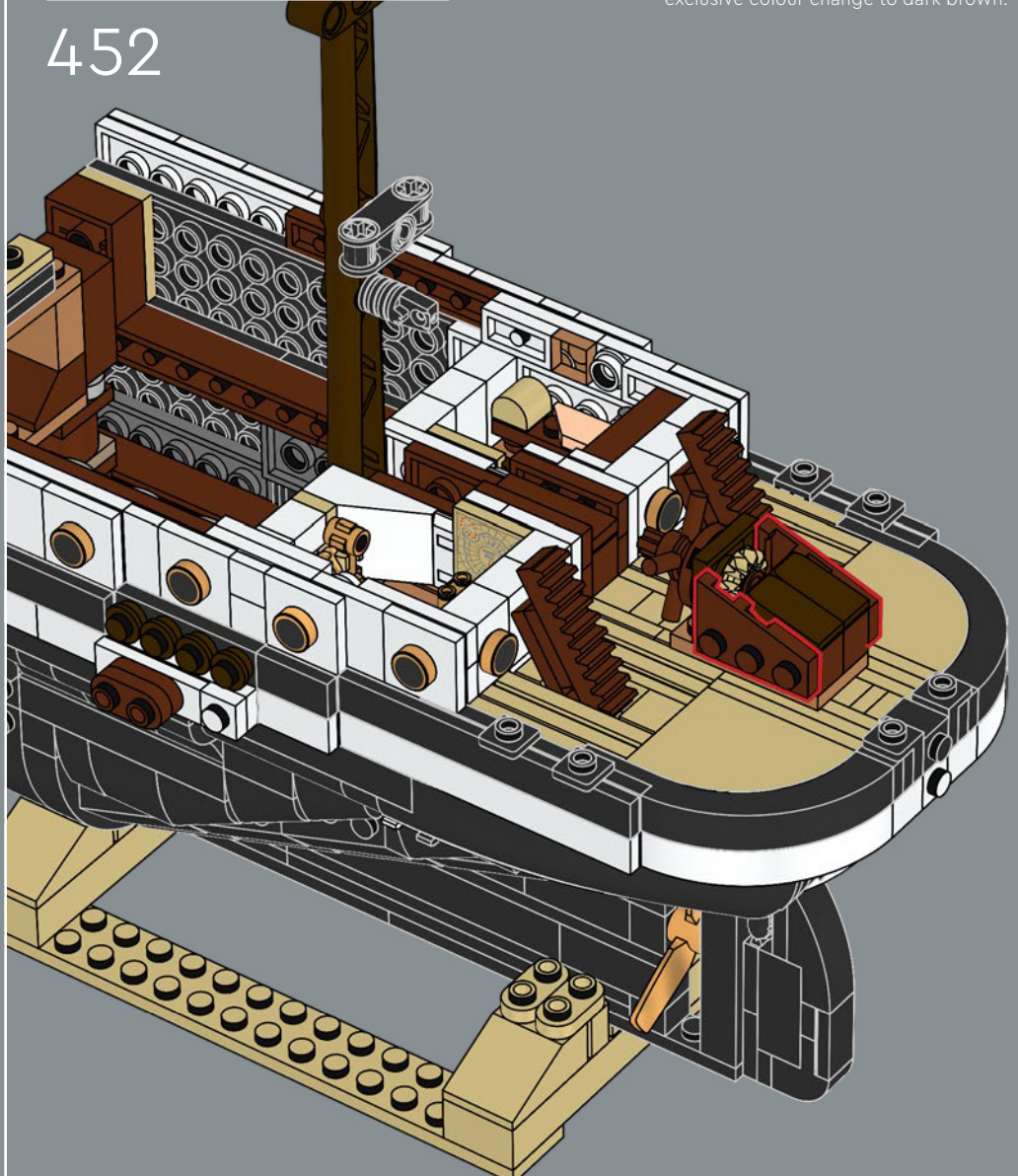

For the steering cabinet controlling the rudder, we designed one of the smallest-ever LEGO® gearboxes with an original 2x2 angle plate. Here, we gave it an exclusive colour change to dark brown.



6x

453

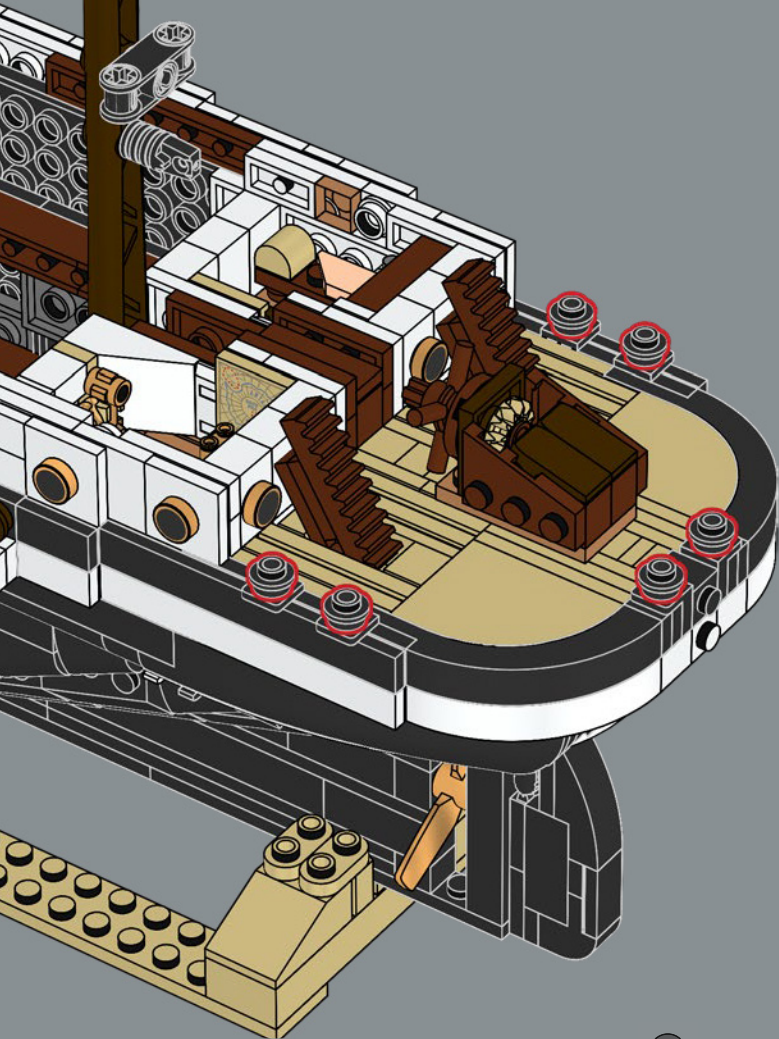

6x

454

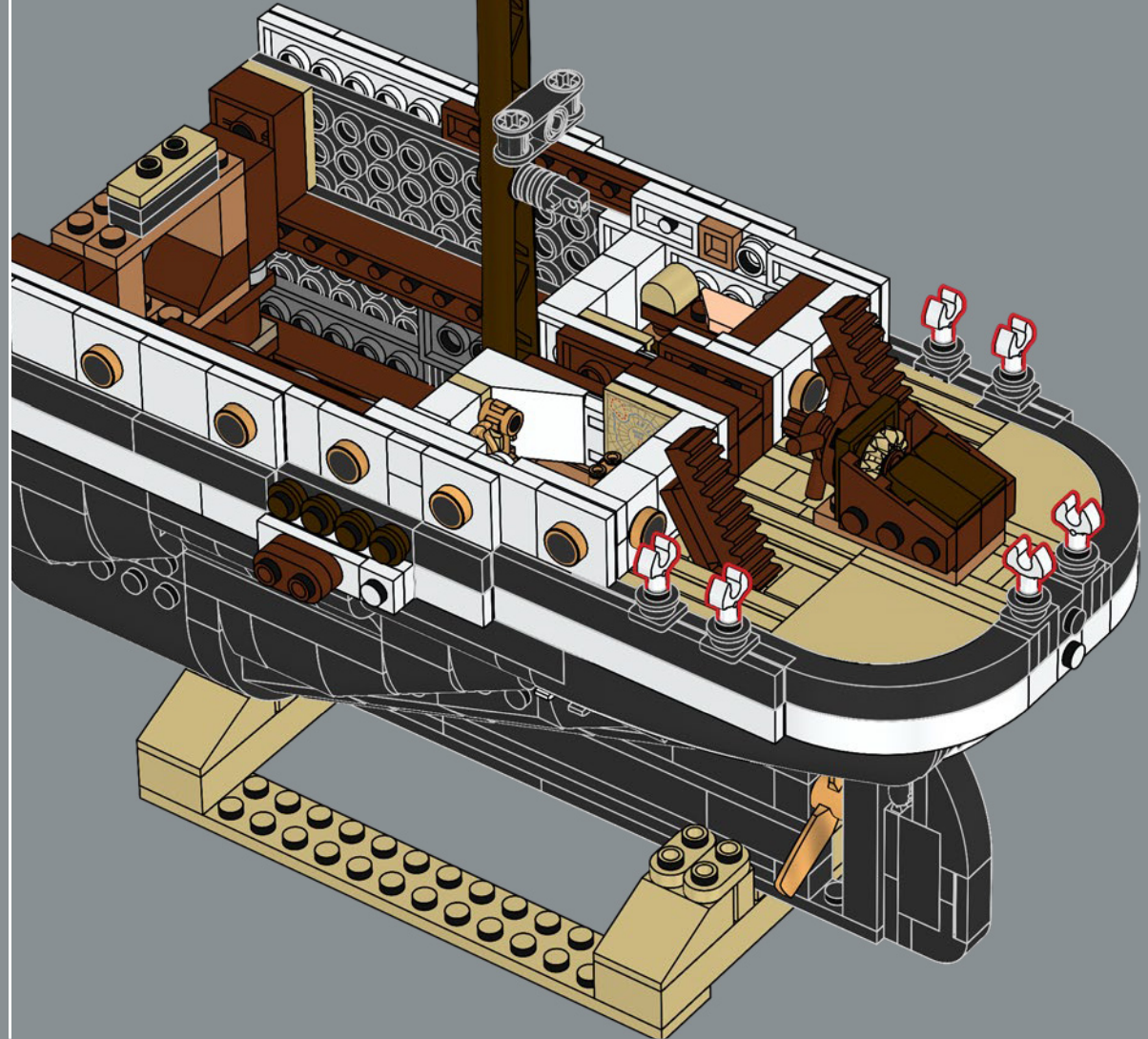

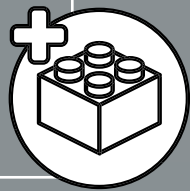
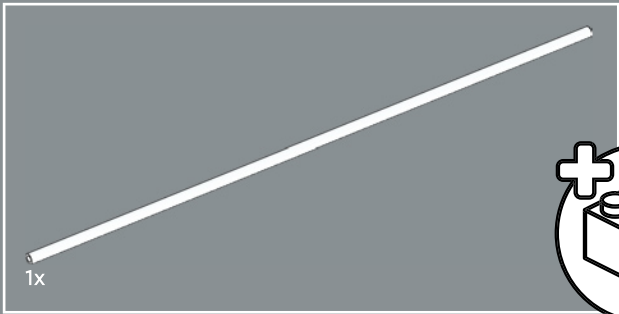

455

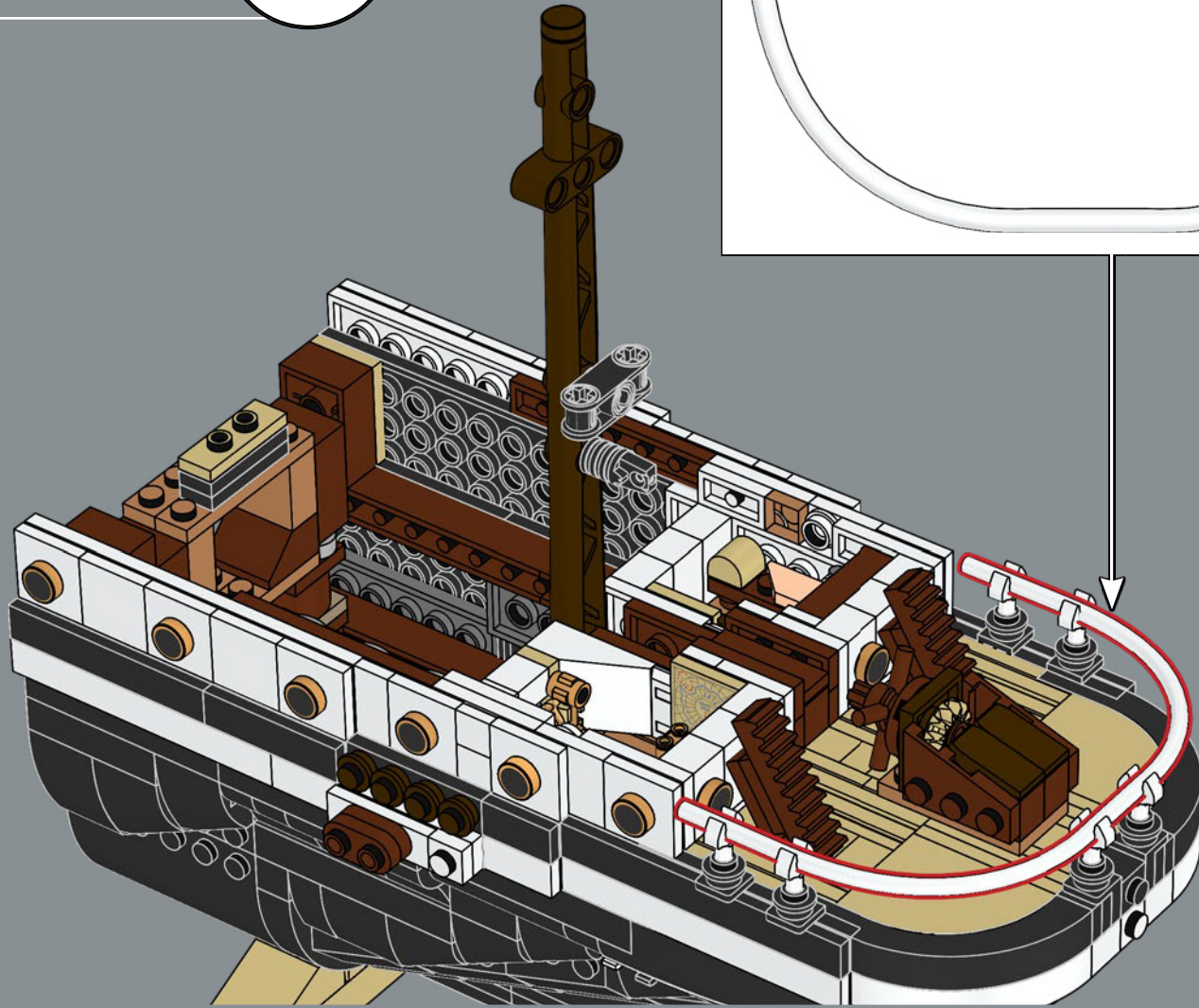
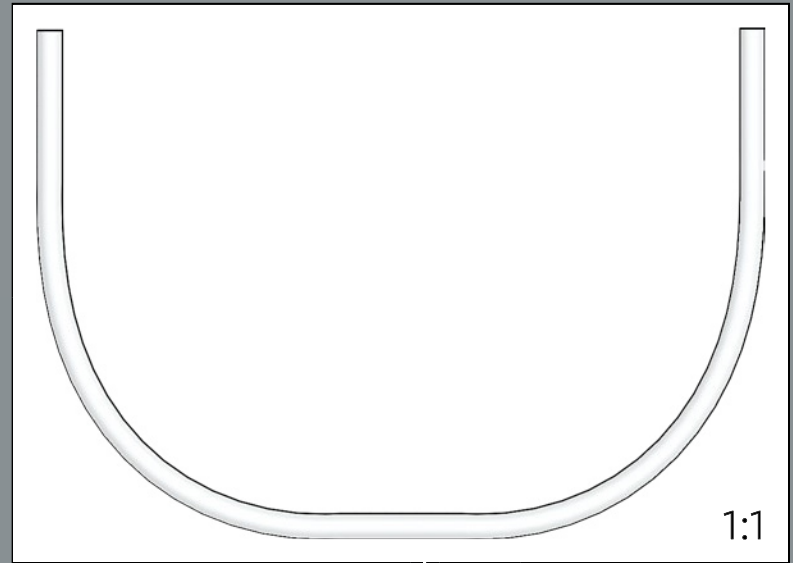



2x

456

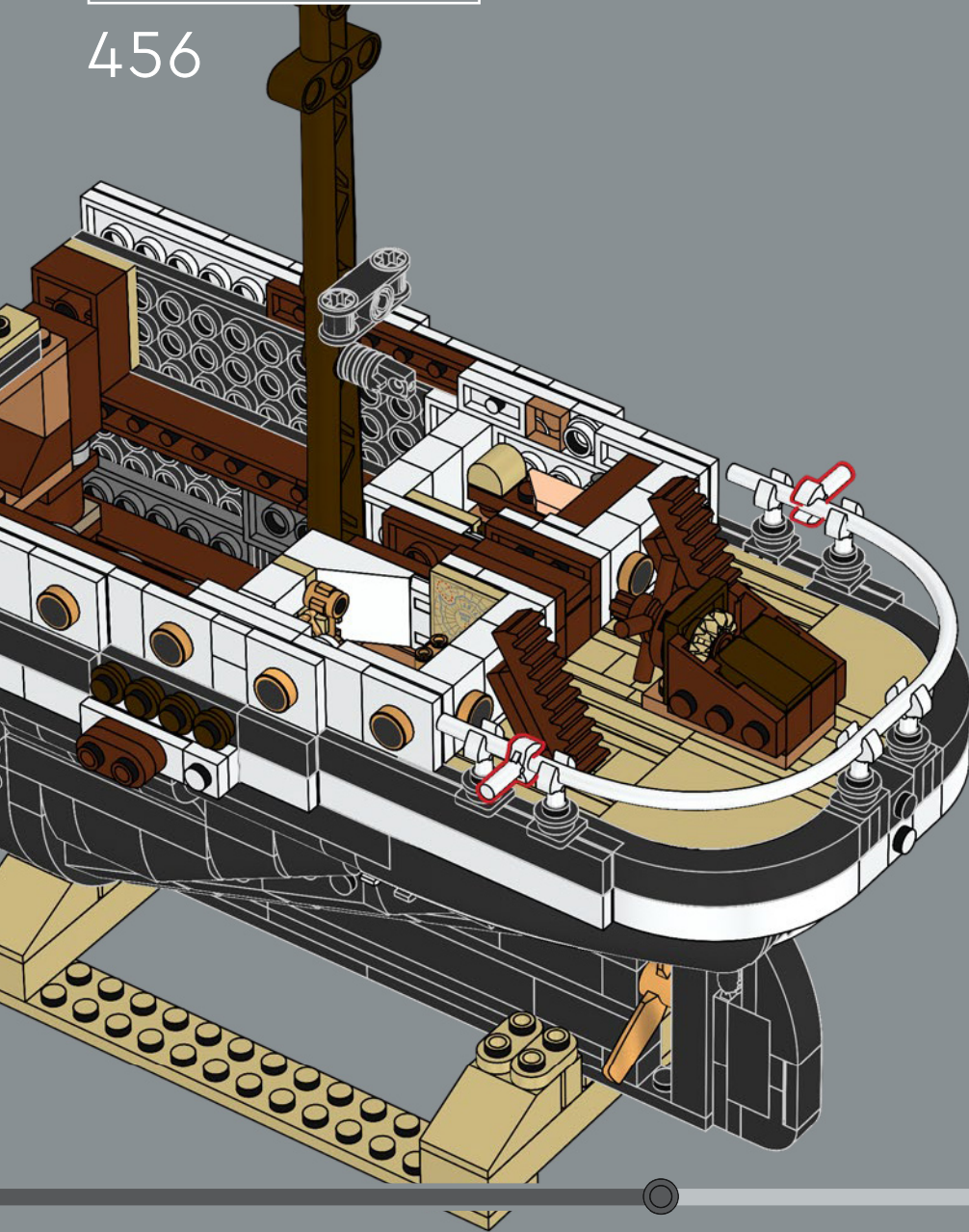

2x

457

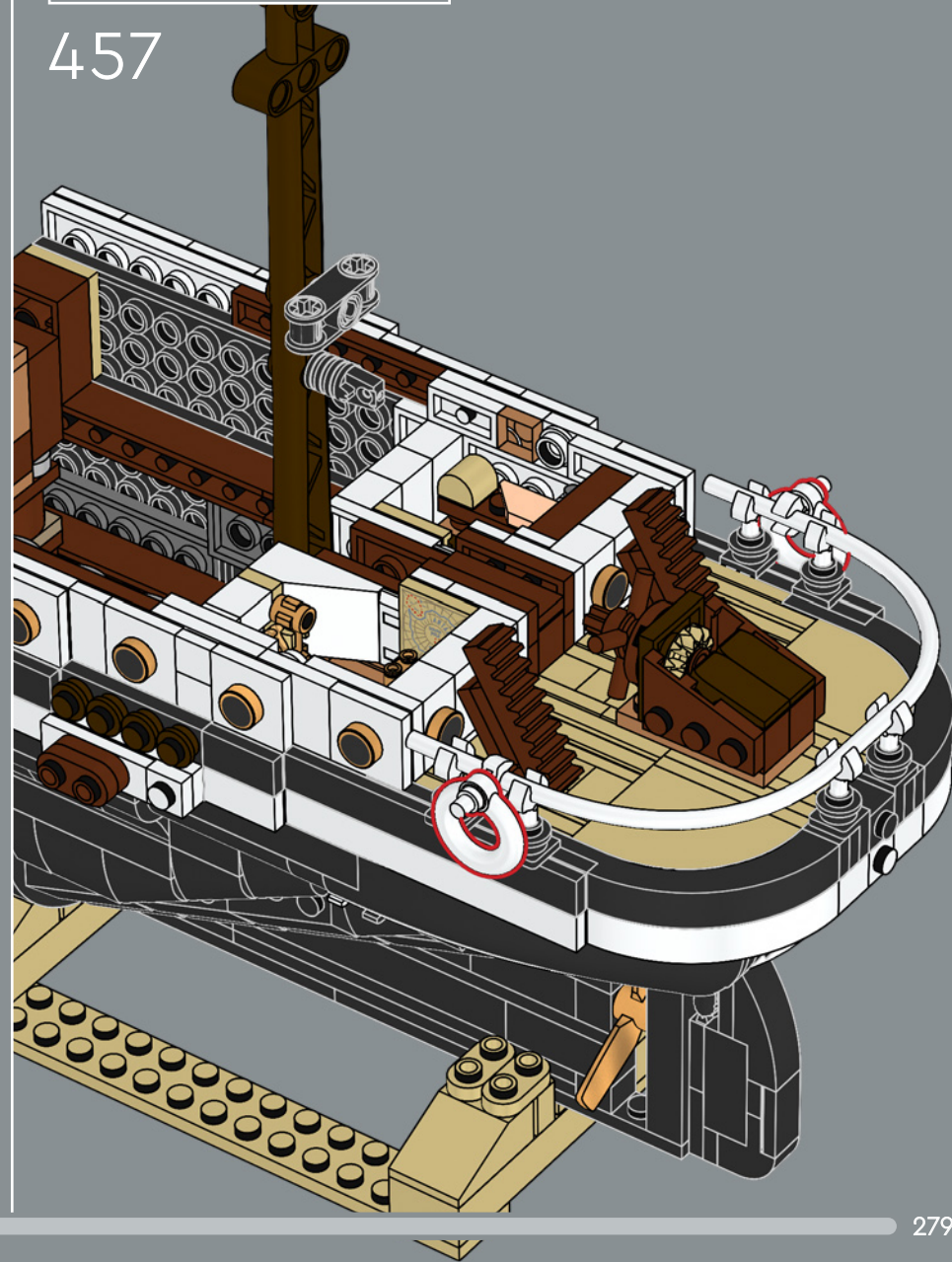

458

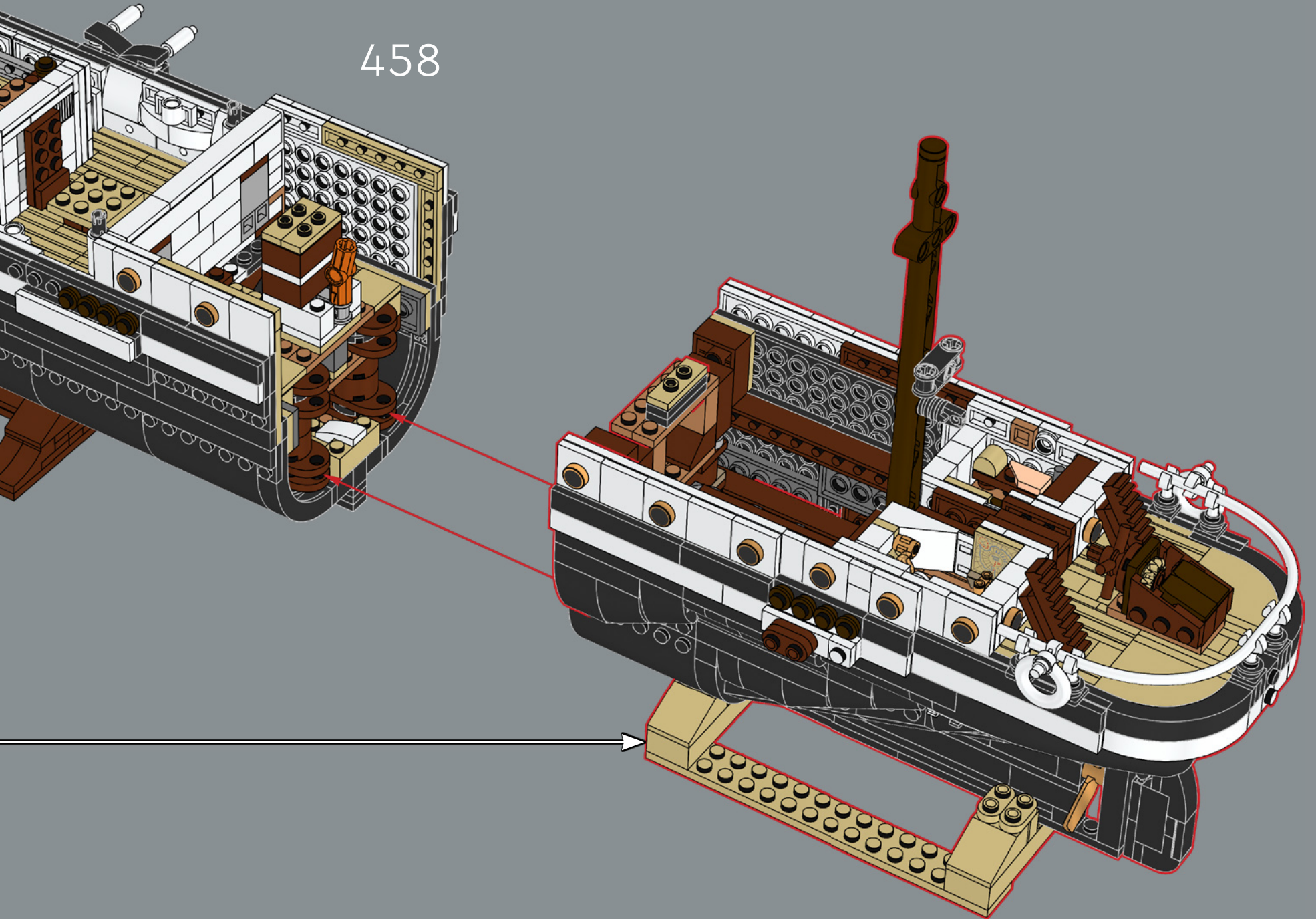

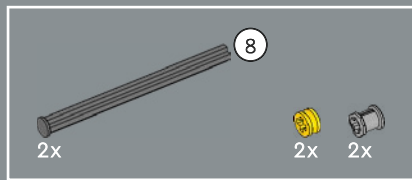

459

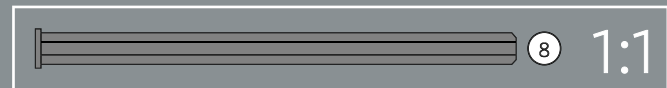
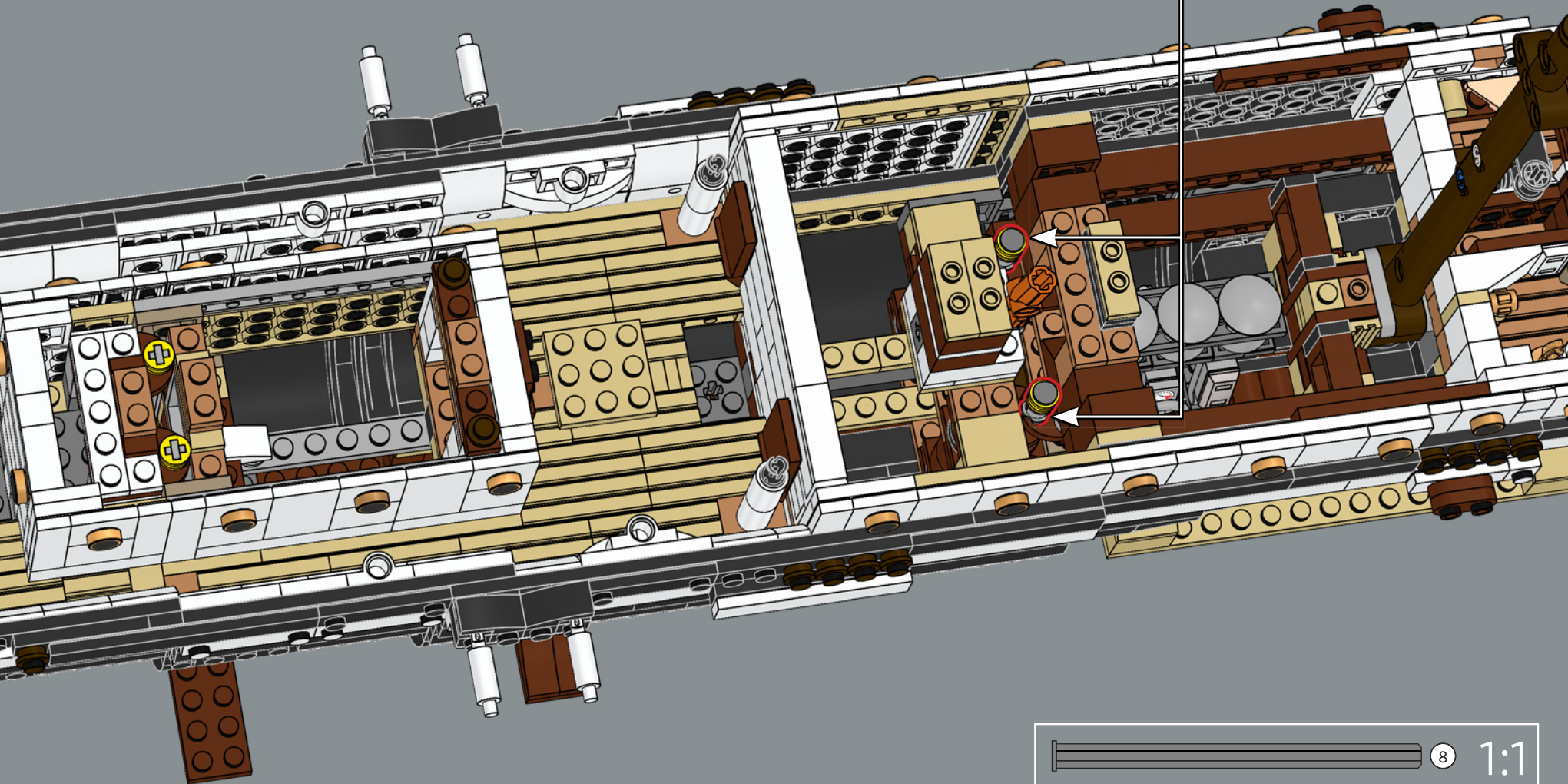
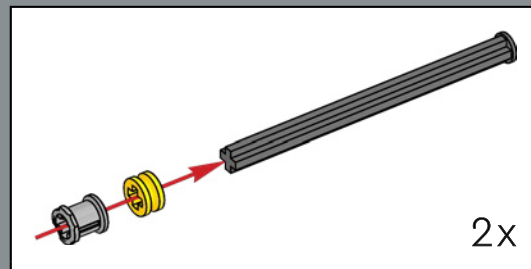

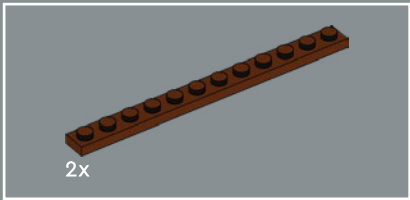

2x

460

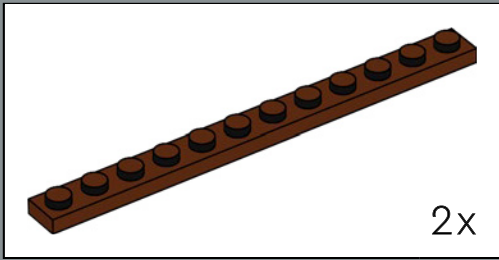

2x

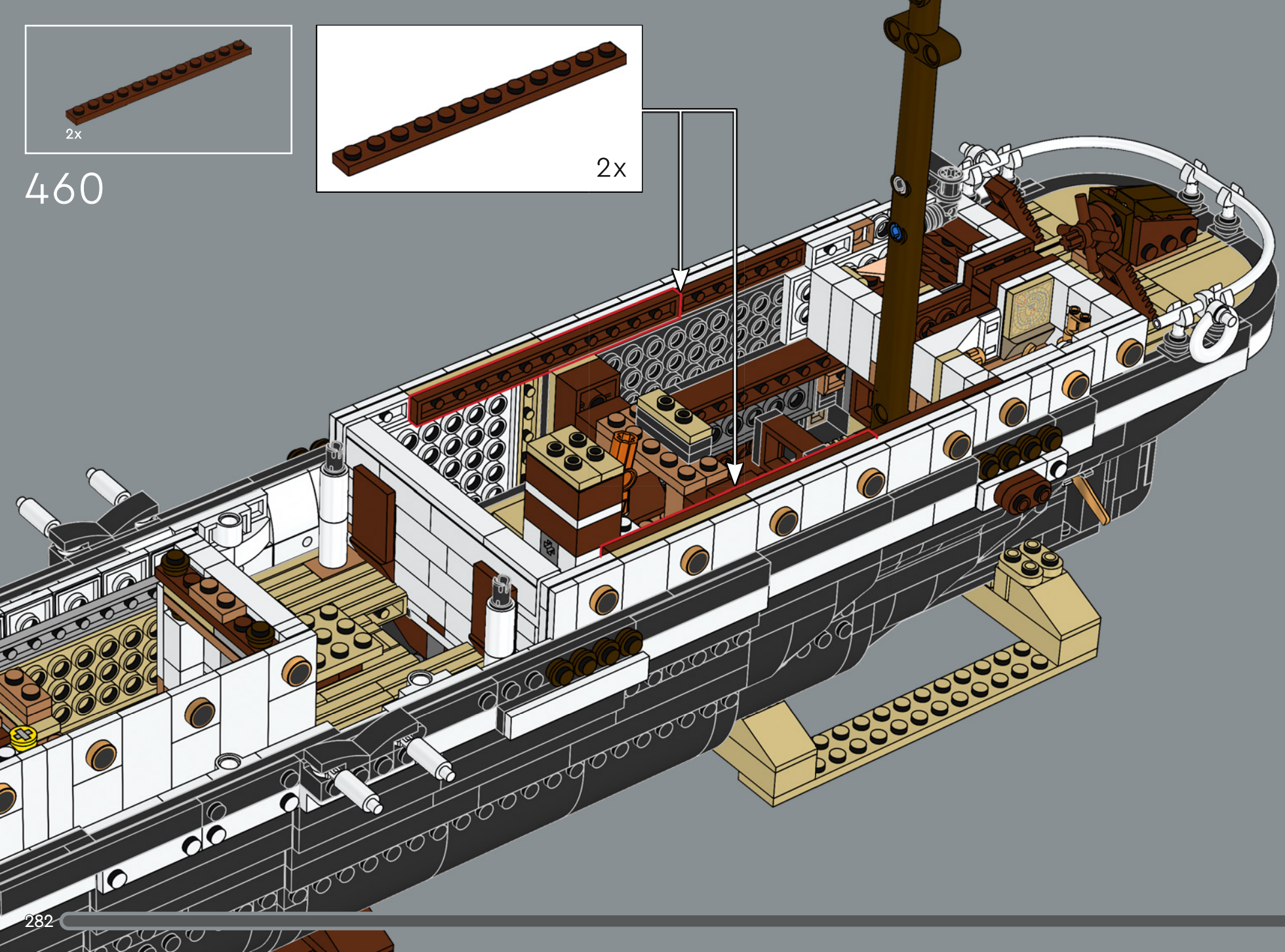

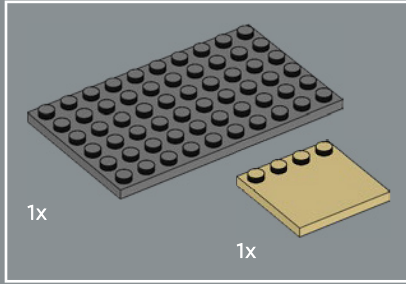
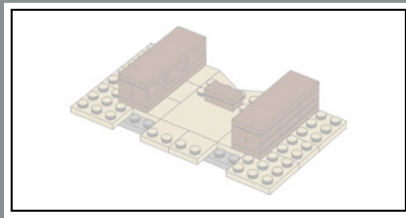

461

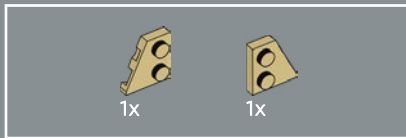
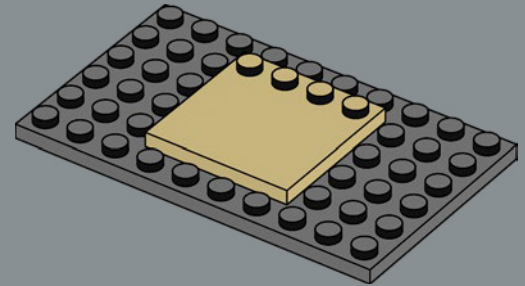

462

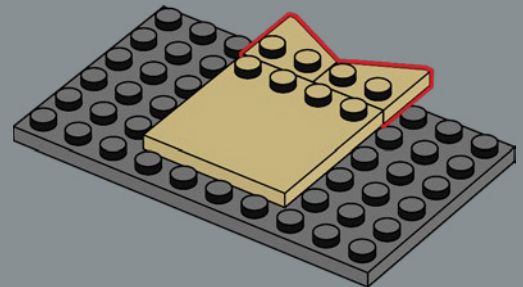

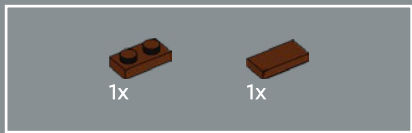

463

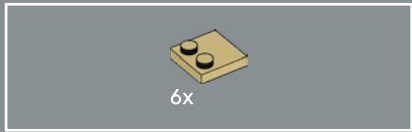
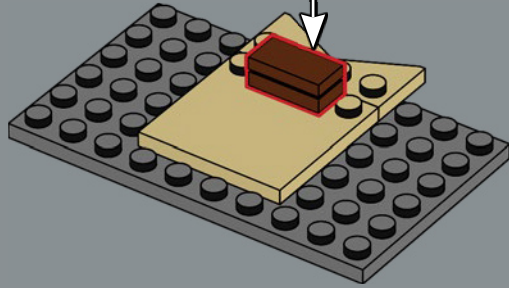
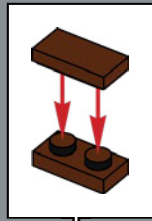

464

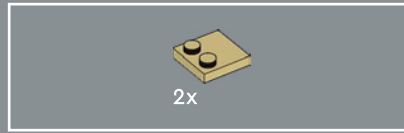
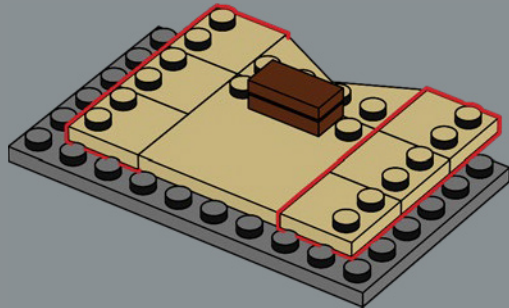

465

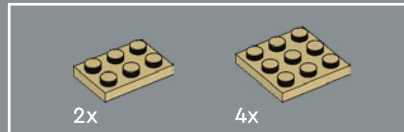
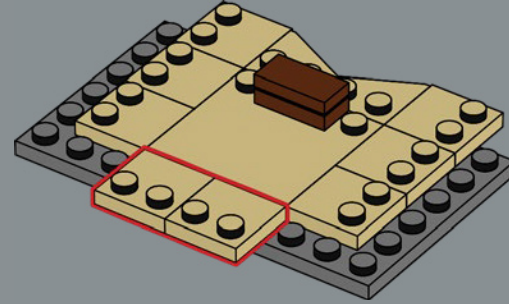

466

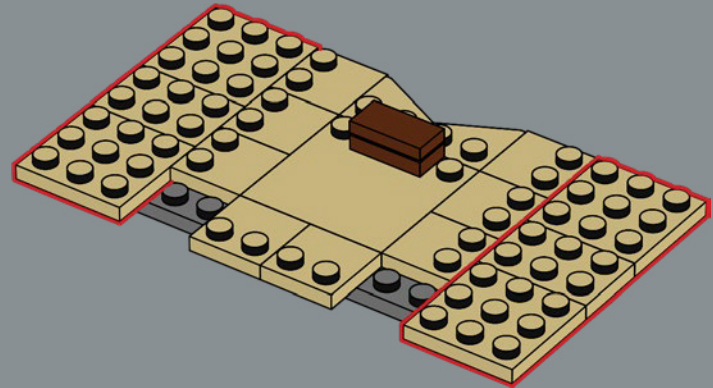

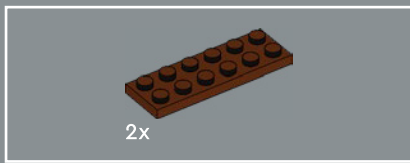

467

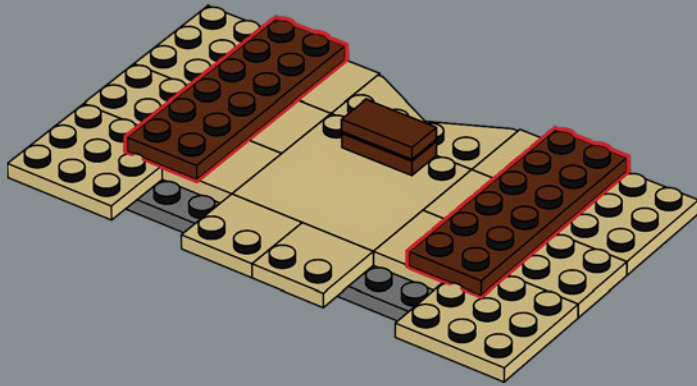

468

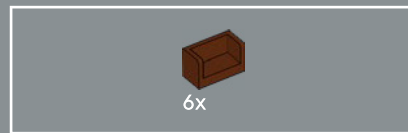
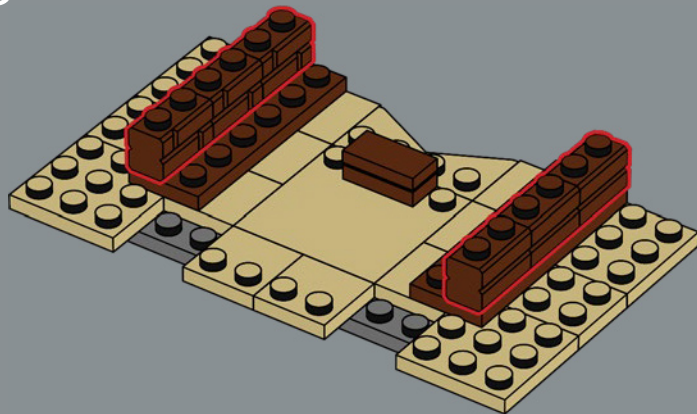

469

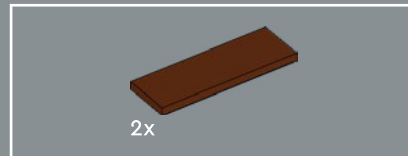
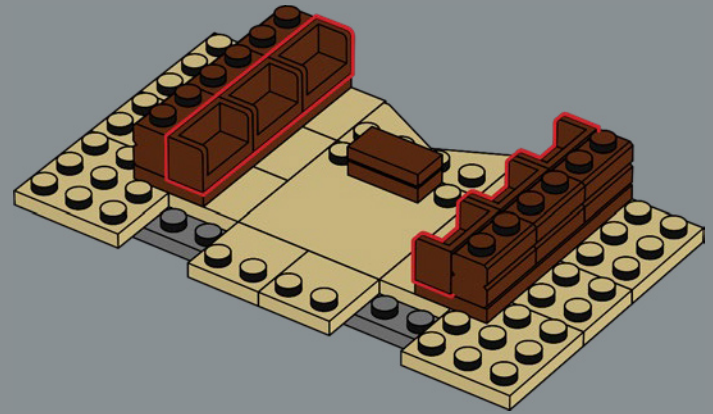

470

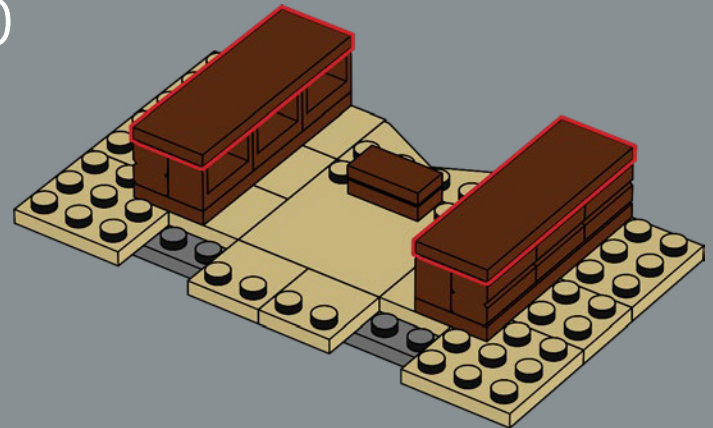

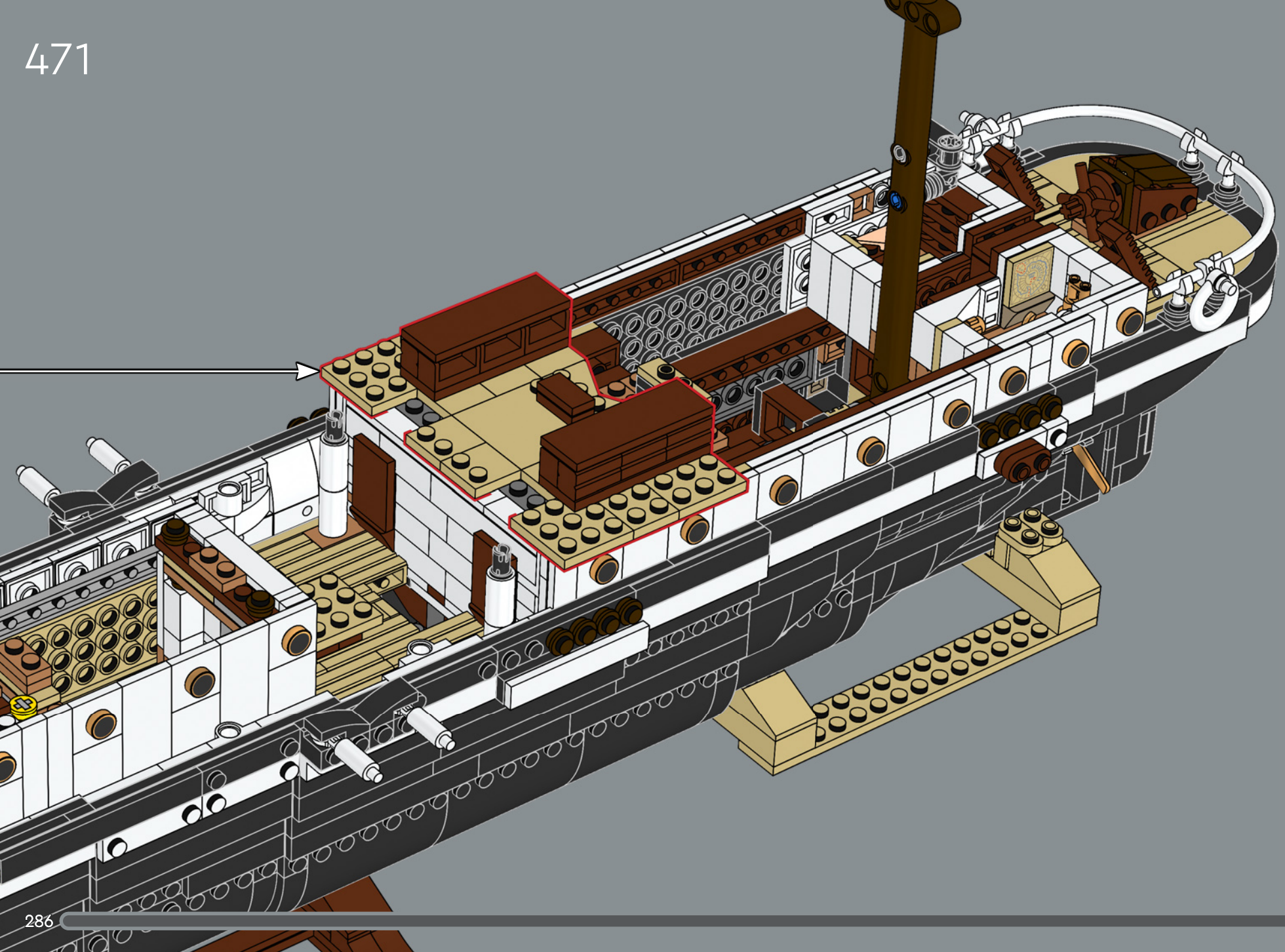

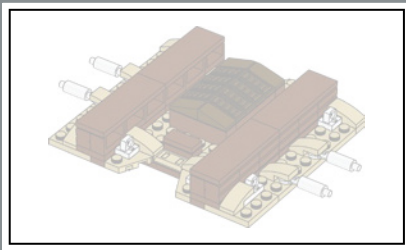

472

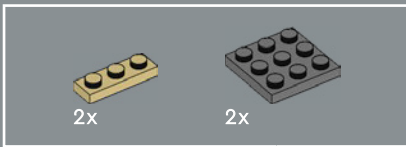
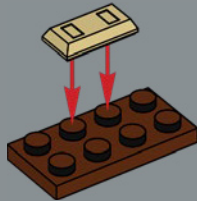

473

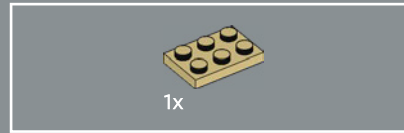
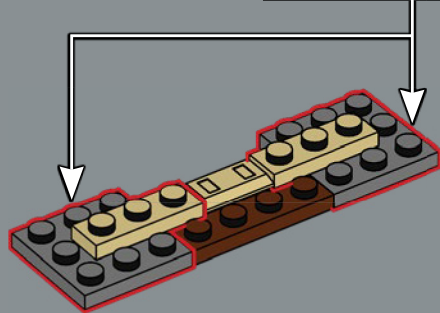
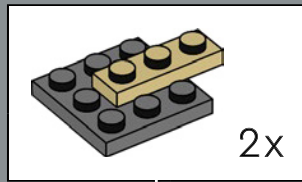

474

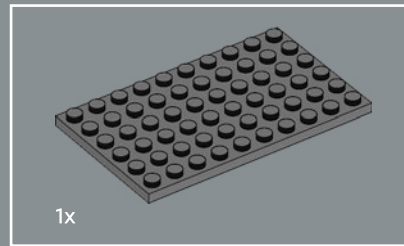
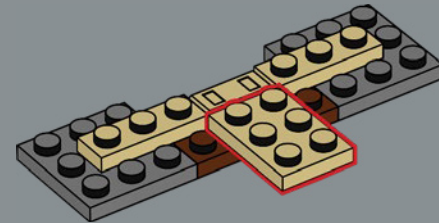

475

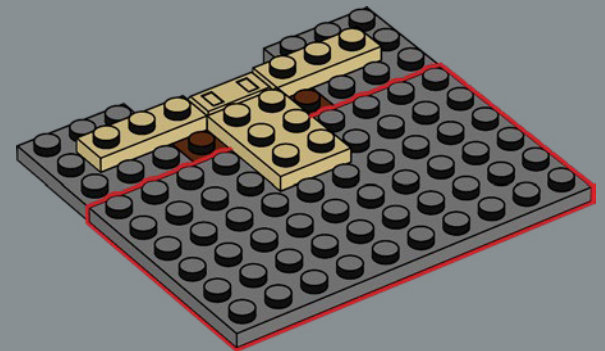

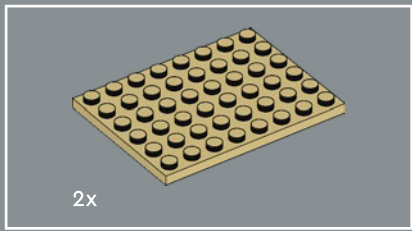

476

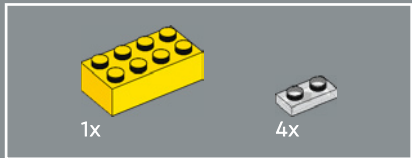
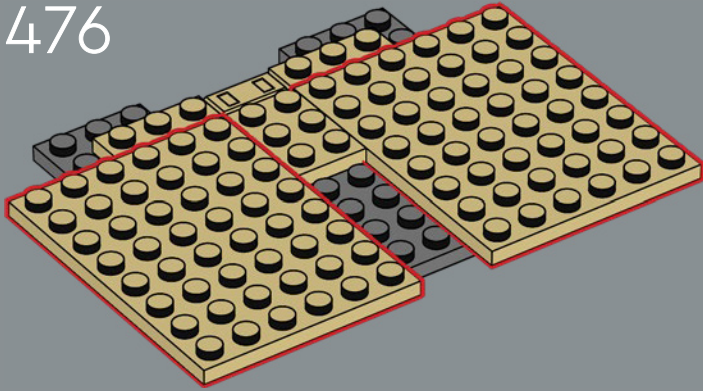

477

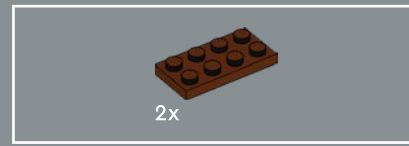
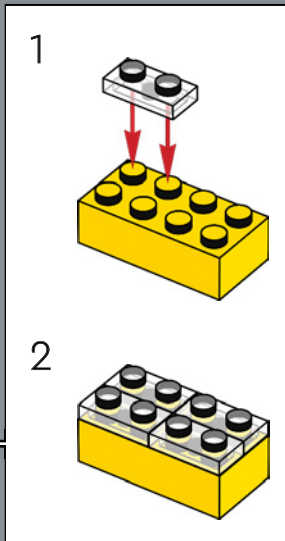
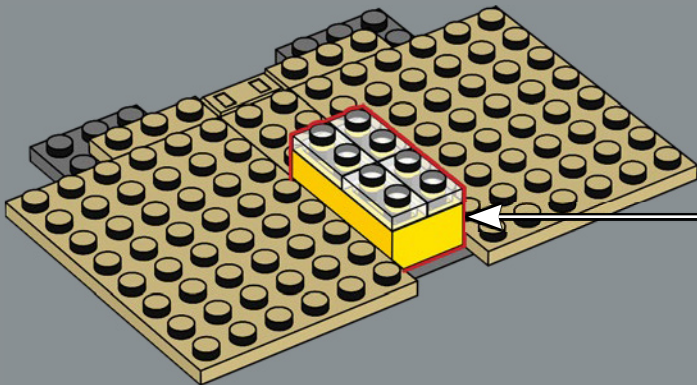

478

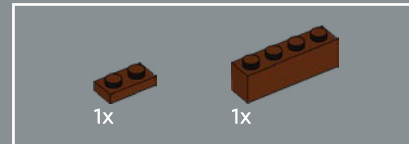
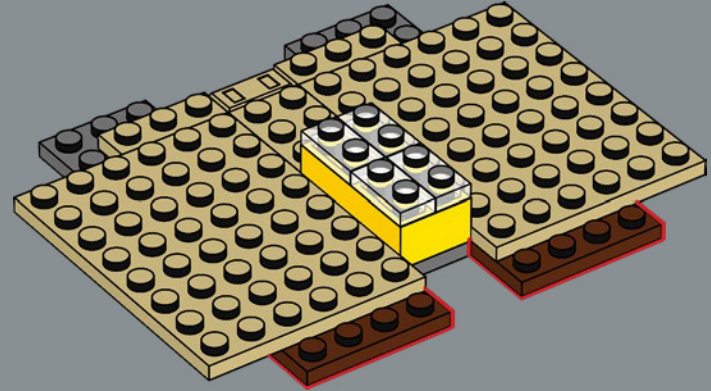

479

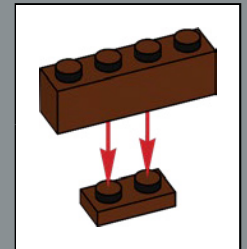
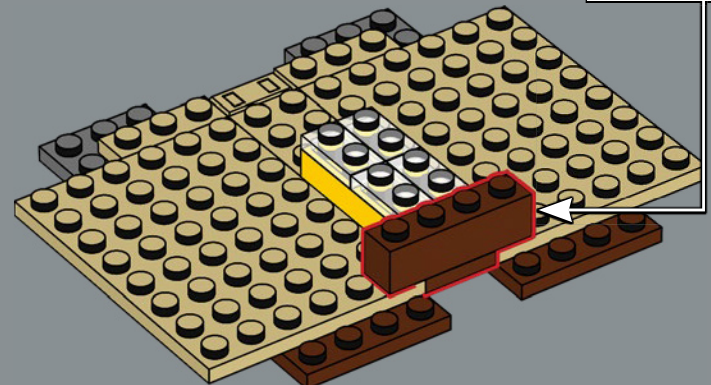

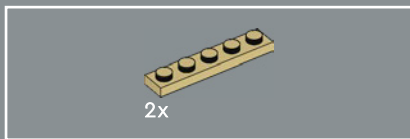

480

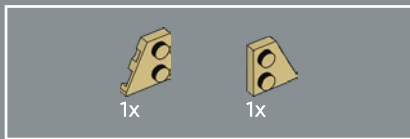
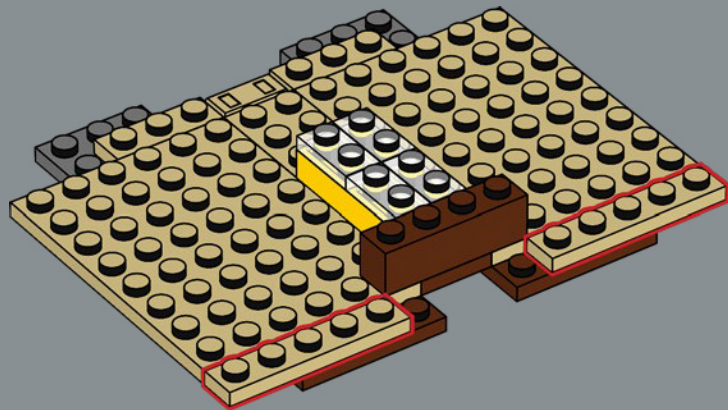

481

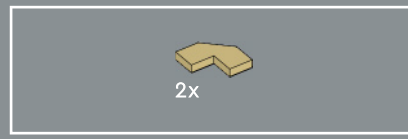
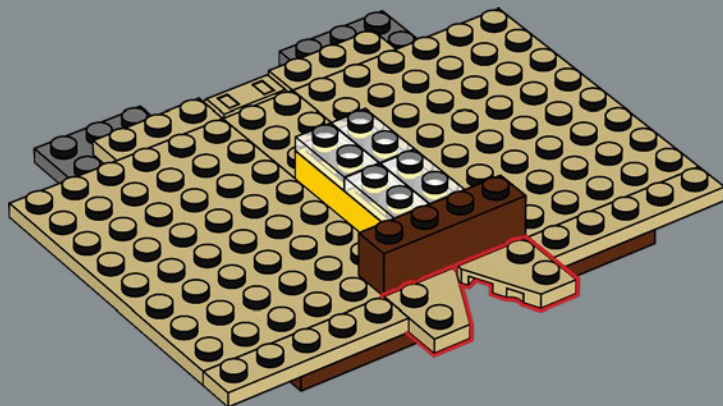

482

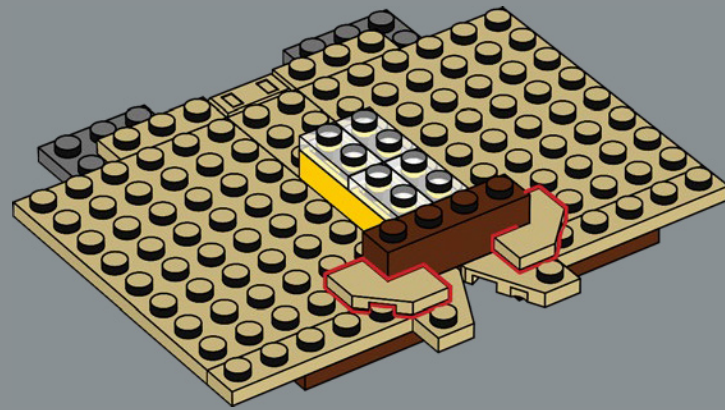

483

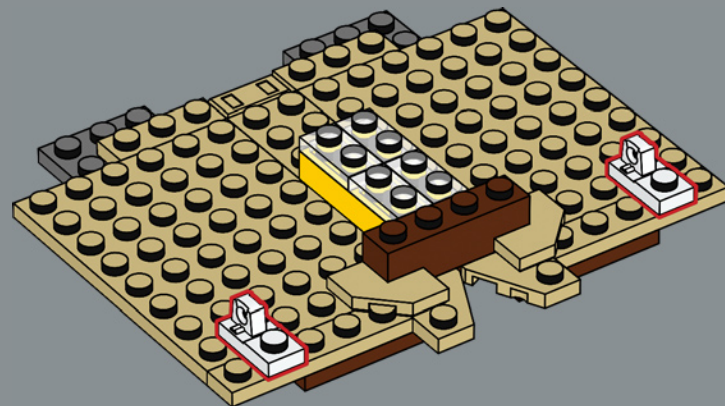



2x

484

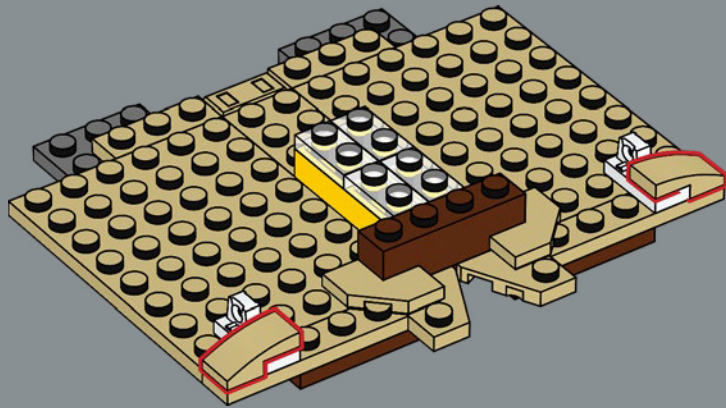

3x

485

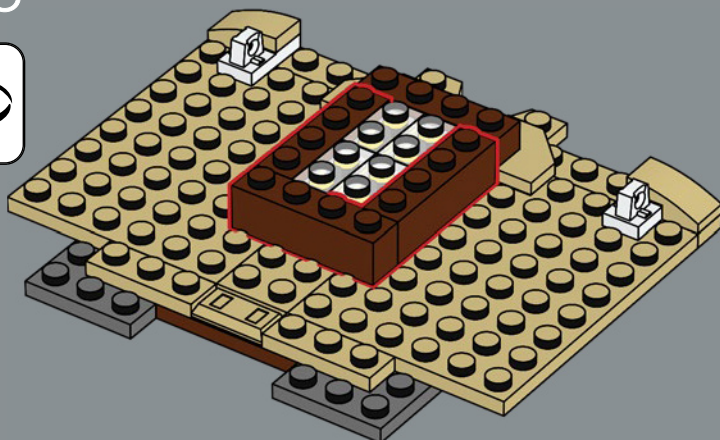

4x



8x

486

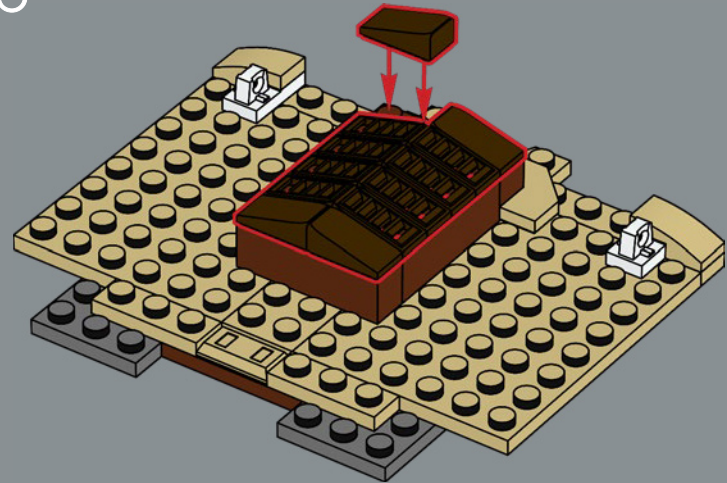

To give the top of the model's cabins a more rugged appearance, small 1x2 slope elements for the cabins' roofs were made in dark brown for the first time.

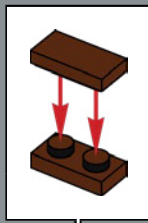
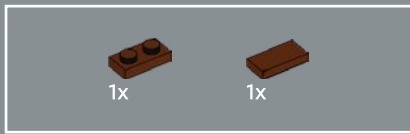

487

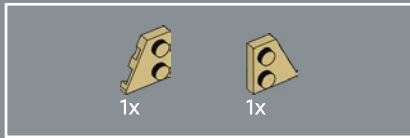
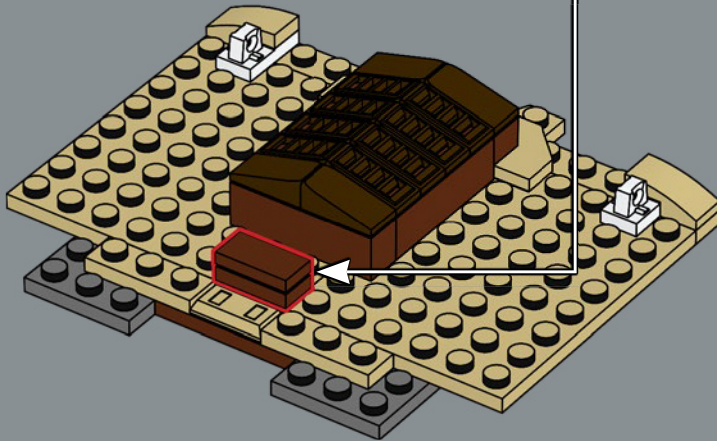

488

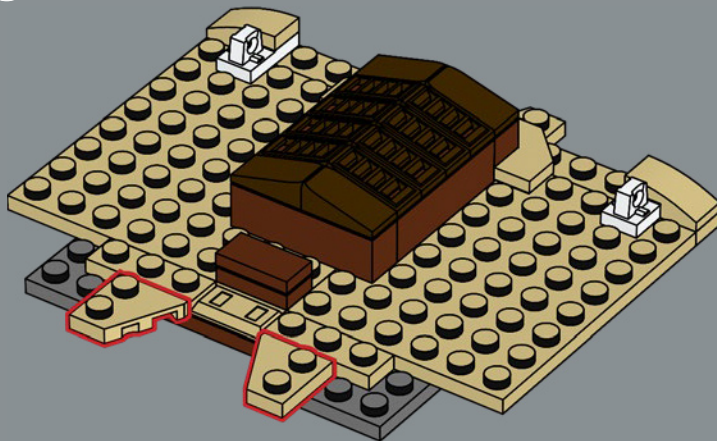

489

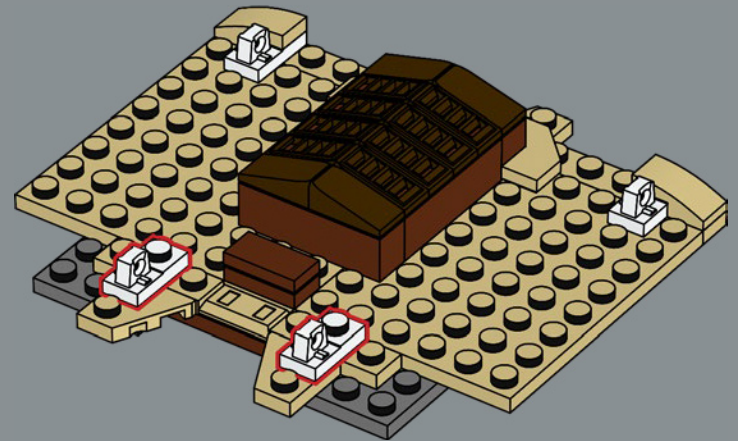

490

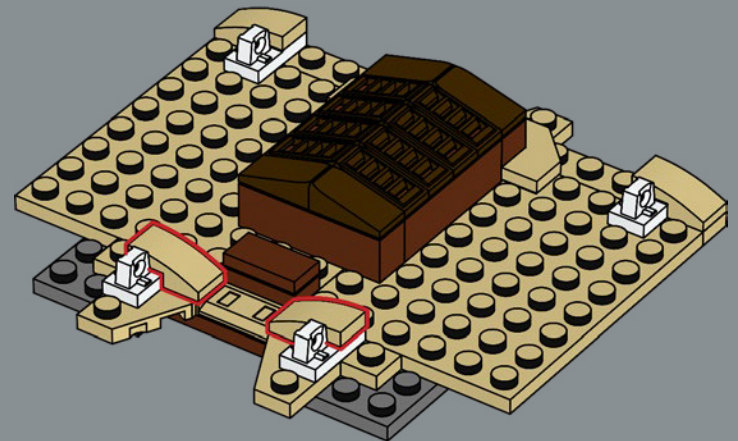



495

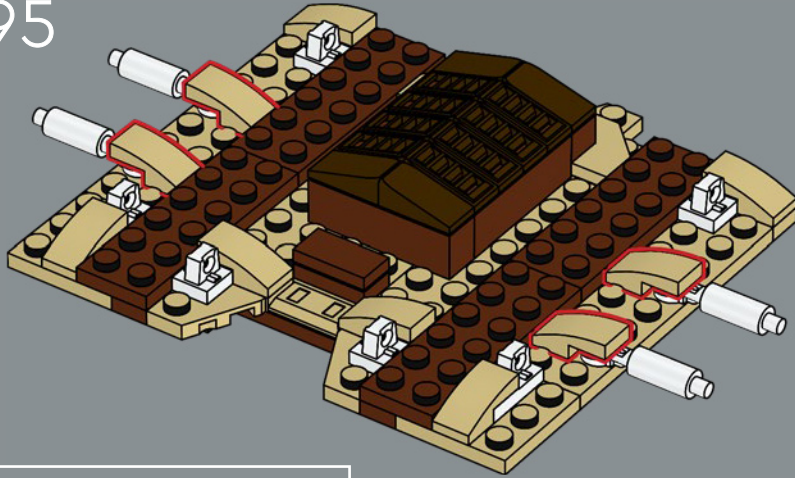

496

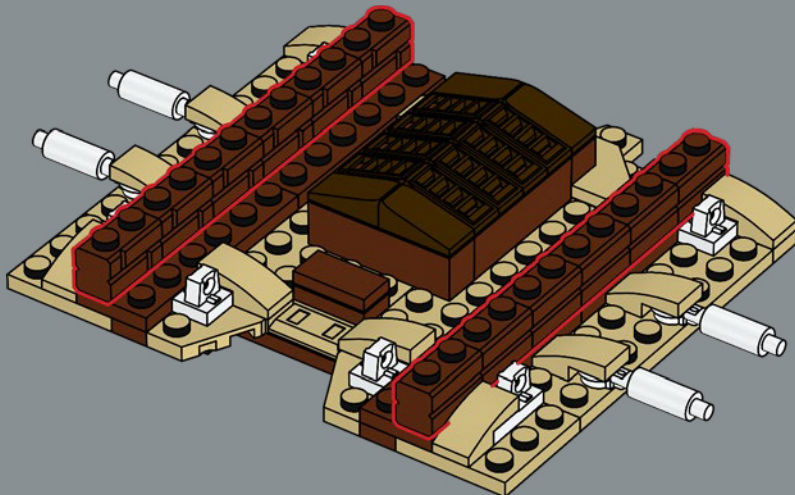

497

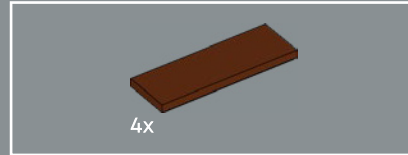
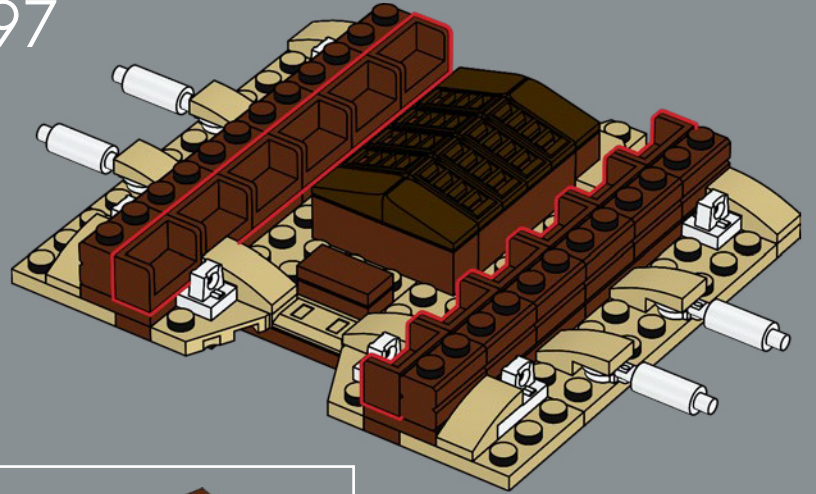

498

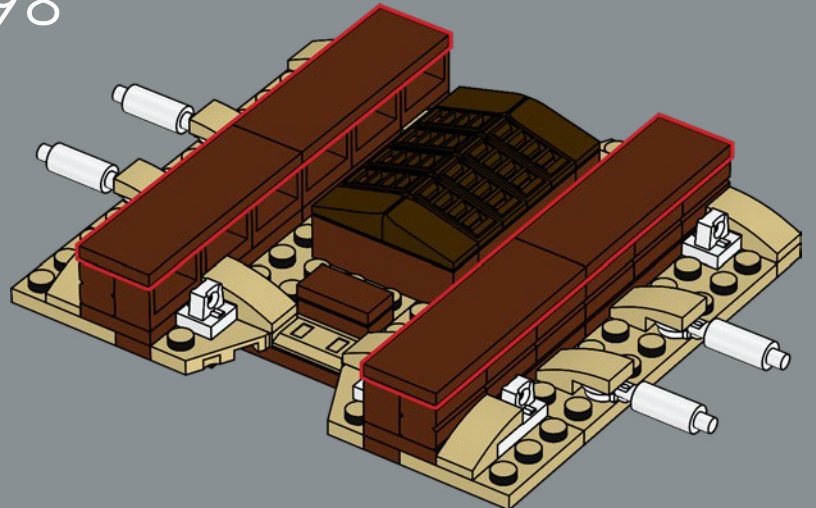

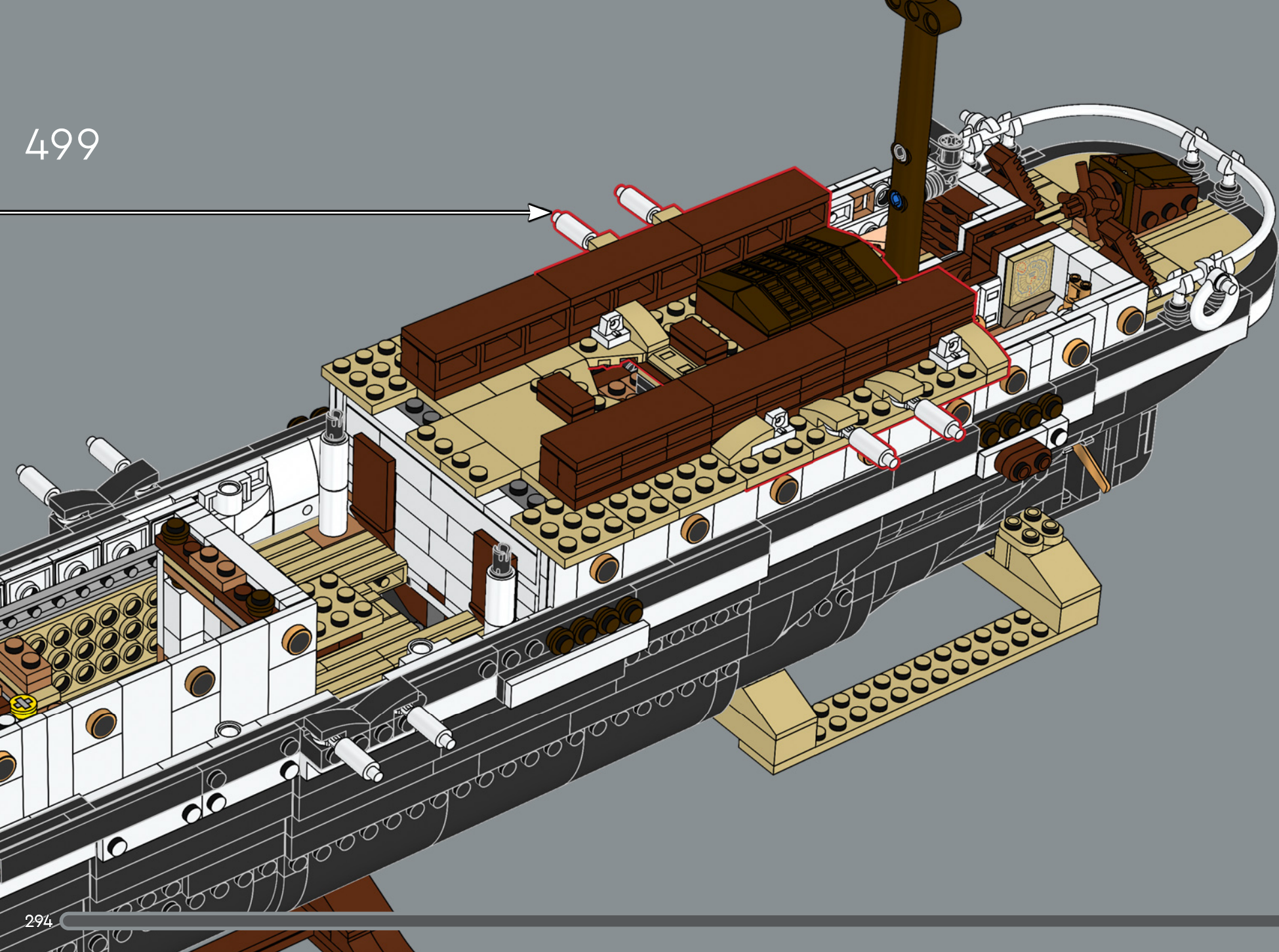

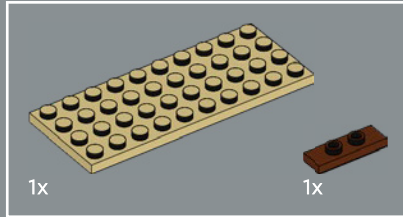
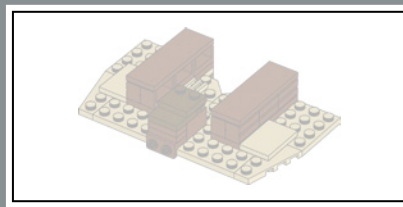

500

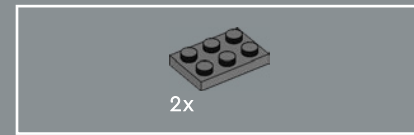
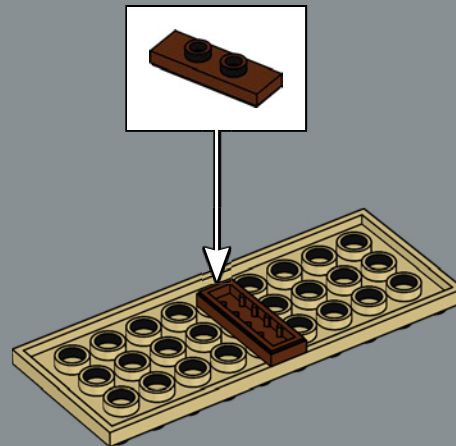

501

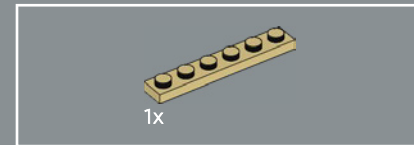
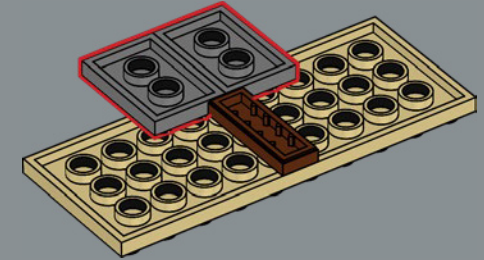

502

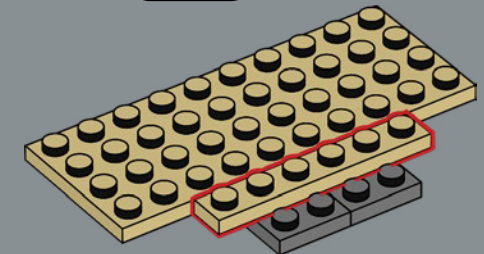

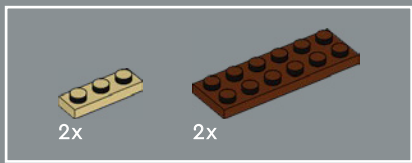

503

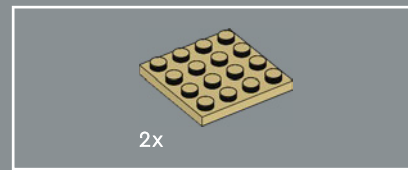
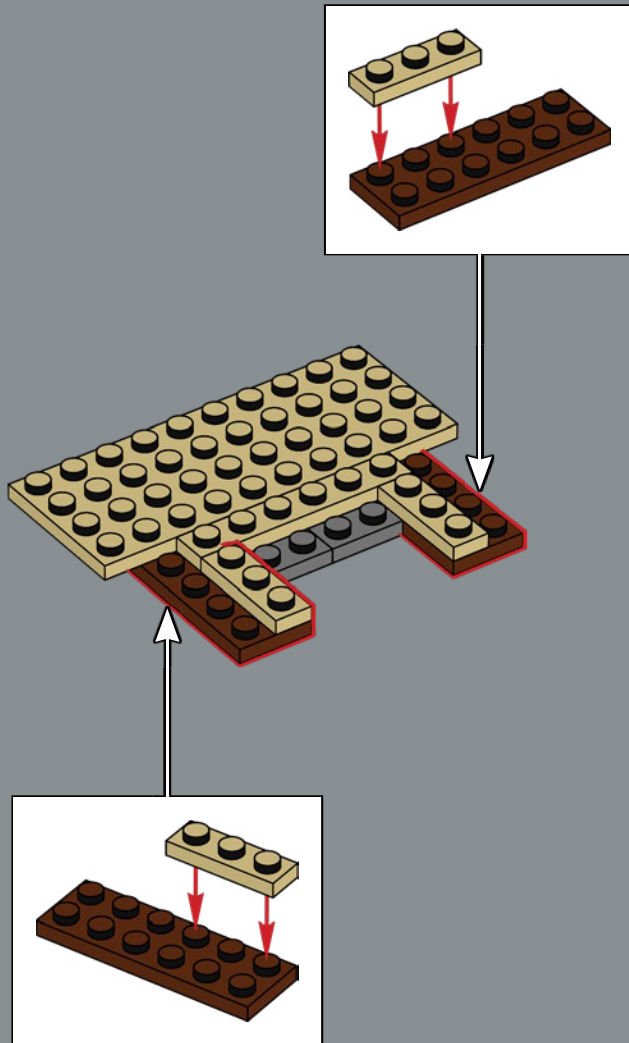

504

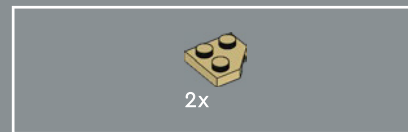
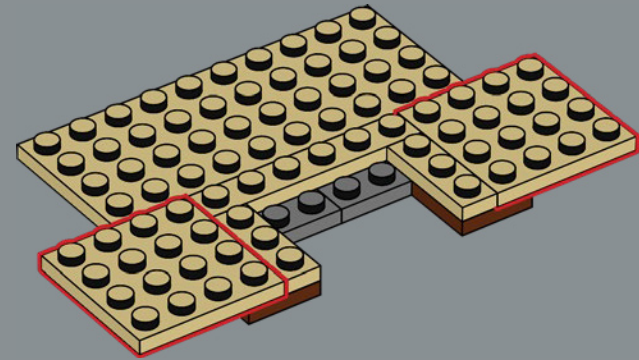

505

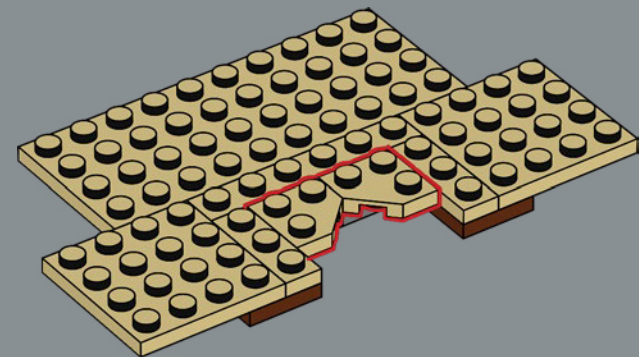

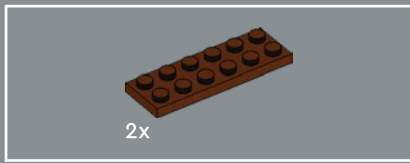

506

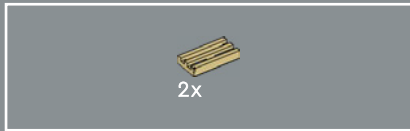
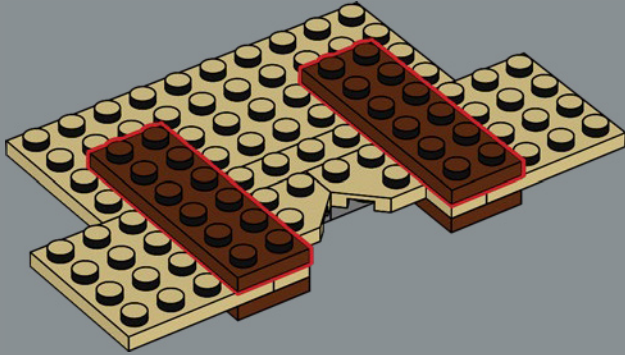

507

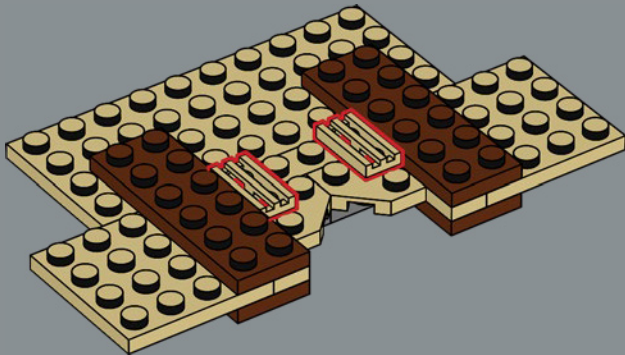

508

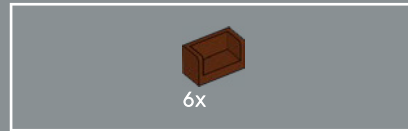
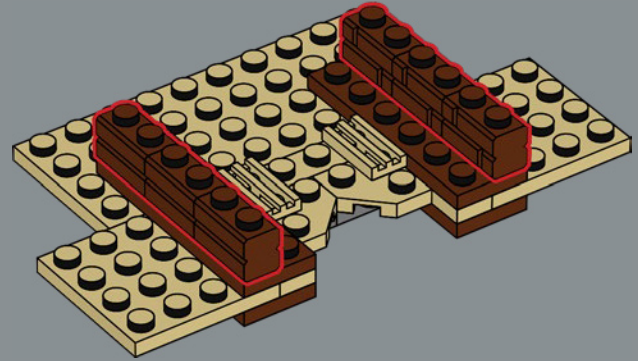

509

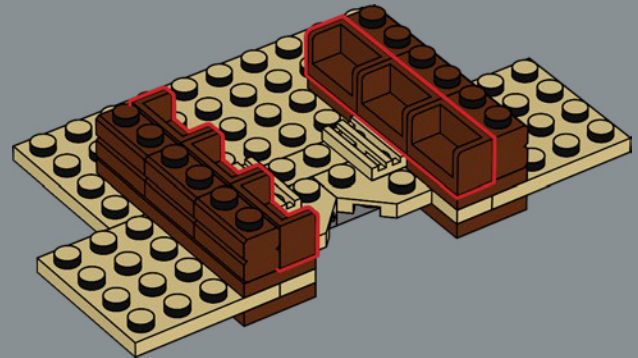

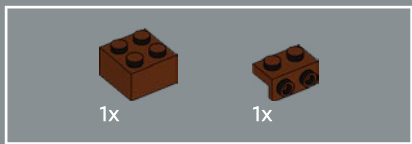

510

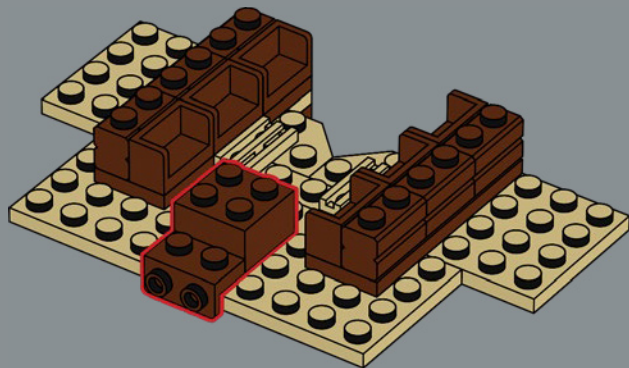

511

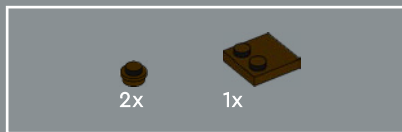
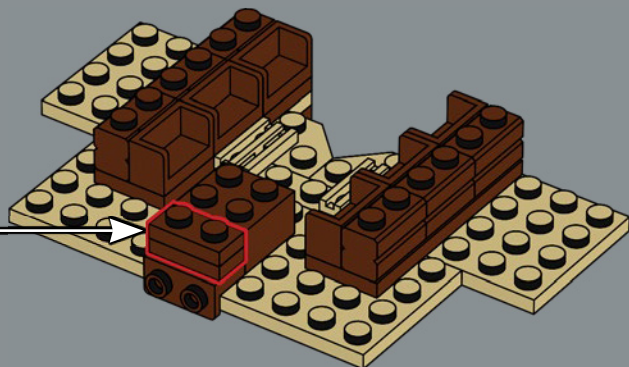
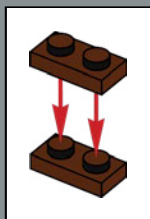

512

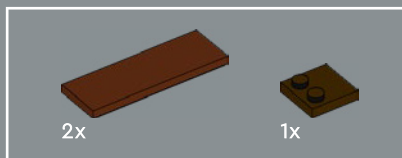
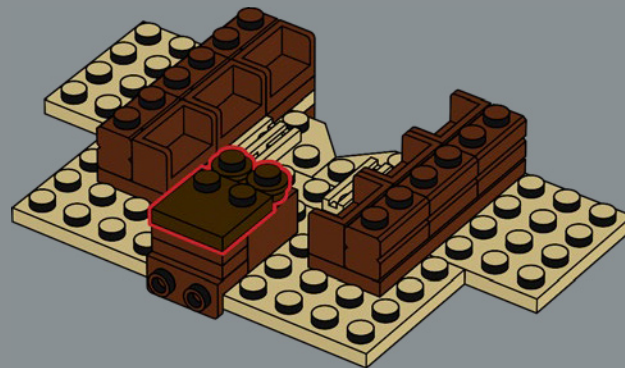

513

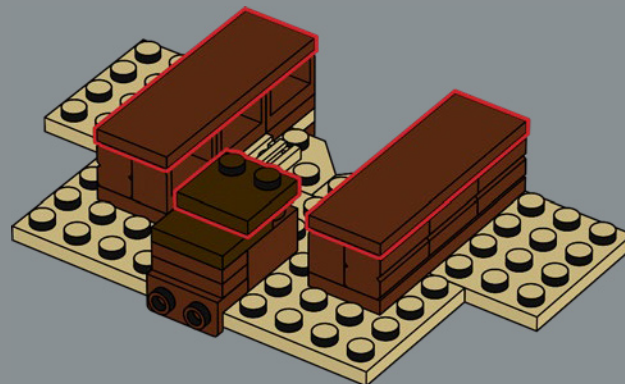

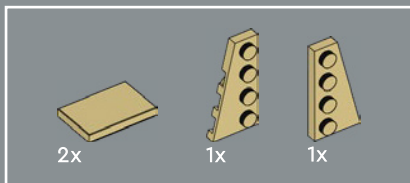

514

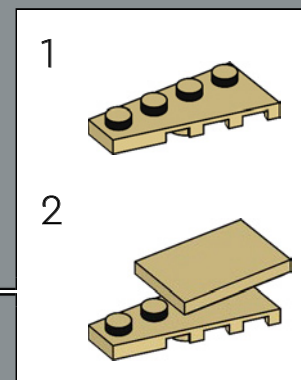
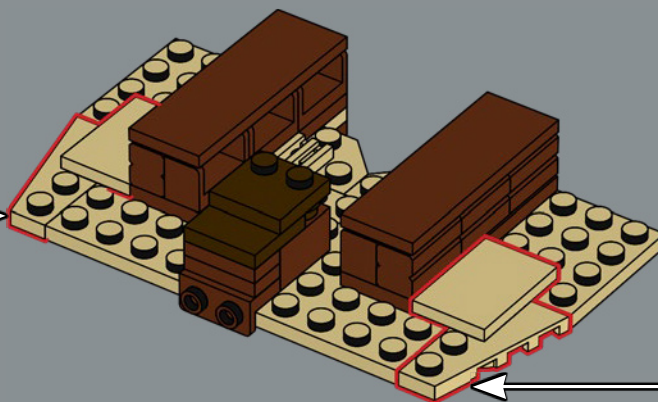
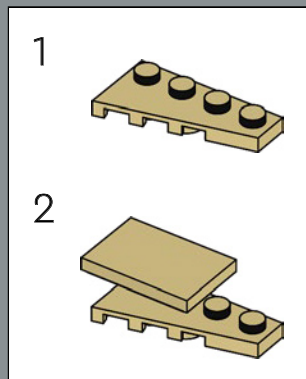

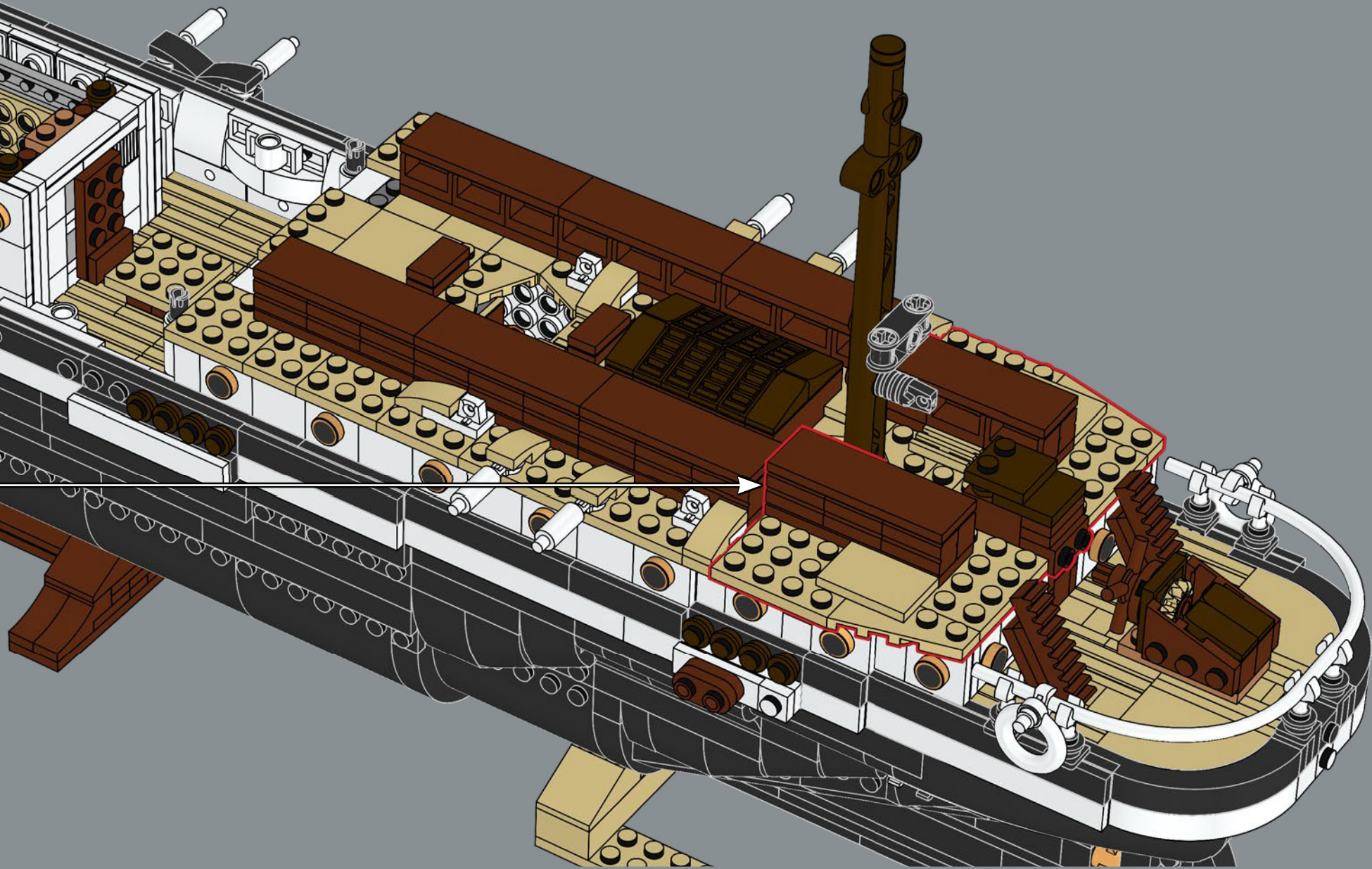

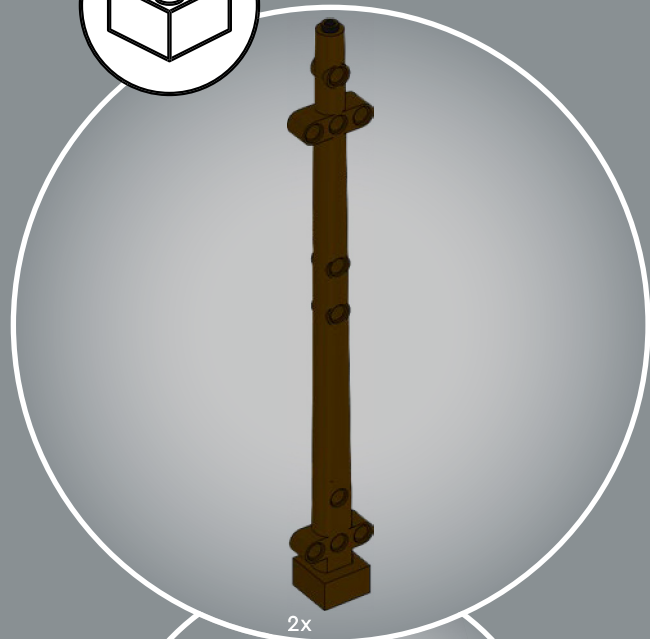
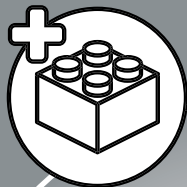

2x



4x

516

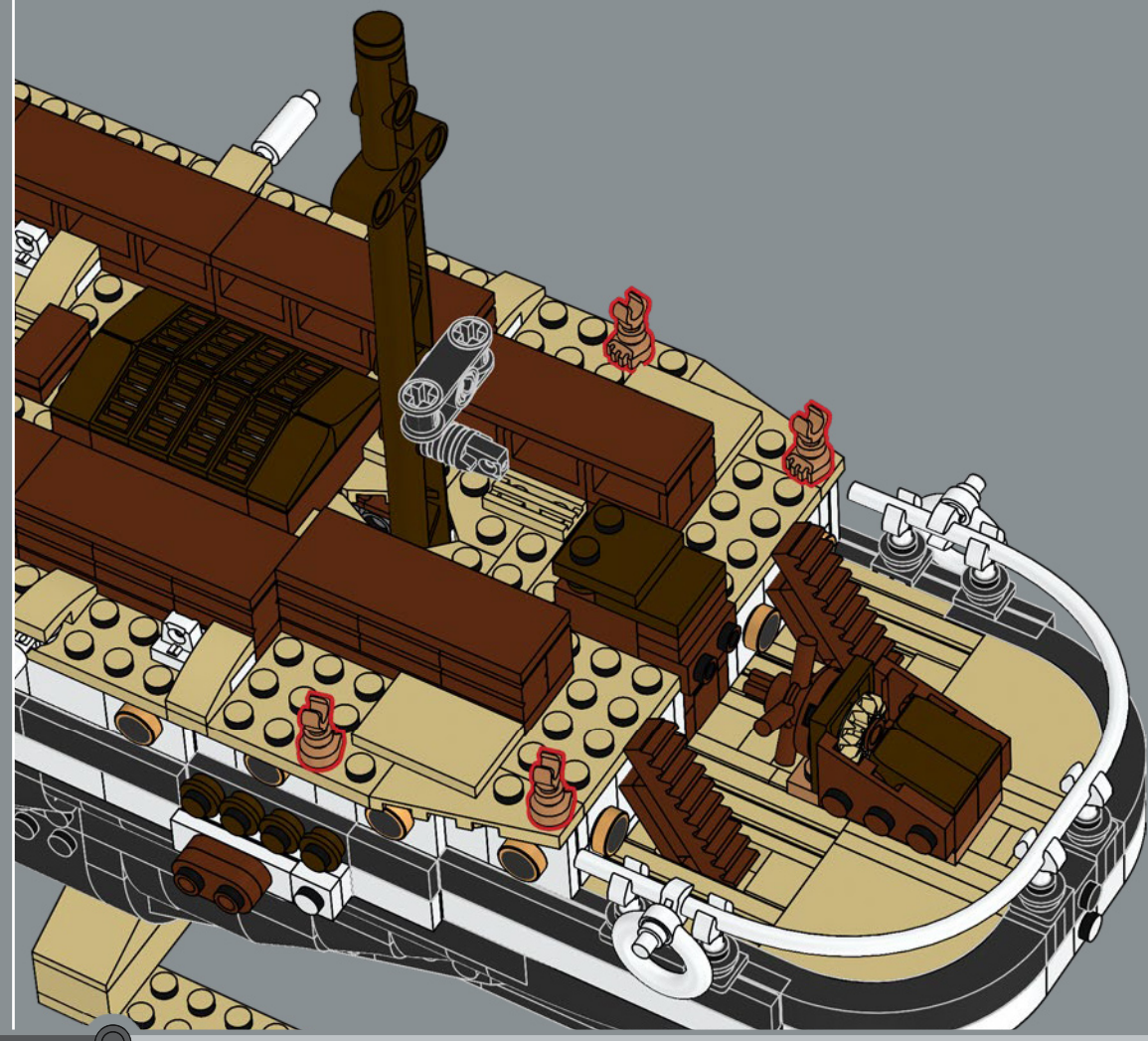



517

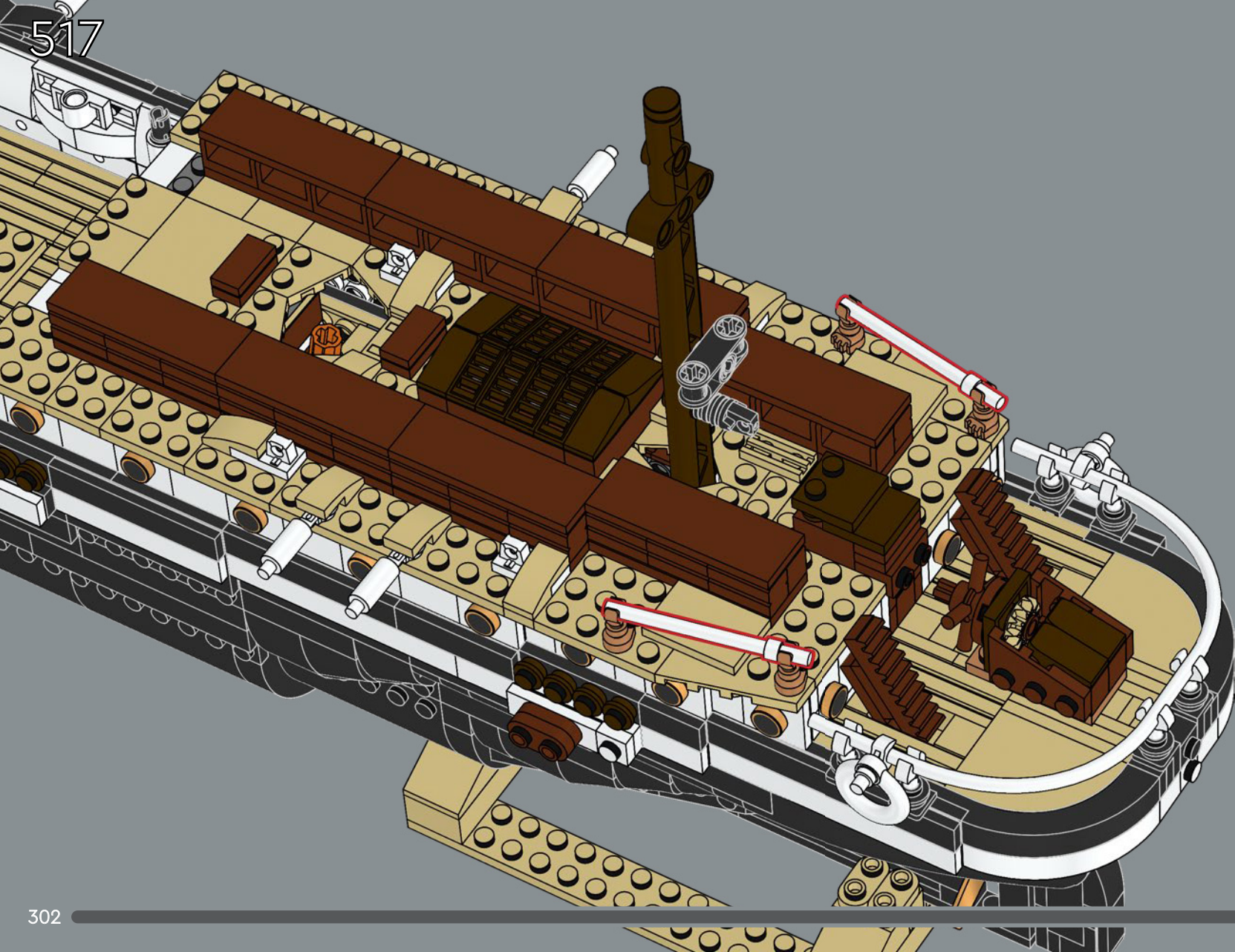

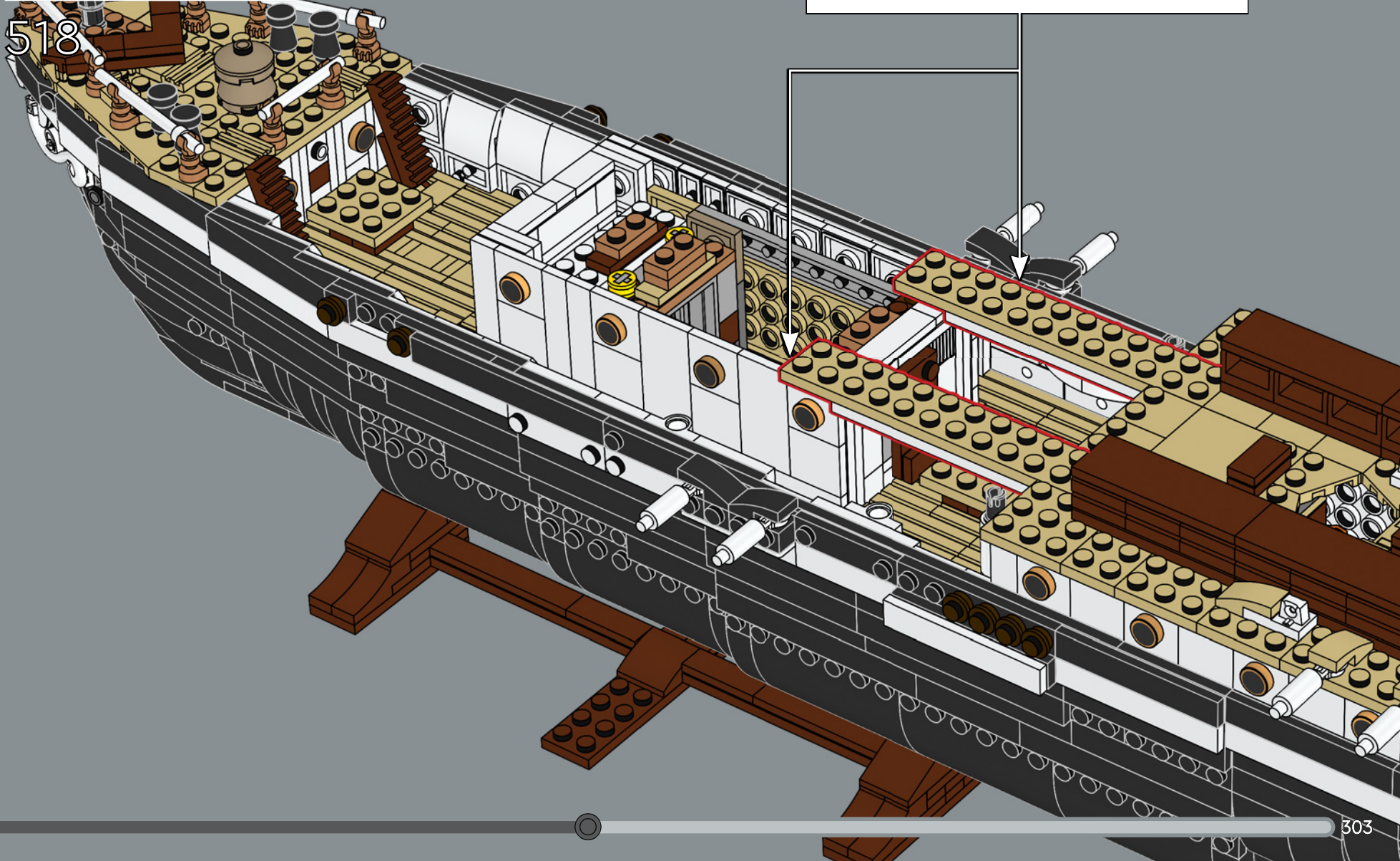
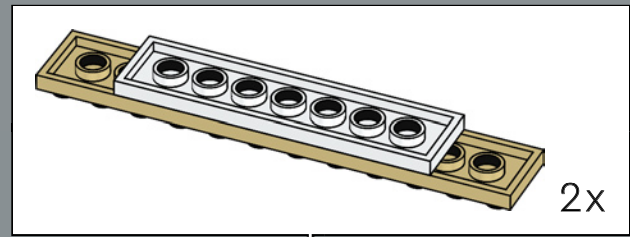
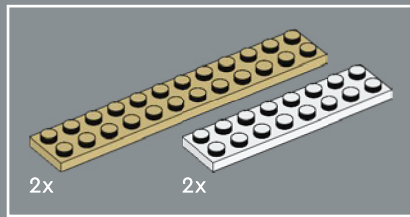

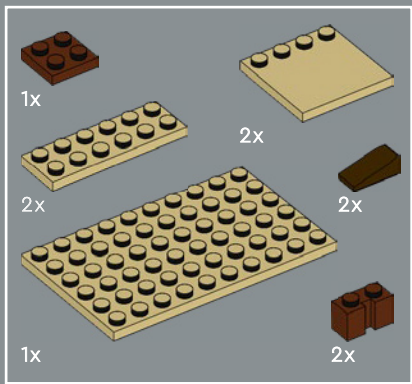

519

1

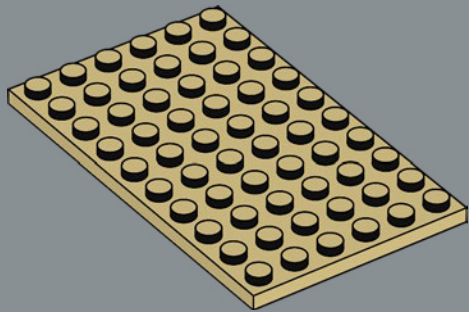

2

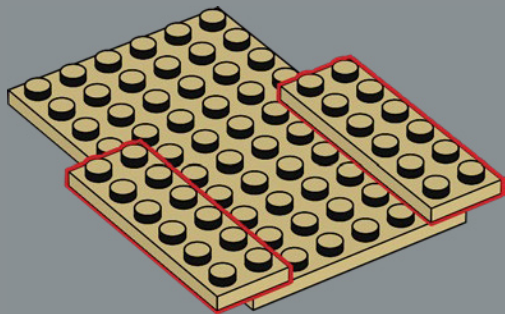

3

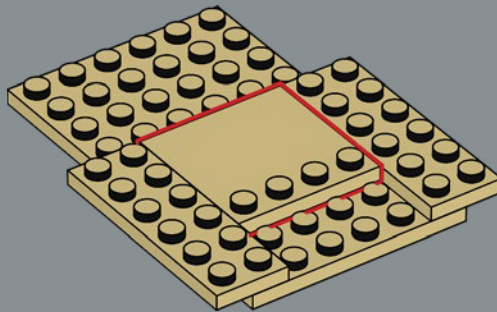

4

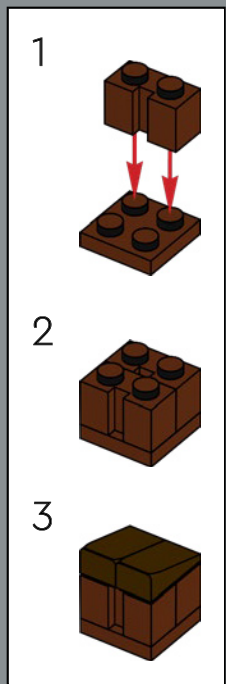
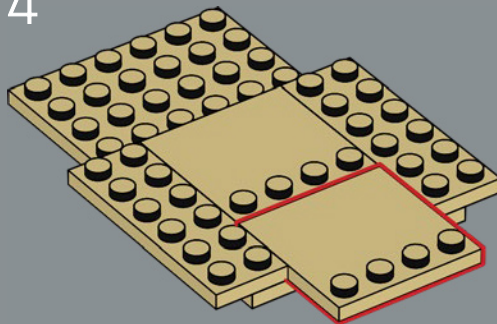

5

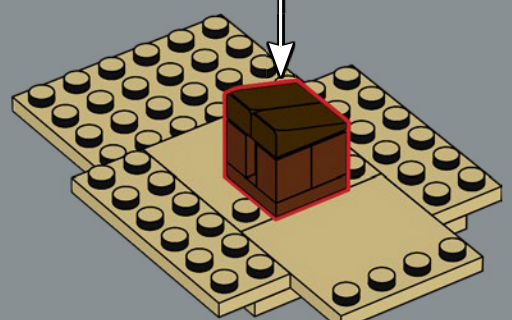

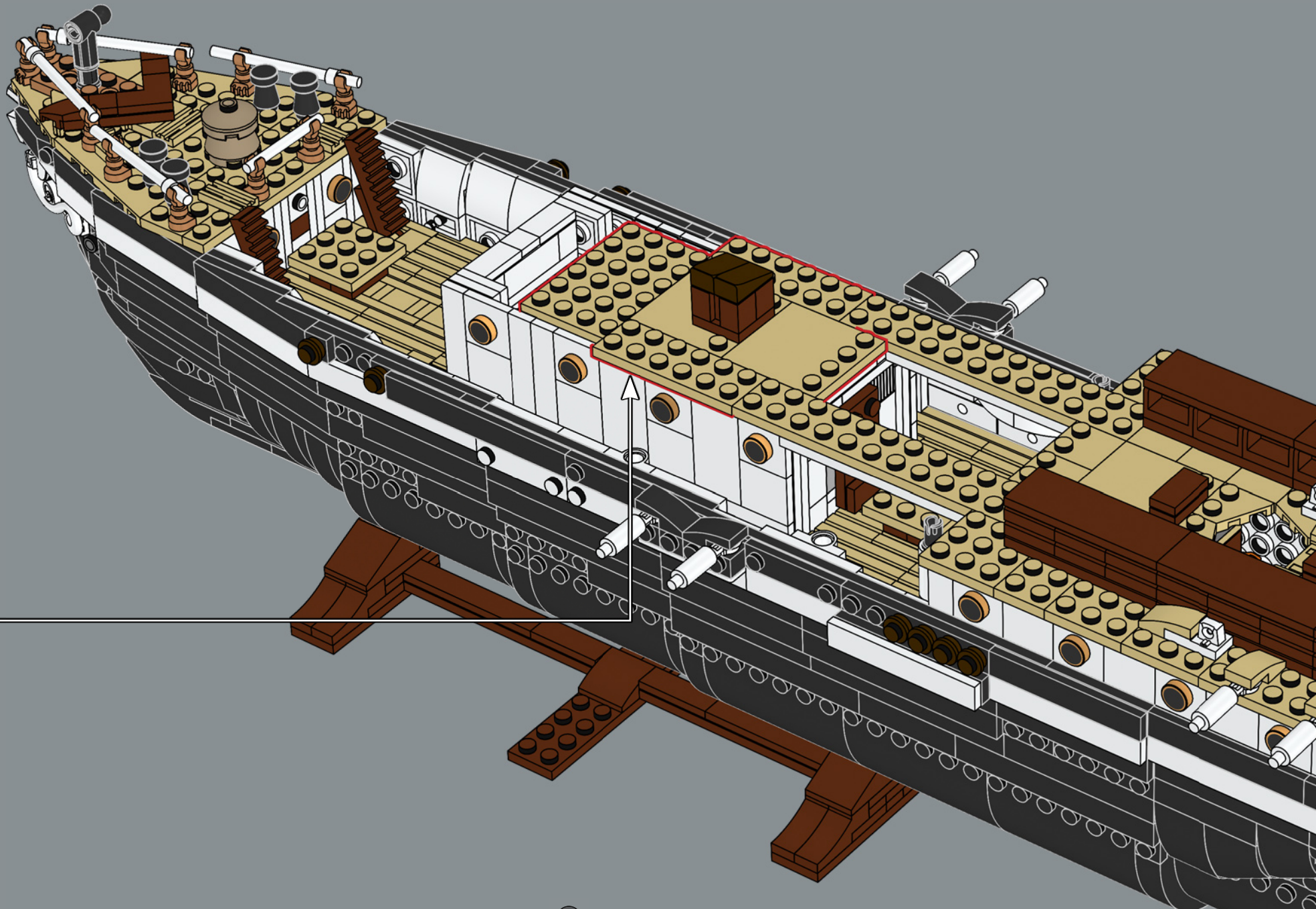

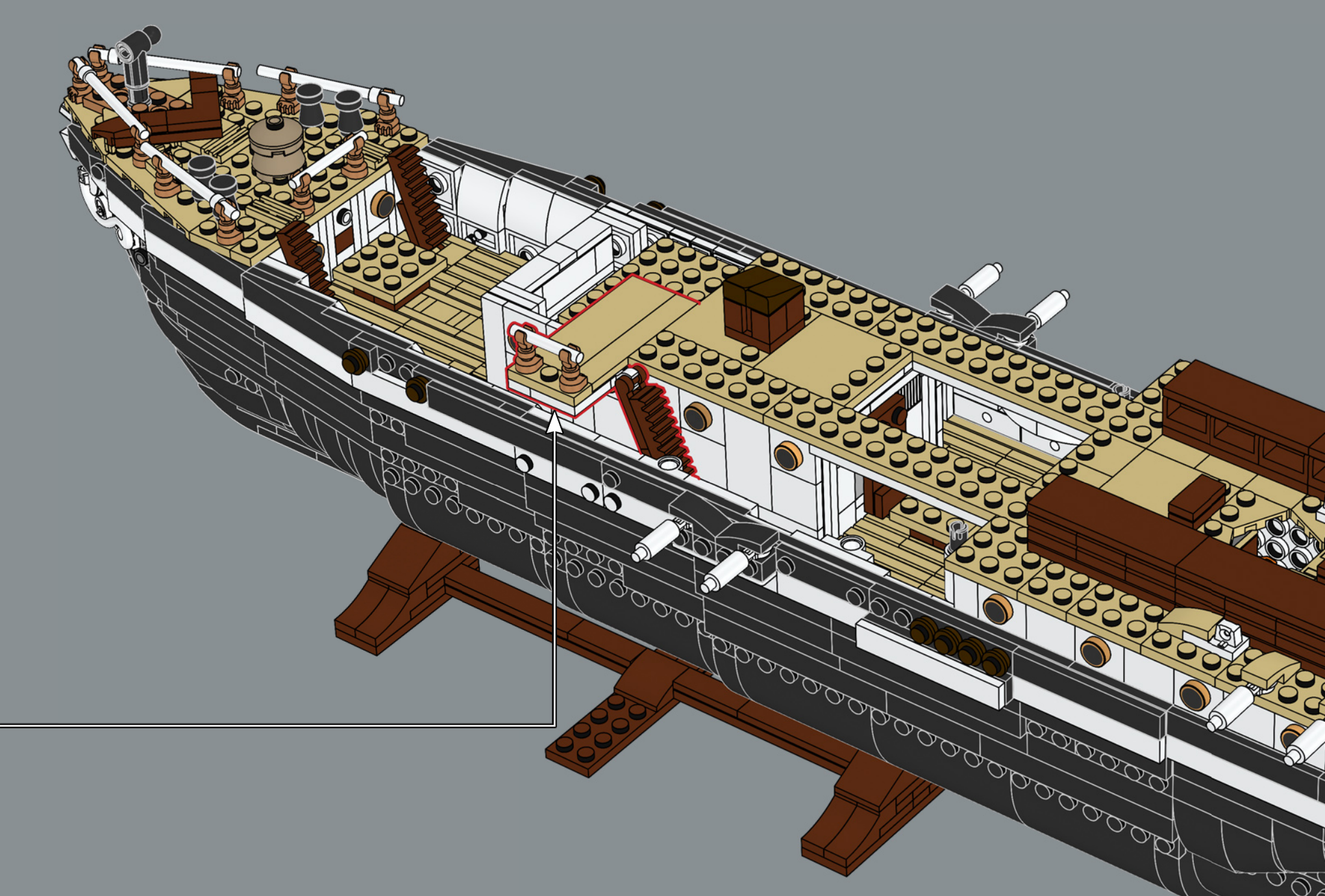

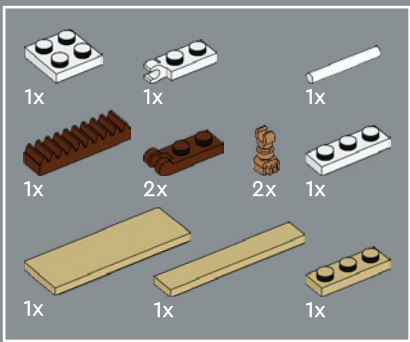

521

1

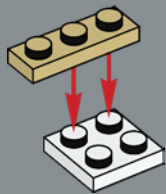

2

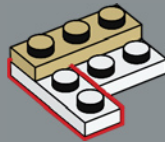

3

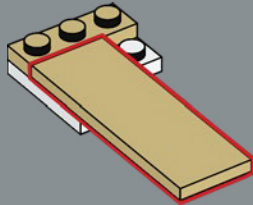

4

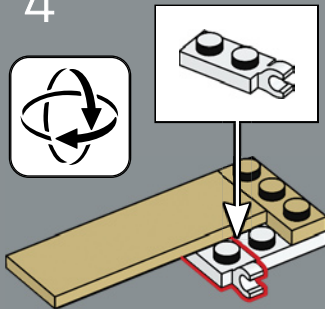

5

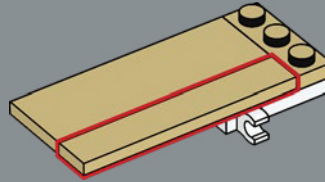

6

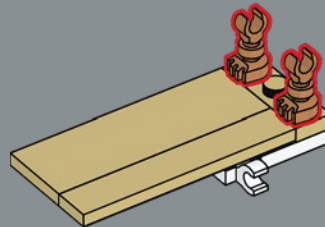

7

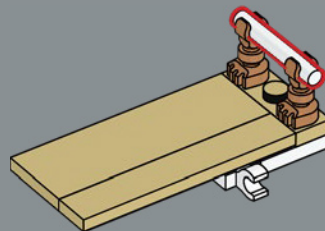

8

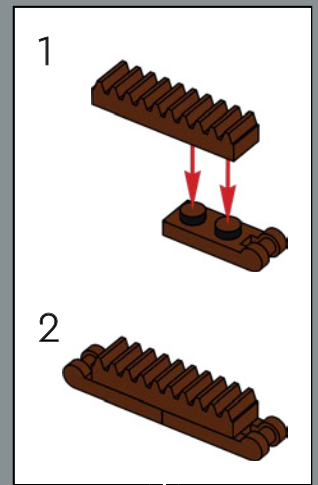

9

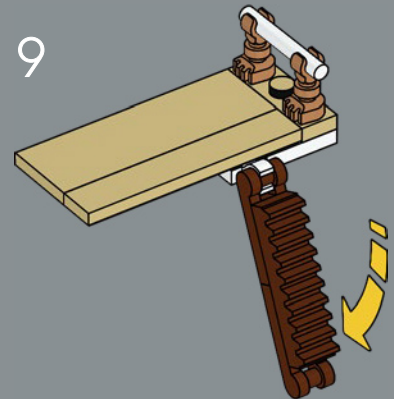

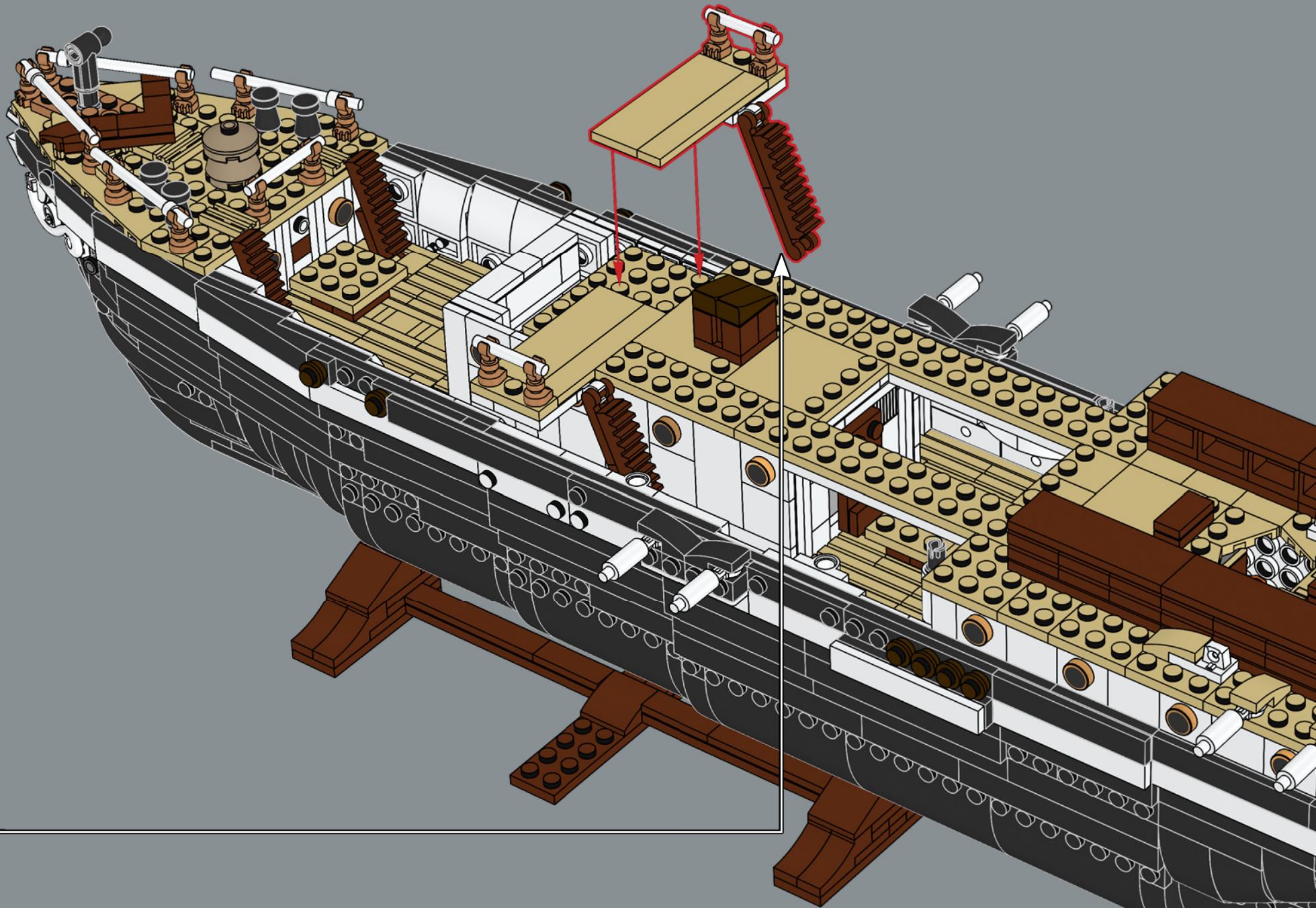

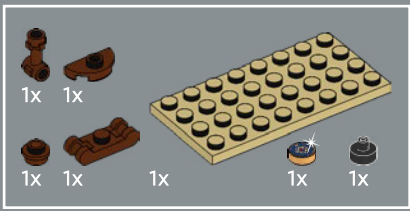

522

1

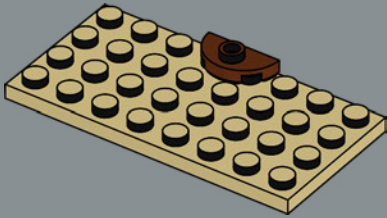

2

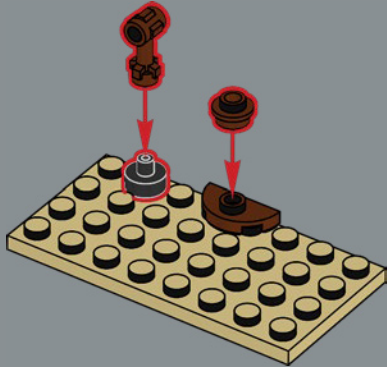

3

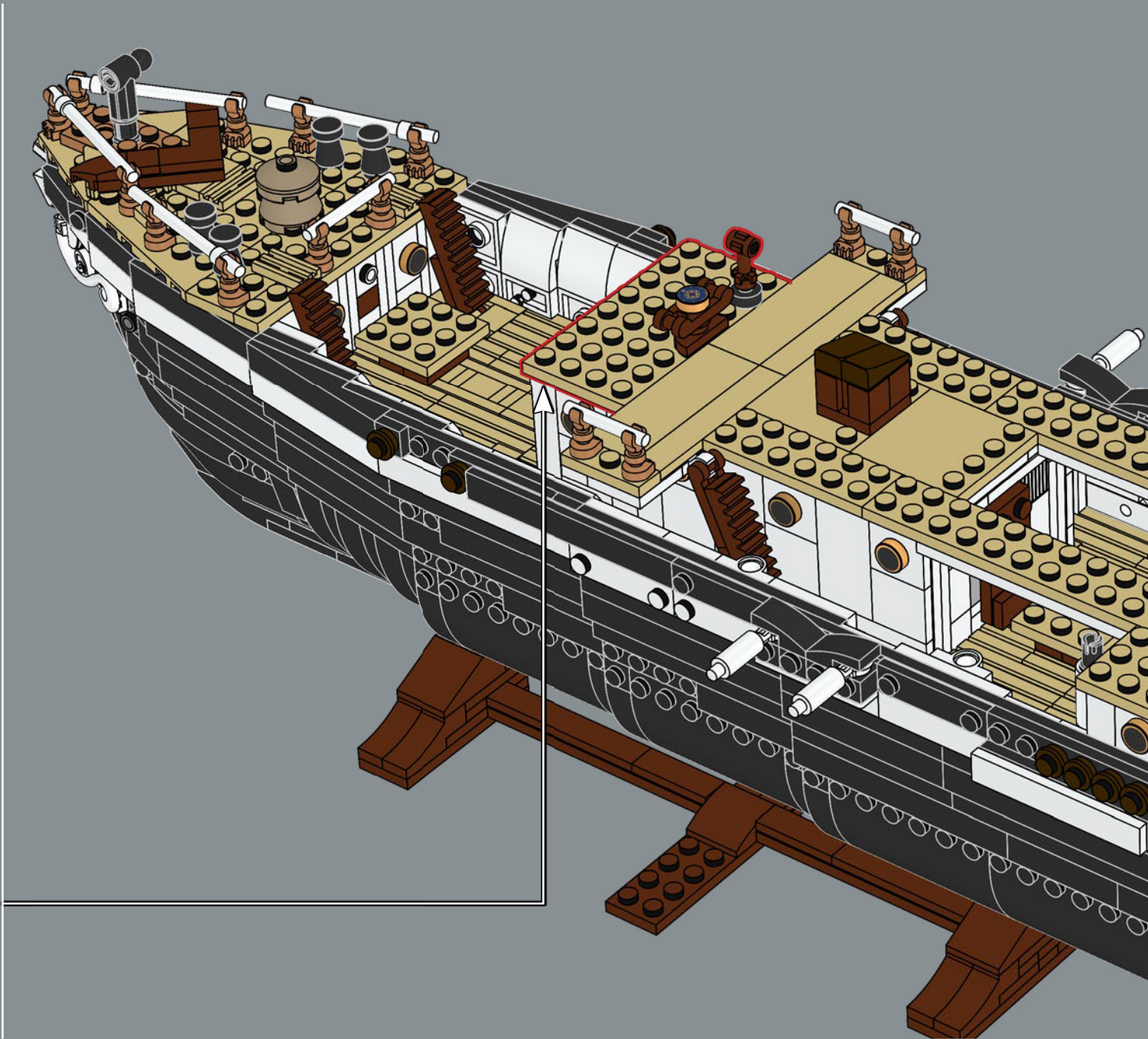

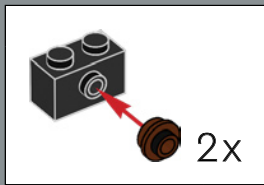

523

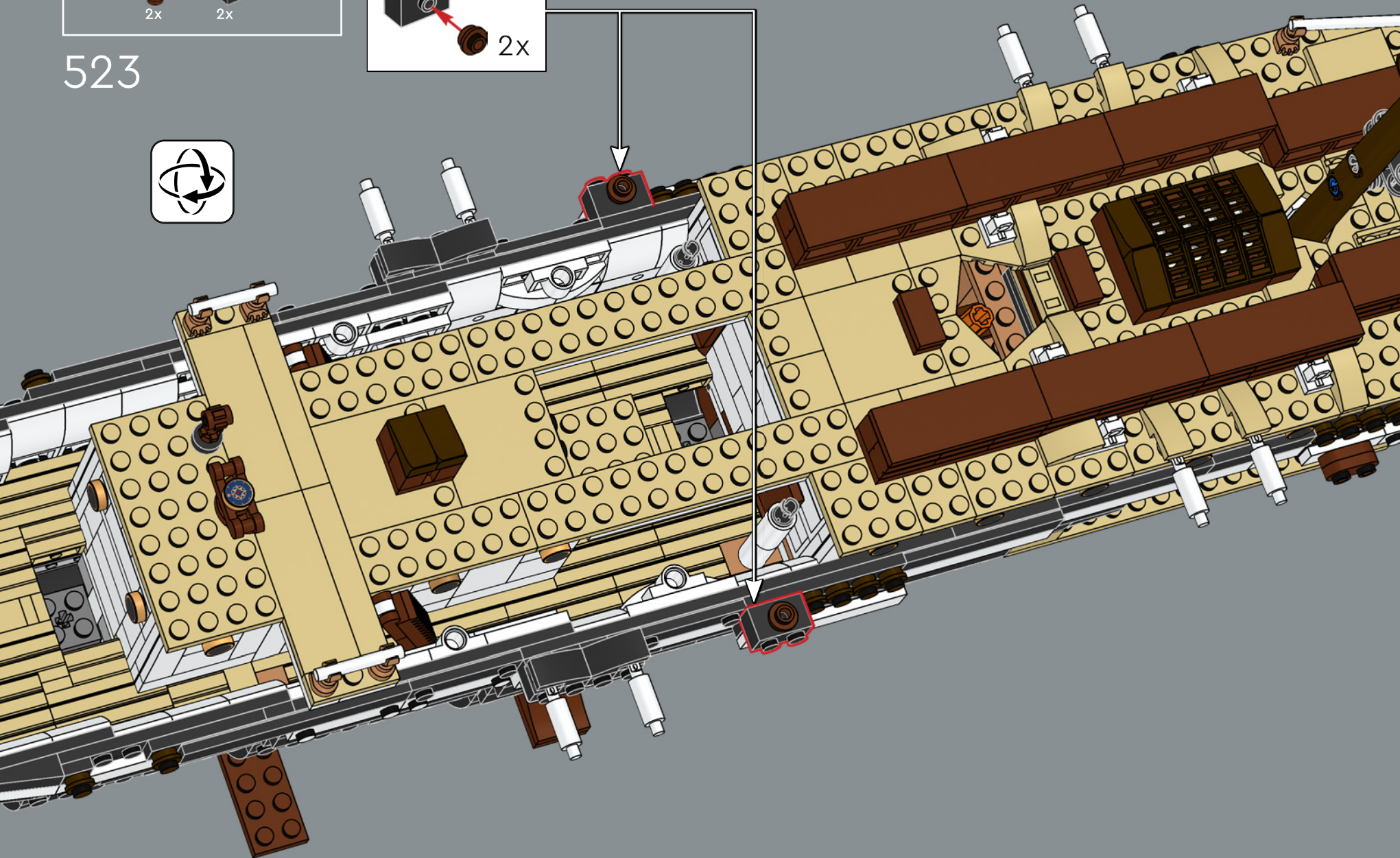



38x

524

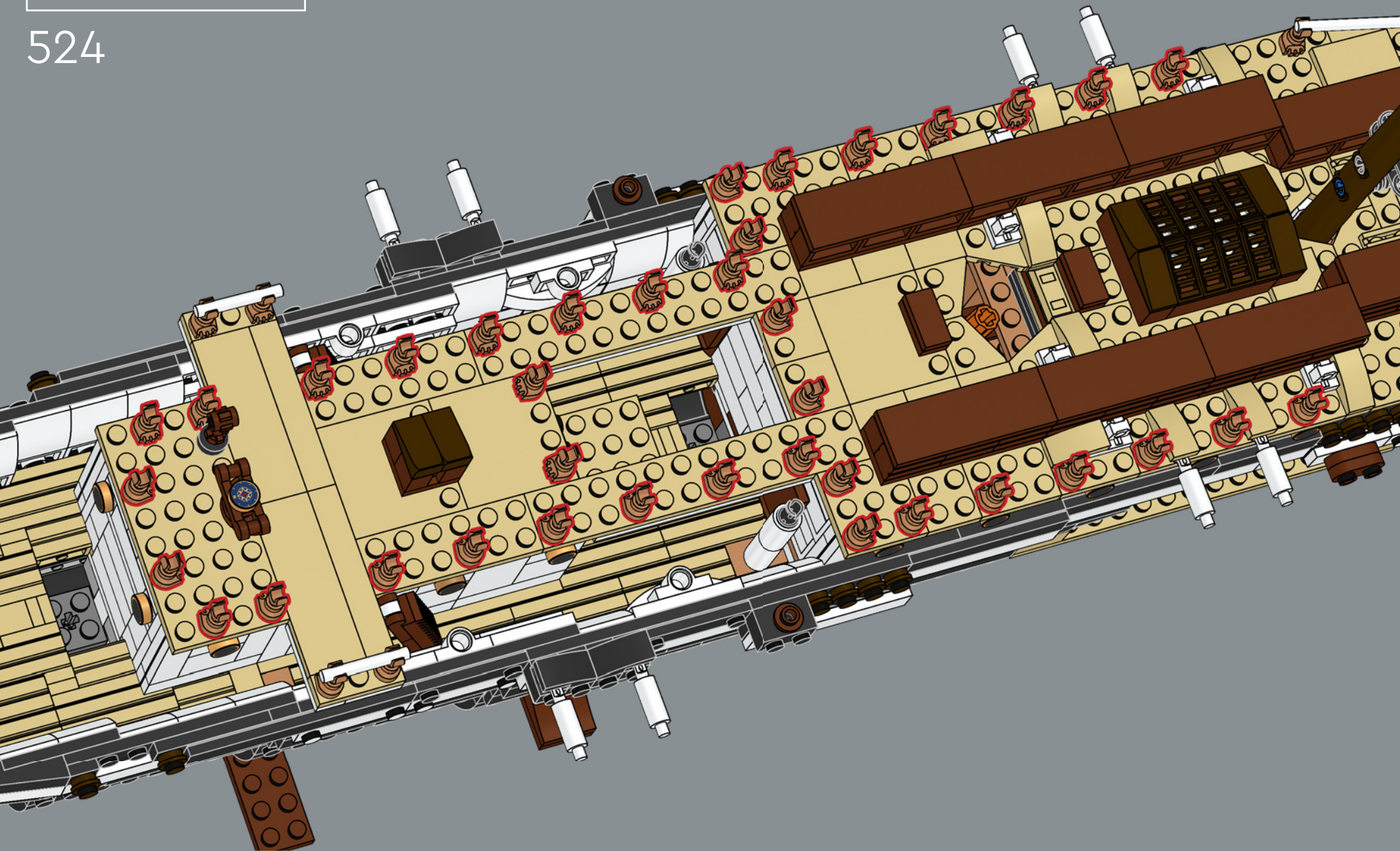

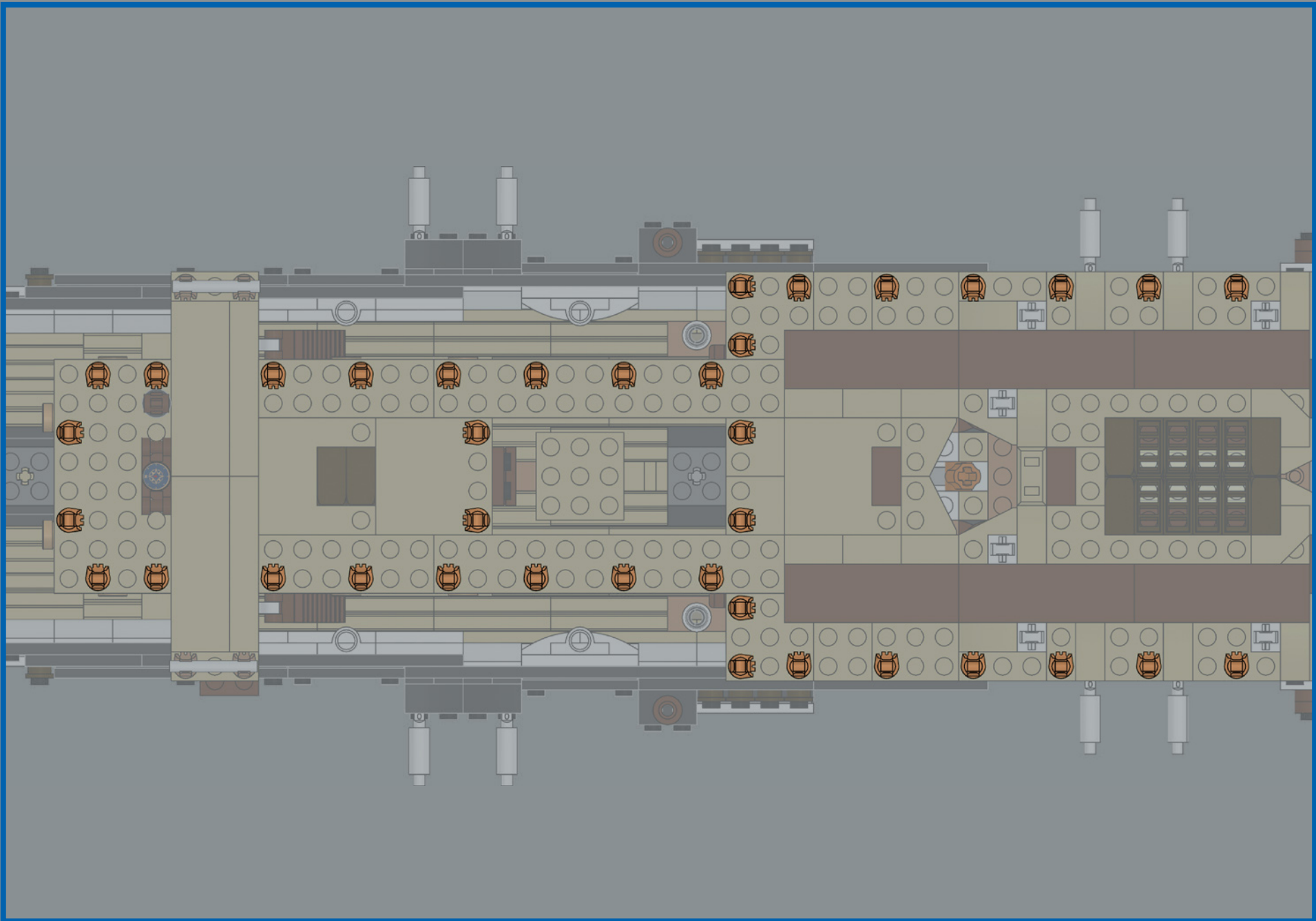

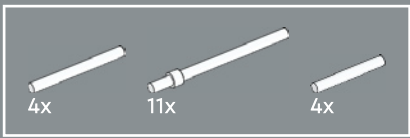

525

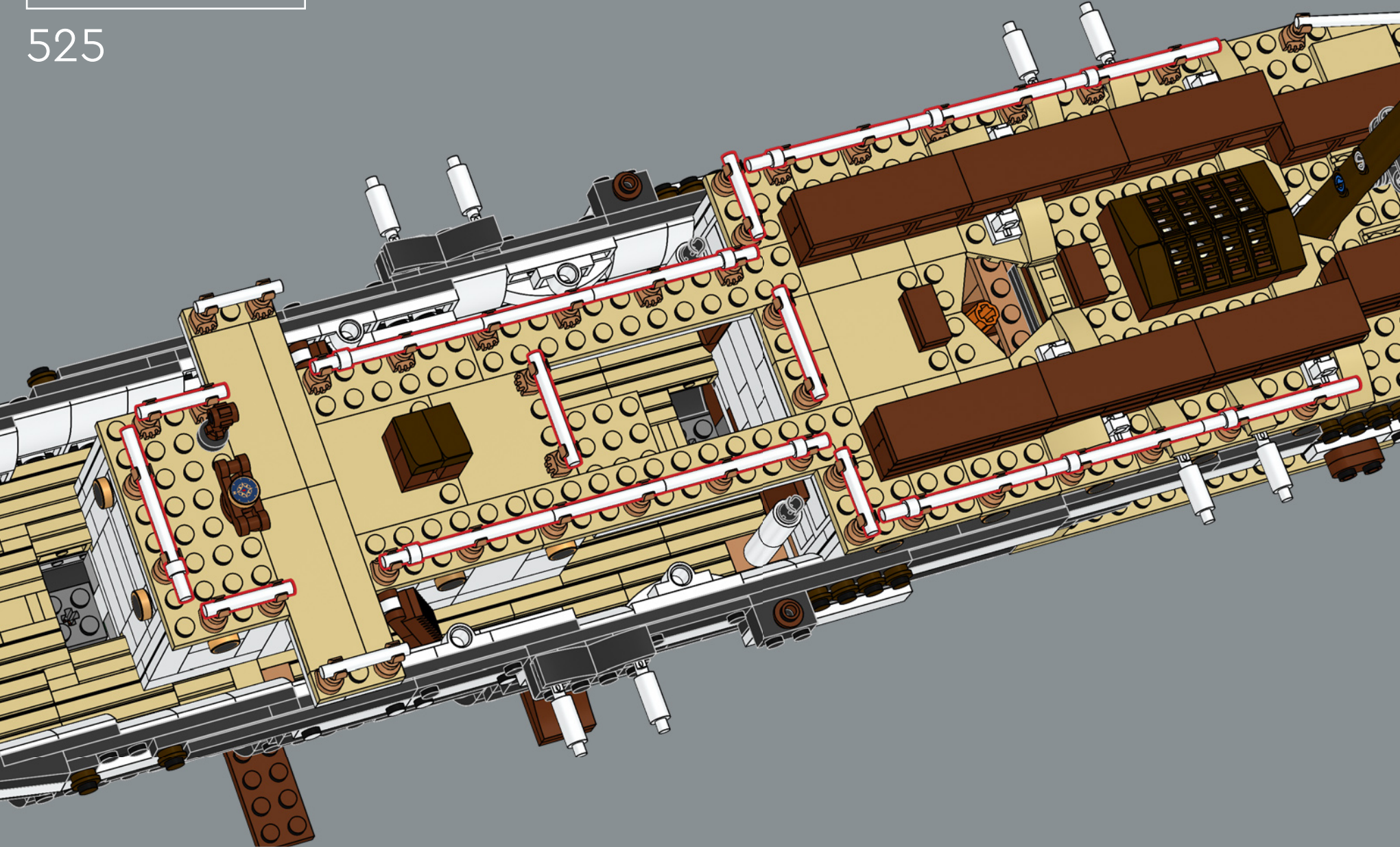

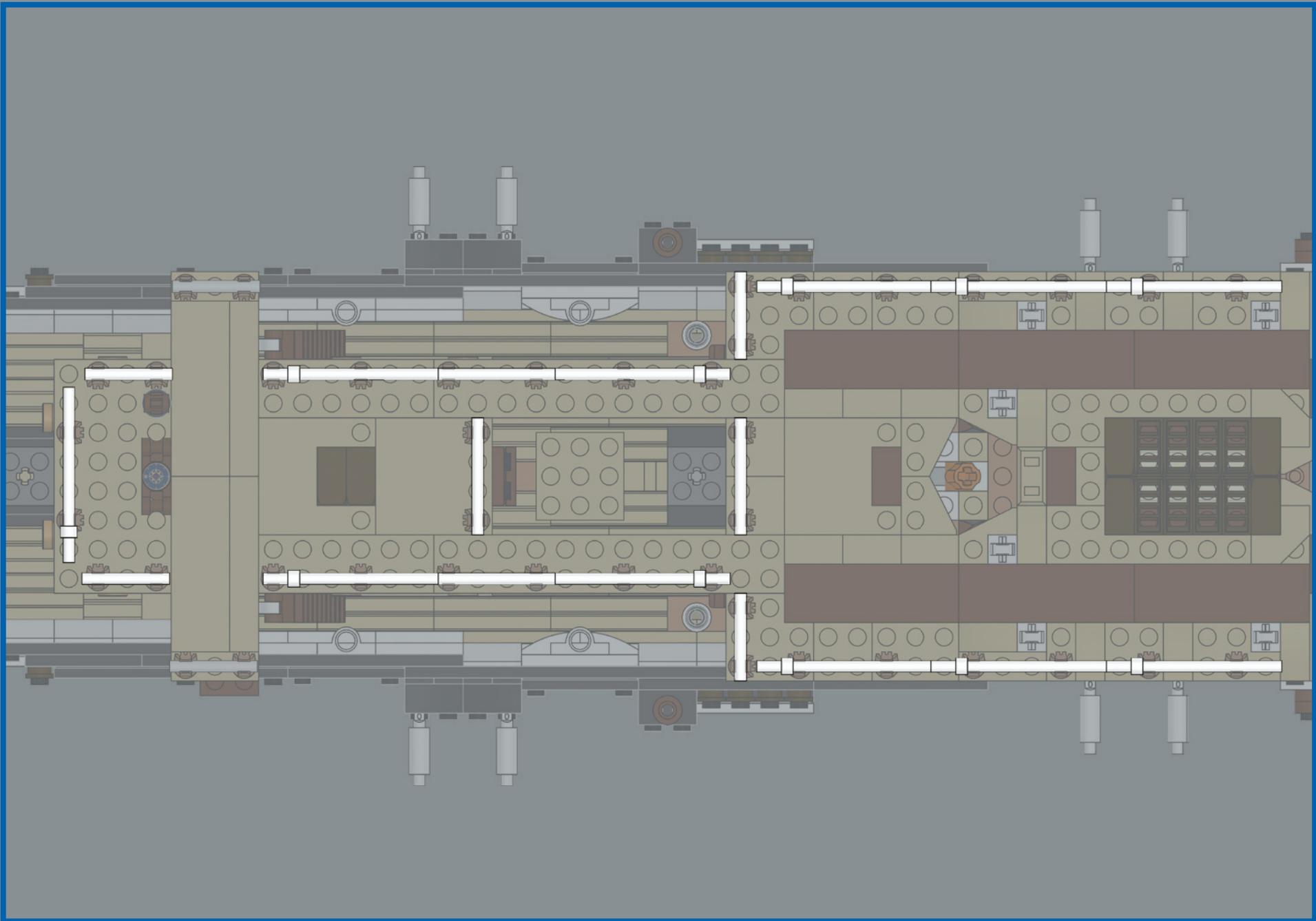

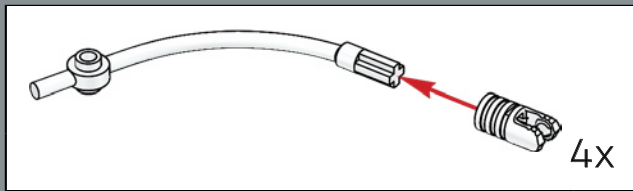
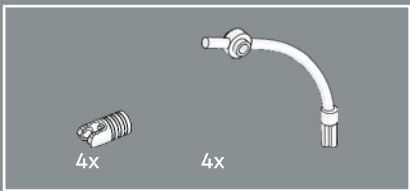

526

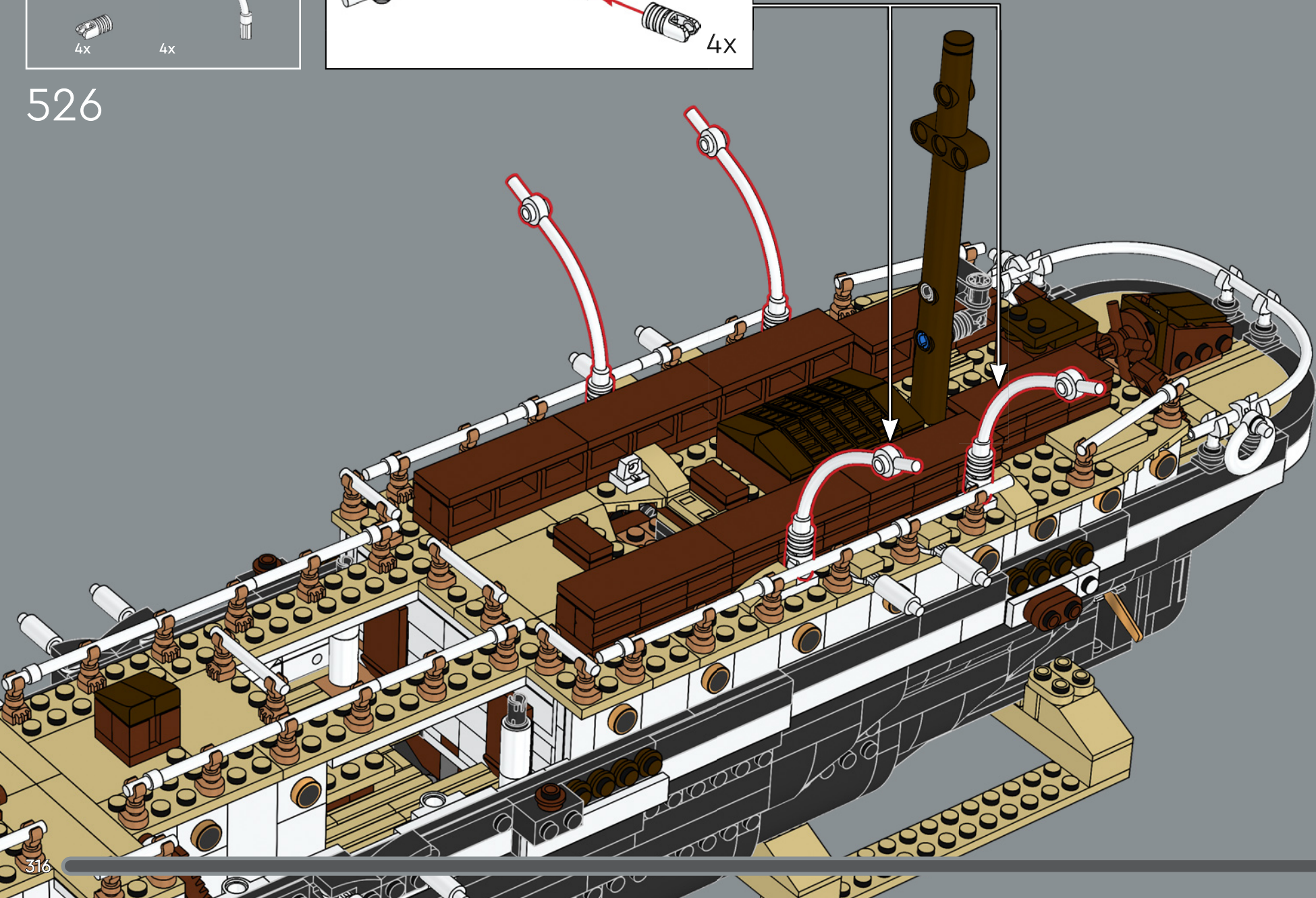

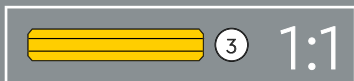
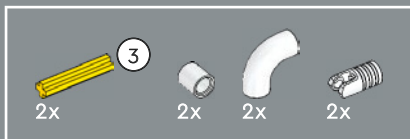

527

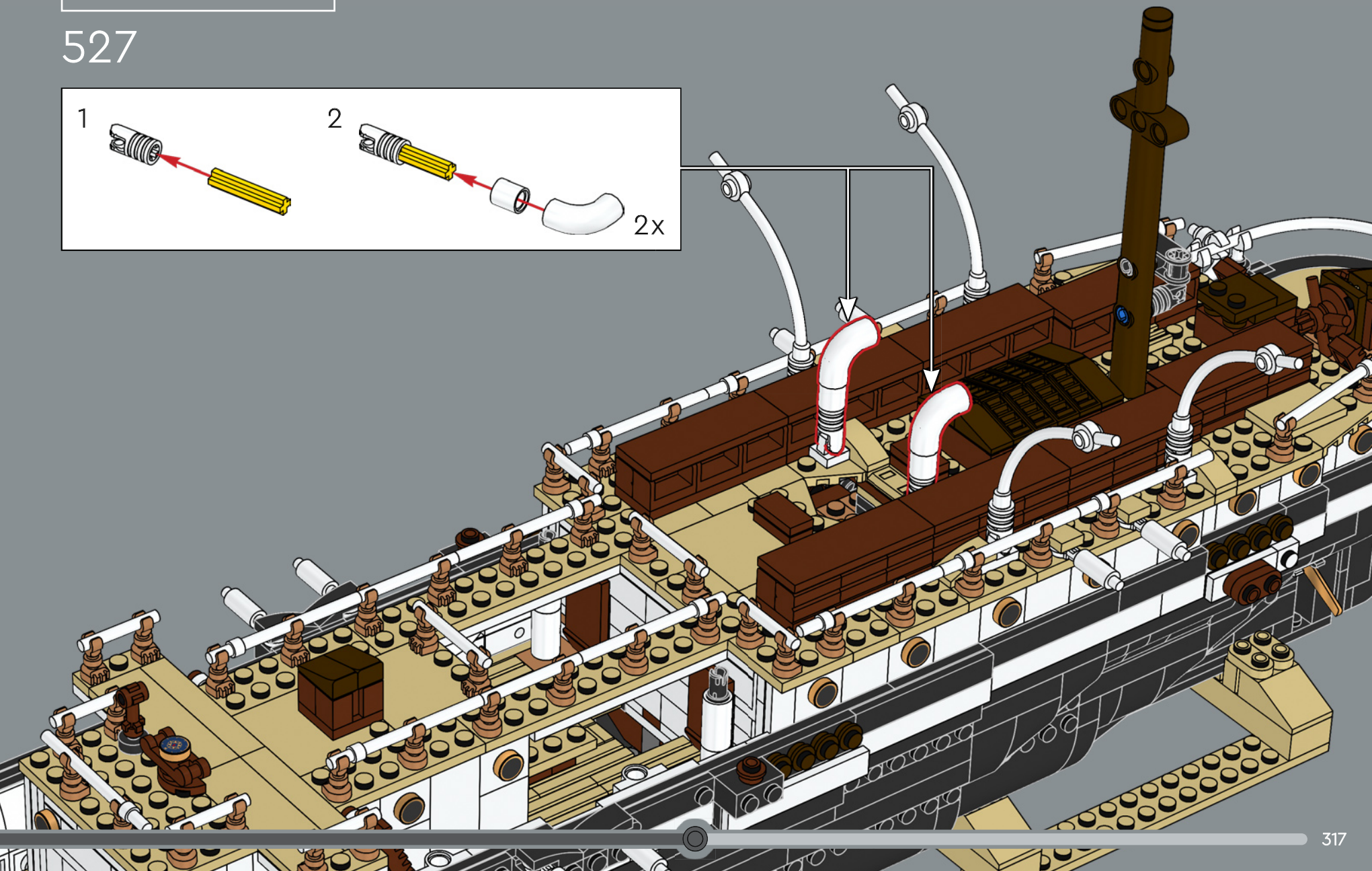
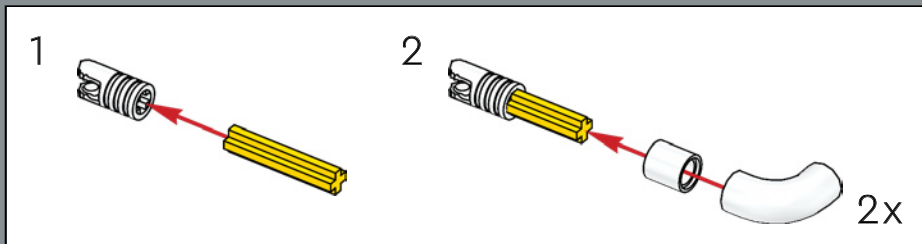

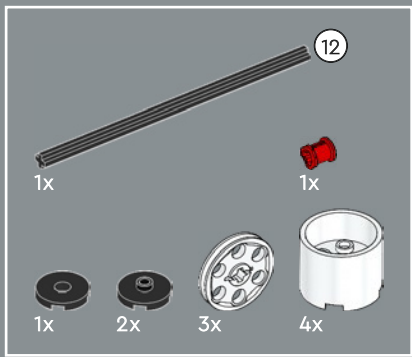

528

1

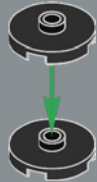

2

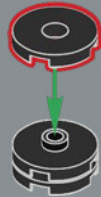

3



4

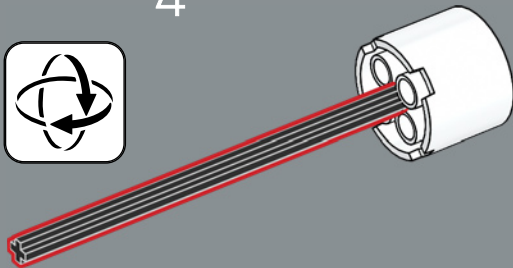

5



6

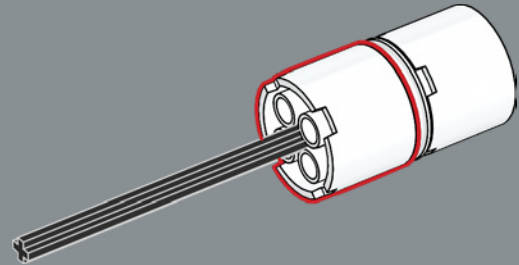

7

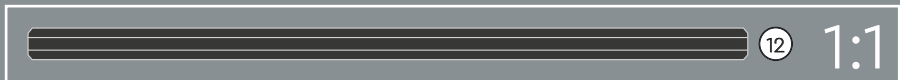
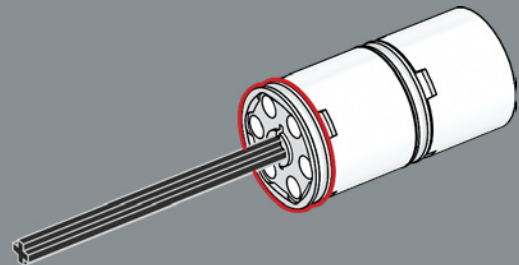

8

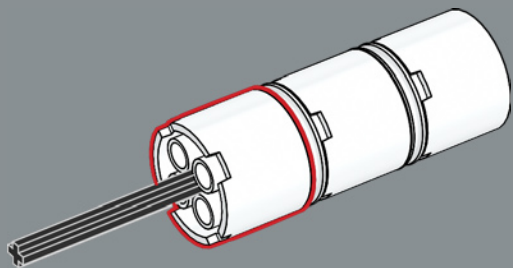

9

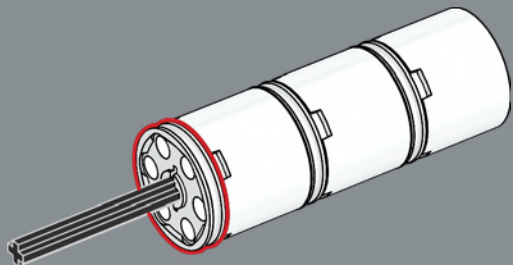

10

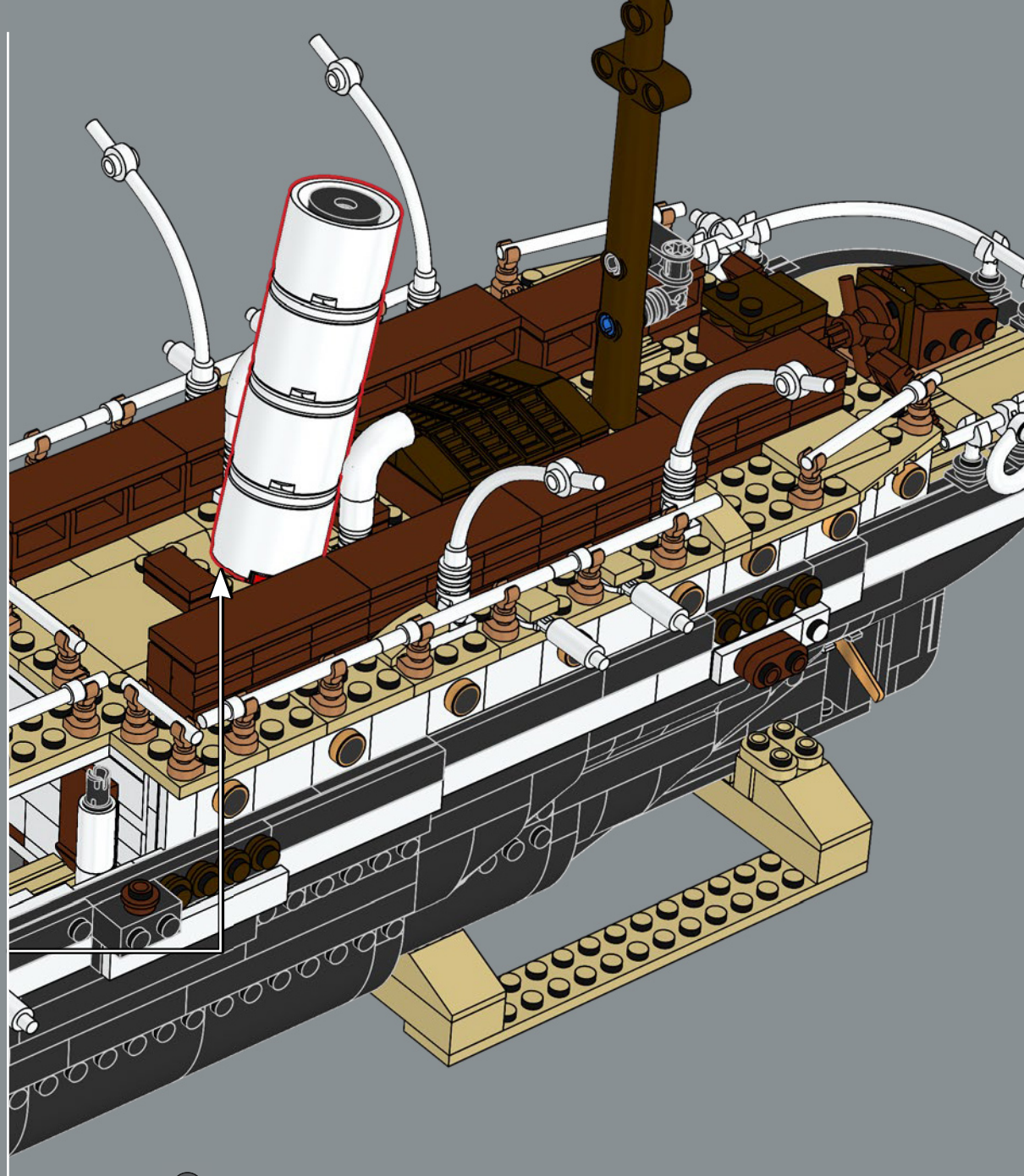
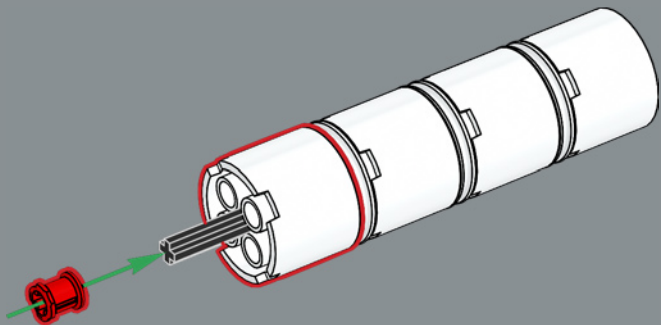



529

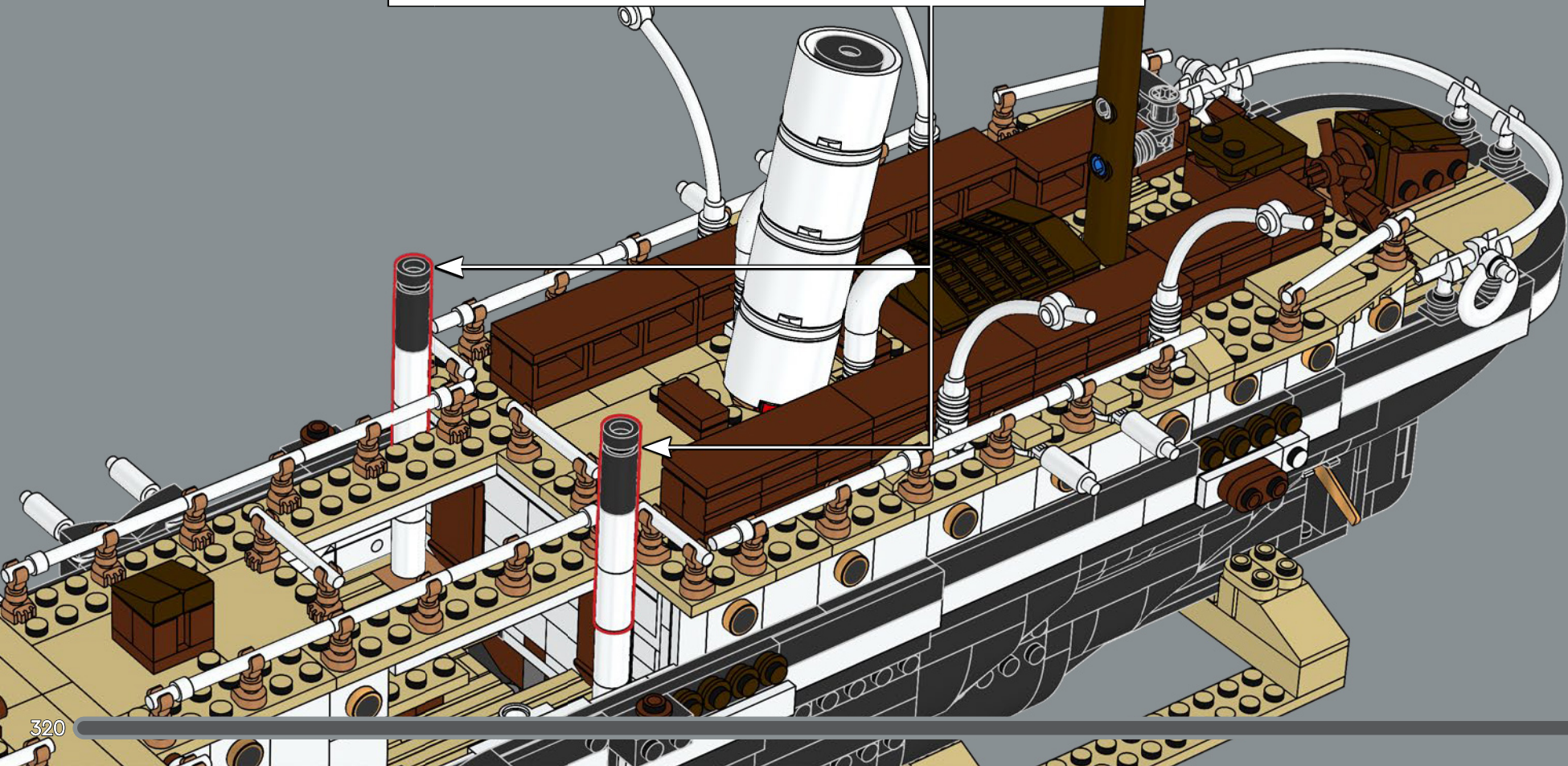
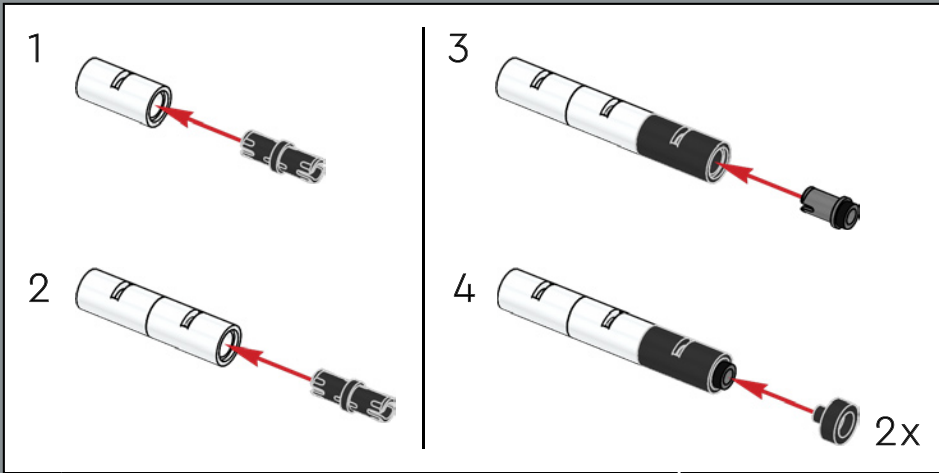

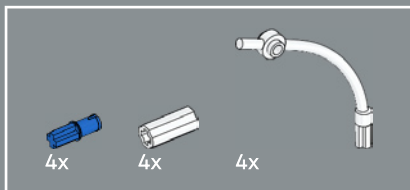

530

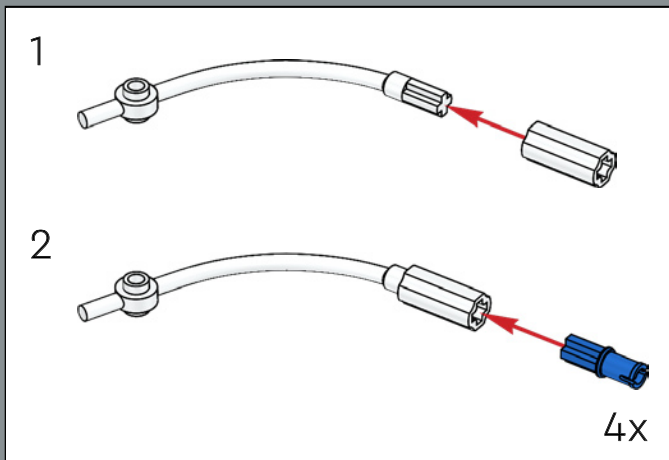

The curved arms holding the four lifeboats were originally designed as LEGO® minifigure holder elements.

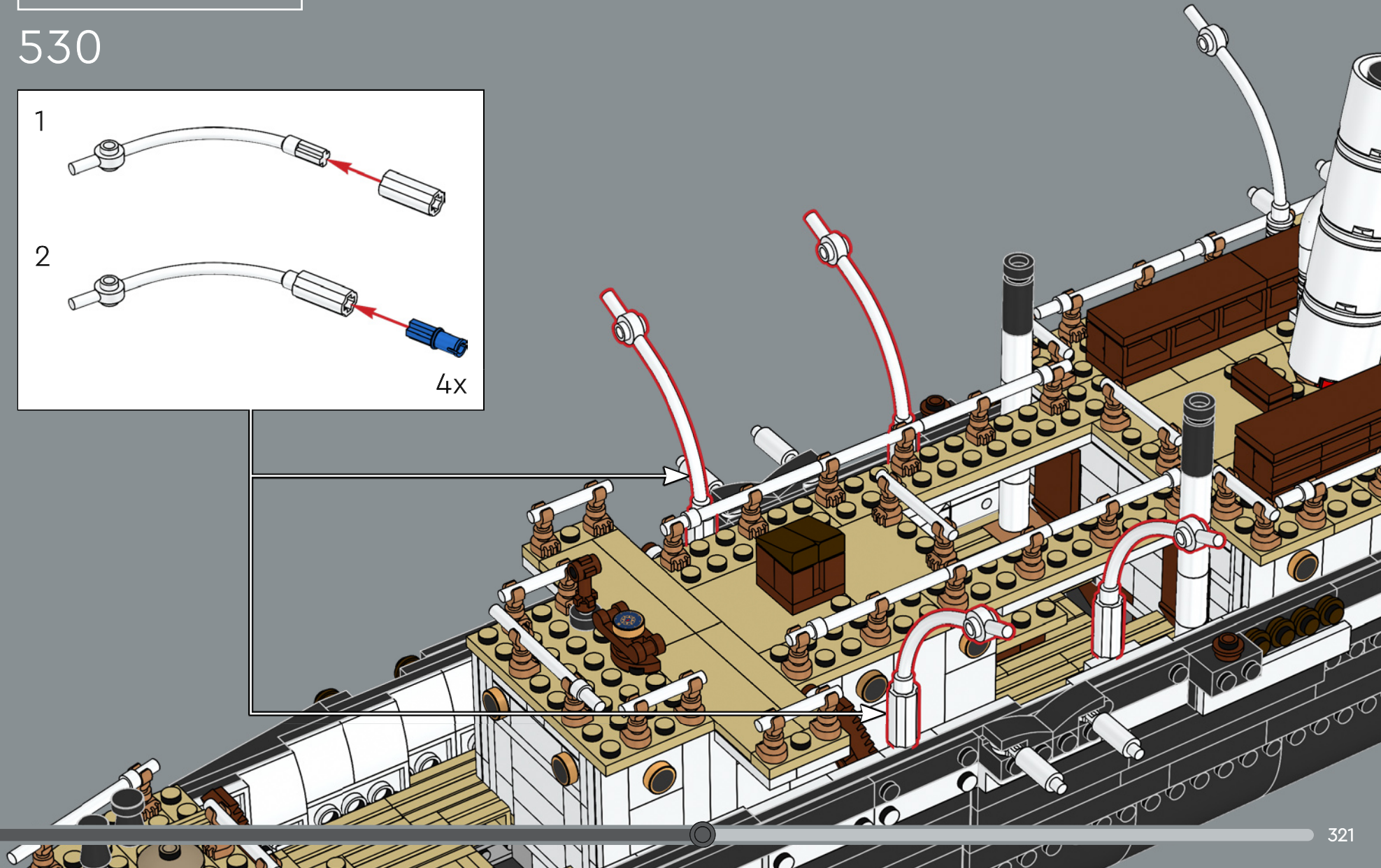

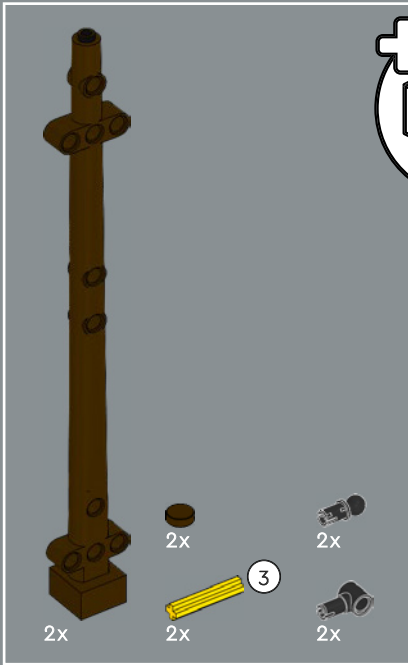
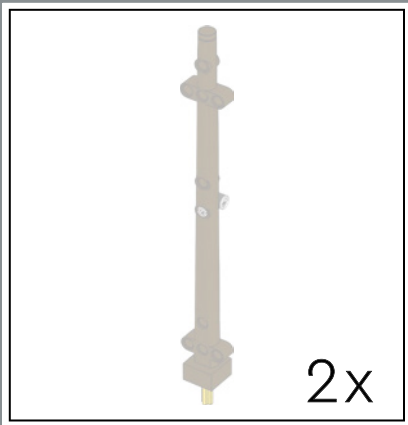

531

1



2

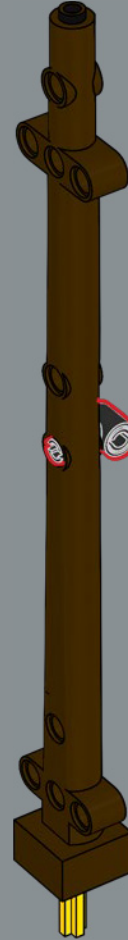

3



2x



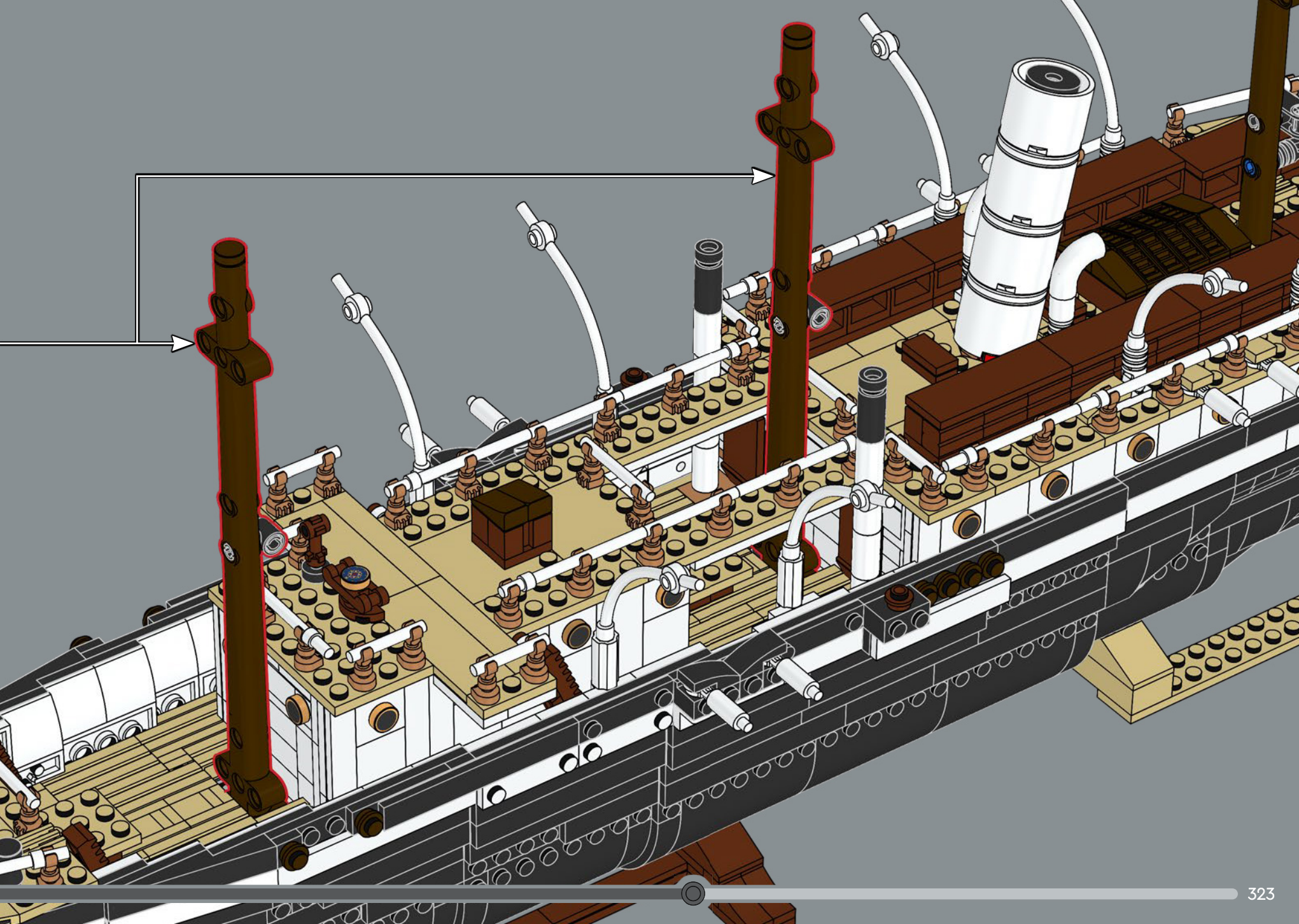

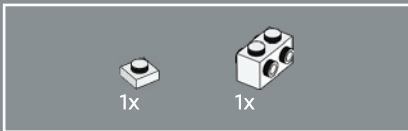
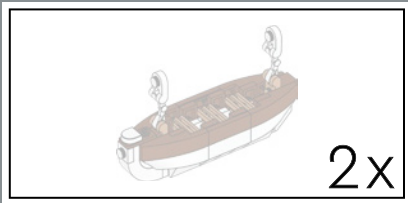

532

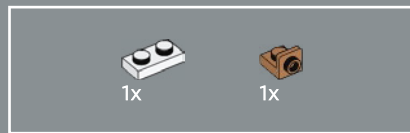
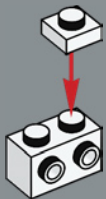

533

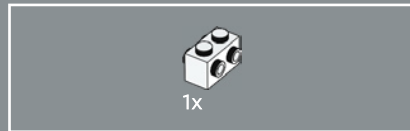
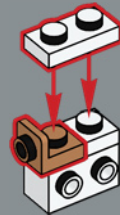

534

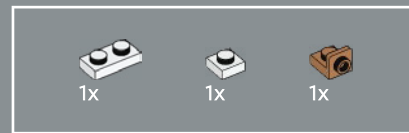
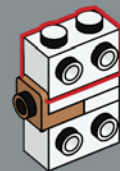

535

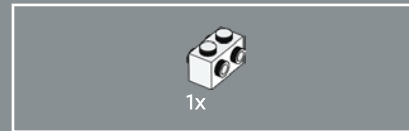
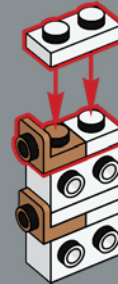

536

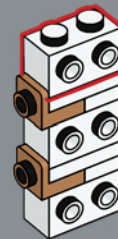

537

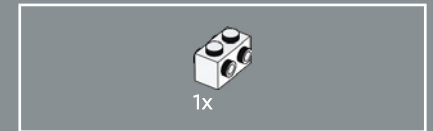
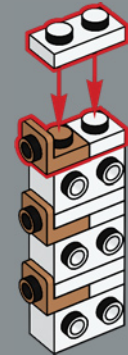

538

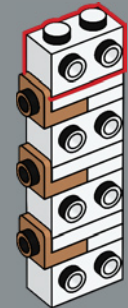

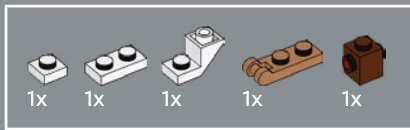

539

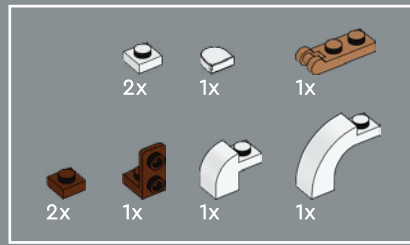
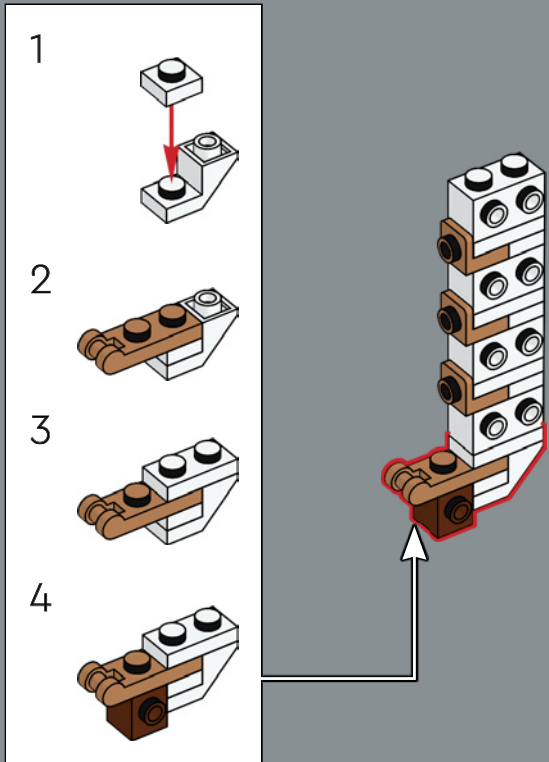

540

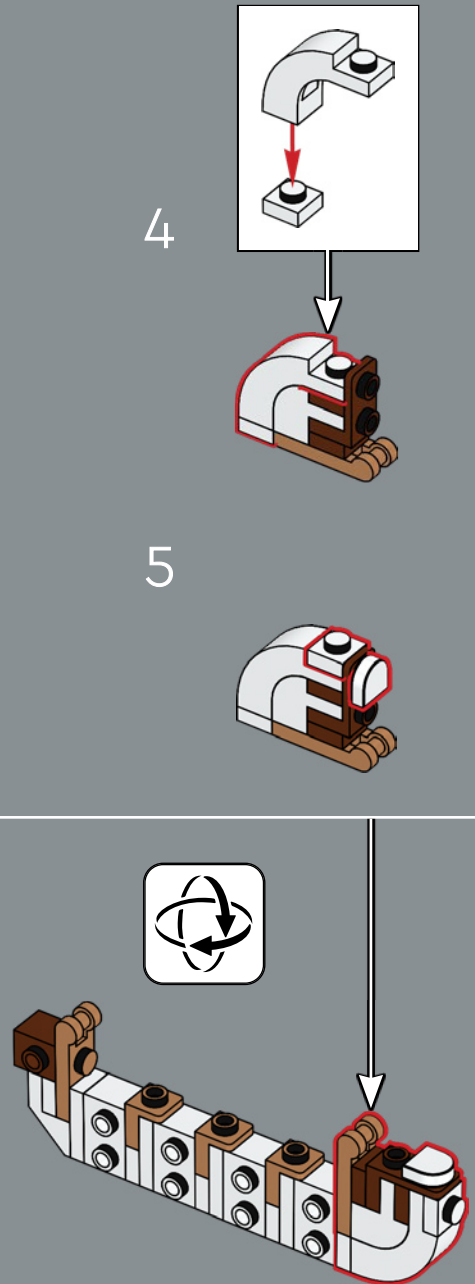
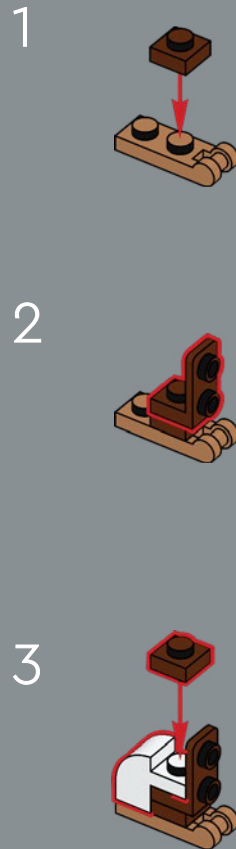

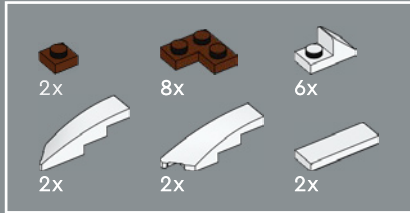
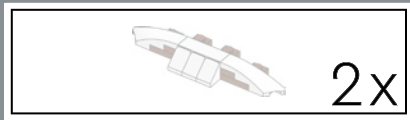

541

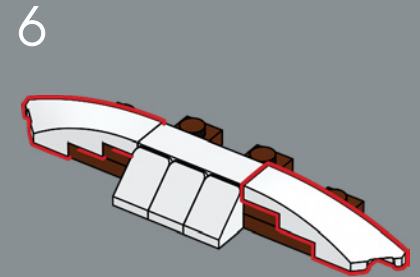
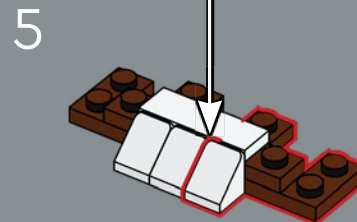
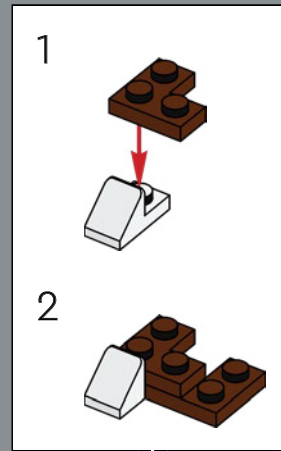
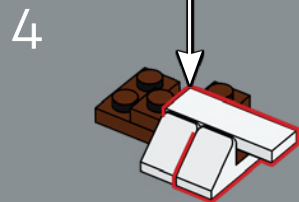
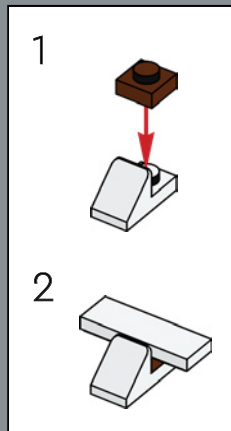
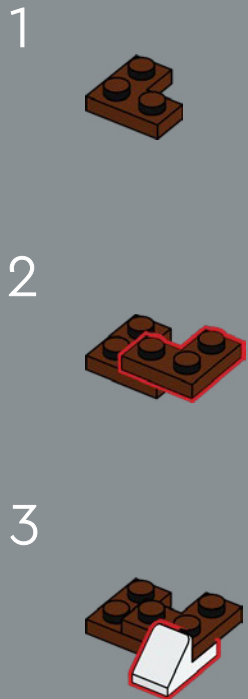

2x

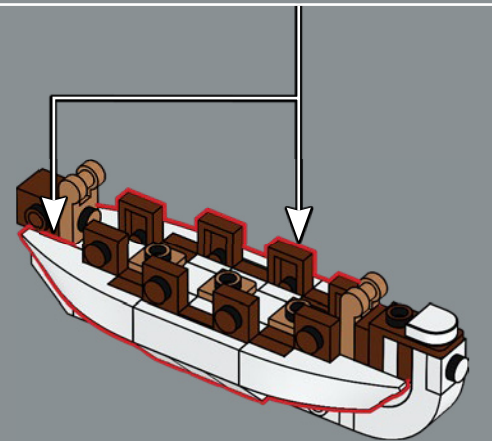



542

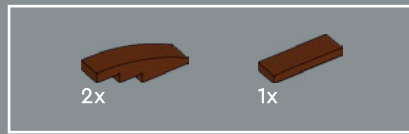
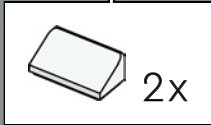
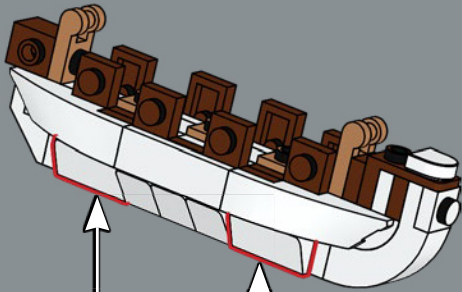

543

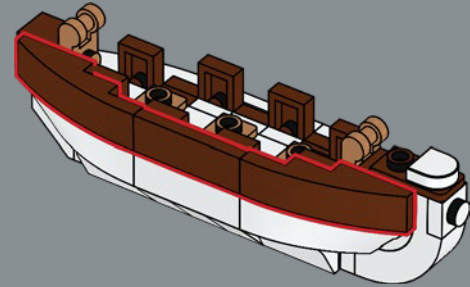

544

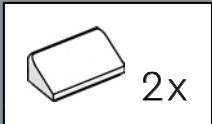
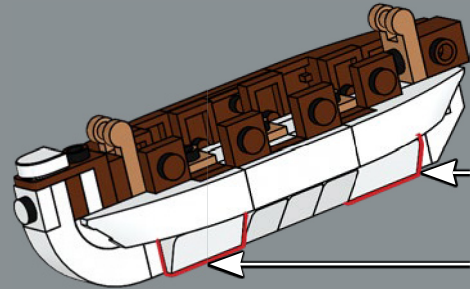



3x

545

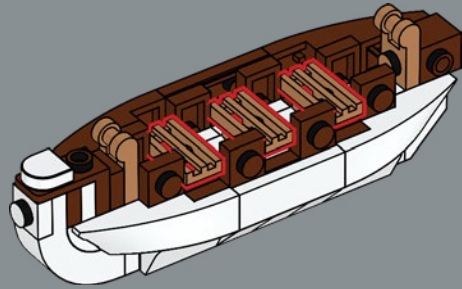

2x



1x

546

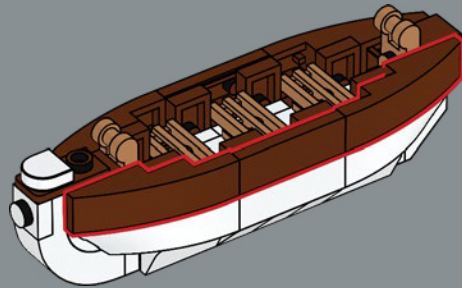

2x

547

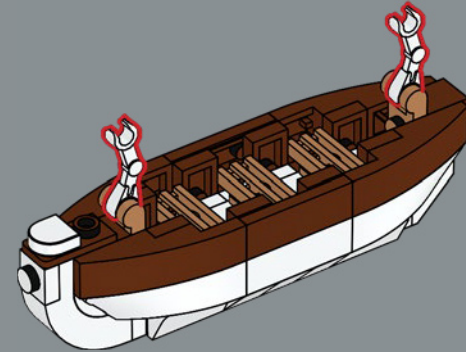

2x

548

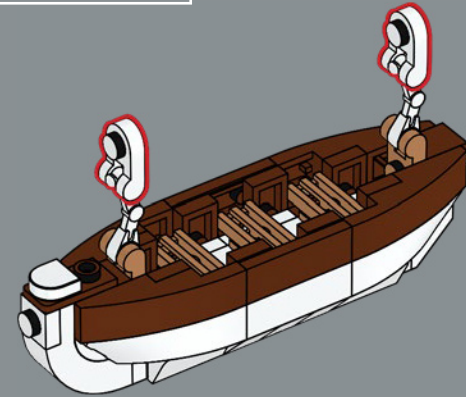

2x

549

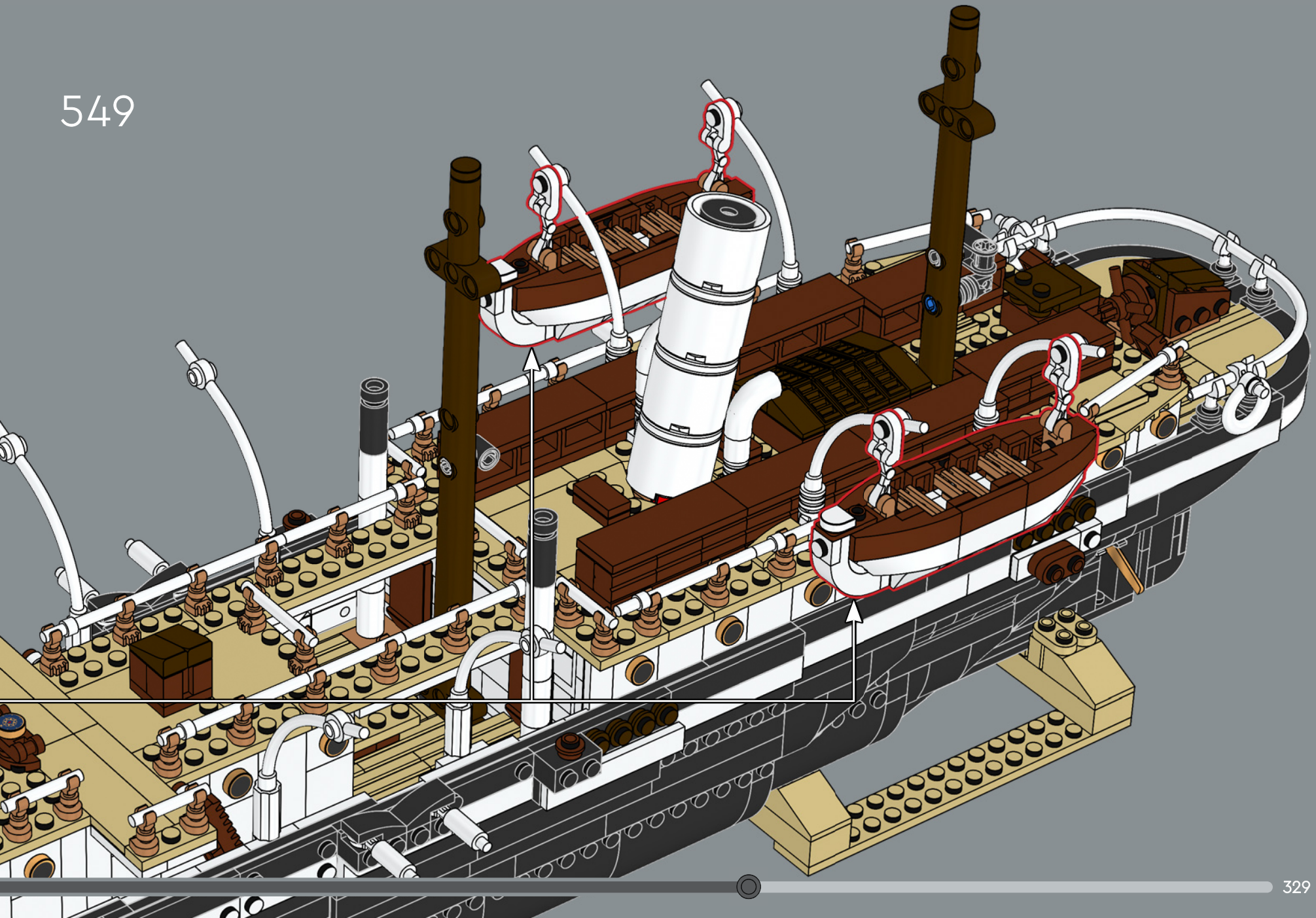

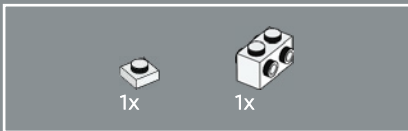
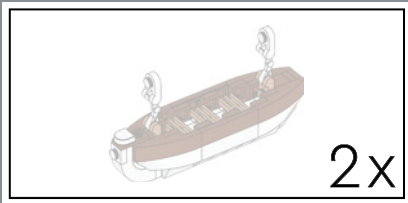

550

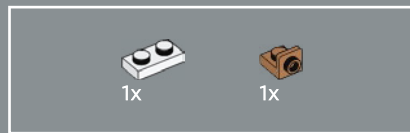
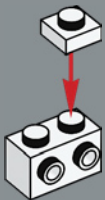

551

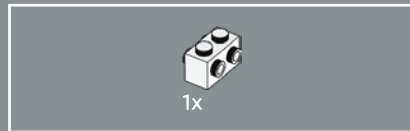
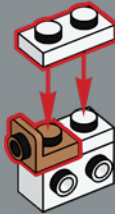

552

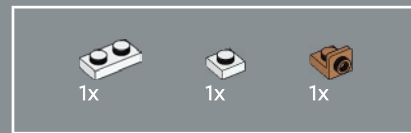

553

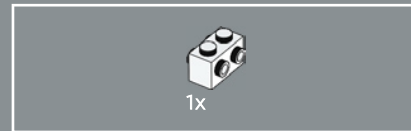
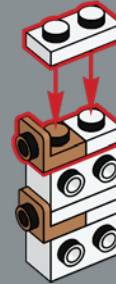

554

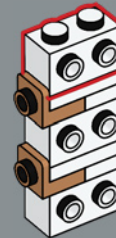

555

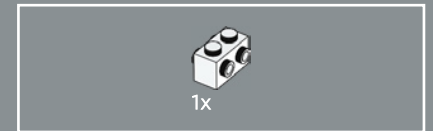

556

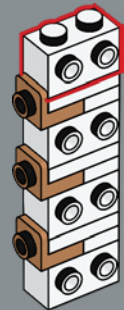

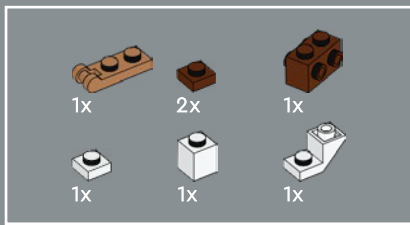

557

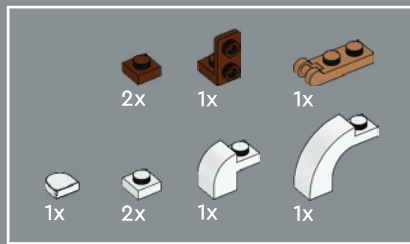
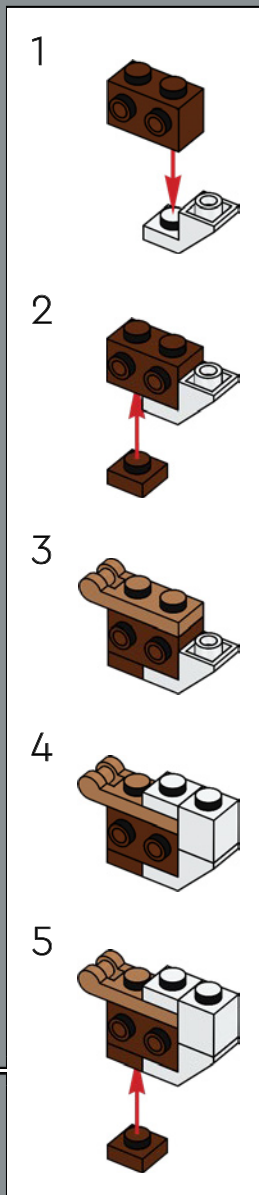
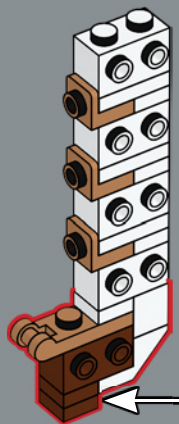

558

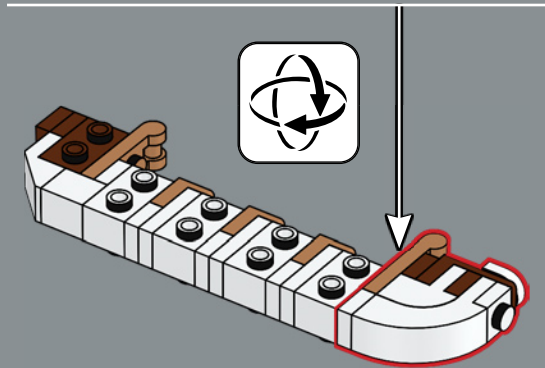
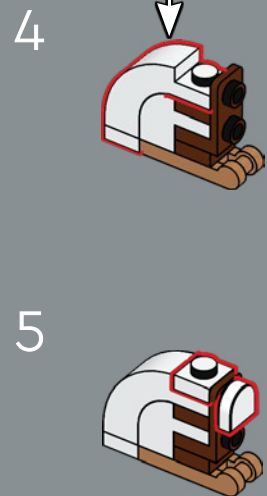
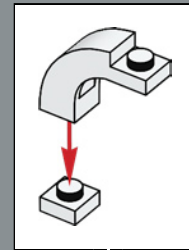
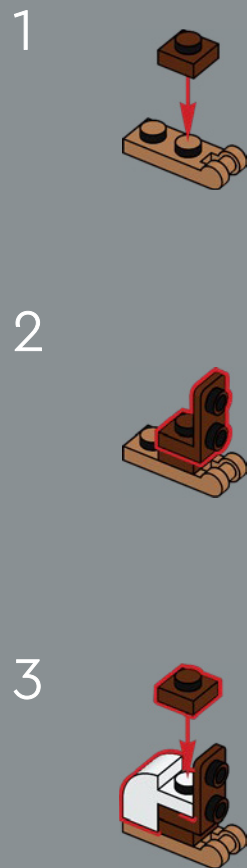

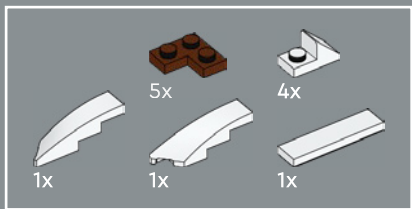

559

1



2



3

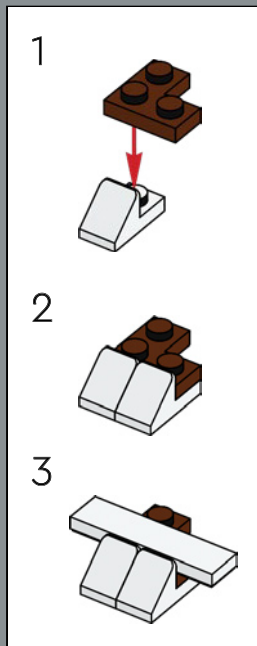

4

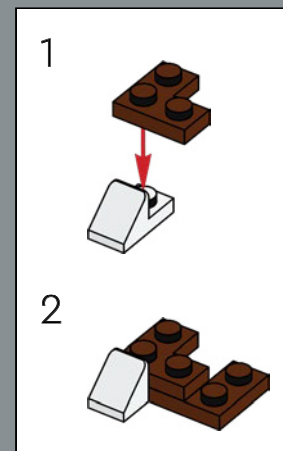
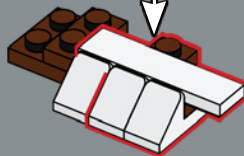

5

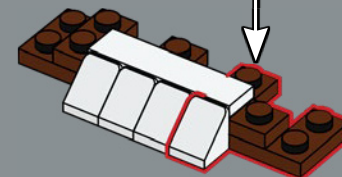

6

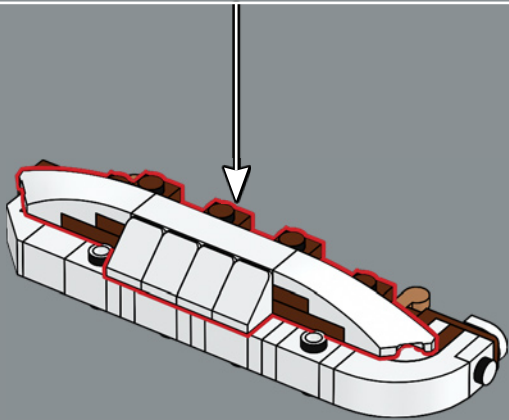
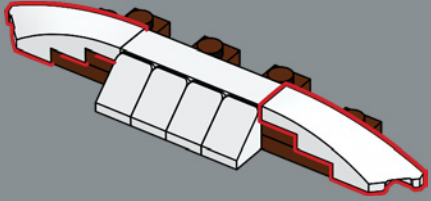

2x

560

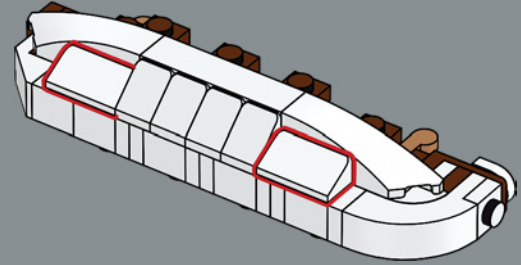

1x

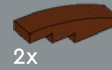

2x

561

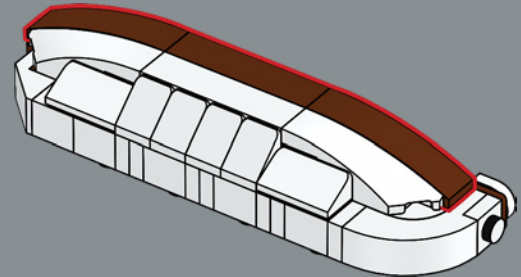

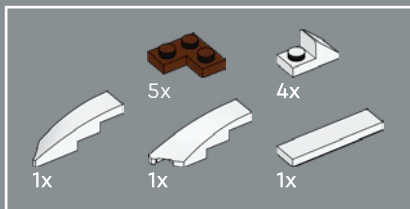

562

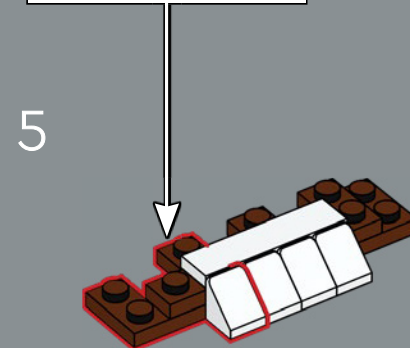
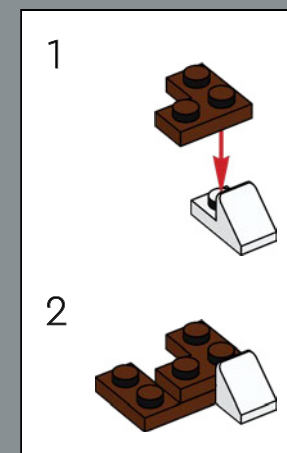
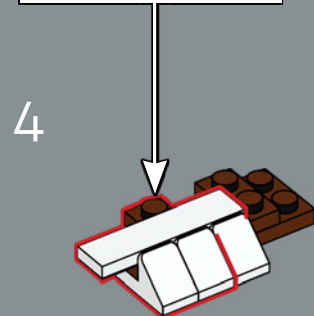
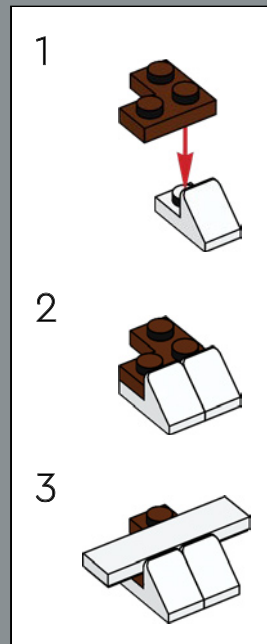
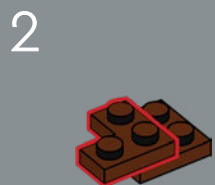

6

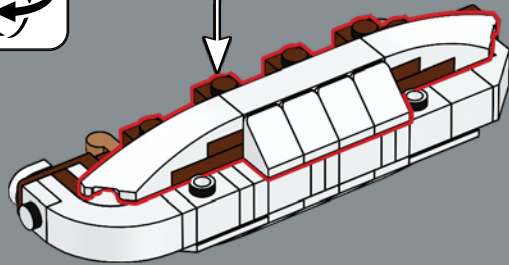
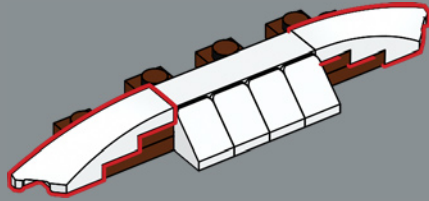

2x

563

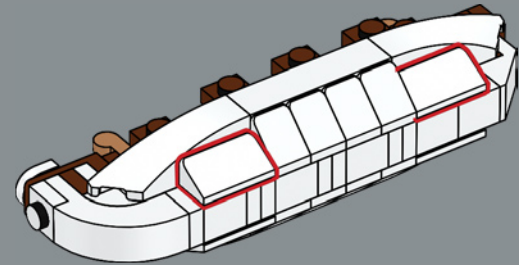

3x

564

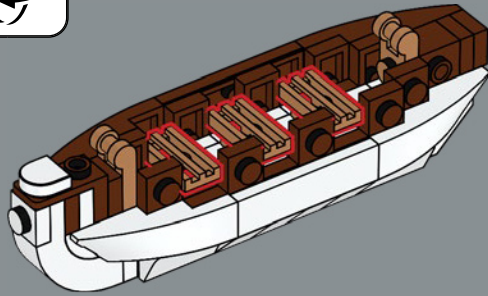

1x

2x

565

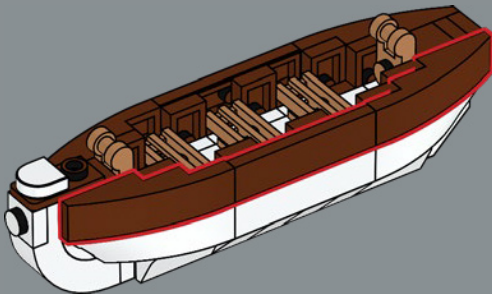

2x

566

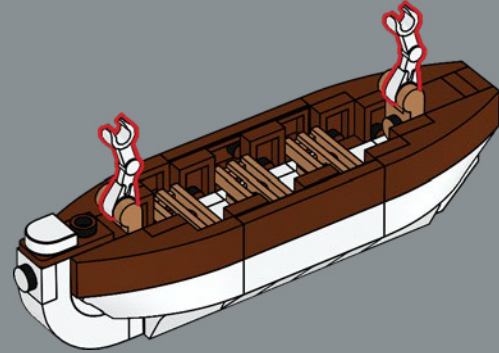

2x

567

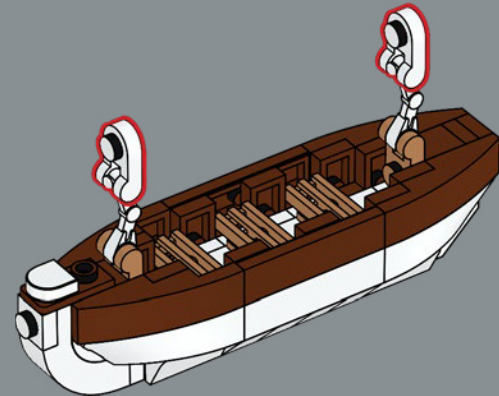

2x

568

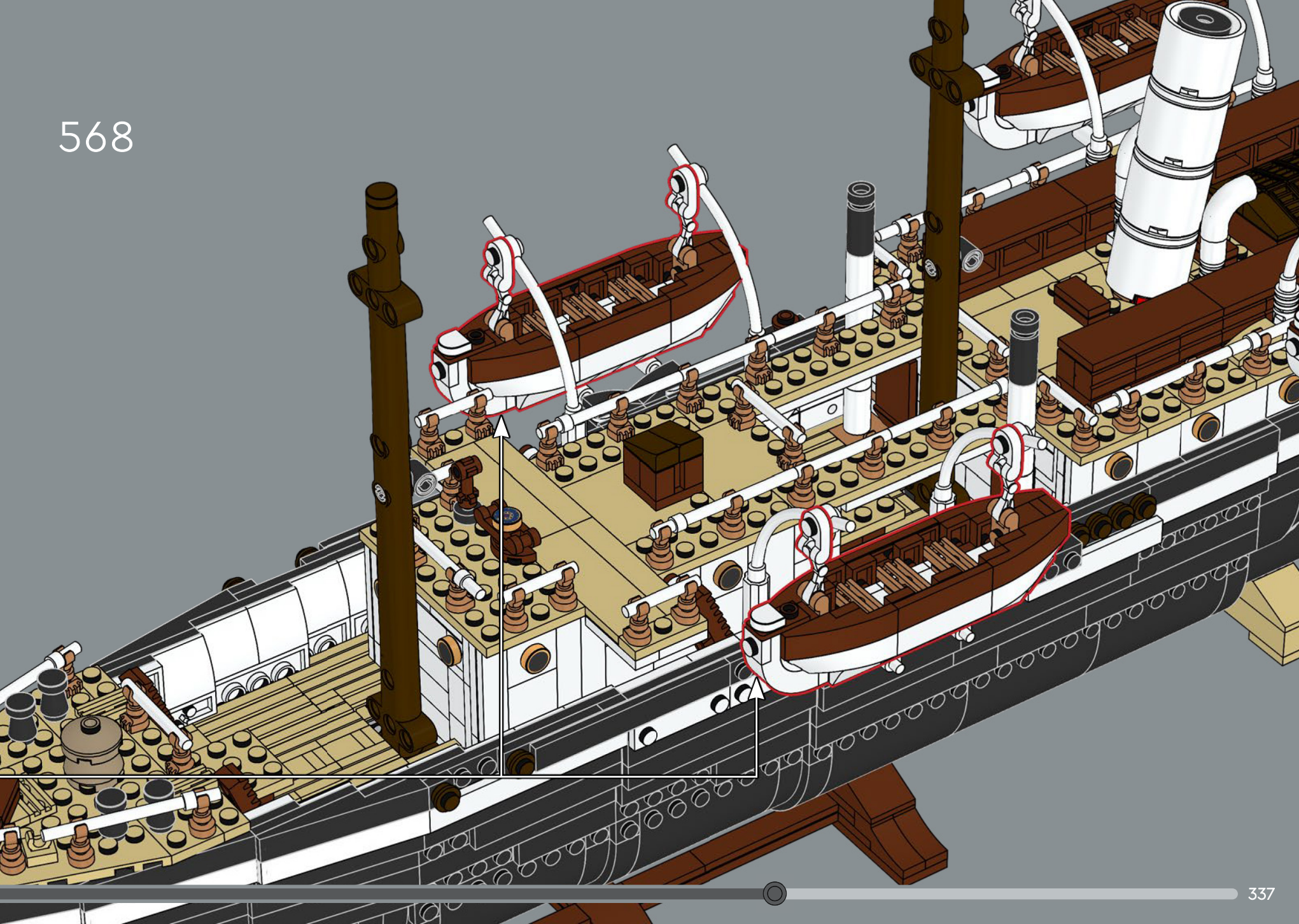

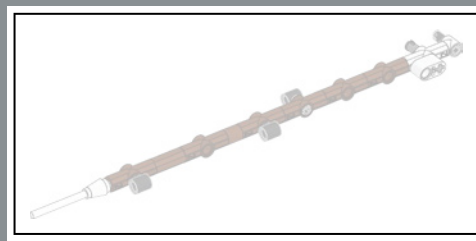

569

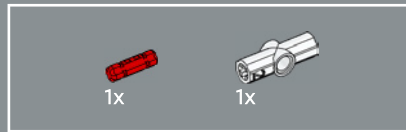
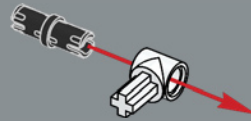

570

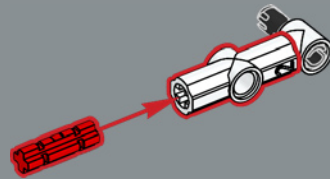

571

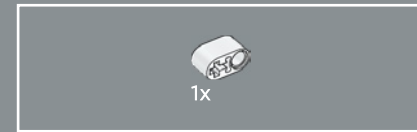
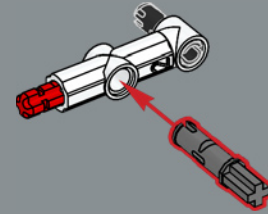

572

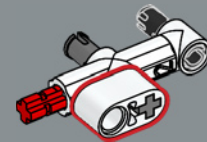

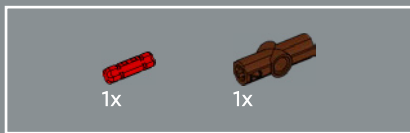

573

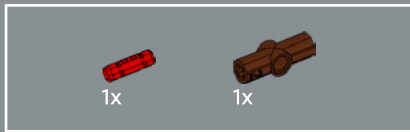
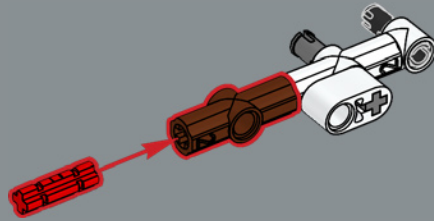

574

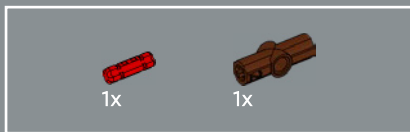
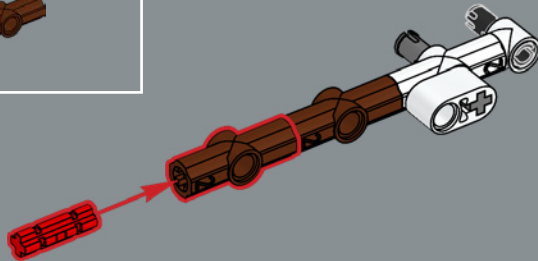

575

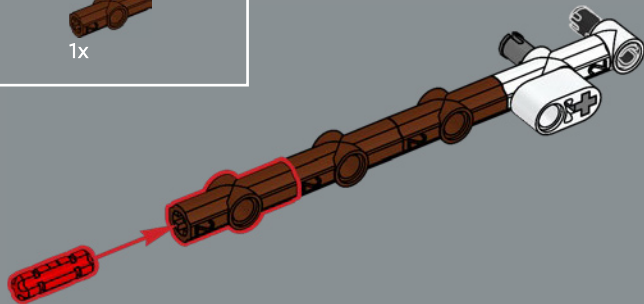

576

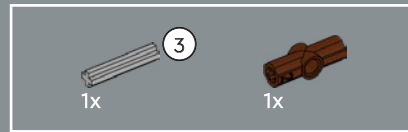
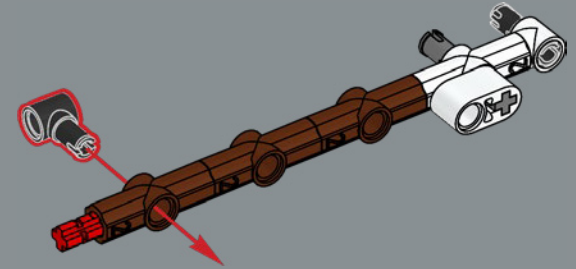

577

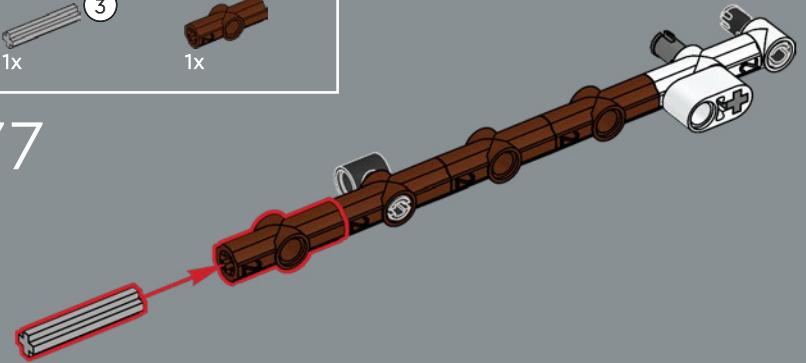

578

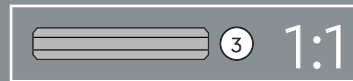
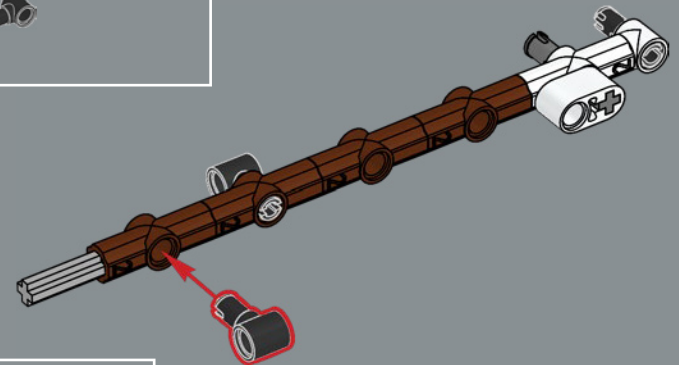



579

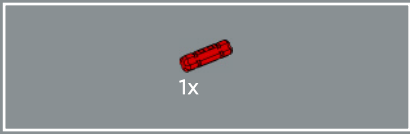
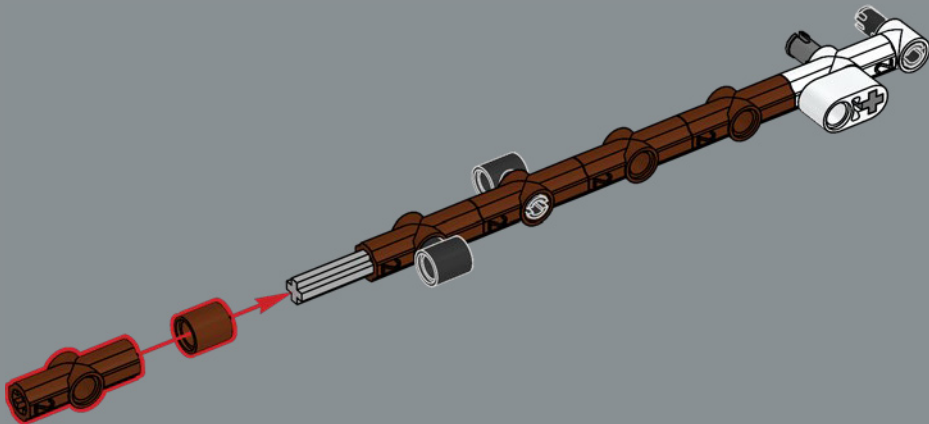

580

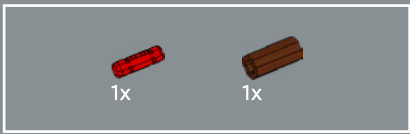
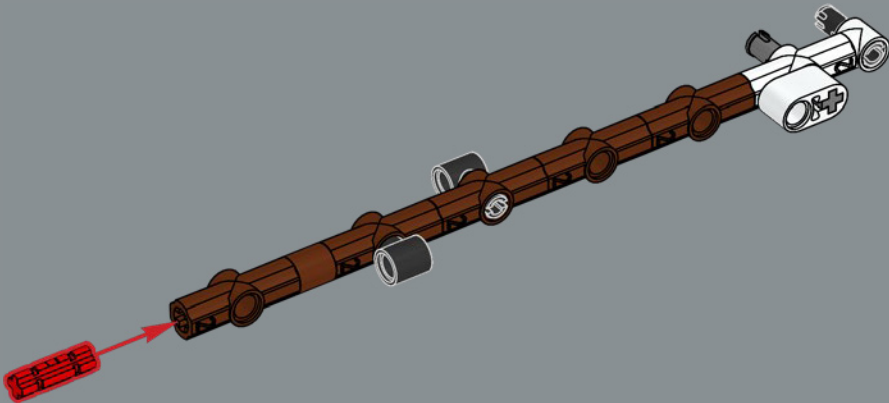

581

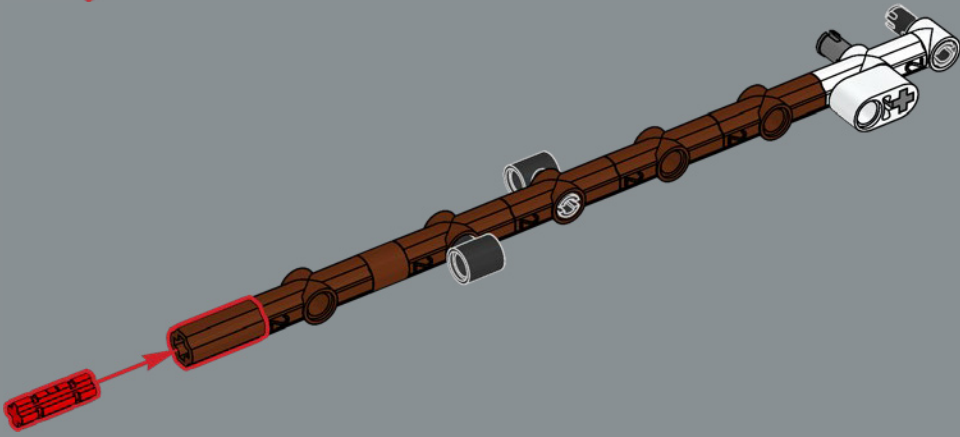



582

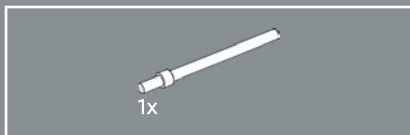
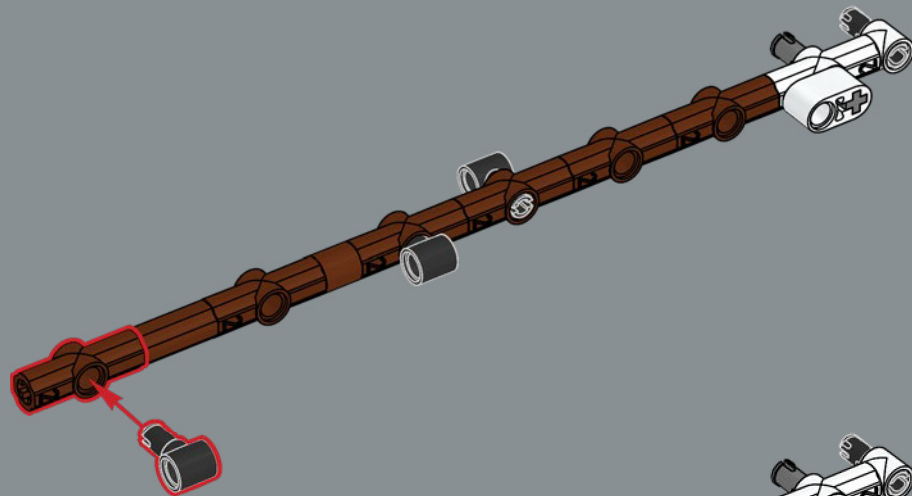

583

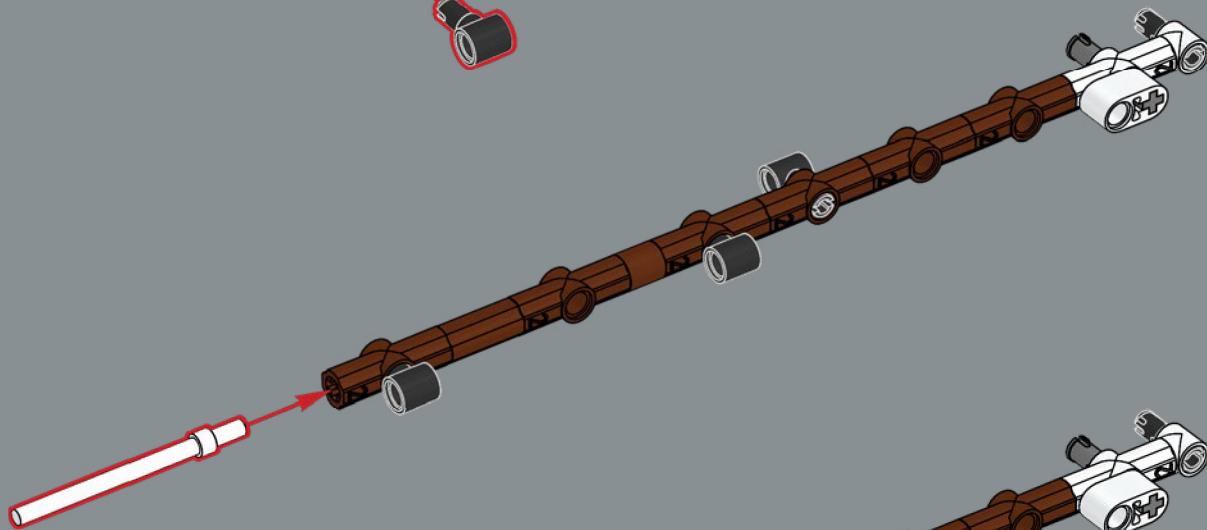

584

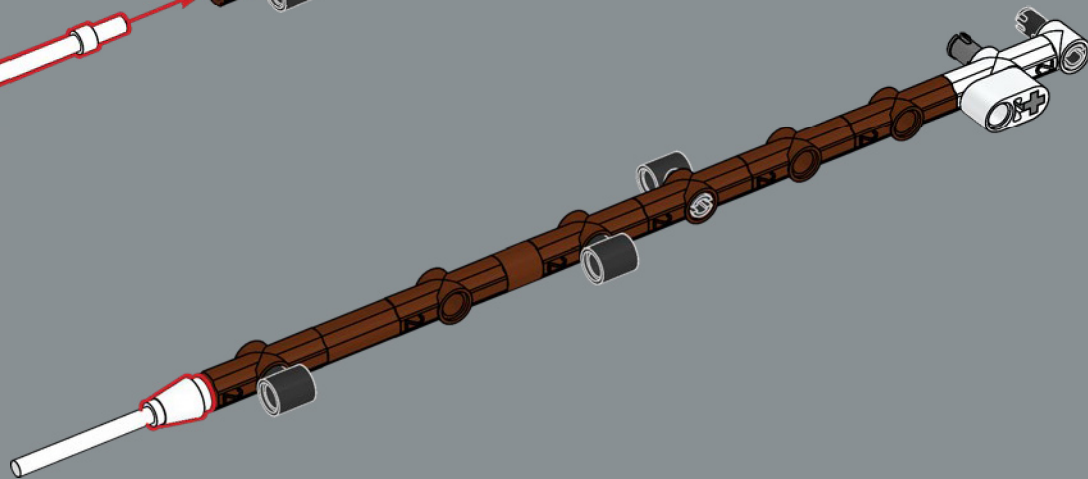

585

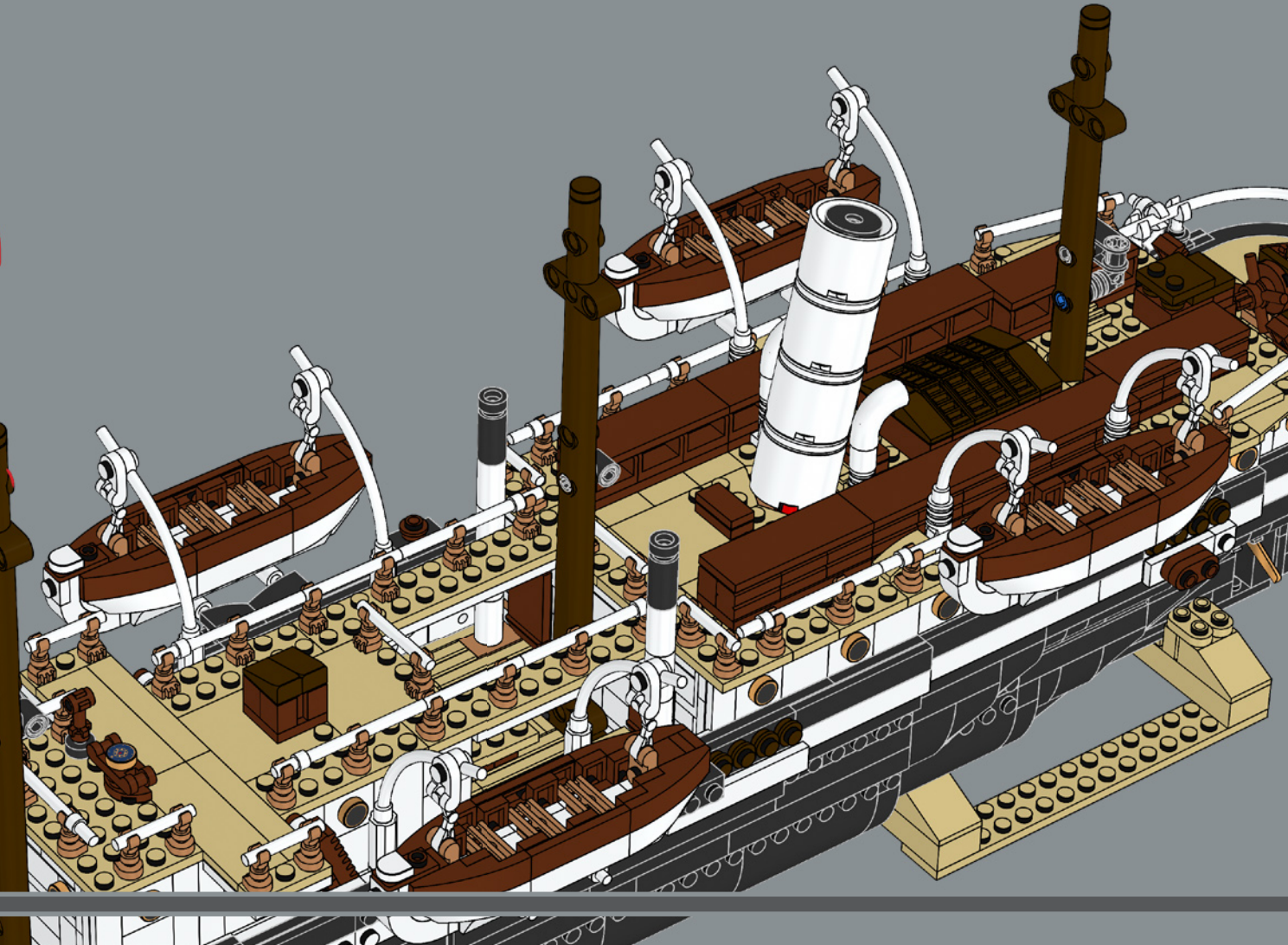
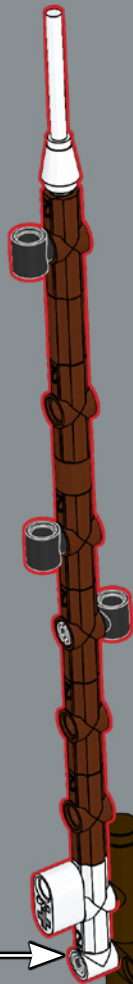

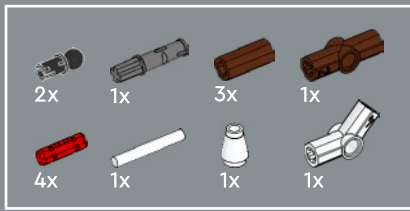

586

1

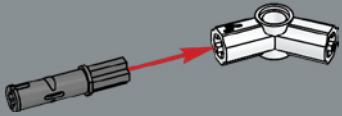

2

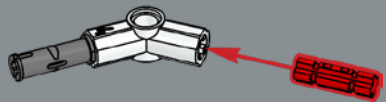

3

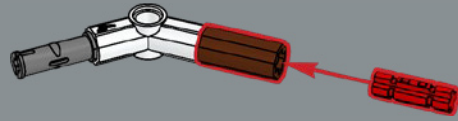

4



5

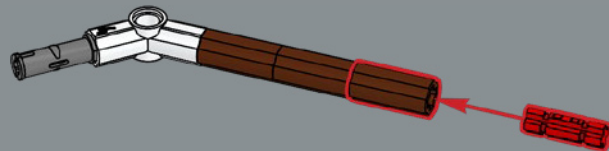

6

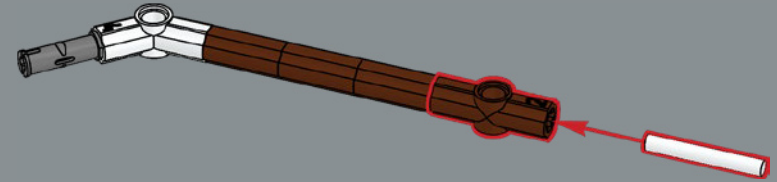

7

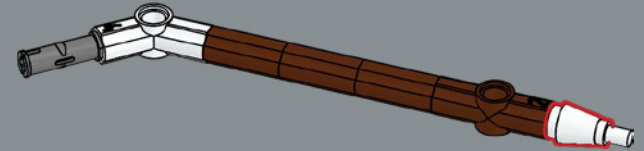

8

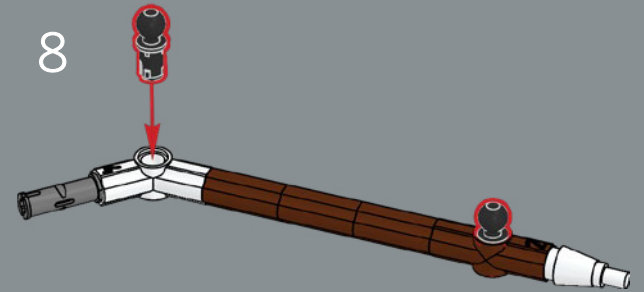

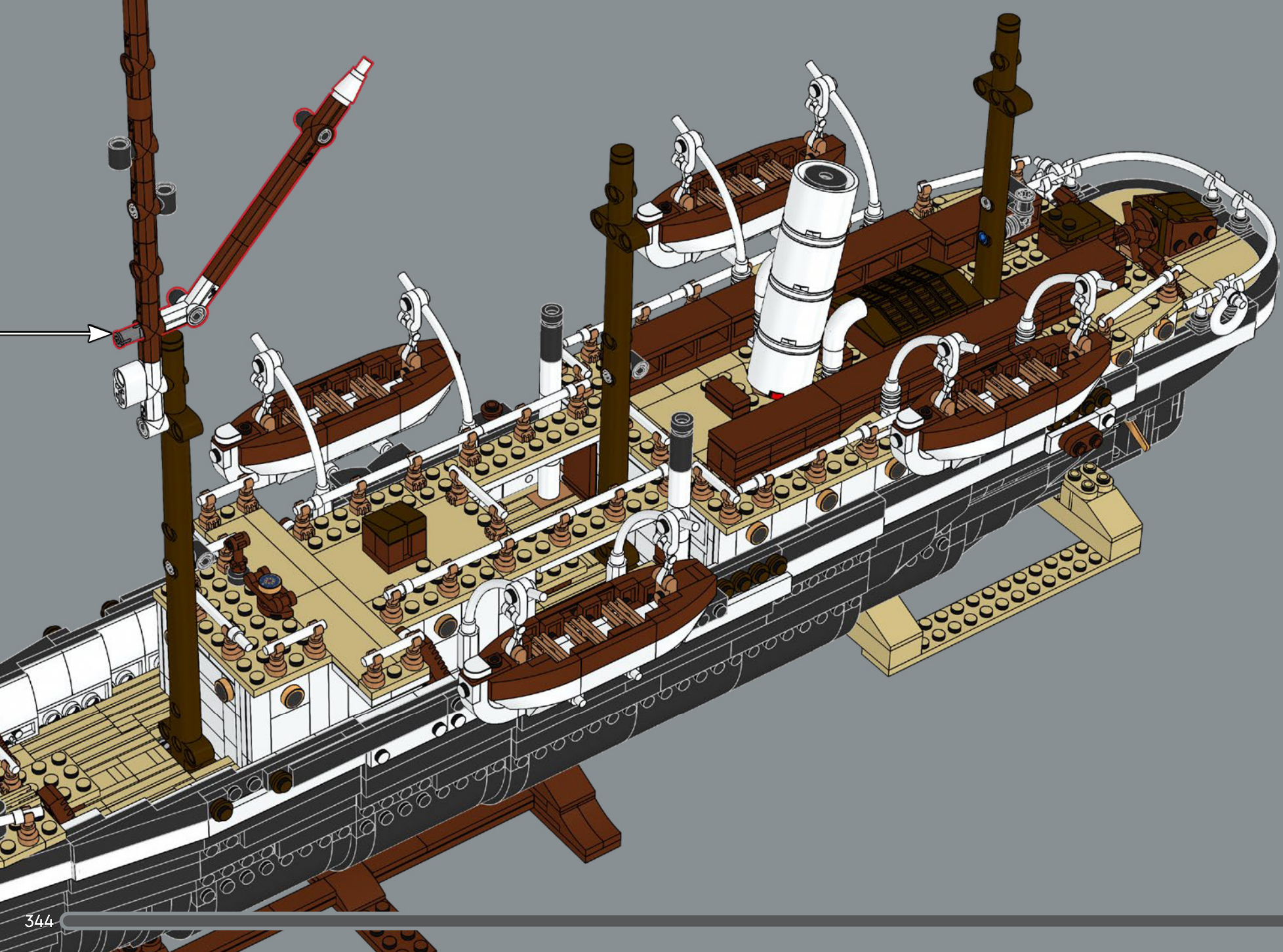

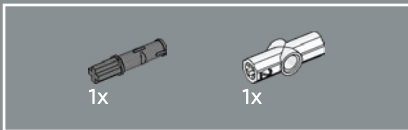
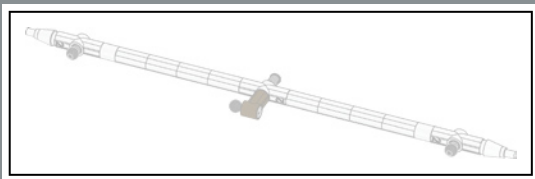

587

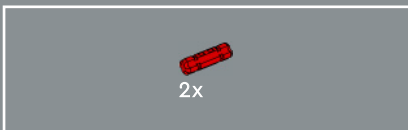
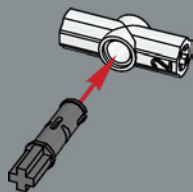

588

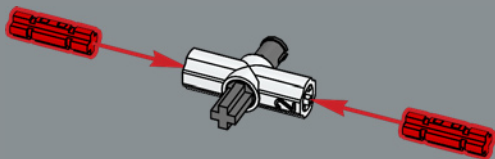

589

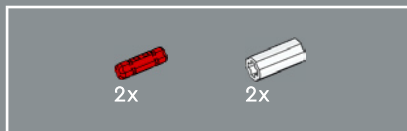
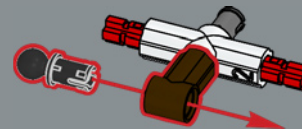

590

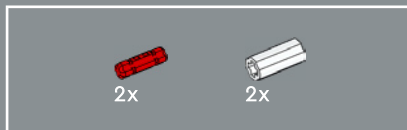
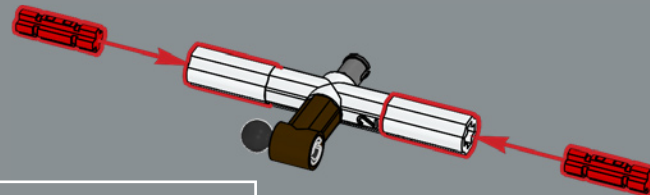

591

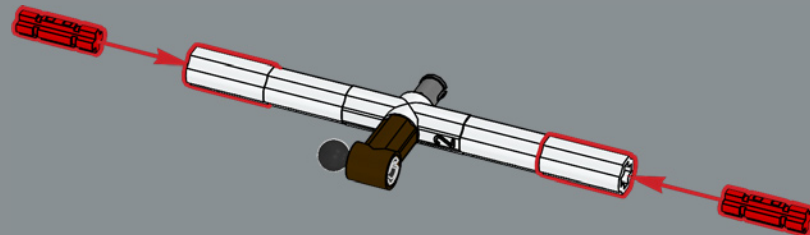

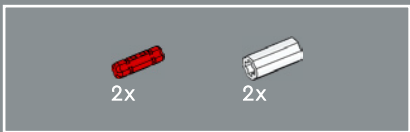

592

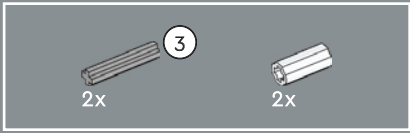
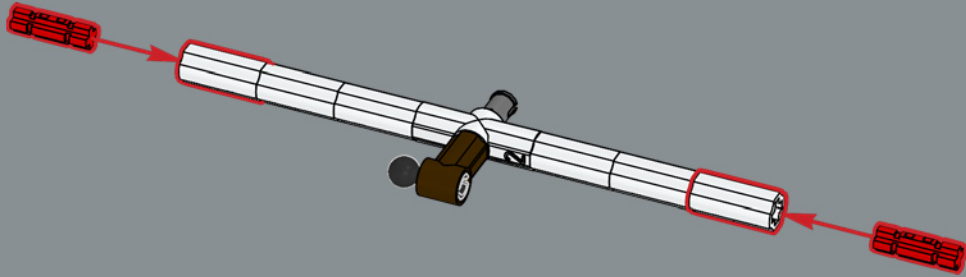

593

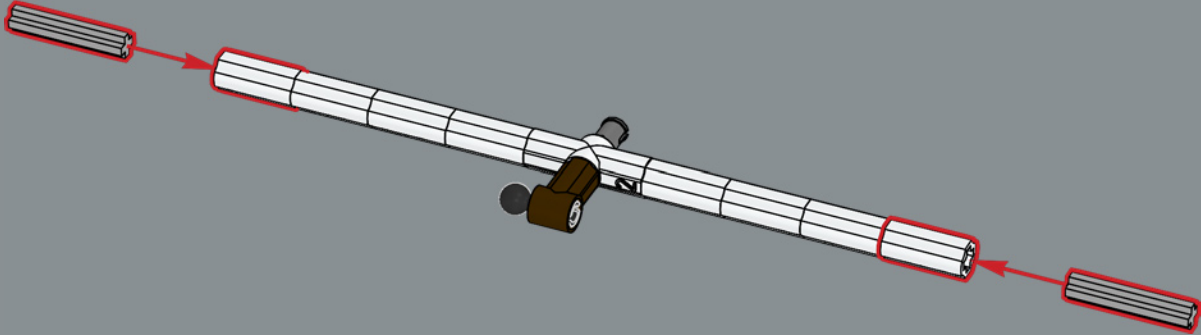

594

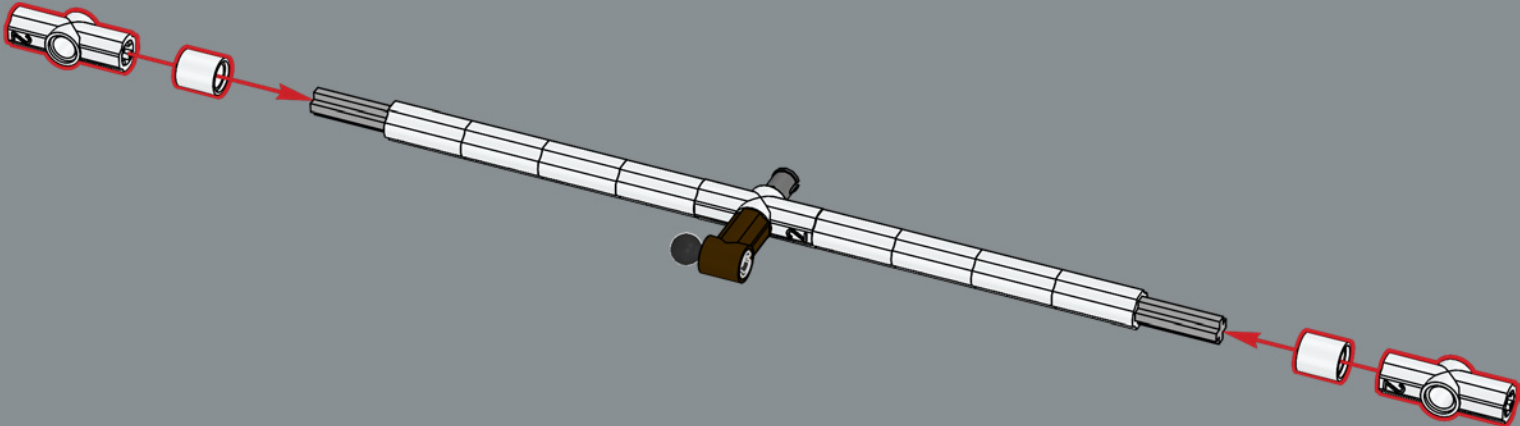



595

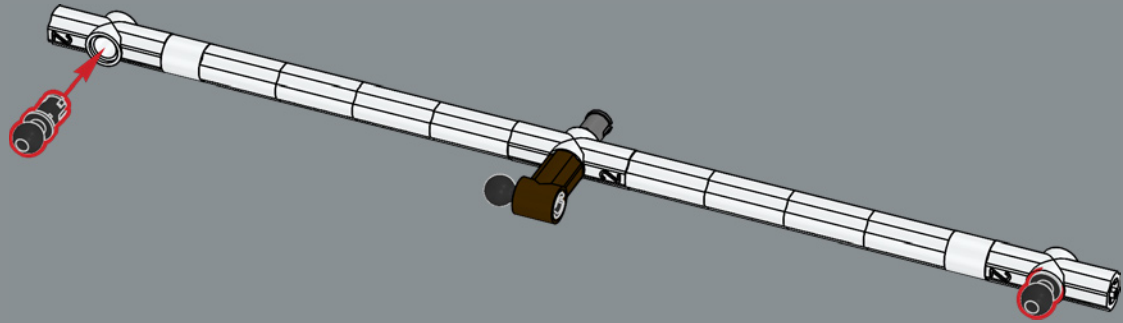

596

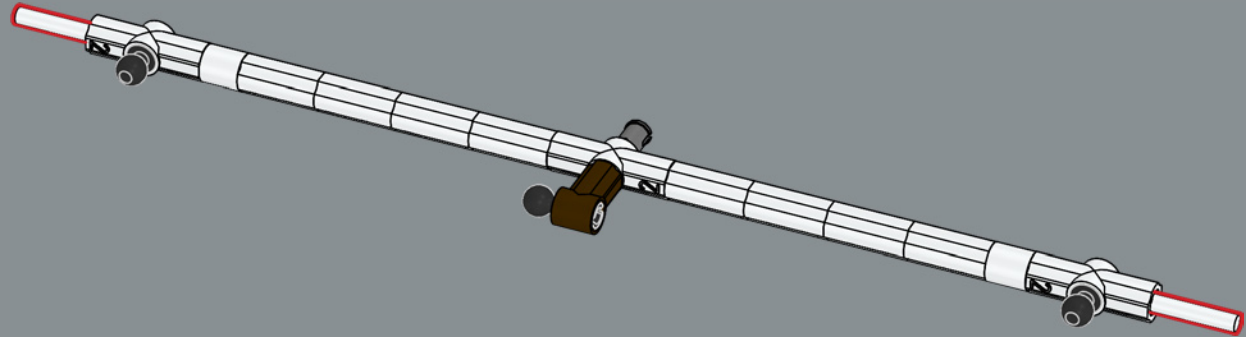

597

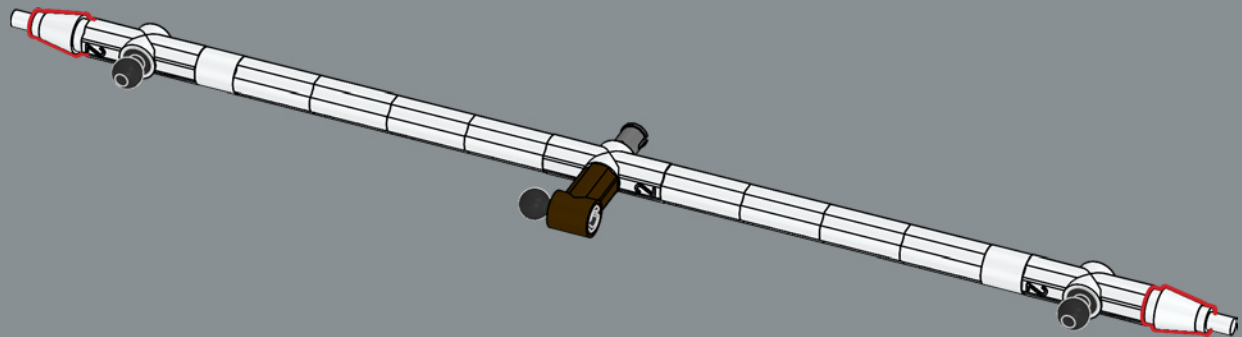

598

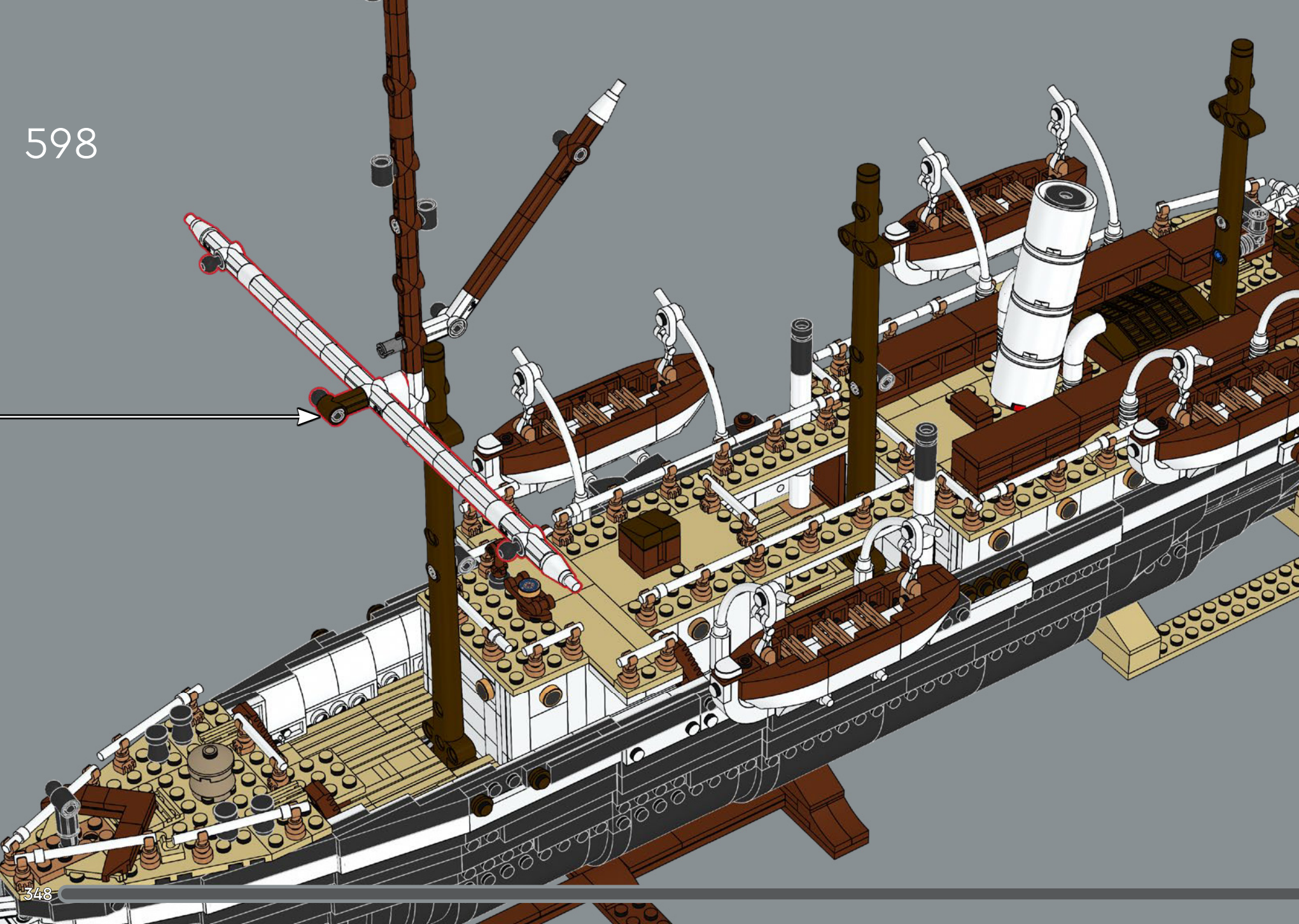



599

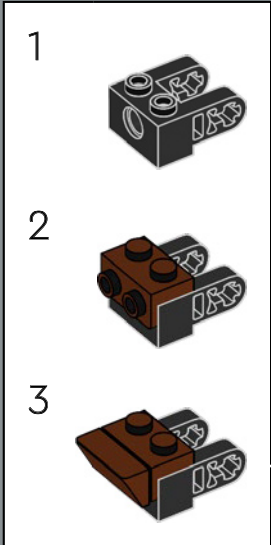

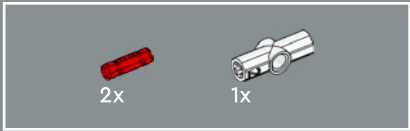
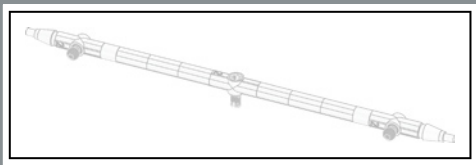

600

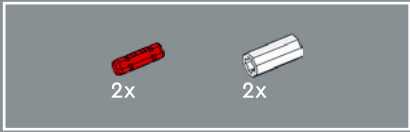
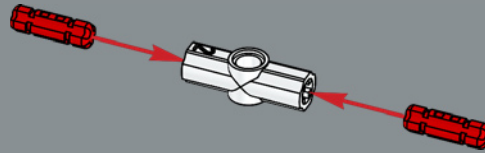

601

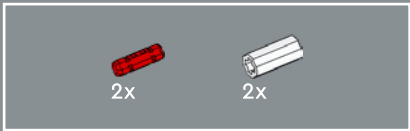
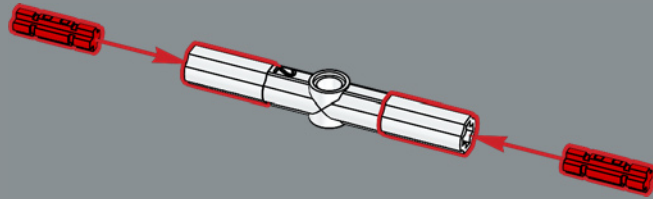

602

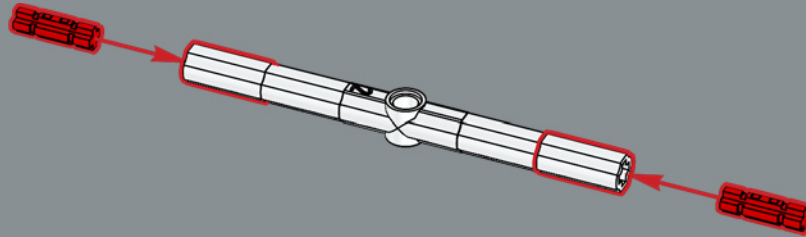

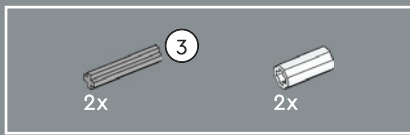

603

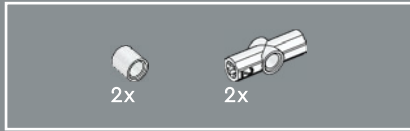
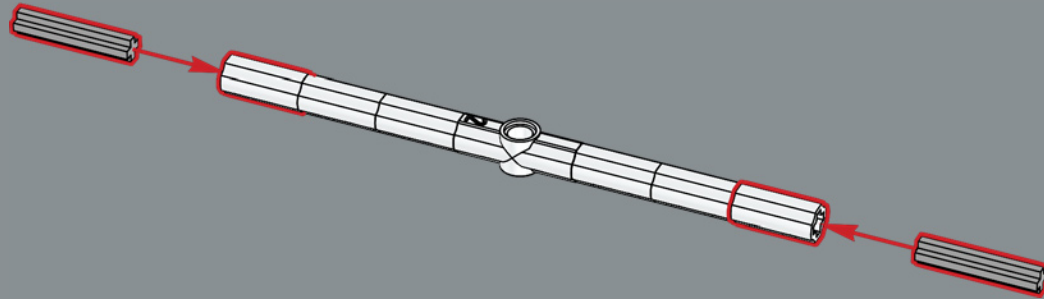

604

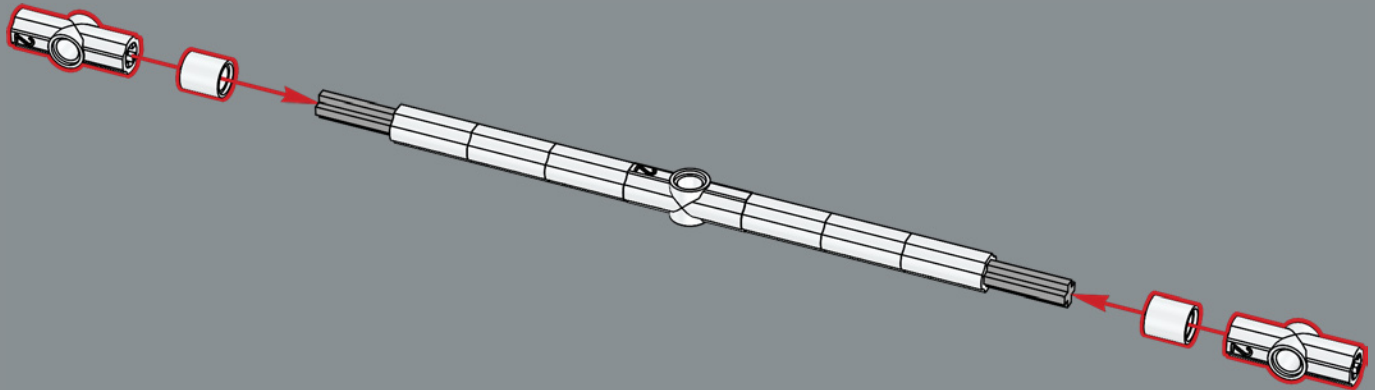

605

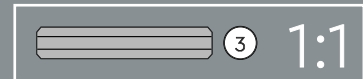
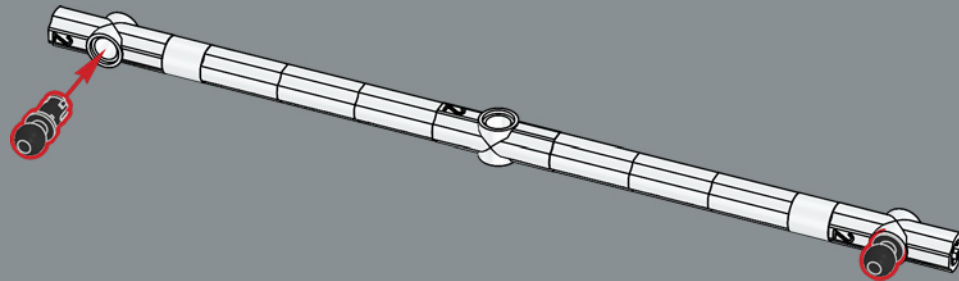



606

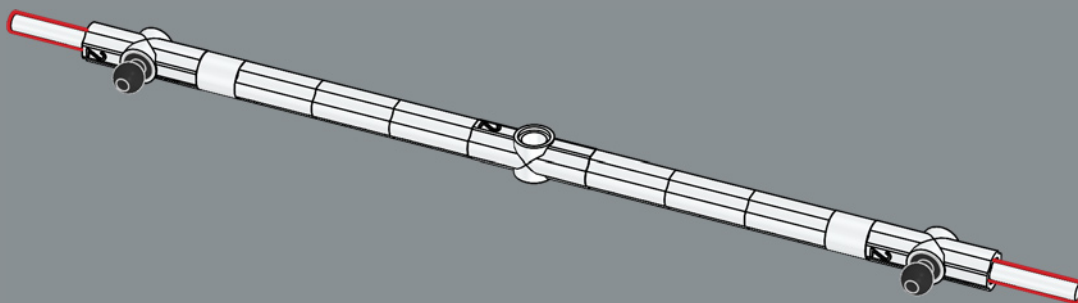

607

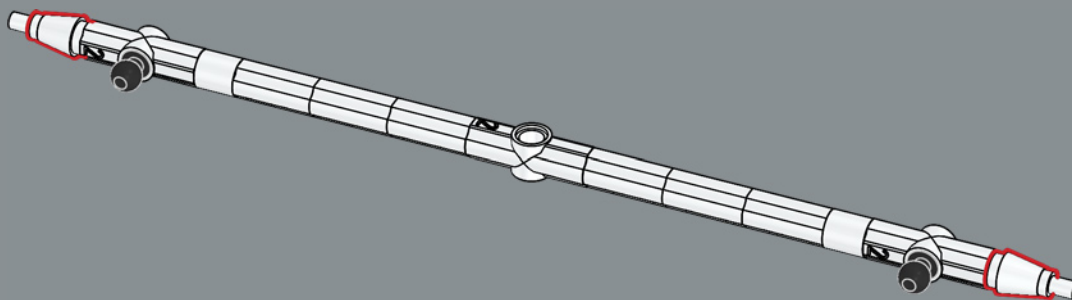

608

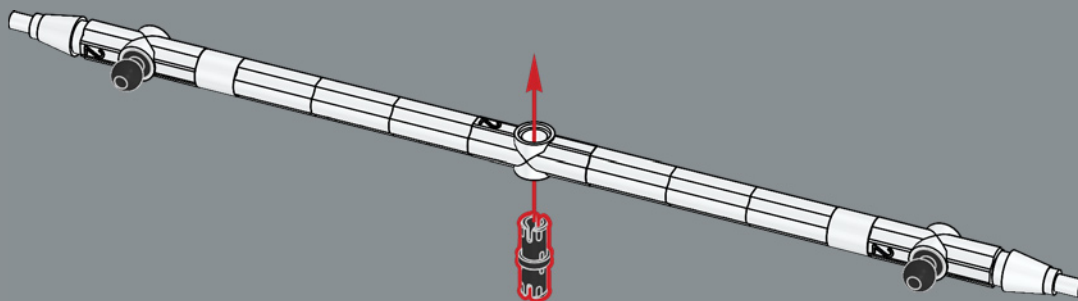

609



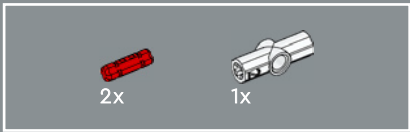
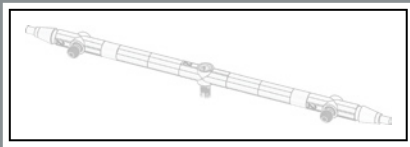

610

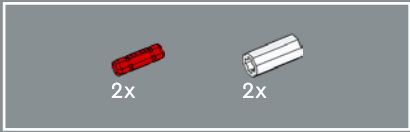
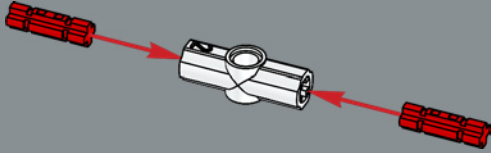

611

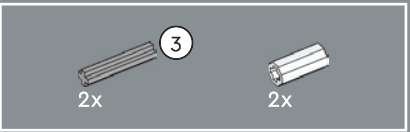
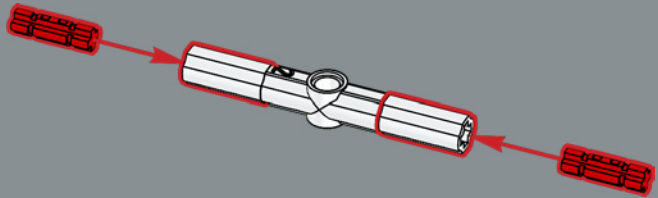

612

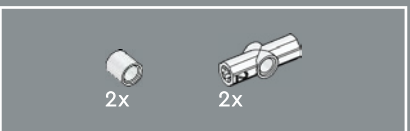
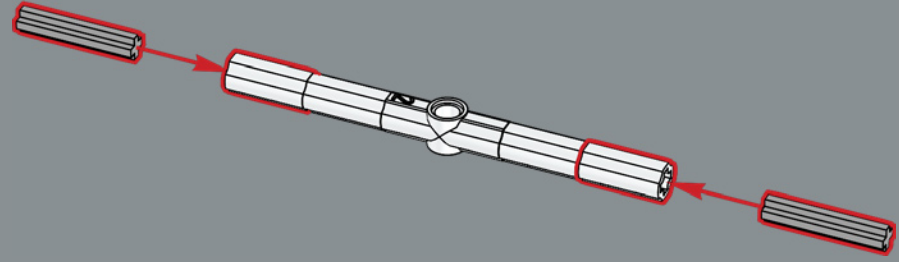

613

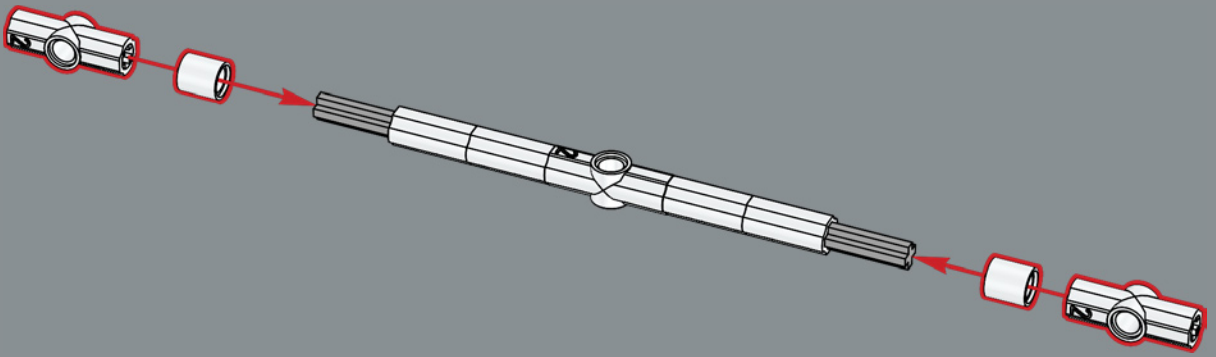



614

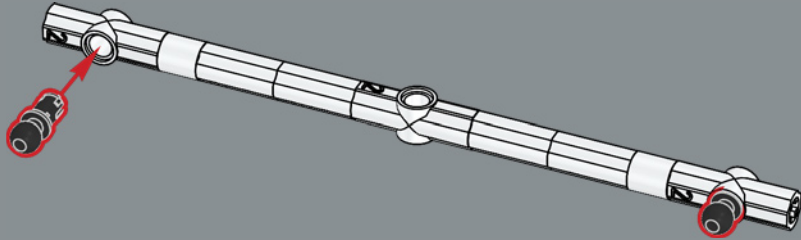

615

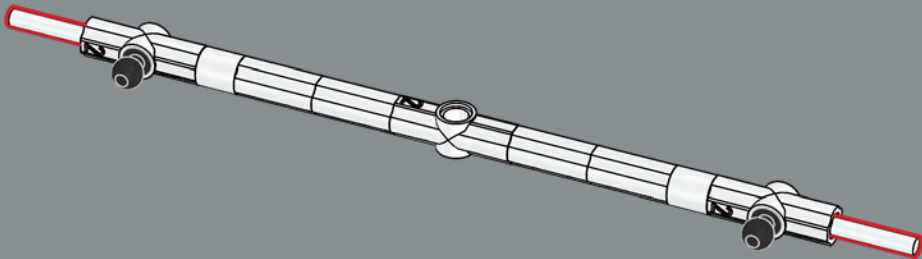

616

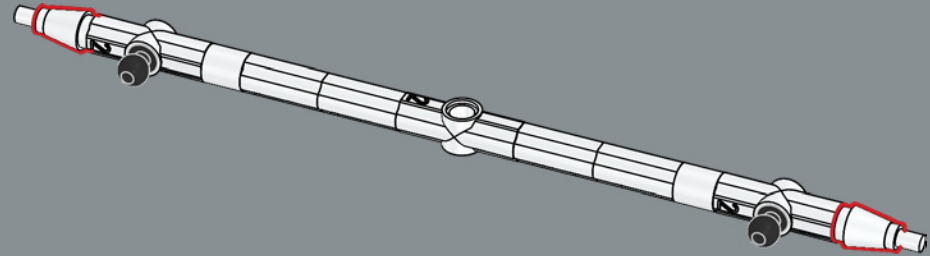

617

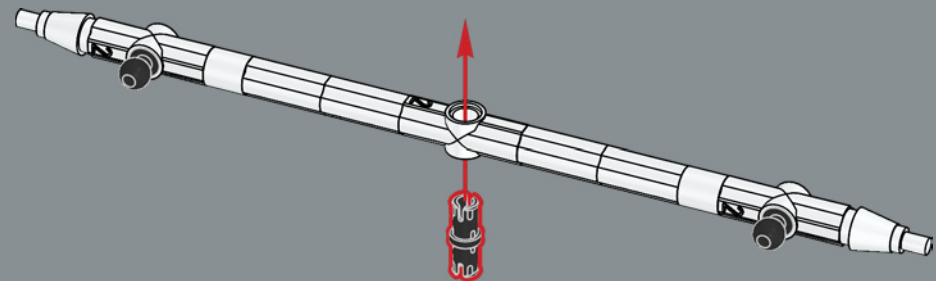

618



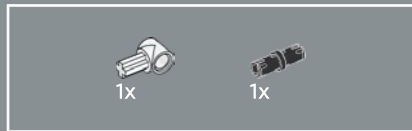
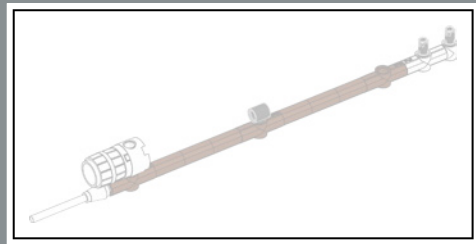

619

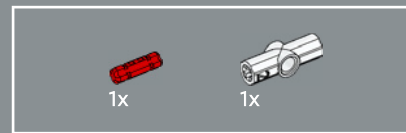
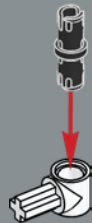

620

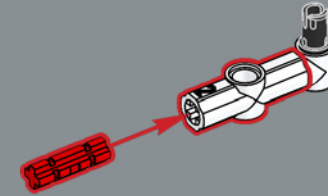

621

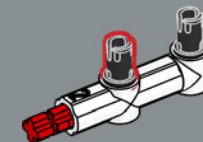

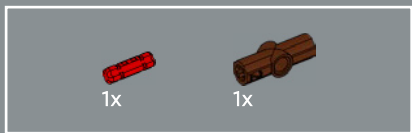

622

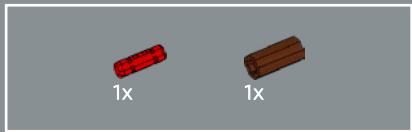
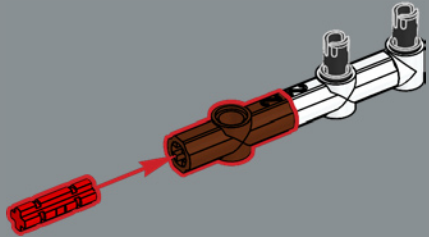

623

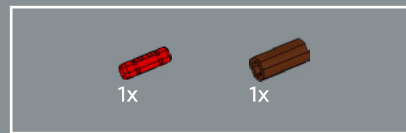
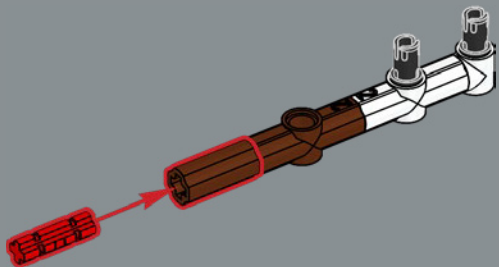

624

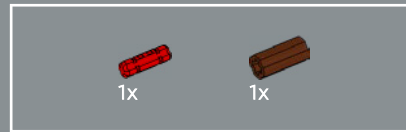
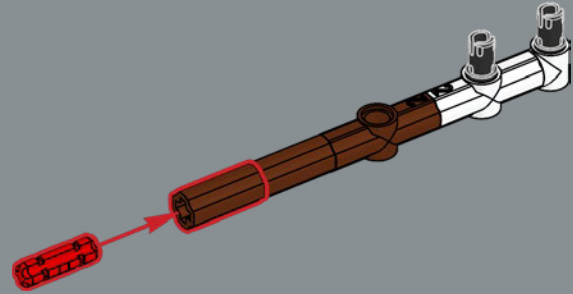

625

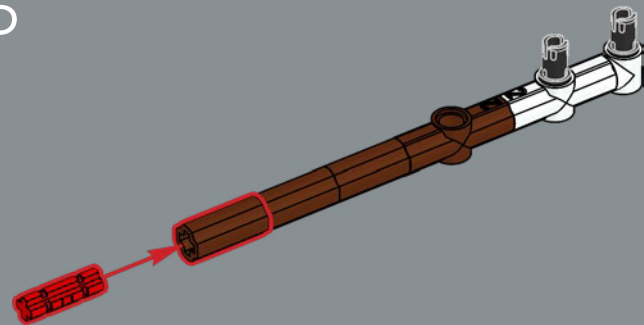

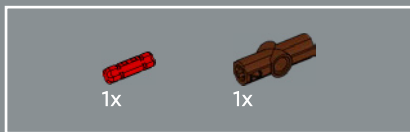

626

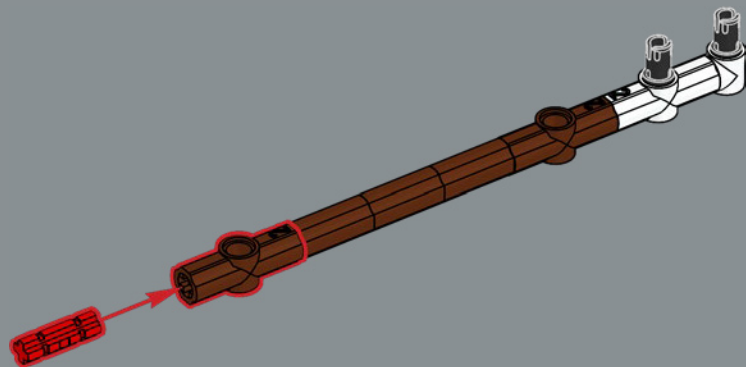

627

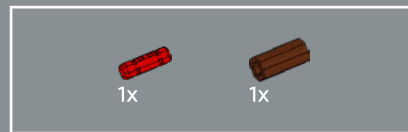
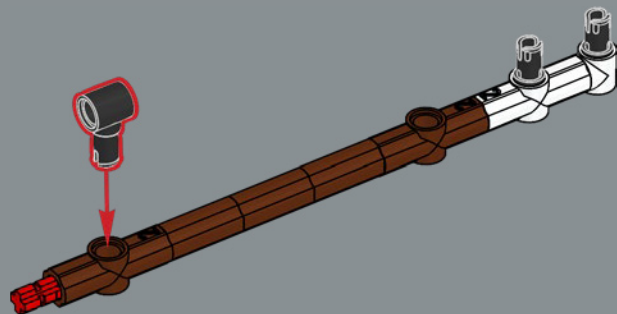

628

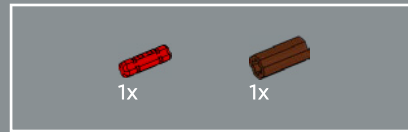
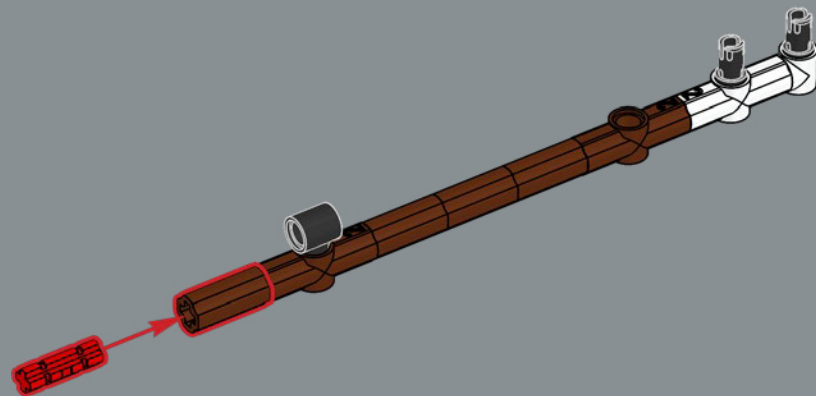

629

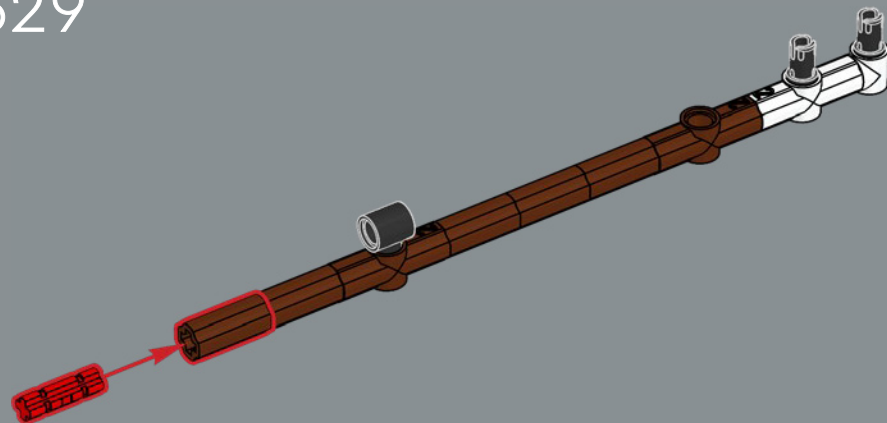

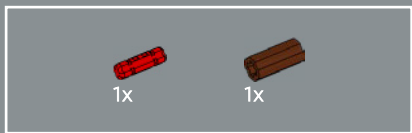

630

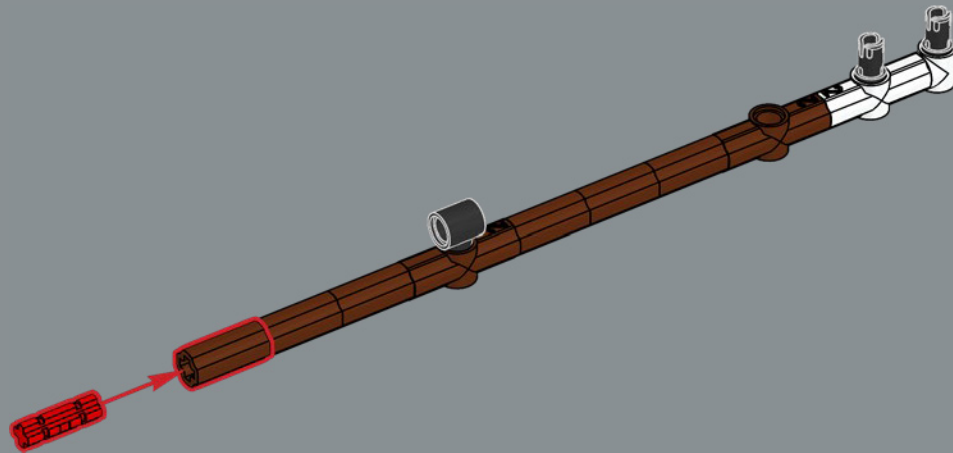

631

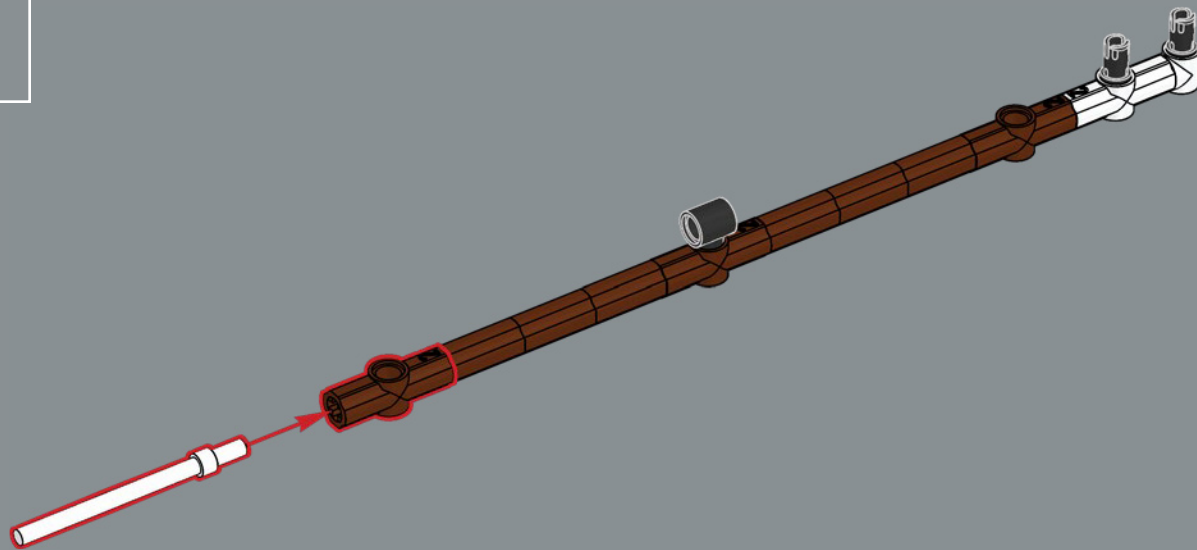



632

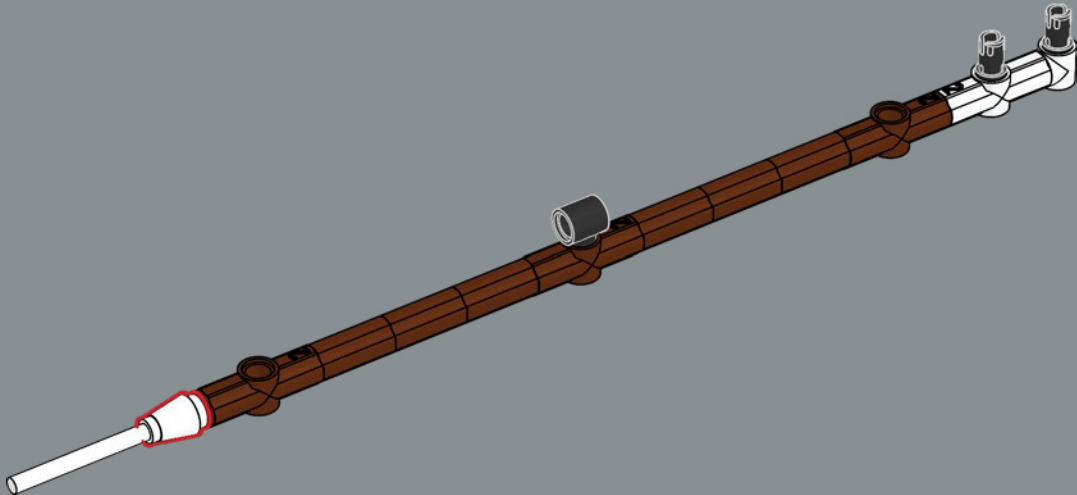

633

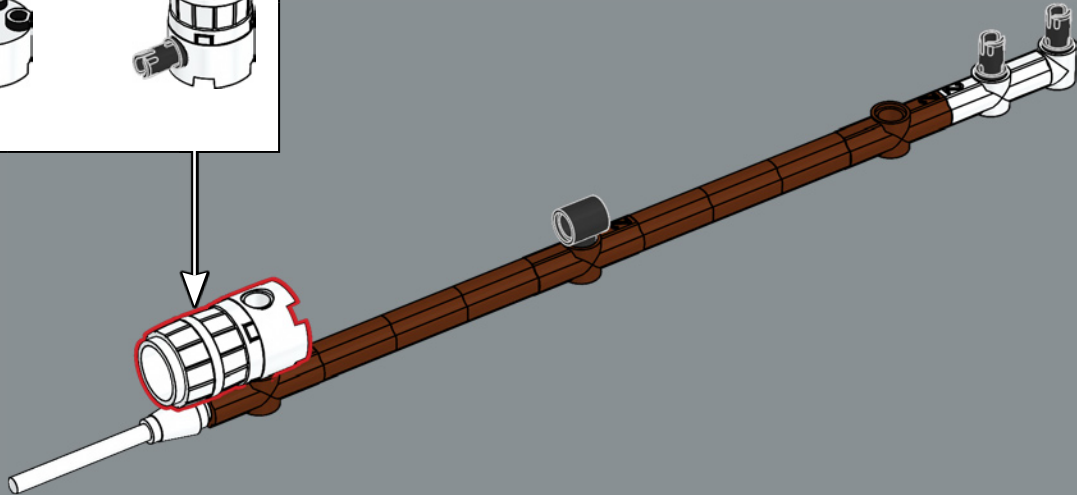
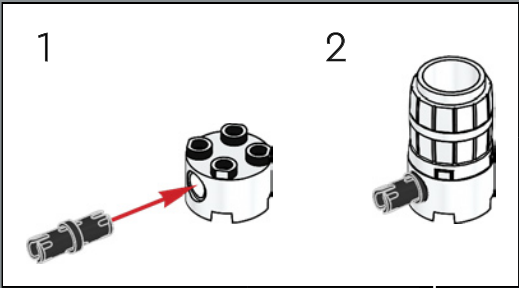

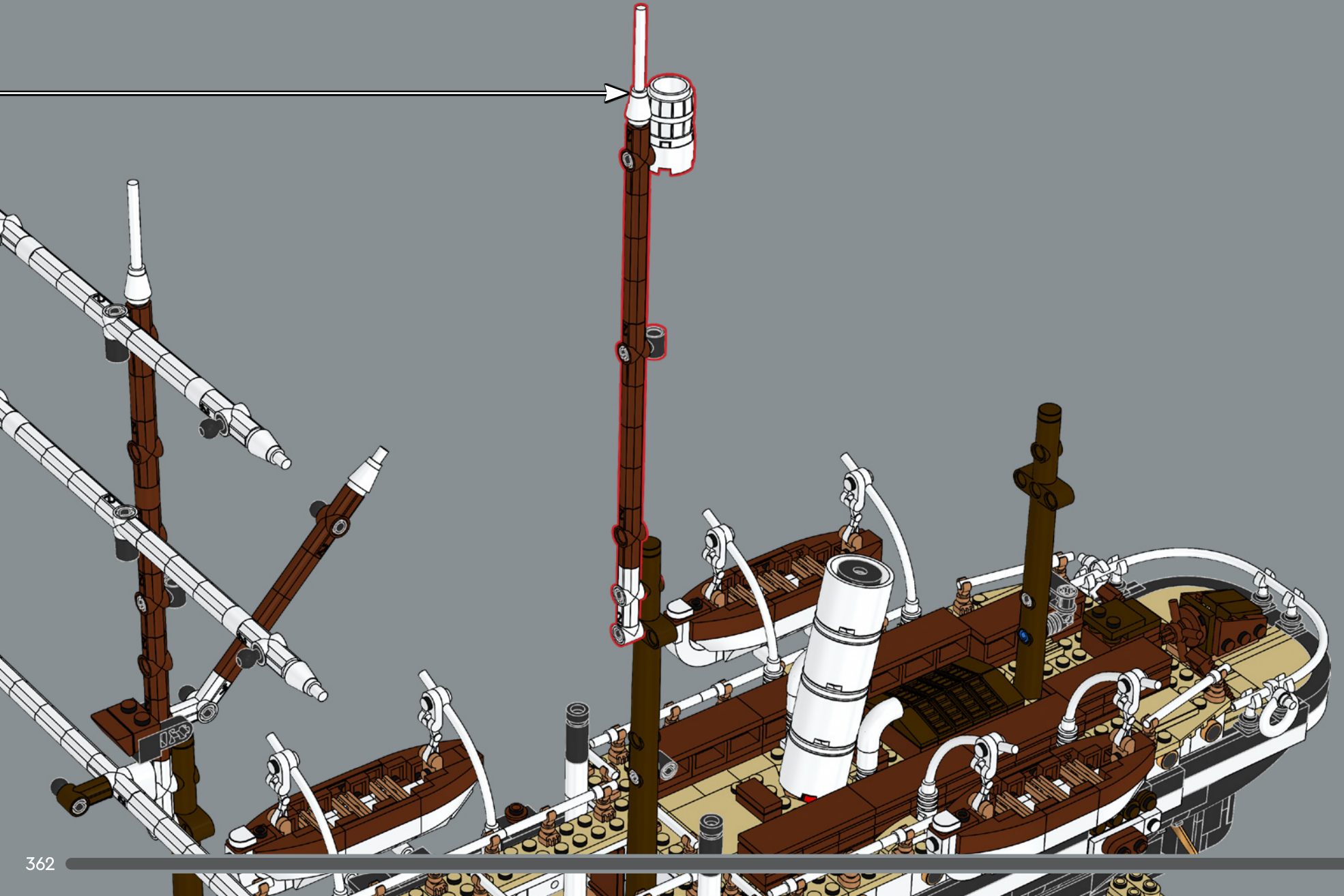

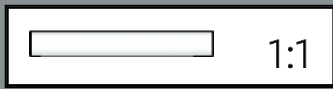
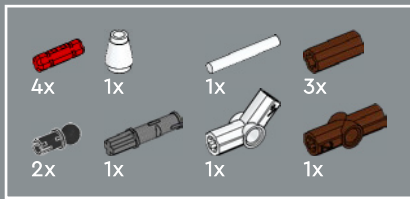

635

1

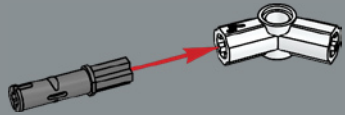

2

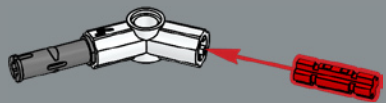

3

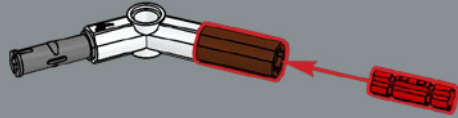

4



5

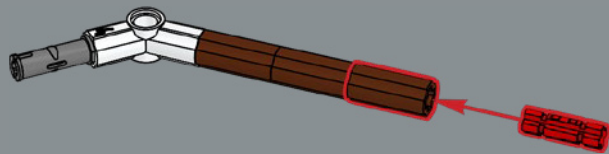

6

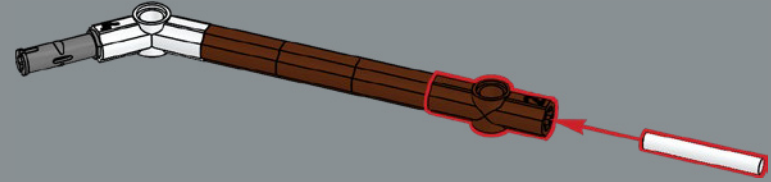

7

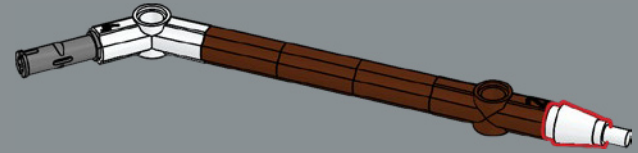

8

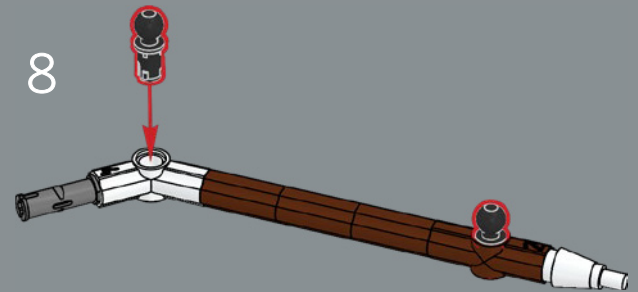





636

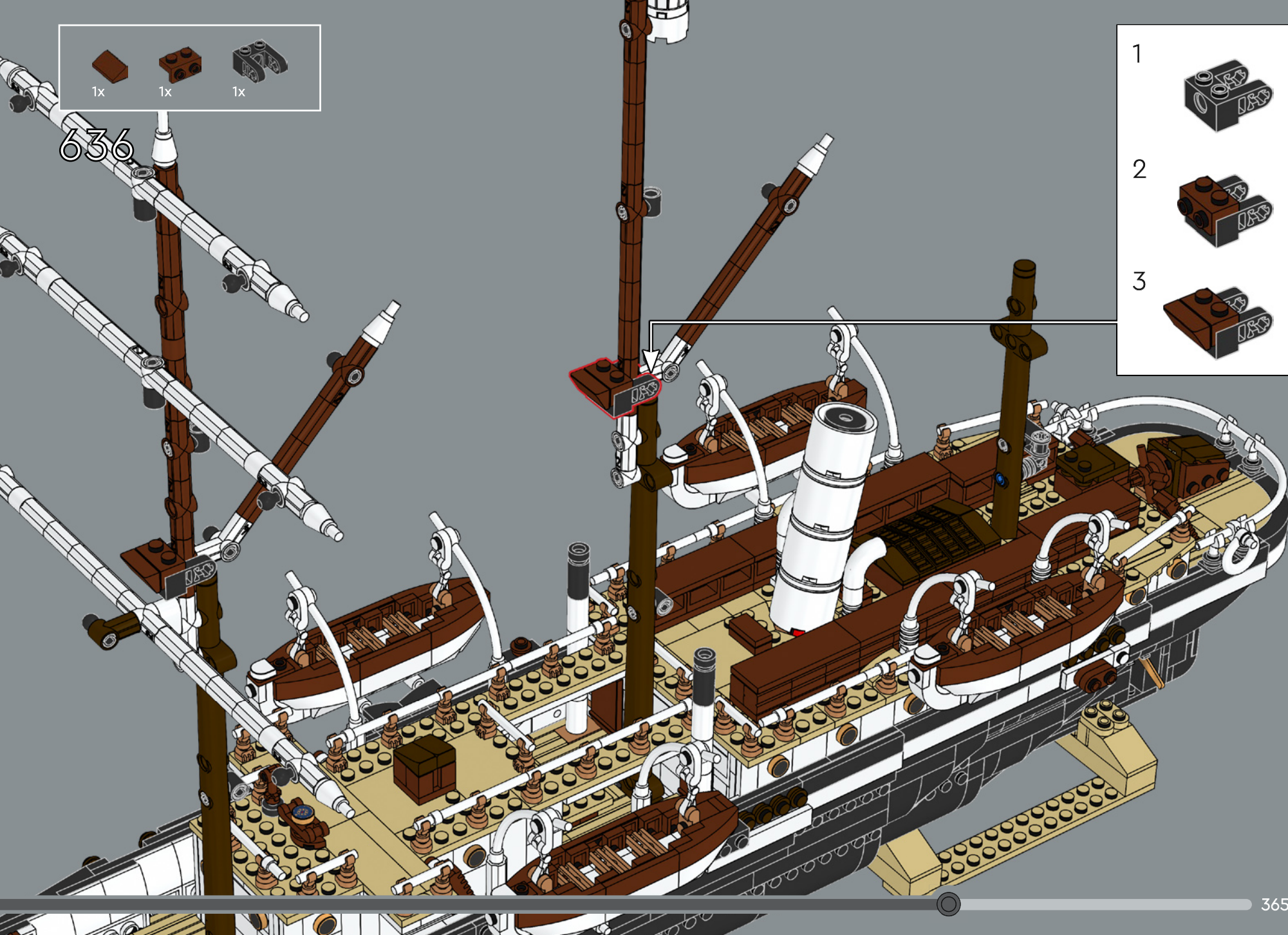
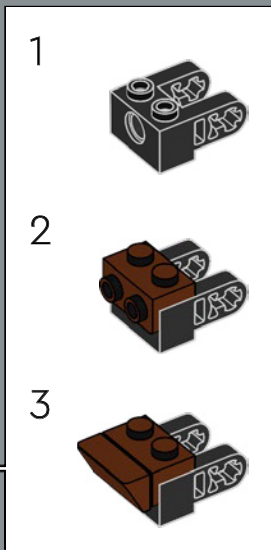

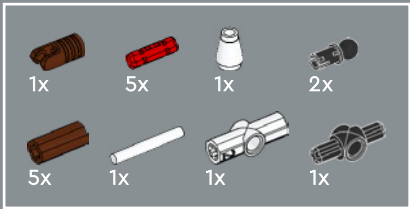

637

1

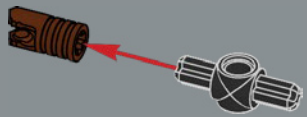

2

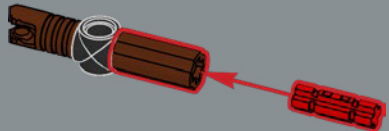

3

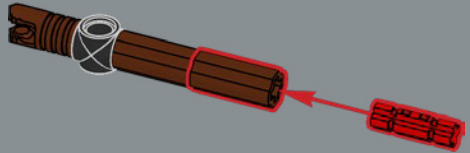

4

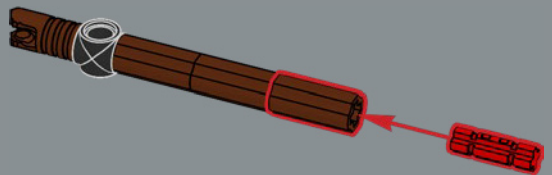

5

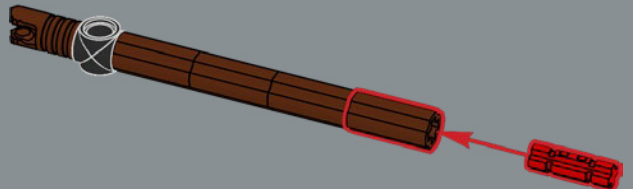

6

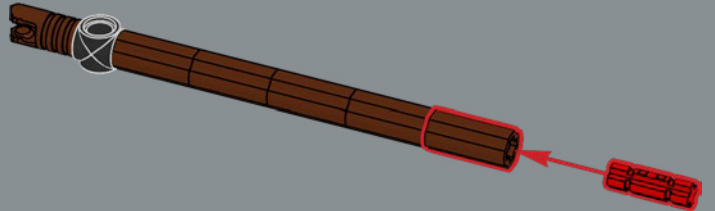

7

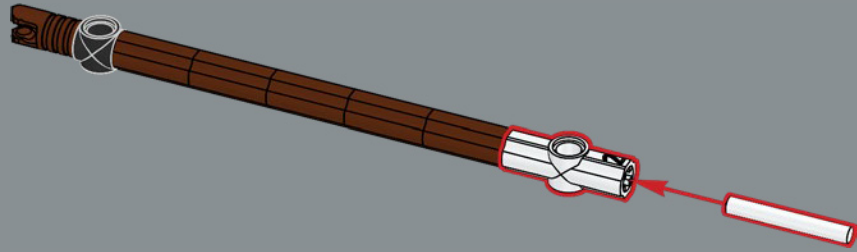

8

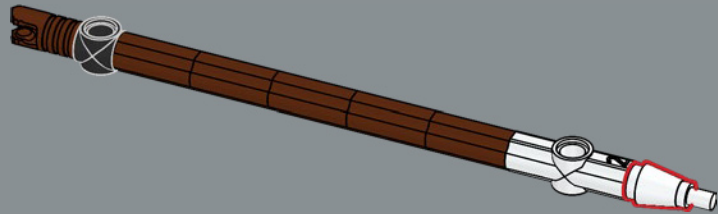

9

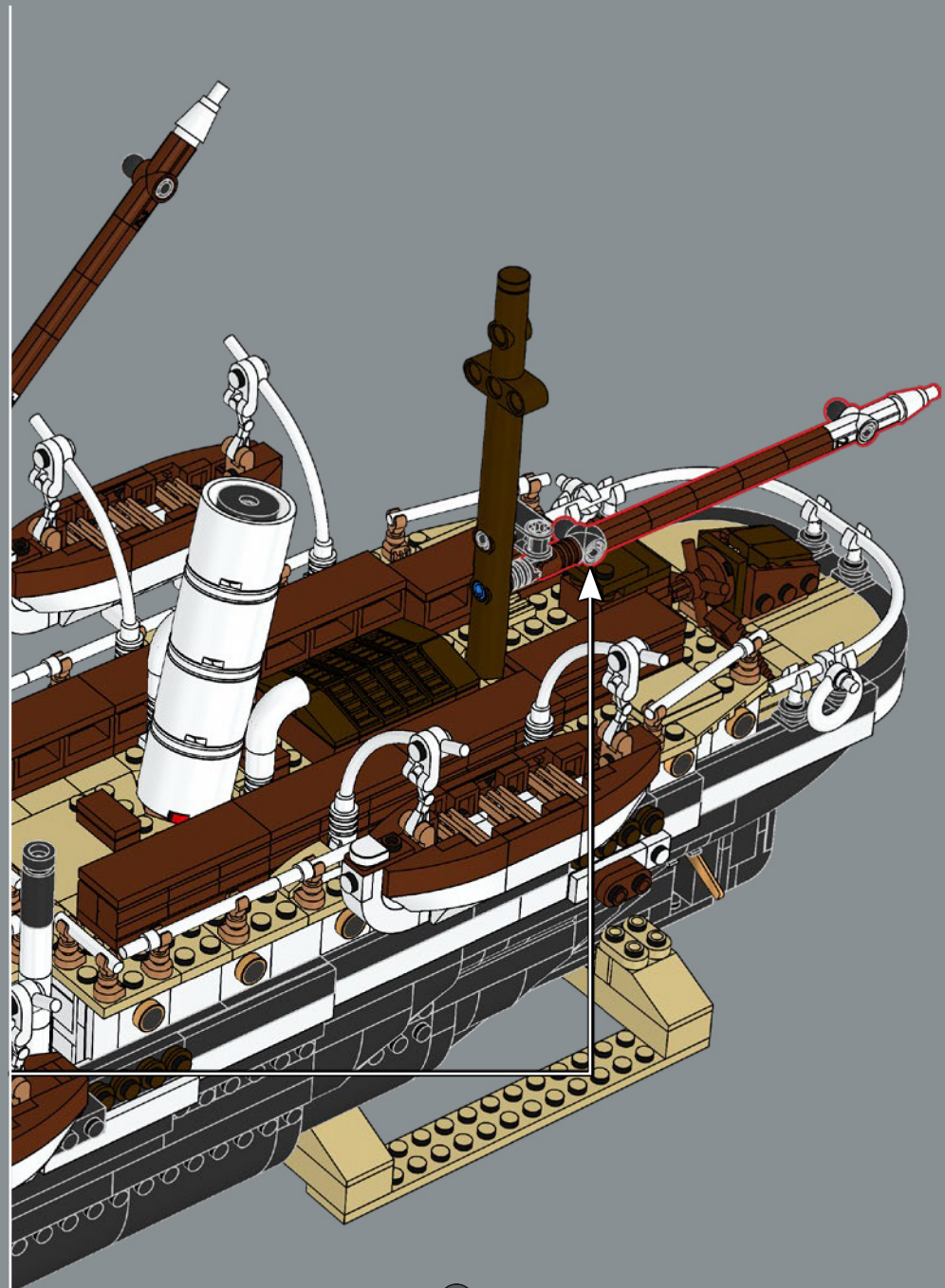
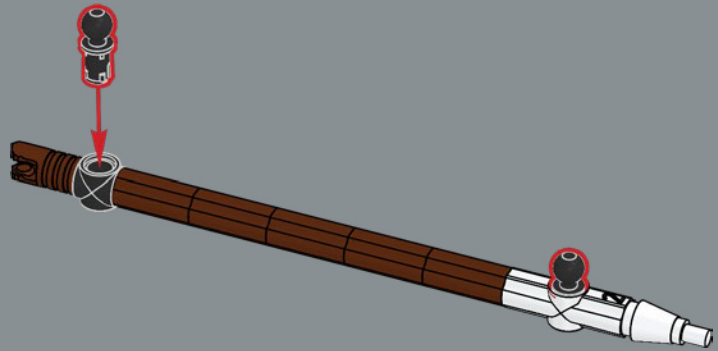

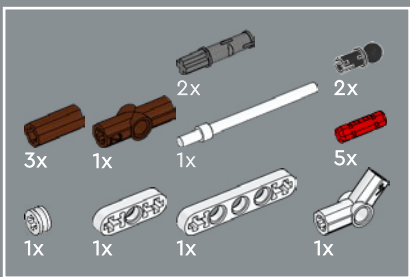

638

1

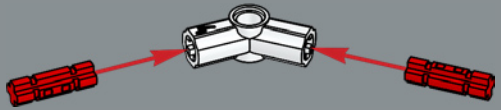

2

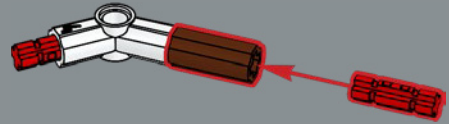

3

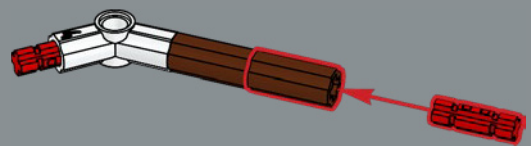

4

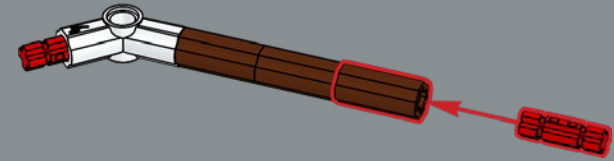

5

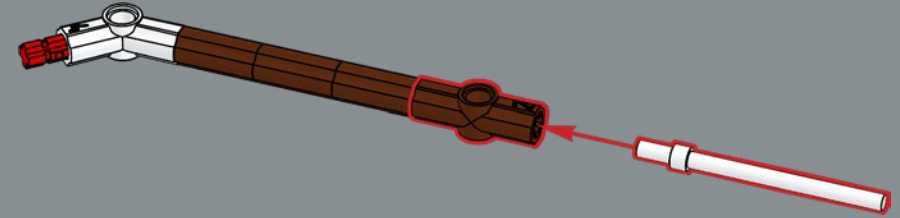

6

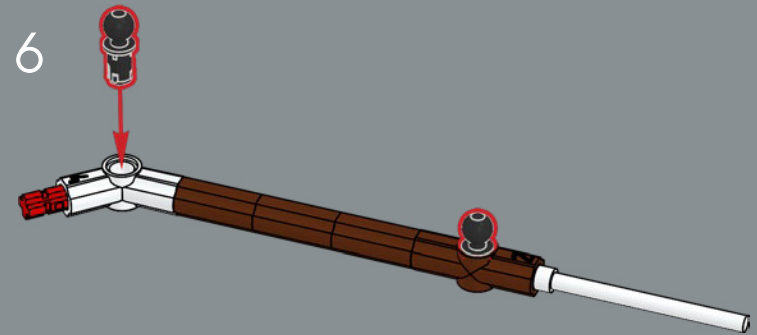

7

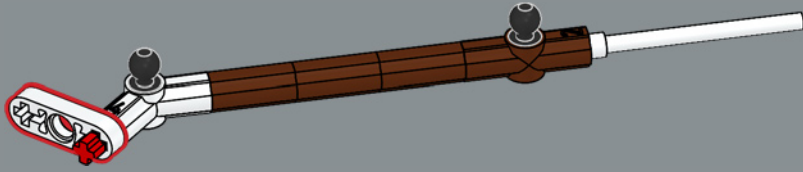

9

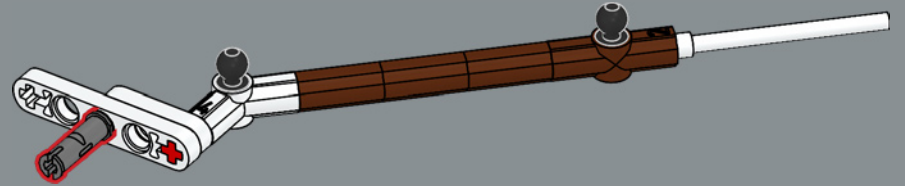

8

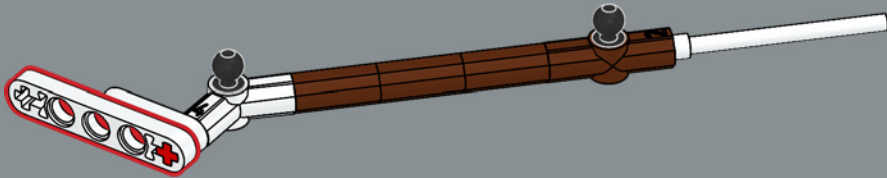

10

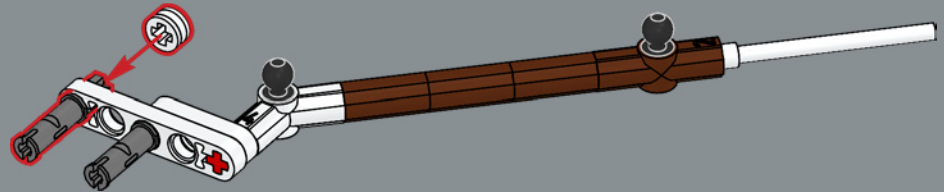

7

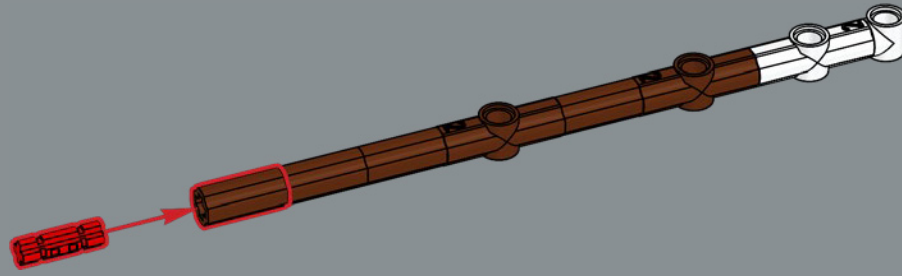

8

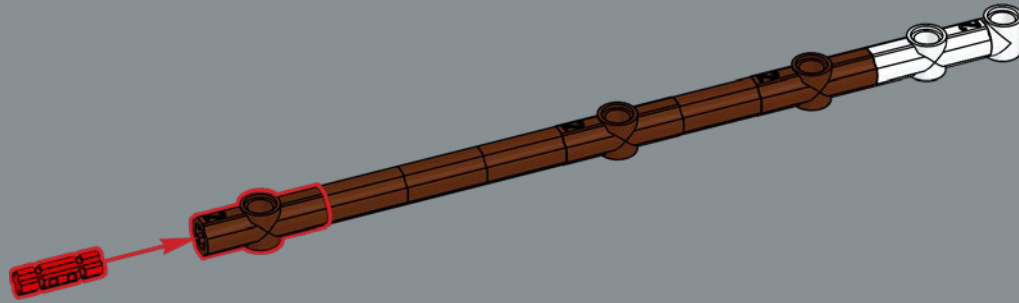

9

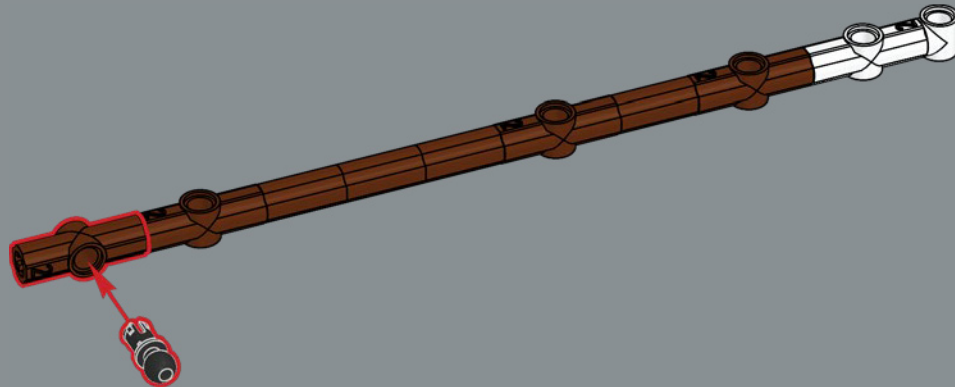

10

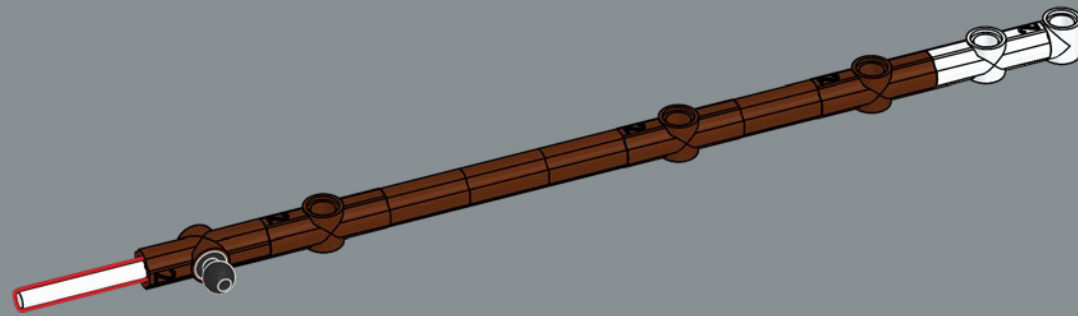

11

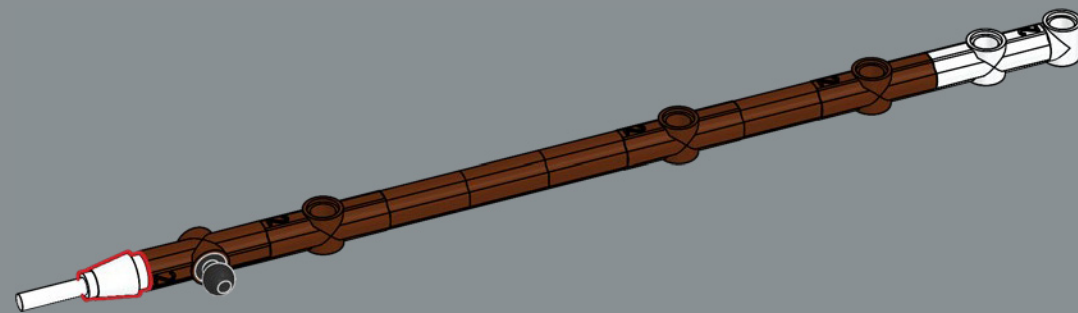

12

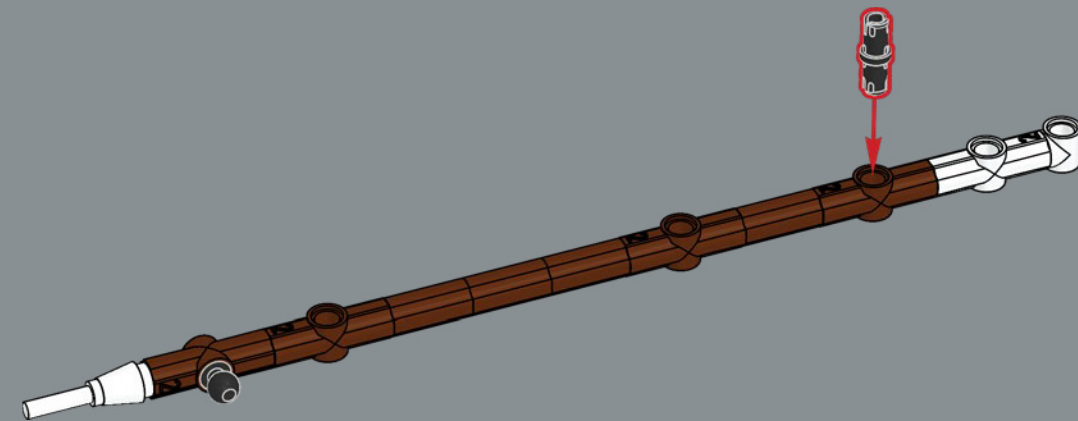





640

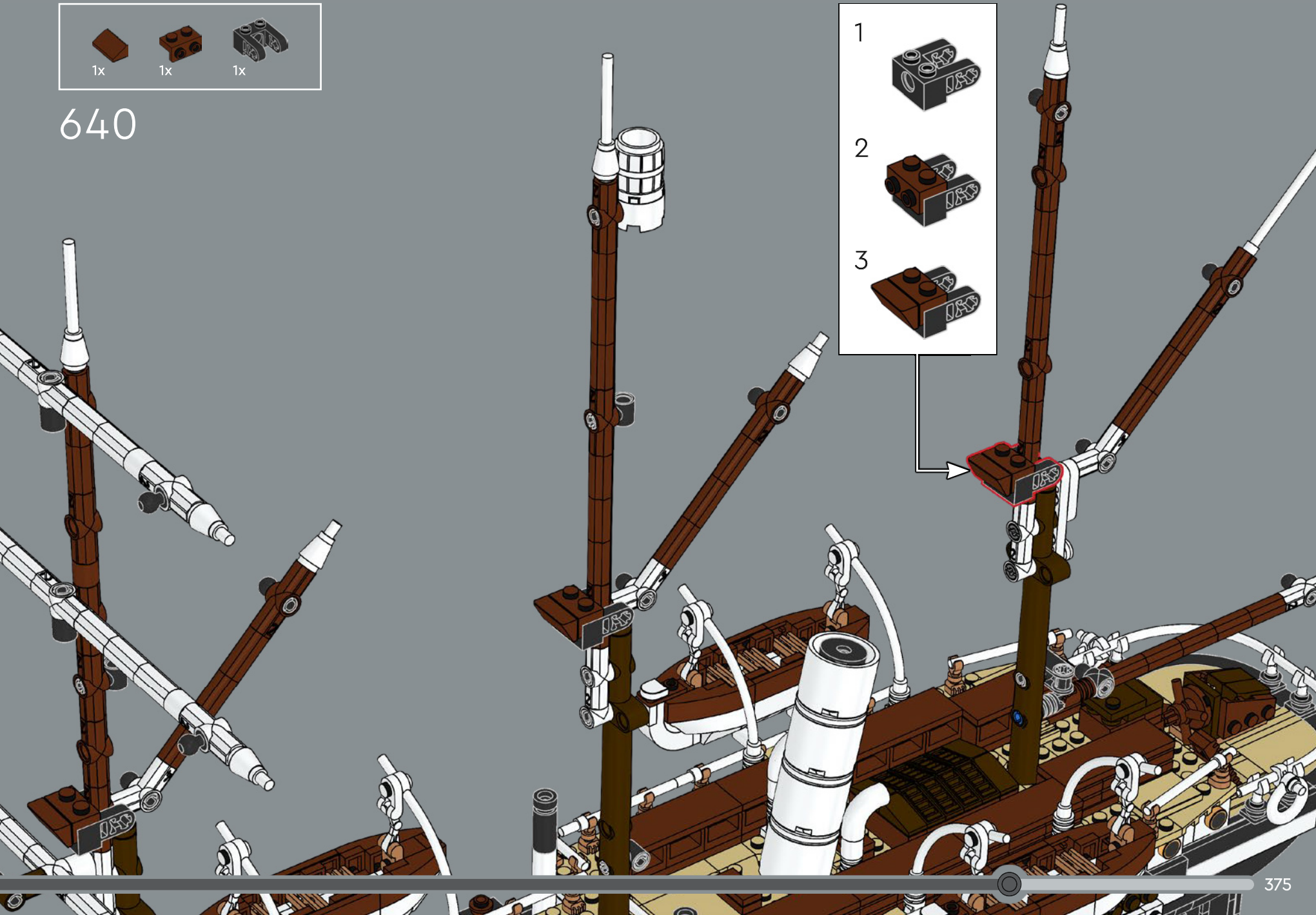
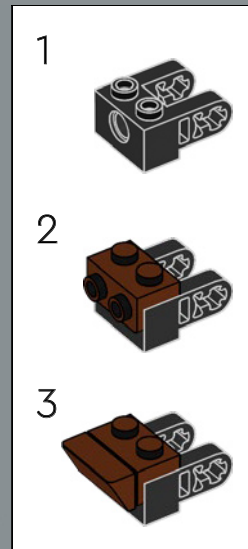

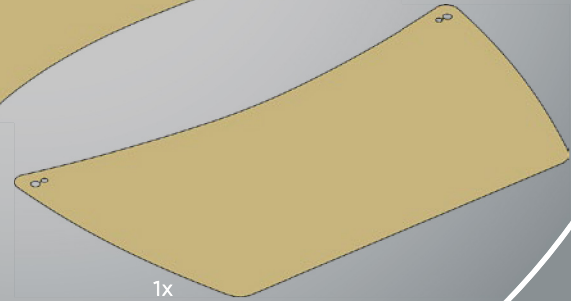
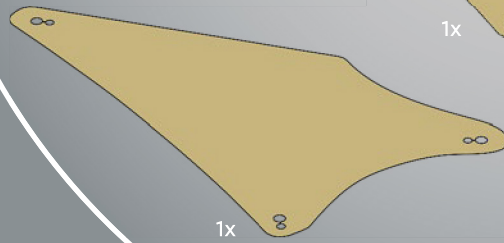
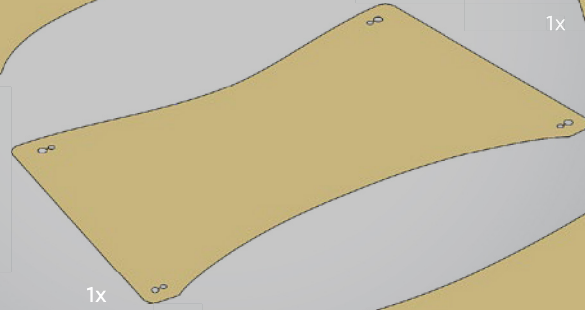
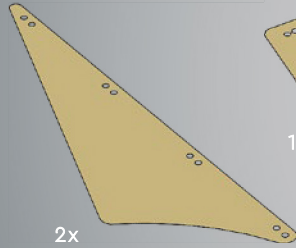
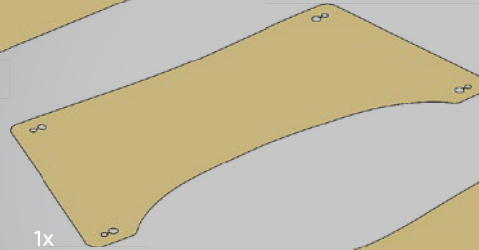
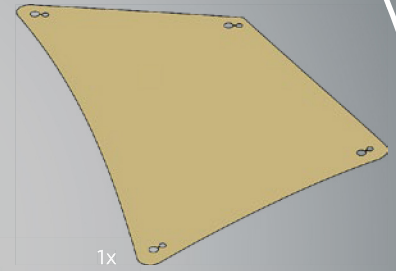
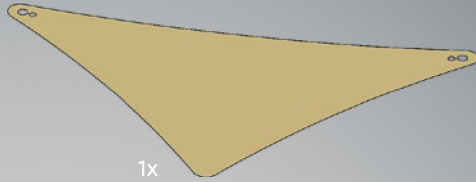
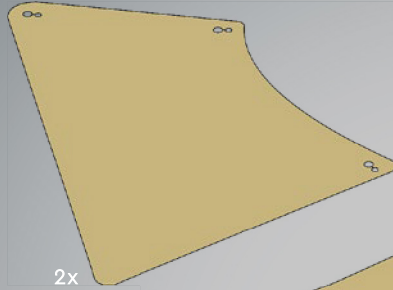
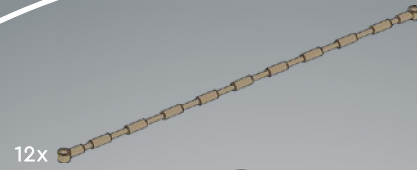
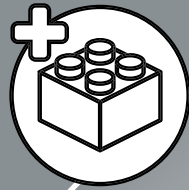



641

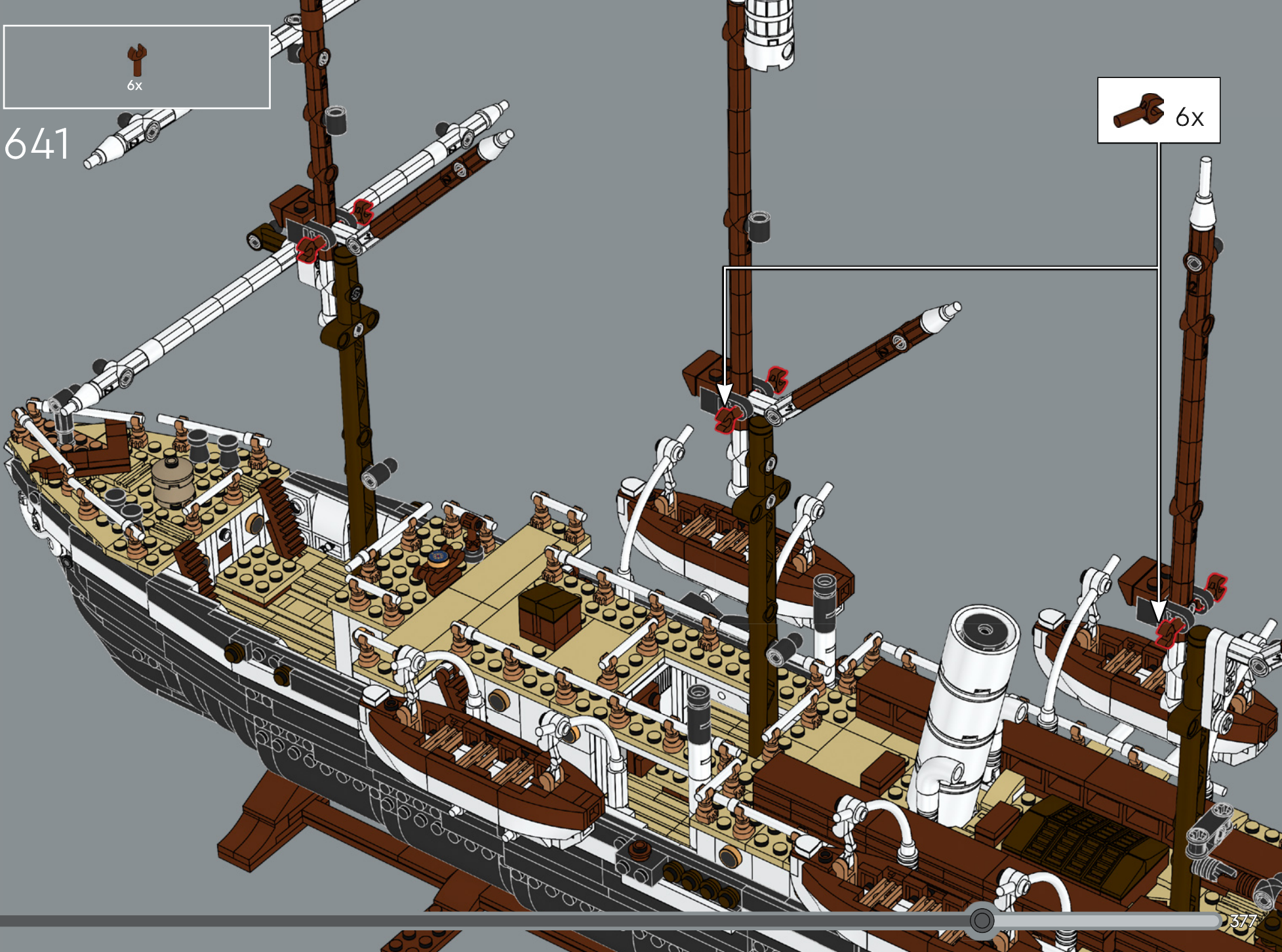

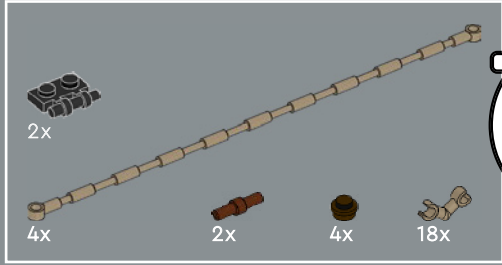
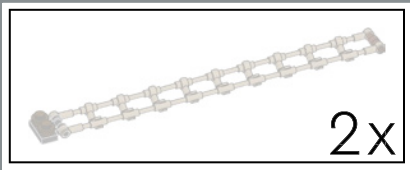

642

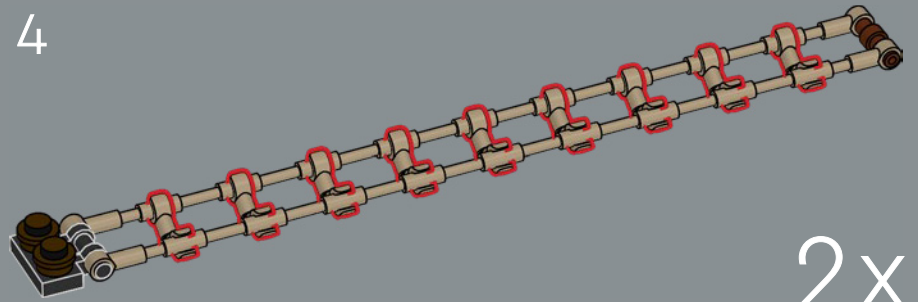
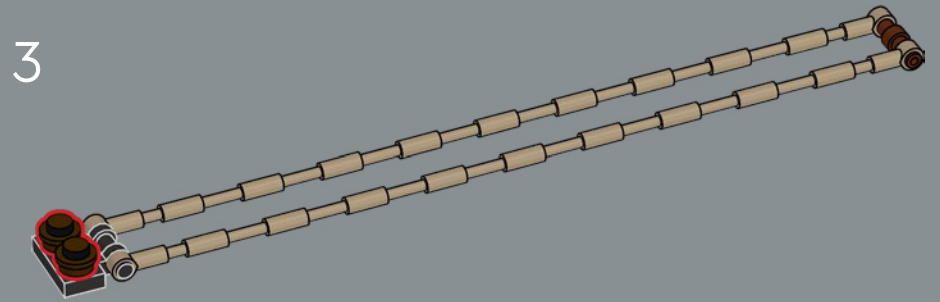
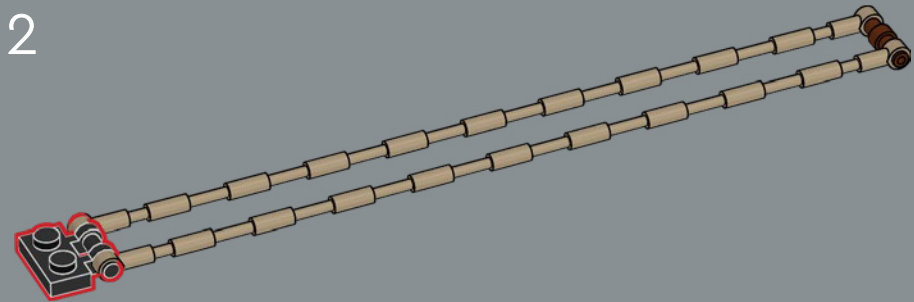
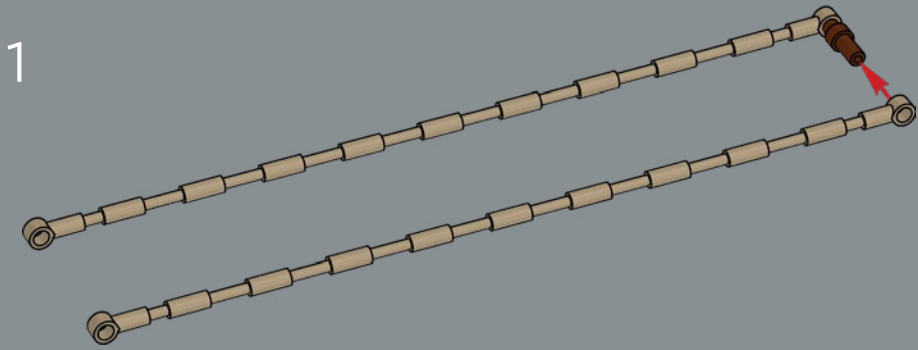



The rope ladders were made in dark tan to distinguish the material from most of the ship's wooden structure.

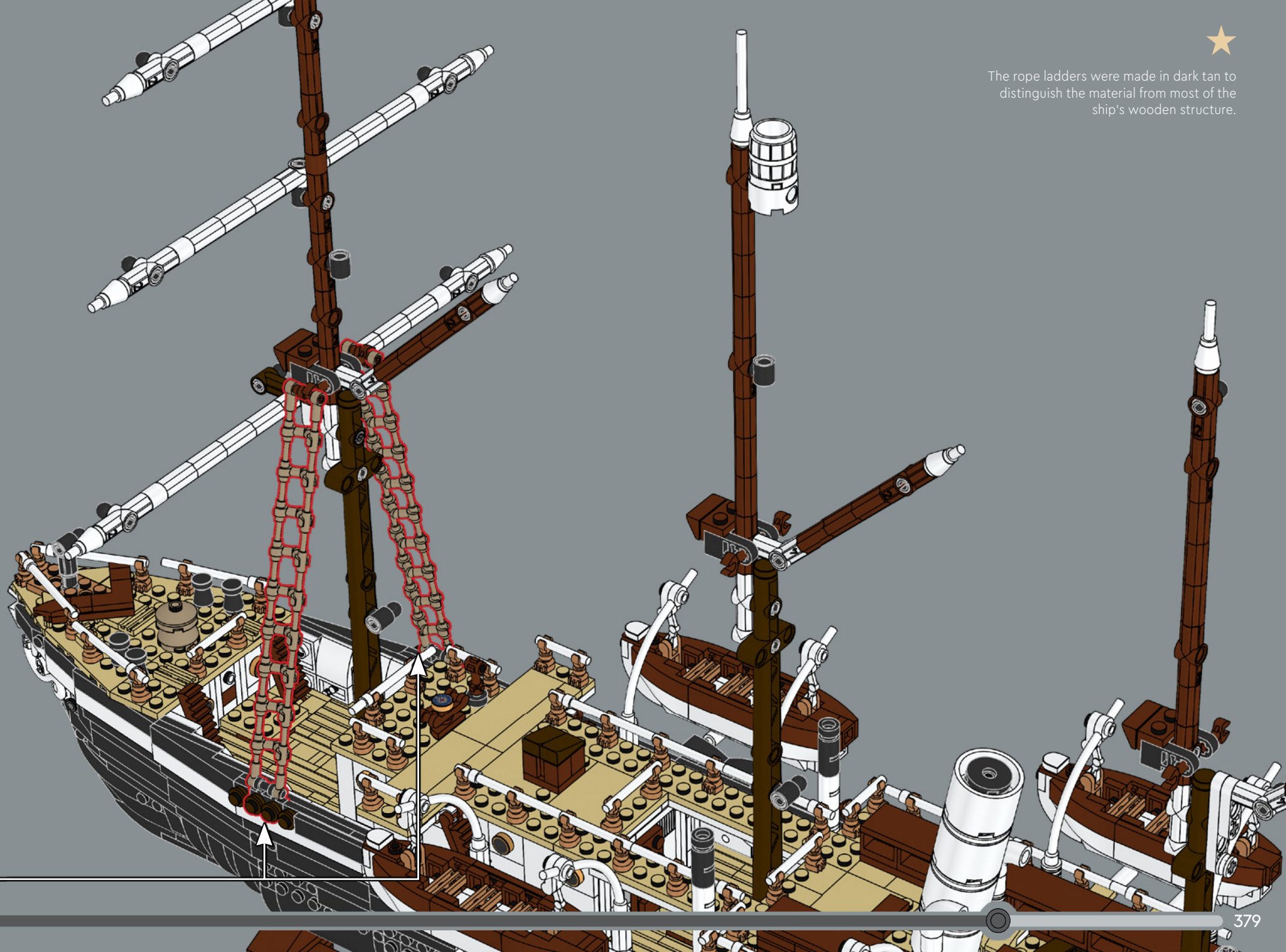

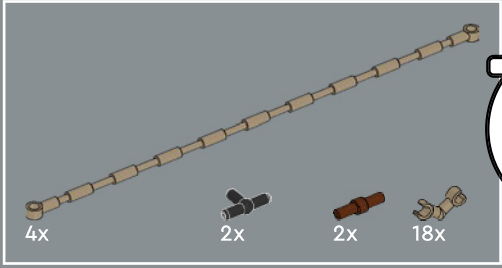
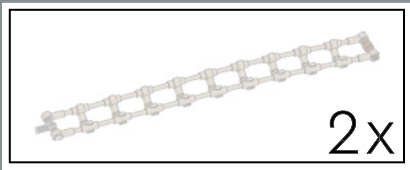

643

1

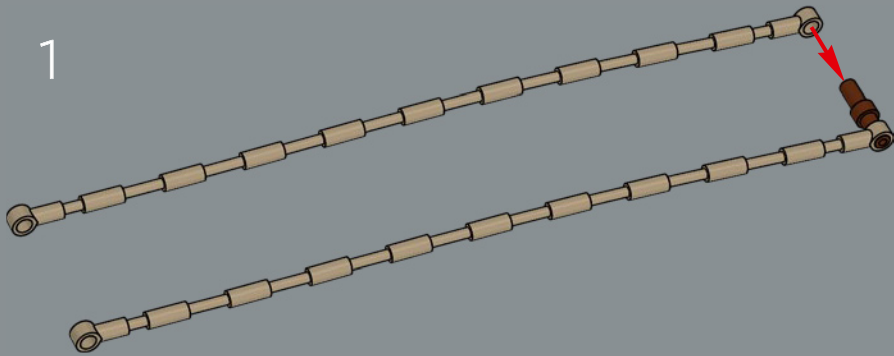

2

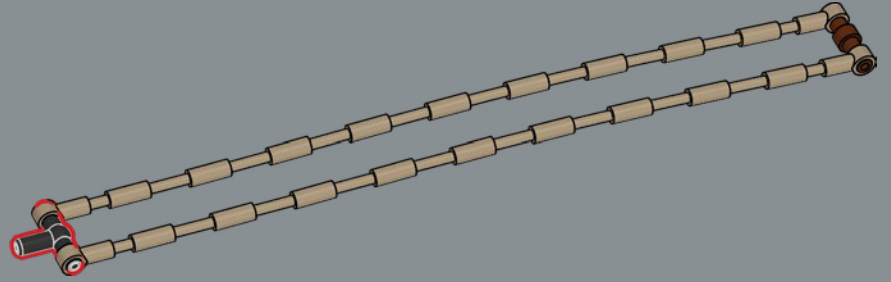

3

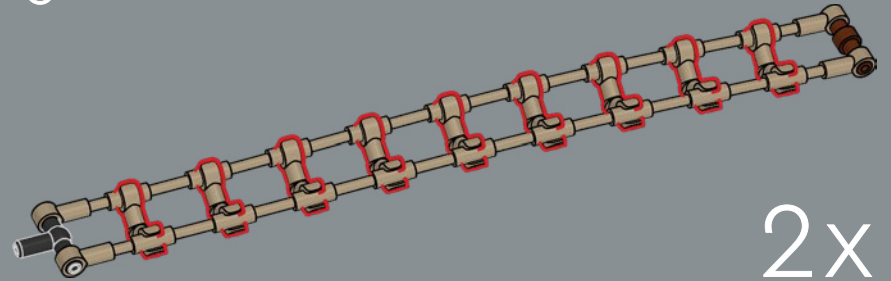

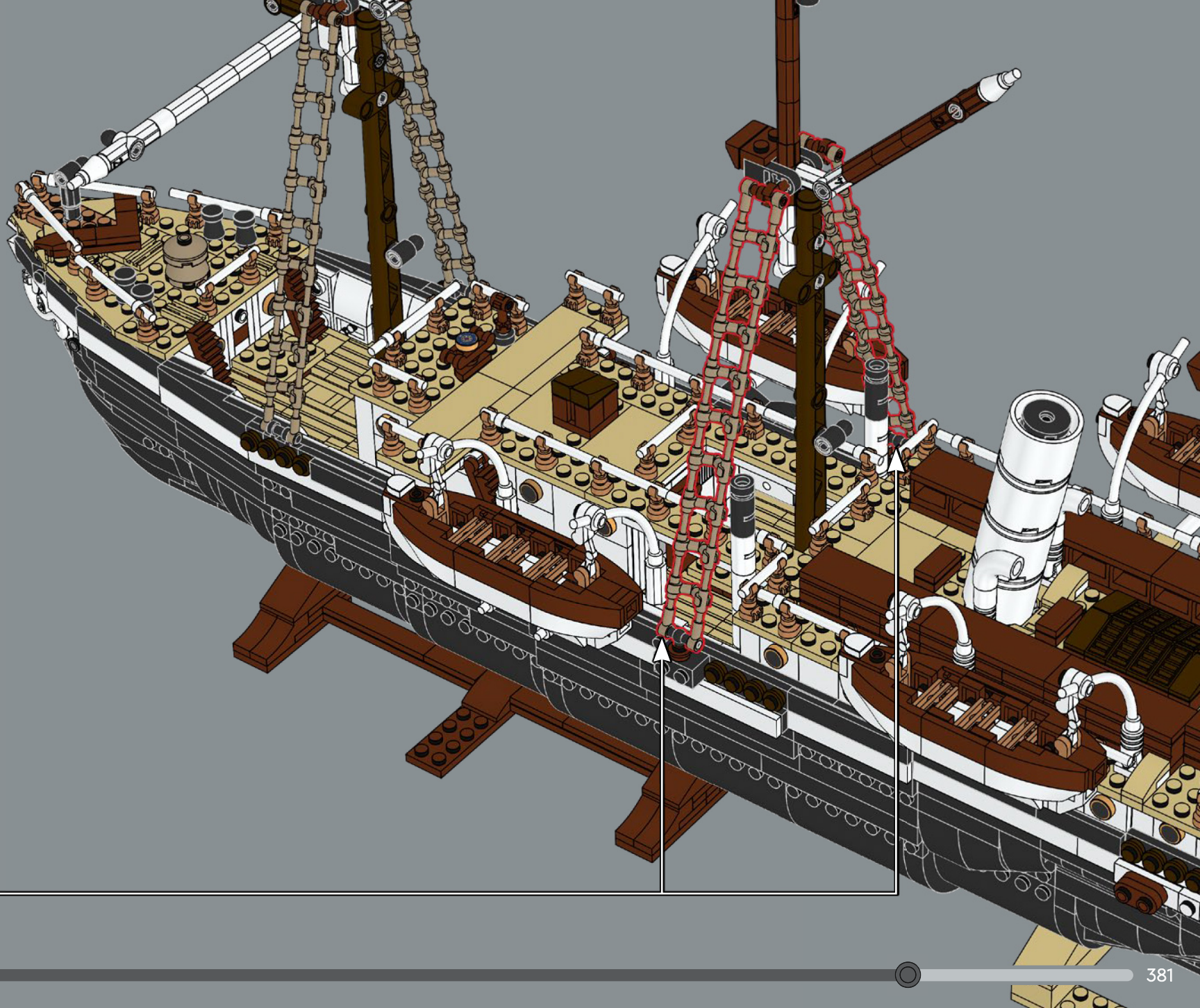

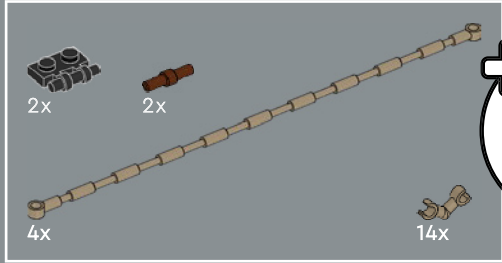
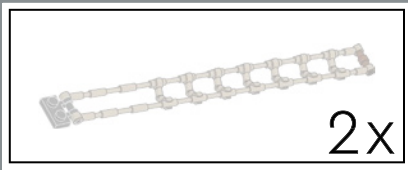

644

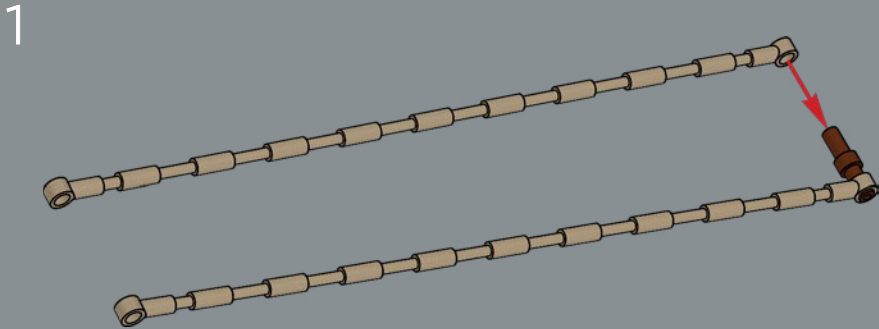

2

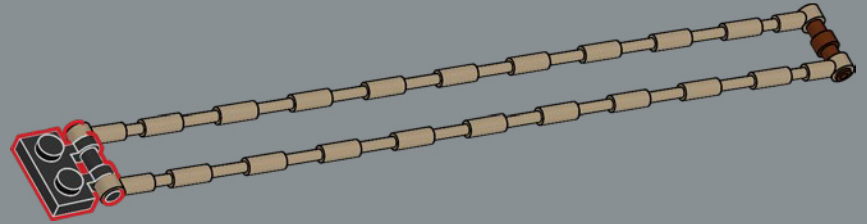

3

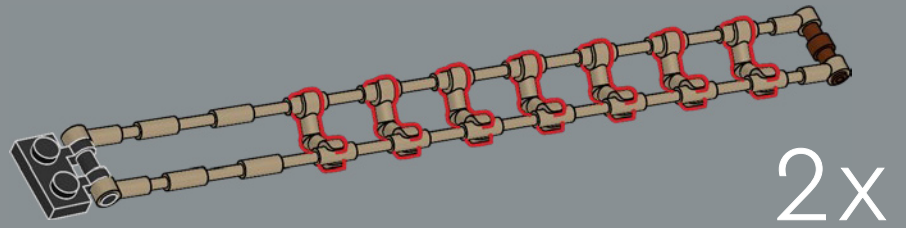

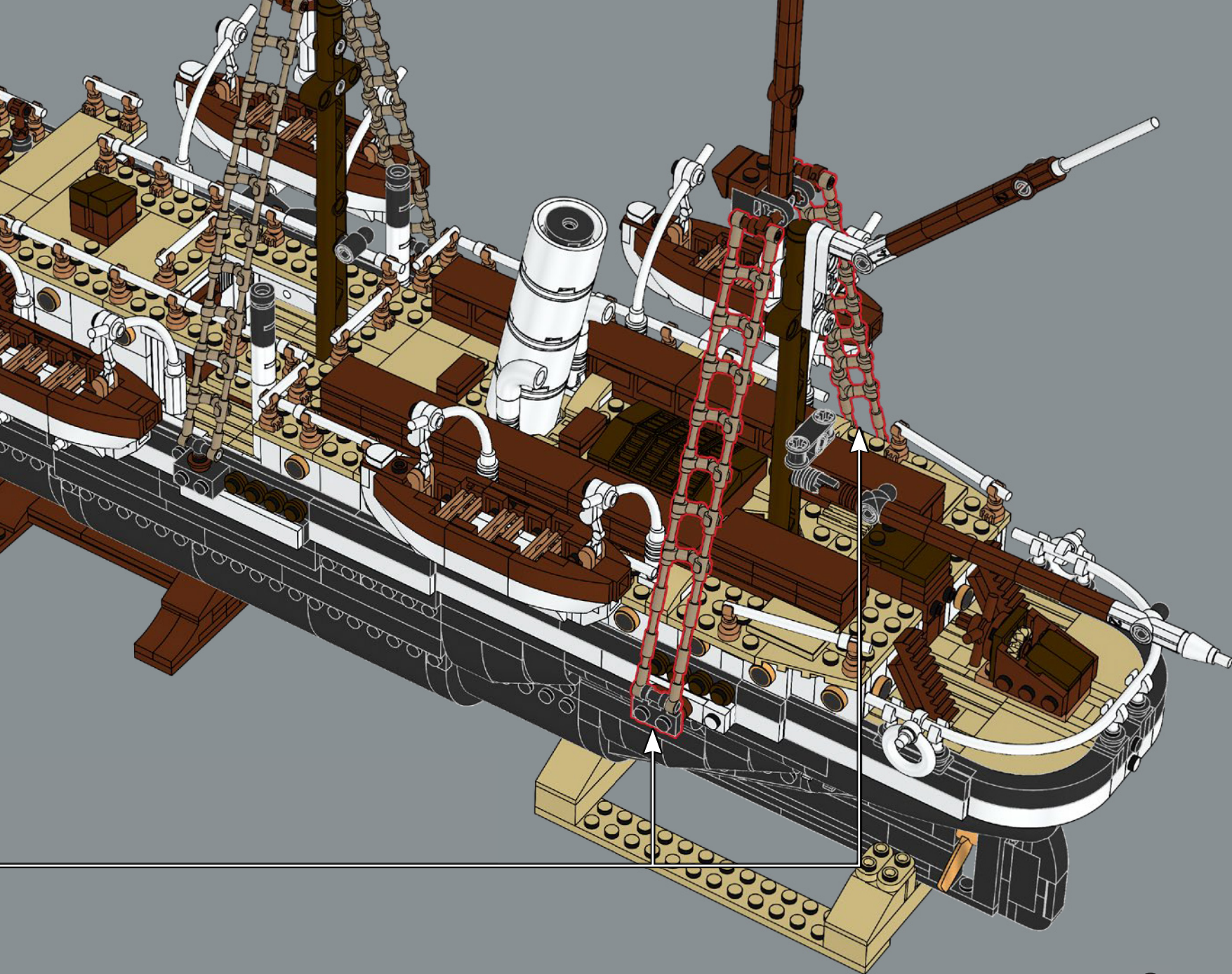



645



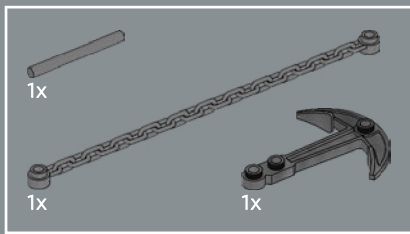

646

1

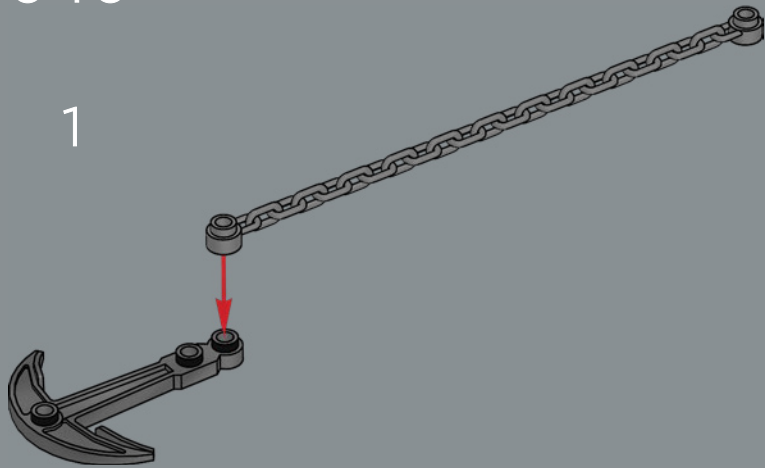

2

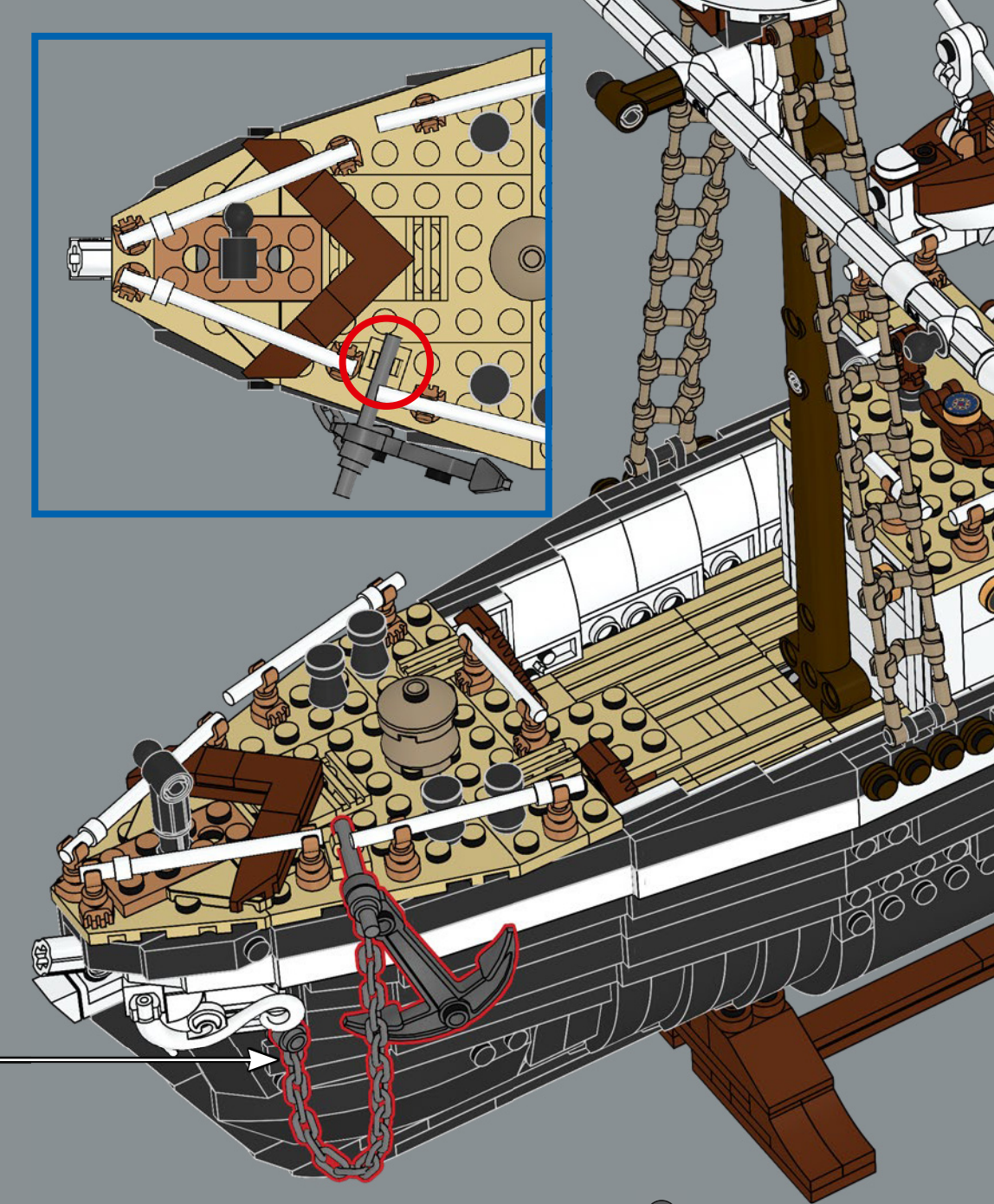
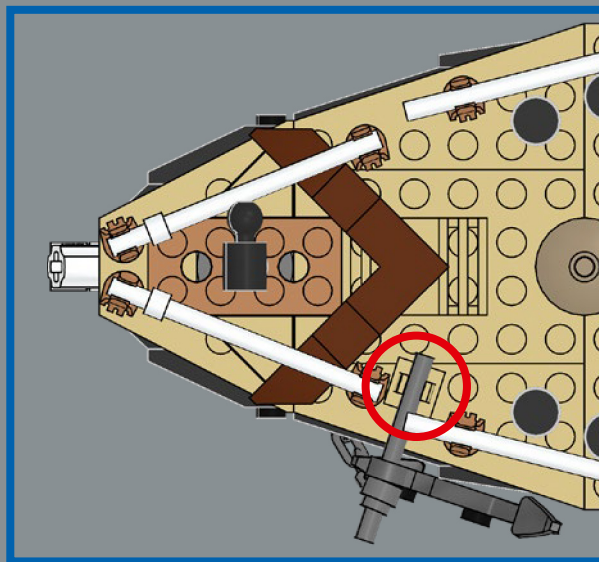
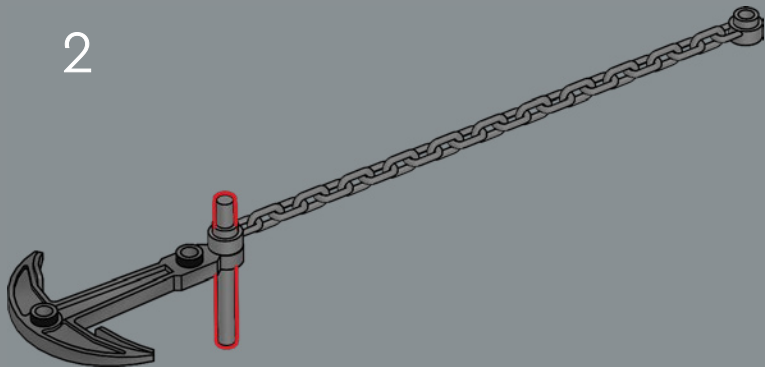

647

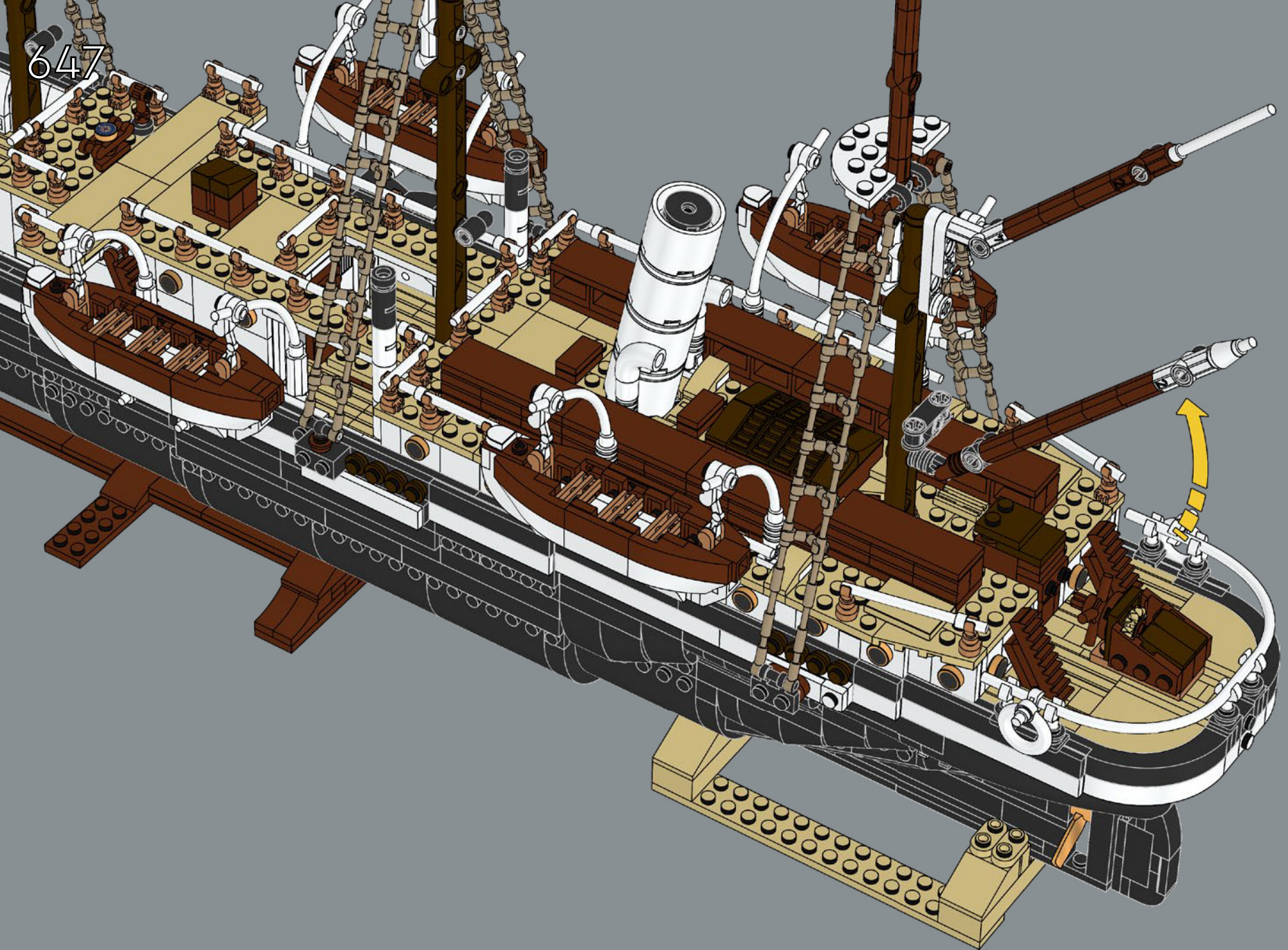

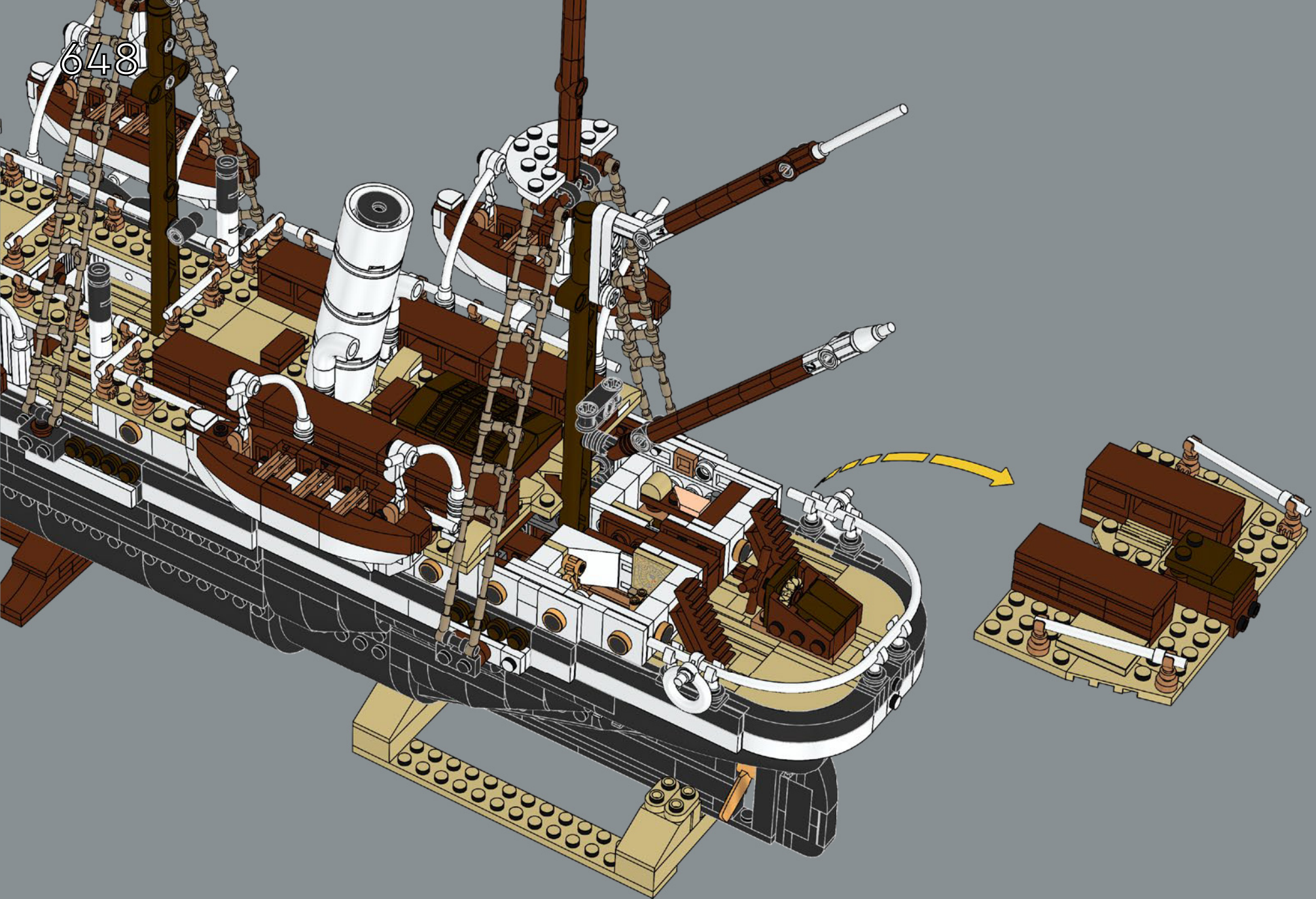

649

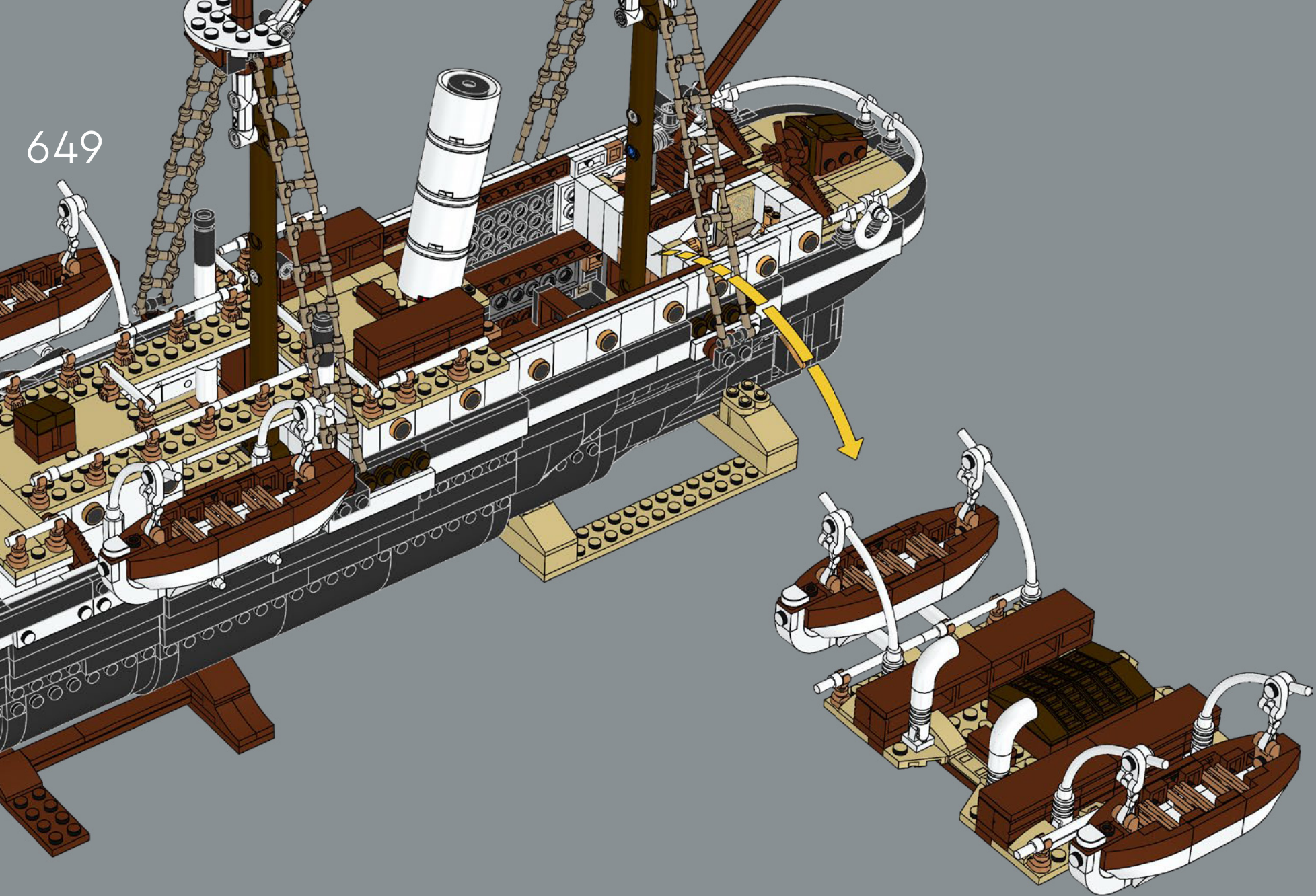

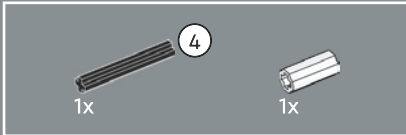
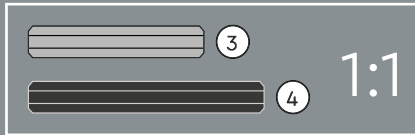
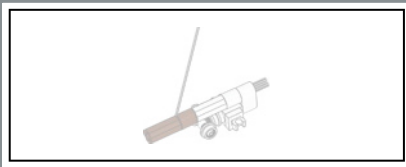

650

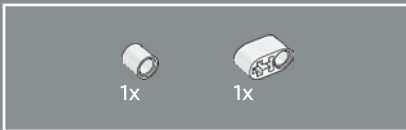
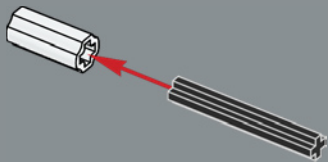

651

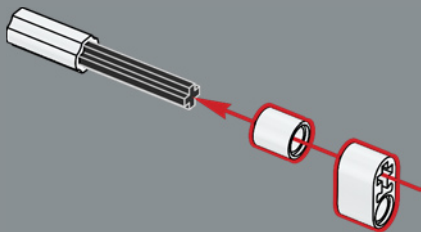

652

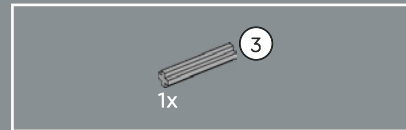
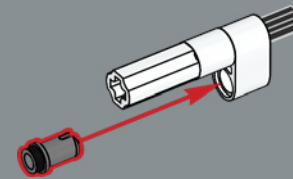

653

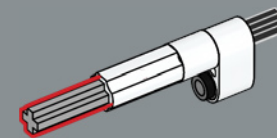

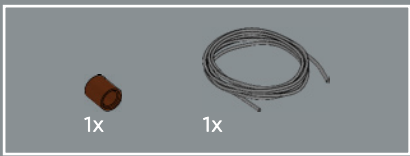

654

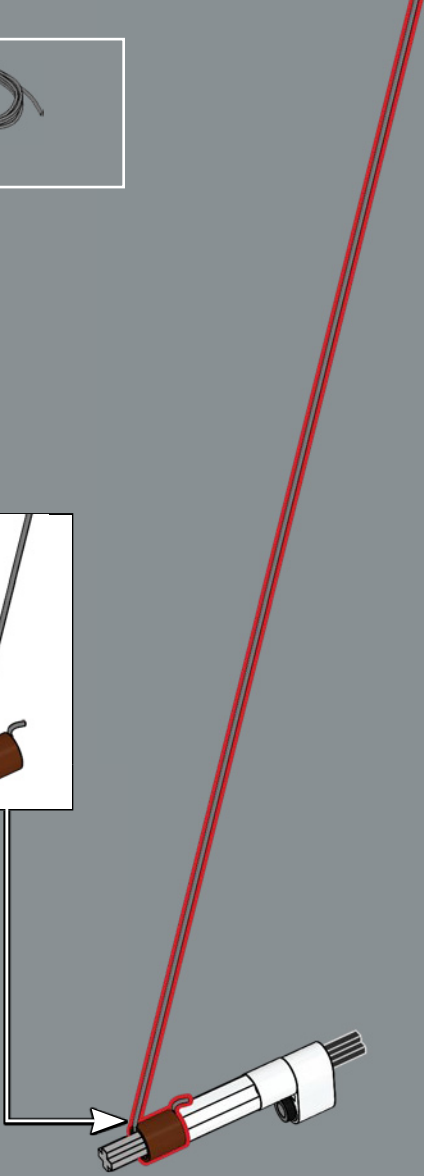
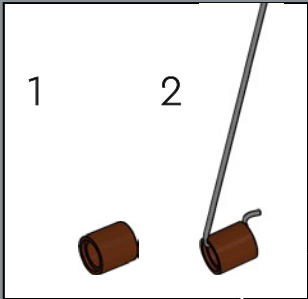

655

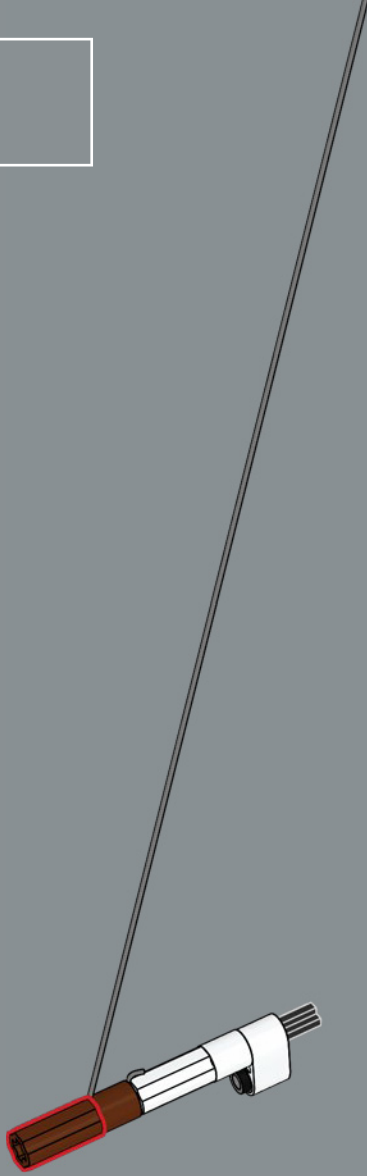

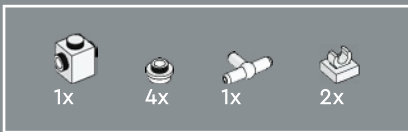

656

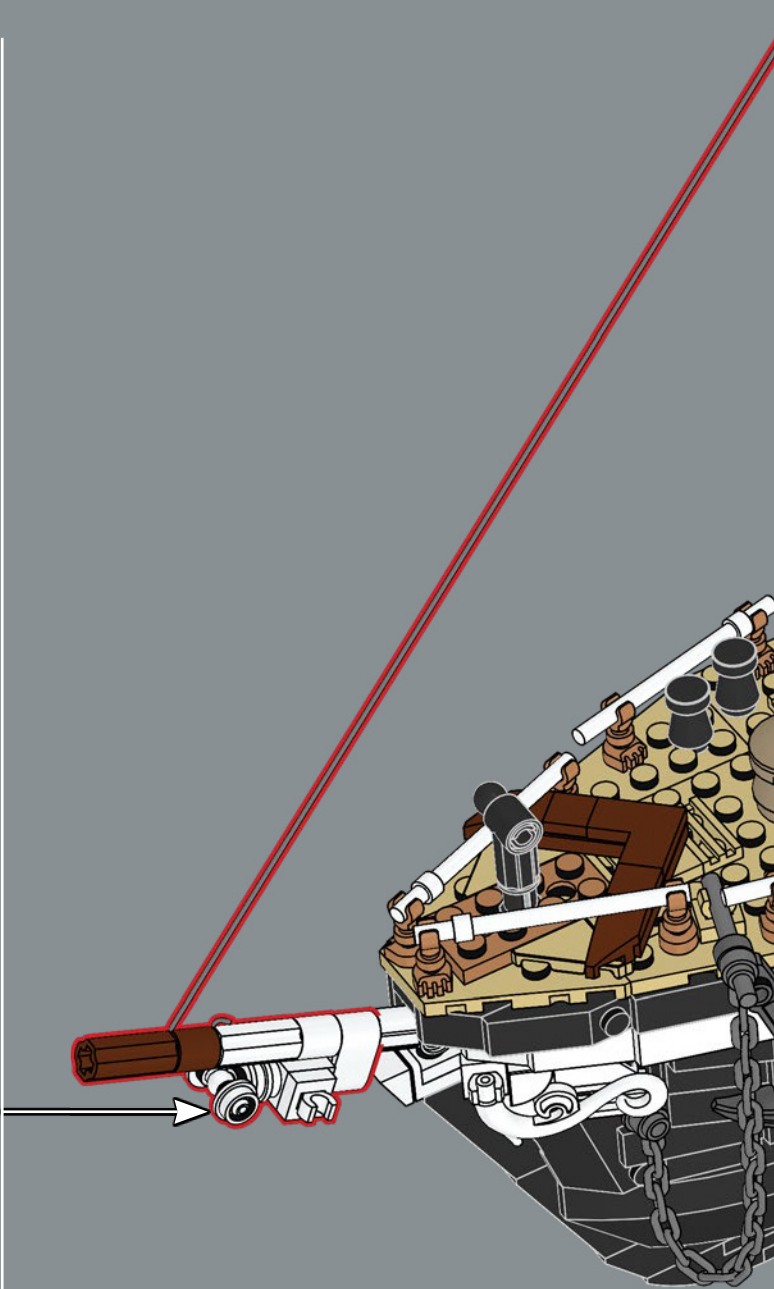
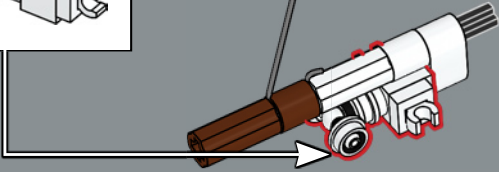
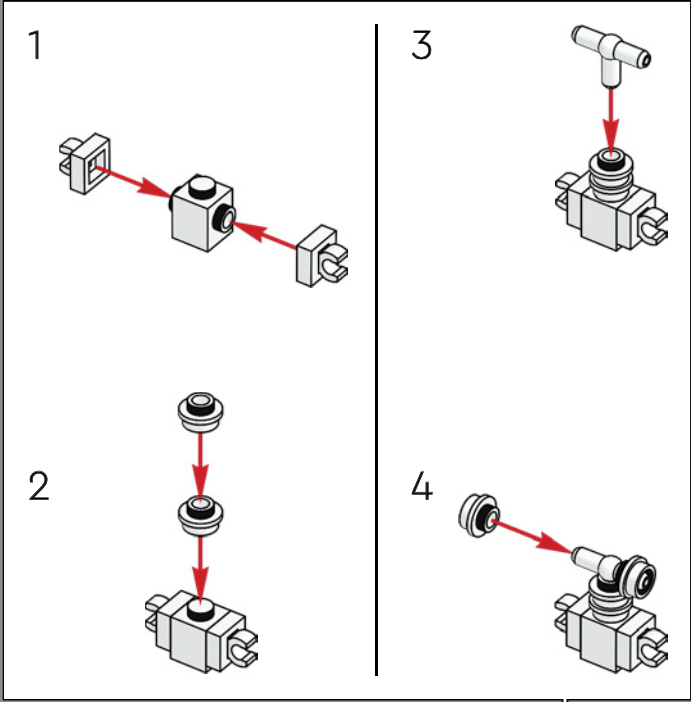



657

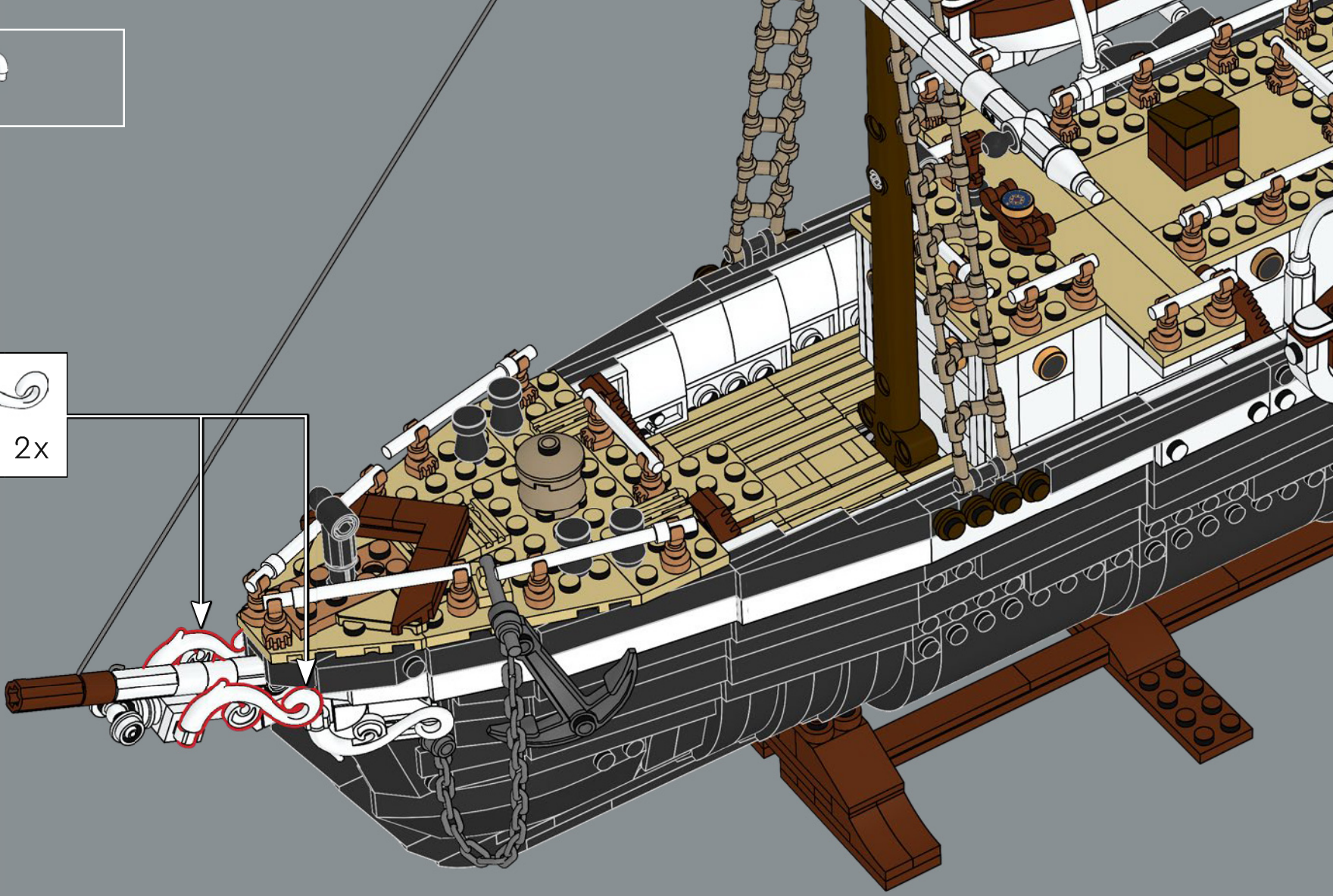
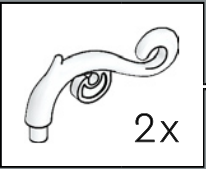

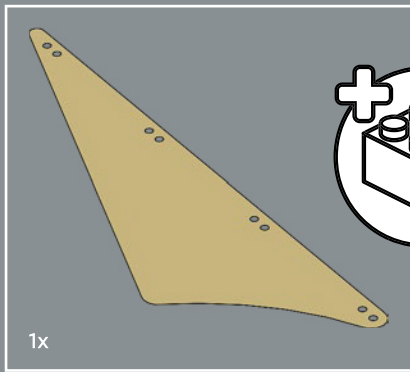

1x

658



LEGO® textiles use the same colours as LEGO bricks. For the sails, tan was considered the most attractive and appropriate colour.

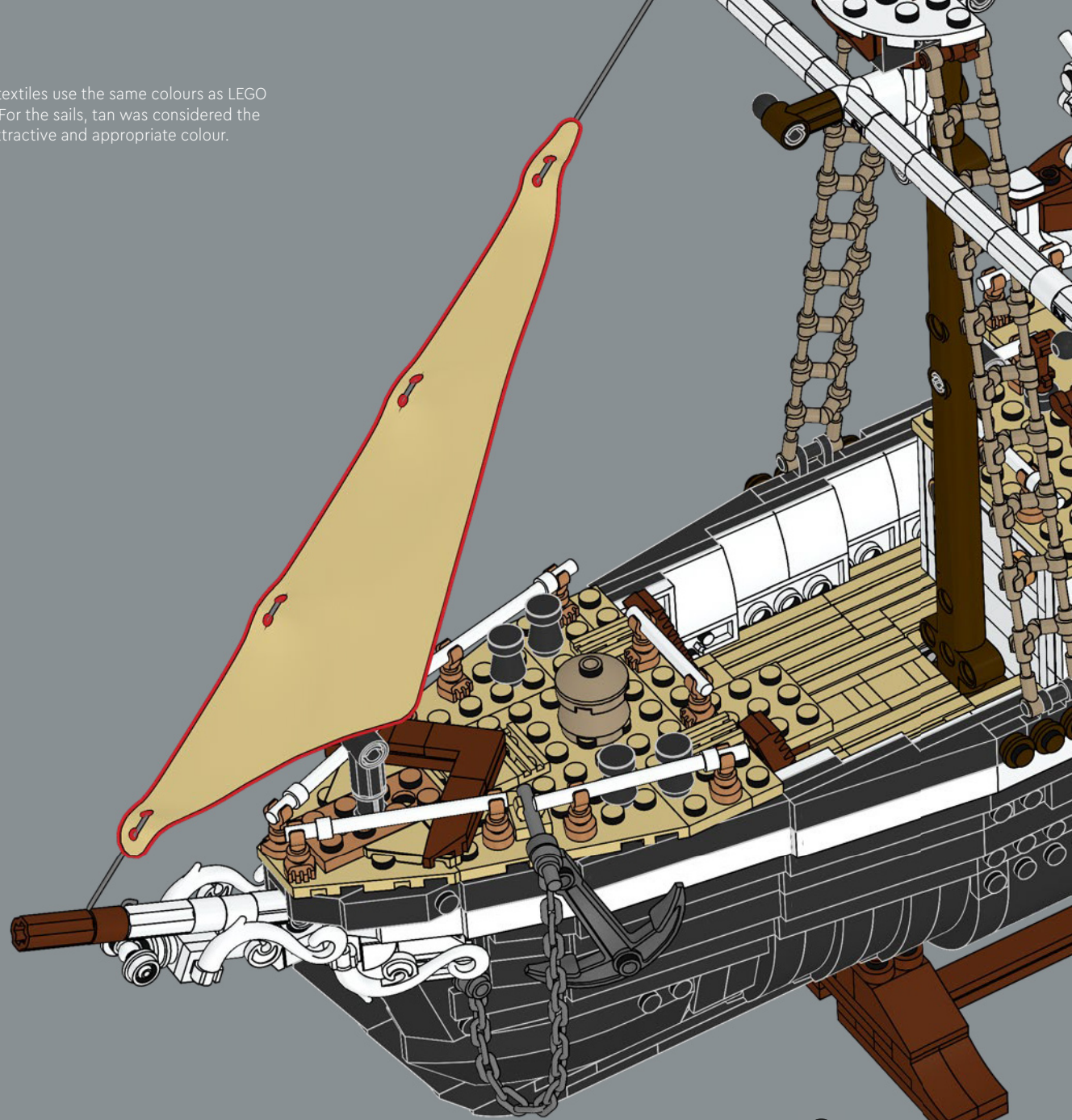

659

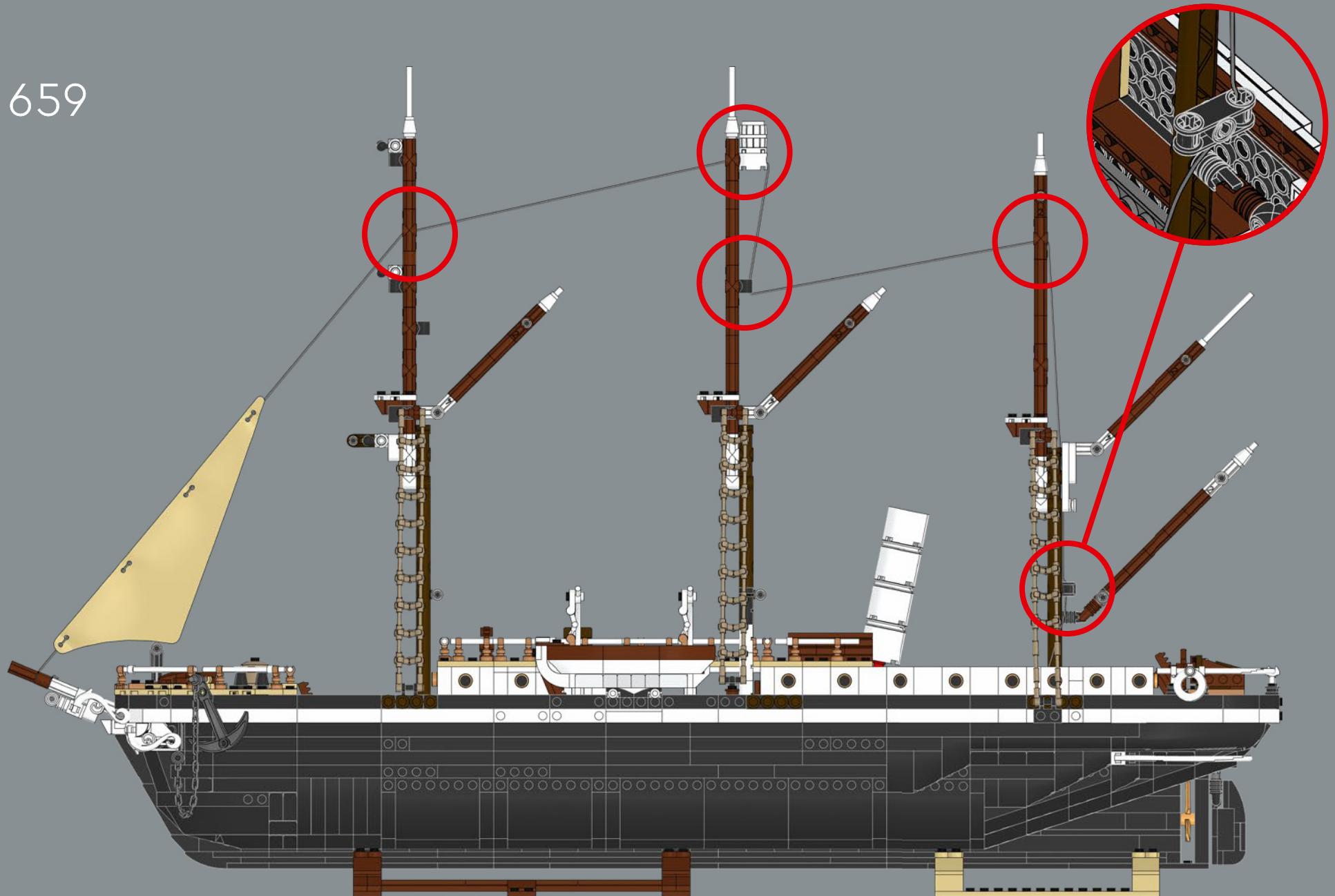

1x

660

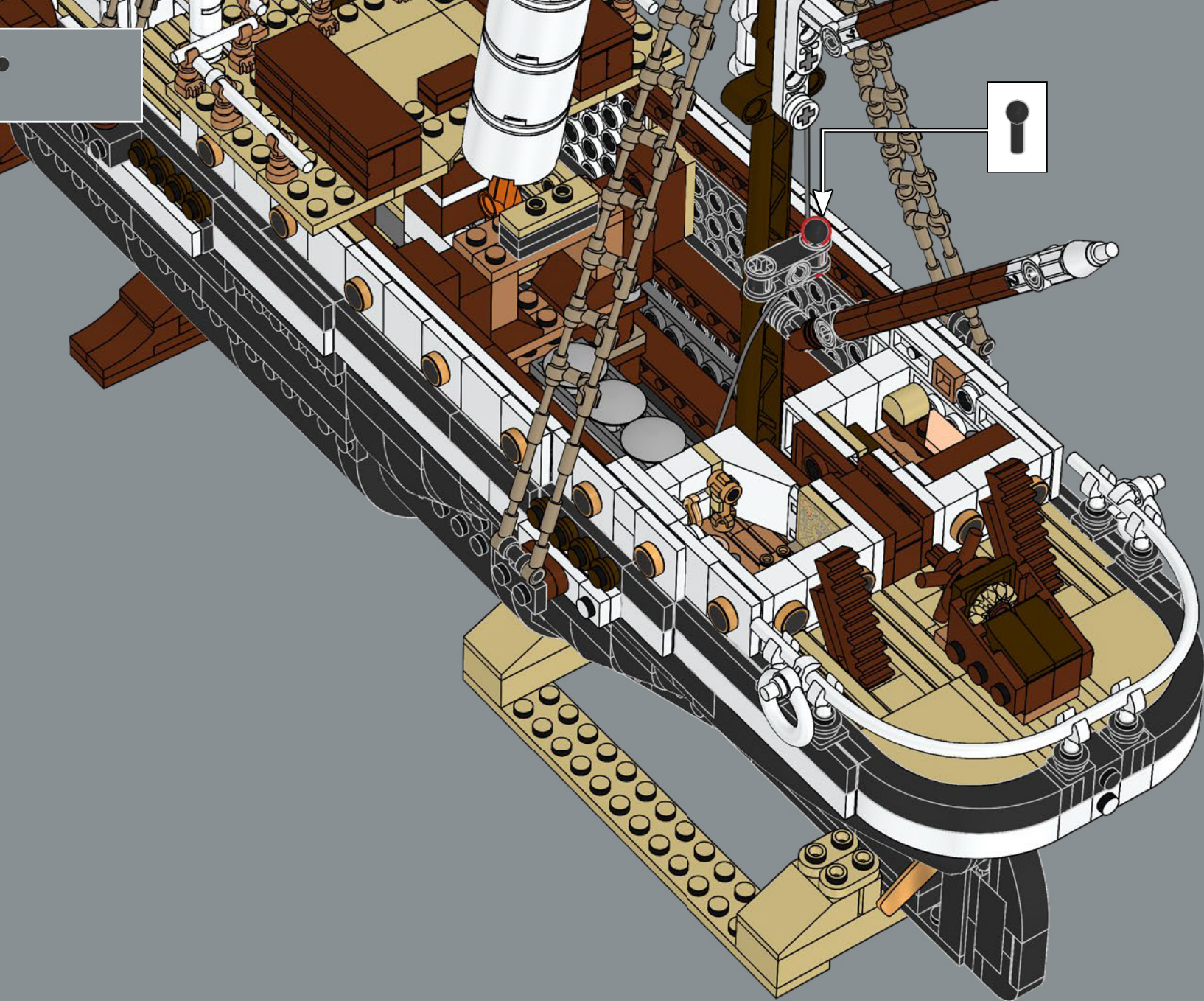

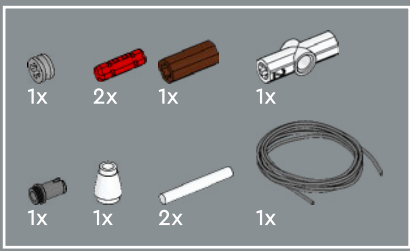

661

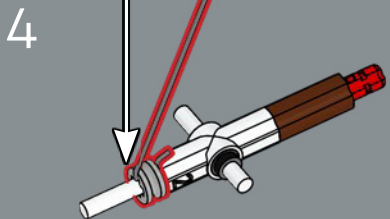
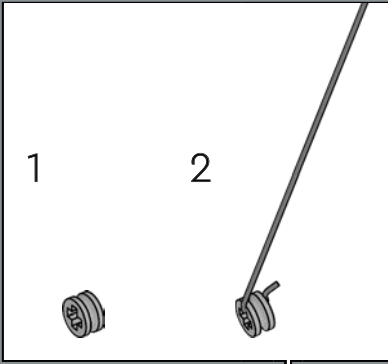
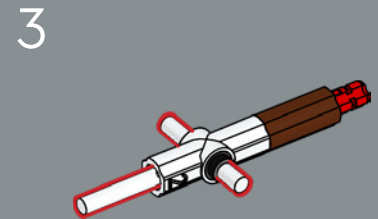
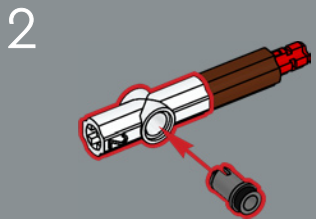
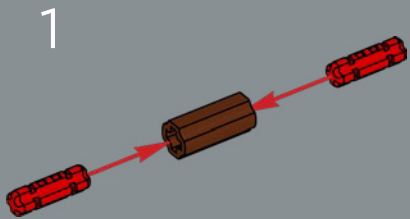

5

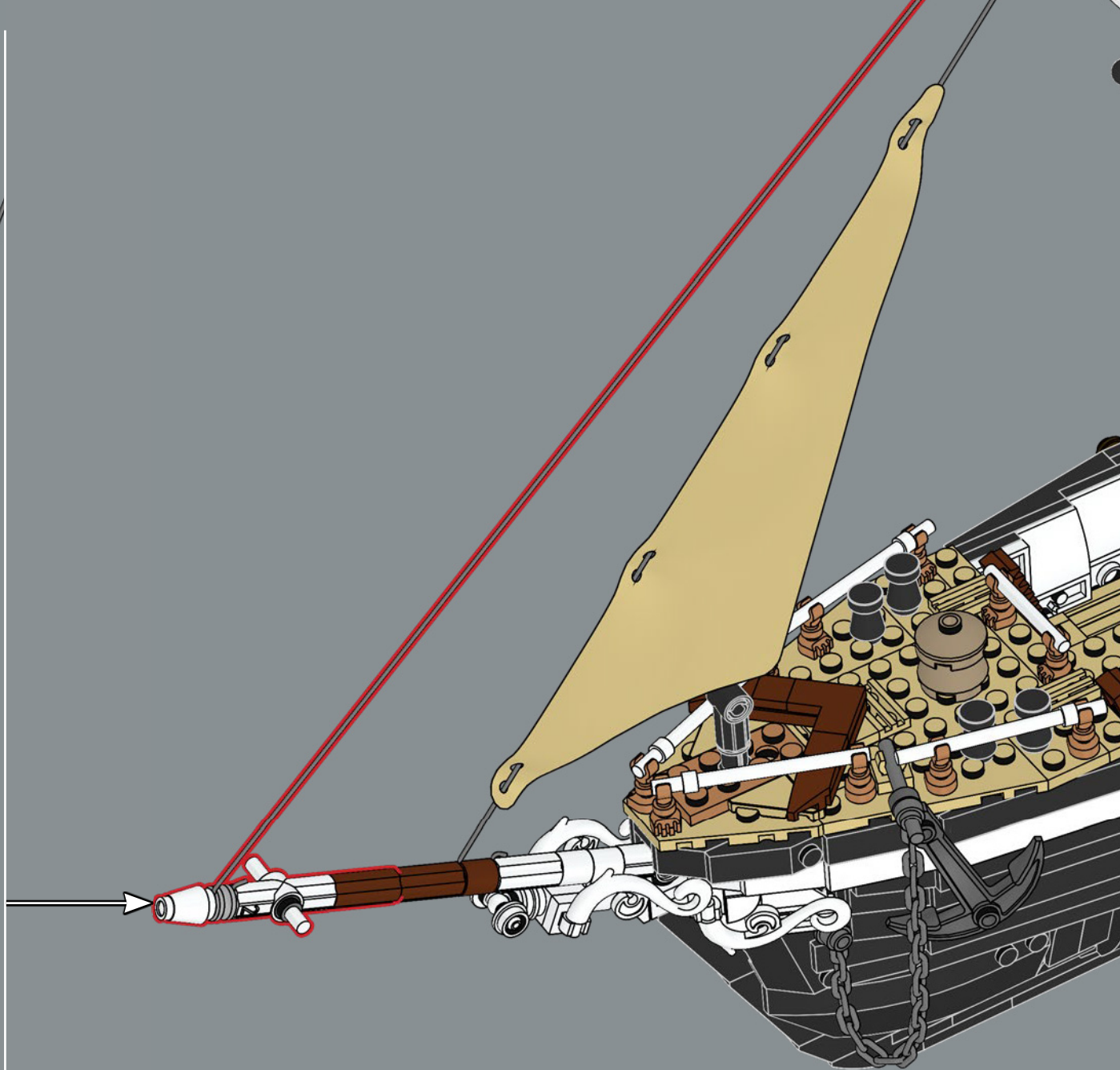
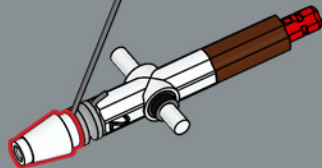

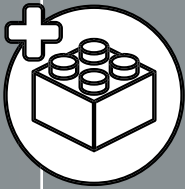
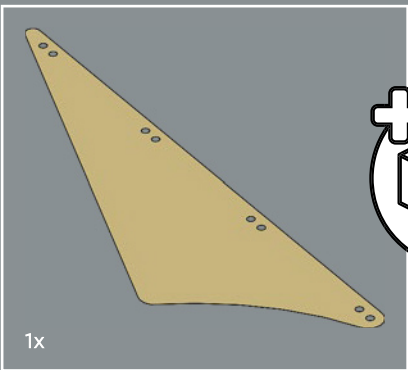

662

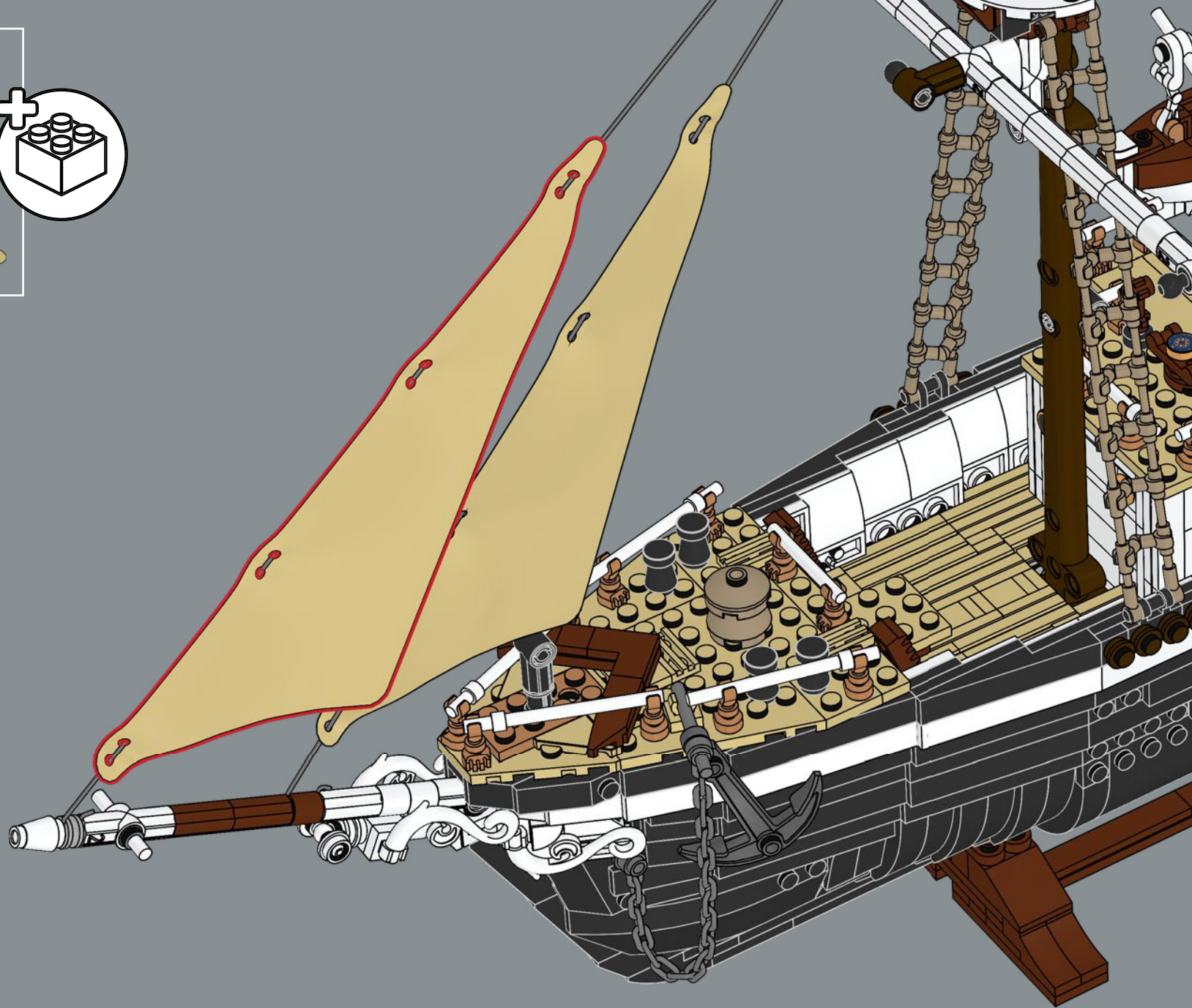

663

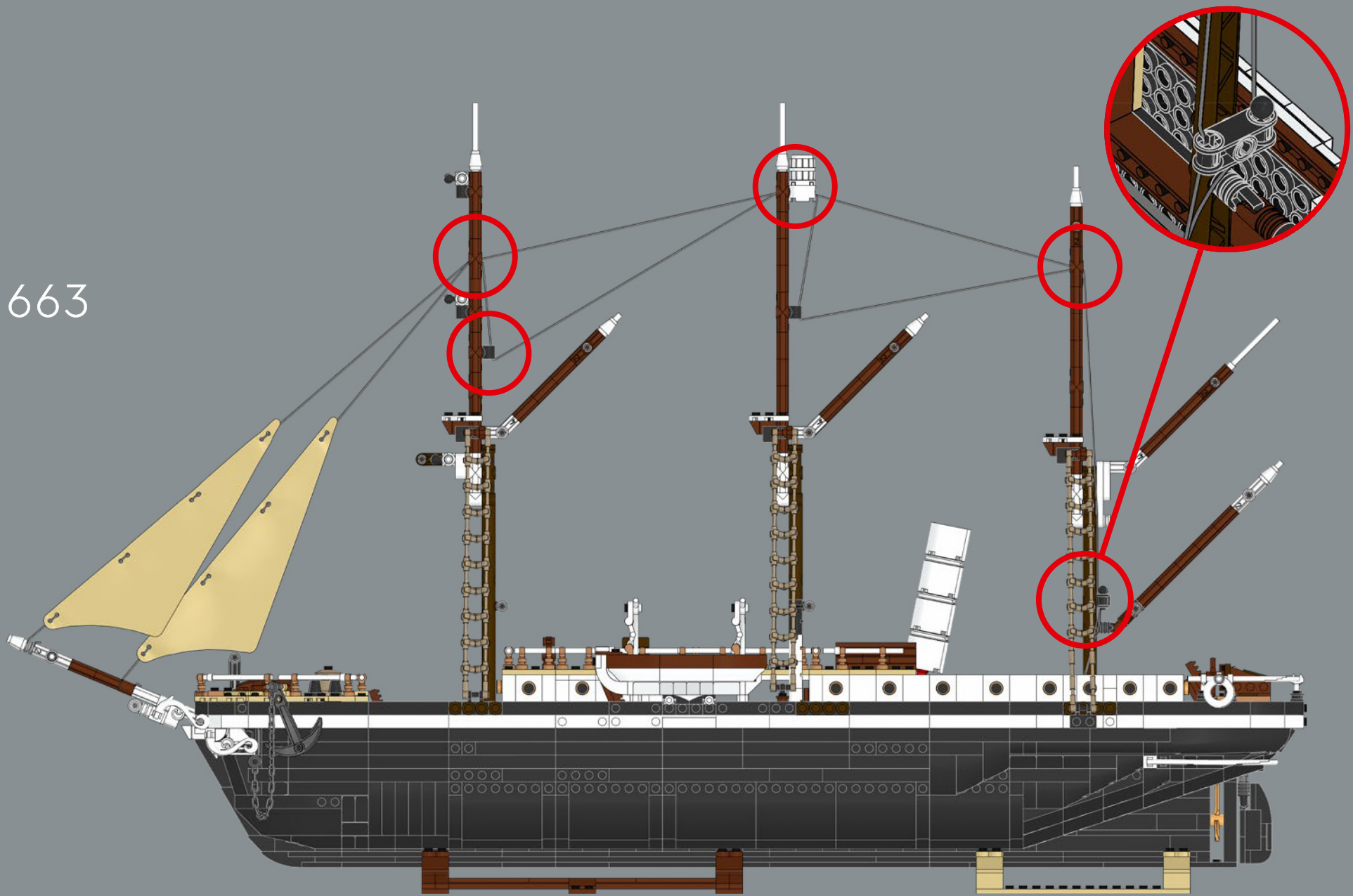



1x

664



LEGO® string elements are heat-cut to keep the ends from fraying. For this model, we found a no-knots and no-cutting solution, with excess string wrapped around a bobber and tucked away below deck.

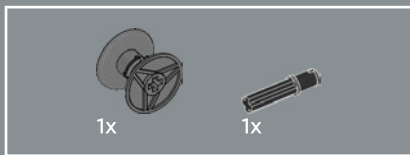

665

1

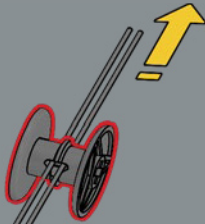

2

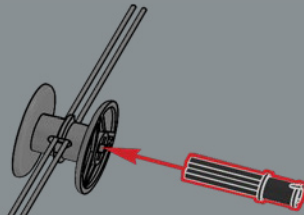

3

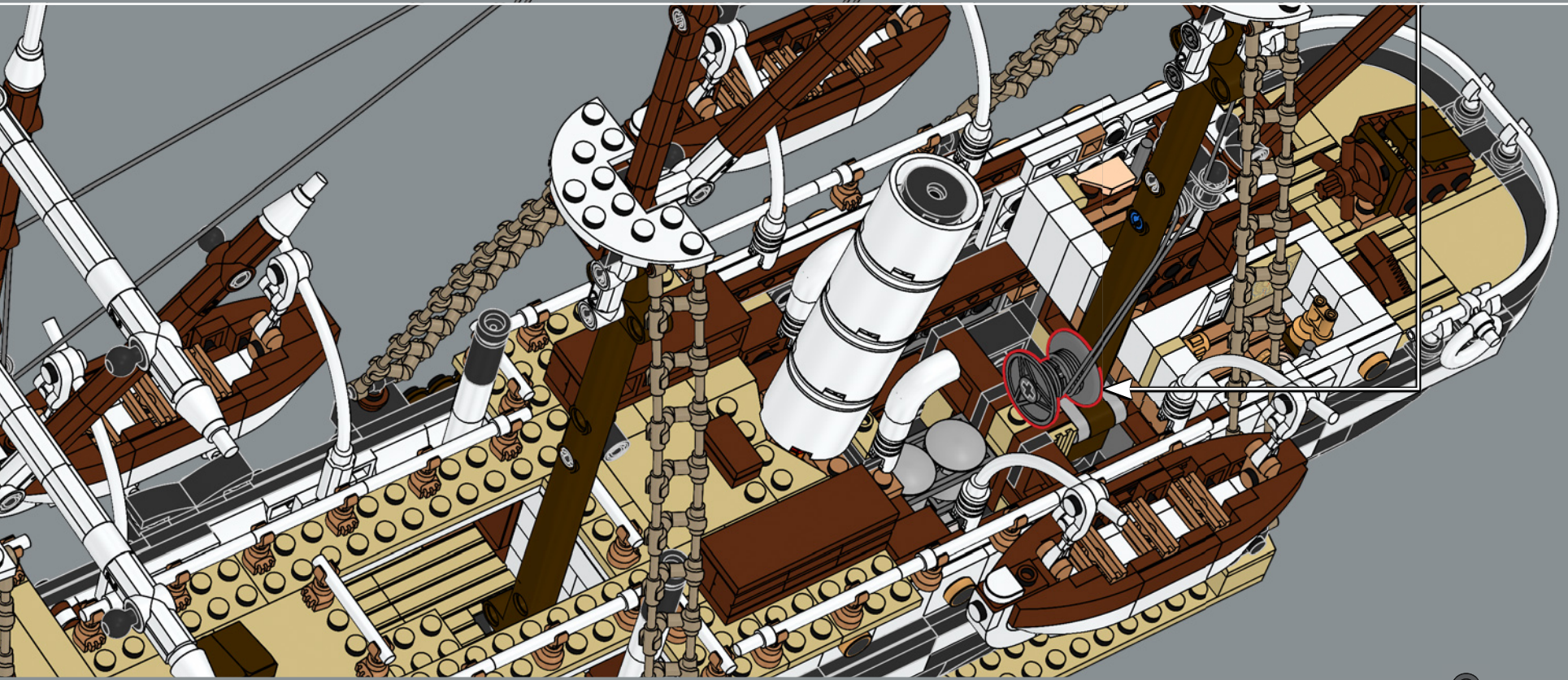
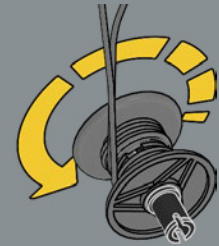

666

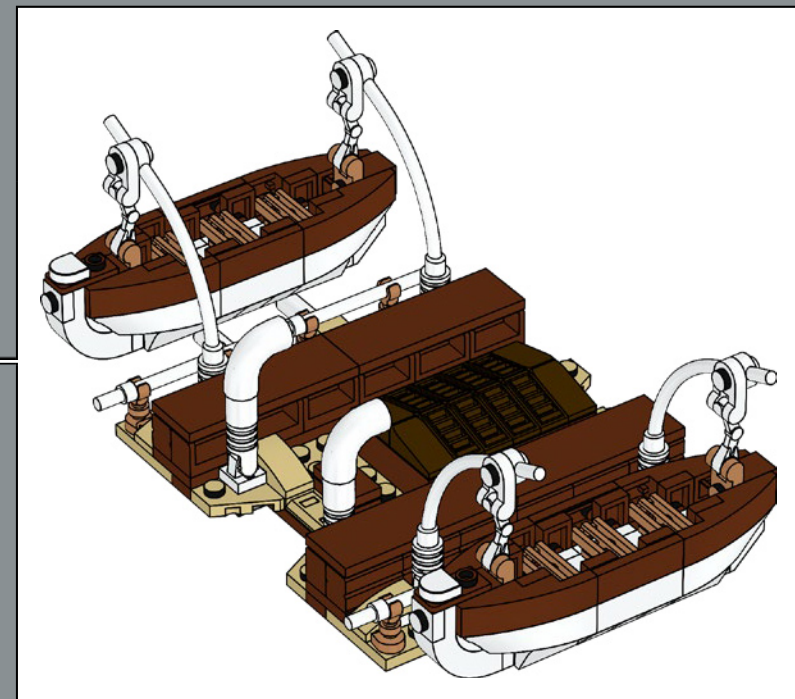
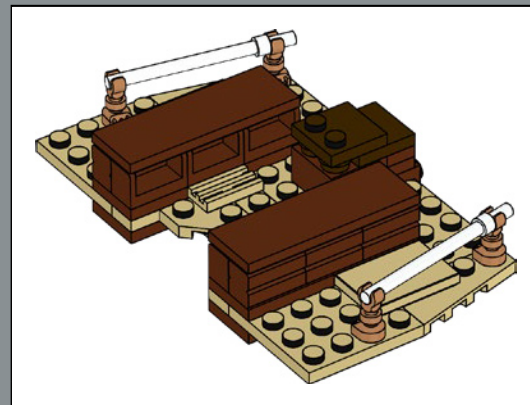
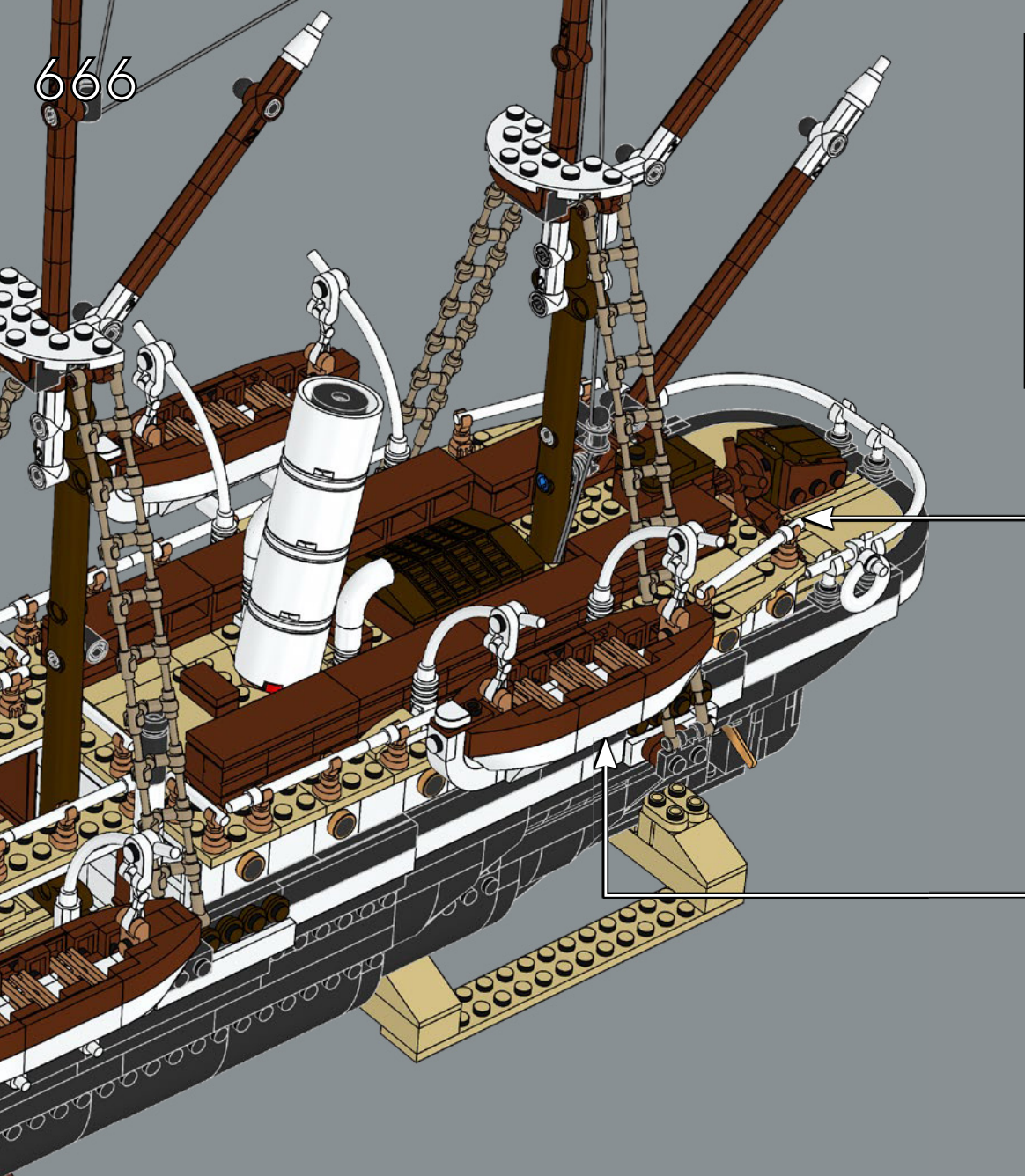

667

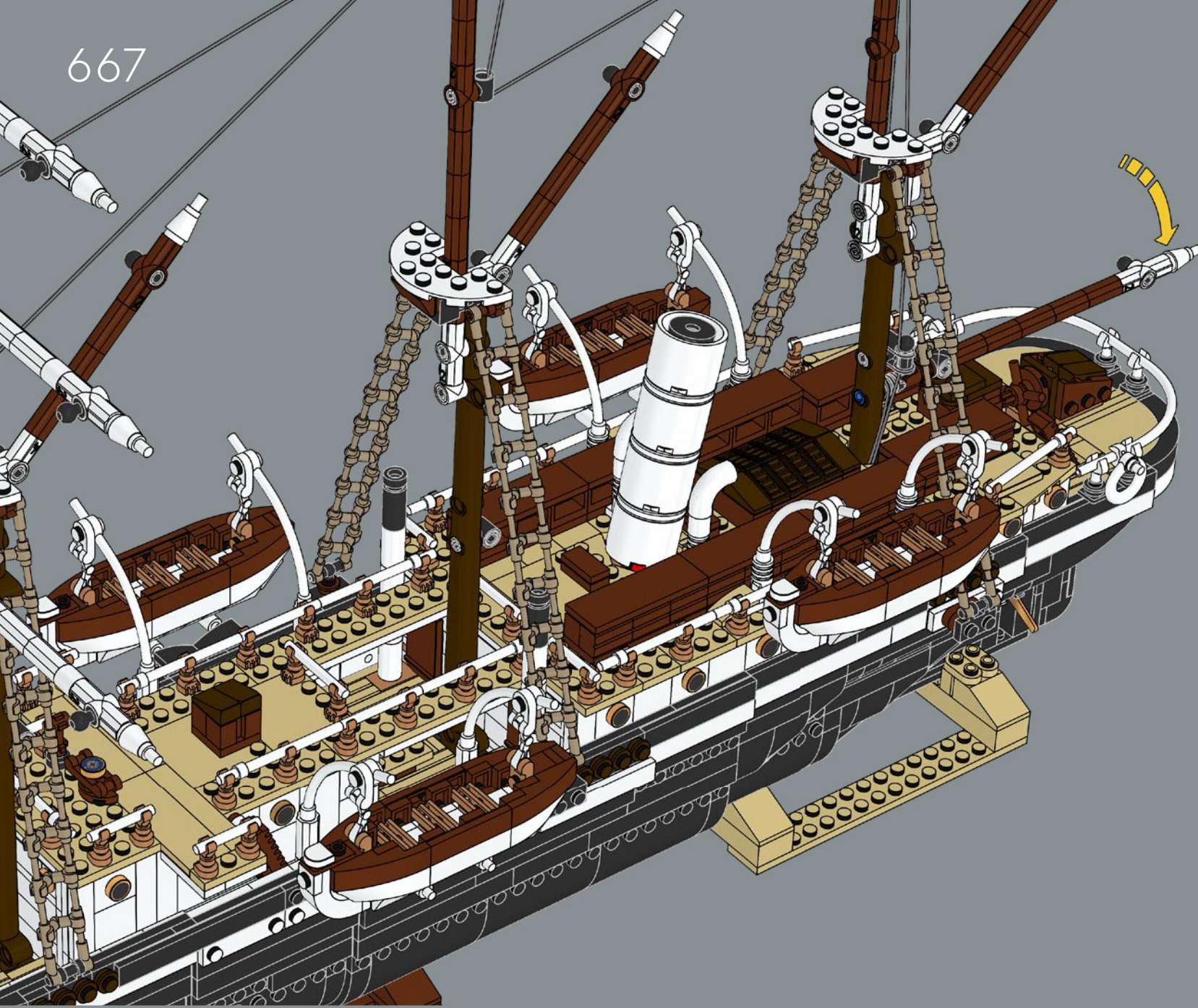

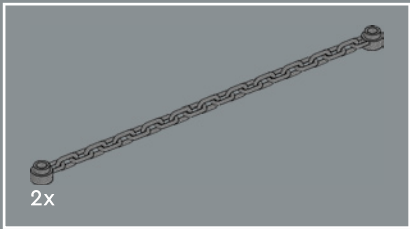

668

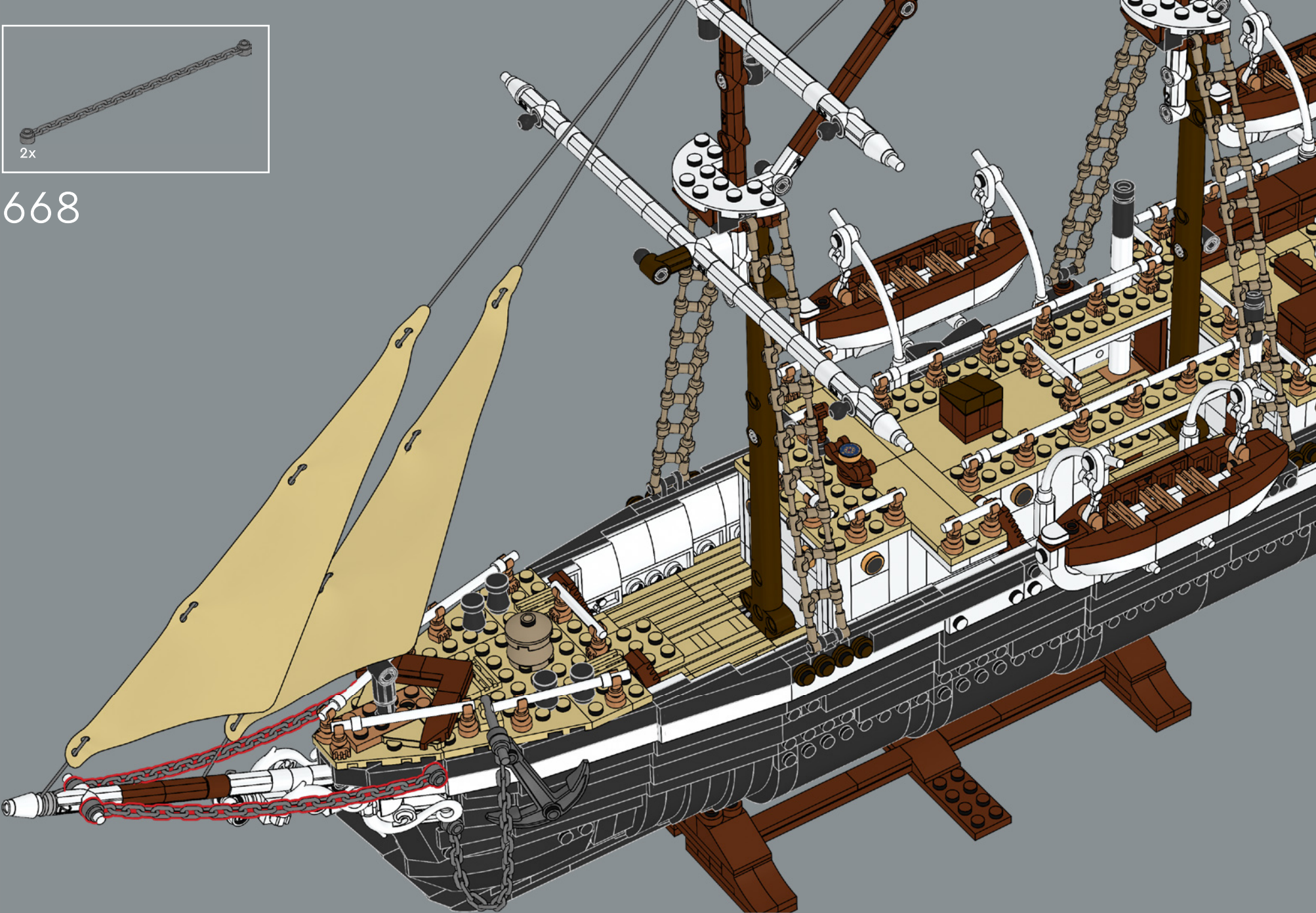

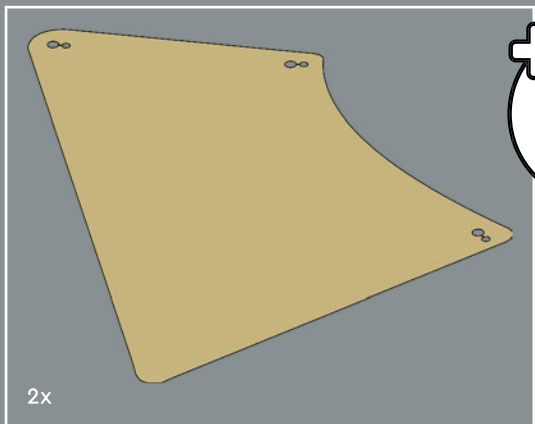

2x

669



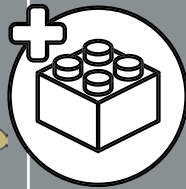
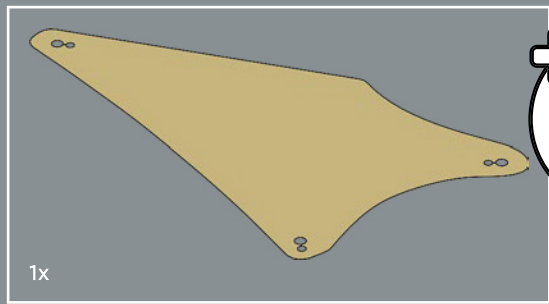

670

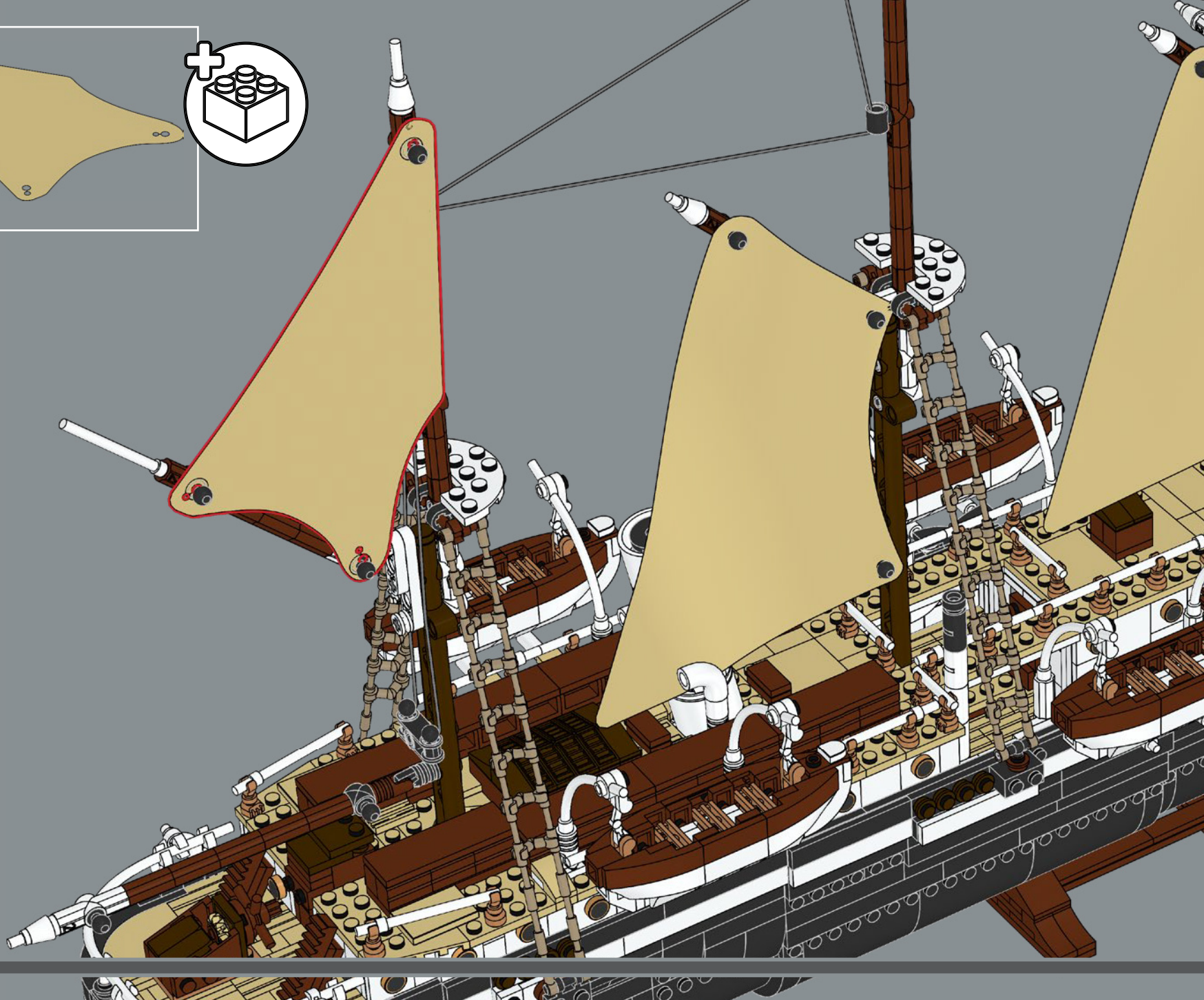



1x

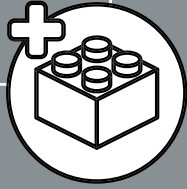

671



This British flag is called the 'Red Ensign' and was the appropriate flag for merchantmen and private ships to fly during that period.

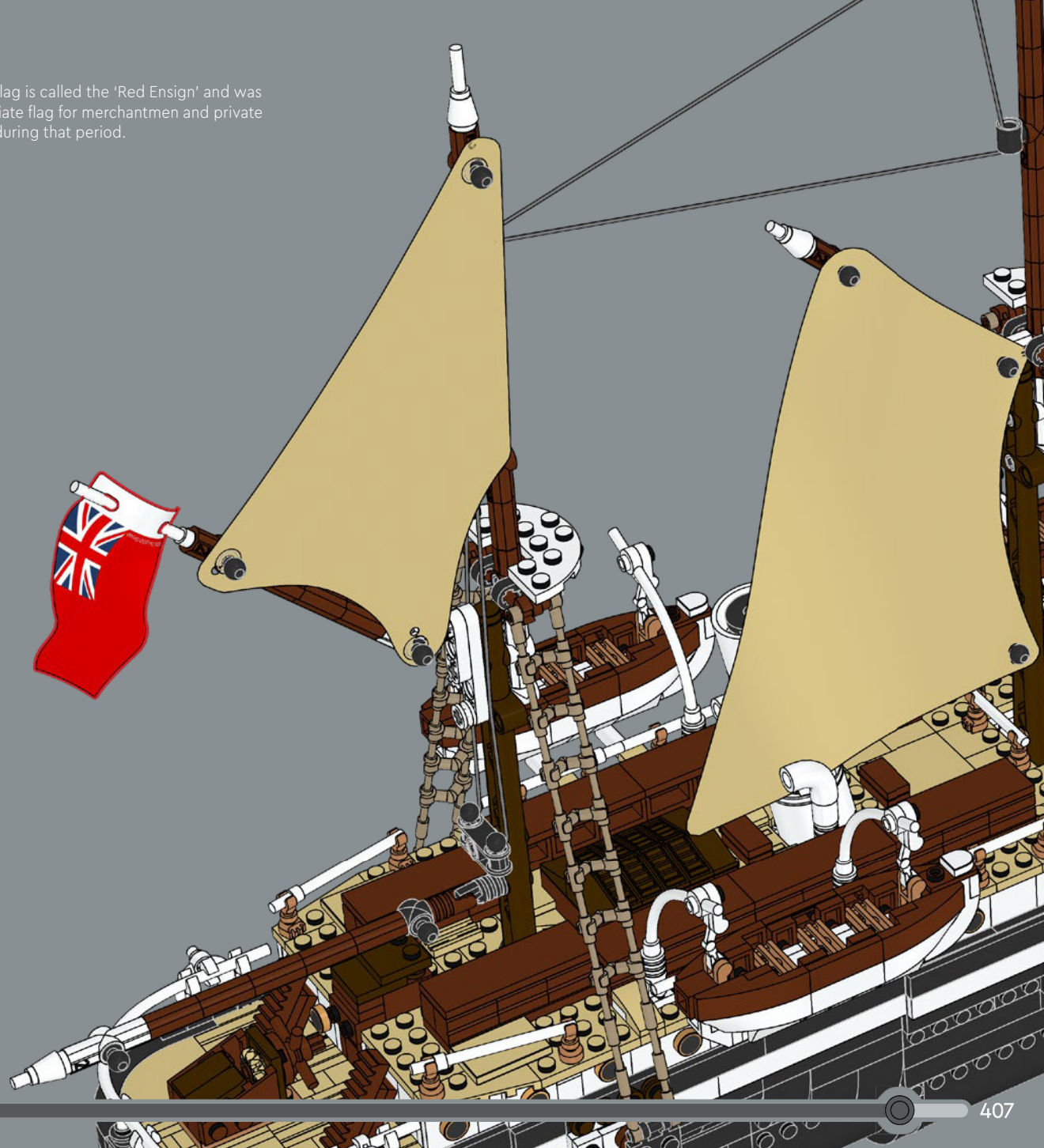

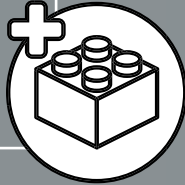
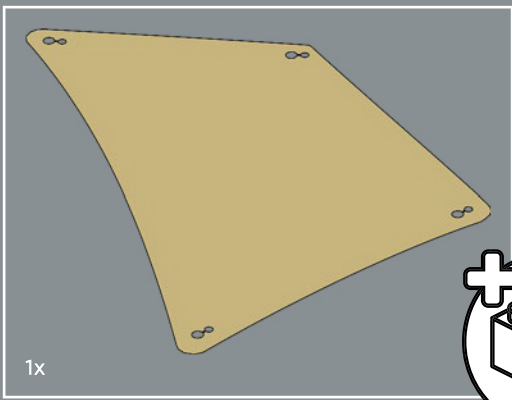

1x

672

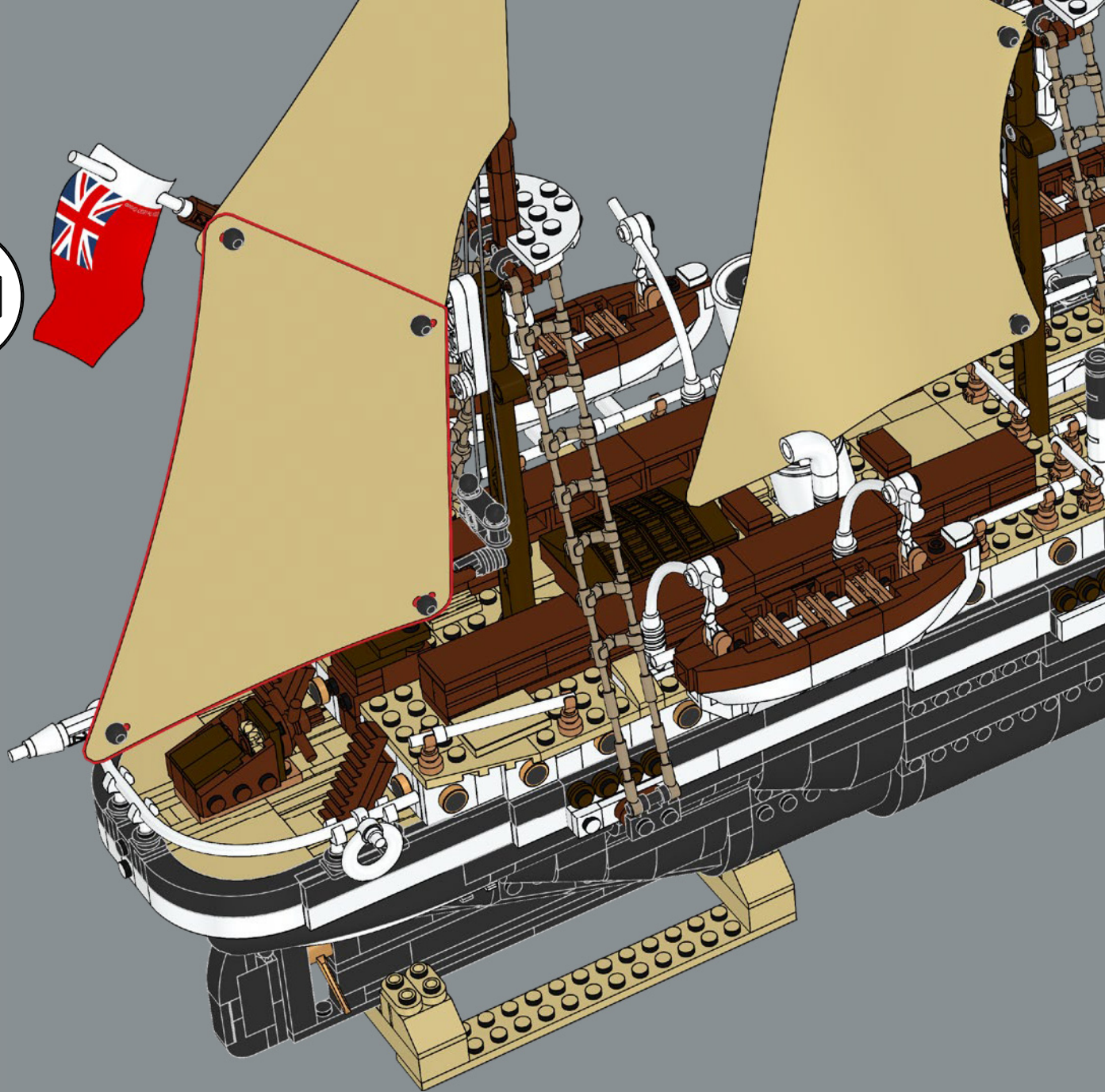

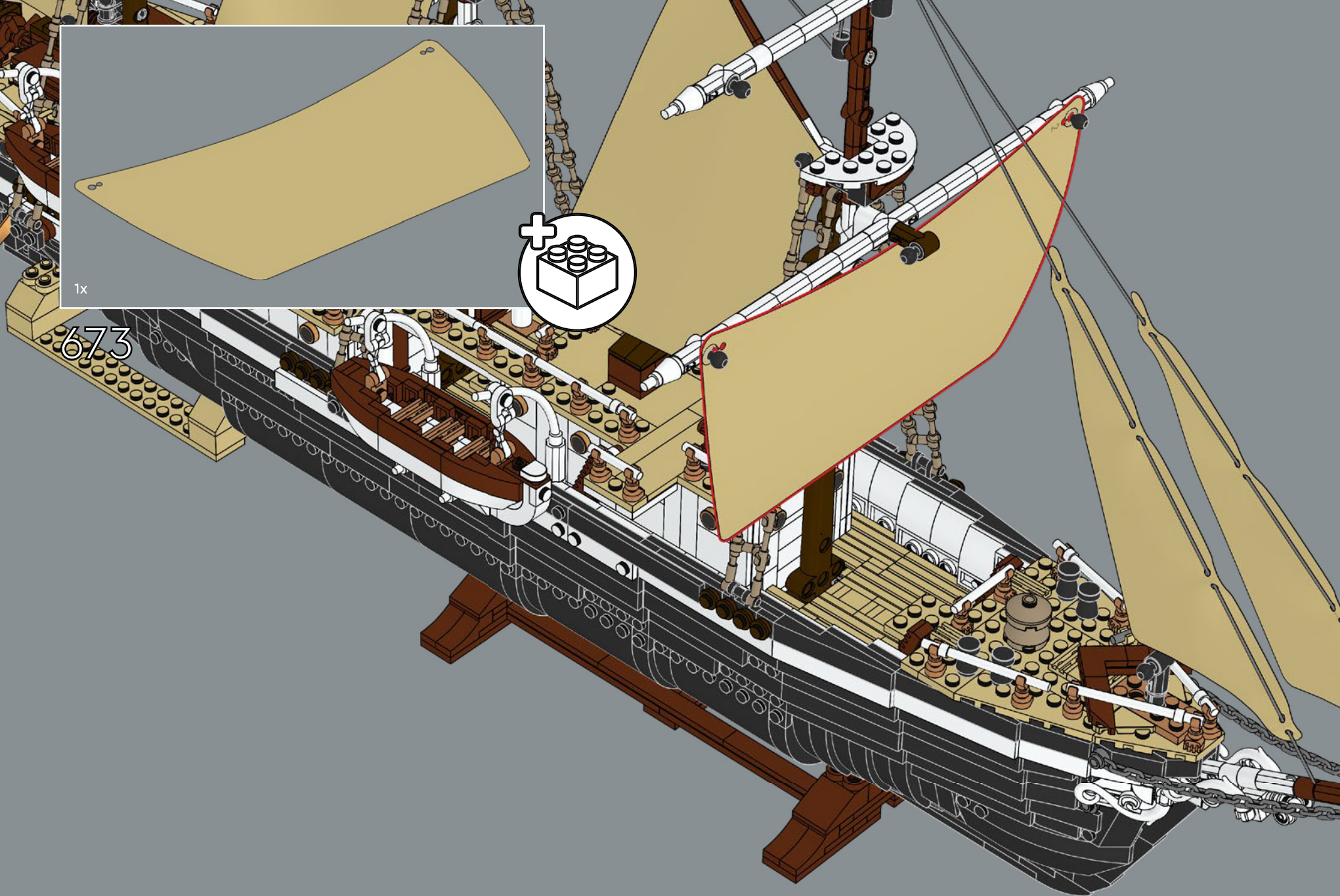

1x

673

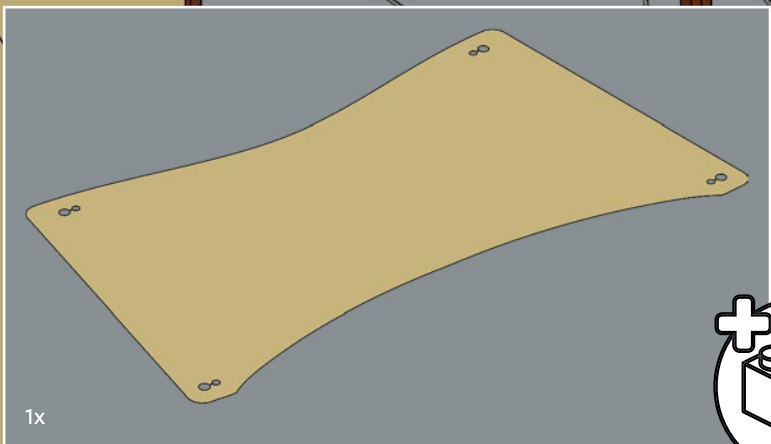

1x

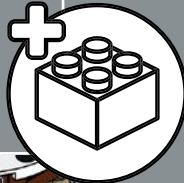

674

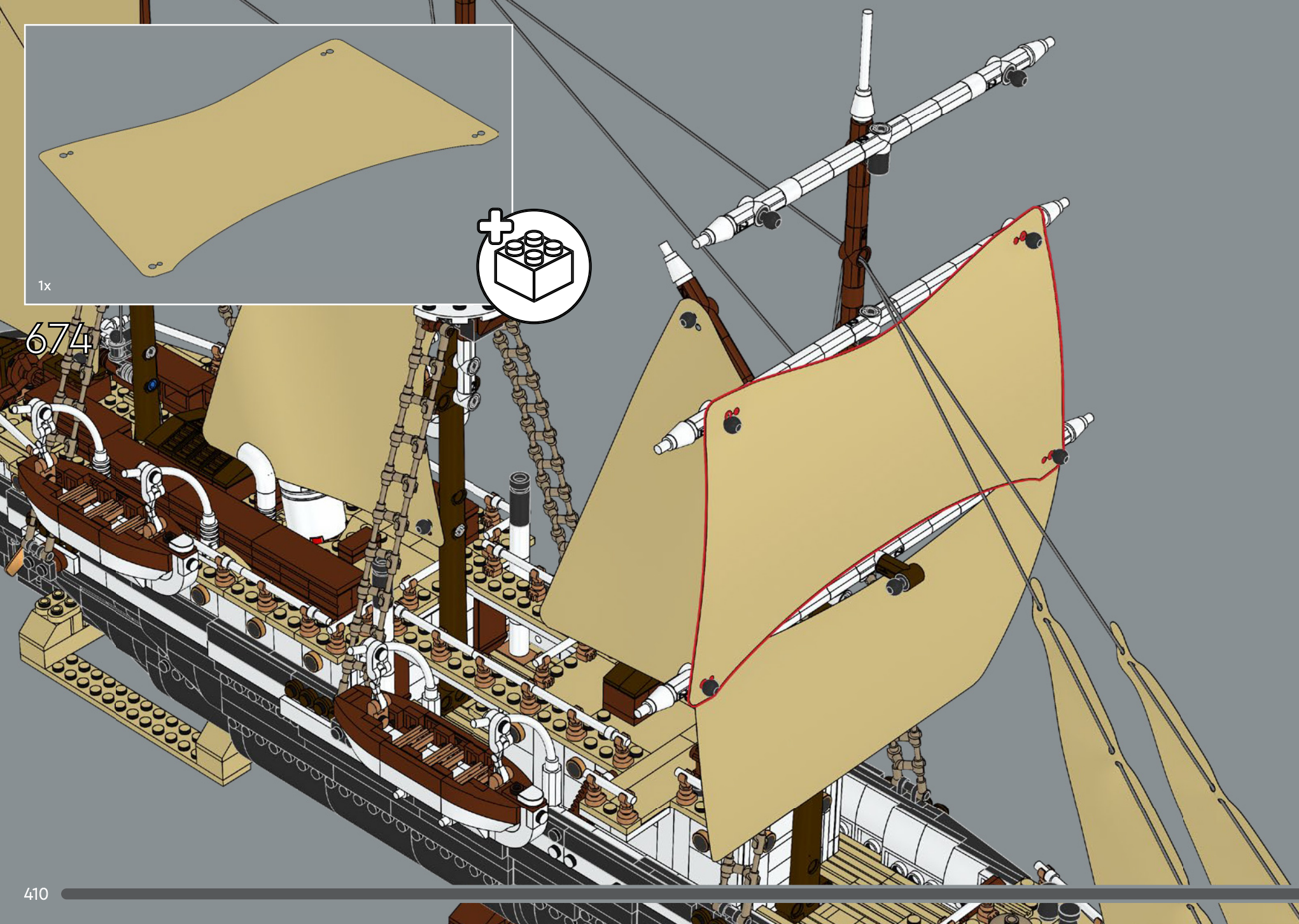

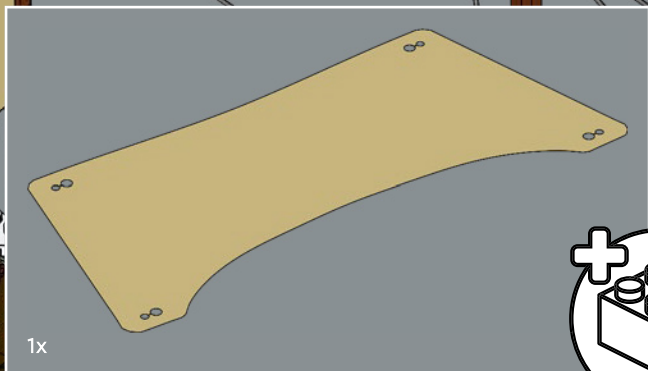

1x

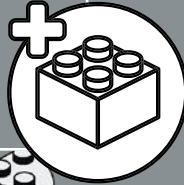

675

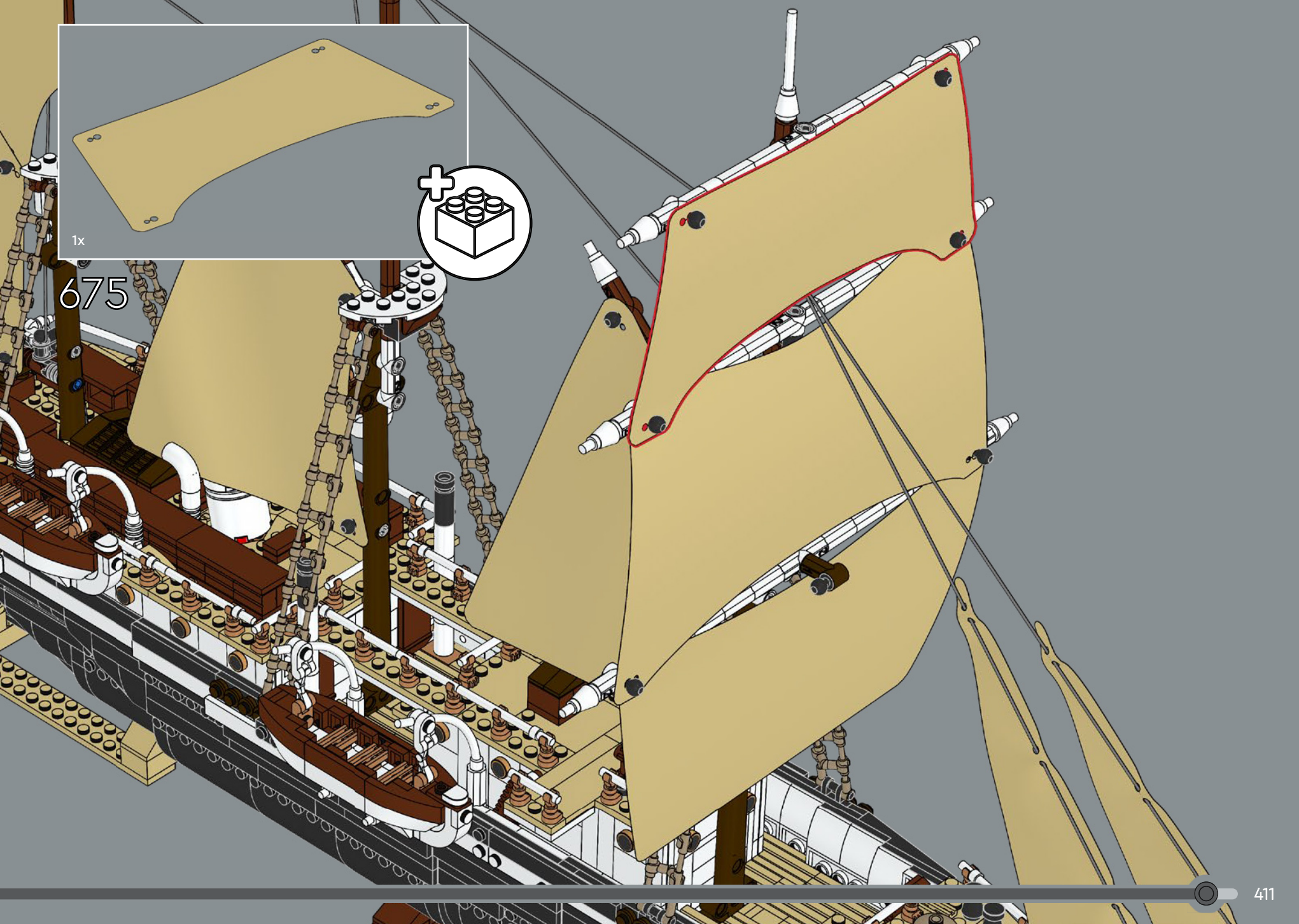

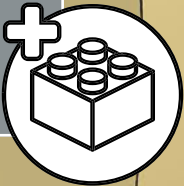
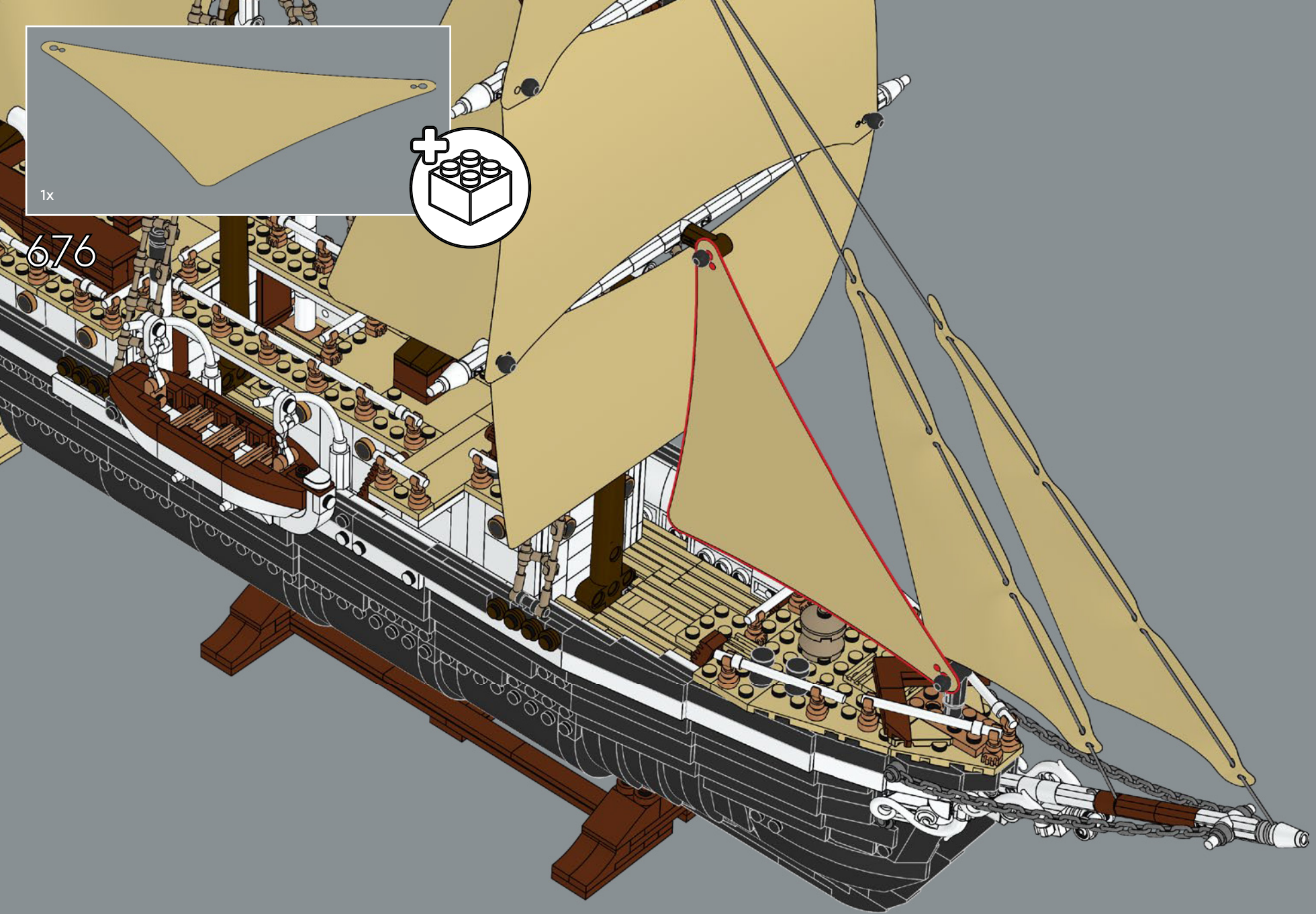

1x

676

677

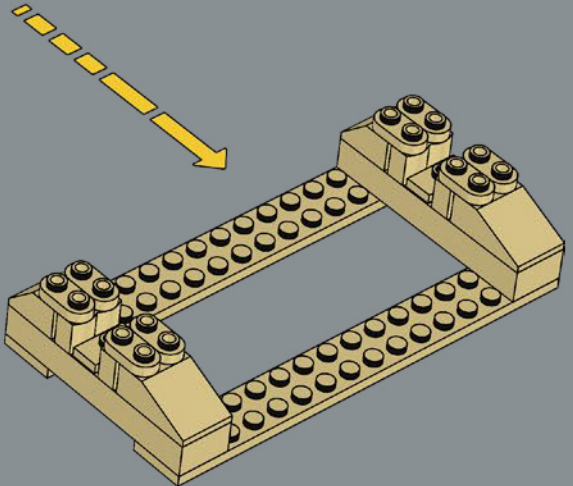
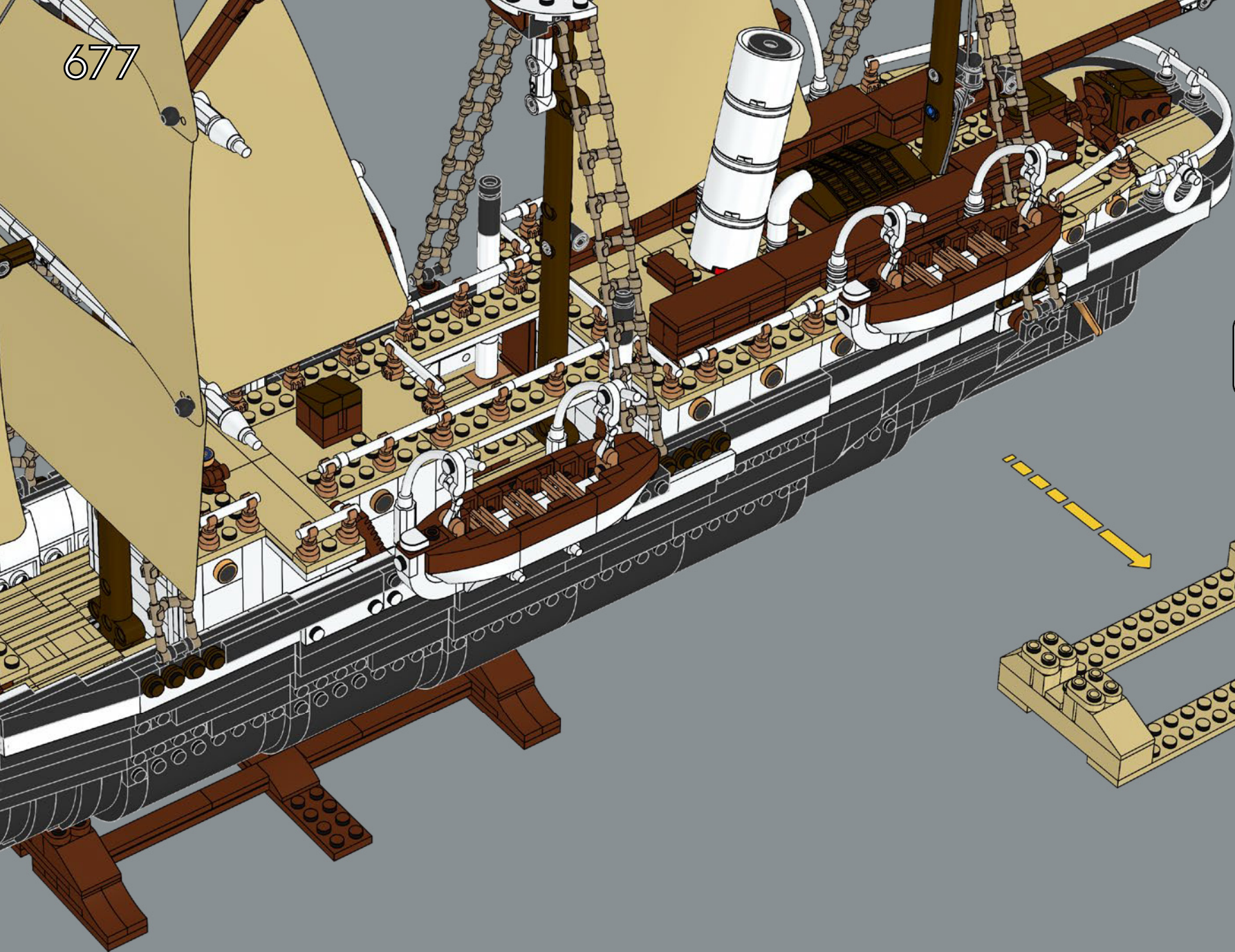

678

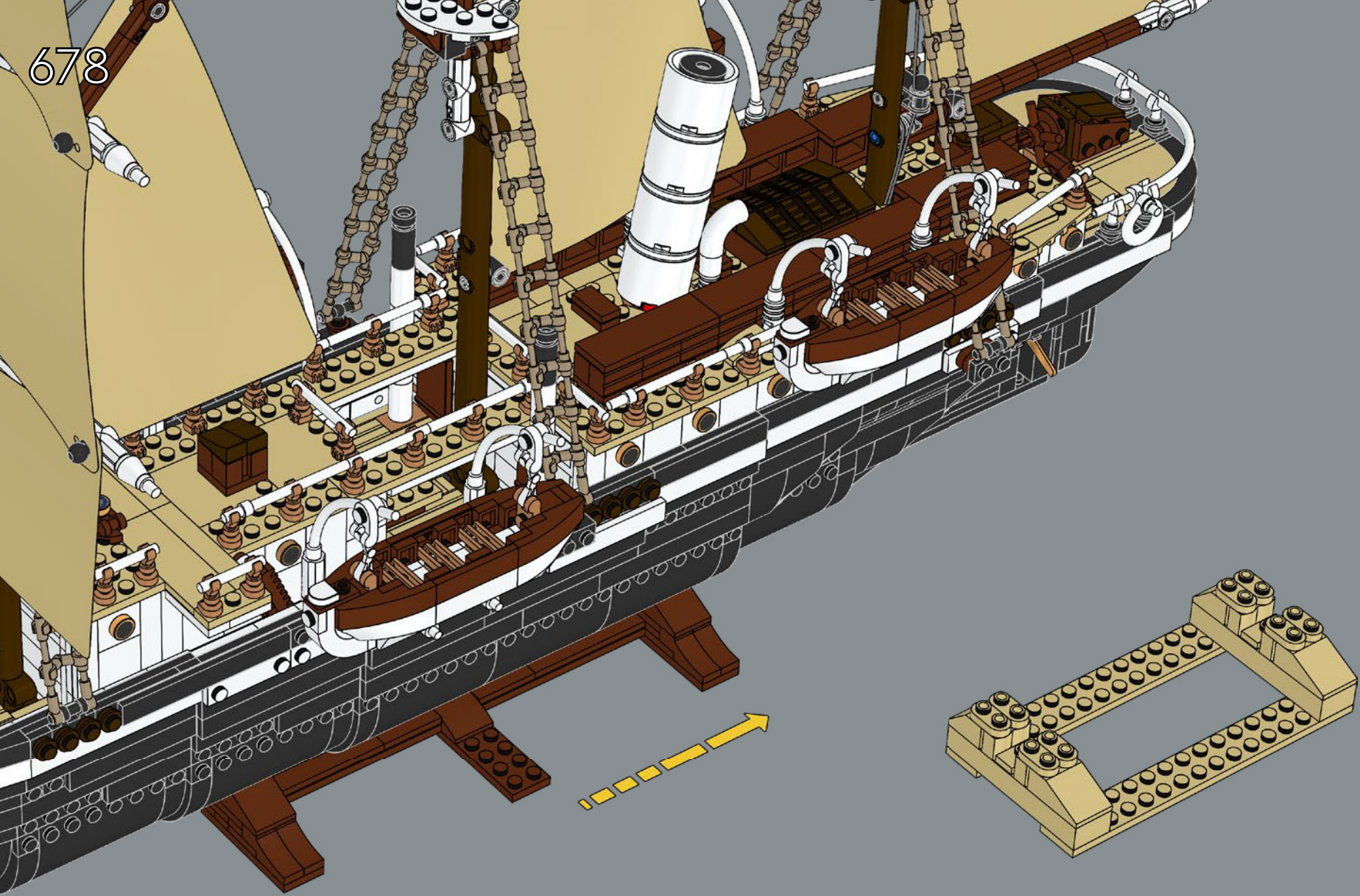

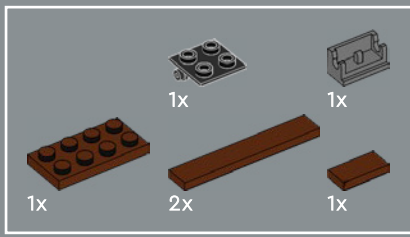

679

1

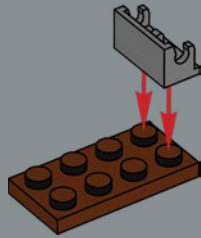

2

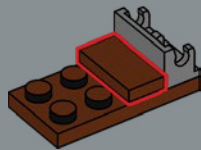

3

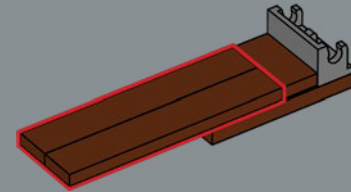

4

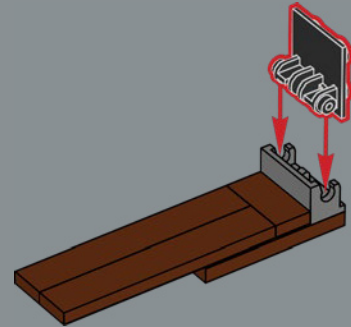

5

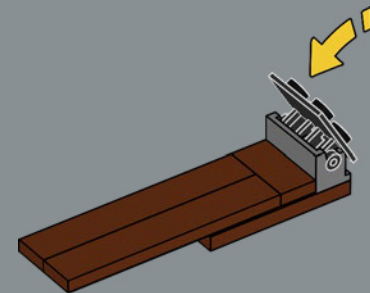

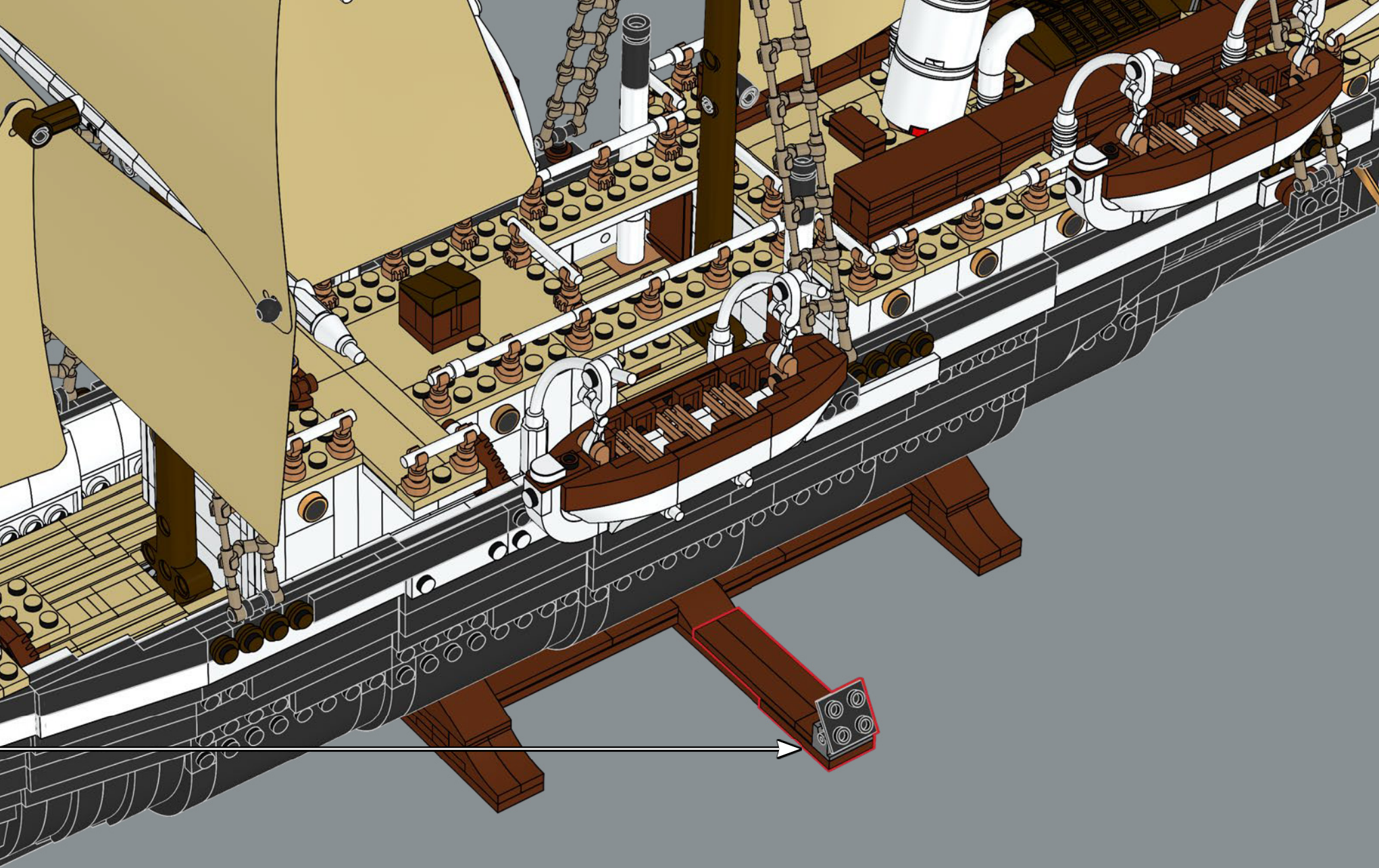

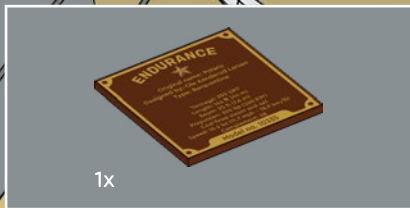

680



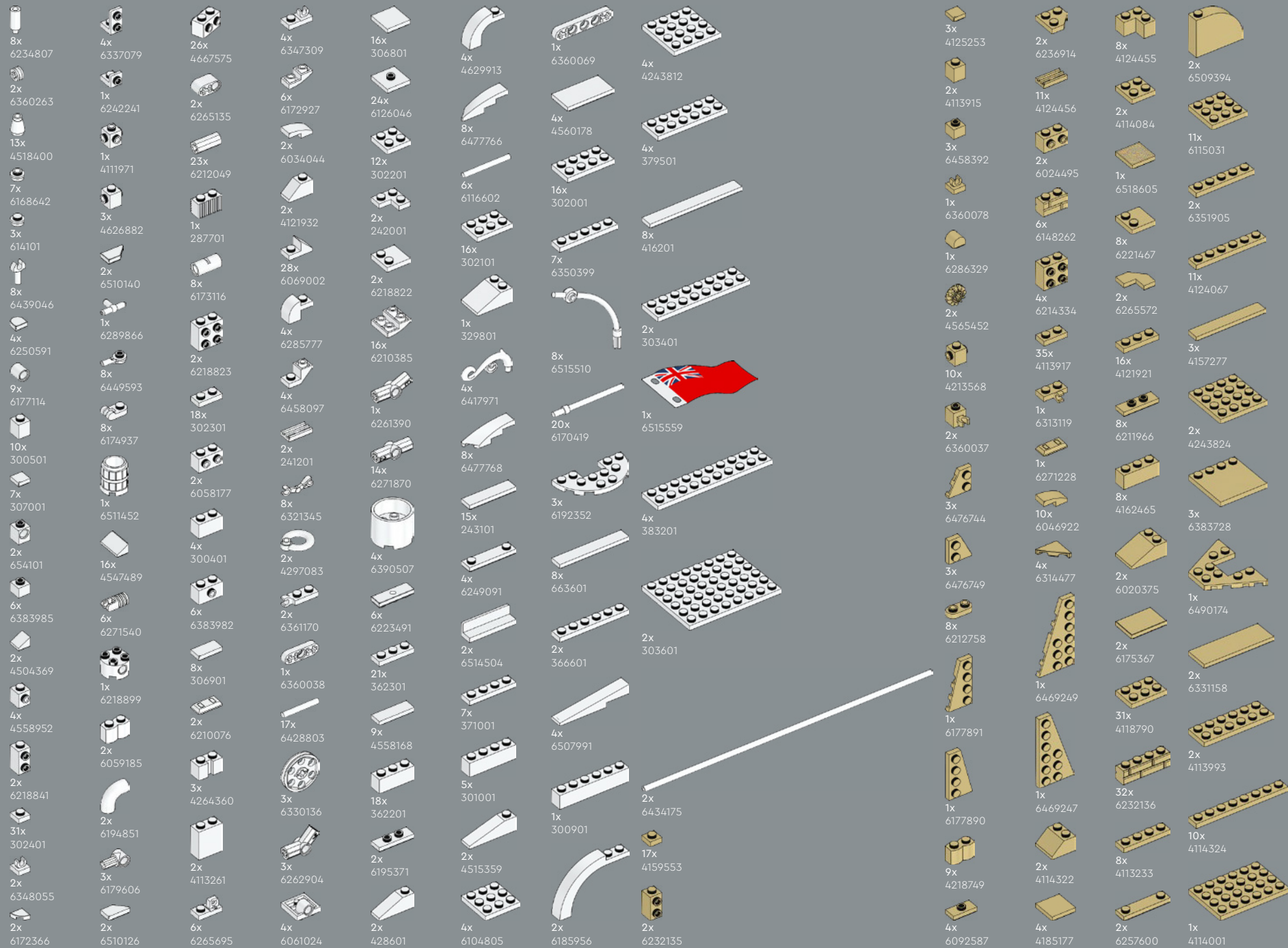

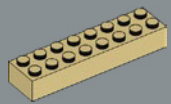

2x
6037398

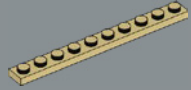

3x
4143409

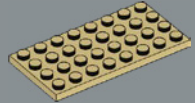

3x
4509897

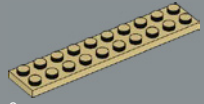

9x
4249019

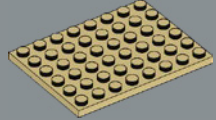

2x
6070501

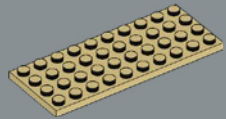

3x
6037834

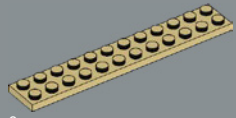

2x
6093864

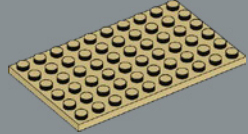

1x
4624185

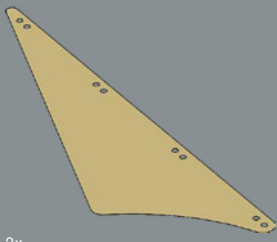

2x
6509959

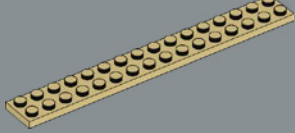

2x
6030980

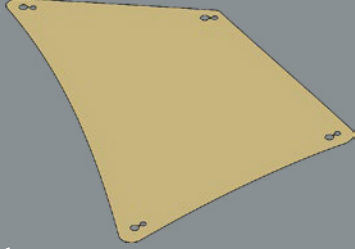

1x
6509952

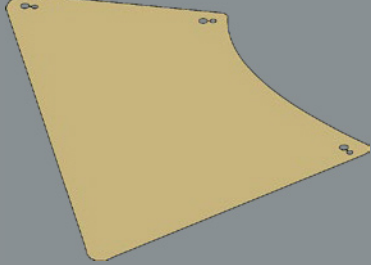

2x
6509954

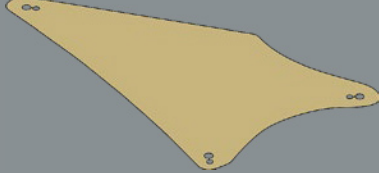

1x
6509953

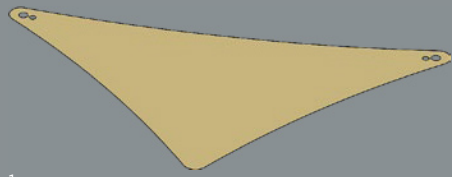

1x
6509958

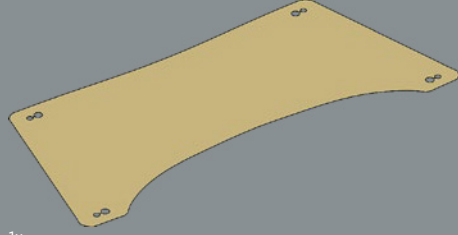

1x
6509955

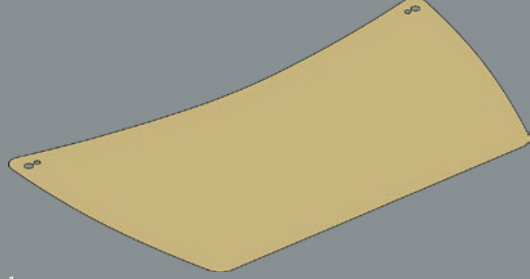

1x
6509957

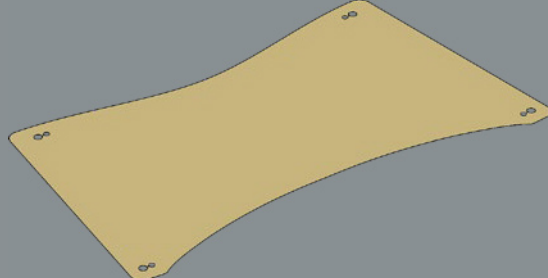

1x
6509956

2x
614121

1x
6271820

64x
4142865



1x
6129995



8x
300121



5x
4206482



4x
6271167

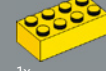

4x
6130007



1x
300124



4x
6186675



6x
6168646



4x
6284070



4x
4529236



1x
6332148



1x
6284699



8x
407026

4x
307026

22x
302426

2x
4504382

1x
654126

4



5x
6388352



2x
6335388



1x
4566308



6x
6234695



3x
4214559



2x
6509664



19x
6344752



1x
6141554



2x
6104209



1x
6265699



1x
6141556



2x
4180536



2x
4180508

6x
6513918

10x
4548180



2x
6051508



4x
6477759



9x
403226



18x
6279875



1x
4109810



1x
6271535



2x
6195325



1x
6143850



4x
6507846



6x
6282140



1x
4283260



28x
4253815



2x
6173119

7x
6047276

2x
6475339

18x
302326



2x
393726



1x
366526



8x
300426



9x
6092585



5x
306926



7x
6184784



6x
6069000



2x
4121966



4x
4140588



3x
4283047



3x
4283046



1x
6266224



1x
6396457

8x
242026



6x
303926



10x
302226



2x
6053077



2x
6390748



2x
4567436



3x
4124096



1x
6089119



1x
6276951



14x
362326



8x
428626



7x
362226



5x
4526931



1x
4251161

3x
6517676

2x
6390749





2x
4271874



1x
6511449



2x
6469351



3x
4211214



6x
6055145

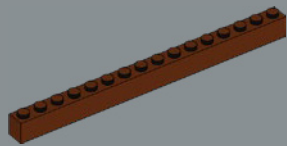

2x
6258989

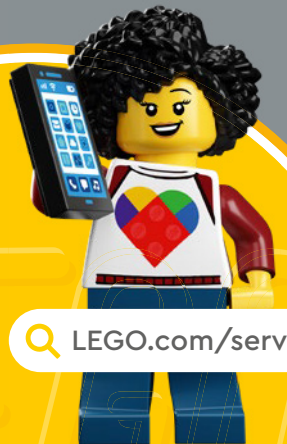

[LEGO.com/service](https://www.LEGO.com/service)

1x
6271165

2x
6275844

4x
6225242

6x
4211476

2x
4211389

1x
6329584

1x
6253856

2x
6248890

1x
6227897

1x
4211807

3x
4278273

3x
4211526

1x
6092956

1x
4512360

3x
6066097

4x
6123809

2x
6383177

6x
4211398

1x
4211470

1x
6004990

2x
6360043

10x
4211387

4x
4211397

9x
4211815

1x
4211536

4x
4211429

1x
6381253

6x
6093058

1x
4211773

8x
4211394

8x
4211425

8x
4251149

2x
6178172

2x
4211522

3

4x
4211090

6x
6231765

2x
6439040

4x
6395635

3x
6362259

7x
6344022

2x
6388133

1x
6225494

1x
4211042

1x
6115080

1x
6514456

2x
6230233

1x
4211066

3x
6092572

2x
6310596

6x
4210635

11

2x
6405646

6x
6015356

2x
4211133

3x
6365692

1x
4239891

1x
6378143

12x
4211043

4x
4211105

8x
4211001

1x
4211103

13x
6039176

2x
6431485

1x
4508553

11x
4211002

55

2x
4499858

1x
4211099

2x
4211114

3x
6258887

1x
6510133

32x
6511448

1x
6287847

2x
6186672

1x
6328909

1x
6034543

1x
6490722

32x
6315780

3x
6322813

1x
6332586

8

8x
6509391

8x
6509392

1x
4566688

2x
6058221

2x
6347604

1x
6515036

1x
6331950

3x
6258887

1x
6510133

32x
6511448

1x
6287847

2x
6186672

1x
6328909

1x
6034543

1x
6490722

3x
6057986

3x
6314190

3x
6457557

4x
6215606

2x
6474266

12x
6324205

2x
6360035

10x
4651231

2x
6192920

22x
6218360

2x
6431328

4x
6411587

2x
4656783

12x
6452541

8x
6167699

1x
6336665

4x
6055309

1x
6257605

2x
6489195

31x
6343854

2x
6313600

4x
6208446

1x
6474270

1x
6474270

1x
6474270

1x
6492479

1x
6452866

1x
6452866

1x
6452866

1x
6452866

1x
6452866



YOU COULD WIN



YOU COULD WIN

Your feedback will help shape the future development of this product series.

Visit:

DU KÖNNTEST GEWINNEN

Dein Feedback trägt zur Weiterentwicklung dieser Produktreihe bei.

Geh auf:

VOUS POURRIEZ GAGNER

Vos commentaires nous aideront à concevoir les futurs produits de cette gamme.

Visitez :

POTRESTI VINCERE TU

La tua opinione ci aiuterà a migliorare la creazione futura di questa linea di prodotti.

Visita:

PUEDES GANAR

Tu opinión contribuirá al futuro de esta serie de productos.

Visita:

轻松获奖

您的反馈将有助于我们在今后改进本产品系列。

请访问:

[LEGO.com/productfeedback](https://www.lego.com/productfeedback)

You also have the chance to win a LEGO® set.

Terms and conditions apply.*

Außerdem hast du die Chance, ein LEGO® Set zu gewinnen.

Es gelten die Teilnahmebedingungen.*

Vous pourriez également gagner un ensemble LEGO®.

Des conditions s'appliquent.*

Hai anche la possibilità di vincere un set LEGO®.

Termini e condizioni sono applicabili.*

También tienes la oportunidad de ganar un set LEGO®.

Aplican términos y condiciones.*

您还有机会赢取乐高®套装。

条款和条件适用。*

*[LEGO.com/productfeedback-terms](https://www.lego.com/productfeedback-terms)



LEGO and the LEGO logo are trademarks of the LEGO Group.
©2024 The LEGO Group. 6541880