

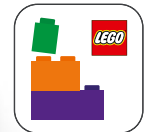

10340



Booklet available in English
Livret disponible en français
Folleto disponible en español



LEGO® Builder

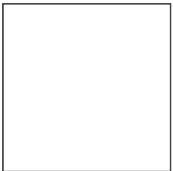



WE'RE MAKING OUR PACKAGING MORE SUSTAINABLE

We're transitioning from single-use plastic to paper-based packaging. As we progress, you may find a mix of paper and plastic in our boxes.

NOUS RENDONS NOS EMBALLAGES PLUS DURABLES

Nous passons des emballages en plastique à usage unique aux emballages à base de papier. Durant la transition, vous pourriez trouver un mélange de papier et de plastique dans nos boîtes.

QUEREMOS HACER MÁS SUSTENTABLES NUESTROS MATERIALES DE EMBALAJE

Estamos cambiando las bolsas de plástico desechables por bolsas con base de papel. Conforme avanzamos en este propósito, puedes encontrar una mezcla de papel y de plástico en nuestras cajas.

LEGO.com/sustainable-packaging



BUILDER



Apple and the Apple logo are trademarks of Apple Inc., registered in the U.S. and other countries and regions. App Store is a service mark of Apple Inc. Google Play and the Google Play logo are trademarks of Google LLC. Tencent and the Tencent logo are trademarks of Tencent Inc.

LEGO.com/devicecheck



LEGO® Builder



Warm feelings for cold days

When the first signs of fall and winter set in, it seems nature invites us to play with all its beautiful, seasonal colors and bounties. Bright berries complement evergreen branches, and leaves seem to radiate and spread rays of warm hues as they fall at your feet. Bringing these gorgeous bundles of color into your home can create cozy sparkles of joy as we wait for lighter days to return. Add to that the delightful sense of accomplishment in the creative process as you bring all the shapes and colors that inspire you together, and you have a perfect excuse to snuggle up and indulge your senses. With this elegantly crafted LEGO® wreath or garland, you can extend that feeling of joy and change your décor all through your winter season.

Des idées chaleureuses pour les jours froids

Lorsque les premiers signes de l'automne et de l'hiver apparaissent, il semble que la nature nous invite à jouer avec toutes ses belles couleurs et ses richesses saisonnières. Les baies éclatantes complètent les branches des arbres à feuilles persistantes, et les feuilles semblent rayonner et répandre des rayons de teintes chaudes lorsqu'elles tombent à nos pieds. L'introduction de ces magnifiques grappes de couleurs dans votre maison peut créer des étincelles de joie douillettes en l'attente d'un retour à des jours plus légers. Ajoutez à cela le merveilleux sentiment d'accomplissement que procure l'assemblage des formes et des couleurs qui vous inspirent, et voilà l'excuse parfaite pour vous emmitoufler et satisfaire vos sens. Avec cette élégante couronne ou guirlande LEGO®, vous pouvez prolonger ce sentiment de joie et modifier votre décor tout au long de la saison hivernale.

Cálidos sentimientos para los días fríos

Cuando el otoño y el invierno dan sus primeras señales, la naturaleza pareciera invitarnos a jugar con los hermosos colores y las bondades de la temporada. Bayas en tonos vivos adornan las ramas de follaje perenne, con hojas que aparentan derramar luminosos reflejos en cálidas tonalidades al caer a tus pies. Llevar esos espléndidos ramilletes cromáticos a tu casa puede llenarla de acogedores destellos de alegría mientras esperamos el regreso de días más luminosos. Si añades a eso la gratificante sensación de logro que conlleva el creativo proceso de conjuntar las formas y colores que más te inspiran, tendrás la excusa perfecta para acurrucarte y complacer a tus sentidos. Con esta elegante corona o centro de mesa LEGO®, podrás dar una pincelada de novedad a tu decoración y prolongar la alegre experiencia durante toda la temporada invernal.



Holiday aromas

Each season has its charms. Even dark winter days give us moments of light to share with loved ones. Nothing evokes fond memories like the sweet, aromatic fragrances of the holiday season – invigorating fir tree foliage, zesty orange slices, warm cinnamon, or earthy pine sap. When you sit down to build this set, you can find inspiration from all these familiar scents and spices. Build a decorative wreath to hang on the wall, or a festive garland centerpiece for your table. Add your own creative touch and customize it to suit your celebration, mood, or interior décor. From the shape of the arrangement to the tiny details, simply swap out the berries or reconfigure the decorative elements and experiment with the elements to create new expressions. We hope this leaves you feeling toasty and comfortable on cool days, and that you will create new memories to look back on for years to come.

KENYON ANDREW BRADY

LEGO® Model Designer

Arômes festifs

Chaque saison a ses charmes. Même les sombres journées d'hiver nous offrent des moments de lumière à partager avec nos proches. Rien n'évoque autant de bons souvenirs que les doux parfums aromatiques des Fêtes : le feuillage vivifiant du sapin, les tranches d'orange acidulées, la cannelle chaude ou la sève de pin terreuse. Lorsque vous construirez cet ensemble, vous pourrez vous inspirer de toutes ces senteurs et épices familières. Créez une couronne décorative à accrocher au mur ou une guirlande festive à placer au centre de votre table. Ajoutez votre propre touche créative et personnalisez votre modèle en fonction de votre célébration, de votre humeur ou de votre décor intérieur. De la forme de la composition aux moindres détails, il suffit de remplacer les baies ou de reconfigurer les éléments décoratifs et d'expérimenter avec les éléments pour créer de nouvelles expressions. Nous espérons que vous vous sentirez bien au chaud et à l'aise pendant les journées froides, et que vous créerez de nouveaux souvenirs dont vous vous souviendrez pendant des années.

KENYON ANDREW BRADY

concepteur de modèles LEGO®





El aroma de la temporada de celebraciones

Cada estación tiene su encanto. Incluso los oscuros días del invierno nos regalan momentos de luz para compartir con nuestros seres queridos. Y nada evoca tan buenos recuerdos como las dulces y aromáticas fragancias de las fiestas: el vigorizante follaje de los abetos, las revitalizantes rebanadas de naranja, la cálida canela o la terrosa savia de pino. Cuando te sientes a construir este set, podrás inspirarte en todos esos aromas y especias que tan bien conoces. Crea una corona decorativa para colgar en la pared o un centro de mesa para decorar tu comedor. Añádele tu propio toque creativo al modelo y personalízalo para adaptarlo a tu celebración, estado de ánimo o decoración interior. Desde la forma del arreglo hasta los pequeños detalles, basta con que cambies de lugar las bayas o reconfigures los elementos decorativos y experimentes con ellos para crear nuevas expresiones. Esperamos que esta experiencia te brinde calidez y comodidad en los días fríos, así como la oportunidad de crear nuevos recuerdos para los años venideros.

KENYON ANDREW BRADY
Modelista de LEGO®



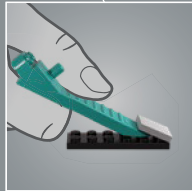
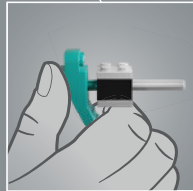
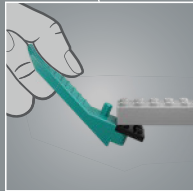
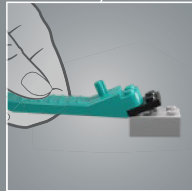
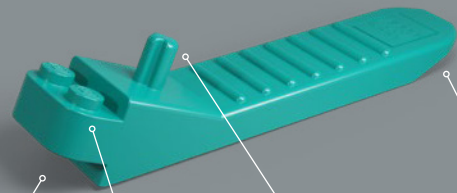

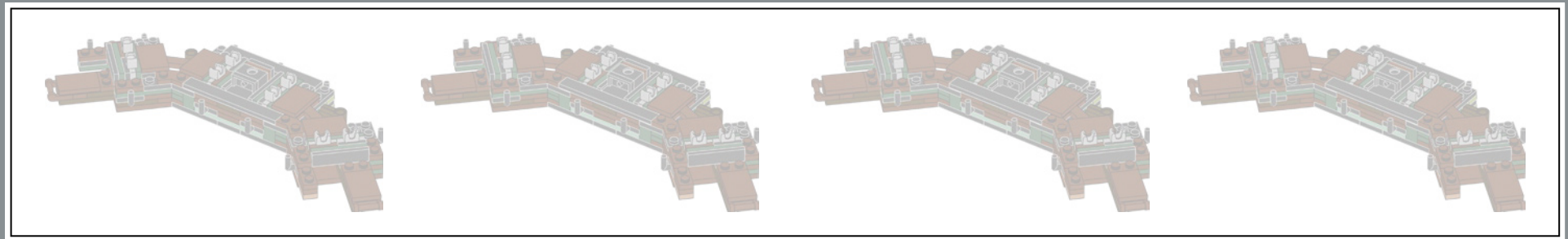

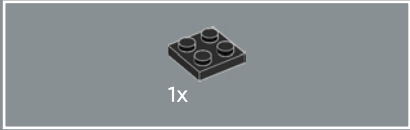
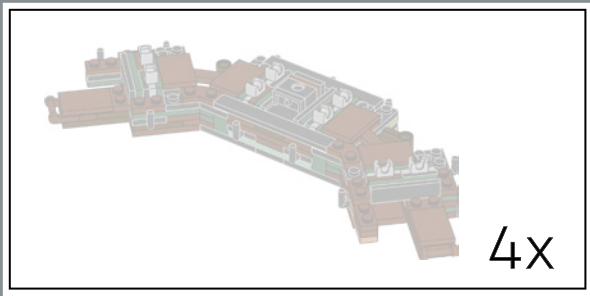

1

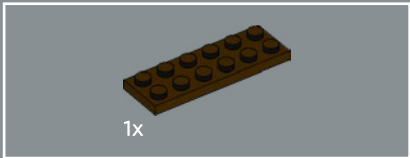
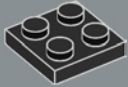

2

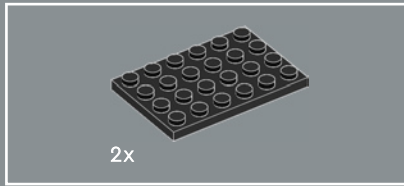
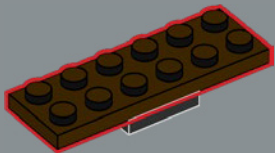

3

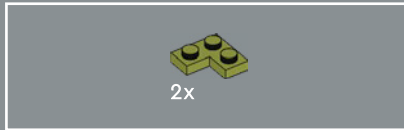
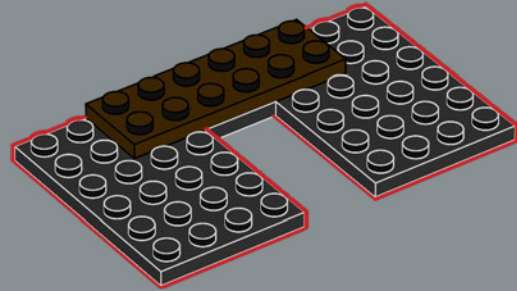

4

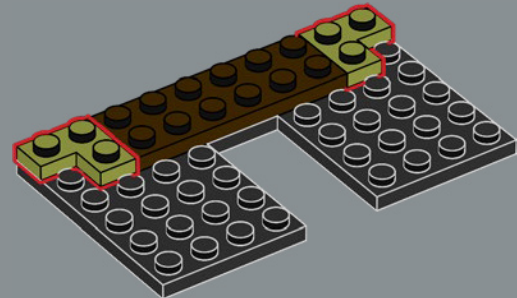

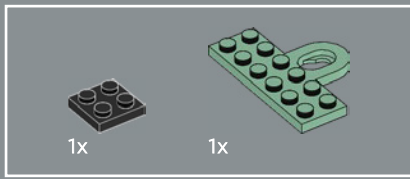

5

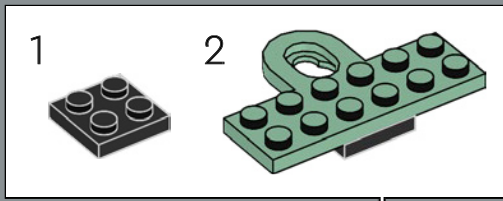
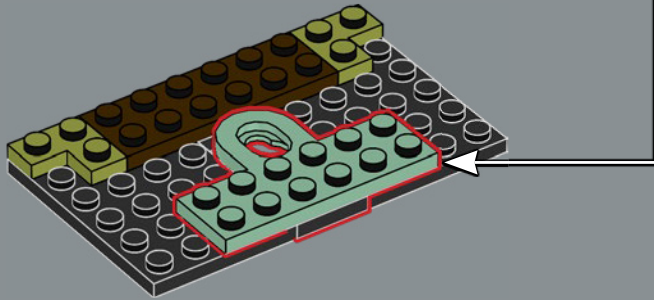

7

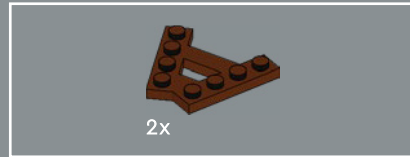
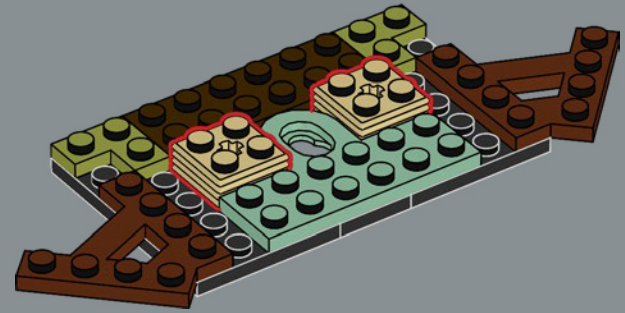

6

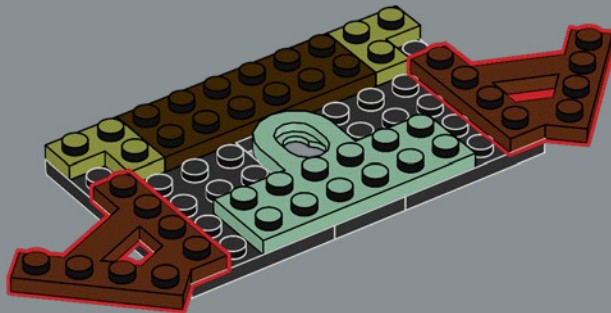

8

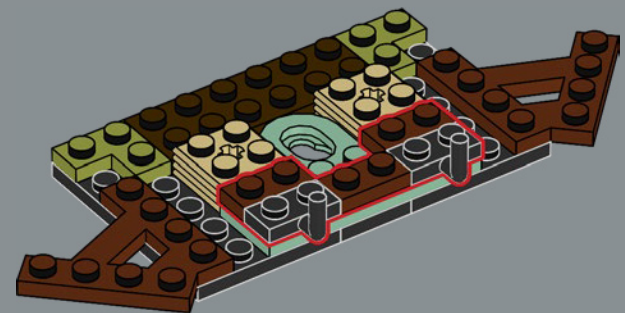

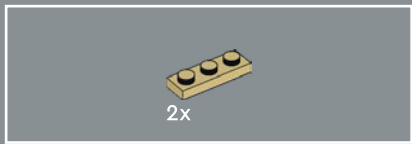

9

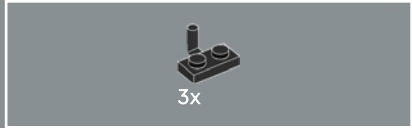
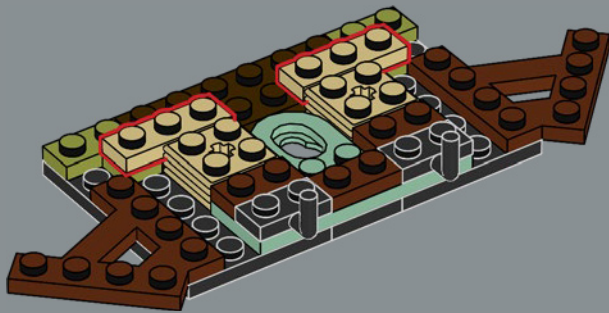

10

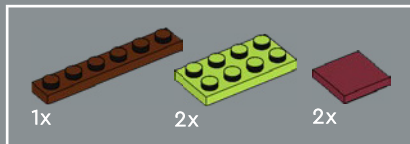
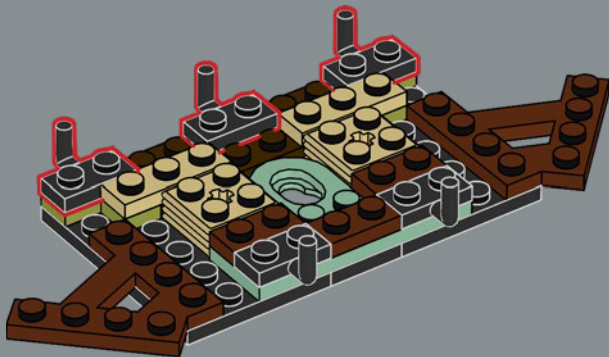

11

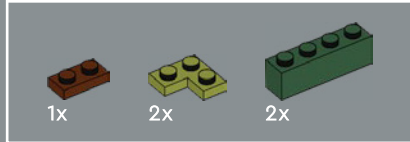
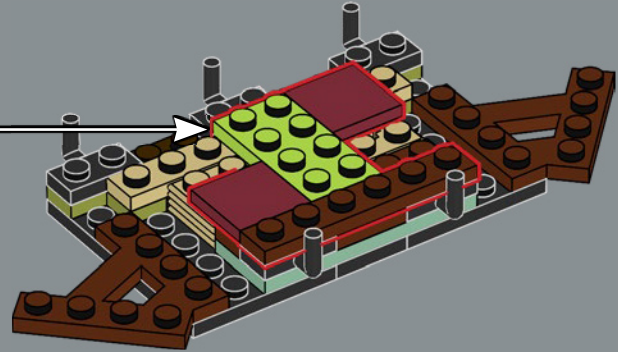
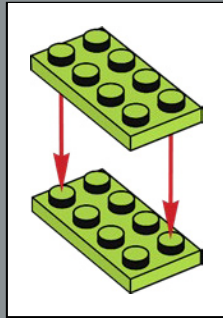

12

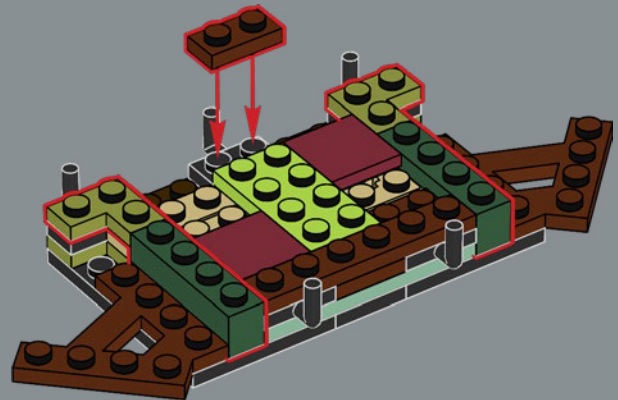



13

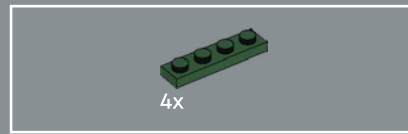
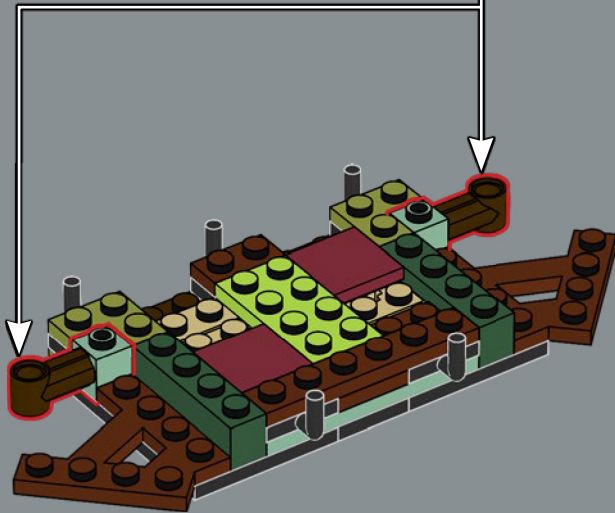
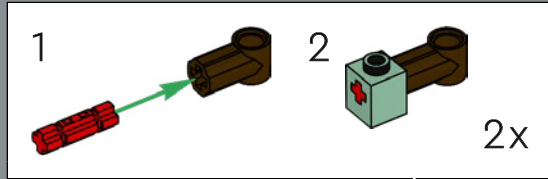

14

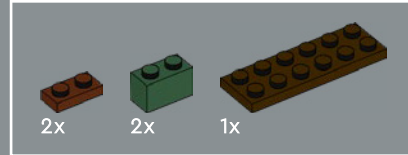
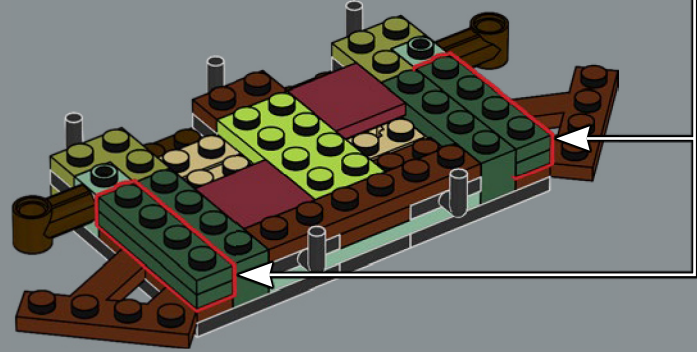
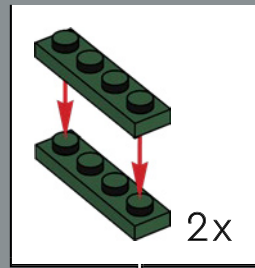

15

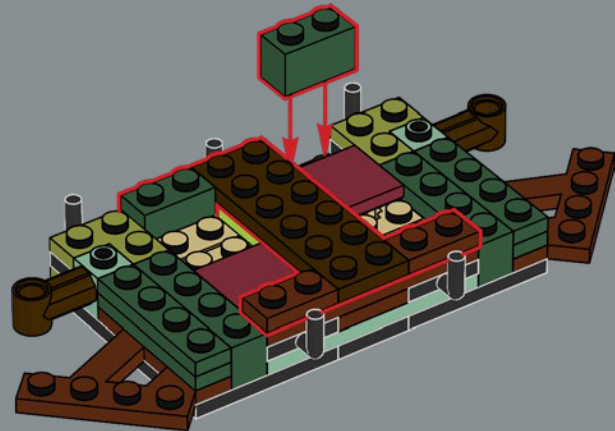

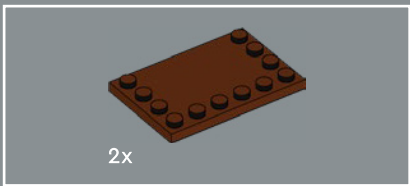

16

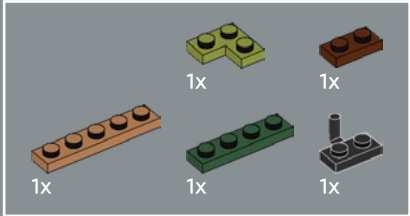
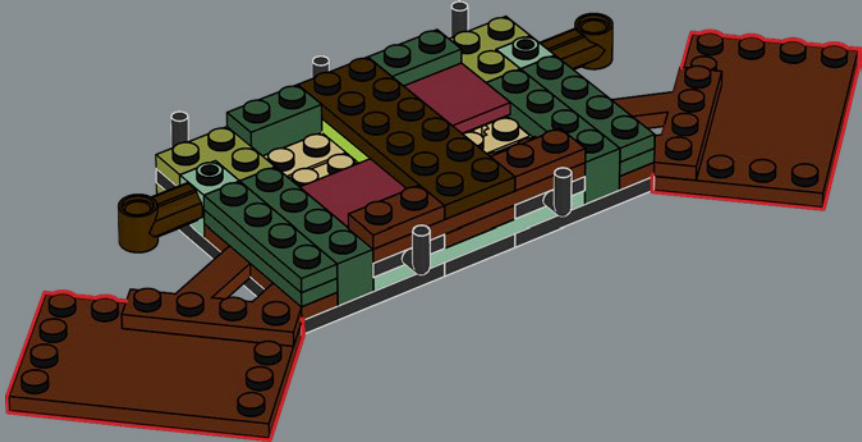

17

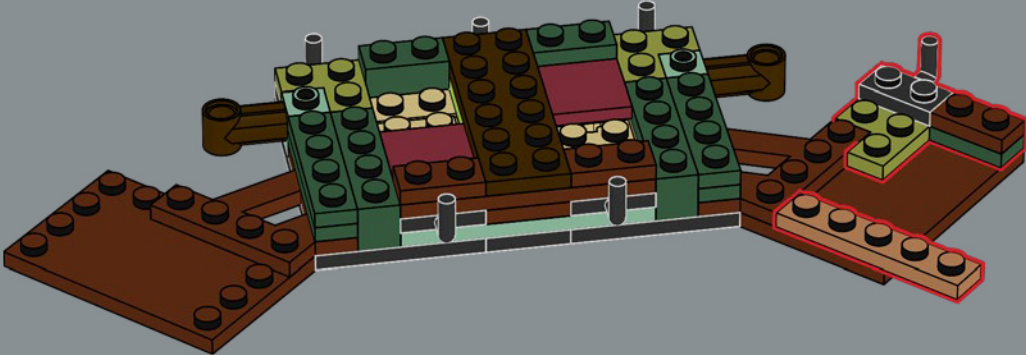
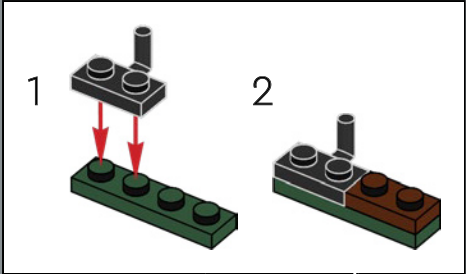

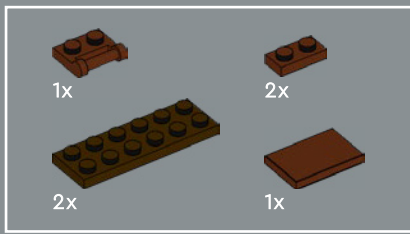

18

1

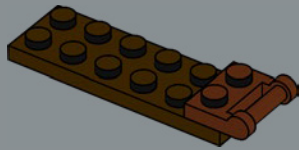

2

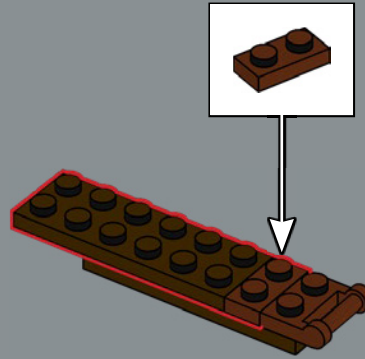

3

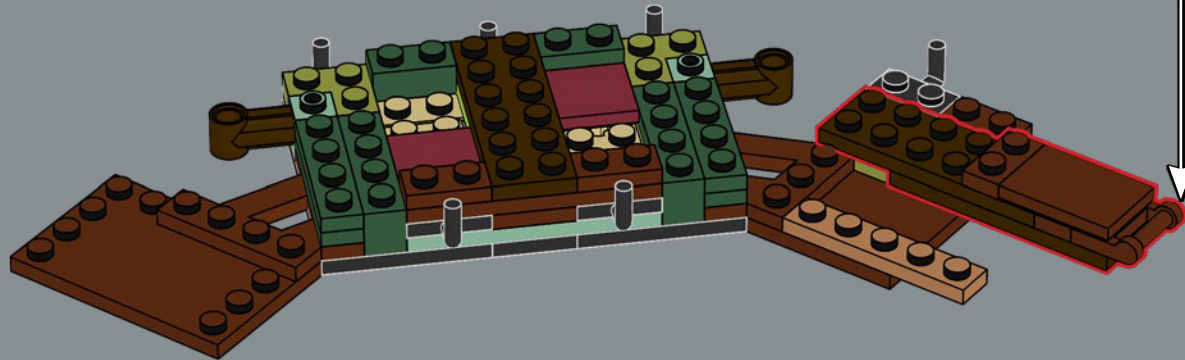
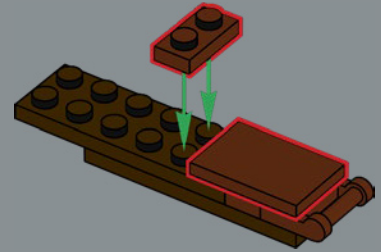

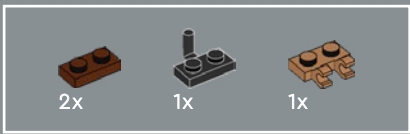

19

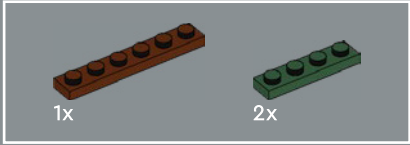
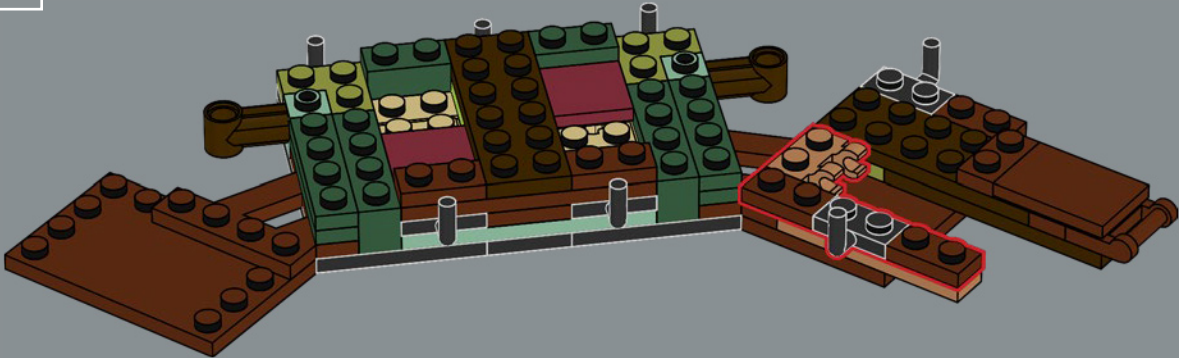

20

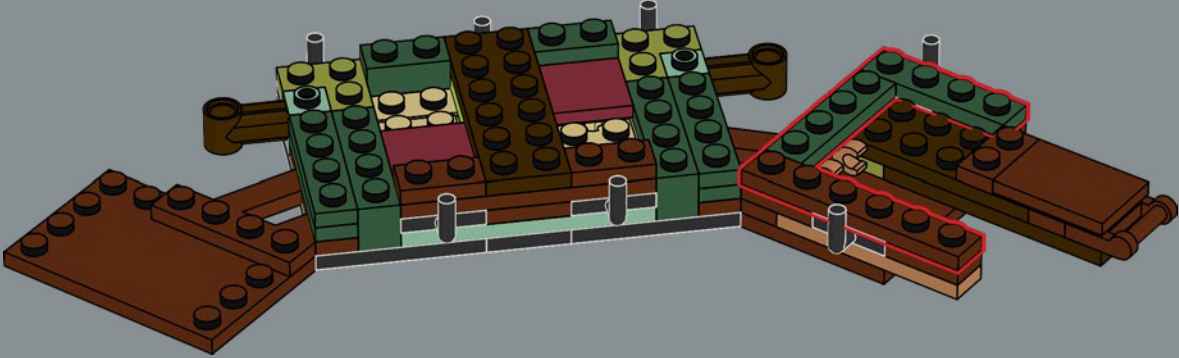



21

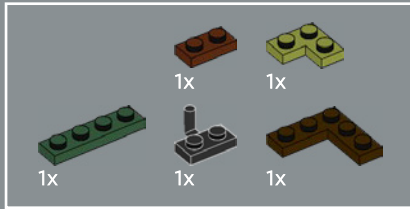
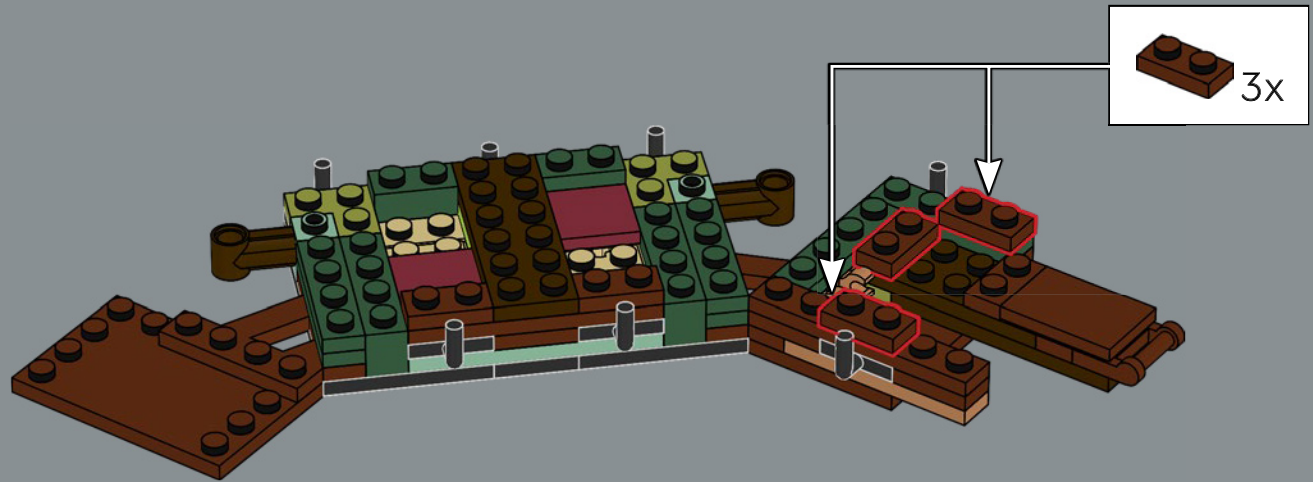

22

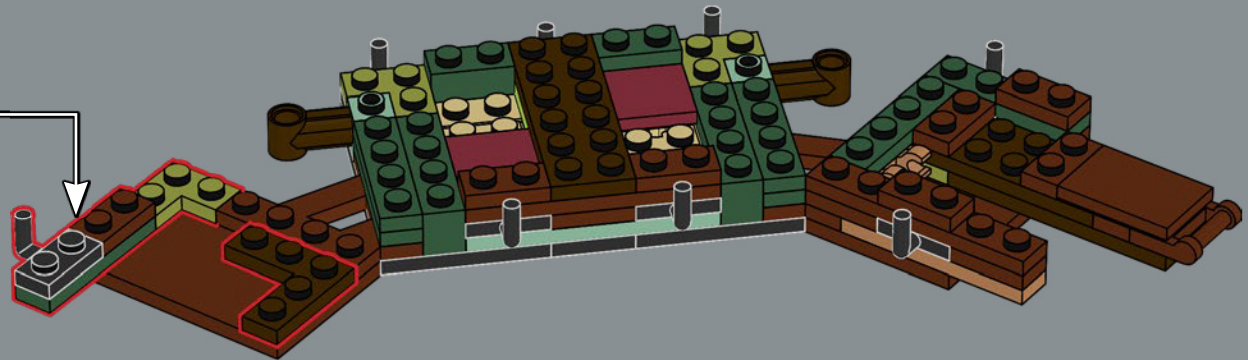
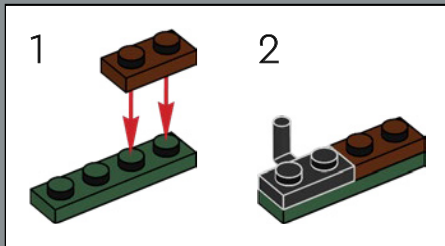



23

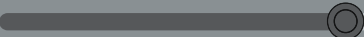
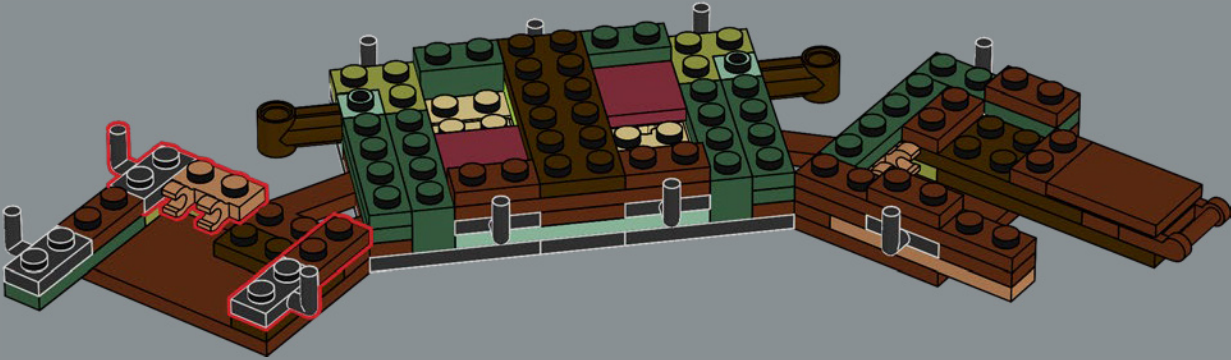

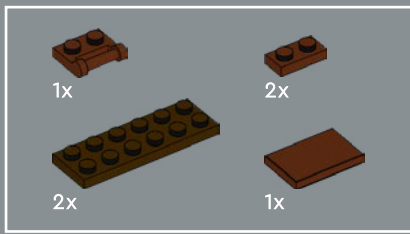

24

1

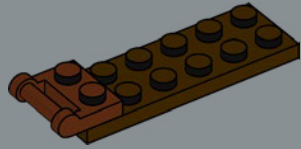

2

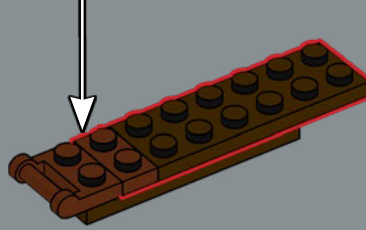

3

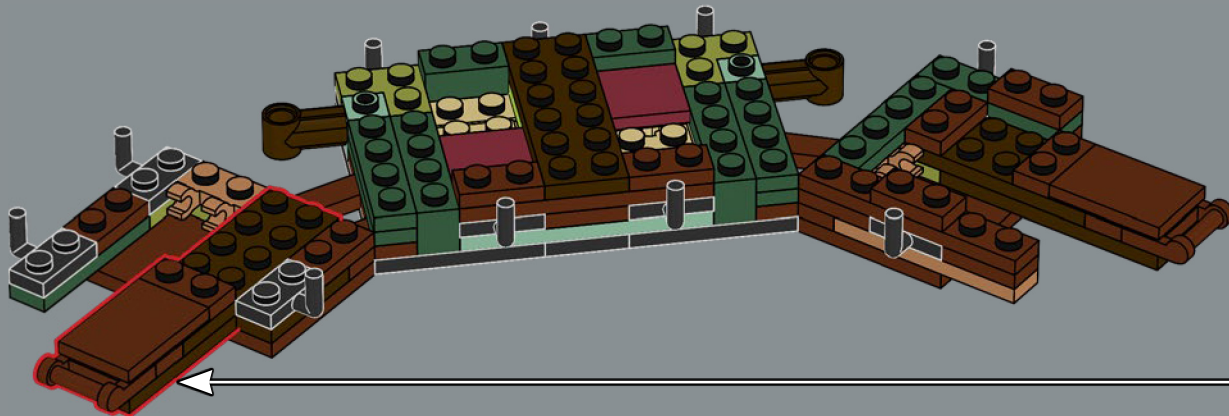
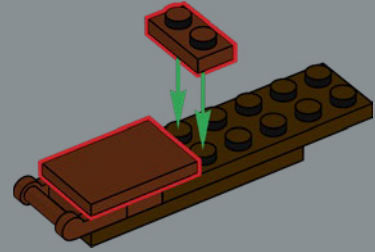

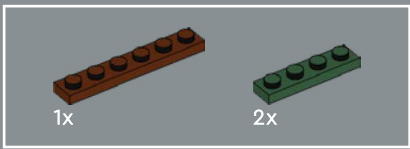

25

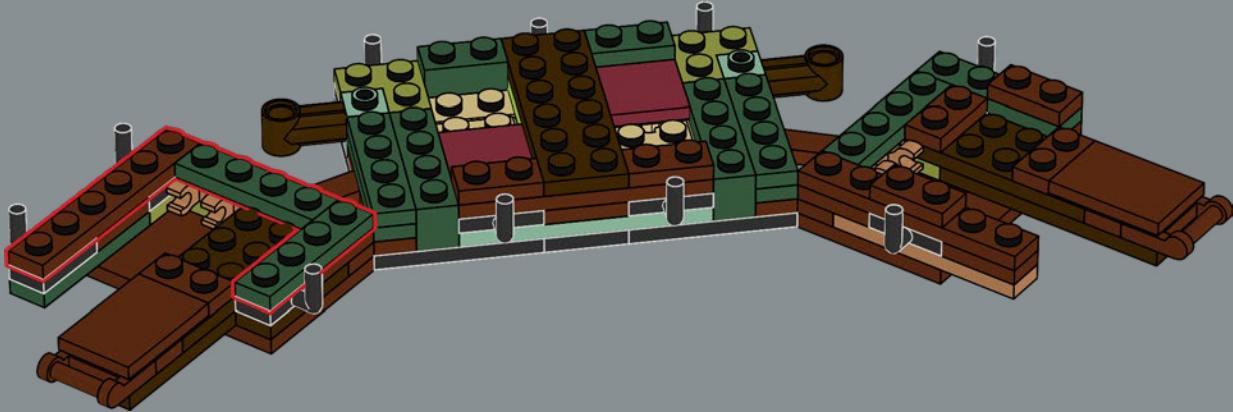

26

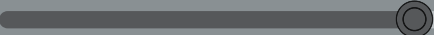
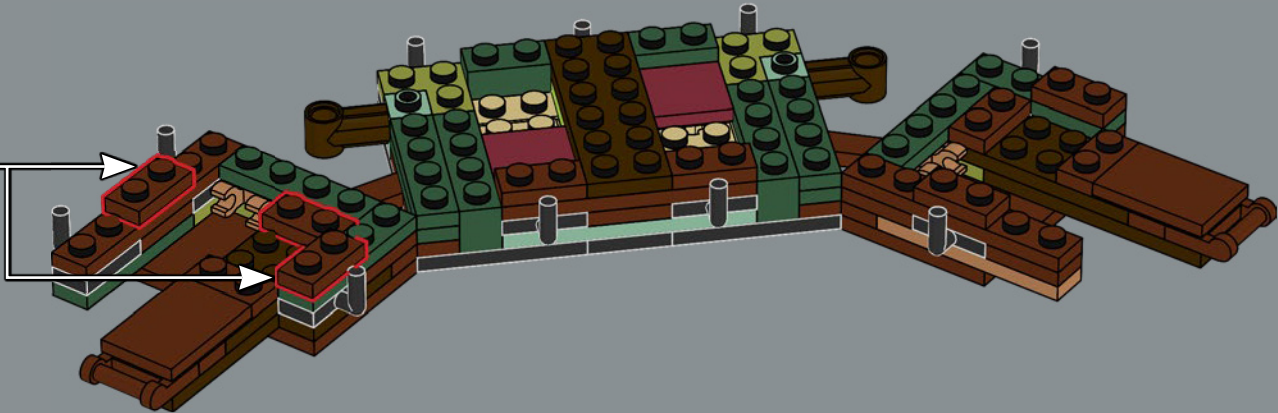

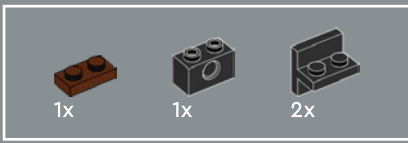

27

1

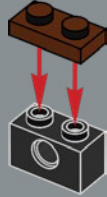

2

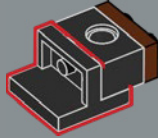

3

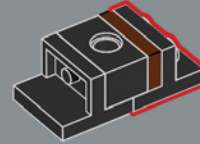

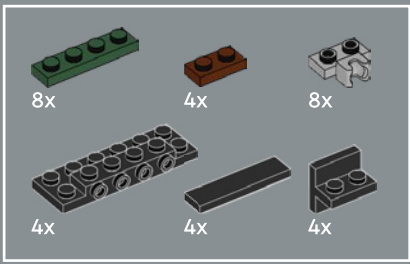

28

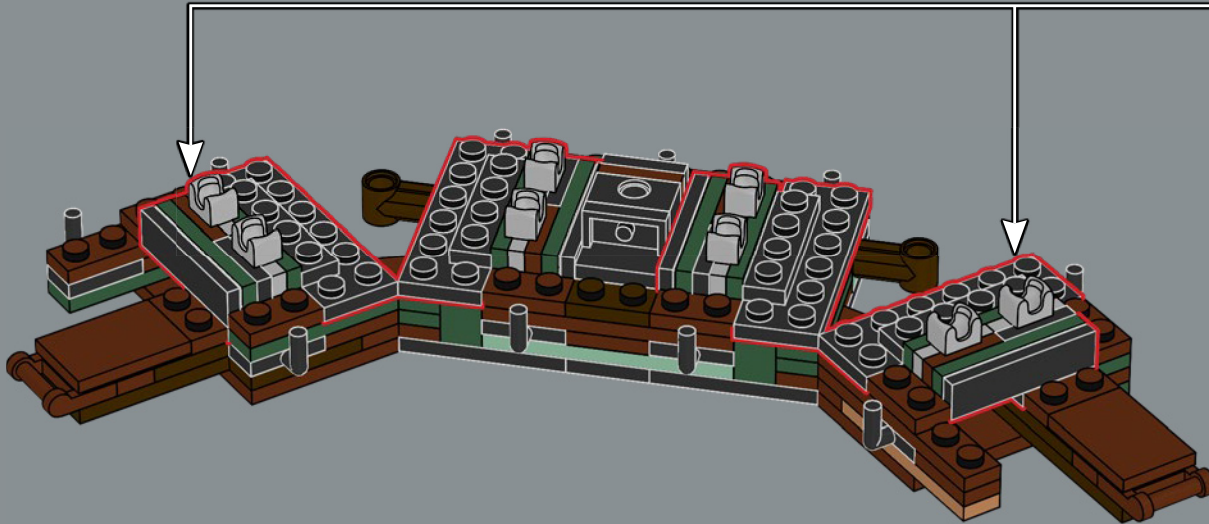
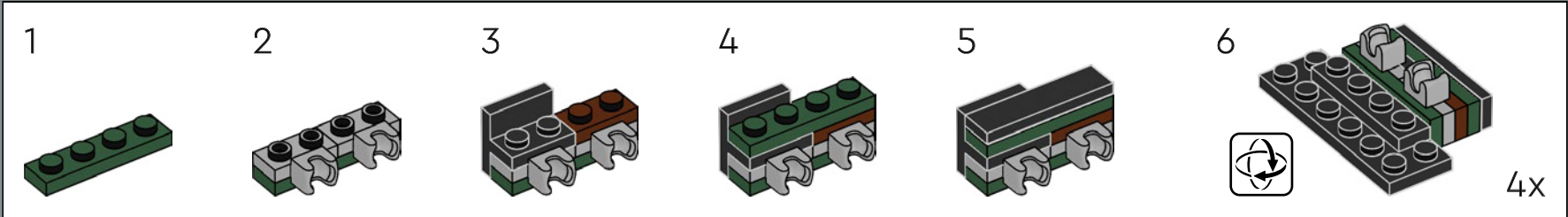



29

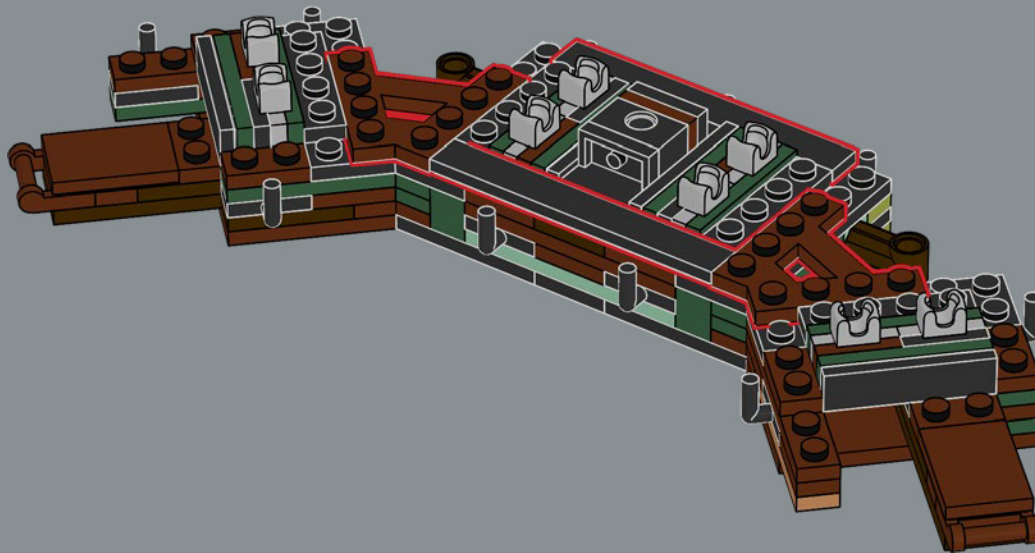

30

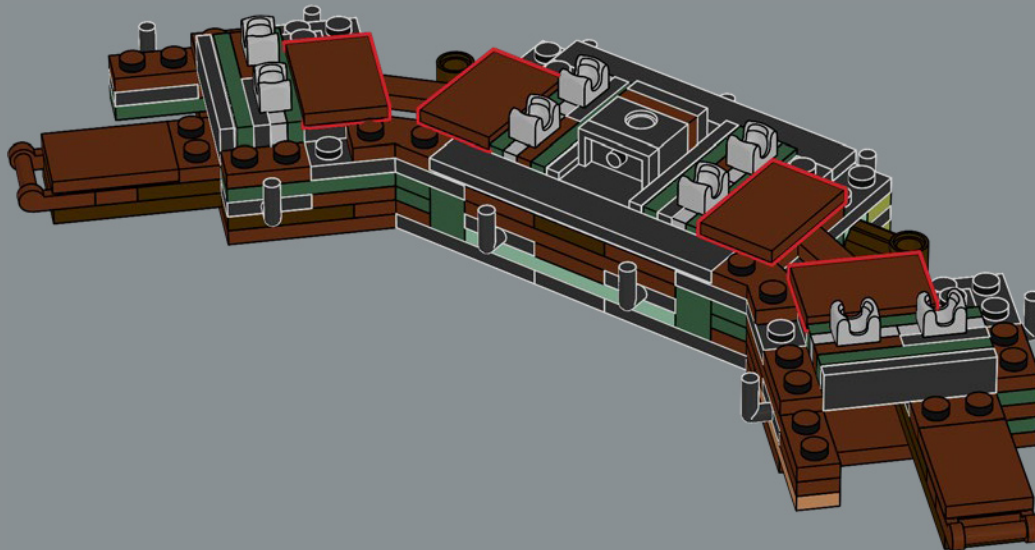

4x

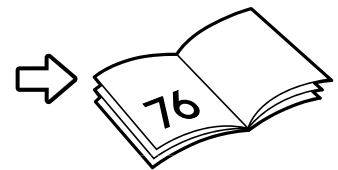
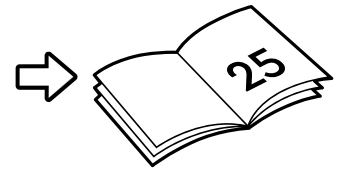



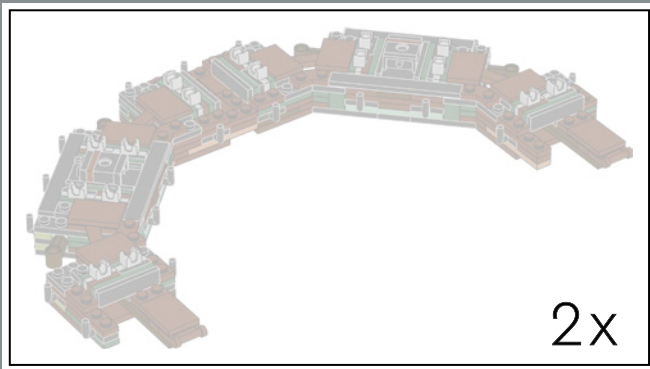

2x

31

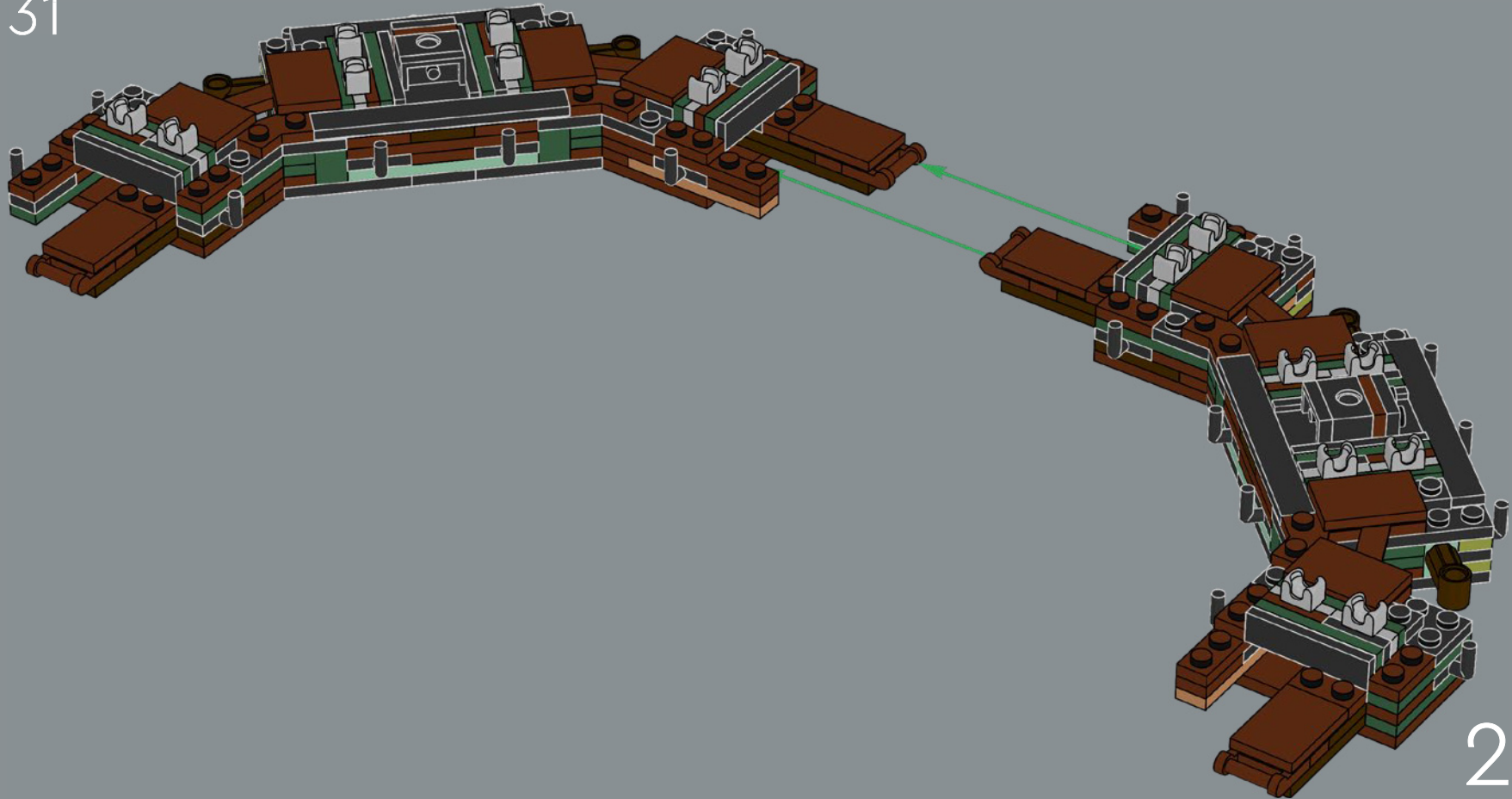

2x



32

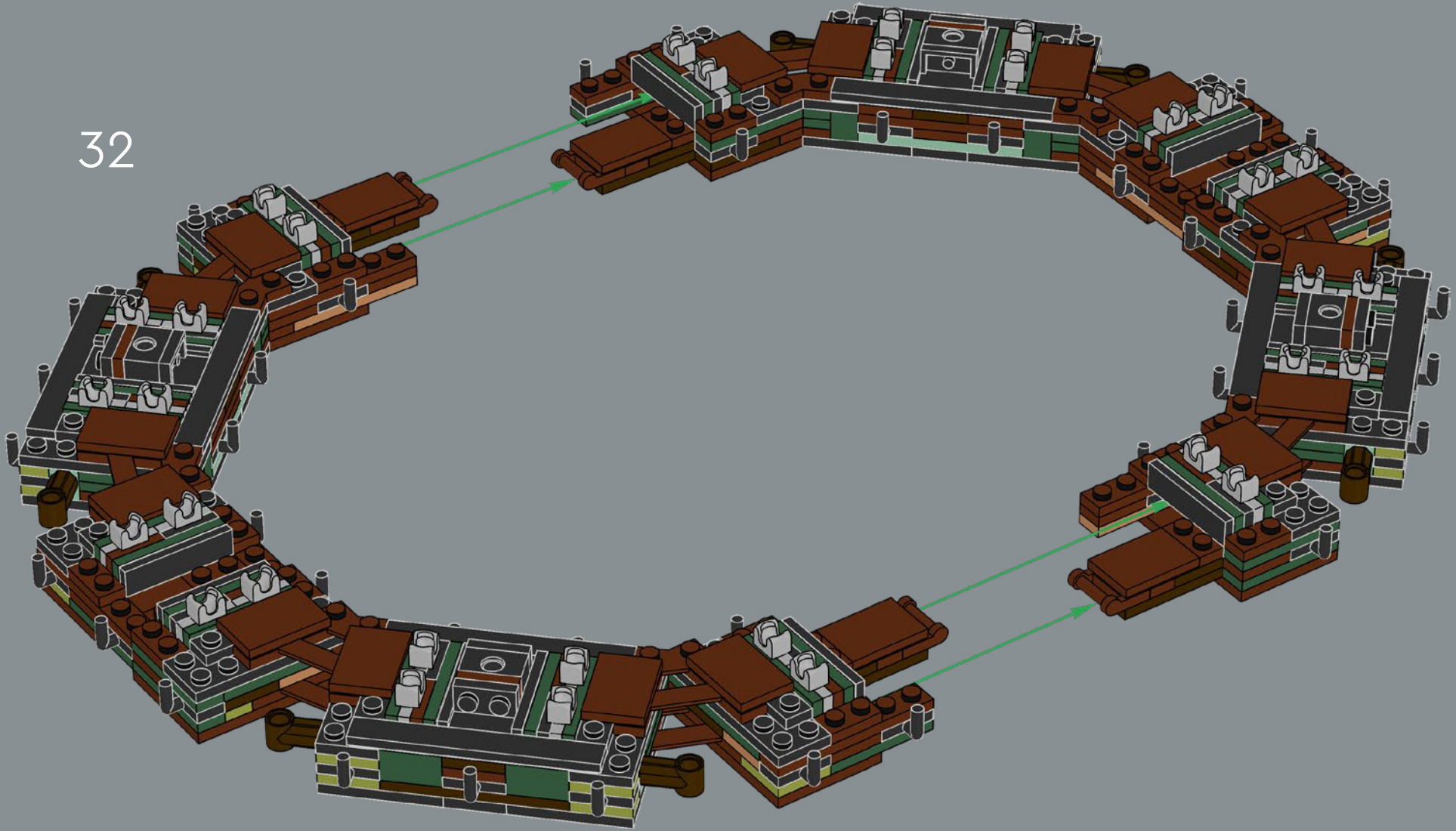



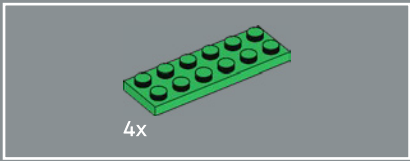

33



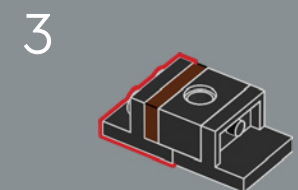
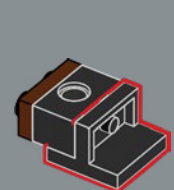
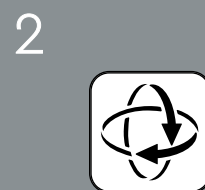
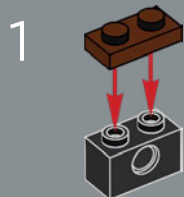
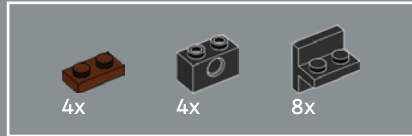
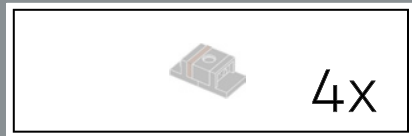

4x

34

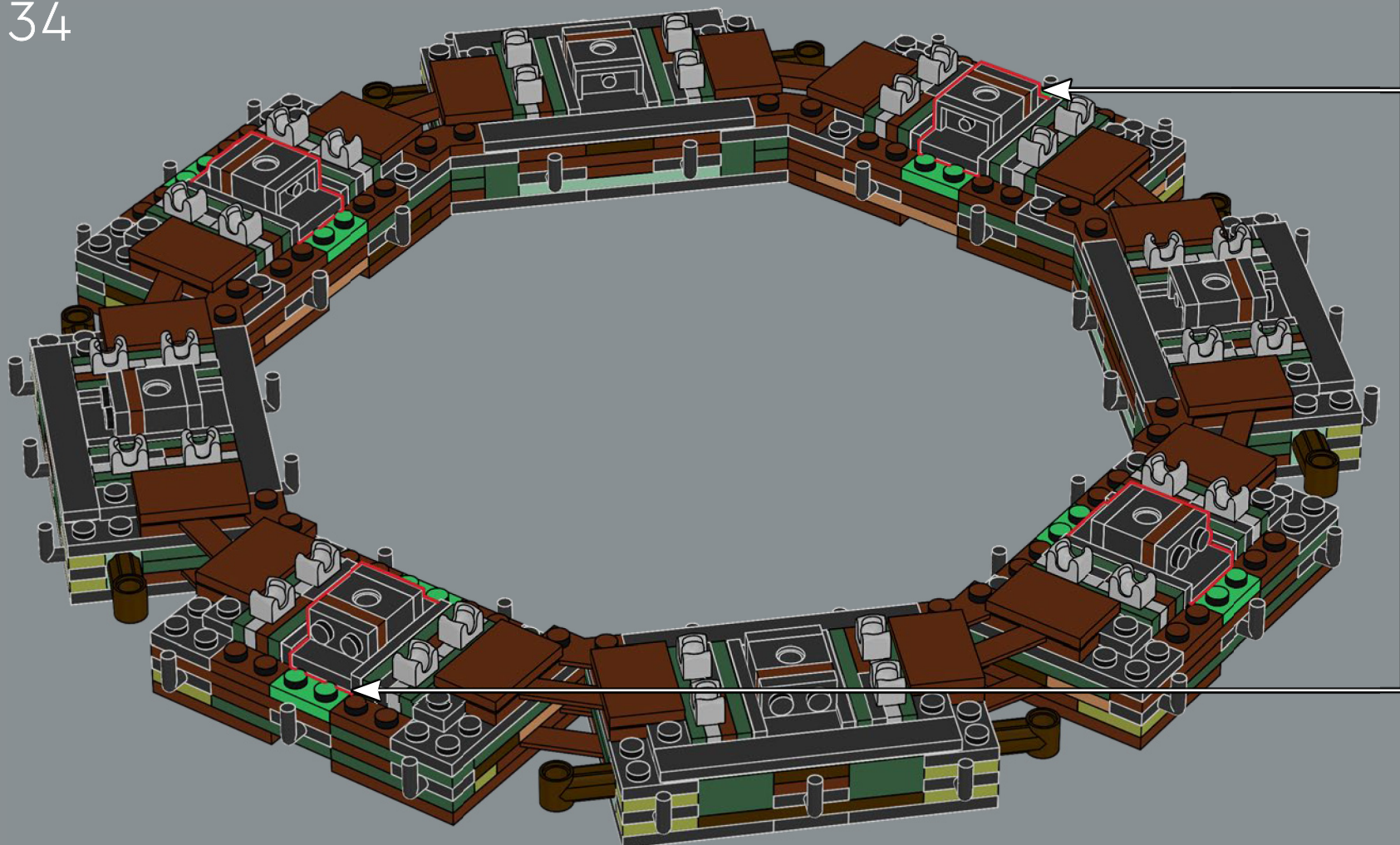

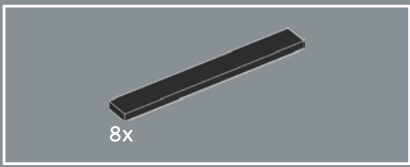

35

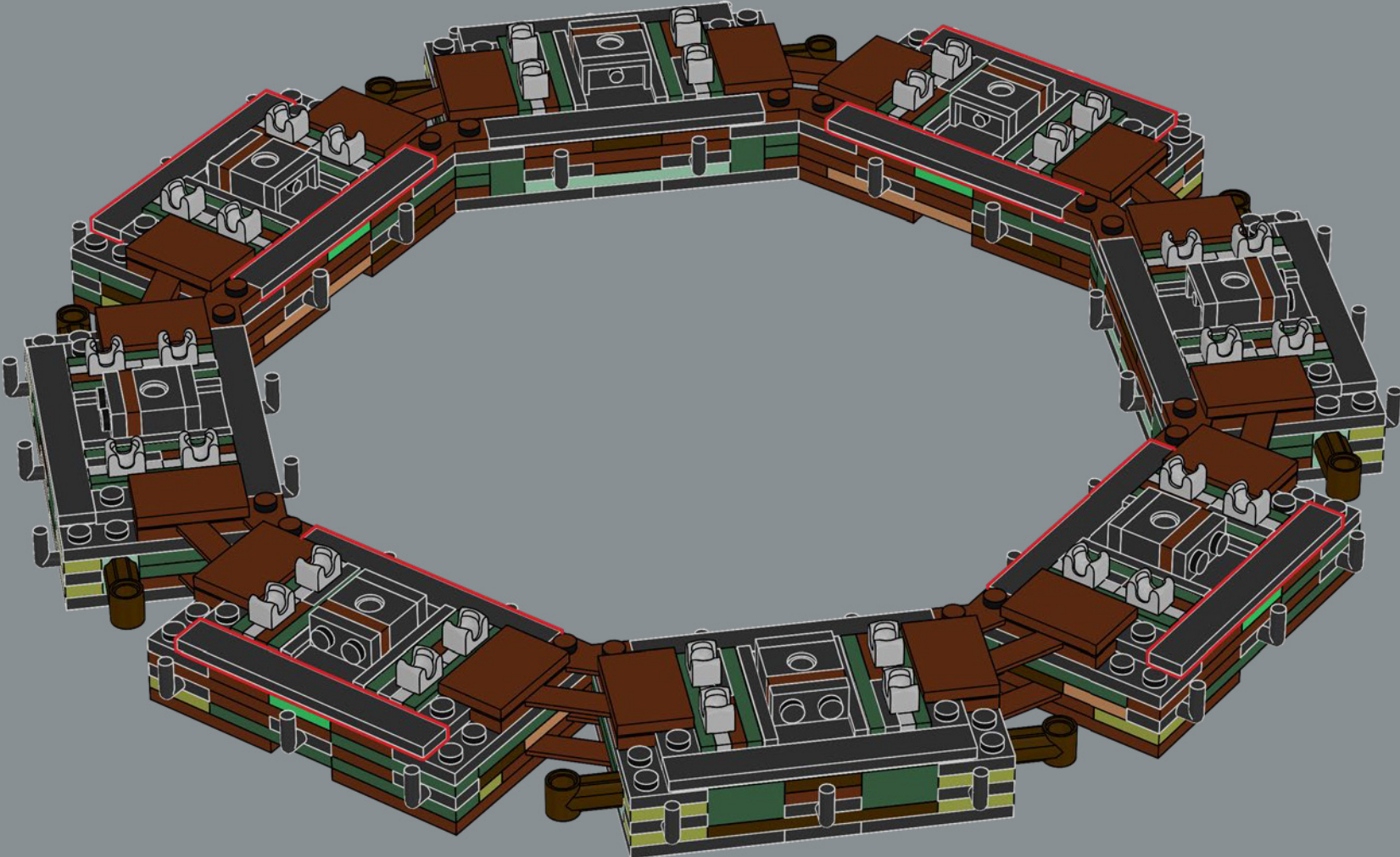

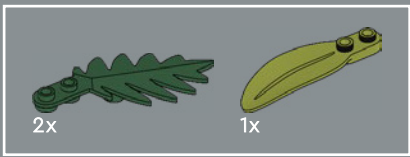

36



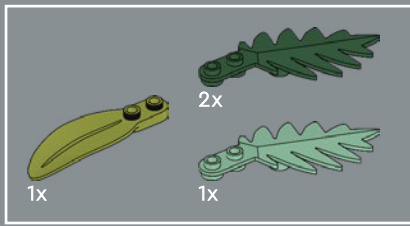

37



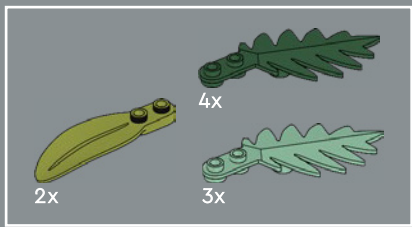

38





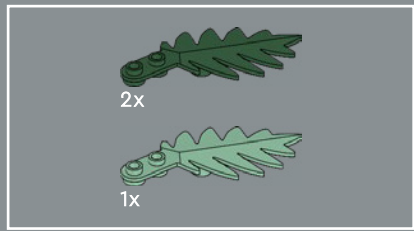

40



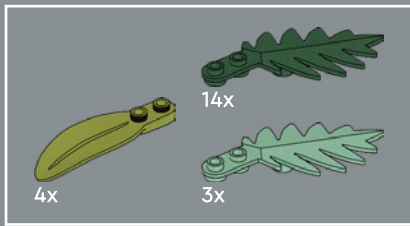

41





8x

42



8x



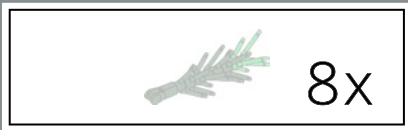

43

When connected in sequence, the LEGO® flower stem elements make for perfectly pointy pine needles.

Lorsqu'ils sont connectés en séquence, les éléments de tige de fleur LEGO® donnent des aiguilles de pin parfaitement pointues.

Conectados en secuencia, los elementos LEGO® que representan tallos de flores resultan ideales para recrear agujas de pino.

1

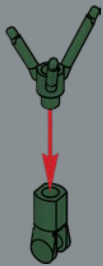

2

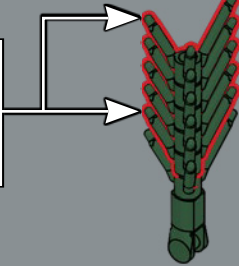
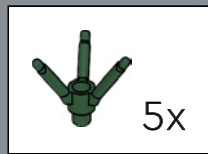

3



4

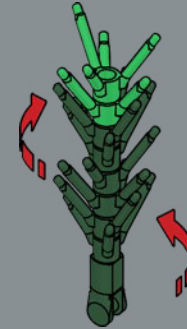

8x





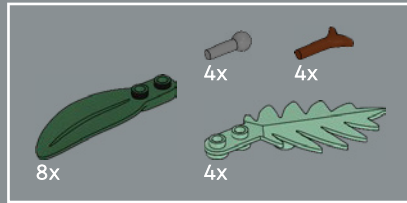
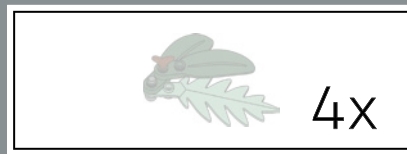

45

The underside of Fraser fir needles has a blueish tint, represented here by sand-green palm leaf elements – a new color for this classic LEGO® element that first appeared in 1989.

Le dessous des aiguilles de sapin de Fraser a une teinte bleutée, représentée ici par des éléments de feuilles de palmier vert sable, une nouvelle couleur pour cet élément LEGO® classique qui est apparu pour la première fois en 1989.

El tono azulado de la parte inferior de las agujas del abeto de Fraser se reproduce aquí mediante elementos que representan hojas de palmera en verde arena, un nuevo color para este elemento LEGO® clásico que apareció por primera vez en 1989.

1

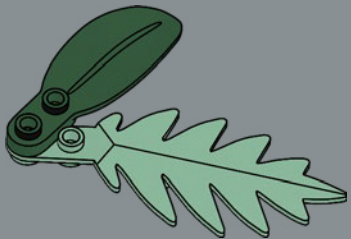

2

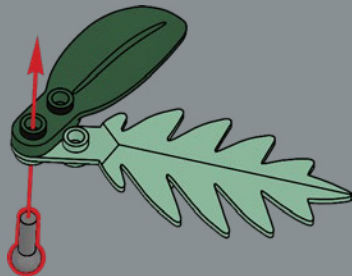

3

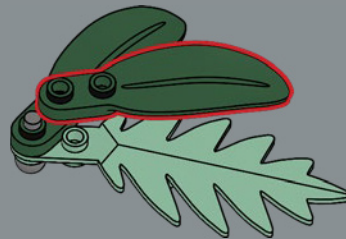

4

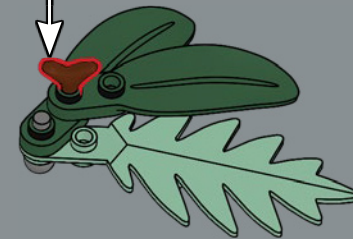

4x



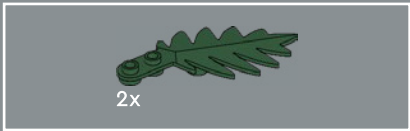
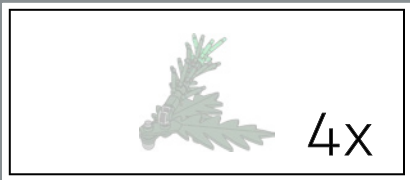

46

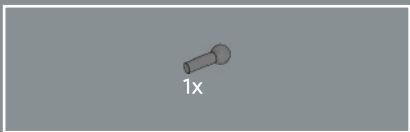
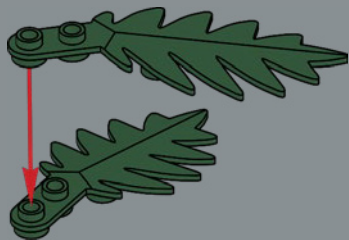

47

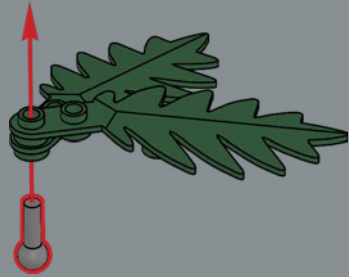

48

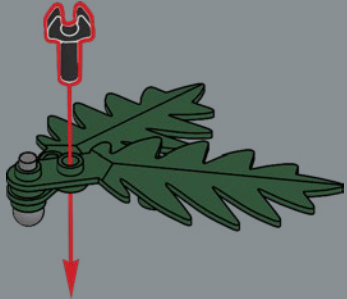



49

1

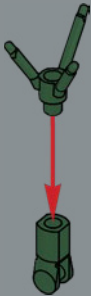

2

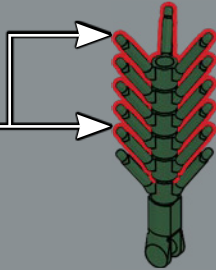
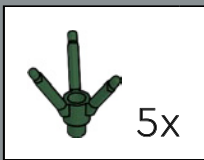

3



4

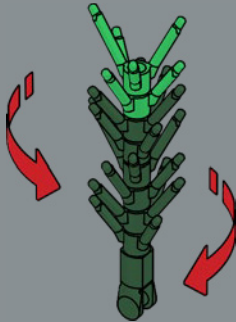



4x







Some species of Magnolia are evergreen, making their leaves perfect for year-round arrangements.

Certaines espèces de magnolia sont à feuilles persistantes, ce qui rend leur feuillage parfait pour des compositions tout au long de l'année.

Algunas especies de magnolia son perennes, por lo que sus hojas son perfectas para hacer arreglos en todas las épocas del año.

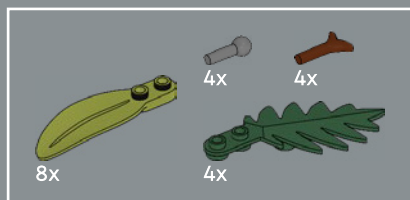

51

1

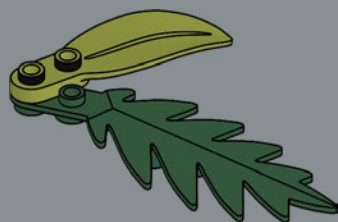

2

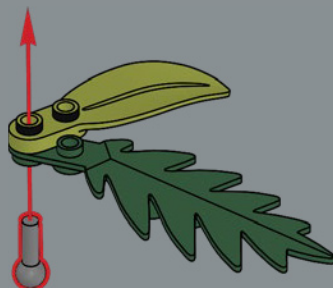

3

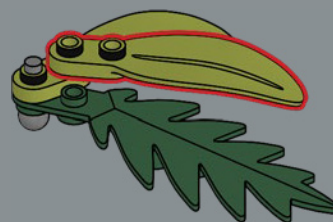

4

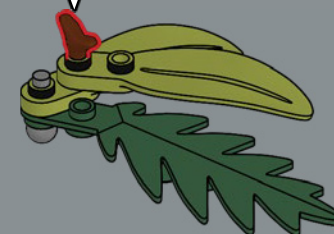
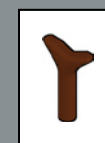

4x





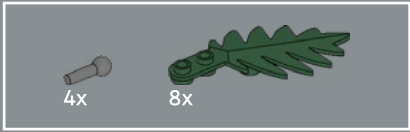
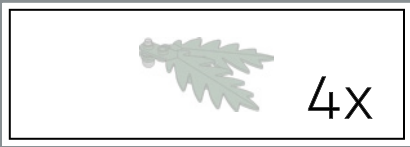

52

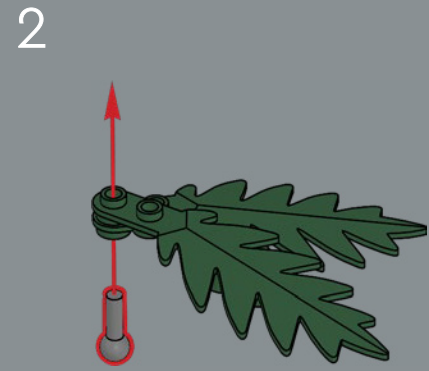
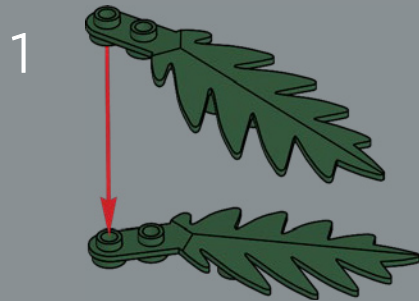

4x





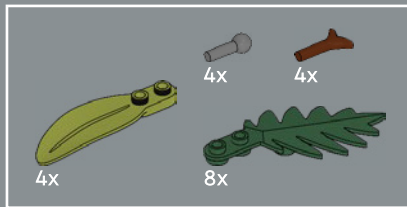

53

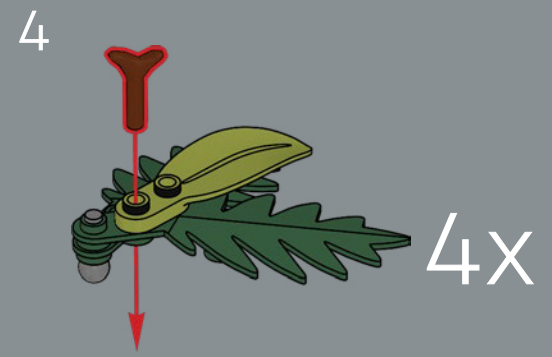
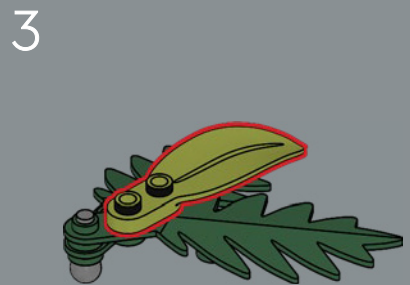
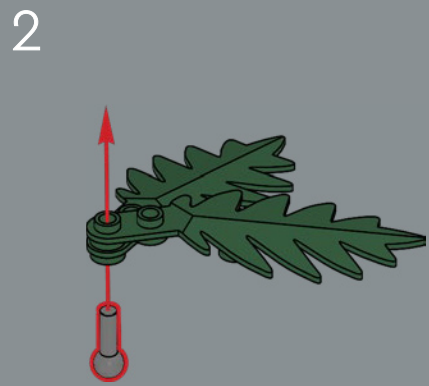
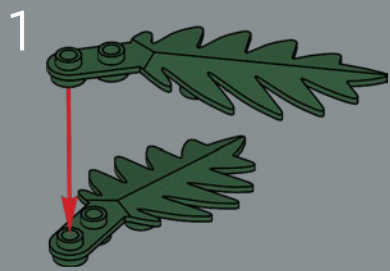



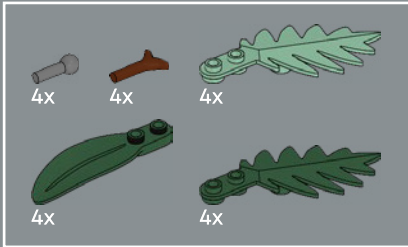

54

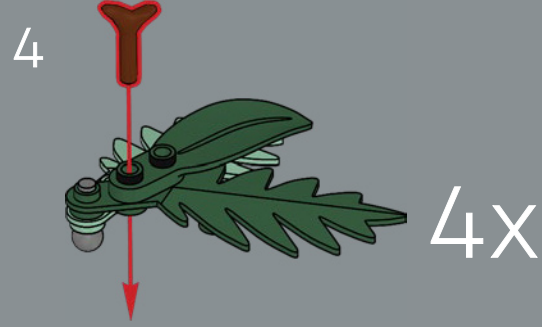
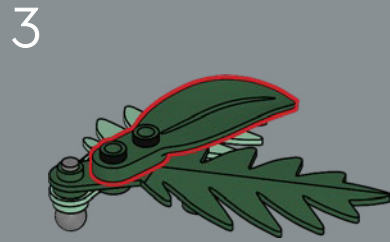
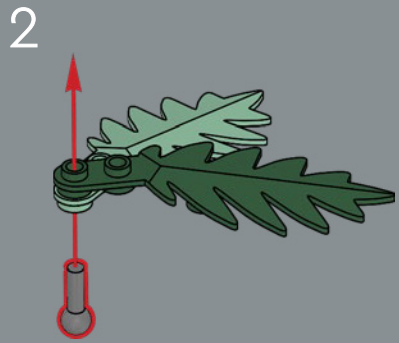





55

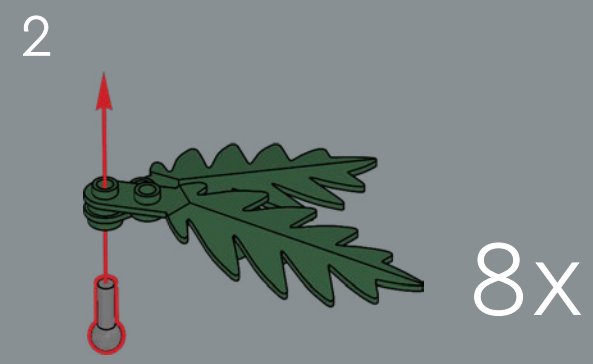
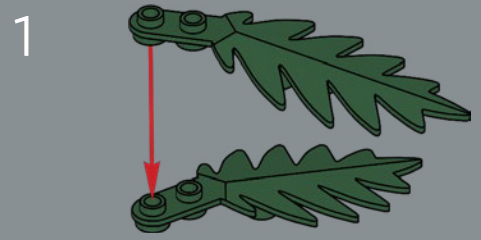





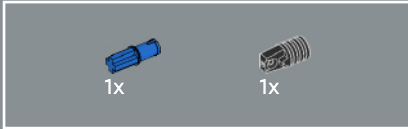

56

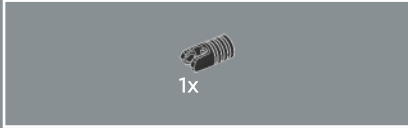

57

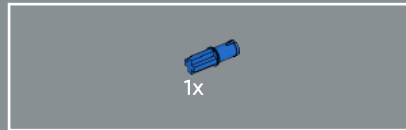

58



59



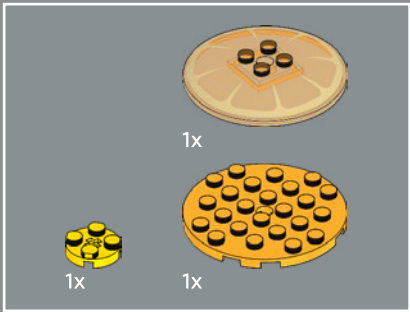

60

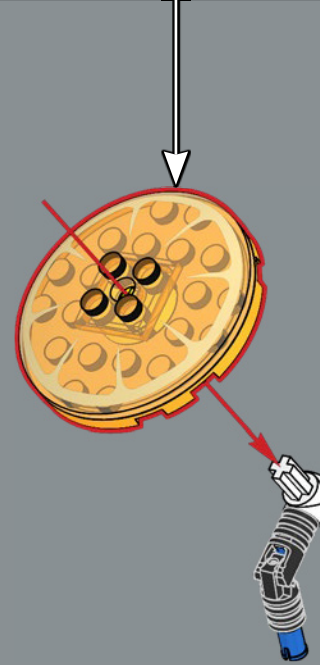
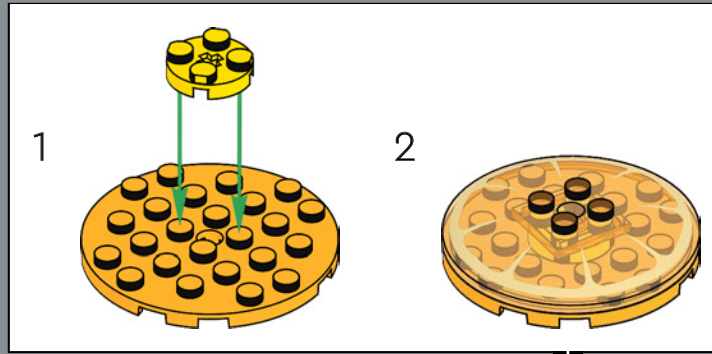

3x



Printed transparent orange satellite dish elements replicate the translucent quality of dried orange slices.

Les éléments imprimés d'antenne parabolique orange transparente reproduisent la qualité translucide des tranches d'orange séchées.

Los elementos estampados de color naranja transparente originalmente concebidos como antenas parabólicas representan rebanadas de naranja deshidratadas.



61

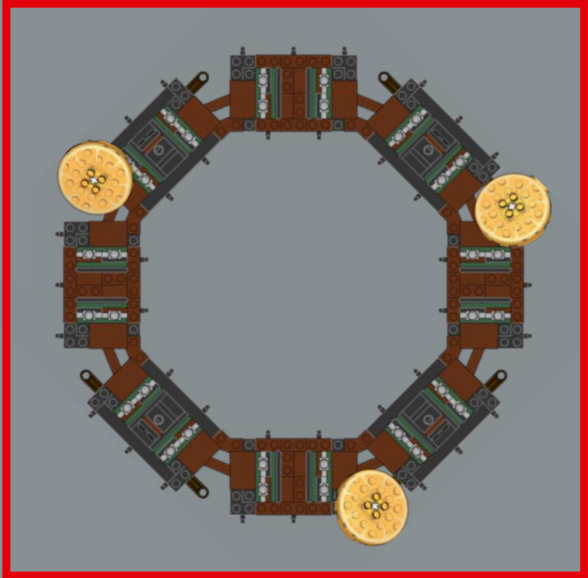



62



63

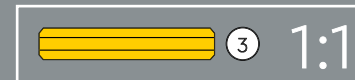
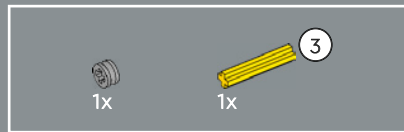

64



65





66



67

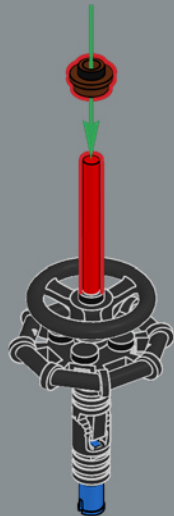

68

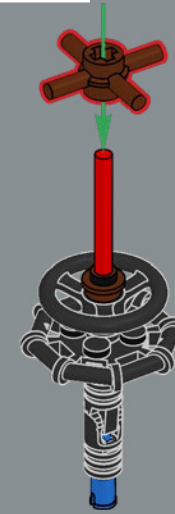

69

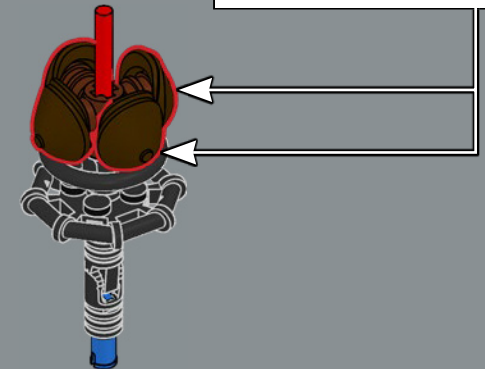
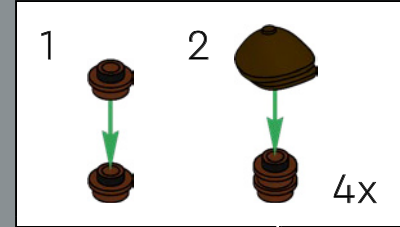



70

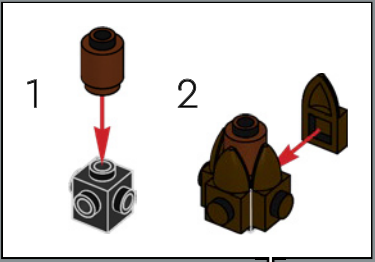

71

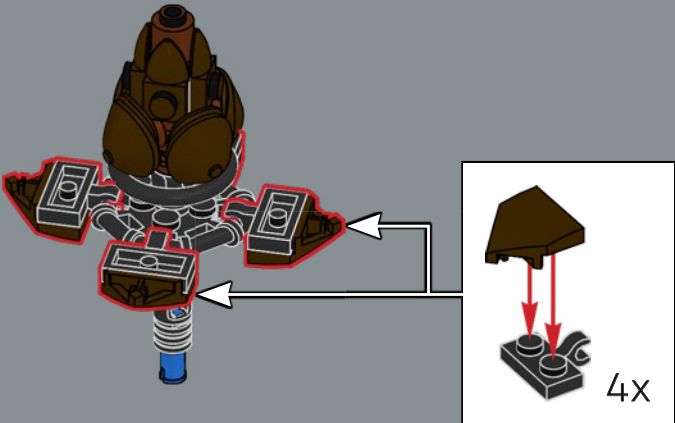

72

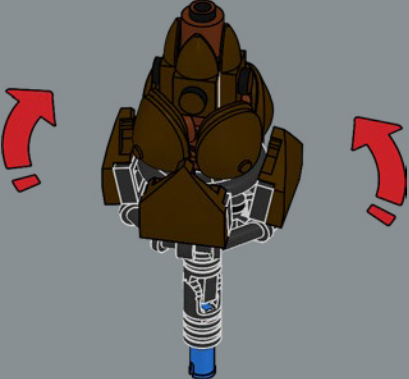

3x



73



The pinecone of the Scots pine (or Scotch pine) has scales that feature a small protuberance resembling the button on the top of a newsie cap.

La pomme de pin du pin sylvestre (ou pin écossais) a des écailles qui présentent une petite protubérance ressemblant au bouton du dessus d'une casquette.

La piña del pino silvestre (o pino escocés) tiene escamas que presentan una pequeña protuberancia parecida al botón de la parte superior de una boina.



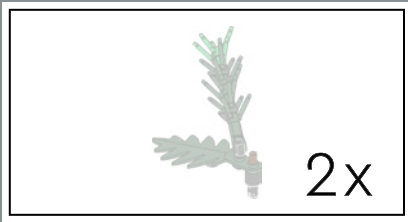

74



75

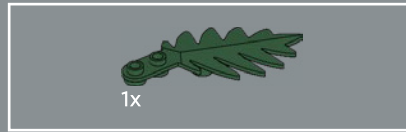

76

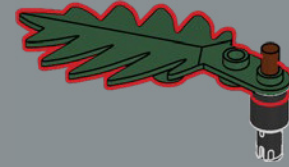

77

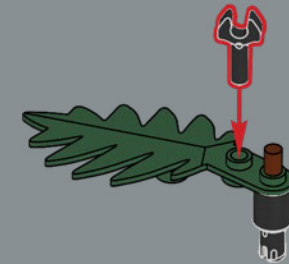



78

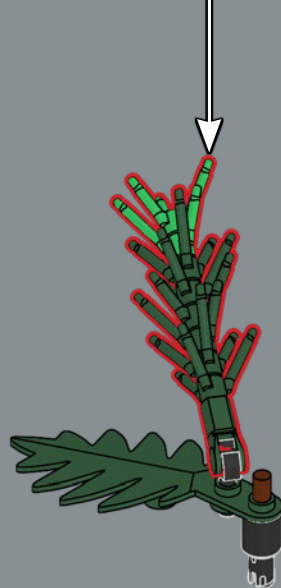
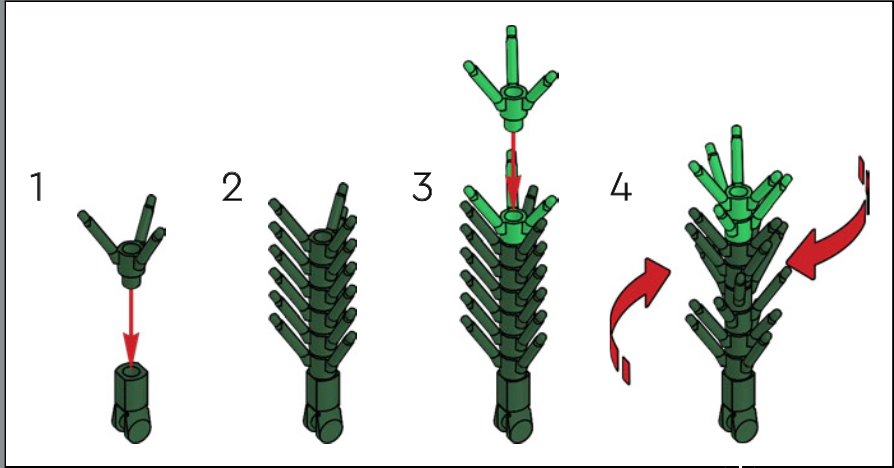

2x





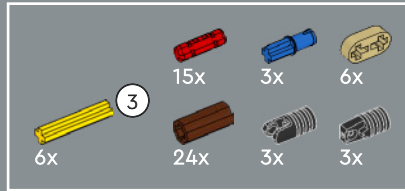
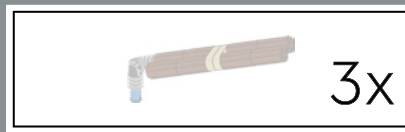

80

1



2



3



4





A cinnamon stick comes from the dried inner bark of a cinnamon tree. In ancient times, the spice was considered more valuable than gold.

Un bâton de cannelle provient de l'écorce intérieure séchée d'un cannelier. Dans l'Antiquité, cette épice était considérée comme plus précieuse que l'or.

La canela en rama proviene de la corteza interior seca del canelo. En la antigüedad, esta especia se consideraba incluso más valiosa que el oro.

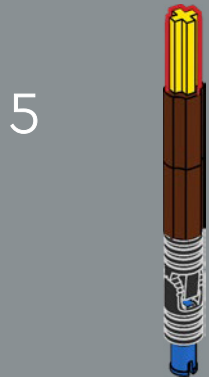
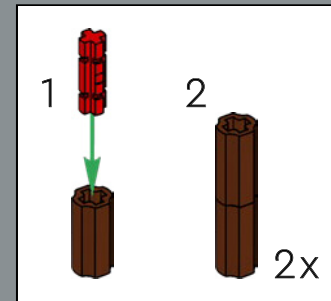
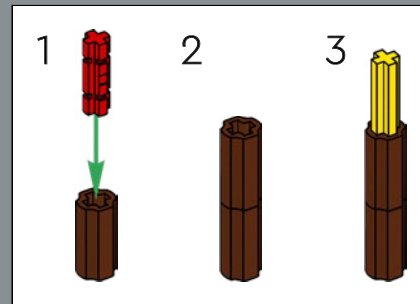

5

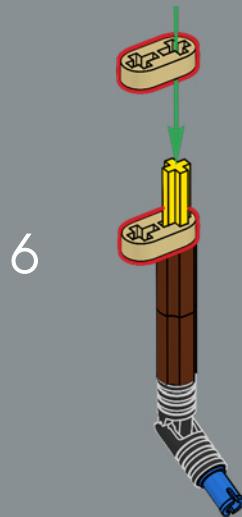

6

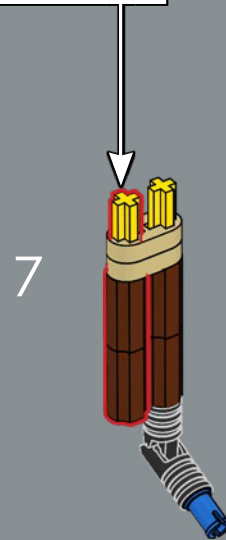

7

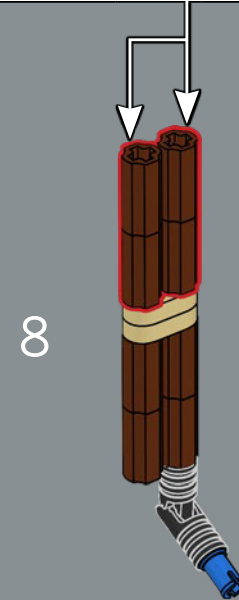

8

3x





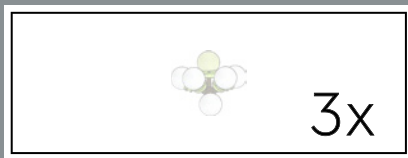

3x



82

1



2

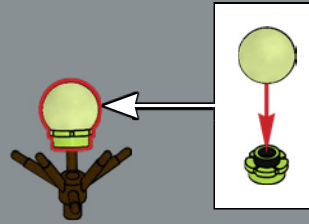

3

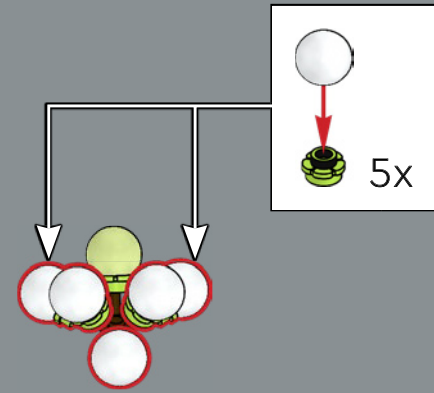

3x

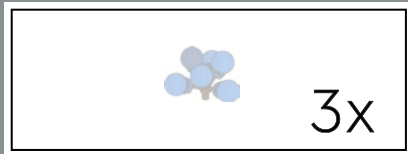

3x

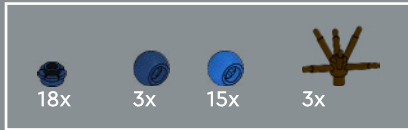

83

1



2

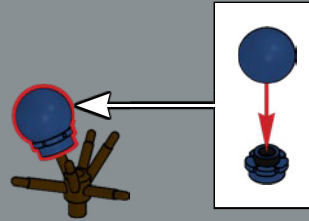

3

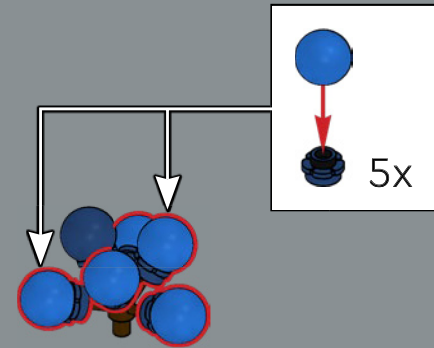

3x

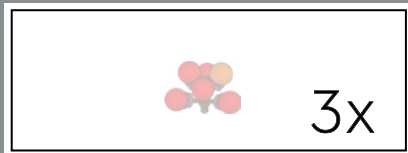

3x



84

1



2

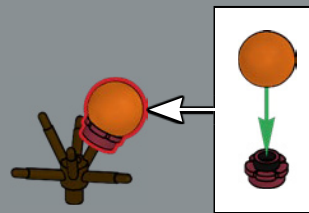

3

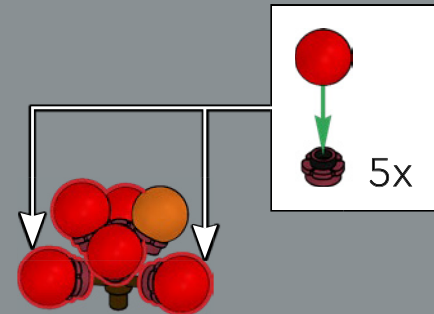

3x

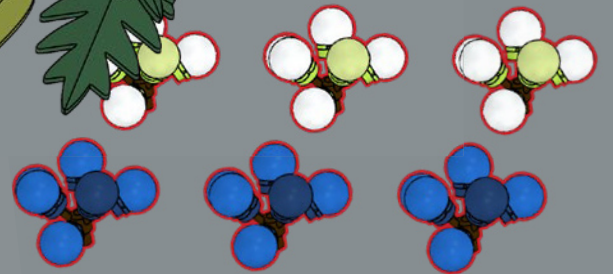
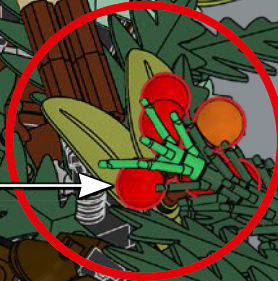
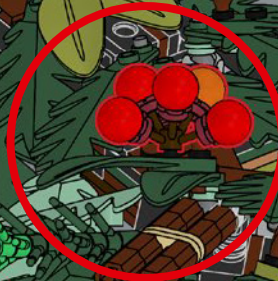
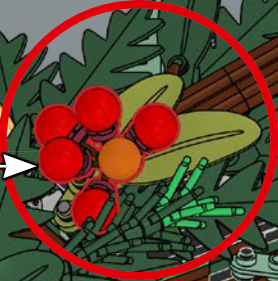
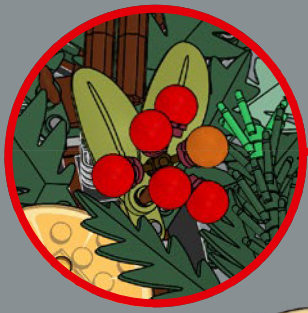



Vibrant red winterberries provide an important food source for birds through the winter season.

Les baies d'hiver, d'un rouge éclatant, constituent une source de nourriture importante pour les oiseaux pendant la saison hivernale.

De color rojo brillante, las bayas de abeto son una importante fuente de alimento para las aves durante los meses más fríos.



31

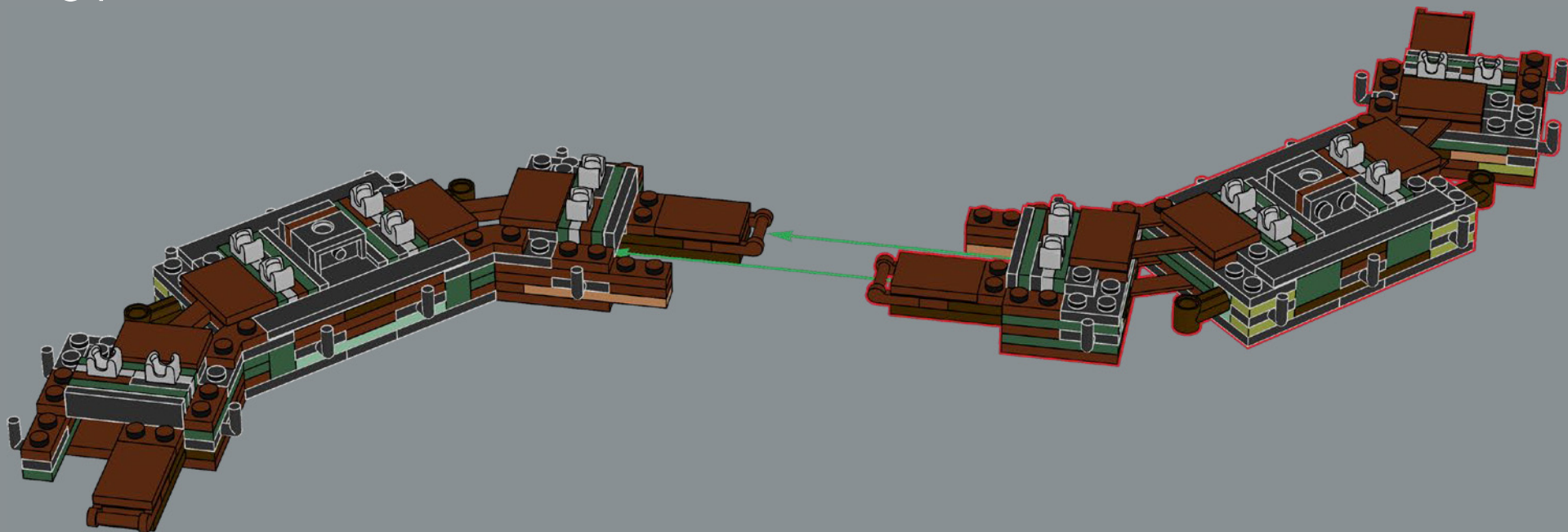

32

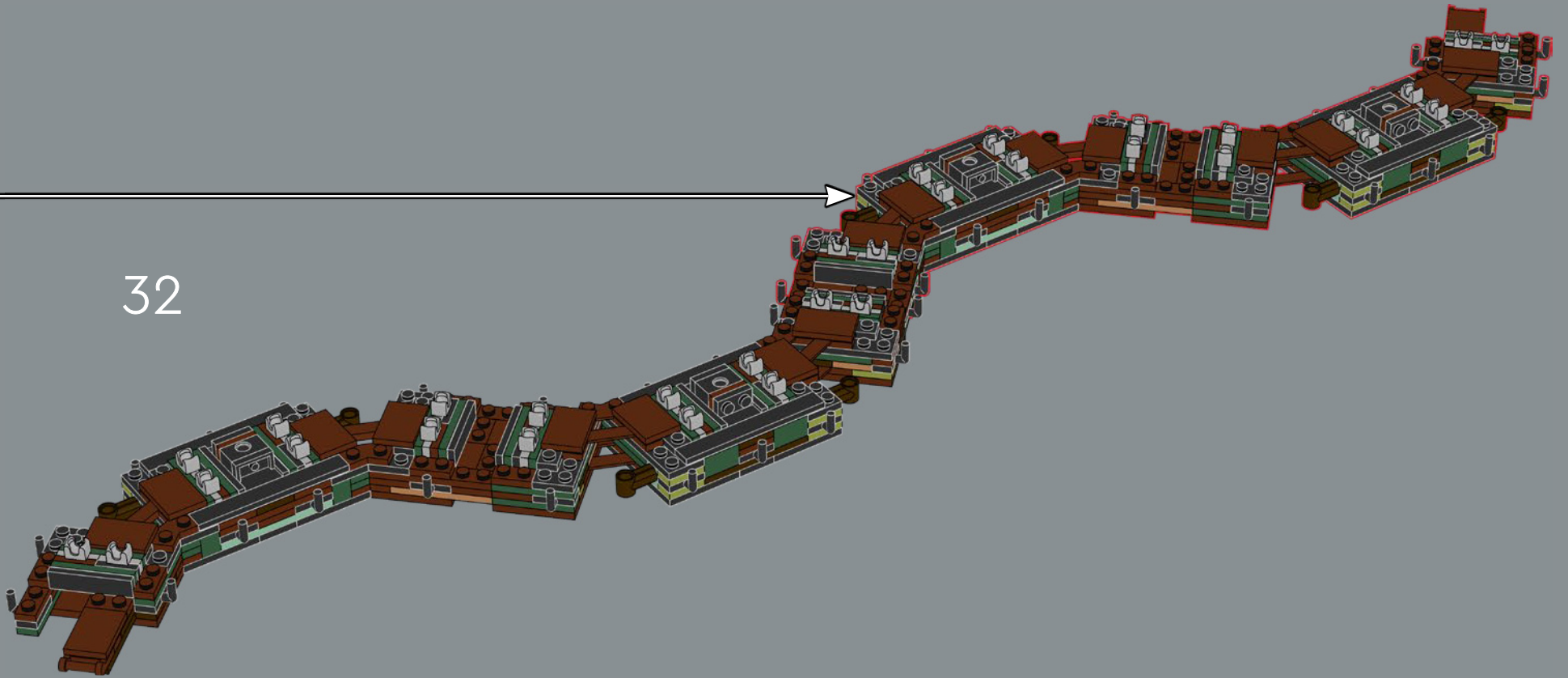

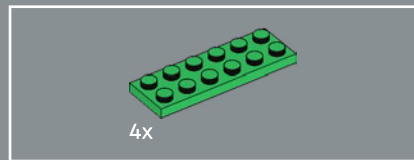

33



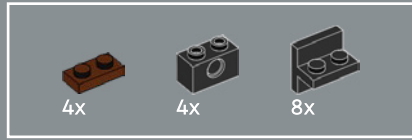
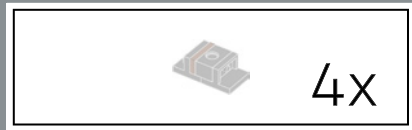

34

1

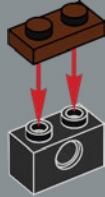

2

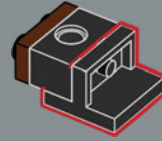

3

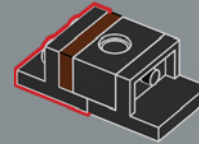

4x

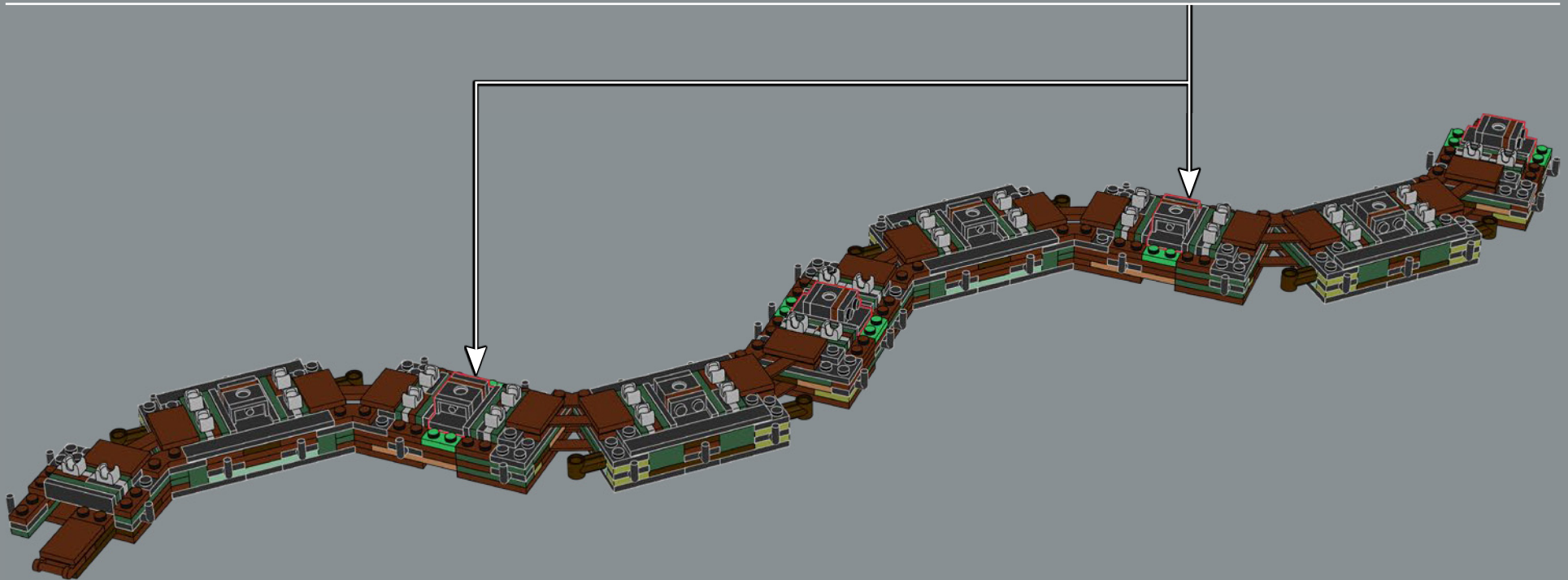

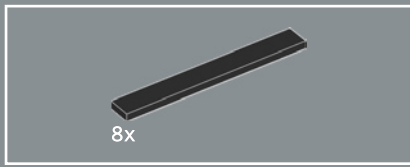

35

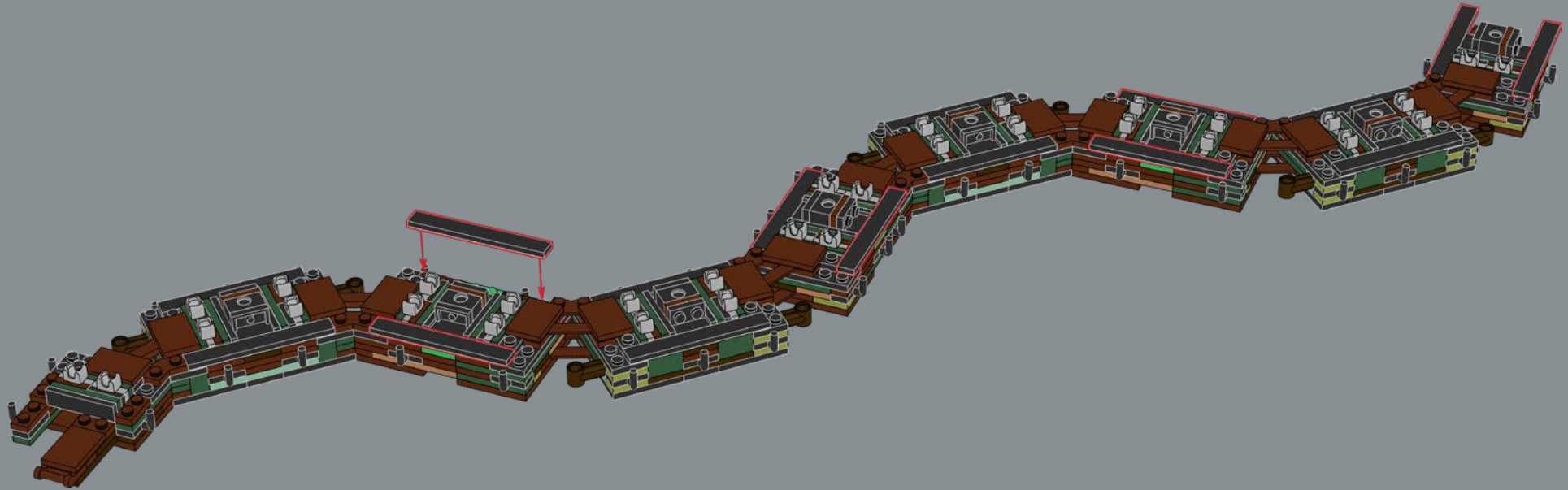

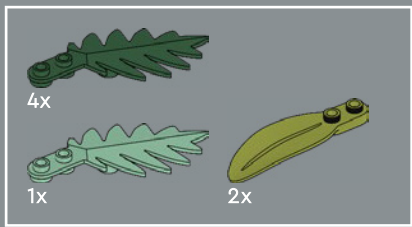

36

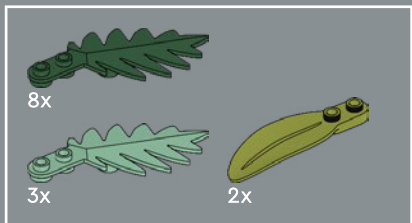
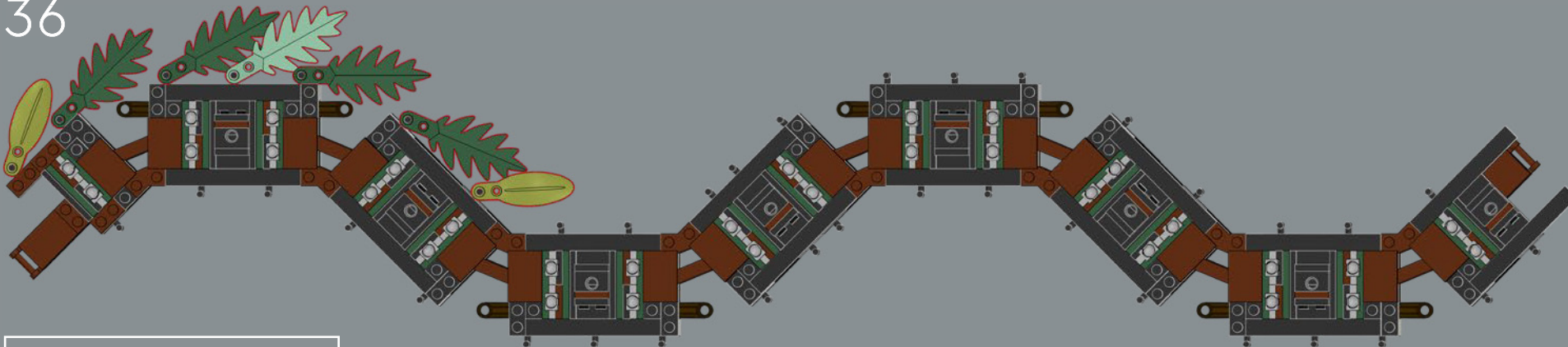

37

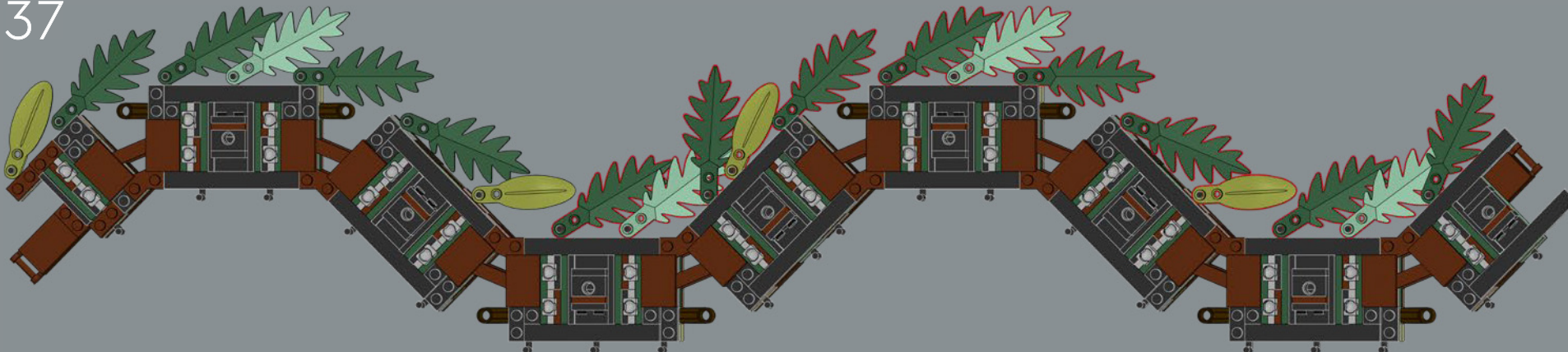

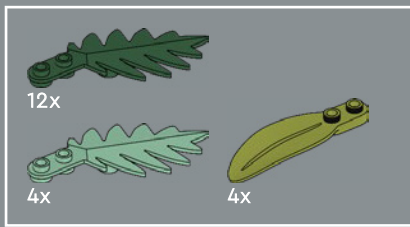

38

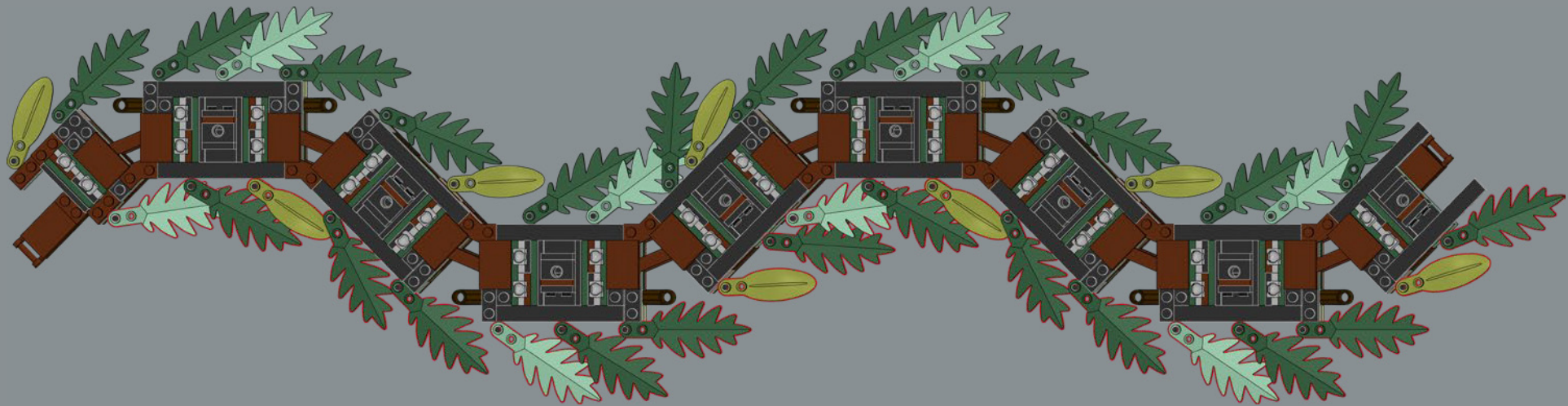



8x

39

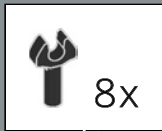
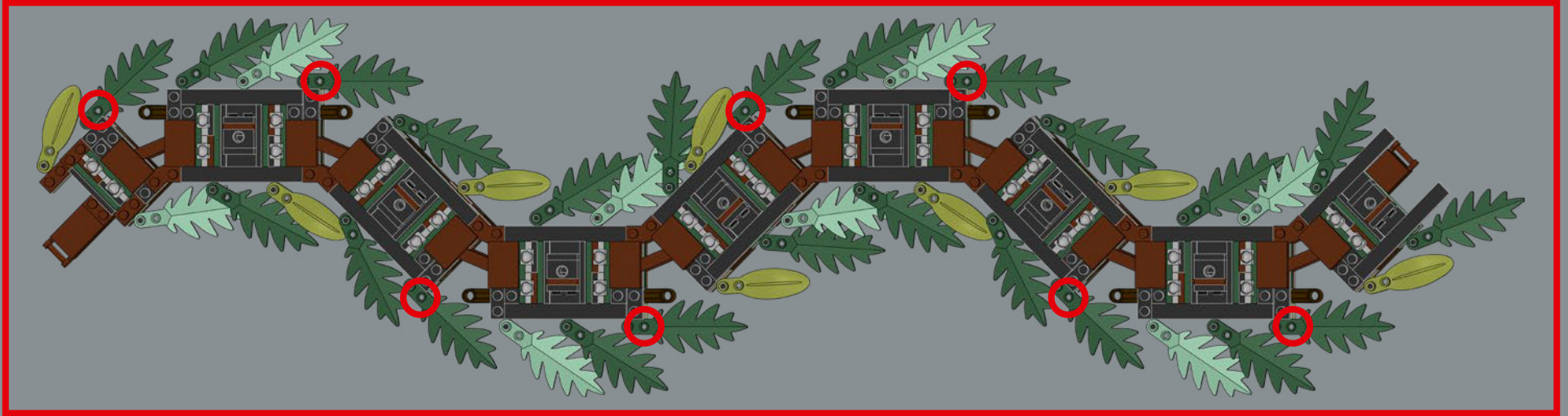

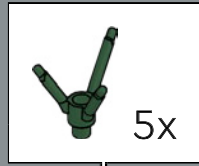
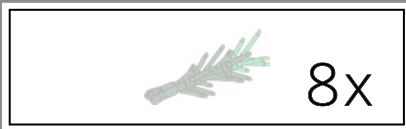

40

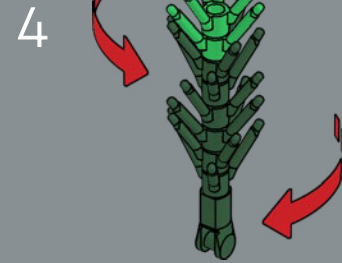
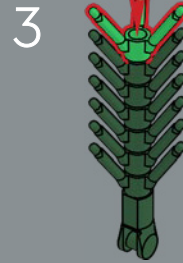
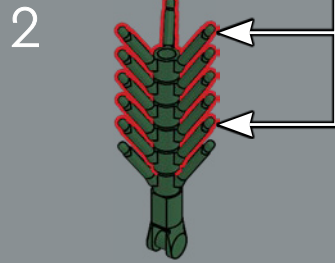
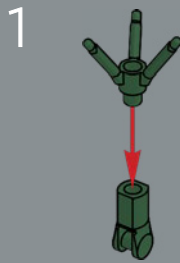

8x



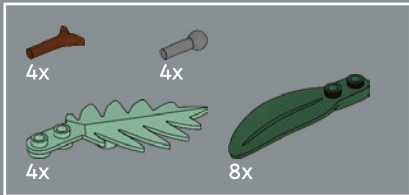

41

1

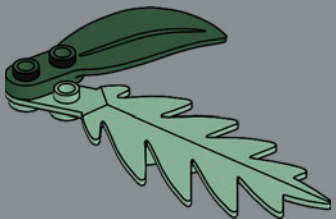

2

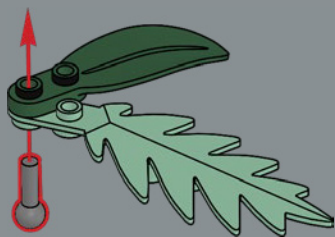

3

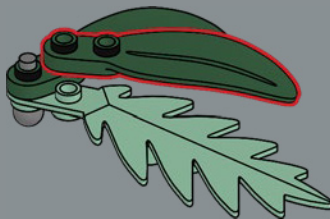

4

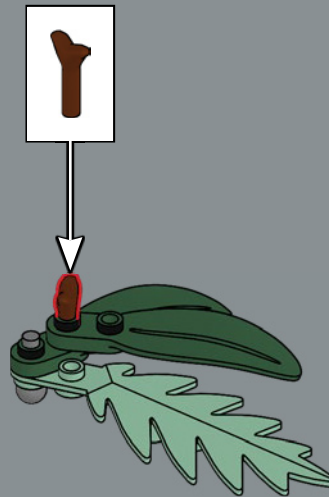

4x

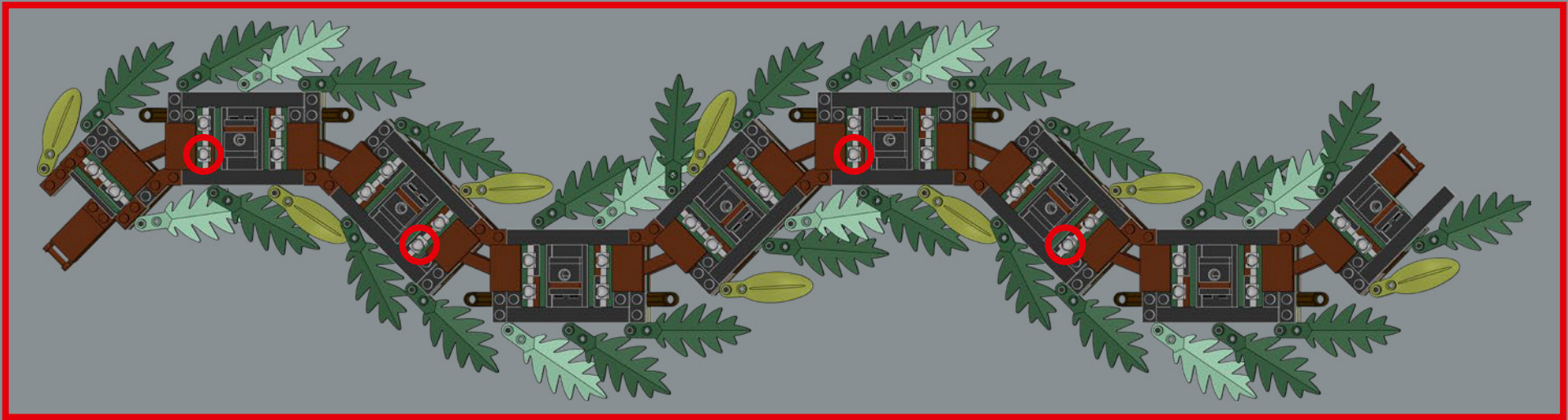

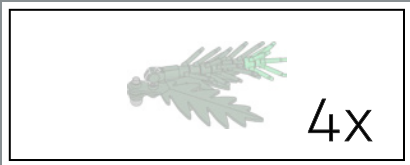

42

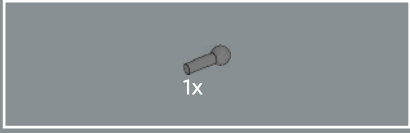
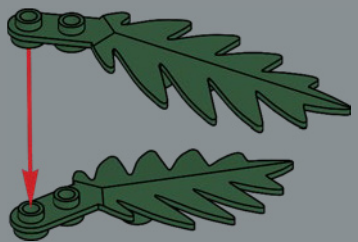

43

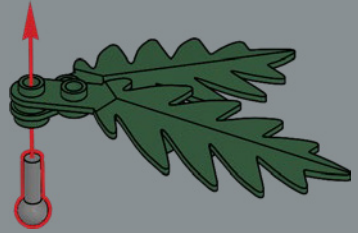

44

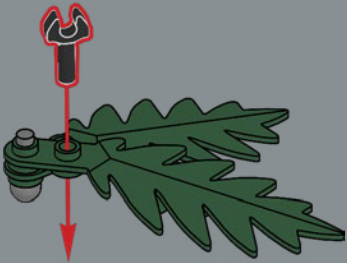



45

1

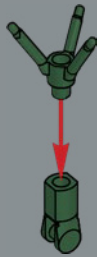

2

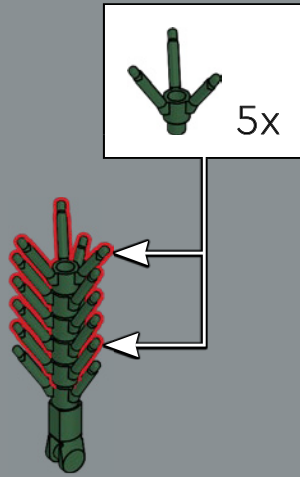

3

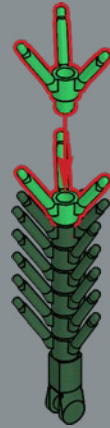

4

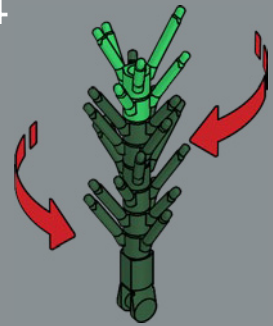



4x

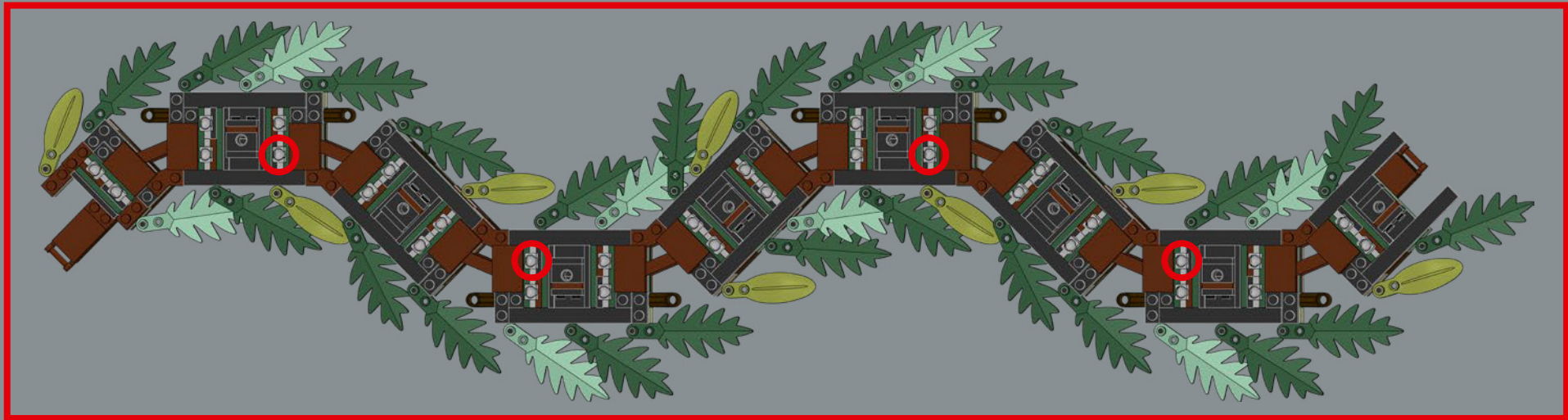

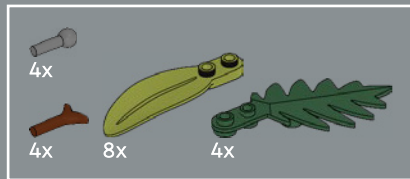
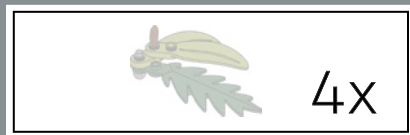

47

1

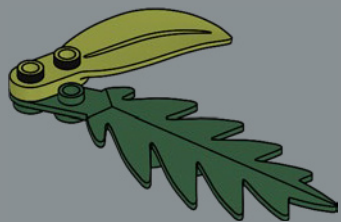

2

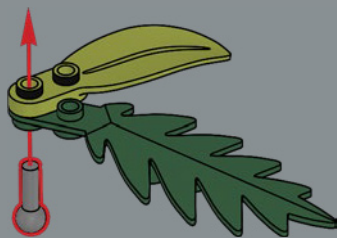

3

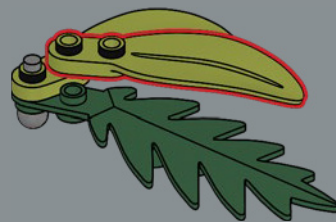

4

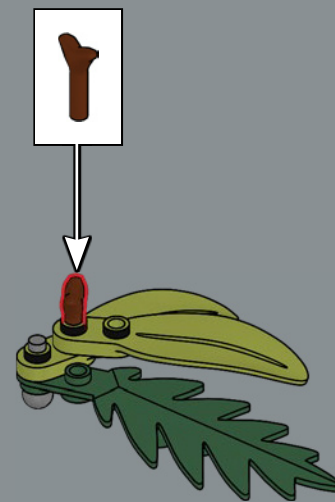

4x

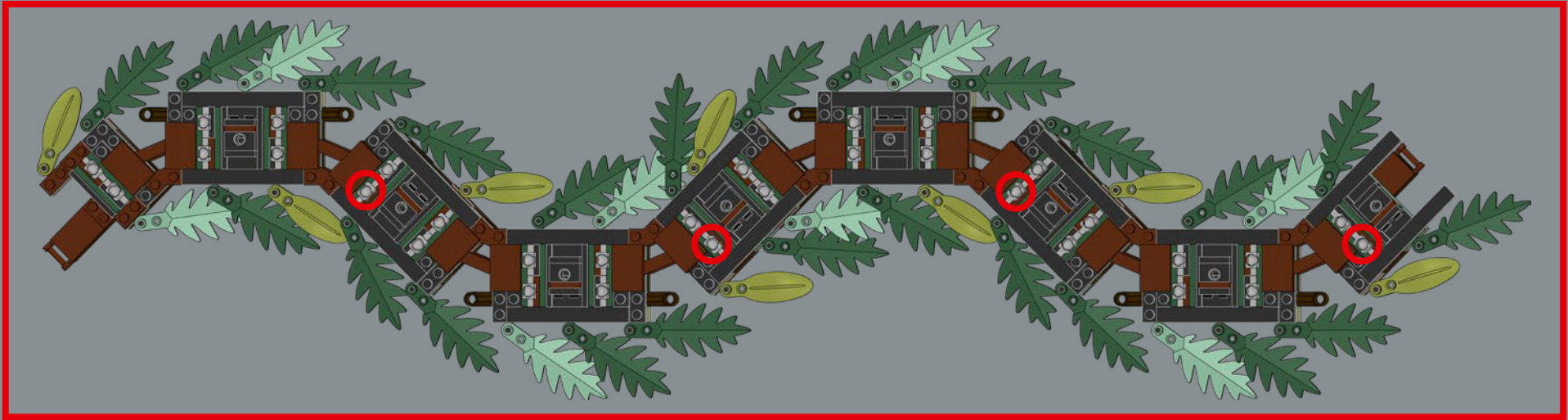

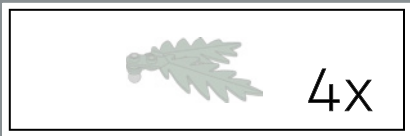

48

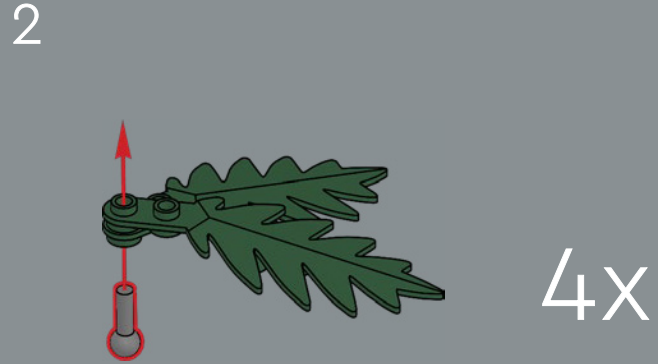
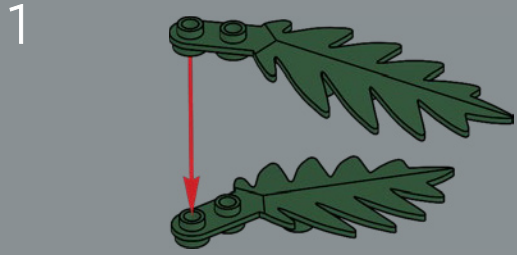

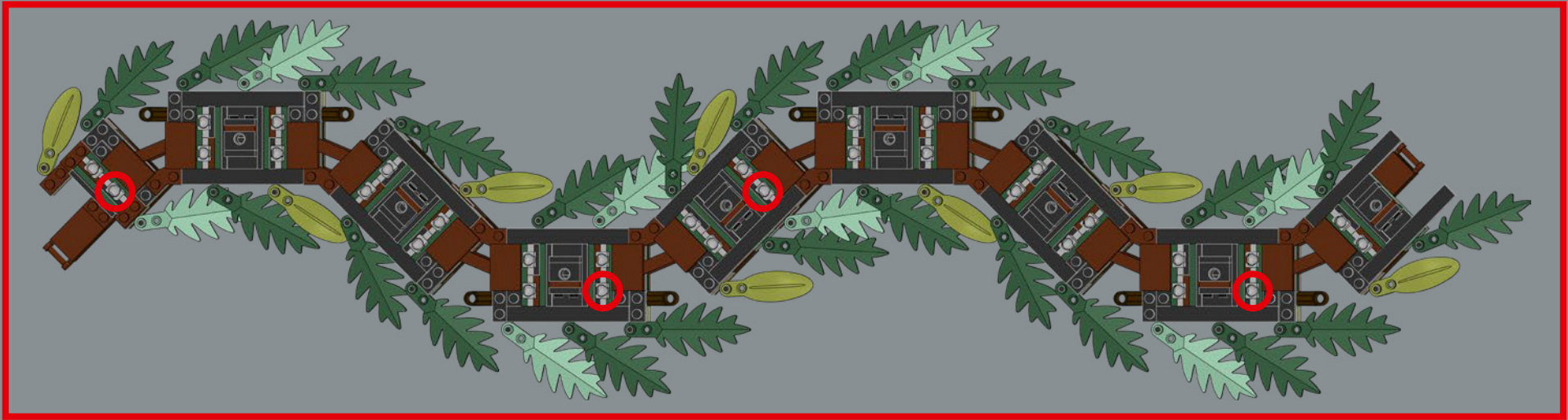

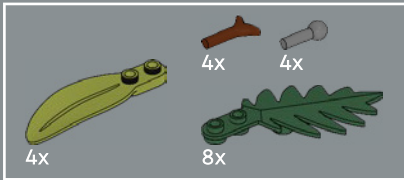

49

1

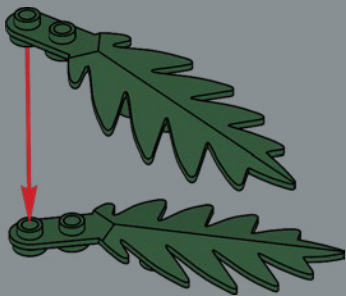

2

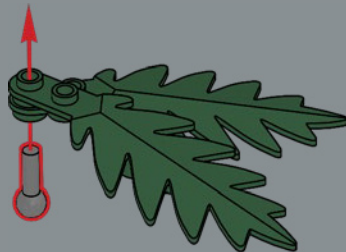

3

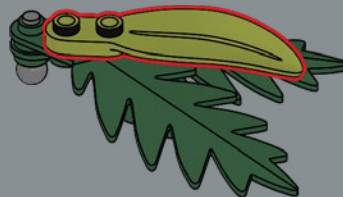

4

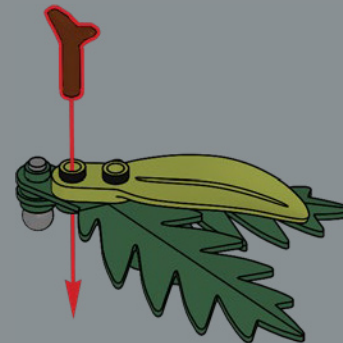

4X

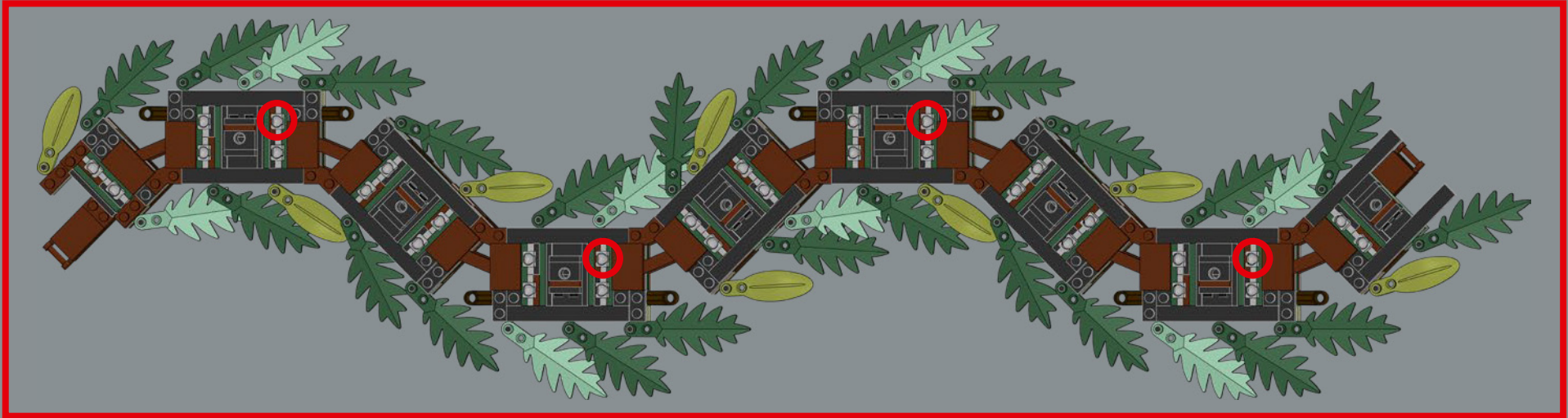

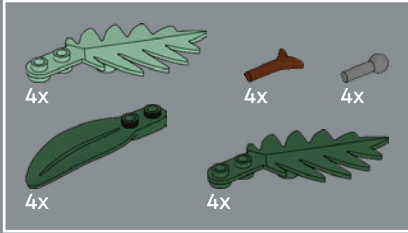
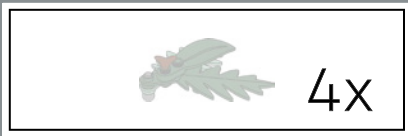

50

1



2

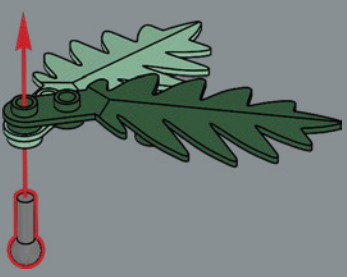

3



4



4x

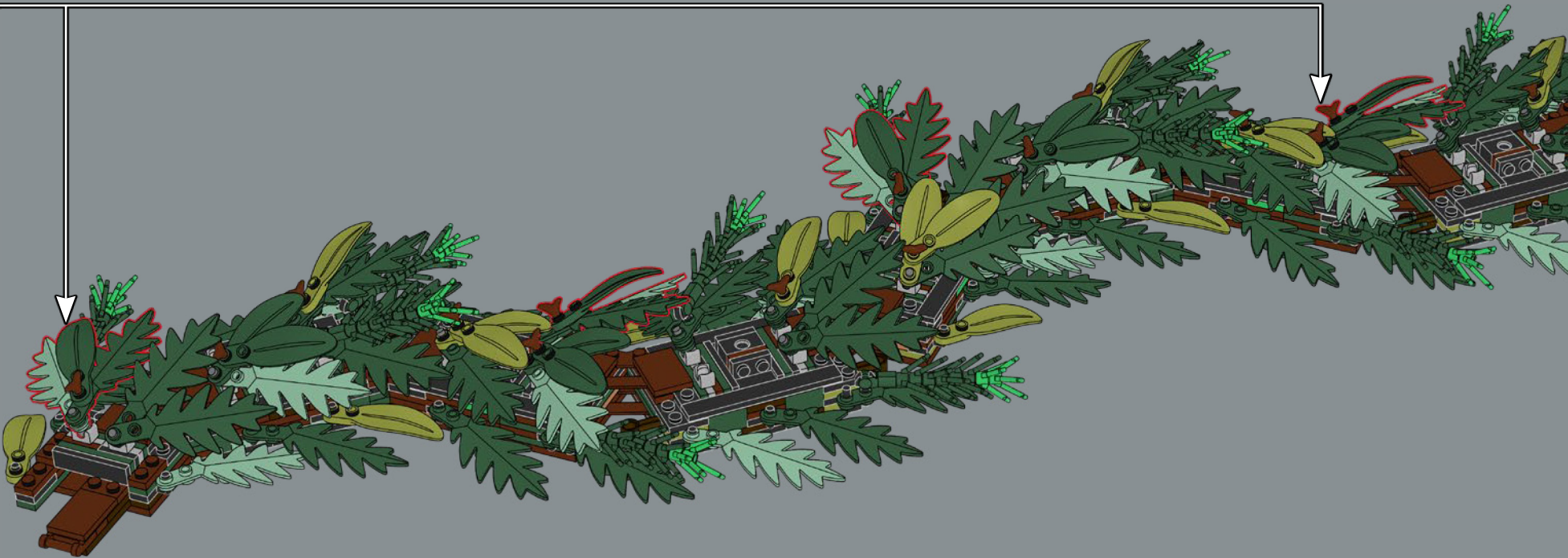
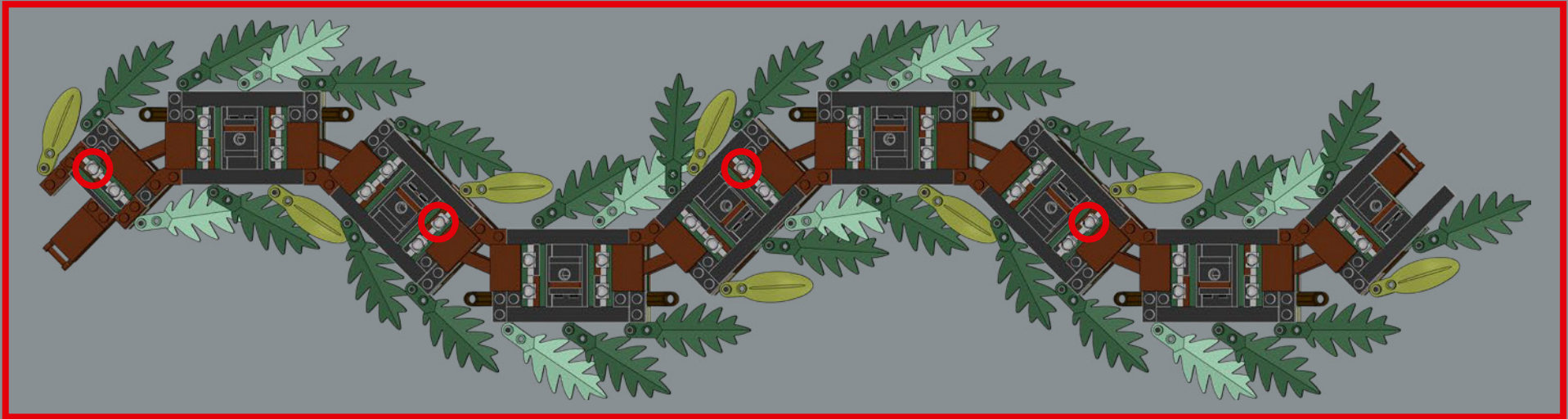



51

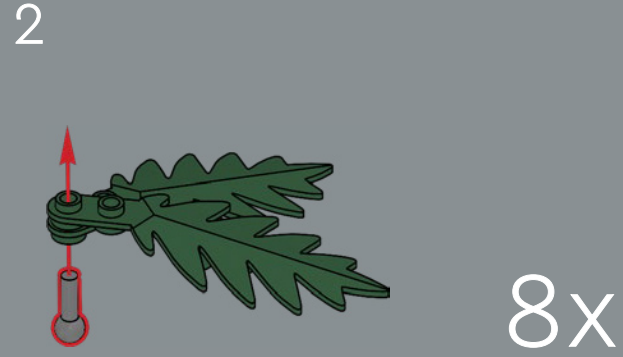
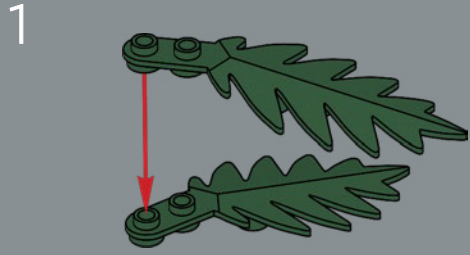

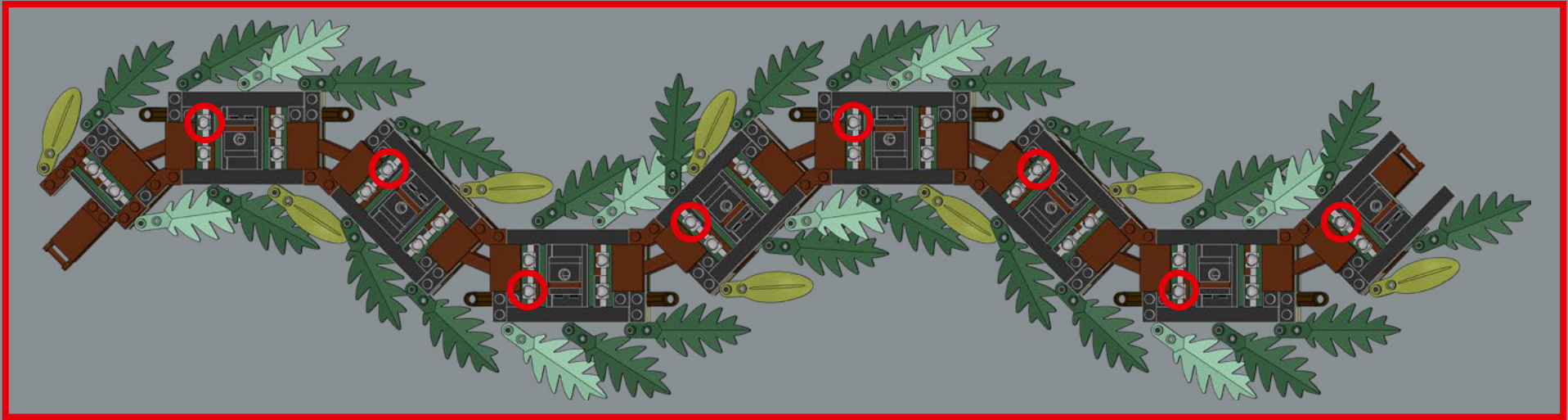

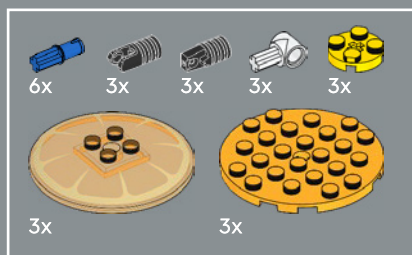

52

1



2



3



4

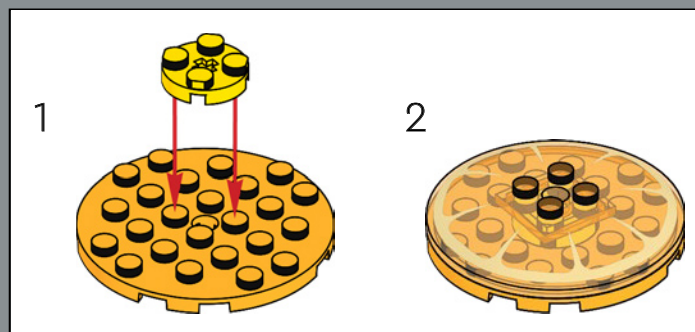
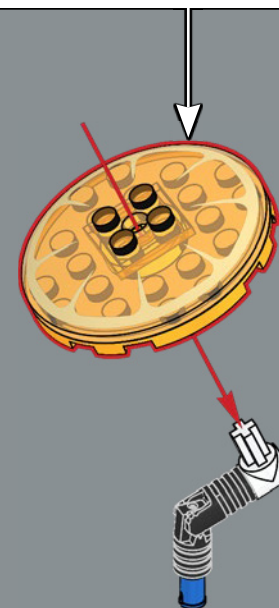

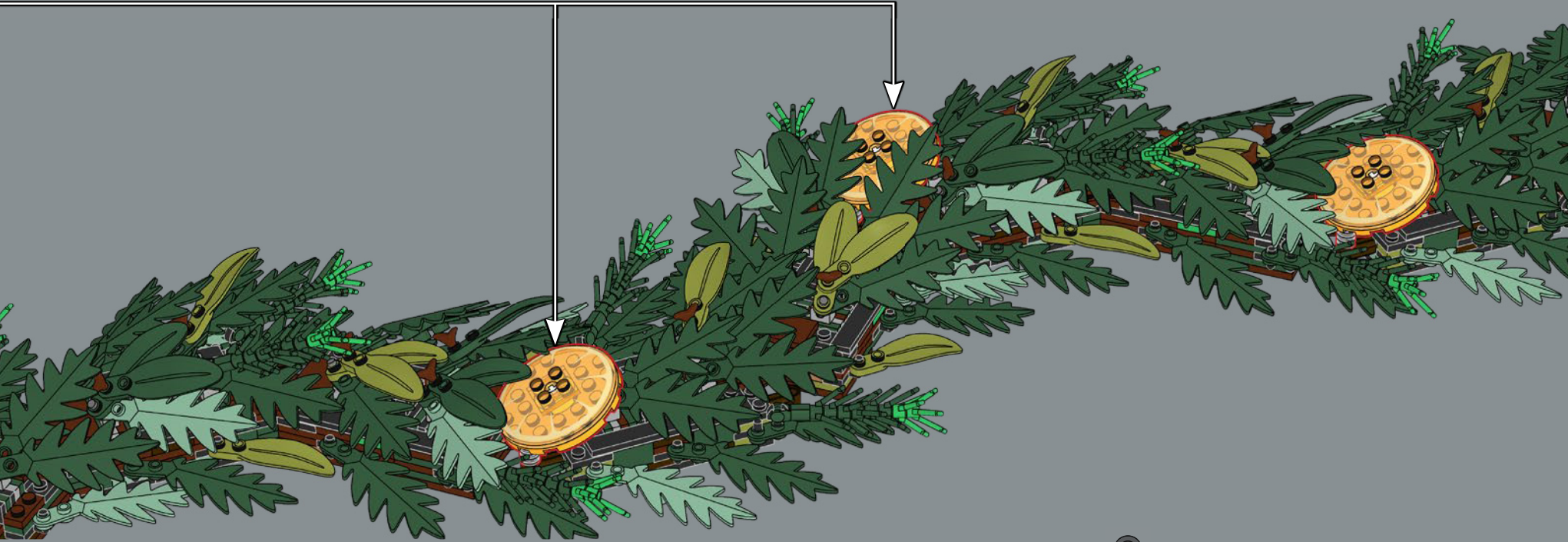
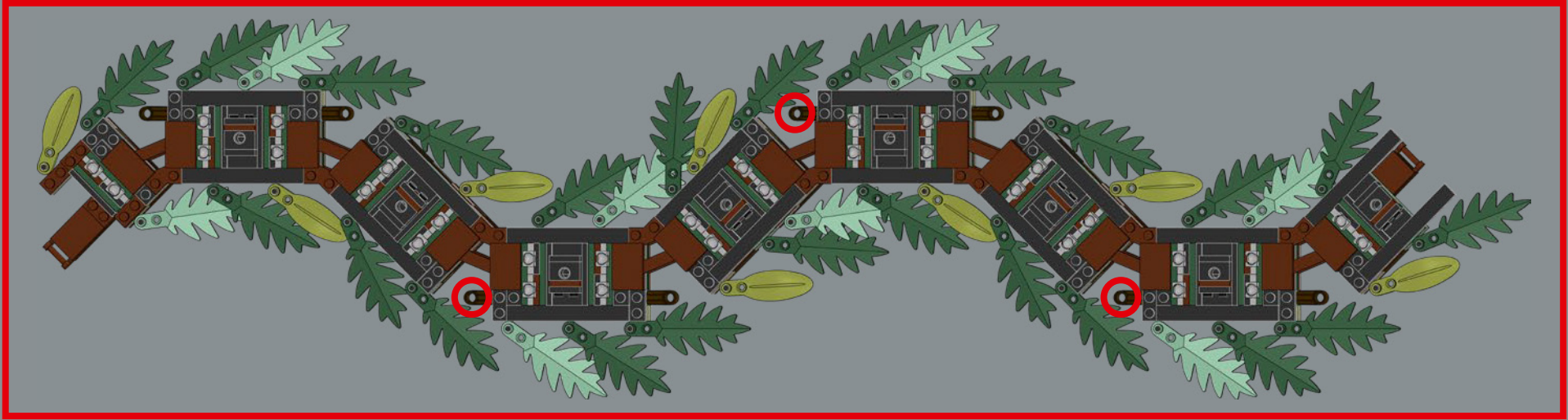

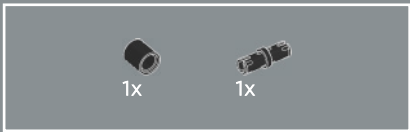
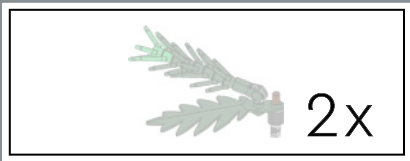

53



54

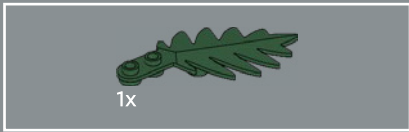

55



56

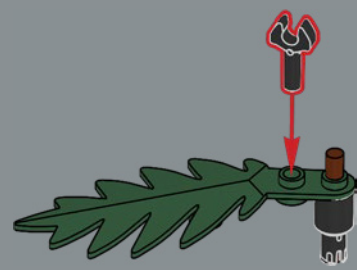



57

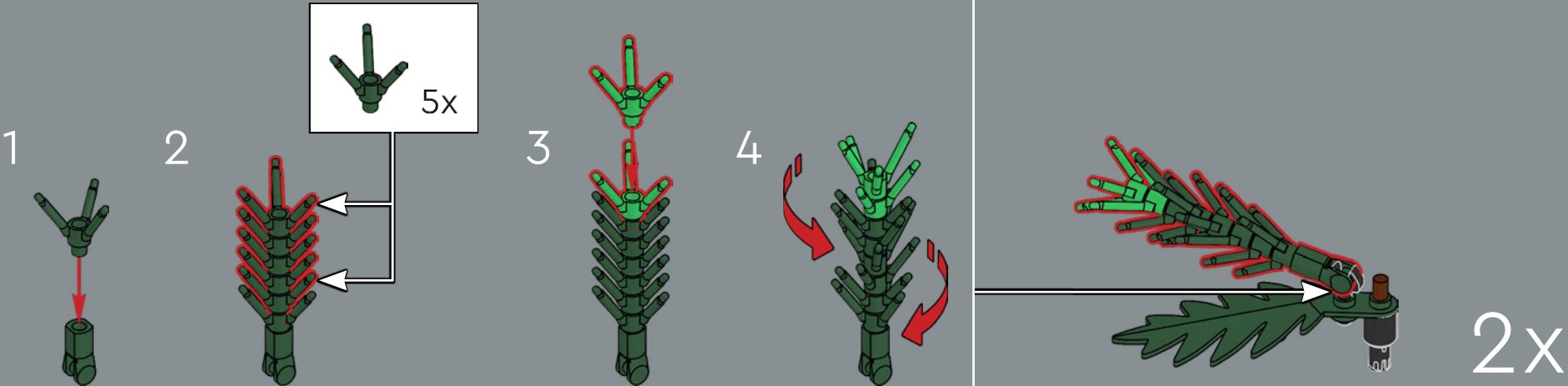

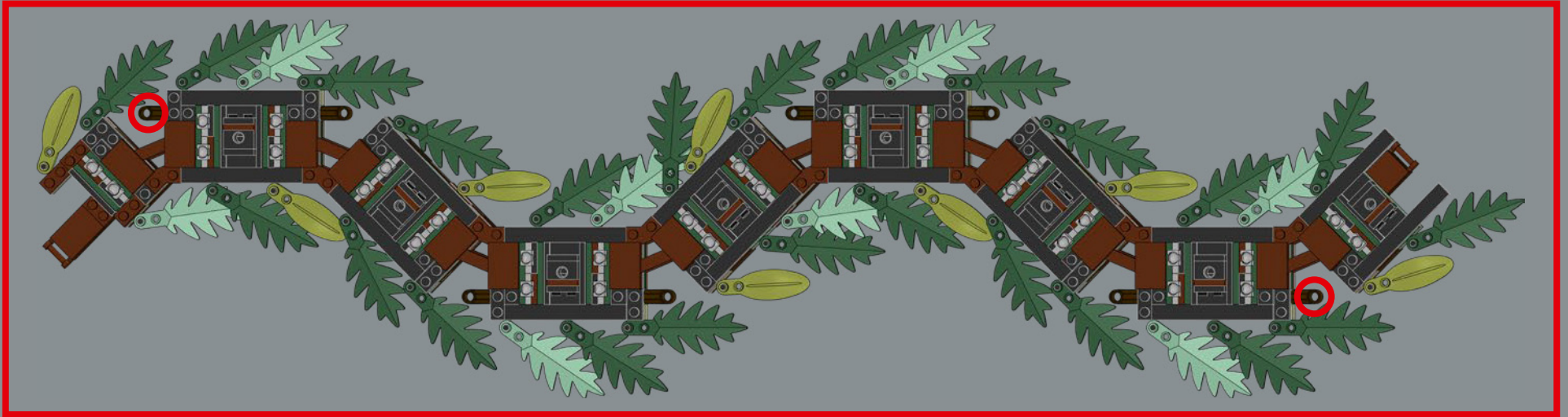

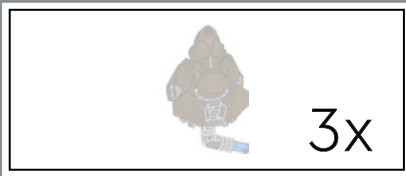

59



60

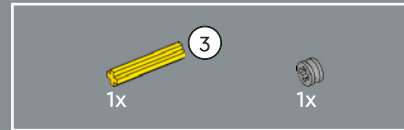

61



62





63

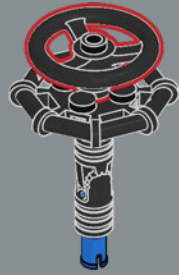

64

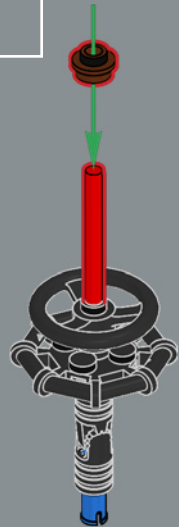

65

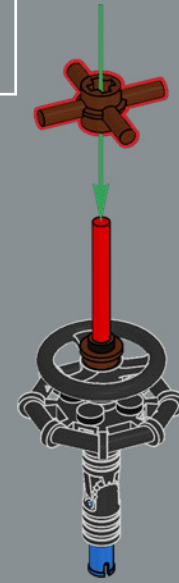

66

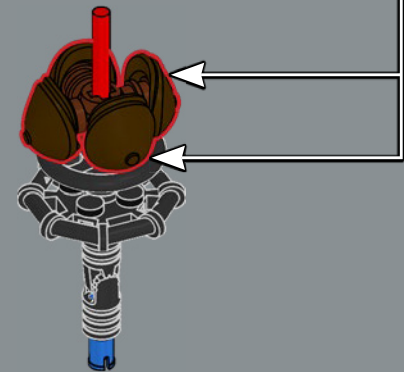
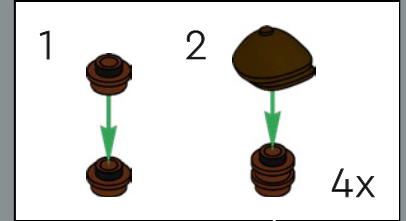



67

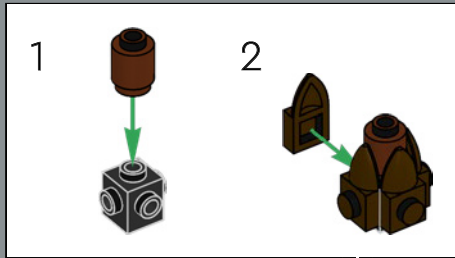

68

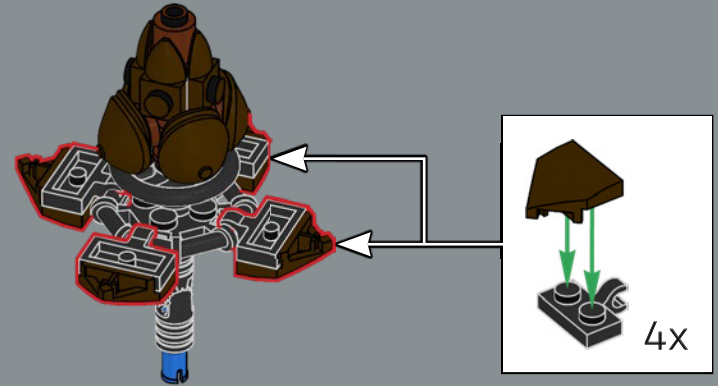

69

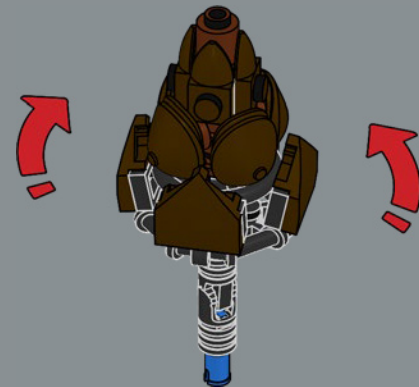

3x



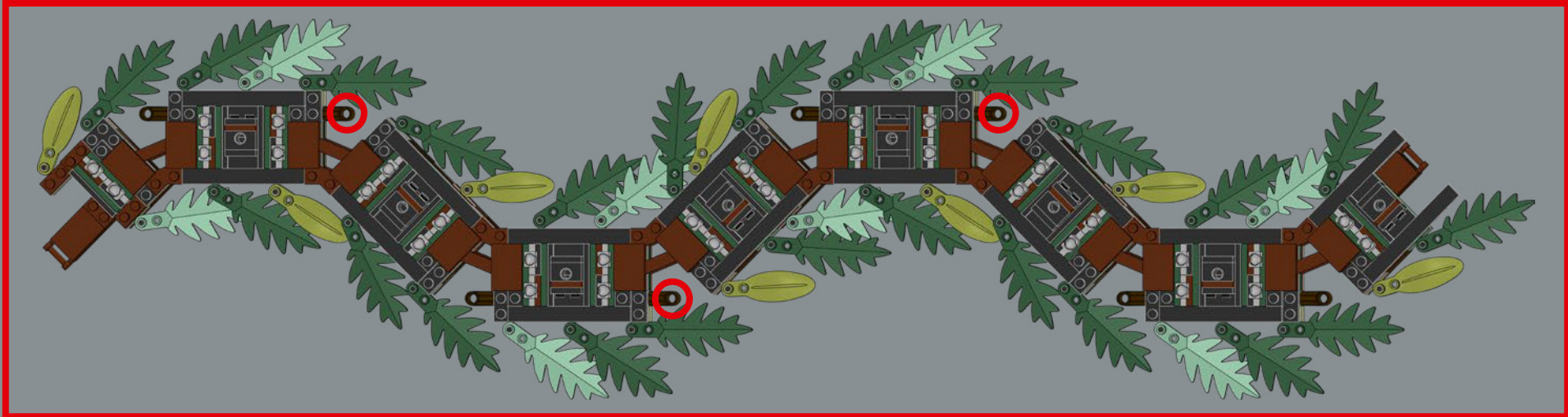

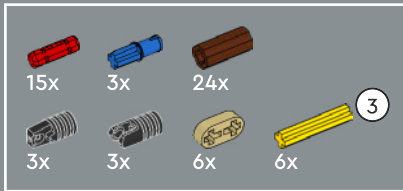
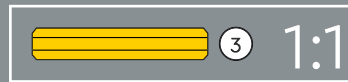
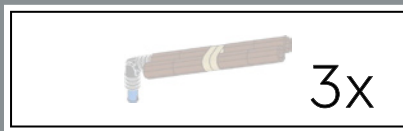

71

1



2



3



4



5



6

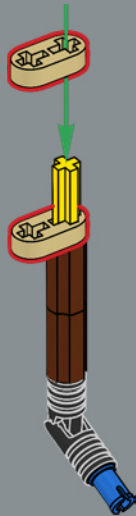

7

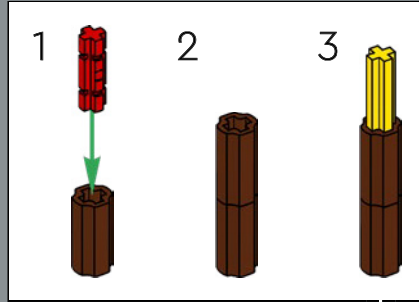
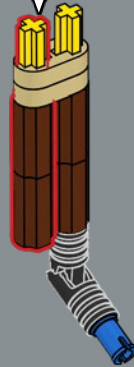

8

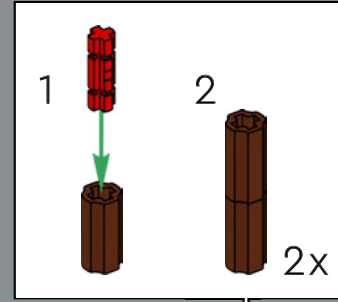
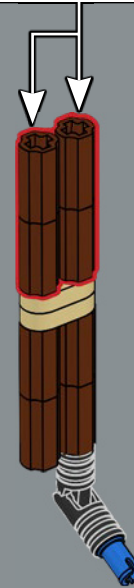

3x

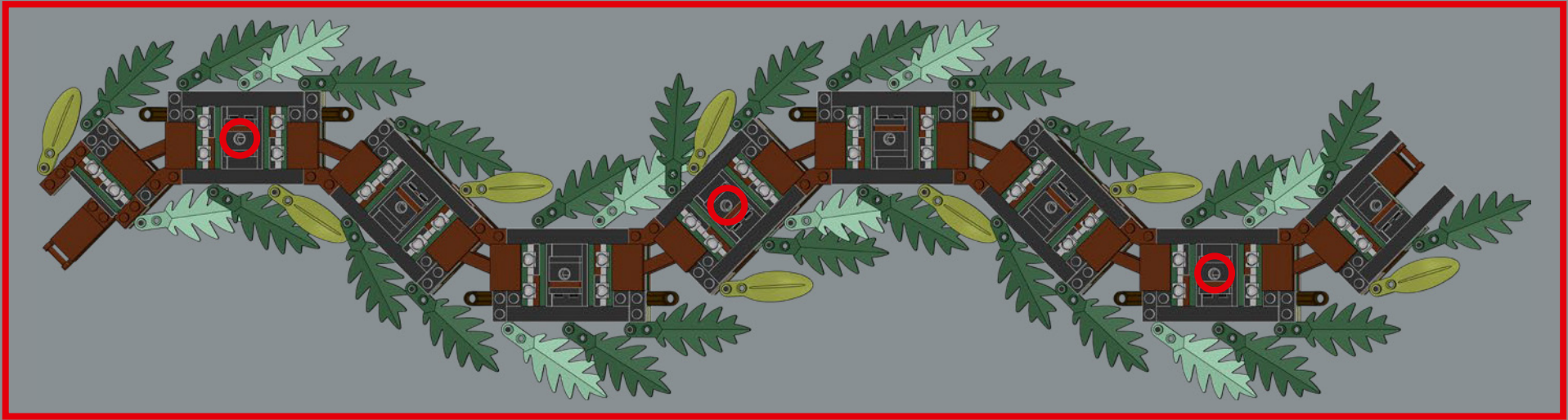

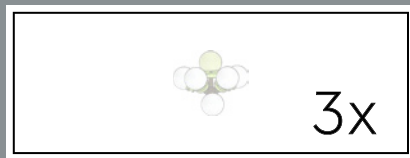

72

1



2

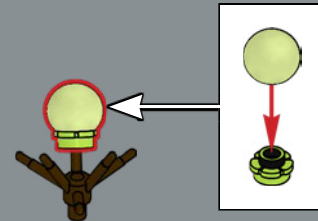

3

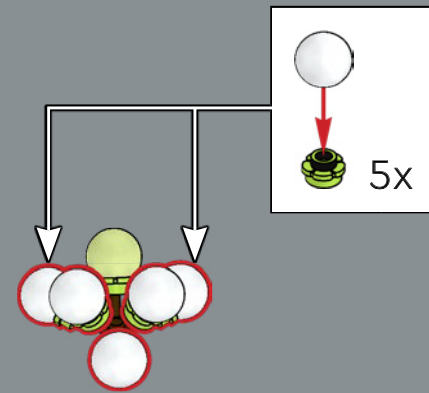

3x

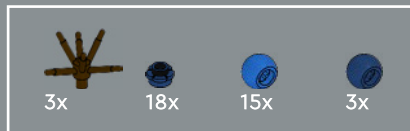
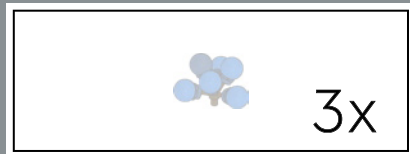

73

1



2

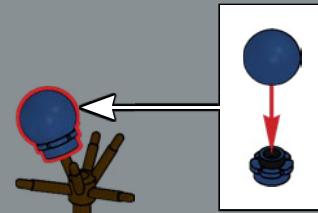

3

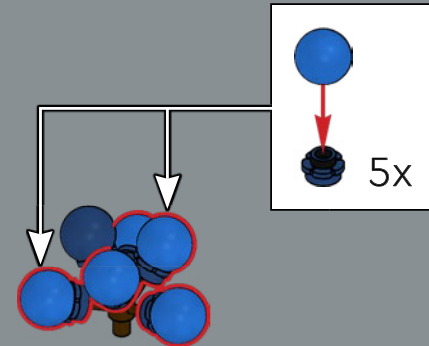

3x



74

1



2

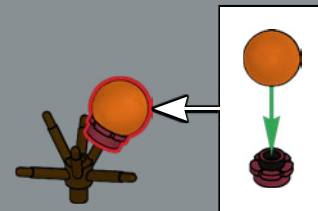

3

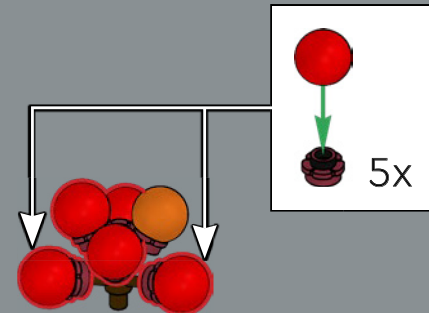

3x







15x
6052864

3x
6179606

6x
6376461

8x
6330903

8x
4121921

15x
4290714

23x
4142865

3x
6296954

15x
6224247

12x
4206482

3x
403224

9x
6130007

18x
6495167

3x
6498566

3x
6495163

3x
6491212

18x
6209692

8x
4537936

24x
6473460

20x
6495168

28x
6269971

4x
379528

3x
6509614

3x
6131694

8x
6347306

4x
6343854

14x
6499873

84x
6498565

8x
4245570

72x
6020923

8x
4245571

12x
6491214

74x
6420219

8x
6359069

16x
6491215

4x
6495166

1x
6254100

3x
6271165

32x
6043656

3x
4211183

27x
6215659

16x
6078605

24x
4531751

108x
4211150

8x
6236915

2x
6428805

3x
6316697

24x
6311441

16x
6084573

12x
4221590

8x
6370000

18x
6458394

8x
4539105

32x
6364352

12x
6491211

8x
6332586

12x
6501311

12x
6308903

9x
6452882

4x
6473454

24x
4518687

14x
6439039

9x
6265699

9x
6271535

2x
6279875

2x
6121485

3x
473326

12x
6313116

40x
6261348

8x
370026

32x
6250020

8x
302226

3x
4580509

3x
6018805

16x
243126

16x
6401209

16x
416226

8x
303226



LEGO.com/service



YOU COULD WIN



YOU COULD WIN

Your feedback will help shape the future development of this product series.

Visit:

DU KÖNNTEST GEWINNEN

Dein Feedback trägt zur Weiterentwicklung dieser Produktreihe bei.

Geh auf:

VOUS POURRIEZ GAGNER

Vos commentaires nous aideront à concevoir les futurs produits de cette gamme.

Visitez :

POTRESTI VINCERE TU

La tua opinione ci aiuterà a migliorare la creazione futura di questa linea di prodotti.

Visita:

PUEDES GANAR

Tu opinión contribuirá al futuro de esta serie de productos.

Visita:

轻松获奖

您的反馈将有助于我们在今后改进本产品系列。

请访问:

LEGO.com/productfeedback

You also have the chance to win a LEGO® set.

Terms and conditions apply.*

Außerdem hast du die Chance, ein LEGO® Set zu gewinnen.

Es gelten die Teilnahmebedingungen.*

Vous pourriez également gagner un ensemble LEGO®.

Des conditions s'appliquent.*

Hai anche la possibilità di vincere un set LEGO®.

Termini e condizioni sono applicabili.*

También tienes la oportunidad de ganar un set LEGO®.

Aplican términos y condiciones.*

您还有机会赢取乐高®套装。

条款和条件适用。*

*LEGO.com/productfeedback-terms

